

## FS8-C

### INSTRUCTIONS AND PARTS LIST

(including FS8 Basic)



FS8-C Stainless Steel Trim Saw (shown)

**LORTONE** Trim Saws are high quality saws for trimming slabs to finished configuration. Cuts cleanly and easily with excellent visibility and has plenty of room for larger slabs. For use with oil coolants. Follow these basic operating and care instructions to help keep your saw in optimal running condition.

- Rugged Stainless Steel Frame
- Spacious Work Table
- Large Removable Coolant Tank
- 1/3 Hp. Motor (included with FS8-C)
- Accepts 8" Blade (included with FS8-C)
- Optional Clear Hood (included with FS8-C)
- Optional Vise (included with FS8-C)

# SETTING UP YOUR MACHINE

- Check to make sure you have the following parts:

(1) FS8 Frame	(1) Blade Guard
(1) Splash Shield	(1) Blade (included in FS8-C only)
(1) Belt Guard	(1) Vise (included in FS8-C only)
(1) Belt (included in FS8-C only)	(1) Hood (included in FS8-C only)
(1) Motor (included in FS8-C only)	(1) Operators Manual
(1) Warranty Card	

*If any parts are missing, please contact your dealers or the factory immediately.*

## IMPORTANT!!!

Read the following instructions before assembly or use of your machine. Failure to follow instructions could result in damage to the machine or injury to operator.

## MOTOR INSTALLATION

*Note: A 1/3 hp, 1725 RPM is recommended for proper operation. Motor pulley should be 2" to 2 1/2" diameter. Drive belt should be selected to match desired motor mounting position. Pulley and drive belt are included with the FS8-C only.*

- Secure motor to motor mount with bolts provided. (Fig. 1)
- Place motor pulley on the motor shaft and securely tighten the set screw on flat of motor shaft. (Fig. 2)
- Install belt and adjust motor to obtain correct belt tension. Do not overtighten the belt as this will lead to excessive noise and premature bearing wear. The belt should not deflect more than 1". (Fig. 3)

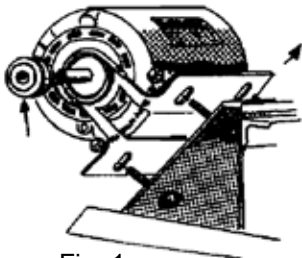

Fig. 1

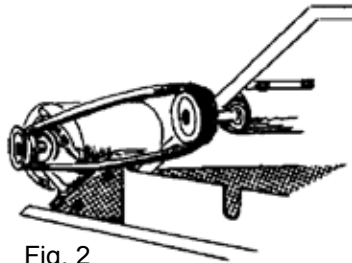

Fig. 2

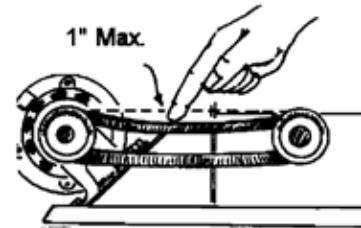

Fig. 3

## BLADE INSTALLATION

- Install the flange with the 5/8" bore on the arbor shaft.
- Slip the blade into the saw slot at an angle (Fig. 4) and slide it onto the shaft.
- Slide the second flange next to the blade and tighten the arbor nut securely (Fig. 5).
- Do not over tighten as this can warp the blade.

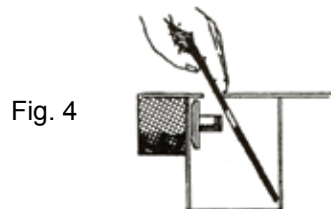

Fig. 4

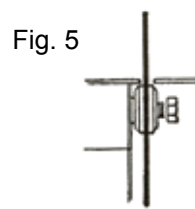

Fig. 5

## OPTIONAL VISE INSTALLATION

- Attach the vise parallel to the trim table using the two self-tapping screws (Fig. 6).
- Clamp a pencil into the vise with the point just touching the front of the blade behind the rim.
- Rotate the blade (Fig. 7) rearward so pencil mark shows above the table.
- Slide the vise and pencil rearward. Pencil point should touch the blade at the same spot.
- If necessary loosen the screws and adjust the guide bar supports.

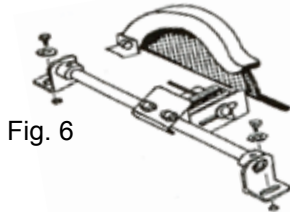

Fig. 6

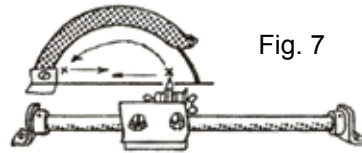

Fig. 7

## OPERATION

- Fill the coolant tank with lapidary cutting oil until coolant covers approximately 1/4" of the blade rim (Fig. 8).

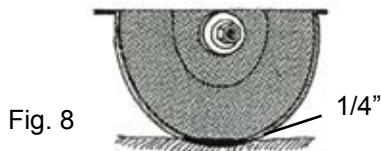

Fig. 8

### CAUTION!!!

Do not operate without coolant.  
Injury to operator or damage to  
blade and machine may occur.

- Cut slowly using a straight forward motion (Fig. 9). Do not force stone into blade or apply side pressure.
- If using the vise, make sure the rock is clamped firmly before starting (Fig. 10). Slowly feed stone into blade.

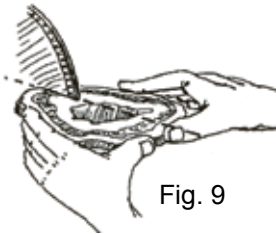

Fig. 9



Fig. 10

## MAINTENANCE

- The FS-8 is designed for minimum maintenance however the following should be periodically checked.
- Check belt for wear and proper tension. Refer to Motor Installation.
- Check blade for wear and correct alignment.
- Keep blade sharpened by periodically making a cut into a dressing stick or an old medium grit aluminum oxide or silicon carbide grinding wheel. This helps to expose fresh diamond crystals. (Fig 11). Cascade™ dressing sticks #566-012 are recommended.
- Maintain a proper coolant level.
- Change the coolant frequently or when it becomes dirty (Fig. 12).



Fig. 11

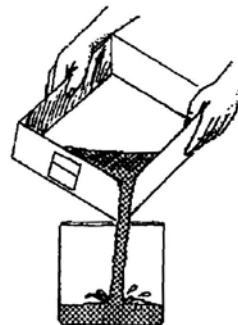
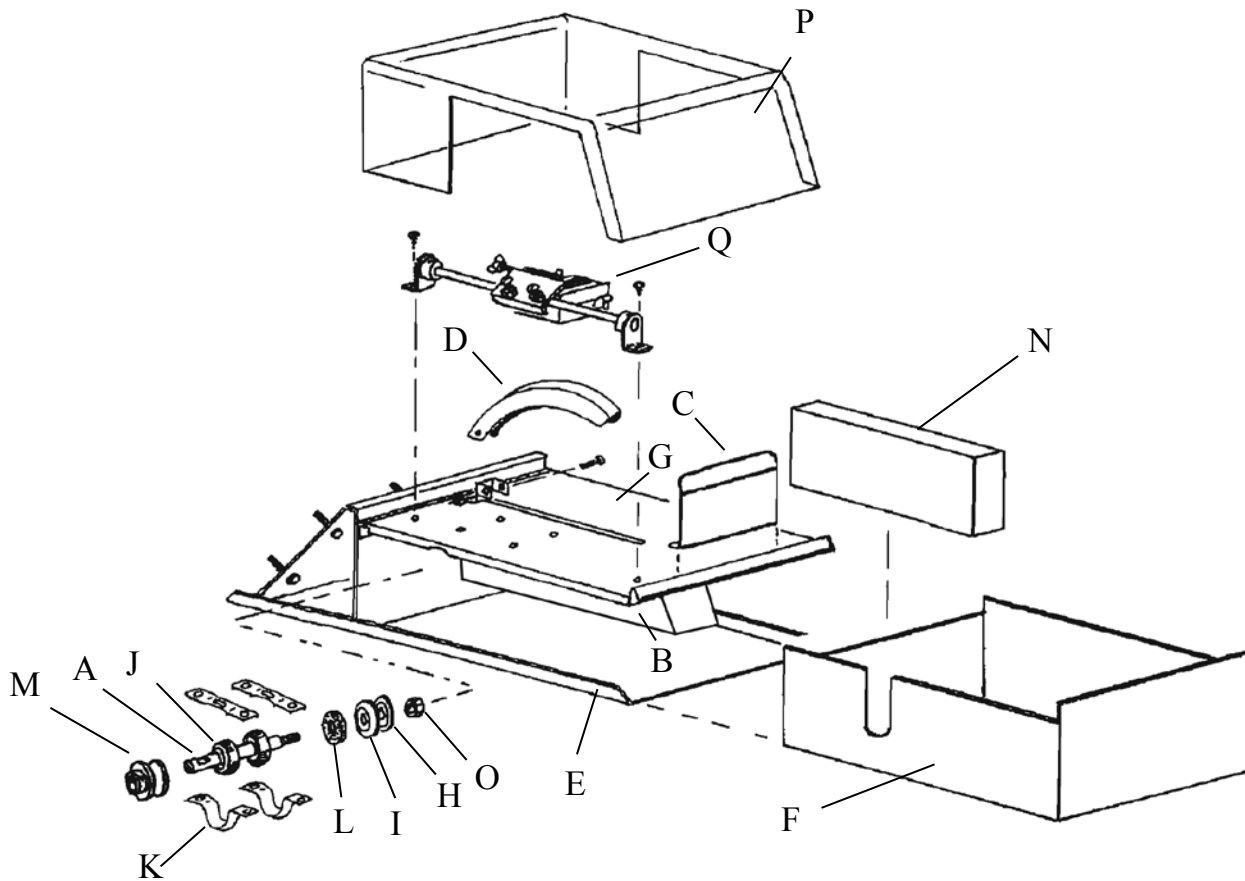

Fig. 12

**Model**  
**Stainless Steel FS8-C / FS8**



**PARTS LIST FS8-C & FS8**

Part No.	Description
A	056-004 Arbor Shaft
B	056-206 Pan Splash Guard
C	056-002 Splash Shield
D	056-006 Blade Guard
E	056-203 Frame Assembly
F	056-204 Coolant Pan(Classic)
F	056-304 Coolant Pan(Stainless Steel)
G	056-205 Trim Table Assembly
H	101-012 Plated Flange, 2" x 1/2"
I	101-012 Plated Flange, 2" x 5/8"
J	200-006 Bearing (2 required)
K	204-001 Bearing Strap (2 required)
L	205-010 Felt Washer
M	211-015 Arbor Pulley, 2 1/2" x 3/4"
N	056-102 FS8 Belt Guard
O	481-024 Hex Nut

<b>Included with FS8-C Only</b>	
P	074-095 Hood
Q	071-097 Vise
(Not shown)	
	211-013 2 1/2" x 1/2" Motor pulley
	210-035 4L-310 Belt
	300-022 1/3 hp motor
	522-047 8" Blade