

# Basic Concepts of Thermodynamics

|   |                              |   |
|---|------------------------------|---|
|  | <b>Reading</b><br>2-1 → 2-10 | <b>Problems</b><br>2-44, 2-59, 2-78, 2-98 |
|---|------------------------------|---|

## Thermal Sciences

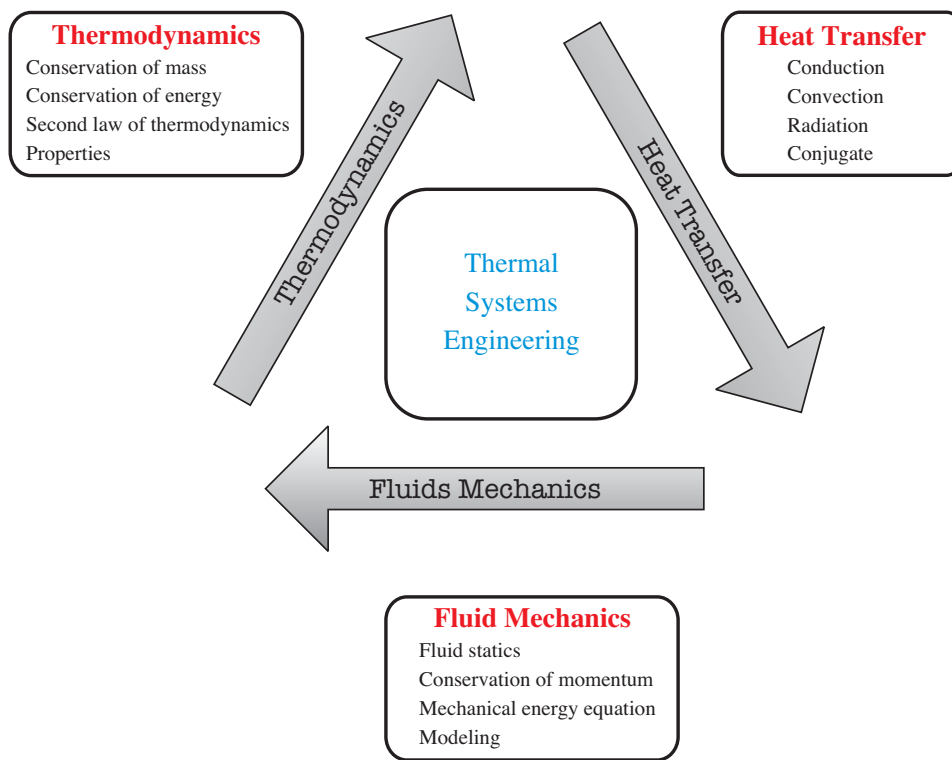

**Thermodynamics:** the study of energy, energy transformations and its relation to matter. The analysis of thermal systems is achieved through the application of the governing conservation equations, namely *Conservation of Mass*, *Conservation of Energy* (1st law of thermodynamics), the 2nd law of thermodynamics and the property relations.

**Heat Transfer:** the study of energy in transit including the relationship between energy, matter, space and time. The three principal modes of heat transfer examined are conduction, convection and radiation, where all three modes are affected by the thermophysical properties, geometrical constraints and the temperatures associated with the heat sources and sinks used to drive heat transfer.

**Fluid Mechanics:** the study of fluids at rest or in motion. While this course will not deal extensively with fluid mechanics we will be influenced by the governing equations for fluid flow, namely *Conservation of Momentum* and *Conservation of Mass*.

## Thermodynamics

**Microscopic:** tracking the movement of matter and energy on a particle by particle basis

**Macroscopic:** use the conservation equations (energy and mass) to track movement of matter and energy on an average over a fixed domain (referred to as classical thermodynamics)

## Energy

- the total energy of the system per unit mass is denoted as  $e$  and is given as

$$e = \frac{E}{m} \quad \left( \frac{kJ}{kg} \right)$$

- if we neglect the contributions of magnetic, electric, nuclear energy, we can write the total energy as

$$E = U + KE + PE = U + \frac{m\mathcal{V}^2}{2} + mgz$$

## Dimensions and Units

### *SI: International System*

- SI is the preferred because it is logical (base 10) and needs no correction factors
- unit convention:

| Parameter               | Units                                   | Symbol  |
|-------------------------|---|---------|
| length, $L$             | meters                                  | $m$     |
| mass, $m$               | kilograms                               | $kg$    |
| time, $t$               | seconds                                 | $s$     |
| temperature, $T$        | kelvin                                  | $K$     |
| velocity, $\mathcal{V}$ | meter per second, $\equiv L/t$          | $m/s$   |
| acceleration, $a$       | meter per second squared $\equiv L/t^2$ | $m/s^2$ |
| force, $F$              | newton, $\equiv m \cdot L/t^2$          | $N$     |
| energy, $E$             | joule $\equiv m \cdot L^2/t^2$          | $J$     |

# Thermodynamic Systems

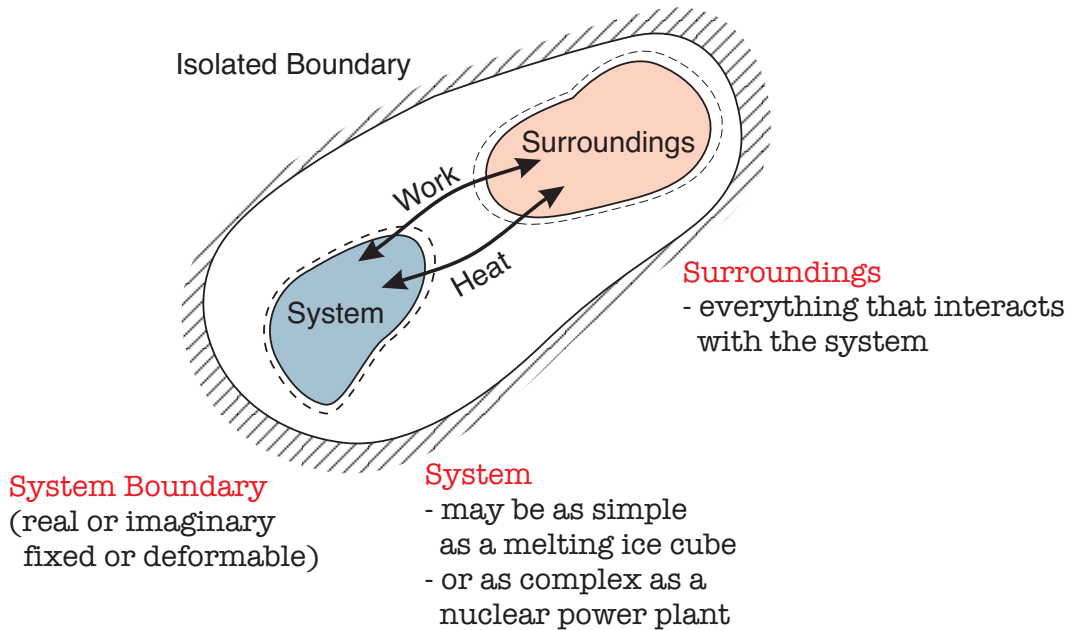

## SYSTEM:

**Closed System:** composed of a control (or fixed) mass where heat and work can cross the boundary but no mass crosses the boundary.

**Open System:** composed of a control volume (or region in space) where heat, work, and mass can cross the boundary or the control surface

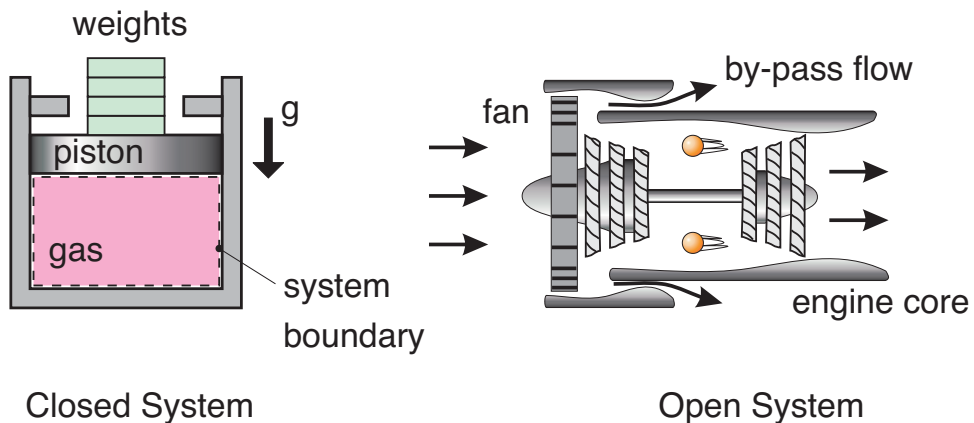

## WORK & HEAT TRANSFER:

- work and heat transfer are NOT properties → they are the forms that energy takes to cross the system boundary

# Thermodynamic Properties of Systems

## *Basic Definitions*

**Thermodynamic Property:** Any observable or measurable characteristic of a system. Any mathematical combination of the measurable characteristics of a system

**Intensive Properties:** Properties which are independent of the size (or mass) of the system

- they are **not** additive  $\Rightarrow X_{A+B} \neq X_A + X_B$
- examples include: pressure, temperature, and density

**Extensive Properties:** Properties which are dependent of the size (or mass) of the system

- they are additive  $\Rightarrow X_{A+B} = X_A + X_B$
- examples include: volume, energy, entropy and surface area

**Specific Properties:** Extensive properties expressed per unit mass to make them intensive properties

- specific property (intensive)  $\longrightarrow \frac{\text{extensive property}}{\text{mass}}$

## *Measurable Properties*

- $P, V, T,$  and  $m$  are important because they are measurable quantities. Many other thermodynamic quantities can only be calculated and used in calculations when they are related to  $P, V, T,$  and  $m$ 
  - Pressure ( $P$ ) and Temperature ( $T$ ) are easily measured intensive properties.  
Note: They are not always independent of one another.
  - Volume ( $V$ ) and mass ( $m$ ) are easily measured extensive properties

## Pressure

- $Pressure = \frac{Force}{Area} ; \rightarrow \frac{N}{m^2} \equiv Pa$ 
  - in fluids, this is pressure (normal component of force per unit area)
  - in solids, this is stress

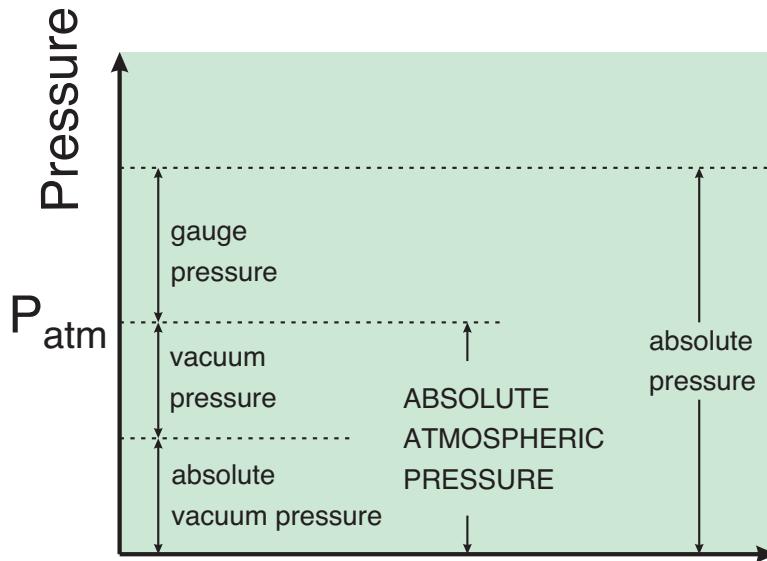

## Temperature

- temperature is a pointer for the direction of energy transfer as heat

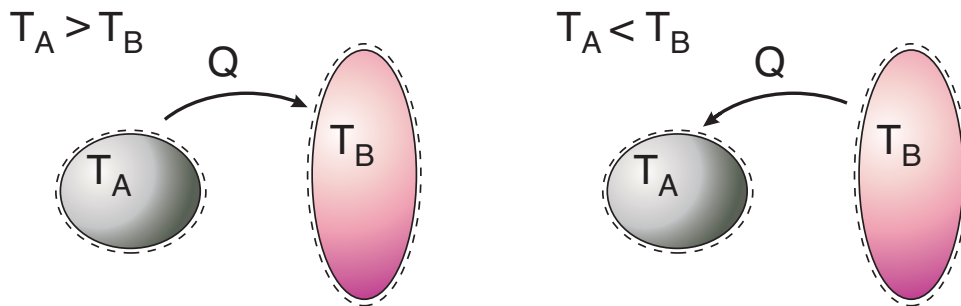

**0<sup>th</sup> Law of Thermodynamics:** if system C is in thermal equilibrium with system A, and also with system B, then  $T_A = T_B = T_C$

## State and Equilibrium

### *State Postulate*

- how long does the list of intensive properties have to be in order to describe the intensive state of the system?

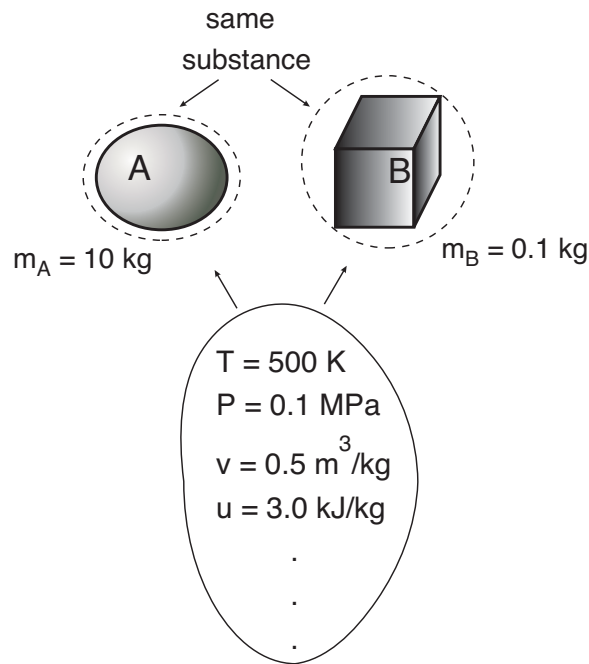

- System A and B have the same intensive state, but totally different extensive states.

**State Postulate (for a simple compressible system):** The state of a simple compressible system is completely specified by 2 independent and intensive properties.

- note: a simple compressible system experiences negligible electrical, magnetic, gravitational, motion, and surface tension effects, and only  $PdV$  work is done
- in a single phase system,  $T$ ,  $v$ , and  $P$  are independent and intensive (in a multiphase system however,  $T$  and  $P$  are not independent)
- if the system is not simple, for each additional effect, one extra property has to be known to fix the state. (i.e. if gravitational effects are important, the elevation must be specified and two independent and intensive properties)
- it is important to be able to:
  - find two appropriate properties to fix the state
  - find other properties when the state is fixed (we will discuss this later)

## Thermodynamic Processes

- the *process* is any change from one equilibrium state to another. (If the end state = initial state, then the process is a cycle)

- the *process path* is a series intermediate states through which a system passes during the process (we very seldom care what the process path is)
- *processes* are categorized based on how the properties behave:
  - isobaric ( $P = \text{constant}$ )
  - isothermal ( $T = \text{constant}$ )
  - isochoric or isometric ( $V = \text{constant}$ )
  - isentropic ( $s = \text{constant}$ )
  - isenthalpic ( $h = \text{constant}$ )
  - adiabatic (no heat transfer)

## Stored Energy

- how is energy stored in matter?

$$\text{Stored Energy} = E = KE + PE + U$$

- Kinetic Energy: Energy due to motion of the matter with respect to an external reference frame ( $KE = m\mathcal{V}^2/2$ )
- Potential Energy: Energy due to the position of the matter in a force field (gravitational, magnetic, electric). It also includes energy stored due to elastic forces and surface tension ( $PE = mgz$ )
- Internal Energy = microscopic forms of energy,  $U$ 
  - forms of the energy in the matter due to its internal structure (independent of external reference frames)

## Transit Energy

### Heat

- transit form of energy that occurs when there is  $\Delta T$  (a temperature gradient)
- notation -  $Q$  ( $kJ$ ),  $q$  ( $kJ/kg$ ),  $\dot{Q}$  ( $kW$ ),  $\dot{q}$  ( $kW/kg$ )

### Work

- transit form of energy that occur due to all other driving forces
- notation -  $W$  ( $kJ$ ),  $w$  ( $kJ/kg$ ),  $\dot{W}$  ( $kW$ ),  $\dot{w}$  ( $kW/kg$ )

## *Properties of Pure Substances*

|   |                         |  |
|---|-------------------------|--|
|  | <b>Reading</b>          | <b>Problems</b>                                      |
|   | 3-1 → 3-7<br>3-9 → 3-11 | 3-49, 3-52, 3-57, 3-70, 3-75, 3-106,<br>3-121, 3-123 |

## Pure Substances

- a *Pure Substance* is the most common material model used in thermodynamics.
  - it has a fixed chemical composition throughout (chemically uniform)
  - a homogeneous mixture of various chemical elements or compounds can also be considered as a pure substance (uniform chemical composition)
  - a pure substance is not necessarily physically uniform (different phases)

## Phases of Pure Substances

- a pure substance may exist in different phases, where a phase is considered to be a physically uniform
- 3 principal phases:

### **Solids:**

- strong molecular bonds
- molecules form a fixed (but vibrating) structure (lattice)

### **Liquids:**

- molecules are no longer in a fixed position relative to one another
- molecules float about each other

### **Gases:**

- there is no molecular order
- intermolecular forces  $\approx 0$

## Behavior of Pure Substances (Phase Change Processes)

- **Critical Point:** liquid and vapor phases are not distinguishable
- **Triple point:** liquid, solid, and vapor phases can exist together



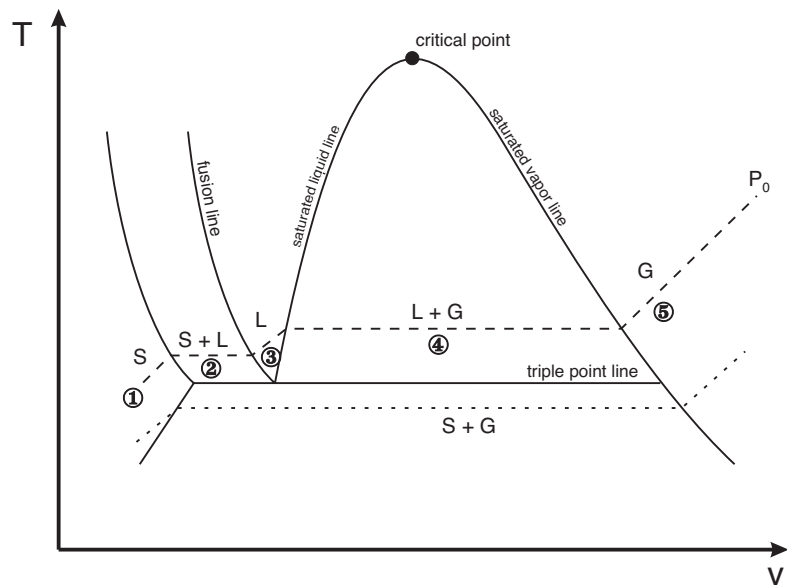
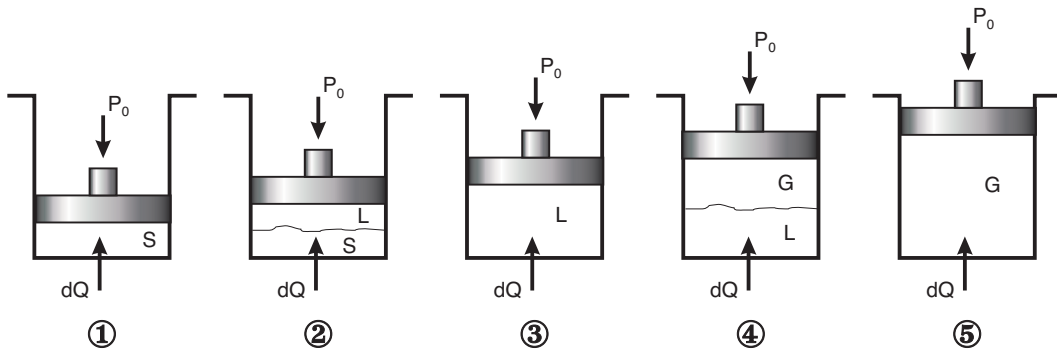
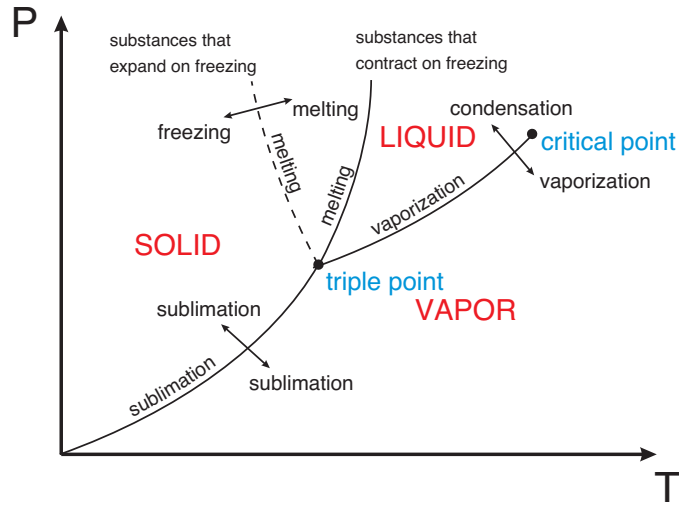

## *T – v Diagram for a Simple Compressible Substance*

- consider an experiment in which a substance starts as a solid and is heated up at constant pressure until it all becomes as gas
- depending on the prevailing pressure, the matter will pass through various phase transformations. At  $P_0$ :
  1. solid
  2. mixed phase of liquid and solid
  3. sub-cooled or compressed liquid
  4. wet vapor (saturated liquid-vapor mixture)
  5. superheated vapor

## *The Vapor Dome*

- general shape of a  $P – v$  diagram for a pure substance is similar to that of a  $T – v$  diagram

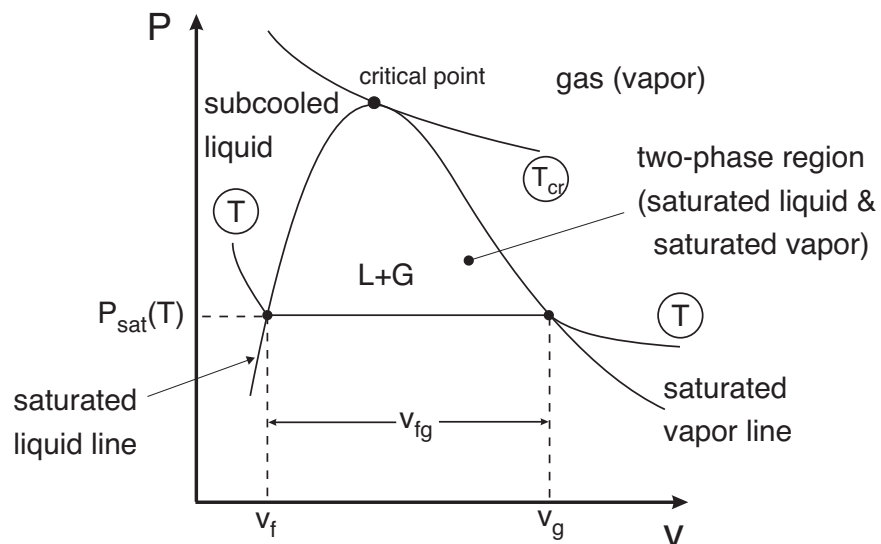

- express values of properties for conditions on the vapor dome as:

**specific volume:**  $v_f, v_g$  and  $v_{fg} = v_g - v_f$

**internal energy:**  $u_f, u_g$  and  $u_{fg} = u_g - u_f$

**specific enthalpy:**  $h_f, h_g$  and  $h_{fg} = h_g - h_f$

**specific entropy:**  $s_f, s_g$  and  $s_{fg} = s_g - s_f$

- in the two phase region, pressure and temperature cannot be specified independently

$$P_{sat} = P(T_{sat}) \Leftrightarrow T_{sat} = T(P_{sat})$$

this only holds true under the vapor dome in the two-phase region.

### ***The Two-Phase Region***

$$\text{Quality} \Rightarrow x = \frac{m_g}{m} = \frac{m_g}{m_g + m_f}$$

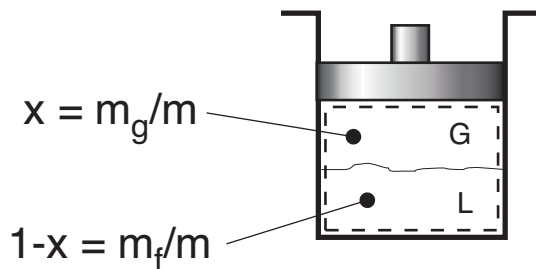

$$\text{total mass of mixture} \Rightarrow m = m_g + m_f$$

$$\text{mass fraction of the gas} \Rightarrow x = m_g/m$$

$$\text{mass fraction of the liquid} \Rightarrow 1 - x = m_f/m$$

### ***Properties of Saturated Mixtures***

- all the calculations done in the vapor dome can be performed using Tables.
  - in Table A-4, the properties are listed under Temperature
  - in Table A-5, the properties are listed under Pressure
- use if given mixture:

1) is saturated, 2) has a quality, 3) liquid & vapor are present

$$\begin{aligned} v &= \frac{V}{m} = \frac{V_f + V_g}{m} = \frac{m_f v_f + m_g v_g}{m} = (1 - x) v_f + x v_g \\ &= v_f + x(v_g - v_f) \\ &= v_f + x v_{fg} \\ x &= \frac{v - v_f}{v_{fg}} \end{aligned}$$

## Properties of Superheated Vapor

- superheated vapor is a single phase (vapor phase only).
  - $T$  and  $P$  are independent of each other in the single-phase region
  - properties are typically calculated as a function of  $T$  and  $P$

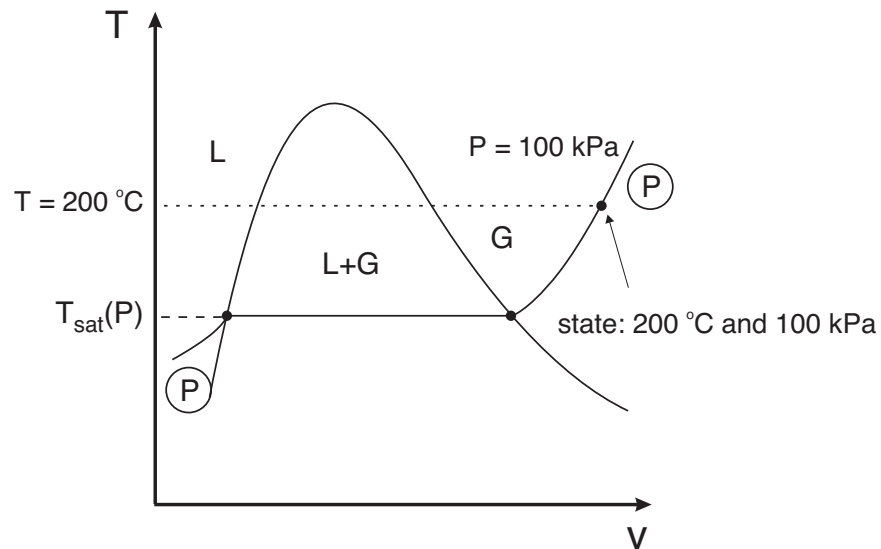

## Properties of Sub-cooled Liquid

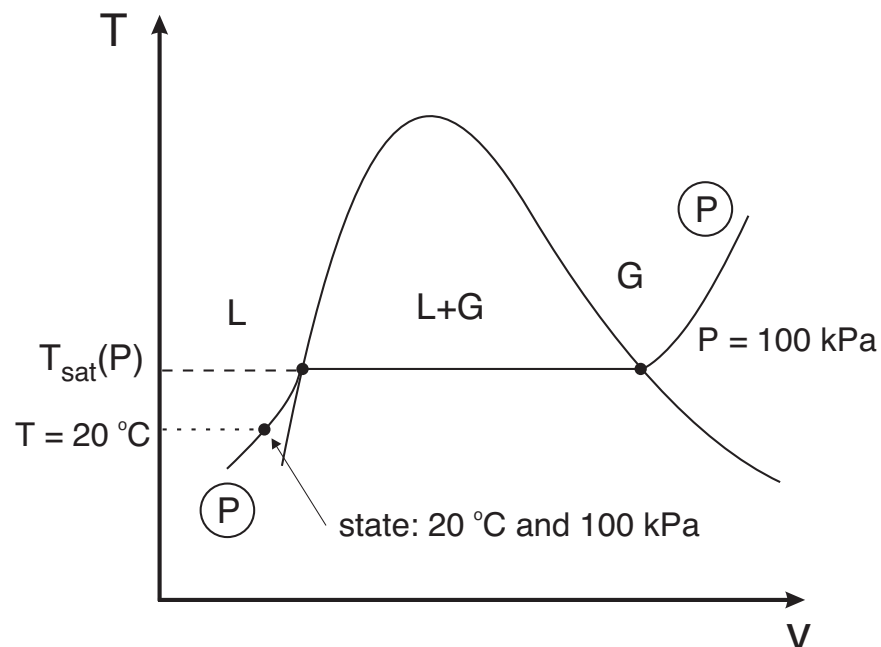

- can be treated as incompressible (independent of  $P$ )

$$v = v(T, P) \Rightarrow v \approx v(T) = v_f(T)$$

$$u = u(T, P) \Rightarrow u \approx u(T) = u_f(T)$$

$$s = s(T, P) \Rightarrow s \approx s(T) = s_f(T)$$

- while property values for the sub-cooled liquids are not available as a function of temperature and pressure, they are available as a function of temperature only.
- for enthalpy:

$$\begin{aligned} h(T, P) &= u(T, P) + v(T, P)P \approx u_f(T) + v_f(T)P \\ &= \underbrace{u_f(T) + v_f(T)P_{sat}(T)}_{h_f(T)} + v_f(T)[P - P_{sat}(T)] \\ &= h_f(T) + v_f(T)[P - P_{sat}(T)] \end{aligned}$$

## Equation of State for Gaseous Pure Substances

Thermodynamic relations are generally given in three different forms:

**Tables:** water (Tables A-4 → A-8), R134a (Tables A-11 → A-13)

**Graphs:** water (Figures A-9 & A-10), R134a (Figure A-14)

**Equations:** air (Tables A-2 & 3-4)

- since most gases are highly superheated at atmospheric conditions. This means we have to use the **superheat tables** – but this can be very **inconvenient**
- *a better alternative for gases:* use the Equation of State which is a functional relationship between  $P$ ,  $v$ , and  $T$  (3 measurable properties)

### Ideal Gases

- gases that adhere to a pressure, temperature, volume relationship

$$Pv = RT \quad \text{or} \quad PV = mRT$$

referred to as ideal gases

- where  $R$  is the gas constant for the specified gas of interest ( $R = R_u/\tilde{M}$ )
  - $R_u =$  Universal gas constant,  $\equiv 8.314 \text{ kJ}/(\text{kmol} \cdot \text{K})$
  - $\tilde{M} =$  molecular weight (or molar mass) of the gas (see Table A-1))

- When is the ideal gas assumption viable?

- for a low density gas where:
  - \* the gas particles take up negligible volume
  - \* the intermolecular potential energy between particles is small
  - \* particles act independent of one another
- Under what conditions can it be used?
  - \* low density
  - \* high temperatures - considerably in excess of the saturation region
  - \* at very low pressures

## Real Gases

- experience shows that **real gases** obey the following equation closely:

$$Pv = ZRT \quad (T \text{ and } P \text{ are in absolute terms})$$

- this equation is used to find the third quantity when two others are known
- $Z$  is the compressibility factor
- Note:  $R_{air} = 0.287 \text{ kJ}/\text{kg} \cdot \text{K}$ ,  $R_{H_2} = 4.124 \text{ kJ}/\text{kg} \cdot \text{K}$

- what is the compressibility factor ( $Z$ )?

- $Z$  charts are available for different gases, but there are generalized  $Z$  charts that can be used for all gases
- if we “reduce” the properties with respect to the values at the critical point, i.e.

$$\text{reduced pressure} = P_r = \frac{P}{P_c} \quad P_c = \text{critical pressure}$$

$$\text{reduced temperature} = T_r = \frac{T}{T_c} \quad T_c = \text{critical temperature}$$

## Reference Values for $u$ , $h$ , $s$

- values of enthalpy,  $h$  and entropy,  $s$  listed in the tables are with respect to a datum where we arbitrarily assign the zero value. For instance:

**Tables A-4, A-5, A-6 & A-7:** saturated and superheated water - the reference for both  $h_f$  and  $s_f$  is taken as  $0^\circ\text{C}$ . This is shown as follows:

$$u_f(@T = 0^\circ\text{C}) = 0 \text{ kJ/kg}$$

$$h_f(@T = 0^\circ\text{C}) = 0 \text{ kJ/kg}$$

$$s_f(@T = 0^\circ\text{C}) = 0 \text{ kJ/kg} \cdot \text{K}$$

**Tables A-11, A-12 & A-13:** saturated and superheated R134a - the reference for both  $h_f$  and  $s_f$  is taken as  $-40^\circ\text{C}$ . This is shown as follows:

$$h_f(@T = -40^\circ\text{C}) = 0 \text{ kJ/kg}$$

$$h_f(@T = -40^\circ\text{C}) = 0 \text{ kJ/kg}$$

$$s_f(@T = -40^\circ\text{C}) = 0 \text{ kJ/kg} \cdot \text{K}$$

**Others:** sometimes tables will use  $0 \text{ K}$  as the reference for all tables. While this standardizes the reference, it tends to lead to larger values of enthalpy and entropy.

## Calculation of the Stored Energy

- for most of our 1st law analyses, we need to calculate  $\Delta E$

$$\Delta E = \Delta U + \Delta KE + \Delta PE$$

- for stationary systems,  $\Delta KE = \Delta PE = 0$
- in general:  $\Delta KE = \frac{1}{2}m(\mathcal{V}_2^2 - \mathcal{V}_1^2)$  and  $\Delta PE = mg(z_2 - z_1)$
- how do we calculate  $\Delta U$ ?

1. one can often find  $u_1$  and  $u_2$  in the thermodynamic tables (like those examined for the states of water).
2. we can also explicitly relate  $\Delta U$  to  $\Delta T$  (as a mathematical expression) by using the thermodynamic properties  $C_p$  and  $C_v$ .

## Specific Heats: Ideal Gases

- for any gas whose equation of state is exactly

$$Pv = RT$$

the specific internal energy depends only on temperature

$$u = u(T)$$

- the specific enthalpy is given by

$$h = u + Pv$$

where

$$h(T) = u(T) + RT$$

Note: Since  $u = u(T)$ , and  $R$  is a constant, enthalpy is only a function of temperature.

- for an ideal gas

$$C_v = \frac{du}{dT} \Rightarrow C_v = C_v(T) \text{ only}$$

$$C_p = \frac{dh}{dT} \Rightarrow C_p = C_p(T) \text{ only}$$

From the equation for enthalpy,

$$RT = h(T) - u(T)$$

If we differentiate with respect to  $T$

$$R = \frac{dh}{dT} - \frac{du}{dT}$$

$$\boxed{R = C_p - C_v}$$



- the calculation of  $\Delta u$  and  $\Delta h$  for an ideal gas is given as

$$\Delta u = u_2 - u_1 = \int_1^2 C_v(t) dT \quad (\text{kJ/kg})$$

$$\Delta h = h_2 - h_1 = \int_1^2 C_p(t) dT \quad (\text{kJ/kg})$$

- to carry out the above integrations, we need to know  $C_v(T)$  and  $C_p(T)$ . These are available from a variety of sources

**Table A-2a:** for various materials at a fixed temperature of  $T = 300 \text{ K}$

**Table A-2b:** various gases over a range of temperatures  $250 \text{ K} \leq T \leq 1000 \text{ K}$

**Table A-2c:** various common gases in the form of a third order polynomial

## Specific Heats: Solids and Liquids

- solids and liquids are incompressible. (i.e.,  $\rho = \text{constant}$ ).
- for solids and liquids it can be shown (mathematically) that for incompressible materials:

$$C_p = C_v = C \quad \text{and} \quad dQ = mCdT$$

- Table A-3 gives  $C$  for incompressible materials
- as with ideal gases, for incompressible materials  $C = C(T)$

$$\Delta u = \int_1^2 C(T) dT \approx C_{avg} \Delta T$$

$$\Delta h = \Delta u + \Delta(Pv) = \Delta u + v\Delta P \approx C_{avg}\Delta T + v\Delta P$$

– for **solids**:

$$\Delta h = \Delta u = C_{avg}\Delta T \quad (v\Delta P \text{ is negligible})$$

– for **liquids**:

$$\text{If } P = \text{const}, \Delta h = C_{avg}\Delta T$$

If  $T = \text{const}$ ,  $\Delta h = v\Delta P$  (we already used this to do more accurate calculations in the subcooled region).

## *First Law of Thermodynamics*

|   |                |  |
|---|----------------|--|
|  | <b>Reading</b> | <b>Problems</b>                              |
|   | 4-1 → 4-6      | 4-19, 4-24, 4-42, 4-61, 4-65                 |
|   | 5-1 → 5-5      | 5-37, 5-67, 5-84, 5-104, 5-120, 5-141, 5-213 |

### **Control Mass (Closed System)**

A thermodynamic analysis of a system can be performed on a fixed amount of matter known as a *control mass* or over a region of space, known as a *control volume*.

### **Conservation of Mass**

Conservation of Mass, which states that mass cannot be created or destroyed, is implicitly satisfied by the definition of a control mass.

### **Conservation of Energy**

The first law of thermodynamics states:

*Energy cannot be created or destroyed it can only change forms.*

- energy transformation is accomplished through energy transfer as work and/or heat. Work and heat are the forms that energy can take in order to be transferred across the system boundary.
- the first law leads to the principle of Conservation of Energy where we can stipulate the energy content of an *isolated* system is constant.

*energy entering – energy leaving = change of energy within the system*

## *Sign Convention*

There are many potential sign conventions that can be used.

### Cengel Approach

**Heat Transfer:** heat transfer to a system is positive and heat transfer from a system is negative.

**Work Transfer:** work done by a system is positive and work done on a system is negative.

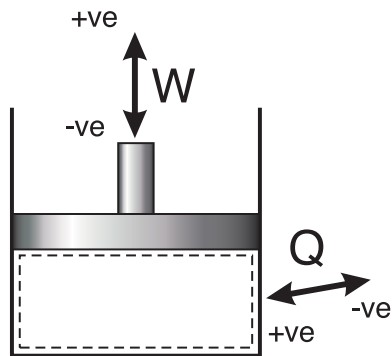

### Culham Approach

Anything directed into the system is positive, anything directed out of the system is negative.

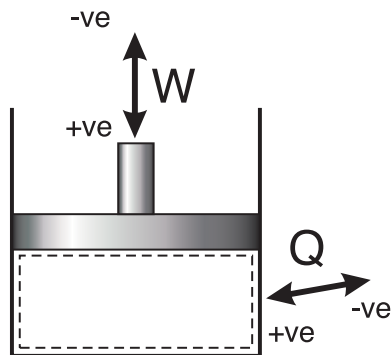

## Example: A Gas Compressor

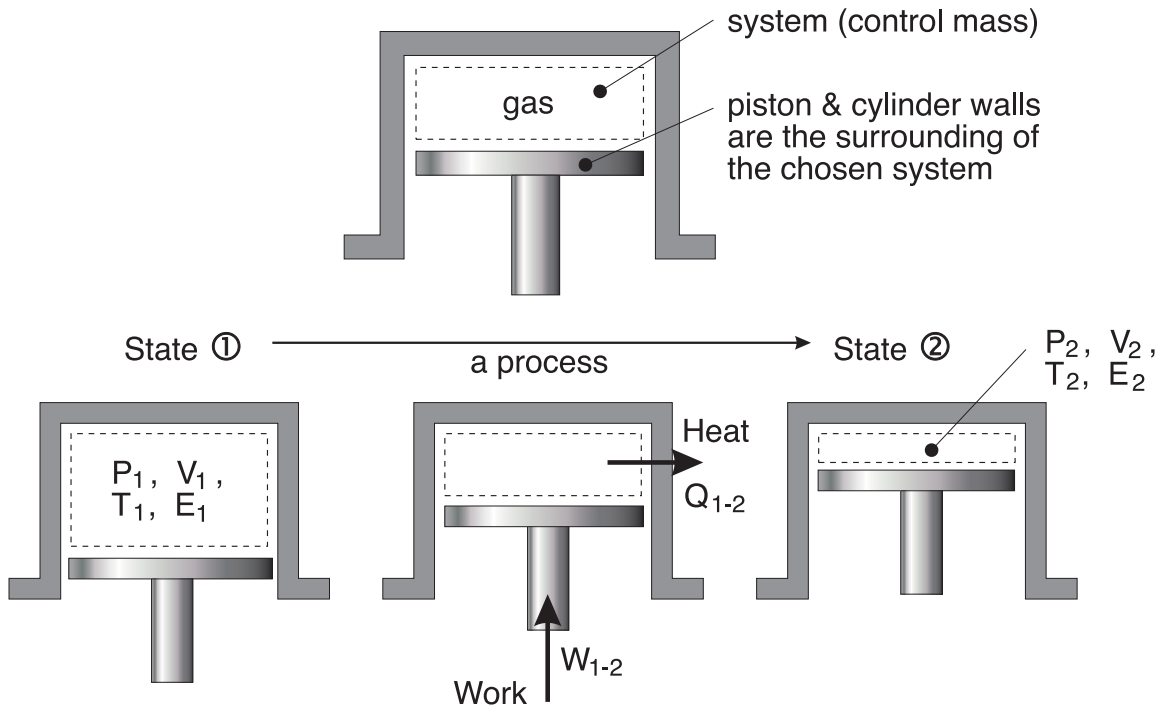

Performing a 1st law energy balance:

$$\left\{ \begin{array}{c} \text{Initial} \\ \text{Energy} \\ E_1 \end{array} \right\} + \left\{ \begin{array}{c} \text{Energy gain } W_{1-2} \\ \text{Energy loss } Q_{1-2} \end{array} \right\} = \left\{ \begin{array}{c} \text{Final} \\ \text{Energy} \\ E_2 \end{array} \right\}$$

A first law balance for a control mass can also be written in differential form as follows:

$$dE = \delta Q - \delta W$$

Note:  $d$  or  $\Delta$  for a change in property and  $\delta$  for a path function

## Forms of Energy Transfer

### *Work Versus Heat*

- Work is macroscopically organized energy transfer.
- Heat is microscopically disorganized energy transfer.

## ***Heat Energy***

- Notation:
  - $Q$  ( $kJ$ ) amount of heat transfer
  - $\dot{Q}$  ( $kW$ ) rate of heat transfer (power)
  - $q$  ( $kJ/kg$ ) - heat transfer per unit mass
  - $\dot{q}$  ( $kW/kg$ ) - power per unit mass
- modes of heat transfer:
  - **conduction:** diffusion of heat in a stationary medium (Chapters 8 & 9)
  - **convection:** it is common to include convective heat transfer in traditional heat transfer analysis. However, it is considered mass transfer in thermodynamics. (Chapters 10 & 11)
  - **radiation:** heat transfer by photons or electromagnetic waves (Chapter 12)

## ***Work Energy***

- Notation:
  - $W$  ( $kJ$ ) amount of work transfer
  - $\dot{W}$  ( $kW$ ) power
  - $w$  ( $kJ/kg$ ) - work per unit mass
  - $\dot{w}$  ( $kW/kg$ ) - power per unit mass
- work transfer mechanisms in general, are a force acting over a distance

## **Mechanical Work**

- force (which generally varies) times displacement

$$W_{12} = \int_1^2 F ds$$

## Moving Boundary Work

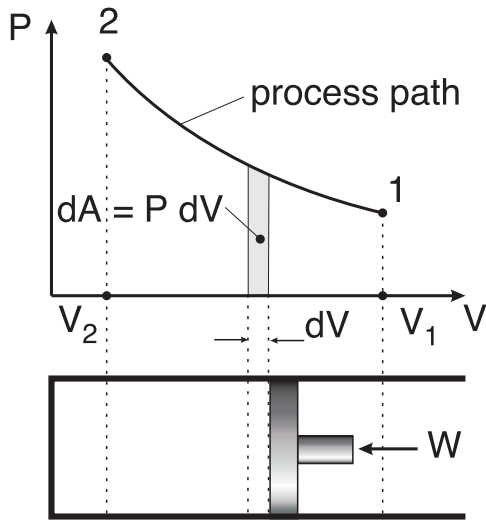

- compression in a piston/cylinder, where  $A$  is the piston cross sectional area (frictionless)
- the area under the process curve on a  $P - V$  diagram is proportional to  $\int_1^2 P dV$
- the work is:
  - $+ve$  for compression
  - $-ve$  for expansion
- sometimes called  $P dV$  work or compression /expansion work

$$W_{12} = -\int_1^2 F ds = -\int_1^2 P \cdot A ds = -\int_1^2 P dV$$

**Polytropic Process:** where  $PV^n = C$

- examples of polytropic processes include:

**Isobaric process:** if  $n = 0$  then  $P = C$  and we have a constant pressure process

**Isothermal process:** if  $n = 1$  then from the ideal gas equation  $PV = RT$  and  $PV$  is only a function of temperature

**Isometric process:** if  $n \rightarrow \infty$  then  $P^{1/n}V = C^{1/n}$  and we have a constant volume process

**Isentropic process:** if  $n = k = C_p/C_v$  then we have an isentropic process

## Gravitational Work

Work is defined as force through a distance

$$W_{12} = \int_1^2 F ds$$

Since in the case of lifting an object, force and displacement are in the same direction, the work will be positive and by definition positive work is into the system.

$$W_{12} = \int_1^2 F ds = \int_1^2 mg ds = \int_1^2 mg dz$$

- integrating from state 1 to state 2 gives

$$W_{12} = mg(z_2 - z_1)$$

- the potential energy of the system increases with an addition of gravitational work,  
 $\Delta PE = W = mg(z_2 - z_1)$

## Acceleration Work

- if the system is accelerating, the work associated with the change of the velocity can be calculated as follows:

$$W_{12} = \int_1^2 F ds = \int_1^2 ma ds = \int_1^2 m \frac{d\mathcal{V}}{dt} ds = \int_1^2 m d\mathcal{V} \underbrace{\frac{ds}{dt}}_v$$

and we can then write

$$W_{12} = \int_1^2 m\mathcal{V} d\mathcal{V} = m \left( \frac{\mathcal{V}_2^2}{2} - \frac{\mathcal{V}_1^2}{2} \right)$$

- if we drop an object with the assistance of gravity, the first law balance gives  
 $\Delta PE + \Delta KE = 0$ . Potential energy decreases and kinetic energy increases.

## Charge Transfer Work (Electrical Work)

- current,  $I$  is the rate of charge transfer

$$I \equiv \frac{dq^+}{dt}, \quad \frac{\text{coulomb}}{\text{sec}} = \text{Ampere}$$

where

$$q^+ = -Ne$$

with  $N$  being the number of electrons and  $e$  the charge of the electron.

- the electrical work done is given as

$$\delta W_e = (\epsilon_1 - \epsilon_2) dq^+ = \epsilon dq^+$$

where  $\epsilon$  is the electrical potential difference with units  $\text{volt} = \frac{\text{Joule}}{\text{Coulomb}}$

- the electrical work done per unit time is power

$$\dot{W}_e = \text{Power} = \frac{\delta W_e}{dt} = \epsilon I \text{ (W)}$$

$$\begin{aligned} W_e &= \int_1^2 \epsilon I dt \\ &= \epsilon I \Delta t \end{aligned}$$



## Control Volume (Open System)

The major difference between a *Control Mass* and *Control Volume* is that mass crosses the system boundary of a control volume.

### CONSERVATION OF MASS:

Unlike a control mass approach, the control volume approach does not implicitly satisfy conservation of mass, therefore we must make sure that mass is neither created nor destroyed in our process.

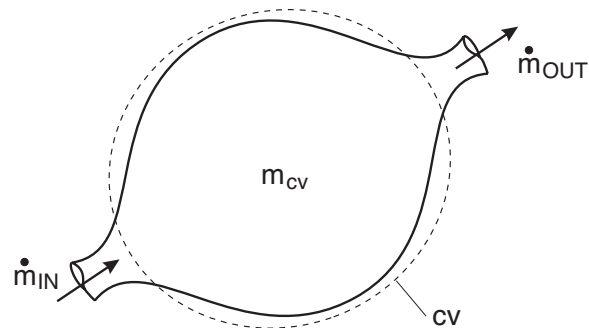

$$\left\{ \begin{array}{l} \text{rate of increase} \\ \text{of mass within} \\ \text{the CV} \end{array} \right\} = \left\{ \begin{array}{l} \text{net rate of} \\ \text{mass flow} \\ \text{IN} \end{array} \right\} - \left\{ \begin{array}{l} \text{net rate of} \\ \text{mass flow} \\ \text{OUT} \end{array} \right\}$$

$$\frac{d}{dt}(m_{CV}) = \dot{m}_{IN} - \dot{m}_{OUT}$$

where:

$$m_{CV} = \int_V \rho dV$$

$$\dot{m}_{IN} = (\rho \mathcal{V} A)_{IN}$$

$$\dot{m}_{OUT} = (\rho \mathcal{V} A)_{OUT}$$

with  $\mathcal{V}$  = average velocity

**CONSERVATION OF ENERGY:**

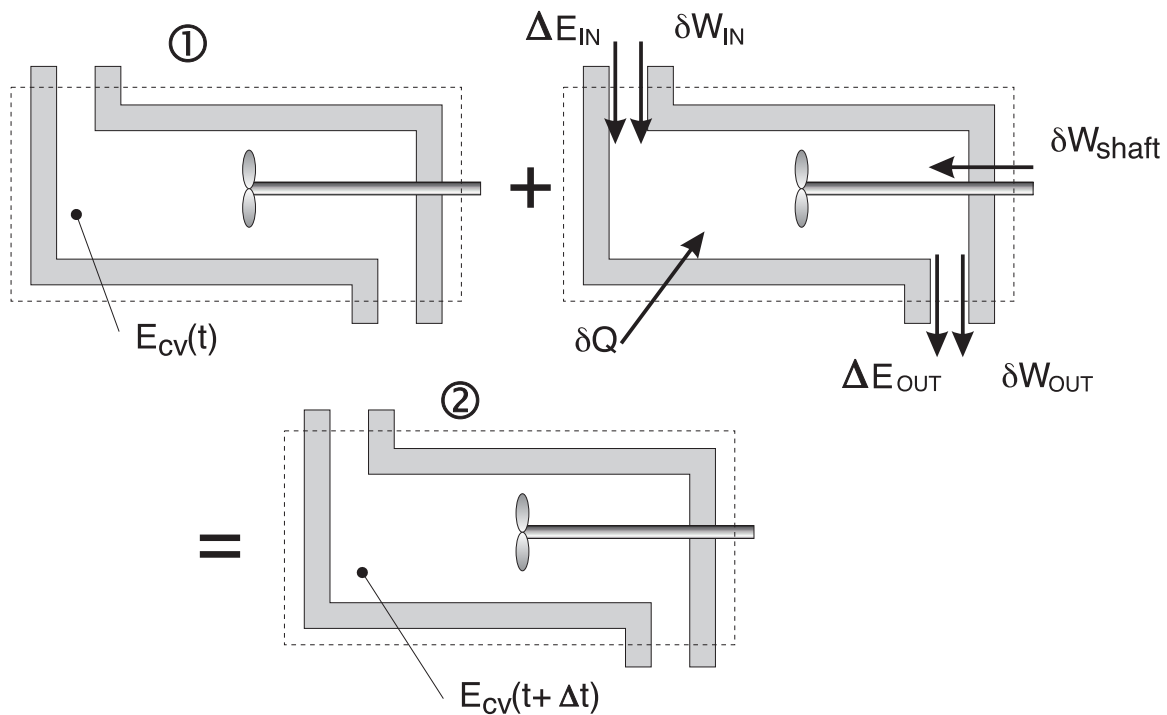

The 1st law states:

$$E_{CV}(t) + \delta Q + \delta W_{shaft} + (\Delta E_{IN} - \Delta E_{OUT}) + (\delta W_{IN} - \delta W_{OUT}) = E_{CV}(t + \Delta t) \quad (1)$$

where:

$$\Delta E_{IN} = e_{IN} \Delta m_{IN}$$

$$\Delta E_{OUT} = e_{OUT} \Delta m_{OUT}$$

$$\delta W = \text{flow work}$$

$$e = \frac{E}{m} = \underbrace{u}_{\text{internal}} + \underbrace{\frac{v^2}{2}}_{\text{kinetic}} + \underbrace{gz}_{\text{potential}}$$

## What is flow work?

This is the work required to pass the flow across the system boundaries. When mass enters/leaves a control volume, some work is done on/by the control volume.

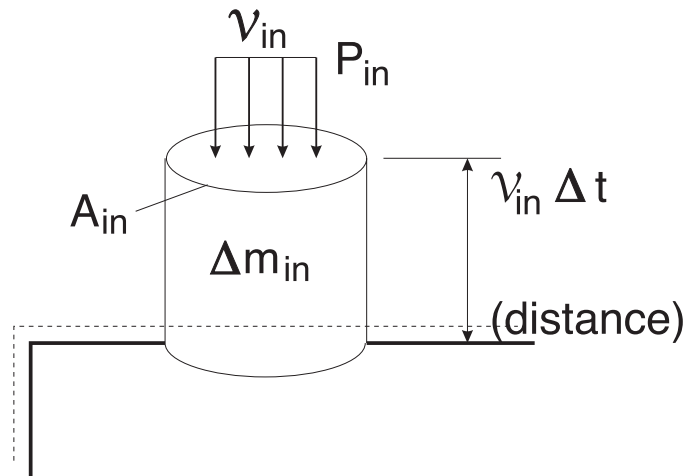

$$\Delta m_{IN} = \rho_{IN} \overbrace{A_{IN} v_{IN} \Delta t}^{\text{volume}}$$

$$\begin{aligned} \delta W_{IN} &= F \cdot \text{distance} \\ &= \underbrace{P_{IN} A_{IN}}_F \cdot \underbrace{v_{IN} \Delta t}_{\Delta s} \\ &= \frac{P_{IN} \Delta m_{IN}}{\rho_{IN}} \end{aligned}$$

with

$$v = \frac{1}{\rho}$$

$$\delta W_{IN} = (P v \Delta m)_{IN} \rightarrow \text{flow work} \quad (2)$$

Similarly

$$\delta W_{OUT} = (P v \Delta m)_{OUT} \quad (3)$$

Substituting Eqs. 2 and 3 into Eq. 1 gives the 1st law for a control volume

$$\begin{aligned} E_{CV}(t + \Delta t) - E_{CV}(t) &= \delta Q + \delta W_{shaft} + \Delta m_{IN}(e + Pv)_{IN} \\ &\quad - \Delta m_{OUT}(e + Pv)_{OUT} \end{aligned} \quad (4)$$

Equation 4 can also be written as a rate equation  $\rightarrow$  divide through by  $\Delta t$  and take the limit as  $\Delta t \rightarrow 0$

$$\frac{d}{dt} E_{CV} = \dot{Q} + \dot{W}_{shaft} + [\dot{m}(e + Pv)]_{IN} - [\dot{m}(e + Pv)]_{OUT}$$

where:

$$\dot{m} = \rho v^* A$$

Note that:

$$\begin{aligned} e + Pv &= \underbrace{u + Pv} + \frac{(v^*)^2}{2} + gz \\ &= h(\text{enthalpy}) + KE + PE \end{aligned}$$

By using enthalpy instead of the internal energy to represent the energy of a flowing fluid, one does not need to be concerned with the flow work.

## Some Practical Assumptions for Control Volumes

**Steady State Process:** The properties of the material inside the control volume do not change with time. For example

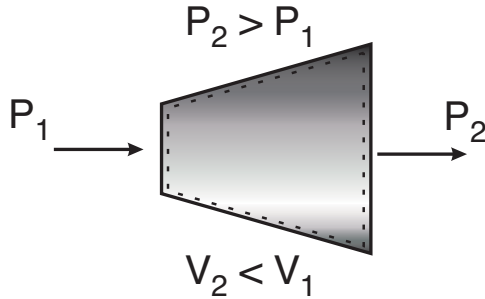

**Diffuser:**  $P$  changes inside the control volume, but the pressure at each point does not change with time.

**Steady Flow Process:** The properties of the material crossing the control surface do not change with time. For example

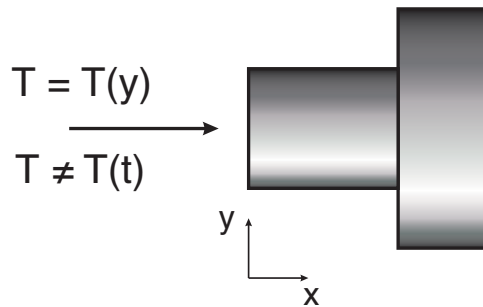

**Inlet Pipe:**  $T$  at the inlet may be different at different locations, but temperature at each boundary point does not change with time.

The steadiness refers to variation with respect to time

- if the process is not steady, it is *unsteady* or *transient*
- often steady flow implies both *steady flow* and *steady state*

**Uniform State Process:** The properties of the material inside the control volume are uniform and may change with time. For example

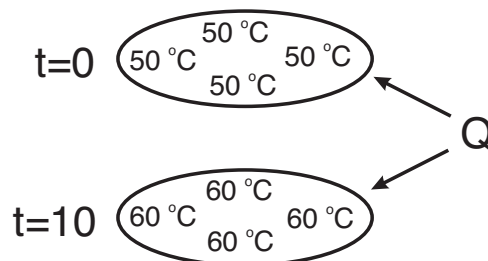

**Heating Copper:** Cu conducts heat well, so that it heats evenly.

**Uniform Flow Process:** The properties of the material crossing the control surface are spatially uniform and may change with time. For example

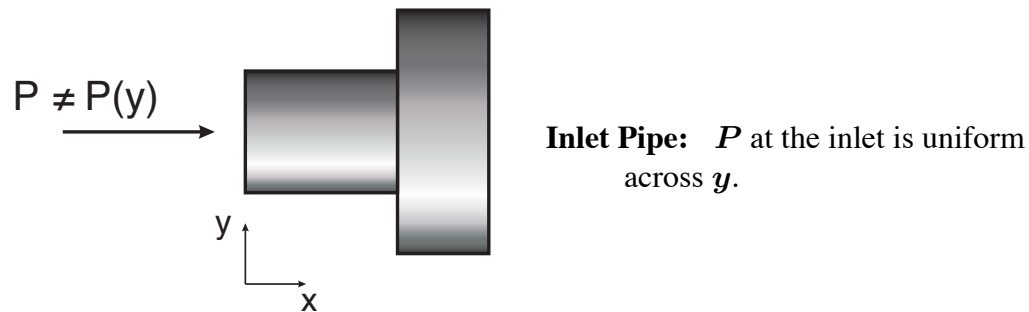

Uniformity is a concept related to the spatial distribution. If the flow field in a process is not uniform, it is *distributed*.

### ***Steady-State, Steady-Flow Process***

#### **Idealizations:**

- the control volume does not move relative to the reference frame
- the state of the mass at each point within the control volume does not change with time
- the flows in and out of the control volume are steady, i.e. there is no mass accumulation within the control volume
- the rates at which work and heat cross the control volume boundary remain constant

## Control Volume Analysis for Electrical Devices

We recall from the 1st law for a control volume

$$\frac{dE_{cv}}{dt} = \dot{Q} - \dot{W} + \dot{m}_{in}(e + Pv)_{in} - \dot{m}_{out}(e + Pv)_{out}$$

We can consider the following analogy

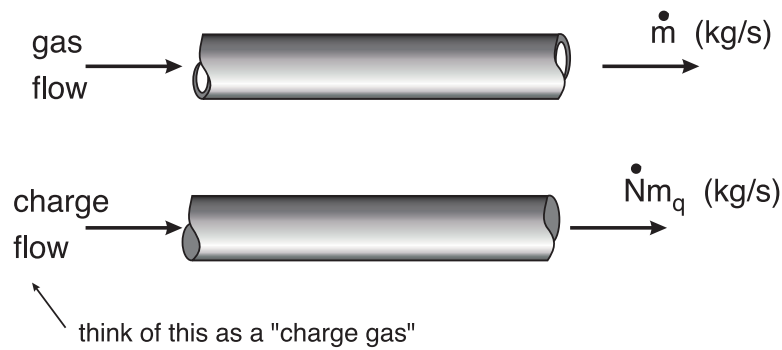

Let

- $N$  = number of charged particles
- $q^+$  = +ve charge on each particle
- $Nq^+$  = total charge
- $m_q$  = mass of each charged particle
- $Nm_q$  = total mass of the "charge gas"
- $\dot{N}m_q$  = flow rate of the "charge gas"
- $\epsilon$  = electrical potential

$$\dot{m}(e + Pv) = (\dot{N}m_q) \left( \underbrace{u + Pv + \frac{v^2}{2} + gz}_{\text{negligible}} + \underbrace{\frac{(Nq^+)\epsilon}{(Nm_q)}}_{\text{electrical potential per unit mass}} \right)$$

$$\dot{m}(e + Pv) = (\dot{N}m_q) \left( \frac{(Nq^+)\epsilon}{(Nm_q)} \right)$$

$$\begin{aligned} &= \dot{N}q^+\epsilon \\ &= I\epsilon \end{aligned}$$

where  $I = \text{current} \equiv \dot{N}q^+ = -\dot{N}e$

The first law takes the form

$$\frac{dE_{cv}}{dt} = \dot{Q} - \dot{W} + (\dot{N}q^+\epsilon)_{in} - (\dot{N}q^+\epsilon)_{out}$$



# Entropy and the Second Law of Thermodynamics

|   |  |   |
|---|--|---|
|  | <b>Reading</b><br>6-1, 6-2, 6-7, 6-8, 6-11<br>7-1 → 7-10, 7-12, 7-13 | <b>Problems</b><br>6-81, 6-87,<br>7-39, 7-46, 7-61, 7-89, 7-111,<br>7-122, 7-124, 7-130, 7-155, 7-158 |
|---|--|---|

## Why do we need another law in thermodynamics?

**Answer:** While the 1st law allowed us to determine the quantity of energy transfer in a process it does not provide any information about the direction of energy transfer nor the quality of the energy transferred in the process. In addition, we can not determine from the 1st law alone whether the process is possible or not. The second law will provide answers to these unanswered questions.

*A process will not occur unless it satisfies both the first and the second laws of thermodynamics.*

### 1. Direction:

Consider an isolated system where  $Q = W = 0$

From the 1st law we know

$$\underbrace{(U + KE)_1}_{E_1} = \underbrace{U_2}_{E_2} \quad \left\{ \begin{array}{l} \text{same both ways} \\ 1 \rightarrow 2 \\ 2 \rightarrow 1 \end{array} \right.$$

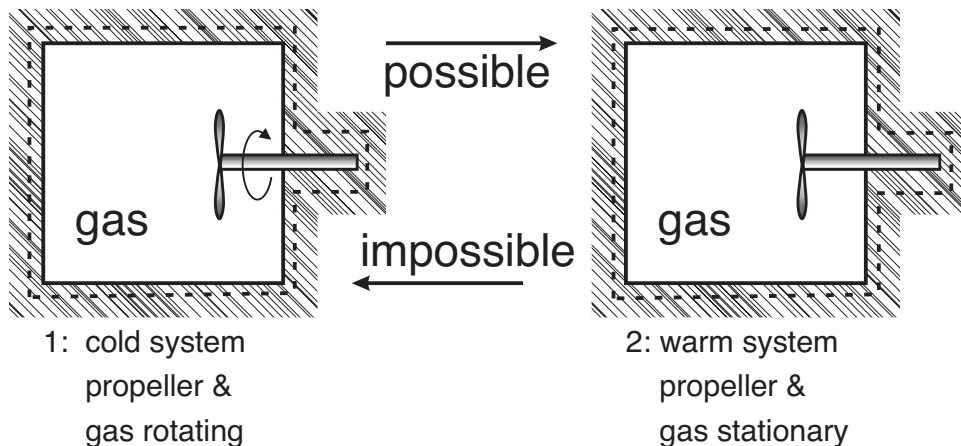

The physical interpretation of this is:

**State 1:** Most of the energy is in a highly organized form residing in the macroscopic  $KE$  of the propeller and the rotating gas.

**State 2:** All of the energy is now in a disorganized form residing in the microscopic  $E$ , i.e.  $U$  of the propeller and the gas.

- The process  $1 \rightarrow 2$  has resulted in a higher state of molecular chaos. **ENTROPY** is the thermodynamic property that describes the degree of molecular disorder in matter. Hence,  $S_2 > S_1$ . Entropy can be considered a quantitative index that describes the quality of energy.
- The process  $2 \rightarrow 1$  is impossible because it would require disorganized  $KE$  to produce macroscopically organized  $KE$ . That is  $S_2 < S_1$  which is impossible for an isolated system.
- A thermodynamic process is only possible if it satisfies both the 1st and 2nd laws simultaneously.

## 2. Quality of Energy:

A heat engine produces reversible work as it transfers heat from a high temperature reservoir at  $T_H$  to a low temperature reservoir at  $T_L$ . If we fix the low temperature reservoir at  $T_L = 300\text{ K}$ , we can determine the relationship between the efficiency of the heat engine,

$$\eta = 1 - \frac{Q_L}{Q_H} = 1 - \frac{T_L}{T_H}$$

as the temperature of the high temperature reservoir changes. In effect we are determining the quality of the energy transferred at high temperature versus that transferred at low temperature.

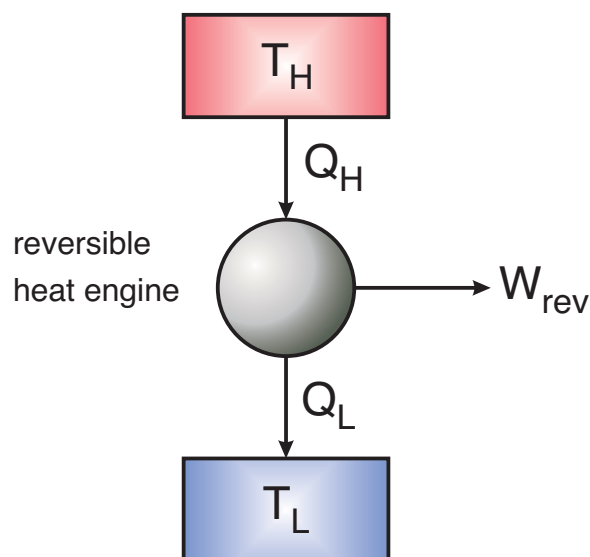

| $T_L$ (K) | $T_H$ (K) | $\eta$ |
|-----------|-----------|--------|
| 300       | 1000      | 0.700  |
| 300       | 800       | 0.625  |
| 300       | 600       | 0.500  |
| 300       | 400       | 0.250  |

Since the purpose of the heat engine is to convert heat energy to work energy, we can clearly see that more of the high temperature thermal energy can be converted to work. Therefore the higher the temperature, the higher the quality of the energy.

## Second Law of Thermodynamics

The second law of thermodynamics states:

*The entropy of an isolated system can never decrease. When an isolated system reaches equilibrium, its entropy attains the maximum value possible under the constraints of the system*

### Definition

$$\mathcal{P}_S = S_{gen} = S_2 - S_1 \geq 0 \rightarrow \text{2nd law}$$

- the 2nd law dictates why processes occur in a specific direction i.e.,  $S_{gen}$  cannot be  $-ve$
- The second law states, for an isolated system:

$$(\Delta S)_{system} + (\Delta S)_{surr.} \geq 0$$

where  $\Delta \equiv \text{final} - \text{initial}$

## Gibb's Equation

From a 1st law energy balance when KE and PE are neglected

$$\text{Energy Input} = \text{Energy Output} + \text{Increase in Energy Storage}$$

$$\underbrace{\delta Q}_{\text{amount}} = \delta W + \underbrace{dU}_{\text{differential}} \quad (1)$$

We know that the differential form of entropy is

$$dS = \frac{\delta Q}{T} \quad (2) \quad \delta W = PdV \quad (3)$$

Combining Eqs. 1, 2 and 3

$$dS = \frac{dU}{T} + \frac{PdV}{T} \Rightarrow \underbrace{ds = \frac{du}{T} + \frac{Pdv}{T}}_{\text{per unit mass}}$$

## 2nd Law Analysis for a Closed System (Control Mass)

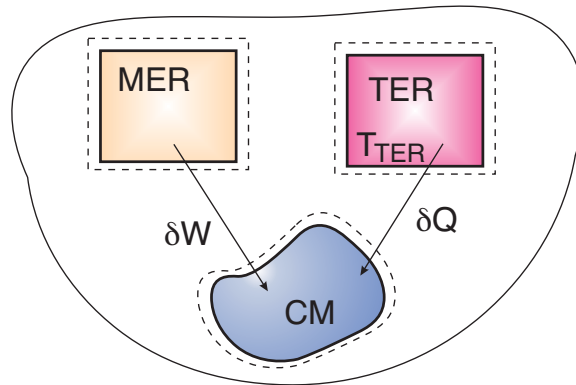

We can first perform a 1st law energy balance on the system shown above.

$$dU = \delta Q + \delta W \quad (1)$$

For a simple compressible system

$$\delta W = -PdV \quad (2)$$

From Gibb's equation we know

$$T_{TER} dS = dU + PdV \quad (3)$$

Combining (1), (2) and (3) we get

$$T_{TER} dS = \delta Q$$

Therefore

$$\underbrace{(dS)_{CM}}_{\equiv \text{storage}} = \underbrace{\frac{\delta Q}{T_{TER}}}_{\equiv \text{entropy flow}} + \underbrace{d\mathcal{P}_S}_{\equiv \text{production}}$$

Integrating gives

$$(S_2 - S_1)_{CM} = \frac{Q_{1-2}}{T_{TER}} + \underbrace{S_{gen}}_{\geq 0}$$

where

$\frac{Q_{1-2}}{T_{TER}}$  - the entropy associated with heat transfer across a finite temperature difference, i.e.  $T > 0$

## 2nd Law Analysis for Open Systems (Control Volume)

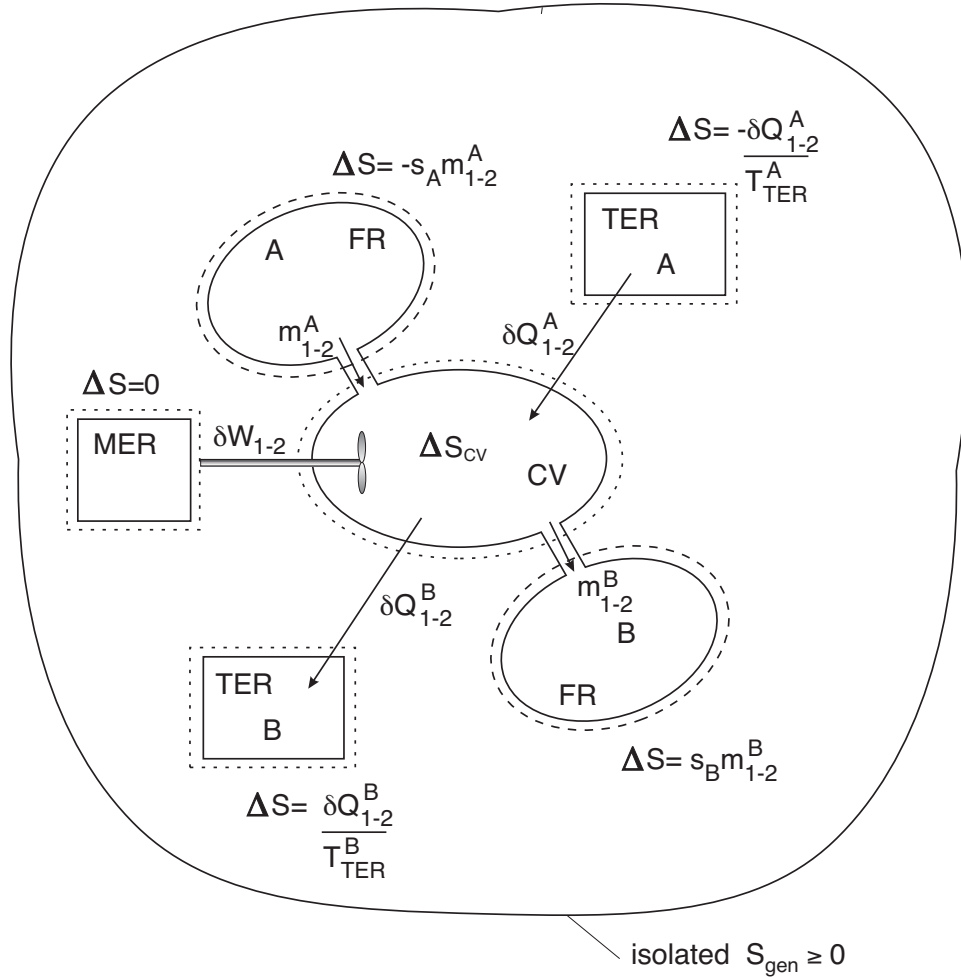

$$\delta S_{gen} = (\Delta S)_{sys} + (\Delta S)_{sur}$$

$$\delta S_{gen} = \underbrace{\Delta S_{CV}}_{system} + \underbrace{\left( -s_A m_{1-2}^A + s_B m_{1-2}^B - \frac{\delta Q_{1-2}^A}{T_{TER}^A} + \frac{\delta Q_{1-2}^B}{T_{TER}^B} \right)}_{surroundings}$$

or as a rate equation

$$\dot{S}_{gen} = \left( \frac{dS}{dt} \right)_{CV} + \left( s\dot{m} + \frac{\dot{Q}}{T_{TER}} \right)_{OUT} - \left( s\dot{m} + \frac{\dot{Q}}{T_{TER}} \right)_{IN}$$

This can be thought of as

$$generation = accumulation + OUT - IN$$

# Reversible Process

## Example: Slow adiabatic compression of a gas

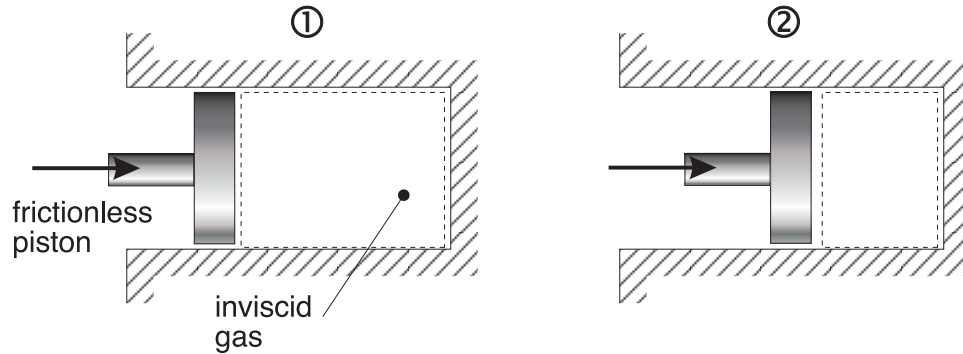

Idealization - which makes  
the process completely  
reversible

A process  $1 \rightarrow 2$  is said to be reversible if the reverse process  $2 \rightarrow 1$  restores the system to its original state without leaving any change in either the system or its surroundings.

$\rightarrow$  idealization where  $S_2 = S_1 \Rightarrow S_{gen} = 0$

$T_2 > T_1 \Rightarrow$  increased microscopic disorder

$V_2 < V_1 \Rightarrow$  reduced uncertainty about the whereabouts of molecules

$$\underbrace{\text{Reversible}}_{S_{gen}=0} + \underbrace{\text{Adiabatic Process}}_{Q=0} \Rightarrow \underbrace{\text{Isentropic Process}}_{S_1=S_2}$$

## Calculation of $\Delta s$ in Processes

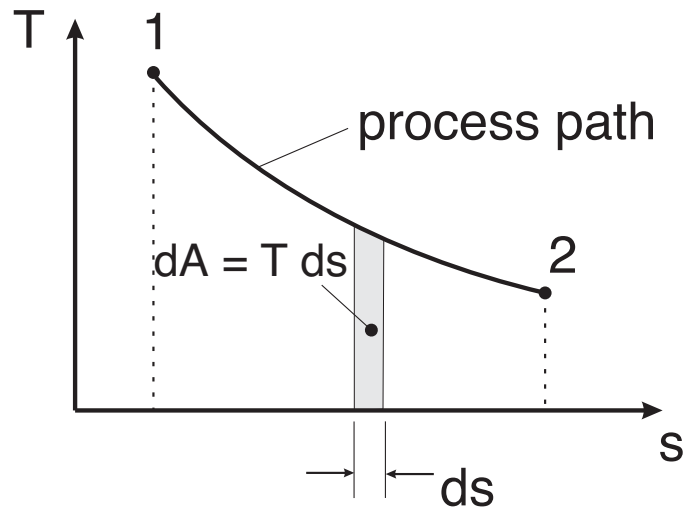

- the area under the curve on a  $T - s$  diagram is the heat transfer for internally reversible processes

$$q_{int,rev} = \int_1^2 T ds \quad \text{and} \quad q_{int,rev,isothermal} = T \Delta s$$

### *Tabulated Calculation of $\Delta s$ for Pure Substances*

#### **Calculation of the Properties of Wet Vapor:**

Use Tables A-4 and A-5 to find  $s_f$ ,  $s_g$  and/or  $s_{fg}$  for the following

$$s = (1 - x)s_f + xs_g \qquad s = s_f + xs_{fg}$$

#### **Calculation of the Properties of Superheated Vapor:**

Given two properties or the state, such as temperature and pressure, use Table A-6.

#### **Calculation of the Properties of a Compressed Liquid:**

Use Table A-7. In the absence of compressed liquid data for a property  $s_{T,P} \approx s_{f@T}$



### ***Calculation of $\Delta s$ for Incompressible Materials***

- for an incompressible substance,  $dv = 0$ , and  $C_p = C_v = C$

$$ds = \frac{du}{T} = C \frac{dT}{T}$$

$$s_2 - s_1 = \int_1^2 C(T) \frac{dT}{T}$$

$$\Delta s = C_{avg} \ln \frac{T_2}{T_1} \quad \text{where} \quad C_{avg} = [C(T_1) + C(T_2)]/2$$

### ***Calculation of $\Delta s$ for Ideal Gases***

For an ideal gas with constant  $C_p$  and  $C_v$

$$\text{Ideal Gas Equation} \Rightarrow Pv = RT$$

$$du = C_v dT \quad \Rightarrow \quad u_2 - u_1 = C_v(T_2 - T_1)$$

$$dh = C_p dT \quad \Rightarrow \quad h_2 - h_1 = C_p(T_2 - T_1)$$

There are 3 forms of a change in entropy as a function of  $T$  &  $v$ ,  $T$  &  $P$ , and  $P$  &  $v$ .

$$\begin{aligned} s_2 - s_1 &= C_v \ln \frac{T_2}{T_1} + R \ln \frac{v_2}{v_1} \\ &= C_p \ln \frac{T_2}{T_1} - R \ln \frac{P_2}{P_1} \\ &= C_p \ln \frac{v_2}{v_1} + C_v \ln \frac{P_2}{P_1} \end{aligned}$$

By setting the above equations to zero (isentropic, i.e.  $\Delta s = 0$ ) we can obtain the isentropic equations

$$\frac{T_2}{T_1} = \left( \frac{P_2}{P_1} \right)^{(k-1)/k} = \left( \frac{v_1}{v_2} \right)^{(k-1)}$$

where  $k = C_p/C_v$  which can be found tabulated in Table A-2 for various gases.

# The Carnot Cycle

- an ideal theoretical cycle that is the most efficient conceivable
- based on a fully reversible heat engine - it does not include any of the irreversibilities associated with friction, viscous flow, etc.
- in practice the thermal efficiency of real world heat engines are about half that of the ideal, Carnot cycle

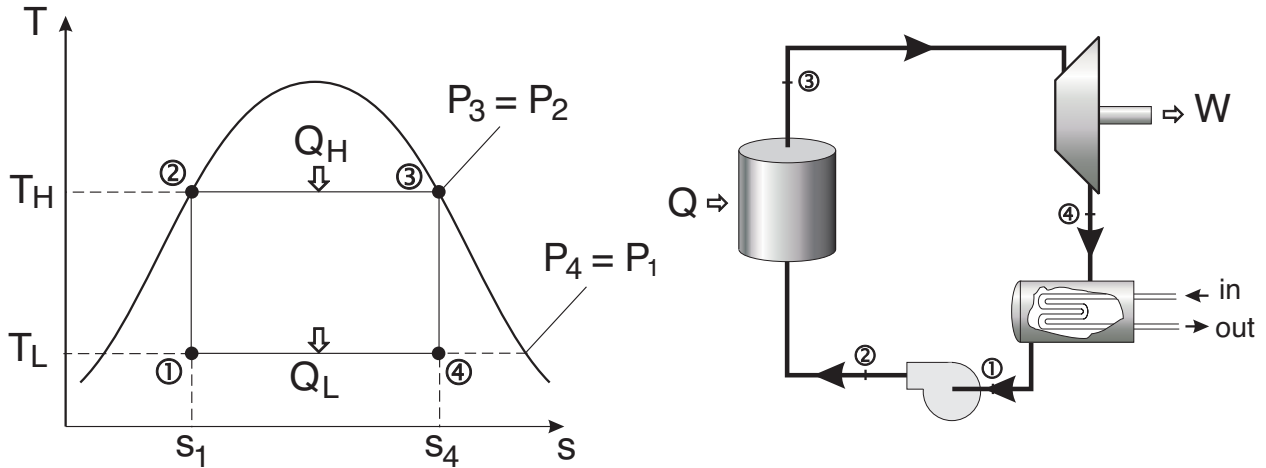

| Process     | State Points | Description   |
|-------------|--------------|---|
| Pump        | 1 → 2        | isentropic compression from $T_L \rightarrow T_H$ to return vapor to a liquid state         |
| Heat Supply | 2 → 3        | heat is supplied at constant temperature and pressure                                       |
| Work Output | 3 → 4        | the vapor expands isentropically from the high pressure and temperature to the low pressure |
| Condenser   | 4 → 1        | the vapor which is wet at 4 has to be cooled to state point 1                               |

The cycle is totally reversible.

The reversed Carnot cycle is called the Carnot refrigeration cycle.

# Conduction Heat Transfer

|   |                            |  |
|---|----------------------------|--|
|  | <b>Reading</b>             | <b>Problems</b>  |
|   | 17-1 → 17-6<br>18-1 → 18-2 | 17-35, 17-57, 17-68, 17-81, 17-88, 17-110<br>18-14, 18-20, 18-34, 18-52, 18-80, 18-104 |

## Fourier Law of Heat Conduction

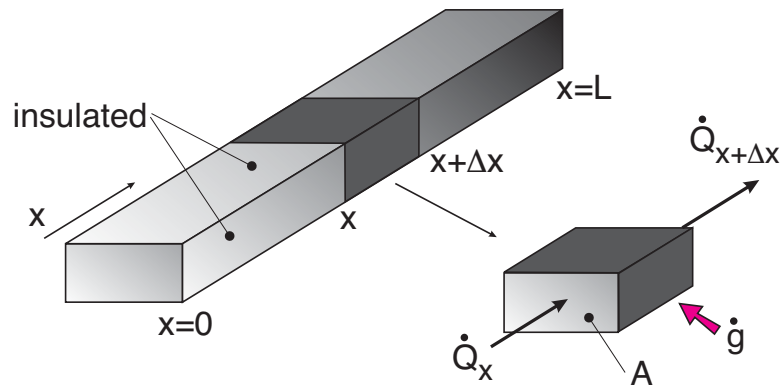

The general 1-D conduction equation is given as

$$\underbrace{\frac{\partial}{\partial x} \left( k \frac{\partial T}{\partial x} \right)}_{\text{longitudinal conduction}} + \underbrace{\dot{g}}_{\text{internal heat generation}} = \underbrace{\rho C \frac{\partial T}{\partial t}}_{\text{thermal inertia}}$$

where the heat flow rate,  $\dot{Q}_x$ , in the axial direction is given by *Fourier's law of heat conduction*.

$$\dot{Q}_x = -kA \frac{\partial T}{\partial x}$$

## Thermal Resistance Networks

### Resistances in Series

The heat flow through a solid material of conductivity,  $k$  is

$$\dot{Q} = \frac{kA}{L} (T_{in} - T_{out}) = \frac{T_{in} - T_{out}}{R_{cond}} \quad \text{where} \quad R_{cond} = \frac{L}{kA}$$

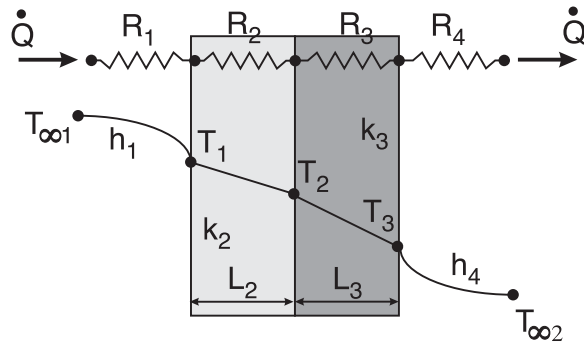

The total heat flow across the system can be written as

$$\dot{Q} = \frac{T_{\infty 1} - T_{\infty 2}}{R_{total}} \quad \text{where} \quad R_{total} = \sum_{i=1}^4 R_i$$

This is analogous to current flow through electrical circuits where,  $I = \Delta V/R$

### ***Resistances in Parallel***

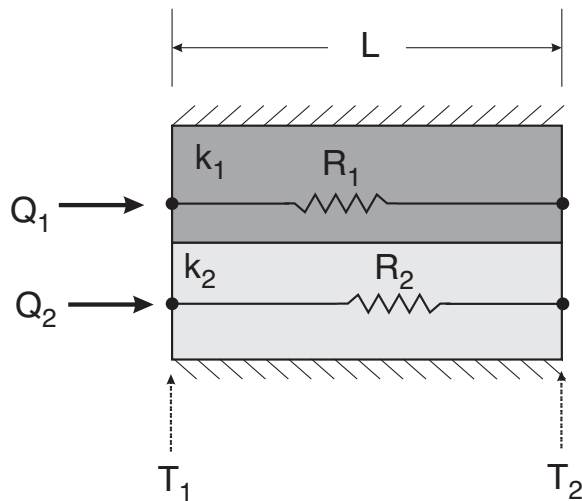

In general, for parallel networks we can use a parallel resistor network as follows:

where

$$\frac{1}{R_{total}} = \frac{1}{R_1} + \frac{1}{R_2} + \frac{1}{R_3} + \dots$$

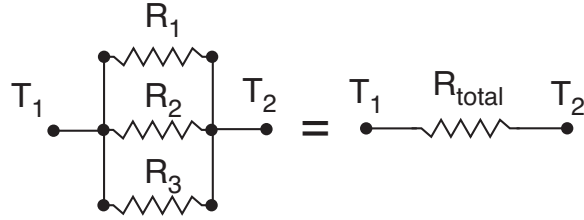

and

$$\dot{Q} = \frac{T_1 - T_2}{R_{total}}$$

## Cylindrical Systems

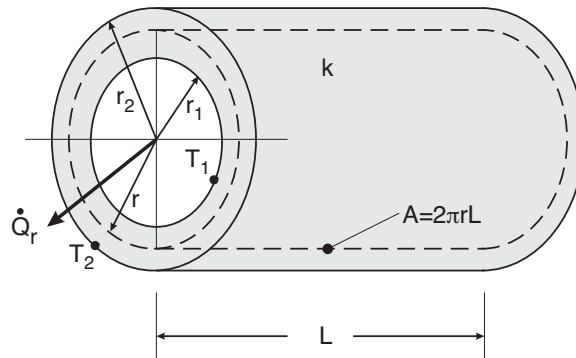

Steady, 1D heat flow from  $T_1$  to  $T_2$  in a cylindrical systems occurs in a radial direction where the lines of constant temperature (isotherms) are concentric circles, as shown by the dotted line in the figure above and  $T = T(r)$ .

$$T_2 - T_1 = -\frac{\dot{Q}_r}{2\pi k \mathcal{L}} (\ln r_2 - \ln r_1) = -\frac{\dot{Q}_r}{2\pi k \mathcal{L}} \ln \frac{r_2}{r_1}$$

Therefore we can write

$$\dot{Q}_r = \frac{T_2 - T_1}{\left( \frac{\ln(r_2/r_1)}{2\pi k \mathcal{L}} \right)} \quad \text{where } R = \left( \frac{\ln(r_2/r_1)}{2\pi k \mathcal{L}} \right)$$

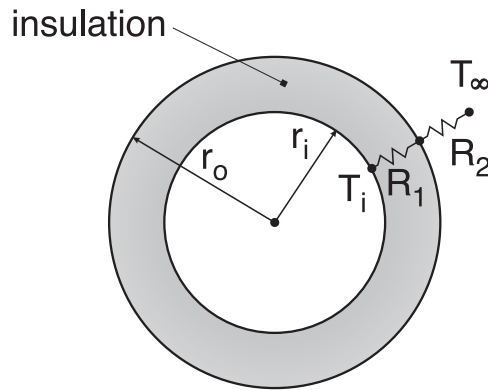

## Critical Thickness of Insulation

Consider a steady, 1-D problem where an insulation cladding is added to the outside of a tube with constant surface temperature  $T_i$ . What happens to the heat transfer as insulation is added, i.e. we increase the thickness of the insulation?

The resistor network can be written as a series combination of the resistance of the insulation,  $R_1$  and the convective resistance,  $R_2$

$$R_{total} = R_1 + R_2 = \frac{\ln(r_o/r_i)}{2\pi k\mathcal{L}} + \frac{1}{h2\pi r_o\mathcal{L}}$$

Note: as the thickness of the insulation is increased the outer radius,  $r_o$  increases.

Could there be a situation in which adding insulation increases the overall heat transfer?

To find the critical radius,  $r_c$ , where adding more insulation begins to decrease heat transfer, set

$$\frac{dR_{total}}{dr_o} = 0$$

$$\frac{dR_{total}}{dr_o} = \frac{1}{2\pi k r_o \mathcal{L}} - \frac{1}{h 2\pi r_o^2 \mathcal{L}} = 0$$

$$r_c = \frac{k}{h}$$

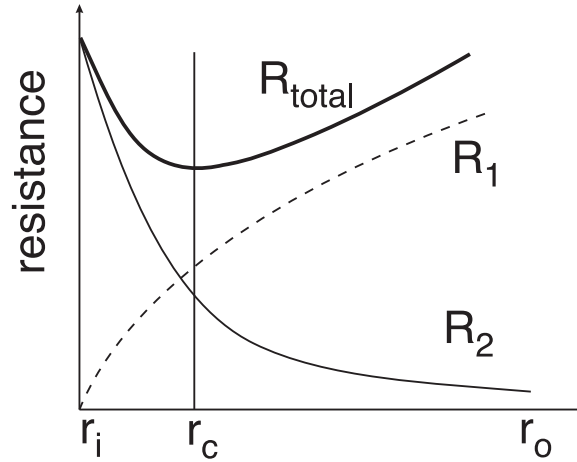

## Heat Generation in a Solid

Heat can be generated within a solid as a result of resistance heating in wires, chemical reactions, nuclear reactions, etc.

A volumetric heat generation term will be defined as follows:

$$\dot{g} = \frac{\dot{E}_g}{V} \quad (\text{W}/\text{m}^3)$$

for heat generation in wires, we will define  $\dot{g}$  as

$$\dot{g} = \frac{I^2 R_e}{\pi r_o^2 \mathcal{L}}$$

### Slab System

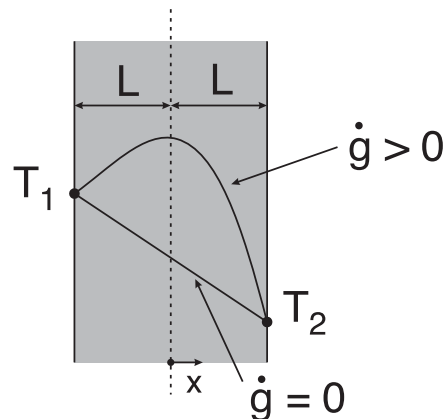

$$T = \frac{T_1 + T_2}{2} - \left( \frac{T_1 - T_2}{2} \right) \frac{x}{L} + \frac{\dot{q}L^2}{2k} \left( 1 - \left( \frac{x}{L} \right)^2 \right)$$

### Cylindrical System

$$T = T_s + \frac{\dot{q}r_0^2}{4k} \left( 1 - \left( \frac{r}{r_0} \right)^2 \right)$$

where

$$BC1 : \frac{dT}{dr} = 0 \quad @r = 0$$

$$BC2 : T = T_s \quad @r = r_0$$

### Heat Transfer from Finned Surfaces

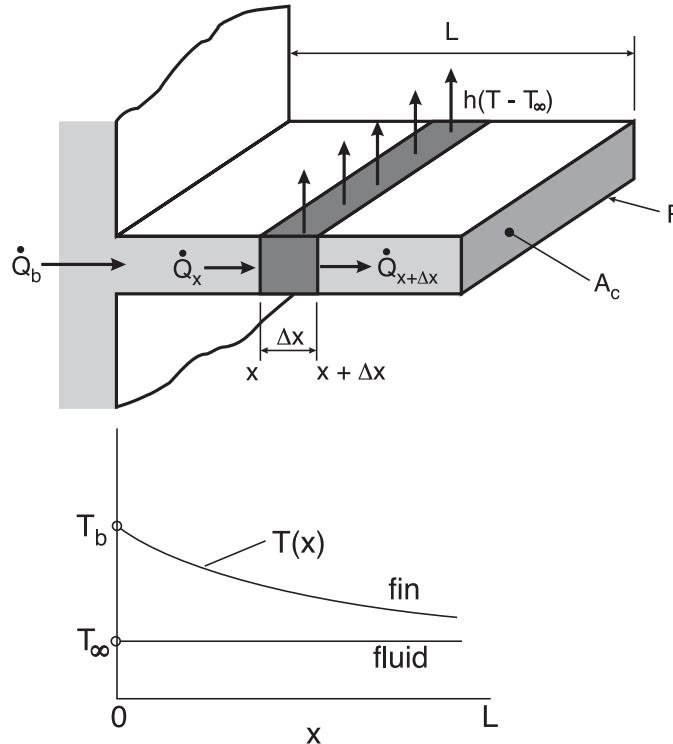

The temperature difference between the fin and the surroundings (temperature excess) is usually expressed as

$$\theta = T(x) - T_\infty$$



which allows the 1-D fin equation to be written as

$$\frac{d^2\theta}{dx^2} - m^2\theta = 0$$

where the fin parameter  $m$  is

$$m = \left( \frac{hP}{kA_c} \right)^{1/2}$$

and the boundary conditions are

$$\theta = \theta_b \quad @ \quad x = 0$$

$$\theta \rightarrow 0 \quad \text{as} \quad x \rightarrow \infty$$

The solution to the differential equation for  $\theta$  is

$$\theta(x) = C_1 \sinh(mx) + C_2 \cosh(mx)$$

substituting the boundary conditions to find the constants of integration

$$\theta = \theta_b \frac{\cosh[m(L-x)]}{\cosh(mL)}$$

The heat transfer flowing through the base of the fin can be determined as

$$\begin{aligned} \dot{Q}_b &= A_c \left( -k \frac{dT}{dx} \right)_{@x=0} \\ &= \theta_b (kA_c hP)^{1/2} \tanh(mL) \end{aligned}$$

### ***Fin Efficiency and Effectiveness***

The dimensionless parameter that compares the actual heat transfer from the fin to the ideal heat transfer from the fin is the *fin efficiency*

$$\eta = \frac{\text{actual heat transfer rate}}{\text{maximum heat transfer rate when the entire fin is at } T_b} = \frac{\dot{Q}_b}{hPL\theta_b}$$

If the fin has a constant cross section then

$$\eta = \frac{\tanh(mL)}{mL}$$

An alternative figure of merit is the *fin effectiveness* given as

$$\epsilon_{fin} = \frac{\text{total fin heat transfer}}{\text{the heat transfer that would have occurred through the base area in the absence of the fin}} = \frac{\dot{Q}_b}{hA_c\theta_b}$$

## Transient Heat Conduction

Performing a 1<sup>st</sup> law energy balance on a plane wall gives

$$\dot{E}_{in} - \dot{E}_{out} \Rightarrow \dot{Q}_{cond} = \frac{T_H - T_s}{L/(k \cdot A)} = \dot{Q}_{conv} = \frac{T_s - T_\infty}{1/(h \cdot A)}$$

where

$$\begin{aligned} \frac{T_H - T_s}{T_s - T_\infty} &= \frac{L/(k \cdot A)}{1/(h \cdot A)} = \frac{\text{internal resistance to H.T.}}{\text{external resistance to H.T.}} \\ &= \frac{hL}{k} = Bi \equiv \text{Biot number} \end{aligned}$$

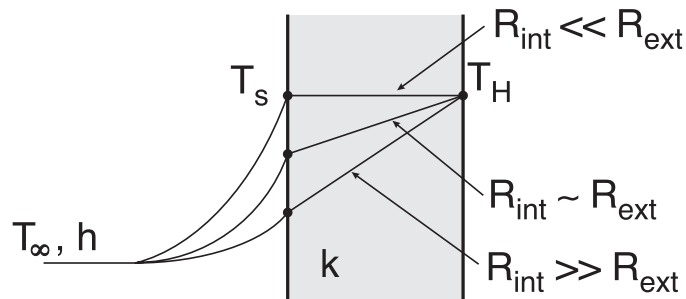

$R_{int} \ll R_{ext}$ : the Biot number is small and we can conclude

$$T_H - T_s \ll T_s - T_\infty \quad \text{and in the limit } T_H \approx T_s$$

$R_{ext} \ll R_{int}$ :

$R_{int} \ll R_{ext}$ : the Biot number is large and we can conclude

$$T_s - T_\infty \ll T_H - T_s \quad \text{and in the limit } T_s \approx T_\infty$$

## Lumped System Analysis

- if the internal temperature of a body remains relatively constant with respect to position
  - can be treated as a lumped system analysis
  - heat transfer is a function of time only,  $T = T(t)$
- internal temperature is relatively constant at low Biot number
- typical criteria for lumped system analysis  $\rightarrow Bi \leq 0.1$

## Transient Conduction Analysis

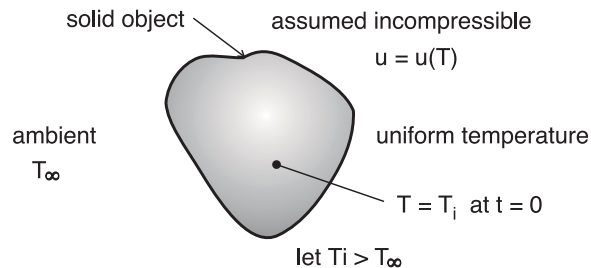

For the 3-D body of volume  $V$  and surface area  $A$ , we can use a lumped system analysis if

$$Bi = \frac{hV}{kA} < 0.1 \quad \Leftrightarrow \text{results in an error of less than 5\%}$$

The characteristic length for the 3-D object is given as  $\mathcal{L} = V/A$ . Other characteristic lengths for conventional bodies include:

---

|               |   |
|---------------|---|
| <b>Slab</b>   | $\frac{V}{A_s} = \frac{WH2L}{2WH} = L$                            |
| <b>Rod</b>    | $\frac{V}{A_s} = \frac{\pi r_o^2 L}{2\pi r_o L} = \frac{r_o}{2}$  |
| <b>Sphere</b> | $\frac{V}{A_s} = \frac{4/3\pi r_o^3}{4\pi r_o^2} = \frac{r_o}{3}$ |

---

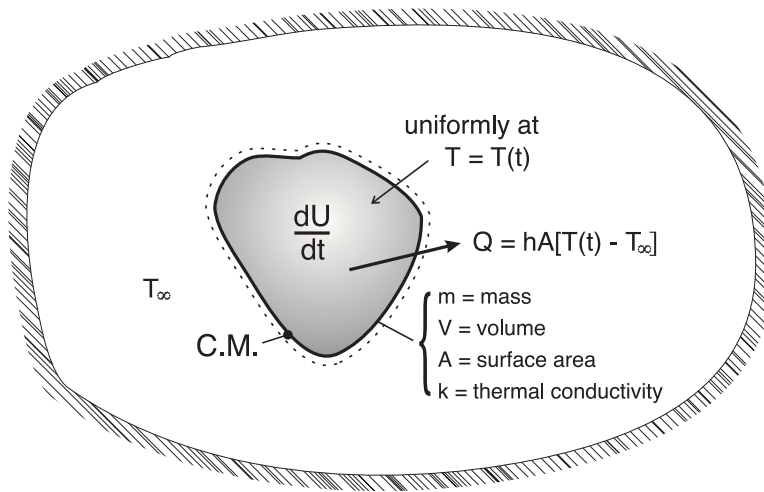

For an incompressible substance we can write

$$\underbrace{mC}_{\equiv C_{th}} \frac{dT}{dt} = - \underbrace{Ah}_{1/R_{th}} (T - T_\infty)$$

where

$C_{th}$  = lumped thermal capacitance

It should be clearly noted that we have neglected the spatial dependence of the temperature within the object. This type of an approach is only valid for  $Bi = \frac{hV}{kA} < 0.1$

We can integrate and apply the initial condition,  $T = T_i$  @  $t = 0$  to obtain

$$\frac{T(t) - T_\infty}{T_i - T_\infty} = e^{-t/(R_{th} \cdot C_{th})} = e^{-t/\tau}$$

where

$$\tau = R_{th} \cdot C_{th} = \text{thermal time constant} = \frac{mC}{Ah}$$

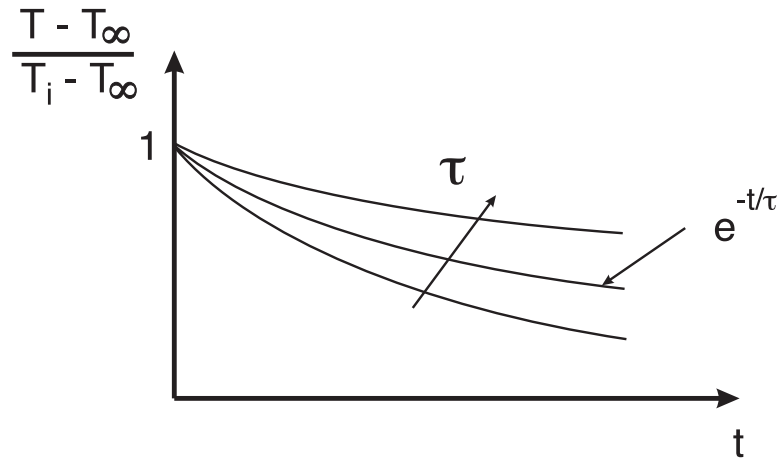

The total heat transfer rate can be determined by integrating  $\dot{Q}$  with respect to time.

$$\dot{Q}_{total} = hA(T_i - T_{\infty})(\tau)[1 - e^{-t^*/\tau}]$$

Therefore

$$\dot{Q}_{total} = \dot{m}C(T_i - T_{\infty})[1 - e^{-t^*/\tau}]$$

# Heisler Charts

The lumped system analysis can be used if  $Bi = hL/k < 0.1$  but what if  $Bi > 0.1$

- need to solve the partial differential equation for temperature
- leads to an infinite series solution  $\Rightarrow$  difficult to obtain a solution

The solution procedure for temperature is a function of several parameters

$$T(x, t) = f(x, L, t, k, \alpha, h, T_i, T_\infty)$$

By using dimensionless groups, we can reduce the temperature dependence to 3 dimensionless parameters

| Dimensionless Group | Formulation  |
|---------------------|--|
| temperature         | $\theta(x, t) = \frac{T(x, t) - T_\infty}{T_i - T_\infty}$ |
| position            | $x = x/L$  |
| heat transfer       | $Bi = hL/k$ Biot number                                    |
| time                | $Fo = \alpha t/L^2$ Fourier number                         |

note: Cengel uses  $\tau$  instead of  $Fo$ .

Now we can write

$$\theta(x, t) = f(x, Bi, Fo)$$

The characteristic length for the Biot number is

|          |                     |
|----------|---------------------|
| slab     | $\mathcal{L} = L$   |
| cylinder | $\mathcal{L} = r_o$ |
| sphere   | $\mathcal{L} = r_o$ |

contrast this versus the characteristic length for the lumped system analysis.

With this, two approaches are possible

1. use the first term of the infinite series solution. This method is only valid for  $Fo > 0.2$
2. use the Heisler charts for each geometry as shown in Figs. 18-13, 18-14 and 18-15

**First term solution:  $Fo > 0.2 \rightarrow$  error about 2% max.**

**Plane Wall:** 
$$\theta_{wall}(x, t) = \frac{T(x, t) - T_{\infty}}{T_i - T_{\infty}} = A_1 e^{-\lambda_1^2 Fo} \cos(\lambda_1 x / L)$$

**Cylinder:** 
$$\theta_{cyl}(r, t) = \frac{T(r, t) - T_{\infty}}{T_i - T_{\infty}} = A_1 e^{-\lambda_1^2 Fo} J_0(\lambda_1 r / r_o)$$

**Sphere:** 
$$\theta_{sph}(r, t) = \frac{T(r, t) - T_{\infty}}{T_i - T_{\infty}} = A_1 e^{-\lambda_1^2 Fo} \frac{\sin(\lambda_1 r / r_o)}{\lambda_1 r / r_o}$$

where  $\lambda_1, A_1$  can be determined from Table 18-1 based on the calculated value of the Biot number (will likely require some interpolation).

### **Heisler Charts**

- find  $T_0$  at the center for a given time
- find  $T$  at other locations at the same time
- find  $Q_{tot}$  up to time  $t$

# Convection Heat Transfer

|   |                            |  |
|---|----------------------------|--|
|  | <b>Reading</b>             | <b>Problems</b>  |
|   | 19-1 → 19-8<br>20-1 → 20-6 | 19-15, 19-24, 19-35, 19-47, 19-53, 19-69, 19-77<br>20-21, 20-28, 20-44, 20-57, 20-79 |

## Introduction

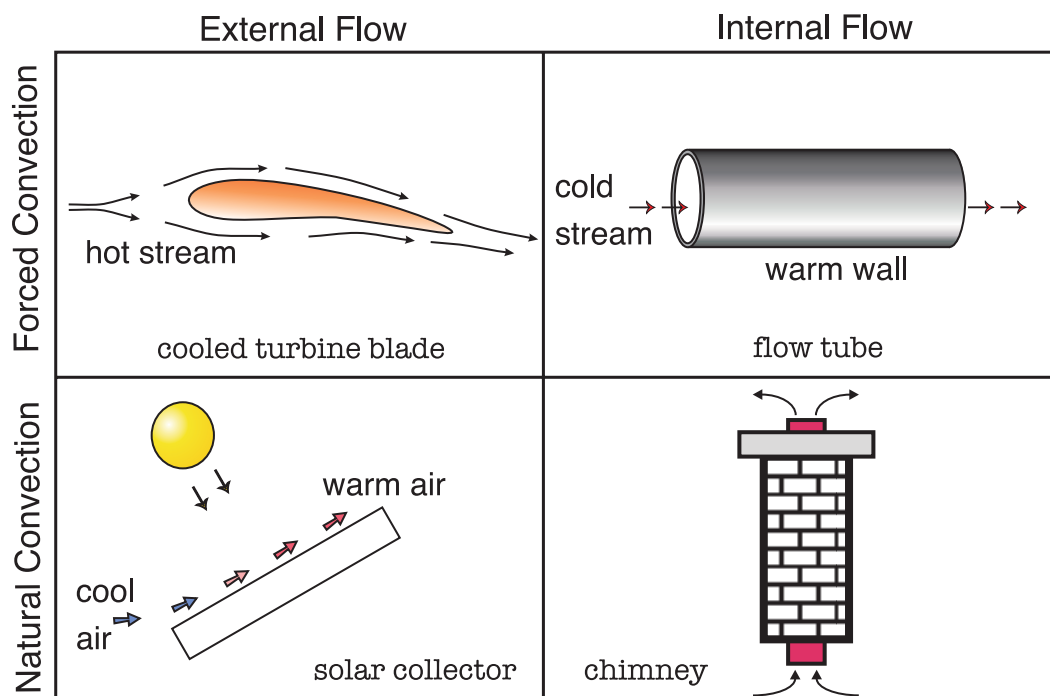

- in convective heat transfer, the bulk fluid motion of the fluid plays a major role in the overall energy transfer process. Therefore, knowledge of the velocity distribution near a solid surface is essential.
- the controlling equation for convection is *Newton's Law of Cooling*

$$\dot{Q}_{conv} = \frac{\Delta T}{R_{conv}} = hA(T_w - T_\infty) \quad \Rightarrow \quad R_{conv} = \frac{1}{hA}$$

where

$A$  = total convective area,  $m^2$



$h$  = heat transfer coefficient,  $W/(m^2 \cdot K)$

$T_w$  = surface temperature,  $^{\circ}C$

$T_{\infty}$  = fluid temperature,  $^{\circ}C$

**External Flow:** the flow engulfs the body with which it interacts thermally

**Internal Flow:** the heat transfer surface surrounds and guides the convective stream

**Forced Convection:** flow is induced by an external source such as a pump, compressor, fan, etc.

**Natural Convection:** flow is induced by natural means without the assistance of an external mechanism. The flow is initiated by a change in the density of fluids incurred as a result of heating.

**Mixed Convection:** combined forced and natural convection

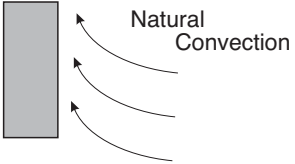
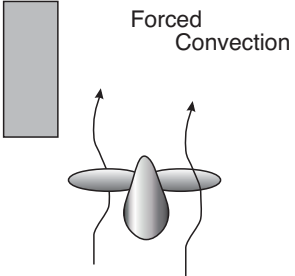
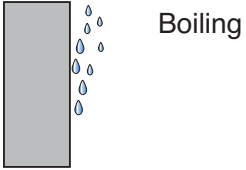
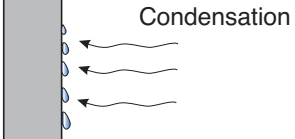
| Process   | $h$ [ $W/(m^2 \cdot K)$ ]  |
|---|--|
|  | <ul style="list-style-type: none"> <li>• gases 3 - 20</li> <li>• water 60 - 900</li> </ul>                                 |
|  | <ul style="list-style-type: none"> <li>• gases 30 - 300</li> <li>• oils 60 - 1 800</li> <li>• water 100 - 1 500</li> </ul> |
|  | <ul style="list-style-type: none"> <li>• water 3 000 - 100 000</li> </ul>  |
|  | <ul style="list-style-type: none"> <li>• steam 3 000 - 100 000</li> </ul>  |

## Dimensionless Groups

**Prandtl number:**  $Pr = \nu/\alpha$  where  $0 < Pr < \infty$  ( $Pr \rightarrow 0$  for liquid metals and  $Pr \rightarrow \infty$  for viscous oils). A measure of ratio between the diffusion of momentum to the diffusion of heat.

**Reynolds number:**  $Re = \rho U \mathcal{L} / \mu \equiv U \mathcal{L} / \nu$  (forced convection). A measure of the balance between the inertial forces and the viscous forces.

**Peclet number:**  $Pe = U \mathcal{L} / \alpha \equiv Re Pr$

**Grashof number:**  $Gr = g \beta (T_w - T_f) \mathcal{L}^3 / \nu^2$  (natural convection)

**Rayleigh number:**  $Ra = g \beta (T_w - T_f) \mathcal{L}^3 / (\alpha \cdot \nu) \equiv Gr Pr$

**Nusselt number:**  $Nu = h \mathcal{L} / k_f$  This can be considered as the dimensionless heat transfer coefficient.

**Stanton number:**  $St = h / (U \rho C_p) \equiv Nu / (Re Pr)$

## Forced Convection

The simplest forced convection configuration to consider is the flow of mass and heat near a flat plate as shown below.

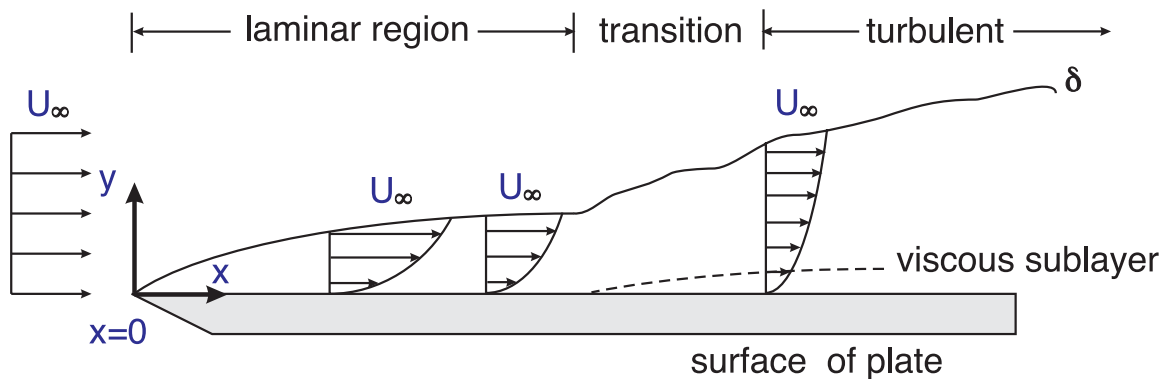

- as Reynolds number increases the flow has a tendency to become more chaotic resulting in disordered motion known as turbulent flow
  - transition from laminar to turbulent is called the critical Reynolds number,  $Re_{cr}$

$$Re_{cr} = \frac{U_\infty x_{cr}}{\nu}$$

- for flow over a flat plate  $Re_{cr} \approx 500,000$

- for engineering calculations, the transition region is usually neglected, so that the transition from laminar to turbulent flow occurs at a critical location from the leading edge,  $x_{cr}$

## Boundary Layers

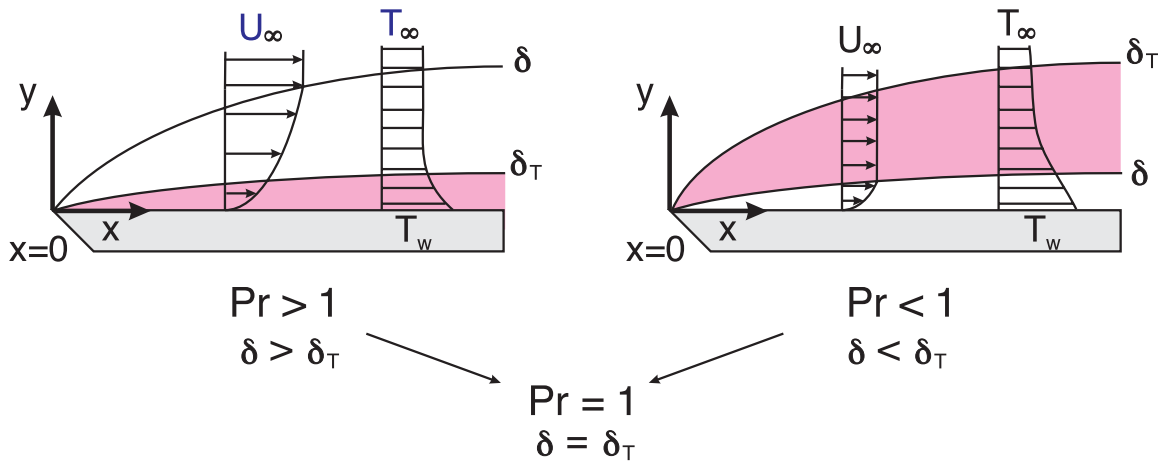

### Velocity Boundary Layer

- the region of fluid flow over the plate where viscous effects dominate is called the *velocity* or *hydrodynamic* boundary layer
- the velocity of the fluid progressively increases away from the wall until we reach approximately  $0.99 U_\infty$  which is denoted as the  $\delta$ , the *velocity boundary layer thickness*. Note: 99% is an arbitrarily selected value.

### Thermal Boundary Layer

- the thermal boundary layer is arbitrarily selected as the locus of points where

$$\frac{T - T_w}{T_\infty - T_w} = 0.99$$

## Heat Transfer Coefficient

The local heat transfer coefficient can be written as

$$h = \frac{-k_f \left( \frac{\partial T}{\partial y} \right)_{y=0}}{(T_w - T_\infty)} \equiv h(x) = h_x$$

The average heat transfer coefficient is determined using the mean value theorem such that

$$h_{av} = \frac{1}{L} \int_0^L h(x) dx$$

The Nusselt number is a measure of the dimensionless heat transfer coefficient given as

$$Nu = f(Re, Pr)$$

While the Nusselt number can be determine analytically through the conservations equations for mass, momentum and energy, it is beyond the scope of this course. Instead we will use *empirical correlations* based on experimental data where

$$Nu_x = C_2 \cdot Re^m \cdot Pr^n$$

### Flow Over Plates

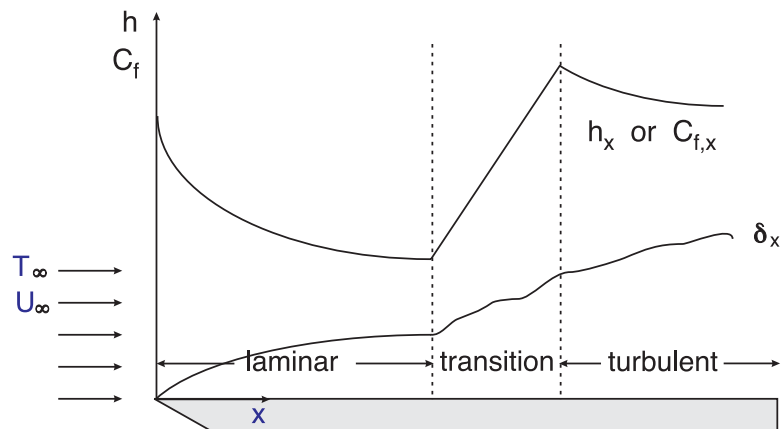

#### 1. Laminar Boundary Layer Flow, Isothermal (UWT)

The local value of the Nusselt number is given as

$$\boxed{Nu_x = 0.332 Re_x^{1/2} Pr^{1/3}} \Rightarrow \text{local, laminar, UWT, } Pr \geq 0.6$$

where  $x$  is the distance from the leading edge of the plate.

$$\boxed{Nu_L = \frac{h_L L}{k_f} = 0.664 Re_L^{1/2} Pr^{1/3}} \Rightarrow \text{average, laminar, UWT, } Pr \geq 0.6$$

For low Prandtl numbers, i.e. liquid metals

$$\boxed{Nu_x = 0.565 Re_x^{1/2} Pr^{1/2}} \Rightarrow \text{local, laminar, UWT, } Pr \leq 0.6$$

### 2. Turbulent Boundary Layer Flow, Isothermal (UWT)

$$\boxed{Nu_x = 0.0296 Re_x^{0.8} Pr^{1/3}} \Rightarrow \text{local, turbulent, UWT, } 0.6 < Pr < 100, Re_x > 500,000$$

$$\boxed{Nu_L = 0.037 Re_L^{0.8} Pr^{1/3}} \Rightarrow \text{average, turbulent, UWT, } 0.6 < Pr < 100, Re_x > 500,000$$

### 3. Combined Laminar and Turbulent Boundary Layer Flow, Isothermal (UWT)

$$\boxed{Nu_L = \frac{h_L L}{k} = (0.037 Re_L^{0.8} - 871) Pr^{1/3}} \Rightarrow \text{average, turbulent, UWT, } 0.6 < Pr < 60, Re_L > 500,000$$

### 4. Laminar Boundary Layer Flow, Isoflux (UWF)

$$\boxed{Nu_x = 0.453 Re_x^{1/2} Pr^{1/3}} \Rightarrow \text{local, laminar, UWF, } Pr \geq 0.6$$

### 5. Turbulent Boundary Layer Flow, Isoflux (UWF)

$$\boxed{Nu_x = 0.0308 Re_x^{4/5} Pr^{1/3}} \Rightarrow \text{local, turbulent, UWF, } Pr \geq 0.6$$

## ***Flow Over Cylinders and Spheres***

### **1. Boundary Layer Flow Over Circular Cylinders, Isothermal (UWT)**

The Churchill-Berstein (1977) correlation for the average Nusselt number for long ( $L/D > 100$ ) cylinders is

$$\boxed{Nu_D = S_D^* + f(Pr) Re_D^{1/2} \left[ 1 + \left( \frac{Re_D}{282000} \right)^{5/8} \right]^{4/5}} \Rightarrow \text{average, UWT, } Re < 10^7 \\ \Rightarrow 0 \leq Pr \leq \infty, Re \cdot Pr > 0.2$$

where  $S_D^* = 0.3$  is the diffusive term associated with  $Re_D \rightarrow 0$  and the Prandtl number function is

$$f(Pr) = \frac{0.62 Pr^{1/3}}{[1 + (0.4/Pr)^{2/3}]^{1/4}}$$

All fluid properties are evaluated at  $T_f = (T_w + T_\infty)/2$ .

### **2. Boundary Layer Flow Over Non-Circular Cylinders, Isothermal (UWT)**

The empirical formulations of Zhukauskas and Jakob are commonly used, where

$$\boxed{Nu_D \approx \frac{\bar{h}D}{k} = C Re_D^m Pr^{1/3}} \Rightarrow \text{see Table 19-2 for conditions}$$

### **3. Boundary Layer Flow Over a Sphere, Isothermal (UWT)**

For flow over an isothermal sphere of diameter  $D$

$$\boxed{Nu_D = S_D^* + [0.4 Re_D^{1/2} + 0.06 Re_D^{2/3}] Pr^{0.4} \left( \frac{\mu_\infty}{\mu_w} \right)^{1/4}} \Rightarrow \text{average, UWT,} \\ \Rightarrow 0.7 \leq Pr \leq 380 \\ \Rightarrow 3.5 < Re_D < 80,000$$

where the diffusive term at  $Re_D \rightarrow 0$  is  $S_D^* = 2$

and the dynamic viscosity of the fluid in the bulk flow,  $\mu_\infty$  is based on  $T_\infty$  and the dynamic viscosity of the fluid at the surface,  $\mu_w$ , is based on  $T_w$ . All other properties are based on  $T_\infty$ .

## Internal Flow

Lets consider fluid flow in a duct bounded by a wall that is at a different temperature than the fluid. For simplicity we will examine a round tube of diameter  $D$  as shown below

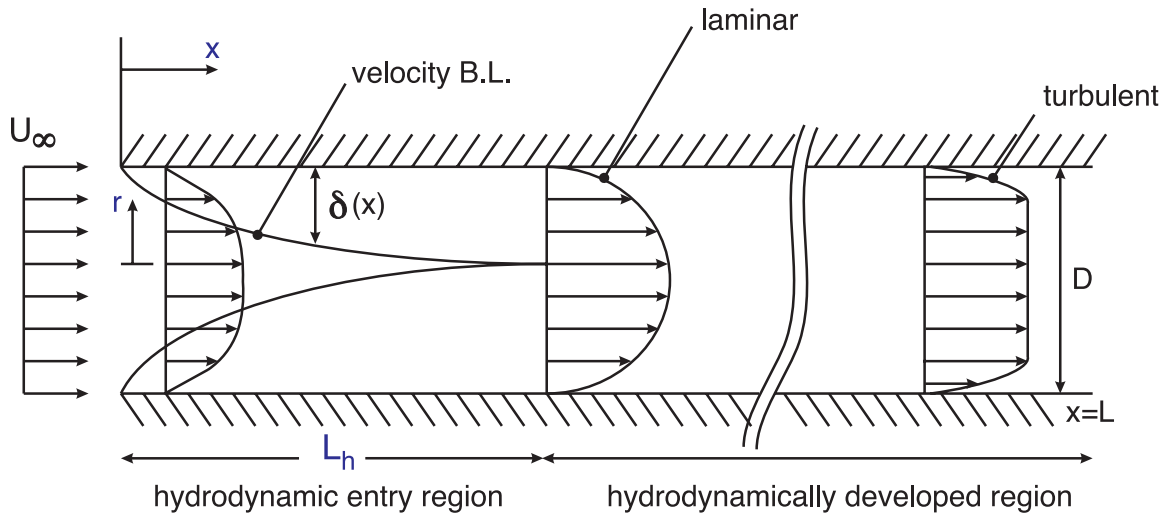

The velocity profile across the tube changes from  $U = 0$  at the wall to a maximum value along the center line. The average velocity, obtained by integrating this velocity profile, is called the *mean velocity* and is given as

$$U_m = \frac{1}{A_c} \int_{A_c} u \, dA = \frac{\dot{m}}{\rho_m A_c}$$

where the area of the tube is given as  $A_c = \pi D^2/4$  and the fluid density,  $\rho_m$  is evaluated at  $T_m$ .

The Reynolds number is given as

$$Re_D = \frac{U_m D}{\nu}$$

For flow in a tube:

|                      |                              |
|----------------------|------------------------------|
| $Re_D < 2300$        | laminar flow                 |
| $2300 < Re_D < 4000$ | transition to turbulent flow |
| $Re_D > 4000$        | turbulent flow               |

## Hydrodynamic (Velocity) Boundary Layer

- the hydrodynamic boundary layer thickness can be approximated as

$$\delta(x) \approx 5x \left( \frac{U_m x}{\nu} \right)^{-1/2} = \frac{5x}{\sqrt{Re_x}}$$



## Thermal Boundary Layer

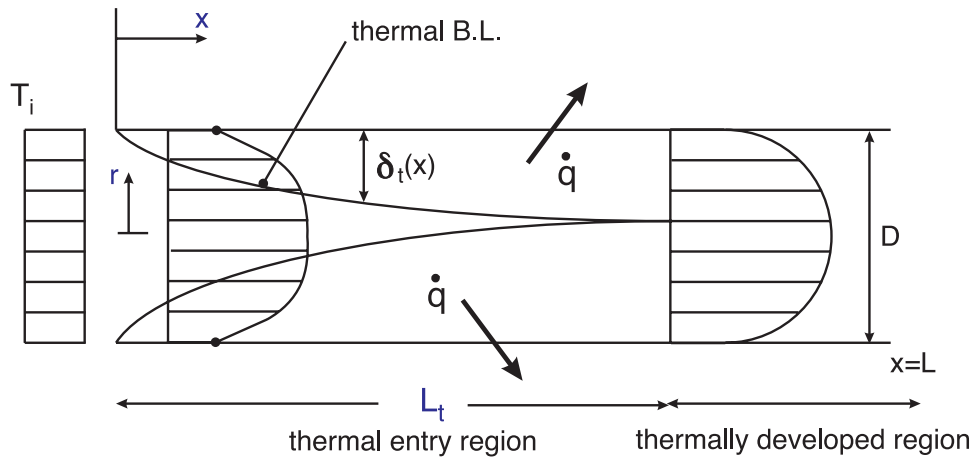

- the thermal entry length can be approximated as

$$L_t \approx 0.05 Re_D Pr D \quad (\text{laminar flow})$$

- for turbulent flow  $L_h \approx L_t \approx 10D$

### 1. Laminar Flow in Circular Tubes, Isothermal (UWT) and Isoflux (UWF)

For laminar flow where  $Re_D \leq 2300$

$$\boxed{Nu_D = 3.66} \Rightarrow \text{fully developed, laminar, UWT, } L > L_t \text{ \& } L_h$$

$$\boxed{Nu_D = 4.36} \Rightarrow \text{fully developed, laminar, UWF, } L > L_t \text{ \& } L_h$$

$$\boxed{Nu_D = 1.86 \left( \frac{Re_D Pr D}{L} \right)^{1/3} \left( \frac{\mu_b}{\mu_w} \right)^{0.4}} \Rightarrow \begin{array}{l} \text{developing laminar flow, UWT,} \\ Pr > 0.5 \\ L < L_h \text{ or } L < L_t \end{array}$$

For non-circular tubes the hydraulic diameter,  $D_h = 4A_c/P$  can be used in conjunction with

Table 10-4 to determine the Reynolds number and in turn the Nusselt number.

In all cases the fluid properties are evaluated at the mean fluid temperature given as

$$T_{mean} = \frac{1}{2} (T_{m,in} + T_{m,out})$$

except for  $\mu_w$  which is evaluated at the wall temperature,  $T_w$ .

## 2. Turbulent Flow in Circular Tubes, Isothermal (UWT) and Isoflux (UWF)

For turbulent flow where  $Re_D \geq 2300$  the Dittus-Bouler equation (Eq. 19-79) can be used

turbulent flow, UWT or UWF,

$$0.7 \leq Pr \leq 160$$

$$Re_D > 2,300$$

$$n = 0.4 \text{ heating}$$

$$\boxed{Nu_D = 0.023 Re_D^{0.8} Pr^n} \Rightarrow n = 0.3 \text{ cooling}$$

For non-circular tubes, again we can use the hydraulic diameter,  $D_h = 4A_c/P$  to determine both the Reynolds and the Nusselt numbers.

In all cases the fluid properties are evaluated at the mean fluid temperature given as

$$T_{mean} = \frac{1}{2} (T_{m,in} + T_{m,out})$$

# Natural Convection

## What Drives Natural Convection?

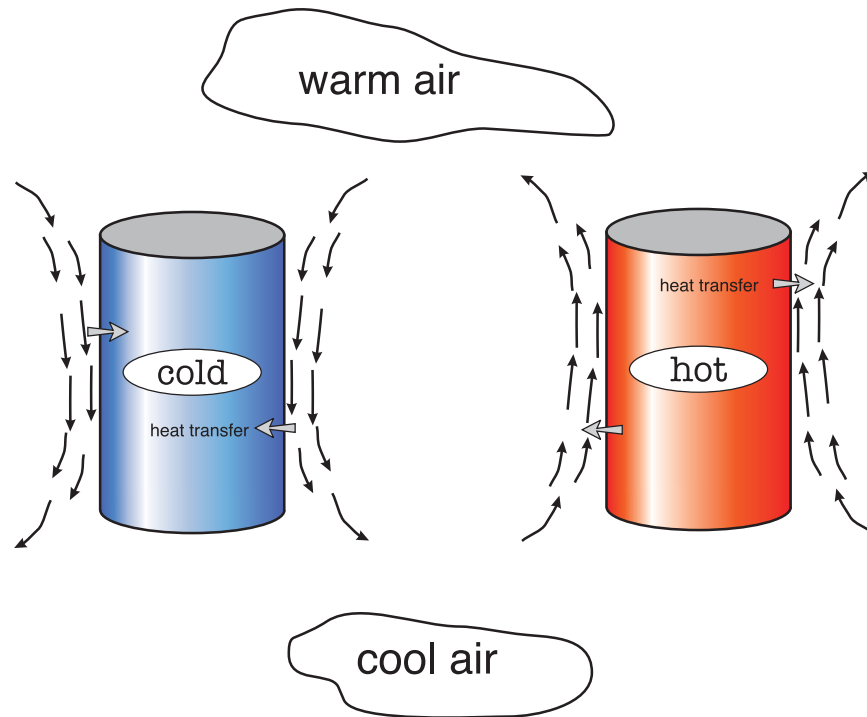

- a lighter fluid will flow upward and a cooler fluid will flow downward
- as the fluid sweeps the wall, heat transfer will occur in a similar manner to boundary layer flow however in this case the bulk fluid is stationary as opposed to moving at a constant velocity in the case of forced convection

We do not have a Reynolds number but we have an analogous dimensionless group called the *Grashof number*

$$Gr = \frac{\text{buoyancy force}}{\text{viscous force}} = \frac{g\beta(T_w - T_\infty)\mathcal{L}^3}{\nu^2}$$

where

$g$  = gravitational acceleration,  $m/s^2$

$\beta$  = volumetric expansion coefficient,  $\beta \equiv 1/T$  ( $T$  is ambient temp. in  $K$ )

- $T_w$  = wall temperature,  $K$   
 $T_\infty$  = ambient temperature,  $K$   
 $\mathcal{L}$  = characteristic length,  $m$   
 $\nu$  = kinematic viscosity,  $m^2/s$

The volumetric expansion coefficient,  $\beta$ , is used to express the variation of density of the fluid with respect to temperature and is given as

$$\beta = -\frac{1}{\rho} \left( \frac{\partial \rho}{\partial T} \right)_P$$

### ***Natural Convection Heat Transfer Correlations***

The general form of the Nusselt number for natural convection is as follows:

$$Nu = f(Gr, Pr) \equiv C Ra^m Pr^n \quad \text{where } Ra = Gr \cdot Pr$$

- $C$  depends on geometry, orientation, type of flow, boundary conditions and choice of characteristic length.
- $m$  depends on type of flow (laminar or turbulent)
- $n$  depends on the type of fluid and type of flow

#### **1. Laminar Flow Over a Vertical Plate, Isothermal (UWT)**

The general form of the Nusselt number is given as

$$Nu_{\mathcal{L}} = \frac{h\mathcal{L}}{k_f} = C \left( \underbrace{\frac{g\beta(T_w - T_\infty)\mathcal{L}^3}{\nu^2}}_{\equiv Gr} \right)^{1/4} \left( \underbrace{\frac{\nu}{\alpha}}_{\equiv Pr} \right)^{1/4} = C \underbrace{Gr_{\mathcal{L}}^{1/4} Pr^{1/4}}_{Ra^{1/4}}$$

where

$$Ra_{\mathcal{L}} = Gr_{\mathcal{L}} Pr = \frac{g\beta(T_w - T_\infty)\mathcal{L}^3}{\alpha\nu}$$

## 2. Laminar Flow Over a Long Horizontal Circular Cylinder, Isothermal (UWT)

The general boundary layer correlation is

$$Nu_D = \frac{hD}{k_f} = C \left( \underbrace{\frac{g\beta(T_w - T_\infty)D^3}{\nu^2}}_{\equiv Gr} \right)^n \left( \underbrace{\frac{\nu}{\alpha}}_{\equiv Pr} \right)^n = C \underbrace{Gr_D^n Pr^n}_{Ra_D^n}$$

where

$$Ra_D = Gr_D Pr = \frac{g\beta(T_w - T_\infty)D^3}{\alpha\nu}$$

All fluid properties are evaluated at the film temperature,  $T_f = (T_w + T_\infty)/2$ .

## Natural Convection From Plate Fin Heat Sinks

Plate fin heat sinks are often used in natural convection to increase the heat transfer surface area and in turn reduce the boundary layer resistance

$$R \downarrow = \frac{1}{hA \uparrow}$$

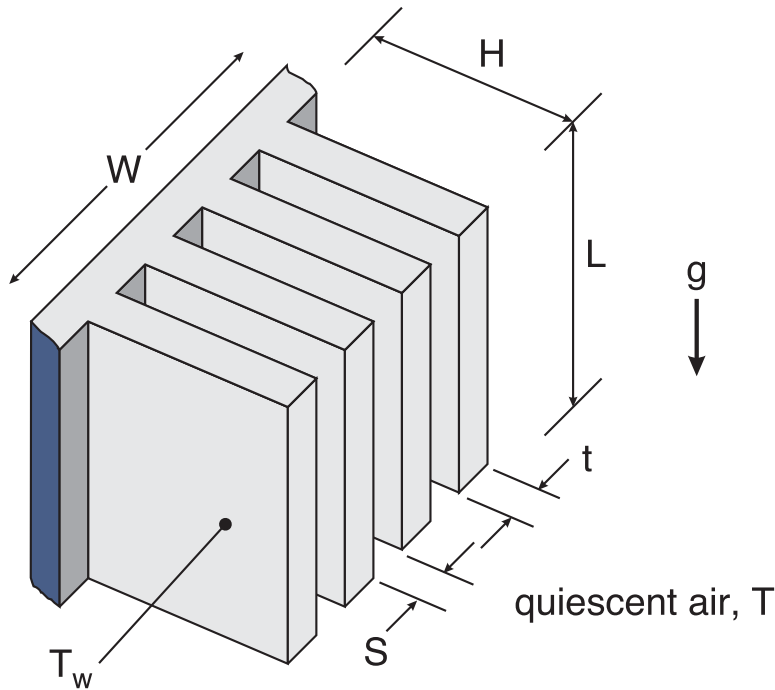

For a given baseplate area,  $W \times L$ , two factors must be considered in the selection of the number of fins

- more fins results in added surface area and reduced boundary layer resistance,

$$R \downarrow = \frac{1}{hA \uparrow}$$

- more fins results in a decrease fin spacing,  $S$  and in turn a decrease in the heat transfer coefficient

$$R \uparrow = \frac{1}{h \downarrow A}$$

A basic optimization of the fin spacing can be obtained as follows:

$$\dot{Q} = hA(T_w - T_\infty)$$

where the fins are assumed to be isothermal and the surface area is  $2nHL$ , with the area of the fin edges ignored.

For isothermal fins with  $t < S$

$$S_{opt} = 2.714 \left( \frac{L}{Ra^{1/4}} \right)$$

with

$$Ra = \frac{g\beta(T_w - T_\infty L^3)}{\nu^2} Pr$$

The corresponding value of the heat transfer coefficient is

$$h = 1.31k/S_{opt}$$

All fluid properties are evaluated at the film temperature.

# Radiation Heat Transfer

|   |                            |   |
|---|----------------------------|---|
|  | <b>Reading</b>             | <b>Problems</b>   |
|   | 21-1 → 21-6<br>22-1 → 21-5 | 21-21, 21-24, 21-41, 21-61, 21-69<br>22-11, 22-17, 22-26, 22-36, 22-71, 22-72 |

## Introduction

It should be readily apparent that radiation heat transfer calculations required several additional considerations in addition to those of conduction and convection, i.e.

- optical aspects: the manner in which an emitting body “sees” its neighbors
- surface conditions

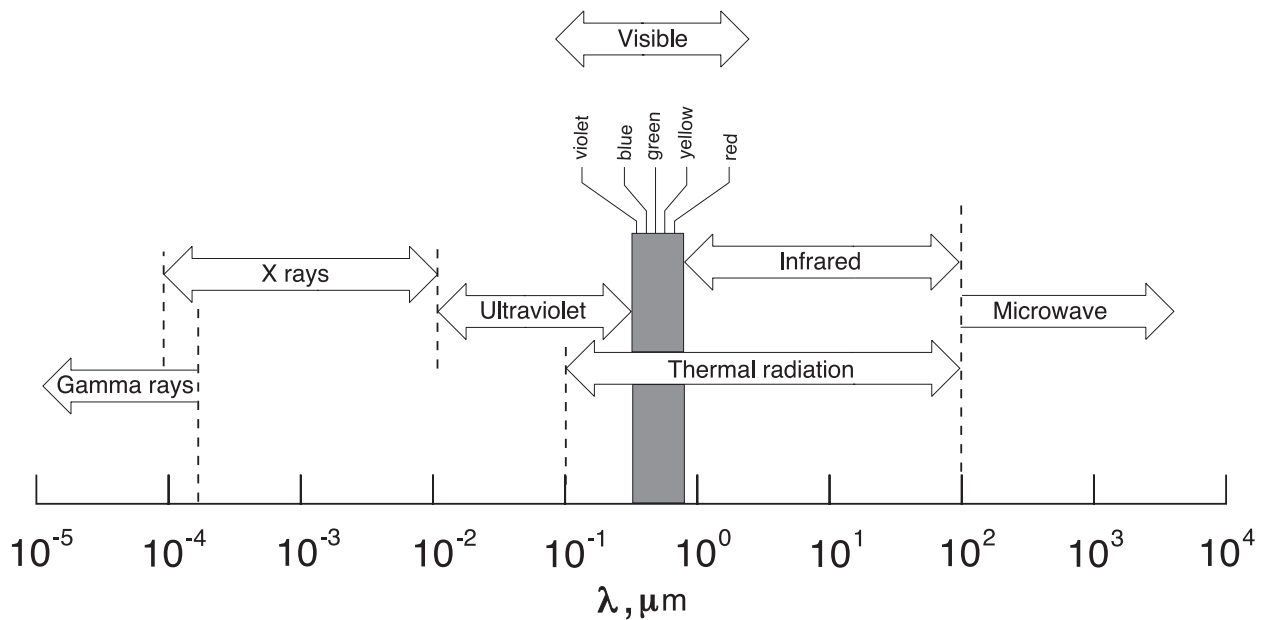

## Blackbody Radiation

A blackbody is an ideal radiator that

- *absorbs* all incident radiation regardless of wavelength and direction



- at a given temperature and wavelength, no surface can emit more energy than a blackbody
- *emitted* radiation is a function of wavelength and temperature but is independent of direction, i.e. a black body is a diffuse emitter (independent of direction)

## Definitions

1. **Blackbody emissive power:** the radiation emitted by a blackbody per unit time and per unit surface area

$$E_b = \sigma T^4 \quad [W/m^2] \quad \Leftarrow \text{ Stefan-Boltzmann law}$$

where  $\sigma =$  Stefan-Boltzmann constant  $= 5.67 \times 10^{-8} W/(m^2 \cdot K^4)$  and the temperature  $T$  is given in  $K$ .

2. **Spectral blackbody emissive power:** the amount of radiation energy emitted by a blackbody per unit surface area and per unit wavelength about the wavelength  $\lambda$ . The following relationship between emissive power, temperature and wavelength is known as *Plank's distribution law*

$$E_{b,\lambda} = \frac{C_1}{\lambda^5 [\exp(C_2/\lambda T) - 1]} \quad [W/(m^2 \cdot \mu m)]$$

where

$$C_0 = 2.998 \times 10^8 [m/s] \quad (\text{vacuum conditions})$$

$$C_1 = 2\pi h C_0^2 = 3.743 \times 10^8 [W \cdot \mu m^4/m^2]$$

$$C_2 = h C_0 / K = 1.439 \times 10^4 [\mu \cdot K]$$

$$K = \text{ Boltzmann constant } \equiv 1.3805 \times 10^{-23} [J/K]$$

$$h = \text{ Plank's constant } \equiv 6.63 \times 10^{-34} [J \cdot s]$$

$$E_{b,\lambda} = \text{ energy of radiation in the wavelength}$$

band  $d\lambda$  per unit area and time

If we integrate the spectral emissive power between  $d\lambda = \lambda_2 - \lambda_1$  we will obtain the blackbody emissive power given as  $E_b(T) = \sigma T^4$ .

3. **Blackbody radiation function:** the fraction of radiation emitted from a blackbody at temperature,  $T$  in the wavelength band  $\lambda = 0 \rightarrow \lambda$

$$f_{0 \rightarrow \lambda} = \frac{\int_0^\lambda E_{b,\lambda}(T) d\lambda}{\int_0^\infty E_{b,\lambda}(T) d\lambda} = \frac{\int_0^\lambda \frac{C_1}{\lambda^5 [\exp(C_2/\lambda T) - 1]} d\lambda}{\sigma T^4}$$

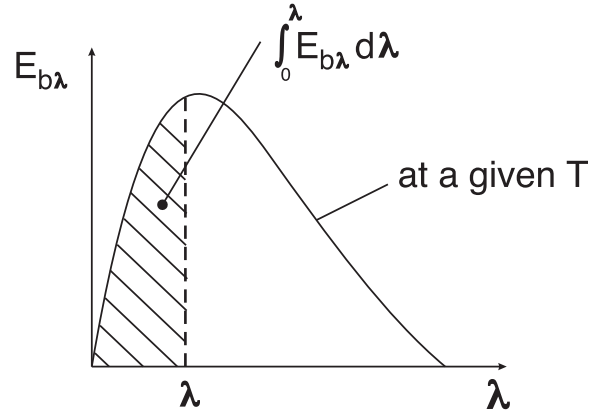

let  $t = \lambda T$  and  $dt = T d\lambda$ , then

$$\begin{aligned} f_{0 \rightarrow \lambda} &= \frac{\int_0^\lambda \frac{C_1 T^5 (1/T) dt}{t^5 [\exp(C_2/t) - 1]}}{\sigma T^4} \\ &= \frac{C_1}{\sigma} \int_0^{\lambda T} \frac{dt}{t^5 [\exp(C_2/t) - 1]} \\ &= f(\lambda T) \end{aligned}$$

$f_{0 \rightarrow \lambda}$  is tabulated as a function  $\lambda T$  in Table 21.2

We can easily find the fraction of radiation emitted by a blackbody at temperature  $T$  over a discrete wavelength band as

$$\begin{aligned} f_{\lambda_1 \rightarrow \lambda_2} &= f(\lambda_2 T) - f(\lambda_1 T) \\ f_{\lambda \rightarrow \infty} &= 1 - f_{0 \rightarrow \lambda} \end{aligned}$$

# Radiation Properties of Real Surfaces

The thermal radiation emitted by a real surface is a function of surface temperature,  $T$ , wavelength,  $\lambda$ , direction and surface properties.

$$E_\lambda = f(T, \lambda, \text{direction}, \text{surface properties}) \Rightarrow \text{spectral emissive power}$$

while for a blackbody, the radiation was only a function of temperature and wavelength

$$E_{b,\lambda} = f(T, \lambda) \rightarrow \text{diffuse emitter} \Rightarrow \text{independent of direction}$$

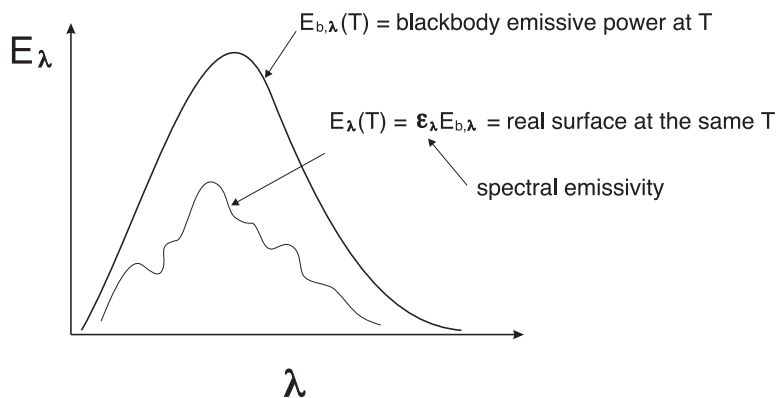

## Definitions

1. **Emissivity:** defined as the ratio of radiation emitted by a surface to the radiation emitted by a blackbody at the same surface temperature.

$$\begin{aligned} \epsilon(T) &= \frac{\text{radiation emitted by surface at temperature } T}{\text{radiation emitted by a black surface at } T} \\ &= \frac{\int_0^\infty E_\lambda(T) d\lambda}{\int_0^\infty E_{b\lambda}(T) d\lambda} = \frac{\int_0^\infty \epsilon_\lambda(T) E_{b\lambda}(T) d\lambda}{E_b(T)} = \frac{E(T)}{\sigma T^4} \end{aligned}$$

where  $\epsilon$  changes rather quickly with surface temperature.

2. **Diffuse surface:** properties are independent of direction.

3. **Gray surface:** properties are independent of wavelength.
4. **Irradiation,  $G$ :** the radiation energy incident on a surface per unit area and per unit time

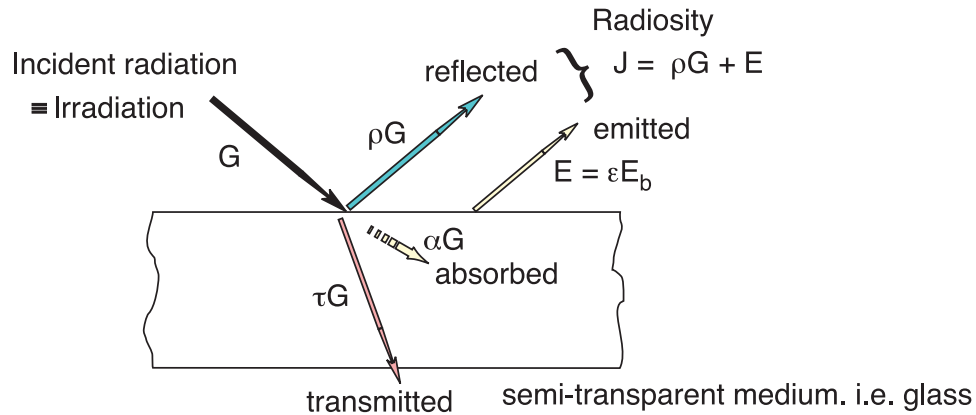

An energy balance based on incident radiation gives

$$G = \rho G + \alpha G + \tau G$$

where

$$G = \text{incident radiation or irradiation, } W/m^2$$

$$\rho G = \text{reflected radiation, } W/m^2$$

$$\alpha G = \text{absorbed radiation, } W/m^2$$

$$\tau G = \text{transmitted radiation, } W/m^2$$

with the associated surface properties being

$$\left. \begin{array}{l} \rho = \text{reflectivity} \\ \alpha = \text{absorptivity} \\ \tau = \text{transmissivity} \end{array} \right\} \Rightarrow \text{function of } \lambda \text{ \& } T \text{ of the incident radiation } G$$

$$\epsilon = \text{emissivity} \Rightarrow \text{function of } \lambda \text{ \& } T \text{ of the emitting surface}$$

If we normalize with respect to the total irradiation

$$\alpha + \rho + \tau = 1$$

In general  $\epsilon \neq \alpha$ . However, for a diffuse-gray surface (properties are independent of wavelength and direction)

$$\epsilon = \alpha \quad \text{diffuse-gray surface}$$

These unsubscripted values of  $\alpha$ ,  $\rho$  and  $\tau$  represent the average properties, i.e. due to incident radiation energy from all directions over a hemispherical space and including all wavelengths.

We can just as easily define these properties for a specific wavelength, such that

$$G_\lambda = \rho_\lambda G_\lambda + \alpha_\lambda G_\lambda + \tau_\lambda G_\lambda$$

where

$$\rho_\lambda = \text{spectral reflectivity} = f(\lambda, T)$$

$$\alpha_\lambda = \text{spectral absorptivity} = f(\lambda, T)$$

$$\tau_\lambda = \text{spectral transmissivity} = f(\lambda, T)$$

and

$$\rho_\lambda + \alpha_\lambda + \tau_\lambda = 1$$

$\epsilon_\lambda$  depends strongly on the temperature of the emitting surface but not at all on the irradiation field  $G_\lambda$ .

5. **Radiosity,  $J$ :** the total radiation energy leaving a surface per unit area and per unit time.

For a surface that is gray and opaque, i.e.  $\epsilon = \alpha$  and  $\alpha + \rho = 1$ , the radiosity is given as

$$\begin{aligned} J &= \text{radiation emitted by the surface} + \text{radiation reflected by the surface} \\ &= \epsilon E_b + \rho G \\ &= \epsilon \sigma T^4 + \rho G \end{aligned}$$

Since  $\rho = 0$  for a blackbody, the radiosity of a blackbody is

$$J = \sigma T^4$$

## Diffuse-Gray Surfaces, $\epsilon = \alpha$

### Conditions for $\epsilon = \alpha$

- in many radiation problems, the calculations are greatly simplified when  $\epsilon = \alpha$ , which defines a gray surface. Here, we seek the necessary conditions for  $\epsilon = \alpha$ . This is a 3-step procedure.

- the first step involves adopting *Kirchhoff's law* which is stated here without proof:

$$\epsilon(\lambda, T, \phi, \theta) = \alpha(\lambda, T, \phi, \theta)$$

This equation is always applicable because both  $\epsilon(\lambda, T, \phi, \theta)$  and  $\alpha(\lambda, T, \phi, \theta)$  are inherent surface properties

- the second step involves finding the requirements for  $\epsilon(\lambda, T) = \alpha(\lambda, T)$ . This is done using the definitions hemispherical radiation, as given below:

$$\left. \begin{aligned} \epsilon(\lambda, T) &= \frac{\int_0^{2\pi} \int_0^{\pi/2} \epsilon_{\lambda, \theta} \cos \theta \sin \theta d\theta d\phi}{\int_0^{2\pi} \int_0^{\pi/2} \cos \theta \sin \theta d\theta d\phi} \\ \alpha(\lambda, T) &= \frac{\int_0^{2\pi} \int_0^{\pi/2} \alpha_{\lambda, \theta} I_{\lambda} \cos \theta \sin \theta d\theta d\phi}{\int_0^{2\pi} \int_0^{\pi/2} I_{\lambda} \cos \theta \sin \theta d\theta d\phi} \end{aligned} \right\} \Rightarrow ??? \quad \epsilon(\lambda, T) = \alpha(\lambda, T)$$

From this, we can see that for  $\epsilon(\lambda, T) = \alpha(\lambda, T)$ , we must have either a *diffuse surface* or a *diffuse irradiation*. As indicated before, in most engineering calculations, we use direction averaged properties which amounts to the assumption of a diffuse surface.

- having adopted  $\epsilon(\lambda, T, \phi, \theta) = \alpha(\lambda, T, \phi, \theta)$  and  $\epsilon(\lambda, T) = \alpha(\lambda, T)$ , the third step involves finding the requirements for  $\epsilon = \alpha$ ; that is:

$$\epsilon(T) = \frac{\int_0^{\infty} \epsilon_{\lambda} E_{\lambda, b} d\lambda}{\int_0^{\infty} E_{\lambda, b} d\lambda} \stackrel{=?}{=} \frac{\int_0^{\infty} \alpha_{\lambda} G_{\lambda} d\lambda}{\int_0^{\infty} G_{\lambda} d\lambda} = \alpha(T)$$

From this, we can see that for  $\epsilon(T) = \alpha(T)$ , we must have either  $G_{\lambda} = E_{\lambda, b}$  which means that the irradiation originated from a blackbody or  $\epsilon(\lambda, T) = \text{constant}$  and  $\alpha(\lambda, T) = \text{constant}$ . To see the last point, remember that if  $\epsilon(\lambda, T) = \text{constant}$  then  $\epsilon(T) = \epsilon(\lambda, T)$  and similarly  $\alpha(T) = \alpha(\lambda, T)$ . But at step two, we have already established that  $\epsilon(\lambda, T) = \alpha(\lambda, T)$ , hence it follows that  $\epsilon(T) = \alpha(T)$ .

- by definition, a gray surface is one for which  $\epsilon(\lambda, T)$  and  $\alpha(\lambda, T)$  are independent of  $\lambda$  over the dominant spectral regions of  $G_{\lambda}$  and  $E_{\lambda}$ .

## View Factor (Shape Factor, Configuration Factor)

- **Definition:** The view factor,  $F_{i \rightarrow j}$  is defined as the fraction of radiation leaving surface  $i$  which is intercepted by surface  $j$ . Hence

$$F_{i \rightarrow j} = \frac{\dot{Q}_{i \rightarrow j}}{A_i J_i} = \frac{\text{radiation reaching } j}{\text{radiation leaving } i}$$

$$A_i F_{i \rightarrow j} = A_j F_{j \rightarrow i}$$

This is called the reciprocity relation.

- consider an enclosure with  $N$  surfaces

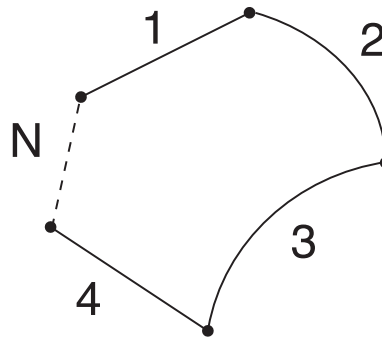

$$\sum_{j=1}^N F_{i \rightarrow j} = 1 \quad ; \quad i = 1, 2, \dots, N$$

This is called the *summation rule*.

Note that  $F_{i \rightarrow i} \neq 0$  for a concave surface. For a plane or convex surface  $F_{i \rightarrow i} = 0$ .

### *Hottel Crossed String Method*

Can be applied to 2D problems where surfaces are any shape, flat, concave or convex. Note for a 2D surface the area,  $A$  is given as a length times a unit width.

$$A_1 F_{12} = A_2 F_{21} = \frac{(\text{total crossed}) - (\text{total uncrossed})}{2}$$

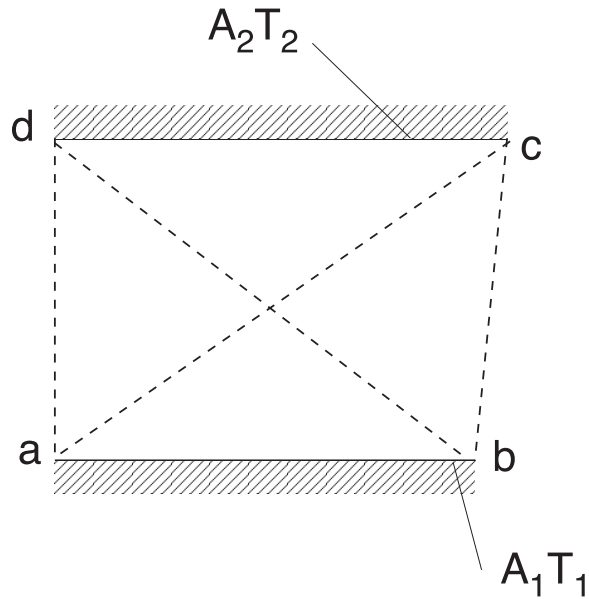

$A_1$  and  $A_2$  do not have to be parallel

$$A_1 F_{12} = A_2 F_{21} = \frac{1}{2} \left[ \underbrace{(ac + bd)}_{\text{crossed}} - \underbrace{(bc + ad)}_{\text{uncrossed}} \right]$$

### Radiation Exchange Between Diffuse-Gray Surfaces Forming an Enclosure

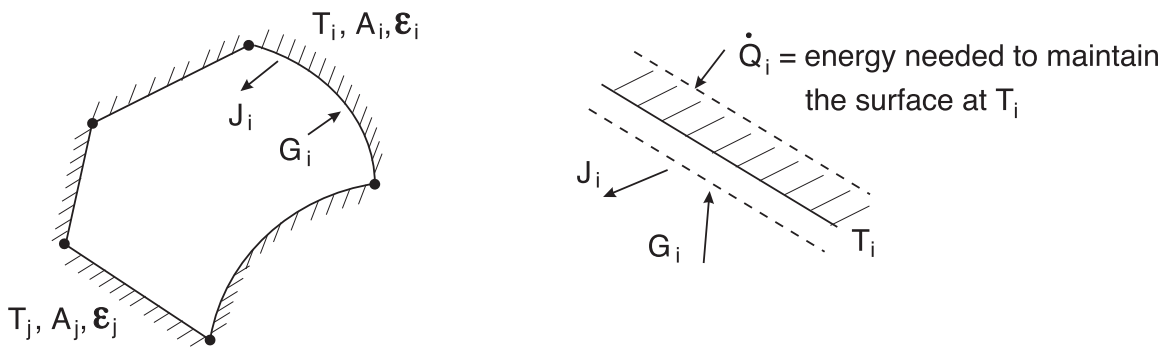

- an energy balance on the  $i$ 'th surface gives:

$$\dot{Q}_i = \dot{q}_i A_i = A_i (J_i - G_i)$$

$$\dot{Q}_i = \frac{E_{b,i} - J_i}{\left( \frac{1 - \epsilon_i}{\epsilon_i A_i} \right)} \equiv \frac{\text{potential difference}}{\text{surface resistance}}$$



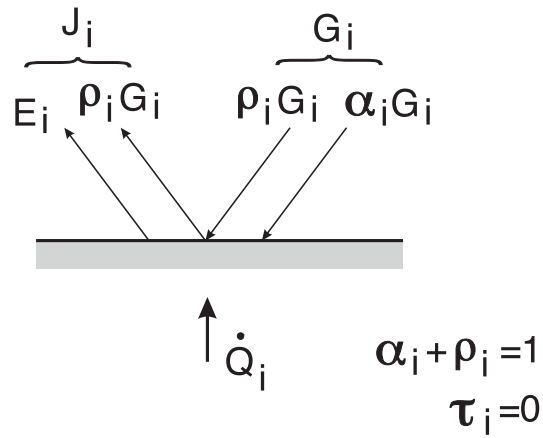

- next consider radiative exchange between the surfaces.

By inspection it is clearly seen that

$$\left\{ \begin{array}{l} \text{irradiation on} \\ \text{surface } i \end{array} \right\} = \left\{ \begin{array}{l} \text{radiation leaving the} \\ \text{remaining surfaces} \end{array} \right\}$$

$$A_i G_i = \sum_{j=1}^N F_{j \rightarrow i} (A_j J_j) = \sum_{j=1}^N A_i F_{i \rightarrow j} J_j$$

$$\dot{Q}_i = \sum_{j=1}^N \frac{J_i - J_j}{\left( \frac{1}{A_i F_{i \rightarrow j}} \right)} \equiv \frac{\text{potential difference}}{\text{configuration resistance}}$$

---

**Special Diffuse, gray, two-surface enclosures**

---

Large (infinite) Parallel Plates

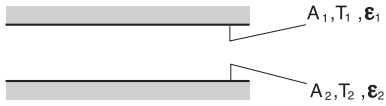

$$A_1 = A_2 = A$$

$$F_{1 \rightarrow 2} = 1$$

$$\dot{Q}_{12} = \frac{A\sigma(T_1^4 - T_2^4)}{\frac{1}{\epsilon_1} + \frac{1}{\epsilon_2} - 1}$$

Long (infinite) Concentric Cylinders

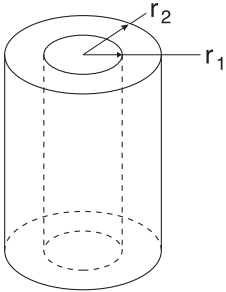

$$\frac{A_1}{A_2} = \frac{r_1}{r_2}$$

$$F_{1 \rightarrow 2} = 1$$

$$\dot{Q}_{12} = \frac{A\sigma(T_1^4 - T_2^4)}{\frac{1}{\epsilon_1} + \frac{1 - \epsilon_2}{\epsilon_2} \left(\frac{r_1}{r_2}\right)}$$

Concentric Spheres

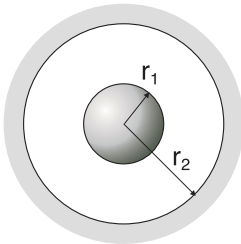

$$\frac{A_1}{A_2} = \frac{r_1^2}{r_2^2}$$

$$F_{1 \rightarrow 2} = 1$$

$$\dot{Q}_{12} = \frac{A\sigma(T_1^4 - T_2^4)}{\frac{1}{\epsilon_1} + \frac{1 - \epsilon_2}{\epsilon_2} \left(\frac{r_1}{r_2}\right)^2}$$

Small Convex Object in a Large Cavity

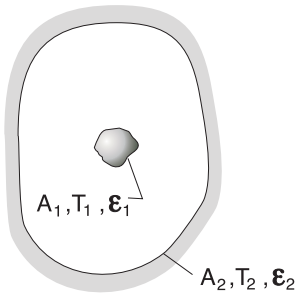

$$\frac{A_1}{A_2} = 0$$

$$F_{1 \rightarrow 2} = 1$$

$$\dot{Q}_{12} = \sigma A_1 \epsilon_1 (T_1^4 - T_2^4)$$

# Cooling of Electronic Equipment

|   |                |                 |
|---|----------------|-----------------|
|  | <b>Reading</b> | <b>Problems</b> |
|---|----------------|-----------------|

## Introduction

Why should we worry about the thermal behavior of electronic equipment?

- a standard Intel Pentium 4 chip is:
  - $10.4 \text{ mm} \times 10.4 \text{ mm}$
  - contains millions of electronic components
  - dissipates approximately 75 watts of power
  - is restricted to a maximum temperature of  $85 \text{ }^\circ\text{C}$

This does not seem like a big deal. A 100 W light bulb dissipates more power than this.

## Power vs. Heat Flux

### 100 W light bulb



$$\begin{aligned} \text{Power} &= 100 \text{ W} \\ \text{Area} &= 100 \text{ cm}^2 \\ \text{Flux} &= 1.0 \text{ W/cm}^2 \end{aligned}$$

### Pentium 4 Processor



$$\begin{aligned} \text{Power} &= 75.3 \text{ W} \\ \text{Area} &= 1.08 \text{ cm}^2 \\ \text{Flux} &= 69.7 \text{ W/cm}^2 \end{aligned}$$

*70 times larger!*

- the heat flux at the surface on a chip is exceedingly high

- this is primarily because of the miniaturization of electronic devices in order to maximize signal processing speed
- if we track the evolution of Intel processors over the course of the past several decades we see a pattern which is expected to continue for the next several years

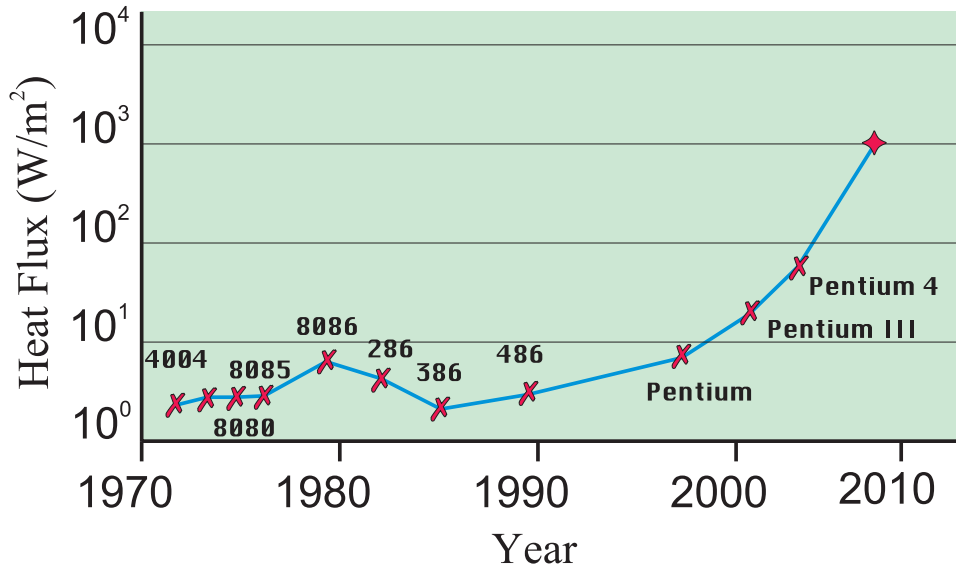

- the following figure puts the magnitude of this heat flux into perspective

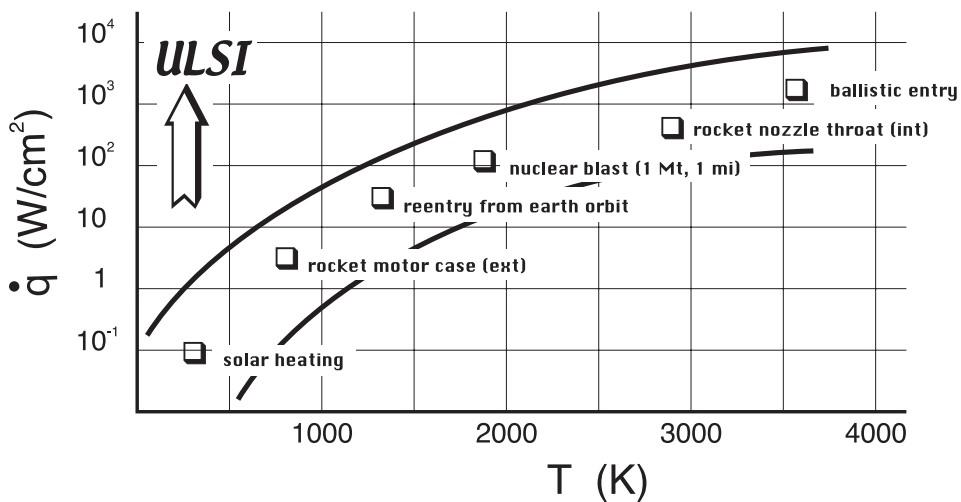

- the problem is further compounded by the fact that a maximum operating temperature of approximately 85 – 100 °C is necessary in order to ensure long term reliable operation
- failure rate increases dramatically as operating temperatures rise above 100 °C

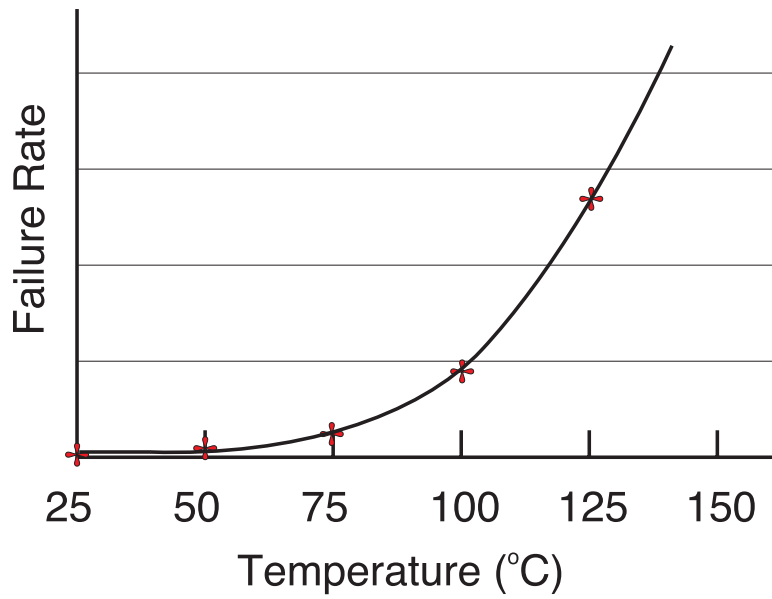

- electronic cooling presents a significant challenge to design engineers
- is the problem expected to get better anytime soon? not likely. By 2007, Intel expects to have **1 billion transistors/chip!** with power dissipation of more than **100 W** and heat fluxes of order **1000 W/m<sup>2</sup>**.

Therefore we must deal with the problem with engineering solutions that necessitate a good understanding of all forms of heat transfer.