



**PDHonline Course C539 (8 PDH)**

---

# **Geotechnical Engineering Series - Shallow Foundations**

*Instructor: Yun Zhou, Ph.D., PE*

**2020**

**PDH Online | PDH Center**

5272 Meadow Estates Drive  
Fairfax, VA 22030-6658  
Phone: 703-988-0088  
[www.PDHonline.com](http://www.PDHonline.com)

An Approved Continuing Education Provider



U.S. Department of Transportation  
Federal Highway Administration

Publication No. FHWA NHI-06-089  
December 2006

**NHI Course No. 132012**

---

# **SOILS AND FOUNDATIONS**

**Reference Manual – Volume II**

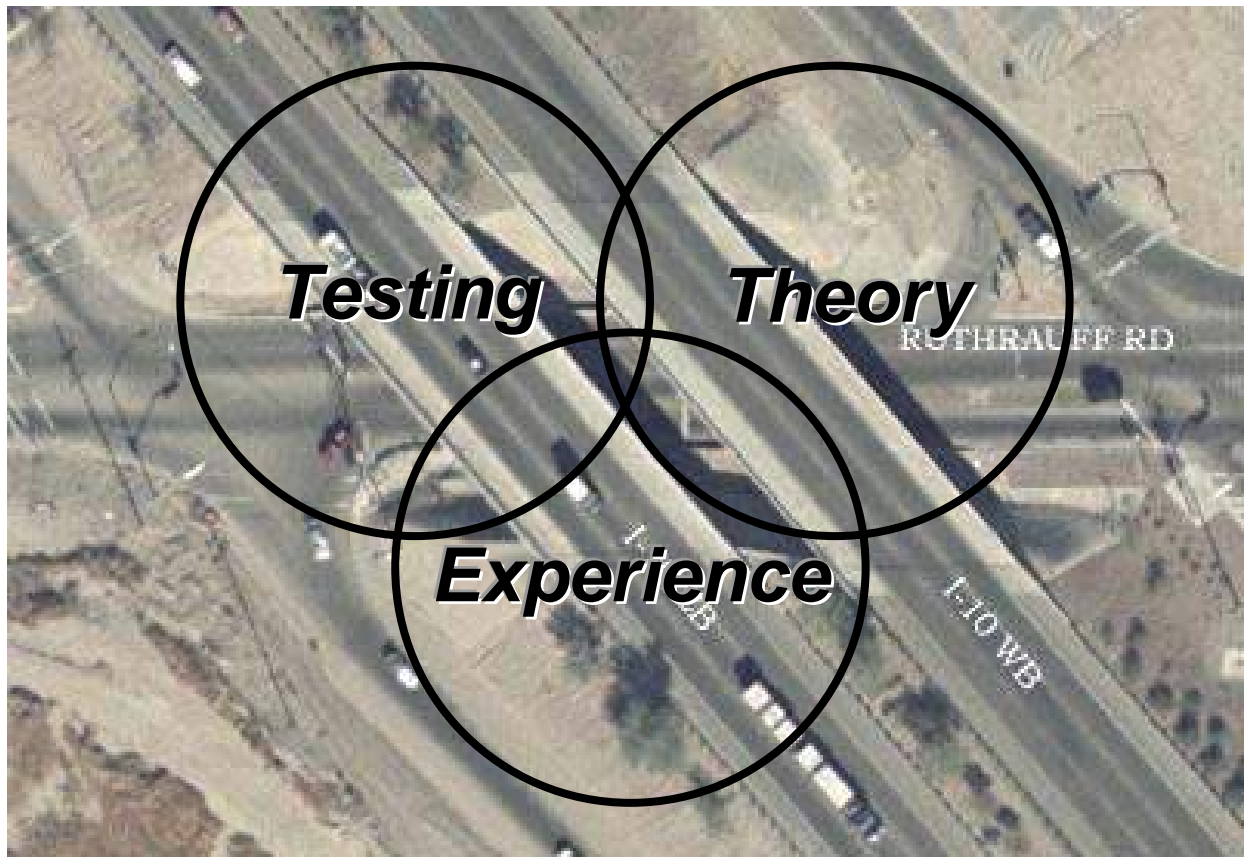

*National Highway Institute*

**Technical Report Documentation Page**

|  |                                      |   |           |
|--|--------------------------------------|---|-----------|
| 1. Report No.<br>FHWA-NHI-06-089   | 2. Government Accession No.          | 3. Recipient's Catalog No.                      |           |
| 4. Title and Subtitle<br><br>SOILS AND FOUNDATIONS<br>REFERENCE MANUAL – Volume II   |                                      | 5. Report Date<br>December 2006                 |           |
|  |                                      | 6. Performing Organization Code                 |           |
| 7. Author(s)<br>Naresh C. Samtani*, PE, PhD and Edward A. Nowatzki*, PE, PhD   |                                      | 8. Performing Organization Report No.           |           |
| 9. Performing Organization Name and Address<br>Ryan R. Berg and Associates, Inc.<br>2190 Leyland Alcove, Woodbury, MN 55125<br>* NCS GeoResources, LLC<br>640 W Paseo Rio Grande, Tucson, AZ 85737   |                                      | 10. Work Unit No. (TRAIS)                       |           |
|  |                                      | 11. Contract or Grant No.<br>DTFH-61-02-T-63016 |           |
| 12. Sponsoring Agency Name and Address<br>National Highway Institute<br>U.S. Department of Transportation<br>Federal Highway Administration, Washington, D.C. 20590  |                                      | 13. Type of Report and Period Covered           |           |
|  |                                      | 14. Sponsoring Agency Code                      |           |
| 15. Supplementary Notes<br>FHWA COTR – Larry Jones<br>FHWA Technical Review – Jerry A. DiMaggio, PE; Silas Nichols, PE; Richard Cheney, PE; Benjamin Rivers, PE; Justin Henwood, PE.<br>Contractor Technical Review – Ryan R. Berg, PE; Robert C. Bachus, PhD, PE; Barry R. Christopher, PhD, PE<br><i>This manual is an update of the 3<sup>rd</sup> Edition prepared by Parsons Brinckerhoff Quade &amp; Douglas, Inc, in 2000. Author: Richard Cheney, PE. The authors of the 1<sup>st</sup> and 2<sup>nd</sup> editions prepared by the FHWA in 1982 and 1993, respectively, were Richard Cheney, PE and Ronald Chassie, PE.</i>   |                                      |   |           |
| 16. Abstract<br><br>The Reference Manual for Soils and Foundations course is intended for design and construction professionals involved with the selection, design and construction of geotechnical features for surface transportation facilities. The manual is geared towards practitioners who routinely deal with soils and foundations issues but who may have little theoretical background in soil mechanics or foundation engineering. The manual's content follows a project-oriented approach where the geotechnical aspects of a project are traced from preparation of the boring request through design computation of settlement, allowable footing pressure, etc., to the construction of approach embankments and foundations. Appendix A includes an example bridge project where such an approach is demonstrated. Recommendations are presented on how to layout borings efficiently, how to minimize approach embankment settlement, how to design the most cost-effective pier and abutment foundations, and how to transmit design information properly through plans, specifications, and/or contact with the project engineer so that the project can be constructed efficiently.<br><br>The objective of this manual is to present recommended methods for the safe, cost-effective design and construction of geotechnical features. Coordination between geotechnical specialists and project team members at all phases of a project is stressed. Readers are encouraged to develop an appreciation of geotechnical activities in all project phases that influence or are influenced by their work. |                                      |   |           |
| 17. Key Words  |                                      | 18. Distribution Statement                      |           |
| Subsurface exploration, testing, slope stability, embankments, cut slopes, shallow foundations, driven piles, drilled shafts, earth retaining structures, construction.  |                                      | No restrictions.                                |           |
| 19. Security Classif. (of this report)   | 20. Security Classif. (of this page) | 21. No. of Pages                                | 22. Price |
| UNCLASSIFIED   | UNCLASSIFIED                         | 594   |           |

## **CHAPTER 8.0**

### **SHALLOW FOUNDATIONS**

Foundation design is required for all structures to ensure that the loads imposed on the underlying soil will not cause shear failures or damaging settlements. The two major types of foundations used for transportation structures can be categorized as “shallow” and “deep” foundations. This chapter first discusses the general approach to foundation design including consideration of alternative foundations to select the most cost-effective foundation. Following the general discussion, the chapter then concentrates on the topic of shallow foundations.

#### **8.01 Primary References:**

The two primary references for shallow foundations are:

FHWA (2002c). *Geotechnical Engineering Circular 6 (GEC 6), Shallow Foundations*. Report No. FHWA-SA-02-054, Author: Kimmerling, R. E., Federal Highway Administration, U.S. Department of Transportation.

AASHTO (2004 with 2006 Interims). *AASHTO LRFD Bridge Design Specifications*, 3rd Edition, American Association of State Highway and Transportation Officials, Washington, D.C.

#### **8.1 GENERAL APPROACH TO FOUNDATION DESIGN**

The duty of the foundation design specialist is to establish the most economical design that safely conforms to prescribed structural criteria and properly accounts for the intended function of the structure. Essential to the foundation engineer’s study is a rational method of design, whereby various foundation types are systematically evaluated and the optimum alternative selected. The following foundation design approach is recommended:

1. Determine the direction, type and magnitude of foundation loads to be supported, tolerable deformations and special constraints such as:
  - a. Underclearance requirements that limit allowable total settlement.
  - b. Structure type and span length that limits allowable deformations and angular distortions.
  - c. Time constraints on construction.
  - d. Extreme event loading and construction load requirements.

In general, a discussion with the structural engineer about a preliminary design will provide this information and an indication of the flexibility of the constraints.

2. Evaluate the subsurface investigation and laboratory testing data with regard to reliability and completeness. The design method chosen should be commensurate with the quality and quantity of available geotechnical data, i.e., **don't use state-of-the-art computerized analyses if you have not performed a comprehensive subsurface investigation to obtain reliable values of the required input parameters.**
3. Consider alternate foundation types where applicable as discussed below.

### **8.1.1 Foundation Alternatives and Cost Evaluation**

As noted earlier, the two major alternate foundation types are the “shallow” and “deep” foundations. Shallow foundations are discussed in this chapter. Deep foundation alternatives including piles and drilled shafts are discussed in the next chapter. Proprietary foundation systems should not be excluded as they may be the most economical alternative in a given set of conditions. Cost analyses of all feasible alternatives may lead to the elimination of some foundations that were otherwise qualified under the engineering study. Other factors that must be considered in the final foundation selection are the availability of materials and equipment, the qualifications and experience of local contractors and construction companies, as well as environmental limitations/considerations on construction access or activities.

Whether it is for shallow or deep foundations, it is recommended that foundation support cost be defined as the total cost of the foundation system divided by the load the foundation supports in tons. Thus, the cost of the foundation system should be expressed in terms of **dollars per ton load** that will be supported. For an equitable comparison, the total foundation cost should include all costs associated with a given foundation system including the need for excavation or retention systems, environmental restrictions on construction activities, e.g., vibrations, noise, disposal of contaminated excavated spoils, pile caps and cap size, etc. For major projects, if the estimated costs of alternative foundation systems during the design stage are within 15 percent of each other, then alternate foundation designs should be considered for inclusion in contract documents. If alternate designs are included in the contract documents, both designs should be adequately detailed. For example, if two pile foundation alternatives are detailed, the bid quantity pile lengths should reflect the estimated pile lengths for each alternative. Otherwise, material costs and not the installed foundation

cost will likely determine the low bid. Use of alternate foundation designs will generally provide the most cost effective foundation system.

A conventional design alternate should generally be included with a proprietary design alternate in the final project documents to stimulate competition and to anticipate value engineered proposals from contractors.

### **8.1.2 Loads and Limit States for Foundation Design**

Foundations should be proportioned to withstand all anticipated loads safely including the permanent loads of the structure and transient loads. Most design codes specify the types of loads and load combinations to be considered in foundation design, e.g., AASHTO (2002). These load combinations can be used to identify the “limit” states for the foundation types being considered. A limit state is reached when the structure no longer fulfills its performance requirements. There are several types of limit states that are related to maximum load-carrying capacity, serviceability, extreme event and fatigue. Two of the more common limit states are as follows:

- An **ultimate limit state** (ULS) corresponds to the maximum load-carrying capacity of the foundation. This limit state may be reached through either structural or geotechnical failure. An ultimate limit state corresponds to collapse. The ultimate state is also called the **strength limit state** and includes the following failure modes for shallow foundations:
  - bearing capacity of soil exceeded,
  - excessive loss of contact, i.e., eccentricity,
  - sliding at the base of footing,
  - loss of overall stability, i.e., global stability,
  - structural capacity exceeded.
  
- A **serviceability limit state** (SLS) corresponds to loss of serviceability, and occurs before collapse. A serviceability limit state involves unacceptable deformations or undesirable damage levels. A serviceability limit state may be reached through the following mechanisms:
  - Excessive differential or total foundation settlements,
  - Excessive lateral displacements, or
  - Structural deterioration of the foundation.

The serviceability limit state for transportation structures is based upon economy and the quality of ride. The cost of limiting foundation movements should be compared to the cost of designing the superstructure so that it can tolerate larger movements, or of correcting the consequences of movements through maintenance, to determine minimum life cycle cost. More stringent criteria may be established by the owner.

All relevant limit states must be considered in foundation design to ensure an adequate degree of safety and serviceability. Therefore, all foundation design is geared towards addressing the ULS and the SLS. In this manual, the allowable stress design (ASD) approach is used. Further discussion on ASD and other design methods such as the Load and Resistance Factor Design (LRFD) can be found in Appendix C.

## **8.2 TYPES OF SHALLOW FOUNDATIONS**

The geometry of a typical shallow foundation is shown in Figure 8-1. Shallow foundations are those wherein the depth,  $D_f$ , of the foundation is small compared to the cross-sectional size (width,  $B_f$ , or length,  $L_f$ ). This is in contradistinction to deep foundations, such as driven piles and drilled shafts, whose depth of embedment is considerably larger than the cross-section dimension (diameter). The exact definition of shallow or deep foundations is less important than an understanding of the theoretical assumptions behind the various design procedures for each type. Stated another way, it is important to recognize the theoretical limitations of a design procedure that may vary as a function of depth, such as a bearing capacity equation. Common types of shallow foundations are shown in Figures 8-2 through 8-9.

### **8.2.1 Isolated Spread Footings**

Footings with  $L_f/B_f$  ratio less than 10 are considered to be isolated footings. Isolated spread footings (Figure 8-2) are designed to distribute the concentrated loads delivered by a single column to prevent shear failure of the soil beneath the footing. The size of the footing is a function of the loads distributed by the supported column and the strength and compressibility characteristics of the bearing materials beneath the footing. For bridge columns, isolated spread footings are typically greater than 10 ft by 10 ft (3 m by 3 m). These dimensions increase when eccentric loads are applied to the footing. Structural design of the isolated footing includes consideration for moment resistance at the face of the column in the short direction of the footing, as well as shear and punching around the column.

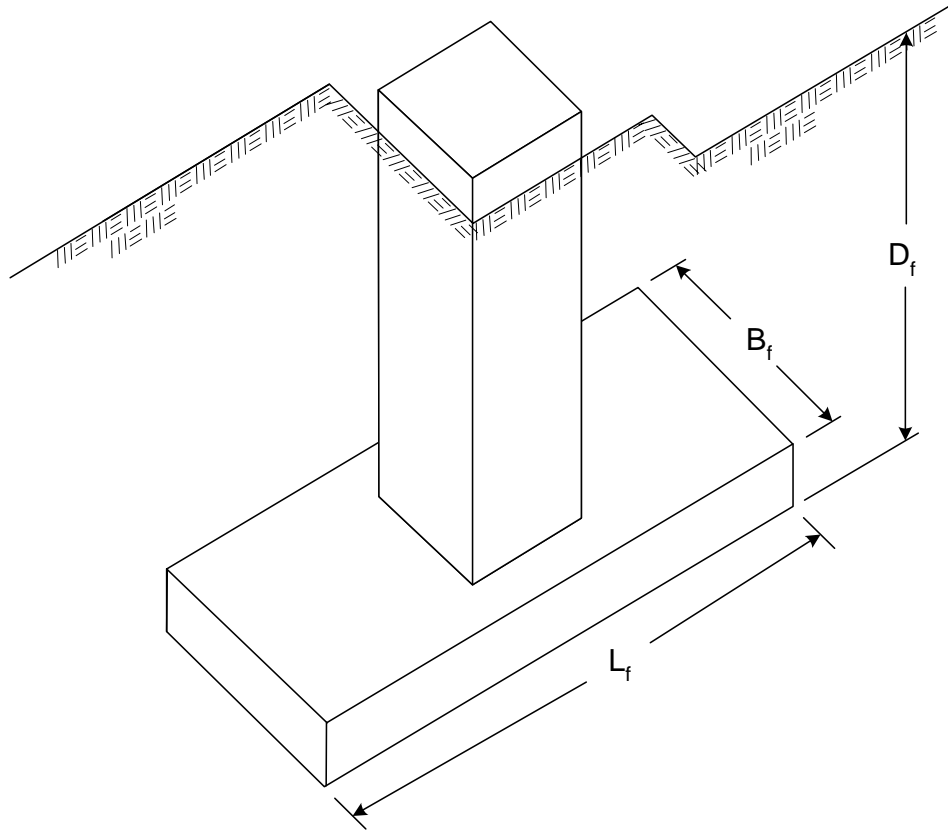

**Figure 8-1. Geometry of a typical shallow foundation (FHWA, 2002c, AASHTO 2002).**

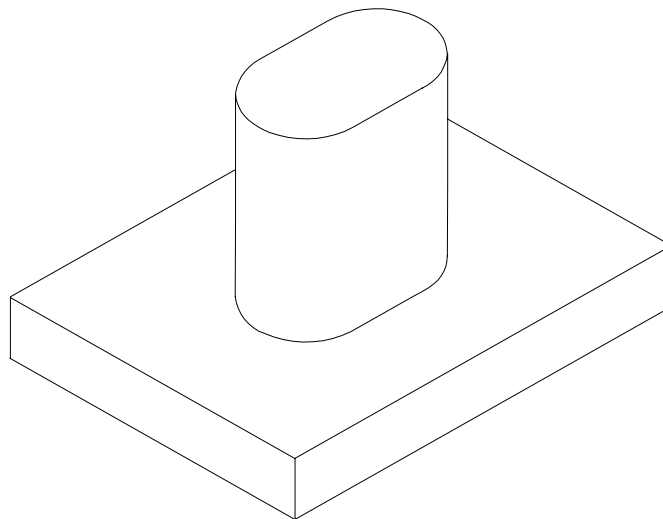
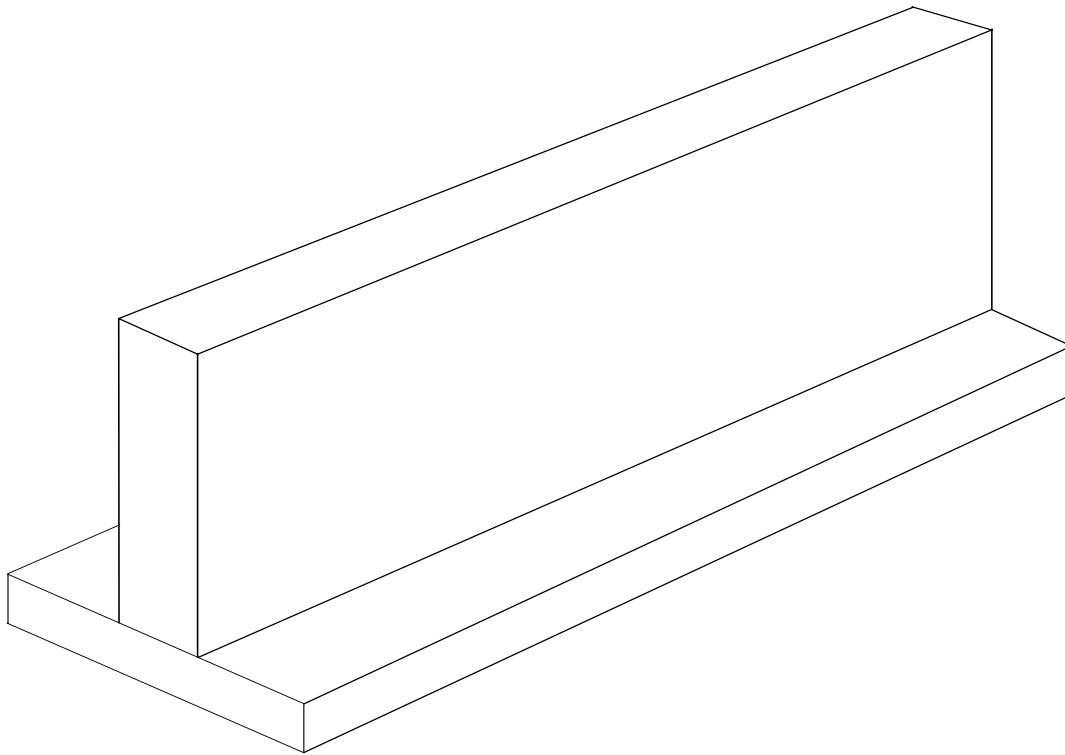

**Figure 8-2. Isolated spread footing (FHWA, 2002c).**



## 8.2.2 Continuous or Strip Footings

The most commonly used type of foundation for buildings is the continuous strip footing (Figure 8-3). For computation purposes, footings with an  $L_f/B_f$  ratio  $\geq 10$  are considered to be continuous or strip footings. Strip footings typically support a single row of columns or a bearing wall to reduce the pressure on the bearing materials. Strip footings may tie columns together in one direction. Sizing and structural design considerations are similar to those for isolated spread footings with the exception that plane strain conditions are assumed to exist in the direction parallel to the long axis of the footing. This assumption affects the depth of significant influence (DOSI), i.e., the depth to which applied stresses are significantly felt in the soil. For example, in contrast with isolated footing where the DOSI is between 2 to 4 times the footing width, the DOSI in the case of the strip footings will always be at least 4 times the width of the footing as discussed in Section 2.4.1 of Chapter 2. The structural design of strip footings is generally governed by beam shear and bending moments.



**Figure 8-3. Continuous strip footing (FHWA, 2002c).**

### **8.2.3 Spread Footings with Cantilevered Stemwalls**

An earth retaining system consisting of a spread footing supporting a cantilevered retaining wall is frequently used to resist lateral loads applied by a backfill and other external loads that may be acting on top of the backfill (refer to Figures 8-4 and 8-5). The system must offer resistance to both vertical and horizontal loads as well as to overturning moments. The spread footing is designed to resist overturning moments and vertical eccentric loads caused by the lateral earth pressures and the horizontal components of the externally applied loads acting on the cantilever stemwall. The wall itself is designed as a simple cantilevered structure to resist the lateral earth pressures imposed by the backfill and other external loads that may be applied on top of the backfill.

### **8.2.4 Bridge Abutments**

Bridge abutments are required to perform numerous functions, including the following:

- Retain the earthen backfill behind the abutment.
- Support the superstructure and distribute the loads to the bearing materials below the spread footing, assuming that a spread footing is the foundation system chosen for the abutment.
- Provide a transition from the approach embankment to the bridge deck.
- Depending on the structure type, accommodate shrinkage and temperature movements within the superstructure.

Spread footings with cantilevered stemwalls are well suited to perform these multiple functions. The general arrangement of a bridge abutment with a spread footing and a cantilevered stemwall is shown in Figures 8-4 and 8-5. In the case of weak soils at shallow depths, deep foundations, such as drilled shafts or driven piles, are often used to support the abutment. There are several other abutment types such as those that use mechanically stabilized earth (MSE) walls with spread foundations on top or with deep foundation penetrating through the MSE walls. Several different types of bridge abutments are shown in Figure 7-2 in Chapter 7.

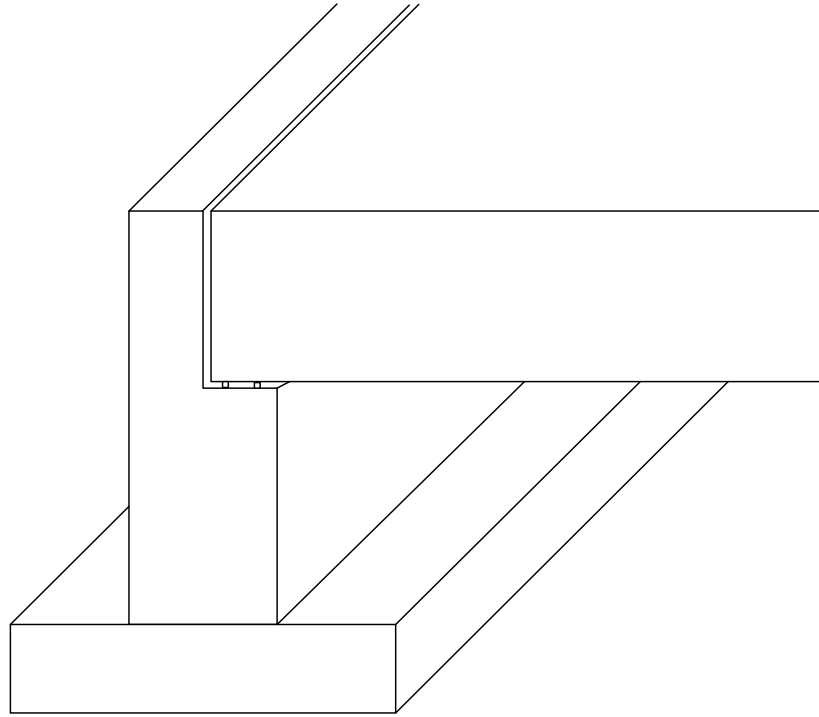

**Figure 8-4. Spread footing with cantilever stemwall at bridge abutment.**



**Figure 8-5. Abutment/wingwall footing, I-10, Arizona.**

### 8.2.5 Retaining Structures

The foundations for semi-gravity concrete cantilever retaining walls (inverted “T” walls) are essentially shallow spread footings. The wall derives its ability to resist loads from a combination of the dead weight of the backfill on the heel of the wall footing and the structural cantilever of the stem (Figure 8-6).

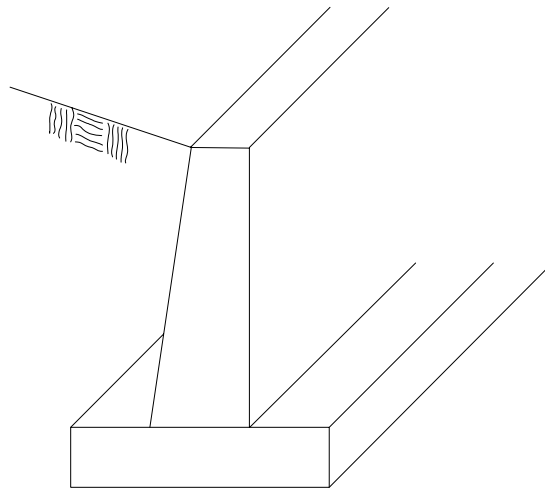

**Figure 8-6. Footing for a semi-gravity cantilever retaining wall (FHWA, 2002c).**

### 8.2.6 Building Foundations

When a building stemwall is buried, partially buried or acts as a basement wall, the stemwall resists the lateral earth pressures of the backfill. Unlike bridge abutments where the bridge structure is usually free to move horizontally on the abutment or the semi-gravity cantilever wall, the tops or the ends of the stemwalls in buildings are frequently restrained by other structural members such as beams, floors, transverse interior walls, etc. These structural members provide lateral restraint that affects the magnitude of the design lateral earth pressures

### 8.2.7 Combined Footings

Combined footings are similar to isolated spread footings except that they support two or more columns and are rectangular or trapezoidal in shape (Figure 8-7). They are used primarily when the column spacing is non-uniform (Bowles, 1996) or when isolated spread footings become so closely spaced that a combination footing is simpler to form and construct. In the case of bridge abutments, an example of a combined footing is the so-called

“spill-through” type abutment (Figure 8-8). This configuration was used during some of the initial construction of the Interstate Highway System on new alignments where spread footings could be founded on competent native soils. Spill-through abutments are also used at stream crossings to make sure that foundations are below the scour depth of the stream.

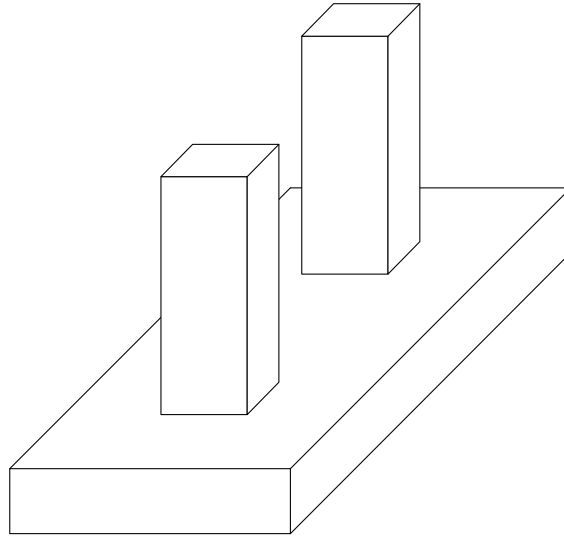

**Figure 8-7. Combined footing (FHWA, 2002c).**

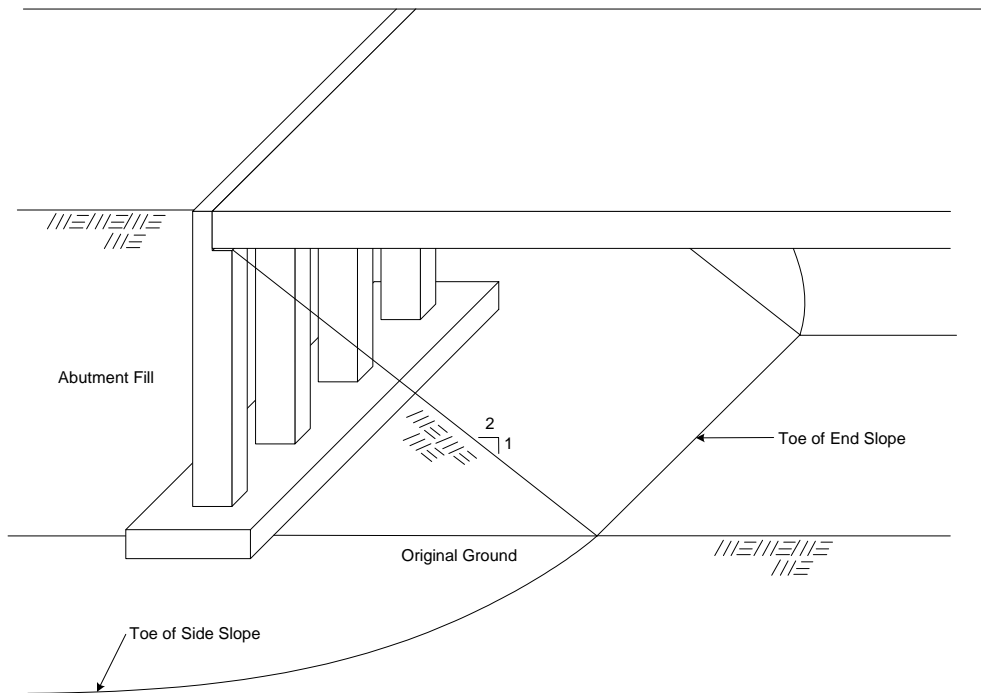

**Figure 8-8. Spill-through abutment on combination strip footing (FHWA, 2002c).**

Due to the frame action that develops with combined footings, they can be used to resist large overturning or rotational moments in the longitudinal direction of the column row.

There are a number of approaches for designing and constructing combined footings. The choice depends on the available space, load distribution among the columns supported by the footing, variations of soil properties supporting the footing, and economics.

### 8.2.8 Mat Foundations

A mat foundation consists of a single heavily reinforced concrete slab that underlies the entire structure or a major portion of the structure. Mat foundations are often economical when spread footings would cover more than about 50 percent of the plan area of the structure's footprint (Peck, *et al.*, 1974). A mat foundation (Figure 8-9) typically supports a number of columns and/or walls in either direction or a uniformly distributed load such as that imposed by a storage tank. The principal advantage of a mat foundation is its ability to bridge over local soft spots, and to reduce differential movement.

Structures founded on relatively weak soils may be supported economically on mat foundations. Column and wall loads are transferred to the foundation soils through the mat foundation. Mat foundations distribute the loads over a large area, thus reducing the intensity of contact pressures. Mat foundations are designed with sufficient reinforcement and thickness to be rigid enough to distribute column and wall loads uniformly. Although differential settlements may be minimized by the use of mat foundations, greater uniform settlements may occur because the zone of influence of the applied stress may extend to considerable depth due to the larger dimensions of the mat. Often a mat also serves as the base floor level of building structures.

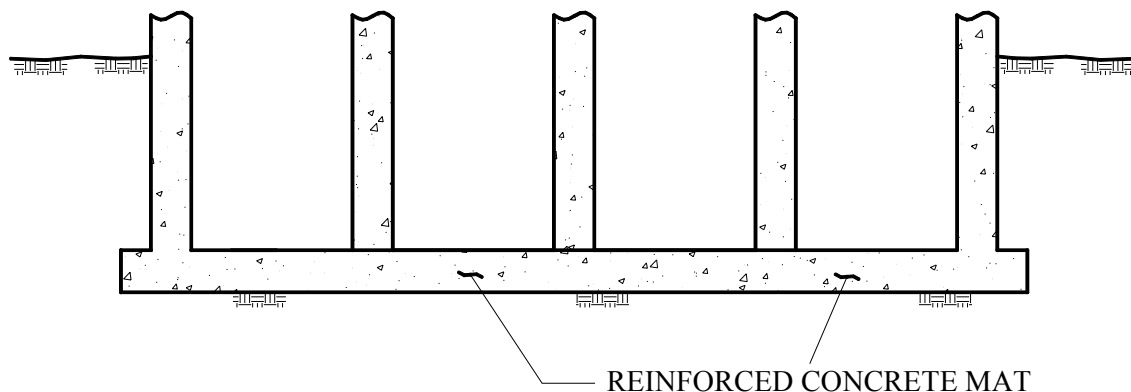

**Figure 8-9. Typical mat foundation (FHWA, 2002c).**

Mat foundations have limited applicability for bridge support, except where large bridge piers, such as bascules or other movable bridge supports, bear at relatively shallow depth without deep foundation support. This type of application may arguably be a deep foundation, but the design of such a pier may include consideration of the base of the bascule pier as a mat. Discussion of mat foundation design is included in FHWA (2002c).

A more common application of mat foundations for transportation structures includes lightly loaded rest area or maintenance facilities such as small masonry block structures, sand storage bins or sheds, or box culverts constructed as a continuous structure.

### 8.3 SPREAD FOOTING DESIGN CONCEPT AND PROCEDURE

The geotechnical design of a spread footing is a two-part process. First the allowable soil bearing capacity must be established to ensure stability of the foundation and determine if the proposed structural loads can be supported on a reasonably sized foundation. Second, the amount of settlement due to the actual structural loads must be predicted and the time of occurrence estimated. Experience has shown that settlement is usually the controlling factor in the decision to use a spread footing. This is not surprising since structural considerations usually limit tolerable settlements to values that can be achieved only on competent soils not prone to a bearing capacity failure. Thus, the **allowable bearing capacity** of a spread footing is defined as the lesser of:

- The applied stress that results in a shear failure divided by a suitable factor of safety (FS); this is a criterion based on an **ultimate limit state** (ULS) as discussed previously.
- or
- The applied stress that results in a specified amount of settlement; this is a criterion based on a **serviceability limit state** (SLS) as discussed previously.

Both of the above considerations are a function of the least lateral dimension of the footing, typically called the footing width and designated as  $B_f$  as shown in Figure 8-1. The effect of footing width on allowable bearing capacity and settlement is shown conceptually in Figure 8-10. The allowable bearing capacity of a footing is usually controlled by shear-failure considerations for narrow footing widths as shown in Zone A in Figure 8-10. As the footing width increases, the allowable bearing capacity is limited by the settlement potential of the soils supporting the footing within the DOSI which is a function of the footing width as discussed in Section 2.4 of Chapter 2. Stated another way, as the footing width increases, the stress increase “felt” by the soil may decrease but the effect of the applied stress will extend

more deeply below the footing base. Therefore, settlements may increase depending on the type of soils within the DOSI. This is schematically shown in Zone B in Figure 8-10.

The concept of decreasing allowable bearing capacity with increasing footing width for the settlement controlled cases is an important concept to understand. In such cases, the allowable bearing capacity is the value of the applied stress at the footing base that will result in a given settlement. Since the DOSI increases with increasing footing width, the only way to limit the settlements to a certain desired value is by reducing the applied stress. The more stringent the settlement criterion the less the stress that can be applied to the footing which in turn means that the allowable bearing capacity is correspondingly less. This is conceptually illustrated in Figure 8-10 wherein it is shown that decreasing the settlement, i.e., going from 3S to 2S to S decreases the allowable bearing capacity at a given footing width. An example of the use of the chart is presented in Section 8.8.

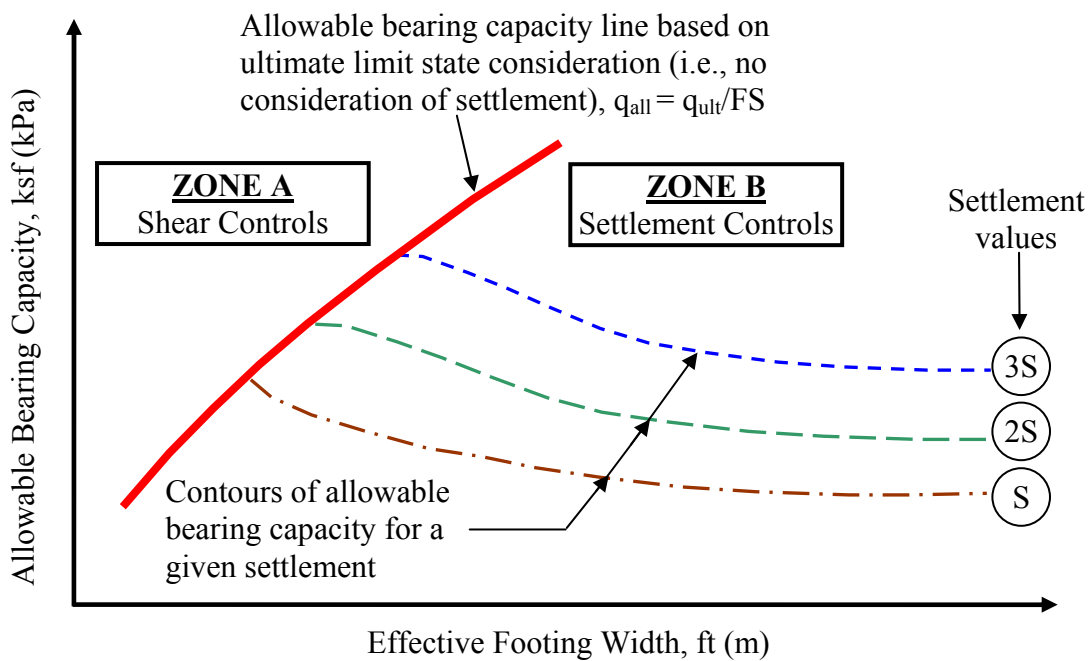

**Figure 8-10. Shear failure versus settlement considerations in evaluation of allowable bearing capacity.**

The design process flow chart for a bridge supported on spread footings is shown in Figure 8-11. In the flow chart, the foundation design specialist is a person with the skills necessary to address both geotechnical and structural design. Section 8.4 discusses the bearing capacity aspects while Section 8.5 discusses the settlement aspects of shallow foundation design.



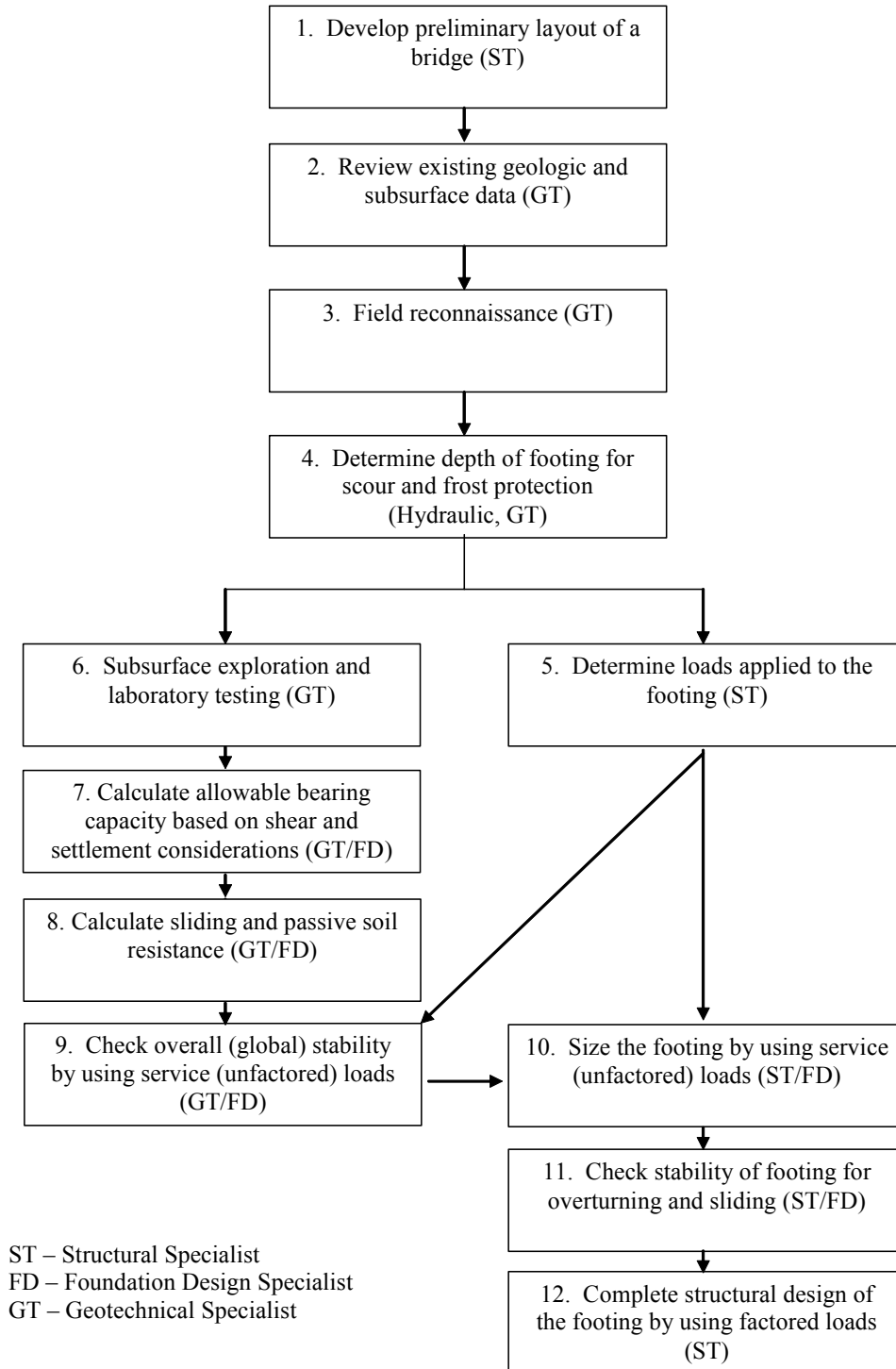

**Figure 8-11. Design process flow chart – bridge shallow foundation (modified after FHWA, 2002c).**

## 8.4 BEARING CAPACITY

This section discusses bearing capacity theory and its application toward computing allowable bearing capacities for shallow foundations.

A foundation failure will occur when the footing penetrates excessively into the ground or experiences excessive rotation (Figure 8-12). Either of these excessive deformations may occur when,

- (a) the shear strength of the soil is exceeded, and/or
- (b) large uneven settlement and associated rotations occur.

The failure mode that occurs when the shear strength is exceeded is known as a bearing capacity failure or, more accurately, an **ultimate bearing capacity failure**. Often, large settlements may occur prior to an ultimate bearing capacity failure and such settlements may impair the serviceability of the structure, i.e., the ultimate limit state (ULS) has not been exceeded, but the serviceability limit state (SLS) has. In this case, to control the settlements within tolerable limits, the footprint and/or depth of the structure below the ground may be dimensioned such that the imposed bearing pressure is well below the ultimate bearing capacity.



**Figure 8-12. Bearing capacity failure of silo foundation (Tschebotarioff, 1951).**

### 8.4.1 Failure Mechanisms

The type of bearing capacity failure is a function of several factors such as the type of the soil, the density (or consistency) of the soil, shape of the loaded surface, etc. This section discusses three failure mechanisms.

#### 8.4.1.1 General Shear

When a footing is loaded to the ultimate bearing capacity, a condition of plastic flow develops in the foundation soils. As shown in Figure 8-13, a triangular wedge beneath the footing, designated as Zone I, remains in an elastic state and moves down into the soil with the footing. Although only a single failure surface (CD) is shown in Zone II, radial shear develops throughout Zone II such that radial lines of failure extending from the Zone I boundary (CB) change length based on a logarithmic spiral until they reach Zone III. Although only a single failure surface (DE) is shown in Zone III, a passive state of stress develops throughout Zone III at an angle of  $45^\circ - (\phi'/2)$  from the horizontal. This configuration of the ultimate bearing capacity failure, with a well-defined failure zone extending to the surface and with bulging of the soil occurring on both sides of the footing, is called a “general shear” type of failure. General shear-type failures (Figure 8-14a) are believed to be the prevailing mode of failure for soils that are relatively incompressible and reasonably strong.

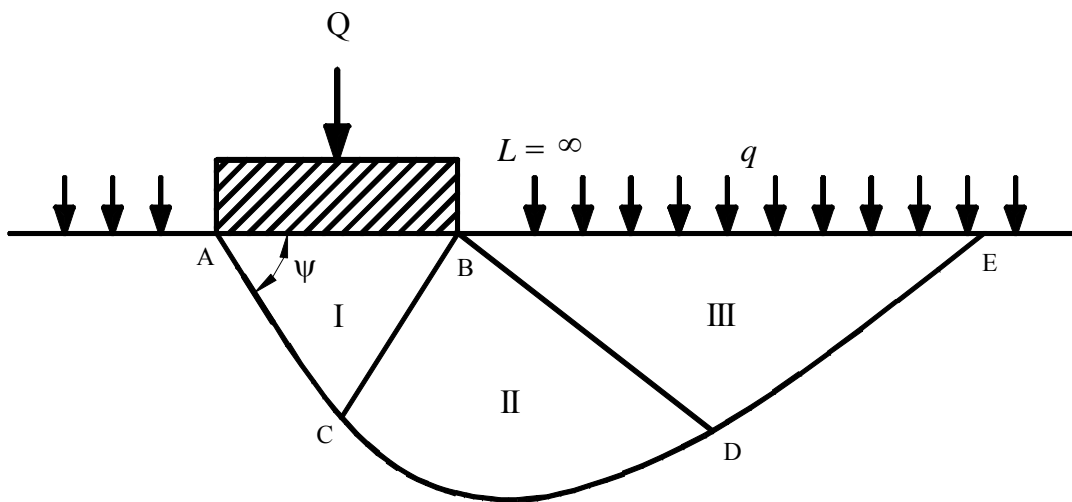

**Figure 8-13. Boundaries of zone of plastic equilibrium after failure of soil beneath continuous footing (FHWA, 2002c).**

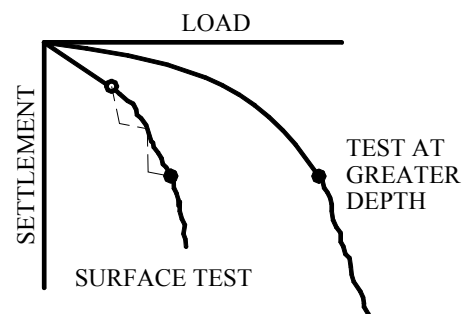
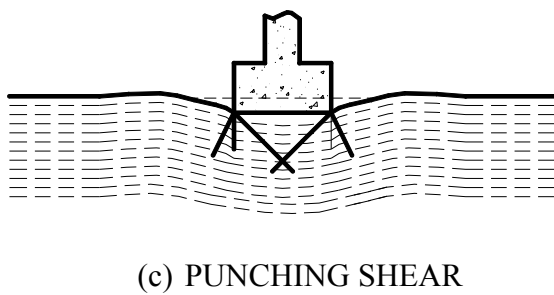
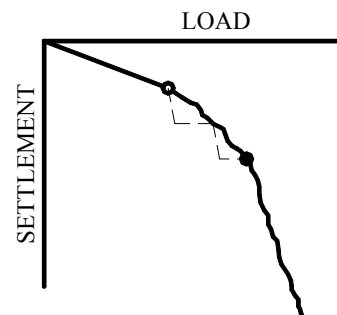
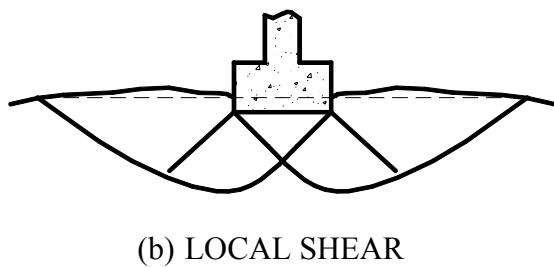
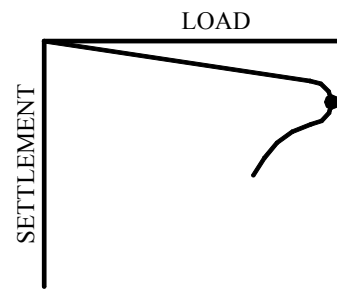
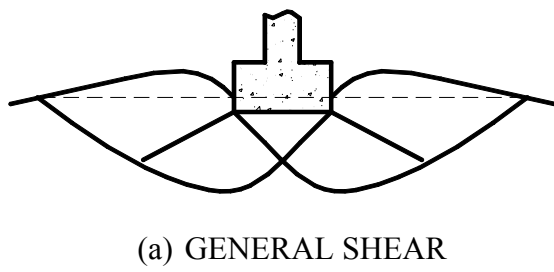

**Figure 8-14. Modes of bearing capacity failure (after Vesic, 1975) (a) General shear (b) Local shear (c) Punching shear**

### 8.4.1.2 Local Shear

Local shear failure is characterized by a failure surface that is similar to that of a general shear failure but that does not extend to the ground surface. In the case of a local shear failure the failure zone ends somewhere in the soil below the footing (Figure 8-14b). Local shear failure is accompanied by vertical compression of soil below the footing and visible bulging of soil adjacent to the footing, but not by sudden rotation or tilting of the footing. Local shear failure is a transitional condition between general and punching shear failure. Local shear failures may occur in soils that are relatively loose compared to soils susceptible to general shear failure.

### 8.4.1.3 Punching Shear

Punching shear failure is characterized by vertical shear around the perimeter of the footing and is accompanied by a vertical movement of the footing and compression of the soil immediately below the footing. The soil outside the loaded area is not affected significantly (Figure 8-14c). The ground surface adjacent to the footing moves downward instead of bulging as in general and local shear failure. Punching shear failure generally occurs in loose or compressible soils, in weak soils under slow (drained) loading, and in dense sands for deep footings subjected to high loads.

Note that from a perspective of bridge foundation design, soils so obviously weak as to experience local or punching shear failure modes should be avoided for supporting shallow foundations. Additional guidance on dealing with soils that fall in the intermediate or local shear range of behavior is provided in Section 8.4.5.

## 8.4.2 Bearing Capacity Equation Formulation

In essence, the bearing capacity failure mechanism is similar to the embankment slope failure mechanism discussed in Chapter 6. In the case of footings, the ultimate bearing capacity is equivalent to the stress applied to the soil by the footing that causes shear failure to occur in the soil below the footing base. For a concentrically loaded rigid strip footing with a rough base on a level homogeneous foundation material without the presence of water, the gross ultimate bearing capacity,  $q_{ult}$ , is expressed as follows (after Terzaghi, 1943):

$$q_{ult} = \underbrace{c(N_c)}_{\text{“Cohesion” term}} + \underbrace{q(N_q)}_{\text{“Surcharge” term}} + \underbrace{0.5(\gamma)(B_f)(N_\gamma)}_{\text{Foundation soil “Weight” term}} \quad 8-1$$

where:  $c$  = cohesion of the soil (ksf) (kPa)

$q$  = total surcharge at the base of the footing =  $q_{\text{appl}} + \gamma_a D_f$  (ksf) (kPa)

$q_{\text{appl}}$  = applied surcharge (ksf)(kPa)

$\gamma_a$  = unit weight of the overburden material above the base of the footing causing the surcharge pressure (kcf) (kN/m<sup>3</sup>)

$D_f$  = depth of embedment (ft) (m) (Figure 8-1)

$\gamma$  = unit weight of the soil under the footing (kcf) (kN/m<sup>3</sup>)

$B_f$  = footing width, i.e., least lateral dimension of the footing (ft) (m) (Figure 8-1)

$N_q$  = bearing capacity factor for the “surcharge” term (dimensionless)

$$= e^{\pi \tan \phi} \tan^2 \left( 45^\circ + \frac{\phi}{2} \right) \quad 8-2$$

$N_c$  = bearing capacity factor for the “cohesion” term (dimensionless)

$$= (N_q - 1) \cot \phi \quad \text{for } \phi > 0^\circ \quad 8-3$$

$$= 2 + \pi = 5.14 \quad \text{for } \phi = 0^\circ \quad 8-4$$

$N_\gamma$  = bearing capacity factor for the “weight” term (dimensionless)

$$= 2 (N_q + 1) \tan(\phi) \quad 8-5$$

Many researchers proposed different expressions for the bearing capacity factors,  $N_c$ ,  $N_q$ , and  $N_\gamma$ . The expressions presented above are those used by AASHTO (2004 with 2006 Interims). These expressions are a function of the friction angle,  $\phi$ . Table 8-1 can be used to estimate friction angle,  $\phi$ , from corrected SPT N-value,  $N_{160}$ , for cohesionless soils. Otherwise, the friction angle can be measured directly by laboratory tests or in situ testing. The values of  $N_c$ ,  $N_q$ , and  $N_\gamma$  as computed for various friction angles by Equations 8-3/8-4, 8-2, and 8-5, respectively are included in Table 8-1 and in Figure 8-15. Computation of ultimate bearing capacity is illustrated in Example 8-1.

**Table 8-1**  
**Estimation of friction angle of cohesionless soils from Standard Penetration Tests**  
**(after AASHTO, 2004 with 2006 Interims; FHWA, 2002c)**

| Description  | Very Loose | Loose    | Medium    | Dense     | Very Dense |
|--|------------|----------|-----------|-----------|------------|
| Corrected SPT $N_{160}$  | 0          | 4        | 10        | 30        | 50         |
| Approximate $\phi$ , degrees*  | 25 – 30    | 27 – 32  | 30 – 35   | 35 – 40   | 38 – 43    |
| Approximate moist unit weight, ( $\gamma$ ) pcf*   | 70 – 100   | 90 – 115 | 110 – 130 | 120 – 140 | 130 – 150  |
| * Use larger values for granular material with 5% or less fine sand and silt.<br>Note: Correlations may be unreliable in gravelly soils due to sampling difficulties with split-spoon sampler as discussed in Chapter 3. |            |          |           |           |            |

**Table 8-2**  
**Bearing Capacity Factors (AASHTO, 2004 with 2006 Interims)**

| $\phi$ | $N_c$ | $N_q$ | $N_\gamma$ | $\phi$ | $N_c$ | $N_q$ | $N_\gamma$ |
|--------|-------|-------|------------|--------|-------|-------|------------|
| 0      | 5.14  | 1.0   | 0.0        | 23     | 18.1  | 8.7   | 8.2        |
| 1      | 5.4   | 1.1   | 0.1        | 24     | 19.3  | 9.6   | 9.4        |
| 2      | 5.6   | 1.2   | 0.2        | 25     | 20.7  | 10.7  | 10.9       |
| 3      | 5.9   | 1.3   | 0.2        | 26     | 22.3  | 11.9  | 12.5       |
| 4      | 6.2   | 1.4   | 0.3        | 27     | 23.9  | 13.2  | 14.5       |
| 5      | 6.5   | 1.6   | 0.5        | 28     | 25.8  | 14.7  | 16.7       |
| 6      | 6.8   | 1.7   | 0.6        | 29     | 27.9  | 16.4  | 19.3       |
| 7      | 7.2   | 1.9   | 0.7        | 30     | 30.1  | 18.4  | 22.4       |
| 8      | 7.5   | 2.1   | 0.9        | 31     | 32.7  | 20.6  | 26.0       |
| 9      | 7.9   | 2.3   | 1.0        | 32     | 35.5  | 23.2  | 30.2       |
| 10     | 8.4   | 2.5   | 1.2        | 33     | 38.6  | 26.1  | 35.2       |
| 11     | 8.8   | 2.7   | 1.4        | 34     | 42.2  | 29.4  | 41.1       |
| 12     | 9.3   | 3.0   | 1.7        | 35     | 46.1  | 33.3  | 48.0       |
| 13     | 9.8   | 3.3   | 2.0        | 36     | 50.6  | 37.8  | 56.3       |
| 14     | 10.4  | 3.6   | 2.3        | 37     | 55.6  | 42.9  | 66.2       |
| 15     | 11.0  | 3.9   | 2.7        | 38     | 61.4  | 48.9  | 78.0       |
| 16     | 11.6  | 4.3   | 3.1        | 39     | 67.9  | 56.0  | 92.3       |
| 17     | 12.3  | 4.8   | 3.5        | 40     | 75.3  | 64.2  | 109.4      |
| 18     | 13.1  | 5.3   | 4.1        | 41     | 83.9  | 73.9  | 130.2      |
| 19     | 13.9  | 5.8   | 4.7        | 42     | 93.7  | 85.4  | 155.6      |
| 20     | 14.8  | 6.4   | 5.4        | 43     | 105.1 | 99.0  | 186.5      |
| 21     | 15.8  | 7.1   | 6.2        | 44     | 118.4 | 115.3 | 224.6      |
| 22     | 16.9  | 7.8   | 7.1        | 45     | 133.9 | 134.9 | 271.8      |

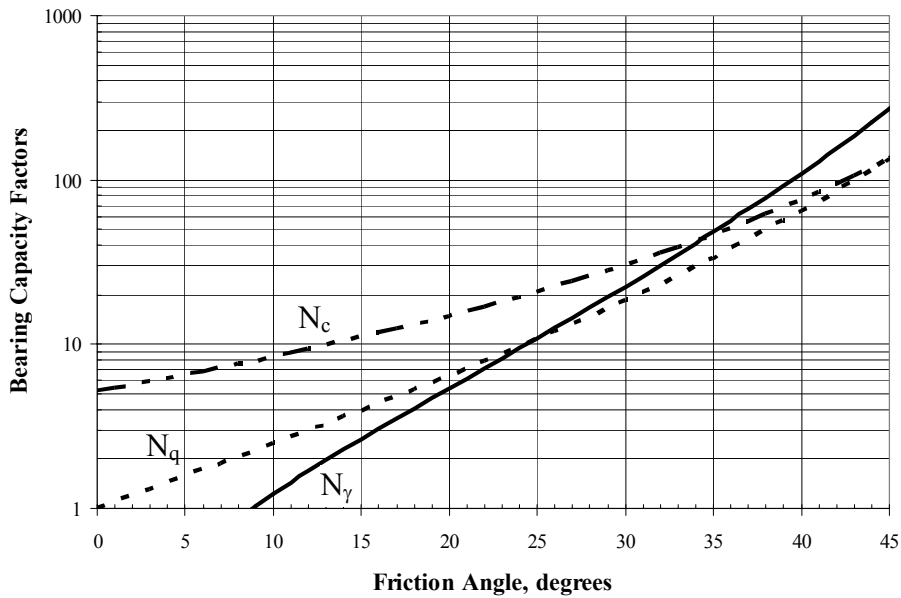

**Figure 8-15. Bearing capacity factors versus friction angle.**

**Example 8-1:** Determine the ultimate bearing capacity for a rigid strip footing with a rough base having the dimensions shown in the sketch below. Assume that the footing is concentrically loaded and that the total unit weight below the base of the footing is equal to the total unit weight above the base of the footing, i.e., in terms of the symbols used previously,  $\gamma = \gamma_a$ . First assume that the ground water table is well below the base of the footing and therefore it has no effect on the bearing capacity. Then, assume that the groundwater table is at the base of the footing and recompute the ultimate bearing capacity.

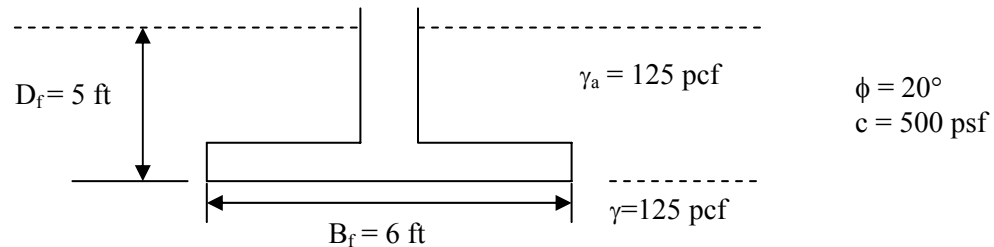

**Solution:**

Assume a general shear condition and enter Table 8-2 for  $\phi = 20^\circ$  and read the bearing capacity factors as follows:

$N_c = 14.8$ ,  $N_q = 6.4$ ,  $N_\gamma = 5.4$ . These values can also be read from Figure 8-15.

$$q_{ult} = c(N_c) + \gamma_a(D_f)(N_q) + 0.5(\gamma)(B_f)(N_\gamma)$$

$$\begin{aligned} q_{ult} &= (500 \text{ psf})(14.8) + (125 \text{ pcf})(5 \text{ ft})(6.4) + 0.5(125 \text{ pcf})(6 \text{ ft})(5.4) \\ &= 7,400 \text{ psf} + 4,000 \text{ psf} + 2,025 \text{ psf} \\ q_{ult} &= 13,425 \text{ psf} \end{aligned}$$

Effect of water: If the ground water table is at the base of the footing, i.e., a depth of 5 ft from the ground surface, then effective unit weight should be used in the “weight” term as follows:

$$\begin{aligned} q_{ult} &= (500 \text{ psf})(14.8) + (125 \text{ pcf})(5 \text{ ft})(6.4) + 0.5(125 \text{ pcf} - 62.4 \text{ pcf})(6 \text{ ft})(5.4) \\ &= 7,400 \text{ psf} + 4,000 \text{ psf} + 1,014 \text{ psf} \\ q_{ult} &= 12,414 \text{ psf} \end{aligned}$$

Sections 8.4.2.1 and 8.4.3.2 further discuss the effect of water on ultimate bearing capacity.



### 8.4.2.1 Comparative Effect of Various Terms in Bearing Capacity Formulation

In Equation 8-1, the first term is called the “cohesion” term, the second term is called the “surcharge” term since it represents the loads above the base of the footing, and the third term is called the “weight” term since it represents the weight of the foundation soil in the failure zone below the base of the footing. Consider now the effect that each of these terms has on the computed value of the ultimate bearing capacity ( $q_{ult}$ ).

- **Purely cohesive soils,  $\phi = 0$  (corresponds to undrained loading):** In this case, the last term is zero ( $N_\gamma = 0$  for  $\phi = 0$ ) and the first term in Equation 8-1 is a constant. Therefore the ultimate bearing capacity is a function of only the cohesion as it appears in the cohesion term in Equation 8-1 and the depth of embedment of the footing as it appears in the surcharge term in Equation 8-1. For this case, the footing width has no influence on the ultimate bearing capacity.
- **Purely frictional or cohesionless soils,  $c = 0$  and  $\phi > 0$ :** In this case, there will be large changes in ultimate bearing capacity when properties and/or dimensions are changed. The embedment effect is particularly important. Removal of the soil over an embedded footing, either by excavation or scour, can substantially reduce its ultimate bearing capacity and result in a lower factor of safety than required by the design. Removal of the soil over an embedded footing can also cause greater settlement than initially estimated. Similarly, a rise in the ground water level to the ground surface will reduce the effective unit weight of the soil by making the soil buoyant, thus reducing the surcharge and unit weight terms by essentially one-half.

Table 8-3 shows how bearing capacity can vary with changes in physical properties or dimensions. Notice that for a given value of cohesion, the effect of the variables on the bearing capacity in cohesive soils is minimal. Only the embedment depth has an effect on bearing capacity in cohesive soils. Also note that a rise in the ground water table does not influence cohesion. Interparticle bonding remains virtually unchanged unless the clay is reworked or the clay contains minerals that react with free water, e.g., expansive minerals.

Table 8-3 also shows that for a given value of internal friction angle, the effect on cohesionless soils is significant when dimensions are changed and/or a rise in the water table takes place. The embedment effect is particularly important. Removal of soil from over an embedded footing, either by excavation or scour, can substantially reduce the ultimate bearing capacity and possibly cause catastrophic shear failure. Rehabilitation or repair of an existing spread footing often requires excavation of the soil above the footing. If the effect of this removal on bearing capacity is not considered, the footing may move downward resulting in structural distress.

**Table 8-3**

**Variation in bearing capacity with changes in physical properties or dimensions**

| Properties and Dimensions  | Cohesive Soil                                    | Cohesionless Soil                               |
|--|--|---|
|  | $\phi = 0$<br>$c = 1,000$ psf<br>$q_{ult}$ (psf) | $\phi = 30^\circ$<br>$c = 0$<br>$q_{ult}$ (psf) |
| A. <u>Initial situation</u> : $\gamma = 120$ pcf, $D_f = 0'$ , $B_f = 5'$<br>deep water table      | 5,140  | 6,720   |
| B. <u>Effect of embedment</u> : $\gamma = 120$ pcf,, $D_f = 5'$ ,<br>$B_f = 5'$ , deep water table | 5,740  | 17,760  |
| C. <u>Effect of width</u> : $\gamma = 120$ pcf, $D_f = 0'$ , $B_f = 10'$<br>deep water table       | 5,140  | 13,440  |
| D. <u>Effect of water table at surface</u> : $\gamma' = 57.6$<br>pcf, $D_f = 0'$ , $B_f = 5'$      | 5,140  | 3,226   |

**8.4.3 Bearing Capacity Correction Factors**

A number of factors that were not included in the derivations discussed earlier influence the ultimate bearing capacity of shallow foundations. Note that Equation 8-1 assumes a rigid strip footing with a rough base, loaded through its centroid, that is bearing on a level surface of homogeneous soil. Various correction factors have been proposed by numerous investigators to account for footing shape adjusted for eccentricity, location of the ground water table, embedment depth, sloping ground surface, an inclined base, the mode of shear, local or punching shear, and inclined loading. The general philosophy of correcting the theoretical ultimate bearing capacity equation involves multiplying each of the three terms in the bearing capacity equation by empirical factors to account for the particular effect. Each correction factor includes a subscript denoting the term to which the factor should be applied: “c” for the cohesion term, “q” for the surcharge term, and “ $\gamma$ ” for the weight term. Each of these factors and suggestions for their application are discussed separately below. In most cases these factors may be used in combination.

The general form of the ultimate bearing capacity equation, including correction terms, is:

$$q_{ult} = cN_c s_c b_c + qN_q C_{wq} s_q b_q d_q + 0.5\gamma B_f N_\gamma C_{w\gamma} s_\gamma b_\gamma \tag{8-6}$$

where:  $s_c$ ,  $s_\gamma$  and  $s_q$  are **shape correction factors**

$b_c$ ,  $b_\gamma$  and  $b_q$  are **base inclination correction factors**

$C_{w\gamma}$  and  $C_{wq}$  are **groundwater correction factors**

$d_q$  is an **embedment depth correction factor** to account for the shearing resistance along the failure surface passing through cohesionless material above the bearing elevation. Recall that the embedment is modeled as a surcharge pressure applied at the bearing elevation. To be theoretically correct, the “q” in the surcharge term consists of two components, one the embedment depth surcharge to which the correction factor applies, the other an applied surcharge such as the traffic surcharge to which the correction factor, by definition, does not apply. Therefore, theoretically the “q” in the surcharge term should be replaced with  $(q_a + \gamma D_f d_q)$  where  $q_a$  is defined as an applied surcharge for cases where applied surcharge is considered in the analysis;

$N_c$ ,  $N_q$  and  $N_\gamma$  are **bearing capacity factors** that are a function of the friction angle of the soil.  $N_c$ ,  $N_q$  and  $N_\gamma$  can be obtained from Table 8-2 or Figure 8-15 or they can be computed by Equation 8-3/8-4, 8-2 and 8-5, respectively. As discussed in Section 8.4.3.6,  $N_c$  and  $N_\gamma$  are replaced with  $N_{cq}$  and  $N_{\gamma q}$  for the case of sloping ground or when the footing is located near a slope. In these cases the  $N_q$  term is omitted.

The following sections provide guidance on the use of the bearing capacity correction factors, and whether or not certain factors should be used in combination.

#### **8.4.3.1 Footing Shape (Eccentricity and Effective Dimensions)**

The following two issues are related to footing shape:

- Distinguishing a strip footing from a rectangular footing. The general bearing capacity equation is applicable to strip footings, i.e., footings with  $L_f/B_f \geq 10$ . Therefore, footing shape factors should be included in the equation for the ultimate bearing capacity for rectangular footings with  $L_f/B_f$  ratios less than 10.
- Use of the effective dimensions of footings subjected to eccentric loads. Eccentric loading occurs when a footing is subjected to eccentric vertical loads, a combination

of vertical loads and moments, or moments induced by shear loads transferred to the footing. Abutments and retaining wall footings are examples of footings subjected to this type of loading condition. Moments can also be applied to interior column footings due to skewed superstructures, impact loads from vessels or ice, seismic loads, or loading in any sort of continuous frame. Eccentricity is accounted for by distributing the non-uniform pressure distribution due to the eccentric load as an equivalent uniform pressure over an “effective area” that is smaller than the actual area of the original footing such that the point of application of the eccentric load passes through the centroid of the “effective area.” The eccentricity correction is usually applied by reducing the width ( $B_f$ ) and length ( $L_f$ ) such that:

$$B'_f = B_f - 2e_B \quad 8-7$$

$$L'_f = L_f - 2e_L \quad 8-8$$

where, as shown in Figure 8-16,  $e_B$  and  $e_L$  are the eccentricities in the  $B_f$  and  $L_f$  directions, respectively. These eccentricities are computed by dividing the applied moment in each direction by the applied vertical load. It is important to maintain consistent sign conventions and coordinate directions when this conversion is done. The reduced footing dimensions  $B'_f$  and  $L'_f$  are termed the effective footing dimensions. When eccentric load occurs in both directions, the equivalent uniform bearing pressure is assumed to act over an effective fictitious area,  $A'$ , where (AASHTO, 2004 with 2006 Interims):

$$A' = B'_f L'_f \quad 8-9$$

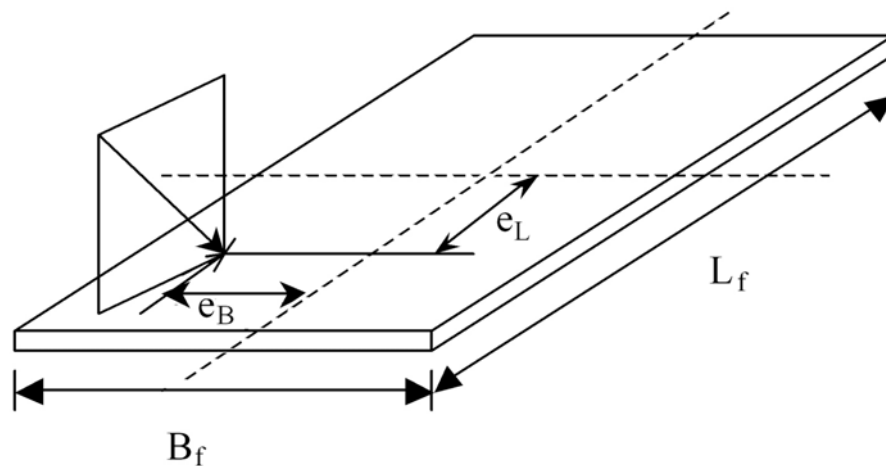

**Figure 8-16. Notations for footings subjected to eccentric, inclined loads (after Kulhawy, 1983).**

The concept of an effective area loaded by an equivalent uniform pressure is an approximation made to account for eccentric loading and was first proposed by Meyerhof (1953). Therefore, the equivalent uniform pressure is often referred to as the “**Meyerhof pressure.**” The concept of equivalent footing and Meyerhof pressure is used for geotechnical analysis during sizing of the footing, i.e., bearing capacity and settlement analyses. However, the structural design of a footing should be performed using the actual trapezoidal or triangular pressure distributions that model the pressure distribution under an eccentrically loaded footing more conservatively. A comparison of the two loading distributions is shown in Figure 8-17.

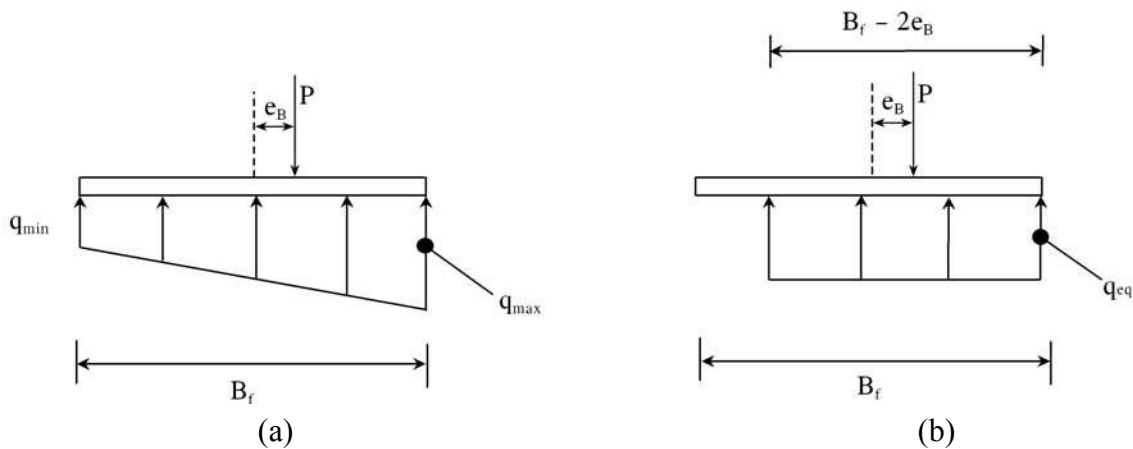

**Figure 8-17. Eccentrically loaded footing with (a) Linearly varying pressure distribution (structural design), (b) Equivalent uniform pressure distribution (sizing the footing).**

Limiting eccentricities are defined to ensure that zero contact pressure does not occur at any point beneath the footing. These limiting eccentricities vary for soil and rock. Footings founded on soil should be designed such that the eccentricity in any direction ( $e_B$  or  $e_L$ ) is less than one-sixth ( $1/6$ ) of the actual footing dimension in the same direction. For footings founded on rock, the eccentricity should be less than one-fourth ( $1/4$ ) of the actual footing dimension. If the eccentricity does not exceed these limits, a separate calculation for stability with respect to overturning need not be performed. If eccentricity does exceed these limits, the footing should be resized.

The shape correction factors are summarized in Table 8-4. For eccentrically loaded footings, AASHTO (2004 with 2006 Interims) recommends use of the effective footing dimensions,  $B'_f$  and  $L'_f$ , to compute the shape correction factors. However, in routine foundation design, use of the effective footing dimensions is not practical since the effective dimensions will

change for various load cases. Besides, the difference in the computed shape correction factors for actual and effective footing dimensions will generally be small. Therefore the geotechnical engineer should make reasonable assumptions about the footing shape and dimensions and compute the correction factors by using the equations in Table 8-4.

**Table 8-4**  
**Shape correction factors (AASHTO, 2004 with 2006 Interims)**

| Factor   | Friction Angle | Cohesion Term ( $s_c$ )   | Unit Weight Term ( $s_\gamma$ )          | Surcharge Term ( $s_q$ )                       |
|--|----------------|---|--|--|
| Shape Factors,<br>$s_c, s_\gamma, s_q$   | $\phi = 0$     | $1 + \left( \frac{B_f}{5L_f} \right)$                               | 1.0                                      | 1.0  |
|  | $\phi > 0$     | $1 + \left( \frac{B_f}{L_f} \right) \left( \frac{N_q}{N_c} \right)$ | $1 - 0.4 \left( \frac{B_f}{L_f} \right)$ | $1 + \left( \frac{B_f}{L_f} \tan \phi \right)$ |
| <i>Note:</i> Shape factors, $s$ , should not be applied simultaneously with inclined loading factors, $i$ . See Section 8.4.3.5. |                |   |  |  |

#### 8.4.3.2 Location of the Ground Water Table

If the ground water table is located within the potential failure zone above or below the base of a footing, buoyant (effective) unit weight should be used to compute the overburden pressure. A simplified method for accounting for the reduction in shearing resistance is to apply factors to the two terms in the bearing capacity equation that include a unit weight term. Recall that the cohesion term is neither a function of soil unit weight nor effective stress. The ground water factors may be computed by interpolating values between those provided in Table 8-5 ( $D_w$  = depth to water from ground surface).

**Table 8-5**  
**Correction factor for location of ground water table**  
**(AASHTO, 2004 with 2006 Interims)**

| $D_w$  | $C_{w\gamma}$ | $C_{wq}$ |
|--|---------------|----------|
| 0  | 0.5           | 0.5      |
| $D_f$  | 0.5           | 1.0      |
| $> 1.5B_f + D_f$   | 1.0           | 1.0      |
| <i>Note:</i> For intermediate positions of the ground water table, interpolate between the values shown above. |               |          |

### 8.4.3.3 Embedment Depth

Because the effect on bearing capacity of the depth of embedment was accounted for by considering it as an equivalent surcharge applied at the footing bearing elevation, the effect of the shearing resistance due to the failure surface actually passing through the footing embedment cover was neglected in the theory. If the backfill or cover over the footing is known to be a high-quality, compacted granular material that can be assumed to remain in place over the life of the footing, additional shearing resistance due to the backfill can be accounted for by including in the surcharge term the embedment depth correction factor,  $d_q$ , shown in Table 8-6. Otherwise, the depth correction factor can be conservatively omitted.

**Table 8-6**  
**Depth correction factors**  
**(Hansen and Inan, 1970; AASHTO, 2004 with 2006 Interims)**

| Friction Angle, $\phi$ (degrees)  | $D_f/B_f$ | $d_q$ |
|---|-----------|-------|
| 32  | 1         | 1.20  |
|   | 2         | 1.30  |
|   | 4         | 1.35  |
|   | 8         | 1.40  |
| 37  | 1         | 1.20  |
|   | 2         | 1.25  |
|   | 4         | 1.30  |
|   | 8         | 1.35  |
| 42  | 1         | 1.15  |
|   | 2         | 1.20  |
|   | 4         | 1.25  |
|   | 8         | 1.30  |
| <i>Note:</i> The depth correction factor should be used only when the soils above the footing bearing elevation are as competent as the soils beneath the footing level; otherwise, the depth correction factor should be taken as 1.0. |           |       |

Spread footings should be located below the depth of frost potential due to possible frost heave considerations discussed in Section 5.7.3. Figure 5-29 may be used for preliminary guidance on depth of frost penetration. Similarly, footings should be located below the depth of scour to prevent undermining of the footing.

#### 8.4.3.4 Inclined Base

In general, inclined footings for bridges should be avoided or limited to inclination angles,  $\alpha$ , less than about 8 to 10 degrees from the horizontal. Steeper inclinations may require keys, dowels or anchors to provide sufficient resistance to sliding. For footings inclined to the horizontal, Table 8-7 provides equations for the correction factors to be used in Equation 8-6.

**Table 8-7**  
**Inclined base correction factors (Hansen and Inan, 1970; AASHTO, 2004 with 2006 Interims)**

| Factor   | Friction Angle | Cohesion Term (c)                                    | Unit Weight Term ( $\gamma$ )   | Surcharge Term (q)              |
|--|----------------|--|---------------------------------|---------------------------------|
|  |                | $b_c$  | $b_\gamma$                      | $b_q$                           |
| Base Inclination Factors, $b_c, b_\gamma, b_q$ | $\phi = 0$     | $1 - \left( \frac{\alpha}{147.3} \right)$            | 1.0                             | 1.0                             |
|  | $\phi > 0$     | $b_q - \left( \frac{1 - b_q}{N_c \tan \phi} \right)$ | $(1 - 0.017\alpha \tan \phi)^2$ | $(1 - 0.017\alpha \tan \phi)^2$ |

$\phi$  = friction angle, degrees;  $\alpha$  = footing inclination from horizontal, upward +, degrees

#### 8.4.3.5 Inclined Loading

A convenient way to account for the effects of an inclined load applied to the footing by the column or wall stem is to consider the effects of the axial and shear components of the inclined load individually. If the vertical component is checked against the available bearing capacity and the shear component is checked against the available sliding resistance, the inclusion of load inclination factors in the bearing capacity equation can generally be omitted. The bearing capacity should, however, be evaluated by using effective footing dimensions, as discussed in Section 8.4.3.1 and in the footnote to Table 8-4, since large moments can frequently be transmitted to bridge foundations by the columns or pier walls. **The simultaneous application of shape and load inclination factors can result in an overly conservative design.**

Unusual column geometry or loading configurations should be evaluated on a case-by-case basis relative to the foregoing recommendation before the load inclination factors are omitted. An example might be a column that is not aligned normal to the footing bearing surface. In this case, an inclined footing may be considered to offset the effects of the inclined load by providing improved bearing efficiency (see Section 8.4.3.4). Keep in mind that bearing surfaces that are not level may be difficult to construct and inspect.



### 8.4.3.6 Sloping Ground Surface

Placement of footings on or adjacent to slopes requires that the designer perform calculations to ensure that both the bearing capacity and the overall slope stability are acceptable. The bearing capacity equation should include corrections recommended by AASHTO as adapted from NAVFAC (1986b) to design the footings. Calculation of overall (global) stability is discussed in Chapter 6.

For sloping ground surface, Equation 8-6 is modified to include terms  $N_{cq}$  and  $N_{\gamma q}$  that replace the  $N_c$  and  $N_\gamma$  terms. The modified version is given by Equation 8-10. There is no surcharge term in Equation 8-10 because the surcharge effect on the slope side of the footing is ignored.

$$q_{ult} = c(N_{cq})s_c b_c + 0.5\gamma B_f(N_{\gamma q})C_{w\gamma}s_\gamma b_\gamma \quad 8-10$$

Charts are provided in Figure 8-18 to determine  $N_{cq}$  and  $N_{\gamma q}$  for footings on (Figure 8-18a) or close to (Figure 8-18d) slopes for cohesive ( $\phi = 0^\circ$ ) and cohesionless ( $c = 0$ ) soils. As indicated in Figure 8-18d, the bearing capacity is independent of the slope angle if the footing is located beyond a distance, 'b,' of two to six times the foundation width, i.e., the situation is identical to the case of horizontal ground surface.

Other forms of Equation 8-10 are available for cohesive soils ( $\phi = 0^\circ$ ). However, because footings located on or near slopes consisting of cohesive soils, they are likely to have design limitations due to either settlement or slope stability, or both, the presentation of these equations is omitted here. The reader is referred to NAVFAC (1986a, 1986b) for discussions of these equations and their applications and limitations.

Equation 8-10, which includes the width term for cohesionless soils, is useful in designing footings constructed within bridge approach fills. In this case, obtain  $N_{\gamma q}$  from Figure 8-18(c) or 8-18(f) and then compute the ultimate bearing capacity by using Equation 8-10.

### 8.4.3.7 Layered Soils

For layered soils, the reader is referred to the guidance provided in AASHTO (2004 with 2006 Interims).

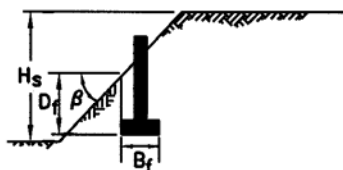

$$N_s = 0 \text{ (FOR } B_f < H_s)$$

$$N_s = \frac{\gamma H_s}{c} \text{ (FOR } B_f \geq H_s)$$

(a) Geometry

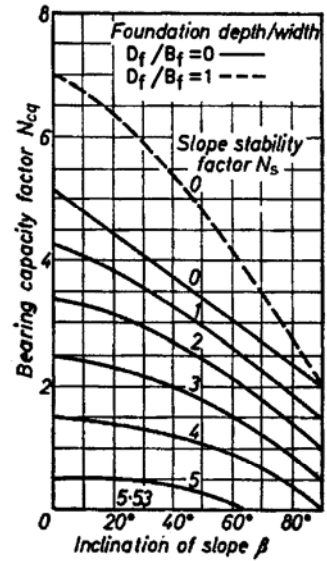

(b) Cohesive Soil ( $\phi=0$ )

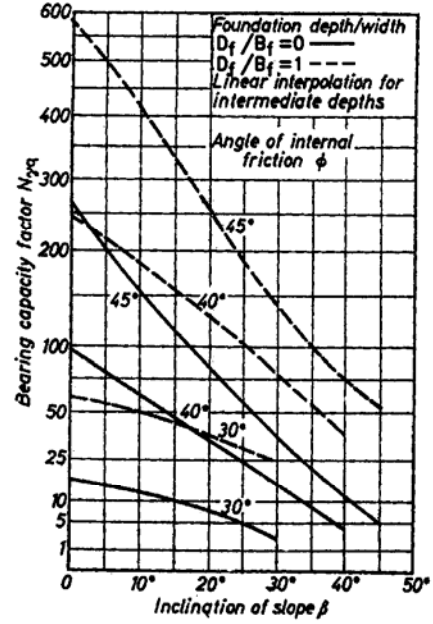

(c) Cohesionless Soil ( $c=0$ )

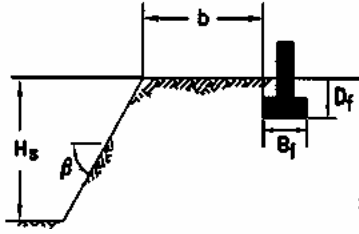

$$N_s = 0 \text{ (FOR } B_f < H_s)$$

$$N_s = \frac{\gamma H_s}{c} \text{ (FOR } B_f \geq H_s)$$

(d) Geometry

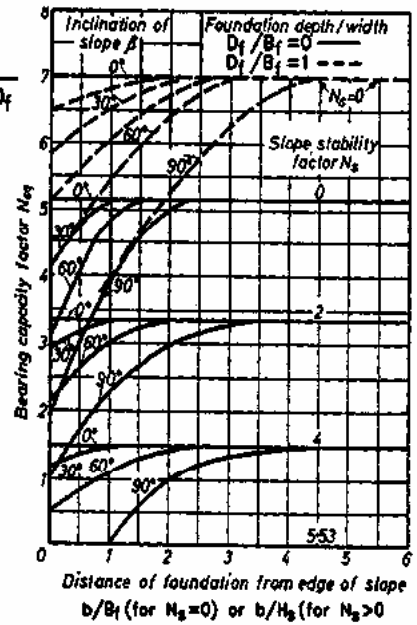

(e) Cohesive Soil ( $\phi=0$ )

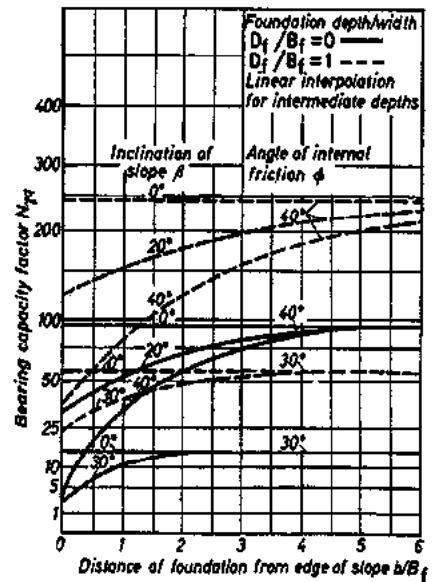

(f) Cohesionless Soil ( $c=0$ )

**Figure 8-18. Modified bearing capacity factors for continuous footing on sloping ground (after Meyerhof, 1957, from AASHTO, 2004 with 2006 Interims)**

#### 8.4.4 Additional Considerations Regarding Bearing Capacity Correction Factors

The inherent or implied factor of safety of a settlement-limited allowable bearing capacity relative to the computed ultimate bearing capacity is usually large enough to render the magnitude of the application of the individual correction factors small. Some comments in this regards are as follows:

- AASHTO (2002) guidelines recommend calculating the shape factors,  $s$ , by using the effective footing dimensions,  $B'_f$  and  $L'_f$ . However, the original references (e.g., Vesic, 1975) do not specifically recommend using the effective dimensions to calculate the shape factors. Since the geotechnical engineer typically does not have knowledge of the loads causing eccentricity, it is recommended that the full footing dimensions be used to calculate the shape factors according to the equations given in Table 8-4 for use in computation of ultimate bearing capacity.
- Bowles (1996) also recommends that the shape and load inclination factors ( $s$  and  $i$ ) should not be combined.
- In certain loading configurations, the designer should be careful in using inclination factors together with shape factors that have been adjusted for eccentricity (Perloff and Baron, 1976). The effect of the inclined loads may already be reflected in the computation of the eccentricity. Thus an overly conservative design may result.

Further, the bearing capacity correction factors were developed with the assumption that the correction for each of the terms involving  $N_c$ ,  $N_\gamma$  and  $N_q$  can be found independently. The bearing capacity theory is an idealization of the response of a foundation that attempts to account for the soil properties and boundary conditions. Bearing capacity analysis of foundations is frequently limited by the geotechnical engineer's ability to determine material properties accurately as opposed to inadequacies in the theory used to develop the bearing capacity equations. Consider Table 8-2 and note that a one degree change in friction angle can result in a 10 to 15 percent change in the factors  $N_c$ ,  $N_\gamma$  and  $N_q$ . Determination of the in situ friction angle to an accuracy of  $1^\circ$  is virtually impossible. Also note that the value of  $N_\gamma$  more than doubles when the friction angle increases from  $35^\circ$  to  $40^\circ$ . Clearly, the uncertainties in the material properties will control the uncertainty of a bearing capacity computation to a large extent. **The importance of the application of the correction factors is therefore secondary to adequate assessment of the inherent strength characteristics of the foundation soil through correctly performed field investigations and laboratory testing.**

Unfortunately, very few spread footings of the size used for bridge support have been load-tested to failure. Therefore, the evaluation of ultimate bearing capacity is based primarily on theory and laboratory testing of small-scale footings, with modification of the theoretical equations based on observation.

#### 8.4.5 Local or Punching Shear

Several references, including AASHTO (2004 with 2006 Interims), recommend reducing the soil strength parameters if local or punching shear failure modes can develop. Figure 8-19 shows conditions when these modes can develop for granular soils. The recommended reductions are shown in Equations 8-11 and 8-12.

$$c^* = 0.67c \quad 8-11$$

$$\phi^* = \tan^{-1} (0.67 \tan \phi) \quad 8-12$$

where:  $c^*$  = reduced effective stress soil cohesion for punching shear (tsf (MPa))  
 $\phi^*$  = reduced effective stress soil friction angle for punching shear (degrees)

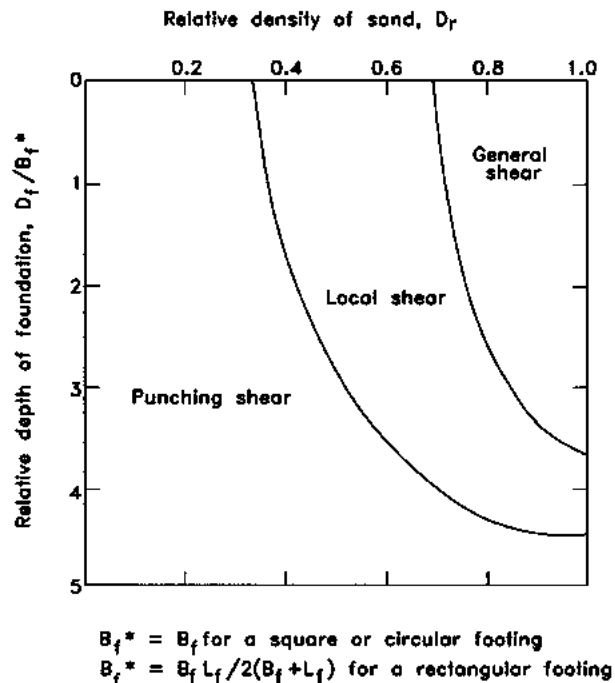

**Figure 8-19. Modes of failure of model footings in sand (after Vesic, 1975; AASHTO, 2004 with 2006 Interims)**

Soil types that can develop local or punching shear failure modes include loose sands, quick clays (i.e., clays with sensitivity,  $S_t > 8$ ; see Table 3-12 in Chapter 3), collapsible sands and silts, and brittle clays ( $OCR > 4$  to 8). As indicated in Section 3.12, **sensitivity of clay** is defined as the ratio of the peak undrained shearing strength to the remolded undrained shearing strength. These soils present potential “problem” conditions that should be identified through a comprehensive geotechnical investigation. In general, these problem soils will have other characteristics that make them unsuitable for the support of shallow foundations for bridges, including large settlement potential for loose sands, sensitive clays and collapsible soils. Brittle clays exhibit relatively high strength at small strains, but they generally undergo significant reduction in strength at larger strains (strain-softening). This behavior should be identified and quantified through the field and laboratory testing program and compared to the anticipated stress changes resulting from the shallow foundation and ground slope configuration under consideration.

Although local or punching shear failure modes can develop in loose sands or when very narrow footings are used, this local condition seldom applies to bridge foundations because spread footings are not used on obviously weak soils. In general, relatively large footing sizes are needed for structural stability of bridge foundations.

The geotechnical engineer may encounter the following two situations where the application of the one-third reduction according to Equation 8-12 can result in an unnecessarily over-conservative design.

- The first is when a footing bears on a cohesionless soil that falls in the local shear portion of Figure 8-19. Note that a one-third reduction in the tangent of a friction angle of 38 degrees, a common value for good-quality, compacted, granular fill, results in a 73 percent reduction in the bearing capacity factor  $N_q$ , and an 81 percent reduction in  $N_\gamma$ . Also note that Figure 8-19 does not consider the effect of large footing widths, such as those used for the support of bridges. **Therefore, provided that settlement potential is checked independently and found to be acceptable, spread footings on normally consolidated cohesionless soils falling within the local shear portion of Figure 8-19 should not be designed by using the one-third reduction according to Equation 8-12.**
- The second situation is when a spread footing bears on a compacted structural fill. The relative density of compacted structural fills as compared to compactive effort, i.e., percent relative compaction, indicates that for fills compacted to a minimum of 95 percent of maximum dry density as determined by AASHTO T 180, the relative

density should be at or above 75 percent (see Figure 5-33 in Chapter 5). This relationship is consistent with the excellent performance history of spread footings in compacted structural fills (FHWA, 1982). Therefore, the one-third reduction should not be used in the design of footings on compacted structural fills constructed with good quality, granular material.

#### 8.4.6 Bearing Capacity Factors of Safety

The minimum factor of safety applied to the calculated ultimate bearing capacity will be a function of:

- The confidence in the design soil strength parameters  $c$  and  $\phi$ ,
- The importance of the structure, and
- The consequence of failure.

Typical minimum factors of safety for shallow foundations are in the range of 2.5 to 3.5. A minimum factor of safety against bearing capacity failure of 3.0 is recommended for most bridge foundations. This recommended factor of safety was selected through a combination of applied theory and experience. **Uncertainty in the magnitudes of the loads and the available soil bearing strength are combined into this single factor of safety.** The general equation to compute the allowable bearing capacity as a function of safety factor is:

$$q_{\text{all}} = \frac{q_{\text{ult}}}{\text{FS}} \quad 8-13$$

where:  $q_{\text{all}}$  = allowable bearing capacity (ksf) (kPa)  
 $q_{\text{ult}}$  = ultimate bearing capacity (ksf) (kPa)  
FS = the applied factor of safety

##### 8.4.6.1 Overstress Allowances

Allowable Strength Design (ASD) criteria permit the allowable bearing capacity to be exceeded for certain load groups (e.g., seismic) by a specified percentage that ranges from 25 to 50 percent (AASHTO, 2002). These overstress allowances are permitted for short-duration, infrequently occurring loads and may also be applied to calculated allowable bearing capacities. Construction loading is often a short-duration loading and may be considered for overstress allowances. **Overstress allowances should not be permitted for cases where soft soils are encountered within the depth of significant influence (DOSI) or durations are such that temporary loads may cause unacceptable settlements.**

## 8.4.7 Practical Aspects of Bearing Capacity Formulations

This section presents some useful practical aspects of bearing capacity formulations. Several interesting observations are made here that provide practical guidance in terms of implementation and interpretation of the bearing capacity formulation and computed results.

### 8.4.7.1 Bearing Capacity Computations

The procedure to be used to compute bearing capacity is as follows:

1. Review the structural plans to determine the proposed footing widths. In the absence of data assume a pier footing width equal to  $1/3$  the pier column height and an abutment footing width equal to  $1/2$  the abutment height.
2. Review the soil profile to determine the position of the groundwater table and the interfaces between soil layer(s) that exist within the appropriate depth below the proposed footing level.
3. Review soil test data to determine the unit weight, friction angle and cohesion of all of the impacted soils. In the absence of test data, estimate these values for coarse-grained granular soils from SPT N-values (refer to Table 8-3). NOTE SPT N-values in cohesive soils should not be used to determine shear strengths for final design since the reliability of SPT N-values in such soils is poor.
4. Use Equation 8-6 with appropriate correction factors to compute the ultimate bearing capacity. The general case (continuous footing) may be used when the footing length is 10 or more times the footing width. Also the bearing capacity factor  $N_\gamma$  will usually be determined for a rough base condition since most footings are poured concrete. However the smoothness of the contact material must be considered for temporary footings such as wood grillages (rough), or steel supports (smooth) or plastic sheets (smooth). The safety factor for the bearing capacity of a spread footing is selected both to limit the amount of soil strain and to account for variations in soil properties at footing locations.
5. The mechanism of the general bearing capacity failure is similar to the embankment slope failure mechanism. However, the footing analysis is a 3-dimensional analysis as opposed to the 2-dimensional slope stability analysis. The bearing capacity factors  $N_c$ ,  $N_q$  and  $N_\gamma$  relate to the actual volume of soil involved in the failure zones. A

cursory study of the failure cross sections in Figure 8-13, discloses that the depth and lateral extent of the failure zones and the values of  $N_c$ ,  $N_q$  and  $N_\gamma$  are determined by the dimensions of the wedge-shaped zone directly below the footing. As the friction angle increases, the depth and width of the failure zones increase, i.e., more soil is impacted and more shear resistance is mobilized, thereby increasing the bearing capacity.

6. Substantial downward movement of the footing is required to mobilize the shearing resistance within the entire failure zone completely. Besides providing a margin of safety on shear strength properties, the relatively large safety factor of 3 commonly used in the design of footings controls the amount of strain necessary to mobilize the allowable bearing capacity fully. Settlement analysis (Section 8.5) is recommended to compute the allowable bearing capacity corresponding to a specified limiting settlement. That allowable bearing capacity may result in a factor of safety with respect to ultimate bearing capacity much larger than 3.
7. In reporting the results of bearing capacity analyses, the footing width that was used to compute the bearing capacity should always be included. Most often the geotechnical engineer must assume a footing width since bearing capacity analyses are completed before structural design begins. It is recommended that bearing capacity be computed for a range of possible footing widths and those values be included in the foundation report with a note stating that if other footing widths are used, the geotechnical engineer should be contacted. The state of the practice today is for the geotechnical engineer to develop location-specific bearing capacity charts on which allowable bearing capacity is plotted versus footing width for a family of curves representing specific values of settlement. Refer to Figure 8-10 for a schematic example of such a chart.
8. The **net** ultimate bearing pressure is the difference between the gross ultimate bearing pressure and the pressure that existed due to the ground surcharge at the bearing depth before the footing was constructed,  $q$  ( $= \gamma_a D_f$ ). The net ultimate bearing pressure can thus be computed by subtracting the ground surcharge ( $q$ ) from Equation 8-6:

$$q_{ult \text{ net}} = q_{ult} - q \quad 8-14$$

$$q_{ult \text{ net}} = cN_c s_c b_c + q(N_q - 1) C_{wq} s_q b_q d_q + 0.5\gamma B_f N_\gamma C_{w\gamma} s_\gamma b_\gamma \quad 8-15$$



The structural designer will typically include the self-weight of the concrete footing and the backfill over the footing (approximately equal to  $\gamma_a D_f$ ) in the loads that contribute to the applied bearing stress. Therefore, if the geotechnical engineer computes and reports a net ultimate bearing pressure, the effect of the surcharge directly over the footing area is counted twice. Reporting an allowable bearing capacity computed from a net ultimate bearing pressure is conservative and generally not recommended provided that a suitable factor of safety is maintained against bearing capacity failure. If the geotechnical engineer chooses to report an allowable bearing capacity computed from a net ultimate bearing pressure, this fact should be clearly stated in the foundation report.

#### 8.4.7.2 Failure Zones

Certain practical information based on the geometry of the failure zone is as follows:

1. The bearing capacity of a footing is dependent on the strength of the soil within a depth of approximately 1.5 times footing width below the base of the footing unless much weaker soils exist just below this level, in which case a potential for punching shear failure may exist. Continuous soil samples and SPT N-values should be routinely specified within this depth. If the borings for a structure are done long before design, a good practice is to obtain continuous split spoon samples for the top 15 ft (4.5 m) of each boring where footings may be placed on natural soil. The cost of this sampling is minimal but the knowledge gained is great. At a minimum, continuous sampling to a depth of 15 ft (4.5 m) will generally provide the following information:
  - a. thickness of existing topsoil.
  - b. location of any thin zones of unsuitable material.
  - c. accurate determination of depth of existing fill.
  - d. improved ground water determination in the critical zone.
  - e. representative samples in this critical zone to permit reliable determination of strength parameters in the laboratory and confident assessment of bearing capacity.
2. Often questions arise during excavation near existing footings as to the effect of soil removal adjacent to the footing on the bearing capacity of that footing. In general, for weaker soils the zone of lateral influence extends outside the footing edge less than twice the footing width. Reductions in bearing capacity can be estimated by

considering the effects of surcharge removal within these zones. The theoretical lateral extent of this zone is shown in Figure 8-20. This figure is also useful in determining the effects of ground irregularities on bearing capacity or the effects of footing loads on adjacent facilities.

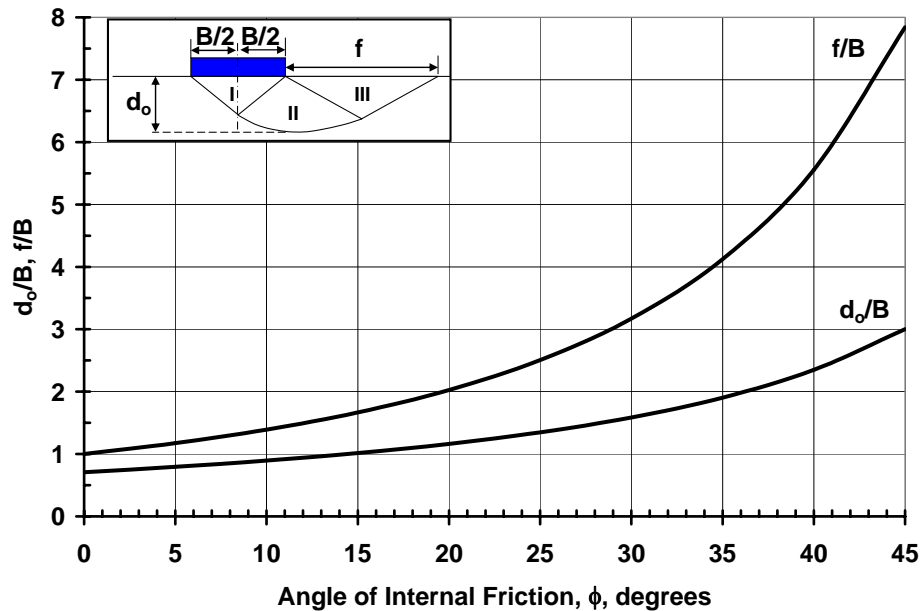

**Figure 8-20. Approximate variation of depth ( $d_o$ ) and lateral extent ( $f$ ) of influence of footing as a function of internal friction angle of foundation soil.**

As noted earlier, the general mechanism by which soils resist a footing load is similar to the foundation of an embankment resists shear failure. The load to cause failure must exceed the available soil strength within the failure zone. When failure occurs the footing plunges into the ground and causes an uplift of the soil adjacent to the sides of the footing. The resistance to failure is based on the soil strength and the amount of soil above the footing. Therefore, the bearing capacity of a footing can be increased by:

1. replacing or densifying the soil below the footing prior to construction.
2. increasing the embedment of the footing below ground, provided no weak soils exist within 1.5 times the footing width.

Common examples of improving bearing capacity are the support of temporary footings on pads of gravel or the embedment of mudsills a few feet below ground to support falsework. The design of these support systems is primarily done by bearing capacity analysis in which the results of subsurface explorations and testing are used. Structural engineers who review falsework designs should carefully check the soil bearing capacity at foundation locations.

## 8.4.8 Presumptive Bearing Capacities

Many building codes include provisions that arbitrarily limit the amount of loading that may be applied on various classes of soils by structures subject to code regulations. These limiting loads are generally based on bearing pressures that have been observed to result in acceptable settlements. The implication is that on the basis of experience alone it may be presumed that each designated class of soil will safely support the loads indicated without the structure undergoing excessive settlements. Such values listed in codes or in the technical literature are termed presumptive bearing capacities.

### 8.4.8.1 Presumptive Bearing Capacity in Soil

**The use of presumptive bearing capacities for shallow foundations bearing in soils is not recommended for final design of shallow foundations for transportation structures, especially bridges.** Guesses about the geology and nature of a site and the application of a presumptive value from generalizations in codes or in the technical literature are not a substitute for an adequate site-specific subsurface investigation and laboratory testing program. As an exception, presumptive bearing values are sometimes used for the preliminary evaluation of shallow foundation feasibility and estimation of footing dimensions for preliminary constructability or cost evaluations.

### 8.4.8.2 Presumptive Bearing Capacity in Rock

Footings on intact sound rock that is stronger and less compressible than concrete are generally stable and do not require extensive study of the strength and compressibility characteristics of the rock. However, site investigations are still required to confirm the consistency and extent of rock formations beneath a shallow foundation.

Allowable bearing capacities for footings on relatively uniform and sound rock surfaces are documented in applicable building codes and engineering manuals. Many different definitions for sound rock are available. **In simple terms, however, “sound rock” can generally be defined as a rock mass that does not disintegrate after exposure to air or water and whose discontinuities are unweathered, closed or tight, i.e., less than about 1/8 in (3 mm) wide and spaced no closer than 3 ft (1 m) apart.** Table 8-8 presents allowable bearing pressures for intact rock recommended in selected local building codes (Goodman, 1989). These values were developed based on experience in sound rock formations, with the intention of satisfying both bearing capacity and settlement criteria in order to provide a satisfactory factor of safety. However, the use of presumptive values may lead to overly conservative and costly foundations. In such cases, most codes allow for a

variance if the request is supported by an engineering report. Site-specific investigation and analysis is strongly encouraged.

In areas where building codes are not available or applicable, other recommended presumptive bearing values, such as those listed in Table 8-9, may be used to determine the allowable bearing pressure for sound rock. For footings designed by using these published values, the elastic settlements are generally less than 0.5 in (13 mm). Where the rock is reasonably sound, but fractured, the presumptive values listed in Tables 8-8 and 8-9 should be reduced by limiting the bearing pressures to tolerable settlements based on settlement analyses. Most building codes also provide reduced recommended bearing pressures to account for the degree of fracturing.

Peck, *et al.* (1974) presented an empirical correlation of presumptive allowable bearing pressure with Rock Quality Designation (RQD), as shown in Table 8-10. If the recommended value of allowable bearing pressure exceeds the unconfined compressive strength of the rock or allowable stress of concrete, the allowable bearing pressure should be taken as the lower of the two values. Although the suggested bearing values of Peck, *et al.* (1974) are substantially greater than most of the other published values and ignore the effects of rock type and conditions of discontinuities, they provide a useful guide for an upper-bound estimation as well as an empirical relationship between allowable bearing values and the intensity of fracturing and jointing (Table 8-10). Note that with a slight increase of the degree of fracturing of the rock mass, for example when the RQD value drops from 100 percent to 90 percent, the recommended bearing capacity value is reduced drastically from 600 ksf (29 MPa) to 400 ksf (19 MPa).

In no instance should the allowable bearing capacity exceed the allowable stress of the concrete used in the structural foundation. Furthermore, Peck, *et al.* (1974) also suggest that the average RQD for the bearing rock within a depth of the footing width ( $B_f$ ) below the base of the footing should be used if the RQD values within the depth are relatively uniform. If rock within a depth of  $0.5B_f$  is of poorer quality, the RQD of the poorer quality rock should be used to determine the allowable bearing capacity.

**Table 8-8****Allowable bearing pressures for fresh rock of various types (Goodman, 1989)**

| Rock Type                               | Age        | Location          | Allowable Bearing Pressure tsf (MPa) |
|---|------------|-------------------|--------------------------------------|
| Massively bedded limestone <sup>5</sup> |            | U.K. <sup>6</sup> | 80 (3.8)                             |
| Dolomite                                | L. Paleoz. | Chicago           | 100 (4.8)                            |
| Dolomite                                | L. Paleoz. | Detroit           | 20-200 (1.0 – 9.6)                   |
| Limestone                               | U. Paleoz. | Kansas City       | 20-120 (0.5 – 5.8)                   |
| Limestone                               | U. Paleoz. | St. Louis         | 50-100 (2.4 – 4.8)                   |
| Mica schist                             | Pre-Camb.  | Washington        | 20-40 (0.5 – 1.9)                    |
| Mica schist                             | Pre-Camb.  | Philadelphia      | 60-80 (2.9 – 3.8)                    |
| Manhattan schist                        | Pre-Camb.  | New York          | 120 (5.8)                            |
| Fordham gneiss                          | Pre-Camb.  | New York          | 120 (5.8)                            |
| Schist and slate                        | -          | U.K. <sup>6</sup> | 10-25 (0.5 – 1.2)                    |
| Argillite                               | Pre-Camb.  | Cambridge, MA     | 10-25 (0.5 – 1.2)                    |
| Newark shale                            | Triassic   | Philadelphia      | 10-25 (0.5 – 1.2)                    |
| Hard, cemented shale                    | -          | U.K. <sup>6</sup> | 40 (1.9)                             |
| Eagleford shale                         | Cretaceous | Dallas            | 13-40 (0.6 – 1.9)                    |
| Clay shale                              | -          | U.K. <sup>6</sup> | 20 (1.0)                             |
| Pierre shale                            | Cretaceous | Denver            | 20-60 (1.0 – 2.9)                    |
| Fox Hills sandstone                     | Tertiary   | Denver            | 20-60 (1.0 – 2.9)                    |
| Solid chalk                             | Cretaceous | U.K. <sup>6</sup> | 13 (0.6)                             |
| Austin chalk                            | Cretaceous | Dallas            | 30-100 (1.4 – 4.8)                   |
| Friable sandstone and claystone         | Tertiary   | Oakland           | 8-20 (0.4 – 1.0)                     |
| Friable sandstone (Pico formation)      | Quaternary | Los Angeles       | 10-20 (0.5 – 1.0)                    |

*Notes:*

<sup>1</sup> According to typical building codes; reduce values accordingly to account for weathering or unrepresentative fracturing

<sup>2</sup> Values from Thorburn (1966) and Woodward, Gardner and Greer (1972).

<sup>3</sup> When a range is given, it relates to usual range in rock conditions.

<sup>4</sup> Sound rock that rings when struck and does not disintegrate. Cracks are unweathered and open less than 10 mm.

<sup>5</sup> Thickness of beds greater than 3 ft (1 m), joint spacing greater than 2 mm; unconfined compressive strength greater than 160 tsf (7.7 MPa) (for a 4 in (100 mm) cube).

<sup>6</sup> Institution of Civil Engineers Code of Practice 4.

**Table 8-9**

**Presumptive values of allowable bearing pressures for spread foundations on rock  
(modified after NAVFAC, 1986a, AASHTO 2004 with 2006 Interims)**

| Type of Bearing Material   | Consistency In Place    | Allowable Bearing Pressure tsf (MPa) |                           |
|--|-------------------------|--------------------------------------|---------------------------|
|  |                         | Range                                | Recommended Value for Use |
| Massive crystalline igneous and metamorphic rock: granite, diorite, basalt, gneiss, thoroughly cemented conglomerate (sound condition allows minor cracks) | Hard, sound rock        | 120-200<br>(5.8 - 9.6)               | 160<br>(7.7)              |
| Foliated metamorphic rock: Slate, schist (sound condition allows minor cracks)   | Medium-hard, sound rock | 60-80<br>(2.9-3.8)                   | 70<br>(3.4)               |
| Sedimentary rock; hard cemented shales, siltstone, sandstone, limestone without cavities   | Medium-hard, sound rock | 30-50<br>(1.4-2.4)                   | 40<br>(1.9)               |
| Weathered or broken bedrock of any kind except highly argillaceous rock (shale). RQD less than 25  | Soft rock               | 16-24<br>(0.8-1.2)                   | 20<br>(1)                 |
| Compacted shale or other highly argillaceous rock in sound condition   | Soft rock               | 16-24<br>(0.8-1.2)                   | 20<br>(1)                 |

*Notes:*

1. For preliminary analysis or in the absence of strength tests, design and proportion shallow foundations to distribute their loads by using presumptive values of allowable bearing pressure given in this table. Modify the nominal value of allowable bearing pressure for special conditions described in notes 2 through 8.
2. The maximum bearing pressure beneath the footing produced by eccentric loads that include dead plus normal live load plus permanent lateral loads shall not exceed the above nominal bearing pressure.
3. Bearing pressures up to one-third in excess of the nominal bearing values are permitted for transient live load from wind or earthquake. If overload from wind or earthquake exceeds one-third of nominal bearing pressures, increase allowable bearing pressures by one-third of nominal value.
4. Extend footings on soft rock to a minimum depth of 1.5 in (40 mm) below adjacent ground surface or surface of adjacent floor, whichever elevation is the lowest.
5. For footings on soft rock, increase allowable bearing pressures by 5 percent of the nominal values for each 1 ft (300 mm) of depth below the minimum depth specified in Note 4.
6. Apply the nominal bearing pressures of the three categories of hard or medium hard rock shown above where the base of the foundation lies on rock surface. Where the foundation extends below the rock surface, increase the allowable bearing pressure by 10 percent of the nominal values for each additional 1ft (300 mm) of depth extending below the surface.
7. For footings smaller than 3 ft (1 m) in the least lateral dimension, the allowable bearing pressure shall be the nominal bearing pressure multiplied by the least lateral dimension.
8. If the above-recommended nominal bearing pressure exceeds the unconfined compressive strength of intact specimen, the allowable pressure equals the unconfined compressive strength.

**Table 8-10**

**Suggested values of allowable bearing capacity (Peck, *et al.*, 1974)**

| RQD (%) | Rock Mass Quality | Allowable Pressure ksf (MPa) |
|---------|-------------------|------------------------------|
| 100     | Excellent         | 600 (29)                     |
| 90      | Good              | 400 (19)                     |
| 75      | Fair              | 240 (12)                     |
| 50      | Poor              | 130 (6)                      |
| 25      | Very Poor         | 60 (3)                       |
| 0       | Soil-like         | 20 (1)                       |

## **8.5 SETTLEMENT OF SPREAD FOOTINGS**

The controlling factor in the design of a spread footing is usually tolerable settlement. Estimation of settlement may be routinely accomplished with adequate geotechnical data and knowledge of the structural loads. The accuracy of the estimation is only as good as the quality of the geotechnical data and the estimation of the actual loads. Settlements of spread footings are frequently overestimated by engineers for the following reasons:

1. The structural load causing the settlement is overestimated. In the absence of actual structural loads, geotechnical engineers conservatively assume that the footing pressure equals the maximum allowable soil bearing pressure.
2. Settlement occurring during construction is not subtracted from total predicted amounts (See discussion in Section 8.9 for more details).
3. Preconsolidation of the subsoil is not accounted for in the analysis. Preconsolidation may be due to a geologic load applied in past time or to removal of significant amounts of soil in construction prior to placement of the foundation. This error can cause a grossly overestimated settlement.

As explained in Chapter 7, there are two primary types of settlement, immediate (short-term) and consolidation (long-term). The procedures for computing these settlements under spread footings are similar to those under embankments as discussed in Chapter 7. The following sections illustrate the computation of immediate and consolidation settlements.

### **8.5.1 Immediate Settlement**

As noted in Chapter 7, there are several methods available to evaluate immediate settlements. Modified Hough's method was introduced in Chapter 7 and was illustrated by an example. Modified Hough's method can also be applied to shallow foundations by using the same approach demonstrated in Chapter 7. Studies conducted by FHWA (1987) indicate that Modified Hough's procedure is conservative and over-predicts settlement by a factor of 2 or more. Such conservatism may be acceptable for the evaluation of the settlement of embankments due to reasons discussed in Chapter 7. However, in the case of shallow foundations such conservatism may lead to unnecessary use of costlier deep foundations in cases where shallow foundations may be viable. Therefore, use of a more rigorous procedure such Schmertmann's modified method (1978) is recommended for shallow foundations, and is presented here.

### 8.5.1.1 Schmertmann's Modified Method for Calculation of Immediate Settlements

An estimate of the immediate settlement,  $S_i$ , of spread footings can be made by using Equation 8-16 as proposed by Schmertmann, *et al.* (1978).

$$S_i = C_1 C_2 \Delta p \sum_{i=1}^n \Delta H_i \quad \text{where} \quad \Delta H_i = H_c \left( \frac{I_z}{XE} \right) \quad 8-16$$

where:  $I_z$  = strain influence factor from Figure 8-21a. The dimension  $B_f$  represents the least lateral dimension of the footing after correction for eccentricities, i.e. use least lateral effective footing dimension. The strain influence factor is a function of depth and is obtained from the strain influence diagram. The strain influence diagram is easily constructed for the axisymmetric case ( $L_f/B_f = 1$ ) and the plane strain case ( $L_f/B_f \geq 10$ ) as shown in Figure 8-21a. The strain influence diagram for intermediate conditions can be determined by simple linear interpolation.

$n$  = number of soil layers within the zone of strain influence (strain influence diagram).

$\Delta p$  = net uniform applied stress (load intensity) at the foundation depth (see Figure 8-21b).

$E$  = elastic modulus of layer  $i$  based on guidance provided in Table 5-16 in Chapter 5.

$X$  = a factor used to determine the value of elastic modulus. If the value of elastic modulus is based on correlations with  $N_{160}$ -values or  $q_c$  from Table 5-16 in Chapter 5, then use  $X$  as follows.

$$X = 1.25 \text{ for axisymmetric case } (L_f/B_f = 1)$$

$$X = 1.75 \text{ for plane strain case } (L_f/B_f \geq 10)$$

Use interpolation for footings with  $1 < L_f/B_f \leq 10$

If the value of elastic modulus is estimated based on the range of elastic moduli in Table 5-16 or other sources use  $X = 1.0$ .



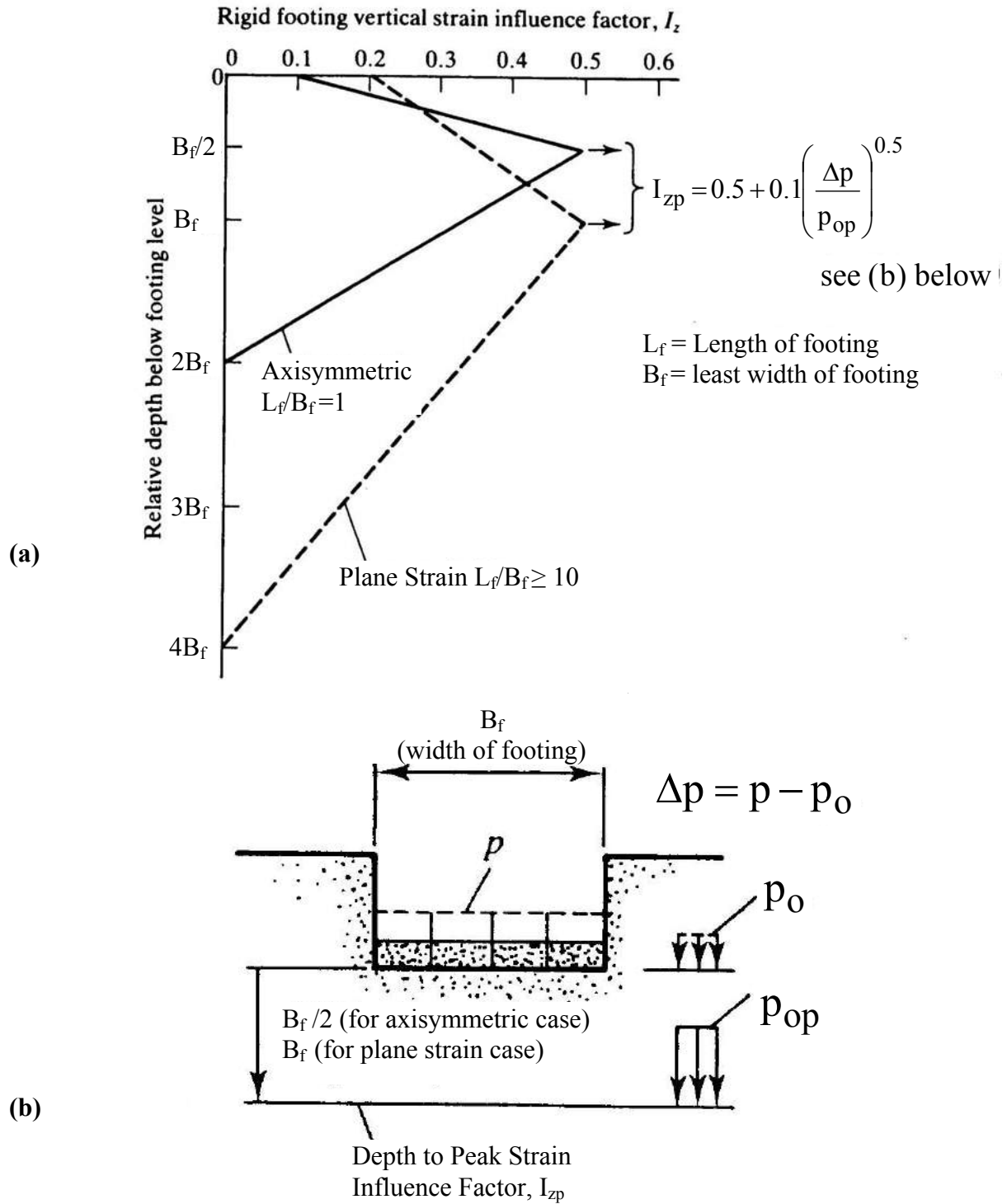

**Figure 8-21. (a) Simplified vertical strain influence factor distributions, (b) Explanation of pressure terms in equation for  $I_{zp}$  (after Schmertmann, *et al.*, 1978).**

$C_1$  = a correction factor to incorporate the effect of strain relief due to embedment where:

$$C_1 = 1 - 0.5 \left( \frac{p_o}{\Delta p} \right) \geq 0.5 \quad 8-17$$

where  $p_o$  is effective in-situ overburden stress at the foundation depth and  $\Delta p$  is the net foundation pressure as shown in Figure 8-21b

$C_2$  = a correction factor to incorporate time-dependent (creep) increase in settlement for  $t$  (years) after construction where:

$$C_2 = 1 + 0.2 \log_{10} \left( \frac{t(\text{years})}{0.1} \right) \quad 8-18$$

### 8.5.1.2 Comments on Schmertmann's Method

- **Effect of lateral strain:** Schmertmann and his co-workers based their method on the results of displacement measurements within sand masses loaded by model footings, as well as finite element analyses of deformations of materials with nonlinear stress-strain behavior that expressly incorporated Poisson's ratio. Therefore, the effect of the lateral strain on the vertical strain is included in the strain influence factor diagrams.
- **Effect of preloading:** The equations used in Schmertmann's method are applicable to normally loaded sands. If the sand was pre-strained by previous loading, then the actual settlements will be overpredicted. Schmertmann, *et al.* (1978) recommend a reduction in settlement after preloading or other means of compaction of half the predicted settlement. Alternatively, in case of preloaded soil deposits, the settlement can be computed by using the method proposed by D'Appolonia (1968, 1970), which includes explicit consideration of preloading.
- **$C_2$  correction factor:** The time duration,  $t$ , in Equation 8-18 is set to 0.1 years to evaluate the settlement immediately after construction, i.e.,  $C_2 = 1$ . If long-term creep deformation of the soil is suspected then an appropriate time duration,  $t$ , can be used in the computation of  $C_2$ . **As explained in Sections 5.4.1 and 7.6, creep deformation is not the same as consolidation settlement.** This factor can have an important influence on the reported settlement since it is included in Equation 8-16 as a multiplier. For example, the  $C_2$  factor for time durations of 0.1 yrs, 1 yr, 10 yrs and 50 yrs are 1.0, 1.2, 1.4 and 1.54, respectively. In cohesionless soils and unsaturated fine-grained cohesive

soils with low plasticity, time durations of 0.1 yr and 1 yr, respectively, are generally appropriate and sufficient for cases of static loads. Where consolidation settlement is estimated in addition to immediate settlement,  $C_2 = 1$  should be used.

The use of Schmertmann's modified method to calculate immediate settlement is illustrated numerically in Example 8-2.

**Example 8-2:** A 6 ft x 24 ft footing is founded at a depth of 3 ft below ground elevation with the soil profile and average  $N_{160}$  values shown. Determine the settlement in inches (a) at the end of construction and (b) 1 year after construction. There is no groundwater. The footing is subjected to an applied stress of 2,000 psf.

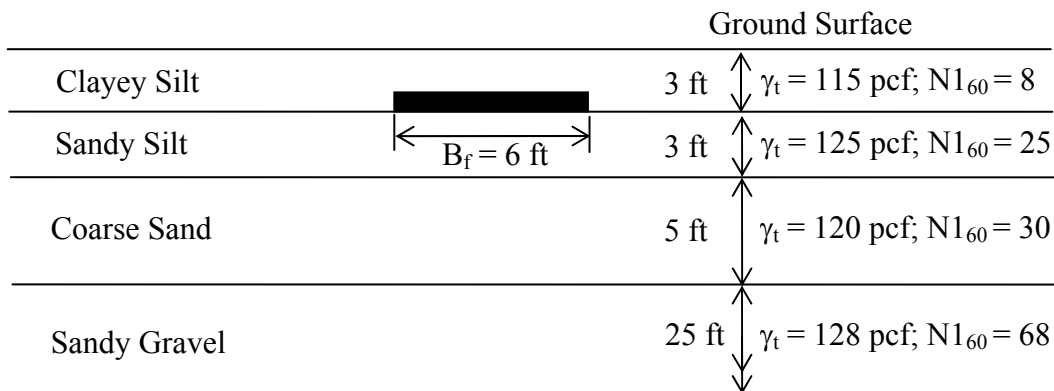

**Solution:**

**Step 1:** Begin by drawing the strain influence diagram. The  $L_f/B_f$  ratio for the footing is  $24'/6' = 4$ . From Figure 8-21(a), determine the value of the strain influence factor at the base of the footing,  $I_{ZB}$ , as follows:

$$I_{ZB} = 0.1 \text{ for axisymmetric case } (L_f/B_f = 1)$$

$$I_{ZB} = 0.2 \text{ for plane strain case } (L_f/B_f \geq 10)$$

Difference between axisymmetric  $L_f/B_f$  and plane strain  $L_f/B_f = 9$

Difference between axisymmetric  $I_{ZB}$  and plane strain  $I_{ZB} = 0.1$

Use linear interpolation for  $L_f/B_f = 4$ :

$\Delta(L_f/B_f)$  with respect to axisymmetric  $L_f/B_f = 4 - 1 = 3$ . Therefore

$$I_{ZB} = 0.1 + \frac{(0.2 - 0.1)}{9}(3) = 0.1 + \frac{0.1}{3} = 0.133$$

**Step 2:** Determine the maximum depth of influence,  $D_I$ , as follows:

$$D_I = 2B_f \quad \text{for } L_f/B_f = 1$$

$$D_I = 4B_f \quad \text{for } L_f/B_f > 10$$

By using linear interpolation  $L_f/B_f = 4$  as before:

$\Delta (L_f/B_f)$  with respect to axisymmetric  $L_f/B_f = 4-1 = 3$ . Therefore

$$D_I = 2B_f + \frac{(4B_f - 2B_f)}{9}(3) = 2B_f + \frac{2B_f}{3} = \frac{6B_f + 2B_f}{3} = \frac{8B_f}{3}$$

$$D_I = \frac{8}{3}(6 \text{ ft}) = 16 \text{ ft}$$

**Step 3:** Determine the depth to the peak strain influence factor,  $D_{IP}$ , as follows:

$$\text{From Figure 8-21(a)} \quad D_{IP} = B_f/2 \quad \text{for } L_f/B_f = 1$$

$$D_{IP} = B_f \quad \text{for } L_f/B_f > 10$$

Use linear interpolation for  $L_f/B_f = 4$ :

$\Delta (L_f/B_f)$  with respect to axisymmetric  $L_f/B_f = 4-1 = 3$ . Therefore

$$D_{IP} = \frac{B_f}{2} + \frac{\left(B_f - \frac{B_f}{2}\right)}{9}(3) = \frac{B_f}{2} + \frac{B_f}{6} = \frac{3B_f + B_f}{6} = \frac{4B_f}{6}$$

$$D_{IP} = \frac{4}{6}(6 \text{ ft}) = 4 \text{ ft}$$

**Step 4:** Determine the value of the maximum strain influence factor,  $I_{ZP}$ , as follows:

$$I_{ZP} = 0.5 + 0.1 \left( \frac{\Delta p}{p_{op}} \right)^{0.5}$$

$$\Delta p = 2,000 \text{ psf} - 3 \text{ ft}(115 \text{ pcf}) = 1,655 \text{ psf}$$

$$p_{op} = 3 \text{ ft}(115 \text{ pcf}) + 3 \text{ ft}(125 \text{ pcf}) + 1 \text{ ft}(120 \text{ pcf})$$

$$p_{op} = 345 \text{ psf} + 375 \text{ psf} + 120 \text{ psf} = 840 \text{ psf}$$

$$I_{ZP} = 0.5 + 0.1 \sqrt{\frac{1,655 \text{psf}}{840 \text{psf}}} = 0.64$$

**Step 5:** Draw the  $I_Z$  vs. depth diagram as follows and divide it into convenient layers by using the following guidelines:

- The depth of the peak value of the strain influence is fixed. To aid in the computation, develop the layering such that one of the layer boundaries occurs at this depth even though it requires that an actual soil layer be sub-divided.
- Limit the top layer as well as the layer immediately below the peak value of influence factor,  $I_{zp}$ , to  $2/3B_f$  or less to adequately represent the variation of the influence factor within  $D_{IP}$ .
- Limit maximum layer thickness to 10 ft (3 m) or less.
- Match the layer boundary with the subsurface profile layering.

In accordance with the above guidelines, the influence depth of 16 ft is divided into 4 layers as shown below. Since the strain influence diagram starts at the base of the footing, the thickness of Layer 1 corresponds to the thickness of the sandy silt layer shown in the soil profile. Likewise, Layer 4 corresponds to the thickness of the sandy gravel layer that has been impacted by the strain influence diagram. The sum of the thicknesses of Layers 2 and 3 correspond to the thickness of the coarse sand layer shown in the soil profile. The subdivision is made to account for the strain influence diagram going through its peak value within the coarse sand layer. The minimum and maximum layer thicknesses are 1 ft (Layer 2) and 8 ft (Layer 4), respectively. The layer boundaries are shown by solid lines while the layer centers are shown by dashed lines.

**Step 6:** Determine value of elastic modulus  $E_s$  from Table 5-16 from Chapter 5.

Layer 1: Sandy Silt:  $E = 4N_{160}$  tsf

Layer 2: Coarse Sand:  $E = 10N_{160}$  tsf

Layer 3: Coarse Sand:  $E = 10N_{160}$  tsf

Layer 4: Sandy Gravel:  $E = 12N_{160}$  tsf

Since the elastic modulus  $E_s$  is based on correlations with  $N_{160}$ -values obtained from Table 5-16, calculate the X multiplication factor as follows:

$X = 1.25$  for  $L_f/B_f = 1$

$X = 1.75$  for  $L_f/B_f \geq 10$

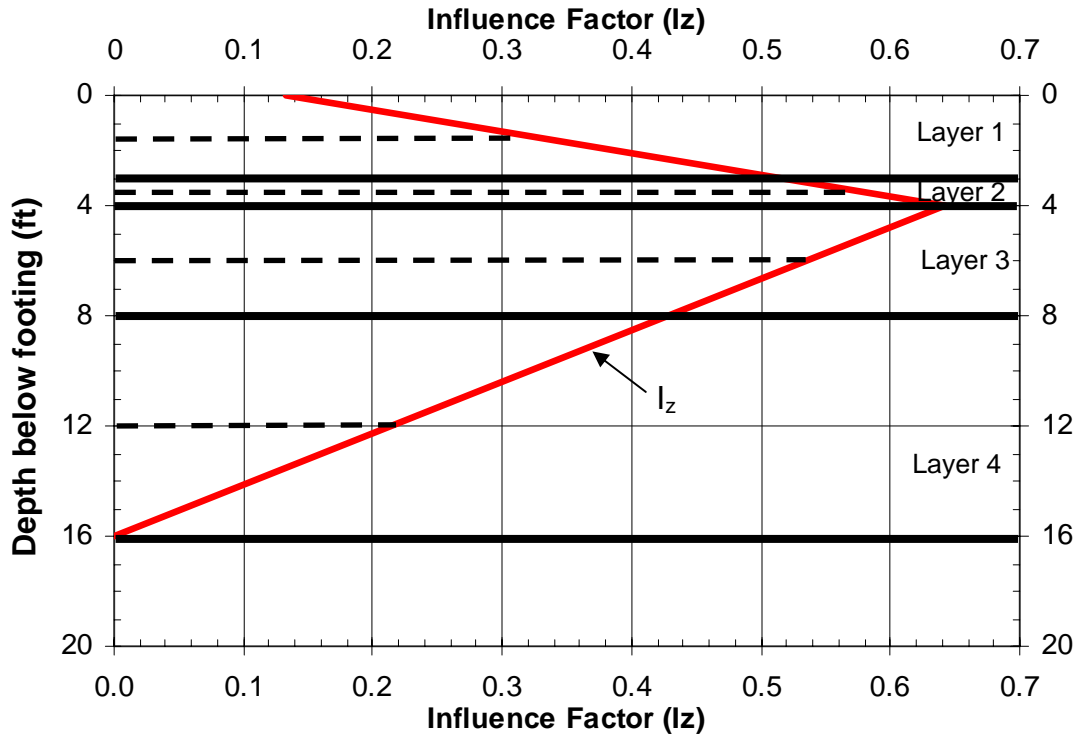

Use linear interpolation for  $L_f/B_f = 4$

$\Delta (L_f/B_f)$  with respect to axisymmetric  $L_f/B_f = 4 - 1 = 3$

$$X = 1.25 + \frac{(1.75 - 1.25)}{9} (3) = 1.42$$

**Step 7:** Using the thickness of each layer,  $H_c$ , and the relevant values for that particular layer, determine the settlement by setting up a table as follows:

| Layer          | $H_c$<br>(inches) | $N_{160}$ | $E$<br>(tsf) | $XE$<br>(tsf) | $Z_1$<br>(ft) | $I_z$ at $Z_i$ | $\Delta H_i = \frac{I_z}{XE} H_c$<br>(in/tsf) |
|----------------|-------------------|-----------|--------------|---------------|---------------|----------------|---|
| 1              | 36                | 25        | 100          | 142           | 1.5           | 0.323          | 0.0819  |
| 2              | 12                | 30        | 300          | 426           | 3.5           | 0.577          | 0.0163  |
| 3              | 48                | 30        | 300          | 426           | 6             | 0.533          | 0.0601  |
| 4              | 96                | 68        | 816          | 1,159         | 12            | 0.213          | 0.0177  |
| $\Sigma H_i =$ |                   |           |              |               |               |                | <b>0.1760</b>                                 |

**Step 8:** Determine embedment factor ( $C_1$ ) and creep factor ( $C_2$ ) as follows:

a) Embedment factor

$$C_1 = 1 - 0.5 \left( \frac{p_o}{\Delta p} \right) = 1 - 0.5 \left( \frac{3 \text{ ft} \times 115 \text{ pcf}}{1655 \text{ psf}} \right) = 0.896$$

b) Creep Factor

$$C_2 = 1 + 0.2 \log_{10} \left( \frac{t(\text{years})}{0.1} \right)$$

- For end of construction  $t(\text{yrs}) = 0.1 \text{ yr}$  (1.2 months)

$$C_2 = 1 + 0.2 \log_{10} \left( \frac{0.1}{0.1} \right) = 1.0$$

- For end of 1 year:

$$C_2 = 1 + 0.2 \log_{10} \left( \frac{1}{0.1} \right) = 1.2$$

**Step 9:** Determine the settlement at end of construction as follows:

$$S_i = C_1 C_2 \Delta p \sum H_i$$

$$S_i = (0.896)(1.0) \left( \frac{1,655 \text{ psf}}{2,000 \text{ psf/tsf}} \right) \left( 0.1760 \frac{\text{in}}{\text{tsf}} \right)$$

$$S_i = 0.130 \text{ inches}$$

**Step 10:** Determine the settlement after 1 year as follows:

$$S_i = 0.130 \text{ inches} \left( \frac{1.2}{1.0} \right) = 0.156 \text{ inches}$$

### 8.5.1.3 Tabulation of Parameters in Schmertmann's Method

To facilitate computations, Table 8-11 presents a tabulation of the various parameters involved in computation of settlement by Schmertmann's method. This table was generated by using the linear interpolation scheme demonstrated in Example 8-2. Linear interpolation may be used for  $L_f/B_f$  values between those presented in Table 8-11.

Table 8-11

Values of parameters used in settlement analysis by Schmertmann's method

| $L_f/B_f$   | $I_z$ at footing base, $I_{zB}$ | Depth to $I_{zp}$ , $D_{IP}$ | Depth of $I_z$ diagram, $D_1$ | X factor     | $L_f/B_f$    | $I_z$ at footing base, $I_{zB}$ | Depth to $I_{zp}$ , $D_{IP}$ | Depth of $I_z$ diagram, $D_1$ | X factor     |
|-------------|---------------------------------|------------------------------|-------------------------------|--------------|--------------|---------------------------------|------------------------------|-------------------------------|--------------|
|             |                                 | Note 1                       | Note 1                        | Note 2       |              |                                 | Note 1                       | Note 1                        | Note 2       |
| <b>1.00</b> | <b>0.100</b>                    | <b>0.500</b>                 | <b>2.000</b>                  | <b>1.250</b> | <b>6.00</b>  | <b>0.156</b>                    | <b>0.778</b>                 | <b>3.111</b>                  | <b>1.528</b> |
| 1.25        | 0.103                           | 0.514                        | 2.056                         | 1.264        | 6.25         | 0.158                           | 0.792                        | 3.167                         | 1.542        |
| 1.50        | 0.106                           | 0.528                        | 2.111                         | 1.278        | 6.50         | 0.161                           | 0.806                        | 3.222                         | 1.556        |
| 1.75        | 0.108                           | 0.542                        | 2.167                         | 1.292        | 6.75         | 0.164                           | 0.819                        | 3.278                         | 1.569        |
| <b>2.00</b> | <b>0.111</b>                    | <b>0.556</b>                 | <b>2.222</b>                  | <b>1.306</b> | <b>7.00</b>  | <b>0.167</b>                    | <b>0.833</b>                 | <b>3.333</b>                  | <b>1.583</b> |
| 2.25        | 0.114                           | 0.569                        | 2.278                         | 1.319        | 7.25         | 0.169                           | 0.847                        | 3.389                         | 1.597        |
| 2.50        | 0.117                           | 0.583                        | 2.333                         | 1.333        | 7.50         | 0.172                           | 0.861                        | 3.444                         | 1.611        |
| 2.75        | 0.119                           | 0.597                        | 2.389                         | 1.347        | 7.75         | 0.175                           | 0.875                        | 3.500                         | 1.625        |
| <b>3.00</b> | <b>0.122</b>                    | <b>0.611</b>                 | <b>2.444</b>                  | <b>1.361</b> | <b>8.00</b>  | <b>0.178</b>                    | <b>0.889</b>                 | <b>3.556</b>                  | <b>1.639</b> |
| 3.25        | 0.125                           | 0.625                        | 2.500                         | 1.375        | 8.25         | 0.181                           | 0.903                        | 3.611                         | 1.653        |
| 3.50        | 0.128                           | 0.639                        | 2.556                         | 1.389        | 8.50         | 0.183                           | 0.917                        | 3.667                         | 1.667        |
| 3.75        | 0.131                           | 0.653                        | 2.611                         | 1.403        | 8.75         | 0.186                           | 0.931                        | 3.722                         | 1.681        |
| <b>4.00</b> | <b>0.133</b>                    | <b>0.667</b>                 | <b>2.667</b>                  | <b>1.417</b> | <b>9.00</b>  | <b>0.189</b>                    | <b>0.944</b>                 | <b>3.778</b>                  | <b>1.694</b> |
| 4.25        | 0.136                           | 0.681                        | 2.722                         | 1.431        | 9.25         | 0.192                           | 0.958                        | 3.833                         | 1.708        |
| 4.50        | 0.139                           | 0.694                        | 2.778                         | 1.444        | 9.50         | 0.194                           | 0.972                        | 3.889                         | 1.722        |
| 4.75        | 0.142                           | 0.708                        | 2.833                         | 1.458        | 9.75         | 0.197                           | 0.986                        | 3.944                         | 1.736        |
| <b>5.00</b> | <b>0.144</b>                    | <b>0.722</b>                 | <b>2.889</b>                  | <b>1.472</b> | <b>10.00</b> | <b>0.200</b>                    | <b>1.000</b>                 | <b>4.000</b>                  | <b>1.750</b> |
| 5.25        | 0.147                           | 0.736                        | 2.944                         | 1.486        | > 10         | <b>0.200</b>                    | <b>1.000</b>                 | <b>4.000</b>                  | <b>1.750</b> |
| 5.50        | 0.150                           | 0.750                        | 3.000                         | 1.500        |              |                                 |                              |                               |              |
| 5.75        | 0.153                           | 0.764                        | 3.056                         | 1.514        |              |                                 |                              |                               |              |

**Notes:**

1. The depths are obtained by multiplying the value in this column by the footing width,  $B_f$ .
2. If elastic modulus is not based on SPT or CPT, then  $X=1.0$ . See Section 8.5.1.1 for a discussion on values of X factor.

**Legend**

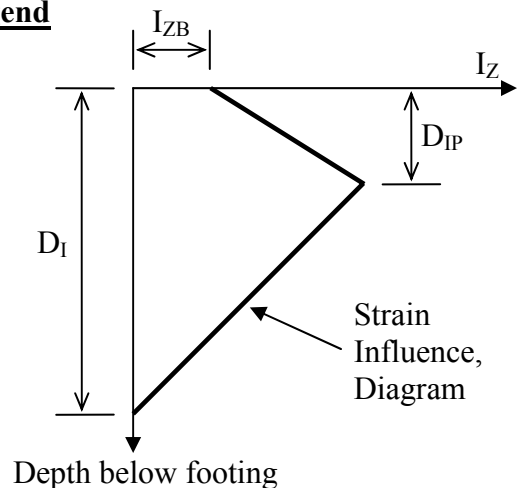



### 8.5.2 Obtaining Limiting Applied Stress for a Given Settlement

As indicated in Section 8.3, the allowable bearing capacity based on settlement considerations is defined as “the applied stress that results in a specified amount of settlement.” Thus, the quantity of interest is often the limiting applied stress for a specified amount of settlement. In this case, Equation 8-16 can be inverted and solved to obtain the limiting applied stress,  $\Delta p$ , for a given settlement,  $S_i$ . By repeating the computation for a range of settlement values, the curves shown in Zone B of Figure 8-10 can be generated. It is important to realize that the applied stress computed by the inverted form of Equation 8-16 is a uniform stress. Consequently, that value of stress should be compared to the Meyerhof equivalent uniform pressure ( $q_{eq}$ ) acting on an effective footing width as shown in Figure 8-17b and not the maximum stress ( $q_{max}$ ) of the trapezoidal pressure distribution on the total footing width as shown in Figure 8-17a. It is for this reason that the X-axis of an allowable bearing capacity chart refers to an effective footing width and not total footing width.

### 8.5.3 Consolidation Settlement

The procedures to compute consolidation settlements discussed in Chapter 7 can be applied to spread footings also. The following example illustrates the method for determining consolidation settlement due to a load applied to a spread footing.

**Example 8-3:** Determine the settlement of the 10 ft  $\times$  10 ft square footing due to a 130 kip axial load. Assume the gravel layer is incompressible.

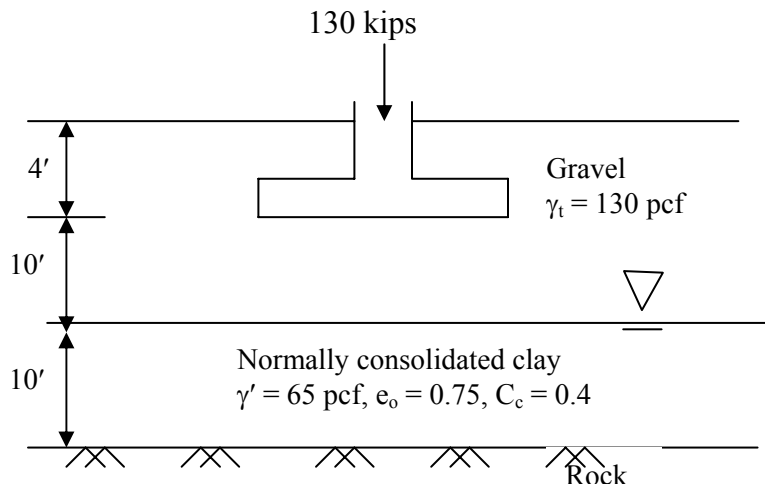

**Solution:**

Find overburden pressure,  $p_o$ , at center of clay layer

$$p_o = (14 \text{ ft} \times 130 \text{ pcf}) + (5 \text{ ft} \times 65 \text{ pcf}) = 2,145 \text{ psf}$$

Find change in pressure ( $\Delta p$ ) at center of clay layer due to applied load. Use the approximate 2:1 stress distribution method discussed in Section 2.5 of Chapter 2.

$$\Delta p = \frac{130 \text{ kips}}{(10 \text{ ft} + 15 \text{ ft})^2} = \frac{130 \text{ kips}}{625 \text{ ft}} = 0.208 \text{ ksf} = 208 \text{ psf}$$

Use Equation 7-2 to calculate the magnitude of consolidation settlement.

$$\Delta H = H \frac{C_c}{1 + e_o} \log_{10} \left( \frac{p_o + \Delta p}{p_o} \right)$$
$$\Delta H = 10 \text{ ft} \left( \frac{0.4}{1 + 0.75} \right) \log_{10} \left( \frac{2,145 \text{ psf} + 208 \text{ psf}}{2,145 \text{ psf}} \right) = 0.09 \text{ ft} = 1.1 \text{ in}$$

In reality, the magnitude of the total settlement of the foundation would be the sum of the consolidation settlement of the clay and the immediate settlement of the gravel. The gravel was assumed to be incompressible in this example. However, in practice, the component of the total settlement due to the immediate settlement of the gravel would be determined by using Schmertmann's method with only that portion of the strain influence diagram in the gravel being considered.

## 8.6 SPREAD FOOTINGS ON COMPACTED EMBANKMENT FILLS

Geotechnical engineers have long recognized the desirability of placing footings on engineered fills. In general, the load imposed by the weight of the fill is many times that of the imposed footing load. If adequate time is allowed for the foundation soils to settle under the fill load, subsequent application of a smaller structural load will result in negligible settlement of the structure. In bridge construction, common practice is to build the approach embankment excluding the area to be occupied by the abutment and allow settlement to occur prior to abutment construction. Details of the settlement of approach embankment fills are presented in Chapter 7.

Field evaluation of spread footings placed in or on engineered fills constructed of select granular material, show that spread footings provide satisfactory performance, i.e., minimal vertical and lateral displacements, if all relevant factors are considered in the design of the embankment and the footing. A performance evaluation of spread footings on compacted embankment fills was conducted through a joint study between FHWA and the Washington State Department of Transportation (FHWA, 1982). A visual inspection was made of the structural condition of 148 highway bridges supported by spread footings on engineered fills throughout the State of Washington. The approach pavements and other bridge appurtenances were also inspected for damage or distress that could be attributed to the use of spread footings on engineered fill. This review, in conjunction with detailed survey investigations of the foundation movement of 28 selected bridges, was used to evaluate the performance of spread footings on engineered fills. None of the bridges investigated displayed any safety problems or serious functional distress. The study concluded that spread footings can provide a satisfactory alternative to deep foundations, especially when high embankments of good quality borrow materials are constructed over satisfactory foundation soils. Further studies were made to substantiate the feasibility of using spread footings in lieu of more expensive deep foundation systems. Cost analyses showed that spread footings were 50 to 65 percent less expensive than the alternate choice of deep foundations. Studies of foundation movement showed that bridges easily tolerated differential settlements of 1 to 3 inches (25 to 75 mm) without serious distress.

In addition to the FHWA (1982) study which was limited to the bridges in the State of Washington, a nationwide study of 314 bridges was conducted (FHWA, 1985). The nationwide study arrived at similar conclusions. Unfortunately many agencies continue to disregard spread footings as alternative foundations for highway structures. Yet another study (NCHRP, 1983), states the following:

"In summary, it is very clear that the tolerable settlement criteria currently used by most transportation agencies are extremely conservative and are needlessly restricting the use of spread footings for bridge foundations on many soils. Angular distortions of 1/250 of the span length and differential vertical movements of 2 to 4 inches (50 to 100 mm), depending on span length, appear to be acceptable, assuming that approach slabs or other provisions are made to minimize the effects of any differential movements between abutments and approach embankments. Finally, horizontal movements in excess of 2 inches (50 mm) appear likely to cause structural distress. The potential for horizontal movements of abutments and piers should be considered more carefully than is done in current practice."

It is recommended that **compacted structural fills used for supporting spread footings should be a select and specified material that includes sand- and gravel-sized particles. Furthermore, the fill should be compacted to a minimum relative compaction of 95% based on Modified Proctor compaction energy. This structural fill should extend for the entire embankment below the footing.** FHWA (2002c) notes that the Washington Department of Transportation (WSDOT) successfully used the gradation listed in Table 8-12 to design spread footings for the I-5 Kalama Interchange. WSDOT limited the maximum bearing pressures to 3 tsf (290 kPa) and the measured settlements were found to be less than 1.5 in (40 mm) within the fill. In addition to WSDOT, the Nevada Department of Transportation (NDOT) commonly uses spread foundations founded within compacted structural embankment fills.

Direct shear testing of materials such as those described in Table 8-12 is not practical on a project-by-project basis since such materials require large specialized test equipment. Therefore the design of spread footings on compacted sand and gravel is based on a combination of experience and the results of infrequent large-scale laboratory testing on specified gradations of select fill materials. Materials specifications are then developed based on the specified gradations to ensure good quality control during construction. This procedure helps ensure that the conclusions from the laboratory tests are valid for the construction practices used to place the fills.

**Table 8-12**  
**Typical specification of compacted structural fill used by WSDOT (FHWA, 2002c)**

| Sieve Size  | Percent Passing |
|---|-----------------|
| 4" (100 mm)   | 100             |
| 2" (50 mm)  | 75 – 100        |
| No. 4 (4.75 mm)   | 50 – 80         |
| No. 40 (0.425 mm)   | 30 max          |
| No. 200 (0.075 mm)  | 7 max           |
| Sand Equivalent (See Note 1)  | 42 min          |
| <b>Notes:</b>   |                 |
| 1. See Section 5.3.4.1 in Chapter 5 for a discussion of sand equivalent test. |                 |

### **8.6.1 Settlement of Footings on Structural Fills**

Calculation of the settlement of a spread footing supported in or on an engineered fill requires an assumption about the compressibility of the fill material. Because structural fills should be constructed of good-quality granular materials and by following good construction techniques, the estimation of settlement lends itself to the application of the methods

discussed in this Chapter. To estimate settlements of footings in structural fills by Schmertmann's method, an assumption must be made about the SPT N-value that is representative of the engineered fill.

FHWA (1987) used a SPT N-value of 32 blows per foot corrected for overburden pressure as a representative value for estimating settlement in structural fills. This value of SPT N-value corresponds to a relative density,  $D_r$ , of approximately 85 percent at an overburden stress of about 1 tsf (100 kPa) (FHWA, 1987); this is confirmed by the data in Figure 5-23. Based on Figure 5-33 or Equation 5-21, this value of  $D_r$  is at approximately 97% relative compaction based on Modified Proctor compaction energy (ASTM D 1557). Under such compacted conditions, and in the absence of other SPT data in structural fills, the settlement of a footing supported on structural fill can be estimated by using an assumed corrected SPT N-value ( $N_{160}$ ) of 32. However, a relative compaction of 95% based on Modified Proctor compaction energy is often used. For this case, a corrected SPT N-value ( $N_{160}$ ) of 23 is more appropriate.

## 8.7 FOOTINGS ON INTERMEDIATE GEOMATERIALS (IGMs) AND ROCK

The assumption made in this chapter is that intermediate geomaterials (IGMs) are stiff and strong enough that bearing capacity and settlement considerations will generally not govern the design of a spread footing supported on such a material. If a settlement estimate is necessary for shallow foundations supported on an IGM or rock, a method based on elasticity theory is probably the best approach. As with any of the methods for estimating settlement that use elasticity theory, the accuracy of the values estimated for the elastic parameter(s) required by the method is a major factor in determining the reliability of the predicted settlements.

Equation 8-19 may be used to compute the settlement of a shallow spread footing founded on rock based on Young's modulus of the intact rock. In this equation, the stress applied at the top of the rock surface can be calculated by using the stress distribution methods presented in Chapter 2.

$$\delta_v = \frac{C_d \Delta p B_f (1 - \nu^2)}{E_m} \quad 8-19$$

where:  $\delta_v$  = vertical settlement at surface  
 $C_d$  = shape and rigidity factors (Table 8-13)

- $\Delta p$  = change in stress at top of rock surface due to applied footing load
- $B_f$  = footing width or diameter
- $\nu$  = Poisson's ratio (refer to Table 5-22 in Chapter 5)
- $E_m$  = Young's modulus of rock mass (see Section 5.12.1 in Chapter 5)

The elastic modulus of IGMs and some rocks may be measurable by in situ testing with equipment such as the pressuremeter (FHWA 1989a), the dilatometer (FHWA 1992b), and plate load tests or flat jacks. ASTM standards are available for each of these in situ tests and they provide details regarding performance and the interpretation of the test data. The method for determining elastic modulus based on RMR discussed in Chapter 5.

To preserve the stability of footings on IGMs or rock, the geotechnical engineer must evaluate the potential for a global stability failure and the potential of limitations of the allowable bearing capacity because of the presence of rock mass discontinuities. The bearing capacity of IGMs derived from sedimentary rock can dramatically decrease when the IGM is exposed to weathering and moisture.

**Table 8-13**

**Shape and rigidity factors,  $C_a$ , for calculating settlements of points on loaded areas at the surface of a semi-infinite elastic half space (after Winterkorn and Fang, 1975)**

| Shape                     | Center | Corner | Middle of Short Side | Middle of Long Side | Average |
|---------------------------|--------|--------|----------------------|---------------------|---------|
| Circle                    | 1.00   | 0.64   | 0.64                 | 0.64                | 0.85    |
| Circle (rigid)            | 0.79   | 0.79   | 0.79                 | 0.79                | 0.79    |
| Square                    | 1.12   | 0.56   | 0.76                 | 0.76                | 0.95    |
| Square (rigid)            | 0.99   | 0.99   | 0.99                 | 0.99                | 0.99    |
| Rectangle (length/width): |        |        |                      |                     |         |
| 1.5                       | 1.36   | 0.67   | 0.89                 | 0.97                | 1.15    |
| 2                         | 1.52   | 0.76   | 0.98                 | 1.12                | 1.30    |
| 3                         | 1.78   | 0.88   | 1.11                 | 1.35                | 1.52    |
| 5                         | 2.10   | 1.05   | 1.27                 | 1.68                | 1.83    |
| 10                        | 2.53   | 1.26   | 1.49                 | 2.12                | 2.25    |
| 100                       | 4.00   | 2.00   | 2.20                 | 3.60                | 3.70    |
| 1000                      | 5.47   | 2.75   | 2.94                 | 5.03                | 5.15    |
| 10000                     | 6.90   | 3.50   | 3.70                 | 6.50                | 6.60    |

## 8.8 ALLOWABLE BEARING CAPACITY CHARTS

The concept of an allowable bearing capacity chart was discussed in Section 8.3. The curves shown in Figure 8-10 can be obtained by performing computations for allowable bearing capacity and settlement for a range of values of footing widths by using the procedures described in Sections 8.4 to 8.7. This section presents an example bearing capacity chart and a step-by-step procedure to use such a chart for the sizing of footings.

**Example 8-3:** The abutments of a bridge will be founded on spread foundations similar to the configuration shown in Figure 8-4. The length,  $L_f$ , of the abutment footing is 130 ft. The minimum depth of embedment,  $D_f$ , of the footing base is 5 ft. The geotechnical engineer developed a bearing capacity chart based on site-specific subsurface data. This chart is shown in Figure 8-22. Determine the footing width,  $B_f$ , such that the settlement of the footing is less than or equal to 1 in.

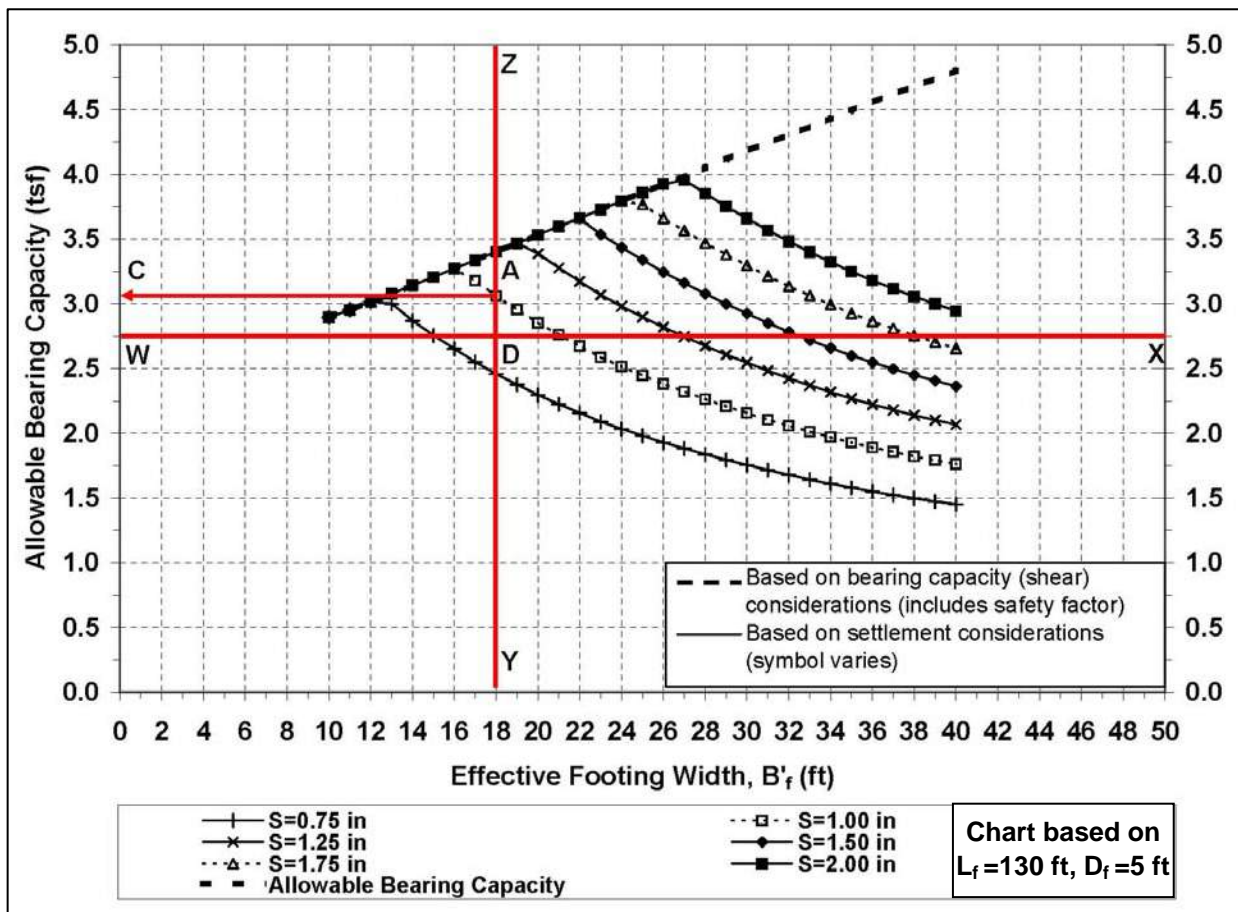

Figure 8-22. Example allowable bearing capacity chart.

**Solution:**

**Step 1:**

Assume a footing width,  $B_f$ , and compute the equivalent ***net*** uniform (Meyerhof) bearing pressure,  $q_{eu}$ , at the base of the footing. The equivalent net uniform bearing pressure,  $q_{eu}$ , is obtained by dividing the resultant vertical load,  $R$ , by the effective area,  $A'$ , of the footing as follows:

$$q_{eu} = R/A'$$

The resultant vertical load, i.e., the vertical component of the resultant load, should be determined by using the **unfactored** dead load, plus the **unfactored** component of live and impact loads assumed to extend to the footing level (Section 4.4.7.2 of AASHTO, 2002). The effective area,  $A'$ , is determined as follows based on Equation 8-7, 8-8 and 8-9:

$$A' = B'_f L'_f = (B_f - 2e_B) (L_f - 2e_L)$$

where  $e_B$  and  $e_L$  are the eccentricities of the resultant load,  $R$ , in the  $B_f$  and  $L_f$  directions, respectively, as indicated in Figure 8-16. The eccentricities,  $e_B$  and  $e_L$  should be such that they are less than  $B_f/6$  and  $L_f/6$ , respectively to ensure that no uplift occurs anywhere within the base of the footing. In cases where there is no load eccentricity, the effective length,  $L'_f$ , and the effective width,  $B'_f$ , are equal to the actual length,  $L_f$ , and actual width,  $B_f$ , respectively.

For the example problem stated above, assume for the sake of illustration that the computed equivalent net uniform bearing pressure,  $q_{eu}$ , at the base of the footing is 2.75 tsf for a retaining wall footing that is 130 ft long ( $L_f = L'_f$ ), has an effective width,  $B'_f$ , of 18 ft, and is embedded 5 ft.

**Step 2:**

Since the minimum required allowable bearing capacity has to be at least equal to the net equivalent uniform bearing pressure,  $q_{eu}$ , draw a horizontal line on the chart corresponding to the value of  $q_{eu}$ . Thus, for the example problem, draw a horizontal line WX on the chart corresponding to a value of 2.75 tsf as shown in Figure 8-22. This horizontal line will intersect the curves of equal settlement, e.g.,  $S=0.75$  in,  $S = 1.0$  in and so on as shown in Figure 8-22.



### **Step 3:**

Draw a vertical line YZ for the effective footing width,  $B'_f$ , of 18 ft. Like the horizontal line, WX, the vertical line, YZ, will intersect the curves of equal settlement, e.g.,  $S=0.75$  in,  $S = 1.0$  in as shown in Figure 8-22.

### **Step 4:**

From the point of intersection of the vertical line, YZ, with the appropriate acceptable settlement curve (1.00-in for this example) draw a horizontal line to the Y-axis to determine the allowable bearing capacity. By drawing the horizontal line, AC, it can be determined that the allowable bearing capacity corresponding to an effective footing width of 18 ft is approximately 3.2 tsf (see Point C in Figure 8-22). This value is greater than the  $q_{eu}$  value of 2.75 tsf and therefore the footing whose effective width,  $B'_f$ , is 18 ft is acceptable.

An alternative way to evaluate the acceptability of a footing size is to determine the estimated settlement corresponding to the computed equivalent net uniform bearing pressure,  $q_{eu}$ , and compare it with the acceptable settlement. From the bearing capacity chart for the example problem, it can be seen that at an effective footing width,  $B'_f$ , of 18 ft and a  $q_{eu}$  value of 2.75 tsf, the estimated settlement will be approximately 0.88 in (see Point D that falls between the  $S=0.75$  in and  $S=1.00$  in curves in Figure 8-22). This value of estimated settlement is less than the limiting settlement of 1 in and is therefore acceptable.

### **Step 5:**

Repeat Steps 1 to 4 as necessary to optimize the footing design or to resize the footing based on the “available” allowable bearing capacity. In this example, the “available” allowable bearing capacity for an 18 ft wide footing is 3.2 tsf which is greater than the required value of 2.75 tsf. Thus, it is possible that the footing width can be reduced. During the optimization process, linear interpolation within the limits of the data presented in the chart is acceptable. However, extrapolation of data is not advisable.

## **8.8.1 Comments on the Allowable Bearing Capacity Charts**

- A factor of safety, FS, against ultimate bearing capacity (shear) failure is included in the computations that yield the steeply rising line on the left side of the chart, i.e., the line that is based on bearing capacity considerations. Since the settlement based allowable bearing capacity curves plot on the right side of the bearing capacity line, the actual factor of safety against shear failure will be higher than the assumed minimum FS.

- The effective footing width,  $B'_f$ , on the X-axis of the charts represents the least lateral effective dimension of the footing. The footing size determined from the chart is a function of the depth of embedment of the footing,  $D_f$ , and the length of the footing,  $L_f$ . The depth of embedment,  $D_f$ , is the vertical distance between the lowest finished permanent ground surface above the footing to the base of the footing. Each bearing capacity chart is developed for a given footing length,  $L_f$ , and a minimum depth of embedment,  $D_f$ . Therefore, these quantities must be clearly labeled on the chart as shown in Figure 8-22. If the actual dimensions of  $D_f$  and/or  $L_f$  vary by more than  $\pm 10\%$  from those noted on the charts then a new chart should be developed for the actual values of  $D_f$  and  $L_f$ .
- Finally, each bearing capacity chart should be specific to a given foundation element and should be developed based on location-specific geotechnical data. Consequently the charts should not be used for foundations at locations other than at which they are applicable.

## 8.9 EFFECT OF DEFORMATIONS ON BRIDGE STRUCTURES

Bridge foundations and other geotechnical features such as approach embankments should be designed so that their deformations (settlements and/or lateral movements) will not cause damage to the bridge structure. Uneven displacements of bridge abutments and pier foundations can affect the quality of ride and the safety of the traveling public as well as the structural integrity of the bridge. Such movements often lead to costly maintenance and repair measures. Therefore, it is important that the geotechnical specialist as well as the structural engineer fully understand the effect of deformations of geotechnical features on bridge structures.

FHWA (1985) and Duncan and Tan (1991) studied tolerable movements for bridges and found that “foundation movements would become intolerable for some other reason before reaching a magnitude that would create intolerable rider discomfort.” The “other” reasons might include reduction of clearance at overpasses and drainage considerations, as discussed later. Therefore, if movements are within a tolerable range with regard to structural distress for the bridge superstructure, they will also be acceptable with respect to user comfort and safe vehicle operation. The severity of the consequences of uneven movements of bridge structures, superstructure as well as substructure, increases with the magnitude of the settlements and lateral movements. Both of these components of bridge movements are discussed below.

### A. Settlement

Settlement can be subdivided into the following three components, which are illustrated in Figure 8-23 (Duncan and Tan, 1991):

1. **Uniform settlement:** In this case, all bridge support elements settle equally. Even though the bridge support elements settle equally, they can cause differential settlement with respect to the approach embankment and associated features such as approach slabs and utilities that are commonly located in or across the end-spans of bridges. Such differential settlement can create several problems. For example, it can reduce the clearance of the overpass, create a bump at the end of the bridge, change grades at the end of the bridge causing drainage problems, and distort underground utilities at the interfaces of the bridge and approaches.

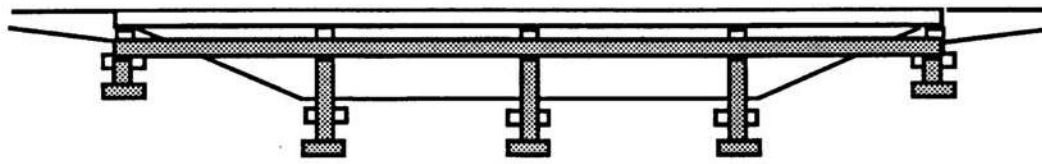

Uniform Settlement

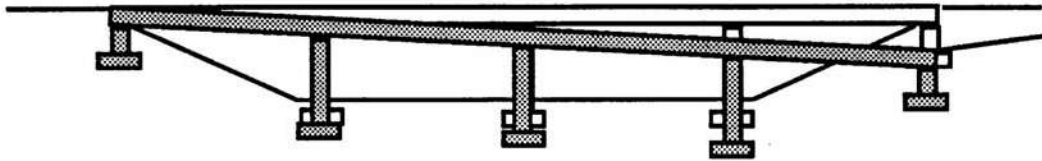

Tilt (Rotation)

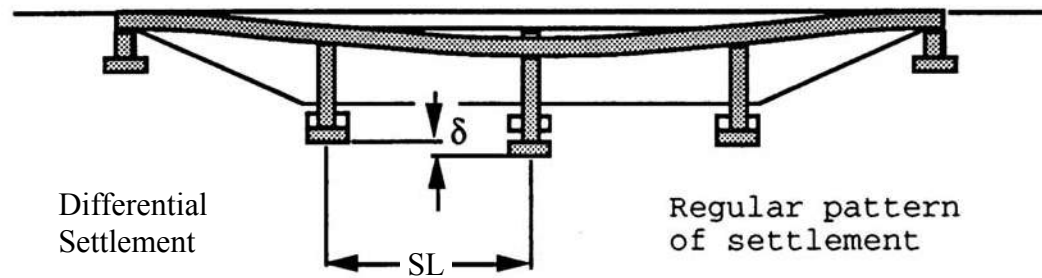

Differential Settlement

Regular pattern of settlement

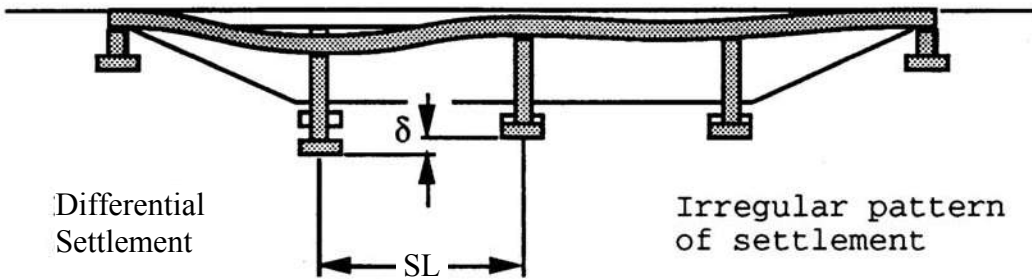

Differential Settlement

Irregular pattern of settlement

$A = \text{Angular Distortion}$

$$A = \frac{\text{Difference in Settlement Between Foundations}}{\text{Distance Between Foundations}} = \frac{\delta}{SL}$$

**Figure 8-23. Components of settlement and angular distortion in bridges (after Duncan and Tan, 1991).**

Although uniform settlements may be computed theoretically, from a practical viewpoint it is not possible for the bridge structure to experience truly uniform settlement due to a combination of many factors including, but not limited to, the variability of loads and soil properties

2. **Tilt or rotation:** Tilt or rotation occurs mostly in single span bridges with stiff superstructures. Tilt or rotation may not cause distortion of the superstructure and associated damage, but due to its differential movement with respect to the facilities associated with approach embankments, tilt or rotation can create problems similar to those of uniform settlement that were discussed above, e.g., a bump at the end of the bridge, drainage problems, and damage to underground utilities.
3. **Differential settlement:** Differential settlement directly results in deformation of the bridge superstructure. As shown in Figure 8-23, two different patterns of differential settlement can occur. These are:
  - a. **Regular pattern:** In this case, the settlement increases progressively from the abutments towards the center of the bridge
  - b. **Irregular pattern:** In this case, the settlement at each support location varies along the length of the bridge.

Both of the above patterns of settlement lead to angular distortion, which is defined as the ratio of the difference in settlement between two points divided by the distance between the two points. For bridge structures, the two points to evaluate the differential settlement are commonly selected as the distance between adjacent support elements, SL, as shown in Figure 8-23. Depending on the type of connections between the superstructure and support columns (pinned or fixed) and the locations of expansion and construction joints along the bridge deck (mid-span or elsewhere), the irregular pattern of differential settlement has the potential to create greater structural distress than the regular pattern of differential settlement. The distress may occur due to increased internal stresses associated with flexure and/or shear of the bridge superstructure and is generally manifested by cracks in the bridge deck and/or girders at support locations.

In addition to the problems they create in the bridge superstructure, differential settlements can create the same problems as uniform settlements discussed earlier, i.e., problems with bumps at the junctures with approach slabs, problems with drainage, problems with clearance at underpasses, etc.

## **B. Horizontal Movements**

Horizontal movements cause more severe and widespread problems than do equal magnitudes of vertical settlement. The types of problems that arise as a result of differential horizontal movements between bridge decks and abutments, or between adjacent spans of bridges, include the following (Duncan and Tan, 1991):

- Shearing of anchor bolts,
- Excessive opening of expansion joints,
- Reduced effectiveness of expansion joints when clearance is reduced,
- Complete closing of expansion joints and jamming of bridge decks into abutments or adjacent spans,
- Shifting of abutments when expansion joints jam,
- Severe damage to abutment walls, approach slabs or bridge decks due to excessive loads when expansion joints jam,
- Distortion and damage to bearing devices,
- Excessive tilting of rockers,
- Damage to rail curbs, sidewalks and parapets.

## **C. Reliability of Estimation of Movements**

All analytical methods used for estimating movements are based on certain assumptions. Therefore, there is an inherent uncertainty associated with the estimated values of movements. The uncertainty of estimated differential settlement is larger than the uncertainty of the estimated settlement at the two support elements used to calculate the differential settlement, e.g., between abutment and pier, or between piers. For example, if one support element settles less than the amount estimated while the other support element settles the amount estimated, the actual differential settlement will be larger than the difference between the two values of estimated settlement at the support elements. Duncan and Tan (1991) suggest the following assumptions to estimate the likely value of differential settlement:

- The settlement of any support element could be as large as the value calculated by using conservative procedures, and
- At the same time, the settlement of the adjacent support element could be zero.

Use of these conservative assumptions would result in an estimated maximum possible differential settlement equal to the largest settlement calculated at either end of any span.

## 8.9.1 Criteria for Tolerable Movements of Bridges

### 8.9.1.1 Vertical Movements

The FHWA (1985) study used the following definition of intolerable movement:

“Movement is not tolerable if damage requires costly maintenance and/or repairs and a more expensive construction to avoid this would have been preferable.”

This definition is somewhat subjective based on the cost and practical problems involved in the repair and maintenance or use of an alternative more expensive construction technique. FHWA (1985) studied data for 56 simple span bridges and 119 continuous span bridges and chose to express the definition for tolerable movement quantitatively in terms of limiting angular distortion as shown in Table 8-14.

**Table 8-14**

**Tolerable movement criteria for bridges (FHWA, 1985; AASHTO 2002, 2004)**

| <b>Limiting Angular Distortion, <math>\delta/SL</math></b> | <b>Type of Bridge</b>                   |
|--|---|
| 0.004  | Multiple-span (continuous span) bridges |
| 0.005  | Single-span bridges                     |

Note:  $\delta$  is differential settlement,  $SL$  is the span length. The quantity,  $\delta/SL$ , is dimensionless and is applicable when the same units are used for  $\delta$  and  $SL$ , i.e., if  $\delta$  is expressed in inches then  $SL$  should also be expressed in inches.

For example, the criteria in Table 8-14 suggest that for a 100 ft (30 m) span, a differential settlement of 4.8 inches (120 mm) is acceptable for a continuous span and 6 inches (150 mm) is acceptable for a simple span.

Such relatively large values of differential settlements create concern for structural designers, who often arbitrarily limit the criteria to one-half to one-quarter of the values listed in Table 8-14. While there are no technical reasons for structural designers to set such arbitrary additional limits for the criteria listed in Table 8-14, there are often practical reasons based on the tolerable limits of deformation of other structures associated with a bridge, e.g., approach slabs, wingwalls, pavement structures, drainage grades, utilities on the bridge, deformations that adversely affect quality of ride, etc. Thus, the relatively large differential settlements based on Table 8-14, should be considered in conjunction with functional or performance criteria not only for the bridge structure itself but for all of the associated facilities. The following steps are suggested in this regard:

- Step 1: Identify all possible facilities associated with the bridge structure, and the tolerance of those facilities to movements.
- Step 2: Due to the inherent uncertainty associated with estimated values of settlement, determine the differential settlement by using the conservative assumptions described earlier. It is important that the estimation of differential settlement is based on a realistic evaluation of the sequence and magnitude of the loads as described in Section 8.9.2.
- Step 3: Compare the differential settlement from Step 2 with the various tolerances identified in Step 1 and in Table 8-14. Based on this comparison identify the critical component of the facility. Review this critical component to check if it can be relocated or if it can be designed to more relaxed tolerances. Repeat this process as necessary for other facilities. In some cases, a simple re-sequencing of the construction of the facility based on the construction sequence of the bridge may help mitigate the issues associated with intolerable movements.

The above approach will help to develop project-specific limiting angular distortion criteria that may differ from the general guidelines listed in Table 8-14.

### **8.9.1.2 Horizontal Movements**

Based on a survey of bridges, FHWA (1985) found that horizontal movements less than 1 in (25 mm) were almost always reported as being tolerable, while horizontal movements greater than 2 in (50 mm) were quite likely to be considered to be intolerable. Based on this observation, FHWA (1985) recommended that horizontal movements be limited to 1.5 in (38 mm). The data presented by FHWA (1985) showed that horizontal movements tended to be more damaging when they were accompanied by settlement than when they were not. The estimation of magnitude of horizontal movements should take into account the movements associated with considerations of slope instability and lateral squeeze as discussed in Chapter 6 and 7, respectively.

Abutments are often designed for active lateral earth pressure conditions, which require a certain amount of movement (see Chapter 9). Depending on the configuration of the bridge end spans and expansion joints, horizontal movements of an abutment can be restrained, however, such restraint can lead to an increase in the lateral earth pressures above the active earth pressures normally used in design. Design of expansion joints should allow for sufficient movement to keep earth pressures at or close to their design values and still allow the joints to perform properly under all temperature conditions.



## 8.9.2 Loads for Evaluation of Tolerable Movements Using Construction Point Concept

Most designers use the criteria described in Section 8.9.1 as if a bridge structure is instantaneously wished into place, i.e., all the loads are applied at the same time. In reality, loads are applied gradually as construction proceeds. Consequently, settlements will also occur gradually as construction proceeds. There are several critical construction points that should be evaluated separately by the designer. Table 8-15 illustrates this critical construction concept for a bridge abutment footing that was constructed as part of a 2-span bridge in the southwest United States. The prestressed concrete beam bridge is 64.4 ft (19.6 m) wide and 170 ft (52 m) long. The bridge is continuous with mechanically stabilized earth (MSE) walls wrapped around both of the abutments. The abutments are fixed for shear transfer through semi-integral diaphragms connected to spread footings on top of the MSE walls.

Even though the total settlement cited in Table 8-15 is 7.5 inches, in reality only 2.0 in is significant because it occurs progressively during the first 10 years the bridge is in service. (Note that immediately after construction the net settlement was estimated to be only 0.5 in even though the total settlement computed at this stage is 5.0 in)

The pier for this bridge is supported by a group of pipe piles and was estimated to experience a settlement of approximately 0.5 in. To compute the worst angular distortion, it was assumed that the pier would not experience settlement while the abutment would experience the full estimated settlement. Thus, the angular distortion criterion where 0 in settlement is assumed at the pier yields the following results for an 85 ft span (1/2 of the 170 ft long bridge):

- *With Construction Point Concept*

$$\text{Angular Distortion, } A = (2.0 \text{ in} - 0.0 \text{ in}) / (85 \text{ ft} \times 12 \text{ in/ft}) = 2.0 \text{ in} / 1,020 \text{ in} = 0.002$$

In this case, A is one-half of the limiting angular distortion of 0.004 as per Table 8-14. Therefore, the settlements are acceptable.

- *Without Construction Point Concept*

$$\text{Angular Distortion, } A = (7.5 \text{ in} - 0.0 \text{ in}) / (85 \text{ ft} \times 12 \text{ in/ft}) = 7.5 \text{ in} / 1,020 \text{ in} = 0.0073$$

Since  $A > 0.004$ , the angular distortion is deemed intolerable.

**Table 8-15****Example of settlements evaluated at various critical construction points**

| <b>Construction Point</b>  | <b>Estimated Net Applied Stress<sup>1</sup><br/>(psf)</b> | <b>Settlement<br/>(inches)<sup>2</sup></b> | <b>Net Settlement<br/>(inches)</b> |
|--|---|--|------------------------------------|
| I. Embankment only   | 2,770   | 3.4  | -                                  |
| II. MSE Wall + Spread footing<br>(no deck)                           | 6,020   | 5.0  | 1.6 (during<br>construction)       |
| III. MSE Wall + Spread footing +<br>Deck (DL + LL)                   | 6,520   | 5.5  | 0.5<br>(= 5.5 – 5.0)               |
| IV. MSE Wall + Spread Footing +<br>Deck (DL+LL) + Creep <sup>3</sup> | 6,520   | 7.5  | 2.0<br>(= 7.5 – 5.5)               |

Notes:

1. The 2 ft depth of embedment for the MSE wall was taken into account while estimating the net applied stress from new construction.
2. Settlement analyses were performed by using Schmertmann's method (1978) that allows for estimation of long-term (creep) settlement. In this project, relatively dry, low plastic fine grained soils were encountered that could possibly deform for some time after construction.
3. A time period of 1.5 months was assumed for each Point II and III analyses. For this duration, the creep component of the deformation was less than 5% of the settlements reported above for Point II and III. Conservatively, a time period of 10 years was assumed for the creep deformations for Point IV, after which it was assumed that no significant creep deformations would occur. Note, that the net settlement of 2.0 inches between construction Point III and IV is attributed entirely to creep settlement.

In this example, if the designer did not take into account the various construction points when evaluating settlement, then not only would the angular distortion criteria listed in Table 8-15 not be met but it would also likely lead to implementation of costly and unnecessary ground improvement measures. This approach was used successfully for 55 bridges constructed as part of the I25/I40 (“BIG I”) traffic interchange in Albuquerque, NM. This critical construction point approach permitted the use of true bridge abutments, i.e., spread footings on top of MSE walls, on 28 of the 55 bridges on the BIG I project, which resulted in significant cost savings for the New Mexico Department of Transportation (NMDOT). The project was completed in 2001 and all of the bridges have performed well to date (2006).

A key point in evaluating settlements at critical construction points is that the approach requires close coordination between the structural and geotechnical specialists. In the case of the BIG I project, the structural specialist performed a realistic evaluation of the loads and construction sequence and communicated them to the geotechnical specialist, who then evaluated the settlements for those loads. As demonstrated by the above example, this approach resulted in a realistic evaluation of the deformation of the bridge structure. This critical construction point approach can also often help in making other decisions such as the need for costly ground improvement measures.

## **8.10 SPREAD FOOTING LOAD TESTS**

Spread footing load tests can be used to verify both bearing capacity and settlement predictions. Briaud and Gibbens (1994) present the results of predicted and measured behavior of five spread footings on sand. Full scale tests have been done on predominantly granular soils. An example is the I-359 project in Tuscaloosa, Alabama where dead load was placed on 12 ft x 12 ft (3.7 m x 3.7 m) footings to create a foundation contact pressure of over 4 tsf (383 kPa). A settlement of 0.1 in (2.5 mm) was recorded when the footing concrete was placed. The greatest settlement recorded after application of the load was also approximately 0.1 in (2.5 mm). Spread footing load tests can help develop confidence in the use of such foundations for transportation structures.

## **8.11 CONSTRUCTION INSPECTION**

Construction inspection requirements for shallow foundations are similar to those for other concrete structures. In some cases, agencies may have inspector checklists for construction of shallow foundations. Table 8-16 provides a summary of construction inspection check points for shallow foundations. Throughout construction, the inspector should check submittals for completeness before transmitting them to the engineer.

### **8.11.1 Structural Fill Materials**

Fill requirements should be strictly adhered to because the fill must perform within expected limits with respect to strength and, more importantly, within tolerance for differential settlement. Sometimes the area for construction of the fill is small, such as behind abutment and wingwalls. In such situations, the use of hand compactors or smaller compaction equipment may be necessary.

When the construction of structural fills that will support shallow foundations is being monitored, particular attention should be paid to the following items:

- The material should be tested for gradation and durability at sufficient frequency to ensure that the material being placed meets the specification.
- The specified level of compaction must be obtained in the fill. Testing, if applicable, should be performed in accordance with standard procedures and at the recommended intervals or number of tests per lift.

If a surcharge fill is required for pre-loading, it should be verified that the unit weight of the surcharge fill meets the value assumed in the design.

**Table 8-16**

**Inspector responsibilities for construction of shallow foundations**

| <b>CONTRACTOR SET UP</b>   |
|--|
| <ul style="list-style-type: none"> <li>• Review plans and specifications.</li> <li>• Review contractor’s schedule.</li> <li>• Review test results and certifications for pre-approved materials, e.g., cement, coarse and fine aggregate.</li> <li>• Confirm that the contractor’s stockpile and staging area are consistent with locations shown on plans.</li> <li>• Discuss anticipated ground conditions and potential problems with the contractor.</li> <li>• Review the contractor’s survey results against the plans.</li> </ul>   |
| <b>EXCAVATION</b>  |
| <ul style="list-style-type: none"> <li>• Verify that excavation slopes and/or structural excavation support is consistent with the plans.</li> <li>• Confirm that limits of any required excavations are within right-of-way limits shown on the plans.</li> <li>• Confirm that all unsuitable materials, e.g., sod, snow, frost, topsoil, soft/muddy soils, are removed to the limits and depths shown on the plans and the excavation is backfilled with properly compacted granular material. <b>The in-place bearing stratum of soil or rock should be checked to verify the in-situ condition and the degree of improvement achieved by the contractor’s preparation approach. Some soil types can become remolded and weakened from disturbance. If the conditions deviate from those anticipated in the geotechnical report and/or the plans and specifications, the geotechnical engineer should be consulted to determine if additional measures are necessary.</b></li> <li>• Confirm that leveling and proof-rolling of the foundation area is consistent with the requirements of the specifications. Probing is recommended for verification of subgrade.</li> <li>• Confirm that contractor’s excavation operations do not result in significant water ponding.</li> <li>• Confirm that existing drainage features, utilities, and other features are protected.</li> <li>• Identify areas not shown on the plans where unsuitable material exists and notify engineer.</li> </ul> |
| <b>SHALLOW FOUNDATION</b>  |
| <ul style="list-style-type: none"> <li>• Approve footing foundation condition before concrete is poured.</li> <li>• Confirm reinforcement strength, size, and type consistent with the specifications.</li> <li>• Confirm consistency of the contractor’s outline of the footing (footing size and bottom of footing depth) with the plans.</li> <li>• Confirm location and spacing of reinforcing steel consistent with the plans.</li> <li>• Confirm water/cement ratio and concrete mix design consistent with the specifications.</li> <li>• Record concrete volumes poured for the footing.</li> <li>• Confirm appropriate concrete curing times and methods as provided in the specifications.</li> <li>• Confirm that concrete is not placed on ice, snow, or otherwise unsuitable ground.</li> <li>• Confirm that concrete is being placed in continuous horizontal layers and that the time between successive layers is consistent with the specifications.</li> </ul>   |
| <b>POST INSTALLATION</b>   |
| <ul style="list-style-type: none"> <li>• Verify pay quantities.</li> </ul>   |

### **8.11.2 Monitoring**

The elevations of constructed foundations should be checked before and after the structural load is applied. The measurements made at those times will serve as a baseline for the long-term monitoring of the bridge. Subsequently, additional survey measurements should be made to confirm satisfactory performance or to identify whether potentially harmful settlements are occurring. It may be important to check the completion of fill settlements before foundation construction if the fill was constructed over soft compressible soils. As indicated in Chapter 7, settlement plates, horizontal inclinometers, or other types of instrumentation are typically installed in such cases. The lateral displacement potential can be greater than the vertical movements; therefore, if conditions warrant, monitoring may also include complete survey coordinates and possibly more accurate instrumentation.

Monitoring may also be necessary to evaluate the impact of the new construction on neighboring facilities or the ground surface. Such concerns could be monitored with simple survey tag lines with benchmarks and monitoring hubs and telltales to measure lateral deviations and vertical subsidence/heave. Greater reliability may require more sophisticated instrumentation, such as inclinometers, strain gages, extensometers and tiltmeters. Surveys of the pre-construction condition of neighboring structures should be conducted, particularly in congested urban areas. The instrumentation program should be developed with a consideration of the anticipated performance, risks and potential consequences. Parameters should be identified that are critical to project success and appropriate instrumentation selected. A key to successful use of instrumentation is to measure, plot and interpret the data in a timely manner to be able to take corrective measures, if needed.