

Introduction to Basic Human Genetics

Professor Hanan Hamamy
Department of Genetic
Medicine and Development
Geneva University Hospital
Switzerland

Training Course in Sexual and
Reproductive Health Research
Geneva 2011

Module for community genetics educational objectives

- Knowledge of basic human genetics concepts
- Training in taking and recording a basic genetic family history
- Guidelines on detecting possible genetic risks and where and when to refer
- Training in the basic ethical principles and techniques of genetic counseling
- Training in preconception counseling
- Training in prescreening counseling, how to detect at risk couples or individuals and appropriate referral
- Information on the advantages and disadvantages of consanguineous marriages
- Information on common genetic disorders in the community
- Information on the existing specialist services and patient and family support organizations
- Information on genetic programs that would be introduced on the national level

Contents

- Categories of genetic diseases
- Birth defects(Congenital Disorders)
- Impact of genetic diseases
- DNA and protein synthesis
- Mutations

Spectrum of Human Disease

- Human diseases are caused by a multitude of genetic and environmental factors which are acting together
- In certain conditions such as Down syndrome, genetic factors predominate, while in tuberculosis for example, environmental factors predominate
- Most chronic non-communicable conditions such as schizophrenia and diabetes are caused by an interaction of both genetic and environmental factors

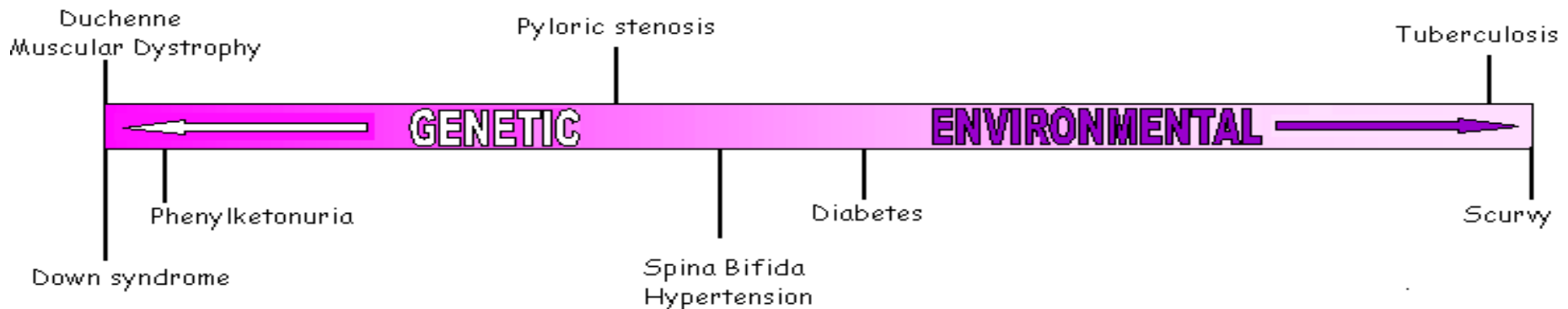

Categories of Genetic Diseases

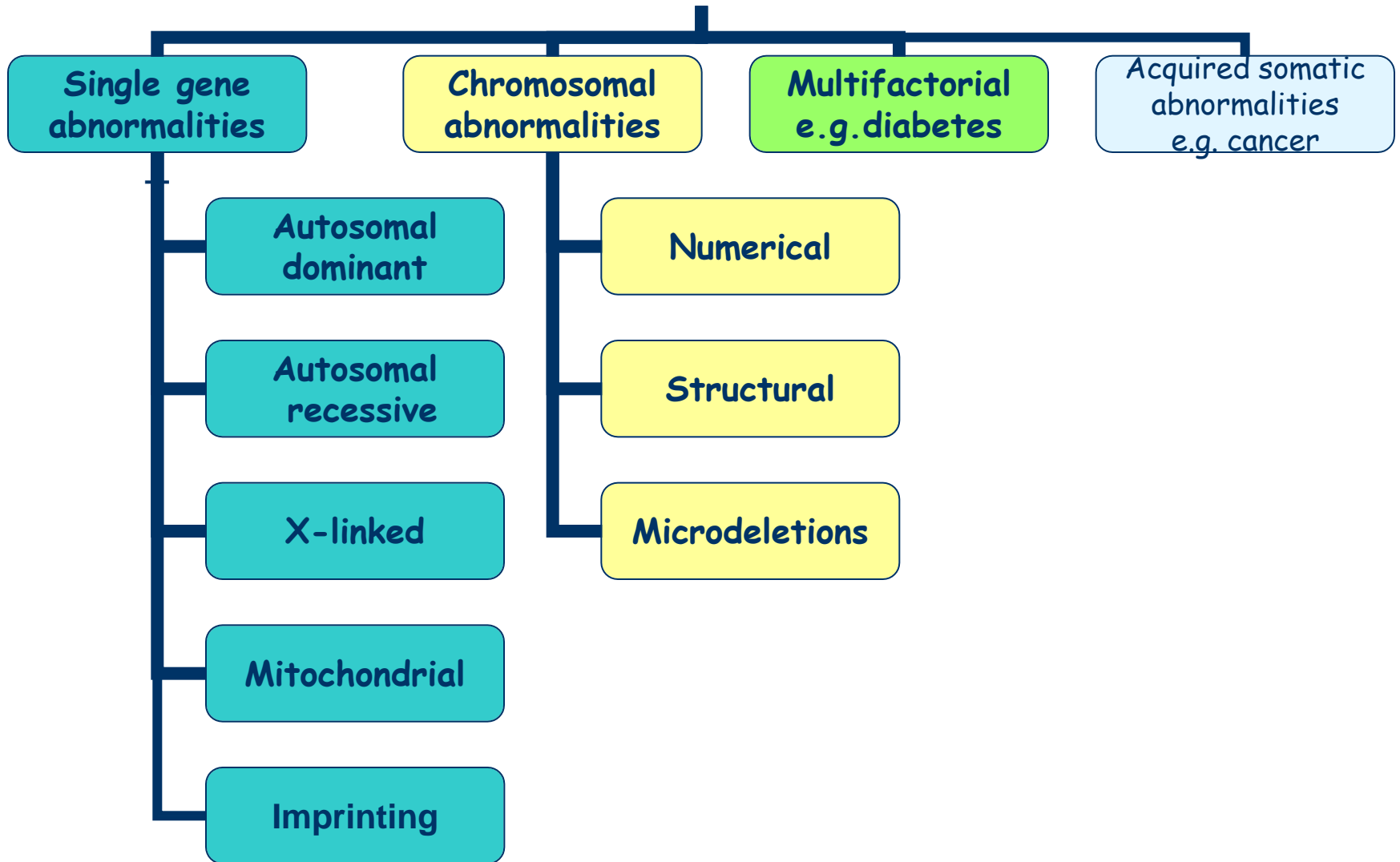

Family history and construction of a pedigree could point to the category of genetic disease in the family

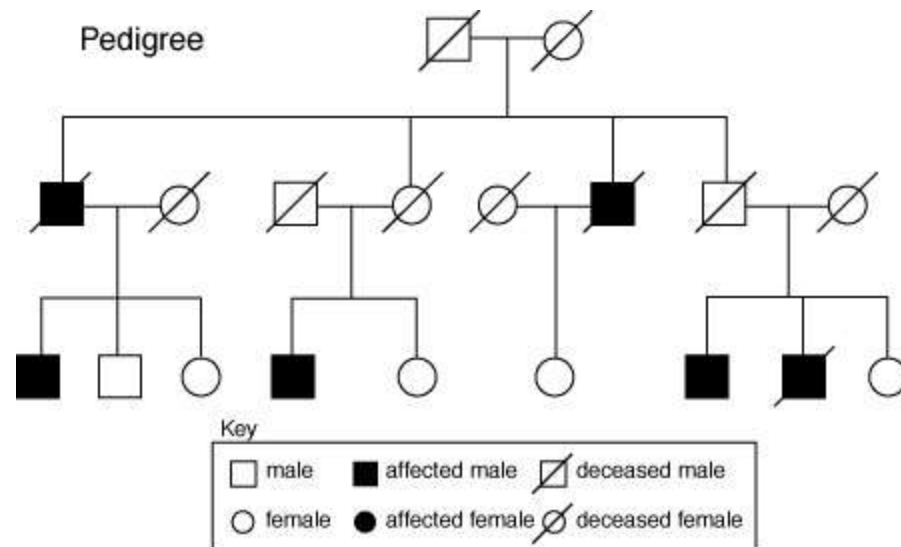

Categories of Genetic Diseases

- Single gene or unifactorial or Mendelian disorders: examples: thalasseмииs, sickle cell anemia, cystic fibrosis, albinism
- Chromosomal disorders such as Down syndrome , Turner syndrome
- Multifactorial disorders : both genetic and environmental factors play a role in causing the disease such as diabetes, asthma and schizophrenia

Birth defects (Congenital Disorders)

- According to the World Health Organization, the term congenital disorder includes any morphological, functional and biochemical-molecular defects that may develop in the embryo and fetus from conception until birth, whether detected at birth or later.
- This term is synonymous with the term birth defect used in the United States of America

Underlying causes of birth defects

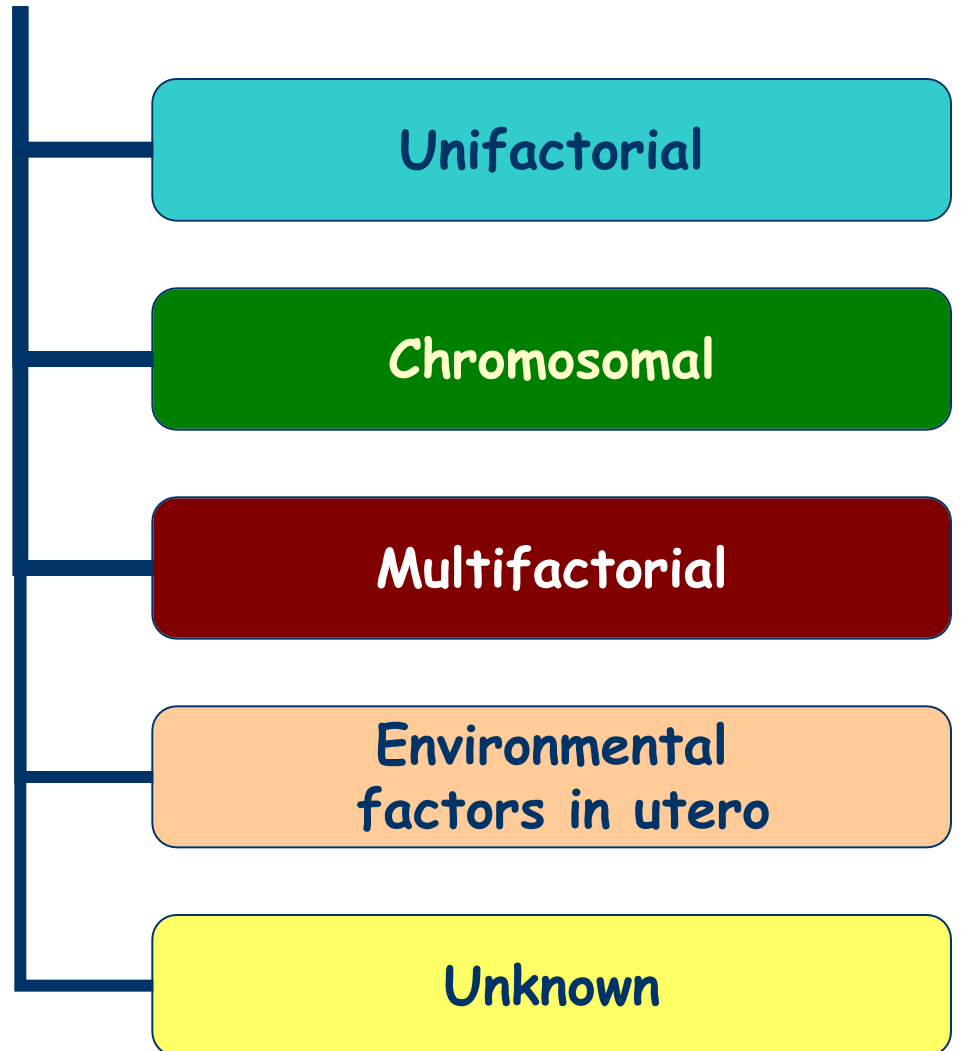

Classification of Congenital Disorders (Birth Defects)

Congenital abnormality (CA), or malformation (e.g. congenital heart defect)

Disability (e.g. mental subnormality)

Fetal disease (e.g. fetal toxoplasmosis)

Genetic disease (e.g. Down syndrome)

Intrauterine growth retardation (idiopathic)

Impact of genetic diseases

- Of all neonates, 2-3% have at least one major congenital abnormality, at least 50% of which are caused exclusively or partially by genetic factors.
- chromosome abnormalities occur in about 0.5% in neonates
- single-gene disorders occur in about 1% of in neonates
- A chromosome abnormality is present in 40-50% of all recognized first-trimester pregnancy loss. Approximately 1 in 6 of all pregnancies results in spontaneous miscarriage, thus around 5-7% of all recognized conceptions are chromosomally abnormal.

Impact of genetic diseases

- Genetic disorders account for 50% of all childhood blindness, 50% of all childhood deafness and 50% of all cases of severe learning difficulty.
- Approximately 1% of all malignancy is caused by single-gene inheritance, and between 5% and 10% of common cancers such as breast, colon and ovary have a strong hereditary component.
- Taking into account common diseases as diabetes and hypertension (multifactorial disorders) , it has been estimated that over 50% of the older adult population will have a genetically determined medical problem.

Prevalent disorders

The 4 most serious and prevalent genetic and congenital disorders are:

- Hemoglobin disorders (thalassemia and sickle cell anemia) and G6PD deficiency
- Down syndrome
- Neural tube defects
- Congenital heart defects

DNA

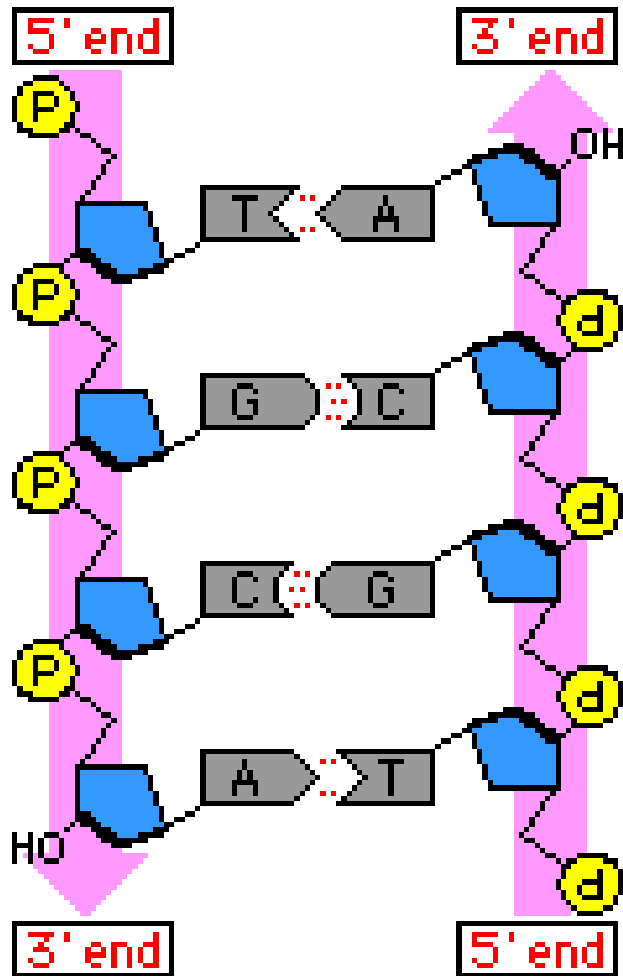

- DNA molecule is composed of two chains of nucleotides arranged in a double helix. The backbone of each chain is formed by phosphodiester bonds between the 3' and 5' carbons of adjacent sugars, the two chains being held together by hydrogen bonds between the nitrogenous bases (adenine, guanine, cytosine and thymine)
- The arrangement of the bases in the DNA molecule shows specific pairing of the base pairs: guanine (G) in one chain always pairs with cytosine (C) in the other chain and adenine (A) always pairs with thymine (T).

Chromosome structure

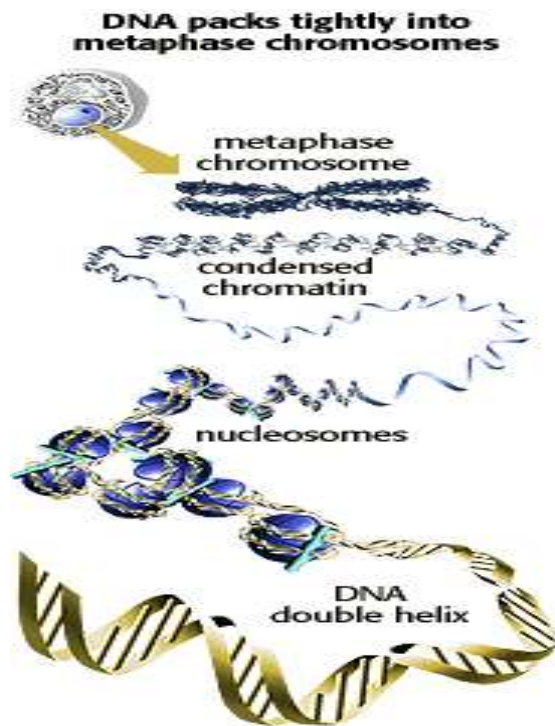

The packaging of DNA into chromosomes involves several orders of DNA coiling and folding. There is the primary coiling of the DNA double helix, the secondary coiling around spherical *histone* 'beads', forming what are called *nucleosomes*. There is a tertiary coiling of the nucleosomes to form the *chromatin fibres*

DNA Replication

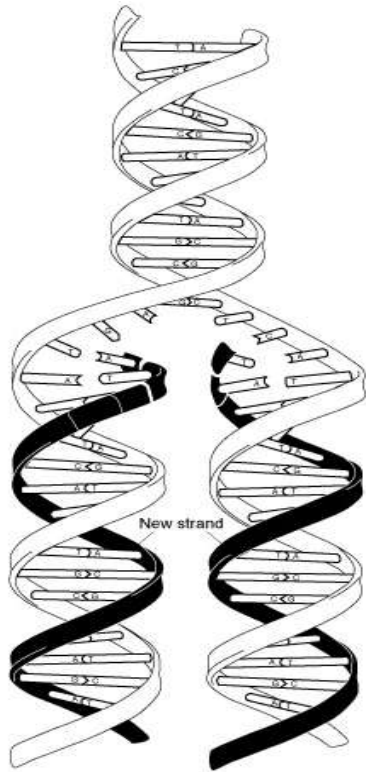

- During nuclear division the two strands of the DNA double helix separate through the action of the enzyme DNA helicase, each DNA strand directing the synthesis of a complementary DNA strand through specific base pairing, resulting in two daughter DNA duplexes that are identical to the original parent molecule. The process of DNA replication is termed *semiconservative*, as only one strand of each resultant daughter molecule is a newly synthesized strand.

Genes

- It is estimated that there are approximately 20,000-25,000 genes in the nuclear genome
- These unique single-copy genes in humans represent less than 2% of the genome
- There are 37 mitochondrial genes in the cytoplasm that are only inherited from the mother

Structure of a gene

- The gene is formed of a DNA segment of coding regions called exons and non-coding regions called introns. The sequence of bases in the exons determine the sequence of aminoacids and hence the protein structure

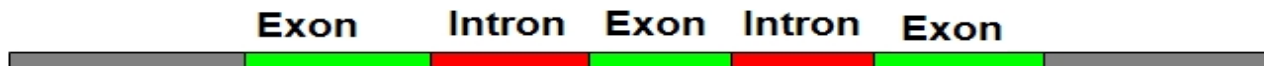

Protein synthesis: involves two processes, transcription and translation

- Transcription: information is passed from the DNA to mRNA (messenger RNA)
- Translation: Occurs in the ribosomes in the cytoplasm where the information is passed from mRNA to construct a chain of aminoacids

Transcription

- The information is transferred from DNA in the nucleus to messenger RNA (mRNA) in the cytoplasm. Each base in mRNA is complementary to the corresponding base in DNA template strand (in RNA, uracil (U) replaces the place of thymine to complement adenine)

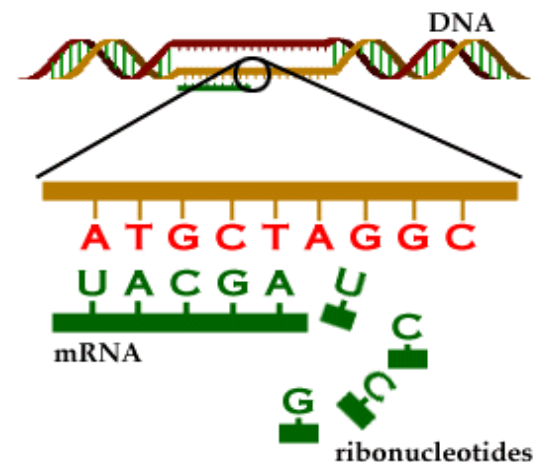

RNA splicing

- Process by which non-coding sequences of base pairs (**introns**) are removed from the initial mRNA so that only exons (the coding sequences) of a gene to form the final messenger RNA (mRNA.)

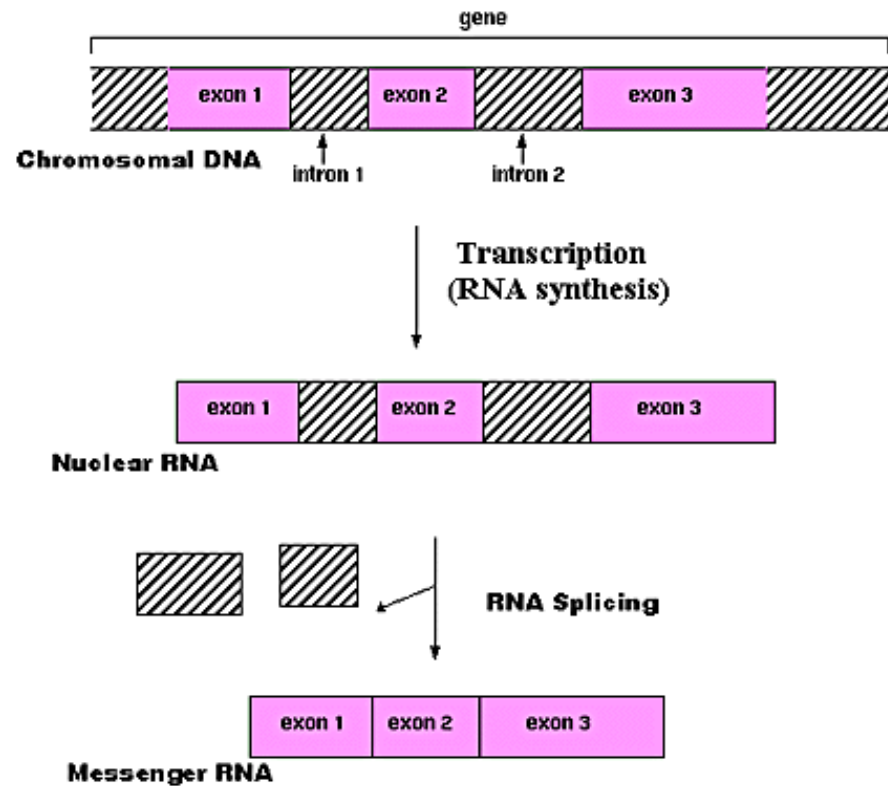

RNA synthesis and processing

Translation

- It is the transmission of genetic information from mRNA to protein.
- mRNA is transported from nucleus to cytoplasm where it is associated with the ribosomes.
- Each tRNA specific for an amino acid has a specific trinucleotide sequence called anticodon complementary to the mRNA codon

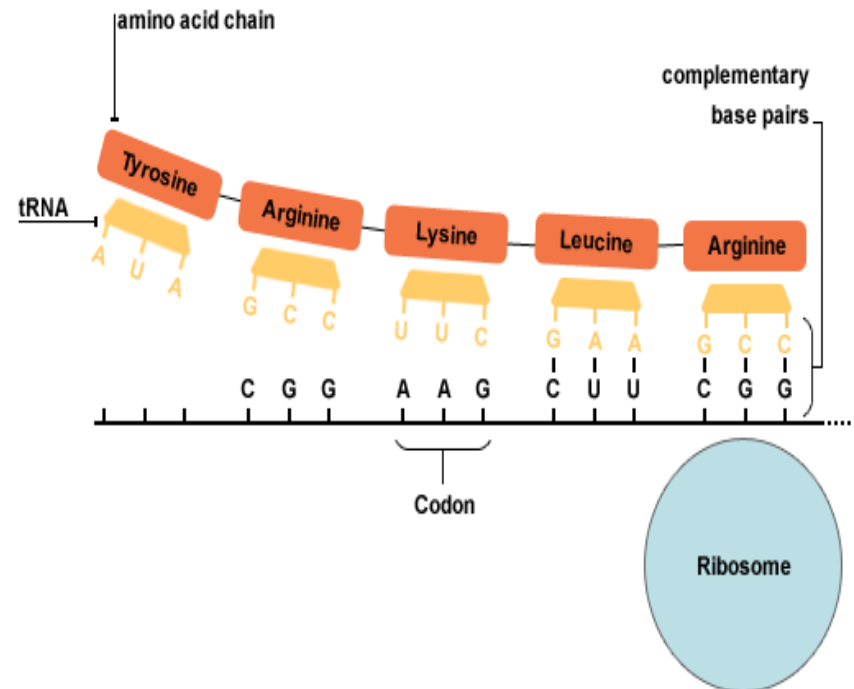

Transfer RNA and codon

- Twenty different amino acids are found in proteins and, as DNA is composed of four different nitrogenous bases, then obviously a single base cannot specify one amino acid. If two bases were to specify one amino acid, there would be only 16 possible combinations. If, however, three bases specified one amino acid then the possible number of combinations of the four bases would be 64. The triplet of nucleotide bases in the mRNA that codes for a particular amino acid is called a *codon*. There is a specific tRNA for each amino acid that has 3 series of 3 bases called anticodons that are complementary to the e bases (codon) on mRNA

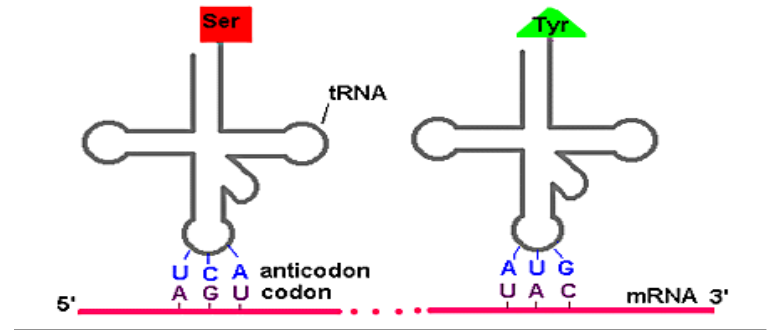

		2nd base in codon					
		U	C	A	G		
1st base in codon	U	Phe Phe Leu Leu	Ser Ser Ser Ser	Tyr Tyr STOP	Cys Cys STOP Trp	U C A G	3rd base in codon
	C	Leu Leu Leu Leu	Pro Pro Pro Pro	His His Gln Gln	Arg Arg Arg Arg	U C A G	
	A	Ile Ile Ile Met	Thr Thr Thr Thr	Asn Asn Lys Lys	Ser Ser Arg Arg	U C A G	
	G	Val Val Val Val	Ala Ala Ala Ala	Asp Asp Glu Glu	Gly Gly Gly Gly	U C A G	

The Genetic Code

Transfer RNA and codon

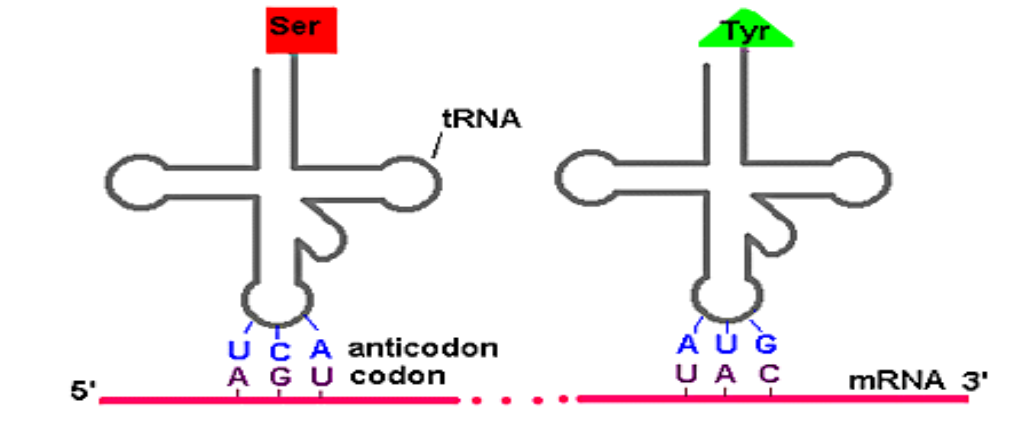

2nd base in codon

	U	C	A	G		
1st base in codon	U	Phe Phe Leu Leu	Ser Ser Ser Ser	Tyr Tyr STOP STOP	Cys Cys STOP Trp	U C A G
	C	Leu Leu Leu Leu	Pro Pro Pro Pro	His His Gln Gln	Arg Arg Arg Arg	U C A G
	A	Ile Ile Ile Met	Thr Thr Thr Thr	Asn Asn Lys Lys	Ser Ser Arg Arg	U C A G
	G	Val Val Val Val	Ala Ala Ala Ala	Asp Asp Glu Glu	Gly Gly Gly Gly	U C A G

3rd base in codon

The Genetic Code

Gene Mutations

- A *mutation* is defined as a change in the genetic material. Mutations can arise through exposure to mutagenic agents, or spontaneously through errors in DNA replication and repair.
- *Somatic* mutations may cause adult-onset disease such as cancer but cannot be transmitted to offspring. A mutation in *gonadal tissue* or a *gamete* can be transmitted to future generations

Types of DNA mutations

- Substitution: replacement of a single nucleotide by another
- Deletion: loss of one or more nucleotides
- Insertion: addition of one or more nucleotides
- Expansion of trinucleotide repeat sequences

Effects of mutations on the protein

- Silent mutation (synonymous): replacement of a single nucleotide by another but with no change in the amino acid
- Missense (non synonymous) replacement of a single nucleotide by another with change in the amino acid
- Nonsense: (non synonymous) replacement of a single nucleotide by another which leads to a change from a codon for an amino acid to a stop codon and truncation of the polypeptide chain
- Frameshift

DNA Sequence Variation in a Gene Can Change the Protein Produced by the Genetic Code

Gene A from Person 1

GCA AGA GAT AAT TGT...
↓ ↓ ↓ ↓ ↓
Ala Arg Asp Asn Cys ...
1 2 3 4 5

Protein Products



Gene A from Person 2

Codon change made no difference in amino acid sequence

GCG AGA GAT AAT TGT...
↓ ↓ ↓ ↓ ↓
Ala Arg Asp Asn Cys ...
1 2 3 4 5

Gene A from Person 3

Codon change resulted in a different amino acid at position 2

GCA AAA GAT AAT TGT...
↓ ↓ ↓ ↓ ↓
Ala Lys Asp Asn Cys ...
1 2 3 4 5

OR



Missense mutation

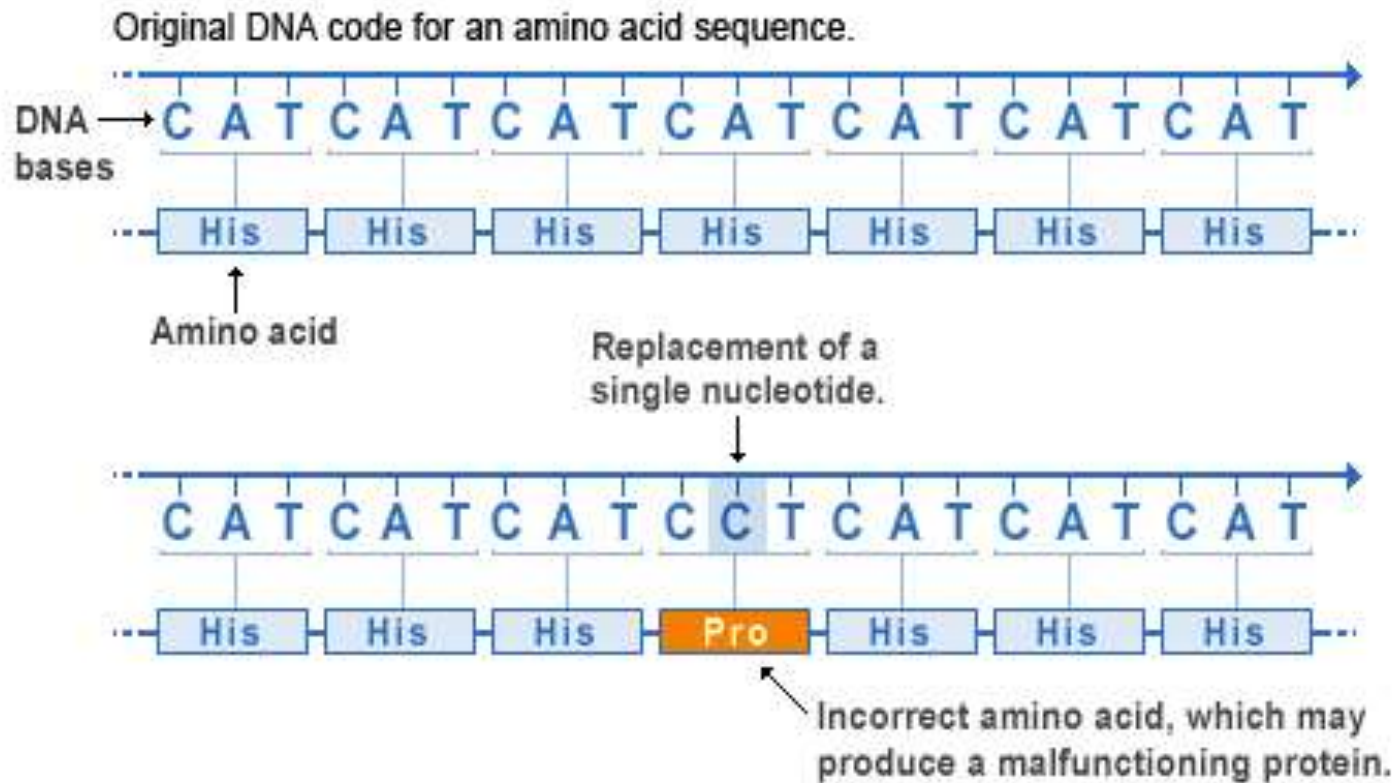

Nonsense mutation

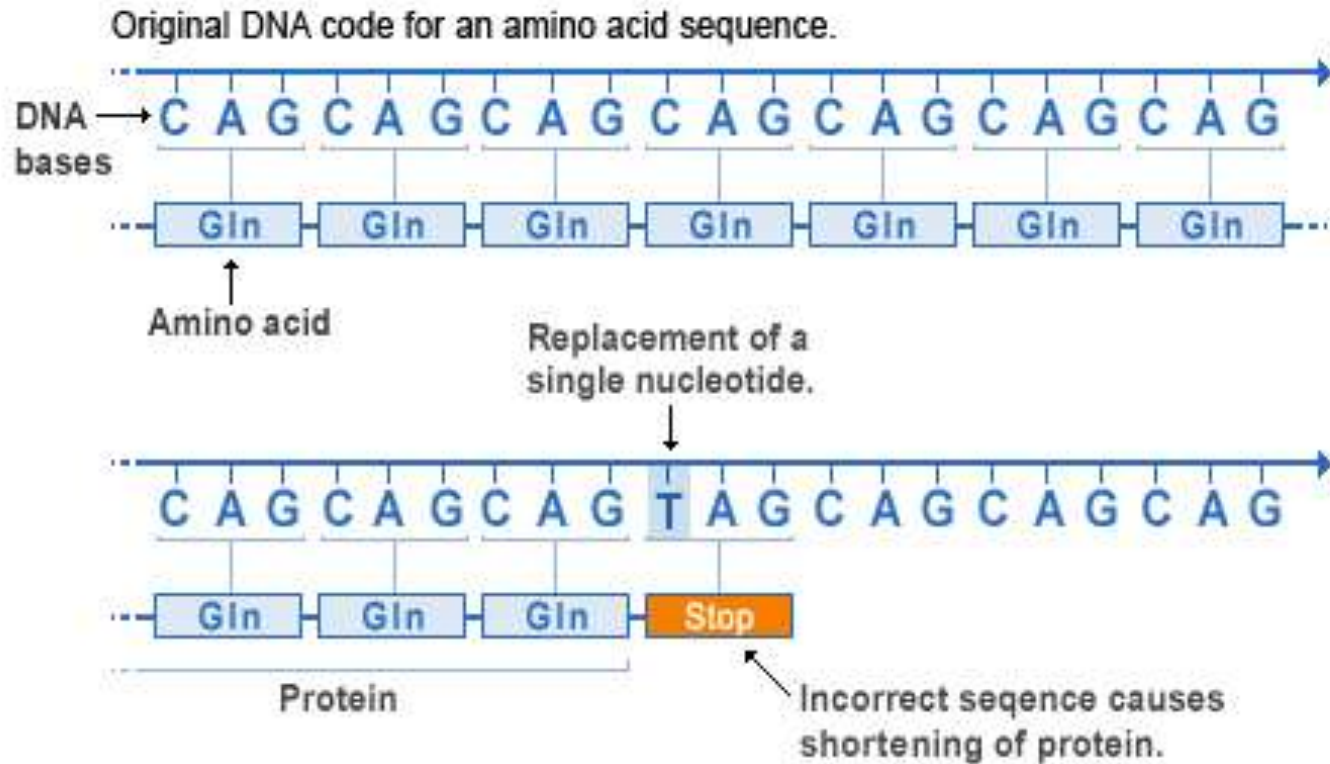

U.S. National Library of Medicine:

Insertion mutation

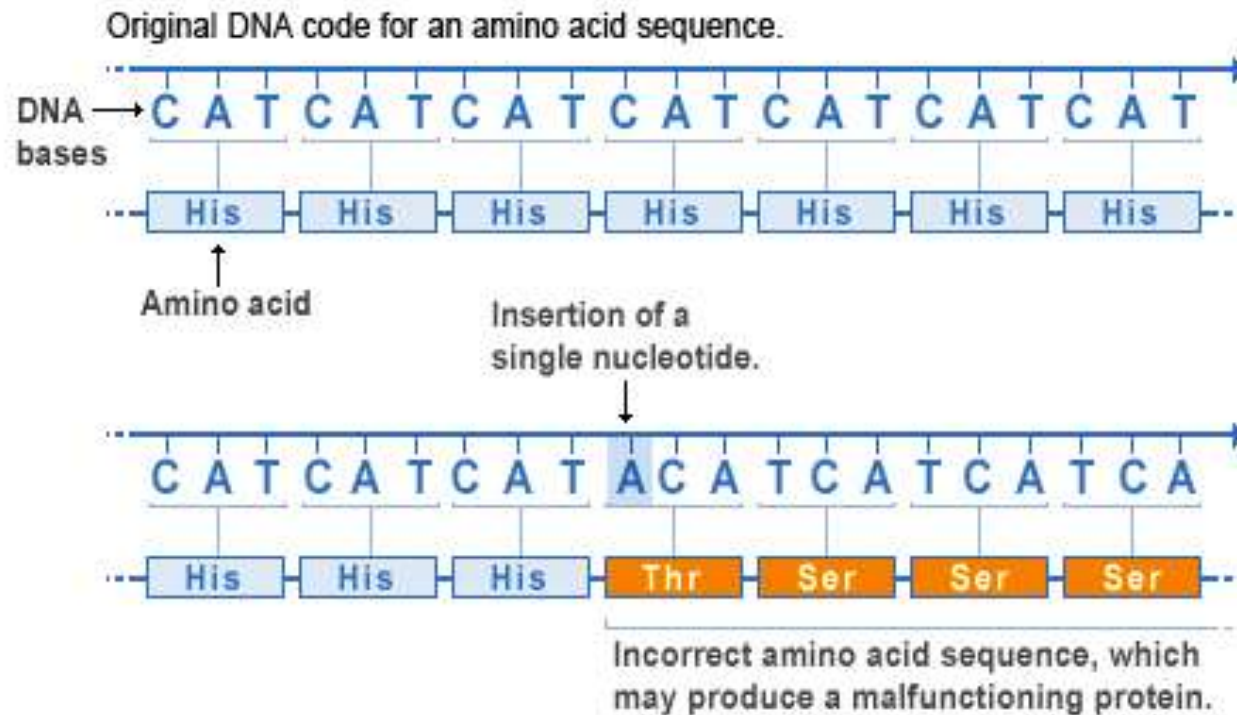

Deletion mutation

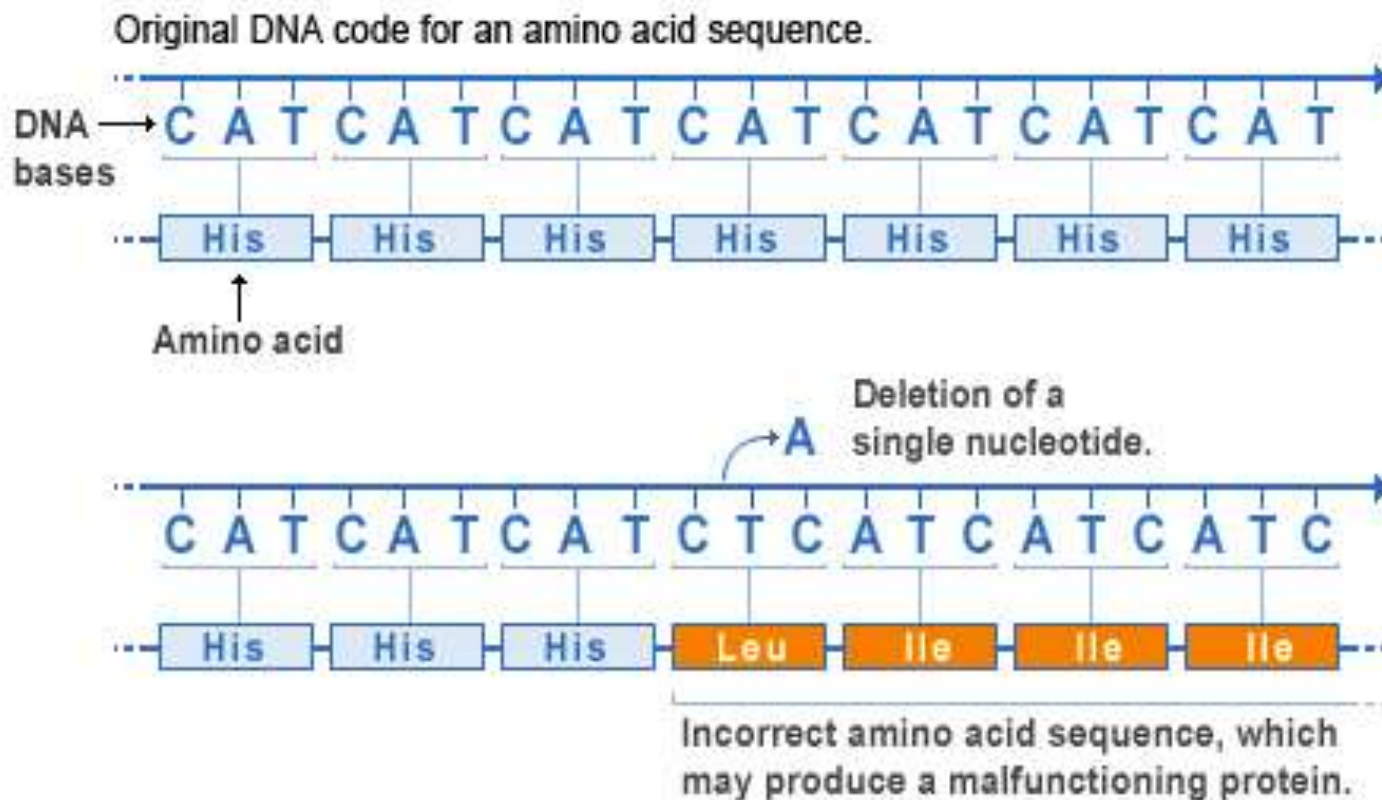

Repeat expansion mutation

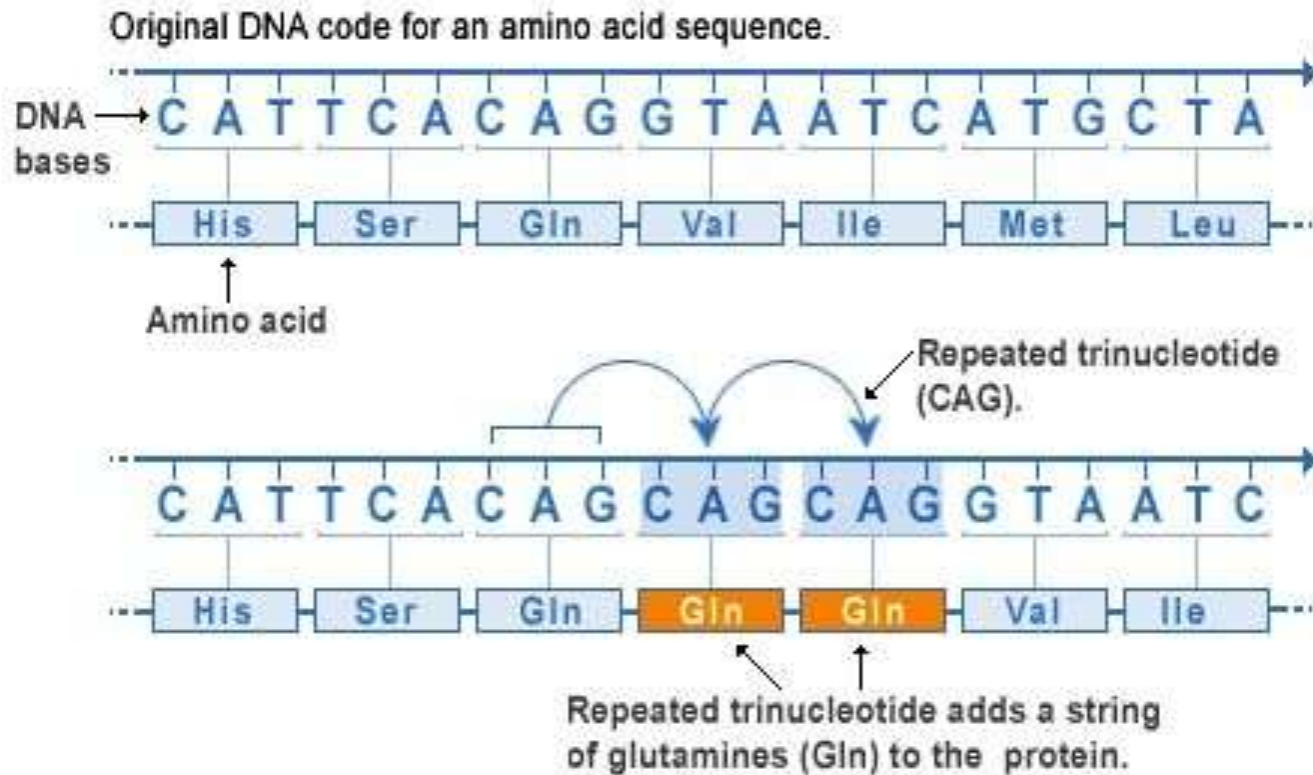

U.S. National Library of Medicine:

Factors implicated in mutagenesis

- **Ionizing radiation** includes electromagnetic waves of very short wavelength (X-rays and γ rays), and high-energy particles (α particles, β particles and neutrons).
- **Chemical mutagens** : In humans, chemical mutagenesis may be more important than radiation in producing genetic damage. Experiments have shown that certain chemicals, such as mustard gas, formaldehyde, benzene, some basic dyes and food additives, are mutagenic in animals.
- **Defective DNA repair**: The occurrence of mutations in DNA, if left unrepaired, would have serious consequences for both the individual and subsequent generations.

Cell Cycle

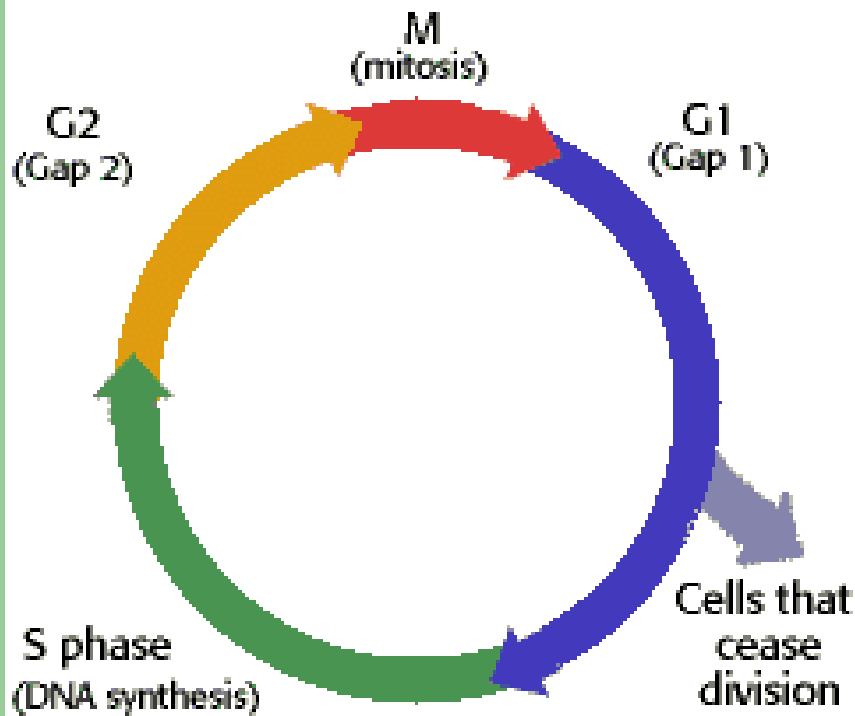

The cell passes through 2 stages:

1. Mitosis=cell division
 2. Interphase: divided into G1, S and G2
- G1 is the period for protein synthesis
 - S is the period for DNA replication

Chromosomes can only be visualised under the microscope during mitosis (46,XX in female and 46,XY in male)

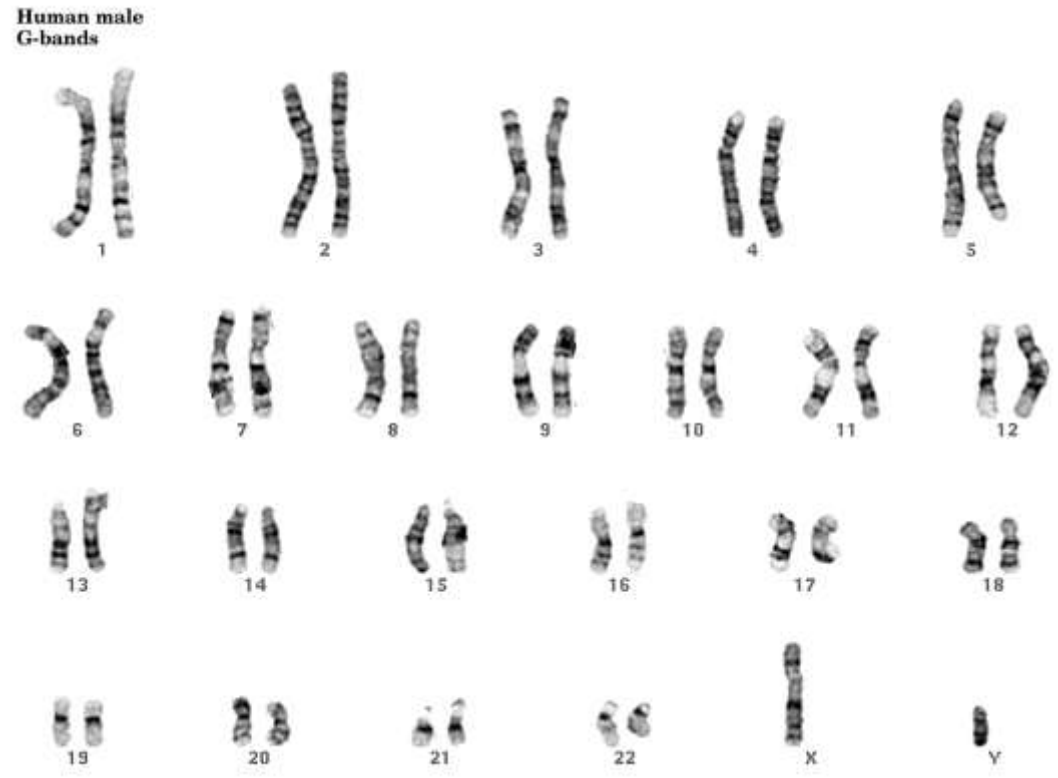

Metaphase plate
(chromosomes of one cell as
seen under the microscope)

Karyotype (chromosomes
arranged in a special way)

Chromosome types



Metacentric chromosome = centromere in middle chromosomes 1,2,3,19,20

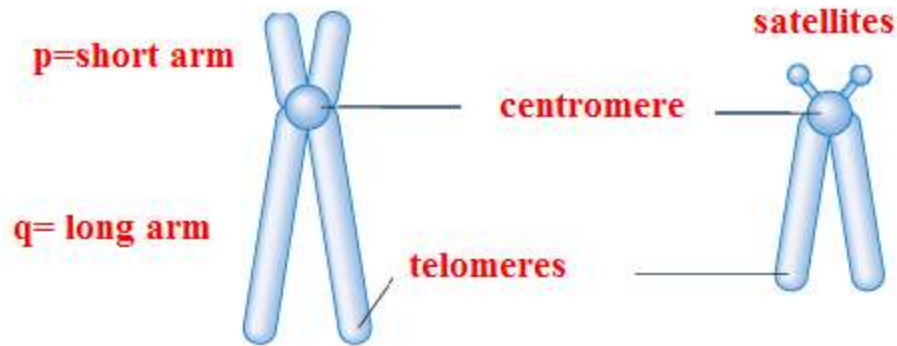

submetacentric chromosome = centromere between middle and one end chromosomes 4,5,6,7,8,9,10,11,12,16,17,18,X

Acrocentric chromosomes = centromere at one end chromosomes 13,14,15,21,22,Y

X and Y chromosomes

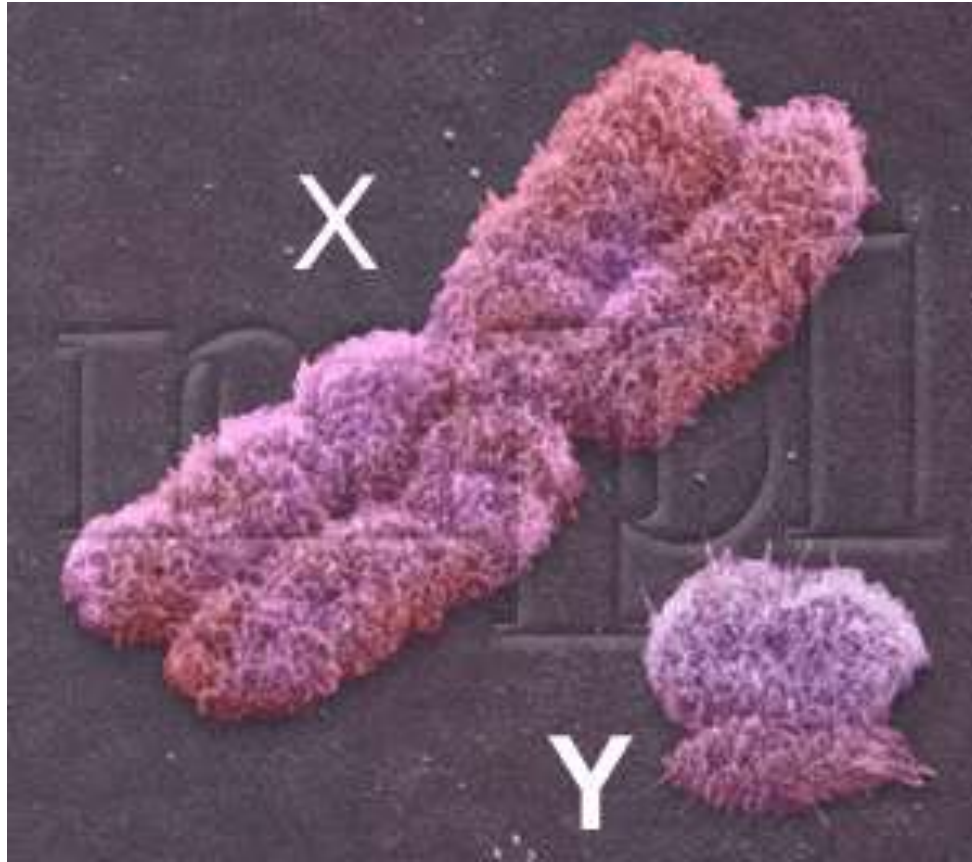

Conclusions

- When a baby is suspected to have a congenital disorder, it is important to differentiate between single gene, chromosomal and multifactorial disorders because the methods of investigations differ and the risk of recurrence in future pregnancies differs as will be discussed later