

# MATCOM

- **EASY LETTERING FOR SINGS AND POSTERS**  
a learning element for staff of consumer cooperatives

international labour office, geneva

© MATCOM 1978-2001

by Lars Josefson



**MATCOM**  
**Material and techniques for cooperatives management training**

The MATCOM Project was launched in 1978 by the International Labour Office, with the financial support of Sweden. In its third phase (1984-1986) MATCOM is financed by Denmark, Finland and Norway.

In collaboration with cooperative organizations and training institutes in all regions of the world, MATCOM designs and produces material for the training of managers of cooperatives and assists in the preparation of adapted versions for use in various countries. MATCOM also provides support for improving the methodology of cooperative training and for the training of trainers.

Publications of the International Labour Office enjoy copyright under Protocol 2 of the Universal Copyright Convention. For reproduction, adaptation or translation, application should be made to ILO Publications, International Labour Office, CH-1211 Geneva 22, Switzerland. The International Labour Office welcomes such applications.

Copyright © International Labour Organization

# EASY LETTERING FOR SIGNS AND POSTERS

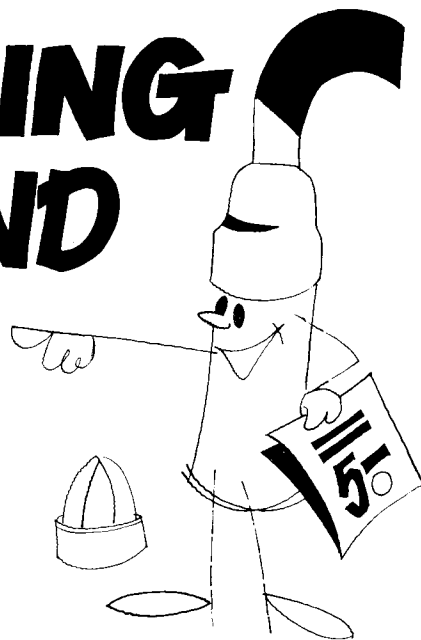

## CONTENTS

A nice shop	2
Some practical advice	4
Introductory exercises	5
Quick lettering-the method	8
Numbers	9
Letters	14
Words	17
Signs and posters	24

MATCOM Element No.: 13-04

Edition: Universal 1983  
ISBN: 92-2-103330-9

Prepared by Lars Josefson  
Printed in Turin, Italy, 1983

# A NICE SHOP!

- You enter a nice shop. The first things that catch your attention are the attractive posters and price signs here and there in the shop. They function as "silent salesmen", and they are very effective. If they are well made, they give quick information to the customers, and they may even "sell" the goods by themselves. We realize that these posters and signs must be very *important aids* for the customers and for the shop personnel.
- The big posters that you see in co-operative shops are sometimes prepared by professional draftsmen, and then printed and distributed for use in all co-operative retail shops. But very often the signs and posters, especially the smaller ones and those used for special displays, must be prepared by the shop staff. So someone in the shop must be able to *write nice block letters*. If they are not nice, customers will have a bad impression of the shop.

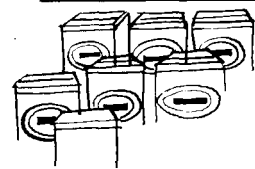

● This booklet will help you to learn how to write nice block letters.  
 It is easy to learn. Don't say you have no talent for it!  
 Already after the first hour of practice you will see your progress.  
 You will learn it! It is interesting and fun!

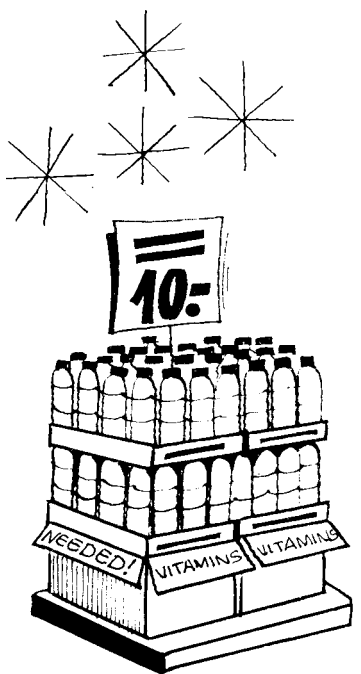

# FIRST- SOME PRACTICAL ADVICE!

- **EQUIPMENT NEEDED**

Marking pens with points about 1/4 inch.  
Colours: black, red and blue.

To do the exercises in this booklet you need tracing paper and some wrapping paper or cardboard for practice.

For the actual signs and posters you need white cardboard.

- **ALWAYS USE A BASE**

A newspaper or an old sign will do nicely.

- **REPLACE THE PEN CAP IMMEDIATELY AFTER USE!**

- **KEEP YOUR MATERIAL AND YOUR WORKING PLACE CLEAN AND TIDY!**

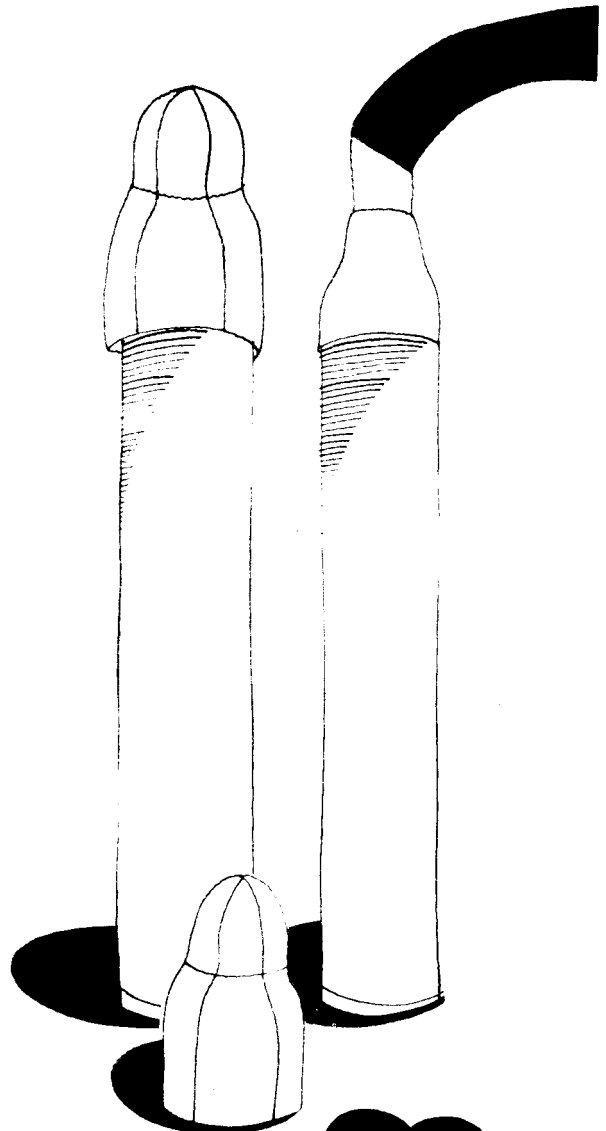

- **ANYONE CAN LEARN QUICK LETTERING.**

**JUST FOLLOW FROM BEGINNING TO END THE ADVICE AND INSTRUCTIONS GIVEN!**

**GOOD LUCK!**

# NOW YOU TRY!

- Place the marking pen between your thumb and your index finger. Hold the pen near the point. The angle between the marking pen and the writing surface should be about 50°. As shown in the figure, you should write using the edge of the pen point.

- Keep your wrist on the table!

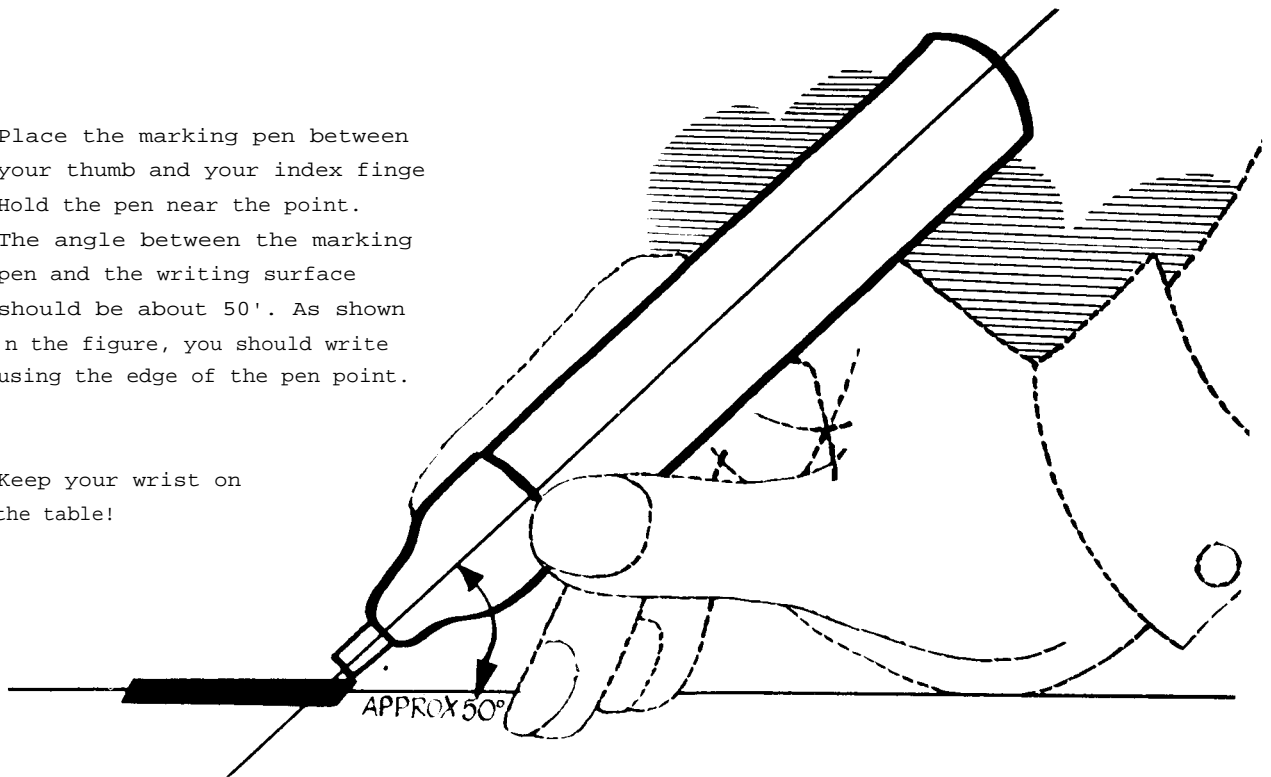

- If the pen squeaks or the line blots, you are holding the pen too upright.

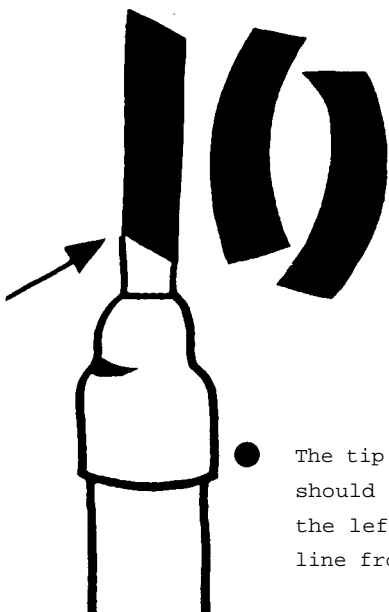

- The tip of the pen point should always be kept to the left when you draw a line from top to bottom.

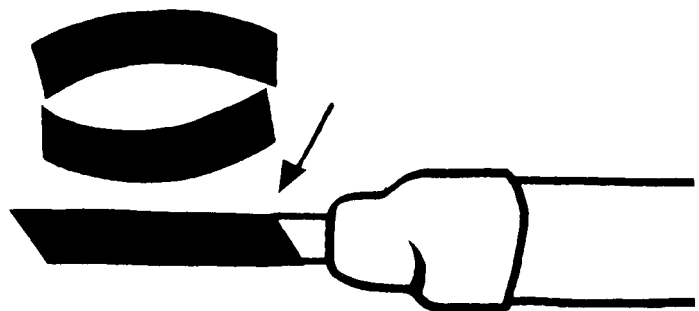

- To draw lines horizontally, turn the marking pen so that the tip is upwards (see figure). Lean the pen softly to the right and draw.
- To get good results, make wide strokes.

● Place tracing paper on these pages and fill in the patterns. Draw as the arrows show. Use long, smooth strokes and keep the pressure steady.

● Practise until you get even, broad lines, vertically and horizontally. It is not important if your pen does not wholly fill the pattern. Do not try to fix it afterwards.

● You will print best with both arms on the table, with the sign placed so that the printing is done about 20-25 centimetres from the edge of the table. After a while you will see that you will get best results when you are standing up.

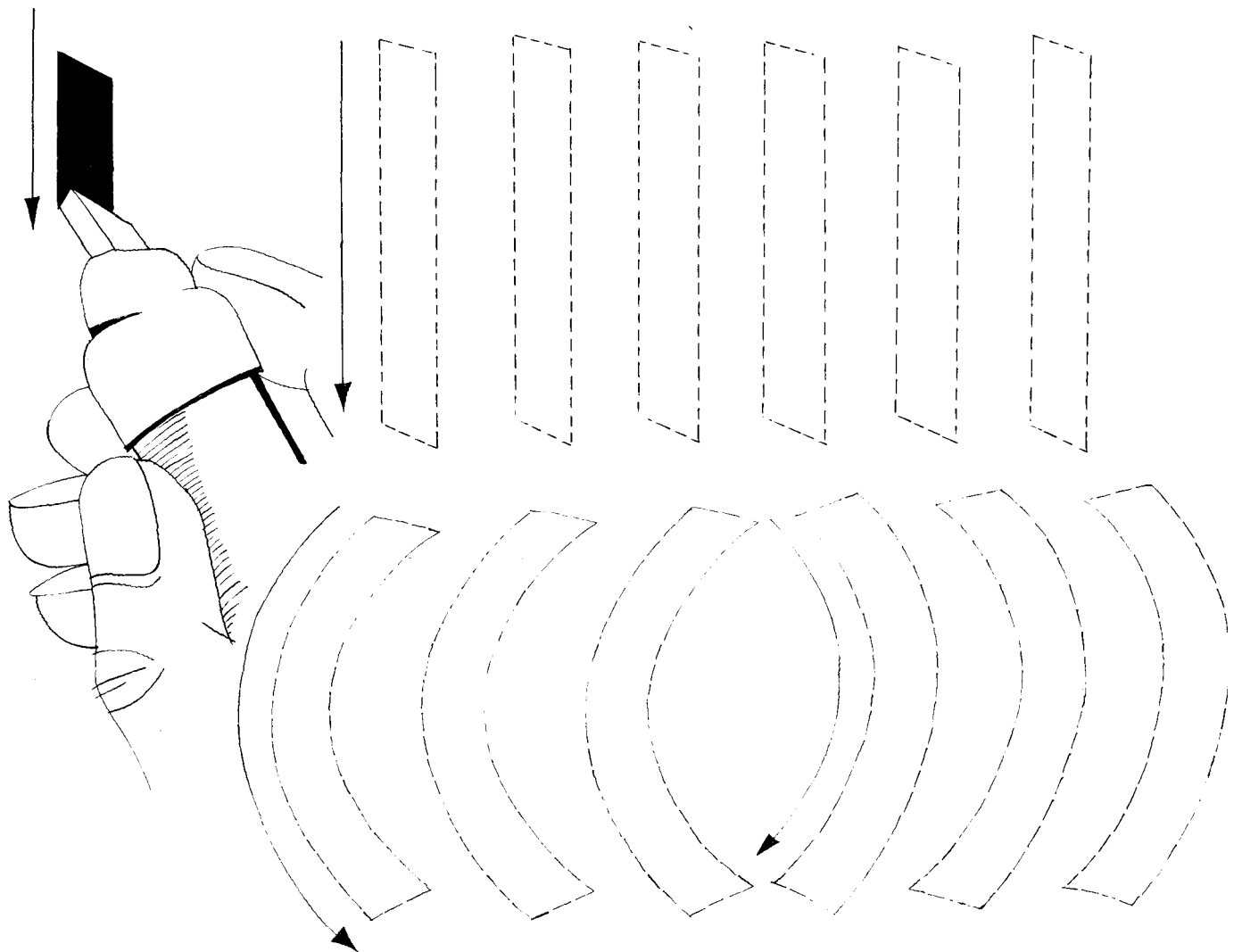

- If your lines are uneven, it usually means that you are moving the marker too fast, or that the point of the marker is not completely touching the paper.
- If the finishing is uneven, or if the strokes are drawn longer than the pattern, it is often caused by lifting your hand from the table before the stroke is ended.





KEEP THE TIP UPWARDS !

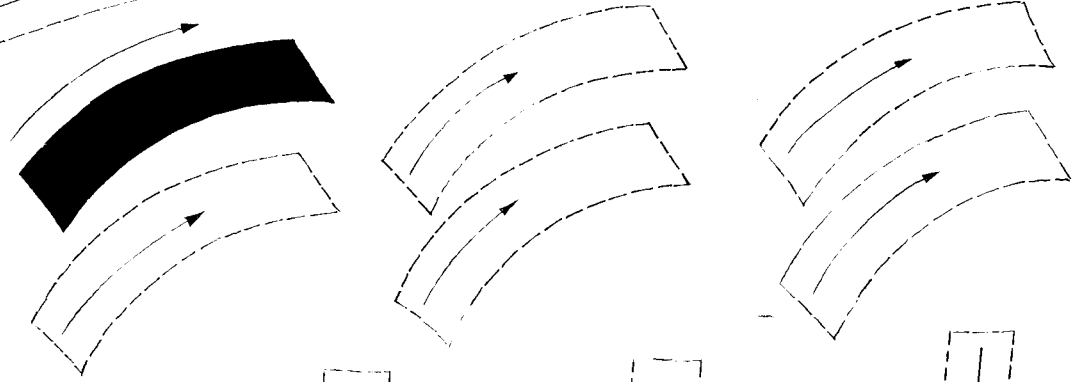
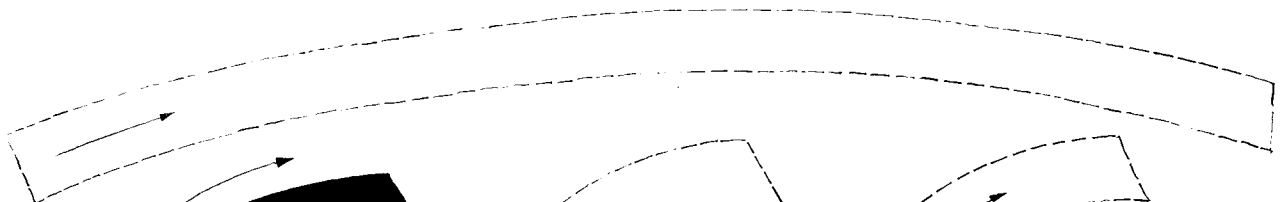
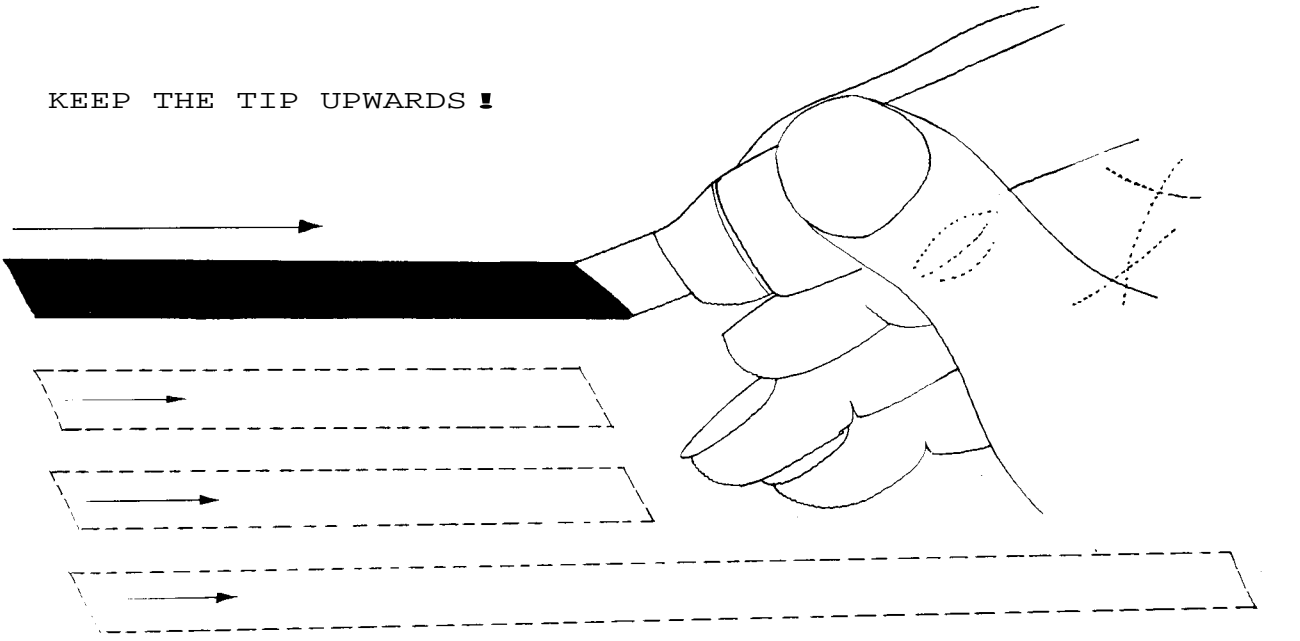

Practise to join two different lines. Do not try to improve the result by "touching up" afterwards.

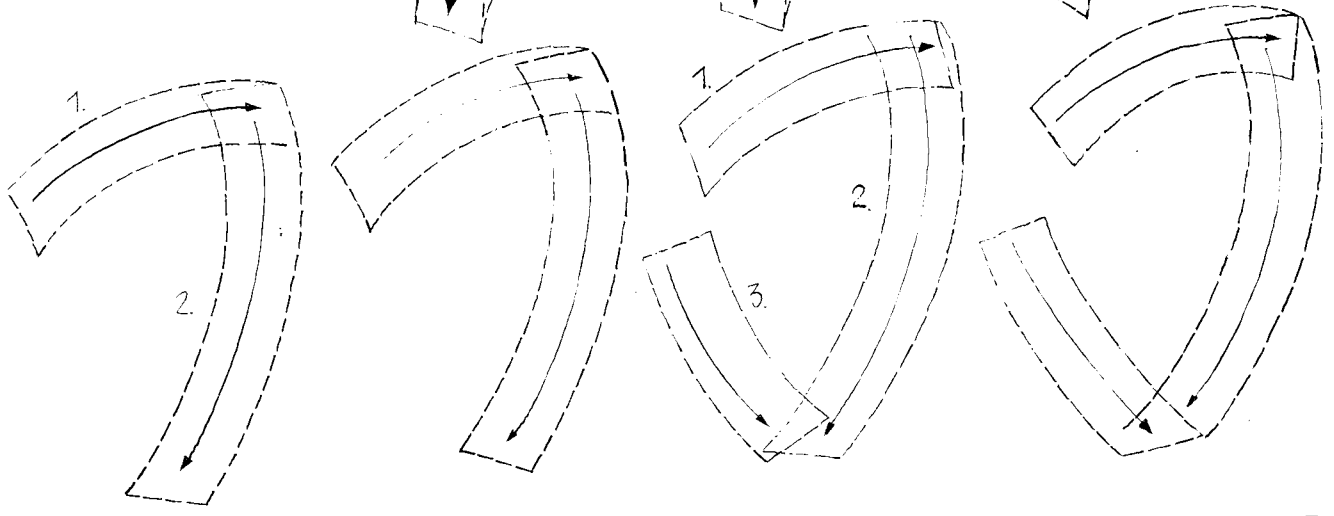
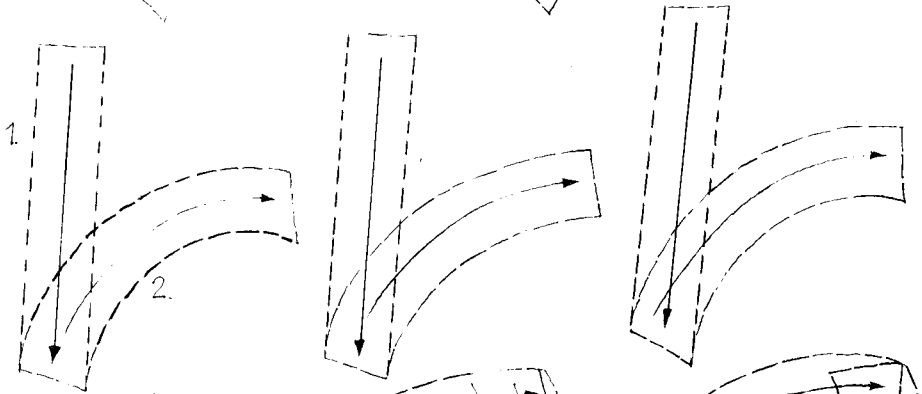

# QUICK LETTERING!

- We have developed a method which makes it easy for you to learn how to draw numbers and letters quickly.

The numbers 3, 5, 6 and 8 give you an idea of the method.

The arrows show that they are all made in the same way.

You should move your pen as the arrows show.

In this way you can write numbers and letters in an attractive style which is easy to read.

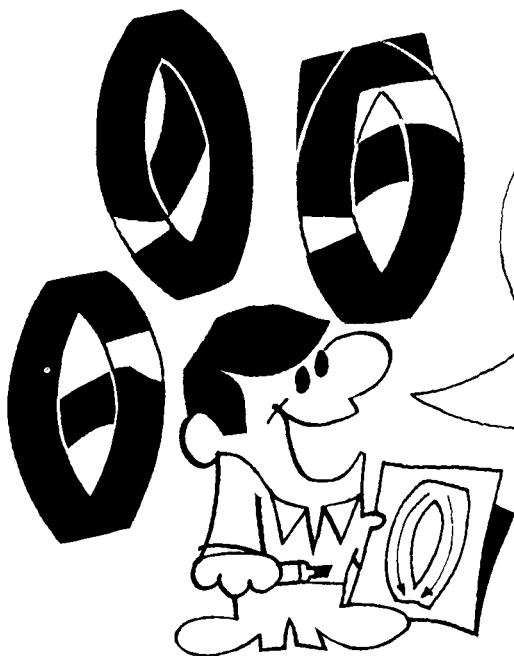
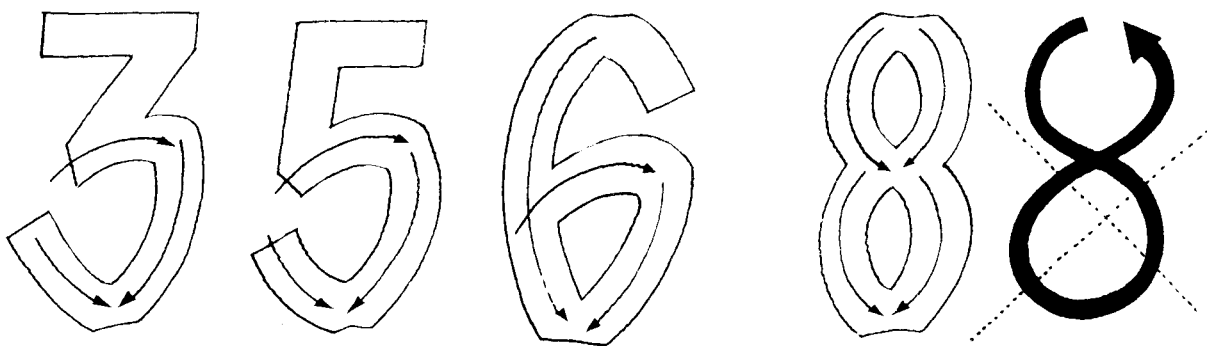

Numbers and letters that are either too round or too thin are difficult to read at a glance.

The number zero can be used as an aid to get the right proportions, and as a starting point for other rounded numbers. Try to move the pen in half circles.

# NUMBERS!

Trace the numbers on this page!

Place tracing paper over the numbers, draw each line only once. Even if your pen point is not as wide as the number, do not go back to fill it out.

Move your pen the way the arrows show!

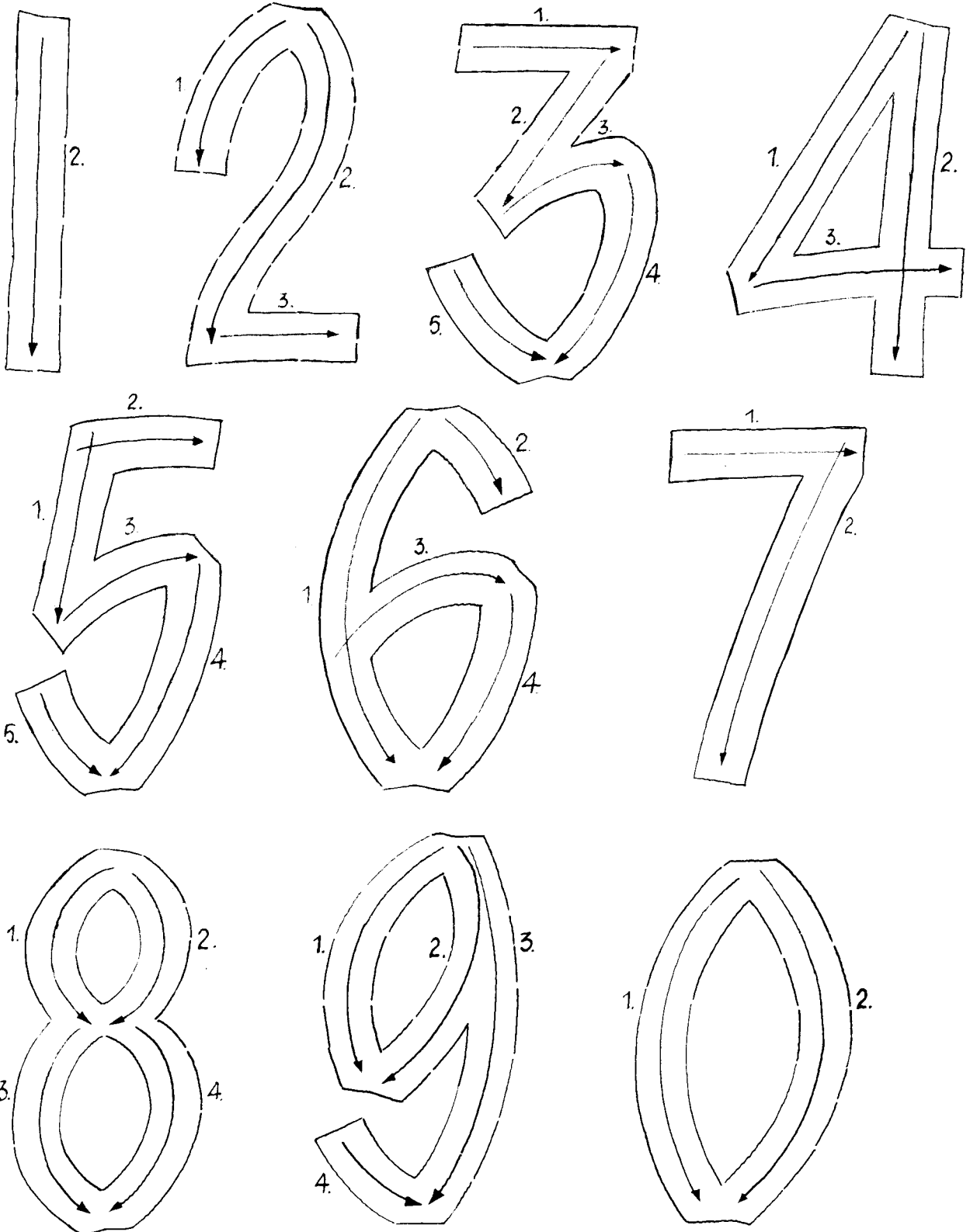

**LETTERING  
IS FUN!**

**PRACTICE  
MAKES  
PERFECT!**



Now try to draw numbers on a card-board. Use the same sizes as those on page 9. Practise all the numbers, then different combinations such as 490, 356, 696, 1000, 864 . . .

The most common mistakes are shown below.  
Check the numbers you have drawn and make the necessary corrections.

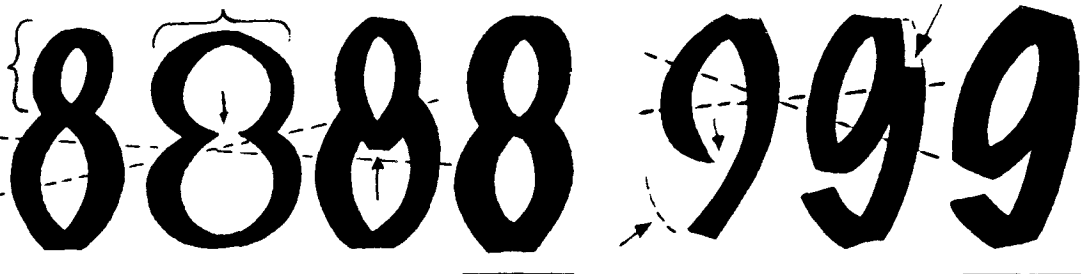
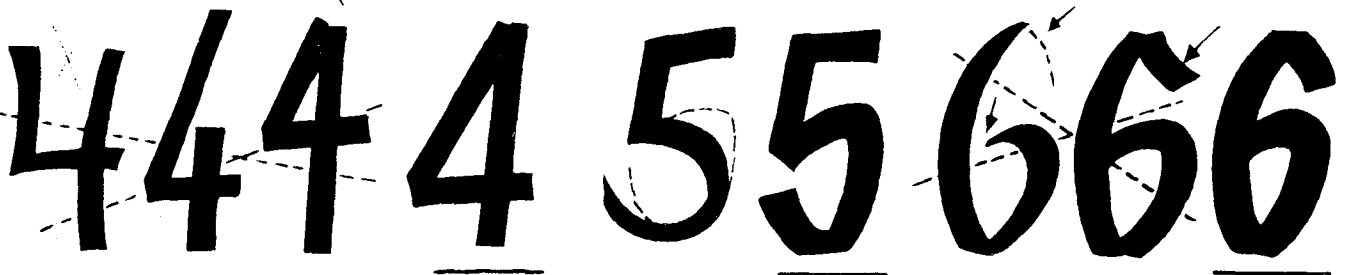

**YOUR  
POSTERS MUST  
BE EASILY  
READ!**

- Use the same size for all the common price signs in the shop -otherwise the overall impression may be messy!

- Use large numbers. but always remember to leave a space around them.

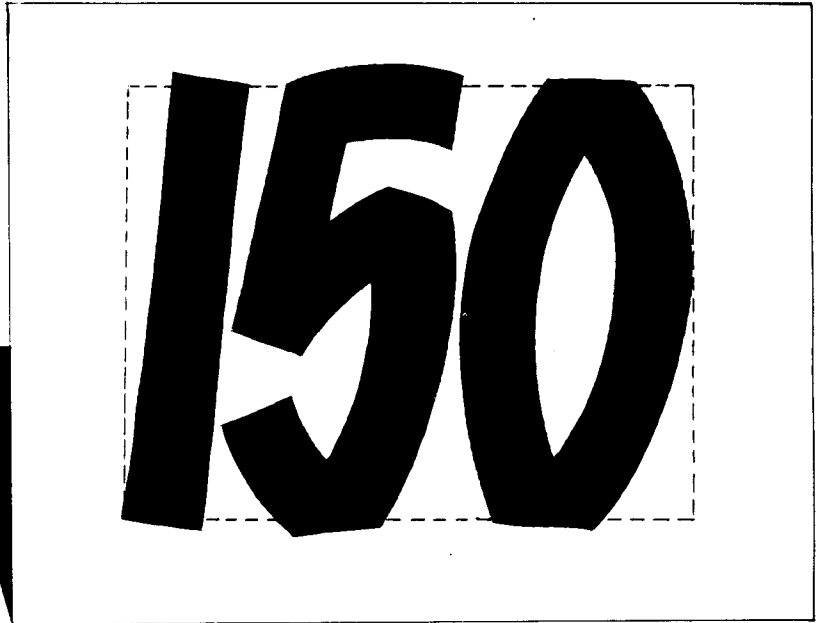

- Keep the numbers together!

**450 450**

**150 150 15.**

- Decimals can be underlined as shown above.



When you arrange special displays and sales campaigns you need more "striking" signs and posters to make sure the customers see them.

You can get a good effect if you print black numbers on a yellow or orange background. Other designs are shown in the following illustrations.

First write the price in red or orange. The spacing between the numbers should be a bit larger than usual. Then draw a wide black or blue line to the left of each column or loop. You get a three-dimensional effect. Do not let the colours cover each other. Once you lift your pen, do not try to "touch up", it won't improve the result.



Use the tip of the pen when you need shadow-lines on smaller numbers.



- A simple mark or symbol can "give life" to a sign and to the whole display. Make larger copies of these examples. Try your own ideas.

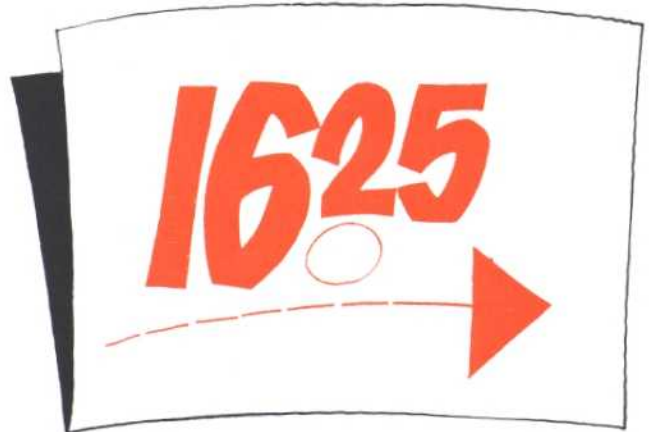

- First write the price (13-15 cm high numbers) in red or orange. Then draw a black or blue line around and inside each number. Keep a few millimetres between the colours. Note: the contour line should always be in a darker colour.



- You can also draw the figures in yellow, orange, red or green, and then draw a heavy black line in the middle.

# LETTERS!

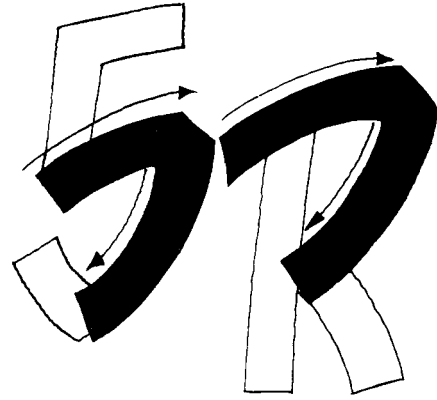

- Draw letters the same way you draw numbers. The arrows in the figures show you how to move the marker.

Put tracing paper on top of the pages and draw each letter until you know you can do it by yourself.



Bend the lines just a little.



Do not dot  
the capital I.

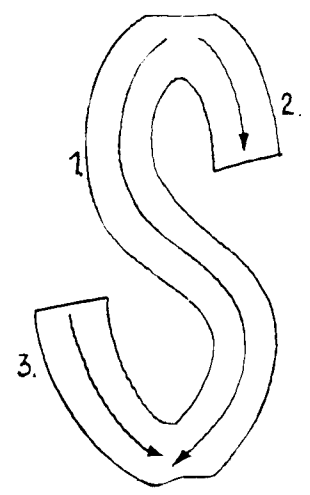
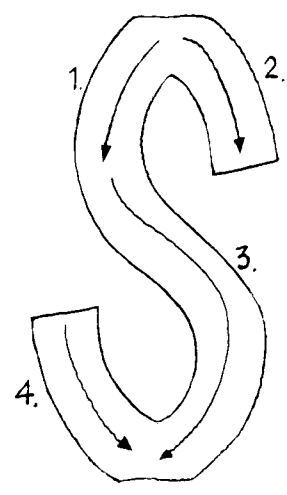
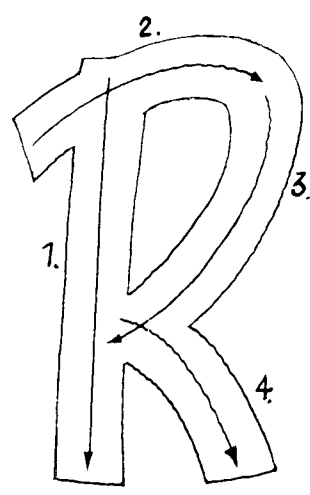
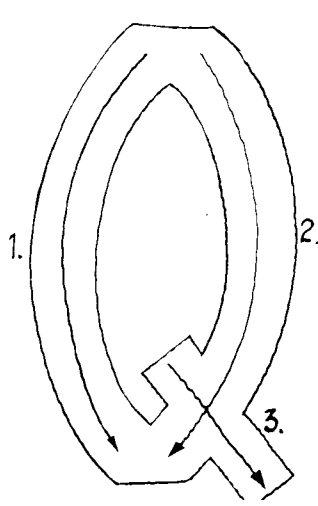
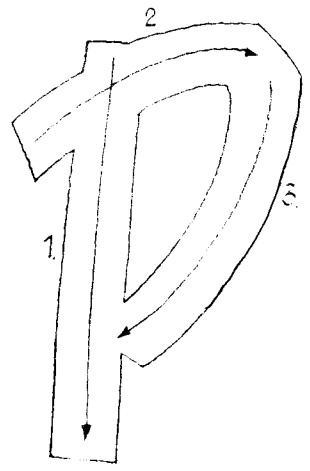
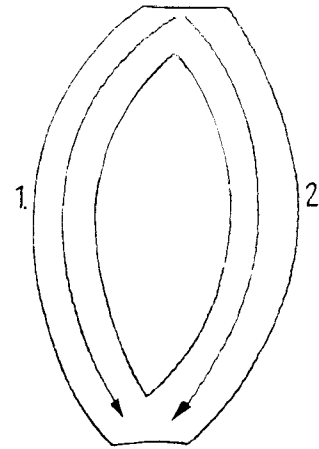
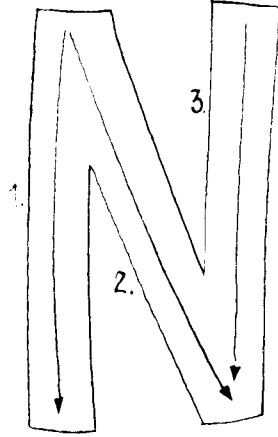
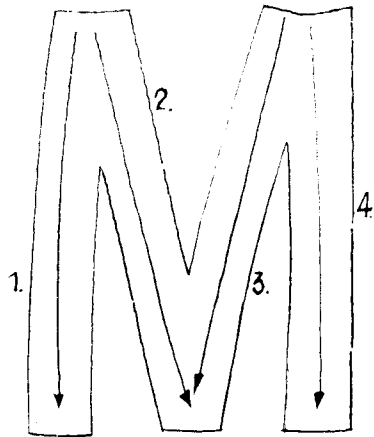
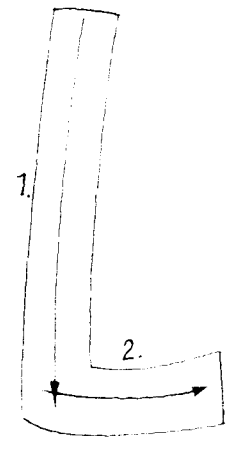
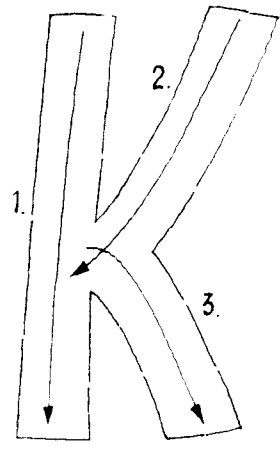
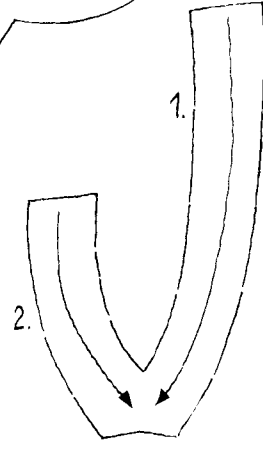
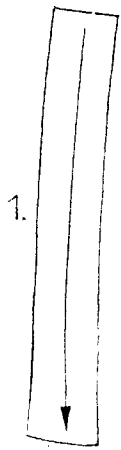

First practise the letter S as shown on the left  
When your hand and eye are used to the  
shape of the letter, practise the example on  
the right.

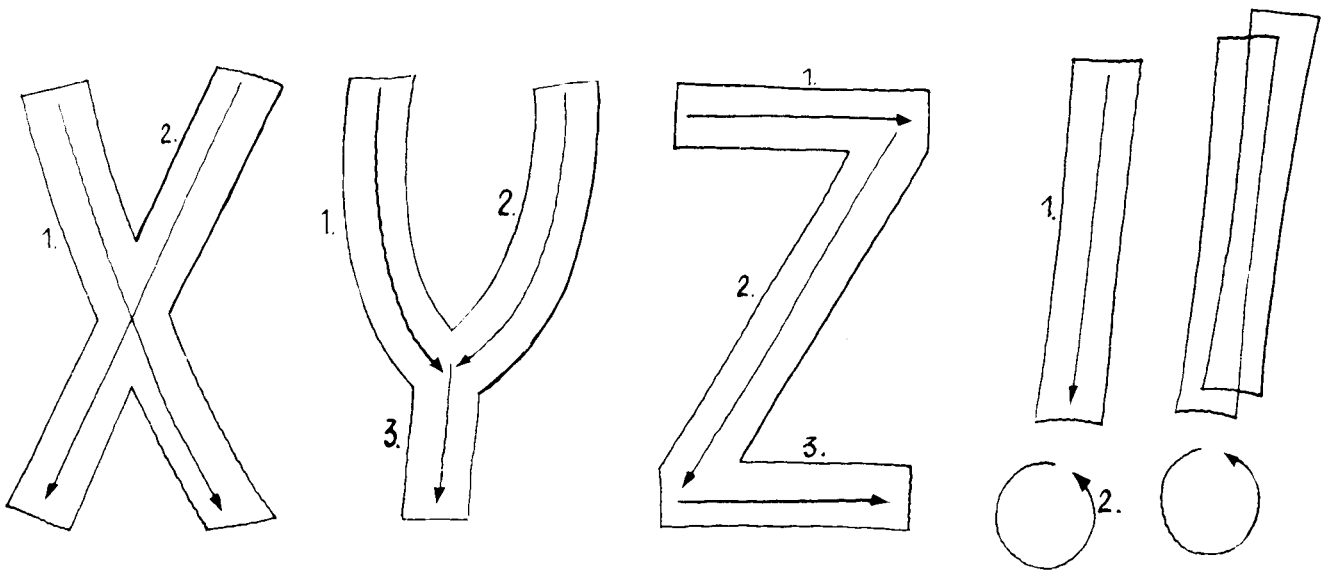
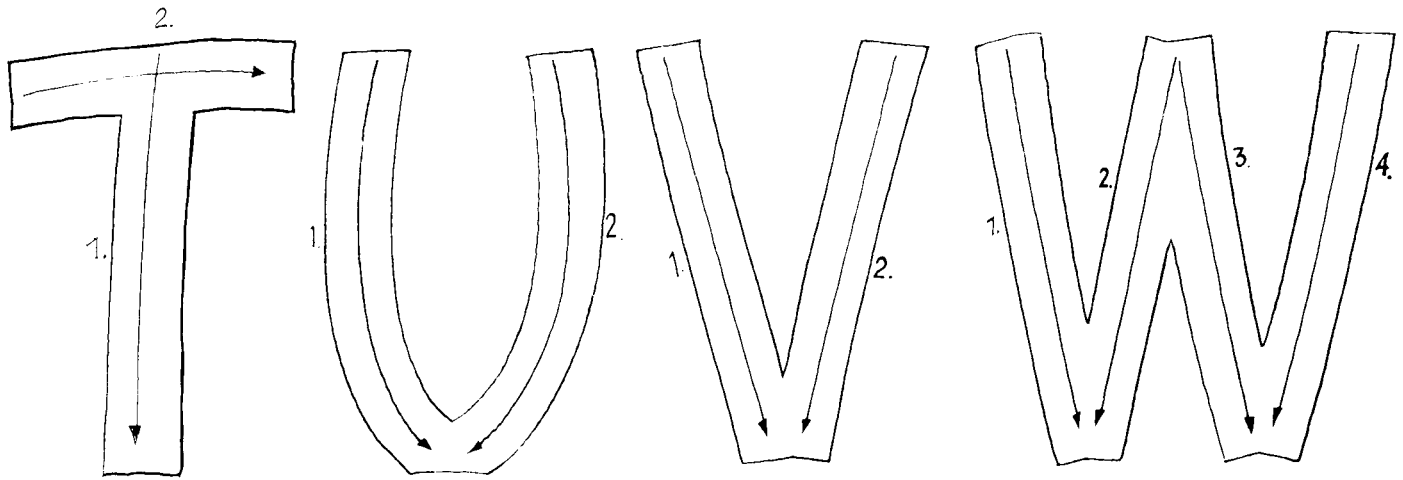

Now try to write these letters by yourself. Write them again and again until you feel confident. Always check to see if your own letters look like the letters in this book!

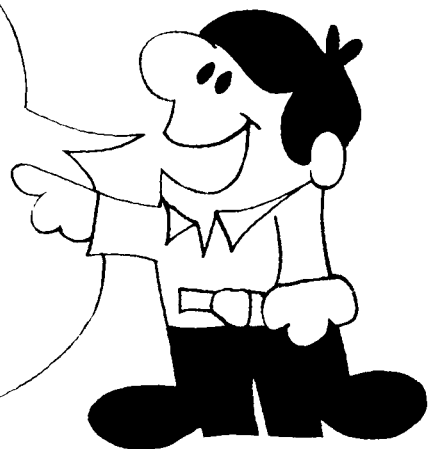

# WORDS!

When you know how to write separate letters, it is time to practise the writing of *words* and *short* sales messages.

First--here are some helpful points.

## BARGAIN PRICE!

- This is badly written. Too much space between the letters makes it hard to read the words.

## BARGAIN PRICE!

- Again, varying spaces between letters have the same negative effect.

## BAGAIN PRICE!

- Always check your signs carefully. It is easy to make mistakes in spelling or word order.

- This is how it should look!  
Underline important sales words with a thick line in the same colour.

**BARGAIN  
PRICE!**

- Use two lines for a message with longer words—it is easier to read.

Always put an exclamation point at the end of “sales words” like these.



~~PRICE!~~

~~PRICE!~~

- This does not look nice! The loops are too small in P and R; the middle line in E is too high up.

Now the word is better balanced, as the line shows. It looks nicer and it is easier to read.

SALE! →

SALE! →

SALE! →

- Your words are easier to read if they are put on a straight line or are slanted upwards.

TODAY! TODAY!

- If you write the letters too fast, they may be uneven, but you can improve the result if you put a line under the word.

- When you practise some letter combinations you will see that you can make the words easier to read if you make some lines shorter, and other lines longer.

EXTENDED TA EXTENDED LR SHORTENED LA TURNED TT SHORTENED LL  
SHORTENED PULLED DOWN A BIT

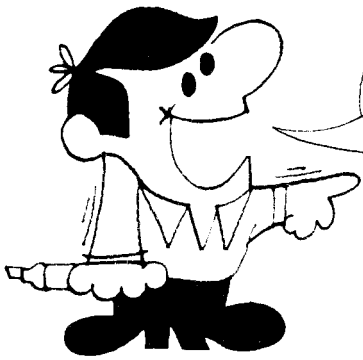

# PRACTISE!

- Here are some examples of typical shop lettering. Use a tracing paper and practise. Then practise freehand lettering of other words which are common in our business.

SALE!

TODAY!

NEW!



The text is a bit slanted.  
This "gives life" to the message.

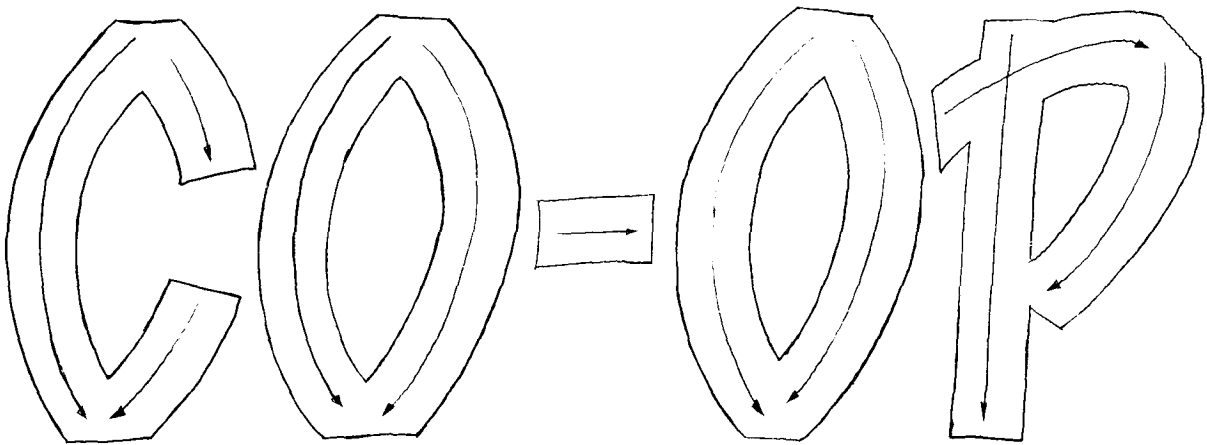

TONIGHT  
OPEN 'TIL

8 PM.

As you can see, the text lines must be kept close together, and letters and numbers must be close to each other.

How to make sales messages  
and slogans look different and  
interesting.

**BARGAINS!**

**NEW!**

Write slogans and "sales words" in the same ways  
as the numbers on pages 12-13.



**SALE!**

**DISCOUNT!**

ftme

no

ISCO

SALE

# SIGNS AND POSTERS

## THE PRICE CARD LAYOUT!

If you have just a few lines of copy, keep the left margin straight-the text will be easier to read and easier to write.

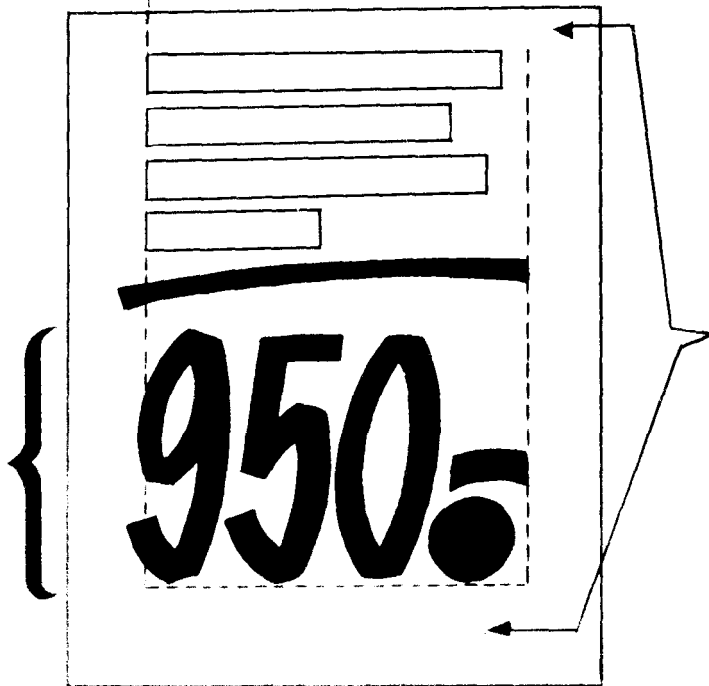

The price does the selling, so let it dominate the poster. Print large, easy-to-read numbers covering 50% of the surface.

The bottom margin should be somewhat wider than the space at the top. This raises the sales message and makes it easier to read. (This is also true for framing prints and photographs.)

### DIRECTIONS:

- First make a little pencil sketch of your idea. It saves time and builds confidence.
- Make it as simple as possible and make sure it is readable.
- Use one, two-but certainly no more than three colours on a poster.
- Dark letters on a light background are easy to read. The smaller the printing the darker should be the colour.
- Short, easily read messages sell best.
- Add simple drawings or clippings for interest.
- Advertising posters should be varied and be changed often.

# EXAMPLES!

On the following pages you will find examples of price signs which are "selling" and easy to read. Practise writing signs of this type. Use A4-size for your signs (it is the size of this page).

A simple, easy-to-read design, very good for a whole series of price signs. →



These price signs have both text and price. They can be fastened with tape, put in special holders or hung up close to the actual product. Inside the shop it is best to use signs which are higher than they are wide; they are easier to read and do not block the goods as much as wider signs.



**RAIN-  
COATS!  
EXTRA LARGE**

**15.**

**TODAY!**  

---

**SANDALS  
ALL SIZES**

**11.75**

**SCHOOL  
BEGINS!**

---

**6.50**

Use two lines for long or combined words, so that they are easier to read.

If the "sales word", the name of the product and the price are in the same poster, underline the sales word. Use the same colour for sales word and price.

Keep the lines well together. The lines bring out the price.

**PLEASE  
HAVE  
A BITE  
TO TASTE!**

---

**COOP**

**WALDA  
TOMATO  
KETCHUP**

**1.95**

**COOP**

This is a good idea!

Have the co-operative union preprint cardboards for signs and posters with your co-operative emblem.

**MATCHES  
6 BOXES**

---

**-60**

**COOP**

**BUCKET  
PLASTIC 12 LIT.**

**9.20**

**COOP**



# GIVE "LIFE"...

... to the signs with simple symbols. Always use the wide side of the marking pen.

Warning:  
do not overdo it!

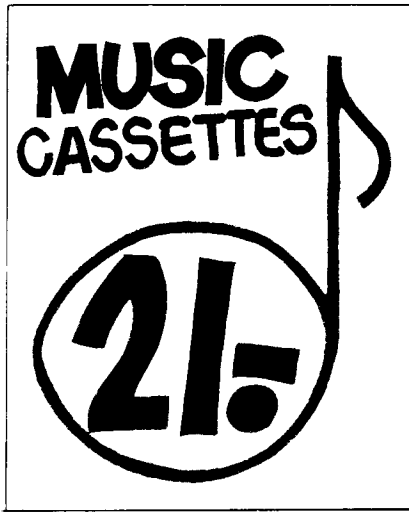
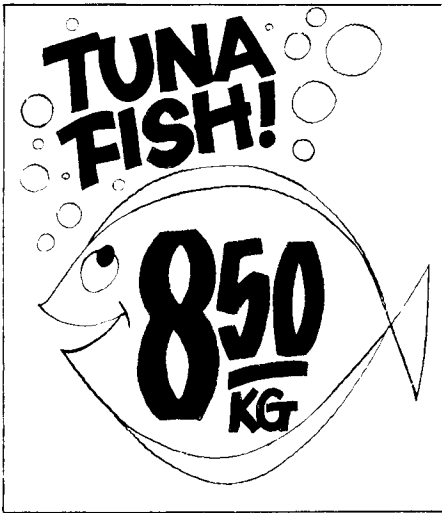

**GARDEN TOOLS!**

- SPADE ..... 14.50
- RAKE ..... 8.40
- SHEARS ..... 12.50
- HOE ..... 12.50

**THIS WEEK!**

**SPECIAL PRICE!**

REG. PRICE: ~~8.50~~

200 GR. **5.50**

# HOLIDAY HOURS!

- MONDAY ..... 9-18
- TUESDAY ..... 9-20
- INDEP. DAY ..... 9-12

WELCOME! 

- LALOKI -  
CO-OPERATIVE

MEMBER-  
SHIP  
FORMS!



# ANNUAL MEETING

**DATE:** MONDAY 24 OCTOBER

**TIME:** 7 P.M.

**PLACE:** ALBERT HALL

**PROGRAMME:**

- THE ANNUAL REPORT
- FILM
- ENTERTAINMENT

WELCOME! 

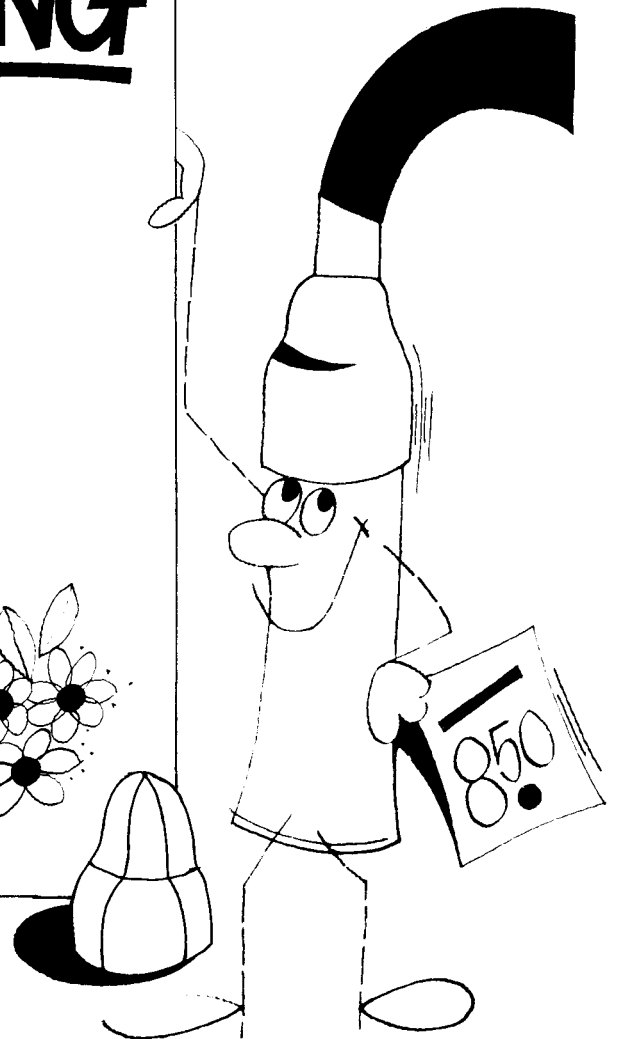

Now you know how to make signs and posters.  
Remember: practice makes perfect. From time to time,  
come back to this booklet and check up that you  
follow the rules given here for quick and nice lettering.