

**BME 205**

**Materials Engineering (M)**

**B. Tech, 4th Semester**



**Veer Surendra Sai University of Technology, Burla, Sambalpur, Odisha**

**Course Coordinator**

**1. Renu Kumari**

**Assistant Professor**

**Department of Metallurgical & Materials Engineering (MME)**

**Email: [renumetalbit@gmail.com](mailto:renumetalbit@gmail.com), Mob. No-09564452009**

**2. Suneeti Purohit**

**Assistant Professor**

**Department of Metallurgical & Materials Engineering (MME)**

**E-mail: [suneeti.purohit@gmail.com](mailto:suneeti.purohit@gmail.com) Mob. No: (+91) 8339037187**

**3. Gautam Behera**

**Assistant Professor**

**Department of Metallurgical & Materials Engineering (MME)**

**Email: [gautamiitkgpian@gmail.com](mailto:gautamiitkgpian@gmail.com), Mob. No: +91 7855856611**

## Module-1

---

### Introduction of Materials Science and Engineering

**Materials Science** – Investigating relationships that exist between the structure and properties of materials.

**Materials Engineering** – On the basis of these structure-property correlations, designing or engineering the structure of a material to produce a pre-determined set of properties.

#### **Structure**

Structure of a material usually relates to the arrangement of its internal components.

- **Subatomic** - Structure involves electrons within the individual atoms and interactions with their nuclei.
- **Atomic level-** structure encompasses the organization of atoms or molecules relative to one another.
- **Microscopic** – Which contains large groups of atoms that are normally agglomerated together.
- **Macroscopic** – Viewable with the naked eye.

#### **Property**

A property is a material trait in terms of the kind and magnitude of response to a specific imposed stimulus. Properties are made independent of material shape and size.

#### **Example-**

- A specimen subjected to forces will experience deformation,
- A polished metal surface will reflect light.

**Properties of solid materials may be grouped into six different categories:** (1) mechanical, (2) electrical, (3) thermal, (4) magnetic, (5) optical and (6) deteriorative. The four components of the discipline of materials science and engineering and their interrelationship.



## **Classification of Materials**

Solid materials have been conveniently grouped into three basic classifications:

(1) metals, (2) ceramics, and (3) polymers.

### **Metals**

- Materials in this group are composed of one or more metallic elements (such as iron, aluminum, copper, titanium, gold, and nickel), and often also nonmetallic elements (for example, carbon, nitrogen, and oxygen) in relatively small amounts.
- Atoms in metals and their alloys are arranged in a very orderly manner.
- In comparison to the ceramics and polymers, are relatively dense.
- Mechanical Property- relatively stiff and strong, ductile (i.e., capable of large amounts of deformation without fracture), and are resistant to fracture.
- Metallic materials have large numbers of nonlocalized electrons; that is, these electrons are not bound to particular atoms. Many properties of metals are directly attributable to these electrons.
- Example, metals are extremely good conductors of electricity, and heat, and are not transparent to visible light; a polished metal surface has a lustrous appearance.
- Some of the metals (viz., Fe, Co, and Ni) have desirable magnetic properties.

### **Ceramics**

- Ceramics are compounds between metallic and nonmetallic elements; they are most frequently oxides, nitrides, and carbides.
- Examples- aluminum oxide (or alumina,  $Al_2O_3$ ), silicon dioxide (or *silica*,  $SiO_2$ ), silicon carbide (SiC), silicon nitride ( $Si_3N_4$ ).
- Examples of traditional ceramics — clay minerals (i.e., porcelain), cement, and glass.

### **Properties-**

- Relatively stiff and strong—stiffnesses and strengths are comparable to those of the metals, very hard, extremely brittle (lack ductility), highly susceptible to fracture.
- Thermal and electrical Properties- Insulative to the passage of heat and electricity low electrical conductivities and are more resistant to high temperatures
- Optical characteristics- Ceramics may be transparent, translucent, or opaque.

## **Polymers**

- Carbon-based compounds.
- Chain of H-C molecules. Each repeat unit of H-C is a monomer e.g. ethylene (C<sub>2</sub>H<sub>4</sub>), Polyethylene – (–CH<sub>2</sub> –CH<sub>2</sub>)<sub>n</sub>.
- Polymers include the familiar plastic and rubber materials.
- Many of them are organic compounds that are chemically based on carbon, hydrogen, and other nonmetallic elements (viz. O, N, and Si).
- They have very large molecular structures, often chain-like in nature that have a backbone of carbon atoms. Some of the common and familiar polymers are polyethylene (PE), nylon, poly (vinyl chloride)(PVC), polycarbonate (PC), polystyrene (PS), and silicone rubber.

## **Properties**

- Low densities, not as stiff nor as strong as ceramics and metals.
- Extremely ductile and pliable (i.e., plastic).
- Relatively inert chemically and unreactive in a large number of environments.

## **Limitations**

- Tendency to soften and/or decompose at modest temperatures, which, in some instances, limits their use.
- Low electrical conductivities and are nonmagnetic.

## **Composites**

- A composite is composed of two (or more) individual materials, which come from the categories discussed above—viz., metals, ceramics, and polymers.
- Objective-to achieve a combination of properties that is not displayed by any single material

## **Examples**

- Cemented carbides (WC with Co binder)
- Plastic molding compounds containing fillers
- Rubber mixed with carbon black

- Wood (a natural composite as distinguished from a synthesized composite)

### **Advance Materials**

- Materials that are utilized in high-technology (or high-tech) applications are sometimes termed advanced materials.

### **Examples**

- Include electronic equipment (camcorders, CD/DVD players, etc.), computers, fiber-optic systems, spacecraft, aircraft, and military rocketry, liquid crystal displays (LCDs), and fiber optics.
- These advanced materials may be typically traditional materials types (e.g., metals, ceramics, polymers) whose properties have been enhanced, and, also newly developed, high-performance materials.
- Advanced materials include semiconductors, biomaterials, and what we may term “materials of the future.”

### **Biomaterials**

- Biomaterials are employed in components implanted into the human body for replacement of diseased or damaged body parts.
- These materials must not produce toxic substances and must be compatible with body tissues (i.e., must not cause adverse biological reactions).
- All of the above materials—metals, ceramics, polymers, composites, and semiconductors—may be used as biomaterials.

### **Example-**

Titanium and its alloy, Co-Cr alloy, stainless steel, zirconia, HA, TiO<sub>2</sub> etc.

### **Semiconductors**

- Semiconductors have electrical properties that are intermediate between the electrical conductors (viz. metals and metal alloys) and insulators (viz. ceramics and polymers).
- The electrical characteristics of these materials are extremely sensitive to the presence of minute concentrations of impurity atoms, for which the concentrations may be controlled over very small spatial regions.

- Semiconductors have made possible the advent of integrated circuitry that has totally revolutionized the electronics and computer industries (not to mention our lives) over the past three decades.

### The Materials Selection Process

- ✓ Pick Application and determine required Properties.
- ✓ Properties: mechanical, electrical, thermal, magnetic, optical, deteriorative.
- ✓ Properties- Identify candidate Material(s)
- ✓ Material: structure, composition.
- ✓ Material- Identify required Processing
- ✓ Processing: changes structure and overall shape  
**Example:** casting, sintering, vapor deposition, doping forming, joining, annealing.

### Elastic deformation in metals:

- ✓ Deformation in which stress and strain are proportional is called elastic deformation.
- ✓ In elastic deformation a limited distortion of the crystal lattice is produced, but the atoms do not move permanently from their ordered positions, and as soon as the stress is removed the distortion disappears and the body returns to its original configuration (shape and size).
- ✓ When metal is stressed beyond the elastic limit plastic deformation takes place and there must, clearly, be some movement of the atoms in to new positions, since considerable permanent distortion can be produced.
- ✓ Usually in metals and ceramics elastic deformation is seen at low strains ( $< 10^{-3}$ ).
- ✓ Elasticity can be linear or Non linear. Metals and ceramics usually show linear elastic behavior.
- ✓ Some materials (e.g., gray cast iron, concrete, and many polymers) exhibit non linear elasticity.

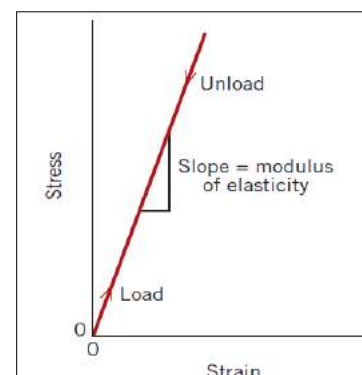
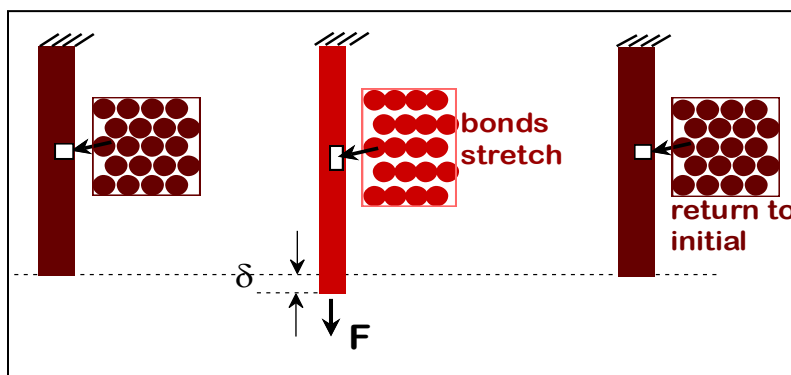

Stress-Strain curve showing linear elastic behavior

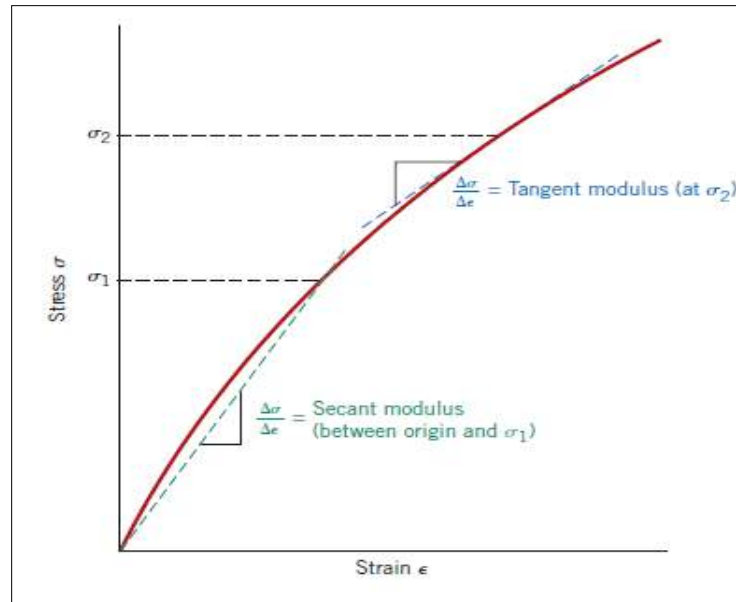

Stress-Strain curve showing non-linear elastic behavior

### **Plastic deformation in metals:**

- ✓ Plastic deformation in the broadest sense means permanent deformation in the absence of external constraints (forces, displacements).
- ✓ From an atomic perspective, plastic deformation corresponds to the breaking of bonds with original atom neighbors and then reforming bonds with new neighbors as large numbers of atoms or molecules move relative to one another; upon removal of the stress they do not return to their original positions.
- ✓ For most metallic materials, elastic deformation persists only to strains of about 0.005. As the material is deformed beyond this point, the stress is no longer proportional to strain (Hooke's law) and permanent/nonrecoverable/plastic deformation occurs.
- ✓ The transition from elastic to plastic is a gradual one for most metals; some curvature results at the onset of plastic deformation, which increases more rapidly with rising stress..
- ✓ The mechanism of plastic deformation is not the same for all classes of materials and it is necessary to consider the various materials groups separately.
- ✓ Metals, in general, are characterized by possessing high elastic modulus values, and also the ability to be strained in a plastic manner.

- ✓ Some metals will begin to deform plastically at very low values of stress and will yield to a very considerable extent before fracture occurs. Other metals and alloys show little plastic yielding before fracture. These latter materials are termed brittle.

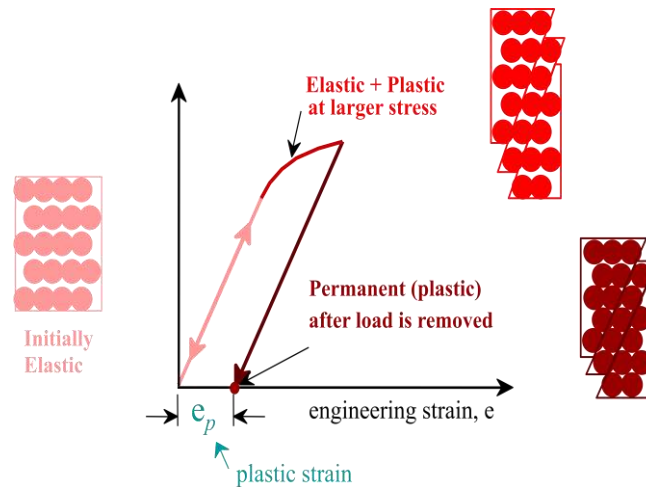
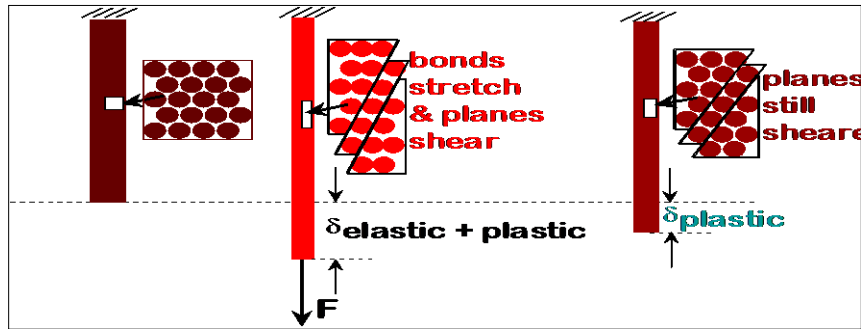

### **Mechanism/Modes of plastic deformation in metals:**

- ✓ Plastic deformation in crystalline solid is accomplished by means of various processes mentioned below; among which slip is the most important mechanism.
- ✓ Plastic deformation of crystalline materials takes place by mechanisms which are very different from that for amorphous materials (glasses).
- ✓ Plastic deformation in amorphous materials occurs by other mechanisms including flow (~viscous fluid) and shear banding.



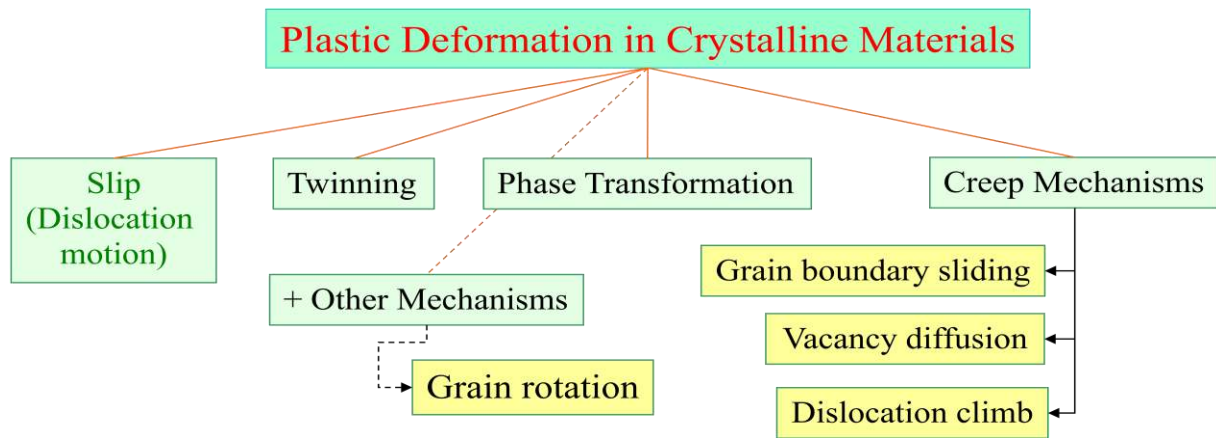

### **Plastic deformation by Slip:**

- ✓ Slip is the most important mechanism of plastic deformation. At low temperatures (especially in BCC metals) twinning may also become important.
- ✓ At the fundamental level plastic deformation (in crystalline materials) by slip involves the motion of dislocations on the slip plane (*creating a step of Burgers vector*).
- ✓ Slip is caused by shear stresses (at the level of the slip plane). Hence, a purely hydrostatic state of stress cannot cause slip.
- ✓ A slip system consists of a slip direction lying on a slip plane.
- ✓ Slip is analogous to the mode of locomotion employed by a caterpillar.

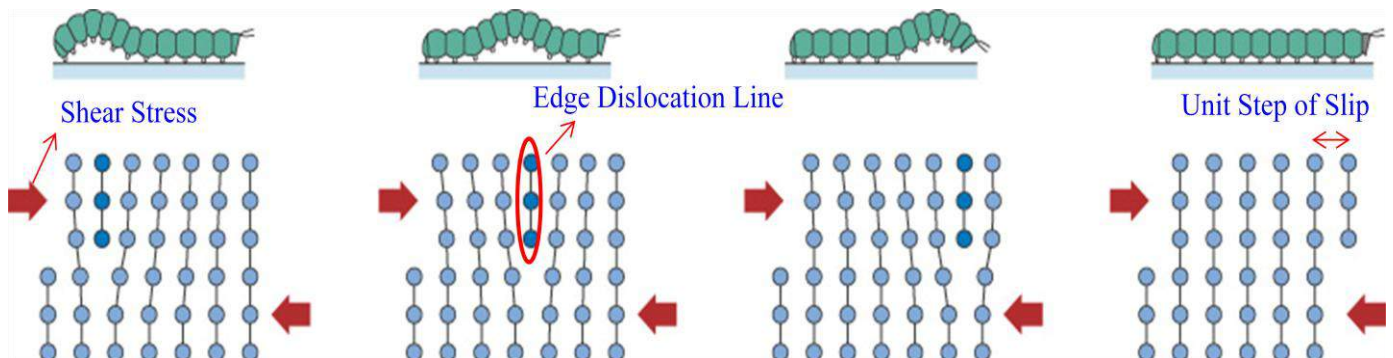

Microscopic slip to macroscopic deformation

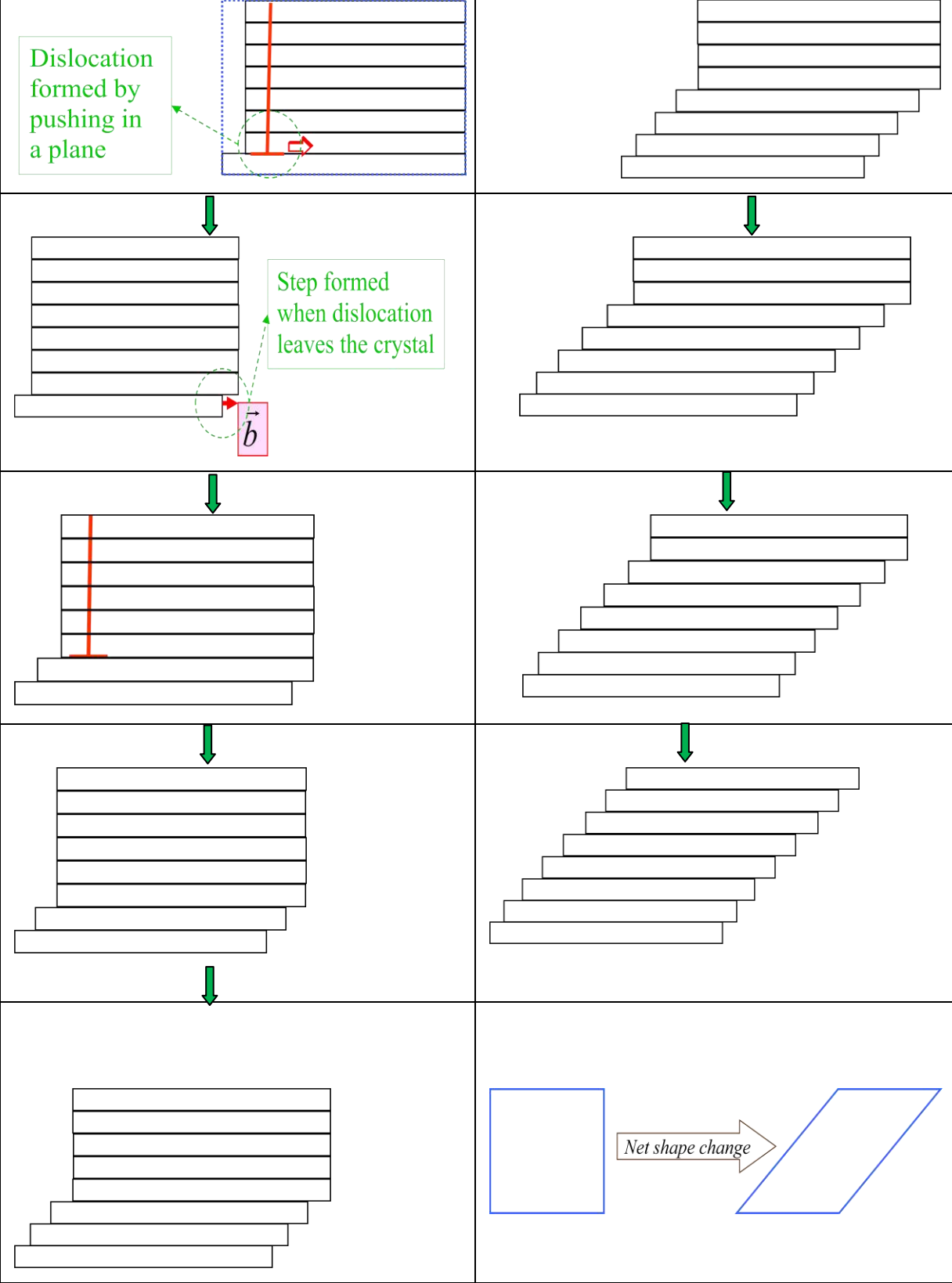

### Slip systems:

- ✓ Dislocations move more easily on specific planes and in specific directions.
- ✓ Ordinarily, there is a preferred plane (slip plane), and specific directions (slip direction) along which dislocations move. The combination of slip plane and slip direction is called the slip system.
- ✓ The slip system depends on the crystal structure of the metal.
- ✓ The slip plane is the plane that has the most dense atomic packing (the greatest planar density). The slip direction is most closely packed with atoms (highest linear density)

Crystal	Slip plane(s)	Slip direction (b vector)	Number of slip systems
FCC	{111}	$\frac{1}{2}\langle 110 \rangle$	12
HCP	(0001)	$\langle 11 \bar{2}0 \rangle$	3
BCC	{110}, {112}, {123}	$\frac{1}{2}[111]$	48

### Stress to move a dislocation: Peierls – Nabarro (PN) stress:

- ✓ At the fundamental level the motion of a dislocation involves the rearrangement of bonds which requires application of shear stress on the slip plane.
- ✓ Consider plastic deformation is the transition between unslipped to slipped state. As this process is opposed by an energy barrier  $\Delta E$ , the materials cannot make the transition simultaneously.
- ✓ To minimize the energetic of the process the slipped material will grow at the expenses of the unslipped region by the advance of an interfacial region (width of the dislocation  $w$ ).

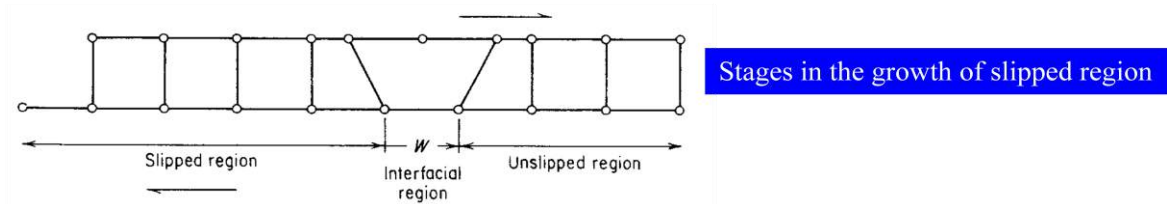
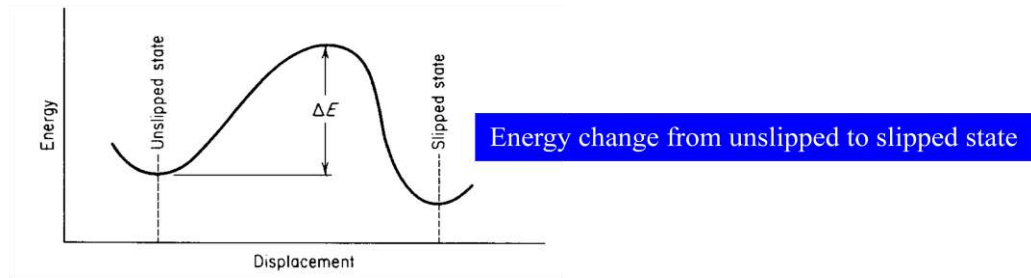

- ✓ The original model is due to Peierls & Nabarro (formula as below) and the ‘sufficient’ stress which needs to be applied is called Peierls-Nabarro stress (PN stress) or simply Peierls stress.

$$\tau_{PN} = G e^{-\left(\frac{2\pi w}{b}\right)}$$

- $G$  → shear modulus of the crystal
- $w$  → width of the dislocation !!!
- $b$  → Distance between atoms in the slip direction

- ✓ Width of the dislocation is considered as a basis for the ease of motion of a dislocation in the model which is a function of the bonding in the material.
- ✓ Peierls equation shows that wide dislocations will require low stress to move the dislocations.
- ✓ In ceramics the interfacial energy is high and the dislocation width is very narrow. Hence they are relatively immobile compared to ductile materials (dislocation width nearly 10 atomic spacings).
- ✓ Ceramics become ductile at high temperature as thermal activation help the dislocations to overcome the energy barrier.

### Slip in single crystal:

- ✓ If a single crystal of a metal is stressed in tension beyond its elastic limit, it elongates slightly and a step appears on the surface due to the relative displacement of one part of the crystal with respect to the others and the elongation stops.

- ✓ Further increase in the load causes movement of another parallel plane, resulting in another step. Similarly number of small steps is formed on the surface of the single crystal that are parallel to one another and loop around the circumference of the specimen.
- ✓ Each step (shear band) results from the movement of a large number of dislocations and their propagation in the slip system.

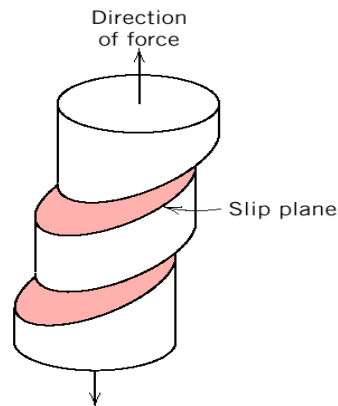

Macroscopic slip in single crystal

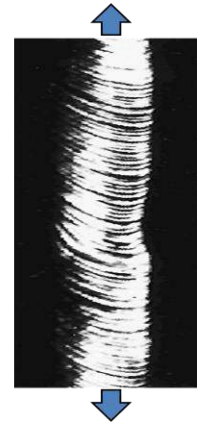

Slip in a zinc single crystal

### Critical Resolved Shear Stress (CRSS):

- ✓ Extent of slip in a single crystal depends on the magnitude of shearing stress produced by external loads, geometry of the crystal structure and the orientation of the active slip planes with respect to the shearing stress.
- ✓ Slip begins when the shearing stress on slip plane in the slip direction/Resolved Shear Stress (RSS) reaches a critical value called the Critical Resolved Shear Stress (CRSS) and plastic deformation starts (*The actual Schmid's law*)
- ✓ Even if we apply a tensile force on the specimen → the shear stress resolved onto the slip plane is responsible for slip.

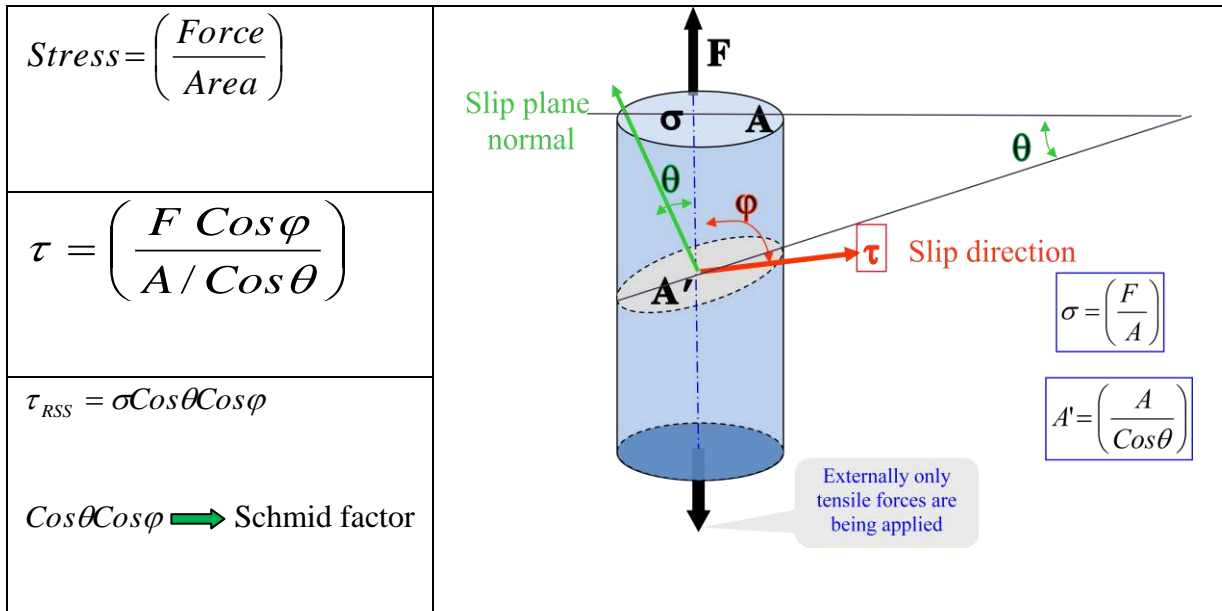

- ✓  $\tau_{RSS}$  is maximum ( $F/2A$ ) when  $\phi = \lambda = 45^\circ$
- ✓ If the tension axis is normal to slip plane i.e.  $\lambda = 90^\circ$  or if it is parallel to the slip plane i.e.  $\phi = 90^\circ$  then  $\tau_{RSS} = 0$  and slip will not occur as per Schmid's law.

$$\tau_{RSS} \geq \tau_{CRSS}$$

- ✓ **Schmid's law:** Slip is initiated when
- ✓  $\tau_{CRSS}$  is a material parameter, which is determined from experiments

- ✓ Yield strength of a single crystal 
$$\sigma_y = \frac{\tau_{CRSS}}{\cos \theta \cos \phi}$$

**Solved Example:** Determine the tensile stress that is applied along the  $[\bar{1}\bar{1}0]$  axis of a silver crystal to cause slip on the  $(111)[0\bar{1}\bar{1}]$  system. The critical resolved shear stress is 6 MPa.

**Solution:** Determine the angle  $\phi$  between the tensile axis  $[\bar{1}\bar{1}0]$  and normal to  $(111)$  using the following equation.

$$\cos\theta = \left( \frac{u_1u_2 + v_1v_2 + w_1w_2}{\sqrt{(u_1^2 + v_1^2 + w_1^2)(u_2^2 + v_2^2 + w_2^2)}} \right)$$

$$\cos\phi = \left( \frac{(1)(1) + (-1)(-1) + (0)(-1)}{\sqrt{[(1)^2 + (-1)^2 + (0)^2][(1)^2 + (-1)^2 + (-1)^2]}} \right) = \frac{1}{\sqrt{2}\sqrt{3}} = \frac{2}{\sqrt{6}}$$

Determine the angle  $\lambda$  between tensile axis  $[\bar{1}10]$  and slip direction  $[0\bar{1}1]$

$$\cos\lambda = \left( \frac{(1)(0) + (-1)(-1) + (0)(-1)}{\sqrt{[(1)^2 + (-1)^2 + (0)^2][(0)^2 + (-1)^2 + (-1)^2]}} \right) = \frac{1}{\sqrt{2}\sqrt{2}} = \frac{1}{2}$$

Then calculate the Tensile Stress using the expression:

$$\sigma = \frac{P}{A} = \frac{\tau_{RSS}}{\cos\phi \cos\lambda} = \frac{6MPa}{\frac{2}{\sqrt{6}} \times \frac{1}{2}} = 6\sqrt{6} = 14.7Mpa$$

**Solved Example:** Consider a single crystal of BCC iron oriented such that a tensile stress is applied along a  $[010]$  direction.

(a) Compute the resolved shear stress along a  $(110)$  plane and in a  $[111]$  direction when a tensile stress of 52 MPa (7500 psi) is applied

(b) If slip occurs on a  $(110)$  plane and in a  $[\bar{1}11]$  direction, and the critical resolved shear stress is 30 MPa (4350 psi), calculate the magnitude of the applied tensile stress necessary to initiate yielding.

**Solution:**

Determine the value of the angle between the normal to the  $(110)$  slip plane (i.e., the  $[110]$  direction) and the  $[010]$  direction using  $[u_1v_1w_1] = [110]$ ,  $[u_2v_2w_2] = [010]$  and the following equation.

$$\theta = \cos^{-1} \left( \frac{u_1u_2 + v_1v_2 + w_1w_2}{\sqrt{(u_1^2 + v_1^2 + w_1^2)(u_2^2 + v_2^2 + w_2^2)}} \right)$$

$$\phi = \cos^{-1} \left( \frac{(1)(0) + (1)(1) + (0)(0)}{\sqrt{[(1)^2 + (1)^2 + (0)^2][(0)^2 + (1)^2 + (0)^2]}} \right)$$

$$= \cos^{-1} \left( \frac{1}{\sqrt{2}} \right) = 45^\circ$$

Similarly determine the value of  $\lambda$ , the angle between  $[\bar{1}11]$  and  $[010]$  directions as follows:

$$\lambda = \cos^{-1} \left( \frac{(-1)(0) + (1)(1) + (1)(0)}{\sqrt{[(-1)^2 + (1)^2 + (1)^2][(0)^2 + (1)^2 + (0)^2]}} \right) = \cos^{-1} \left( \frac{1}{\sqrt{3}} \right) = 54.7^\circ$$

Then calculate the value of  $\tau_{RSS}$  using the following expression:

$$\tau_{RSS} = \sigma \cos \phi \cos \lambda$$

$$= (152 \text{ Mpa})(\cos 45)(\cos 54.7)$$

$$= 21.3 \text{ Mpa}$$

$$= 13060 \text{ psi}$$

Yield Strength  $\sigma_Y$ :

$$\sigma_y = \frac{30 \text{ Mpa}}{(\cos 45)(\cos 54.7)} = 73.4 \text{ Mpa}$$

### **Plastic deformation by Twin:**

- ✓ Twins are generally of two types: Mechanical Twins and Annealing twins
- ✓ Mechanical twins are generally seen in bcc or hcp metals and produced under conditions of rapid rate of loading and decreased temperature.
- ✓ Annealing twins are produced as the result of annealing. These twins are generally seen in fcc metals.
- ✓ Annealing twins are usually broader and with straighter sides than mechanical twins.



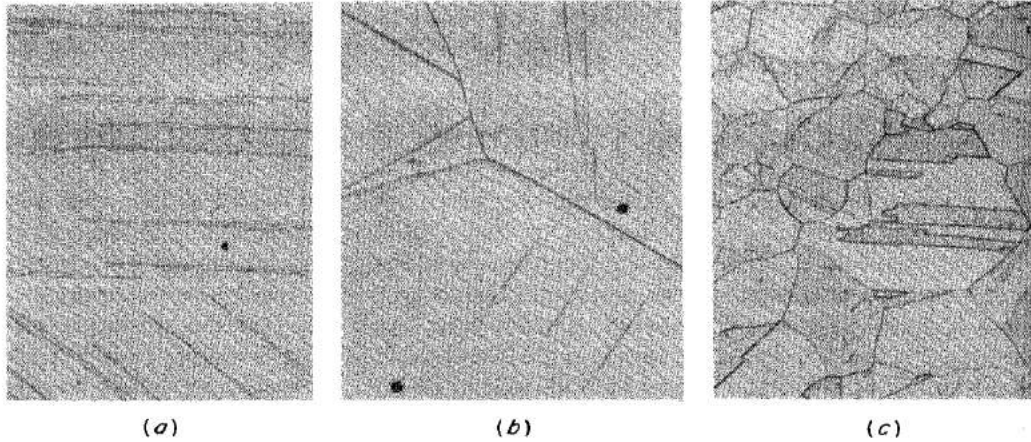

(a) Mechanical Twins (Neumann bands in iron), (b) Mechanical Twins in zinc produced by polishing (c) Annealing Twins in gold-silver alloy

- ✓ Twinning generally occurs when the slip systems are restricted or when the slip systems are restricted or when something increases the critical resolved shear stress so that the twinning stress is lower than the stress for slip.
- ✓ So, twinning generally occurs at low temperatures or high strain rates in bcc or fcc metals or in hcp metals.
- ✓ Twinning occurs on specific twinning planes and twinning directions.

Crystal Structure	Typical Examples	Twin Plane	Twin Direction
BCC	$\alpha$ -Fe, Ta	(112)	[111]
HCP	Zn, Cd, Mg, Ti	(10 $\bar{1}2$ )	[ $\bar{1}011$ ]
FCC	Ag, Au, Cu	(111)	[112]

(Twin planes and Twin directions)

## Difference between in slip in Twin:

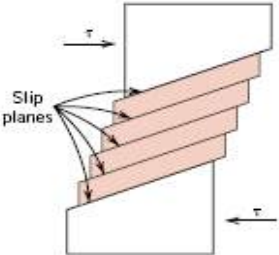
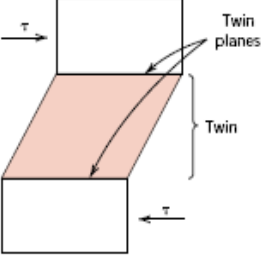
SLIP	TWIN
<ul style="list-style-type: none"> <li>✓ The crystallographic orientation above and below the slip plane is the same both before and after the deformation</li> <li>✓ Slip occurs in distinct atomic spacing multiples</li> <li>✓ Slip Leaves a series of steps (lines)</li> <li>✓ Normally slip results in relatively large deformations</li> <li>✓ Mostly seen in FCC and BCC structure, as they have more slip systems</li> <li>✓ Occurs on widely spread planes</li> </ul>	<ul style="list-style-type: none"> <li>✓ Orientation difference is seen across the twin plane</li> <li>✓ the atomic displacement for twinning is less than the inter-atomic separation</li> <li>✓ Twinning leaves small but well defined regions of the crystal deformed</li> <li>✓ Only small deformations result for twinning</li> <li>✓ Is most important for HCP structure, because of its small number of slip system</li> <li>✓ Occurs on every plane of region involved</li> </ul>
	

## Plastic deformation of Polycrystalline Materials:

- ✓ Plastic deformation in polycrystalline materials is very complex than those in the single crystals due to the presence of grain boundaries, different orientation of neighboring crystals, presence of several phases etc.
- ✓ Due to random crystallographic orientations, the slip planes and slip direction varies from one grain to another.
- ✓ As a result the resolved shear stress  $\tau_{RSS}$  will vary from one crystal to another and the dislocations will move along the slip systems with favorable orientation (i.e. the highest resolved shear stress).

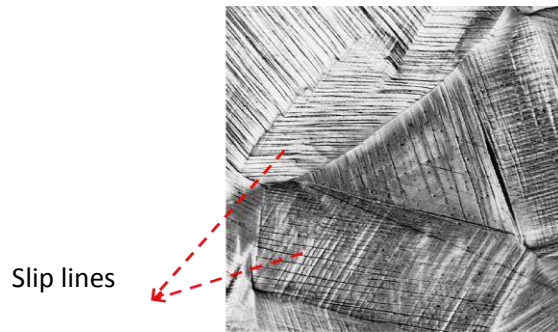

- ✓ When a polished polycrystalline specimen of copper is plastically deformed, two slip systems operate for most of the grains (evidenced by two sets of parallel yet intersecting sets of lines).
- ✓ Slip lines are visible, and the variation in grain orientation is indicated by the difference in alignment of the slip lines for several grains.
- ✓ During deformation, mechanical integrity and coherency are maintained along the grain boundaries; i.e. the grain boundaries usually do not come apart or open up.
- ✓ As a consequence, each individual grain is constrained, to some degree in the shape it may assume by its neighboring grains.

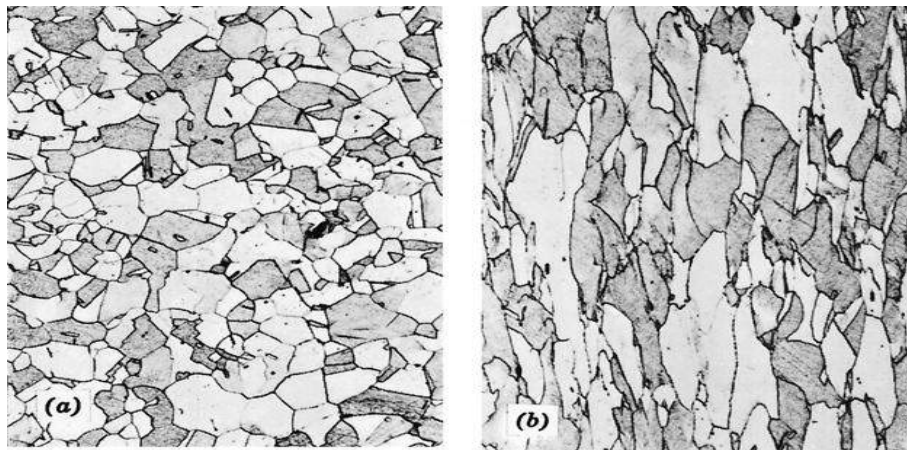

Alteration of the grain structure of a polycrystalline metal as a result of plastic deformation (a) before deformation the grains are equiaxed. (b) after deformation elongated grains are produced

## Strengthening Mechanisms

The ability of a metal to deform depends on the ability of the dislocations to move and the slip of dislocations weakens the crystal. Hence we have two strategies to strengthen the crystal/material:

- completely remove dislocations → difficult, but dislocation free whiskers have been produced (*however, this is not a good strategy as dislocations can nucleate during loading*)
- Increase resistance to the motion of dislocations or put impediments to the motion of dislocations → this can be done in many ways as listed below.

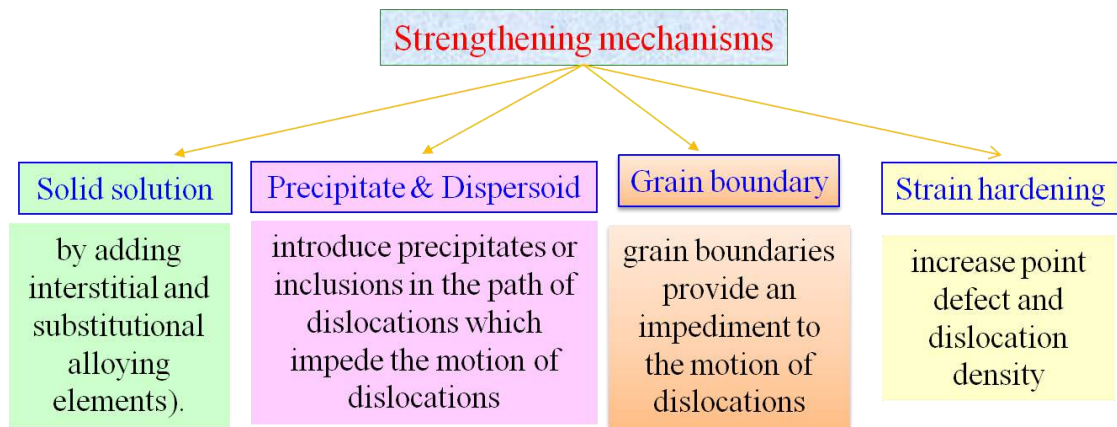

### Solid Solution Strengthening:

- ✓ The introduction of solute atoms into solid solution in the solvent-atom lattice invariably produces an alloy which is stronger than the pure metal.
- ✓ Two types of solid solutions:
  - Substitutional solid solutions → Solute atoms occupy lattice points in the solvent lattice (Hume Rothery's rules are to be satisfied)
  - Interstitial solid solutions → Solute atoms occupy interstitial positions in the solvent lattice (Carbon, Nitrogen, Boron, Oxygen, Hydrogen are the common interstitial solutes)
- ✓ Smaller solute atoms → Tensile stress field & Larger solute atoms → Compressive stress field
- ✓ The stress fields around solute atoms interact with the stress fields around the dislocation.

- ✓ This interaction provides frictional resistance to dislocations motion and static locking of dislocations
- ✓ The factors playing an important role on strengthening effect:
  - Size of the solute
  - Concentration of solute
  - Elastic modulus of the solute (higher E → greater strengthening effect)
  - Nature of solute atoms (Interstitial or substitutional)

- ✓ More the size difference, more the intensity of stress field around solute atoms and more is the hardening effect.
- ✓ Large the concentration of solute, more obstacles to dislocations motion and strength increases (Increase in  $\sigma_Y$  is proportional to the square root of concentration of the solute).
- ✓ Interstitial solute atoms can elastically interact with both edge and screw dislocations and results in intense distortion compared to that of substitutional atoms.
- ✓ Hence they give a higher hardening effect (per unit concentration) as compared to substitutional atoms.

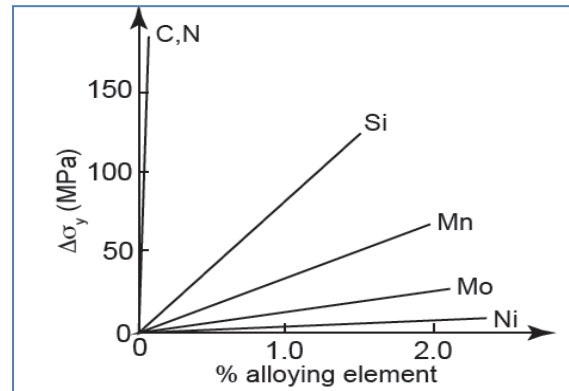
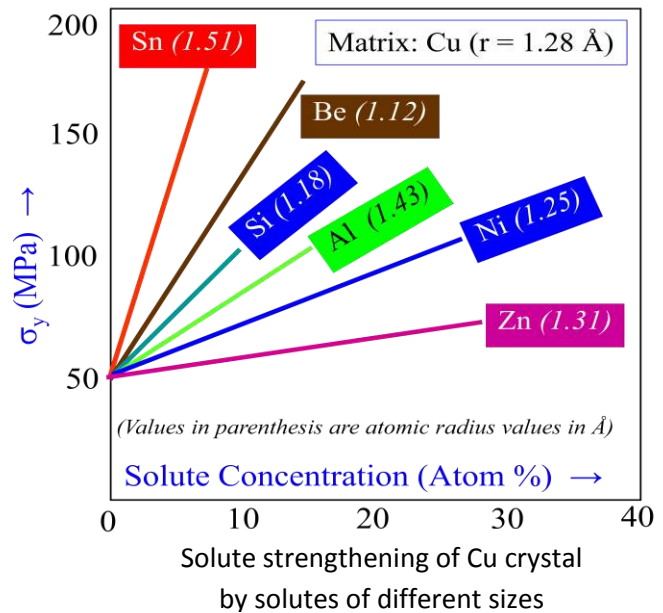

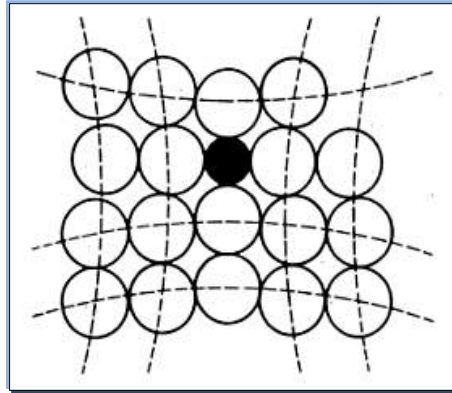

(Substitutional)

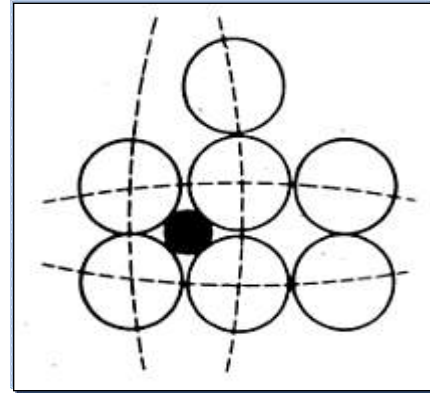

(Interstitial)

### Hardening by precipitates and dispersoids:

- ✓ Small second-phase particles distributed in a ductile matrix can hinder the dislocation motion and thus increase the strength of a material. Second-phase particles either can be introduced by mixing and consolidation (dispersion strengthening) or precipitated in solid state (precipitation hardening).

### Precipitation hardening:

- ✓ Precipitation hardening or age hardening is produced by solution treating and quenching an alloy. Term 'Age hardening' is used to describe the process because strength develops with time.
- ✓ Requisite for precipitation hardening to take place is that second phase must be soluble at an elevated temperature but precipitates upon quenching and aging at a lower temperature.
- ✓ Mostly seen in: Al-alloys, Cu-Be alloys, Mg-Al alloys, Cu-Sn alloys.
- ✓ Precipitates may be coherent, semi-coherent or incoherent. Coherent (& semi-coherent) precipitates are associated with coherency stresses.
- ✓ If the precipitate is coherent with the matrix then Dislocations can glide through it. Glide of the dislocation causes a displacement of the upper part of the precipitate w.r.t the lower part by  $\mathbf{b} \rightarrow \sim$  *cutting of the precipitate*.

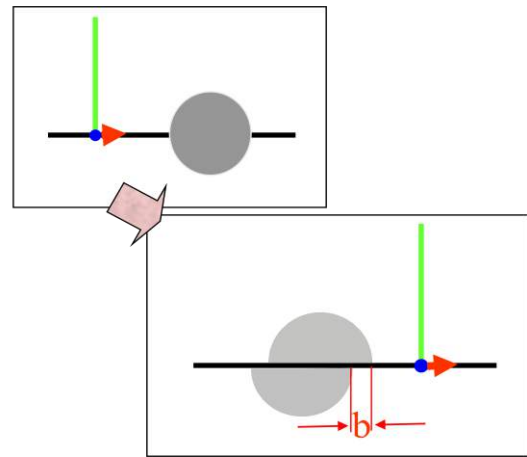
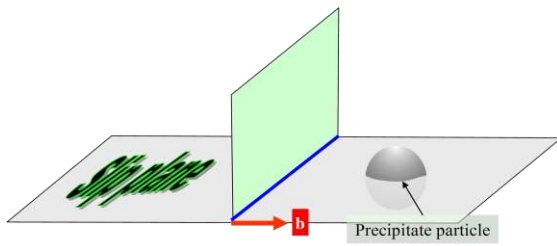
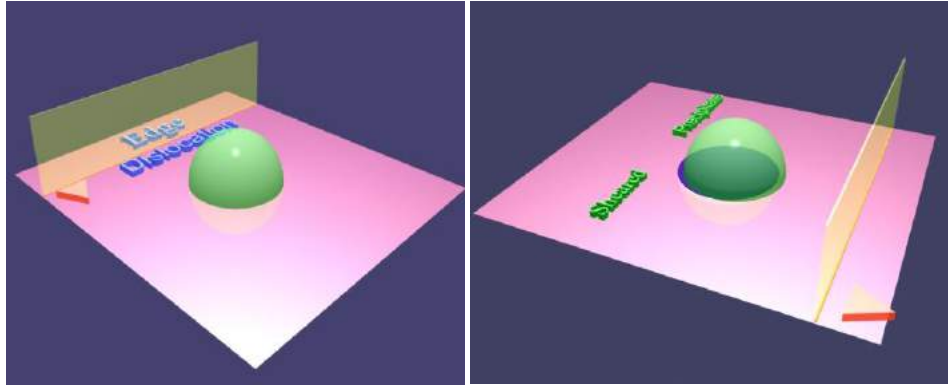

- ✓ Dislocations cannot glide through incoherent precipitates and widely separated inclusions. Hence they bow around the widely separated inclusions. In this process they leave dislocation loops around the inclusions, thus leading to an increase in dislocation density. This is known as the **Orowan bowing mechanism**.

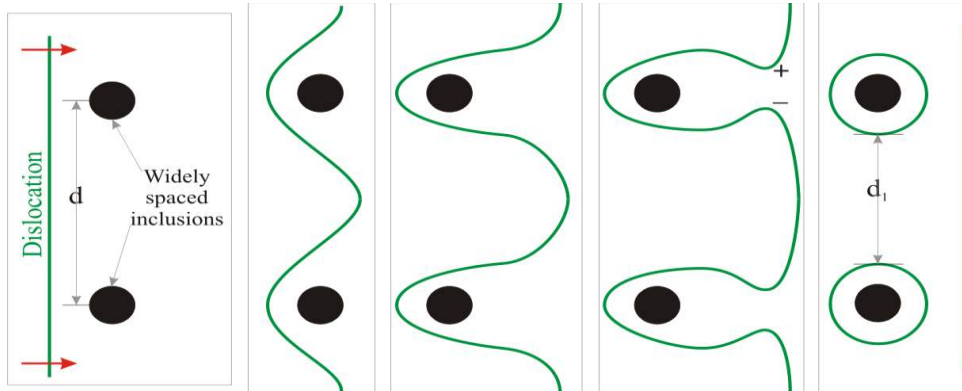

- ✓ The next dislocation arriving (similar to the first one), feels a repulsion from the dislocation loop and hence the stress required to drive further dislocations increases. Additionally, the effective separation distance (through which the dislocation has to bow) reduces from 'd' to 'd<sub>1</sub>'.
- ✓ Inclusions behave similar to incoherent precipitates in this regard (precipitates are part of the system, whilst inclusions are external to the alloy system).
- ✓ A pinned dislocation (at a precipitate) has to either climb over it (which becomes favorable at high temperatures) or has to bow around it.

### Dispersion hardening:

- ✓ In dispersion hardening, the hard particles are mixed with matrix powder and consolidated and processed by powder metallurgy techniques.
- ✓ Example: Thoria dispersed Nickel → Fine particles of Thoria are dispersed in the nickel matrix and the inter particle distance is enough to hinder the dislocation movement thereby increasing the strength up to 0.9 times  $T_m$  ( $T_m$  in °C).
- ✓ In dispersion hardening, dispersoids are incoherent with the matrix and dislocations cannot glide through these dispersoids and gets pinned.
- ✓ A pinned dislocation (at a precipitate) has to either climb over it (which becomes favorable at high temperatures) or has to bow around it (Orowan's Mechanism of Dispersion Hardening)
- ✓ Dislocation loop exert a back stress on dislocation which needs to be overcome for additional slip to take place and this causes hardening.

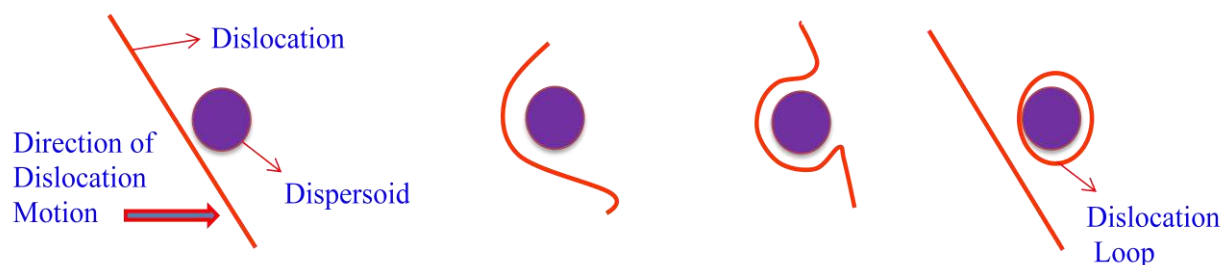



## Strengthening by Grain Boundary:

- ✓ Grain boundary is the boundary between two grains in a polycrystalline aggregate and this is the region of a disturbed lattice which is of few atomic diameters distance.
- ✓ There are two important ways in which grain boundary acts as a barrier to the dislocation
  - Difficulty for a dislocation to pass through two different grain orientations (need to change the direction)
  - The atomic disorder within a grain boundary region contributes to a discontinuity of slip planes from one grain to other.
- ✓ Hence dislocations are stopped by a grain boundary and pile up against it.

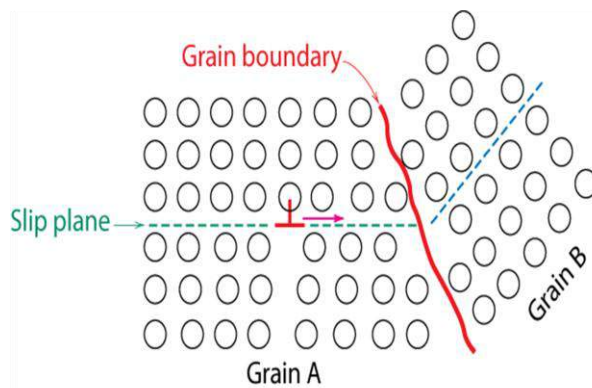

- ✓ A fine grained material is harder and stronger than one that is coarse grained since greater amounts of grain boundaries in the fine grained materials impede dislocation motion.
- ✓ The general relationship between yield stress (tensile strength) and grain size was proposed by Hall and Petch, which is known as **Hall-Petch relation**.

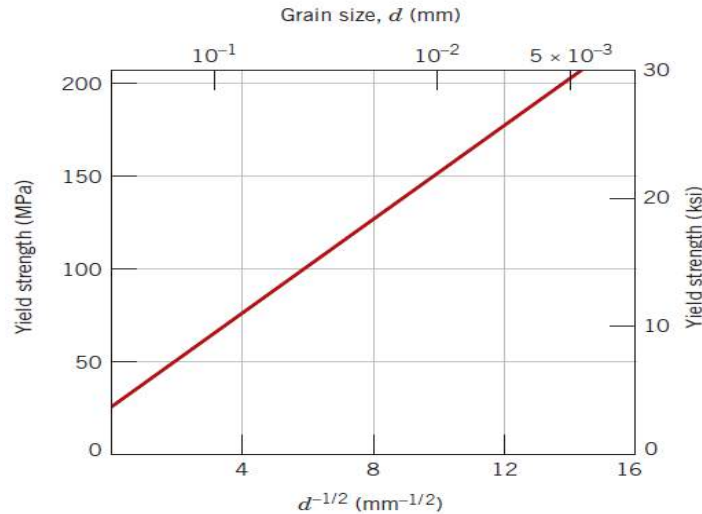

$$\sigma_{Yield} = \sigma_o + k_y d^{-\frac{1}{2}}$$

Where,

$\sigma_{yield}$  = Yield stress

$\sigma_o$  = Friction stress or resistance to dislocation motion

$k_y$  = Locking parameter or the hardening contribution from the grain boundary

$d$  = Grain diameter

(Influence of grain size on yield strength of 70Cu-30Zn Brass)

### Strain Hardening: Forest Dislocations:

- ✓ Increasing strength and hardness by plastic deformation is called strain hardening or work hardening. Also referred as cold working as deformation takes place at room temperature.
- ✓ With plastic deformation dislocation density increases because under applied stress dislocation sources, like Frank-Reed source, becomes active.

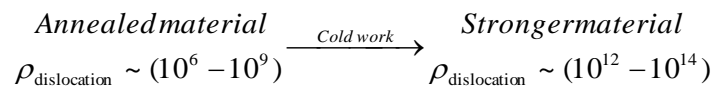

- ✓ Extent of strain hardening increases with degree of cold working (% area reduction).
- ✓ Since the metal is deformed in a certain direction, grains are elongated in the direction of working.
- ✓ The consequence of strain hardening a material is improved strength and hardness but material's ductility will be reduced.

### Mechanism:

- ✓ Cold working generates dislocations – dislocation density increases. Higher density of dislocations impedes their motion due to interactions of dislocation strain fields.
- ✓ Hence the strength increases according to the relation:  $\tau = \tau_o + A\rho^{\frac{1}{2}}$ , where  $\tau$  is the shear stress to move a dislocation that increases with increase in dislocation density ( $\rho$ ).

## **Cold Working & its effect on properties:**

- ✓ Plastic deformation in the temperature range  $(0.3 - 0.5) T_m \rightarrow$  Cold Work
- ✓ Point defects and dislocations have strain energy associated with them
- ✓ (1 -10) % of the energy expended in plastic deformation is stored in the form of strain energy (in these defects)  $\rightarrow$  *The material becomes battery of energy.....!*
- ✓ The cold worked material is in a micro structurally metastable state.
- ✓ Depending on the severity of the cold work the dislocation density can increase 4-6 orders of magnitude more. The material becomes stronger, but less ductile.
- ✓ In addition to mechanical properties, physical properties of a material also changes during cold working. There is usually a small decrease in density, an appreciable decrease in electrical conductivity, small increase in thermal coefficient of expansion and increased chemical reactivity (decrease in corrosion resistance).
- ✓ Cold working is typically done on ductile metals (e.g. Al, Cu, Ni).
- ✓ Heating the material (typically below  $0.5T_m$ ) is and holding for sufficient time is a heat treatment process called annealing.
- ✓ Depending on the temperature of annealing processes like Recovery at lower temperatures) or Recrystallization (at higher temperatures) may take place. During these processes the material tends to go from a micro structurally metastable state to a lower energy state (towards a stable state).
- ✓ Further ‘annealing’ of the recrystallized material can lead to grain growth.

## **Recovery, Recrystallization and Grain Growth:**

Annealing is an important industrial process to relieve the stresses from cold working. During cold working grain shape changes, while material strain hardens because of increase in dislocation density. Between 1-10% of the energy of plastic deformation is stored in material in the form of strain energy associated with point defects and dislocations. On annealing i.e. on heating the deformed material to higher temperatures and holding, material tends to lose the extra strain energy and revert to the original condition before deformation by the processes of recovery and recrystallization. Grain growth may follow these in some instances.

## Recovery:

- ✓ Recovery takes place at low temperatures of annealing
- ✓ “Apparently no change in microstructure”
- ✓ Excess point defects created during Cold work are absorbed:
  - At surface or grain boundaries
  - By dislocation climb
- ✓ Random dislocations of opposite sign come together and annihilate each other.
- ✓ Dislocations of same sign arrange into low energy configurations ((POLYGONIZATION):
  - Edge → Tilt boundaries
  - Screw → Twist boundaries
- ✓ Overall reduction in dislocation density is small
- ✓ At the early stage of annealing of cold formed metals, external thermal energy permits the dislocations to move and form the boundaries of a polygonized subgrain structure while the dislocation density stays almost unchanged. This process also removes the residual stresses formed due to cold working significant. The recovering of physical and mechanical properties varies with the temperature and time.

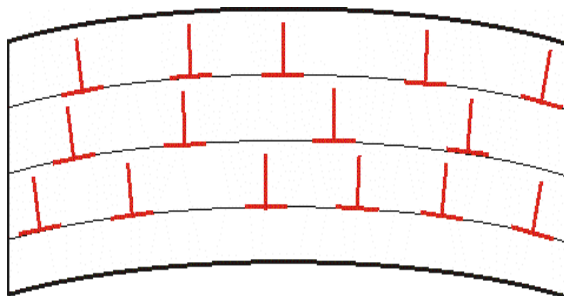

Bent  
crystal

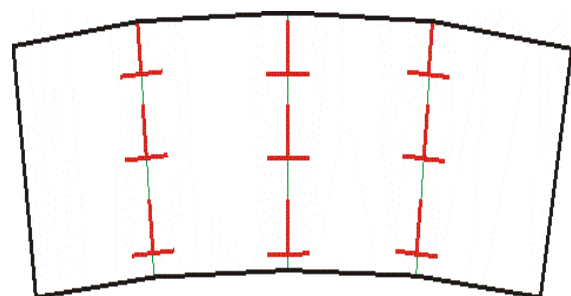

Low angle grain  
boundaries

## Recrystallization:

- ✓  $T_{\text{Recrystallization}} \in (0.3 - 0.5) T_m$
- ✓ “Nucleation” and growth of new, strain free crystals
- ✓ Nucleation of new grains in the usual sense may not be present and grain boundary migrates into a region of higher dislocation density
- ✓  $\Delta G$  (recrystallization) =  $G$  (deformed material) –  $G$  (undeformed material)
- ✓  $T_{\text{Recrystallization}}$  is the temperature at which 50 % of the material recrystallizes in 1 hour

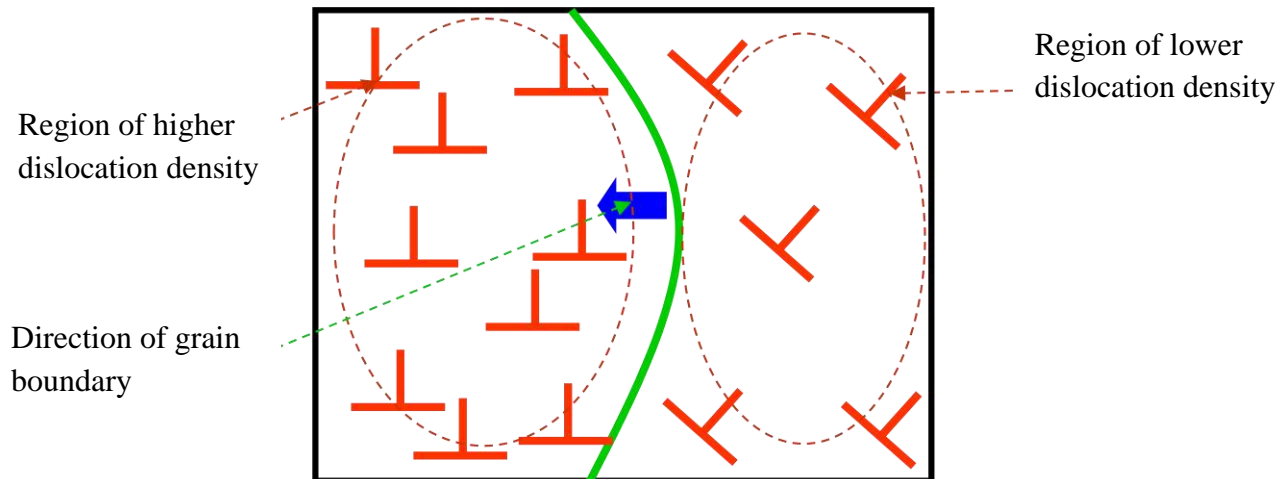

- ✓ There are many variables that influence recrystallization behavior, namely amount of prior deformation, temperature, time, initial grain size, composition and amount of recovery prior to the start of the recrystallization. This dependence leads to following empirical laws:
  - Deformation  $\uparrow \Rightarrow$  recrystallization temperature ( $T_{\text{recrystallization}}$ )  $\downarrow$
  - Initial grain size  $\downarrow \Rightarrow$  recrystallization temperature  $\downarrow$
  - High cold work + low initial grain size  $\Rightarrow$  finer recrystallized grains

- $\uparrow$  cold work temperature  $\Rightarrow$  lower strain energy stored  $\Rightarrow \uparrow$  recrystallization temperature
- Rate of recrystallization = exponential function of temperature
- $T_{\text{recrystallization}}$  = strong function of the purity of the material
  - $T_{\text{recrystallization}}$  (very pure materials)  $\sim 0.3 T_m$
  - $T_{\text{recrystallization}}$  (impure)  $\sim (0.5 - 0.6) T_m$
  - $T_{\text{recrystallization}}$  (99.999% pure Al)  $\sim 75^\circ\text{C}$
  - $T_{\text{recrystallization}}$  (commercial purity)  $\sim 275^\circ\text{C}$
- The impurity atoms segregate to the grain boundary and retard their motion  $\rightarrow$  *Solute drag* (can be used to retain strength of materials at high temperatures).
- Second phase particles also pin down the grain boundary during its migration.

### Grain Growth:

- ✓ Large grains have lower free energy than small grains. This is associated with the reduction of the amount of grain boundary.
- ✓ Therefore, under ideal conditions, the lower energy state for a metal would be as a single crystal. This is driving force for grain growth.
- ✓ Opposing this force is the rigidity of the lattice. As the temperature increases, the rigidity of the lattice decreases and the rate of grain growth is more rapid.
- ✓ At any given temperature there is a maximum grain size at which these two effects are in equilibrium

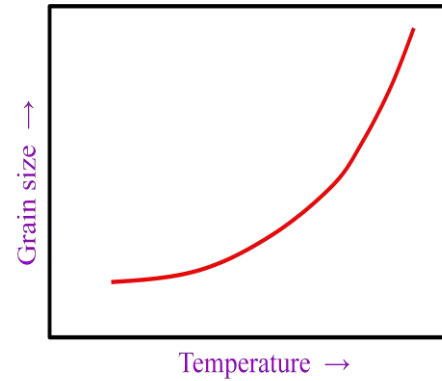
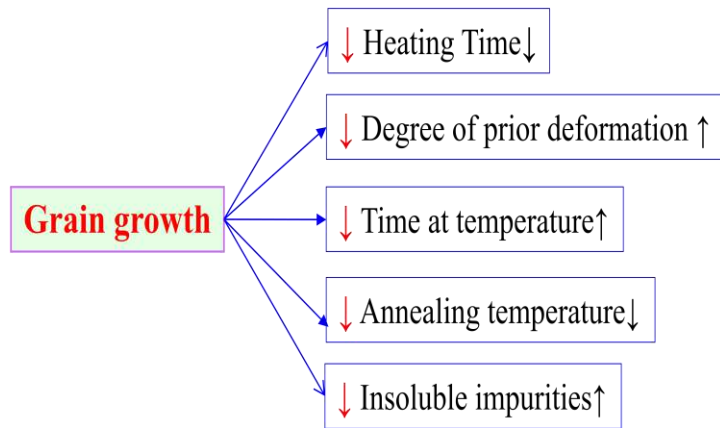

Effect of temperature on recrystallized grain size

**Hot Work** ⇔ Plastic deformation **above**  $T_{\text{Recrystallization}}$

**Cold Work** ⇔ Plastic deformation **below**  $T_{\text{Recrystallization}}$

✚ When a metal is hot worked, the conditions of deformation are such that the sample is soft and ductile. The effects of strain hardening are negated by dynamic and static processes (*which keep the sample ductile*).

✚ The lower limit of temperature for hot working is taken as  $0.6 T_m$

### Constitution of Alloys:

Structure of metals and materials is the most important aspect as properties depend upon the features of the materials.

#### Phase:

- ✓ Anything which is homogenous and physically distinct.
- ✓ It can also be defined as anything which is physically distinct, chemically homogeneous, and mechanically separable.
- ✓ And it must be kept in mind that chemically homogeneity or uniformity does not mean on atomic scale for alloy, such as composition of each unit cell. But it is on large scale.
- ✓ Any structure which is visible as physically distinct under microscope is called phase.
- ✓ For pure elements phase means the states of the metals:
  - Solid state –solid phase
  - Liquid state –liquid phase
  - Gaseous state-gaseous phase.
  
- ✓ Certain metals show allotropic modification and change its crystal structure changing its phase.
- ✓ Example of metals showing allotropic transformation: iron, tin, zirconium, titanium, tungsten
- ✓ Tin shows two allotropic modification
  - Alpha tin (grey tin) → it exists below 13.2 degree centigrade
  - Beta tin (white tin) → it exists above 13.2 degree centigrade.
- ✓ Iron showing three allotropic transformation:
  - Fcc (Atmospheric pressure) → gamma iron
  - Bcc (Atmospheric pressure)
    - delta iron, alpha iron, beta iron (beta iron is paramagnetic in nature where as alpha iron ferromagnetic in nature)
    - alpha iron is room temperature phase.



- Hcp (high pressure)

- ✓ In solid states three types of phases are possible to form: Pure Metal, Compound and Solid Solution

**Pure Metal:**

- ✓ Sharp melting and freezing point under equilibrium condition.
- ✓ Cooling curve (Temp vs Time) of a pure metal shows a horizontal line at its melting or freezing point.

**Alloy:**

- ✓ It a combination of two or more elements from which at least one is metal, the substance formed will must showing properties of metals.
- ✓ Alloys are made by mixing the constituents in liquid state. Here one will be the host metal and other is alloying elements.
- ✓ Example of alloys: plain carbon steels, alloy steels etc.
- ✓ Classification of alloy on basis of no of elements present:

- Binary alloy system-990 system possible
- Ternary alloy system-14000 system possible

- ✓ Alloys can also classified as

1. Homogeneous alloy (consist of single phase)
2. Heterogeneous alloy or mixture (consists of multiple or mixture of phases)

<b>Alloy system</b>	
Homogeneous (Single phase)	Heterogeneous alloy or mixture
<p><b>1-solid solution</b></p> <p>Solid solution are <b>two</b> types :</p> <p>a-interstitial solid solution (ex-plain carbon steel)</p>	<p>Any combination of solid phases; may be combination of Pure metals , solid solution, intermediate alloy</p>

b-substitution solid solution i-Order solid solution (form a regular pattern of arrangements) ii-Disorder solid solution (ex- nikel and copper form monel alloy)  2-intermediate alloy phase (compound)	
---	--

### Compound or Intermediate Alloy Phase:

- ✓ Combination of two or more atoms in a definite proportion.
- ✓ Combination of positive and negative valence elements.
- ✓ After forming a compound the elements lose their individual identity and properties.
- ✓ Some compound behaves like pure metals having a definite melting point with narrow limits of temperature. So cooling curve for a compound is similar to that of a pure metal. It is referred to as a congruent melting phase.
- ✓ Chemical composition of intermediate alloy phase is intermediate between the two pure metals and generally has crystal structure different from those of pure metals.

### Intermetallic compounds

- ✓ If two elements have high difference in electronegativity, they tend to form a system called intermetallic compound.
- ✓ Intermetallic compounds like MgSe, PbSe, Mg<sub>2</sub>Si, Cu<sub>2</sub>S are cubic whereas NiAs, MnSe, CuSn are hexagonal.

### Electron or Hume Rothery phases

- ✓ These compounds have wide range of solubility and occur at certain values of valence electrons to atom ratio such as 3:2
- ✓ (CuZn), 21:13 (Cu<sub>5</sub>Zn<sub>8</sub>), 7:4 (CuZn<sub>3</sub>).

### Laves phase

- ✓ Laves phases have a general formula of  $AB_2$ , for example  $MgCu_2$  (cubic),  $MgZn_2$  (hexagonal),  $MgNi_2$  (hexagonal)

### **Sigma phase**

- ✓ Sigma phase has a very complex crystal structure and is very brittle. This phase can act as a source of embrittlement in some alloys such as steels.

### **Metal carbides and nitrides**

- ✓ Metals which have high chemical affinity for carbon and nitrogen form carbides and nitrides such as VC, NbC, VN, NbN, TiC, TiN. They can act as source of hardening in many alloys.

### **Solid solution:**

- ✓ It can be defined as a solution in solid state, which consists of two kinds of atoms combined in one type of space lattice.
- ✓ Example: Austenite, ferrite, delta iron, martensite
- ✓ Solution may be solid, liquid or gaseous; Example – sugar or salt in water.
- ✓ Solution may consist of two parts one is major part called solvent and minor called solute.
- ✓ On the basis of dissolution capacity or amount of solute present in solution there possible condition of solution are there :

- 1- Unsaturated
- 2- Saturated
- 3- Supersaturated.

- ✓ Solubility of solute is a function of temperature with pressure constant.
- ✓ Solid solution are of two types: Substitutional and Interstitial

### **Substitutional Solid Solution:**

- ✓ In this type of solution, the atoms of the solute substitute for atoms of the solvent in the lattice structure of the solvent.
- ✓ Several factors are now known, largely through the work of *Hume-Rothery*, that control the range of solubility in alloy systems.

- ✓ *Empirical rules for the formation of substitutional solid solution (Hume-Rothery's Rule)*
  - **Crystal structure factor:** For complete solid solubility, the two elements should have the same type of crystal structure i.e., both elements should have either F.C.C. or B.C.C. or H.C.P. structure.
  - **Relative size factor:** As the size (atomic radii) difference between two elements increases, the solid solubility becomes more restricted. For extensive solid solubility the difference in atomic radii of two elements should be less than about 15 percent. If the relative size factor is more than 15 percent, solid solubility is limited. For example, both silver and lead have F.C.C. structure and the relative size factor is about 20 percent. Therefore the solubility of lead in solid silver is about 1.5 percent and the solubility of silver in solid lead is about 0.1 percent. Copper and nickel are completely soluble in each other in all proportions. They have the same type of crystal structure (F.C.C.) and differ in atomic radii by about 2 percent.
  - **Chemical affinity factor:** Solid solubility is favoured when the two metals have lesser chemical affinity. If the chemical affinity of the two metals is greater then greater is the tendency towards compound formation. Generally, if the two metals are separated in the periodic table widely then they possess greater chemical affinity and are very likely to form some type of compound instead of solid solution.
  - **Relative valence factor:** It is found that a metal of lower valence tends to dissolve more of a metal of higher valence than vice versa. For example in aluminium-nickel alloy system, nickel (lower valence) dissolves 5 percent aluminium but aluminium (higher valence) dissolves only 0.04 percent nickel.
- ✓ Solid solutions which have a negative enthalpy of mixing ( $\Delta H_{mix} < 0$ ) prefer unlike nearest neighbours → show tendency for ordering and forms **order solid solution**.
- ✓ Solid solutions which have a positive enthalpy of mixing ( $\Delta H_{mix} > 0$ ) forms clusters of same types of atoms → Forms **disorder solid solution**.
- ✓ Solid solutions with zero enthalpy of mixing ( $\Delta H_{mix} = 0$ ) forms **ideal solution**.

### **Interstitial Solid Solution:**

- ✓ The second species added goes into the voids of the parent lattice

- ✓ E.g. Octahedral and tetrahedral voids in CCP, HCP (& BCC) crystals  
E.g. of solvents: Fe, Mo, Cr etc.  
E.g. of solute: C ( $r = 0.77 \text{ \AA}$ ), N ( $r = 0.71 \text{ \AA}$ ), O ( $r = 0.66 \text{ \AA}$ ), H ( $r = 0.46 \text{ \AA}$ )
- ✓ If the solute atom has a diameter  $< 0.59 r_{\text{host}}$  then extensive solubility is expected (*may or may not happen!*)
- ✓ Solubility for interstitial atoms is more in transition elements (Fe, Ti, V, Zr, Ni, W, U, Mn, Cr) → due to electronic structure (*incomplete inner shell*)
- ✓ C is especially insoluble in most non-transition elements

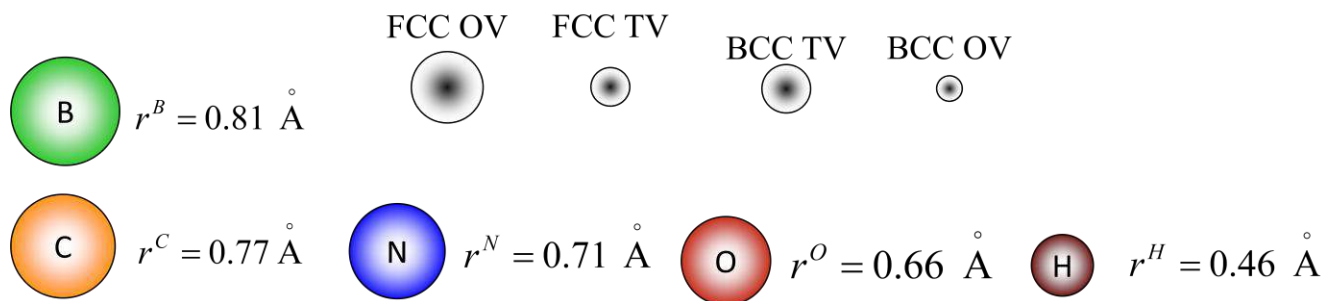

### Phase Diagram:

- ✓ Phase diagrams are an important tool in the armory of an materials scientist.
- ✓ In the simplest sense a phase diagram demarcates regions of existence of various phases. (*Phase diagrams are maps*)
- ✓ Phase diagrams are also referred to as “equilibrium diagrams” or “constitutional diagrams”. This usage requires special attention: through the term used is “equilibrium”, in practical terms the equilibrium is *not global equilibrium but Microstructural level equilibrium*.
- ✓ Broadly two kinds of phase diagrams can be differentiated → those involving time and those which do not involve time.
- ✓ Phase diagrams involving time can be further sub classified into:
  - Those with composition as a variable (e.g. T vs. %Composition)
  - Those without composition as a variable (e.g. P vs. T)

- ✓ Time-Temperature-Transformation (TTT) diagrams and Continuous-Cooling-Transformation (CCT) diagrams involve time. These diagrams will be considered in the chapter on Heat treatment.

### Some Important definitions:

#### Phase:

- ✓ A physically homogeneous and distinct portion of a material system (e.g. gas, crystal, amorphous etc.)
- ✓ Gases: Gaseous state always a single phase → mixed at atomic or molecule level.
- ✓ Liquids: Liquid solution is a single phase → e.g. NaCl in H<sub>2</sub>O and Liquid mixtures consists of two or more phases → e.g. Oil in water (no mixing at the atomic level)
- ✓ Solids: In general due to several compositions and crystals structures many phases are possible.
- ✓ For the same composition different crystal structures represent different phases. E.g. Fe (BCC) and Fe (FCC) are different phases.

#### Components of a system:

- ✓ Independent chemical species which comprise the system. These could be Elements, Ions, and Compounds.
- ✓ Example: Au-Cu system : Components → Au, Cu (elements)  
Ice-water system: Component → H<sub>2</sub>O (compound)  
Al<sub>2</sub>O<sub>3</sub>-Cr<sub>2</sub>O<sub>3</sub> system: Components → Al<sub>2</sub>O<sub>3</sub>, Cr<sub>2</sub>O<sub>3</sub>

#### What kinds of phases exist?

- ✓ Based on state → Gas, Liquid, Solid
- ✓ Based on atomic order → Amorphous, Quasi-crystalline, Crystalline
- ✓ Based on band structure → Insulating, Semi-conducting, Semi-metallic, Metallic
- ✓ Based on Property → Para-electric, Ferromagnetic, Superconducting
- ✓ Based on stability → Stable, Metastable, Unstable
- ✓ Also sometimes- Based on size/geometry of an entity → Nanocrystalline, mesoporous, layered.

### Phase transformation:

- ✓ Phase transformation is the change of one phase into another. For example
- ✓ Water → Ice and  $\alpha$ -Fe (BCC) →  $\gamma$ -Fe (FCC)

### Grain:

- ✓ The single crystalline part of polycrystalline metal separated by similar entities by a grain boundary.

### Microstructure:

- ✓ (Phases + defects + residual stress) & their distributions
- ✓ Structures requiring magnifications in the region of 100 to 1000 times. (or) The distribution of phases and defects in a material.

### Variables/Axis of phase diagrams:

- ✓ The axes can be:
  - Thermodynamic (T, P, V)
  - Kinetic (t) or Composition variables (C, %X)
- ✓ In single component systems (unary systems) the usual variables are T & P
- ✓ In phase diagrams used in materials science the usual variable are T & %X
- ✓ In the study of phase transformation kinetics TTT diagrams or CCT diagrams are also used where the axis are T & t

### Degree of Freedom:

The degree of freedom, F, are those externally controllable conditions of temperature, pressure, and composition, which are independently variable and which must be specified in order to completely define the equilibrium state of the system.

### Phase Rule:

- ✓ The phase rule connects the Degrees of Freedom, the number of components in a system and the number of phases present in a system via a simple equation:  $F = C - P + 2$ , where C – No. of components, P – No. of phases and F – No. of degrees of freedom
- ✓ The degrees of freedom cannot be less than zero so that we have an upper limit to the number of phases that can exist in equilibrium for a given system.

Variation of the number of degrees of freedom with number of components and number of phases:

$C = 2$	No. of Phases	Total Variables $P(C-1)+2$	Degrees of freedom $C-P+2$	Degrees of freedom $C-P+1$
	1	3	3	2
	2	4	2	1
	3	5	1	0
	4	6	0	<i>Not possible</i>

### Experimental Methods for Determination of Phase Diagram:

#### Metallography methods:

- ✓ It is microscopic observation of metallic samples (alloys)
- ✓ Metallo- metals alloys & Graphy-images
- ✓ In this methods heating the sample (alloy) to different temperature when equilibrium between phases is established then it is cooled quickly to retained the high temperature structure.
- ✓ Limitation :
  - 1-rapid cooling samples from high temperature do not allow retaining their high temperature structure.
  - 2-very difficult to interpret the observed microstructure excellent skill is required.

#### X ray diffraction:



- ✓ It studies the lattice dimension or measure the lattice dimension, so it indicates the appearance of a new phase either by the change in the lattice dimension or by appearance of the new crystal structure.
- ✓ Since for different phase the value of  $a$  is different to determine the value of  $a$  we have to find out the value of  $d$ .
- ✓  $d = a / (h^2 + k^2 + l^2)^{1/2}$
- ✓ This method is simple, precise very useful tool to determine the changes in the solid solubility with temperature.

### **Thermal analysis:**

- ✓ Here temperature vs time at constant composition plot (Cooling Curve) is drawn. It shows a change in the slope at the point where there is a phase transformation occurs due to evolution or absorption of heat.
- ✓ By this method we can determine initial and final temperature of solidification so it is a best method for this but not a best methods to determine the phase transformation as very less amount of heat change occurs during the solid state phase transformation.

### **Cooling curve:**

- ✓ It's a plot between temperature and time.
- ✓ Cooling curves gives us idea about the solidification start and end temperature.
- ✓ Since a metal is having a sharp melting and freezing temperature we will get a horizontal line for the cooling curve. And since alloy has a range of melting temperature we will get a curved cooling curve. So for the pure metals beginning and end of the solidification occurs at a constant temperature.

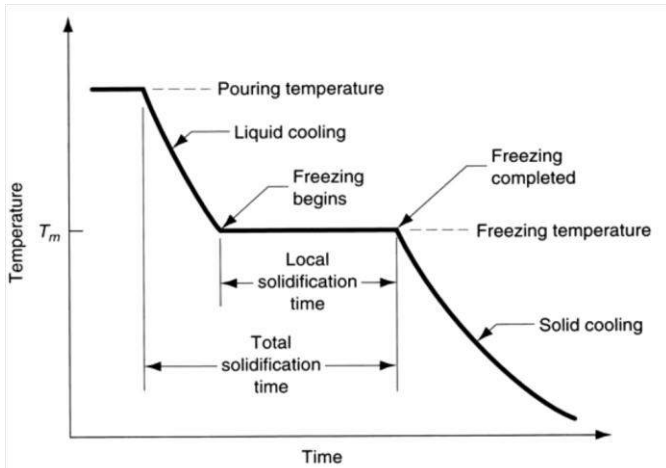

(Cooling Curve of Metal)

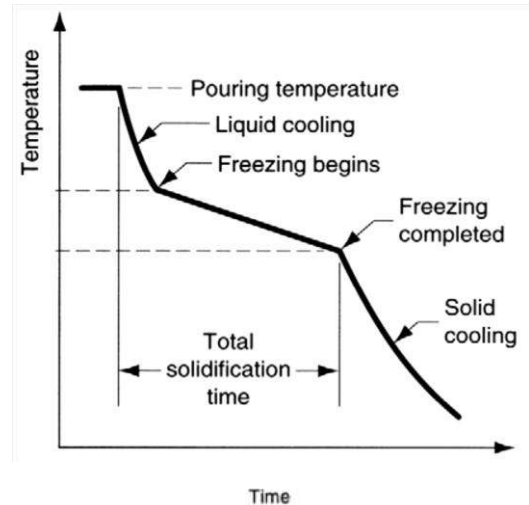

(Cooling Curve of Alloy)

### Working with Phase Diagrams

**Solidus:** Temperature at which alloy is completely solid or temperature at which liquefaction begins

**Liquidus:** Temperature at which alloy is completely liquid or temperature at which solidification begins

**Limits of Solid Solubility:** Unlimited Solid Solubility: Solute and solvent are mutually soluble at all concentrations, e.g., Cu-Ni. System Meets the requirements of the Hume-Rothery Rules → Result is a “single phase alloy”

**Limited or Partial Solid Solubility:** There is a limit to how much of the solute can dissolve in the solvent before “saturation” is reached, e.g., Pb-Sn and most other systems does not meet the requirements of the Hume-Rothery Rules → Results in a “multi-phase alloy”

### Unary Phase Diagrams:

✓ Unary system: Simplest system possible wherein there is just one component.

- ✓ Though there are many possibilities even in unary phase diagram (in terms of the axis and phases), we shall only consider a T-P unary phase diagram.
- ✓ Let us consider the water ( $H_2O$ ) unary phase diagram
- ✓ The Gibbs phase rule here is:  $F=C-P+2$  (2 is for T&P) (no composition variables here)
- ✓ Along the 2 phase co-existence (at B & C) lines the degree of freedom (F) is 1  $\rightarrow$  i.e. we can chose either T or P and the other will be automatically fixed.
- ✓ The 3 phase co-existence points (at A) are invariant points with  $F=0$ . (Invariant point implies they are fixed for a given system).
- ✓ The single phase region at point D, T and P can both be varied while still being in the single phase region with  $F = 2$ .

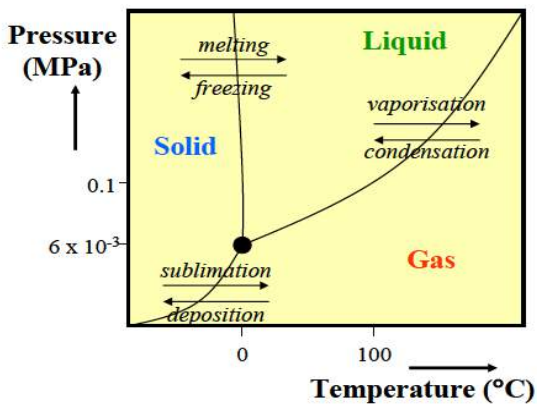

(Phase diagram for water)

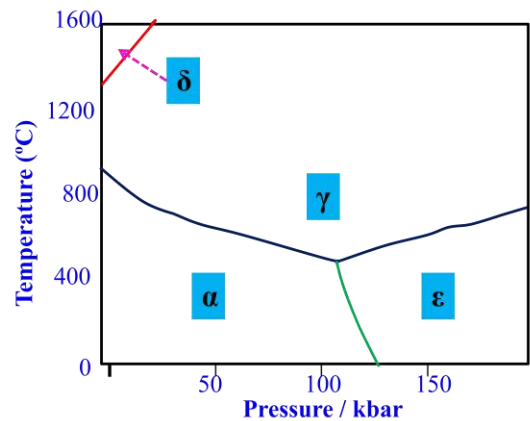

(Phase diagram for pure iron)

### Binary Phase Diagrams:

- ✓ Binary implies that there are two components.
- ✓ Pressure changes often have little effect on the equilibrium of solid phases (unless of course we apply 'huge' pressures).

- ✓ Hence, binary phase diagrams are usually drawn at 1 atmosphere pressure.
- ✓ The Gibbs phase rule is reduced to: Variables are reduced to:  $F = C - P + 1$  (1 is for T).
- ✓ T & Composition (these are the usual variables in materials phase diagrams)
- ✓ Binary phase diagrams can be classified based on:
  - Complete solubility in both liquid & solid states
  - Complete solubility in both liquid state, but limited solubility in the solid state
  - Limited solubility in both liquid & solid states

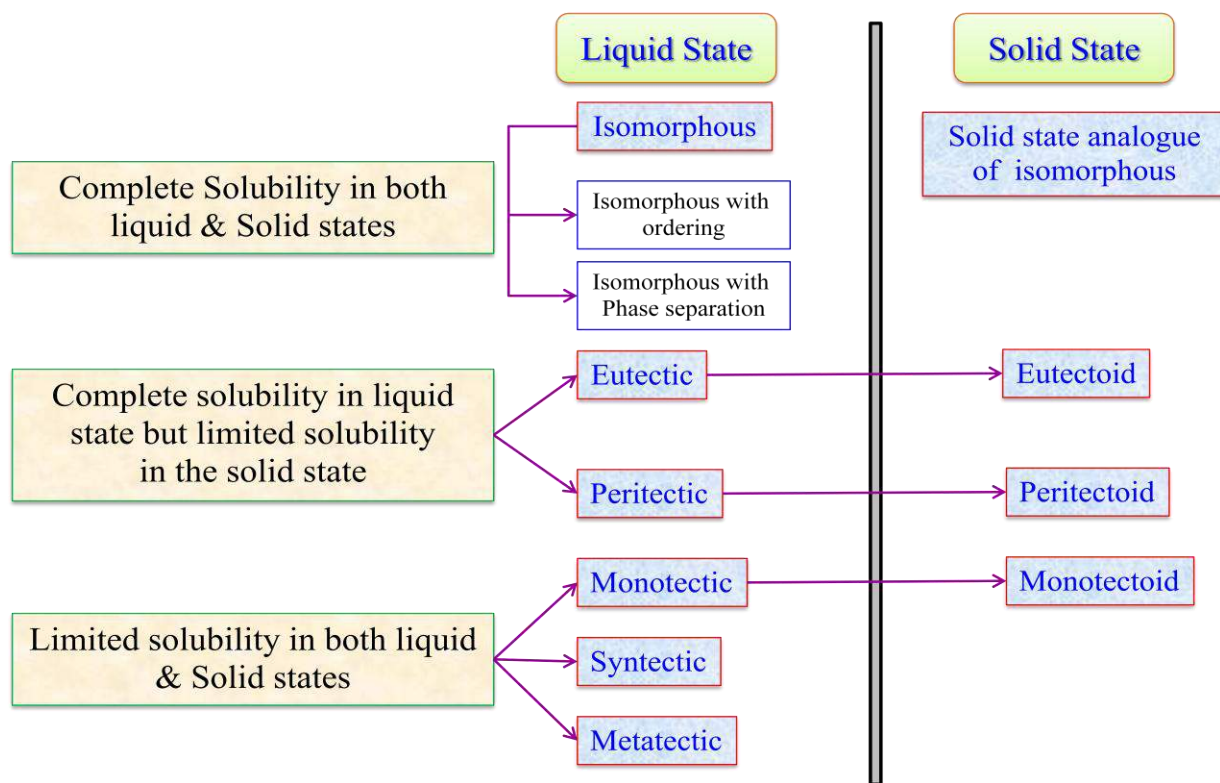

### **Isomorphous Phase Diagram:**

- ✓ Isomorphous phase diagrams form when there is complete solid and liquid solubility.
- ✓ Complete solid solubility implies that the crystal structure of the two components has to be same and Hume-Rothery rules are to be followed.
- ✓ Examples of systems forming isomorphous systems: Cu-Ni, Ag-Au, Ge-Si,  $Al_2O_3-Cr_2O_3$
- ✓ Both the liquid and solid contain the components A and B.

- ✓ In binary phase diagrams between two single phase regions there will be a two phase region → in the isomorphous diagram between the liquid and solid state there is the (Liquid + Solid) state.
- ✓ The Liquid + Solid state is NOT a semi-solid state → it is a solid of fixed composition and structure, in equilibrium with a liquid of fixed composition.
- ✓ In some systems (e.g. Au-Ni system) there might be phase separation in the solid state (i.e. the complete solid solubility criterion may not be followed) → these will be considered as a variation of the isomorphous system (with complete solubility in the solid and the liquid state).
- ✓ In the Cu-Ni isomorphous diagram shown below; the single phase regions have degree of freedom=2 i.e. T and Composition can both be varied while still being in the single phase region. In the two phase region, if we fix T (and hence exhaust our DOF), the composition of liquid and solid in equilibrium are automatically fixed (i.e. we have no choice over them). Alternatively we can use our DOF to choose  $C_1$  then T and  $C_s$  are automatically fixed.

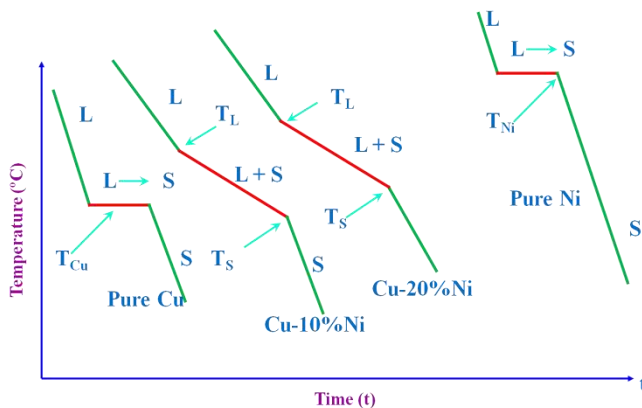

(Cooling Curve: Isomorphous System)

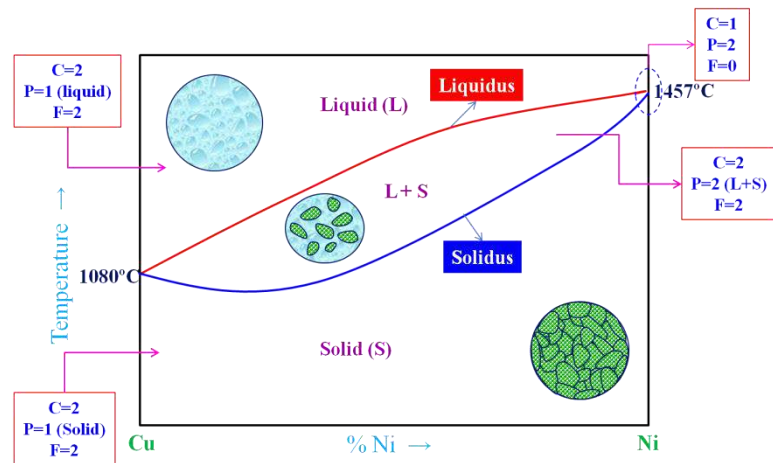

(Cu-Ni isomorphous phase diagram)

### Chemical Composition of Phases:

- ✓ To determine the actual chemical composition of the phases of an alloy, in equilibrium at any specified temperature in a two phase region, draw a horizontal temperature line, called a *tie line*, to the boundaries of the field.
- ✓ These points of intersection are dropped to the base line, and the composition is read directly.

### Relative Amounts of Each Phase:

- ✓ To determine the relative amounts of the two phases in equilibrium at any specified temperature in a two phase region, draw a vertical line representing the alloy and a horizontal temperature line to the boundaries of the field.
- ✓ The relative lengths of the lever arms multiplied by the amounts of the phases present must balance.

### Tie line and Lever rule

- ✓ We draw a horizontal line (called the Tie Line) at the temperature of interest (say  $T_0$ ). Let Tie line is XY.
- ✓ Solid (crystal) of composition  $C_1$  coexists with liquid of composition  $C_2$
- ✓ Note that tie lines can be drawn only in the two phase coexistence regions (fields). Though they may be extended to mark the temperature.
- ✓ To find the fractions of solid and liquid we use the lever rule.
- ✓ The portion of the horizontal line in the two phase region is akin to ‘lever’ with the fulcrum at the nominal composition ( $C_0$ )

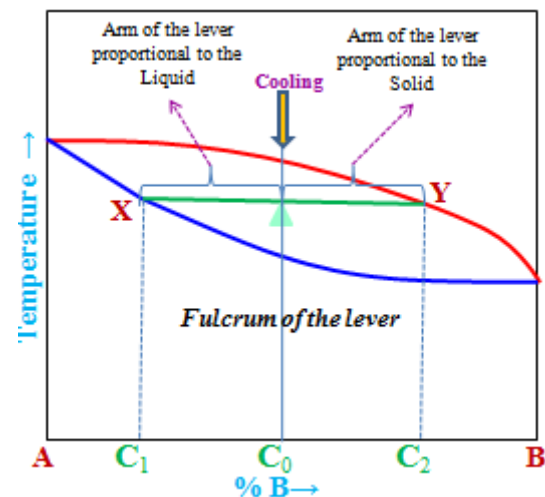

- ✓ The opposite arms of the lever are proportional to the fraction of the solid and liquid phase present

$$f_{liquid} = \frac{C_0 - C_1}{C_2 - C_1}$$

$$f_{Solid} = \frac{C_2 - C_0}{C_2 - C_1}$$

### Example

At  $C_0 = 35 \text{ wt\% Ni}$

At  $T_A$ : Only Liquid (L)

$$W_{\text{liquid}} = 100 \text{ wt\%}, W_{\text{solid}} = 0$$

At  $T_D$ : Only Solid (S)

$$W_L = 0, W_{\text{solid}} = 100 \text{ wt\%}$$

At  $T_B$ : Both S and L

$$W_L = \frac{S}{R+S} = \frac{43-35}{43-32} = 73 \text{ wt\%}$$

$$W_S = \frac{R}{R+S} = 27 \text{ wt\%}$$

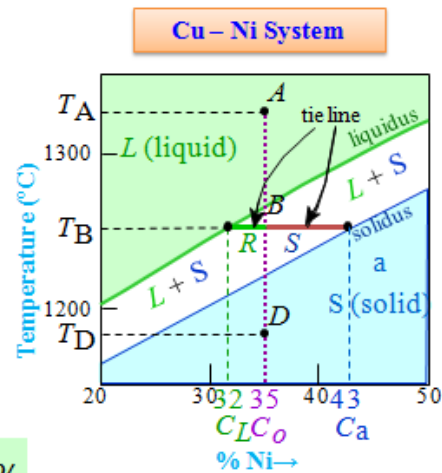

Notice: as in a lever "the opposite leg" controls with a balance (fulcrum) at the 'base composition' and  $R \rightarrow S$  = tie line length = difference in composition limiting phase boundary, at the temp of interest

### Variations of Isomorphous System:

- ✓ An alloy typically melts over a range of temperatures. However, there are special compositions which can melt at a single temperature like a pure metal. There is no difference in the liquid and solid composition. It begins and ends solidification at a constant temperature with no change in composition, and its cooling curve will show a horizontal line.
- ✓ Such alloys are known as congruent-melting alloys, sometimes known as a **pseudo-eutectic alloy**. Ex: Cu-Au, Ni-Pd.

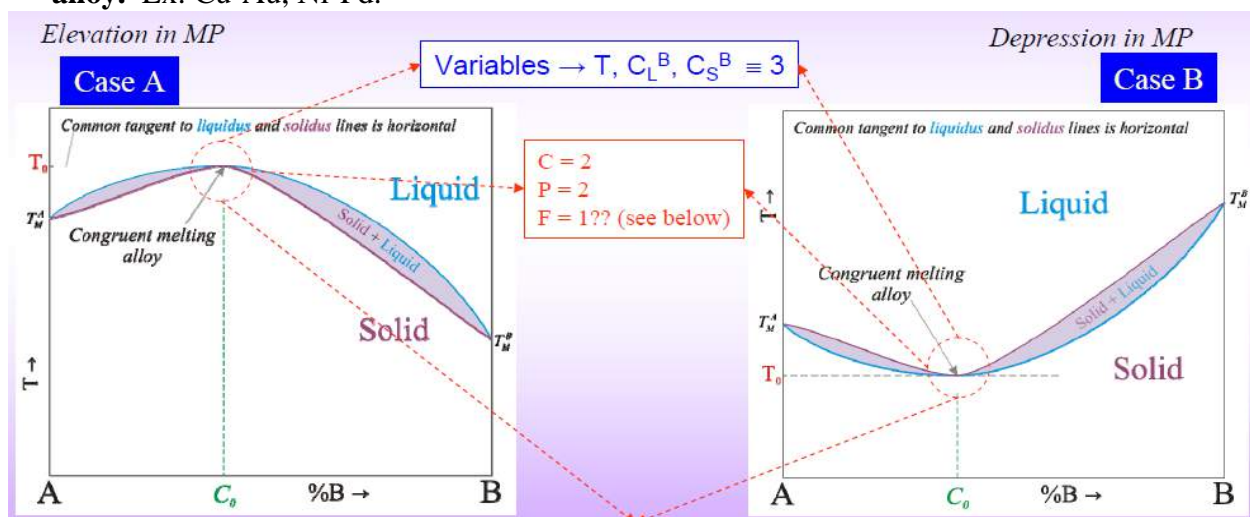

- ✓ Elevation in the MP means that the solid state is 'more stable' (*crudely speaking the ordered state is more stable*) → ordering reaction is seen at low T.
- ✓ Depression in MP 'means' the liquid state (disordered) is more stable → phase separation is seen at low T. (*phase separation can be thought of as the opposite of ordering. Ordering (compound formation) occurs for -ve values for  $\Delta H_{mix}$* ).

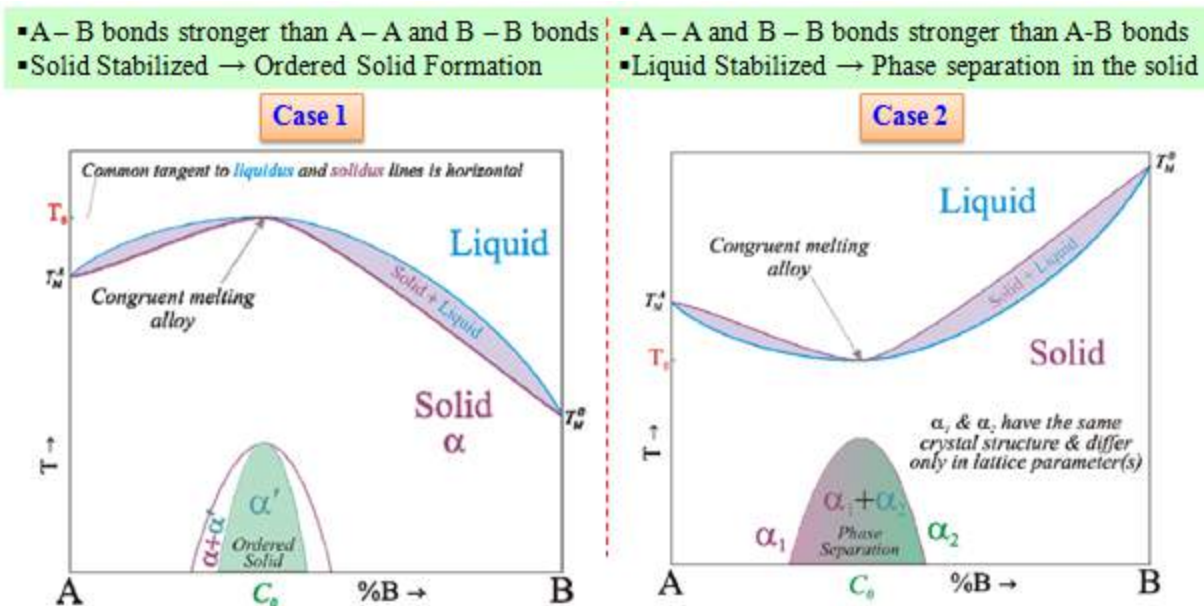

### Equilibrium Cooling:

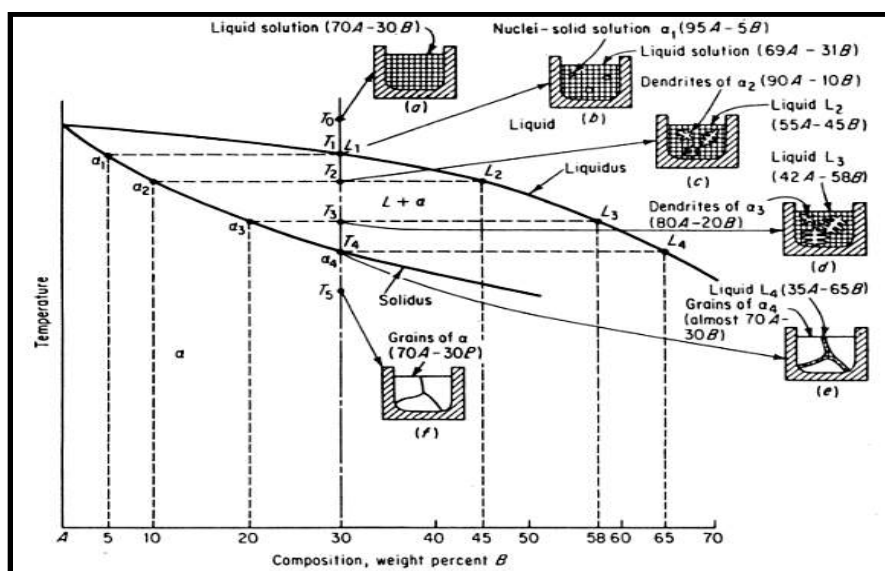



(Slow cooling, under equilibrium conditions, of a particular alloy 70A-30B)

- ✓ This alloy at temperature  $T_0$  is a homogeneous single-phase liquid solution (a) and remains so until temperature  $T_1$  is reached. Since  $T_1$  is on the liquidus line, freezing or solidification now begins.
- ✓ The first nuclei of solid solution to form  $\alpha_1$  will be very rich in the higher melting point metal A and will be composed of 95A-5B (by tie line rule). Since the solid solution in forming takes material very rich in A from the liquid, the liquid must get richer in B. Just after the start of solidification, the composition of the liquid is approximated as 69A-31B (b).
- ✓ When the lower temperature  $T_2$  is reached, the liquid composition is at  $L_2$ . The only solid solution in equilibrium with  $L_2$  and therefore the only solid solution forming at  $T_2$  is  $\alpha_2$ . Applying tie line rule,  $\alpha_2$  is composed of 10B. Hence, as the temperature is decreased, not only does the liquid composition become richer in B but also the solid solution.
- ✓ At  $T_2$ , crystals of  $\alpha_2$  are formed surrounding the  $\alpha_1$  composition cores and also separate dendrites of  $\alpha_2$  (see figure in below).

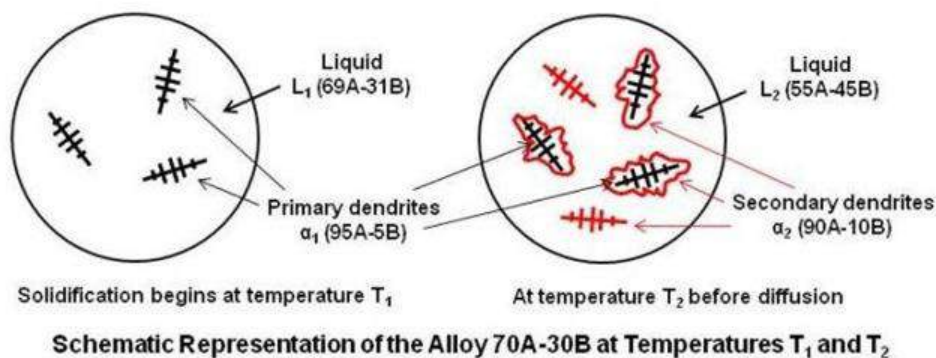

- ✓ In order for equilibrium to be established at  $T_2$ , the entire solid phase must be a composition  $\alpha_2$ . This requires diffusion of B atoms to the A-rich core not only from the solid just formed but also from the liquid. This is possible in crystal growth (c).
- ✓ The composition of the solid solution follows the solidus line while the composition of liquid follows the liquidus line, and both phases are becoming richer in B.
- ✓ At  $T_3$  (d), the solid solution will make up approximately three-fourths of all the material present.

- ✓ Finally, the solidus line is reached at  $T_4$ , and the last liquid  $L_4$ , very rich in B, solidifies primarily at the grain boundaries (e).
- ✓ However, diffusion will take place and all the solid solution will be of uniform composition  $\alpha(70A-30B)$ , which is the overall composition of the alloy (f).
- ✓ There are only grains and grain boundaries. There is no evidence of any difference in chemical composition inside the grains, indicating that diffusion has made the grain homogeneous.

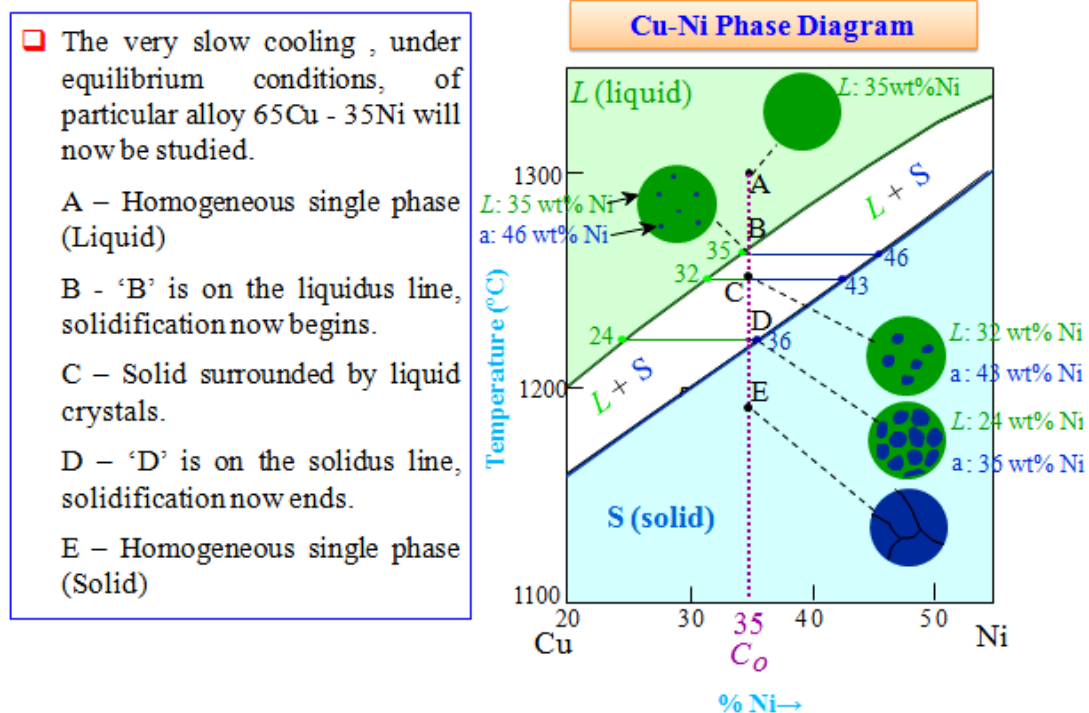

### Non Equilibrium Cooling:

- ✓ In actual practice it is extremely difficult to cool under equilibrium conditions. Since diffusion in the solid state takes place at a very slow rate, it is expected that with ordinary cooling rates there will be some difference in the conditions as indicated by the equilibrium diagram.

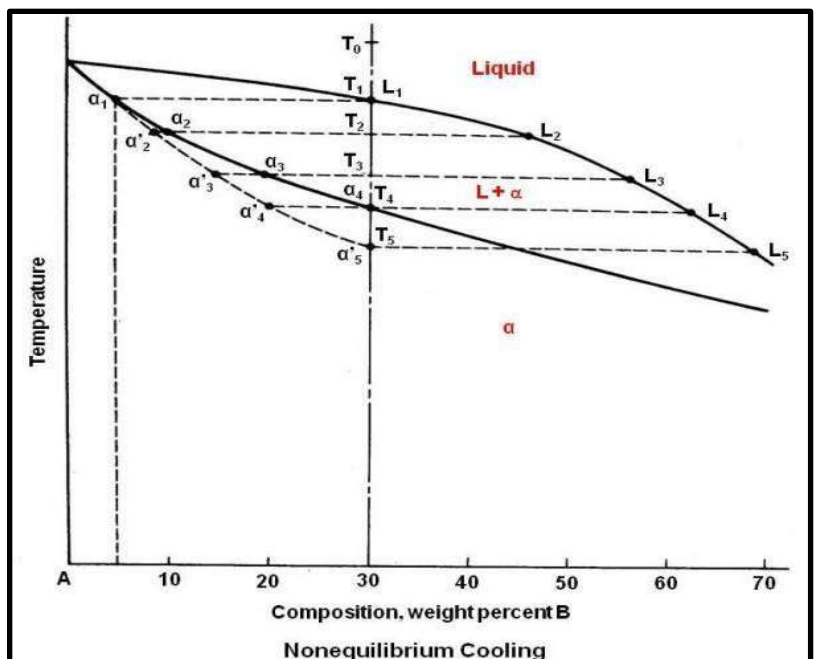

- ✓ Consider again 70A-30B alloy, solidification starts at  $T_1$  forming a solid solution of composition  $\alpha_1$ .
- ✓ At  $T_2$  the liquid is  $L_2$  and the solid solution now forming is of composition  $\alpha_2$ . Since diffusion is too slow to keep pace with crystal growth, not enough time will be allowed to achieve uniformity in the solid, and the average composition will be between  $\alpha_1$  and  $\alpha_2$ , say  $\alpha'_2$ .
- ✓ As the temperature drops, the average composition of the solid solution will depart still further from equilibrium conditions. It seems that the composition of the solid solution is following a “nonequilibrium” solidus line  $\alpha_1$  to  $\alpha'_5$ , shown dotted lines in the figure.
- ✓ The liquid, on the other hand, has essentially the composition given by the liquidus line, since diffusion is relatively rapid in liquid. At  $T_3$  the average solid solution will be of composition  $\alpha'_3$  instead of  $\alpha_3$ .
- ✓ Under equilibrium cooling, solidification should be complete at  $T_4$ ; however, since the average composition of the solid solution  $\alpha'_4$  has not reached the composition of the alloy, some liquid must still remain. Applying lever rule at  $T_4$  gives  $\alpha'_4 = 75\%$  and  $L_4 = 25\%$ .
- ✓ Therefore, solidification will continue until  $T_5$  is reached. At this temperature the composition of the solid solution  $\alpha'_5$  coincides with the alloy composition, and solidification is complete. The last liquid to solidify,  $L_5$ , is richer in B than the last liquid to solidify under equilibrium conditions.
- ✓ *The more rapidly the alloy is cooled the greater will be the composition range in the solidified alloy. Since the rate of chemical attack varies with composition, proper etching will reveal the dendritic structure microscopically (see below figure). The final solid consists of a “cored” structure with a higher-melting central portion surrounded by the lower-melting, last-to-solidify shell. The above condition is referred to as coring or dendritic segregation.*
- ✓ To summarize, nonequilibrium cooling results in an increased temperature range over which liquid and solid are present; Since diffusion has not kept pace with crystal growth, there will

be a difference in chemical composition from the center to the outside of the grains. The faster the rate of cooling, the greater will be the above effects.

Consider Cu-Ni phase diagram case

First a to solidify has  $C_{solid} = 46 \text{ wt\% Ni}$ .  
Last a to solidify has  $C_{solid} = 35 \text{ wt\% Ni}$ .

On Fast rate of cooling  
Cored structure

On Slow rate of cooling  
Equilibrium structure

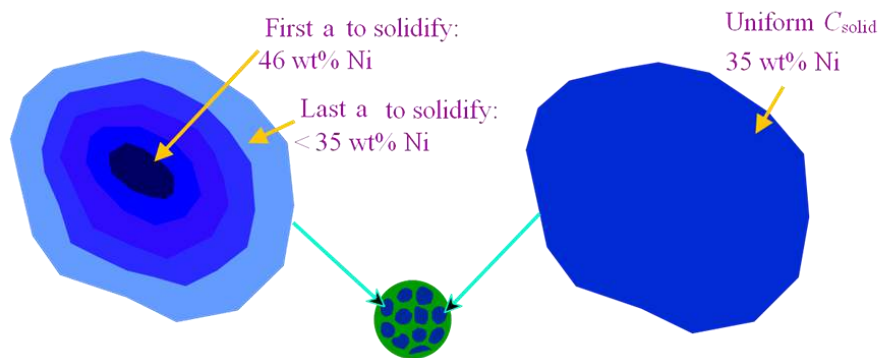

### Eutectic Phase Diagram:

- ✓ Very few systems exhibit an isomorphous phase diagram (usually the solid solubility of one component in another is limited).
- ✓ Often the solid solubility is severely limited – through the solid solubility is never zero (due to entropic reasons).
- ✓ In a Simple eutectic system (binary), there is one composition at which the liquid freezes at a single temperature. This is in some sense similar to a pure solid which freezes at a single temperature (unlike a pure substance the freezing produces a two solid phases both of which contain both the components).
- ✓ The term Eutectic means easy melting → The alloy of eutectic composition freezes at a lower temperature than the melting points of the constituent components.

✓ This has important implications → e.g. the Pb-Sn eutectic alloy melts at 183 °C, which is lower than the melting points of both Pb (327°C) and Sn (232°C) → Can be used for soldering purposes (as we want to input least amount of heat to solder two materials).

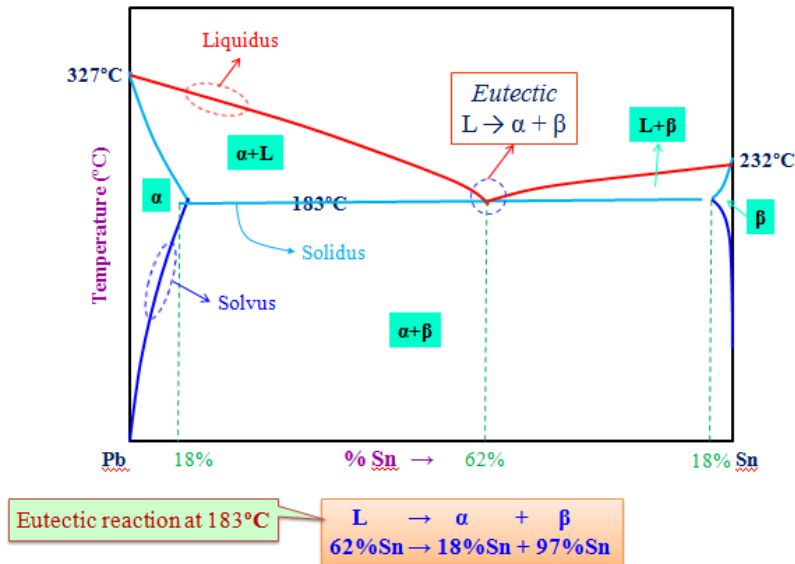

**Microstructural Characteristics of Eutectic System:**

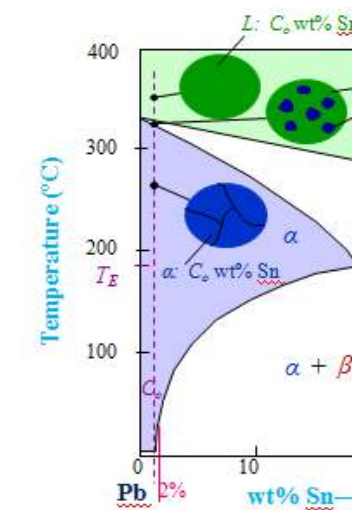
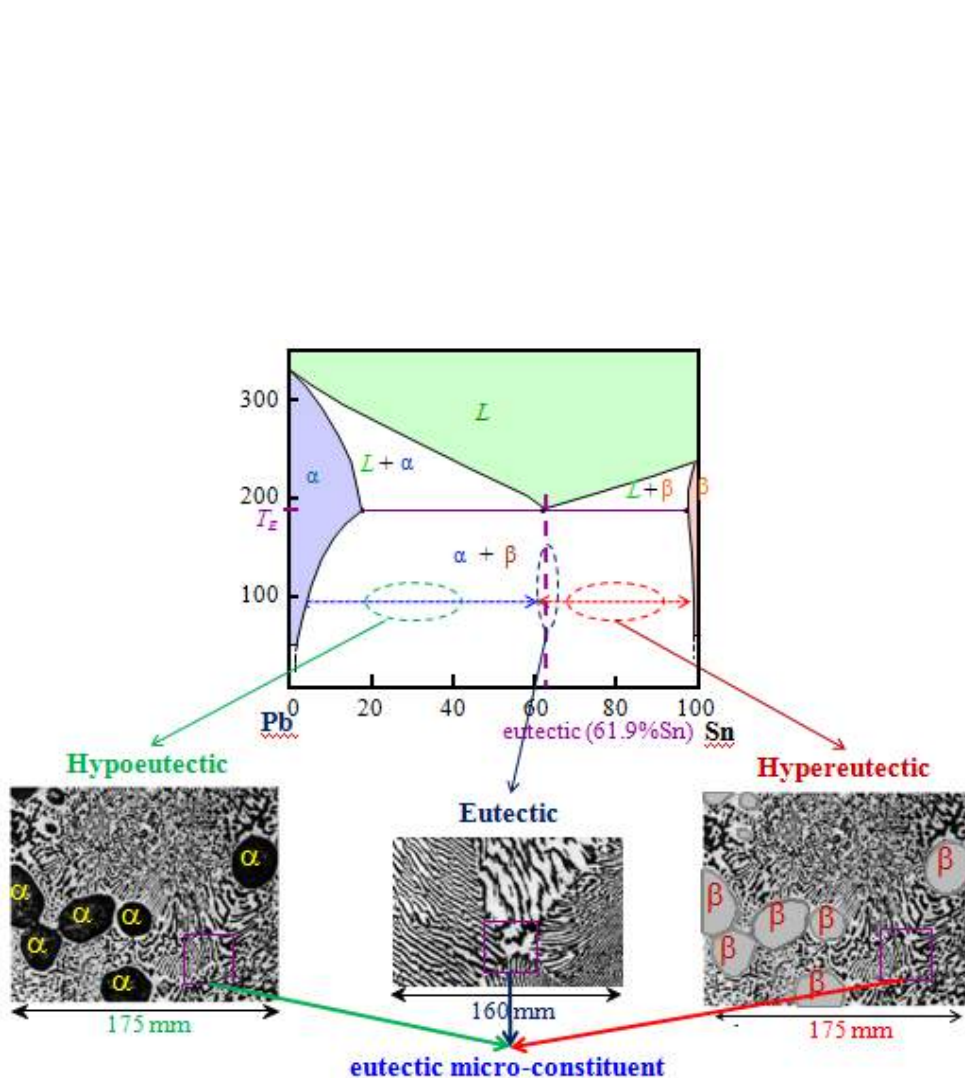

✓ To reiterate an important point: Phase diagram

do not contain microstructural information (i.e. they cannot tell you what the microstructures produced by cooling is. Often microstructural information is overlaid on phase diagram for convenience. Hence, strictly cooling is not in the domain of phase diagram – but we can overlay such information keeping in view the assumptions involved.

### Application of Lever rule in Eutectic System:

**SOLVED EXAMPLE:** For a 40 wt% Sn-60 wt% Pb alloy at 150°C, find the phases present:  $\alpha$  and  $\beta$ , Composition of phases.

$C_0 = 40 \text{ wt\% Sn}$   
 $C_a = 11 \text{ wt\% Sn}$   
 $C_b = 99 \text{ wt\% Sn}$

The relative amount of each phase by using lever rule

$$W_a = \frac{S}{R+S} = \frac{C_b - C_0}{C_b - C_a}$$

$$= \frac{99 - 40}{99 - 11} = \frac{59}{88} = 67 \text{ wt\%}$$

$$W_b = \frac{R}{R+S} = \frac{C_0 - C_a}{C_b - C_a}$$

$$= \frac{40 - 11}{99 - 11} = \frac{29}{88} = 33 \text{ wt\%}$$

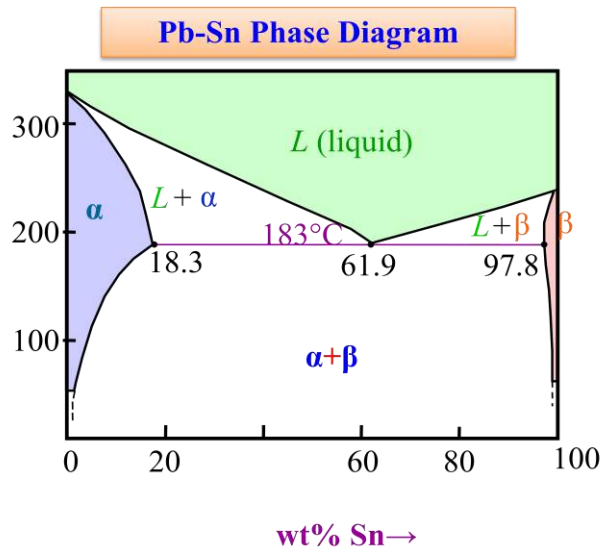

### Peritectic Phase Diagram:

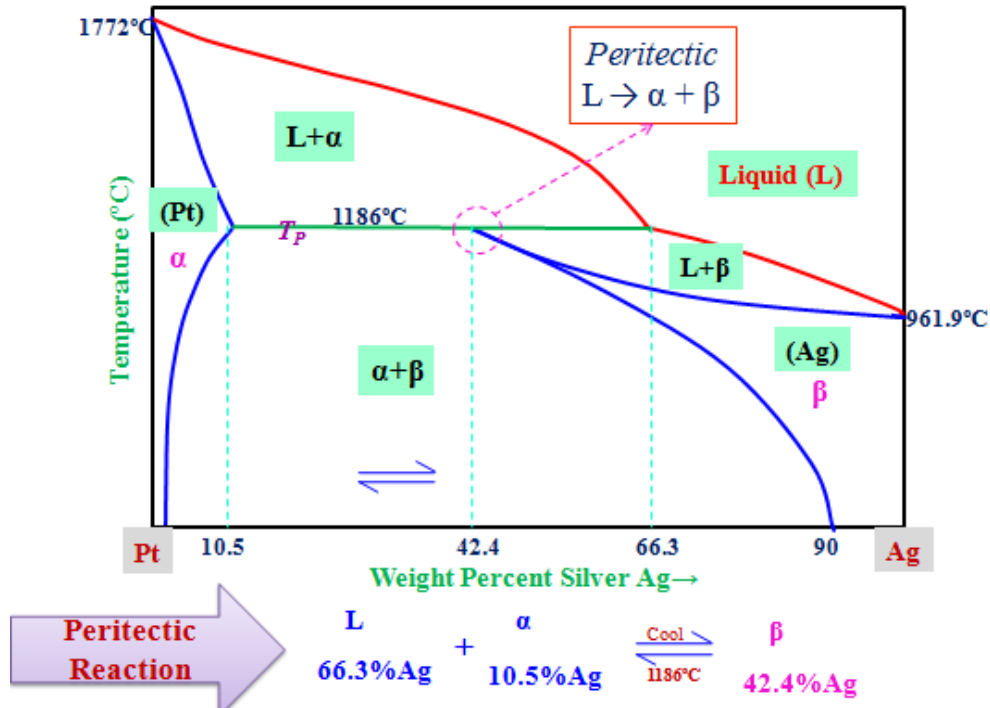

- ✓ Like the eutectic system, the Peritectic reaction is found in systems with complete liquid solubility but limited solid solubility.
- ✓ In the Peritectic reaction the liquid (L) reacts with one solid ( $\alpha$ ) to produce another solid ( $\beta$ ).  
 $L + \alpha \rightarrow \beta$
- ✓ Since the solid  $\beta$  forms at the interface between the L and  $\alpha$ , further reaction is dependent on solid state diffusion. Needless to say this becomes the rate limiting step and hence it is difficult to 'equilibrate' peritectic reactions (as compared to say eutectic reactions).
- ✓ In some Peritectic reactions (e.g. the Pt-Ag system – previous page). The (pure)  $\beta$  phase is not stable below the Peritectic temperature ( $T_P = 1186^\circ\text{C}$  for Pt- Ag system) and splits into a mixture of ( $\alpha + \beta$ ) just below  $T_P$ .

### Monotectic Phase Diagram:

- ✓ In all the types discussed previously, it was assumed that there was complete solubility in the liquid state. It is quite possible, however, that over a certain composition range two liquid solutions are formed that are not soluble in each other.

- ✓ Another term for solubility is miscibility. Substances that are not soluble in each other, such as oil and water, are said to be immiscible. Substances that are partly soluble in each other are said to show a miscibility gap, and this is related to Monotectic Systems.
- ✓ When one liquid forms another liquid, plus a solid, on cooling, it is known as a Monotectic Reaction.
- ✓ It should be apparent that the Monotectic reaction resembles the eutectic reaction, the only difference being that one of the products is a liquid phase instead of a solid phase.
- ✓ An example of an alloy system showing a Monotectic reaction is that between copper and lead given in next page. Notice that in this case the  $L_1 + L_2$  is closed.
- ✓ Also, although the terminal solids are indicated as  $\alpha$  and  $\beta$ , the solubility is actually so small that they are practically the pure metals, copper and lead.

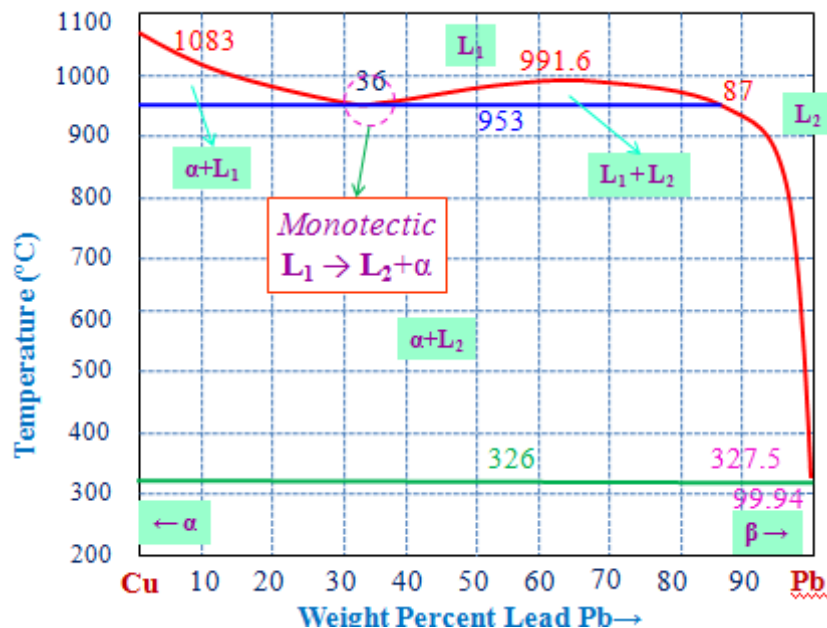

### Eutectoid Reaction:

- ✓ This is a common reaction in the solid state. It is very similar to the eutectic reaction but does not involve the liquid. In this case, a solid phase transforms on cooling into two new solid phases. The general equation may be written as..!



- ✓ The resultant Eutectoid mixture is extremely fine, just like the eutectic mixture. Under the microscope both mixtures generally appear the same, and it is not possible to determine microscopically whether the mixture resulted from a eutectic reaction or eutectoid reaction.
- ✓ An equilibrium diagram of Cu-Zn, illustrating the eutectoid reaction is shown in figure.
- ✓ In copper (Cu) – Zinc (Zn) system contains two terminal solid solutions i.e. these are extreme ends of phase diagram  $\alpha$  and  $\eta$ , with four intermediate phases called  $\beta$ ,  $\gamma$ ,  $\delta$  and  $\epsilon$ . The  $\beta'$  phase is termed an ordered solid solution, one in which the copper and zinc atoms are situated in a specific and ordered arrangement within each unit cell.

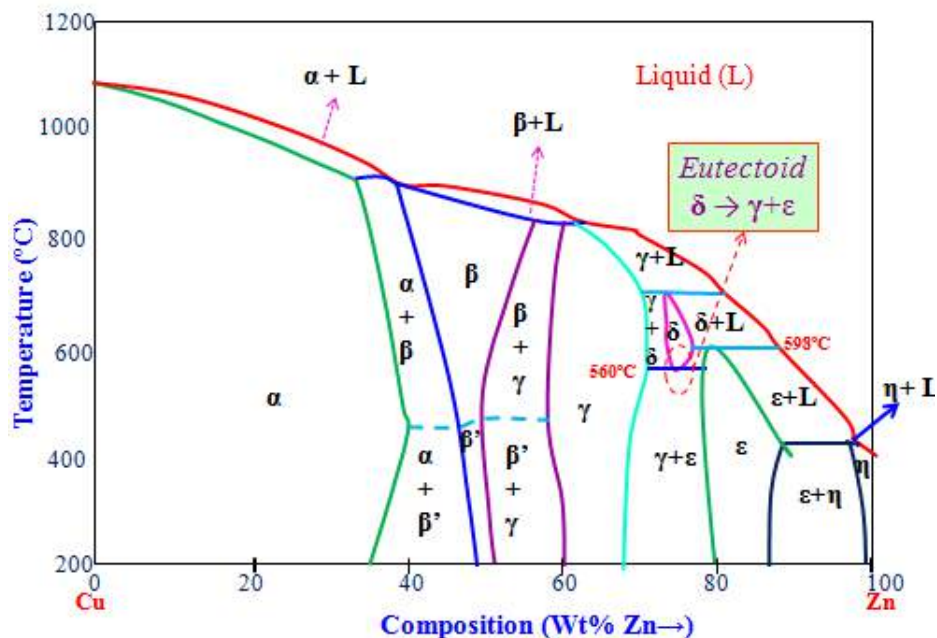

- ✓ In the diagram, some phase boundary lines near the bottom are dashed to indicate that these positions have not been exactly determined. The reason for this is that at low temperatures, diffusion rates are very slow and inordinately long times are required for the attainment of equilibrium.
- ✓ Again only single- and two- phase regions are found on the diagram, and the same and we can utilize the lever rule for computing phase compositions and relative amounts.

- ✓ The commercial material brasses are copper-rich copper-zinc alloys: for example, cartridge brass has a composition of 70 wt% Cu-30 wt% Zn and a microstructure consisting of a single  $\alpha$  phase.

In Cu-Zn Phase diagram the eutectoid reaction occurs at 560 °C with 75% Zn



Cu 70, Zn 30 (wt%),  
recrystallized  
annealing twins



### The Peritectoid Reaction:

- ✓ This is a fairly common reaction in the solid state and appears in many alloy systems. The peritectoid reaction may be written as



- ✓ The new solid phase is usually an intermediate alloy, but it may also be a solid solution. The peritectoid reaction has the same relationship to the peritectic reaction as the eutectoid has to the eutectic. Essentially, it is the replacement of a liquid by a solid.
- ✓ The peritectoid reaction occurs entirely in the solid state and usually at lower temperatures than the peritectic reaction, the diffusion rate will be slower and there is less likelihood that equilibrium structures will be reached.
- ✓ Consider Silver (Ag) – Aluminium (Al) phase diagram (*in next page*) containing a peritectoid reaction.

- ✓ If a 7% Al alloy is rapidly cooled from the two phase area just above the peritectoid temperature the two phases will be retained, and the microstructure will show a matrix of  $\gamma$  with just a few particles of  $\alpha$ . When we cool at below the peritectoid temperature by holding we get single phase  $\mu$ .

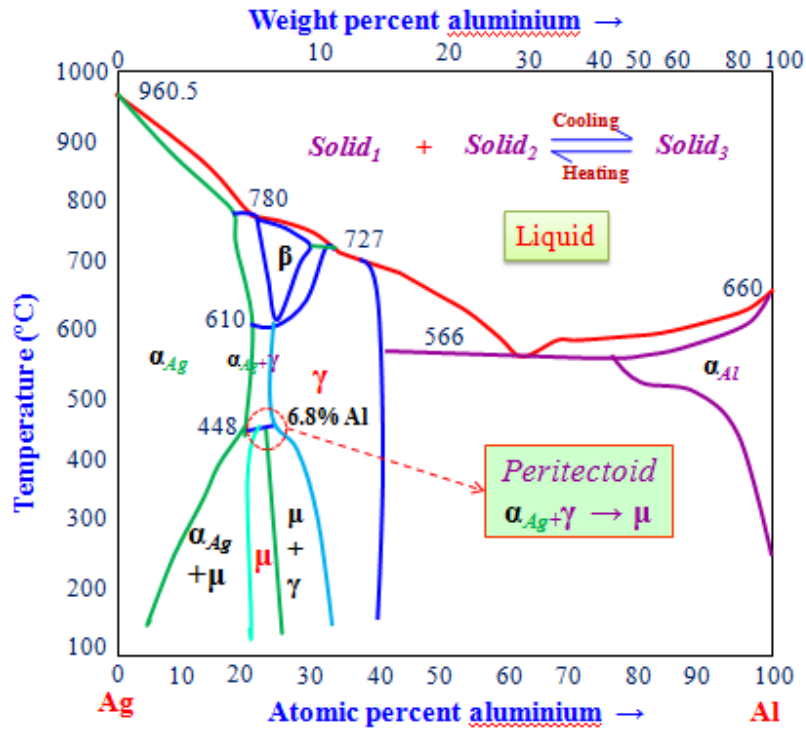

**Monotectoid Reaction : Al-Zn Phase Diagram**

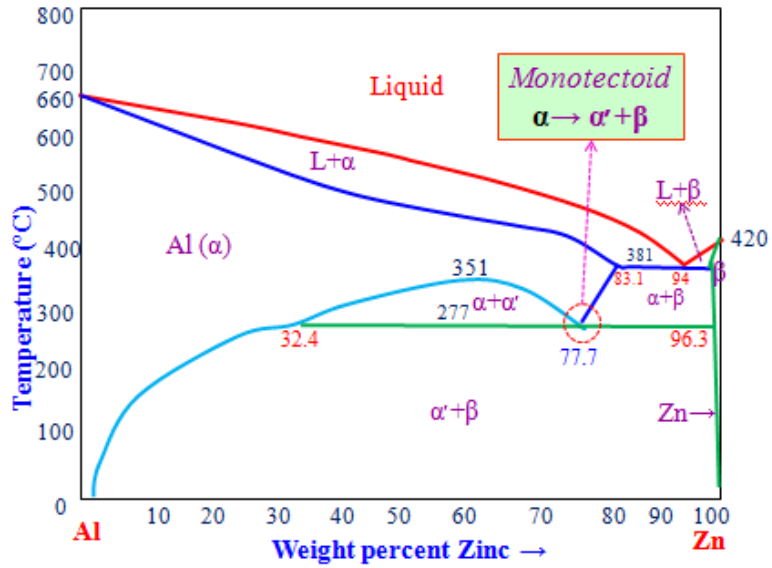

**Syntectic Reaction : Ga – I Phase Diagram**

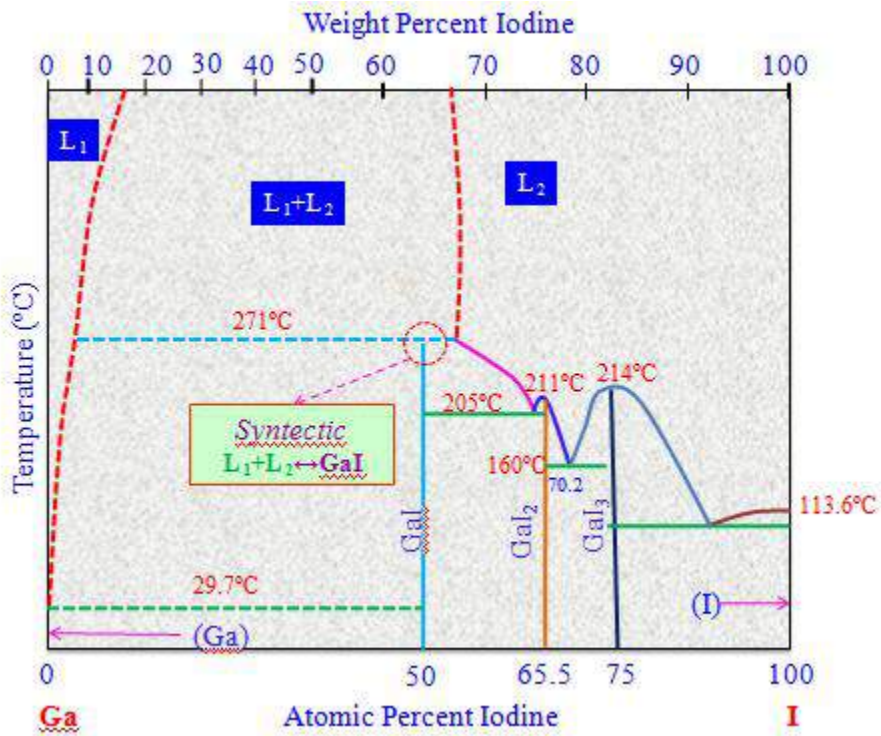

## Summary of Invariant reactions

Name of reaction	Phase equilibrium	Schematic representation
<b>Eutectic</b>	$L \leftrightarrow S_1 + S_2$	
<b>Peritectic</b>	$S_1 + L \leftrightarrow S_2$	
<b>Monotectic</b>	$L_1 \leftrightarrow S_1 + L_2$	
<b>Eutectoid</b>	$S_1 \leftrightarrow S_2 + S_3$	
<b>Peritectoid</b>	$S_1 + S_2 \leftrightarrow S_3$	
<b>Monotectoid</b>	$S_{1a} \leftrightarrow S_{1b} + S_2$	
<b>Metatectic</b>	$S_1 \leftrightarrow S_2 + L$	
<b>Syntectic</b>	$L_1 + L_2 \leftrightarrow S$	

## Allotropic Transformations

- ✓ As we discussed earlier that several metals may exist in more than one type of crystal structure depending upon temperature, Iron, Tin, Manganese and Cobalt are examples of metals which exhibit this property, known as *Allotropy*.
- ✓ On an equilibrium diagram, this allotropic change is indicated by a point or points on the vertical line which represents the pure metal. This is illustrated in below figure. In this diagram, the gamma solid solution field is 'looped'. The pure metal Fe and alloys rich in Fe undergo two transformations.

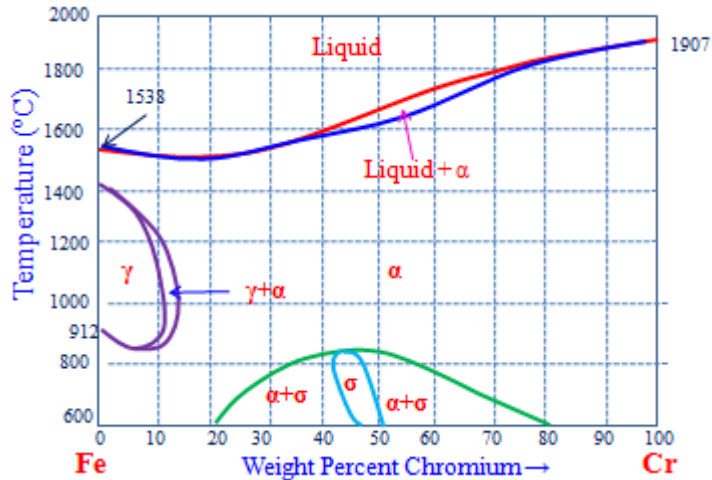

### Order-disorder Transformations

- ✓ Ordinarily in the formation of substitutional type of solid solution the solute atoms do not occupy any specific position but are distributed at random in the lattice structure of the solvent. The alloy is said to be in a ‘disordered’ condition.
- ✓ Some of these random solid solutions, if cooled slowly, undergo a rearrangement of the atoms where the solute atoms move into definite positions in the lattice. This structure is known as an *ordered solid solution or superlattice*.
- ✓ Ordering is most common in metals that are completely soluble in the solid state, and usually the maximum amount of ordering occurs at a simple atomic ratio of the two elements.
- ✓ For this reason, the ordered phase is sometimes given a chemical formula, such as AuCu and AuCu<sub>3</sub> in the gold-copper alloy system. On the equilibrium diagram, the ordered solutions are frequently designated as α′, β′, etc. or α′, α″, etc., and the area in which they are found is usually bounded by a dot-dash line.

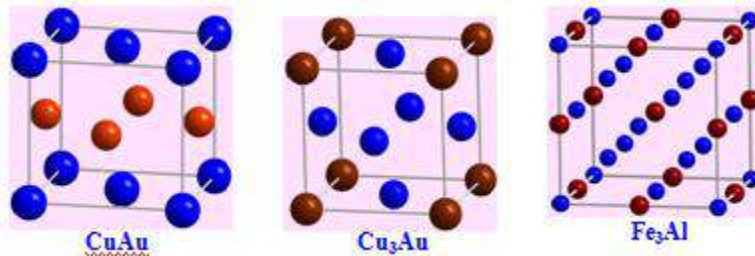

- ✓ When the ordered phase has the same lattice structure as the disordered phase, the effect of ordering on mechanical properties is negligible. Hardening associated with the ordering process is most pronounced in those systems where the shape of the unitcell is changed by ordering.
- ✓ Regardless of the structure formed as a result of ordering, an important property change produced, even in the absence of hardening, is a significant reduction in electrical resistance. Notice the sharp decrease in electrical resistivity at the compositions which correspond to the ordered

AuCu  
AuCu<sub>3</sub>.

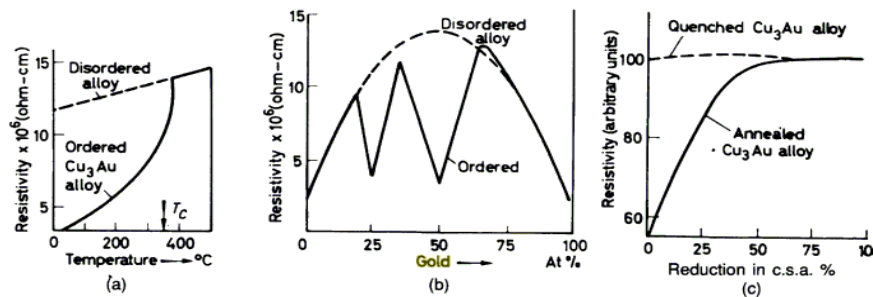

phases  
and

Figure : Effect of (a) temperature, (b) composition, and (c) deformation on the resistivity of copper-gold alloys

**Allotropic**

**Transformations in Iron:**

- ✓ Iron is an allotropic metal, which means that it can exist in more than one type of lattice structure depending upon temperature. A cooling curve for pure iron is shown below:

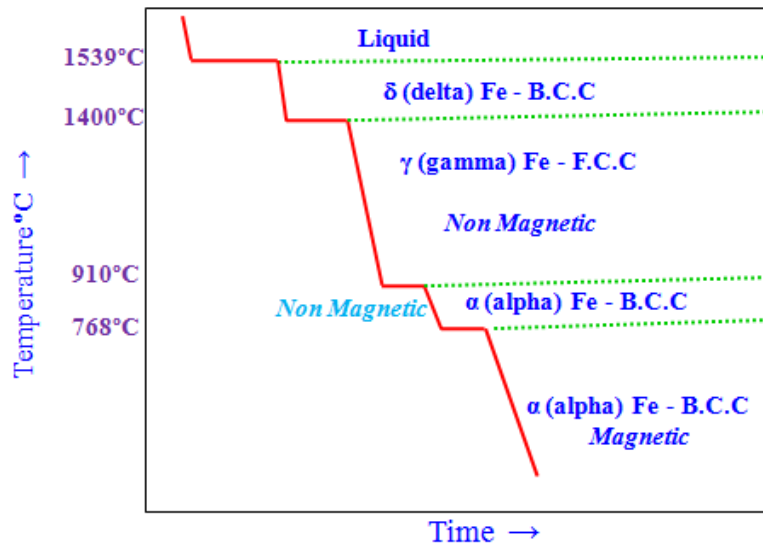

### Iron – Cementite Phase Diagram

- ✓ The Fe-C (or more precisely the Fe-Fe<sub>3</sub>C) diagram is an important one. Cementite is a metastable phase and ‘strictly speaking’ should not be included in a phase diagram. But the decomposition rate of cementite is small and hence can be thought of as ‘stable enough’ to be included in a phase diagram. Hence, we typically consider the Fe-Fe<sub>3</sub>C part of the Fe-C phase diagram.
- ✓ A portion of the Fe-C diagram – the part from pure Fe to 6.67 wt.% carbon (*corresponding to cementite, Fe<sub>3</sub>C*) – *is technologically very relevant.*
- ✓ Cementite is not an equilibrium phase and would tend to decompose into Fe and graphite. This reaction is sluggish and for practical purpose (at the microstructural level) cementite can be considered to be part of the phase diagram. Cementite forms as it nucleates readily as compared to graphite.
- ✓ Compositions upto 2.1%C are called steels and beyond 2.1% are called cast irons. *In reality the classification should be based on ‘castability’ and not just on carbon content.*
- ✓ Heat treatments can be done to alter the properties of the steel by modifying the microstructure → we will learn about this in coming chapters.



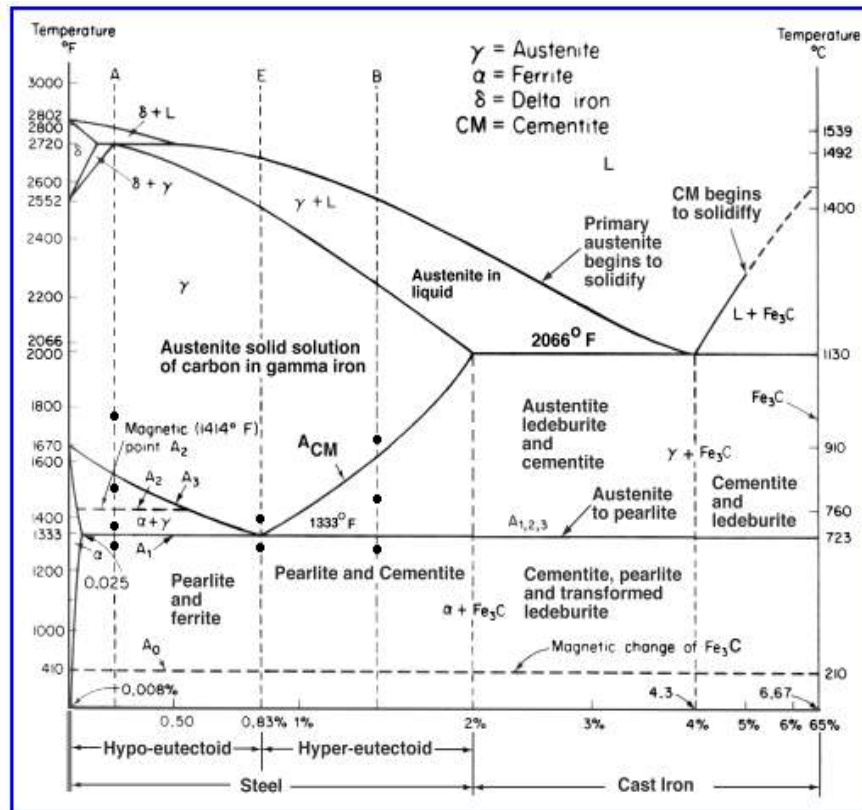
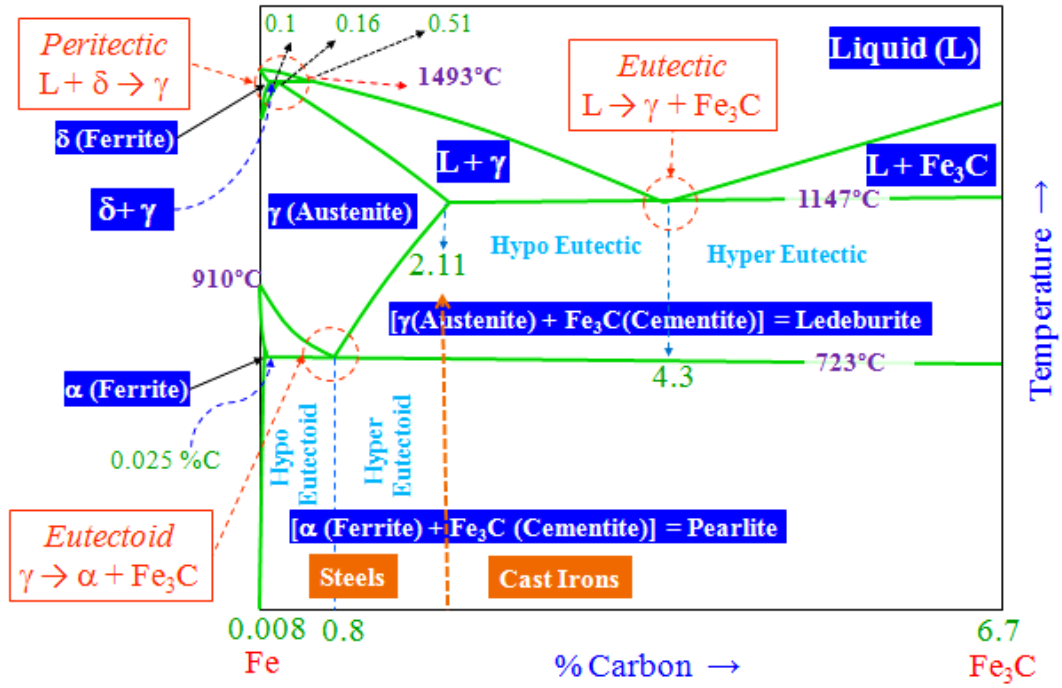

## (Iron – Cementite Phase Diagram)

### Carbon Solubility in Iron:

Solubility of carbon in Fe = f (structure, temperature)

*Where is carbon located in iron lattice?*

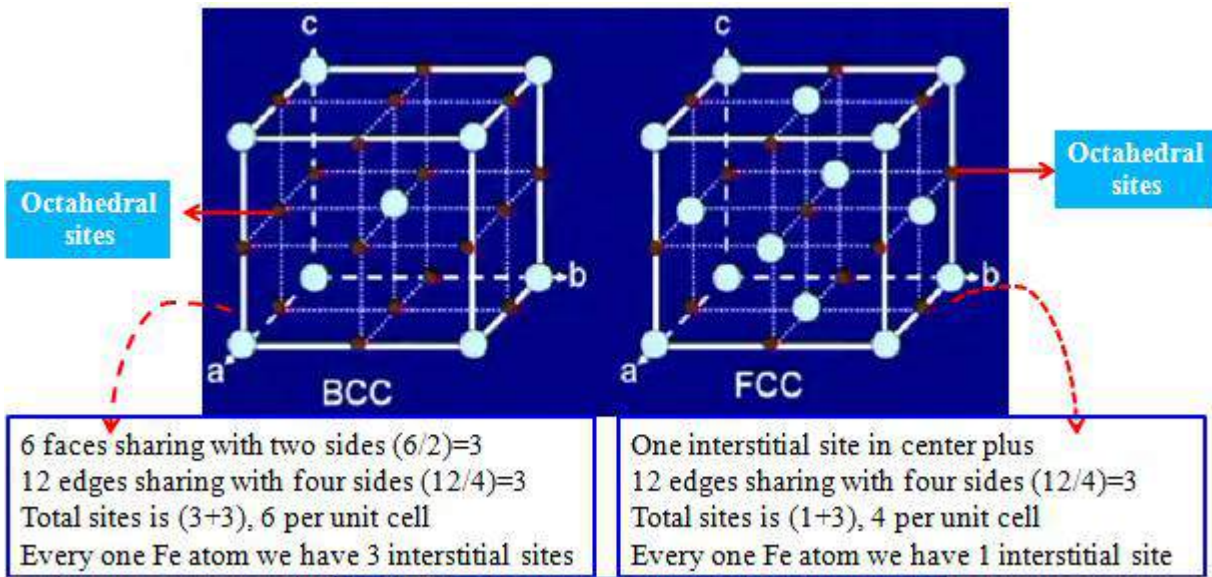

### Characteristics of phases appeared in Fe-Fe<sub>3</sub>C phase diagram:

#### Ferrite ( $\alpha$ )

- ✓ It is an interstitial solid solution of a small amount of carbon dissolved in  $\alpha$  iron.
- ✓ The maximum solubility is 0.025%C at 723°C and it dissolves only 0.008%C at room temperature. *It is the softest structure that appears on the diagram*
- ✓ The crystal structure of ferrite ( $\alpha$ ) is B.C.C
- ✓ Tensile strength – 40,000 psi or 275 Mpa
- ✓ Elongation – 40% in 2 in.
- ✓ Hardness - < 0 HRC or < 90 HRB

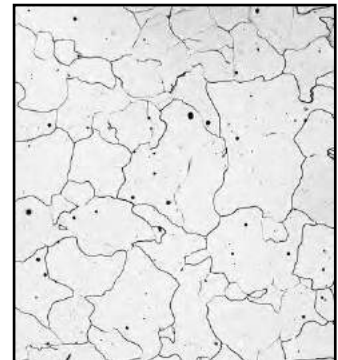

### Cementite ( $\text{Fe}_3\text{C}$ )

- ✓ Cementite or iron carbide, chemical formula  $\text{Fe}_3\text{C}$ , contains 6.67% C by weight and it is a metastable phase.
- ✓ It is typically hard and brittle interstitial compound of low tensile strength (approx. 5000 psi) but high compressive strength.
- ✓ It is the hardest structure that appears on the diagram.
- ✓ Its crystal structure is orthorhombic

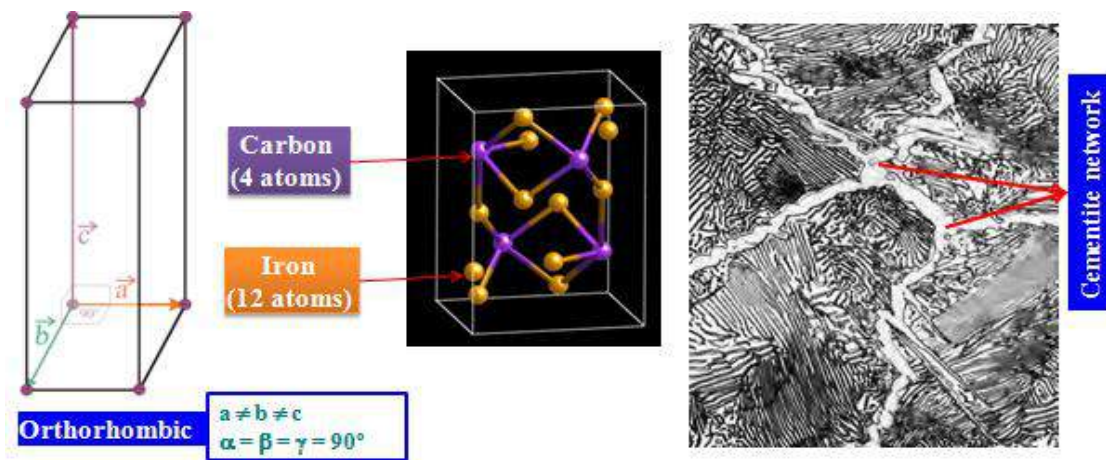

### Pearlite ( $\alpha + \text{Fe}_3\text{C}$ )

- ✓ Pearlite is the eutectoid mixture containing 0.80 %C and is formed at  $723^\circ\text{C}$  on very slow cooling.
- ✓ It is very fine plate-like or lamellar mixture of ferrite and cementite. The fine fingerprint mixture called pearlite is shown in below figure.
- ✓ Tensile strength – 120,000 psi or 825 Mpa
- ✓ Elongation – 20 percent in 2 in.
- ✓ Hardness – HRC 20, HRB 95-100, or BHN 250-300

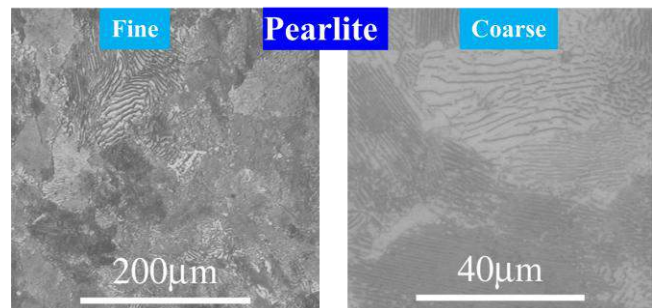

### Austenite ( $\gamma$ )

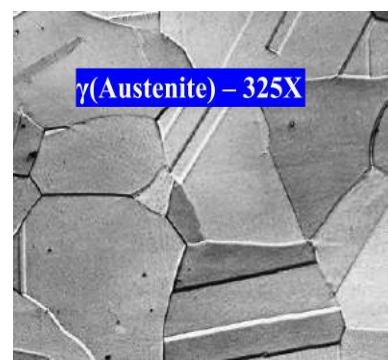

- ✓ It is an interstitial solid solution of a small amount of carbon dissolved in  $\gamma$  iron. The maximum solubility is 2.1% C at 1147°C.
- ✓ The crystal structure of Austenite ( $\gamma$ ) is F.C.C
- ✓ Tensile strength – 150,000 psi or 1035 Mpa
- ✓ Elongation – 10% in 2 in.
- ✓ Hardness - 40 HRC and Toughness is high.

### Ledeburite ( $\gamma + \text{Fe}_3\text{C}$ )

- ✓ Ledeburite is the eutectic mixture of austenite and cementite.
- ✓ It contains 4.3% C and is formed at 1147°C
- ✓ Structure of ledeburite contains small islands of austenite are dispersed in the carbide phase.
- ✓ Not stable at room temperature

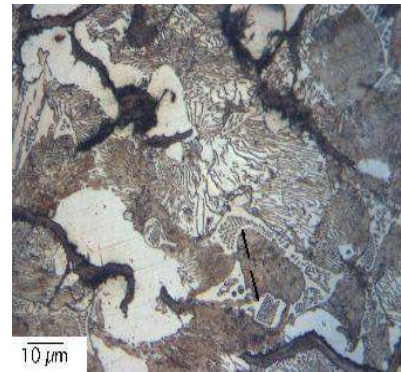

### Ferrite ( $\delta$ )

- ✓ Interstitial solid solution of carbon in iron of body centered cubic crystal structure. ( $\delta$  iron) of higher lattice parameter (2.89 Å) having solubility limit of 0.09 wt% at 1495°C with respect to austenite. The stability of the phase ranges between 1394-1539°C.
- ✓ This is not stable at room temperature in plain carbon steel. However it can be present at room temperature in alloy steel especially duplex stainless steel.

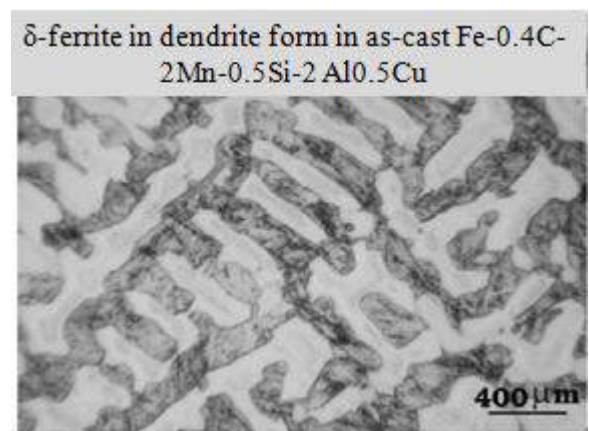

### Microstructures involved in eutectoid mixture/Eutectoid reaction:

- ✓ Phase changes that occur upon passing from the  $\gamma$  region into the  $\alpha + \text{Fe}_3\text{C}$  phase field.
- ✓ Consider, for example, an alloy of eutectoid composition (0.8% C) as it is cooled from a temperature within the  $\gamma$  phase region, say  $800^\circ\text{C}$  – that is, beginning at point ‘a’ in figure and moving down vertical  $xx'$ . Initially the alloy is composed entirely of the austenite phase having composition 0.8 wt.% C and then transformed to  $\alpha + \text{Fe}_3\text{C}$  [pearlite]
- ✓ The microstructure for this eutectoid steel that is slowly cooled through eutectoid temperature consists of alternating layers or lamellae of the two phases  $\alpha$  and  $\text{Fe}_3\text{C}$ .
- ✓ The pearlite exists as grains, often termed “colonies”; within each colony the layers are oriented in essentially the same direction, which varies from one colony to other.
- ✓ The thick light layers are the ferrite phase, and the cementite phase appears as thin lamellae most of which appear dark.

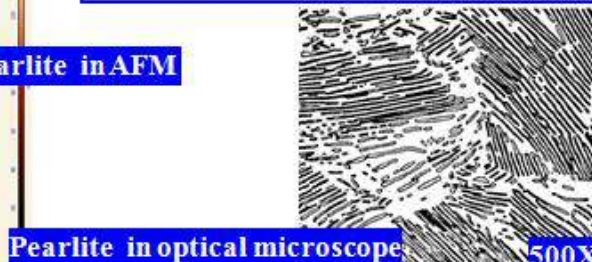
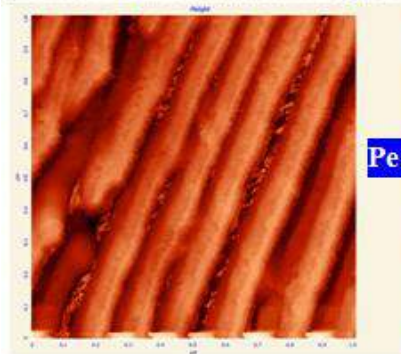
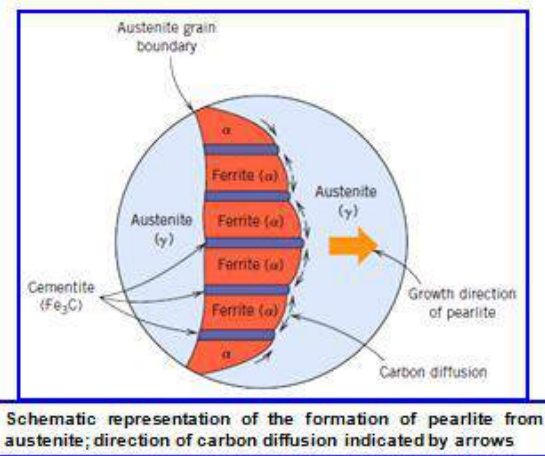
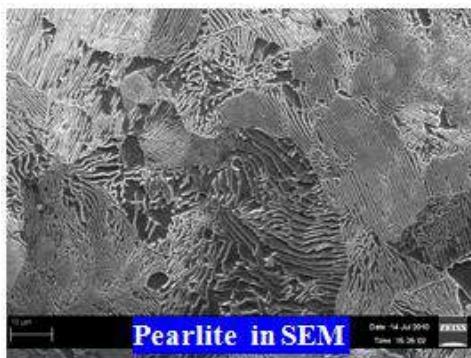
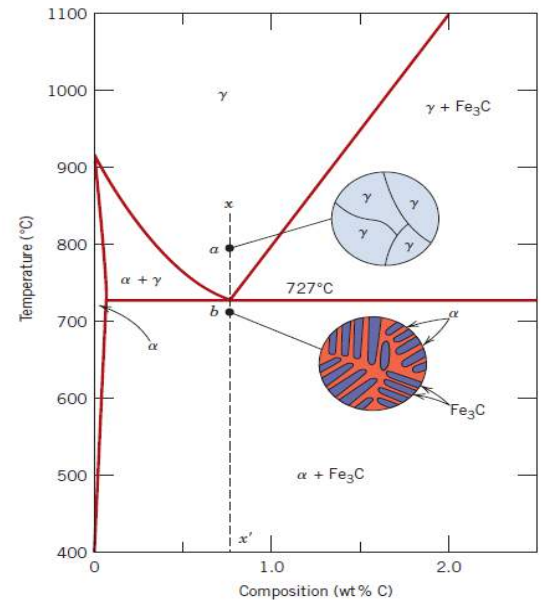

## Microstructures involved in Hypo eutectoid region:

- ✓ Hypo eutectoid region – 0.008 to 0.8 %C
- ✓ Consider vertical line  $yy'$  in figure, at about 875°C, point  $c$ , the microstructure will consist entirely of grains of the  $\gamma$  phase.
- ✓ In cooling to point  $d$ , about 775°C, which is within the  $\alpha+\gamma$  phase region, both these phases will coexist as in the schematic microstructure. Most of the small  $\alpha$  particles will form along the original  $\gamma$  grain boundaries.
- ✓ Cooling from point  $d$  to  $e$ , just above the eutectoid but still in the  $\alpha+\gamma$  region, will produce an increased fraction of  $\alpha$  phase and a microstructure similar to that also shown: the  $\alpha$  particles will have grown larger.
- ✓ Just below the eutectoid temperature, at point  $f$ , all the  $\gamma$  phase that was present at temperature  $e$  will transform pearlite. Virtually there is no change in  $\alpha$  phase that existed at point  $e$  in crossing the eutectoid temperature – it will normally be present as a continuous matrix phase surrounding the isolated pearlite colonies.
- ✓ Thus the ferrite phase will be present both in the pearlite and also as the phase that formed while cooling through the  $\alpha+\gamma$  phase region. The ferrite that is present in the pearlite is called eutectoid ferrite, whereas the other, is termed proeutectoid (meaning pre- or before eutectoid) ferrite.

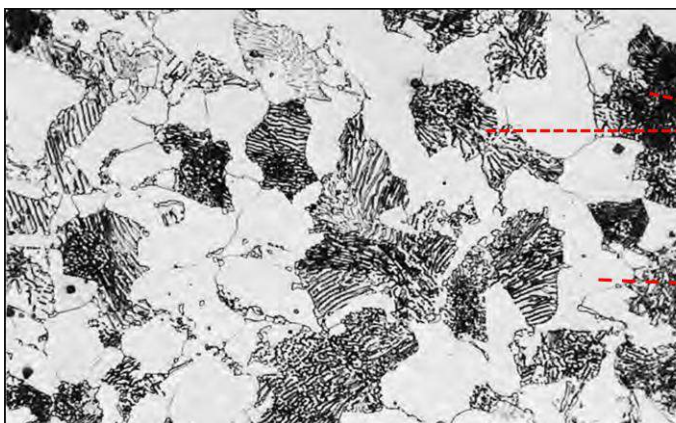
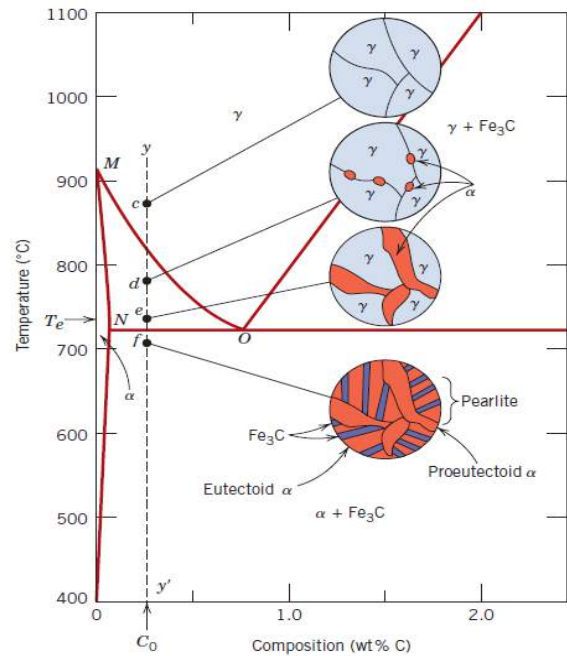

Pearlite

Pro-eutectoid ferrite

## Microstructures involved in Hypo eutectoid region:

- ✓ Hyper eutectoid region – 0.8 to 2.1 %C
- ✓ Consider an alloy of composition  $C_1$  in figure that, upon cooling, moves down the line  $zz'$ . At point  $g$  only the  $\gamma$  phase will be present and the microstructure having only gamma grains.
- ✓ Upon cooling into the  $\gamma + Fe_3C$  phase field – say to point  $h$  – the cementite phase will begin to form along the initial  $\gamma$  grain boundaries, similar to the  $\alpha$  phase in point  $d$ . this cementite is called *proeutectoid cementite* that which forms before the eutectoid reaction.
- ✓ As the temperature is lowered through the eutectoid to point  $I$ , all remaining austenite of eutectoid composition is converted into pearlite; thus the resulting microstructure consists of pearlite and proeutectoid cementite as micro constituents.

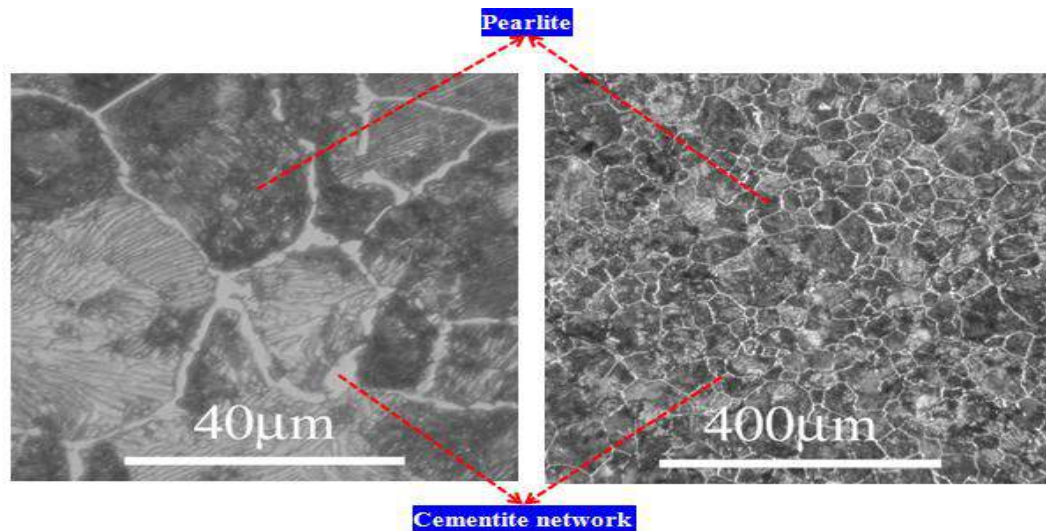
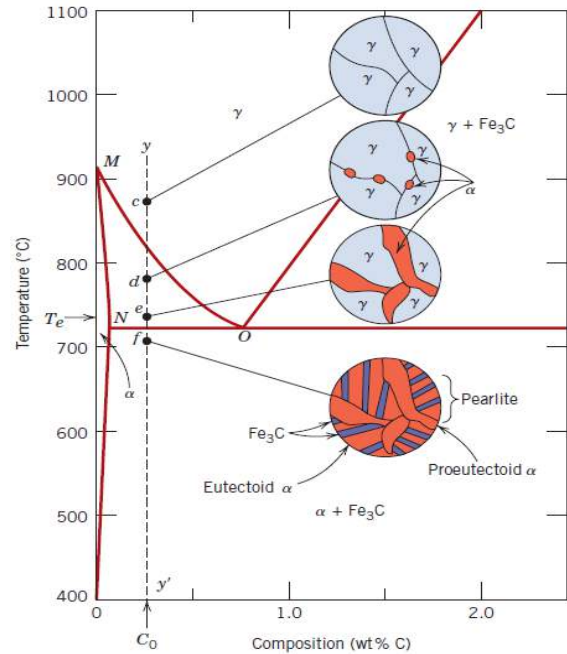

## Application of Lever rule in Fe-Fe<sub>3</sub>C phase diagr

### Solved Example

For a 99.6 wt% Fe-0.40 wt% C at a temperature just below the eutectoid, determine the following:

- The amount of Fe<sub>3</sub>C, ferrite (α) and pearlite
- The amount of pearlite and proeutectoid ferrite (α)

a) The amount of Fe<sub>3</sub>C and ferrite (α)

$$\text{Percentage of Fe}_3\text{C} = \frac{0.4 - 0.025}{6.67 - 0.025} * 100$$

Percentage of Fe<sub>3</sub>C in 0.4 %C steel is 5.64 %

Percentage of Ferrite (α) in 0.4 %C steel = (100- 5.64)%

Percentage of ferrite in 0.4 %C steel = 94.36%

or

$$\text{Percentage of ferrite} = \frac{6.67 - 0.4}{6.67 - 0.025} * 100 = 94.36\%$$

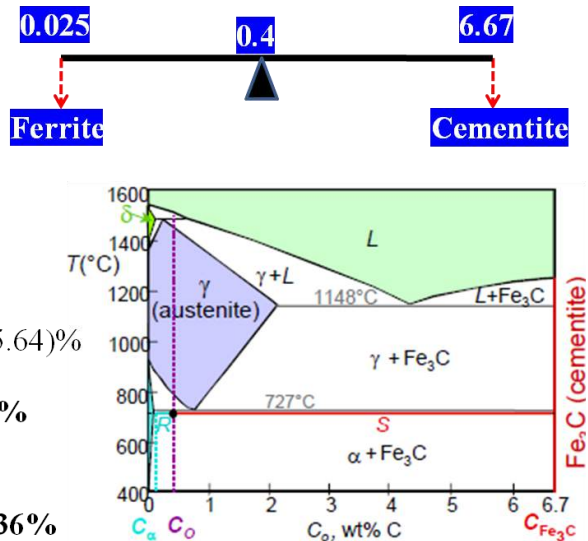

b) Phase fraction of pearlite and proeutectoid ferrite (α)

$$\text{Percentage of pearlite} = \frac{0.4 - 0.025}{0.8 - 0.025} * 100$$

Percentage of pearlite = 48 %

Percentage of proeutectoid ferrite (α) in 0.4 %C steel = (100- 48)%

Percentage of proeutectoid ferrite (α) = 52 %

or

$$\text{Percentage of proeutectoid ferrite} = \frac{0.8 - 0.4}{0.8 - 0.025} * 100 = 52\%$$



### Critical temperature lines:

- ✓ In general,  $A_0$  – Subcritical temperature,  $A_1$  - lower critical temperature,  $A_3$  - upper critical temperature,  $A_4$  – Eutectic temperature,  $A_5$  – Peritectic temperature and  $A_{cm}$  -  $\gamma/\gamma$ +cementite phase field boundary.
- ✓ While heating we denoted as  $Ac_1$ ,  $Ac_2$ ,  $Ac_3$  etc., 'c' stands for *chauffage* (French word), which means heating and while cooling we denoted as  $Ar_1$ ,  $Ar_2$ ,  $Ar_3$  etc., 'r' stands for *refroidissement*, (French word) which means cooling.

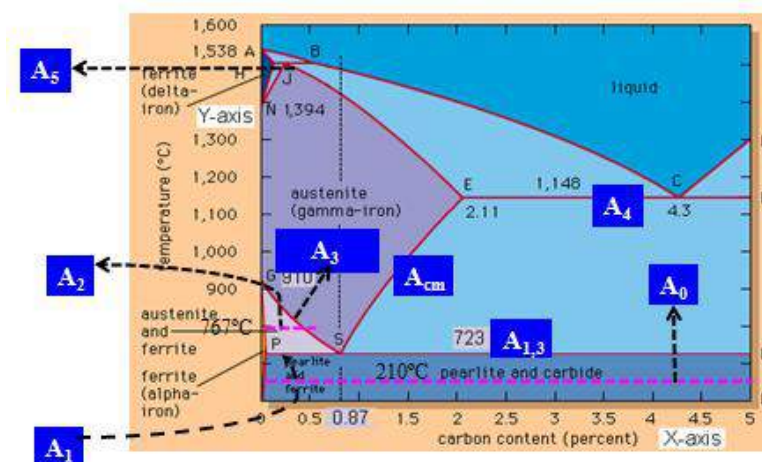

### Martensitic Transformations:

Under slow cooling rates, the carbon atoms are able to diffuse out of the austenite structure and it leads to gamma to alpha transformation. This process involves nucleation and growth and it is time dependent.

With a still further increase in cooling rate, insufficient time is allowed for the carbon to diffuse out of solution, and although some movement of the iron atoms takes place, the structure cannot become B.C.C. while the carbon is trapped in solution.

*The resultant structure is called Martensite, is a supersaturated solid solution of carbon trapped in a body-centered tetragonal structure and it is a metastable phase.*

The highly distorted lattice structure is the prime reason for the high hardness of martensite.

After drastic cooling, martensite appears microscopically as a white needlelike or acicular structure or lenticular, sometimes described as pile of straw.

Shape of the Martensite formed → Lenticular (or thin parallel plates)

Associated with shape change (shear)

This condition requires:

- Bain distortion → Expansion or contraction of the lattice along certain crystallographic directions leading to homogenous pure dilation
- Secondary Shear Distortion → Slip or twinning
- Rigid Body rotation

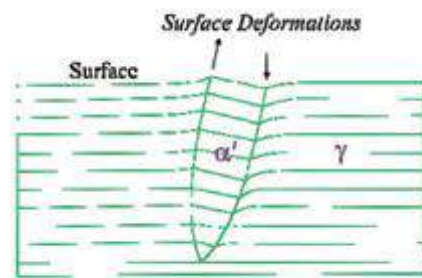
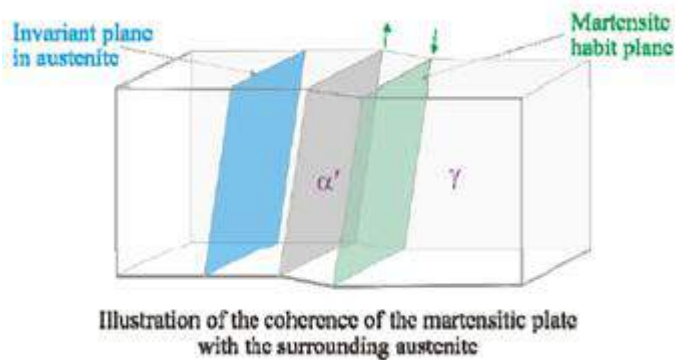

- ✓ Martensitic transformation can be understood by first considering an alternate unit cell for the Austenite phase as shown in the figure below.
- ✓ If there is no carbon in the Austenite (as in the schematic below), then the Martensitic transformation can be understood as a ~20% contraction along the c-axis and a ~12%

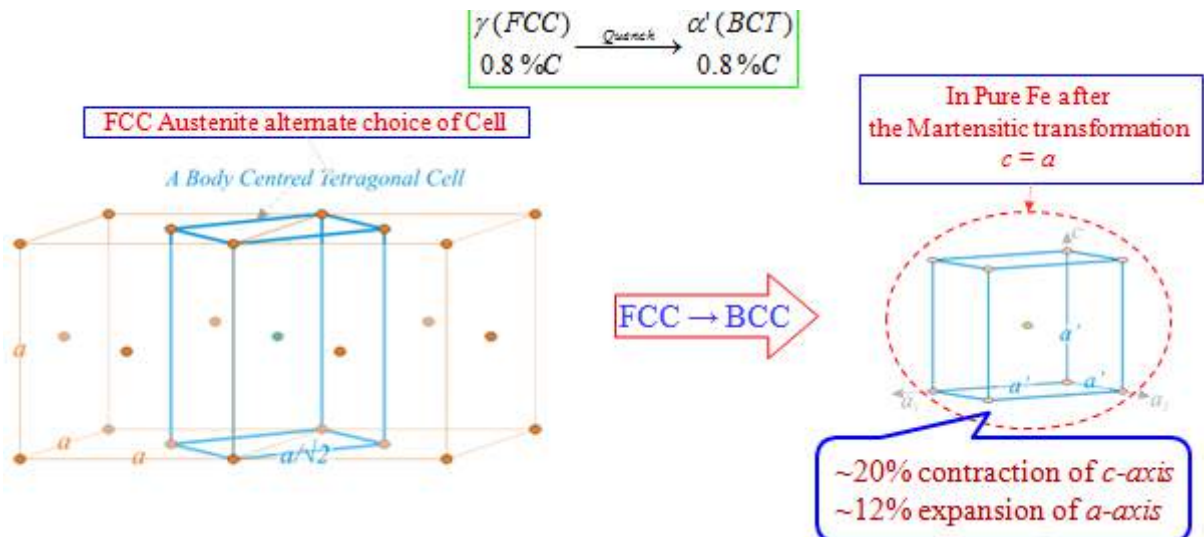

expansion of the a-axis → accompanied by no volume change and the resultant structure has a BCC lattice (the usual BCC-Fe) → c/a ratio of 1.0.

- ✓ In the presence of Carbon in the octahedral voids of CCP (FCC)  $\gamma$ -Fe (as in the schematic below) → the contraction along the c-axis is impeded by the carbon atoms. (*Note that only a fraction of the octahedral voids are filled with carbon as the percentage of C in Fe is small*).
- ✓ However the  $a_1$  and  $a_2$  axis can expand freely. This leads to a product with c/a ratio ( $c'/a'$ ) > 1
- ✓ In this case there is an overall increase in volume of ~4.3% (*depends on the carbon content*) → the Bain distortion.

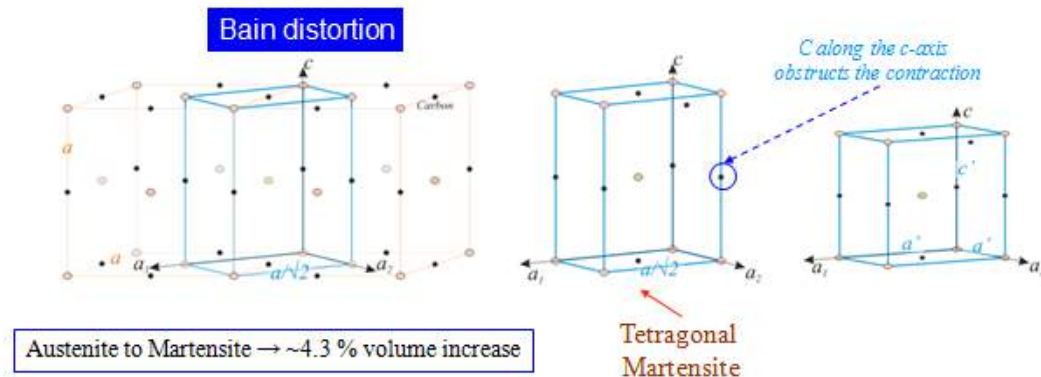

- The Martensitic transformation occurs without composition change
- The transformation occurs by shear without need for diffusion and is called diffusion less transformation
- The atomic movements (*shearing*) required are only a fraction of the inter atomic spacing
- The shear changes the shape of the transforming region
  - results in considerable amount of shear energy
  - plate-like shape of Martensite
- The amount of martensite formed is a function of the temperature to which the sample is quenched and not of time
- Hardness of martensite is a function of the carbon content → but high hardness steel is very brittle as martensite is brittle
- Steel is reheated to increase its ductility → this process is called TEMPERING

- The martensite transformation, for many years, was believed to be unique for steel. However, in recent years, this martensite type of transformation has been found in a number of other alloy systems, such as iron-nickel, copper-zinc, and copper-aluminum.
- The basic purpose of hardening is to produce a fully martensitic structure, and the minimum cooling rate (per second) that will avoid the formation of any of the softer products of transformation is known as the *critical cooling rate*.
- The critical cooling rate, determined by chemical composition and austenitic grain size, is an important property of steel since it indicates how fast steel must be cooled in order to form only martensite.

## Module 3

---

### Heat Treatment

A heat treatment can be defined as the process to subject a material to a predetermined time-temperature profile in the solid state to achieve desired combination of properties through alteration of microstructural features, such as, grain size, phase distribution, etc.

### General heat treatment processes

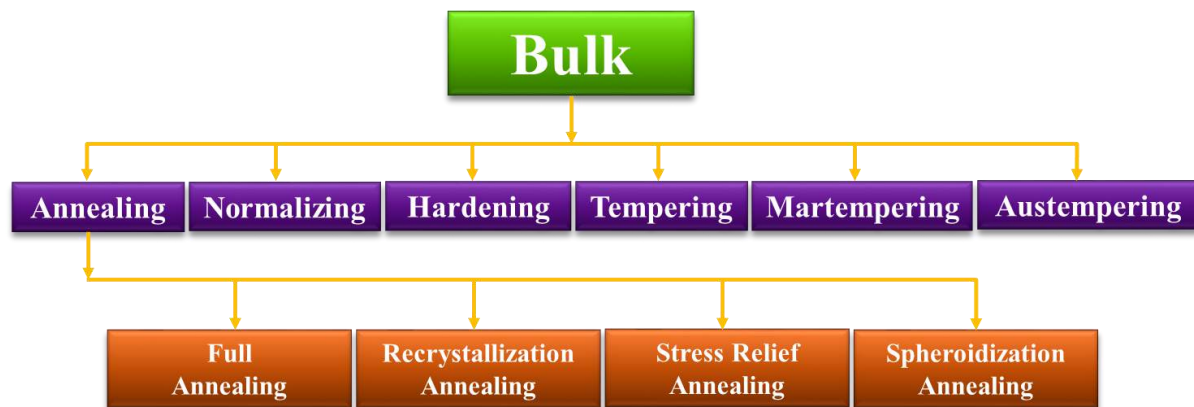

### Time-Temperature-Transformation (TTT) Diagrams:

- Davenport and Bain were the first to develop the TTT diagram of eutectoid steel. They determined pearlite and bainite portions whereas Cohen later modified and included  $M_S$  and  $M_F$  temperatures for martensite.
- There are number of methods used to determine TTT diagrams. The most popular method is salt bath techniques combined with metallography and hardness measurement with addition of this we have other techniques like dilatometry, electrical resistivity method, magnetic permeability, *in situ* diffraction techniques (X-ray, neutron), acoustic emission, thermal measurement techniques, density measurement techniques and thermodynamic predictions.

- TTT diagrams, also called as Isothermal (temperature constant) Transformation diagrams.
- TTT diagrams give the kinetics of isothermal transformations.
- For every composition of steel we should draw a different TTT diagram.
- For the determination of isothermal transformation (or) TTT diagrams, we consider molten salt bath technique combined with metallography and hardness measurements.
- In molten salt bath technique two salt baths and one water bath are used. Salt bath I is maintained at austenising temperature ( $780^{\circ}\text{C}$  for eutectoid steel). Salt bath II is maintained at specified temperature at which transformation is to be determined (below  $A_{e1}$ ), typically  $700\text{-}250^{\circ}\text{C}$  for eutectoid steel. Bath III which is a cold water bath is maintained at room temperature.
- In bath I number of samples is austenite at  $A_1+20\text{-}40^{\circ}\text{C}$  for eutectoid,  $A_3+20\text{-}40^{\circ}\text{C}$  for hypo-eutectoid steel and  $A_{Cm}+20\text{-}40^{\circ}\text{C}$  for hyper-eutectoid steels for about an hour.
- Then samples are removed from bath I and put in bath II and each one is kept for different specified period of time say  $t_1, t_2, t_3, t_4, \dots, t_n$  etc. After specified times, the samples are removed and quenched in cold water. The microstructure of each sample is studied using metallographic techniques. The type, as well as quantity of phases, is determined on each sample.

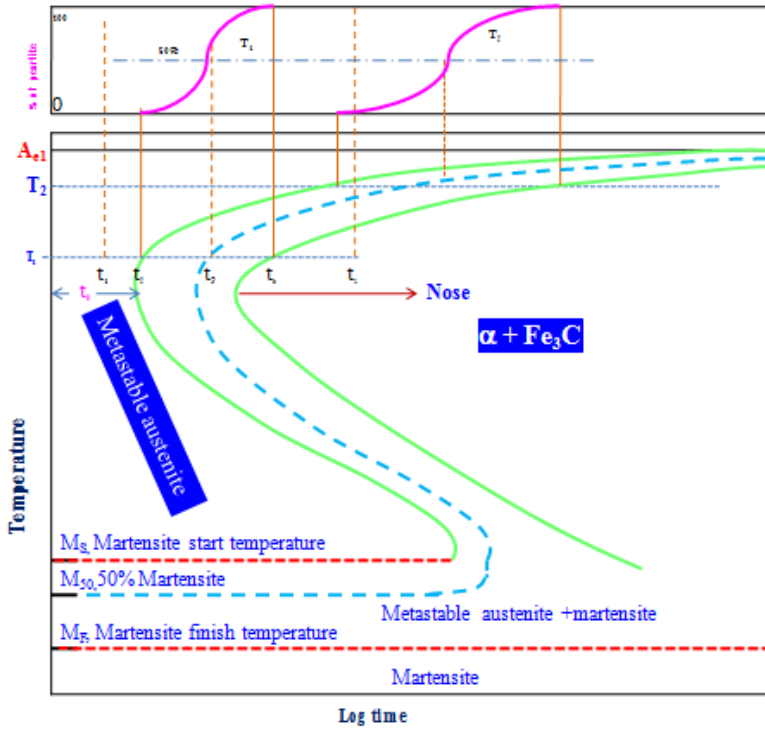

✓ At  $T_1$ , incubation period for pearlite =  $t_2$ , Pearlite finish time =  $t_4$

✓ Minimum incubation period  $t_0$  at the nose of the TTT diagram,

*Important points to be noted:*

✓ The x-axis is log scale. 'Nose' of the 'C' curve is in ~sec and just below  $T_F$  transformation times may be ~day.

✓ The starting phase (left of the C curve) has to  $\gamma$ .

✓ To the right of finish C curve is ( $\gamma + Fe_3C$ ) phase field. This phase field has more labels included.

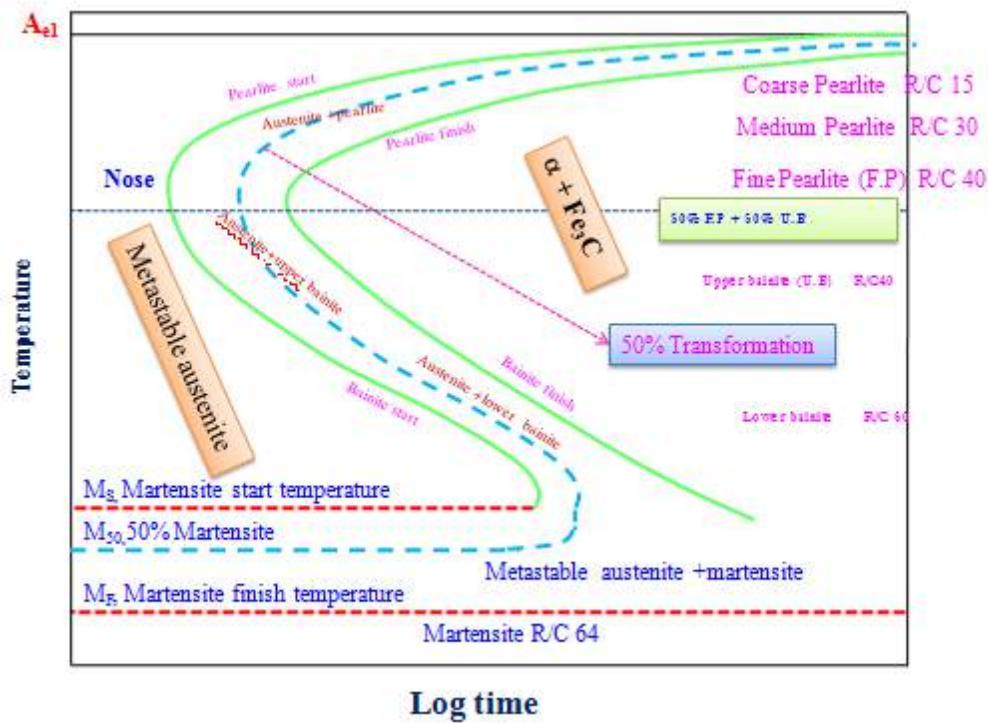

- As pointed out before one of the important utilities of the TTT diagrams comes from the overlay of micro-constituents (microstructures) on the diagram.
- Depending on the T, the ( $\gamma + \text{Fe}_3\text{C}$ ) phase field is labeled with micro-constituents like Pearlite, Bainite.
- The time taken to 1% transformation to, say pearlite or bainite is considered as transformation start time and for 99% transformation represents transformation finish.
- We had seen that TTT diagrams are drawn by instantaneous quench to a temperature followed by isothermal hold.
- Suppose we quench below ( $\sim 225^\circ\text{C}$ , below the temperature marked  $M_s$ ), then Austenite transforms via a diffusionless transformation (involving shear) to a (hard) phase known as Martensite. Below a temperature marked  $M_f$  this transformation to Martensite is complete. Once  $\gamma$  is exhausted it cannot transform to ( $\gamma + \text{Fe}_3\text{C}$ ).
- Hence, we have a new phase field for Martensite. The fraction of Martensite formed is not a function of the time of hold, but the temperature to which we quench (between  $M_s$  and  $M_f$ ).
- Strictly speaking cooling curves (including finite quenching rates) should not be overlaid on TTT diagrams (remember that TTT diagrams are drawn for isothermal holds!).



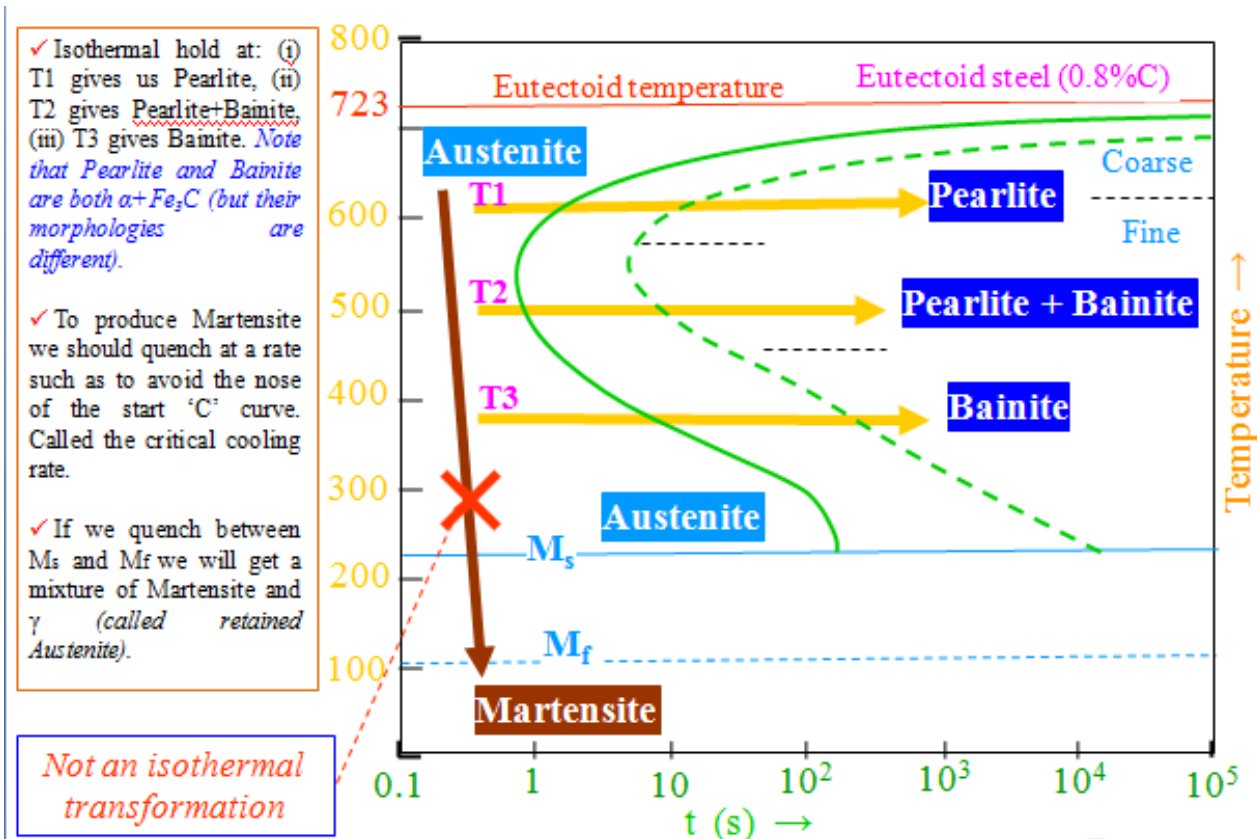

### TTT diagram for Hypo eutectoid steel

- In hypo- (and hyper-) eutectoid steels (say composition  $C_1$ ) there is one more branch to the 'C' curve-NP (next slide: marked in red).
- The part of the curve lying between  $T_1$  and  $T_E$  (marked in fig : next slide) is clear, because in this range of temperatures we expect only pro-eutectoid  $\alpha$  to form and the final microstructure will consist of  $\alpha$  and  $\gamma$ . (E.g. if we cool to  $T_x$  and hold).
- The part of the curve below  $T_E$  is a bit of a 'mystery'

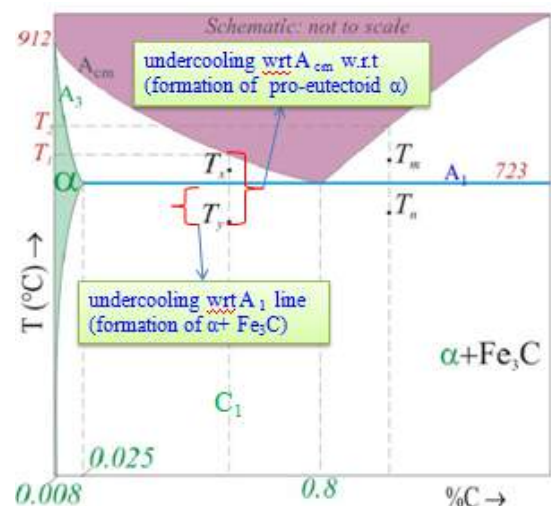

(since we are instantaneously cooling to below  $T_E$ , we should get a mix of  $\alpha + Fe_3C$  what is the meaning of a 'pro'-eutectoid phase in a TTT diagram? (remember 'pro-' implies 'pre-')

- Suppose we quench instantaneously an hypo-eutectoid composition  $C_1$  to  $T_x$  we should expect the formation of  $\alpha + Fe_3C$  (and not pro-eutectoid  $\alpha$  first).
- The reason we see the formation of pro-eutectoid  $\alpha$  first is that the undercooling w.r.t to  $A_{cm}$  is more than the undercooling w.r.t to  $A_1$ . Hence, there is a higher propensity for the formation of pro-eutectoid  $\alpha$ .

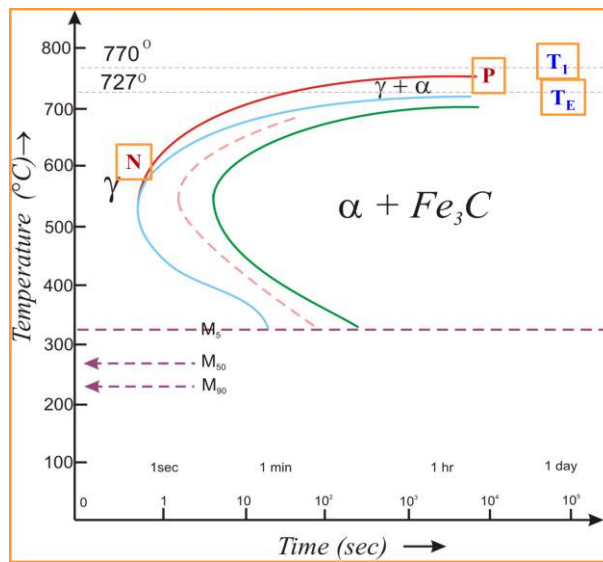

### TTT diagram for Hyper eutectoid steel

- Similar to the hypo-eutectoid case, hyper-eutectoid compositions  $C_2$  have a  $\gamma + Fe_3C$  branch.
- For a temperature between  $T_2$  and  $T_E$  (say  $T_m$  (not melting point- just a label)) we land up with  $\gamma + Fe_3C$ .
- For a temperature below  $T_E$  (but above the nose of the 'C' curve) (say  $T_n$ ), first we have the formation of pro-eutectoid  $Fe_3C$  followed by the formation of eutectoid  $\gamma + Fe_3C$ .

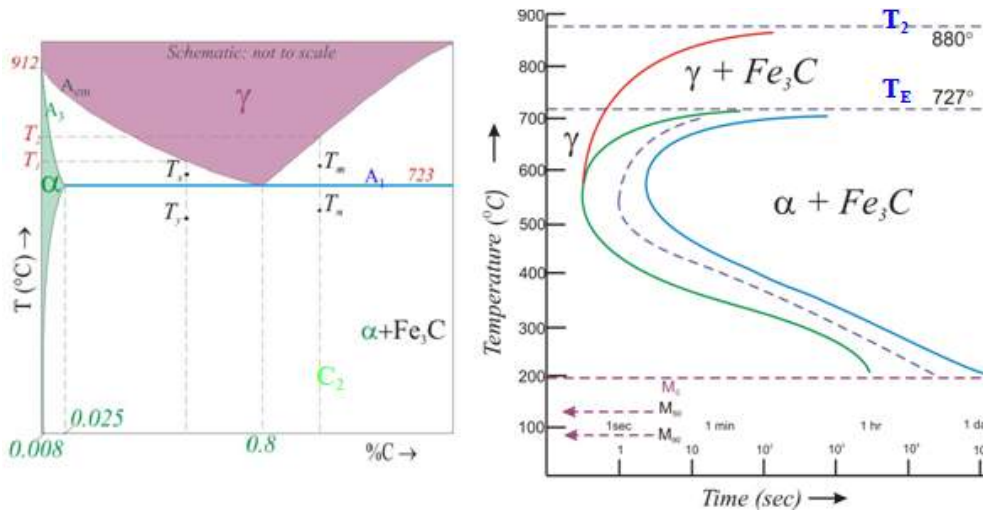

### Transformation to Pearlite

- The transformation product above the nose region is pearlite. The pearlite microstructure is the characteristic lamellar structure of alternate layers of ferrite and cementite.
- As the transformation temperature decreases, the characteristic lamellar structure is maintained, but the spacing between the ferrite and carbide layers becomes increasingly smaller until the separate layers cannot be resolved with the light microscope.
- As the temperature of transformation and the fineness of the pearlite decreases, it is apparent that the hardness will increase.

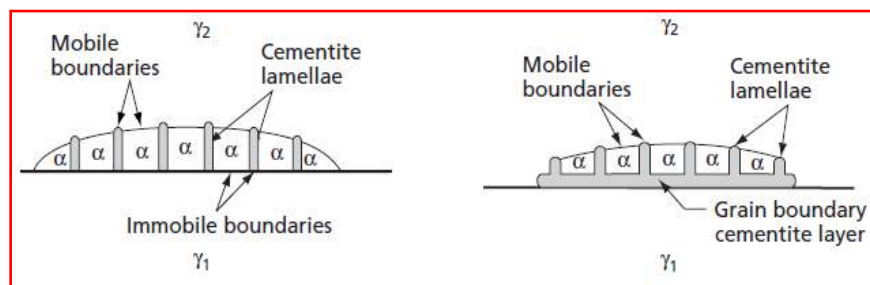

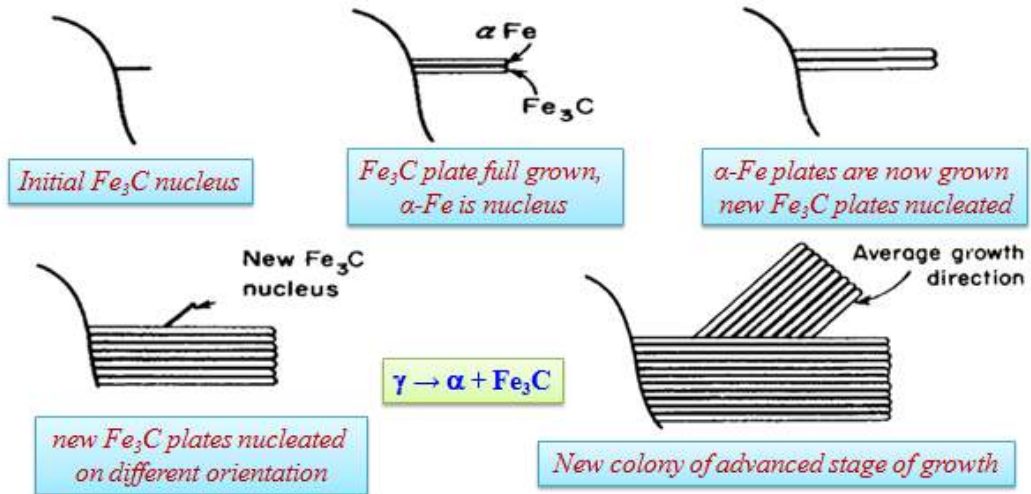

- Nucleation and growth
- Heterogeneous nucleation at grain boundaries
- Interlamellar spacing is a function of the temperature of transformation
- Lower temperature  $\rightarrow$  finer spacing  $\rightarrow$  higher hardness

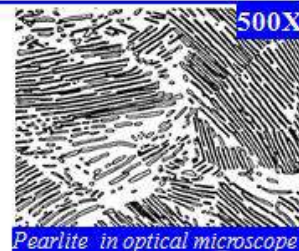
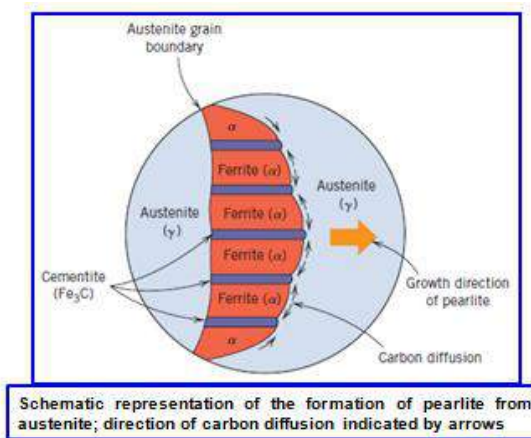
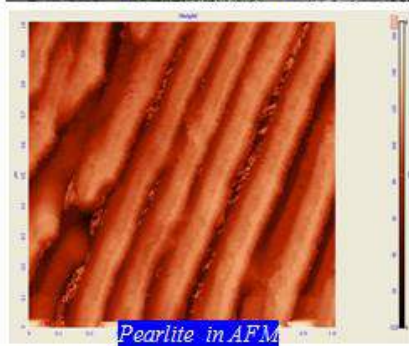

## Transformation to Bainite

- In between the nose region of approximately 510°C and the  $M_s$  temperature, a new, dark-etching aggregate of ferrite and cementite appears. This structure, named after E.C.Bain, is called bainite.
- At upper temperatures of the transformation range, it resembles pearlite and is known as upper or feathery bainite. At low temperatures it appears as a black needlelike structure resembling martensite and is known as lower or acicular bainite.

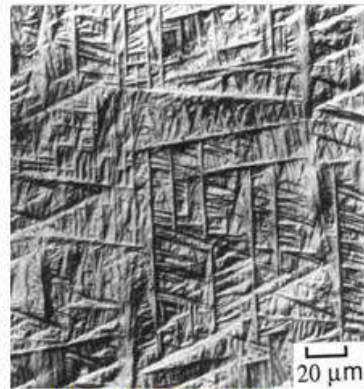

Upper or Feathery bainite

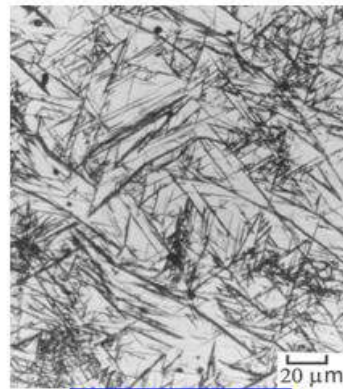

Lower or Acicular bainite

- Pearlite is nucleated by a carbide crystal, bainite is nucleated by a ferrite crystal, and this results in a different growth pattern.
- Acicular, accompanied by surface distortions
- Lower temperature → carbide could be  $\epsilon$  carbide (hexagonal structure, 8.4% C)
- Bainite plates have irrational habit planes
- Ferrite in Bainite plates possess different orientation relationship relative to the parent Austenite than does the Ferrite in Pearlite

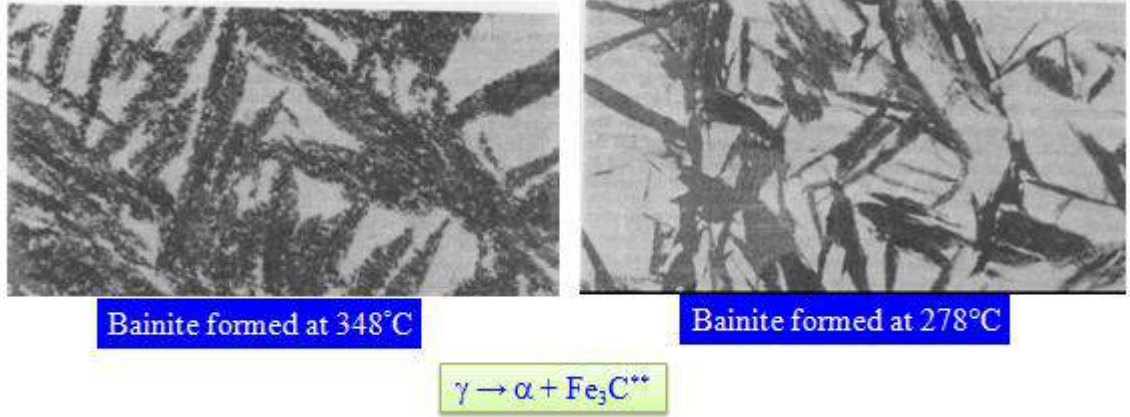

- **Continuous cooling transformation (CCT) diagram**

Isothermal heat treatments are not the most practical to conduct because an alloy must be rapidly cooled to and maintained at an elevated temperature from a higher temperature above the eutectoid. Most heat treatments for steels involve the continuous cooling of a specimen to room temperature. An isothermal transformation diagram is valid only for conditions of constant temperature; this diagram must be modified for transformations that occur as the temperature is constantly changing. For continuous cooling, the time required for a reaction to begin and end is delayed. Thus the isothermal curves are shifted to longer times and lower temperatures, as indicated in Fig. 3.1 shown below for an iron–carbon alloy of eutectoid composition.

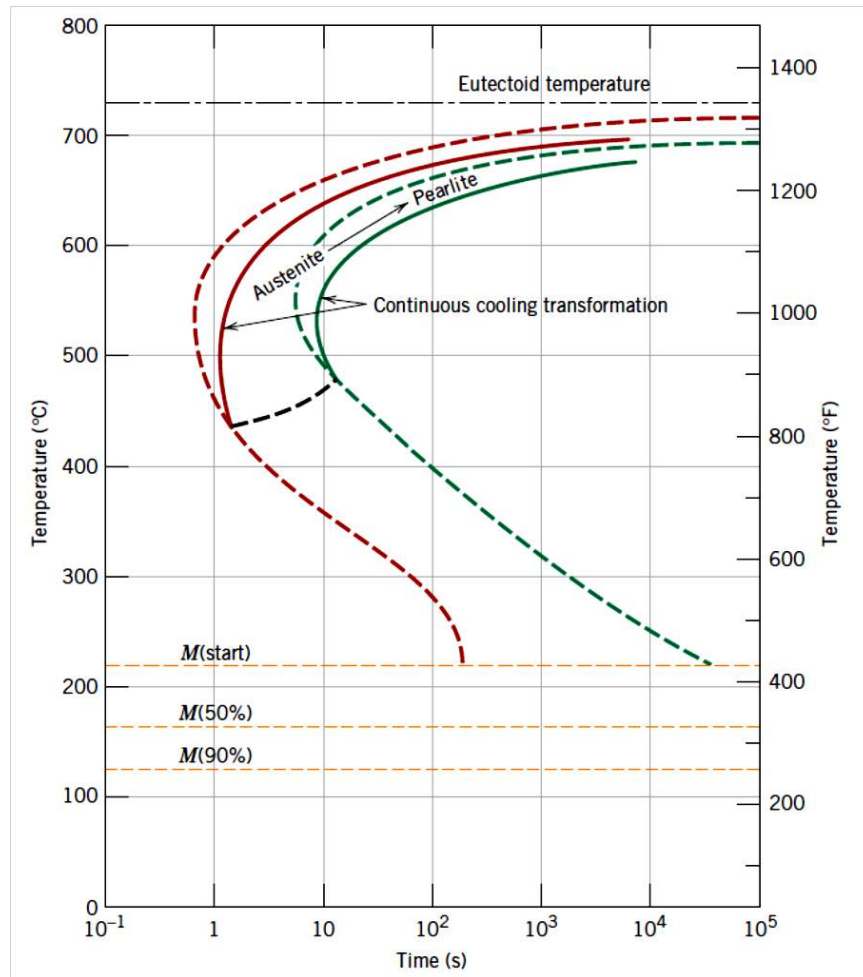

Fig.3.1 Superimposition of isothermal and continuous cooling transformation diagrams for a eutectoid iron–carbon alloy.

A plot containing such modified beginning and ending reaction curves is termed a **continuous cooling transformation (CCT) diagram**. Some control may be maintained over the rate of temperature change depending on the cooling environment. Two cooling curves corresponding to moderately fast and slow rates are superimposed and labeled in Figure 3.2, again for a eutectoid steel. The transformation starts after a time period corresponding to the intersection of the cooling curve with the beginning reaction curve and concludes upon crossing the completion transformation curve. The microstructural products for the moderately rapid and slow cooling rate curves in Fig. 3.2 are fine and coarse pearlite, respectively.

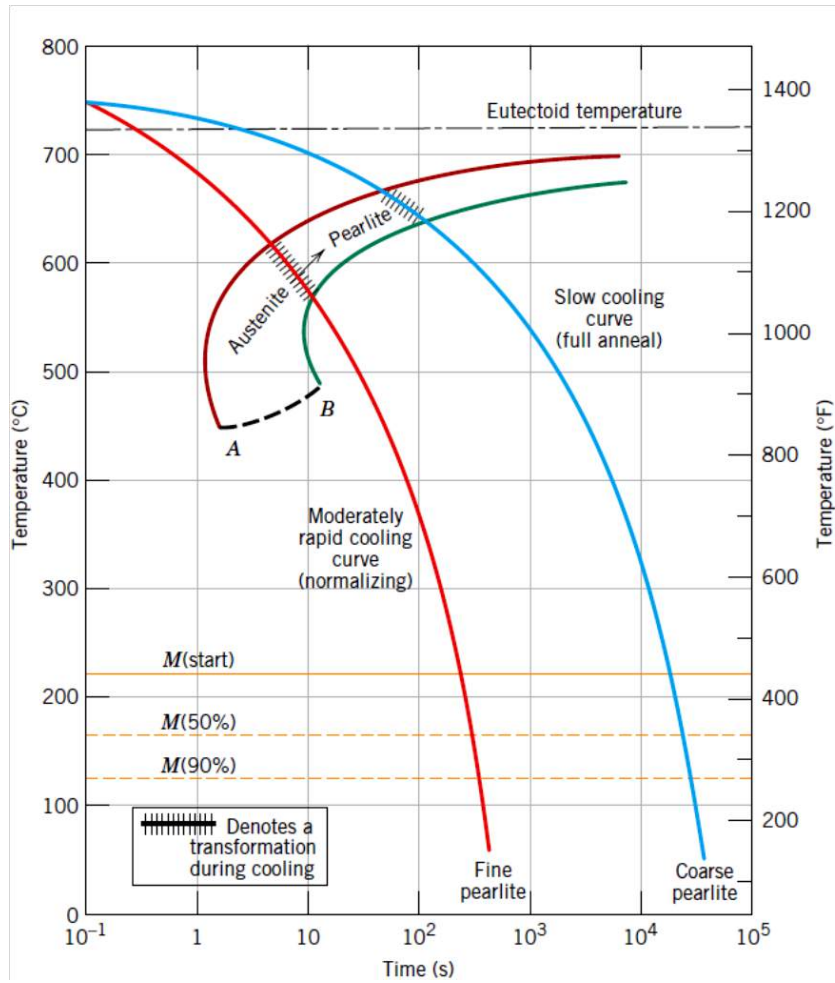

Fig.3.2: Moderately rapid and slow cooling curves superimposed on a continuous cooling transformation diagram for a eutectoid iron–carbon alloy.

Normally, bainite will not form when an alloy of eutectoid composition or, for that matter, any plain carbon steel is continuously cooled to room temperature. This is because all the austenite will have transformed to pearlite by the time the bainite transformation has become possible. Thus, the region representing the austenite–pearlite transformation terminates just below the nose (Fig.3.2) as indicated by the curve *AB*. For any cooling curve passing through *AB* in Fig.3.2, the transformation ceases at the point of intersection; with continued cooling, the unreacted austenite begins transforming to martensite upon crossing the *M*(start) line.



With regard to the representation of the martensitic transformation, the  $M(\text{start})$ ,  $M(50\%)$ , and  $M(90\%)$  lines occur at identical temperatures for both isothermal and continuous cooling transformation diagrams.

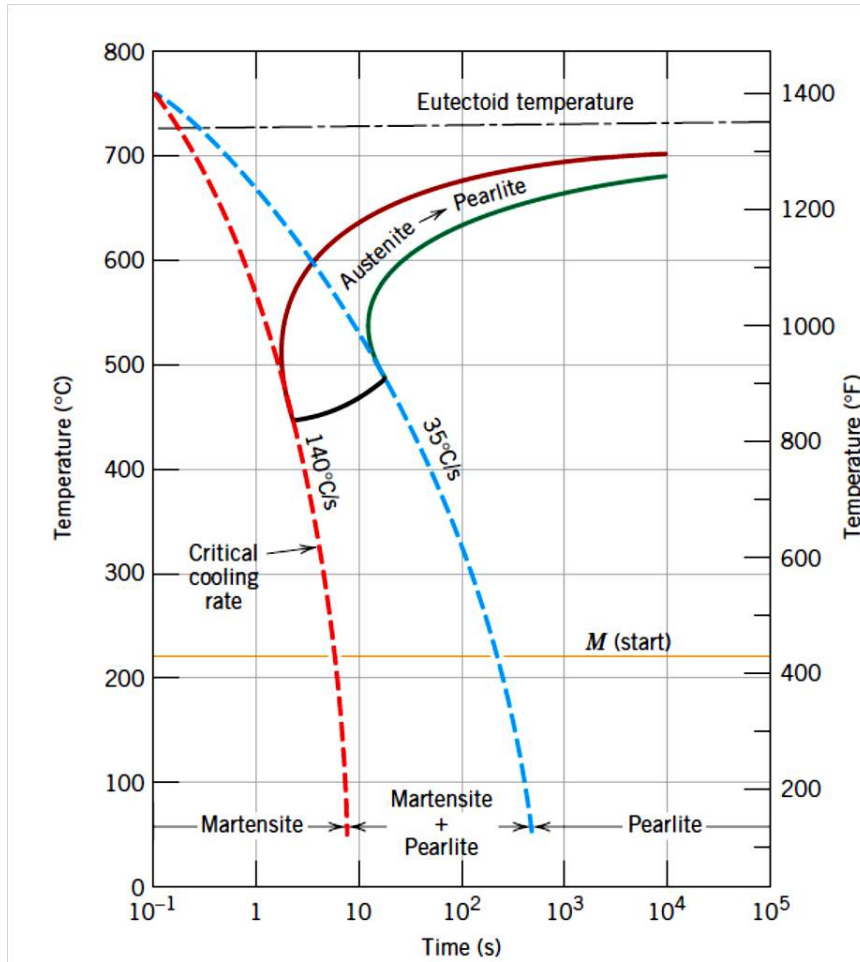

Fig.3.3: Continuous cooling transformation diagram for a eutectoid iron-carbon alloy and superimposed cooling curves, demonstrating the dependence of the final microstructure on the transformations that occur during cooling.

For the continuous cooling of a steel alloy, there exists a critical quenching rate, which represents the minimum rate of quenching that will produce a totally martensitic structure. This critical cooling rate, when included on the continuous transformation diagram, will just miss the nose at which the pearlite transformation begins, as illustrated in Fig.3.3. As the figure also shows, only martensite will exist for quenching rates greater than the critical; in addition, there will be a range of rates over which both pearlite and martensite are produced. Finally, a totally pearlitic structure develops for low cooling rates.

### **Annealing**

Annealing cycles are varied according to the temperature and the method of cooling used. Annealing temperatures may be classified as:

- Subcritical annealing (below the lower critical temperature,  $A_1$ )
- Intercritical annealing (above  $A_1$  but below the upper critical temperature,  $A_3$  in hypoeutectoid steels, or  $A_{cm}$  in hypereutectoid steels)
- Supercritical annealing to achieve full austenitization of either hypo- or hyper-eutectoid steels.

Some commonly used heat treatment cycle superimposed on Fe-C equilibrium diagram is shown in Fig.3.4.

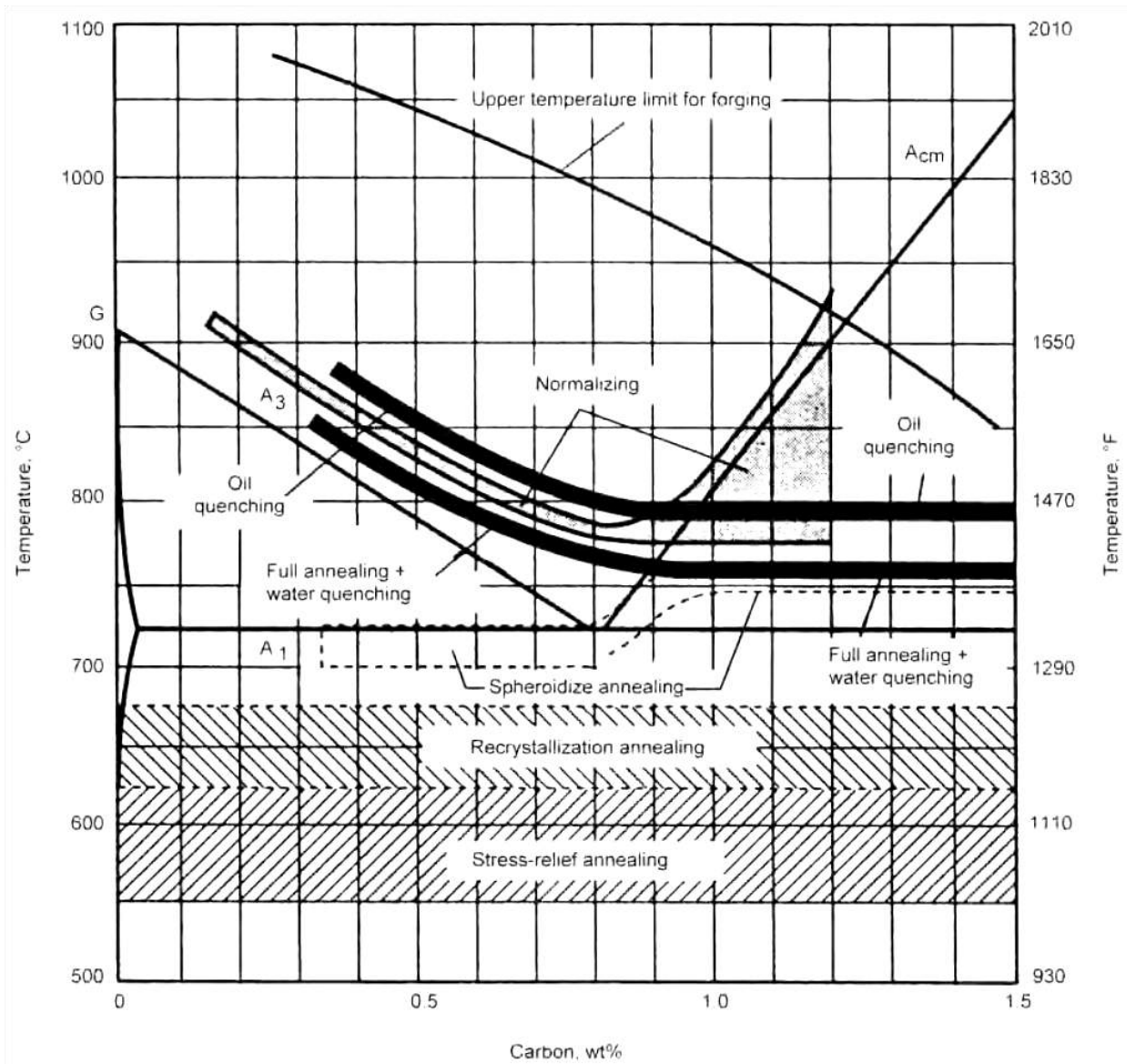

Fig.3.4 Approximate temperature ranges for various heat treatments applied to steels.

### Full Annealing

- The temperatures for full annealing are typically 50°C (90°F) above the upper critical temperature (A3) for hypoeutectic steels and the lower critical temperature (A1) for hypereutectoid steels.
- It is referred to as *full annealing* because it achieves full austenitization of hypoeutectoid steels.

- The indicated temperatures for full annealing are a supercritical anneal for hypoeutectoid steels, but are in the range of an intercritical anneal for hypereutectoid steels.
- Full annealing produces a microstructure that is softer and more amenable to other processing such as forming or machining.
- In addition, stainless and high-alloy steels may be austenitized (fully annealed) and quenched to minimize the presence of grain boundary carbides or to improve the ferrite distribution.
- The temperatures for full annealing are in approximately the same range of austenitization temperatures for water quenching (Fig. 3.4) but are below austenitization temperatures for either normalizing or hardening by oil quenching.

### **Recrystallization Annealing**

- When cold worked metals are heated to a sufficiently high temperature, the badly deformed cold worked grains are replaced by new strain-free grains.
- This process is referred to as recrystallization, which is distinct from the recovery process during stress relief. At a constant temperature, recovery starts rapidly and then decreases with time. On the other hand, recrystallization, which is a nucleation and growth process, starts slowly and then builds up to a maximum rate before rapidly leveling off. Recrystallization annealing of steel is done at subcritical temperatures (Fig. 3.4).
- Recrystallization annealing of cold worked metal can produce a new grain structure without inducing a phase change. The *recrystallization temperature* is often defined as the temperature required for the microstructure to undergo 50% recrystallization in 30 min, and for complete recrystallization in approximately one hour.
- Although there is a trade-off between time and temperature, temperature is a much more dominant variable than time. Recrystallization occurs more rapidly at higher temperatures. For most kinetic processes, increasing the temperature by approximately 11°C (20°F) doubles the reaction rate. Once recrystallization is complete, further heating causes grain growth to occur. The recrystallized grain size is dependent on both the recrystallization time and temperature, particularly the temperature. Higher temperatures tend to promote larger grain sizes.

- The temperature required for recrystallization is not exact—it depends on the composition of the alloy and in particular on the amount of cold work performed. Therefore, recovery may affect the recrystallization temperature, because the tendency toward recrystallization is lowered when appreciable recovery has occurred; that is, a higher temperature may then be required to cause recrystallization. In addition, grain size affects the nucleation rate and the recrystallization temperature. For equal amounts of cold work, a lower recrystallization temperature and shorter recrystallization time occurs for fine-grained metal than in coarse grained metal.

### **Stress Relief Annealing**

- Annealing at subcritical temperatures (below  $A_{c1}$ ) includes three different temperature regions (Fig. 4.1). The first is the temperature range for stress-relief annealing.
- Annealing involves uniform heating of a structure, or portion thereof, and holding at this temperature for a predetermined period of time, followed by uniform cooling. Stress relief temperatures are sufficiently high to help activate the microstructural process of *recovery*, such that stored internal strain energy is relieved by rearrangement of dislocations into lower-energy configurations without any change in the shape and orientation of grains.
- Stress-relief heat treating is used to relieve stresses from cold working. Care must be taken to ensure uniform cooling, particularly when a component is composed of variable section sizes. If the rate of cooling is not constant and uniform, new residual stresses can result that are equal to or greater than those that the heat-treating process was intended to relieve.
- Stress-relief heat treating can reduce distortion and high stresses from welding that can affect service performance. The presence of residual stresses can lead to stress-corrosion cracking (SCC) near welds and in regions of a component that has been cold strained during processing.

## Spheroidizing

- Depending on the time-temperature exposure of a steel, the cementite carbides in a steel can form different morphologies, such as the lamellar cementite of pearlite, or a network of cementite along prior austenite grain boundaries in a hypereutectoid steel.
- The shape and distribution of the carbides can be modified by heat treatment, and spheroidization treatments are used to produce carbides with a more spherical morphology.
- Because spherical shapes have lower surface energy than angular shapes, the lamellar shape of cementite in pearlite changes morphology to form spheroids. Portions of the lamellae “pinch off” (dissolve) to form a spheroid from the remaining portions of lamellae. This process can occur over a long period of time, or it can be accelerated by heat treatment. Depending on the steel, spheroidized carbides can lead to improved machinability, toughness, and formability.
- In hypoeutectoid steels, prolonged holding at a temperature just below  $Ae_1$  accelerates the process of spheroidization. The process may take several hours. To improve on kinetics for full spheroidization, some treatments involve heating and cooling alternately between temperatures that are just above  $Ac_1$  and just below  $Ar_1$ .
- In low-carbon steels, the typical purpose of spheroidizing is to improve the cold formability of steels. The formability of steel is altered significantly depending on whether carbides are spheroids or present as lamellae in pearlite. Low-carbon steels are seldom spheroidized for machining, because in the spheroidized condition they are excessively soft and “gummy,” cutting with long, tough chips.
- In hypereutectoid steels ( $C > 0.77\%$ ) and tool steels, spheroidization is done to improve machinability and improve toughness. Heating of hypereutectoid steels above  $Ac_1$  is done to create dispersed cementite particulates. Heating to dissolve the carbide prevents reformation of a carbide network. If a temperature slightly above  $Ac_1$  is to be used, good loading characteristics and accurate temperature controls are required for proper results; otherwise, it is conceivable that  $Ac_1$  may not be reached and that austenitization may not occur.

## Normalizing

- Steel is normalized to refine grain size, make its structure more uniform, make it more responsive to hardening, and to improve machinability.
- When steel is heated to a high temperature, the carbon can readily diffuse, resulting in a reasonably uniform composition from one area to the next. The steel is then more homogeneous and will respond to the heat treatment more uniformly.
- Normalizing is an austenitizing heating cycle followed by cooling in still or slightly agitated air. Typically, the temperatures for normalizing (Fig. 3.4) are approximately 55°C (100°F) above the upper critical line (that is, above  $A_{c3}$  for hypoeutectoid steels and above  $A_{cm}$  for hypereutectoid steels).
- To be properly classed as a normalizing treatment, the heating portion of the process must produce a homogeneous austenitic phase prior to cooling. Fig. 3.5 compares the time-temperature cycle of normalizing to that of full annealing.

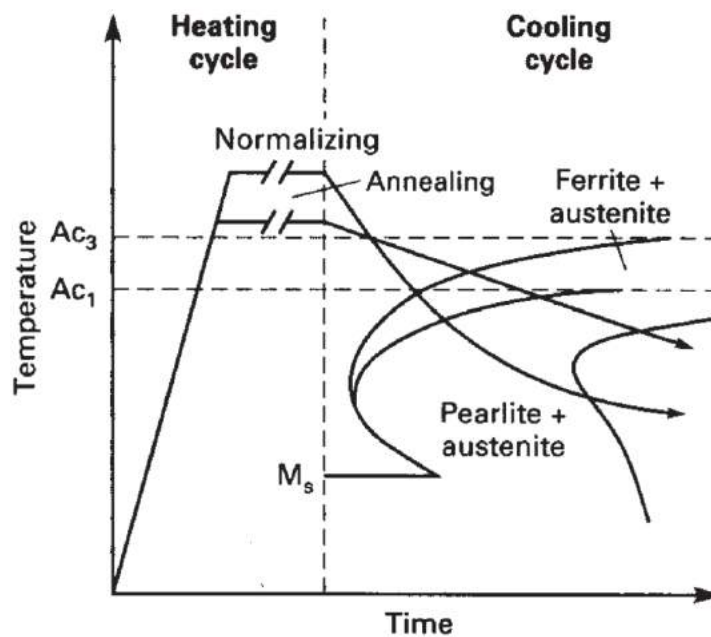

Fig. 3.5: Comparison of normalizing and full annealing heat treatment cycle.

## Hardening

- The maximum hardness of any steel is associated with a fully martensitic structure. This microstructure can be produced only if the cooling rate applied is higher than the critical cooling rate for the corresponding steel.
- Hardenability is defined as the “susceptibility to hardening by rapid cooling”, or as “the property, in ferrous alloys, that determines the depth and distribution of hardness produced by quenching”. Both of these definitions emphasize hardness. As discussed previously, the source of hardening is the formation and presence of martensite, and therefore a third definition of hardenability, “the capacity of a steel to transform partially or completely from austenite to some percentage of martensite at a given depth when cooled under some given conditions,” more accurately describes the physical process underlying hardening.

## Severity of Quench

- The effectiveness of a given quenching medium is ranked by a parameter referred to as its “severity of quench.” This measure of cooling or quenching power is identified by the letter “H” and is determined experimentally by quenching a series of round bars of a given steel.
- Table I lists  $H$  values for a number of commonly used quenches. Note that apart from the nature of the quenching medium, the vigorousness of the shake determines the severity of the quench. When a hot solid is put into a liquid medium, gas bubbles form on the surface of the solid (interface with medium). As gas has a poor conductivity the quenching rate is reduced. Providing agitation (shaking the solid in the liquid) helps in bringing the liquid medium in direct contact with the solid; thus improving the heat transfer (and the cooling rate).



**Table I. Severity of quench (H) for various quenching media**

	Air	Oil	Water	Brine
No circulation of fluid or agitation of piece	0.02	0.25–0.30	0.9–1.0	2
Mild circulation (or agitation)	...	0.30–0.35	1.0–1.1	2–2.2
Moderate circulation	...	0.35–0.40	1.2–1.3	...
Good circulation	...	0.4–0.5	1.4–1.5	...
Strong circulation	0.05	0.5–0.8	1.6–2.0	...
Violent circulation	...	0.8–1.1	4	5

Source: Ref 16.16, 16.22

**Jominy test for Hardenability**

- Fig. 3.6 shows the shape and dimensions of a Jominy specimen and the fixture for supporting the specimen in a quenching system.
- The specimen is cooled at one end by a column of water; thus, the entire specimen experiences a range of cooling rates between those associated with water and air cooling.
- After quenching, parallel flats are ground on opposite sides of the specimen, and hardness readings are taken every 1/16 in. from the quenched end and plotted as shown in Fig. 3.7.
- Hardenability differences between different grades of steels can be readily compared if Jominy curves are available. For example, Fig. 3.8 shows hardenability differences between different grades of alloy steels containing 0.5% C. Higher hardness persists to greater distances from the quenched end in the more hardenable steels.

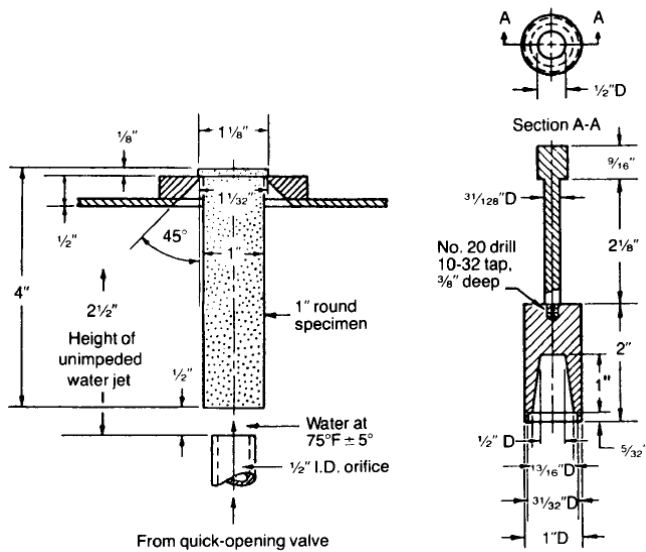

Fig. 3.6: Jominy-Boegehold specimen for end-quench test for hardenability.

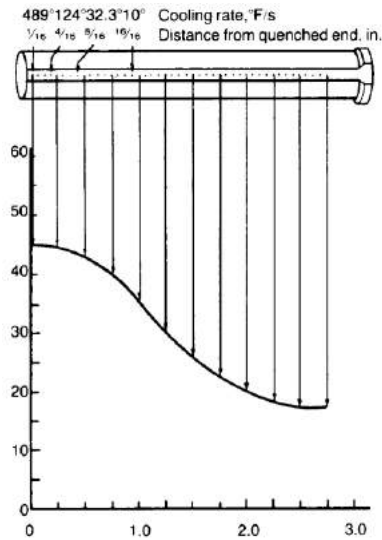

Fig. 3.7: Method of plotting hardness data from an end-quenched Jominy specimen.

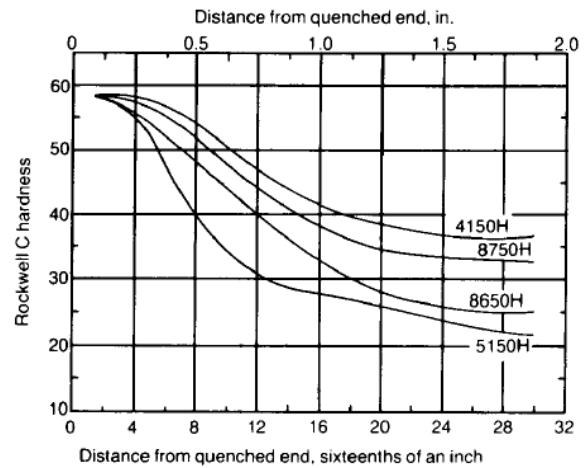

Fig.3.8: Results of end-quench tests for four different grades of alloy steels, all containing 0.5% C.

## Tempering

- Martensite in steels can be a very strong and in its “as quenched” condition rather brittle. It is then necessary to modify its mechanical properties by heat treatment in the range 150–700°C. This process is called *tempering*, in which the microstructure approaches equilibrium under the influence of thermal activation.
- The general trend during the tempering of martensite therefore begins with the rejection of excess carbon to precipitate carbides but the substitutional solutes do not diffuse during this process. The end result of tempering is a dispersion of coarse carbides in a ferritic matrix which bears little resemblance to the original martensite.
- It should be borne in mind that in many steels, the martensite reaction does not go to completion on quenching, resulting in varying amounts of retained austenite which might decompose during the tempering process.

- The effect of tempering temperature on the hardness of steel is shown in Fig.3.9.

### Tempering of Plain Carbon Steels

On reheating as-quenched martensite, the tempering takes place in four distinct but overlapping stages:

Stage 1: up to 250°C: precipitation of  $\epsilon$ -iron carbide; partial loss of tetragonality in martensite.

Stage 2: between 200°C and 300°C: decomposition of retained austenite.

Stage 3: between 200°C and 350°C: replacement of  $\epsilon$ -iron carbide by cementite; martensite loses tetragonality.

Stage 4: above 350°C: cementite coarsens and spheroidizes; recrystallization of ferrite.

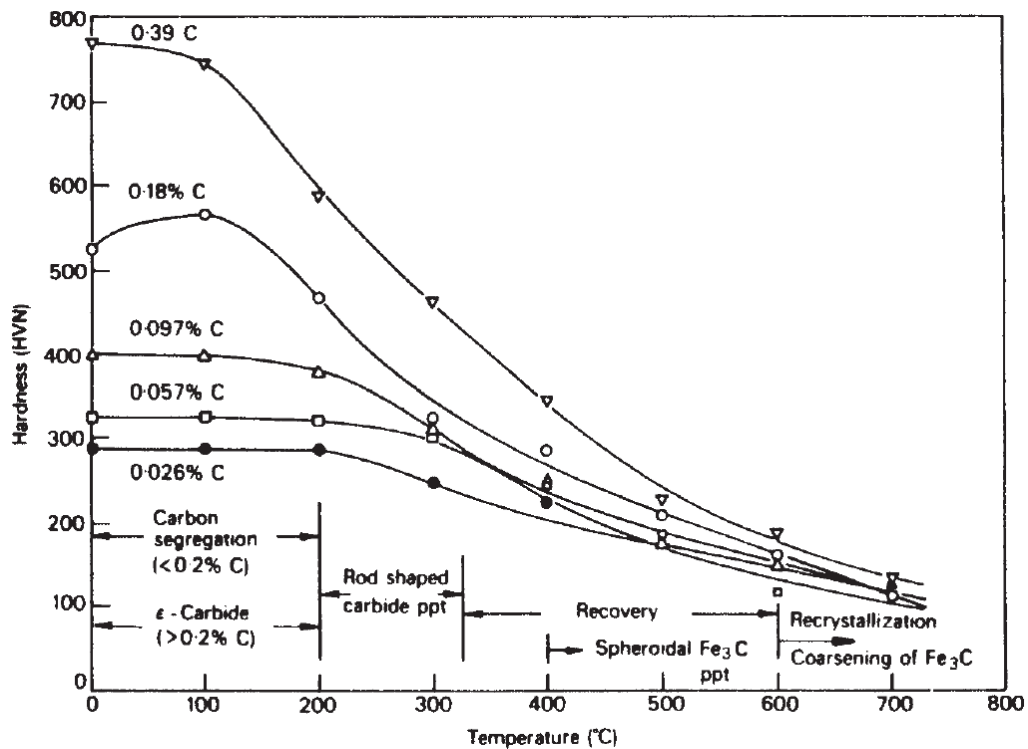

Fig. 3.9: Hardness of iron–carbon martensites tempered 1 h at 100–700°C.

### Martempering

- Martempering is a heat treatment for steel involving austenitisation followed by step quenching, at a rate fast enough to avoid the formation of ferrite, pearlite or bainite to a

temperature slightly above the martensite start ( $M_s$ ) point. A schematic of above the process is shown in Fig.3.10.

- The advantage of martempering lies in the reduced thermal gradient between surface and center as the part is quenched to the isothermal temperature and then is air cooled to room temperature.
- Residual stresses developed during martempering are lower than those developed during conventional quenching because the greatest thermal variations occur while the steel is in the relatively plastic austenitic condition and because final transformation and thermal changes occur throughout the part at approximately the same time. Martempering also reduces or eliminates susceptibility to cracking.

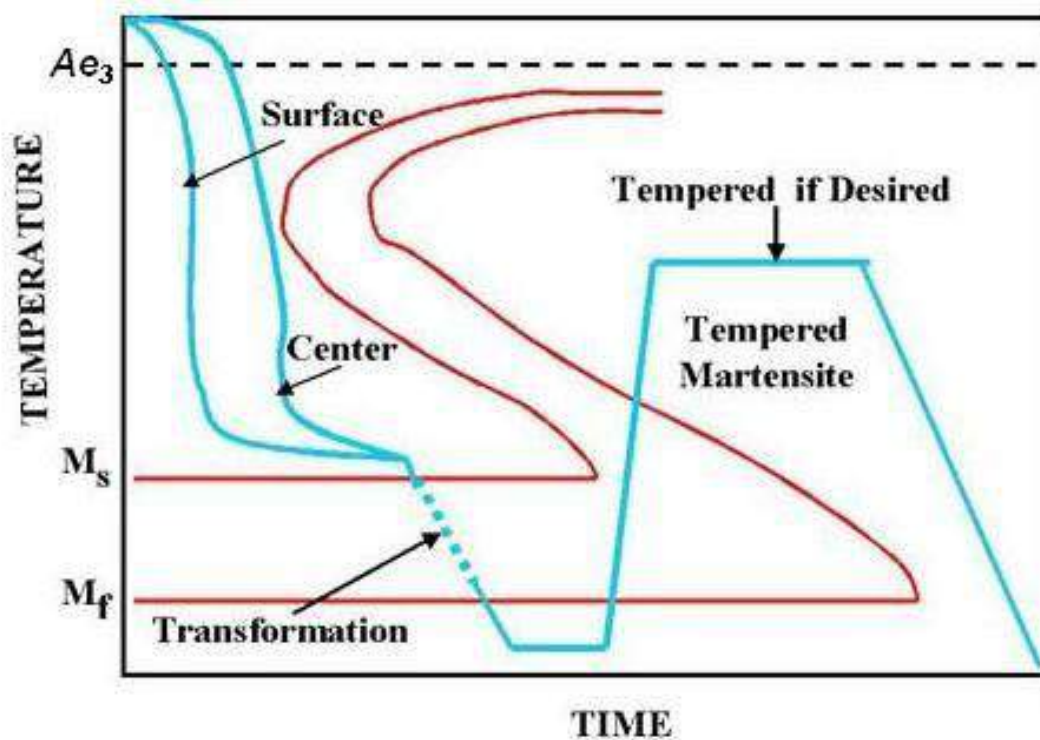

Fig.3.10: Schematic representation of the Martempering process.

## Austempering

- Austempering process is similar to the Martempering process except that the sample after the homogenization of temperature from surface and temperature, instead of quenching, held at that temperature above  $M_s$  for sufficient time (in the bainite transformation range) to produce bainitic microstructure.
- A schematic of this process is shown in Fig. 3.11. An advantage of this process over Martempering is that the tempering can be avoided. Other advantages include, Higher ductility, Resistance to shock, Uniform hardness, Tougher and more wear resistance, Higher impact and Fatigue Strengths.

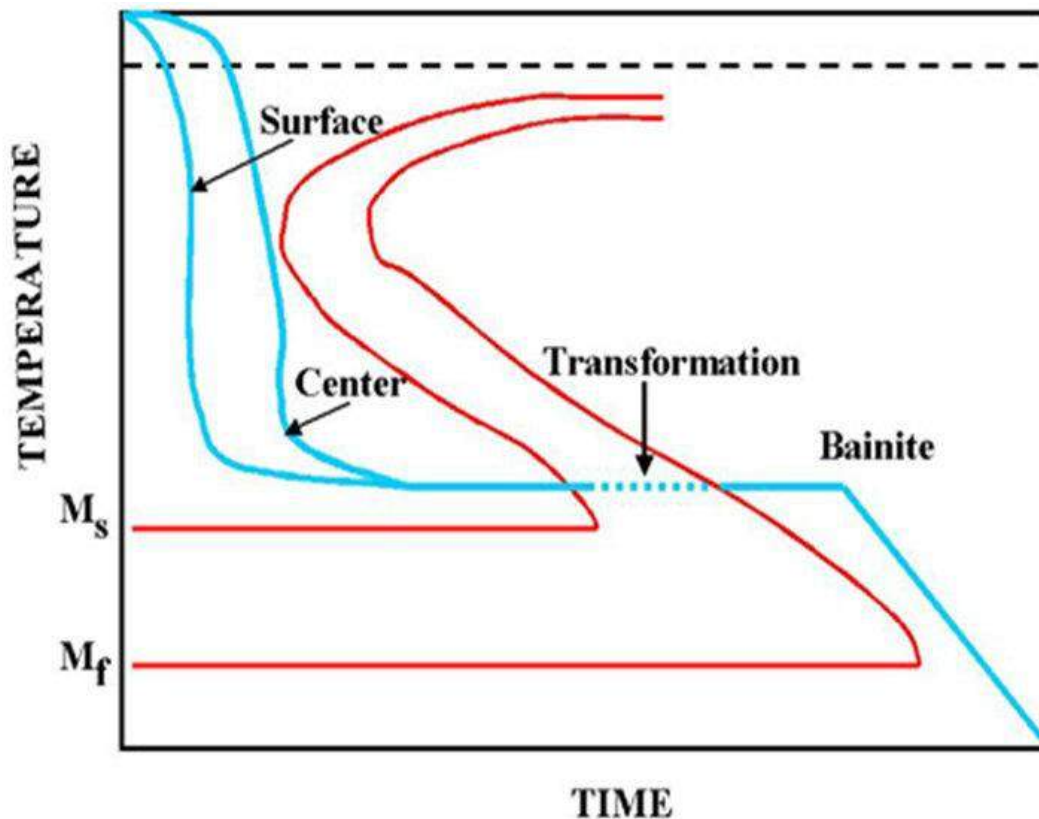
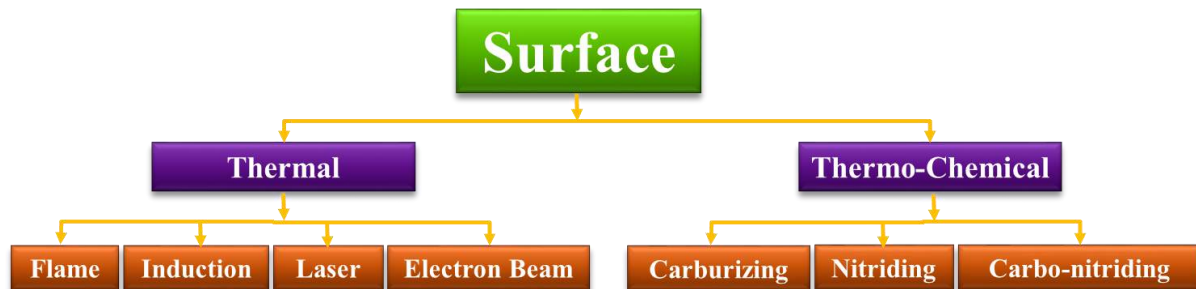

Fig. 3.11. Schematic representation of the Austempering process.

## Surface Hardening

Many metal components require a combination of mechanical properties which at first sight seems impossible to attain. Thus, bearing metals must be both hard and, at the same time, ductile, whilst many steel components, like cams and gears, need to be strong and shock-resistant, yet also hard and wear-resistant. In ordinary carbon steels, these two different sets of properties are found only in materials of different carbon content. Thus, a steel with about 0.1 per cent carbon will be tough, whilst one with 0.9 per cent carbon will be very hard when suitably heat-treated. The problem can be overcome in two different ways:

- By employing a tough low-carbon steel, and altering the composition of its surface, either by case-hardening or by nitriding.
- By using a steel of uniform composition throughout, but containing at least 0.4 per cent carbon, and heat-treating the surface differently from the core, as in flame- and induction-hardening.



### Thermal Treatment

Carbon steels that have minimum carbon content of 0.4%, or alloy steels with a lower carbon content (hardenable stainless steels with only 0.1% Carbon), can be selectively hardened in specific regions by applying heat and quench only to those regions. Parts that benefit by flame hardening include gear teeth, bushings etc. These techniques are best suited for medium carbon steels with a carbon content ranging from 0.4 to 0.6%.

**Flame Hardening:** A high intensity oxy-acetylene flame is applied to the selective region. The temperature is raised high enough to be in the region of Austenite transformation. The "right" temperature is determined by the operator based on experience by watching the color of the steel. The overall heat transfer is limited by the torch and thus the interior never reaches the high temperature. The heated region is quenched to achieve the desired hardness. Tempering can be done to eliminate brittleness.

The depth of hardening can be increased by increasing the heating time. As much as 6.3 mm (0.25 in) of depth can be achieved. In addition, large parts, which will not normally fit in a furnace, can be heat-treated.

**Induction Hardening:** In Induction hardening, the steel part is placed inside a electrical coil which has alternating current through it. This energizes the steel part and heats it up. Depending on the frequency and amperage, the rate of heating as well as the depth of heating can be controlled. Hence, this is well suited for surface heat treatment. The details of heat treatment are similar to flame hardening.

**Laser Beam Hardening:** Laser beam hardening is another variation of flame hardening. A phosphate coating is applied over the steel to facilitate absorption of the laser energy. The selected areas of the part are exposed to laser energy. This causes the selected areas to heat. By varying the power of the laser, the depth of heat absorption can be controlled. The parts are then quenched and tempered. This process is very precise in applying heat selectively to the areas that need to be heat-treated. Further, this process can be run at high speeds, produces very little distortion.

**Electron Beam Hardening:** Electron Beam Hardening is similar to laser beam hardening. The heat source is a beam of high-energy electrons. The beam is manipulated using electromagnetic coils. The process can be highly automated, but needs to be performed under vacuum conditions since the electron beams dissipate easily in air. As in laser beam hardening, the surface can be hardened very precisely both in depth and in location

## **Thermal - Chemical Treatment**

### **Carburizing**

Carburizing is a process of adding Carbon to the surface. This is done by exposing the part to a Carbon rich atmosphere at an elevated temperature and allows diffusion to transfer the Carbon atoms into steel. This diffusion will work only if the steel has low carbon content, because diffusion works on the differential of concentration principle. If, for example the steel had high

carbon content to begin with, and is heated in a carbon free furnace, such as air, the carbon will tend to diffuse out of the steel resulting in Decarburization.

**Pack Carburizing:** Parts to be carburized are packed in a box, embedding them in a powdery mixture of 85% charcoal and 15% of energizers such as BaCO<sub>3</sub> and heated in a furnace for 12 to 72 hours at 900 °C (1652 °F). At this temperature CO gas is produced which is a strong reducing agent. The reduction reaction occurs on the surface of the steel releasing Carbon, which is then diffused into the surface due to the high temperature.

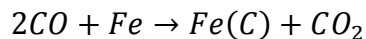
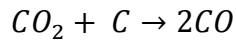
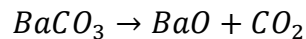

When enough Carbon is absorbed inside the part (based on experience and theoretical calculations based on diffusion theory), the parts are removed and can be subject to the normal hardening methods. The Carbon on the surface is 0.7% to 1.2% depending on process conditions. The hardness achieved is 60 - 65 R<sub>C</sub>. The depth of the case ranges from about 0.1 mm (0.004 in) upto 1.5 mm (0.060 in). Some of the problems with pack carburizing is that the process is difficult to control as far as temperature uniformity is concerned, and the heating is inefficient.

**Liquid Carburizing:** The steel parts are immersed in a molten carbon rich bath. In the past, such baths have Composition is 8% NaCN, 82% BaCl<sub>2</sub> and 10% NaCl. The following reaction take place

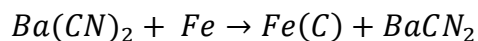
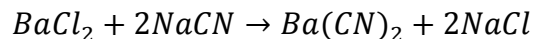

However, safety concerns have led to non-toxic baths that achieve the same result.



**Gas Carburizing:** Gas Carburizing is conceptually the same as pack carburizing, except that Carbon Monoxide (CO) gas is supplied to a heated furnace and the reduction reaction of deposition of carbon takes place on the surface of the part.

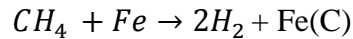

This process overcomes most of the problems of pack carburizing. The temperature diffusion is as good as it can be with a furnace. The only concern is to safely contain the CO gas. A variation of gas carburizing is when alcohol is dripped into the furnace and it volatilizes readily to provide the reducing reaction for the deposition of the carbon.

### **Post heat treatment after carburizing**

After prolonged heating in the austenitic range causes the formation of coarse grain, and further heat-treatment is desirable if optimum properties are to be obtained. The most common method of producing a fine-grained structure in steel is by normalizing it. This involves heating the steel to just above its upper critical temperature, followed by cooling it in air. The need for such treatment poses a problem here, since core and case are of widely different carbon contents, and therefore have different upper critical temperatures. Thus, if the best mechanical properties are to be obtained in both core and case, a double heat-treatment is necessary:

#### **1. Refining the core**

The component is first heat-treated to refine the grain of the core, and so toughen it. This is done by heating the component to a temperature just above the upper critical temperature for the core, so that the coarse ferrite/ pearlite will be replaced by fine-grained austenite. The component is then generally water-quenched, so that a mixture of fine-grained ferrite and a little martensite is produced. The temperature of this treatment is well above the uppercritical temperature for the case (723°C), so at this stage the case will be of coarse- grained martensite (because the steel was quenched). Further heat-treatment is therefore necessary to refine the grain of the case.

#### **2. Refining the case**

The component is now heated to 760°C, so that the structure of the case changes to fine-grained austenite. Quenching then gives a hard case of fine-grained martensite and, at the same time, any brittle martensite present in the core as a result of the first quenching process will be tempered to some extent by the second heating operation. Finally, the component is tempered at 200°C to relieve any quenching-stresses present in the case.

## Carbonitriding

Carbonitriding process is most suitable for low carbon and low carbon alloy steels. In this process, both Carbon and Nitrogen are diffused into the surface. The parts are heated in an atmosphere of hydrocarbon (such as methane or propane) mixed with Ammonia (NH<sub>3</sub>). The process is a mix of Carburizing and Nitriding.

Carburizing involves high temperatures (around 900 °C, 1652 °F) and Nitriding involves much lower temperatures (around 600 °C, 1112 °F). Carbonitriding is done at temperatures of 760 - 870 °C (1400 - 1598 °F), which is higher than the transformation temperatures of steel that is the region of the face-centered Austenite.

It is then quenched in a natural gas (Oxygen free) atmosphere. This quench is less drastic than water or oil-thus less distortion. However this process is not suitable for high precision parts due to the distortions that are inherent. The hardness achieved is similar to carburizing (60 - 65 R<sub>C</sub>) but not as high as Nitriding (70 R<sub>C</sub>). The case depth is from 0.1 to 0.75 mm (0.004 to 0.030 in). The case is rich in Nitrides as well as Martensite. Tempering is necessary to reduce the brittleness.

## Nitriding

Nitriding is a heat treating process that diffuses nitrogen into the surface of a metal to create a case hardened surface. These processes are most commonly used on low-carbon, low-alloy steels, however they are also used on medium and high-carbon steels, titanium, aluminum and molybdenum.

The parts are then cleaned and heated in a furnace in an atmosphere of dissociated Ammonia (containing N and H) for 10 to 40 hours at 500-625 °C (932 - 1157 °F).

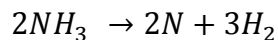

Nitrogen diffuses into the steel and forms nitride alloys, and goes to a depth of upto 0.65 mm (0.025 in). The case is very hard and distortion is low. No further heat treatment is required; in fact, further heat treatment can crack the hard case. Since the case is thin, surface grinding is not recommended.

Typical applications include gears, crankshafts, camshafts, cam followers, valve parts, extruder screws, die-casting tools, forging dies, extrusion dies, firearm components, injectors and plastic-mold tools.

The processes are named after the medium used to donate. The three main methods used are: gas nitriding, salt bath nitriding, and plasma nitriding.

A plasma nitrided part is usually ready for use. It calls for no machining, or polishing or any other post-nitriding operations. Thus the process is user-friendly, saves energy since it works fastest, and causes little or no distortion.

## **Module-4**

**Steel Vs cast iron**

<b>Steel</b>	<b>Cast iron</b>
Percentage of carbon in steel lies between 0.1 to 2%	Percentage of carbon in cast iron is greater than 2 %
Expensive	Cheaper compared to steel
High melting point	Low melting point then steel
It shrinks when get cold or solidified	It doesn't shrink when get solidified and cold so it can be mould into and form and shape
Hardness is mild and depends upon percentage of carbon	More harder due to excess carbon in it
Ductile	Brittle
More tensile strength	More compressive strength
More corrosion resistance	Less corrosion resistance

**Classification of ferrous alloy**

Steel are classified into two types

1-carbon steel(host or base metal is iron and alloying element is carbon)

2-alloy steel (base metal is iron and other alloying elements are other non ferrous metals in small amount other than carbon)

**Carbon steels are further classified into**

(i)- low, medium , high

Alloy steels are further classified into

(II)- low,medium, high

**Cast iron is classified into two types:**

- 1- Grey cast iron
- 2- White cast iron

**Effect of alloying elements on steels :**

- (I)- increases hardenability
- (II)-increase strength at room , low and high temperature .
- (III)-increase toughness
- (IV)-increase resistance to wear
- (V)- increase corrosion and oxidation resistance
- (vi)-Enhance magnetic properties.

**Two types of alloying elements are there:**

- (I)- Elements which dissolves in ferrite
- (II)-elements which combines with carbon

Elements dissolved in ferrite and provides solid solution strengthening (hardening).

The order of increasing effectiveness in strengthening iron is as following:

$Cr < W < V < Mo, Ni < Mn < Si$

Carbon reacts with some alloying elements to form hard and brittle carbides. alloying elements which form carbides are

Mn, Cr, W, Mo, V, Ti

Influence of carbides in steel :

- (I)- Carbides forming elements influence the hardening temperature and soaking time
- (II)-complex carbides are very difficult to dissolve , so they remain out of solution in austenite .This leads to lower the carbon and alloy content of austenite below that of steel as a whole.

(III)- undissolved carbide acts to reduce grain growth .

(iV)V and Cr carbides are excellent in providing hardness and wear resistance.

(v) hardness and wear resistance in alloy steel rich in carbides depend upon :

(A)- Amount

(B)-size

(C)-distribution of hard particle

And all these factors are controlled by:

(I)-chemical composition

(II)-manufacturing methods

(iii)-heat treatment

Influence of alloying elements on iron –iron carbide phase diagram:

(I)-change the critical range (phase transformation temperature).like some elements lower the critical temperature on heating and some rise .

Ni and Mn lowers the critical temperature on heating , where as MO ,Al,Si,W,V,tends to rise the critical temperature.

The change in critical temperature (phase transformation temperature) produced by the presence of alloying elements is important in the heat treatment of alloy steel . since it will rise or lower the proper hardening temperature as compared with plain carbon steel.

(II)-position of the eutectoid point (all the alloying element tends to reduce the carbon content of the eutectoid .where as Ni Mn only Reduce the eutectoid temperature.

If the Ni and Mn content increases the critical temperature may lower sufficiently to prevent the transformation of austenite on slow cooling . that why they are known as austenite stabilizing elements or austenite stabilizers. Due to this asutentite will retain at room temperature.

(III)-location of the alpha and gamma field .

Alloying elements such as Mo, Si, Cr and Ti when added to steel in large quantity they tend to contract the pure austenite region and enlarge the field in which alpha, delta iron is found.

### **Effect of alloying elements in tempering :**

(I)-compared to plain carbon steel alloy steel requires a higher tempering temperature to obtain given hardness.

(II)-the elements like Ni, Mn, Si, which remain dissolved in ferrite have very little effect on the hardness of tempered steel.

(III)-some elements such as V, Mo, Cr, W which form complex carbides and retard softening during tempering .

(iv)-if the alloying element content is high some times they show a range in which the hardness actually increases with increase in tempering temperature. This phenomenon is due to delayed precipitation of fine alloy carbides (secondary hardening) .

### **Nickel steel:**

(I)-Ni has unlimited solubility in gamma iron and it is highly soluble in alpha iron contributing to strength and toughness of this phase.

(II)-Ni lowers the critical temperature and widens the temperature range for successful heat treatment, it retards the decomposition of austenite and does not form any carbides which might be difficult to dissolve during austenitising.

(III)-Ni reduces the carbon content of eutectoid; therefore the structure of unhardened nickel steel contains a high percentage of pearlite than similarly treated plain carbon steels. Since pearlite formed at lower temperature are finer and tougher than the pearlite in unalloyed steel which leads to provide high strength level at lower carbon contents, thus increases toughness, plasticity and fatigue resistance.

(iv)-Ni steels are highly suited for high strength structural steels which are used in the as rolled condition for large forging which are not adapted to quenching.

(V)- Ni is best in providing toughness at lower temperature, but have a mild effect on hardenability.

(vi)-application of different NI steels are

(A)-23xx series steel which contains 3.5 per Ni and low carbon are used for carburising of srives gears ,connecting rod bolts studs, and kingpins.

(b)-25xx series that is 5 per Ni which provide high toughness used for heavy duty applications such as bus and truck gears, cams, and crankshaft.

### **Chromium steel(5XXXseries):**

(i)-cheaper alloying element than Ni Cr mainly form simple( $Cr_7C_3$ ,  $Cr_4C$ ) and complex carbides [ $(Fe_3Cr)_3C$ ] these carbides provides high hardness and wear resistance.

(ii)-solubility of Cr in gamma iron is 13 per and unlimited solubility in alpha ferrite.

(iii)-at low carbon content Cr main remain in solution form in ferrite which leads to high strength and toughness of ferrite.

(iv)-If Cr content is present in excess of 5 per the corrosion resistance and high temperature properties of the steel are greatly improved.

(v)-the plain Cr steel of 15xx series contains 0.15 and 0.64 per carbon and 0.70 and 1.15 per Cr the low carbon alloy steels in this series are usually carburised. The presence of Cr increases the wear resistance of the case ,but the toughness of the core is not so high as Ni steels. With medium carbon these steels are oilhardened and are used for springs, engine bolt, studs, axels,

Steel with high carbon (1 per c) and high cr 1.5 per is characterise by high wear resistance and hardness these are used in ball or roll bearings and for crushing machines.

Steel with 1 per carbon and 2-4 per Cr used for making permanent magnets since it has excellent magnetic properties.

### **Nickel Chromium steel 3XXXseries:**

(I)-in this steel alloying element imparts some of the characteristic properties of each one.



(II)-the effect of Ni is increasing toughness and ductility with effect of Chromium in improving hard ability and wear resistance.

(III)-it is important to remember that the combined effect of two or more alloying elements on hardenability is usually greater than the sum of the effect of the same alloying elements used separately.

(IV)-low carbon nickel chromium steel are carburised , here the chromium provides wear resistance to the case while Ni combined with Cr provides toughness other application are with 1.5 per Ni and 0.60 per Cr used for worm gears, piston pins,

And NI with 3.5 per and Cr with 1.5 per used for heavy duty application like aircraft gears shafts, cams,

#### **Manganese steels (31xxx series):**

(I)-prevents hot shortness (red shortness) making the metal enable to hot worked.

(II)-steel is said be alloyed with Mn if the Mn content is more than 0.80

(III)-it increase the hardness and strength , but at a lesser degree than carbon .and is most effective in high carbon steel.

(IV)-Mn has moderate effect on hardenability and its a weak carbide former.

(V)-it lowers the critical temperature and reduce the carbon content of eutectic like Ni.

(VI)-fine grained Mn steel have unusually toughness and strength

These steel are used for gears , spline shaft, axels, and rifle barrelks, with a moderate amount of vanadium added, manganese steels are used for large forging that must be air cooled.

After normalising this steel will yield properties equivalent to those obtained in a plain carbon steel after a full hardening and tempering operation.

(VII)-when the Mn content exceed about 10 per thge steel will be austenitic after slow cooling .

(viii)-a special steel know as hardfiled Mn steel usually co0ntains 12 per manganese .after a properly controlled heat treatment this steel is characterized by high strength ,high ductility and excellent resistance to wear.

**Stainless steels:**

(I)-used for corrosion and heat resistance application.here corrosion resiatnce is provided by thin adherent,stable,chromium oxide,nickel oxide film that effectively protect the steel against many corroding medium.

(II)- A three numerals numbering system is used to identify stainless steel.here the last 2 numerals have no particular significance, where asthefirst numerals indicates the group as following.

Series designation	Groups
2XX	Chromium-nickel-manganese;non hardenable ,austenitic,non magnetic
3xx	Chromium-nickel;non hardenable,austenitic,non magnetic
4xx	Chromium;hardenable,martensitic,magnetic
4xx	Chromium;nonhardenable,martensitic,magnetic
5xx	Chromium,low chromium,heat resistance

(III)-since percentage of Cr is very high in stainless steel so iron chromium and carbon belongs to ternary system.

(IV)-steel containing 12 per Cr and small amount of carbon when given annealing treatment shows ferritic matrix with some carbides. And when given hardening and tempering treatment show tempered martensite and bainite.

(V)-steel with 18 perCr and low carbon (0.03%C)austentite will not formed on heating .these steels are non hardenable ,since subsequent quenching will only forms ferrite of low hardness.here on heating delta will form no gama is there

(VI)-if the percentage of carbon is increased (0.075% c)and on heating produce delta plus gama then on quenching it give some more hardness due to transformation of gama .

(VII)- to get full hardness carbon content is sufficient or in large amount so that on heating will get gamaplus cementite region .so on quenching and tempering will get tempered martensite and undissolved carbides.

(VIII)-if in addition to 18 per Cr 8 per Ni is there with carbon then austenite formed at elevated temperature is a particularly stable phase reluctant to transformation and tends to be retained after annealing .

(IX)- the response of stainless and heat resisting steels to heat treatment depends upon composition.they are divides into three groups.

(A)-martensitic stainless steel

(B)-ferritic stainless steel

(C)-austenitic stainless steel

#### **Martensitic stainless steel :**

(I)these are primarily Cr steel containing 11.5 to 18 per Cr. Some examples of the group are type 403, 410, 416, 420, 501, and 502.

410 and 416 are mainly used for making turbine blades and corrosion resistance casting .

(II)-martensitic steel are magnetic and can be cold worked without difficulty , eapcially with low carbon content ,can be machines satisfactorily have good toughness, shows good corrosion resistance to some chemicals and weather, and are easily hot worked.

(Iii)- To attain best corrosion resistance when hardened from the recomended temperature but are not as good as the austenitic or ferritic stainless steel.

(iii)- heat treatment process for martensitic steel is easentially the same asfor plain carbon steel or low alloy steel. Where maximum hardness and strength cghiefly depends upon carbon content.

(iv)-the principal difference from low alloy steel or plain carbon steel is here in martensitic stainless steel due to presence of high alloy content cause the transformation to be sluggish and hardenability so high.that maximum hardness is produced by air cooling.

(V)- for these steels hardening is done by heating them above the transformation range to temperature nearly 1850 degree F .then cooling in air or oil.here time of holding is minimum to prevents excess grain growth and prevent decarburisation.

(VI)-tempering of these steel should not be done inthe range of 750 to 950 degree F because of a drop in impact properties.tempering must be done above 1100 degree F .the higher tempering temperature will cause some precipitation of carbides with a subsequent reduction in corrosion resistance however if thye carbon percentage is low the lowering of corrosion resistance is not too severe.

(VII)- martensitic steels are difficult to machining as compared to plain carbon steel to enhance machinability a small amount of sulphur or selenium is added . like in 416 type sulphur is added and in 416 selenium is added.

The use of selenium is less effect in reducing corrosion resistance than sulphur.

(viii)-stainless steel with type 440, with carbon content between 0.06 and 1.20 per and 16 to 18 per chromium , will have high corrosion resistance, strength and wear resistance. The addition of 2 per Ni tothese 16 to 18 per Cr low carbon alloy extend the austenite region and thus renders them heat treatable. They are usually aircooled and heat treatments requires carefull control of composition and quenching temperature because of possible presence of delta ferrite atthe austenitising temperature .

(ix)-type 431 has been used for aircraft fitting paper machinery parts and bolts.

(x)-type 501 and 502)having 5-6 per chromium are excellent corrosion resistance steel used in petroleum refining equipments such as heat exchangers ,valve bodies, pump rings, and other fittings.

### **Ferritic stainless steel :**

(i)- steel with 14 to 27 per Cr .and includes type 405,430,446.

(II)-these steels are low in carbon content but higher in chromium than martensitic stainless grade,

(III)-these steel are not hardened by heat treatments but moderately hardened by cold working.

(IV)-these steel are magnetic in nature and can be cold and hot worked .

(V)these steel develops maximum softness ,ductility and corrosion resistance in annealed condition. In annealed condition , the strength of these steels is approx 50 per higher than that of carbon steels, and these steels are superior to martensitic steel in corrosion resistance and machinability .

Due to easy in cold forming they are extensively for deep drawn parts such as vessels for chemical and food industries and for architectural and automotive trim.

(vi)-the only heat treatment applied to ferritic steels is annealing. This treatments serves primarily to relieve welding or cold working stresses.

(vii)- an important form of brittleness peculiar to ferritic grades can develop from prolonged exposure to , or slow cooling within, the temperature range from about 750 to 950 degree F. Notch impact strength is most adversely affected .the exact cause of the brittleness has not been determined, its effect increases rapidly with chromium contenyt, reaching a maximum in type 446. Certain heat treatment ,such as furnace cooling for maximum ductility , must be controlled to avoid embrittlement.

(viii)- ferritic steels are usually annealed at temperature above the range for 850 degree F embrittlement and below temperature at wich austenite might form. When heat treated above the A1 line to abotain maximum ductility , these steesl are cooled slowly . they are not tempered , since the amount of martensite formed is negligible , and because of possible embrittlement in the 850 degree F range.

### **Austenitic stainless steels :**

1-these are Cr-Ni(3XX type) and Cr-Ni-Mn stainless steels(2XX type)

2-non magnetic in nature in annealed condition and do not harden by heat treatment.

3-total content of Cr and Ni is 23 per.

4-they can be hot worked readily and cold worked when proper allowance is made for their rapid work hardening.

5-cold work develops a wide range range of mechanical properties , and the steel in this condition may becomes slightly magnetic.

6- these steels are extremely shock resistance and difficult to machine unless they contains sulphur and selenium (type 303 and 303se).

7- these steels have high temperature strength and resistance to scaling of the stainless steels.

8- the corrosion resistance of the austenitic stainless stell is usually better than that of the martensitic or ferritic steels.

9- to provides maxium and uniform corrosion resistance in these steel the chromium has to be in solution during processing (during welding or during cooling after welding)as well as during working condition rather then in form of chromium carbides . due to this in many grades the carbon content is kept low that 0.03 per and some strong carbides formers like Ti, Cb,Ta is added to it.

10-these are hardened by cold working . And maximum hardening is obtained by type 301 (17-7Cr –Ni) and type 302 (18-8 ).

11- Mn can substitute the Ni in these steels but due to addition of Mn they reduce the rate of work hardening.

### **Precipitation hardening stainless steel:**

1- These steels are solution annealed then after forming the are aged to get increases in hardness and strength.

2- These steels have lower Ni content which reduces the stability of austenite.

3- These steels may also have Cu and Al which tends to form Coherent alloy precipitate.

4- The 17-4PH alloy is solution treated at 1900 degree F, Followed by air cooling leads to formation of martensite ,. Aging is carried out by reheating in the range from 900 to 1150

degree F. To cause a precipitation effect. The lower temperature results in highest strength and hardness.

- 5- The 17-4 PH alloy should not be put into service in any application in solution treated condition because its ductility can be relatively low and its resistance to stress corrosion cracking is poor.
- 6- Ageing in these steels not only improves strength and ductility it also improve toughness and resistance to stress corrosion.
- 7- The 17-7PH and PH 15-7Mo alloys are solution annealed at 1950 degree F followed by air cooling. This treatment produces a structure of austenite with about 5 to 20 per delta ferrite . In this condition the alloy is soft and can be easily formed.

### **Tool steels :**

1-any steels used as an tool is come under class of tool steel.

2-But the term is restricted to high quality special steels used for cutting and forming .

3-tool steels are classified on the basis of three things :

(A)- Quenching medium used[water hardened , oil hardened , airhardened]

(B)-alloy content (composition)[carbon tool steel,low alloy tool steel, medium alloy tool steel]

(C)-application of tool steels[hot work steel, shock resistance steels, high speed steels,cold work steel.]

### **Selection of tool steels:**

1- Correlating the metallurgical characteristic of tool steel with the requirement of the tool in operation.

2- Expected productivity, easy of fabrication, and cost, and the cost per unit part made by the tool.

Tools may be used for cutting operation, shearing,forming,drawing, extrusion , rolling and battering.

Cutting tools must have (high hardness, wear resistance and good heat resistance)

Shearing tools must have (fair toughness and wear resistance)

Forming tools must have (high toughness and strength and must have high red hardness that is resistance to heat softening).

Drawing tools requires (high wear resistance high strength,

Cold extrusion die must have (wear resistance and toughness)

Hot extrusion must have (wear resistance and toughness with high red hardness).

Rolling dies must have (wear resistance, toughness,

Battering tools must have (high toughness).

Water hardening tool steels(group W):

(A)-these are plain carbon tool steel, and some of the high carbon steels have small amount of Cr, V to enhance the hardenability, and wear resistance. The carbon content varies between 0.60 to 1.40 per and the steel may be roughly placed into three subdivision according to carbon content.

(B)- plain carbon tool steel are less expensive than the alloy tool steels,with proper heat treatment they yield a hard martensite surface with a tough core.

(C)-they have best machinability rating of all tool steel and are best in respect to decarburizing .

(D)-these steel have low resistance toward heat because of this low red hardness , carbon steel cannot be used as cutting tools under condition where an appreciable amount of heat is generated. Their use as cutting tools is limited to condition involving low speed and light cut on relative soft material such as wood, brass, aluminium, and unhardened low carbon steel.

(E)- microstructure of W1 water quenching tool steel which is austenitized at 1450 degree F. Brine quenched and tempered at 325 degree F, shows dark phase (martensite and white dot phase (undissolved carbide)).

### **Shock resistance tool steels (group G )**

(A)-These steels are developed to with stand repeated shock .

(B)-these are medium carbon steel where carbon content varies from 0.45 to 0.65. with some alloying elements are Si,W,Cr,Mo.

(C)- silicon strengthen the ferrite , while chromium increases hardenability and contribute to wear resistance.molybdenum increases the hardenability , while tungsten imparts red hardness to these steels.



- (D)-most of these steels are oil hardened but some are water hardened to get full hardness.
- (E)- silicon have an adverse effect during heat treatment that is accelerates decarburization .
- (F)- used to make forming tools, punches, chisels, pneumatic tools, and shear blade.
- (G)- microstructure consist of spheroidal carbide particles with tempered martensitic matrix.

**Cold work tool steels:**

- (A)-most important group of tool steels
- (B)-oil hardened low alloy type (group O) contains manganese and small amount of chromium and tungsten , they have very good non deformable properties and are less likely to bend , sag,twist,distort,, or crack during heat treatment than are the water hardening steels.
- (C)-microstructure consist of spheroidal carbide particles in a tempered martensitic matrix . during heat treatment if austenitising temperature is raise it produces coarser martensitic needle in a retained austenitic matrix .
- (D)- these are inexpensive steels with high carbon content they produce wear resistance for short run application. At or near room temperature.
- (E)- main function of high silicon content is in O6 steel is to induce graphitization of part of the carbide , there by improving machability in the annealed condition.

**Hot working tool steel (group H):**

- 1- Alloying elements in these steels to provide red hardness is Cr, Mo W. Sum of the alloying elements must be greater than 5.
- 2- There class of hot worked tool steel.
  - (A)-hot work chrome base
  - (B)-hot work tungsten base
  - (C)-hot work molybdenum base.

**High speed tool steels :**

- 1- these steels are among the most highly alloyed tool steels and usually contain a large amount of tungsten or molybdenum along with chromium, vanadium, and sometimes cobalt.
- 3- Carbon content varies from 0.70 to 1 per cent and some contain 1.5 per cent carbon.
- 4- Used for cutting tools, extrusion die, burnishing tools, and blanking punches and dies.
- 5- Properties having high red hardness and shock resistance, and good non-deformable properties.
- 6- Subdivided into two groups
  - (A)-molybdenum based (group M)
  - (B)-tungsten based (group T) highly used tungsten based is known as 18-4-1 (T1). Here 18 per cent W and 4 per cent Cr and 1 per cent V is present.

Molybdenum and tungsten based provide nearly same wear resistance, red hardness and toughness.

Molybdenum based are cheaper than tungsten based since tungsten is imported and molybdenum is domestic based. So 80 per cent of all high speed steel produced is of molybdenum based.

- 7- Where better than average red hardness is required steel containing cobalt are recommended.
- 8- High vanadium content is desirable when the material being cut is highly abrasive.

### **Mold steel (group P)**

- 1- These steels contain Cr and Ni as the principle alloying elements with Mo and Al as additives.
- 2- Most of these steels are alloy carburizing steels produced to tool steel quality they are generally characterized by very low hardness in annealed condition and resistance to work hardening; both are properties are favourable for hobbing operation.

### **Special purpose tool steels**

- 1- Low alloy steel type (group L) contains chromium as the principle alloying element, with addition of vanadium, molybdenum, and nickel. The high chromium content promotes wear resistance by the formation of hard complex iron-chromium carbides, and together with molybdenum they increase hardenability. Nickel increases toughness while vanadium serves

to refine the grain. These steels are oil hardened thus only fair in resisting dimensional change.

- 2- Application like bearings, clutch, plates, cams dies, drills, taps knurls, and gages.
- 3- The carbon tungsten type (group F) are generally shallow hardening , water quenching steels with high carbon and tungsten content to promotes high wear resistance . under some condition of operation these steels have four to ten times the wear resistance of the plain – carbon sgroup W tool steel.
- 4- They are relatively brittle so that in general they are used for high wear , low temperature , low shock application . typical used are paper cutting knives , wire drawing dies, plug gages, and forming and finishing tools.

### **Cast iron**

- 1- Alloy of iron and carbon like steels
- 2- Cast iron contains 2 to 6.67 per carbon
- 3- Due to presence of high carbon in cast iron it is very brittle, so commercial produced cast iron contains mainly 2-4 per carbon.
- 4- Ductility of cast iron is low so it cannot be rolled , drawn, or worked to room temperature. Most of the cast iron are not malleable at any temperature. However they can be melt readily and can be cast into complicated shapes which are machined to final dimension.
- 5- Since casting is the only suitable process applied to these alloys, they are known as cast irons.
- 6- It has lower strength than steels and are cheaper.

#### **Types of cast iron :**

(I)-On the basis of metallographic structure cast iron are classified into many types.

(II)\_Four variables to be considered which leads to the different types of cast iron

(A)-carbon content

(B)-the alloy and impurity content

(C)-the cooling rate during and after freezing .

(D)-heat treatment after casting

(III)-These above variables controls the condition of the carbon and its physical forms.

In cast iron carbon may be exist in form of carbides (cementite) or it can exist in form of free carbon graphite.

(IV)-the shape and distribution of free carbon particles will greatly influence the physical properties of the cast iron.

**Types of cast iron are as follows :**

<b>Cast iron types</b>	<b>Form of carbon</b>
White cast iron	Carbon is in combined form as cementite
Malleable cast iron	Most or all the carbon is uncombined in the form of irregular round particles known as temper carbon. This is obtained by heat treatment of white cast iron
Grey cast iron	Most or all the carbon is combined is uncombined in the form of graphite flakes.
Chilled cast iron	In which a white cast –iron layer at the surface is combined with a grey –iron interior
Nodular cast iron	In which by special alloy addition, the carbon is largely combined in the form of compact spheroids. This structure differs from malleable iron in that it is obtained directly from solidification and the round carbon particles are more regular in shape.
Alloy cast iron	In which the properties or structure of any of the above types are modified by the addition of alloying elements.

**Plastic:**

(i)- Plastic are materials comes under polymers materials.

(II)-plastic are materials that have some structural rigidity under load and are used in general purpose application .

(iii)- polythene , polypropylene , pvc, polyster and fluorocarbon, epoxies phenolics, polyester, may all be classified as plastic.

(IV)- wide variety of combination of properties , some plastics are rigid and brittle , some are flexible having exhibiting both elastic and plastic deformation when stressed and sometimes experiencing considerable defoemation before fracture.

(V)- polymer falling under this type of classification may have any degree of crystallinity and all molecular structure and configuration (linera , branched , isotectic, etc) can be possible.

**Classification of plastic material :**

- 1- Thermoplastic
- 2- Theromosetting

<b>Material Type</b>	<b>Major Application Characteristics</b>	<b>Typical Applications</b>
Acrylonitrilebutadienestyrene (ABS)	Thermoplastics Outstanding strength and toughness, resistant to heat distortion; good electrical properties; flammable and soluble in	Refrigerator linings lawns garden equipment, toys, highway safety devices

	some organic solvents	
Acrylics [poly(methyl methacrylate)]	Outstanding light transmission and resistance to weathering; only fair mechanical properties	Lenses, transparent aircraft enclosures, drafting equipment, outdoor signs
Fluorocarbons (PTFE or TFE)	Chemically inert in almost all environments, excellent electrical properties; low coefficient of friction; may be used to relatively weak and poor cold-flow properties	Anticorrosive seals, chemical pipes and valves, bearings, antiadhesive coatings, high temperature electronic parts
Polyamides (nylons)	Good mechanical strength, abrasion resistance, and toughness; low coefficient of friction; absorbs water and some other liquids	Bearings, gears, cams, bushings, handles, and jacketing for wires and cables

Polycarbonates	Dimensionally stable; low water absorption; transparent; very good impact resistance and ductility; chemical resistance not outstanding	Safety helmets, lenses, light globes, base for photographic film
Polyethylene	Chemically resistant and electrically insulating; tough and relatively low coefficient of friction; low strength and poor resistance to weathering	Flexible bottles, toys, tumblers, battery parts, ice trays, film wrapping materials
Polypropylene	Resistant to heat distortion; excellent electrical properties and fatigue strength; chemically inert; relatively	Sterilizable bottles, packaging, film tv cabsinate luggage

	inexpensive; poor resistance to UV light	
Polystyrene	Excellent electrical properties and optical clarity; good thermal and dimensional stability; relatively inexpensive	Wall tile, battery cases, toys, indoor lighting panels, appliance housings
Vinyls	Good low-cost, general-purpose materials; ordinarily rigid, but may be made flexible with plasticizers; often copolymerized; susceptible to heat distortion	Floor coverings, pipe, electrical wire insulation, garden hose, phonograph records
Polyester (PET or PETE)	One of the toughest of plastic films; excellent fatigue and tear strength, and resistance to	Magnetic recording tapes, clothing, automotive tire cords, beverage containers



	humidity, acids, greases, oils, and solvents	
Epoxies	Excellent combination of mechanical properties and corrosion resistance; dimensionally stable; good adhesion; relatively inexpensive; good electrical properties	Electrical moldings, sinks, adhesives, protective coatings, used with fiberglass laminates
Phenolics	Excellent thermal stability to over may be compounded with a large number of resins, fillers, etc.; inexpensive	Motor housings, telephones, auto distributors, electrical fixtures
Polyesters	Excellent electrical properties and low cost; can be formulated for room- or high-temperature	Helmets, fiberglass boats, auto body components, chairs, fans

	use; often fiber reinforced	

## **Ceramics**

(I)-ceramics are inorganic and non metallic materials

(II)-ceramics are composed of at least two elements and often more, their crystalline structure are generally more complex than those for metals.

(III)-the atomic bonding in these metals are range from pure ionic to totally covalent. Many ceramics exhibits a combination of these two bonding types.the degree of ionic character being dependent on the electronegativities of atoms.

### **Properties of Ceramic Materials:**

(A)-High hardness, electrical and thermal insulating, chemical stability, and high melting temperatures

(B)-Brittle, virtually no ductility - can cause problems in both processing and performance of ceramic products

(C)-Some ceramics are translucent, window glass (based on silica) being the clearest example

Three Basic Categories of Ceramics:

1. Traditional ceramics - clay products such as pottery and bricks, common abrasives, and cement
2. New ceramics - more recently developed ceramics based on oxides, carbides, etc., and generally possessing mechanical or physical properties superior or unique compared to traditional ceramics
3. Glasses - based primarily on silica and distinguished by their noncrystalline structure In addition, glass ceramics - glasses transformed into a largely crystalline structure by heat treatment

### **Application of ceramics :**

- Window glass •Containers –cups, jars, bottles •Light bulbs •Laboratory glassware –flasks, beakers, glass tubing •Glass fibers –insulation, fiber optics •Optical glasses – lenses.
- Abrasives (grinding wheel grit) •Bioceramics (artificial bones and teeth) •Electrical insulators and electronic components •Refractory brick •Cutting tool inserts •Spark plug barrels
- Engineering component

## **Composite**

- (i)-multiphase material that is artificially made.as opposed to one that occurs or forms naturally . In addition , the constituent phase must be chemically dissimilar and separated by a distinct interface.
- (ii)- most composite has been created to improve combination of mechanical characteristic such as stiffness , toughness,and ambient and high temperature strength.
- (iii)- many composite material are composed of two just phase that is Matrix phase:which is continuous and surrounds the other phase called Dispersed phase.
- (iv)- the properties of composite material is afunction of the properties of the constituent phases, their relative amount,and the geometry of the dispersed phase. Here dispersed phase geometry means the shape of the particles,the parctiles size,distribution and orientation.

## **Classification of composite material.**

It is classified into three types.

1-particle reinforced

2-fiber reinforce

3-structural

1- Large particle is further divide into

(A)-large particle

(B)-dispersion strengthening

2- Fiber reinforced

(A)-continuous aligned

(B)-discontinuous short (aligned and discontinuous)

3- structural is further divided into

(A)-laminates

(B)- sandwich panel

(I)-the dispersed phase for particle reinforced composite is equiaxed particle dimension are same in all direction. For fiber reinforced composite the dispersed phase has a geometry of fibre (large length to diameter ratio). Structural composite are combination of composite and homogeneous material.

### **Particle reinforced composite:**

large-particle and dispersion-strengthened composites are the two subclassifications of particle-reinforced composites. The distinction between these is based upon reinforcement or strengthening mechanism. The term “large” is used to indicate that particle–matrix interactions cannot be treated on the atomic or molecular level; rather, continuum mechanics is used. For most of these composites, the particulate phase is harder and stiffer than the matrix. These reinforcing particles tend to restrain movement of the matrix phase in the vicinity of each particle. In essence, the matrix transfers some of the applied stress to the particles, which bear a fraction of the load. The degree of reinforcement or improvement of mechanical behavior depends on strong bonding at the matrix–particle interface. For dispersion-strengthened composites, particles are normally much smaller, with diameters between 0.01 and 0.1  $\mu\text{m}$  (10 and 100 nm). Particle–matrix interactions that lead to strengthening occur on the atomic or molecular level. The mechanism of strengthening is similar to that for precipitation hardening discussed in Section 11.9. Whereas the matrix bears the major portion of an applied load, the small dispersed particles hinder or impede the motion of dislocations. Thus, plastic deformation is restricted such that yield and tensile strengths, as well as hardness, improve.

### **Fibre reinforced composite**

Technologically, the most important composites are those in which the dispersed phase is in the form of a fiber. Design goals of fiber-reinforced composites often include high strength and/or stiffness on a weight basis. These characteristics are expressed in terms of specific strength and specific modulus parameters, which correspond, respectively, to the ratios of tensile

strength to specific gravity and modulus of elasticity to specific gravity. Fiber-reinforced composites with exceptionally high specific strengths and moduli have been produced that utilize low-density fiber and matrix materials.

Fiber-reinforced composites are subclassified by fiber length. For short fiber, the fibers are too short to produce a significant improvement in strength.

### **Structural composite**

A structural composite is normally composed of both homogeneous and composite materials, the properties of which depend not only on the properties of the constituent materials but also on the geometrical design of the various structural elements. Laminar composites and sandwich panels are two of the most common structural composites; only a relatively superficial examination is offered here for them

### **Laminar composite :**

A laminar composite is composed of two-dimensional sheets or panels that have a preferred high-strength direction such as is found in wood and continuous and aligned fiber-reinforced plastics. The layers are stacked and subsequently cemented together such that the orientation of the high-strength direction varies with each successive layer

### **Sandwich panel :**

Sandwich panels, considered to be a class of structural composites, are designed to be light-weight beams or panels having relatively high stiffnesses and strengths. A sandwich panel consists of two outer sheets, or faces, that are separated by and adhesively bonded to a thicker core

## Reference

W.D Callister, Materials Science and Engineering, Wiley India (P) Ltd., 2007.

C. Reardon, Metallurgy for the Non-Metallurgist, ASM, Second Edition, 2011.

H. K. D. H. Bhadeshia and R. W. K. Honeycombe, Steels: Microstructure and Properties, Elsevier, Third Edition, 2006.

G. Krauss, Steels: Processing, Structure and Performance, ASM, First Edition, 2005.

H. Avner, Introduction to Physical Metallurgy, McGraw Hill Education (India) Private Limited.

A. Subramaniam & Kantesh Balani (IITK) MHRD, Govt. of India through NMEICT

V. Raghavan, Materials Science and Engineering (5th Edition), Prentice-Hall of India Pvt. Ltd., 2004.

---

