

Learn to Draw: What To Draw and How To Draw It

by E. G. Lutz

Published by [Timeless Reads](#)

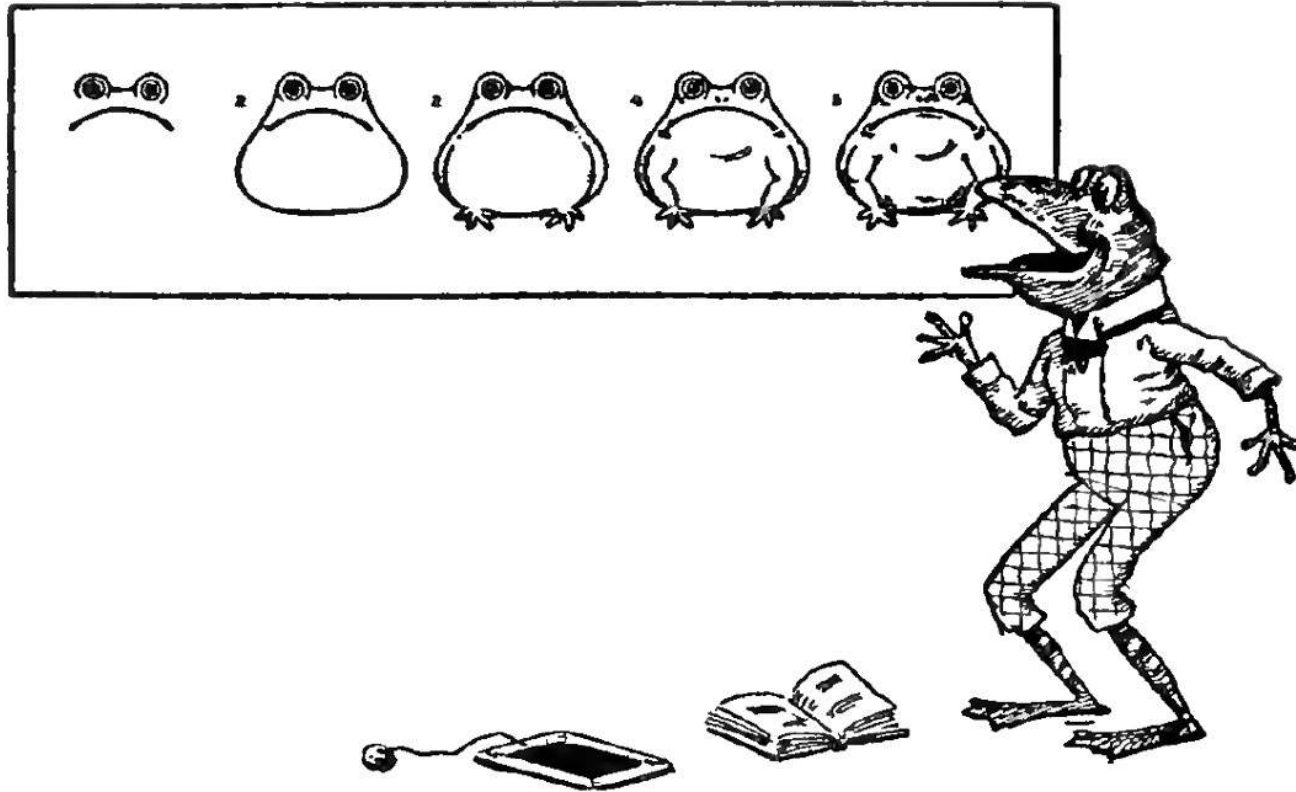

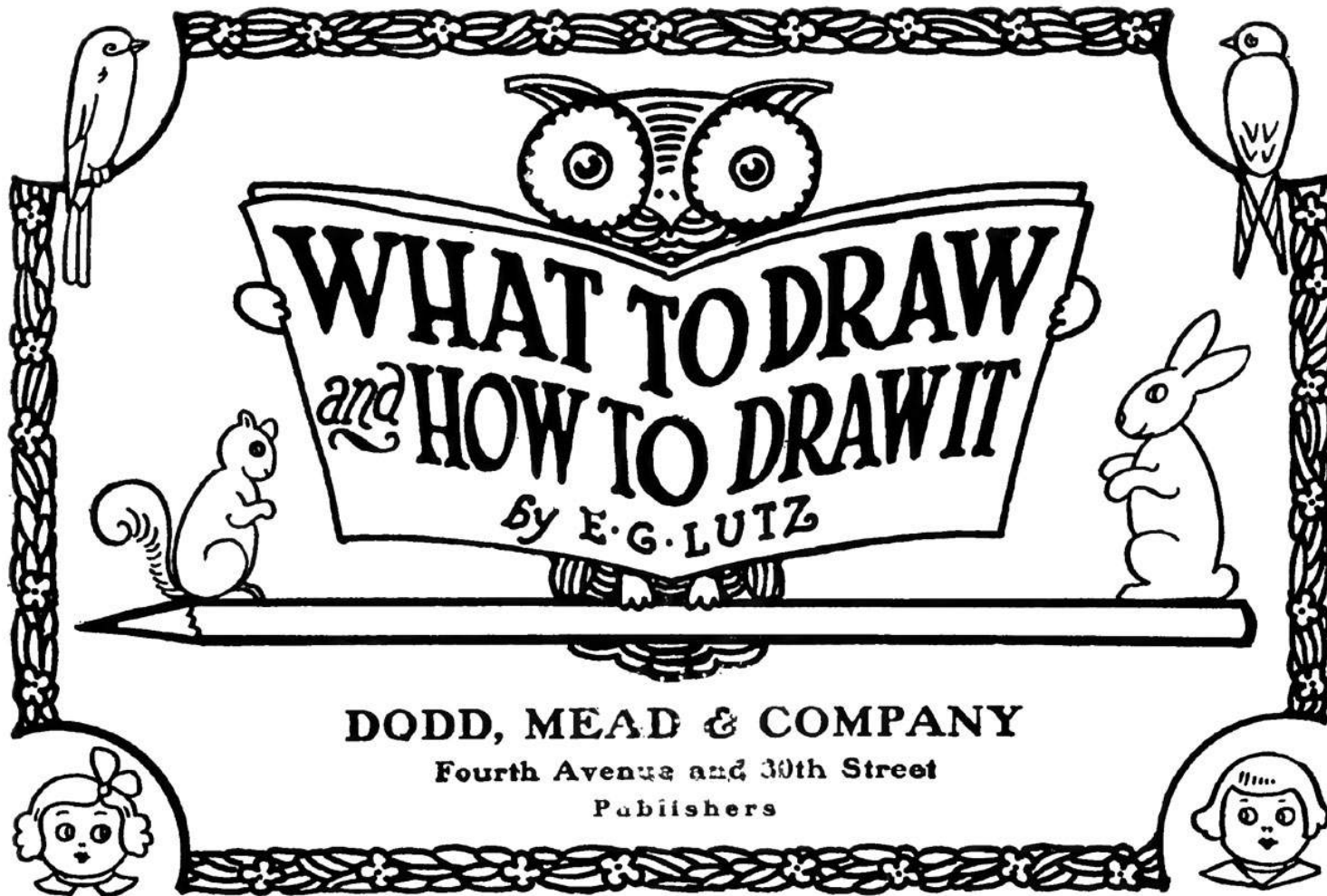

WHAT TO DRAW
and **HOW TO DRAW IT**

By E.G. LUTZ

DODD, MEAD & COMPANY

Fourth Avenue and 30th Street

Publishers



Table of Contents

[How To Use This Book](#)

[Instructions](#)

[Drawing Objects](#)

[Drawing Animals](#)

[Drawing People](#)

[Drawing Ovals and Ellipses](#)

[Suggestions for Water-color Painting](#)

How To Use This Book

Thank you for purchasing this classic drawing tutorial, published by [Timeless Reads \(TimelessReads.com\)](https://TimelessReads.com). We publish classic works and collections in digital format at incredible prices. Please check out our site and great offerings today.

The illustrations in this book will help you draw objects, animals and people step-by-step. Using your e-reader horizontally will allow the pictures to show up largest and with the greatest detail. Also, you may want to turn off 2-column mode if it is on to allow for the greatest illustration size.

If you would like to download a PDF of the complete book for free, please use the link at the end of the book. This is ideal if you'd like to print any of the illustrations to view, or even trace, at a larger size.

Thanks so much for your purchase!

Aaron
Timeless Reads

Instructions

In drawing from this book, copy the last diagram, or finished picture, of the particular series before you.

The other diagrams—beginning with number one, then number two, and so on—show how to go on with your drawing. They give the order in which to make the various strokes of the pencil that together form the completed picture.

The dotted lines indicate where light lines are drawn that help in construction—that is; getting proportions correctly, outlining the general form, or marking details in their proper places. Do not press hard on the pencil in making these construction lines, then they can be erased easily afterwards.

Use a pencil compass to draw the circles, or mark them off by tracing buttons or disks.

To Draw a Five-Pointed Star

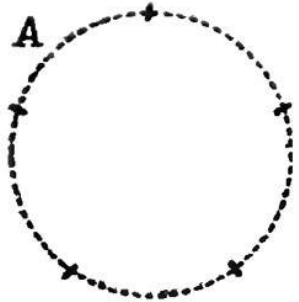

MARK 5 POINTS
AT EQUAL DISTANCES
ON A CIRCLE

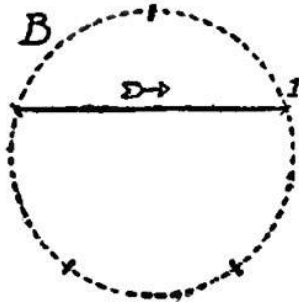

DRAW THIS
LINE FROM
LEFT TO RIGHT

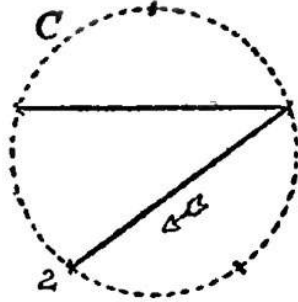

THE NEXT
IN THIS
WAY

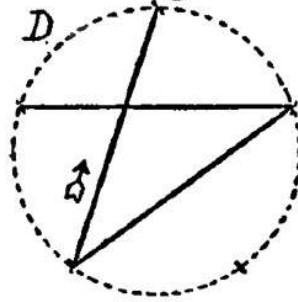

AND SO ON TO THE LAST

WITH PRACTISE THE AID OF CIRCLE
AND POINTS WILL NOT BE NEEDED

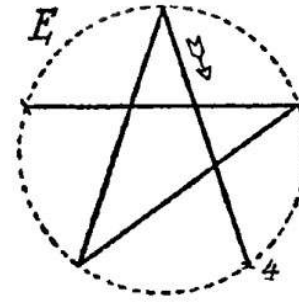

A 1



2

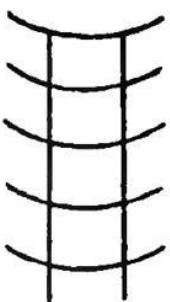

3

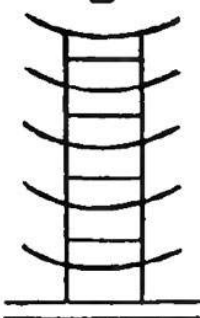

4

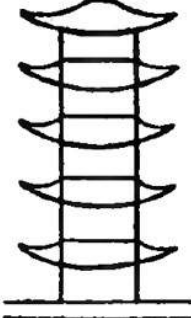

5

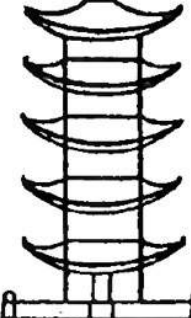

6



Pagoda

B 1



2

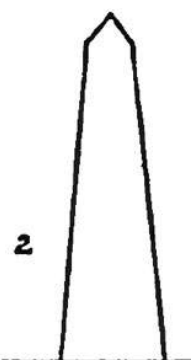

3

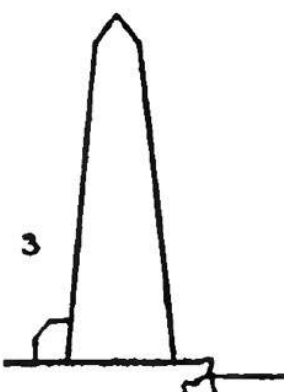

4

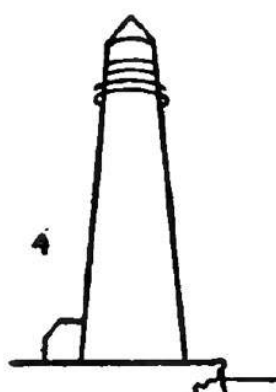

5



6



Lighthouse

C 1



2

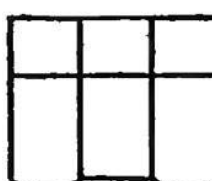

3

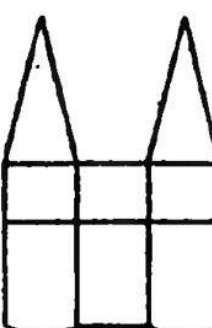

4

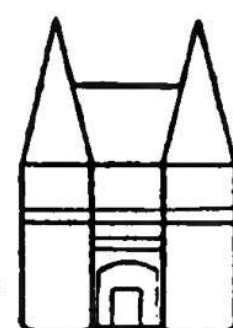

5



Chateau

Tent

1

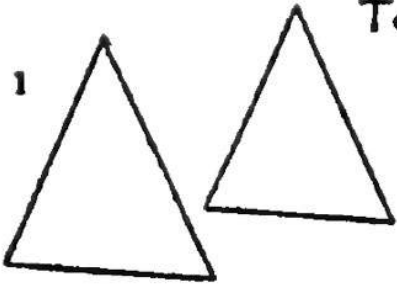

2

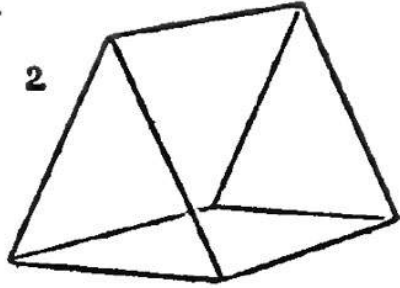

3

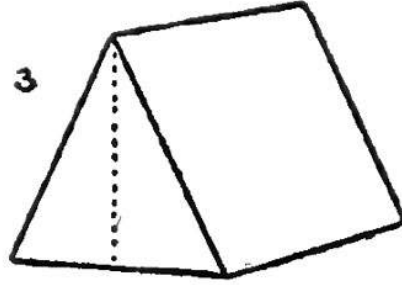

4

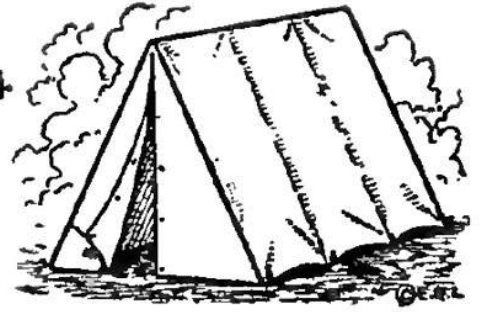

A 1

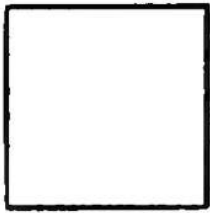

2

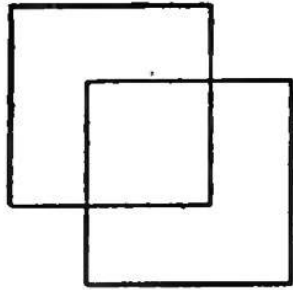

3

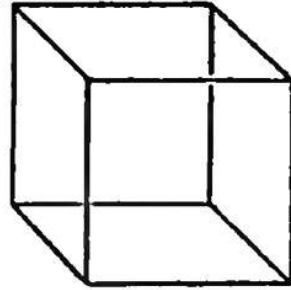

4

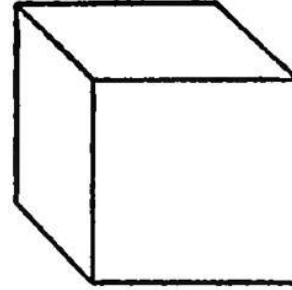

Cube

B

1

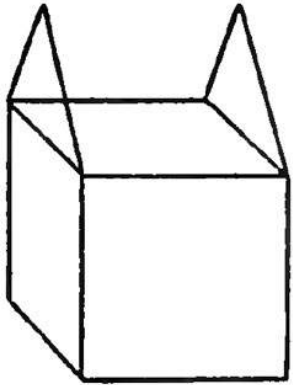

2

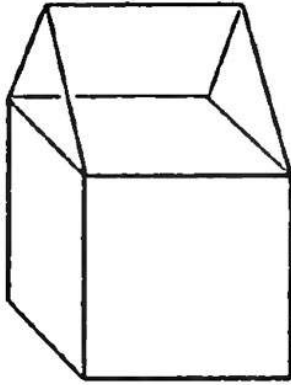

3



House

C 1

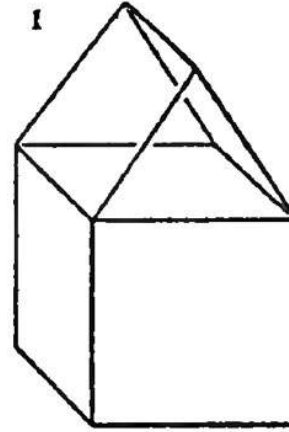

2

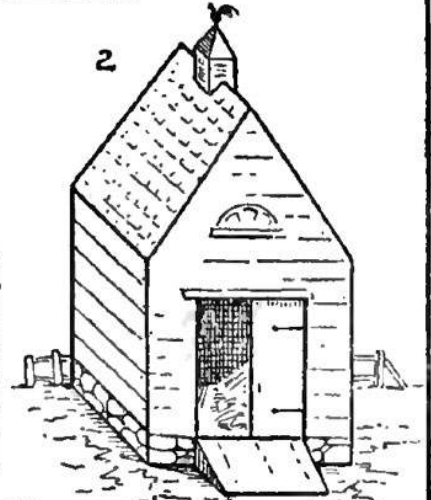

Barn

D

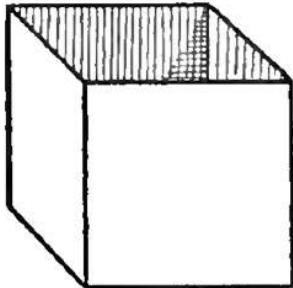

E

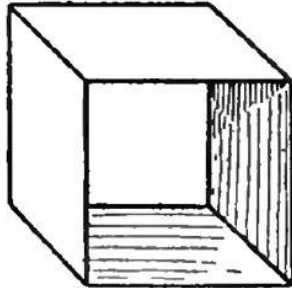

F

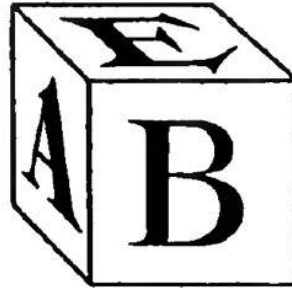

G

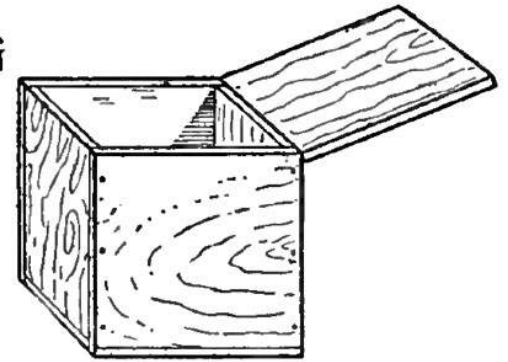

Toy Horse

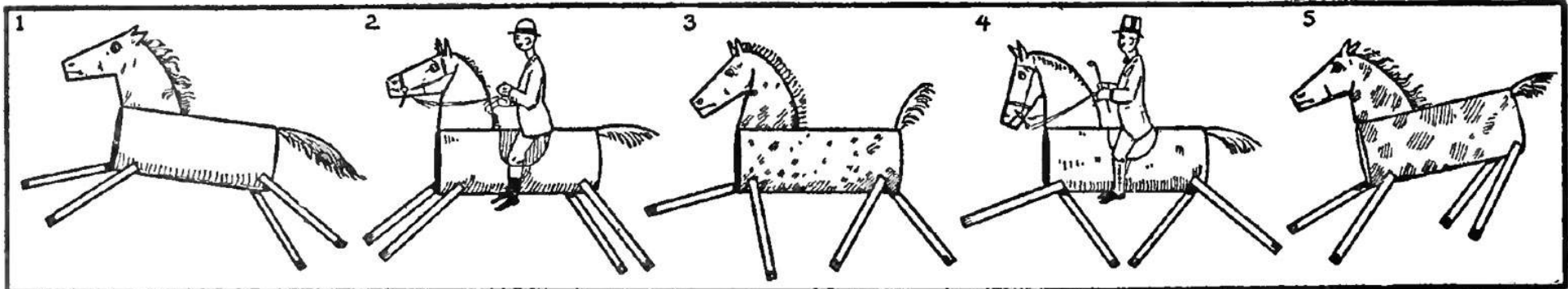
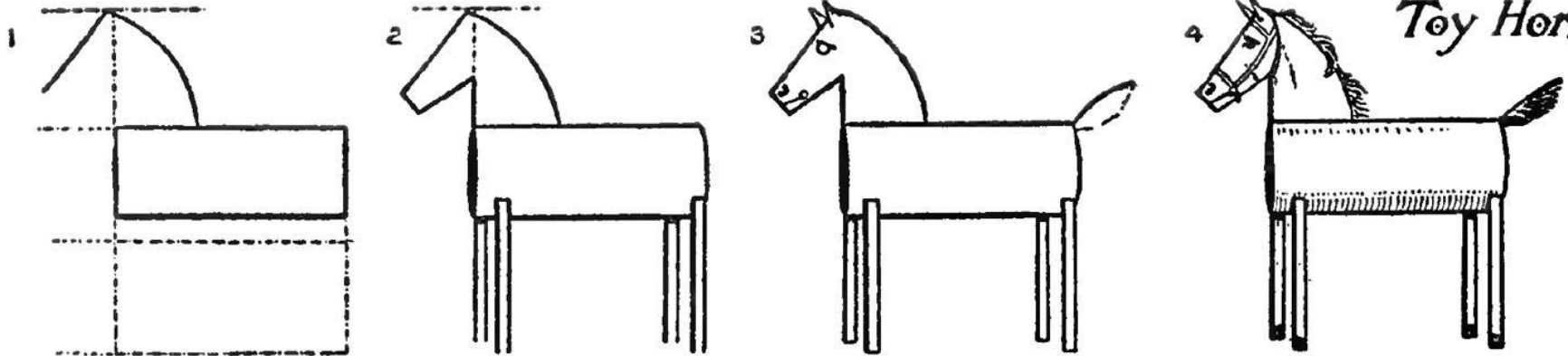

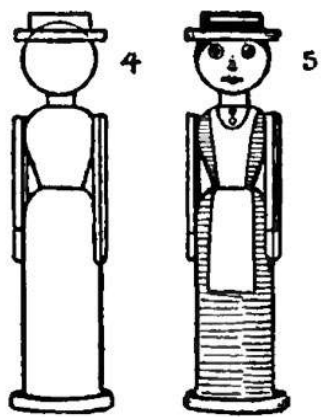
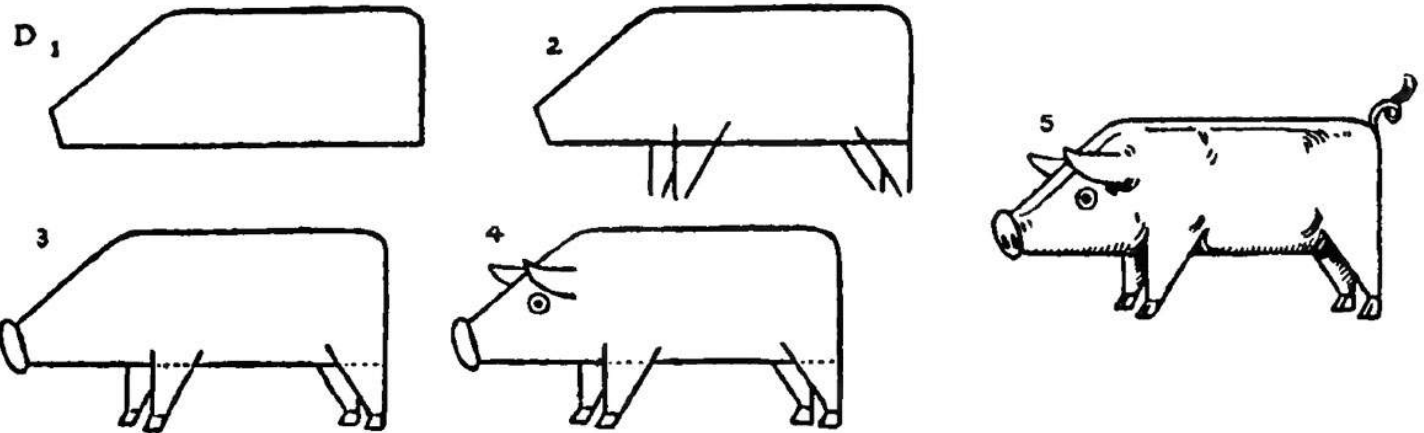
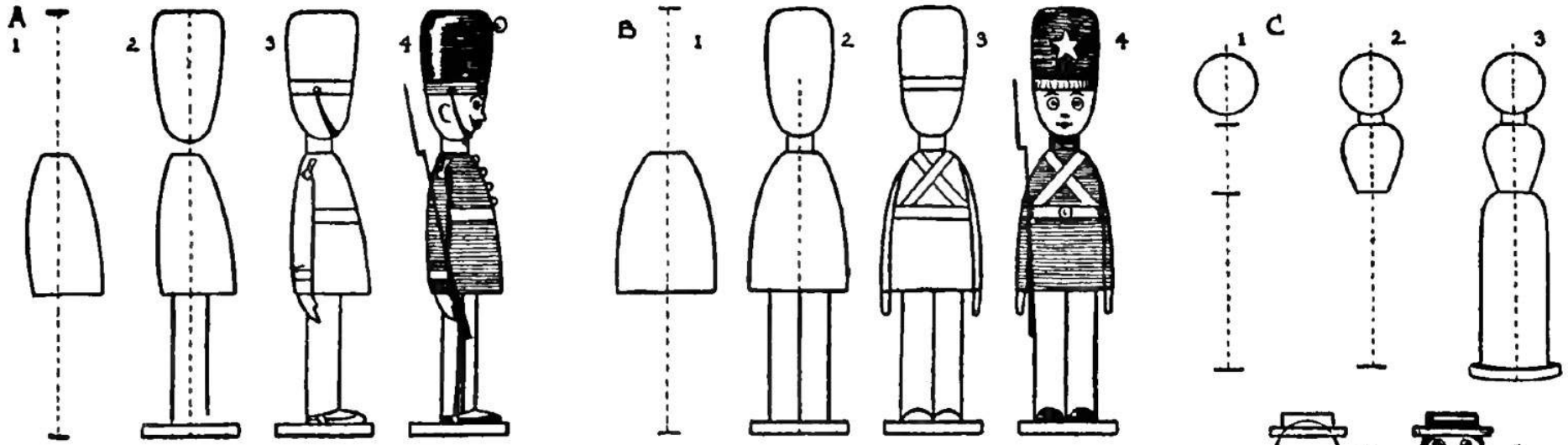

Toys

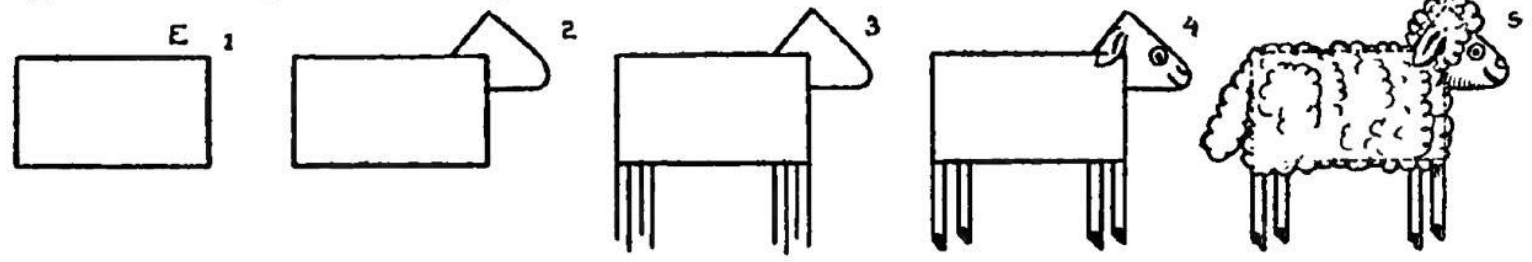

Drawing Animals

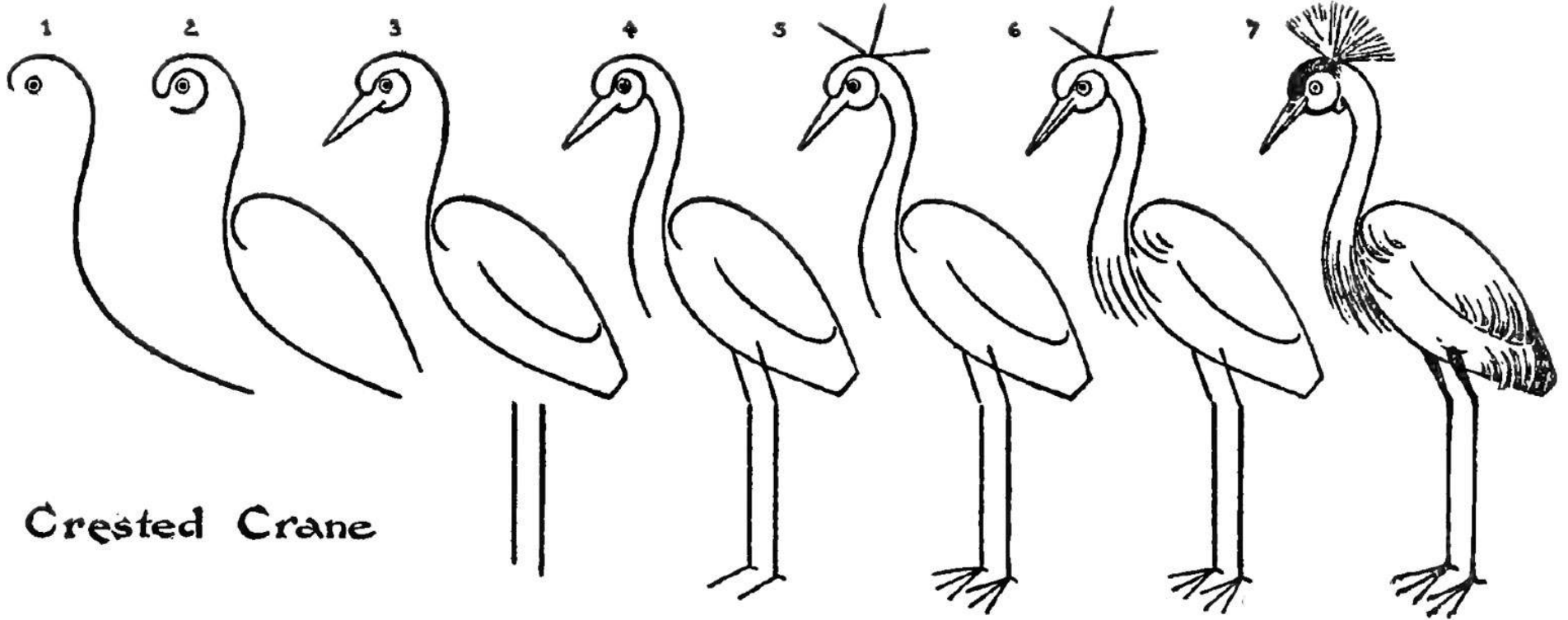

Crested Crane

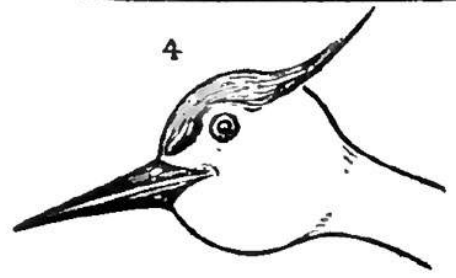
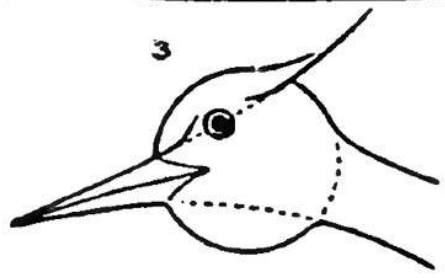
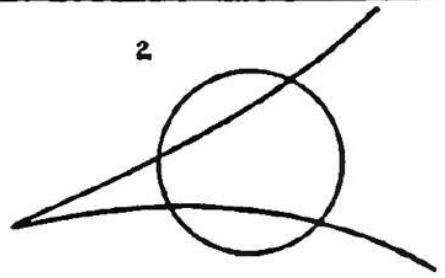
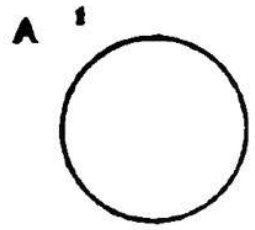

Cranes

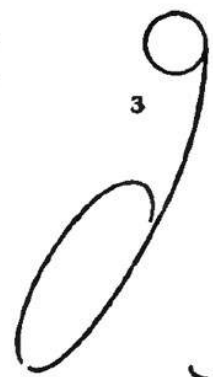
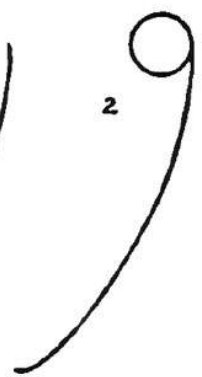
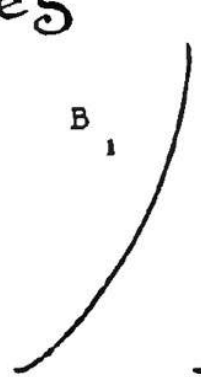

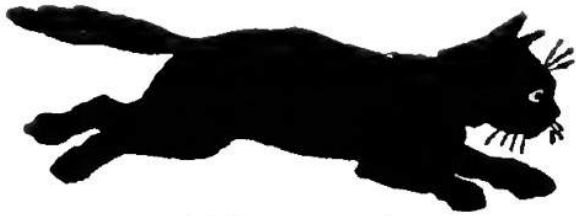

Cat

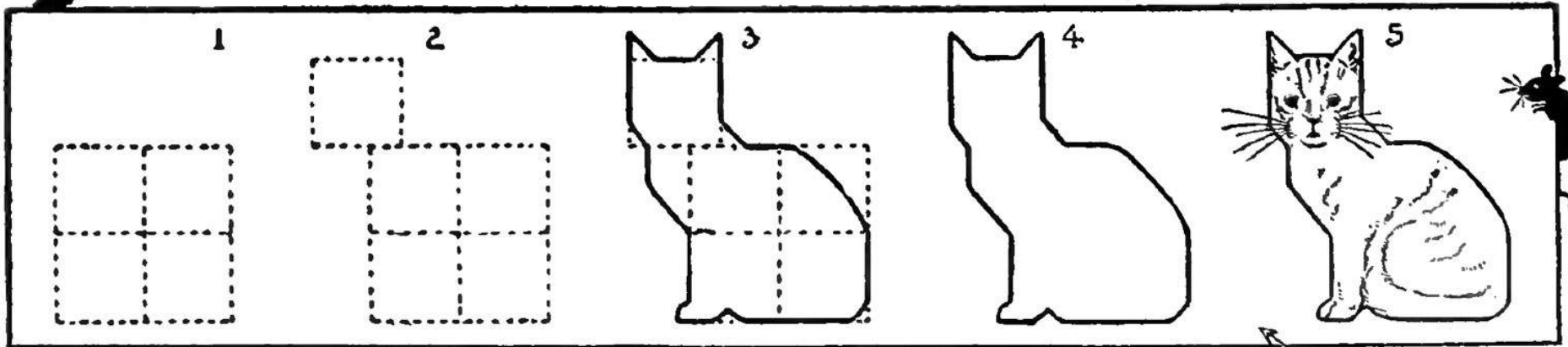

Things to notice when drawing a cat's face

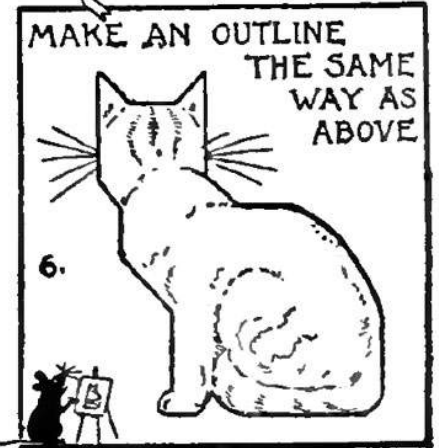
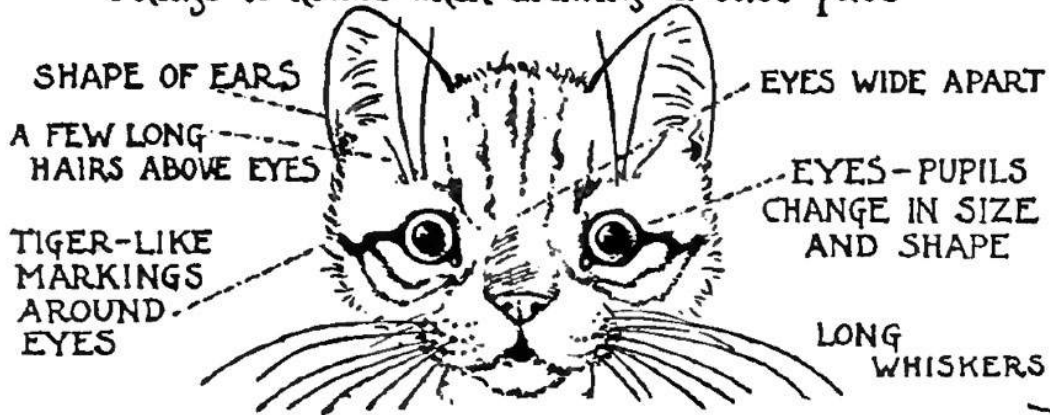

A 1



2



3



4



B 1



2



3

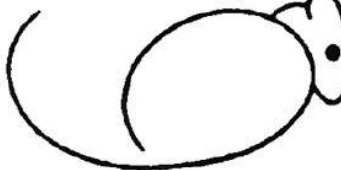

4



5



C 1

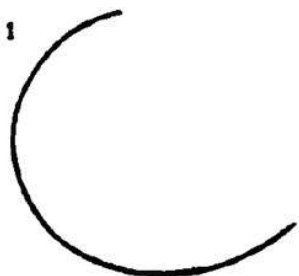

2

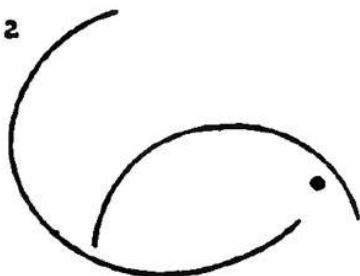

3

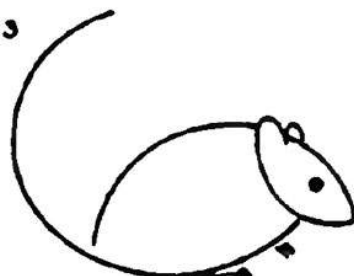

4



Mice

B 1

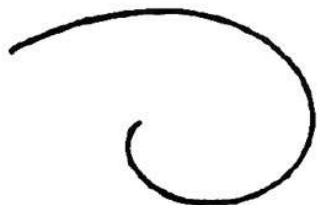

2

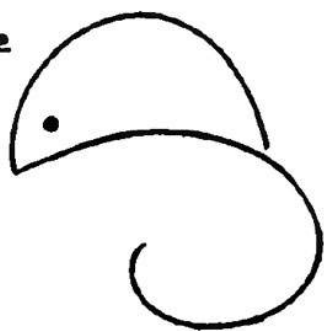

3



4



CURIOUS FISHES

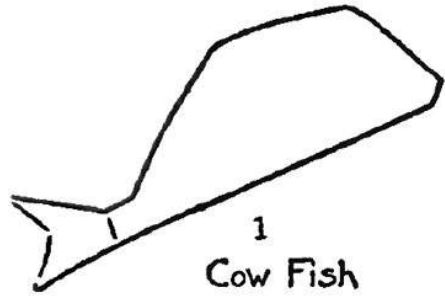

1
Cow Fish

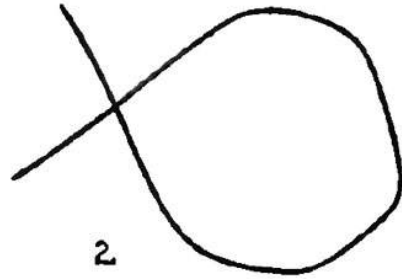

2
Moon Fish

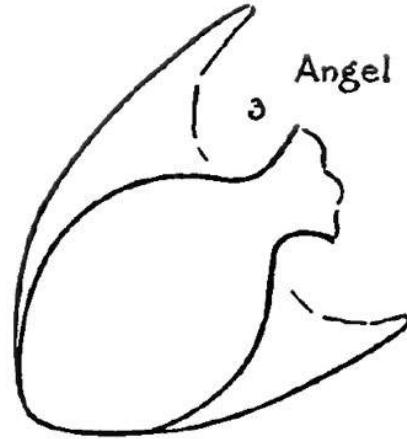

3
Angel Fish

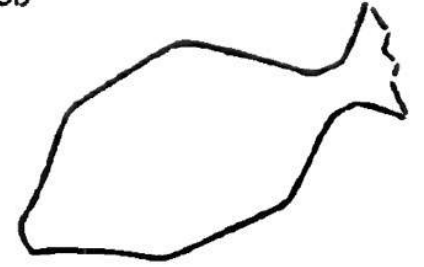

4
Trunk Fish

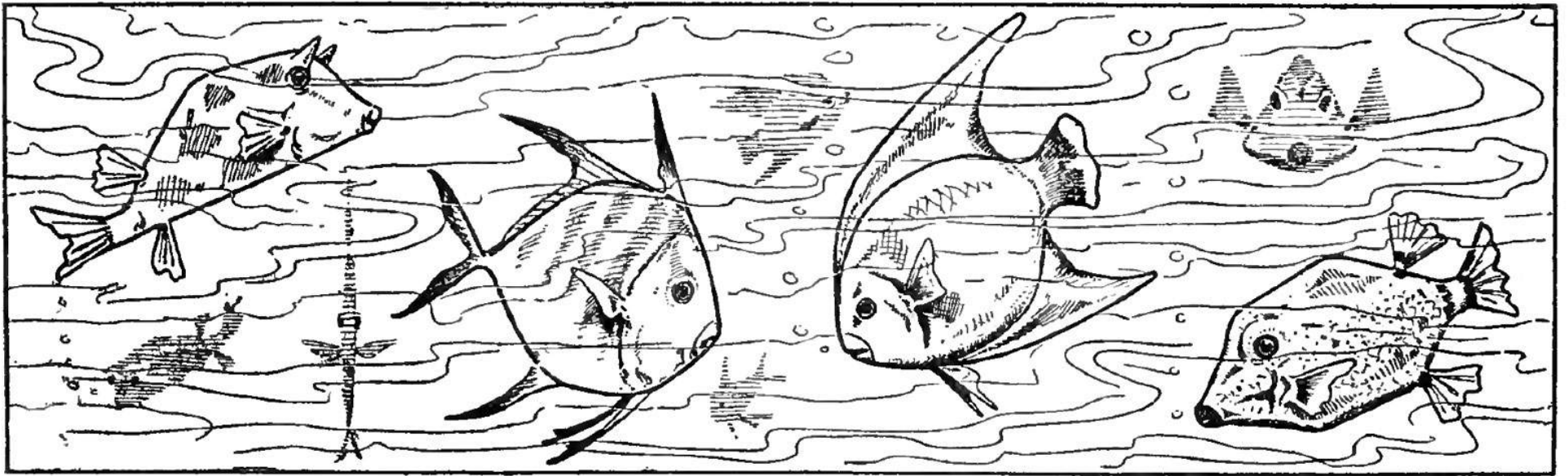

Fishes

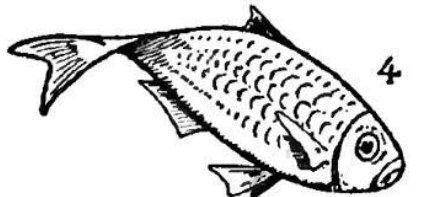
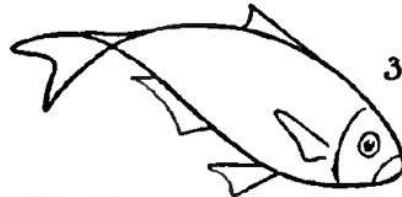
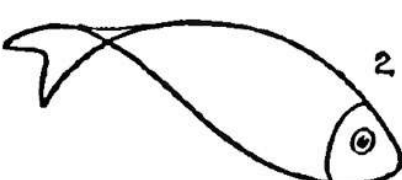
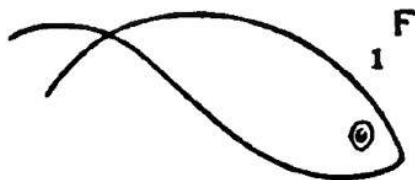
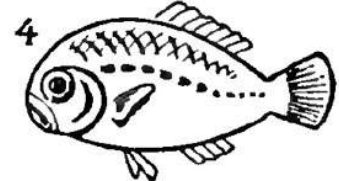
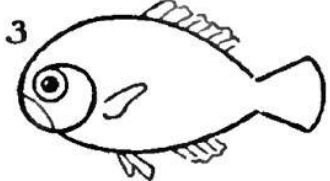
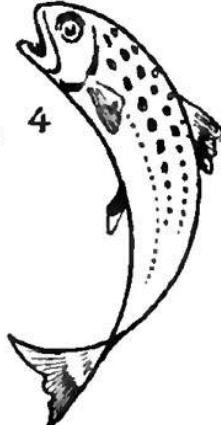
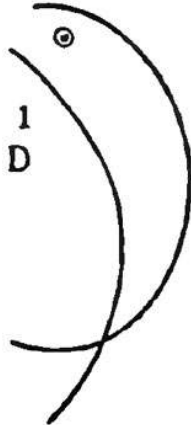
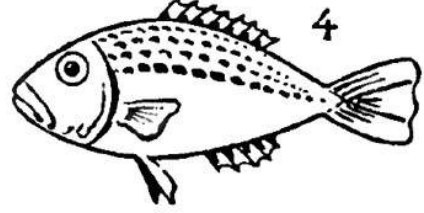
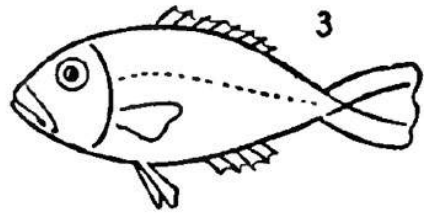
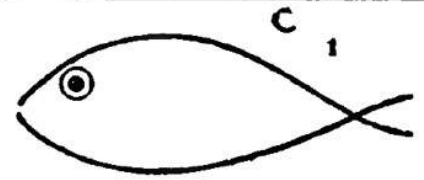
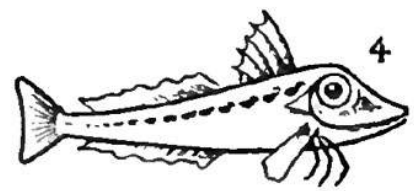
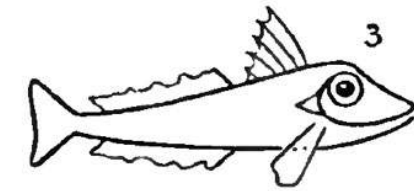
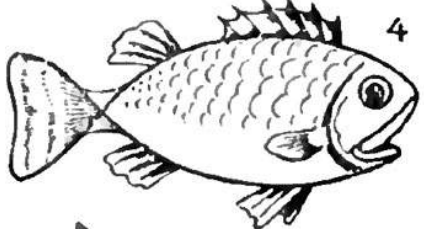
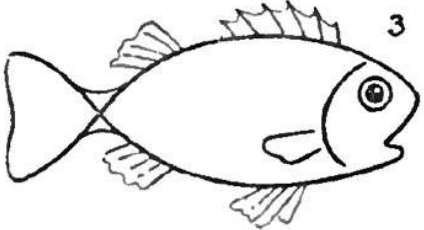
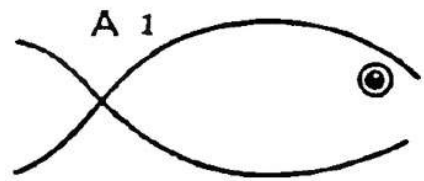

Cattail plant

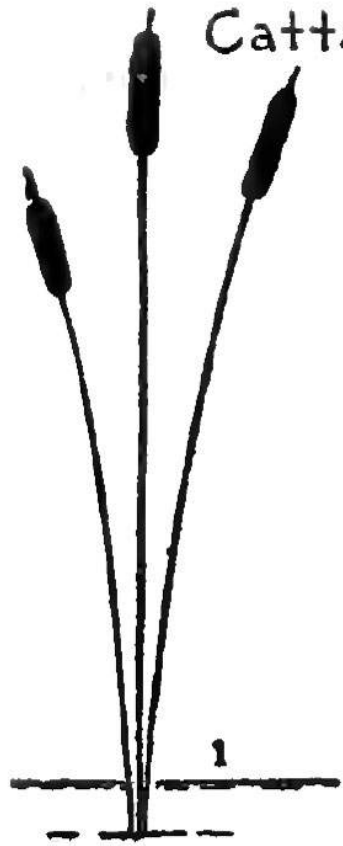

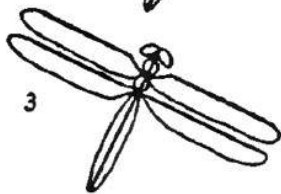
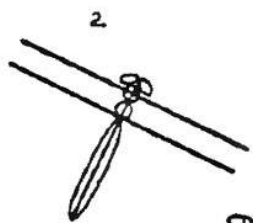
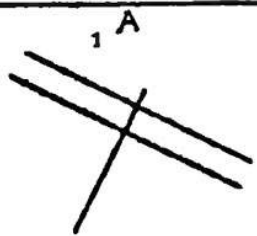

Dragon-fly

Water-lily

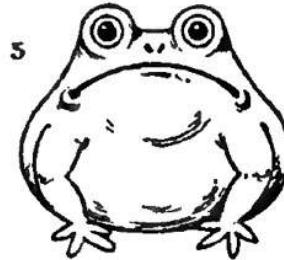
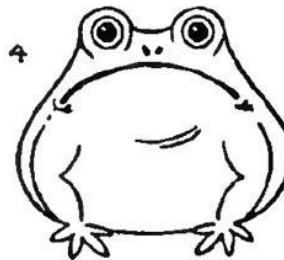
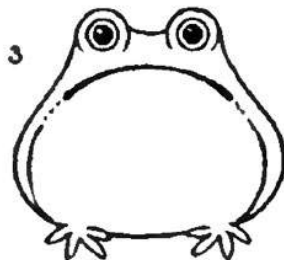
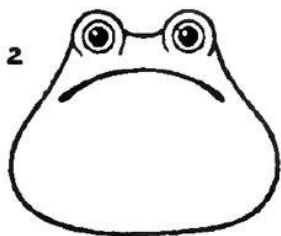
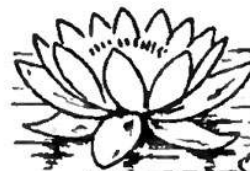

Frogs

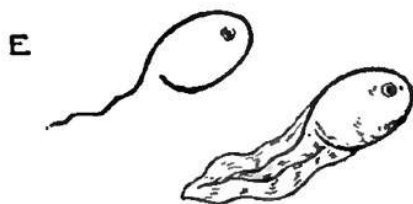
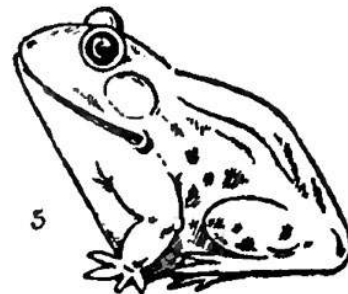
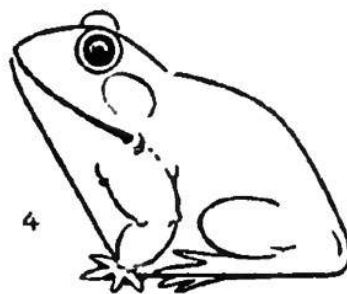
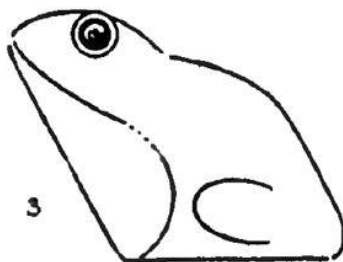
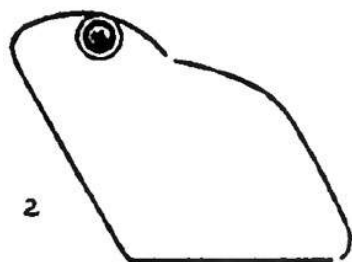
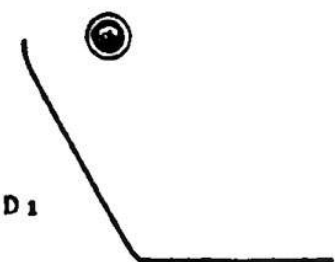

Tadpoles

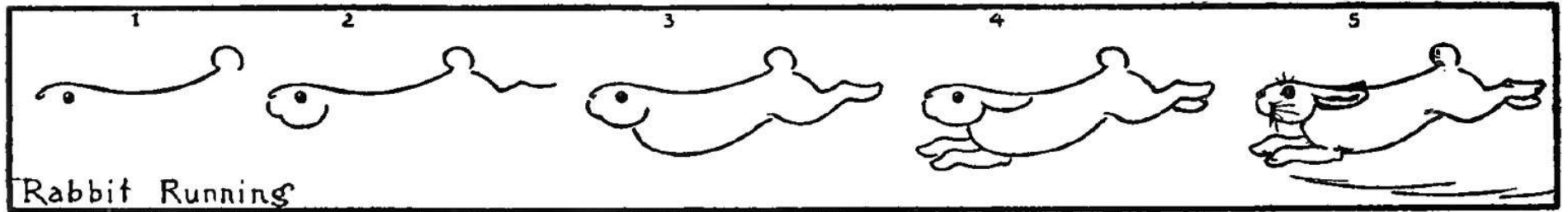
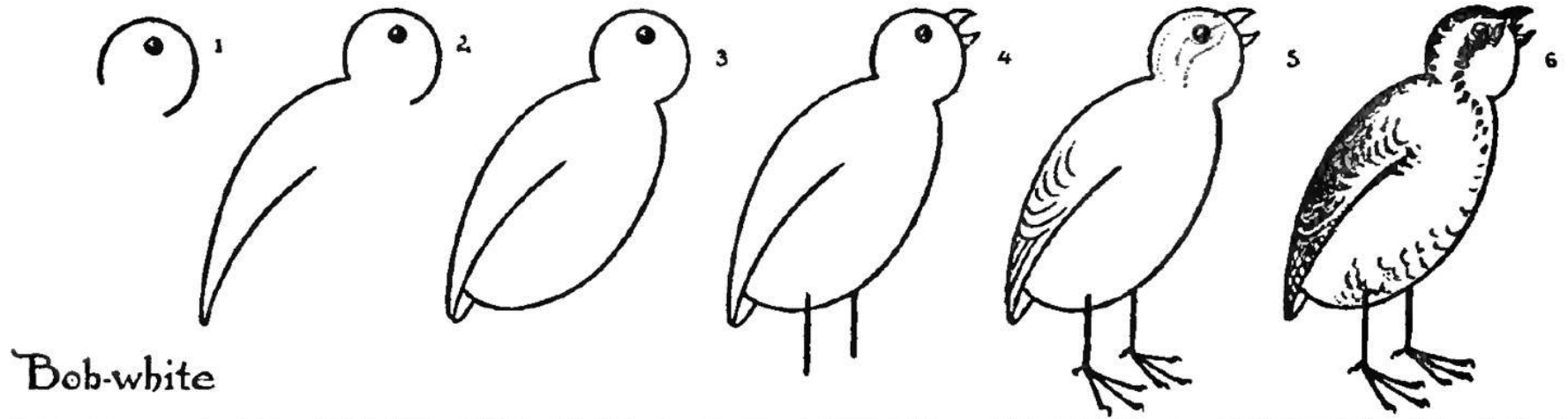
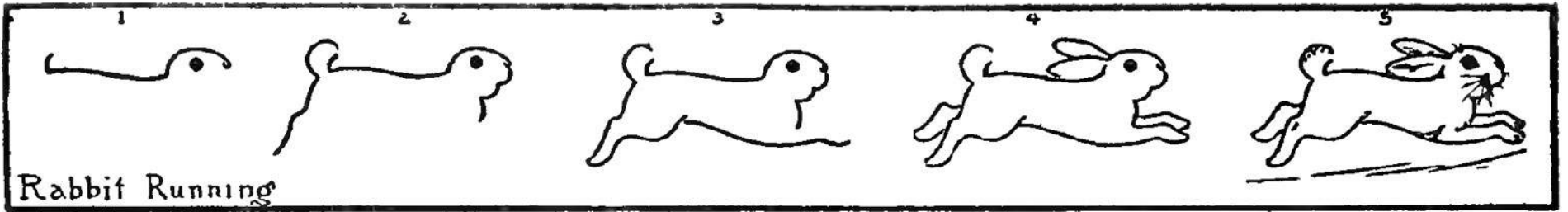

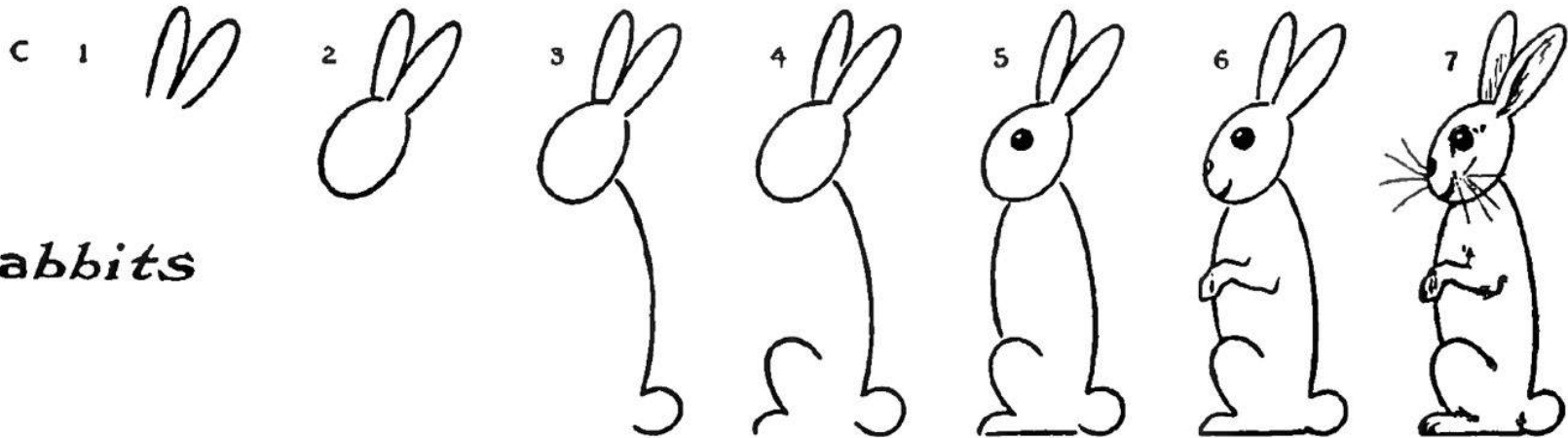
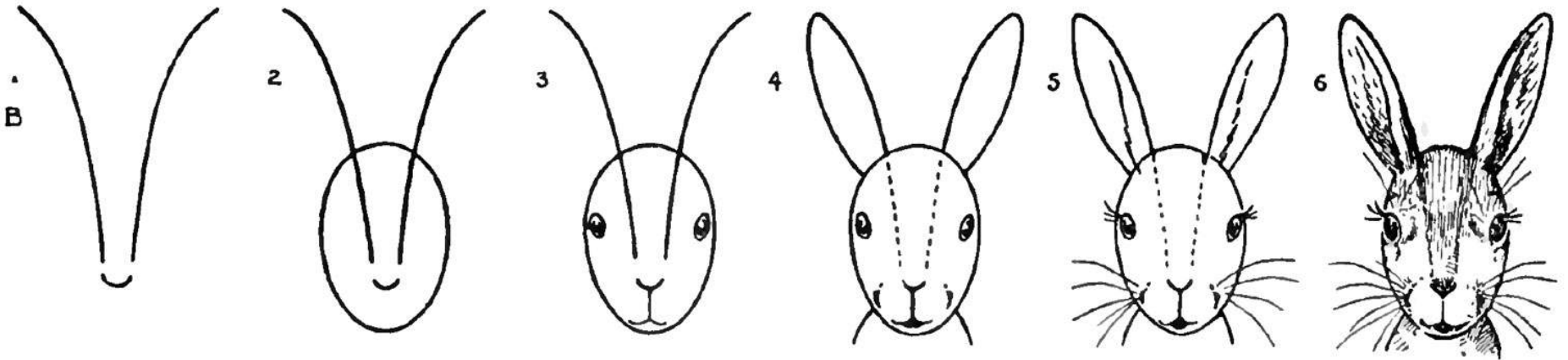
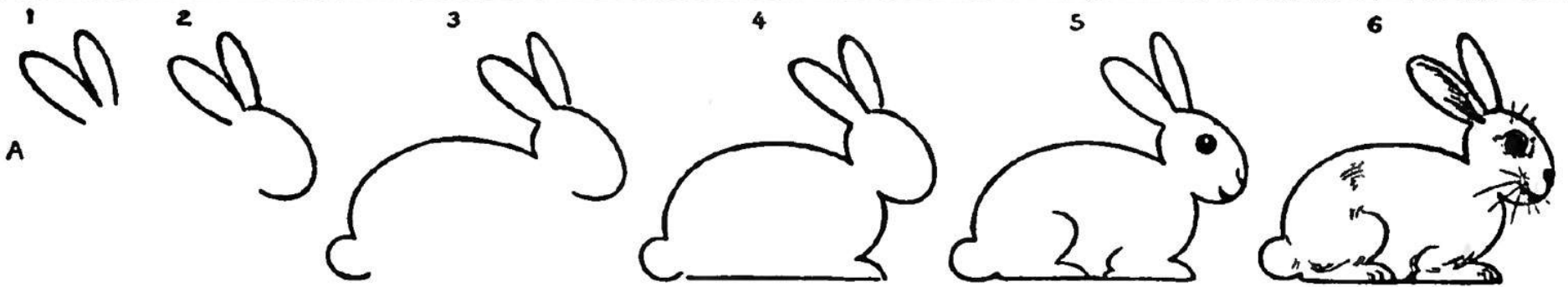

Rabbits

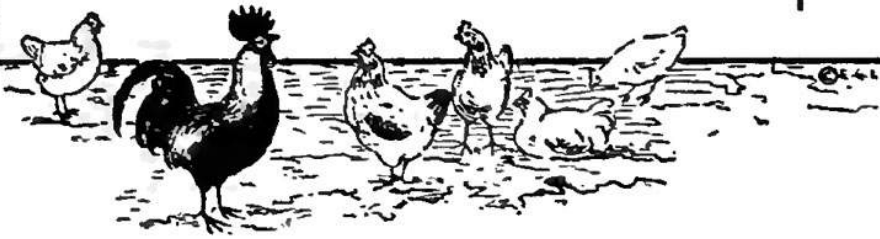
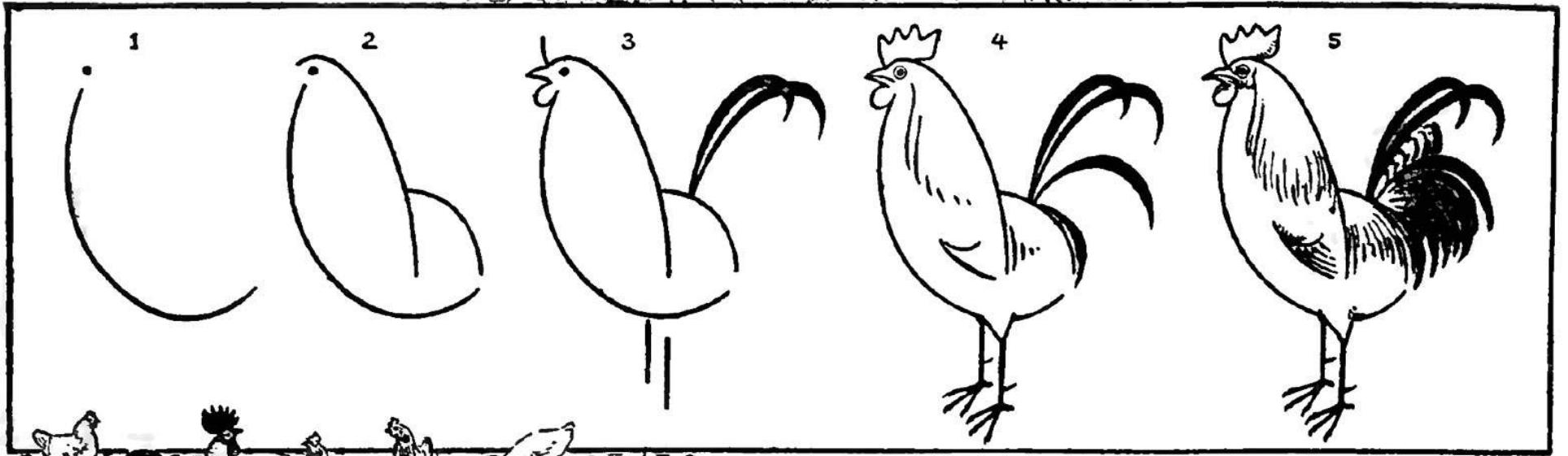

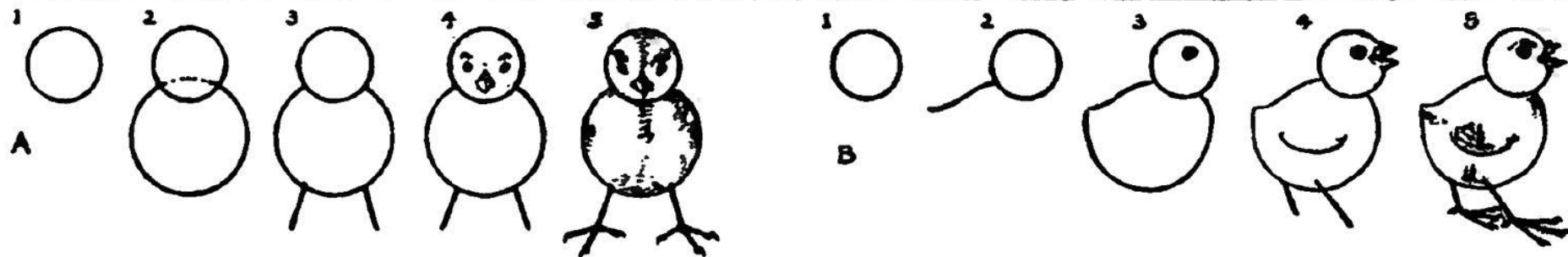

Hen and Chicks

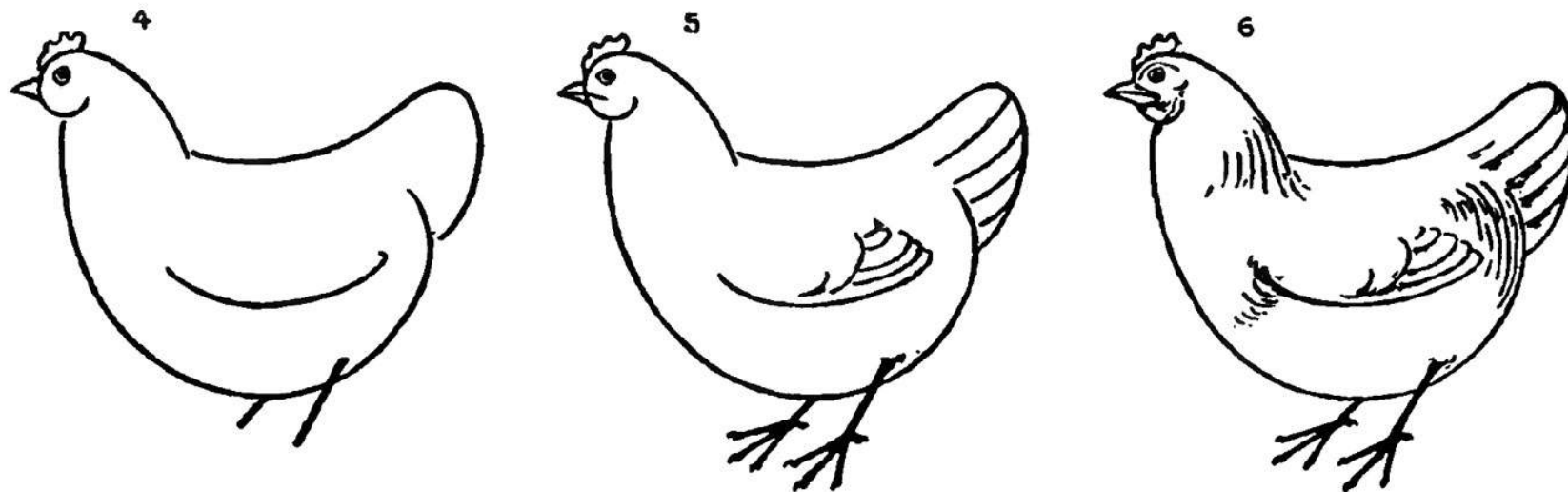

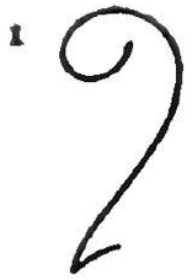

Swan

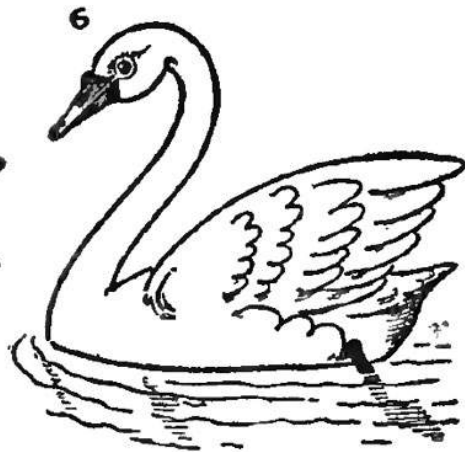
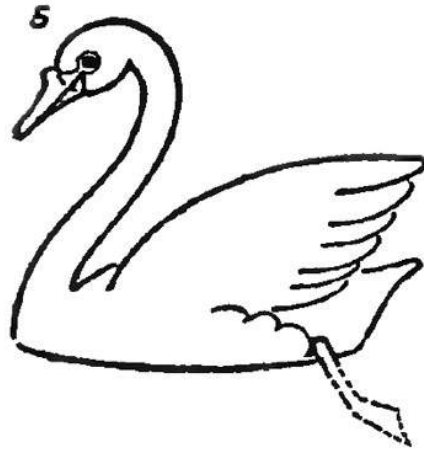

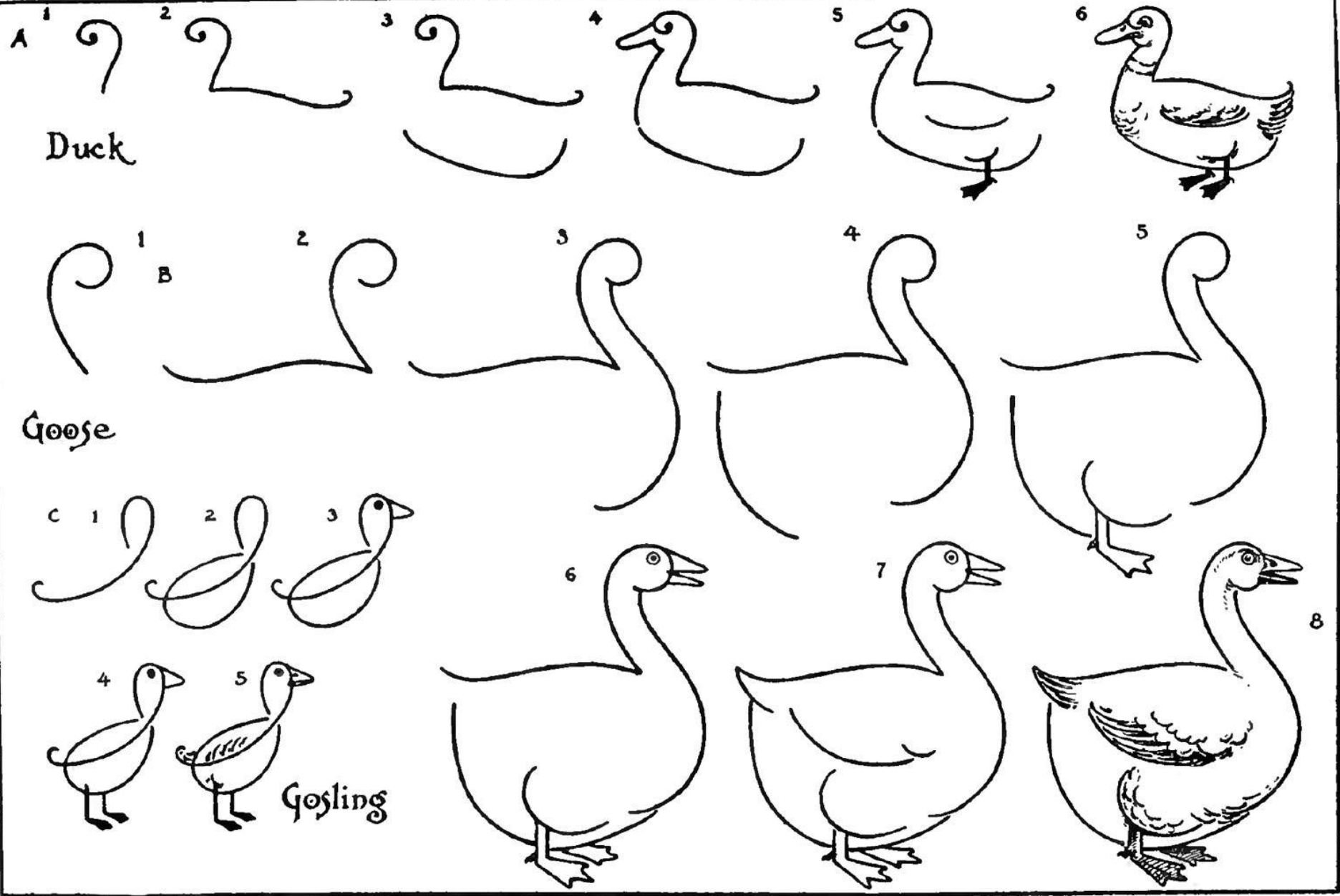

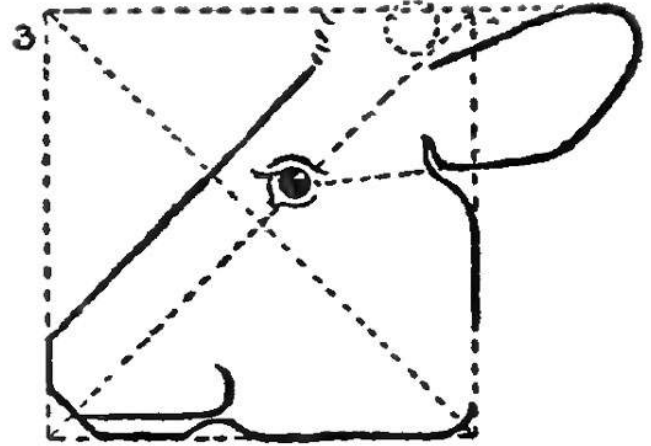
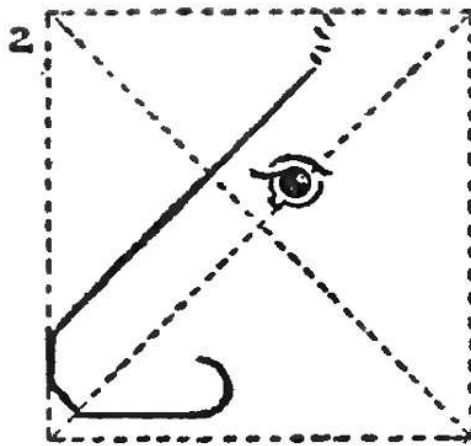
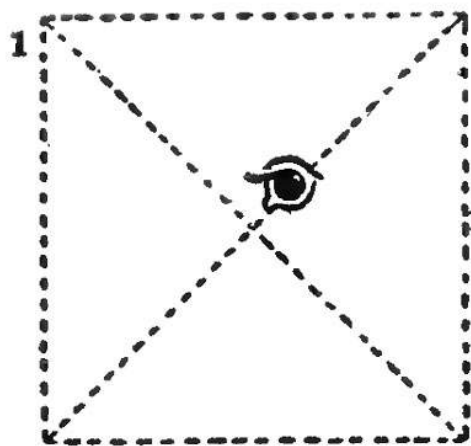

Cow

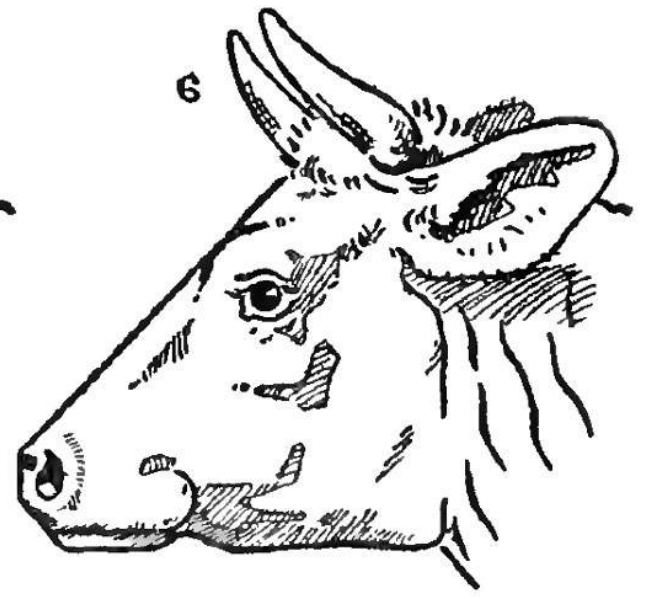
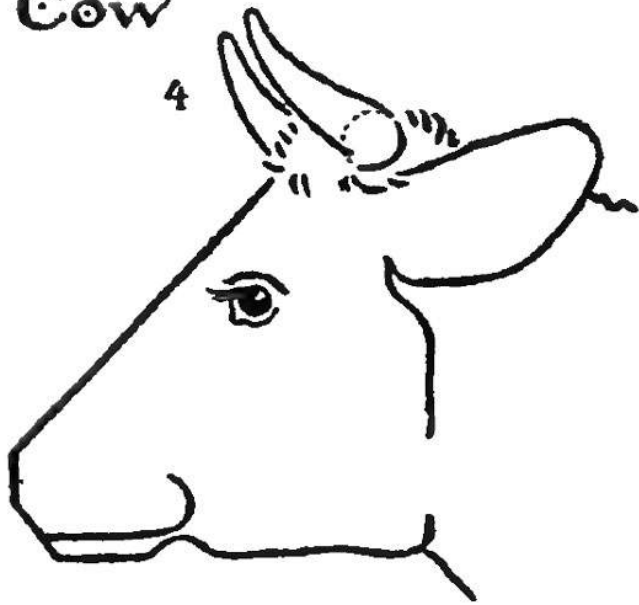

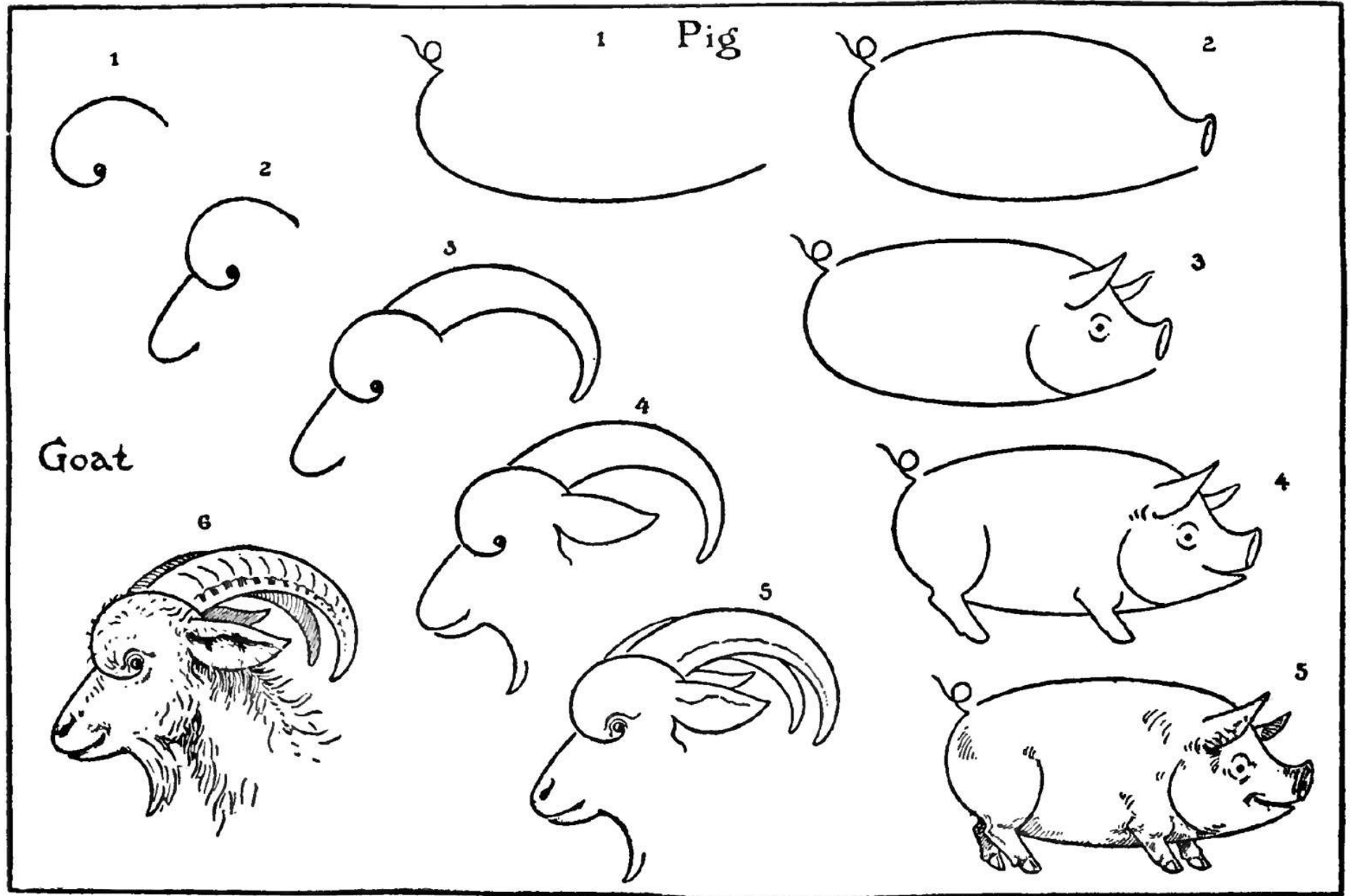

Bulldog

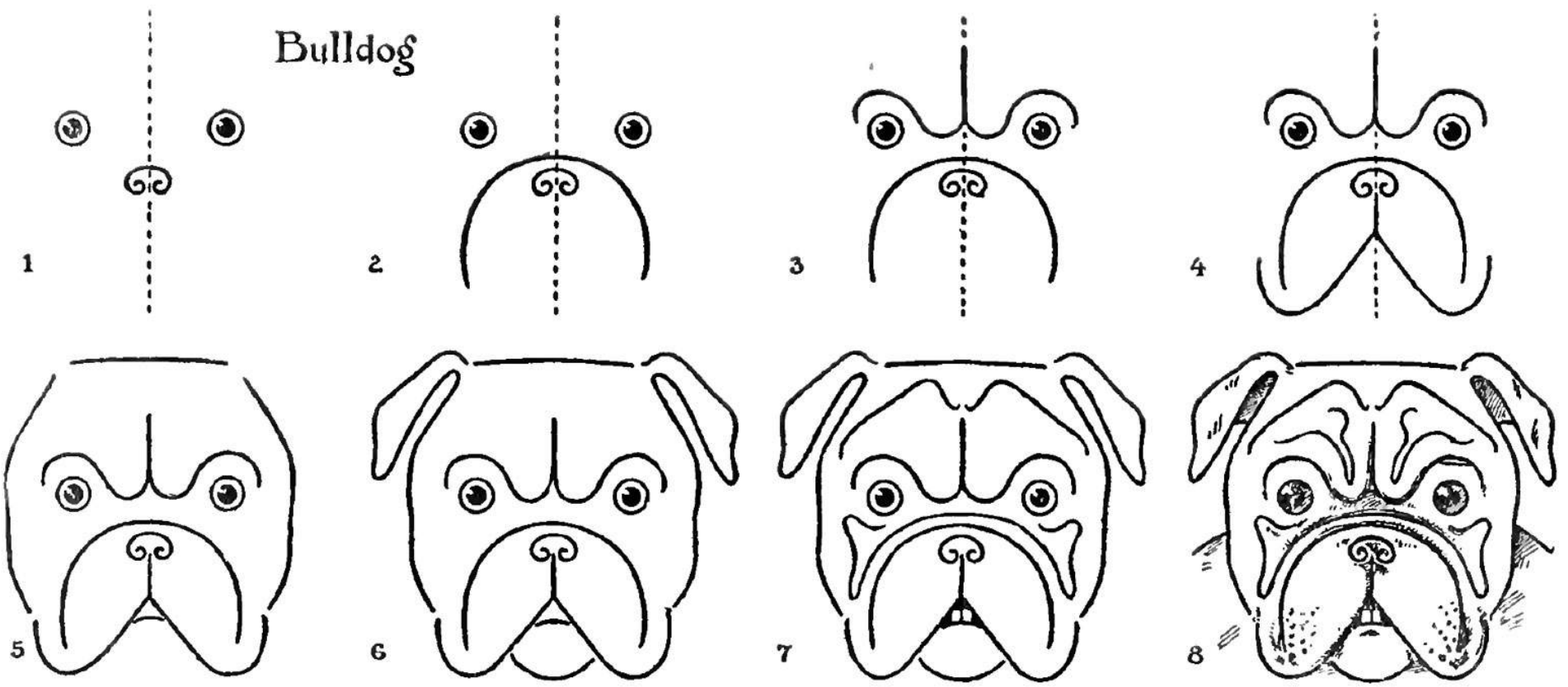

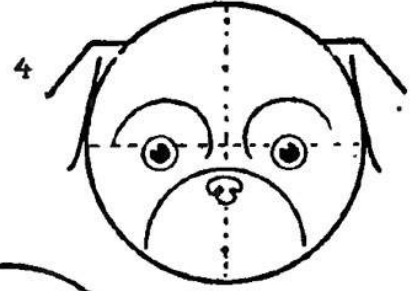
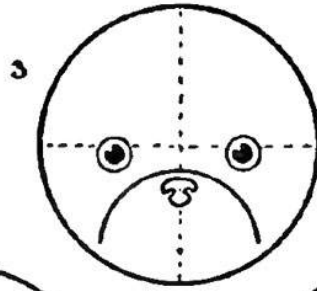
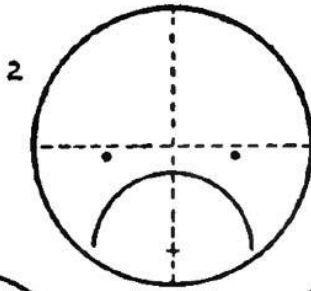
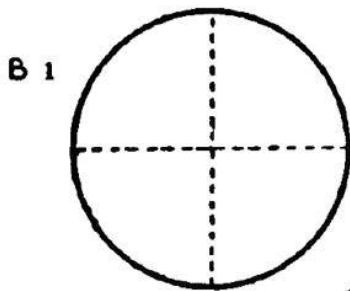
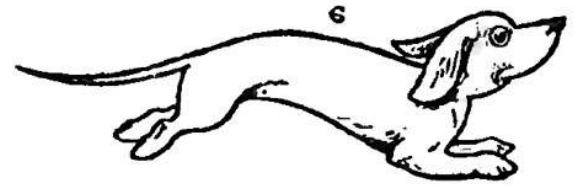
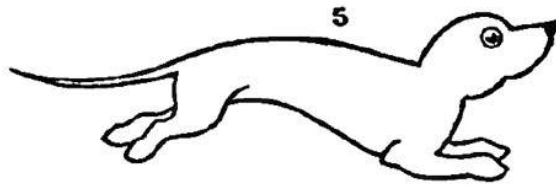
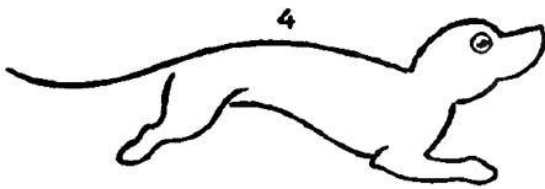
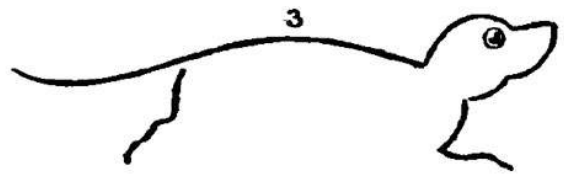
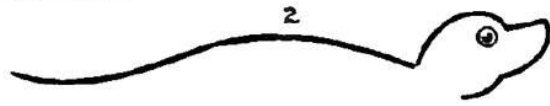

Dogs

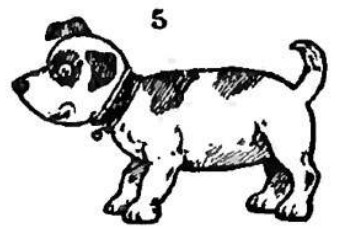
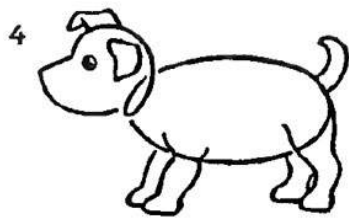
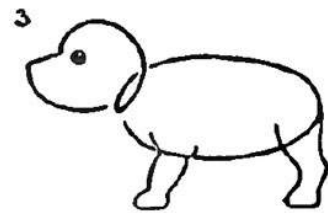
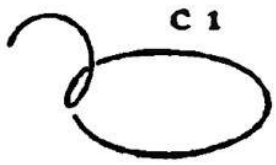

FIRST DRAW A TRIANGLE
WITH SIDES EQUAL

Horse

1

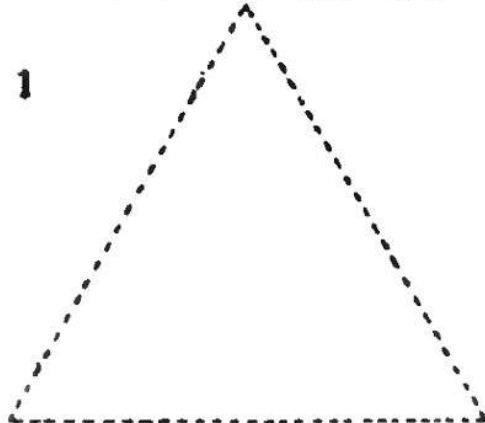

2

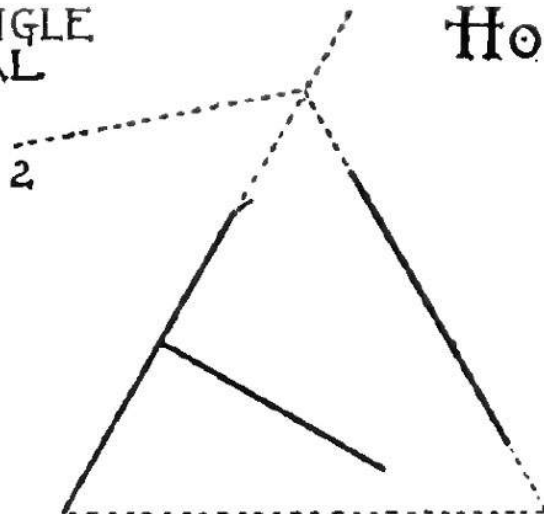

3

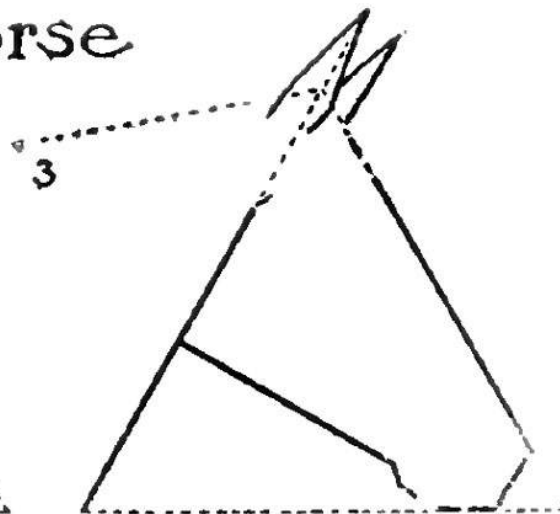

4

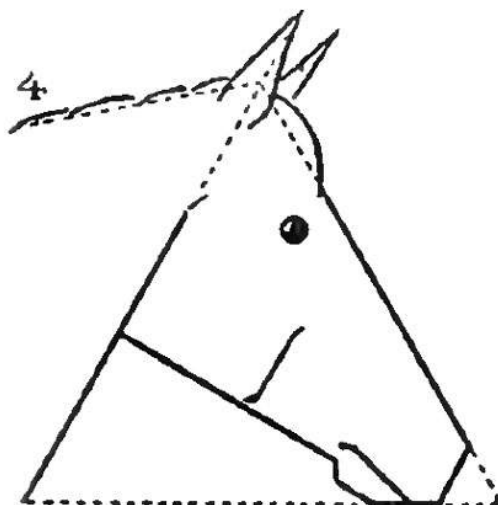

5



6

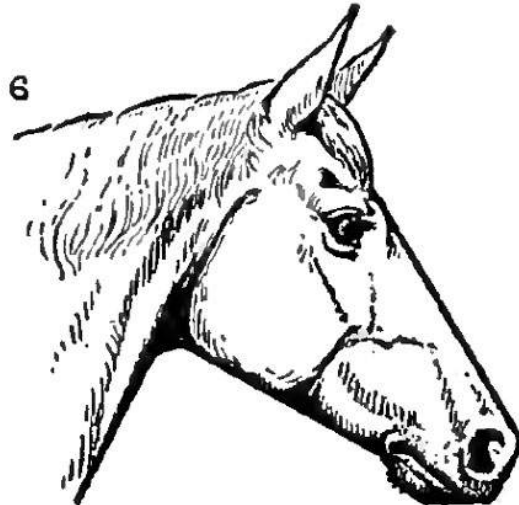

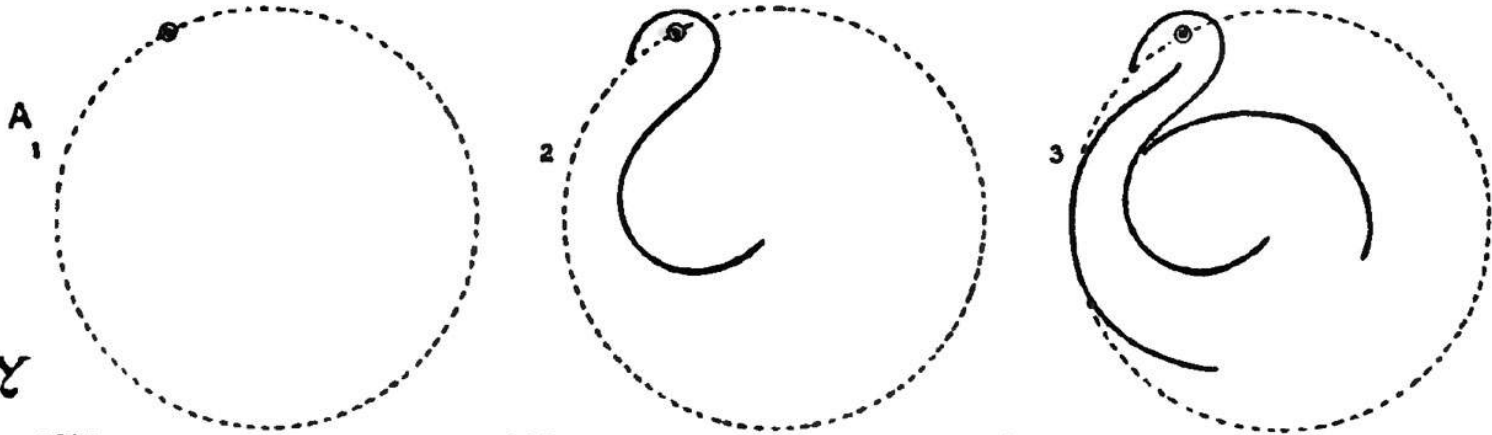

Turkey

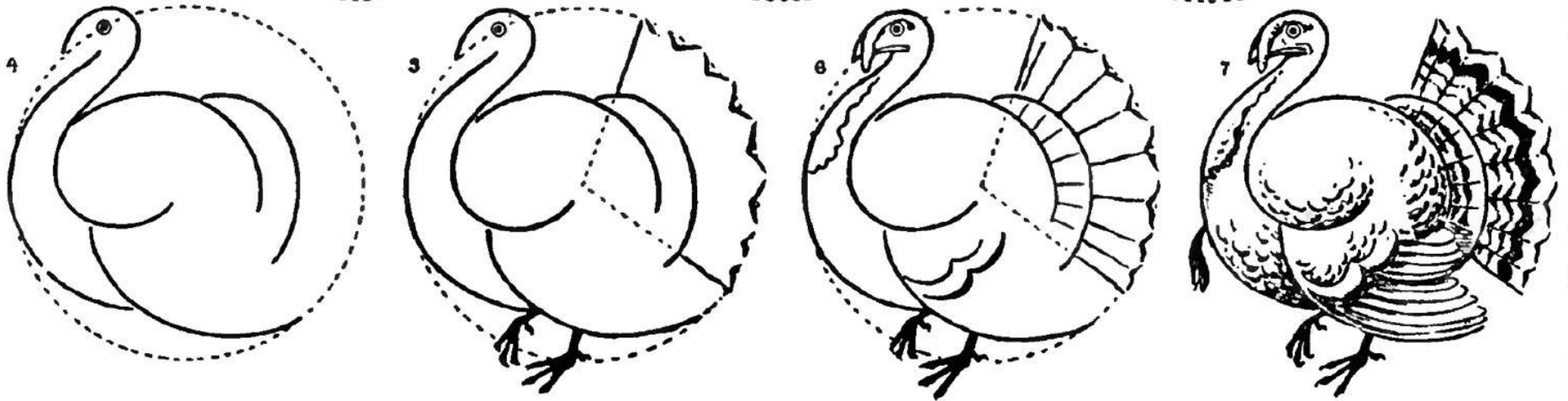

Fantail
Pigeon

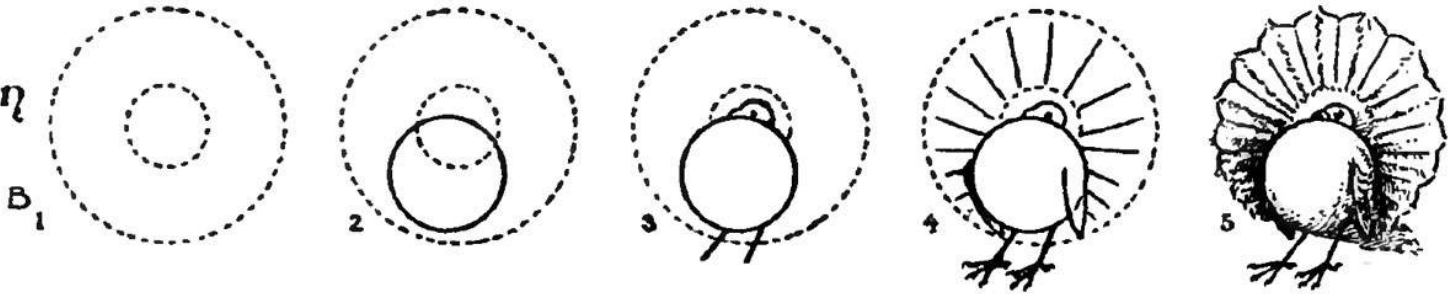

Humming-Birds

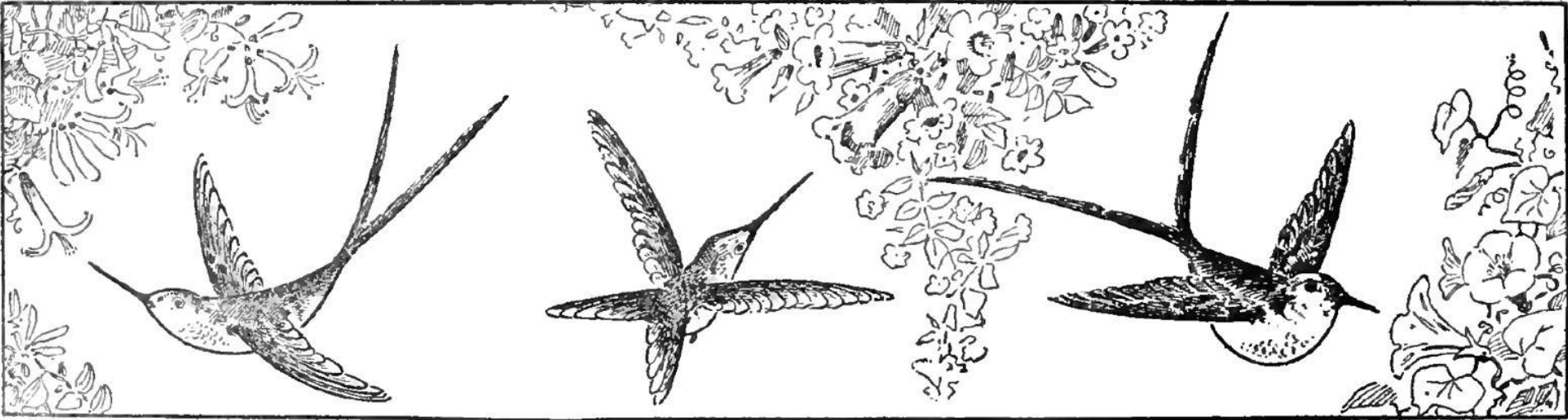
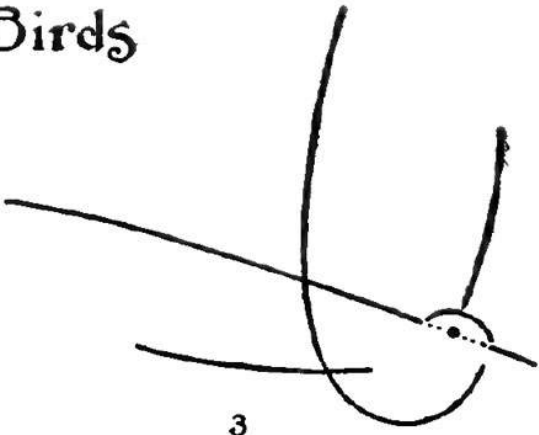
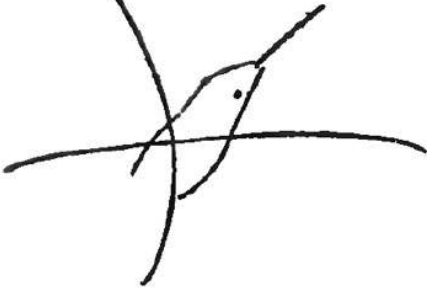
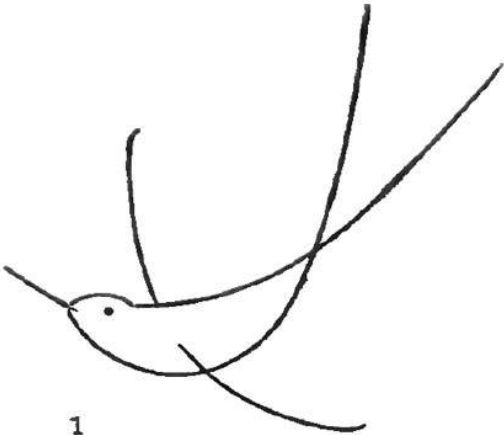

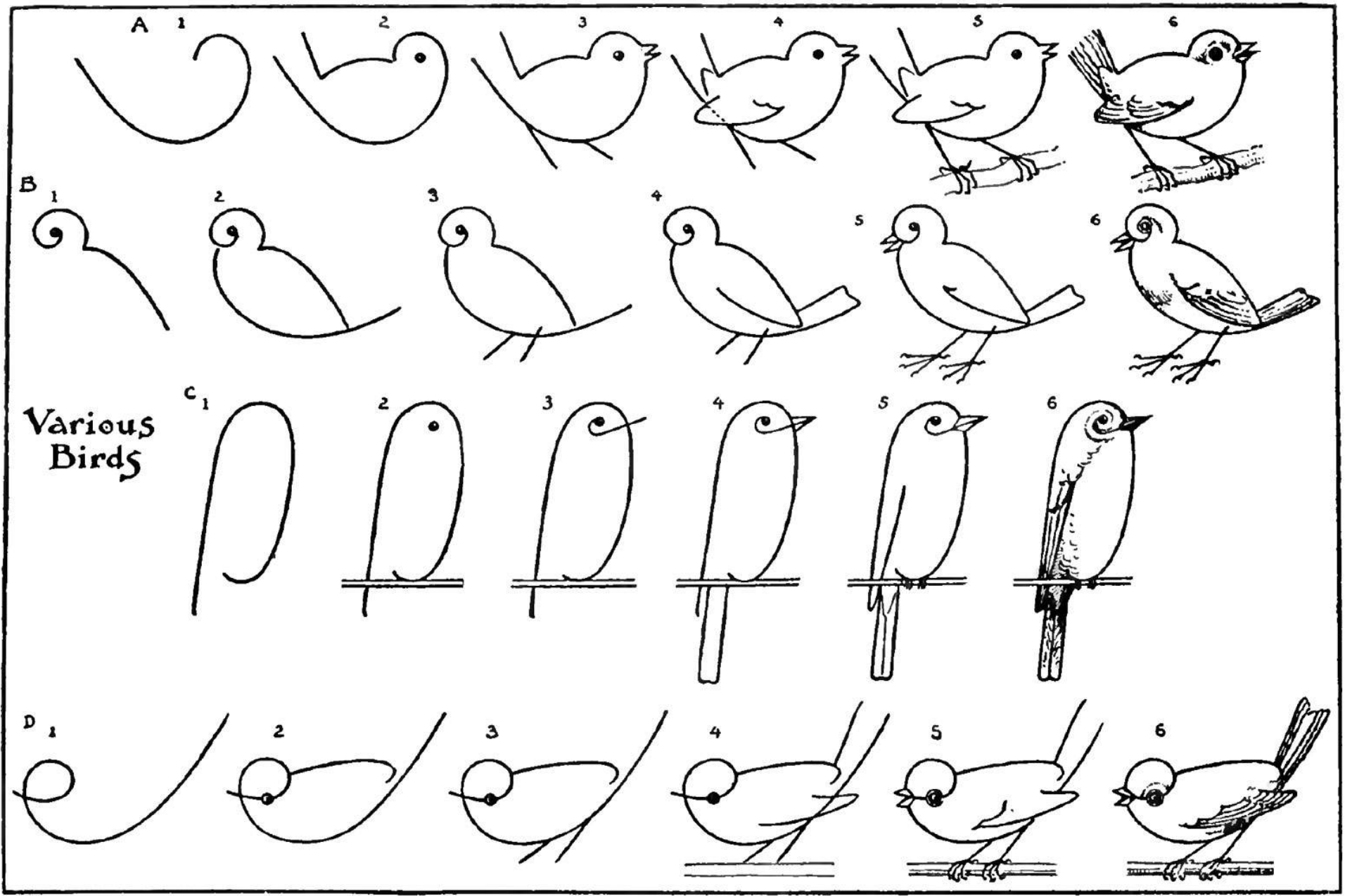

Various
Birds

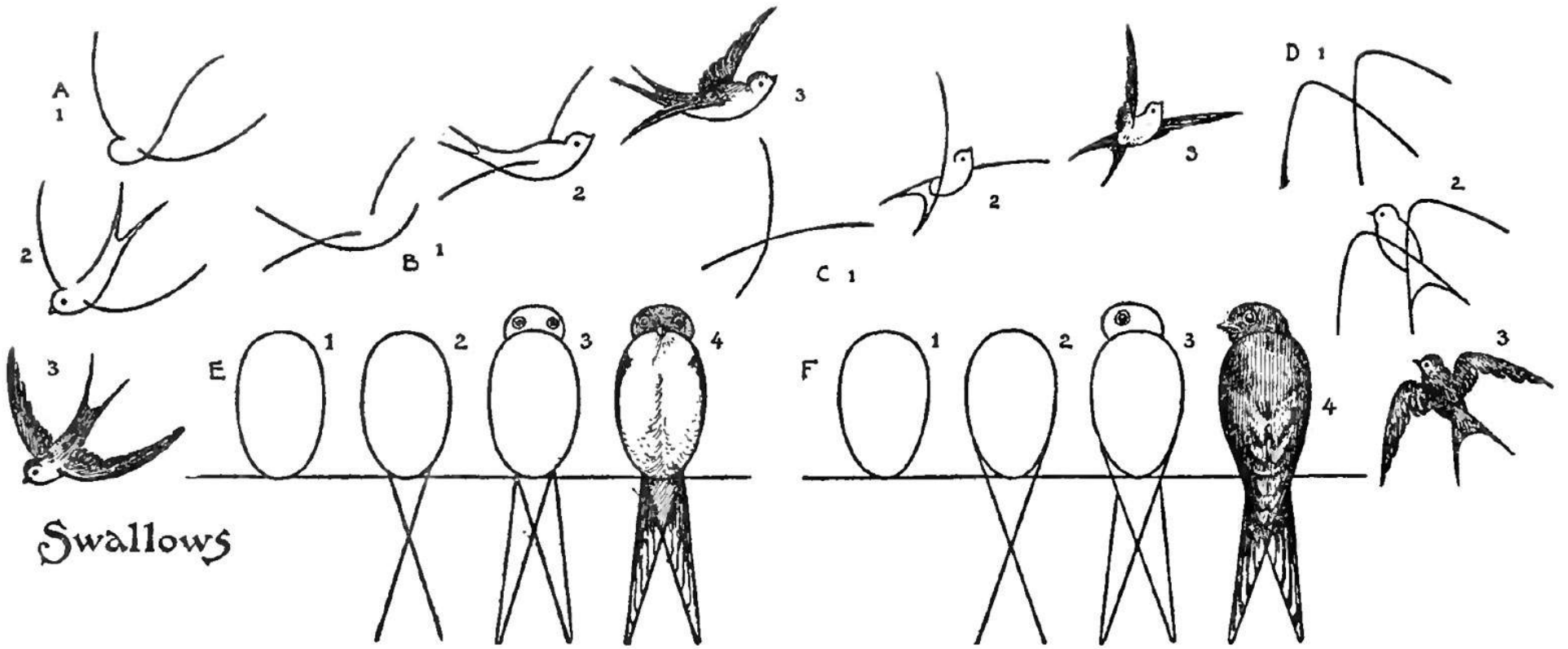

Swallows

Flying Birds

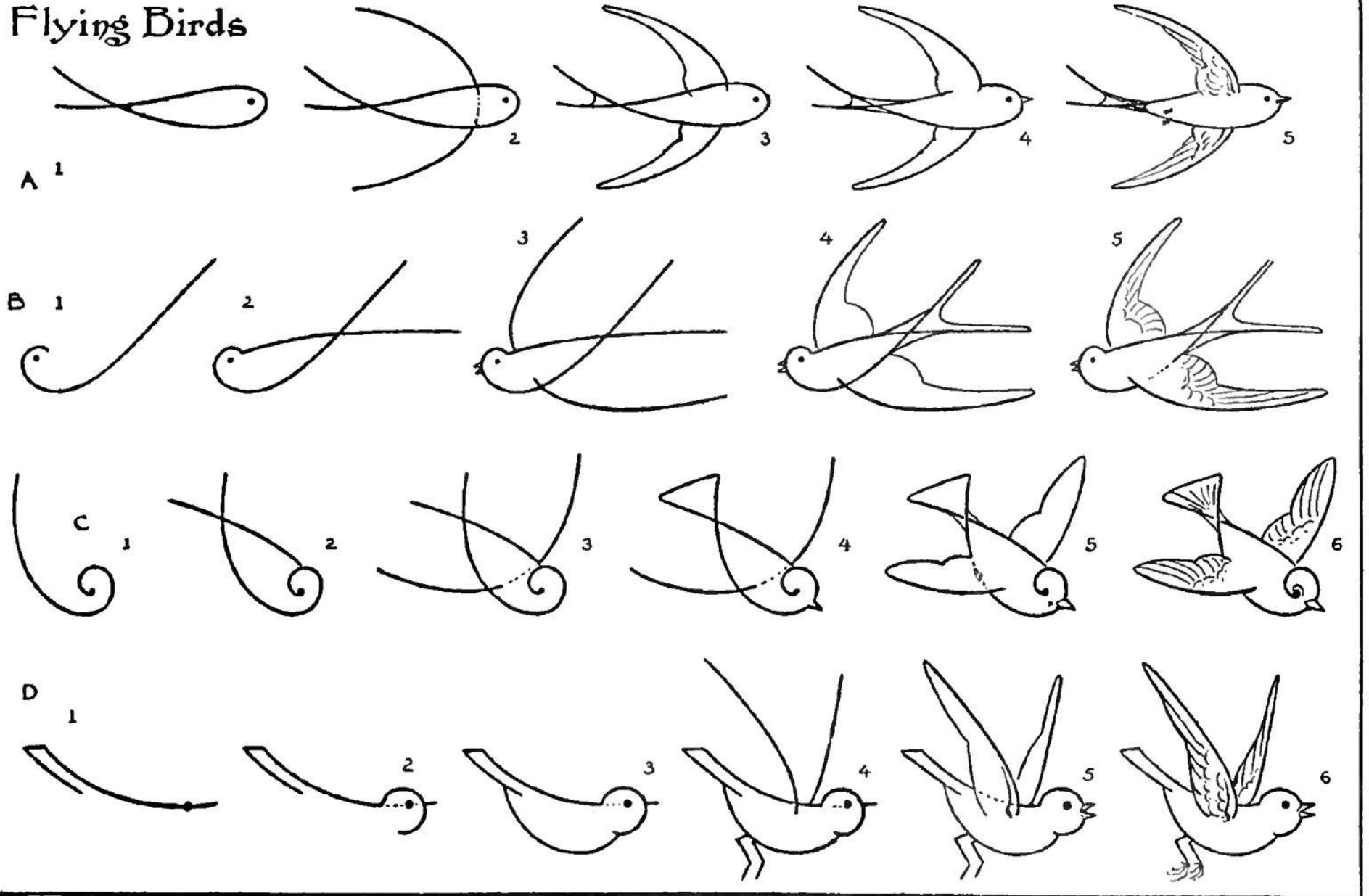

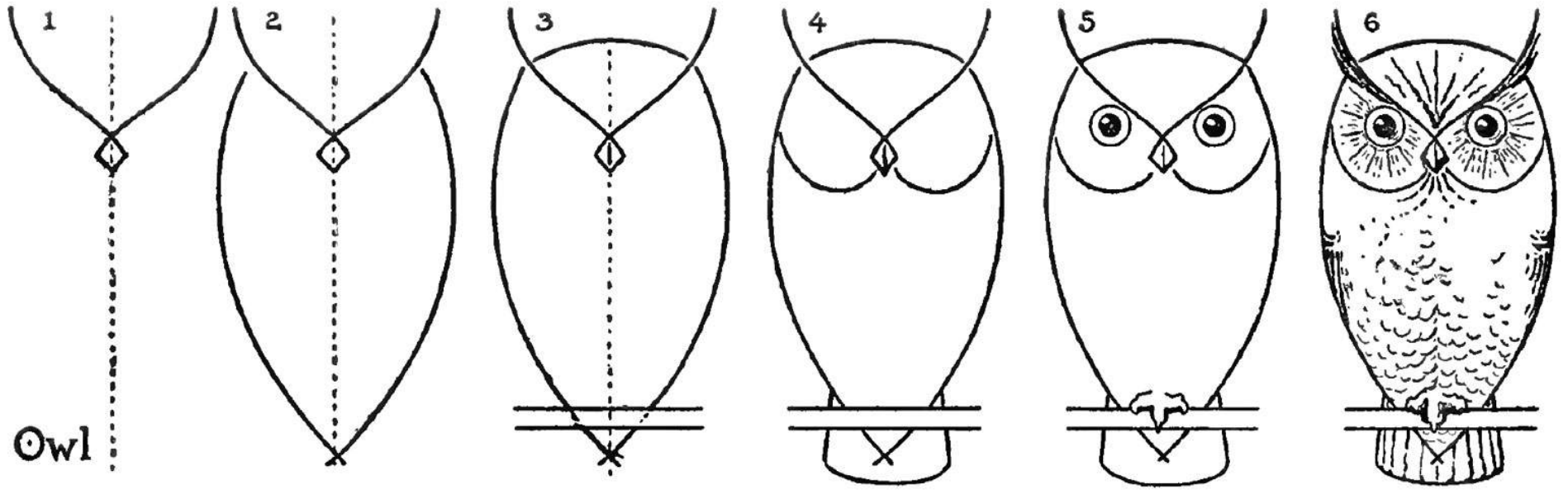

Owl

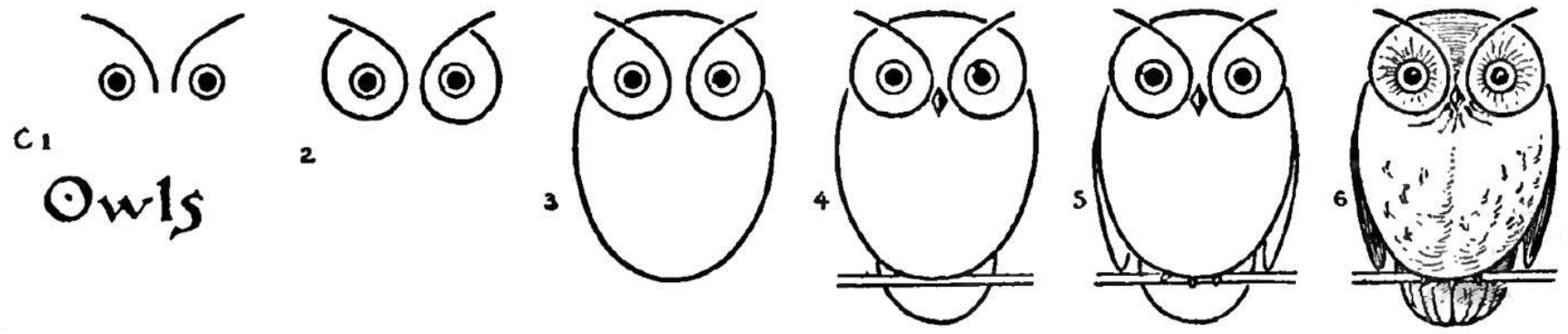
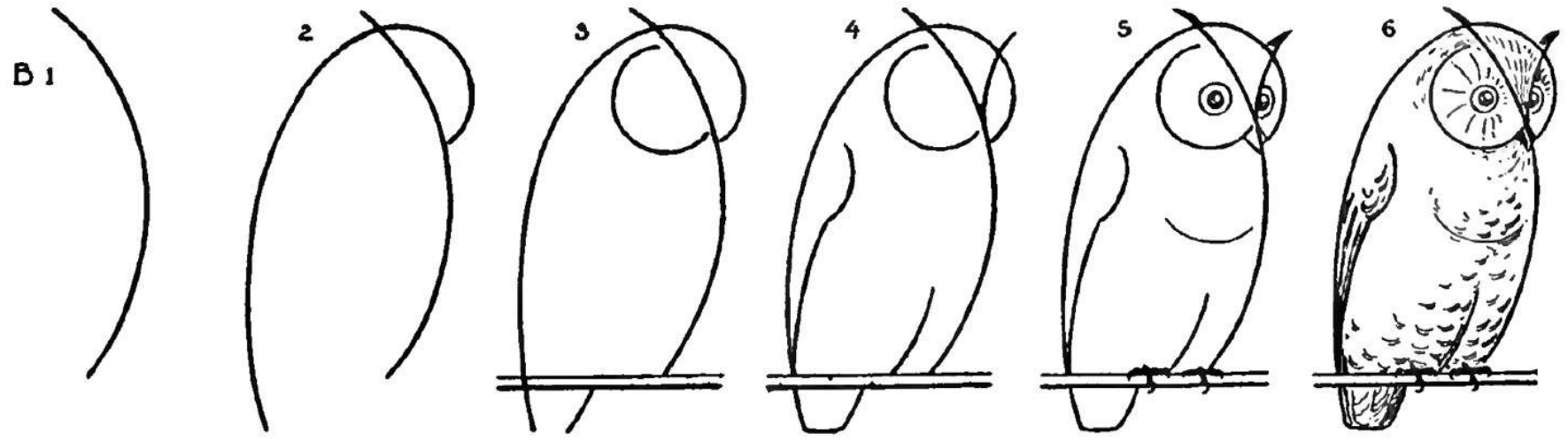
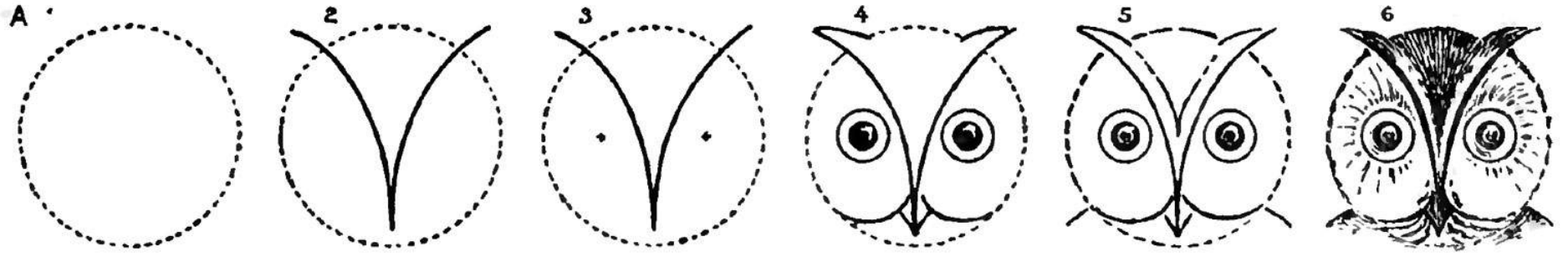

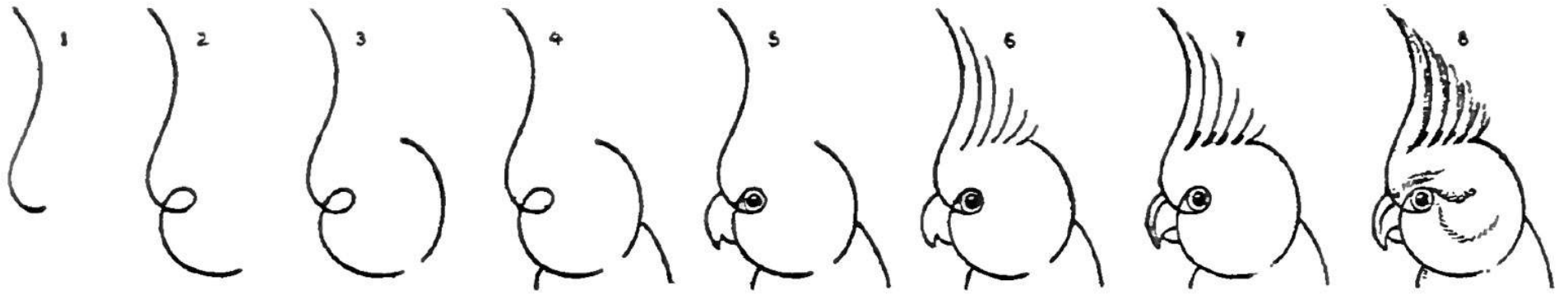

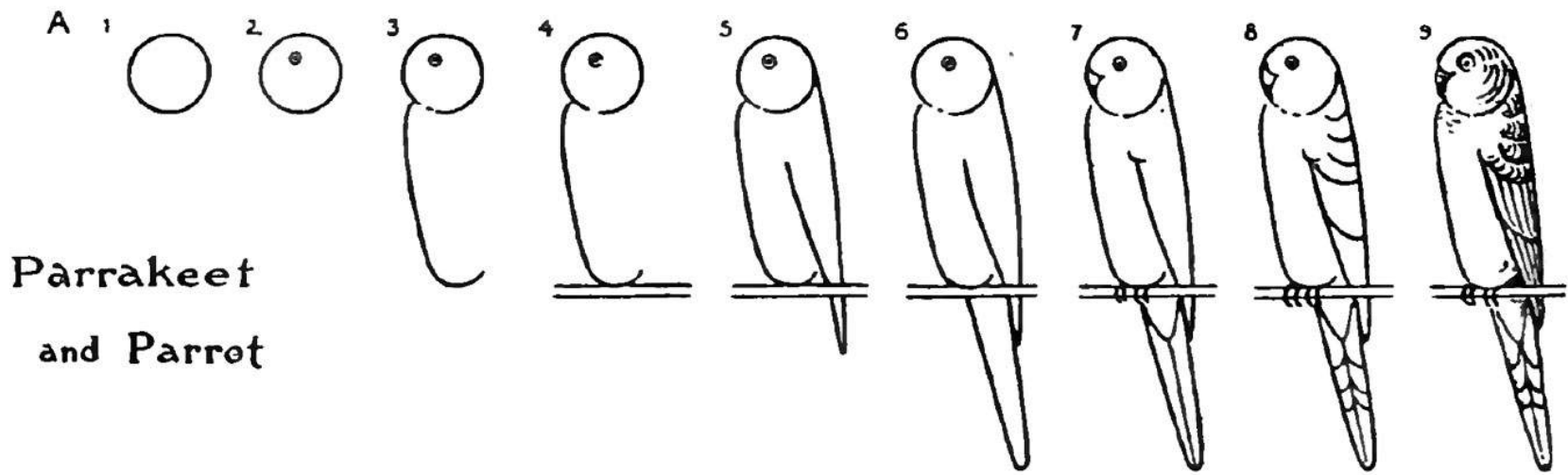

**Parrakeet
and Parrot**

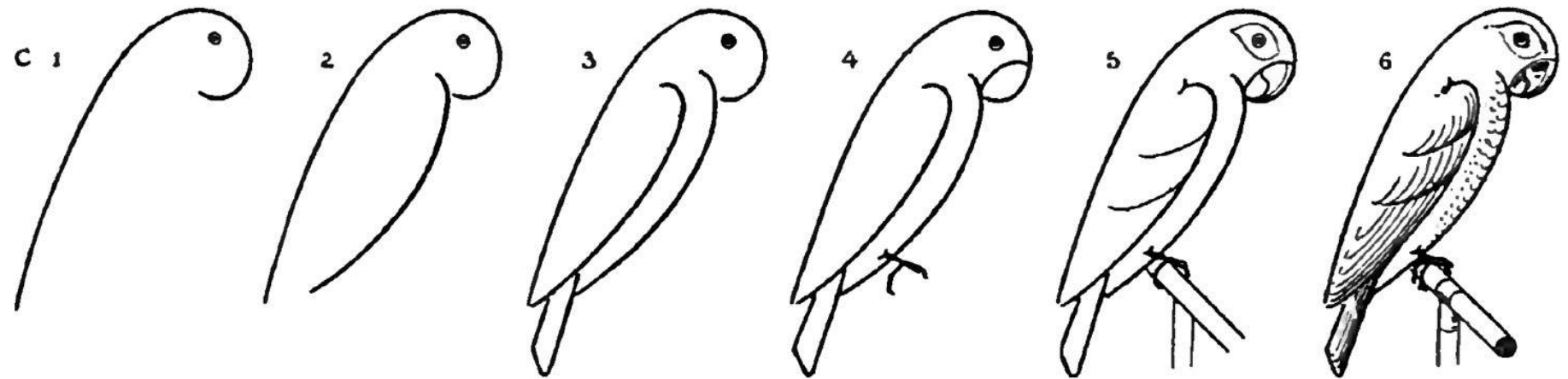
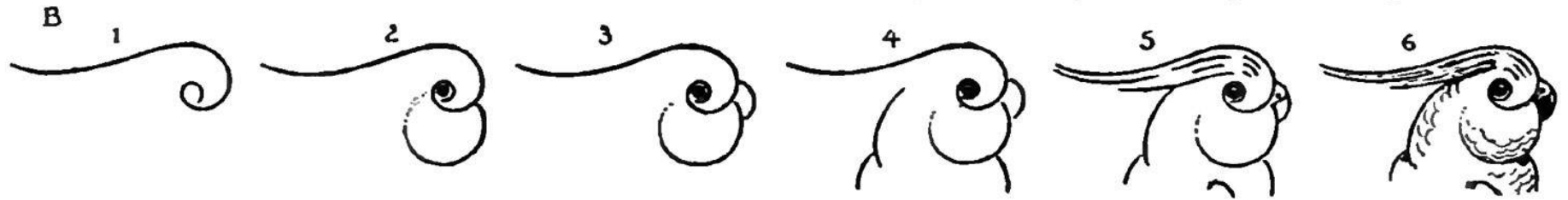

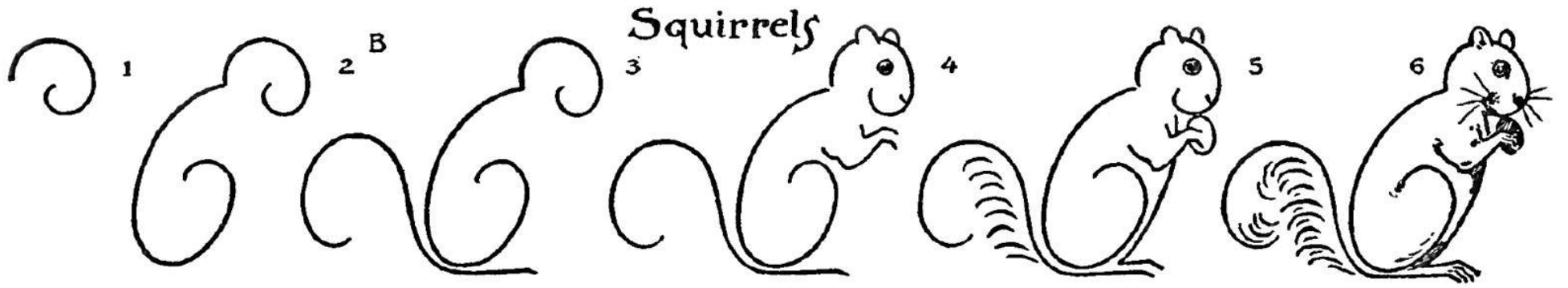
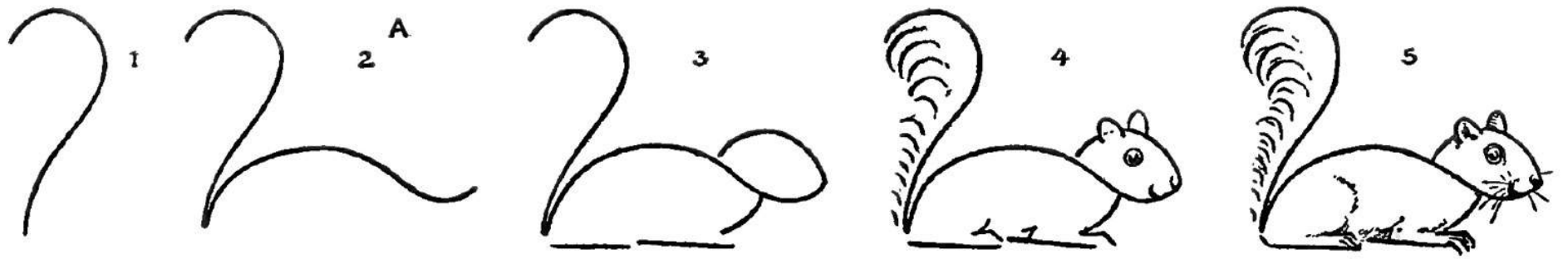

Squirrels



Bears

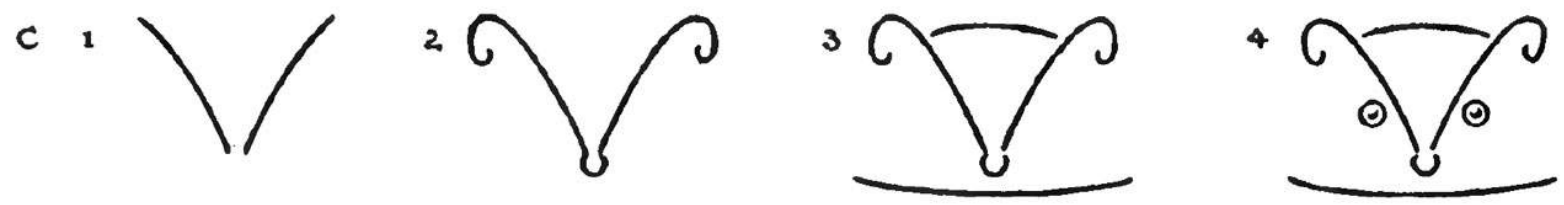
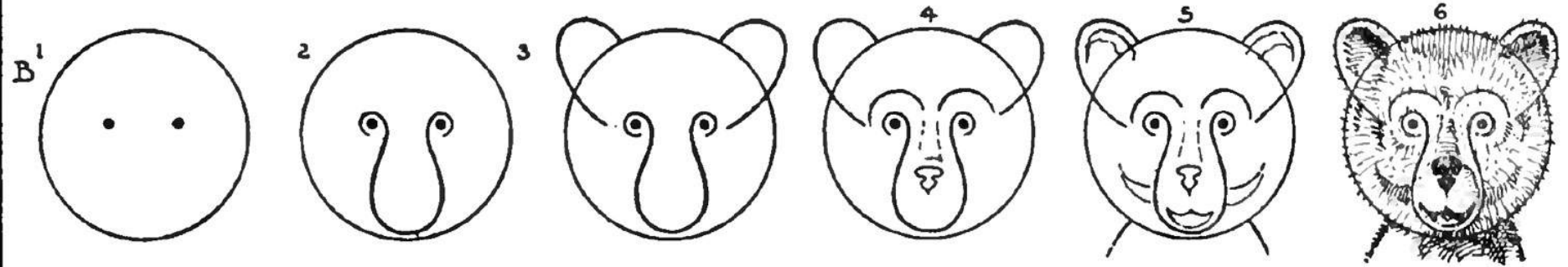

Raccoon

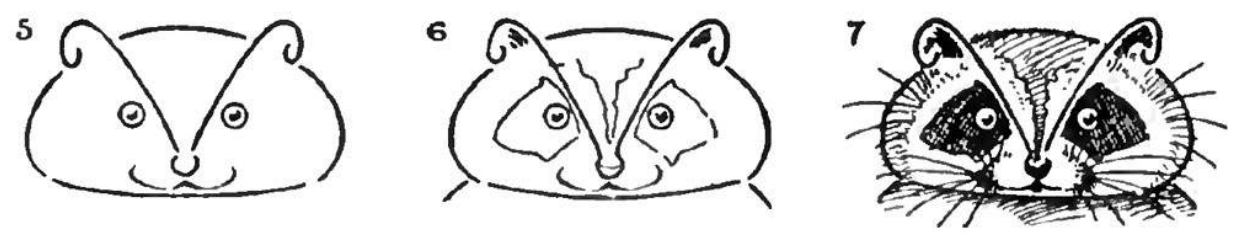

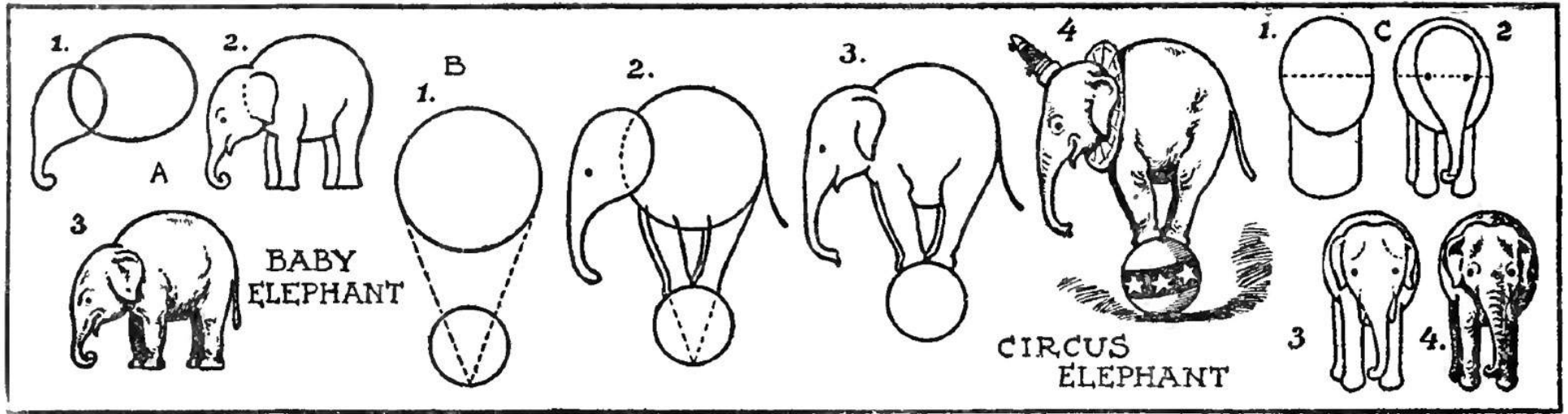

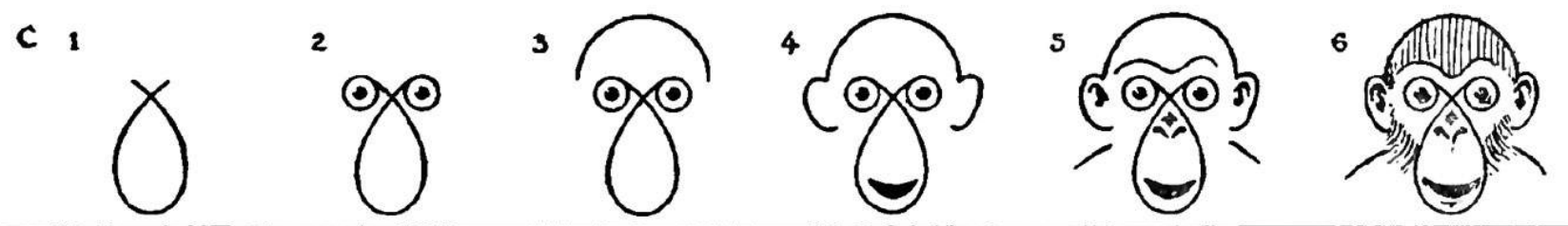
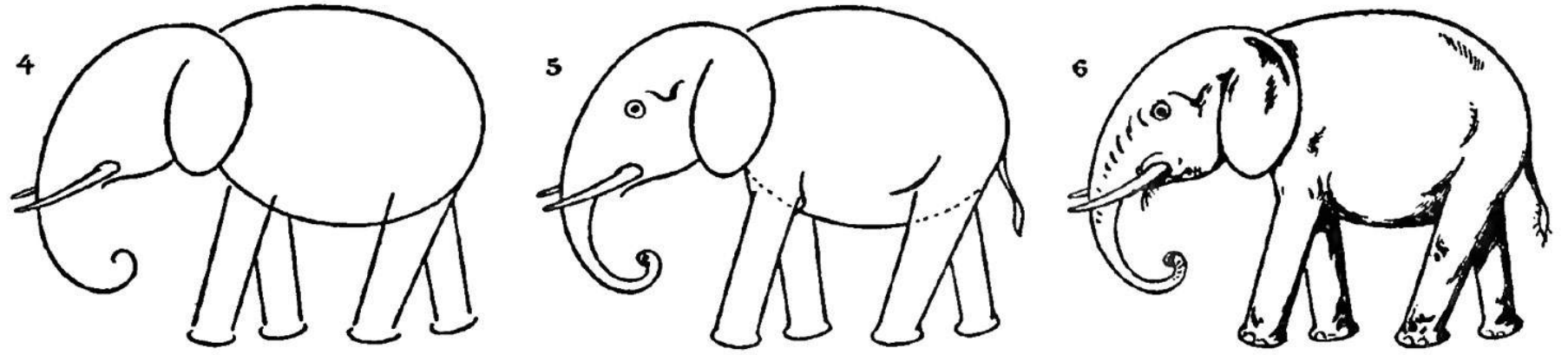
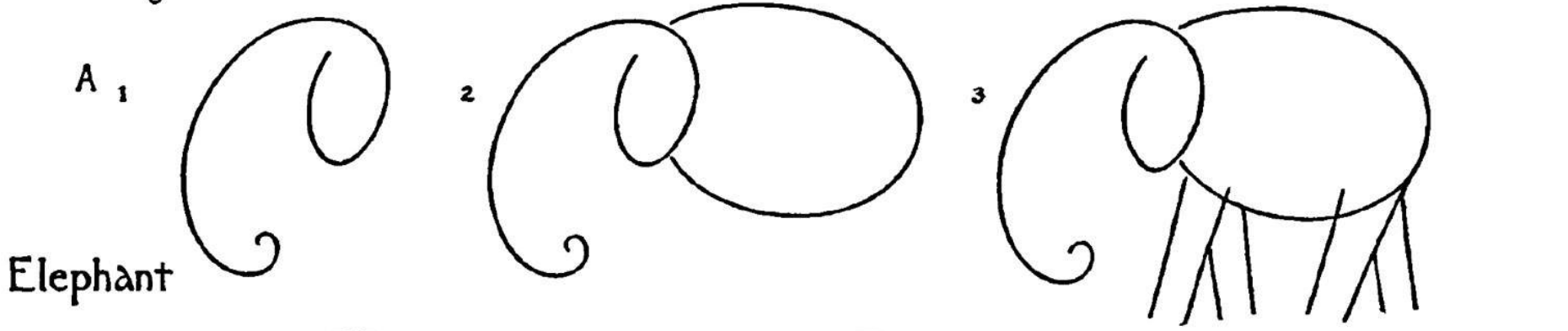

FIRST DRAW
A
RHOMBOID

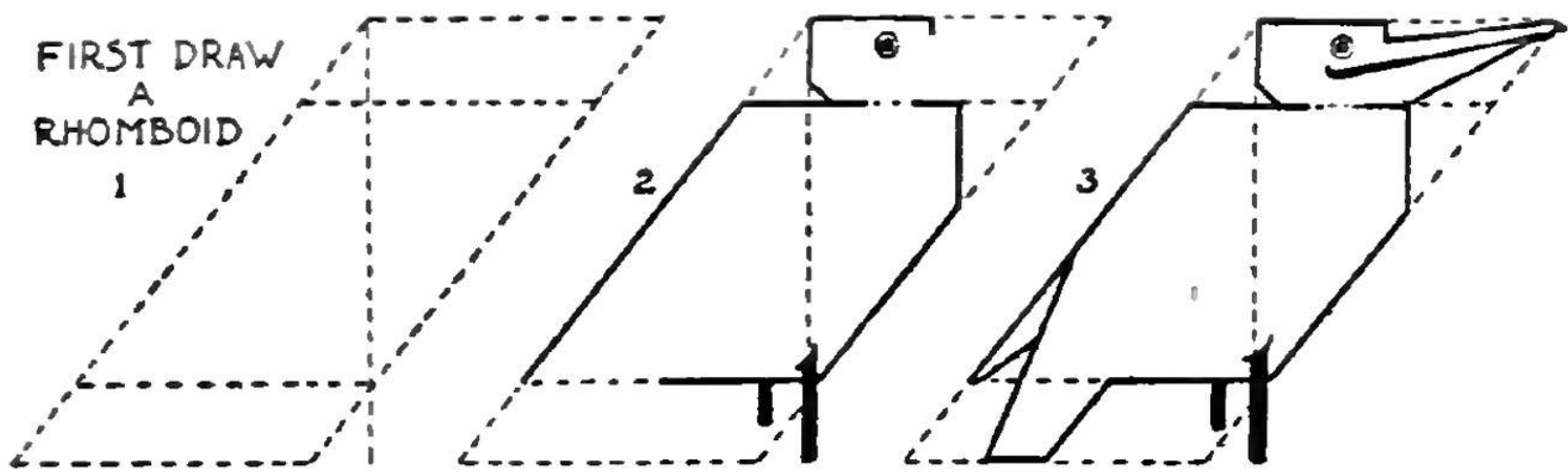

Pelican

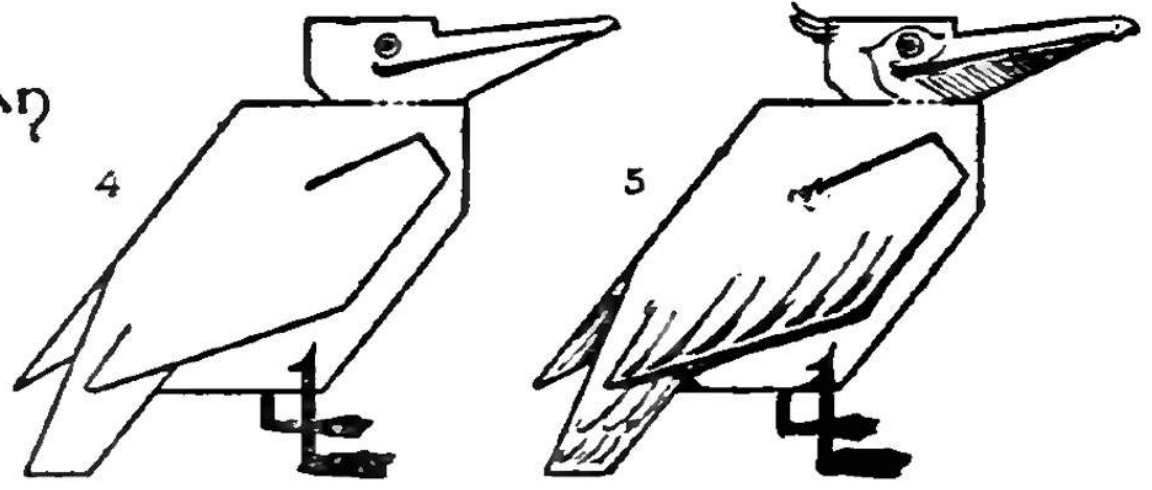

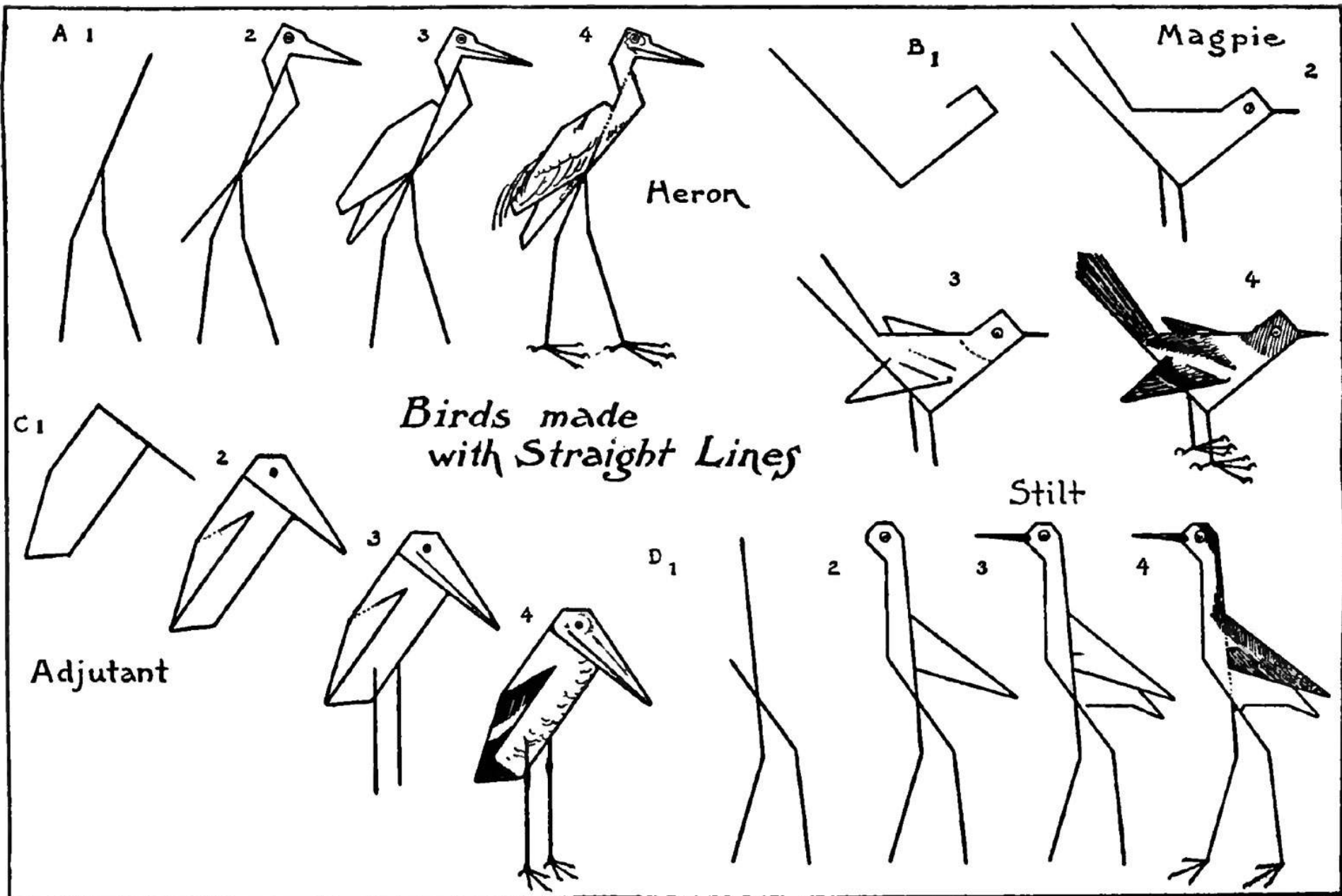

Kangaroo

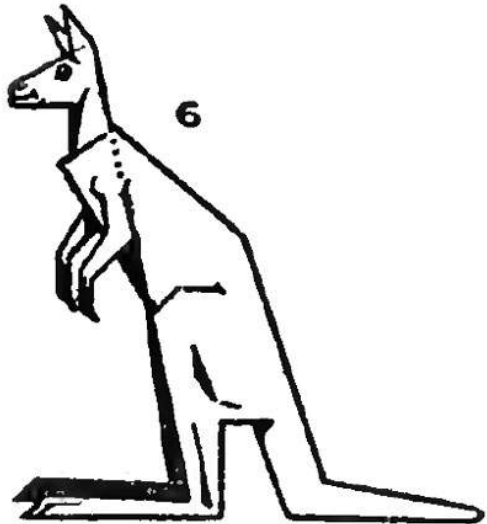
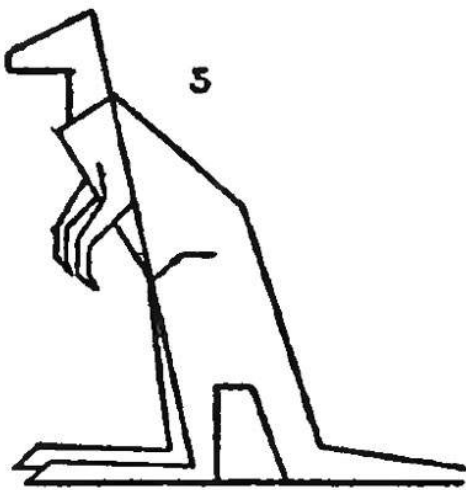
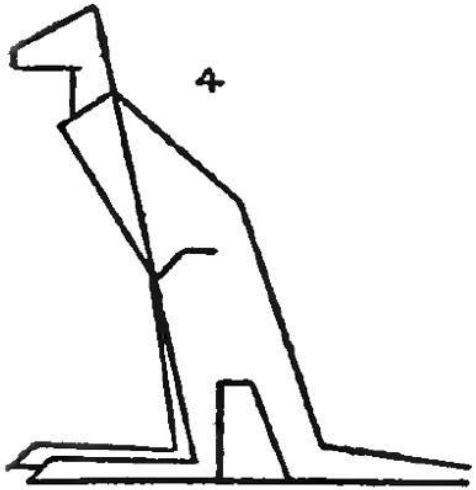
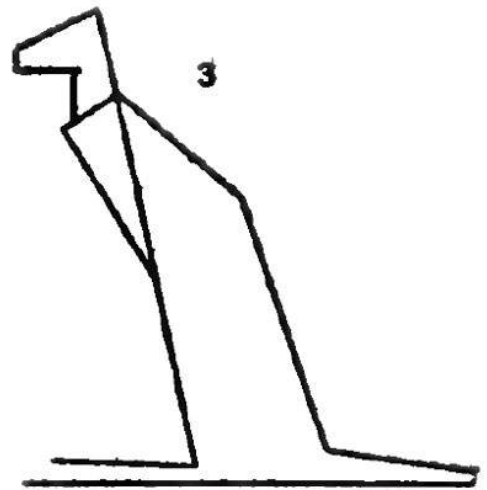
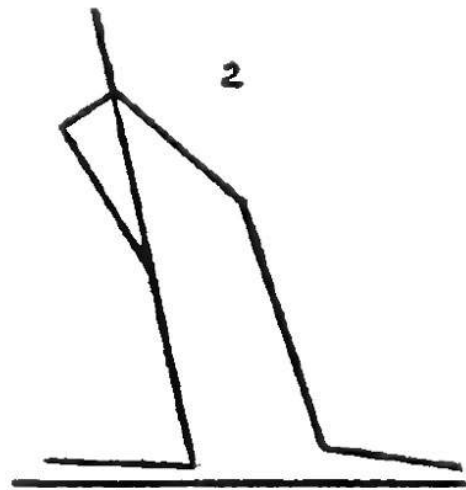
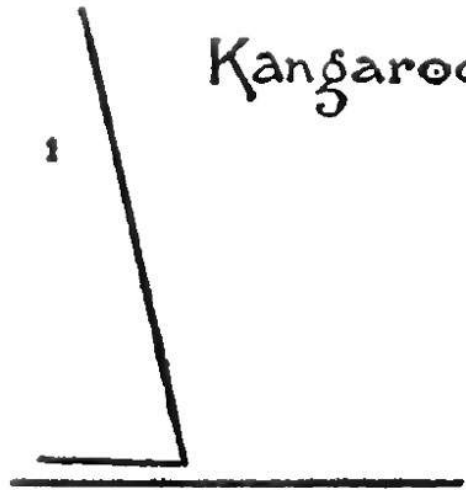

Giraffe and
Camel
Straight Line
Drawings

A 1

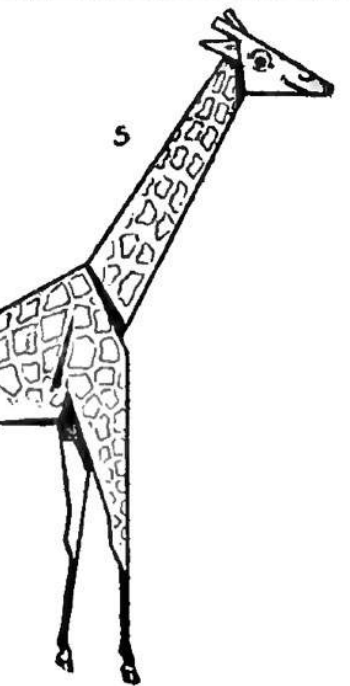
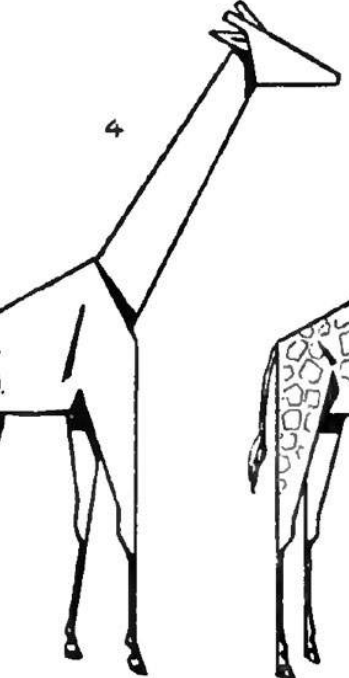
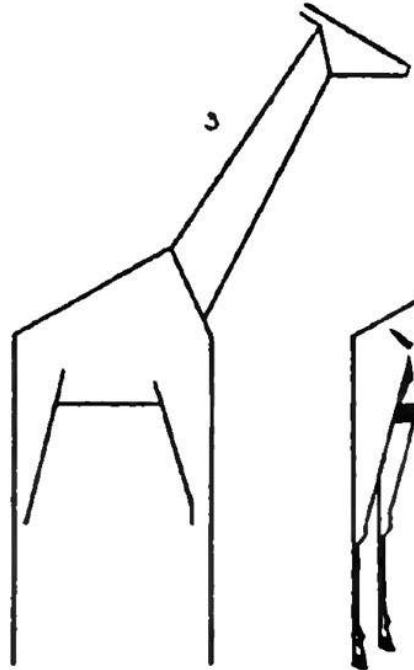
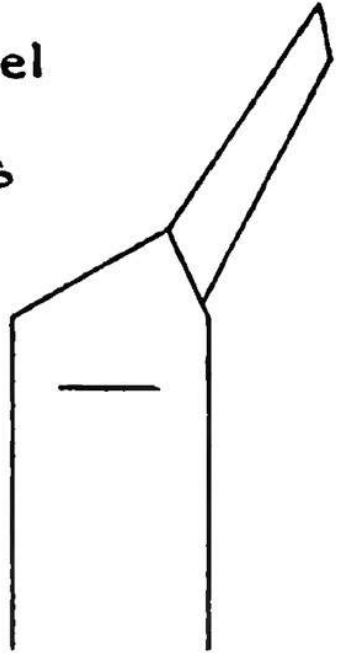
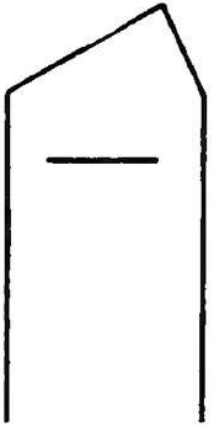

B 1



2

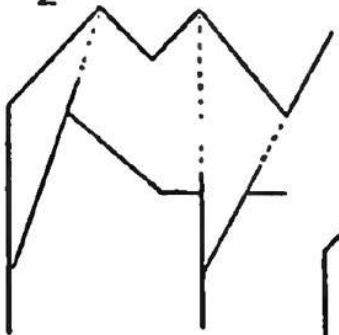

3

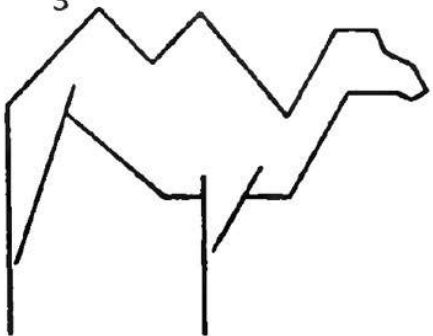

4

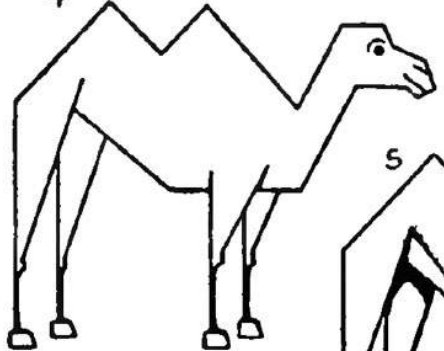

5

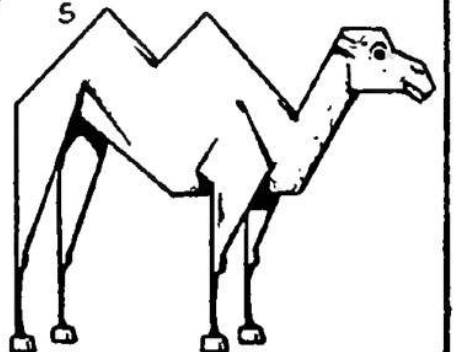

Drawing People

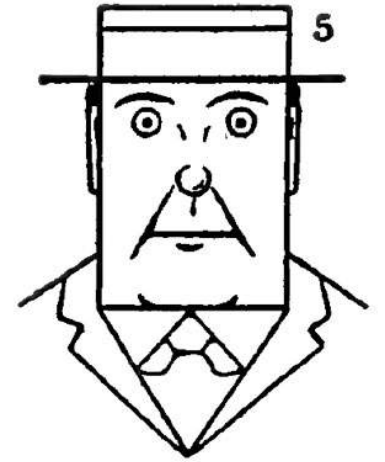
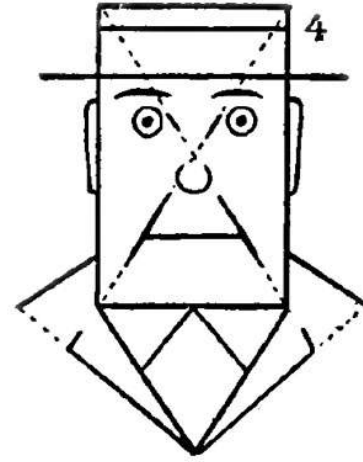
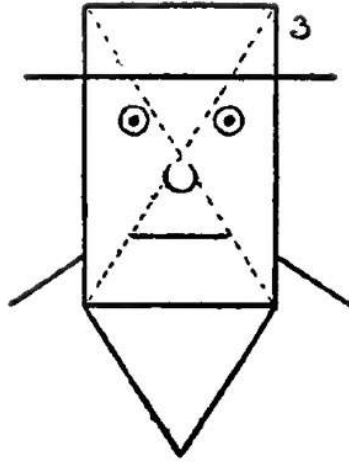
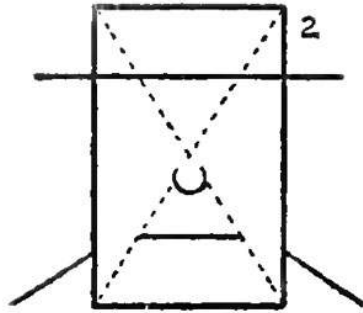
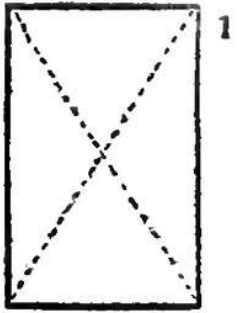

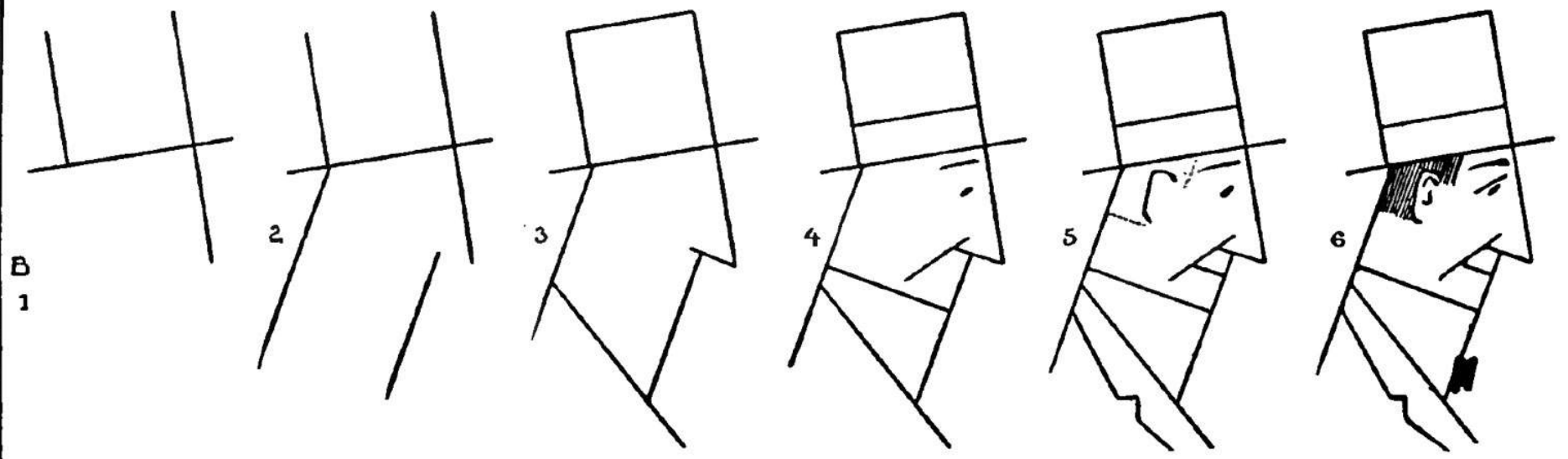
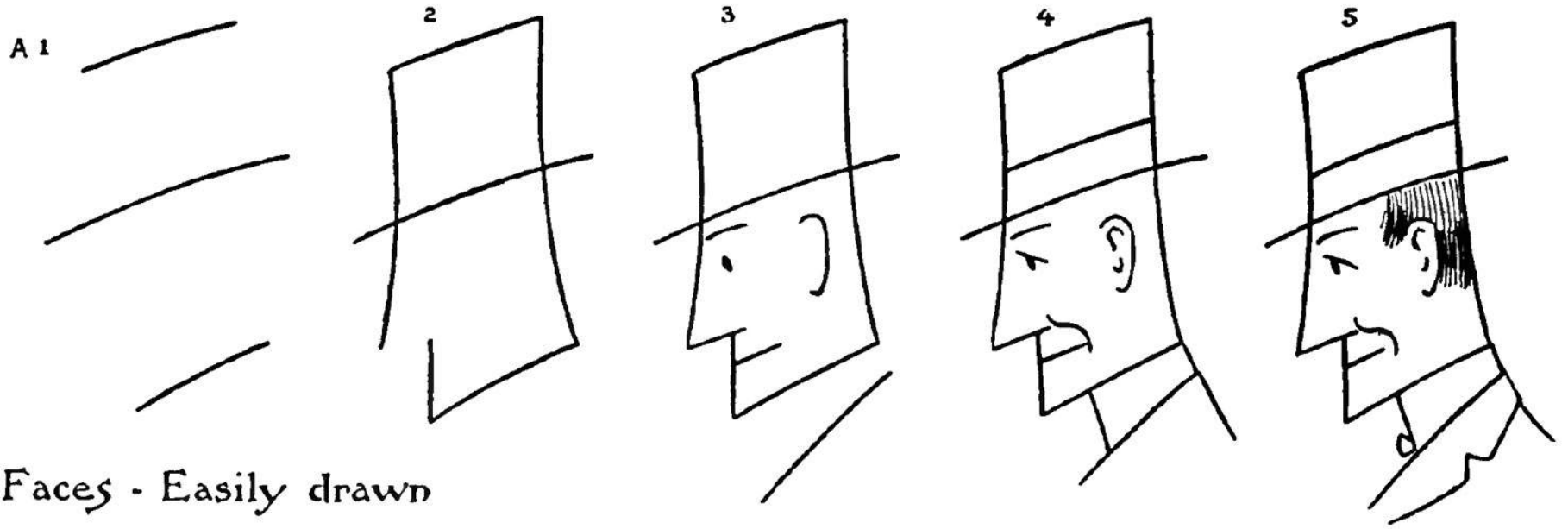

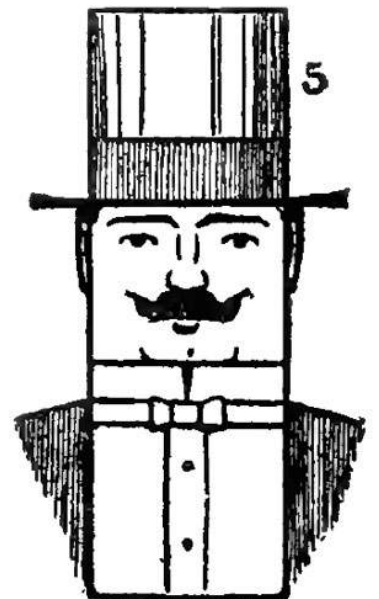
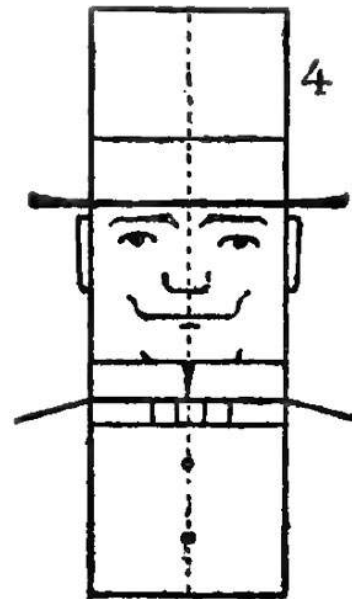
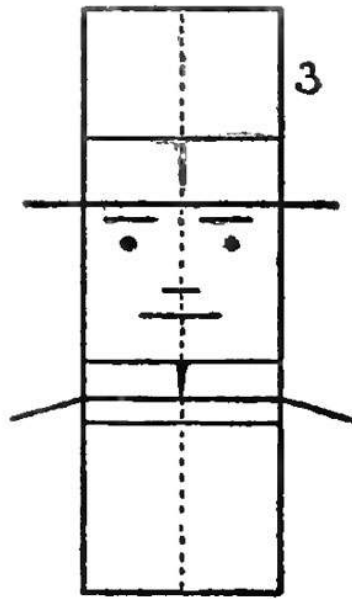
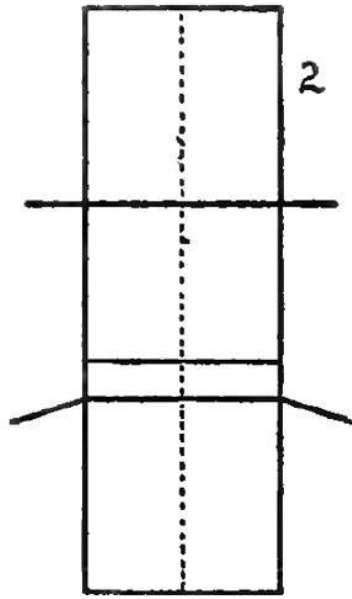
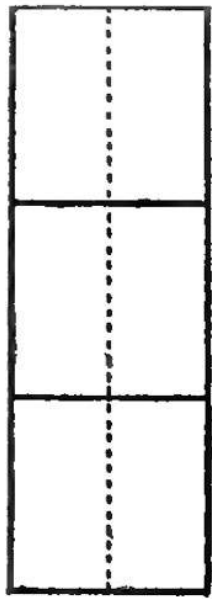

Figures - Men - Drawn with straight lines

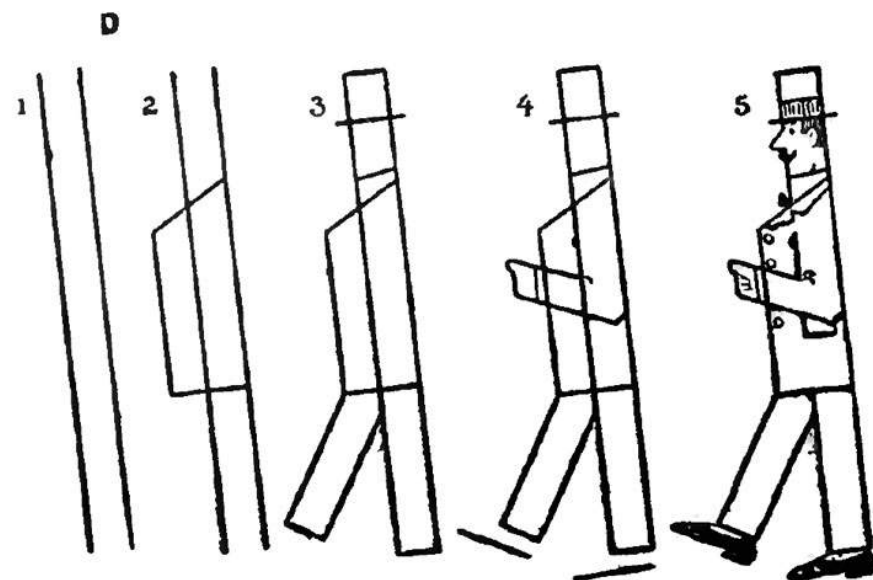
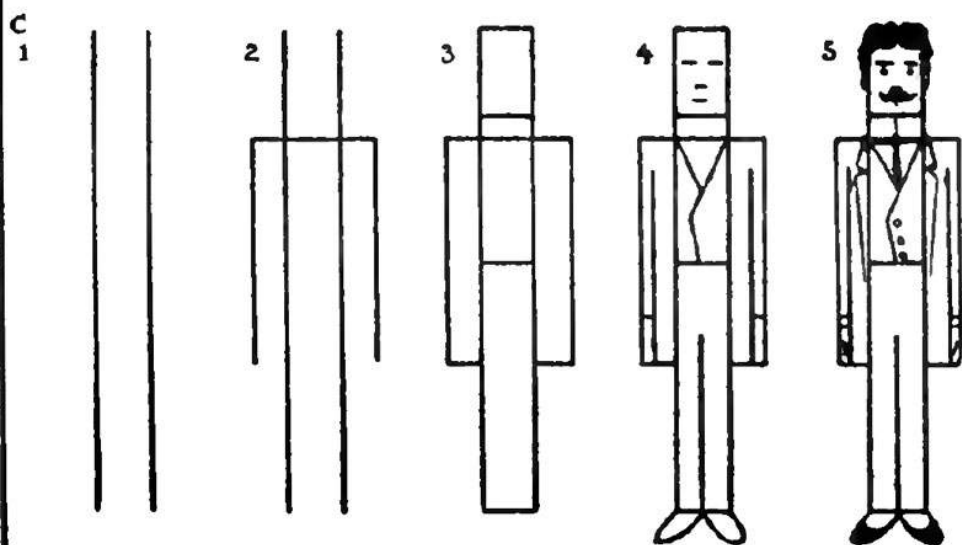
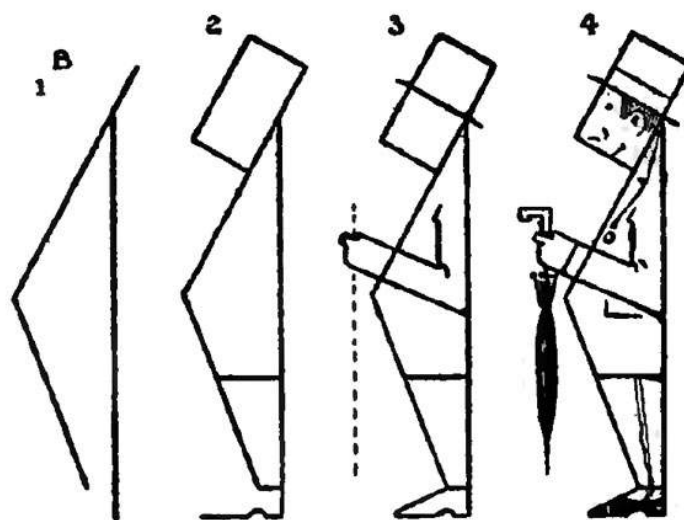
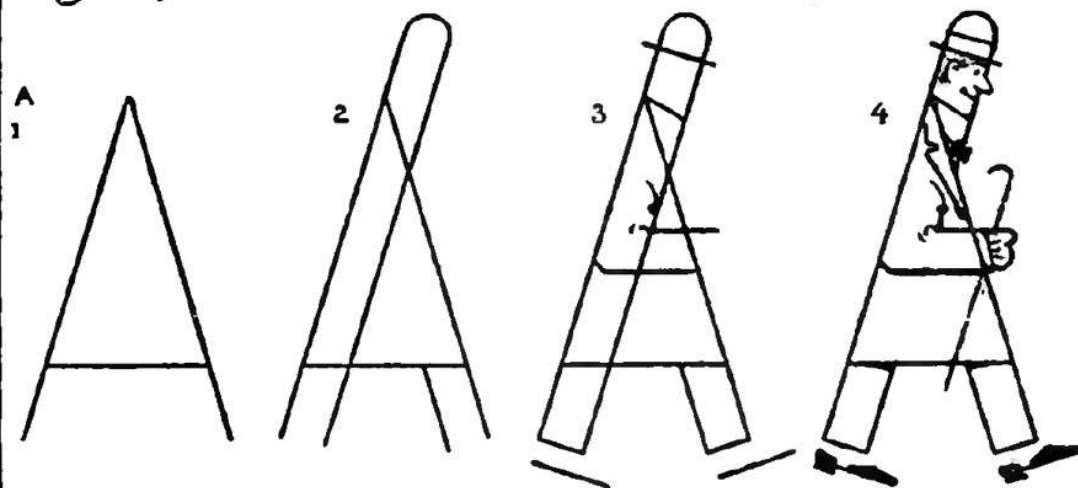

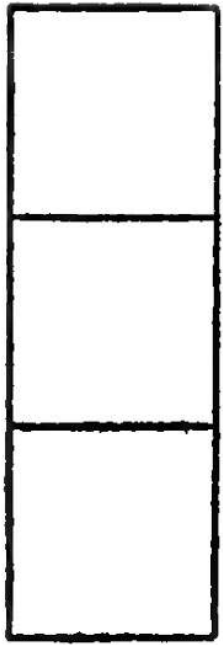

1 B

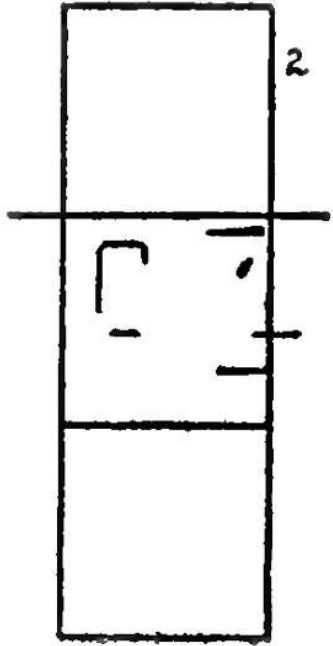

2

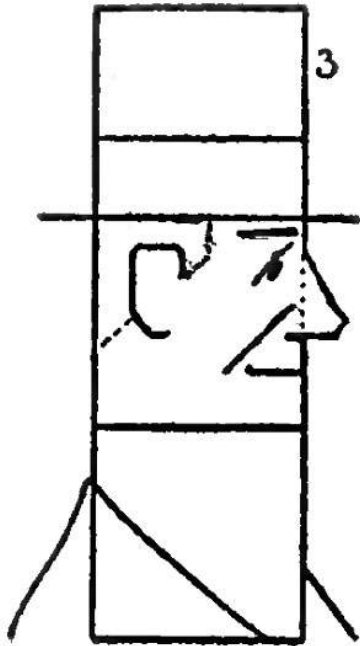

3

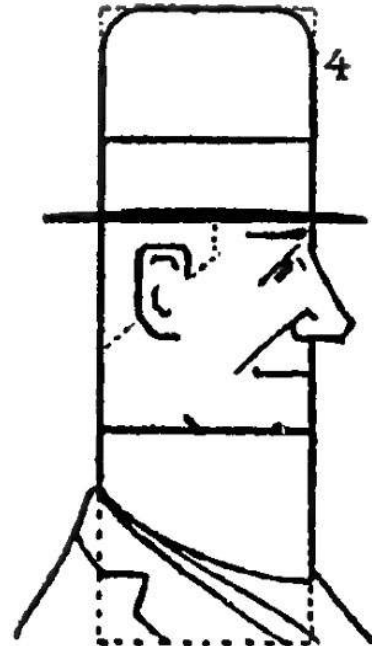

4

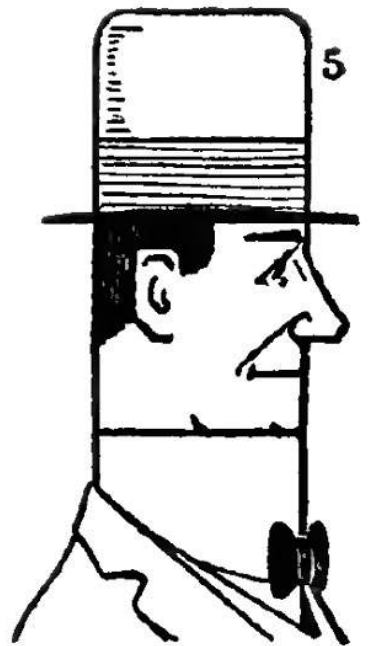

5

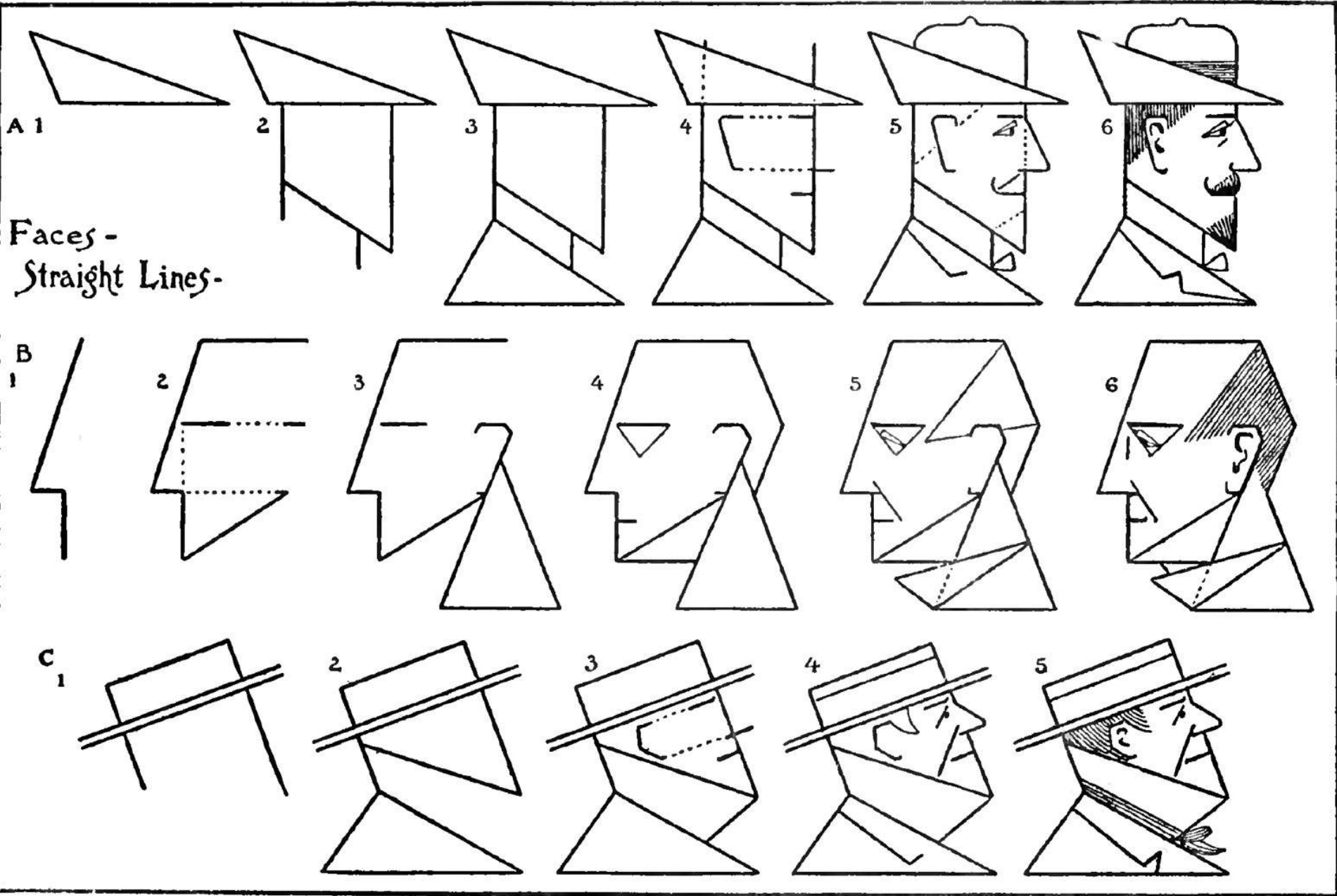

The Clown's.
Droll
Face

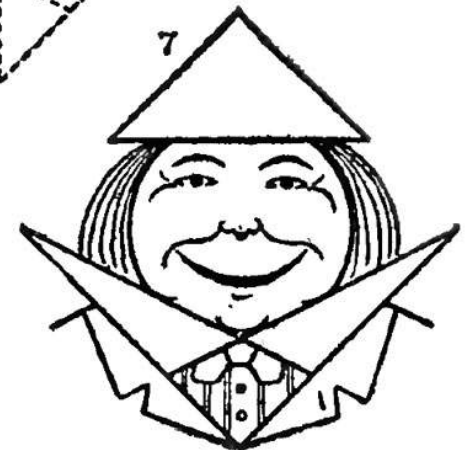
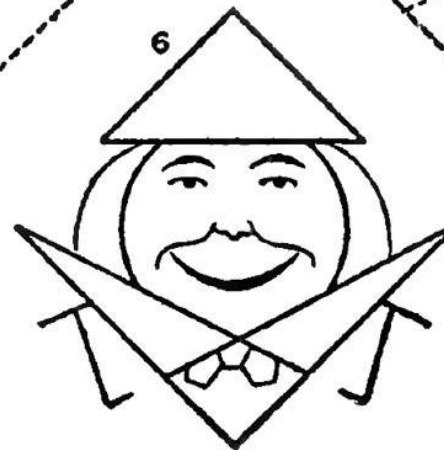
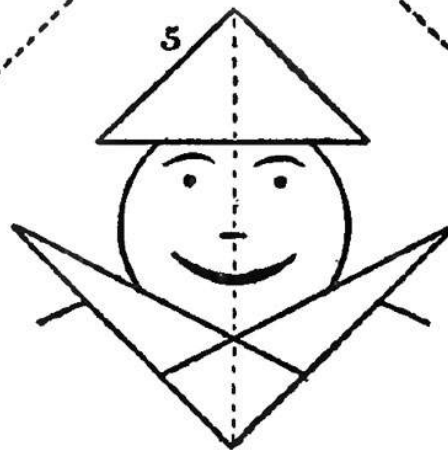
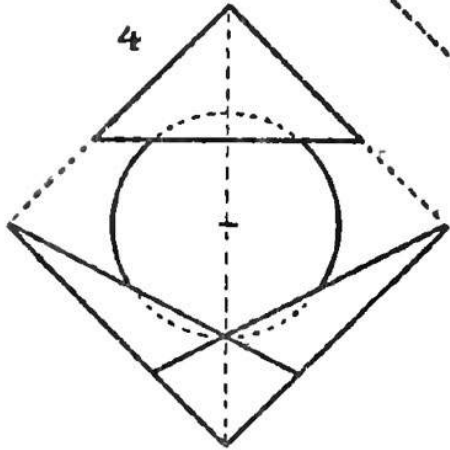
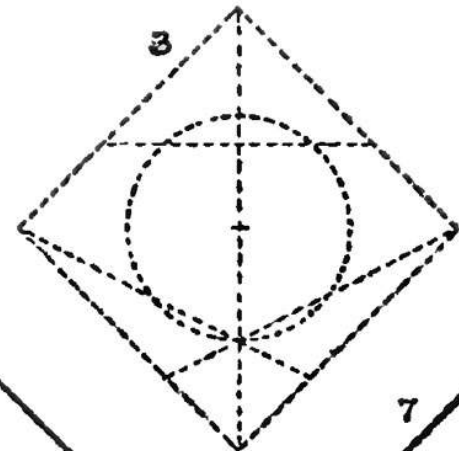
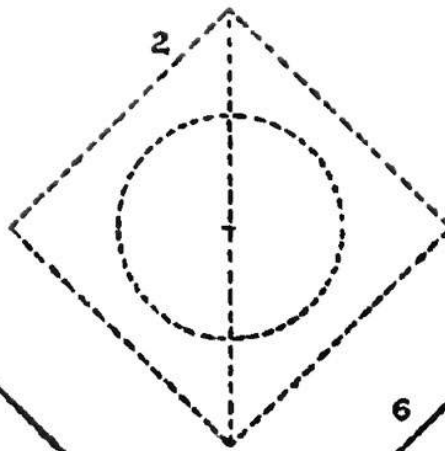
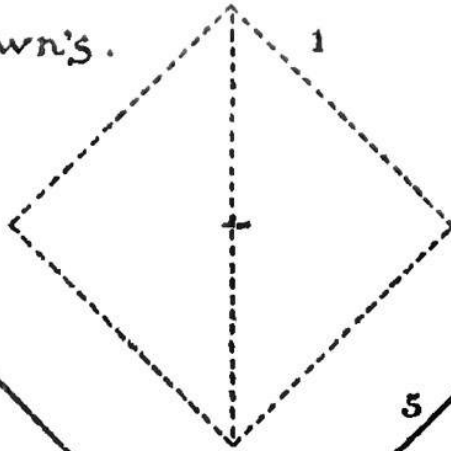

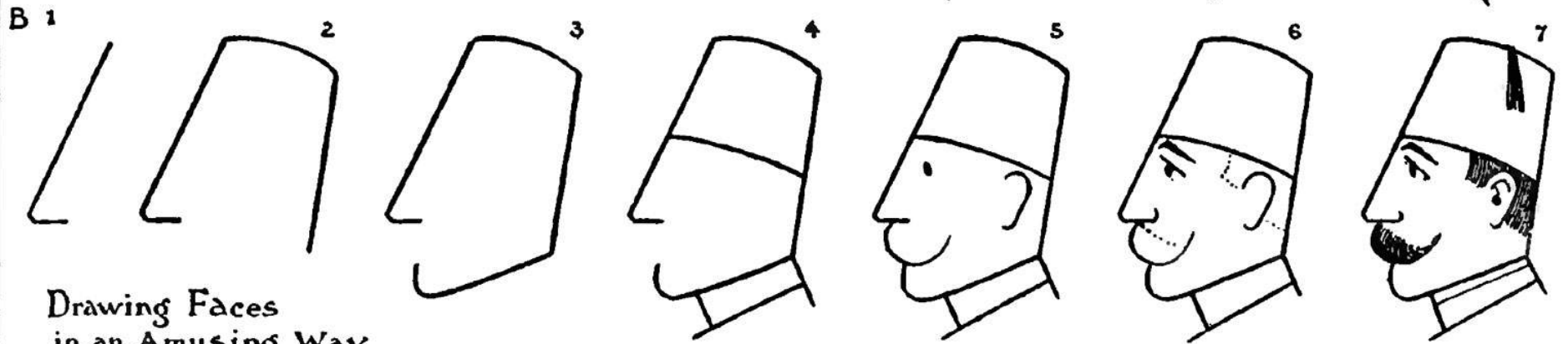
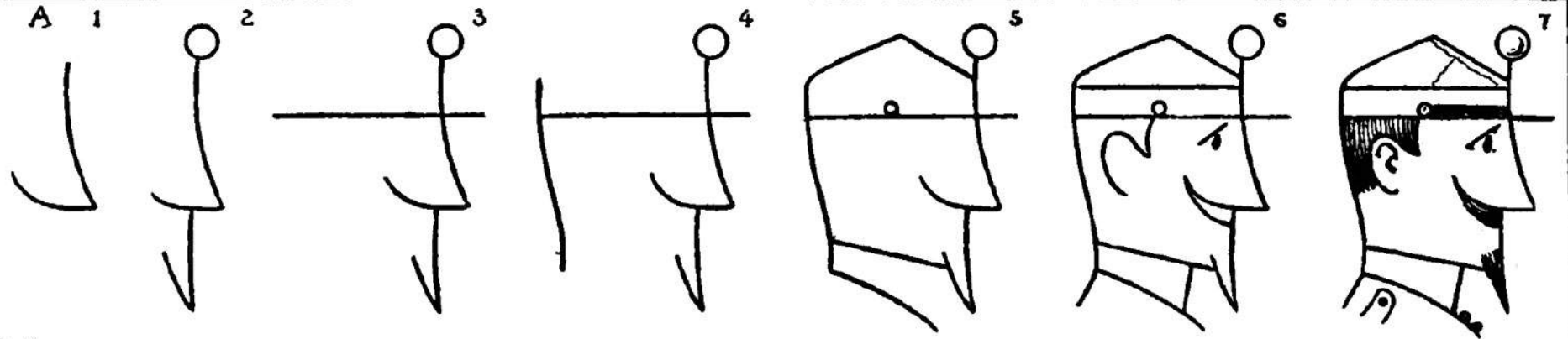

Drawing Faces
in an Amusing Way

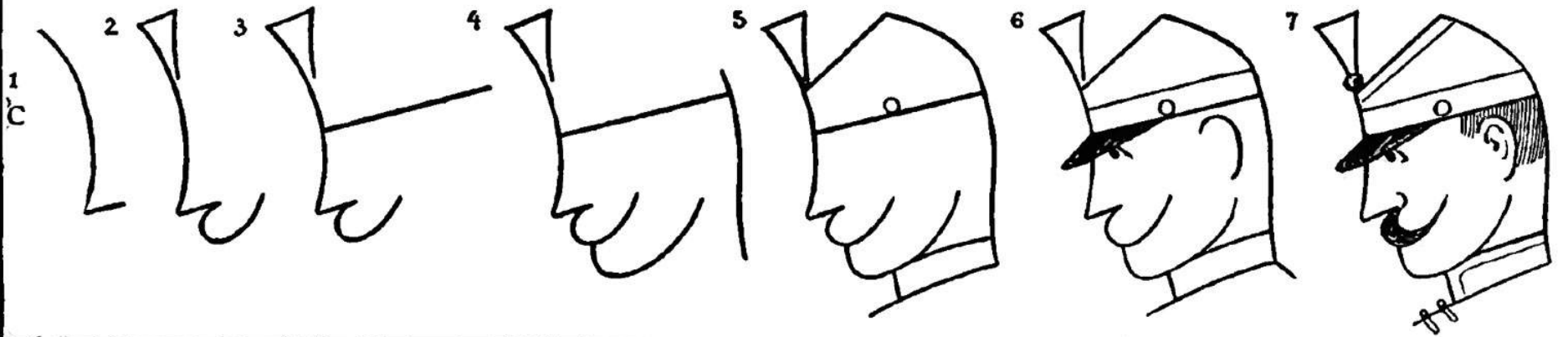

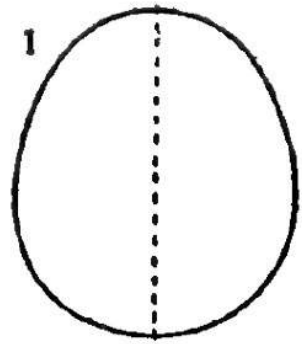

A
Mirthful
Countenance

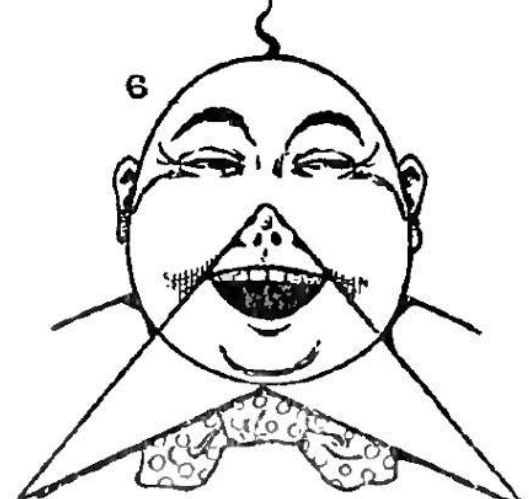
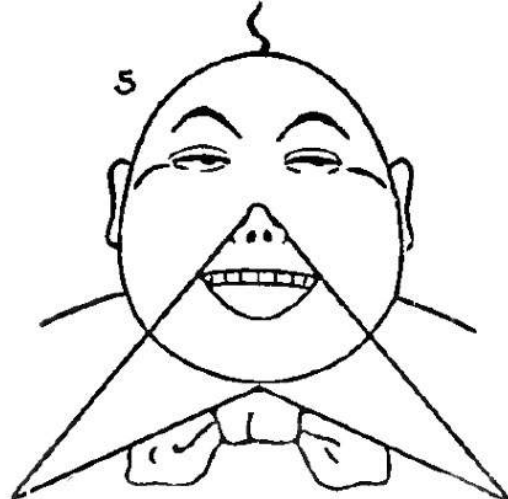
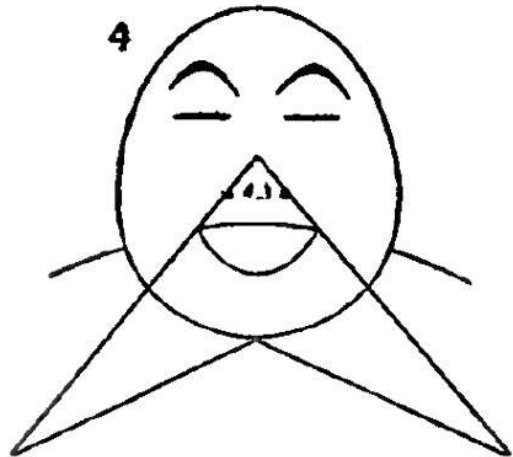
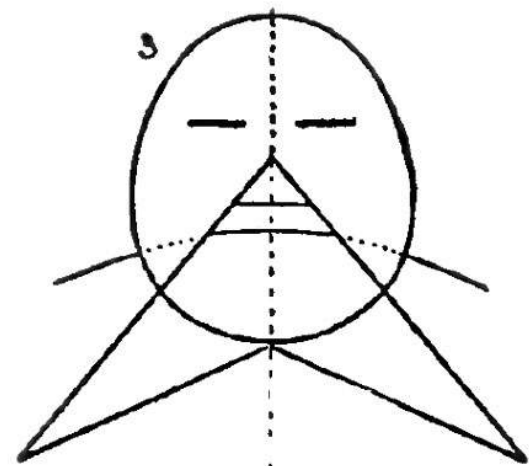
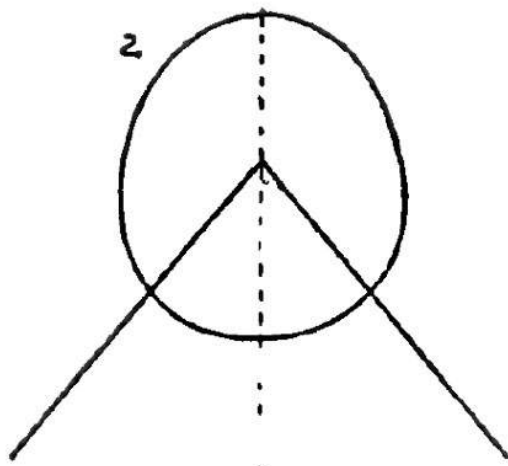

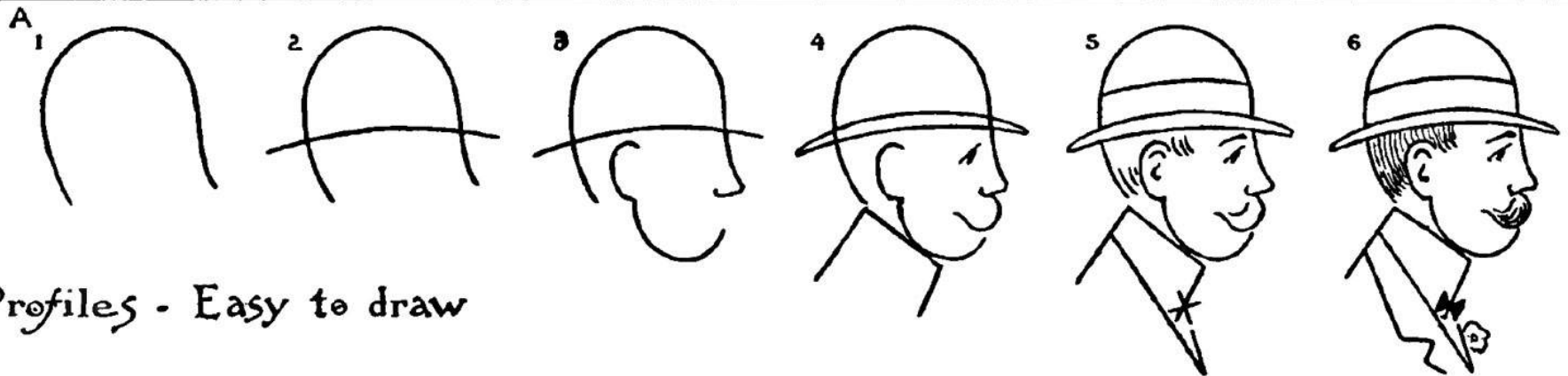

Profiles - Easy to draw

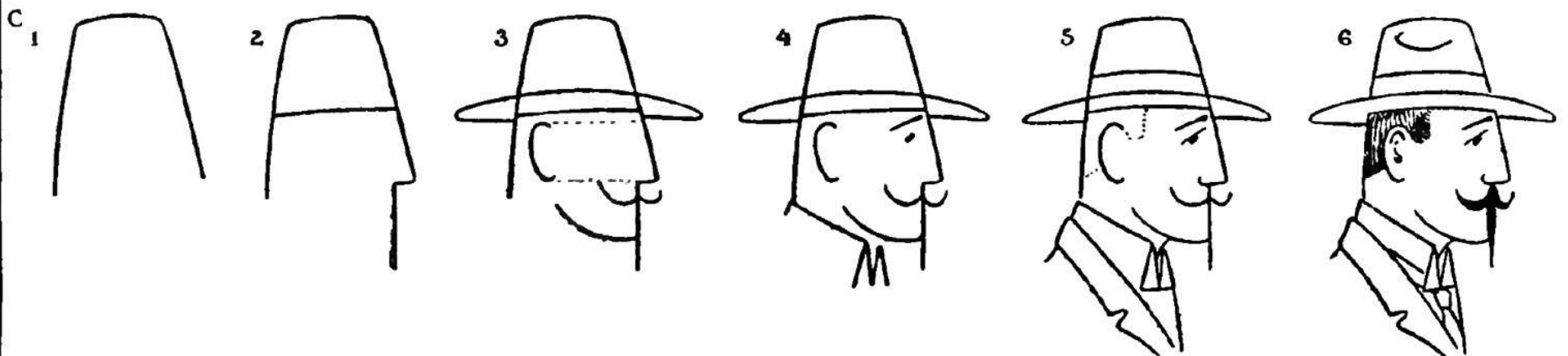
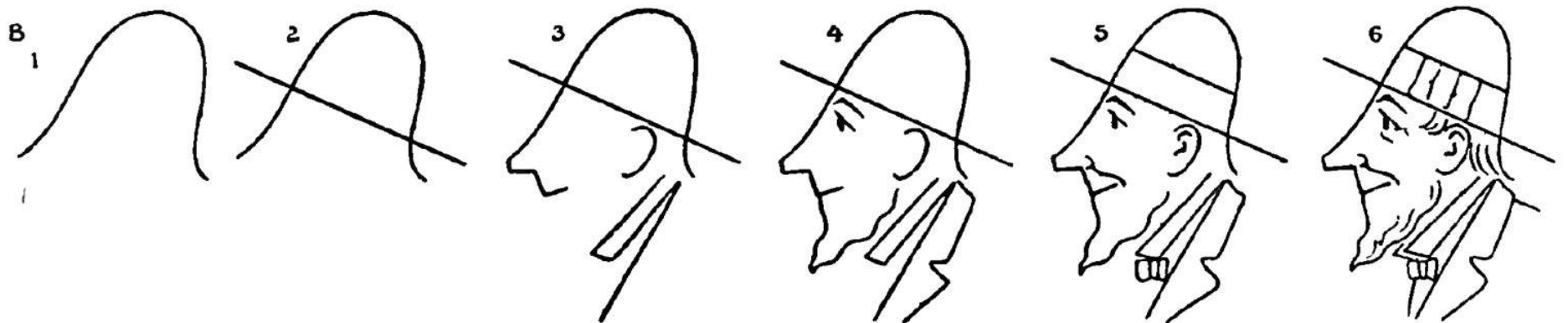

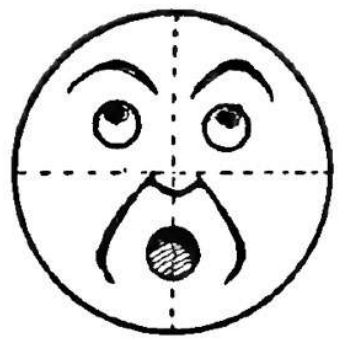
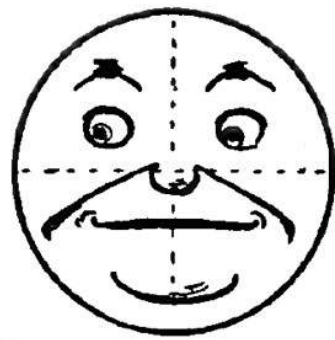
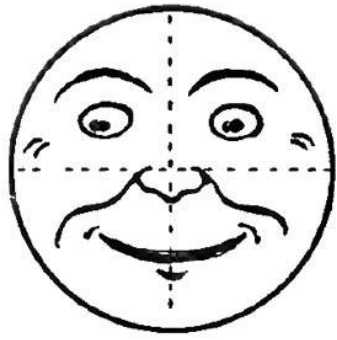
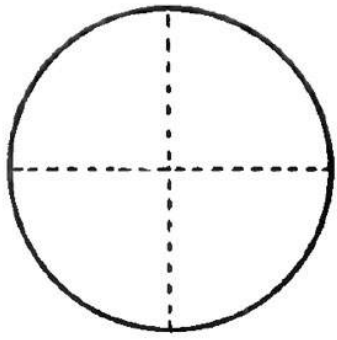

Lightly drawn
lines like above
will help in
making
sketches

Expressions

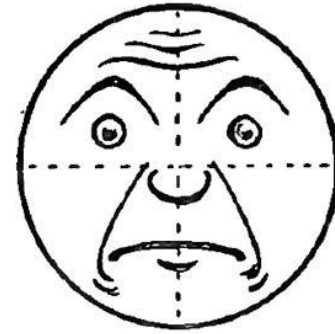
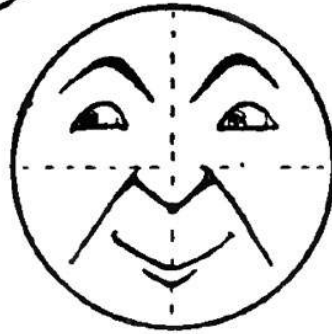
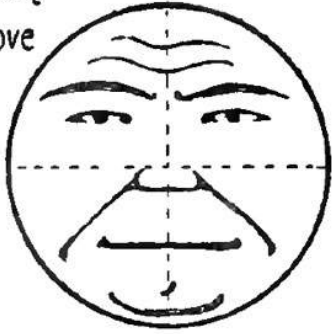

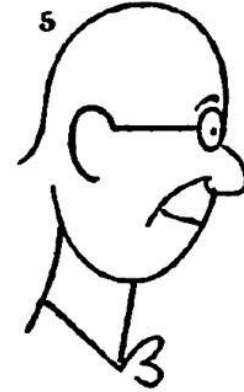
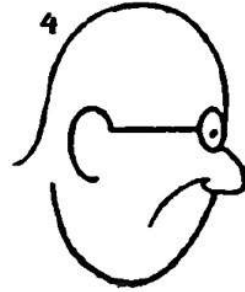
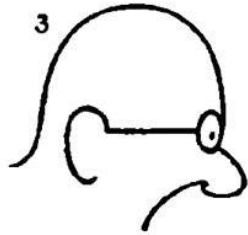
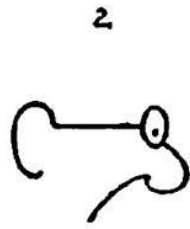
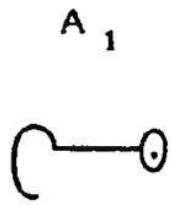

Faces - Curves

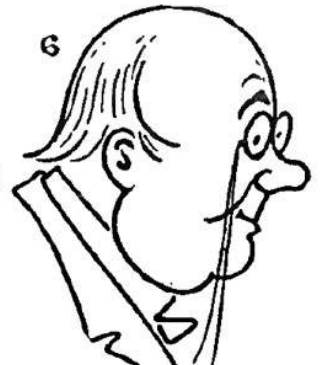
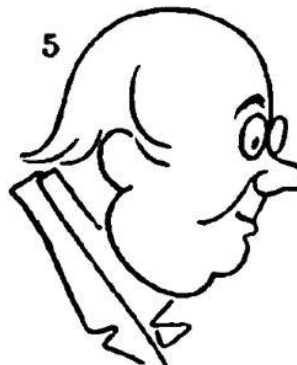
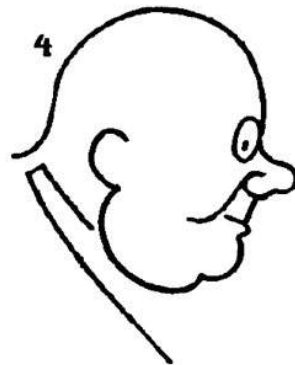
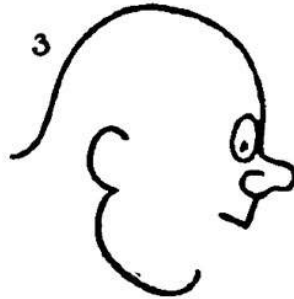
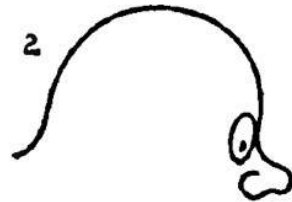
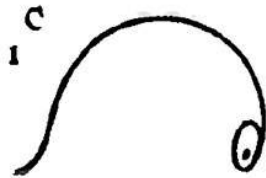
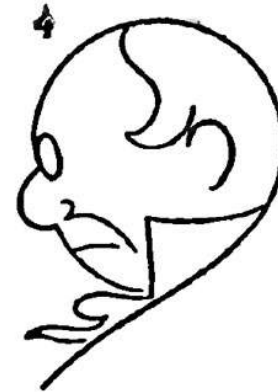
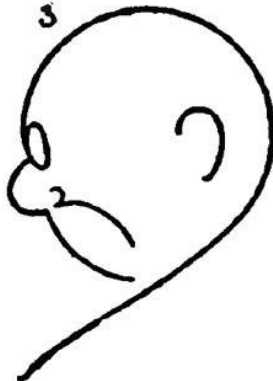
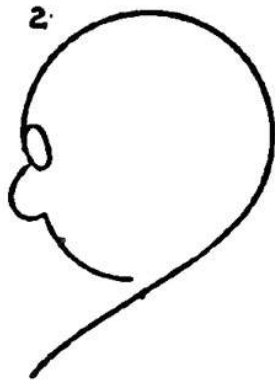
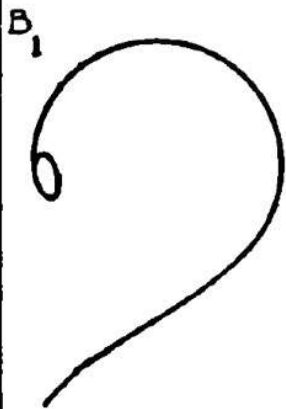

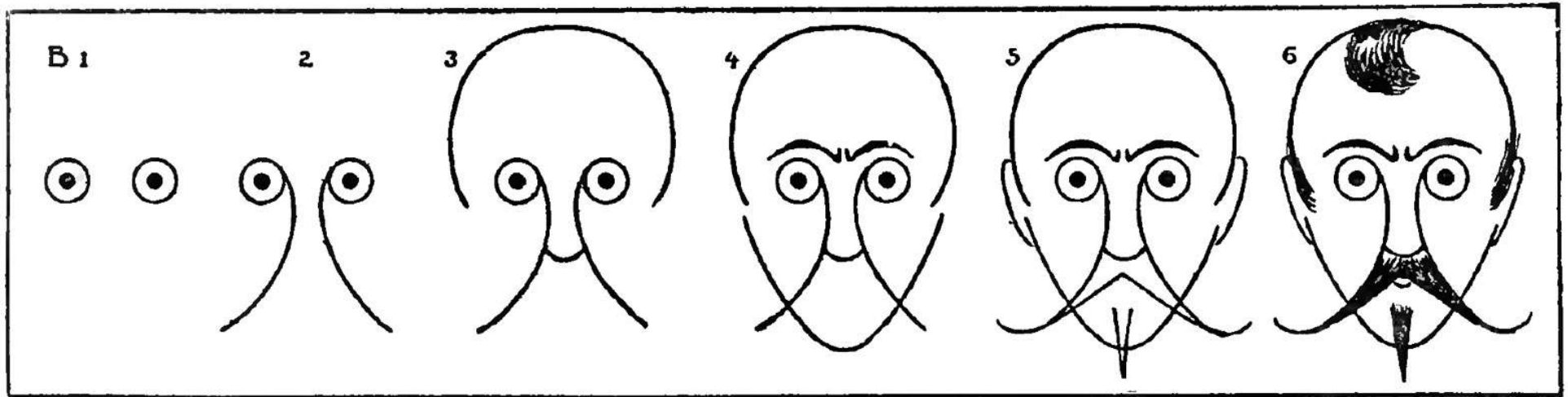
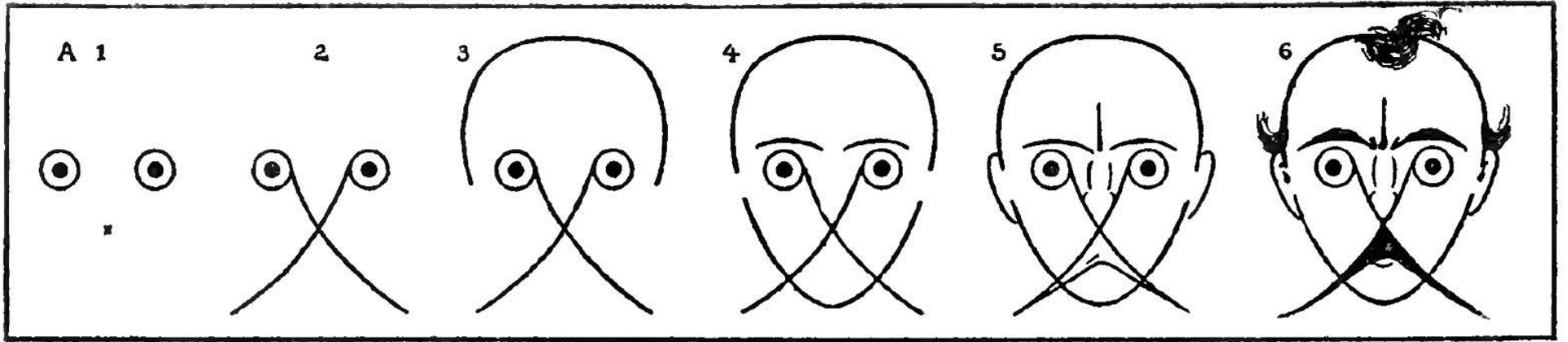

Faces
in
Ovals

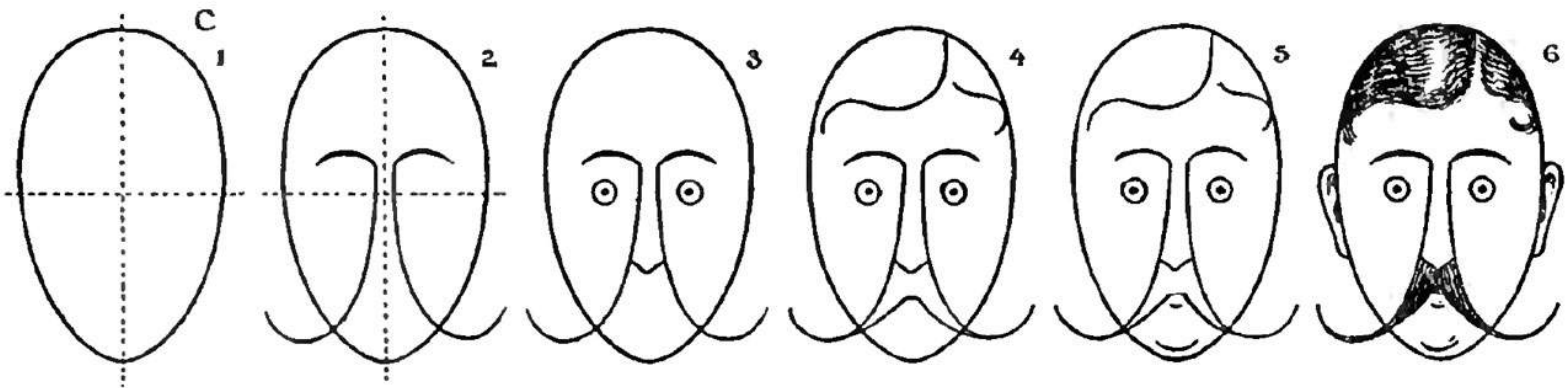
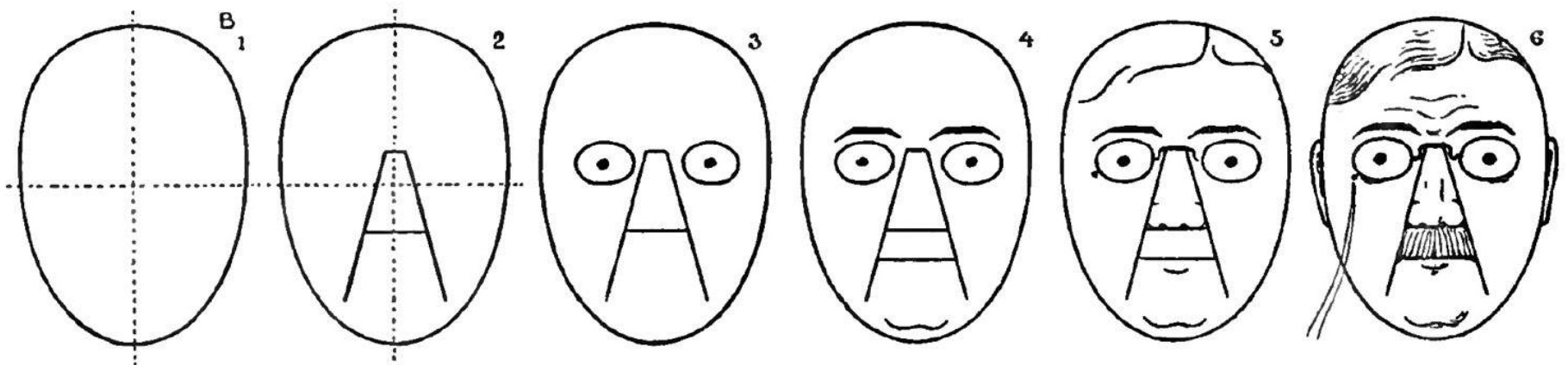
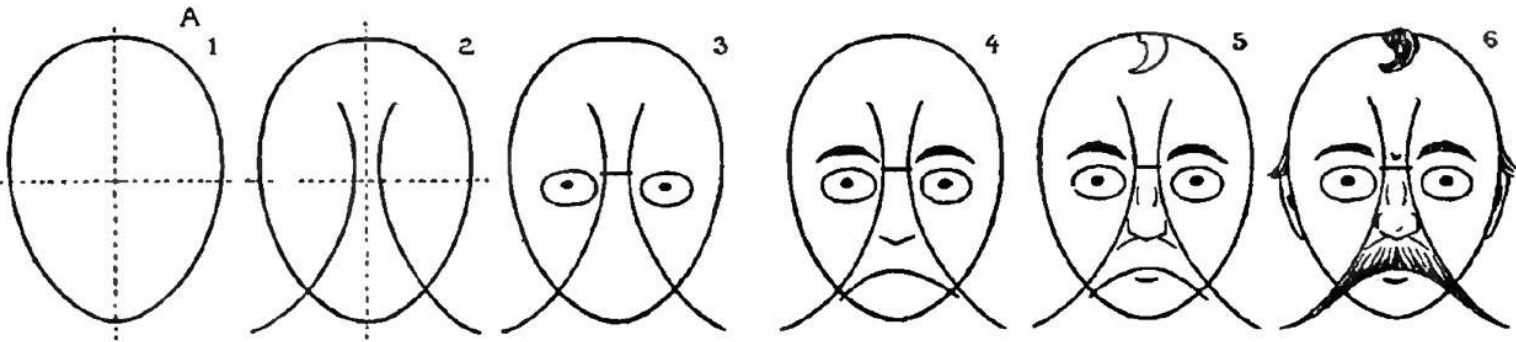

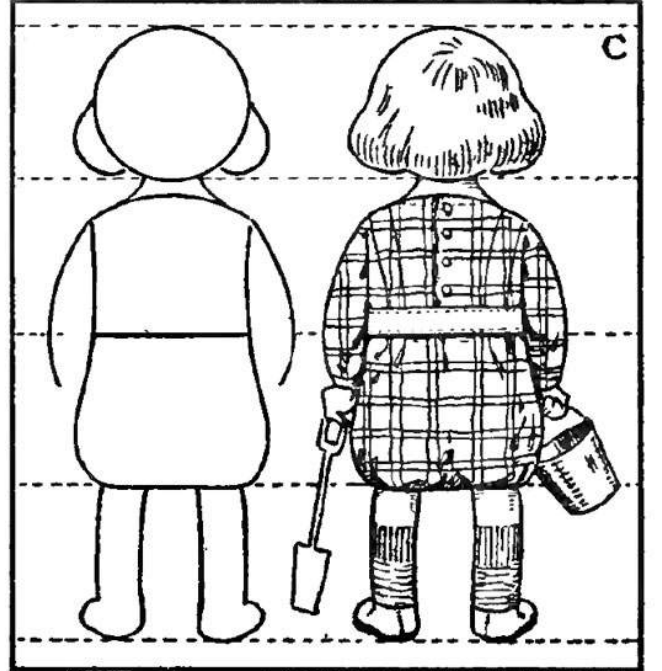
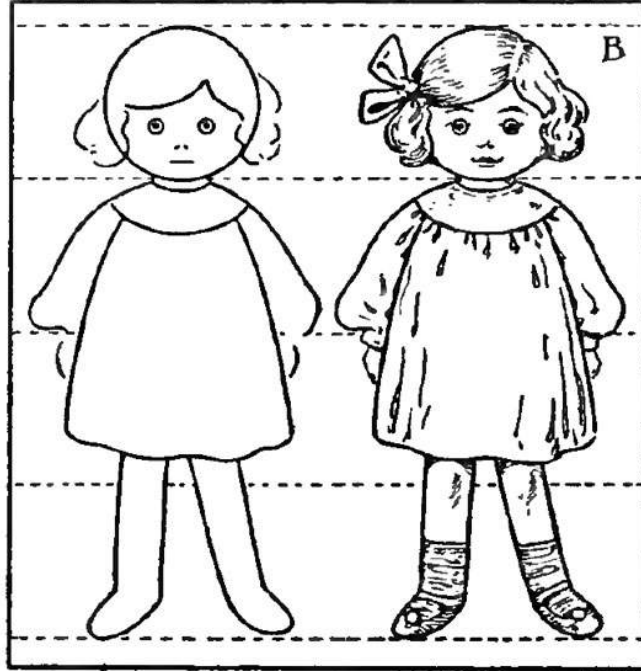
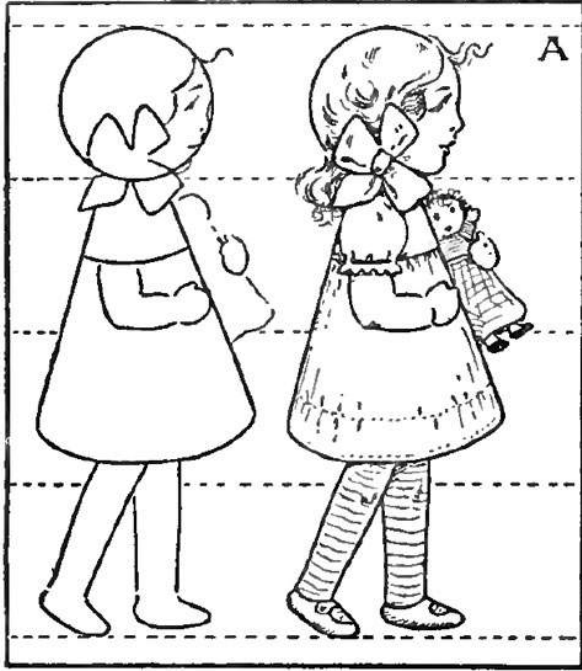

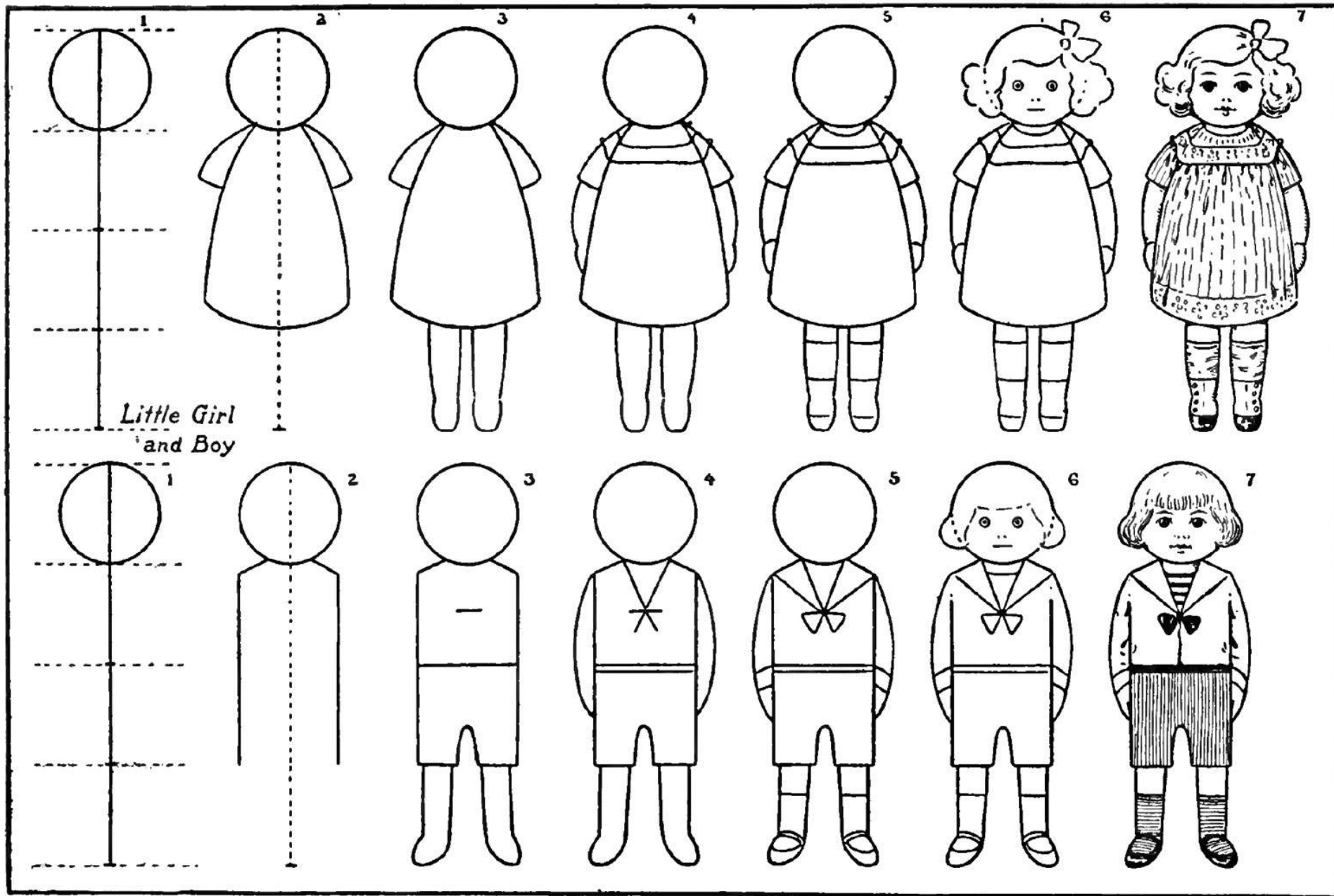

Round Figures

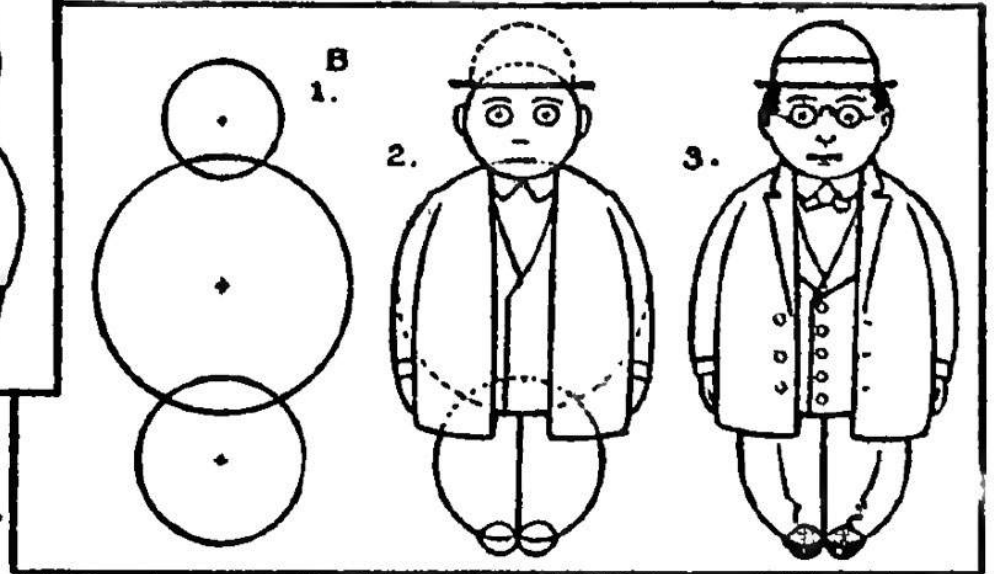
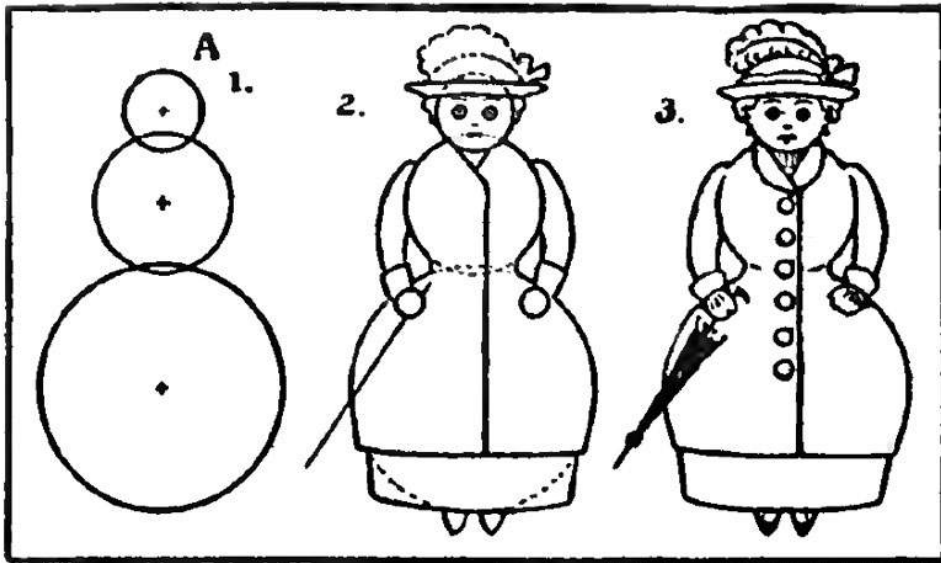

To draw these figures, first make circles as shown in A1. & B1.

An odd way of beginning

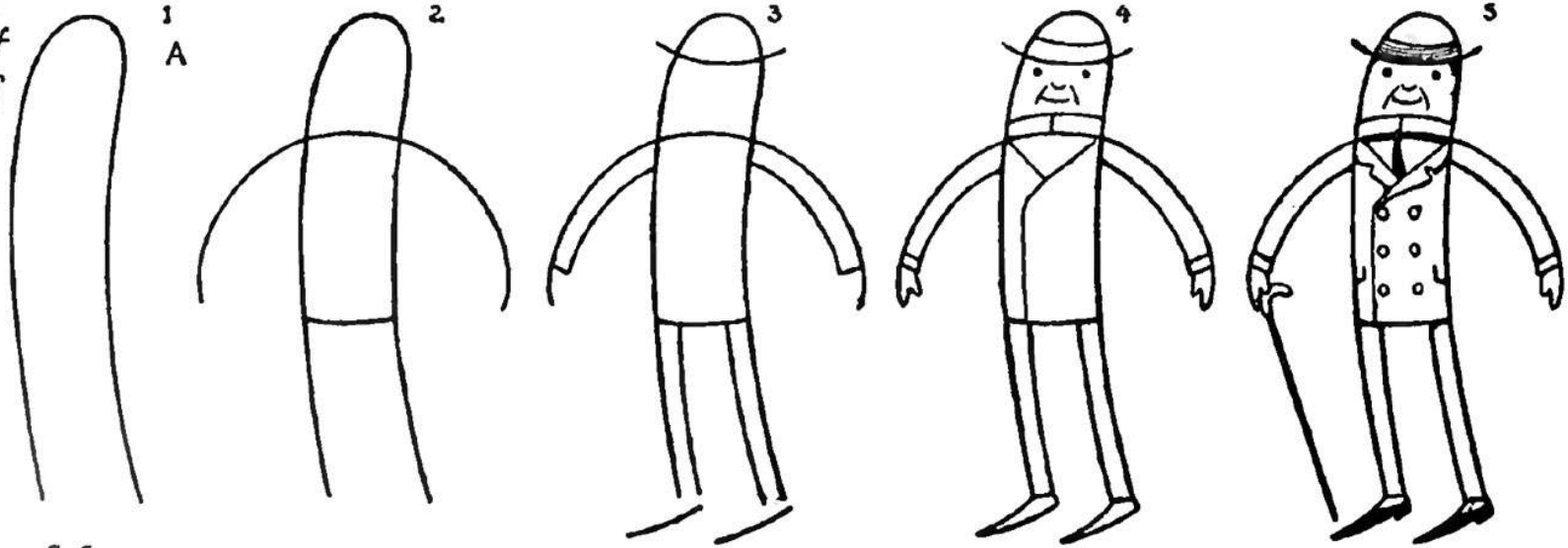

Figures - Men -

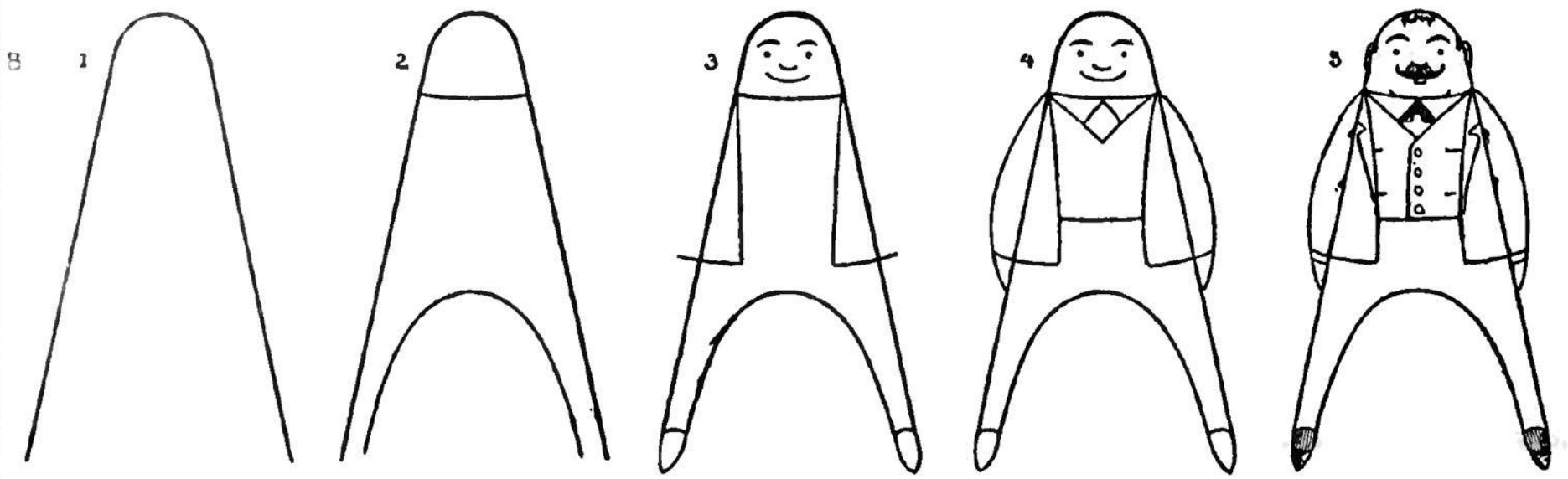

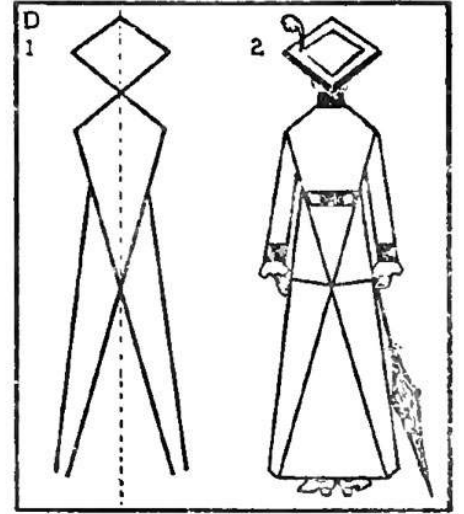
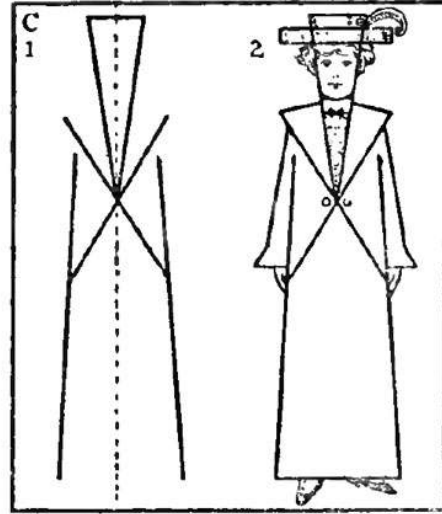
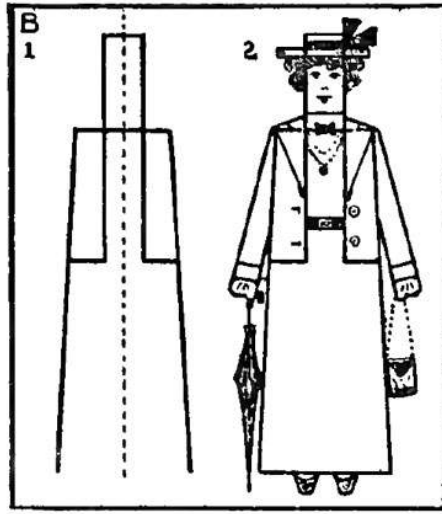
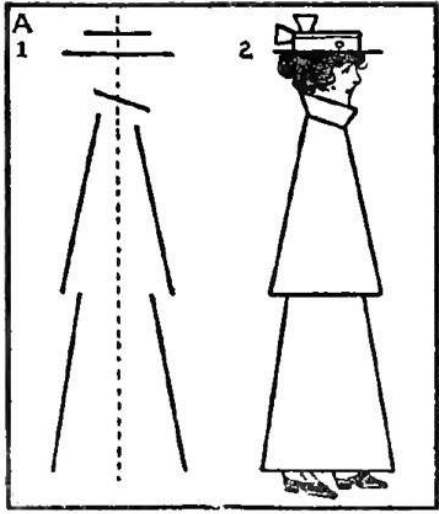

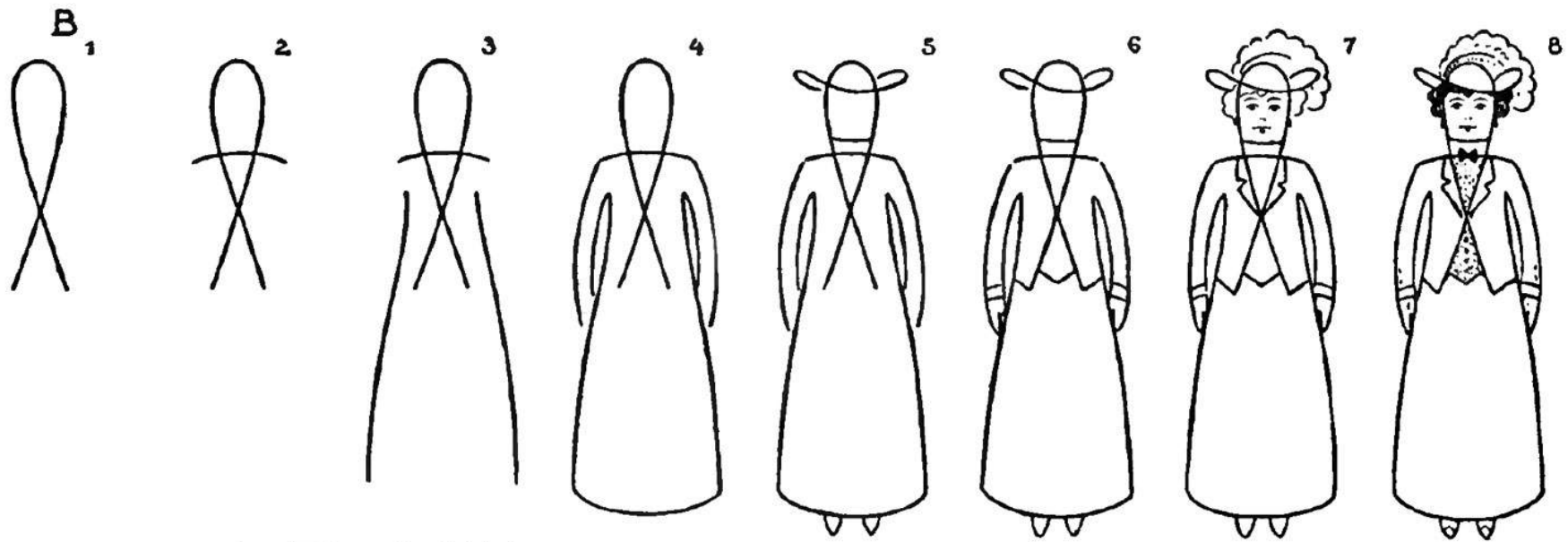
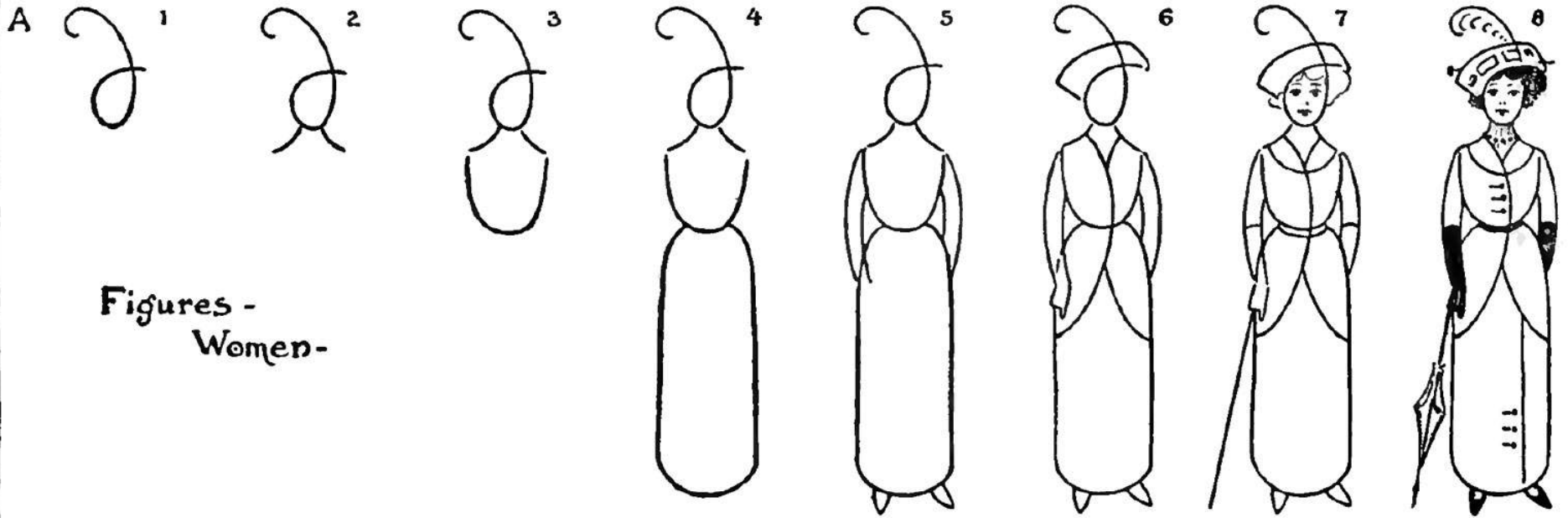

Making an Oval with the Compasses

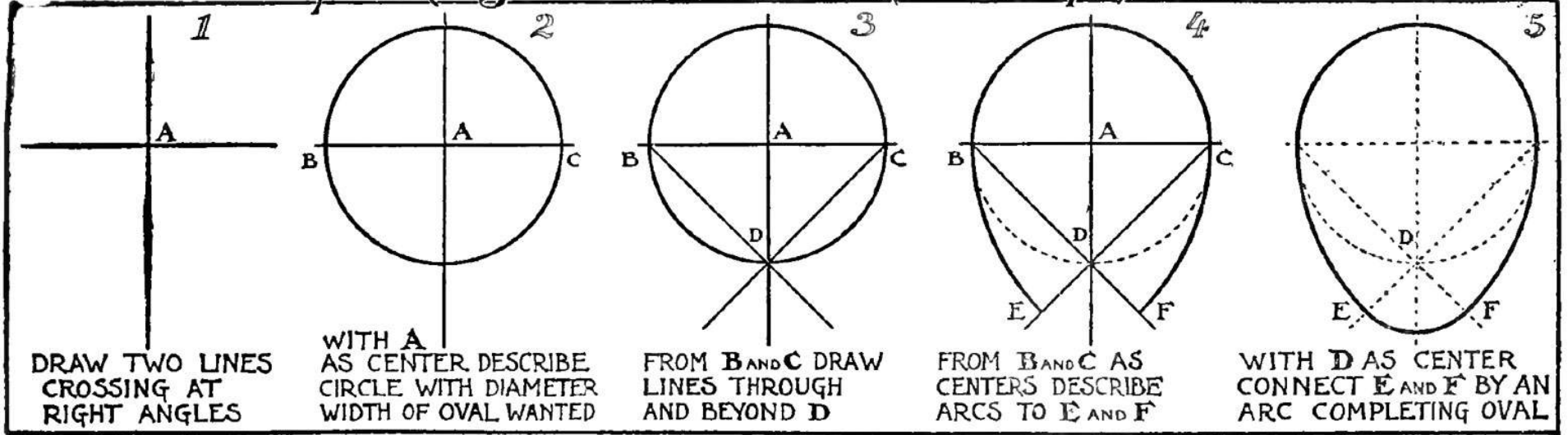

How to make an *ELLIPSE*

ROUGHLY SKETCH
ELLIPSE WANTED



1.

DRAW TWO LINES CROSSING
AT RIGHT ANGLES IN CENTER

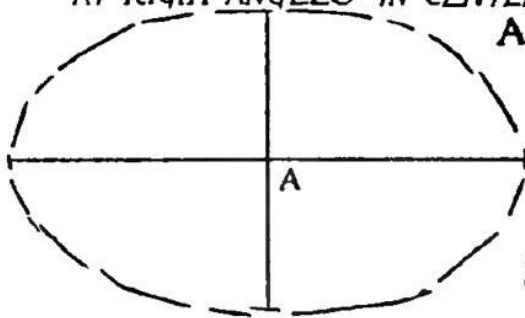

2.

WITH COMPASSES
MEASURE
DISTANCE
BA

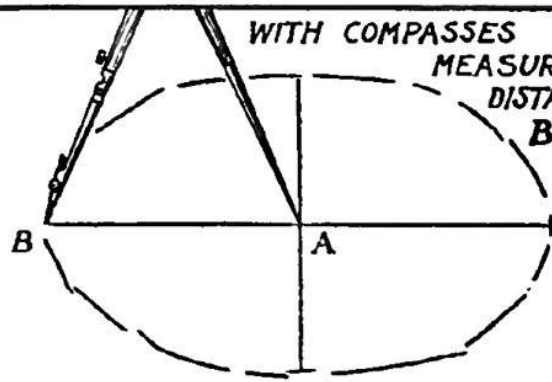

3.

WITH CENTER C AND
DISTANCE BA AS
RADIUS INTERSECT
LINE BD

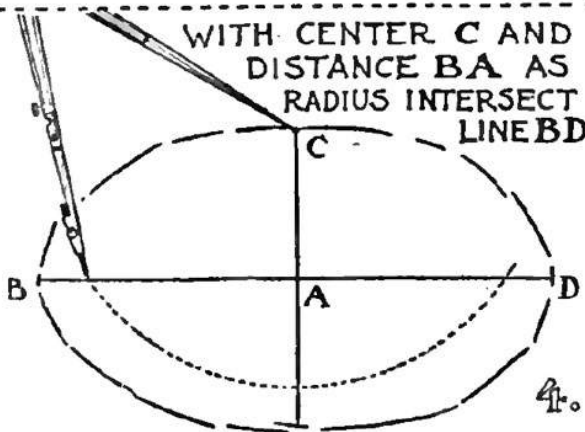

4.

AT POINTS OF INTERSECTION
E AND F PLACE PINS

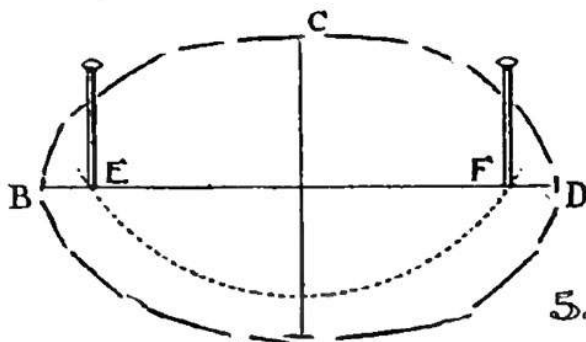

5.

PLACE PIN
AT C

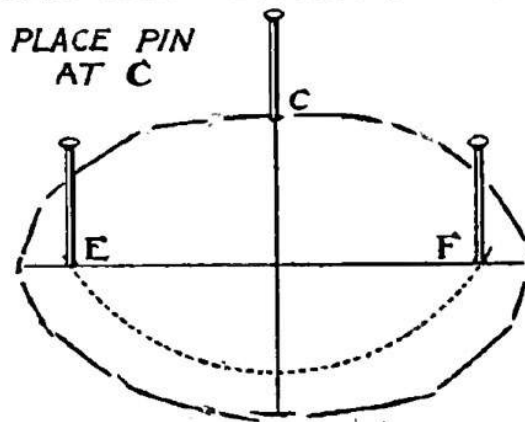

6.

LOOP A STRING
AROUND ALL
THREE PINS

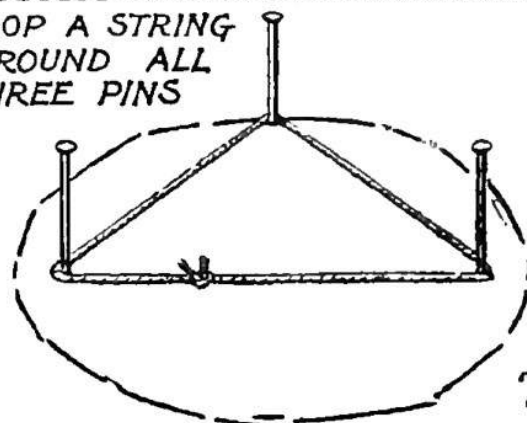

7.

TAKE OUT PIN
AT C AND
REPLACE WITH PENCIL POINT

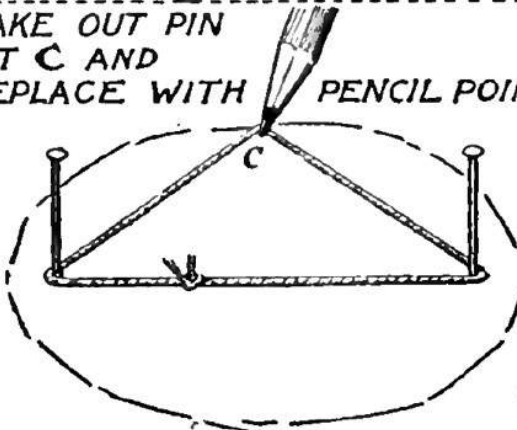

8.

WITH STRING TAUT RUN
THE PENCIL AROUND
UNTIL ELLIPSE IS
COMPLETED

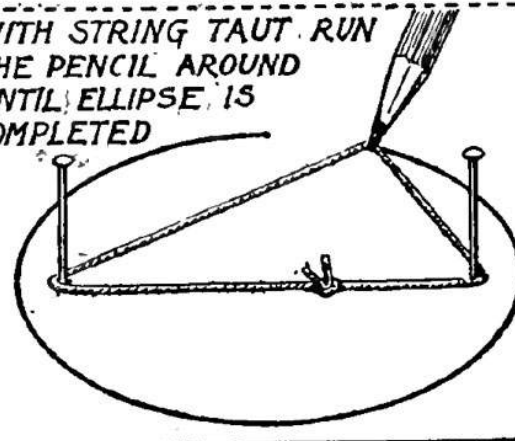

9.

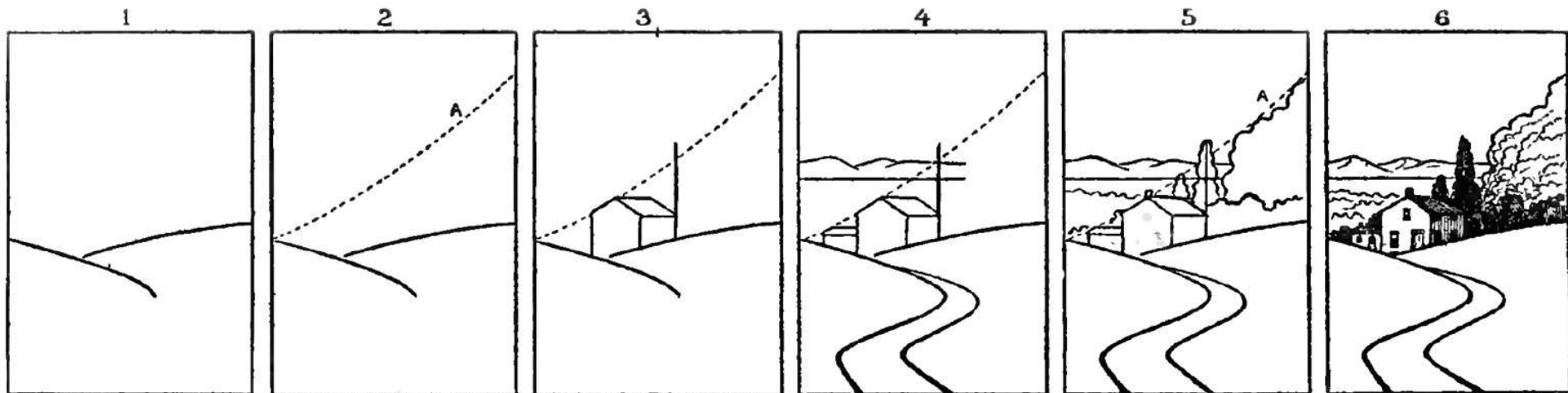

Suggestions for Water-color Painting

A USEFUL LIST OF WATER-COLORS

<i>·COLORS·</i>	<i>·WHAT·TO·ASK· ·FOR·IN·THE·SHOP·</i>
1  YELLOW	YELLOW OCHRE
2  BRIGHT YELLOW	GAMBOGE
3  RED	LIGHT RED
4  CRIMSON	CRIMSON LAKE
5  BROWN	VANDYKE BROWN
6  BLUE	NEW BLUE OR ULTRAMARINE
7  GREEN	HOOKE'S GREEN No. 1
8  GRAY	PAYNE'S GRAY

—Supplementary—

9  PURPLE	MAUVE
10  ORANGE	ORANGE- VERMILION

Here is a good list of colors for practical work. The first eight are enough for every purpose; but add, if you wish, purple and orange. Moist colors in pans are best.

There are many different kinds of red, green, blue and brown paints; and as you may be puzzled and not know what to get, the names of the best hues of these particular colors are also given.

The most useful paints in this list are yellow ochre, light red, Vandyke brown and Payne's gray. Learn to work with them, use them often and see the beautiful effects they produce. Delicate tints are made with thin washes of yellow ochre and light red. Vandyke brown makes a variety of pleasing tints.

Use the bright colors sparingly.

You do not need a black paint. Payne's gray with either brown, blue, crimson or green gives rich dark tones. Payne's gray is also useful in shadows and shading other colors. For the different kinds of greens, mix yellow ochre, blue or brown with Hooker's green. Use thin washes of light red and blue for the gray of distances and clouds.

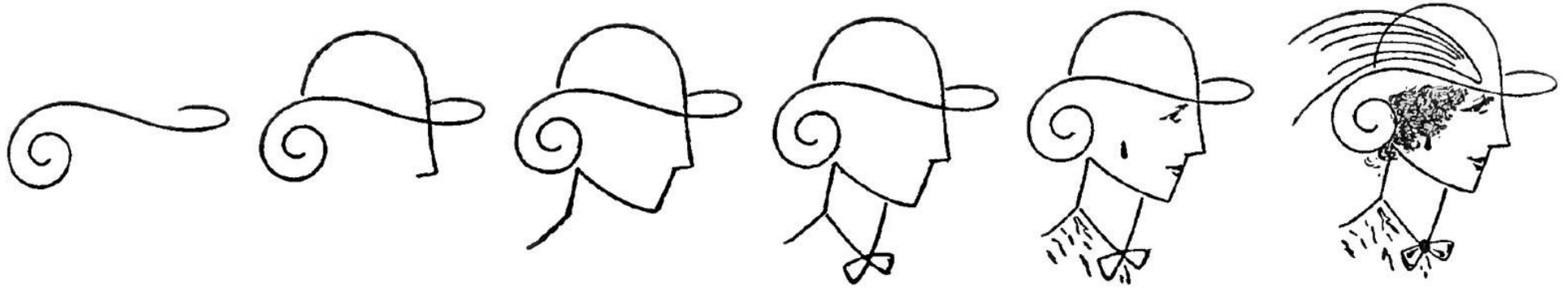

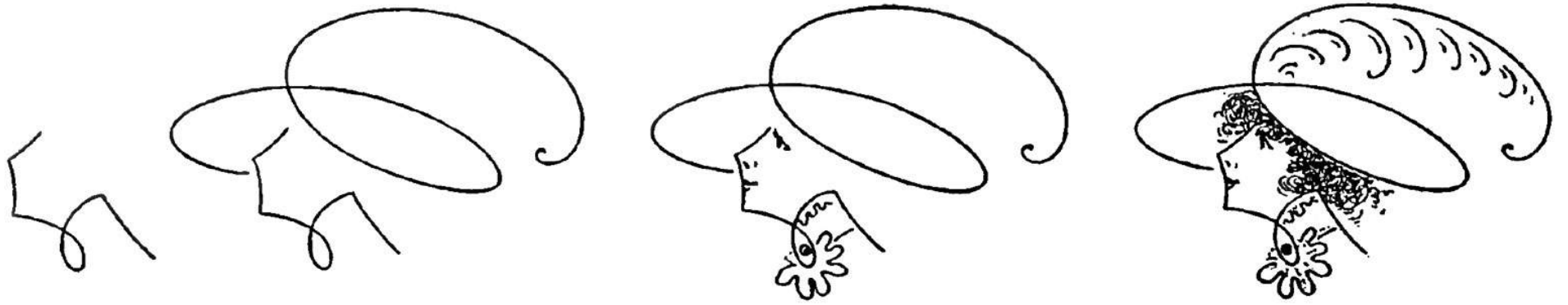
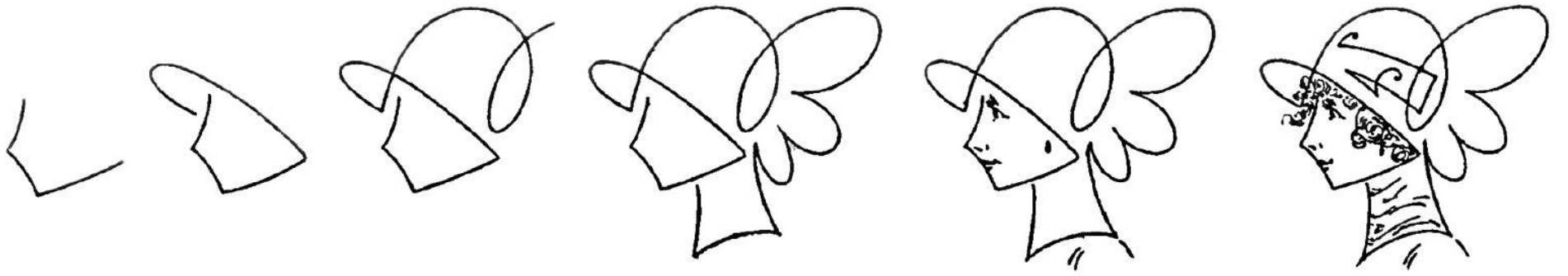

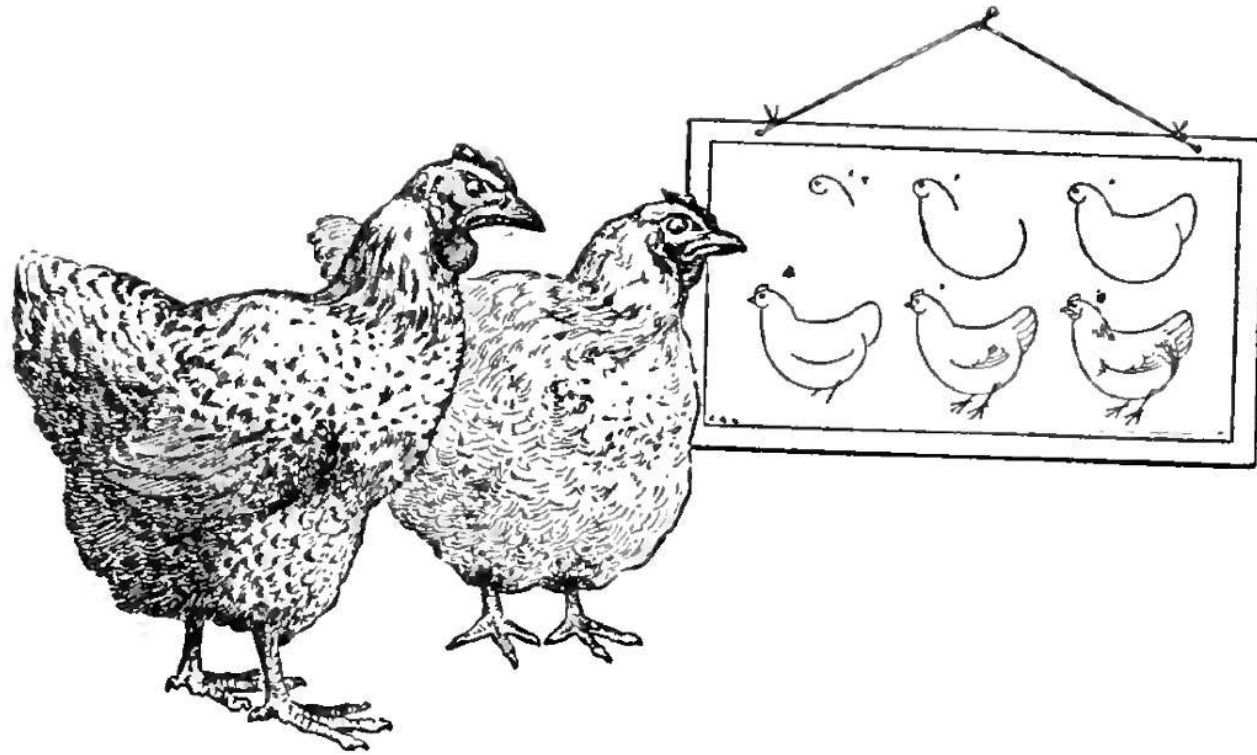

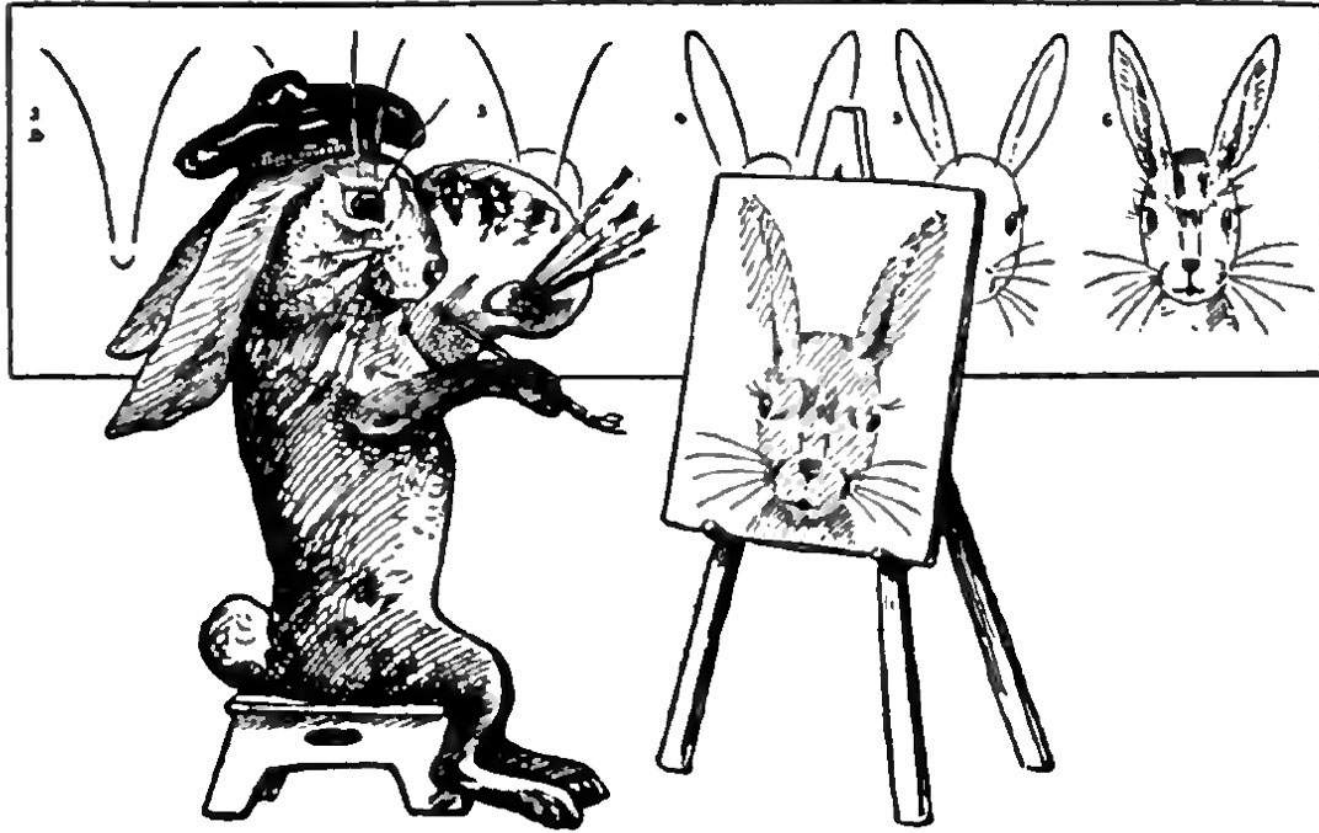

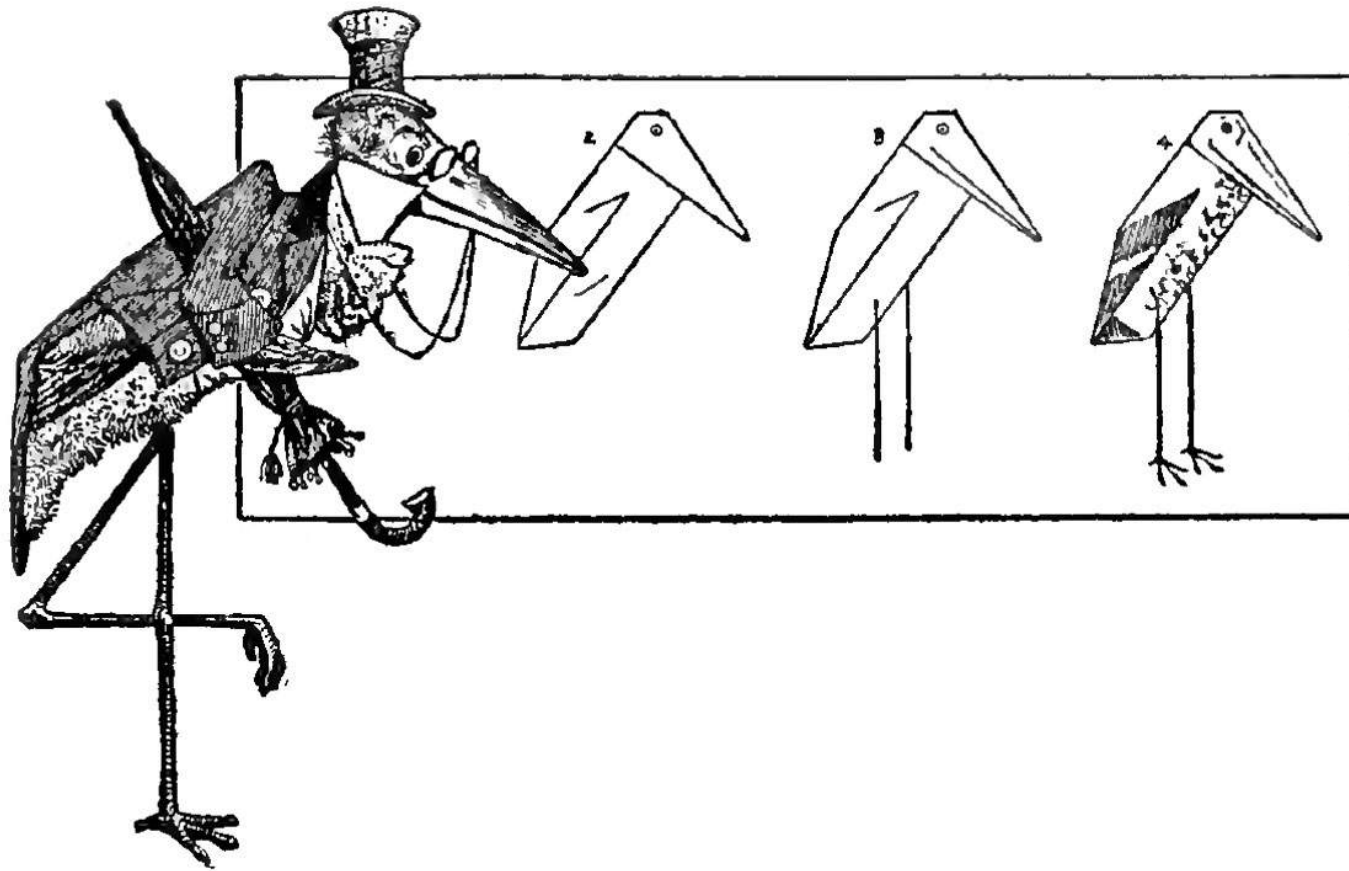

THE END

To download a full PDF of this book so you can print the illustrations for study or tracing, visit:

timelessreads.com/drawingbook