

BIOCLIMATIC FAÇADES

Alain Liébard - André de Herde



BIOCLIMATIC FAÇADES

Preface

For nearly 40 years, Somfy group has been developing innovative solutions to automate the control of openings and closures in houses and other buildings, thus contributing to the day-to-day comfort of millions of users.

Over the years, there have proved to be more and more advantages associated with the automated control of solar shading and window openings, amidst significant changes in the economic and environmental situation, in which the concept of sustainable development is at the heart of architectural design.

In fact, automating windows and solar shading means better control of lighting and ventilation, and better use of solar energy in order to reduce energy consumption for lighting, for heating, or for cooling buildings.

Inside buildings, occupants benefit from a view outside and from the maximum available daylight, without ever being subjected to discomfort due to direct solar radiation or excessive contrasts in light levels. And, nowadays, we know that visual comfort, thermal comfort or air quality can have a direct impact on occupants' well-being, health and productivity...

So Somfy has, as a matter of course, taken an interest in bioclimatic architecture, and meeting the authors of the *Treatise on bioclimatic architecture and town planning*, Alain Liébard and André de Herde, has shaped our understanding of **bioclimatic façades**, the special point at which a building's interior and exterior meet.

Their book, widely read in Europe and the rest of the world, has become the reference work on the subject, and has enabled many architects to discover or to rediscover the principles of bioclimatic design and the modern technical and architectural means to achieve them. Thus, we are seeing more and more low-energy houses and positive-energy buildings, which meet the challenge of reducing energy bills whilst simultaneously improving occupants' comfort.

This book is aimed at everyone interested in bioclimatic building principles, and especially at the many people in the building industry who work specifically on façades, whether it be to define their main characteristics, contribute to their design and construction, or ensure their maintenance...

Jean-Philippe Demaël
Chief Executive Officer of Somfy SAS

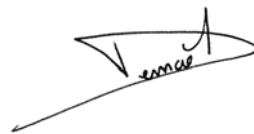

BIOCLIMATIC FACADES

BIOCLIMATIC ARCHITECTURE

The stakes	1
- Demographics and energy	
- Climate change	
- Man's impact on the urban environment	
- The concept of energy-savings	
- The concept of energy management	
About climate factors	6
- The major world climates	
- Solar energy	
- The sun's path	
- Solar radiation	
- Light	
About microclimate factors	11
- The influence of the landscape on microclimates	
- The influence of vegetation on microclimates	
- The influence of buildings on microclimates	
The bioclimatic approach	14
- The occupant, at the centre of bioclimatic architecture	
- The natural lighting strategy	
- The cooling strategy	
- The heating strategy	

THE NATURAL LIGHTING STRATEGY

About the fundamentals	18
- The physical properties of light sources	
- The composition of the light spectrum	
- The phenomenon of illuminance	
- The daylight factor	
- Ways of using natural daylight	
- Light transmission (LT)	
Visual comfort	24
- Visual comfort	
- The parameters of visual comfort	
- Illumination levels	
- The link with the world outside	
- Reducing glare	
Building using natural and artificial lighting	29
- Giving prominence to natural light	
- In offices	
- In homes	
- In hospitals	
- In schools	
- In sports halls	
- In industrial buildings	
- Regulating light – automated controls	

HEATING AND COOLING STRATEGIES

About the fundamentals	36
- Solar energy gain	

BIOCLIMATIC FACADES

Summary

- Internal heat gains	
- The Solar Factor (G)	
- Glazing heat loss (U)	
Thermal comfort	40
- Thermal comfort factors	
- Thermal comfort temperatures	
Tools to regulate temperature	42
- Controlling and programming heating systems	
- Air-conditioning	
- Solar shading	
NATURAL VENTILATION	
Natural ventilation and occupants' comfort	45
- Comfort due to air quality	
- Fresh-air comfort	
- Thermal comfort in hot climates	
The natural ventilation approach	48
- Air renewal	
- Ventilation	
- Air renewal and natural ventilation	
- Natural ventilation in hot climates	
- Natural ventilation and night cooling – automation	
ARCHITECTURAL SOLUTIONS	
Building with the climate	52
- The orientation of façades	
- Actual solar energy received	
Architectural tools	54
- Apertures	
- Windows	
- Clear glazing	
- Absorbent and reflective glazing	
- Dynamic glazing	
- Solar shading : objectives	
- Solar shading : technology choices	
- Solar shading : different types	
- Reflective blinds	
- Daylight redirection systems	
- Reflectors	
- Sizing model : canopies	
Recent trends : highly glazed façades*	66
- A current trend	
- Types of ventilation	
- Façade regulation systems and building performance using solar shading	

* This chapter was contributed by Harris Poirazis, PhD & Mikkel Kragh, PhD - of Arup, 13 Fitzroy Street, London W1T 4BQ, United Kingdom.

When the human race amounted to only 5 or 10 million people, just 10,000 years ago, it hardly made any impact on its ecosystem. It is only recently that man has changed his environment as profoundly as nature had done previously, but in a much shorter time.

Between 1750 and 1950, Europe underwent a demographic explosion. Thanks to the decline in mortality due to major scientific advances (in agriculture, public health, medicine), Europe's population went from 150 to 600 million inhabitants.

According to the United Nations Organisation, the world will have 9.3 billion inhabitants in 2050. 95% of these additional people will be born in less developed countries. The population of Western Europe is expected to decrease while that of North America will increase by 40%. The highest growth between now and 2050 will be in Asia (+46%), in Latin America (+53%) and especially in Africa (+146%). Whilst Europe represented 15.6% of world population in 1950, this figure will drop to 6% in 2050. Southern-hemisphere countries will then account for 87% of world population, so around 8 billion inhabitants, versus 75% in 1990 equating to 3.8 billion.

Figure 1 gives an overview of current demographic trends up to 2100. The blue curve represents primary energy consumption since 1860. The growth rate of energy consumption can be seen to be greater than that of the population.

Energy consumption does not match the distribution of population on the Earth. Industrialised countries only represent 25% of today's population but they consume 75% of the energy used on Earth, 60% of the coal, 73% of the oil and 70% of the natural gas. Per capita energy consumption in the southern hemisphere is less by a factor of 10 than that in industrialised nations. This situation is changing because growth of 6.2% per annum in energy consumption in the southern hemisphere was already observed in 1986, compared with 0.5% for industrialised countries.

Demographic change in the southern hemisphere is coupled with greater urbanisation. In 2000, 26% of the population of these countries lived in urban areas. By 2005, this figure should reach 75% in Latin America, 42% in Africa and 37% in Asia. Consequently, a fifth of the urban population will live in big cities with over 4 million inhabitants.

Such population pressure on the environment is enormous : water consumption, food, waste production and disposal, sharing of energy sources etc. We can already foresee the scale of devastation caused by the pressure exerted on forests, plains, lakes and arable land, that is currently leading to deforestation, soil erosion and exhaustion, reduction of water tables, etc.

By 2050, developing countries will represent more than 85% of the world's population, versus 75% in 1990.

Three quarters of oil-based products are consumed by industrialised countries today.

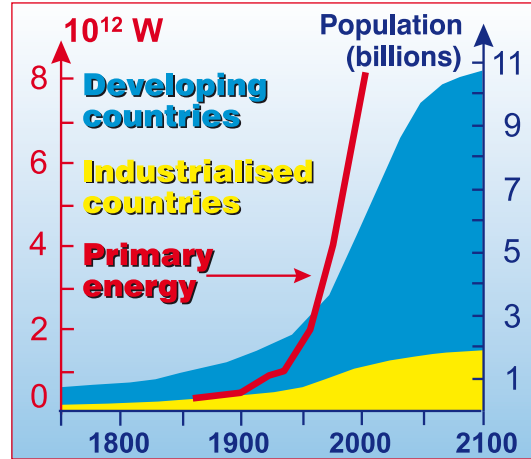

Curves forecasting world population (1750-2100) and primary energy consumption (1860-1975).

1

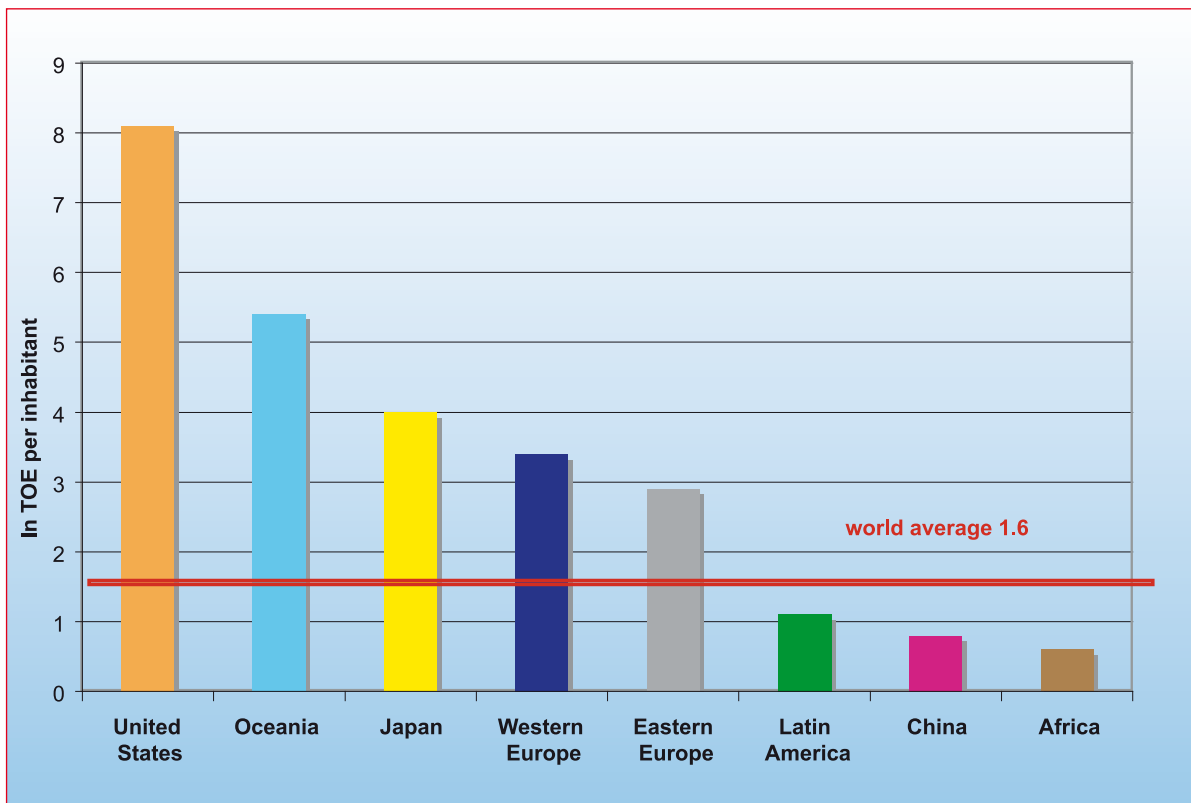

2 Average energy consumption per inhabitant in 2001 (source : AIE/OECD).

Today, the environmental consequences of fossil fuel usage are obvious. It is in this context that the United Nations organised the 1992 Rio conference on the environment and development in which the principle of sustainable development was recognised. It enables today's needs to be met without compromising the capability of future generations to meet their own needs.

One of the features of modern pollution is that it knows no borders. Acid deposits attack the soil, crops and forests hundreds of kilometres from where the pollutants were emitted. In general, air pollution (fuel emissions, industrial emissions) moves over great distances and spreads over large areas.

Figure 2 provides some examples of the causes and effects of warming due to greenhouse gasses : 1. Deforestation (Amazonian rainforest), 2. Drying out of the soil (Burkina Faso) 3. Melting of the ice-caps (South Pole) 4. Atmospheric pollution in big cities (Cubatao in Brazil).

Carbon emissions (CO_2), produced by the oxidation of carbon during the combustion of gas, coal, wood, and oil, are linked to energy consumption. The volumes released over the last few decades are very high (24 billion tons due to fossil fuels out of 30 billion tons released) and exceed nature's ability to absorb them. The International Energy Agency (IEA) foresees a 60% increase in global CO_2 emissions linked to energy between now and 2030. Major climate changes are to be feared because CO_2 encourages the greenhouse effect and global warming. Figure 1 shows the correlation between the increase in CO_2 in the atmosphere (in ppm, on the right), rising sea levels (in cm, on the right) and temperatures in relation to average recorded temperatures between 1950 and 1979 (left-hand axis).

The theory of global warming due to the greenhouse effect goes back to the work of Arrhenius (1895). Today, it is estimated that average global temperatures may increase, between now and 2100 by 1.4°C to 5.8°C which would mean a rise in sea levels of 10 to 80cm. An overall reduction in glaciers and a rise of 15cm in sea levels has already been recorded in the last century. An increase in the number and severity of extreme climate events is possible: the heat-wave in France (2003) and hurricane Katrina (2005) are possible instances. This rise in temperatures could cause devastating floods in sensitive areas such as the fertile deltas of the Nile, the Ganges, the Mekong and the Niger rivers. It could also lead to deterioration of soil quality (desertification, salination) and multiply the number of contagious epidemics sensitive to minor temperature variations.

To mitigate a part of these problems, renewable energies together with sensible energy use constitute a key element of a sustainable energy policy aimed at reducing CO_2 emissions, a goal to which the European Union has committed.

Massive fuel emissions are causing a significant ecological and climate imbalance : global warming, changes in rainfall.

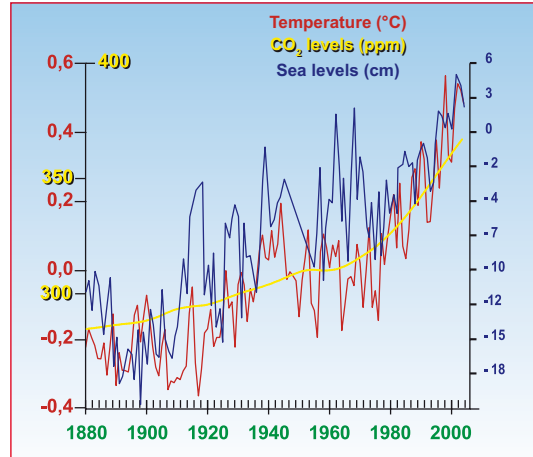

1 Changes in temperature variation and average sea levels, growth in CO₂ emissions.
(Sources : Nasa, Shom, CNRS-CERFACS)

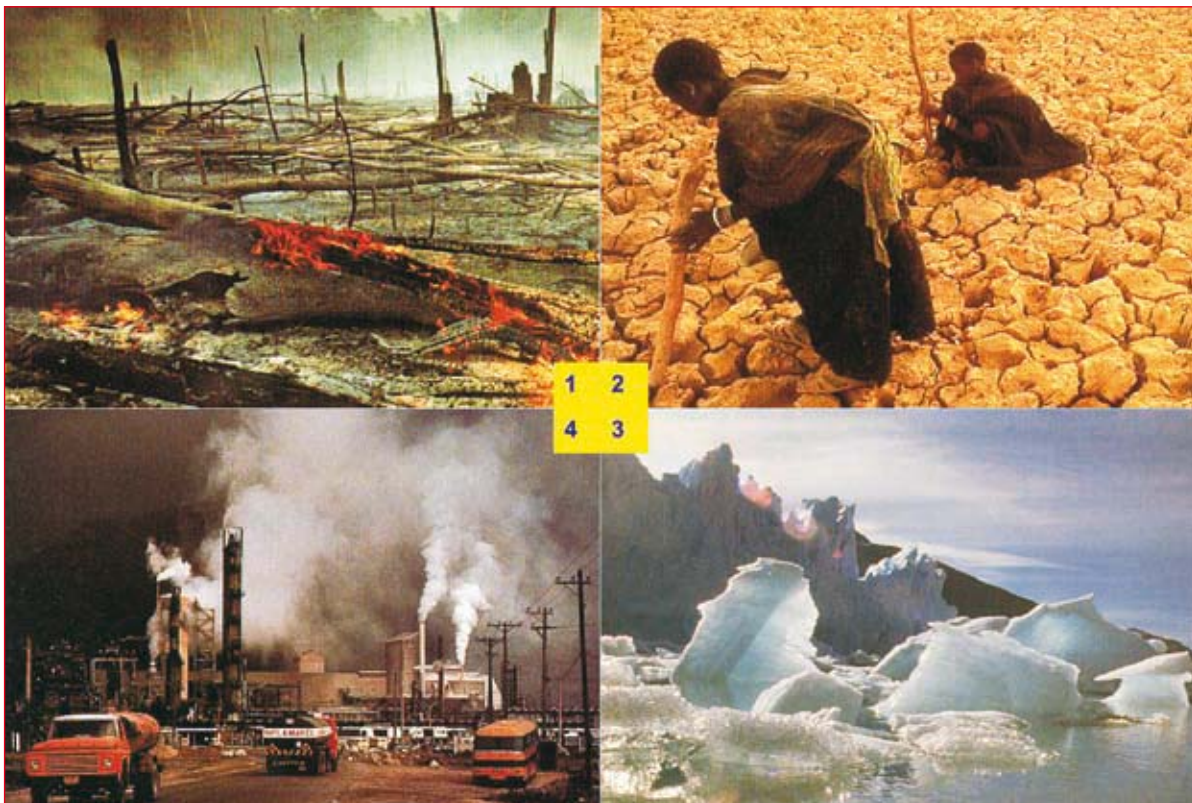

2 Causes and effects of warming due to greenhouse gasses.

Major urban centres have seen their micro-climate change according to the pace of human activity : millions of car journeys daily, the heating and lighting of buildings or of public places, the mere presence of millions of human beings are all different sources of heat and pollution that determine the urban micro-climate. Some cities, such as Mexico (fig. 1) or Athens are notorious for their level of pollution : surrounded by hills, sheltered from strong winds, all the by-products of human activity accumulate there in dangerous quantities as solids, liquids or gasses.

Figure 2 gives an overview of how increasing urban population density interacts with the micro-climate. It presents the effects of air pollution, and the sealing and compacting of the soil. The figures shown are based on comparing current values with average ones (over 30 years) outside the urban environment.

Paris has seen its average temperature increase by 6°C in a century. In the past, there were frosts for 56 days, but only 22 days in the 1970's. Buildings and the urban road network constitute a formidable heat store. The immediate suburbs experience much lower temperatures than Paris; freezing conditions, frosts and fog are more frequent. It is not unusual for someone from the suburbs to feel a temperature difference of more than 10°C when arriving in Paris early in the morning. Humidity and rainfall patterns have also changed : 100 days of fog in 1920 and just 10 days in the 1980's. In the city, drains deal rapidly with rainwater, which no longer has time to refresh the air, except near big public parks. Some districts of the city are hotter than others and air movement follows this pattern. Thus, the warmest districts, attracting polluting breezes, are the most polluted.

In general, all the by-products of human activity, dust, hydrocarbons, products of combustion (SO₃, NO₂ and NO) are concentrated in cities. Ozone (O₃), specifically, is a normal component of the atmosphere. 100 years ago, its average concentration was around 20 µg/m³. In many cities today, it reaches 60 µg/m³ and can reach peaks of 250 µg/m³. Ozone is formed by the transformation of pollutants (NO_x) released by combustion engines. At high altitude, ozone protects the Earth from UV rays; at low altitude, it is an irritant and a toxic gas. During periods of high pollution, admissions to hospitals' respiratory departments increase by 25 to 50% and emergency calls for asthma attacks proliferate. The Institute for Hygiene and Epidemiology in Brussels has published a report linking pollution levels in 1994 to significantly above-average death rates : 1226 additional deaths compared with the expected average.

Basic common sense (sleeping with the window open, getting fresh air in winter, living near trees etc.) no longer apply in cities today, because the air is laden with dust and pollutants that plants retain in their leaves.

By concentrating activities in towns, man changes their microclimate: higher average temperatures, changes in rainfall, haze due to air pollution. Health problems are becoming more acute.



Mexico City, which lies in a basin sheltered from the wind, is notorious for its pollution problems. **1**

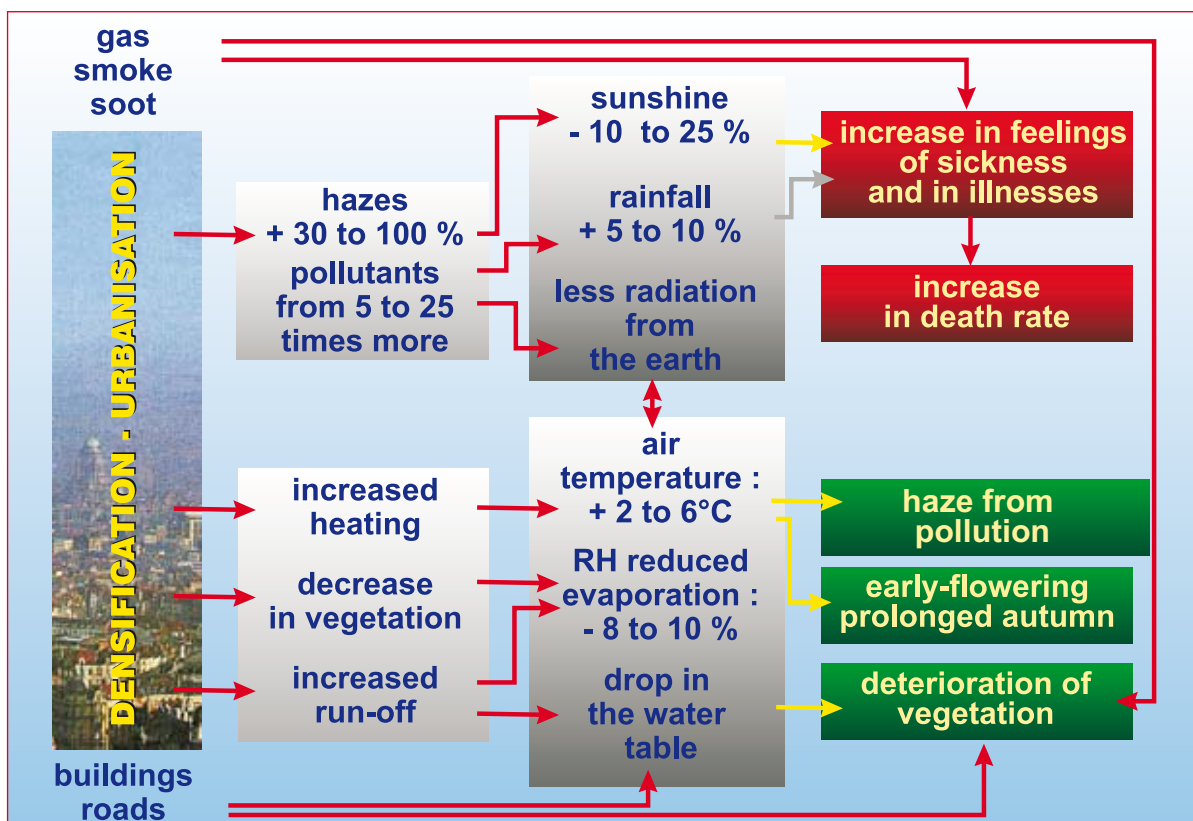

2 Changes in the urban climate compared to average values for non-urban zones.

The prospect of the exhaustion of oil and gas seams, together with international instability are causing energy prices to rise and mean that this trend is likely to continue. Besides this, the effects of pollution, whether in an urban or rural environment, are increasingly felt. These considerations must lead to energy-saving behaviours in order to reduce commercial energy consumption and the release of pollutants.

Energy saving is not a new thing (see Figure 1). For instance, in France, the energy saving Agency (the former Ademe) was created in 1974. Somewhat forgotten in the 1990's, the idea of limiting energy consumption returned to the forefront in the following decade. Oil was less than \$20 a barrel at the end of the 1990's, whereas it was over \$65 by 2005, and reached over \$140 a barrel in 2008. This upward trend will probably continue as worldwide energy consumption is climbing at an average rate of 2% p.a. (3,4% for oil consumption in 2004). At the current rate of consumption, oil and gas seams will probably run out in 2045 for oil and 2075 for gas. The era of cheap fossil fuels is over. All the more so as experts all agree that oil production will reach a maximum, the so-called 'peak' of production, over the next 15 years.

If households as well as industry are aware of direct savings, this 'wallet' effect is less effective in the transport and services industries. In the latter case, energy savings can nonetheless be very significant. A building comprises a complex set of components such as lighting, heating, sometimes air-conditioning and also water supplies. Heat loss from a badly insulated building is significant and means high levels of energy consumption to heat rooms. Lighting is also a major source of energy consumption. Today, we are able to build and renovate buildings that are energy-efficient. Whilst in France a home or an office uses on average 200kWh per m² per annum, we can reduce this requirement to 15 kWh/m²/p.a. using so-called passive building techniques.

Figure 2 shows energy consumption in two homes. The one on the left is poorly insulated. The one on the right is both better insulated and designed to benefit from solar gain. With these parameters and for the same area to be heated, a 40% reduction in heat loss (from 188 kWh/m²/p.a. to 111) equates to a 66% reduction in commercial energy consumption (from 220 kWh/m²/p.a. to 67). This is made possible thanks to better materials (reduction in heat loss for technical reasons) but also through significantly higher solar gain (from 24 kWh/m²/p.a. to 57). The results for the windows go from -6 kWh/m²/p.a. (gain = 24; loss = 30) to +20 kWh/m²/p.a. (gain = 57; loss = 37).

It is to be noted that, if heat loss due to waste gasses are reduced by 39% (from 13 to 10), emissions of pollutants are proportional to the final energy used and are therefore in their turn reduced by 66%.

Reduction in energy consumption without loss of comfort can be achieved by improving the building design and materials.

Saving energy means having the same level of comfort while using less energy. It also means emitting fewer pollutants into the atmosphere.

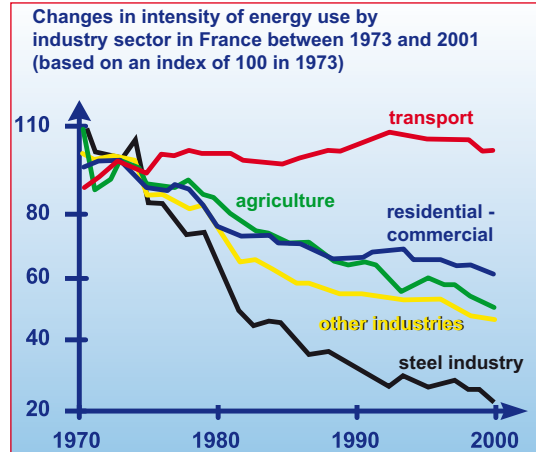

Intensity of energy use measures the amount of primary energy used per unit of added value (source: Economy, Energy and Raw Materials Watchdog, Ministry of Industry, January 2003).

1

Heat losses (kWh/m².year)

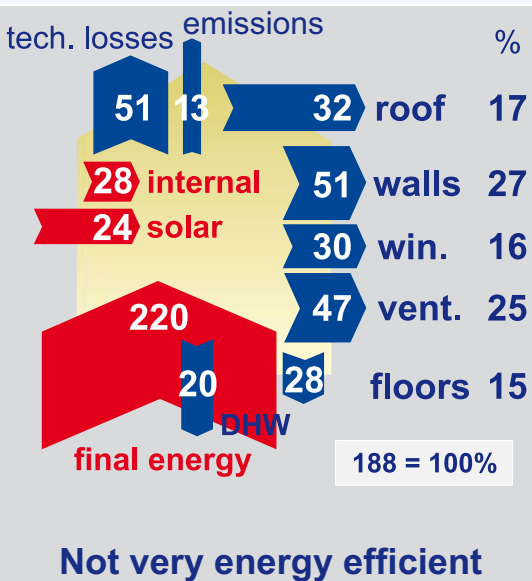

Well-insulated passive solar house

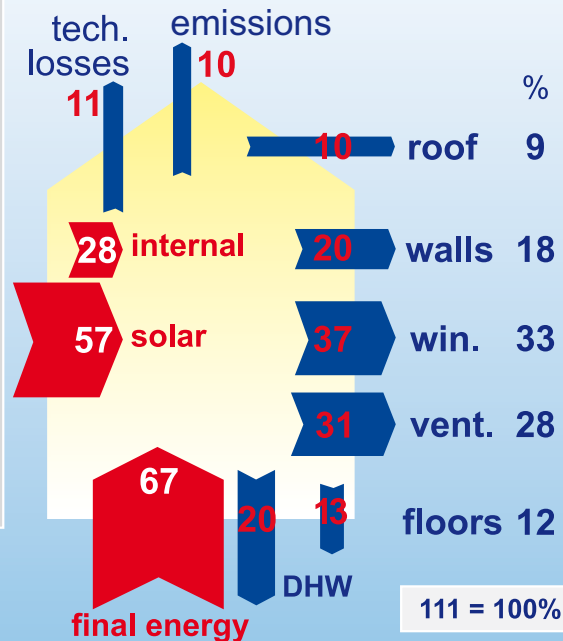

2 Comparative consumption of buildings with different levels of energy efficiency.

The interest in energy management shown by public authorities dates back to the oil crises of 1973 and 1976. Despite these warnings, subsequent falls in the oil price did not encourage the permanent adoption of sensible energy use. During the 1990's, energy consumption started to grow again, especially in the services sector and in transportation.

Energy management is based on controlling the amount of energy used (energy savings) and the types of energy used (the main choice of energy determining a country's independence from its potential supplier countries). Figure 1 compares the average costs of building a school in 1993 (885€ net/m²) to the costs generated through energy consumption (heating, hot water, lighting, cooking etc) over the lifetime of the building (30 years). The figures on the left are for a 'traditional' school (based on a sample of 3000 establishments) whose average annual consumption is 190 kWh/m² /p.a. The figures on the right are for a new school in the Yonne whose average annual consumption in 1987/1988 was 60 kWh/m² /p.a. For each group of figures, the first bar represents the building cost per square metre (885€); the other two show the cost of energy per square metre over 30 years for electricity (average unit cost of 0,15€ per kWh) and for fuel oil (average cost of 0,03€ per kWh NCV¹). Figure 1 is useful in highlighting the importance of a building's energy performance (reducing consumption) as well as the choice of energy type (cost reduction).

Sensible use of energy means all actions enabling the achievement of the requisite comfort for living and working whilst getting the best from energy resources. Using such resources well implies taking the consumption and cost of energy, the organisational processes, individual behaviour, and the harmful effects of pollution all into account.

Figure 2 shows continuous growth in global energy consumption, a trend that will continue in the future, especially in the southern hemisphere. Consumption in these countries – much lower than in the north – will increase significantly. The Middle-East and North Africa's consumption will double between 2000 and 2020. Cumulative figures for the whole of Africa and the Middle-East show consumption of MTOE², which goes from 843 in 2000 and accelerates to 1606 in 2020. In general, southern hemisphere countries are experiencing conditions of urbanisation, demographic and industrial growth, particularly in China, India, and Brazil, that are based on high energy consumption. In northern countries, a deceleration of growth in demand for energy is visible, and can be explained as much by improvements in energy efficiency as by phenomena due to saturation of demand. As far as the drop in consumption in Eastern Europe between 1990 and 2000 is concerned, this results from the collapse of the former Soviet bloc and the acquisition of energy-efficient plant. But an extrapolation up to 2020 highlights an upward trend there as well.

¹ The Net Calorific Value (NCV) represents the real calorific output of a fuel when burnt and the heat from water vapour is not recoverable, which is valid for most traditional combustion systems.

² MTOE = Millions of Tons of Oil Equivalent. A TOE is the energy contained in a ton of oil, i.e. 1165 litres of fuel oil.

The world needs to face up to the foreseeable end of fossil fuel reserves as energy needs increase.

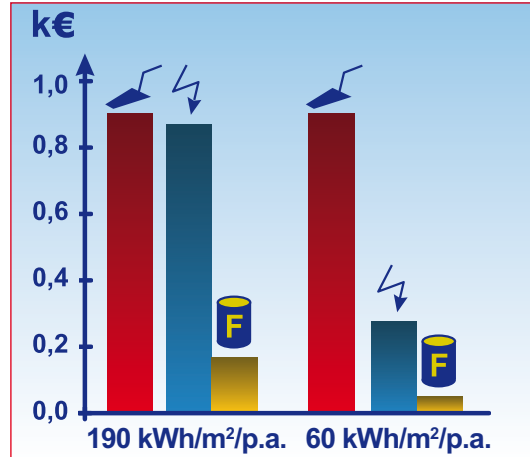

1 Comparative construction and consumption costs per sq.m. (for heating and lighting) for a school over 30 years.

MTOE	1990 Actual	2000 Actual	2020 Extrapolated
Western Europe	1 468	1 625	1 990
Eastern Europe	1718	1 227	1 277
North America	2 178	2 603	3 718
Latin America	517	691	1 234
Africa	618	843	1606
Asia-Pacific	2 351	3 116	5 513
Total	8 850	10 105	15 338

2 Extrapolation of energy consumption to 2020 if 1990-2000 trends continue (source: *Les Cahiers de Global Chance* no 16, November 2002).

The earth has five major climate types, classified according to temperature and humidity : a tropical climate, a dry climate, a warm temperate climate, a cold temperate climate and a cold climate (Fig.1). This classification may be further refined with reference to seasonal cycles such as the monsoon or geographical features such as proximity to the sea, altitude, forestation, etc.

Tropical climates (rain forest, monsoon or savannah climates) can be found in latitudes 15°N to 15°S (cf. Cayenne, Guyana, figure 2). They are typified by minimal seasonal variation. Air temperatures vary from 27 to 32°C in the day and from 21 to 27 °C at night. Relative humidity is around 75 % throughout the year. The amount of solar irradiation is high, albeit partially mitigated by cloud cover; winds are light; rainfall is heavy.

Monsoon climates can be found near the tropics of Cancer and Capricorn. They are typified by a long hot dry season and a short hot wet season. Air temperatures vary from 32 to 43°C in the day and from 21 to 27°C at night in the dry season. In the wet season air temperatures vary from 27 to 32°C in the day and from 24 to 27°C at night. Daytime/night-time temperature variation is thus very small. Relative humidity is low (20 to 55 %) in the daytime, but increases significantly in the wet season (55 to 95 %). Solar irradiation is intense; winds are strong and continuous, mainly during the monsoon; rainfall can reach 200 to 250 mm during the wettest month.

Dry climates (steppe or desert climates) can be found in latitudes 15° to 30° N and S (cf. Phoenix, USA, figure 2). They are typified by a hot season and a cold season. Air temperatures vary from 43 to 49°C in the day and from 24 to 30°C at night. In the cold season, air temperatures vary from 27 to 30°C in the day and from 10 to 18°C at night. Daytime/nighttime temperature variation is significant; relative humidity is low (10 to 55 %) and solar irradiation is intense ; winds are often hot and localised, carrying sand and dust; rainfall is very low (50 to 155 mm/p.a.). Near the oceans, these climates are influenced by significant seawater evaporation. Humidity goes back up to 50 to 90 %, which reduces daytime/nighttime temperature variation. Winds alternate between a sea breeze during the day and a land breeze at night.

Temperate climates are apparent in the context of European climates and are the subject of a specific section.

Cold climates (tundra or high altitude or polar climates) can be found in North America and in Asia. This continental climate sees very short wet summers and long winters with light snowfall (North-American continent) or very dry and very cold ones (Northeast Asia). Polar climates can be found above the Arctic circle (cf. Murmansk, Russia, figure 2).

The earth has five major climate types, classified according to temperature and humidity : a tropical climate, a dry climate, a hot temperate climate, a cold temperate climate and a cold climate.

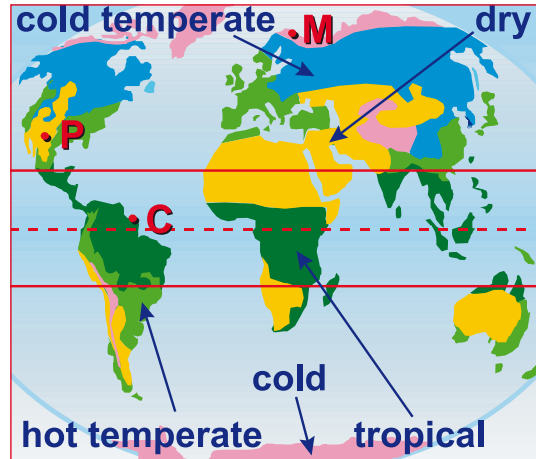

Distribution of tropical, dry, temperate and cold climates. **1**

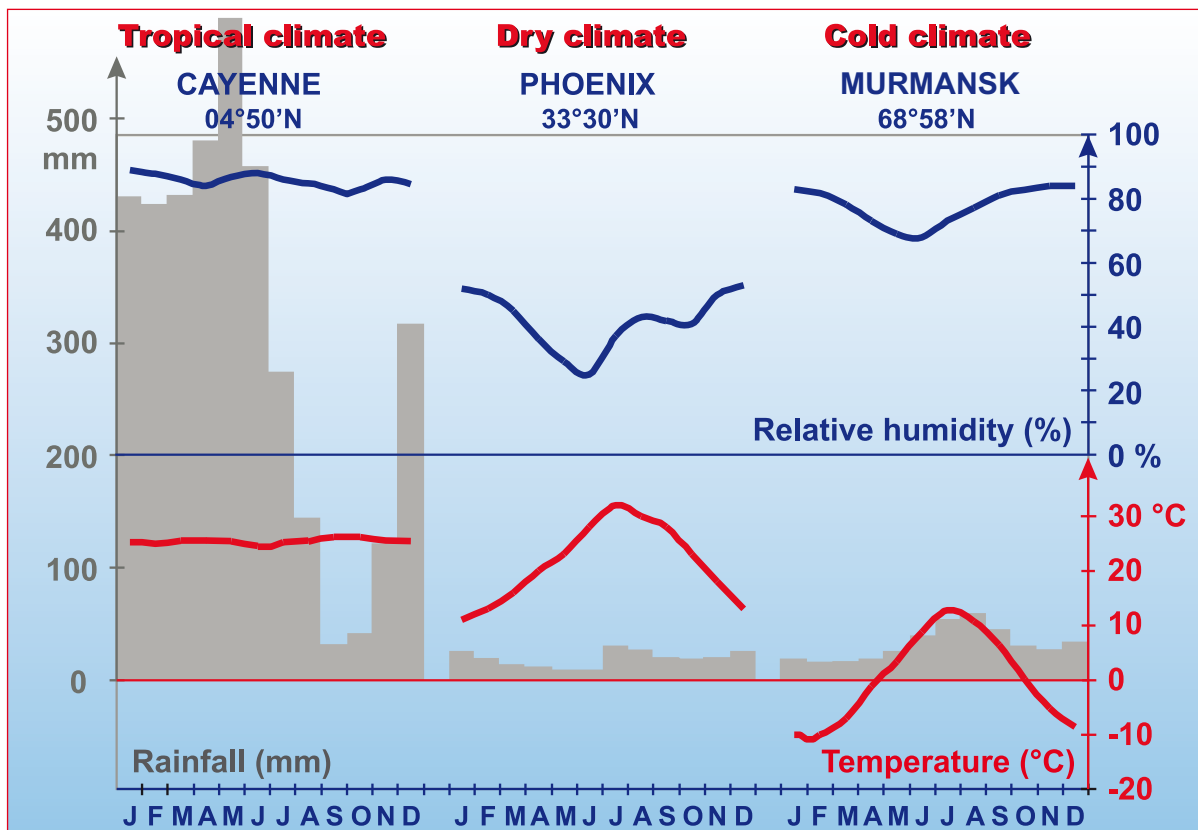

2 Typical climate values for Cayenne, Phoenix and Murmansk.

The sun is an incandescent star (its surface temperature is calculated to be 5,750°C) that emits electromagnetic radiation in the form of light and heat (Fig. 1). The sun's rays are needed on the earth's surface to maintain the temperature and light conditions essential for the biochemical reactions of plant and animal life.

The earth only intercepts around 2 billionths of the energy emitted by the sun. This amount of energy equates to $\pm 10,000$ times the total power generated by man today. At the outer limit of the atmosphere, the intensity of the radiation is equal to the solar constant, i.e. 1,350 W/m². With a clear sky, at noon (universal time) radiant solar energy reaches a level of the order of 1,000 W on a 1 m² surface perpendicular to the rays. On any given site, the energy intercepted by the wall of a building depends on the angle at which the rays strike the wall in relation to its orientation and slope. If, for rays perpendicular to the wall, the energy transmitted equals 100, for a 60° angle of incidence, it will equal 50 (equivalent to $\cos 60^\circ$) and 0 (equivalent to $\cos 90^\circ$) for a parallel ray.

Solar energy is present everywhere ('ambient' energy), regular (daily and seasonal cycles), clean (no waste) and available (no costs, no intermediaries, no network). However, equipment is needed to convert it into heat or electricity.

Of the energy intercepted by the earth, 60 % is directly reflected by the atmosphere (Fig. 2) ; 16 % contributes to seawater evaporation, initiating the water cycle and hydraulic energy ; 11,5 % is reflected on the earth's surface (according to its albedo factor), only 9,5 % is absorbed by earth and air mass, and around 3% is used in photosynthesis (on land and in water). A minute amount contributes to the formation of fossil fuels (0,02 %).

Not all regions of the world receive the same amount of sunshine, owing to cloud cover between the sun and the earth. For example, the Côte d'Azur benefits from 2,882 hours of sun per year, compared with 2,038 hours in the Vendée region and only 1,514 hours in the North of France.

Bioclimatic architecture tries to exploit these ambient energies available in the form of light and heat: more natural light to enhance the connection between people and their surroundings and to reduce the running costs of artificial lighting; more free heating to slow down consumption of commercial energy and to limit the environmental impact.

Solar energy is currently used in the context of solar architecture both passively (by bay-windows, greenhouses, solar water heaters, etc.) and actively (by solar panels used for heating systems). As for photovoltaic solar panels, these enable the conversion of the sun's rays into electricity (yielding 10 to 12 %) as well as some interesting applications for remote zones not connected to the mains network (radio beacons, lighthouses, solar television or telephones, lighting, water pumps, refrigeration, etc).

The earth receives from the sun 10,000 times the total power generated by man today. Solar energy is regular, clean and available.

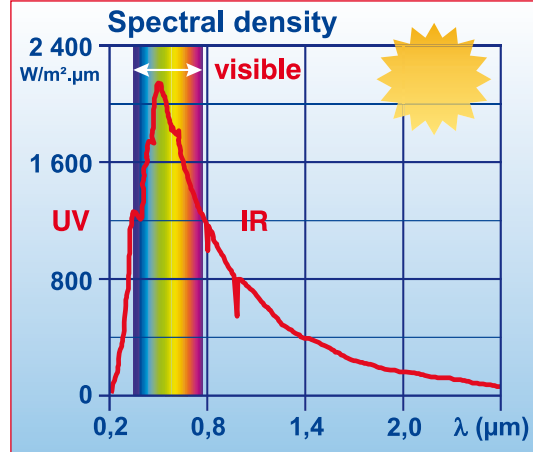

Solar energy is composed of electromagnetic waves. **1**

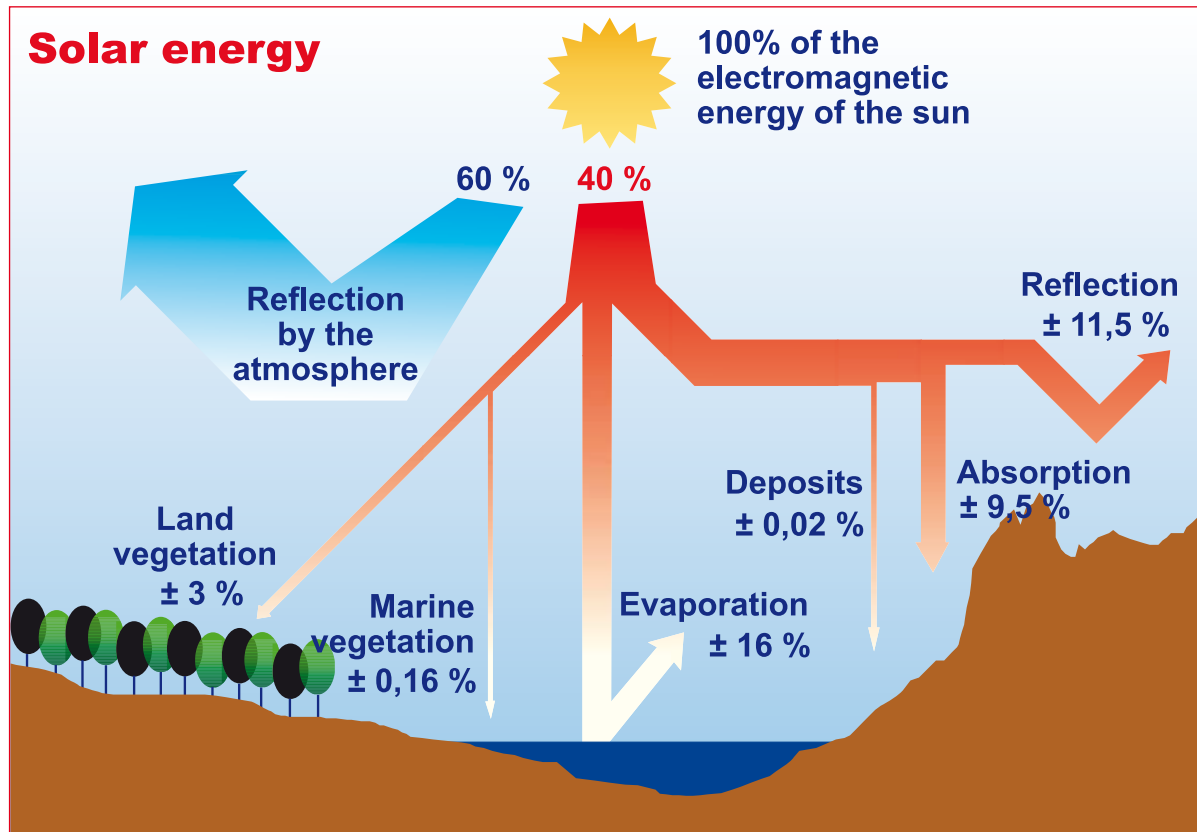

2 What the earth receives from the sun.

Sunshine levels are determined by the sun's trajectory and hours of sunshine. The geometric state of the sun-earth system determines the relative position of the sun, which is fixed by its azimuth γ and its angular elevation α (Fig. 1).

The azimuth is the horizontal angle formed by a vertical plane passing through the sun and the meridian plane of the observation point. The convention is to assign a value of zero to the South.

The angular elevation of the sun is the angle formed by the path travelled by the sun in the relation to the horizon.

Formula for the sun's elevation at noon :

at the summer solstice : $\alpha = 90^\circ - \text{latitude} + 23^\circ 27'$

at the winter solstice : $\alpha = 90^\circ - \text{latitude} - 23^\circ 27'$

After taking into account the influence of cloud cover, the sun's path determines exposure to the sun's energy (hours of sunshine) and the angle of incidence (intensity). The sun's rays are generally only considered useful if its elevation $> 10^\circ$, in order to take account of obstacles generally present in the environment and of the weakness of its rays at sunrise and sunset.

The intensity of its rays varies according to the angle of incidence or, more precisely, the density of the layers of atmosphere it passes through. Geometrically, it seems that with the sun's elevation at 30° , its rays have to pass through an air mass equivalent to twice the thickness of the atmosphere. At an elevation of 20° and 15° , its rays have to pass through the equivalent of 3 to 4 times this thickness.

The diagram showing a cylindrical view (Fig. 2) makes it possible to fix the sun's position using its azimuth (horizontal axis) and its angular elevation (vertical axis). The red curves represent the sun's path in a given location at predetermined dates (generally the 15th of the month) over a 6 month period. The dotted-line curves represent the mean time points.

In Paris ($48^\circ 50'N$), the sun displays an angular elevation of $64^\circ 27'$ at noon on 15th June (it will be at its highest point on 21st June, at $64^\circ 37'$). On 15th March and on 15th September, this value is $37^\circ 45'$. On 15th December, the sun's elevation is only $17^\circ 54'$ (its minimum being reached on 21 December: $17^\circ 43'$). The times of day shown on the curves correspond to universal time.

The sun follows a path every point of which is determined, in a given place, by its angular elevation and its azimuth. Its elevation is greatest at the summer solstice and lowest at the winter one.

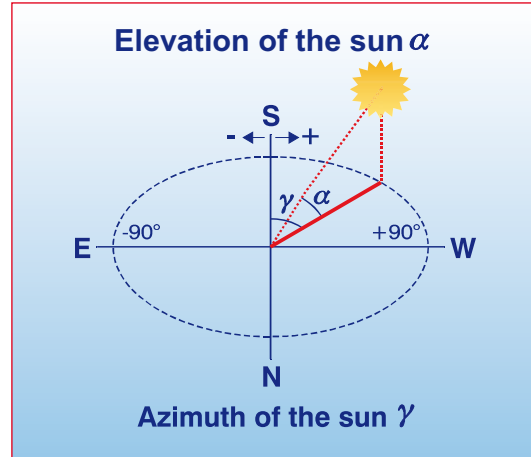

The sun's position. **1**

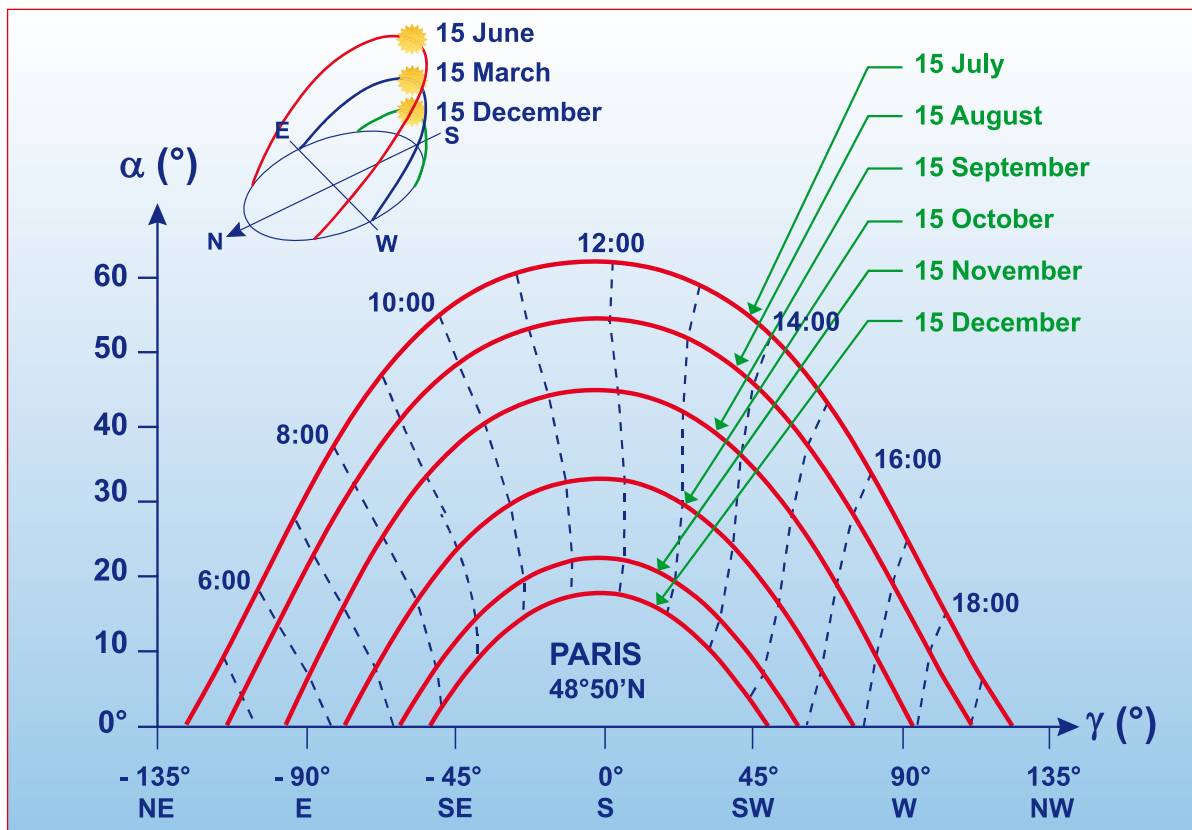

2 Cylindrical projection of the sun's trajectory (Paris).

The sun's radiation is characterised by the direct and the diffuse components of this radiation.

The sun emits electromagnetic radiation that varies little outside the earth's atmosphere (the solar constant: $\pm 1,350 \text{ W/m}^2$). Conversely, its radiation at ground level depends on the composition of the atmosphere. In effect, as it passes through, its radiation is partially absorbed and reflected by dust and micro-droplets of water in the air. Part of the radiation is also scattered by air molecules and particles contained in the atmosphere. These rays as they hit a place on the ground constitute diffuse solar irradiance. The remaining radiation reaches earth directly: this is direct solar irradiance.

The sum of the direct and diffuse irradiance constitutes global solar radiation G. In our latitudes, it equates to approximately 700 W/m^2 with a clear sky, i.e. around 50 % of the solar constant. The proportion of diffuse solar irradiance is considered to range from 10 % with a clear sky to 100 % for a cloudy one.

In calculating global solar radiation G, one is sometimes led to consider an additional term : the reflected component. Whether it be in a rural setting due to lakes, or in an urban setting due to the reflection of the sun on neighbouring buildings, this component can prove important. Besides this, the presence of water has an impact on solar radiation due to evaporation and cloud formation, which reduce direct radiation.

Figure 2 shows a map of total average daily solar radiation on a vertical south-facing surface, for the month of January. The wide spacing of the curves depending on latitude and with the same level of radiation is noteworthy. Nearer the Alps, the curves are tighter together: the increase in energy received through irradiation becomes greater as altitude increases notably because of longer hours of sunshine.

The solar radiation available in a given place consists of direct and diffuse components. The amount of radiation varies according to the time of year, the latitude, the altitude and local cloud conditions.

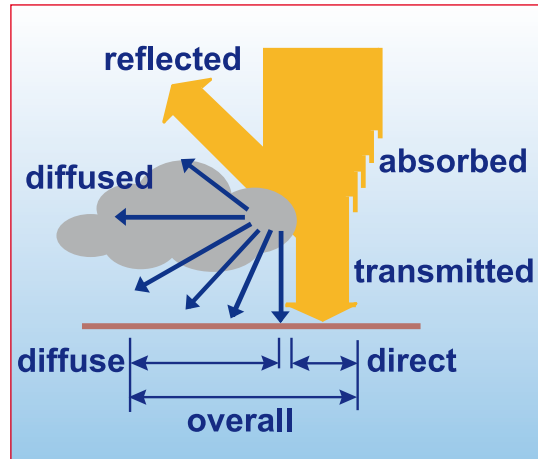

Components of global solar radiation. 1

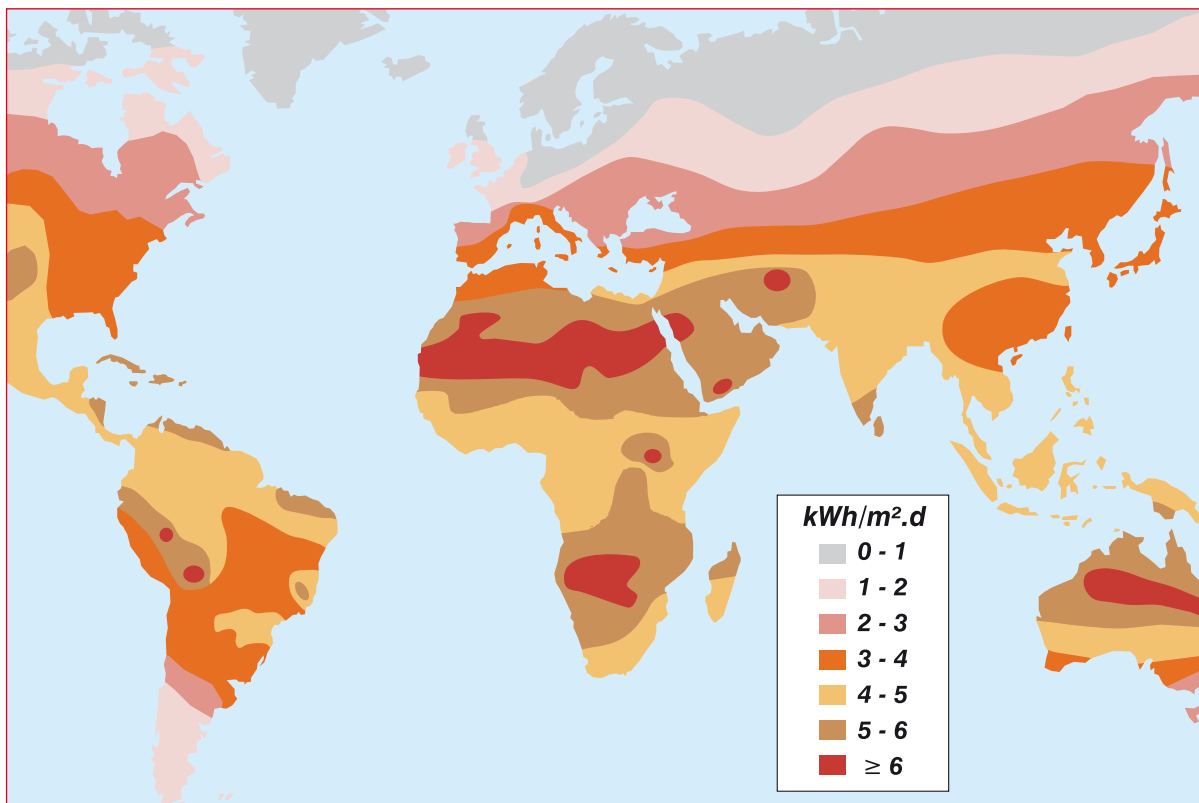

2 Solar radiation on the earth's surface.

As a source of natural lighting, light and sunshine are climate factors that should be exploited. A good design and the intelligent use of a building will reduce lighting requirements even when the sky is overcast. This is based on knowing the amount of light available for a specific day and time. The analysis of natural light for a building is carried out based on data for an overcast day equating to unfavourable conditions. Data for a clear sky is used as an additional parameter to evaluate variations in natural light within the building.

Natural light has a visible spectrum (rays whose wavelength is between 380 and 760 nanometers) which is continuous in form. Figure 1 shows the spectral distribution of energy of natural light falling on a horizontal surface with the sun at 30° on a clear day. The level of light is indicated in W/m^2 . The scale of the wavelengths indicates the range of what is visible.

The amount of light falling in a given place varies according to the day and time involved. It is also affected by meteorological conditions and levels of air pollution. Natural daylight, on a clear day, on an open site, is expressed as the sum of the light coming from the sky and the sun: this is total illuminance. In summer, the proportion of daylight coming from light from the sky is 20% at midday, 25% with the sun at 30°, reaches 50% at 10° and is close to 100% when the sun is below 2°. With an average sky, this proportion is of the order of 50% whereas with an overcast sky, it is 100%.

The large variation in daylight illuminance, measured in lux, results in basing the analysis of natural lighting in buildings on minimum light conditions. Figure 2 shows the average hourly change in daylight illuminance observed in Belgium on a horizontal surface with a clear sky and with an overcast one over a period of four months. The graph is created using a logarithmic vertical scale (a very wide range of illuminance, from 1 to 200) representing illuminance in lux. The horizontal axis represents different times of day. In the early morning, illuminance corresponding to $\pm 4,500$ lux with an overcast sky can be observed (2nd red curve) and $\pm 15,000$ lux with a clear sky (2nd yellow curve). The second green curve shows an intermediate value used to calculate illuminance from the sky alone.

Daylight illuminance is a climate factor that varies during the year.
Natural light is made up of the sum of light coming from the sky and the sun.

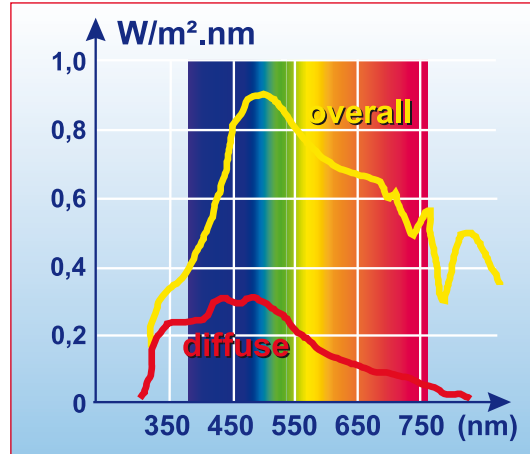

Spectral distribution of energy from natural light on a clear day. **1**

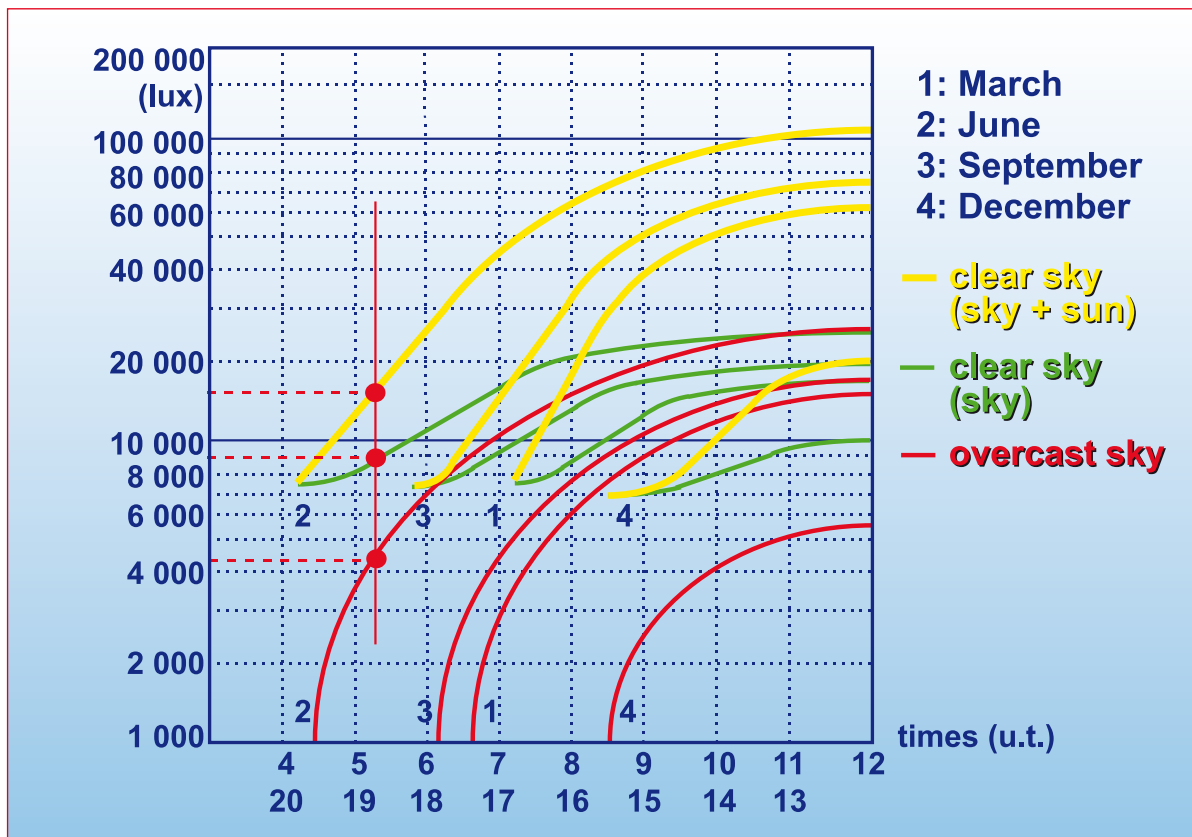

2 Average hourly change in daylight illuminance on a horizontal surface in Belgium over a period of four months.

The landscape influences temperature variations, the amount of sunshine as well as cloud phenomena and wind systems. Landscape impacts temperatures as much by variations induced by the irradiation of slopes during the day (depending on their orientation and steepness) as by its influence on wind systems. Slopes exposed to the wind are colder than sheltered ones and if the landscape protects some places, it over-exposes others.

Figure 1 tries to show typical external temperature variations over 24 hours in a mountain landscape. Valleys are seen to be warmer than summits during the day. Conversely, at night, without the sun's effect, the air cools down and collects in the valley bottom and in low-lying areas. A positive difference in temperature is thus created on those slopes directly in contact with what is referred to as the 'warm belt'. In long valleys, this phenomenon tends to create a longitudinal movement of air which is all the more powerful if the valley is long and the temperature gradient is high.

Altitude also influences temperatures. As pressure drops with altitude, the air expands and cools. This drop in temperature is of the order of 0,7 °C for every 100 m.

Figure 2 again shows problems connected with exposure (south and north-facing slopes), mutual shadow casting and the warm belt. Topography can lead to significant shadowing of the sun in winter, in which valleys oriented east to west risk being permanently in shadow. In Northern Europe, it is preferable to site buildings high enough up a hillside to benefit from the sun even in winter.

Variations in the amount of sun lead to a temperature variation between the bottom and the top of a valley. This situation induces pressure fluctuations and air movements. Breezes move up along the valleys during the day when the summits benefit from a greater degree of sunshine and warmth than in the plain.

Figure 2 also illustrates the 'foehn' phenomenon: air temperature decreases as it rises in altitude. At saturation point, much of the water is released as rain or snow. On the other slope, unsaturated air comes back down and warms up through compression, arriving at the foot of the mountain with very low relative humidity, often less than 30 % of its original level, which makes the air very clear. This quite widespread foehn effect, can cause temperatures to increase by 20 °C in a day.

The landscape impacts variations in temperature and potential hours of sunshine as well as cloud phenomena and wind systems.

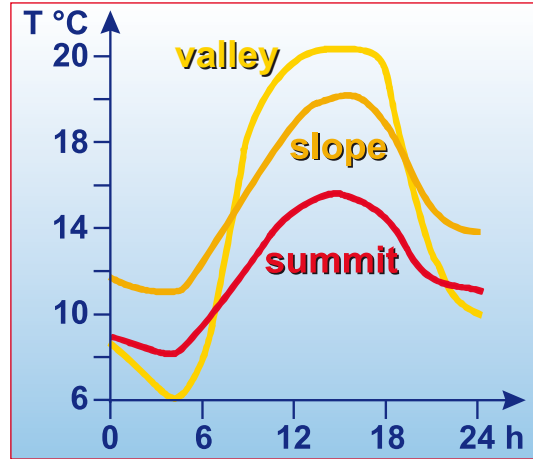

Temperature variations depending on position in a mountain landscape. **1**

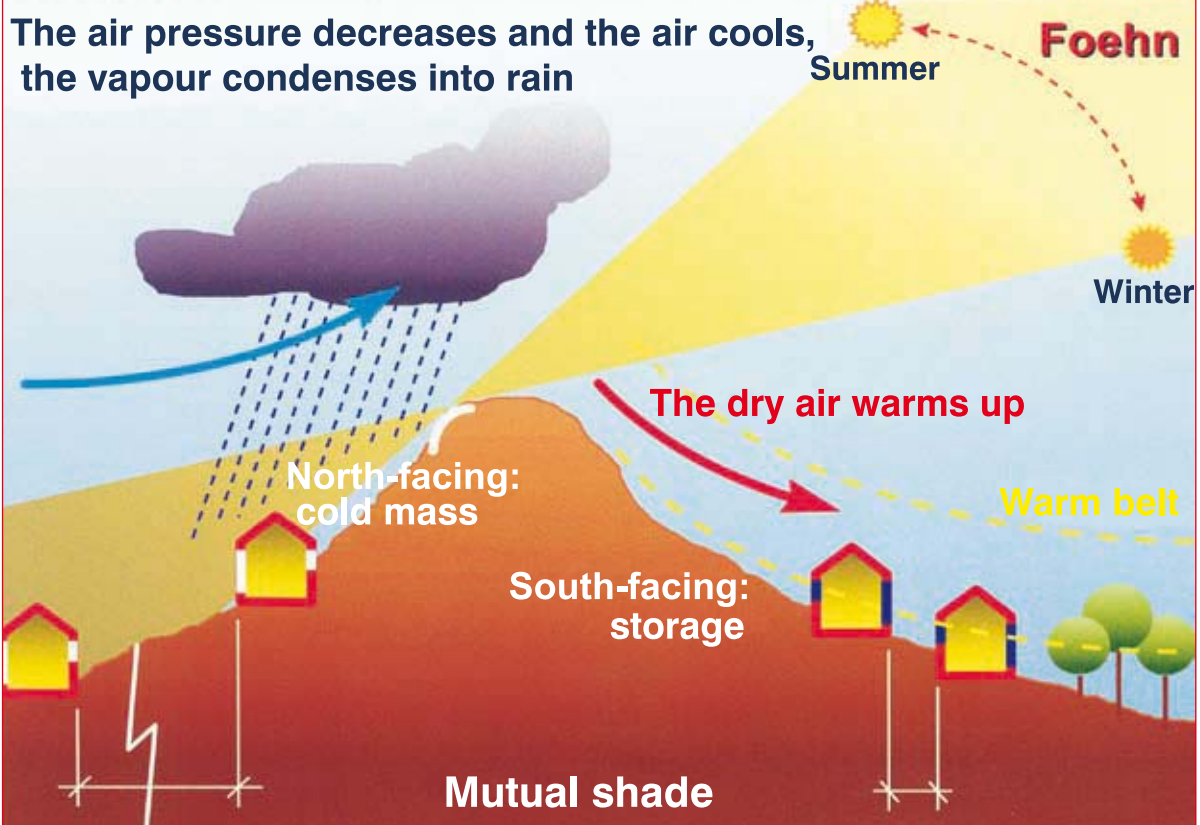

2 The influence of landscape: south and north-facing slopes, 'foehn' effect.

Vegetation provides seasonal shade for buildings, screens them from the wind, cools the air through water loss and filters dust in the atmosphere (Fig. 2).

Vegetation differs from other elements owing to its potentially seasonal aspect (deciduous plants) and due to the fact that its effectiveness depends on the growth of individual plants. Furthermore, it only offers partial protection : it filters rather than stop the sun (Fig. 1).

If plants are used to provide shade, they should be deciduous varieties in order to exploit solar gains in the winter season and to progressively shield glazed areas when the spring starts. Climbing or trailing plants may be used, and those with dense foliage are the best choice in order to provide maximum protection in summer, but with small branches in order to reduce shade to a minimum in winter. However, studies have shown that even in winter most trees maintain an amount of shade corresponding to almost 50% of the amount in summer.

Trees are also able to filter or retain dust, and to absorb or produce water vapour. A hectare of forest can produce nearly 5,000 ton of water per year. Thanks to photosynthesis, trees renew the air by producing oxygen. In heavily wooded regions, trees intercept 60 to 90 % of solar radiation, thus preventing an increase in ground temperature. This phenomenon may be permanent or seasonal depending on whether deciduous or evergreen varieties are involved. Conversely, trees reduce night-time radiation back up into the air : the foliage constitutes a 'canopy' for the ground at the foot of the trees and its radiant temperature is greater than that of the sky. The drop in temperature at night is therefore reduced. Moreover, only small variations in ground temperature are observed in wooded regions.

A 3.5°C difference in average temperature can also be observed between a town centre and districts alongside a green belt varying from 50 to 100 metres in width. Horizontal convection from the cold zones (vegetation) towards the warmer zones (neighbouring buildings) enables this cooling effect. Due to this, relative humidity increases by 5 %.

Finally, vegetation provides protection from strong winds. Hedges, rows of trees, climbing plants all serve to break up the airflow: windspeed is reduced and heat-loss from buildings through convection diminishes.

Vegetation provides seasonal shade for buildings, screens them from the wind, cools the air through water loss and filters dust in the atmosphere.



A path shaded by trellis in Anacapri (Island of Capri). **1**

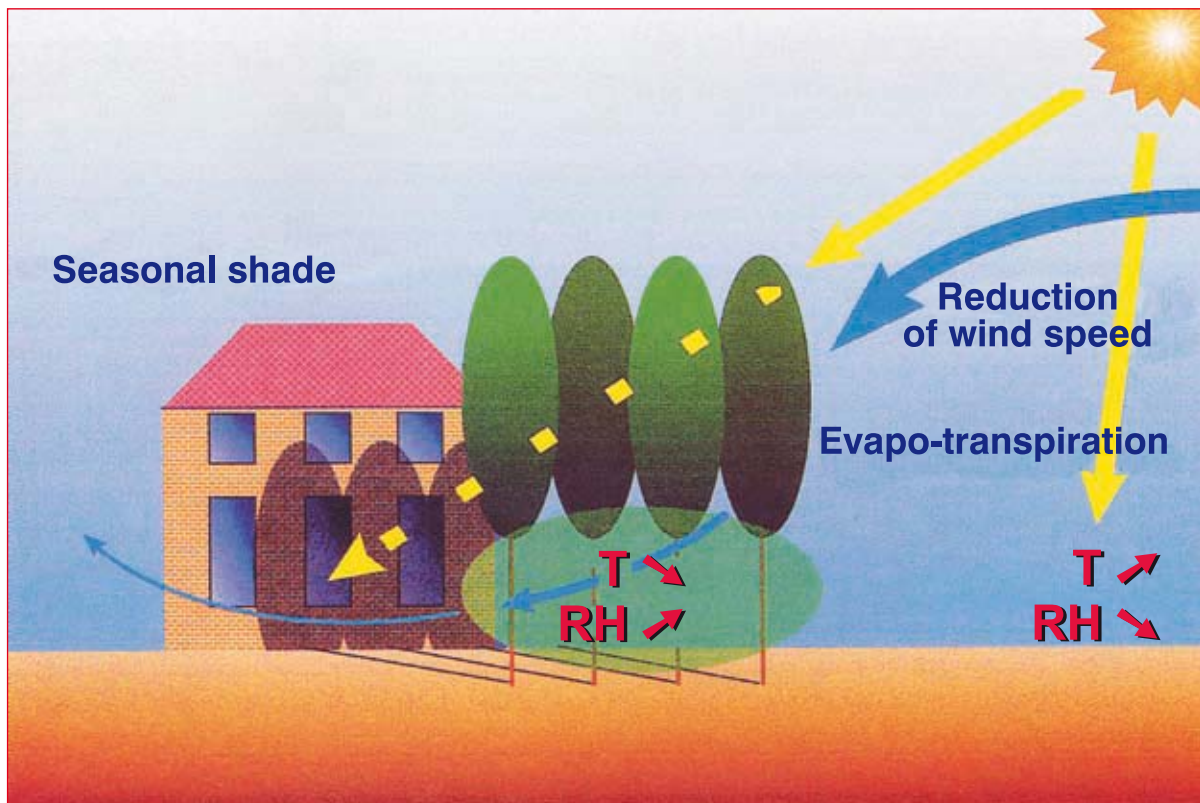

2 Vegetation differs from other types of shading by its seasonal aspect.

Buildings provide a shield from the sun and wind, store heat and increase the temperature outside. They can also create winds and reflect the sun's rays.

Buildings constitute fixed screens for their surrounding area. Their role can be positive if protection from the sun is sought: this is the case for traditional Mediterranean towns, in which the narrowness of the streets and the height of the buildings considerably reduce direct radiation and provide welcome shade.

This role can be negative if the neighbouring buildings mask the sun when solar gains are desired. In the case of a passive solar design, it is important to gauge the impact of this masking effect. The curves of the sun's annual path and the outline of neighbouring buildings can be marked on a cylindrical or stereographic diagram (Fig. 2). Placing oneself to the right of the windows on each side of the building, one can determine the angle within which the direct rays of the sun disappear behind the buildings opposite. One can thus easily determine the periods when sunshine is present and one can calculate the factors that reduce solar gains.

The nature of a building's surfaces also influences the microclimate by retaining heat. In an urban setting, average temperatures are a few degrees higher than average temperatures in the open countryside. Building on the land also prevents water from percolating under the ground. Finally, buildings can create paradoxes. They reduce average windspeeds whilst forcing winds to go around them, thus increasing turbulence. Tall buildings are particularly well known for generating violent gusts at their foot.

The use of reflective materials (glazing) can also influence a building's effective exposure to the sun (Fig. 1). A north-facing building equipped with large clear-glazed windows to make the most of natural light can find itself in a south-facing position if the building is built opposite and fitted with reflective glazing, specifically to protect it from the sun. Quite clearly, in the first building, the factors of comfort are significantly changed by the construction of the second one.

Buildings provide a shield from the solar radiation and wind, store heat and increase the temperature outside. Paradoxically, they can also create winds or reflect the sun's rays.



A building's solar gain can be affected if a neighbour builds one of these...

1

Masks due to constructions

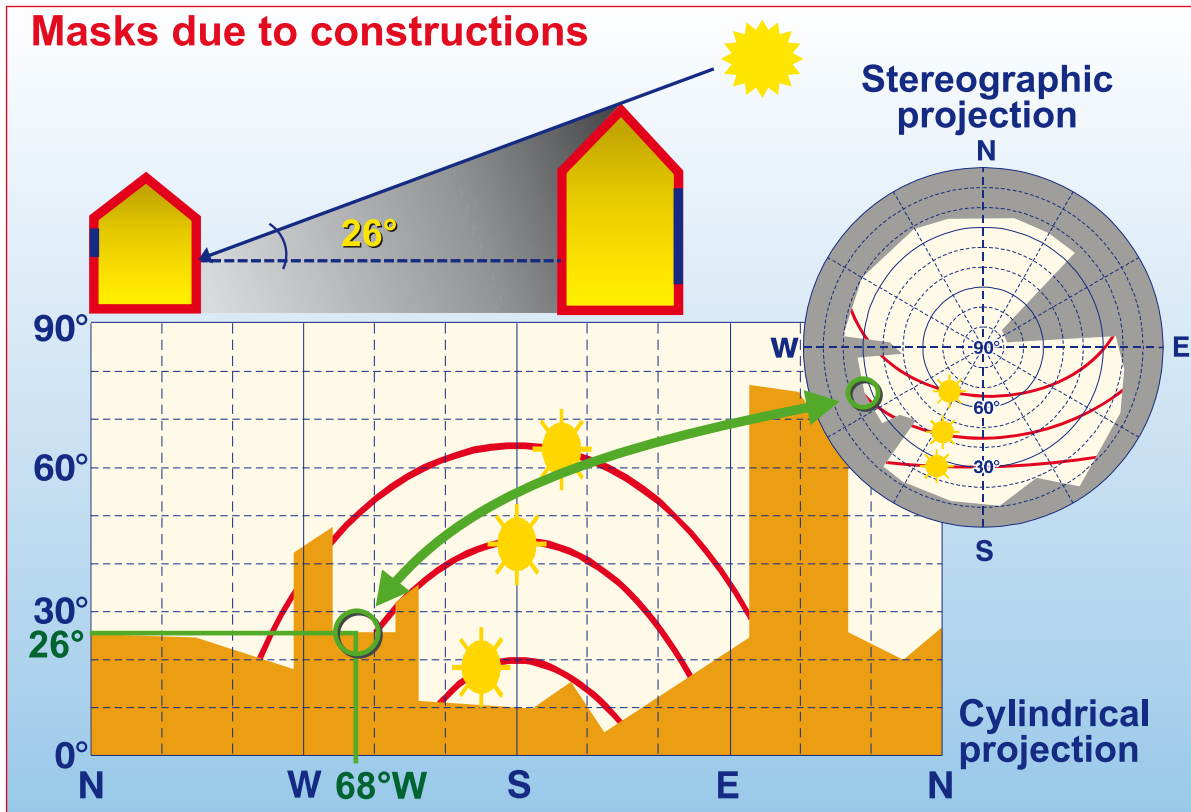

2 Determining the masking effect by cylindrical or stereographic projection.

All architectural works embody in a microcosm the degree of closeness of their relationship with their environment. The purpose of the design, renovation and construction of a building is to create this microcosm in optimum harmony with its surroundings, and thereby to give climate its rightful place among the basic factors used by architects whenever they modify the environment (Fig. 1). Defined thus, architecture includes climate and its implicit dynamics: this is bioclimatic architecture.

The occupant is at the centre of bioclimatic architecture (Fig. 2). It exists with the sole objective of trying to meet the demand for comfort. Bioclimatic architecture is therefore concerned with the parameters that affect the well-being of the inhabitant.

The behaviour of the occupants determines the 'good running' of a bioclimatic dwelling. It is important for the inhabitants be aware of the importance of their role and to learn to live symbiotically with their environment as the days and the seasons pass by.

The notion of the environment is a two-pronged concept: it defines the climate but also, reciprocally, it involves man's impact on his immediate environment. Living in symbiosis with one's environment means both adapting to and respecting it.

Climate is the most crucial aspect of the concept of bioclimatic architecture: variations in hours of sunshine and in temperatures, wind systems and rainfall all contribute to defining the physical environment to which architects attempt to respond.

Our different climates do not provide the climate conditions needed to ensure thermal comfort all year long, hence the necessity of heating or cooling buildings to correct these effects of climate. The goal to be pursued is therefore to achieve the best interaction between climates, buildings and occupants' behaviour.

Bioclimatic dwellings exploit climate in order to offer their occupants the most comfortable living conditions possible. In our temperate climates, variations in hours of sunshine, in temperatures, and rainfall mean establishing various strategies according to seasonal differences. In winter, making the most of solar gain and protecting ourselves from the cold (the heating strategy) are important; in summer, we need protection from the sun and, sometimes, to open our houses to the airs (the cooling strategy).

Finally, bioclimatic dwellings stay in tune with these natural rhythms by making the most of natural light (the natural lighting strategy).

To refer to bioclimatic architecture is, beyond questions of energy savings and protecting the environment, above all to speak of the home-dweller and of his well-being.

Bioclimatic architecture re-establishes the architectural link between man (the occupant) and climate (interior and exterior ambiances).



A building reacts to the climate to ensure greater comfort for its occupants (arch. Y. Célaire). **1**

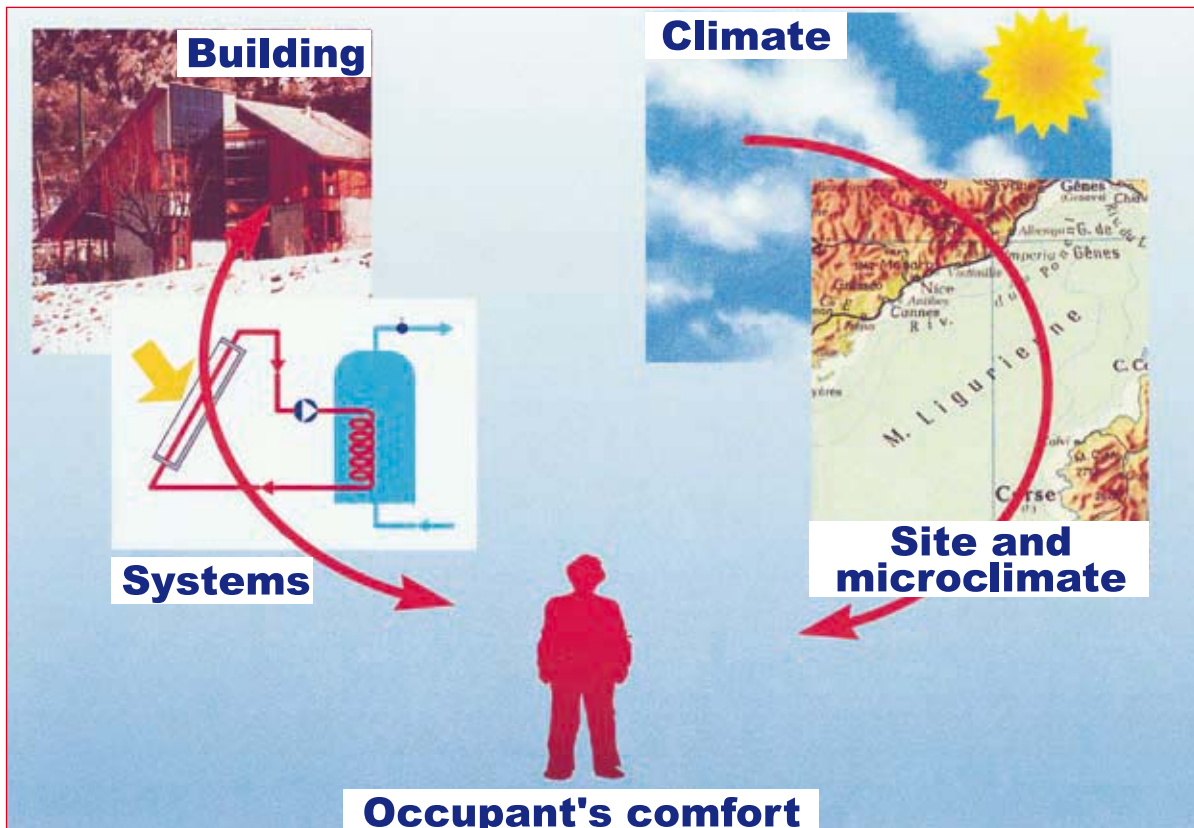

2 Bioclimatic architecture puts the occupant at the centre of its considerations.

The natural lighting strategy aims to improve how natural light is captured and allowed to penetrate a building, and to improve how it is then diffused and focused. Controlling light to avoid visual discomfort must also be considered. The intelligent use of natural light enables the reduction of electricity consumption for lighting.

- Light Capture

A certain amount of daylight is transmitted by windows into a building. The amount of light captured in a room depends on the nature and type of glazed surface, on its roughness, its thickness and how clean it is. The construction of the window surrounds may also create a barrier to direct sunlight entering in winter or in summer, whilst leaving a large opening for diffuse daylight to enter. Conversely, reflective surfaces on the ground (paving, lakes) may contribute to capturing more light.

- Penetration

The way light penetrates into a building creates very diverse lighting effects not only depending on external conditions (type of sky, atmospheric disturbances, season, time of day, and how open the site is) but also depending on the position, the orientation, the angle, the size and the type of glazing. Lateral lighting provides a directed light that highlights outlines but is limited in depth, unlike toplighting which is more uniform but possible only on the top floor of buildings.

- Diffusion

Light is all the better reflected around all interior surfaces of a building if it does not encounter any obstacles created by the geometry of the room or its furniture and if surfaces are matt and bright. It can also be diffused by the very type of glazing used (translucent) or by systems of reflectors that enable light to penetrate right to the back of a room.

- Shading and control

Excessive natural light penetration can cause visual discomfort (glare, eye-fatigue). This can be controlled by constructing fixed architectural features (overhangs, roof lights or light-shelves, roof eaves, etc.) in conjunction with adjustable screens (awnings, shutters, louvre-shutters or blinds).

- Focusing

It is occasionally necessary to focus some natural light in order to enhance a particular place or object. Top lighting – or high lateral lighting – creates a significant contrast with less-powerful ambient light. An atrium in the centre of a building enables more daylight to enter a building whilst creating an attractive space in which to move and to relax. Tall and deep buildings can thus benefit from natural light in their centres thanks to these shafts of light.

The natural lighting strategy aims to improve how natural light is captured and allowed to penetrate a building, and to improve how it is then diffused and focused. Controlling light to avoid visual discomfort must also be considered.



Controlling light improves the ambience (arch. J. Battle). **1**

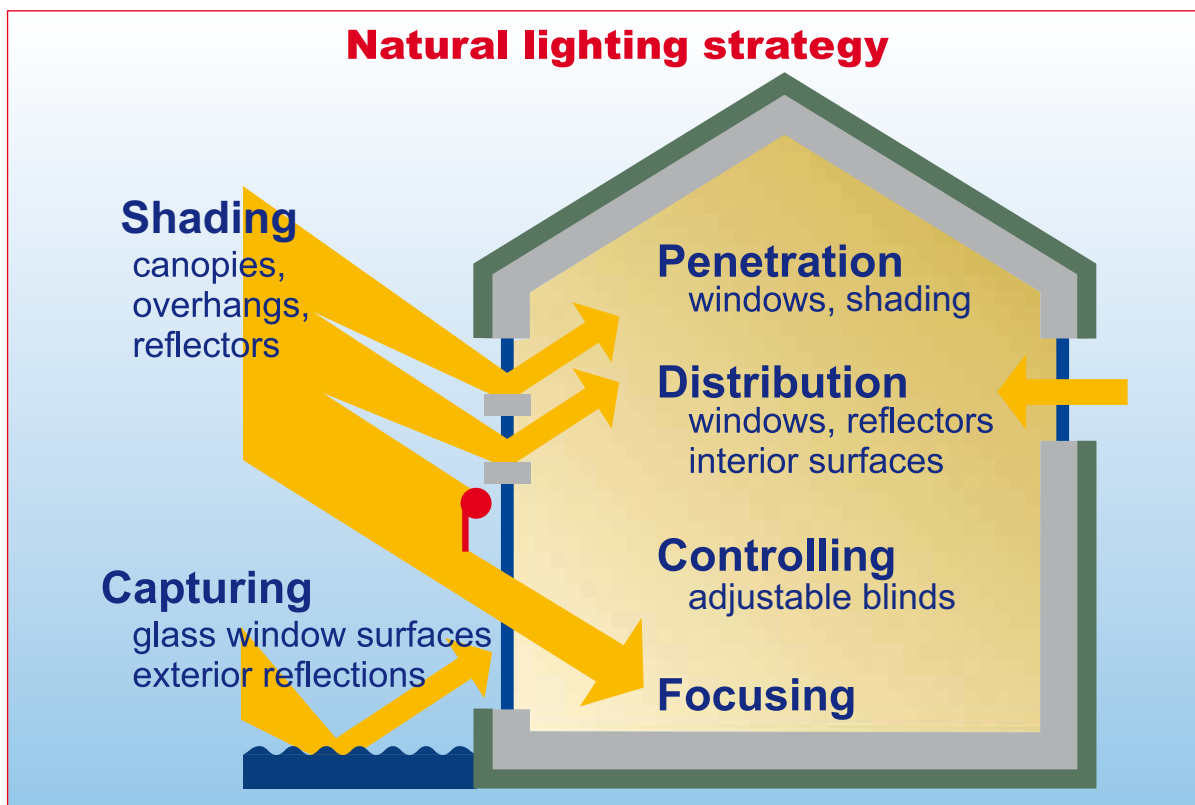

2 Strategies to control the entry of natural light.

The cooling strategy is a response to the need for summer comfort: shading from solar radiation and heat gain, minimising internal heat sources, dissipating excess heat and cooling down naturally.

- Shading

Shading the building - and, in particular, its apertures - from direct sun in order to limit direct gain means basically erecting screens, externally if possible, to shade it. These screens can be permanent, mobile or seasonal (plants). Furthermore, in order to prevent solid vertical walls from heating up the building, sufficient insulation should be used to prevent the accumulation of heat. In a hot climate, allowing heat to enter through walls and roofs heated by the sun should particularly be avoided. This can be achieved by increasing their insulation or their inertia, by having reflective surfaces facing the sun or else by reducing the hot air entering the building.

- Minimising internal heat sources

Minimising internal heat sources is aimed at avoiding excessive heat in buildings due to the occupants and equipment: artificial lighting, electrical equipment, number of occupants, etc. Some sources can easily be minimised by adopting, for example, natural lighting.

- Dissipating excess heat

Dissipation of excess heat can be achieved through natural ventilation, by using outlets where temperature differences create a 'chimney' effect. Wind pressure and channelling air flows can also be useful in expelling hot air from a building.

- Cooling the building

Cooling the building can easily be achieved by natural means. The first solution is to ensure good ventilation (especially at night, in order to eliminate heat stored up during the day) or to increase the speed of air circulation (the Venturi effect, wind towers, etc.). Another way consists of cooling the air using natural features such as water features, fountains, plants, underground ducting, etc.

Figure 1 shows the multitude of natural cooling systems developed by Moorish architects in the 13th century: large shaded porticoes, open arcades, fountains and water features, abundant vegetation, etc.

The cooling strategy is a response to the need for summer comfort: shading from solar radiation and heat gain, minimising internal heat sources, dissipating excess heat and cooling down naturally.



Patio of la Acequia, Generalife in Granada, Spain. **1**

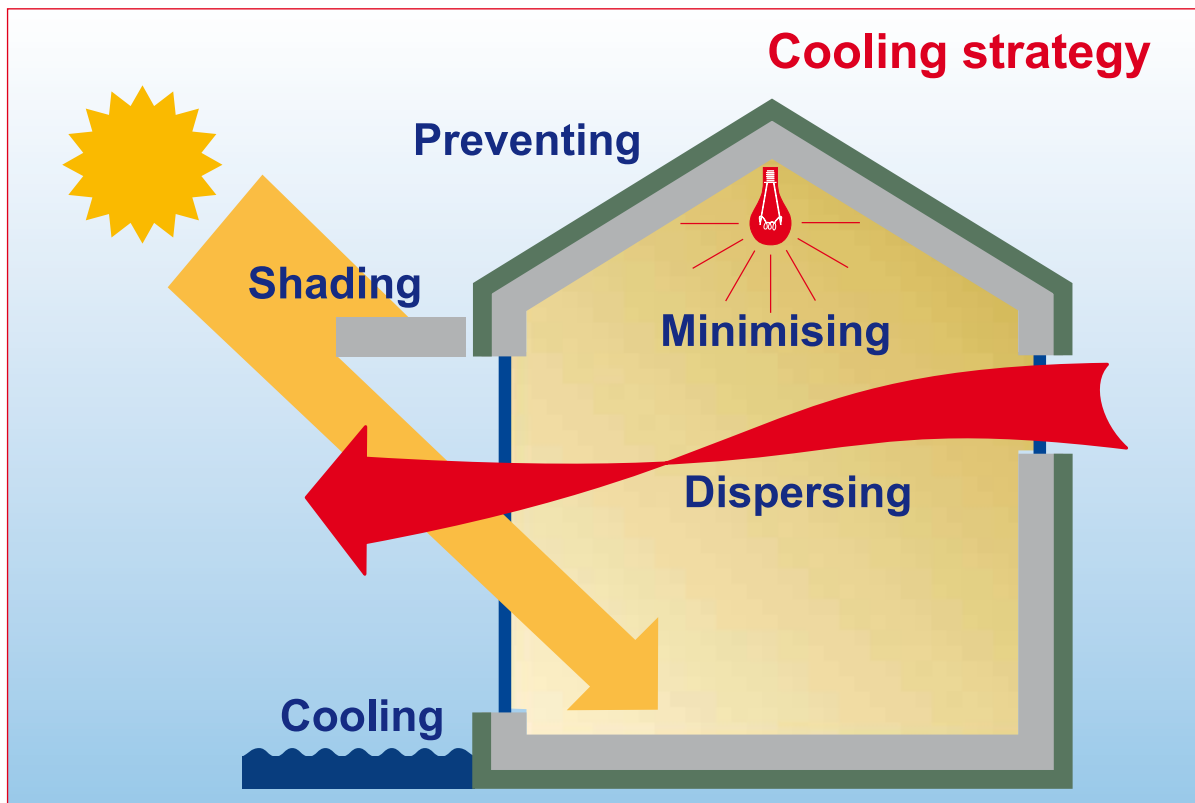

2 The principles of summer comfort.

The heating strategy is a response to winter comfort: capturing the heat from solar radiation, storing it in the mass of the building, retaining it using insulation, and distributing it around the building.

- Heat Capture

Capturing heat consists of collecting solar energy and turning it into heat. The solar radiation received by a building depends on climate with its daily and seasonal variations, but also on the orientation of the building, the nature of its surfaces and the materials used, on the topography of the site, on shade, etc. Solar radiation is only useful in practice when at right-angles to glazed surfaces, by which it is partly transmitted into the inner space and provides a direct heat gain.

- Storage

Solar radiation often produces heat when not needed. It is therefore useful to be able to store heat until it is needed. This storage takes place within all types of material according to their capacity to accumulate heat, thus enabling heat absorption which, owing to this inertia, attenuates temperature variations within a building.

- Retention

In a cold or cool climate, all forms of heat should be retained, whether they emanate from the sun, from internal heat gains or from heating systems. It is the basic shape and air-tightness of the building's skin together with the insulation properties of its walls that reduce heat loss. Dividing a building into different spaces to create distinct temperature zones (for different heating requirements or buffer zones) according to their use, also enables the demand for heating to be better distributed.

- Distribution

Distributing heat around a building whilst regulating it means conveying it to the different living spaces where it is desired. This distribution can be carried out naturally when the heat accumulated in materials during periods of sun is released back into the ambient air by radiation and convection. Another way of distributing heat is thermocirculation of the air (the natural upwards movement of warm air). Lastly, this distribution can also be carried out by a powered ventilation system. This heat must also be regulated according to differences in the living spaces and their usage.

The heating strategy is a response to winter comfort: capturing the heat from solar radiation, storing it in the mass of the building, retaining it using insulation, and distributing it around the building.



Rooms well exposed to the sun (arch. M. Gerber). **1**

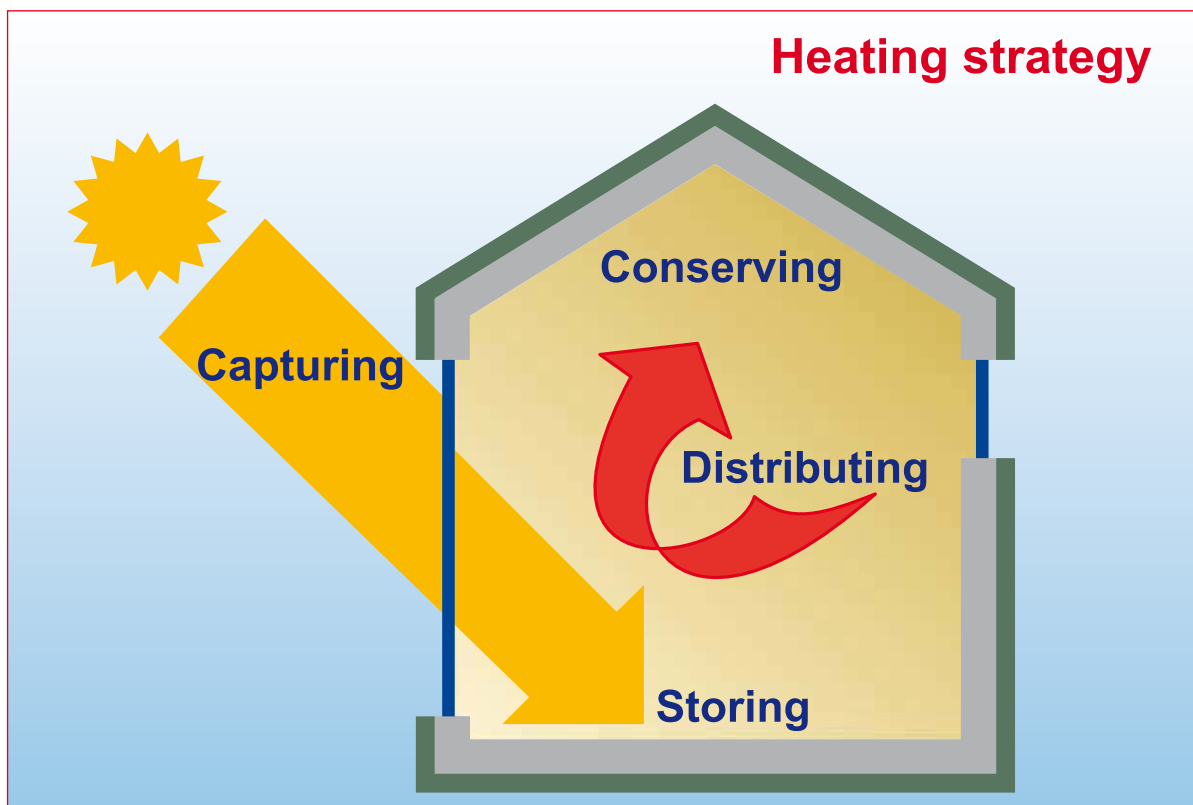

2 The principles of winter comfort.

Modern physics recognises two properties in electromagnetic radiation: waves and particles.

The wave property is based on the notion of monochromatic radiation, i.e. a sinusoidal wave characterised by its duration T (in seconds) or the opposite, its frequency $\nu=1/T$ (in hertz).

In practice, it is preferable to speak of wavelength λ representing the distance travelled by the wave for a time period measured in nanometers (Fig. 1). Wavelength is related to frequency by the speed c at which the wave travels: $c = \lambda \cdot \nu$ where c depends only on the medium through which it travels (around 300,000km/s through air).

The particle property of light was made clear through the observation of the fact that the emission and absorption of light is discontinuous in nature, as if radiation were composed of particles (photons) whose energy $\Delta E = h \cdot \nu$ in which h is the Planck constant and is expressed in electron volts (as in quantum theory).

Natural light, or white light – the only kind that enables the eye to distinguish colours precisely - consists of visible electromagnetic radiation of various wavelengths. The different colours of radiation making up natural light can easily be seen when refracted through a prism or water droplets (the rainbow effect). They enable us to define a continuous spectrum of radiation of natural light (Fig.2, the white curve).

The eye is naturally adjusted for daylight. Consequently, light emitted by artificial light sources should have the same spectral composition as natural light in order that the perception of colours is not distorted. In fact, any object selectively reflects the coloured radiation striking it. For example, if it receives only red light, it appears to be red. If, on the other hand, incidental artificial light contains no radiation in the red range, the object will appear to be a different colour. This phenomenon is common with fluorescent lighting, especially with regard to tones that appear orange-red in natural light.

If you study an artificial light source and establish its radiation spectrum, you will notice that it can be continuous (Fig. 2, fluorescent or tungsten light) or discontinuous (Fig. 2, sodium light) i.e. the light emitted is not white light (natural). Any light spectrum that differs from that of daylight changes the apparent colour of an object.

Figure 2 enables the spectrum of natural light (the white curve) to be compared with those of different forms of artificial light. Frequencies in nanometers and in ordinates and the relative energy of the light output of the lights studied (in %) are shown on the different axes. In yellow, a curve showing the sensitivity of the human eye is depicted, its maximum corresponding to yellow-green (555nm). The wavelengths corresponding to this maximum sensitivity are:

- for blue: 450nm
- for green: 540nm
- for red: 610nm

The wave property of light is characterised by its duration T , its frequency ν , and its wavelength λ .

Natural light is referred to as white light.

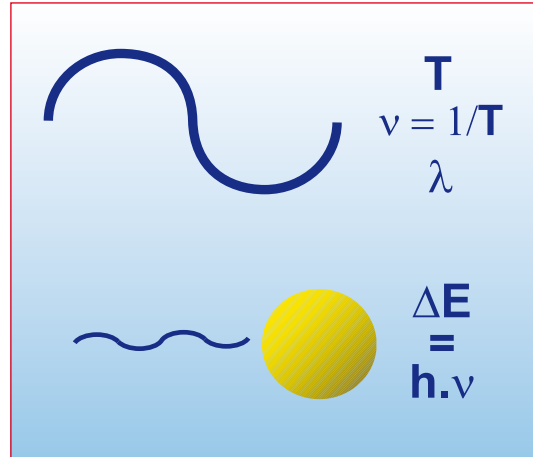

The wave and particle properties of light. **1**

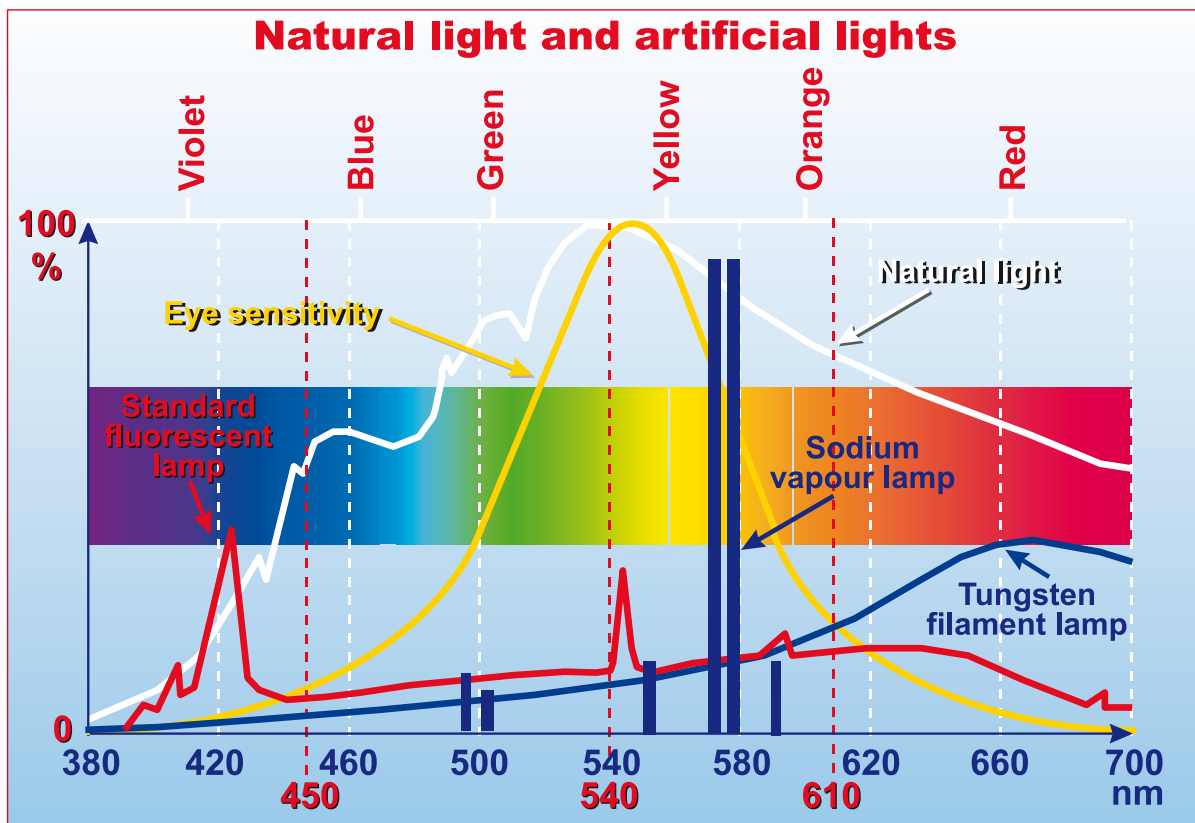

2 Comparison of the spectral distribution of natural light (the white curve) and artificial light.

Man is exposed to a great variety of sources of natural or artificial energy that emit radiation across several bands of the electromagnetic spectrum. Radiation passes through a void at high velocity. It can be considered as either waves or particles but it travels in a straight line.

Not all electromagnetic radiation is visible to the naked eye : x-rays, ultraviolet, infrared, radio waves, etc. are outside the visible spectrum. Only those with a wavelength in the 380 to 700 nanometer range provoke a response in the eye and form the visible spectrum. Some authors place the upper limit at 700nm: a precise limit cannot be defined because it depends on the intensity of light striking the retina and the visual acuity of the observer. This feature is derived from the structure of the eye and, in particular, the sensitivity of the receptor cells in the retina, which vary for each wavelength λ .

Figure 1 again shows the range of colours which compose, by definition, so-called white light, this time with reference to their respective wavelengths. Natural light is the only kind that enables the eye to appreciate the colours of objects and their most delicate hues with great precision. Quite often, architects tend to conceive a project in a visual setting of shades of black and white. It is important to see the significance of colours as an additional source of information enabling the observer to distinguish between objects that may be identical in shape and size. Furthermore, colour affects many physiological human characteristics, such as blood pressure, heartbeat, breathing, etc.

Figure 2 reprises the spectral distribution of electromagnetic radiation, i.e. the strength of the radiation in relation to its wavelength. The visible spectrum, ranging from 380 to 700 nanometers, includes wavelengths in which energy is at its most intense.

X-rays (XR) have a wavelength of 100nm. Between 200 and 380nm, ultraviolet radiation is to be found. This has an anti-bacterial effect (UV-C) between 200 and 280nm, burns the skin (UV-B) between 280 and 315nm and the eyes (UV-A) between 315 and 380nm.

The perception of colour depends on its wavelength. The spectrum of colours perceived ranges from violet to red in ascending order of wavelength. In the visible spectrum, a wavelength of 555nm corresponds to the eye's greatest sensitivity and to the green-yellow zone (relative sensitivity = 1).

The eye's sensitivity to red hues with a wavelength greater than 700nm is poor, as it is to violet with a wavelength of less than 400nm. The eye is not sensitive to wavelengths outside the visible spectrum (relative sensitivity = 0). The curve showing relative spectral sensitivity (in yellow) thus reflects the filtering carried out by the eye, and allocates a weighting (from 0 to 1) to each wavelength according to the visual stimulation it induces.

In the zone of the longest wavelengths, infrareds IR-A (from 760 to 1400nm), IR-B (from 1400 to 3000nm) and IR-C (>3000nm) only have a thermal effect.

Not all electromagnetic radiation is visible to the naked eye: only wavelengths in the 380 to 700 nanometer range provide a light stimulus.

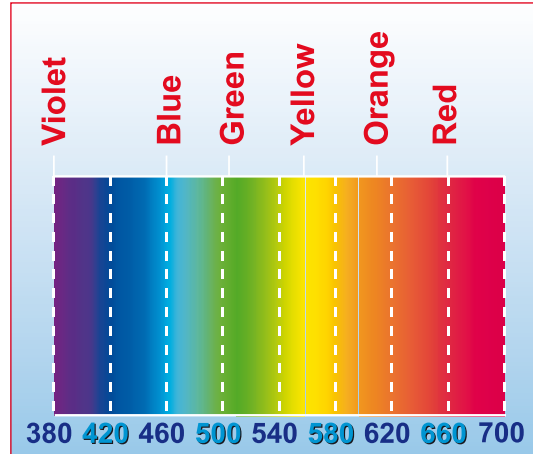

The colours of the light spectrum. **1**

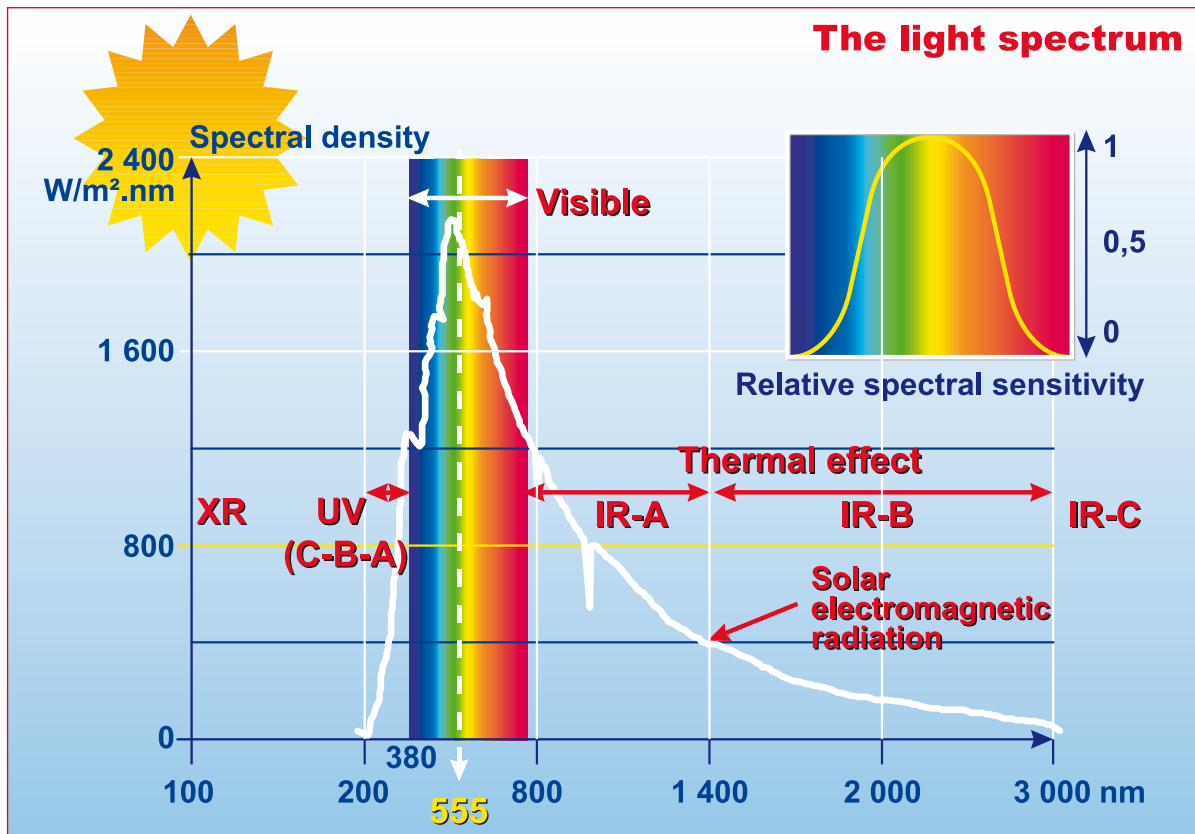

2 Position of the visible spectrum within electromagnetic radiation. Relative spectral sensitivity.

Illumination is the effect produced by the luminous flux striking a given surface and emanating directly or indirectly from an artificial or a natural light source (the sky, the sun). It is expressed in lux (lx).

Illuminance describes the luminous flux emitted by a surface within a field of vision and directed towards the eye of an observer (Fig. 1). It is expressed as the ratio of the light intensity on a surface to the visible area of that surface. It is expressed in candela per square metre (cd/m^2). The illuminance of a surface is greater when the light it receives is brighter and its index of refraction is close to 1.

Illuminance is the photometric measurement that best corresponds to the visual perception of a surface's luminosity. The human eye perceives levels of illuminance ranging from $0,001 \text{ cd}/\text{m}^2$ (night vision in which colours cannot be seen) to $10,000 \text{ cd}/\text{m}^2$. However, the eye cannot distinguish variations in illuminance of less than 20%: it can only compare, rather than measure, perceptions of light.

The main factor in distinguishing an object is the contrast in illuminance or colours between the object and its immediate surroundings. Reading black text on a white background is easier than reading black on a grey background. The contrast in illuminance is in this case equal to the ratio of the indices of refraction of the black ink and the paper, i.e. 20-1 in the first instance and of 10-1 to 2-1 in the second, depending on the shade of grey.

Glare is the effect of visual conditions in which a person sees objects less clearly owing to excessive illuminance or contrasting illuminance in space or time terms. In natural light, glare can be induced by looking directly at the sun, by excessive illuminance of the sky seen through a window, or by sunlight reflecting too strongly on walls and creating too great a contrast with other neighbouring surfaces. In artificial light, glare can be induced by looking directly at a source of light or at its reflection on the polished glass of a lamp, or on other surfaces or objects in a room.

The position of light sources can also cause glare (Fig. 2). When a major source of illuminance is in one's field of vision, it causes discomfort or distraction depending on its position. To prevent this type of problem, the source should be positioned in such a way that the angle it forms with the viewer and the object viewed is greater than 30° .

The illuminance of a surface is a difficult measurement to calculate. As it is directly proportional to the light received and the index of refraction of the surface, the amount of light recommended for any visual task is expressed in terms of illumination. The level of illumination required varies according to the size of detail to be viewed and the contrast in illuminance between the object and its background.

Illuminance is the measurement that best corresponds to the visual perception of a surface's luminosity. Illuminance is the ratio of the light intensity on a surface to the visible area of that surface:

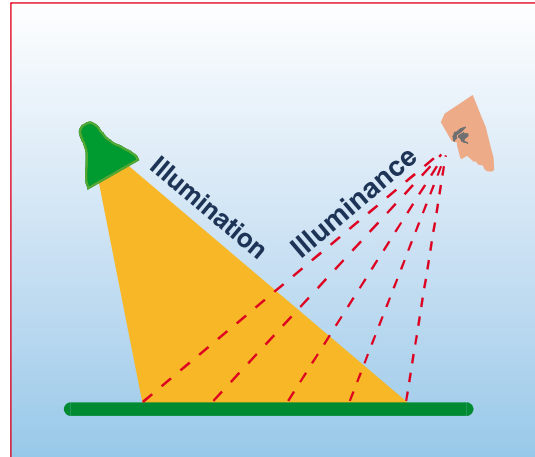
$$I = I / \text{vis}A$$

The perception of illuminance depends on illumination and a surface's refraction index.

1

Acceptable level of illuminance

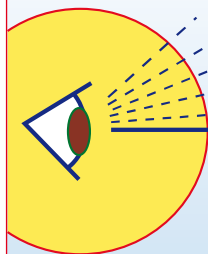

45°	: 2 500 cd/m ²
35°	: 1 800
25°	: 1 250
15°	: 850
5°	: 580

Illuminance and glare

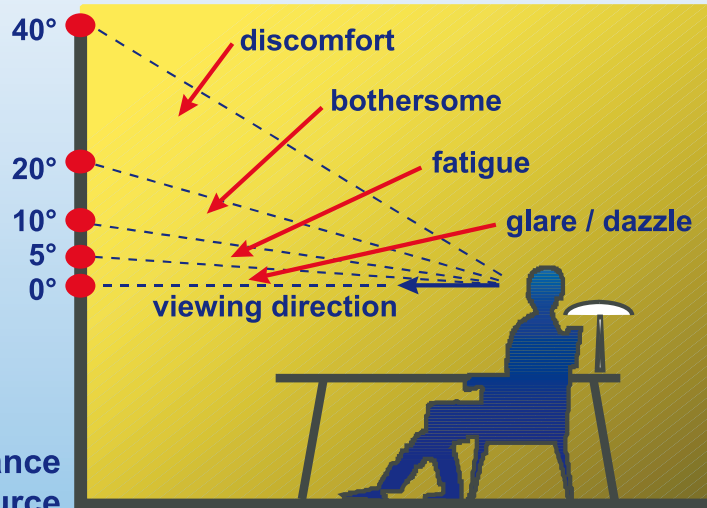

High illuminance light source

2 Comfort, acceptable levels of illuminance and position of light source.

For natural lighting, illumination requirements do not necessarily translate into lux but can be expressed in terms of a daylight factor (DF). This factor is the ratio of the internal illumination received at a particular point within an enclosure (generally a work surface or floor) to the simultaneous unobstructed outdoor illuminance on a horizontal surface. It is expressed as a percentage.

In overcast conditions, DF values are the same irrespective of the season, of the time, or the orientation of bay windows: they thereby provide a measurement of the intrinsic ability of the building to capture natural light. Minimum DF reference values are therefore recommended for any building according to its use, in clear sky conditions (a theoretically 'average' sky, whose illumination equals 5,000 lx). The recommended DF values for interior spaces are:

- factories: 5%
- offices: 2%
- classrooms: 2%
- hospitals: 1%

With exterior illumination of 5,000lx under an overcast sky, the level of interior illumination obtained inside offices must therefore be a minimum of 100lx.

Light takes an infinite variety of paths to reach a specific point. Natural interior lighting includes three components (Fig. 1 and 2):

1. The daylight component: this is the illumination reaching a specific point from the visible part of the sky.
2. The exterior reflected light component: this is illumination reaching a specific point by light being reflected on exterior surfaces.
3. The interior reflected light component: this is illumination reaching a specific point by light being reflected on interior surfaces.

Figure 2 describes these components. It also shows the variations in DF within a classroom 6 metres deep by 3 metres high, leading onto a corridor with a second window. The red curve represents the DF variation without a rooflight, whereas the dotted-line curve shows the effect of the rooflight on light levels at the back of the classroom. It should be stressed that the DF curves are valid for a particular window configuration (here a 15m² glass dome over the entire length of the room, i.e. 8 metres). It is therefore clear that light levels at a given point vary according to its position in relation to the windows.

In order to increase the DF, the daylight component can be increased by using glazed areas, the component of reflected exterior light by using different types of external surfaces, and the component of reflected interior light by using different types of internal surfaces.

The daylight factor (DF) is the ratio of the internal illumination received on a work surface to the outdoor illuminance on a horizontal surface. It is made up of three components and is expressed as a percentage.

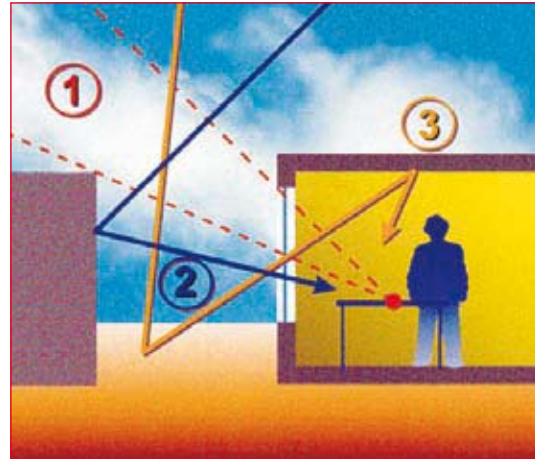

The three components of the DF. 1

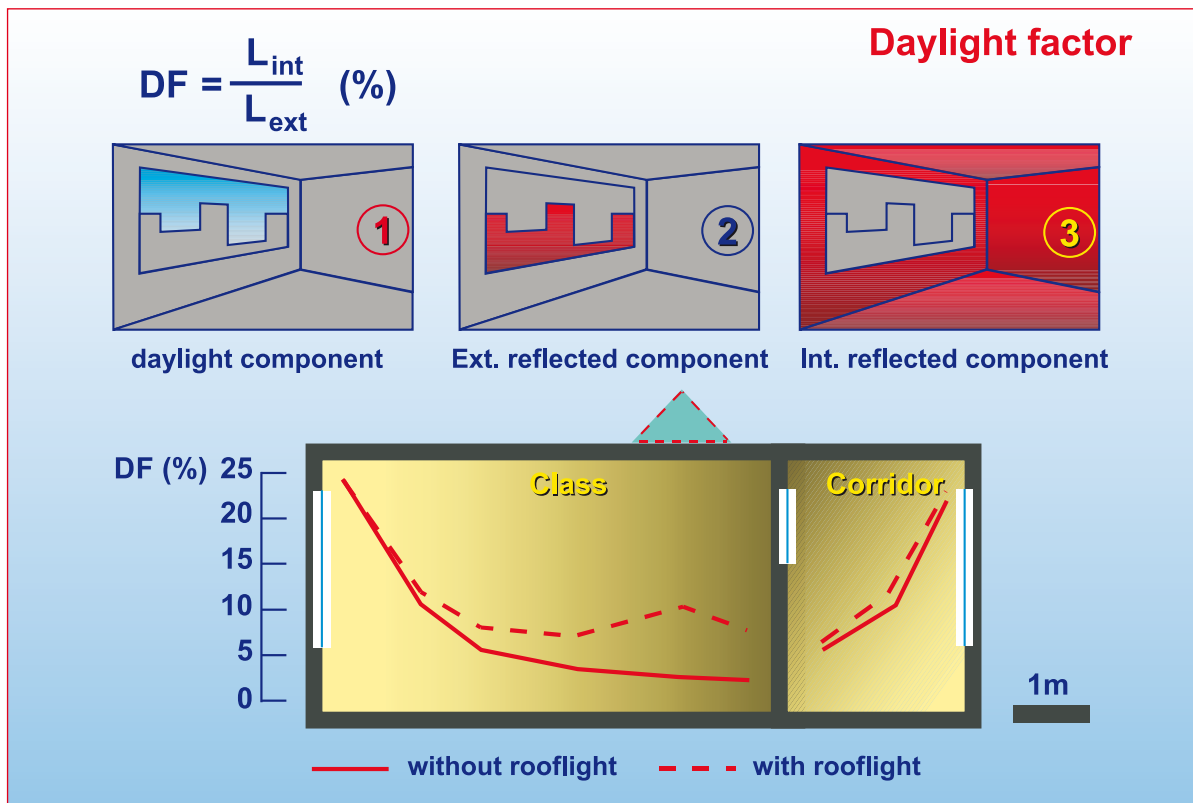

2 Typical DF values for a classroom.

Some bodies radiate light, some do not. Light, whether emitted by natural sources (sun, fire) or artificial ones (lamps), is considered to be direct light. Non-luminous objects reflect a part of the light falling on them: in this respect, they contribute to distributing and diffusing light. These are sources of indirect light.

In fact, light is only visible when reflected by a solid object. This is why architects need to determine the nature and levels of the desired natural and artificial light they wish to install.

Figure 1 shows the importance of regulating direct and indirect light. The Kimbell Art Museum in Texas, by the architect L.Kahn, is a remarkable example of managing natural light. Long curved ceilings split open to allow the very harsh Texan light to enter. A filtering/reflecting system redirects the light onto the vaulted ceilings. Direct light is turned into indirect lighting.

In architecture, natural light reaches us through windows or after being reflected off walls. The size of the window determines the quantity of light received. Its position (high up, low down, etc.) and its shape (vertical, horizontal, etc.) influences how light is diffused and distributed, as does the type of wall surface (colour, brightness, etc.). Consequently, the type of light perceived by human beings is directly linked to their architectural environment.

Figure 2 shows different ways of enhancing the use of natural daylight, according to the classification developed in 'Daylighting in Architecture' (Baker-Franchiotti-Steemers). Based on an architectural analysis, it distinguishes between spaces that bring additional light, features enabling light to enter and systems to regulate light :

- Spaces bringing additional light may be intermediate spaces (galleries, porches, conservatories) or internal light spaces (internal courtyards, atriums, light ducts) (Fig. 2-1).
- Components enabling light to enter a building are either on the side (windows, curtain walls, translucent walls) or on the top (clear panels, skylights, translucent ceilings, tubular skylights) (Fig. 2-3) or indeed both (side and top).
- Lastly, the possibility of regulating natural light by filtering it (translucent glass, glass bricks, stained glass, solar shading, screens, etc.) (Fig. 2-4).

Natural daylight can illuminate a space directly or indirectly, from the sides or the top. It can also be regulated or filtered.



1
Regulating direct and indirect lighting in the Kimbel Art Museum in Fort Worth, Texas (arch. L.Kahn).



2
1. Atrium (arch. J. Bouillot) ; 2. Lateral lighting (arch. F. Nicolas) ;
3. Toplighting (arch. A. Gaudi) ; 4. Filtering (arch. Bermond & Porchon).

Light transmission (LT) refers to the percentage of light transmitted through a glazed panel into a room. Consequently, the higher the LT, the greater the amount of light entering a building and the less electric lighting is needed during the day.

Like the sun factor, it is possible to define light transmission for three types of glazing: clear, absorbent, and reflective. Figure 2 summarises the LT characteristics of single glazing with these three types of glass. With clear glazing, 90% of the light is transmitted, whilst 8% is reflected and 2% is broken down into heat within the material.

- Clear glazing is recognised for its excellent ability to transmit light.

Clear single glazing: $LT = 0.90$ (Fig.2)

Clear double glazing: (6-12-6): $0.78 < LT < 0.8$

- Absorbent glazing enables the glass to reduce the proportion of solar radiation transmitted by increasing the proportion that is absorbed.

Absorbent single glazing: $LT = 0.41$ (Fig. 2)

Absorbent double glazing: (6-12-6): $0.36 < LT < 0.65$

- Reflective glazing is characterised by an increase in the amount of radiation reflected and a reduction in the amount transmitted.

Reflective single glazing: $LT = 0.32$ (Fig. 2)

Reflective double glazing: (6-12-6): $0.07 < LT < 0.66$

It should not be overlooked that choosing reflective glazing may well impact the building's immediate surroundings : dazzling the occupants of neighbouring buildings and passers-by, excessive warming of the ground nearby, or even of buildings struck by the reflected light.

The choice of LT factor is dependent on the level of light desired within a building. It should be noted that the level of natural light available varies dynamically over a very wide range: from 5,000 lux with an overcast sky to nearly 10,000 lux in full summer sunshine, i.e. a ratio of 1 to 20. The risk of glare is all the higher owing to rapidly changing cloud conditions. A seemingly low light transmission factor (0.50) only slightly modifies the illumination with an overcast sky but can help significantly to reduce visual discomfort in direct sunlight.

Light transmission (LT) refers to the percentage of light transmitted through a glazed panel into a room.



The choice of glazing determines the amount of light transmitted and reflected outwards.

1

Light transmission

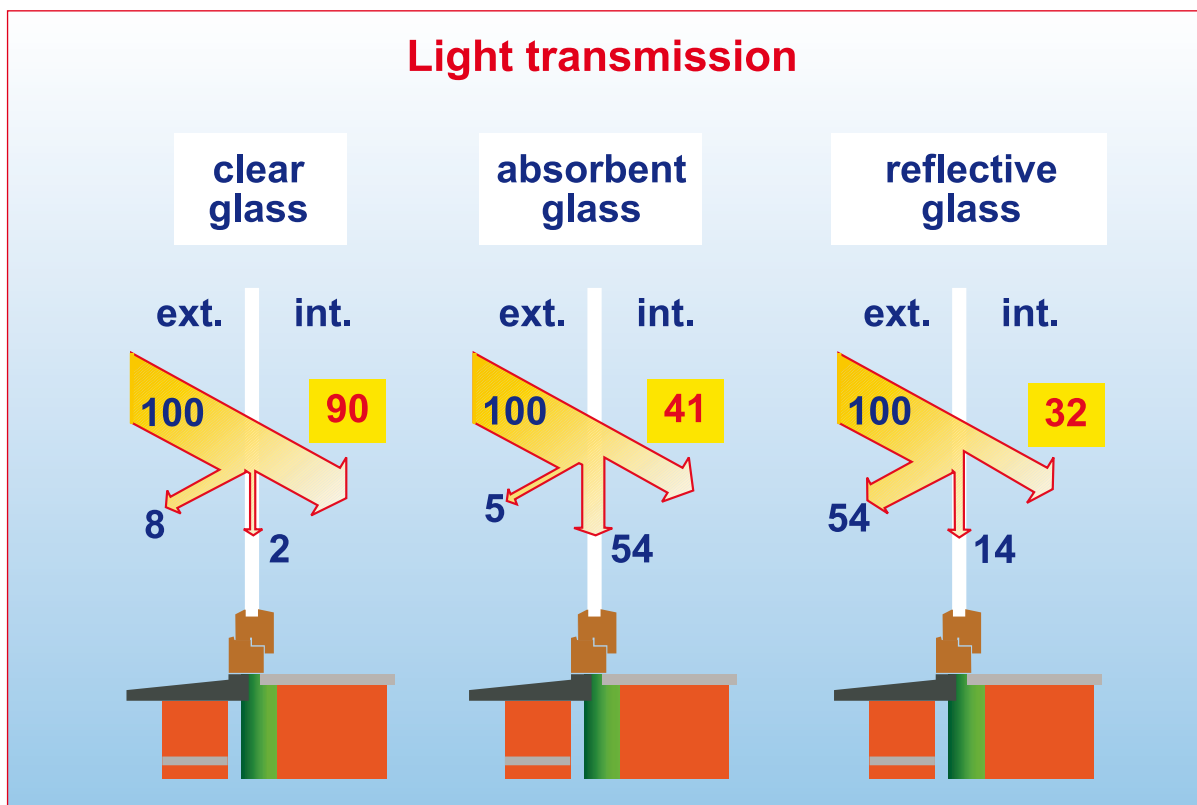

2 Light transmission for single glazing.

Good lighting should guarantee that the occupants of a building can conduct their activities as effectively as possible (visual performance), while ensuring their well-being (visual comfort) and providing some visual pleasure (natural light).

The desired level of visual performance is determined by the type of work to be done and depends on the following parameters:

- the level of illumination of the work surface (Fig.2)
- the contrast in illuminance between the object viewed and its background

Illumination is the effect produced by the luminous flux falling on a given surface from a natural or artificial light source. It is expressed in lux (lx).

Illuminance describes the luminous flux directed from a surface towards the eye of an observer. It is expressed in candela per square metre (Fig. 1).

Visual discomfort is linked to glare, i.e. the presence of a marked contrast of illuminance within a field of vision. There are two types of glare:

- physiological: veiling the field of vision making it impossible to distinguish objects
- psychological: glare does not totally affect vision

In practice, windows and inappropriate lighting installations are the most common causes of situations of visual discomfort. Inadequate illumination due to defective lighting is a source of eye-fatigue. Rapid changes in natural light levels (from 5,000 lux with an overcast sky to 10,000 lux in full sun) can produce glare.

As far as visual pleasure is concerned, this is a subjective concept generally associated with:

- the presence of natural light (colour rendition)
- variations in the duration of this light
- certain artificial lighting effects and harmonious colours

The visual environment must allow people to see objects clearly, without strain, in pleasantly toned surroundings.

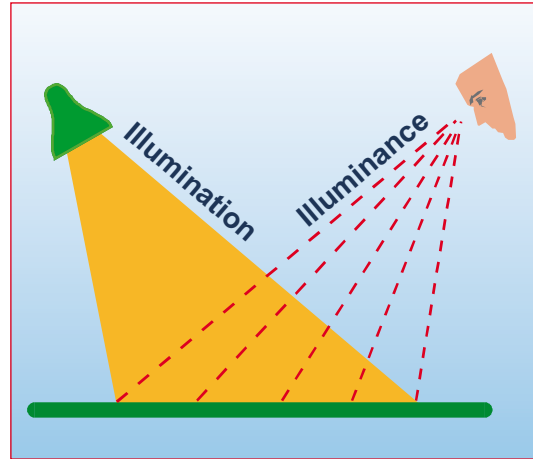

Illumination and illuminance. **1**

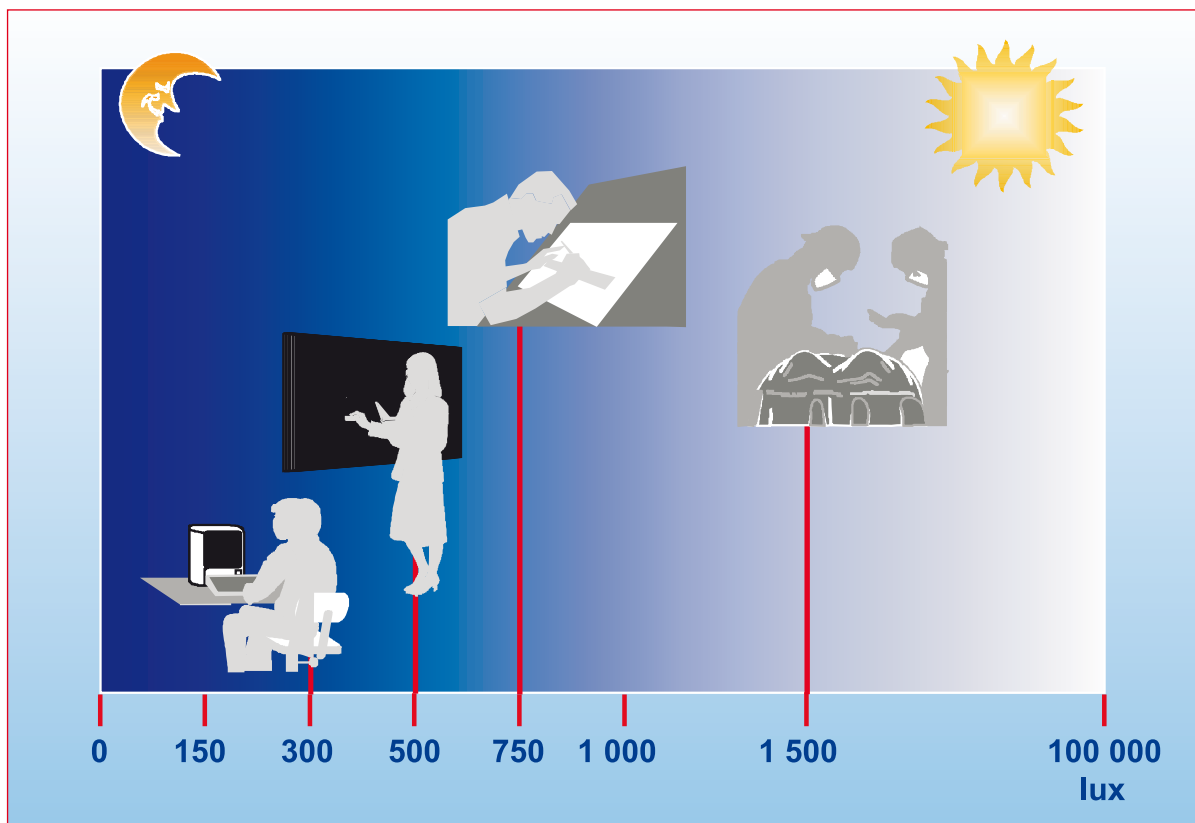

2 Reference levels of illumination are adjusted to suit the activity.

Our visual environment gives us a feeling of comfort if we can see objects clearly and without straining, in pleasantly decorated surroundings.

Achieving a comfortable visual environment in a room enhances the well-being of its occupants. Conversely, lighting that is too feeble or too strong, badly diffused around the room or whose light spectrum is badly adapted to the eye's ability to perceive colours, sooner or later leads to eye-strain or even eyesight problems, together with a feeling of discomfort and diminished visual performance.

Visual comfort depends on a combination of physical parameters: illumination, illuminance, contrast, glare and the light spectrum to which can be added specific features of the environment and of the visual task to be carried out, such as the size of the items viewed and the time available to view them. Visual comfort also relies on a person's physiological or psychological factors, such as their age, their eyesight, or being able to look outside.

The parameters of visual comfort for which architects play a dominant role are:

- the level of illumination of visual tasks
- the harmonious distribution of light within a space
- the ratios of illuminance within a building
- the absence of unwanted shadows
- highlighting the outlines and shapes of objects
- an exterior view
- good colour rendition
- pleasant tones of light
- the absence of glare

It is, however, very difficult to quantify the ideal values that these parameters should aim for: there is no universal solution to the problem of visual comfort because the latter is affected by the type of task, the configuration of a building, and personal preferences. Furthermore, how the quality of light is judged is influenced by personal, cultural and historical factors.

Visual comfort is a subjective impression linked to the amount, distribution and quality of light.



A visually comfortable space. **1**

<p>a</p>	<p>b</p>	<p style="writing-mode: vertical-rl; transform: rotate(180deg);">Giacomo</p> <p>c</p>	<p>d</p>
<p>The illuminaiton level of the visual task</p>	<p>A correct rendering of colors</p>	<p>Balances of brightness in a room and harmonious distribution of light in the space</p>	<p>the absence of unwanted shadows</p>
<p>e</p>	<p>f</p>	<p>g</p>	<p>h</p>
<p>Highlighting the outlines and shapes of objects</p>	<p>View to the exterior and pleasant shade of light</p>	<p>View to the exterior and pleasant shade of light</p>	<p>Absence of glare and dazzle</p>

2 The parameters of visual comfort.

The average recommended illumination level is generally defined according to the use of the premises and the degree of precision of the visual task carried out there. The level of illumination selected for an open plan office can prove to be disastrous if implemented in a room serving a totally different purpose, such as the foyer of a theatre or the living room in a home.

Recommendations are often made in terms of illumination, rather than illuminance, because it is easier to measure. As the impression of brightness is better represented by illuminance, the refraction index should be taken into account when lighting a surface. The lower it is, or the darker in colour, the more difficult it is to see and the more illumination is needed.

In addition, recommended levels of illumination must be fine-tuned according to the contrast in illuminance between the subject viewed and its background.

Illuminating engineering has in practice shown that it is important, in terms of maintaining visual performance, to consider variations in lighting over time. Figure 1 represents the variation in average levels of lighting in a building according to the length of time an installation is used. This illustration shows in detail the notion of average levels of illumination 'in operation', 'to be maintained' and 'initial'. The level effectively maintained must always be higher than the value 'to be maintained'.

The average illumination in operation is the illumination that should be observed at the mid point between two consecutive maintenance operations.

The average illumination to be maintained is the level of illumination that is just still acceptable prior to a maintenance operation: cleaning of light fittings whether bulbs are replaced at the same time or not.

The initial average illumination level is the illumination level when the installation is new. The initial average illumination level is the value used in calculations related to a lighting project. In the absence of any other information, the initial average illumination level will be, respectively : 1.5/ 1.75/ 2 times the illumination level to be maintained in premises with low/ medium/high levels of dust.

Figure 2 shows the values for average illumination to be maintained in different types of building , as recommended by the Association Française de l'Eclairage (AFE – French Lighting Association).

Natural lighting is preferable to artificial lighting because of its variability and its different tones. The variability of natural light enables the creation of harmony with the world outside and creates a warmer atmosphere inside. Its cyclical nature is an important factor for our psychological equilibrium. Natural light forms an indispensable part of correctly perceiving the time and the place we are living in.

In addition, the spectral properties of natural light ensure the best possible visibility of objects and colours. If we compare the spectral distribution of natural light with the sensitivity graph of the eye, it shows that the human eye is naturally adjusted for natural light (figure 1). Daylight therefore constitutes the ambient lighting par excellence.

Natural lighting is the most appropriate both on a physiological and a psychological level but its variability necessitates additional complementary artificial lighting or, at other times, the use of temporary window coverings. Artificial lighting should therefore be considered as a complement to natural light and should be harmonised as far as possible with its light spectrum and its variations thanks to an appropriate control system. For the comfort of a building's occupants, the main source of light should be the sun.

Bay windows, through which natural light can enter, offer the dual benefits of connecting visually with the outside and of providing a distant view to rest the eyes after working close-up.

A view through a window, even if it is not particularly attractive, provides a way of finding one's location in relation to the world outside. The possibility of looking out through a window is restful and is all the more essential when a visual task needs detailed, close-up work.

Lastly, bay windows play an undeniably aesthetic role by bringing the external landscape into the visual ambience of a given space.

Natural daylight is one of the elements strongly perceived as needed by man and impacting his activities. It influences the psychosomatic well-being of a building's occupants.

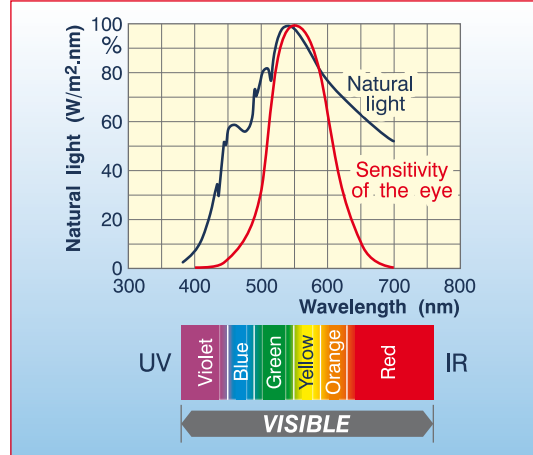

Spectral sensitivity curve of the human eye. **1**



2 Windows, the link to the world outside (arch. Le Corbusier).

Glare is caused by too bright a light on surfaces placed in the line of sight or by too great a luminous contrast between neighbouring surfaces. It puts people in situations of great visual discomfort.

With natural lighting, the main sources of glare are:

- looking directly at the sun
- the sun or sky's reflection on neighbouring buildings
- an excessive contrast in illuminance between a window and the surrounding wall
- an excessive contrast in illuminance between a window and its frame
- a surface that is too bright compared with surrounding ones

In the specific case of computer screens, the following points should be taken into account:

- there should be no windows in front of or behind the screen
- the main line of sight should be parallel to the windows
- windows on all façades should be fitted with visually-efficient solar shading. These should be controllable by the occupants themselves.
- surfaces next to the screen should be matt and have a refraction index of 0.2 to 0.5
- the illuminance of all surrounding areas visible to the user as a reflection on the screen must be as low and as uniform as possible
- to reduce the difference in illuminance between the sky and the screen, it may help to put a row of lights along the window
- reflections on a screen with a dark background are more irritating than on a light one. If all other measures fail, anti-reflective screens should be fitted, even if not generally recommended because of reducing visibility of the screen image.

Figure 1 shows different positions for a screen in relation to a window-opening with natural light. The first configuration is ideal because it enables a reduced contrast in illuminance within the user's field of vision (the screen and the background).

Various precautions can be taken to reduce the risk of glare due to natural lighting (figure 2):

- a) fit one large window rather than several small ones. In practice, one large opening with natural light causes less glare than a small one because it makes it easier for the eyes to adjust and reduces the contrast in illuminance as well as associated impressions of glare.
- b) reduce sunlight by using solar shading
- c) partially reduce sunlight by shading the window with a deflective device (light-shelf, partition, eaves...)
- d) partially reduce sunlight by installing external features that are less bright than sunlight (atrium, internal courtyard)
- e) place apertures high up (rooflights, clerestories...) in order to reduce direct glare as most visual tasks require a horizontal or downward view
- f) reduce the window-to-frame contrast by increasing the refraction index of the frame by means of light, matt colours
- g) reduce the wall-to-window contrast by lighting the window wall
- h) reduce the wall-to-window contrast by increasing the refraction index of the wall
- i) reduce the wall-to-window contrast by increasing the proportion of indirect natural light by means of very light-coloured walls
- j) encourage use of matt surfaces because they diffuse light

Glare is the effect of visual conditions in which people are subjected to a reduced ability to perceive objects which may extend to momentary blindness.

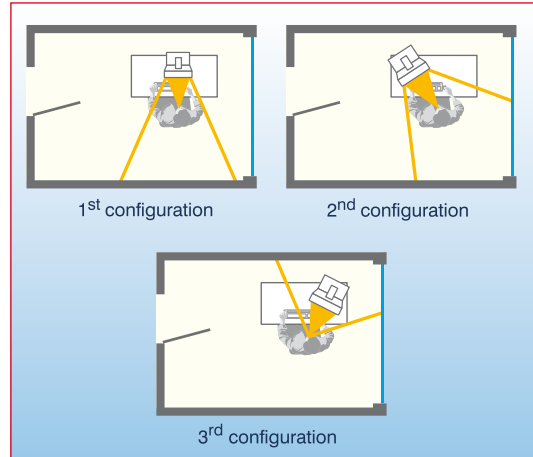

Positions of a computer screen in relation to windows. **1**

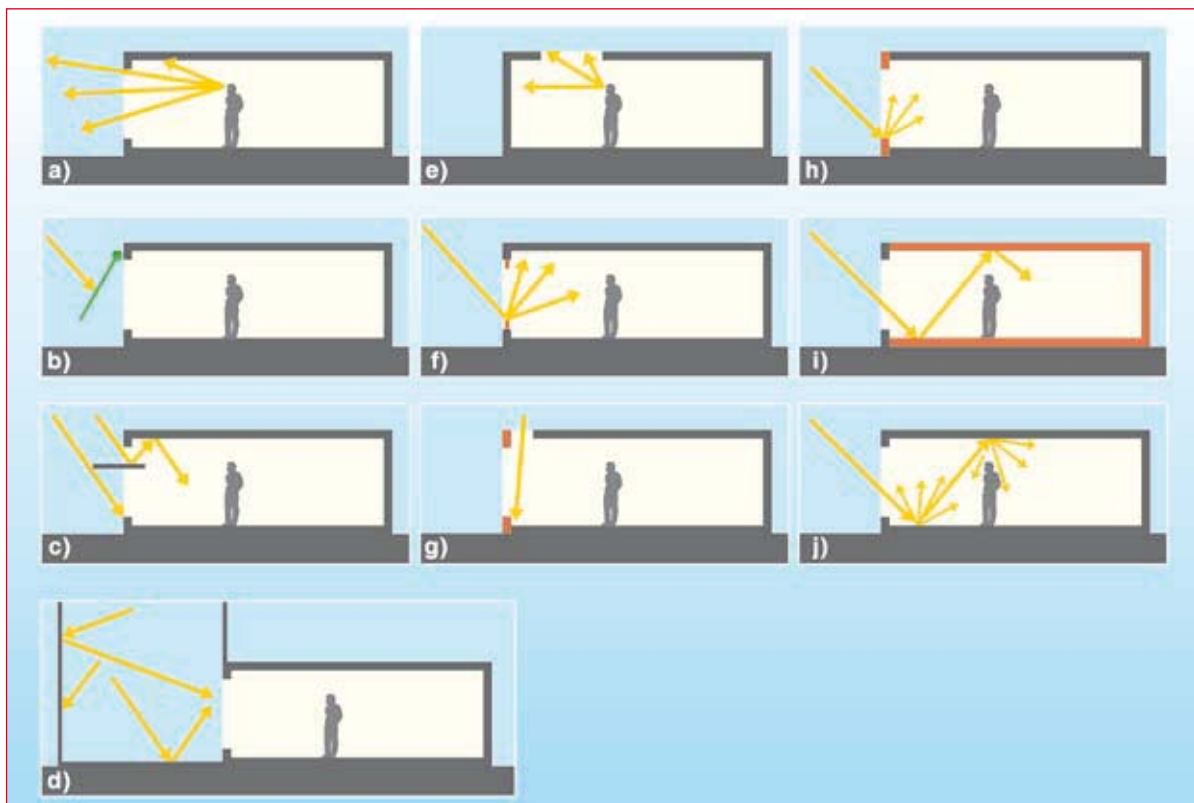

2 Reducing glare thanks to natural lighting.

Bioclimatic projects (schools, offices, dwellings....) emphasised natural light quite early on, doing so for several reasons:

- financially attractive through savings in electricity consumption. Some European studies show a 30% improvement in electricity consumption used in lighting public buildings today. This saving also contributes to reducing internal heat gains from artificial lighting, thereby reducing cooling requirements.
- environmentally attractive through the reduction in various pollutants produced by power generation and by electrical equipment (radioactive waste, greenhouse gasses, hazardous waste from neon tubes...)
- psychologically and physiologically attractive through the germicidal role of natural light and the way it varies at different times of day. By combining warm colour temperatures with a continuous visible spectrum, its performance is unequalled even by the highest quality artificial lighting. This aspect is particularly important in office design, in which poor visual conditions are a source of eyestrain, attention loss, headaches, bad posture... Generally speaking, bringing controlled natural light into interior spaces enhances the visual comfort of the building's users.

In this context, a designer mainly uses the simplified daylight factor method. It defines the daylight factor values at work surface level on an overcast day, i.e. the ratio of the internal illumination received at a particular point on a work surface to the simultaneous unobstructed outdoor illumination on a horizontal surface on an overcast day.

$$DF = I_{\text{interior}} / I_{\text{exterior}} (\%)$$

This equation works by breaking the daylight factor down into three variables : the direct component of sunlight, the reflected external component and the reflected internal component. The result is not dependent on the orientation of the building, the time of day, or of year. It takes into account a theoretical standard sky defined by the 'International Commission on Illumination' (known as CIE) characterised by zenith illuminance three times that of horizon illuminance. The CIE typically proposes using a light level of 5000 lux on a horizontal surface with an overcast sky as a practical basis for applying the calculation of natural lighting to buildings.

Qualitative concepts, such as those of uniform illumination or of contrasts, still remain little used.

The Daylight Factor (DF) indicates the ratio of levels of daylight available outdoors under an overcast sky to the natural light received at a particular point on an indoor work surface.

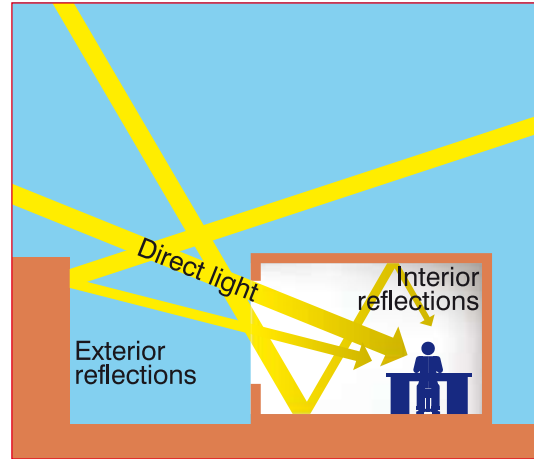

The different components of natural light. **1**

Daylight factor	Less than 1% Very low	From 1% to 2% Low	From 2% to 4% Moderate	From 4% to 7% Average	From 7% to 12% High	More than 12% Very high
Considered zone	Zone away from windows (distance greater than 3 times window height)			Zone near windows or under skylight		
Impression of brightness	Dark to little light		Little light to clear		Clear to very clear	
Remarks	Suitable for passageways of circulation, storage, etc.		Suitable for work areas		Beware of glare and dazzle	
Visual impression	This zone seems to be separated from this zone					
Environment	The room seems closed on to itself			The room is opened to the exterior		

2 Variations in visual impressions of clarity and comfort depending on DF (AFE – Association Française de l'éclairage).

The area of the window that contributes most to natural lighting is the upper part. Glazed areas located below the level of work surfaces are of no interest at all in terms of natural lighting. It is therefore not useful to glaze the whole of a façade.

In offices, it is appropriate to enhance the reflection of natural light by using walls of the lightest colour possible and by placing furniture so as to minimise obstructions.

It is essential to fit solar shading on south, east and west-facing sides. In certain instances, north-facing walls may also require it. The ideal situation, from a visual and a thermal standpoint, is to combine exterior and interior solar shading that adjusts to the seasons.

In terms of natural lighting, the design of office premises depends on the type of office envisaged. In fact, the term 'office' encompasses several different types of premises:

- individual offices (figure 2a) are generally not very deep. Their occupants enjoy high level of daylight availability. Desks should therefore be positioned at right-angles to the windows and as close as possible to them.
- shared offices (figure 2b) contain 5 to 10 people who do not need to interact. Desks can therefore be lined up at right-angles to the windows so that light comes from the left for right-handed or from the right for left-handed people.
- team offices (figure 2c) are a response to the need for contact, communication and flexibility between team members. It is difficult to ensure high-quality lighting for everyone, as the line of sight and the amount of daylight available differ for each individual. The biggest difficulty is to avoid problems with glare from natural or artificial lighting.
- open-plan offices (figure 2d) are generally very deep. They must therefore be illuminated from multiple directions and furniture must be placed so as to create the least possible obstructions. It is also appropriate to group together activities according to their lighting requirements and to put the most demanding tasks by the windows. It is also vital to divide the lighting into zones in order to manage electricity consumption.

It is essential to restrict the depth of office buildings, and to ensure that walls are bright and furniture well-positioned.



EOS building in Lausanne (Switzerland) **1**
 (arch. Richler & Dahl Roche).



2 a : layout of individual offices
 c : layout of team offices

b : layout of shared offices
 d : layout of open-plan offices

To integrate natural lighting into the home serves a different purpose than in the office. In offices, functional and efficient lighting is desirable. In homes, natural lighting contributes to the overall ambience and may vary according to the occupants' moods. However, it is important to design the house or apartment block such that all the living areas are close to windows. Here is some general advice that can serve to improve natural daylight availability in the home.

Kitchens, eating areas and living-rooms should be as open as possible. These are the living areas of the house, in which we spend 80% of our time during the day (1).

It is very important to have a well-lit space in each bedroom in order to encourage children's development. From a toddler's earliest games to learning to read or doing homework, natural light must accompany a child's psychomotor development (2).

Bilateral lighting is to be encouraged as much as possible. The presence of window-apertures on opposing façades provides balanced illumination and attenuates shadows (3).

Similarly, using glazed doors or fanlights serves to make the most of potential secondary daylight (4).

Top-floor rooms can be illuminated from the roof but the importance of a direct view to the outside (and not just of the sky) should not be overlooked. Toplighting is to be combined with lateral apertures wherever possible (5).

Light ducts are very attractive solutions for lighting central areas within a home, generally those used as functional rooms (6).

Lighting attics and cellars naturally should be considered: creating apertures, albeit small ones, means that people can see and move around these areas in safety.

Taking the external environment into account should not be overlooked: eaves and balconies as well as neighbouring buildings can greatly reduce the amount of natural light that enters (8).

It is important to take advantage of the orientation of each façade and to plan solar shading when designing the building (9).

Bright, light spaces, the interplay of colours and even the privacy created by shadows should be a part of and enhance our various day-to-day activities.



PLEIADE house, Louvin-La-Neuve **1**
(arch : P. Jaspard).

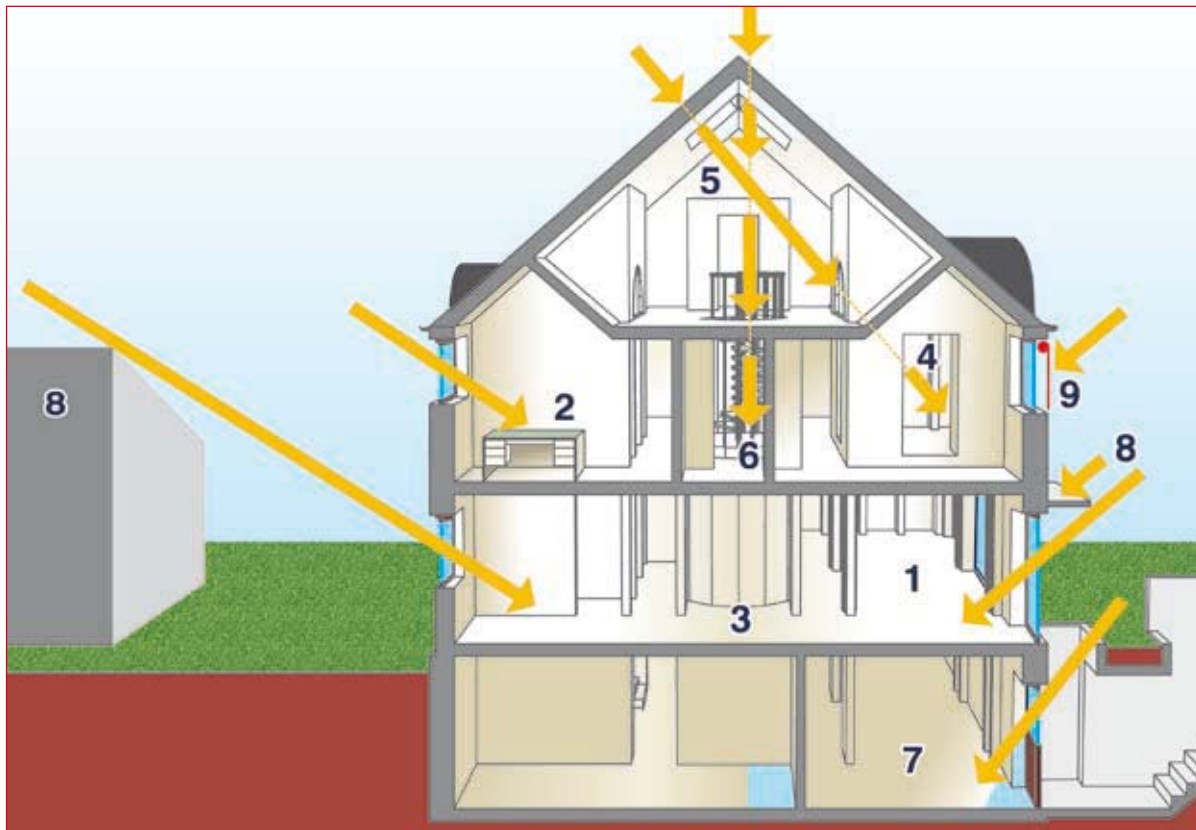

2 Natural lighting concepts for a detached house.

Using natural light in hospitals, especially in the bedrooms and in intensive care units, is vital. Even if the impact of natural lighting on health is not quantifiable yet, researchers agree that it is positive. Patients unable to move, spending 24 hours a day in the same environment, should benefit from as much natural light as possible.

Scientific studies have also shown that a view outside can have a positive effect on patients' health. More specifically, for patients recovering from an operation, it seems that being able to see the natural world outside is particularly beneficial. But that does not mean that a view onto gardens is always the best: for other types of patient, other types of view can possibly be more rewarding.

Windows should be dimensioned so as to enable a view from the hospital bed, from a lying-down position. An effective shading system should be in place, so that patients do not suffer from glare all the time, thus causing them to forego natural lighting. A system of blinds also needs to be fitted in order to ensure patients' privacy.

Natural lighting should not be used in places where the overall lighting should be constant, such as in specialised laboratories, operating theatres or in radiology.

Using natural lighting in corridors is also attractive and enables a significant reduction in energy consumption because they would need to be lit artificially if they did not benefit from natural lighting.

The beneficial effects that natural light and the positive effect that a view outside can have on patients' health are encouraging the adoption of natural lighting in hospitals.



1 Providing natural lighting is essential for people in hospitals or in retirement homes.

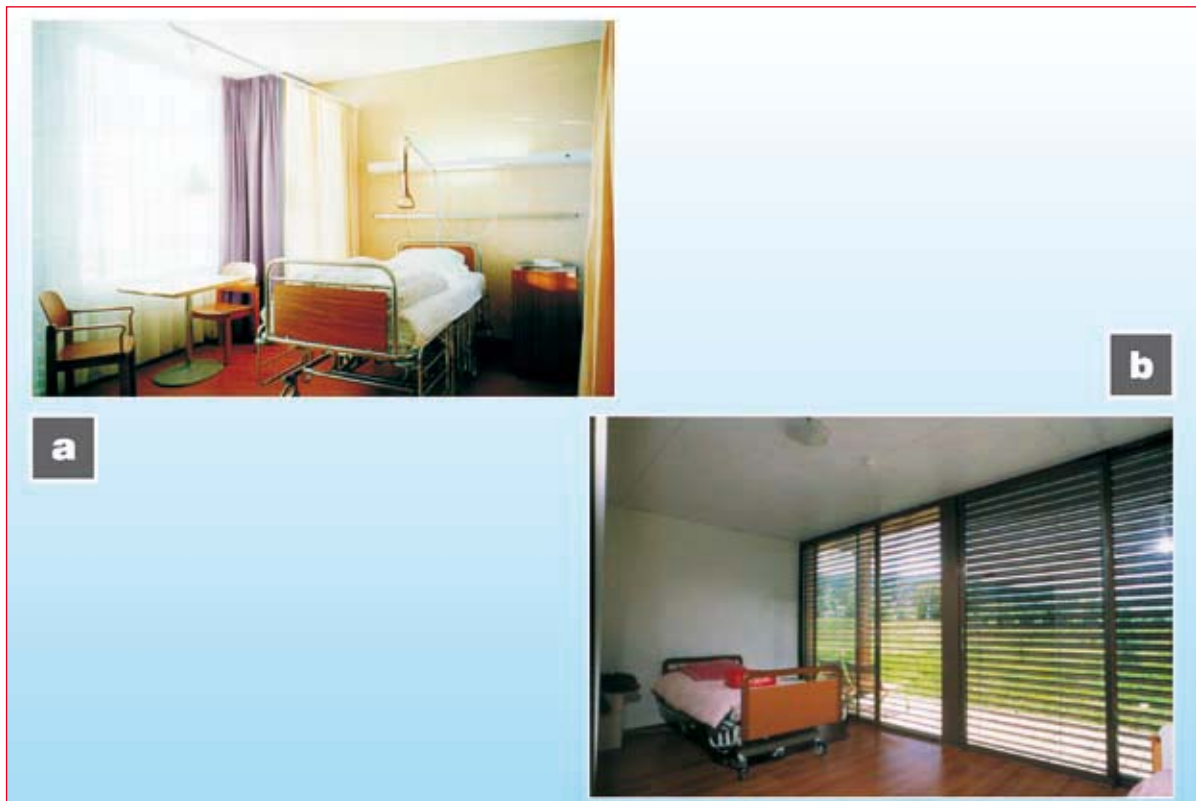

2 a : shading system shielding patients from glare.
b : calming exterior view.

Many studies have shown the importance of natural lighting for children's development and health as well as their success at school.

The two most important points relating to natural lighting in schools are as follows:

- care should be taken to fit quite large glazed areas in order to allow sufficient daylight to enter so as to ensure acceptable levels of illumination whilst distributing light evenly.
- particular attention should also be paid to problems of glare

In general, as most schoolchildren are right-handed, window-apertures should be placed on the left-hand side of classrooms, in order to avoid casting obtrusive shadows whilst children are writing. The ideal solution is to use predominantly multilateral lighting in order not to place children sitting furthest from the windows at a disadvantage.

The lighting of the board, whether natural or artificial, is critical. The board must not be positioned too close to the window-apertures, so as to reduce reflections. Desks in the first row, on the opposite side to the windows, are more prone to this phenomenon.

In addition to using solar shading aimed at preventing glare, consideration should be given to the option of completely covering the windows. A sufficient number of solid wall areas, for use as display boards, should also be planned.

Strategies to adopt depending on the type of building

There are many different types of school. The way to capture natural daylight will vary accordingly.

Buildings with deep rooms (plan view) should adopt the use of rooflights and light ducts. This type of building can be a disaster if it has several storeys.

Buildings with an internal courtyard are an attractive alternative to deep buildings because they promote the use of multilateral lighting. Transparent or translucent materials can be used to roof all or a part of the courtyard in order to create an all-weather recreation area.

School buildings of elongated design have the great advantage of being oriented along an east-west axis. The biggest façades are thus north and south-facing, these orientations facilitating protection from glare and overheating in summer.

Schools of 'composite' design should adopt the same principles as those outlined above: preference should be given to north and south orientations, rooflights or courtyards and atriums in order to provide light in less accessible spaces.

In order to make the most of energy savings thanks to natural lighting, artificial lighting should be regulated in accordance with this. Programme timer systems and movement detectors are very useful in this type of building.

Taking natural lighting into account when designing a school building is fundamental.



1 Natural lighting impacts children's development and health as well as their success at school.

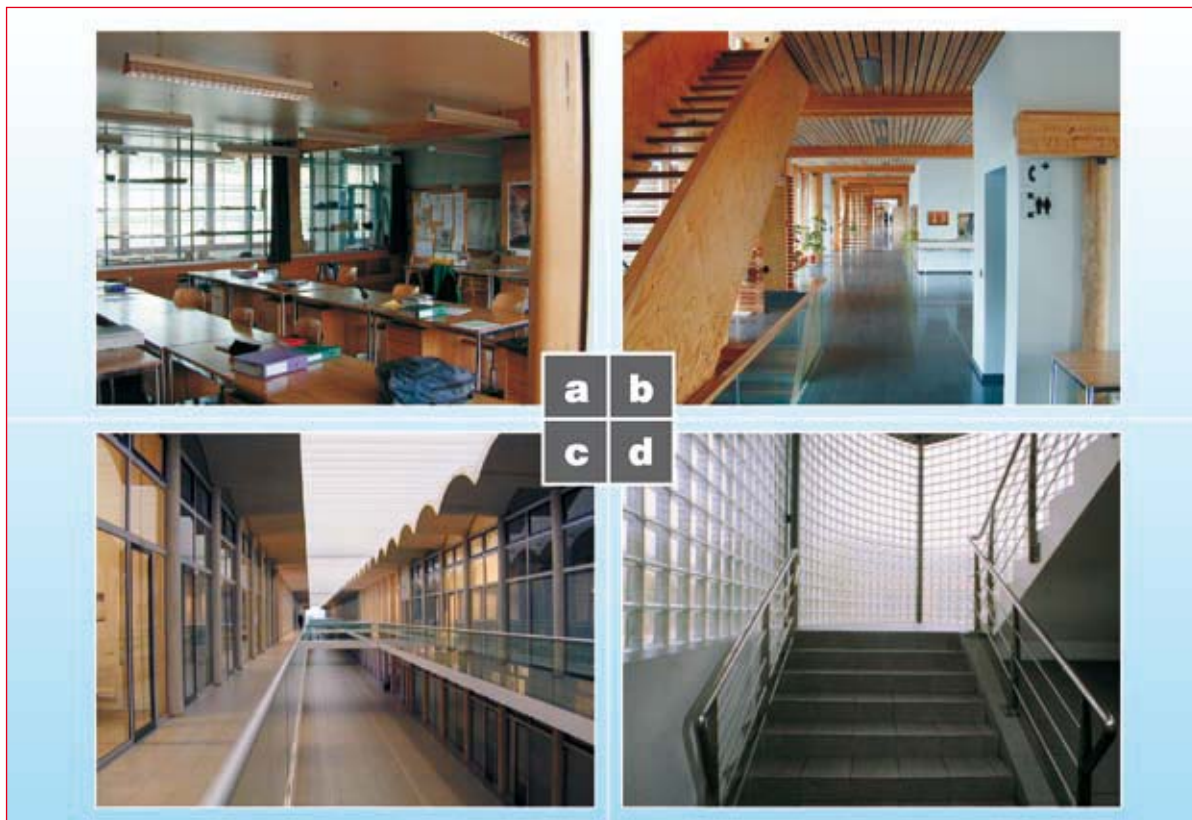

- 2** a : Forester's school in Lyss (Switzerland) (arch. Itten et Brechbühl)
b : Forester's school in Lyss (Switzerland) (arch. Itten et Brechbühl)
c : Lycée Albert Camus in Fréjus (France) (arch. Sir Norman Foster)
d : Lycée Léonard de Vinci in Calais (France) (arch. Isabelle Colas)

The lighting in sports hall is difficult to design. Small projectiles need to be seen as they travel at speed. For sports requiring fast movement, uniform lighting is important as the eyes have no time to adjust to varying levels of light in different parts of the hall. Glare is also a particular problem because bright light sources may cause an object travelling in front of them to be lost from sight. In extreme cases, they can even cause discomfort.

Table 1, provided by the International Commission on Illumination (known as the CIE), gives the illumination values to be achieved (at 1m above floor level) depending on the type sport, during training or during competitive events. According to the CIE, window-openings should provide these illumination values for a significant proportion of the time that the hall is in use.

In sports halls it is essential to avoid direct sunlight in order to prevent problems of overheating and of glare. North-facing windows should therefore be preferred, together with solar shading. Multilateral lighting should also be used in order to provide uniform illumination within the hall: this final point is crucial.

Visual contact with the outside is desirable and can be achieved using side windows. Their sills should not be more than a metre above the floor and the top of the window should not be more than 2 metres fifty from the floor.

The Vrin sports hall (Switzerland), designed by Gion A. Caminada, is an interesting example of natural lighting (figures 2a and 2b). Light enters this hall from both sides via windows placed high up, which allows the use of large wall surfaces for wall bars or for storage facilities. The latter are in fact fitted into the side walls. The building is oriented along an east-west axis. Windows opening onto the outside are located on the smaller west-facing façade. All windows are fitted with interior solar shading.

Diagram 2c shows the Brune Park school sports hall, designed by architects Jackson Greenen Down & Partner. Light enters this hall through two linear skylights below which a light-diffusing canopy has been suspended, thereby giving the hall very uniform illumination. Artificial lighting is also positioned between the canopy and the roof of the hall.

Diagram 2d, on the other hand, shows the sports hall of the Mountbatten school (Jackson Greenen Down & Partner with Mr D. Poole) which is illuminated from the roof using angled skylights and walls painted matt white.

THE NATURAL LIGHTING STRATEGY
Building using natural and artificial lighting

In sports halls

Intelligently integrating natural lighting into sports facilities enables a significant reduction in artificial lighting use whilst protecting users from potential problems of glare.

Type of sport	Leisure / Training E_h in lux	Competition E_h in lux
Basketball, football, judo, acrobatics, gymnastics, handball, athletics, skating, dance, volleyball, hockey, cycling	300	500
Batminton, fencing, tennis, table tennis	500	750
Boxing, wrestling	300	1500 - 3000

Lighting levels required depending on type of sport, during training and competition (CIE). **1**

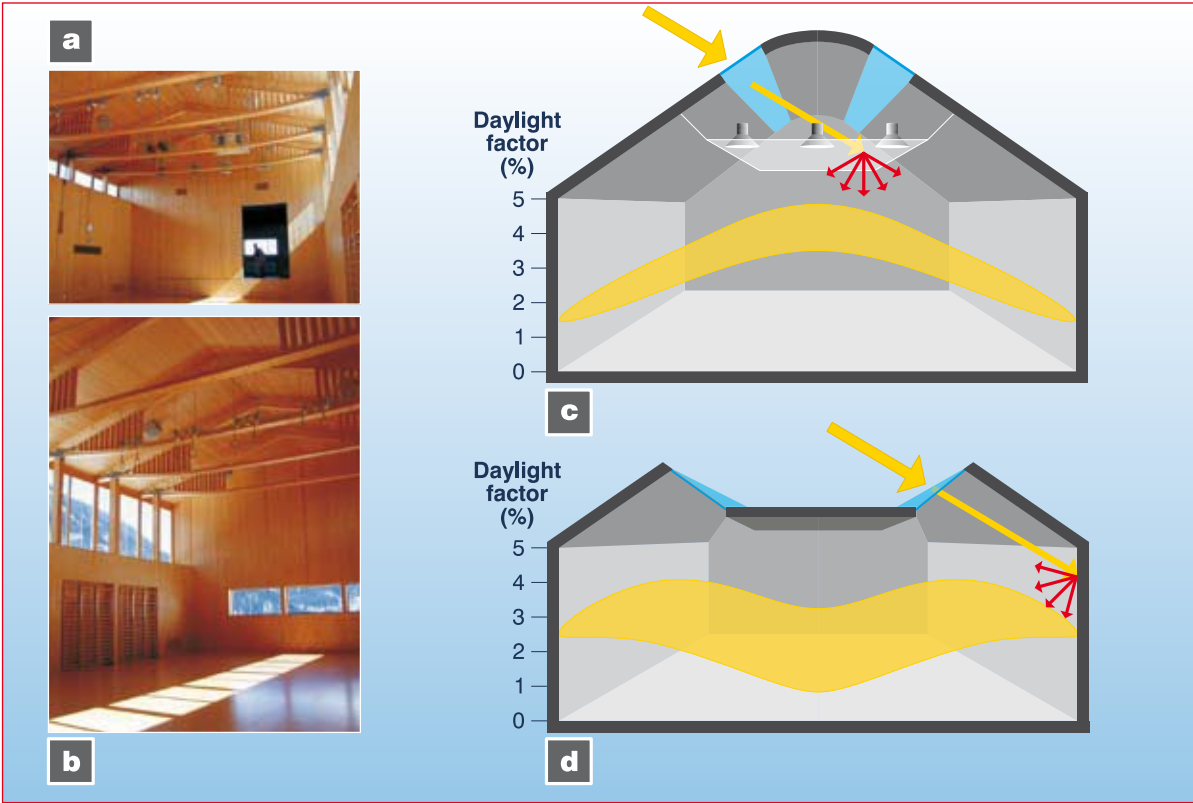

2 a et b : Sports hall in Vrin, Switzerland (arch. Gion A. Caminada).
 c : Brune Park school (arch. Jackson Greenen Down & Partner).
 d : Mountbatten school sports hall (arch. Jackson Greenen Down & Partner).

Quality control and inspection procedures require the human eye to detect minute variations in colour and texture. The quality of natural light and its ability to render colours faithfully is very useful.

Workshops are generally very wide and very deep buildings that have two main features which make them somewhat different in terms of natural lighting: they often have very high ceilings and are generally only one storey.

This type of building therefore lends itself to the use of natural toplighting or windows placed high up. Skylights are in fact very advantageous when the outer walls of the building need to be used, when lateral apertures would be inappropriate for security or safety reasons, when an external view is inappropriate or when light variations in the line of sight of the users could cause problems or even accidents. In general, it is not recommended that direct light be allowed in because of direct glare and possible reflections on metallic surfaces reducing productivity and potentially putting workers at risk, notably if working on machines. It is recommended that diffuse light be preferred and shadows be avoided, again for safety reasons.

North-facing apertures in sawtooth-type roofs, are useful in this type of application because they allow diffuse daylight to enter whilst protecting the building from overheating due to direct sunlight.

Figure 2a shows light distribution in premises fitted with a sawtooth roof. The three curves correspond to a clear, sunny day, when the sun is facing the opening (curve 1), to an overcast day (curve 2) and to a clear, sunny day when the sun is on the opposite side to the opening (curve 3).

Figure 2b shows the impact of density of daylight glazing surface area on illumination levels and distribution in the building. Logically, the more frequent the apertures, the more glazed surface and therefore the higher the level of illumination. Light is also more uniform if there are many more apertures.

Due to their interior and exterior environment, industrial workshops are generally submitted to harsher conditions than office blocks, for example. Windows therefore quickly become dirty. The impact of window dirtiness on levels of building illumination is shown graphically in figure 2c. Curve 1 is obtained with a window-cleaning interval of 4 months, curve 2 corresponds to cleaning every 6 months and curve 3, every 12 months.

In the case of horizontal skylights, cleaning the panes has an even greater influence because they become dirty much faster.

Industrial tasks are many and varied. Natural lighting is particularly important for some of them, particularly in textile and food producing industries.



Emergency services building in Mont-de-Marsan (France) (arch. C. et J-F. Bats). **1**

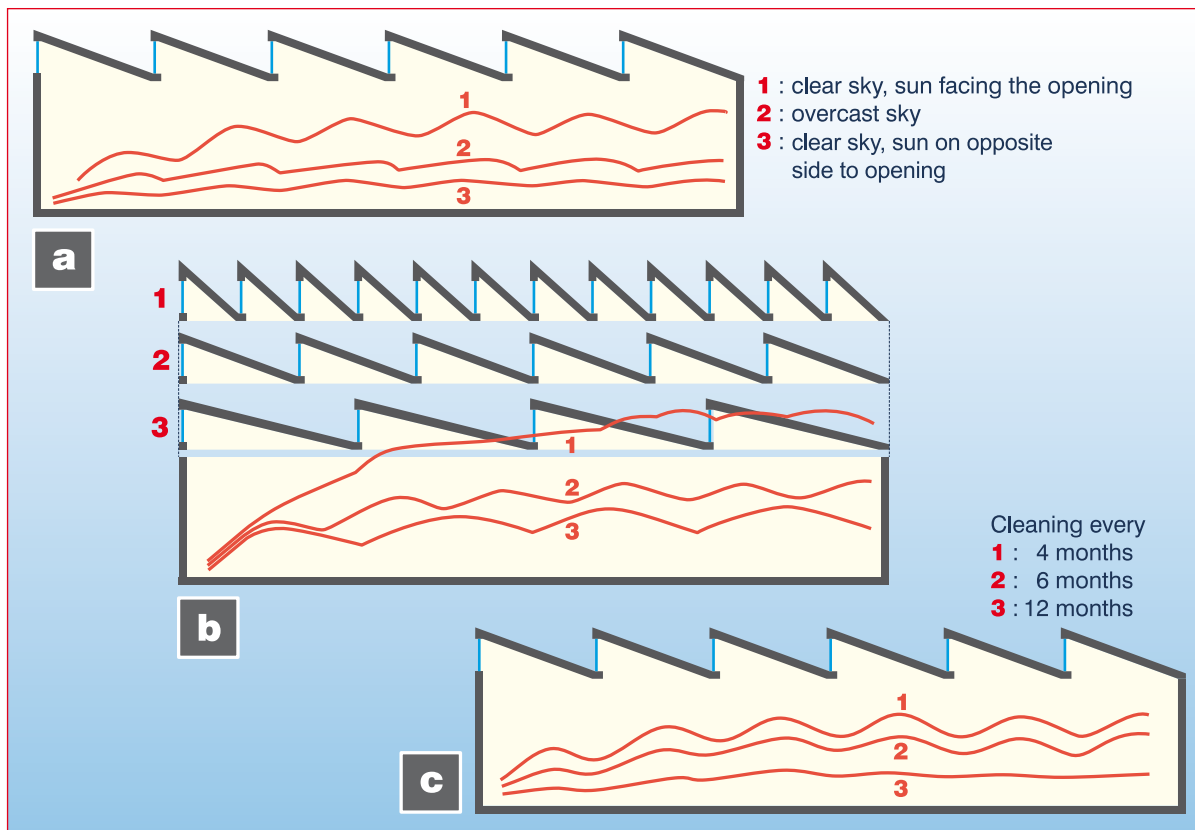

2 a : Distribution of light depending on cloud conditions.
 b : Impact of frequency of openings on interior lighting.
 c : Impact of window dirtiness on interior lighting.

Actual solar radiation reaching the Earth depends on local climate, particularly on cloud cover, and its intensity varies depending on the orientation and incline of the wall it strikes.

The sun can help heat buildings in winter by a greenhouse effect through glazed surfaces or by warming solid walls. That said, solar gain is not always useful because in summer it is preferable to be protected from it. Besides, in certain types of building (schools, offices, etc.) the heat produced internally is so great that additional solar heat gain can only lead to overheating.

Figure 1 shows again how solar radiation reaches us in a direct or a diffuse manner. The diagram represents the average energy falling on a horizontal surface in Brussels. In the north of France and in Belgium, the proportion of diffuse solar energy (about 55%) is greater than direct radiation, even during the summer months (due to cloud cover). It can be observed that in Belgium, only the months of August and September see more direct than diffuse sunshine.

When the sun's rays strike transparent materials, they are partially reflected and absorbed, and partially transmitted. The fraction that is absorbed is subsequently re-emitted as long wavelength radiation on both sides of the transparent surface. Glazing being virtually opaque to radiation with wavelengths greater than 2.5 microns, solar radiation re-emitted within the heated area will be trapped by the effect of transformation into long wavelengths. This heat trap has a name: the greenhouse effect.

In the case of a solid wall, part of the radiated energy is absorbed while the rest is reflected: there is therefore no direct transmission. Part of the solar energy absorbed is diffused on the other side of the wall after some delay, provided that the air temperature inside is lower than the external temperature which, in our regions, sometimes happens in summer. This heat transfer into the interior is, however, only possible if the wall is not insulated.

Sun shining on solid walls does, however, influence heat transfer. In fact, letting the outer surface of the wall heat up reduces heat loss from the building because this is proportional to the difference between interior and exterior surface temperatures.

Figure 2 illustrates the variations in solar gain on a July day. Solar gain reaches a maximum ($> 400\text{W/m}^2$) on east-facing walls in the early morning and west-facing at around 4 p.m. (with a risk of overheating).

Furthermore, the curves relating to variations in solar gain over a complete year show that south-facing walls capture relatively little solar energy in summer (due to the sun's elevation in the sky) but more in winter. Vertical south-facing apertures therefore provide the best passive heat-regulation capability.

Solar gain is principally transmitted through windows. It varies depending on the sun's relative position and the orientation and slope of the wall it strikes.

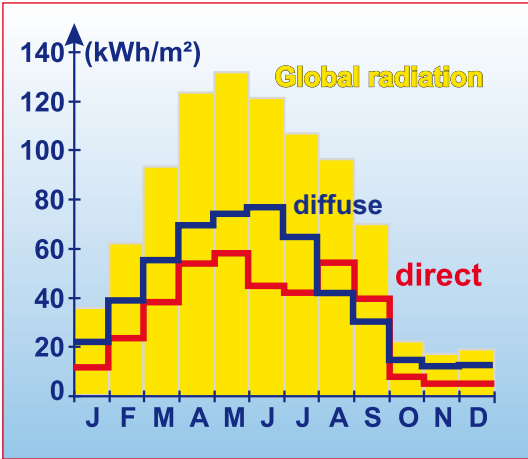

Average energy received on horizontal surface in Brussels. **1**

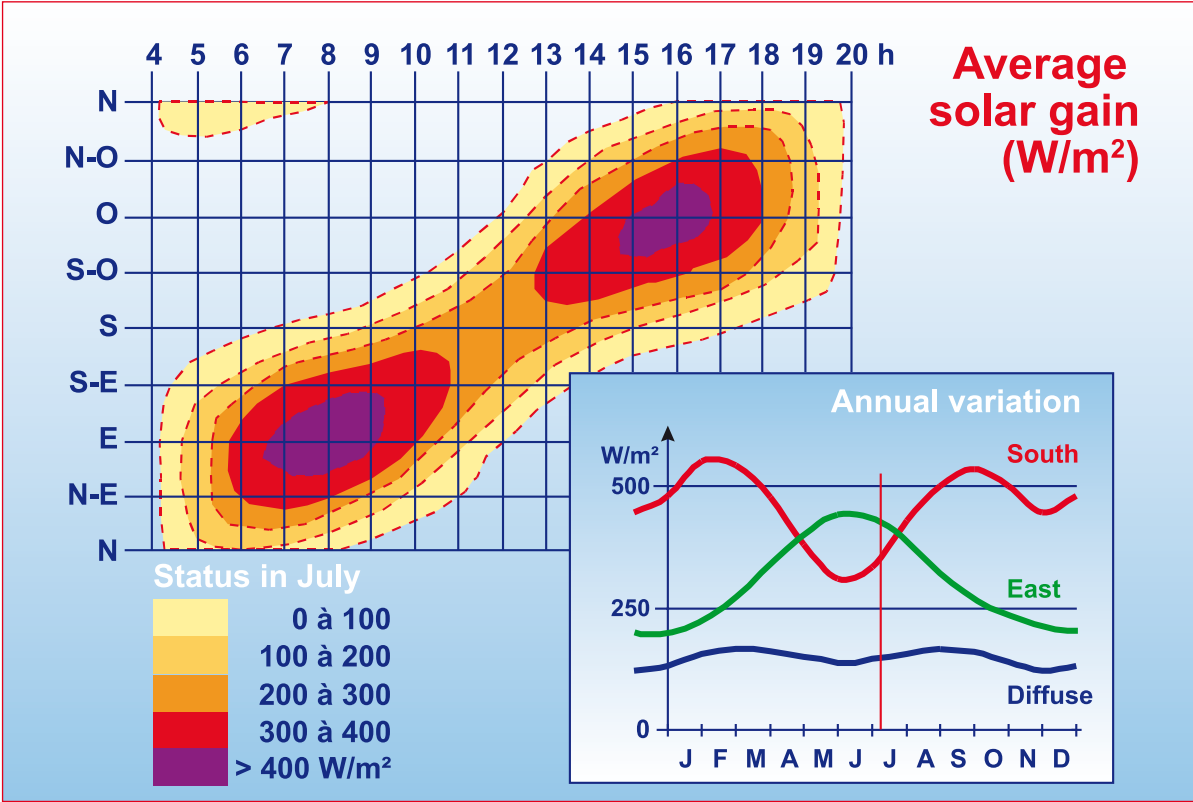

2 Average solar gain on a vertical surface in Carpentras, France.

The energy footprint of a building takes into account heat-loss through walls and due to ventilation, as well as heat gains. These heat gains may be external (solar gain) or internal (heat sources connected with the internal environment, coming from its occupants, lighting, electrical equipment or water evaporation).

It is quite rare for internal heat gains to be simultaneous or to reach a peak at the same time. So, they constitute a source of diffuse heat within the building. On the other hand, adding them on top of other heat sources (the heating system, direct solar radiation) may lead to an excessive and uncomfortable increase in temperature.

- The presence of people is accompanied by heat and humidity being produced. This heat is continuously removed by convection (35%), radiation (35%) and by evaporation (25%) depending on people's activities and on temperature and humidity conditions. Figure 1 shows changes in temperature in a classroom during a 45-minute class. The space is heated to a background temperature of 18° C and lighting constitutes a constant additional internal heat gain. The increase in temperature to 25° C is due purely to the presence of the schoolchildren.

- Electrical equipment, due to the way it works, emits a certain amount of heat into the atmosphere. Office equipment has a calorific output equivalent to the average electrical energy input and electric motors emit different levels of heat depending on their performance in terms of converting electrical energy into mechanical energy. Gas-powered equipment generates heat and produces humidity.

- Lighting also contributes to the overall footprint. All electrical energy used is considered to be totally converted into heat, then diffused by convection into the ambient air or by radiation towards surrounding materials and walls. The energy radiated by an incandescent light corresponds to 80% of this converted energy compared with 50% for a fluorescent light. After a while, the capacity to store heat reaches saturation and the temperature of the building rises.

The tables in figure 2 bring together some data relating to the production of heat and humidity by the occupants and by equipment. The table of people's activities uses watts and grams of water per person per hour. The equipment table uses watts and grams of water per hour. It should be noted that the duration of use of such equipment varies greatly. The table relating to lighting shows again the average lighting consumption of incandescent and fluorescent lights in W/m².

Heat sources relating to the interior environment are: occupants, lighting, electrical or gas appliances, and water evaporation.

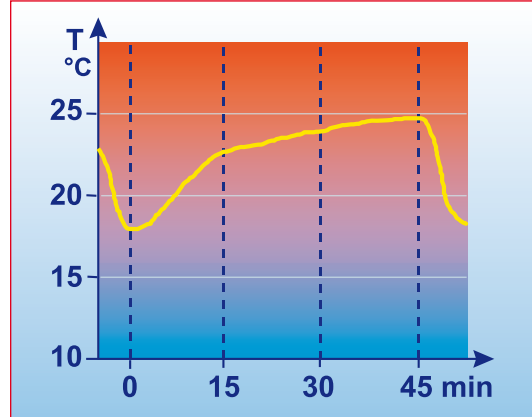

Temperature variations due to human presence in a classroom. **1**

Per person :	W	g/h
seated at rest	114	37
standing at rest	128	46
seated, moderate work	145	61
standing, light work	174	99
moderate work	197	116
active work	232	141
intense work	290	213
hard work	406	319

	W	g/h
electric oven	3000	880
toaster	500	140
refrigerator	100	-
washing machine (5 kg)	6000	4320
iron	500	400
hair dryer	500	230
PC	200	-
typewriter	100	-

	W/m ²	
	inc.	fluo.
residential	10	-
schools	25	12
offices	30	16

Estimation of internal contributions

2 Estimate of internal heat gain: heat from people and equipment.

The solar factor (G) refers to the percentage of incidental solar energy transmitted into a building through a glazed surface. The choice of solar factor affects energy-savings because the more the glazing restricts radiation inwards, the lower the air-conditioning costs and the risk of overheating. Conversely, the benefit of solar gain in winter will be reduced.

Total solar energy transmittance, and therefore solar gain through a transparent medium, is proportional to the angle of incidence of the sun's rays striking the glass. Important parameters are thus: the latitude and the time of year (relating to the sun's position); the orientation and angle of the surface (relating to the geometry of the building and the properties of the glazing used).

Figure 1 shows the rapid reduction in the solar factor due to an incidence greater than 60° regardless of the type of glazing used (single, double or triple).

Figure 2 summarises the characteristics of the solar factor (G) for three different types of glass: clear, absorbent and reflective glazing. The values shown only relate to one specific angle of incidence. For clear single glazing: 84% of the incidental energy is directly transmitted; 8% is reflected and 8% is absorbed, of which 6 is released outwards and 2 inwards. The solar factor corresponds to the sum of the fractions transmitted directly and released inwards, so 86%.

- Clear glazing is known for its excellent ability to let in light. It is produced from silica, lime and soda, mixed together and melted. The melted glass is poured into a molten tin bath. The two ingredients do not combine and their contact surfaces are perfectly smooth and flat. For single glazing where the G value = 0.86 (fig.2) and for inert clear double glazing (6cm - 12cm - 6cm), the solar factor varies between 0.65 and 0.76.

- Absorbent glass is body-tinted using metal oxides. These enable the glass to reduce the fraction of solar radiation transmitted while increasing the fraction that is absorbed. The energy absorbed is then released in infrared form on both sides of the glazing, according to a ratio that depends on wind speed and interior and exterior temperature conditions. The actual reduction in solar energy transmitted is therefore connected to the fraction of infrared released outwards. The directly transmitted fraction added to the fraction released inwards makes up the global transmittance G. For single glazing, a G value = 0.58 is obtained (fig. 2) and for absorbent double glazing (6-12-6) the solar factor ranges from 0.46 to 0.67.

- Reflective glazing is characterised by the presence of a very fine reflective transparent metallic film which increases the proportion of solar radiation that is reflected and so reduces the proportion transmitted. The choice of metals or of oxides determines the tint of the glazing: blue, green, gold, etc. These different types of glass are used to reduce unwanted solar gains, especially in office buildings. For single glazing, a G value = 0.49 is obtained (fig. 2) and for reflective double glazing (6-12-6) the solar factor ranges from 0.10 to 0.63.

The solar factor (G) refers to the percentage of incidental solar energy transmitted into a building through a glazed surface.

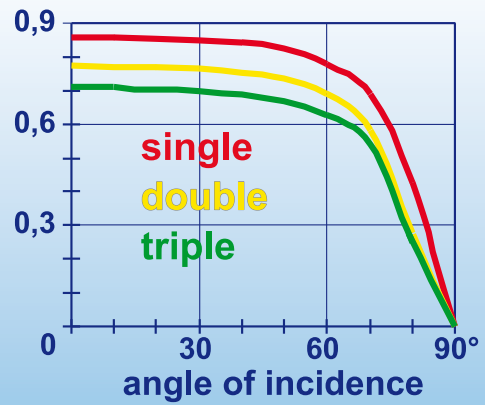

Variations in solar factor depending on the angle of incidence of the sun's rays.

1

Solar factor

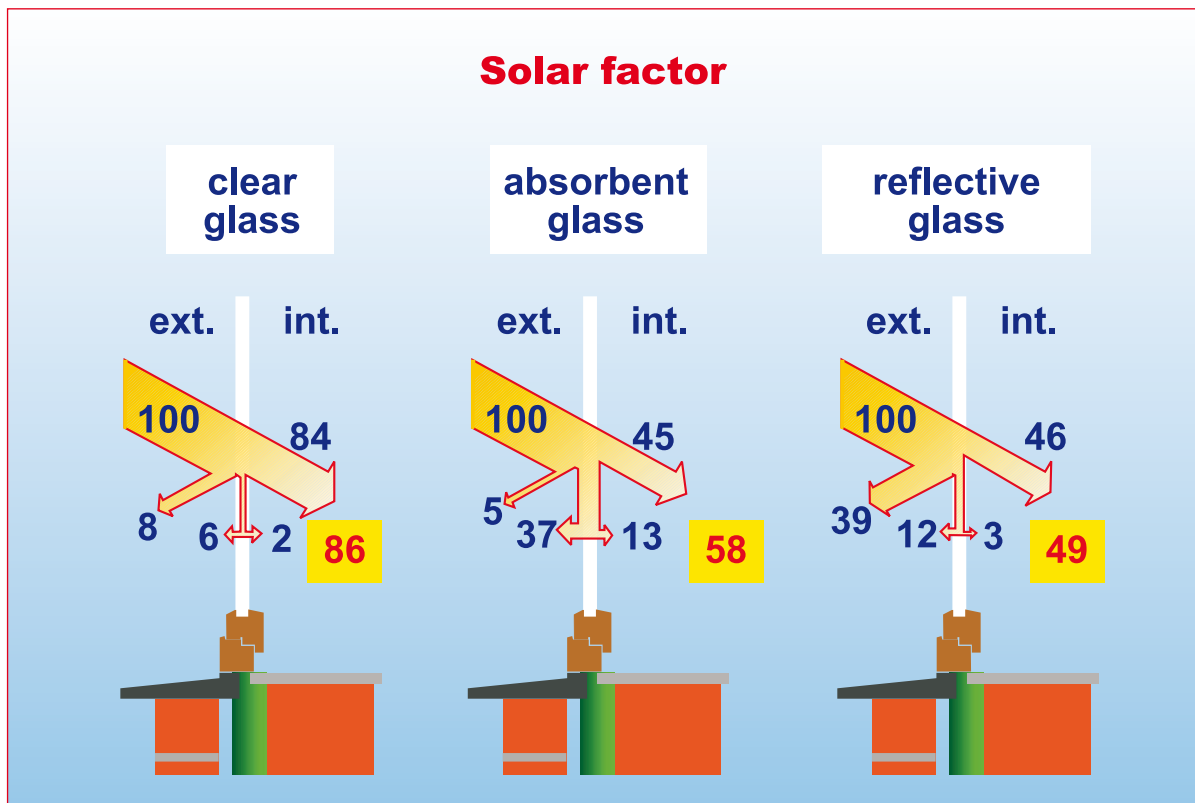

2 Solar factors for single glazing and for specific angles of incidence.

Glazing represents the weak spot in a building's thermal insulation, but its performance is continuously improving. Thanks to different combinations and types of glass now available, glazing can play a better role in ensuring good thermal insulation, and good noise insulation, and in guaranteeing the security of goods and people.

The better the insulation of the glazing used (low U-factor), the less heat is lost through it in winter and the warmer its inside glass surface. It follows that the ambient air temperature should be lower in order to ensure the occupants' comfort (the definition of perceived thermal comfort).

Figure 2 shows U heat-loss factors for clear glass: single glazing, double glazing and low emissivity double glazing, as well as the proportions of absorbed, transmitted and reflected energy enabling the sun factor (G) to be estimated.

Different methods have been used to reduce thermal conductance through glazing. The first was to reduce heat-loss due to conductance by putting an excellent freely available transparent insulator between the panes: inert, dry air. In fact, air provides a good thermal break provided that convection currents are prevented. The insulating properties of this glazing depend on the width of the air gap: the wider it is, the better the insulation of the glazing (above 20mm, convection currents occur and the insulation gain is lost). The U-values of this glazing range from 2.76 to 3.59.

Along the same lines, triple glazing was invented. The U-values then range from 1.90 to 2.61.

Another approach consists of changing the characteristics of the glass's surface. Low-emissivity glazing is covered with a thin coat of perfectly clear metal oxide, which enables a reduction in the outward release of infrareds. Glazing may have one or two low-emissivity coatings but the air space may also be replaced by a noble gas (argon, krypton) whose thermal conductance is lower than that of air. These gasses are non-toxic and non-flammable. The U-values of this glazing range from 1.13 to 2.40.

Many experimental materials enable U-values of between 0.3 and 0.7, comparable with those of insulated walls, to be reached. For the record, we should mention 'superwindows' (triple-coated, low-emissivity, noble gas), 'vacuum windows' (a vacuum is maintained between the two panes), windows using aerogel (microporous transparent insulating foam) and 'smart windows'. The latter consist of a liquid crystal film placed between the panes. An electrical field is used to align the crystals so that the window becomes clear (fig. 1).

Glazing represents the weak spot in a building's thermal insulation, but its performance is continuously improving.



Smart windows: a liquid crystal film is sandwiched between the panes. **1**

Coefficient U (W/m².K)

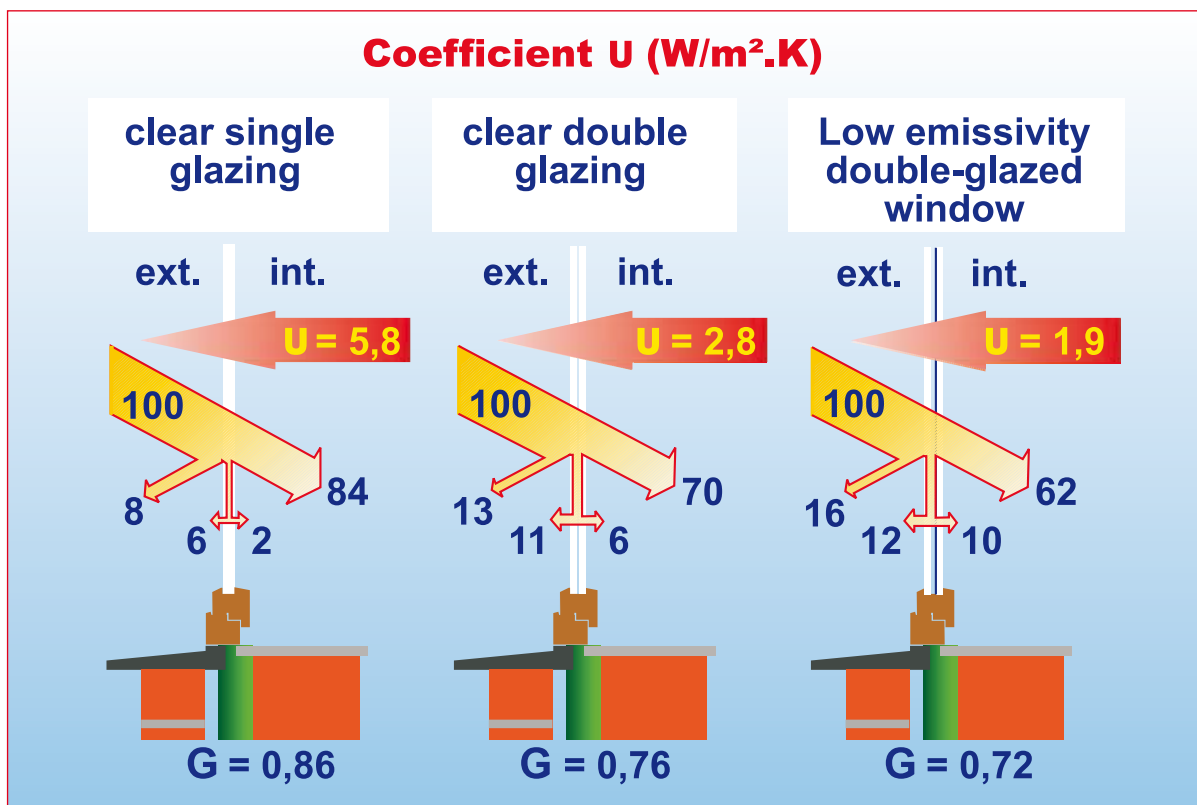

2 Thermal performance of different types of glazing.

Under normal conditions, a person keeps their body temperature at around 36.7 °C. This temperature is always higher than the ambient temperature, so a balance needs to be found in order to ensure the individual's well-being.

Figure 1 depicts the sensation of thermal comfort as expressed by the people concerned. It involves predictable percentages of dissatisfied people (PPD), shown on the vertical axis, for people sitting down to rest or doing light work. It is impossible to define a temperature that suits everyone: at best, 5% of people remain dissatisfied. The curve representing light work slips down towards the low temperatures: people with more heat to lose prefer lower temperatures. Conversely, the curve for people resting is tighter: these people are more sensitive to minor variations in temperature.

Body heat is dissipated in various ways into the ambient air: more than 50% of heat lost by the human body is through convection with the ambient air (convection and evaporation through breathing or from the surface of the skin). Heat exchanged by radiation from the surface of the skin represents up to 35% of the total whereas losses due to contact (conductance) are negligible (<1%). The body also loses 6% of its heat in digesting food.

Thermal comfort consists of 6 parameters (fig. 2):

1. The metabolic rate is the production of heat within the body enabling it to remain at around 36.7 °C. The metabolic rate while working on a particular task is on top of the basic metabolic rate of the body at rest.

2. Clothing provides thermal resistance against heat exchanges between the surface of the skin and the surrounding air.

3. The ambient air temperature, T_a .

4. Wall temperature, T_w . Simply expressed, the perceived thermal comfort temperature (also known as the operative temperature) can be defined as: $T_o = (T_a + T_w) / 2$

5. Relative air humidity (RH) is the ratio of the amount of water vapour in the air at air temperature T_a to the saturated amount of water vapour at the same temperature, expressed as a percentage.

6. Air movement affects heat exchange through convection. Indoors, air movements do not generally exceed 0.2 m/s.

The human body's self-regulating mechanisms reveal an area in which thermal comfort varies little: this is the comfort zone.

Thermal comfort is defined as a feeling of satisfaction with the thermal environment. This is determined by the dynamic balance resulting from heat exchanges between the body and its surroundings.

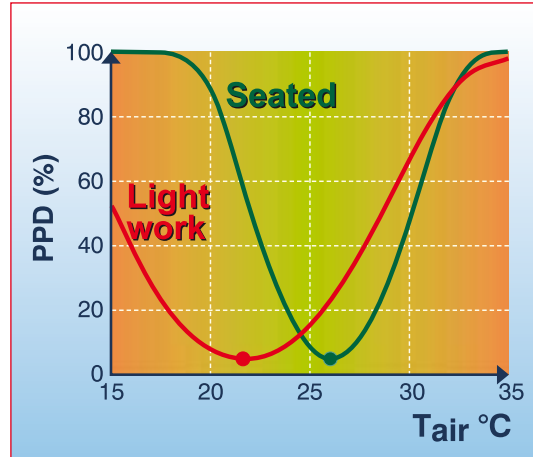

Predictable percentages of dissatisfied people: thermal comfort temperatures for two different activities.

1

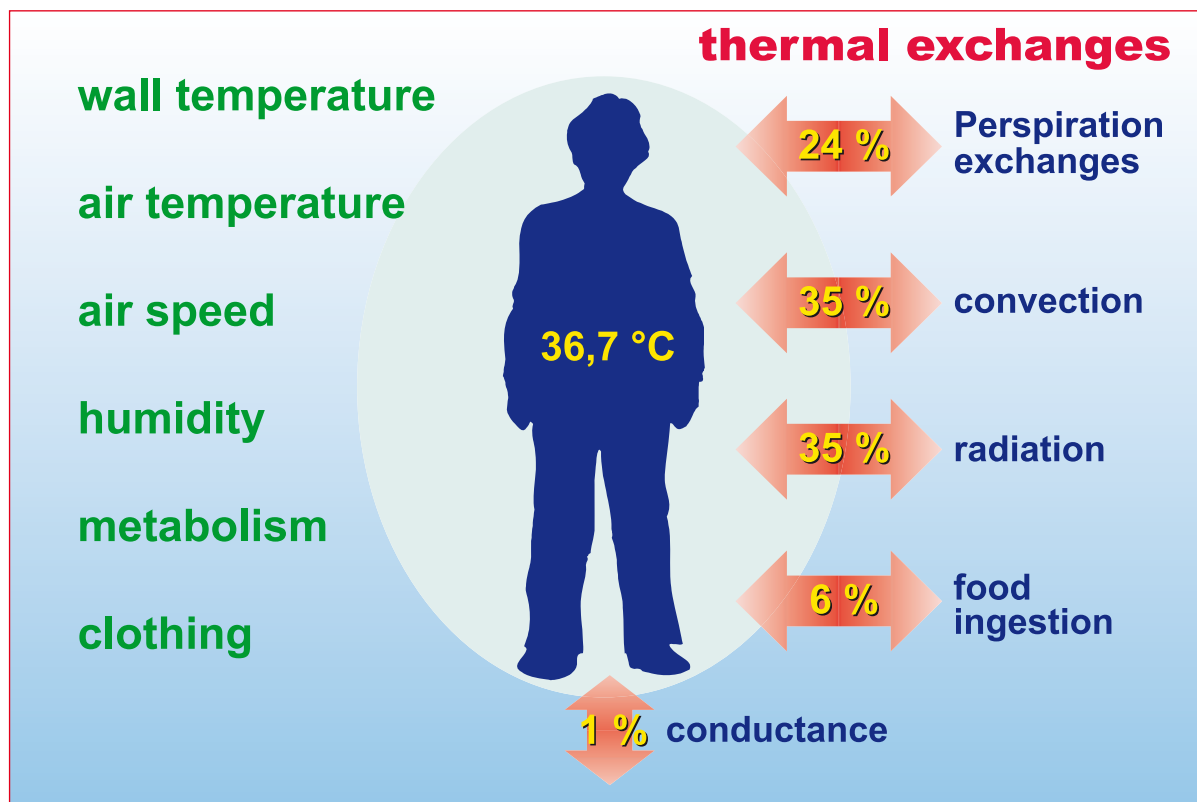

2 Heat loss by the human body depends on 6 physical parameters.

Wall temperature T_w affects heat exchange through radiation. The distribution of temperatures over a wall is a complex phenomenon but it is accepted that T_w is equal to the average of the temperatures of the surrounding walls weighted by their surface areas.

To simplify, the perceived thermal comfort temperature, also known as the operative or dry-bulb temperature, can be defined as:

$$T_o = (T_a + T_w) / 2$$

T_a represents air temperature or dry-bulb temperature, measured by an ordinary thermometer.

The human body's self-regulating mechanisms reveal an area in which thermal comfort varies little: this is the comfort zone. Thus, for a given situation, the operative temperature can vary to a certain extent around the thermal comfort point without affecting an individual's comfort level.

Figure 1 restates the thermal comfort temperatures for different activities measured according to the metabolic heat produced, based on indoor winter clothing (trousers, shirt, long-sleeved pullover, thick socks and shoes), on an air speed of 0.4 m/s and relative humidity of 50%.

Several studies have provided a scientific basis for guidelines regulating the comfort zone at work. For example, the 'Protection du Travail' regulations specify minimum and maximum air temperatures according to the type of work carried out, i.e. on the metabolic rate, with relative humidity ranging from 40% to 70%.

Figure 2 shows the concept of dry-bulb temperature (thermal comfort temperature) as defined earlier. For an uninsulated wall (on the left), the surface temperature is low: 12 °C. With an ambient air temperature of 20 °C, the operative temperature is 16 °C, i.e. an uncomfortable level: this is the 'cold wall' effect. The body loses heat in the direction of cold zones.

For an insulated wall (the wall on the right), the surface temperature equals 16 °C and the operative temperature climbs to 18 °C. The wall temperature is still lower than body temperature, the latter continuing to lose heat but by a smaller amount, thus enabling a comfortable condition to be achieved.

Thermal comfort temperatures

In a given situation, temperatures can vary around the thermal comfort point T_o without affecting a person's individual thermal comfort.

$T_o = (T_a + T_w) / 2$

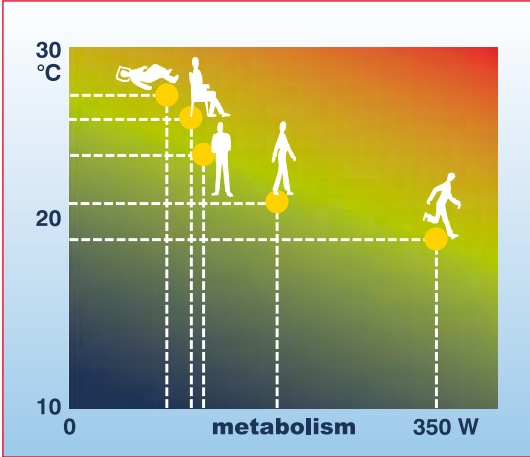

Thermal comfort temperatures for different activities (based on O.Fanger). **1**

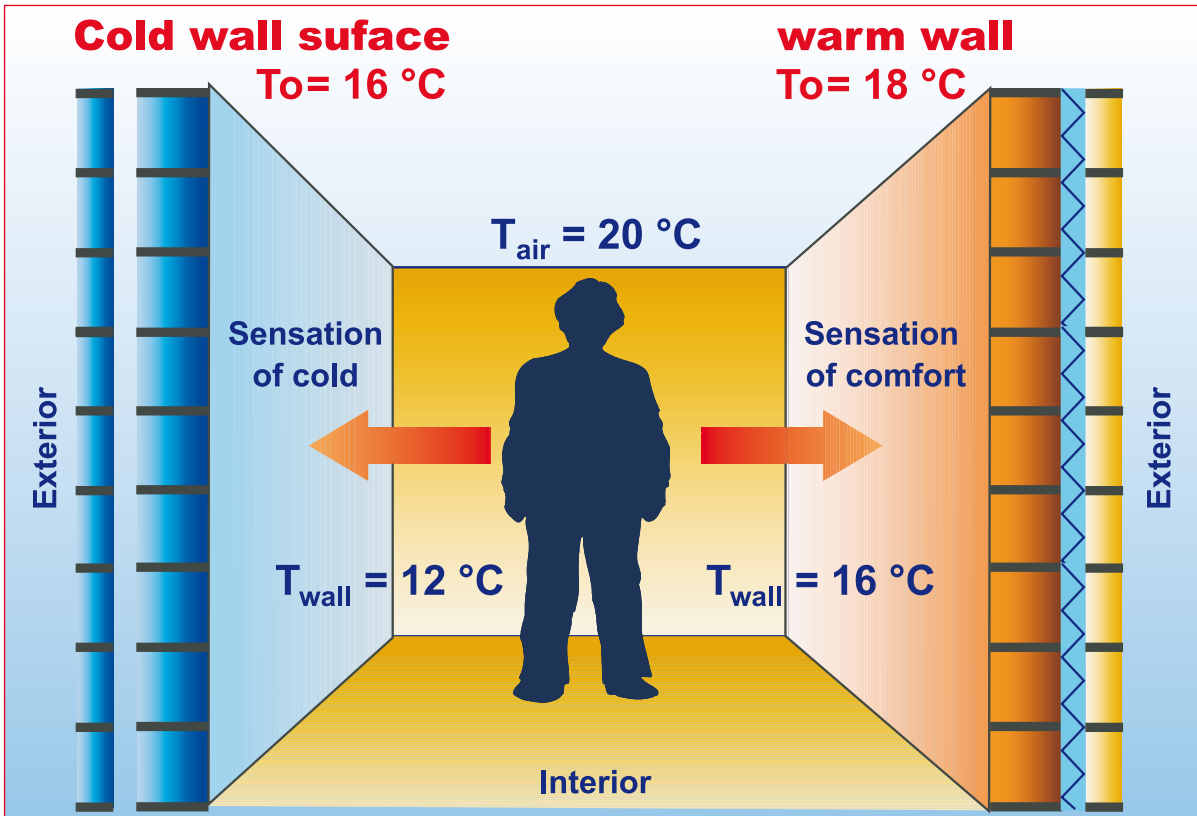

2 The thermal comfort temperature depends on air temperature and wall temperatures.

A heating system is always sized to cope with periods of extreme cold. For the rest of the winter period, it is the heating controls that do the job of regulating the power output, whatever the interference, be it internal (from the occupants and their activities) or external (from the climate) to the building. If the demand for heating does not match supply, this may cause discomfort through lack of heat.

Heating systems can be managed by a programme (of the daytime/night-time type, etc.) that defines the desired temperature levels for specific periods. For example, the heating comes on at 6.30 a.m. at a temperature of 20 °C, is kept at 18 °C during the day, then comes on full again at 5.00 p.m. and is kept at 16 °C overnight. This mode of operation is directly linked to the mode of operation of the building.

Figure 1 compares the heating profiles of three very different types of building: homes, schools and offices. The vertical axis shows the heating output (as a % of maximum output) and the horizontal axis represents a day. It can be observed that homes need more heating than other types of building. Conversely, schools virtually need to be heated in the morning only, owing to significant internal heat gains due mainly to heat released by the pupils' metabolisms. Offices have the same heating profile as schools, but spread over a longer period. Internal heat gains are equally significant, coming essentially from equipment. The curves correspond to an external temperature of 4 °C on an overcast winter's day.

Maintaining a comfortable temperature inside an inhabited building depends on the external temperature conditions. In a constant state, the heating system provides heat a part of which is lost by conduction through the envelope of the building to the outside or by heating cooler air. This heat loss is proportional not only to the extent of insulation in the building, but also to the temperature differential between the inside and the outside. This is why it is useful to base the calculation of the heating system's output fluid temperature on the temperature outside the building (fig. 2).

Heating programmes cannot take into account local conditions to which the occupants are subject: significant internal heat gains, intense solar radiation, etc. Therefore, it is essential to control heat distribution locally. For example, a room thermostat can determine the temperature in the room at any time and switch the heating on or off. Lastly, to complete the system, radiators can be fitted with thermostatic valves. These are taps whose needle valve is activated by a wax plug that reacts to changes in room temperature.

Control of heating system is aimed at matching the supply of heat to the exact demands of the occupants: at what temperature, where and when?

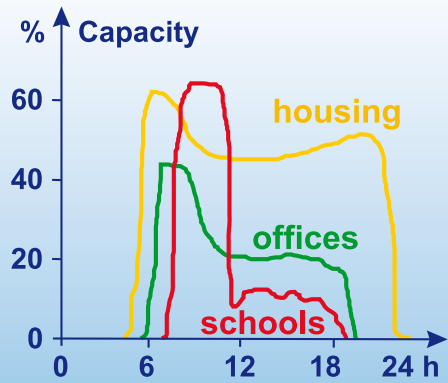

Variations in heating requirements during the day. **1**

Controls

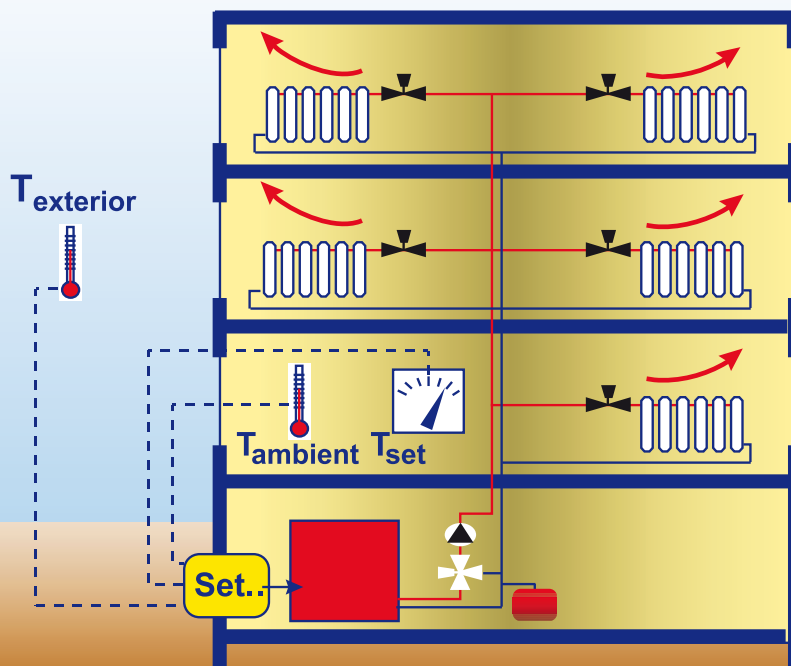

2 Functional diagram of a heating system with an exterior sensor, central thermostat and thermostatic radiator valves.

Air-conditioning encompasses a set of techniques aimed at maintaining specific conditions of temperature, relative humidity, and possibly air purity, totally regardless of climate and its variations.

Air-conditioning, as opposed to conventional heating systems, can respond both to cold (by producing heat or calories) and to excess heat (by producing cold or negative calories). Its use is prevalent in the USA, in both the commercial and the residential sectors: 'light' building techniques (in wood) are not able to provide a comfortable response to the great variations in temperature on the North American continent.

Air-conditioning therefore provides a 'real-time' response to comfort issues, even though the energy consumption of air-conditioning systems is heavy and constitutes one of the highest-growth areas of energy consumption, particularly in some regions such as southern Europe.

Bioclimatic architecture considers that an appropriate design for living must firstly aim to prevent situations of discomfort (overheating, excessive humidity, etc.) by natural methods before envisaging the installation of energy-devouring mechanical corrective technologies. It should, however, be recognised that ensuring comfort can be extremely difficult in certain climate conditions (mainly in warm, humid climates) without using air-conditioning.

Air-conditioning relies on the principle of dual flows: (clean, cool) air flows in, replacing (stale, warm) air flowing out (fig.1). The circulation of air being a closed circuit, it is vital to be able to control the inflow of unwanted air. This is why it is generally not possible to open the windows in a building equipped with air-conditioning: opening a bay-window would ruin the balance of the airflows and interfere with the system.

Air-conditioning systems manage several parameters relating to comfort: air temperature, relative humidity of the air, air flow and possibly air purity (via filters and control sensors). The problem to which air-conditioning systems must respond is generally based on removing calories (originating mainly from internal heat-gains) because they have to reduce the temperature of the ducted air whilst avoiding cold spots, and manage throughflow whilst avoiding draughts.

Figure 2 shows an air-conditioning system in operation in the summertime. As long as the air outside (1) passing through the cooling unit remains above the dew point temperature (T_1) its temperature decreases whilst retaining a constant amount of water vapour per cubic metre of air (2). Then, when cooling below T_1 , part of the water vapour in the air condenses on the surface of the cooling unit: the air is dehumidified and cooled according to the saturation curve and arrives at (3), the minimum temperature corresponding to the dew point temperature of the air in room T_2 . This air is then warmed until it reaches an acceptable temperature for the occupants' comfort before being blown out.

Air-conditioning is a means of regulating comfort based on dual flows (air inflow - air outflow), regardless of climate. These systems are also big energy consumers.

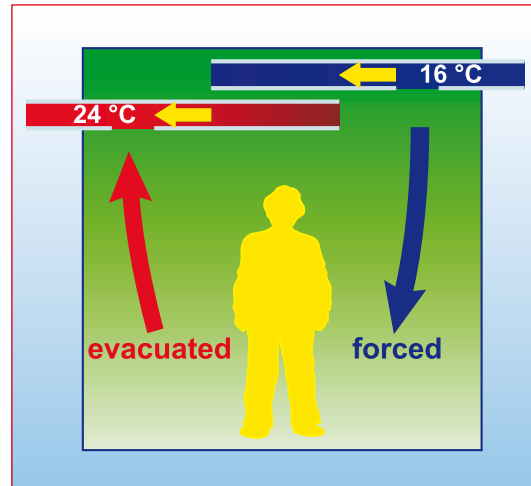

Dual flow principle. **1**

Air conditioning

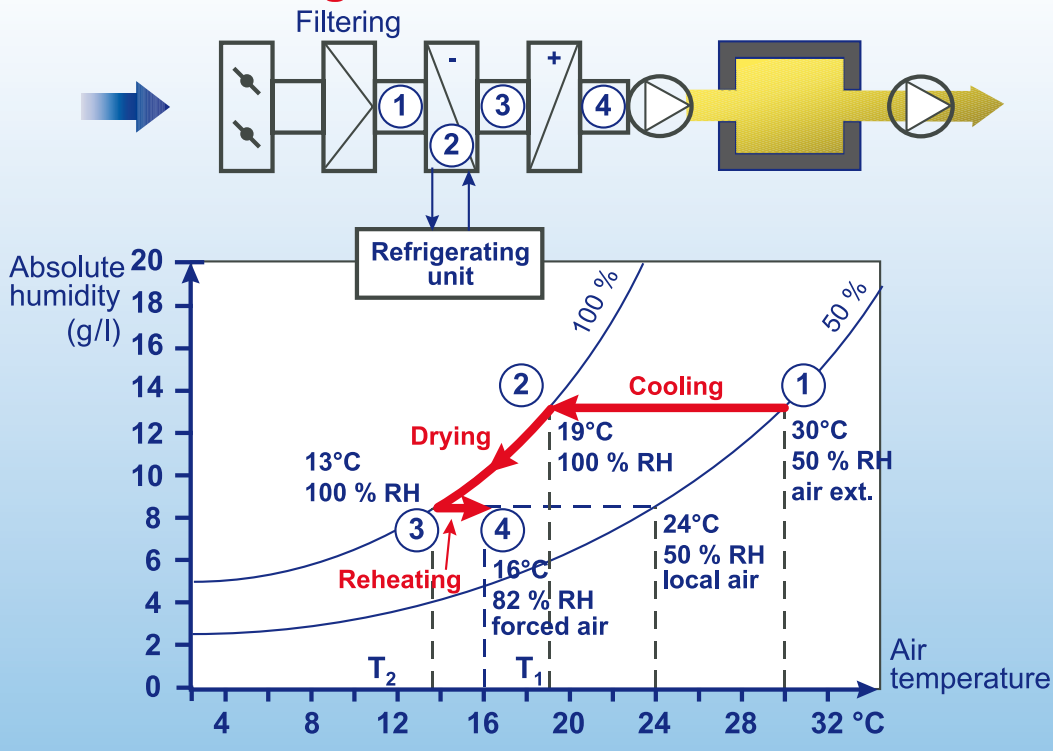

2 Table of recommended settings for the climate in Belem (Brazil) (based on C.Mahoney).

One of the fundamental concepts of bioclimatic architecture in warm climates is to shade windows from the sun's rays. Insulating materials, reflective coatings and shade screens represent different types of shading systems.

In the southern hemisphere, it is the northern façade that gets the sun. In the tropics, the sun shines alternately on the northern or southern façade depending on the time of year.

In hot regions near the equator, an east-west orientation is preferred. The sun is higher above walls facing north or south. East and west-facing façades are illuminated by a low sun during the morning and afternoon. Shading devices vary depending on orientation and the surface to be shaded.

Different types of screens enable the sun's rays to be blocked, reflected or cut down. On north or south façades, roof overhangs and the creation of intermediate spaces attenuate the incidence of the sun's rays. On the east and west sides, vertical projections block the low sun in the morning and afternoon. Exterior vegetation also contributes to solar shading, to which the use of adjustable shading can be added: shutters, blinds, louvre shutters.

The sun's elevation and its azimuth vary depending on the day and the time. It is the same for shadows. So, in order to analyse the shading of a building's walls and apertures from the sun's rays, it is essential to know the exact location and the sun's visible path for all hours of the day and times of year. Analysing insolation, and shadows in particular, is simplified by using sunpath diagrams. The effectiveness of this system will depend on the appropriate choice and correct sizing of the device according to the orientation of the surface to be shaded.

The solar factor is the ratio of solar gain through a shaded window to the gain through an unshaded window.



Office and workshop buildings in Baie Mahault (Guadeloupe) (arch. P. Huguet)

1

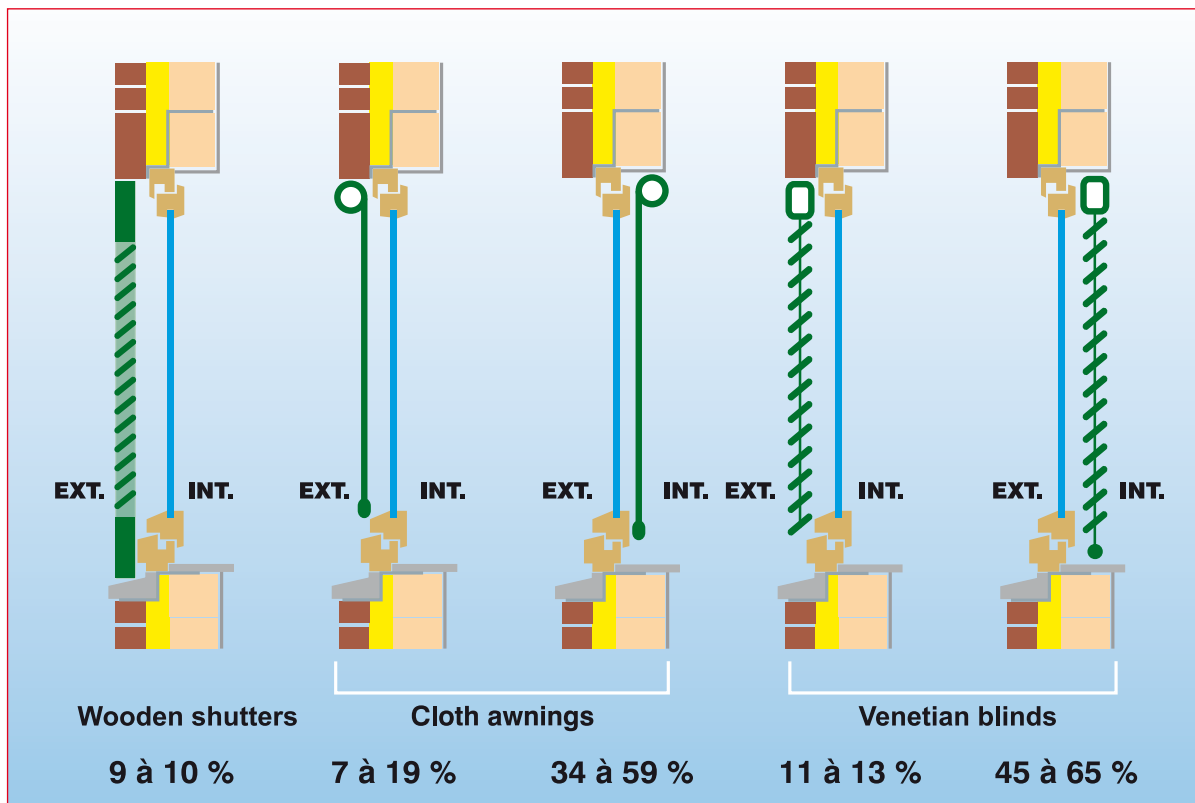

2 Solar factors for different types of solar shading with single glazing.

The air breathed in an enclosed space can have an impact on comfort and health, ranging from being simply unpleasant – odours, drowsiness, eye and skin irritation - even to leading to illnesses, such as respiratory allergies. Indoor air quality, neglected for many years, is henceforth a topic of concern for health authorities and one of the criteria of a high-quality environment. Many pollutants are effectively concentrated in the air indoors, coming simultaneously from our activities, the products we use, and from building materials (fig. 1). The primary source of pollution is still carbon monoxide (CO), followed by carbon dioxide (CO₂), animal allergens, mites, mildew, volatile organic compounds (VOC) – which includes the formaldehyde group – nitrogen oxide (NO_x) as well as artificial mineral fibres.

Depending on how concentrated it is, carbon monoxide can cause sickness, dizziness and even poisoning. It is produced by fires (gas, oil, wood, etc.) that are misused or are badly connected to a flue, by exhaust gasses from cars or by tobacco smoke (each cigarette smoked emits 50mg of CO). As far as formaldehydes are concerned, they are respiratory irritants. They are present in many products: insulating foam, paint, glue, varnish, household products and pesticides. Most composite and laminated wood products contain them. As a final example, excessive levels of humidity in a room lead to sensations of discomfort and the growth of mould, which in turn is responsible for bad smells, irritations and allergic reactions.

Well-insulated houses are often air-tight. Air is not refreshed sufficiently and it is common to notice that the indoor air pollution is worse than outside. The best remedy for the unpleasantness just mentioned is both to ventilate the room and to reduce pollution. Continuous ventilation is important (opening windows, centralised ventilation system), especially during activities such as cooking, DIY or housework, in order to expel stale air. In addition, choosing natural building materials, limiting the use of household products and deodorants and expelling cigarette smoke, all enable the emission of pollutants to be reduced. With a little determination, it is now possible to find boron salt wood-treatment in the shops, fruit-based solvents, water, natural resin or oil-based paints, solvent-free varnish and glue, and also cleaning products based on essential oils.

In the early years of this century, air quality surveys conducted by the French Observatory of indoor air quality (www.air-interieur.org) showed that the renewal rates of indoor air in homes and schools were not satisfactory. Measurements varied in homes but were mostly between 11 and 31 m³/h per person. In schools, they were very low with levels down to 7.7 m³/h per person, well below the minimum rate of 15 m³/h per person specified in French legislation.

NATURAL VENTILATION
 Natural ventilation and occupants' comfort
 Comfort due to air quality

Good interior air quality is important for everyone's metabolic processes and health. Good ventilation and reducing pollutants at their source are conducive to better respiratory comfort and better health.

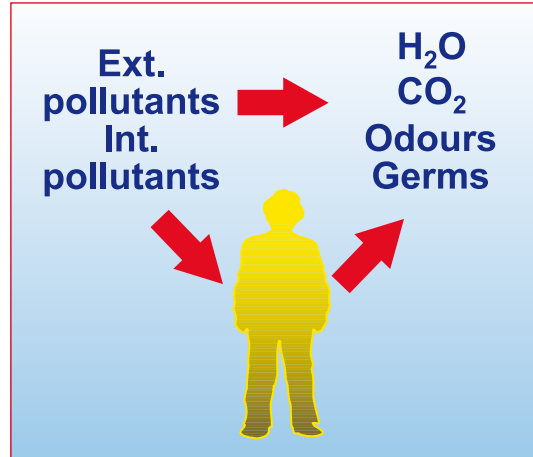

Different parameters affecting air quality. **1**

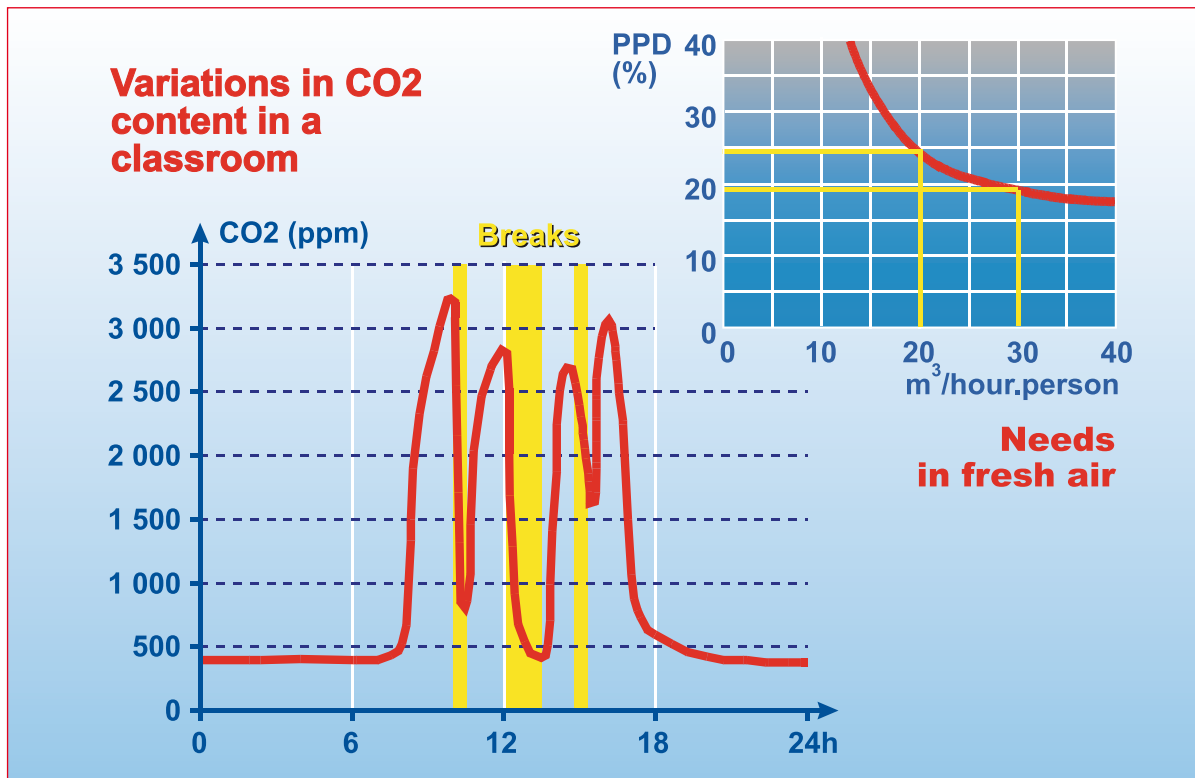

2 Variations in CO₂ levels in a classroom. Fresh air flows and predictable percentages of dissatisfied people.

An odour is an airborne mixture of chemical compounds that our sense of smell detects, analyses and decodes ultimately to reach a qualitative judgement about air quality. If analysing smells enables their molecules and their strength to be identified, no clear information can be derived about the nature of the aroma of a given mixture. Some unpleasant odours can be detected immediately. Others only become a nuisance when their strength goes beyond a certain threshold. And others remain undetected by our senses. They vary mainly according to the sensitiveness of the individual, his socio-cultural background, his physiology or his ability to adapt (to become accustomed to an odour).

In buildings, smells can originate from a variety of sources:

- building materials (mould, volatile organic compounds, formaldehyde...)
- air handling equipment (humidity, dust, ozone...)
- users (cigarette smoke, cooking, metabolism...)

Except in newly-built or renovated buildings, odours come mainly from the occupants' metabolisms. However, cigarette smoke is still one of the main sources associated with the perception of unpleasant smells.

Although there are no regulations or standards concerning air freshness (except those pertaining to the ban on smoking in public places), architects are responsible for ensuring optimum air quality. Effective building ventilation often enables the risk of poor air quality to be reduced. Although it is virtually impossible to measure smells and to estimate maximum levels, O.Fanger has been able to establish a connection between the percentage of dissatisfied people, the strength of smells and levels of CO₂. Figure 1 thus shows that a high concentration of carbon gasses (expressed in ppm) is closely related to the strength of certain odours. His research enables us to distinguish stale air indoors from fresh air outside when the CO₂ content exceeds 0.15 vol. %. A maximum CO₂ concentration of 0.15 vol. % corresponds to an air renewal rate of 20 m³/h per person, i.e. a predictable percentage of dissatisfied people of around 25%. International standards propose that more than 20% dissatisfied is not acceptable, and therefore that an air renewal rate of 30 m³/h per person be achieved. In special purpose facilities, these reference levels may be increased. So, in a hospital room, an air renewal rate of 50 m³/h per person is appropriate.

To reduce the risk of poor air quality, VOC or CO₂ sensors may be used, enabling ventilation throughput to be regulated according to the levels actually measured. According to studies conducted by Costic, VOC or air quality sensors are more sensitive inside premises highly polluted by such things as tobacco smoke. CO₂ sensors, on the other hand, only detect the presence of CO₂ corresponding to the number of occupants of the premises concerned.

NATURAL VENTILATION
 Natural ventilation and occupants' comfort
 Fresh-air comfort

An odour is an airborne mixture of chemical compounds that our sense of smell detects, analyses and decodes.

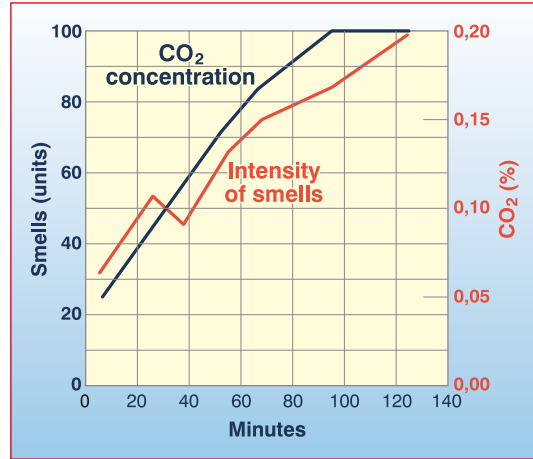

Parallel increases in CO₂ concentrations and the strength of odours. **1**

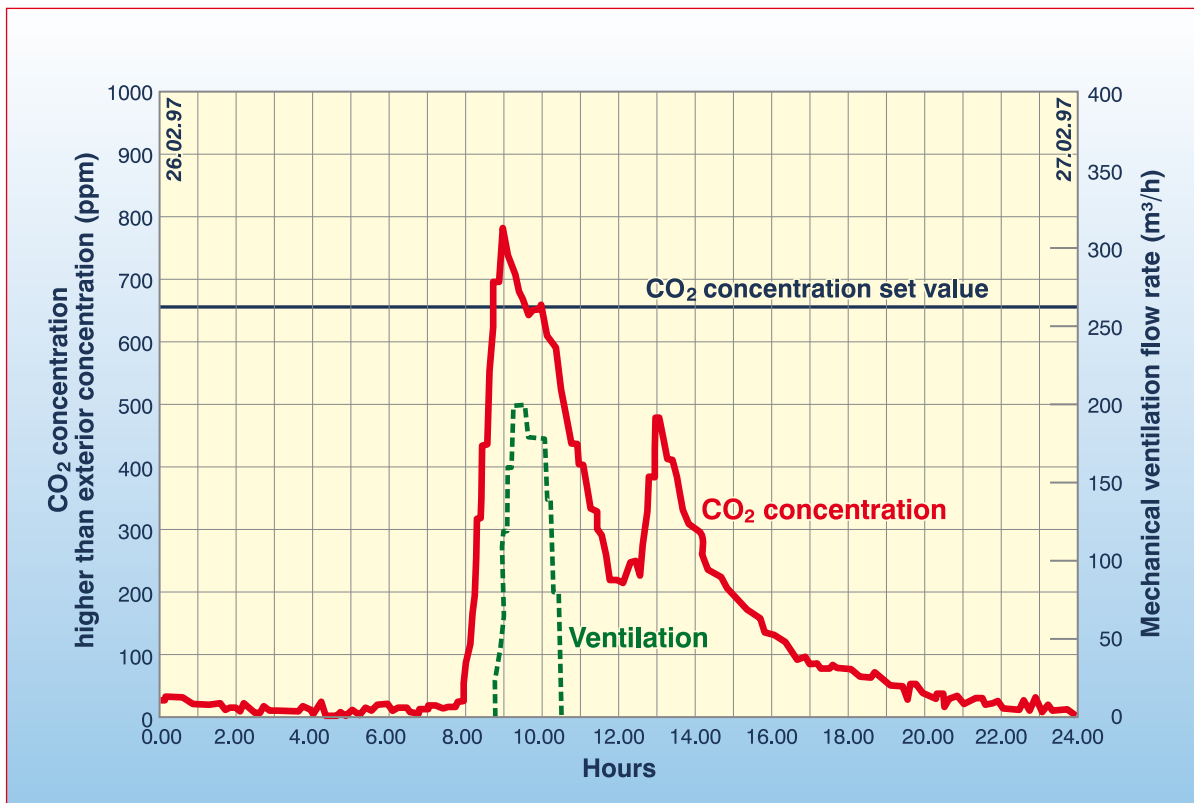

2 Ventilation on demand based on measuring CO₂ levels in a meeting room (CSTC – Centre Scientifique et Technique de la Construction).

Thermal comfort is defined by a range of temperatures, of air movement and velocity, and of humidity levels within which building occupants do not feel discomfort. It is essentially a function of heat exchanges between the human body and its environment.

These exchanges are brought about by the following mechanisms:

- warming or cooling of the skin by air convection, depending on whether the ambient air temperature is lower or higher than that of the skin
- cooling of the skin by evaporation of perspiration
- warming of the skin by direct or indirect solar radiation. This is short wavelength radiation.
- warming or cooling of the skin by radiation from the walls of a room, depending on whether their temperature is higher or lower than that of the skin. This is long wavelength radiation.
- the presence of machines or of other people in the building can be a source of heat. The increase in temperature in this case induces warming of the skin by convection

In a hot, dry climate, air temperature is often higher than that of the skin. It is essential to choose building designs with high thermal inertia to accumulate coolness at night in order to release it during the day. Low levels of humidity mean that water evaporation can be used to cool the air. The presence of plants also helps to meet the demand for comfort.

In a hot, humid climate, air temperature is commonly lower than that of the skin, but higher than the comfort threshold. Humidity levels prevent any cooling of the air by water evaporation. One of the ways to achieve the theoretical comfort level is to increase air velocity. This increases heat exchange via convection and lowers skin temperature. Evaporation through perspiration attenuates feelings of dampness.

Chart 2 opposite shows the thermal comfort temperature in relation to relative humidity and air velocity. This diagram indicates that in a dry climate, a higher temperature is acceptable than in a humid one. Evaporation of perspiration from the skin is more effective when relative humidity is lower. By increasing air velocity with certain limits, the comfort zone moves higher up the chart.

NATURAL VENTILATION
 Natural ventilation and occupants' comfort
 Thermal comfort in hot climates

The feeling of thermal comfort is obtained by dissipating heat from the body. Air movement increases heat loss by convection and facilitate the evaporation of humidity from the skin's surface.

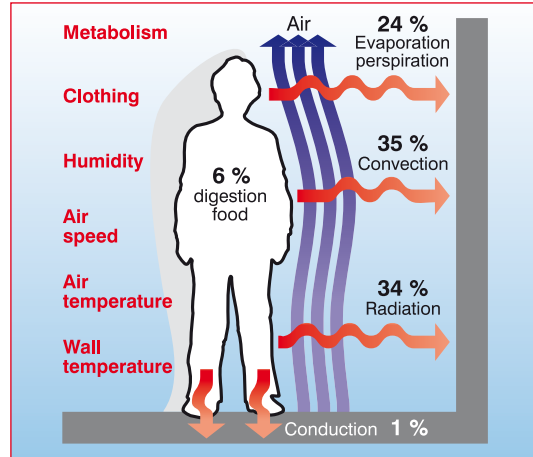

Heat loss from the human body depends on 6 physical parameters including air speed.

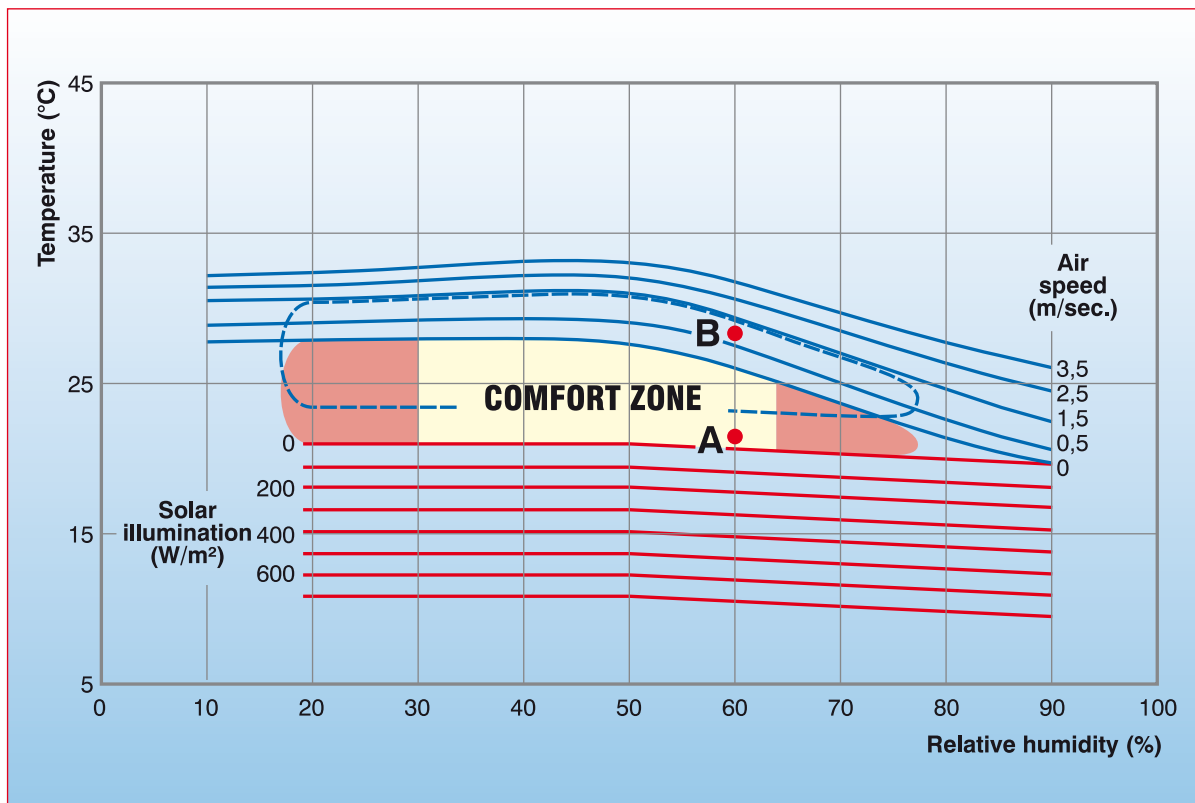

2 Thermal comfort zones depending on air speed (based on V. Olgyay).

Air quality, as much as temperature or humidity, is a determining factor of a comfortable atmosphere indoors. Whilst most people spend most of their time inside buildings, indoor pollution is more readily accepted than pollution outdoors. In this respect, we should not be deluded by the body's physiological ability to become accustomed, to a degree, to the presence of pollutants in the air: certain substances are still harmful, even though they are bearable. Maintaining air quality is a question of managing air renewal.

Figure 1 illustrates this notion with a ventilation chimney that demonstrates how ventilation constraints can inspire architecture that meets both aesthetic and utilitarian criteria.

The issue of air renewal is raised today in terms both of quantity and quality of air. Current trends of saving energy by generalised draught-proofing lead to reduced ventilation through lack of air renewal. A greater volume of air needs to be renewed, which means making some concessions regarding additional heat loss. Regulations have been improved in some European countries (France, Belgium, Netherlands, etc.) that define either the minimum fresh air levels to be maintained in a building or compulsory minimum dimensions of air vents.

The issue of air quality is also a question for air-conditioned premises in which the aim is to recycle and condition the air whilst avoiding draughts. One of the major drawbacks of air-conditioning systems is bacteria (bacterial build-up), dust and fibres picked up by the air as it flows through badly-shielded building materials (mineral fibres, asbestos, etc.).

When all possible steps have been taken to eliminate sources of impurities, ventilation is still needed to ensure an adequate supply of oxygen, to eliminate carbon gasses released by people (an average of 20l/h at rest), to regulate the air humidity content and to remove odours.

Figure 2 summarises fresh-air needs per person according to Swedish standards. On the vertical axis, an individual's fresh-air needs are measured, and on the horizontal axis, the volume of space allocated to each individual (m³ per person). It is noticeable that the required air renewal rate diminishes as the space occupied by a person increases. Air renewal needs to be far greater if smokers are present (the red curves) than if they are not (the green curves). The dotted-line curves show throughput for premises with more than 20 people present. The blue curve shows what should be added to the nominal throughput if the occupant does not have access to an opening window.

The minimum air renewal must do is ensure that interior air quality is maintained.



Ventilation stack, School of Engineering, Leicester (arch. Short Ford & Associates).

1

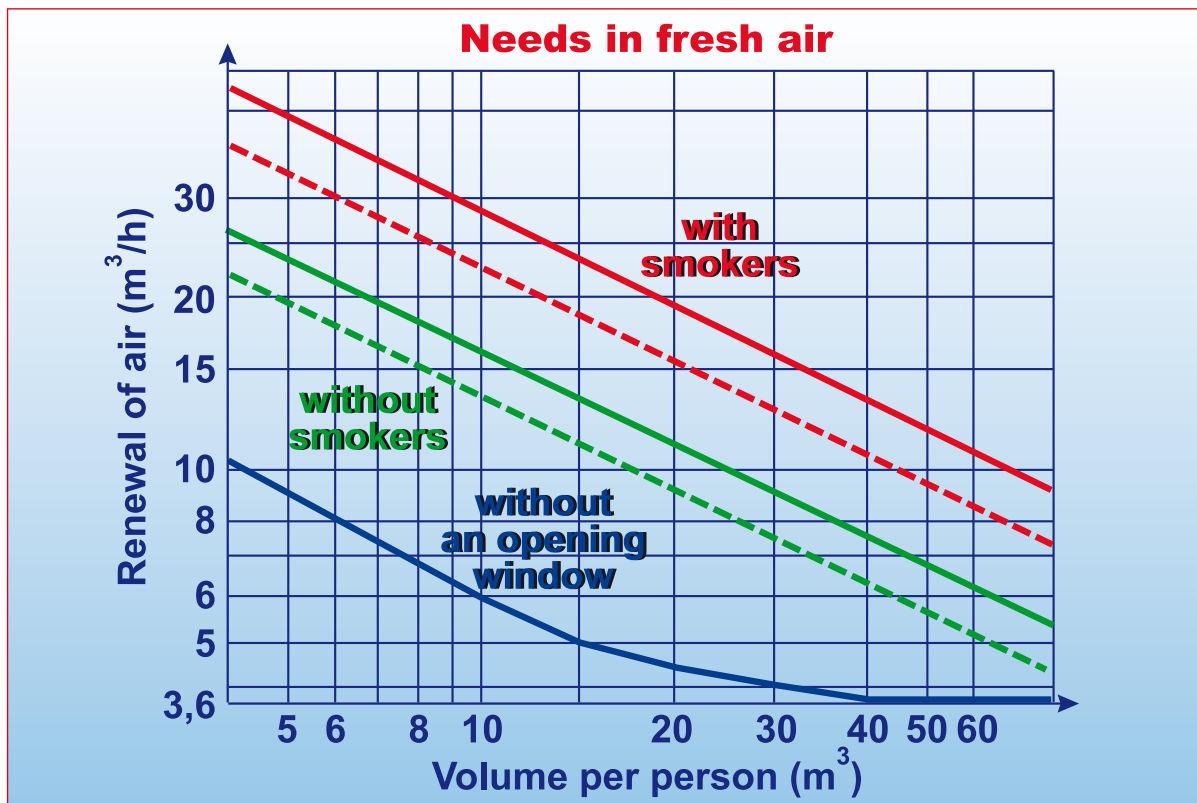

2 Swedish air renewal standards.

Ventilation and air renewal contribute to maintaining air quality provided that the purity of the air source is verified (which is not always the case in towns), and to cooling buildings in summer.

Air quality is normally achieved in buildings through air renewal. The latter can come into the building through window-vents or by air passing through badly-sealed areas. This air may be expelled naturally through ventilation ducts thanks to pressure differences between the air inside and the air outside or by extractors generally fitted in humid rooms (kitchens, bathrooms, WCs). Fresh air can be used to counter indoor pollution and to remove water vapour (approx. 50g per person/h).

Figure 1 presents the results of a survey involving homes built in Belgium between 1920 and 1980. On the vertical axis, the number of rooms exhibiting condensation problems is shown. Current buildings being far more airtight than in the past, many condensation problems arise in the absence of ventilation. We can observe in the yellow zone that more than one room per building exhibits condensation problems in buildings constructed between 1970 and 1980. Condensation problems may also be a sign of mediocre air quality.

Overheating a building, generally due to excessive air temperatures, causes its occupants to feel thermal discomfort. The air temperature depends on the surface temperature of walls, on external heat gains due to the sun, on the building's heating system and on internal heat gains due to the people inside. Ventilation represents a means of reducing this temperature by expelling hot air via a heat sink or a recycling system. Figure 2 shows temperature variations in a passive solar house (Maison Pléiade in Louvain-la-Neuve) early in July 1995. The house, being very open to the sun, risks significantly overheating. Two methods of preventing this can be used: solar shading and night-time ventilation, carried out by leaving the windows part-open. Only ventilation enables heat accumulated during the day to be expelled: notice that the blue curve (indoor temperatures) goes up but less so than the red curve (outside temperatures).

Whether it is carried out by natural means (pressure differences) or mechanical means (fans or extractors), fresh air must flow through the building efficiently whilst being limited to speeds lower than 2m/s for the occupants' comfort. To this end, hot-air outflow vents should be larger than fresh air inflow vents and their position will determine the trajectory of the air flow and hence the presence of any areas not supplied. It should not be overlooked that small construction features (canopies, eaves, etc.) can have a significant impact on air movement and on the effectiveness of ventilation.

Regulating air renewal enables air quality to be maintained (by expelling pollutants and water vapour) and to cooling buildings in summer (expelling heat).

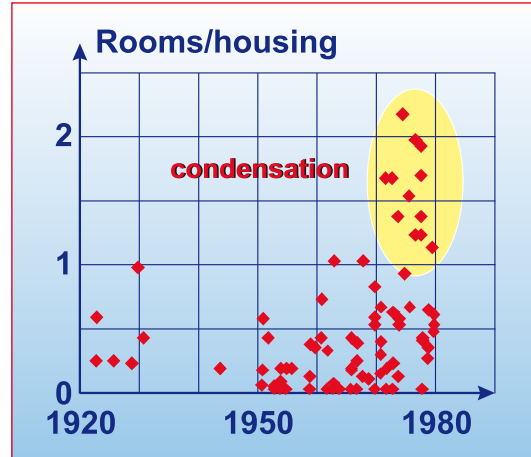

Only ventilation can solve air quality and condensation problems. **1**

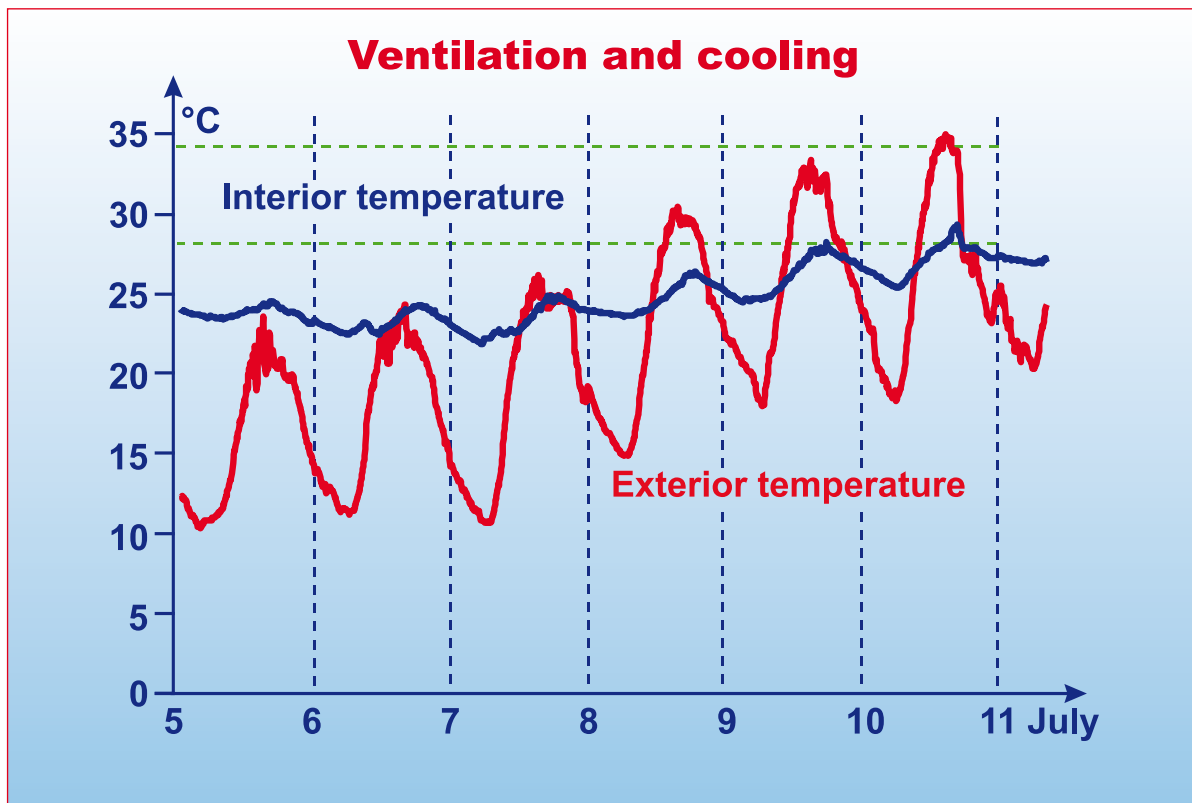

2 Effects of night-time ventilation on temperatures in a very well-insulated house in summer.

Air renewal and ventilation are aimed at maintaining air quality inside buildings. Ventilation, in a stricter sense, is also a tool to combat overheating.

Air quality is ensured by regulating the flow of air into and out of buildings. Air circulation should be planned with fresh air inlets and stale air outlets in mind. If renewal is natural, it should react to differences in pressure. Generally, a tall chimney drawing the air through is a natural outlet: warm air rises naturally and escapes via the chimney whilst fresh air from outside enters the building through its openings. This pressure difference can be ensured by a difference in temperature between the air on a façade exposed to the sun and air on a façade in the shade. The inside of the building should, however, be set out so as to allow the air to circulate freely. A minimum renewal rate of the air can be maintained by using fixed air vents built into the windows (fig. 1).

Even if a building is shaded, summer temperatures indoors can move outside the comfort zone. In hot and humid climates, the question of ventilation is a fundamental issue because only by forcing air to circulate can any release of heat stored in the fabric of the building and any feeling of coolness be found. Figure 2 illustrates this point with a photograph of the Indian Institute of Management, in India, where the architect L.Kahn has given the buildings a north-east orientation (the prevailing wind direction) and built a deep façade to reduce the amount of sunlight on the windows and also planned the natural ventilation of the roof-terrace to release heat accumulated during the day and to allow the occupants to sleep there in the open at night.

To promote natural ventilation, architects must also study local wind systems. Winds are inherently variable but there is always a prevailing wind on any given site. When it strikes a building, the wind creates high and low-pressure areas along a façade and inside it. If a building offers a 45° angle to the wind, these high and low-pressures are maximised and promote ventilation. Features such as deflectors can be built into the building to alter the effects of the wind locally and to create low-pressure areas that facilitate the outflow of stale air. Using the Venturi effect, an increase in air velocity can be created which also encourages the flow of air to the outside.

In a hot, dry climate, a good way to try to cool a home is by increasing the level of humidity in the air. Various systems are used around the Mediterranean, such as wind towers (fig. 2), which force dry winds to absorb humidity as they pass over jars of water before ventilating and cooling the home. In fact, a dry wind loses some of its heat when taking up water by transforming it from a liquid to a vapour.

NATURAL VENTILATION
The natural ventilation approach
Air renewal and natural ventilation

Regulating air renewal enables air quality to be maintained and the building to be cooled.

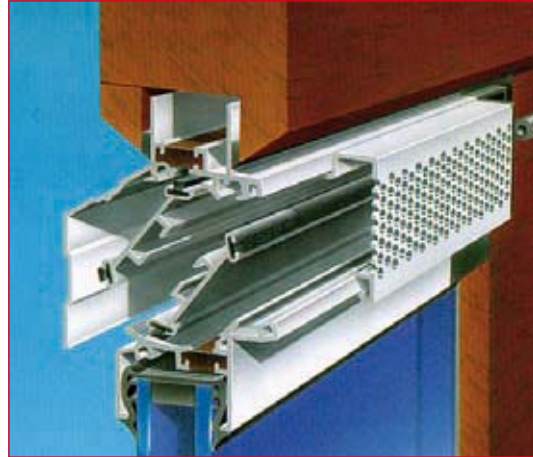

Ventilation device integrated into window-frame(doc. Aralco). **1**

**Indian Institute of Management
Ahmedabad (arch. Kahn)**

**Ventilation of terraces
(night time heat removal)**

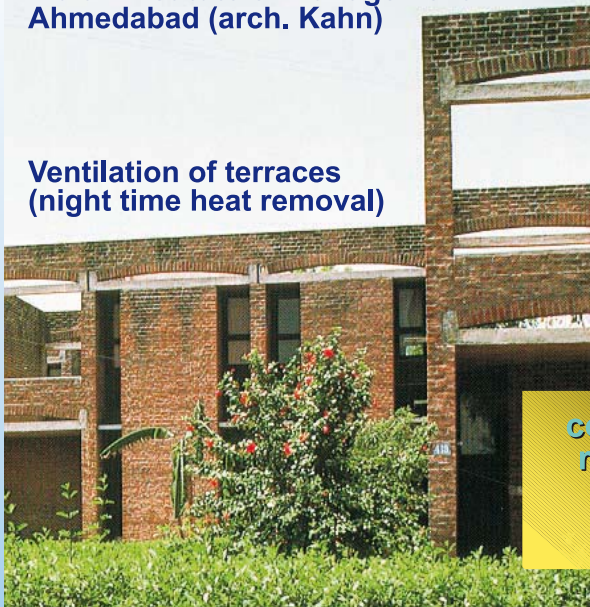

**Renewal of air and
natural ventilation**

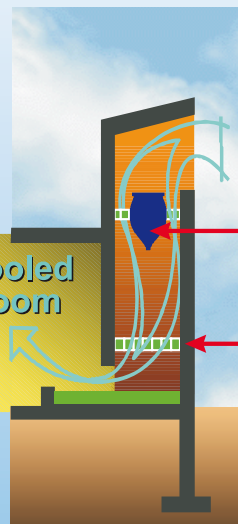

air inlet
earthenware
water jar
loose pieces
of plaster

**Diagram of a wind tower
(Iran)**

2 Accommodation at the Indian Institute of Management (India) and diagram of a wind tower (Iran).

Unlike climate-responsive architecture in cold and temperate regions, that of hot climates needs to avoid solar heat gain. Two complementary approaches to limiting increases in temperature exist. The first consists of shading living areas from solar radiation. The second implements airflows to release internal heat gains as well as solar ones.

Outflows of air enable the release of heat from a building caused by electrical equipment, lighting, and its occupants. Vernacular buildings in many regions are designed to exploit climate phenomena in order to achieve comfortable levels of temperature, humidity and wind velocity. The combination of these physical factors contributes to feeling cool.

As explained in diagram 2, natural ventilation is always the result of a difference in pressure. This variation is due to the wind or to a temperature difference.

Various approaches can be used to optimise natural ventilation:

- evaluating the potential of the site with regard to ventilation
- facing façades into the prevailing wind during the hottest months
- placing the structure at a distance from obstacles to air flow
- shading the foot and the envelope of the structure from solar radiation
- sizing apertures and systems to promote the outflow of air from inside the building
- planning the interior layout such that air circulation is handled with minimum friction

In a hot, dry climate it is also possible:

- to humidify and cool the air through evapotranspiration
- to exploit overnight cooling thanks to a building's inertia

Vernacular architecture spontaneously offers types of buildings that are adapted to the rigours of hot climates. For hot and humid climates, Malaysia provides examples of buildings raised above ground level. The long, narrow buildings with multiple openings, the slatted wall panels, the roof overhangs are all features that add to comfort. The materials used have low thermal inertia. Large spaces between houses enable the wind to pass through without meeting obstacles. North and south-facing parts are raised to enable crossflow ventilation.

In a hot, dry climate, the four façades of houses with patios shade the central courtyard in the daytime and allow heat to be released at night.

Natural ventilation results from a temperature or pressure difference between the different façades of a building. It enables internal and solar heat gains to be expelled from the building.



Régis House – Fort de France (Martinique) (arch. Chiatello/Dabilly). **1**

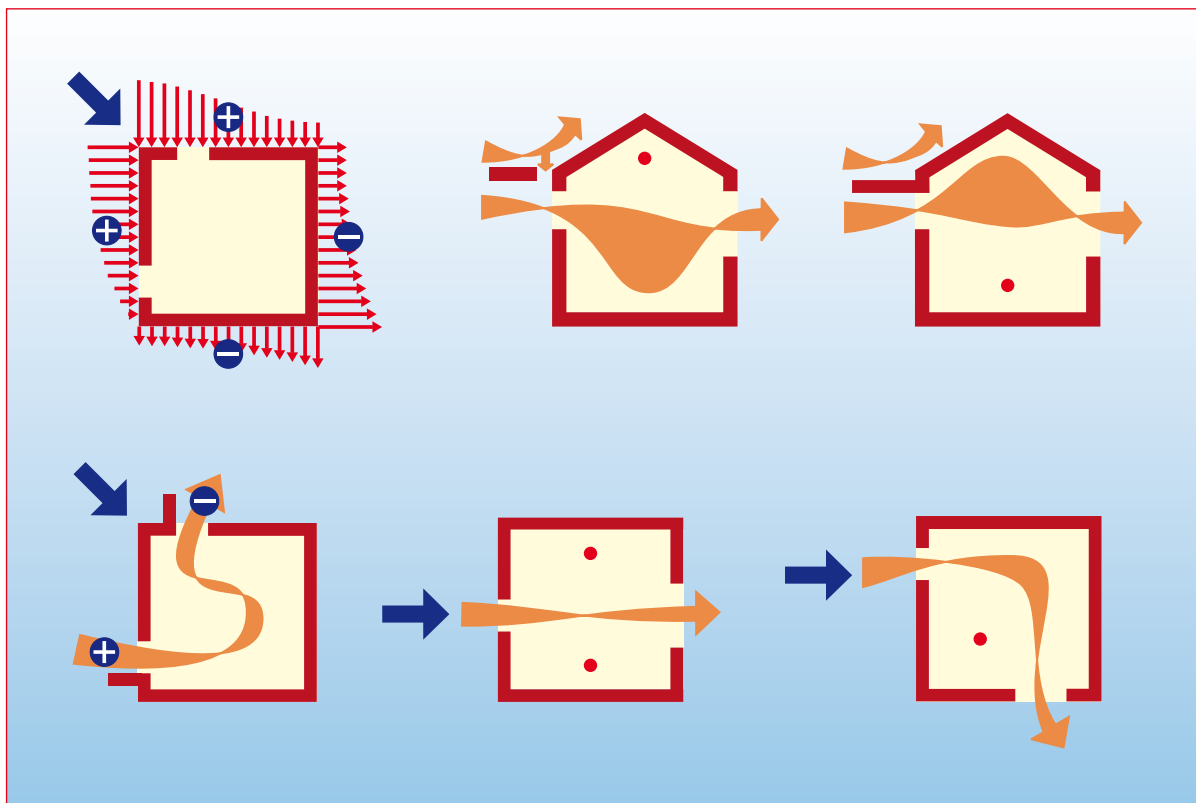

2 Natural ventilation is always due to a pressure difference, caused by the wind, or by a temperature difference.

A building's orientation depends on its final use: natural light requirements, the attraction of using solar radiation to heat the building or, conversely, the need to provide shade to prevent overheating, and the presence of winds that make the building cold in winter or cool in summer, are all important parameters in deciding on orientation.

Whilst sometimes pleasant in summer, the wind is always a source of discomfort in winter. Consequently, protecting the façades from cold winds is always desirable, indeed a priority, in order to minimise heating costs.

The sun plays a role in providing light and heat. Adapting the orientation to fit the building's needs thereby enables a reduction in the need for heating and lighting. Figure 1 illustrates this point by comparing the annual heating requirements of a building depending on the orientation and proportions of its windows (the ratio of glazed surfaces to that of the whole façade). A perceptible reduction in heating needs with a southerly orientation contrasts with ever-increasing needs with a northerly one. The progressive widening of the curves reflects the windows' thermal performance: whilst capturing the heat if south-facing, the same surfaces lose heat when north-facing.

Figure 2 recapitulates the basic rules governing the orientation of rooms. A cylindrical projection of the sun's path viewed from Paris provides a link between orientation and solar elevation through the seasons. The azimuth is given by the cardinal points and solar elevation is measured using concentric circles. A percentage indicates the fraction of solar radiation available compared with south – considered to equal 100% - with respect to the 8 main orientations.

North-oriented rooms benefit from even light and diffuse solar radiation all year round. In summer, they may suffer from direct sunlight in the early morning and evening because the sun is low and its rays cause unmanageable glare.

East-oriented rooms benefit from the morning sun but the light is difficult to regulate because the sun's rays are low on the horizon. Insolation is low in winter but, in summer, it is higher than for a southerly orientation, which is not useful.

West-oriented rooms have identical characteristics: potential visual discomfort due to glare and excessive sunshine in summer. In addition, in summer, these rooms being exposed to intense solar radiation which, on top of high temperatures towards the end of the day, makes it difficult to prevent overheating.

South-oriented rooms benefit from more manageable light and from maximum sunshine in winter but minimum in summer. In fact, the low sun in winter ($\pm 17^\circ$) comes further into a house whereas in summer, the solar elevation is greater ($\pm 60^\circ$) and the sun comes less far inside. South is the orientation that enables the best passive regulation of sunlight. Solar heat gain on a vertical surface (a window) are also far lower on the south side because they are reduced by a factor equal to the cosine of the angle of incidence.

Each room is oriented according to its function.

South-facing rooms make the most of solar radiation when this is required for the thermal functioning of the building.

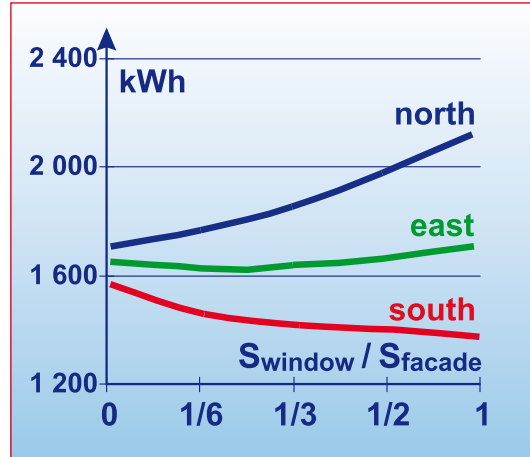

Variations in annual heating requirements of houses depending on orientation and the proportion of glazed surfaces.

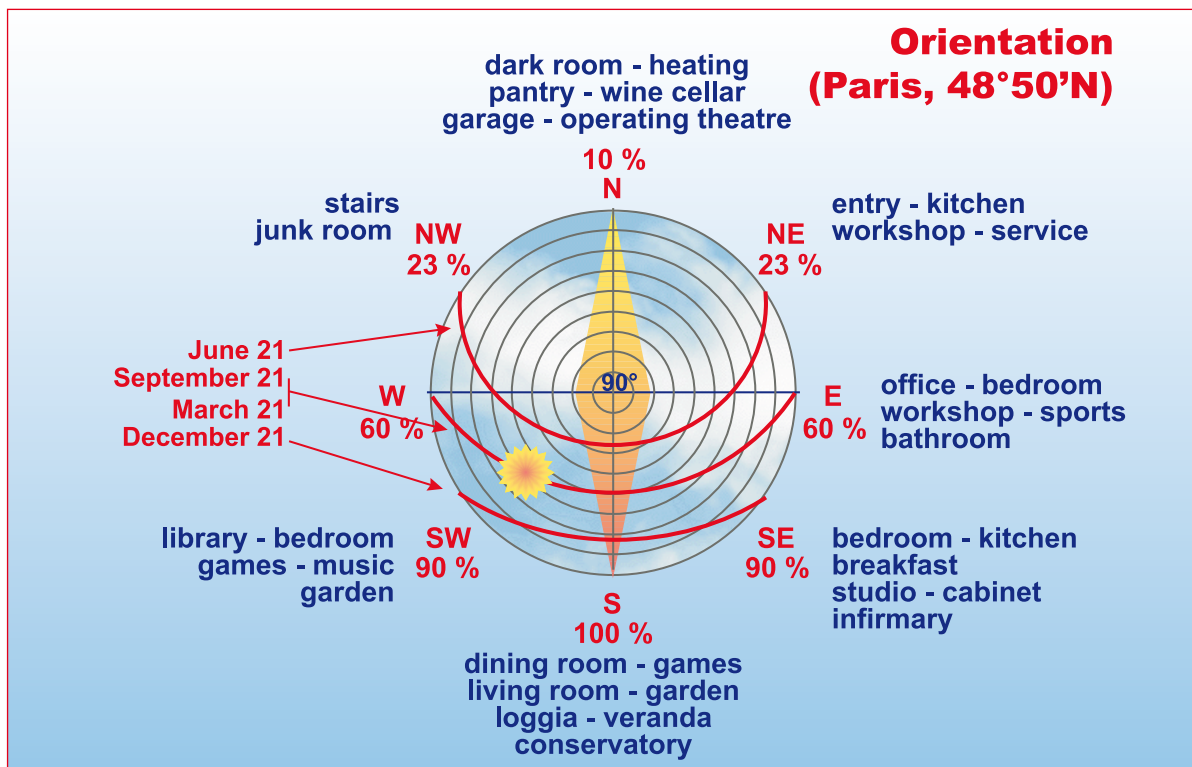

2 Orientation of buildings in relation to winds and sun.

Shading living spaces from the sun is an essential factor of thermal comfort. To incorporate shading into the design of a building, understanding the geometrical and energy characteristics of global solar radiation is necessary. The latter can be broken down into **direct, diffuse and reflected radiation**.

The intensity of the incidental **direct solar radiation** striking a building's exterior is dependent on the orientation of the various exterior surfaces, on latitude, and on the sun's path. There are different ways of evaluating these variables. Engineers generally use polar coordinate or cylindrical projection sun path charts or else monthly charts of shadows cast on the ground by a tall object. Software can simulate the shadows cast by buildings at different times of day, at different times of year and at different latitudes. These tools provide valuable help during design.

Diffuse radiation comes from solar radiation reflected by particles contained in the atmosphere. The amount of diffuse radiation is greater in heavy cloud (mainly in humid climates) and less under very clear skies. Diffusion on a horizontal surface under a 'clear sky' equals around 10% of direct radiation.

Reflected radiation comes from direct and diffuse radiation reflected by the environment. It depends mainly on surface types. The reflectance of sand, for example, is described as varying from 10 to 40% depending on the time of year and the latitude.

The most common simplified methods of gauging average global solar radiation are universal solar energy measurement diagrams. They enable the intensity of the solar flux striking a surface to be measured. Depending on the complexity of a building's envelope, this method can be more or less labour-intensive.

Software tools that simulate global solar radiation around buildings offer an approach better suited to urban architecture. They provide a physical simulation of the results, which it would not be possible to obtain using manual calculations, right at the start of the design.

In order to design a building's envelope correctly, we need to know how much solar energy it actually receives at any given time.



Town of Hadhramaut (Yemen). **1**

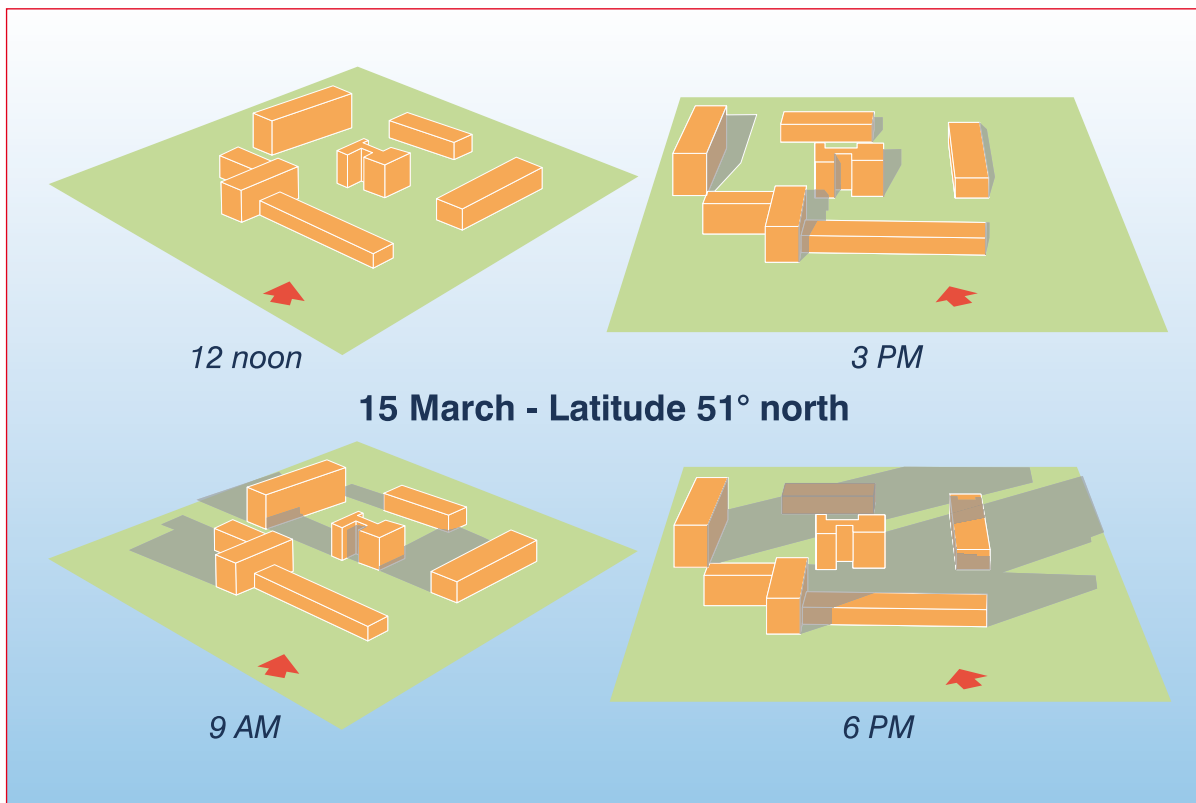

2 Computer software that simulates solar radiation can be a design support tool. (*OPTI software – Architecture et Climat*).

Apertures, and the windows that fit inside them, play an important role in the relationship of buildings and their occupants with their surroundings. In fact, heat exchange, heat loss and heat gains as well as solar gain mainly come from these apertures. They establish the contact between the inside and the outside and act thus to improve the occupants' well-being. Apertures, and particularly windows, are therefore a major component of any building and have always been a particular focus of attention for architects (Fig. 1).

From a thermal point of view, even the best-insulated windows demonstrate a greater heat-loss coefficient 'K' than insulated walls. They are therefore one of the main sources of heat-loss in buildings. This heat-loss can be reduced by recourse to insulating shutters or curtains.

In winter, the sun entering through windows ensures energy-savings. In summer, it can have the opposite effect if cooling the house becomes necessary. The orientation, angle and layout of apertures are crucial elements in the design of a project. From an energy point of view, south-facing is best in winter (strong direct sunlight) and in summer (less direct sunlight, reduces overheating). The most effective angle is between 45° and vertical (90°).

Figure 2 shows details of a 150m² house built in Wolfhausen in Germany which enables us to look at a sectional view of how the windows work relative to winter and summer sunlight. Everything is designed to let in the sun's rays in winter and to shield it in summer: the height of the windows, the depth of the rooms, the width of the balconies or the length of roof overhangs. The slight extra height of the bedroom on the south side allows the sun to come further into the living-room, whilst a high window allows light into the second bedroom from two sides. A porch allows natural light into the cellar. The south balcony also acts as a sun-screen in summer. A system of adjustable insulated shutters enables control not only of heat-loss in winter but also of potential overheating in summer.

It is important to note that if vertical, south-facing windows can be effectively screened in summer by fixed screens such as awnings or eaves, this is not the case for windows facing in other directions or at other angles.

Besides this, the fact that the use of fixed screens (sun-screens, reflective glazing, etc.) means somewhat reducing the amount of natural light and solar gain in winter also needs taking into account.

Apertures are a building's means of communication: their positions, their dimensions and their proportions regulate the entry of air, light and solar energy.



A window is a building's view onto its surroundings. villa Poiano, Palladio, Italy.

1

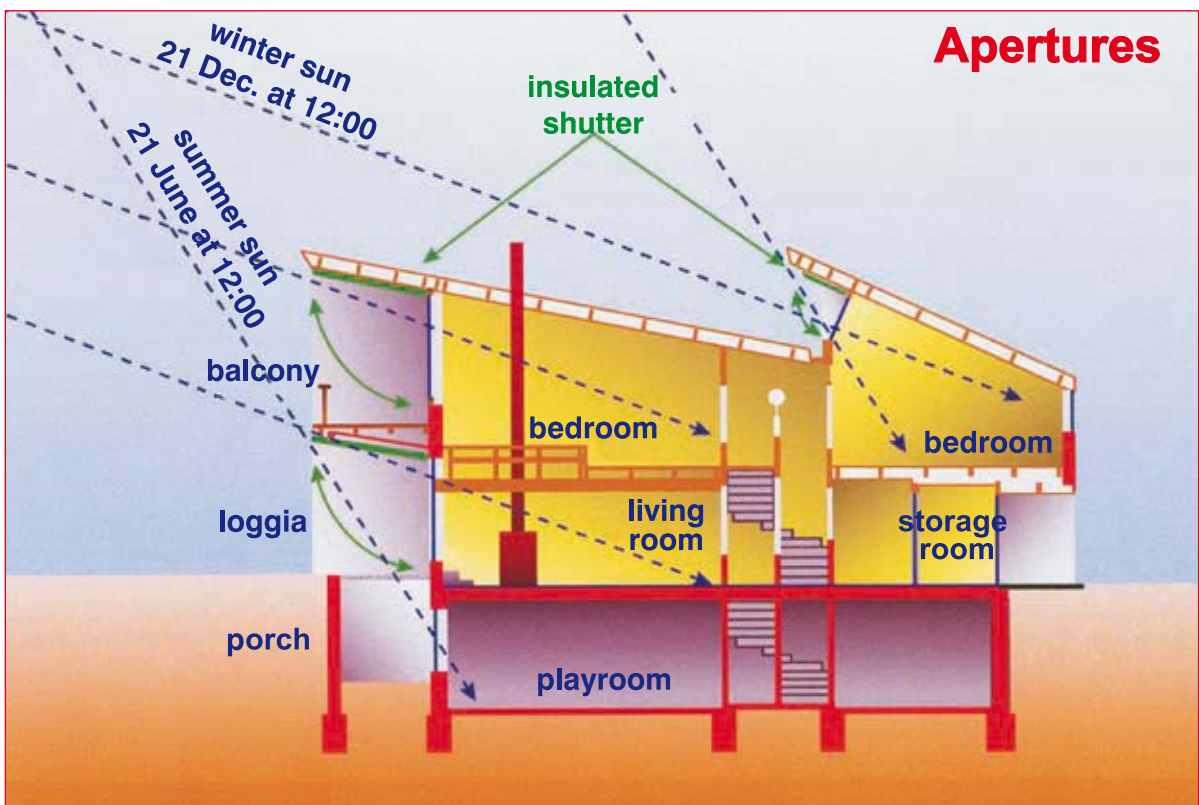

2 Studying a cross-section of a building's apertures enables the levels and timetable of daylight and solar gains to be determined. (arch. H. Bolliger).

Windows are an indispensable part of buildings:

- proposed outlook: which parts of the landscape to look out onto, or to conceal?
- proposed thermal properties: facing which way, at what angle? Which solar factor and which K coefficient should be selected? Which light transmission properties?
- proposed building ventilation: what is the role of the window in the building's ventilation system? Which solar shading should be selected?

Figure 1 shows a window whose components display different thermal and light characteristics: at the top, a fixed pane is protected by an external adjustable sunblind; in the middle, the opening lights use clear double-glazing; the lower windows are covered on the outside with translucent insulation, which improves the thermal performance of the glazing and means that some additional light is let in.

Figure 2 summarises the quality criteria that enable the choice of window components to be determined and identifies the factors that reduce solar gains. Lastly, the aperture sizes (ratio of window area/floor area), depending on orientation, are given for residential buildings constructed in our climates.

The sun's rays pass through glazed areas directly into rooms used for living or working. They then accumulate as heat in the solid parts of the building. External solar shading is used to prevent too much sun entering and internal blinds are used to avoid glare by deflecting light towards the ceiling. Thermal performance is good for windows having certain properties linked to the surface heat-loss coefficient K, to the solar factor F and the light transmission factor LT, if their orientation is good (between south-east and south-west). They can be oriented differently but then their thermal performance is less good. Conversely, windows have poor heat retention qualities (1 or 2 days without sun) and heat loss at night is significant, hence the attraction of covering them at night or in bad weather.

Windows bring together numerous components: glazing, frames, external coverings, curtains, etc. These components can be considered as obstacles since they perceptibly reduce solar gain without having any appreciable impact on heat loss. The space they take is all too often underestimated, both in calculating solar gains and in calculating natural light (daylight factor: DF). It is estimated that the real level of passive solar energy captured is about 33%.

In addition, reducing the surface-area of north-facing windows should be avoided (problems of overuse of artificial lighting) and west-facing windows should not be too big (risks of over-heating).

Windows are the simplest and most common receptive devices : they bring light and heat and provide the immediate potential to store heat.



The window's head, jamb and transom all have a different look. **1**

Quality criteria :

Windows

$U_{\text{glass}} < 3 \text{ W/m}^2.\text{K}$

$U_{\text{frame}} < 3 \text{ W/m}^2.\text{K}$

F

LT

solar shading

wind tightness

integrated ventilation

acoustic damping

$S_{\text{window}} / S_{\text{floor}} :$
south : 10 - 35 %
east-west : 15 - 25 %
north : 10 - 15 %

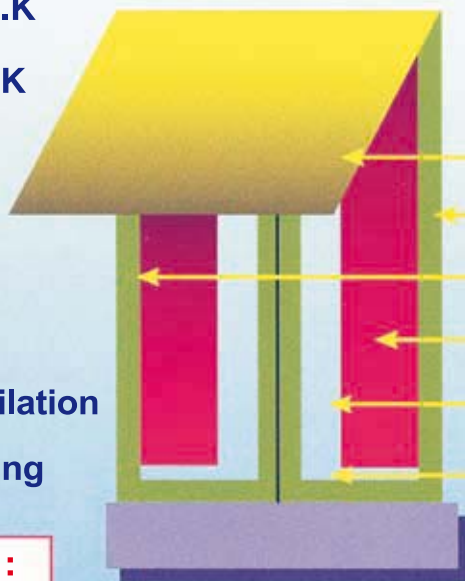

Reduction of solar gains

- window shades : 0 to 100 %
- window-frame : 20 to 40 %
- shadow : 10 to 20 %
- curtains : 0 to 30 %
- reflection absorption : 10 to 60 %
- cleanliness : 0 to 50 %

Effective solar gains between 0 % and 50 % of available sunshine

2 Choice of components and list of criteria involved in windows' thermal performance.

Light falling on a window is transmitted, absorbed and reflected in varying proportions depending mainly on the type of glazing used. The choice of glazing affects not only the light transmitted but also solar heat gain and heat loss through the window. The light transmission and thermal qualities of glazing can be defined using three parameters: the light transmission factor, the solar factor and the heat-loss coefficient.

6mm thick clear single glazing has a light transmission factor of 89%, a solar factor of 82% and a U value of 5.7 W/m²K. This low U-value encouraged glass producers to develop double glazing from 1965 on. Currently, thermal problems in buildings are more to do with overheating, at least in commercial buildings. The latest developments in glazing attempt to solve this problem by moving towards the development of selective glazing, i.e. glazing that allows transmission of only part of the solar spectrum, generally the visible part, whilst reflecting the rest.

Currently, there are three different basic approaches to improving the energy performance of glazing:

1. Modifying the glass itself by changing its chemical composition or its physical characteristics. This is the case for tinted glass, for example.
2. Applying a thin coating to the surface of the glazing. Reflective coatings or films have been developed to reduce heat gains and glare and, more recently, low-emissivity or spectrally selective coatings have been developed as a response to the specific conditions of cold or hot climates.
3. Assembling multiple panes and exploiting the properties of or the gaps between the panes.

Altering a window's light transmission factor

If 6mm thick clear single glazing has a light transmission factor of 89%, combining two panes in double glazing will result in a light transmission factor of $89\% \times 89\% = 79\%$.

When studying a whole window, one should be aware that the window frame greatly reduces the window's light transmission. Figure 1 shows the percentage of a window's total surface area obscured by the window frame. One can observe that the surface area obscured by an opening window is already 45% and that dividing it into small panes reduces the net glazed surface by a further 10%.

The quantity and quality of light transmitted into a building depend on the type of glazed surface, its smoothness, its thickness, the number of panes used and on how clean it is.

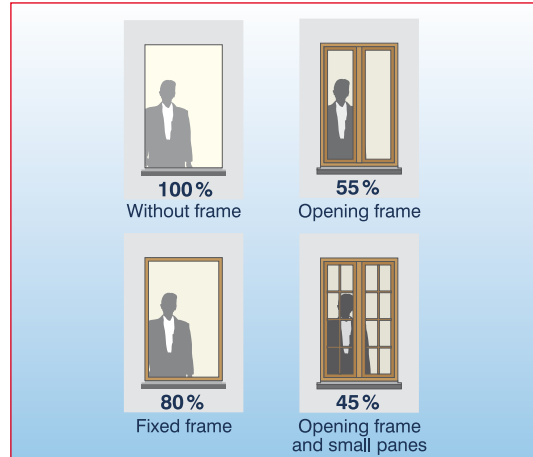

Impact of window-frame on net window surface area. **1**

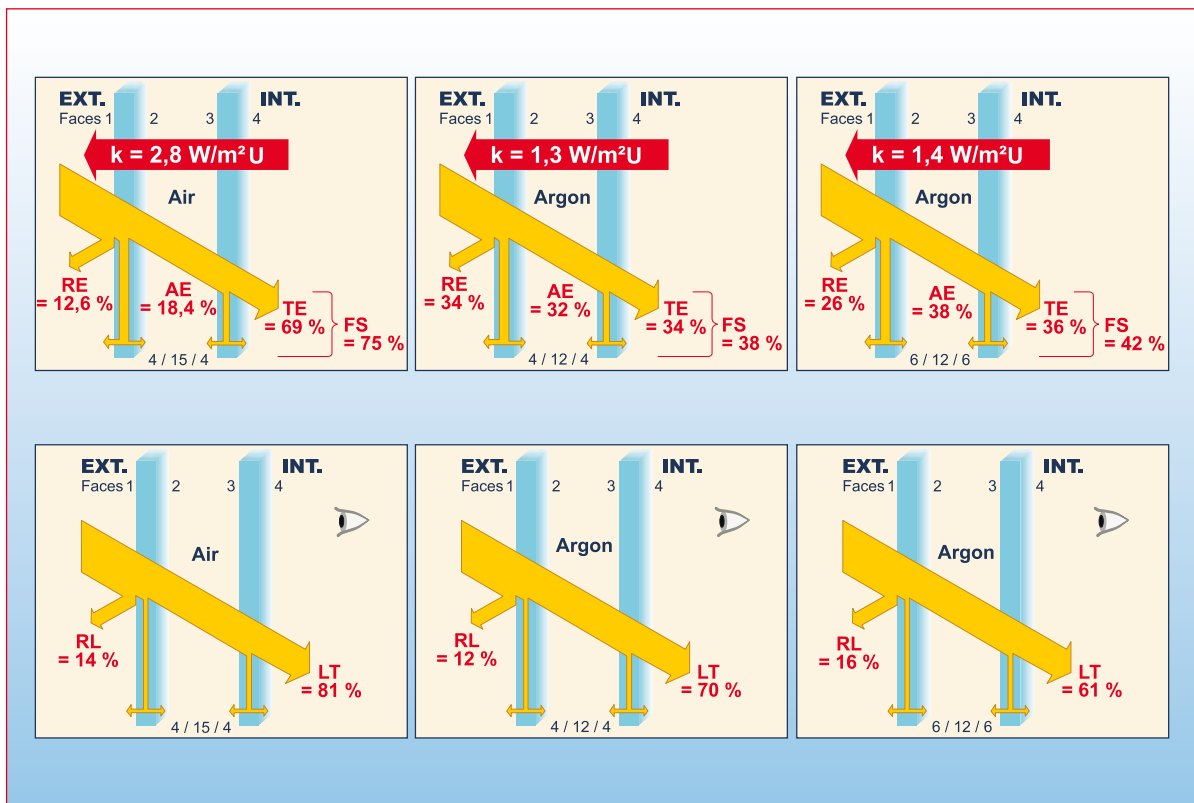

2 Characteristics of traditional double glazing, of spectrally selective double glazing and reflective double glazing.

Absorbent or tinted glazing

Tinted glazing is glass to which a chemical additive has been added which modifies its colour and therefore its physical properties. It is specially designed to maximise the absorption of all or part of the solar spectrum.

Using tinted glazing changes a window's appearance and can improve privacy inside a building during the day. However, this effect is reversed at night, making it more difficult to see out from the inside. From the inside, tinted glass retains its transparent quality. The most common colours are plain grey, bronze, and blue-green, which do not overly affect colour-perception and tend to harmonise with other colours currently used in architecture.

There are two categories of tinted glazing: traditional tinted glazing which reduces the amount of light and solar heat gains, and selective glazing which reduces heat gains but allows more light to penetrate than traditional tinted glazing. This glazing, which is light blue or light green in colour, has a higher light transmission factor than traditional bronze or grey tinted glazing but a lower solar heat gain factor than the latter. Tinted glazing thus enables a reduction in the solar heat gain factor but, as a result, the light transmission factor goes down rapidly. Tinted glazing is not able in any case to reduce the solar heat gain factor beyond a certain point.

Reflective glazing

If a lower solar heat gain factor than that achieved by using tinted glazing is required, a reflective coating can be applied to the glazing, which increases its reflection coefficient.

In general, these coatings consist of very fine metallic layers that exist in different colours (silver, gold and bronze) and which can be applied to clear or tinted glass. The solar heat gain factor of the glazing may be slightly or significantly reduced depending on the thickness and the reflection coefficient of the layer and its position on the window.

When deciding to use reflective glazing, one should be aware that light will react as if it were a mirror and that problems of glare may result that could affect pedestrians or motorists or even people in neighbouring buildings. In addition, it is important to remember that reflective glazing behaves like a mirror on the side exposed to the light. It therefore produces a mirror effect on the outside during the day, but this mirror effect is reversed and will appear inside the building at night, making it difficult to see out.

The physical characteristics of glazing can be changed by tinting it or covering it with a coating that reflects all or part of the solar spectrum.



Reflective glazing acts like a mirror reflecting neighbouring buildings. **1**

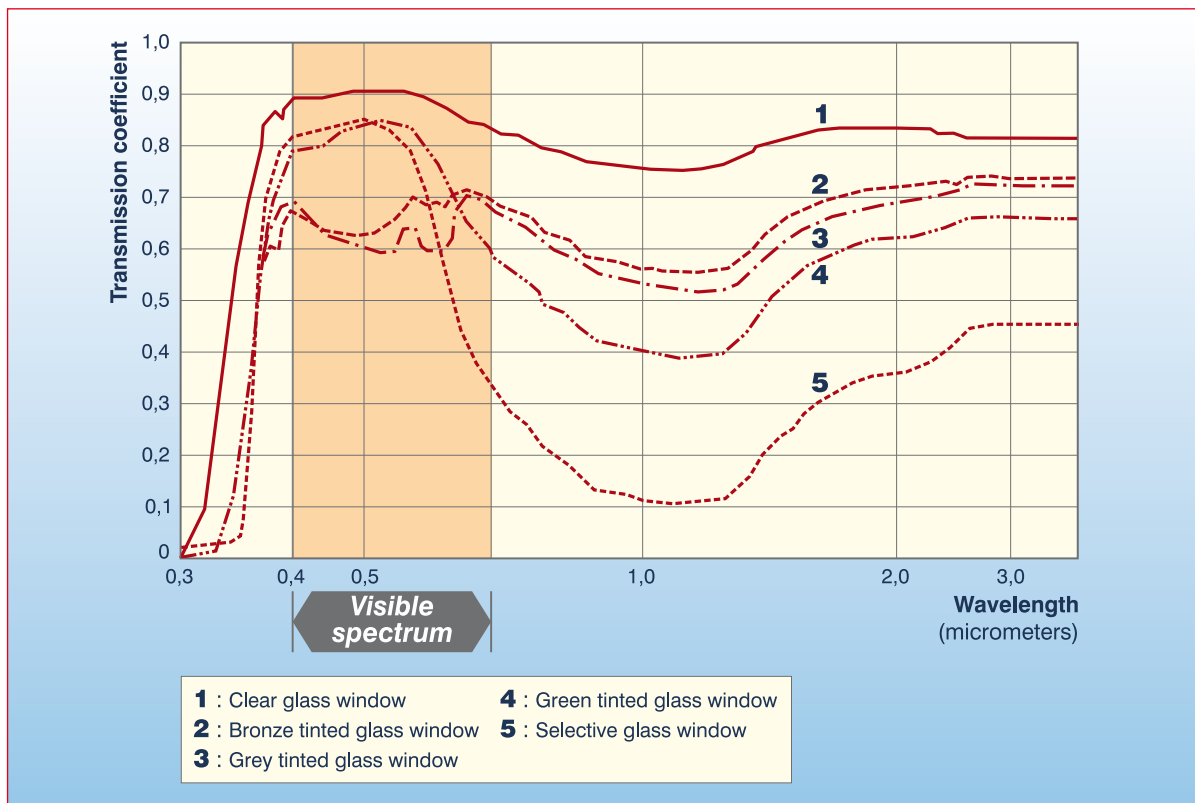

2 Spectral light transmission curve for various tinted glazings.

Electrochromic and gasochromic glazing is dynamic glazing that can be made alternately opaque or clear in a continuous manner under the effects, respectively, of a low-voltage charge or the introduction of gas into the gap. Their optical and thermal characteristics can thus be varied according to climate conditions. In summer, transmittance is reduced in order to prevent overheating whilst during cold periods transmittance is increased in order to obtain maximum benefit from natural lighting and solar heat gain. The darkness of the glazing can also change daily in response to the sun's position.

Electrochromic glazing

Each transition between a coloured state and a bleached one is caused by applying an electronic and ionic charge across two thin layers using an electrolyte. The transmittance of this type of glazing remains the same until a new charge is applied. By reversing the polarity, it returns to the initial state of transparency and light transmission.

The most commonly used electrochromic material is tungsten oxide which turns dark blue. This system features light transmission that can be adjusted between 50% (bleached state) to 15% (coloured state) depending on the quantity of ions exchanged. Simultaneously, the solar heat gain factor of the glazing can vary from 12% to 45%. This type of glazing exists in the laboratory and is starting to be commercially available in sizes up to 1m². However, several difficulties remain: homogeneity, durability over many cycles and building-specific applications stall on the UV-resistance of the system.

Gasochromic glazing

A gasochromic unit is made up of gasochromic insulating glazing, a gas supply unit and a control unit. The active component of a gasochromic system is, as for electrochromic glazing, a tungsten oxide film (WO₃). This is located on the inner side of the exterior triple-glazing pane. When this gasochromic film is exposed to a low concentration of hydrogen contained in a bearer gas (argon or nitrogen), it turns blue. When it is exposed to oxygen, it turns lighter and returns to its initial transparent state. The gas mixture is introduced into the gap between the exterior pane and the middle one. The gas supply unit consists of an electrolyser and a pump, which is connected to the window by tubes forming a closed loop. Ideally, the gas unit should be built into the façade. A gas unit produces enough gas to supply 10m² of gasochromic glazing. The transition from the bleached state to the coloured one (and vice-versa) takes between 2 and 10 minutes.

Dynamic glazing is glazing whose physical properties vary at different times.



Electrochromic glazing going from coloured state (on the right) to bleached state (on the left).

1

Electrochromic glass window

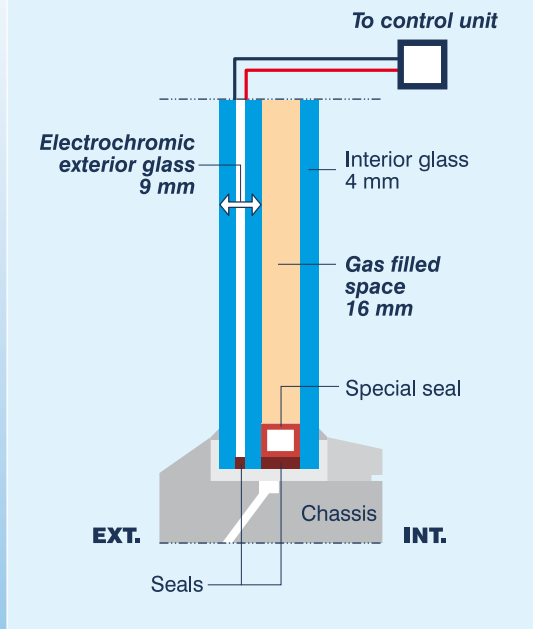

Gasochromic glass window

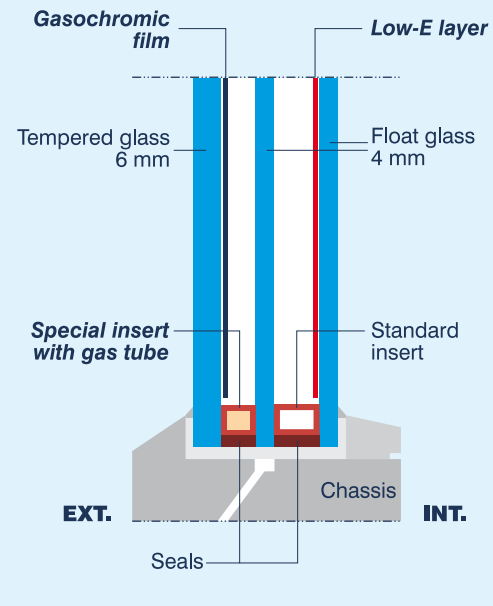

2 a : how electrochromic glazing works
b : how gasochromic glazing works

1. Reducing glare

Problems with glare are prevalent when the sun is low on the horizon: in the morning for east-facing windows, in the evening for west-facing or, in winter, those facing south. In our latitudes, the problem of shading north-facing apertures should not be overlooked. In fact, in mid summer, the sun rising in the north-east and setting in the north-west can cause problems of glare at the start and end of the day through such apertures. In addition, looking directly at too bright a sky can be uncomfortable whatever the orientation of a bay window.

It is important to distinguish whether the main cause of glare is direct solar radiation or simply diffuse radiation. To block direct solar radiation, opaque or nearly-opaque solar shading is indispensable. Translucent materials such as tinted glass, thin, pale blinds or thin curtains can become secondary light sources and create glare with direct solar radiation on them, whereas they suffice to block out glare from the sky.

2. Reducing overheating

Fitting good solar shading can, in some cases, eliminate the need to install air-conditioning or, at the very least, reduce its use, thus leading to positive consequences in terms of energy savings and the environment.

3. Eliminating direct insolation

An increase in a room's ambient temperature is not the only source of thermal discomfort for its occupants. In fact, despite the ambient temperature being bearable, radiated heat from windows and direct solar radiation on a part of the body can rapidly become unbearable for the occupants. It should therefore be possible to eliminate direct insolation.

4. Increasing a window's insulation properties

Using solar shading changes a window's thermal insulation characteristics more or less noticeably. Some internal shading or shading inside double glazing can reduce heat loss by 25 to 40%.

5. Ensuring occupants' privacy or closing off a room.

6. Prevent fading of certain fabrics.

7. Decorating windows.

Solar shading can be used for various purposes depending on different situations. Choosing a particular type of shading will depend on the priority given to each of these based on users' needs.

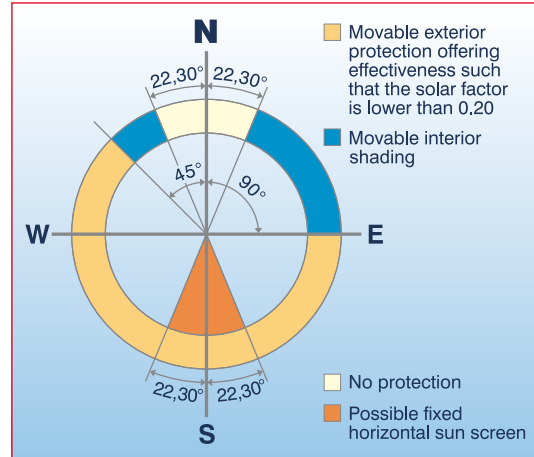

Fixed or movable solar shading (based on E.Dufrases). **1**

2 Different purposes of solar shading.

The ideal type of solar shading to be used for a specific project depends on a number of factors, such as the latitude of the site in question, the orientation of bay windows, the desired type of contact with the outside or the type of usage of the room to be shaded. Other criteria can be added that affect the choice of shading such as its mechanical strength, its cost, maintenance, or the ability to open the windows to create natural ventilation in the building.

The positioning of solar shading

Whether it be inside, outside or built into the glazing, the same solar shading will provide the exactly same control over the level of light; conversely, it will always be more effective in preventing overheating if fitted outside the window. Choosing the position of solar shading is therefore mainly a matter of thermal, maintenance and aesthetic considerations.

The main advantage of external shading lies in the fact that it blocks solar radiation before it reaches the windows.

Solar shading is effective against overheating in the following cases:

- if it is external. In this case, it blocks the sun's rays before they reach the window.
- if it is internal, provided it repels the sun's rays after passing through the window. To do so, it must be non-absorbent and reflective.

External shading nonetheless has three limitations, namely that it is bulkier, that it must be weather-resistant and that it is more difficult to clean and to maintain.

Mobile solar shading

Permanent shading represents a fixed system offering the same level of shading irrespective of the time of day or of year. Examples of this include adhesive films for windows or special glazing.

Fixed shading does not change regardless of the time of day or the season but the amount of shading varies depending on the position of the sun.

Movable shading can be adjusted according to the sun's position or the occupants' wishes. Using mobile screens enables shading to be adapted to meet users' real needs.

Solar gain can thus be controlled by partial or complete withdrawal of the shading or by angling its slats. This adjustment can be carried out manually by the occupants, motorised (via a remote control) , or automated (using a control unit).

The main drawback of movable shading is related to managing adjustments to the shading. In fact, shading that is not automated will never be used efficiently and can even undermine the objectives of visual comfort and energy saving. In the case of automated shading, the occupants' ability to override the system needs to be taken into account.

Another disadvantage of this system is the size of the folding mechanism of the shading, which can reduce the effective surface area of a window.

The two main categories of solar shading are based on their position in relation to the window and on their adjustability.

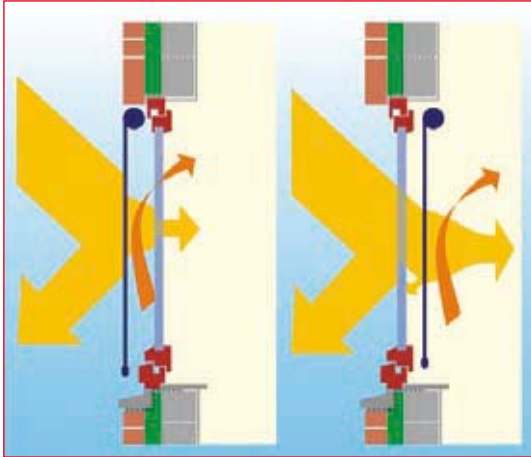

Behaviour of solar shading in relation to heat, depending on its position. **1**

a

b

2 a : fixed shading
 b : movable shading

Shading related to the surroundings

Vegetation can effectively be used to reduce the exposure of windows to the sun. Plants need to be carefully chosen taking into account their size and type as this choice influences the shape of the shade that they cast in summer and in winter as well.

Buildings can provide a fixed screen for neighbouring ones. They can play a positive role if protection from the sun is sought: this is the case in traditional Mediterranean towns where the narrowness of the streets and the height of the buildings significantly reduces direct sunshine and provides welcome shade.

Architectural features

The shape of a building can cast shadows on some of its walls. Many parts of a façade contribute to the architectural design of a building can constitute shading devices. We should mention roof eaves, overhangs, projecting storeys, balconies and arcades.

Additional shading

Among these types, we should mention light-shelves which, in addition to shading the building, also reflect light towards the back of a room (figure 2a).

Sun-breaks, on the other hand, are composed of slats fixed onto a frame (figure 2b). Their effectiveness will depend on the angle of the slats as well as the gaps between them.

Slatted shutters are external or internal devices made up of slatted screens placed over the whole window opening (figure 2c). They block direct sunlight whilst allowing indirect light to enter. Slatted

shutters enable natural ventilation and ensure the privacy of a room.

Venetian blinds are made up of slats that can move thanks to a system of cords and chains (figure 2d). Shading depends on the angling of the slats. Adjusting the level of solar shading at need is the main feature of blinds with adjustable slats. This adjustment is by means either of closing or by angling the slats.

A louvred shutter is made up of a series of fixed or mobile external slats fitted into the vertical plane of the façade (figure 2e).

Roller blinds are made up of a fabric that unrolls in front of the window (figure 2f). Shading is completely adjustable: the blind can be partly or totally lowered or raised depending on the need to let in sunshine.

Canopies, made of flexible and adjustable components, either opaque or translucent, shade windows whilst potentially providing a view (figure 2g).

Sliding-arm awnings combine the qualities of vertical and horizontal roller shading devices (figure 2h). They allow some natural light to enter.

Protective glazing

Using absorbent and reflective glazing is a way of reducing solar transmittance continuously all year round. Special glazing can provide a solution when fixed or mobile shading systems are undesirable or difficult to fit.

There are different types of solar shading: shading linked to the surroundings, architectural features, shading added later, as well as protective glazing.



Shading linked to the surroundings. **1**

a	b	c	d
e	f	g	h

Architects :
a : M. Hopkins and Partner **b** : Bennetts Associate **c** : A. Gaudi **d** and **e** : Feilden Clegg Architects

2 Different types of solar shading.

Reflective blinds

These blinds can be fixed or adjustable.

There are many different types of reflective venetian blind. They generally consist of a highly reflective upper surface, which is sometimes concave in shape and perforated. Reflective blinds are generally positioned inside double-glazing and are around 10 to 12mm wide. They are designed so as to reflect as much light as possible towards the ceiling whilst maintaining low levels of light at any angle below the horizontal.

The 'fish' system

This system is made up of fixed horizontal slats with a triangular cross-section that are specially aligned and fixed together. The system, designed for vertical windows only, is aimed at reducing glare and redirecting diffuse light. An additional shading system is necessary if solar gain and direct sunshine need to be reduced. The slats are designed so that the upper part redirects light from the sky towards the ceiling. In theory, a system with an aluminium surface with a reflection factor of 85% transmits 60% of the diffuse light (without taking the glazing into account).

The 'okasolar' system (figure 2a)

This system is made up of reflective slats with a triangular cross-section placed inside double-glazing. It redirects sunlight at an angle that varies according to its angle of incidence. In winter, part of the light is reflected towards the ceiling whereas the rest is transmitted directly. In summer, part of the light is reflected towards the ceiling whereas the rest is reflected back towards the exterior. The slats are designed according to the latitude where they are installed.

The 'ETAP' system (figures 2b and c)

This is a combination of a highly reflective venetian blind and a specially shaped reflective ceiling.

From the inside, these blinds look like ordinary venetian blinds but they are covered with a highly reflective film. The amount of direct light entering the room equals 2 to 3% of the direct available light. This light is directed towards the ceiling which, because of its special shape, distributes it within the room.

Reflective blinds are used for the dual objectives of shading a space from direct solar radiation whilst redirecting natural light towards the ceiling.



Light redirection system (Okasolar). **1**

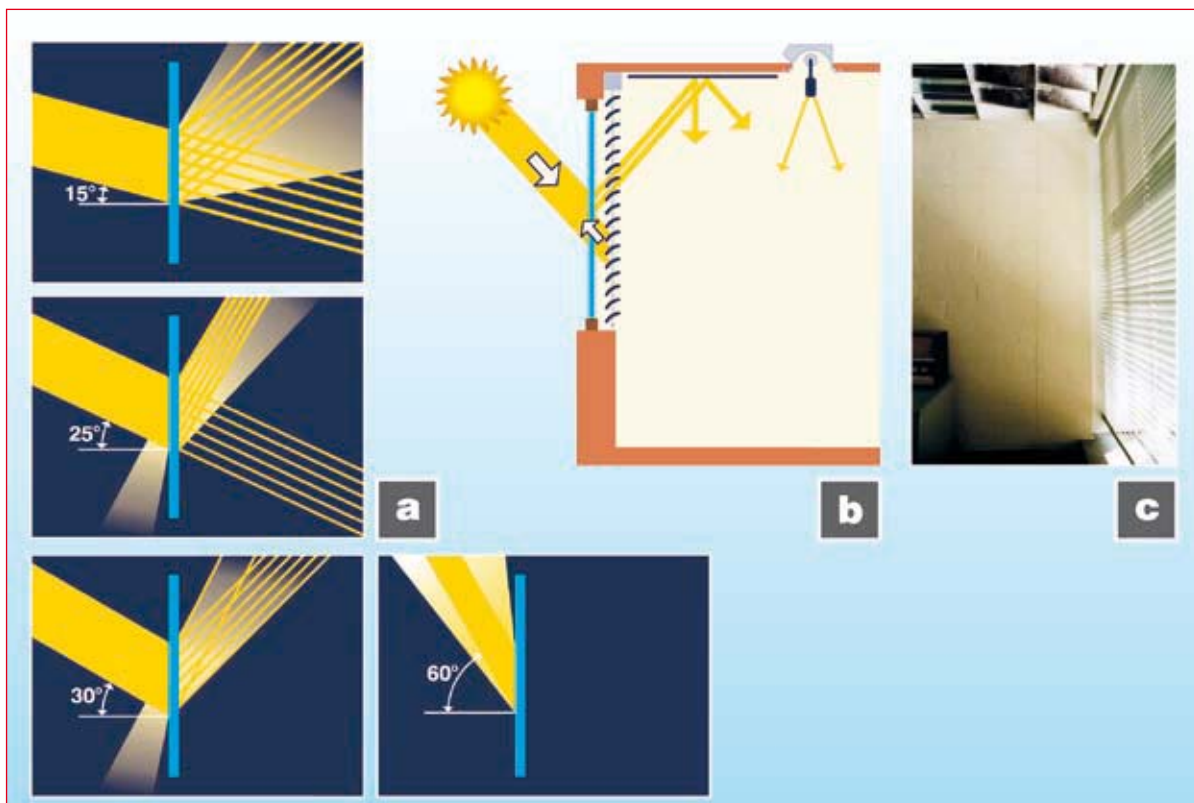

2 a : Okasolar system.
 b : Functional diagram of 'ETAP' system.
 c : Redirecting light towards the ceiling in a building fitted with the 'ETAP' system.

These systems are based on the principles of reflection and refraction of light as they pass through different materials. They are generally highly expensive and sometimes cause problems with light diffraction i.e. of colour changes due to this. They should not be used for new projects to compensate for badly-designed natural lighting but can be useful in renovation projects or in specific cases subject to factors restricting the use of natural lighting. Here are some examples of directional systems:

Prismatic panels (figure 2a)

Prismatic panels are thin, flat panels made of transparent acrylic, with a saw-tooth cross-section. They are used in temperate climates to redirect or refract light. The geometry of the prisms and the position of the panels determine the system's characteristics. When they are used for shading, the prismatic panels refract direct daylight but transmit diffuse light. They are often incorporated inside double glazing for maintenance purposes. These panels are quite transparent but distort the view to the outside. It is therefore appropriate to use these panels only in the upper part of a window so that the occupants' view outside is unchanged. These panels present a high risk of colouring the light when they are used in a fixed shading system. Other additional components need to be installed in this case (such as, for example, an acid-etched pane of glass) in order to remedy this problem.

Laser-cut panels (figure 2b)

Laser-cut panels are thin panels divided into a series of rectangular areas cut by lasers into acrylic material. These panels provide good visibility to the exterior. Positioned vertically, they induce a deflection of light falling at wide angles of incidence ($> 30^\circ$) whilst transmitting light at smaller angles. Placed horizontally, they act as solar shading. They can be used in fixed or adjustable systems.

Acrylic elements (figure 2c)

These are concave elements stacked inside double-glazing. They provide the capability to redirect light coming from any direction towards the room's ceiling. The latter plays an important role in redistributing light because it receives light reflected by the acrylic elements and redirects it towards work surfaces. The shape of the ceiling can therefore be designed specifically for this function but a classic reflective white ceiling can provide quite good results.

Holographic optical elements (HOE) (figure 2d)

Holographic systems are still in their infancy. The holographic technique consists of a layer of diffractive material aimed at redirecting light at a specific angle depending on the angle of incidence of the light. It enables diffuse light to be redirected whilst blocking direct light.

Different systems can be used to redirect or block out light depending on specific angles of incidence and/or transmission. These different systems are utilised either as shading systems or to enable light to penetrate further into a building.

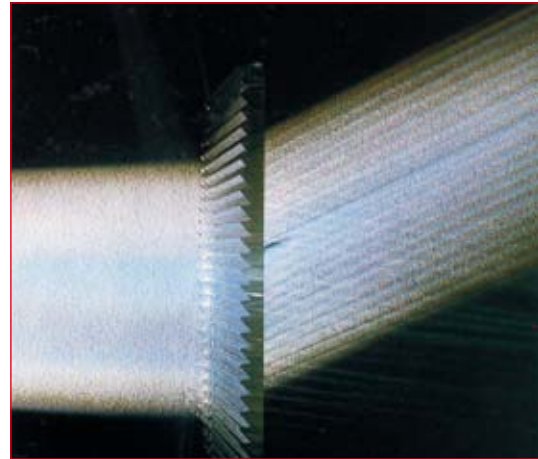

Prism system redirecting light. **1**

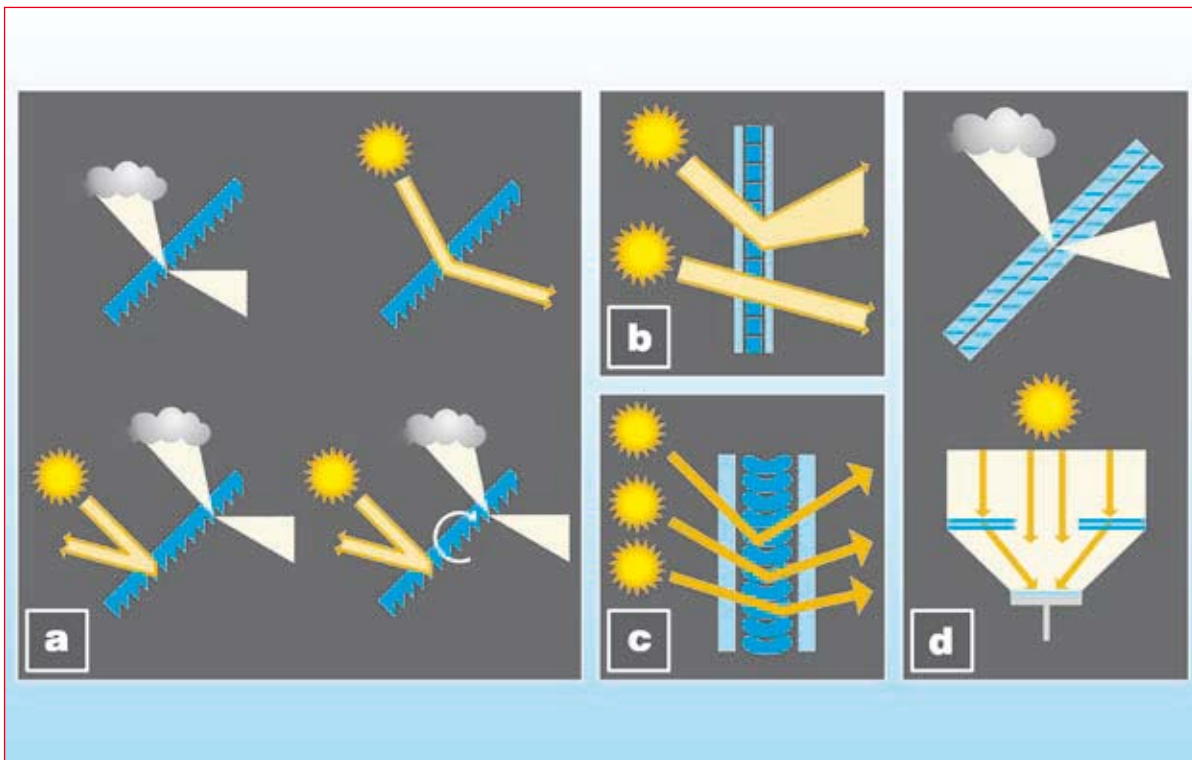

2 a: Prismatic panels
c: Acrylic elements

b: Laser-cut panels
d: Holographic Optical Elements

A light-shelf is a reflective device. Whether flat, curved, horizontal or slightly angled, it can be fitted anywhere on a wall. Its function is to redirect natural light towards the ceiling whilst shielding the occupants from direct sunlight. A light-shelf is generally placed above eye-level. It must make it possible to look outside whilst avoiding glare.

A reflector is designed specifically according to the orientation of a window, the room layout and the latitude. Choosing a particular type of light-shelf (internal (c), external (a) or combined (b) and its depth is a compromise between natural daylight requirements and the need for shade. On the inside, this device reduces the amount of light entering. Fitted outside, it provides a shaded surface close to the façade. This option reduces light levels near the window and enhances the uniformity of the light throughout the room. Angling light-shelves can either reduce the amount of light entering the building and increase the amount of shade (d) or increase the amount of light entering the building and reduce the amount of shade (e).

Ceilings affect light-shelves' performance because light is reflected on them before being diffused into the room. The ceiling's characteristics are its finish (more or less glossy), which determines its degree of reflectiveness, its colour and its slope. A reflective surface reflects more light into the building and increases the risk of glare. The way light is distributed by a light-shelf will also depend on the slope of the ceiling. A ceiling that slopes or curves towards a building's interior (f) will greatly increase the extent that light penetrates into the building.

Reflectors enable direct sunlight to be blocked at all times of day and of year and to increase natural daylighting levels at up to 10m from a window. However, their use is undesirable in certain climates.

Reflectors are building features that reflect natural daylight into a building. They also enable the shading of glazed surfaces.



Reflectors at the Laboratoire d'Energie Solaire (LESO) in Lausanne (arch. D. Pagadaniel).

1

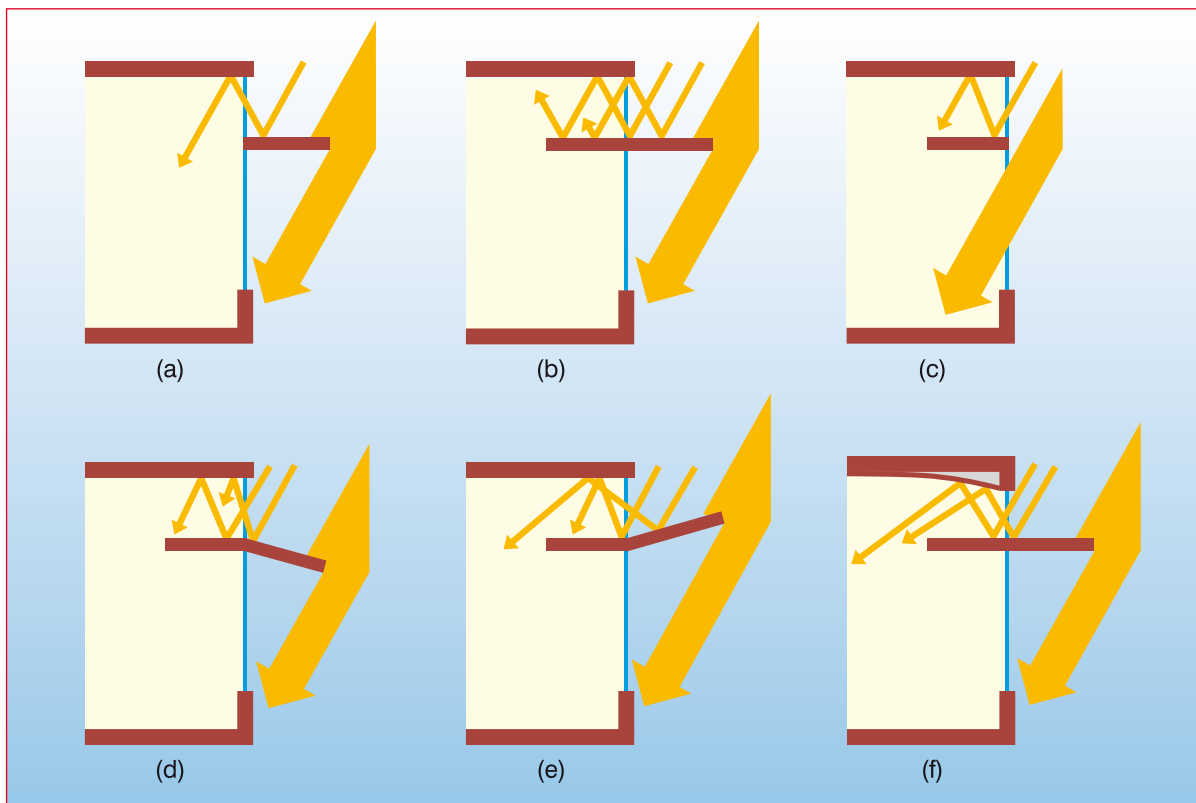

2 Different types of reflector.

Canopies are horizontal solar shades. Unlike horizontal sun-screens, they form part of the fabric of the building. Sun-screens can be made up of slats and contribute to filtering the sun; a canopy, on the other hand, is opaque. Sun-screens, being adjustable, offer the dual advantage of being useable only at certain times and retracted in the event of major storms or hurricanes, so they do not need to be dimensioned to withstand such natural onslaughts.

Sizing a canopy is carried out in the same way as that of a sun-screen as described on the relevant page. The diagram on the opposite page shows how the geometry of a canopy is calculated in the case of a vertical façade, depending on its height (α), the azimuth (γ) of the sun, as well as the orientation of the façade (β).

Generally speaking, sun-screens and canopies can play several roles: shielding walls and apertures from direct solar radiation but also protecting them from rain, from onlookers and, potentially, from noisy neighbours and from vandalism. Canopies must be able to withstand bad weather, such as storms or hurricanes. Their aesthetic impact, their impact on the layout of the façade and on the amount of light entering the building must also be taken into account.

Solar shading of external apertures must not take into account direct solar radiation alone, but also light due to reflections and diffuse solar radiation. The shading of openings onto the outside of a living space should be considered with reference to global solar radiation : direct, diffuse, and reflected.

Canopies shade vertical walls, their geometric shape resulting from a double calculation relating to their depth and extra width.

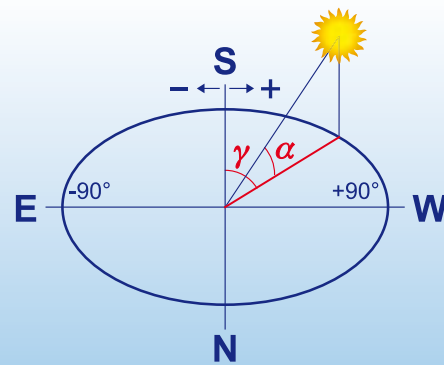

γ : sun's azimuth
 α : sun's altitude

Solar co-ordinates enable the geometry of horizontal awnings to be calculated. **1**

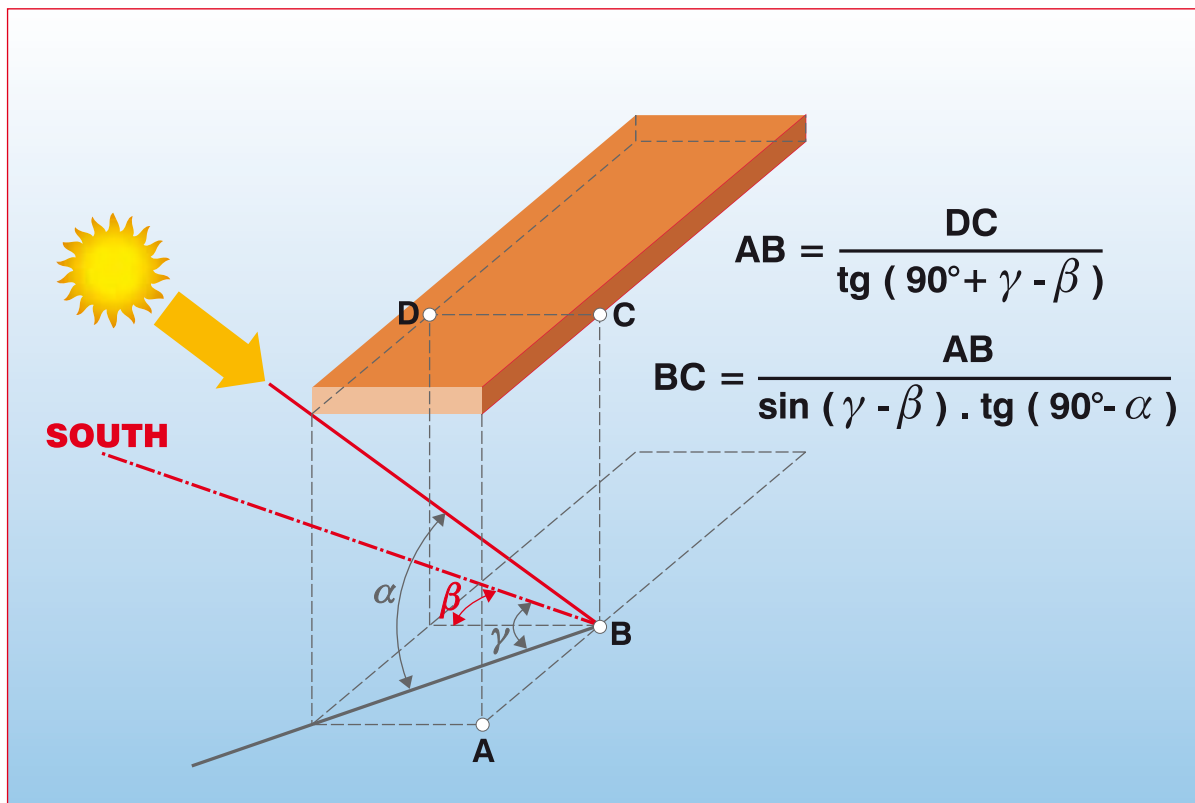

$$AB = \frac{DC}{\text{tg} (90^\circ + \gamma - \beta)}$$

$$BC = \frac{AB}{\sin (\gamma - \beta) \cdot \text{tg} (90^\circ - \alpha)}$$

2 Calculation of a canopy's geometric shape for a vertical façade.

Highly glazed office buildings offer transparency, access to daylight and a sense of connection between indoor and outdoor environments, which is superior to that provided by conventional buildings (where windows typically make up approximately 30 per cent of the external wall area).

Despite the energy issues, this trend is on the increase around the world, especially in office buildings. Its popularity can be explained by:

- architects' desire to offer views to (and from) the outside and to provide as much access to daylight as possible (even if tinted glazing is used)
- users' idea of increased glass area, relating it to a better view of the outside and a more pleasant indoor environment
- occupiers' preference for the distinctive corporate image provided by a glazed office (for instance, in terms of transparency or openness).

The energy performance of highly glazed buildings is, however, often questioned. Fully glazed façades can be a great challenge in terms of combining energy consumption with thermal comfort. The thermal transmittance of glazing is greater than that of insulated walls, regardless of the type of window. In buildings with highly glazed façades, which are exposed to direct and reflected solar radiation it is also a challenge to secure the visual comfort of occupants. The use of movable solar shading is an essential way of facilitating visual comfort in highly glazed buildings.

The main challenge with highly glazed buildings lies especially in their ability to respond and adapt rapidly to the external environment according to occupants' needs throughout the year. This is feasible by means of sophisticated systems to control temperature, light and ventilation. Estimating and defining the characteristics of glazing including solar control systems should be carried out during the early stages of a project. Various software tools are available, which enable the designers to assess the energy performance of the whole or a part of a building to be simulated.

Two types of highly glazed façades : double skin façades and airflow windows are systems consisting of two glass skins (where each skin is either single or double glazed) arranged with a ventilated intermediate cavity. For double skin façades, the insulating glazing (thermal barrier) is usually the inner skin, while for airflow windows the insulating glazing is the outer skin. The distance between the two skins typically varies from 0.2m up to 2.0m, depending on concept and system detailing. Solar shading devices are located within the cavity between the two skins.

The potential benefits of these types of façades include improved acoustic insulation, protection of shading devices from the outdoor environment and provision of natural ventilation to the office spaces, even in windy conditions.

Highly glazed façades offer transparency, access to daylight and a connection to the outside. They also present energy issues.



A highly glazed office building **1**

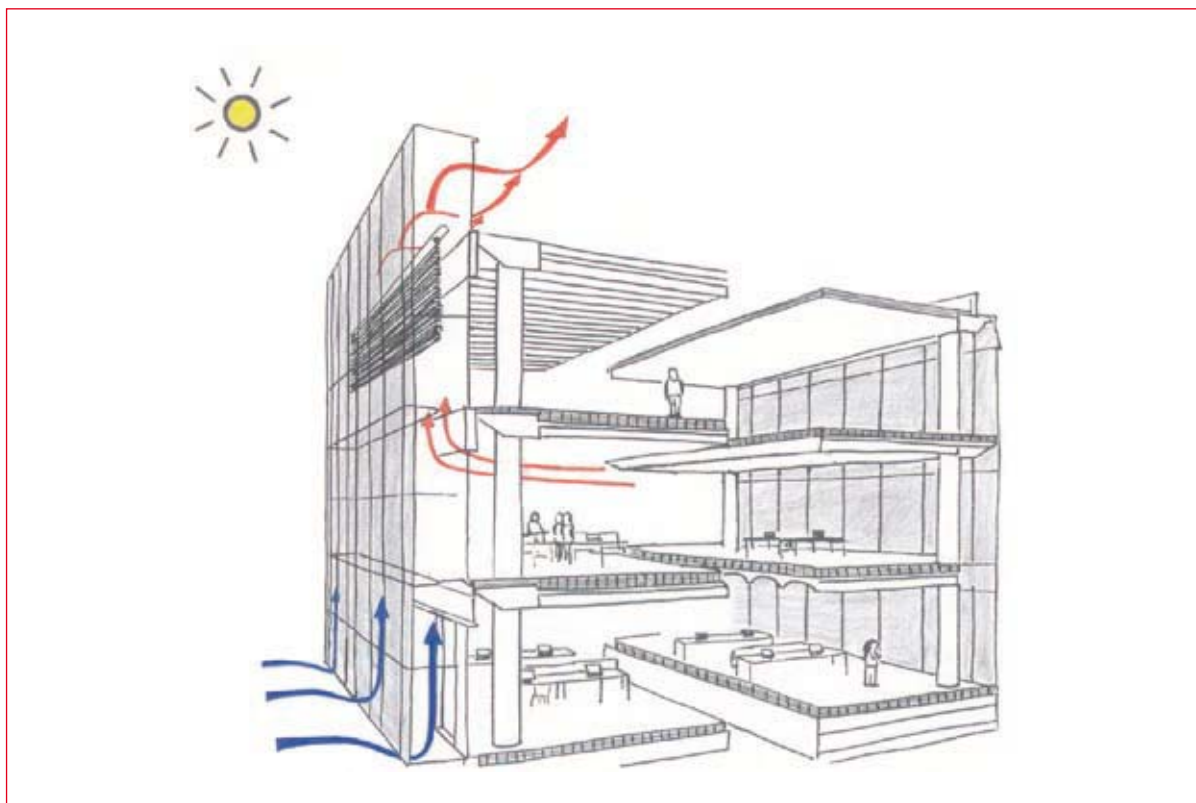

2 Key performance parameters: air, light and shading.

The ventilation of the double skin façade cavity can be natural (i.e. driven by buoyancy and/or wind), fan-supported, or mechanical. The ventilation of the airflow window is always mechanical.

A principal difference between these two systems is the origin of the inlet air (which is passed through the cavity). The double skin façade is ventilated from outdoors, while the airflow window is ventilated from the occupied space. The destination of the air can vary, depending on the local climate, the building use, and the building environmental (HVAC) strategy. The systems can be further divided into subcategories depending on their functionality as described in the following.

a. Naturally ventilated double skin façades

The cavity inlet and/or outlet can be closed during the heating season for increased thermal insulation (Figure 2-a). When the building is in cooling mode, the cavity inlets and outlets are opened, allowing natural ventilation for heat extraction (i.e. buoyancy and/or wind driven) (Figure 2-b).

b. Mechanically ventilated double skin façades

During the heating season, the cavity can be used to preheat fresh air supplied to the air handling unit (AHU) (Figure 2-c). When the building is in cooling mode, the outdoor air is mechanically extracted through the cavity (Figure 2-d).

c. Hybrid ventilated double skin façades

This is a combination of naturally and mechanically ventilated facades. During winter they function as mechanically ventilated, aimed at reducing heating demand, while during summer (or when the building is in cooling mode) they function as naturally ventilated ones, aimed at lowering cooling demand (Figures 2-e and 2-f).

d. Airflow windows

For the airflow window mode the air enters the cavity from indoors as exhaust air, throughout the year (Figures 2-g and 2-h). The aim is to control the indoor glass surface temperatures for extreme winter and extreme summer conditions. In principle, during the heating season, the cavity air is returned to the AHU for heat recovery purposes, while the air is exhausted to the outside during the cooling season.

Which type of ventilation is appropriate depends on a number of factors, such as building location, orientation, type of climate, local environment, density of occupation, etc. The use of dynamic thermal simulation tools enables designers to compare expected performance levels for alternative systems, and compare with energy consumption targets and desired levels of thermal comfort.

The ventilation of the double skin façade cavity can be natural, hybrid, or mechanical. The ventilation of the airflow window is always mechanical.

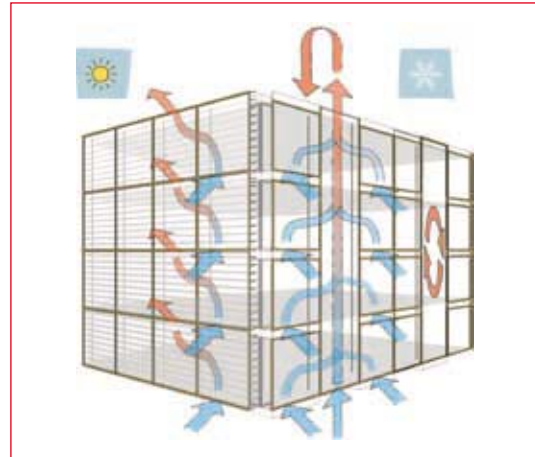

Façade ventilation. **1**

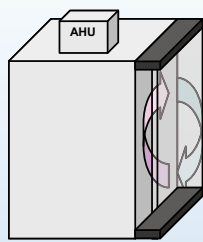

Figure a: Naturally ventilated double skin façade: winter function

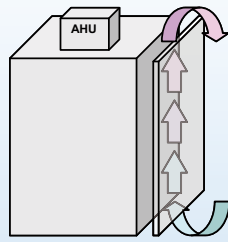

Figure b: Naturally ventilated double skin façade: summer function

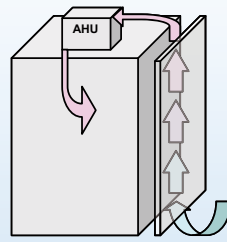

Figure c: Mechanically ventilated double skin façade: winter function

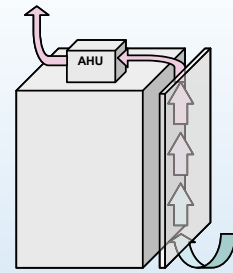

Figure d: Mechanically ventilated double skin façade: summer function

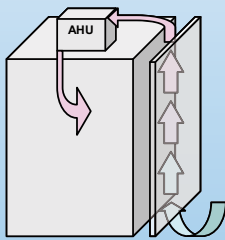

Figure e: Hybrid ventilated double skin façade: winter function

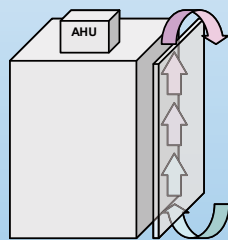

Figure f: Hybrid ventilated double skin façade: summer function

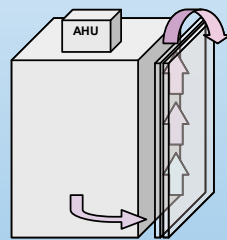

Figure g: Airflow windows: winter function

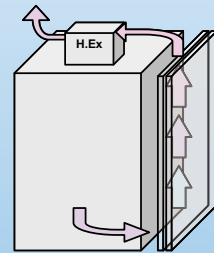

Figure h: Airflow windows: summer function

2 Types of ventilation.

Controls are an essential means of enhancing a building's performance in terms of energy consumption and occupant comfort. Control systems should aim to maintain the desired temperature range for occupants, sufficient fresh air and the right levels and quality of natural (and artificial) light within the building. Heating, cooling and lighting systems, together with solar shading constitute façade regulation systems.

Four basic principles for control systems are of particular note when referring to 'control systems':

- occupants should be able to manually override the controls within set limits
- energy savings can be achieved when control systems take advantage of the outdoor environmental conditions before they switch over to mechanically controlled modes of operation
- focus on providing the required comfort levels with the lowest possible energy consumption
- during unoccupied periods, focus on energy savings

An example of façade regulation systems: automatic control of shading devices

The thermal study shown in Figure 2 was conducted in July, i.e. during the cooling period, in an office building located in the northern hemisphere. The façade in question faces due south. A thermal comfort temperature was defined for the offices situated along the façade.

The horizontal line indicates a threshold value defined by the capacity of the cooling system. The curves show the sensible loads due to solar gains for different settings of the shading device. The angles denote the position of slats of the venetian blinds, with 0° being horizontal.

This example clearly shows that, for a part of the day, the existing cooling system cannot cope with the additional solar heat gains. To do so, it is essential to provide appropriate solar shading during the hottest part of the day.

The study highlights the fact that by adjusting the angle of the slats depending on the time of day, the occupants are able to benefit from a view to the outside (albeit partial), whilst the same level of thermal comfort is guaranteed throughout the day.

Graphs like this can thus provide architects with useful data to inform the shading control strategy, including definition of preset slat positions, sensor parameters and positioning, etc.

Heating, cooling and lighting systems, together with solar shading constitute façade regulation systems.



Media Tower, Düsseldorf **1**
(Arch. Findeisen & Wächter GmbH).

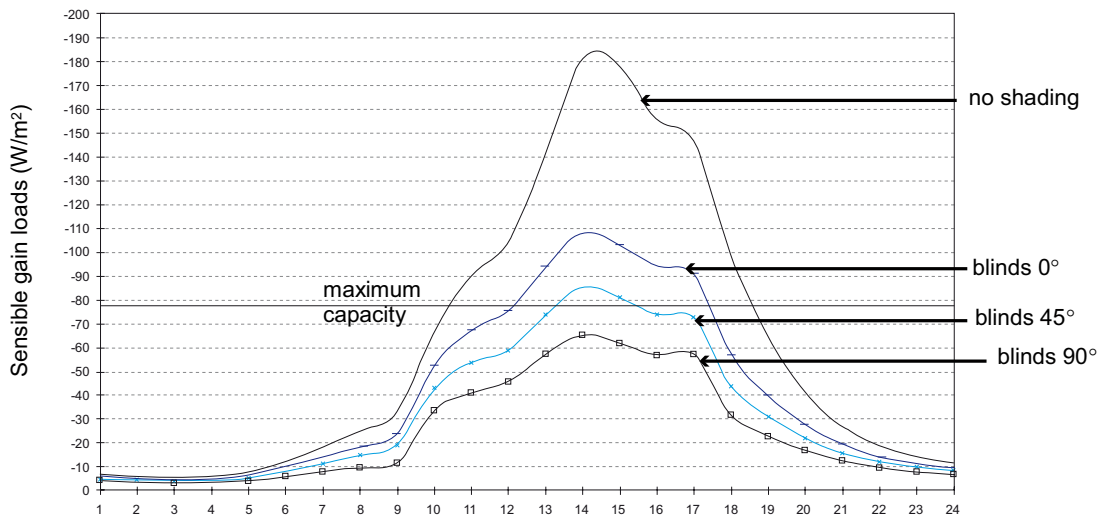

- No shading is required until around 10.30am
- Venetian blinds can be deployed with horizontal slats, preserving (partly) the views until around 12.30 am

At mid-day the slats need to be closed more, either in steps such as 45° until 1.30pm and then 60° until 3.30pm, or directly to 60°.

2 Impact of automatic shading on building performance.

Source : Harris Poirazis, PhD et Mikkel Kragh, PhD - Arup, UK.

BIOCLIMATIC FACADES

Photo acknowledgements

12 : Architectures d'été, construire pour le confort d'été, J.-L. Izard / 13 : Documentation St-Roch / 14.1 : Systèmes Solaires n°112, R. Delacloche / 14.2 : Systèmes Solaires n°77-78 / 15 : A la recherche des ambiances, R. Delacloche / 16 : Architecture islamique en Espagne, Taschen / 17 : Maisons solaires maisons d'aujourd'hui, Guide régional des réalisations, Comité d'Action pour le Solaire / 22.1 : A + U Publishing, L. Kahn / 22.2.1 : Systèmes Solaires n° 101, J. Bouillot / 22.2.2 : Systèmes Solaires n° 112, R. Delacloche / 22.2.4 : Systèmes Solaires n° 101, Bermond-Pochon / 25.1 : R. Delacloche - HSHA Observ'ER / 25.2b : Philips Lighting / 25.2c, 25.2d : Architecture et Climat / 25.2 e à g : Philips Lighting / 27.2 : M. Bodart / 30.1, 31.1 : Architecture et Climat / 32.1 : C. Cochy - HSHA Observ'ER / 32.2a: Zumtobel Staff Benelux NV / 32.2b: R. Delacloche - HSHA Observ'ER / 33.1, 33.2a, 33.2b, 33.2c : Architecture et Climat / 33.2d : R. Delacloche - HSHA Observ'ER / 34.2a, 34.2b : Architecture et Climat / 35.1 : J.-M. Tinarrage - CG 40 / 39 : Documentation St-Roch / 44.1 : P. Huguet - HSHA Observ'ER / 48 : Design of educational buildings, S. Yannas / 50 : Documentation Aralco / 51.1 : Chiatello-Dabilly – HSHA Observ'ER / 54 : Palladio, Taschen / 55 : Transparent Insulation Technology / 57.1 : M. Bodart / 58.1: S. Altomonte (La Sapienza, Rome) / 60.2a, 60.2b, 61.1 : S. Reiter / 61.2a, 61.2b : Architecture et Climat / 61.2c, 61.2d: S. Reiter / 61.2e, 61.2f : Architecture et Climat / 61.2g, 61.2h : S. Reiter / 62.1: Okalux GmbH / 62.2c: ETAP NV / 63.1: Siemens / 64.1 : J.-B. Gay / 67b.1: Kista Science Tower (photo: Harris Poirazis) / 67b.2: Harris Poirazis (Single and Double Skin Glazed Office Buildings; Analyses of Energy Use and Indoor Climate, Department of Architecture and Built Environment, Lund University, Sweden) / 68b.1: Harris Poirazis (Double Skin Facades for Office Buildings - Literature review report, Department of Architecture and Built Environment, Lund University, Sweden) / 68b-2 : Harris Poirazis

Translation by Robin Williams - Marketing in Europe

www.somfyarchitecture.com

somfy[®]
FOR BIOCLIMATIC FAÇADES

SOMFY SAS, capital 20.000.000 euros, RCS Bonneville 303.970.230 • ©SOMFY.COM081000 - Réf. 9015150