

# Earthquake-Resistant Design Concepts

An Introduction to the NEHRP Recommended Seismic Provisions for New Buildings and Other Structures

*FEMA P-749 / December 2010*

Prepared for the  
Federal Emergency Management Agency of the U. S. Department of Homeland Security  
By the National Institute of Building Sciences Building Seismic Safety Council

**NOTICE:** Any opinions, findings, conclusions, or recommendations expressed in this publication do not necessarily reflect the views of the Federal Emergency Management Agency of the Department of Homeland Security. Additionally, neither FEMA nor any of its employees make any warranty, expressed or implied, nor assume any legal liability or responsibility for the accuracy, completeness, or usefulness of any information, product, or process included in this publication.

This report was prepared under Contract HSFEHQ-06-C-1139 between the Federal Emergency Management Agency and the National Institute of Building Sciences. For further information on Building Seismic Safety Council activities and products, see the Council's website ([www.bsscconline.org](http://www.bsscconline.org)) or write the Building Seismic Safety Council, National Institute of Building Sciences, 1090 Vermont Avenue, N.W., Suite 700, Washington, D.C. 20005; phone 202-289-7800; fax 202-289-1092; e-mail [bssc@nibs.org](mailto:bssc@nibs.org). Copies of this report may be obtained from the FEMA Publication Distribution Facility at 1-800-480-2520. The report can also be downloaded in pdf form from the FEMA website or the BSSC website.

## About The Building Seismic Safety Council

The Building Seismic Safety Council (BSSC) was established in 1979 under the auspices of the National Institute of Building Sciences as a forum-based mechanism for dealing with the complex regulatory, technical, social, and economic issues involved in developing and promulgating building earthquake hazard mitigation regulatory provisions that are national in scope. By bringing together in the BSSC all of the needed expertise and all relevant public and private interests, it was believed that issues related to the seismic safety of the built environment could be resolved and jurisdictional problems overcome through authoritative guidance and assistance backed by a broad consensus.

The BSSC is an independent, voluntary membership body representing a wide variety of building community interests. Its fundamental purpose is to enhance public safety by providing a national forum that fosters improved seismic safety provisions for use by the building community in the planning, design, construction, regulation, and utilization of buildings.

### 2010 BSSC BOARD OF DIRECTION

**Chair** – William Holmes, Rutherford & Chekene

**Vice Chair** – James Cagley, Cagley and Associates (representing the Applied Technology Council)

**Secretary** – Curtis Campbell, J. E. Dunn Construction Company (representing the Associated General Contractors of America)

**Ex Officio** – David Bonneville, Degenkolb Engineers

**Members** – Bradford Douglas, American Wood Council; Cynthia J. Duncan, American Institute of Steel Construction; John E. Durrant, American Society of Civil Engineers; Melvyn Green, Melvyn Green and Associates (representing the Earthquake Engineering Research Institute); Jay W. Larson, PE, FASCE, American Iron and Steel Institute; Joseph Messersmith, Portland Cement Association; Ronald E. Piester, RA, New York State Department, Division of Code Enforcement and Administration (representing the International Code Council); Timothy Reinhold, Institute for Building and Home Safety; R. K. Stewart, FAIA, Hon. FRAIC, Hon. JAI, LEED AP, Perkins + Will (representing the National Institute of Building Sciences); Gregory Schindler, KPFF Consulting Engineers (representing the National Council of Structural Engineers Associations); Charles Spitz, NCARB, AIA, CSI, Architect/Planner Code Consultant (representing the American Institute of Architects); S. Shyam Sunder, National Institute of Standards and Technology (representing the Interagency Committee for Seismic Safety in Construction); Robert D. Thomas, National Concrete Masonry Association

**BSSC MEMBER ORGANIZATIONS:** AFL-CIO Building and Construction Trades Department, American Concrete Institute, American Consulting Engineers Council, American Wood Council, American Institute of Architects, American Institute of Steel Construction, American Iron and Steel Institute, American Society of Civil Engineers, American Society of Heating, Refrigeration, and Air-Conditioning Engineers, American Society of Mechanical Engineers, American Welding Society, APA - The Engineered Wood Association, Applied Technology Council, Associated General Contractors of America, Association of Engineering Geologists, Association of Major City Building Officials, Brick Industry Association, Building Owners and Managers Association International, California Seismic Safety Commission, Canadian National Committee on Earthquake Engineering, Concrete Masonry Association of California and Nevada, Concrete Reinforcing Steel Institute, Division of the California State Architect, Earthquake Engineering Research Institute, General Services Administration Seismic Program, Hawaii State Earthquake Advisory Board, Institute for Business and Home Safety, Interagency Committee on Seismic Safety in Construction, International Code Council, International Masonry Institute, Masonry Institute of America, Metal Building Manufacturers Association, Mid-America Earthquake Center, National Association of Home Builders, National Concrete Masonry Association, National Conference of States on Building Codes and Standards, National Council of Structural Engineers Associations, National Elevator Industry, Inc., National Fire Sprinkler Association, National Institute of Building Sciences, National Ready Mixed Concrete Association, Portland Cement Association, Precast/Prestressed Concrete Institute, Rack Manufacturers Institute, Steel Deck Institute, Inc., Structural Engineers Association of California, Structural Engineers Association of Central California, Structural Engineers Association of Colorado, Structural Engineers Association of Illinois, Structural Engineers Association of Kansas and Missouri, Structural Engineers Association of Kentucky, Structural Engineers Association of Northern California, Structural Engineers Association of Oregon, Structural Engineers Association of San Diego, Structural Engineers Association of Southern California, Structural Engineers Association of Texas, Structural Engineers Association of Utah, Structural Engineers Association of Washington, The Masonry Society, U.S. Army Corps of Engineers Engineer Research and Development Center-Construction Engineering Research Laboratory, Western States Clay Products Association, Wire Reinforcement Institute

**AFFILIATE MEMBERS:** Baltimore Aircoil Company, Bay Area Structural, Inc., Building Technology, Incorporated, CH2M Hill, City of Hayward, California, Felten Engineering Group, Inc., Flexhead Industries, H&H Group, HLM Design, LaPay Consulting, Inc., Sea Hawk Enterprises, Inc., Square D Company, State Farm Insurance Company, Steel Joist Institute, Vibration Mountings and Controls, York-a Johnson Controls Company, Inc.

## Foreword

One goal of the Federal Emergency Management Agency (FEMA) and the National Earthquake Hazards Reduction Program (NEHRP) is to encourage design and building practices that address the earthquake hazard and minimize the resulting risk of damage and injury. Publication of this document, which is a companion guide to the 2009 edition of the *NEHRP Recommended Seismic Provisions for New Buildings and Other Structures* (FEMA P-750), reaffirms FEMA's ongoing support of efforts to achieve this goal. First published in 1985, the 2009 edition of the *Provisions* marks the seventh in a series of updates to the document.

The *Provisions* and the building codes and consensus standards based on its recommendations are technical documents used primarily by the professionals who design and construct buildings and other structures. Understanding the basis for the seismic regulations in the nation's codes and standards is nevertheless important to others outside the technical community including elected officials, decision-makers in the insurance and financial communities, and individual building or business owners and other concerned citizens. This document is intended to provide these interested individuals with a readily understandable explanation of the intent and requirements of seismic design in general and the *Provisions* in particular.

FEMA wishes to express its deepest gratitude for the significant efforts of the over 200 volunteer experts as well as the BSSC Board of Direction, member organizations, consultants, and staff who made possible the 2009 *NEHRP Recommended Seismic Provisions* and, by extension, this report. Americans unfortunate enough to experience the earthquakes that will inevitably occur in the future will owe much, perhaps even their lives, to the contributions and dedication of these individuals. Without the expertise and efforts of these men and women, this document and all it represents with respect to earthquake risk mitigation would not have been possible.

*Federal Emergency Management Agency of the  
U. S. Department of Homeland Security*



## Preface and Acknowledgements

This document reflects very generous contributions of time and expertise on the part of the many individuals who participated in the development of the *2009 NEHRP Recommended Seismic Provisions for New Building and Other Structures*. The Building Seismic Safety Council (BSSC) is particularly grateful to Ronald O. Hamburger, SE, PE, SECB, Senior Principal, Simpson Gumpertz and Heger, San Francisco, California. Not only did Mr. Hamburger serve as chair of the Provisions Update Committee responsible for both the 2003 and 2009 editions of the *Provisions*, but he also drafted this report. The BSSC also wishes to acknowledge the conscientious support and assistance of Michael Mahoney, Geophysicist, FEMA, Mitigation Directorate, Building Science Branch, and the project officer overseeing development of this introduction to the concepts presented in the *Provisions*.

## Table of Contents

|  |     |
|--|-----|
| <b>Forward</b> .....   | iii |
| <b>Preface and Acknowledgements</b> .....  | v   |
| <b>Executive Summary</b> .....   | 1   |
| <br>   |     |
| <b>Chapter 1   The U.S. Building Regulatory Process and Its Approach to Seismic Risk</b> | 3   |
| 1.1 Model Building Codes .....   | 4   |
| 1.2 Consensus Standards .....  | 5   |
| 1.3 Code Adoption and Enforcement .....  | 6   |
| 1.4 The <i>NEHRP</i> and the <i>NEHRP Recommended Seismic Provisions</i> .....           | 7   |
| <br>   |     |
| <b>Chapter 2   Seismic Risk and Performance</b>  |     |
| 2.1 Basic Concepts .....   | 13  |
| 2.2 Acceptable Risk .....  | 13  |
| 2.3 Geologic Earthquake Effects .....  | 14  |
| 2.4 Seismic Hazard Analysis .....  | 20  |
| <br>   |     |
| <b>Chapter 3   Design and Construction Features Important to Seismic Performance</b>     |     |
| 3.1 Stable Foundations .....   | 35  |
| 3.2 Continuous Load Path .....   | 36  |
| 3.3 Adequate Stiffness and Strength .....  | 37  |
| 3.4 Regularity .....   | 38  |
| 3.5 Redundancy .....   | 39  |
| 3.6 Ductility and Toughness .....  | 40  |
| 3.7 Ruggedness .....   | 41  |
| <br>   |     |
| <b>Chapter 4   Buildings, Structures, and Nonstructural Components</b>                   |     |
| 4.1 Buildings .....  | 43  |
| 4.1.1 Structural Systems .....   | 43  |
| 4.1.2 Nonstructural Components .....   | 48  |
| 4.2 Nonbuilding Structures .....   | 49  |
| 4.3 Protective Systems .....   | 51  |
| 4.4 Existing Buildings and Structures .....  | 52  |
| <br>   |     |
| <b>Chapter 5   Design Requirements</b>   |     |
| 5.1 Seismic Design Categories .....  | 57  |
| 5.2 Site Class .....   | 60  |
| 5.3 Design Ground Motion .....   | 66  |
| 5.4 Structural System Selection .....  | 70  |
| 5.5 Configuration and Regularity .....   | 73  |

5.6 Required Strength ..... 75

    5.6.1 Seismic Design Category A ..... 76

    5.6.2 Seismic Design Category B ..... 77

    5.6.3 Seismic Design Category C ..... 83

    5.6.4 Seismic Design Categories D, E, and F ..... 84

5.7 Stiffness and Stability ..... 85

5.8 Nonstructural Components and Systems ..... 87

5.9 Construction Quality Assurance ..... 89

**Chapter 6 | Future Directions**

6.1 Rationalization of Design Parameters ..... 91

6.2 Manufactured Component Equivalence ..... 91

6.3 Nonbuilding Structures ..... 92

6.4 Nonstructural Components ..... 92

6.5 Performance-based Design ..... 92

6.5 Damage-tolerant Systems ..... 93

Glossary ..... 95

Selected References and Bibliography ..... 103

**FIGURES**

**Chapter 1**

Figure 1 Examples of how NEHRP-funded basic research and application activities stimulate earthquake risk mitigation (image courtesy of NIST). 9

**Chapter 2**

Figure 2 Major tectonic plates (courtesy of U.S. Geological Survey). For a more complete explanation of plate tectonics, see <http://pubs.usgs.gov/gip/dynamic/dynamic.pdf/> 15

Figure 3 Fault movements can break the ground surface, damaging buildings and other structures. This fence near Point Reyes was offset 8 feet ( 2.5 m) when the San Andreas Fault moved in the 1906 San Francisco (magnitude 7.8) earthquake (photo courtesy of USGS ). 16

Figure 4 Vertical fault offset in Nevada resulting from the 1954 Dixie Valley earthquake (photo by K. V. Steinbrugge). 16

Figure 5 Earthquakes can trigger landslides that damage roads, buildings, pipelines, and other infrastructure. Steeply sloping areas underlain by loose or soft rock are most susceptible to earthquake-induced landslides. The photo on the left shows Government Hill School in Anchorage, Alaska, destroyed as a result of a landslide induced by the 1964 earthquake; the south wing of the building collapsed into a graben at the head of the landslide (photo courtesy of USGS). The home shown on the right was destroyed when the hillside beneath it gave way following the 1994 magnitude 6.7 Northridge earthquake (FEMA photo). 17

|                  |   |    |
|------------------|---|----|
| Figure 6         | Top photo shows liquefaction-induced settlement of apartment buildings in the 1964 earthquake in Nigata, Japan (photo courtesy of the University of Washington). The bottom photo shows one of many manholes that floated to the surface as a result of soil liquefaction caused by the 2004 Chuetsu earthquake near Nigata, Japan (photo courtesy of Wikimedia Commons). | 18 |
| Figure 7         | Lateral spreading damage to highway pavement near Yellowstone Park resulting from the 1959 Hegben Lake earthquake (photo courtesy of the USGS).   | 19 |
| Figure 8         | Locations of earthquakes in the continental United States between 1750 and 1996. Although not shown in this map, Alaska, Hawaii, Puerto Rico, and the Marianas also experienced earthquakes during this period.   | 21 |
| Figure 9         | Acceleration response spectrum for the 1940 Imperial Valley earthquake, north-south component.  | 24 |
| Figure 10        | Generalized shape of smoothed response spectrum.  | 24 |
| Figure 11        | Hazard curve for spectral acceleration at a site in Berkeley, California.   | 26 |
| Figure 12        | 1940 Imperial Valley earthquake north-south and east-west spectra.  | 27 |
| Figure 13        | Collapse fragility curve for a hypothetical structure.  | 28 |
| Figure 14        | Distribution of short-period risk-targeted maximum considered earthquake response acceleration, $S_y$ , for the conterminous United States.   | 30 |
| Figure 15        | Distribution of 1-second period risk-targeted maximum considered earthquake response acceleration, $S_y$ , for the conterminous United States.  | 32 |
| <b>Chapter 3</b> |   |    |
| Figure 16        | Collapse of a tilt-up building in the 1971 San Fernando earthquake (photo by P. Yanev).   | 36 |
| Figure 17        | Houses in Watsonville, California, that fell off their foundations in the 1989 Loma Prieta earthquake.  | 37 |
| Figure 18        | First story of an apartment building in San Francisco, California, leaning to the side after the 1989 Loma Prieta earthquake.   | 38 |
| Figure 19        | Imperial County Services Building, El Centro, California (courtesy of USGS). The photo on the right shows the crushed columns at the base of the building.  | 39 |
| Figure 20        | Failure of an unreinforced masonry wall in a building in Santa Cruz, California, in the 1989 Loma Prieta earthquake.  | 41 |



### Chapter 4

|           |  |    |
|-----------|--|----|
| Figure 21 | Wood studs and structural panel sheathing of typical wood frame bearing wall construction.   | 44 |
| Figure 22 | Typical low-rise concrete bearing wall building.   | 44 |
| Figure 23 | A three-story masonry bearing wall building.   | 45 |
| Figure 24 | A high-rise braced frame building in San Francisco, California.  | 46 |
| Figure 25 | A tall steel moment-frame structure under construction.  | 47 |
| Figure 26 | Structures commonly found in petroleum refineries and chemical plants.   | 49 |
| Figure 27 | Seismic design criteria for steel storage racks of the type used in large warehouses and big-box retail stores are included in the Provisions. | 50 |
| Figure 28 | The San Bernardino County Justice Center in California was one of the first base-isolated buildings in the United States.                      | 52 |

### Chapter 5

|           |   |    |
|-----------|---|----|
| Figure 29 | Seismic Design Categories for low-rise buildings of ordinary occupancy on alluvial soils. | 62 |
| Figure 30 | Generalized design response spectrum.   | 67 |
| Figure 31 | Map of long-period transition period, $T_L$ , for the continental United States.          | 68 |
| Figure 32 | Re-entrant corner irregularity.   | 73 |
| Figure 33 | Diaphragm discontinuity irregularity.   | 73 |
| Figure 34 | Out-of-plane offset irregularity.   | 73 |
| Figure 35 | Examples of buildings with a soft first story, a common type of stiffness irregularity.   | 74 |
| Figure 36 | Examples of in-plane discontinuity irregularities.  | 75 |
| Figure 37 | Required seismic design forces for Seismic Design Category A structures.                  | 76 |
| Figure 38 | Continuity forces for Seismic Design Category A structures.                               | 77 |
| Figure 39 | Distribution of lateral earthquake force in three-story structure.                        | 79 |
| Figure 40 | Eccentric application of story forces.  | 82 |
| Figure 41 | Deflection of diaphragm under lateral loading.  | 83 |
| Figure 42 | Interstory drift.   | 86 |

**TABLES****Chapter 2**

|         |                                   |    |
|---------|-----------------------------------|----|
| Table 1 | Modified Mercalli Intensity Scale | 22 |
|---------|-----------------------------------|----|

**Chapter 5**

|         |  |    |
|---------|--|----|
| Table 2 | Seismic Design Categories, Risk, and Seismic Design Criteria       | 58 |
| Table 3 | Occupancy  | 59 |
| Table 4 | Site Class and Soil Types  | 61 |
| Table 5 | Values of Site Class Coefficient $F_a$ as a Function of Site Class | 67 |
| Table 6 | Values of Site Class Coefficient $F_v$ as a Function of Site Class | 67 |

## Executive Summary

Of the 500,000 or so detectable earthquakes that occur on Planet Earth each year, people will “feel” about 100,000 of them and about 100 will cause damage.<sup>1</sup> Although most earthquakes are moderate in size and destructive potential, a severe earthquake occasionally strikes a community that is not adequately prepared and thousands of lives and billions of dollars in economic investment are lost.

For example, a great earthquake and the fires it initiated destroyed much of San Francisco in 1906 and a significant portion of Anchorage, Alaska, was destroyed by a large earthquake in 1964. Within the past 200 years, major destructive earthquakes also occurred in Charleston, South Carolina, and Memphis, Tennessee. Within the past 50 years, smaller but damaging earthquakes occurred several times in both Los Angeles and Seattle. Overall, more than 20 states have a moderate or high risk of experiencing damaging earthquakes. Earthquakes are truly a national problem.

One of the key ways a community protects itself from potential earthquake disasters is by adopting and enforcing a building code with appropriate seismic design and construction standards. The seismic requirements in U.S. model building codes and standards are updated through the volunteer efforts of design professionals and construction industry representatives under a process sponsored by the Federal Emergency Management Agency (FEMA) and administered by the Building Seismic Safety Council (BSSC). At regular intervals, the BSSC develops and FEMA publishes the *NEHRP (National Earthquake Hazards Reduction Program) Recommended Seismic Provisions for New Buildings and Other Structures* (referred to in this publication as the *NEHRP Recommended Seismic Provisions* or simply the *Provisions*). The *Provisions* serves as a resource used by the codes and standards development organizations as they formulate sound seismic-resistant design and construction requirements. The *Provisions* also provides design professionals, building officials, and educators with in-depth commentary on the intent and preferred application of the seismic regulations.

The 2009 edition of the *Provisions* (FEMA P-750) and the building codes and consensus standards based on its recommendations are, of necessity, highly technical documents intended primarily for use by design professionals and others who have specialized technical training. Because of this technical focus, these documents are not clearly understandable to those not involved in design and construction. Nevertheless, understanding the basis for the seismic regula-

---

<sup>1</sup>For more information, see <http://earthquake.usgs.gov/learning/facts.php>.

tions contained in the nation's building codes and standards is important to many people outside this technical community including elected officials, decision-makers in the insurance and financial communities, and individual business owners and other citizens. This introduction to the *NEHRP Recommended Seismic Provisions* is intended to provide these interested individuals with a readily understandable explanation of the intent of the earthquake-resistant design and requirements of the *Provisions*.

Chapter 1 explains the history and purpose of building regulation in the United States, including the process used to develop and adopt the nation's building codes and the seismic requirements in these codes. Chapter 2 is an overview of the performance intent of the *Provisions*. Among the topics addressed are the national seismic hazard maps developed by the U.S. Geological Survey (USGS); the seismic design maps adopted by the *Provisions* as a basis for seismic design; and seismic risk, which is a function of both the probability that a community will experience intense earthquake ground shaking and the probability that building construction will suffer significant damage because of this ground motion. Chapter 3 identifies the design and construction features of buildings and other structures that are important to good seismic performance. Chapter 4 describes the various types of structures and nonstructural components addressed by the *Provisions*. Chapter 5 is an overview of the design procedures contained in the *Provisions*. Chapter 6 addresses how the practice of earthquake-resistant design is likely to evolve in the future. A glossary of key technical terms, lists of notations and acronyms used in this report, and a selected bibliography identifying references that may be of interest to some readers complete this report.

## Chapter 1

# THE U.S. BUILDING REGULATORY PROCESS AND ITS APPROACH TO SEISMIC RISK

Building regulation in the United States began in the late 1800s when major cities began to adopt and enforce building codes in response to the large conflagrations that frequently occurred in these densely populated urban areas. The early building codes were intended primarily to reduce the fire risk but, over time, their scope was broadened to address many other issues deemed important to protecting public health, safety, and welfare – including natural hazards like earthquakes – and they became known as “model” building codes since they could be tailored to reflect community concerns before they were adopted.

Building codes generally are intended to be applied by architects and engineers but also are used for various purposes by safety inspectors, environmental scientists, real estate developers, contractors and subcontractors, manufacturers of building products and materials, insurance companies, facility managers, tenants, and others.

Today, most U.S. communities formally adopt a building code and have a system in place for building regulation, but this was and still is not always the case. In fact, some rural areas in America still have not adopted a building code and, in these areas, it is legal to design and construct structures using any standards deemed appropriate by the designers and builders. Further, not all codes enforced at the local level will result in adequate earthquake-resistant design and construction. Some communities in the central and eastern United States, for example, are at significant risk of experiencing damaging earthquakes but do not acknowledge this risk and, consequently, have not adopted adequate seismic design and construction requirements into their local building codes. As a result, although the cost of incorporating appropriate seismic resistance into new construction is small, many buildings continue to be constructed without adequate protection, leaving people in these communities at considerable risk.

***One of the primary ways a community protects itself and its individual citizens from potential earthquake disasters is by adopting and enforcing a building code with appropriate seismic design and construction requirements.***

### 1.1 Model Building Codes

By the mid-1900s, three organizations were publishing model building codes for adoption by U.S. communities and each represented a major geographic region:

- The Building Officials and Code Administrators International (BOCAI) published the *National Building Code* that served as the basis for most building regulation in the northeastern and central states.
- The Southern Building Code Congress International (SBCCI) published the *Standard Building Code* that was commonly adopted throughout the southeastern part of the country.
- The International Conference of Building Officials (ICBO) published the *Uniform Building Code* that was commonly adopted in the western United States.

Each of the three building codes tended to develop particular strengths in certain areas. The *National Building Code* was heavily influenced by the major cities in the northeastern and central states and developed strong provisions on fire resistance and urban construction. The *Standard Building Code* was influenced primarily by building interests in the southeastern states where hurricanes were a common hazard and consequently developed advanced wind design requirements. The *Uniform Building Code*, reflecting the interest of the western states, became a leader in the development and adoption of earthquake design provisions.

The three organizations continued to issue their model codes for more than 50 years, typically publishing revised and updated editions every three years. All three used a similar process that began with a public call for proposals for change. Anyone could respond to these public calls and submit a proposal to change the code. Typical code changes involved the prohibition of certain types of construction or the introduction of requirements governing the design of other types of construction. These proposals generally were made by proponents of building products and construction processes as well as by individual building officials and design professionals and associations representing these interests. Code change proposals often were made in response to observations that some types of construction performed poorly in certain events (e.g., fires or earthquakes) or situations (e.g., in areas of very heavy snow) and that changes in design or construction were needed to improve performance. Once proposals were submitted, the model code organization would hold a series of hearings to obtain public input on the validity of the proposals and the organization's membership would then vote to either reject or accept the proposals, sometimes modifying the original proposal in the process.

In the late 1990s, the three original code development organizations (BOCAI, ICBO, and SBCCI) agreed to merge into a single organization called the International Code Council (ICC) and, in 2000, published a single series of model building codes called the International or I-Codes. The I-Codes are intended to be nationally and internationally applicable and include:

- The *International Building Code* (IBC) that addresses almost all types of buildings including residential, commercial, institutional, government, and industrial structures;
- The *International Residential Code* (IRC) that addresses one- and two-family dwellings; and
- The *International Existing Buildings Code* (IEBC) that addresses existing buildings.

The ICC publishes new editions of these codes every three years (i.e., 2000, 2003, 2006, 2009, 2012). Currently, all 50 states and most U.S. communities have adopted building codes based on the I-Codes. Depending on the state and its specific regulations, some adopt the codes verbatim while others modify or adopt only portions of the model codes. The development and widespread adoption of the I-Codes is beneficial in that it has created a more uniform regulatory environment in which design professionals and contractors need to become familiar with only a single set of requirements regardless of where they are practicing.

## 1.2 Consensus Standards

As the model building codes were evolving, various industries (e.g., concrete, masonry, steel, wood) established professional associations to develop technical criteria for the design and construction of structures using each industry's specialized materials and systems. Eventually, the industry associations began issuing their guidance documents in the form of industry standards developed following rigorous consensus procedures promulgated by the American National Standards Institute (ANSI) and the model code organizations began adopting those documents into their codes by reference. The industry consensus standards typically are revised and updated every five years.

Among the more important consensus standards presently referenced by the building codes are the following:

- *Minimum Design Loads for Buildings and Other Structures*, ASCE/SEI 7, published by the Structural Engineering Institute of the American Society of Civil Engineers;

- *Building Code Requirements for Reinforced Concrete*, ACI 318, published by the American Concrete Institute;
- *National Design Specification*, NDS, published by the American Forest and Paper Association;
- *Specification for Steel Buildings*, AISC 360, published by the American Institute of Steel Construction;
- *North American Specification for the Design of Cold Formed Steel Structural Members*, AISI S100, published by the American Iron and Steel Institute; and
- *Building Code Requirements and Specification for Masonry Structures*, TMS 402/ACI 530/ASCE 5 and TMS 602/ACI 530.1/ASCE 6, jointly published by the Masonry Society, the American Concrete Institute, and the American Society of Civil Engineers.

### 1.3 Code Adoption and Enforcement

Building codes are adopted by state and local governments to protect the health, safety, and welfare of the public by establishing minimum acceptable design and construction requirements intended to provide safe and reliable buildings and structures. These codes affect all aspects of building construction including structural stability, fire resistance, means of egress, ventilation, plumbing and electrical systems, and even energy efficiency. Once adopted by a state or local government, the building code becomes law and is typically enforced by a government official. This official generally is identified as the Chief Building Official but he or she may have another title such as Fire Marshall or Clerk. Collectively, the people empowered to enforce the requirements of a building code are identified in the codes as the Authority Having Jurisdiction (AHJ).

In communities that have adopted a building code, it is illegal to construct a structure unless the AHJ issues a building permit. Before issuing the permit, the AHJ typically will review the design documents to ensure that they were prepared by an appropriately qualified and licensed (generally by the state) professional and that they conform, in a general sense, to the technical requirements of the building code. Once the AHJ is satisfied that a design conforms to the applicable requirements and appropriate fees are paid, the AHJ issues a permit for construction, a document commonly referred to as the “building permit” that generally is posted at the construction site.

During the construction period, the AHJ requires a series of inspections to ensure that the design is being properly executed by the builders. These inspections may



be directly performed by the AHJ or the AHJ's staff, by private individuals or firms with the appropriate qualifications, or by a combination of the two. When an inspection is performed, the conformance of the construction with the design and code requirements is documented by a series of reports and/or by the inspector's signature on the building permit. If an inspector finds that the construction does not conform in some way to the code requirements, the builder must correct this situation before a sign-off is given. Upon completion of construction and submittal of documentation by the builder of evidence that the building has passed all required inspections, the AHJ will issue an "occupancy permit" that allows the structure to be open to the public. If a building is occupied without this permit, the AHJ can require that other law enforcement officials vacate the premises and lock it. Even after an occupancy permit has been issued for a structure, the AHJ can revoke the permit if there is reason to believe that the structure has become unsafe in some way. It is not uncommon for this to occur after a fire, earthquake, hurricane, or other event that causes extreme damage to buildings and structures. This also can occur if a building's occupants allow its various systems to deteriorate to a point at which the structure is no longer safe for use.

## 1.4 The NEHRP and the NEHRP Recommended Seismic Provisions

Even though the largest earthquakes affecting the United States actually occurred in the central states, most 20th century U.S. earthquakes struck in the western states – primarily Alaska, California, and Washington – and most Americans think of earthquakes as a West Coast problem. As a result, the development of seismic requirements for building codes occurred primarily in the western states, notably California. These earthquake design requirements initially were developed by volunteers from the Structural Engineers Association of California (SEAOC) in cooperation with ICBO. These initial requirements appeared as a non-mandatory appendix in the 1927 *Uniform Building Code*. Over the years, as more earthquakes occurred in western states, SEAOC worked with its sister associations in other states, most notably Washington, to refine and improve these regulations and eventually they were moved into the body of the code and became mandatory.

During the early years of seismic code provision development, the principal basis for code changes was observation of the performance of actual buildings in earthquakes. When an earthquake occurred, engineers and building officials would survey the damage and, when certain types of construction performed poorly, they would develop code changes to address the observed problems. Noteworthy code changes resulted after earthquakes that occurred in Long Beach, California,

in 1933; Olympia, Washington, in 1949; Kern County, California, in 1952; and Prince William Sound, Alaska, in 1964. By 1970, many West Coast engineers and building officials believed they had developed a building code capable of providing buildings with superior earthquake performance. However, in 1971, a magnitude 6.6 earthquake occurred in Sylmar, California, a community located in the San Fernando Valley just north of Los Angeles, and resulted in extensive damage to many modern code-conforming structures and the collapse of some such structures.

This earthquake made it clear that the building code needed significant improvement, but the involved engineers and building officials concluded they did not have the resources to address the problem adequately on a volunteer basis. Several things occurred in response to this need. First, SEAOC formed a nonprofit entity – the Applied Technology Council (ATC) – to seek the funding needed to assemble the best available talent to research problems with the building code requirements and to develop recommendations for improving those requirements.

At about the same time, Congress passed the Earthquake Hazards Reduction Act of 1977 (Public Law 95-124) that established the National Earthquake Hazards Reduction Program (NEHRP). Under the NEHRP, four federal agencies – the Federal Emergency Management Agency (FEMA), the National Institute of Standards and Technology (NIST), the National Science Foundation (NSF), and the United States Geological Survey (USGS) – were authorized and provided with dedicated funding to develop effective ways to mitigate earthquake risks to the national economy and the life safety of building occupants. The NEHRP has been reauthorized periodically since that time, and it has funded and continues to support many important initiatives involving basic research and the application of this research in ways that will foster broad-scale mitigation of earthquake risks. Figure 1 identifies some of the many activities conducted under the NEHRP and the agency primarily responsible for each.

Under the NEHRP, the USGS focuses on identification of the level of earthquake hazard throughout the United States. As part of this effort, USGS operates a network of strong-ground-motion instruments that record the effects of earthquakes at sites that range from a few to hundreds of kilometers from the event's geographic origin. These data permit the USGS to identify the likely intensity of future earthquakes throughout the United States and to develop the national seismic hazard maps that serve as the basis for the design maps incorporated into the *NEHRP Recommended Seismic Provisions* and building codes and standards.

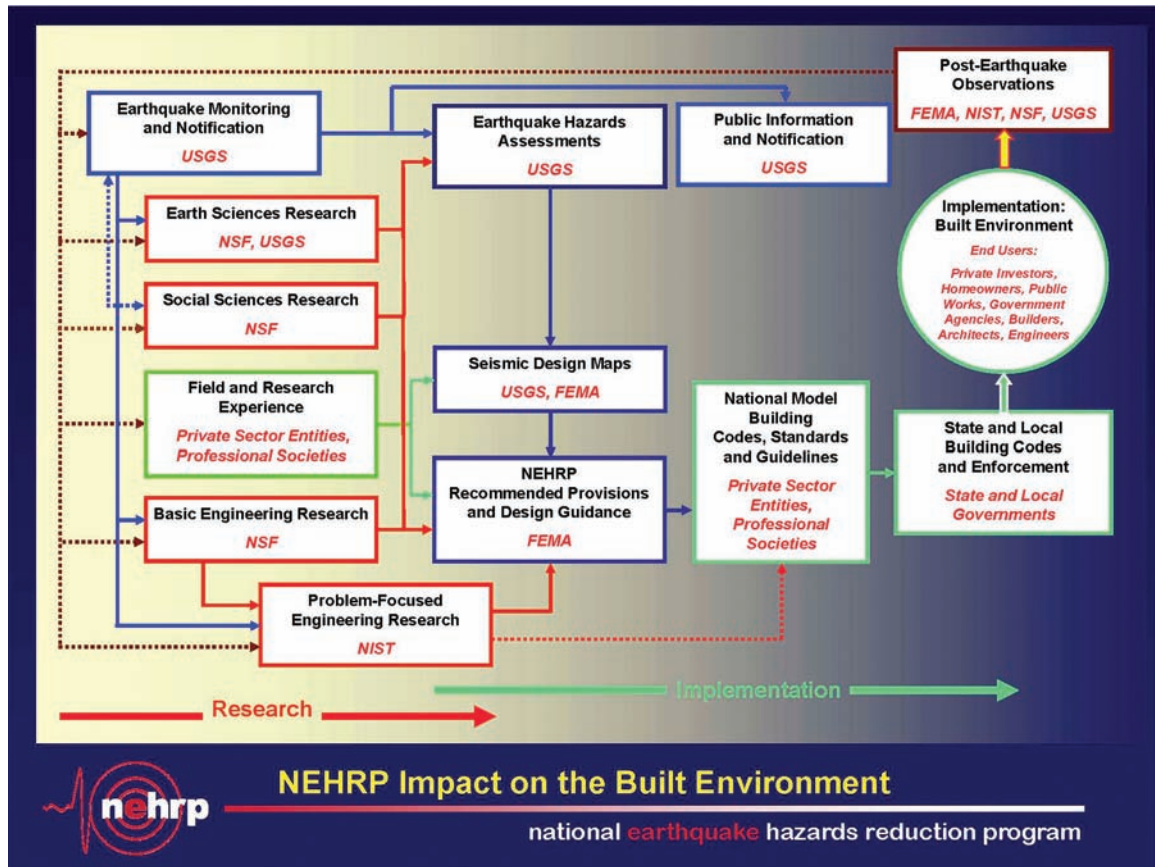

NSF fosters technological leadership by sponsoring basic research and the development of new generations of scientists and engineers. Over the years it has sponsored a broad range of earthquake engineering research including field investigations of damage caused by earthquakes and laboratory and analytical research performed by individual students and their professors. NSF also originally funded national earthquake engineering research centers to conduct fundamental research focused on mitigating U.S. earthquake hazards. Much of this research is reflected in requirements contained in today's building codes. One of the early research programs sponsored by NSF under the NEHRP was the development by ATC of a guidance document containing recommendations for next-generation seismic building code requirements. Published in 1978, this document, *Tentative Provisions for the Development of Seismic Regulations for Buildings*, acknowledged that the new concepts and procedures presented should be evaluated in comparative designs to test their workability, practicability, enforceability, and cost impact before they were considered for code adoption. Later, FEMA took over this initiative and funded the BSSC to conduct this comparative design effort, which resulted in consensus-approved modifications to the original document. These

Figure 1 Examples of how NEHRP-funded basic research and application activities stimulate earthquake risk mitigation (image courtesy of NIST).

amended seismic design procedures then served as the basis for the initial edition of the *NEHRP Recommended Seismic Provisions* and, hence, the procedures reflected in today's building codes.

NIST conducts research and development work and also supports public/private partnerships that perform such work with the goal of improving the technological competitiveness of the United States. It has sponsored and participated in research that led to development of some of the seismic-resistant technologies reflected in the current model building codes. In the 2004 reauthorization of the NEHRP program, NIST was identified as the lead NEHRP agency with responsibility for coordinating the activities of the four NEHRP agencies and for establishing an advisory committee to assess scientific and engineering trends, program effectiveness, and program management.

FEMA provides public and individual assistance after an earthquake disaster occurs, speeding community recovery and minimizing the disaster's impact on the nation as a whole. Under the NEHRP, it sponsors the development of tools and practices that will encourage the development of a more earthquake-resistant nation. It is in this role that, in the early 1980s, FEMA funded the development of a resource document that would serve as the basis for future seismic regulations in building codes. This effort resulted in the 1985 edition of the *NEHRP Recommended Provisions*. As noted above, the first edition of the *Provisions* reflected the results of a series of trial designs conducted to test the ATC report and was presented in a format that could be directly adopted by building codes. FEMA has continued to sponsor regular updating of the *Provisions* since 1985 (initially a new edition was published every three years but now every five years).

The first building code adoption of the *Provisions* occurred in 1992 when both BOCAI and SBCCI adopted seismic provisions in their buildings codes based on the 1991 edition of the *Provisions*. In 1998, the Structural Engineering Institute of the American Society of Civil Engineers adopted the 1997 edition of the *Provisions* almost verbatim into the ASCE/SEI 7 standard. Two years later, the 2000 *International Building Code* also adopted seismic provisions based on the 1997 *Provisions* and, since that time, both the IBC and ASCE/SEI 7 standard have continued to base their seismic design criteria on the recommendations contained in the latest edition of the *Provisions*.

A key step in this process occurred in 1990 when Executive Order 12699, *Seismic Safety of Federal and Federally Assisted or Regulated New Building Construction*, was issued. This executive order required all new federally owned, leased, regulated, or funded structures to be constructed using building codes that contained suitable seismic standards and charged the Interagency Committee on Seismic Safety in Construction (ICSSC) to identify appropriate standards for

seismic safety in building construction. The ICSSC identified the *Provisions* as the appropriate reference standard, thus providing a great incentive for the model code development organizations to adopt the *Provisions* as the basis for their seismic requirements so that new construction involving federal money could use their model building codes.

## Chapter 2

# SEISMIC RISK AND PERFORMANCE

### 2.1 Basic Concepts

Every year, 100,000 or more earthquakes that can be felt by people occur worldwide. These earthquakes range from very small events felt by only a few individuals to great earthquakes that destroy entire cities.<sup>2</sup> The number of lives lost and the amount of economic losses that result from an earthquake depend on the size, depth and location of the earthquake, the intensity of the ground shaking and related effects on the building inventory, and the vulnerability of that building inventory to damage.

Today's design professionals know how to design and construct buildings and other structures that can resist even the most intense earthquake effects with little damage. However, designing structures in this manner can significantly increase their construction cost. Even in the areas of highest earthquake risk in the United States, severe earthquakes occur infrequently, often with 100 or more years between events capable of causing widespread damage. Given that many structures have, on average, useful lives of 50 years, constructing every structure so that it is invulnerable to earthquake damage would not be a wise use of society's resources. Instead, the *NEHRP Recommended Seismic Provisions*, and the building codes and industry standards that reflect the *Provisions* requirements, are based on the concept of "acceptable risk," which involves the establishment of minimum standards that attempt to balance the cost of seismic-resistant construction against the chance of incurring unacceptable losses in future earthquakes.

### 2.2 Acceptable Risk

Defining acceptable risk is difficult because the risk that is acceptable to one person may be unacceptable to many others. Often a person's perception of an acceptable level of risk depends on whether or not the person believes he or she will be personally affected and how much the person is being asked to personally spend to avoid the risk. The *NEHRP Recommended Seismic Provisions* has adopted the following target risks as the minimum acceptable for buildings and structures constructed in the United States:

---

<sup>2</sup>The U.S. Geological Survey website at <http://earthquake.usgs.gov/learning/facts.php> provides an abundance of information on earthquakes and their effects on the built environment. Some of the information presented there is somewhat technical but much of it has been prepared for the general public and parts of the website are designed for children and their teachers.

- A small chance (on the order of 10 percent) that any structure will experience partial or total collapse as a result of the most intense earthquake ground motion considered by the building codes. These very rare and intense earthquake effects are called risk-targeted maximum considered earthquake ( $MCE_R$ ) ground motions and the probability of their occurrence varies across the nation. This collapse-prevention goal is intended as the primary means of ensuring life safety in that most casualties in past earthquakes occurred as a result of structural collapse. Although protection at this level does not guarantee no lives will be lost, it should prevent the loss of tens of thousands of lives in individual earthquake events such as those that occurred in Armenia, China, Haiti, Turkey, and other nations in recent years.
- Limit the chance of collapse (to perhaps 6 percent) as a result of  $MCE_R$  ground shaking for structures intended primarily for public assembly in a single room or area (e.g., theaters or convention centers), for structures with a very large number of occupants (e.g., high-rise office buildings and sports arenas); and for structures housing a moderately large number of people with limited mobility (e.g., prisons) or who society generally regards as particularly vulnerable and important to protect (e.g., school children).
- For structures that contain a large quantity of toxic materials that could pose a substantial risk to the public (e.g., some chemical plants), provide a small probability that structural damage will result in release of those materials.
- Limit the chance of total or partial collapse as a result of  $MCE_R$  ground motions (to approximately 3 percent) for structures deemed essential to emergency response following a natural disaster (e.g., police and fire stations and hospitals) and further limit the chance that earthquake shaking will cause damage to these structures or to their architectural, mechanical, electrical, and plumbing systems sufficient to prevent their post-earthquake use.
- For all structures, minimize the risk that, in likely earthquakes, debris generated by damage to cladding, ceilings, or mechanical or electrical systems will fall on building occupants or pedestrians.
- To the extent practicable, avoid economic losses associated with damage to structural and nonstructural systems as a result of relatively frequent moderate earthquake events.

### 2.3 Geologic Earthquake Effects

The earth's crust is composed of a series of large plates as shown in Figure 2. These "tectonic plates" are constantly being pushed and twisted by forces created by the earth's rotation and the flow of magma within the earth's molten core. At their boundaries, the plates are locked together by friction, which prevents them from moving relative to one another. Over a period of hundreds to thousands

of years, stress builds up along these boundaries. Occasionally, the stress along a plate boundary exceeds the frictional force that locks the plates together or the stress at an internal location in a plate exceeds the strength of the rock itself. When this occurs, the rock fractures or slips at locations of overstress, releasing stored energy and causing an earthquake.

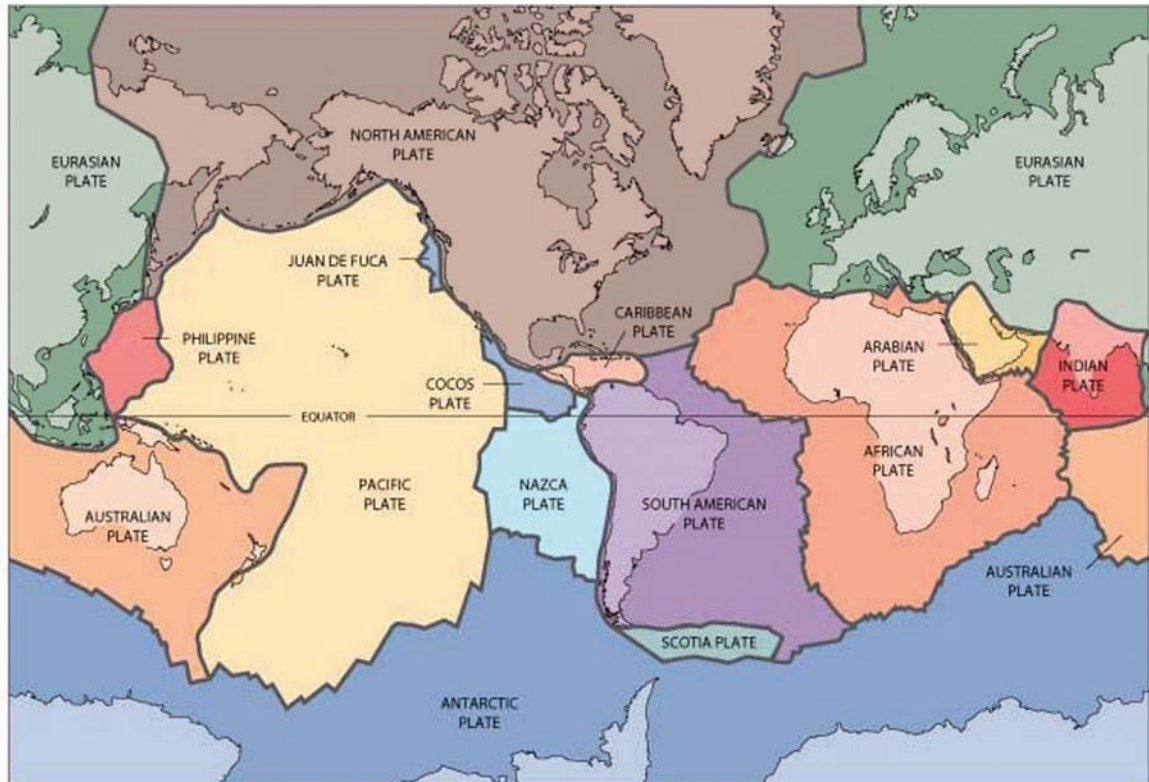

Most earthquakes occur along plate boundaries or in other areas of the earth's surface that have previously slipped in earthquakes. These locations are collectively known as "faults." Faults often concentrate near the plate boundaries but can also occur within the interior of a plate. Future earthquakes are most likely to occur on existing faults; however, stress patterns in the earth shift over time and occasionally new faults are created.

The slippage within the rock during an earthquake can occur near the earth's surface or many kilometers beneath it. When it extends to the surface, it can result in abrupt lateral (Figure 3) and vertical (Figure 4) offsets known as "ground fault ruptures." The forces produced by these ground fault ruptures can be very large, and it is very difficult to design structures for locations where ruptures occur so that they will not be ripped apart. The best defense against damage from ground

Figure 2 Major tectonic plates (courtesy of USGS). For a more complete explanation of plate tectonics, see <http://pubs.usgs.gov/gip/dynamic/dynamic.pdf>



fault rupture is to avoid building over the known trace of an active fault. A fault is considered to be active if there is evidence that it has moved within the past 10,000 years.

Figure 3 Fault movements can break the ground surface, damaging buildings and other structures. This fence near Point Reyes was offset 8 feet ( 2.5 m) when the San Andreas Fault moved in the 1906 San Francisco (magnitude 7.8) earthquake (photo courtesy of USGS).

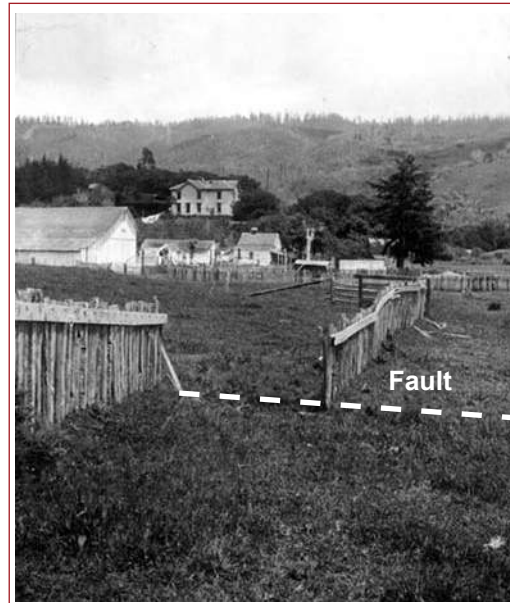

Figure 4 Vertical fault offset in Nevada resulting from the 1954 Dixie Valley earthquake (photo by K. V. Steinbrugge).

The energy released when an earthquake occurs radiates outward in the form of random vibrations in all directions from the area of slippage within the rock. These vibrations are felt on the surface as “ground shaking.” Ground shaking can last from a few seconds in small earthquakes to several minutes in the largest earthquakes, and it causes more than 90 percent of earthquake damage and losses.

In addition to causing direct damage to structures, ground shaking can cause several types of ground failure that also damage structures. Among the most common ground failures caused by earthquakes are landslides. An earthquake-induced landslide typically will occur on a steeply sloping site with loose soils. Earthquake-induced landslides have destroyed buildings and even entire communities in past earthquakes (Figure 5). For example, landslides resulting from the 1964 Prince William Sound earthquake that affected Anchorage, Alaska, destroyed an entire subdivision.



Figure 5 Earthquakes can trigger landslides that damage roads, buildings, pipelines, and other infrastructure. Steeply sloping areas underlain by loose or soft rock are most susceptible to earthquake-induced landslides. The photo on the left shows Government Hill School in Anchorage, Alaska, destroyed as a result of a landslide induced by the 1964 earthquake; the south wing of the building collapsed into a graben at the head of the landslide (photo courtesy of USGS). The home shown on the right was destroyed when the hillside beneath it gave way following the 1994 magnitude 6.7 Northridge earthquake (FEMA photo).

Another significant earthquake-induced ground failure is soil liquefaction. Soil liquefaction can occur when loose saturated sands and silts are strongly shaken. The strong shaking compacts or densifies these materials and, in the process, forces out a portion of the water that saturates them. As the water is pushed out, it flows upward creating a condition in which the soils lose bearing pressure. When soil liquefaction occurs, structures supported on the liquefied soils can sink and settle dramatically and underground structures can float free (Figure 6).



Figure 6 Top photo shows liquefaction-induced settlement of apartment buildings in the 1964 earthquake in Nigata, Japan (photo courtesy of the University of Washington). The bottom photo shows one of many manholes that floated to the surface as a result of soil liquefaction caused by the 2004 Chuetsu earthquake near Nigata, Japan (photo courtesy of Wikimedia Commons).

A ground instability related to liquefaction is lateral spreading. When liquefaction occurs on sites with even a mild slope, surface soils can move downhill, much like a fluid, and carry with them any structures they support. Figure 7 shows damage to pavement on a site that experienced liquefaction and lateral spreading.



Figure 7 Lateral spreading damage to highway pavement near Yellowstone Park resulting from the 1959 Hegben Lake earthquake (photo courtesy of the USGS).

Whether a building will experience any of these earthquake-induced ground failures depends on where it is located relative to potential causative faults, the local geology and types of soil present at the building site, and the site's topography.

### 2.4 Seismic Hazard Analysis

Earthquakes have occurred in nearly every region of the United States and have damaged buildings in all 50 states. Figure 8 is a map of the continental United States showing the locations of earthquakes that occurred between 1750 and 1996. The locations of these earthquakes are shown using symbols that represent the maximum intensity of earthquake effects that were reported for each earthquake based on the Modified Mercalli Intensity (MMI) scale.

The MMI scale ranges from MMI I (earthquakes that are not felt) to MMI XII (earthquakes causing total destruction). Table 1 presents one of several common versions of the MMI scale. It is a qualitative scale based on how people react to the earthquake ground shaking and other effects as well as the damage suffered by typical structures. A quick review of Figure 8 reveals that the largest concentration of earthquakes in the United States has occurred in California and western Nevada but that the most intense earthquakes (represented by red squares) actually occurred elsewhere. Other areas of frequent earthquake activity include the Pacific Northwest; the intermountain region of Utah, Idaho, Wyoming, and Montana; a band that extends along the Mississippi embayment and into the Saint Lawrence Seaway; and a belt that extends along the entire Appalachian Mountain range. Isolated earthquakes have occurred in most other regions of the nation as well.

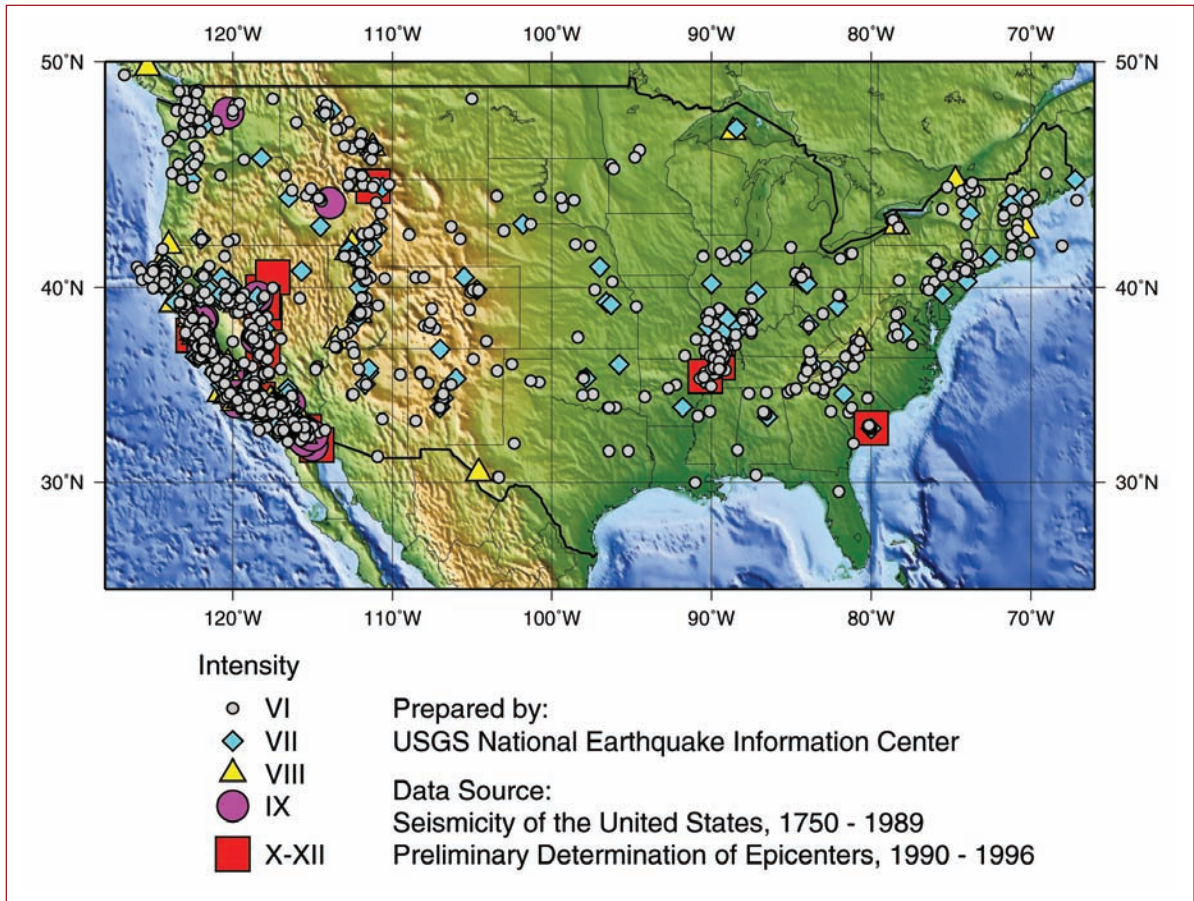

Figure 8 Locations of earthquakes in the continental United States between 1750 and 1996. Although not shown on this map, Alaska, Hawaii, Puerto Rico, and the Marianas also experienced earthquakes during this period.

Table 1 Modified Mercalli Intensity Scale

| Intensity | Description  |
|-----------|--|
| I         | Not felt except by a very few under especially favorable conditions  |
| II        | Felt only by a few persons at rest, especially on upper floors of buildings  |
| III       | Felt quite noticeably by persons indoors, especially on upper floors of buildings. Many people do not recognize it as an earthquake. Standing motor cars may rock slightly. Vibrations similar to the passing of a truck. Duration estimated.                  |
| IV        | Felt indoors by many, outdoors by few during the day. At night, some awakened. Dishes, windows, doors disturbed; walls make cracking sound. Sensation like heavy truck striking building. Standing motor cars rock noticeably.                                 |
| V         | Felt by nearly everyone; many awakened. Some dishes, windows broken. Unstable objects overturned. Pendulum clocks may stop.  |
| VI        | Felt by all, many frightened. Some heavy furniture moved; a few instances of fallen plaster. Damage slight.  |
| VII       | Damage negligible in buildings of good design and construction; slight to moderate in well-built ordinary structures; considerable damage in poorly built or badly designed structures; some chimneys broken.  |
| VIII      | Damage slight in specially designed structures; considerable damage in ordinary substantial buildings with partial collapse. Damage great in poorly built structures. Fall of chimneys, factory stacks, columns, monuments, walls. Heavy furniture overturned. |
| IX        | Damage considerable in specially designed structures; well-designed frame structures thrown out of plumb. Damage great in substantial buildings, with partial collapse. Buildings shifted off foundations.   |
| X         | Some well-built wooden structures destroyed; most masonry and frame structures destroyed with foundations. Rails bent.   |
| XI        | Few, if any (masonry) structures remain standing. Bridges destroyed. Rails bent greatly.   |
| XII       | Damage total. Lines of sight and level are distorted. Objects thrown into the air.   |

In a general sense, the risk of high-intensity earthquake ground shaking in a region is related to the frequency and intensity of earthquakes that affected the region in the past. Most active earthquake faults will produce small earthquakes relatively frequently and large earthquakes less often. If a fault produces a small magnitude earthquake, the intensity of shaking will be slight. As earthquake magnitude increases, so does the maximum intensity of effects produced and the size of the geographic area that experiences these effects. The most intense effects of an earthquake generally occur at sites closest to the area on the fault that produced the earthquake. Sites with hard rock formations near the surface will experience less intense shaking than sites that have loose or soft soils or deep deposits of soils over the rock.

Seismologists, geotechnical engineers, and earth scientists use seismic hazard analysis to quantify the probability that a site will experience high-intensity ground shaking. Although it is not possible to predict the specific size, location or time of future earthquakes with any certainty, these specialists use data on the past activity rate for a fault, as well as information on its length and how quickly stress builds up in the rock along the fault, to determine the probability that the fault will produce future earthquakes of various sizes. The mathematical relationships used to express these probabilities are called “recurrence relationships.”

In addition, earth scientists and geotechnical engineers use data on the intensity of motion that was experienced at sites with known soil types and at known distances from past earthquakes to develop ground motion prediction equations (GMPEs) that indicate the likely intensity of motion at a site if an earthquake of a specific size and at a specific distance from a site occurs. Using the recurrence equations for individual faults and the GMPEs, these earth scientists and engineers develop mathematical relationships that indicate the probability of different intensities of ground shaking occurring at specific sites.

Because the MMI scale referred to above is a qualitative measure of earthquake intensity, it is not directly useful for structural design. Instead structural engineers quantify earthquake intensity using a mathematical relationship known as an “acceleration response spectrum.” An acceleration response spectrum is a curve that shows the peak acceleration that different structures with different dynamic properties would experience if subjected to a specific earthquake motion. Figure 9 is a representative acceleration response spectrum obtained from a recording of the 1940 earthquake in Imperial Valley, California. The horizontal axis is structural period, a measure of the dynamic properties of structures. If a structure is pushed to the side by a lateral force (e.g., a strong gust of wind) and then released, it will vibrate back and forth. A structure’s “period” is the amount of time, in seconds, that a structure will take to undergo one complete cycle of free vibration. Tall structures like high-rise buildings tend to have natural periods on the order of



several seconds while short buildings have natural periods of a few tenths of a second. Structural engineers use the symbol  $T$  to denote the period of a structure.

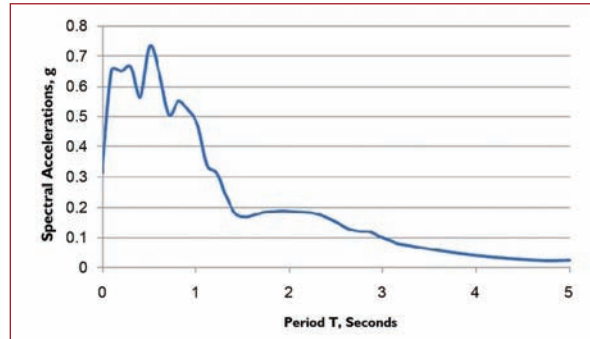

Figure 9 Acceleration response spectrum for the 1940 Imperial Valley earthquake, north-south component.

The vertical axis of the acceleration response spectrum is the acceleration that a structure will experience depending upon its period. “Spectral acceleration,” that is, the acceleration derived from a response spectrum, is designated  $S_a$  and is usually calculated in units of the acceleration due to gravity,  $g$ . This plot indicates that tall structures with long natural periods of about 3 seconds or more would experience relatively slight accelerations (0.1g or less) when subjected to this earthquake while short structures with periods of 1 second or less would experience accelerations of approximately 0.7g.

The acceleration response spectrum will be different at each site and for each earthquake. Factors that affect the shape and amplitude of the spectra include the earthquake’s magnitude, depth, distance from the site, and the types of soil present. Ground shaking at each site and in each earthquake is unique. To facilitate representation of these complex phenomena, building codes specify the use of smoothed spectra similar to that shown in Figure 10.

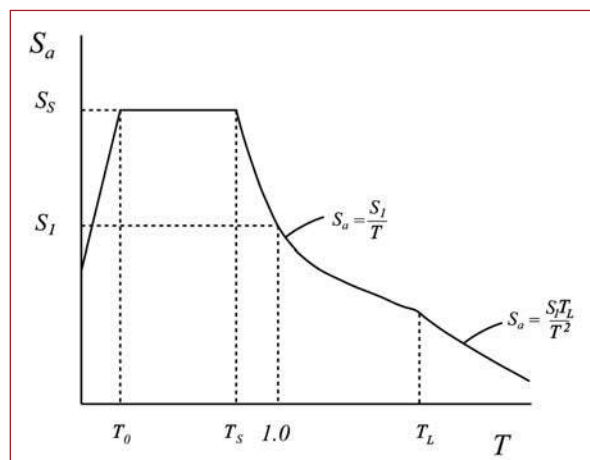

Figure 10 Generalized shape of smoothed response spectrum.

The generalized smoothed response spectrum shown in Figure 10 can be derived for any site in the United States based on three parameters:

- The spectral response acceleration at short periods,  $S_s$ ,
- The spectral response acceleration at 1-second period,  $S_1$ , and
- The long-period transition period,  $T_L$ .

The U.S. Geologic Survey (USGS) has performed a national seismic hazard analysis to determine the values of the  $S_s$ , and  $S_1$  parameters for different recurrence intervals (probabilities of exceedance) on a Cartesian grid with 2 kilometer spacing. The results of this analysis are reflected in the 2009 *NEHRP Recommended Seismic Provisions*.

For a given set of geographic coordinates expressed by longitude and latitude, it is possible using software developed by the USGS to display a plot of any of these three acceleration parameters as a function of annual frequency of exceedance. Figure 11 is one such plot showing the annual frequency of exceedance for the  $S_s$  parameter for a site located in Berkeley, California. Such plots are known as hazard curves.

In Figure 11, the vertical axis is the “annual frequency of exceedance” for  $S_s$  or, in other words, the number of times in any one year that, on average, the specific site can experience ground shaking greater than or equal to that shown on the horizontal axis. The average return period is the number of years likely to elapse between two events, each producing ground shaking of at least the level indicated on the horizontal axis. It is equal to the inverse of the annual frequency of exceedance (i.e., 1 divided by the annual frequency). For example, Figure 11 indicates that for this particular site, ground shaking producing a short-period spectral acceleration with a value of 0.7g has an annual frequency of exceedance of  $10^{-2}$  per year, which is equivalent to an average return period of 100 years. At an annual frequency of exceedance of  $10^{-3}$  (return period of 1,000 years), one would expect shaking producing a short-period response acceleration ( $S_s$ ) value of 2.1g and, at an annual frequency of exceedance of  $10^{-4}$  (return period of 10,000 years), of 3.7g.

All hazard curves take the approximate form of Figure 11. This form indicates that low-intensity earthquakes producing low accelerations occur relatively frequently while high-intensity earthquakes producing large highly damaging accelerations occur rarely.

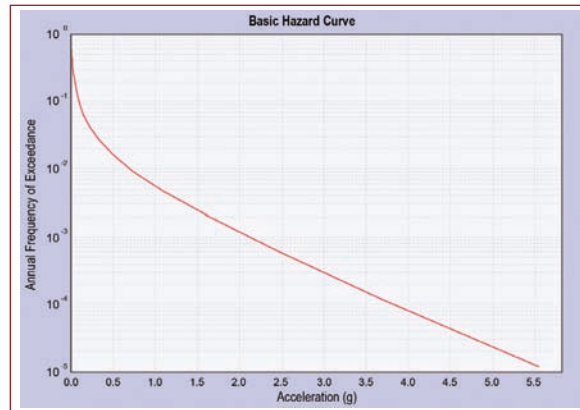

Figure 11 Hazard curve for spectral acceleration at a site in Berkeley, California.

## 2.5 Maximum Considered Earthquake Shaking

If subjected to sufficiently strong ground shaking, any structure will collapse. The goal of the *Provisions* is to provide assurance that the risk of structural collapse is acceptably small, while considering that there are costs associated with designing and constructing structures to be collapse-resistant. The *Provisions* defines a reference earthquake shaking level, termed risk-targeted maximum considered earthquake shaking ( $MCE_R$ ), and seeks to provide a small probability (on the order of 10 percent or less) that structures with ordinary occupancies will collapse when subjected to such shaking. The acceptable collapse risk for structures that house large numbers of persons or that fulfill important societal functions is set lower than this and additional objectives associated with maintaining post-earthquake occupancy and functionality are added. This section describes how  $MCE_R$  shaking is determined under the *Provisions*.

There is no single unique ground shaking acceleration that will cause the collapse of a particular structure. In part, this is because the ground motion actually experienced at each site, in each earthquake, and in each direction is unique and unpredictable. Consider the 1940 Imperial Valley earthquake for which a response spectrum was shown in Figure 9. Two ground motion recording instruments captured the ground shaking from that earthquake at that particular site in El Centro, California. These instruments were oriented so that one recorded ground accelerations in the north-south direction and the other in the east-west direction. Figure 12 plots the acceleration response spectra for the motions recorded by these two instruments.

As Figure 12 shows, for this earthquake and for this site, structures with a natural period of about 1 second or less would be more strongly affected by shaking in the north-south direction than by shaking in the east-west direction. Although north-south shaking for this earthquake and this site was generally stronger than east-west shaking, the north-south direction of shaking was not necessarily the most severe direction. The most severe shaking may have occurred at some other orientation. The peaks and valleys in the spectra for the two directions of shaking also are somewhat different, meaning that each of these two directions of shaking would affect structures somewhat differently and shaking in other orientations also would affect structures differently. Both spectra are for a single earthquake and a single site. The same earthquake produced ground shaking with different spectra at other sites and other earthquakes at this site would likely produce spectra different from those shown. Thus, it is impossible to precisely predict either the acceleration spectra that will occur at a site in future earthquakes or what ground acceleration will cause a structure to collapse. In addition to the randomness of ground motions, other factors that make precise collapse predictions impossible include variability in the strength of construction materials and quality of workmanship as well as inaccuracies in the models that engineers use to assess structural response to earthquakes.

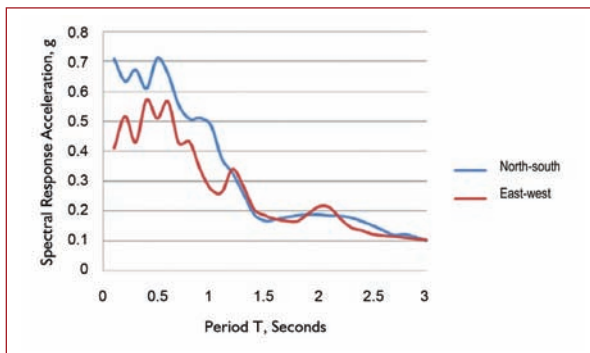

Figure 12 1940 Imperial Valley earthquake north-south and east-west spectra.

It is possible, however, to develop a probabilistic estimate of the acceleration that will cause collapse of a structure. These probabilistic estimates are called “fragility functions.” Figure 13 presents a plot of a typical structural fragility function. The horizontal axis is the spectral response acceleration of earthquake shaking while the vertical axis is the probability of collapse if the structure experiences ground motion having that spectral response acceleration. For the hypothetical structure represented by this fragility curve, there is approximately a 20 percent chance that the structure will collapse if subjected to ground shaking with a spectral response acceleration at its fundamental period of 0.5g, a 50 percent chance that it will collapse if subjected to ground shaking with a spectral response acceleration at its fundamental period of 0.8g, and a near certainty that the structure will col-

lapse if it experiences ground shaking producing spectral response accelerations at its fundamental period in excess of about 2.5g. Fragility functions such as this are assumed to conform to a mathematical relationship known as a lognormal distribution. Such functions are completely defined by two parameters: the probability of collapse at a particular value of the spectral acceleration and the dispersion, which is a measure of the uncertainty (width of the curve) associated with collapse vulnerability assessment.

The risk that a structure will collapse is a product of its fragility (Figure 13) and the seismic hazard at its site represented in the form of a hazard curve like that in Figure 11. By mathematically combining the two functions (fragility and hazard), it is possible to calculate the probability that a structure will collapse in any given year or number of years (for seismic mapping, the period of time considered is usually 50 years). For ordinary structures, the *NEHRP Recommended Seismic Provisions* seeks to provide a probability of 1 percent or less in 50 years that a structure will experience earthquake-induced collapse.

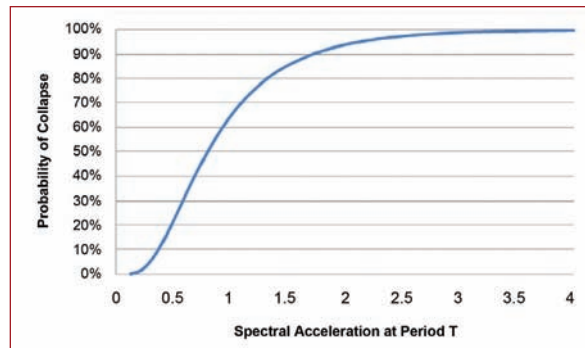

Figure 13 Collapse fragility curve for a hypothetical structure.

In order to determine the return period for  $MCE_R$  shaking at a particular site that will achieve this target risk, the *Provisions* uses an iterative process in which:

- A trial return period for  $MCE_R$  shaking is selected;
- The spectral response acceleration at this return period for the site, assuming reference soil conditions, is determined from the site's hazard curve;
- A standard structural fragility function having a 10 percent probability of collapse at this spectral response acceleration and a dispersion of 0.6 is constructed; and
- The hazard and fragility curves are integrated to produce an annual collapse probability, which is then converted to a 50-year collapse probability.

If the collapse probability determined in this manner is 1 percent in 50 years, the trial return period for  $MCE_R$  shaking was appropriate. If the computed collapse probability was more than 1 percent in 50 years, this indicates that the trial return

period was too short, and a new, longer return period must be selected and the process is repeated. If the computed collapse probability is less than 1 percent in 50 years, the trial return period was too long, and a new, shorter return period is selected. This process is repeated until the return period results in a 1 percent in 50 year collapse probability. This return period defines the  $MCE_R$  shaking probability. Once this is known, seismic hazard analysis can be used to define the spectral response acceleration values at various periods, typically 0.3 seconds and 1.0 second.

Using this process, the USGS determined hazard curves and  $MCE_R$  shaking parameters  $S_s$  and  $S_l$  for sites having reference soil conditions on a 2 kilometer by 2 kilometer grid across the United States. At most sites in the United States, the  $MCE_R$  shaking defined by these parameters generally has a mean recurrence interval of approximately 2,500 years. At sites where earthquakes occur relatively frequently like some in California, the recurrence interval is somewhat shorter than this; at sites that rarely experience earthquakes, the recurrence interval may be somewhat longer.

In some regions of the country with major active faults that are capable of producing large-magnitude earthquakes frequently (on the order of every few hundred to perhaps one thousand years), the above process would yield earthquake ground motions so severe that it is not practicable to design most structures to withstand them. These large motions are driven in part by statistics rather than by physical data and, in fact, the mapped shaking parameters at some sites in these regions are so large that they exceed the strongest ground shaking that has ever been recorded. In these regions, a deterministic estimate of the ground shaking that would occur at these sites if the nearby fault produced a maximum magnitude event is used in place of the risk-based shaking. By doing this, the *NEHRP Recommended Seismic Provisions* allows for a somewhat higher risk for structures that are constructed very close to these major active faults. The USGS has produced a series of composite maps that include either the risk-targeted ground shaking parameters or the ground shaking parameters for a maximum magnitude earthquake, whichever controls. These maps are referenced in the building codes and standards as the basis for determining design ground shaking for individual buildings.

Figures 14 and 15 present maps for the continental United States that show the values of the  $S_s$  and  $S_l$  coefficients developed by the USGS and recommended by the *Provisions* for use in determining design ground motions in the United States. These  $S_s$  and  $S_l$  coefficients represent, respectively, the lesser of the spectral response acceleration for  $MCE_R$  shaking or the deterministic shaking, whichever controls as specified in more detail in the *Provisions*. See Chapter 5 for a more simple depiction of the seismic risk in the United States and its territories that reflects the maps approved for inclusion in the 2012 edition of the *International Residential Code*.

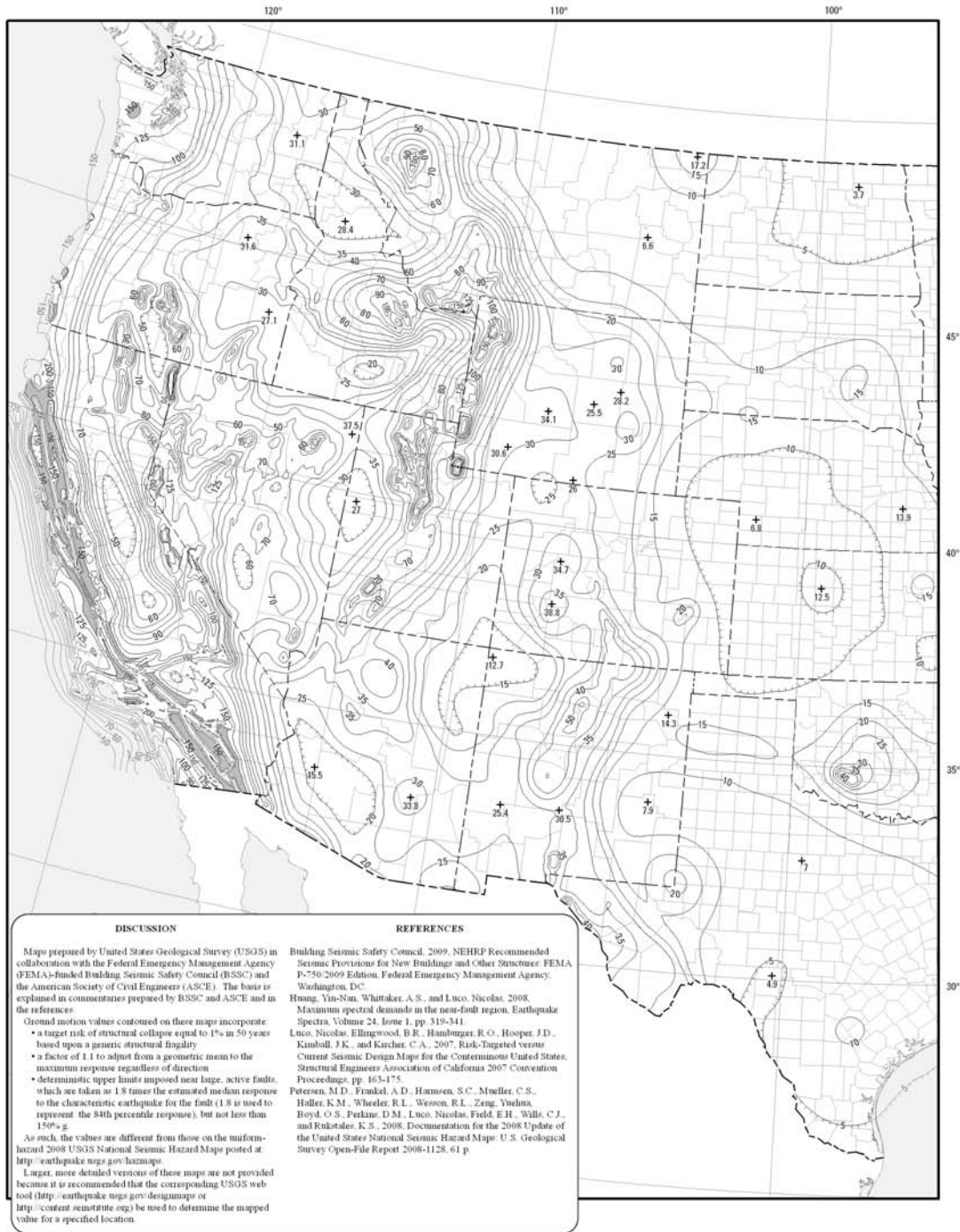
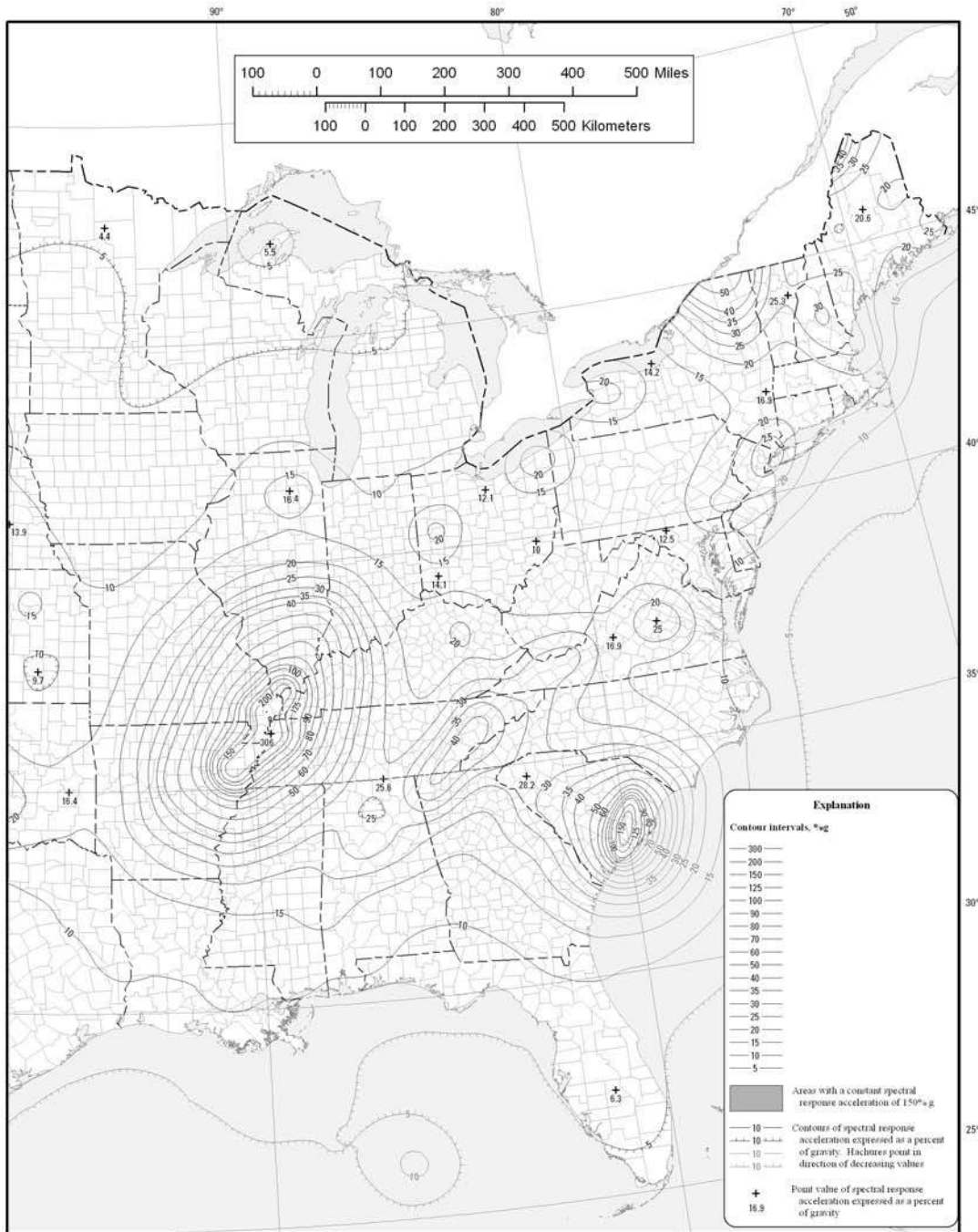

Figure 14 Distribution of short-period risk-targeted maximum considered earthquake response acceleration,  $S_s$ , for the coterminous United States.





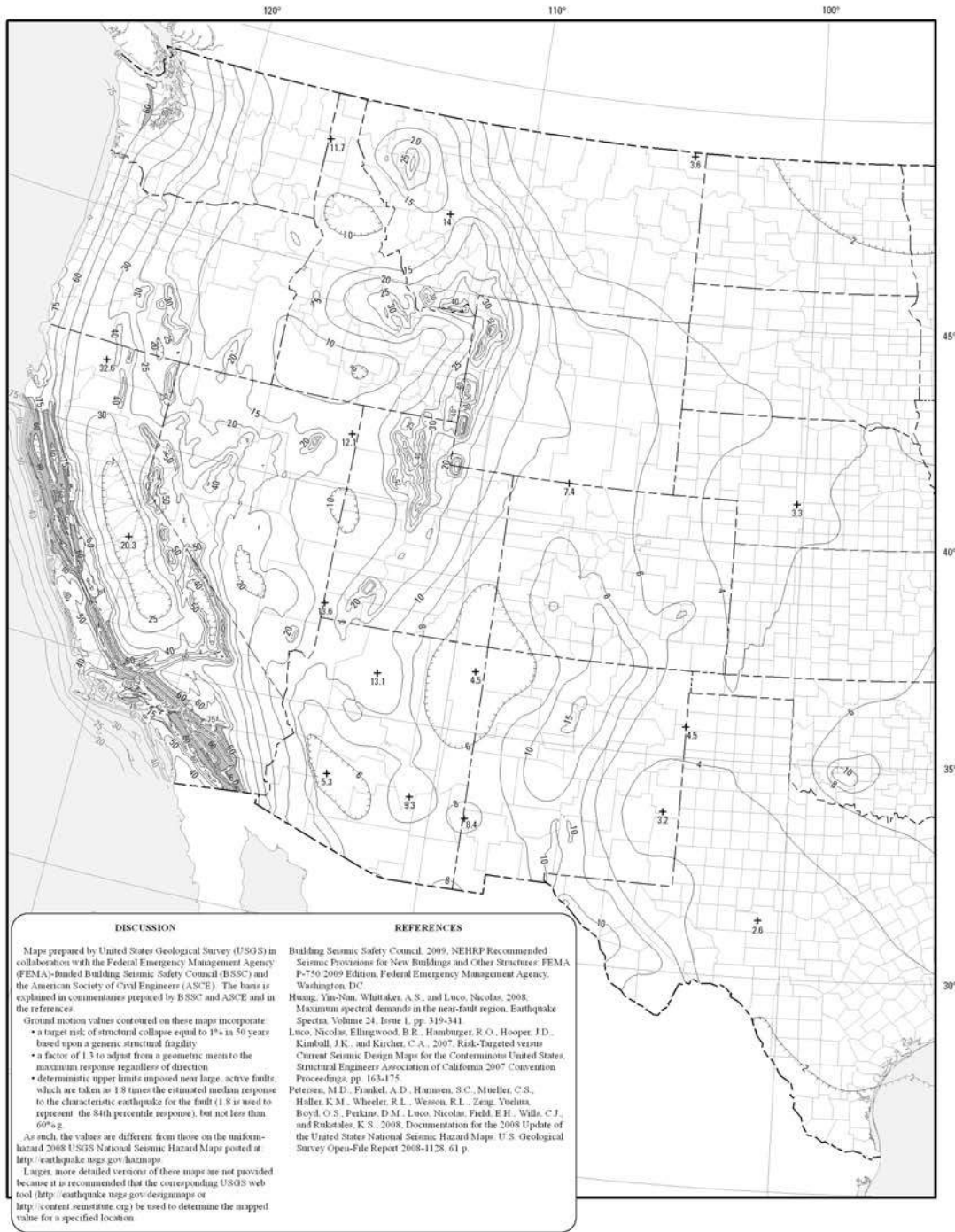
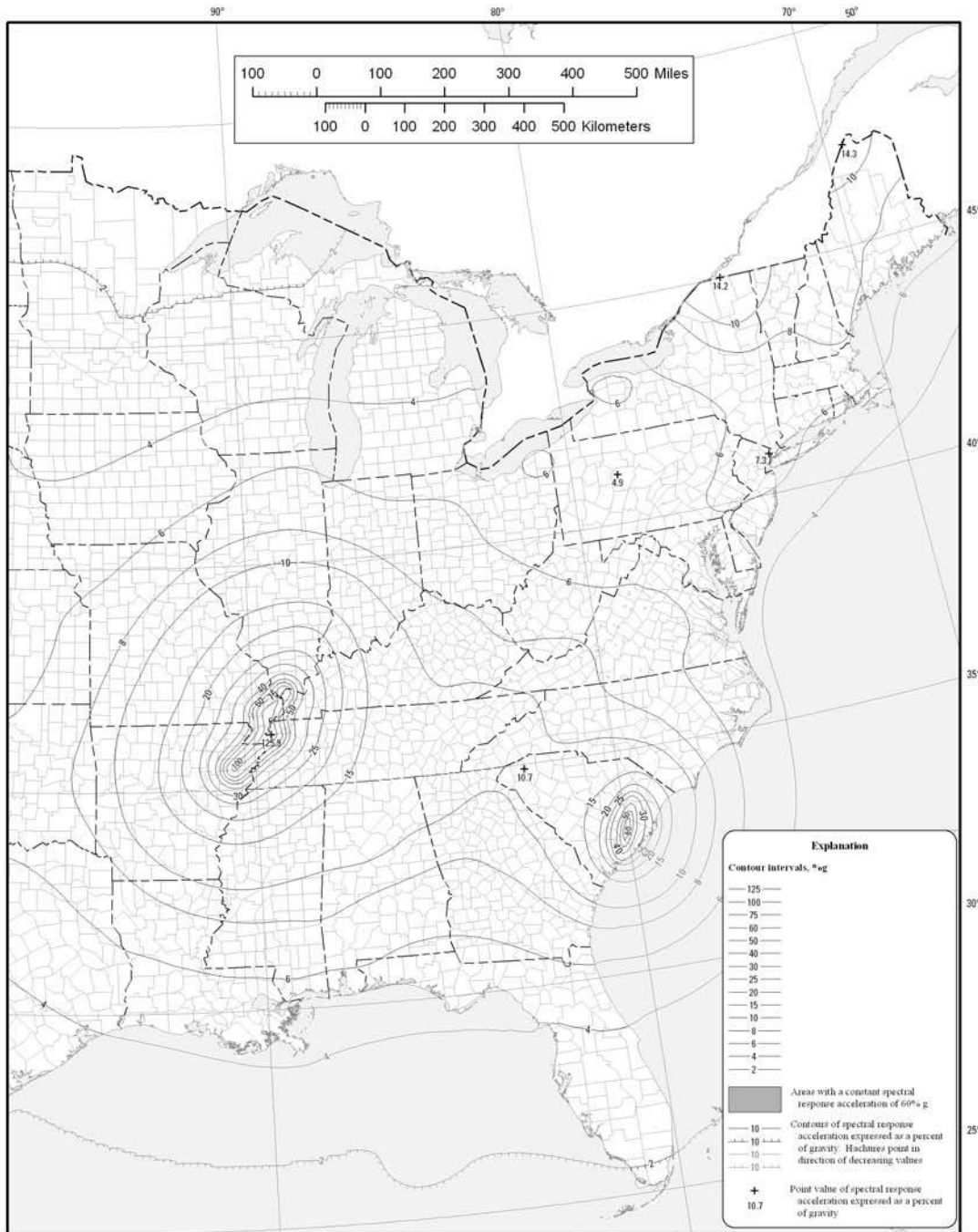

Figure 15 Distribution of 1-second period risk-targeted maximum considered earthquake response acceleration,  $S_1$ , for the conterminous United States.



## Chapter 3

# DESIGN AND CONSTRUCTION FEATURES IMPORTANT TO SEISMIC PERFORMANCE

To satisfy the performance goals of the *NEHRP Recommended Seismic Provisions*, a number of characteristics are important to the design of buildings and structures to ensure that they will behave adequately in strong earthquakes. These include:

- Stable foundations,
- Continuous load paths,
- Adequate stiffness and strength,
- Regularity,
- Redundancy,
- Ductility and toughness, and
- Ruggedness.

In areas of highest seismic risk (i.e., where the strongest earthquakes may occur) and for the most important structures in those areas, the *Provisions* requires inclusion of all of these features in the design and construction of buildings and other structures. In areas of lower seismic risk and for less important structures, the *Provisions* permits some of these features to be neglected if the structures are designed stronger. This chapter presents a brief overview of these important features of seismic design.

### 3.1 Stable Foundations

In addition to being able to support a structure's weight without excessive settlement, the foundation system must be able to resist earthquake-induced overturning forces and be capable of transferring large lateral forces between the structure and the ground. Foundation systems also must be capable of resisting both transient and permanent ground deformations without inducing excessively large displacements in the supported structures. On sites that are subject to liquefaction or lateral spreading, it is important to provide vertical bearing support for the foundations beneath the liquefiable layers of soil. This often will require deep foundations with drilled shafts or driven piles. Because surface soils can undergo large lateral displacements during strong ground shaking, it is important to tie together the individual foundation elements supporting a structure so that the struc-

ture is not torn apart by the differential ground displacements. A continuous mat is an effective foundation system to resist such displacements. When individual pier or spread footing foundations are used, it is important to provide reinforced concrete grade beams between the individual foundations so that the foundations move as an integral unit.

### 3.2 Continuous Load Path

It is very important that all parts of a building or structure, including nonstructural components, be tied together to provide a continuous path that will transfer the inertial forces resulting from ground shaking from the point of origination to the ground. If all the components of a building or structure are not tied together in this manner, the individual pieces will move independently and can pull apart, allowing partial or total collapse to occur. Figure 16 shows the near total collapse of a concrete tilt-up structure near Los Angeles that occurred in the 1971 San Fernando earthquake. This collapse occurred because the exterior concrete walls, which supported the structure's wood-framed roof, were not adequately connected to the roof; under the influence of strong shaking, the walls pulled away, allowing both the walls and roof to collapse. Figure 17 shows houses in Watsonville, California, that were not connected to their foundations and, as a result, fell off their foundations during strong shaking from the 1989 Loma Prieta earthquake. If structures are properly tied together to provide a continuous load path, damage like this can be avoided.



Figure 16 Collapse of a tilt-up building in the 1971 San Fernando earthquake (photo by P. Yaney).



Figure 17 Houses in Watsonville, California, that fell off their foundations in the 1989 Loma Prieta earthquake.

### 3.3 Adequate Stiffness and Strength

Strong earthquake shaking will induce both vertical and lateral forces in a structure. The lateral forces that tend to move structures horizontally have proven to be particularly damaging. If a structure has inadequate lateral stiffness or strength, these lateral forces can produce large horizontal displacements in the structure and potentially cause instability. Figure 18 shows large permanent deformation in the first story of a four-story apartment building in the Marina District of San Francisco, California, damaged by the 1989 Loma Prieta earthquake. Greater strength and stiffness at the first story would have prevented this damage.



Figure 18 First story of an apartment building in San Francisco, California, leaning to the side after the 1989 Loma Prieta earthquake.

### 3.4 Regularity

A structure is “regular” if the distribution of its mass, strength, and stiffness is such that it will sway in a uniform manner when subjected to ground shaking – that is, the lateral movement in each story and on each side of the structure will be about the same. Regular structures tend to dissipate the earthquake’s energy uniformly throughout the structure, resulting in relatively light but well-distributed damage. In an irregular structure, however, the damage can be concentrated in one or a few locations, resulting in extreme local damage and a loss of the structure’s ability to survive the shaking. Figure 19 shows the Imperial County Services Building in El Centro, California, an irregular structure that was damaged by the 1979 Imperial Valley earthquake.

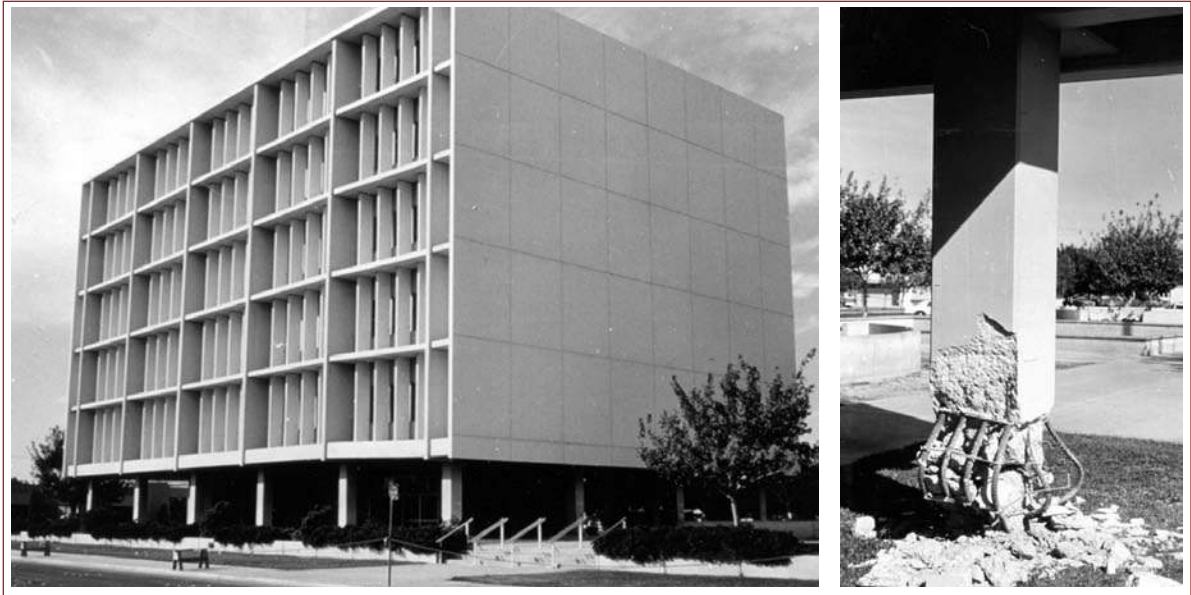

This six-story structure had several types of irregularity including end shear walls that stopped below the second floor and a first story with less strength and stiffness than the stories above. As a result, earthquake energy dissipation and damage were concentrated in the first story columns, a condition that could not be repaired and required demolition of the building after the earthquake. In a more severe earthquake, this type of damage could have caused the building to collapse.

Figure 19 Imperial County Services Building, El Centro, California (photocourtesy of USGS). The photo on the right shows the crushed columns at the base of the building.

### 3.5 Redundancy

As noted above, for economic reasons the *NEHRP Recommended Seismic Provisions* reflects a design philosophy that anticipates damage to buildings and other structures as a result of strong earthquake shaking. If all of a structure's strength and resistance is concentrated in only one or a few elements, the structure will not have any residual strength if these elements are seriously damaged and it could collapse. If a structure is redundant, a relatively large number of elements participate in providing a structure's strength and, if only a few are badly damaged, the remaining elements may have adequate residual strength to prevent collapse. This can be thought of as not putting all of your earthquake-resistant eggs in one basket.

### 3.6 Ductility and Toughness

Ductility and toughness are structural properties that relate to the ability of a structural element to sustain damage when overloaded while continuing to carry load without failure. These are extremely important properties for structures designed to sustain damage without collapse.

Most structural elements are designed to provide sufficient strength to support anticipated loads without failure and enough stiffness so that they will not deflect excessively under these loads. If such an element is subjected to a load substantially larger than it was designed to carry, it may fail in an abrupt manner, losing load-carrying capacity and allowing the structure to collapse. Masonry and concrete, for example, will crush when overloaded in compression and will crack and pull apart when placed in tension or shear. Wood will crush when overloaded in compression, will split when overloaded in shear, and will break when overloaded in tension. Steel will buckle if overloaded in compression and will twist when loaded in bending if not properly braced but will yield when overloaded in tension. When steel yields, it stretches a great deal while continuing to carry load, and this property allows it to be used in structures of all types to provide them with ductility and toughness. Figure 20 shows the failure of an unreinforced masonry wall in a building in Santa Cruz, California, in the 1989 Loma Prieta earthquake. Such buildings, having no steel reinforcement in the masonry, are not very ductile or tough and frequently collapse in earthquakes.

In masonry and concrete structures, steel is used in the form of reinforcing bars that are placed integrally with the masonry and concrete. When reinforced masonry and concrete elements are loaded in bending or shear, the steel reinforcing bars will yield in tension and continue to carry load, thus protecting the masonry and concrete from failure. In wood structures, steel fasteners (typically nails, bolts, and straps) bind the pieces of wood together. When the wood is loaded in shear or bending, these steel connectors yield and protect the wood from splitting and crushing. In steel structures, ductility is achieved by proportioning the structural members with sufficient thickness to prevent local buckling, by bracing the members to prevent them from twisting, and by joining the members together using connections that are stronger than the members themselves so the structure does not pull apart. In structures of all types, ductility and toughness are achieved by proportioning the structure so that some members can yield to protect the rest of the structure from damage.

The measures used to achieve ductility and toughness in structural elements are unique to each construction material and to each type of structural system. The building codes specify the measures to use to provide ductility and toughness



through reference to the various materials industry design standards (e.g., ACI 318, AISC 341, TMS 402), each of which contain detailed requirements for obtaining structural ductility.



Figure 20 Failure of an unreinforced masonry wall in a building in Santa Cruz, California, in the 1989 Loma Prieta earthquake.

### 3.7 Ruggedness

Ruggedness is a property of some mechanical and electrical equipment and other nonstructural building components that permits these items to remain functional after experiencing strong shaking. A rugged piece of equipment will have adequate structural strength and will be composed of components that do not lose their ability to properly perform their intended functions when shaken. For example, some types of electrical control equipment employ mercury type switches to activate certain operations. In strong shaking, the mercury, being liquid, can flow and trigger electrical shutdowns. Such equipment would not be considered rugged as opposed to equipment with mechanical or solid state switches. Similarly, some computer equipment is intentionally constructed with slide-out boards and cards. If these boards or cards can be dislodged by shaking and fall out of the equipment, the equipment would not be considered rugged unless the cards were provided with locking mechanisms that would prevent them from becoming dislodged during shaking. Ruggedness of equipment usually can be demonstrated only by subjecting the equipment to shaking, either in a real earthquake or using special laboratory devices (called shake tables) that simulate the shaking induced by earthquakes.

## Chapter 4

# BUILDINGS, STRUCTURES, AND NONSTRUCTURAL COMPONENTS

The *NEHRP Recommended Seismic Provisions* includes seismic design and construction requirements for a wide range of buildings and structures and their nonstructural components. This chapter presents an overview of those different types of buildings, structures, and nonstructural components.

### 4.1 Buildings

Generally, a building can be defined as an enclosed structure intended for human occupancy. However, a building includes the structure itself and nonstructural components (e.g., cladding, roofing, interior walls and ceilings, HVAC systems, electrical systems) permanently attached to and supported by the structure. The scope of the *Provisions* provides recommended seismic design criteria for all buildings except detached one- and two-family dwellings located in zones of relatively low seismic activity and agricultural structures (e.g., barns and storage sheds) that are only intended to have incidental human occupancy. The *Provisions* also specifies seismic design criteria for nonstructural components in buildings that can be subjected to intense levels of ground shaking.

#### 4.1.1 Structural Systems

Over many years, engineers have observed that some structural systems perform better in earthquakes than others. Based on these observations, the *Provisions* design criteria for building structures are based on the structural system used. Structural systems are categorized based on the material of construction (e.g., concrete, masonry, steel, or wood), by the way in which lateral forces induced by earthquake shaking are resisted by the structure (e.g., by walls or frames), and by the relative quality of seismic-resistant design and detailing provided.

The *Provisions* recognizes six broad categories of structural system:

- Bearing wall systems,
- Building frame systems,
- Moment-resisting frame systems,

## EARTHQUAKE-RESISTANT DESIGN CONCEPTS

---

- Dual systems,
- Cantilever column systems, and
- Systems not specifically designed for seismic resistance.

In bearing wall systems, structural walls located throughout the structure provide the primary vertical support for the building's weight and that of its contents as well as the building's lateral resistance. Bearing wall buildings are commonly used for residential construction, warehouses, and low-rise commercial buildings of concrete, masonry, and wood construction. Figures 21, 22, and 23 show typical bearing wall buildings.

Figure 21 Wood studs and structural panel sheathing of typical wood frame bearing wall construction.



Figure 22 Typical low-rise concrete bearing wall building.





Figure 23 A three-story masonry bearing wall building.

Building frames are a common structural system for buildings constructed of structural steel and concrete. In building frame structures, the building's weight is typically carried by vertical elements called columns and horizontal elements called beams. Lateral resistance is provided either by diagonal steel members (termed braces) that extend between the beams and columns to provide horizontal rigidity or by concrete, masonry, or timber shear walls that provide lateral resistance but do not carry the structure's weight. In some building frame structures, the diagonal braces or walls form an inherent and evident part of the building design as is the case for the high-rise building in San Francisco shown in Figure 24. In most buildings, the braces or walls may be hidden behind exterior cladding or interior partitions.

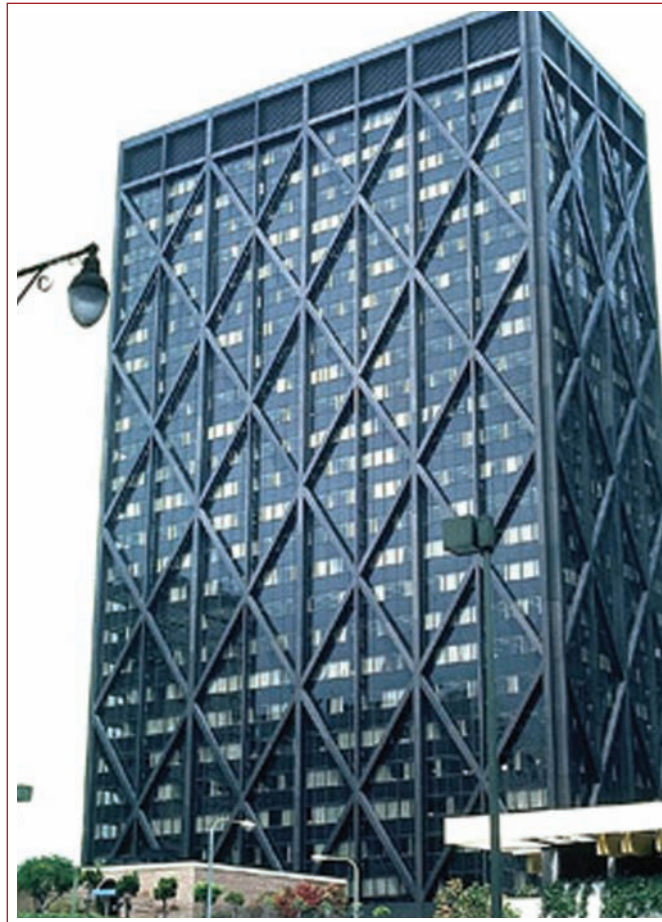

Figure 24 A high-rise braced frame building in San Francisco, California.

Moment-resisting frame systems are commonly used for both structural steel and reinforced concrete construction. In this form of construction, the horizontal beams and vertical columns provide both support for the structure's weight and the strength and stiffness needed to resist lateral forces. Stiffness and strength are achieved through the use of rigid connections between the beams and columns that prevent these elements from rotating relative to one another. Although somewhat more expensive to construct than bearing wall and braced frame structural systems, moment-resisting frame systems are popular because they do not require braced frames or structural walls, therefore permitting large open spaces and facades with many unobstructed window openings. Figure 25 shows a steel moment-resisting frame building under construction.

Dual systems, an economical alternative to moment-resisting frames, are commonly used for tall buildings. Dual system structures feature a combination of moment-resisting frames and concrete, masonry, or steel walls or steel braced

frames. The moment-resisting frames provide vertical support for the structure's weight and a portion of the structure's lateral resistance while most of the lateral resistance is provided either by concrete, masonry, or steel walls or by steel braced frames. Some dual systems are also called frame-shear wall interactive systems.

Cantilever column systems are sometimes used for single-story structures or in the top story of multistory structures. In these structures, the columns cantilever upward from their base where they are restrained from rotation. The columns provide both vertical support of the building's weight and lateral resistance to earthquake forces. Structures using this system have performed poorly in past earthquakes and severe restrictions are placed on its use in zones of high seismic activity.

In regions of relatively low seismic risk, the *NEHRP Recommended Seismic Provisions* permits the design and construction of structural steel buildings that do not specifically conform to any of the above system types. These buildings are referred to as "structures not specifically detailed for seismic resistance."



Figure 25 A tall steel moment-frame structure under construction.

In addition to these basic structural systems and the primary materials of construction, the *Provisions* also categorizes structural systems based on the quality and extent of seismic-resistant detailing used in a structure's design. Systems that employ extensive measures to provide for superior seismic resistance are termed "special" systems while systems that do not have such extensive design features are typically called "ordinary" systems. The *Provisions* also includes design rules for structural systems intended to provide seismic resistance that is superior to that of "ordinary" systems but not as good as that of "special" systems; these systems are called "intermediate" systems.

### 4.1.2 Nonstructural Components

In addition to the structural framing and the floor and roof systems, buildings include many components and systems that are not structural in nature but that can be damaged by earthquake effects. The types of nonstructural components covered by the *NEHRP Recommended Seismic Provisions* include:

- Architectural features such as exterior cladding and glazing, ornamentation, ceilings, interior partitions, and stairs;
- Mechanical components and systems including air conditioning equipment, ducts, elevators, escalators, pumps, and emergency generators;
- Electrical components including transformers, switchgear, motor control centers, lighting, and raceways;
- Fire protection systems including piping and tanks; and
- Plumbing systems and components including piping, fixtures, and equipment.

The design and construction requirements contained in the *Provisions* are intended to ensure that most of these components are adequately attached to the supporting structure so that earthquake shaking does not cause them to topple or fall, injuring building occupants or obstructing exit paths. For those pieces of equipment and components that must function to provide for the safety of building occupants (e.g., emergency lighting and fire suppression systems), the *Provisions* provides design criteria intended to ensure that these systems and components will function after an earthquake. The *Provisions* also includes recommendations intended to ensure that nonstructural components critical to the operability of essential facilities such as hospitals can operate following strong earthquake shaking.

## 4.2 Nonbuilding Structures

The *NEHRP Recommended Seismic Provisions* also includes seismic design criteria for many structures that are not considered to be buildings. These structures are called nonbuilding structures and include:

- Storage tanks, pressure vessels, and pipe supports such as those commonly found in petroleum refineries and chemical plants (Figure 26);
- Water towers;
- Chimneys and smokestacks;
- Steel storage racks (Figure 27);
- Piers and wharves;
- Amusement structures including roller coasters; and
- Electrical transmission towers.

Some nonbuilding structures, however, are not covered by the design recommendations contained in the *Provisions* because they are of a highly specialized nature and industry groups that focus on the design and construction of these structures have developed specific criteria for their design. Some such structures are highway and railroad bridges, nuclear power plants, hydroelectric dams, and offshore petroleum production platforms.



Figure 26 Structures commonly found in petroleum refineries and chemical plants.





Figure 27 Seismic design criteria for steel storage racks of the type used in large warehouses and big-box retail stores are included in the *Provisions*.

Just as it does for buildings, the *NEHRP Recommended Seismic Provisions* classifies nonbuilding structures based on the structural system that provides earthquake resistance. Some nonbuilding structures use structural systems commonly found in buildings such as braced frames and moment frames. These structures are identified as nonbuilding structures with a structural system similar to buildings, and the design requirements for these structures are essentially identical to those for building structures. Other nonbuilding structures are called nonbuilding structures with structural systems not similar to buildings, and the *Provisions* contains special design requirements that are unique to the particular characteristics of these structures.

### 4.3 Protective Systems

Most of the seismic-resistant structural systems used in both buildings and nonbuilding structures are variations of systems that were traditionally used in structures not designed for earthquake resistance. Over the years, engineers and researchers improved the earthquake resistance of these traditional systems by observing their behavior in laboratory tests and actual earthquakes and incrementally refining the design criteria to achieve better performance. Nevertheless, these systems are still designed with the intent that they will sustain damage when subjected to design-level or more severe earthquake effects.

Beginning in the 1970s, engineers and researchers began to develop systems and technologies capable of responding to earthquake ground shaking without sustaining damage and thereby protecting the building or structure. The *NEHRP Recommended Seismic Provisions* presently includes design criteria for two such technologies – seismic isolation and energy dissipation systems.

Seismic isolation systems consist of specially designed bearing elements that are typically placed between a structure and its foundation (Figure 28). Two types of bearing are commonly used – one is composed of layers of natural or synthetic rubber material bonded to thin steel plates in a multilevel sandwich form and the second consists of specially shaped steel elements coated with a low-friction material. Both types of bearings are capable of accommodating large lateral displacements while transmitting relatively small forces into the structure above. When these isolation systems are placed in a structure, they effectively “isolate” the building from ground shaking so that, when an earthquake occurs, the building experiences only a small fraction of the forces that would affect it if it were rigidly attached to its foundations.

Energy dissipation systems are composed of structural elements capable of dissipating large amounts of earthquake energy without experiencing damage, much like the shock absorbers placed in the suspensions of automobiles. Energy dissipation systems usually are placed in a structure as part of a diagonal bracing system. Several types of energy dissipation system are available today including hydraulic dampers, friction dampers, wall dampers, tuned mass dampers, and hysteretic dampers.

Hydraulic dampers are very similar to automotive shock absorbers. They consist of a double acting hydraulic cylinder that dissipates energy by moving a piston device through a viscous fluid that is contained within an enclosed cylinder. Friction dampers are essentially structural braces that are spliced to the structure using slotted holes and high-strength bolts with a tactile material on the mating surfaces of the connection. When the braces are subjected to tension or com-

pression forces, they slip at the splice connection and dissipate energy through friction. Wall dampers are a form of viscous damper that consists of vertical plates arranged in a sandwich configuration with a highly viscous material. One set of plates is attached to one level of a structure and another set to the adjacent level. When the structure displaces laterally in response to earthquake shaking, the plates shear the viscous material and dissipate energy. Hysteretic dampers dissipate energy by yielding specially shaped structural elements that are placed in series with conventional wall or brace elements. Tuned mass dampers consist of a large mass on a spring-like device. When they are mounted on a structure, the lateral displacement of the structure excites the mass, which then begins to move and dissipate significant portions of the earthquake's energy, protecting the structure in the process.

Although seismic isolation and energy dissipation systems have been available for more than 20 years, their use in new buildings has been confined primarily to very important structures that must remain functional after a strong earthquake and to buildings housing valuable contents such as museums or data centers. This is because their use adds to the construction cost for a structure and most owners have not viewed the additional protection provided by these technologies as worth the additional cost.

Figure 28 The San Bernardino County Justice Center in California was one of the first base-isolated buildings in the United States.



### 4.4 Existing Buildings and Structures

The *NEHRP Recommended Seismic Provisions* primarily addresses the design of new buildings and structures. However, the most significant seismic risks in the United States today are associated with existing buildings and structures designed and constructed prior to the adoption and enforcement of current seismic design requirements in building codes. It is possible to upgrade these existing hazard-

ous structures so that they will perform better in future earthquakes and some communities in the United States have adopted ordinances that require seismic upgrades of the most hazardous types of existing building.

Chapter 34 of the *International Building Code* and Appendix 11B of the ASCE/SEI 7 standard include requirements aimed at improving the seismic resistance of existing structures, typically as part of a significant expansion, repair, or alteration of the building. These requirements are intended to prevent existing buildings from being made more hazardous than they already are (by either reducing their current strength or adding mass to them) and to trigger a seismic upgrade of these buildings when their expected useful life is extended by a major renovation project.

When a structurally dependent addition to an existing building is proposed, Appendix 11B of ASCE/SEI 7 requires that the entire structure, including the original building and the addition, be brought into compliance with the seismic requirements for new construction. The upgrade requirement is waived if it can be demonstrated that the addition does not increase the seismic forces on any existing element by more than 10 percent unless these elements have the capacity to resist the additional forces and that the addition in no way reduces the seismic resistance of the structure below that required for a new structure.

The ASCE/SEI 7 standard contains similar requirements for building alterations such as cutting new door openings into walls, cutting new stairway openings in floors, or relocating braces within a structure. Such alterations trigger a requirement to bring the entire structure into conformance with the seismic requirements for new buildings unless the alteration does not increase the seismic force on any element by more than 10 percent, the seismic resistance of the structure is not reduced, the forces imposed on existing elements do not exceed their capacity, new elements are detailed and connected to the structure in accordance with the requirements for new structures, and a structural irregularity is not created or made more severe.

Both ASCE/SEI 7 and the *International Building Code* require a seismic upgrade of an existing structure when an occupancy change will result in a higher risk to the public. An example of such an occupancy change would be the conversion of a normally unoccupied warehouse building into condominiums or an emergency shelter intended to provide living space for the public after a disaster. Further discussion of occupancies and the design requirements associated with them is contained in the next chapter.

Although both ASCE/SEI 7 and the *International Building Code* require that existing buildings and structures be upgraded to comply with the requirements for

new structures under some circumstances, it often is impractical and technically impossible to do this for many structures because they are constructed of systems and materials that are no longer permitted by the building codes and for which suitable design criteria are no longer available. In order to obtain literal compliance with the requirements to upgrade such structures, it would be necessary to demolish the nonconforming elements and replace them with new conforming construction, which is seldom economically practical. Recognizing this, FEMA has developed a series of publications specifically intended to help engineers identify the likely performance of existing nonconforming buildings and design effective means of upgrading these structures. Several of these publications have since evolved into national consensus standards issued by the American Society of Civil Engineers and they are widely accepted by building officials as suitable alternatives to the requirements of the building code for existing structures.

One such standard, ASCE/SEI 31-02, *Seismic Evaluation of Existing Buildings*, is based on FEMA 310 and employs a tiered methodology that enables engineers to determine whether buildings are capable of meeting either life safety or immediate occupancy performance objectives. The lowest tier of evaluation provides a simple checklist to assist the engineer in identifying deficiencies that are known to have caused poor performance in buildings in past earthquakes. Higher tier evaluations utilize progressively more complex analytical procedures to quantitatively evaluate an existing building's probable performance.

ASCE/SEI 41-06, *Seismic Rehabilitation of Existing Buildings*, is based on several FEMA publications (notably, FEMA 273/274 and FEMA 356) and provides design criteria for the seismic upgrading of existing buildings to meet alternative performance criteria ranging from a reduction of collapse risk to the capability to survive design-level earthquakes and remain functional. FEMA 547, *Techniques for the Seismic Rehabilitation of Existing Buildings*, is an important companion document to ASCE/SEI 41-06; it provides engineers with alternative structural techniques that can be used to effectively upgrade existing buildings.

Many jurisdictions have adopted ordinances that require owners of some types of buildings known to be particularly hazardous to perform seismic upgrades of these structures. The targets of such ordinances include unreinforced masonry buildings, older precast concrete tiltup buildings, and wood frame buildings with weak first stories or inadequately attached to their foundations. Some of these ordinances adopt technical provisions contained in the *International Existing Buildings Code* produced by the International Code Council as a companion publication to the IBC. Other ordinances permit the use of the ASCE 41 procedures or specify other acceptable procedures developed for that particular community.

Owners often elect to undertake upgrades of buildings independent of requirements contained in the building codes or locally adopted ordinances. These upgrades may range from incremental projects that address specific building deficiencies to complete upgrades intended to provide performance equivalent or superior to that anticipated by the building code for new construction. The *International Building Code* includes permissive language that enables such upgrades so long as the engineer designing the upgrade can demonstrate that the proposed changes do not create new seismic deficiencies or exacerbate existing seismic deficiencies. FEMA 390 through 400 suggest some ways to incrementally improve a building's seismic performance and FEMA 420 is an engineering guide for use with those publications.

## Chapter 5

# DESIGN REQUIREMENTS

### 5.1 Seismic Design Categories

The *NEHRP Recommended Seismic Provisions* recognizes that, independent of the quality of their design and construction, not all buildings pose the same seismic risk. Factors that affect a structure's seismic risk include:

- The intensity of ground shaking and other earthquake effects the structure is likely to experience and
- The structure's use including consideration of the number of people who would be affected by the structure's failure and the need to use the structure for its intended purpose after an earthquake.

The *Provisions* uses the Seismic Design Category (SDC) concept to categorize structures according to the seismic risk they could pose. There are six SDCs ranging from A to F with structures posing minimal seismic risk assigned to SDC A and structures posing the highest seismic risk assigned to SDC F. As a structure's potential seismic risk as represented by the Seismic Design Category increases, the *Provisions* requires progressively more rigorous seismic design and construction as a means of attempting to ensure that all buildings provide an acceptable risk to the public. Thus, as the SDC for a structure increases, so do the strength and detailing requirements and the cost of providing seismic resistance. Table 2 summarizes the potential seismic risk associated with buildings in the various Seismic Design Categories and the primary protective measures required for structures in each of the categories.

As noted in Table 2, structures are assigned to a Seismic Design Category based on the severity of ground shaking and other earthquake effects the structure may experience and the nature of the structure's occupancy and use. The nature of the structure's occupancy and use used in determining a Seismic Design Category is broken into four categories of occupancy as summarized in Table 3.

**Table 2 Seismic Design Categories, Risk, and Seismic Design Criteria**

| SDC | Building Type and Expected MMI   | Seismic Criteria   |
|-----|--|--|
| A   | Buildings located in regions having a very small probability of experiencing damaging earthquake effects   | No specific seismic design requirements but structures are required to have complete lateral-force-resisting systems and to meet basic structural integrity criteria.  |
| B   | Structures of ordinary occupancy that could experience moderate (MMI VI) intensity shaking   | Structures must be designed to resist seismic forces.  |
| C   | Structures of ordinary occupancy that could experience strong (MMI VII) and important structures that could experience moderate (MMI VI) shaking     | Structures must be designed to resist seismic forces.<br>Critical nonstructural components must be provided with seismic restraint.  |
| D   | Structures of ordinary occupancy that could experience very strong shaking (MMI VIII) and important structures that could experience MMI VII shaking | Structures must be designed to resist seismic forces.<br>Only structural systems capable of providing good performance are permitted.<br>Nonstructural components that could cause injury must be provided with seismic restraint.<br>Nonstructural systems required for life safety protection must be demonstrated to be capable of post-earthquake functionality.<br>Special construction quality assurance measures are required.  |
| E   | Structures of ordinary occupancy located within a few kilometers of major active faults capable of producing MMI IX or more intense shaking          | Structures must be designed to resist seismic forces.<br>Only structural systems that are capable of providing superior performance permitted.<br>Many types of irregularities are prohibited.<br>Nonstructural components that could cause injury must be provided with seismic restraint.<br>Nonstructural systems required for life safety protection must be demonstrated to be capable of post-earthquake functionality.<br>Special construction quality assurance measures are required. |
| F   | Critically important structures located within a few kilometers of major active faults capable of producing MMI IX or more intense shaking           | Structures must be designed to resist seismic forces.<br>Only structural systems capable of providing superior performance permitted are permitted.<br>Many types of irregularities are prohibited.<br>Nonstructural components that could cause injury must be provided with seismic restraint.<br>Nonstructural systems required for facility function must be demonstrated to be capable of post-earthquake functionality.<br>Special construction quality assurance measures are required. |



**Table 3 Occupancy**

| Category | Representative Buildings   | Acceptable Risk  |
|----------|--|--|
| I        | Buildings and structures that normally are not subject to human occupancy (e.g., equipment storage sheds, barns, and other agricultural buildings) and that do not contain equipment or systems necessary for disaster response or hazardous materials.  | Low probability of earthquake-induced collapse.  |
| II       | Most buildings and structures of ordinary occupancy (e.g., residential, commercial, and industrial buildings) except those buildings contained in other categories.  | Low probability of earthquake-induced collapse.<br>Limited probability that shaking-imposed damage to nonstructural components will pose a significant risk to building occupants.   |
| III      | Buildings and structures that: <ul style="list-style-type: none"> <li>• Have large numbers of occupants (e.g., high-rise office buildings, sports arenas, and large theaters),</li> <li>• Shelter persons with limited mobility (e.g., jails, schools, and some healthcare facilities);</li> <li>• Support lifelines and utilities important to a community's welfare; or</li> <li>• Contain materials that pose some risk to the public if released.</li> </ul> | Reduced risk of earthquake-induced collapse relative to Occupancy Category II structures.<br>Reduced risk of shaking-imposed damage to nonstructural components relative to Occupancy Category II structures.<br>Low risk of release of hazardous materials or loss of function of critical lifelines and utilities. |
| IV       | Buildings and structures that: <ul style="list-style-type: none"> <li>• Are essential to post-earthquake response (e.g., hospitals, police stations, fire stations, and emergency communications centers) or</li> <li>• House very large quantities of hazardous materials.</li> </ul>   | Very low risk of earthquake induced-collapse.<br>Low risk that the building or structure will be damaged sufficiently to impair use in post-earthquake response and recovery efforts. Very low risk of release of hazardous materials.   |

The intensity of earthquake shaking and other effects used to assign structures to a Seismic Design Category is determined using the national seismic maps previously presented in Figures 14 and 15. Figure 14 is used to determine a short-period shaking parameter,  $S_s$ . This acceleration parameter is the maximum shaking considered for the design of low-rise buildings located on sites conforming to a reference soil condition. Figure 15 is used to determine the 1-second period shaking parameter,  $S_1$ . This shaking parameter, also derived for sites conforming to a reference soil condition, is important to the design of taller buildings.

In order to determine a structure's Seismic Design Category, it is necessary to determine the value of the  $S_s$  and  $S_l$  parameters at the building site, adjust those values to account for the soil conditions actually present at the building site, and then reduce the values by two-thirds to represent design-level ground shaking. The resulting design acceleration parameters are labeled  $S_{DS}$  and  $S_{DI}$ , respectively. In general, sites that have deep deposits of soft soils will have larger values of the design acceleration parameters than sites with shallow deposits of firm soils or near-surface rock. More discussion of these parameters appears below.

In communities where soil conditions vary, similar buildings constructed on different sites may be assigned to different Seismic Design Categories and this can result in very different seismic design requirements for similar buildings in the same city. Figure 29 provides a series of maps<sup>3</sup> of the United States and its territories showing the Seismic Design Category for low-rise Occupancy Category I and II structures located on sites with average alluvial soil conditions. This map is used in the *International Residential Code* (IRC). Structures of a higher Occupancy Category would be assigned to a higher SDC. Tall structures and structures on sites with other than average alluvial soils also may be assigned to different SDCs.

## 5.2 Site Class

Site soil conditions are important in determining Seismic Design Category. Hard, competent rock materials efficiently transmit shaking with high-frequency (short-period) energy content but tend to attenuate (filter out) shaking with low-frequency (long-period) energy content. Deep deposits of soft soil transmit high-frequency motion less efficiently but tend to amplify the low-frequency energy content. If the nature and depth of the various soil deposits at a site are known, geotechnical engineers can perform a site response analysis to determine the importance of these effects. For most sites, however, these effects can be approximated if the nature of soil at the site is known. The *NEHRP Recommended Seismic Provisions* uses the concept of Site Class to categorize common soil conditions into broad classes to which typical ground motion attenuation and amplification effects are assigned.

Site Class is determined based on the average properties of the soil within 100 feet (30 meters) of the ground surface. Geotechnical engineers use a variety of parameters to characterize the engineering properties of these soils, including general soil classifications as to the type of soil, (e.g. hard rock, soft clay), the number

---

<sup>3</sup>The Seismic Design Category maps that follow are those approved for inclusion in the 2012 edition of the *International Residential Code*. In the *International Building Code* and the *Provisions*, Categories D<sub>0</sub>, D<sub>1</sub> and D<sub>2</sub> are combined into a single Category D.

of blows ( $N$ ) needed to drive a standard penetration tool 1 foot into the soil using a standard hammer, the velocity ( $v_s$ ) at which shear waves travel through the material as measured by on-site sonic and other tests, and the shear resistance of the soil ( $s_u$ ) as measured using standard laboratory test procedures. Table 4 lists the six Site Classes recognized by the *NEHRP Recommended Seismic Provisions* and the engineering parameters used to define them. On many sites, the nature of soils will vary with depth below the surface.

**Table 4 Site Class and Soil Types**

| Site Class | General Description           | Shear Wave Velocity, $v_s$ (ft/sec) | Blows/foot ( $N$ ) | Shear strength, $s_u$ (psf) |
|------------|-------------------------------|-------------------------------------|--------------------|-----------------------------|
| A          | Hard rock                     | >5,000                              |                    |                             |
| B          | Rock                          | 2,500-5,000                         |                    |                             |
| C          | Very dense soil and soft rock | 1,200-2,500                         | >50                | >2,000                      |
| D          | Stiff soil                    | 600-1,200                           | 15-50              | 1,000 – 2,000               |
| E          | Soft clay soil                | <600                                | <15                | <1,000                      |
| F          | Unstable soils                |                                     |                    |                             |

Rock associated with Site Class A is typically found only in the eastern United States. The types of rock typically found in the western states include various volcanic deposits, sandstones, shales, and granites that commonly have the characteristics appropriate to either Site Class B or C. Sites with very dense sands and gravels or very stiff clay deposits also may qualify as Site Class C. Sites with relatively stiff soils including mixtures of dense clays, silts, and sands are categorized as Site Class D, and this is the most common site class throughout the United States. Sites along rivers or other waterways underlain by deep soft clay deposits are categorized as Site Class E. Sites where soils are subject to liquefaction or other ground instabilities are categorized as Site Class F and site-specific analyses are required.

As indicated above, the properties of the soils in the 100 feet below ground surface must be known to determine the Site Class, and this requires an investigation that includes drilling borings into the soil and removing samples of the soil at various depths in order to classify it. The *NEHRP Recommended Seismic Provisions* permits any site to be categorized as Site Class D unless there is reason to believe that it would be more properly classified as Site Class E or F. However, classification of a site as conforming to either Site Class A, B, or C generally will lead to a more economical structural design than an assumption that a site conforms to Class D because Site Classes A, B, and C produce less intense shaking than does Site Class D.

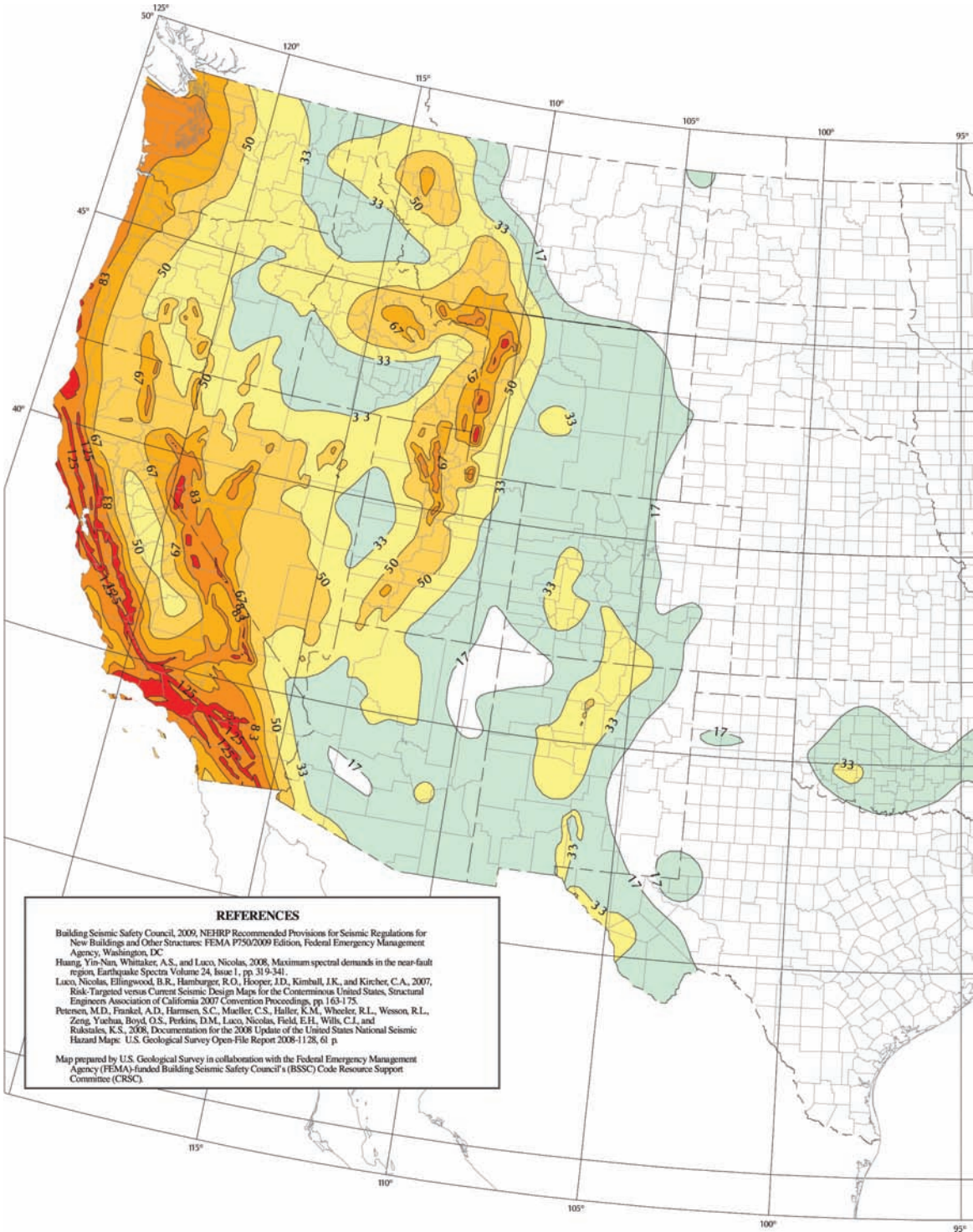
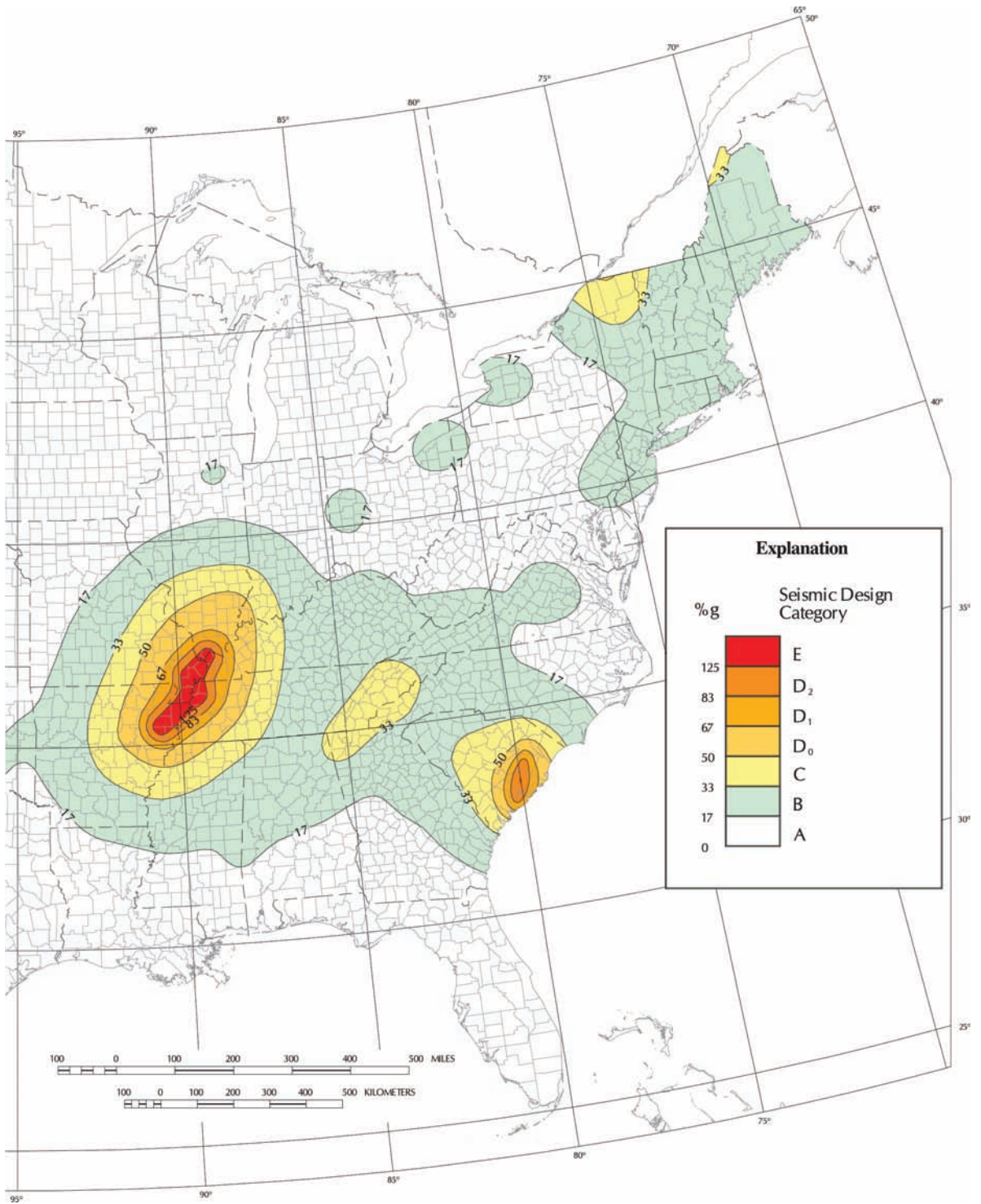

Figure 29 Seismic Design Categories for low-rise buildings of ordinary occupancy on alluvial soils.



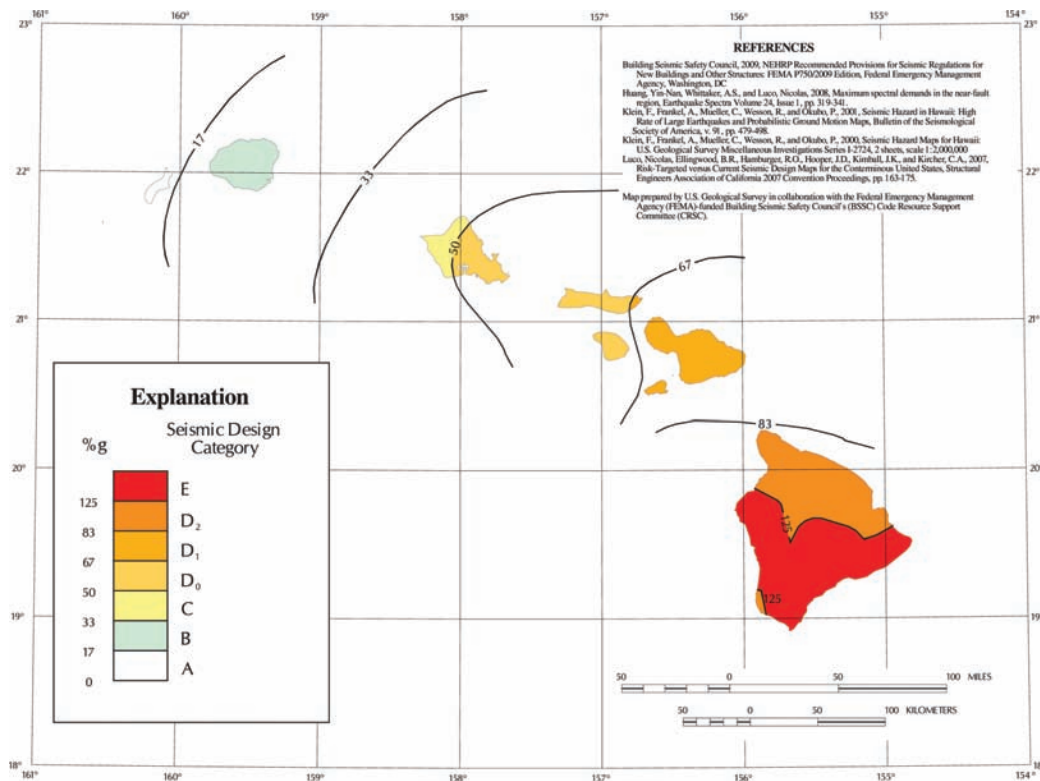
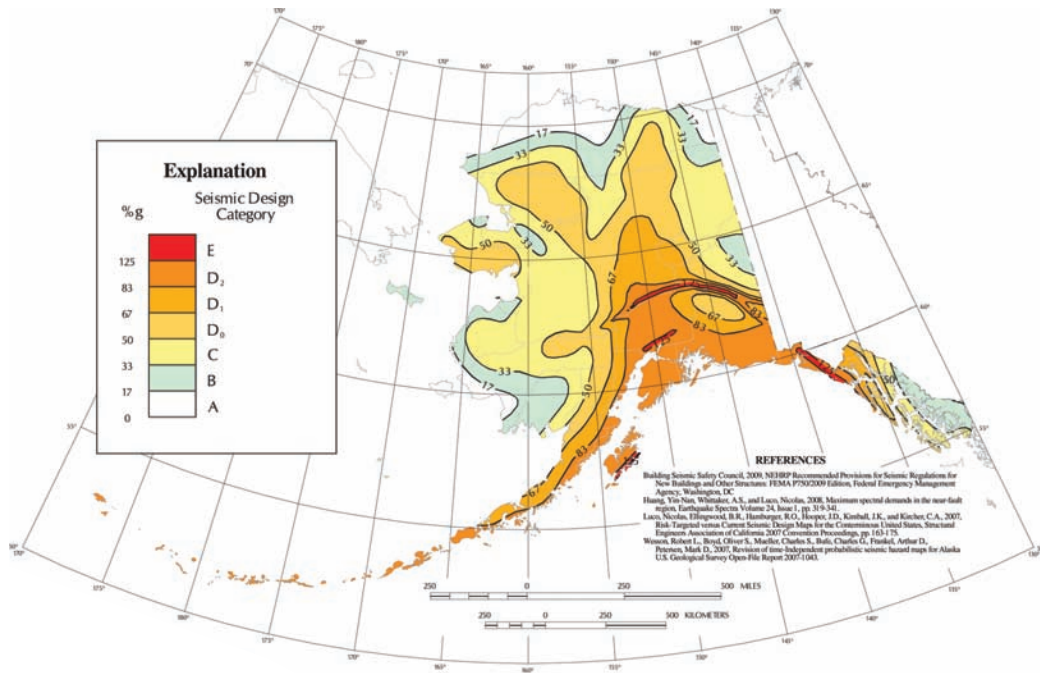

Figure 29 continued

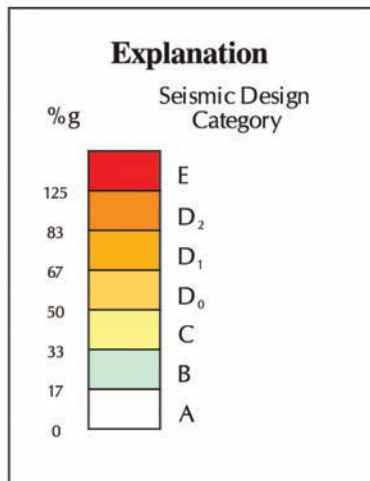
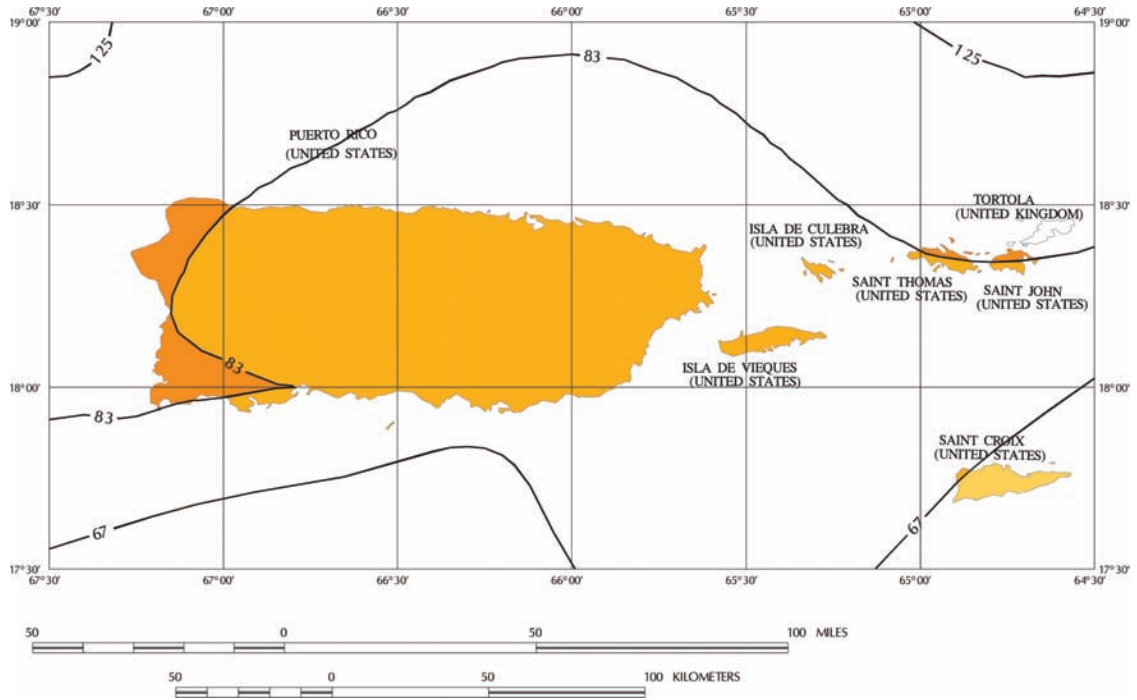

Figure 29 continued

### 5.3 Design Ground Motion

In order to determine the Seismic Design Category for a structure, it is first necessary to determine the design ground motion, which is one of the primary factors used to determine the required seismic resistance (strength) of structures and supported nonstructural components.

Design ground motion is defined by an acceleration response spectrum having a shape similar to that shown previously in Figure 10 and characterized by the following parameters:

- $S_{DS}$  – short-period design response acceleration, in units of percent g
- $S_{DI}$  – one-second period design response acceleration, in units of percent g
- $T_s$  – transition period from constant response acceleration to constant response velocity, in units of seconds
- $T_L$  – transition period from constant response velocity to constant response displacement, in units of seconds

Figure 30 is the generalized form of the design acceleration response spectrum showing each of these parameters. The values of  $S_{DS}$  and  $S_{DI}$ , respectively, are determined as follows:

$$S_{DS} = \frac{2}{3} F_a S_s \quad (1)$$

$$S_{DI} = \frac{2}{3} F_v S_l \quad (2)$$

In these equations,  $F_a$  and  $F_v$  are coefficients related to the Site Class that indicate, respectively, the relative amplification or attenuation effects of site soils on short-period (high-frequency) and long-period (low-frequency) ground shaking energy. Tables 5 and 6 present the values of these coefficients for the Site Classes defined above.

$S_s$  and  $S_l$  are the mapped values of  $MCE_R$  spectral accelerations for reference soil conditions. The USGS maintains a web-based application accessible at <http://earthquake.usgs.gov/research/hazmaps/> that will calculate values of  $S_s$ ,  $S_l$ ,  $S_{DS}$ , and  $S_{DI}$  based on input consisting of either geographic coordinates (latitude and longitude) or postal zip code and Site Class. It should be noted that the use of zip code to determine these acceleration parameters is not recommended in regions of the nation where structures are assigned to Seismic Design Category D or higher because there can be great variation in the value of these parameters across the area encompassed by a postal zip code. A number of internet sites include



look-up features for longitude and latitude of a site based on address; one such site is <http://www.zipinfo.com/search/zipcode.htm>.

**Table 5 Values of Site Class Coefficient  $F_a$  as a Function of Site Class**

| Site Class | Value of Short-Period MCE Response Acceleration, $S_s$ |             |              |             |                 |
|------------|--|-------------|--------------|-------------|-----------------|
|            | $S_s < 0.25$   | $S_s = 0.5$ | $S_s = 0.75$ | $S_s = 1.0$ | $S_s \geq 1.25$ |
| A          | 0.8  | 0.8         | 0.8          | 0.8         | 0.8             |
| B          | 1.0  | 1.0         | 1.0          | 1.0         | 1.0             |
| C          | 1.2  | 1.2         | 1.1          | 1.0         | 1.0             |
| D          | 1.6  | 1.4         | 1.2          | 1.1         | 1.0             |
| E          | 2.5  | 1.7         | 1.2          | 0.9         | 0.9             |
| F          | Site specific study required.                          |             |              |             |                 |

**Table 6 Values of Site Class Coefficient  $F_v$  as a Function of Site Class**

| Site Class | Value of 1-Second MCE Response Acceleration, $S_1$ |             |             |             |                |
|------------|--|-------------|-------------|-------------|----------------|
|            | $S_1 \leq 0.1$                                     | $S_1 = 0.2$ | $S_1 = 0.3$ | $S_1 = 0.4$ | $S_1 \geq 0.5$ |
| A          | 0.8  | 0.8         | 0.8         | 0.8         | 0.8            |
| B          | 1.0  | 1.0         | 1.0         | 1.0         | 1.0            |
| C          | 1.7  | 1.6         | 1.5         | 1.4         | 1.3            |
| D          | 2.4  | 2.0         | 1.8         | 1.6         | 1.5            |
| E          | 3.5  | 3.2         | 2.8         | 2.4         | 2.4            |
| F          | Site specific study required.                      |             |             |             |                |

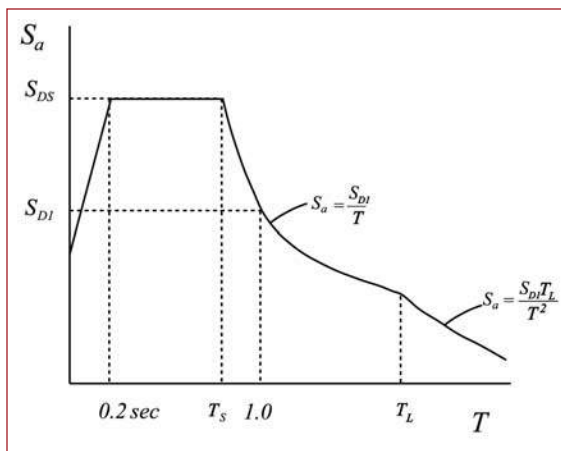

Figure 30 Generalized design response spectrum.

The value of  $T_L$  is obtained from a map prepared by the USGS based on the maximum magnitude earthquake anticipated to produce strong shaking in a region. Figure 31 presents this map of  $T_L$  values (in units of seconds) for the continental United States.

The value of  $T_s$  (in units of seconds) is calculated by the following equation:

$$T_s = S_{DI} / S_{DS} \tag{3}$$

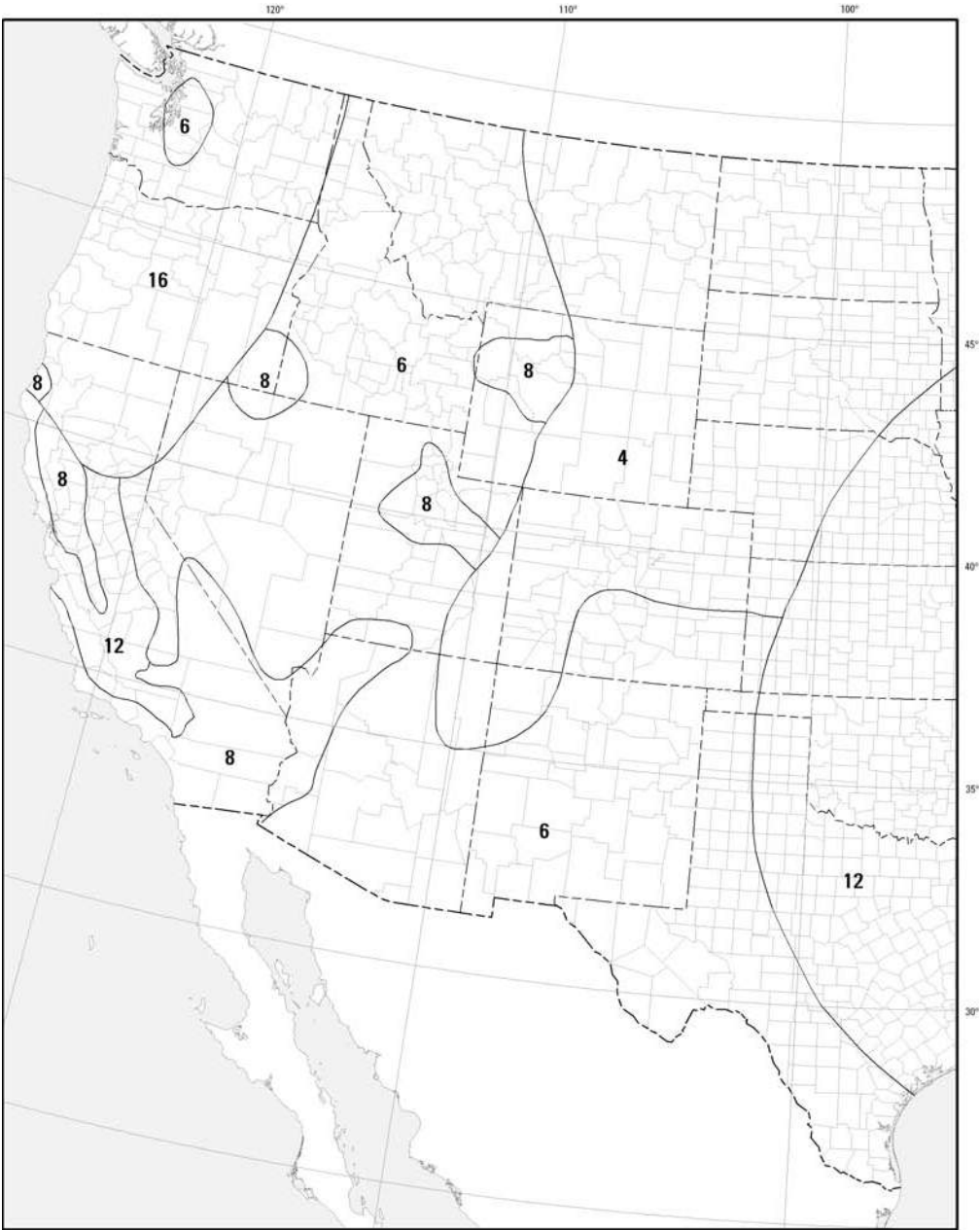

Figure 31 Map of long-period transition period,  $T_s$ , for the continental United States.



## 5.4 Structural System Selection

The next step in the design process consists of selecting an appropriate seismic-force-resisting system (SFRS). As explained in Chapter 3, the seismic-force-resisting systems for building structures and nonbuilding structures with structural systems like buildings are categorized by construction material (e.g., concrete, masonry, steel, or wood), type of system (bearing wall, braced frame, moment frame, dual, or cantilever column), and level of seismic detailing (special, intermediate, ordinary, or not detailed for seismic resistance). Structures assigned to Seismic Design Category A can use any type of SFRS as long as the system is complete and provides minimum specified strength. Structures assigned to Seismic Design Categories B or higher must utilize one of the specific SFRSs or combinations of these systems listed in Table 12.2-1 of the ASCE/SEI 7 standard. This table lists more than 90 different structural systems providing designers with a wide range of choices.

Some types of SFRS have proven to exhibit undesirable behavior when subjected to very intense ground shaking; therefore, the use of these SFRSs in higher SDCs is restricted. Some structural systems are prohibited from use in these design categories and other structural systems are permitted only for buildings and structures meeting specific height and weight limitations. Some notable restrictions on structural systems include the following:

- Plain concrete and plain masonry bearing wall systems are not permitted in Seismic Design Categories C or higher.
- Ordinary concrete and ordinary masonry bearing wall systems are not permitted in Seismic Design Categories D or higher.
- Ordinary concentric braced steel frames are not permitted in Seismic Design Categories D and E for buildings in excess of 35 feet in height or in Seismic Design Category F for buildings of any height.
- Braced frames and walls of any material cannot be used as the only SFRS in structures exceeding 160 feet in height in Seismic Design Categories D, E, or F unless certain configuration limitations are met.
- Braced frames and walls of any material cannot be used as the only SFRS in structures exceeding 240 feet in height in Seismic Design Categories D, E, or F regardless of building configuration.

Many other limitations apply to the individual SFRSs listed in the ASCE/SEI 7 table.

In order to qualify as a particular SFRS, the structure's seismic-force-resisting elements must be designed and detailed to conform to the specific requirements contained in industry specifications. For example, special concentric braced steel frames must comply with the design requirements contained in Chapter 13 of AISC 341, *Seismic Provisions for Structural Steel Buildings*. Intermediate concrete moment resisting frames must be designed and detailed to conform to the requirements contained in Section 21.12 of ACI 318, *Building Code Requirements for Structural Concrete*. Table 12.2.1 of ASCE/SEI 7 references the mandatory specification requirements for each structural system. Part 1 of the *NEHRP Recommended Seismic Provisions* adds additional design and detailing requirements for some structural systems.

For nonbuilding structures with structural systems similar to buildings, ASCE/SEI 7 Table 15.4-1 provides an alternative set of limitations on system use that considers the reduced human occupancies and different characteristics of nonbuilding structures. ASCE/SEI 7 Table 15.4-2 provides similar information for nonbuilding structures that do not have structural systems similar to buildings.

All three of the ASCE/SEI 7 tables specify the values of the three design coefficients used to determine the required strength and stiffness of a structure's seismic-force-resisting system:

- $R$  is a response modification factor that accounts for the ability of some seismic-force-resisting systems to respond to earthquake shaking in a ductile manner without loss of load-carrying capacity.  $R$  values generally range from 1 for systems that have no ability to provide ductile response to 8 for systems that are capable of highly ductile response. The  $R$  factor is used to reduce the required design strength for a structure.
- $C_d$  is a deflection amplification coefficient that is used to adjust lateral displacements for the structure determined under the influence of design seismic forces to the actual anticipated lateral displacement in response to design earthquake shaking. The  $C_d$  factors assigned to the various structural systems are typically similar to, but a little less than, the  $R$  coefficients, which accounts in an approximate manner for the effective damping and energy dissipation that can be mobilized during inelastic response of highly ductile systems. Generally, the more ductile a system is, the greater will be the difference between the value of  $R$  and  $C_d$ .
- $\Omega_o$  is an overstrength coefficient used to account for the fact that the actual seismic forces on some elements of a structure can significantly exceed those indicated by analysis using the design seismic forces. For most structural systems, the  $\Omega_o$  coefficient will have a value between 2 and 3.

## 5.5 Configuration and Regularity

The design procedures contained in the *NEHRP Recommended Seismic Provisions* were developed based on the dynamic response characteristics of structures that have regular configurations with a relatively uniform distribution of mass and stiffness and continuous seismic-force-resisting elements. To the extent that structures have nonuniform distribution of strength or stiffness and discontinuous structural systems, the assumptions that underlie the design procedures can become invalid. These conditions are known as irregularities, and structures that have one or more of these irregularities are termed “irregular structures.”

Some irregularities trigger requirements for the use of more exact methods of analysis that better account for the effects of these irregularities on the distribution of forces and deformations in the structure during response to earthquake shaking. Other irregularities trigger requirements for portions of the structure to be provided with greater strength to counteract the effects of the irregularity. Still other irregularities have led to very poor performance in past earthquakes and are prohibited from use in structures assigned to Seismic Design Categories E or F.

The *Provisions* identifies two basic categories of irregularity: horizontal or plan irregularity and vertical irregularity. Horizontal irregularities include:

- Torsional irregularity – This condition exists when the distribution of vertical elements of the seismic-force-resisting system within a story, including braced frames, moment frames and walls, is such that when the building is pushed to the side by wind or earthquake forces, it will tend to twist as well as deflect horizontally. Torsional irregularity is determined by evaluating the difference in lateral displacement that is calculated at opposite ends of the structure when it is subjected to a lateral force.
- Extreme torsional irregularity – This is a special case of torsional irregularity in which the amount of twisting that occurs as the structure is displaced laterally becomes very large. Structures with extreme torsional irregularities are prohibited in Seismic Design Categories E and F.
- Re-entrant corner irregularity – This is a geometric condition that occurs when a building with an approximately rectangular plan shape has a missing corner or when a building is formed by multiple connecting wings. Figure 32 illustrates this irregularity.
- Diaphragm discontinuity irregularity – This occurs when a structure’s floor or roof has a large open area as can occur in buildings with large atriums. Figure 33 illustrates this irregularity.

- Out-of-plane offset irregularity – This occurs when the vertical elements of the seismic-force-resisting system, such as braced frames or shear walls, are not aligned vertically from story to story. Figure 34 illustrates this irregularity.
- Nonparallel systems irregularity – This occurs when the structure’s seismic-force-resisting does not include a series of frames or walls that are oriented at approximately 90-degree angles with each other.

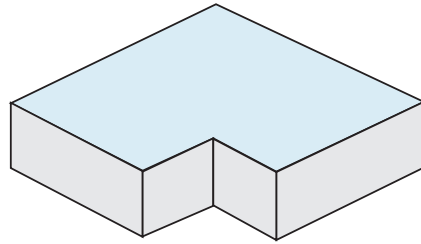

Figure 32 Re-entrant corner irregularity.

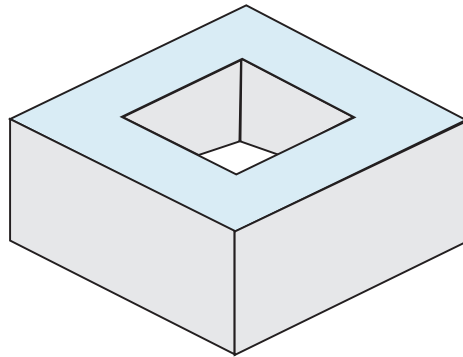

Figure 33 Diaphragm discontinuity irregularity.

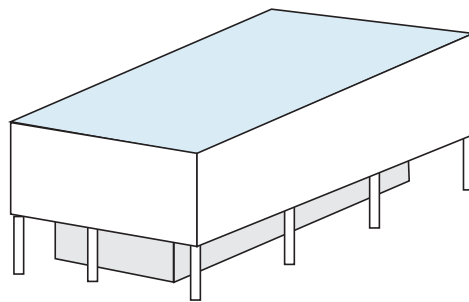

Figure 34 Out-of-plane offset irregularity.

Vertical irregularities include the following:

- Stiffness soft-story irregularity – This occurs when the stiffness of one story is substantially less than that of the stories above. This commonly occurs at the first story of multistory moment frame buildings when the architectural design calls for a tall lobby area. It also can occur in multi-story bearing wall buildings when the first story walls are punched with a number of large openings relative to the stories above. Figure 35 illustrates these two conditions.

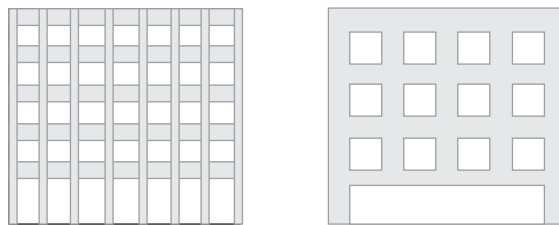

Figure 35 Examples of buildings with a soft first story, a common type of stiffness irregularity.

- Extreme stiffness soft-story irregularity – As its name implies, this is an extreme version of the first soft-story irregularity. This irregularity is prohibited in Seismic Design Categories E and F structures.
- Weight/mass irregularity – This exists when the weight of the structure at one level is substantially in excess of that at the levels immediately above or below it. This condition commonly occurs in industrial structures where heavy pieces of equipment are located at some levels. It also can occur in buildings that have levels with large mechanical rooms or storage areas.
- In-plane discontinuity irregularity – This occurs when the vertical elements of a structure's seismic-force-resisting system such as its walls or braced frames do not align vertically within a given line of framing or the frame or wall has a significant setback. Figure 36 provides examples of this irregularity.



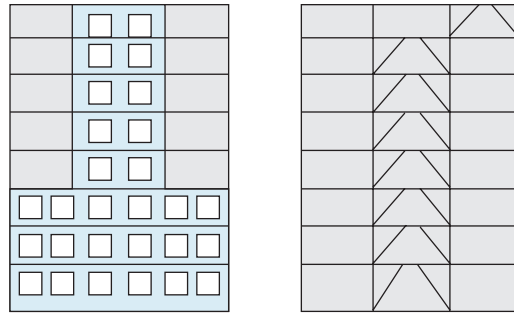

Figure 36 Examples of in-plane discontinuity irregularities.

- Weak-story irregularity – This occurs when the strength of the walls or frames that provide lateral resistance in one story is substantially less than that of the walls or frames in the adjacent stories. This irregularity often accompanies a soft-story irregularity but does not always do so.
- Extreme weak-story irregularity – As its name implies, this is a special case of the weak-story irregularity. Structures with this irregularity are prohibited in Seismic Design Categories E and F.

## 5.6 Required Strength

Earthquake shaking induces both vertical and horizontal forces in structures. These forces vary during an earthquake and, for brief periods ranging from a few tenths of a second to perhaps a few seconds, they can become very large. In structures assigned to Seismic Design Categories D, E or F, these forces easily can exceed the forces associated with supporting the structure's weight and contents. In keeping with the basic design philosophy of accepting damage but attempting to avoid collapse, the *NEHRP Recommended Seismic Provisions* requires that structures be provided with sufficient strength to resist specified earthquake forces in combination with other loads. Typically, engineers design a structure so that only some of the structure's elements (e.g., beams, columns, walls, braces) and their connections provide the required seismic resistance. As previously noted, the system created by these elements and their connections is called the seismic-force-resisting system (SFRS). The specific combinations of seismic load with other loads, including dead and live loads, that members of the SFRS must be proportioned to resist are specified in the ASCE/SEI 7 standard.

The specified earthquake forces are typically a fraction of the forces that design level earthquake shaking will actually produce in these structures. The magnitude of the specified earthquake forces and how they are calculated depends on the structure's Seismic Design Category, the type of structural system that is used, the structure's configuration, and the type of element or connection being designed. These are described briefly below.

### 5.6.1 Seismic Design Category A

Structures assigned to Seismic Design Category A are required to have adequate strength to resist three different types of specified forces:

- Global system lateral forces,
- Continuity forces, and
- Wall anchorage forces.

The global system lateral forces on elements of the SFERS are determined by applying a total static lateral force, equal to 1 percent (0.01) of the structure's weight and that of its supported nonstructural components and contents at each level, in each of two perpendicular directions. The forces in each direction are applied independently, but when the forces are applied in a given direction, they must be applied simultaneously at all levels. Figure 37 illustrates this concept.

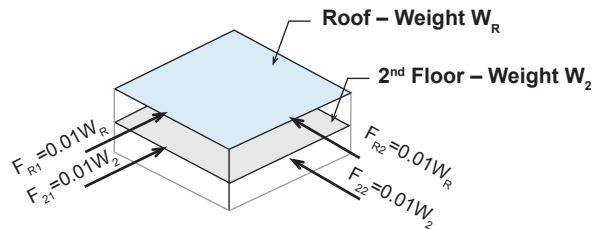

Figure 37 Required seismic design forces for Seismic Design Category A structures.

The design professional must use methods of elastic structural analysis to determine the individual forces in each of the SFERS elements and their connections under the influence of these global applied loads.

Continuity forces apply to those elements that “tie” or interconnect a small piece of a structure (e.g., a cantilevered deck to the main structure). The *NEHRP Recommended Seismic Provisions* specifies that such forces be equal to 5 percent (0.05) of the weight of the smaller portion of the structure as illustrated in Figure 38.

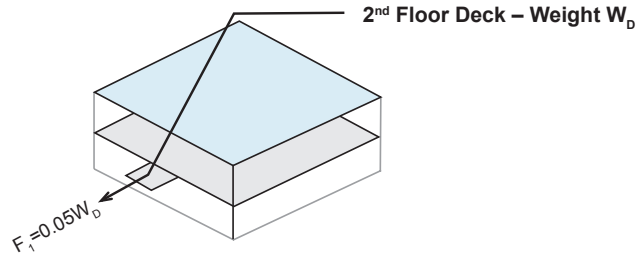

Figure 38 Continuity forces for Seismic Design Category A structures.

In addition to the forces illustrated in Figure 37, the *Provisions* also requires that each beam, girder, truss, or other framing member that provides vertical support for a floor or roof be connected to its supporting member with sufficient strength to resist a force applied along the axis of the member equal to 5 percent of the weight supported by the member.

Wall anchorage forces are intended to prevent the type of failure illustrated previously in Figure 16. The *Provisions* requires that all concrete and masonry walls in Seismic Design Category A structures be connected to the floors and roofs that provide out-of-plane support for the wall and that these connections have a strength not less than 280 pounds per linear foot of wall.

## 5.6.2 Seismic Design Category B

The forces illustrated above are sometimes called lateral forces because they result from actions that attempt to move the structure, or a portion of the structure, laterally to the side. Elements of structures in Seismic Design Category B must be designed for both lateral earthquake forces and vertical earthquake forces. Every structural element in these structures must be designed for stresses that result from vertical earthquake forces whether the element is part of the SFRS or not. These vertical forces are a result of vertical ground shaking. To account for these forces, the *NEHRP Recommended Seismic Provisions* requires that the stresses due to vertical earthquake shaking be taken as a fraction of the stresses in the members due to the weight of the structure itself and its permanent attachments (i.e., the dead load,  $D$ ). The fraction is given by the formula:

$$E_v = 0.2S_{DS}D \quad (4)$$

In this equation,  $E_v$  is the magnitude of forces due to vertical earthquake shaking,  $D$  is the magnitude of force due to the weight of the structure itself and its permanent attachments, and  $S_{DS}$  is the design spectral response acceleration at 0.2-second period determined in accordance with Equation 1.

The lateral earthquake forces are determined using procedures that approximate calculation of the structure's dynamic inelastic response to horizontal earthquake shaking. Several methods are available for calculating these lateral forces:

- Nonlinear response history analysis is a complex technique that calculates the forces and deformations induced in a structure in response to a particular earthquake record and accounts explicitly for the structure's dynamic and hysteretic properties. This is an elegant technique but it is computationally complex and, except for some structures incorporating seismic isolation or energy dissipation systems, it is not required so it is almost never used for the design of structures assigned to Seismic Design Category B.
- Linear dynamic analysis, commonly called response spectrum analysis (RSA), is substantially less complex than nonlinear response history analysis. It accounts for a structure's dynamic properties but only approximates the effects of nonlinear behavior. Its use is not required for the design of Seismic Design Category B structures but it is occasionally employed to design highly irregular or tall structures.
- The so-called equivalent lateral force (ELF) method is a simplification of the response spectrum analysis method, and it produces similar estimates of the earthquake forces and displacements for structures that are relatively regular and have primary response to earthquake shaking in their first mode. The first mode is the deformed shape associated with the lowest period at which a structure will freely vibrate. All structures in Seismic Design Category B can be designed using the ELF technique and it is the method most commonly used in this design category.

The actual magnitude of forces that act on a structure during earthquake shaking depends on the deflected shape of the structure as it responds to earthquake shaking and on the weight of the structure at each level. Figure 39 illustrates this concept for a three-story structure.<sup>4</sup>

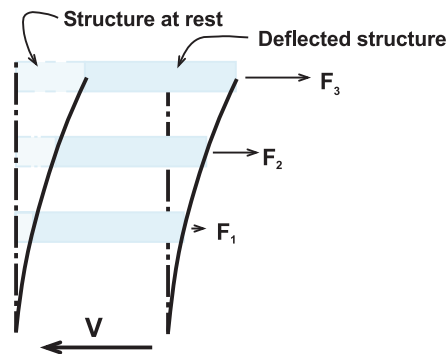

Figure 39 Distribution of lateral earthquake force in three-story structure.

In Figure 39,  $V$  is the total lateral earthquake force, which is sometimes called the “base shear.”  $F_1$  is the force applied at level 1,  $F_2$  is the force applied at the second level, and  $F_3$  is the applied force at the third level. According to the *Provisions*, the total lateral force or base shear,  $V$ , has a value given by the formula:

$$V = C_s W \quad (5)$$

In this equation,  $C_s$  is the seismic base shear coefficient and  $W$  is the structure’s seismic weight. The seismic weight is equal to the weight of the structure and all permanently attached nonstructural components and systems including cladding, roofing, partitions, ceilings, mechanical and electrical equipment, etc. In storage and warehouse occupancies,  $W$  also includes 25 percent of the design storage load. For buildings with a flat roof in areas susceptible to a snow load of 30 psf or more, the seismic weight also includes 20 percent of the uniform design snow load.

<sup>4</sup>The *Provisions* also contains a simplified version of the equivalent lateral force (ELF) procedure that can be used for some low-rise structures. This simplified design procedure is almost identical to the ELF procedure described above except that the equations used to determine the base shear forces ( $V$ ) and story forces ( $F_i$ ) are simplified, and it is not necessary to determine the deflections of the structural system. For buildings that do not have the irregularities described in Section 5.5, the simplified procedure and the full ELF procedure will produce very similar results; however, these results are sometimes relatively conservative. The simplified procedure cannot be used for buildings that have torsional irregularities because it does not provide for distribution of forces considering eccentric (torsional) effects. Therefore, before the simplified procedure can be used for a building with diaphragms that are not flexible, the building must be evaluated to determine if it is torsionally sensitive. In addition, since the simplified procedure does not include an evaluation of lateral deflection, it can be used only for buildings with relatively stiff structural framing systems including bearing wall systems and some types of building frame systems.

The base shear coefficient ( $C_s$ ) depends on a number of factors including the structure's fundamental period of vibration ( $T$ ), the structure's Occupancy Category (discussed in Section 5.1), and the type of seismic-force-resisting system used (discussed in Section 5.4). The fundamental period of vibration ( $T$ ) is the amount of time, in seconds, the structure will take to undergo one complete cycle of motion if it is laterally displaced and released (similar to what is shown in Figure 39). For structures with fundamental periods of vibration less than the mapped value of  $T_L$  at their site, the base shear coefficient ( $C_s$ ) is taken as the lesser of the value given by:

$$C_s = \frac{S_{DS}}{(R/I)} \quad (6)$$

$$C_s = \frac{S_{DI}}{(R/I)T} \quad (7)$$

where  $S_{DS}$  and  $S_{DI}$  are the spectral response acceleration parameters obtained from Equations 1 and 2 as indicated previously,  $R$  is the response modification coefficient discussed in Section 5.4;  $I$  is an occupancy importance factor, the value of which depends on the Occupancy Category previously described in Section 5.1, and  $T$  is the structure's fundamental period of vibration. The quantity  $R/I$  in Equations 6 and 7 is an expression of the permissible amount of inelastic structural response. The value of  $R$  is determined from the ASCE/SEI 7 standard based on the selected structural system. For buildings in Occupancy Category I or II, the importance factor ( $I$ ) has a value of 1.0. For structures in Occupancy Categories III and IV, the importance factors are 1.25 and 1.5, respectively. Thus, for structures in higher occupancy categories, less inelastic behavior is permitted, which is consistent with the desired reduced risk of damage.

For structures with a fundamental period of vibration greater than  $T_L$ , the value of  $C_s$  can be determined using the formula:

$$C_s = \frac{S_{DI}T_L}{(R/I)T^2} \quad (8)$$

The value of the base shear coefficient for any structure, however, cannot be taken as less than the value obtained from the following formula:

$$C_s = 0.44S_{DS}I \quad (9)$$

The lateral earthquake force ( $F_i$ ) applied at each story “ $i$ ” is obtained from the following formula:

$$F_i = \frac{w_i h_i^k}{\sum_{j=1}^n w_j h_j^k} V \quad (10)$$

In Equation 10, the superscript  $k$  has a value of unity for structures with a fundamental period ( $T$ ) less than or equal to 0.5 second, has a value of 2 for structures with a fundamental period greater than or equal to 2.5 seconds, and has a value that is linearly interpolated from these values for structures with a fundamental period that falls between these values. The value of the period can be determined using either a series of approximate formula that depend on the type of seismic-force-resisting system used or methods of structural dynamics that consider the distribution of the structure’s mass and stiffness.

The fundamental period ( $T$ ), seismic base shear force ( $V$ ), and individual story forces ( $F_i$ ) must be computed and applied independently in each of the structure’s two primary orthogonal directions of response. The major vertical elements of the seismic-force-resisting system (frames or walls) will be aligned in these two orthogonal directions in most structures but, when this is not the case, any two orthogonal axes may be used. The story forces ( $F_i$ ) are applied as static loads, and an elastic analysis is performed to determine the distribution of seismic forces in the various beams, columns, braces, and walls that form the vertical elements of the seismic-force-resisting system. These forces then are combined with the forces associated with dead, live, vertical seismic, and other forces using load combinations contained in the ASCE/SEI 7 standard and evaluated against permissible strengths contained in the various materials design standards referenced by ASCE/SEI 7. The design seismic forces on some elements in irregular structures must be amplified by the  $\Omega_0$  coefficient described previously. The purpose of design using these amplified forces is to avoid damage to elements whose failure could result in widespread damage and collapse of the structure.

The lateral forces ( $F_i$ ) at each level are applied at a location that is displaced from the center of mass of the level by a distance equal to 5 percent of the width of the level perpendicular to the direction of application of the force. Figure 40 illustrates this concept. If the structure is not symmetrical, the 5 percent displacement of the point of application of the forces must be taken to both sides of the center of mass, and the design seismic forces on the elements must be taken as the highest forces obtained from either point of application. The purpose of this eccentric application of the forces is to account for any potential torsional loading that may

occur if, for example, one side of a building is occupied during earthquake shaking while the other side is vacant. This requirement also is intended to ensure that all structures have a minimum amount of resistance to torsional effects.

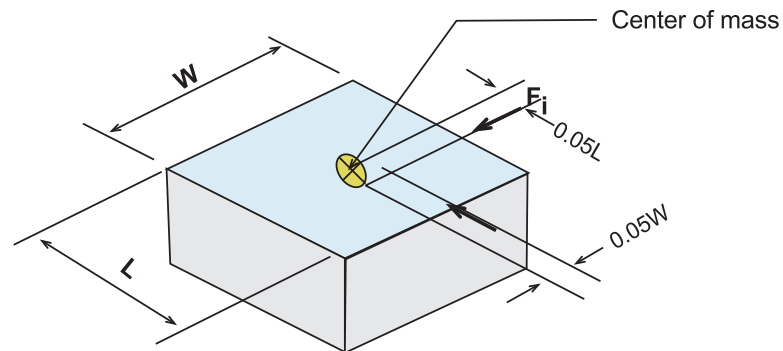

Figure 40 Eccentric application of story forces.

In addition to determining the seismic forces ( $E$ ) on the vertical elements of the lateral-force-resisting system, the *NEHRP Recommended Seismic Provisions* requires determination of the seismic forces on the horizontal elements, typically called diaphragms. In most structures, the diaphragms consist of the floors and roofs acting as large horizontal beams that distribute the seismic forces to the various vertical elements. Diaphragms are categorized as being rigid, flexible, or of intermediate stiffness depending on the relative amounts of deflection that occur in the structure when it is subjected to lateral loading. Figure 41 shows the deflected shape of a simple single-story rectangular building under the influence of lateral forces in one direction. The roof diaphragm has deflection  $\delta_L$  at the left side,  $\delta_R$  at the right side and  $\delta_c$  at its center. If the deflection at the center of the diaphragm ( $\delta_c$ ) exceeds twice the average of deflections  $\delta_L$  and  $\delta_R$  at the ends, the diaphragm can be considered flexible. The *Provisions* permits diaphragms of untopped wood sheathing or steel deck to be considered flexible regardless of the computed deflection. Diaphragms consisting of reinforced concrete slabs or concrete-filled metal deck that meet certain length-to-width limitations can be considered perfectly rigid. Other diaphragms must be considered to be of intermediate stiffness.



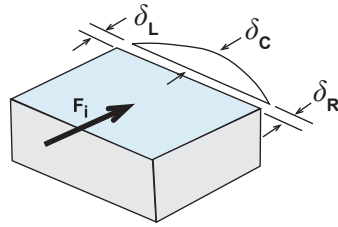

Figure 41 Deflection of diaphragm under lateral loading.

A flexible diaphragm is considered to distribute forces to the supporting vertical elements of the seismic-force-resisting system in the same way as a simple beam spanning between the vertical elements. For other diaphragms, the distribution of forces to the vertical elements must be considered on the basis of the relative rigidity of the vertical elements and the diaphragms using methods of structural analysis. Regardless, the diaphragm shears and moments at each level ( $i$ ) of the structure must be determined for lateral forces using the following formula:

$$F_{px_i} = \frac{\sum_{j=i}^n F_j}{\sum_{j=i}^n w_j} w_{px_i} \quad (11)$$

In this formula,  $F_{px_i}$  is the total force to be applied to the diaphragm at level  $i$ ,  $F_j$  is the seismic design force at each level  $j$  determined from Equation 10,  $w_{px_i}$  is the seismic weight of the structure tributary to the diaphragm at level  $i$ , and  $w_j$  is the seismic weight at each level  $j$  of the structure.

### 5.6.3 Seismic Design Category C

The design requirements for structures assigned to SDC C are almost identical to those for SDC B but there are a few important differences. First, some structural systems that can be used for SDC B are not permitted for SDC C because it is believed they will not perform adequately under the more intense ground motions associated with SDC C. In addition, SDC C structures with vertical seismic-force-resisting elements (shear walls, braced frames, moment frames, or combinations of these systems) located in plan such that they can experience significant seismic forces as a result of shaking in either of the major orthogonal building axes must be designed considering this behavior. An example of such a structure is one with columns common to intersecting braced frames or moment frames aligned in different directions. Another example is a structure with vertical elements aligned

in two or more directions that are not orthogonal to each other. The *NEHRP Recommended Seismic Provisions* requires this type of structure to be designed considering that forces can be incident in any direction. The *Provisions* permits satisfaction of this requirement by considering 100 percent of the specified design forces applied along one primary axis simultaneously with 30 percent of the specified design forces in an orthogonal direction. When this approach is used, at least two load cases must be considered consisting of 100 percent of the specified forces in direction A taken with 30 percent of the specified forces in direction B and 30 percent of the specified forces in direction A taken with 100 percent of the forces in direction B where directions A and B are, respectively, orthogonally oriented to each other.

For SDC C structures that are torsionally irregular, the 5 percent accidental torsion (discussed in the previous section) is amplified by an additional factor related to the amount of twisting that occurs when the design seismic forces are applied.

The *Provisions* also includes anchorage and bracing requirements for nonstructural components in SDC C structures and requires a site-specific geotechnical investigation to evaluate the potential for earthquake-induced ground instability including liquefaction, landsliding, differential settlement, and permanent ground deformation. If the geotechnical investigation report indicates that the site has significant potential to experience any of these instabilities, it also must include a discussion of potential mitigation strategies that can be used in the foundation design.

### 5.6.4 Seismic Design Categories D, E, and F

The requirements for determination of lateral seismic forces in SDCs D, E, and F are very similar to those for SDC C. The ELF method of analysis can be used for all structures of wood or cold-formed steel light frame construction and for all regular structures having a fundamental period ( $T$ ) less than or equal to  $3.5T_s$  as determined by Equation 3. The simplified analysis procedure also can be used for regular structures having three or fewer above-grade stories. Regardless of whether structures are regular or not, the design of SDC D, E, and F structures must include consideration of seismic forces acting concurrently in two orthogonal directions as discussed above.

For structures assigned to SDCs E and F, an additional lower bound is placed on the base shear coefficient ( $C_s$ ) determined as follows:

$$C_{S_{min}} = 0.5 \frac{S_I}{(R/I)} \quad (12)$$

This additional limit on base shear is intended to ensure that structures located close to major active faults have sufficient strength to resist the large impulsive forces that can occur on such sites.

The lateral seismic forces for structures that cannot be determined using either the complete ELF or the simplified procedures must be determined using either the response spectrum analysis (RSA) or the nonlinear response history procedures. A complete discussion of these procedures is beyond the scope of this document but can be found in the references at the conclusion of this report.

Finally, the strength design of structures assigned to SDC D, E, or F is subject to consideration of the structure's redundancy. A structure is considered to be sufficiently redundant if the notional removal of any single element in the structure's seismic-force-resisting system (e.g., a shear wall or brace) does not reduce the structure's lateral strength by more than one third and does not create an extreme torsional irregularity. If the configuration of a structure's seismic-force-resisting system meets certain prescriptive requirements, a rigorous check of the structure's redundancy is not required. If a structure does not meet these prescriptive requirements or the minimum strength and irregularity criteria described above, the required strength of all elements and their connections comprising the seismic-force-resisting system, other than diaphragms, must be increased by 30 percent.

## 5.7 Stiffness and Stability

If the simplified analysis procedure (see footnote in Section 5.6.2) is not used, Seismic Design Categories B through F structures must be evaluated to ensure that their anticipated lateral deflection in response to earthquake shaking does not exceed acceptable levels or result in instability. Two evaluations are required – the first is an evaluation of the adequacy of the structure's interstory drift at each level and the second is an evaluation of stability.

Interstory drift is a measure of how much one floor or roof level displaces under load relative to the floor level immediately below. It is typically expressed as a ratio of the difference in deflection between two adjacent floors divided by the

height of the story that separates the floors. Figure 42 illustrates the concept of interstory drift, showing this as the quantity  $\delta_i$ , the drift that occurs under the application of the design seismic forces.

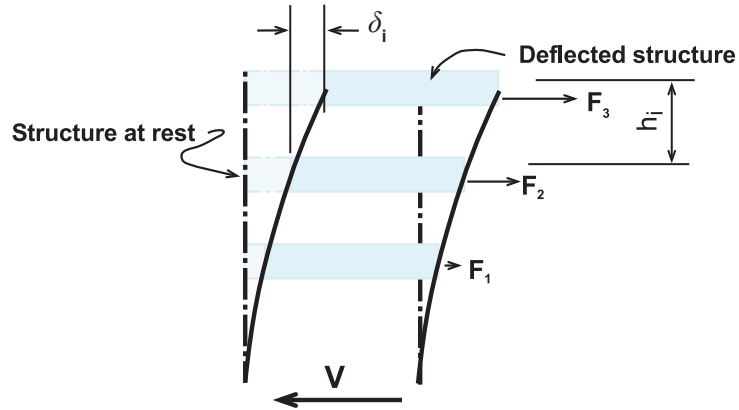

Figure 42 Interstory drift.

The *NEHRP Recommended Seismic Provisions* sets maximum permissible interstory drift limits based on a structure’s Occupancy Category and construction type. The adequacy of a structure in this respect is determined by calculating the design story drift,  $\Delta$ , as follows:

$$\Delta = \frac{C_d \delta_i}{I} \leq \Delta_a h_i \tag{13}$$

In this equation,  $\delta_i$  is the computed interstory drift under the influence of the design seismic forces,  $C_d$  is the deflection amplification coefficient described in Section 5.4, and  $I$  is the occupancy importance factor. The acceptable drift ratio,  $\Delta_a$ , varies from 0.007 to 0.025 depending on the structure’s Occupancy Category and construction type.

Drift is also an important consideration for structures constructed in close proximity to one another. In response to strong ground shaking, structures located close together can hit one another, an effect known as pounding. Pounding can induce very high forces in a structure at the area of impact and has been known to cause the collapse of some structures. Therefore, the *NEHRP Recommended Seismic Provisions* requires that structures be set far enough away from one another and from property lines so that pounding will not occur if they experience the design drifts determined using Equation 13.

In addition, the *Provisions* requires an evaluation of a structure's stability under the anticipated lateral deflection by calculating the quantity  $\Theta$  for each story:

$$\Theta = \frac{P_x \Delta}{V_x h_x C_d} \quad (14)$$

In this formula,  $P_x$  is the weight of the structure above the story being evaluated,  $\Delta$  is the design story drift determined using Equation 13,  $V_x$  is the sum of the lateral seismic design forces above the story,  $h_x$  is the story height, and  $C_d$  is the deflection amplification coefficient described earlier. If the calculated value of  $\Theta$  at each story is less than or equal to 0.1, the structure is considered to have adequate stiffness and strength to provide stability. If the value of  $\Theta$  exceeds 0.1, the lateral force analysis must include explicit consideration of P-delta effects. These effects are an amplification of forces that occurs in structures when they undergo large lateral deflection. The limiting value for  $\Theta$  ( $\Theta_{\max}$ ) is calculated as:

$$\Theta_{\max} = \frac{0.5}{\beta C_d} \leq 0.25 \quad (15)$$

If the structure exceeds this limiting value, it is considered potentially unstable and must be redesigned unless nonlinear response history analysis is used to demonstrate that the structure is adequate. In the equation for  $\Theta_{\max}$ ,  $\beta$  is calculated as the ratio of the story shear demand under the design seismic forces to the story shear strength. It can conservatively be assumed to have a value of 1.0. This requirement can become a controlling factor in areas of moderate seismicity for relatively flexible structures like steel moment-resisting frames.

## 5.8 Nonstructural Components and Systems

In Seismic Design Categories C and higher, nonstructural components and systems also must be designed for seismic resistance. The first step in the process is determining the component importance factor,  $I_p$ . Nonstructural components and systems that satisfy any of the following criteria are assigned an  $I_p$  of 1.5:

- The component is required for life-safety purposes following an earthquake. Fire sprinkler systems and emergency egress lighting and similar components are included in this category.

- The component contains hazardous material that, if released, could pose a threat to life safety. This would include piping carrying potentially toxic gases, tanks containing corrosive materials, laboratory equipment containing potentially harmful bacteria, and similar components.
- The component is attached to an Occupancy Category IV structure and is required for continued operation of the structure.

Some nonstructural components with a component importance factor of 1.5 can be further classified as “designated seismic systems.” Designated seismic systems are those active mechanical and electrical components that must remain operable following an earthquake and those components containing hazardous components. In addition to meeting all of the other requirements for nonstructural components, the suppliers of designated seismic system components must provide certification that the components have either been subjected to shake-table testing or that earthquake experience data are available to demonstrate that the components will be capable of fulfilling their intended purpose following a design level earthquake.

Some nonstructural components including the following are exempt from seismic requirements:

- Mechanical and electrical components in Seismic Design Category C structures except those assigned an  $I_p$  of 1.5.
- Mechanical and electrical components in Seismic Design Category D, E, or F structures that are mounted at floor level, have an  $I_p$  of 1.0, weigh less than 400 pounds, and are connected to any piping or ductwork with flexible connections.
- Mechanical and electrical components in Seismic Design Category D, E, or F structures that have an  $I_p$  of 1.0, are mounted more than 4 feet above the floor, weigh less than 20 pounds, and are connected to any piping or ductwork with flexible connections.

Components that are not exempt must be installed in structures using anchorage and bracing that have adequate strength to resist specified seismic forces. In addition, components attached at multiple points in a structure that can move differentially with respect to one another must be able to withstand anticipated earthquake displacements without failing in a manner that would endanger life safety.

The required strength of component attachments is determined as follows:

$$F_p = 0.3S_{DS}I_pW_p \leq \frac{0.4a_pS_{DS}W_p}{(R_p/I_p)} \left( 1 + 2\frac{z}{h} \right) \leq 1.6S_{DS}I_pW_p \quad (16)$$

In this formula,  $F_p$  is the required attachment force,  $I_p$  is the component importance factor,  $W_p$  is the weight of the component,  $S_{DS}$  is the design short-period response acceleration calculated in accordance with Equation 1,  $h$  is the height above grade that the component is mounted in the structure,  $z$  is the height above grade of the component's point of attachment,  $h$  is the total height of the structure; and  $a_p$  and  $R_p$  are component-specific coefficients obtained from the ASCE/SEI 7 standard that are intended to reflect the dynamic amplification of floor accelerations that some types of component can experience and the ability of some components to experience overstress without failure.

In addition to these general strength and deformation requirements, the *NEHRP Recommended Seismic Provisions* identifies design requirements for some architectural components including exterior glazing and ceiling systems. The requirements for exterior glazing are relatively new in the construction industry and are not familiar to many cladding system suppliers. They are intended to ensure that large quantities of exterior glazing do not break during earthquakes and fall onto occupied street and sidewalk areas.

## 5.9 Construction Quality Assurance

Post-earthquake investigations have shown that a considerable amount of the serious earthquake damage to modern structures has occurred, not because of design deficiencies, but rather because contractors did not construct structural elements and nonstructural components as required in the design drawings and specifications. In order to minimize this problem, the *NEHRP Recommended Seismic Provisions* requires formalized construction quality assurance measures as part of the design and construction process. Among the key points of these construction quality assurance measures are the following:

- The design professional of record is required to designate on the drawings those structural elements that are part of the seismic-force-resisting-system,
- The design professional of record is required to indicate designated seismic system nonstructural components on the drawings,
- The design professional of record or another qualified design professional must observe the construction of some critical elements to ensure that the design is properly interpreted and executed,
- The design professional of record is required to develop a formal Quality Assurance Plan that identifies the number and types of inspections and tests that must be performed during construction, and

- Qualified independent inspectors must perform special inspections of key elements to ensure that the construction is performed in accordance with the design intent.



## Chapter 6

# FUTURE DIRECTIONS

Earthquake engineering has been one of the most rapidly evolving areas of structural engineering practice during the past 40 years. Extensive research and development has occurred at major universities and new technologies have been rapidly adopted into engineering practice. The *NEHRP Recommended Seismic Provisions* plays an essential role in this process by serving as the effective bridge between academic research and practical criteria that can be adopted into the model building codes and standards. This chapter identifies important areas of future development, some of which are introduced in Part 3 of the *Provisions* and are likely to become requirements in future editions of the *Provisions*.

### 6.1 Rationalization of Design Parameters

As described in Chapter 5, the determination of required strength and acceptable drift for structures in all but Seismic Design Category A is dependent on a number of coefficients ( $R$ ,  $C_d$ , and  $\Omega_o$ ) based on the selection of a structural system. The values of these coefficients, which are specified in the ASCE/SEI 7 standard, are based on historical precedent and engineering judgment rather than on quantitative analytical study. FEMA recently sponsored the development of a rational procedure for determining appropriate values for these coefficients, which is described in *Quantification of Building Seismic Performance Factors*, FEMA P-695. The National Institute of Standards and Technology is funding pilot studies using this methodology to evaluate the adequacy of the design coefficient values presently specified in the ASCE/SEI 7 standard. It is expected that additional studies of this type will be performed in the future and that some adjustment of the present design coefficients will be made.

### 6.2 Manufactured Component Equivalence

In recent years, a number of manufacturers have developed proprietary products that are intended to be used as replacements for structural elements designed in conformance with requirements for various seismic-force-resisting systems specified by the *Provisions*. As an example, a number of manufacturers have developed and market proprietary shear panels for use as alternatives to structural sheathed light frame walls and proprietary moment connections for use in structural steel

frames. Building officials require guidance as to when such products can safely be accepted as equivalents to elements that are designed and constructed in accordance with the requirements of the *Provisions*. To satisfy this need, FEMA recently funded the development of a simplified component-based comparative procedure that is described in *Quantification of Building Seismic Performance Factors: Component Equivalency Methodology*, FEMA P-795.

### 6.3 Nonbuilding Structures

The design requirements for buildings contained in the building codes have been developed over many years and are quite mature. However, the building codes also are used to regulate the design and construction of a wide range of nonbuilding structures such as industrial plants, tanks, piers, and wharves. These structures have long been designed using the criteria for buildings even though the earthquake response characteristics of many of these structures are not similar to those of buildings. In recent years, the *NEHRP Recommended Seismic Provisions* has included specific design criteria appropriate to the various types of these structures. Additional development in this area can be expected in the future.

### 6.4 Nonstructural Components

Building code requirements for earthquake resistance were developed principally to result in structures capable of resisting strong earthquake ground motions without collapse. Nevertheless, a significant amount of earthquake economic loss results from the failure of nonstructural components such as walls, ceilings, glazing, and elevators and injuries and even life loss also can occur. The *NEHRP Recommended Seismic Provisions* now includes extensive criteria for the design and installation of these nonstructural components. However, earthquake damage to these components remains a significant factor and installation problems continue to be observed. It is likely that substantial additional development will occur in this area.

### 6.5 Performance-based Design

The *NEHRP Recommended Seismic Provisions* presents design criteria that are intended to result in buildings and other structures capable of withstanding strong earthquake effects with acceptable levels of damage and attendant consequences in terms of life, economic, and functionality losses. Although the design procedures are intended to provide acceptable performance, they are not directly tied to this

performance and it is not clear to designers how these criteria should be changed in order to provide buildings and structures with different performance capabilities. Further, because these design procedures do not include actual evaluations of a building's performance capability, many buildings designed in conformance with the *Provisions* may not actually be capable of attaining the desired performance. Performance-based design procedures are an alternative to the prescriptive approaches contained in the *Provisions* that enable engineers to directly consider a building's probable performance as they perform the design and to tailor the design to attain specific desired performance. These procedures can allow more reliable, and sometimes more economical, attainment of the performance intended by the *Provisions* and also can allow buildings to be designed for superior performance.

Over the past 20 years, the earthquake engineering community has been engaged in the development of performance-based procedures directly focused on providing existing buildings with the capability to deliver specific levels or types of desired performance. The ASCE/SEI 31 and ASCE/SEI 41 standards that evolved from earlier FEMA-funded studies and products (FEMA 310 and FEMA 356, respectively) provide criteria for the evaluation and upgrading of existing buildings and both represent a first generation of performance-based design criteria. FEMA now is engaged in a major project with the Applied Technology Council to develop the next-generation of performance-based design criteria. These next generation criteria will enable engineers to more reliably design and upgrade buildings to achieve specific levels of performance as measured by the probable casualties and economic and occupancy losses that may result from future earthquakes.

Engineers currently use performance-based design procedures under a clause in the building codes that allows the application of alternative procedures subject to the approval of the authority having jurisdiction. Future editions of the *NEHRP Recommended Seismic Provisions* are likely to include procedures for performance-based design that can be adopted by the building codes.

## 6.6 Damage-tolerant Systems

The basic premise underlying the design procedures in the *NEHRP Recommended Seismic Provisions* is that buildings and other structures will be damaged when subjected to the effects of rare intense earthquakes. This damage, when it occurs, can result in great economic loss. These losses are experienced by the owners of the damaged structures, the people who must live or work in them, and the nation as a whole because the economic resources needed for damage repair are diverted from other productive uses. In recent years, a significant amount

of academic research has been devoted to the development of structural systems capable of surviving intense earthquake effects without damage. Should these systems (e.g., rocking frame systems, post-tensioned frame systems, and structures with sacrificial links that can be replaced easily following an earthquake) become economically competitive with more traditional systems, the technology of seismic-resistant construction will change considerably. Future editions of the *NEHRP Recommended Seismic Provisions* are likely to introduce new damage-tolerant systems.

## GLOSSARY

**Acceleration** – Rate of change of velocity with time.

**Acceleration Response Spectrum** – A graphical plot of the maximum acceleration that structures having different characteristics will experience when subjected to a specific earthquake ground motion.

**Addition** – An increase in the aggregate floor area, height, or number of stories of a structure.

**Alteration** – Any construction or renovation to an existing structure other than an addition.

**Appendage** – An architectural component such as a canopy, marquee, ornamental balcony, or statuary.

**Amplification** – A relative increase in the magnitude of a quantity, such as ground motion or building shaking.

**Amplitude** – The maximum value of a time-varying quantity.

**Architectural Components** – Components such as exterior cladding, ceilings, partitions, and finishes.

**Base** – The level at which the horizontal seismic ground motions are considered to be imparted to a structure.

**Base Shear Force** – A term used in linear structural analysis techniques to describe the vector sum of the lateral forces that are applied to the structure to represent the effects of earthquake shaking

**Beam** – A horizontal structural element.

**Bearing Wall System** – A structural system in which vertical structural walls serve the dual purpose of providing vertical support for a significant portion of the structure's weight as well as resistance to lateral forces.

**Building** – An enclosed structure generally used for human occupancy.

**Building Frame System** – A structural system in which vertical forces associated with the structure's weight and that of its supported contents are carried by beams and columns while lateral forces associated with wind or earthquake loading are carried by either diagonal braces or vertical walls that do not support significant portions of the structure's weight.

**Braced Frame** – A structural system in which diagonally inclined members provide the structure's primary resistance to lateral forces.

**Cantilever Column System** – A structural system in which resistance to lateral forces is provided by the bending strength of the vertical column elements, which are fixed against rotation at their bases and free to translate and rotate at their tops.

**Center of Mass** – Point on the building plan about which, the building's weight is evenly distributed.

**Coefficient of Variation** – A measure of the amount of scatter between the average value in a normally distributed group or population and the value that is exceeded by only 84 percent of the members of the population divided by the average value.

**Column** – A slender vertical structural element.

**Component (also Element)** – Part of an architectural, structural, electrical, or mechanical system.

**Concrete** – A mixture of Portland cement, sand, rock, water, and other materials that is placed into forms, and allowed to harden into a structural element.

**Concrete Tilt-up Building** – A type of reinforced concrete structure in which the exterior concrete walls are constructed laying flat against the ground and then tilted vertically into position.

**Configuration** – The size, shape, and geometrical proportions of a building.

**Connection** – A method by which different components are joined to one another.

**Cycle of Motion** – For a shaking object, the motion that occurs as the object moves from an initial position to a maximum displacement in one direction, back through the initial position to a maximum displacement in the opposite direction, and then back to the initial position.

**Damping** – The natural dissipation of energy that occurs in a vibrating structure as a result of friction, cracking, and other behaviors and that eventually brings a vibrating structure to rest.

**Damping Device** – A structural element that dissipates energy due to relative motion of each end of the device.

**Dead Load** – The weight of a structure and all of its permanently attached appurtenances including cladding and mechanical, plumbing, and electrical equipment

**Deflection** – The state of being displaced from an initial at-rest position; see also “Drift.”

**Deformation** – Load-induced distortion of structural or nonstructural elements or components .

**Design Earthquake Shaking** – In the *Provisions*, the earthquake shaking that is two-thirds of maximum considered earthquake shaking

**Design Seismic Map** – A map contained in building codes and referenced standards that specifies the geographic distribution of the value of ground shaking parameters that are specified as minimum values to be used in design.

**Designated Seismic System** – A nonstructural component that must remain functional to protect life safety or to support the operation of an essential facility.

**Diaphragm** – A horizontal or nearly horizontal assembly of structural elements used to tie a structure together, typically at a floor or roof level

**Diaphragm Discontinuity Irregularity** – A type of horizontal irregularity.

**Displacement** – Movement of a structure due to applied forces.

**Distribution, Force** – Portion of the total forces applied to a structure that is resisted by each structural element.

**Drift** – Vertical deflection of a building or structure caused by lateral forces; see also “Story Drift.”

**Dual System** – A structural system in which a combination of moment-resisting frames and braced frames or walls are provided to resist lateral forces.

**Ductility** – The ability of some structural systems to experience extensive deformation and damage without loss of load-carrying capability

**Earthquake** – A sudden motion or vibration in the earth caused by the abrupt release of energy in the earth’s lithosphere.

**Eccentricity** – Non coincidence between the center of mass and center of resistance of a building or characteristic of a braced frame design in which the center lines of the braces and the structural members to which they are connected do not meet at a point.

**ELF** - See “Equivalent Lateral Force Procedure.”

**Elastic** – Capable of recovering size and shape after deformation.

**Elastic Analysis** – See “Linear Analysis.”

**Essential Facility** – A building or structure intended for use during post-earthquake recovery operations including police and fire stations, hospitals, and emergency communications centers

**Equivalent Lateral Force Procedure** – An approximate method of structural analysis used to predict the forces and deformations induced in a structure by earthquake ground shaking that represents the effects of such shaking as a series of lateral static forces applied to the structure.

**Exceedance Probability** – The probability that a specified level of ground motion will be exceeded at a site or in a region during a specified exposure time.

**Extreme Stiffness Irregularity** – A type of vertical structural irregularity sometimes also referred to as extreme soft story irregularity.

**Extreme Torsional Irregularity** – A type of horizontal irregularity.

**Extreme Weak Story Irregularity** – A type of vertical structural irregularity.

**Fault** – A fracture in the earth’s crust along which displacement of one side of the fracture with respect to the other in a direction parallel to the fracture can occur.

**Fault, Active** – A fault that has moved one or more times in the past 10,000 years.

**Fault Trace** – The path along the earth’s surface that overlies a zone of fracture in the earth’s crust along which past earthquake movement has occurred

**Flexible Diaphragm** – A floor, roof, or horizontal bracing system that experiences lateral deformations equal to or greater than those experienced by the vertical frames or walls it connects.

**Force** – In physics, the influence that causes a free body to undergo an acceleration. Force also can be described by intuitive concepts such as a push or pull that can cause an object with mass to change its velocity (which includes to begin moving from a state of rest) or that can cause a flexible object to deform.

**Frame, Braced** – A structural framework which derives its resistance to lateral displacement through the action of diagonal members.

**Frame System, Building** – A structural system with an essentially complete space frame providing support for vertical loads; seismic forces are resisted by shear walls or braced frames.

**Frame System, Moment Resisting** – A structural frame that derives resistance to lateral displacement through the rigid or nearly rigid interconnection of beams and columns.

- Frame, Space** – A structural system composed of interconnected members, other than bearing walls, that is capable of supporting vertical loads and that also may provide resistance to seismic forces.
- Frame-Shear Wall Interactive System** – A type of structural system in which a structure's resistance to lateral forces is provided by a combination of moment-resisting frames and shear walls without limitation on the relative strength of each.
- Frequency** – For a vibrating structure, the number of times per second that the structure will undergo one complete cycle of motion.
- g** – The acceleration due to gravity or 32 feet per second per second.
- Ground Failure** – Physical changes to the ground surface produced by an earthquake; these include landslides, lateral spreading, and liquefaction.
- Grout** – A mixture of sand, Portland cement, water, and other elements used to fill voids in masonry construction, bond the masonry units together, and bond reinforcing steel.
- Hysteretic Properties** – For a structural element or member, the variation of stress in the element as a function of imposed deformation considering the prior loading history.
- Inelastic Structural Response** – The force and deformation behavior of a structure after the onset of damage.
- Intensity** – The apparent effect that an earthquake produces at a given location; in the United States, intensity generally is measured by the modified Mercalli intensity (MMI) scale.
- Intermediate System** – A structural system that has been designed to provide more ductility and toughness than that required for an “ordinary” system but less than that for a “special” system.”
- Interstory Drift** – The difference in peak lateral displacement from the at-rest position of the center of mass of the diaphragm levels immediately above and below a story.
- Interstory Drift Ratio** – The ratio of interstory drift in a story to the story height.
- In-plane Discontinuity Irregularity** – A type of vertical structural irregularity.
- Irregularity** – A condition relating to a structure's shape or the distribution of its weight, stiffness, or strength that could lead to atypical behavior when subjected to earthquake shaking.
- Irregular Structure** – A structure that has one or more specified irregularities.
- Landslide** – Disturbance in hillside ground, sometimes caused by earthquake ground motion, in which one land mass slides down and over another,
- Lateral Force** – A force that affects an element or portion of a structure as a result of the building's horizontal acceleration in an earthquake
- Linear Analysis** – Any method of structural analysis that ignores the effects of both structural damage and large displacements on internal forces and displacements
- Linear Dynamic Analysis** – An approximate method of structural analysis that predicts the forces and deformations induced in a structure by ground shaking without consideration of the effects of structural damage that may occur.
- Liquefaction** – The conversion of a solid into a liquid by heat, pressure, or violent motion; sometimes occurs to the ground in earthquakes.



- Live Load** – The weight of objects supported by a structure but not permanently attached to it; the live load changes frequently with time and includes the weight of occupants, furniture, and similar items.
- Loss** – Any adverse economic or social consequences caused by earthquakes.
- Masonry** – A form of structural construction in which individual blocks of fired clay (bricks) or concrete are stacked together and joined with mortar to form an integral element.
- Mass** – A constant quantity or aggregate of matter; the inertia or sluggishness that an object, when frictionlessly mounted, exhibits in response to any effort made to start it or stop it or to change in any way its state of motion.
- Mat Foundation** – A form of foundation in which a monolithic reinforced concrete slab underlying a large portion of a structure or perhaps the entire structure is used to transfer the structure's weight to the underlying soil.
- Mercalli Scale (or Index)** – A measure of earthquake intensity named after Giuseppe Mercalli, an Italian priest and geologist.
- Moment** – The force effect associated with the application of a force at a distance from the point under consideration.
- Moment Resisting Frame** – A structural system in which the rigid or nearly rigid interconnection of the horizontal beams and vertical columns provides the primary resistance to lateral forces.
- Monolithic** – In reinforced concrete construction, a term used to describe elements that are cast in one continuous placement of concrete without joints.
- Mortar** – A mixture of sand, cement, lime, and water used to bond bricks or concrete blocks together to form an integral structural element.
- Natural Period** – The time, in seconds or fractions of a second, that a structure in free vibration will take to undergo one complete cycle of motion.
- Nonbuilding Structure** – Generally, a self-supporting structure, other than a building, that carries gravity loads and that may be required to resist the effects of earthquakes.
- Nonstructural Components** – Components of a building that are not designed to contribute to its structural resistance.
- Nonlinear Analysis** – Any of several types of structural analysis that consider the effects of structural damage and large displacement on forces and displacements.
- Nonlinear Response History Analysis** – A method of structural analysis that uses numerical integration of the equation of motion to simulate the forces and deformations that occur in a structure in response to earthquake shaking considering the effects of structural damage that may occur.
- Nonparallel Systems Irregularity** – A type of horizontal irregularity.
- Nonstructural Component** – A portion of a building or structure that is provided for purposes other than acting as a structural element including doors, windows, some types of wall, and mechanical and electrical equipment.
- Occupancy Category** – A categorization of buildings and other structures based on their intended use and the risk that structural failure would pose to the public.

**Ordinary System** – A structural system that has been designed with only limited ductility and toughness.

**Out-of-Plane Offset Irregularity** – A type of horizontal irregularity.

**P-delta Effects** – A tendency of vertical loads placed on a laterally displaced structure to increase the lateral displacements, potentially capable of causing instability.

**Permanent Deformation** – A change in the permanent shape and geometry of the ground or of a structure that occurs as a result of damage sustained during an earthquake.

**Period** – The elapsed time (generally in fractions of a second or seconds) of a single cycle of a vibratory motion or oscillation; the inverse of frequency.

**Pier Foundation** – A type of cast-in-place concrete pile that has a large diameter, usually greater than 18 inches and sometimes as large as 5 or 6 feet.

**Pile Foundation** – A type of foundation in which a vertical or nearly vertical element (the pile) is embedded directly into the ground to transfer the weight of a structure into the ground either through friction between the sides of the pile and the surrounding soil or end bearing of the pile against stiff soils and rock beneath it.

**Plain Concrete** – A structural element of concrete construction that does not include sufficient steel reinforcement or prestressing to be classified as reinforced or prestressed concrete.

**Plain Masonry** – A structural element of masonry construction that does not include sufficient steel reinforcement to be classified as reinforced masonry. Also termed “unreinforced masonry” or “URM.”

**Prestressed Concrete** – A form of concrete construction in which reinforcement is provided by steel cables or rods that have been embedded in the concrete and then stressed in tension to place the concrete in compression.

**Recurrence Interval** – see “Return Period.”

**Redundancy** – A property of some structures in which multiple elements are used to provide support for the structure so that if one or some of these elements are damaged, other elements are available to continue to support the structure.

**Re-entrant Corner Irregularity** – A type of horizontal irregularity.

**Regular Structure** – A structure that does not have any specified irregularities.

**Reinforced Concrete** – A type of structural element formed of concrete with embedded steel rod reinforcement.

**Reinforced Masonry** – A type of structural element formed of masonry units with embedded steel rod reinforcement.

**Reinforcing Steel** – Round steel bars that have been deformed to provide bond with concrete and/or grout.

**Response Spectrum Analysis** – An approximate method of linear dynamic analysis that computes the forces and deformations induced in a structure by earthquake shaking using a response spectrum as the representation of the ground motion.

**Resonance** – The amplification of a vibratory motion occurring when the period of an impulse or periodic stimulus coincides with the period of the oscillating body.

- Response, Building** – The way in which a building reacts to earthquake ground motion; includes, for example, rocking, sliding, distorting, and collapsing.
- Response Modification Factor** – The factor in the equivalent lateral force equation that accounts for damping and ductility inherent in the structure; often referred to as the “R factor.”
- Return Period** – The average time interval, in years, that can be expected between repeat occurrences of similar extreme events such as earthquakes, floods, snow and ice accumulations.
- Rigid Diaphragm** – A floor, roof, or horizontal bracing system that deflects substantially less than the vertical frames or walls it connects when subjected to lateral forces.
- Risk-Targeted Maximum Considered Earthquake Shaking** – The most severe earthquake effects considered by the 2009 *NEHRP Recommended Seismic Provisions*.
- Seismic Design Category** – A categorization of buildings and other structures based on consideration of each structure’s seismic risk.
- Seismic-Force-Resisting System** – The part of a structural system designed to provide required resistance to prescribed seismic forces.
- Seismic Hazard Map** – A map showing contours of the maximum ground motion intensity or acceleration expected across a geographic region within a defined return period or probability of exceedance; in the United States, these maps are produced by the U.S. Geological Survey.
- Seismic-Load-Resisting System** – The assembly of columns, beams, braces, walls, and other structural elements that provide a structure’s resistance to seismic loads.
- Seismic Risk** – A measure of the severity of the possible losses associated with the behavior of a building or structure in likely earthquakes
- Shear** – A force that acts by attempting to cause the fibers or planes of an object to slide over one another.
- Site Class** – A system used to categorize site soil conditions in general terms based on the stiffness and depth of soil deposits and the likely effect of these characteristics on ground shaking strength and frequency content.
- Static Load** – A force that remains constant with time.
- Stiffness** – A quantitative measure of the amount of force required to produce a unit amount of deflection or displacement in a structure.
- Stiffness Irregularity** – A type of vertical structural irregularity.
- Story Drift** – Vertical deflection of a single story of a building caused by lateral forces.
- Strain** – Deformation of a material per unit of the original dimension.
- Strength** – The capability of a material or structural member to resist or withstand applied forces.
- Stress** – Applied load per unit area or the internal resistance of a material to deformation forces.
- Soft Story Irregularity** – See “Stiffness Irregularity.”

**Special System** – A structural system that is designed to provide high levels of ductility and toughness.

**Structural Element** – A piece of a structure that is used to both support the structure's weight and that of its supported contents and attachments and resist various types of environmental loads including earthquakes and wind.

**Structural Steel** – An alloy of iron, carbon, and other elements that has been formed by a hot rolling process into either flat plates or shaped elements for use in construction.

**Spectral acceleration** – The maximum acceleration that a structure having a specific natural period of vibration would experience when subjected to a particular earthquake.

**Spread Footing Foundation** – A type of foundation in which individual reinforced concrete slabs are placed beneath individual building columns (or sometimes closely spaced groups of columns) to transfer the weight supported by the column(s) to the underlying soil.

**System** – An assembly of components or elements designed to perform a specific function (e.g., a structural system or a force-resisting system).

**Torsion** – Structural behavior associated with twisting about a vertical axis for structures or a longitudinal axis for individual structural elements.

**Torsional Irregularity** – A type of horizontal irregularity.

**Transient Deformation** – Deformation (movement) of the ground or a structure supported on the ground that occurs during an earthquake event; all or a part of this deformation may be disappear after the earthquake is over.

**Unreinforced Masonry** – Masonry construction that does not include sufficient steel reinforcement to be classified as reinforced masonry; also referred to as “plain masonry.”

**Vertical Bearing Support** – The mechanism by which the weight of a structure and its supported contents is transferred to and resisted by the ground.

**Vertical Force** – A force that acts vertically; vertical earthquake forces represent the effects of vertical accelerations experienced in an earthquake.

**Weak Story Irregularity** – A type of vertical structural irregularity.

**Weight/Mass Irregularity** – A type of vertical structural irregularity.

## SELECTED REFERENCES AND BIBLIOGRAPHY

- Algermissen, S.T. 1983. *An Introduction to the Seismicity of the United States*. Earthquake Engineering Research Institute, Oakland, California.
- American Concrete Institute. 2008. *Building Code Requirements for Structural Concrete and Commentary*, ACI 318-08. American Concrete Institute, Farmington Hills, Michigan.
- American Institute of Steel Construction. 2005. *Seismic Provisions for Steel Buildings*, ANSI/AISC 341-05. American Institute of Steel Construction, Chicago, Illinois
- American Iron and Steel Institute. 2008. *S100 North American Specification for the Design of Cold Formed Steel Structural Members*. American Iron and Steel Institute, Washington, D.C.
- American Society of Civil Engineers/Structural Engineering Institute. 2005. *Minimum Design Loads for Buildings and Other Structures*, ASCE/SEI 7-05. American Society of Civil Engineers, Reston, Virginia.
- American Society of Civil Engineers/Structural Engineering Institute. 2003. *Seismic Evaluation of Existing Building*, ASCE/SEI 31-03. American Society of Civil Engineers, Reston, Virginia.
- American Society of Civil Engineers/Structural Engineering Institute. 2006. *Seismic Rehabilitation of Existing Buildings*, ASCE/SEI 41-06. American Society of Civil Engineers, Reston, Virginia.
- Chen, W. F., and C. R. Scawthorn. 2003. *Earthquake Engineering Handbook*. CRC Press, New York, New York.
- Chopra, A. K. 2005. *Earthquake Dynamics of Structures, A Primer*; Earthquake Engineering Research Institute, Oakland, California.
- Federal Emergency Management Agency. 2009. *NEHRP Recommended Seismic Provisions for Seismic Regulation of Buildings and Other Structures*, FEMA P-750, prepared for FEMA by the Building Seismic Safety Council. Federal Emergency Management Agency, Washington, D.C.
- Federal Emergency Management Agency. 2006. *Homebuilders' Guide to Earthquake-Resistant Design and Construction*, FEMA 232, prepared for FEMA by the Building Seismic Safety Council. Federal Emergency Management Agency, Washington, D.C.
- Federal Emergency Management Agency. 2008. *Techniques for the Seismic Rehabilitation of Existing Building*, FEMA P-547. Federal Emergency Management Agency, Washington, D.C.
- Federal Emergency Management Agency. 2009. *A Quantification of Building Seismic Performance Factors*, FEMA P-695, prepared for FEMA by the Applied Technology Council. Federal Emergency Management Agency, Washington, D.C.
- Federal Emergency Management Agency. 2009. *Reducing the Risks of Nonstructural Earthquake Damage – A Practical Guide*, FEMA P-74, prepared for FEMA by the Applied Technology Council. Federal Emergency Management Agency, Washington, D.C.

Federal Emergency Management Agency. 2007. *Risk Management Series – Designing for Earthquakes: A Manual for Architects*, FEMA P-454. Federal Emergency Management Agency, Washington, D.C.

Lee, W. H. K., H. Kanamori, P. C. Jennings, and C. Kisslinger. 2003. *Earthquake and Engineering Seismology*. Academic Press, San Diego, California.

The Masonry Society. 2008. *Building Code Requirements for Masonry Structures*, ACI-530-02/ASCE 5-02/TMS402-02. American Concrete Institute, Farmington Hills, Michigan.

Naeim, F., Ed. 2001. *The Seismic Design Handbook*. Springer (formerly Kluwer Academic Publishers), New York/Heidelberg.

Newmark, N. M., and W. J. Hall. 1982. *Earthquake Spectra and Design*. Earthquake Engineering Research Institute, Oakland, California.