

Biblical Exegesis

Discovering the Meaning of Scriptural Texts

By John Piper

For more free resources, go to www.desiringgod.org

Preface

John Wesley once said, “I have thought I am a creature of a day, passing through life as an arrow through the air. I am a spirit come from God, and returning to God, just hovering over the great gulf, till a few moments hence, I am no more seen; I drop into an unchangeable eternity! I want to know one thing—the way to heaven, how to land safe on that happy shore. God himself has condescended to teach the way; for this very end He came from heaven. He has written it down in a book. O give me that Book at any price, give me the Book of God” (from the preface of *Sermons on Several Occasions* by John Wesley, originally published in 1771).

This Book has been costly. Martyrs wrote it and others have suffered intensely for their faithfulness to it. The book has been preserved and passed down through painstaking efforts. It has been translated into the vernacular of thousands of peoples, sometimes at the cost of life, not to mention time, energy, and money.

This Book is a “treasure chest of holy joy.” It is from this Book that we learn what the apostles taught concerning the ultimate sacrifice of the Son of God. It’s from this Book that we learn about the supremacy of God in all things. It is from this Book that we learn about what our sovereign and good Father requires of us, his dependent children.

If a rich uncle left his huge inheritance to the person named in his will, and you knew that you were that person, you would be very zealous to see that the court interpreted his will in a way consonant with the author’s intended meaning. Or if you were desperately sick with a terminal disease, and you heard of a doctor who knew the cure, and he wrote down a health regimen for you, you would do everything in your power to understand what the doctor meant in his health regimen and do whatever the regimen called for. How much more should we, like Wesley, regard the Word of God to be precious and most worthy of study!

Because the Bible alone is the inerrant, infallible authority for what we are to believe about God and how he wants us to live, it is no surprise that we bring a lot of baggage to the text. By nature we don’t like the thought of absolute authority residing in anyone outside of ourselves. What if God commands me to do something I don’t want to do? Or what if he portrays himself in a way that differs from the way I think he should be? This would lead to a tremendous pressure to import our own meanings into the text rather than content ourselves with the author’s intended meaning wherever it leads us.

Thus, we need three things to be careful interpreters of the Word of God. First, we must admit we need help and that we will die without it. Left to ourselves, and our own unaided human reason, we are hopeless. We need revelation from above. Our eternal life hangs on this! Secondly, we need faith in the sovereign goodness of the Author. This

faith not only frees us to go where the Bible leads us, but it impels us to go where the Bible leads us. It is, as Wesley said, “the Book of God!” Thirdly, we need to learn how to read with the kind of care that corresponds to the preciousness of the Book.

In this pamphlet, John Piper passes on to us a way of reading the text that he learned from Daniel Fuller, Professor-Emeritus at Fuller Theological Seminary. There is nothing magical about this method. It is simply designed to help us slow down, let the author invite us into his world, and follow his train of thought. It teaches us how to discover the author’s main point and to see how the other points illustrate or support the main point.

As a young Christian at Bethel College, I had the privilege of taking several of Pastor John’s courses (I knew him then only as Dr. Piper!) in which he coached us, proposition by proposition, through Romans, 1 Peter, 1 John, Ephesians, Luke and others. His passion was that we would see Reality for ourselves through the eyes of the Biblical writers. He didn’t claim to see this Reality perfectly, he was (and is!) still very much in process. He didn’t spoon feed us his conclusions, but helped us to reach our own and to see things he hadn’t yet seen. I remember one time, when we were studying Romans 11:33-36, that the weight of glory from that text inspired the class to break forth spontaneously in singing the Doxology. Biblical theology leads to doxology!

Upon graduation my appetite for understanding and applying the Word of God was whetted for more. It led me to spend the next two years being mentored by John’s mentor. Daniel Fuller trembled under the privilege and responsibility of studying and teaching the Word of God like few people I have ever met. Each word of God was precious; each proposition of Scripture was not merely a pearl on a string, but a link in the chain. And the study of this Book mattered. Eternity was at stake in how we understood and taught the Bible. There was no academic gamesmanship. We were blood earnest in our study.

During the last 19 years, as a pastor at Bethlehem, I have sought to pass on to young and old alike, in one form or another, the method of Bible study taught in this pamphlet. Some people catch on more quickly than others, but all have pressed home on them the preciousness of the Word of God.

As you read this pamphlet, may God increase your passion to study the Word of God for yourself and then to pass on what you learn to others.

Tom Steller
Pastor for Missions and Leadership Development
Bethlehem Baptist Church, Minneapolis
July 1999

1

Goals

The Affections

This is the man upon whom I will look, he that is humble and contrite in spirit, and trembles at my Word. (Isaiah 66:2)

It is an awesome thing to confess that in the Bible we hear the Word of God. And there is no hope for the exegete who never trembles in his trade; God has no regard for him, and he will come to nothing, though he write a thousand books.

I believe that the Bible is God's Word. Therefore I must define the ultimate goal of exegesis so as to embrace the heart as well as the head. The Scriptures aim to affect our hearts and change the way we feel about God and his will. The exegete, who believes that this aim is the aim of the living God for our day, cannot be content with merely uncovering what the Scriptures originally meant. He must aim, in his exegesis, to help achieve the ultimate goal of Scripture: its contemporary significance for faith. It is the will of God that his Word crush feelings of arrogance and self-reliance and that it give hope to the poor in spirit.

The Lord has given me the tongue of those who are taught, that I may sustain with a word him that is weary. (Isaiah 50:4)

Exegesis that does not sooner or later touch our emotions, and through us, the emotions of others, is ultimately a failure because it does not mediate the effect which the Scripture ought to have.

Whatever was written in former days was written for our instruction, that by the steadfastness and encouragement of the Scriptures we might have hope. (Romans. 15:4)

Therefore, Biblical exegesis should be the intellectual enzyme that transforms the stupor of our worldly and futile affections into a deep and glad and living hope. Jesus said:

These things I have spoken to you, that my joy may be in you, and that your joy may be full. (John 15:11)

Biblical scholarship that does not share this goal works ill in two ways: by extinguishing in some people the flickers of affection with a frigid indifference and by alienating those whose candles will not go out. But neither of these is necessary if Biblical exegesis is handled for what it really is, the cognitive catalyst that triggers a combustion of divine

joy in the human heart. Theology very quickly becomes idle chatter if it does not give birth in the heart to doxology. There is no reason why the most rigorous Biblical scholar cannot and should not say with Jonathan Edwards:

I should think myself in the way of my duty, to raise the affections of my hearers as high as I possibly can, provided they are affected with nothing but truth, and with affections that are not disagreeable to the nature of what they are affected with.¹

Of course, defining the ultimate goals of Biblical exegesis in this way assumes that the exegete is convinced that the Scriptures do mediate truth. However, many exegetes do not share this conviction. The goal I have described so far does not apply to them. That is why I described it as an ultimate goal. There is a more immediate goal that I as an evangelical share with all good exegetes whether they believe the Scriptures are true or not. We both want to understand and state accurately what the original Biblical authors willed to communicate. A person who has no vested interest in confessing the Bible's truth may be able, in any given case, to understand and restate the meaning of the original author as accurately as an exegete who believes the Bible is true. This is why we can make profitable use of Biblical scholarship from all sorts of people. I add this note to avoid confusion: the goals I am describing are those that I think should be set in view of my conviction of the Bible's truth. As such they are different from, yet overlapping with, the goals of exegetes who do not share this conviction.

The Intellect

I referred to exegesis as an intellectual enzyme and a cognitive catalyst. This means that the exegete is inevitably somewhat of an intellectual. He is very much occupied with the life of the mind. The most obvious reason for this is that the truth he cherishes comes to him in a divinely inspired book. But a book must be read, and good reading is an intensely intellectual act.

An evangelical believes that God humbled himself not only in the incarnation of the Son, but also in the inspiration of the Scriptures. The manger and the cross were not sensational. Neither are grammar and syntax. But that is how God chose to reveal himself. A poor Jewish peasant and a prepositional phrase have this in common, they are both human and both ordinary. That the poor peasant was God and the prepositional phrase is the Word of God does not change this fact. Therefore, if God humbled himself to take on human flesh and to speak human language, woe to us if we arrogantly presume to ignore the humanity of Christ and the grammar of Scripture.

But it is not enough to say that God's revelation in Scripture comes to us in human language. It comes in the language of particular humans in particular times and places. There are no distinctively divine language conventions. That is, when God spoke through men, he did not always use the same language or the same style or the same vocabulary. Rather all the evidence points to the fact that God always availed himself of the language,

style, vocabulary and peculiar usages of individual Biblical writers. Even in the prophetic speeches where God is directly quoted there are language traits that distinguish one author from another.

The implications of this for setting our goal in exegesis are crucial. Let me illustrate. In view of this conception of inspiration, if we want to construe what God intends by the word “wisdom” in James 1:5, we do not import the meaning of “wisdom” from Proverbs 8. That is, we do not assume that since these two uses of “wisdom” have the same divine author, they will likely have the same meaning. Rather, we recognize that since God avails himself of the language conventions of his individual revelatory spokesmen, we would do better to go to James 3:15 to see how James employs the word “wisdom,” and thus discover God’s intention.

I conclude, therefore, that God’s meaning in Scripture is only accessible through the particular language conventions of the various human authors. My belief in inspiration, therefore, is a belief that to grasp what these human authors willed to communicate in their particular historical situation is also to grasp God’s own intention for that situation. Consequently, the most immediate goal of exegesis is to understand what the Biblical authors willed to communicate in their situation. The goal is to see reality through another person’s eyes.

This has two further implications.

For those who think the Bible is infallible and authoritative in matters of faith and practice, good exegesis becomes a very humbling task. It demands that our own ideas take second place. The way we feel and think about life is restrained as we allow ourselves to listen to what the author feels and thinks. Good exegesis becomes a threat to our pride. By it we run the risk of honestly discovering that the prophetic and apostolic view of life is different from our own, so that our view — and with it our pride — must crumble.

Can we fallen creatures, who proudly love our own glory so much, ever do good exegesis? Will we not use every connivance to hide our ignorance or rebellion? Will we not twist and distort the meaning of Scripture so that it always supports our own view and our own ego? We all know this happens every day. But must it always happen?

It is precisely at this point that I believe the Holy Spirit performs a crucial role in the exegetical process for the reliant believer. He does not whisper in our ears the meaning of a text. He cares about the text which he inspired and does not short circuit the study of it. The primary work of the Holy Spirit in exegesis is to abolish the pride and arrogance that keep us from being open to the Scriptures. The Holy Spirit makes us teachable because he makes us humble. He causes us to rely wholly on the mercy of God in Christ for our happiness so that we are not threatened if one of our views is found to be wrong. The person who knows himself finite and unworthy, and who thus rejoices in the mercy of God, has nothing to lose when his ego is threatened.

The fruit of the Spirit is love. It is crucial for exegesis. Love seeks not its own; is not

puffed up. On the contrary, love rejoices in the truth. This is the mark of the good exegete. He seeks not his own; he seeks the truth. If the truth he finds conflicts with his own idea, he rejoices to have found the truth and humbly acknowledges that his own is wrong.

The Holy Spirit makes possible the exhilarating experience of growth. Only the open, humble mind truly grows in understanding. The proud mind is more interested in protecting itself than in expanding and correcting itself. It must therefore stay small. Arrogant people are always little people. Humble people look little but they are inheriting the whole world. So while good exegesis is humbling, it is also tremendously enlarging. It reduces us to our true finiteness, so that we may see and enjoy the magnificent eternal truth revealed in the Scripture.

A second implication which follows from our goal in exegesis is that exegesis involves what all reading involves, namely, the intellectual and often tedious work of construing an author's language conventions. To become a good exegete means simply to continue refining the skill we began to learn at the age of three. Then we struggled with, "Sally's hair is curled." Now we struggle with, "God so loved the world." Then we asked our mommy what "curled" means. Now we use concordances and commentaries.

God has spoken to us in written, human languages. We cannot grasp the meaning of language unless we understand the language conventions which a Biblical author employed. Therefore, we must make every effort to deal with the Bible grammatically (and historically since an author's specific use of language is determined by his situation in history).

2

Procedures

To reach the immediate goals of exegesis simply means to read well. That is why Mortimer Adler's excellent book on interpretation can be entitled simply, *How to Read a Book*.² And that is why Paul said,

By reading you can apprehend my understanding of the mystery of Christ.
(Ephesians 3:4)

The principles of Biblical exegesis are simply the principles of good reading. They are what every elementary school and high school should be teaching above all else; what the scholastics thought of in terms of grammar, dialectic, and rhetoric.³

I see five steps one must pass through on his way to understanding an expository text in the New Testament.

Finding a Reliable Text

You cannot begin to rethink an author's intention until you have a text which corresponds substantially with what the author actually wrote. This means that for the readers of Greek, textual criticism⁴ is foundational to all reliable exegesis. Those who cannot read Greek have to depend not only on the text critics, but also on the translators. Apart from a knowledge of Greek, the best an interpreter can do is to understand the intention of the translator and then trust that this corresponds to the intention of the original author. It is therefore incumbent upon interpreters of the English Bible to find a reliable translation. But those who taste the exhilaration of theological discovery through careful grammatical exegesis will never be satisfied until they can drink fully at the fountain of the original source!

Coming to Terms with an Author

The second step is discovering what an author's words and phrases mean. Since any word or phrase may carry more than one meaning, our task is to determine precisely which meaning an author intends a given word or phrase to have. Adler calls a word or phrase a "term" when it is used with a determinate meaning in a given context.⁵ "Coming to terms" is what we do when we discover what that determinate meaning is.

You cannot come to terms with a Biblical author by looking his words up in a dictionary; not even a Greek dictionary. Dictionaries give a list of possible meanings, but do not specify with certainty which meaning a word has in any given text. How then do you

come to terms? Adler answers rightly. You have to discover the meaning of a word in its context that you do understand. This is true no matter how merry-go-roundish it may seem at first.⁶ The only way to know when the Greek word *zelos* means “zeal” and when it means “jealousy” is by the context in which it occurs.

Adler calls this method “merry-go-roundish” because we find ourselves going around in the notorious hermeneutic circle; namely: words can only be understood from their context. A context is nothing more than words and phrases which also need to be understood. The fact that we all communicate with words every day, with a great deal of success, shows that the hermeneutic circle is not as vicious as it sounds. Most words, phrases, and syntactical patterns are, to a certain degree, autonomous. Some aspects remain the same regardless of context.⁷ We should make every effort to understand the context in which a word stands so that we ascribe to it only the meaning that the author intended.

Understanding The Propositions

Words begin to convey determinate meanings only as they are seen to be parts of a proposition. Propositions are the basic building blocks of a text. The third step in reading a text is to understand each proposition. Obviously, from what we have seen, the second and third steps relate to each other, not sequentially, but reciprocally. Each is pursued simultaneously and is an aid to the attainment of the other.

A proposition is a simple assertion about something. The word “Jesus” conveys no determinate meaning when I say it alone. But, when I say, “Jesus wept,” a very clear meaning is conveyed because this statement is a proposition. In order to understand propositions, one must know at least the rudiments of grammar and syntax. Propositions only have meanings because they are put together according to established rules. You cannot communicate if you disobey all the rules. “Paul carried the basket” and “The basket carried Paul” are two propositions which use exactly the same words but convey very different meaning. There is a syntactical rule in English that says the subject of such a sentence precedes the verb. A new set of rules has to be learned when we want to read the Greek New Testament. Whether you are reading the Greek or English New Testament, you must attend to the appropriate rules of grammar if the meaning of an author’s propositions is to be understood.

Much of God’s Word remains unheard today because some devout people think it is unspiritual to look for subjects, objects, modifiers and antecedents in a Biblical sentence. And others, alas, have never even been taught that there are such things.⁸

Relating the Propositions to Each Other

After mastering the syntax of a proposition, and coming to terms with the words in it, we still may not understand its meaning. Just as words derive meaning from their use in a

proposition, so a proposition receives its precise meaning from its use in relationship to other propositions.

For example, in Colossians 3:21 Paul says, “Do not handle, do not taste, do not touch.” Taken alone, these three propositions would suggest that Paul is prescribing certain rules of behavior. That would be a complete misunderstanding. The preceding proposition, the rhetorical question of verse 20, says, “Why do you submit to regulations?” So what Paul really means is the very opposite of what the three propositions of verse 21 seem to mean when isolated from their context. He means, beware of such regulations as, “Do not handle, do not taste, do not touch.” Another example would be Philippians 2:12: “Work out your salvation with fear and trembling.” This proposition will not be properly construed unless it is viewed in relation to the clause which follows, “God is at work in you both to will and to work for his good pleasure”(Philippians 2:13). A whole theology hangs on the way you relate these two propositions. If you make the second clause the result of the first, then God’s action in sanctification is contingent upon our working. If you make the second clause the ground of the first, then our efforts toward holiness are initiated by God, and possible only because God is already at work in us. Paul leaves no room for doubt when he joins the two clauses by the conjunction “*gar*” or “because.” God’s work in us is the ground and enabling of our working.

The point of seeing propositions in relationship is not merely to elucidate the meaning of each proposition, but also to help us grasp the flow of an author’s argument. It was a life-changing revelation to me when I discovered that Paul, for example, did not merely make a collection of divine pronouncements, but that he argued. This meant, for me, a whole new approach to Bible reading. No longer did I just read or memorize verses. I sought also to understand and memorize arguments. This involved finding the main point of each literary unit and then seeing how each proposition fit together to unfold and support the main point.

To carry this step of exegesis through, we need two things. First, we need to know the kinds of relationships that can exist between propositions. If we do not know how thoughts relate to each other, it is a great hindrance to understanding how propositions form complex units of meaning. If we have only a vague idea of how two propositions are related, we are hindered because we do not know how to put our understanding into words. We need a list of possible logical relationships, with descriptive names, so that we can use them when we discuss a text’s meaning.

We also need some kind of method or device to help us hold a long or complex argument in view. For most of us, it is impossible to hold in our heads the complex interrelationships of an argument developed at the top of a page while we are struggling to see how the propositions at the bottom of the page cohere. It may be that the earlier argument holds the key to the later one. So we must find a way to preserve, in a brief space, the interrelationships of an author’s progressive line of argument. Otherwise it will be nearly impossible to grasp the totality and unity of what he wants to say.

These are the two things needed to trace out the thread of an author’s thought. In Daniel

Fuller's unpublished *Hermeneutics* syllabus, (Chapter 4)⁹ have I found a method which meets both of these needs. No other books on New Testament interpretation, that I am aware of, provide what, in my own devotional and scholarly work, has been most essential: a means of seeing the intricate development of an author's thought in its complexity and unity. What has come to be known as "arcing," has proven to be a most fruitful exegetical tool. Its principles undergird my whole approach to Biblical interpretation.

I will not reproduce Fuller's entire chapter on the interrelationships of propositions, but will condense it and provide some of my own illustrations of its application.

The relationships between propositions fall into two major classes: coordinate relationships and subordinate relationships. Two clauses have a coordinate relationship if one does not support the other in some way, but each is independent and makes its own contribution to the whole. For example:

I went to the post office, and I picked Noël up on the way home.
These two propositions do not support each other, but describe a series of things I did.

A clause has a subordinate relationship to another clause if it supports that clause in some way. For example:

I went to the post office because I had a letter to mail.

Here the proposition, "because I had a letter to mail," is subordinate to the main clause, "I went to the post office." It supports the main clause by giving the ground or cause for going to the post office.

There are a number of subclasses under these two classes. The arcs following represent groups of propositions. The symbols between or within them are abbreviations for the kind of relationship that exists between the symbolized propositions.

3

Coordinate Relationships Between Propositions (Non-Supportive)

Series

Definition: Each proposition makes its own independent contribution to a whole.

Conjunctions: and, moreover, furthermore, likewise, neither, nor, etc.

Example: “The sun will be darkened, and the moon not will give its light, and the stars will fall from heaven, and the powers of the heaven will be shaken” (Matthew 24:29; see also Matthew 7:8; Romans 12:12).

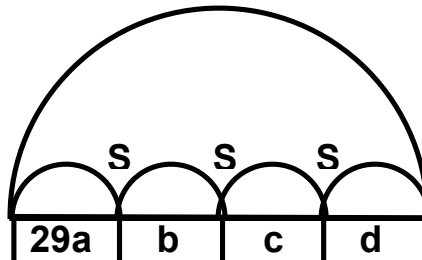

Progression

Definition: Like series, but each proposition is a further step toward a climax.

Conjunctions: then, and, moreover, furthermore, etc.

Example: “Those whom he predestined he also called; and those whom he called he also justified; and those whom he justified, he also glorified” (Romans 8:30; see also Mark 4:28; 1 Peter 1:5-7).

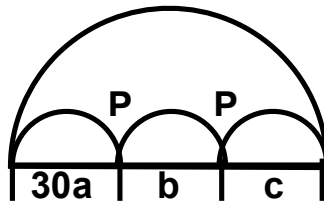

Alternative

Definition: Each proposition expresses a different possibility arising from a situation.

Conjunctions: or, but, while, on the other hand, etc.

Example: “Some were convinced while others disbelieved” (Acts 28:24; see also John 10:21, 22; Matthew 11:3).

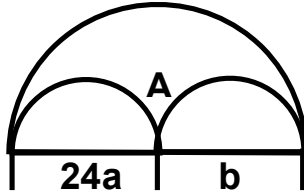

Subordinate Relationships Between Propositions (Supportive)

Support by Restatement

Action-Manner

Definition: The statement of an action, followed by a more precise statement that indicates the way or manner in which this action is carried out.

Conjunctions: in that, by, etc.

Example: “God has not left himself without a witness in that he gave you from heaven rains and fruitful seasons” (Acts 14:17; see also Philippians 2:7; Acts 16:16; 17:21).

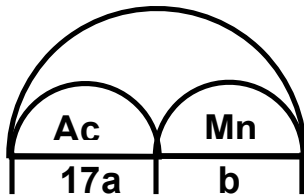

Comparison

Definition: The relationship between two statements expressing an action more clearly by showing what it is like.

Conjunctions: even as, as . . . so, like, just as, etc.

Example: “As my Father has sent me, so send I you” (John 20:21; see also 1 Corinthians 11:1; 1 Thessalonians 2:7).

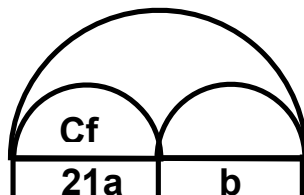

Negative-Positive

Definition: The relationship between two alternatives, one of which is denied so that the other is enforced. It is also the relationship implicit in contrasting statements.

Conjunctions: not . . . but, etc.

Example: “Do not be foolish, but understand what the will of the Lord is” (Ephesians 5:17; see also Hebrews 2:16; Ephesians 5:18; see also 1 Corinthians 4:10 for an example of contrast: “We are fools for the sake of Christ, but you are wise in Christ.”)

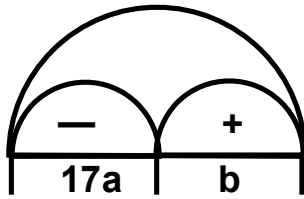

Idea-Explanation

Definition: The relationship between an original statement and one clarifying its meaning. The clarifying proposition may define only one word of the previous proposition.

Conjunctions: that is, etc.

Example: “Jacob supplanted me these two times; he took away my birthright and now he has taken away my blessing” (Genesis 27:36).

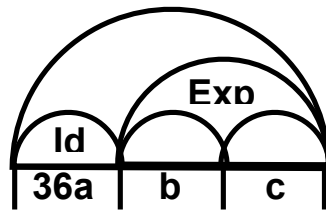

Question-Answer

Definition: Statement of question and answer to that question.

Conjunction: (question mark)

Example: “What does the Scripture say? Abraham believed God...” (Romans 4:3; see also Romans. 6:1; Psalms 24:3, 4).

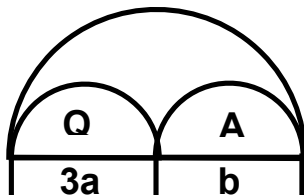

Support by Distinct Statement

Ground (Main Clause-Causal Clause)

Definition: The relationship between a statement and the argument or reason for the statement (supporting proposition follows).

Conjunctions: for, because, since, etc.

Example: “Blessed are the poor in spirit, for theirs is the kingdom of God” (Matthew 5:3; see also 1 Corinthians 7:9; Philippians 2:25-26).

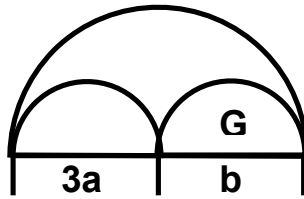

Inference (Main Clause-Inferential Clause)

Definition: The relationship between a statement and the argument or reason for the statement (supporting proposition precedes).

Conjunctions: therefore, wherefore, consequently, accordingly, etc.

Example: “The end of all things is at hand, therefore be sensible and sober in prayer” (1 Peter 4:7; see also Romans 6:11-12; Matthew 23:3; 1 Peter 5:5b-6).

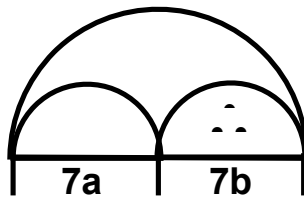

Action-Result (Main Clause-Result Clause)

Definition: The relationship between an action and a consequence or result which accompanies that action.

Conjunctions: so that, that, with the result that, etc.

Example: “There arose a great storm in the sea, so that the boat was being swamped by the waves” (Matthew 8:24; see also John 3:16; James 1:11).

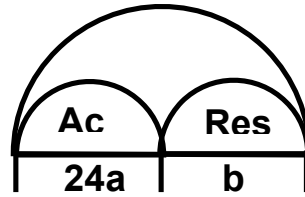

Action-Purpose (Main Clause-Purpose Clause)

Definition: The relationship between an action and the one that is intended to come as a result.

Conjunctions: in order that, so that, that, with a view to, to the end that, lest

Example: “Humble yourselves under God’s mighty hand that he may lift you up” (1 Peter 5:6; see also Romans 1:11; Mark 7:9).

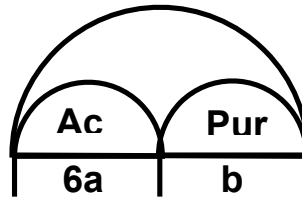

Conditional (Main Clause-Conditional Clause)

Definition: This is like Action-Result except that the existence of the action is only potential.

Conjunctions: if . . . then, provided that, except, etc.

Example: “If you are led by the Spirit, you are not under law” (Galatians 5:18; see also Galatians 6:1; John. 15:14).

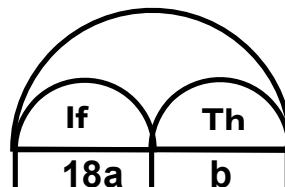

Temporal (Main Clause-Temporal Clause)

Definition: The relationship between the main proposition and the occasion when it can occur.

Conjunctions: when, whenever, after, before, etc.

Example: “When you fast, do not look gloomy” (Matthew 6:16; see also James 1:2; Luke 6:22).

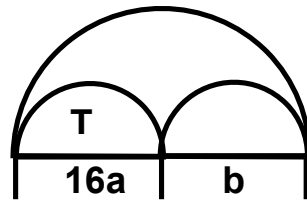

Locative (Main Clause-Locative Clause)

Definition: The relationship between a proposition and the place where it can be true.

Conjunctions: where, wherever, etc.

Example: “Where two or three are gathered together in My name, there I am in their midst” (Matthew 18:20; see also 2 Corinthians 3:17; Ruth 1:16).

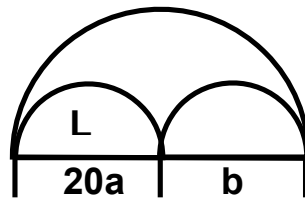

Bilateral

Definition: A bilateral proposition supports two other propositions, one preceding and one following.

Conjunctions: for, because, therefore, so, etc.

Example: “Let the nations be glad and sing for joy, for you will judge the peoples with uprightness and guide the nations on the earth. Let the peoples praise you, O God” (Psalm 67:4-5; see also Romans 2:1b-2).

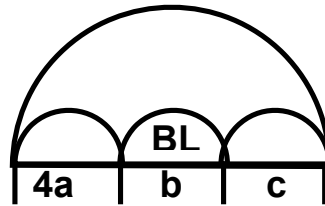

Support by Contrary Statement

Concessive

Definition: The relationship between a main clause and a contrary statement.

Conjunctions: although . . . yet, although, yet, nevertheless, but, however, etc.

Example: “Although he was a Son, he learned obedience from what he suffered” (Hebrews 5:8; see also 1 Corinthians. 4:15; 9:13-15).

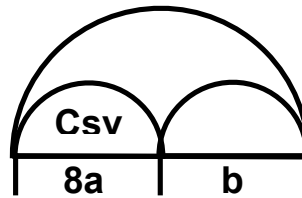

Situation-Response

Definition: The relationship between a situation in one clause and a response in another.

Conjunctions: and, etc.

Example: “How often would I have gathered your children together as a hen gathers her brood under her wings, and you would not” (Matthew 23:37; see also John. 7:21).

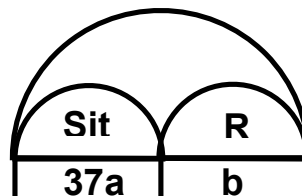

Note: In the example above, the response is surprising. In instances like this, one clause is

concessive to the other. However, when the response is that which follows naturally from the situation, then it is an *Action-Result* and fits under the category of *Support by Distinct Statement*.

Some Illustrations

How to Arc Romans 12:1, 2

Let me illustrate the process of relating propositions by using Romans 12:1-2. First, here is my translation of the text. (If you cannot work from the Greek text, it is most helpful to work from a very literal translation like the *New American Standard Bible*. Other translations may be superior for communicating with contemporary readers, but the *NASB* preserves many grammatical structures that allow you to make interpretational decisions which other translations, for the sake of clarity, make for you.)

Therefore, I beseech you by the mercies of God, brothers, to present your bodies to God as a living, holy, acceptable sacrifice, which is your spiritual service of worship. And do not be conformed to this age but be transformed by the renewing of your mind in order that you might approve what the will of God is, namely, the good, the acceptable, and the perfect.

I see four individual propositions or assertions in this paragraph:

12:1 I beseech you by the mercies of God, brothers, to present your bodies to God as a living, holy, acceptable sacrifice which is your spiritual service of worship.

12:2a *And* do not be conformed to this age

12:2b *but* be transformed by the renewing of your mind,

12:2c *in order that* you might approve what the will of God is, namely, the good, the acceptable, and the perfect.

We may symbolize each of these propositions with an arc as follows:

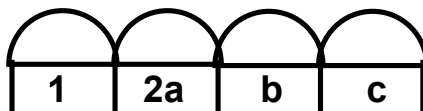

The easiest relationship to see is between 2a and b. They command virtually the same

thing; one negatively and the other positively. “Don’t be conformed, but be transformed.” We can symbolize this relation with a larger arc as follows:

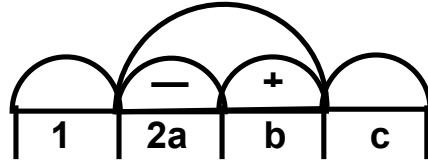

When a larger arc is drawn, we regard what is under it as asserting one main thing; in this case, “Be a transformed person with a new mind and thus different from this age!”

Then Paul makes it very plain to us how 2ab relates to 2c because he connects them with the conjunction “in order that” (*eis to* + the infinitive). Therefore, 2c is the purpose or end of 2ab, which is the means. This relationship we can symbolize as follows:

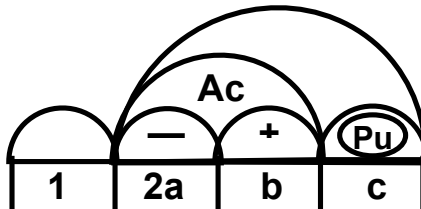

I circle the Pur (= purpose) because that is primary in Paul’s mind; it is the goal, the main point of Romans 12:2. (The only relationships in which one symbol has to be circled are Ac-Pur, Ac-Res, and Sit-R.) Verse 2ab is simply the necessary means to accomplish 2c. To paraphrase: Get yourself transformed so that with your new mind you can think like God thinks and approve what he approves. The necessary prerequisite to knowing and embracing the holy is a renewed mind.

Now comes the final relationship. How does the main point of verse two (2c) relate to the proposition of verse one? To answer this we must have some idea of what verse one is asserting. This we can learn from a parallel earlier, in Romans 6:13, “Do not present your members as weapons of unrighteousness to sin but present yourselves to God as those alive from the dead and your members as weapons of righteousness of God” (see 6:19). There is no reason to think Paul means anything very different in 12:1 when he says, “Present your bodies to God,” than he did in 6:13 when he said, “Present your members to God.” This makes very good sense in the context of Romans 12:1-2, and the same word for “present” is used in both places. Romans 12:1 is not a command to the unconverted to submit to God, but rather a command to believers to honor God in their bodies.

Paraphrased, Romans 12:1 means something like this: In view of how merciful God has been to you, make it your aim in all your daily, bodily existence to do what honors God;¹⁰ worship God by doing his will with your body (see 1 Corinthians 6:20). Now we are prepared to relate verses 1 and 2. Knowing and approving the will

of God is a means of doing His will with your body. The link of verse 1 with verse 2c is evident in the repetition of the word “acceptable.” Approving what is acceptable (2c) is the prerequisite of offering the body in daily life as an acceptable sacrifice (1). Therefore, I symbolize the relationship as Purpose (verse 1) to Action [means] (verse 2).

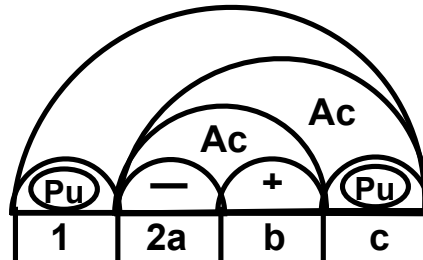

In this way, we arrive at an interpretation of Romans 12:1, 2: The most basic change that must occur in the believer is that he cease to think like this age and think with a new mind, with new sentiments, priorities, and values. With this new mind he is then able to judge and assess what is holy and good and acceptable. He not only can assess it properly with his new mind, but he now approves of it and delights in it.¹¹ This leads necessarily to a bodily life given up to God for his purposes. The daily deeds of the body become acts of worship in that they demonstrate the great worth we ascribe to God’s mercy. By this is fulfilled the command of our Lord that we should let our light shine that men may see our good deeds and give glory to our Father in heaven.

Notice the structure of the final arcing. There is now one arc over the whole, which suggests that we have gotten a glimpse of the main thesis of this unit. Under this one arc are two arcs related as action-purpose. Under the larger of these are another two arcs related as action-purpose. Under the larger of these are two arcs related as negative-positive. In other words, the smallest arcs are gradually grouped together into larger units, that are then related to other units until there is one arc over the whole. We can then see how each of the smaller propositions functions to help communicate one main point. It cannot be determined in advance which units to arc together first. This comes from guided practice.

The Levels of Romans 12:1, 2

A variation on arcing, that is simpler and more easily used in church Bible teaching, is a procedure involving levels. This brings out the main point of a text and the

varying levels of support for it. The levels of Romans 12:1, 2 look like this:

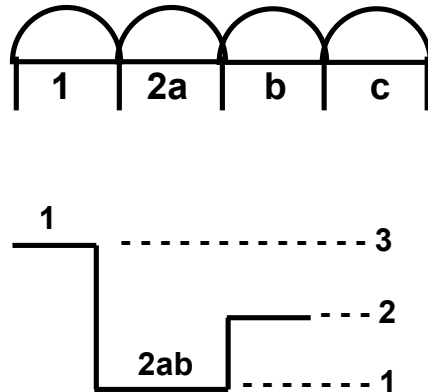

The numbers to the right designate the three levels in the argument. (Verse 2a and b are on the same level because they simply restate each other rather than one advancing the argument over the other.) Once the levels of an argument are identified and numbered, they can be briefly paraphrased from the bottom (most basic argument) to the top (main conclusion).

For example:

1. Be changed in the way you think
2. *in order that* you can heartily approve God's will,
3. *in order that* you can honor him in your daily, bodily existence.

It is helpful, as shown here, to use an explicit connecting phrase between each level of the argument and to highlight it.

The Arcs and Levels of Luke 12:35-38

Here is another example of arcing and levels using a unit from the teaching of Jesus.

Luke 12:35-38

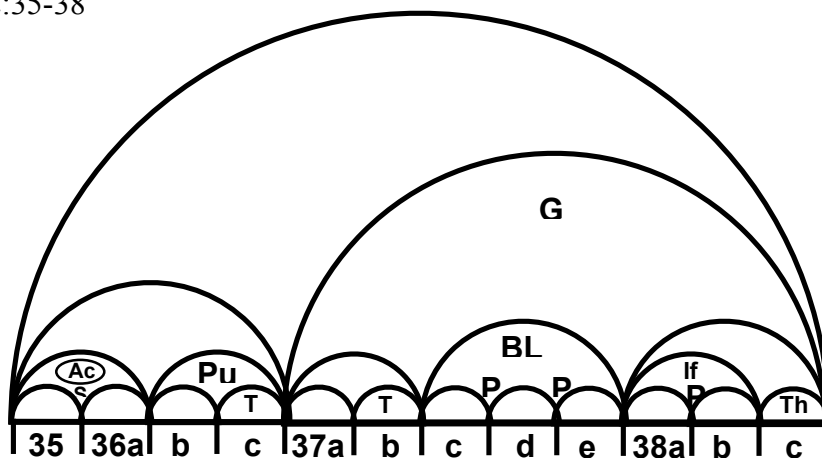

- 35 Let your loins be girded and your lamps burning.
- 36a *And* be like men who are waiting for their master to come home from the marriage feast,
 b *so that* they may open to him at once
 c *when* he comes and knocks.
- 37a (*For*) blessed are those servants whom the master finds awake
 b *when* he comes
 c (*for*) truly I say to you he will gird himself
 d *and* have them sit at table,
 e *and* he will come and serve them.
- 38a (*Therefore*) if he comes in the second watch or in the third,
 b *and* finds them so,
 c (*then*) blessed are those servants.

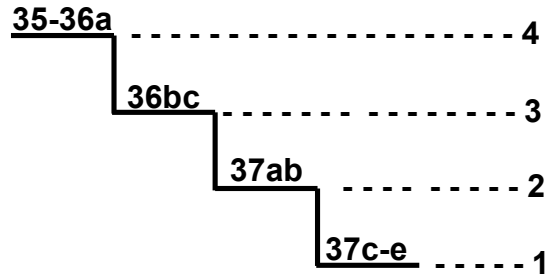

1. Christ is going to serve a glorious eternal banquet to those who do not slumber in unbelief.
2. *Therefore*, when he finds us wide awake trusting him, we will be very happy.
3. *Therefore, in order to* open the door to this great blessing,
4. be vigilant in maintaining the obedience of faith.

6

Special Problems in Finding the Propositions

Before we can do any arcing, we must divide a text into its significant propositions. This is not always easy since a sentence can have several propositions, and since propositions can be concealed in different kinds of phrases. We previously discussed the nature of propositions and defined a proposition as an assertion (having a subject and a predicate). This, of course, is over-simplified. Language can be very complex and writers can make assertions in a great variety of ways. These may not always look like the standard proposition: “Jesus wept.” At these points a keen, sometimes delicate, sensitivity to the author’s intention is needed to tell whether a certain grammatical construction should be construed as a proposition or not. There are no rigid rules for making these decisions. There are only general guidelines. Note the following examples.

Questions

Are we to continue in sin that grace may abound? May it never be! How shall we who died to sin still live in it? (Romans 6:1, 2)

The principle to follow in handling questions is that when an answer is given, let the question and the answer stand as separate propositions and relate them as Q-A. Together they make one assertion. In Romans 6:1-2, the first question is answered with, “May it never be.” The second question is not answered. When questions are not answered, the author is indirectly asserting something. Therefore, you should always restate such questions as indicative statements. The question, “How shall we who died to sin still live in it?” is really asserting: It is impossible for us who have died to sin to still live in it. The relationship between the first question/answer and the second question then becomes plain. The second is a ground for the first. We would set out the propositions like this:

- 1a Are we to continue in sin
- b *in order that* grace may abound?
- 2a *Answer:* Absolutely not!
- b *the reason is that* we who died to sin cannot still live in it.

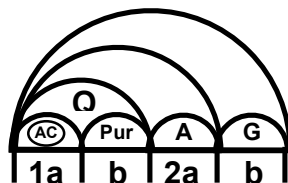

Note: The first question is really two propositions, each having its own subject and its own predicate. 1a relates to 1b as action to purpose. That is, 1b is the purpose of 1a.

Relative Clauses

A relative clause usually begins with “who,” “which,” or “that.” It usually functions to define some person or thing in the sentence. Therefore, as a modifier, a relative clause usually is not construed as a distinct proposition even though it has a subject and a predicate. (Note how the relative clause was handled back in Romans 12:1.)

For example, notice in Romans 6:2 above, the proposition “How shall we who died to sin still live in it?” Within this proposition is a relative clause. Its predicate is “died to sin.” Its subject is “who.” The function of this relative clause is to modify “we,” the subject of the main clause. Therefore, I have not given it the status of a separate proposition.

But when you stop to ponder the logic of Romans 6:2b, it becomes evident that this relative clause could be given a separate status. Paul is really saying that, since we died to sin, the result is we cannot live on in it. Logically, that is, the relative clause is functioning as the cause of our not continuing in sin. If we choose to set out the propositions this way it would look like this:

- 1a Are we to continue in sin
- b *in order that* grace may abound
- 2a *Answer:* No!
- b The reason is that we have died to sin
- c *with the result that* we can’t continue to live in it

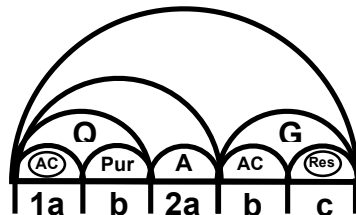

The difference between this paraphrase and the one above is that this is more detailed. Both are right. In the end you must decide whether a relative clause is so crucial that it demands its own proposition. An example of a relative clause which must be given its own status as a proposition is John 1:13, “who were born, not of blood nor of the will of the flesh nor of the will of man, but of God.” In this verse, the means of becoming children of God is given in a relative clause.

Note: the one thing Romans 6:1, 2 is saying in verse 2a is, “Don’t go on sinning” (imperative). This imperative, then, is supported by the indicative 2c: “you can’t continue

in sin,” which is in turn supported by 2b: “you died to sin.” The whole aim of arcing is to find the one main thing each literary unit is saying and to discover how the rest of the unit functions to support or unfold it.

Participial Clauses

A common way of making an assertion (especially in New Testament Greek) is by using the participle. An example of this is Romans 5:1, “Having been justified by faith, we have peace with God through our Lord Jesus Christ.” “Having been justified by faith” is a participial clause. We call it a clause even though it has no expressed subject because it makes an assertion. It asserts: “we have been justified by faith.” So it is up to you, the interpreter, to discover how this assertion is related to the other assertion in Romans 5:1, “we have peace with God ...” I would suggest the following relationship:

5:1a *Since we have been justified by faith*
 1b *the result is that we have peace with God through our Lord Jesus Christ.*

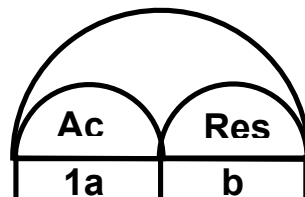

Infinitives

Sometimes infinitives, with their objects and modifiers, function as propositions. For example, John 14:2, “I go to prepare a place for you.” Here the words “to prepare a place for you” could be paraphrased “in order that I might prepare a place for you.” This infinitive, with its object, makes an assertion about Christ’s going. It tells the purpose. Thus we would set out the propositions like this:

14:2a I go
 b *in order that I might prepare a place for you.*

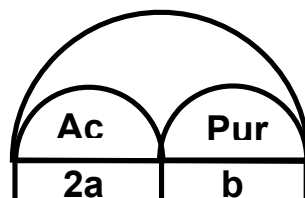

Note: Not all infinitives make distinct assertions like this and so not all will be given the status of separate propositions. But be alert to those that do assert something crucial.

You will often find peculiar problems in trying to determine the propositions of a text. But I hope these few examples will give you an idea of what is involved. It is an

extremely rewarding job, for in the struggle to untangle the logic of a passage in this way, its meaning begins to dawn.

The Role of Meditation

The final procedure in Biblical exegesis is to meditate upon the Biblical author's intention—especially in relation to things he and the other Biblical writers have said elsewhere. As we muse over the interrelationships of these things, implications start to emerge which take us deeper and deeper into reality as the author conceived it. Thus, little by little we come to perceive the unity of the Bible.

Conclusion

If it is true, as Paul says, that without a new (sanctified) mind one cannot approve what is holy, and if it is true, as Jesus says, that we become sanctified through the Word of God (John 17:17), then it is a necessary implication of Scripture that the new mind of the believer must be characterized by an intense longing to hear the Word of God, that is, to do good Biblical exegesis.

End Notes



- 1 C.H. Faust and T.H. Johnson, eds., *Jonathan Edwards* (New York: Hill and Wang, 1962), p. xxiii.
- 2 Mortimer Adler and Charles Van Doren, *How to Read a Book*, rev. ed. (New York: Simon and Schuster, 1972).
- 3 For a splendid essay on how the modern educational system has abandoned its true task of teaching people how to learn see Dorothy Sayers, “The Lost Tools of Learning” in *A Matter of Eternity*, ed. Rosemary Kent Sprague (Grand Rapids: Williams B. Eerdmans Pub. Co., 1973), pp. 107-135.
- 4 Textual criticism is the science devoted to reconstructing, from the thousands of manuscripts preserved, a text of the New Testament (and Old Testament) that comes as close as possible to what the authors originally wrote. For a thorough treatment of how text critics work and the history of the discipline, see Bruce M. Metzger, *The Text of the New Testament: Its Transmission, Corruption and Restoration* (New York: Oxford University Press, 1969). For a briefer treatment, see George Ladd, *The New Testament and Criticism* (Grand Rapids: William B. Eerdmans Pub. Co., 1967), chapter three. Aside from the apparatus in the Greek New Testament, the most practical help in making text critical judgments is Bruce Metzger’s *A Textual Commentary on the Greek New Testament* (New York: United Bible Societies, 1995) which explains why the Bible Societies’ Greek NT has made the textual choices it has.
- 5 *How to Read a Book*, pp. 96-113.
- 6 *How to Read a Book*, p. 107.
- 7 E.D. Hirsch, *Validity in Interpretation* (New Haven: Yale University Press, 1967) p. 76f. This is one of the most important books I have ever read. It gives the classical formulation of the hermeneutic circle and why “it is less mysterious and paradoxical than many in the German hermeneutical tradition have made it out to be.”
- 8 It might be worth remembering that we would not have the New Testament if the apostolic writers had not expended the intellectual energy, as children, to learn Greek grammar and syntax and, as adults, to compose grammatically intelligible prose.
- 9 Fuller’s method has been described clearly in Tom Schreiner’s *Interpreting the Pauline Epistles* (Grand Rapids: Baker Book House Co., 1990), chapter six.
- 10 It would be wrong, I think, to insist that the aorist tense of *parastesai* in Romans 12:1

necessarily implies that this presentation of our bodies is a once-for-all event at conversion. The reason I reject this interpretation is that 1) Paul is talking to believers; 2) the structure of the two verses commends my interpretation; and 3) the use of the aorist tense in Romans 6:19 (with reference to what unbelievers do with their members) shows that it does not have to mean a once-for-all event.

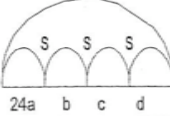
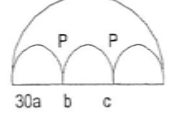
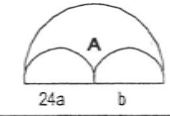
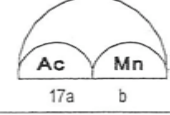
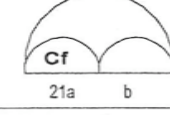
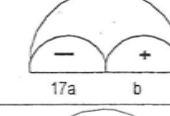
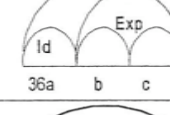
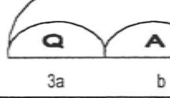
11 This meaning for *dokimazo* (prove and approve) is illustrated in Romans 1:28 and is called for in the logic of Romans 12:12.

TYPE	NAME / SYMBOL	DEFINITION	SOME KEY WORDS	EXAMPLES	NOTES	SYMBOL			
COORDINATE	(one proposition does not support the other, but each makes its own contribution in the whole)	Series (S)	each proposition makes its own independent contribution to a whole	and, moreover, furthermore, likewise, neither, nor, etc. (καί, δέ, τε, οὔτε, οὔδε, μήτε, μηδέ)	The sun will be darkened, and the moon will not give its light, and the stars will fall from heaven, and the powers of the heaven will be shaken. Mt. 24:29 (also Mt. 7:8; Rom. 12:12)	main clauses coexisting		WRITTEN BETWEEN ARCS	
		Progression (P)	like series, but each proposition is a further step toward a climax	then, and, moreover, furthermore, etc. (καί, δέ, τε, οὔτε, οὔδε, μήτε, μηδέ)	Those whom he predestined he also called; and those whom he called he also justified; and those whom he justified, he also glorified. Rm. 8:30 (also Mk. 4:28; 1 Pet. 1:5-7)	main clauses climaxing			
		Alternative (A)	each proposition expresses a different possibility arising from a situation	or, but, while, on the other hand, etc. (ἀλλά, δέ, ἢ, μέν...δέ)	Some were convinced while others disbelieved. Acts 28:24 (also Jn. 10:21, 22; Mt. 11:3)	main clauses contrasting			
SUBORDINATE RELATIONSHIPS	SUPPORT BY RESTATEMENT	Action-Manner (Ac/Mn)	the statement of an action, and then a more precise statement which indicates the way or manner in which this action is carried out	in that, by, etc. (in Greek this relationship is often introduced by an adverbial participle of means or manner)	God has not left himself without a witness in that he gave you from heaven rains and fruitful seasons. Acts 14:17 (also Phil. 2:7; Acts 16:16; 17:21)	main clause modal clause		SYMBOLS ARE WRITTEN INSIDE THE ARCS	
		Comparison (Cf)	the relationship between a statement expressing an action clearer by showing what it is like	even as, as...so, like, just as (ὡς, καθώς, οὕτως, ὡςπερ)	As my Father has sent me, so send I you. Jn. 20:21 (also 1 Cor. 11:1; 1 Th. 2:7)	main clause comparative clause			
		Negative-Positive (+)	the relationship between two alternatives, one of which is denied so that the other is enforced. It is also the relationship implicit in contrasting statements	not...but (οὐ, μή, ἀλλά, δέ)	Do not be foolish, but understand what the will of the Lord is. Eph. 5:17 (also Heb. 2:16; Eph. 5:18) Cf. 1 Cor. 4:10 for an example of contrast: "We are fools for the sake of Christ, but you are wise in Christ."	Ask: "How does this proposition relate to that one?" 1. Divide 2. Assign 3. Summarize	main clause adversative clause		
		Idea-Explanation (Id/Exp)	the relationship between an original statement and one clarifying its meaning. The clarifying proposition may define only one word of the previous proposition	that is (τοῦτ' ἐστίν)	Jacob supplanted me these two times; he took away my birthright and now he has taken away my blessing. Gen. 27:36	Used when clarifying the meaning of a word phrase, or sentence; however if author is speaking of an action and giving details about it, use Ac-Mn instead.	main clause epexegetical clause		
		Question-Answer (Q/A)	statement of question and answer to that question	(look for the question mark)	What does the Scripture say? Abraham believed God... (Romans 4:3) also Romans 6:1; Psalm 24:3,4	Note: rhetorical questions can be rephrased into statements and arced as statements.	interrogative clause main clause		

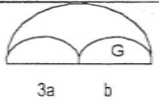
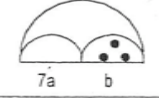
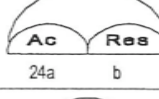
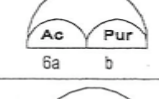
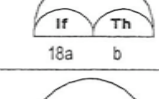
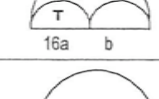
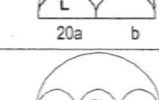
* Symbols with asterisk can be reversed in order

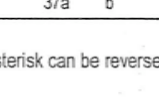
TYPE	NAME / SYMBOL	DEFINITION	SOME KEY WORDS	EXAMPLES	NOTES	SYMBOL		
SUBORDINATE RELATIONSHIPS	SUPPORT BY DISTINCT STATEMENT	Ground (G)	the relationship between a statement and the argument or reason for the statement (supporting proposition follows)	for, because, since, etc. (γάρ, ὅτι, ἐπεὶ, ἐπειδὴ, διότι)	Blessed are the poor in spirit, for theirs is the kingdom of God (Matt. 5:3) also 1 Cor. 7:9; Phil. 2:25-26	BE CAREFUL NOT TO MIX THESE TWO UP! In Ground, the conclusion comes first.	main clause causal clause	
		Inference (I)	the relationship between a statement and the argument or reason for the statement (supporting proposition precedes)	therefore, wherefore, consequently, accordingly, etc. (οὖν, διό, ὡστε)	The end of all things is at hand, therefore be sensible and sober in prayer. (1 Peter 4:7) also Rom. 6:11-12; Matt. 23:3; 1 Peter 5:5b-6	In Inference, the conclusion comes second.	main clause inferential clause	
		Action-Result (Ac/Res)	The relationship between an action and a consequence or result which accompanies that action	so that, that, with the result that (ὡστε)	There arose a great storm in the sea, so that the boat was being swamped by the waves. (Matt. 8:24) also John 3:16; James 1:11		main clause result clause	
		Action-Purpose (Ac/Pur)	the relationship between an action and the one that is intended to come as a result	in order that, so that, that, with a view to, to the end that, lest (ἵνα, ὅπως, ἵνα...μή)	Humble yourselves under God's mighty hand that he may lift you up. (1 Peter 5:6) also Romans 1:11; Mark 7:9		main clause purpose clause	
		Conditional (If/Th)	this is like Action-Result except that the existence of the action is only potential	if . . . then, provided that, except, etc. (εἰ, ἐάν)	If you are led by the spirit, you are not under law. Gal. 5:18) also Gal. 6:1; John 15:14		main clause conditional clause	
		Temporal (T)	the relationship between the main proposition and the occasion when it can occur	when, whenever, after, before, etc. (ὅτε, ὅταν)	When you fast, do not look gloomy. (Matt. 6:16) also James 1:2; Luke 6:22	The author chooses to emphasize the occasion rather than the cause even though the occasion may be the cause.	main clause temporal clause	
		Locative (L)	the relationship between a proposition and the place where it can be true	where, wherever, etc. (ὅπου, οὓ)	Where two or three are gathered together in My name, there I am in their midst. (Matt. 18:20) also 2 Cor. 3:17; Ruth 1: 16		main clause locative clause	
		Bilateral (BL)	a bilateral proposition supports two other propositions, one preceding and one following	see conjunctions for Ground and Inference	Let the nations be glad and sing for joy, for you will judge the peoples with uprightness and guide the nations on the earth. Let the peoples praise you, O God. (Ps. 67:4-5) also Rom. 2:1b-2	Note that "BL" tells that there is a relationship in each direction, and that the "G" and ••• specify exactly what the relationships are.		
SUPPORT-CONTRARY STATEMENT	SUPPORT-CONTRARY STATEMENT	Concessive (Csv)	the relationship between a main clause and a contrary statement	although . . . yet, although, yet, nevertheless, but, however (καίπερ, εἰ, καί, ἐάν καί)	Although he was a Son, he learned obedience from what he suffered. (Heb. 5:8) also 1 Cor. 4:15; 9:13-15	The concessive clause "supports" the main clause because it highlights the strength of the main clause which stands despite the obstacle of the concessive clause.	main clause concessive clause	
		Situation-Response (Sit/R)	the relationship between a situation in one clause and a response in another		How often would I have gathered your children together as a hen gathers her brood under her wings, and you would not. (Matt. 23:37) also John 7:21	The relationship between the two clauses can either be what would be expected or a surprise, depending upon the response of one's will.		

SYMBOLS ARE WRITTEN INSIDE THE ARCS

* Symbols with asterisk can be reversed in order