

Chapter 1

Surveying

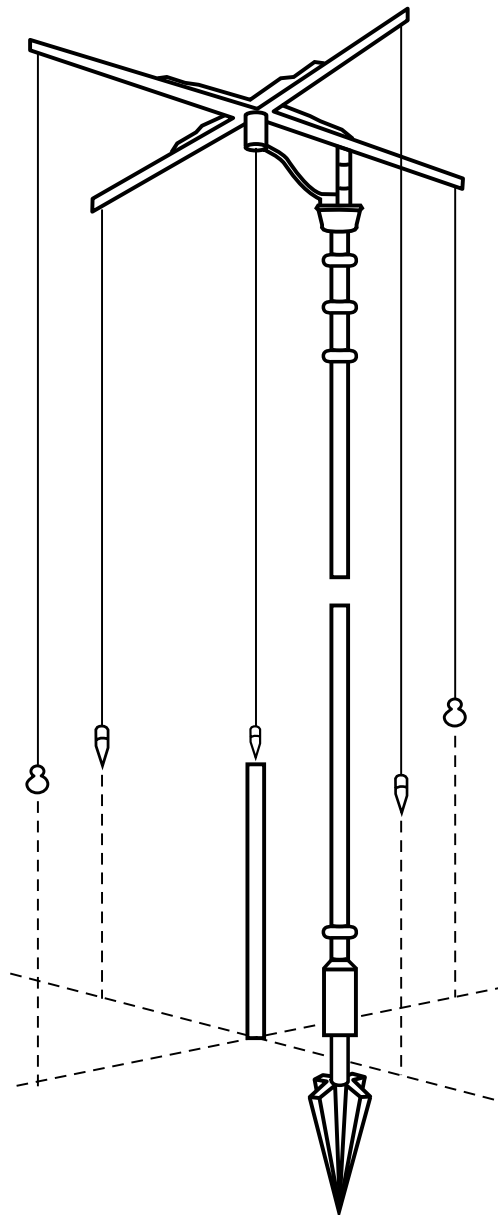

Issued October 2008

Cover illustration: Roman groma

The early Roman surveyors used an instrument called the groma to lay out their cities and roads by right angles. The word “groma” is thought to have come from the root Greek word “gnome,” which is defined as the pointer of a sundial. The importance of turning right angles is shown in the layout of several cities in northern Italy, as well as North Africa. The land was subdivided into 2,400 Roman feet square. Each square was called a centuria. The centurias were crossed by road at right angles to each other. The roads that ran north-south were called cardines, and the roads that ran east-west were called decumani. The groma was also used to locate and place monummentation for property corners. Once the centurias were in place, maps were drawn on bronze tablets giving a physical representation of the centuria.

The U.S. Department of Agriculture (USDA) prohibits discrimination in all its programs and activities on the basis of race, color, national origin, age, disability, and where applicable, sex, marital status, familial status, parental status, religion, sexual orientation, genetic information, political beliefs, reprisal, or because all or a part of an individual's income is derived from any public assistance program. (Not all prohibited bases apply to all programs.) Persons with disabilities who require alternative means for communication of program information (Braille, large print, audiotape, etc.) should contact USDA's TARGET Center at (202) 720-2600 (voice and TDD). To file a complaint of discrimination write to USDA, Director, Office of Civil Rights, 1400 Independence Avenue, S.W., Washington, D.C. 20250-9410 or call (800) 795-3272 (voice) or (202) 720-6382 (TDD). USDA is an equal opportunity provider and employer.

Preface

This manual is a revision of the Engineering Survey chapter of the 1969 Soil Conservation Services Engineering Field Manual for Conservation Practices. The chapter has been revised with respect to general surveying practices relevant to the NRCS engineering practices and includes new sections on global positioning systems, as well as other newer electronic technologies. In addition, a new section has been added on Public Land Survey Systems (PLSS). Many sections that deal with more outdated technologies or tools have been retained as important to practitioners who may need to understand previous survey procedures and techniques, especially in the case of resurveys.

The objective of this chapter is to provide guidance in the use of basic surveying principles, techniques, and procedures for the field layout and survey of soil and water conservation projects. The material presented is limited to the types of conservation surveying practices which are used most often.

The chapter is intended primarily for use at the field office level. Basic principles of surveying are essentially the same regardless of the project location. But, to assure the applicability of the chapter nationally, it was necessary to treat certain portions of the text in a more general manner than would have been the case had it been prepared for a specific region or area. This is especially the case with regard to the section on Public Land Survey.

Jim Kiser

Instructor of Surveying and Land Measurements
Department of Forest Engineering
College of Forestry, Oregon State University
Corvallis, Oregon 97331

Acknowledgments

Development of this manual was guided by the following committee, assigned by **Sam Carlson**, P.E., former national construction engineer, Conservation Engineering Division, NRCS, Washington, DC.

Dennis Clute P.E., construction engineer, National Design, Construction, and Soil Mechanics Center, NRCS, Fort Worth, Texas

H. Grady Adkins, Jr., P.E., former State conservation engineer, NRCS, Columbia, South Carolina

Michael Cox, P.E., State conservation engineer, NRCS, Indianapolis, Indiana

Brett Nelson, P.E., State conservation engineer, NRCS, Palmer, Alaska

Development of the Satellite-based Surveying section of this manual was guided by the following committee, assigned by **Noller Herbert**, P.E., director, Conservation Engineering Division, NRCS, Washington, DC. Consultation was provided by **Mike Rasher**, soil conservationist, National Cartography and Geospatial Center, NRCS, Fort Worth, Texas.

Keith Admire, P.E., director, National Water Management Center, NRCS, Little Rock, Arkansas

Dave Dishman, P.E., State conservation engineer, NRCS, Portland, Oregon

Mike Hammitt, civil engineering technician, NRCS, Columbus, Ohio

David Nelson, P.E., assistant State conservation engineer, NRCS, Amherst, Massachusetts

Chuck Schmitt, P.E., assistant State conservation engineer, NRCS, Casper, Wyoming

Tony Stevenson, P.E., agricultural engineer, National Water Management Center, NRCS, Little Rock, Arkansas

Nathaniel Todea, P.E., hydraulic engineer, NRCS, Salt Lake, Utah

David Williams, P.E., State construction engineer, NRCS, Columbia, Missouri

Kenneth Worster, P.E., civil engineer (Design), National Design, Construction, and Soil Mechanics Center, NRCS, Fort Worth, Texas

Kip Yasumiishi, P.E., agriculture engineer, West National Technology Support Center, NRCS, Portland, Oregon

Contents	650.0100 Introduction	1-1
	650.0101 Errors in survey measurements	1-1
	(a) Random errors.....	1-1
	(b) Systematic errors	1-1
	(c) Blunders	1-1
	650.0102 Precision and accuracy	1-2
	(a) Precision.....	1-2
	(b) Accuracy.....	1-2
	650.0103 Units of measure	1-4
	650.0104 Specialized types of surveys	1-5
	650.0105 Field notes	1-5
	(a) Other information.....	1-6
	650.0106 Communication	1-13
	(a) Hand signals.....	1-13
	(b) Radios	1-13
	650.0107 Fundamentals of surveying	1-16
	(a) Measurement of dimensions.....	1-16
	650.0108 Basic surveying mathematics	1-18
	650.0109 Conversion of degrees to decimal equivalents	1-22
	650.0110 Basic surveying measurements	1-22
	(a) Determining horizontal position	1-22
	(b) Determining horizontal distance.....	1-26
	(c) Measurement of horizontal distances.....	1-26
	(d) Determining horizontal angles.....	1-30
	(e) Determining direction.....	1-31
	(f) Determining vertical position	1-32
	(g) Determining vertical distance.....	1-32
	(h) Determining vertical angles	1-33
	(i) Determining vertical coordinate position	1-33
	650.0111 Surveying equipment	1-34
	(a) Orders of accuracy.....	1-34
	(b) Allowable error in a survey.....	1-34
	(c) Instruments that measure horizontal distance.....	1-35
	(d) Instruments that measure horizontal direction.....	1-37
	(e) Instruments that measure vertical distance	1-38
	(f) Instruments that measure vertical angle.....	1-42
	(g) Instruments that measure both horizontal and vertical distance	1-42

	(h) Surveying accessories.....	1-47
	(i) Care and handling of surveying instruments	1-49
	(j) Checking and adjusting instruments	1-50
650.0112	Surveying procedures	1-55
	(a) Horizontal survey	1-55
	(b) Vertical survey	1-56
	(c) Topographic and control surveys.....	1-56
650.0113	Engineer's transit or total station (primary instrument)	1-57
	(a) Setting up the instrument.....	1-57
	(b) Measuring horizontal angles	1-58
	(c) Measuring vertical angles.....	1-58
	(d) Offset ties	1-58
650.0114	Transverse surveys	1-59
	(a) Traverse by deflection angles	1-59
	(b) Transit-stadia traverse	1-61
	(c) Grid surveys	1-64
	(d) Topographic surveys by aerial photos, ground control surveys,	1-68
	and stereoplotter	
	(e) Differential leveling.....	1-68
650.0115	Satellite-based surveying	1-88
	(a) GPS overview.....	1-88
	(b) Controlling error in GPS measurements	1-92
	(c) GPS reference systems	1-94
	(d) GPS surveying concepts and techniques.....	1-99
	(e) Planning a differential carrier phase RTK survey	1-102
	(f) GPS quality control.....	1-104
	(g) GPS survey procedures	1-104
650.0116	Specialized surveys	1-112
	(a) Route surveying.....	1-112
	(b) Public Land Survey System.....	1-120

Tables			
Table 1-1	Accuracy standards for horizontal and vertical control		1-3
Table 1-2	List of common abbreviations used		1-12
Table 1-3	Calculations for the angles and sides in figure 1-7		1-19
Table 1-4	Relationships between azimuths and bearings		1-25
Table 1-5	FGCS standards for horizontal and vertical order of survey		1-34
Table 1-6	Relative expected accuracies with code phase and carrier phase GPS		1-91
Table 1-7	Relative comparisons of static and rapid static techniques		1-100

Figures			
Figure 1-1	Differences in the terms “accuracy,” “precision,” and “bias”		1-2
Figure 1-2	Set of field survey notes		1-7
Figure 1-3	Code of hand signals for instructions		1-14
Figure 1-4	Code of hand signals for numbers		1-15
Figure 1-5	Types of angles		1-17
Figure 1-6	Right triangle showing the trigonometric relationships of the lengths of the sides (a,b,c) to the interior angles (A,B,C)		1-18
Figure 1-7	Right triangle for table 1-3		1-18
Figure 1-8	Relationships of the trigonometric functions to the quadrant of the line		1-20
Figure 1-9	Open traverse		1-23
Figure 1-10	Control survey (triangulation)		1-23
Figure 1-11	Control survey (trilateration)		1-23
Figure 1-12	Azimuths and bearings		1-24
Figure 1-13	Calculating horizontal latitude and longitude coordinates from survey data		1-25

Figure 1-14	Calculating horizontal latitude and longitude coordinates from survey data	1-26
Figure 1-15	Distance measured as either horizontal or slope distance	1-26
Figure 1-16	Odometer wheel	1-27
Figure 1-17	Breaking chain	1-28
Figure 1-18	Digital laser EDM	1-30
Figure 1-19	Six-sided polygon showing the interior angles	1-30
Figure 1-20	Six-sided polygon showing the exterior angles	1-31
Figure 1-21	Deflection angles as extensions of the previous course	1-31
Figure 1-22	Course direction determination from measured angles	1-31
Figure 1-23	Measurement of vertical distance	1-32
Figure 1-24	Calculation of vertical distance	1-32
Figure 1-25	Reading of vertical angles	1-33
Figure 1-26	Reading of zenith angles	1-33
Figure 1-27	Traverse with seven interior angles	1-35
Figure 1-28	String box or hip chain	1-35
Figure 1-29	Steel tape	1-36
Figure 1-30	Typical cloth tape and woven cloth tape	1-36
Figure 1-31	Ball-swivel head of the Jacob staff and the compass	1-37
Figure 1-32	Hand compass	1-37
Figure 1-33	Hand level	1-38
Figure 1-34	Dumpy level	1-39
Figure 1-35	Self-leveling levels	1-39
Figure 1-36	Types of level rods and range pole	1-40
Figure 1-37	Laser level receiver and transmitter	1-41
Figure 1-38	Abney hand level	1-42

Figure 1-39	Clinometer	1-42
Figure 1-40	Telescopic alidade	1-43
Figure 1-41	Engineer's transit	1-44
Figure 1-42	Electronic theodolite	1-45
Figure 1-43	Electronic distance measuring device	1-46
Figure 1-44	Total station instrument	1-46
Figure 1-45	Electric data collector	1-47
Figure 1-46	Surveying accessories used with the major instruments	1-48
Figure 1-47	Two-peg method for adjusting levels	1-52
Figure 1-48	Line of sight adjustment for the transit and theodolite	1-53
Figure 1-49	Backsight from the instrument position at point 1	1-55
Figure 1-50	Backsight from the instrument position at point 2	1-56
Figure 1-51	One-minute vernier set at 0 degrees	1-57
Figure 1-52	One-minute vernier set for measurement	1-57
Figure 1-53	Offset ties to a traverse station	1-58
Figure 1-54	Deflection angles	1-59
Figure 1-55	Survey notes for the deflection angle example	1-60
Figure 1-56	Azimuths showing 0° oriented to the north	1-61
Figure 1-57	Survey notes—stadia traverse survey for horizontal control (English)	1-63
Figure 1-58	3-4-5 method of laying out a right angle	1-65
Figure 1-59	Method of topographic survey by gridding	1-66
Figure 1-60	Survey notes—grid survey	1-67
Figure 1-61	Method of differential leveling	1-69
Figure 1-62	Survey notes for a bench level circuit	1-71
Figure 1-63	Survey notes—profile and cross section	1-75

Figure 1-64	Survey notes—ditch survey using the grade rod	1-79
Figure 1-65	Grade rod method for an earth dam	1-83
Figure 1-66	Survey notes—slope stakes for dam	1-84
Figure 1-67	Slope stakes	1-87
Figure 1-68	Conceptual diagram of the three major segments that comprise the GPS	1-89
Figure 1-69	Conceptual diagram of the differential baseline setup to an unknown (rover) position	1-90
Figure 1-70	Conceptual diagram of a large area reference base utilizing multiple available CORS or the High Accuracy Network Service, HARN network reference base positions	1-90
Figure 1-71	Dilution of precision shown is analogous to strength of figure	1-93
Figure 1-72	Multipath delay is caused by the deflection of the incoming GPS signal off of a reflective object prior to hitting the receiver resulting in a longer time path	1-94
Figure 1-73	Divisions of the 60 longitudinal strips that make up the UTM system	1-95
Figure 1-74	Latitudes and longitude coordinate system	1-96
Figure 1-75	Cartesian coordinate system showing the rectangular coordinates of points P1 and P2 with respect to an origin (0, 0)	1-96
Figure 1-76	The relationship of the geoid model, ellipsoid model, and topographic ground surface to each other	1-98
Figure 1-77	Relationship of the ground distance to the grid distance	1-99
Figure 1-78	Conceptual setup for eRTK using Virtual Reference technology	1-102
Figure 1-79	Typical equipment setup	1-105
Figure 1-80	Typical setup for the base station over a known control point	1-105
Figure 1-81	Sample output data from an OPUS run	1-110

Figure 1-82	Preliminary line (P-line)	1-112
Figure 1-83	Location line (L-line)	1-112
Figure 1-84	New route survey	1-112
Figure 1-85	Survey of the baseline	1-112
Figure 1-86	Types of route curves	1-113
Figure 1-87	Circular curves in a traverse survey	1-113
Figure 1-88	Elements of a circular curve	1-115
Figure 1-89	Principle of curve layout by deflection angle	1-116
Figure 1-90	Layout of circular curve (English)	1-116
Figure 1-91	Survey notes—circular curve	1-118
Figure 1-92	Curve layout by tangent offsets	1-119
Figure 1-93	Division of lands into townships under the PLSS	1-121
Figure 1-94	Division of single township into approximate 1-mile sections under the PLSS	1-121
Figure 1-95	Division of a single sections into fractions of sections under the PLSS	1-121

650.0100 Introduction

Surveying is the science, art, and technology by which lines, distances, angles, and elevations are established and measured on or beneath the Earth's surface. Surveying can be divided into *geodetic surveying*, where the curvature of the Earth is accounted for, and *plane surveying*, as it pertains to this chapter, where the curvature of the Earth is neglected, and measurements are made with the Earth considered as a plane surface. Locations, directions, areas, slopes, and volumes are determined from these measurements. Surveying information obtained and recorded in the field can be represented as numerical data, as well as graphically by diagrams, maps, profiles, and cross sections. The required precision and accuracy of a survey vary with its purpose. Whether the survey is rough or precise, enough checks must be applied to the fieldwork and in the preparation of the plans to provide acceptable accuracy of the results.

Surveying skill is obtained only with practice. A surveyor should practice working accurately, and should check and recheck the work until assured of its correctness. Accuracy checks should be made as soon as possible after the survey is completed, preferably before the surveying party leaves the site. Speed is important, but accuracy always takes precedence. Each survey presents specific problems. When the surveyor has mastered the principles, there is no difficulty in applying the proper method. However, a surveyor must understand the limits of the instruments used, the possibility of errors affecting the surveying process, and the mistakes that can occur through carelessness. No surveying measurements are exact, so errors must be continuously dealt with. Although errors can result from sources that cannot be controlled, they can be kept within proper limits if the surveyor is careful.

650.0101 Errors in survey measurements

All measurements have some degree of error. Three types of errors exist in surveying.

(a) Random errors

Sometimes called accidental errors, random errors are due to limitations or imperfections in the instrument used, either from faults in manufacturing or improper adjustment of parts. They are caused also by lack of skill in determining values with instruments. Random errors occur according to the laws of chance. They tend to cancel with repeated measurements. The accidental error in the final result varies with the square root of the number of individual measurements.

(b) Systematic errors

Sometimes called cumulative errors, systematic errors occur in the same direction, thereby tending to accumulate. Measurement of a line with a tape of incorrect length is an example. Others are due to changing field conditions that remain constant in sign but vary in magnitude in proportion to the change. Measurement with a steel tape at low winter temperature and again at high summer temperature is an example. Systematic errors can be compensated for if the error is known. For example, measurements with a steel tape in very cold conditions can be compensated for by a correction factor.

(c) Blunders

Blunders are mistakes that can usually be traced back to poor field procedures. Blunders can be avoided by a good system of checking while in the field. Examples of blunders include writing the wrong number in the field books, calling out the wrong direction on a compass reading, etc. Good field practice and experience help to eliminate blunders.

650.0102 Precision and accuracy

The goal of any measurement is to be as close to the actual truth as possible. Because of the errors present in all measurements, we are interested in how close our measurements can be, and we express this by the terms precision and accuracy. Figure 1–1 shows the differences in the terms “accuracy,” “precision,” and “bias.” The points on the first target show results that are neither accurate nor precise. In the second target, the points are precise in that they are closely grouped but are not accurate. These points share a similar bias. In the third target, the points are both precise and accurate. It could be said that these points have very little bias.

(a) Precision

Precision refers to the repeatability of measurements and can be thought of as the degree of tolerance applied in instruments, methods, and observations. An instrument or method with a very high tolerance will generally yield results that are tightly clustered, while an instrument or method with a low tolerance will yield a wider spread of results.

(b) Accuracy

Accuracy refers to how close to the actual value the measurement is. Accuracy is a result of both good instruments and good field methods. It is important to understand that high precision is not necessarily high accuracy. A highly precise instrument that is out of adjustment, for example, a compass that has its declination set incorrectly, will give a precise reading but an inaccurate one. The magnitude of inaccuracy is often referred to as bias.

An objective of surveying is to obtain the required data with the desired accuracy at the lowest cost. Since 1925, accuracy has been defined for Federal Government surveys and mapping by classes of first-, second-, third-, and fourth-order. Third-order and fourth-order accuracy generally apply in soil and water conservation engineering work as ordinary and rough surveys, respectively. Ordinary survey accuracy should be attained in establishing benchmarks, level circuits involving six or more instrument setups, and surveys for drainage, irrigation, large channels, and other major structural practices. Rough survey accuracy is adequate for level circuits of less than six instrument setups, preliminary and reconnaissance surveys, and surveys for such conservation practices as diversions, waterways, and small ponds (table 1–1).

Figure 1–1 Differences in the terms “accuracy,” “precision,” and “bias”

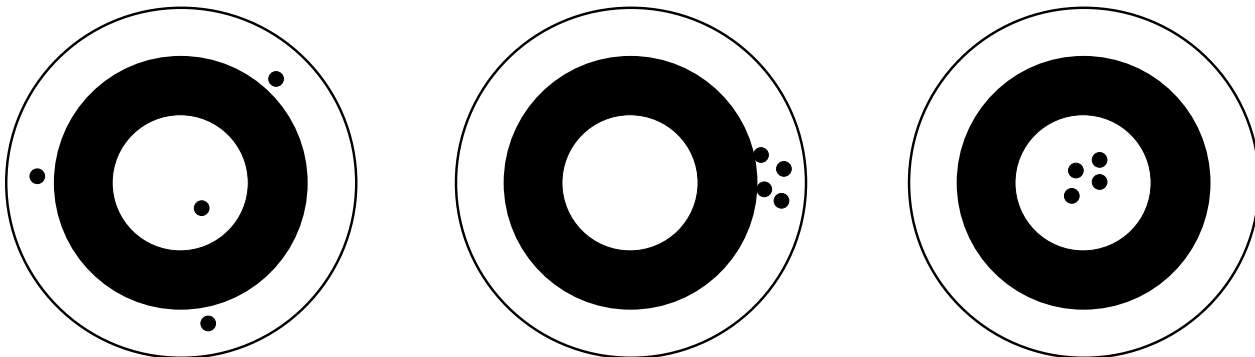

Table 1-1 Accuracy standards for horizontal and vertical control

Type of survey	Ordinary surveys	Rough surveys
Triangulation		
Maximum error of angular closure	$1.0 \text{ min}\sqrt{N}$	$1.5 \text{ min}\sqrt{N}$
Maximum error of horizontal closure		
By chaining	1.0/5000	1.0/1000
By stadia	1.0/1000	3.0/1000
Traverse		
Maximum error of angular closure	$1.0 \text{ min}\sqrt{N}$	$1.5 \text{ min}\sqrt{N}$
Maximum error of horizontal closure		
By chaining	1.0/5000	1.0/1000
By stadia	1.0/1000	3.0/1000
Leveling		
Maximum error of vertical closure		
By level and rod		
Metric	$0.02 \text{ m}\sqrt{\text{km}}$	$0.08 \text{ m}\sqrt{\text{km}}$
English	$0.10 \text{ ft}\sqrt{M}$	$0.40 \text{ ft}\sqrt{M}$
By transit and stadia		
Metric	$0.06 \text{ m}\sqrt{\text{km}}$	$0.02 \text{ m}\sqrt{\text{km}}$
English	$0.30 \text{ ft}\sqrt{M}$	$1.0 \text{ ft}\sqrt{M}$
Topographic	The elevation of 90 percent of all readily identifiable points shall be in error not more than half contour interval. No point shall be in error more than one full contour interval.	

N = number of angles turned

M = number of miles of levels run

km = number of kilometers of levels run

When surveys are not carried out in accordance with a carefully prepared plan, many staff hours are lost, needed data are omitted, and many useless data are collected. The survey plan should contain the following:

- list of the data needed
- best method of obtaining the data
- degree of accuracy acceptable
- list of the people needed to perform the work
- list of needed equipment
- complete time schedule for performing the survey work

650.0103 Units of measure

The basic unit of measure in English units is the foot, and in metric units is the meter. Within this text, English (foot/pound) units are used. In the case of metric units, note that conversions are not necessarily direct. Direct conversions of single measurements were made using the following relationships:

1 meter	= 3.281 feet
	= 39.37 inches
1 centimeter	= 0.3937 inches
1 kilometer	= 3,281 feet
	= 0.6214 miles
1 foot	= 0.3048 meters
1 mile	= 1.609 kilometers

Some other units in common use for surveying include:

1 cubic meter	= 35.31 cubic feet
1 hectare	= 2.47 acres
1 chain	= 66 feet
1 mile	= 80 chains
1 rod	= 16½ feet
1 fathom	= 6 feet

In some parts of the country, the surveyor may come across previous surveys using historic units of measure; therefore, it may be necessary to research the accepted conversions for these. For example, in Louisiana, the French measure of length was the arpent.

Some other historic units the surveyor may come across include:

1 arpent	= about 191.8 feet (primarily in Louisiana and Canada)
1 vara	= about 33 inches in California and Mexico (33 1/3 inches in Texas)
1 perch	= 16½ feet
1 pole	= 16½ feet
1 furlong	= 40 poles or 660 feet

650.0104 Specialized types of surveys

The fundamental procedures for surveying are universal. However, there are specialized types of surveys that have some unique features, and those individuals in the surveying practice should be aware of these. These types of surveys are briefly defined here. Several of these specialized surveys are covered in detail later in this chapter.

- *Control survey*—A control survey is a high-order survey primarily used to establish horizontal and/or vertical monuments that serve as a reference for other surveys.
- *Topographic survey*—A topographic survey is a special type of survey used to establish ground elevation points for map contour generation.
- *Cadastral survey*—A cadastral survey, also known as a boundary survey, is used to establish property lines and boundary corners. Surveys that are done to create new boundaries are called original surveys. Those that are done to relocate property or boundary lines previously surveyed are called retracement surveys.
- *Hydrographic survey*—A hydrographic survey is a special type of survey that defines water boundaries such as ocean, lake, and reservoir shorelines, as well as depth. The hydrographic survey is a form of water topographic surveying.
- *Route survey*—A route survey is performed to define and help plan and construct roads, highways, pipelines, etc. In addition to the survey of linear features, route surveys generally include the estimation of earthwork quantities for construction purposes.
- *Construction survey*—A construction survey is performed to provide horizontal and vertical positions for construction projects like buildings and parking lots and to assist in construction quantity estimates.
- *As-built survey*—An as-built survey provides positioning for the exact and final location for construction projects as they proceed. These surveys are especially important in documenting any construction changes to original plans.

650.0105 Field notes

The primary job of the surveyor is to be the eyes of the engineer who is not in the field. To this end, the field notes are the permanent written records of the survey taken at the time the work was done in the field. Field notes have a particular format and order dependent on the type of survey and consist of a record of both measurements and observations. It must be remembered that others who were not there will read the field notes and, therefore, great care should be exercised to ensure that the notes are clear and in a form others can readily interpret. The preparation and technical skill of the surveyors will be wasted if the field notes are not legible or cannot be deciphered. A general rule of thumb in the preparation of good field notes is to assume the person reading the notes has poor eyesight, is not clairvoyant, and will try to place the blame for any mistakes in the project on the field notes.

Field notes have five main features:

- *Accuracy*—Measurements should be recorded to the correct degree of precision. For example, if measuring with a steel tape to the nearest one-tenth unit, the recorded measurement should be to the same. This is especially true when recording a calculated measurement, for example, a calculated horizontal distance from slope distance.
- *Integrity*—Field notes should be recorded in the field at the time of the measurement, not later from memory. Field notes should be original. If necessary to submit a copy, the original notes should be attached. If data are copied from another source, it should be noted in the field book that the data are a copy.
- *Legibility*—All lettering in field books should be block style printing with a number 3H or harder lead. All symbols and abbreviations should be consistent and a key should be provided or referenced somewhere in the field book. A key should only be included by reference when it is readily available and accessible to those who will utilize the notes; otherwise, the key should be included in full text with the notes.

- *Arrangement*—Various surveys have their own style of notes arrangement and this should always be followed. For example, *traverse* notes may be arranged from the bottom of the page upward or from the top of the page downward, while *leveling* notes usually are arranged downward. Leveling notes also follow very specific column headings.
- *Clarity*—The most important aspect of recording field notes is probably the consistency of the note taker. It should be clear as to what measurements go with what heading. When writing decimals, either use a strong decimal point including a zero in front, or use a style that emphasizes the decimal, for example, underlining and placing above as a superscript. This format is used extensively in *route* surveys.

Example: for a measurement of 17.51, it might be written as 17 ⁵¹ or 17.51.

(a) Other information

Field books should have the following information on both the front page and the first inside page in case they are lost:

- name
- address
- phone number
- project name
- number book of books

Each project should also have a listing of the equipment including any serial numbers or other identifying numbers. This is in case an instrument has a built-in error (systematic error) that may be corrected at a later date, for example, a compass with the incorrect declination set. For each project, there should also be a listing of the crew members and their duties for that project. This is in case a question arises about a specific part of the survey. The magnetic declination used should be entered for any survey using a magnetic compass. Examples of the first pages of a field survey book and notes are shown in figure 1–2. Note that several pages in the beginning of the survey are purposefully left blank. This is to provide space to add additional notes. For example, a page may be used to provide a key for abbreviations used in the notes.

Some of the common mistakes in notekeeping can be eliminated by observing the following points.

- Use a well-pointed 3H or 4H pencil. A piece of sandpaper taped in the back of the field book is handy to keep the pencil sharp.
- Use the Reinhardt system of slope lettering for clarity and speed. Do not mix upper and lower case letters.
- Make a neat title on the cover and on the first page inside the cover showing the owner or the company making the survey.
- Leave a page or two in the front of the book, immediately following the title page for an index of the work done in the field. Keep the index up-to-date. The index should show the name of the survey, location, and page number.
- If the page of notes becomes illegible or if celluloid sheets are used for recording notes in wet weather, make a copy of the data while the information is still fresh in mind. Then mark it COPY in the field notebook.
- If a page is to be voided, draw diagonal lines from the opposite corners and mark it VOID prominently, but do not obscure any numerical values or any part of the sketch.
- The left-hand page contains the numerical values for the corresponding explanatory notes on the right-hand page, and the two pages are almost always used in pairs. Therefore, they carry the same page number, which should be placed in the upper left-hand corner of the left page and the upper right-hand corner of the right page.
- Always record directly in the field book rather than on a scrap of paper for copying later.

The forms and methods of notekeeping are different for various types of survey work. Information recorded in the field notes are generally classified into three parts: numerical values, sketches, and explanatory notes.

Numerical values are tabulated records for all measurements and are recorded from the bottom of the page toward the top, with the exception of level notes. Specific instructions regarding these are as follows:

Figure 1-2 Set of field survey notes

(a) Field book cover

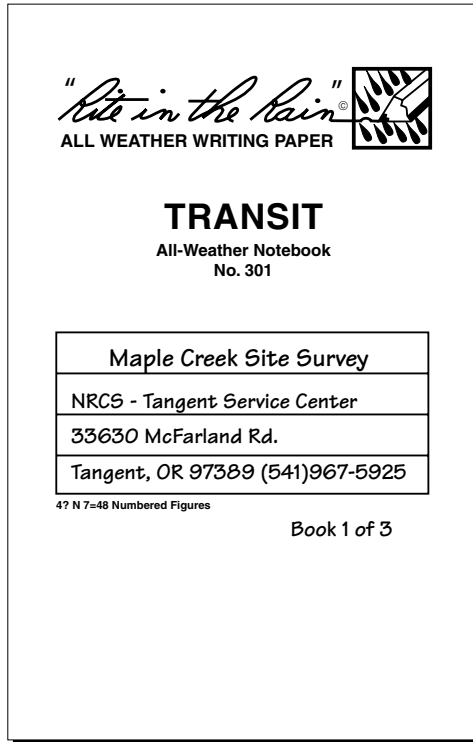

(b) Inside cover and table of contents

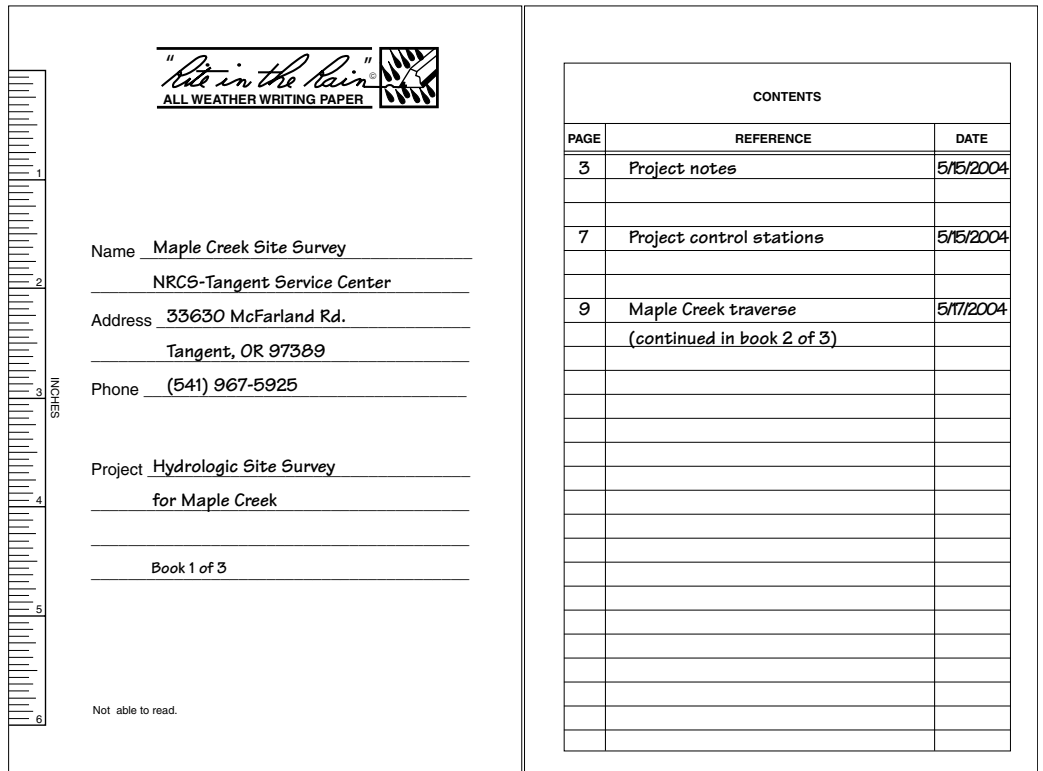

Figure 1-2 Set of field survey notes—Continued

(c) Project notes

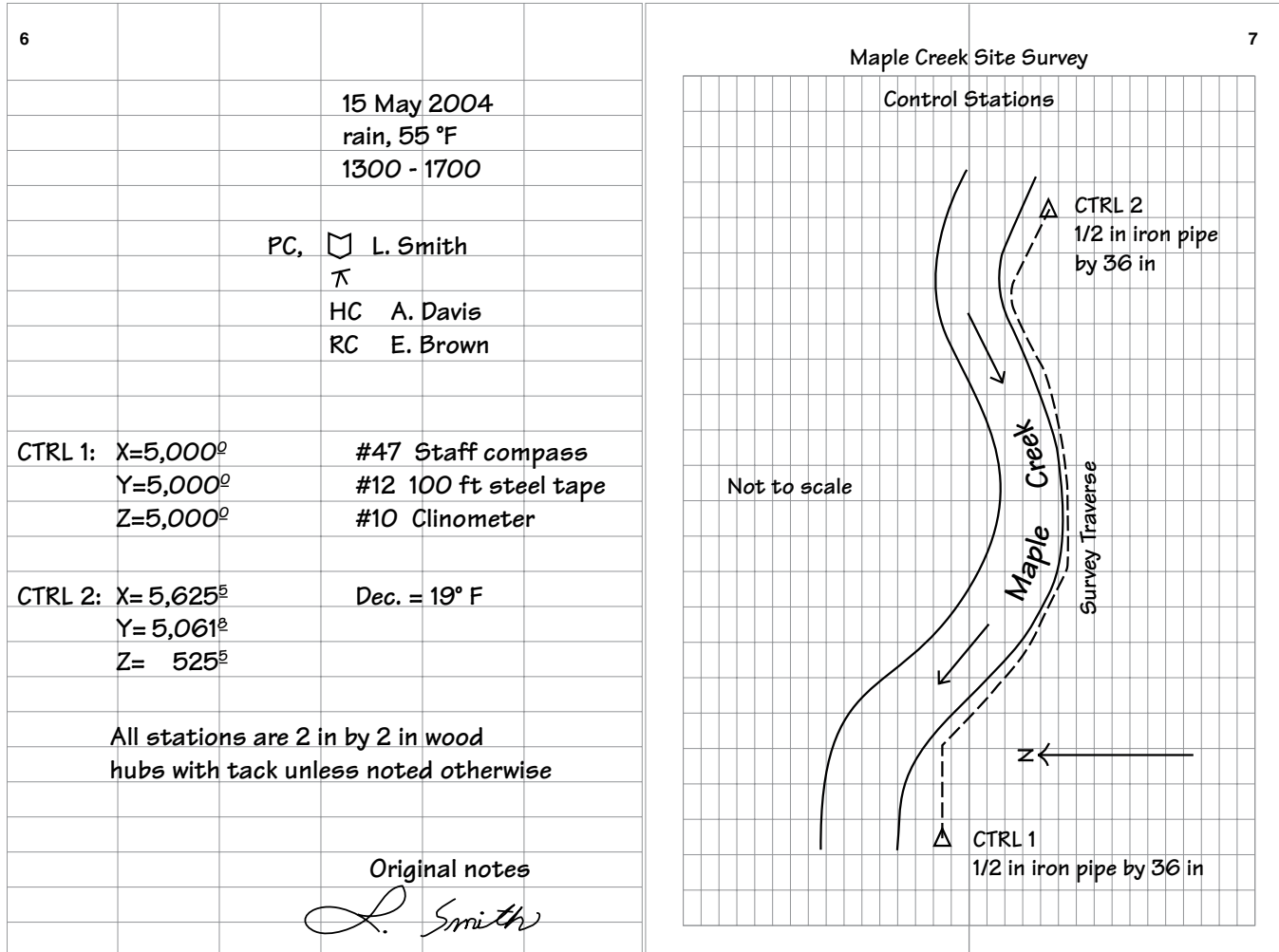

Figure 1-2 Set of field survey notes—Continued

(d) Survey control page

2			3
			<p data-bbox="1312 520 1448 554">15 May zoom</p> <p data-bbox="971 596 1117 625">Project Notes</p> <p data-bbox="971 667 1416 823">The purpose of this survey is to establish and document horizontal and vertical ground control stations and perform a hydrologic traverse and cross-section survey of Maple Creek.</p>

Figure 1-2 Set of field survey notes—Continued

(e) First page for the project survey

8	Sta.	SD	%	HD	BRG	Notes
	4					
		41 ^S	-2	41 ^S		
	3				S41° 00'E	
		37 ^E	+2	37 ^E		
	2				S87° 00'E	
		121 ^S	+8	121 ^L		
△	CTRL 1				N55° 30'E 1/2 in IP	
						Begin survey

Maple Creek Traverse

9

17 May 2004
sunny, 60 °F
0900 - 1400

PC, L. Smith
RC E. Brown
H.C. J. Jones

#47 Staff compass
#12 100 ft steel tape
#10 Clinometer

Mixed conifer

Original notes
L. Smith

-
- Make large plain figures.
 - Never write one figure on top of another.
 - Avoid trying to change one figure into another.
 - Erasing is prohibited. Draw a line through the incorrect value and write the correct value directly above.
 - Repeat aloud values for recording. For example, before recording 143.57, call out “one, four, three, point, five, seven” for verification.
 - Place a zero before the decimal point for numbers less than one and show the precision of measurements by recording significant zeros.
 - Record compass bearings in whole degrees, degree-minute, or degree-minute-second format depending on the degree of accuracy of the survey. Do not use fractions in recording compass bearings.
- title of project or problem at top of left-hand page
 - location of project at top of right-hand page
 - date of project
 - names of the survey party
 - duties of each member of the survey crew
 - equipment used, with identifying numbers, if any
 - weather conditions
 - show true north, magnetic north, and magnetic declination





Some of the more common abbreviations and symbols used in field notes are listed in table 1–2.

Sketches are graphic records of boundary outlines, relative locations, topographic features, or any diagram to further clarify the tabulated values.

- They are rarely drawn to scale. It may be necessary to exaggerate certain portions of the sketch for purposes of clarity.
- Use a straight edge for sketches.
- The red line in the center of the right page may be used to represent the route of travel on a traverse.
- Make sketches large, open, and clear.
- Line up description and sketches with corresponding numerical data if possible.
- Avoid crowding.
- When in doubt about the need for recording any information, include it in the sketch.

Explanatory notes clarify the numerical values and sketches that might otherwise be misunderstood. Such notes are always printed. In all cases, one should ask if the numerical values and sketches require additional explanation for easy interpretation. The following explanatory notes are usually included in every set of field notes and are recorded on the right-hand page with the exception of the title.

Table 1-2 List of common abbreviations used

	angle	HI	height or elevation of instrument triangulation
	station	Int.	interior angle
	instrument station	Mg. Decl.	magnetic declination
	instrument	MN	magnetic north
	center line	Mg. Brg.	magnetic bearing
1/4. Sec. Cor.	1/4 section corner	PC	point of curvature
Az	azimuth	PT	point of tangent
BM	bench mark	R	range
BS	backsight	RC	rear chainman
Brg	bearing	SD	slope distance
Calc.Brg.	calculated bearing	Sec.	section
CC	crew chief	Sec. Cor.	section corner
Comp.	compass	Sta.	station
DE	difference in elevation	T	township
Defl.	deflection angle	TBM	temporary bench mark
Elev.	elevation	TN	true north
FS	foresight	TP	turning point
HC	head chainman	Vert.	vertical angle
HD	horizontal distance	WM*	Willamette* Meridian

* This is region specific. The name Willamette, for example, refers to the Pacific Northwest.

650.0106 Communication

(a) Hand signals

A good system of hand signals between members of a surveying party is a more efficient means of communication than is possible by word of mouth. Any code of signals mutually understood by the persons handling the instrument and the rod is good if it works. When the “shot” is finished, prompt signaling by the instrument handler allows the rod holder to move promptly to the next point. It is also desirable to have a system

of signaling so that numbers can be transmitted from rod holder to instrument handler or vice versa.

The code of signals illustrated in figures 1–3 and 1–4 is suggested. This code may be enlarged upon or altered to suit the needs of the job. A definite code, however, should be determined and mutually understood in order to speed up the job.

(b) Radios

Two-way radios are now being used extensively, are relatively inexpensive, and provide an efficient means of communication within a survey party.

Figure 1-3 Code of hand signals for instructions

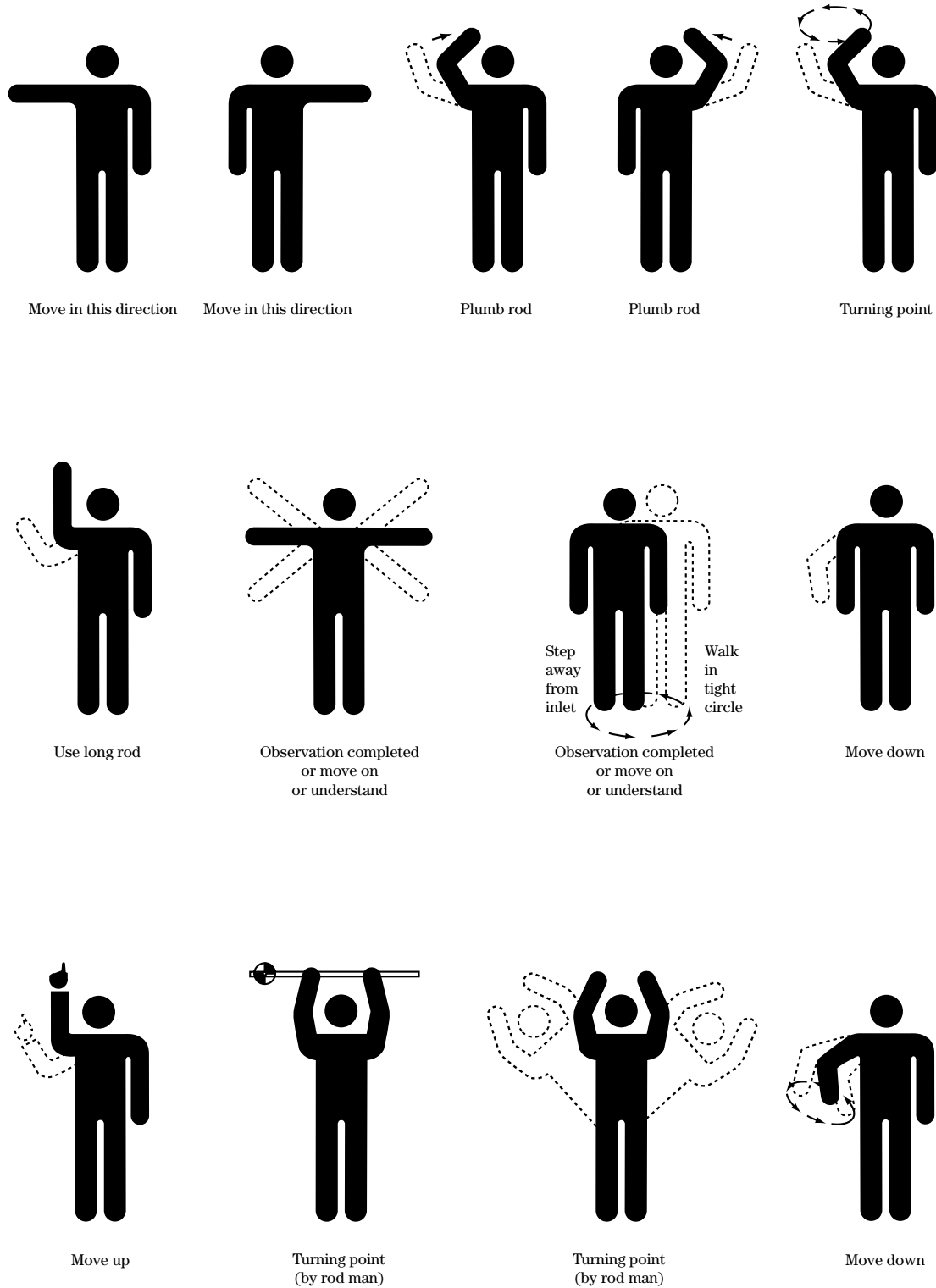

Figure 1-4 Code of hand signals for numbers



650.0107 Fundamentals of surveying

Surveying processes are generally divided into two categories: geodetic and plane. The primary difference between geodetic and plane surveying is the reference that they use.

Geodetic surveying measures all elevations from a level surface, and because all instruments use a straight reference plane, this requires all instrument readings to be adjusted for the curvature of the Earth. Geodetic surveys are used when a high degree of accuracy is needed and when the survey will cover long distances or a large area.

Plane surveying assumes the Earth is flat and all elevations are measured from a flat surface (plane). In plane surveying, every elevation measurement has a small amount of error; however, plane surveying is easier to complete and provides sufficient accuracy for smaller areas.

The basic unit in surveying is the point. All surveying measurements are made between points that have been located or established. The survey methods used to make measurements and determine direction and position between points are based on the following definitions and techniques.

(a) Measurement of dimensions

Four dimensions are measured: horizontal lengths, vertical lengths, horizontal angles, and vertical angles.

A horizontal length is the straight line distance measured in a horizontal plane. In most cases, horizontal distance is calculated from a distance measured on a slope. Measurements are made by direct and indirect methods. Direct measurements are made by wheels, human pacing, and tapes of cloth, metallic cloth, or steel. Indirect measurements are typically made by use of electronic distance-measuring equipment (EDM). EDMs vary from inexpensive laser devices that measure distance only to those that are part of more complex instruments such as total stations. The type of measurement and equipment used depends on required accuracy, access to the line, and the experi-

ence, time and cost involved. Another form of indirect measurement is performed using Global Positioning Systems (GPS) that calculate horizontal distance from position coordinates.

A vertical length is a measurement of a difference in height or elevation. Direct measurements can be made by an altimeter, which indicates barometric pressure or by a plumb line and tape for short vertical distances. In most cases, remoteness of points and accuracy require indirect measurements with instruments such as the level and graduated rod or total station or transit. Some EDMs have the capability to measure vertical distance, as well as horizontal distance.

A horizontal angle is the difference in direction between: (1) two intersecting lines in a horizontal plane; (2) two intersecting vertical planes; (3) or two intersecting lines of sight to points in different vertical planes. It is measured in the horizontal plane in degrees of arc. Horizontal angles usually are measured clockwise (called an angle-right), but may be measured counterclockwise (angle-left). Angles are usually measured directly by total station, theodolite, or transit. An interior angle is on the inside of an enclosing figure, and an exterior angle is on the outside of an enclosing figure. A deflection angle is that angle which any line extended makes with the succeeding or forward line. The direction of the deflection is identified as right or left. An angle-to-the-right is the clockwise angle at the vertex between the back line and forward line (fig. 1-5a).

A vertical angle is the difference in direction between a horizontal plane and an intersecting line, plane, or a line of sight to a point. It is measured in the vertical plane in degrees of arc. Measurements are referenced up or down from the horizontal as plus angles or minus angles (fig. 1-5b).

Figure 1-5 Types of angles

(a) Types of horizontal angles

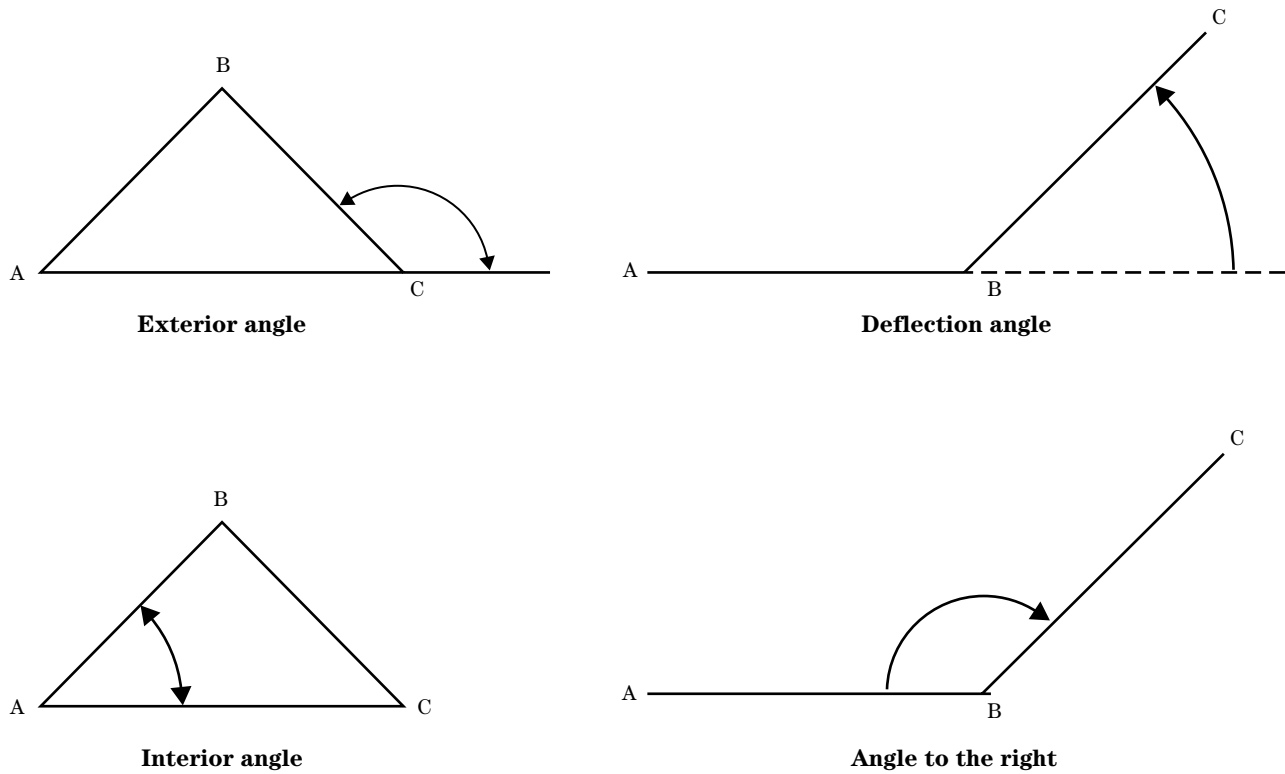

(b) Types of vertical angles

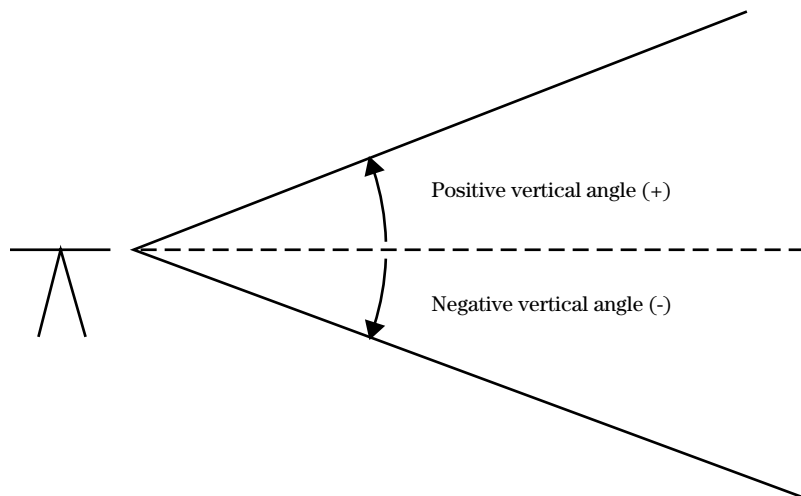

650.0108 Basic surveying mathematics

There are basic trigonometric relationships that are used in plane surveying to define angles and their relationships to each other. In most instances, field surveying problems can be constructed in the form of right triangles. The trigonometric functions of right triangles are defined by the ratios of the lengths of the triangle sides to the angles of the triangle. For the field surveyor, these can be reduced to a simple set of functions shown in figure 1-6 and the following example.

The primary trigonometric functions used by surveyors are the sine (sin), cosine (cos), and tangent (tan) along with the Pythagorean Theorem. The three general relationships are:

$$\sin \text{ angle} = \frac{\text{opposite side}}{\text{hypotenuse}}$$

$$\cos \text{ angle} = \frac{\text{adjacent side}}{\text{hypotenuse}}$$

$$\tan \text{ angle} = \frac{\text{opposite side}}{\text{adjacent side}}$$

$$\text{Pythagorean Theorem} = a^2 + b^2 = c^2$$

$$A + B + C = 180^\circ$$

We are only concerned with five relationships since angle C in a right triangle is always known. Table 1-3 shows these relationships for the right triangle in figure 1-7 with example calculations.

Another function of angles is that they can be considered as positive or negative. Figure 1-8 shows the relationship of any angle to the quadrant of a circle and the trigonometric relationship of that angle.

Figure 1-6 Right triangle showing the trigonometric relationships of the lengths of the sides (a,b,c) to the interior angles (A,B,C)

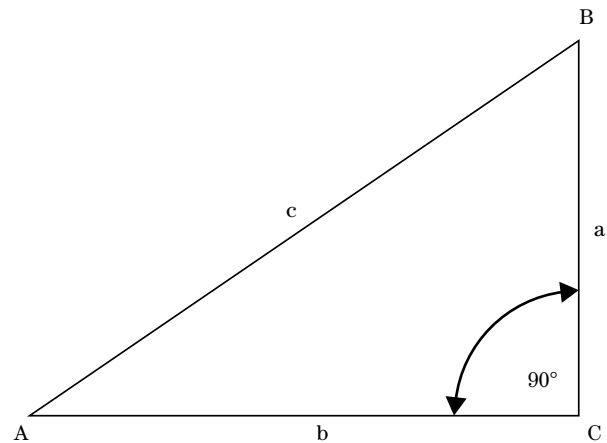

Figure 1-7 Right triangle for table 1-3

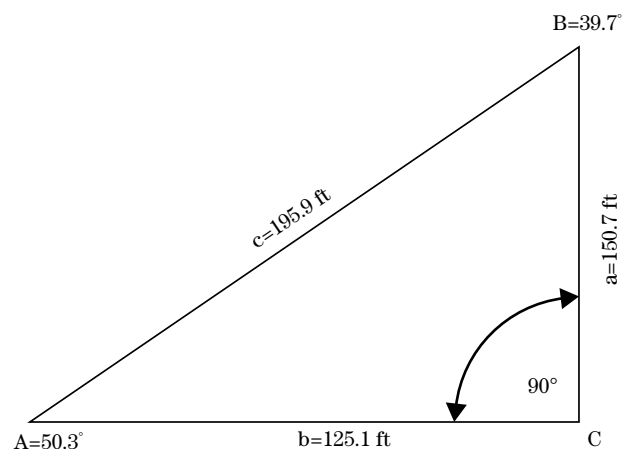
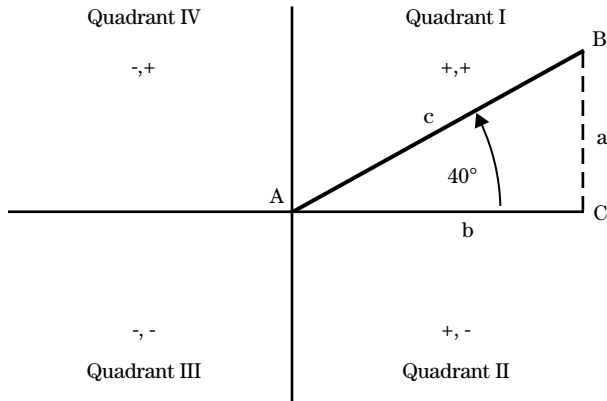

Table 1-3 Calculations for the angles and sides in figure 1-7

Function	Relationship	Example calculation
c	$= \sqrt{b^2 + a^2}$	$= \sqrt{125.1^2 + 150.7^2} = 195.9$
a	$= \sqrt{c^2 - b^2}$	$= \sqrt{195.9^2 - 125.1^2} = 150.7$
b	$= \sqrt{c^2 - a^2}$	$= \sqrt{195.9^2 - 150.7^2} = 125.1$
sin A	$= \frac{a}{c}$	$= \frac{150.7}{195.9} = 0.7693; A = \sin^{-1} 0.7693 = 50.3^\circ$
sin B	$= \frac{b}{c}$	$= \frac{125.1}{195.9} = 0.6386; B = \sin^{-1} 0.6386 = 39.7^\circ$
cos A	$= \frac{b}{c}$	$= \frac{125.1}{195.9} = 0.6386; A = \cos^{-1} 0.6386 = 50.3^\circ$
cos B	$= \frac{a}{c}$	$= \frac{150.7}{195.9} = 0.7693; B = \cos^{-1} 0.7693 = 39.7^\circ$
tan A	$= \frac{a}{b}$	$= \frac{150.7}{125.1} = 1.2046; A = \tan^{-1} 1.2046 = 50.3^\circ$
tan B	$= \frac{b}{a}$	$= \frac{125.1}{150.7} = 0.8301; B = \tan^{-1} 0.8301 = 39.7^\circ$

Figure 1-8 Relationships of the trigonometric functions to the quadrant of the line

(a) Quadrant I



Quadrant I

Line	Direction	sin a/c	cos b/c	tan b/a
a	+	+	+	+
b	+			
c	+			

(b) Quadrant II

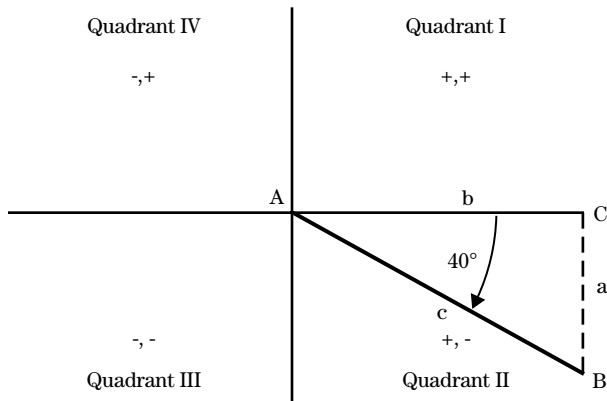

Quadrant II

Line	Direction	sin a/c	cos b/c	tan b/a
a	-	+	-	-
b	+			
c	-			

Figure 1-8 Relationships of the trigonometric functions to the quadrant of the line—Continued

(c) Quadrant III

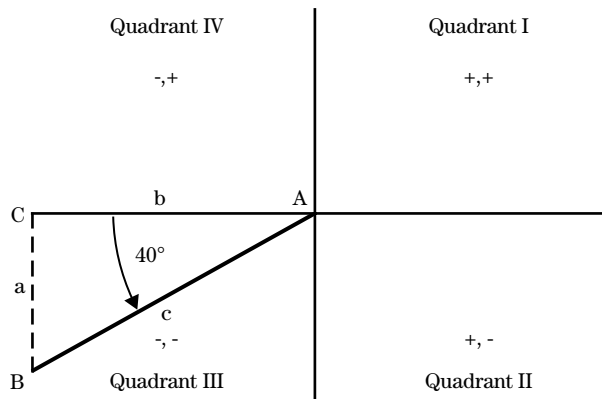

Quadrant III

Line	Direction	sin a/c	cos b/c	tan b/a
a	-	-	-	+
b	-			
c	+			

(d) Quadrant IV

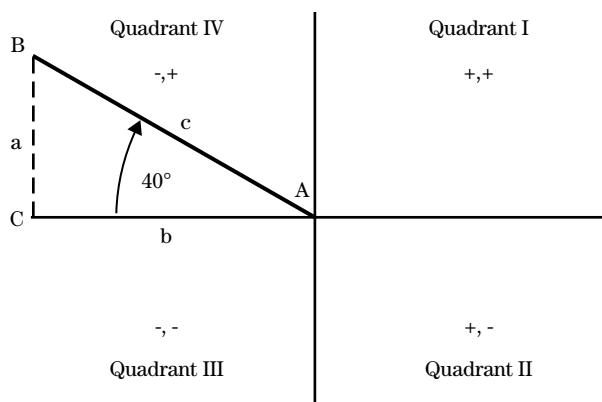

Quadrant IV

Line	Direction	sin a/c	cos b/c	tan b/a
a	+	-	+	-
b	-			
c	-			

650.0109 Conversion of degrees to decimal equivalents

It is important to note that anytime trigonometric functions are used, all bearings or azimuths must be converted from degrees-minutes-seconds to their decimal equivalent. Some calculators can do this automatically. This can also be done easily as the following example shows.

To convert $35^{\circ}17'23''$ to the decimal equivalent:

1. Degrees do not change.

$$35^{\circ}$$

2. Divide the seconds by 60 to get the fraction of a minute and add the whole minutes to this.

$$23/60 + 17 = 17.38$$

3. Divide this value by 60 to get the fraction of a degree and add to the whole degrees.

$$17.38/60 + 35 = 35.2897^{\circ}$$

To convert back to degrees-minutes-seconds:

4. Degrees do not change.

$$35^{\circ}$$

5. Multiply the decimal number remaining by 60. The whole number is the minutes.

$$0.2897 \times 60 = 17.382 = 35^{\circ}17' + 0.382$$

6. Again, multiply the decimal number remaining by 60. This is the seconds.

$$0.382 \times 60 = 23'' = 35^{\circ}17'23''$$

650.0110 Basic surveying measurements

(a) Determining horizontal position

The horizontal position of points is determined by traverse, triangulation, trilateration, or grids referenced to a known direction and position.

(1) Traverse

A traverse consists of a number of points, called traverse stations, connected in series between horizontal angles by horizontal lengths, called courses. Traverses may be continuous (open) or closed (fig. 1–9). The open traverse is a series of courses that does not close back on the initial point. This type of survey is often used for routes, pipelines, etc. The closed traverse center is a series of courses that closes back on the initial point. Closed traverses are either loop traverses or connecting traverses. Loop traverses close on themselves. Continuous traverses cannot be checked completely. Connecting traverses start and end in known directions and positions.

(2) Triangulation

Triangulation consists of a series of connecting triangles in which one side of a triangle and all of the interior angles are measured and the remaining sides are computed by trigonometry (fig. 1–10). The first triangle (solid lines) is established using a known length and bearing (heavy line) and the known interior angles. The remaining sides of the triangle are calculated and the next triangle is started from these measurements. Triangulation is used primarily for control surveys where a series of triangles can be computed to establish control stations.

(3) Trilateration

Trilateration consists of a series of connecting triangles in which all three sides of a triangle are measured and one bearing is known. Coordinate values are computed by right-angle trigonometry (fig. 1–11). The first triangle (solid lines) is established using a known length for all three sides and bearing (heavy line) for one line. Coordinates are calculated for the corners. The next triangle is based on the calculated bearing of the common side and so on. Trilateration is used primarily for control surveys computed from EDMs with their high order distance accuracy.

Figure 1-9 Open traverse

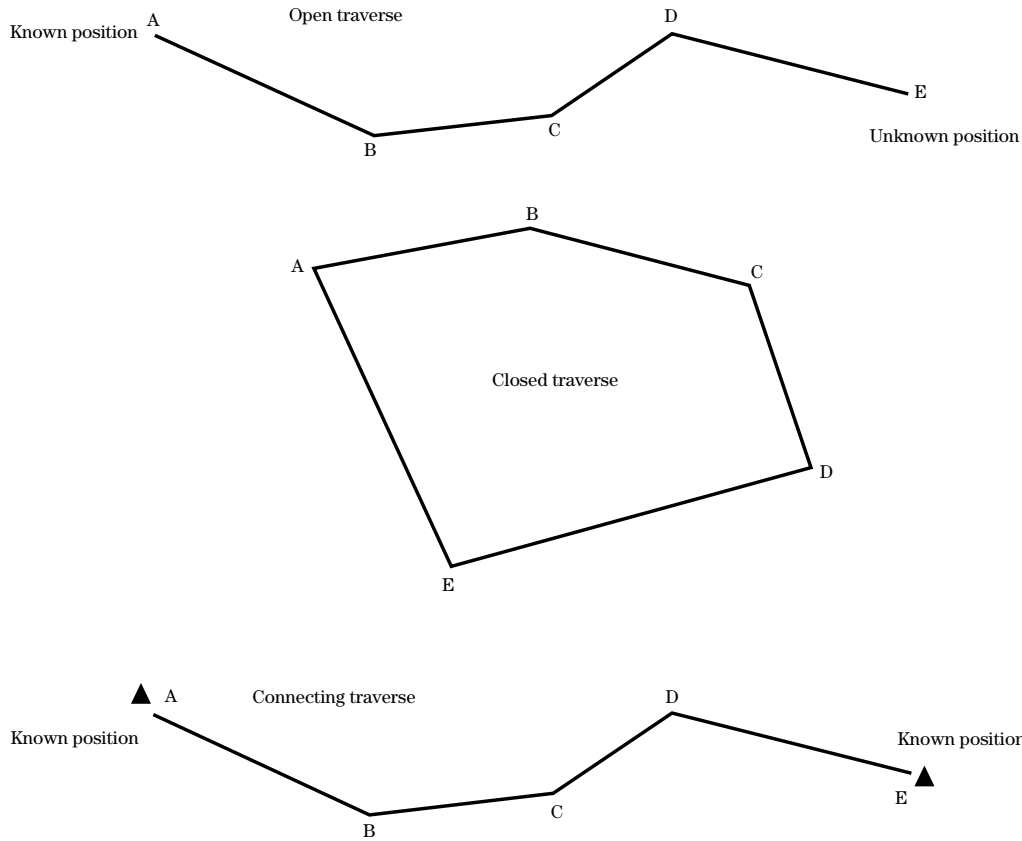

Figure 1-10 Control survey (triangulation)

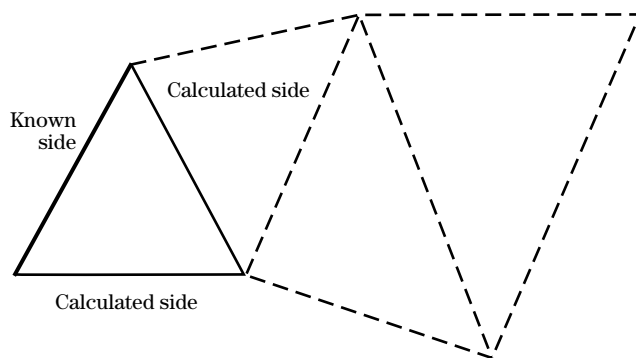
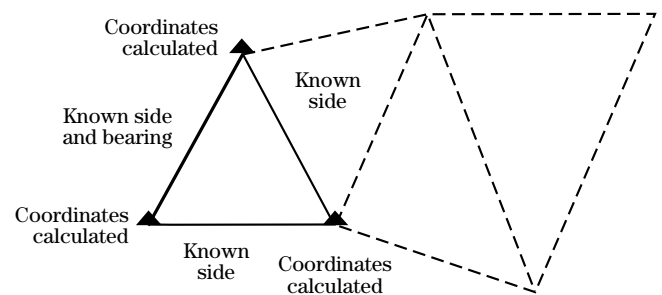

Figure 1-11 Control survey (trilateration)



(4) Grid

A grid consists of a series of measured parallel and perpendicular reference lines laid out an equal distance apart to form adjoining tiers of equal squares.

The direction of courses or sides of angles is expressed as an azimuth or bearing (fig. 1-12). An azimuth is a clockwise horizontal angle from a north

reference direction. *Azimuths* cannot exceed 360 degrees. A *bearing* is an angle between 0 degrees and 90 degrees measured from the north or south pole, whichever is closer, and east or west, i.e., N 48°27' E, S 15°10' E, S 32°30' W, and N 20°15' W.

Table 1-4 shows the relationships between azimuths and the corresponding bearings.

Figure 1-12 Azimuths and bearings

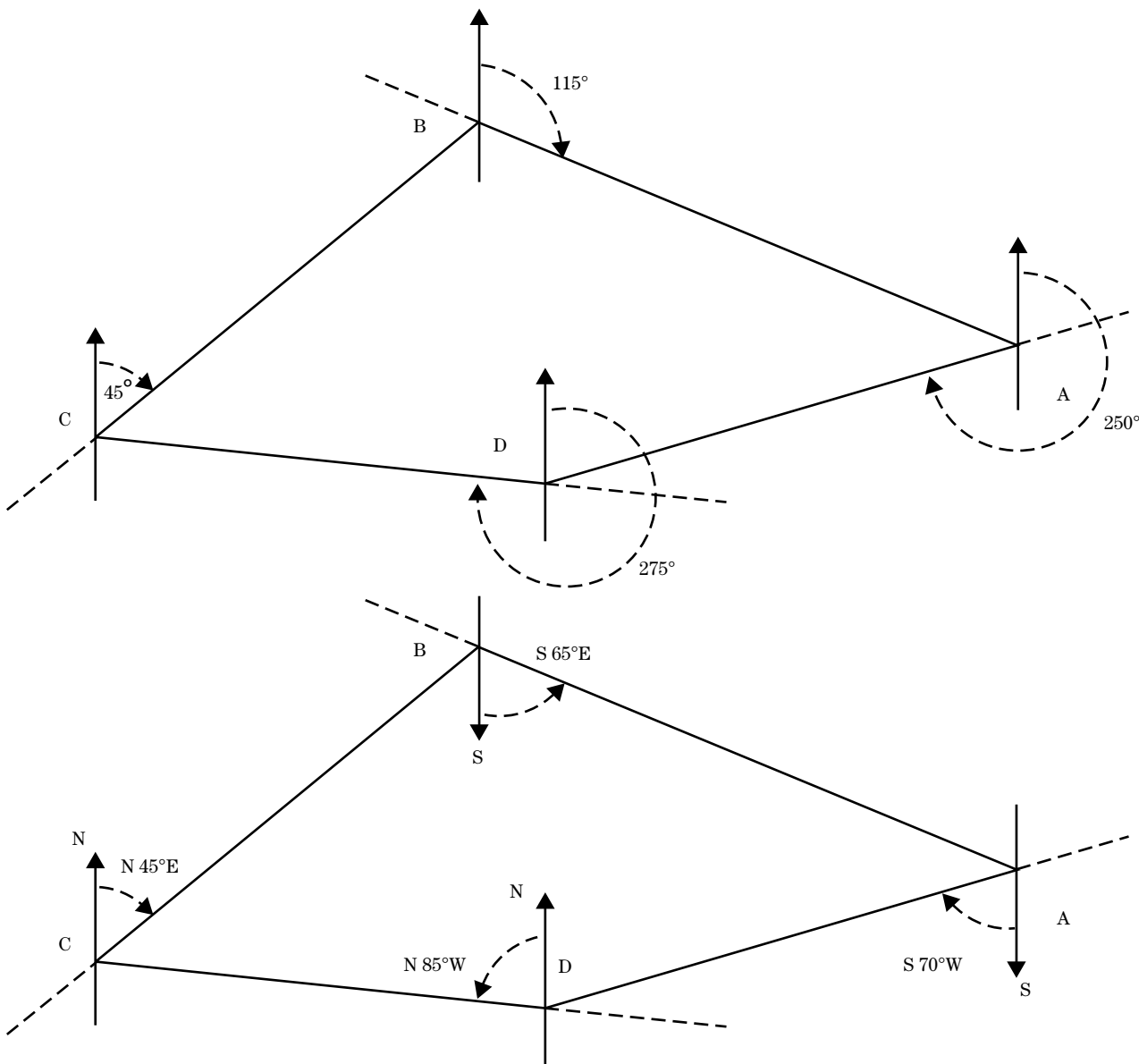

Bearings may be measured along the Earth's magnetic lines of force by the compass. These magnetic bearings will vary from the geographic or true bearings determined by astronomic observation. Declinations from true bearings vary daily, monthly, yearly, and with location. In certain cases, adjustments must be made for these variations, however, not for the typical soil and water conservation engineering surveys.

The position of a point, line, traverse, triangulation, or grid can be defined by coordinates that are northerly or southerly (latitudes), measured from an arbitrarily chosen east-west or x axis; and easterly or westerly (departures), measured from an arbitrarily chosen north-south or y axis. North and east directions are taken as positive values and south and west as negative. When the measurement and direction for one course or side are given, direction of all other courses or sides can be computed from measured angles or from triangulation, traverse, or grid. Some states require that state coordinate systems be used to define survey positions.

The latitude and longitude of any point can be calculated from the previous point as follows:

$$\text{Latitude} = \cos(\text{bearing}) \times \text{horizontal distance}$$

$$\text{Longitude} = \sin(\text{bearing}) \times \text{horizontal distance}$$

Table 1-4 Relationships between azimuths and bearings

Azimuth	Bearing
120°	S60°E
200°	S20°W
290°	N70°W
30°	N30°E

Example:

Beginning at a point A with coordinates 1,000.0, 1,000.0, the surveyor measures 350.0 feet at N 30° E to point B (fig. 1-13). The coordinates of point B are calculated as:

$$\text{Latitude} = \cos(N 30^\circ E) \times 350.0 \text{ ft} = +303.1 \text{ ft}$$

$$\text{Longitude} = \sin(N 30^\circ E) \times 350.0 \text{ ft} = +175.0 \text{ ft}$$

The coordinates of B are:

$$1000.0 + 303.1 \text{ and } 1000.0 + 175.0 = 1303.1, 1175.0$$

Notice in figure 1-14 that we can reverse the positions going from point B to point A. The bearing now changes to S 30° W, which causes the signs to change to negatives.

$$\text{Latitude} = \cos(S 30^\circ W) \times 350 \text{ ft} = -303.1 \text{ ft}$$

$$\text{Longitude} = \sin(S 30^\circ W) \times 350 \text{ ft} = -175.0 \text{ ft}$$

When working with coordinate data, it is best to work with azimuths to keep the signs correct. Otherwise, you must remember the quadrant you are working in, as in the above example. In addition, it is important to change all bearings and azimuths to decimals before using any trigonometric functions (sine or cosine). For example, if you are using N 75° 30' E, you must first change it to 75.5° (refer back to the section on converting degrees to decimals).

Figure 1-13 Calculating horizontal latitude and longitude coordinates from survey data

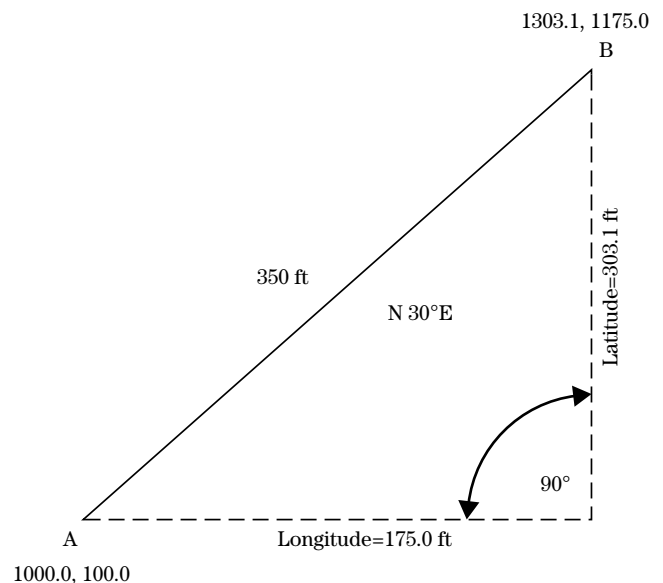
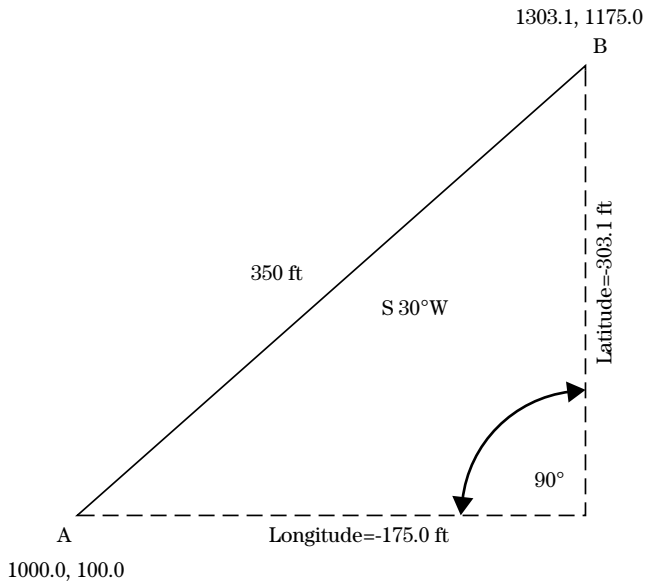

Figure 1-14 Calculating horizontal latitude and longitude coordinates from survey data**(b) Determining horizontal distance**

Horizontal distance and slope distance are the two types of distance measurement that can be taken. Horizontal distance is also known as plane distance and is either measured directly with the measuring tape held so that the slope is zero or is calculated from the slope distance. The slope distance is that distance measured parallel to the ground accounting for differences in elevation (fig. 1-15).

Unless the slope distance is all that is needed, slope distances must be reduced to horizontal distance. Horizontal distance is calculated from slope distance and the slope angle (usually in percent slope) as follows:

$$\text{Horizontal distance} = \cos(\tan^{-1} \text{percent angle}) \times \text{slope distance}$$

For example, if you measured 175.6 feet on a 30 percent slope, the horizontal distance equals

$$\begin{aligned} \text{Horizontal distance} &= \cos(\tan^{-1} 0.30) \times 175.6 \\ &= 168.2 \text{ feet} \end{aligned}$$

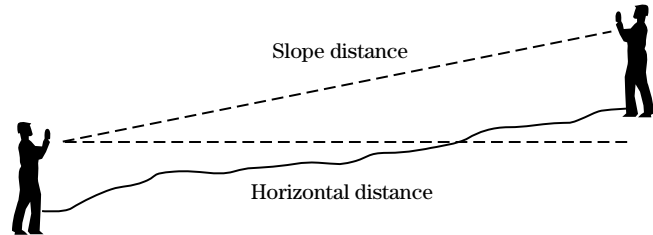
Figure 1-15 Distance measured as either horizontal or slope distance**(c) Measurement of horizontal distances**

Measurement of horizontal distances can be accomplished by a number of methods including pacing, taping, stadia, and EDM devices. The choice of measurement device usually is determined by the accuracy required.

Each point along a surveyed line is called a station. Stations are usually designated by their horizontal distance from the beginning point in the format XX + YY.ZZ where X = hundreds of feet, Y = ones of feet, and Z = fractions of feet. For example, a station 1880.59 feet from the beginning would be designated as 18 + 80.59.

(1) Pacing

Pacing may be used for approximate measurement when an error as large as 2 percent is permissible. Measurements by pacing generally are permissible for terrace and diversion layouts, preliminary profile work, and gridding for surface drainage surveys.

Measurement by pacing consists of counting the number of steps between two points and multiplying the number by a predetermined pace factor, which is the average distance in meters or feet per pace for each individual. It can be determined best if one walks, in a natural stride, a measured distance, usually 500 feet, several times. It should be paced enough times to make certain the number of paces for the distance does not vary more than two or three. The pace factor then would be the distance in meters or feet divided by the number of paces. The pace factor may vary with the roughness and slope of the ground. Adjustments should be made to take care of these variations.

Some people prefer to use a stride instead of a pace. It consists of two paces, so the stride factor would be two times the pace factor.

(2) Odometer wheel

The odometer wheel is an inexpensive alternative to pacing on ground that is relatively smooth and free of obstacles is the odometer wheel (fig. 1-16). The wheel consists of a unicycle wheel with a measuring odometer that usually reads to the tenth of a foot, and a handle for the operator. The wheel is moved into a starting position and the odometer is zeroed out. The operator simply walks along keeping the wheel on a line and at the end of the line records the odometer reading. One of the benefits to this is the ability to quickly repeat measurements, especially over short distances. The operator should take care not to walk too fast or allow the wheel to leave the ground.

(3) Taping

Taping is the method of measuring horizontal distances typically with a steel tape. Survey distances are recorded by stations, which are usually 100 feet apart. The fractional part of a distance between full stations is called a plus station. Fractions of a foot are indicated by decimals, to the nearest 0.1 feet, depending upon the accuracy of the measurement required. For example, a point on a line 309.2 feet beyond station 10+00 feet is indicated as station 13+09.2.

Figure 1-16 Odometer wheel



Stakes set along the line are marked with a waterproof lumber crayon, known as a keel, or with a permanent ink marker or paint pen. Markings are placed on the face of stakes so that as a person walks along the line in the direction of progressive stationing, the station markings can be seen as each stake is approached. In instances where it is not possible or practical to set a stake in the surveyed position, an offset distance and direction may be recorded on both the stake and in the notes, for example 6.5 feet right.

Accurate taping with a steel tape or chain requires skill on the part of the surveyor in the use of plumb bobs, steel chaining pins, range poles, hand levels, and tension indicator apparatus. The following procedure should be observed:

- Keep the tape on the line being measured.
- Keep uniform tension on tape for each measurement.
- “Break” chain on slopes as necessary to keep chain level (fig. 1-17).
- Mark each station accurately.
- Keep accurate count of the stations.

The following procedure is generally used for chaining a line:

- If the line to be measured is a meandering line along a drainage ditch or gully channel, the measurements are taken parallel, or nearly so, to the meandering line. If the line is straight, a range pole is set ahead on the line as far as can be seen, or the direction is marked by a tree, fence post, or other convenient point. This mark is used in sighting in a straight line from the point of beginning.
- For purposes of this explanation, it will be assumed a straight line is to be measured, and a stake has been set at the point of beginning marked 0+00.
- The lead surveyor takes the zero end of the tape and advances in the general direction of the line to be measured. When the end of the tape approaches, the rear surveyor calls out “chain.” This signals the lead surveyor to stop.

Figure 1-17 Breaking chain

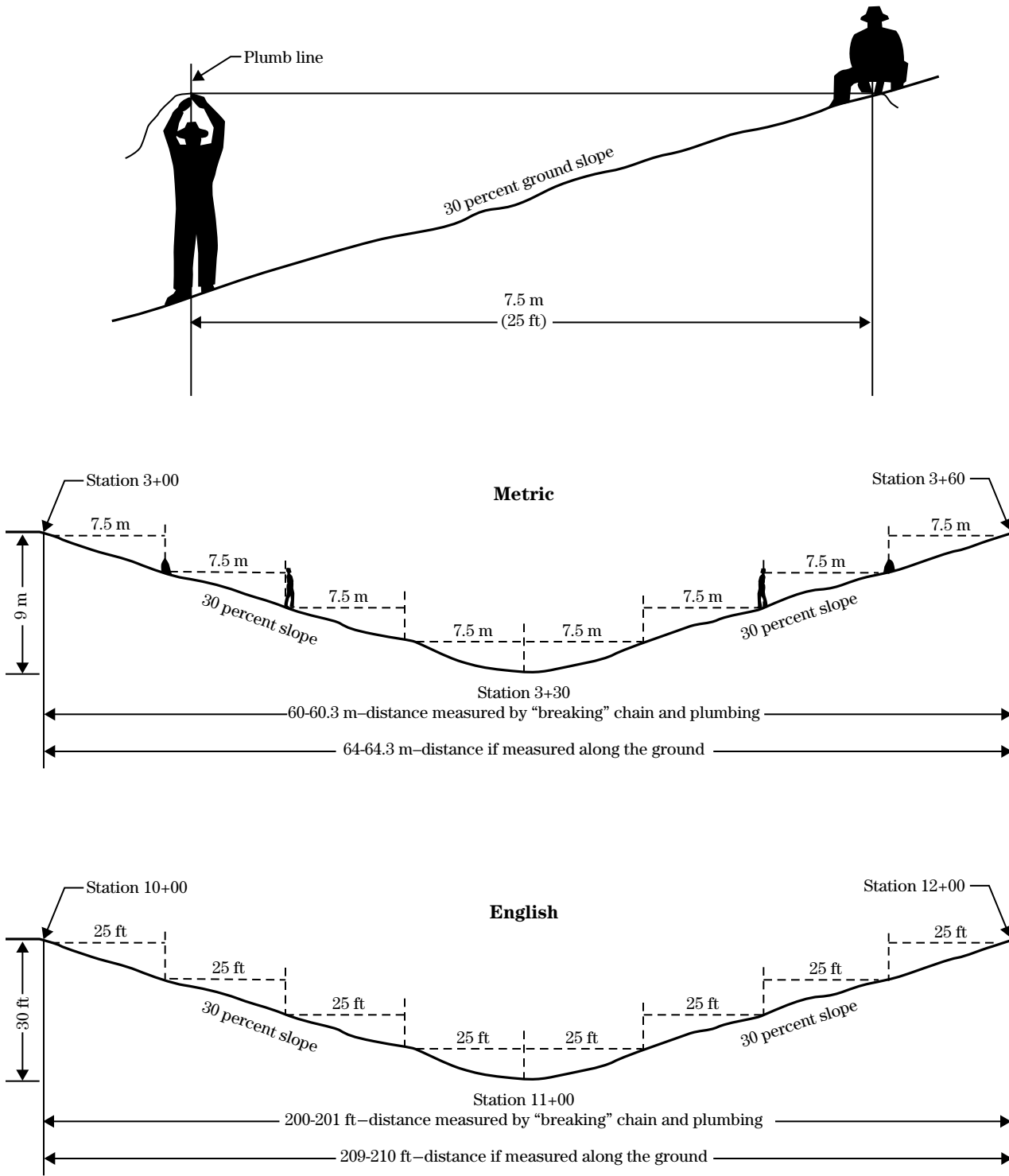

- The rear surveyor then sights-in the lead surveyor on the line to be measured and holds the required distance mark of the tape exactly on the beginning stake. The lead surveyor pulls the tape straight and reasonably tight and sets a stake or pin on line exactly at the zero end of the tape.
- Each time the rear surveyor calls out the station number, the lead surveyor should answer with the number at that stake, indicating the front station. In so doing, the rear surveyor can mentally check and verify the addition to the forward station.

On slopes, the uphill end of the tape should be held on the ground and the surveyor at the other end should hold the tape so that it is level or at least as high as the surveyor can reach and plumb down by means of a plumb bob. On grades too steep for level taping, the tape should be broken in such convenient lengths that it can be held approximately level, plumbing down to the ground. Figure 1-17 illustrates the process of breaking chain and indicates the errors that can occur if this is not done on steep slopes.

(4) Stadia

The stadia method is a much faster way to measure distances than chaining, and is sufficiently accurate under some conditions. EDMs have mostly replaced stadia, but it is still important to understand how the measurements are made.

The equipment required for stadia measurements consists of a telescope with stadia hairs, and a graduated rod. Most transits and telescopic alidades, and some engineering levels have stadia hairs above and below the center horizontal crosshair.

To take a stadia measurement, observe the interval on the rod between the two stadia hairs when the rod is plumbed on a point. The stadia rod must be held plumb to avoid considerable error in the measurement. This interval, called the stadia interval, is a direct function of the distance from the instrument to the rod. On most instruments, the ratio of this distance to the stadia interval may be taken as 100 to 1 with no appreciable error. The exact ratio for instruments with stadia hairs is usually indicated on the card placed in the instrument box. To determine the distance from the instrument to any given point, observe the stadia interval on the rod held plumb on the point and multiply this interval by 100.

In reading stadia intervals, it is usually convenient to set the lower stadia hair on some even meter or foot mark and read the interval to the upper stadia hair. When the distance is such that one of the stadia hairs falls off the rod, one-half the interval may be read between one stadia hair and the horizontal crosshair. When this is done, the distance will be twice the interval that is read on the rod times 100.

The distances obtained by the stadia are as measured along the line of sight from the instrument to the rod. If the line of sight is on an appreciable grade, you will need to make a correction to obtain the true horizontal distance. The correction can be made by the use of tables or a stadia slide rule, either of which give both horizontal and vertical distances from stadia readings on various grades. For slopes less than 5 percent, the horizontal distance will be within 0.3 percent of the measured distance and may be used without need of correction.

(5) Aerial photographs

Horizontal distances may be obtained between points on an aerial photograph by direct scaling if the scale of the photograph is known. If the scale is not known or if you want to check it, the scale may be determined as follows:

- Select two well-defined points on the photograph located so that measurement with the chain can be made conveniently between them on the ground and, also, so that the measurement between them on the photograph will cross a good portion of the center section of the photograph.
- Measure, in inches, the distance (A) between the points on the photograph.
- Use a chain to measure, in feet, the distance (B) between the points on the ground.
- Scale of the photograph = feet per inch. The scale thus determined may be applied to other measurements in other areas on the same photograph, although measurements made in other areas on the same photograph will be less accurate than those made near the area where the measurement was made to determine the scale.

(6) Electronic distance measuring equipment

To take a measurement with EDM equipment, simply sight the unit onto a reflector target. Then, press the

range button and numerals will appear on the display screen showing the distance in feet. This procedure may vary slightly depending upon the type of equipment used. Most modern EDMs have an option to measure with or without the use of a reflector target (fig. 1-18). This is especially useful for working alone, but the user should develop a feel for approximate distance. Without the target, the laser will reflect from even the slightest object and can return incorrect distances. In brushy conditions, it is best to always use the reflector.

GPS units may also be used to provide horizontal distances by measuring positions of points and calculating the distance between them. The type of unit and how it is used will determine accuracy (as with any survey equipment).

(d) Determining horizontal angles

The direction of any line on a course is determined by the reference angle in the horizontal plane to the previous line on the course. There are three types of reference angles that may be used to determine course direction.

(1) Interior angles

Interior angles are angles that are measured on the inside of a closed polygon or closed traverse (fig. 1-19). Interior angles may be checked by summing all of the interior angles and subtracting from $(n-2)180^\circ$, where n equals the number of sides on the polygon. For example a six-sided polygon has $(6-2)180^\circ$ or 720° in the interior.

(2) Exterior angles

Exterior angles are angles that are measured on the outside of a closed polygon or closed traverse (fig. 1-20). Exterior angles may be checked by summing the exterior angle with the interior angle. The sum of any exterior angle with the corresponding interior angle must always be 360 degrees. Exterior angles should always be turned clockwise or to the right by convention to avoid any confusion.

(3) Deflection angles

Deflection angles are measured by extending the previous course direction and then turning right or left to the next course direction (fig. 1-21). Deflection angles are always less than 180 degrees and by convention may be turned either right or left.

Figure 1-18 Digital laser EDM



Figure 1-19 Six-sided polygon showing the interior angles

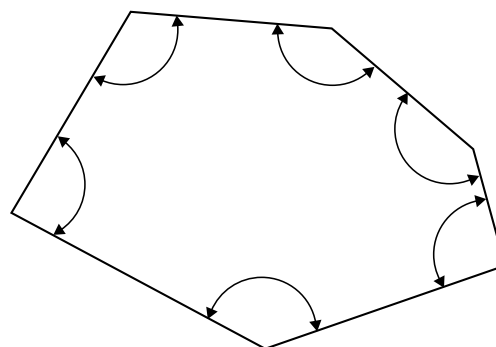
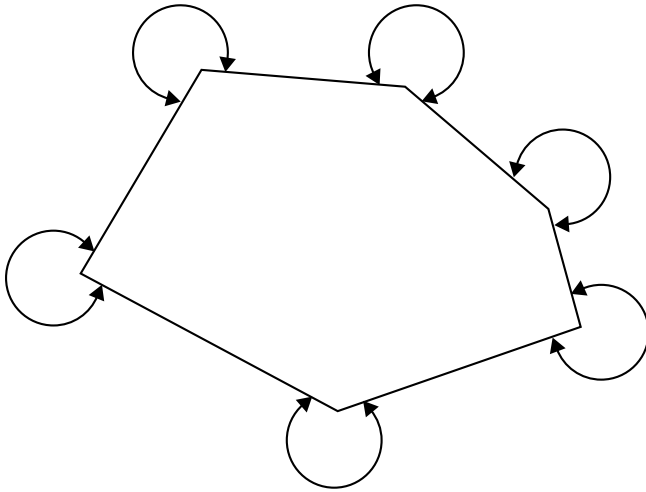

Figure 1-20 Six-sided polygon showing the exterior angles



(e) Determining direction

Course direction is expressed by the bearing of a particular leg of the course. When there is a change in course direction, a new bearing can be calculated given the bearing of the first course direction and the angle of the change in course direction. For example, in figure 1-22, the starting course direction is N 63° E and the deflection angle measured is 39 degrees to the right. When bearings are used to express direction, the best method of accomplishing this is to draw a sketch for each station showing the two courses involved as shown.

Figure 1-21 Deflection angles as extensions of the previous course

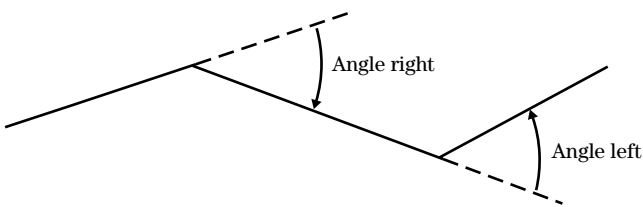
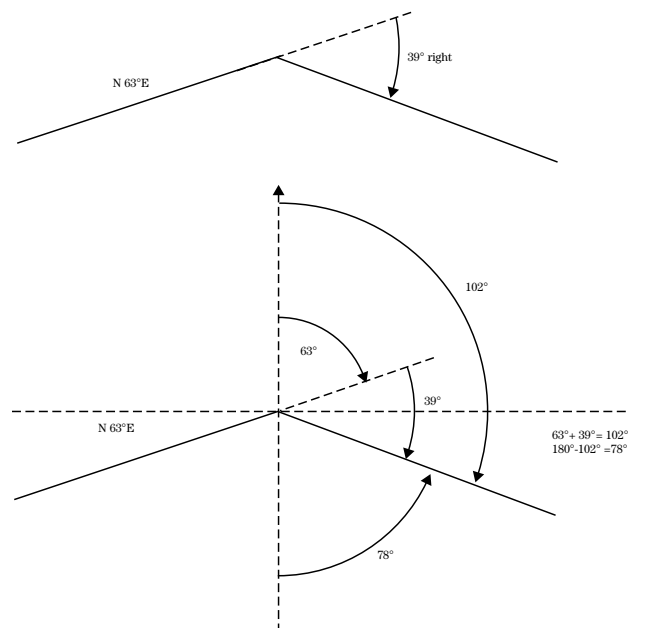

Figure 1-22 Course direction determination from measured angles



(f) Determining vertical position

The vertical position of points is determined from a series of level readings. Level surveys are referenced to a datum. Mean sea level usually is used as a standard datum; however, an assumed datum may be used for minor surveys. Vertical distances above and below a datum are called elevations. Vertical distance is measured as the elevation difference between any two points with reference to a datum (fig. 1-23).

The vertical position is the Z coordinate of a position and adds the third dimension to any position. The horizontal position discussed earlier is the X and Y position and is two-dimensional.

(g) Determining vertical distance

Vertical distance is one side of a right triangle and is easily calculated by the relationship:

$$\% \text{ Slope} = \frac{\text{Rise}}{\text{Run}} = \frac{\text{Vertical distance}}{\text{Horizontal distance}}$$

The horizontal distance and percent slope are easily measured in the field so the equation can be changed to calculate vertical distance by the relationship:

$$\text{Vertical distance} = \text{Horizontal distance} \times \% \text{ Slope}$$

Example (fig. 1-24)

Suppose that in the field you have measured a percent slope of -26% between two points and the calculated horizontal distance is 229.7 feet and the elevation of point A is 549.9 feet. You need to know the elevation of point B.

$$\begin{aligned} \text{Vertical distance point B from point A} &= 229.7 \text{ ft} \times -0.26 \text{ slope} \\ &= -59.7 \text{ ft} \end{aligned}$$

$$\begin{aligned} \text{The elevation of point B} &= 549.9 \text{ ft} + -59.7 \text{ ft} \\ &= 490.2 \text{ ft} \end{aligned}$$

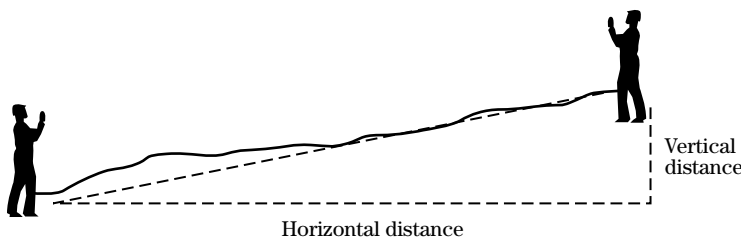
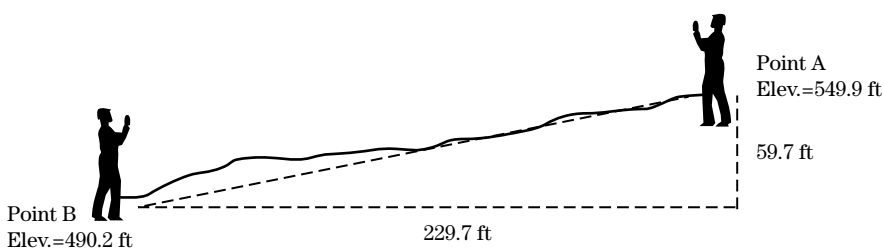
Figure 1-23 Measurement of vertical distance**Figure 1-24** Calculation of vertical distance

(h) Determining vertical angles

Vertical angles can be expressed either as a true vertical angle or as a zenith angle. A true vertical angle is an angle measured from the horizontal either upward or downward (fig. 1–25). Vertical angles measured upwards from the horizontal are positive angles and those measured downward are negative angles. Angles may be measured in degrees or in percent scale.

Zenith angles are measured downward from a vertical plumb line above the point (fig. 1–26). The zenith angle is measured from 0 degrees directly above and is equal to 90 degrees minus the vertical angle. Certain instruments have vertical verniers that read zenith angles while total stations generally read both. It is important that the instrument person check to see which vertical angle is read.

(i) Determining vertical coordinate position

Vertical coordinate position is also known as the elevation of the point and is determined by adding or subtracting the vertical difference between a known point and the position being calculated to the elevation of the known point (fig. 1–24).

Determination of the vertical coordinate of a point can be determined in a number of ways including barometric leveling, differential leveling, trigonometric leveling, and GPS. Each of these methods has its own systematic errors including (but not limited to) instrument precision, refraction (especially on longer sightings), and sighting precision. In addition, operator error is always inherent on all measurements. In any situation where the accuracy of elevations is critical, a bench level circuit should always be run to verify and adjust elevations, if necessary.

Figure 1–25 Reading of vertical angles

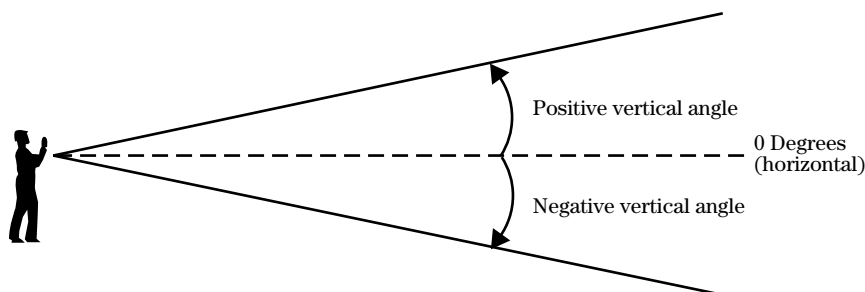
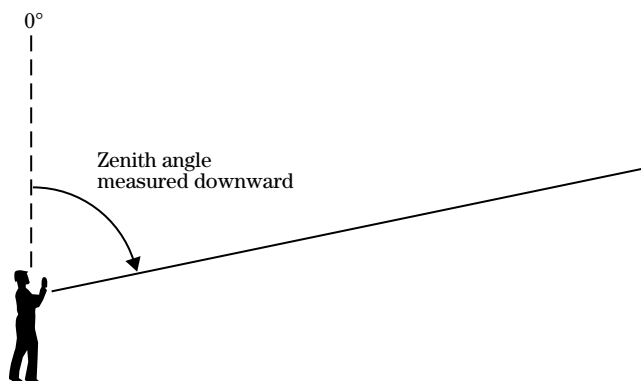

Figure 1–26 Reading of zenith angles



650.0111 Surveying equipment

Surveying equipment can be classified as:

- Manual instruments
- Electronic (digital) instruments

Manual instruments are those that rely on visual reading of the instrument values and manual recording of the values. While more and more surveying is done with digital equipment, it is important to understand the uses and process involved with manual equipment especially where resurveys are done from original notes.

Electronic equipment uses either a microwave or a light wave (laser) to determine measurement values using the known value for the speed of light and multiplying by the time it takes the signal to travel to the object being measured.

Instruments can be broken down further into:

- instruments that measure horizontal distance and direction (or angle)
- instruments that measure vertical distance and angles
- instruments that measure both horizontal and vertical distance and angles
- instruments that measure coordinate position only

In addition, instruments can be classified by the expected accuracy of the instrument.

(a) Orders of accuracy

The orders of accuracy of a survey is determined by the accuracy requirements for the project. Some projects require high orders of accuracy, for example, a principal spillway or watershed dam survey, while other projects require lower orders of accuracy, for example a trail or dirt road.

The Federal Geodetic Control Subcommittee (FGCS) has established recommendations for allowable errors for horizontal and vertical measurements. The recom-

mended allowable errors are computed using the survey constant (K) shown in table 1–5. Survey errors are a function of instrument accuracy and the care of the surveyor in making measurements. Assuming that great care in the surveying process is followed, the order of the survey required will dictate which instruments should be selected for use. In modern surveying, almost all high order surveying is done with electronic equipment.

(b) Allowable error in a survey

Allowable error in a horizontal traverse is calculated by:

$$c = K\sqrt{N}$$

where:

- c = allowable error
- K = survey order constant
- N = number of angles

Table 1–5 FGCS standards for horizontal and vertical order of survey

Type of survey	Order of survey	Survey order constant (K)
Horizontal	First order	1.7 seconds
	Second order	
	Class I	3 seconds
	Class II	4.5 seconds
	Third order	
	Class I	10 seconds
	Class II	12 seconds
	First order	
	Class I	4 mm
Vertical	Class II	5 mm
	Second order	
	Class I	6 mm
	Class II	8 mm
	Third order	
	Class I	12 mm

The error for a horizontal survey is defined as the angle misclosure. For a closed polygon traverse, the angle misclosure is the difference between the sum of the measured angles and the geometrically correct sum of the angles which is calculated as:

$$(N - 2)180^\circ$$

where:

N = number of angles in the closed traverse

For example, suppose a second order class 2 survey has been completed that consists of seven interior angles ($N = 7$) (fig. 1-27). The geometrically correct sum of the angles is $(7 - 2)180^\circ = 900^\circ$. The sum of the surveyed interior angles = $900^\circ 00' 23''$. The angle misclosure is 23 seconds.

The allowable error for this survey order is calculated as:

$$c = 4.5'' \sqrt{7}$$

$$c = 31.5''$$

Because the calculated error is less than the allowable error, the survey is within the standards for this order.

Allowable error in a vertical traverse is calculated by:

$$c = K\sqrt{M}$$

where:

c = allowable error

K = survey order constant

M = total length of the level loop (or section) surveyed in miles

Figure 1-27 Traverse with seven interior angles

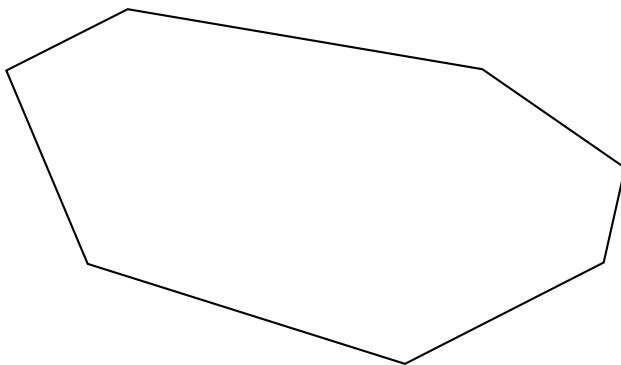

For example, suppose the leveling for the same second order class 2 survey in figure 1-27 has been completed and the total horizontal distance is 2027.81 meters. The allowable error in the level loop is calculated as:

$$c = 8 \text{ mm} \sqrt{2.02781 \text{ km}}$$

$$c = 11.39 \text{ mm} = \frac{0.45 \text{ in}}{12 \text{ in}}$$

$$c = 0.038 \text{ ft}$$

(c) Instruments that measure horizontal distance

(1) String box or hip chain

The string box or hip chain is an inexpensive instrument that can give quick and rough estimates for horizontal (and slope) distance. It is a very efficient instrument when only rough estimates are needed, but should never be used where accurate distance is required. The box uses a string roll wrapped around a counter wheel to keep track of total distance (fig. 1-28).

Figure 1-28 String box or hip chain

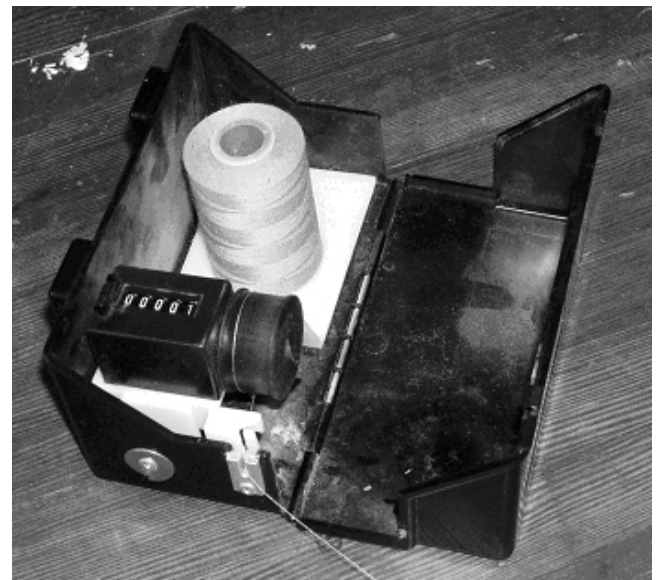

(2) Tapes

Tapes constructed primarily of steel, cloth, or woven tapes (fiberglass or metal) are made for surveying. Steel tapes are made of flat steel bands (or cables known as cam-lines). The markings on steel tapes may be etched, stamped on clamps or soldered sleeves (fig. 1-29), or stamped on bosses. Steel tapes may be obtained in lengths up to 500 feet, although the most commonly used are 100 feet long. Steel tapes are usually marked at 1-foot intervals, except the last foot, which is graduated in tenths and hundredths of a foot. Because tapes are marked in a variety of ways, the surveyor should inspect them carefully to determine how they are marked.

Metallic or woven tapes (fig. 1-30) are actually made of fabric with fine brass wire or fiberglass woven into them to minimize stretching. Tapes made from glass fibers are gradually replacing woven metallic tapes and are safer when used near power lines. They usually come in lengths of 50 feet, but may be obtained in lengths up to 300 feet. Measurements not requiring a high degree of accuracy, such as dimensions of existing bridge openings, short distances in taking cross sections or topography, and distances for stripcropping, orchard, and terracing layouts, usually are made with metallic or fiberglass tapes.

Figure 1-29 Steel tape

(a) Typical steel tape rolled

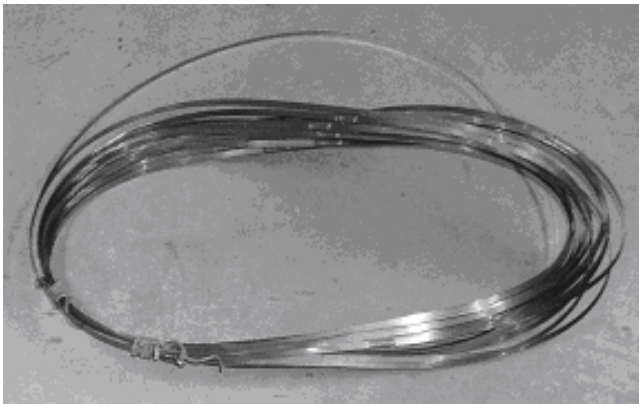

(b) Stamped soldered sleeve

**Figure 1-30** Typical cloth tape and woven cloth tape

(a) Cloth tape rolled

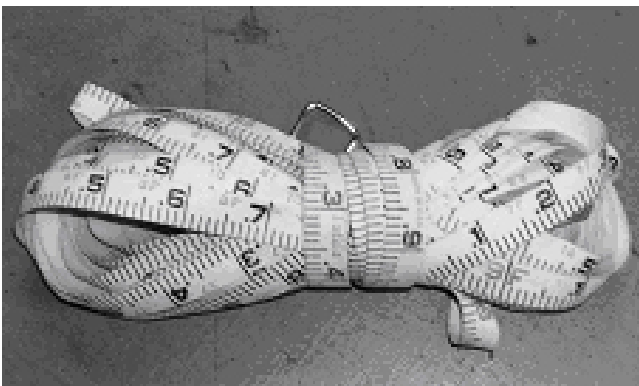

(b) Woven cloth tape on a reel



(3) Electronic distance measuring

Most EDMs are built into more sophisticated instruments such as total stations that measure both horizontal and vertical distance and angles. However, some simple EDMs that only measure distance are available.

(d) Instruments that measure horizontal direction

Instruments measuring horizontal direction use a magnetic needle and generally have the ability to offset magnetic declination to allow the user to measure true north. Horizontal angle can be calculated as the difference in any two directions. The staff compass and hand compass are instruments that measure horizontal direction (azimuth or bearing).

(1) Staff compass

The staff compass (fig. 1-31) is a precision compass mounted on a special rod called a Jacob staff that has a ball socket to allow the compass to rotate and be balanced. The compass uses a set of level bubbles to position correctly over the survey point.

The staff compass is accurate to about 30 minutes of a degree and is adequate for most surveys not requiring a high degree of accuracy (access roads for example).

(2) Hand compass

The hand compass (fig. 1-32) is a general direction, hand-held compass. The hand compass allows local declination to be set but is generally only accurate to about ± 2 degrees at best. The hand compass should only be used for general direction or for surveys that require rough precision.

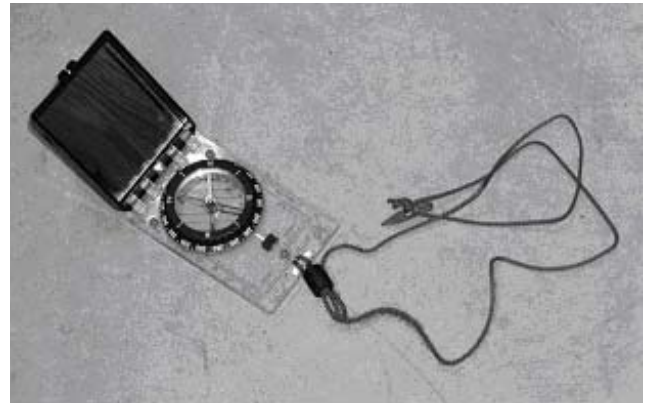
Figure 1-32 Hand compass**Figure 1-31** Ball-swivel head of the Jacob staff and the compass

(a) Ball swivel head of the Jacob staff and the compass



(b) Staff compass in a setup position



(e) Instruments that measure vertical distance

Elevation differences between any two or more points can be read directly with several different instruments or calculated from the measured vertical angle between any two points with several other instruments. Those that read elevation differences directly include simple hand levels, engineer's levels, and laser levels. Direct reading level instruments also make use of some type of measurement rod to take readings from. Different types of rods are discussed at the end of this section.

(1) Hand levels

The hand level (fig. 1-33) is used for rough measurements of differences in elevation. The user stands erect and sights through the eyepiece, holding the tube in the hand, and moving the objective end up and down until the image of the spirit level bubble on the mirror is centered on the fixed cross wire. The point where the line of sight in this position strikes the rod or other object is then noted. The vertical distance from the ground to the surveyor's eye determines the

height of instrument and other ground elevations. A rough line of levels may be carried with the hand level for a distance of 400 to 500 feet provided the length of each sight is not over about 50 feet. These instruments used along with a level rod provide rough elevation differences between points.

(2) Engineer's levels

The dumpy level (fig. 1-34) was once the principal level in use because of its sturdiness, convenience, and stability of adjustment. These instruments used along with a level rod provide very accurate elevation differences between points. For the most part, it has since been replaced by the self-leveling level. Its adjustment and use are discussed later in the chapter.

The self-leveling level, which has no tubular spirit level, automatically levels its line of sight with great accuracy. Self-leveling levels are used with a level rod to provide accurate elevation differences between points (fig. 1-35) It levels itself by means of a compensator after the circular spirit level is centered approximately. Precise, simple, and quick, it can be used for any level survey.

Figure 1-33 Hand level

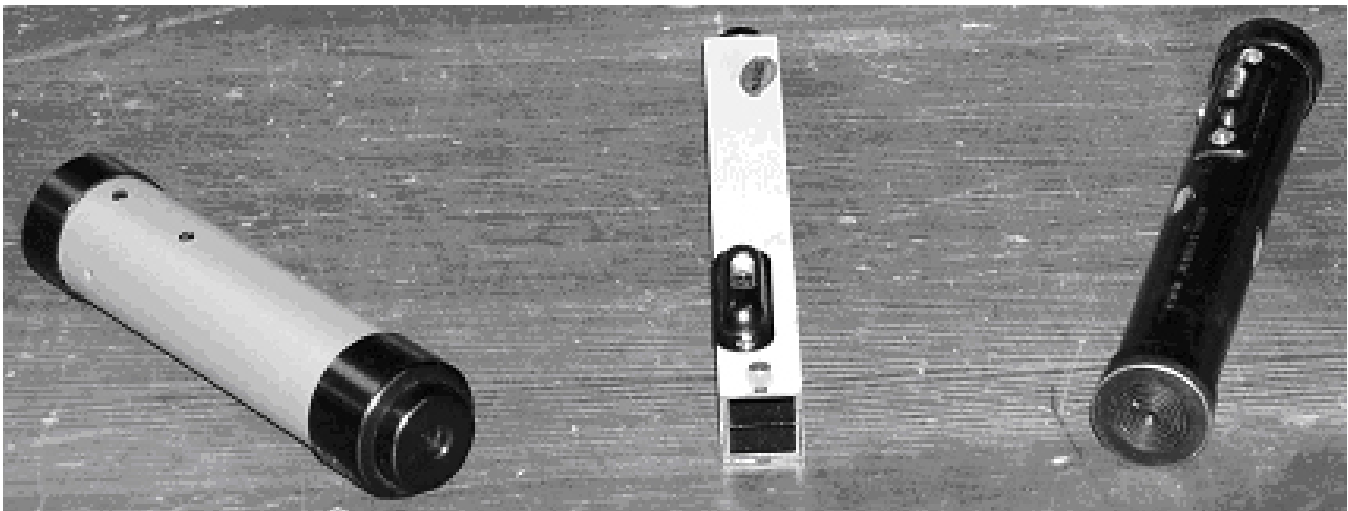

Figure 1-34 Dumpy level

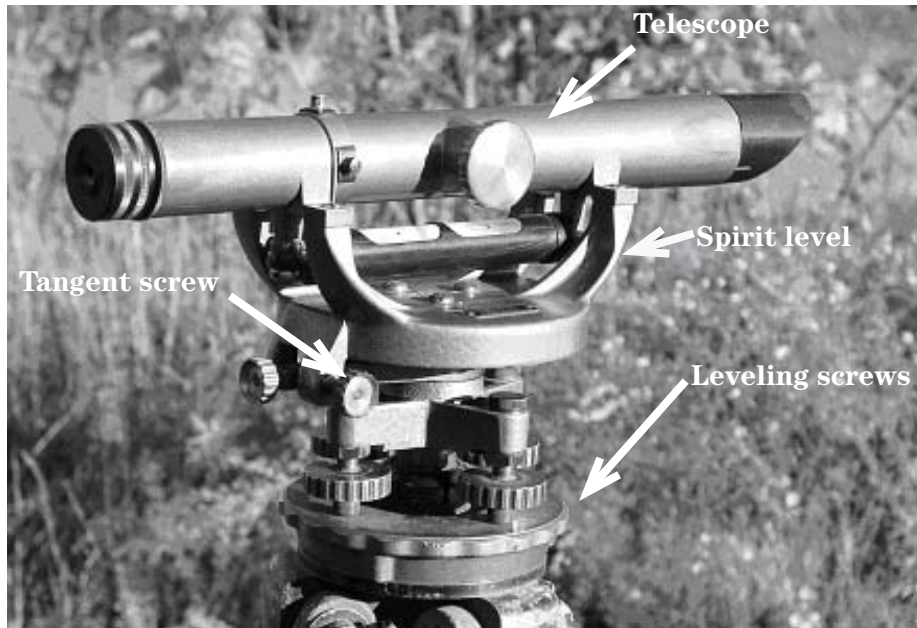

Figure 1-35 Self-leveling levels



(3) Level rods and accessories

The kinds of level rods and accessories generally used by NRCS are shown in figure 1–36. All the rods with the exception of range pole are graduated in meters, decimeters, and centimeters or in feet and tenths and hundredths of a foot.

The Philadelphia level rod is a two-section rod equipped with clamp screws. Its length is approximately 7 feet, extending to 13 feet. It may be equipped with a round or oval target that may be plain or include a vernier scale.

The Frisco or California level rod is a three-section rod equipped with clamp screws. It is about 4 feet 6½ inches long, extending to 12 feet. This rod is not equipped for use with a target. These are rarely used anymore.

The Chicago or Detroit level rod is a three- or four-section rod with metal friction joints. Each section is about 4½ feet long, extending from 12½ to 16½ feet. It is generally equipped for use with a target. These are rarely used anymore.

Fiberglass telescoping level rods are usually round or oval, 16 or 25 feet in length, and in sections that will telescope down to a 5-foot barrel for transporting. It is equipped for use with a target or prism.

The stadia rod is a two-, three-, or four-piece rod, 12 to 16 feet long, joined together with hinges and with a suitable locking device to ensure stability. It has metal shoes on both ends. The face is about 3½ inches wide. Designed primarily for use in making topographic surveys, it is not equipped for use with a target. These are rarely used anymore.

Figure 1–36 Types of level rods and range pole

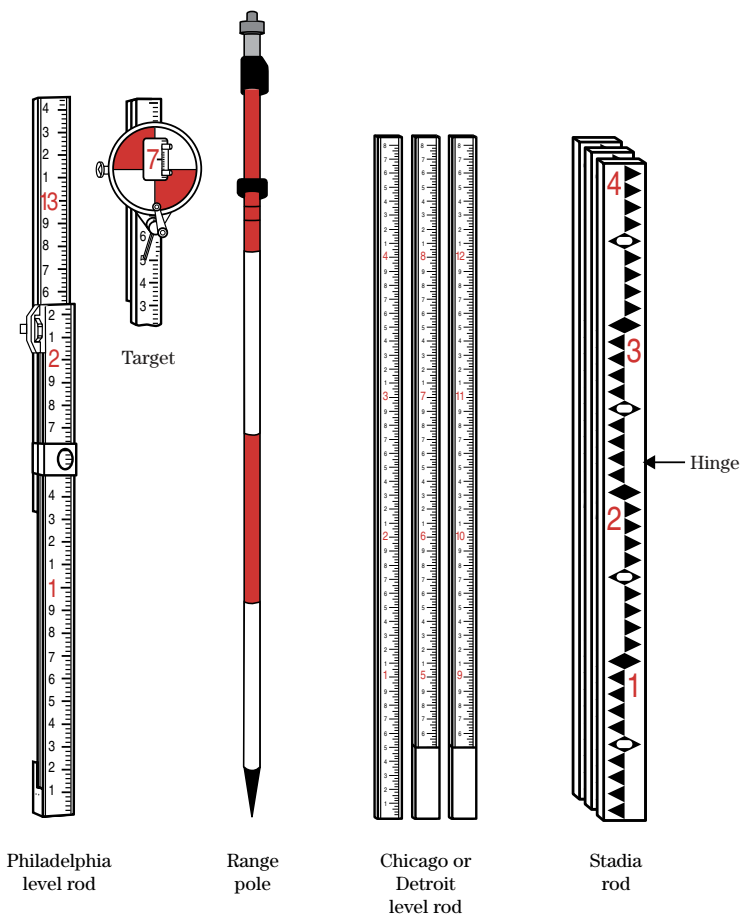

The range pole is a one-, two-, or three-piece pole generally used to establish a “line of sight.” A standard metric range pole is 2.5 meters long and graduated in 0.5-meter segments painted red and white. The English range pole is from 6 to 10 feet long and is graduated in 1-foot segments.

(4) Laser levels

A laser level consists of a transmitter and receiver. Most transmitters are self-leveling units that emit a plane of light usable up to 1,000 feet in any direction. On some models, the plane of light may be adjusted from level to a grade usually up to 10 percent.

For measuring field elevations, a small laser receiver is mounted on a direct-reading survey rod (fig. 1–37). The user moves the receiver up or down the rod until a

light or audible tone indicates the receiver is centered in the plane of laser light. The rod reading is then taken directly from the rod which allows the survey to be performed by one person.

Other uses for laser levels and receivers include mounting a receiver on a vehicle, tractor, or earthmoving equipment having a photoelectric device and telescoping mast that automatically adjusts to the laser plane of light. The receiver also has a mounted control box that senses the distance from the ground to the light beam overhead and reflects this information on a dial as a rod reading. This control system may also be mounted on earthmoving equipment so that the receiver can automatically activate a solenoid-operated hydraulic valve to raise and lower a blade or other earthmoving device. Similar types of receivers and

Figure 1–37 Laser level receiver and transmitter

(a) Laser level receiver



(b) Laser level transmitter

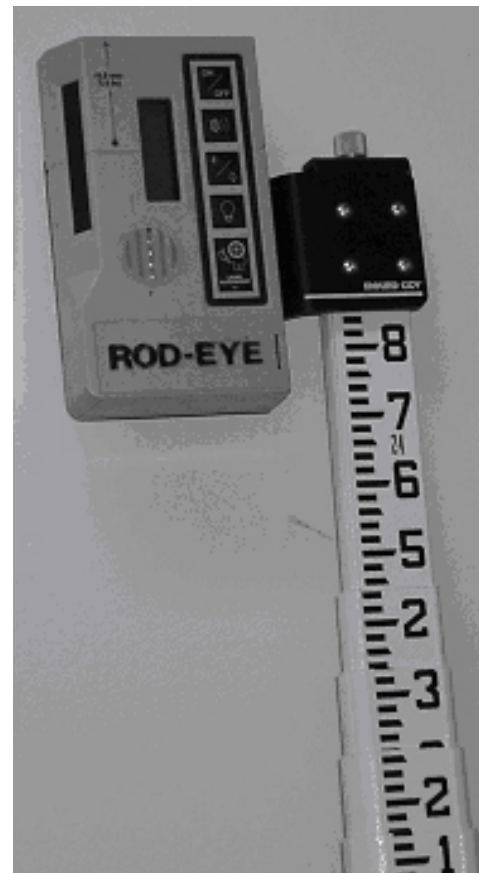

equipment are being used on equipment used for projects such as land leveling, trenching, border terracing, and other practices where precision grade control is required.

(f) Instruments that measure vertical angle

Instruments that read vertical angles directly include simple clinometers and abneys.

(1) Abney hand level

The Abney hand level (fig. 1-38) is constructed with a graduated arc for reading percent of slope. A tubular spirit level is attached to the arc on the Abney level. The user sights through the tube and fixes the line of sight so that it will be parallel to the slope to be measured. The indicator is then adjusted with the free hand until the image of the spirit level bubble is centered on the cross wire. The indicator is then clamped and the percent of slope read. The Abney hand level is typically read in percent slope.

(2) Clinometers

Clinometers with a floating pendulum may be used instead of Abney hand levels. The optical clinometer (fig. 1-39) is used for measuring vertical angles, computing heights and distances, rough surveying, leveling, and contouring. Readings can be taken with either eye, but both eyes must be kept open. The support-

ing hand must not obstruct the vision of the nonreading eye.

The instrument is held before the reading eye so that the scale can be read through the optics, and the round side-window faces to the left. The user aims the instrument by raising or lowering it until the hair line is sighted against the point to be measured. At the same time, the position of the hair line against the scale gives the reading. Because of an optical illusion, the hair line (crosshair) seems to continue outside the frame, so it can be easily observed against the terrain of the object. Clinometers are available in a variety of configurations with dual reading scales (typical is percent on one side and degrees on the other). You should take care when using a clinometer to verify the scales.

(g) Instruments that measure both horizontal and vertical distance

Instruments that measure both horizontal and vertical distance can be either manual reading, as with transits and theodolites, or electronic as with total stations that automatically read and can record if equipped with an internal or external data collector. Manual instruments include the plane table and alidade, engineer's transit, and the theodolite. Electronic instruments include the hand-held lasers and the total station.

Figure 1-38 Abney hand level

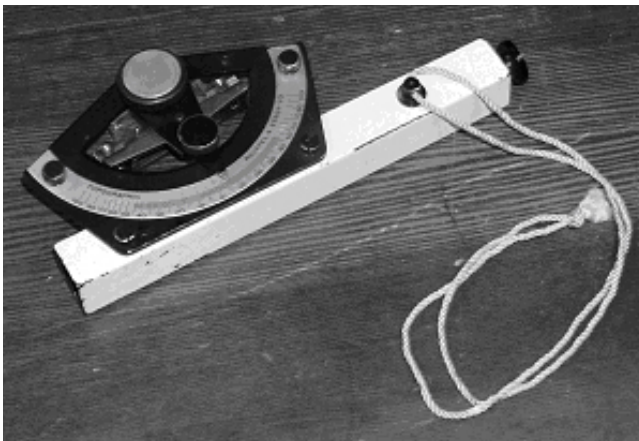
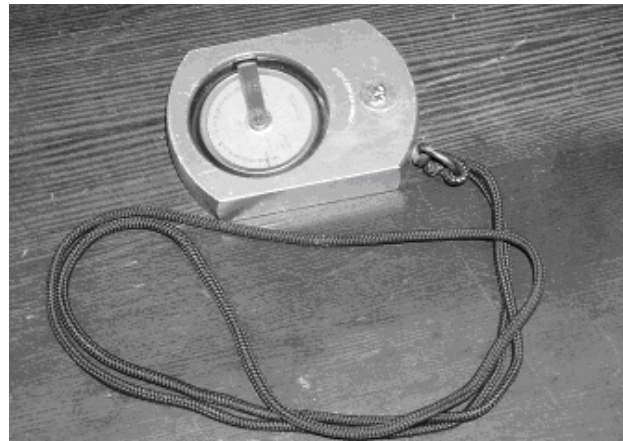

Figure 1-39 Clinometer



(1) Plane table and alidade

The plane table consists of a drawing board attached to a tripod so that it can be leveled, rotated, and locked into the position selected. Drawing paper attached to the board allows survey data to be plotted in the field. The table size most commonly used is 24 by 31 inches. Screws are provided for attaching drawing paper to the board.

The alidade is an instrument containing a line of sight and a straightedge parallel to it. The line of sight may be a peepsight provided by standards at either end of the straightedge, or it may be a telescope mounted on a standard and fixed with its line of sight parallel to the straightedge. The telescope is provided with a spirit level (ordinarily a detachable striding level), so the line of sight may be horizontal. The telescopic alidade is the more useful of the two instruments. Mapping with it on a plane table is one of the fastest ways to obtain topographic information.

The telescopic alidade (fig. 1–40) consists of a telescope mounted on a horizontal axis and supported by standards attached to a straightedge either directly or by means of a post. The telescope is equipped with a vertical arc and a striding or attached level bubble. Many instruments are also equipped with a Beaman stadia arc and a vernier control bubble.

The self-indexing alidade is a telescopic alidade in which a pendulum automatically brings the index of the vertical arc to the correct scale reading even if the plane table board is not quite level. All scales are read directly through a microscope.

The plane table and alidade are used most effectively for obtaining detail and topography. Because the operator can plot the form of the ground while surveying it, mapping can be done rapidly, in real-time, and an accurate representation of the terrain can be obtained. The plane table and alidade have been replaced for the most part by more modern electronic equipment.

Figure 1–40 Telescopic alidade

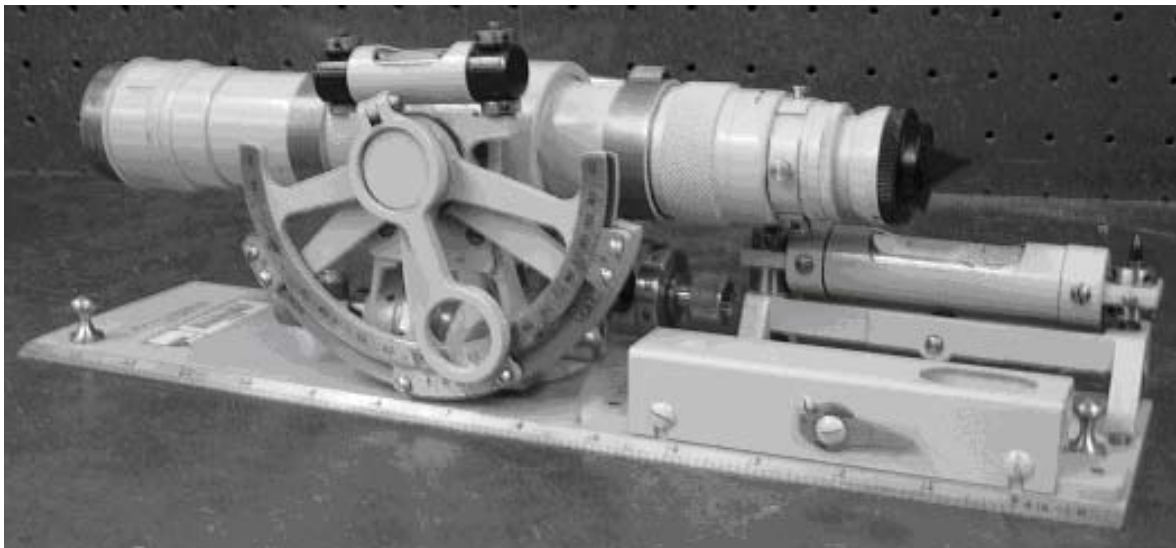

(2) Engineer's transit

The engineer's transit is used primarily for measuring horizontal and vertical angles, prolonging or setting points in line, measuring approximate distances by the stadia principle, and leveling (fig. 1-41). It can also be used as a compass when equipped with a compass needle. Horizontal and vertical plates graduated in degrees and fractions measure the angles. They are mounted at right angles to the axes. Spirit levels

are provided for leveling the horizontal plates. A telescope, equipped with a spirit level, is mounted at right angles to a horizontal axis supported by two uprights (standards) attached to the upper horizontal plate. In use, the instrument is mounted on a tripod and is equipped with a small chain and hook to which a plumb bob can be attached. The plumb bob provides a way to center the instrument over a point.

Figure 1-41 Engineer's transit

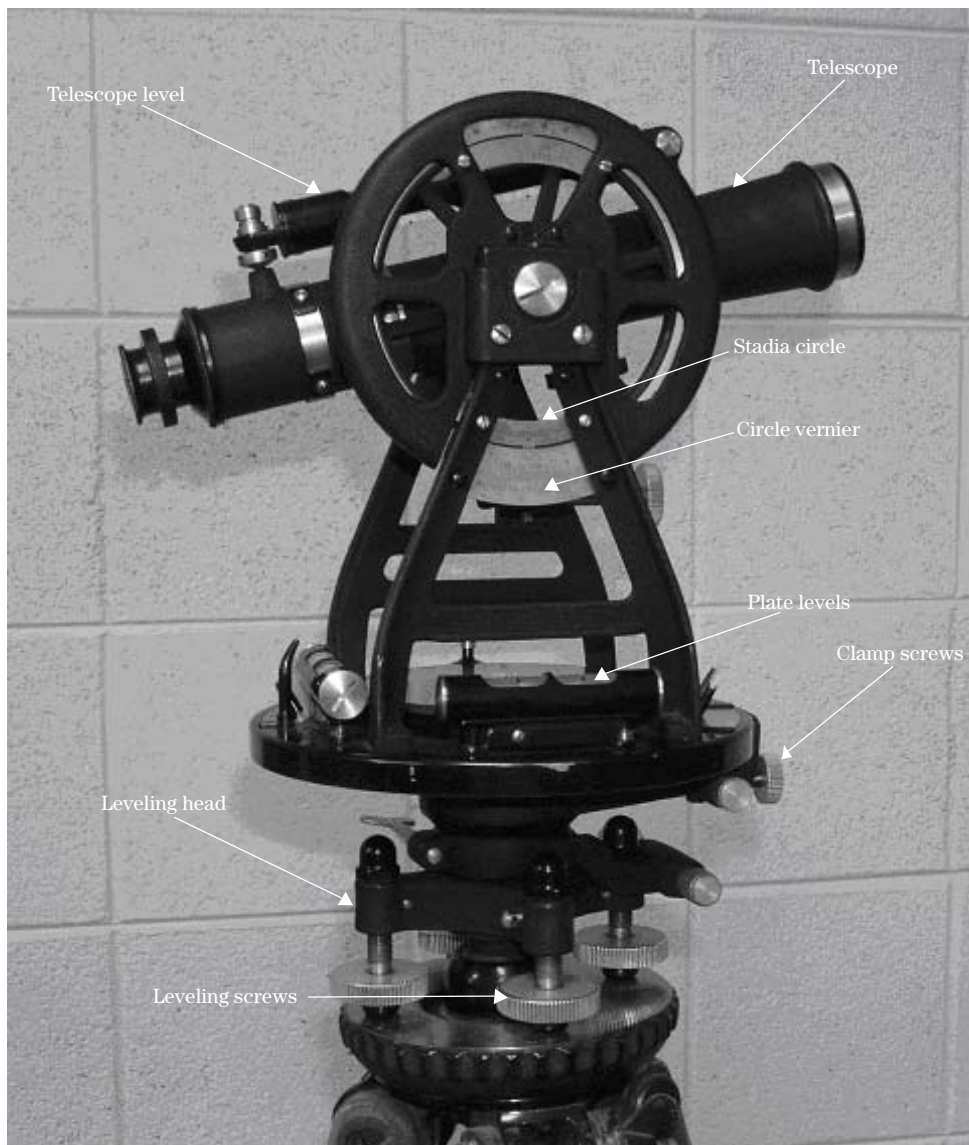

The electronic theodolite (fig. 1-42) is used in the same way as an engineer's transit, but angles are displayed on a screen in a direct digital readout, allowing fewer errors in reading and interpretation of the vernier scales. The theodolite serves the same purpose as

the transit but can be generally read with higher precision. Some models have such features as internal reading, self-leveling, and an optical plummet. The plummet allows the operator to center the instrument over the point without the use of a plumb bob.

Figure 1-42 Electronic theodolite

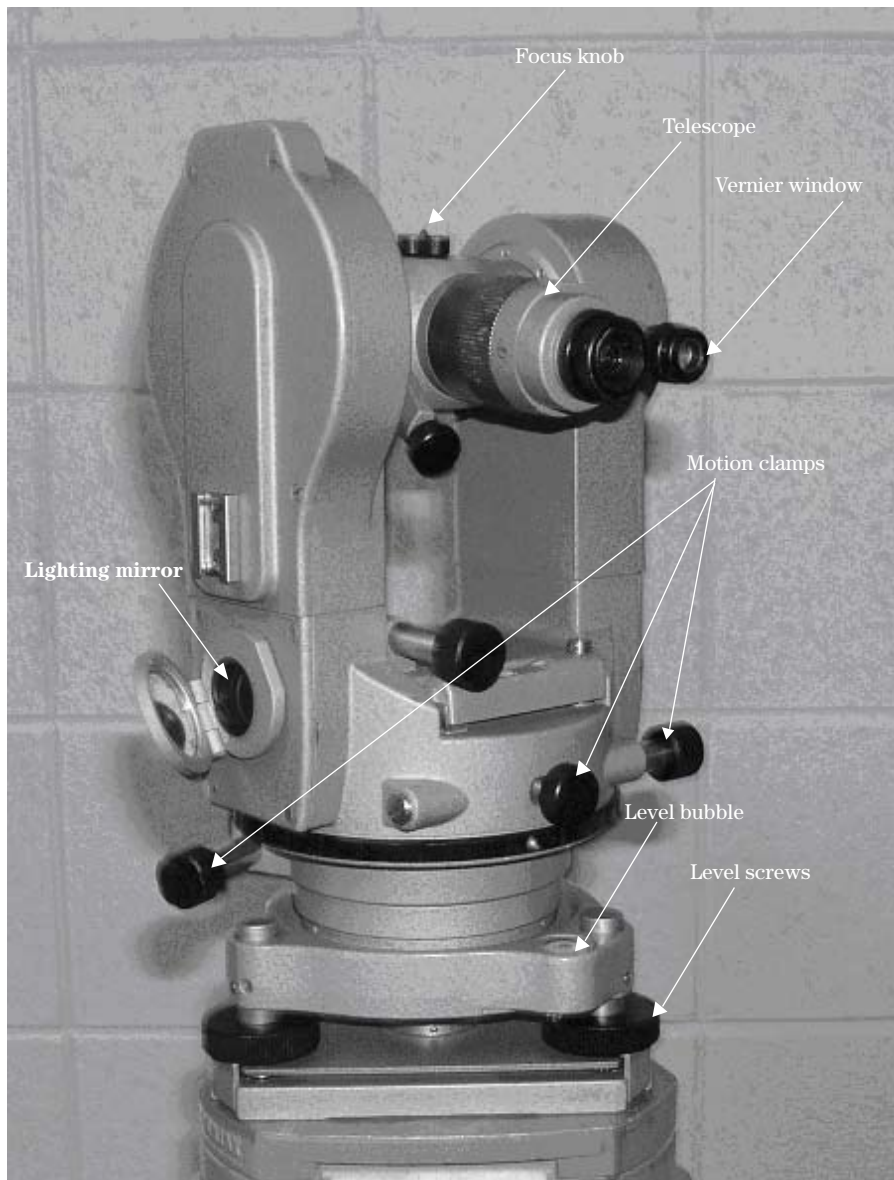

(3) Electronic distance measuring equipment

EDM equipment makes use of a laser and infrared beams. The model in figure 1-43 shows an EDM with an attached digital compass.

The general design of EDMs consists of a repeating beam that travels through one lens and returns through another. A series of rapid measurements are averaged to obtain the desired measurement. On some newer model EDMs, a digital compass is internal or can be attached externally.

(4) Total stations

Modern total station instruments have the EDM built into an electronic theodolite. These instruments are capable of measuring and displaying all direct and indirect measurements in real-time. Figure 1-44 shows a total station instrument. Note the keyboard that controls the internal processor for a large number of survey applications including standard survey data collection, stakeout, and direct coordinate reading. Also, note the cable that feeds data output directly to an electronic data recorder. Some have on-board data

Figure 1-43 Electronic distance measuring device



Figure 1-44 Total station instrument



storage while others require an optional data collector (fig. 1–45). In addition to downloading current survey data, archive or design survey data may be uploaded to total stations for resurvey or construction stakeout.

The total station is a part of what is called a field-to-finish survey system that includes data collection, data manipulation, layout design input, data upload, and construction stakeout.

(5) Global Positioning Systems

GPS have been available for civilian use primarily in the last decade. Because of their specialized nature, a separate section of the chapter is devoted to GPS.

Figure 1–45 Electric data collector



(h) Surveying accessories

A small number of accessories should be considered essential to any survey crew in addition to the major surveying instruments. Some or all may be omitted depending on specific situations, but it is best to have these along in any event. The following accessories are shown in fig. 1–46.

(1) Chaining pins

Chaining pins are usually in a standard set of 11 pins on a steel ring. These are used to mark intermediate positions along course lengths and to help establish the line position.

(2) Plumb bob

Plumb bobs are weighted brass cones with special sharp points for accurately marking final taping positions. The plumb bob is generally about 8 ounces and usually has a 6-foot length of cord attached to a spring loaded gammon reel. The gammon reel usually has a target painted on it for sighting by the instrument person.

(3) Tension handles

Tension handles are a part of a complete set for taping with steel tapes. They consist of a spring weighted balance device with handles and are used to measure the pull tension on a steel tape. Persons new to using steel tapes should practice the proper pull tension for various lengths of steel tape.

(4) Tape clamps

Tape clamps (also called chain grips) are small metal handles that allow the surveyor to properly grip and pull steel tapes without damage to the tape or hands.

(5) Thermometer

Precision survey instruments (total station, for example) rely on temperature compensation for correct measurements. In addition, proper field note practice and procedure calls for notation of the day's temperature at the time of the survey.

(6) Tack ball and survey tacks

Survey tacks are sharp specialty tacks used for marking accurate positions. The tack ball is used to carry the tacks.

Figure 1-46 Surveying accessories used with the major instruments

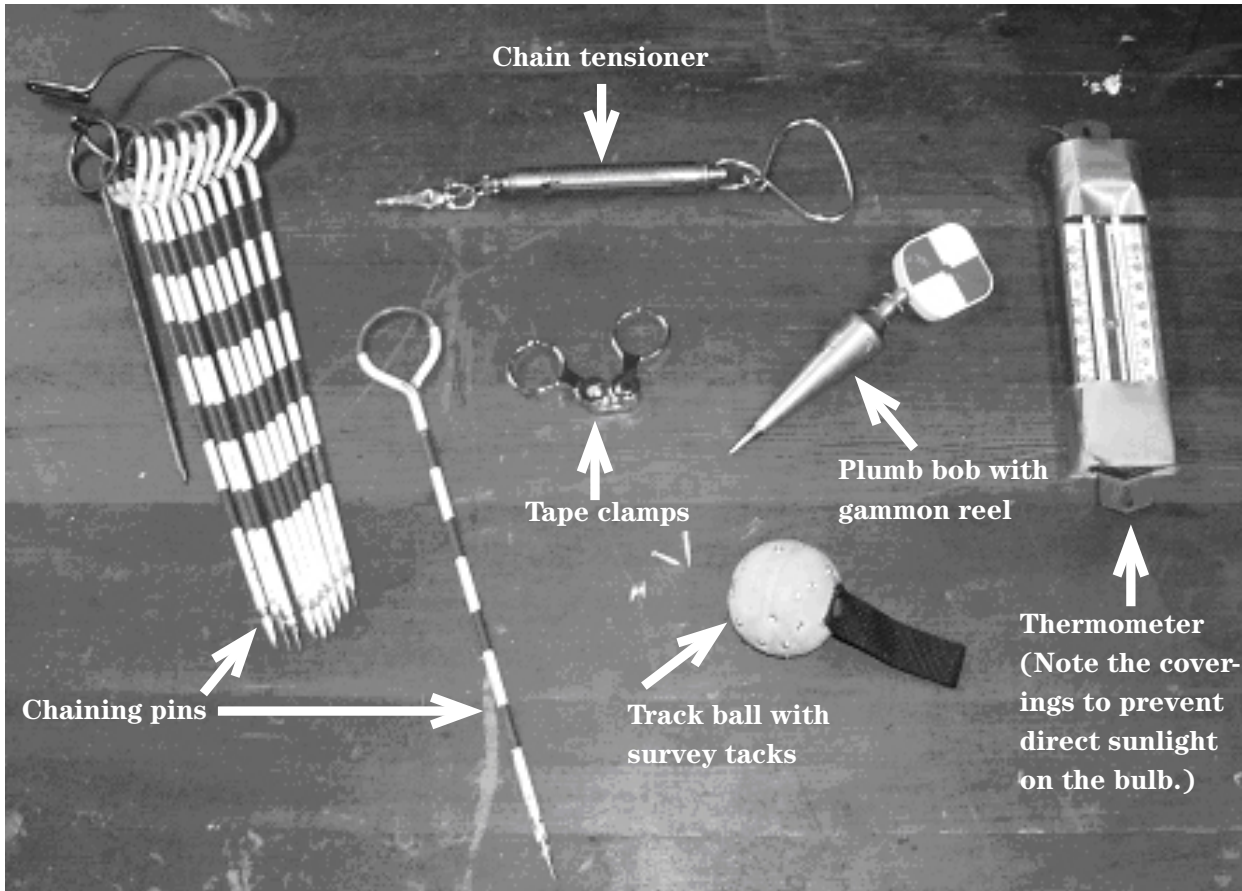

(7) Field books

Special books for recording field notes are available. Some contain paper that can be written on when wet. The advantage to field books like these is the sequential numbering of pages. Loose-leaf notepaper may also be used in binders, but all pages should be numbered so there is no confusion about possible missing pages.

There are a number of types of field books, but the most common are level books and transit books. The only difference is that the transit books have one side of the page gridded for sketches. It is a good habit to carry a scale, straightedge, and small protractor for drawing clear and accurate sketches in the notes.

(i) Care and handling of surveying instruments

Proper care and protection is necessary to keep the instruments adjusted and operating accurately. Certain procedures and precautions must be observed in using surveying instruments to prevent needless damage and unnecessary wear.

(1) Maintaining steel tapes

Steel tapes are broken easily if not handled properly. They should not be jerked needlessly, stepped on, bent around sharp corners, or run over by vehicles. The most common cause of a broken tape is pulling on it when there is a loop or kink in it. Slight deformations caused by kinking should be straightened carefully.

Insofar as practicable, avoid dragging the tape with markings face down because abrasive action will remove markings. In spite of reasonable care, tapes will be broken occasionally, so a tape repair kit is necessary if you use steel tapes and chains.

After each day's use, wipe the tapes dry and clean them with a clean cloth. After being cleaned, steel tapes should be given a light covering of oil by wiping with an oily cloth. Steel tapes and chains are often wound on a reel for storage and ease of handling.

(2) Transporting surveying instruments and accessories

Surveying instruments should be carried in the instrument case in the cab of the vehicle, preferably on the floor or in a well-padded equipment box. Rods should

be in cases and carried where they will be protected from weather and from materials being piled on top of or against them. Tripods and other surveying equipment should be similarly protected from damage and the weather.

(3) Mounting instruments on tripod

To set up a basic tripod with wooden legs and a screw-top head, remove the tripod cap and place it in the instrument box for safekeeping; blow dust and sand particles from the tripod head before screwing it on; tighten the wing nuts on the tripod just enough so that when a tripod leg is elevated, it will drop gradually from its own weight. Carefully remove the instrument from the case. It is best to place your fingers beneath the horizontal bar of a level or the plate of a transit when removing it from the case. See that the instrument is attached securely to the tripod.

When screwing the instrument base on the tripod, turn it first in the reverse direction until you feel a slight jar, indicating that the threads are engaged properly. Then screw it on slowly until you cannot turn it further, but not so tightly that it will be difficult to unscrew when the instrument is dismounted.

For most theodolites and self-leveling levels, the tripod head is triangular, with a shifting clamp screw that has a centering range of about 2 inches. To mount these levels, remove from the case and place on the tripod. Then, thread the hold-down screw attached to the tripod into the hole at the base of the instrument. Tighten the screw firmly.

Remove the objective lens cap and place it in the instrument case for safekeeping. Attach the sunshade to the telescope with a slight clockwise twisting movement. The sunshade should be used regardless of the weather.

When the compass is not in use, be sure the compass needle lifter on the transit or alidade is tightened.

Usually the instrument is carried to the field in the case and not mounted to the tripod until at the site. When passing through doors, woods, or brush with instruments that can be carried on the tripod, hold the instrument head close to the front of your body, so it will be protected. Instruments should never be carried on the tripod over or on the shoulder.

Before crossing a fence, set the instrument firmly in a location where it will be safe and may be reached easily from the other side. Do not allow the instrument to fall.

(4) Cleaning and storing equipment

Always return the instrument to the case before returning from the field. When placing the instrument in the case, loosen the lower clamp screw (transit) and replace the objective lens cap on the telescope. Return the sunshade to the case. After placing the instrument into the case, tighten the transit telescope clamp screw. The lid should close freely and easily. If it does not, the instrument is not properly placed on the pads. Never force the lid; look for the cause of the obstruction.

In setting up the instrument indoors for inspection or cleaning, be careful that the tripod legs do not spread and drop the instrument on the floor. Spreading of the legs can be prevented by tying a cord around and through the openings in the legs. Never leave an instrument standing unguarded.

Dust and grime that collect on the outside moving parts must be carefully removed from surveying instruments. Use light machine oil for softening grime on leveling screws, foot plate threads, clamp screws, and other outside parts that you can clean without dismantling the instrument. Place a drop of oil on the leveling screws, and then screw them back and forth to bring out dirt and grime. They should be wiped off with a clean cloth and the process repeated until the oil comes through clean. Do not leave any oil on the moving parts of the instrument. They do not need lubrication. Oil catches and holds dust, which abrades the soft brass parts.

Do not remove or rub the lenses of the telescope. These lenses are made of soft glass that scratches easily. Dust them with a clean, soft, camel's hair brush, or wipe them very carefully with a clean, soft cloth to avoid scratching or marring the polished surfaces. If the instrument gets wet during use, dry it with a soft piece of cloth as much as possible before transporting. Upon arrival where the instrument will be stored, remove it from its case and air dry it overnight.

Equipment should always be stored in a dry place. Level rods, stadia rods, and tripods must be stored in such a manner that they will not warp or become

otherwise damaged. They should be fully protected from the elements when not in use. The tripod screws should be loosened. Level rods should be stored in their fully extended position if wet and allowed to dry before collapsing and storing. It is best to store level rods flat on at least three supports. Never leave rods leaning against a wall for long periods since they may warp from their own weight. It is satisfactory to store them in a plumb position. A coat of varnish should be maintained on the wooden parts.

Electronic surveying equipment should be cleaned and stored in accordance with manufacturer's recommendations.

(j) Checking and adjusting instruments

Engineering surveys cannot be accurate unless the instruments are kept in adjustment. Untrained personnel should not attempt to adjust instruments. Adjustment of instruments is primarily the responsibility of an engineer or an experienced surveyor. However, all personnel using surveying instruments must be familiar with the procedure for checking and making simple adjustments. Major repairs should be done by the manufacturer or a repair shop. The adjustment of an instrument should be checked frequently. The frequency of checking depends on the amount of use, the type of use, and the type of instrument. For example, an instrument that normally might not be checked often but has recently been used in rough and dusty conditions may need more periodic checking. An instrument check and adjustment record should be attached inside the lid of each instrument case.

(1) Hand levels

To adjust a hand level, hold it alongside an engineer's level that has been leveled and sighted on some well-defined point. The line of sight of the hand level should strike the same point when the bubble is centered. If it does not, adjust the hand level. A quick way to determine if the hand level is in adjustment is to stand in front of a mirror and look through the hand level at the mirror. If you can see your eye looking back at you through the level when the bubble is centered it is in adjustment.

Set the index site of the Abney level at zero on the graduated arc. Then raise or lower one end of the level tube until the bubble is centered. The two-peg method

of adjustment, as described for the dumpy level, may also be used.

(2) Dumpy level

The dumpy level is in adjustment when: the horizontal crosshair is truly horizontal when the instrument is leveled; the axis of the bubble tube is perpendicular to the vertical axis; and the axis of the bubble tube and the line of sight are parallel.

See that the eyepiece and crosshairs are in proper focus. Sight the vertical crosshair on a point. Move your head slightly and slowly sideways and observe if the vertical hair moves off the point. If it does, parallax exists. This indicates imperfect focusing. To focus the eyepiece, point the telescope at the sky or at some white surface. Turn the eyepiece until the crosshairs appear as distinct as possible. Retest for parallax. After a few trials a position is found where there is no parallax.

To make the horizontal crosshairs lie in a plane perpendicular to the vertical axis, set up the level and sight a definite fixed point in the field of view. Next, turn the telescope about the vertical axis. If the point appears to travel along the crosshair, no adjustment is necessary. If a point leaves the crosshair, loosen the capstan screw that holds the crosshair ring in place. Turn ring with pressure from fingers or tapping with a pencil and retest until the point remains on the crosshair as the telescope is rotated. Then retighten the capstan screw.

To make the axis of the bubble tube perpendicular to the vertical axis, center the bubble over both pairs of leveling screws and then bring it to center exactly over one pair of screws. If the telescope is rotated horizontally 180 degrees over the same pair of screws, the bubble will remain centered if in adjustment. If not, the amount of movement away from center is double the error adjustment. Bring the bubble back halfway with the adjusting screw at one end of the bubble tube. Then bring the bubble back to center with the leveling screws. It should remain centered when the telescope is rotated to face the opposite direction.

To make the line of sight parallel to the axis of the bubble, perform the two-peg test (fig. 1-47). First, set two pegs or stakes 200 to 300 feet apart. Then set the instrument midway between them and take a rod reading on each peg with the telescope bubble centered at

each reading. The difference in the two rod readings, 4.19 feet (9.61 ft – 5.42 ft), gives the true difference in elevation between the pegs.

Next, set the instrument near point A, the higher peg, so that the rod can be plumbed and read. You may prefer to take this reading backwards through the telescope. Add this reading (5.10 ft) to the above difference in elevation (4.19 ft). If the line of sight is horizontal the operator will read the correct value for point B. In figure 1-47, that would be 9.29 feet.

With the horizontal crosshair on this reading on the rod at point B, the line of sight is parallel to the axis of the bubble if the bubble is in the center of the tube. If it is out of adjustment, keep the bubble tube centered and move the horizontal crosshair until the line of sight intercepts the true reading on the rod at point B. Then repeat the process to check the adjustments made.

If the bubble fails to center on the self-leveling level, bring it halfway toward the center with the leveling screws and the rest of the way by tightening the most logical adjusting screws until the bubble is precisely centered. Do not loosen any of them. Turn the telescope 180 degrees in azimuth until it is parallel to the same pair of leveling screws. If the bubble does not center, repeat the adjustment.

(3) Transit or theodolite

A transit or theodolite is in adjustment when the:

- axes of the plate bubbles are perpendicular to the vertical axis
- vertical hair is perpendicular to the horizontal axis
- line of sight is perpendicular to the horizontal axis
- standards are at the same height
- line of sight and the axis of the telescope level are parallel
- telescope is level, with zeros of the vertical arc and vernier coinciding

Before adjusting the instrument, see that no parts, including the objective lens, are loose.

Figure 1-47 Two-peg method for adjusting levels

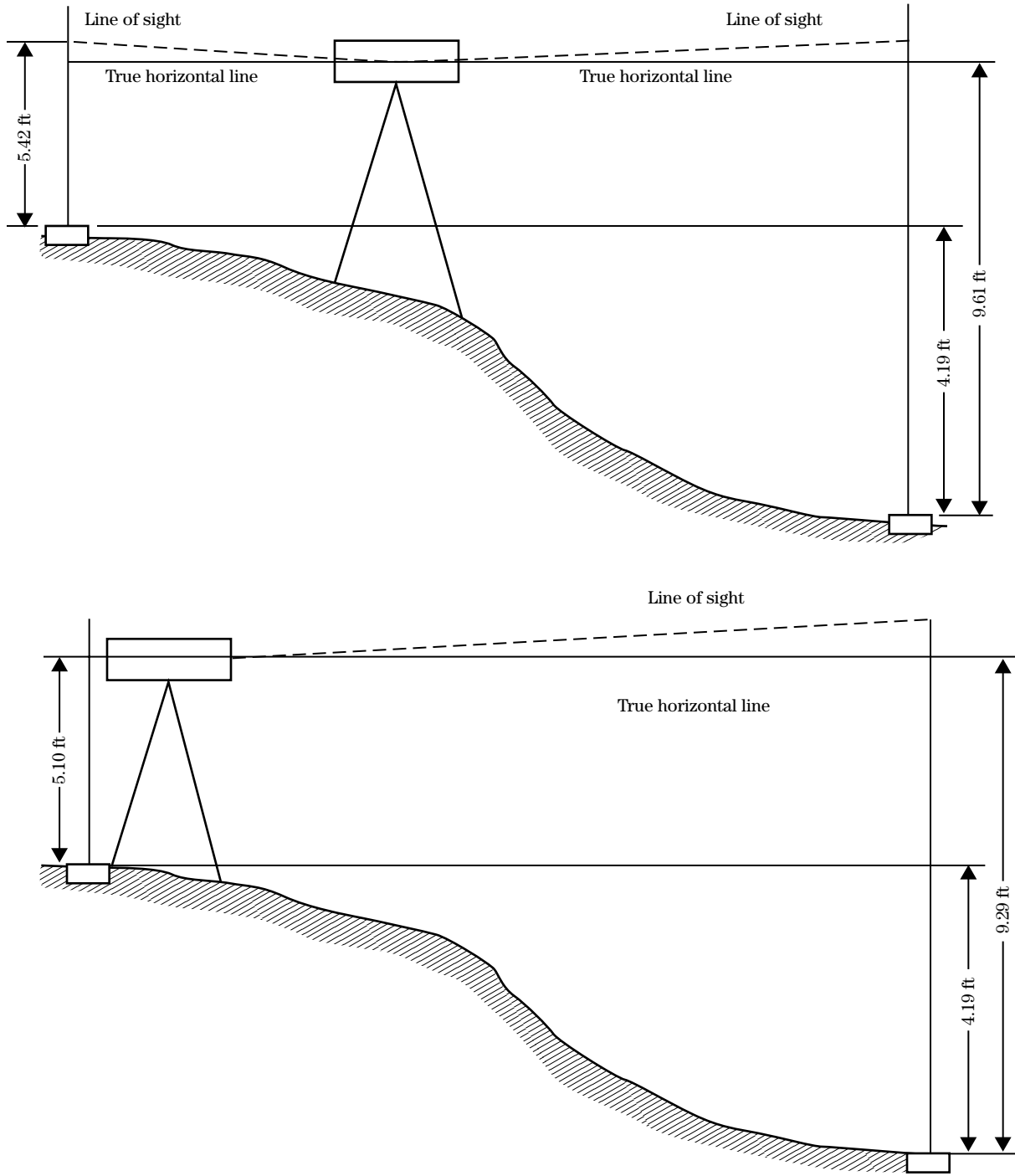

To adjust the plate levels so that each lies in a plane perpendicular to the vertical axis of the instrument, set up the transit and bring the bubbles to the center of their tubes by means of the leveling screws. Loosen the lower clamp and turn the plate 180 degrees about its vertical axis. If the bubbles move from their center, half the distance of movement is the error. Make the adjustment by turning the capstan screws on the bubble tube until the bubble moves halfway back to center. Each bubble must be adjusted independently. Test again by re-leveling and reversing as before, and continue the process until the bubbles remain in the center when reversed. When both levels are adjusted, the bubbles should remain in the center during an entire revolution of the plate about the vertical axis.

To put the vertical crosshair in a plane perpendicular to the horizontal axis, sight the vertical hair on some well-defined point. Then, leaving both plates clamped, elevate or depress the telescope. The point should appear to travel on the vertical crosshair throughout its length. If it does not, loosen the screws holding the crosshair ring. Tap lightly on one of the screws and

rotate the ring until the above condition is satisfied. Tighten the screws and proceed with the next adjustment.

Adjustment of the line of sight makes use of the principle of double-centering to extend a straight line of sight. To make the line of sight perpendicular to the horizontal axis (fig. 1-48), set the transit up and sight on some point A that is approximately 500 feet away. Clamp both plates, invert the telescope, and sight accurately on some point at B about the same distance away and which is approximately at the same level as A. Unclamp the upper plate and rotate the instrument to again accurately sight on A. If the instrument is in adjustment you should be sighting on point B again. If not, set a stake at a new point C in the line of sight. Next mark a point D that is one-fourth the distance between points B and C and adjust the cross-hair ring until the line of sight passes over point D. Note that the reason for adjusting the distance by one-fourth rather than one-half is that a double-reversal has occurred. The process of reversal should be repeated until no further adjustment is required. When finally adjust-

Figure 1-48 Line of sight adjustment for the transit and theodolite

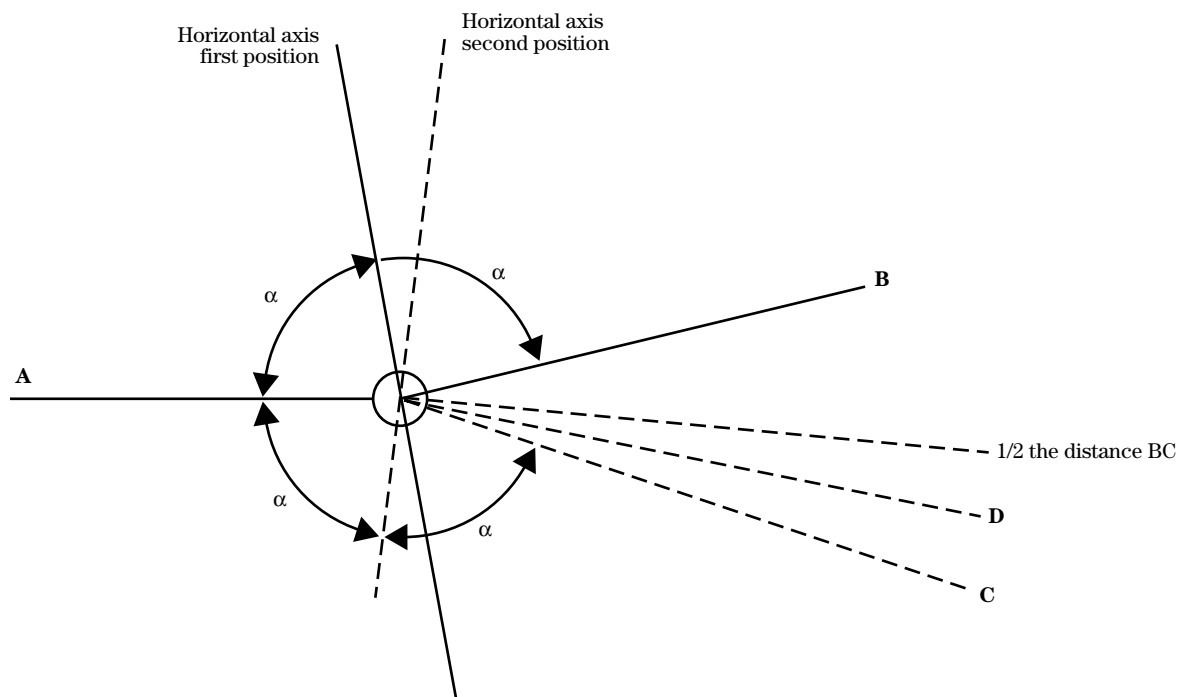

ed, the screws should hold the ring firmly but without straining it.

To make the line of sight parallel to the axis of the bubble, make the two-peg test as described for the dumpy level. If the telescope bubble is out of adjustment, raise or lower one end of the telescope bubble tube by turning the capstan nut until the telescope bubble is centered. Note the true reading at B. After this adjustment has been made, examine the vertical arc and the vernier zero-line to see whether they coincide when the telescope bubble is in the center of the tube. If not, move the vernier by loosening the capstan-headed screws that hold the vernier to the standard. Bring the zero lines together, and tighten the screws.

All other adjustments may vary depending upon the manufacturer. Field adjustments should be in accordance with manufacturer's recommendations.

(4) Plane table and telescopic alidade

Adjustments of the telescopic alidade require no principles of adjustment other than those for the transit or level. Survey work performed with the plane table and the telescopic alidade need not be as precise as that done with the transit, so the adjustments are not as refined.

Because the telescope is not reversed in a vertical arc, no appreciable error is caused if the line of sight is not perpendicular to the horizontal axis, or the line of sight is not parallel to the edge of the ruler. It can also be assumed without appreciable error that the edges of the ruler are straight and parallel and that the horizontal axis is parallel to the surface of the ruler.

Adjust the control level so that its axis is parallel to the ruler. The test and correction are the same as described for adjustment of the plate levels of the transit except that the plate or ruler is reversed by carefully marking a guideline on a plane table sheet. The board is not reversed.

Adjust the vertical crosshair so that it lies in a plane perpendicular to the horizontal axis. Adjust the telescope level so that its axis is parallel to the line of sight. These tests and adjustments are the same as for the transit.

If the alidade is one in which the telescope can be rotated about its axis in a sleeve, the two following adjustments should be used.

First, make the line of sight coincide with the axis of the telescope sleeve. In making the test, sight the intersection of the crosshairs on some well-defined point and rotate the telescope carefully through 180 degrees. Generally, the rotation is limited by a shoulder and lug. If the intersection of the crosshairs stays on the point, the line of sight coincides with the axis of the telescope sleeve.

Second, make the axis of the striding level parallel to the telescope sleeve and therefore parallel to the line of sight. In making the test, place the striding level on the telescope and bring the bubble to the center of the level tube. Then carefully remove the striding level, turn it end for end, and replace it on the telescope barrel. If the bubble returns to the center of the tube, the level is in adjustment. If the bubble is not centered, it should be brought back one-half of the displacement by means of the adjusting screw on one end of the bubble tube. Then bring the bubble to the center by means of the tangent screw and repeat the test.

Adjust the vernier to read zero when the line of sight is horizontal. This adjustment is the same as described for the transit under Adjustment of telescope bubble.

(5) Electronic and self-leveling surveying equipment

Self-leveling equipment, laser levels, and total stations can be tested using the same methods as that for levels or transits. Field adjustments should not be attempted unless recommended by the manufacturer.

650.0112 Surveying procedures

This section covers general survey practices and survey field note format. Most every project will have a horizontal component, vertical component, and corresponding field notes for each. More specialized types of surveys may have other components that are described later.

Higher order surveys will generally have a set of horizontal books (transit books) and a set of vertical books (level books) that make up the entire project. Simple surveys or lower order surveys may have all of the work in one book type. Before beginning any survey, you should determine the field book requirements. The following sections assume that the horizontal and vertical are being recorded in separate books.

(a) Horizontal survey

The first requirement for all surveys is that they must begin at a point of beginning (POB). For surveys that are required to tie into some existing feature, the POB is generally a benchmark from a previous survey. For surveys not required to tie in, it is general practice to set a temporary benchmark (TBM) at some location and begin the survey from that point.

The second requirement is to establish direction for the survey. In the case of surveys using a magnetic compass, direction is already established by magnetic North. When using instruments that do not have a magnetic compass (total stations, for example) it is necessary to establish direction by use of two known points.

If the bearing or azimuth between the two points is known, the instrument is simply set up over one of the points and sighted in on the other. When the instrument has been accurately sighted in, the bearing or azimuth is input either manually or digitally, depending on the instrument.

In many cases, the coordinates of the two points will be known, and the azimuth must be calculated. This is a simple procedure. The coordinates will be in values of X and Y. Values of X are known as departures

or eastings, and values of Y are known as latitudes or northings (described in 650.0100).

The difference between the two departures is called the run, and the difference between the two latitudes is called the rise. The azimuth of the line between the two points is calculated as:

$$\text{Azimuth} = \tan^{-1} \frac{\text{rise}}{\text{run}} = \tan^{-1} \frac{\Delta \text{ departures}}{\Delta \text{ latitudes}}$$

For example, let us say we have two points with coordinates of 5500.12, 7356.45 for one point and 6337.33, 8641.62 for the other (fig. 1-49). You wish to set up the instrument on point 1 and backsight to point 2.

The azimuth is calculated as:

$$\tan^{-1} \frac{5,500.12 - 6,337.33}{7,356.45 - 8,641.62} = \tan^{-1} \frac{-837.21}{-1,285.17} = 33.08179^\circ$$

The azimuth for this line is 33°04'54" or the bearing is N 33°04'54" E.

Figure 1-49 Backsight from the instrument position at point 1

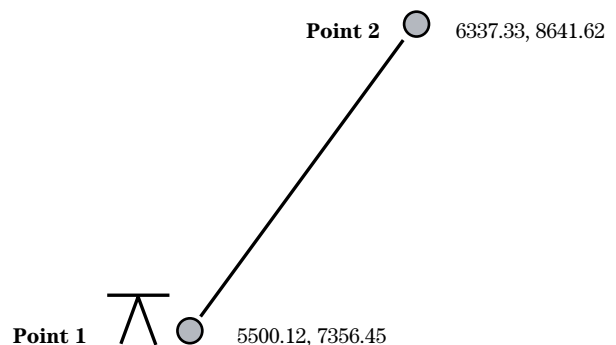

If you wanted to set up the instrument at point 2 and backsight on point 1, the same procedure is used but the numbers are reversed (fig. 1-50).

$$\tan^{-1} \frac{6,337.33 - 5,500.12}{8,641.62 - 7,356.45} = \tan^{-1} \frac{837.21}{1,285.17} = 33.08179^\circ$$

Note that the same value is calculated, but the direction is reversed. The surveyor needs to pay careful attention to this point. In this example, the bearing becomes S 33°04'54" W and the azimuth is 213°04'54".

Once the direction has been established, the survey may proceed. Specifics for the horizontal survey are covered under the section on topographic and control surveys.

(b) Vertical survey

The only requirement for the vertical component of the survey is that it must begin at a known elevation or benchmark. For surveys that are required to tie-in to an established vertical control, a known benchmark is located. If the survey is not required to tie in vertically, a TBM may be set with some arbitrary elevation established. Specifics for the vertical survey are covered under the section on differential leveling.

(c) Topographic and control surveys

Topographic surveys are used to obtain ground relief data and locations of natural and constructed features and are the basis for many soil and water conservation projects. Such surveys involve both control surveys and surveys for topographic features. A relatively few points or stations are established by the control survey. They are arranged so that they can be easily observed and measured by triangulation, traverse, or grid. Elevations of such points are determined by leveling. These provide an accurate framework on which less accurate survey data, such as ground elevations, can be based without accumulating accidental errors or incurring high cost of making all measurements precise.

There are two general types of topographic surveys: route surveys and area surveys. Route surveys are comprised of ribbon or strip shaped tracts as would be required of a natural stream or a drainage or irrigation ditch. These surveys are usually open traverses with horizontal control throughout its length fixed by stationing (as described in the EFH 650.0110(c) Measurement of Horizontal Distances: Taping) and by offset ties that allow you to reestablish a station if it is destroyed. Such traverses may not be checked completely by calculations; however, when started and ended on points of known position, the surveys become closed traverses for which complete mathematical checks can be made. Vertical controls can be determined in conjunction with the traverse survey or independently from a closed circuit of differential levels.

Area surveys are comprised of block-shaped tracts as for a pond or reservoir site, surface drainage plan, or irrigation system. An area survey requires a closed traverse with a control network of stations and benchmarks, even though it is only a rudimentary one for a small tract. Several types of surveys are used in making route and area surveys.

In an area survey, the transit station may have many points to which measurements are taken to obtain adequate information for construction of a map. Sometimes details are collected as the work of laying out the transit line proceeds. For other surveys, the details are obtained after the transit line has been established and checked, especially if the survey covers a large territory.

Figure 1-50 Backsight from the instrument position at point 2

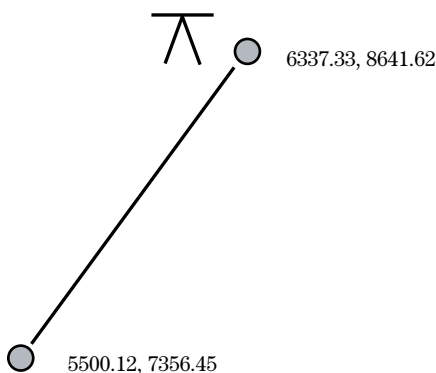

650.0113 Engineer's transit or total station (primary instrument)

(a) Setting up the instrument

The transit or total station is the primary instrument for making route or area surveys. Ordinarily, you should set the instrument on the tripod over some definite point, such as a tack in a hub. The plumb bob or optical plumb (total station) provides a means of centering the instrument over the point. Adjust the tripod legs until the tripod head is nearly level using the level bubble on the instrument as a guide. Press each leg firmly into the ground, at the same time adjusting its location until the plumb bob or optical plumb falls close to the point and the tripod plate is nearly level. Then, loosen the tripod mounting screw and shift the instrument until the center of the instrument is over the point.

The preferred method used by experienced surveyors is to grasp two legs of the tripod and place the third leg on the ground at such a point with respect to the hub that when the other two legs are allowed to touch the ground, the tripod plate will be nearly level, the height of the telescope will be convenient, and the center of the instrument will be nearly over the tack in the hub.

After the instrument is centered over the point, level it. First, loosen the lower clamp screw, and turn the instrument about its vertical axis until one of the plate level tubes is parallel to a line through a pair of opposite leveling screws. The second plate bubble will then be parallel to a line through the other pair of leveling screws. To level the instrument, uniformly turn a pair of opposite leveling screws. Tighten one screw by the same amount that the other is loosened. This will tilt the leveling head and at the same time maintain definite support for it on both screws. The screws should rest firmly on the tripod plate at all times but should not be allowed to bind. Center the other bubble in a similar manner, using the other pair of leveling screws. Alternate the process until both bubbles are centered. Now, observe the position of the plumb bob. If it has moved off the point, reset it by shifting the head and releveling the instrument.

The instrument is now ready for measurement of horizontal and vertical angles. Transits most widely used in NRCS have two verniers (figs. 1-51 and 1-52) for reading horizontal angles, the zeros being 180 degrees apart. The horizontal circles of NRCS transits are graduated in one of four ways: 30 minutes reading to 1 minute; 20 minutes reading to 30 seconds; 15 minutes reading to 20 seconds; or 20 minutes reading to 20 seconds. The graduations of the circle usually are numbered at intervals of 10 degrees continuously from 0 degrees to 360 degrees in both directions from 0 degrees. The inner row of numbers increases clockwise, whereas, the outer row increases counterclockwise. The verniers are provided so that the angle can be read closer than the smallest circle division. In every case, the graduations on the vernier depend upon the subdivision of the circle. For example, when the circle is graduated in half-degree (30') spaces (fig. 1-52), the space between each line on the vernier will be 29/30 of the 30-foot arc space on the circle; thus, an arc consisting of 29 divisions of 30 feet each (equivalent of 14°30' on the circle) is subdivided into 30 equal parts to obtain the space between the lines on the vernier. One

Figure 1-51 One-minute vernier set at 0 degrees

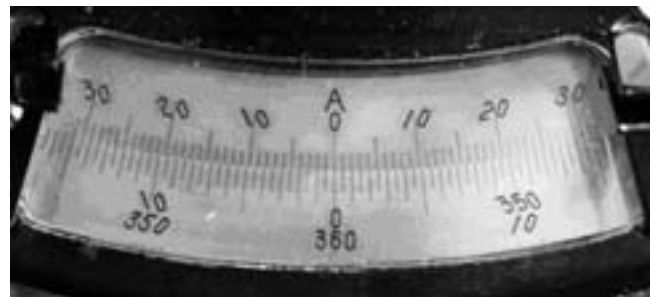

Figure 1-52 One-minute vernier set for measurement



division on the vernier, then, is 1 foot less in angular measurement than one division of the circle. When the horizontal angles are measured with the transit, the inner circle within the vernier moves with the telescope while the outer circle remains fixed. The zero of the vernier always points to the reading on the outer circle.

Theodolites generally do not have external verniers but, instead, have an internal window with a magnified vernier. Total stations are generally digital and have no verniers. Total stations generally have only one horizontal and one vertical knob. The onboard processor of the instrument allows the user to set precise angle values.

(b) Measuring horizontal angles

The upper and lower clamps for transits and theodolites are similar. To measure a horizontal angle, loosen both the upper and lower clamps and set the 0 of the vernier close to 0 on the circle. Then tighten the upper clamp by means of the upper fine adjustment screws. Set the index of the vernier exactly opposite 0 on the circle, and direct the telescope at one of the objects to be sighted.

When the object is in the field of view and near the vertical hair, tighten the lower clamp. Set the vertical hair exactly on the object by using the lower fine adjustment screw. The telescope should be clearly focused to avoid parallax of the crosshairs.

Now, loosen the upper clamp and sight the telescope on the second object. Tighten the upper clamp, and use the fine adjustment screw to bring the object on the vertical crosshair. Now, you can read the angle by adding to the circle, reading the minutes read on the vernier. To eliminate instrument errors, measure the angle again with the telescope inverted (plunging the scope), and take the mean of the measured angles. The vernier is read in the direction the angle is turned.

(c) Measuring vertical angles

To measure a vertical angle, carefully level the instrument, and direct the telescope at the object. When the object is observed in the telescope, clamp the vertical motion and, using the vertical motion tangent screw, set the middle horizontal crosshair exactly on the point. The reading on the vertical arc is the vertical an-

gle. When the point is above the horizontal plane, the angle is a positive angle or angle of elevation; when the point is below the horizontal plane, the angle is a negative angle or angle of depression. In the survey notes, angles are designated by a + sign or a - sign.

If the instrument line of sight and the axis of the telescope bubble are not in adjustment, it is impossible to obtain a correct vertical angle with the vertical arc only. If the instrument has a full vertical circle, the error can be eliminated by reading the vertical angle first with the telescope direct, then with it reversed, and then taking the average of the two readings.

In figure 1-51, a 1-minute vernier is shown with its 0 (A) opposite the 0 (360°) of the circle, ready to measure an angle. The vernier lines on both sides of 0 fail to match the line on the circle by 1 minute; the next lines of the vernier fail to match the lines of the circle by 2 minutes, and so on. To set exactly at 0, note that the first vernier lines on either side of 0 fail to match the circle divisions by the same amount. Figure 1-52 shows a 1-minute vernier reading 17°25' from left to right and 342°35' right to left.

(d) Offset ties

Tie in important points or stations by establishing offset ties. No fewer than three horizontal measurements to the nearest 0.10 foot should be taken to the station from readily identifiable permanent points. Accurately record the measurements by means of a sketch in the notes as in figure 1-53.

Figure 1-53 Offset ties to a traverse station

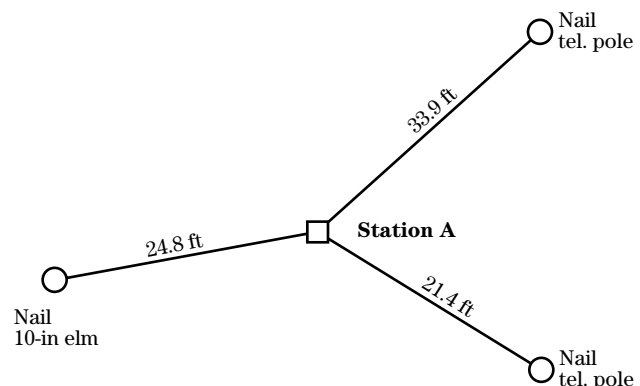

650.0114 Transverse surveys

(a) Traverse by deflection angles

This type of survey applies primarily to the control traverse of the route or area survey. Distance between traverse points may be determined by appropriate methods. With the transit or theodolite, chaining is recommended when a high degree of accuracy is required. The transit is used to keep the chain person on line and to obtain any vertical angles necessary to correct inclined distances to true horizontal. When the total station is used, true horizontal distance is calculated by the instrument automatically.

Angles are measured with any of the instruments. Checks are made by doubling the angles or repeating the angular measurement enough times to obtain the desired precision. Angles are measured in several ways by: turning to the right; measurement of the interior angles; measurement of the deflection angles; or measurement of the azimuths.

Most traverse surveys used in NRCS work consist of establishing a route using a deflection-angle traverse that provides a means of locating points for either a closed or continuous traverse. Regardless of the instrument used, the methods are the same.

A deflection angle is the angle between a line and the extension of the preceding line. Deflection angles are recorded as right or left. In figure 1-54, the angle at B is $29^{\circ}10'$ left because the angle was measured counterclockwise from the extension of the preceding line (A-B). The angle at C is $48^{\circ}30'$ right because the angle was measured clockwise from the extension of line B-C.

This method of angular measurement readily lends itself to the calculation of bearings if one of the lines is known.

In figure 1-54, the bearing of line A-B is given as $S 82^{\circ}00' E$; therefore,

$$\text{bearing of line B-C} = 180^{\circ} - 82^{\circ} - (29^{\circ}10') = N 68^{\circ}50' E$$

$$\text{bearing of line C-D} = 180^{\circ} - (68^{\circ}50') - (48^{\circ}30') = S 62^{\circ}40' E$$

To take deflection angles with the transit or theodolite (fig 1-55):

- Step 1.* Set transit on point E, and set index of vernier at 0° .
- Step 2.* With lower clamp loose, sight on point D and tighten clamp. With lower slow-motion screw, sight point C exactly. (Telescope is direct.)
- Step 3.* Reverse telescope, loosen upper clamp, and rotate transit about its vertical axis in the direction (to the left) of point F. Tighten upper clamp and, using the tangent screw, sight point F exactly. Then read the angle and record it ($58^{\circ}00' L$).
- Step 4.* Leaving the telescope in a reversed position, loosen the lower clamp and rotate the transit about its vertical axis and sight point C again by use of tangent screw and lower clamp.
- Step 5.* Rotate telescope (now in direct position), turn angle (to the left), and sight point F by means of upper clamp and tangent screw.

The angle has been doubled ($116^{\circ}02' L$), and one-half of the total recording is the correct deflection angle to use. For example, in figure 1-55, point E:

$$\text{First angle} = 58^{\circ}00' L$$

$$\text{Double angle} = 116^{\circ}02' L$$

$$\text{Mean deflection angle} = 58^{\circ}01' L$$

- Step 6.* Deflection angles are obtained in this manner for each point around the traverse.

Figure 1-54 Deflection angles

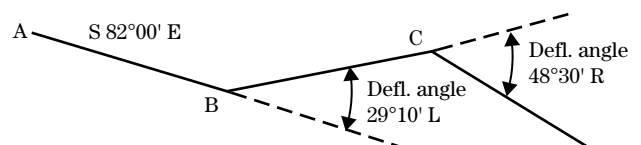
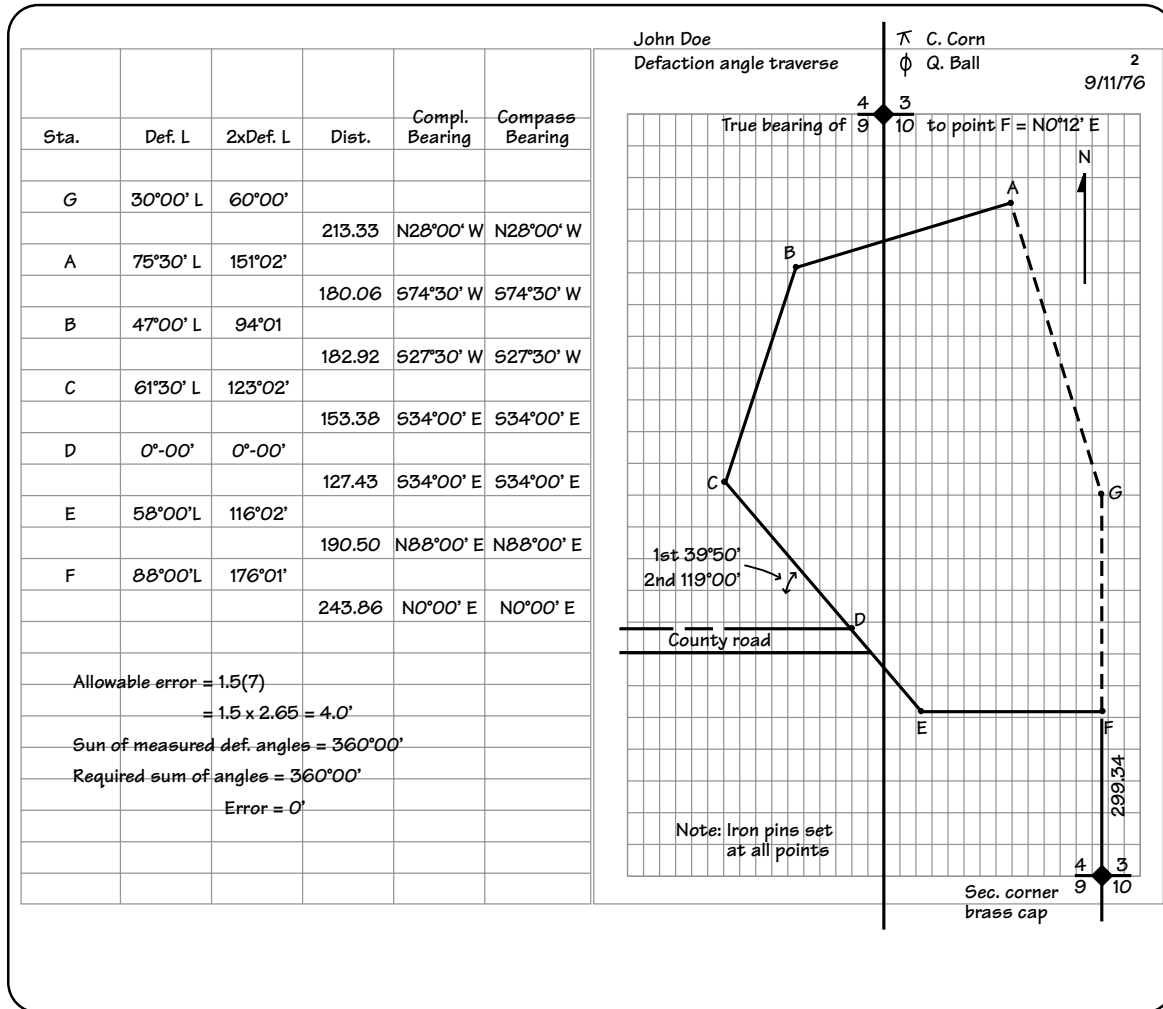

Figure 1-55 Survey notes for the deflection angle example



The procedure is slightly different for the total station.

- Step 1.* Set the total station on point E and sight in point C.
- Step 2.* Set the angle to 0° using the onboard display.
- Step 3.* Reverse telescope and rotate the total station about its vertical axis in the direction (to the left) of point F. Total stations can display angles to the right and left so make sure you are reading the correct direction, in this case to the left. Then read the angle and record it ($58^\circ 00' L$).
- Step 4.* Leaving the telescope in a reversed position rotate the total station about its vertical axis and sight point C again and input the angle $58^\circ 00' L$.
- Step 5.* Rotate telescope (now in direct position), turn angle (to the left), and sight point F again.

The angle has been doubled ($116^\circ 02' L$), and half of the total recording is the correct deflection angle to use as with the transit.

(b) Transit-stadia traverse

The transit-stadia survey (sometimes called a stadia-azimuth survey) is used frequently for preliminary work requiring the locations of boundaries, or the position of points, objects, lines, and elevations. This method of surveying is rapid and sufficiently accurate for many types of NRCS work. Stadia surveys usually consist of two parts traverse and taking of topography.

The first is the horizontal control, and the second is the vertical control. The controls provide for the taking of elevations for preparing topographic maps, locating details, or taking side shots. The two parts of a transit-stadia survey may be done together or separately. For small areas, the traverse and the topography surveys frequently are done together. For large areas, it is advisable to run the vertical and horizontal controls and check them before taking the topography. This will detect any errors in the traverse before the topographic shots are taken and plotted on the map being prepared.

(1) Horizontal control only

The fieldwork in this survey consists of determining horizontal angles (azimuths) to points or objects and obtaining distances between points by stadia. When a traverse is run by the transit-stadia method, all directions and angles are referred to a reference line. This may be an established line from a previous survey, a true meridian, magnetic meridian, or an assumed meridian. The azimuth angle is always measured clockwise from the zero azimuth. On any given survey, the position of zero azimuth should always be north (fig. 1-56).

When starting the transit-stadia survey, orient the instrument at the first station as follows:

- Step 1.* Set the instrument on station A (assume azimuths will be taken from magnetic north).
- Step 2.* Set horizontal circle on 0 degrees.
- Step 3.* Point telescope toward magnetic north and release needle. Place 0 degrees of magnetic circle at north point, and tighten lower clamp.

Figure 1-56 Azimuths showing 0° oriented to the north

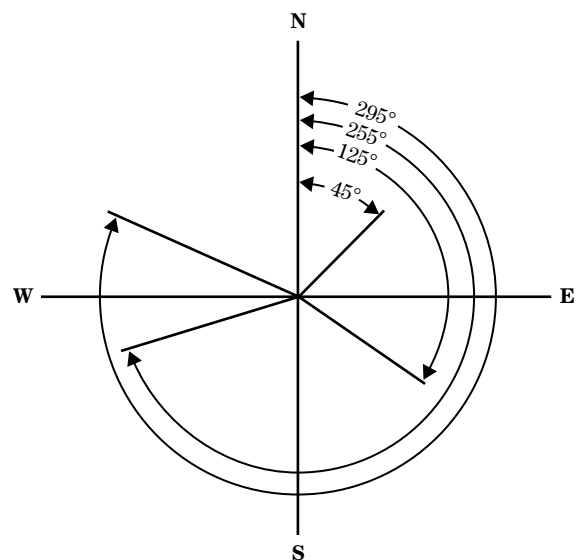

With the instrument oriented:

- Step 1.* Loosen upper clamp.
- Step 2.* Measure all angles from magnetic north, turning and reading all angles clockwise.
- Step 3.* Complete all work at station A.
- Step 4.* Sight on station B and read azimuth of line A B.
- Step 5.* Keep this azimuth reading set on the circle, and move instrument to station B.

To carry the direction of the meridian from one transit station to the next (station A to B), use one of two methods:

Method 1—Set the instrument on station B.

- Step 1.* Invert the telescope and sight on A (also called plunging the scope).
- Step 2.* Tighten lower clamp.
- Step 3.* Read the azimuth again as a check to see that the reading was not changed while instrument was moved from A to B.
- Step 4.* Invert the telescope again. It now points in the direction of A to B, the azimuth we already have. The instrument is now oriented.
- Step 5.* Loosen the upper clamp and proceed with the survey as before.

Method 2—Set instrument on station B.

- Step 1.* Determine azimuth of line B to A either by subtracting 180 degrees from the azimuth reading of line A to B if the azimuth is greater than 180 degrees or by adding 180 degrees to the azimuth reading of line A to B if the azimuth is less than 180 degrees.
- Step 2.* Set the circle on the azimuth reading of line B to A sight to A with the telescope direct, and proceed with the survey as before.

This second method avoids the danger of shifting the circle setting as the instrument is carried from station A to B. It also eliminates any error that would result if the line of sight is not perpendicular to the horizontal axis. (In method 2, the telescope is not plunged.) There is a possibility, however, of computing the back azimuth B to A incorrectly with method 2, whereas, this is not possible with method 1.

Distances between transit stations are read twice; that is, readings are taken both from A to B and from B to A (fig. 1-57). At each setup of the instrument, a distance reading will be made both backward and forward. This will give two independent stadia readings between transit stations and the average of the two readings will be the most probable value and also serve as a check. Whenever possible, stadia readings should be taken with the telescope approximately level, thereby, eliminating the necessity for reading vertical angles.

Figure 1-57 shows a method of note keeping by which the azimuths, magnetic bearings, rod interval, vertical angles, and horizontal distances are recorded. The rod interval is shown because it facilitates checking the horizontal distance.

Ignore vertical angles under 2 degrees when using stadia to obtain distances on preliminary surveys. The stadia distances shown in figure 1-57 that had vertical angles associated with them were corrected by use of tables.

Stadia surveys should be tied into existing surveys, legal corners, etc., whenever possible, as this facilitates plotting and orienting the survey. Clear, complete sketches in the field notes are necessary for the correct interpretation of the notes.

(2) Horizontal and vertical control

In this type of survey, the elevations of points, as well as their locations in a horizontal plane, are determined. This may be done after the original traverse for horizontal control has been established or may be performed concurrently with the establishment of the transit stations.

To obtain elevations of the transit points and other details after a traverse has been completed and checked, use the following procedure (using same survey as fig. 1-57).

- Step 1.* Set the instrument on E.
- Step 2.* Set an angle of $175^{\circ}13'$ on the horizontal circle and sight the instrument on BM $\frac{615}{718}$. This is the azimuth of E to $\frac{615}{718}$ (fig. 1-57). The instrument is now oriented horizontally.

Figure 1-57 Survey notes—stadia traverse survey for horizontal control (English)

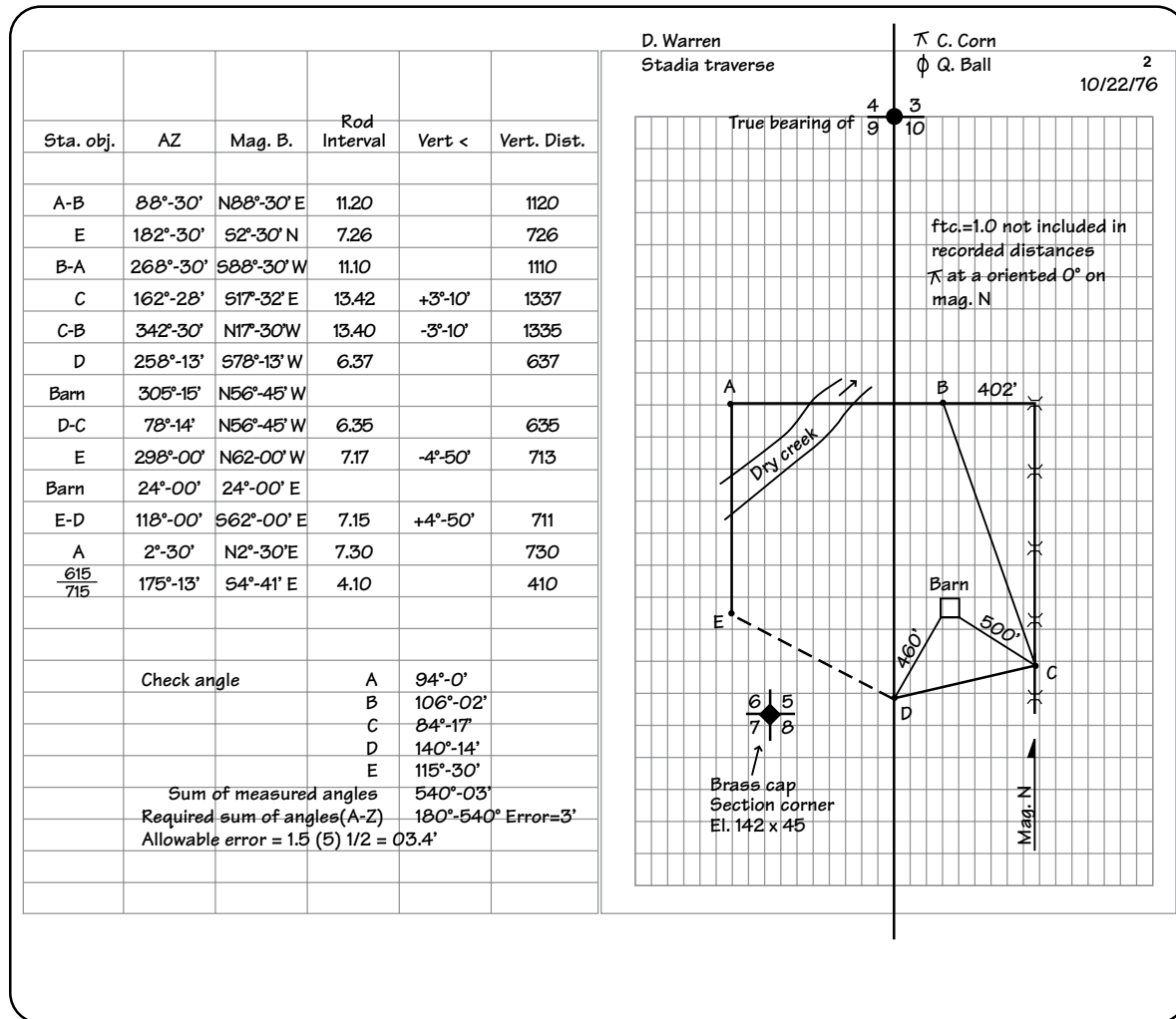

Step 3. Proceed with establishing elevations as follows: Find elevation of point E and HI by taking rod reading 4.63 feet on BM $\frac{615}{718}$ (elevation 1,421.45 ft) with the telescope level. Next, measure the HI with tape 4.37 ft. Then $432.953 + 4.63 - 4.37 =$ elevation of point E = 1,421.71 feet. A BM with an assumed elevation may be used if sea level datum is not required.

When it is necessary to take vertical angles for the determination of elevations:

- Step 1.* Set the target on the rod to mark HI, 4.37 feet
- Step 2.* Sight the middle horizontal crosshair on the rod target. Read the vertical angle between the ground at the instrument and the ground at the foot of the rod for any location the rod may be placed.
- Step 3.* Clamp the vertical circle and read the angle. Record the angle if the angle exceeds 2 degrees.

To locate points, take readings in the following order:

- Step 1.* Set the vertical hair on the rod and clamp the upper plate.
- Step 2.* Read the distance by accurately setting one stadia hair on one of the closest lines on the rod and noting the position of the other stadia hair on the rod. The difference between these two numbers is called the stadia interval. The slope distance between the instrument and the point being observed equals the stadia interval multiplied by a constant (normally 100).
- Step 3.* Set the middle horizontal hair on the point (HI) on the rod, and measure the vertical angle. Record the angle if it exceeds 2 degrees.
- Step 4.* Turn azimuths and take stadia readings and elevations of points accessible to point E. Record all azimuths, stadia intervals, rod readings or elevations, and any remarks. Make sketches to better describe each point and associated survey data.

Once you have collected all possible data from this point, move the instrument to the next point, and repeat the process.

Contour maps can be prepared from the surveyed points and their elevations, with the contour lines located by interpolation.

(c) Grid surveys

Grid surveys are particularly applicable to surveys of small areas and where substantial topographic data are needed. Grid surveys should not be arbitrarily performed where substantial changes in topography exist. Proper planning of the grid distance is necessary. The system is simple in that a level, rod, and tape are all that are necessary, but it may require more time than planetable and alidade or transit and stadia surveys.

Obtaining topography by using the grid system consists of selecting and laying out a series of lines on the ground that can be reproduced to scale on paper. All topography, including ground elevation, is then obtained in the field with reference to these lines and is later plotted. Contour lines can be drawn in by interpolating between plotted ground elevations.

In any survey for a topographic sketch, a survey plan must be developed in advance. The following questions should be considered:

- What ground features are conveniently located for use as baselines?
- Can the baselines be reproduced on a drawing in their true relationship to each other?
- How far apart shall gridlines be set?
- How close together will ground elevations need to be taken?
- What is the most efficient procedure to use?

In planning the survey procedure, remember that rod readings for elevations cannot be read with accuracy over 300 feet with the ordinary level and level rod. If a stadia rod is used, it can be read at a distance of 500 to 600 feet. Generally, the distance between any two adjacent shots for ground elevations should not exceed 200 feet. On very flat, uniform terrain, this distance might be increased to 300 feet.

In some instances, it may be necessary to establish right angles for making grid layouts. If the surveying instrument does not have a horizontal circle for turning off right angles, they can be established by the

3-4-5 method (fig. 1-58). An alternative procedure is to use a right-angle prism. The prism saves time and is accurate enough for grid layouts and cross sections.

The following example explains the procedure for gridding a field. See figure 1-59 with accompanying field notes in figures 1-60. It is assumed that a level with a horizontal circle is available for use in laying out right angles from baselines and gridlines. This gridding procedure has the advantage over other systems in that fewer instrument setups are required for taking the levels. Also, the entire job can be done at a reasonable rate with a survey party of two people.

In the example, a particular area was gridded for preparation of a topographic map. Inspection of this area on an aerial photo showed that the north line of the area was the farm boundary which was well defined, clear of brush, and would serve best as the base line. Further inspection showed that the south field boundary was parallel to the north boundary and that the east and west sides diverged from the north to the south.

- An onsite check was made to determine if this gridding plan was workable. No trees, hills, or other obstacles were noted that would prevent use of the plan. The field and grid plan (fig. 1-59) were sketched in the field notebook. A range pole was set in the northwest corner of the field at point A, 2. This point was called A,

2 so that no minus coordinates would have to be used. Had it been called A, 0 the point at the southwest corner of the field might be G, -1 or some other minus designation. Distances of 400 feet and 600 feet from A, 2 were chained off eastward along the base line, and a range pole was set at A, 6 and a stake was set at A, 8.

- The level was then set up over stake A, 8 and sighted on range pole at A, 2. A 90-degree angle was then turned left. A range pole was sighted in and set at point G, 8. This established direction for grid line 8. Line 8 was then chained off, beginning at point A, 8 and working toward the range pole at point G, 8. Lath were set at 200-foot intervals along the line. The rear surveyor lined in each stake by eye between the succeeding stake and range pole at G, 8. The distance between points F, 8 and G, 8 was found to be 190 feet and was so noted on field book sketch (fig. 1-60).
- Gridlines D and E were staked next. The level was set up over points D, 8 and E, 8, and 90-degree angles were turned off from line 8. Lath were set at 200-foot intervals on each line, starting measurement from the level and staking to east field boundary, then returning and staking to west field boundary.
- Line 6 was then staked, starting at point G, 6 on the south property line; 190 feet was chained off to correspond to the stake previously set at F, 8. Staking of line 6 was continued at 200-foot intervals to the range pole at A, 6. This completed lines 6 and 8.
- With the four gridlines staked, the elevation shots for the entire field were completed without further use of tape and with a minimum of pacing measurements, simply by locating any other points by lining in by eye from the north, south, east, and west stakes. Obviously, the gridline stakes must be distinguishable for a considerable distance. A field up to 60 acres in area can be gridded with a four-line layout such as this. A survey party of three people can lay out and stake these lines much quicker than two people. A motor vehicle can be used to advantage in setting range poles and distributing stakes when crops and other field conditions will permit. Survey notes (fig. 1-60) illustrate a commonly used method of keeping notes for this type of survey. Note the intermediate shots, which are

Figure 1-58 3-4-5 method of laying out a right angle

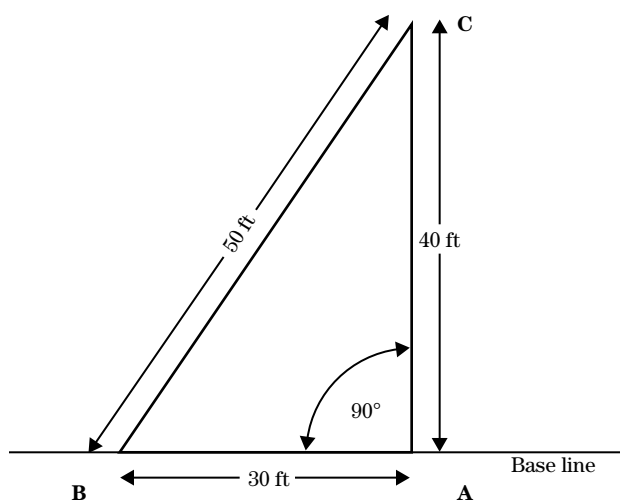

Figure 1-59 Method of topographic survey by gridding

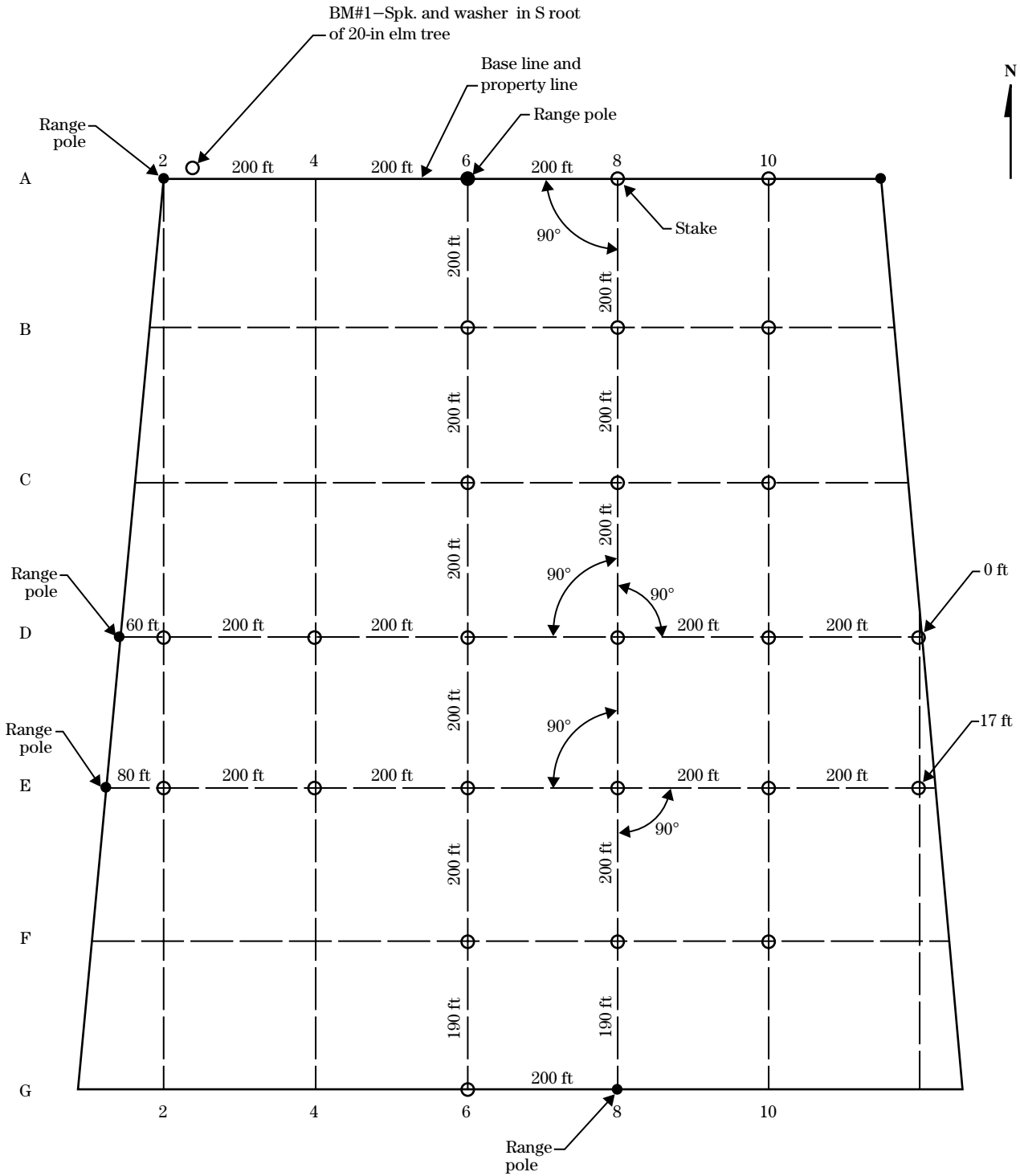
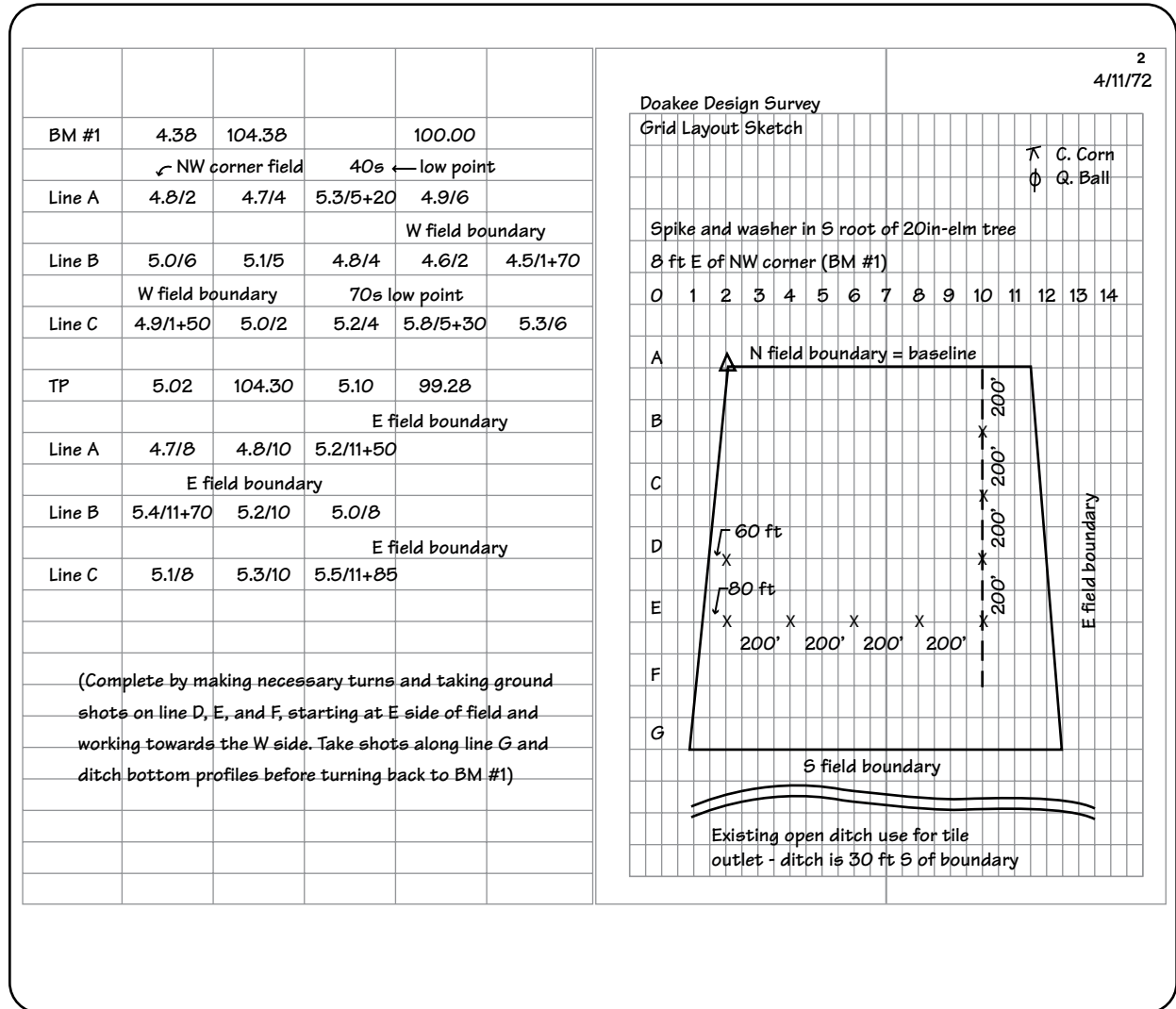

Figure 1-60 Survey notes—grid survey



not on regular grid points. Nearly all gridding will require some intermediate shots to locate and get elevations in low spots, high spots, and existing ditches. A sheet of cross-section paper on a clipboard or on a planetable is often used to record the survey notes directly on a sketch drawn to scale in the field, thus eliminating the need for field survey books.

(d) Topographic surveys by aerial photos, ground control surveys, and stereoplotter

Topographic surveys can be made economically by use of aerial photos, ground control surveys, and a stereoplotter. Aerial photos must be studied to select identifiable image points suitable for making vertical and horizontal control measurements used to scale the plotter stereoscopic models. The stereoscopic models are the areas covered by two overlapping photos called a stereo pair. The control points must be positively identified in the field, identified and marked on the photos, and easily seen in the stereoscopic model.

The scale of the aerial photo is the ratio of the camera focal length to the height of the flight above ground. Scale of photos generally used by the USDA and by NRCS in soil surveys and photo interpretations is 1:20,000. This is obtained usually with an 8 1/4-inch lens camera at a flying height of 13,750 feet within an accuracy of 5 percent. In flat areas, scale of exposures should range within 3 percent accuracy, whereas in mountainous areas, variation between photos may range from plus 10 percent to minus 20 percent.

A new technology using laser altimetry called Light Detection and Ranging (LiDAR) is evolving to allow topographic data to be collected by aircraft equipped with GPS for ground control. The system uses laser pulses that are bounced off of the target topography and back to the LiDAR receiver. Recorded timing of the laser pulses is converted to distance and these distances, in turn, are converted to coordinate data by use of the GPS coordinate positions.

(e) Differential leveling

Planning and establishment of all permanent practices used in NRCS work requires information regarding

the relative elevation of points on the Earth's surface. As a matter of good surveying practice, vertical control should be performed only by differential leveling.

Three principal methods are used to determine differences in elevation:

- barometric
- trigonometric
- differential (or spirit) leveling

Differential leveling, the method most commonly used, is the only one explained here. It uses the principle that a spirit level can be used to fix a line of sight perpendicular to the action of gravity. This line of sight can then be used to determine differences in elevation between nearby points on the Earth's surface.

(1) Common terms used in leveling

Common terms used in leveling (fig. 1-61) are benchmark (BM), temporary benchmark (TBM), turning point (TP), backsight (BS), foresight (FS), and height of instrument (HI).

A benchmark is a point of known or assumed permanent elevation. Such points may be marked with a brass pin or a cap set in concrete, cross or square mark cut on concrete, lone metal stake driven into the ground, specifically located point on a concrete bridge, culvert, or foundation, or similar objects that are not likely to be disturbed. Temporary benchmarks are points of known or established elevation usually provided for convenient reference in the course of surveys and construction when permanent benchmarks are too far away or are inconveniently located. Such benchmarks may be established on wooden stakes set near a construction project or on nails driven into trees. Benchmarks on trees will have more permanence if set near the ground line where they will remain on the stump if the tree is cut and removed.

Federal, State, and municipal agencies and private and public utility companies have established benchmarks. These benchmarks are located in nearly all major cities in the United States and at scattered points in less populated areas. They are generally bronze caps securely set in stone or concrete with elevations referenced to mean sea level. Their primary purpose is to provide control points for topographic mapping. They are also useful as points from which other benchmarks

may be established for public or private projects. Such benchmarks should be used when convenient and should always be used for all higher order surveys. Caution should be exercised in using existing benchmarks in areas of subsidence due to mineral or water removal. County or state surveying offices can usually provide maps and coordinate positions for benchmarks throughout the area.

A turning point is a point on which the elevation is determined in the process of leveling, but which is no longer needed after necessary readings have been taken. A turning point should be located on a firm object, whose elevation will not change while moving the instrument setup. A small stone, fence post, temporary stake, or axe head driven firmly into the ground usually is satisfactory.

A backsight is a rod reading taken on a point of known elevation. It is the first reading taken on a benchmark or turning point, and is taken immediately after the initial or new setup.

A foresight is a rod reading taken on any point on which an elevation is to be determined. Only one backsight is taken during each setup; all other rod readings are foresights.

Height of instrument is the elevation of the line of sight. It is determined by adding the backsight rod reading to the known elevation of the point on which the backsight was taken.

(2) Setting up the level

Before attempting to set up the level, ensure that the tripod wing nuts have been tightened so that when held horizontally, each leg will barely fall under its own weight.

- Step 1.* Holding two tripod legs, one in each hand, place the third leg on the ground. Using the third leg as a pivot, move the held legs until the footplate is nearly horizontal.
- Step 2.* Lower the two legs to the ground without altering the horizontal position of the footplate.
- Step 3.* Apply pressure to the legs to ensure a stable setup. Ensure that the tripod legs are spread at such an angle that the tripod is stable and that objects may be viewed through the telescope from a convenient posture.

For a level with four leveling screws:

- Step 4.* Line up the telescope over one pair of leveling screws and center the bubble approximately. The process should be repeated with the telescope over the other pair. Continue this procedure until the bubble remains centered, or nearly so, for any position of the telescope. Final centering of the bubble is usually easier if only one screw is turned rather than trying to adjust two opposite screws at the same time. The leveling

Figure 1-61 Method of differential leveling

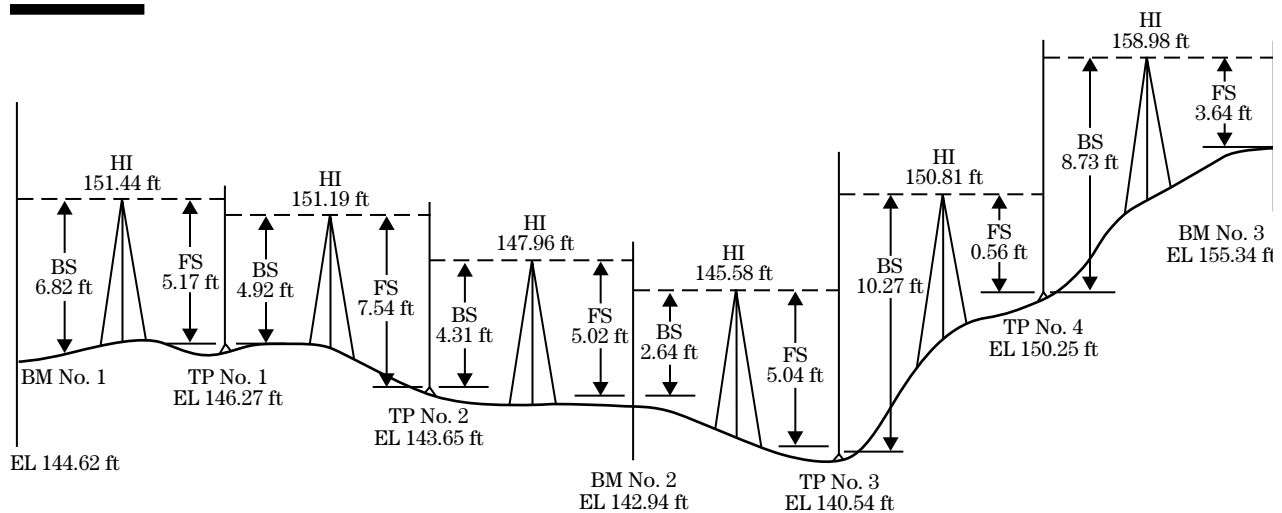

screws should be tightened only enough to secure a firm bearing.

For self-leveling levels with three leveling screws:

- Step 4.* Turn the telescope until it is parallel with two of the screws and bring the bubble to the center using both the screws.
- Step 5.* Then with the third screw, bring the bubble to the center of the circle. When you rotate the telescope, the bubble should remain centered in any position. If it does not, the bubble needs adjustment (refer to EFH 650.0100, Checking and Adjusting Instruments).
- Step 6.* Before attempting to take sights, focus the crosshairs with the eyepiece. Point the telescope at some light surface such as a white building or the sky and turn the eyepiece slowly in or out until the most distinct appearance of the crosshairs is obtained. Focus the telescope (by means of the focusing screw) on a level rod, held at some point about 30 meters (100 ft) from the instrument. Then, move your eye slowly up and down to observe if the crosshair apparently moves over the face of the rod. If the crosshair does not appear to move, it is properly focused. If you detect movement, further adjustment is necessary. Once the eyepiece has been adjusted, no further adjustments are necessary so long as the same individual uses the instrument.

After focusing on the rod, center the bubble exactly in the level vial before taking the rod reading. Be sure that the reading is taken with the rod in a vertical position and that no foreign material prevents clear contact between the rod and the point to be read. On benchmarks and for more precision, some surveyors ask the person holding the rod to move the rod back and forth over the center, using its base as a pivot. A rod level could also be used for this purpose. The minimum reading thus observed is the true vertical reading.

Be sure not to lean on the instrument or step close to the tripod legs, because this may throw the instrument off level. It is good practice to check the bubble regularly to make sure no inadvertent movement has oc-

curred. If this is the case, the entire circuit should be repeated. Adjustments to the level should never be made part way through a circuit.

(3) Bench level circuit

The procedure and field notes used in running a bench level circuit may be considered as the basic system for all differential leveling. The beginner should be thoroughly familiar with this basic system. A bench level circuit is run to determine the relative elevations of two or more bench marks. The circuit may start from a highway or U.S. Geological Survey (USGS) benchmark or from some point of assumed elevation (a TBM, for example). A bench level circuit is frequently run as a part of a profile, cross section levels, or topographic survey. The basic procedure and notes are the same in any event.

On large projects, the bench level circuit should be run before all the other survey work, or much more work will be required to carry corrections through the survey notes if mistakes occur. Bench levels should always be closed on the starting point. That is, after the last benchmark is set, levels should be run back to the starting point, unless the circuit can be closed on another proven point. The procedure for running a bench level circuit is:

- The level is set up at some convenient point between the starting benchmark and the next benchmark or turning point, but usually not over 400 feet from the starting benchmark. It is usually difficult to read the level rod at distances over 500 feet. A little practice will reveal what should be the limiting distance for the particular level being used. Keeping foresight and backsight distances approximately equal makes it possible to compensate for any adjustment errors in the instrument.
- The instrument operator begins the field notes by recording the following information (fig. 1-62 (a)).
 - location of survey, including name of landowner or project
 - type of survey such as design survey, construction layout, construction check, or similar description
 - column headings on left-hand sheet
 - names of surveyors

- date of survey
 - instruments used including serial numbers or other identifying numbers
 - description of starting benchmark; include reference to the field book in which the elevation of the benchmark was originally recorded; if it is a new benchmark with an assumed elevation, it should also be described; this assumed elevation should be in even meters or feet, such as 100 feet
- With the rodholder holding the rod on the benchmark, the instrument operator observes the rod reading and records it in the backsight column opposite the station (Sta.) BM 1. Referring to figures 1–61 and 1–62(b), note that the backsight on benchmark 1 was 6.82 feet. This reading added to 144.62 feet, the elevation of BM 1, gives 151.44 feet. This is the HI, or elevation of the line of sight.
 - The rodholder then moves ahead and picks out a convenient point for a turning point, or drives a small stake into the ground for this purpose. The instrument operator turns the telescope and takes a rod reading on this turning point and records this reading in the foresight (FS) column opposite TP 1. In figures 1–61 and 1–62(b), the foresight for TP 1 was 5.17 feet. This reading subtracted from the HI, 151.44 feet, gives 146.27 feet, the elevation of the turning point.
 - The instrument operator then picks up the level, moves ahead, and goes through a process similar to that described above, taking a backsight on TP 1, and a foresight on a new turning point ahead.
 - After the elevation of the last benchmark has been determined, the survey party runs levels back to the starting benchmark to close the circuit. Note in figure 1–62(b) that the foresight on BM 3, the last BM in the circuit, was 3.64 feet, giving an elevation of 155.34 feet for BM 3. In making the return run, the instrument operator resets the instrument and uses BM 3 as the turning point to include it in the closed circuit. In a bench level circuit, BMs should always be used as turning points.
 - After the final foresight on the starting BM is taken, the error of closure can be determined. This is the difference between the actual elevation of

the BM and the elevation computed from the final foresight. Figure 1–62(b) shows that the elevation computed from the final foresight was 0.01 foot too low. Length of circuit is about 0.8 kilometers (0.5 mi). To determine permissible error, use the formula given in accuracy standards (table 1–1). Permissible error is:

$$0.10 \text{ ft} \sqrt{M} = 0.10 \text{ ft} \sqrt{0.5M} = 0.07 \text{ ft}$$

Actual error is 0.01 foot, which is acceptable. Level note computations should be checked by adding the backsight and foresight columns (fig. 1–62(b)). The difference should equal the error of closure and should

Figure 1–62 Survey notes for a bench level circuit

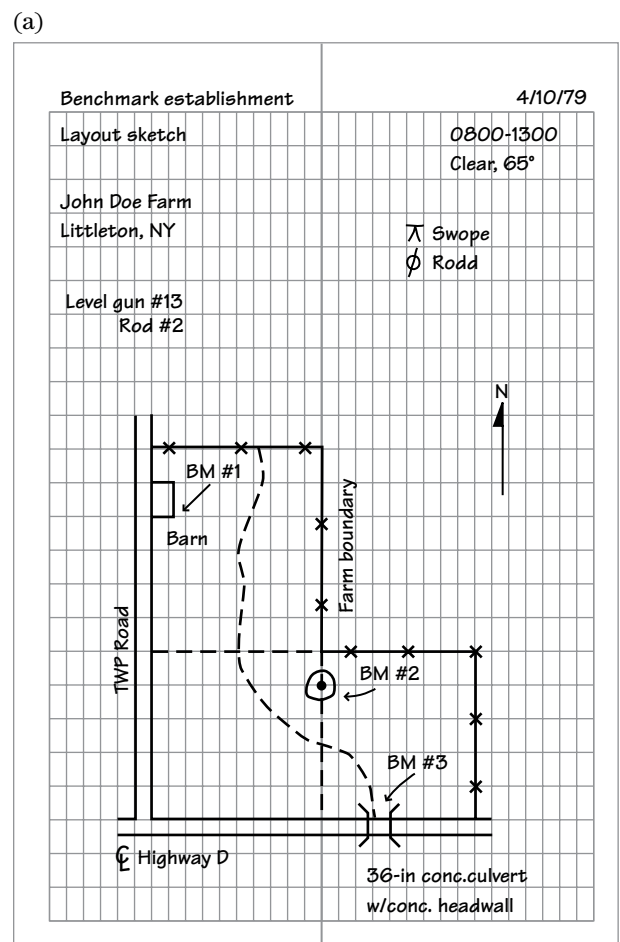

Figure 1-62 Survey notes for a bench level circuit—Continued

(b)

Sta.	BS	HI	FS or Grade rod	Elev.	
BM #1	6 ⁸²	151 ⁴⁴		144 ⁶²	
TP	4 ⁹²	151 ¹⁹	5 ¹⁷	146 ²⁷	
TP	4 ³¹	147 ⁹⁶	7 ⁵⁴	143 ⁶⁵	
BM #2	2 ⁶⁴	145 ⁵⁸	5 ⁰²	142 ⁹⁴	
TP	10 ²⁷	150 ⁸¹	5 ⁰⁴	140 ⁵⁴	
TP	8 ⁷³	158 ⁹⁸	0 ⁵⁶	150 ²⁵	
BM #3	0 ⁹²	156 ²⁶	3 ⁶⁴	155 ³⁴	
TP	0 ¹⁹	146 ⁴³	10 ⁰²	146 ²⁴	
BM #2	1 ²³	144 ¹⁷	3 ⁴⁹	142 ⁹⁴	
TP	1 ⁵¹	144 ⁹⁶	0 ⁷²	143 ⁴⁵	
BM #1			0 ³⁵	144 ⁶¹	
	+41 ⁵⁴		-41 ⁵⁵		
		Closure= -0 ⁰¹		OK	

Bench Level Circuit		4/10/79
		0800-1300
		∟ Swope ∅ Rodd
BM #1		
Cross on top of foundation, NE corner of barn.		
Ref. field notebook 12, p 43.		
BM #2		
Spike in base of blazed 30-in maple, 244 ft		
N of 36-in conc. culvert.		
BM #3		
Cross cut on top of NE corner of culvert headwall		
215 ft E of Jct. TWP road and highway D.		

be in the same direction; that is, plus or minus. This check merely proves the accuracy of the addition and subtraction performed in the notes. If the foresights and backsights do not check, computation of elevations and heights of the instrument will have to be rechecked until the mistake is found.

(4) Profiles and cross sections

The object of profile leveling is to determine the elevation of the ground at measured distances along a selected line. These elevations can then be plotted on profile paper at selected scales so that studies can be made of grades, depths, and high and low spots, and so that estimates can be made of quantities of cuts and fills.

Cross sections are simply profiles usually taken at right angles to a baseline such as the center of a road, ditch gully, or other selected baseline. Cross sections may be run along with profile levels or they may be run after the profile line has been staked and profiles have been taken.

On many projects it is customary to stake out a traverse line with a transit and tape or total station before running the levels for profiles and cross sections. The traverse line may be the centerline of a drainage ditch, dam, irrigation ditch, or an offset line. It may be a continuous straight line, a broken line, or a curved line. The procedure for running traverse surveys is as follows:

Step 1. The procedure in running a profile, and recording field notes, is essentially the same as in running bench levels, except that rod readings are taken on the ground at field stations and at major breaks in slope between stations. Distances between readings are measured and recorded by full or plus stations. Normally, a line on which a profile is to be run is located and stationed before or during the time profile levels are taken.

Step 2. Whenever possible, a TBM should be set near the starting point stake. If this cannot be done, it will be necessary to run levels from the nearest BM to the starting point. Location of the starting point stake is described in the notes so that it can be relocated if it is pulled out or otherwise lost. The start of the profile should be a full station. It may be 0+00 or any other se-

lected full station. Frequently, it is desirable to use a higher station such as 10+00, if in feet, where it may be necessary to run the profile both ways from the starting point. This avoids having to record minus stationing, which is always confusing.

Normally, the starting station for surveys involving streams, waterways, irrigation canals or ditches, and gullies should be located at the upstream end and proceed in the direction of flow. In some cases, however, topography and the system to be surveyed might be such that the survey could be done quicker and easier by locating the starting point at the downstream end and proceeding upstream. This is especially true for drainage surveys. In all surveys that might involve computations for water surface profiles by computers, the station numbering should proceed progressively downstream. The sample field survey notes (fig. 1-63 (a-d)) illustrate the use of a station other than 0+00 for the starting point.

Step 3. After establishing a starting point, the instrument operator sets up the level and reads a backsight on the TBM to determine the HI and then observes a rod reading with the rod held on the ground at the starting point. A rod reading is taken on the ground at each full station and at such plus stations as are necessary. Rod readings are taken to the nearest 0.1 foot, and ground elevations are computed only to the nearest 0.1 foot.

Step 4. When the rodholder has moved to about 300 to 325 feet away from the instrument, a TP is taken on a solid object. The instrument operator then moves ahead, sets up, takes a backsight on the TP, computes a new HI, and continues as before. Rod readings and elevations on TPs and TBMs should be read and recorded to 0.01 foot.

Step 5. If a transit line has not been run previously, the instrument operator should draw a sketch in the field book to indicate changes in direction of the profile and its relationship to nearby landmarks. Stations should always be measured and recorded at all important points along the profile line, such as at branch ditches, subsurface drain laterals,

gullies, overfalls, culverts, bridges, roads, fence lines, headgates or takeouts, drops, checks, and similar features. It is useful to have this information in studying the profile for design and later in staking construction work on the ground.

Step 6. Frequently, it will be desirable to set a hub stake driven flush with the ground every 500 feet or less in order to tie in or relate other survey work to the profile.

Step 7. The sample survey notes indicate the method of recording cross-sectional notes when cross sections are run at the same time as the profile. Stations are selected where cross sections are wanted. The stationing line or transit line is used as the baseline from which measurements are taken to both sides at right angles to the baseline.

Sometimes an offset line is used, and cross sections are taken only to one side or both sides as is deemed necessary to obtain the information desired. A rod reading is taken on the stationing line at the station and recorded on the right-hand page opposite the appropriate station, for example, station 30+00 (fig. 1-63b). Since this reading was taken on the baseline, 11.2 feet is recorded directly on the centerline of the righthand sheet of the field book. The rodholder then moves out at right angles to the baseline with the rod and one end of the tape to the first major break in ground slope. The rear chainperson stands at the base line, reads and calls off the distance from this point to the rodholder. The instrument handler reads the rod and records the distance and rod reading either to the right or left of the centerline of the right-hand sheet, depending on which side of the line the shot was taken. The rod reading and distance are recorded as 10.6/7, the top number being the rod reading and the bottom number the distance.

The process is continued until the cross section is run out as far as necessary in one direction. The rodholder then returns to the base line, and a similar process is repeated in the opposite direction. Elevations along the cross-section line generally are not computed in

the field unless they will be plotted in the field. This work is usually done in the office.

The zero of the cross section may be the centerline of the gully, ditch, or stream. In some cases the baseline will be the same as the profile line and will be located on the centerline of a gully, ditch, or stream. In other cases, the profile line may be along the bank of a ditch. In any case, the zero of the cross section is on the baseline. The instrument operator must indicate in the field notes the direction of the cross section so that it will be clear. It is standard practice to refer to right and left when one faces the direction of progressive stationing of the profile line. A cross section taken at a proposed structure site should be located and well described in the field notes so that this line may be reproduced later if necessary. This can be done by setting a hub stake at the zero point of the cross section and one or more additional stakes on the cross-section line 30 to 100 feet from the zero point. These stakes should be driven nearly flush with the ground so that they will not be disturbed, and guard stakes should be driven beside them for protection and ease in finding. In addition, it may be necessary to set reference points (RPs) to assist in relocating these baseline points at a later time.

(5) Use of grade rod

In surveys for construction layout and construction checking, the use of grade rod readings, determined from the established HI, eliminates the need for converting rod readings to elevations at each layout or checkpoint.

Grade rod is the reading that would be obtained from the present instrument position if the rod were placed at the planned grade. (Grade rod = HI – planned grade elevation). When the HI is above grade elevation, the grade rod has a plus value and is so marked in the notes, such as +6.3 feet. If the HI is below grade elevation, the grade rod has a minus value and is so marked, such as –8.3 feet.

To find the cut or fill in construction layout surveys, the actual ground rod reading is subtracted from the grade rod. If the result has a minus value, a fill is indicated. If the result has a plus value, a cut is indicated. For example: if the HI is 249.3 feet, and the planned grade elevation is 243.0 feet, the grade rod would equal 249.3 feet minus 243.0 feet or 6.3 feet. If the foresight of the point were 9.8 feet, then 6.3 feet minus 5.8 feet would equal –3.5 feet, indicating a fill. If the foresight

Figure 1-63 Survey notes—profile and cross section

(a)

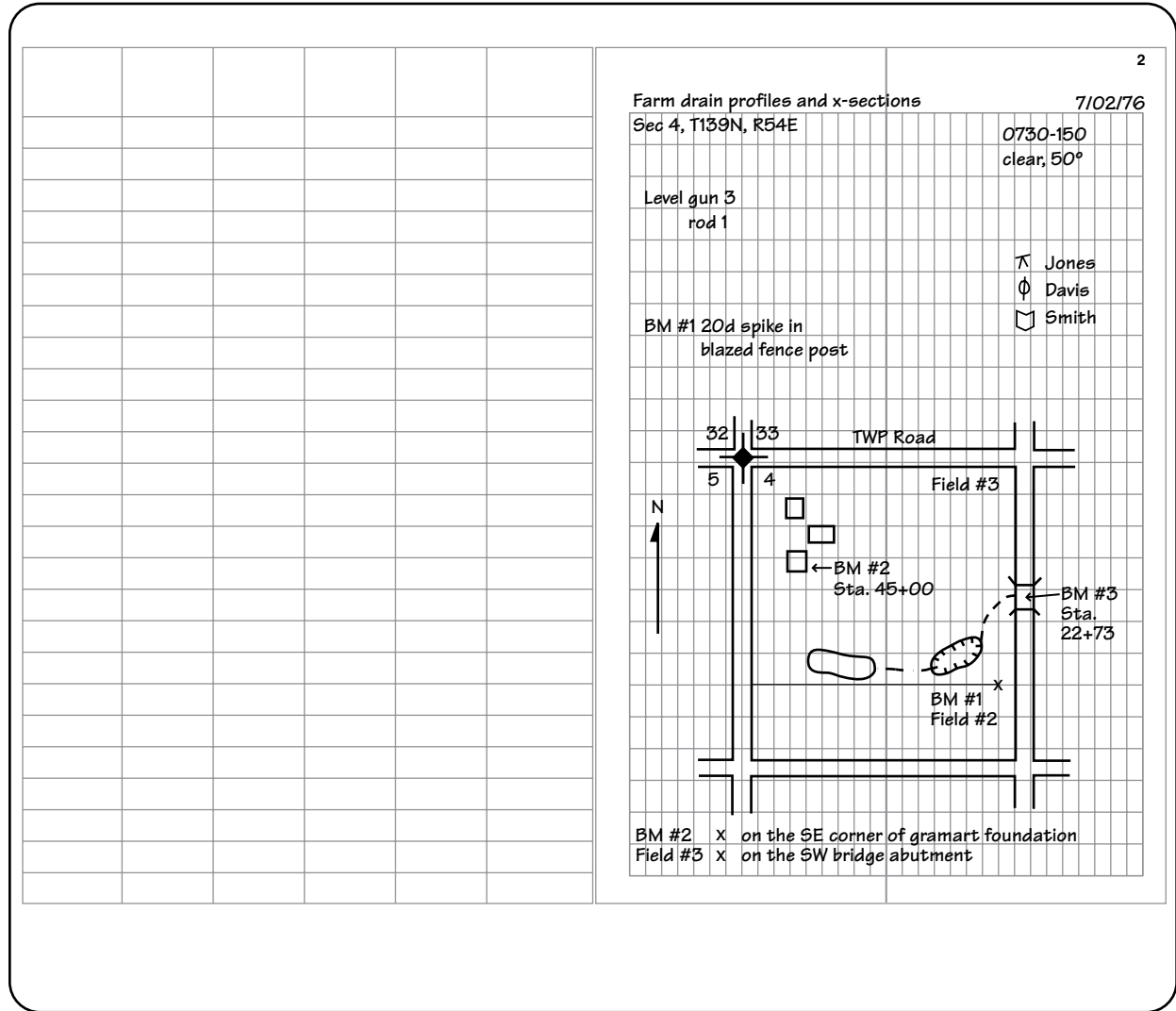

Figure 1-63 Survey notes—profile and cross section—Continued

(b)

Sta.	BS	HI	FS or grade rod	Elev. or planned elev.	
BM #1	1 ³⁴	501 ³⁴		500 ⁰⁰	Assumed data
30+00					
30+50					
31+00					
31+50					
32+00					
33+00					
34+00					
35+00					
36+00					
37+00					
TP #1	9 ⁷⁶	509 ²²	1 ⁰²	499 ⁴⁶	
38+00					

20d spike in blazed fence post 5 fence right side looking from sta. 30+00 toward 38+00						
7 ³	9 ¹	10 ⁴	11 ²	10 ⁶	9 ⁴	7 ¹
21	14	7	490 ³	7	10	15
8 ⁵	9 ³	10 ²	11 ²	9 ¹	8 ⁴	4 ²
18	12	7	490 ⁵	15	14	20
8 ⁵	8 ⁷	9 ³	10 ⁵	9 ²	9 ⁷	7 ⁵
20	15	11	491 ⁰	10	14	26
7 ²	9 ⁷	10 ²	10 ³	10 ⁴	4 ²	7 ⁵
24	17	9	491 ²	8	16	28
7 ³	8 ²	9 ⁶	10 ¹	9 ⁵	9 ⁰	7 ⁵
24	18	14	491 ⁵	10	15	20
			9 ⁵			
			491 ²			
			9 ⁴			
			491 ¹			
			10 ²			
			490 ⁵			
			10 ⁵			
			494 ⁵			
			14 ⁷			
			490 ¹			
			13 ¹			

HI = 509²²

Gross sections continue down page as taken

Figure 1-63 Survey notes—profile and cross section—Continued

(c)

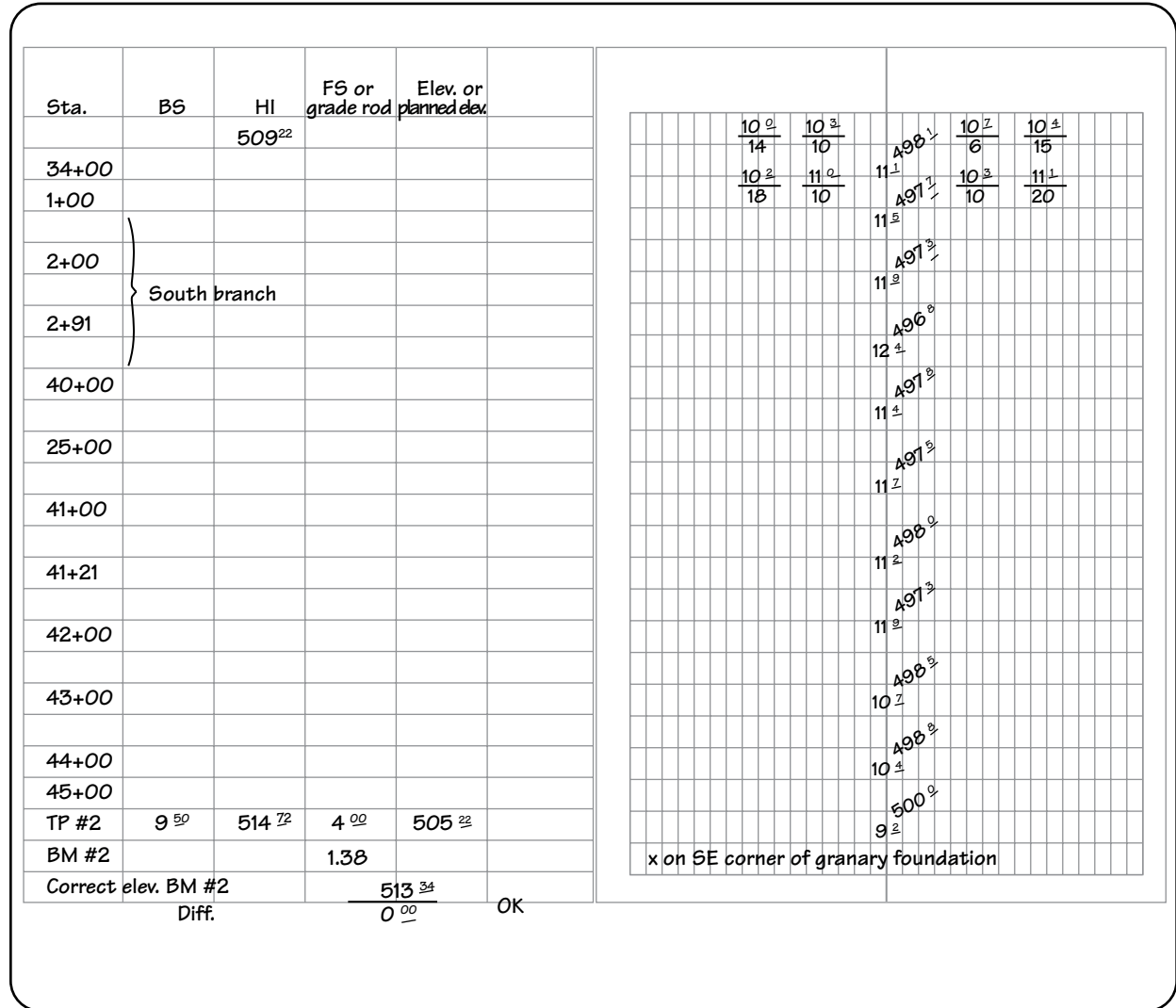
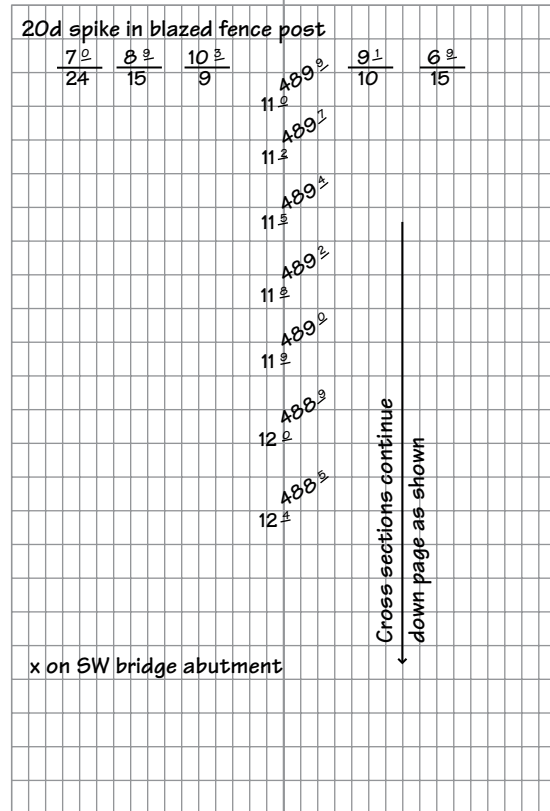

Figure 1-63 Survey notes—profile and cross section—Continued

(d)

Sta.	BS	HI	FS or grade rod	Elev. or planned elev.
BM #1	0 ⁸⁷	500 ⁸⁷		500 ⁰⁰
24+00				
28+00				
27+00				
26+00				
25+00				
24+00				
23+00				
22+00	W end of bridge			
BM #3		9 ⁸²		491 ⁰⁵
	Current elev. BM #3			491 ⁰⁵
	Diff.			0 ⁰⁰ OK



were 5.1 feet, then $6.3 - 5.1 = +1.2$ feet, indicating a cut (fig. 1-64).

Figure 1-64 illustrates survey notes for design, construction layout, and construction check of a small field ditch project. A few prior random shots with a level indicated the ditch could be constructed to provide the necessary surface drainage on a 0.02 foot per foot bottom grade with a 1-foot drop at its outlet to the bottom of the main ditch.

(6) Setting up slope stakes

Slope stakes are set as part of a layout procedure widely used to guide and check earthwork construction. The procedure given can be applied to excavation of ditches, diversions, spillways, and other embankment work such as levees and dikes, that require construction to specified slopes. Figure 1-65 shows an example of the use of the grade rod method, and figure 1-66 shows field notes to set slope stakes for an earth dam. In the example, assume that the earthfill will be

staked to the following dimensions: top width, 8 feet; upstream side slope, 3:1; downstream side slope, 2:1; elevation at top of settled fill, 101.9 feet. Also, assume location and elevation of benchmark and centerline of dam have been previously staked, and proceed as follows:

- Step 1.* Run levels from BM to point of convenience at dam site and compute HI = 102.42 feet (fig. 1-65).
- Step 2.* Compute difference between HI elevation and top of fill: $102.42 - 101.9 = 0.5$ feet. This is grade rod at station 1+00 feet.
- Step 3.* With centerline rod reading of 4.2 feet at station 1+00 feet, compute elevation of ground surface, then compute fill height, $101.9 - 98.2 = 3.7$ feet. This can be done also by merely subtracting the difference between HI and top of fill from the centerline rod reading, $4.2 - 0.5 = 3.7$ feet.

Figure 1-64 Survey notes—ditch survey using the grade rod

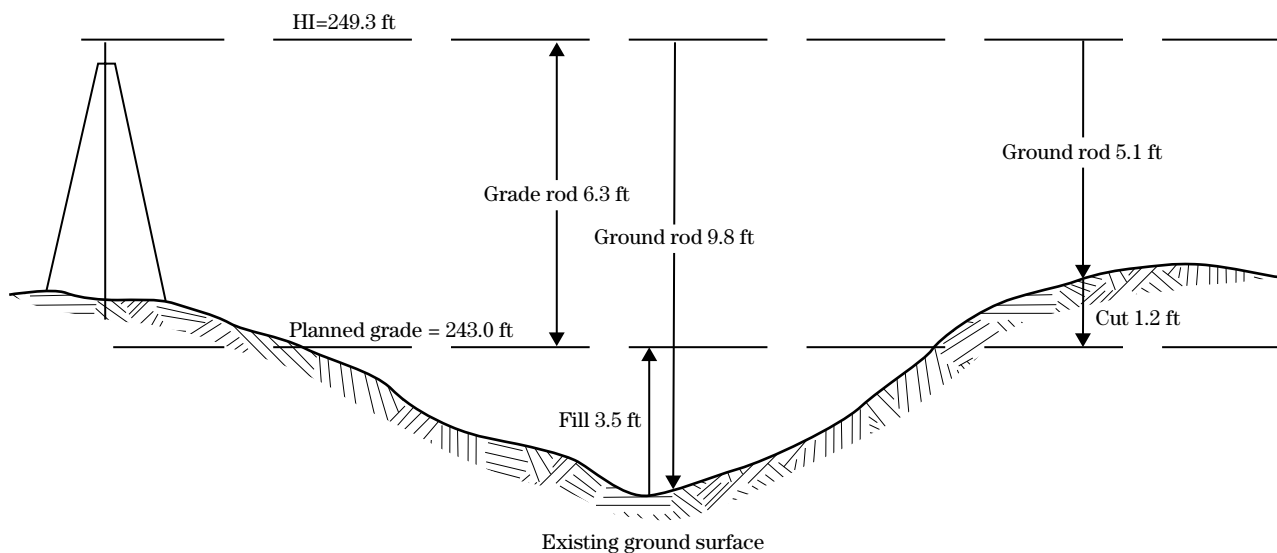

Figure 1-64 Survey notes—ditch survey using the grade rod—Continued

Sta.	BS	HI	FS or grade rod	Elev. or planned elev.	
					<div style="border: 1px solid black; padding: 5px;"> <p>SCD Big Hill Date 2/26/77</p> <p>Field Office Greg Hill</p> <p>Name _____</p> <p>Individual _____ Group _____ Unit of Govt. _____ (circle one)</p> <p>Job Drainage ditch #1</p> <p>Design Sur. <input checked="" type="checkbox"/> Const. Layout <input checked="" type="checkbox"/></p> <p>Const Check <input checked="" type="checkbox"/> Other _____</p> <p>Ident. No. _____ Field No. 2</p> <div style="text-align: center;"> </div> <p>Legal Description Scale 1 in = 800 ft</p> <p>Sec _____</p> <p>or _____</p> <p>Location: 3 mi NE Greyhill on So. Hwy 2nd R</p> </div>

Figure 1-64 Survey notes—ditch survey using the grade rod—Continued

Sta.	BS	HI	FS or graded	Elev. or planned elev.
TBM 1	4.22	45.22		41.00
Side shot	Bottom of outlet ditch		9.0	36.2
0+00			+8.0	37.2
2+00			+7.9	37.3
4+00			+7.6	37.4
6+00			+7.7	37.5
8+00			+7.6	37.6
TP 1	3.94	44.34	4.82	40.40
TBM 1			3.34	41.00
	8.16	OK.	8.16	

J. Jones Ditch #1		T. Edwards		2
Design a corner layout		R. Roy		5/23/77
Left	⊕	Right		
"V" ditch 4:1 S. S.				
60-in D. rod near ground in W side 16-in cottonwood in NE corner fence.				
50' (R.H.)				
5.6	5.6	5.5	5.0	
C-2.4-9.6	C-2.4	C-2.5-10.0	C-3.0	
5.4	5.4	5.3	4.9	
C-2.5-10.0	C-2.5	C-2.4-9.6	C-3.0	
6.0	4.9	4.9	4.6	
C-2.8-11.12	C-2.9	C-2.9-11.6	C-3.2	
4.7	4.7	4.7	4.3	
C-3.0-12.0	C-3.0	C-3.0-12.0	C-3.4	
5.7	5.7	5.7	4.3	
C-1.9-7.6	C-1.9	C-1.9-7.6	C-2.9	
Note: Cut to be measured form top of reference hub (RH)				

Figure 1-64 Survey notes—ditch survey using the grade rod—Continued

Sta.	BS	HI	FS or Graded	Elev. or planned elev.	
TBM 1	4.00	45.00		41.00	
0+00			+7.8	37.2	
2+00			+7.7	37.3	
4+00			+7.6	37.4	
6+00			+7.5	37.5	
8+00			+7.4	37.6	
TBM 1			4.00	41.00	O.K.

J. Jones Ditch #1					J. Ryans					
Const. check					φ J. Jones					
Left			Center	Right			6/25/77			
See page 1										
Spoil					7.9	Spoil				
5.2	4.7	4.7	5.5	7.9	5.4	4.6	4.7	5.8		
56	44	16	12		10	16	43	45		
					7.8					
4.9	4.4	4.3	4.4	7.7	4.7	4.1	4.2	4.5		
45	43	16	12		18	16	44	46		
					7.6					
Construction meets plans and specifications.										
 Eng Aid 6-24-77										

Figure 1-65 Grade rod method for an earth dam

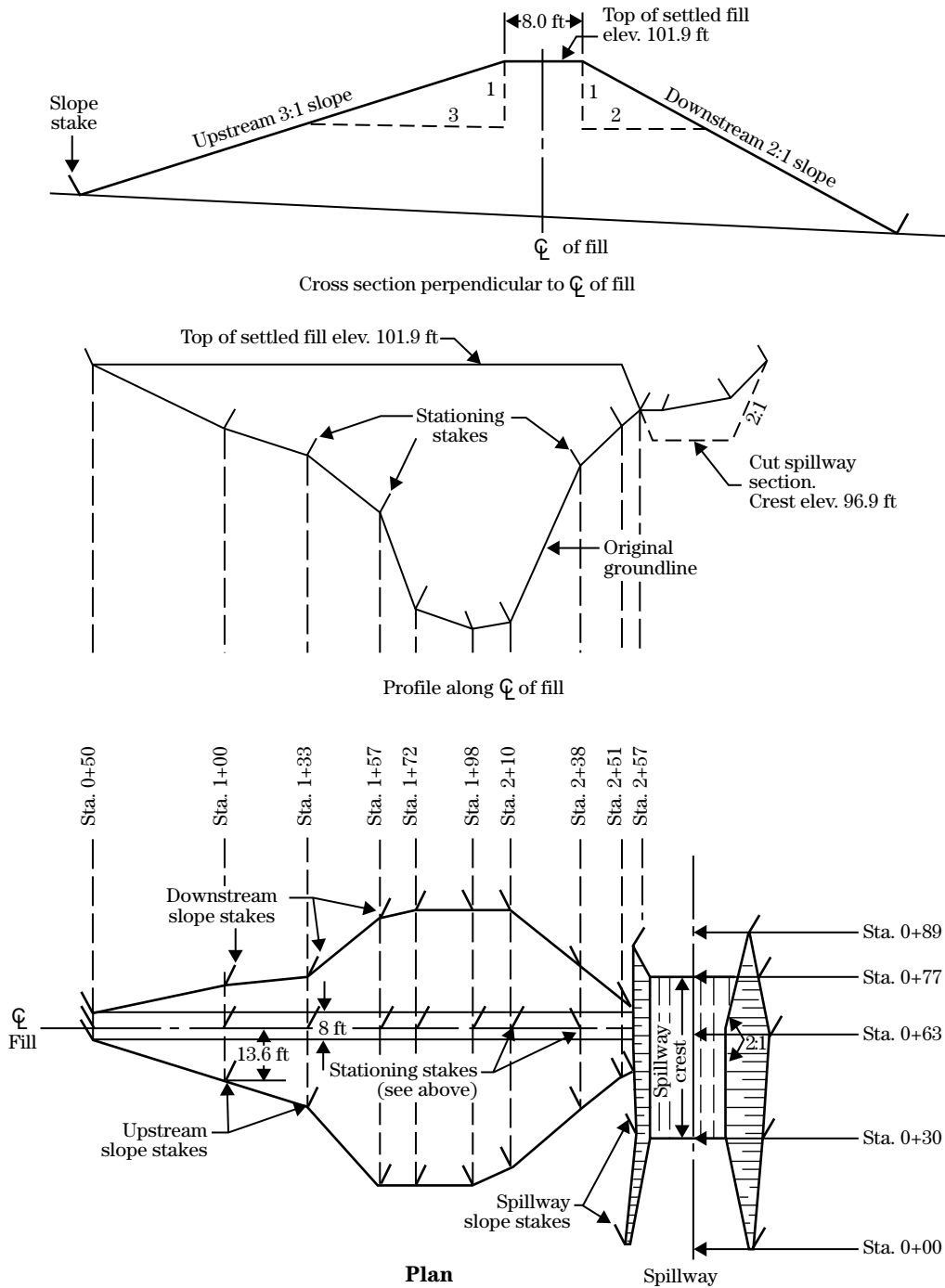

Figure 1-66 Survey notes—slope stakes for dam

						1					
SCD						Date 3/7/79					
Work Unit											
Farm Group Geo. Smith											
Location Sandy Nook North Dakota											
NE 1/2 NE 1/4, Sec 7 T 151 N,											
R 103 W											
Job Slope stakes for earthfill dam											
Design S						Const. Layout <input checked="" type="checkbox"/>					
Const. Check						Other					
Dist. Agent No. 237						Field No. 2					
ACP No.											
						<p>BM #1 Steel axle in fence line, 200 ft W to W end of dam</p>					

Figure 1-66 Survey notes—slope stakes for dam—Continued

Sta.	BS	HI	FS or Graded	Elev. or planned elev.	Shrinkage	Geo. Smith Const. slope stakes			T John Doe J. Jones		
BM #1	2.42	102.42		100.00		Steel axle in fence line 200 ft N of W end of dam			5/7/79		
W end of dam 0+50			+5.0	101.9	0.0	Downstream - 2:1	¢	Upstream - 3:1			
						F 0.0 0.5 4.0	F 0.0 0.5 0	F 0.0 0.5 4.0			
1+00			+0.5	101.9	0.4	F 4.0 5.0 13.0	F 2.7 4.2 0	F 5.2 5.7 13.6			
1+33			+0.5	101.9	0.5	F 5.6 6.1 15.2	5.7 0	F 5.8 6.3 21.4			
T.P1	0.89	95.12	8.19	94.23		F 14.8 8.0 33.6	F 8.4 1.6 0	F 14.0 7.2 46.0			
1.57			-6.8	101.9	0.8	F 16.2 9.4 36.4	F 1.49 8.1 0	F 14.1 7.3 46.3			
1+72			-6.8	101.9	1.5	F 16.0 12 36.0	15.5 8.7 0	F 14.4 7.6 47.2			
1+98			-6.8	101.9	1.6	F 16.0 9.2 36.0	F 15.1 6.5 0	F 13.0 6.2 43.0			
2+10			-6.8	101.9	1.5	F 7.8 10.7 19.6	F 5.4 8.3 0	F 6.3 9.2 22.4			
TP #2	11.50	104.86	1.78	93.34		F 3.6 6.5 11.2	3.3 1.2 0	F 3.5 6.4 14.5			
2+38			+2.9	101.9	0.5	F 0.0 5.9 0	0.0 5.4 0	F 0.0 5.9 13.0			
2+51			+2.9	101.9	0.3						
End of dam 2+57			+5.9	48.9	0.0						

Step 4. The centerline fill has now been determined. To set the slope stakes at right angles to the centerline you must keep in mind side slope; top width; berm width, if any; and fill (or cut) at the centerline. The distance out from the centerline at which a slope stake is correctly set is given by the relationship:

$$d = w/2 + hs \text{ (without berm) or}$$

$$d = w/2 + b + hs \text{ (with berm)}$$

where:

- d = distance in meters or feet
- w = top width in meters or feet
- h = fill (or cut) in meters or feet
- s = side slope
- b = berm width in meters or feet

Step 5. For the first trial at setting a slope stake on the upstream side of the dam at station 1+00 feet, measure a distance at right angles to the centerline stake of $d = w/2 + 3(4.2 - 0.5) = 15.1$ feet. Take a rod reading at this point. In the example the rod read-

ing was 3.7 feet, which gave a distance of $d = w/2 + 3(3.7 - 0.5) = 13.6$ feet. When the rod was moved from 15.1 to 13.6 feet from the centerline, the rod reading again was 3.7 feet, so the stake was put in and marked (fig. 1-65). Allowance for settlement should be marked on the slope stake. The distance, rod reading, and elevation are recorded in the field book.

Step 6. Slope staking is a trial and error method. Practice will develop judgment in making distance adjustments so that a minimum of trials will be necessary to find the location for the slope stake. The same procedure is used to find the downstream slope stake at station 1+00 feet and the stakes at the other stations.

Step 7. Normal practice is to set an RP as an offset to each slope stake. In practice, the slope stake will be lost during construction, and the RP stake will assist in relocating the position. Figure 1-67 shows several examples of construction stakes.

Figure 1-67 Slope stakes

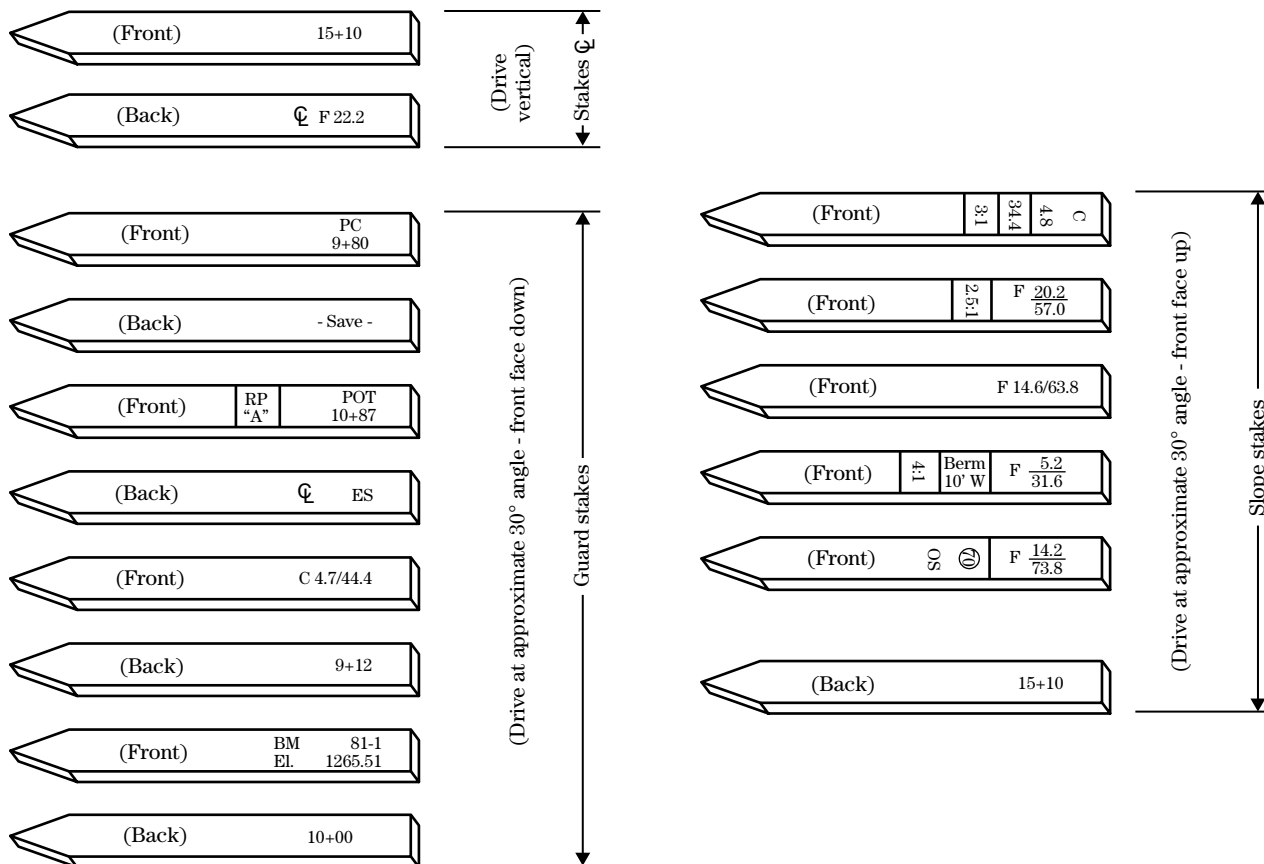

650.0115 Satellite-based surveying

This section provides guidance for high accuracy carrier phase GPS surveying for engineering projects within NRCS. Real-time Kinematic (RTK) and Post Processed methods are covered with a greater emphasis placed on RTK since a majority of GPS surveying in NRCS for engineering projects uses this method. GPS surveying is not an all-encompassing method for all projects and at times will require the user to combine this with more traditional surveying methods (i.e., with total stations). This is covered later in this section. Although briefly mentioned, lower accuracy code phase GPS surveying methods used by NRCS for GIS mapping are not covered in this section.

(a) GPS overview

GPS is a highly accurate satellite-based alternative to traditional surveying practices. The system uses advances in satellite technology combined with traditional ground-based measurement systems to provide highly accurate ground positions in three dimensions. The system uses the World Geodetic reference system (WGS84) as the basis for all coordinates. The intent of this section is to help the user understand the basics of the system with as little of the theory as possible. As with any technology, there are advantages and disadvantages to using GPS over traditional methods.

Advantages of GPS versus traditional surveying:

- GPS allows the user to establish control onsite.
- GPS does not require intervisibility between stations.
- GPS is generally (not always) unaffected by weather conditions.
- GPS can be more flexible and used around the clock.
- High accuracies can be achieved with less effort.
- Data can be directly tied to GIS more easily.
- Field crews can be much smaller; often an individual can run a GPS survey alone.
- Data points are independent and survey error is not cumulative.

Disadvantages of GPS versus traditional surveying:

- GPS produces substantial data files and data management can become overwhelming if not managed properly.
- GPS requires a fairly open sky above the receiver and is affected by overhanging obstacles.
- GPS is a power-hungry technology and power management is an issue of concern.
- GPS requires new knowledge and skills combined with those of traditional surveying.
- Data points are independent and traverse closure is not easily accomplished.

GPS is a generic term for satellite-based navigation systems based on the concepts of the Global Navigation Satellite System (GNSS). The GNSS provides independent (autonomous) three-dimensional coordinates to fixed or mobile receivers on the ground. A number of systems have and are currently being developed worldwide including the initial NAVSTAR (United States), GLONASS (Russia), GALILEO (European Union), IRNSS (India) and other regional systems.

(1) GPS segments

The GPS consists of three major segments: space segment, control segment, and user segment (fig. 1–68). The space segment consists of the currently operational satellites for each of the systems described above. The system of satellites and their orbit paths around the Earth is called the GPS constellation. The constellation refers to the series of orbital planes and their respect to the globe and to each other. Each orbital plane has a number of satellites with the combined effect being a global “net” of coverage where a greater than minimum required number of satellites may be viewed at any one time by Earth-bound receivers, typically a minimum of four satellites. Each satellite is monitored by the control segment and produces navigation codes that are received by the user segment and translated into ground coordinates.

The control segment for Navigation Satellite Timing and Ranging, NAVSTAR consists of a series of global tracking stations and one master control station in Colorado Springs, Colorado. The primary function of the control segment is to monitor the satellites and update navigation messages to provide necessary accuracy of positioning of the satellite. While a limited un-

derstanding of the space segment and control segment is required, the user segment is of most concern to the GPS operator.

The user segment consists of a receiver(s) on the ground, processors, and antennas. The user segment also includes the ground reference stations. These may be the user base station at a local project site or a remote reference station (i.e., a continuously operating reference station (CORS)). The primary function of the user segment is to receive the satellite signals and produce information for geographic position, time, and velocity of movement.

A secondary component of the user segment is the services available for postprocessing of collected data. This is an important function that provides more precise positioning, as well as a quality control check on the data collected. Precise positioning is obtained through the use of reference station data and available online correction services like On-Line Positioning User Service (OPUS). More detail on this is covered in a later section.

(2) Differential GPS

The GPS is further improved by the differential GPS (DGPS), for land users. The concept behind differential GPS is to correct bias at one location (rover) with measured bias errors at a known location reference station, for example CORS, or a local base sta-

tion (fig. 1–69). This is also referred to as “baseline reference data.” Calculated errors are then passed to the rover unit to recalculate more precise positions either on-the-fly (i.e., RTK) or later in postprocessing. DGPS utilizes the concept of a stationary receiver (base station), tied into an accurate known position (x,y,z), that is in cooperation with the user’s unit (rover). The requirement of a base station (or reference station) is that it utilizes the same satellites being used by the rover unit. Thus, the base station (or reference station) and the rover should be in the same proximity.

The base station is able to compute the errors inherent in the GPS signal by comparing the computed position (x,y,z) to the known position. The computed errors for the base station position will be the same as those for the signals received by the rover unit for the desired position and the corrections can then be applied to that rover position.

Several alternatives for baseline reference data are available (fig. 1–70) to enable DGPS. The office of the National Geodetic Survey (NGS) maintains two systems of reference data called the National CORS and the Cooperative CORS network. CORS reference sites provide GPS reference data supporting carrier phase and code range measurements for DGPS use by surveyors throughout North America. CORS reference data can be used to differentially correct GPS to centimeter range accuracies relative to the National Spatial

Figure 1–68 Conceptual diagram of the three major segments that comprise the GPS

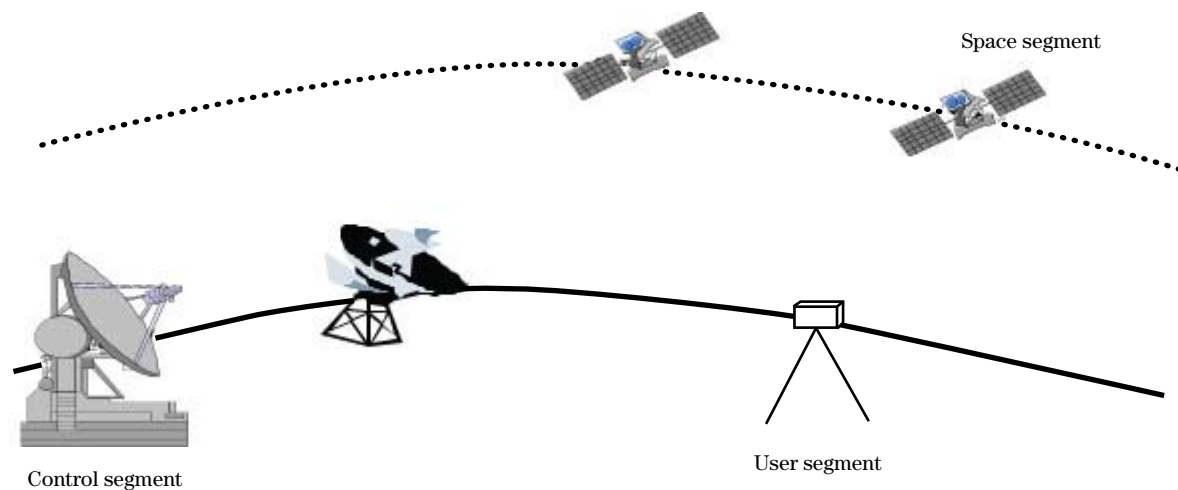

Figure 1-69 Conceptual diagram of the differential baseline setup to an unknown (rover) position. Note that both positions are receiving the same satellite signals.

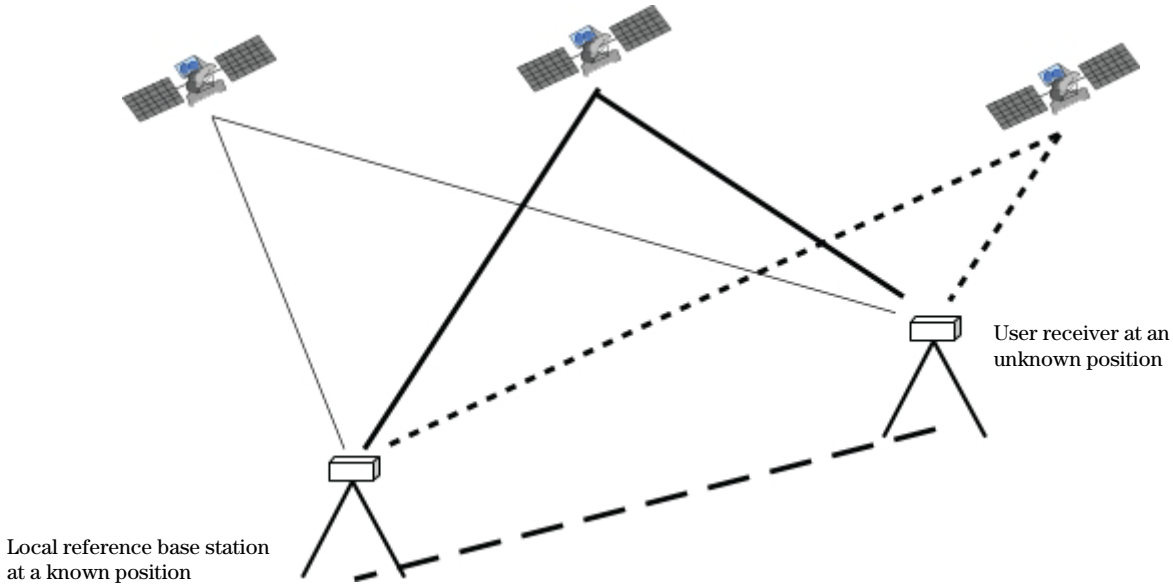
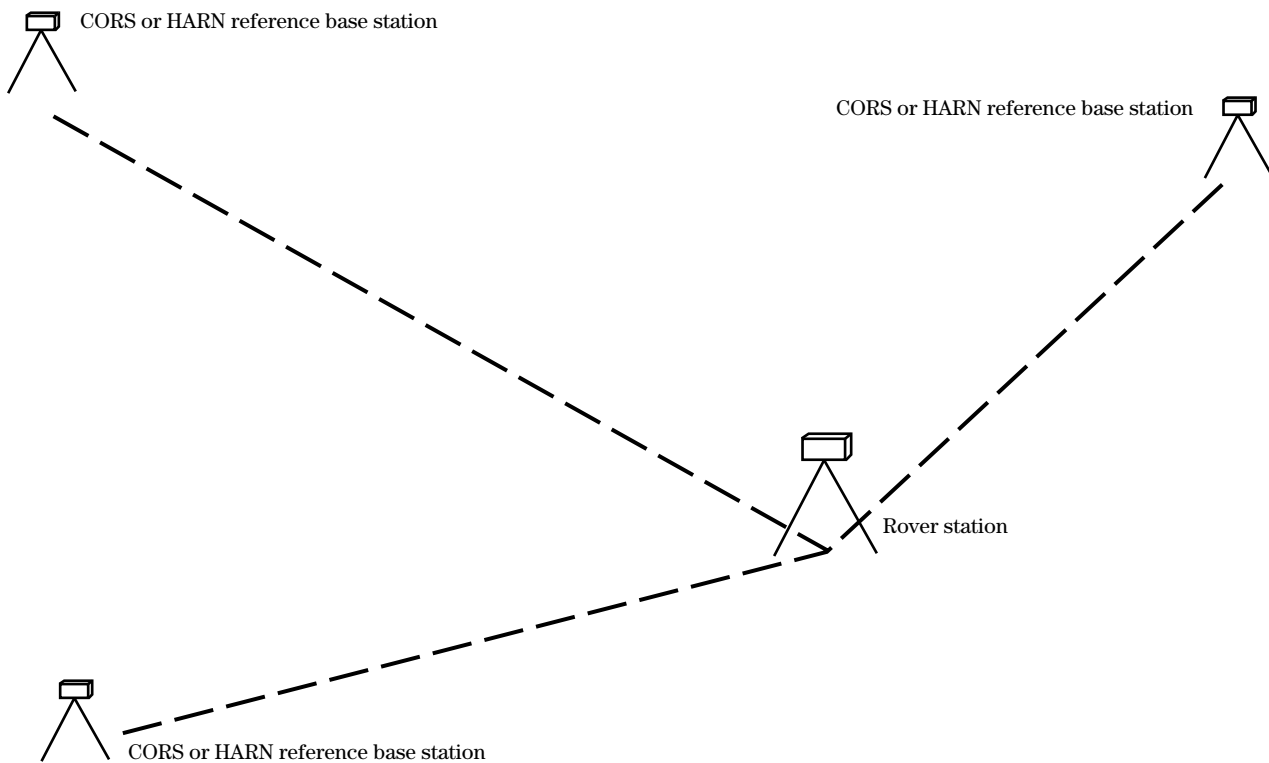

Figure 1-70 Conceptual diagram of a large area reference base utilizing multiple available CORS or the High Accuracy Network Service, HARN network reference base positions



Reference System (NSRS) in horizontal and vertical. Reference data files for NGS sites are available for download up to 30 days after initial sampling from the NGS Web Site. Cooperative CORS data are available from the participating cooperative members at their respective sites. Links to these sites are available from the NGS Web site <http://www.ngs.noaa.gov/CORS/cors-data.html> (last accessed March 20, 2008).

(3) GPS signal—single and dual frequency

High-accuracy carrier phase GPS surveying for engineering projects within the NRCS uses dual frequency GPS signals for precise positioning. Satellites in the constellation transmit three primary codes of binary information to land-based receivers by way of two carrier waves (L1 and L2) and the navigation code. The GPS is considered a passive system in that only the satellites transmit. The user segment of the system receives these signals, but does not transmit. This allows an unlimited number of users to utilize the system at the same time.

Two important elements carried on the navigation code are the ephemeris and the almanac. The broadcast ephemeris is unique to each satellite and is used to calculate the coordinates of the satellite in the WGS84 coordinate system. The almanac contains the truncated ephemerides (location) of all current satellites in the constellation and is used by the receiver to assist in locating the other satellites once the first satellite is found. The user's data collector uses the almanac and ephemeris to map the location of available satellites. This information is automatically downloaded to the GPS receiver when first connecting to the satellites.

It is important at this point to understand that single frequency receivers are able to receive only the L1 carrier wave while dual-frequency receivers are able to receive both L1 and L2. At short distances (< 6 mi), there is little gain in accuracy between the two frequency receivers; however, the dual frequency receivers are able to recover much faster from loss of lock, have much shorter occupation times, and can operate over much longer baselines (up to 25 mi). The biggest advantage to dual frequency is in real-time positional data capture while in kinematic mode (covered in a later section).

The measurement of the signals that allows the determination of the position coordinates is called an observable. A single position is usually an average of many observables when stationary. There are two types of observables called the pseudorange and the carrier phase. In general terms, the pseudorange is used for those applications where lower accuracies (GIS mapping for example) are adequate or where instant point positions are required. For higher precision surveys (typical for construction projects), the carrier phase observable is used (table 1–6).

Carrier phase tracking—Carrier phase tracking techniques are used to obtain the highest precision from GPS. All carrier phase measurements require both a base station unit and a receiver (rover). The base station should be within about 30 kilometers from the rover. During carrier phase measurements, both the base and rover track the same satellites. Carrier phase tracking requires specialized equipment and software that are capable of tracking the L1 and/or L2 signals and processing the carrier phase data.

Table 1–6 Relative expected accuracies with code phase and carrier phase GPS

Type of survey	Expected accuracies	Minimum observation time required
Pseudorange tracking	0.5 to 5 meters	15 minutes
Carrier phase postprocessed static	1 to 5 centimeters	15 minutes for short baselines 2 hours for longer baselines
Carrier phase rapid static	4 to 10 centimeters	15 minutes
Carrier phase real time kinematic	1 centimeter	NA

Postprocessed static carrier-phase surveying can provide 1 to 5 centimeters relative positioning within 30 kilometers of the reference receiver with measurement time of 15 minutes for short baselines (10 km) and 1 hour for long baselines (30 km). Rapid static or fast static surveying can provide 4 to 10 centimeters accuracies with 1 kilometer baselines and 15 minutes of recording time. RTK surveying techniques can provide centimeter measurements in real time over 10-kilometer baselines tracking five or more satellites and real-time radio links between the reference and remote receivers.

(b) Controlling error in GPS measurements

(1) Definitions and differences of precision and accuracy

The goal of any measurement is to be as close to the actual truth as possible. Because of the errors present in all measurement, we are interested in how close our measurements can be, and we determine this by the terms “precision” and “accuracy.” Precision refers to the repeatability of measurements and can be thought of as the degree of tolerance applied in instruments, methods, and observations. An instrument or method with a very high tolerance will generally have measurements tightly clustered, while an instrument or method with a low tolerance will have a wider spread (refer back to fig. 1–1a). Accuracy refers to how close to the actual value is the measurement. Accuracy is a result of both good instruments and good field methods. It is important to understand that high precision is not necessarily high accuracy. A highly precise instrument that is out of adjustment, for example a compass that has its declination set incorrectly, will give a precise reading but an inaccurate one (refer back to fig. 1–1b). This is often referred to as “bias.”

GPS surveys that use calculated position for the reference can be both accurate and precise, (refer back to fig. 1–1c), while a GPS survey that uses local control (assumed coordinates) for its reference base can be highly precise, but not accurate in a global sense. Accuracy is not necessarily a requirement for local projects, as few projects have a need for global accuracy. However, if a project is to be input to a GIS, it is more desirable to use global coordinates.

(2) Sources of errors in GPS measurements

The accuracy of GPS determined positions is affected by a number of variables, most of which are not in the control of the user. The accuracy of the position is referred to as the “User Equivalent Range Error (UERE).” As noted, carrier phase receivers are more accurate due to their ability to resolve the satellite clock bias.

The primary effects the user should be aware of include:

- position dilution of precision (PDOP)
- signal to noise ration (SNR)
- elevation mask
- introduced error-human caused
- multipath

Position dilution of precision (PDOP)—Dilution of precision, or DOP, is a measure of the satellite geometry (fig. 1–71) and is analogous to the strength of figure mentioned previously that surveyors use to control ground surveys. This is more commonly called PDOP. The lower the PDOP values, the better the solution. It is important for users to know that the PDOP changes exponentially. In other words, the decrease in accuracy when going from a PDOP of 7 to 8 is exponentially worse than going from a PDOP of 6 to 7.

PDOP is actually composed of a horizontal dilution of precision (HDOP) and a vertical dilution of precision (VDOP). Other factors include dilution of precision of time (TDOP), dilution related to the number of receivers (RDOP), but these are minor. Together these compute an overall geometric dilution, or GDOP. In practice, the standard deviation of a position multiplied by the GDOP gives the user a calculated position of uncertainty. Manufacturers generally suggest a PDOP setting of 6. The PDOP is always reported as a quality control check in postprocessing for all computed positions for the work as performed.

Signal to noise ratio (SNR)—The second potential source of error is called the signal-to-noise ratio (SNR). SNR is a measure of the background noise infiltrating the incoming signal. Examples of source points for SNR include, but are not limited to, popular ultra-wideband radio signals (UWB), conventional transmission signals, both intentional (jamming) and unintentional, and high-power television transmissions.

Positional accuracy is based on averaging of a number of computed positions. With high SNR values (high signal, low background noise), fewer positions are required for averaging in order to get a confident position. Longer averaging times are required for lower SNR values. Manufacturers generally suggest a SNR setting of 6.

Elevation mask—The elevation mask refers to the angle of the satellite with respect to the horizon. The closer the satellite is to the horizon, the longer the signal has to travel decreasing the reliability of the position calculated. In addition, satellites close to the horizon are affected more by multipath (see EFH 650.0116). Manufacturers suggest an elevation mask of 15 degrees for the base station and slightly higher for the rover to ensure the base and rover are using the same set of visible satellites. For longer base station distances, the rover may be set as much as 5 degrees higher than the base station (20 degrees). This setting will typically offset the majority of multipath errors.

Introduced error-human caused—Most human-introduced error in GPS will be similar to those errors introduced in traditional surveying including poor prac-

tice, blunders, and others. The user should review these in the relevant section of the handbook. Two introduced errors are unique to GPS surveying and can be affected by the user. These are the PDOP and the SNR previously mentioned. These are controlled by settings in the receiver that allow only the stronger signal values to be collected. It is common for the user to manipulate these values (out of frustration) in order to collect data under less than desirable conditions. This occurs generally when the satellite geometry is less than desired or atmospheric conditions weaken the signals. Changing the settings to accept the weaker signals can have measurable effect on accuracy and should be avoided. **Remember, the accuracy due to PDOP changes exponentially!**

Multipath—Multipath is generally not controlled by the user except in the case of the elevation mask. However, the user should be aware of it. Some of the largest errors in multipath delay can be mitigated by software rejection of signals that delay by too long a period of time. However, the shorter multipath errors will still be accepted. Most of these are mitigated by taking a larger number of observables. Multipath delay is caused by the signal bouncing off of nearby reflec-

Figure 1-71 Dilution of precision shown is analogous to strength of figure

(a) Poor solution with satellites grouped in a weak configuration

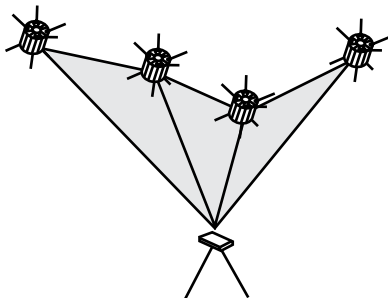

(b) Much stronger figure

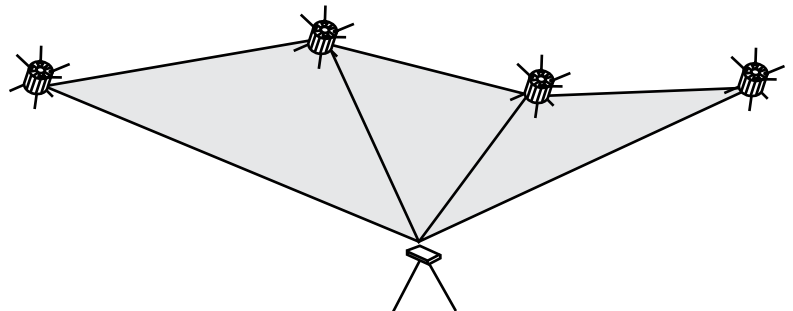

tive objects prior to hitting the receiver (fig. 1-72). The error in position is attributed to the longer apparent range path of the signal. Multipath delay is especially prevalent at satellite altitudes near the horizon. Setting elevation masks in the receiver to only accept satellites above a prearranged elevation (i.e., above 15 degrees) can mitigate this. Typical sources for reflective multipath in the natural environment include trees, water, snow, buildings, vehicles, and the ground.

(c) GPS reference systems

GPS surveying makes it easy to collect positional data using different positional references. This section explains the information needed to properly define a survey point using GPS. In order for the user to collect positional data, they must first specify the following reference information:

- coordinate system and projection (UTM, State plane, latitude/longitude, or local/assumed)
- horizontal datum (typically NAD83)
- vertical datum (typically NAVD88)
- elevation reference (mean sea level (MSL) or height above ellipse (HAE) (typically MSL)
- geoid model

Figure 1-72 Multipath delay is caused by the deflection of the incoming GPS signal off of a reflective object prior to hitting the receiver resulting in a longer time path

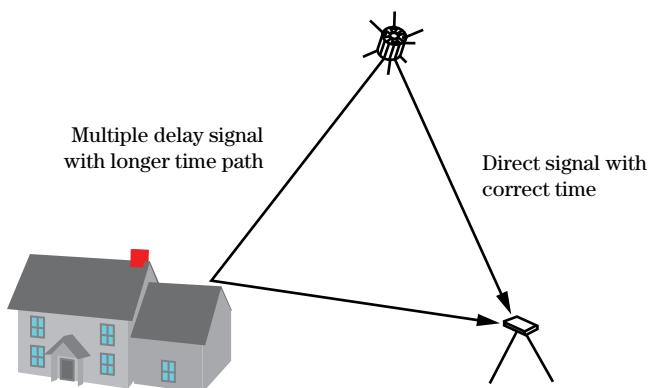

It is very important that the information specified above be included with any publishing of the data. For example, when survey data is sent to a designer as a text or CADD file, the information specified above must be included. Without this information the user of the survey will be unable to accurately reference other geographical information and will be unable to accurately reestablish the survey in the field.

The following is a general explanation of the user required inputs. Often times within the NRCS, the selection of all or most of these inputs is standardized for an entire State or region. With some exception, for example, possible project dependent requirements may require the survey to match published data or a local benchmark that uses a different reference system. A detailed understanding of many of the inputs requires a significant amount of mathematical and geophysical knowledge; but, a general understanding is all that is needed to collect accurate useful positional survey data.

(1) Coordinate systems

In surveying a coordinate system is one of two references needed to define the horizontal location of a point. Since the Earth is not flat, but is an irregular shape, a coordinate system needs to be coupled with a known and constant surface. This surface is called a horizontal datum and is covered in greater detail. A horizontal datum (reference surface) can be a flat/plane or it can account for the curvature of the Earth. **It is very important for the user to know that an identical coordinate point using a different datum can have a very large shift in its location on the Earth.**

There are four coordinate systems commonly used in the surveying community. They are Universal Transverse Mercator (UTM) coordinate system, State Plane Coordinate System (SPC), latitude and longitude coordinate systems, and Cartesian coordinate system. There are advantages and disadvantages to each system, but most often the system is chosen based on the intended use of the survey data.

For the purposes of this handbook, it is important to understand that a mathematical projection is used to transform a geodetic coordinate system to a planar coordinate system. These are based on the latitude, longitude, and ellipsoid being used for the area being surveyed. NGS has published projection tables for each

State. NGS also provides a link to a computation page that converts geodetic coordinates to State Plane coordinates. <http://www.ngs.noaa.gov/TOOLS/spc.shtml> (last accessed 20 March 2008).

Universal Transverse Mercator—Universal Transverse Mercator (UTM) is a two-dimensional horizontal system that divides the Earth sphere in to series of 60 UTM zones. UTM zone *numbers* designate individual longitudinal strips (fig. 1-73). Positions are described by a UTM zone number and northing, easting coordinates measured in meters. Each zone has a central meridian and coordinate positions within the zone are measured eastward from the central meridian and northward from the Equator. Eastings begin *false* easting of 500 kilometers so that only positive eastings are measured anywhere in the zone and increase eastward from the central meridian. Northings increase northward from the Equator with the Equator's value differing in each hemisphere. In the Northern Hemisphere, the Equator has a northing of 0, while in the Southern Hemisphere locations, the Equator is given a false northing of 10,000 kilometers.

State Plane Coordinate System—The State Plane Coordinate System (SPC) is a set of geographic coordinate systems unique to each State and is very popular among surveyors working on smaller projects because it allows for simpler plane surveying techniques. Each State has at least one State plane system that typically follows county lines. The biggest advantage to the SPC is that it is not influenced by the Earth curvature and works extremely well within the State plane zone. However, its disadvantage is that each zone uses its own coordinate system, and it becomes cumbersome to work between zones. Thus, outside of a specific State plane zone the system is not useful for regional or national mapping work.

Latitude and longitude coordinate systems—The latitude and longitude coordinate systems are Earth-centered systems or geocentric coordinate systems. The sphere of the Earth is divided into a series of circular planes north and south of the Equator called latitudes. The latitudes are actually angular measures from the line of origin at the Equator (= 0 degrees) to the poles (= 90 degrees). The east-west divisions

Figure 1-73 Divisions of the 60 longitudinal strips that make up the UTM system (Image is from Wikipedia <http://en.wikipedia.org/wiki/Image:Utm-zones.jpg> (last accessed March 20, 2008)).

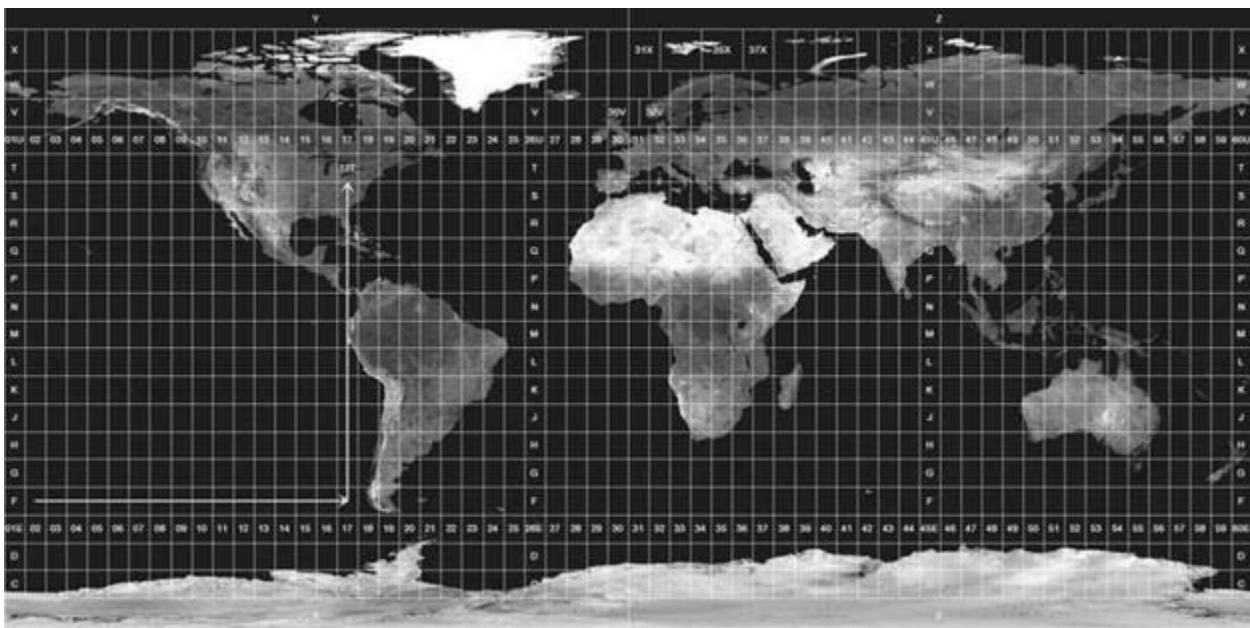

called longitude begin from an arbitrary reference line running north-south (Greenwich meridian). Lines joining points of the same longitude are called meridians. Values of the meridians denote the angular measure between the line of origin to the reference line and the meridian (fig. 1-74).

Cartesian coordinate system—In geometry or plane surveying, a Cartesian coordinate system (or commonly known as the rectangular system) is used to define the horizontal position of a point (P). Typically, x is used for the east-west dimension of P and y for the north-south dimension of P. In addition, the angular position of P to any other point may also be determined by the coordinate values (fig. 1-75).

When surveying using a Cartesian coordinate system, the assumption is made that the Earth is flat. Many NRCS surveys have been done using a Cartesian coordinate system. For most NRCS surveys where the project area is small, the error from not considering the Earth's curvature will be within project tolerances. However, the following should be considered before using a Cartesian coordinate system:

- Will other geographically referenced data be used with the survey data?
- Will the survey data be used in a GIS?
- Will the survey error be within the required tolerances if curvature is not considered?

(2) Horizontal datums

A horizontal datum can be described as a base reference for a coordinate system. Multiple horizontal datums have been created over time to account for the Earth's curvature. The methods used to create new horizontal datums have developed over time, especially since the advent of GPS. The newly created datums more accurately account for the Earth's curvature.

The most important thing to know about horizontal datums is that there is a horizontal shift between different datums. For example, in the State of Oregon, a coordinate system using NAD83 as the horizontal datum (base reference) can have a shift of up to 80 meters from the same coordinate system using NAD27 as the horizontal datum. Therefore, it is very important that the horizontal datum be known when using geodetic coordinates to define a point.

Figure 1-74 Latitudes and longitude coordinate system (Image is from Wikipedia http://en.wikipedia.org/wiki/Geographic_coordinate_system (last accessed March 20, 2008))

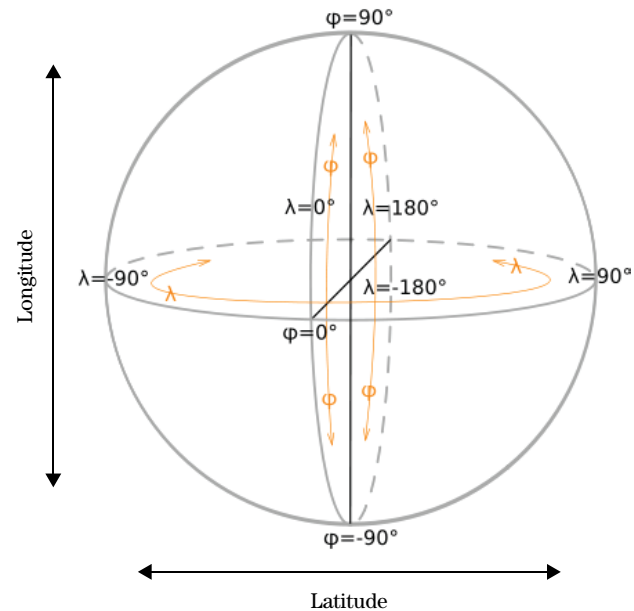
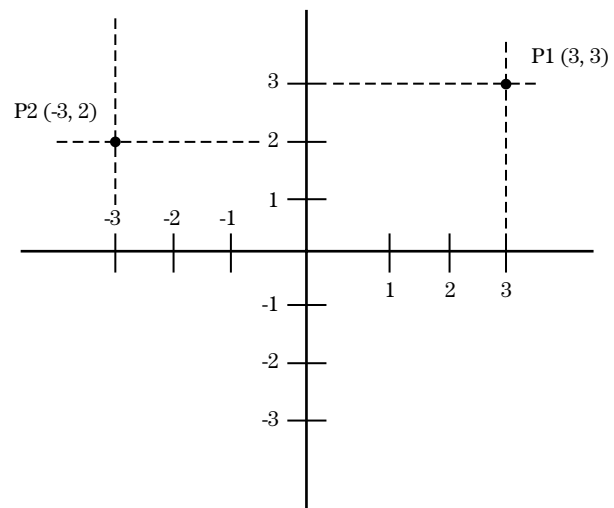

Figure 1-75 Cartesian coordinate system showing the rectangular coordinates of points P1 and P2 with respect to an origin (0, 0). In addition to the rectangular coordinates of each position, the distance and angular position of one point with respect to the other can be determined by simple geometry.



To account for Earth curvature, horizontal datums are based on an ellipsoid model. Ellipsoids are covered below in EFH650.0115(c)(4), Referenced Ellipsoid and Geoid Models.

The following are the most common horizontal datums encountered within NRCS. The majority of NRCS geodetically referenced surveys will use NAD83 as the horizontal datum. Typically, the only time a survey will be done using NAD27 is if important reference data uses NAD27 and there is a need to match the reference data. All GPS surveying equipment uses WGS84 and then converts to the specified horizontal datum. NAD83 is typically specified as the horizontal datum instead of WGS84 since within the United States, the differences between WGS84 and NAD83 are minor and a majority of reference data uses NAD83.

North American Datum of 1927 (NAD27)—Horizontal datums prior to 1927 were based on small and often meager control networks, and work based on measurements between different datums was inconsistent. The North American Datum of 1927, NAD27, was an adjustment made to the entire system of existing datums with a central origin at Meade's Ranch, Kansas, and computations for the ellipsoid based on the Clarke 1866 ellipsoid model. The datum served well incorporating Mexico and Canada and tying into Central and South America.

North American Datum of 1983 (NAD83)—In the decades following the advent of NAD27, increased accuracies and satellite positioning led to the development of a new datum, NAD83. Some of the changes to NAD83 were the adoption of a geocentric origin, slight changes to the flattening ratio of the ellipse, and more importantly was a switch from the foot-unit to the metric with State-defined values for conversion. It should be noted that the fitted ellipse is not consistent with all parts of the world regardless of chosen datum and that inconsistencies exist in routines that change (project) measurement data from one datum to another. Great care should be exercised to collect field measurements in the same datum as that chosen for mapping and calculations. Large positional shifts are to be expected between NAD27 and NAD83.

World Geodetic System of 1984 (WGS84)—With the advent of satellite systems, a new datum was begun in the 1960s by the Department of Defense and revised by 1984 as the *World Geodetic System* (WGS84). It is

currently the reference system being used by GPS and is considered globally consistent within ± 1 meter. The datum uses a geocentric origin and its development was supported by advances in astronomical measurements including surface gravity and other effects on global measures. The supporting ellipsoid model was initially the *Global Reference System* of 1980 (GRS80), but was followed by the WGS84 ellipsoid with minor refinements to the flattening ratios. As technologies evolve, a new global ellipsoid model is expected by 2010 using the *Earth Gravity Model* parameters first developed in 1996. Within the United States, the differences between NAD83 and WGS84 are minor.

(3) Vertical datums

A vertical datum is a point of reference to which elevations or heights are determined. This point of reference can be a *local vertical datum* (assumed elevation) or a *geodetic vertical datum* such as NGVD29, NAVD88, or a High Accuracy Reference Network (HARN). A geodetic vertical datum is used to obtain an elevation that is referenced to mean sea level. **It is important to understand that the zero mean sea level surface does not have a constant curvature. Instead it undulates based on gravitational anomalies.** Geoid models have been created to account for these gravitational anomalies. That is why a vertical datum and a geoid model must be chosen to obtain accurate elevation data. Explanation of geoid models is given under Reference ellipsoid and geoid models.

Local vertical datum—A local vertical datum is an assumed elevation given to a bench mark that is not tied to a geodetic reference system. For example, a point on a rock or a nail in a tree may be used as a temporary bench mark and given a made up elevation of 1000. For improved accuracy, a geoid model should still be used to account for gravitational anomalies.

National Geodetic Vertical Datum reference datum—The National Geodetic Vertical Datum reference datum (NGVD29) was established in 1929 from sets of tidal gauge measures at 26 stations and about 100,000 kilometers of leveling data across North America.

North American Vertical Datum of 1988—Adjustments to the NGVD29 were completed in 1991 with the addition of about 625,000 km of leveling data from 1988 and new measurements on numerous control monuments from the NGVD29 data set. The new stan-

dard adopted in 1991 is called the North American Vertical Datum of 1988 (NAVD88).

High Accuracy Reference Network—Upgrades to the existing NAD83 were undertaken by State and Federal agencies as a means to promote the use of GPS. Within the United States, this was known as the HARN.

Typically, HARN points will be used for larger area control networks and not necessarily on NRCS project areas. GPS users should always make note if the control station used is a HARN point. This will be important during post processing.

(4) Reference ellipsoid and geoid models

Geodetic coordinate systems use sophisticated models of the Earth's surface called ellipsoid models and geoid models to account for the irregular shape of the Earth. The geoid is a modeled surface of the Earth that coincides with the mean sea level elevation. However, because the geoid is affected by the uneven mass of the Earth, its surface is also uneven and is unable to be used as a horizontal reference. Therefore, a separate surface known as an ellipsoid (also called the reference ellipsoid) is used for the horizontal reference surface. The ellipsoid models account for curvature of the Earth by defining the Earth as an ellipse. **It is important for the user to understand that an ellipsoid model is used to define the horizontal datum (NAD27 or NAD83); therefore, by choosing a horizontal datum, they are choosing an ellipsoid**

model. Regardless of the vertical datum chosen, a geoid model must also be specified.

Mean sea level versus height above ellipse—There are two different elevations that can be derived in GPS. The height above mean sea level (MSL) is the topographic height (also called the orthometric height) of the ground above the mean sea level model (geoid model). The height above ellipsoid (HAE) is the topographic height above the geocentric ellipsoid model. For local project areas, the MSL height will always be the most appropriate to use. The HAE has a more global (or very large surface area) application (fig. 1-76). The user will need to specify which elevation model (MSL or HAE) to use and should verify this prior to data collection.

(5) Grid versus ground coordinates

GPS surveying equipment collects all data in ground coordinates. In other words, it follows the curved shape of the Earth. It does this by using the WGS84 ellipsoid for initial data collection. Grid coordinates are horizontal coordinates that are referenced using a planar or flat grid surface. Traditional surveying equipment such as a total station measures the level planer distance between two coordinate points. Because GPS coordinates (ground coordinates) are geodetic in nature, small refinements must be made when using these coordinates against a planar, or flat, grid. An example of this is using GPS to tie into State plane

Figure 1-76 The relationship of the geoid model, ellipsoid model, and topographic ground surface to each other. In typical profile leveling, the topographic surface or orthometric height above the geoid (MSL) is derived.

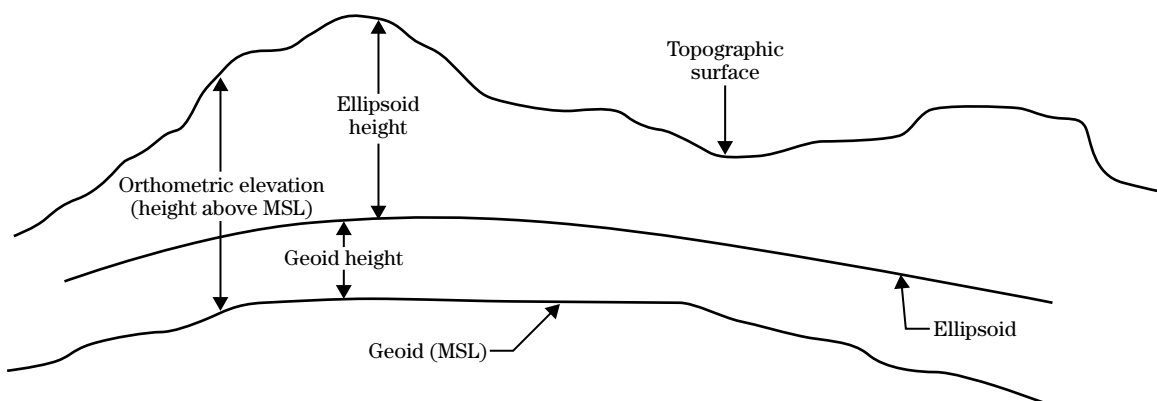

control points or combining GPS with traditional surveying such as a total station. Primary measurement errors occur in the distances computed (fig. 1-77).

The horizontal difference in location between grid coordinates and ground coordinates increases significantly with elevation. A good rule of thumb is there is roughly 0.1 feet of difference between a grid coordinate and a ground coordinate in horizontal location for every 1,000 feet of horizontal measurement per 1,000 feet in elevation.

In simple terms, the grid to ground problem must be addressed anytime a planar (two-dimensional) coordinate system, such as the SPC system or localized planar coordinate, is projected onto the curved surface of the Earth. When this condition is present, a scale factor must be used to move between the two coordinate systems. The scale factor is simply the ratio of the grid (flat surface) distance divided by the ground coordinate distance. The easiest solution is the use of the Earth-centered, Earth-fixed (ECEF) coordinate system which eliminates the problem of grid to ground. In the case of the Earth-centered coordinates, the ground coordinates should be used.

(d) GPS surveying concepts and techniques

This section provides guidance for surveying techniques using high-accuracy carrier phase GPS surveying for engineering projects within the NRCS. RTK and postprocessed methods are covered with a greater emphasis placed on RTK since a majority of GPS surveying in the NRCS for engineering projects uses this method.

GPS positioning techniques are dependant upon the purpose of the survey and its intended use. In general, positioning may be divided into point positioning for high-order control purposes or topographic and construction surveying of unknown positions utilizing the control points. For control purposes, the techniques of static positioning should be used. Kinematic (also called DGPS) or RTK techniques should be used for all construction and topographic purposes.

(1) Carrier phase survey techniques

Real-time kinematic positioning—RTK is currently the most common carrier-phase GPS surveying method used on NRCS projects. It is a later adaptation to kinematic positioning that uses the advantage of low fre-

Figure 1-77 Relationship of the ground distance to the grid distance. Because the grid is planar, it can be simply stated that the lengths on the grid surface are shorter than lengths on the ground surface.

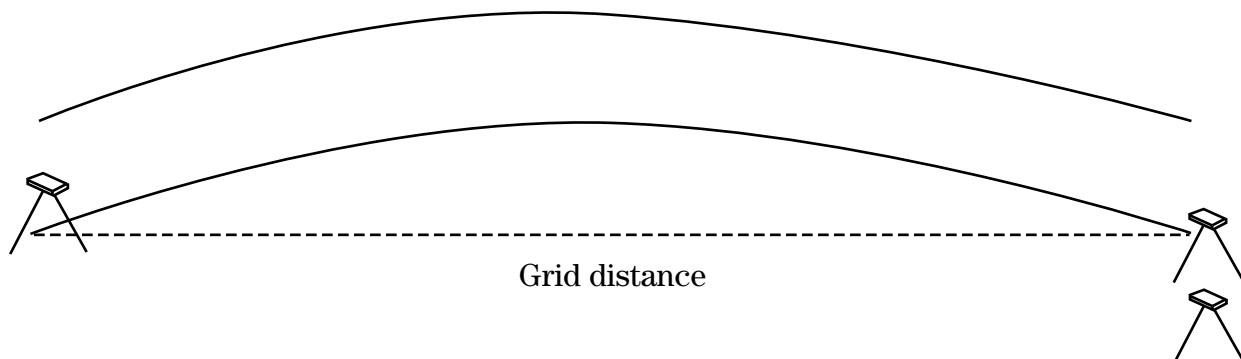

quency radio technology to transfer data from the base station receiver to the rover, where the rover processes the GPS data in real-time outputting a corrected position.

Kinematic surveys use two receivers, one a stationary base receiver, and the other as a rover. The base station does not need to be set over a known control; although, this is an optimal situation. In static mode with long enough occupation times (table 7), the base station point can become an adequate control point. The rover has the option of on-the-fly data collection or may be used in a point-to-point manner with multiple observables at each point. Typical occupation times are less than 1 minute. Accuracies of less than 0.1 foot can be expected when the rover is within 1 mile of the base (provided a good site calibration has been done—see later in this section).

Kinematic surveys are generally done in a radial manner about the base station. During the survey, if the radio link is lost, post-processing techniques similar to those used for kinematic can be used to complete the survey.

It should be noted that when using RTK, the radio frequencies can be limited in range (typically from 1 to 2 miles). Larger projects may require additional base setups or the use of radio frequency repeaters or boosters.

Real-time (RT) surveys differ in that the calculations are made at the time the data is collected and is immediately usable. The base reference receiver need not be onsite, but only within radio link distance. RTK surveys in the recent past were concerned with a number

of variables including float solutions and rover initializations. Modern data collectors and software advances have eliminated these from the concern of the user.

RTK site calibration—The calibration is the most important part of an RTK survey. A calibration is no more than tying into a Cartesian control for a project. The first thing considered is to find out whether the control is either State plane or site specific and then whether there are grid or ground coordinates. When using State plane grid, set up the project or data collector file to State plane. In using any other coordinates, set up the project to default and the data collector file to “no projection-no datum.” If there is a good latitude and longitude in either NAD83 or WGS84, one may use this position to start the base. Only use a latitude or longitude to start the base station. If there is no Lat/Long then you may either calculate a Lat/Long or use a “Here Position.” If you do not have a latitude and longitude for a control point, the user may also set up the base anywhere within or around the project area desired. Considering security and good satellite visibility in where the base station is set up.

In choosing the control for the calibration, a few things have to be kept in mind:

- Does the control constrain the site both horizontally and vertically?
- Is there at least 3 horizontal points and 4 vertical points to derive a residual for the control?
- For vertical, have available either 1 point with a Geoid Model or 5 points surrounding the project. A Geoid Model is strongly recommended for any calibration even if the user does not care about the vertical.

Table 1-7 Relative comparisons of static and rapid static techniques

Method	Minimum number of satellites	Baseline length	Occupation. time day	Occupation time night
Rapid static	4	Up to 5 km	5 to 10 min	5 min
	4	5 to 10 km	10 to 20 min	5 to 10 min
	5	10 to 15 km	More than 20 min	5 to 20 min
Static	4	15 to 30 km	1 to 2 h	1 h
	4	More than 30 km	2 to 3 h	2 h

- If the user does not have enough control to constrain the site, is it enough to fulfill the project objective?
- If the user has the minimum number of points to constrain a site, is all of the control there?
- Is there additional control available or is it necessary to add control to a site?

If a calibration is done in the office, one will not need to be done in the field. Make sure the base station is set up on a known calibration control station.

Remember: Once a calibration is completed, do not under any circumstances “re-do” or append the calibration. Once it is done, it is done.

Kinematic positioning—Kinematic positioning is an earlier generation technology to RTK for survey grade GPS. Standard kinematic surveying methods use a set of receivers. However, only one of the receivers is set in a stationary position collecting data in a static mode while the rover can be mobile and collecting data in a kinematic mode. Data collection requires lock on a minimum of four satellites for at least 10 minutes as with static/fast-static methods. Centimeter-grade precision is possible with occupation times of 30 seconds to 3 minutes. Data reduction is done by postprocessing using DGPS methods. Typical situations for kinematic surveys are the establishment of positions (x, y, z) not used for control purposes. Expected accuracies can range from 1/100,000 to 1/750,000.

Static positioning—Static surveying methods utilize a set of receivers in stationary positions. Establishment of baseline vectors is a routine purpose for static methods. Data collection on the points is done over a period of time (also called a session) that can range from 30 minutes to 2 hours of uninterrupted satellite lock. A requirement is that both receivers are in lock with the at least the same four satellites as a minimum. In a typical situation, the base station is set over a known point (x, y, z) and a rover unit is placed over an unknown point.

Session length is dependant on a number of variables including the number of visible satellites, the accuracy requirements of the baseline, and the type of equipment used. In general, the longer the baseline, the longer the session. Sessions of 30 minutes to 2 hours are

good time estimates for baselines 1 to 30 kilometers. Expected accuracy for static methods can be as high as 1/5,000,000. Actual accuracy for any static survey can be computed following postprocessing.

It is important that the two receivers maintain lock on the same satellites during the same time period (also called satellite common period) in order to calculate the vector differences between the two receivers. Differences in the time periods will not be used in these calculations.

Rapid static positioning—Generally, the only difference between rapid static and static GPS techniques is the occupation time (table 1–7). A good rule of thumb is static positioning uses occupations of 1 hour or longer, while rapid static uses occupation times of less than 1 hour. In general, positions obtained from rapid static will be less precise than static. Rapid static is generally used for shorter baselines.

Cellular network real-time kinematic positioning (eRTK/VRS)—Cellular network RTK is also known as extended RTK or eRTK. The concept behind eRTK is an expansion of the network of baseline coverage by use of an Internet connection over cellular phone technology. The eRTK system can use a number of different base configurations including conventional RTK base, eRTK base, eRTK multiple base, or eRTK virtual reference station (VRS). The rover dials into the base station cellular phone, and the base begins sending back the correction data to the rover via the same cell link.

The use of multiple stations in eRTK expands the operating area to beyond 20 kilometers, the recommended limit for the single base. Use of VRS expands even further using a series of base stations that form a triangulation network. To initialize VRS positioning, the eRTK rover dials into the network and supplies its approximate location. The VRS network generates a set of virtual measurements similar to that which would be observed by an actual reference station located at the user’s position, hence the term “virtual reference station.” Using the VRS, coverage area expands to more than 3,750 square kilometers (fig. 1–78).

The advantage of eRTK over conventional RTK is that conventional RTK is limited to an approximate area of 300 square kilometers, while eRTK is able to work more than 1,250 square kilometers with a single-base

setup. With multiple-base setup on a single frequency, eRTK can cover more than 2,000 square kilometers. Keep in mind the RTK published precision specifications to ensure the required accuracies are maintained. Adding VRS to the eRTK setup expands the operating area to more than 3,750 square kilometers.

The use of VRS requires a number of established base stations as shown by the black triangles in the figure 1-78. Once the rover base has accessed the VRS system by cell phone, a virtual base is created near the approximate survey location of the rover. Correction data from the actual reference stations are used to generate correction values for the virtual station, which are then used to correct the rover real-time. The use of the actual reference stations is the idea behind the expansion of the working area while the virtual reference is generated to ensure close proximity of the rover to the base.

General advantages of VRS include:

- High-accuracy real-time kinematic GPS positioning
- Fixed virtual reference station network available at any time without setting up a base station
- Common control network for large areas
- Real-time atmospheric error correction
- Built-in integrity monitoring by VRS server
- Seamless package of GPS hardware, modeling and networking software, and communications interface

(e) Planning a differential carrier phase RTK survey

This section provides guidance for planning an RTK survey for analysis, design, and construction of engineering projects within the NRCS. This is not an exhaustive list, and not all of the presented steps may be necessary, depending on the scale and scope of the individual project.

(1) General planning considerations

The key steps for planning a GPS survey are outlined below:

- Project objectives
 - How will this survey be used
 - Types of analysis
 - Compatibility with other surveys/data sources (GIS or LIDAR for example)
 - Compatibility with other agencies/public projects
 - Compatibility with traditional survey techniques
 - Number and type of required horizontal control or benchmarks
 - Horizontal and vertical datum to be used
 - Consideration of future design, construction, and mapping activities
 - Accuracy requirements
 - Point density
 - Primary and secondary control for future use

Figure 1-78 Conceptual setup for eRTK using Virtual Reference technology. The VRS generate a virtual reference position in the vicinity of the rover and transmit this via a cellular phone network. Area coverage expands the traditional RTK by magnitudes.

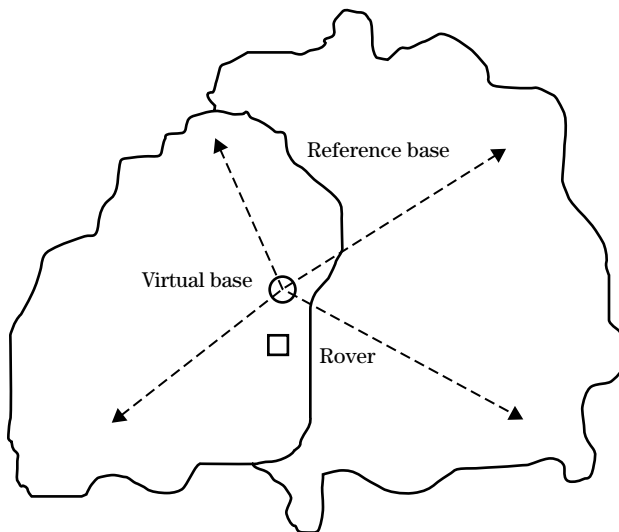

-
- Accuracy requirements
 - Number, location, and type of required horizontal control or benchmarks
 - Number and type of vertical control or benchmarks (Note: Vertical control must be proportionate to create a good geometric plane.)
 - Required design accuracy
 - Required stakeout accuracy
 - Equipment resources
 - GPS equipment availability
 - Number of receivers required
 - Tripods, antennas, rover poles, etc.
 - Data collector(s)
 - Personnel available
 - Traditional survey equipment required (i.e., total station)
 - Auxiliary equipment availability
 - Batteries
 - Necessary cables
 - Power supplies
 - Flashlights for night observations
 - Laptops for field downloading
 - Field transportation (ATV for example)
 - GPS procedures
 - Field procedure
 - Equipment requirements (see above)
 - Observation time schedules
 - Session parameters
 - Control design and setup
 - Postprocessing requirements
 - Is post-processing required on site
 - Quality control requirements
 - Data output requirements (i.e., ASCII, DGN)
 - Is a written record of survey required
 - Session parameters
 - Station numbering designations
 - Specific numbering sequences
 - Logging session requirements
 - Network design and connections
 - Project size and requirements for control
 - If control exists
 - Adequacy of existing control
 - Accuracy of the existing control
 - Datum of record for existing control
 - Site calibration plan
 - Establishment of new control
 - Datum of record to be used and its compatibility with any existing control
 - Physical restrictions to access on the site
 - Land rights
 - Physical ability to access
 - GPS signal accessibility
 - Line of sight requirements
 - Connections to NGRS/CORS (includes existing coordinates, i.e., HARN)
 - Site calibration requirements (i.e., local control being used)
 - Data collection and adjustment techniques
 - Minimum accuracy requirements
 - Feature, attribute, and format requirements (pull-down menus where possible)
 - Metadata compatibility (i.e., compatible feature names)
 - Significant figures, for example
 - Data collection session time
 - Data management
 - How will data be used
 - Consistent format
 - Download data as soon as possible
 - Postprocessing time frames OPUS, for example, has a 30-day limit
 - Baseline requirements
 - Adjustment criteria
 - Quality control requirements
 - Final report format
 - Site access and restrictions
 - Reconnaissance survey
 - Intervisibility
 - Local laws and restrictions

(f) GPS quality control

A summary of the planning process in the previous section can be thought of as a quality control precheck. Quality of GPS data is dependent upon recognition of the error types inherent in the system and the survey. A detailed discussion of modeling and mitigation of all error types is beyond the scope of this document. However, the previous discussion of error types associated with the signal should give an indication of the need to select the appropriate survey techniques for the desired accuracy. With regard to the typical survey crew, careful attention to details of the survey set-up, especially antenna height measurements, and instrumentation checks should nearly eliminate blunders from the survey results.

A key ingredient in any quality control process is reporting and documentation. All data should be downloaded and archived, and proper and complete documentation of all GPS projects should be reported:

- Provide a description of the project in narrative form that includes the project conditions, objectives, methodologies, QC/QA procedures, and conclusions.
- Provide a listing of the observation plan, equipment used, satellite constellation status, and observables recorded.
- Provide a listing of the data processing performed including software used (version number, etc.) and the techniques employed (including ambiguity resolution), and any error modeling used.
- Provide a summary and detailed analysis of the minimally constrained and the constrained Least Squares network adjustments performed. This includes listing of the baseline observations and parameters included in the adjustment. List the absolute and standardized residuals, the variance factor, and the relative error ellipse/ellipsoid information.
- Identify data or baseline solutions excluded from the network with an explanation as to why it was rejected.
- Provide details of the transformation model used, or derived, and any GPS/geoid height information that was determined.
- Include a diagram of the project stations and control points at an appropriate scale. Descriptions

for each of the monuments should be included, perhaps accompanied by photographs.

Validation of the survey itself can be made by:

- equipment and crew testing on a standardized test network established on the premises
- multiple occupations of GPS points and baselines; without redundant measurements, errors may not be detectable
- relative accuracy checks against standards for survey order
- study of measurement residuals following adjustments

(g) GPS survey procedures

This section provides guidance on typical equipment setup for general RTK survey operations, as well as RTK surveying procedures for control, topographic, and construction surveys, which are the three main types of surveys used by the NRCS.

Prior to the start of any GPS session, all data logs or data sheets should be set up. If specific data forms are used, all field reference data should be entered including typical information as:

- project name
- session date and time
- operator(s) name
- weather conditions
- equipment type used
- height of instrument
- antenna(s) height
- field sketch

(1) Typical equipment setup

Questions on specifics regarding software and hardware including configurations and actual unit operation should be referred to manufacturer's operating manuals. **Note:** This section contains information on establishing and initializing equipment. While the manufacturer's manuals should be consulted, a Web site that contains configuration information for most manufacturers can be found at http://update.carlsonsw.com/docu/survc/SurvcE_Help.html?SettingsTopconGPS (last accessed March 20, 2008).

A typical setup is shown in figures 1-79 and 1-80.

Figure 1-79 Typical equipment setup

- (a) Setup for the rover unit with attached data collector. The data collector communicates by low-frequency radio technology with the rover receiver attached to the top of the range pole.
- (b) Base station receiver setup on the tripod. The base station communicates to the rover by radio.

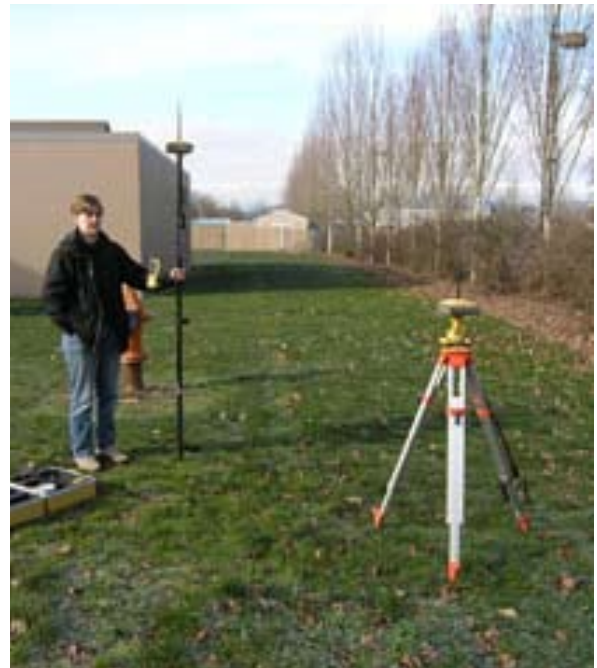

Figure 1-80 Typical setup for the base station over a known control point. The operator has used the optical plummet to center the base. Once the base is set, careful vertical measurement of the antenna slant height is made.



Establish base station—The base station receiver should always be set up in a manner consistent with good survey practices. Tripods should be stable and set in a manner to establish a point position for the base instrument over the control point. Tribrachs should be carefully set where used and optical plumbets should be used in conjunction with a plumb bob as a check for centering accuracy. Power should be supplied to the base station prior to the beginning of the session to allow adequate time for satellite lock, usually 2 to 4 minutes. The base should be located in an area with a free or near free view of the sky to a low zenith position when possible. Additionally, tripods should be set up as high as possible to help reduce multipath.

During the base setup, it is important to correctly measure the antenna and instrument height. All antennas and instruments will have some reference mark, and the user should note where this is and measure correctly to it. The measurement to the reference point should be vertical.

For construction and topographic surveys, the base reference receiver need not be onsite, but only within radio link distance. RTK surveys in the recent past were concerned with a number of variables including float solutions and rover initializations. Modern data collectors and software advances have eliminated these from the concern of the user.

The occupied reference station should be checked for correct coordinate values.

The tripod and tribrach holding the receiver base should be carefully positioned and plumbed over the base point.

Setup survey controller—The survey controller should be setup prior to data collection.

- The preferred geoid model, datum, and projection have been chosen and entered into the controller.
- Height of instrument should be recorded where asked for. The GPS antenna height should be carefully measured and recorded. Follow manufacturer's diagram for the correct antenna reference point.

- In the case of a known control, the correct coordinates should be known ahead of time, and verification should be made that northing and eastings (or UTM) have been entered correctly.
- In the case of State plane coordinates, make sure the correct SPC zone is selected.

Establish connection between controller and base station—Communication parameters between the controller and base should be set and tested prior to the project. Most instruments rely on some type of radio link (i.e., Bluetooth) that has parameters for operation including port number. Refer to the user manual or dealer representative for help with this. It should be noted that during operation it is not uncommon to lose the radio link. A cable should always be on hand as a backup to the wireless communications.

Initialize radio communications—

- The radio link to the base is established and working properly between the base and the rover and controller.
- Communication parameters between the base station and rover should also be set and tested prior to the project. The same instructions apply to this as with the controller link.

Initialize base station and rover—Most modern GPS units do an automatic on-the-fly (OTF) initialization that requires no user input. For initialization on an unknown point, the receiver will do this in a short time period transparent to the user. Most receivers are capable of a more rapid initialization to a known point.

Additionally the rover unit initialization is also transparent. Automatic ambiguity resolution avoids having to initialize from a known mark. The stationary base provides reference signals to the rover unit that moves about to conduct a survey. There is no constraint on the rover during initialization; it may be stationary or moving.

System check—A system check should be done prior to collecting GPS data. RTK system checks should also be done during the course of the survey session. A system check is performed by measurement from the base setup to another known project control monument. The resulting observed position is then compared to the previously observed position for the

known point. The difference in the present and past measurements should typically be within ± 2.5 centimeters in horizontal position and within ± 5 centimeters in elevation.

(2) Main types of surveys

GPS surveys fall into two main types, postprocessed and real-time. Only data collection is done in the field for postprocessed surveys. GPS receivers collect data for different lengths of time, depending on the requirements of the project. Once the data is collected it is taken back to the office and uploaded to a computer. The computer then makes all of the necessary calculations and provides positioning information.

Control surveying—The purpose of a control survey is to establish the location of a reference point in an arbitrary location for use later in additional survey work. The following considerations should be given to the number and location of control monuments:

- A minimum of four control points are needed to perform a full site calibration.
- Consider placing additional control monuments in case some are damaged or removed.
- All control monument locations need to have a clear view of the sky—360-degree clear sky greater than 10 degrees.
- The outer boundary control monuments need to be spaced with significant separation in both the north/south and east/west directions (good strength of figure).
- When a site calibration has been performed, the survey must stay within the polygon created by the outer control points.
- Try to centrally locate the base station control point.
- Try to locate the base station control point at a high point where radio communication between the rover and base will have the least interference from dense trees and landforms such as ravines and hills.

By their nature, control surveys are the highest accuracy surveys. Control surveying will generally use postprocessed static techniques. The general procedure for static control GPS utilizes multiple baselines, multiple observations, and multiple sessions. The results produce redundancy that can be not only postprocessed,

but a highly accurate solution is derived from a least squares network adjustment of the data.

General field procedures for static surveys are:

- The base receiver is set up over a control point (known or to be established).
- To stake out grid coordinates (i.e., working with State plane control monuments), define a projection and datum transformation.
- The rover or second base is set up over a point whose coordinate position is desired for control.
- Both receivers must have lock on a minimum of four of the same satellites during the occupation time.
- A good approximation for occupation time is 30 minutes to 2 hours, depending on the length of the baseline and other conditions that affect the survey.
- For baselines longer than about 30 kilometers, observation times may increase significantly (see table 1–6).
- After the data has been collected at the first set of points, the rover is then moved to the next point, and the process is repeated until all of the points to be surveyed have been occupied.
- Verification of the survey results should be made prior to the end of the survey and any data processing should be done at that time where applicable. In the case of a control network, verification of survey results may be made in the field by a successful least squares adjustment if a laptop and the appropriate software are available.
- After verification it is important to close the survey job. This step sets important information into the data file that will be read later by the processing software. Not closing the survey job may result in problems with the data input during post-processing.
- Data should be downloaded to a PC or laptop as soon as possible following the survey.
- Data must be postprocessed, typically by a least squares adjustment.

Topographic surveying—Topographic surveying will generally use RTK techniques. The accuracy requirements for the design will determine the density of the data points needed to represent the topography. It

is important to obtain breaklines at major slope changes that occur within a small distance. For example the slope changes from the front slope of a dam to the top of a dam and ridgelines and drainages. RT surveys differ in that the calculations are made at the time the data is collected and is immediately usable.

The general procedures for topographic surveys are:

- The RTK base receiver is set over a control (known or to be established) position point.
- If a known position is not available, a static GPS control point can be established while topographic surveying and setting additional control points as long as the base is running for the minimum time shown in table 1. Postprocessing against a different base station or CORS will be required. A minimum of three additional control points should be set on the outer bounds of the construction site for future site calibration
- If control has already been established onsite, a site calibration should be performed.
- The rover is positioned over a point whose coordinate position is desired
 - The rover receiver is then moved in a radial manner to each required point and held until a locked position is acquired (typically 5 seconds to 30 seconds), or
 - The rover is moved OTF, for example, by ATV.
- Verification of the survey results should be made prior to the end of the survey and any data processing should be done at that time where applicable.
- After verification it is important to close the survey job. This step sets important information into the data file that will be read later by the processing software. Not closing the survey job may result in problems with the data input during postprocessing.
- Data should be downloaded to a PC or laptop as soon as possible following the survey.
- Data should be postprocessed.

Construction surveying—Construction surveying is the setting of stakes or other markings used to control the elevation, horizontal position, dimension, and configuration of constructed items. Construction applications for GPS are primarily in survey staking or stake-out, the marking of sites for grade alignment, or

structural locations. Construction surveying procedures with GPS can only be done using RTK.

The general procedures for construction stake out surveys are:

- The RTK base receiver is set over an established benchmark generally published on the project drawings.
- To stake out grid coordinates, define a projection and datum transformation.
- A full site calibration is recommended using a minimum of four 3D points.
- Define the point/line/arc/DTM by keying in the data, transferring a file from a PC, or calculate coordinates using a COGO function.
- Navigate to the point.
- Stake out the point.
- Check point once set.
- Establishment of additional benchmarks by static surveying methods may be required outside the construction limits. It is important to recognize that on a construction site the control point set may be used many times and must be fairly permanent.

(3) Postprocessed methods

Postprocessing is used in DGPS to obtain precise positions of unknown points by relating them to known points such as base stations or other reference points. Following the field data collection the user will need to download data from the GPS to a PC and perform postprocessing. All collected GPS data needs some form of postprocessing (as a quality control check), regardless of whether it has been differentially corrected. While the field data is on the screen, the user can identify any unwanted positions and/or features as well as attribute information. Editing of the data can be done if necessary at this step. It is important to have clear procedures for post-field data management and verification.

Procedures for downloading data are the same for almost all equipment. General procedures are:

- The data collector or receiver is connected to a PC or laptop that has the post processing software on it.

- Postprocessing software is started on the PC and set to a mode for data download or transfer.
- Data files are selected and transfer is begun.

Procedures for postprocessing are also the same for almost all equipment. DGPS postprocessing is done following data collection using either internal software that corresponds to the field GPS equipment or by some online postprocessing positioning service like OPUS.

General procedures for DGPS data are:

- A network or internet connection is required to access remote base files.
- Postprocessing software is started on the PC and set to a mode for postprocessing. Usually, this will be labeled differential correction in the case of DGPS data or baseline processing for carrier data.
- Data files to be processed are selected.
- The base receiver is selected from which to receive base files. Usually, this will be one close to the work site.
- Postprocessing is begun.

Online Positioning User Service (OPUS)—NGS also operates the Online Positioning User Service (OPUS) as another alternative to manufacturer's internal software that allows GPS users access to the National Spatial Reference System (NSRS). OPUS users can submit GPS data files to NGS online where the data is processed and positioning determined with respect to CORS sites selected by a set of variables related to the user data set. Positioning data are e-mailed back to the user in several coordinate files including UTM, State plane and others. OPUS is an automatic system that uses only minimal input from the user. For more information on using OPUS or for downloading files to OPUS, refer to the NGS Web site http://www.ngs.noaa.gov/OPUS/What_is_OPUS.html.

Online Positioning User Service (OPUS) process—The following information is from the OPUS Web site. OPUS allows users to submit their GPS data files to NGS, where the data will be processed to determine a position using NGS computers and software. Each data file that is submitted will be processed with respect to three CORS sites. The sites selected may not be the nearest to the user's site but are selected by dis-

tance, number of observations, site stability, etc. The position for the user's data will be reported back to via e-mail in both ITRF and NAD83 coordinates, as well as UTM, USNG, and SPC northing and easting.

OPUS is completely automatic and requires only a minimal amount of information from the user:

- e-mail address where the user wants the results sent
- data file that the user wants to process (selected using the browse feature)
- antenna type used to collect this data file (selected from a list of calibrated GPS antennas)
- height of the Antenna Reference Point (ARP) above the monument or mark being positioned
- as an option, user may also enter the SPC code if SPC northing and easting is desired
- as an option, user may select up to three base stations to be used in determining the solution

Once this information is complete, click the Upload button to send the data to NGS. The results will be e-mailed to the user, usually within a few minutes. The user may upload multiple data files in a zip archive. However, be careful, the options that chosen will be applied to all of the data files in that archive (i.e., the same antenna type, ARP height will be used for all of the files in the zip file).

Additional detail on using OPUS is found at http://www.ngs.noaa.gov/OPUS/Using_OPUS.html.

In addition, the upload procedures can be found there, as well. A sample of output from OPUS is shown in figure 1–81. It is important to pay attention to the items given in the output report, for example, the elevation height and orthometric heights. Refer back to figure 1–76 for the differences between these heights.

Figure 1-81 Sample output data from an OPUS run

NGS OPUS SOLUTION REPORT			
=====			
USER:	Your.email@somewhere.com		DATE: October 27, 2004
RINEX FILE:	7615289n.04o		TIME: 18:49:54 UTC
SOFTWARE:	page5 0407.16 master7.pl		START: 2004/10/15 13:37:00
EPHEMERIS:	igr12925.eph [rapid]		STOP: 2004/10/15 18:10:00
NAV FILE:	brdc2880.04n		OBS USED: 8686 / 8804 : 99%
ANT NAME:	ASH700829.3 SNOW		# FIXED AMB: 41 / 42 : 98%
ARP HEIGHT:	1.295		OVERALL RMS: 0.020 (m)
REF FRAME:	NAD83 (CORS96) (EPOCH:2002.0000)		ITRF00 (EPOCH:2004.7887)
X:	-552474.327 (m) 0.015 (m)		-552475.001 (m) 0.015 (m)
Y:	-4664767.953 (m) 0.021 (m)		-4664766.631 (m) 0.021 (m)
Z:	4300548.721 (m) 0.024 (m)		300548.654 (m) 0.024 (m)
LAT:	42 39 59.51026 0.007 (m)		42 39 59.53576 0.008 (m)
E LON:	263 14 44.18589 0.013 (m)		263 14 44.14967 0.013 (m)
W LON:	96 45 15.81411 0.013 (m)		96 45 15.85033 0.013 (m)
EL HGT:	314.705 (m) 0.041 (m)		313.753 (m) 0.033 (m)
ORTHO HGT:	340.240 (m) 0.041 (m)		[Geoid03 NAVD88]
UTM COORDINATES		STATE PLANE COORDINATES	
UTM (Zone 14)		SPC (4002 SD S)	
Northing (Y) [meters]	4726229.423	43336.983	
Easting (X) [meters]	684026.367	893325.488	

Figure 1-81 Sample output data from an OPUS run—Continued

Combined Factor		0.99996731	0.99999430
US NATIONAL GRID DESIGNATOR: 14TPN8402626229 (NAD 83)			
BASE STATIONS USED			
PID	DESIGNATION	LATITUDE	LONGITUDE
AI1569	NLGN NELIGH CORS ARP	N421224.250 W0974743.043	DISTANCE (m) 99724.2
DF7469	SDSF EROS DATA CENTER CORS ARP	N434401.727 W0963718.541	119065.7
AH5054	OMH1 OMAHA 1 CORS ARP	N414641.765 W0955440.671	120751.8
NEAREST NGS PUBLISHED CONTROL POINT			
NM0874	D 276	N423846. W0964505.	2286.4
This position was computed without any knowledge by the National Geodetic Survey regarding equipment or field operating procedures used.			

650.0116 Specialized surveys

(a) Route surveying

Route surveying can be defined broadly as the survey of any route of transportation. Generally, this is understood as the transportation of people, for example, roads and highways, but also can be understood as the transportation of materials like liquid, gas, or electrical, as is the case for pipelines and transmission lines. The examples in this section are primarily for roads, but the concepts for other transportation are the same. The survey of any route follows the same principles as any other line survey with the exception of the intersection of two or more routes at a common station (the route traverse) and the survey of curves.

Route traverse—The route traverse is first surveyed as a series of connecting tangents and is called the preliminary line or P-line. Changes in direction of any two tangents occur at a station called the point of intersection or PI (fig. 1-82). The first tangent in the direction of the survey is called the back tangent, and the second is called the forward tangent.

The final design of the route will insert circular or other type curves into the two tangents, and is called the location line or L-line. In figure 1-83, the L-line in bold shows the curve that has been fit to the two tangents from the P-line.

A new route survey almost always will begin from an existing route. For example, a spur or connector road will begin from some established primary road (fig. 1-84).

The survey of any new route will include a partial survey of the primary line called the baseline. The baseline survey is generally a survey of approximately 200 feet on each side of the proposed intersection (fig. 1-85).

This survey usually is done in short stations of about 25 feet each to give the route designers enough ground information to design the intersection. In the case of large route projects, the designer may want longer baselines or shorter stations.

Figure 1-82 Preliminary line (P-line)

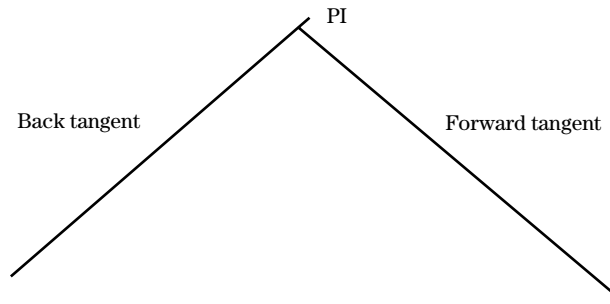

Figure 1-83 Location line (L-line)

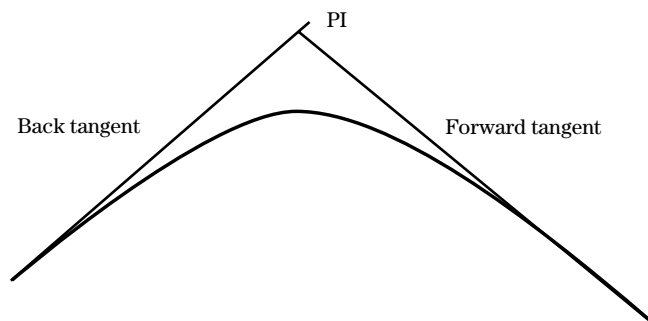

Figure 1-84 New route survey

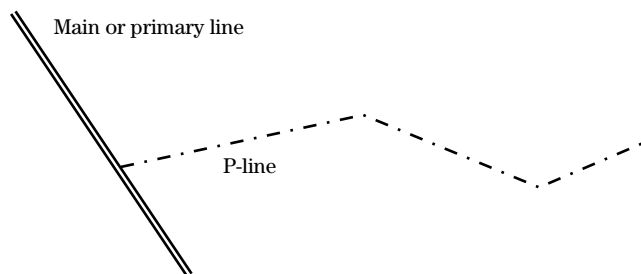
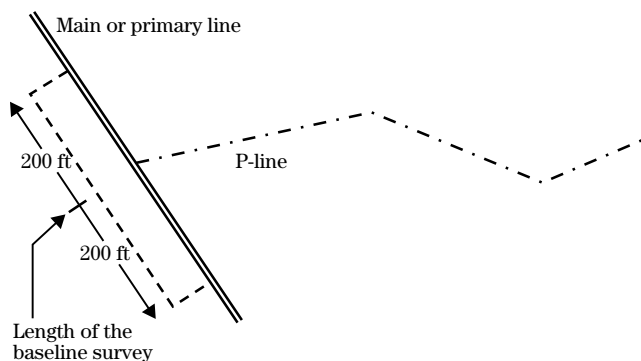

Figure 1-85 Survey of the baseline



At the point of intersection between the baseline and the P-line is a station known as an equation station. The equation station indicates that a survey position on one line is equal to a survey position on another, usually the beginning. The equation station carries a special designation for stationing that includes the station value for the baseline over the station value for the P-line. For example, in figure 1-85, if the baseline survey begins at 0+00⁰ and at the point of intersection the value is 2 + 01⁸, the equation station would be written as:

$$\frac{B \ 2 + 01^8}{P \ 0 + 00^0}$$

where:

B = stationing of the baseline

P = stationing of the P-line

Circular curves—The survey and staking of curve is based on criteria from the design engineer that in-

cludes, but is not limited to, design speed, vehicle type, road surfacing, and natural terrain.

In general, the surveyor will be concerned with simple circular curves (a circular arc tangent to two straight sections of a route or line). A simple circular curve has the same radius and degree of curvature throughout the curve. Other curve types that should be known are compound curves (a curve with different radii and/or degrees of curvature), reverse curves (two curves that accomplish a change in direction with no tangent between them), and spirals (a special type of curve of differing radii designed for either increasing or decreasing speed, for example, on highway off ramps) (fig. 1-86).

Simple circular curves—Sometimes, it is necessary or desirable to place a circular curve at the intersection of two tangent lines. Curves help reduce the rate of change of direction and improve hydraulic characteristics of canals and drains (fig. 1-87).

Figure 1-86 Types of route curves

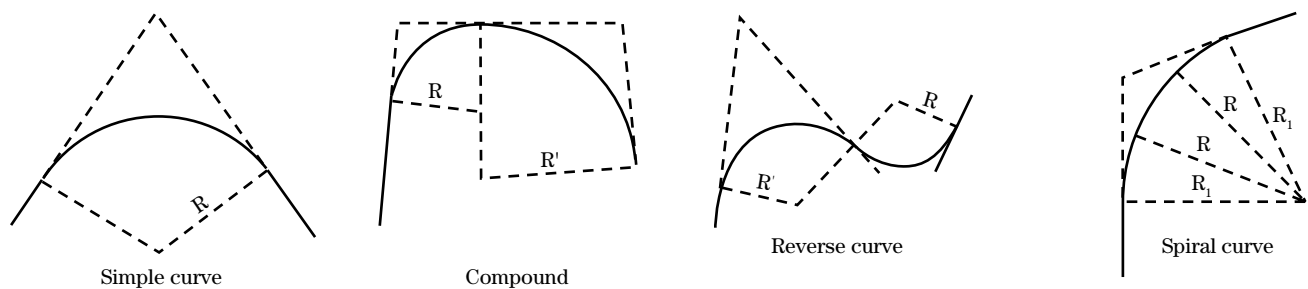
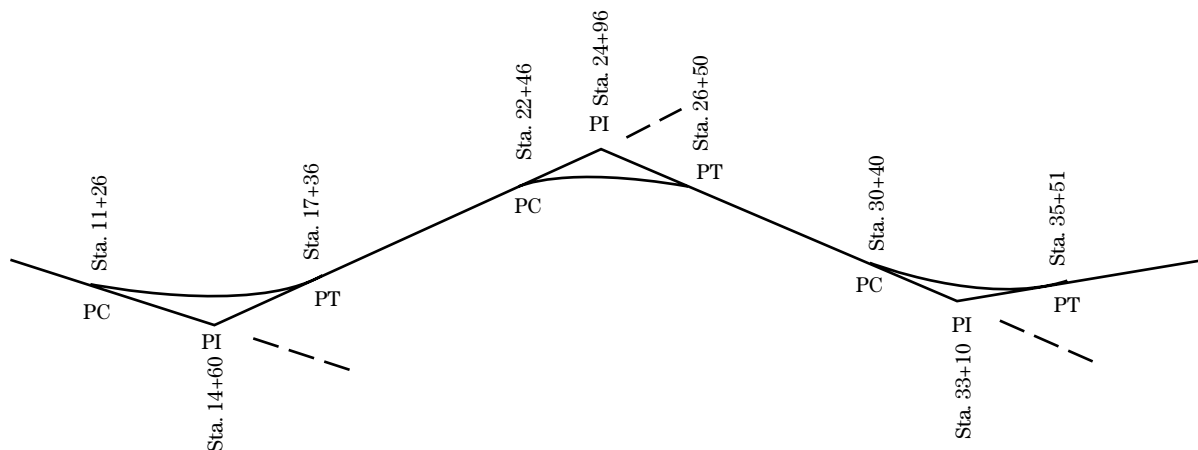

Figure 1-87 Circular curves in a traverse survey



It is easiest to consider the simple curve and its component parts as a section of a circle. The calculation of the various parts of the curve can be done using some simple concepts of circle geometry and applying them as the ratio of the curve to the full circle. Two key principles to use are (a) all circles are 360 degrees, and (b) the circumference of any circle is calculated as:

$$\text{Circumference} = 2\pi R$$

where:

R = the radius of the circle

π = 3.14

A key principle is that for any curve, the ratio of the degree of curvature to 360 degrees is equal to the ratio of the curve length to the circumference of the circle.

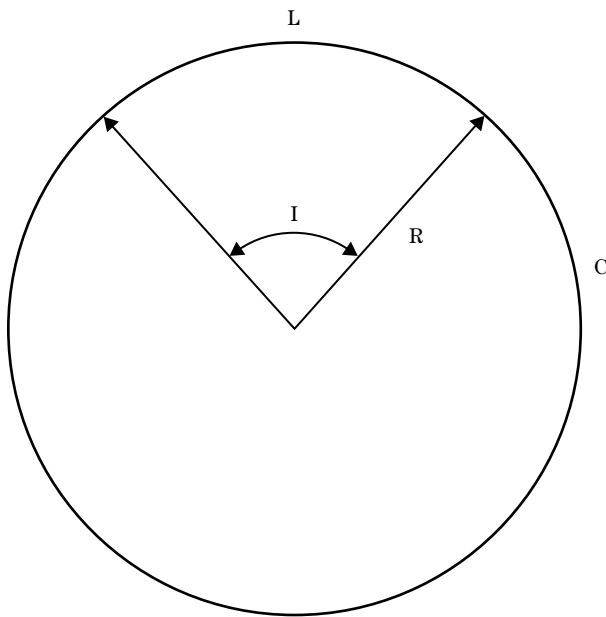

$$\frac{L}{C} = \frac{I^\circ}{360^\circ}$$

where:

C = circumference of the circle

L = the length of the curve

I = the angle of intersection = central angle

For example, suppose we have a simple curve with a radius of 720 feet and a central angle of 55° . The length of the curve can be calculated as:

$$\text{Circumference} = 2\pi(720 \text{ ft}) = 2,362.2 \text{ ft}$$

and

$$\frac{L \text{ (ft)}}{2,362.2 \text{ ft}} = \frac{55^\circ}{360^\circ}$$

and

$$L = 360.9 \text{ ft}$$

Circular curve layout by transit or total station—The elements of a circular curve (fig. 1–88) are:

R – radius of the curve in meters or feet

V – vertex or point of intersection (PI) of the two tangents to the curve

I – intersection angle, which is the deflection angle (right or left) of the two tangents and is equal to the angle between the radii

PC – point of curvature, which is the point on the back tangent where the tangent A ends and the curve begins

PT – point of tangency, which is the point where the curve ends on the forward tangent and the tangent B begins

L – length of curve from the PC to the PT in meters or feet

T – tangent distance, which is the distance from the vertex V (or PI) to the PC or PT in meters or feet

E – external distance, which is the distance from the vertex V to the midpoint of the curve in meters or feet

C – the long chord, which is the straight-line distance from the PC to the PT in meters or feet

M – middle ordinate, which is the distance from the midpoint of the curve to the midpoint of the long chord in meters or feet

D – the degree of curve, which is the angle at the center subtended by a 100 foot arc

d – angle at center subtended by a subchord

c – chord or subchord

The following relationships exist between the various curve elements:

$$T = R \tan\left(\frac{I}{2}\right)$$

$$E = R \left(\frac{1}{\cos\left(\frac{I}{2}\right)} \right)$$

$$\sin \frac{1}{2}D = \frac{c}{2R}$$

$$C = 2R \sin\left(\frac{I}{2}\right)$$

$$L = c \left(\frac{I}{D} \right) \text{ (curve length measured measured along chords)}$$

$$M = R \left(1 - \cos \frac{I}{2} \right)$$

The following example illustrates the use of the formulas with the use of natural trigonometric tables only.

Example:

Given:

$$\begin{aligned} \text{Intersection angle } I &= 38^\circ 40' \\ \text{Tangent distance } T &= 150.0 \text{ ft} \\ \text{Chord length } c &= 100 \text{ ft} \end{aligned}$$

Find:

Radius, R
Degree of curve, D
Length of curve, L
Computed external distance, E
Computed deflection angles and points on the curve

- To find radius, R:

$$T = R \tan \frac{I}{2} \text{ or } R = \frac{T}{\tan \frac{I}{2}}$$

$$I = 38^\circ 40', \frac{I}{2} = 19^\circ 20'$$

$$\tan 19^\circ 20' = 0.35085$$

$$R = \frac{150.0}{0.35085} = 427.53 \text{ ft}$$

- To find degree of curve, D:

$$\sin \frac{1}{2}D = \frac{c}{2R} = \frac{100}{2 \times 427.53} = \frac{50}{855.06}$$

$$\sin \frac{1}{2}D = \frac{50}{855.06} = 0.11695$$

$$\frac{1}{2}D = 6^\circ 42' 58''$$

$$D = 13^\circ 25' 56''$$

- To find length of curve, L:

$$L = c \frac{I}{D}$$

Figure 1-88 Elements of a circular curve

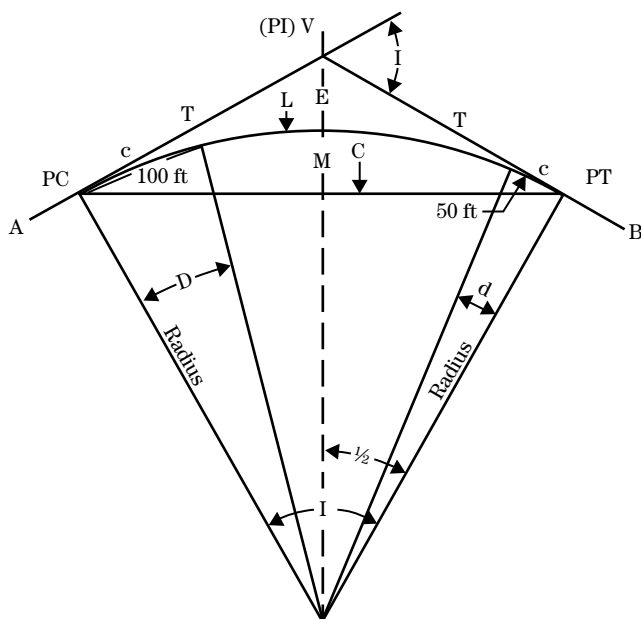

$$L = 100 \times \frac{38.66^\circ}{13.43^\circ} = 287.86 \text{ ft}$$

Note: The length of curve also may be found by the formula $L = RI$, where the angle I is in radians. This length will be slightly longer and more precise, as it represents the true arc length.

4. Since:

$$E = R \operatorname{exsec} \frac{I}{2} = R \left(\frac{1}{\cos \frac{I}{2}} \right) - 1$$

$$e = 427.53(0.05976) = 25.55 \text{ ft}$$

When the elements of the curve have been calculated, the actual fieldwork of laying in the curve may be done by the chord stationing method or by the arc method. A key principle in the layout of any point along the curve is:

The deflection angle to any point along the curve is equal to half the angle subtended by the curve (fig. 1-89).

where:

d = angle subtended by the chord

c = chord

The first step in the field location of a curve is to mark on the ground the PC and PT locations by measuring on line from the vertex or PI. Then, the calculation of the deflection angle for a 100-foot chord or subchords (less than 100 ft.) should be made. The deflection angle for a 100-foot chord is $D/2$ and for a subchord may be found by proportion (fig. 1-90).

$$d1 = \frac{50}{100} \times 6^\circ 42' 58'' = 3^\circ 21' 29'', \frac{d1}{2} = 1^\circ 40' 45''$$

$$d2 = \left(\frac{37.86}{100} \right) \times 13^\circ 26' = 5^\circ 5', \frac{d2}{2} = 2^\circ 32' 34''$$

c = chord length

$$= 2 R \sin d1$$

$$= 2(427.53 \text{ ft}) \sin 6^\circ 42' 38''$$

$$= 99.99 \text{ ft}$$

c_a = subchord length

$$= 2 R \sin d1$$

$$= 2(427.53 \text{ ft}) \sin 3^\circ 21' 39''$$

$$= 50.00 \text{ ft}$$

Figure 1-89 Principle of curve layout by deflection angle

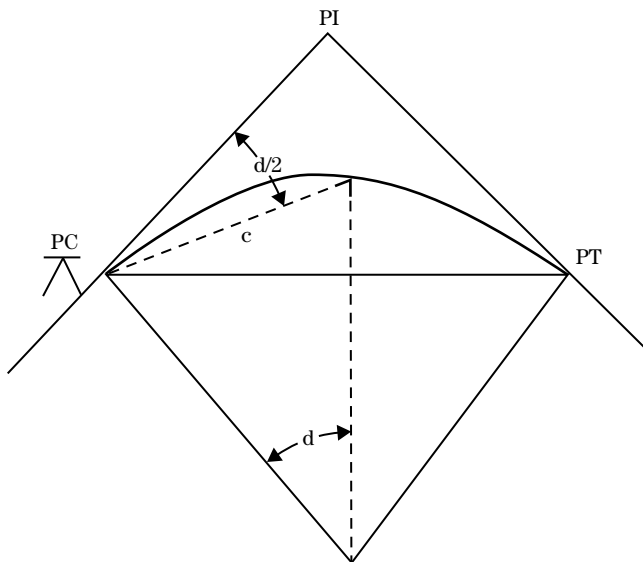
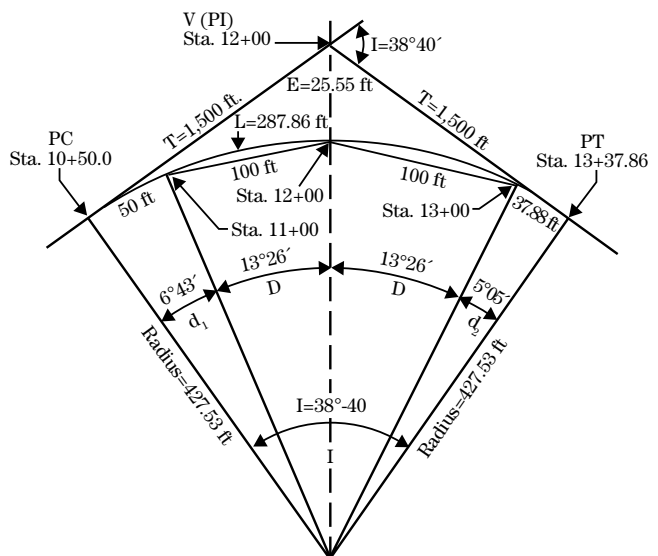

Figure 1-90 Layout of circular curve (English)



In figure 1–91, a subchord of 50 feet was used at the beginning of the curve to make the stationing come out even; for example, Station $10+50 + (0+50) = 11+00$. This curve also could have been run in with two full chords of 100 feet and a subchord of 87.86 feet (curve length = 287.86 ft). With the instrument set on the PC, sight the PI or vertex and set the vernier on $0^{\circ}00'$.

Then, turn a deflection angle from the PC of $3^{\circ}21'29''$ for the subchord of 50.00 feet. Measure a distance of 50.00 feet from the PC to the point on the curve. A flagged nail commonly is used to identify each point where the line of sight intersects the curve centerline. From the PC (station 10+50), the point would fall at station 11+00 on the curve.

For the next full chord of 100 feet, an additional $6^{\circ}42'58''$ is added to $3^{\circ}21'29''$ to give an accumulated deflection of $10^{\circ}04'27''$ from the tangent line. A distance of 100 feet is measured from station 11+00 on the curve to the intersection of the line of sight and the curve centerline (station 12+00). This point also is marked.

The next deflection angle is also $6^{\circ}42'58''$ as the chord is 100 feet long. The additional $6^{\circ}42'58''$ is turned, giving a total deflection from the tangent line of $16^{\circ}47'25''$. A distance of 100 feet is measured from station 12+00 to station 13+00 on the curve and marked. The last deflection angle for this curve is for the subchord of 37.86 feet and is $2^{\circ}32'34''$ and, when added to $16^{\circ}47'25''$, gives a total deflection of $19^{\circ}20'$. This angle, when turned from the tangent line to the PT while the instrument is on the PC, should be equal to $I/2$; i.e., $38^{\circ}40'/2 = 19^{\circ}20'$ and is a check on deflection angle calculations. See figure 1–91 for notes on layout.

When the elements of the curve have been calculated, the actual fieldwork of laying in the curve may be done by the chord stationing method (fig. 1–90) or by the arc method.

Circular curve layout by tangent offsets—When only approximate layout of a curve is necessary, as for the small field ditch, curves can be laid out from tangent offsets. The PC, PT, and external point should be located as in the instrument method. The tangent offsets are used to locate intermediate points on the curve.

Tangent offset may be calculated by the formula:

$$z = \frac{7}{8} n^2 D \text{ or } 0.875 n^2 D$$

where:

z = required offset in feet

n = distance from PC or PT in 100-ft stations

D = degree of curve

Example

Given:

$$I = 30^{\circ}10'$$

$$D = 5^{\circ}00'$$

$$T = 308.93$$

$$E = 40.90$$

$$L = 603.32$$

Solution:

Distance from PC or PT (n) (station)	Offset (z) (ft)
0+00	0
1+00	4.37
2+00	17.50
2+50	27.34

Measure the stations from the PC and PT along the tangent toward the PI, and offset at right angles the distances shown in the table (fig. 1–92). Since the tangent distance of this curve is slightly over 90 meters or 300 feet, the above points are adequate. Chain from the PC to determine the stationing of these stakes on the curve.

Figure 1-91 Survey notes—circular curve

(a)

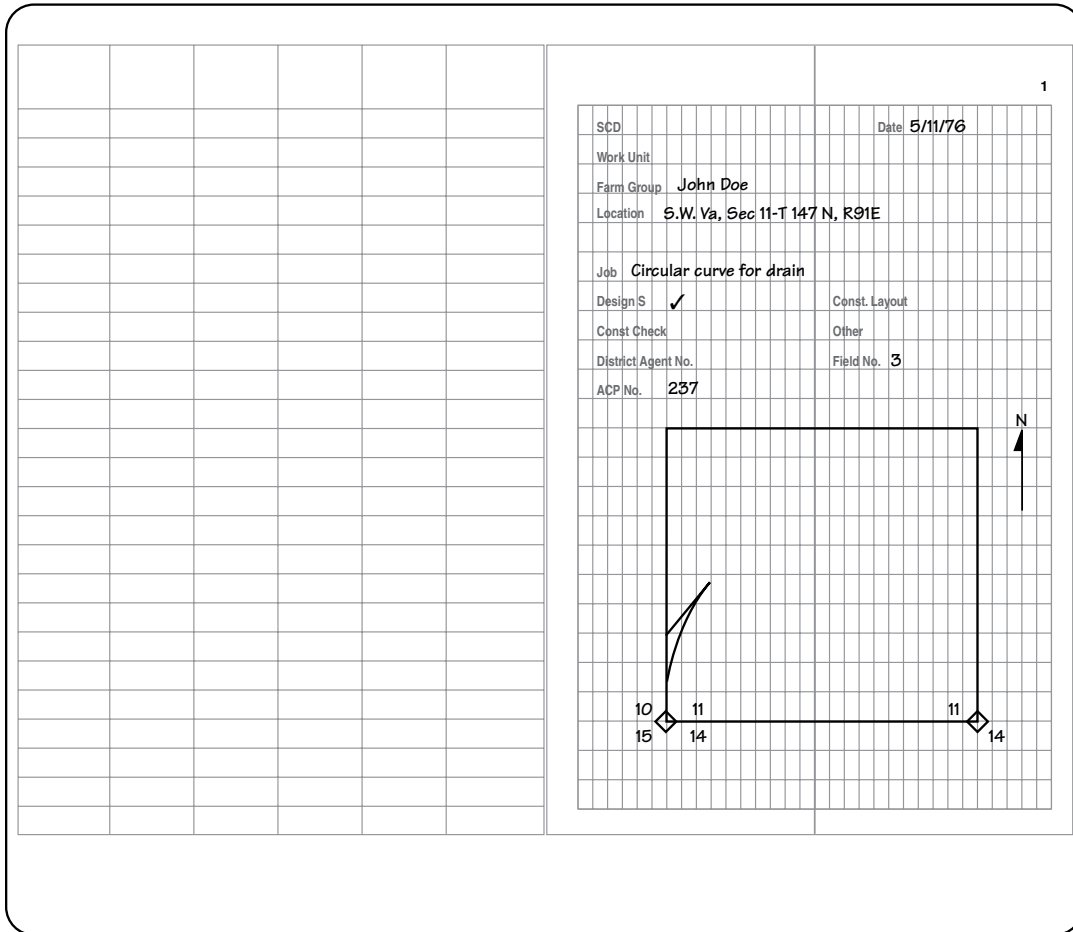

Figure 1-91 Survey notes—circular curve—Continued

(b)

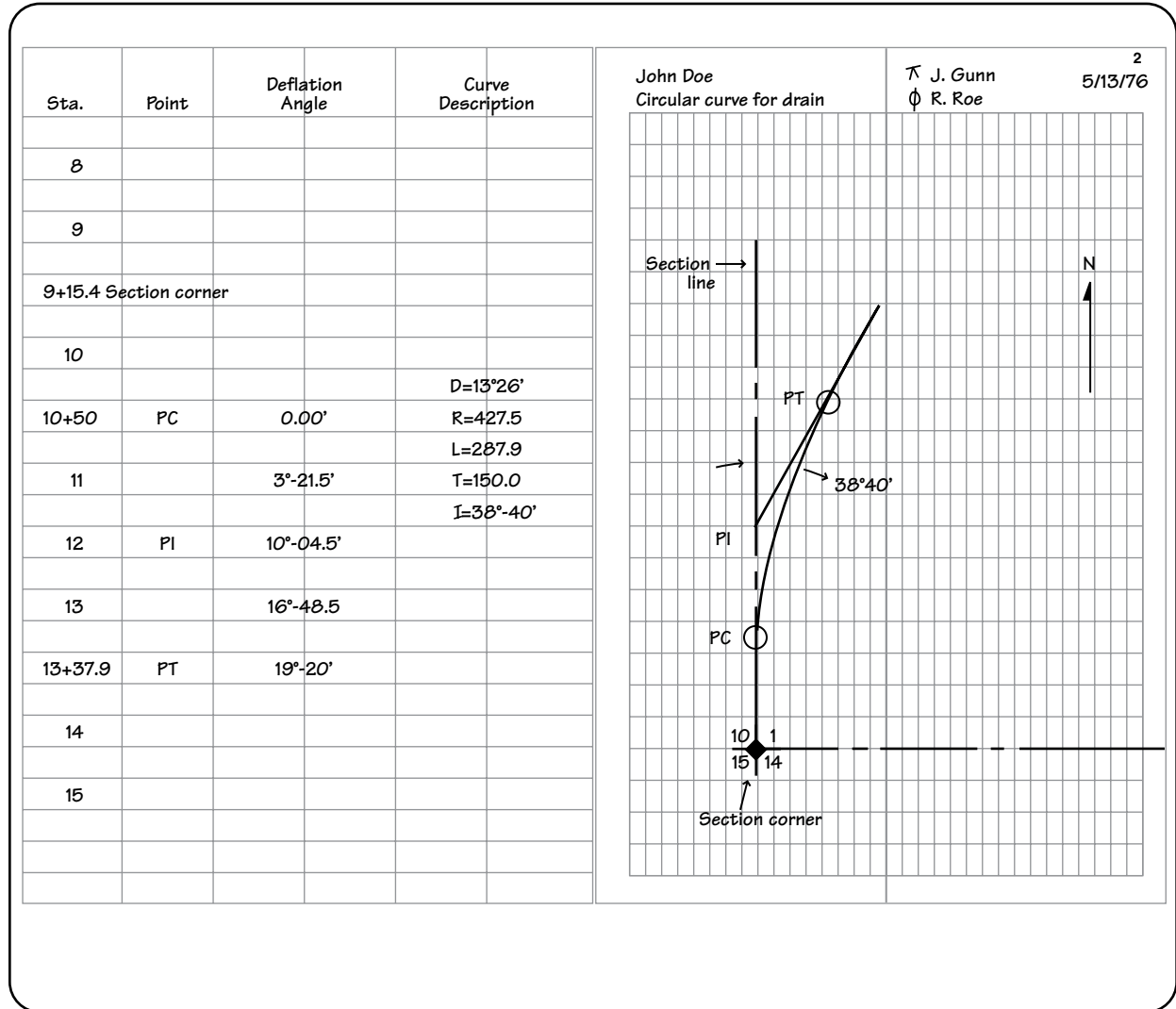
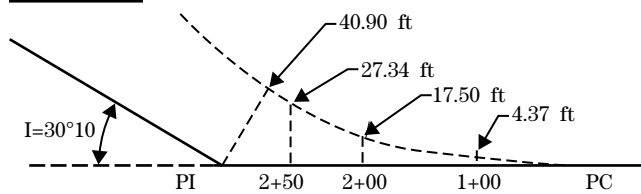

Figure 1-92 Curve layout by tangent offsets



(b) Public Land Survey System

It is important that all surveyors have a general idea of the division of lands of the United States into units of title, both private and public. The laws and methods used for the division of lands are complex, and this section is meant only as an overview. It must be recognized that the survey of any land boundaries between adjacent owners or within a single ownership for the purpose of subdivision falls under the jurisdiction of a professionally licensed surveyor, and surveys of these boundaries should be done only under this license.

(1) History of the division of lands

The Public Land Survey System (PLSS) was developed by Thomas Jefferson under the Land Ordinance Act of 1785 as a way to divide and sell off the public lands granted after the Revolutionary War. The system has been applied to all lands with the exception of the original 13 colonies, Texas, Florida, and Hawaii. The basic units of area are the township and section, and it is often referred to as the rectangular survey system.

The original 13 colonies were surveyed under the older English system of *metes and bounds*. This system defines property boundaries by a description of that which *meets the eye and bounds drawn by humans*. Descriptions may include calls to the banks of creeks or to a large standing oak tree, for example.

There are a number of difficulties with this system including:

- Irregular shapes for properties make for much more complex descriptions.
- Over time, these descriptions become problematic as trees die or streams move by erosion.
- It was not useful for the large, newly surveyed tracts of land being opened in the west, which were being sold *sight unseen* to investors.

Several other problems exist in the west and southwest. In the southwest United States, particularly Texas and New Mexico, the government recognized a large number of Spanish and Mexican Land Grants that do not fit the rectangular system that was being put into place. These are still recognized today, and surveyors working there must be familiar with not only the localized boundary laws but also some unique measurement systems including:

- **Arpent**—Unit of length and area used in France, Louisiana, and Canada. As a unit of length, approximately 191.8 feet (180 old French 'pied', or foot). The (square) arpent is a unit of area, approximately .845 acres, or 36,802 square feet.
- **Pole**—Unit of length and area. Also known as a *perch* or *rod*. As a unit of length, equal to 16.5 feet. A mile is 320 poles. As a unit of area, equal to a square with sides one pole long. An acre is 160 square poles. It was common to see an area referred to as "87 acres, 112 poles", meaning 87 and 112/160 acres.
- **Vara**—Unit of length (the *Spanish yard*) used in the southwest United States. The vara is used throughout the Spanish speaking world and has values around 33 inches, depending on locale. The legal value in Texas was set to 33-1/3 inches in the early 1900s.

(2) Subdivision of lands under the PLSS

The subdivision of lands under the PLSS is nearly rectangular. The convergence of longitude as one moves northward creates a situation where perfect squares are not possible. The system begins with the establishment of a baseline and principle meridian around which a series of township, a unit of land 6 miles more or less on each side, are established (fig. 1-93). Each township is designated by its position to the baseline and meridian with the north-south designator called the range and the east-west designator called the township. The X-marked township in figure 1-94, for example, is designated as township 2 north, range 2 east and is abbreviated as T2N, R2E.

The township then is divided into 1-mile square sections (640 acres). Numbering of the sections is consistent beginning in the upper right (NE) and moving sequentially (fig. 1-95). Each section may be divided further into quarter and sixteenth-quarter sections or even finer divisions may be made. Designations are always made from the smallest unit to the larger unit. This is called the legal description. For example, assume the section in figure 1-92 is section 14 in township 3E, range 2W. The area with the marked X would have a legal description of NW 1/4, SW 1/4, Section 14, T3E, R2W.

Figure 1-93 Division of lands into townships under the PLSS

2W	2W	1W	1E	2E	3E	
						3E
				X		2E
						1E
						Baseline
						1S
						2S
						3S
Meridian						

Figure 1-95 Division of a single sections into fractions of sections under the PLSS

NW $\frac{1}{4}$ 160 acres	NE $\frac{1}{4}$, NE $\frac{1}{4}$ 40 acres	NE $\frac{1}{4}$, NE $\frac{1}{4}$ 40 acres
	SE $\frac{1}{4}$, NE $\frac{1}{4}$ 40 acres	SE $\frac{1}{4}$, NE $\frac{1}{4}$ 40 acres
X		SW $\frac{1}{2}$, NE 80 acres
		S $\frac{1}{2}$, SE $\frac{1}{4}$ 80 acres

Figure 1-94 Division of single township into approximate 1-mile sections under the PLSS

6	5	4	3	2	1
7	8	9	10	11	12
18	17	16	15	14	13
19	20	21	22	23	24
30	29	28	27	26	25
31	32	33	34	35	36