

1

Industrial-Scale Fermentation

Hans-Peter Meyer, Wolfgang Minas, and Diego Schmidhalter

This chapter describes relevant aspects of industrial-scale fermentation, an expanding area of activity, which already generates commercial values of over one third of a trillion US dollars annually, and which will most likely radically change the way we produce chemicals in the long-term future. From biofuels and bulk amino acids to monoclonal antibodies and stem cells, they all rely on mass suspension cultivation of cells in stirred bioreactors, which is the most widely used and versatile way to produce. Today, a wide array of cells can be cultivated in this way, and for most of them genetic engineering tools are also available. Examples of products, operating procedures, engineering and design aspects, economic drivers and cost, and regulatory issues are addressed. In addition, there will be a discussion of how we got to where we are today, and of the real world in industrial fermentation. This chapter is exclusively dedicated to large-scale production used in industrial settings.

1.1

Introduction

Most people are not aware of how deeply biotechnology products manufactured by large-scale fermentation, both recombinant and nonrecombinant, have affected our daily lives. The general public may be aware of the classical antibiotics or of large recombinant therapeutic proteins such as antibodies produced by “industrial-scale fermentation.” However, the role of fermentation for small-molecule pharmaceuticals, steroids, or cytotoxics is generally not known, let alone the role of fermentation for products used in flavors and fragrances, household appliances, chemical manufacturing, and many other markets.

Originally, the term “fermentation” was used to describe anaerobic processes to convert starch grains into alcohol, a process still used in first-generation biofuels. This is why textbooks often refer to these processes, used by ancient civilizations thousands of years ago, as the origin of biotechnology. However, modern fermentation biotechnology was enabled by two distinct features, shown in Figure 1.1.

Period	Technology	Products
1670–1918	Empirical fermentation	Ethyl alcohol Acetic acid ABE
1918–1943	Deep vat (5 m+) fermentation	Vitamin C, Ephedrine Organic acids
1943–1978	Large scale sterile fermentation technology	Antibiotics and steroids Amino acids Vitamins Industrial enzymes
1978–2012	Horizontal gene transfer Mammalian cell culture High cell density culture	Recombinant proteins Monoclonal antibodies Many other different products
2012–	Synthetic biology Bioinformatics	Personalized medicine Chemical manufacturing GMO plants widely accepted Artificial photosynthesis

Figure 1.1 Historical overview of fermentation over the last 350 years. Two crucial events triggered the economic success of biotechnology. The first was the development of large-scale sterile fermentation technology for the production of penicillin during the Second World War. The second was the development of genetic engineering tools for horizontal gene transfer, which

has evolved from transferring a single gene (insulin) into a bacterium (*Escherichia coli*) to transferring multiple genes. As an example, the complete biosynthesis of opioids has been engineered and reconstructed in *Saccharomyces cerevisiae* by transferring 23 different genes from plants, mammals, bacteria, and other yeasts.

Prior to these two developments, fermentation was a nonsterile, empirical endeavor. The first real commercial industrial fermentation application was vinegar production from wine by a continuous “fill and draw” method during the Renaissance in France. Wine in large barrels was allowed to be oxidized by a floating mat of aerobic bacteria. A large part of the liquid containing the acetic acid was then removed from the barrel and replaced with fresh wine; this process step was repeated as long as the oxidative biomass remained active.

Today, the term *fermentation* stands synonymously for any submersed cultivation in a bioreactor, which are now dominated by aerobic processes. It is astonishing how far we have come with the application of industrial-scale fermentation since the development of sterile, large-scale culture technology for antibiotics in 1943 and the advent of genetic engineering in the 1970s. Today’s “living factories” comprise wild-type, mutated, and recombinant microbial, fungal, plant, animal, mammalian, and stem cells, and recently over 20 different genes were transplanted horizontally as in the case of recombinant opioid production in yeast [1]. “Industrial-scale fermentation” embraces commercial targets from biofuels to personalized medicines. The term *industrial-scale* in connection with the liquid working volumes can mean something different for

every product category. Platform chemicals, amino acids, and vitamins for animal feed purposes and other commodities are produced in stirred-tank bioreactors or fermenters with working volumes of up to several hundred cubic meters. The commercial production of recombinant, parenteral (injectable) therapeutic proteins or monoclonal antibodies in stirred-tank reactors requires maximum working volumes of several tens of cubic meters only. Finally, “industrial,” as used in the context of industrial-scale production of adherent stem cells, which are now grown on microcarriers suspended in (disposable) stirred bioreactors, means a mere few hundred liters of working volume. The nominal bioreactor working volume range thus spans over two orders of magnitudes at least, from cheap commodities to high-value medicinal products. While the basic principles of suspension culture in bioreactors and the very basic design of these bioreactors remain the same for all applications, they need to be adapted and modified in response to the particular requirements of the cultivated cell type and the target product with regard to parameters such as follows:

- oxygen demand
- heat transfer requirement
- sensitivity to shear
- sensitivity to process and culture variations
- sensitivity to local variations within the bioreactor
- current good manufacturing practice (cGMP) requirements
- biosafety requirements (containment levels are normally BLS1 and BLS2)
- specific safety requirements for highly potent active pharmaceutical ingredients (HPAPI).

Laboratory-scale fermentations have been described elsewhere [2]. In this chapter, we lead the reader through the most important aspects of industrial-scale fermentation. Which organisms are suitable for large-scale suspension culture? What do standard operating procedures (SOPs) and installations for large fermentation look like? Which are the most important markets? What affects the economics of large-scale fermentation, and which are the important regulatory aspects to be considered?

1.2

Industrial-Scale Fermentation Today

1.2.1

Organisms Used in Large-Scale Fermentation

There are three basic methods for biotechnological production using living matter.

- The first refers to mass cultivation and production by making use of cells in a highly controlled, closed bioreactor. Table 1.1 lists all cells and organisms that are available today for large-scale suspension culture.

Table 1.1 Organisms and cells that can be and are partly used in large-scale submersed cultivation for the purpose of manufacturing a myriad of products for many different markets.

Organism	Manufacturing scale (m ³)
<i>Bacteria</i> : Multitude of strains producing a wide variety of large and small molecule products. While <i>Escherichia coli</i> is the preferred host for therapeutic proteins, numerous other commercial expression systems are available for small molecule production. <i>Streptomyces</i> species are the preferred hosts for secondary metabolites	~250
<i>Yeast</i> : Large and small molecules. Often hosts are methylotrophic <i>Pichia pastoris</i> and <i>Saccharomyces cerevisiae</i> . Other hosts include <i>Hansenula polymorpha</i> and <i>Yarrowia lipolytica</i>	30–80
<i>Fungi</i> : Many different filamentous fungi are used to produce secondary metabolites, enzymes, and organic acids at the industrial scale	≤600
<i>Cyanobacteria</i> : Ancient form of life best known for its edible genus <i>Spirulina</i> grown in open ponds and sold in tablet form as dietary supplement. A recombinant strain is used for phototrophic biofuel production. Potential producer of cytotoxics	~5000 (open pond)
<i>Algae</i> : Industrially used for single cell algae (<i>Chlorella</i>), β -carotene (<i>Dunaliella</i>), or polyunsaturated fatty acids (PUFAs). <i>Chlorella</i> is another genus used as health food. <i>Chlorella</i> is a preferred algal expression host	~250
<i>Plant cells</i> : Production of the anticancer plant secondary metabolite paclitaxel in 75 m ³ bioreactors. Other products are the therapeutic enzymes Elelyso™ in recombinant carrot cells or ginseng saponins. As with cyanobacteria and algae, plant cells can be cultivated hetero-, photo-, or mixotrophically	≤75
<i>Mosses (Bryophyta)</i> : Expression cassettes for <i>Physcomitrella patens</i> have been developed for phototrophic production	<2
<i>Duckweed</i> : Recombinant whole plants of <i>Lemna minor</i> (duckweed) for phototrophic production in suspension systems exist. As with mosses, duckweed is ready for commercial applications but has not yet been used industrially	<2
<i>Protozoa</i> : Two genera (<i>Tetrahymena</i> and <i>Leishmania</i>) are mainly used in suspension culture. Also suitable for large-scale production of proteins but not yet used commercially	<2
<i>Insect cells</i> : Established production system used mainly for vaccines. Expression systems include <i>Spodoptera frugiperda</i> (moth), <i>Trichoplusia ni</i> (moth), <i>Bombyx mori</i> (silkworm), and <i>Drosophila</i> sp. (fruitfly)	<2
<i>Avian cells</i> : Mainly used for the production of viral vaccines. Expression systems using duck embryo, duck retina, quail embryo, and chicken embryo cells are replacing the traditional production from chicken eggs	>10
<i>Mammalian cells</i> : Industrial workhorses for large parenteral proteins, from Factor VIII to monoclonal antibodies. The Chinese hamster ovary (CHO) cells are the preferred expression host cells	~25
<i>Stem cells</i> : Human dermal fibroblasts (HDFs), mesenchymal stem cells (MSCs), and pluripotent stem cells (PSCs) are being produced by expansion on microcarriers in stirred-tank bioreactors. The number of cells needed for clinical allogenic use means that existing mass cultivation methods must be adapted to stem cell mass propagation	<1

All listed organisms and cells include the option of recombination, since the necessary tools of genetic engineering for horizontal gene transfer are available for all of them.

- The use of genetically modified higher plants that produce recombinant products in their leaves, fruits, roots, or other parts is a second option. Transgenic plants are under serious consideration for what is called *molecular farming* or *plant-made pharmaceuticals* for products such as insulin, lactoferrin, trypsin, secondary metabolites, and non-pharmaceutical products such as bioplastics.
- Genetically modified mammals can be used to produce therapeutic proteins in their milk, urine, blood, or other body liquids. In contrast to recombinant plants, only a very few examples of transgenic production animals exist, one being the 2014 Food and Drug Administration (FDA)-approved recombinant protein Ruconest against hereditary angiodema, which is isolated from transgenic rabbit milk [3].

This chapter focuses on the first method, that is, production in a sterile container (bioreactor or fermenter), as it is representative of over 99% of biotechnological products from individual or adherent cells of animals, mammals, plants, fungi, yeast, and bacteria.

Nowadays, and as Table 1.1 shows, not only bacteria, yeasts, and fungi are cultivated in “large-scale” suspension culture. All the industrial manufacturing methods listed in Table 1.1 are described and discussed in much detail in a separate book [4]. Evidently, and as already mentioned earlier, the term *large-scale* or *industrial-scale* is a relative one.

Although the cells and organisms listed in Table 1.1 differ greatly in taxonomy, form, size, and metabolism, there are four common elements that can influence the success of a large-scale suspension culture.

- Genotype of the cell that is controlled and steered by the physicochemical environment within the bioreactor, for which a whole arsenal of inline sterilizable sensors are available for control.
- Composition of the culture medium, which is ideally chemically defined and simple. Moreover, when formulating a culture medium recipe, the coalescence characteristics of the medium, which affect $k_L a$, or the foaming behavior, must be taken into consideration early.
- Cultivation conditions (T , pH, pO_2 , pCO_2 , mixing time, and shear), which are maintained by the bioreactor’s capacity for heat, gas, and momentum transfer. In most cases, *ad hoc* hardware changes to industrial bioreactors are limited to changing turbines and impellers only.
- Operating mode such as batch, fed-batch, continuous, or perfusion.

1.2.2

Contemporary Large-Scale Fermentation

Of the three basic operation options, batch culture is the simplest mode of cell cultivation, with the disadvantage of limited control, for example, on the growth rate (Figure 1.2). The alternative is to feed a batch by controlled linear or nonlinear addition of a carbon source and/or other nutrients, resulting in a

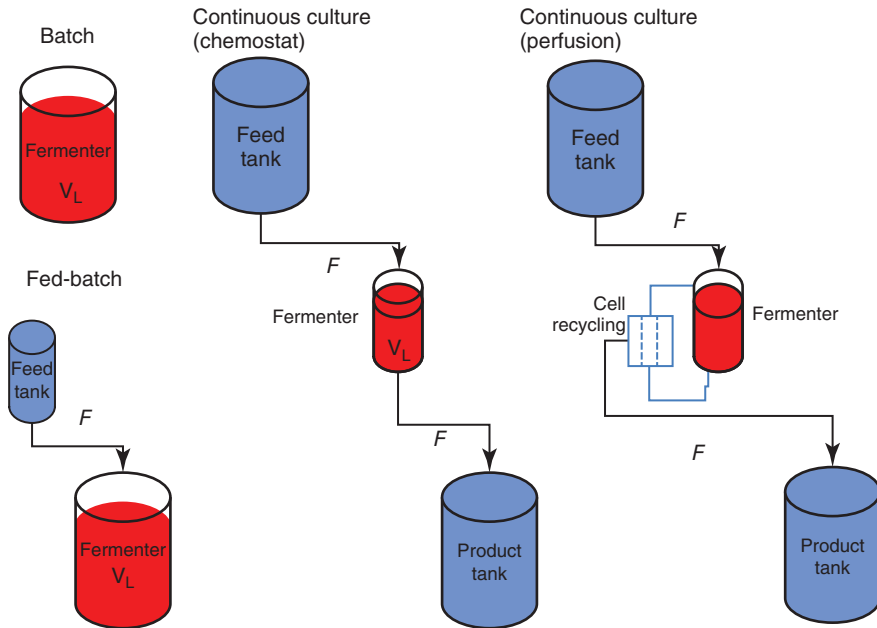

Figure 1.2 The basic operating modes of industrial-scale cultivation of suspended cells. The simplest mode is batch culture without any feed except possibly acid or base for pH control. The productivity of a simple batch can be considerably increased and extended by feeding fresh, usually concentrated sterile medium until the culture vessel is completely full. The continuous

culture mode depicted here is the chemostat with a working volume V_L , where fresh medium is added to a bioreactor at a flow rate F , and the culture medium is removed at the same flow rate. The resulting dilution rate ($D = F/V_L$) allows a steady state to be established, in which the growth rate μ (h^{-1}) is equal to the dilution rate D (h^{-1}).

fed-batch culture with considerably higher volumetric and specific productivities since the phenotype of the cell is under better control. Finally, chemostat culture and its variant perfusion culture, which makes use of cell recycling, is the most sophisticated and productive method of cultivating cells. Fed-batch is most frequently used, since it combines the operational safety of simple batch culture with the high productivity of continuous fermentation.

A bioreactor must be designed for optimal heat, gas, and mass transfer as well as for short mixing times. At the same time, the fluid's dynamic environment in the bioreactor should not destroy shear-sensitive cells, such as mammalian cells, despite the required transfer and mixing conditions.

In this chapter, open-pond operations or other open systems are not considered as a topic of discussion. There are roughly 20 different closed bioreactor design variants; Table 1.2 summarizes the basic design principles. Two major aspects are important: one is whether the cells are growing as individual single cells ("planktonic") suspended in a culture medium, or whether they need to adhere to solid surfaces or to each other (state of biomass in Table 1.2); the second is how the

Table 1.2 A few of the bioreactor designs that have remained important for manufacturing from the large number that have been developed and tested.

State of biomass	Liquid motion	Operation options
Cells in suspension	CSTR and mechanical stirring with turbines mounted on a stirring shaft CSTR and mechanical stirring as above but equipped with a cell recycling system, typically filtration	Batch, fed-batch, continuous Perfusion
Cells in suspension	Pneumatic stirring, such as used in airlift systems	Batch, fed-batch, continuous
Cells in suspension	Plug flow reactor with hydrodynamic stirring with or without static mixing elements in tube or flat-bed bioreactor	Continuous
Adherent, immobilized cells, cross-linked, or aggregated cells	Cells growing on fluidized microcarriers or encapsulated in suspension culture in a continuously stirred bioreactor CSTR	Batch, fed-batch, perfusion
Cells growing as biofilm	Cells multiply on fixed surfaces in bioreactors with fluids typically moved hydrodynamically or pneumatically	Batch operation

The CSTR (continuously stirred tank reactor) with mechanical stirring, typically combining Rushton and marine impellers (see also Figure 1.15) is the standard design for practically all applications. The table gives an overview of all liquid-moving and mixing options.

culture medium is kept in motion. This can be achieved (i) by mechanical mixing, (ii) by air injected at the bottom of a reactor, or (iii) by keeping the culture medium in motion by a pump or by gravitational flow in tubular or flat-plate bioreactors, which are designs used for the phototrophic cultivation of microalgae.

Pneumatic mixing in airlift fermenters was used in the early days of production with animal cells. However, a few cells of higher organisms were even sensitive to air bubbles. Attempts to keep the fermentation medium free of bubbles was associated with serious limitations. Bubble-free aeration comes in two versions. The first and more efficient uses bubble-free aeration through a membrane permeable to gas. The second is less sophisticated and operates by simply aerating through the fermentation liquid surface. However, mixing and mass-transfer processes with airlift and especially with bubble-free cultivation rapidly become limiting with increasing scale. Consequently, the continuously stirred tank reactor (CSTR) has become the bioreactor design of choice for industrial-scale cultivation of mammalian cells. The design is as effective as it is simple: a rotating shaft with mounted impellers and/or propellers of all types. Figure 1.3 summarizes the two most important principles, stirred tank and airlift. Although the most commonly used fermentation vessel type is the CSTR, the largest scale fermentation is still operated as an airlift reactor.

The advantage of an airlift reactor is that aeration and mixing are carried out through the gas phase, and as such it is energy-efficient. On the downside, very large volumes of sterile air are required, and maintaining long-term sterility is

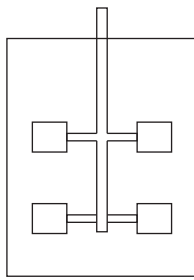

Stirred tank reactor:
mechanical stirring
Rushton impeller

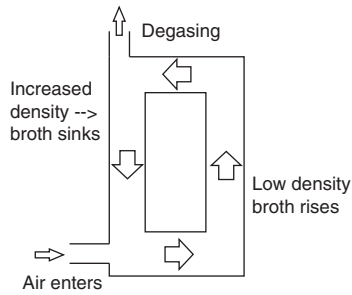

Air lift reactor:
pressure cycle
disengagement of gas

Figure 1.3 Mixing principles in large-scale reactors.

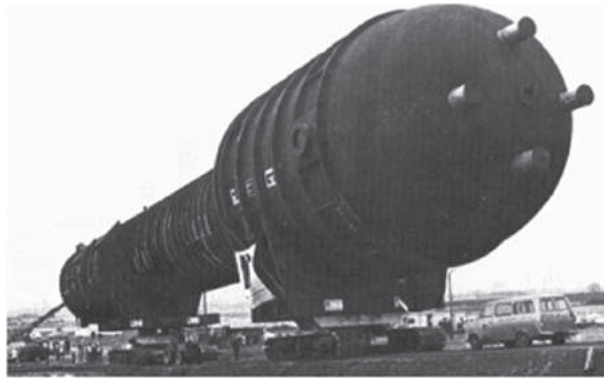
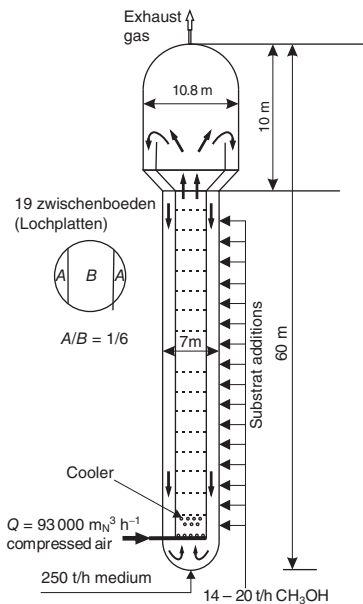

Figure 1.4 Airlift reactor at the ICI factory, Billingham, UK. With permission © 1995, Springer-Verlag [6].

a significant technical challenge. Hence this technology is best suited if process conditions, such as low pH, are selective for the cultivated organism. A very detailed analysis of air lift reactors was published in 2010 [5].

The largest such commercial reactor ever built was for the single-cell protein (SCP) production by Imperial Chemical Industries, ICI, in Billingham, UK, using methanol as carbon source (Figure 1.4). This airlift reactor was 70 m high and had a working volume of 2000 m³. It was installed in the late 1970s, but with rising oil prices after the first oil crisis in 1973 and more dramatically during the second in

1979/1980, the idea to produce SCP-based food cheaply from fossil carbon sources was quickly abandoned and the system was decommissioned in the early 1980s. The only remaining SCP production is in Billingham. A 40-m-high airlift reactor is used for the production of mycoprotein by *Fusarium venenatum* marketed under the trade name of Quorn.

A similar design on an even larger scale can be found in the sewage treatment plant built by Hoechst in Leverkusen, Germany. Multiple internal guide sleeves and radial air nozzles ensure mixing and aeration. The design of this 8000 m³ “BIOHOCH reactor” is shown in Figure 1.5.

Even though these special application examples demonstrate the scalability of the technology, and although airlift reactors have long been used for shear-sensitive cell-culture applications, the CSTR design has become the standard for microbial and mammalian cell suspension culture. Its design is versatile, and cultivations can be scaled from the laboratory to pilot scale and to up to 300 m³ in fully contained sterile fermenters.

During the 1980s, several distinctly different bioreactor designs (CSTR, Torus or horizontal loop bioreactor, jet loop bioreactor, compact loop bioreactor) were tested and compared at the Swiss Federal Institute of Technology, Zürich, by the group of Armin Fiechter. A reference fermentation with the strictly aerobic, non-fermentative, and glucose-insensitive yeast *Trichosporon cutaneum* on a defined medium was used [7]. The results of this study illustrate why the traditional CSTR, with multiple turbines, was and remains the most widely used reactor design.

- The stirred tank is a useful and versatile design for practically all applications. It can handle highly viscous fermentation broths and achieve high oxygen transfer and heat exchange rates and provides short mixing times. For shear-sensitive cells, turbines and flow breakers in the fermenter are replaced by impellers, resulting in lower fluid dynamic stress.
- Since a large, sterile, and fully controlled bioreactor represents a considerable capital expenditure (CAPEX), an investor prefers a solution that offers versatility and flexibility, especially in the area of white biotechnology, with a myriad of different products for different markets are produced using many different organisms.
- Designs, tanks, and equipment for the CSTR fermentation technology are widely standardized today, and this reduces the CAPEX and operational costs.

This gives reason enough to dedicate this chapter to suspension culture in closed containments or bioreactors, and to discuss their large-scale design and operating criteria. However, we would like to draw attention to three applications that demonstrate that there are interesting niches in which biomass is not necessarily grown in standard steel bioreactors.

The first application is the suspension culture of genetically modified cyanobacteria in a 4000-l tube bioreactor, capturing CO₂ for the phototrophic production of biofuels, as developed by Joule Unlimited, Inc. [8]. The other two are related to organs or cells requiring solid supports for their growth. As outlined in



Imagery ©2016 Google, Map data ©2016 GeoBasis-DE/BKG (©2009), Google 20 m

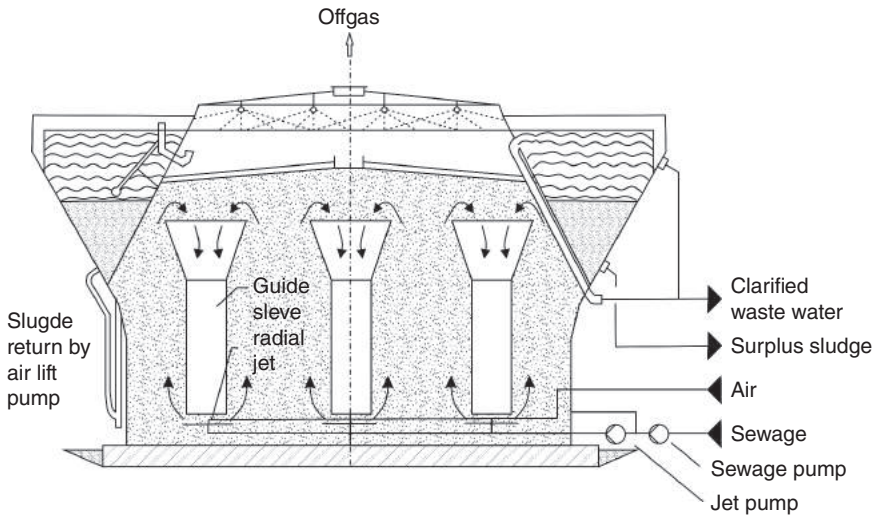

Figure 1.5 Example of an airlift fermenter specifically designed for effective wastewater treatment. This design is the Biohoch Reactor of Hoechst, a jet-loop reactor with multiple internal guide sleeves and a volume of 8000 m³.

Table 1.2, cells can grow either as single cells or as cell aggregates suspended and floating in a culture medium or adherent to a surface. Adherent cells can be cultivated in solid-phase fermentation, where they grow on a solid surface (a fixed bed within the bioreactor), which is percolated top down with culture medium, an option rarely used except for vinegar production and not discussed in detail. However, this can also be a viable option for the rapid production of secondary metabolites. Figure 1.6 shows the cultivation of hairy plant roots for the production of biologically active substances, the advantage being its simple design. Hairy root cells grow on a solid polymer or stainless steel support

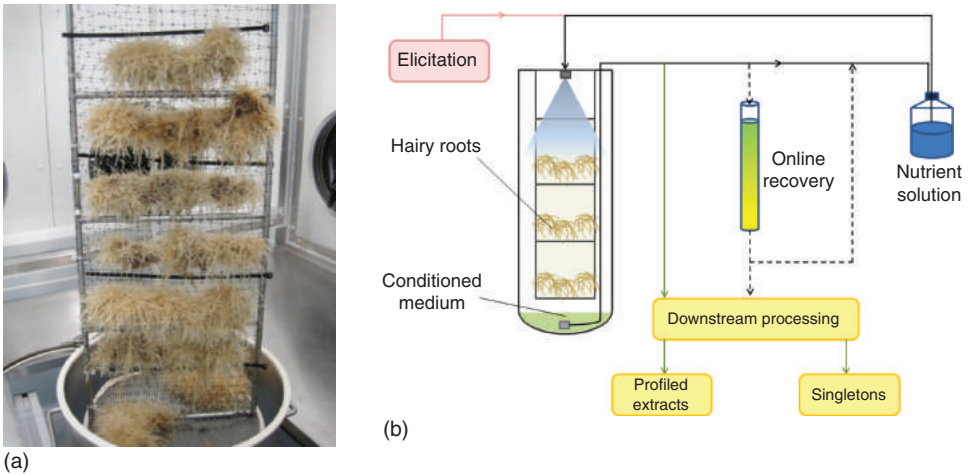

Figure 1.6 (a) Bioreactors for the culture of hairy roots with the cover removed. (b) The scheme explains how this solid-phase fermentation functions. The hairy root cells are sprayed with the culture medium from the top. As the medium trickles down, it accumulates the secreted products

(secondary metabolites in this case) and it is recirculated. An *in situ* product recovery (ISPR) installation, using, for example, a resin that specifically binds the bioactive produced, can be combined with the bioreactor as shown in (b). (Courtesy of Rootec.)

resulting in high productivities. The disadvantage is mainly the limited scalability of the single hairy root bioreactor, requiring parallel operation of several identical smaller bioreactors (scaling out).

Stem cells require a surface to adhere to for their growth. Traditionally, these cells have been multiplied by letting them adhere and grow on the bottom of a flat plastic container (T-flask) covered with a thin film of the cultivation medium. In order to meet the ever-increasing need for such cells, multiple integrated flat-bottom stacks were developed (Figure 1.7), which eventually grew so large that their handling became very cumbersome. In order to meet the cell numbers required for clinical applications, producers were forced to switch to cells growing on carriers suspended in disposable stirred fermenters for the cost-effective mass production of stem cells [9, 10]. Practical ranges of stem cell numbers that can be produced and harvested are <10 billion cells for a 10 stack system, and <100 billion cells in large hyper-stacks. Adherent cultivation in bioreactors is needed to reach a cell number >100 billion per batch.

In conclusion, the stirred-tank bioreactor remains the safest approach for the mass production of practically all the cells mentioned in Table 1.1, including stem cells. The appearance of commercial, larger scale, disposable stirred tanks has extended their range of applications even further.



Figure 1.7 (a) The Nunc automatic cell factory manipulation (ACFM) system of Thermo Fisher Scientific Inc., a well-established system to grow cells on multiple flat bottoms. In order to reach the high cell numbers required in clinical applications, however, stirred disposable bioreactors are increasingly used to grow cells on

microcarriers. (b) Example of a stirred disposable reactor from Sartorius Stedim Biotech. Single-use bioreactors with working volumes of several hundred liters are now available, allowing the production of therapeutic cells for several hundred patient doses. (Courtesy of Thermo Fisher Scientific Inc. and Sartorius Stedim.)

1.2.3

Economic Aspects of Industrial Fermentation from a Market Perspective

It was mentioned in the introduction that biotechnologically produced goods have affected almost all areas of our daily lives. Table 1.3 summarizes the estimated sales of these products and their key markets [11]. The two biggest applications, red and white biotechnology, generate annual global sales of around US\$ 336 billion and both continue to grow strongly (Table 1.3).

A few years ago, the use of biotechnology for chemical products was expected to grow over-proportionally to about US\$ 1000 billion by 2020, and especially high growth rates were expected for sales of fine chemicals produced by biotechnology [12]. In hindsight, the figure of US\$ 1000 billion was probably too optimistic. In particular, applications for small-molecule pharmaceuticals and fine chemicals have not achieved their potential, since the toolbox and commercial enzymes are still not available to the extent required. Another reason for the slow penetration into fine chemistry is the conservative attitude of the industry, not least because of the technological lock-in described later in this chapter. But the basic message remains, that the economic potential of white biotechnology exceeds that of red biotechnology by far. The numbers in Table 1.3 reveal another interesting point, namely that the average value created by one unit of installed fermenter volume is two orders of magnitude lower for white biotechnology!

However, one should also consider that CAPEX for non-cGMP fermentation installations are significantly lower than those for cGMP parenteral products. For a more detailed discussion on this aspect, the readers may refer to Section 1.5.1.

Table 1.3 Estimate of the actual market values of different products produced using large-scale fermentation.

Market	Numbers
<i>Red biotechnology</i> : mainly parenteral large therapeutic proteins and monoclonal antibodies for the pharmaceutical market	US\$ 170 billion
Estimated global fermentation volume	5000 m ³
Value generation in US\$ per cubic meter of fermenter volume per day	~95 000 US\$ per m ³
<i>White biotechnology</i> : a myriad of very different products for different markets and applications	US\$ 166 billion
Biofuels, bulk biopolymers, commodity, and platform chemicals	US\$ 110 billion
Amino and organic acids	US\$ 12 billion
Industrial enzymes	US\$ 5 billion
Vitamins	US\$ 3 billion
Classical antibiotics	US\$ 26 billion
Fine chemicals, secondary metabolites, value added by biocatalysis	US\$ 11 billion
Estimated global fermentation volume	350 000 m ³
Value generation in US\$ per cubic meter of fermenter volume per day	~1300 US\$ per m ³
<i>Red and white biotechnology together</i>	US\$ 336 billion

The numbers, based on own estimates and extrapolations, give the orders of magnitude of the market shares of different fermentation-derived products.

1.2.4

The Drivers and the Future of Industrial Fermentation

The economic drivers for biotechnology and the motivation to switch to industrial fermentation are different for different applications, such as pharmaceuticals or biofuels to choose two extremes, with bioethanol being by far the largest fermentation product by volume and sales. There are, however, four drivers that are more or less valid for all applications.

- *Financial*: feedstock prices and availability, manufacturing costs, new business models, and so on.
- *Legal*: regulation and legislation, subsidy policies, and so on.
- *Perception*: consumer demand for “greenness,” trend from synthetic to “natural,” and so on.
- *Innovation*: massive gene transfer, bioinformatics, cooperation models, and so on.

Flavors and fragrances are an example of how producers can profit by switching their manufacturing basis from extraction and chemical synthesis to fermentation and biocatalysis. The costs of their mostly plant-based raw materials are increasing, while supply is becoming irregular as a result of overharvesting and natural variations of crop quality and quantity. Organic synthesis is not really an alternative for economic reasons and because these products cannot be labeled as “natural.” As a result, the new trend in this industry, which uses over 9000 synthetic and natural ingredients, is to switch to biotechnology to meet the

expectations of consumers, who are increasingly sensitive to considerations of sustainable sourcing and manufacturing.

An opposing trend is observed for first-generation biofuels, which must be subsidized in order to be viable in a free market. Therefore, more and more biofuel manufacturers are trying to move up the value chain by looking for chemicals more valuable than ethanol.

We have already mentioned that the penetration of biotechnology into the chemical industry has remained far below expectations, even though biotechnology is seen as a green manufacturing option and a major driver to sustainably satisfy the needs of an increasing world population with higher income and corresponding consumption. We must, however, keep in mind that sustainability has three dimensions:

- Economy
- Ecology
- Society.

Biotechnology often turns out to be uneconomical. In many cases, this is due to the fact that oil and energy prices, though volatile, are still too low. Nevertheless, this is only half the truth, and Figure 1.8 provides another explanation. Organic chemical manufacturing sites bind large amounts of capital. Highly integrated chemical plants, often equipped with a cracker unit that delivers raw materials for organic chemical manufacturing, can be found throughout the world, with many new facilities recently constructed in Asia. Products produced biotechnologically, using renewable biomass as raw material instead of oil, have to compete in this context.

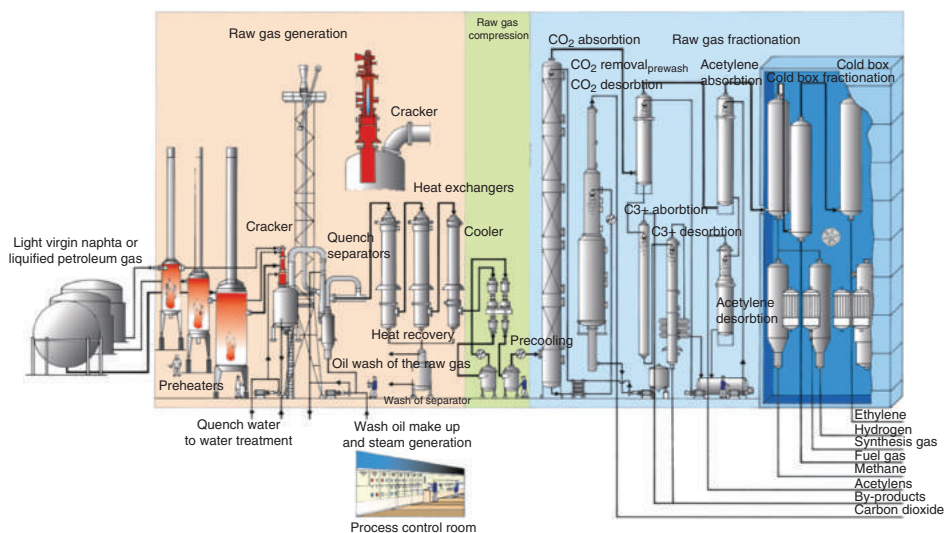

Figure 1.8 Scheme of one of the smallest crackers in the world, operated in Switzerland. The subsequent organic chemical installations for the production of organic fine chemicals are not shown.

It is actually extremely difficult for bio-based products to compete with such “conventional” petroleum-based production. Six facts make the replacement of petrochemicals by bio-based and biotechnological processes very difficult in the current situation:

- The business is capital-intensive
- Many existing chemical plants are already depreciated
- Organic chemistry is a known and reliable technology
- The oil price is far too low
- Highly functionalized biomass cannot be refined in the same chemical installations
- New skills are required that are not familiar to chemical-production personnel.

We are confronted with a classic case of a “technological grid-lock.” Unless oil prices increase drastically (at the time of writing the price per barrel was as low as US\$ 27), the switch to biotechnology will not take place. As with any other large industrial conglomerate, the petrochemical and organic chemical industry is very conservative. The adage “only a wet baby appreciates a change” can be applied, as there will be little or even no change for a long time to come. For this reason, it is up to the biotechnologist to find ways to blend bioprocess-based routes into existing chemical capacities.

While traditional genetic engineering mostly enhances single biological functions with transfer of one or very few genes between organisms, transplanting entire pathways is a recent achievement. Synthetic biology will finally be an even more radical approach to engineer complex biological functions and to integrate them into entirely new organisms. In the long term, this will radically change the way we produce organic chemicals. And this change may well start with the replacement of small-molecule pharmaceuticals manufactured by organic chemical synthesis. Although many of them are actually natural products or accessible to biotechnological production, they continue to be produced by chemical synthesis despite the high ecological impact. The pharmaceutical industry has a large ecological footprint, and the E-factor (kilogram waste per kilogram product), which is particularly high for chemically produced oligopeptides, oligonucleotides, or oligosaccharides, often results in several thousand kilograms of waste produced per kilogram of final product [13]. A growing world population will rightly want the same access to affordable and safe drugs as we have in our privileged part of the world. It is evident that this is difficult to achieve sustainably with available synthetic chemical technologies. Figure 1.9 shows a selection of four small-molecule pharmaceuticals produced by chemical synthesis with particularly high E-factors. On top of that, some pharmaceutical drugs are no longer eligible for reimbursement by health insurance companies because of their high price. Eribulin, a natural product from a marine sponge, is an example of such a drug that was delisted by the UK cancer fund due to cost (Figure 1.9).

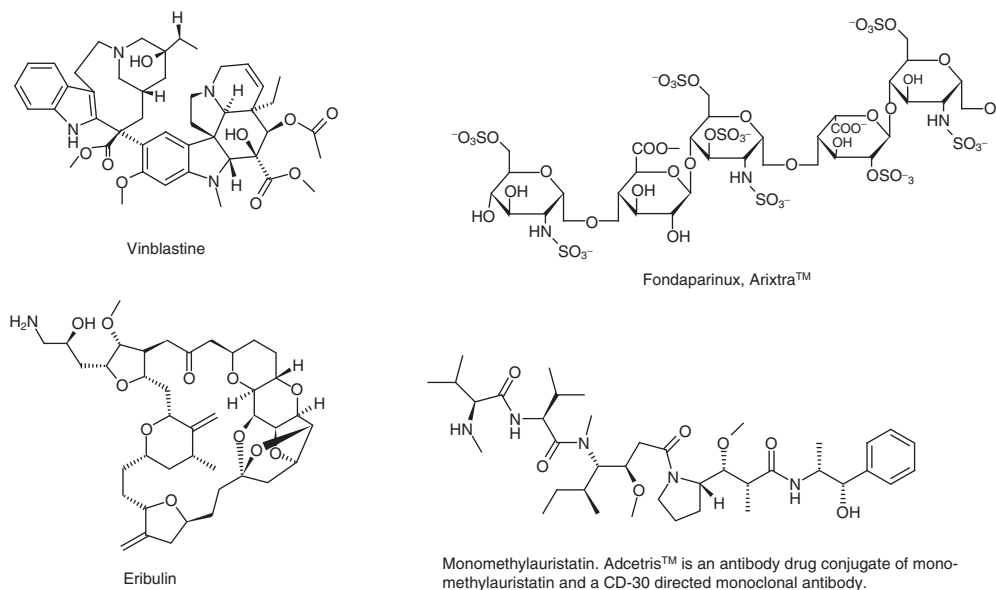

Figure 1.9 Four drugs that are synthesized chemically even though they are natural products. Fondaparinux (Arixtra[®]) a synthetic heparin trisulfated analog requiring over 50 chemical steps. Eribulin (Halaven[™]) is a macrocyclic anticancer ketone with 19 stereocenters. This analog of the marine sponge natural product halichondrin B requires 62 chemical steps. Vinblastine

isolated from the Madagascar Periwinkle (*Catharanthus roseus*) is another example of an expensive synthetic anticancer drug. Monomethylauristatin is a peptide anticancer product of a marine mollusk, which interacts with tubulin polymerization, and is several hundred times more toxic than Vinblastine. For this reason, it is only administered as an antibody drug conjugate.

1.3 Engineering and Design Aspects

1.3.1

Process Development – Scale-Up Starts at Laboratory Scale

Process scale-up should be considered early on while the biological expression system is still under development. Factors such as genetic stability for at least the number of generations needed for a scaled-up production, and the need and impact on the environment of selection markers, should be evaluated before process development is started. The use of antibiotics as selective markers in the production medium should be avoided. Throughout development of media and cultivation conditions, it is important that parameter settings remain realistic and scalable, always indicated with upper and lower limits reflecting the safe operating range (process design space), for example, pH 7 ± 0.3 . Small vessels with mixing times in the seconds range are not representative of large-scale fermentations. In cell culture cultivations, a CO₂–bicarbonate based buffer system is often used, which depends on the delicate balance of dissolved carbon dioxide (CO₂) and

the bicarbonate (HCO_3). In large vessels, the solubility of CO_2 is higher at the bottom due to the hydrostatic pressure, which can impact proper pH control and metabolic activity. Looking at microbial high cell density fermentation (wet biomass $\geq 100 \text{ g l}^{-1}$), in particular those using the methylotrophic yeast *Komagataella* or *Hansenula*, one should carefully consider the power input and cooling requirements since small-scale equipment is often overpowered and parameter settings may not be transferable to large-scale bioreactors. Thus parameter settings in early process development should reflect the technical limitations of the intended industrial production scale (scale-down model).

There are common prerequisites for all industrial operations. Processes should be robust, reliable, and reproducible, and should meet the desired product quantity and quality requirement as demanded by the respective specifications. Since production operators often have limited scientific understanding, the process should be well defined, with minimum risk of technical failure. Therefore, most industrial processes will be controlled only by sensors that are relevant to operate the process in a reproducible manner. SOPs strictly define how the process should be operated. If manual intervention is required, it should be correctly defined and described in the SOP. While unplanned process interventions may be possible in a non-cGMP production, this is generally not acceptable in a GMP production, and will trigger a formal investigation under the supervision of quality assurance (QA).

Commonly used online controls in industrial fermentations are the control of temperature, pressure, dissolved oxygen, and pH. Additional parameters to be controlled may be air/gas flow, feeding of substrates and supplements, or *in situ* product-recovery-related parameters (see Figure 1.6). Quantitative determination of the off-gas composition may further support control of the process. Complex and elaborate online measurements and controls should be avoided in an industrial production setting, although they can be useful during laboratory- or pilot-scale process development.

The situation is different when manufacturing high-value products such as biopharmaceuticals, where more complex inline and at-line measurements of critical process parameters (CPPs) and even critical quality attributes (CQAs) can give feedback on the process state and thus reduce the risk of batch failure. Combining such a system with a process control strategy is also referred to as process analytical technology (PAT). Understanding the CPPs' impact on the fate of the process and the quality of the product (process understanding) is a prerequisite to establishing such a control strategy.

1.3.2

Plant Design Aspects

1.3.2.1 General Aspects of Plant Design

The design of the fermentation plant is not driven by biological constraints alone. Operational factors also have significant impact. The main considerations are as follows:

Dedicated Single Product versus Multiproduct Facility A dedicated facility will follow a process-driven optimized design, whereas a multiproduct plant requires a higher degree of flexibility and possibly a modular design. Fermentation volumes of dedicated microbial (bacteria, yeast fungi; aerobic, anaerobic, etc.) production lines are in the range of 100–200 m³ or even higher, while multiproduct microbial fermentation rarely exceeds 50 m³. This partly contrasts with cell-culture facilities where both dedicated and multiproduct large-scale installations cover a range of 5–25 m³. Depending on commercial product needs, cell cultures may be run at the 1–2 m³ scale, with a trend away from stainless steel toward use of single-use bioreactors (SUBs).

The seed train can also differ. While optimally designed to fit the stages of a specific process in a dedicated facility (see below), a multiproduct plant requires flexibility for integrating or bypassing seed stages. It is a specific challenge of such flexible designs to ensure proper cleaning in place (CIP) and sterilization in place (SIP) of the equipment and all transfer lines to ensure sterility and contamination-free operations. Multiproduct operations also require validated cleaning and steaming procedures to prevent cross-contamination.

In addition, a dedicated facility will be more space-efficient than a multiproduct facility where additional space needs to be foreseen for a vast range of alternative processes.

Scale and Mode of Operation Scale and also the mode of operation (Figure 1.2, batch, fed-batch, or continuous/perfusion cultivation) have an impact on the design and the interface to the peripheral units. A perfusion cell culture facility may have a relatively small bioreactor vessel but a rather large media preparation area and holding tanks for the perfused medium.

The scale of operations also has a major impact on the process utilities. CIP (treated water) and SIP (clean steam) system capacities are defined by the largest vessels and the requirements for parallel operation. Sterile compressed air (aeration), cooling water (temperature control), and electricity (agitation) are the most relevant process utilities. Waste disposal and wastewater treatment also need to be considered.

When considering single-use equipment, a change of the facility layout compared to stainless steel installations needs to be taken into account. Most importantly, single-use-technology-based plants require more storage and handling areas in and around the production setting. Building logistics must be able to cope with increased quantities of materials being moved.

GMP versus Non-GMP Operation As mentioned earlier, cell-culture bioreactors used for GMP production are often located in a classified cleanroom environment, while microbial GMP main fermentation bioreactors are often installed in a CNC (controlled not classified) environment. The installation of cleanrooms has a significant impact on the building design and the required capital investment and operational costs. Cleanrooms are defined and qualified for admissible particles in the air and hence require an HVAC (heating ventilation air-conditioning)

system providing sufficient filtered air for maintaining cleanroom condition specifications including bioburden. In addition, access of personnel and material into cleanrooms is strictly controlled. Separate air locks may be needed for personnel (gowning and de-gowning) and materials (entering and leaving clean rooms).

Also the demand for in-process controls (IPCs) and documentation will be higher compared to non-GMP operations. The plant design needs to consider space for laboratories and offices.

Biosafety and Containment Constraints Large-scale industrial fermentations, generally defined by the authorities as above 10 l with respect to biosafety, require proper handling and decontamination of biological waste. Deliberate release of living material is not permitted and, irrespective of GMP or non-GMP, proper handling and decontamination of waste should be ensured. Safety requirements may exceed biosafety requirements in cases where HPAPI such as botulinum neurotoxin are produced. In these cases, cell-free material should also undergo an inactivation procedure prior to discharge.

Automation and Process Control Industrial fermentation plants vary widely with respect to the extent of their automation and process control. The core fermentation processes are generally well controlled, and the cultivation process is electronically documented. A supervisory and overruling control system may integrate the individual process steps. For auxiliary functions such as media preparation, warehousing, or the operation of transfer panels, controls range from fully manual to highly automated. The MES (manufacturing execution system) may comprise multiple modules including electronic batch records allowing for fully paperless production under GMP.

1.3.2.2 Design Constraints and Guidelines

The purpose of a fermentation facility is to produce biomass and associated products in a controlled environment, protected against contamination by foreign organisms, viruses, or other infective material. Operations should be reproducible and safe, and in line with legal requirements and environmental regulations. A good overview on the general aspects on facility design and operation principles is provided in the “EU GMP Guideline Annex 2: Manufacture of Biological active substances and Medicinal Products for Human Use” [14]. An even more detailed description of the design and quality-relevant topics is provided by the “ICH guideline Q7: Good Manufacturing Practice for active pharmaceutical ingredients” [15]. Even though these references focus on GMP production with all its formal requirements on documentation, the overall idea remains the same for non-GMP production. In both cases, the risk of losing the product due to contamination represents primarily a business risk, and hence should be mitigated by appropriate measures. Cleaning (CIP) and sterilization (SIP, sterilization in place) are generally employed in the upstream (fermentation) part of the operation, while bioburden reduction and control by CIP and SIP of the equipment and

0.2 µm filtration of the product is commonly found in downstream processing (DSP). Two operating principles should be distinguished: open processes, in which the process is exposed to the surrounding environment; and closed processes, which are fully contained. Table 1.4 shows some typical examples.

Special care should be taken for the preparation of the cell bank. It is recommended to perform cell banking operations in dedicated areas and in classified cleanrooms. A cleanroom refers to a controlled environment that requires specific gowning and air locks for access in order to meet the requirements on air quality, in particular particles and bioburden. Based on the recommendation defined for GMP productions in the “Aide-Mémoire Bio- and Gentechnologie, draft 2006 Chapter 3.1,” cell banking should be done in a class C cleanroom with open strain handling performed in a biosafety cabinet that provides a laminar flow of clean air with less than 20 particles of 5 µm in size, and less than 3,520 particles of 0.5 µm in size per cubic meter of air. This is equivalent to a class A cleanroom environment that would apply to fill and finish operations of sterile drugs. Similar precautions are to be taken for non-GMP production cell banks to mitigate any risk of contamination. Dedicated areas for strain, inoculum storage, and handling are common practice, though they may not be classified as cleanrooms. The principles also apply to the preparation of pre-seed cultures for industrial fermentations. The transfer of the inoculum into the pre-seed cultivation vessel (T-flask, Erlenmeyer flask, etc.) is an open process step and should be performed in a class A biosafety cabinet. The same protective measures apply for any open handling or transfer of the pre-seed culture until it is finally transferred to a closed seed train.

Another critical area of open product handling is buffer preparation for DSP. Buffers will be in contact with product or wetting surfaces, which are also in contact with the product. Hence, any risk of either chemical or biological contamination should be avoided. The former is usually achieved by handling of the buffer ingredients in a cleanroom environment (class D or even class C), and biological contamination is generally prevented by 0.2 µm filtration of the buffers. In addition, the water quality used for buffers in a GMP drug production will be at least purified water (PW), but most often and mandatory for sterile products

Table 1.4 General rules and example for open and closed process steps.

Typical open processing	Typical closed processing
Cell bank preparation	Seed train
Inoculum preparation	Inoculation of main bioreactor
Media preparation	Harvest until biomass inactivation
Buffer preparation	Virus inactivation (mammalian cell cultures)
Solids addition into a process vessel	All BSL 2 processes and higher (primary containment)
Filter press handling – handling of the filter cake	Biological wastewater inactivation

is water for injection (WFI, see also: “Note for Guidance on Quality of Water for Pharmaceutical Use” [16]).

Media preparation for GMP production of cell-culture-based biopharmaceuticals will mostly follow the design of buffer preparation. In addition, in particular for the production of parenterals, all material used for media, buffers, and in construction (lubricants, gaskets, tubings, etc.) must be of non-animal origin, certified (transmissible spongiform encephalopathies) TSE-free, and, for cell culture purpose, endotoxin-controlled. Endotoxin control at the media level is of lower importance in microbial processes such as *Escherichia coli*-based ones, as Gram-negative bacteria are the origin of endotoxins and their DSP is designed to remove those lipopolysaccharides.

Often, microbial fermentation media for biochemicals or enzyme production (Figure 1.10) contain cheap complex ingredients such as corn steep liquor, starch, glucose syrup, yeast extract, or other complex compounds that are not fully defined. The source of such raw materials is critical and will greatly impact growth and production. In either case, the medium, transfer lines, and bioreactor vessels are sterilized prior to use.

GMP cell-culture bioreactors are often placed in a class D or even class C cleanroom, even though the process is closed and there is no regulatory requirement for it. However, cell cultures often run for many weeks as perfusion culture, and thus mitigating the risk of contamination is considered a justification for the selected cleanroom environment. For maintenance and cleaning purpose, it is desired to move the majority of technical installations into a nonclassified technical space with only access to vessel ports and probes from within the clean



(a)



(b)

Figure 1.10 (a) Media preparation in a microbial vitamin production facility. Open additions in a technical area are common. Media are sterile-filtered or heat-sterilized before being added to the bioreactor. Therefore the risk of final product

contamination is minimal. (b) A very different degree and level of material handling. It shows a 15 m³ fermentation facility for the production of a recombinant fragment antibody with *Escherichia coli*.

room. Such a design, which facilitates maintenance, has been implemented for vessels with more than 2 m^3 volume.

In contrast, large-scale industrial microbial fermentations ($50\text{--}250\text{ m}^3$ working volume) are typically placed in large industrial halls with floors installed at the levels needed for accessing the bioreactor's ports (Figure 1.11). Ventilation is provided to remove excess heat during the sterilization of the bioreactors. There are also industrial large-scale bioreactor installations that stand in the open air, merely covered by a roof for protection against rain. The shorter processing times and reduced complexity, of especially batch but also fed-batch processes, reduce the risk of contamination and allow for a cost-efficient design.

1.3.2.3 Seed Lines

The steps between the cell bank and the production fermentation serve the purpose of expanding the seed volume (biomass) to finally provide sufficient cells to inoculate the main fermenter. Early seed stages, also referred to as *precultures*, are often run in shake flasks or in T-flasks and roller bottles in the case of cell culture, whereas subsequent stages are performed in stainless steel or single-use bioreactors. The dimensions of the seed bioreactors are adjusted to the biological system, as shown in Table 1.5.

Typically, the number of seed steps is impacted by the inoculation ratio, that is, the volume expansion factor between two seed steps. Depending on the duration of seed cultures and the cycle time of the main fermentation or cell culture, seed trains may feed into one or multiple bioreactors. “Cycle time” defines the time window between start of batch N and batch $N + 1$.

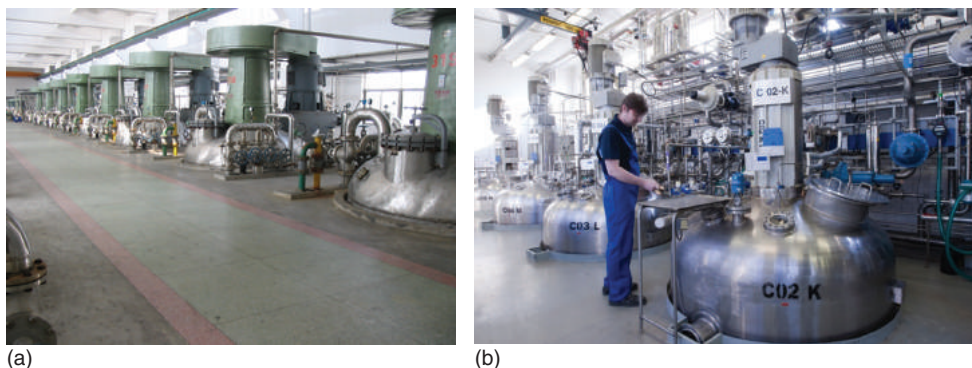

Figure 1.11 (a) The top floor of an installation of 10 bioreactors (55 m^3) for microbial production of secondary metabolites. Such installations, if well maintained, can remain in perfect operating condition for several decades while being entirely depreciated. The control room is at the end of the hall (not visible).

(b) A more modern series of bioreactors for the production of higher value-added fine chemicals and building blocks. The facility in (b) was constructed almost half a century later than the one in (a), but one can immediately see that the basic layout and construction concept has not really changed.

Table 1.5 Examples for typical seed stages for different biological production systems.

	Inoculum	Volume
Bacterium <i>Streptomyces clavuligerus</i>		
Erlenmeyer flask	3 ml spore suspension	0.6 l
Seed	0.6 l	1.5 m ³
Main fermenter	1.5 m ³	50 m ³
Filamentous fungi <i>Acremonium chrysogenum</i>		
Erlenmeyer flask	Spore suspension	4 × 1 l
First seed	4 l	3.2 m ³
Second seed	2.4 m ³	16 m ³
Main fermenter	12 m ³	65 → 85 m ³
Mammalian cell culture CHO		
T-flask	5 million cells	10 ml
T-flask	~1/4	40 ml
Spinner flask (or roller bottle)	~1/5	200 ml
Spinner flask (or roller bottle)	~1/5	1 l
Wave	~1/4	4 l
Wave	~1/5	20 l
Wave	~1/5	100 l
First seed (bioreactor)	~1/5	500 l
Second seed (bioreactor)	~1/5	2.5 m ³
Main fermenter	~1/5	12.5 → 15 m ³

Inoculation ratio for microbial system is typically 1 : 10 to 1 : 1000 for cell cultures 1 : 2 to 1 : 10. Seed cultures are usually operated in batch mode, whereas the production culture is run as fed-batch.

As discussed before, CSTR is the most used reactor design for submerged cultivation of practically all prokaryotic and eukaryotic cells listed in Table 1.1, as it can be scaled from small laboratory scale through pilot scale to 300 m³ fully contained sterile fermenters.

When scaling up fermentations, a suitable cultivation environment is chosen, and critical control parameters must be known and complied with in order to retain the metabolic activities. The most common aspects to consider during scaling up are the following:

- Vessel geometry
- Mass transfer
- Mixing
- Heat dissipation.

These parameters will be looked at in more detail.

1.3.2.4 Vessel Geometry

Vessel and stirrer(s) geometry should be adapted to the process and organism requirements. For example, the aspect ratio between the bioreactor diameter and height for microbial applications is about 1 : 3, permitting better aeration and mixing and a sufficiently large area for heat exchange. In contrast, vessels for cell

cultures typically have a 2 : 3 (diameter to height) ratio owing to reduced requirements for mixing and aeration, and with a stronger focus on reducing shear stress. Additional detailed design parameters for microbial vessels are summarized in Figure 1.12. Unlike a microbial reactor, the cell culture reactor and stirrer design aspects are still treated as trade secret. In some applications, foaming can be an issue. Besides the addition of antifoam agents, mechanical foam breaking systems may be installed in bioreactors. These defoamers may either be independent systems or mounted on a separate drive and shaft for agitator-independent speed control, or the defoamer turbines may be fixed to the agitator shaft rotating with the speed of the agitators. In addition to the classical approaches, a “stirring as foam disruption” (SAFD) concept [17] may be implemented, in which the floating foam is sucked back into a vortex along the stirring axle, which is induced by a downward pumping impeller placed just below the liquid medium. In most instances, however, foaming is controlled by the cultivation (feeds and additions) conditions and a sufficiently large head space (filling height); unexpected and excessive foaming may be indicative of a contaminated cultivation.

For large vessels, the height becomes critical as the hydrostatic pressure in the lower sections of the vessel may directly impact cell viability, or increased gas solubility may become relevant for the metabolic activities possibly impacting productivity and product quality. This is of particular importance considering that Rushton-type impellers provide only very limited axial movement of the broth.

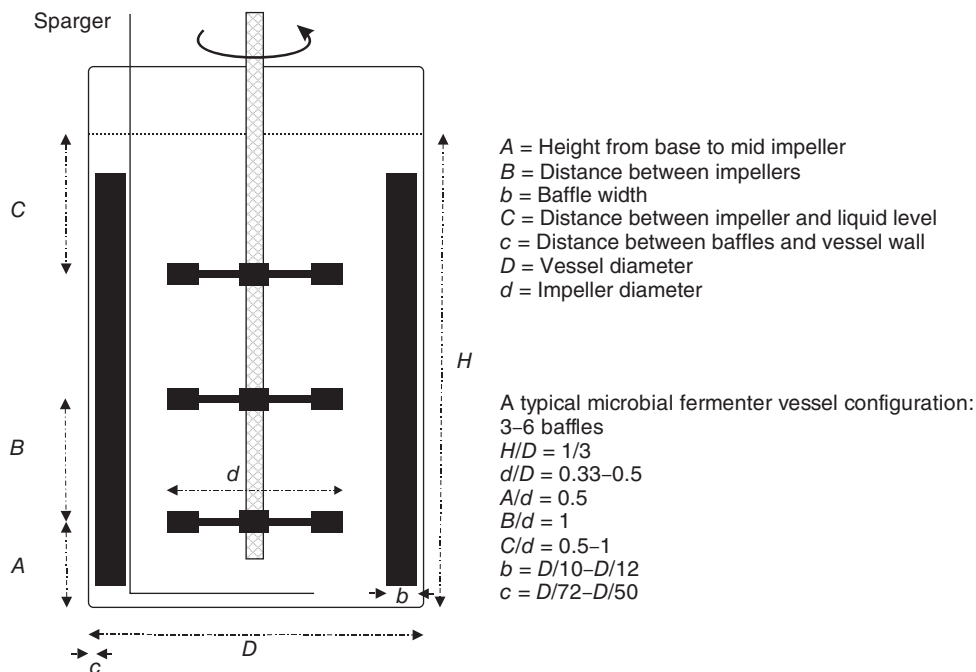

Figure 1.12 Standard design parameters for a microbial bioreactor vessel with typical values included. Parameters may vary based on the specific application.

1.3.2.5 Mixing and Mass Transfer

Finding the best compromise between power input as required for gas–liquid mass transfer, mixing times, and heat transfer is a particular challenge for aerobic, fast-growing, and/or high-cell-density cultivations. A high oxygen transfer rate requirement goes along with a high cooling capacity requirement.

Heat removal, however, is limited by the CSTR vessel surface, the contact time, and the temperature difference between the vessel's internal surfaces (coolant) and culture broth. The heat exchange surface of large vessels may quickly become the limiting factor; hence, coils or bundles of straight pipes besides or instead of baffles may be installed for an increased heat exchange surface (Figure 1.13, with coil and baffles). Reduced automated cleanability is a downside of these installations.

Baffles act to prevent vortex formation. The baffle width is typically $1/10$ – $1/12$ of the vessel's inner diameter, and baffles may be located with a minimum distance of $1/72$ – $1/50$ of the vessel diameter from the wall. The number of baffles installed varies between 4 and 6.

Since the 1950s, bioreactors used for microbial cultivation are generally equipped with one or multiple Rushton-type disk impellers, which, together with baffles, provide turbulent flow and efficient dispersion of gas. A significant increase in mixing time (to the minutes range) is a drawback of installing multiple Rushton turbines. Combining Rushtons with axial pumping stirrers reduces mixing time. The bioreactor in Figure 1.13a combines a Rushton impeller at the

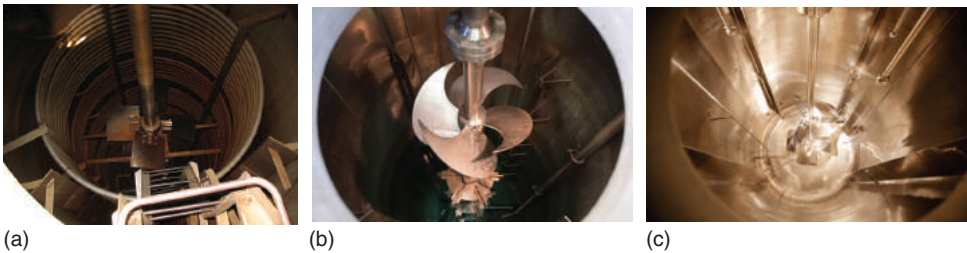

Figure 1.13 (a) A 55 m^3 working volume bioreactor for the production of clavulanic acid by *Streptomyces clavuligerus* (filamentous microorganism). The internal cooling loops make cleaning difficult. The upper stirrer is of a pitched blade type. It increases the axial mixing component and it has a positive impact on foam disruption. (b) An open bioreactor used for the production of fine chemicals and enzymes. Besides the Rushton-type impellers mounted evenly spaced on the shaft, one can again see the downward pumping hydrofoil on the top, which induces an axial movement of the culture medium for better bulk mixing and sucking the foam eventually back into the

liquid. Note the many screws used with the Rushton impellers, allowing changes and modification of the impeller on site, but they are also a possible impediment to efficient cleaning. Today, turbines can be fixed by a simpler “clamping” mechanism that is easier to clean. (c) The interior of a large bioreactor used for the recombinant production of monoclonal antibodies with mammalian culture. Exclusively marine-type impellers are used. One can also see the three spray nozzles at 11 and 1 O’ clock positions used for cleaning in place (CIP). These pictures show, again, how the basic design of a bioreactor is similar for all applications and has not really changed over the last 50 years.

bottom and a pitched blade impeller to reduce the mixing time of a rather viscous broth typical for fermentations with filamentous microorganisms.

Installing dip-pipes for additions to the broth, such as substrates and pH-controlling reagents, lower the mixing time and avoid pockets of high concentration in the broth. Computational fluid dynamic (CFD) studies may be used to assess the correct position of the dip-pipes. Cooling coils may lead to stagnant zones between the tank wall and the cooling coil. Adequate axial mixing may overcome this problem.

Cell-culture bioreactors are commonly equipped with two- or three-blade marine propellers to provide gentler mixing. The axial pumping component of these stirrers supports keeping control on the mixing time during scale-up. A propeller may be operated in the upward or downward pumping mode. The stirrer speed (tip speed) and the number of baffles (prevents vortex formation) are to be scaled with the aim of keeping shear under control. In cases of high sensitivity to shear stress, the stirrer may be placed off-center. This eliminates the need for baffles and still avoids vortexing. Compared to those of turbines, the diameter of a propeller is generally smaller (one-third the vessel diameter) but nevertheless provides efficient mixing of solids (e.g., microcarriers, large mammalian or plant cells) at low power intake [18]. Recent publications by Nienow [19] and Doran [20] provide detailed information on various impeller designs for cell-culture bioreactors.

The typical design characteristics for a Rushton impeller are shown in Figure 1.14.

A single impeller may be sufficient in a vessel as long as the liquid level does not exceed 1–1.25 times the vessel diameter as might be the case for cell-culture bioreactors. Higher microbial bioreactors are typically equipped with several impellers (see Figure 1.15) and usually operated at high speed, resulting in tip velocities of $\sim 3 \text{ m s}^{-1}$.

An indication for the power intake into a system is the dimensionless power number N_p (also the Newton number Ne), which allows comparison of mixing devices. It relates to the resistance force posed by the medium (inertia force) and depends on the power, geometry of the stirrer, stirrer speed, and fluid characteristics. For stirrers, N_p is defined by the fluid density, rotational speed, and diameter [21]:

$$N_p = \frac{P}{\rho n^3 d^5}$$

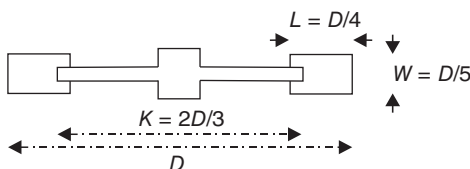

Figure 1.14 Standard design for a Rushton impeller.

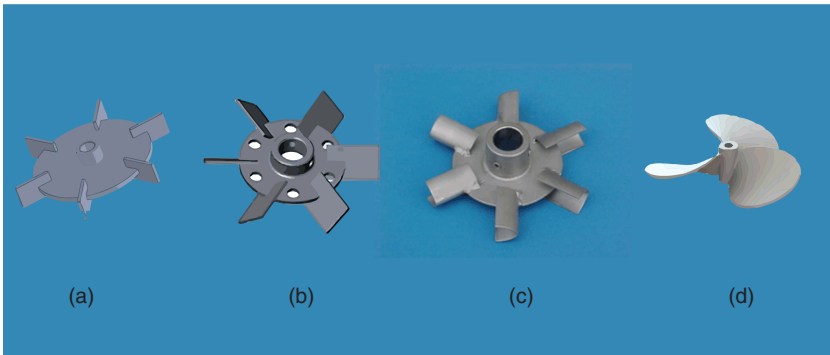

Figure 1.15 Commonly used stirring devices: (a) Rushton, (b) pitched blade, (c) Smith turbine, and (d) marine propeller.

Table 1.6 Impeller development.

First described	Impeller type	Turbulent mixing condition
1950s	Rushton impeller – radial mixing six blades on disk for gas dispersion in liquid	$N_p = 4.5–6.5$ Cavitation
1980s	Smith turbine – radial mixing six concave blades on disk	$N_p = 2.8–3.2$
1988–1993	Scaba and ICI impellers – radial mixing six deeper concave blades and sharp edge of blade	$N_p \sim 1.5$
US Patent 4 779 990 (1988) Hjort US Patent 5 198 156 (1993)	Chemineer BT-6 impeller – radial mixing six asymmetric concave blade design	$N_p = 2.3$
1998 Bakker	Pitched blade – axial mixing four pitched blade 45°	$N_p = 1.3$
	Marine propeller, hydrofoil – axial mixing 3–4 blades, pitch 1–5.5	$N_p = 0.3–1.4$

Compiled from <http://www.postmixing.com/mixing%20forum/impellers/impellers.htm>.

with P the power, ρ the fluid density, n the rotational speed, and d the diameter of the stirrer.

The Rushton impeller is still the most commonly used radial mixing device for standard applications. New, more efficient impeller types were developed in the 1980s and 1990s (see Table 1.6). These developments improved mixing at significantly smaller power numbers. They are also favorable in the context of prevention of stirrer flooding.

Roman and coworkers used a different approach to increase mixing (30% higher oxygen transfer rate) with the same power intake by perforating the Rushton turbine blade and also varying the dimensions of the blade [22, 23].

Looking at larger industrial bioreactors, the mixing times should be kept short and may require additional feed or air/gas injection points on the lateral side of the reactor instead of increasing the power intake. Considering the power requirements of $2\text{--}10\text{ kW m}^{-3}$ (Table 1.7), a 250 m^3 bioreactor would need a $0.5\text{--}2.5\text{ MW}$ motor installed to keep the medium fully dispersed and turbulent.

Skelland and Ramsay [24] reported that the power input P per volume V in a completely dispersed system decreases with increasing size of the tank, provided there is full geometric similarity of the two compared vessels: constant W/D , H/T , B/T , and ϕ , only varying T/D (B : baffle width (m), D : impeller diameter (m), H : height of liquid in vessel (m), T : tank diameter (m), W : width of impeller blade (m), and ϕ : volume fraction of disperse phase).

$$\frac{P}{V} \sim D^{-0.13}$$

where P is the power input to the system (W), V is the volume of total liquid (m^3), and D is the impeller diameter (m).

This is attributed to the reduced density of the aerated liquid and to the formation of air cushions behind the turbine blades that further reduce the friction [25]. Following this finding, a 10-fold increase in vessel size reduces the specific power to about two-thirds, which is of particular importance for large-scale industrial fermentations. Table 1.7 provides an indication of the range for specific power requirements for different types of fermentations.

Even when technically feasible, a specific power requirement between 5 and 10 kW or even 17.5 kW is limiting to the scale of operation and impacts the economics of the process. In addition, the shear and heat transferred into the system may impose additional stress to the biological system. Consequently,

Table 1.7 Fermentation classes and typical ranges for heat generation, power input, and scale of operation.

	Heat generation (kW/m^3)	Power input (kW m^{-3})	Scale of operation (m^3)	Installed stirrer power (kW)	Process temperature ($^{\circ}\text{C}$)
Pilot-scale fermentation	5–15	1–3	1–5	5–15	28–37
<i>E. coli</i> ^{a)} , bacteria	10–20	2–5	50–300	100–1500	30–37
Yeast, fungi ^{b)}	15–25	2–10	20–300	100–3000	20–30
Microbial high cell density	90	17.5	20	350	20–37
Cell culture	0.2–1	0.05–1	5–25	0.25–25	25–37
Plant cell-culture	0.2–1	0.1–0.5	5–75 [27]	0.5–35	25–37
Stem cells	Very low	<0.1	0.01–1	—	37

a) Short time, exponential feed.

b) Longer time, viscosity.

scaling-up starts with process development for a given biological expression system, keeping technical large-scale constraints in mind.

Power is not the only aspect to be kept in mind, as mass transfer, heat transfer, and bulk fluid motion also depend on the rheological properties of the culture medium, which may even significantly change during cultivation as is the case with filamentous organisms. In such cases, the culture broth shows pseudoplastic behavior with increasing biomass concentration. This means that the fermentation broth shows “liquid” behavior close to the stirrer but behaves like a “solid” in bioreactor zones with low turbulence and shear. Viscosities can easily reach 2000 cP, which is the consistency of corn syrup or honey. In such viscous non-Newtonian systems, oxygen and heat transfer rates may be reduced to 5–50% of those typically observed in a typical bacterial cultivation. As a consequence, the homogeneity of the system will also be negatively impacted, rendering proper monitoring of culture conditions difficult. In the cephalosporin C fermentation discussed below, 1.5 MW of power is installed for the agitation of a fed-batch cultivation with a filamentous fungus.

1.3.2.6 Temperature Control and Heat Transfer

Every fermentation has the requirement that the cultivation temperature is controlled within a defined range (see Table 1.10). Temperature control requires heating in the first hours of a microbial fermentation or throughout a mammalian cultivation, but as mentioned earlier, cooling becomes critical or even limiting with high-cell-density microbial fermentations. In large-scale bioreactors, heat transfer is usually more limiting than oxygen transfer, in particular during the late exponential growth of a batch phase when the growth rate is highest. In addition to the heat produced by the biomass (Q_{metab}), also the heat generated by the conversion of a part of the kinetic energy from stirring (Q_{mech}) into heat (friction) needs also to be removed. On the other hand, heat loss occurs through evaporation (Q_{evap}) and by loss to the environment. Thus the total heat load Q_{tot} is defined as

$$Q_{\text{tot}} = Q_{\text{metab}} + Q_{\text{mech}} + Q_{\text{evap}}$$

The bioreactor’s cooling system should ensure that excess heat from Q_{metab} and Q_{mech} can be removed efficiently. Heat transfer may also be important for short heating and cooling times before and after sterilization of the bioreactor if the medium is sterilized in the vessel.

However, most critical is the control of the metabolic heat flux, which can be described using the yield coefficient Y_Q ($\text{kg biomass kJ}^{-1}$). The heat generated for the production of 1 kg biomass can be described as [29]

$$\frac{1}{Y_Q} \left\{ \begin{array}{l} \text{heat of combustion of the} \\ \text{substrate for 1 kg biomass} \end{array} \right\} - \left\{ \begin{array}{l} \text{heat of combustion} \\ \text{of 1 kg biomass} \end{array} \right\}$$

or

$$Y_Q = \frac{Y_X}{H_S - Y_X \times H_X}$$

with

Y_Q : the yield coefficient ($\text{kg biomass kJ}^{-1}$)

H_S : the heat of combustion of substrate (kJ kg^{-1}), which can be found in the literature

H_X : the heat of combustion of biomass (kJ kg^{-1}), to be measured ($\sim 20\text{--}24 \times 10^3 \text{ kJ kg}^{-1}$).

The heat production rate that is relevant for bioreactor design can be derived from the biomass production rate r_X ($\text{kg (m}^3 \times \text{h)}^{-1}$):

$$r_W = \frac{r_X}{Y_Q} (\text{kJ (m}^3 \times \text{h)}^{-1}) = \frac{r_X}{3600 \times Y_Q} (\text{kW m}^{-3})$$

In aerobic fermentations, heat generation is correlated to the oxygen consumption rate, which can be estimated with sufficient accuracy by

$$\frac{r_W}{r_{O_2}} = 14.4 \times 10^3 (\text{kJ kg}^{-1})$$

The following example for a vessel design derives from a project in which the methylotrophic yeast *Pichia pastoris* (new *Komagataella pastoris*) was grown to a density of 150 g l^{-1} CDW (cell dry weight). The vessel had a working volume of 20 m^3 (Figure 1.16).

The metabolic heat flux for growth on methanol is $\sim 260 \text{ kJ (l} \times \text{h)}^{-1}$, corresponding to 72 kW m^{-3} or 1440 kW for 20 m^3 plus the energy input from stirring. The vessel was designed to dissipate up to 1600 kW of heat. To achieve this, the vessel's external surface was completely covered by half-pipe cooling coils, and the baffles were constructed as pipe bundles, which were connected to the cooling circuits. In addition, the surface was increased by changing the diameter-to-height ratio to almost 1:4. In spite of these measures, the use of -20°C brine as cooling agent during the "hottest" phase of the fermentation was needed.

1.3.2.7 Oxygenation

Oxygen availability is critical for all aerobic fermentations, but oxygen solubility in water is very low ($2.18 \text{ mmol O}_2 \text{ l}^{-1}$ of H_2O at 0°C) and drops rapidly with increasing temperature (1.16 and 1.03 mmol O_2 at 30 and 40°C , respectively). The oxygen solubility in water between 0 and 40°C is approximately

$$\text{Air (21 vol\% O}_2\text{)} : C^* = \frac{0.526 \times P(\text{bar})}{36 + T(^{\circ}\text{C})} (\text{kg m}^{-3})$$

$$\text{Pure O}_2 : C^* = \frac{2.506 \times P(\text{bar})}{36 + T(^{\circ}\text{C})} (\text{kg m}^{-3})$$

Oxygen solubility is further reduced by salt and other electrolytes.

$$\frac{C_{\text{solution}}^*}{C_{\text{water}}^*} = \exp(-\alpha \times C_i)$$

where C_i is the concentration of the solute, and α for biotechnologically relevant solutes is in the range $5\text{--}20 \times 10^{-4}$ ($\text{m}^3 \text{ kg}^{-1}$) and for most carbohydrates

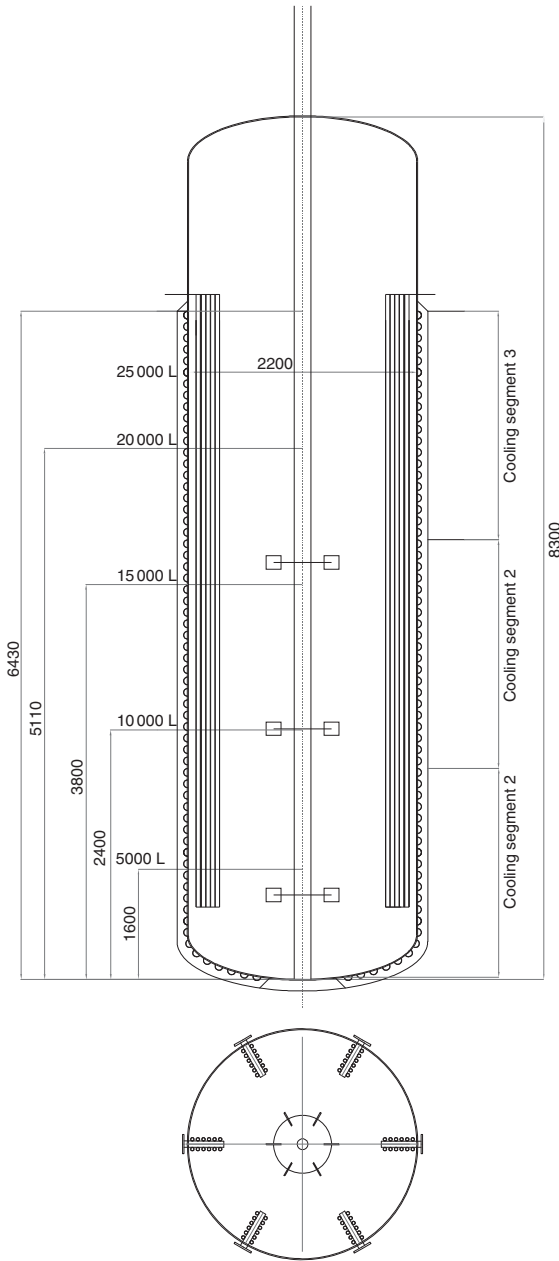

Figure 1.16 Bioreactor for high-cell-density yeast fermentation with the requirement to remove 1600 kW of heat. The design resulted in a diameter to height ratio of 1:4, using

half-pipes for cooling the vessel wall and six heat exchanger bundles for providing the largest possible cooling surface.

14×10^{-4} . Hence the oxygen solubility in a 10% glucose solution is reduced by 13% [29].

The biological oxygen demand (BOD) of a culture depends on the substrate used in the fermentation, ranging from 0.6–0.8 (kg O₂/kg dry weight) for the partially oxidized glucose up to 5.0–5.6 for fully reduced methane. Assuming complete oxidation of the substrate for biomass biosynthesis, the oxygen demand can be expressed as

$$\text{BOD} = \left\{ \begin{array}{l} \text{oxygen for oxidation of substrate} \\ \text{needed for 1 kg biomass} \end{array} \right\} - \left\{ \begin{array}{l} \text{oxygen for oxidation} \\ \text{of 1 kg biomass} \end{array} \right\}$$

Considering that most microbial biomass needs 1.33 kg O₂/kg dry weight for full oxidation, the oxidation of glucose requires 1.067 kg O₂ kg⁻¹, and assuming a biomass yield on glucose $Y_{x/s}$ of ~0.5, the BOD is about 0.8 kg O₂/kg dry weight.

For aerobic growth, organisms require a minimum oxygen concentration; otherwise growth becomes oxygen-limited. As an approximation, the critical oxygen concentration is in the range of 10% of saturation; however, in high-cell-density cultivations it may increase to 30% [28]. Measures to avoid oxygen limitation include increasing gas–liquid mass transfer by increasing agitation, increasing aeration, or supplementary feeding of oxygen. As a side note, excessive gas flow may result in “flooding” of the impeller. Under this condition, the gas dispersion becomes inefficient and hence the gas hold-up and mass transfer decrease sharply.

Alternatively, and if not negatively affecting productivity, nutrient feeds may be adjusted so that p_{O_2} is controlled at the desired level.

During steady state, the oxygen uptake rate (OUR) equals the oxygen intake (or OTR, oxygen transfer rate):

$$\begin{aligned} \text{OUR} = r_{\text{O}_2} &= \text{BOD} \times r_X = \text{BOD} \times \mu \times X \\ &= 3600 \times k_L a \times (C^* - C_L) (\text{kg}(\text{m}^3 \text{h})^{-1}) \end{aligned}$$

with

$$\begin{aligned} k_L a &= \text{volumetric oxygen mass transfer coefficient (s}^{-1}\text{)} \\ \text{OUR} &= \text{oxygen uptake rate (kg O}_2 \text{ (m}^3 \times \text{h)}^{-1}\text{)} \\ C^* &= \text{oxygen solubility (kg m}^{-3}\text{)} \\ C_L &= \text{oxygen concentration in medium (kg m}^{-3}\text{)}. \end{aligned}$$

The volumetric oxygen mass transfer coefficient describes the efficiency with which oxygen can be delivered into the bioreactor under a defined set of conditions. It serves well for comparing reactor designs. It is a valuable tool for scale-up considerations aimed at improved setups, sparger and agitator designs, agitation rate, gas flow, and so on.

The term $k_L a$ is comprised of k_L (gas mass transfer coefficient), which is influenced by the medium composition, while a represents the interfacial area of all bubbles in the bioreactor, which is influenced by aeration, coalescence, and

medium viscosity. Consequently, $k_L a$ changes throughout a fermentation. These complex interactions are not predictable and may change the $k_L a$ by orders of magnitude [30].

From a technical perspective, $k_L a$ can be influenced by the power input and by the superficial gas velocity. In large fermenters, the overall observed $k_L a$ is also dependent on the mixing time, that is, to the presence of oxygen-depleted zones in the bioreactor. Note: In general, the superficial gas velocity increases with increasing scale. With a characteristic time analysis, the impact of mixing on the overall oxygen transfer can be evaluated, for example, by comparing the oxygen consumption time and the mixing time. CFD may help to evaluate the best strategy to increase oxygen transfer for a given process.

The $k_L a$ requirements vary greatly with the biological systems in use. While microbial systems are most demanding with a $k_L a$ requirement of $1-17\text{ s}^{-1}$, plant cell cultures follow with $k_L a$ of $0.08-1.7\text{ s}^{-1}$, ahead of mammalian cell cultures with $k_L a$ requirements of $0.02-0.41\text{ s}^{-1}$ [31, 32].

Putting the above-mentioned points into perspective for implementing an industrial fermentation, one has to identify the best combination between mixing, aeration, and heat transfer. Table 1.8 provides an overview of the measures to improve any one parameter and the impact on the others.

Table 1.8 Some examples of scaling up considerations, finding the balance.

Measures	Opportunities	Weakness	Impact on fermentation
Stirrer rate	Short mixing times, higher $k_L a$, better dispersion, higher OTR, improved solids mixing	High energy consumption, higher heat intake, higher shear stress	Increased cooling requirements, decreased cell viability
Aeration, gas flow	Higher $k_L a$, higher OTR, faster growth and production	Higher gas hold-up, increased foaming tendency, risk of stirrer flooding	Increased cooling requirements, decreased working volume
Oxygen-enriched air	High OTR, lower gas hold-up at equal OTR	Increased risk of reaching toxic CO_2 levels	Increased cooling requirements, adjustment of buffer concentration
Increasing heat transfer by increasing heat exchange surface (coil, pipe bundles), reducing cooling water temperature	Increased feed rates, growth, and productivity at higher cell density	Reduced cleanability due to internal structures, longer mixing times due to installed coils	Increased turnaround times for cleaning

However, it is important to note that only one parameter can be used as scale-up criterion and that this has to be chosen during the piloting phase.

1.4

Industrial Design Examples

1.4.1

Cephalosporin C Production

The following example describes the industrial-scale cephalosporin C fermentation by the filamentous fungus *Acremonium chrysogenum*. Common to many industrial-scale microbial operations, this process is operated as fed-batch fermentation at a scale of 50–100 m³ in the final production stage. The fermentation uses a complex medium and several feeds and requires efficient aeration. While cephalosporin C titers in the pilot-plant scale could reach up to 32 g l⁻¹, titres in the production scale ranged between 24 and 28 g l⁻¹ in the industrial fermentation broth. The design is dedicated to a mono-product facility for the most cost-effective production.

The process flow diagram is shown in Figure 1.17. The plant comprises four 2 m³ (seed 1) and four 20 m³ (seed 2) seed reactors and six identical 120 m³ main fermenters (nominal volumes). All reactors share similar geometry. Table 1.9 notes some key mass balance information. The fed-batch fermentation results in a final liquid harvest volume of ~85 m³.

The operating temperature is controlled by means of chilled water at 10 °C through the vessel jacket and cooling coils, which also serve as baffles.

All fermenters are fitted with top drives, which has the advantage of seals not being in contact with the fermentation broth. This is of particular interest, as the medium contains a high proportion of abrasive solids. In addition, the risk of contamination is lower without broth contact. Thus a broken seal may permit continuation of the fermentation, while a broken bottom seal generally results in a loss of the fermentation. For small vessels (up to 1.5 m³), bottom drives may be advantageous to reduce the overall height of the fermenter and allow for a shorter impeller shaft (without additional internal support), and improve accessibility of the cover, for example, opening for inspections.

To further mitigate the risk of contamination and to increase $k_L a$, the vessels are operated at 0.5 bar overpressure.

Some additional design parameters are given in Table 1.10.

The harvested fermentation broth is treated to remove biomass and colored compounds before the cephalosporin C is converted into 7-amino-cephalosporanic acid (7-ACA) by a two-stage biocatalytic conversion [33].

The media and energy consumption for the entire plant, including the DSP, are quite impressive (Table 1.11).

About 45 km of piping was necessary for the distribution of product and utilities; automation and controls required approximately 5500 signals. The total investment was between US\$ 110 and 120 million including the DSP.

The cephalosporin C fermentation mentioned in the previous paragraph is a sterile process with complete sterilization of bioreactors and peripheral feed vessels prior to inoculation. A total of 45 m³ of the medium is prepared in a

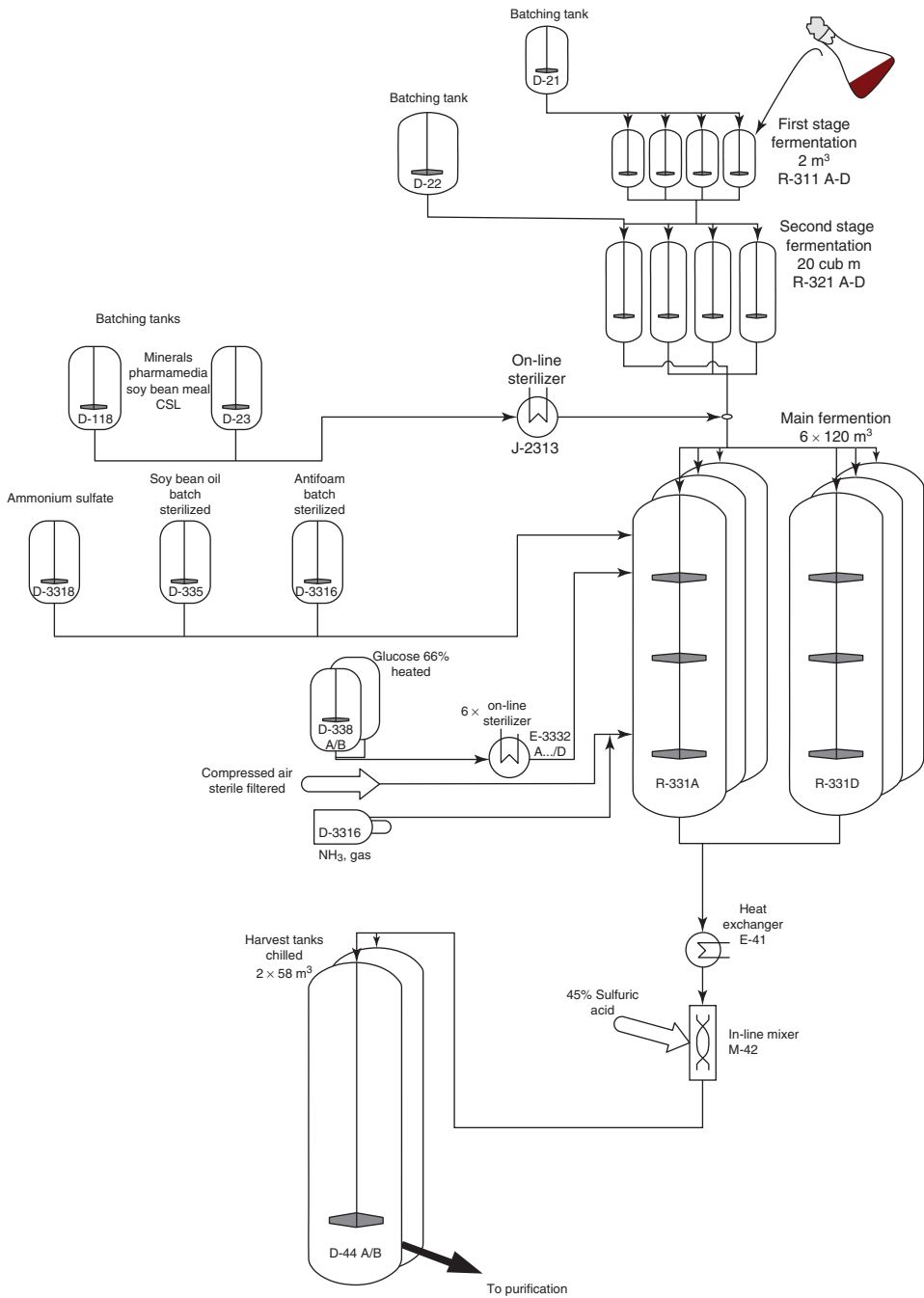

Figure 1.17 Process flow diagram for a 1000 ton per annum cephalosporin C fermentation plant. Only the fermentation part is shown.

Table 1.9 *Acremonium* sp. fed-batch fermentation balance.

	m ³
Post inoculum volume	67
Glucose feed (approximate)	16
Soy bean oil	4.5
Ammonium sulfate solution	3.5
Less evaporation	-6
Harvest volume (approximately)	85.0

Table 1.10 Seed train and main fermentation for cephalosporin C production.

	Volume (m ³)	Inoculum (m ³)	Aeration (N m ³ h ⁻¹)	Installed stirrer (kW)	Feeds
First seed	3.2	41	72	—	—
Second seed	16	2.4 m ³	720	—	—
Main fermenter	120	12 m ³	5100	Approximately 1500	Ammonia 40–700 kg h ⁻¹ Glucose 65–66% 16 t Soy oil 4.5 m ³ Ammonium sulfate 3.5 m ³

Table 1.11 Utilities consumption.

	Quantity	Main consumer/use
Steam	21 000 kg h ⁻¹	Fermentation including harvest
Compressed air	30 000 m ³ h ⁻¹	Fermentation
Cooling water	6 000 m ³ h ⁻¹	Fermentation
Water	1 600 m ³ d ⁻¹	Media preparation and cleaning
Natural gas	2 000 m ³ h ⁻¹	Steam generation
Electricity	12.1 MW	~80% fermentation

stirred media preparation tank and heated up to 90 °C by steam injection before transfer to the main receiving production reactor. Preheating aims at avoiding hydraulic shocks during sterilization.

To prevent sedimentation, the agitator of the receiving tank is turned on as soon as the medium reaches the level of the bottom agitator. Steam is supplied through the sparger to prevent sticking of nutrient solids in the sparger holes.

To sterilize the fermenter, it is steam-heated to 120–122 °C (pressure 2.0–2.2 bar) and kept at this temperature for 30 min. After sterilization, the medium is cooled to 27 °C by water injected into the jacket. During cooling, the fermenter is kept under pressure (1.4 bar) by sterile compressed air. As

a consequence of the direct steam sterilization (condensate formation), the medium volume increases to 55 m³ after sterilization.

The fermentation is highly aerobic, which necessitates a high aeration rate and vigorous agitation throughout the whole process. Compressed, filter-sterilized process air is supplied at 30 °C and 2 bar pressure.

The exhaust air leaves through a gas treatment system (heat exchanger). The heat exchanger, a steam heated (105–110 °C) jacketed pipe, serves as sterile barrier, as it prevents backward contamination of the fermenter.

All feeds are added as sterile solutions. Two tanks are used for the glucose feed for the entire fermentation, one in operation and one under maintenance (washing, loading, etc.). The glucose feed, that is, 16 t of 65–66% glucose solution, is prepared from 74 to 75% glucose syrup by dilution with water. The feed tanks are equipped with agitators and jackets to maintain the syrup at 50–60 °C to reduce viscosity and avoid crystallization or lump formation. The steam-heated jacket ensures temperature control.

A continuous sterilization system ensures sterility of the linearly fed glucose solution. Redundant feed pumps for each fermenter pump the glucose solution through two heat exchangers, one as a common system and the second dedicated to each bioreactor.

Other feeds such as antifoam agents are sterilized batchwise *in situ* and fed via sterile piping.

1.4.2

Monoclonal Antibody Production at the 10 m³ Scale

This section refers to an example of a design for monoclonal antibody production at the 10 m³ scale (working volume) using stirred-tank bioreactors. In order to make best economic use of the DSP line, three production bioreactors feed into one DSP line.

Figure 1.18 shows the process flow diagram. Pre-culture stages are run either in spinner or roller flasks followed by pre-seed growth in wave bioreactors. The design example proposes cell-culture volumes of 400 and 1800 l (post inoculation) for the seed stages N-2 and N-1, respectively. All pre- and seed-cultures are performed in the batch mode. The inoculum to medium ratio increases from 1:2 in the pre-culture stages to 1:5 during the seed stages and the production cell culture. Post-inoculation volume in the production bioreactors, which are typically top-driven, is 8500 l. As is typical for monoclonal antibody processes, the production cell culture is operated in a fed-batch mode, which in our process model results in a final cell culture volume of 10 000 l.

All media and feeds are prepared in dedicated media preparation tanks. During transfer to the respective cleaned and steam-sterilized receiving bioreactors or feed tanks, the final formulated culture medium or feed is sterilized through membrane filtration. Filter sterilization is preferred over heat sterilization due to heat sensitivity of some components. A few smaller volume feeds are held in and supplied from disposable bags.

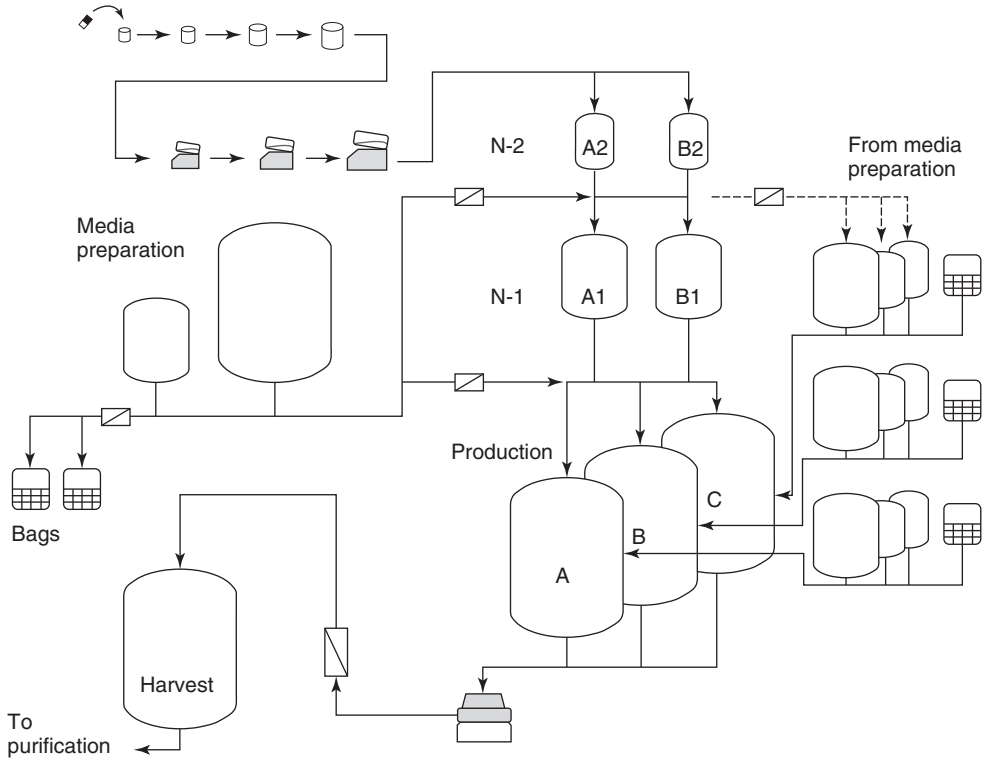

Figure 1.18 Upstream process flow diagram of a design proposal for a $3 \times 10^3 \text{ m}^3$ (working volume) monoclonal antibody manufacturing facility. The tanks and bag(s) at the right contain the carbon feed, base, antifoam, and other feeds. The inoculation ratio is 1:4–1:5 in the stirred-tank bioreactors.

In our example, the cycle time of a production bioreactor is 21 days (Figure 1.19), which comprises time to run the cell culture (17 days), time required for harvest, CIP, sterilization in place (SIP), and media fill to have the reactor ready for inoculation again. As the N-2 and the N-1 seed cultures take less than 6 days (less than 9 days including CIP, SIP, and media fill), two bioreactor seed trains are sufficient to grow the seed for the three production reactors (Figure 1.19). There is no need for CIP or SIP activities on wave reactors, as they are single-use disposable systems. In addition, batch cultures in the wave reactors do not exceed 4 days. Therefore, access to one functional wave line, as shown on the process flow diagram in Figure 1.18, meets requirements to provide inoculum to the first stirred-tank reactor step every 7 days. USP (upstream processing, i.e., pre-culture and fermentation to cell separation) and DSP (meaning all the steps after USP to the final product) and as a consequence utilization of resources look well balanced, given protein purification is operated in a time window of 6–7 days. Over the years, antibody titers increased to about $3\text{--}5 \text{ g l}^{-1}$ in standard fed-batch cell culture processes (duration 10–14 days), some exceeding 10 g l^{-1} based on

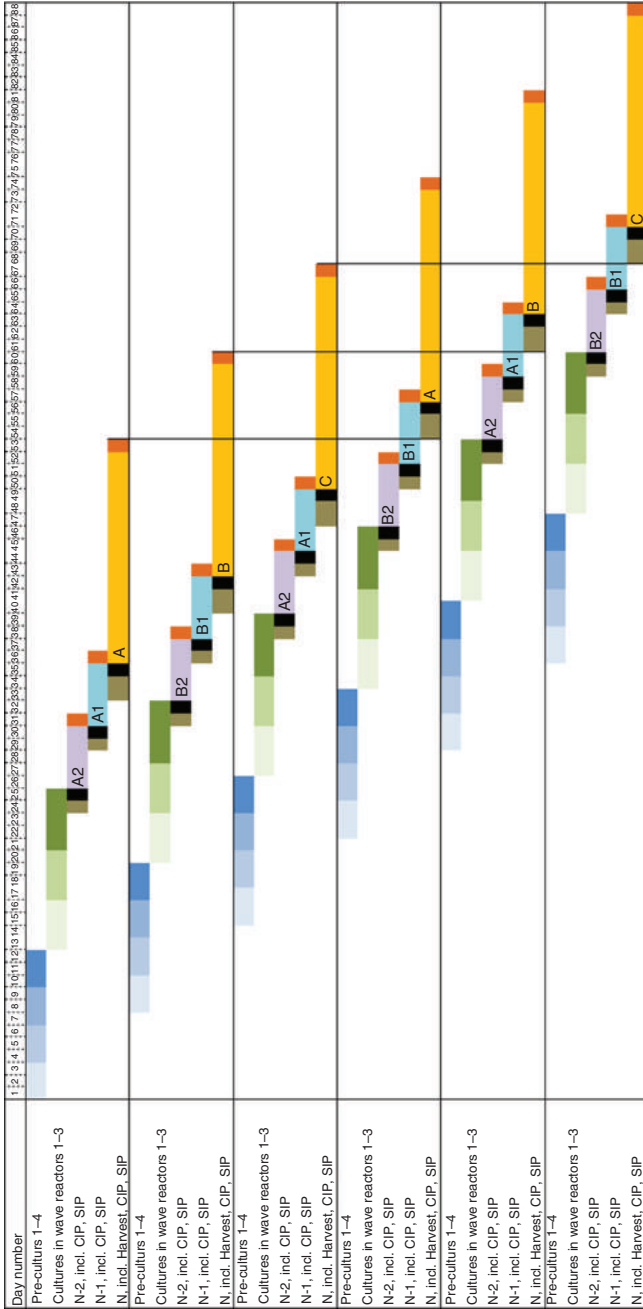

Figure 1.19 Example of an upstream production schedule for a 3 x 10 m³ facility for the manufacture of a monoclonal antibody showing six completed USP production cycles. The black bars in front of the cell cultures N-2, N-1, and N indicate inoculation readiness of the stirred-tank bioreactors.

extended cultivation times. The typical yield of antibody purification processes (DSP) is in the range of 60–80% [34].

In contrast to many aerobic microbial fermentations, cell cultures do not have critically high oxygen transfer demands. However, mammalian cells are characterized by high shear sensitivity. Consequently, at a large scale, supplementation of air with pure oxygen is required to improve gas transfer without increasing the stirrer speed and power input, which would result in excessive shear and cell damage.

1.4.3

Nonsterile Fermentations

Some commodities, organic acids, ethanol, and yeast biomass are produced under nonsterile conditions because either the scale of operation exceeds 200–300 m³ or the operating costs for sterile fermentations would be prohibitively high.

In such settings, the seed stages are mostly conventional bioreactors that are fully sterilized, while the main fermenters are not sterilizable. This works in systems where cultivation conditions are highly selective, for example, low pH or a highly selective media composition, and the inoculum is delivered in sufficient amount to outperform any impact of potential contaminants. Examples are citric acid production by *Aspergillus* (company Jungbunzlauer) and ethanol production by yeast, where both will grow fast on a defined mineral salt medium and at low pH. The ethanol production industry also makes use of the addition of antibiotics such as erythromycin, tylosin, and virginiamycin and small-molecule microbial control chemicals (chlorine dioxides) or a natural hops-derived extract. All of these negatively affect the growth of potential bacterial contaminants and exhibit no or only minimal impact on the production organism [35].

In case of a significant contamination, the bioreactors are cleaned and steamed at ambient pressure with the temperature reaching 80–100 °C, sufficient to kill vegetative cells and fungal spores.

1.5

Cost Analysis for the Manufacture of Biotechnological Products

A cost analysis aims to answer three questions [36]:

- 1) What are the costs of the asset(s) to start up a production (investment)?
- 2) How much will it cost to manufacture a product?
- 3) What return can we expect on the invested capital?

1.5.1

Investment

An investment (CAPEX) comprises all the funds required to build and start up production assets. In addition, labor costs for planning, construction, installation,

and operational qualification and partly for process qualification are capitalized, that is, considered as part of the investment costs. An investment in production assets is also greatly affected by the nature of the products (e.g., highly active, toxic compounds) and the intended use of products, such as, for example, active pharmaceutical ingredients that are to be manufactured under GMP as described in the ICHQ7 [37] guideline. Table 1.12 lists the capital costs for a 20 m³ mono-product facility planned for GMP manufacture of a specific recombinant therapeutic protein by a methylotrophic *P. pastoris* (*Komagataella phaffii* [38]) cultivated on methanol. For comparison purposes, a cost estimate for a related non-GMP facility is also provided in the Table 1.12.

In the case of a GMP facility, equipment investment contributes only about one-third of the total cost; two-thirds go into building infrastructure including clean rooms and the necessary HVAC systems. A similar non-GMP facility will be far less demanding on the building and infrastructure side, while equipment and requirements for sterility, cleanability, and containment will remain largely the same. As a rule of thumb, qualification of equipment as required for GMP increases the costs of the installed equipment by 10–20%. Project planning and execution to commissioning of the facility will take up 10–20% of the investment. Timelines for planning and construction of a GMP or a non-GMP plant will not differ greatly, and will need 1.5–2.5 years, as delivery times for key equipment will be a main driver. For a GMP facility, substantial additional time needs to be invested for qualification and validation. Process and clean hold time studies take substantial time and are usually required for approval of the facility by the authorities. The overall timeline of a GMP facility from credit approval to market authorization can be up to 5 years or more. In a fast changing business environment, this means there is substantial risk related to the decision to build a facility.

While a non-GMP plant is ready for operation directly after completion of commissioning, for a GMP plant it will take another 6–12 months to establish operational readiness due to facility and equipment qualification and process validation requirements. In addition, for commercial GMP manufacture, and depending on the target markets, the facility needs to be approved by national and international health authorities.

Another view on the investment is given in Table 1.13, which describes the average distribution of capital needs between the fermentation part (including biomass separation), product isolation or product purification, and the laboratories required for operating a plant.

1.5.2

Operational Cost, Cost of Manufacturing

Operational cost or operational expenditure (OPEX) is the cost of manufacturing a given product, and it comprises the cost categories shown in Table 1.14.

Material refers to raw material that is consumed during the manufacturing of a product, such as media components, starting materials (educts) in the

Table 1.12 Example of capital cost of a brownfield recombinant protein production facility, planned for a central European location.

Area	Equipment	Cost GMP (million US\$)	Cost non-GMP (million US\$)	Comments
Building				
	Production building USP/DSP HVAC, BMS, internal fit out	38.0 24.0	22.0 10.0	Including warehousing Clean rooms for GMP site
Process equipment USP/DSP Ancillary equipment USP				
	Raw material storage	2.5	2	Tank farm, weighing, and dispensing area
	Media preparation area	2.8	1.3	5 tanks, 100–10 000 l, autoclave washer
	Fermentation	2.8	2.3	100, 1 000, 20 000 l fermenter including peripheral equipment
	Harvest	1.4	1.2	Tanks, separator, autoclave, washer, a.o.
Ancillary equipment DSP				
	Buffer preparation	2.4	1.7	Four tanks, including auxiliary equipment
	Buffer storage	2	1.8	Ten tanks, including auxiliary equipment
	Purification and bulk filling	5.5	5	Four chromatography skids, three UF/DF skids, including auxiliary equipment
Utilities				
	CIP systems, storage, and distribution of process/clean utilities	3.5	2.5	No clean steam and only reverse osmosis water for non-GMP
	Process cooling	2	2	Chiller, and so on

Piping/Automation	Piping Automation 3500–5000 \$US/IO	25 25	17 14	~2–4× equipment cost Up to one-third of equipment cost, vastly depending on automation level: fully automated including electronic batch recording (EBR) and integration into manufacturing execution system (MES) versus manual transfers between autonomously running unit operations
Total investment		136.9	83	
Indirect costs				
cGMP	Qualification/validation	Approximately 10% of invest	None	Costs vary widely and depend on company policies and procedures
Engineering services		15–25% of invest	(15–20) of invest	
Total		~170–180	~90–100	

Costs for similar GMP and non-GMP facilities are compared. While equipment costs are similar, costs for documentation, qualification, and higher requirements on the infrastructure result in significantly higher investment costs.

Table 1.13 General indications on the share of investment between USP, DSP, and support laboratories (fill and finish costs not considered).

Operations	cGMP (%)	ISO (%)
Upstream processing (fermentation and cell harvest)	25	40
Down stream processing (isolation and purification)	50	45
Laboratories	25	15

Table 1.14 Operational expenditure (OPEX) and cost categories.

Primary cost (relate to cash out)	Material
	Energy (external)
	Personnel
	Maintenance and repair (external)
	External services and general expenses
	Depreciation
Secondary cost (no cash-out, from facility point of view)	Utilities (internally produced)
	Internal services
Overhead cost	Administration
	Sales and marketing
	R&D

case of biotransformations, as well as disposable filters, flexible tubing, and chromatography resins. The cost contribution of single-use supplies is especially significant in the case of manufacturing in a facility that is based on end-to-end single-use technology (Figure 1.22).

Energy relates to external cost. In addition to agitation, aeration, cooling, pumping, air conditioning, and lighting in manufacturing areas, a significant proportion of the overall electricity usage can also go into production of utilities as mentioned below.

Personnel or labor cost is usually a significant contributor to the overall production cost, which is especially true for the area of red biotechnology. In contrast to white biotechnology, the manufacture of biopharmaceuticals and, especially, cell therapy products is still characterized by a relatively low level of automation and dependence on manual operation by skilled operators. Additional personnel-related costs such as cost of QC (quality control) and QA (quality assurance) services are secondary costs.

Maintenance, repair and external services, and general expenses refer to cost for keeping the facilities and equipment functional (typically 2–5% of investment) and to cash-out for externally sourced services such as, for example, cleaning of the facility or workwear and outsourced analytical services, respectively.

Depreciation is the cost item that reflects CAPEX and usually represents about 10% of the invested capital. The book value of fixed assets decreases year over year in the balance sheet of a company.

Utilities cover costs related to the production of deionized or purified water, WFI, black and clean steam, process air, and pure oxygen or other process gases. Utilities also include the costs of waste disposal and wastewater treatment.

Internal services are costs of services provided by other internal departments (no cash out) such as QC, QA, engineering cost not considered under maintenance and repair, cost of measurement and control, EM (environmental monitoring), logistics (facility and warehouse), scientific support, and housekeeping.

SAR stands for cost of sales and marketing, administration, and research also referred to as *overheads*. In a pharmaceutical manufacturing environment, the allocation of SAR often amounts to approximately 10% of overall cost of goods. Though SAR is by no means a negligible cost category, it is typically not considered in a manufacturing cost assessment exercise.

1.5.3

Return on Invested Capital

A financial investment is approved only if it is profitable, that is, if a positive financial return is to be expected and if the estimated return is in line with the expectations of the investor. The former can be assessed by *net present value* (NPV) calculations. Related sensitivity analyses give an indication on the key variables affecting profitability and the overall risk associated with a project. Additional criteria might include the *internal rate of return* (IRR), which is an indication of the average annual profitability of an investment or *payback*, which provides a time estimate to reach break-even.

1.6

Influence of Process- and Facility-Related Aspects on Cost Structure

The subsequent discussion on the cost structure of biotechnology products focuses on the upstream part only, that is, media preparation, seed train, and production fermentation. For ease of discussion, the cost categories have been simplified to the following:

- 1) Material
- 2) Energy and utilities
- 3) Labor (primary and secondary)
- 4) Maintenance and general expenses
- 5) Depreciation.

The proportional distribution of the cost categories is driven by process-specific characteristics and site-specific characteristics, whereby the latter comprise investment and local specifics such as local level of wages, number of employees in a facility, and so on. While there are numerous parameters that influence the cost structure of a given biotechnological product, we will focus on a few drivers considered as important.

1.6.1

Process-Related Aspects

Among the important process-related cost drivers are (i) material consumption and (ii) duration of the process. As an example, the cost share of the carbon source (e.g., glucose) for the fermentation (biosynthesis) of a bulk commodity product in a low labor cost environment typically exceeds 70% of the USP cost, while the remaining 30% is distributed over personnel, maintenance, depreciation, and others. This contrasts with high-value specialties such as recombinant proteins, where the cost of the carbon source in fermentation is negligible. In the breakdown shown in the following, material comprises not only the carbon source but also the costs of other consumables and disposables.

The second cost driver, process duration (understood as cycle time), has, on the other hand, a direct impact on the costs of personnel and depreciation; the longer the duration, the higher the costs. Consequently, it is not surprising that improvements on the cycle time typically have a significant positive impact on the cost of goods (COGs).

1.6.2

Site-Related Aspects

The cost drivers (2)–(5) have a strong site-specific component. Local energy and water prices as well as local wage levels often vary tremendously between different countries. Maintenance and general expenses are closely related to local wage levels. Depreciation is also to be considered as site-specific. Though the facility standard is driven by the regulatory status of the product (commodity, GMP) and therefore similar, independent of geographical location, the overall CAPEX is typically lower in low-cost countries due to access to a low-cost labor force. However, when taking decisions, investors are well advised to look also into the productivity of the local work force.

Process scale is another main cost influencer, as personnel needs are only marginally different when producing at, for example, 15 or 50 m³ scale. Figure 1.20 shows the decrease in the cost of goods supplied (COGS) (per kilogram) of an antibiotic by a factor of 1.8 caused by increasing the manufacturing scale. As it is to be expected, there is no difference in material cost.

Figure 1.21 compares the cost structures of different products based on biosynthetic and biotransformation processes run either at the 15 m³ or at the 50 m³ scale and on the same sites in order to avoid effects caused by geographical

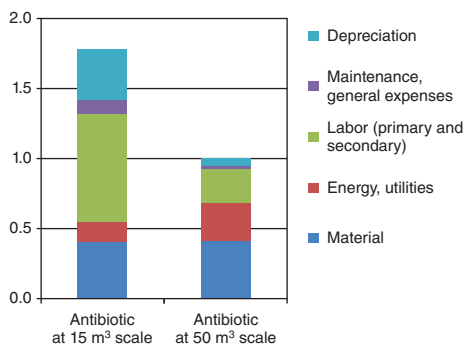

Figure 1.20 Economy of scale. The figure shows the relative cost impact of production of the same antibiotic at the 15 and 50 m³ scale.

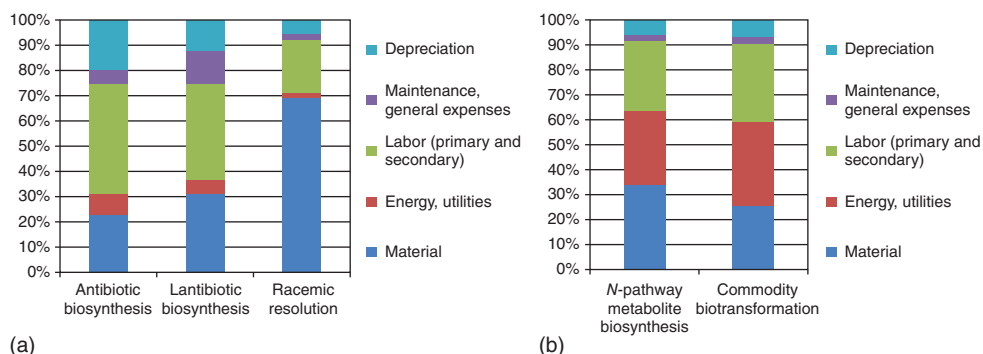

Figure 1.21 (a) Cost structures of an antibiotic, a lantibiotic compound, and a D-aminoalcohol produced in a 15 m³ scale bioreactor in a central European country. The material cost of the chemical intermediate produced by whole-living-cell-mediated racemic resolution is driven by the use of a high-cost racemic chemical starting material, whereas the material cost of

the two biosynthetic compounds mostly represent media cost. (b) Cost structures of a metabolite of the nucleotide pathway (*E. coli*) and a commodity chemical produced by the oxidation of a cheap chemical starting material (*G. oxidans*) at the 50 m³ scale. As the material impact and process durations are similar, the overall cost structures remain similar.

location, as discussed earlier. Figure 1.21a compares the cost structures of an antibiotic and a lantibiotic compound. The two process-related aspects, material and cycle time, do not greatly differ, and the productions were performed in the same plant. The cost structure of the third compound on the same graph is representative for a chemical specialty, D-aminoalcohol, produced by living-cell racemic resolution. In this case, the D,L-racemate is a main contributor to the high material cost as well as the fact that more than 50% of the starting material is destroyed during racemic resolution.

Figure 1.21b compares the cost structure of a metabolite of the nucleotide pathway (*E. coli*) produced by biosynthesis to that of a commodity chemical produced by oxidation of a chemical starting material (*G. oxidans*) at the 50 m³ scale and on the same site. The proportional material cost impact and the cost impact of the other cost categories are similar.

This underlines the importance of the site-specific cost aspects (2)–(5) as discussed at the beginning of this section. If the two process-related aspects, proportional contribution of the material cost and process cycle-time, are similar for two products X and Y, then the proportional contribution of the remaining cost categories, namely energy, labor, maintenance, and depreciation, will also be similar. This is also demonstrated for the antibiotic and lantibiotic produced at 50 m³ scale at a different site.

In general, cell-culture-derived biopharmaceuticals such as monoclonal antibodies show less variation in their cost structure, which is not surprising, as the manufacturing process is almost a generic one. The first case in Figure 1.22 represents the cost structure of USP in a 1000l stainless steel facility. The high degree of manual operation is reflected in a high proportional contribution of labor cost (45%). The relatively high investment and equipment quality requirements drive depreciation and maintenance cost, respectively. The proportional contribution of cost of raw materials and consumables to overall cost is relatively low in spite of high media costs, which are typically in the range of US\$10–20 l⁻¹ for large-scale production.

The use of single-use equipment solutions and especially SUBs has increased tremendously in the last decade. Figure 1.22 compares the cost structure of the

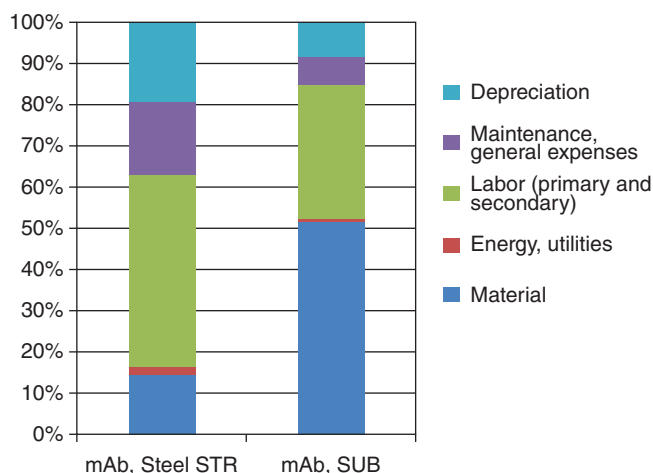

Figure 1.22 Comparison of cost structures of a recombinant biopharmaceutical production (monoclonal antibody) in a 1000-l stainless steel stirred-tank reactor (SS STR) and in single-use bioreactor (SUB) of the same scale.

Contrary to the SUB design, the stainless steel-based design requires investment in utilities such as black, clean steam, as well as in SIP and CIP installations.

upstream part of the two cases, steel versus single-use. As is to be expected, there is a decrease in depreciation costs with increasing use of disposables. The reduced demand for labor and maintenance is due to the omission of equipment cleaning and equipment sterilization procedures. Although (based on current disposables prices) operational cost of the USP may be higher when producing out of an entirely disposable upstream equipment train, there is a significant upside when considering plant preparation time and time for changeover. As a consequence, a larger number of batches can be produced within a given time window, which leads to an improved business case [26].

In conclusion, it should be kept in mind that fermentation is the value-creating step, and volumetric and specific productivities should therefore be maximized. DSP and fill and finish, which were not discussed in this chapter, must conserve the value created during fermentation. This is achieved by reducing the number of purification steps to a minimum and by maximizing yields as well as conserving product integrity and quality. For high-value products, efficient production is far less important than guaranteeing effective purification with complete removal of impurities. In contrast, the production of intermediates and commodity products such as amino acids, ethanol, or platform chemicals requires a highly competitive fermentation.

We can conclude that the economic aspects of white biotechnology are as diverse as its numerous and completely different applications and target markets, offering thousands of structurally very different products. Hence biotechnological applications for the small- and large-molecule pharmaceutical market remain the economic and innovation driver for biotechnology. However, we expect that major shifts will take place over the next 10–20 years, not least because of the progress made in areas such as synthetic biology.

Acknowledgments

The authors thank Gareth Griffiths (Lonza, Visp) for the English correction of the manuscript and Frans Hoeks (Hoffmann-La Roche, Basel) and Rainer Glöckler (Swissfillon, Visp) for the critical reading of the manuscript and valuable comments.

References

- 1 Galanie, S., Thodey, K., Trenchard, I.J., Filsinger, I., and Smolke, C.D. (2015) Complete biosynthesis of opioids in yeast. *Science*, **349** (6252), 1095–1100.
- 2 McNeil, B. and Harvey, L.M. (eds) (2008) *Practical Fermentation Technology*, John Wiley & Sons, Ltd., Chichester.
- 3 www.fda.gov (8 December 2015) FDA News Release, <http://www.fda.gov/newsevents/newsroom/pressannouncements/ucm405526.htm> (accessed 14 June 2016).
- 4 Meyer, H.-P. and Schmidhalter, D. (eds) (2014) *Industrial Scale Suspension Culture of Living Cells*, Wiley-Blackwell, Weinheim.
- 5 Merchuk, C. and Camacho, F.G. (2010) in *Encyclopedia of Industrial Biotechnology: Bioprocess, Bioseparation,*

- and Cell Technology (ed. M.C. Flickinger), John Wiley & Sons, Inc., pp. 887–953.
- 6 Roca, E., Ghommidh, C., Navarro, J.M., and Lema, J.M. (1995) Hydraulic model of a gas-lift bioreactor with flocculating yeast. *Bioprocess Eng.*, **12** (5), 269–272.
 - 7 Meyer, H.-P. (1987) in *Physical Aspects of Bioreactor Performance* (ed. W. Crueger), DEHEMA, Frankfurt am Main, pp. 144–157.
 - 8 Joule www.jouleunlimited.com (accessed 14 June 2016).
 - 9 Kaiser, A.C., Jossen, V., Schirmaier, C., Eibl, D. *et al.* (2013) Fluid flow and cell proliferation of mesenchymal adipose-derived stem cells in small scale, stirred, single use bioreactors. *Chem. Ing. Tech.*, **85** (1-2), 95–102.
 - 10 Van den Bos, C., Keefe, R., Schirmaier, C., and McCaman, M. (2014) in *Industrial Scale Suspension Culture of Living Cells* (eds H.-P. Meyer and D.R. Schmidhalter), Wiley-Blackwell, Weinheim, pp. 465–501.
 - 11 Meyer, H.-P. and Schmidhalter, D. (2014) in *Industrial Scale Suspension Culture of Living Cells* (eds H.-P. Meyer and D. Schmidhalter), Wiley-Blackwell, Weinheim, pp. 1–37.
 - 12 Meyer, H.-P. (2011) Sustainability and biotechnology. *Org. Process Res. Dev.*, **15**, 180–188.
 - 13 Meyer, H.-P., Werbitzky, O., and Signorell, G.A. (2014) Bridging the gap between chemistry and biotechnology – large molecules with potential, how could biotechnology complement chemistry. *Curr. Org. Chem.*, **18**, 944–959.
 - 14 European Commission http://ec.europa.eu/health/files/eudralex/vol-4/vol4-an2_2012-06_en.pdf (accessed 14 June 2016).
 - 15 ICH www.ich.org/fileadmin/Public_Web_Site/ICH_Products/Guidelines/Quality/Q7/Step4/Q7_Guideline.pdf (accessed 14 June 2016).
 - 16 EMEA <http://www.gmp-compliance.org/guidemgr/files/015801EN.PDF> (accessed 14 June 2016).
 - 17 Hoeks, F.W.J., Boon, L.A., Studer, F., Wolff, M.O. *et al.* (2003) Scale-up of stirring as foam disruption (SAFD) to industrial scale. *J. Ind. Microbiol. Biotechnol.*, **30** (2), 118–128.
 - 18 Nienow, A.W. (1992) in *Mixing in the Process Industries*, 2nd edn (eds N. Harnby, M.F. Edwards, and A.W. Nienow), Butterworth-Heinemann, Oxford, pp. 364–393.
 - 19 Nienow, A.W. (2010) in *Encyclopedia of Industrial Biotechnology: Bioprocess, Bioseparation, and Cell Technology* (ed. M.C. Flickinger), John Wiley & Sons, Inc., pp. 1–25.
 - 20 Doran, P.M. (2010) Bioreactors, stirred tank for culture of plant cells, in *Encyclopedia of Industrial Biotechnology: Bioprocess, Bioseparation, and Cell Technology* (ed. M.C. Flickinger), John Wiley & Sons, Inc.
 - 21 Shah, Y.T. (1992) in *Advances in Chemical Engineering* (eds J. Wei, J.L. Anderson, and K.B. Bischoff), Academic Press Inc., pp. 1–196.
 - 22 Roman, R.V. and Gavrilescu, M. (1994) Oxygen transfer efficiency and biosynthesis of antibiotics in bioreactors with modified Rushton turbine agitator. *Acta Biotechnol.*, **14** (2), 181–192.
 - 23 Roman, R.V., Tudose, Z.R., Gavrilescu, M., Cojocar, M., and Luca, S. (1996) Performance of industrial scale bioreactors with modified RUSHTON turbine agitators. *Acta Biotechnol.*, **16** (1), 43–56.
 - 24 Skelland, A.H.P. and Ramsay, G.G. (1987) Minimum agitator speeds for complete liquid-liquid dispersion. *Ind. Eng. Chem. Res.*, **26** (1), 77–81.
 - 25 Bailey, J.E. and Ollis, D.F. (1986) *Biochemical Engineering Fundamentals*, McGraw-Hill, New York.
 - 26 Clapp, K., Lindskog, E., Eriksson, K., and Kristianson, S. (2015) Process economy and production capacity, comparing single-use and stainless steel strategies for microbial fermentation. *Bioprocess Int.*, **13** (11), 1–9, Special Report in supplement 7.
 - 27 Rittershaus, E., Ulrich, J., and Westphal, K. (1990) Large-scale production of plant cells culture. *Int. Assoc. Plant Tissue Cult. (IAPTC)*, **61**, 2–10.
 - 28 Cutayar, J.M. and Poillon, D. (1989) High cell density culture of *E. coli* in a fed-batch system with dissolved oxygen

- as substrate feed indicator. *Biotechnol. Lett.*, **11** (3), 155–160.
- 29 Muttzall, K. (1993) *Einführung in die Fermentationstechnik*, Behr's-Verlag, Hamburg.
- 30 Tribe, L.A., Briens, C.L., and Margaritis, A. (1995) Determination of the volumetric mass transfer coefficient (kLa) using the dynamic “gas out-gas in” method: analysis of errors caused by dissolved oxygen probes. *Biotechnol. Bioeng.*, **46** (4), 388–392.
- 31 Doran, P.M. (2009) in *Encyclopedia of Industrial Biotechnology* (ed. M.C. Flickinger), John Wiley & Sons, Inc., pp. 1–35.
- 32 Zhou, T.-C., Zhou, W.-W., Hu, W., and Zhong, J.-J. (2009) Bioreactors, cell culture, commercial production, in *Encyclopedia of Industrial Biotechnology* (ed. M.C. Flickinger), John Wiley & Sons, Inc.
- 33 Barber, M.S., Giesecke, U., Reichert, A., and Minas, W. (2004) Industrial enzymatic production of cephalosporin-based β -lactams. *Adv. Biochem. Eng./Biotechnol.*, **88**, 179–215.
- 34 Kelley, B. (2009) Industrialization of mAb production technology, the bioprocessing industry at a crossroad. *mAbs*, **1** (5), 443–452.
- 35 <http://www.ethanolproducer.com/articles/5855/report-ethanol-industry-moving-away-from-antibiotic-use> (accessed 16 January 2016).
- 36 Kalk, J.P. and Langlykke, A.F. (1986) in *Manual of Industrial Microbiology and Biotechnology* (eds A.L. Demain and N.A. Solomon), American Society for Microbiology, Washington, DC, pp. 363–388.
- 37 ICHQ7, International Commission of Harmonization, <https://www.ich.org>.
- 38 Kurtzman, C.P. (2009) Biotechnological strains of *Komagataella (Pichia) pastoris* are *Komagataella phaffii* as determined from multigene sequence analysis. *J. Ind. Microbiol. Biotechnol.*, **36**, 1435–1438.

