

## CHAPTER 2

### OVERVIEW OF MOBILE COMMUNICATION SYSTEMS

Mobile radio communication began with Guglielmo Marconi's and Alexander Popov's experiments with ship-to-shore communication in the 1890's. Land mobile radiotelephone systems have been used since 1921 when the Detroit City Police Department installed a system [2.1]. Radio systems have increased in importance since that time for both voice and data communication. Modern mobile systems mostly use high frequencies (UHF and above) because of the larger available bandwidth at these frequencies. In the United States this includes cellular telephone systems operating at 800-900 MHz and personal communication systems (PCS) at 1800-2000 MHz, and a variety of unlicensed devices, including wireless LANs, in the ISM bands at 902-928 MHz and 2.4-2.4835 GHz. Additional high speed, short-range digital communications will use the unlicensed national information infrastructure (U-NII) bands at 5.15-5.35 GHz and 5.725-5.825 GHz. This chapter describes basic categories of wireless communication systems and fundamental concepts.

#### 2.1 The Wireless Communication Link

A wireless communication link includes a transmitter, a receiver, and a channel, as shown in Fig. 2-1, adapted from [2.2]. Quantization, coding and decoding are only performed in digital systems. Most links are full duplex and include a transmitter and a receiver or a transceiver at each end of the link.

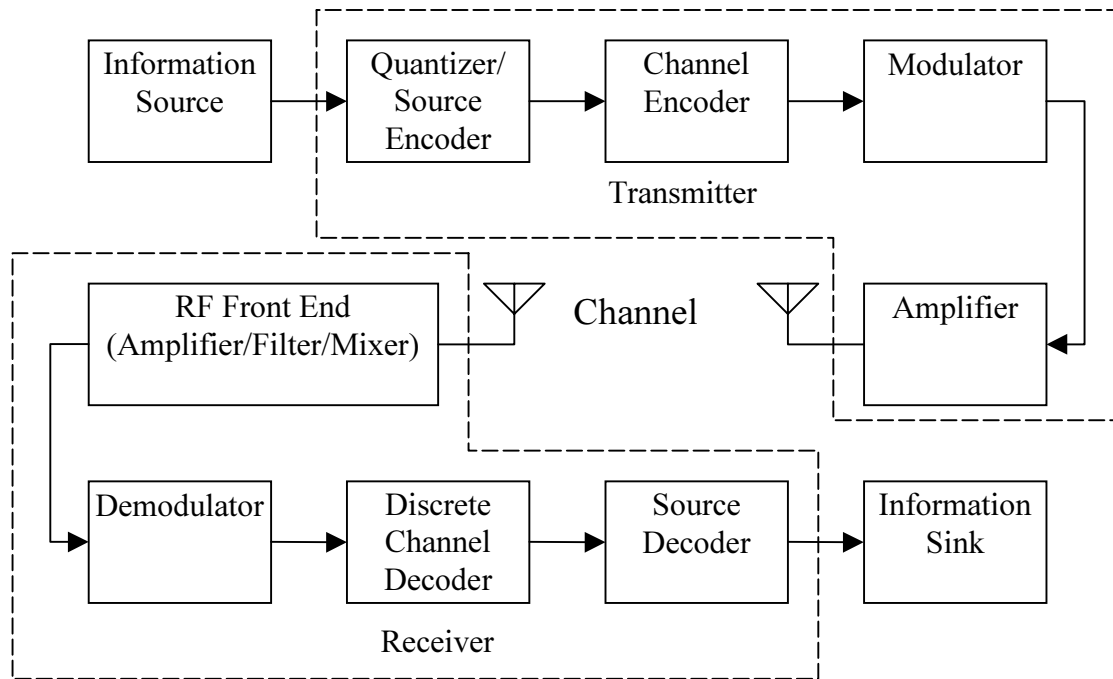

**Figure 2-1.** Block diagram of a wireless communication link

## 2.2 Types of Systems

In a mobile communication system at least one of the transceivers is mobile. It may be on board a vehicle that can move at high speeds, or it may be a handheld unit used by a pedestrian. Basic types of systems include base/mobile, peer-to-peer, repeater, and mobile satellite systems. In a base/mobile system, a base station connected to a public network communicates with a mobile unit. This gives the mobile unit access to the public network. More than one mobile at a time can be supported if a different channel (such as a narrow band of spectrum) is assigned to each user. In most systems, channels are assigned to users as needed rather than giving each user a dedicated channel that is reserved for that user at all times. This is called trunking and allows large numbers of users to be supported with a limited number of available channels, with a small probability that any given call will be blocked because all channels are busy. Cellular telephony uses the base/mobile configuration to give mobile users access to the public switched telephone network, as shown in Fig. 2-2 (a). In peer-to-peer systems, mobile

units communicate directly with each other. Mobile units sharing a frequency channel can communicate with one another, and independent conversations can take place on different channels. Many amateur, and most CB radio contacts fit into this peer-to-peer model, as shown in Fig. 2-2 (b). In peer-to-peer systems, a mobile can sometimes hear only one of two other mobiles that are using a channel, when a total of three users are active.

Fig. 2-2 (c) shows a repeater system. In this system, all users transmit on one channel and listen on a second channel. The repeater, a transceiver that is located at a high point, retransmits the signals with greater power on the second channel. In this system, all users can communicate with each other using one pair of frequencies. A repeater system allows communication over a much greater range than in a direct peer-to-peer system. Repeaters are used for public services and some amateur radio operations at VHF and UHF frequencies. A variation is a trunked radio system that uses several frequency pairs and assigns a frequency pair for each conversation between mobiles. A trunked system can support many more users than the number of frequencies available because all users typically do not operate at once.

In a mobile satellite system, one or more satellites relays signals between a mobile user and an earth-based base station or “gateway” that connects to the public switched network, as shown in Fig. 2-2 (d). The large distances and high speeds of the satellites introduce some difficulties, but a system of this type can provide worldwide coverage.

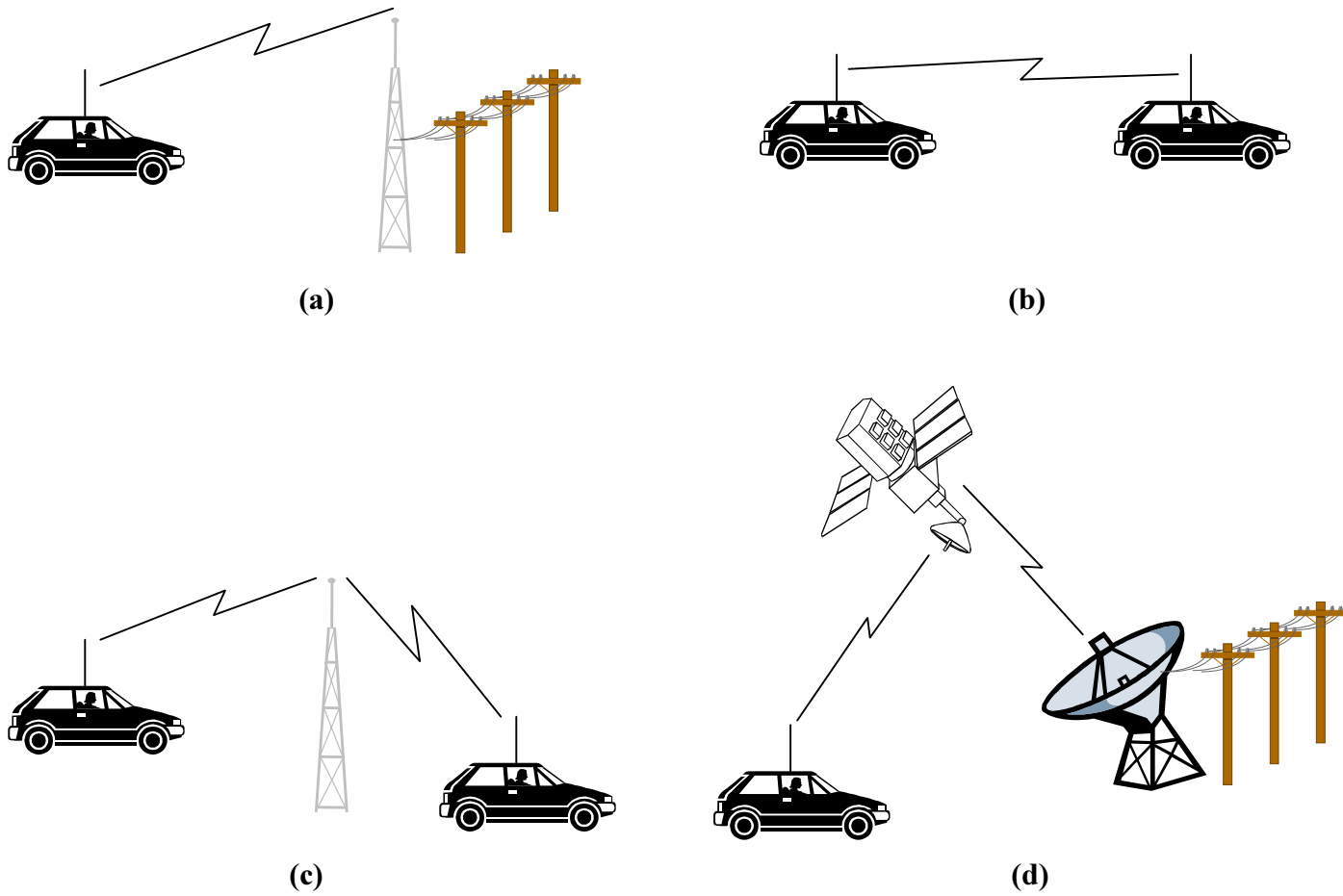

**Figure 2-2.** Mobile radio systems: (a) mobile/base, (b) peer-to-peer, (c) repeater, (d) mobile satellite

## 2.3 Mobile Radio Channels

At VHF and above, radio wave propagation is mostly by line-of-sight, with reflected, diffracted, and scattered signals dominating when the line-of-sight path is blocked. These effects can be modeled directly using ray-tracing or FDTD techniques, but this requires a very detailed representation of the objects in the environment, and is extremely computationally complex. Typically the channel characteristics are described in terms of a few phenomena that can be measured.

### 2.3.1 Large-scale path loss

Large-scale path loss describes the variation in mean received signal strength as a function of distance from the transmitter. The Friis transmission equation gives the received power in a free space environment as follows:

$$P_r = P_t G_t G_r \left( \frac{\lambda}{4\pi R} \right)^2 \quad (2.1)$$

where  $P_r$  is the received power,  $P_t$  is the transmitted power,  $G_t$  is the gain of the transmitting antenna, and  $G_r$  is the gain of the receiving antenna. The remaining term is the inverse of the path loss, and accounts for spherical spreading loss of the transmitted wave due to propagation over the transmit-receive distance  $R$ , and the effective aperture of the receiving antenna,  $A_e = \lambda^2 / (4\pi G_r)$

In obstructed environments the path loss is often modeled as

$$PL = \left( \frac{4\pi d_0}{\lambda} \right)^2 \left( \frac{R}{d_0} \right)^\gamma \quad (2.2)$$

where the first term is the free-space path loss at some reference distance  $d_0$  and the exponent  $\gamma$  (sometimes  $n$  is used) is determined empirically by a curve fit to measured data.

### 2.3.2 Shadowing

At a given distance from the transmitter, variations about the mean path loss will occur due to obstruction by objects in the environment. This can be modeled using a log-normal distribution about the mean value of large-scale path loss that is predicted by a distance-dependent model like the one in (2.2). The probability distribution function (pdf) of the received power is then given by

$$f_{P_r}(P_r[\text{dB}]) = \frac{1}{\sqrt{2\pi}\sigma_{P_r}} \exp\left[-\frac{(P_r - P_{r0})^2}{2\sigma_{P_r}^2}\right] \quad (2.3)$$

where  $P_r$  is the received power in dB and  $P_{r0}$  is the mean received power, also in dB. A standard deviation  $\sigma_{P_r}$  of 6 to 8 dB is typical.

### 2.3.3 Multipath effects: fading, intersymbol interference, and Doppler spread

One of the distinctive features of a mobile radio channel is multipath propagation, in which the received signal consists of multiple reflected, diffracted, and scattered components, as well as (possibly) a direct line-of-sight component. Because all these components travel different distances and encounter different reflections, their phases are different. The relative phases of the received signals change as the mobile moves. Depending on the relative phases of the signals, they can reinforce each other or cancel each other. In the latter case a fade results. As the receiver is moved the received signal power undergoes variations, resulting in a fading envelope that can be measured. Diversity systems that use signals received by two or more antennas can combat this effect.

The difference in path length between multipath components causes them to arrive with different delays. This causes intersymbol interference in digital systems, if the difference is significant in relation to the symbol period. The amplitudes of the multipath components also differ because they undergo different path losses. The received signal can be represented as a superposition of all the received components as follows [2.2]:

$$x(t) = \sum_{n=1}^N \alpha_n(t) e^{j\phi_n} s[t - \tau_n(t)] \quad (2.4)$$

where  $x(t)$  is the received signal,  $\alpha_n(t)$  is the time-varying attenuation coefficient of the  $n^{\text{th}}$  path,  $\phi_n(t)$  is the time-varying phase shift associated with the  $n^{\text{th}}$  path,  $s(t)$  is the original transmitted signal, and  $\tau_n(t)$  is the time-varying delay of the  $n^{\text{th}}$  path.

Two parameters that can be used to describe the delay characteristics of a channel are mean excess delay and rms delay spread. Mean excess delay is given by

$$\bar{\tau} = E[\tau - \tau_{\min}] \quad (2.5)$$

where  $\tau_{\min}$  is the minimum excess delay, and RMS delay spread is given by

$$\tau_{rms} = \sqrt{E[(\tau - \tau_{min})^2]} \quad (2.6)$$

Radio waves transmitted to or from a moving user undergo a shift in frequency if the transmit-receive distance changes with time. The difference in frequency of the received signal and the transmitted signal is called the Doppler shift and is given by

$$\Delta f = -\frac{1}{\lambda} \frac{dl}{dt} \quad (2.7)$$

where  $dl/dt$  is the rate of change in the distance between the transmitter and receiver. In a multipath channel the angles of arrival of the multipath components are different and in general each has a different Doppler shift. This results in a Doppler spread.

## 2.4 Polarization

As an electromagnetic wave propagates, the tip of the time-varying electric field vector at any point in space traces an ellipse. The shape of this ellipse can vary from linear to circular and this is referred to as the polarization of the wave. Linearly polarized waves are referred to by angle, e.g., vertical, horizontal, or  $45^\circ$ . Elliptically or circularly polarized waves have a polarization sense referred to as “left-hand” or “right hand” depending on the direction of rotation of the field vector with time. For example, if the fingers of the left hand curl in the direction of rotation of the electric field vector when the thumb of the left hand is aligned with the direction of propagation, the polarization sense is said to be left-hand. Figure 2-3 shows a left-hand circularly polarized wave.

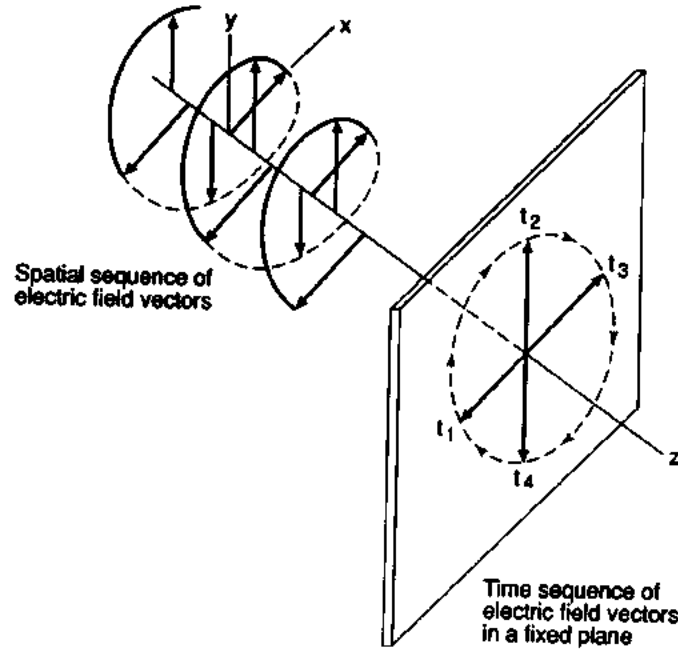

**Figure 2-3.** A left-hand circularly polarized plane wave [2.3]

### 2.4.1 Polarization states

This discussion of polarization states is based on [2.3]. The polarization state of a plane wave can be expressed in terms of the horizontally and vertically polarized components of the wave. These components can be written as

$$\begin{aligned} E_x(t, z) &= E_1 \cos(\omega t - \beta z) \\ E_y(t, z) &= E_2 \cos(\omega t - \beta z + \delta) \end{aligned} \quad (2.8)$$

Horizontally and vertically polarized components of a plane wave are represented in phasor notation as:

$$\begin{aligned} E_H &= E_1 \\ E_V &= E_2 e^{j\delta} \end{aligned} \quad (2.9)$$

$E_1$  and  $E_2$  are the amplitudes of the horizontal and vertical components respectively. Absolute phase is omitted.

Two sets of parameters are used to describe polarization states. These are  $(\epsilon, \tau)$  and  $(\gamma, \delta)$ . The parameters  $\epsilon$ ,  $\tau$ , and  $\gamma$ , relate to the polarization ellipse and are shown in Fig. 2-4. The parameter  $\delta$  is the phase shift of the vertically polarized component relative to the horizontally polarized component as in (2.9)



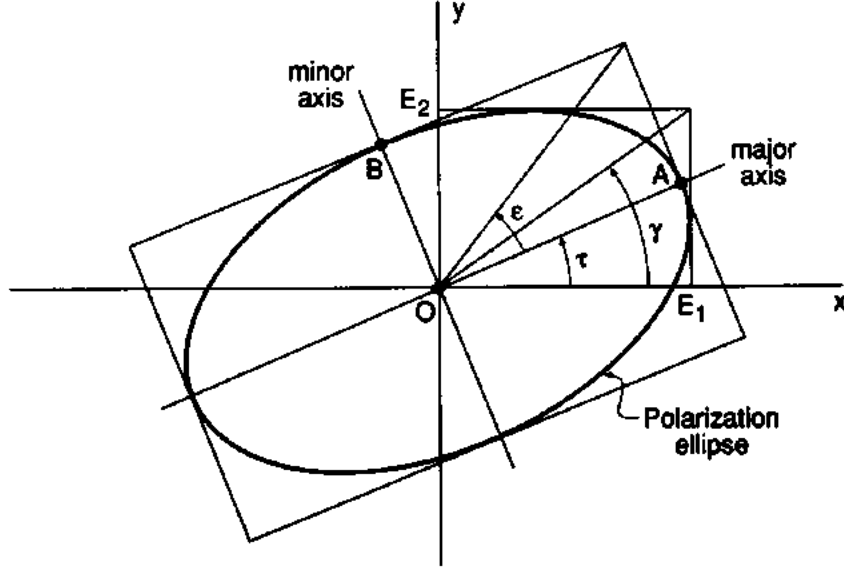

**Figure 2-4.** The polarization ellipse showing parameters  $\varepsilon$ ,  $\tau$ , and  $\gamma$

**Table 2.1** Polarization parameters and their definitions

$(\varepsilon, \tau)$	$(\gamma, \delta)$
$\varepsilon = \cot^{-1}  R , 0 \leq R \leq 45^\circ$	$\gamma = \tan^{-1} \frac{E_2}{E_1}, 0 \leq \gamma \leq 90^\circ$
$0 \leq \tau \leq 180^\circ$	$-90^\circ \leq \delta \leq 90^\circ$

### 2.4.2 Polarization in a multipath channel

The received signal in a multipath channel can be represented as the superposition of  $M$  plane waves. Each plane wave can have a different absolute phase, angle of arrival, and polarization state. Assuming isotropic antenna patterns, the horizontally polarized component is given by:

$$E_H = E_1 e^{j\delta'} = \sum_{i=1}^M E_{1i} e^{j\delta'_i} \quad (2.10)$$

and the vertically polarized component is given by:

$$E_V = E_2 e^{j(\delta''+\delta)} = \sum_{i=1}^M E_{2i} e^{j(\delta''_i+\delta_i)} \quad (2.11)$$

where  $E_{1i}$  and  $E_{2i}$  are the horizontal and vertical components of the  $i^{th}$  plane wave, respectively, and  $\delta''$  is the phase of the horizontally polarized component, and  $\delta$  is the

phase of the vertically polarized component relative to the horizontally polarized component, as in (2.9). For the  $i^{\text{th}}$  multipath component, these phases are denoted by  $\delta''_i$  and  $\delta_i$ .

If a receiver uses two antennas that are oriented vertically and horizontally, the polarization can be defined in terms of the antenna response as:

$$E'_H = E'_1 e^{j\delta''} = \sum_{i=1}^M g(\theta_i, \phi_i, H) E_{1_i} e^{j\delta''_i} \quad (2.12)$$

and

$$E'_V = E'_2 e^{j(\delta''+\delta)} = \sum_{i=1}^M g(\theta_i, \phi_i, V) E_{2_i} e^{j(\delta''_i+\delta_i)} \quad (2.13)$$

## 2.5 Modulation

Various types of modulation can be used for mobile communications. These fall into two basic categories, analog and digital.

### 2.5.1 Analog modulation

In analog modulation formats, some parameter of the transmitted signal varies as a linear function of the amplitude of the original audio or video signal to be transmitted. Analog modulation schemes include amplitude, frequency, and phase modulation. Amplitude modulation (AM) occupies only about twice the bandwidth of the baseband signal but is sensitive to non-linearities in the amplitude response of the RF circuitry in the transmitter and the receiver, and to time-varying fading in the channel. Frequency and phase modulation (FM and PM, respectively) are relatively insensitive to amplitude nonlinearities and provide higher SNR of the demodulated audio signal by spreading the signal over a bandwidth that is many times that of the original baseband signal.

### 2.5.2 Digital modulation

In digital modulation formats, the signal to be transmitted is binary data that may or may not represent an analog signal that has been quantized and digitized. At any given time, the transmitter sends one of a discrete set of symbols, each of which represents one or more bits. In digital modulation each symbol typically occupies a finite time slot, and this requires the receiver to be synchronized to the transmitter so that the receiver demodulates each symbol in turn.

The simplest type of digital modulation is on-off keying (OOK), in which the carrier is turned on and off depending on the value of each bit. In Amplitude-shift keying (ASK), the amplitude of the transmitted signal is varied in discrete steps, with each level representing one or more bits. Frequency-shift keying (FSK) uses discrete frequencies as its symbols. A variation of this is AFSK, in which a carrier is modulated with a baseband FSK signal using one of the analog techniques, typically FM. Phase-shift keying or PSK uses a carrier of a constant nominal frequency and each symbol is represented by a different phase shift from a reference phase that is maintained for the symbol period. Differentially encoded PSK or DPSK is similar to PSK except that each symbol is represented by a phase shift relative to the previously transmitted signal. This is desirable in mobile systems where the phase of the received signal changes rapidly and it is difficult to maintain a constant phase reference. Quadrature-amplitude modulation (QAM) uses symbols that vary in both amplitude and phase. It can potentially provide many more symbols than the other techniques but it is very sensitive to changes in the channel and thus is difficult to implement for mobile systems. QAM is appropriate for fixed microwave and fiber-optic systems where it can support very high data rates.

### **2.5.3 Spread spectrum techniques**

Co-channel interference between digitally modulated signals can be reduced by spreading each signal over a wider bandwidth according to a code that is known by both the transmitter and the receiver. The code is used to extract the desired signal from the interference. Three strategies that can be used are frequency-hopping, direct-sequence spread spectrum (DSSS), and ultra-wideband. In frequency-hopping systems, the transmitter transmits on a predetermined repeating sequence of different frequencies. This includes slow frequency-hopping systems, in which two or more symbols are transmitted on each frequency, and fast frequency hopping systems, in which one or more hops occur for each data symbol [2.4]. In direct-sequence spread spectrum systems, the bit stream is multiplied by a binary pseudo-noise or PN sequence. The PN sequence is incremented at a rate that is higher than the bit rate and each data bit is broken into several chips, where each chip is the product of the data bit and a digit of the PN sequence. This process spreads the signal power over a wide bandwidth. The signal is recovered by correlating the received signal with an identical PN sequence. When the

PN sequence at the receiver is aligned with that of the transmitter, the correlation of the two sequences is high and the product of the two yields an estimate of the transmitted signal. Interfering signals that are not correlated with the PN sequence are significantly attenuated in this process. DSSS can also be used as a form of multiple access by assigning different PN sequences that have low cross-correlations to several users. The users can then share the same frequency spectrum because only the desired transmitter will have a high correlation with the PN code used at each receiver. Another, relatively new technique is called ultra-wideband or UWB. Current systems transmit baseband pulses that have a bandwidth of 1 GHz or more. Pulse-position modulation is used, where value of a given transmitted symbol is given by the precise timing of the pulse.

## **2.6 Multiple Access Techniques and Frequency Reuse**

Both multiple access and frequency reuse are essential to providing radio communication service simultaneously to many users over a wide area using a fixed bandwidth. It is useful to make a distinction between the two approaches. Multiple access schemes allow a frequency channel to be subdivided among many users. Frequency reuse strategies most frequently use spatial separation to enable two or more channels in different areas (called cells) to occupy the same spectrum with minimal interference between channels. The relationship between the two is that frequency reuse increases capacity and multiple access is the allocation of that capacity to multiple users.

### **2.6.1 Capacity of a band-limited AWGN channel**

A useful starting point for this discussion is the theoretical capacity of a band-limited channel with additive white gaussian noise, which was derived by Shannon and is given by [2.5] as

$$C=W\log_2(1+S/N) \tag{2.14}$$

where  $C$  is the channel capacity in bits per second,  $W$  is the bandwidth in Hz,  $S$  is the mean signal power, and  $N$  is the noise variance. Equation (2.14) gives the maximum possible capacity. This capacity is not achieved in practice but as coding techniques improve the limit is approached more closely. The following discussion uses the theoretical capacity to maintain generality.

### 2.6.2 Multiple access

Multiple access is achieved by dividing a channel among multiple users in frequency, time, or code, as shown conceptually in Fig. 2-5. Frequency- and time-division multiple access techniques are discussed below. Code-division multiple access combines multiple access and frequency reuse and is discussed in the next section.

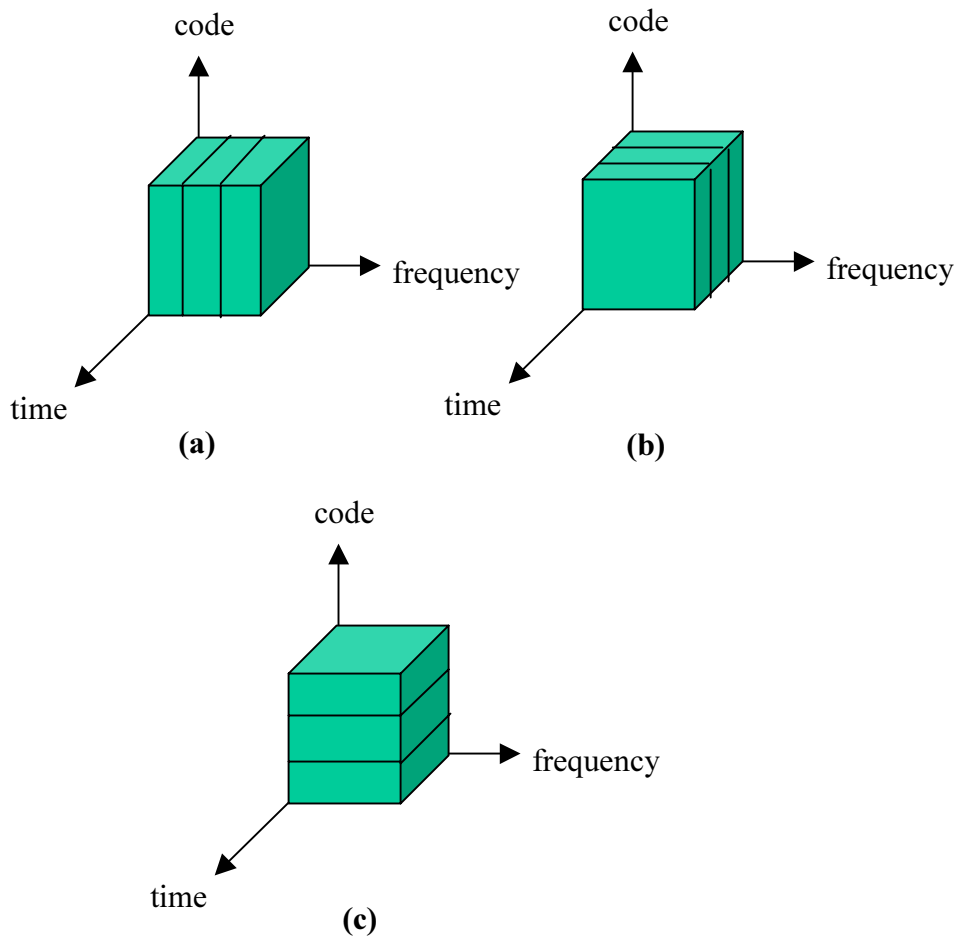

**Figure 2-5.** Multiple access techniques: (a) frequency division, (b) time division, (c) code division. Based on [2.6].

### 2.6.2.1 Frequency division multiple access (FDMA)

In FDMA the total bandwidth is divided among  $M$  simultaneous users such that each user is allocated a channel with a bandwidth of  $W_{FDMA}=W/M$  Hz. From (2.1) the capacity of each channel is

$$C_{FDMA}=(W/M)\log_2(1+S/N)=C/M \quad (2.15)$$

For a constant  $S/N$ , the capacity of the total bandwidth is the same as in eq. (2.14), but is divided among the  $M$  users. In practice, each user occupies a bandwidth slightly narrower than  $W/M$  so that interference between channels will be acceptable in a system using realizable filters, which have a frequency response that does not go to zero abruptly outside the channel bandwidth. This approach is applicable to both digital and analog modulation formats.

### 2.6.2.2 Time division multiple access (TDMA)

In TDMA the channel capacity in bits/s is used to the fullest extent possible, and the bit stream is divided into frames and the frames are divided into time slots that are allocated among the users. A TDMA frame for the North American digital cellular standards (IS-54 and IS-136) is shown in Fig. 2-6. In this system each full-rate data channel uses two time slots per frame, e.g., slots 1 and 4, 2 and 5, or 3 and 6. Half-rate data channels can be supported using one slot per frame. [2.7]. Ideally TDMA results in a capacity for each user that is given by

$$C_{TDMA}=C/M \quad (2.16)$$

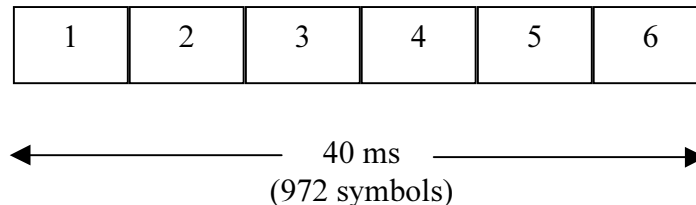
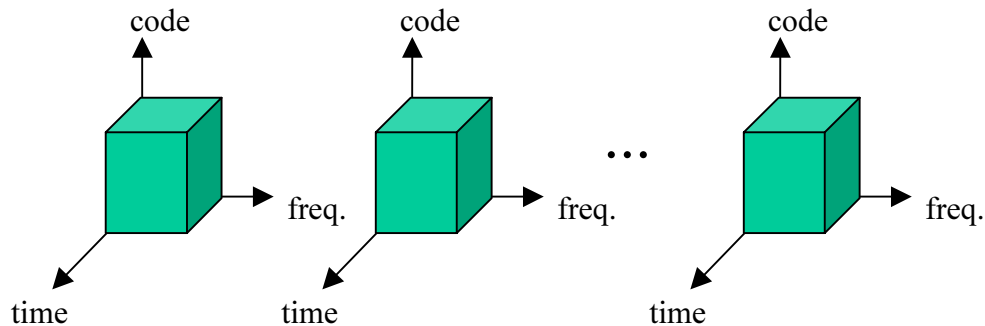

**Figure 2-6.** A TDMA frame [2.7]

In practical implementations this capacity cannot be achieved because guard times are used between the user's time slots, and additional overhead is required for synchronization. In North American TDMA cellular systems the mobile transmits in only 156 of 162 symbol periods during each time slot. TDMA is only applicable for digital modulation. Other techniques of dividing a channel in time are carrier-sense multiple access (CSMA), in which a user listens to see if the channel is in use before transmitting, and ALOHA, in which users transmit packets of data at random times and a finite probability of collisions is accepted. The latter two methods are used for non-realtime data communications.

### 2.6.3 Frequency reuse strategies

In a wireless communication system that covers a wide area with many users, not all users can be accommodated if the available bandwidth is used only once in the entire coverage area. Two or more distinct channels can exist in the same frequency band if some mechanism is used to minimize interference between the channels. This concept is illustrated in Fig 2-7. Typically spatial separation, either in distance, angle, or polarization (the time varying spatial orientation of electromagnetic fields) is exploited for frequency reuse. In such a system capacity per unit area must be sufficient for the density of users and their usage patterns. Capacity per unit coverage area can be measured in bits/second/km<sup>2</sup>.



**Figure 2-7.** Multiple coexisting channels that use the same frequency and code at the same time, but are separated in space

### 2.6.3.1 Cellular frequency reuse

Cellular frequency reuse is the basis of cellular and PCS systems. In these systems frequencies are reused in geographically separated areas, or cells. This concept is illustrated in Fig 2-8, where the same frequencies are used in both cells. A reuse pattern using clusters of  $K$  cells is established, and each of these  $K$  cells uses a different subset of the available frequencies. Each cluster of cells uses the same frequencies in this manner. Cells that use the same frequency are far enough apart that the interfering signals received in any cell from co-channel cells are much weaker than the signals that originate within that cell. This frequency reuse approach introduces co-channel interference, and capacity is limited by interference as well as by noise. Instead of  $S/N$ , the measure of channel quality is  $SINR=S/(I+N)$  where  $I$  is the average total interference power. Cellular frequency reuse allows modern systems to offer much higher capacity than older radiotelephone systems that used the available channels only once to cover a large metropolitan area.

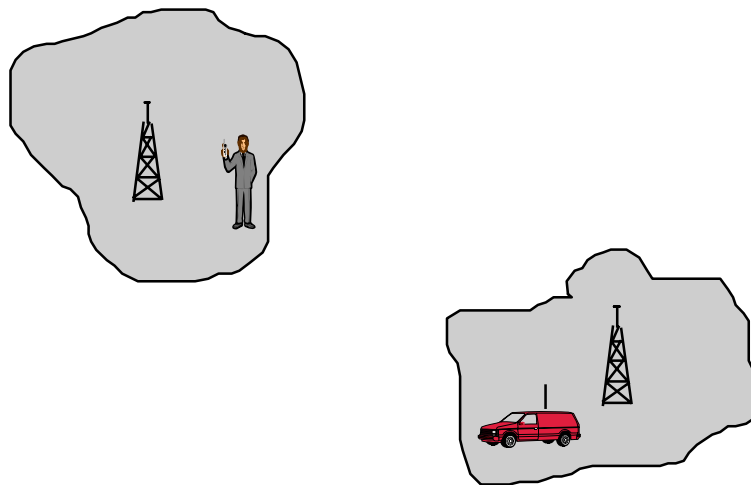

**Figure 2-8.** Frequency reuse in geographically separated cells

For planning purposes the cells are considered to be hexagonal or circular, although in practice their shapes determined by radio coverage and are irregular as shown in Fig. 2-8. The hexagonal shape is, nonetheless, a useful approximation. For  $K$ -cell frequency reuse, the distance between co-channel cells is given by [2.8]



$$D = \sqrt{3KR} \quad (2.17)$$

where  $R$  is the cell radius. In most systems, the interference is much stronger than the noise, and the SINR is approximately equal to the carrier-to-interference ratio or  $C/I$ , which is used in the following equations. The most significant interference comes from the six closest co-channel cells, so

$$\frac{C}{I} \approx \frac{1}{6} \left( \frac{D}{R} \right)^\gamma \quad (2.18)$$

where  $\gamma$  is an empirically determined path loss exponent. For free space,  $\gamma=2$ . For suburban and urban areas  $\gamma$  can be as high as 5 or 6, but is typically between 3 and 4. For example, consider a typical suburban system with a reuse factor of  $K=7$  and a path loss exponent of  $\gamma=3.3$ . The cell radius  $R$  is between 1 and 10 km. From (2.17), the ratio  $D/R$  is 4.583. From (2.18),  $C/I= 25.32$  (power ratio), or 14.0 dB. In many systems the cells are further divided into three sectors each. Directional antennas are used so that each cell sees interference primarily from two of the six closest co-channel cells. In this case  $C/I$  is given by

$$\frac{C}{I} \approx \frac{1}{2} \left( \frac{D}{R} \right)^\gamma \quad (2.19)$$

This is a 4.8 dB improvement over the  $C/I$  of a system with non-sectorized cells. For a three-sector system with  $K=7$  and  $\gamma=3.3$ , using (2.19) we calculate  $C/I=18.8$  dB, which is above the threshold of 17-18 dB that is required for a narrowband FM system such as AMPS.

By the central limit theorem, as the number of interferers becomes large, the total interference will tend towards a Gaussian distribution and will resemble AWGN. Using this with (2.14), capacity is approximated as

$$C \approx W \log_2(1 + SINR) \quad (2.20)$$

where  $SINR \approx C/I$ . A single frequency band can be reused throughout the area, and the capacity per unit area becomes

$$\frac{C}{A} \approx \frac{W \log_2(1 + SINR)}{K\pi R^2} \quad (2.21)$$

where  $A$ =area

In practice, the same modulation and coding techniques are used throughout a communication system, and each technique has a minimum SINR threshold that must be exceeded to achieve satisfactory performance. To maximize capacity, the minimum  $K$  that will provide acceptable SINR is used. From (2.21) it can be seen that decreasing  $R$  will also increase capacity per unit area, but this approach is very expensive because it requires more base stations. Systems that use small cells can also experience higher interference levels because the path loss exponent  $\gamma$  in (2.18) and (2.19) tends to be distance-dependent. As the cell radius  $R$  is decreased, the path loss exponent  $\gamma$  approaches 2 because unobstructed line-of-sight propagation is more likely in smaller cells. It can be seen from (2.18) and (2.19) that if  $\gamma$  decreases,  $C/I$  (and SINR) decrease if the cellular reuse factor  $K$ , and hence the  $D/R$  ratio, are fixed. Thus, if the cell radius is decreased too much,  $K$  must be increased to maintain acceptable SINR, and this reduces the capacity per unit area. Approaches have been proposed that use adaptive antennas to reduce interference and allow a smaller  $K$  and increase capacity.

### **2.6.3.2 Code division multiple access (CDMA)**

Code division multiple access combines aspects of multiple access and frequency reuse. CDMA is typically implemented with direct-sequence spread spectrum modulation, but frequency-hopping can also be used. Each user is allocated a different spreading code or hopping pattern [2.8]. The codes are chosen so that they have low cross-correlations. Multiple users can transmit at one time on the channel, and all interfere with each other, but each receiver correlates the received signal with the

appropriate code or uses the appropriate hopping pattern to sort out the desired user from the interference.

In a direct-sequence CDMA system  $C/I$  is given by [2.8]

$$\begin{aligned} \frac{C}{I} &= \frac{E_b}{I_0} \times \frac{R_b}{B} \\ &= \frac{E_b / I_0}{PG} \end{aligned} \quad (2.22)$$

where

$E_b$  = energy per bit

$I_0$  = total interference per Hz

$R_b$  = information rate in bits/s

$B$  = channel bandwidth

$PG = B/R_b$  = processing gain

$I_0$  is much greater than  $N$ , so  $C/I \approx \text{SNR}$

In CDMA it is possible to use the same frequencies in every cell. Codes may not be reused in adjacent cells. This approach is different from the cellular frequency reuse described in Section 2.3.1. To calculate the capacity of a direct-sequence CDMA system, the minimum acceptable  $E_b/I_0$  for the modulation and coding used is determined. The minimum  $C/I$  is determined by dividing  $E_b/I_0$  by the processing gain. Then the number of users  $N_{CDMA}$  that can operate simultaneously in each cell can be estimated from the worst-case cell geometry. Assuming all cells transmit equal power, this is done by solving the following equation, adapted from [2.8], for  $N_{CDMA}$ .

$$C/I = \frac{R^{-\gamma}}{(N_{CDMA} - 1)R^{-\gamma} + N_{CDMA}(2R^{-\gamma} + 3(2R)^{-\gamma} + 6(2.63R)^{-\gamma})} \quad (2.23)$$

This capacity can usually be exceeded by using power control to reduce interference and by taking advantage of the fact that voice activity is only about 50%. Capacity per unit area could be increased by making cells smaller up to the point where  $\gamma$  begins to decrease.

### 2.6.3.3 Spatial division multiple access (SDMA)

Adaptive antennas also allow a base station to reuse a frequency to communicate with two or more mobiles if the mobiles are separated in angle from the base station. This approach is called space division multiple access (SDMA). By using highly directional beams and/or forming nulls in the directions of all but one of the mobiles on a frequency, the base station creates multiple channels using the same frequency, but separated in space. This approach is shown in Fig. 2-9.

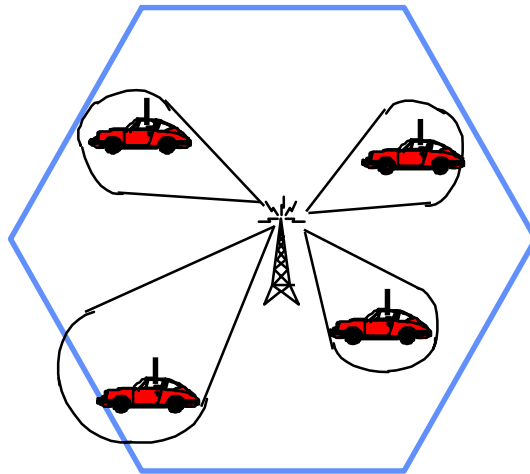

**Figure 2-9.** Spatial division multiple access (SDMA) using adaptive antennas

If SDMA can be achieved, the spectral efficiency can be increased dramatically [2.9], [2.10]. In an SDMA system the capacity ideally becomes

$$C_{SDMA} = N_{SDMA}C \quad (2.24)$$

where  $N_{SDMA}$  is the average number of simultaneous spatial channels per RF channel. In practice interference rejection will not be perfect and each spatial channel will have an SINR slightly lower than if SDMA were not used.

There are practical issues that make SDMA difficult to implement. For example, if two mobiles cross paths it may be necessary to hand off one mobile to a different frequency. Also, an adaptive array that can separate  $N_{SDMA}$  users must have at least

$N_{SDMA}+1$  elements. Both the number of elements and the array geometry determine the angular resolution that can be achieved by the array. Also in frequency division duplex systems, which use different frequencies for receiving and transmitting, some means must be provided of forming a beam for transmitting that is similar to the beam used for receiving.

### 2.6.3.4 Polarization reuse

Frequencies can also be used to transmit and receive two simultaneous signals that have different polarization states. This can increase capacity by up to a factor of two. Ideally, orthogonal polarizations are used. This is the case in geostationary satellite and terrestrial microwave systems. Because it is difficult to align antennas perfectly to achieve orthogonal polarization, and because most channels introduce some depolarization, cross-polarized interference cancellers or XPICs have been developed to actively cancel interference on these links. XPICs are two element adaptive arrays in which the elements have nominally orthogonal polarizations, allowing the array to cancel one interfering signal that has a polarization state different from, but not necessarily orthogonal to, that of the desired signal. Polarization reuse might be extended to mobile communication systems [2.11] and this concept is shown in Fig 2-10, but this will require very rapid adaptation because signal polarizations change rapidly in a multipath environment.

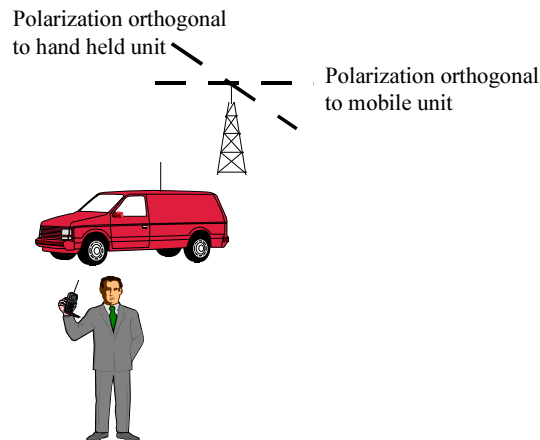

**Figure 2-10.** Polarization reuse

## 2.7 Conclusion

In this chapter a brief overview of wireless communications has been presented. Descriptions of system topologies, radio wave propagation, polarization, modulation techniques, and approaches to multiple access and frequency reuse were included. Additional information can be found in the references.

## References

- [2.1] W. C. Jakes, *Microwave Mobile Communications*, AT&T, 1974, (reprinted by IEEE Press, Piscataway, NJ).
- [2.2] J. G. Proakis, *Digital Communications*, McGraw-Hill, New York, 1989.
- [2.3] W. L. Stutzman, *Polarization in Electromagnetic Systems*, Artech House, Boston, MA, 1993.
- [2.4] J. D. Gibson, Ed., *The Mobile Communications Handbook*, CRC Press, 1996.
- [2.5] R. E. Blahut, *Principles and Practice of Information Theory*, Addison-Wesley, Reading MA, 1987.
- [2.6] J. C. Liberti, Jr., *Analysis of CDMA Cellular Radio Systems Employing Adaptive Antennas*, Ph.D. Dissertation, Virginia Polytechnic Institute and State University, Blacksburg, VA, 1995.
- [2.7] *EIA/TIA Interim Standard, Cellular System Dual-Mode Mobile Station-Base Station Compatibility Standard, IS-54-B*, Telecommunications Industry Association, April 1992.
- [2.8] W. C. Y. Lee, *Mobile Cellular Telecommunications: Analog and Digital Systems*, McGraw-Hill, New York, 1995.
- [2.9] J. C. Liberti, Jr., and T. S. Rappaport, "Analytical Results for Capacity Improvements in CDMA", *IEEE Transactions on Vehicular Technology*, Vol. 43, No. 3, pp. 680-690, August 1994.
- [2.10] A. F. Naguib, A. Paulraj, and T. Kailath, "Capacity Improvement with Base-Station Antenna Arrays in Cellular CDMA," *IEEE Transactions on Vehicular Technology*, Vol. 43, No. 3, pp. 691-698, August 1994.
- [2.11] M. Takahashi, H. Takanashi, and T. Tanaka, "Cross Polarization Interference Canceler for Microcellular Mobile Communication Systems," *IEEE International Conference on Communications*, pp. 910-914, 1995.