



ILLUSTRATED LESSON NOTES FOR TEACHERS

INTRODUCTION

preamble for all lessons

1) cityscape

2) cityscape up

3) cityscape down

4) room interior two point

5) railway

6) room interior CVP

6b) room interior cont.

7) letters

8) shadows basic

9) shadows 2

10) archway

10b) completed arch

11) road

11b) road continued

12) book

12b) book continued

PART TWO INTRODUCTION

1) 'quick sketch page'

2) methods of shading

3) tennis and shadows

4) reference sheet

5) in three dimensions

6) a 'fork' in the road

7) portraiture

8) portraiture cont.

9) drawing roses

[Send me a short message](#) with the phrase "please e-mail" if you'd like to read news of new free drawing lessons as they occur and as the pages are updated (no more often than weekly!) **NEW** John Hagan CD now available! , [COWDISLEY HOME SITE](#)

[Peek into a corner of the John Hagan studio ...!](#)



LESSON NOTES FOR TEACHERS

LEARN HOW TO DRAW Essential and elementary lessons on learning how to draw for 9-14 year olds who have interests in becoming;

Artists,
Architects,
Video game designers,
Cartoon artists,
Special effects artists,
Interior Designers,
Draughtsmen,
Fashion Designers,
Surveyors, Engineers, Builders,
Illustrators,
Graphic designers,
Computer designers,
Set designers for film, opera, ballet, stage etc.

Time - Lessons are separated into approx. 40 min segments.

Homestudy - 10 to 20 minutes per lesson - set work proposals suggested at end of each lesson.

Materials:

30x45cms or 12"x18" standard cartridge paper (thick, white, plain) sketchpad.
2H, HB and 4B pencils
Ruler and eraser

General lesson structure:

5-10 min. revision and homework assessment.
5 min. new page, draw margin and add title (bottom rh corner).
20 min. demo and child practical drawing.
5 min. summary and suggested homework.

NOTES

*These lessons are designed using basic skills already learned by students; to measure and to draw straight lines using a ruler. Elements of self-expression are based on familiarity and habit and will come gradually - particularly when the student grows comfortable with the lesson structure. Such self-expression is first emphasised in the homestudy area.

*The second part of the lessons will deal with the freehand elements of drawing but it has been my experience that these freehand lessons come easier with confidence, enthusiasm, discipline and a general understanding of the principles of perspective and the drawing of regular solids. For those who think good drawing has nothing to do with the understanding of basic structure need not read much further. Be warned that it is my way to teach that basic structure first.

*If the lessons are conducted as I have designed them the teacher will find most children will tend to neglect more formal homework and concentrate on expressing themselves by completing their drawings in their own time. I have taught these lessons to all ages including disturbed children, intelligent young adults, three different cultures, and to individuals completely disinterested in education generally. The end results were universal, the students became more perceptive and desired a career change. Be prepared to be besieged by parents at parent teacher nights.

The Classroom teacher needs a good clean chalkboard, white chalk and a long straight edge (a board tee square for the less adept). The home educator needs the same equipment as the student.



[GO TO ... PREAMBLE LESSON](#)



ALL LESSONS - THE PREAMBLE

Lesson preamble - Pencil control for the start of all lessons

Aim: To teach the importance of eye to hand coordination, pencil control.

Materials:

the sketch pad,
the HB pencil,
ruler.

PENCIL CONTROL

A) The pupil will be asked to rule a light horizontal line 1cm or 1/2 inch from the top of the page. The word **lightly** must be stressed and the student's task will be to draw the line so it is visible at half a meter but **invisible at a meter**.

B) Have the student hold these up and the teacher will discover that only one or two students will be able to achieve this result. Praise those two and demonstrate to the whole class the correct method of holding a pencil for a long light line is to drag the pencil across the page lightly holding it between thumb and index finger. The trick is to move your **ARM** and shoulder and not your fingers!

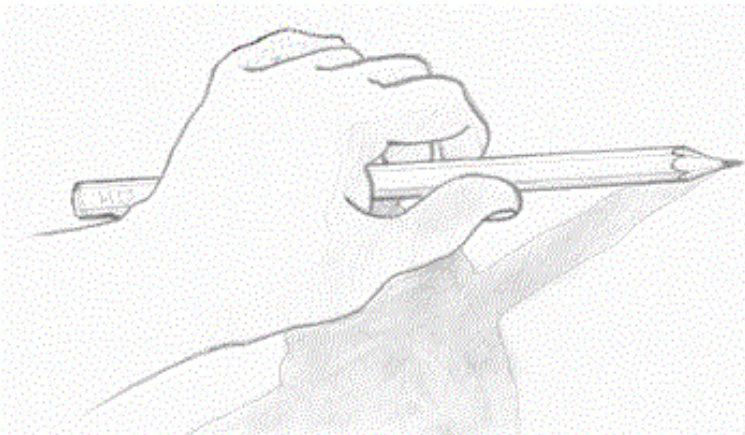

C) Have the class draw a light line across the bottom of the page using this technique and get their next-door neighbour to check it for visibility at a yard.

D) If this proves satisfactory have the student complete the verticals two verticals in the same manner.

E) Hold these up for inspection and then ask the students to firm in the margin with their pencil leaving the corners so they can discern the difference between their light and heavy lines.

F) Lightly construct a little box 2cmx6cm (1" x2") in the bottom right hand corner for a title, then firm it in as shown below.

<div data-bbox="671 465 804 501" data-label="Text"><p>TITLE - NAME</p></div>
--

This exercise is to be done at the beginning of every drawing class for every page as it slots the students mind into line control (allow 5 min. maximum).



[GO TO ... LESSON ONE](#)

[or ... lesson menu](#)



LESSON ONE - ELEMENTARY PERSPECTIVE

TIME: Allow one hour for this initial lesson - if combined with previous lesson 80min. It is strongly suggested the teacher prepares by completing the lesson sometime before attempting to teach. Particular measurements can then be given to those who need them.

Aim: To introduce the student to the notion of creating a three dimensional vista on a two dimensional plane. This lesson is particularly important as its intent is have the student create a picture of great depth by merely copying the lines the teacher makes on the chalkboard. The aim is to generally promote confidence in the student.

Materials; The sketch pad,
HB pencil, ruler.

We will carry on from the page prepared in the preamble lesson using the ruler and HB pencil ...

a) Quarter the page as shown with light lines. Teacher should do this on the chalkboard, then wait for the students to catch up.

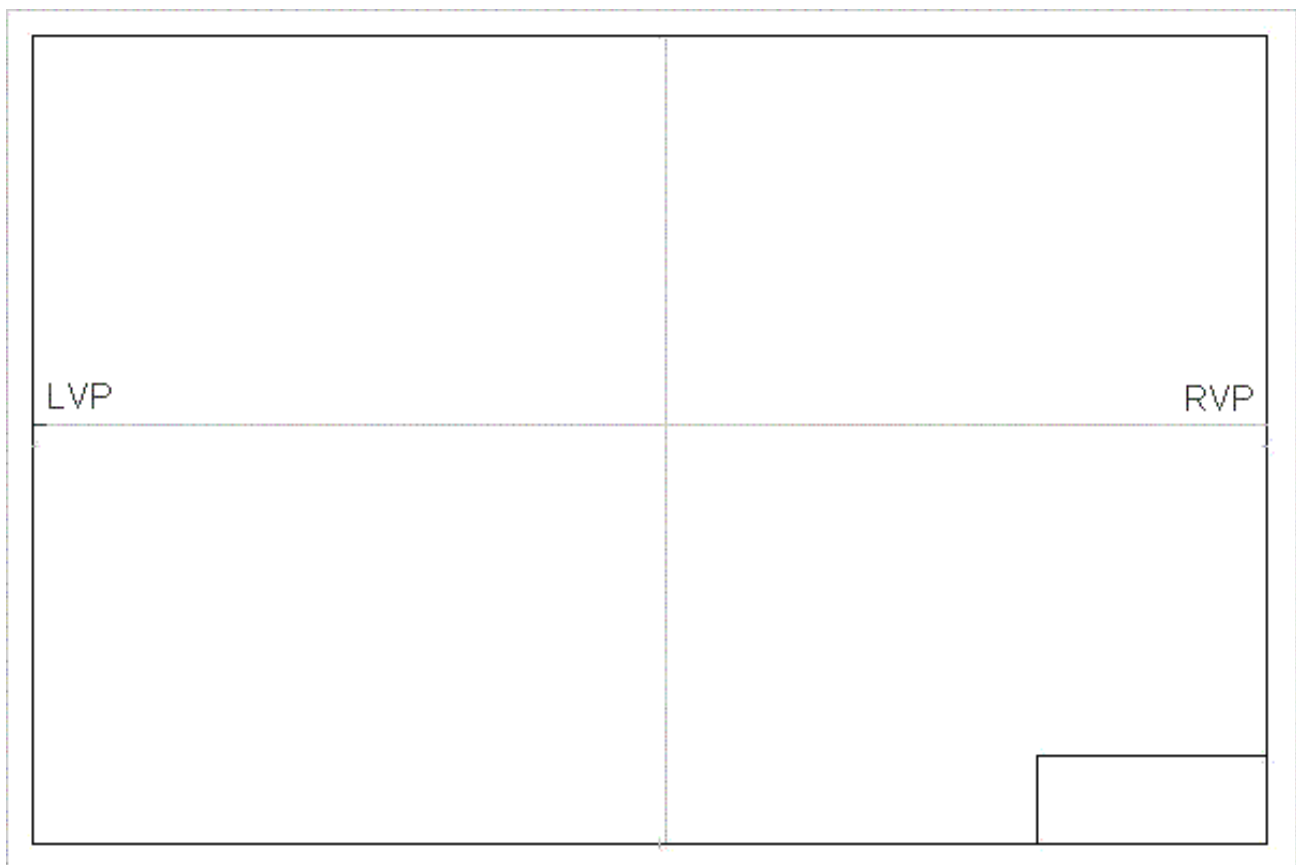

b) Where the middle line touches the border mark two points - these are called ... RVP and LVP (Right and Left Vanishing Points).

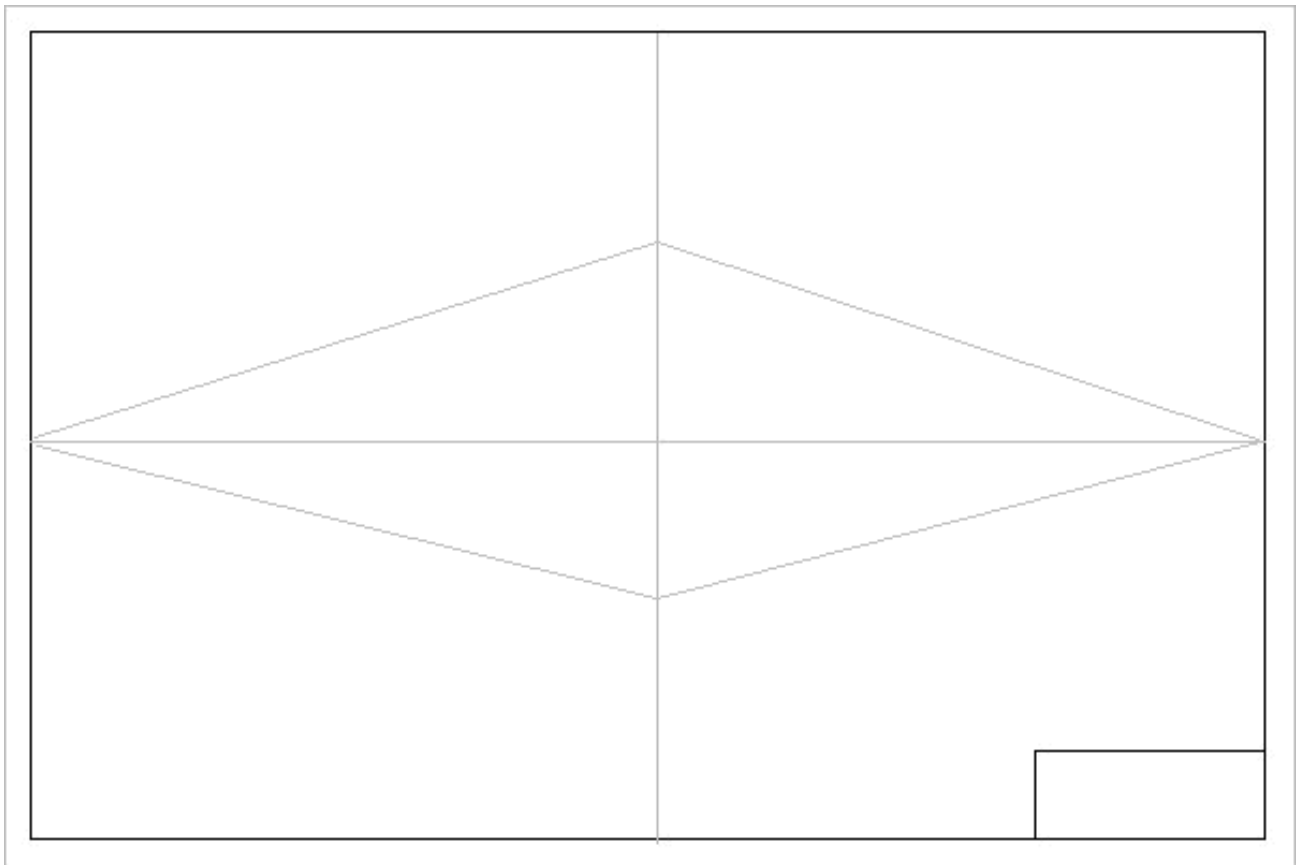

c) Approximate the next four light lines as shown - if the students are unsure then give absolute measurements 50mm (2") down - 75mm(3") up from the center.

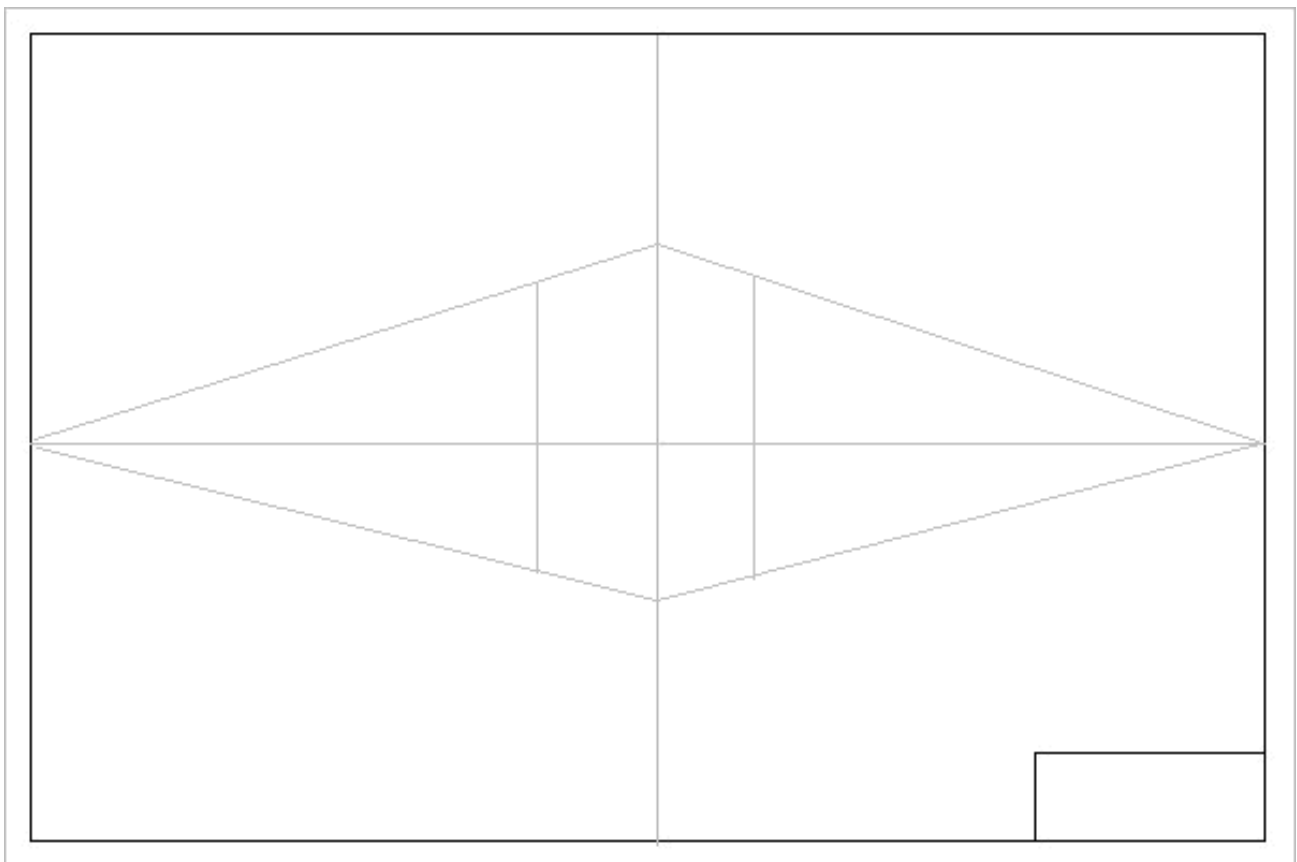

d) Add the verticals as light construction lines. Note to the students that only three types of lines to be made, vertical lines or lines to the right VP or left VP ... there are none other. Again, give measurements if considered necessary. 35mm (1-1/2") right 50mm (2") left of center.

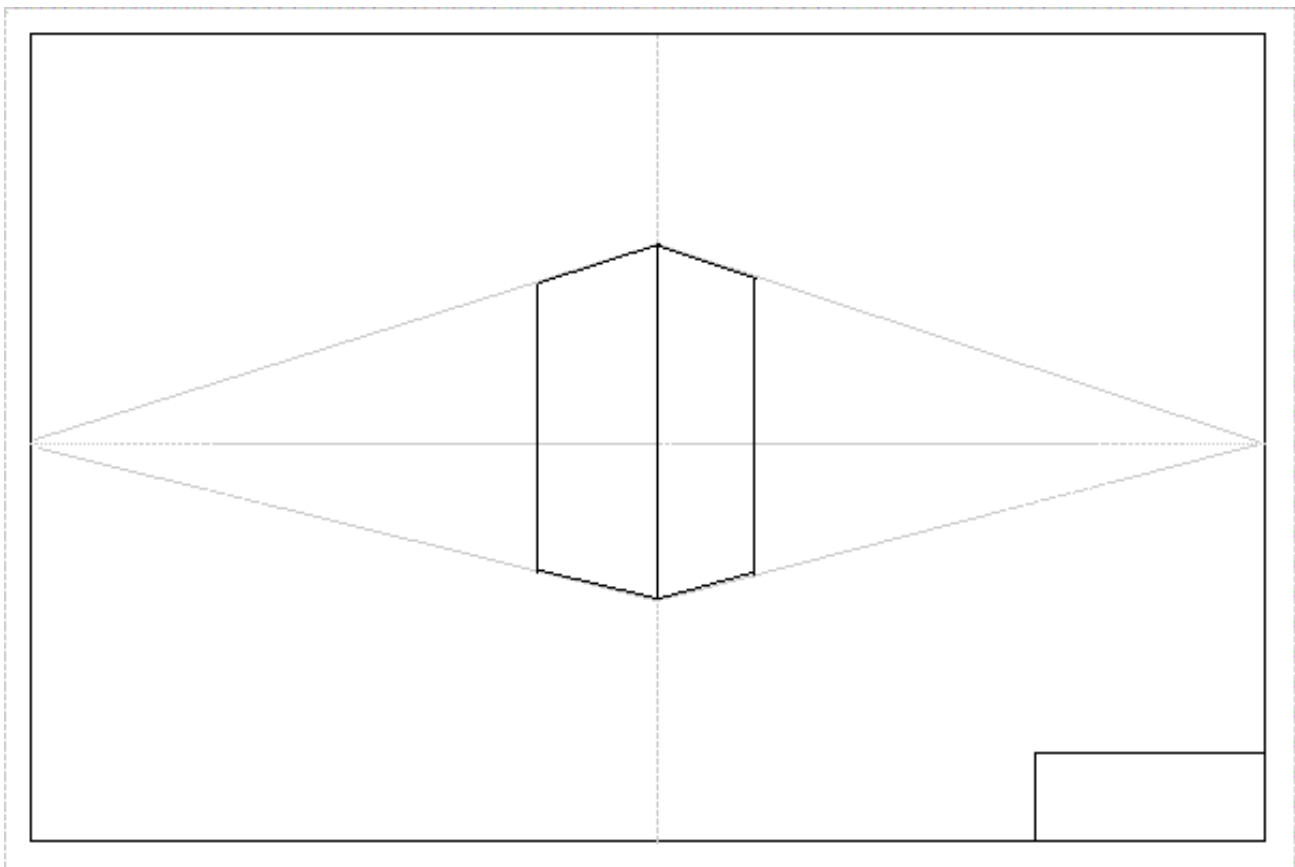

e) Construct the next set of verticals to approximate (below) then join the tops to RVP and LVP.

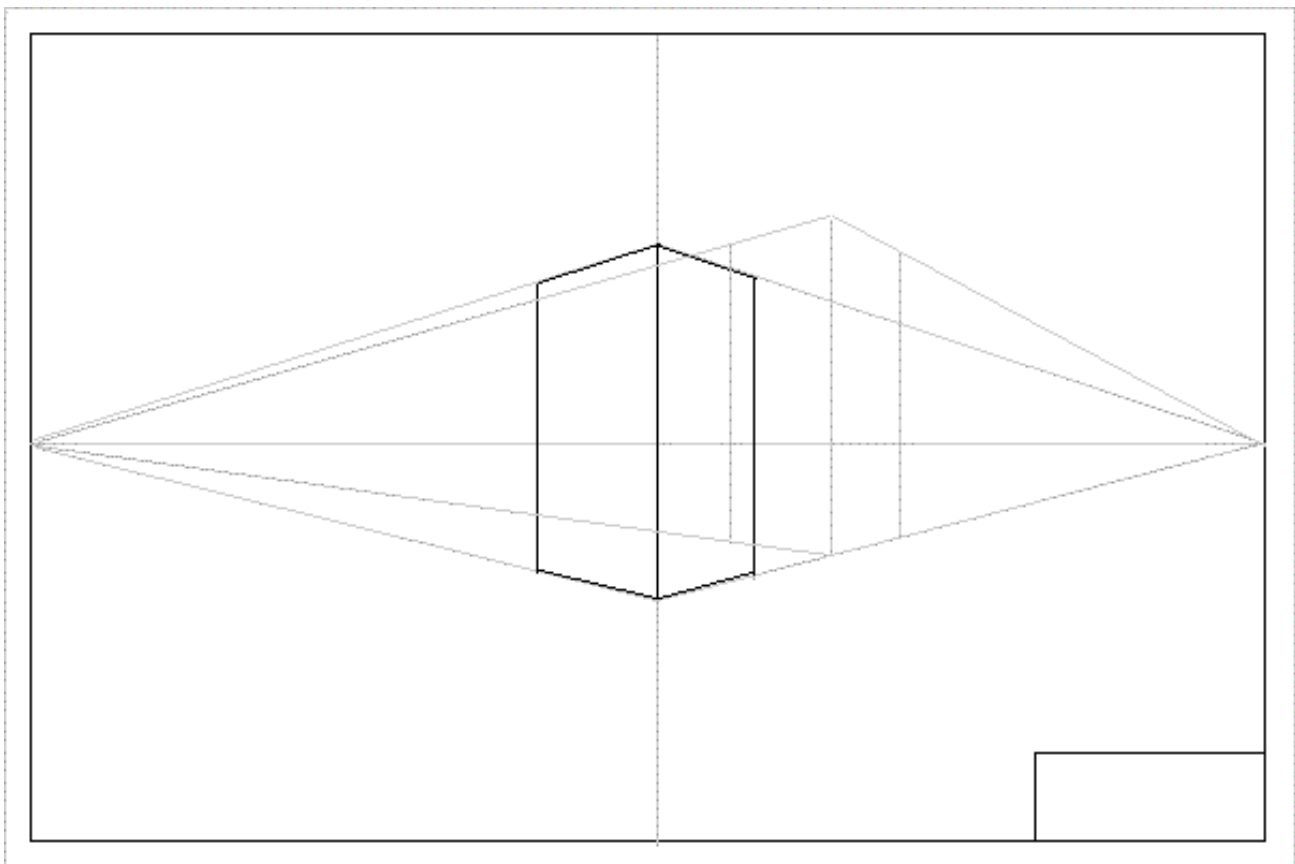

f) Firm in the lines shown.

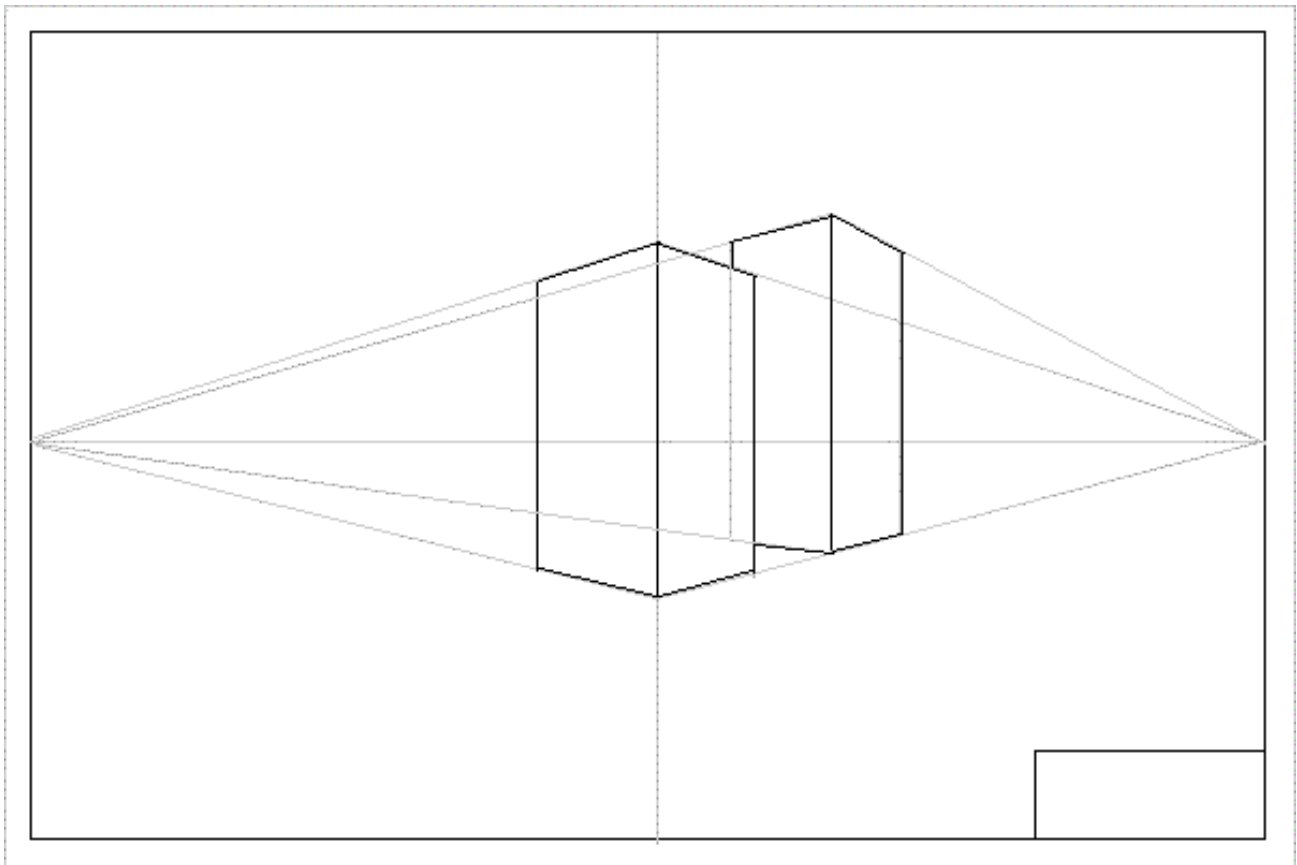

g) Do again on the left of the centre as demonstrated.

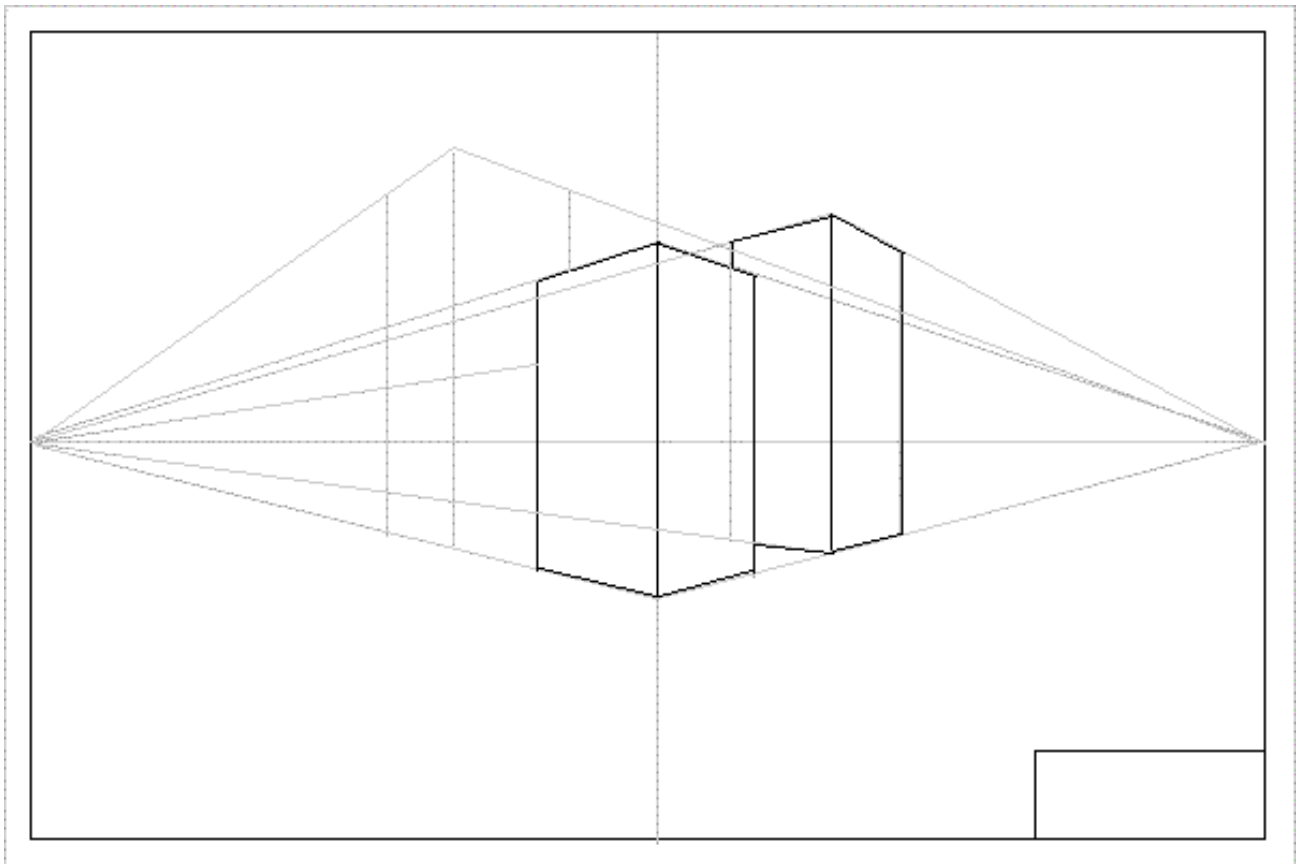

h) Firm in the lines as in my drawing.

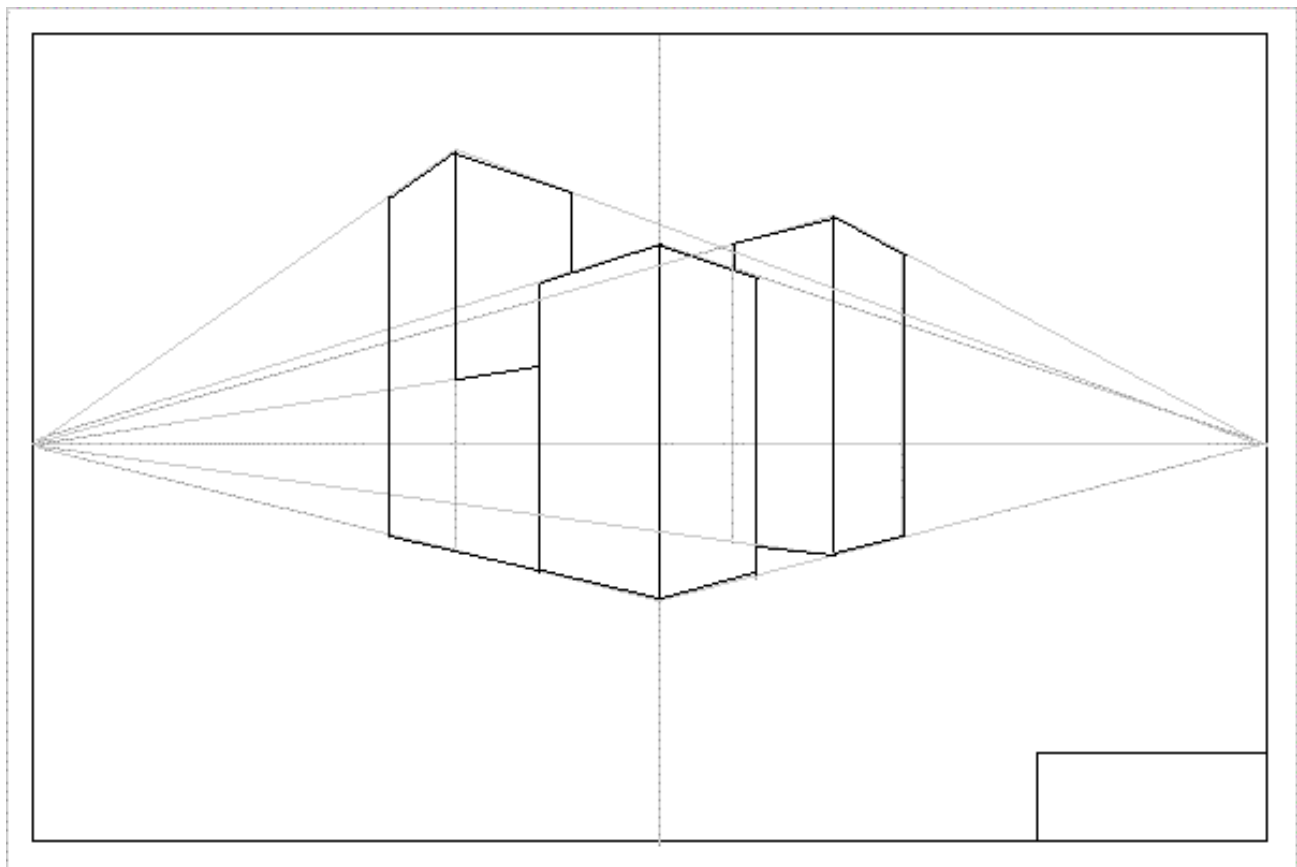

i) Add another lightly.

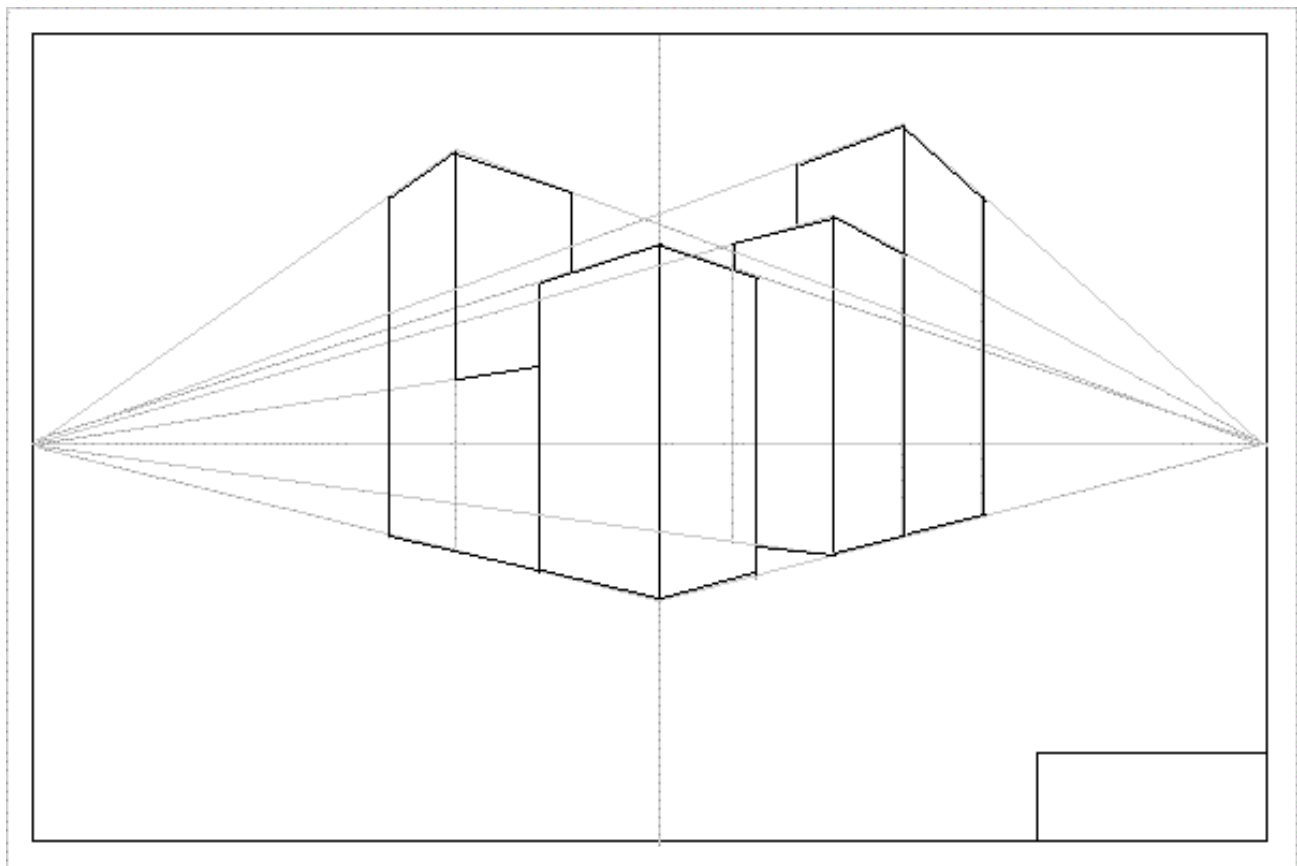

j) Firm in ...

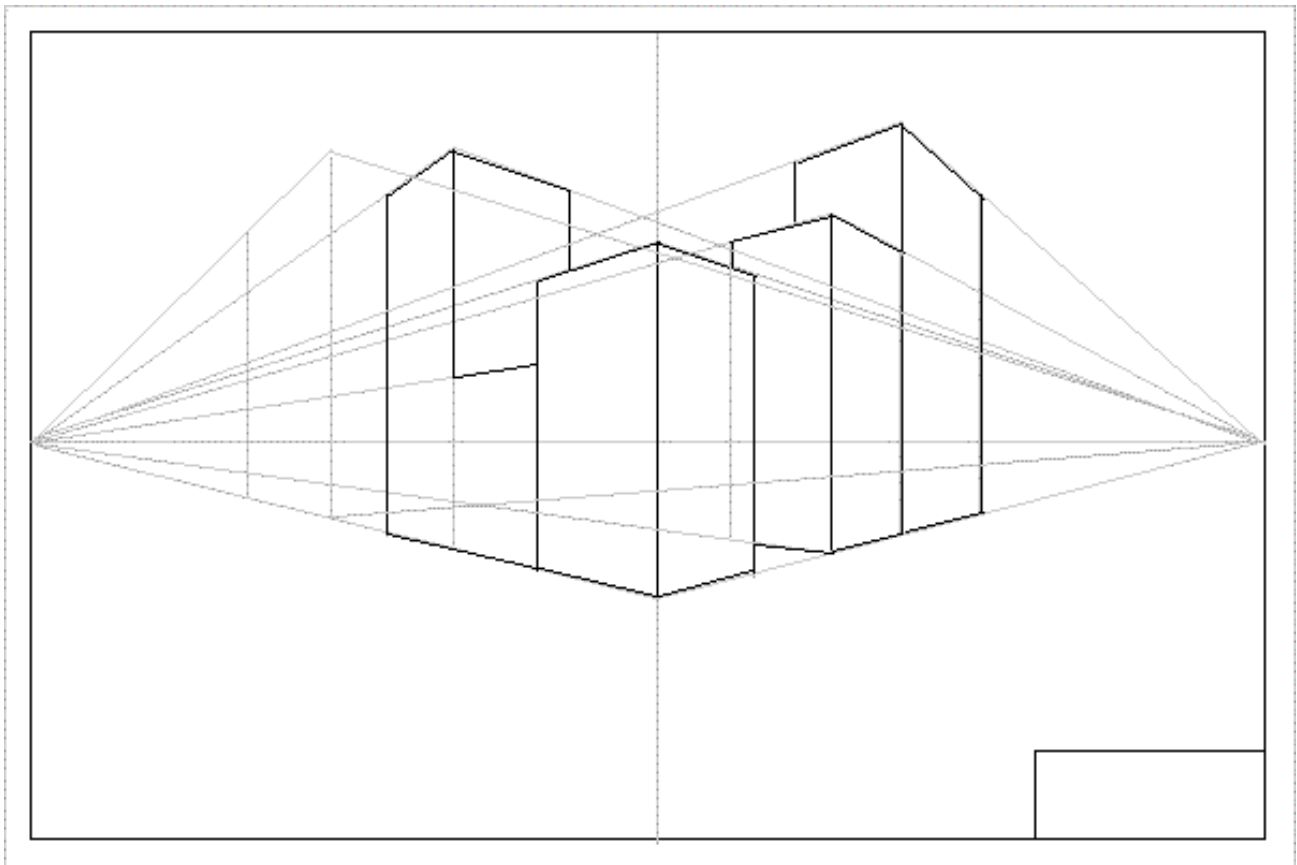

k) and a fifth ...

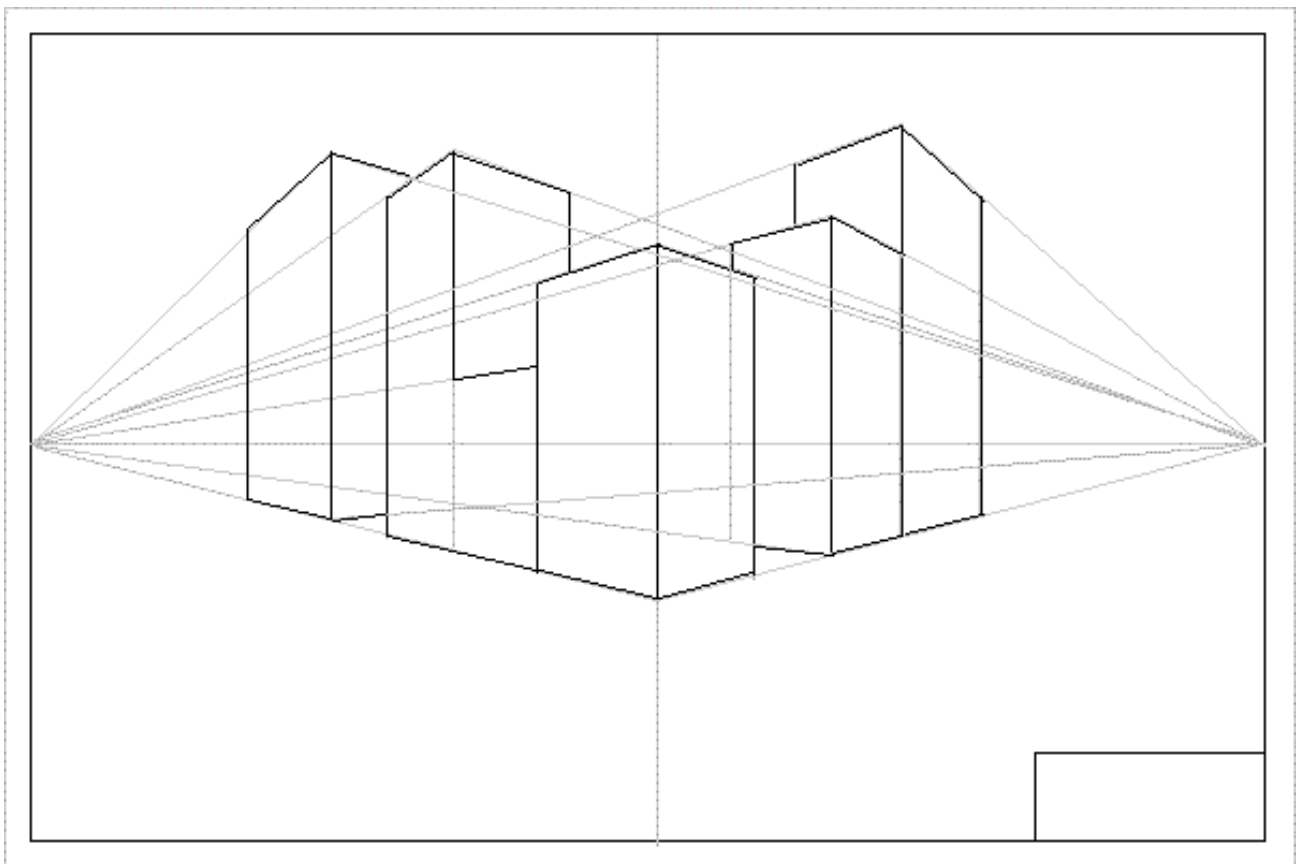

l) Shade the right hand side of the buildings as shown.

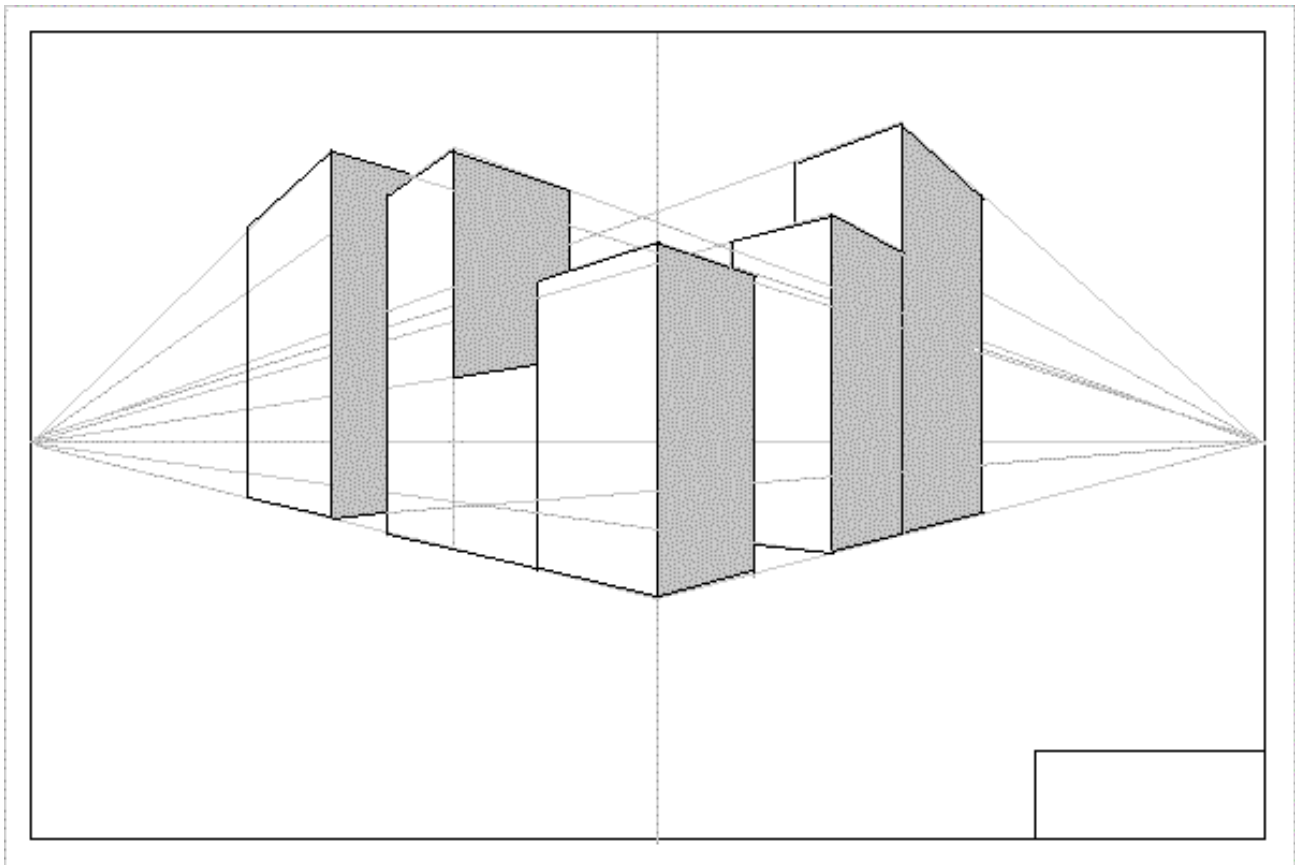

m) Add some light lines as shown to suggest road and pavement - then firm in when satisfied. Demonstrate how to add some suggestions of windows and signs. Have the children hold up their pads at the completion of a particular time. Those who have never drawn in three dimensions will be encouraged and quite keen to continue.

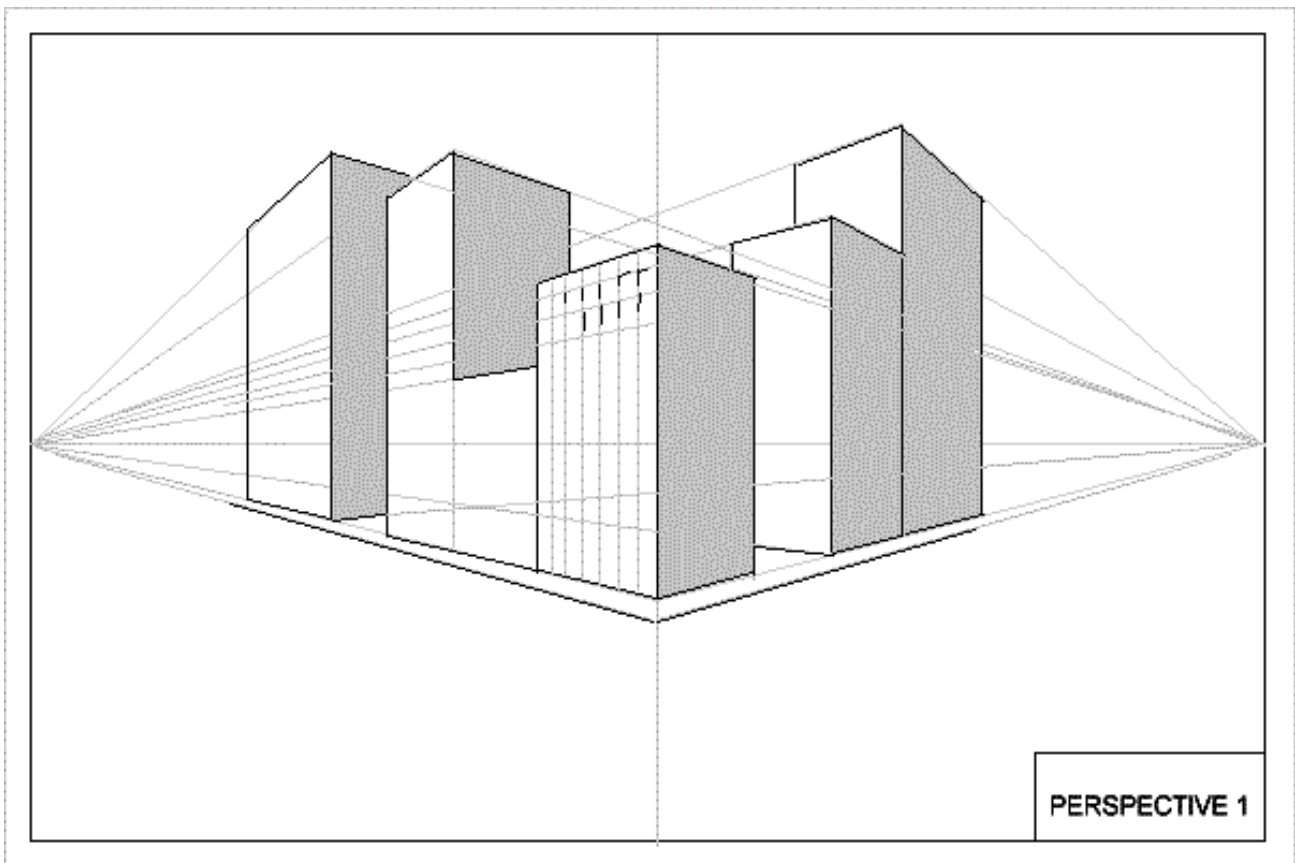

Home work;

Complete the drawing adding more windows, pedestrians, cars, background or more buildings... encourage innovation.

Press [here](#) to go to a master painter's oil painting using two point perspective as shown above.
Press back to return.



[GO TO ... LESSON TWO](#)

[lesson menu](#)



LESSON - PERSPECTIVE TWO - CITY STREET (UP)

TIME:

Allow 40min - teacher preparation: prepare sketch beforehand with measurements.

Aim:

To introduce the student to the notion of creating a three dimensional vista on a two dimensional plane. This lesson follows on and develops the theme of the previous lesson.

Materials:

The sketch pad,
HB pencil, ruler, eraser

Prepare a new page with the margin as in the previous lesson using the ruler and HB pencil ...

a) Quarter the page as shown with light lines. Teacher should do this on the chalkboard then wait for the students to catch up.

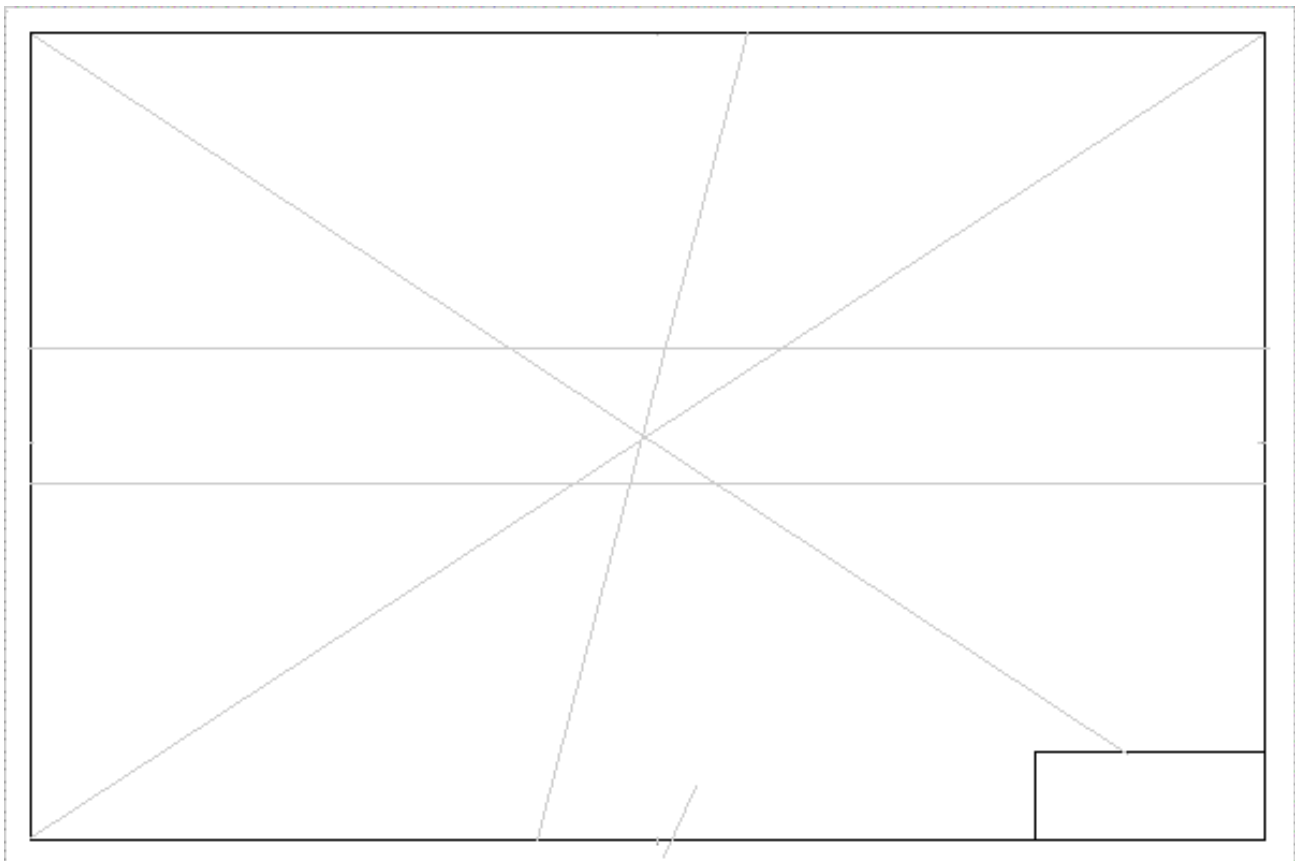

b) In this lesson we are going to use only one vanishing point (CVP) and it is in the center of the page. Place in the lines approximately as shown. Parallel lines are 20mm (3/4") down and 30mm (1,1/4") up from dead center.

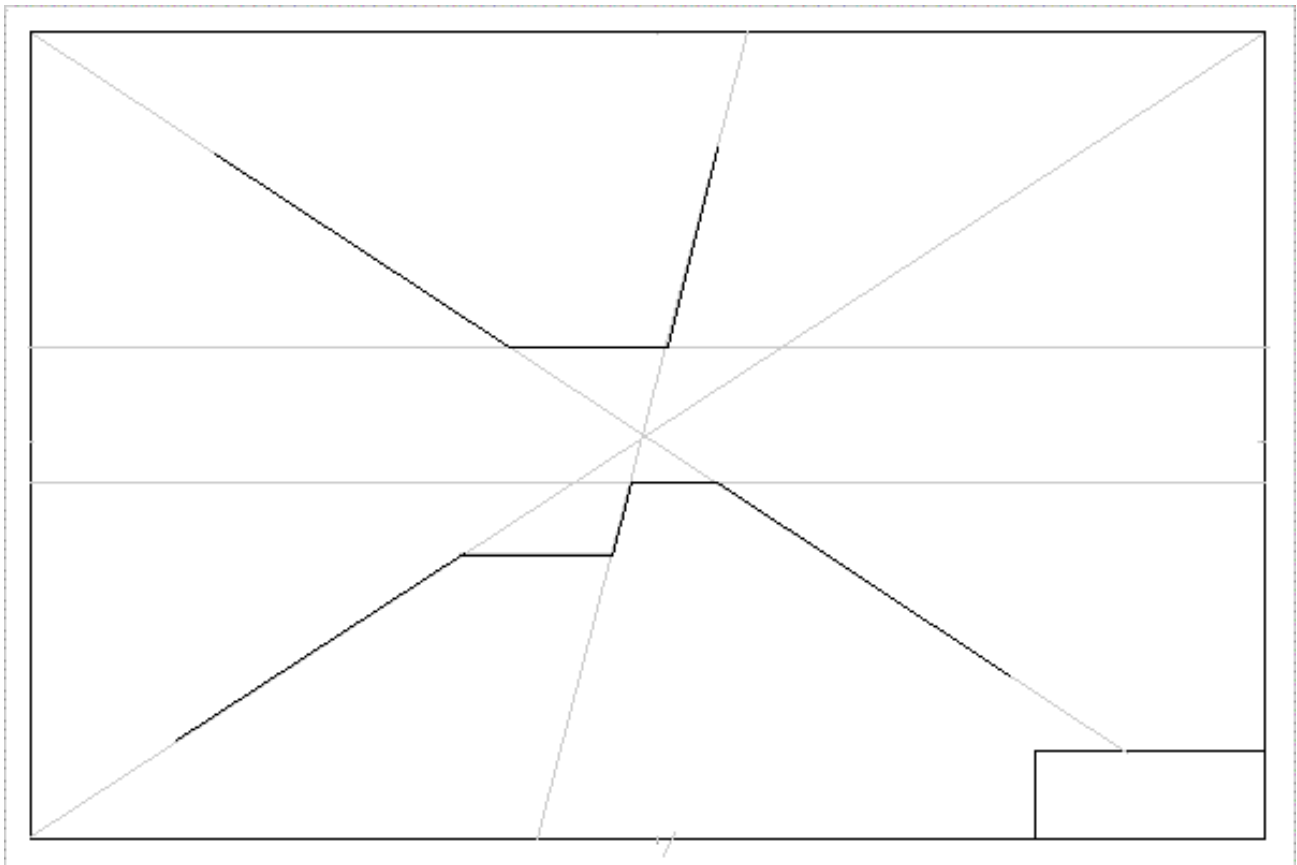

c) Firm in the lines shown.

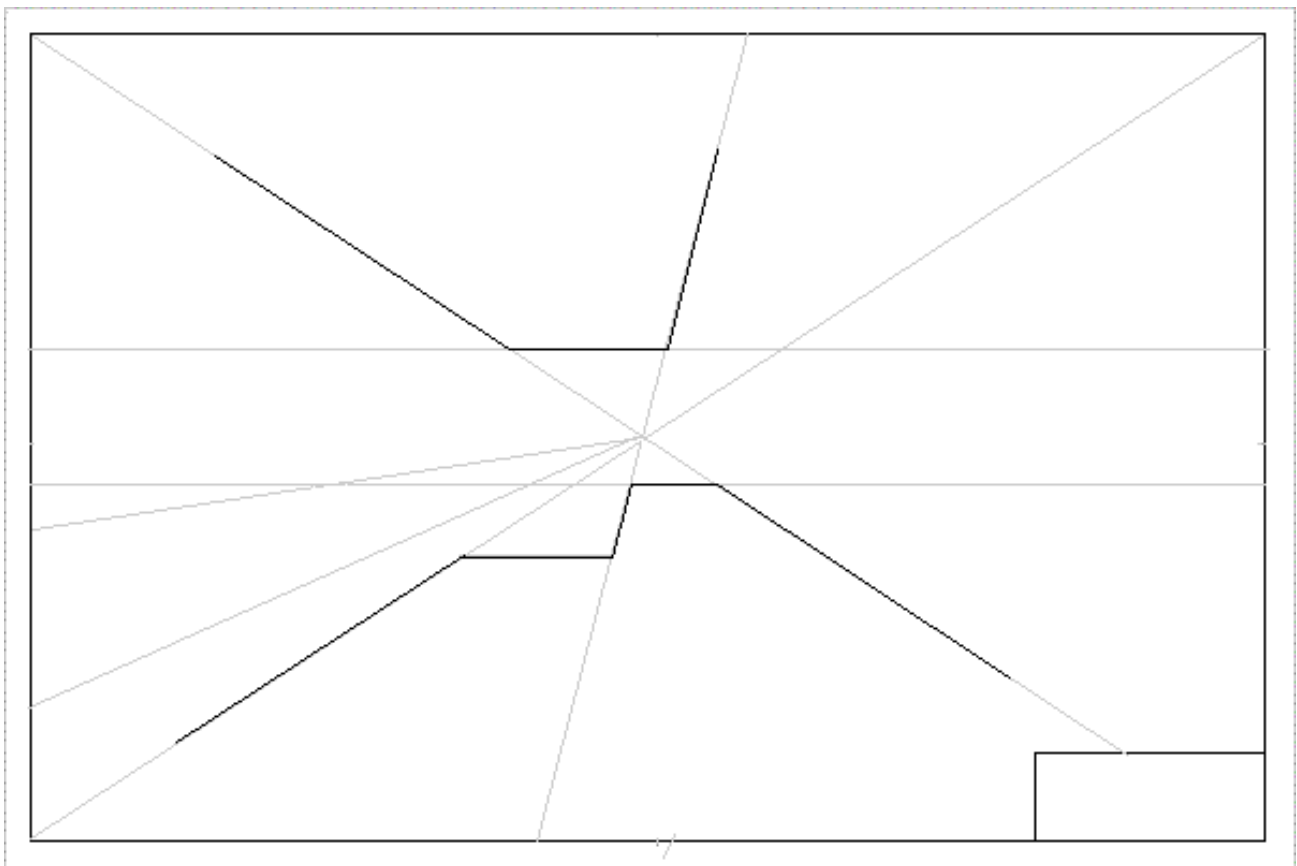

d) Add the next two radiating light lines as demonstrated.

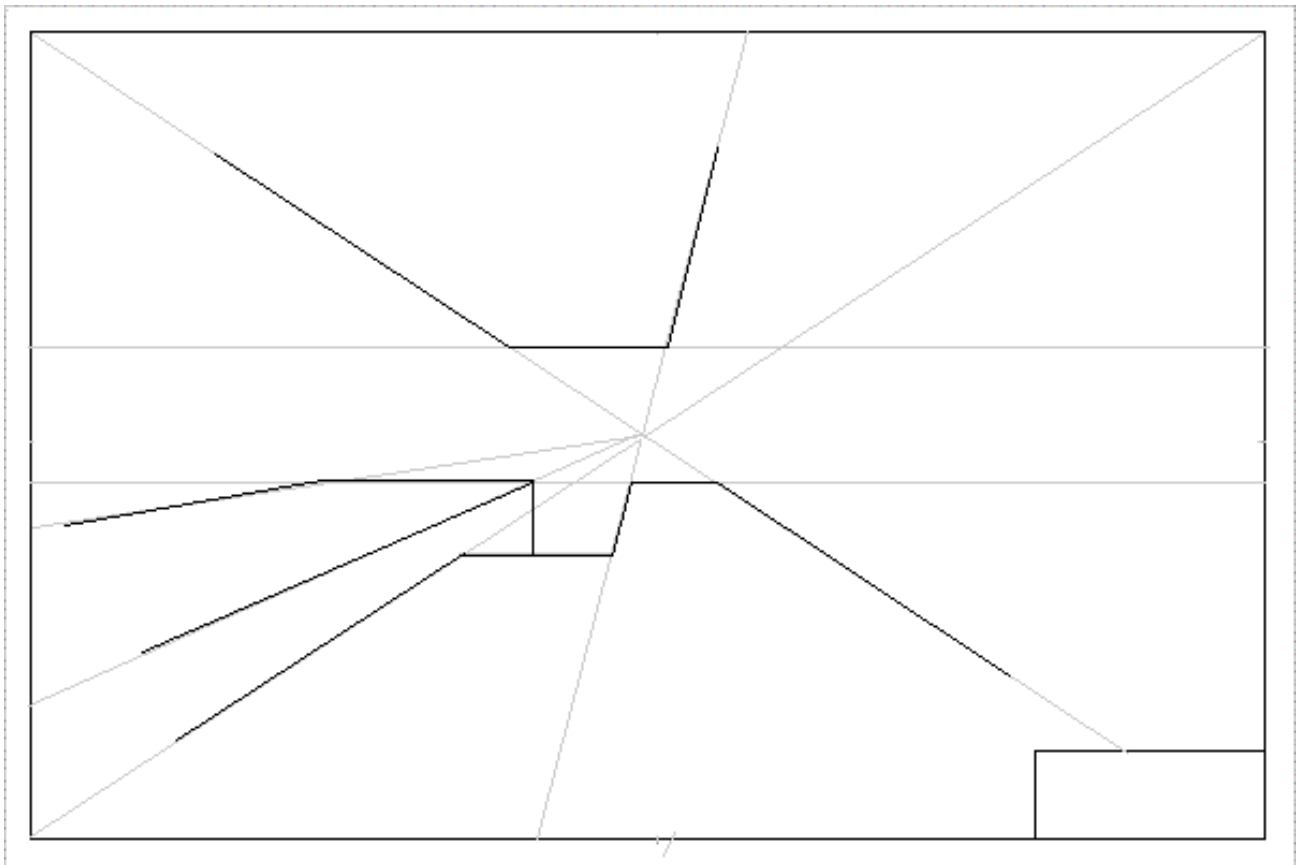

e) Firm in the next skyscraper - note to the student that all lines in this drawing are either horizontal, vertical or radiate out from the center. There are no others!

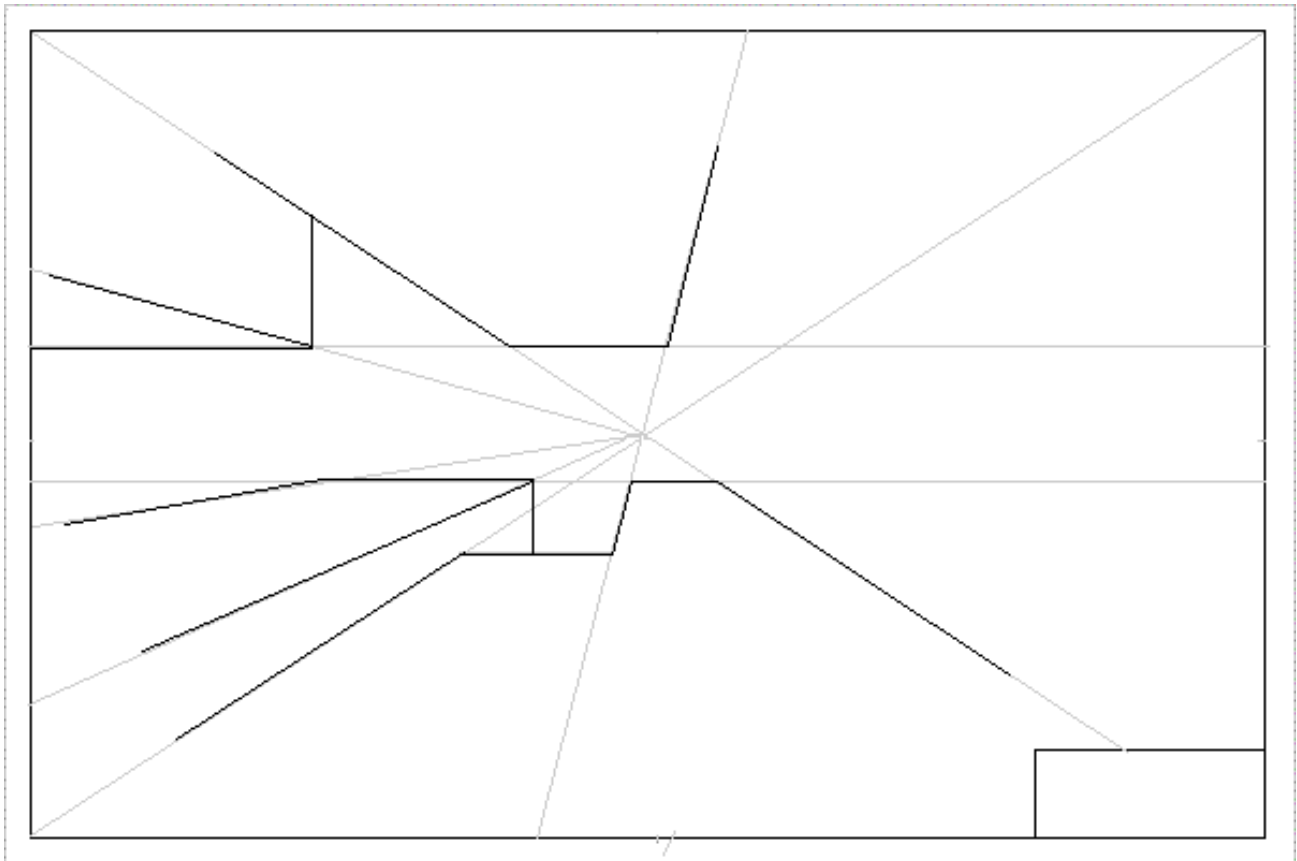

f) Add the next building as shown.

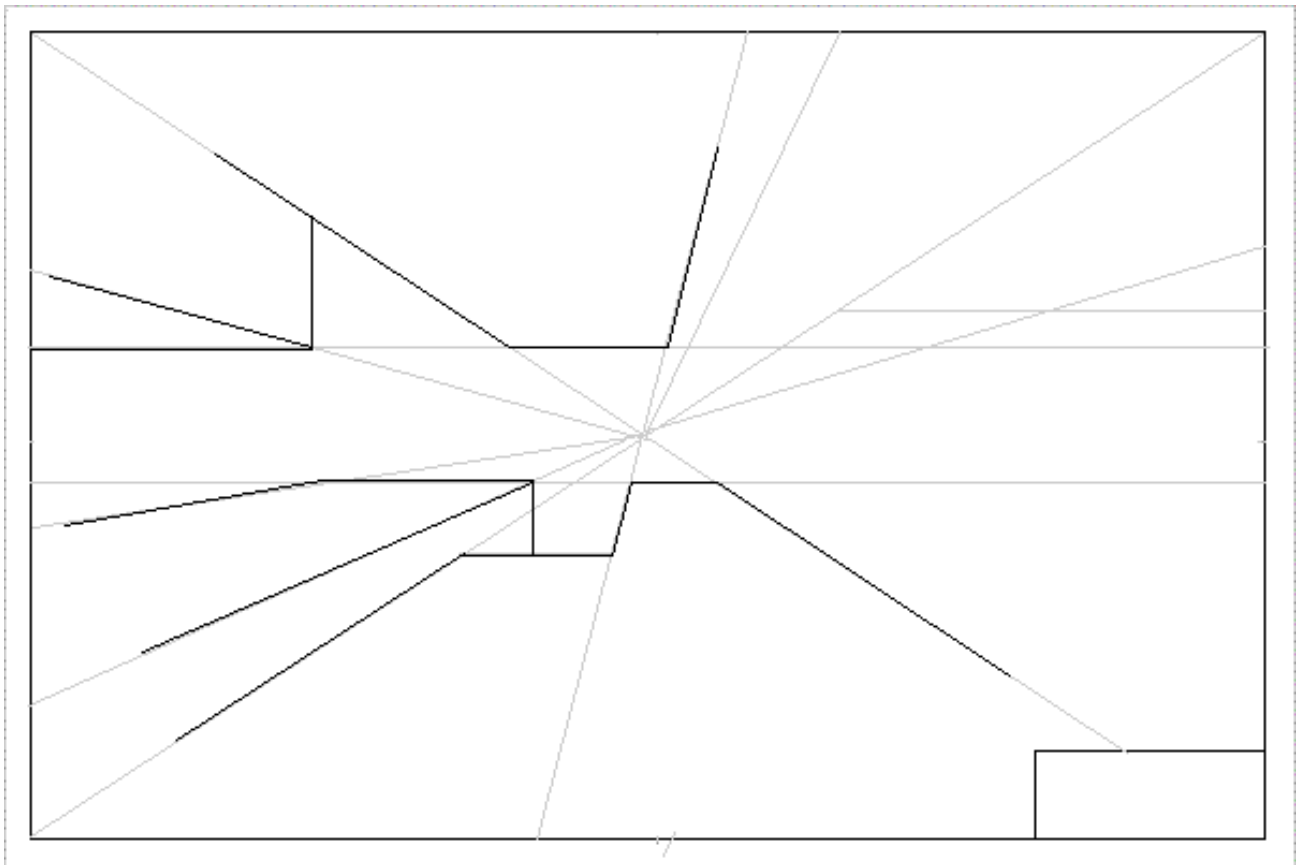

g) Some more light construction lines ...

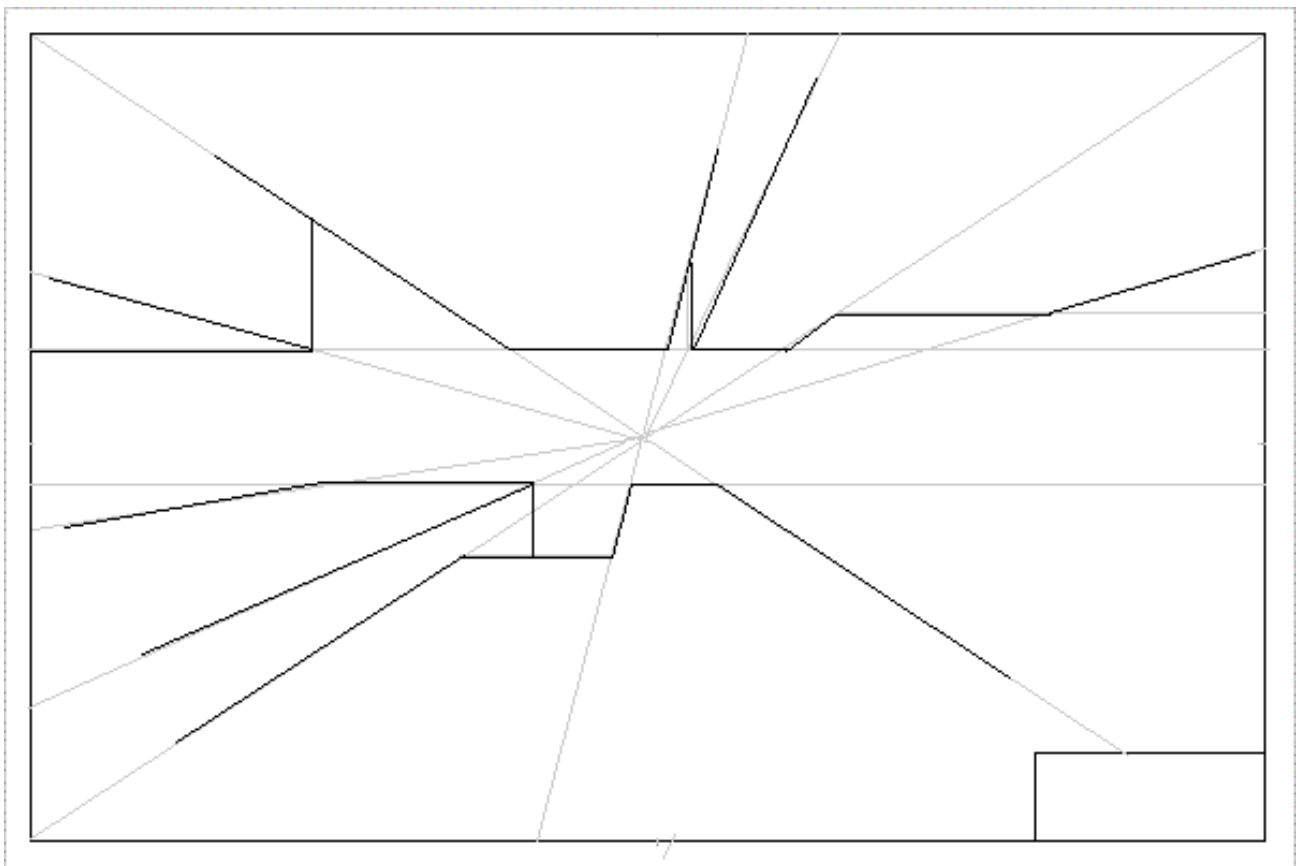

h) ... and firm in the lines as shown.

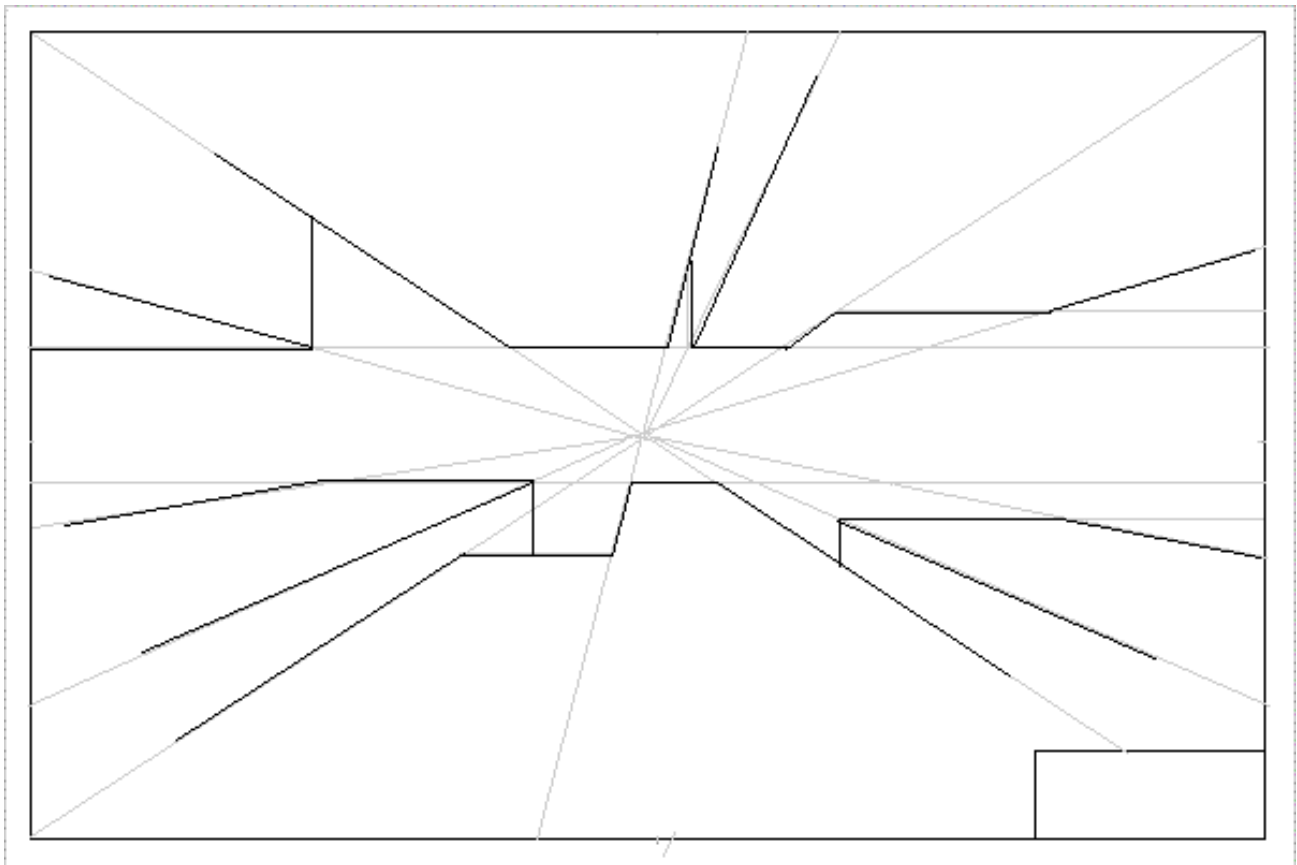

i) The essential 'structure' is complete.

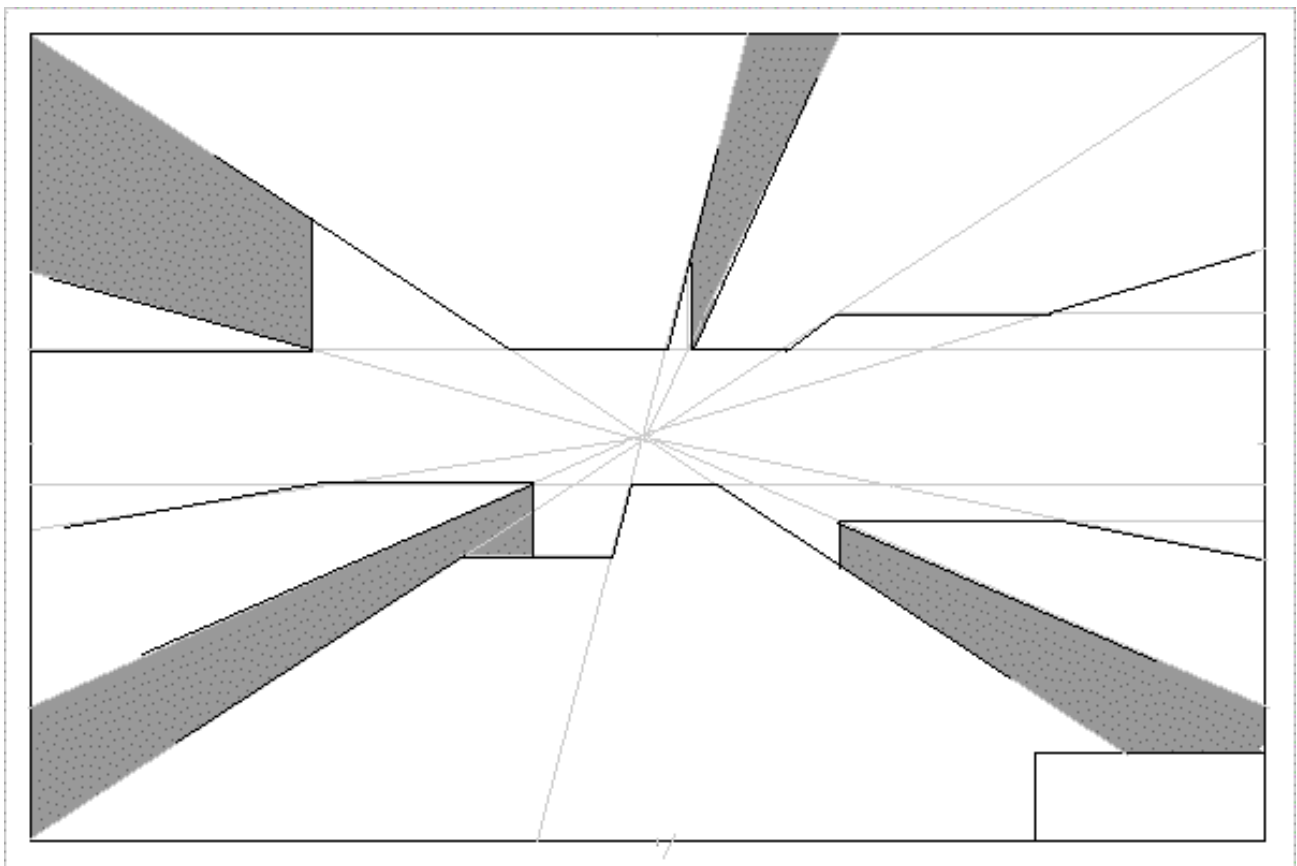

j) Now for a little shading.

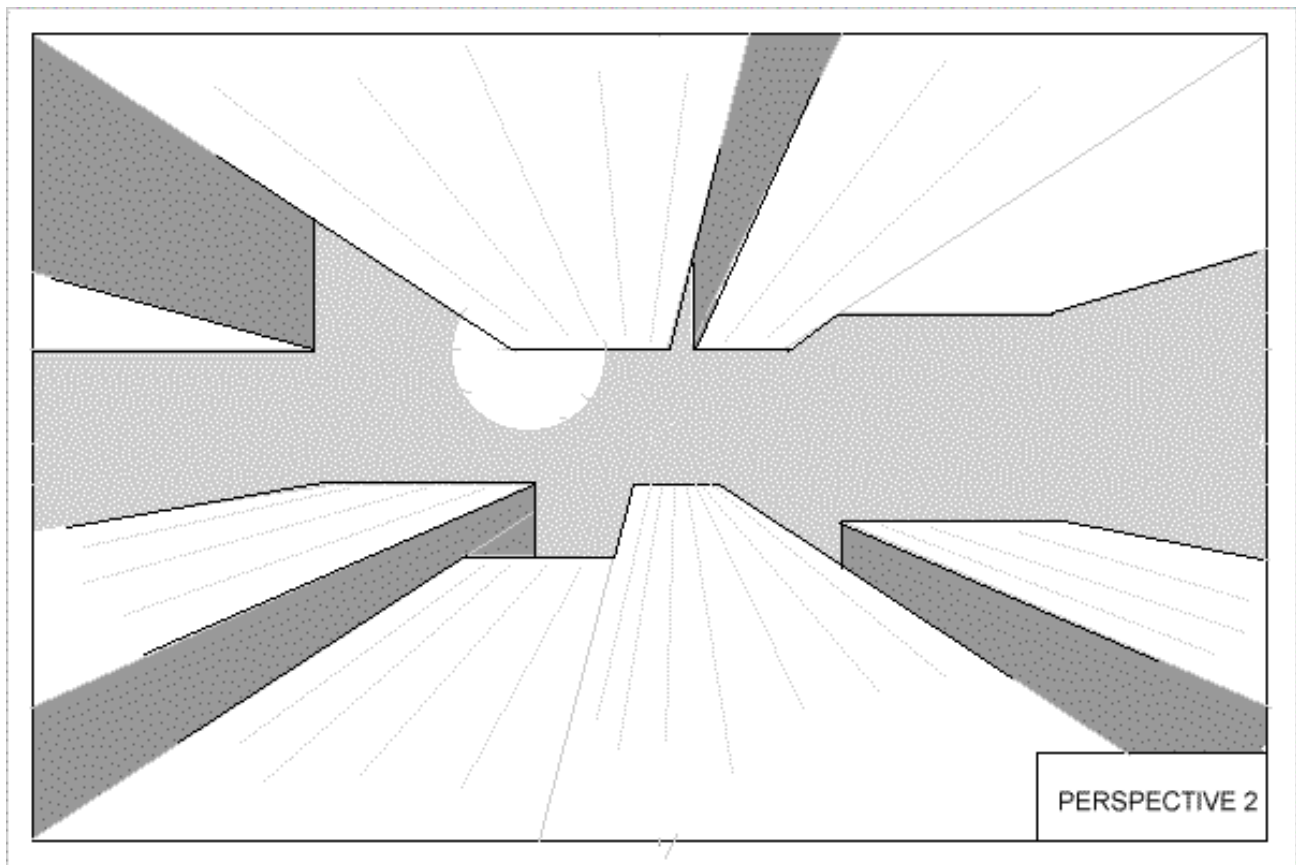

Print in the title, add some light lines as shown to suggest windows, then firm in when satisfied. Further shading and details can be completed at home.

Home work;

Complete the drawing adding clouds, birds, more windows etc ... to your satisfaction.



[GO TO ... LESSON THREE](#)

[lesson menu](#)

For those folk who have enquired a **CD version** of these 'painting' as well as 'drawing lessons' and 'advanced painting' lessons will soon, I hope, be available to everyone. It will be an updated, reformatted for easy printing version so you can create you own reference handbook in your own time, or just browse the CD.

It is anticipated the CD will be available at around \$15 (plus posting) for students and \$19 (plus posting) for others. The CD's will be distributed on a first come first served basis. Isn't that always the way?

To be added to the list just send me a simple [email](#) with the words 'please notify CD' and your name and status (only if a student or teacher).



LESSON - PERSPECTIVE THREE - CITY STREET (DOWN)

TIME: Allow 40min - teacher preparation minimal.

Aim: This lesson follows on and develops the theme of the previous lesson and intends to introduce the notion that views may differ but structural elements of perspective (and drawing) remain very similar.

Materials: The sketch pad,
HB pencil, ruler.

Prepare as in the previous lesson using the ruler and HB pencil

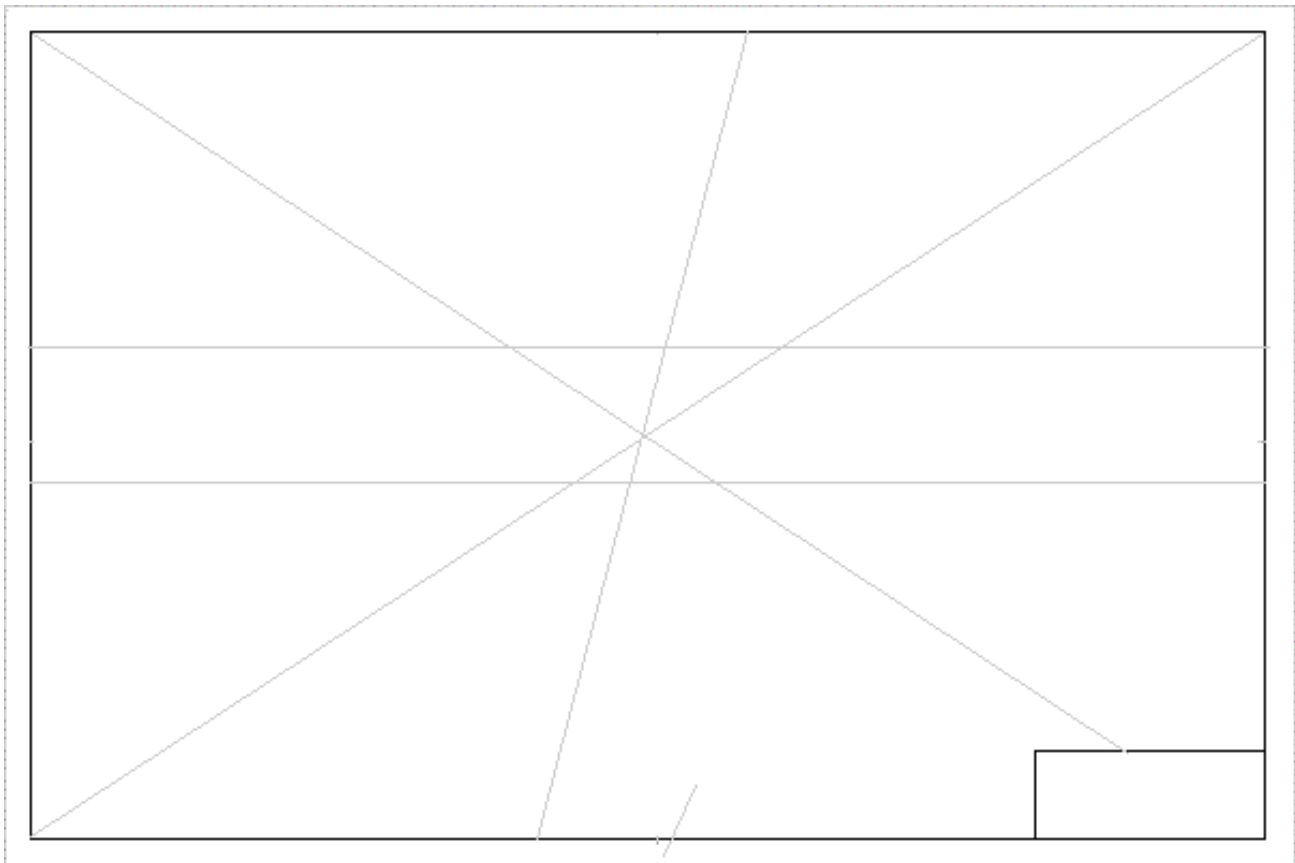

a) Quarter the page as shown with diagonal light lines. Teacher should do this on the chalkboard, then wait for the students to catch up. Add the extra light lines. In this lesson we are again going to use only one vanishing point (CVP) and it is in the center of the page. Place in the lines approximately as shown.

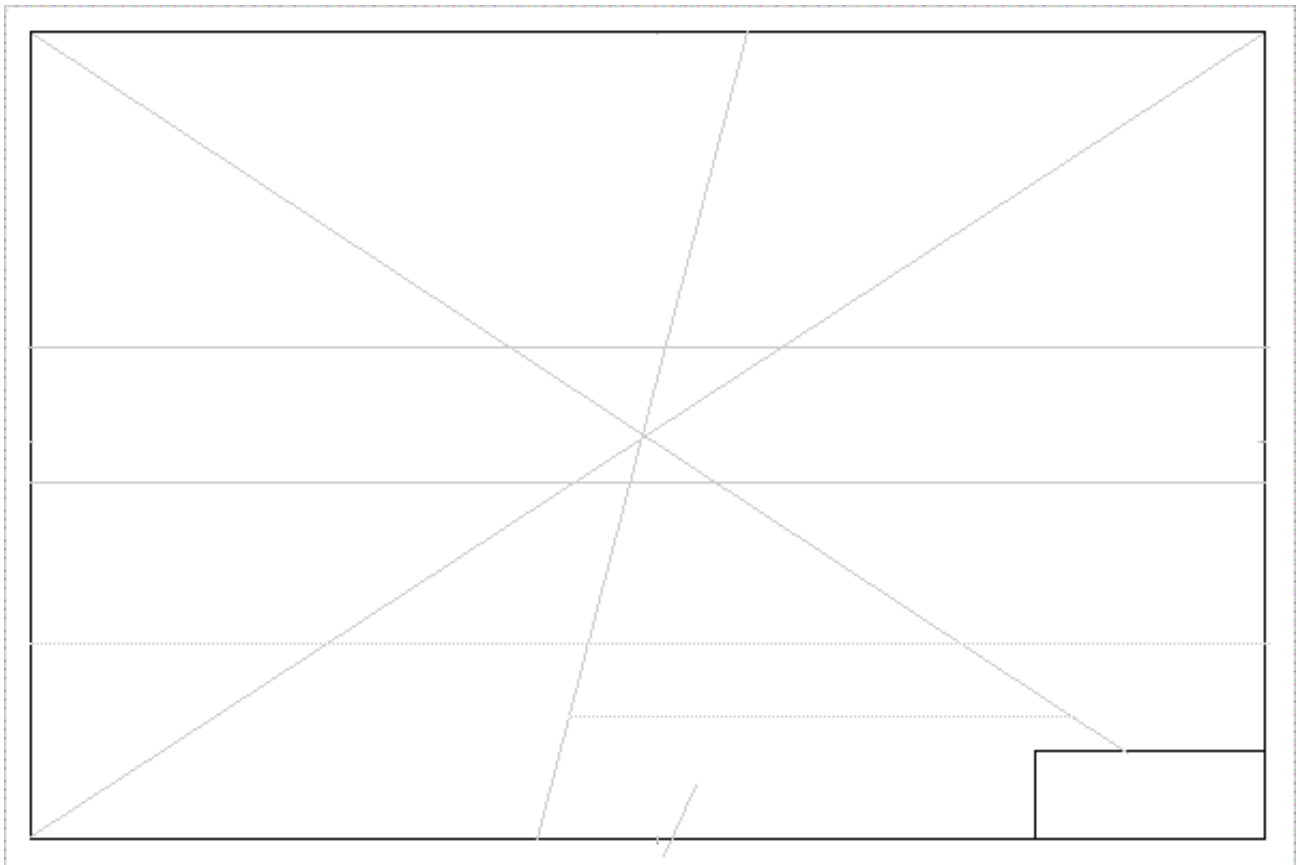

b) Add the two extra light lines.

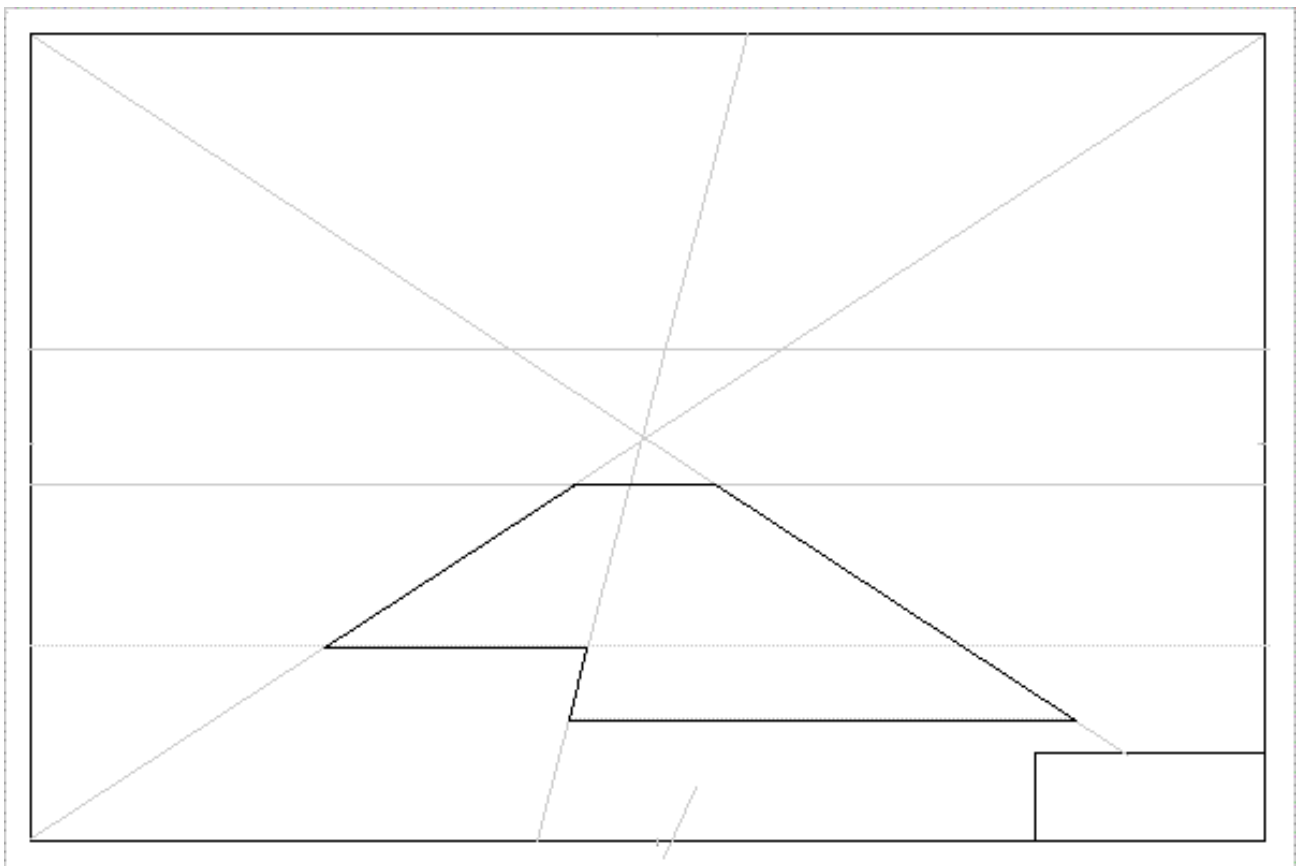

c) Firm in the lines shown.

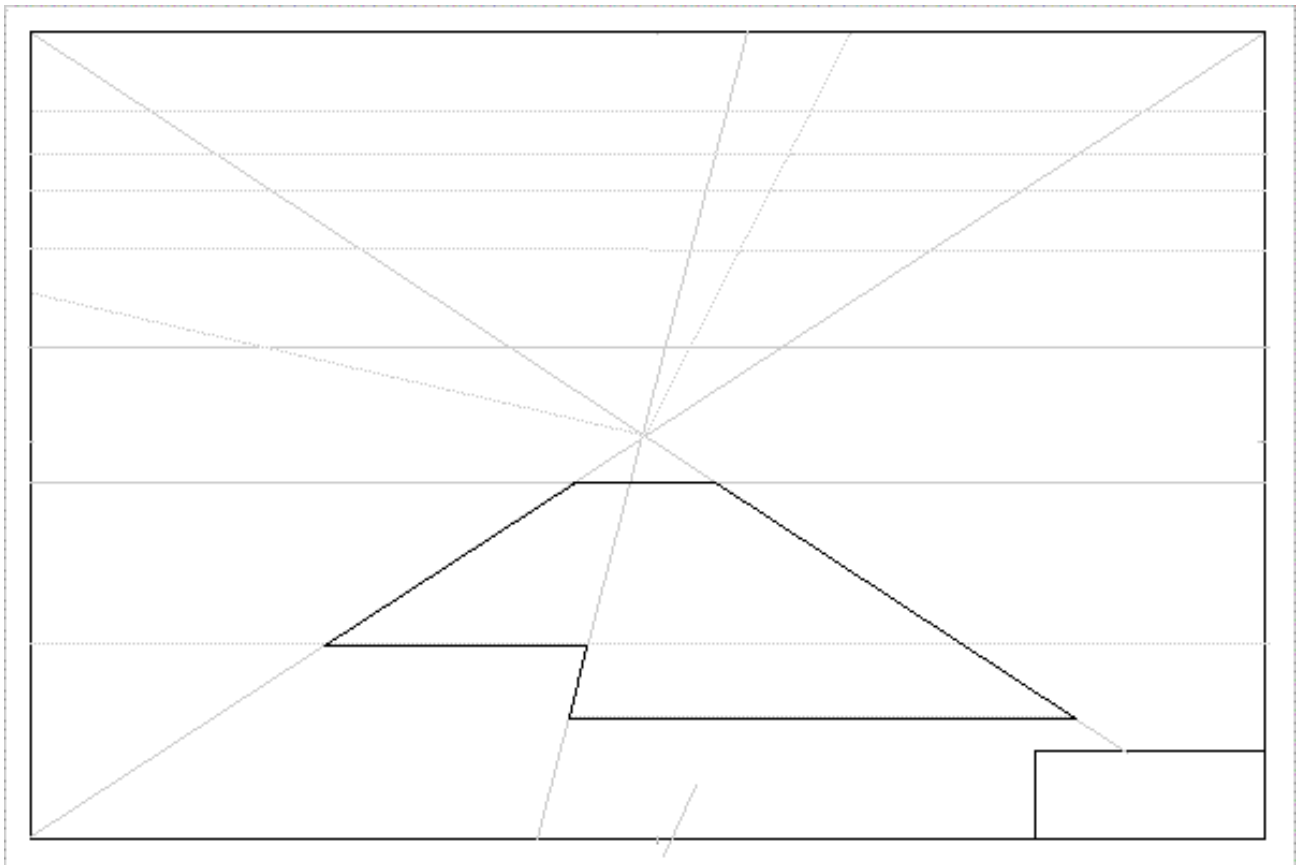

d) Add the next series of horizontal light lines and the two extra radiating lines. Give measurements of students are unsure about the position of the horizontal lines as some students become nervous about mistakes - again note to the student that all lines in this drawing are either horizontal, vertical or radiate out from the center.

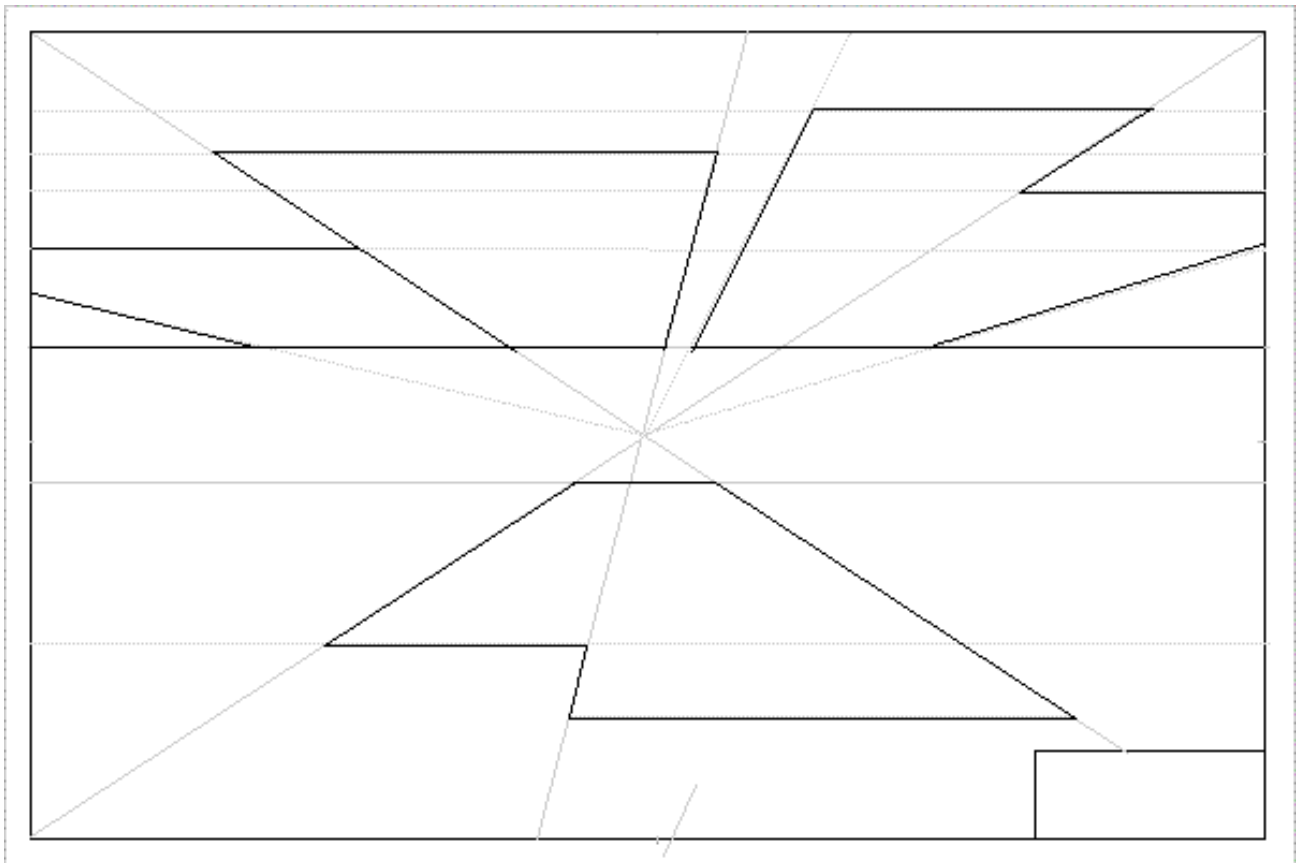

e) Firm in as shown.

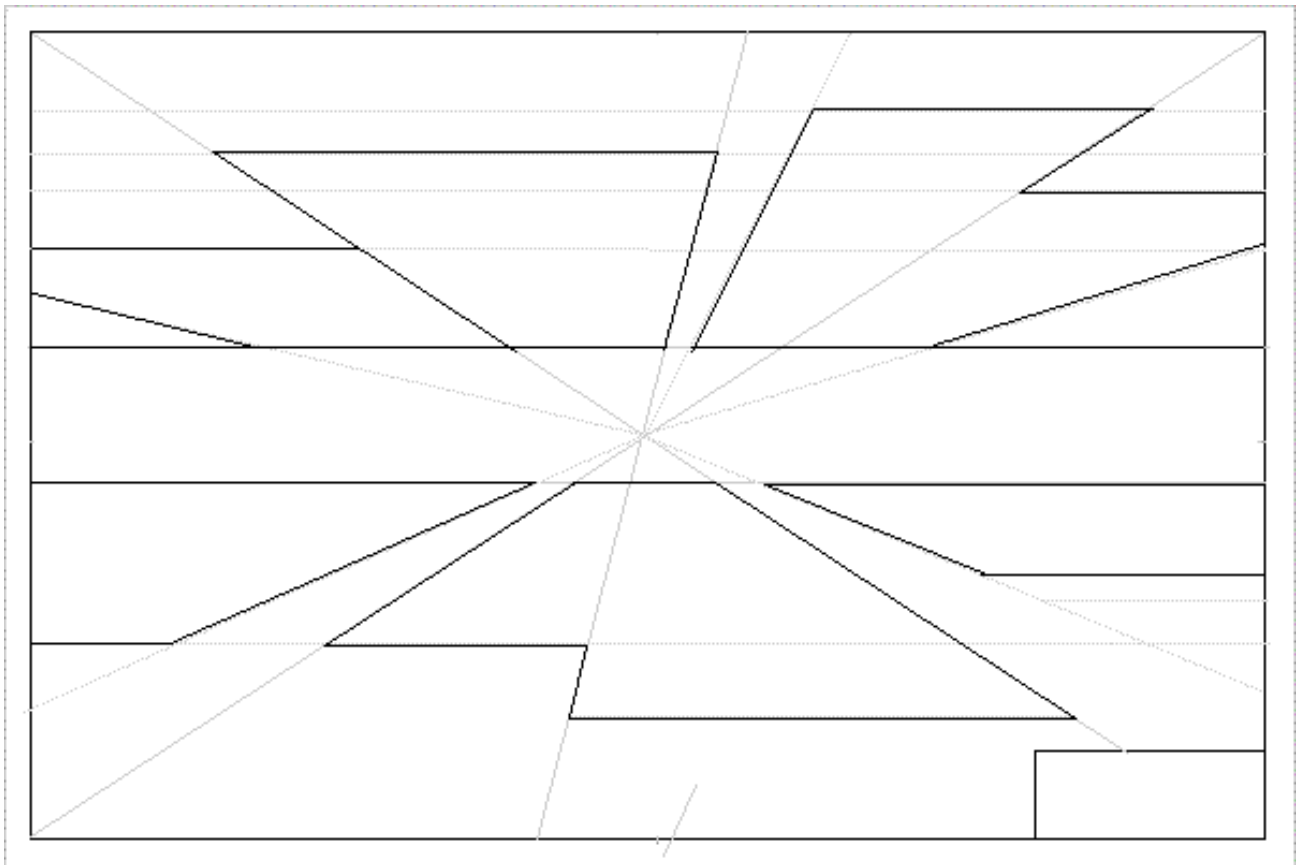

f) Add the extra.

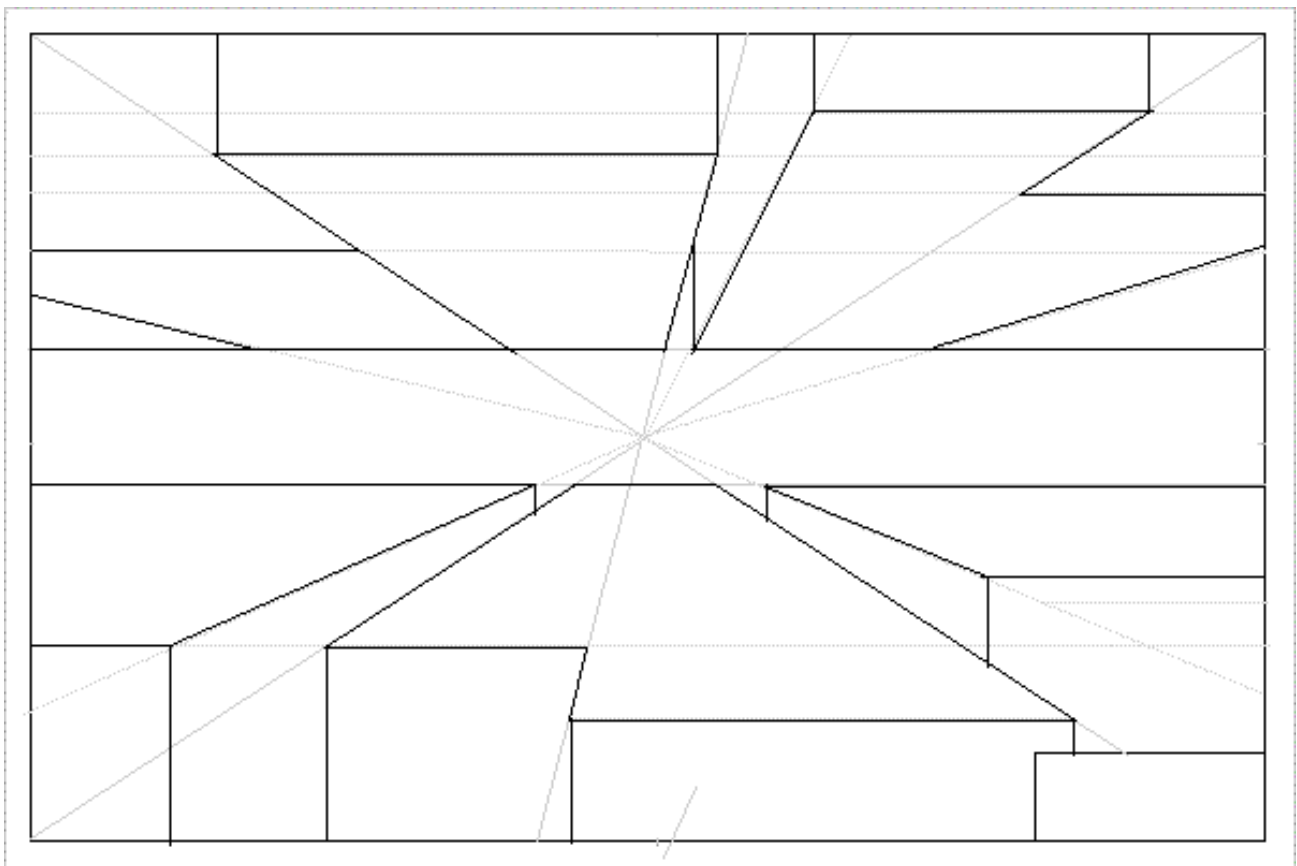

h) Now the vertical lines and the structure begins to take shape.

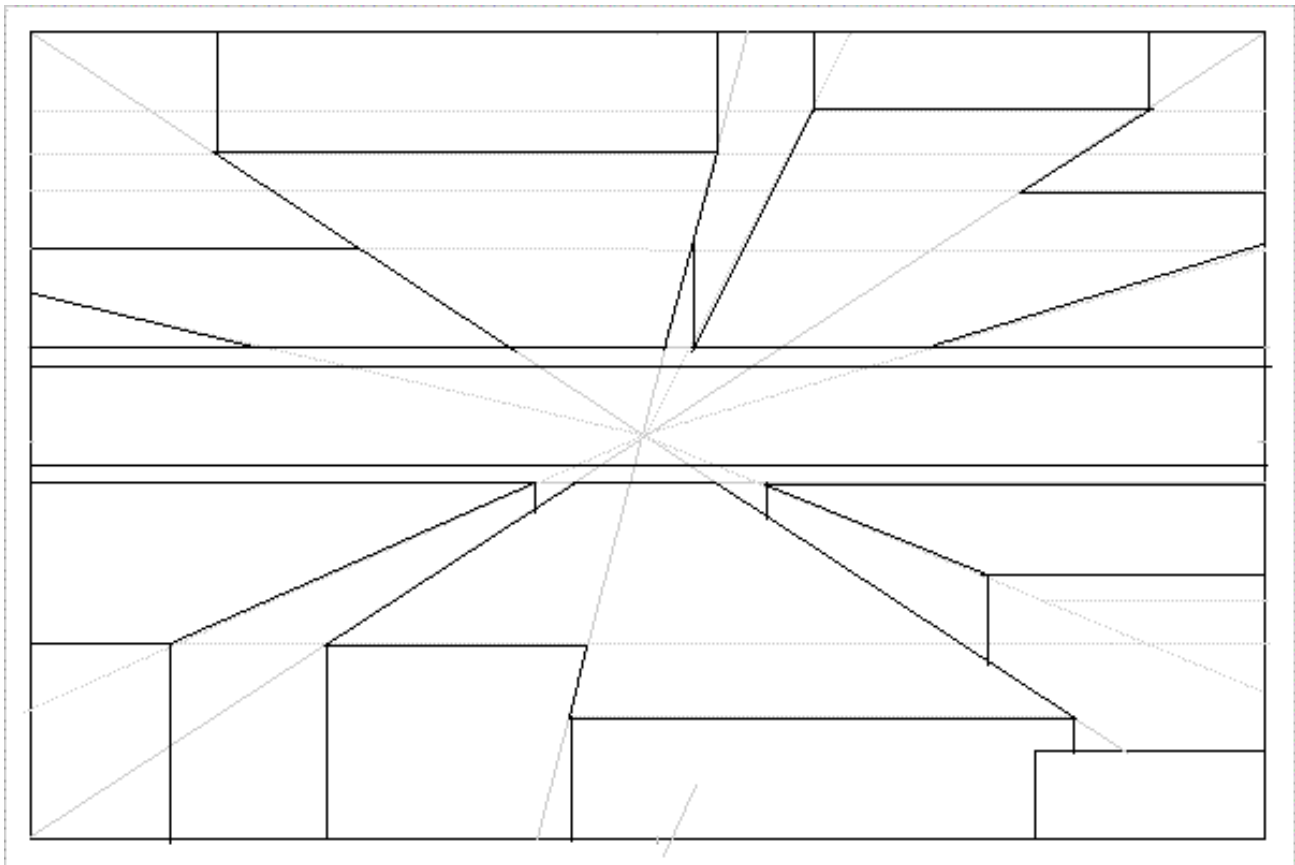

i) The essential 'structure' is done - now two horizontal lines show the pavement edges.

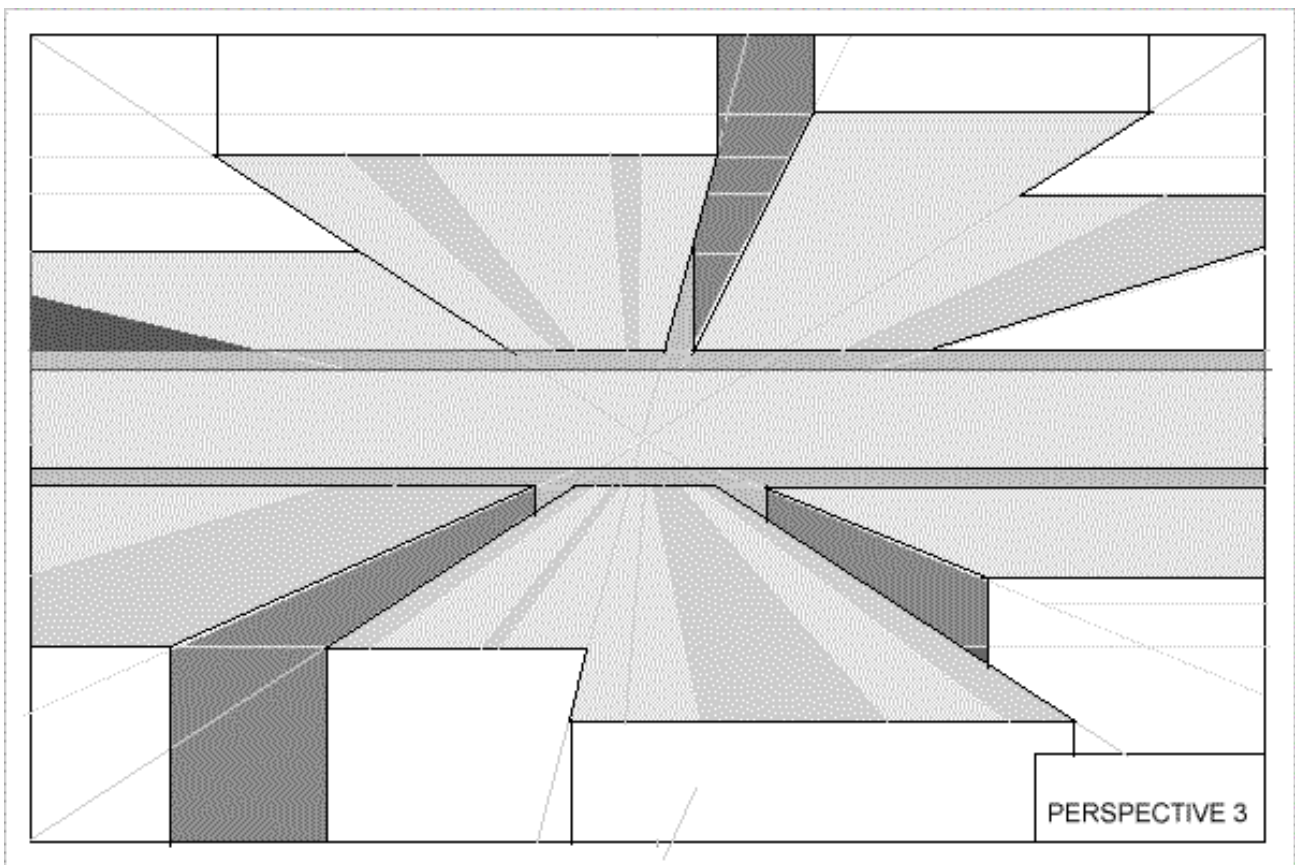

j) Now for a little shading.

Print in the title add some light lines as shown to suggest windows - then firm in when satisfied. Further shading and details can be completed at home.

Homework: Complete the drawing adding cars, pedestrians, heli-pads, more windows etc ...



[GO TO ... LESSON FOUR](#)

[lesson menu](#)



LESSON - PERSPECTIVE FOUR - CORNER OF ROOM

TIME:

Allow 40min

Aim:

To create a perspective grid using a single measurement and three vanishing points. This lesson is to introduce the notion of perspective 'scale'. That is, as things of equal size recede they appear smaller. Perspective is a method of logically determining just how much smaller.

Materials:

The sketch pad,
HB pencil, ruler.

Construct margin and title box then:

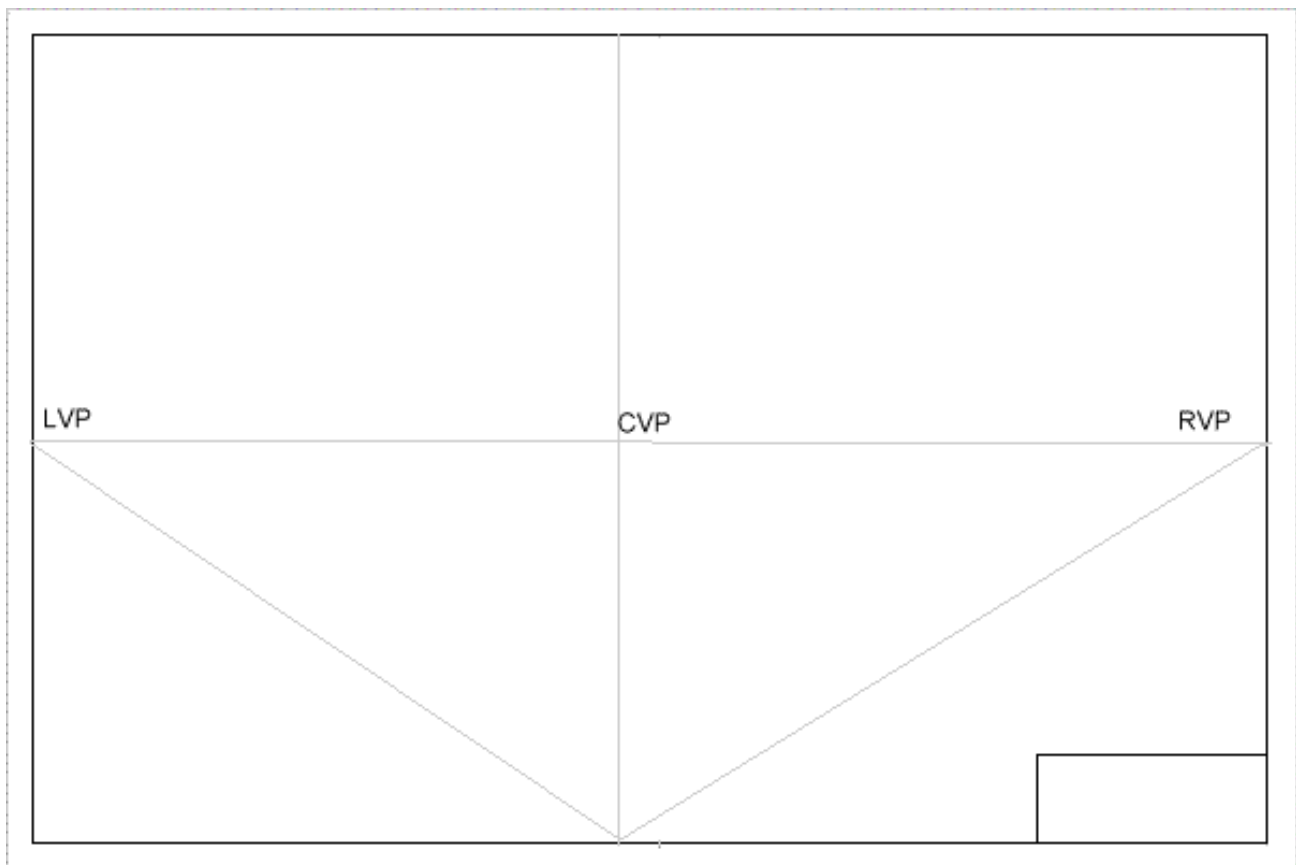

a) Quarter the page as shown with light lines then add the two additional lines as shown.

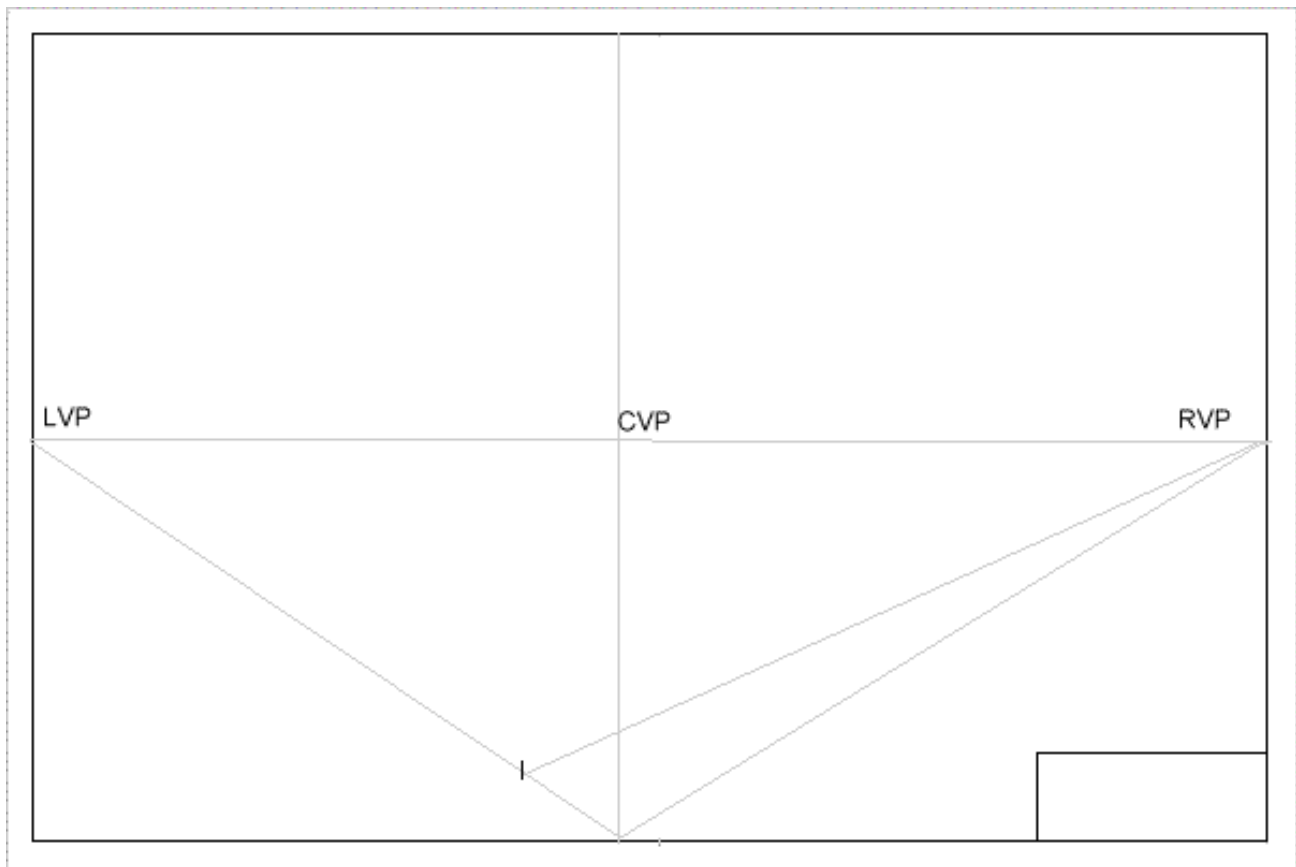

b) Measure a set distance up as shown 30mm (1,1/4") and join to RVP as indicated.

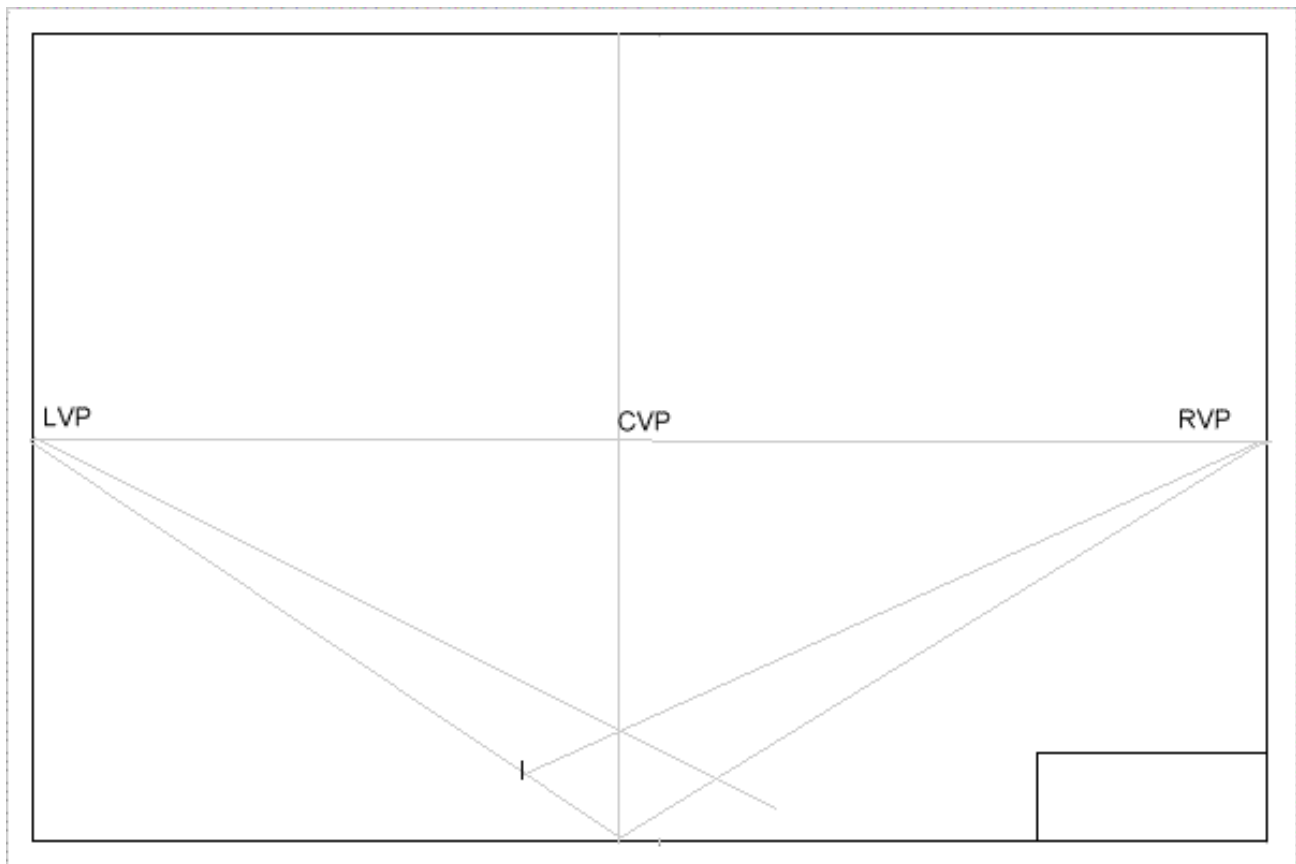

c) Where that line intersects the vertical line down from CVP construct light line from LVP as in the drawing.

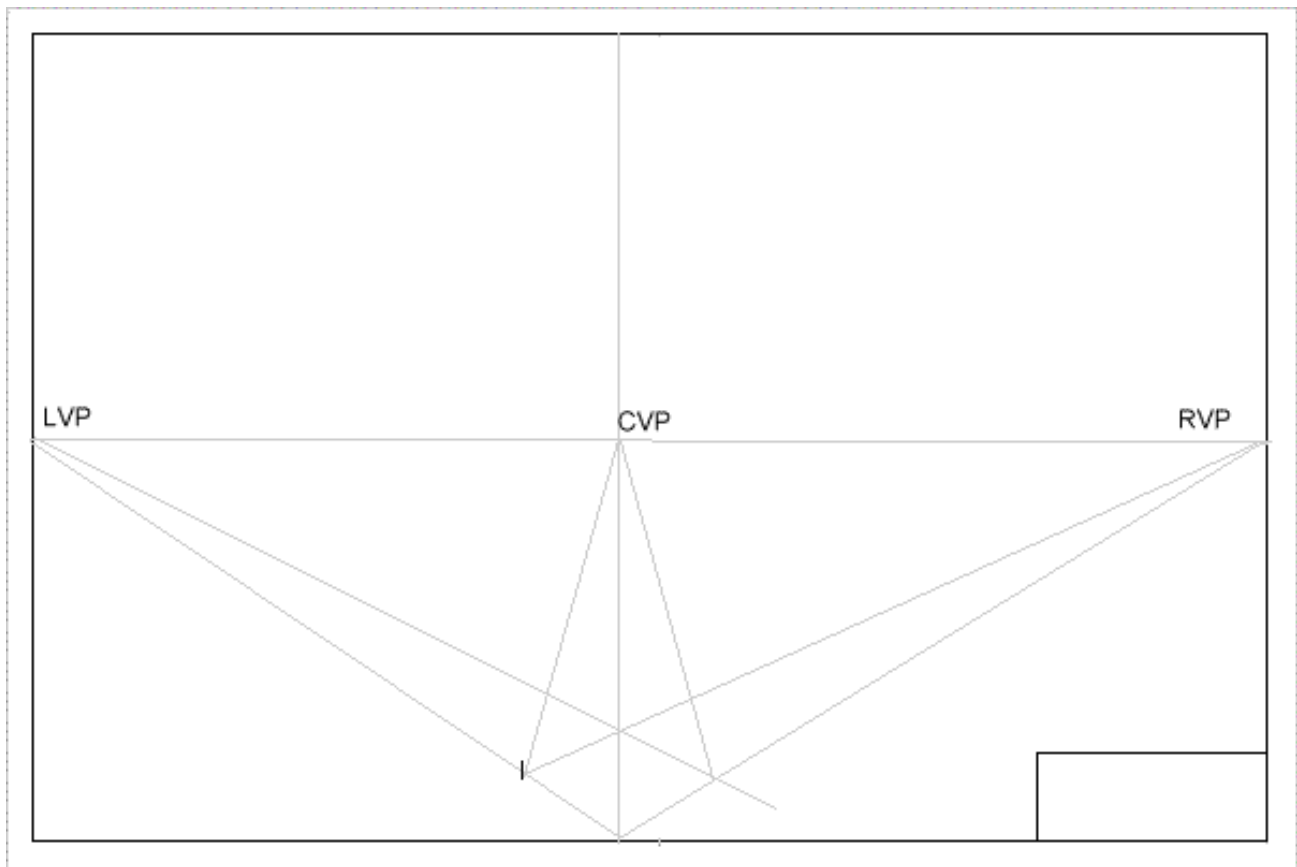

d) Join the two lines to the CVP as shown.

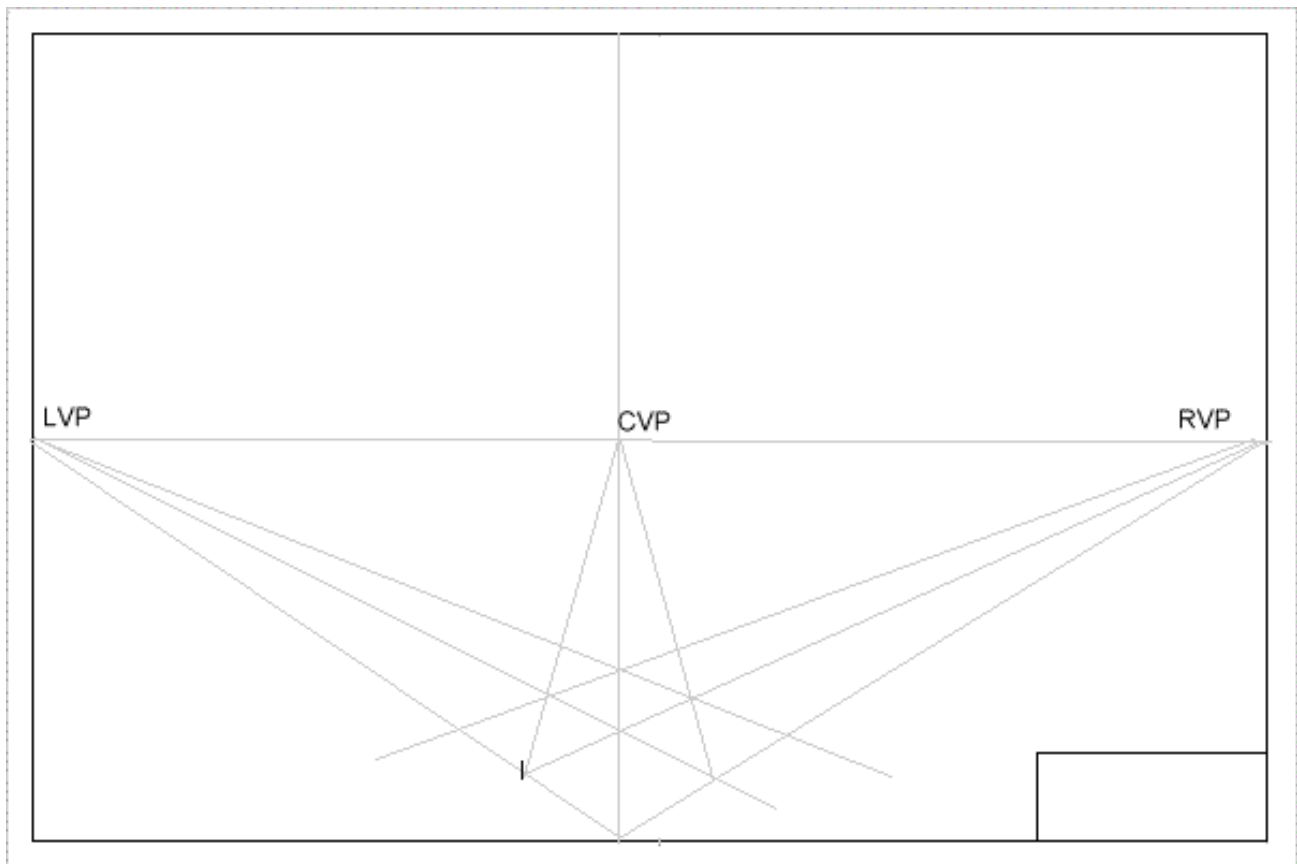

e) Add the two extra light lines from LVP and RVP. We have now drawn four squares on the ground. We can now add many more going backwards using the same method of construction.

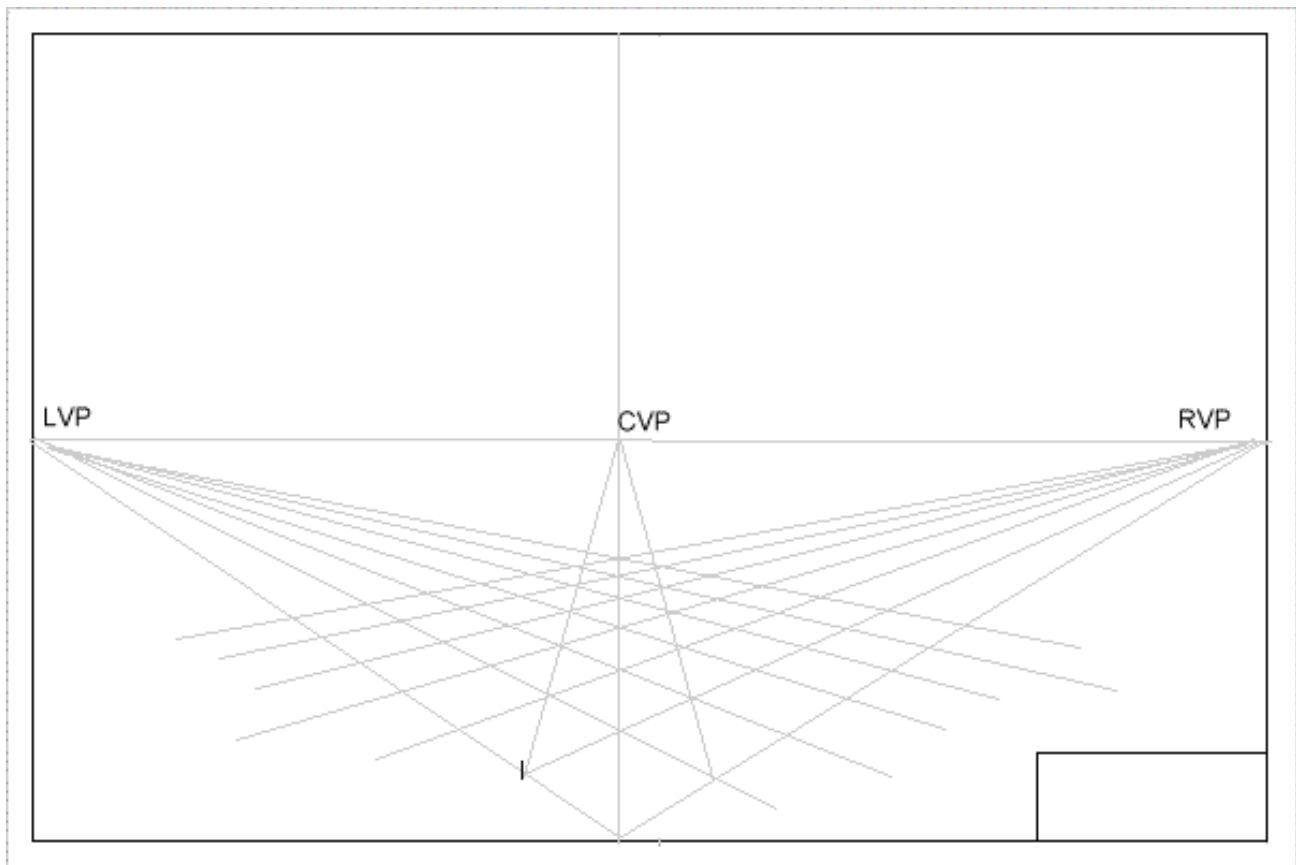

f) We now have 36 squares.

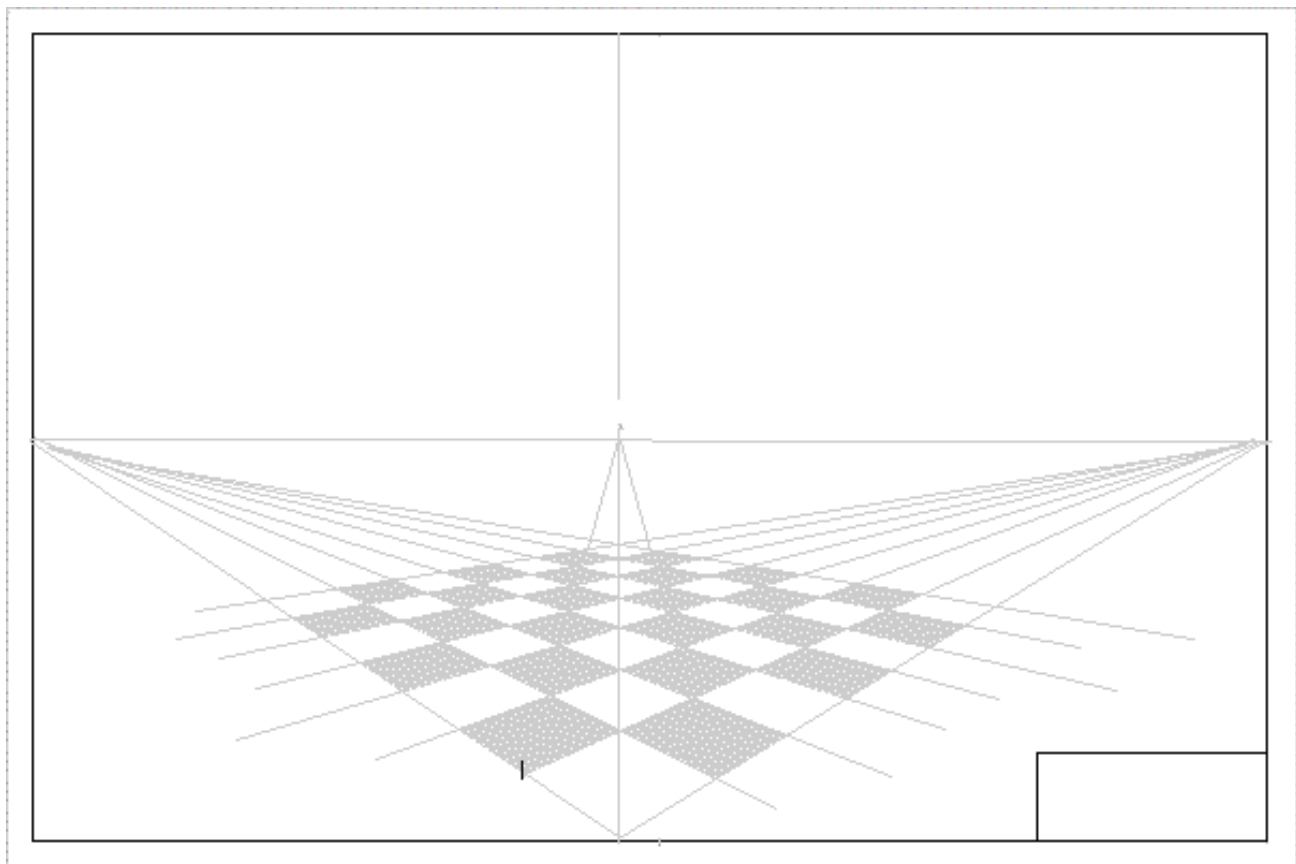

g) Shade the alternate squares as shown. Now we have made a floor. At this stage the student needs to be asked:

- Are the squares of 'equal' size?
- Why are the ones at the back smaller than the ones at the front?
- What happens to parallel lines when we draw them in 'perspective'?
- Is this what the eye or the camera sees?

Next we shall suggest some walls.

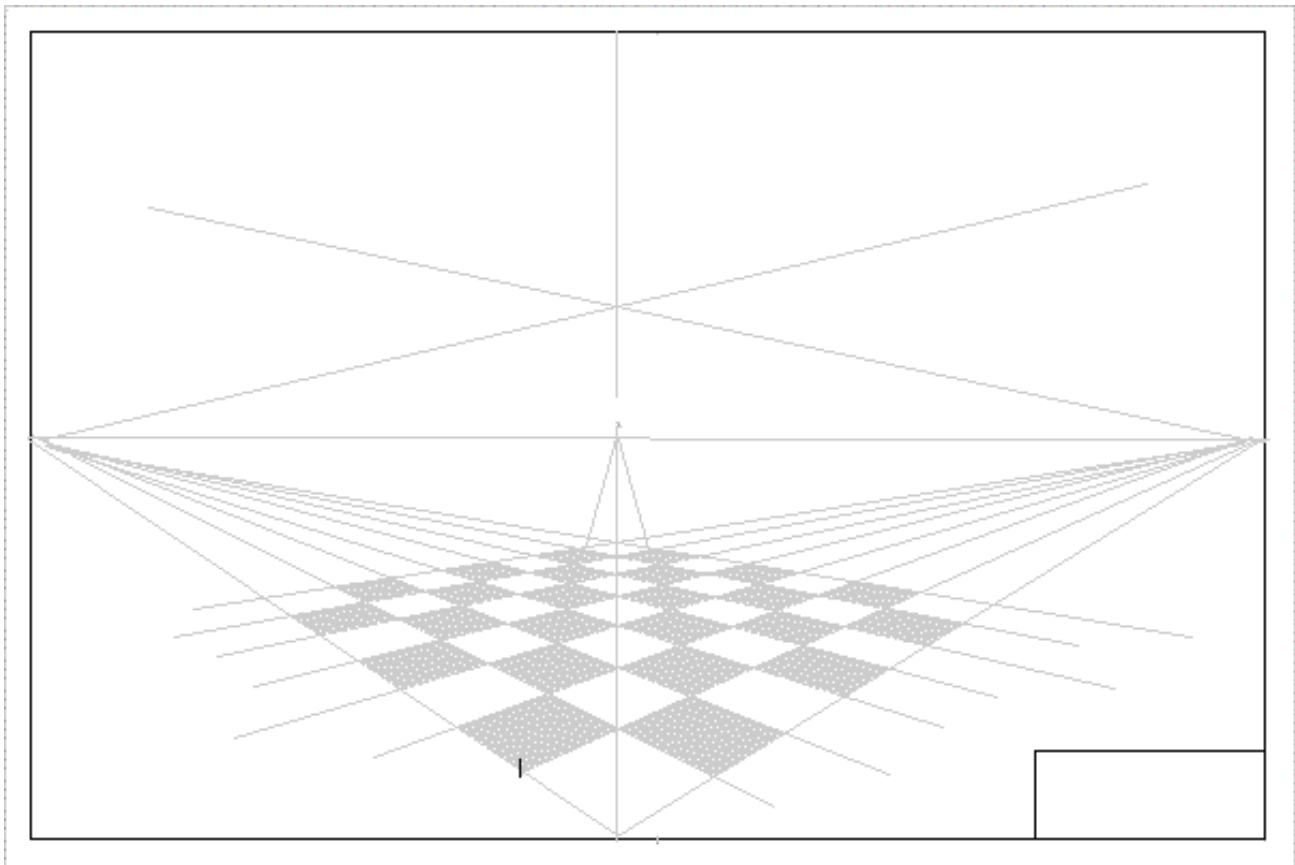

h) Add the two extra light lines 40mm (1,1/2") up from dead center

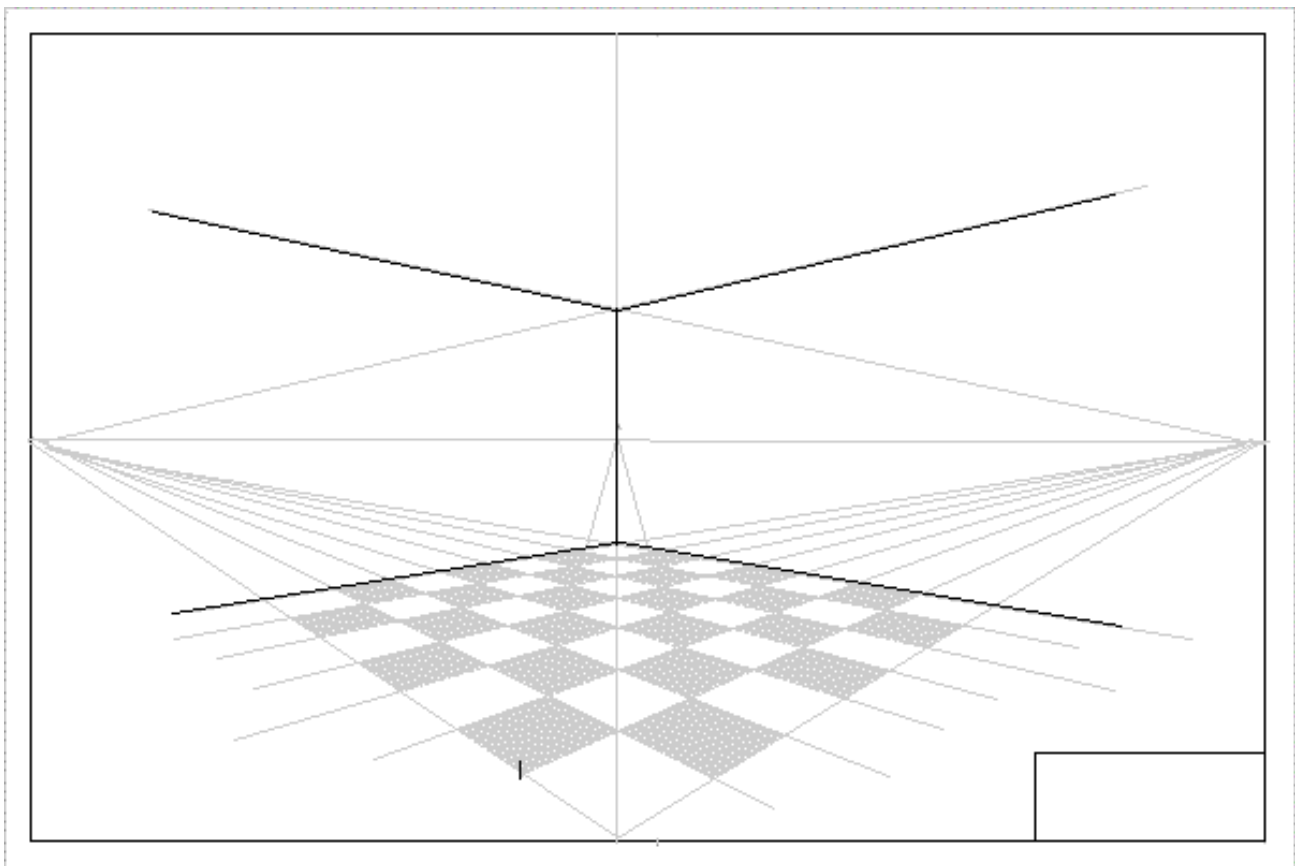

i) Firm in the walls.

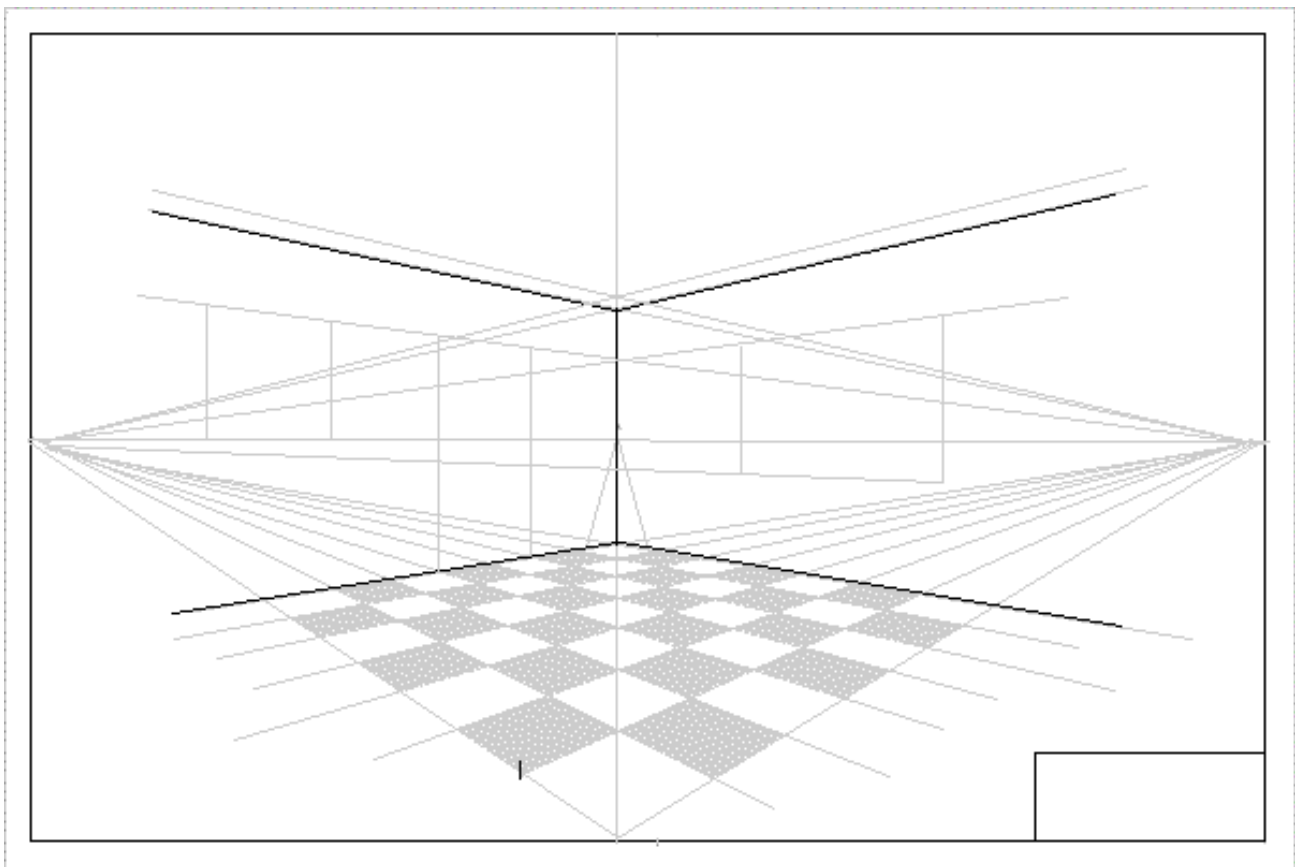

j) Using only vertical lines and lines going to RVP or LVP lightly construct some windows and a door.
Ask:
- how could the room be made larger? (answer - lowering the ceiling).

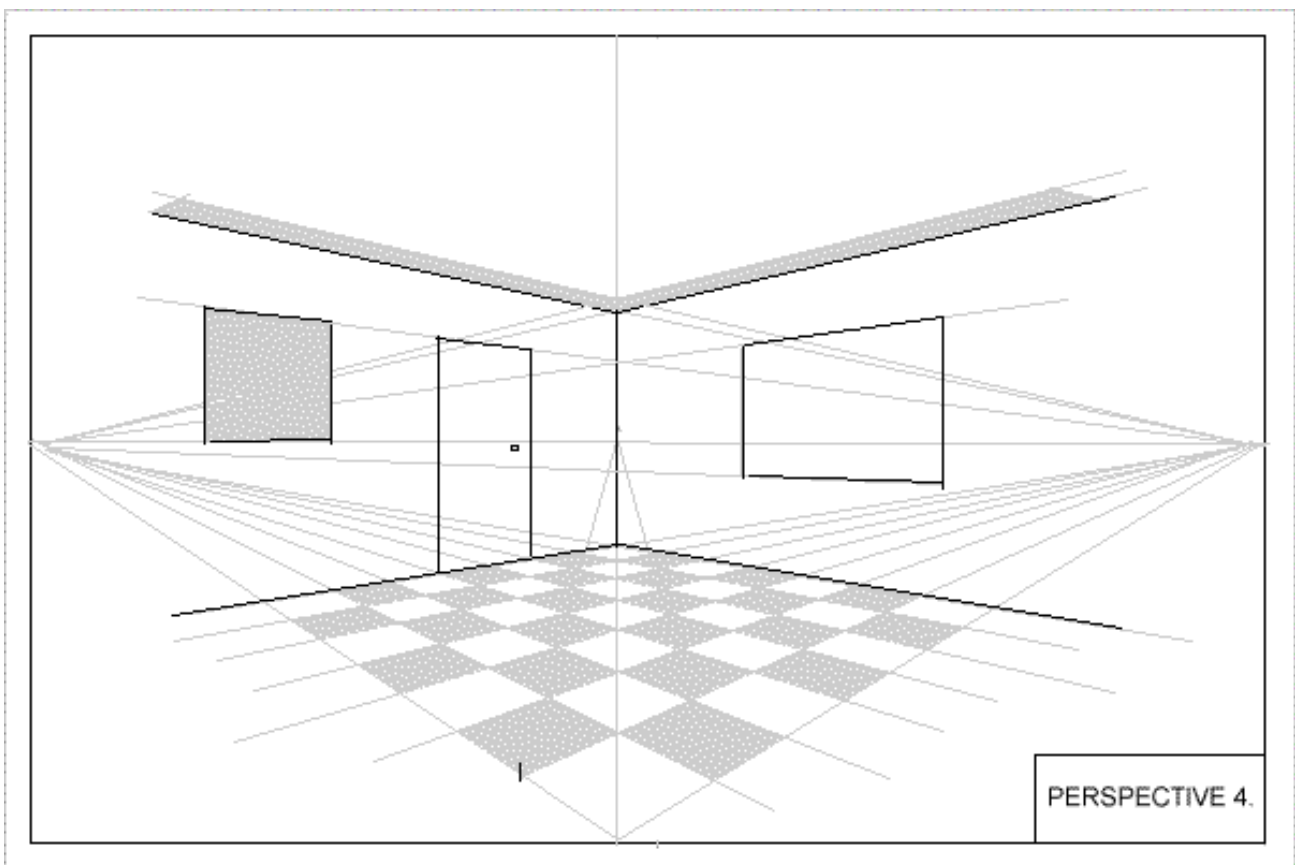

PERSPECTIVE 4.

k) Firm them in and add a door knob and a little shading on the ceiling. Ask:
- How do we know how high to make the door? (stress the importance of observation and look around the classroom for clues).
Is the door handle on the right or left side of the door?

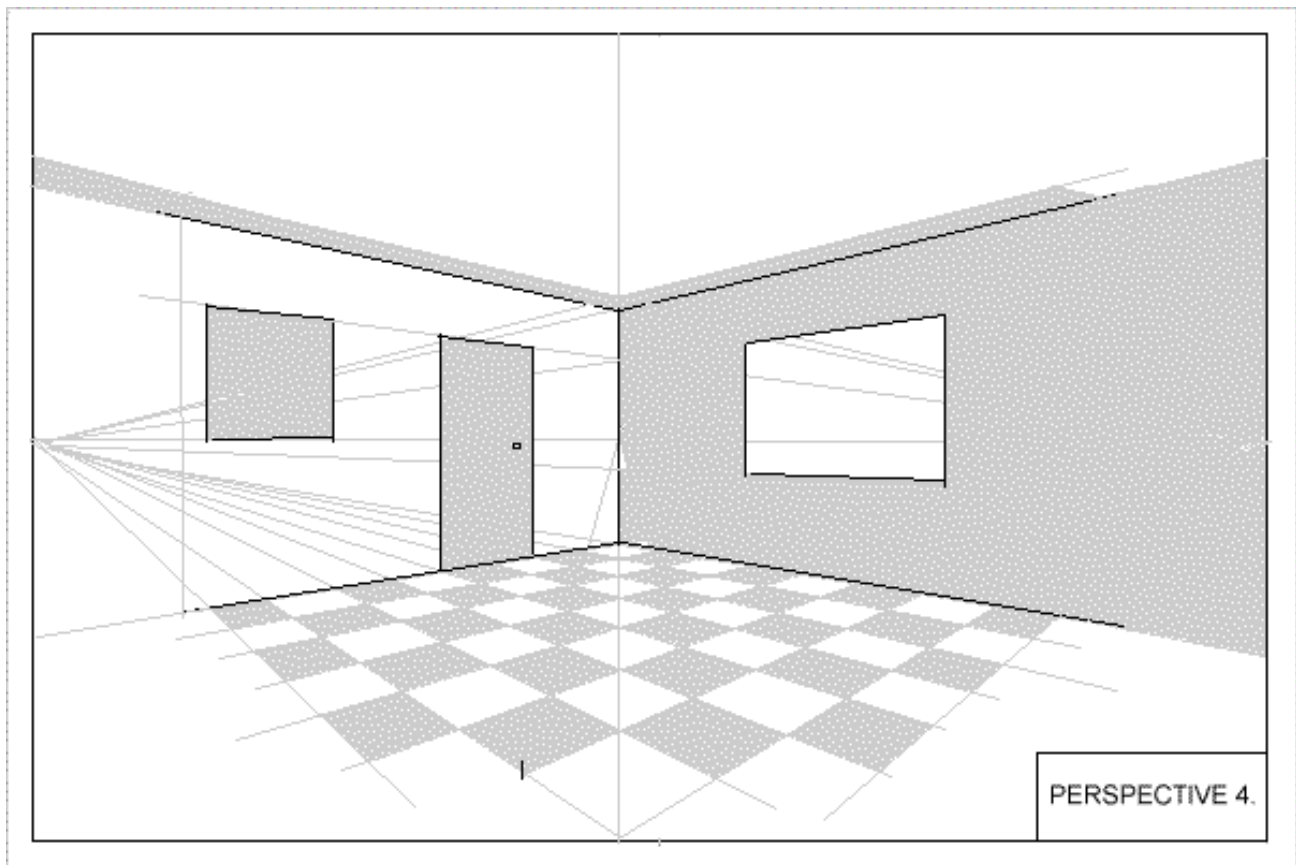

l) I have added some more tiles (see if the student can do this by 'judgement') - an extra row on the right and one on the left - and shaded the door.

Clean up and print in the title as shown.

You will find some students will grasp the ideas and concepts faster than others. Instead of having them idle, and waiting, they can be encouraged to add extra detail of their own choosing. That is the beauty of this type of lesson; it is open ended. Encourage the more advanced student to add the more complicated items.

Home work:

Complete the drawing adding a painting on the wall, curtains, light on the ceiling, a chair or table ... etc.



[GO TO ... LESSON FIVE](#) [lesson menu](#)



LESSON - PERSPECTIVE FIVE - WESTERN RAILWAY

TIME:

Allow 40min

Aim:

To create a perspective grid using a single measurement and three vanishing points. This lesson is to consolidate and further the notion of perspective 'scale'. That is, as things of equal size recede they appear smaller. This time we will use the CVP and a familiar and logical structure, a railway line.

Materials:

The sketch pad,
HB pencil, ruler.

Construct margin and title box then:

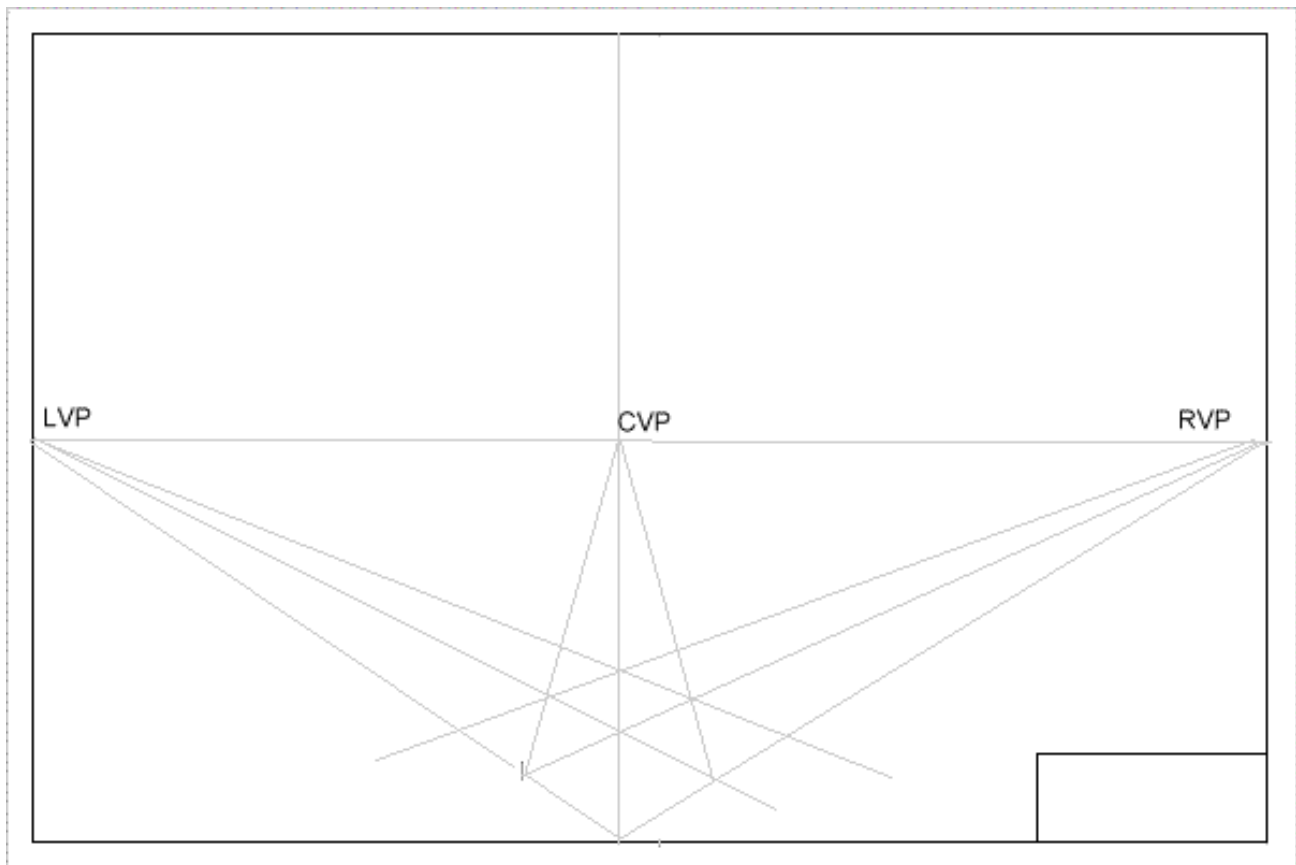

a) Construct the same light lines as in stage a, b, c, d, of the previous lesson until we get the lines shown above.

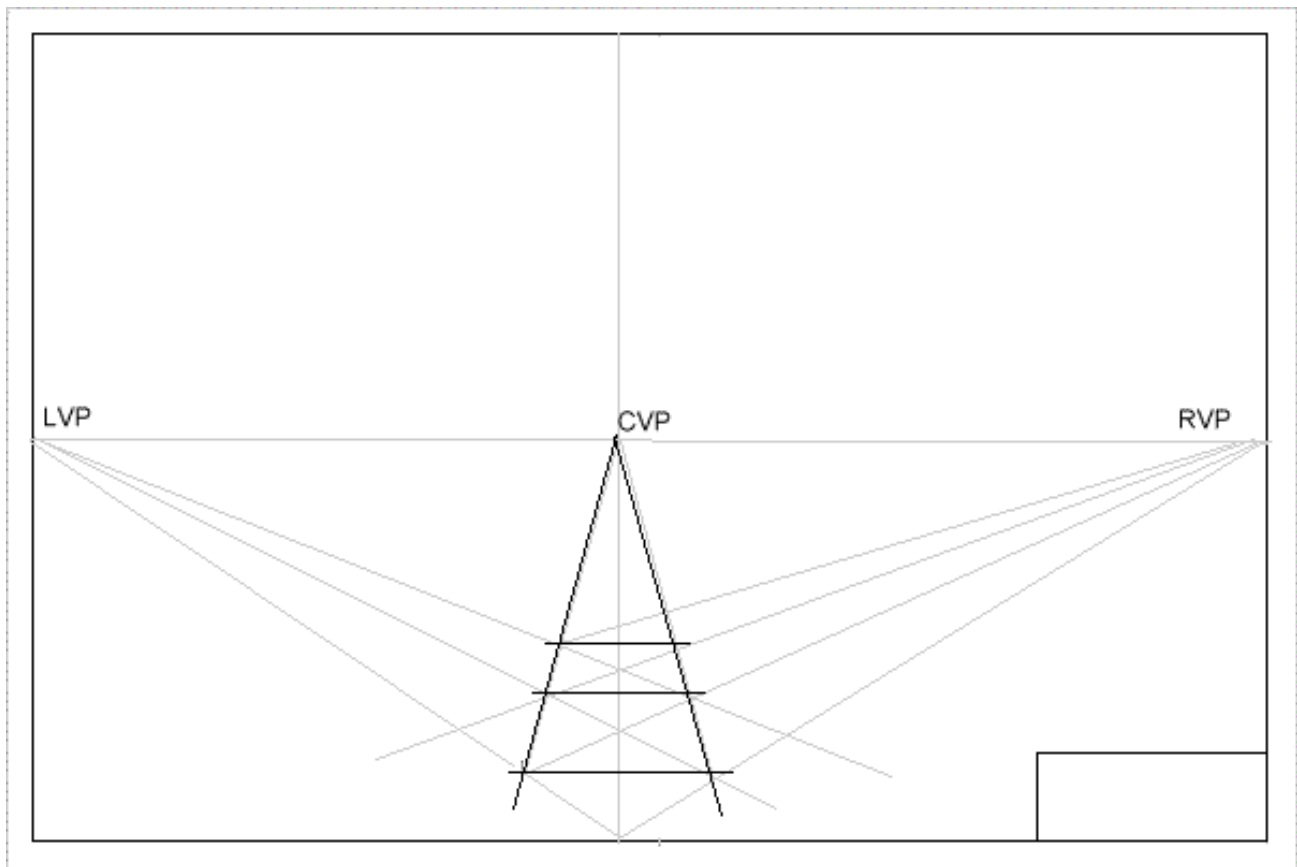

b) This time we firm in the 'diagonals' which become railway line 'sleepers'. Notice here we use a more simplified method of construction.

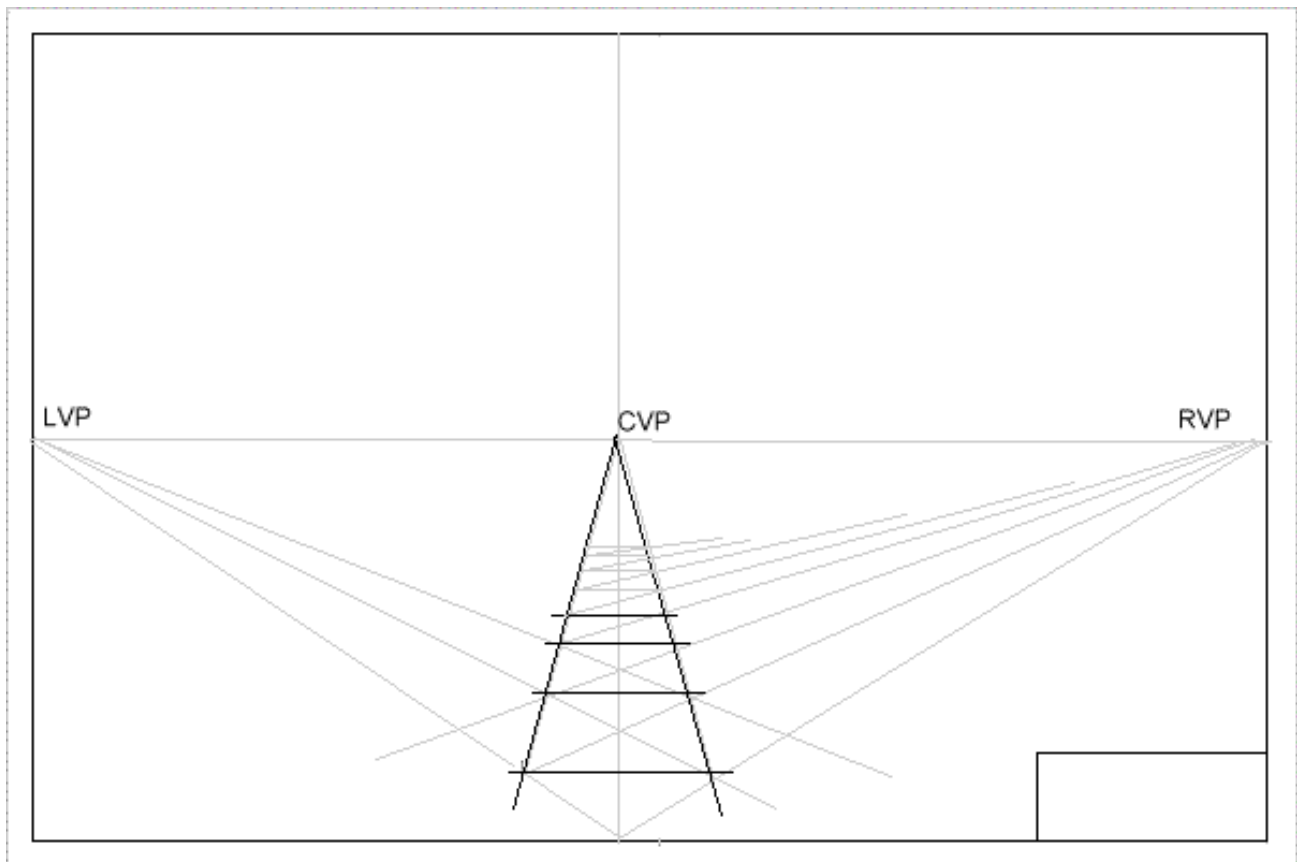

c) Keep adding sleepers.

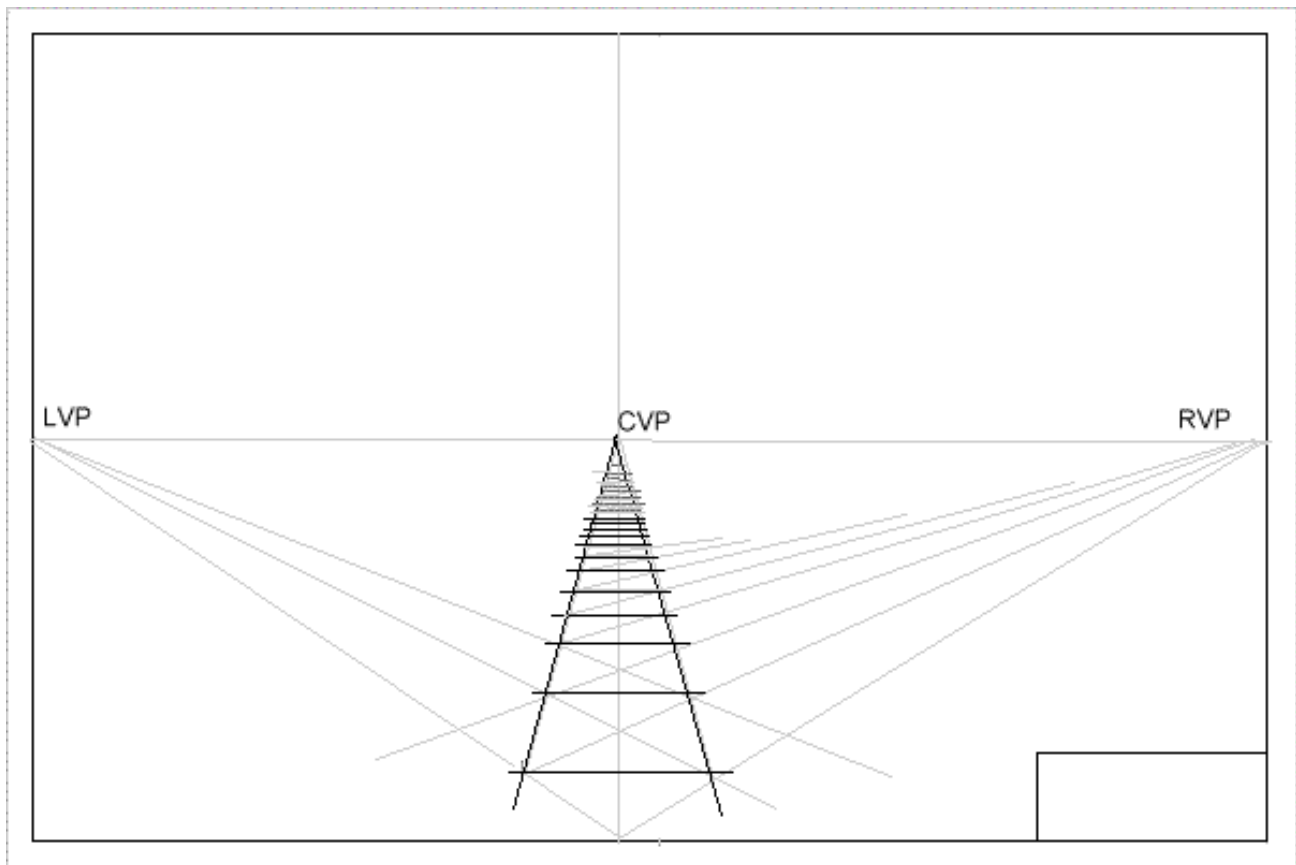

- d) After the student has completed the drawing to the stage above ask:
What shall we call the line that joins LVP, RVP and CVP? (answer 'horizon line').
How wide are railway tracks? (remember the old movies of people tied to railway lines? - answer about 5feet).
If the distance between the sleepers is 5 feet what is the distance between the second and fourth sleepers?

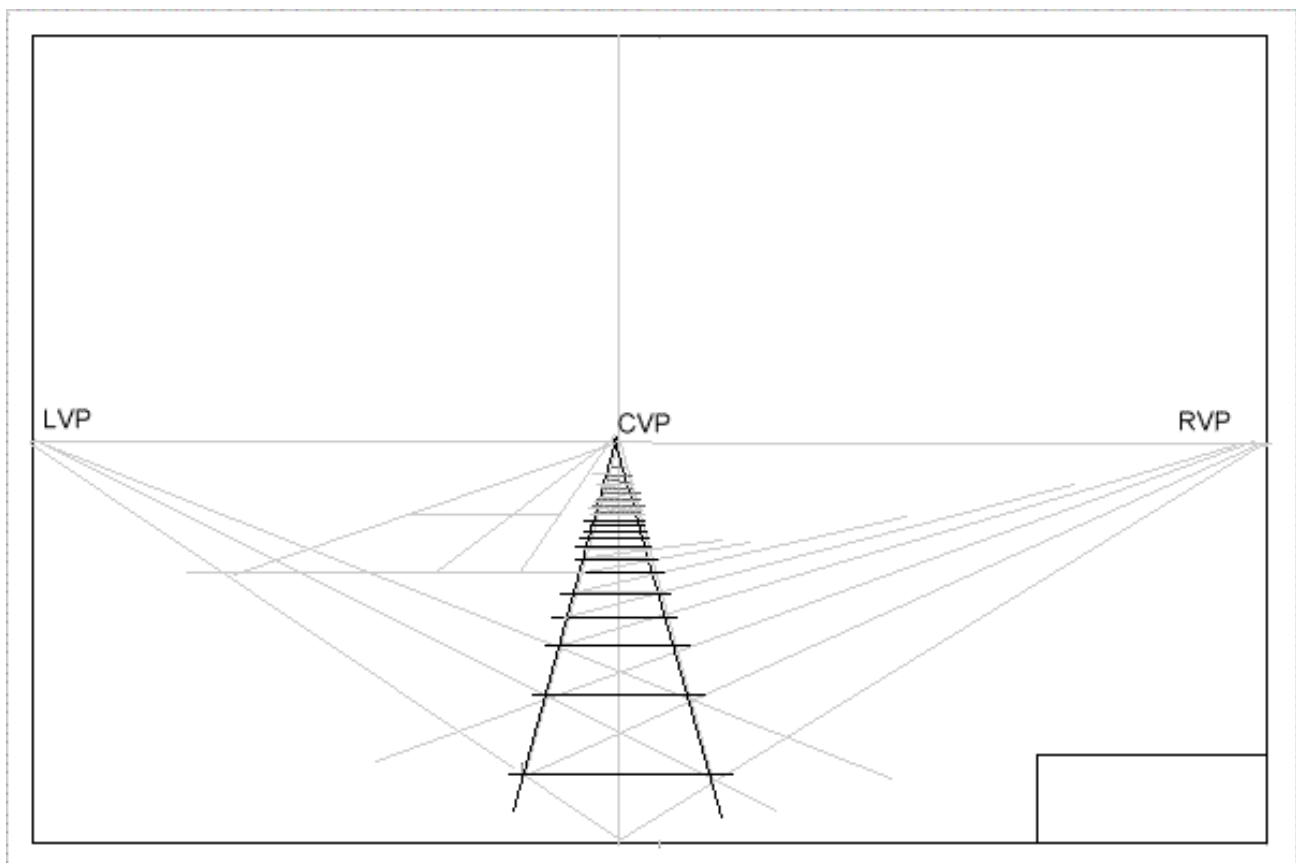

- e) Add the extra light lines on the ground (two horizontal and three to the CVP). We are going to build a station about 30mm (1,1/4") from track 60mm wide.

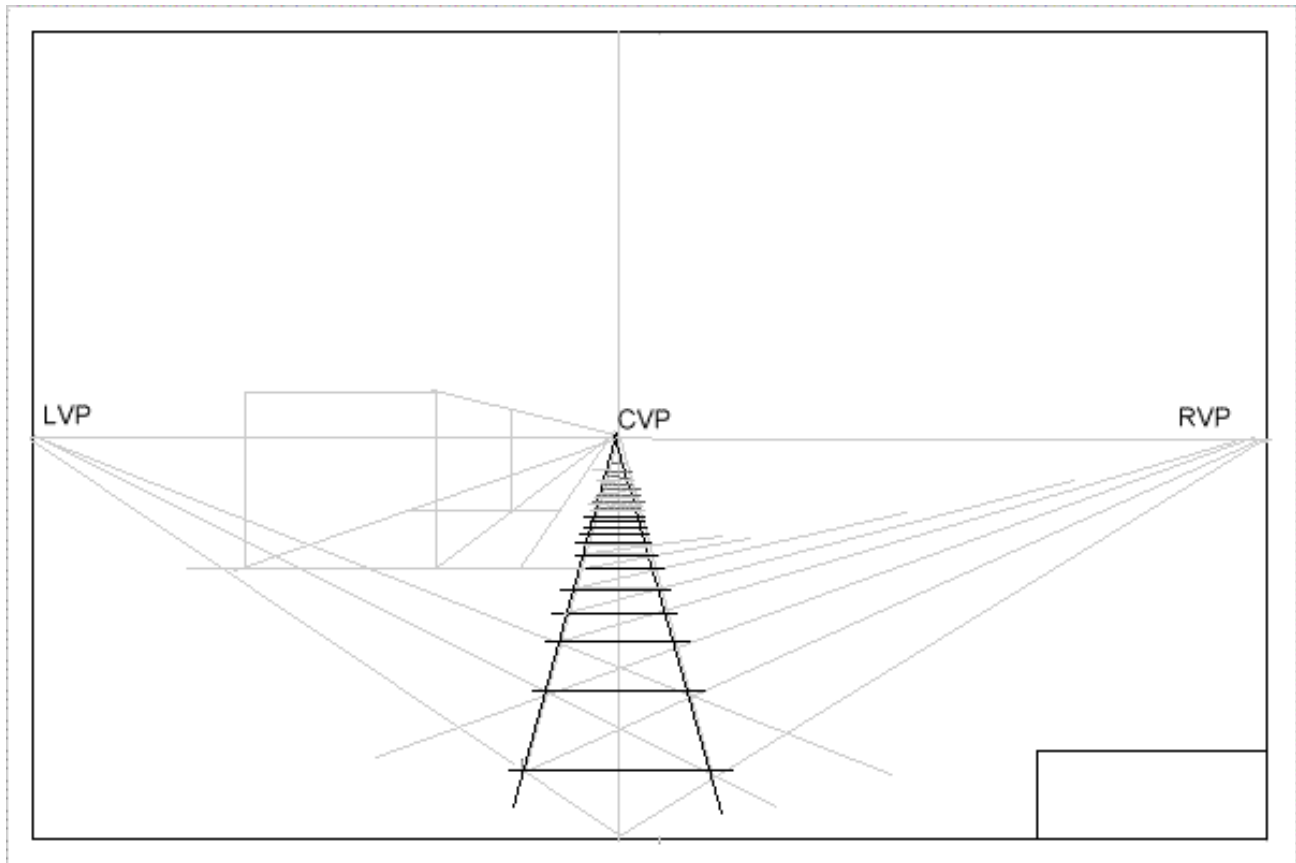

f) Add the vertical lines 50mm (2") high and join to CVP

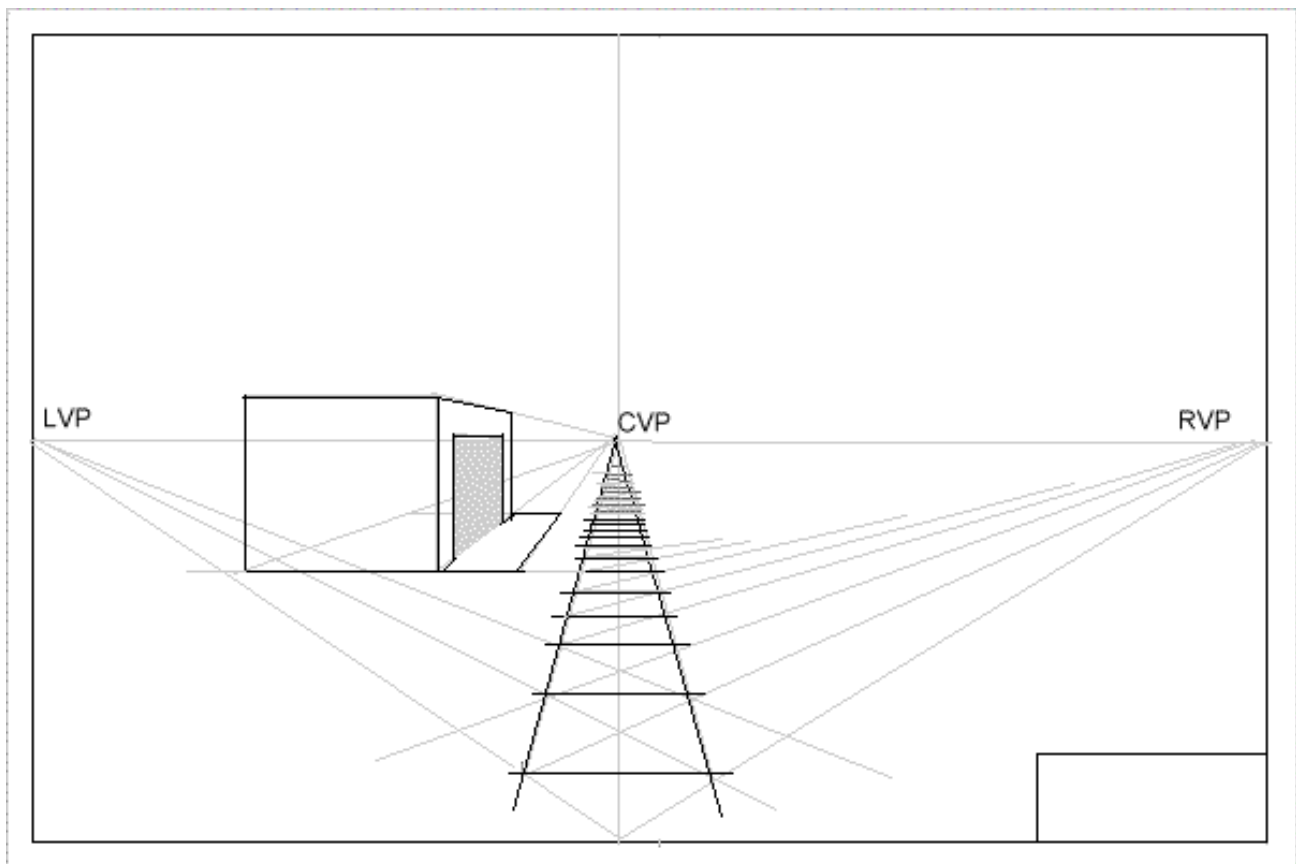

g) Firm in the lines as shown and ask:
How high is the building? The student should measure the width of the tracks on the line directly opposite the front edge of the station and apply that 'scale' to the building's height. **Objects an equal distance away from the 'observer' are subject to the same measurements of 'scale' at that distance.** In this drawing the scale is discovered by knowing the width of the track at that

distance.

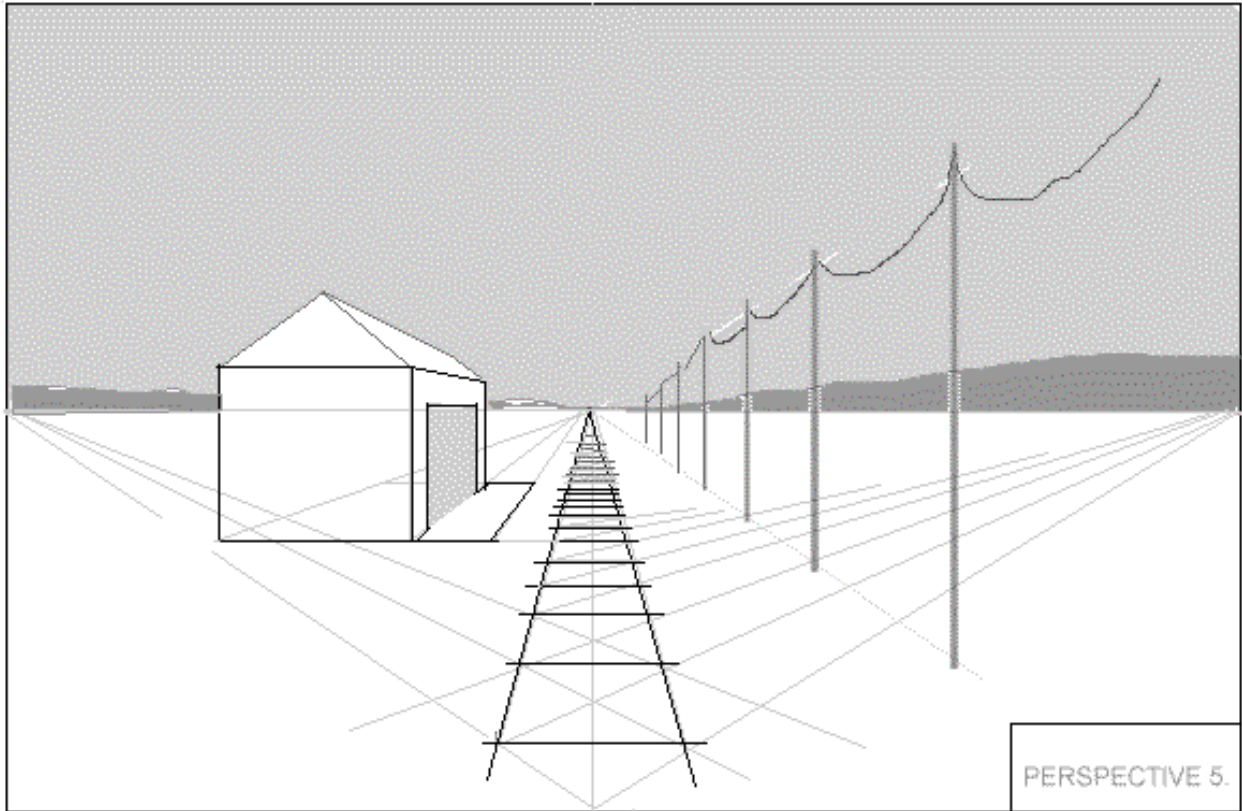

h) Add the telegraph lines and poles and have the student determine their height and distance apart.

Clean up and print in the title as shown.

Encourage the advanced students to add three 12 foot cacti at various locations in the landscape.

Home work:

Complete the drawing adding a roof on the station, cactus, hills , train, and birds etc.

Press [here](#) to see a master work using the CVP (central vanishing point) perspective.



[GO TO ... LESSON SIX](#)

[lesson menu](#)



LESSON - PERSPECTIVE SIX- ROOM INTERIOR (CVP)

TIME:

Allow 60-80min - this is a double lesson

Aim:

To create a perspective grid using a single measurement and three vanishing points but vanishing toward the CVP. We will also introduce the freehand method of constructing curves.

Materials:

The sketch pad,
HB pencil, ruler.

Construct margin and title box then:

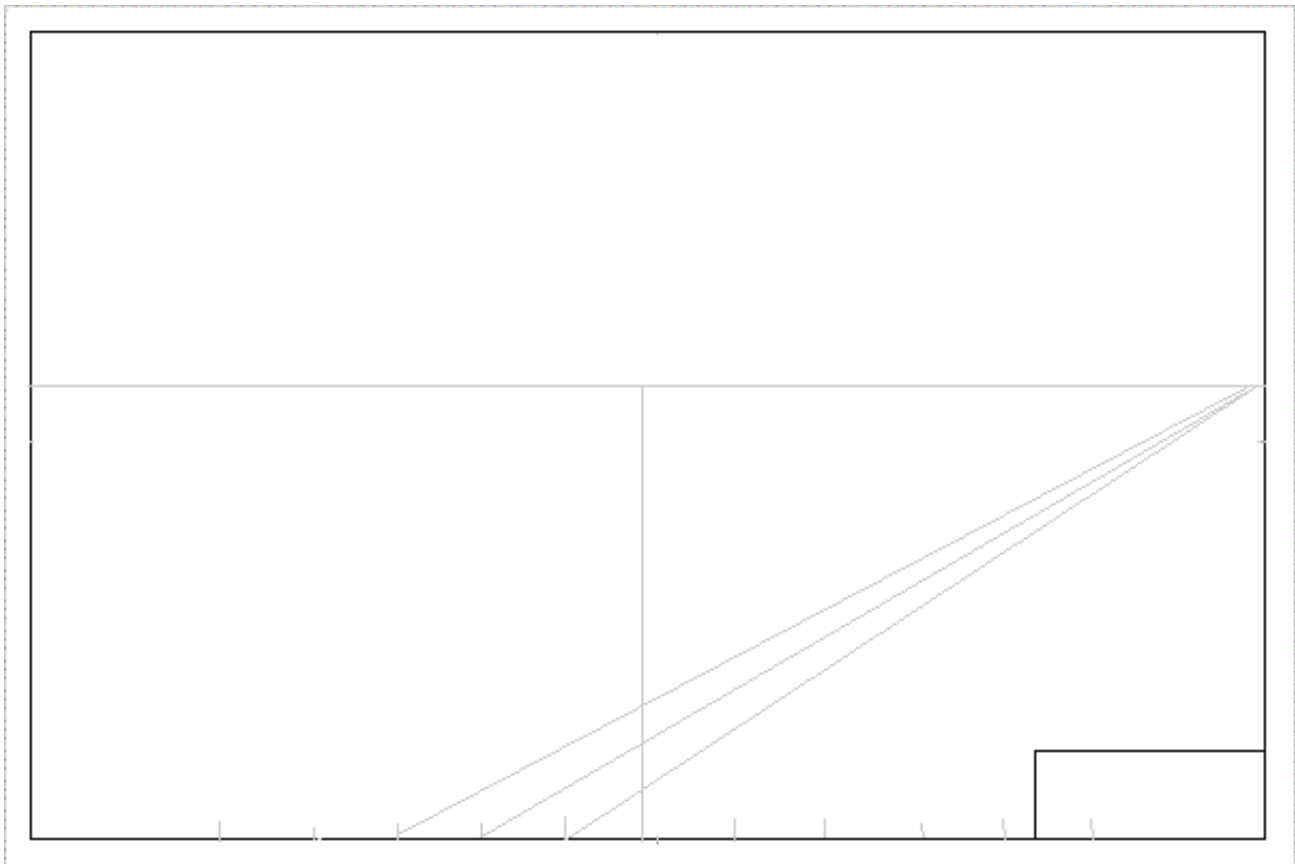

a) Measure intervals of 24mm (1") along the base margin as shown and join to RVP.

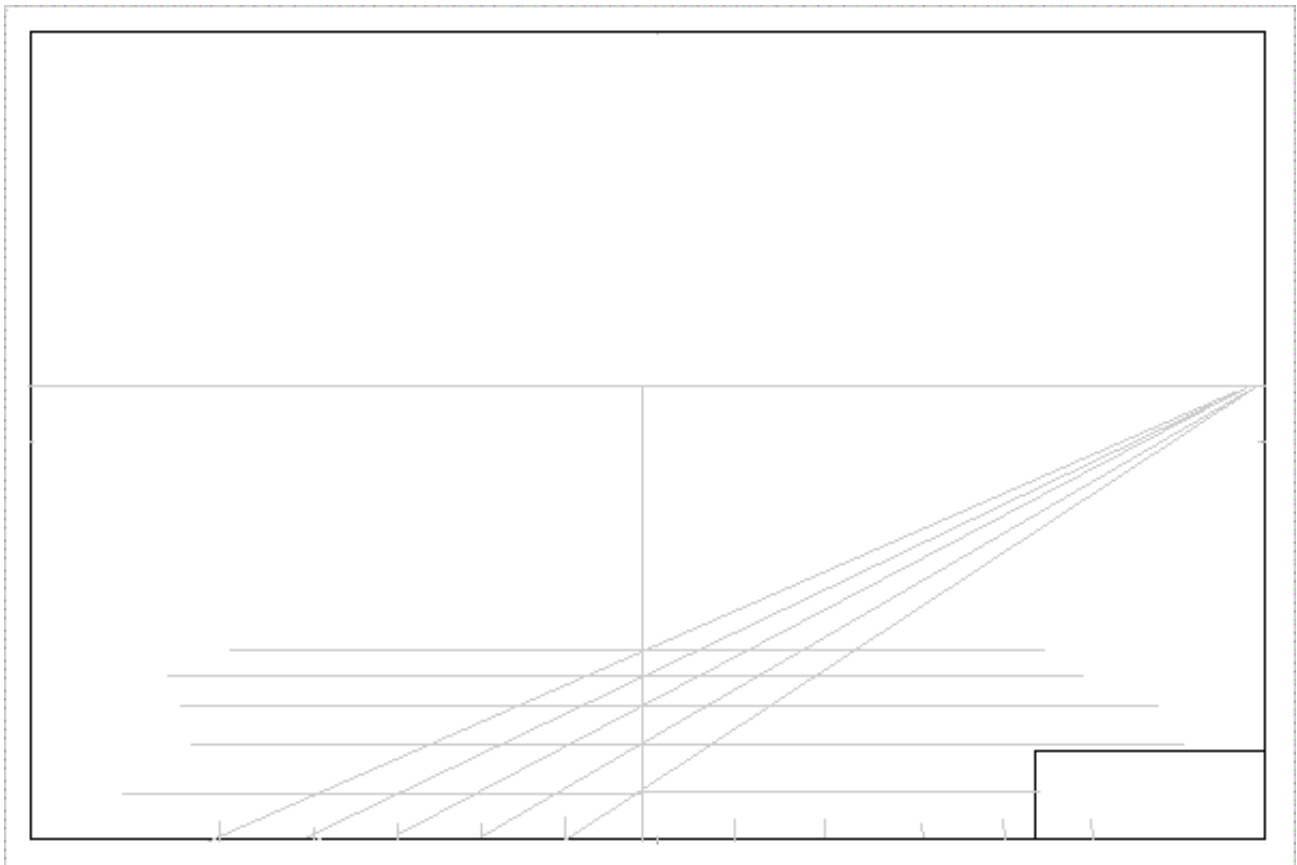

b) Where they cross the vertical line from CVP draw horizontal lines as above.

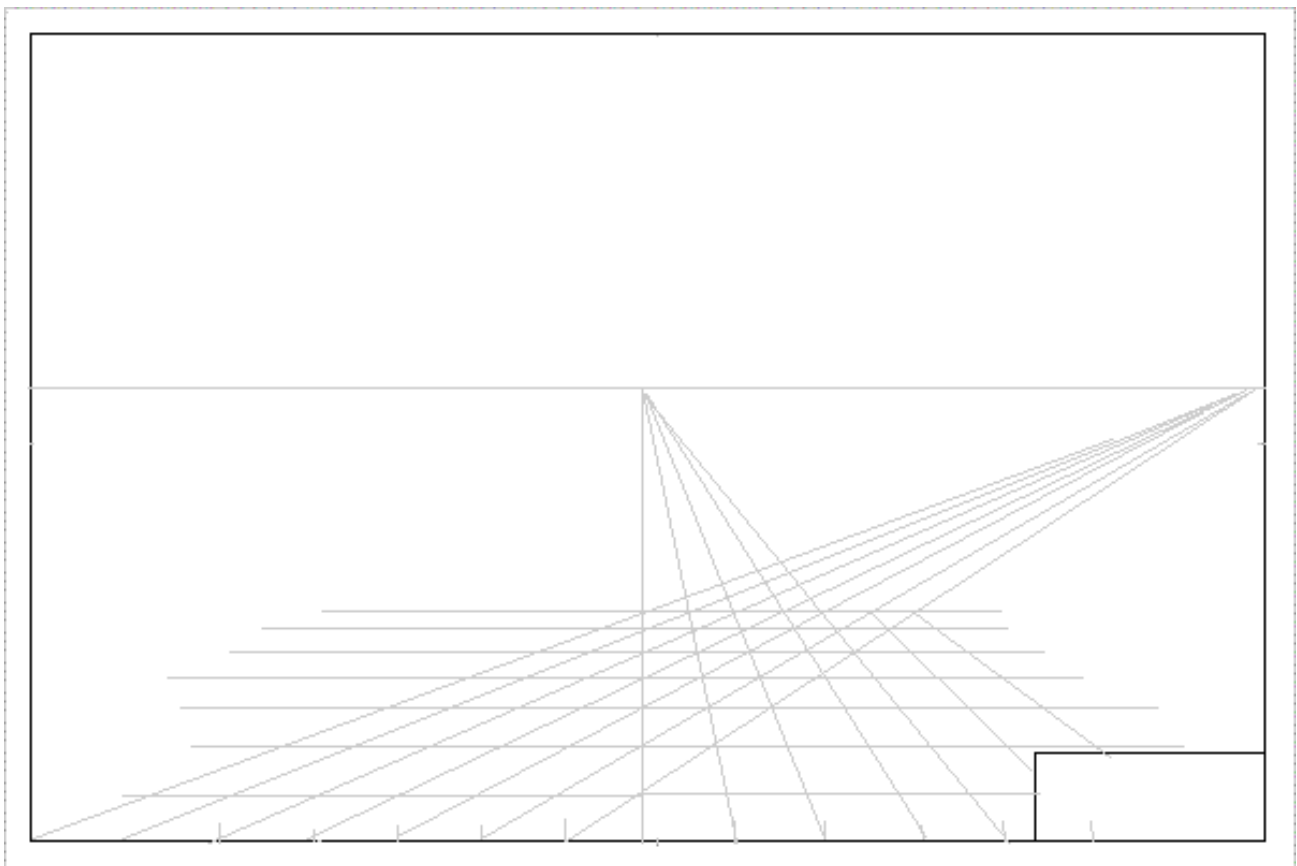

c) Add lines to CVP from marked intervals

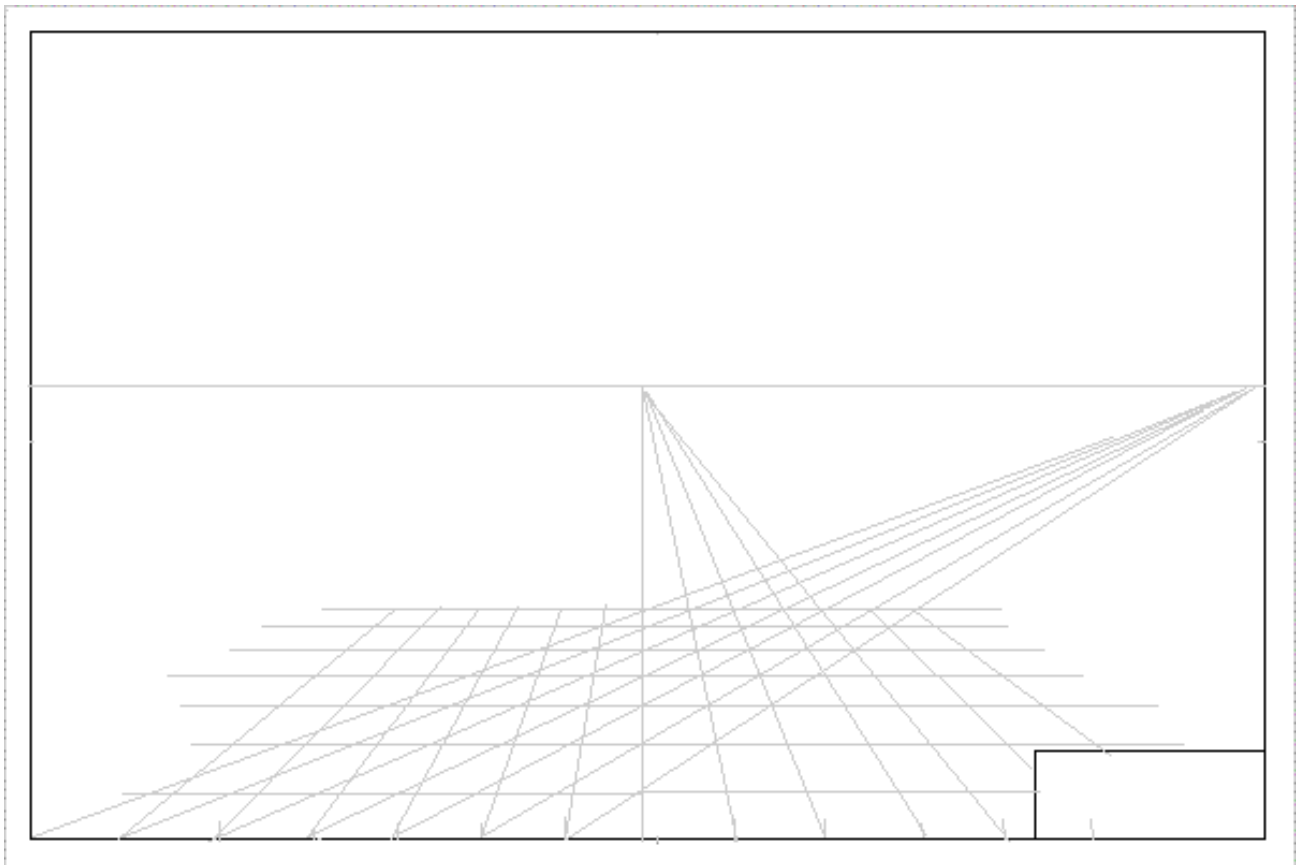

d) Extend and complete.

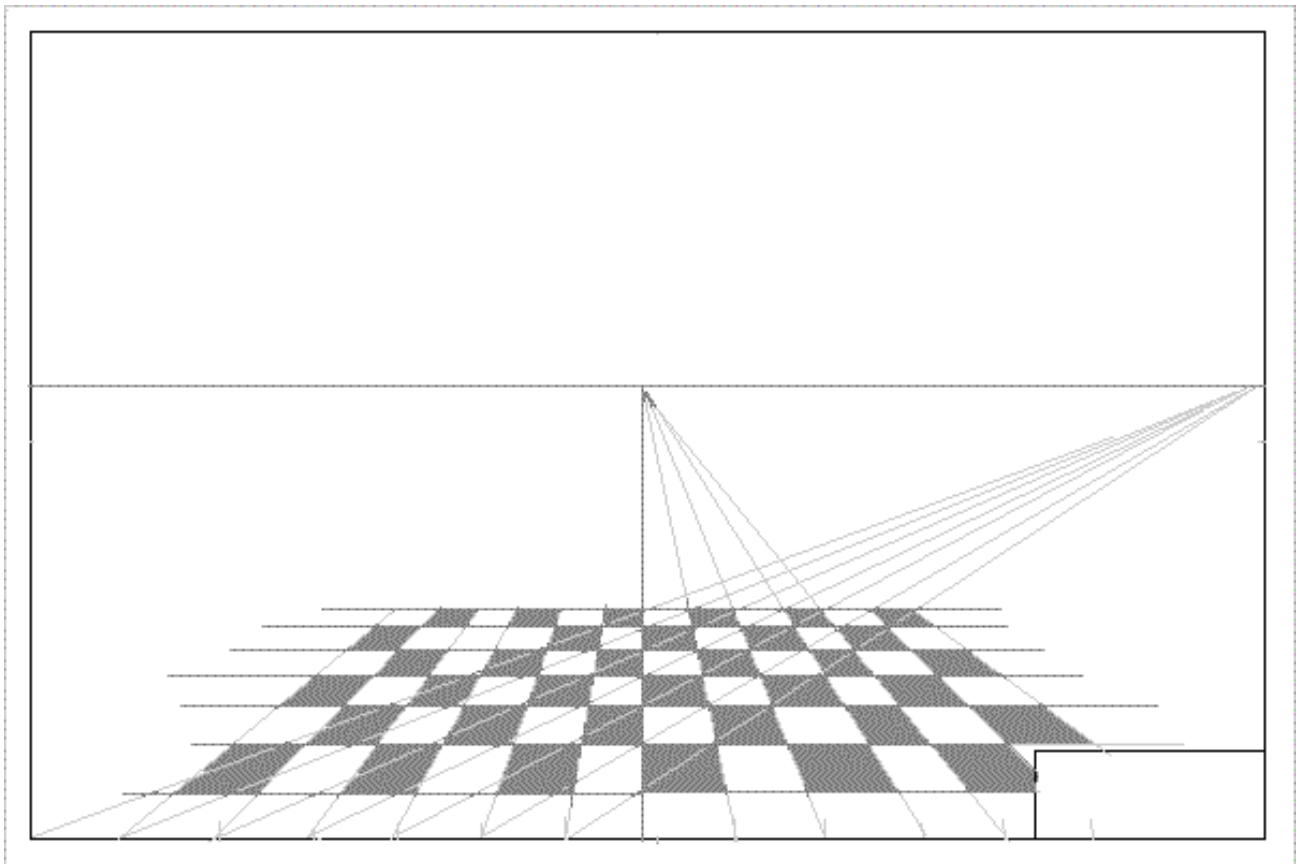

e) Shade alternate tiles.

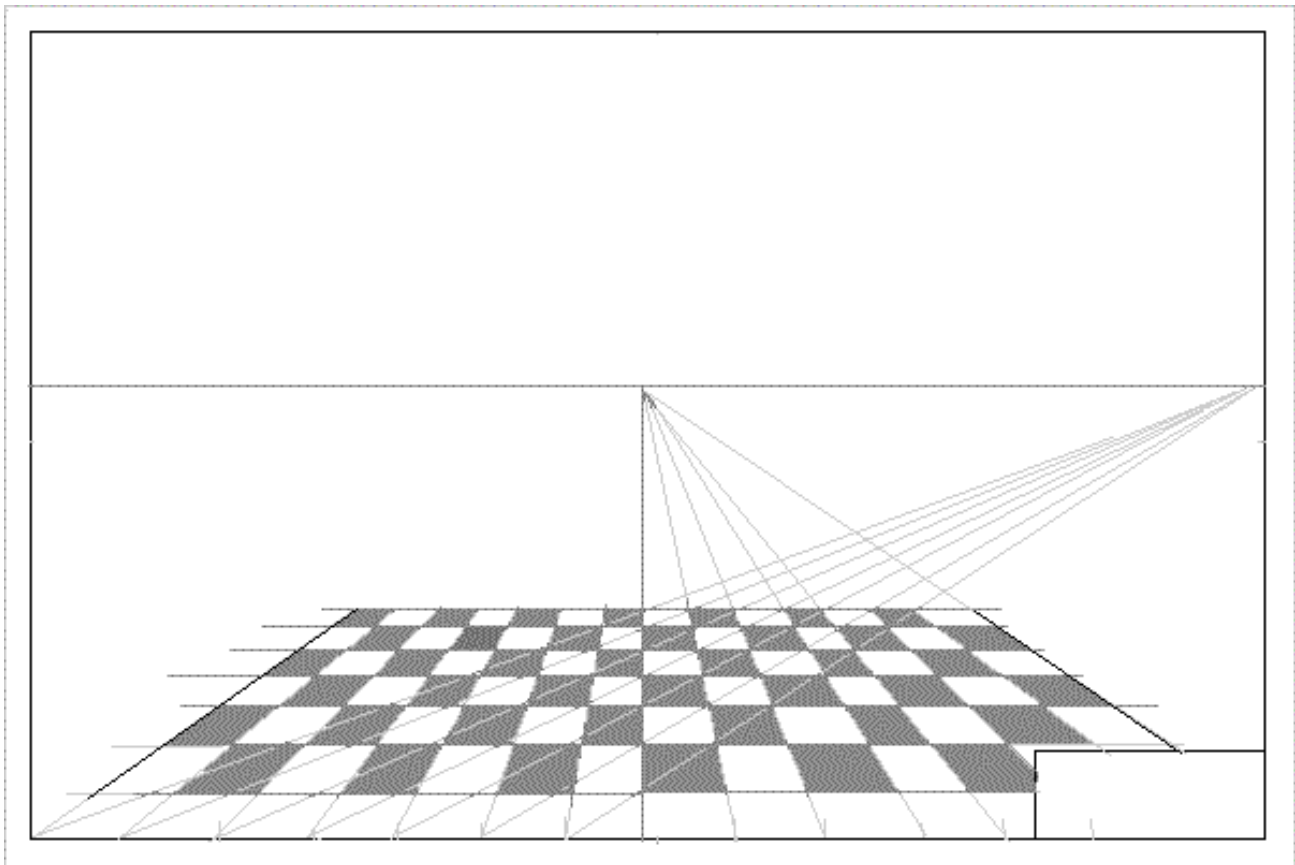

f) Add two more rows to the outside.

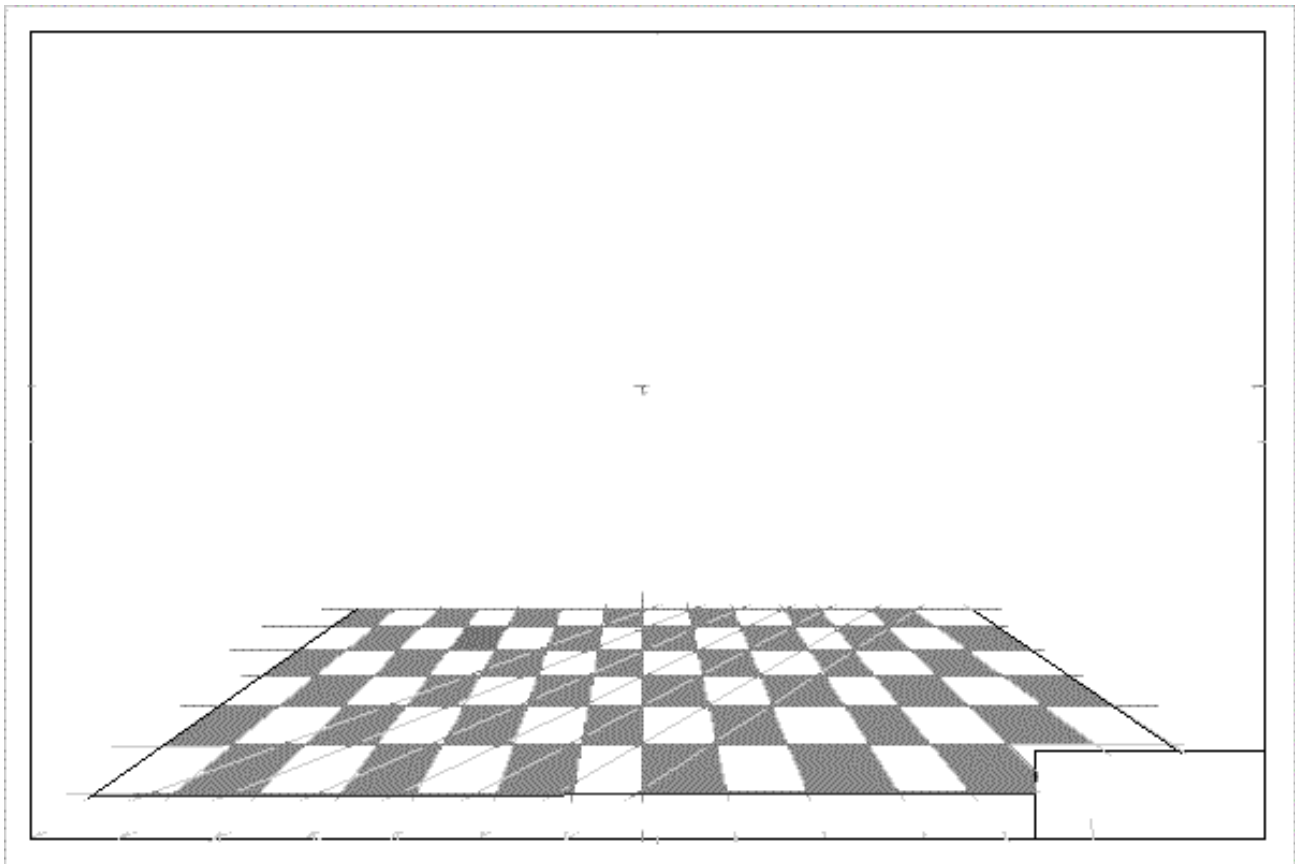

g) Clean up with eraser if necessary.

Revise ask:

What does RVP stand for?

What is the horizon?

How is it we can make a drawing with depth on a flat surface?

EXPLAIN :

The 'flat' surface is like a window or a sheet of glass. It is called a 'picture plane' (PP). The 'observer', the person looking is standing a distance behind the PP and the floor is a particular distance in front of the PP.

At this point we need to interrupt our drawing to learn to draw circles. Since we have no tools to trace or guide us we will need to learn to draw these - freehand. We need to know this to complete our current project. So start a new sheet and ...



[GO TO ... LESSON SIX 'B'](#)

[lesson menu](#)

For those folk who have enquired a **CD version** of these 'painting' as well as 'drawing lessons' and 'advanced painting' lessons will soon, I hope, be available to everyone. It will be an updated, reformatted for easy printing version so you can create you own reference handbook in your own time, or just browse the CD.

It is anticipated the CD will be available at around \$15 (plus posting) for students and \$19 (plus posting) for others. The CD's will be distributed on a first come first served basis. Isn't that always the way?

To be added to the list just send me a simple [email](#) with the words 'please notify CD' and your name and status (only if a student or teacher).



LESSON - PERSPECTIVE SIX- ROOM INTERIOR (CVP)

TIME:

Allow 60-80min - this is the second part of the double lesson

Aim:

To introduce the freehand method and technique for the construction of curves and use this to complete our room interior.

Materials:

The sketch pad,
HB pencil, ruler.

Construct margin and title box on a new page then:

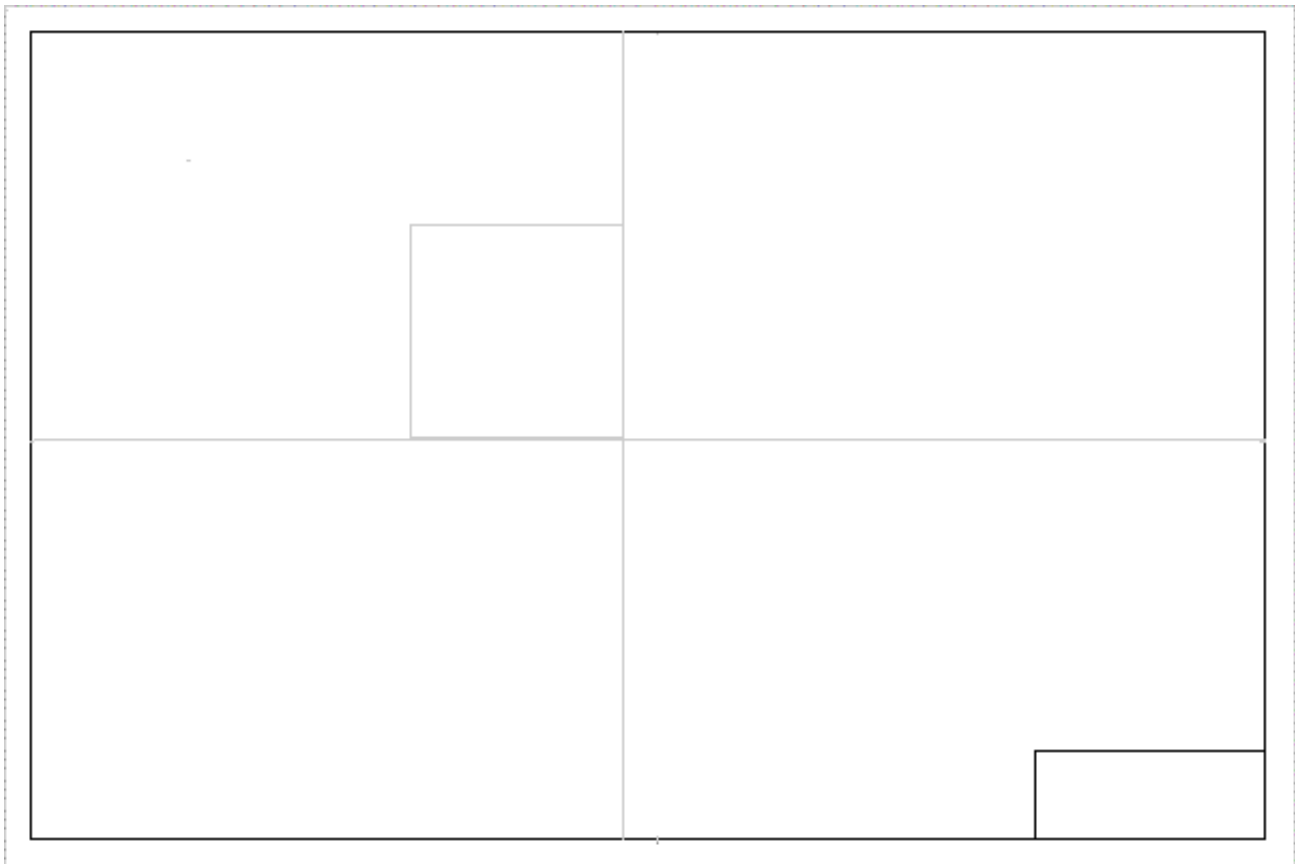

a) Construct a 75mm (3") square as shown

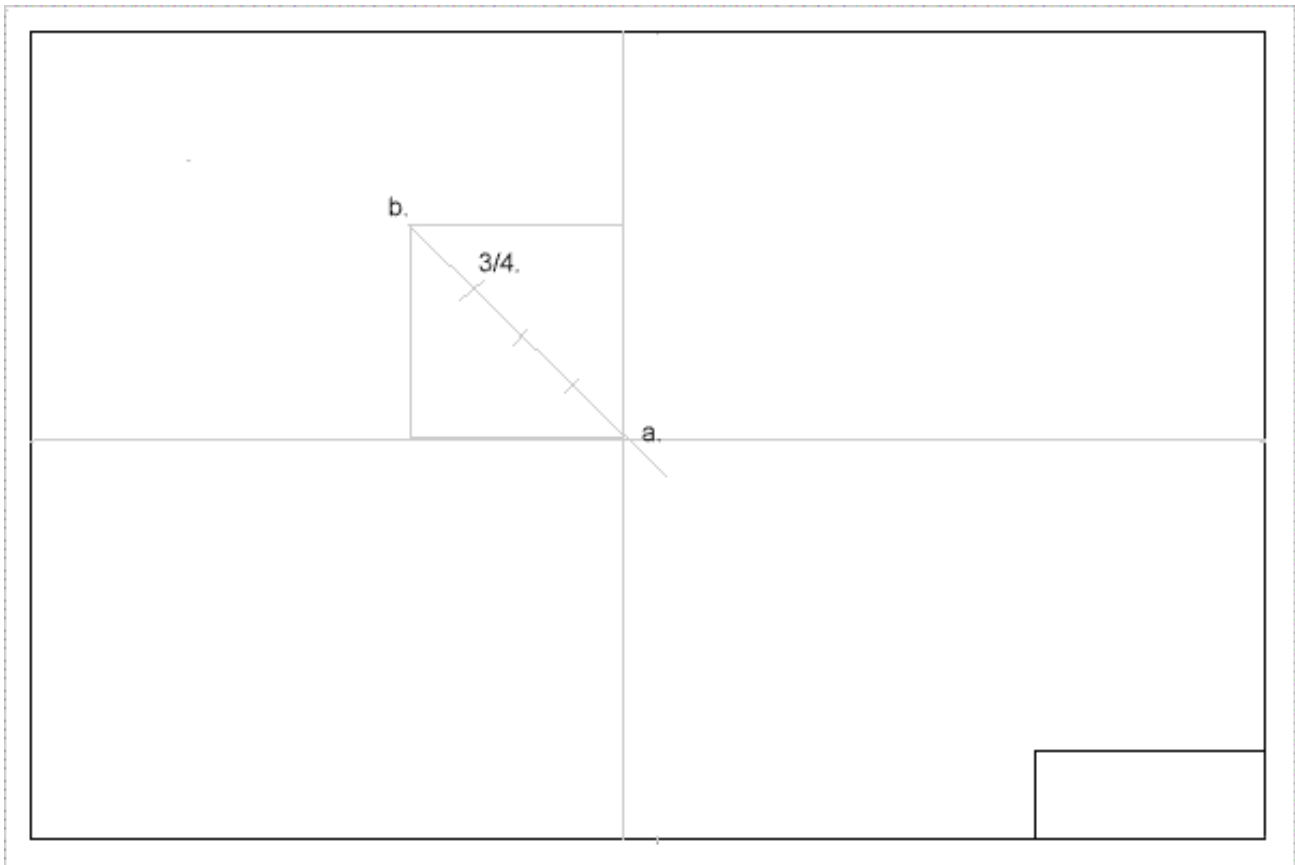

b) Draw the diagonal a-b and without measurement divide into four equal parts.

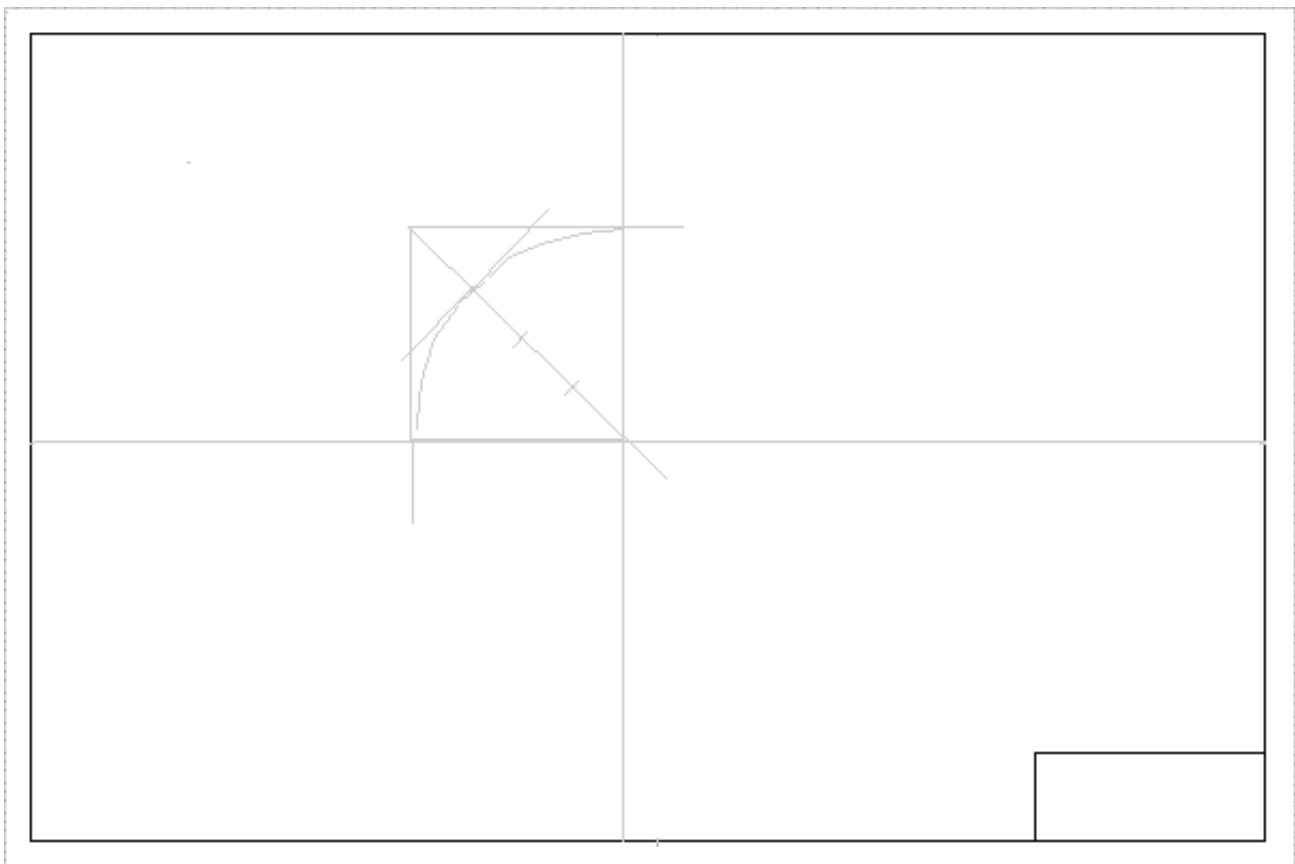

c) Draw a 45 degree tangent through the 3/4 division as shown and **lightly** sketch the freehand curve. The curve actually cuts the diagonal just below the three quarter mark and above the two thirds point. The students should be encouraged to draw the curve so it 'looks right.'

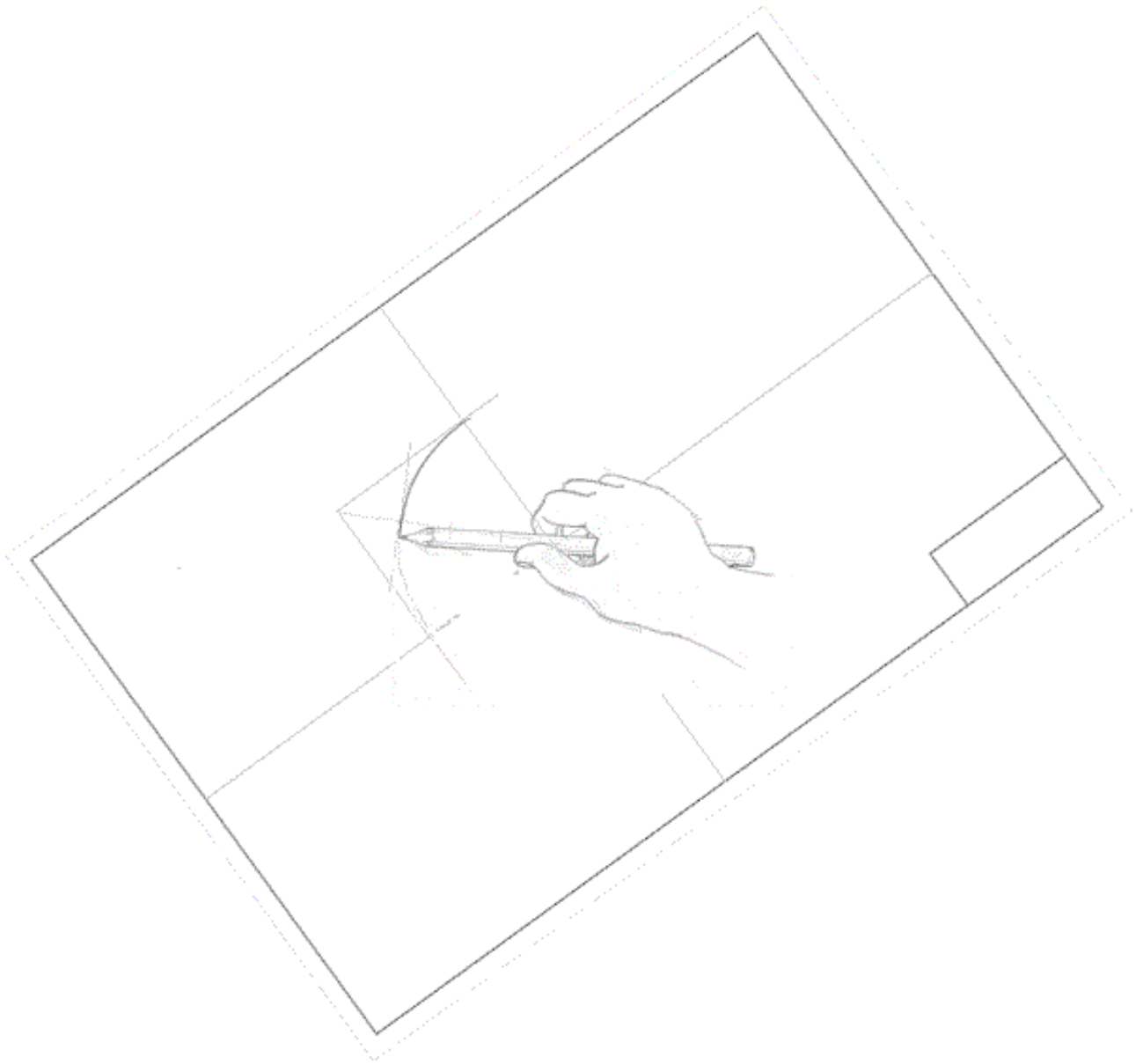

d) When drawing the curve keep the hand on the **inside** of the curve. This may necessitate keeping the hand still and moving the paper as demonstrated above.

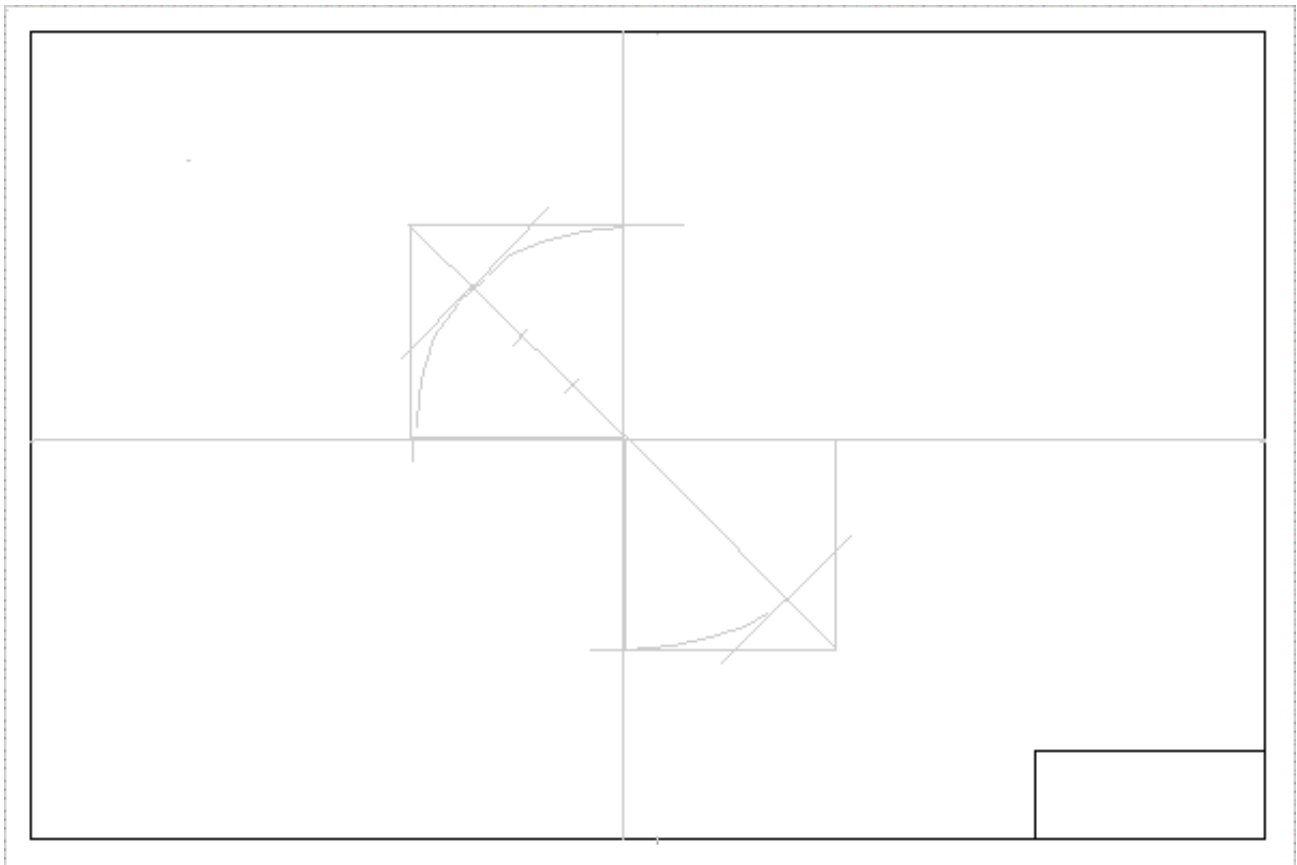

e) Construct the square as shown and turn the page upside down to sketch the opposite curve.

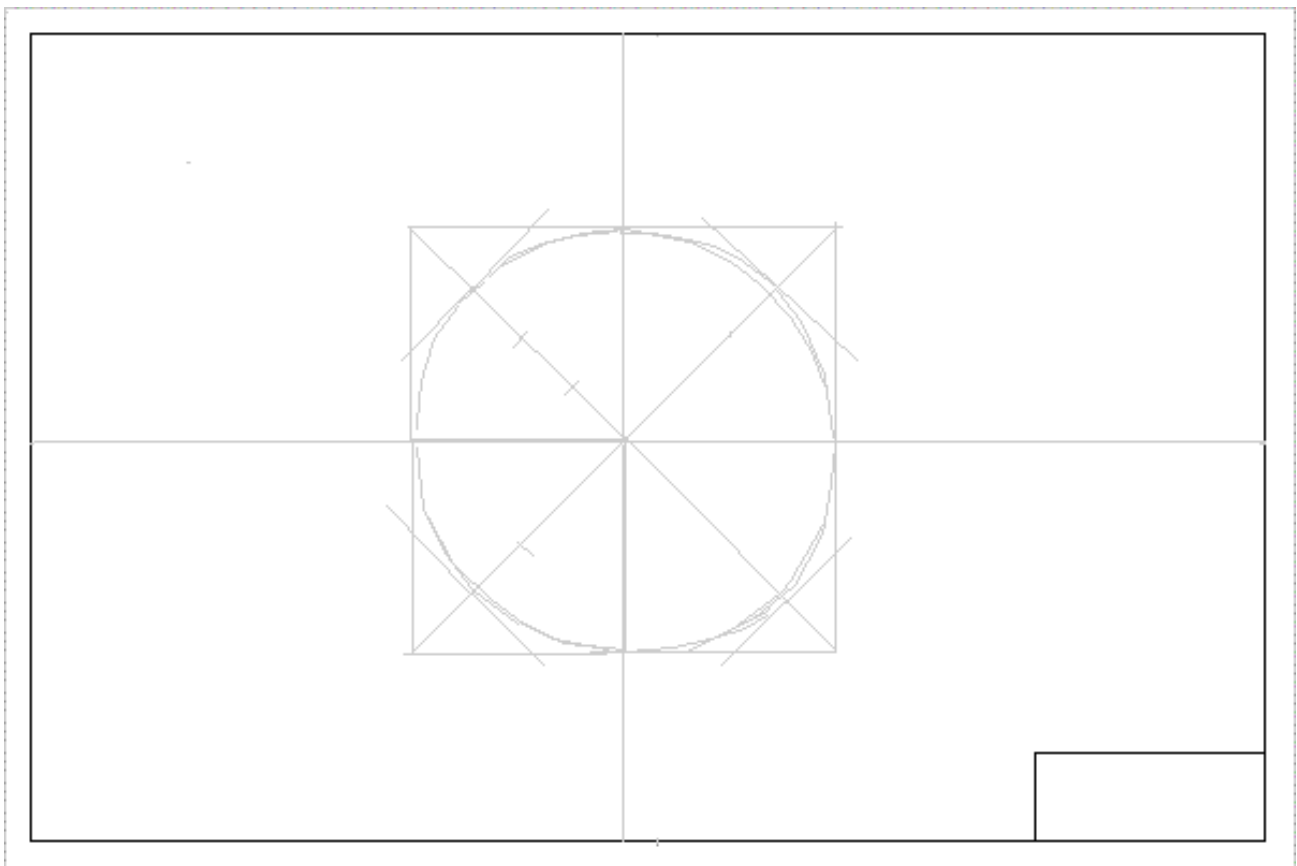

f) Complete the whole circle lightly and make adjustments where necessary.

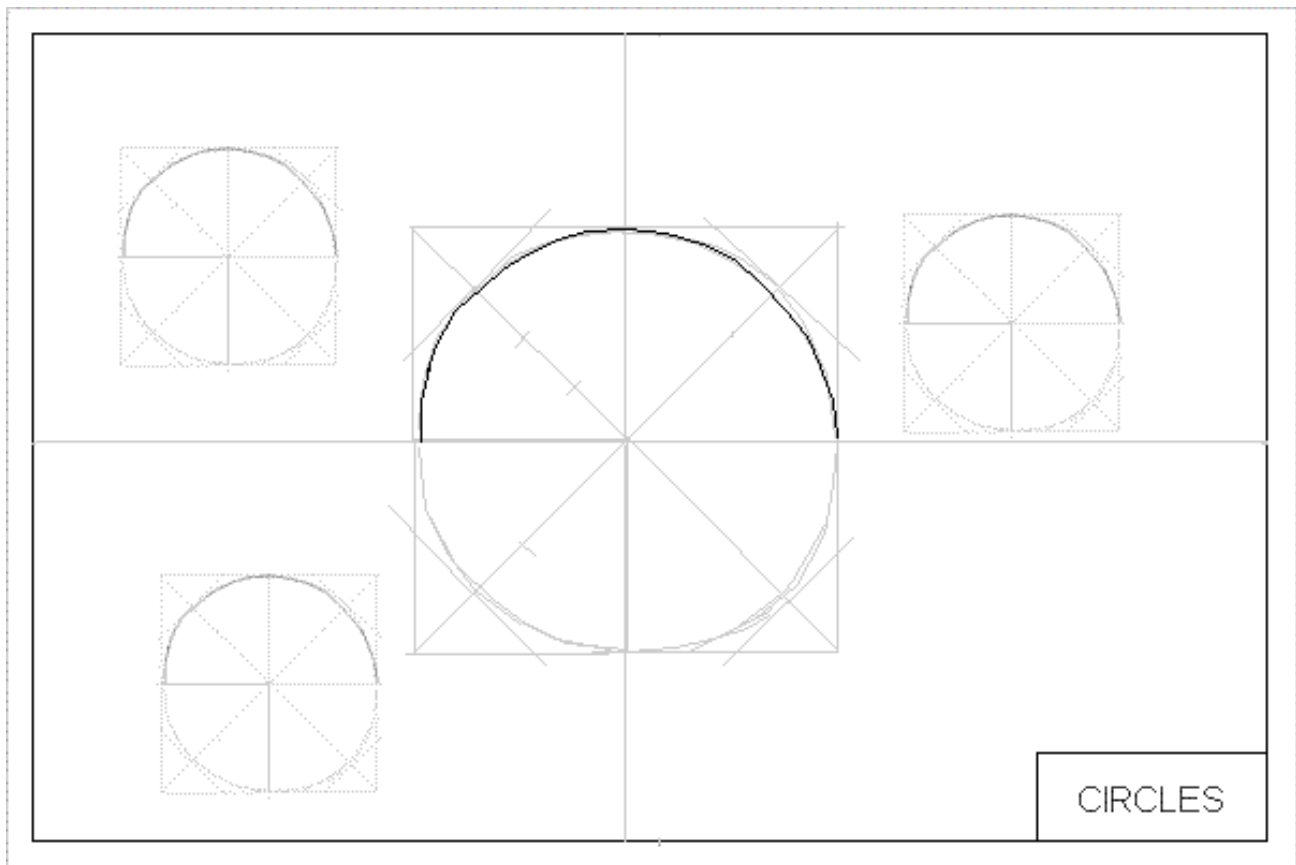

g) Practice circles of differing sizes, label and turn back to interior of room. For homework the student can practice two or three more.

[Return to previous page of room interior ...](#)

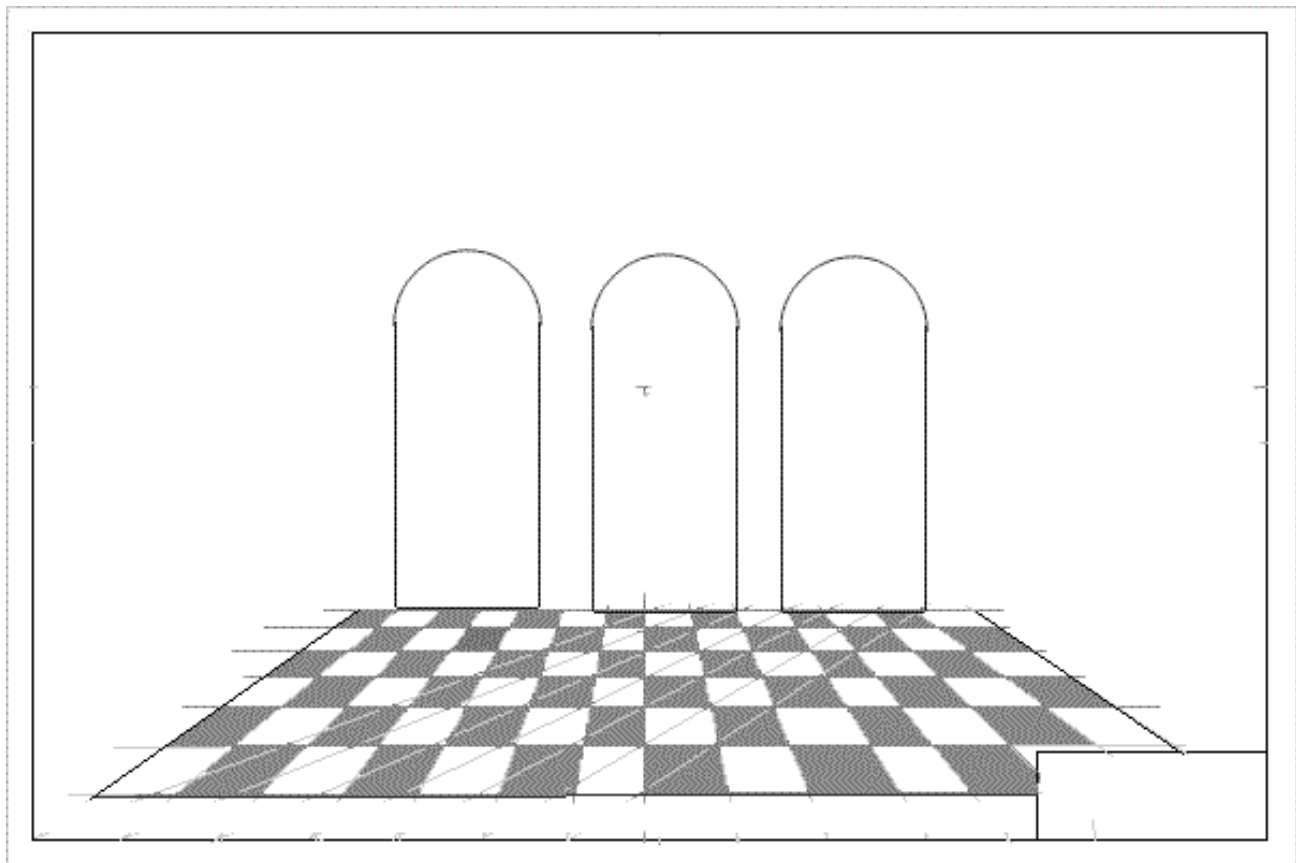

h) Using the method recently learnt construct the three arched portals and firm them in.

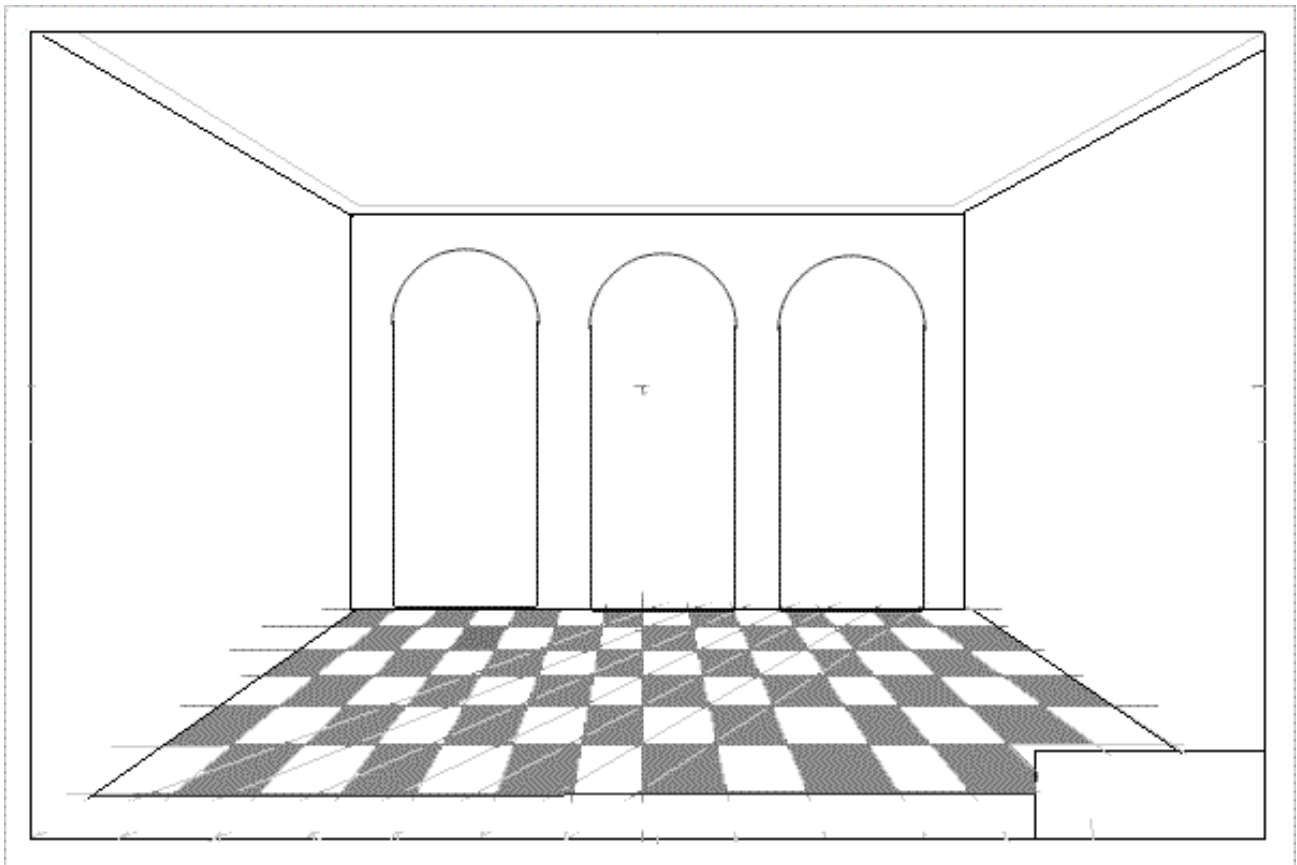

i) Draw a light rectangle around the portals to make a wall and firm in. Using light lines from the CVP draw the ceiling

Revise ask: What does PP stand for?

Home study : Find a picture or photograph from a magazine or elsewhere (it can be a seascape, landscape or whatever) where the horizon can be placed in its right position on the CVP. Cut out and paste on the drawing as shown below. If the student so desires they can draw in a little scene themselves.

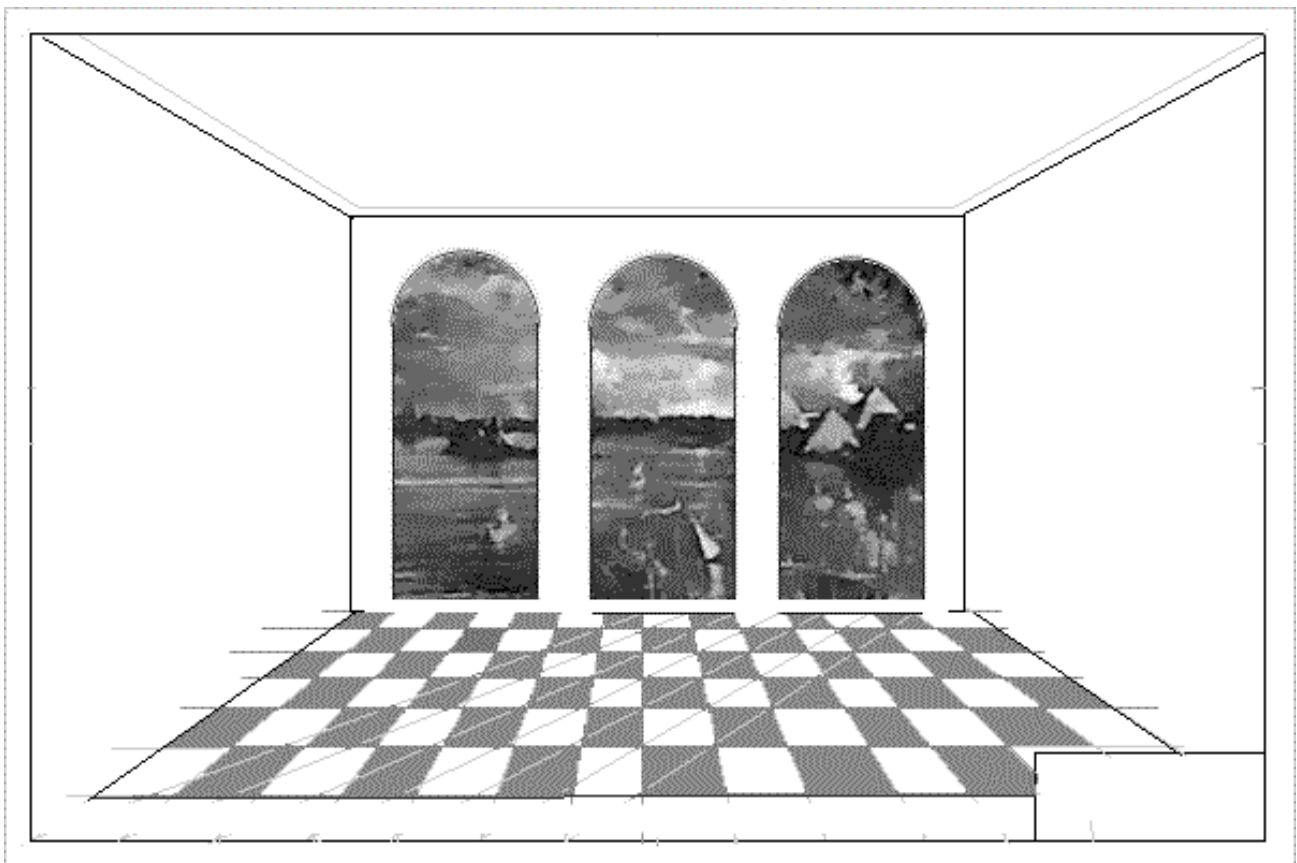

I have used part of a 'masterpiece' by a well known, if slightly erratic and unreliable, individual.

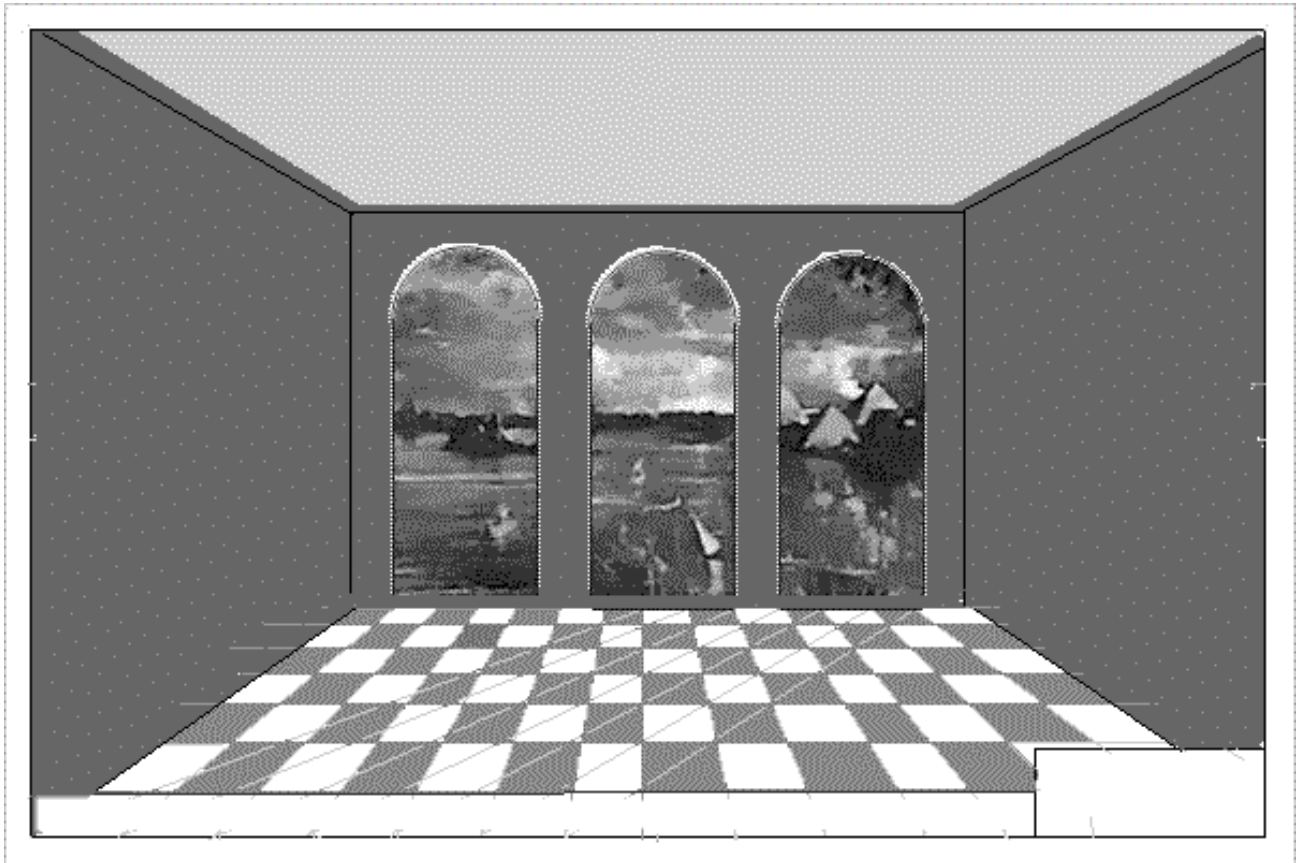

Finally the students can shade the walls, add a painting or two, a side door, etc. The teacher will find it is useful to balance the discipline of the method with the freedom to work within. Press [here](#) to see a room interior using the same method of construction by Michelangelo.



[GO TO ... LESSON SEVEN](#)

[lesson menu](#)



LESSON - PERSPECTIVE SEVEN - LETTERS

TIME: Allow 40 min

Aim: To introduce the freehand method and technique for the construction of curves and use this to complete a drawing. To introduce the notion that drawing and estimating proportion require judgements that need to be recognized, trusted and developed.

Materials: The sketch pad, HB pencil, ruler.

To Begin: (allow 10 min) (Preparation - download the first diagram below, print and make a copy for all students) Hand them out and ask:

- Which is the longest edge in Fig 1 and why? (AD because it is closest - CA and AB recede)
- What are the circumstances that would make $CA=CB$? (if the block was centrally positioned between the LVP and RVP)
- Why is CA bigger than AB in Fig 2?
- Measure all lines in Fig 2. Are any two the same size? (Discuss what we mean by real size or apparent size?)
- Fig 3 does not look quite as 'square' as it should, why is that? (AB and CA are slightly too long making the block appear squatter than the others)

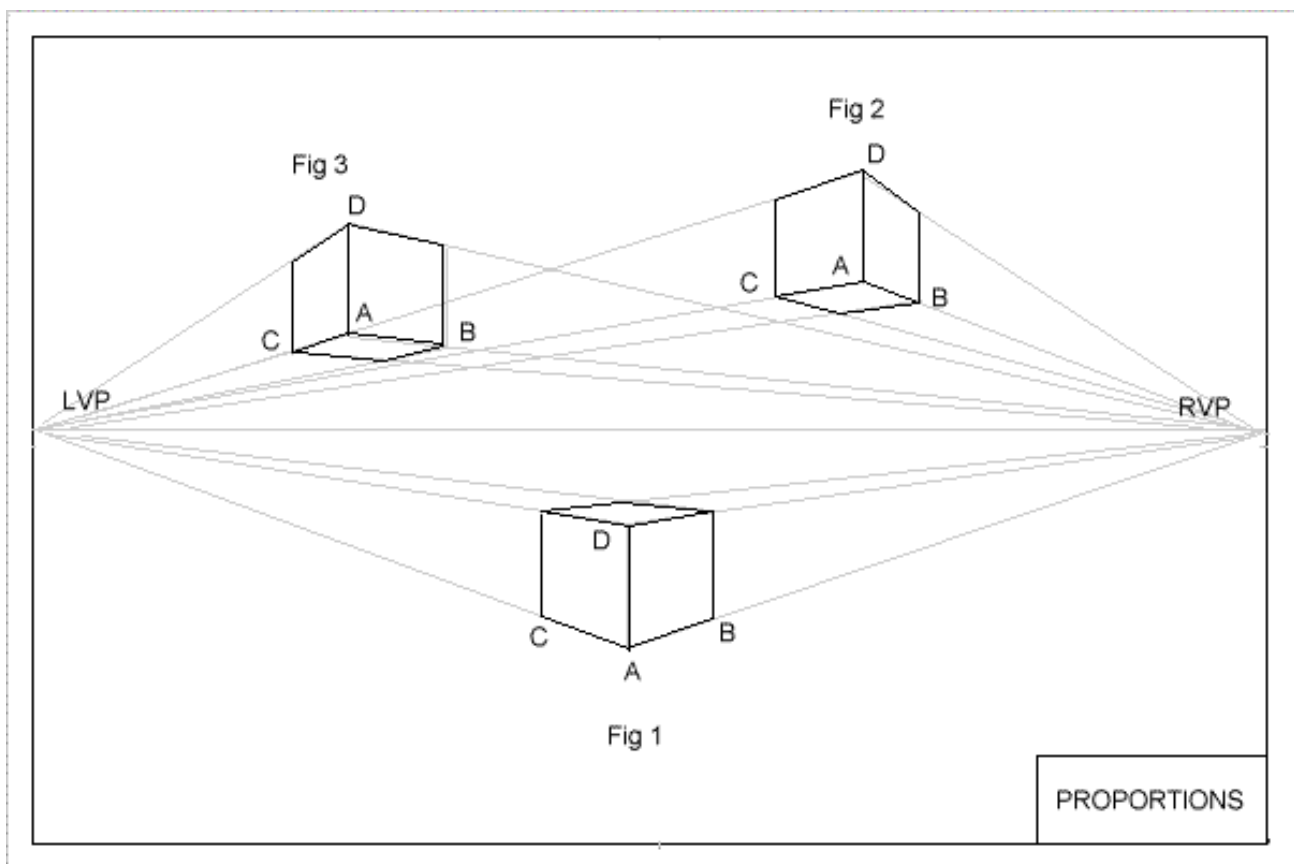

We must learn to use our eyes and judge distances and proportions. We must keep drawing them until they look right. It is the same if drawing a face or a box for always we must judge one thing in relation to all the others in the same space. The simplest object to practice and draw is the cube and we can use the cube to make many other shapes. If the cube is nearer the RVP AC will always be larger than AB while the reverse applies for the LVP.

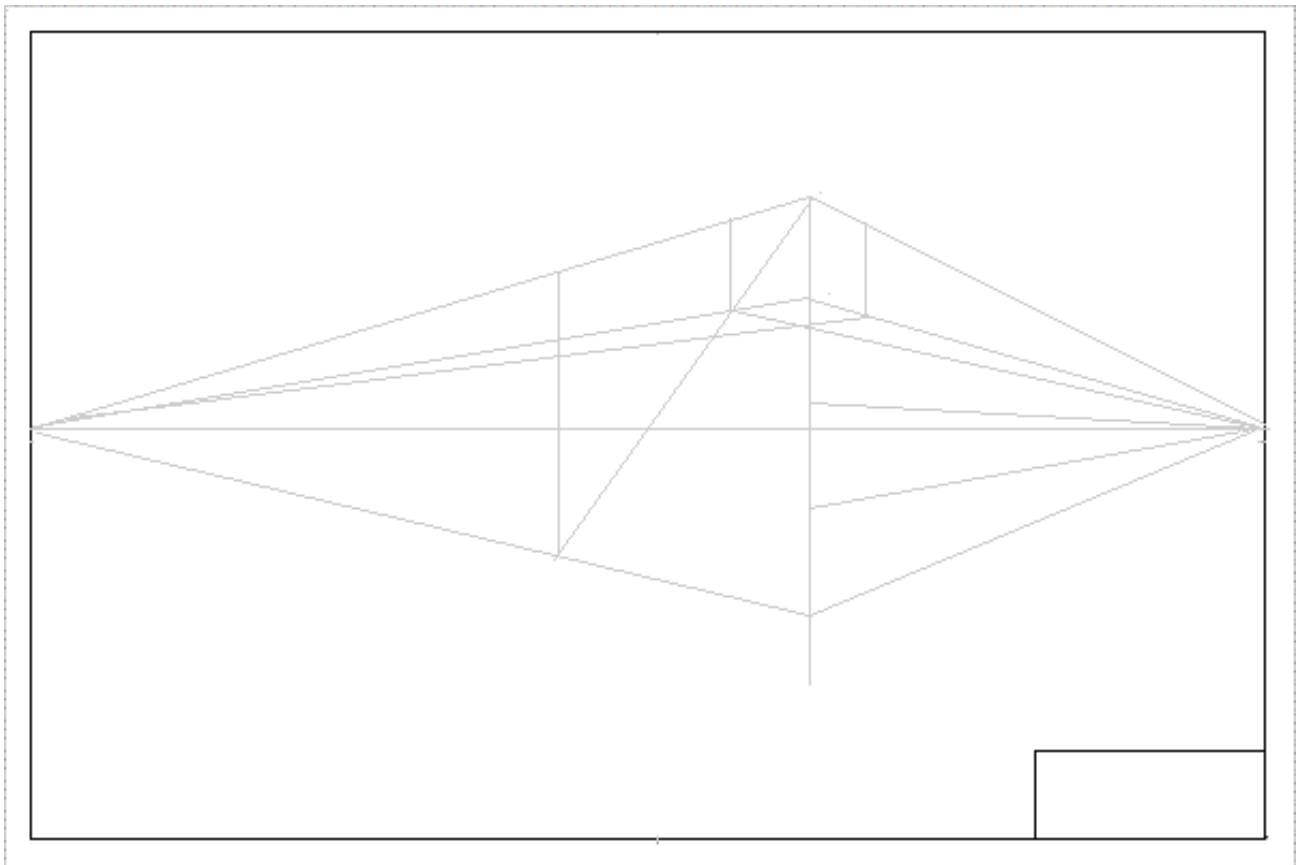

d) Draw the diagonal ... extend it, and form the square.

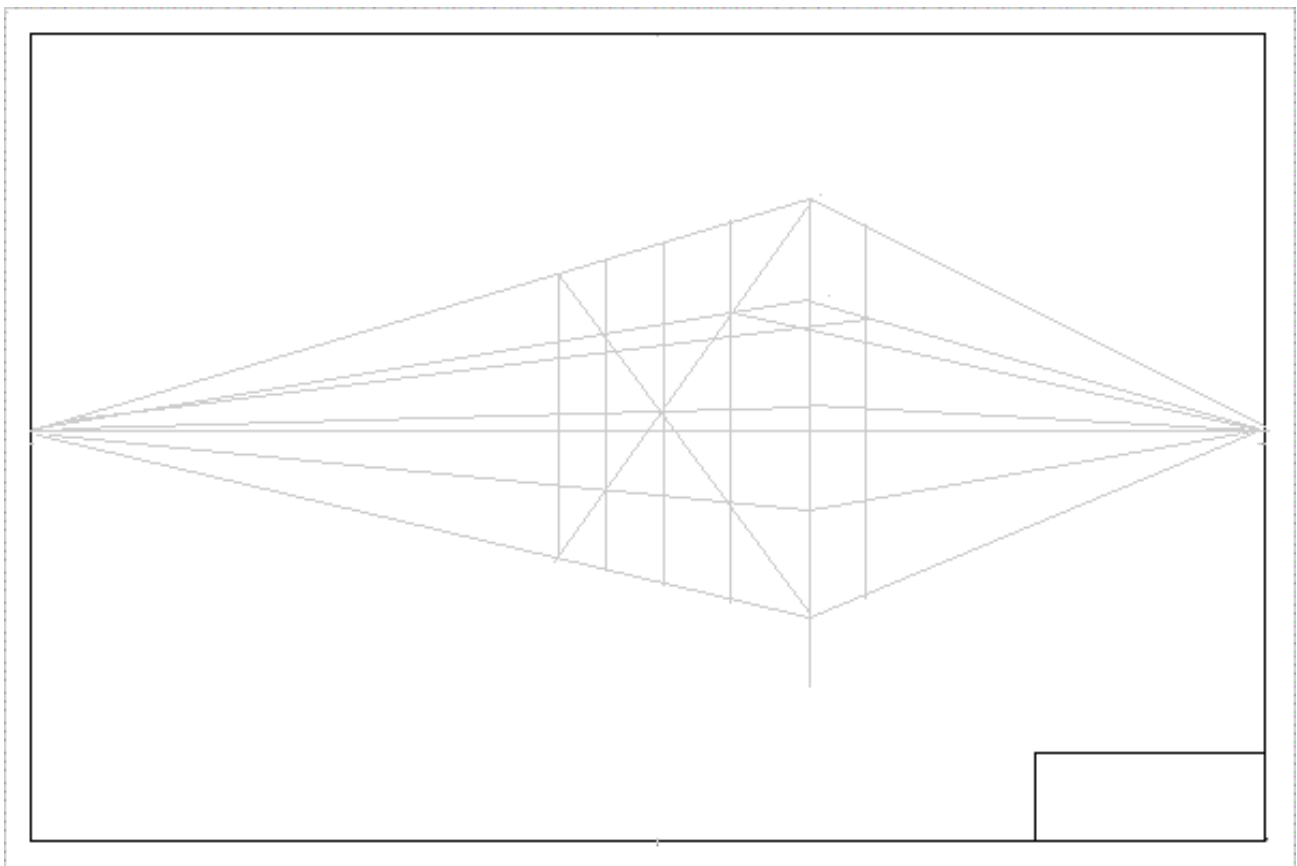

e) Construct diagonal and the 16 little boxes as shown

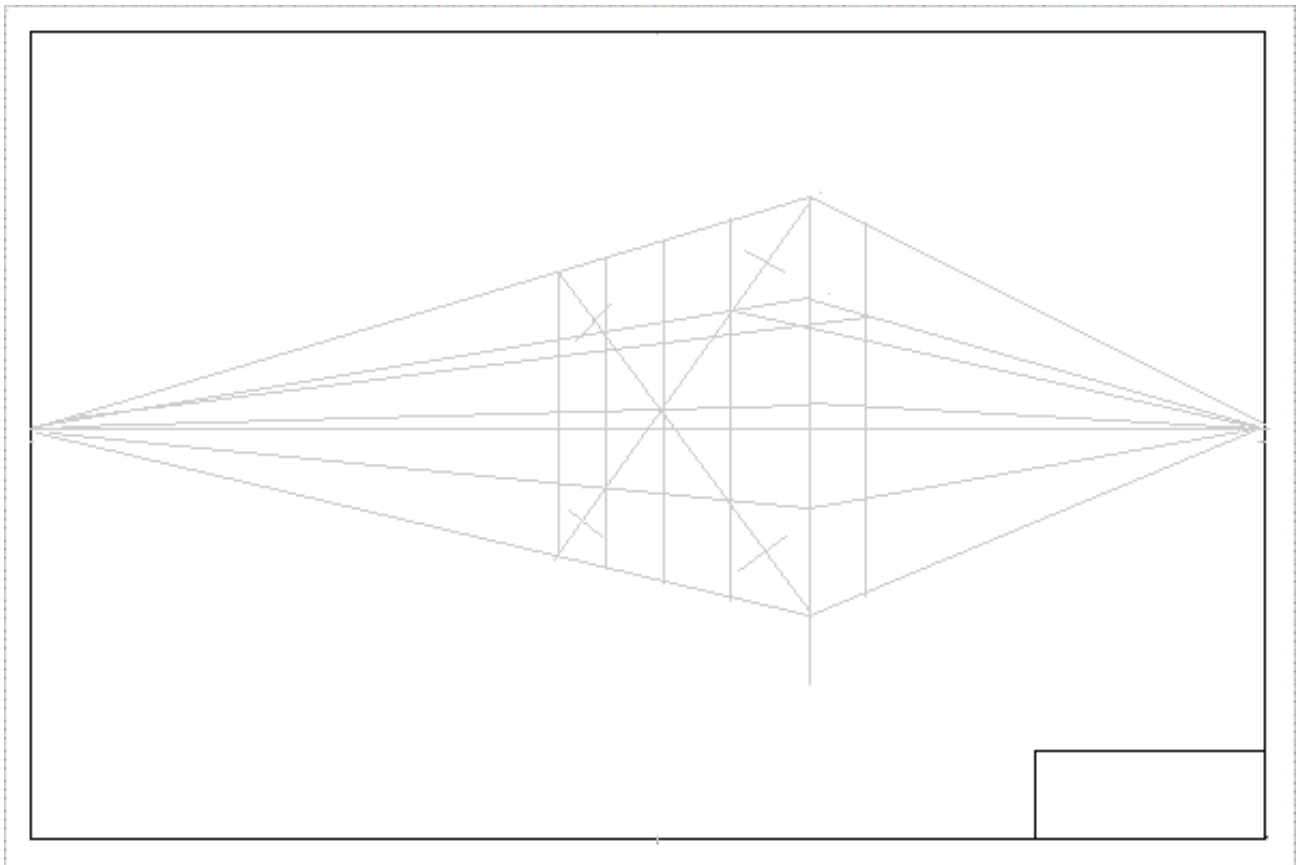

f) Mark approximately 3/4 lengths along the diagonals

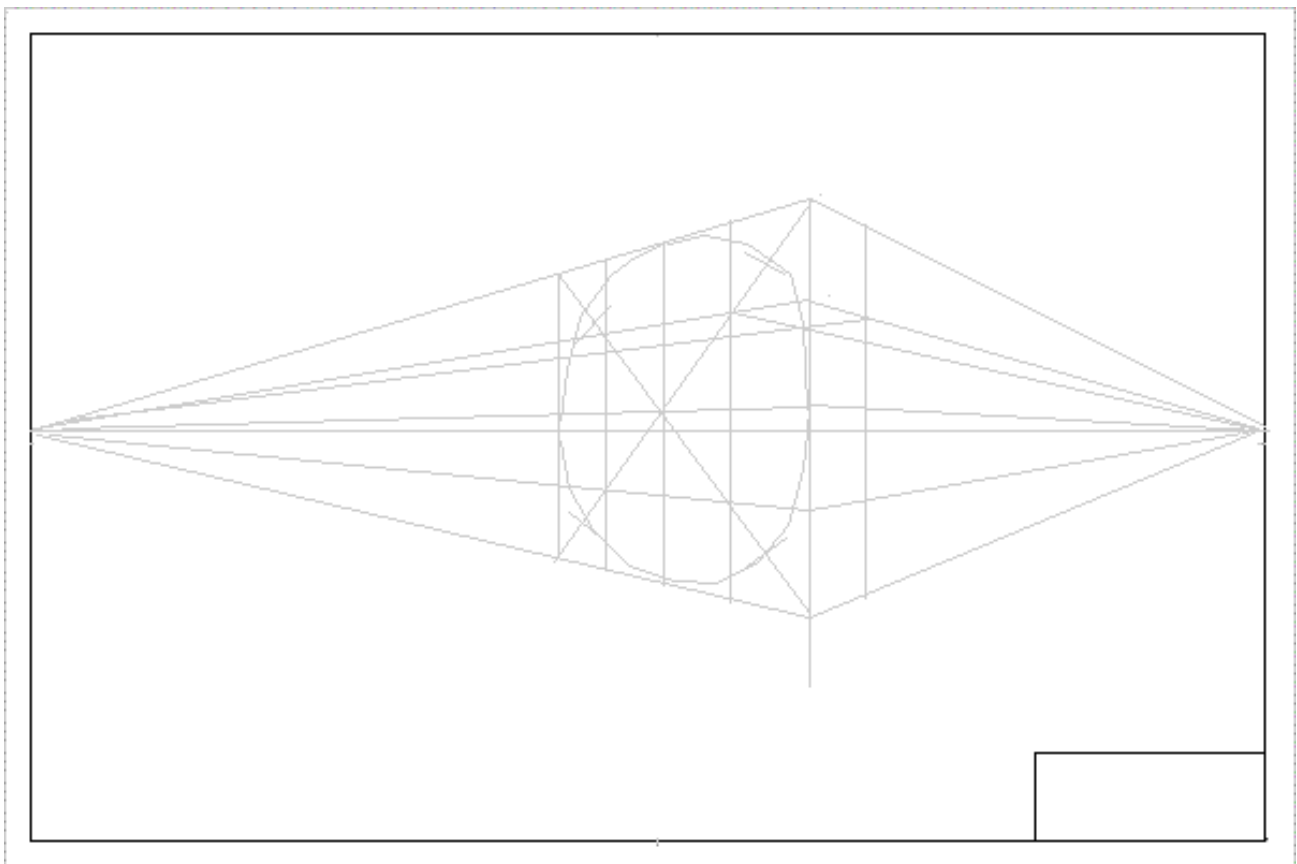

g) Lightly draw in your circle.

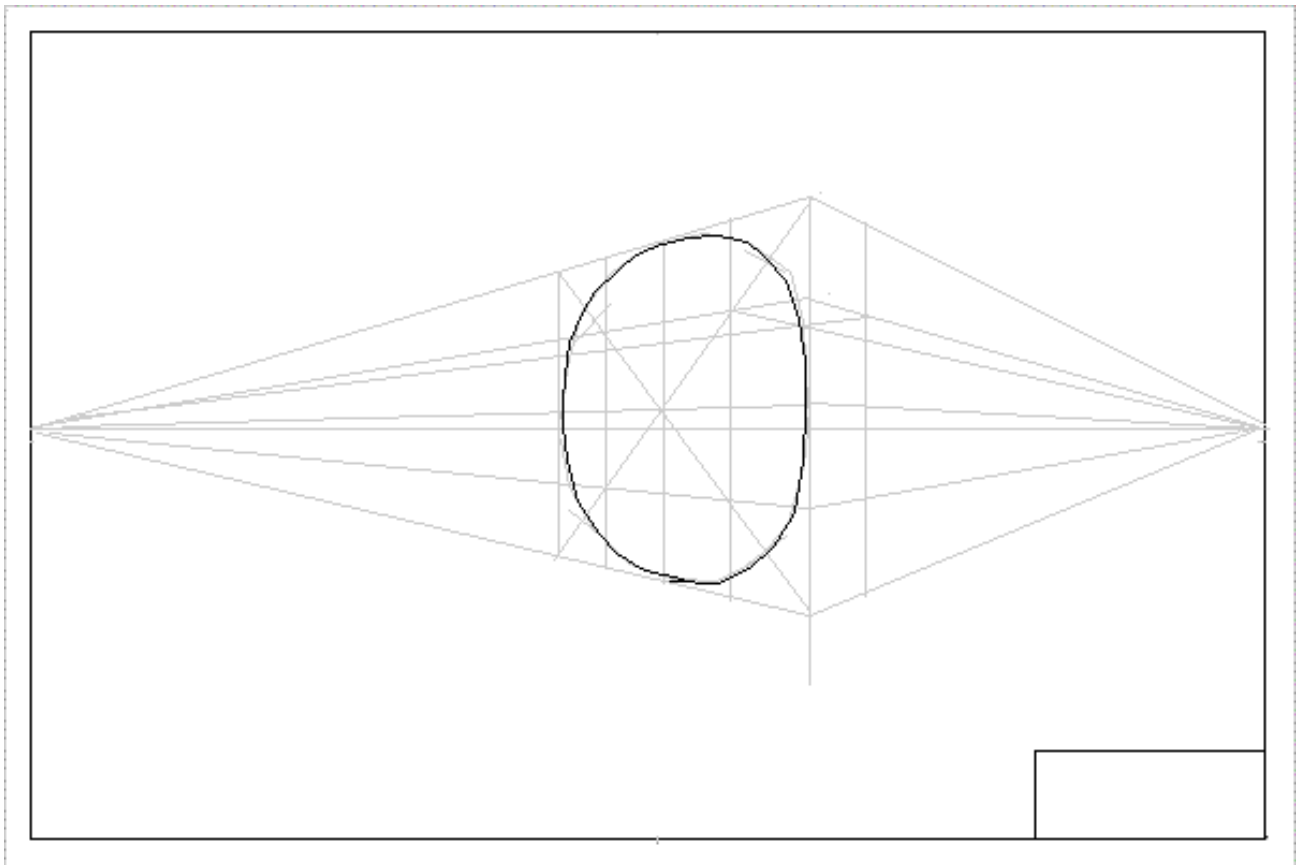

h) Firm it in.

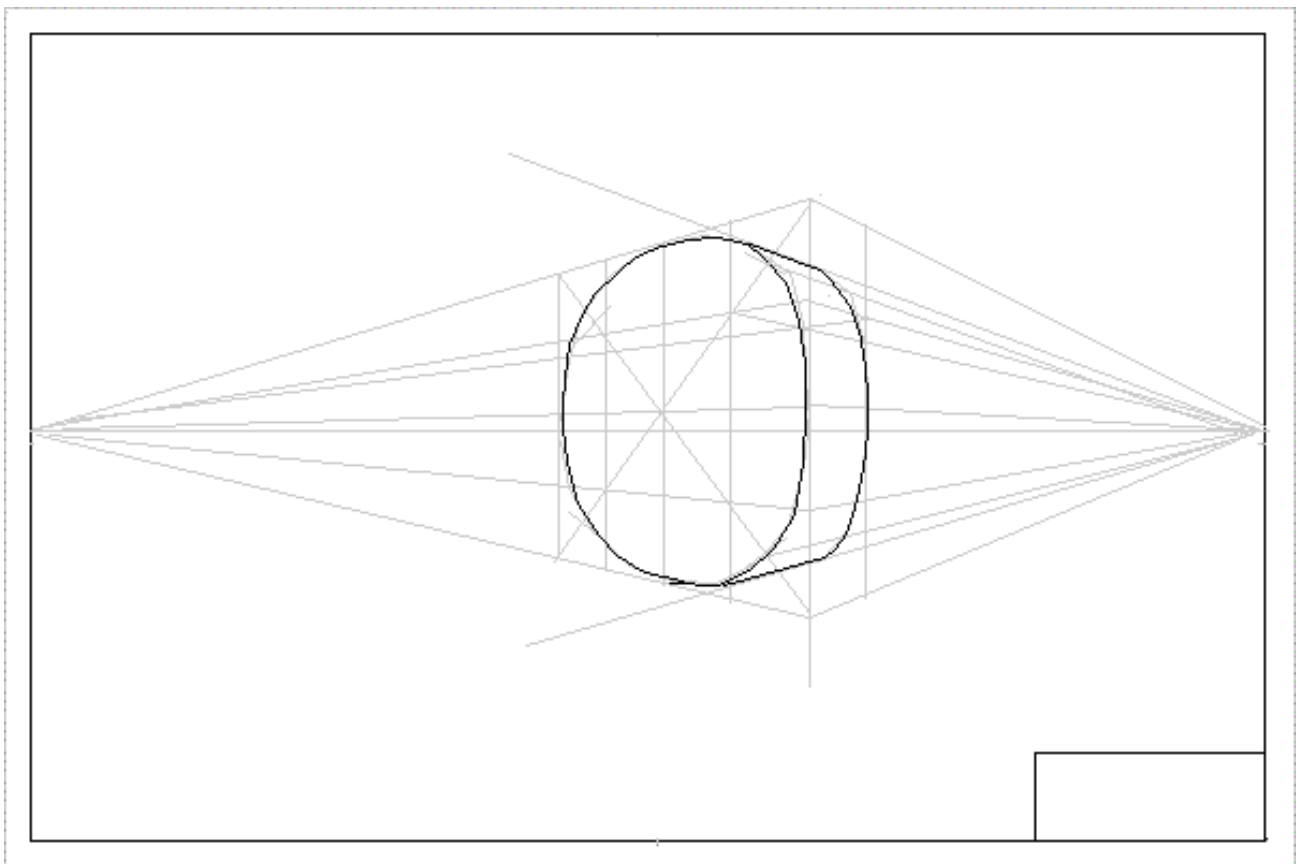

i) Give the disc thickness as shown. The lines to the RVP form 'tangents' to the circle. Sketch in lightly until it looks right then firm it in. The teacher should check ...

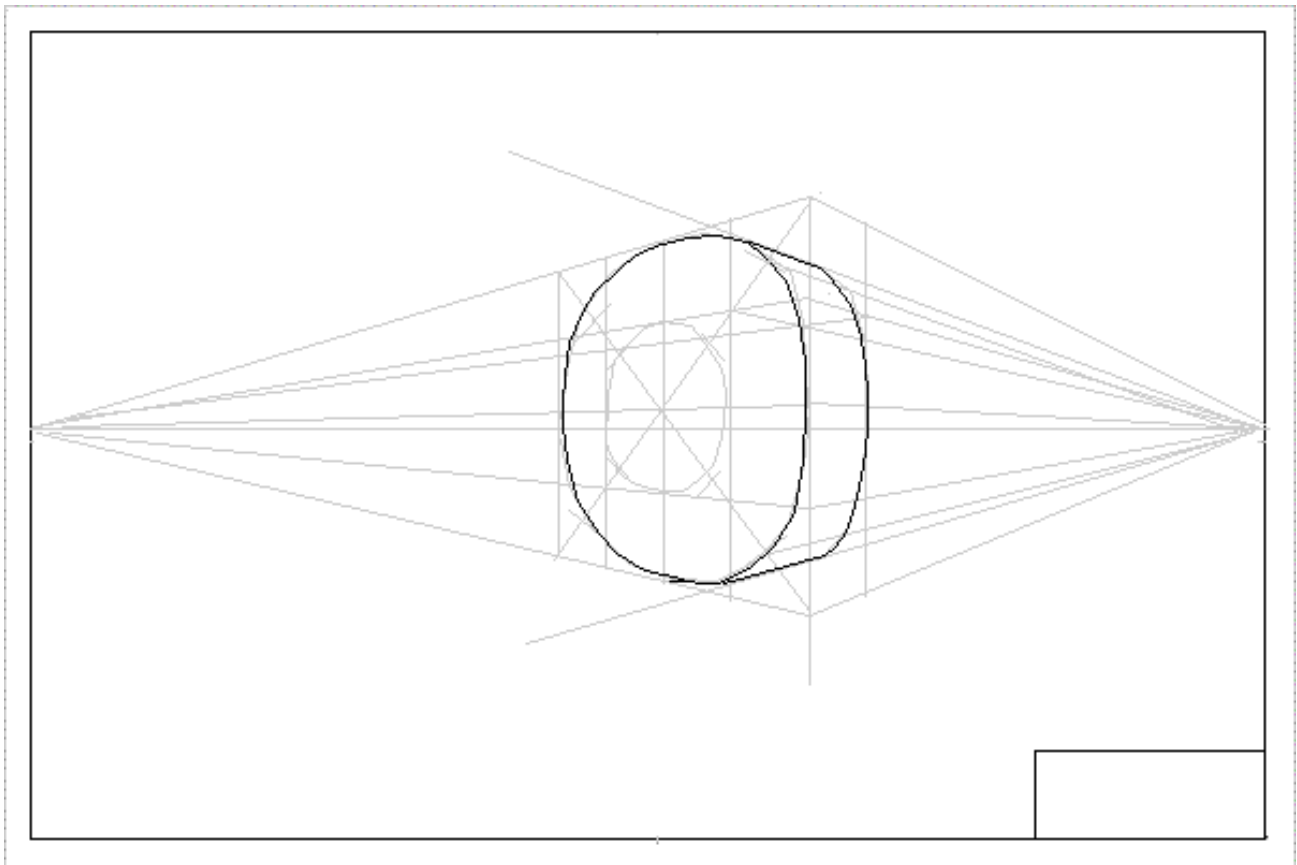

j) In the inner four squares draw another circle.

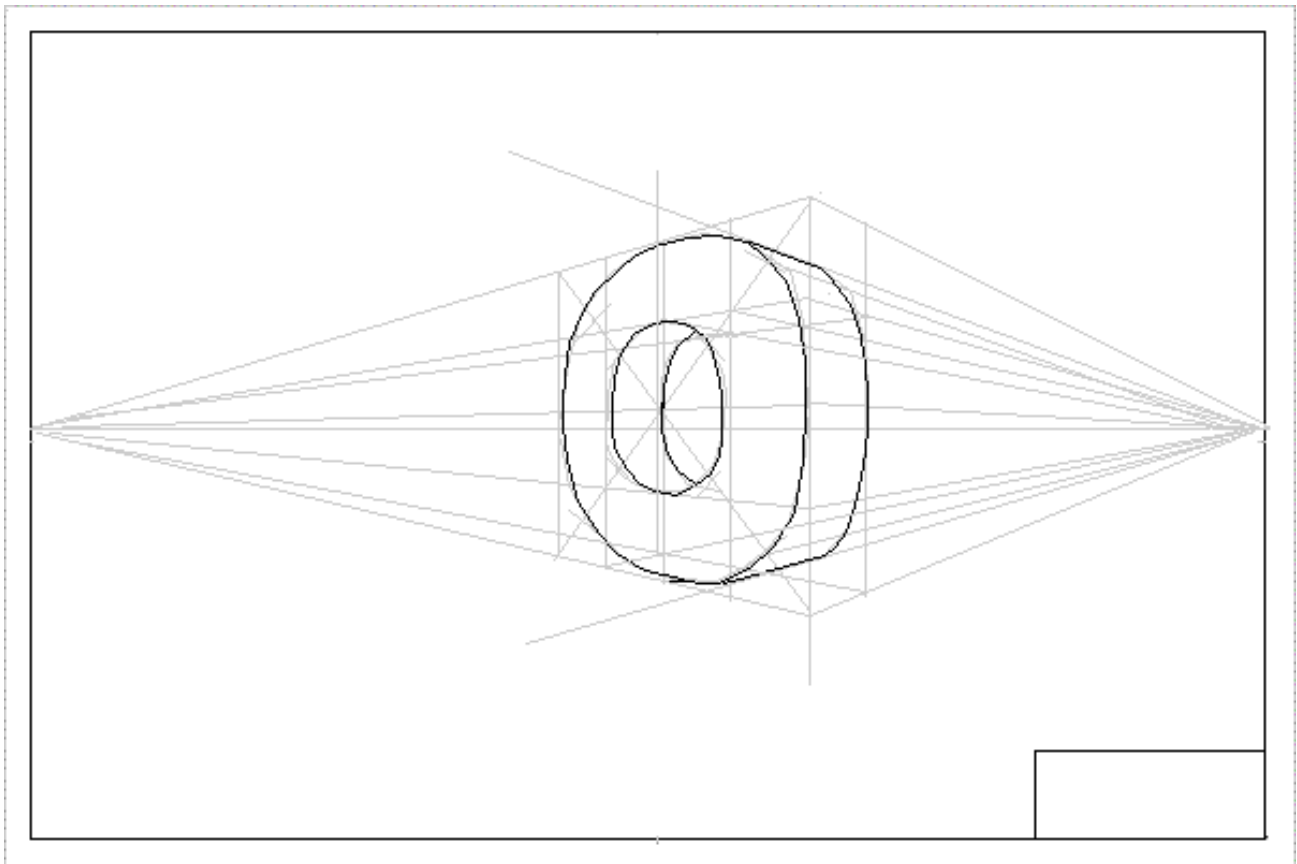

k) Firm it in and complete as shown above.

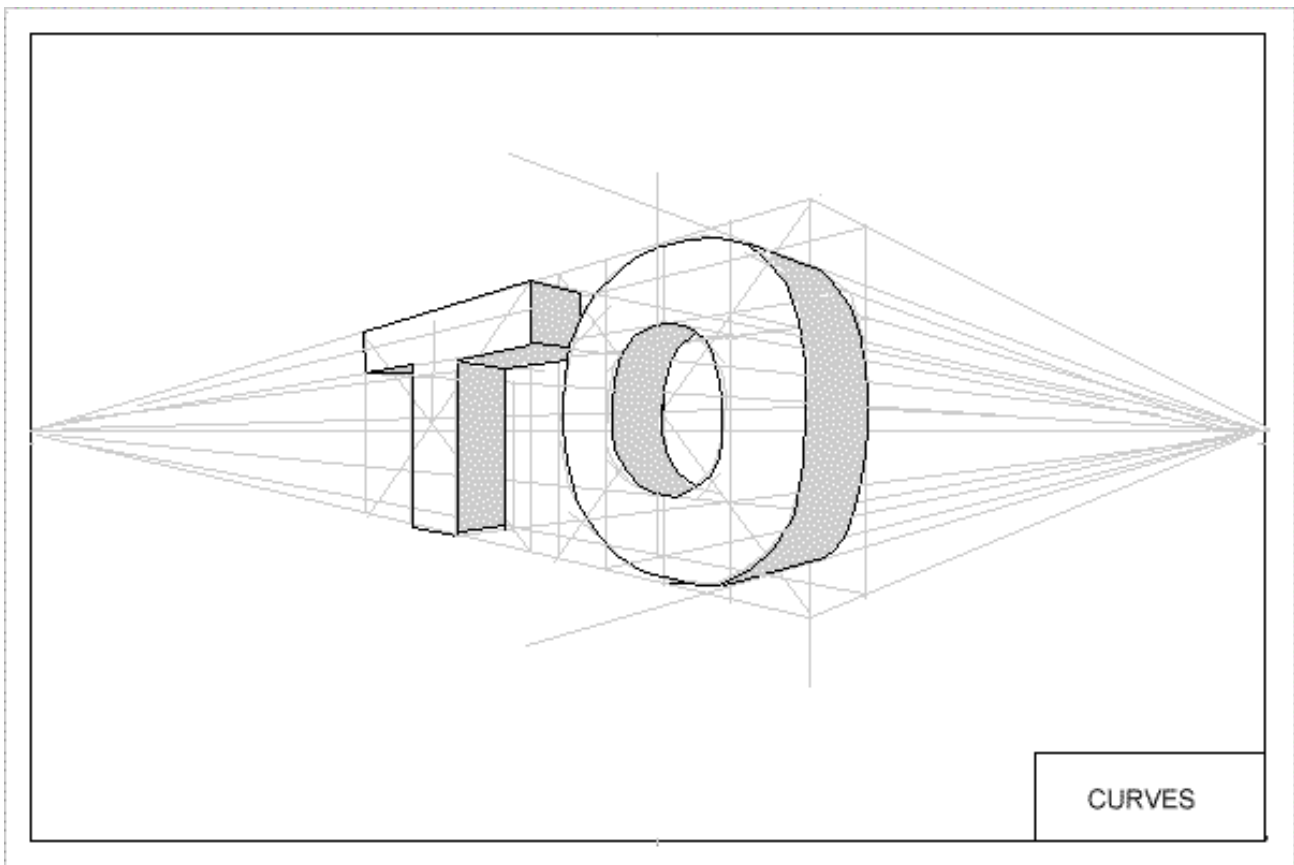

Home study :

Shade the drawing and add another letter. There are thousands of variations of this drawing. The student could perhaps try and draw their own initials in the other direction, or using just the CVP on the ground. The more confident can try and draw a large 'S' for instance as homework or a special project.



[GO TO ... LESSON EIGHT](#)

[lesson menu](#)



LESSON - PERSPECTIVE EIGHT - BASIC SHADOWS

TIME:

Allow 40 min

Aim:

To learn how to plot shadows

Materials:

The sketch pad,
HB pencil, ruler.

To To begin revise: We must learn to use our eyes and judge distances and proportions and keep drawing them until they look right. It is the same if we are drawing a face or a box, we must judge one thing in relation to all the others in the same space.

Construct margin and title box on a new page then:

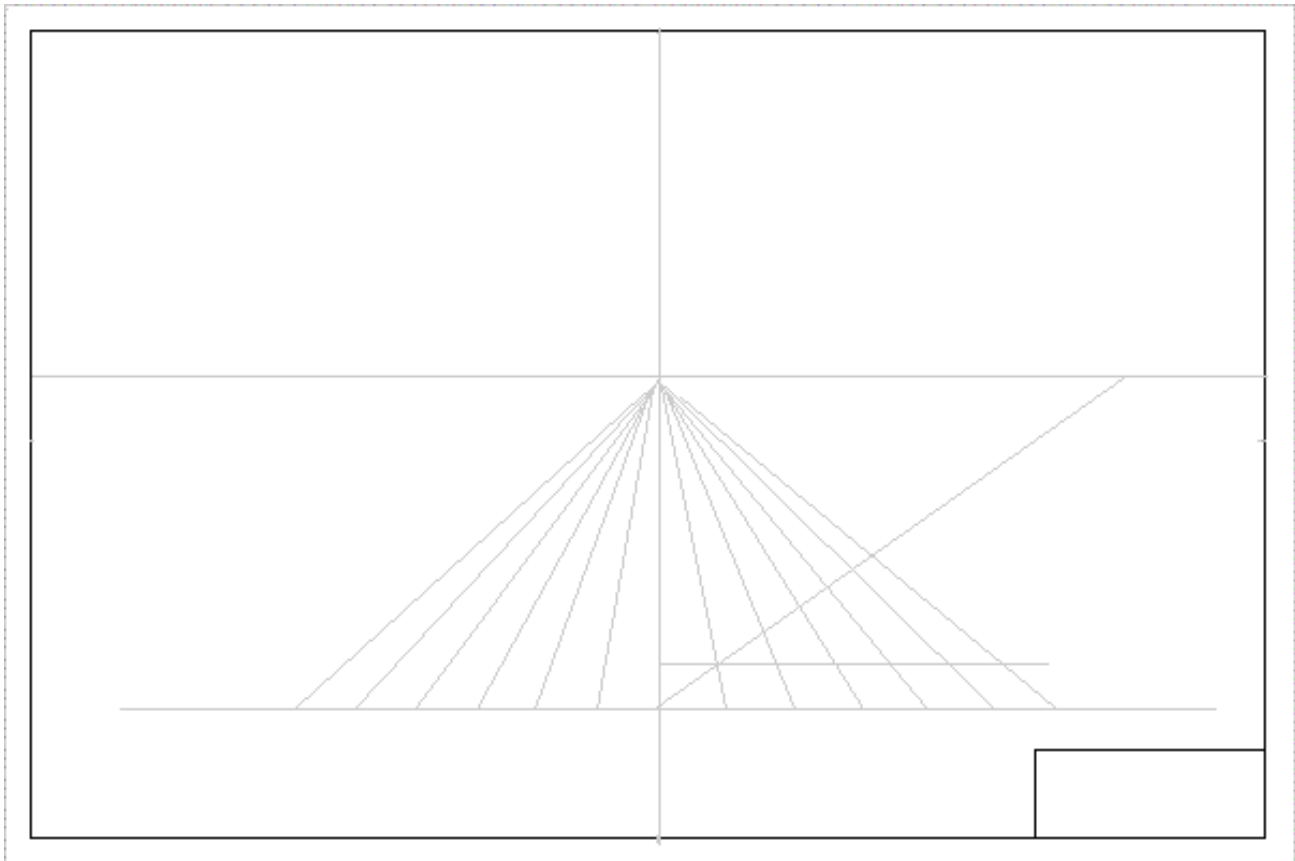

b) As in lesson six construct the grid as shown but start from slightly above the title box.

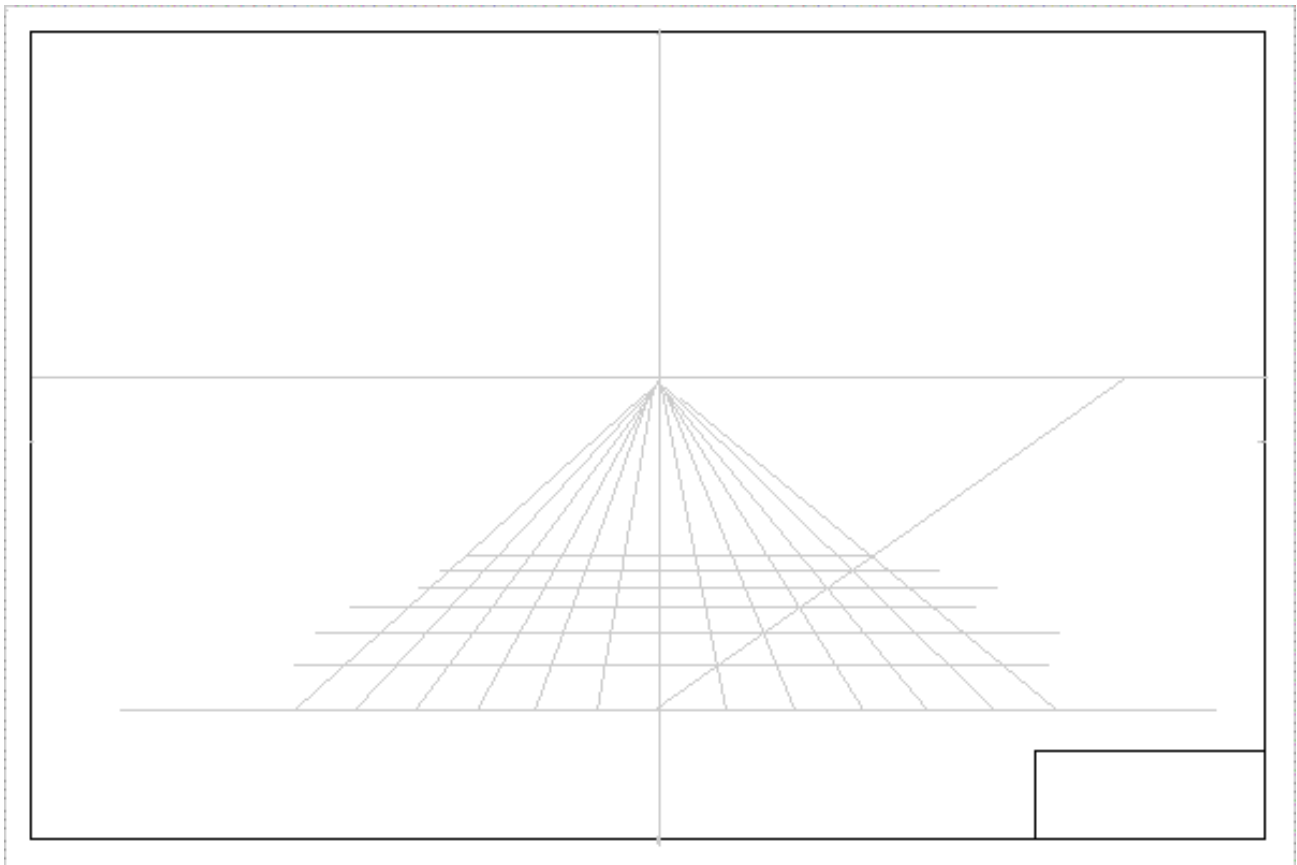

c) Note the RVP is moved slightly toward the center.

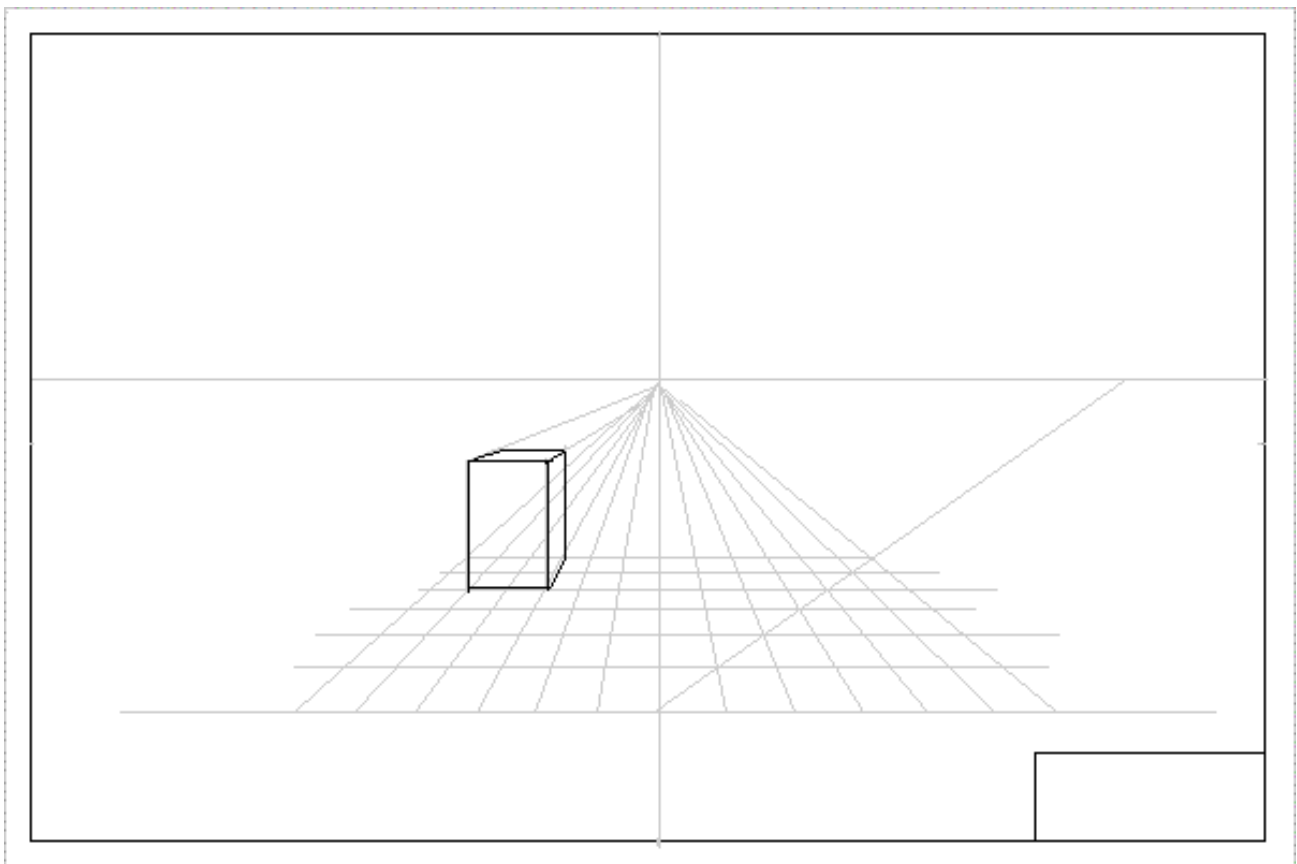

d) Draw the box in lightly then firm it in.

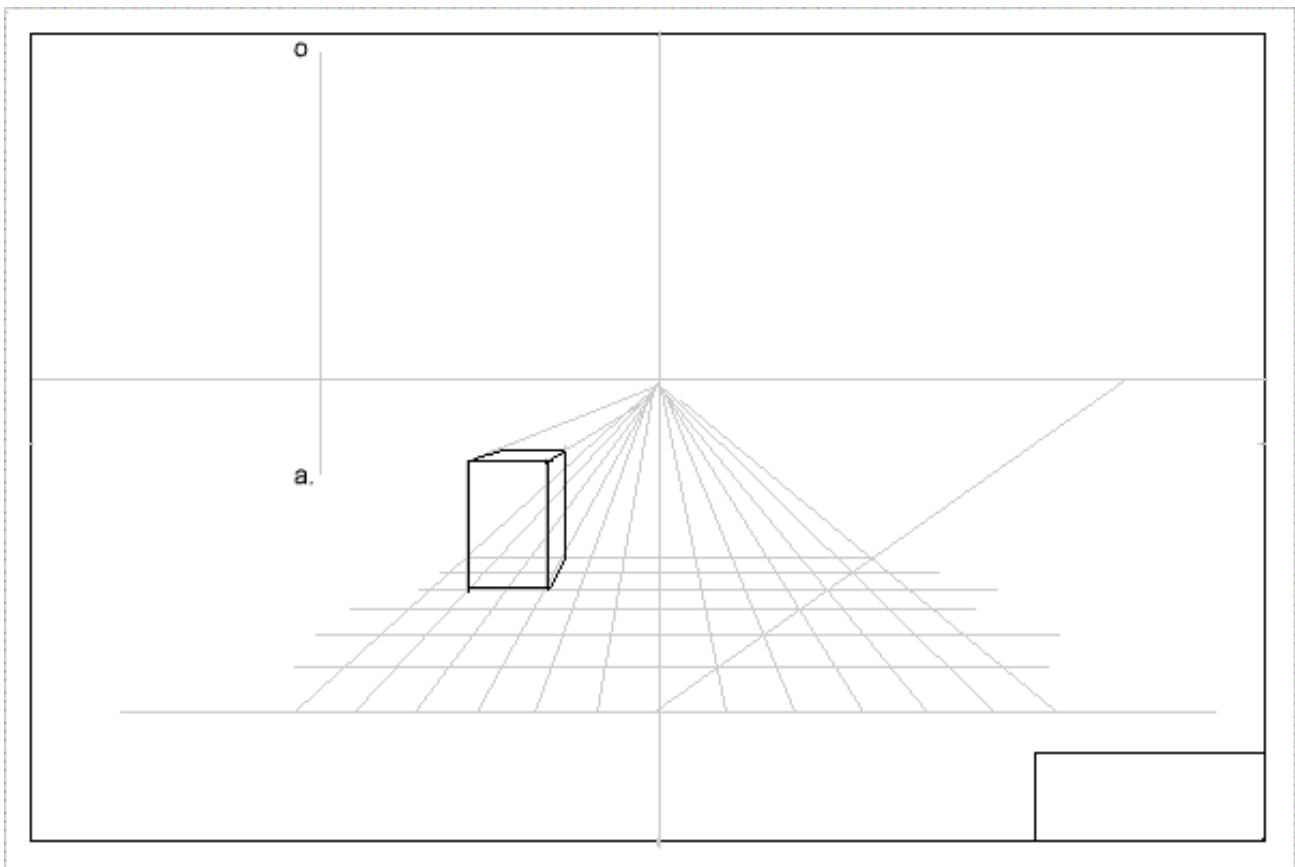

e) Draw the line approximately as shown. 'O' stands for the light source and 'a' is the spot **on the ground** directly beneath the light. You can place the point anywhere you like but I suggest you place it near where I placed mine if you want a similar shadow.

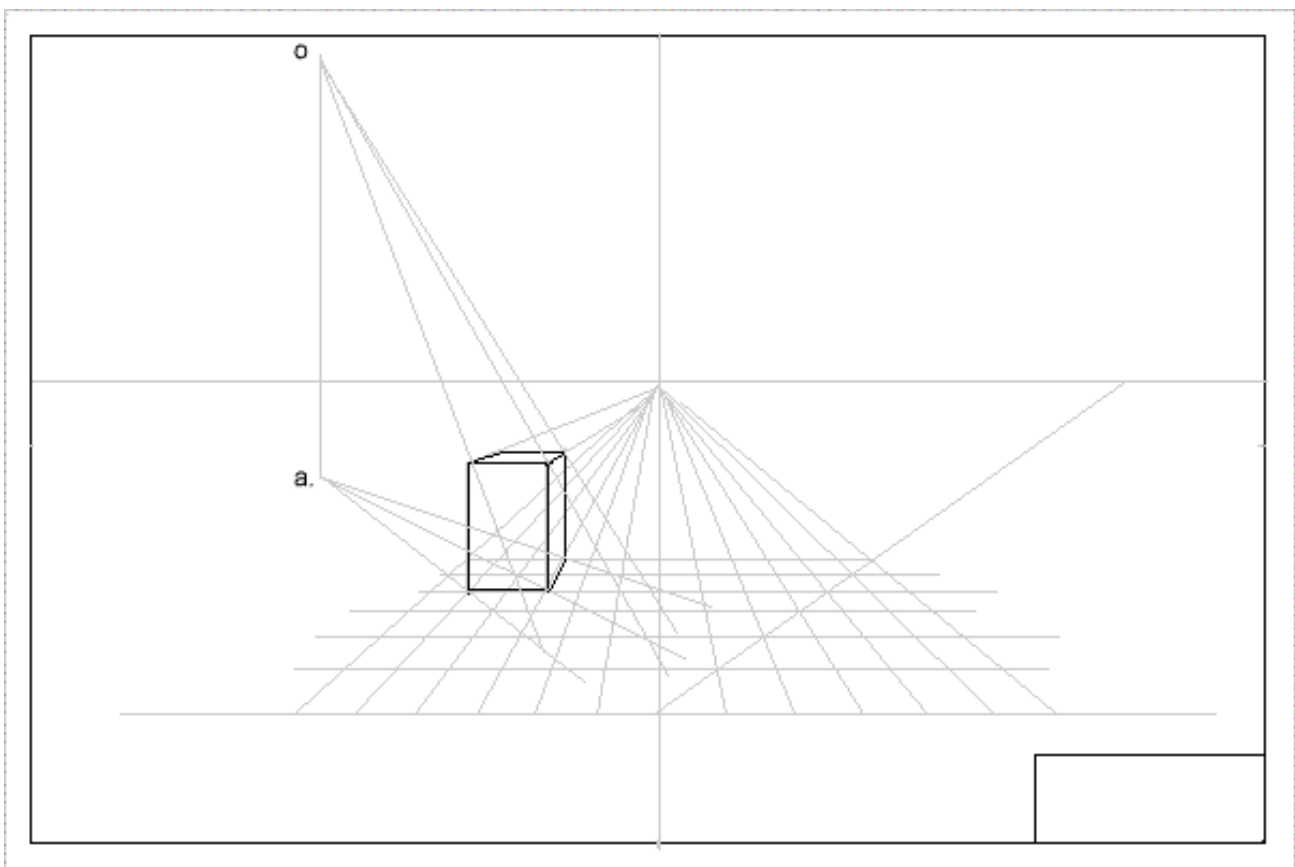

f) Draw light lines from 'O' and 'a' so they cross.

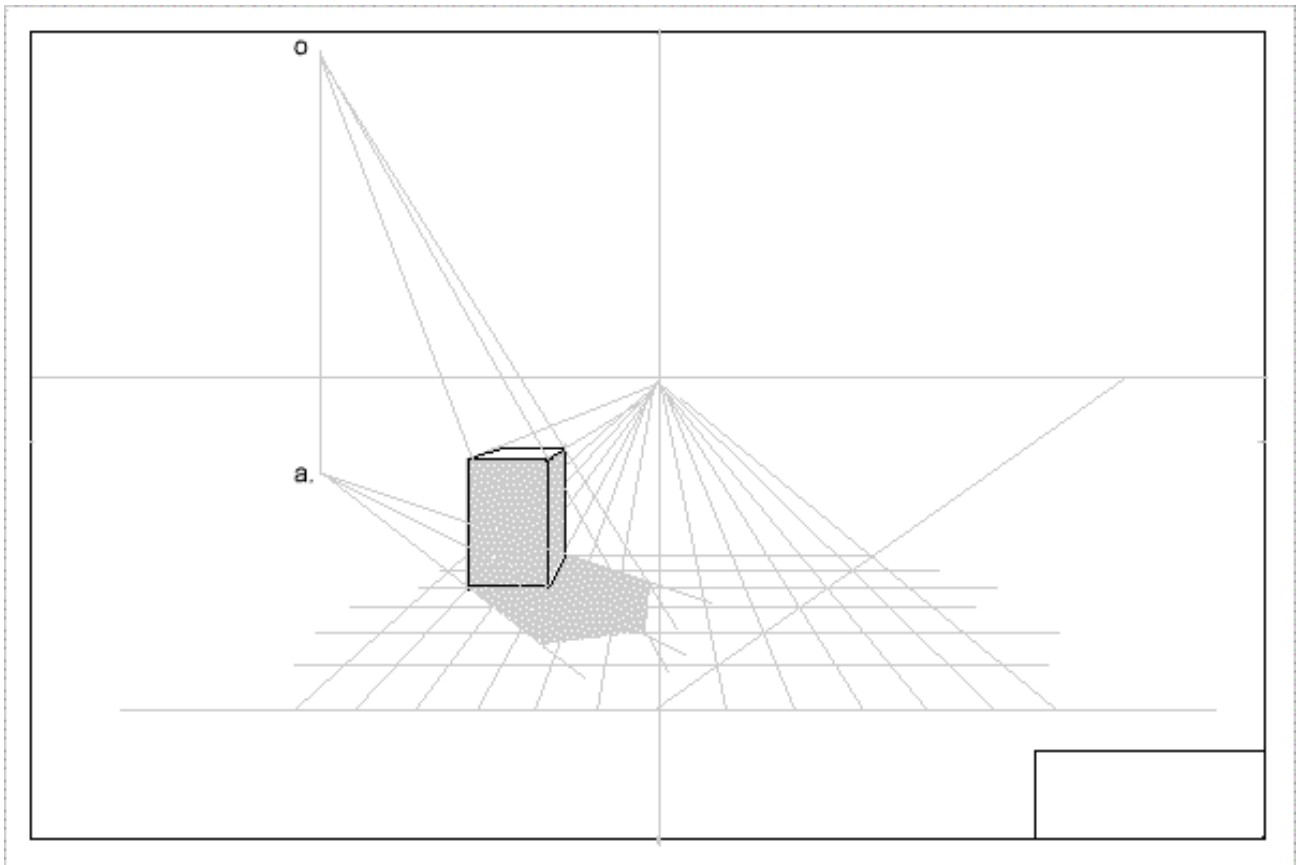

g) That gives us our shadow outline. Shade in as shown.

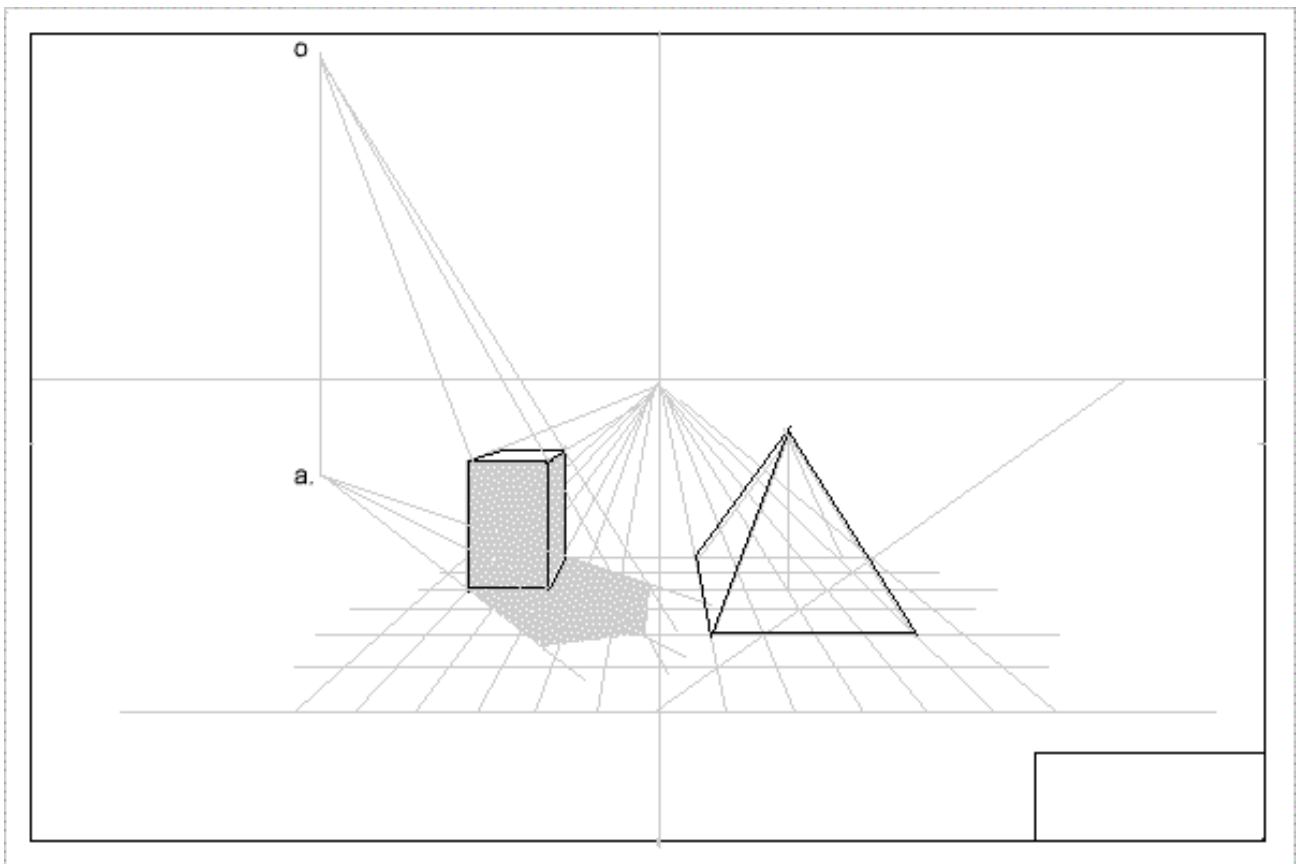

h) Using (4x4) 16 squares draw in the pyramid. The 'apex' is a point directly above the center of the base. Firm in the pyramid.

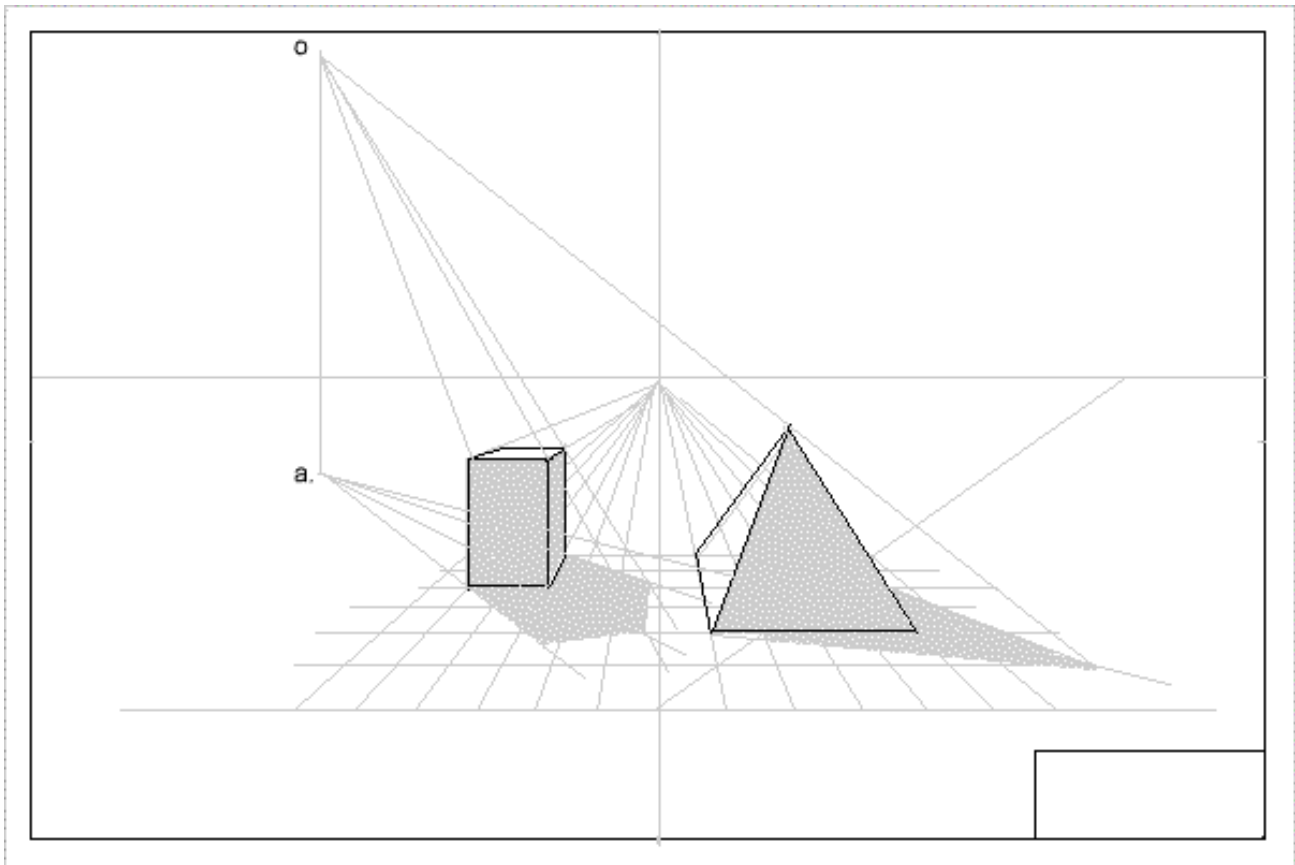

i) Construct and complete the shadow as shown and shade it in. The student should note that if point 'a' is brought forward the shadow will point backward.

Home study :

Experiment, try adding some other objects such as vertical poles and draw their shadows.



[GO TO ... LESSON NINE](#)

[lesson menu](#)



LESSON - PERSPECTIVE NINE - SHADOWS 2

TIME:

Allow 40 min

Aim:

To learn how to plot shadows on differing surfaces. Here we shall plot and draw the shadow of a ladder leaning against a wall.

Materials:

The sketch pad,
HB pencil, ruler.

To Begin revise: Method of introducing light source and estimating its ground position. Ask which way the shadow should be directed, forward or back.

Construct margin and title box on a new page then:

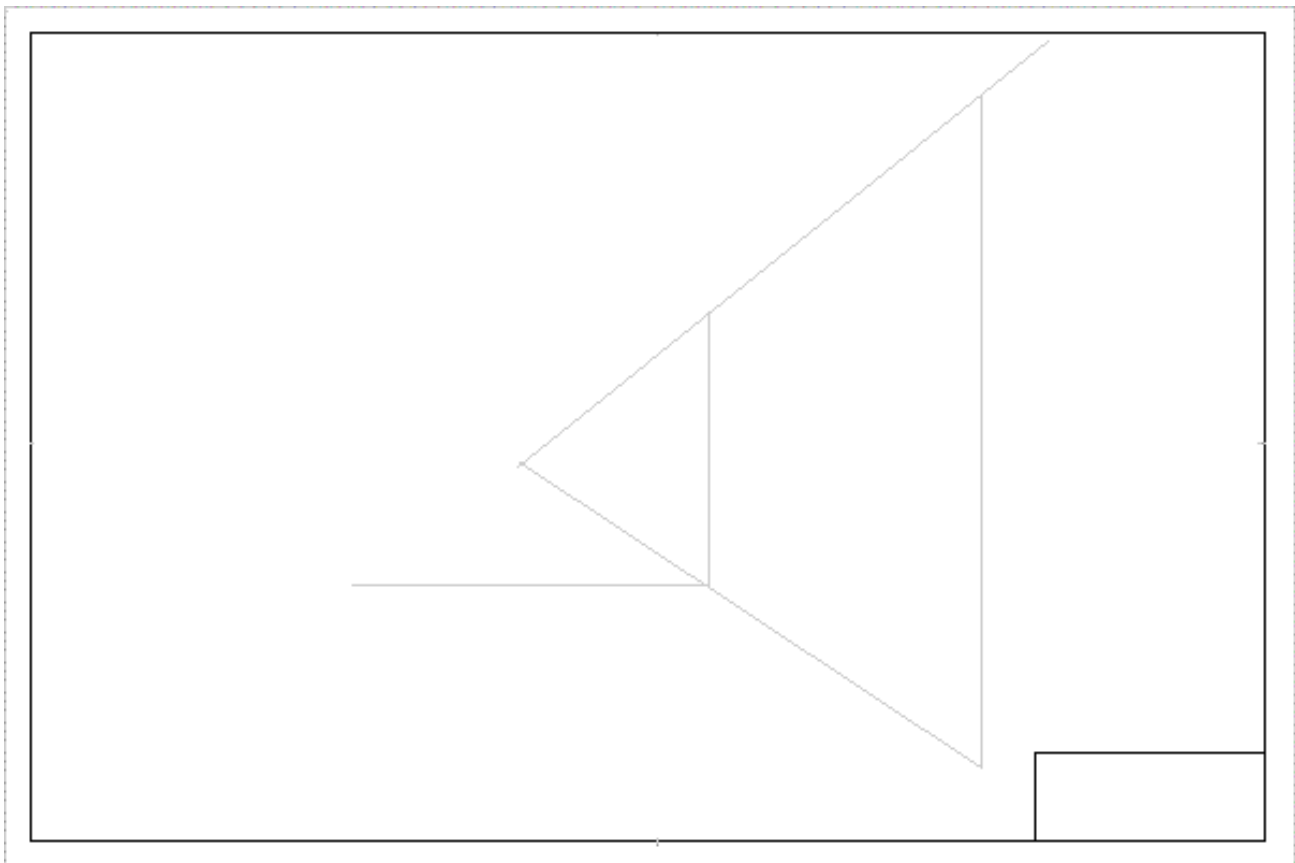

b) Construct the simple corner of a room using a CVP.

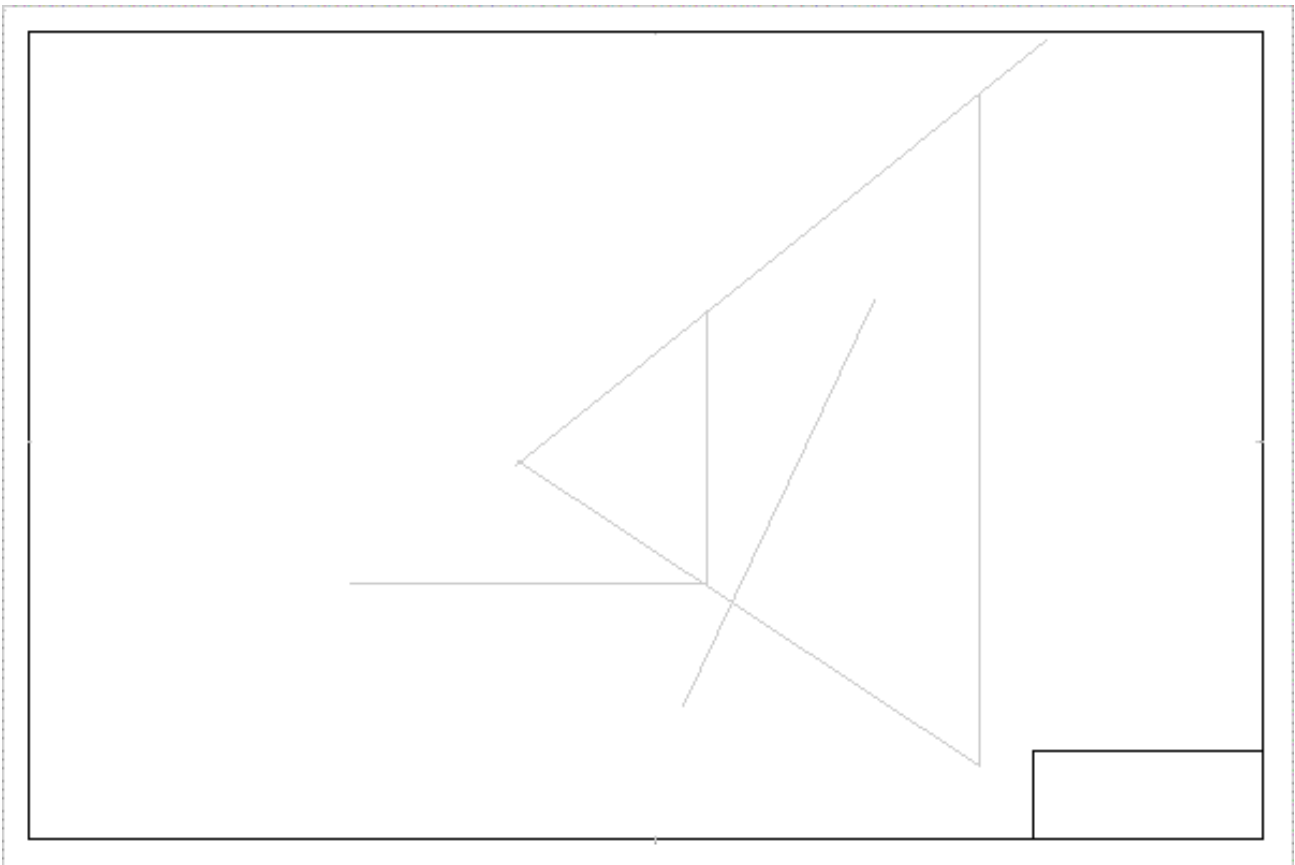

c) This 'oblique' line will represent one runner of the ladder. Call it 'ab'

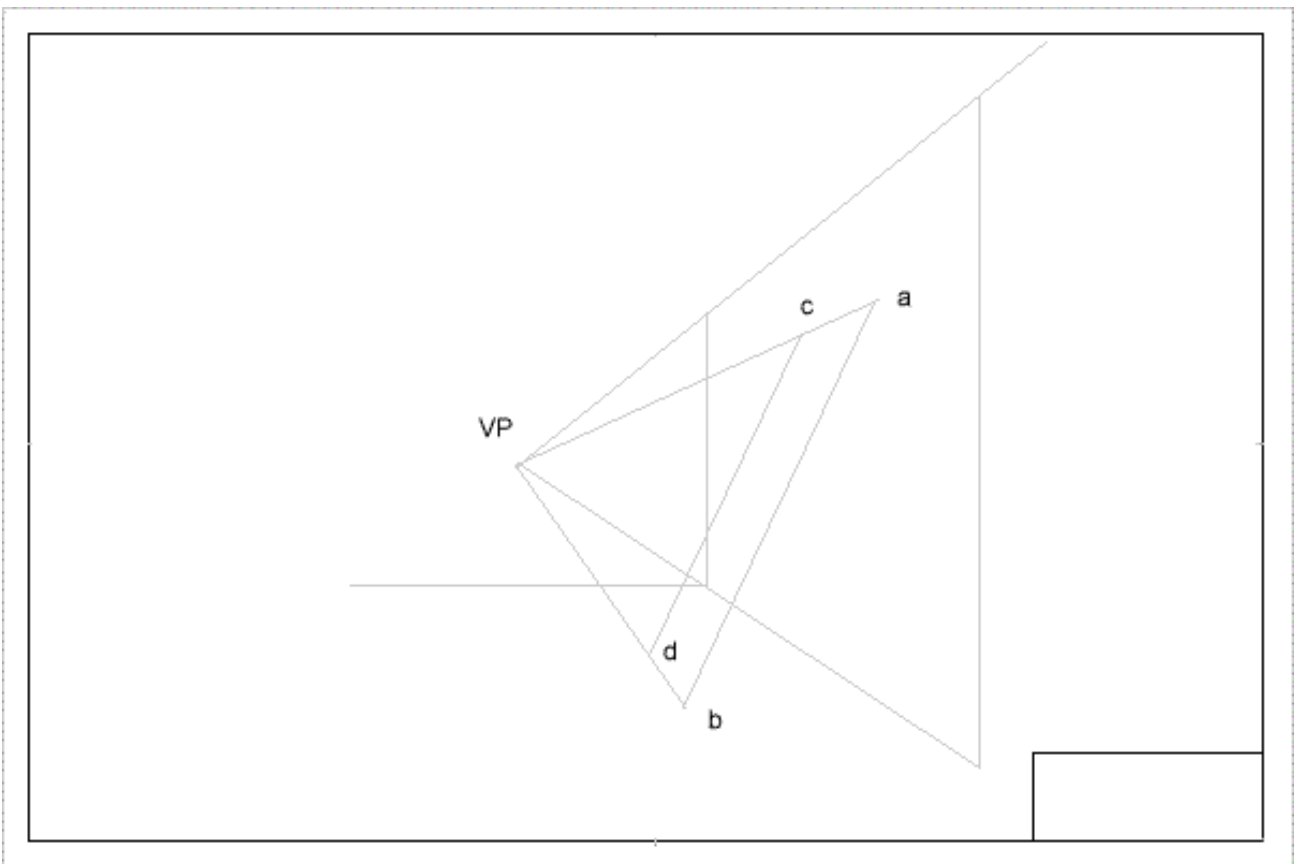

d) 'cd' is parallel to 'ab'. Construct as shown with lines to VP.

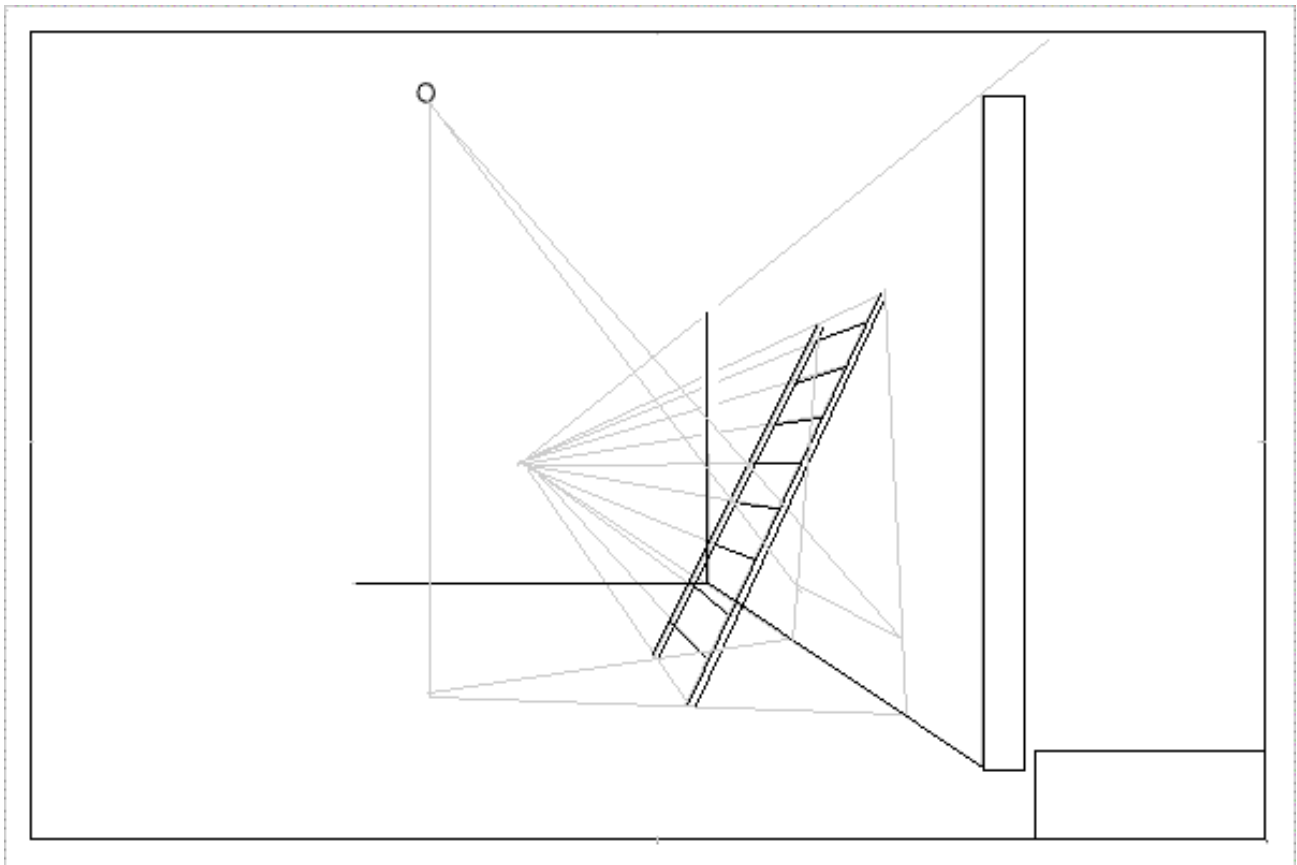

g) This diagram shows the method of constructing a shadow cast by one of the 'rungs.'

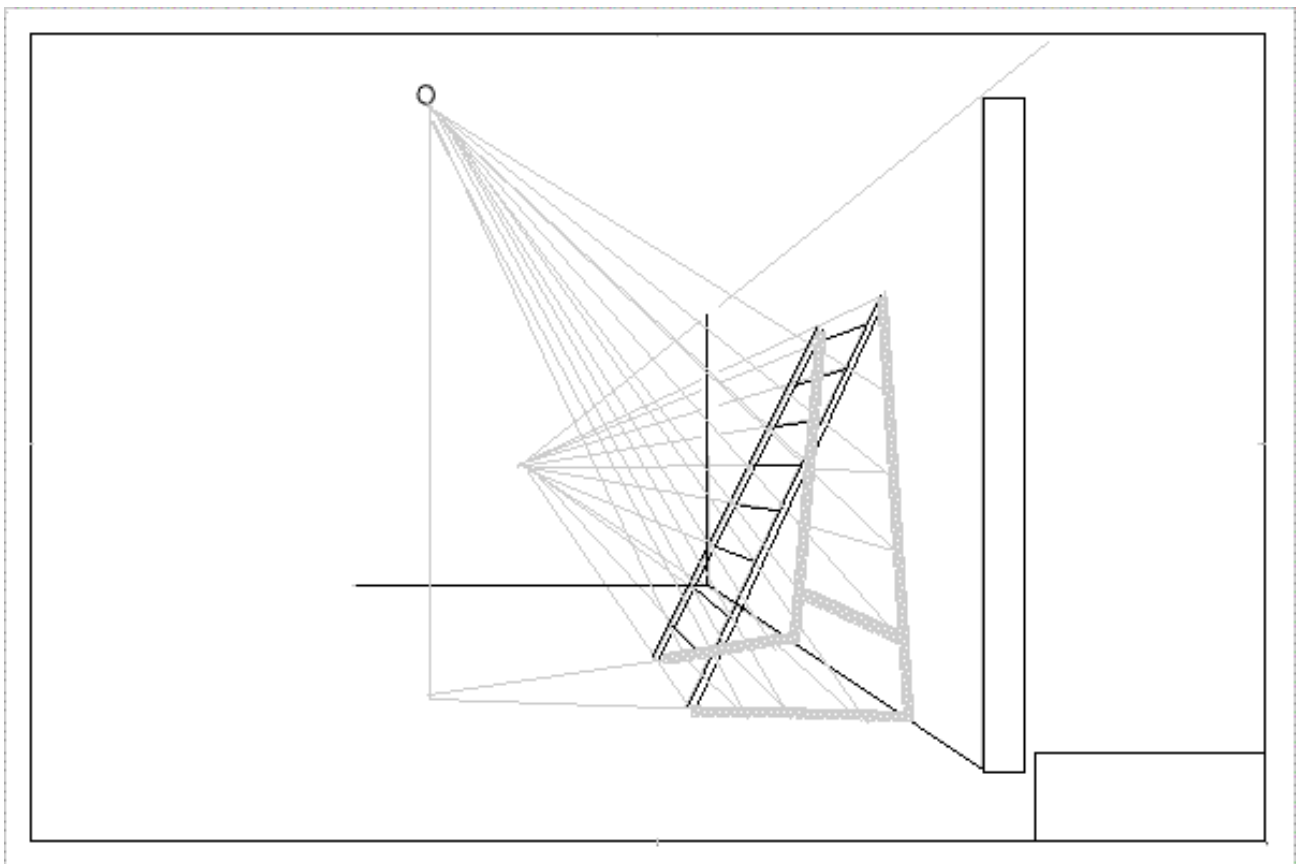

h) Shade in the shadow 'freehand' as shown.

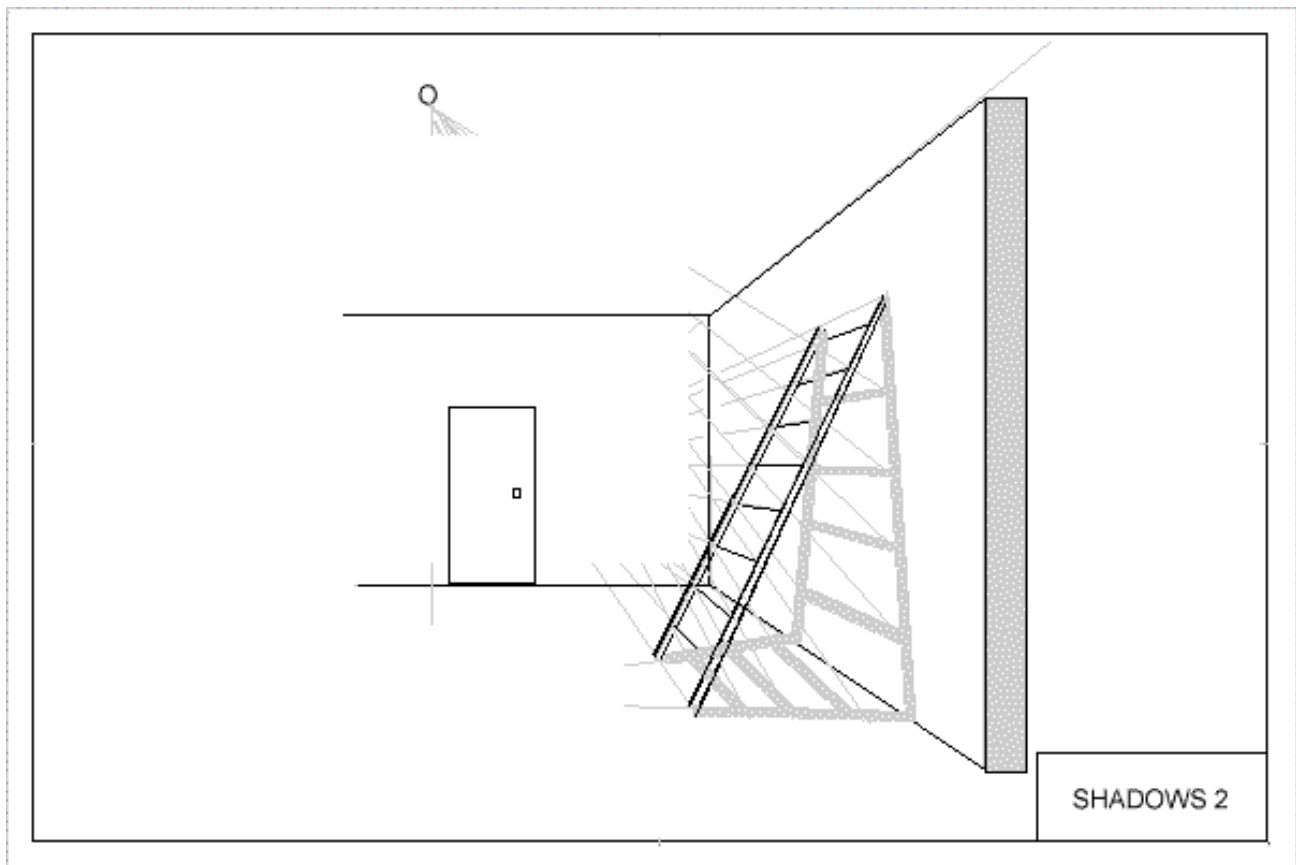

i) Complete the shadow and add other appropriate details

Home study :

Experiment, add other objects ... a bucket on the floor and its shadow.



[GO TO ... LESSON TEN](#)

[lesson menu](#)



LESSON - PERSPECTIVE TEN - ARCHWAY

TIME:

Allow 80 min - best broken into two sessions with set homework in between.

Aim:

To draw a Roman style triumphal arch utilising a freehand approach to drawing lines. This lessons eventual success will depend on the student eventually NOT drawing a straight line ... and thereby not being terrified of making a mistake.

Materials:

The sketch pad,
HB pencil, ruler.

Construct margin and title box on a new page then:

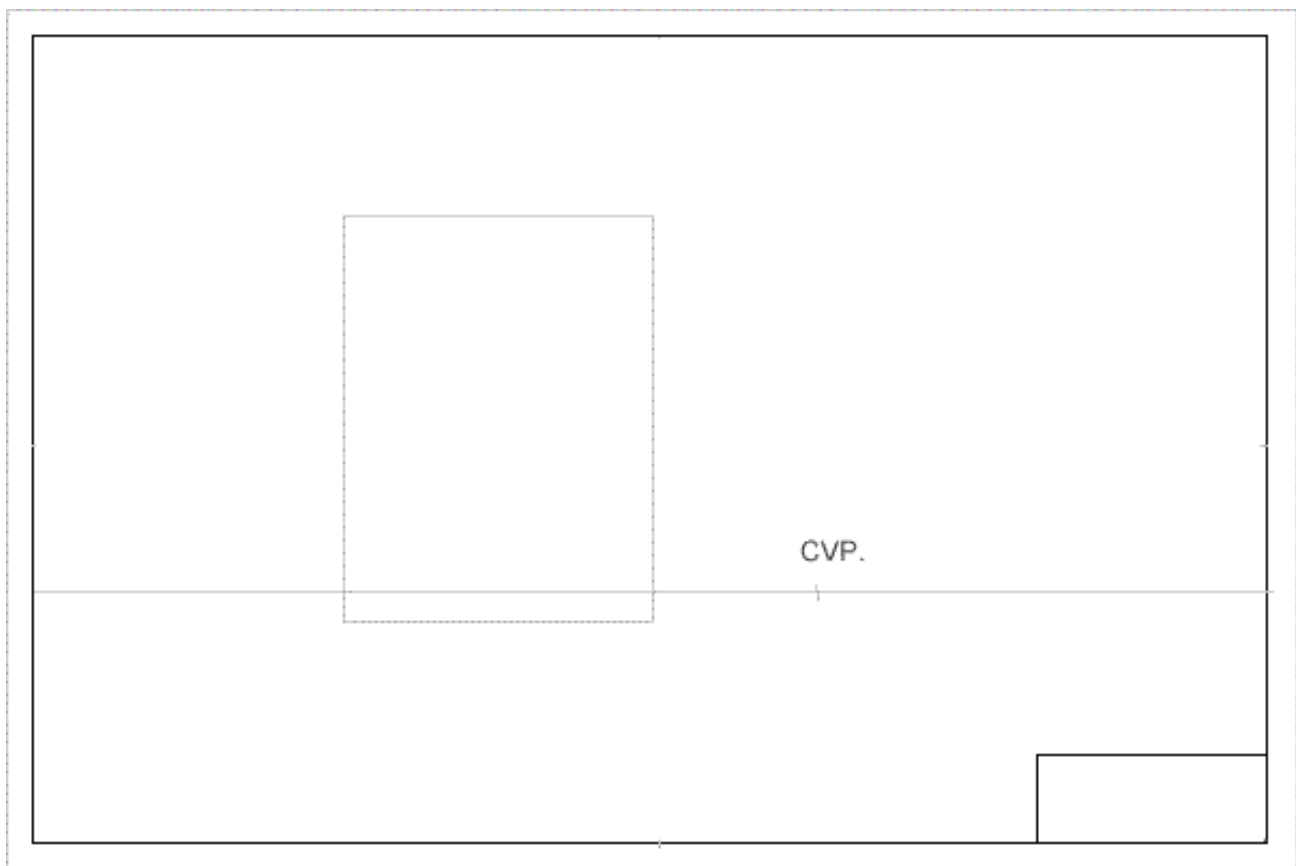

b) Construct the rectangle and place a CVP in the approximate positions shown above.

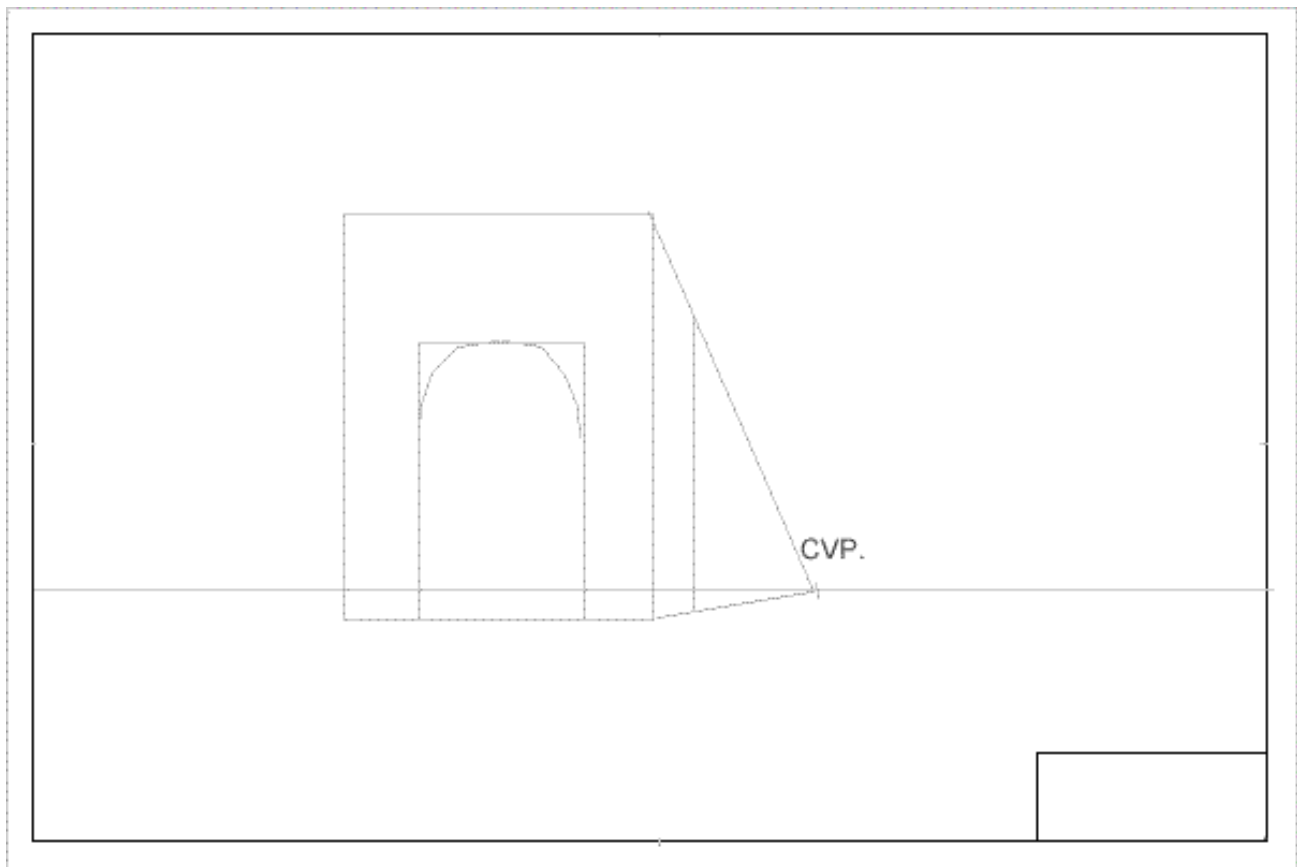

c) Lightly draw the arch with the proportions to approximate those above.

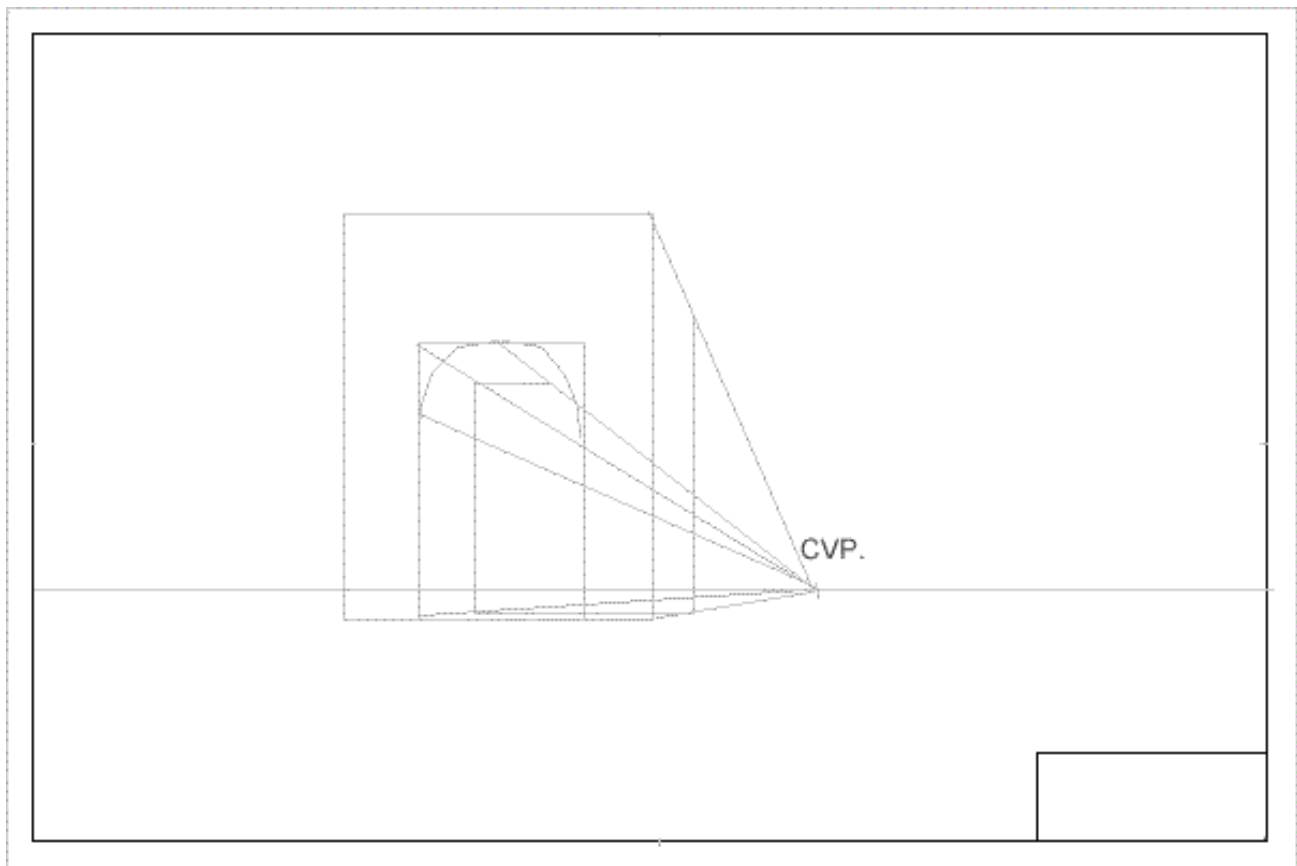

d) Note the method used to position the back (inside curve) of the arch. The intersection point with the front curve is critical.

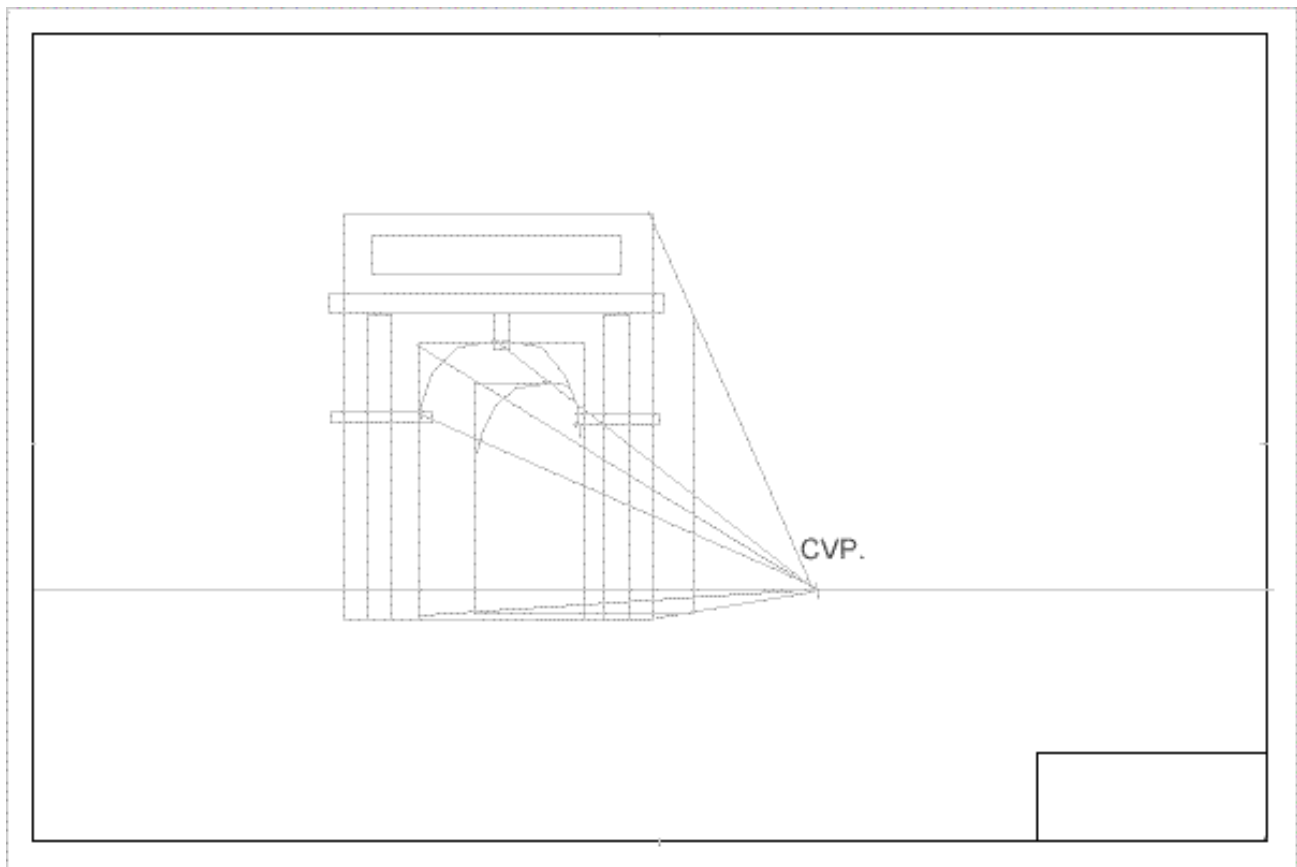

e) Add the 'minor' rectangles as shown on the face of the arch.

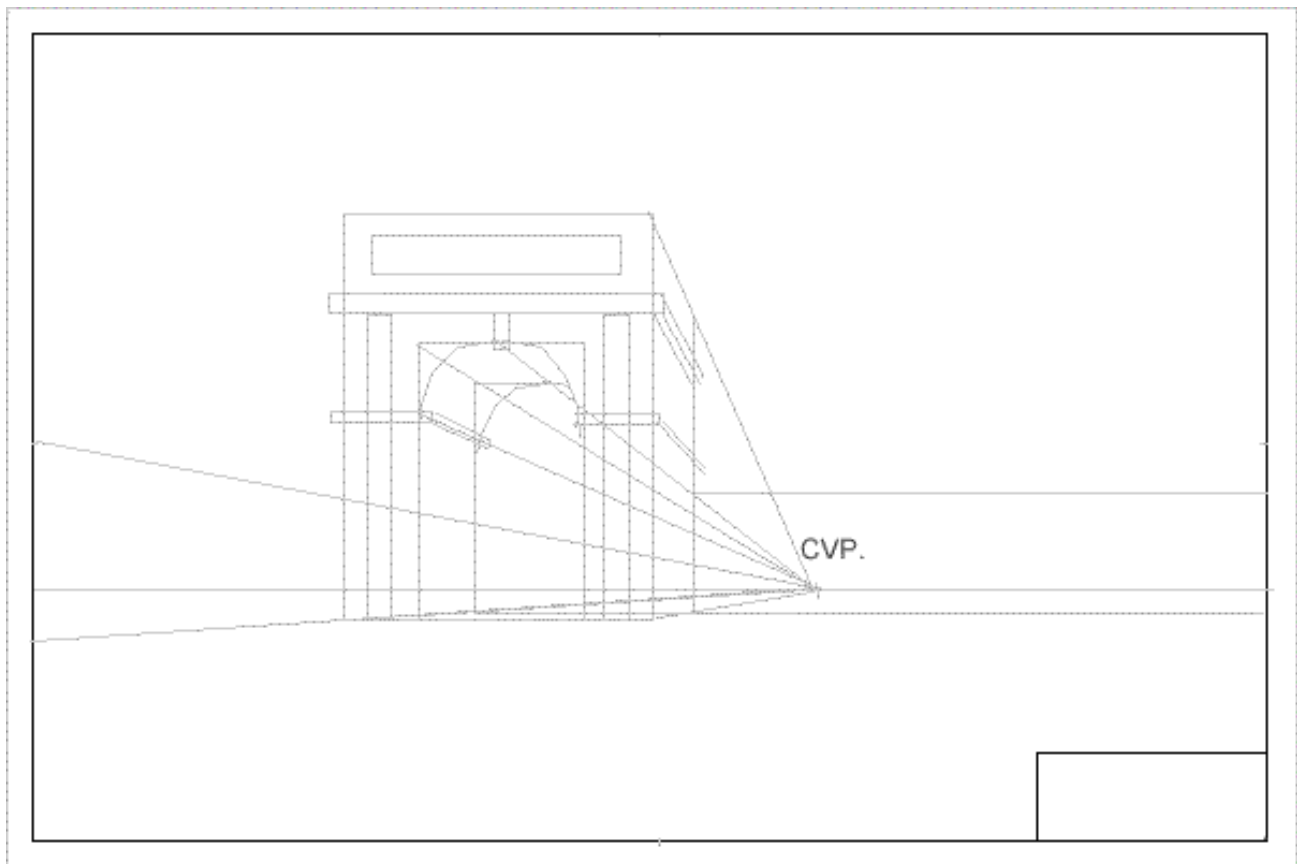

f) There are two walls indicated and lightly sketched in as above. You will see their complete form in the drawing shown next.

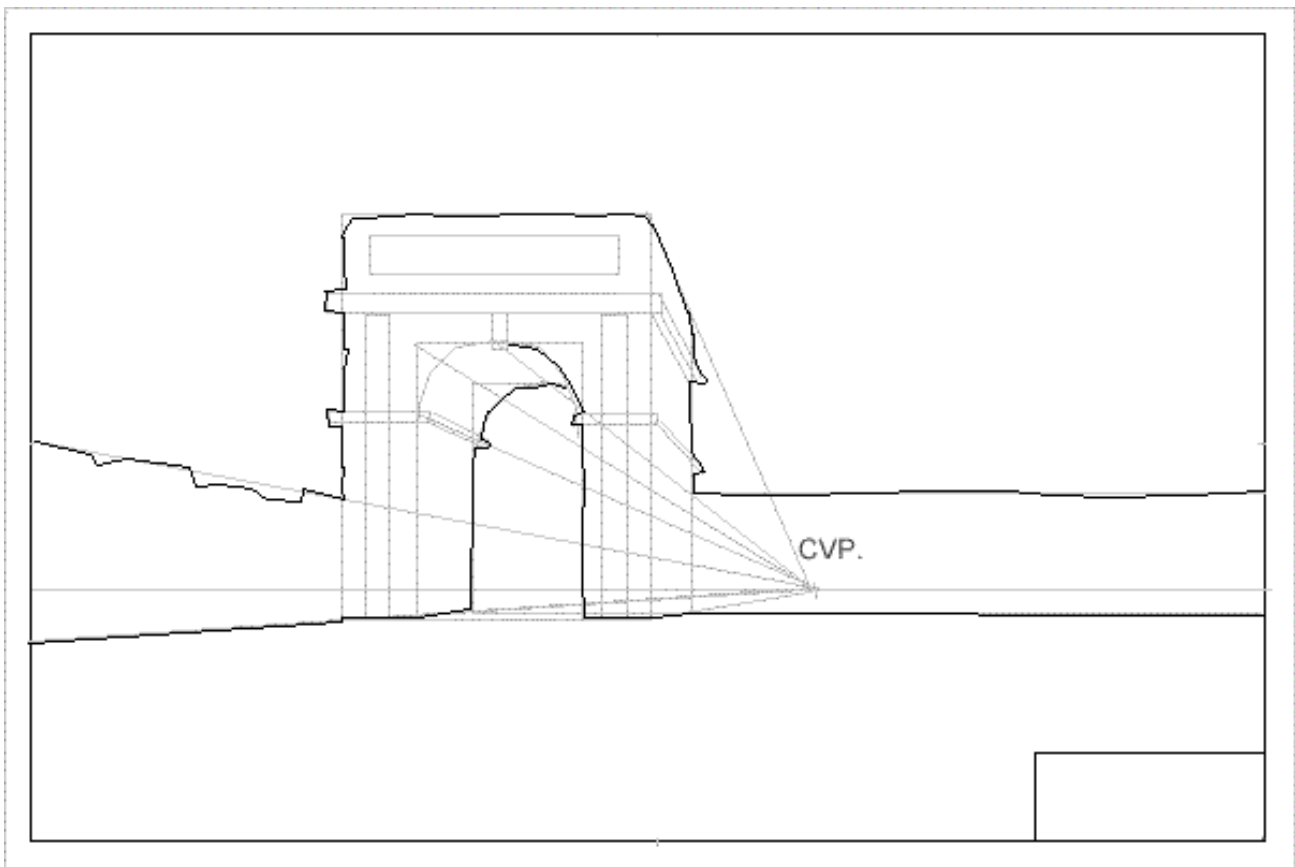

g) The student must now discard the ruler. All the firm lines must be done 'freehand'. Any ruled lines will look inconsistent and out of place. Use short firm strokes rather than trying to be too ambitious. This arch is supposed to be old and decaying therefore irregular lines are what is required. Now the arch and its surrounds should begin to take form.

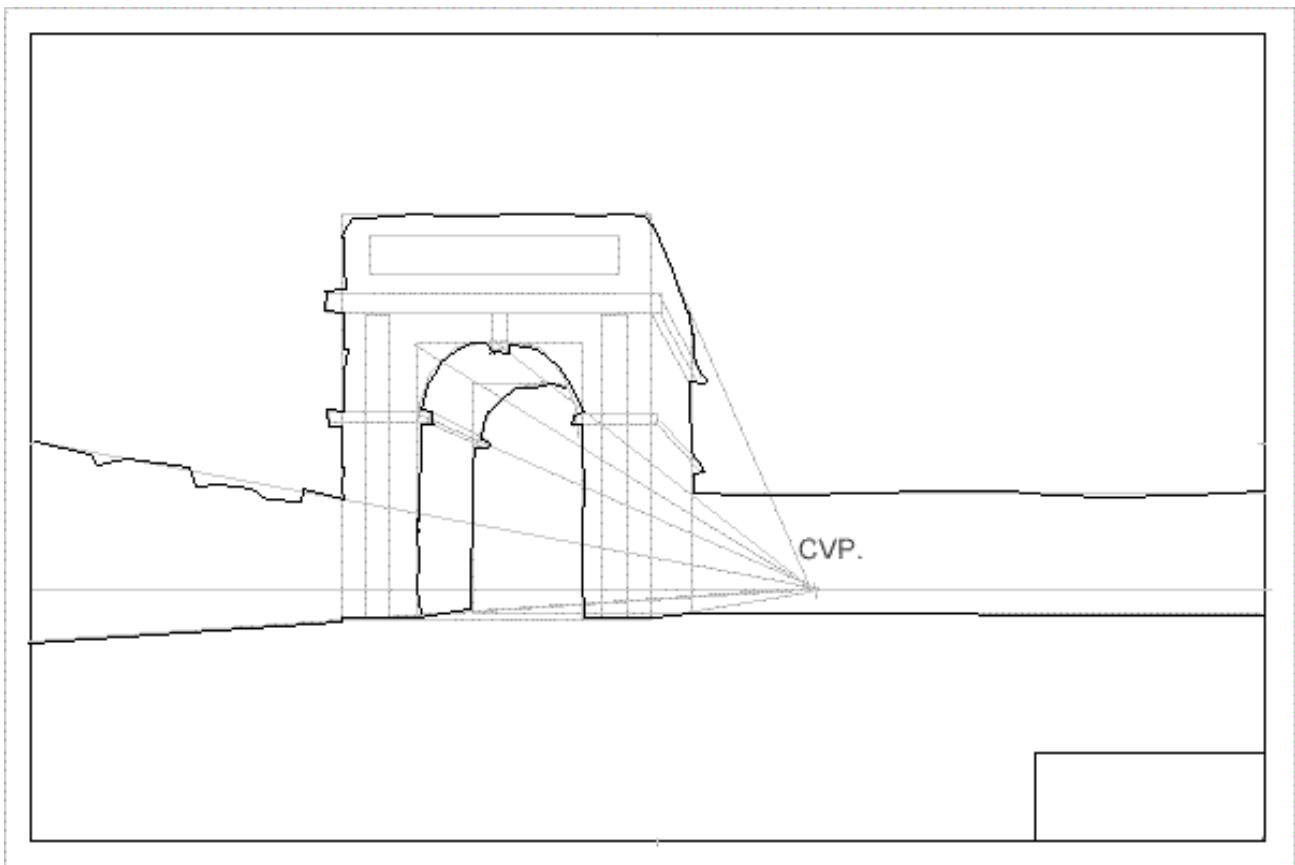

h) Clean it up and add some shading.

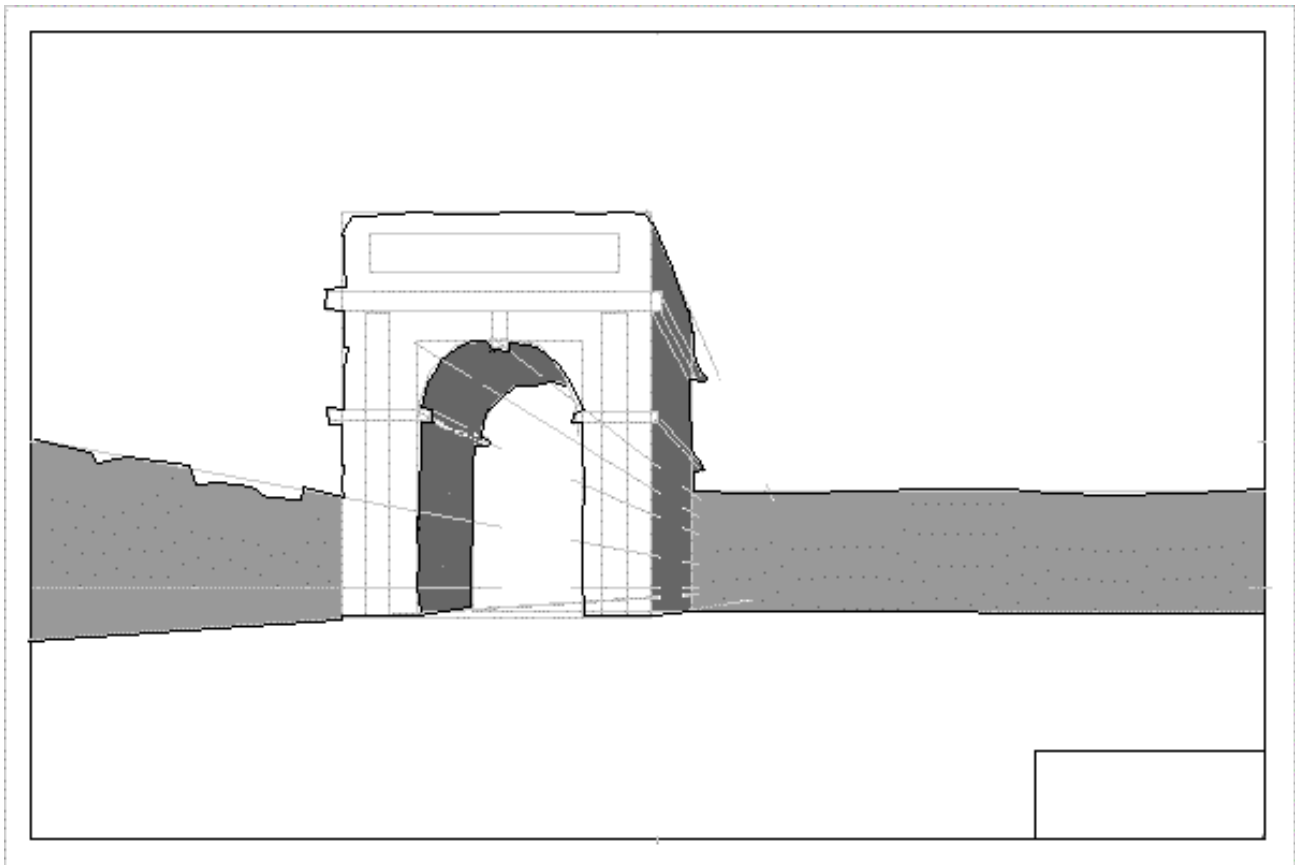

i) The light source is to be from 'top right' so shade the raised frontal areas on the arch as shown ... shading to the right and below.

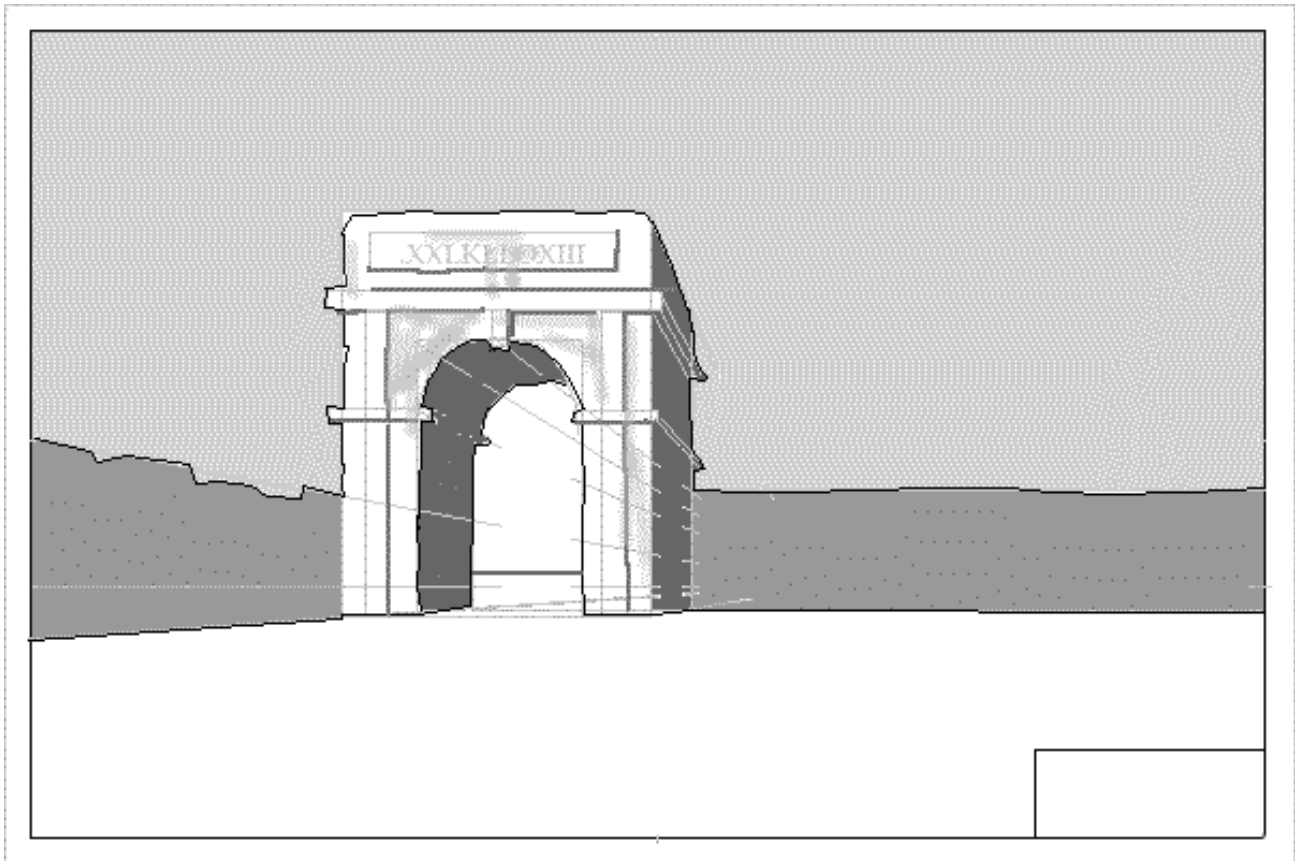

j) Add some 'Roman' letters (the detail is where observation and creativity interact) and shade some areas...

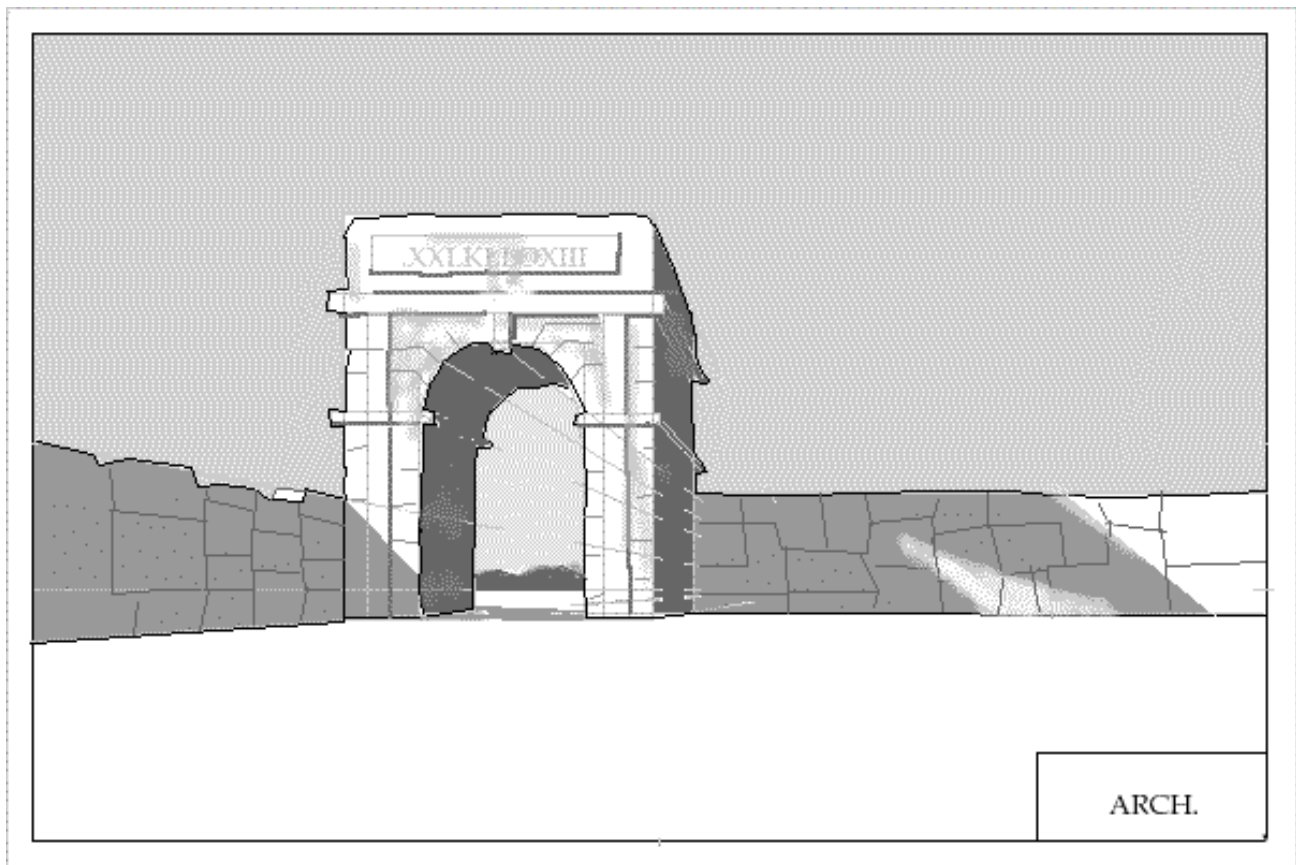

Note the shadows. At this juncture the shadows are merely 'parallel'. Since the drawing is not complicated regarding 'shadows' and the sun is very high and distant we can assume an almost parallel set of light 'rays'.

Homework: This particular arch is a minor detail in a painting by a well known artist who was born in Venice on October 18th. 1697. It appears in at least two of his paintings. The student to gain extra marks for naming the artist and even more for naming one of the paintings that contain the arch. Additional marks could be awarded if the student were to name the origin of the arch.

CONTINUED...



[GO TO ... LESSON TEN \(CONT.\)](#)

[lesson menu](#)



LESSON - TEN ... CONTINUED

Aim: To reinforce the notion of 'logical size'. The size of objects being determined by introducing a familiar object at the same 'level' (a similar distance from the viewer). Then to complete the drawing started in the previous lesson.

The teacher should print off the following three drawings and hand them out as reference drawings.



a) Here I have introduced 'the admiral' and put him in the arch. Suddenly the arch has a particular and definite size. Ask the students, why is that?

From the moment a baby opens its eyes it begins keying-in shapes, with one of the first being the human face and body. Then it learns to recognise various other shapes in order of their importance. The child also learns to judge how far or how close is a particular object. Ask the class how this is done?

You could mention that these common perceptions are what bind people together. There are, of course philosophical implications here concernig the commonality of experience ... but that is what drawing is all about!

Anyway, in the order of things human the body is a far more dominant form than any old archway.

This body of our 'Admiral Cowdisley Shovel' determines the size of the arch (how high is it here?) as we all know the average height of the human body, but, what if we shrink the poor old sailor?

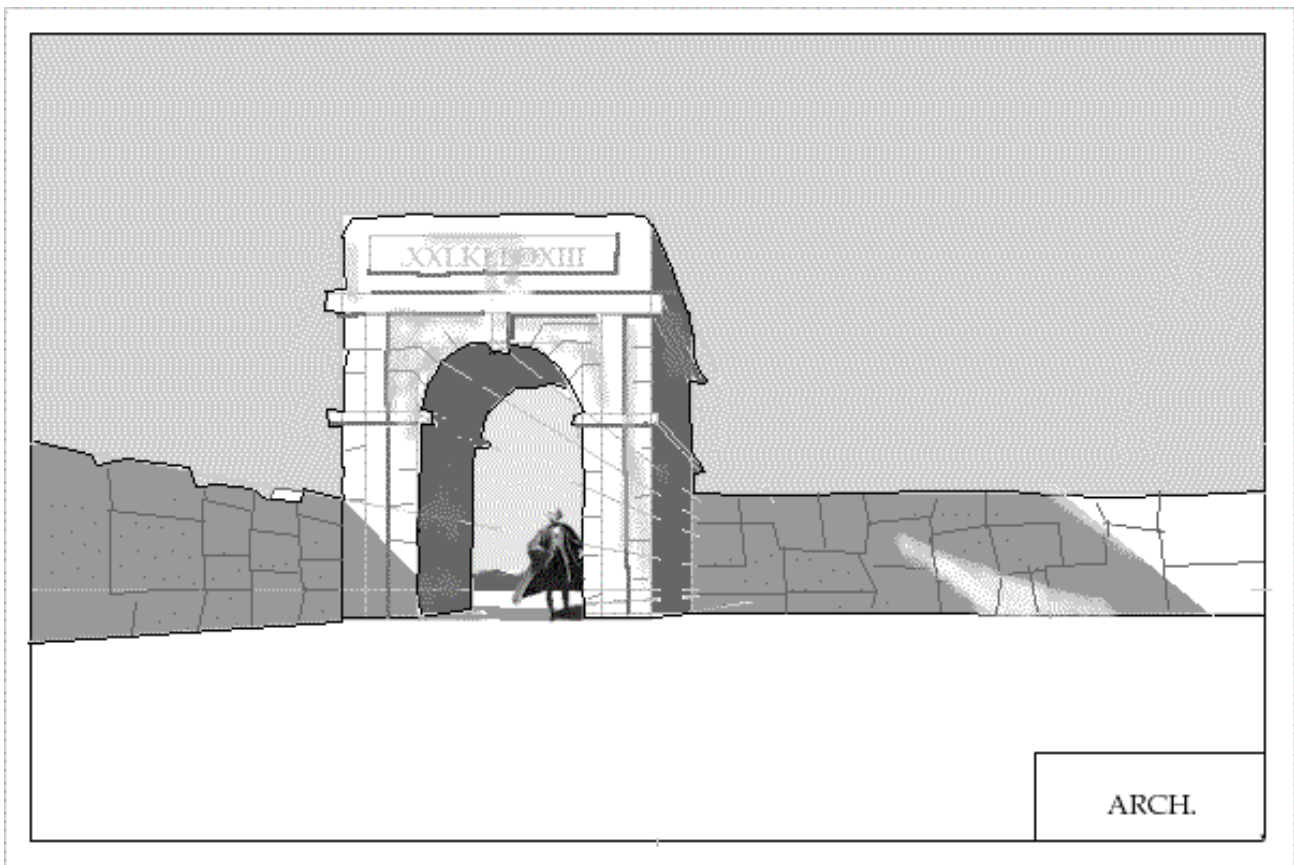

b) Suddenly the arch has grown. How tall is it now?



c) OK so now I have multiplied the figures and drawn them forward. If we roughly draw lines through the Admiral's head and feet where would they meet?
It the person viewing this scene shorter or taller than the 'Admiral'?

Let's go back to our unfinished drawing.

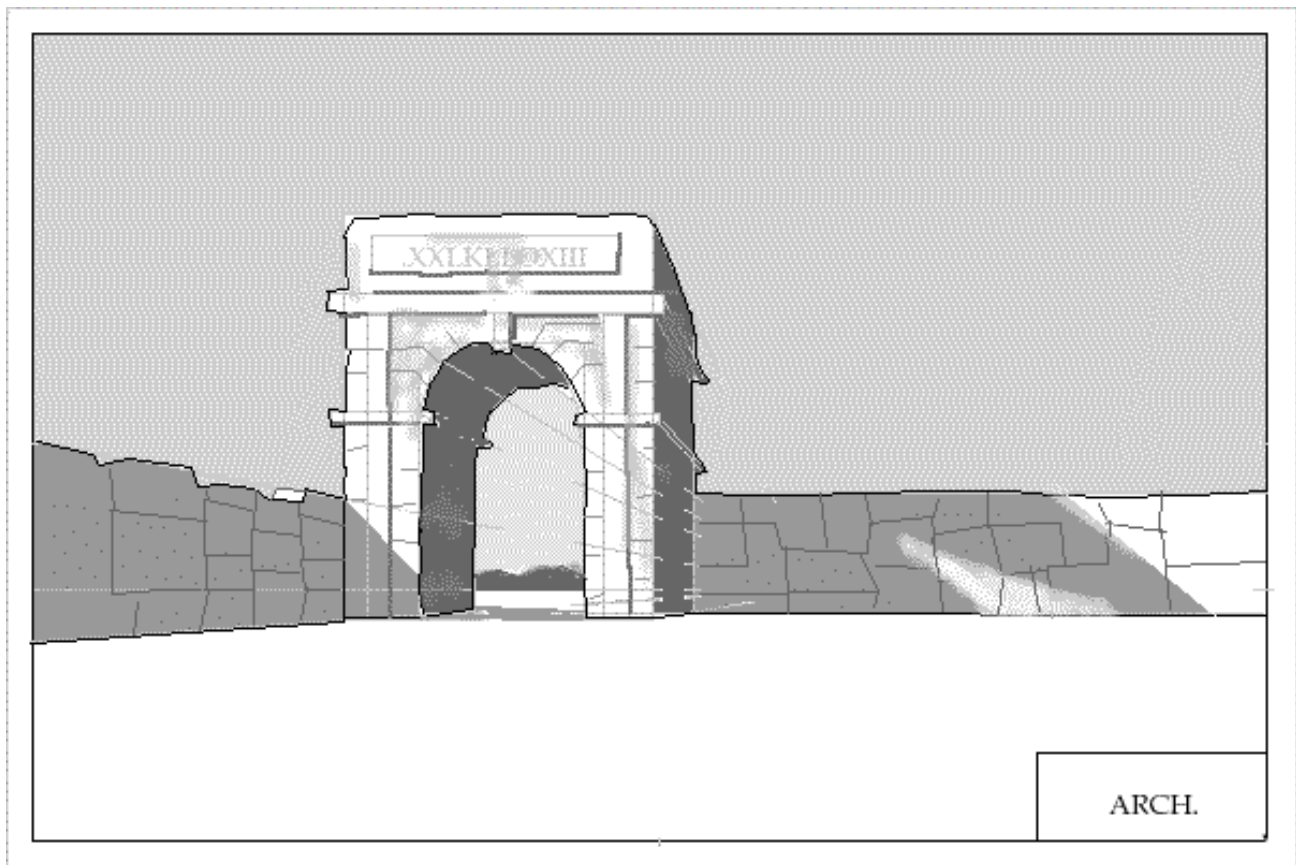

d) Note the detail lines suggesting the blockwork on the arch radiate out from the curve of the arc and then square. This is a tiny detail but one born of awareness. Ask the pupil about laying bricks that will form an arch, or the color of their front gate, or the size of a normal teacup. Test their awareness to common things and ask them to test you.

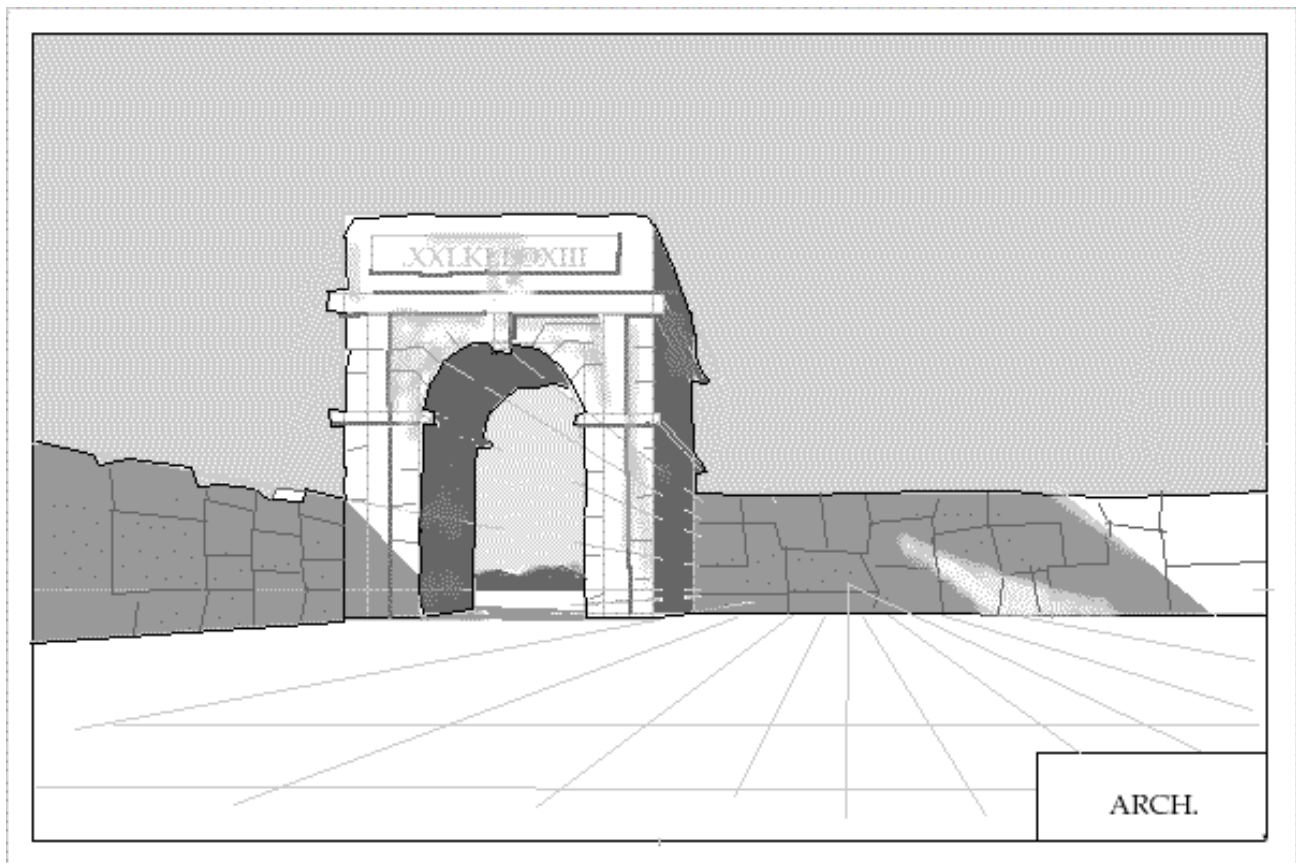

e) Using method in previous construct perspective 'grid' on the ground. Remember the firm lines are to be done freehand.

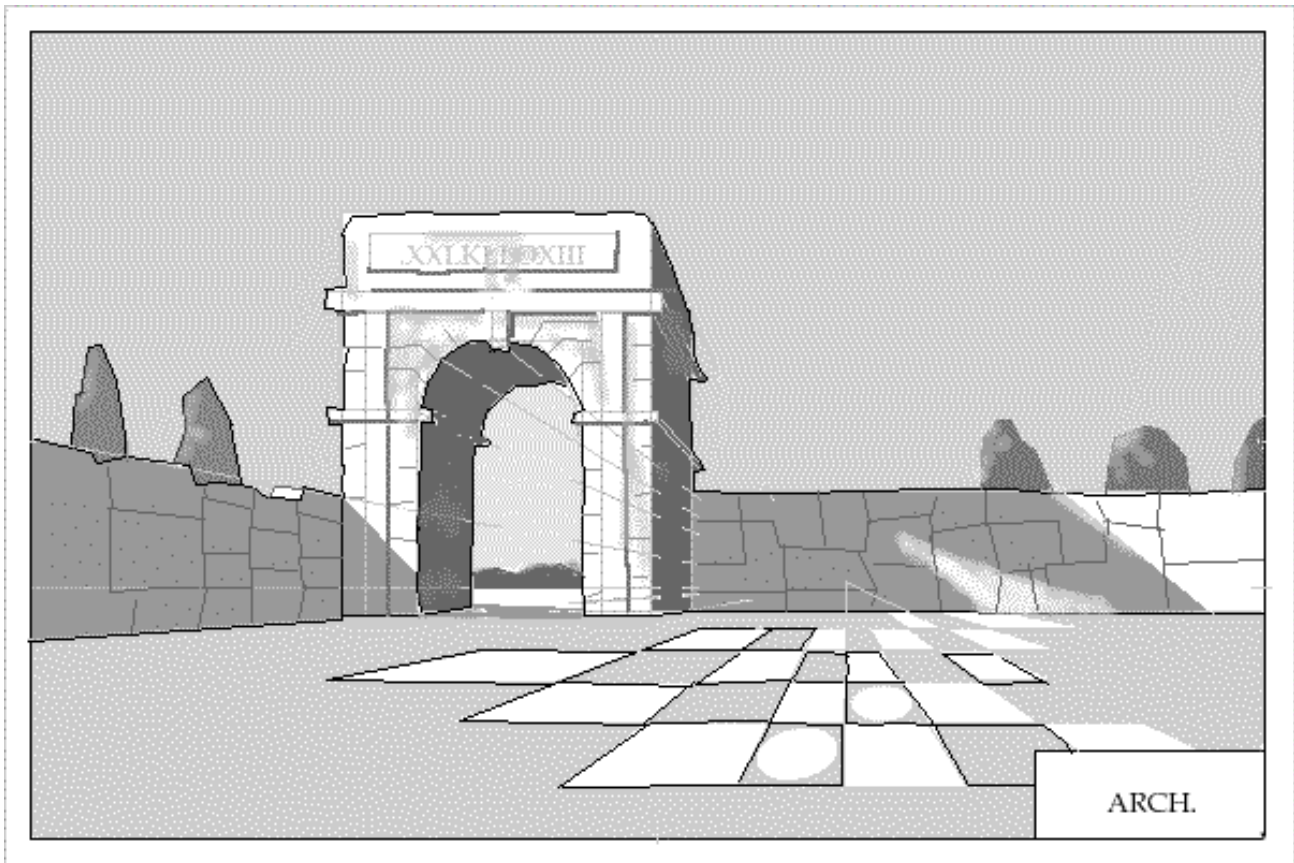

f) The pupil should be encouraged to decide on the design of the forecourt and individualise it as much as possible. Add some trees behind the wall to soften the starkness.

HOMEWORK: Complete the drawing by adding a small figure in the arch.



[GO TO ... THE ROAD - ELEVEN](#)

[lesson menu](#)



LESSON - PERSPECTIVE ELEVEN - ROAD

TIME:

Allow 40 min (TEN MIN INTRODUCTION)

Aim:

To understand the principle of multiple vanishing points and how they work in nature.

Materials: The sketch pad, HB pencil, ruler.

In this, the first part of this lesson the teacher will need to demonstrate the following on the chalkboard or pad ...

Alternatively, if the teacher deems necessary, these first six explanatory diagrams can be printed and handed out. However a quick demonstration on a chalkboard will give **everyone** confidence. The teacher could do this with just ten minutes of preparation ... OK, I know your time is valuable, and I must admit, I never prepared a lesson in my life. I just did it by sensing the needs of the student and seeing where that might lead ...

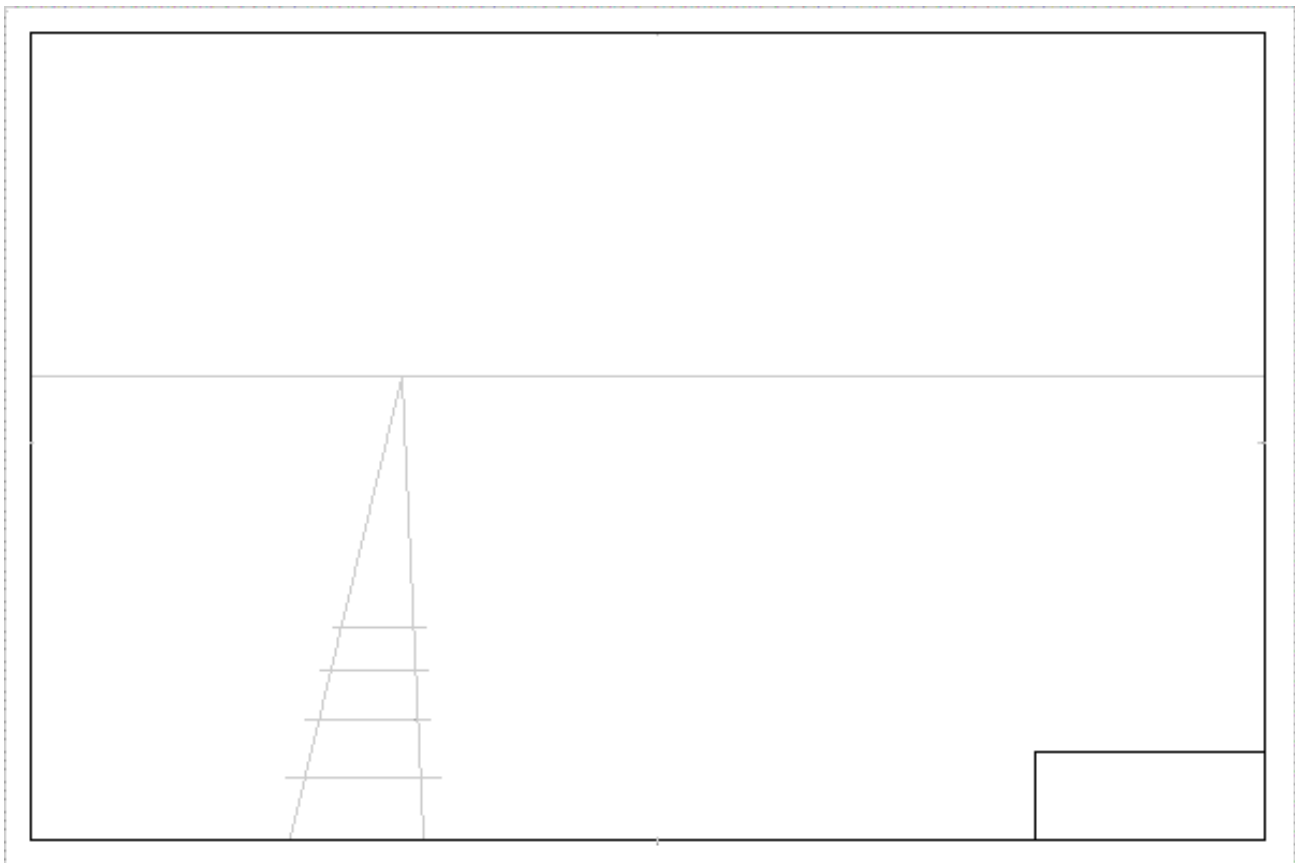

... in a classroom of thirty odd students that is called living on the edge. But then again I am easily bored; anyway, remember our railway line in a previous lesson?

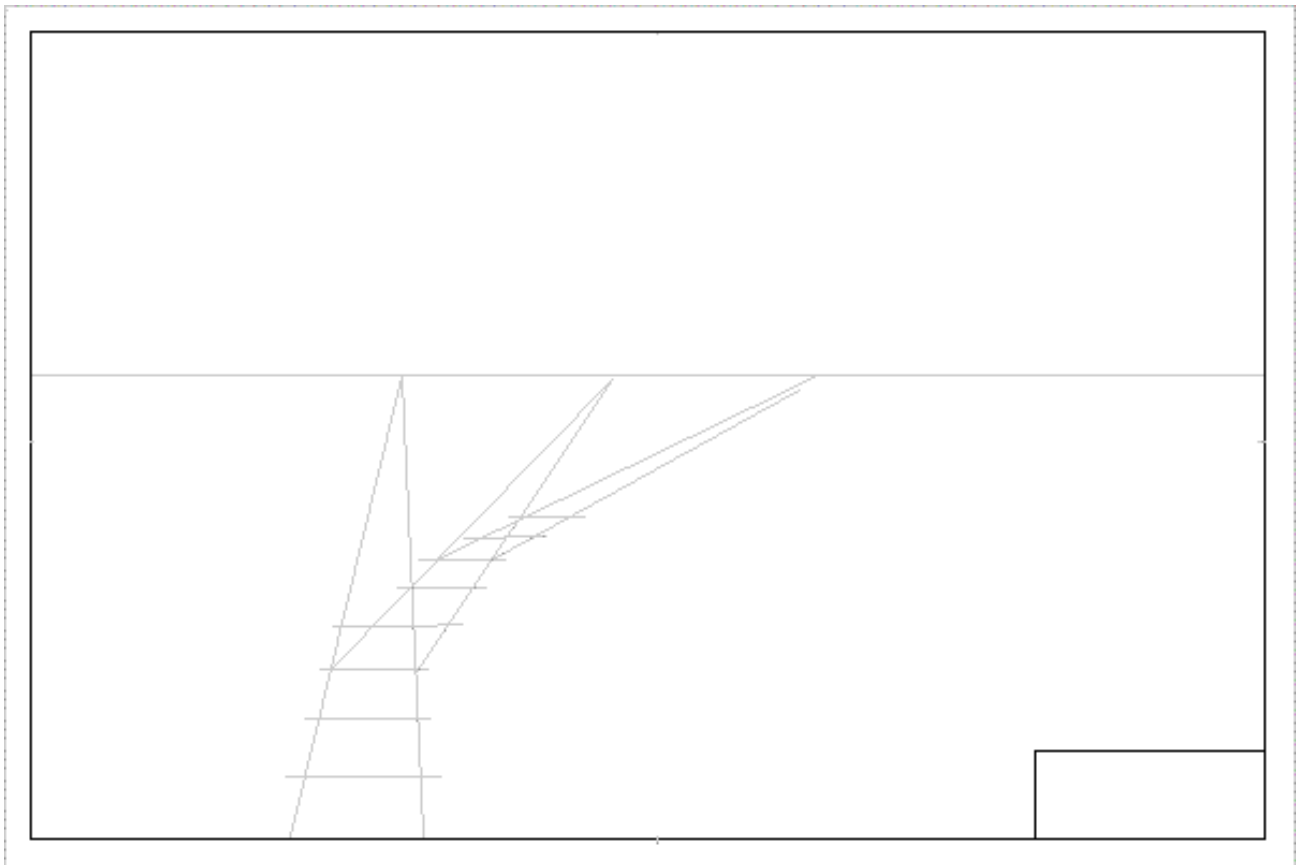

Move the vanishing point along the horizon line to the right as above. Just use common judgement to place the sleepers ... as you might do in any grammar class.

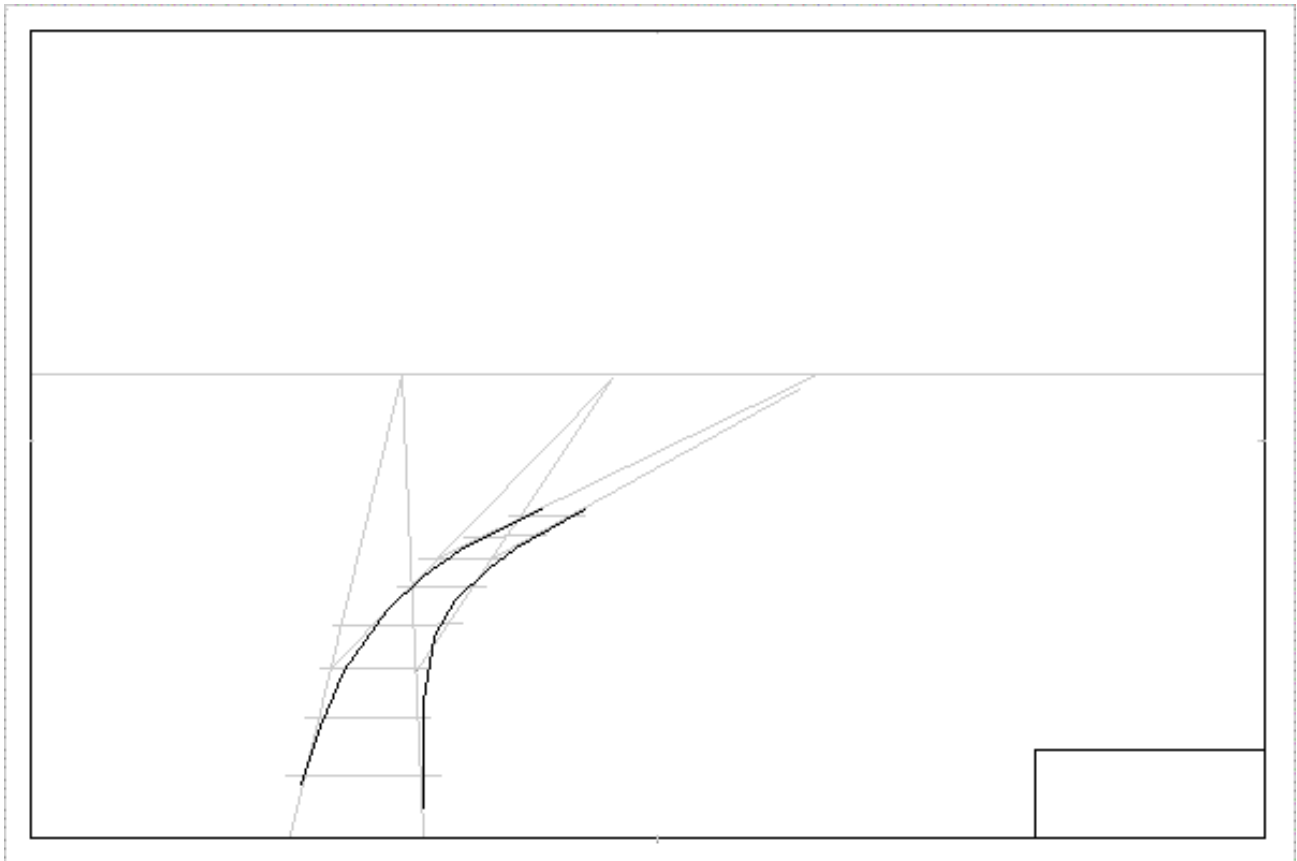

Of course, as the line bends, it does with a 'curve'. Draw in the freehand curve as shown.

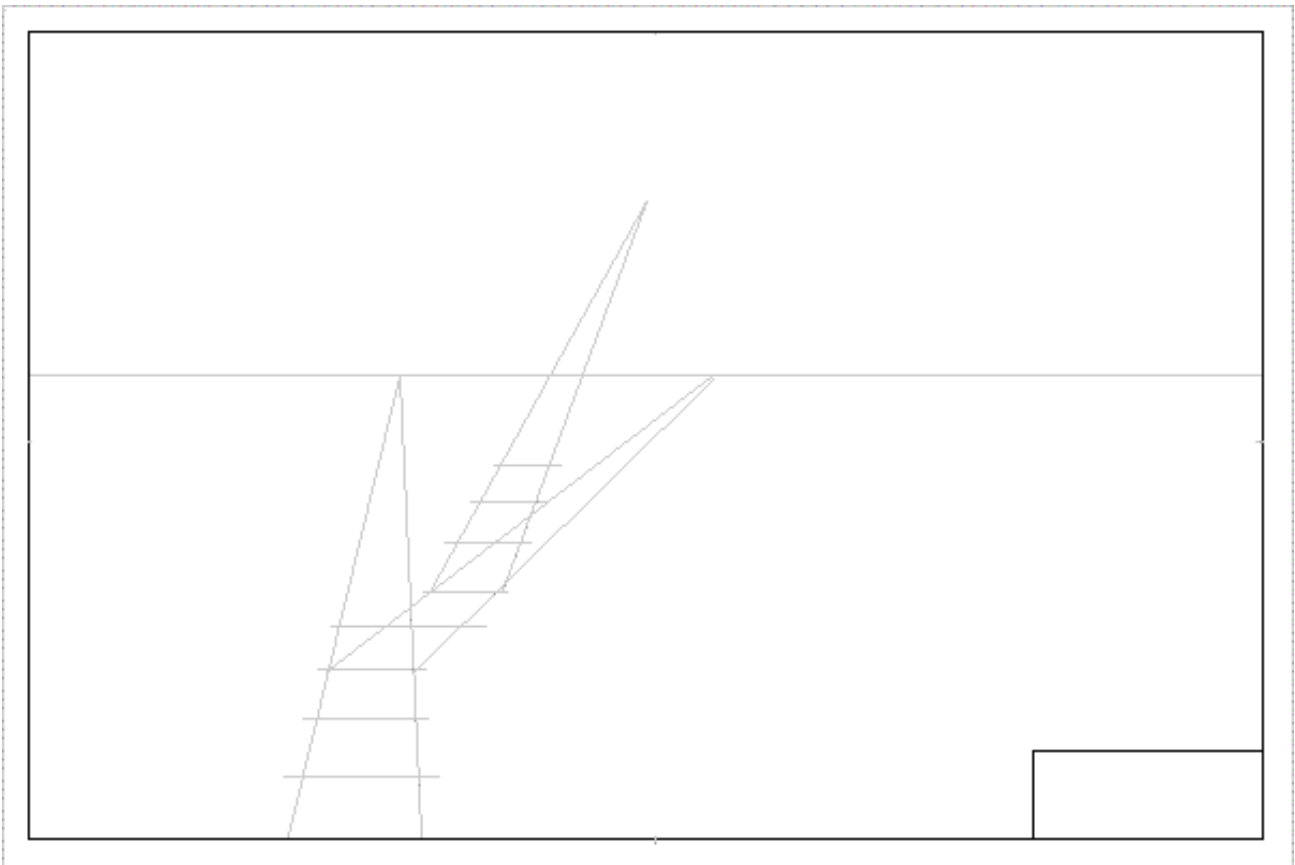

Next, we find a vanishing point 'above' the horizon! This will have the effect of making the line appear to rise up. See above.

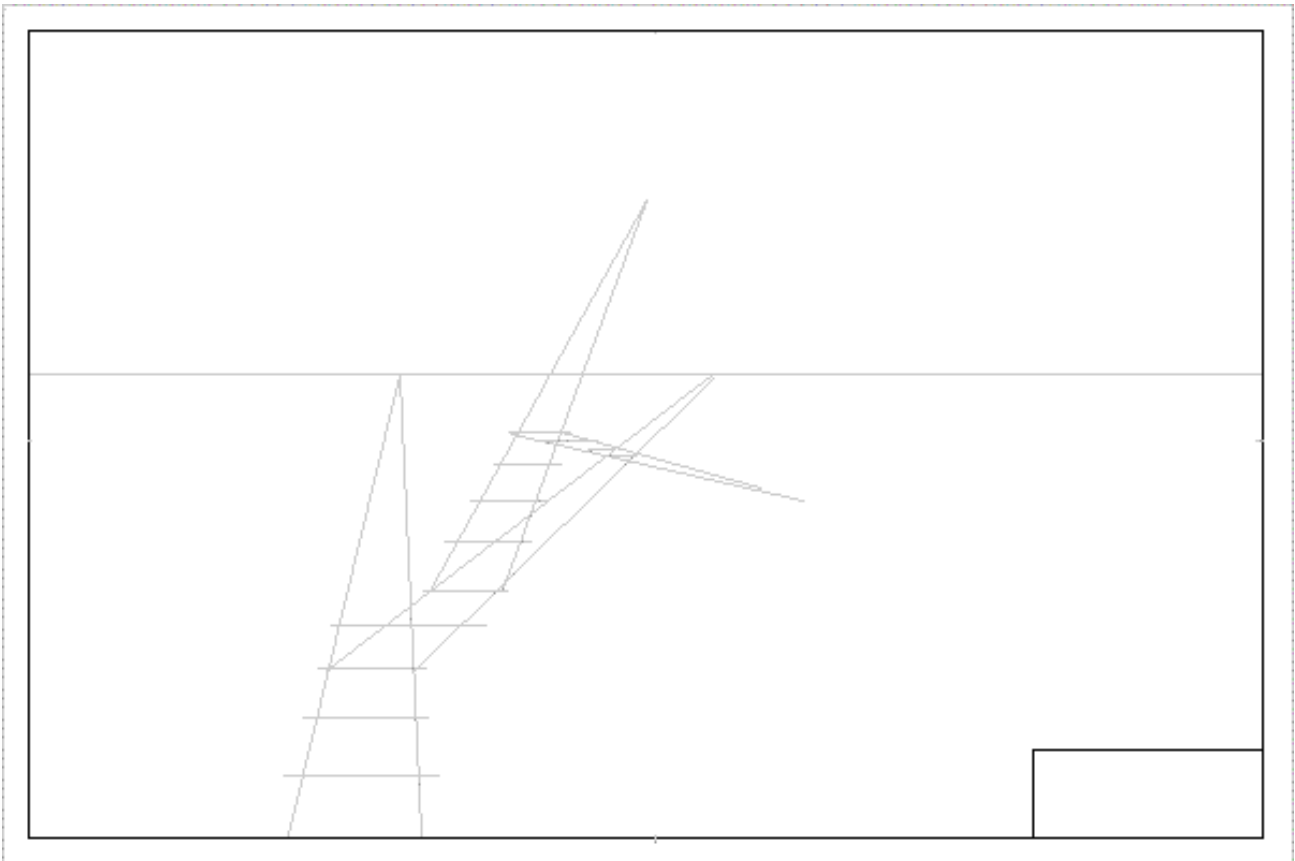

Then go down again ... with a vanishing point now below the line.

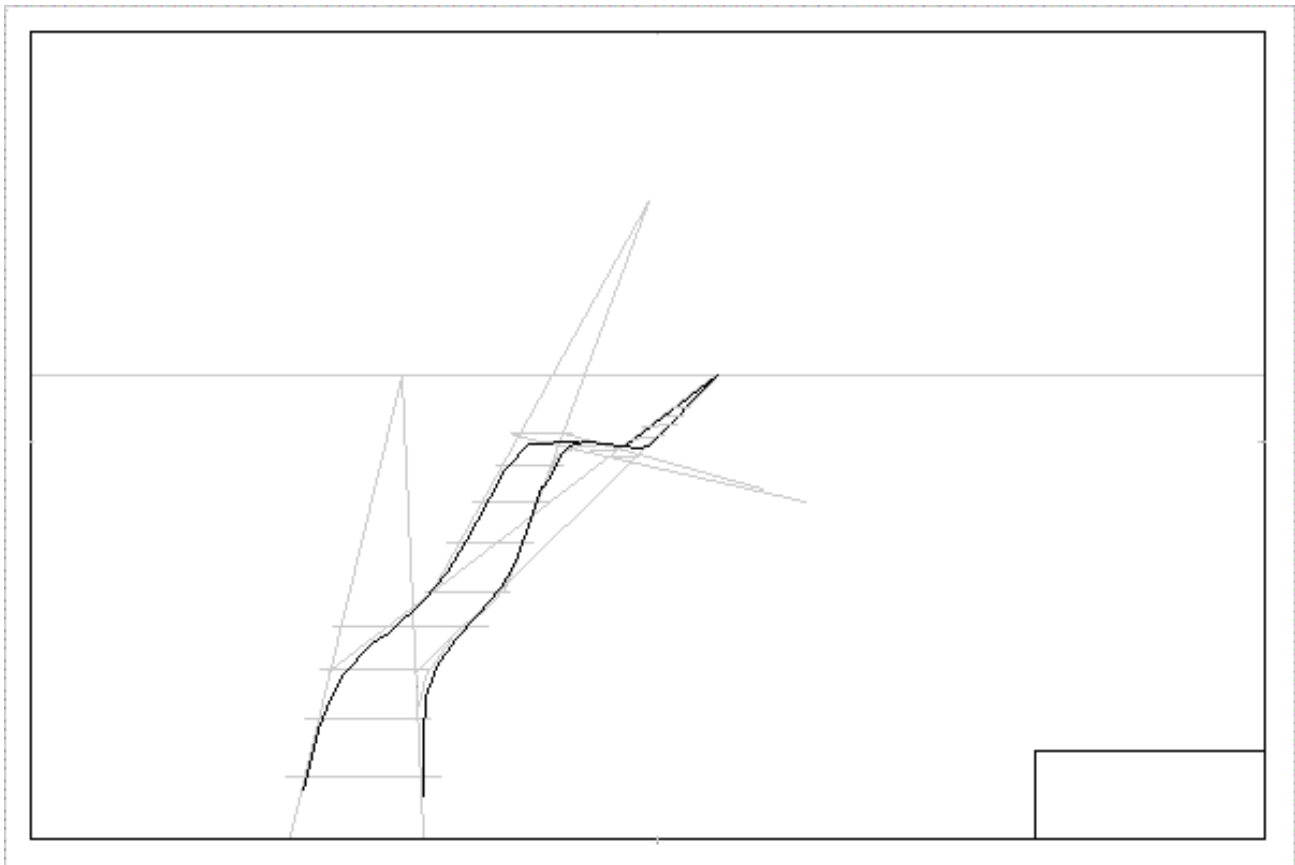

Firm in the lines and explain that every 'regular' object can be placed in space to have its own vanishing point. Here we have merely joined a few together.

Students construct margin and title box on a new page then:

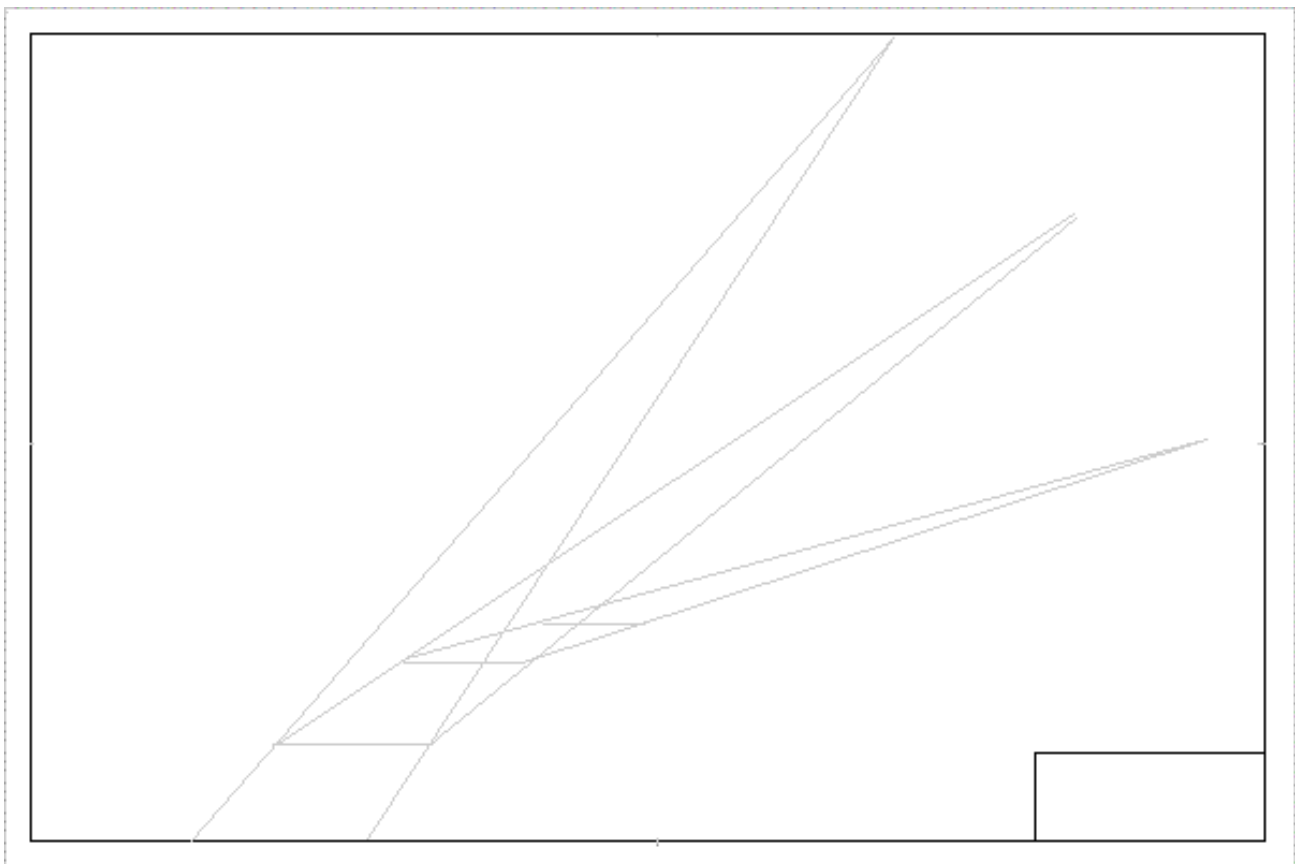

a) In approximate positions, as above, lightly construct a road bending to the right and descending.
...

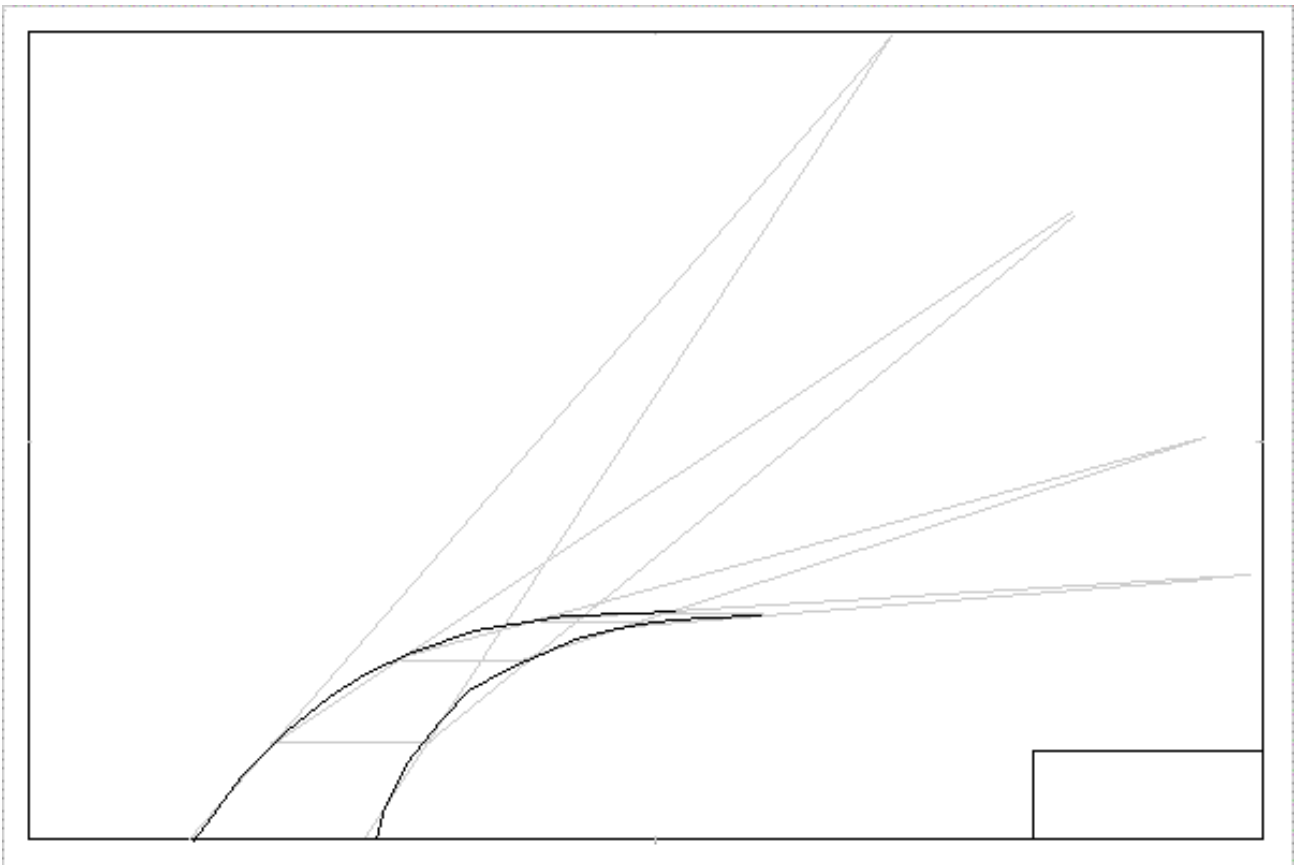

b) Firm in until the curves transcend the horizontal ...

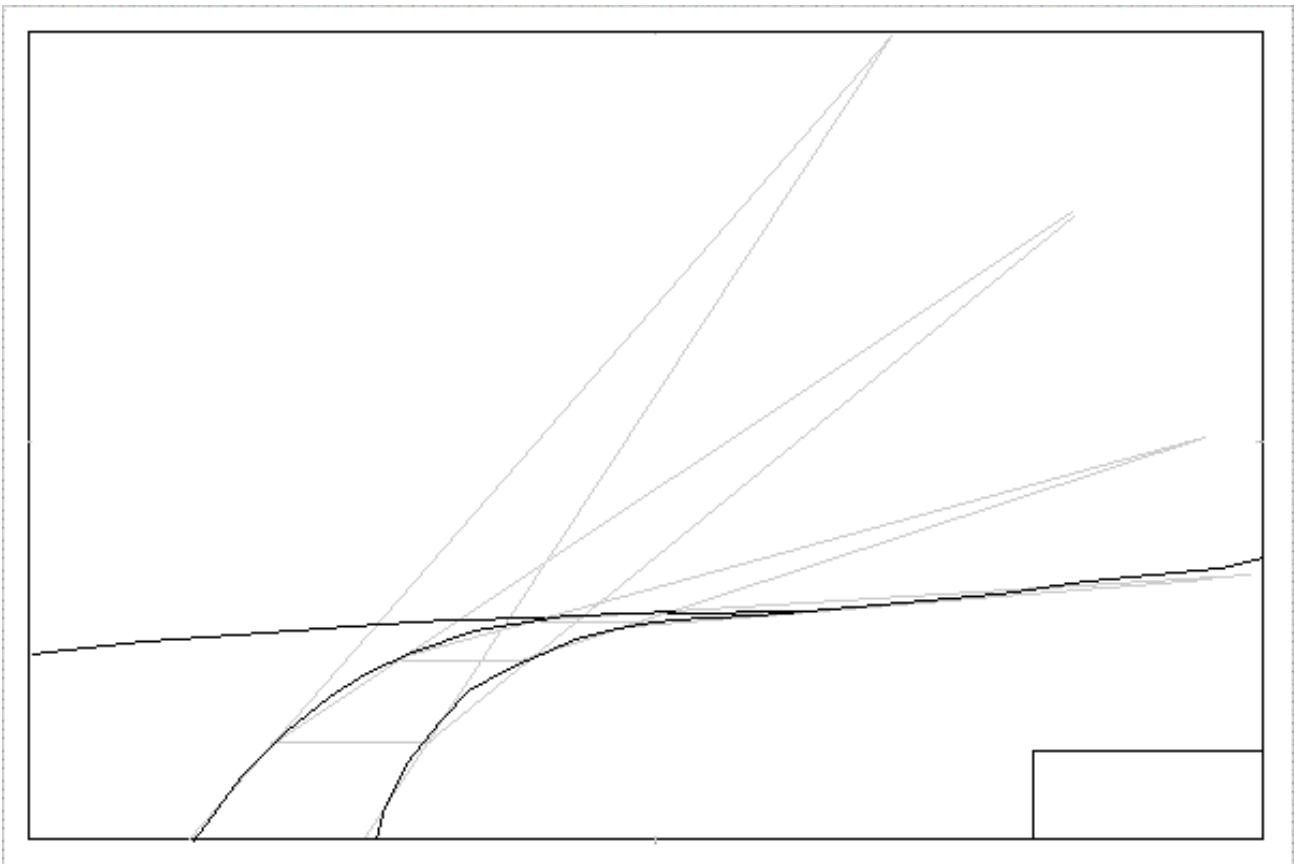

c) and add a nice curving hill.

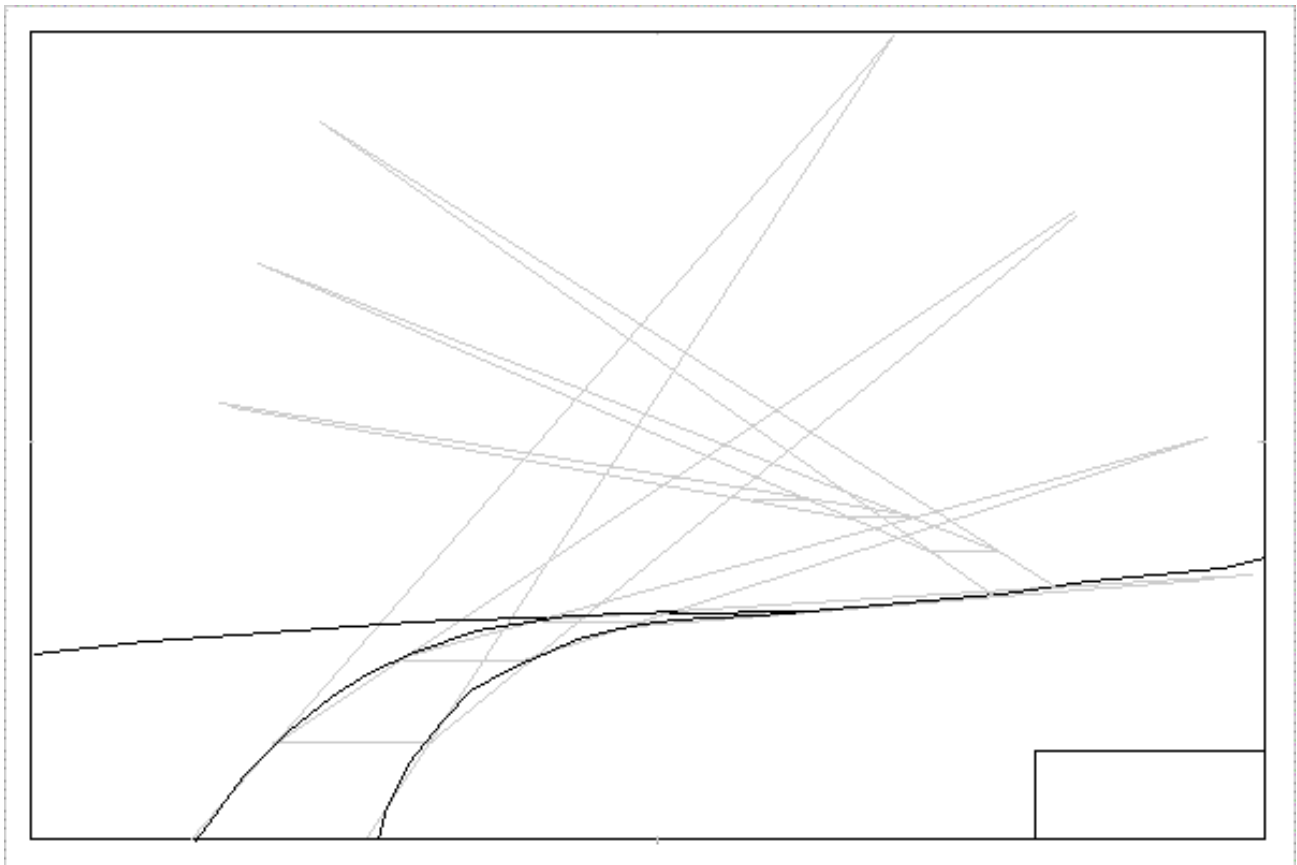

d) Change direction and do the same thing again. Your own 'judgement' should be used to determine the 'new' width of the road. Logically it must be smaller than its width as it disappears over the first hill. Point out that this width will determine just how far the first hill is from the second.

CONTINUED....



[GO TO ... LESSON ELEVEN \(CONT.\)](#)

[lesson menu](#)



LESSON - PERSPECTIVE ELEVEN - ROAD (CONTINUED)

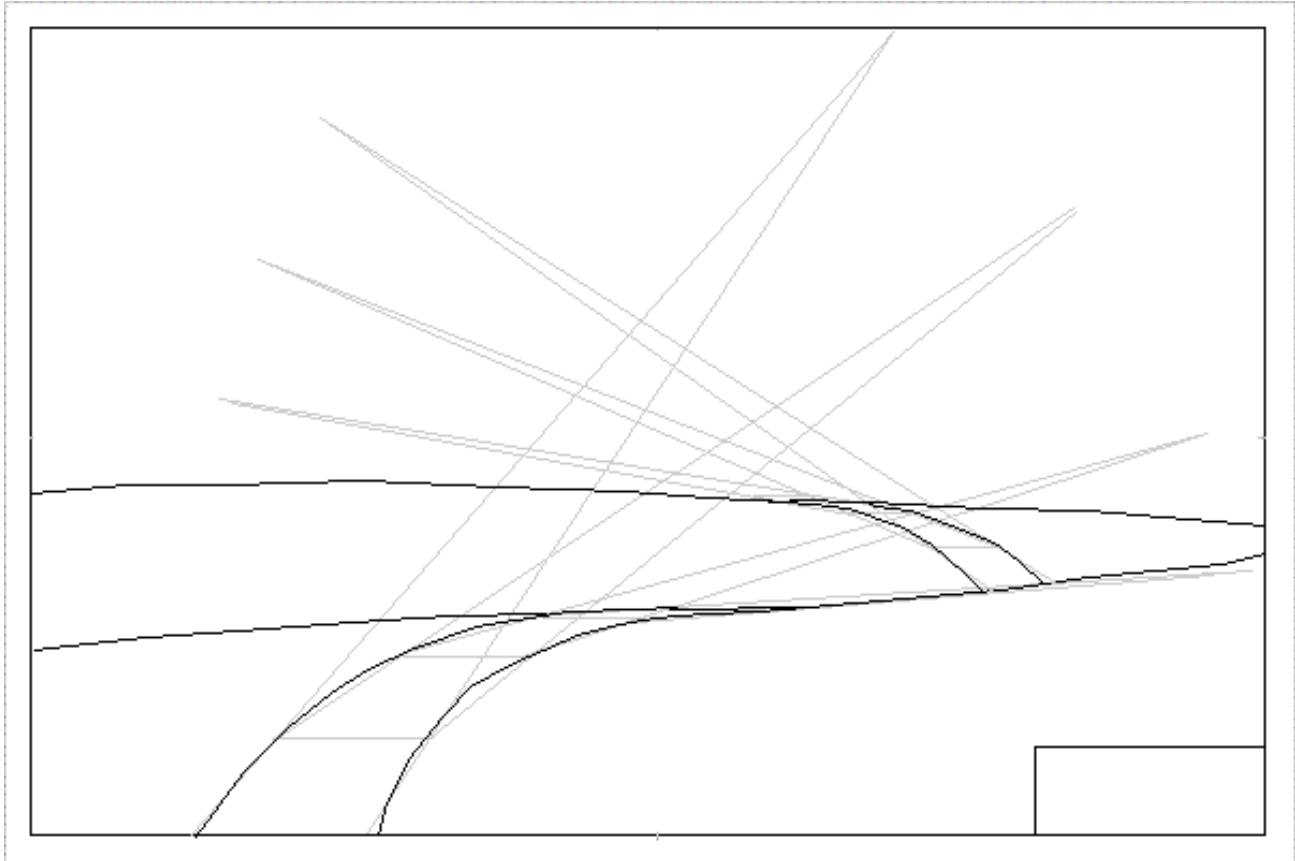

f) Define the second hill as I have, with a nice flowing curve.

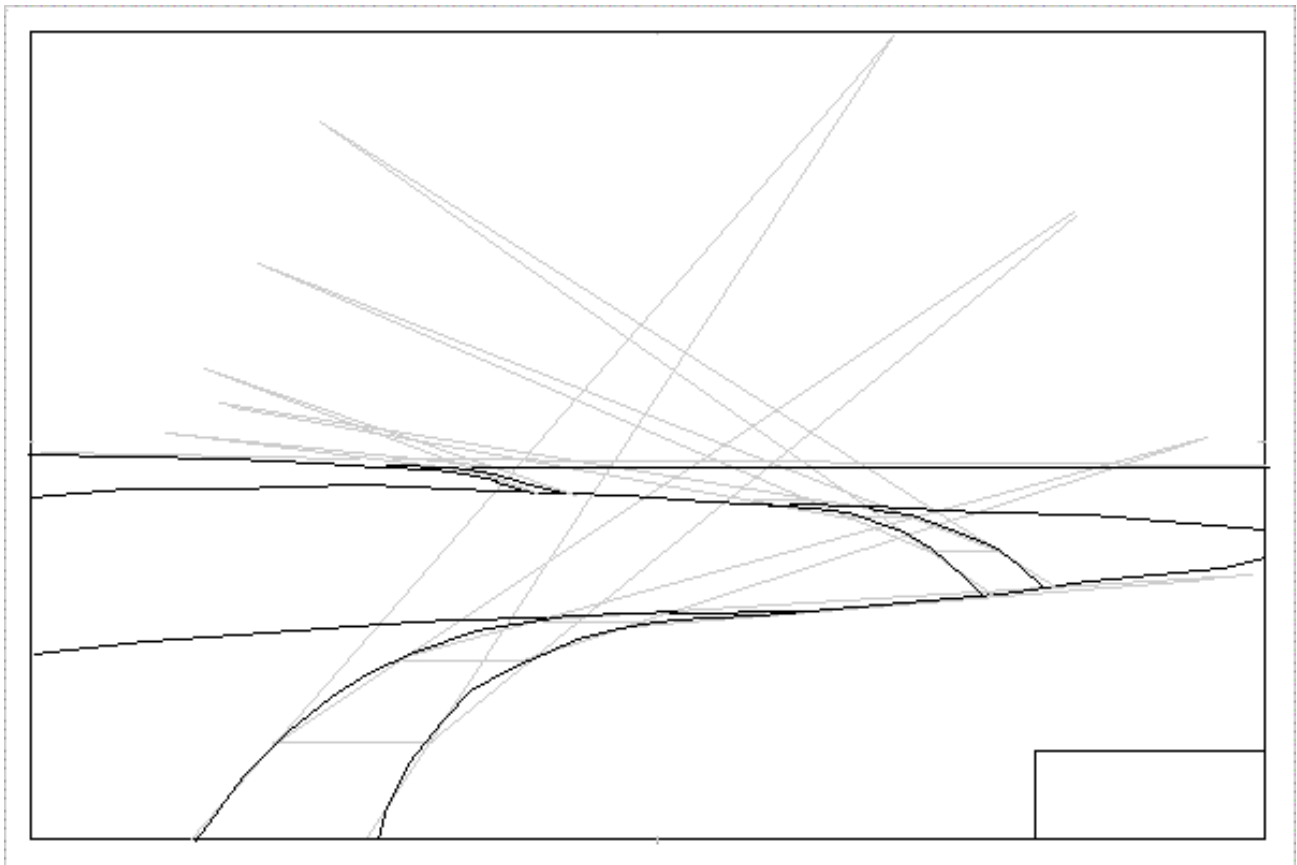

g) Using three more 'vanishing points' (VP's) repeat the exercise; only don't change direction.



e) Title the drawing and if time permits begin some general shading.

Homework: Add a ploughed field, fences, trees, carts, cars, buildings, etc.



[GO TO ... LESSON TWELVE](#)

[lesson menu](#)



LESSON - TWELVE

Aim: To introduce, explain and use extended vanishing points off the page.

The teacher should print off the following four drawings and hand them out as reference sheets.

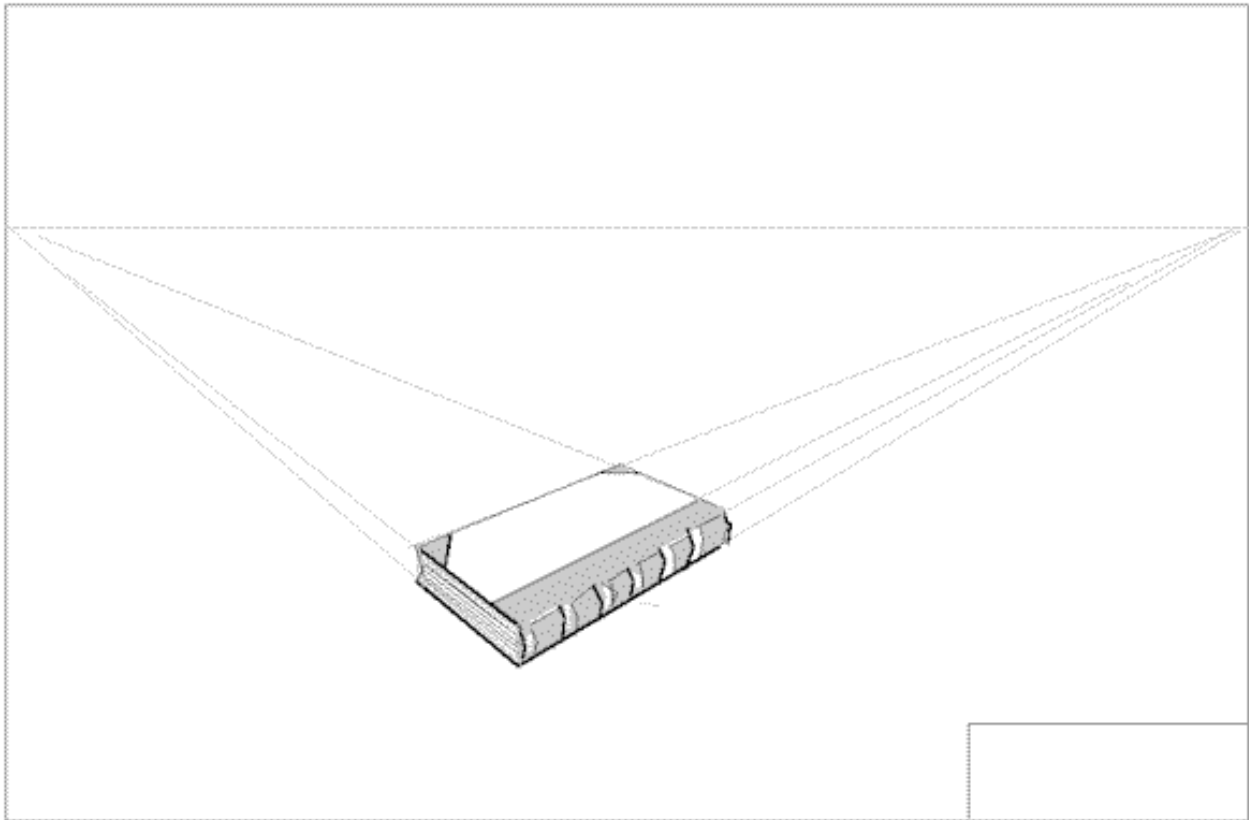

a) This drawing of a book is done as a simple two point perspective using the same method we used on the city buildings in lesson number one.

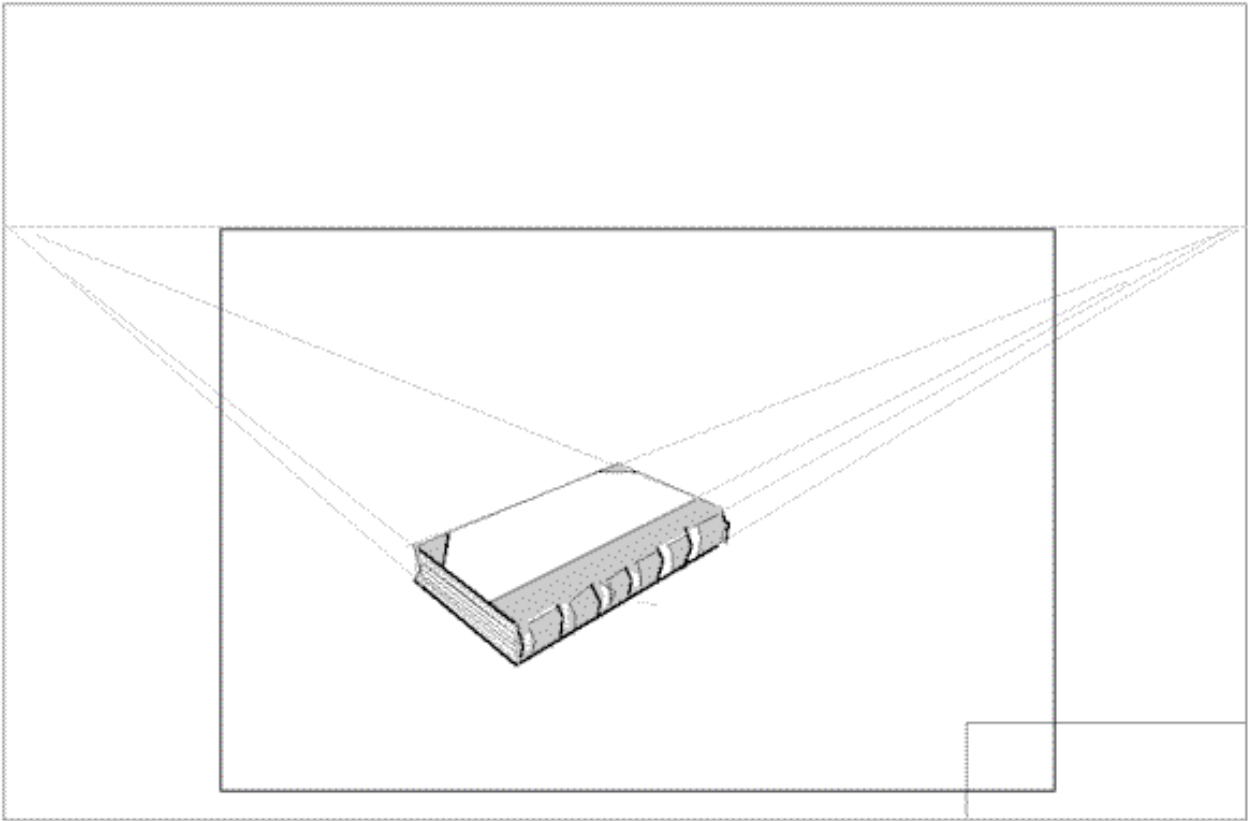

b) What would happen if we zoomed in and cut out a part of our drawing? ...?

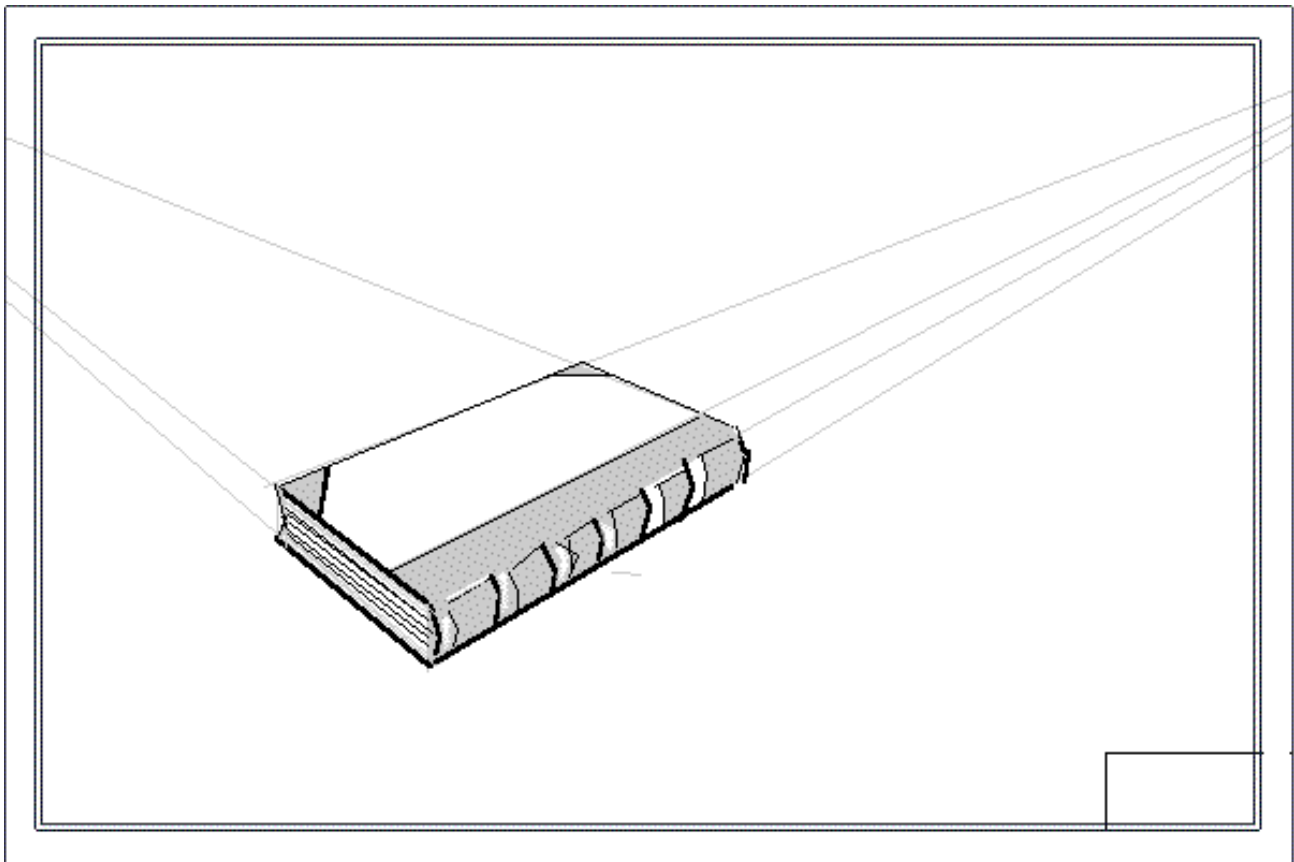

c) Then we made that drawing our full size drawing? Above is the result. The only problem is that our vanishing points have disappeared completely off our page. What then are we to do for this type of drawing?

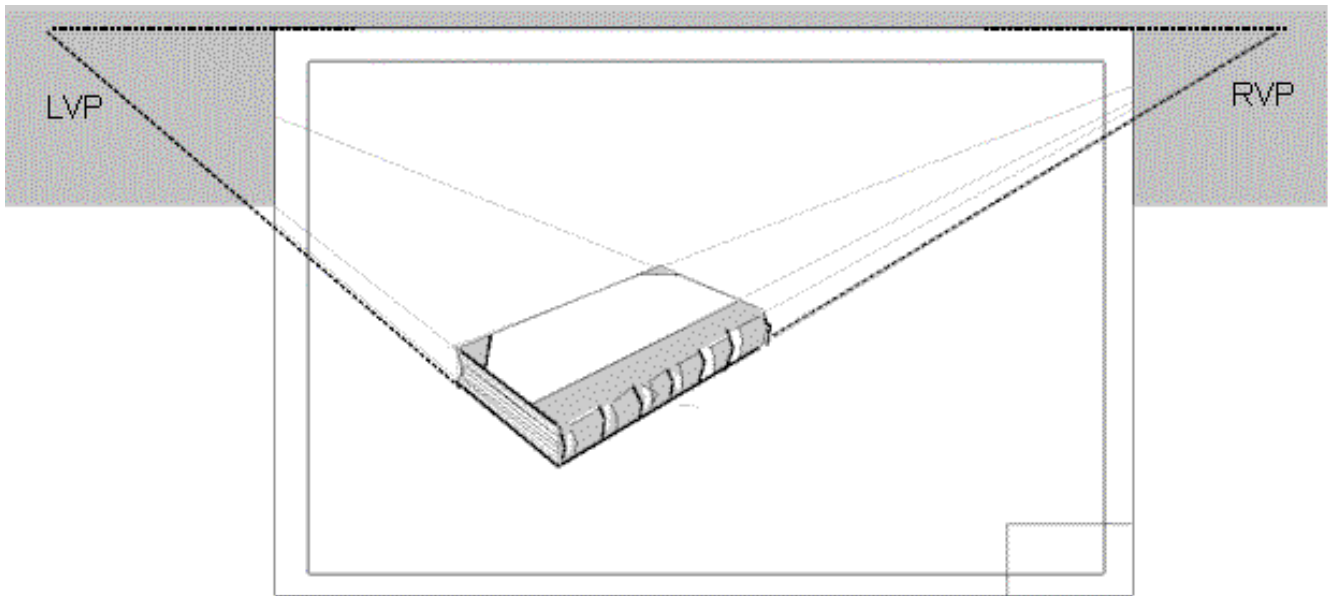

d) We could try and place a much larger piece of paper under our pad and extend our lines as shown above, but more simple is to 'imagine' their position and just draw part of our light lines outwards as if the 'vanishing points' points were actually there.



[GO TO ... TWELVE CONTINUED](#)

[lesson menu](#)



LESSON - TWELVE cont.

Aim: To draw a book using extended vanishing points.

TIME:

Allow 40min

Materials:

The sketch pad,
HB pencil, ruler.

Construct margin and title box then:

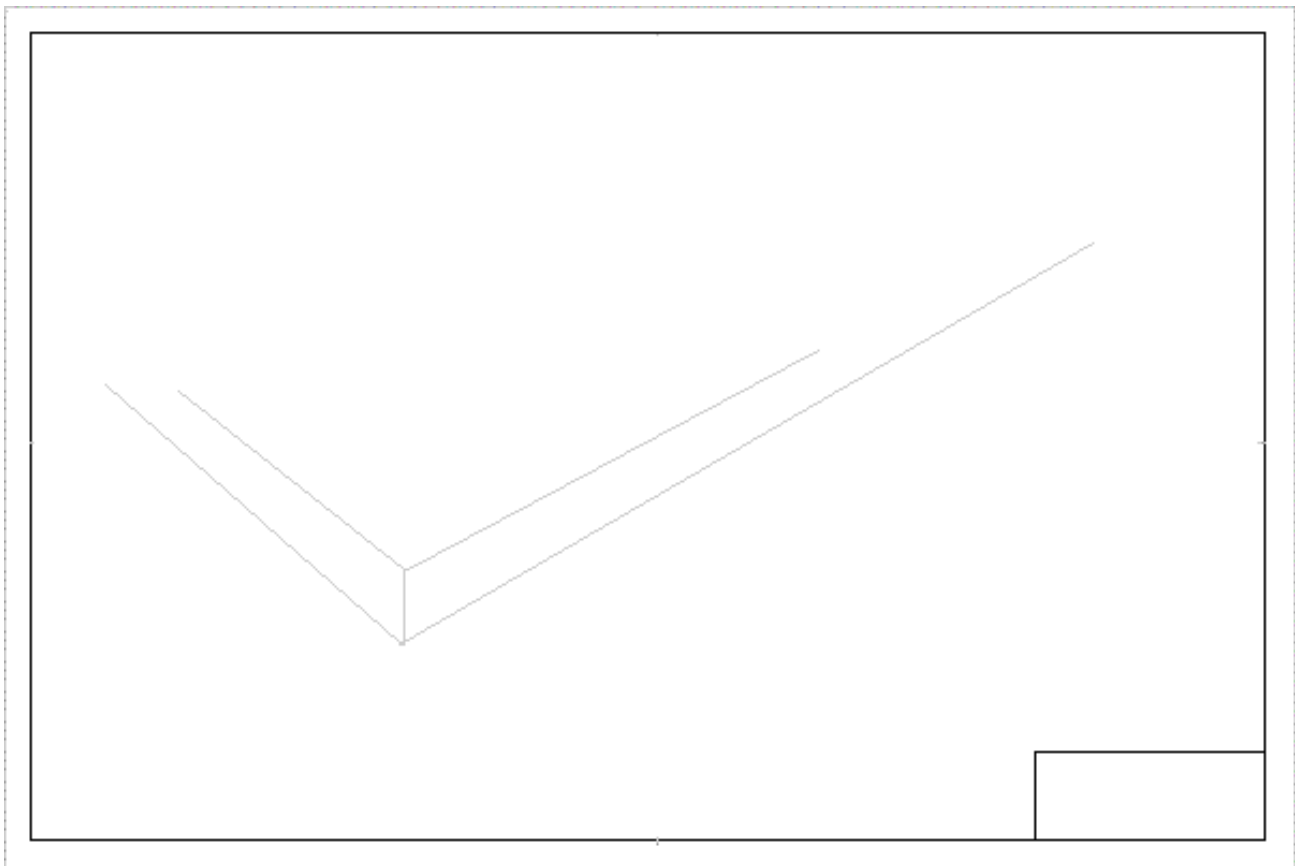

a) As with the example in the previous lesson construct the lines as shown as if there were vanishing points off the page.

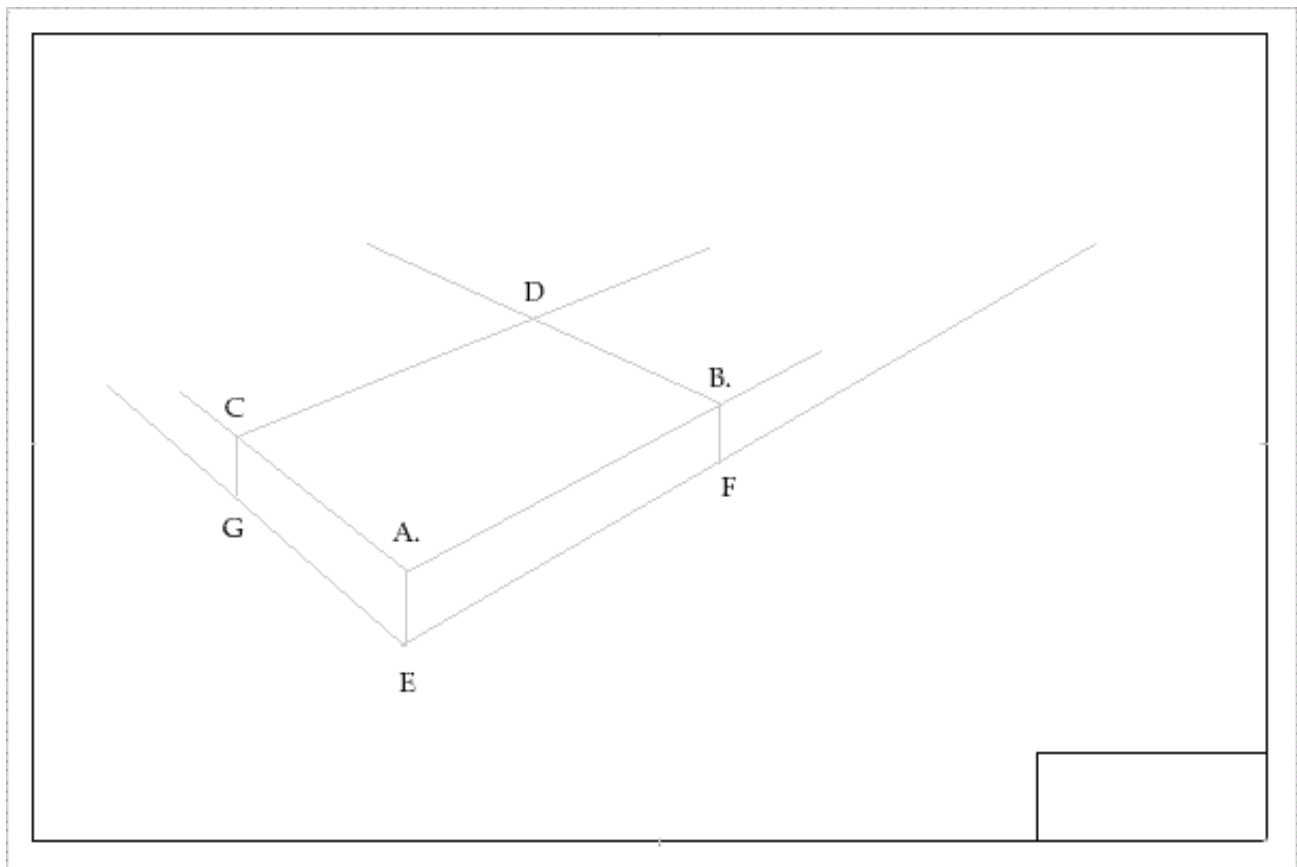

b) Complete the block lightly as it will form the basis of our book. Note CA is larger than DB, AB is larger than CD, AE is larger than BF and GC.

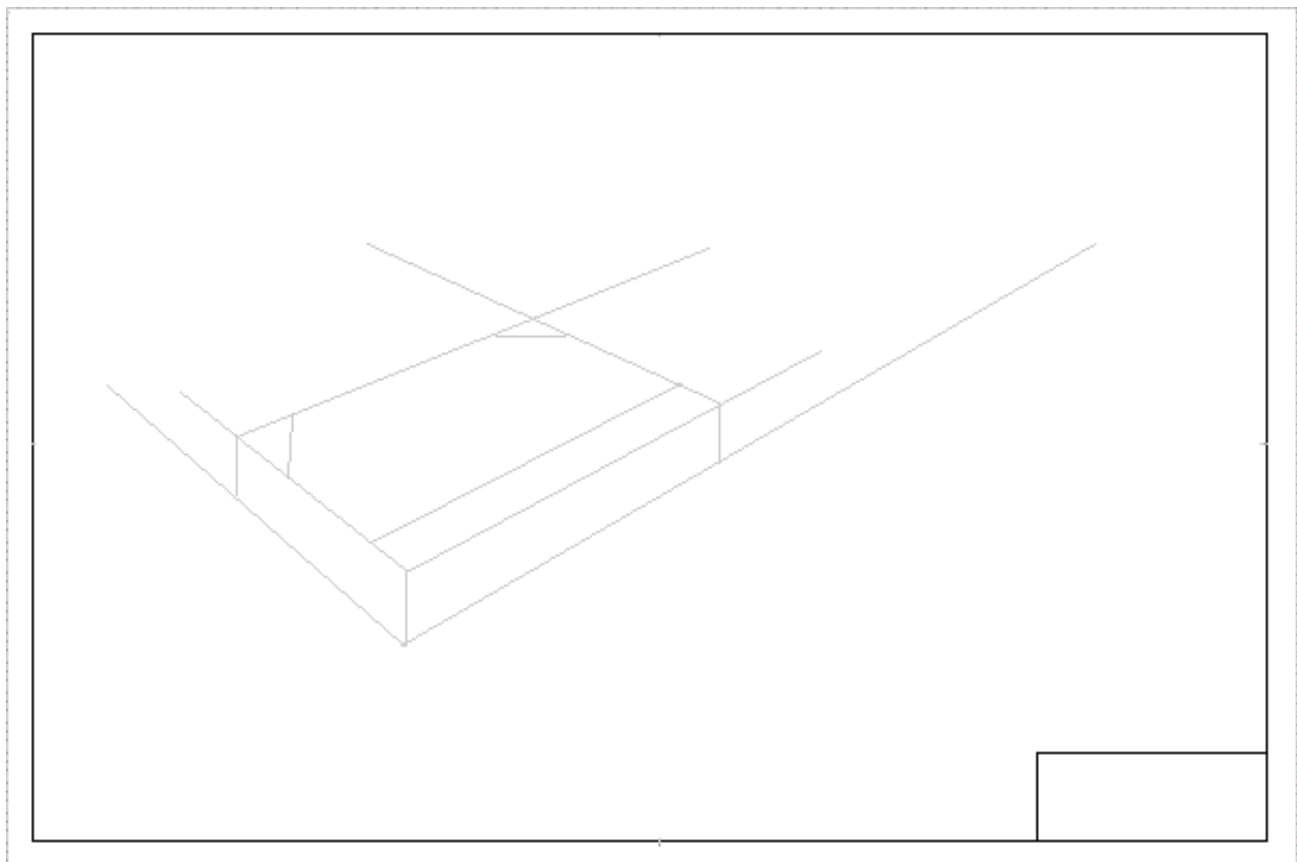

c) Lightly draw in some more main features of the book. It should now look as if it sits on the desk in front of the student.

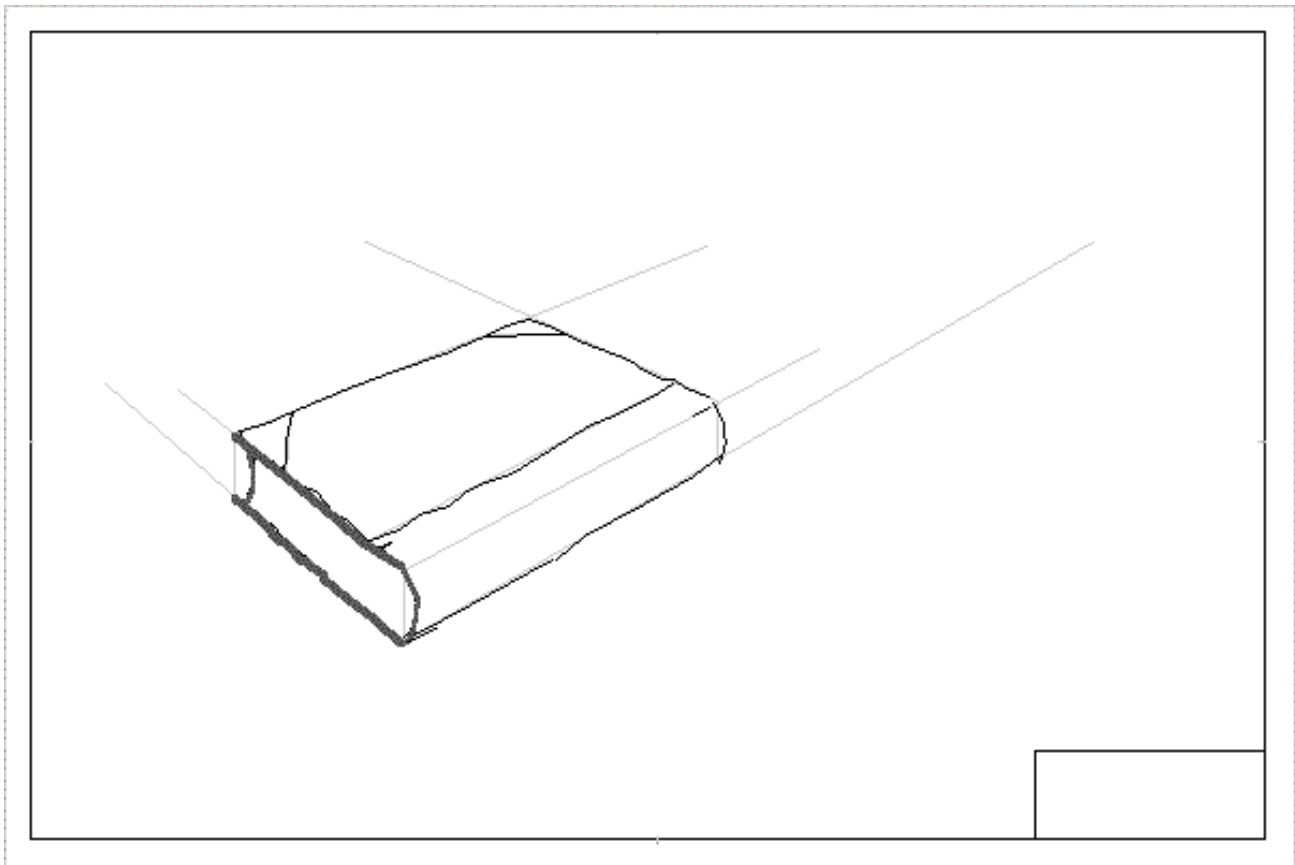

d) Put away the ruler and begin to sketch the book freehand ... using darker lines as shown above.

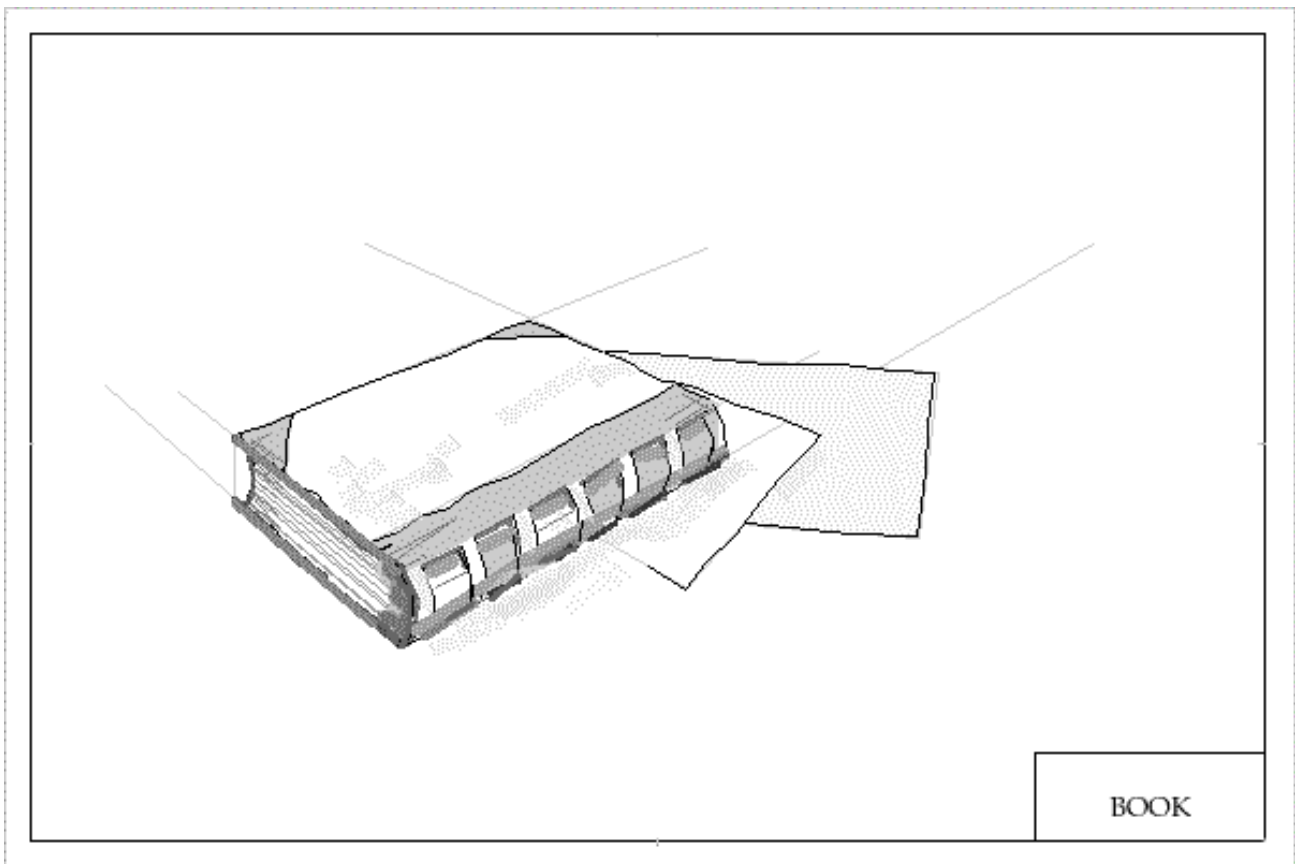

e) Complete the details using shading and your imagination. Add a couple of loose sheets of paper.

HOMEWORK: Complete by adding a pencil.



[GO TO ... PART TWO INTRODUCTION](#)

[lesson menu](#)



LESSON NOTES FOR TEACHERS - PART 2

LEARN HOW TO DRAW

I sometimes refer to an individual as being visually 'literate'. We know the meaning of 'literate' and 'illiterate' regarding reading, comprehension and writing ... which I will refer to as the 'passive' (reading) and 'active' (writing) elements of being literate. The ability to 'read' or understand a drawing is the passive part of visual literacy whereas the ability to actually 'draw' is the active element.



Being 'visually' literate is no less important than being literate in the reading and writing sense. In fact, some may ever agree that 'drawing' should be studied alongside reading and writing. Why? Because before you can write you must learn to draw circles and squares, at least; otherwise how will we make a '3' or '7' ... and 'S' or an 'Z'?

So how does someone become visually literate?

1. **Passive** By learning to recognize things in three dimensions, also learning to read maps and plans etc. in two dimensions. Learning about line, texture, shape and pattern.
2. **Active** By learning to draw just as a writer would learn to compose sentences.

Drawing literacy can best be understood in the absence of language... and its effect can be quite potent. A test might be... 'Using the quickest, simplest drawing and the minimum number of lines you can imagine, draw as economically as you can any of the things on the following list:

A house, caravan, dartboard, pineapple, road, a railway line, a fish a snake, an apple and a pear, a ship, boat, submarine, shark, martini, basketball, helmet, a pair of scissors, sword, spear, banana, cucumber, church, fruit tree, bunch of grapes, traffic lights, ladder, television antenna, lightbulb, scooter, mammoth, the road from your house to the nearest store, comb, fork, paperclip, saucepan, leaf, an anchor, shoe, yoyo, and a button etc.



NO AGE LIMITS: These tests could be given to children as young as five and adults as old as eighty and the results may well determine their 'active visual literacy'. There may sometimes also be little difference in the results. I would test for speed and inventiveness just as you might judge some prose thus. Bear in mind the teacher need not be Leonardo or Rubens to satisfactorily judge the results!

Let's take this active and passive division little further. In what is 'art' today we have the visually semi-literate - in the 'active' sense; they may however, be quite visually literate in the passive sense. Should they be called 'artists' - and would we be as ready to embrace people who called themselves writers if they attempted to write of their experiences neglecting any structure? I don't think so; and some of my own writing proves just that!

Is any of this important to the human species? The children I tested seemed to think so.... maybe

such tests need to be given to some of our national art critics... I made a comment once ... when we talk of educating our children in 'the basics' we should mean the basics of reading, drawing, writing ... and perhaps maths; but then I may be a little biased.

Imagine beginning every art class with 'OK children, open your sketch pads and do two quick sketches; a coconut and a saw. You have three minutes..... then we will be finishing off the drawing we started last week.

Well this is exactly what we shall now be doing with our drawing course.

Time- Lessons separated into approx 40 min segments.

Homestudy - 10 to 20 minutes per lesson - set work proposals suggested at end of each lesson.

Materials;

30x45cms or 12"x18" standard cartridge paper (thick, white, plain) sketchpad.
2H, HB and 4B pencils
eraser

New General lesson structure;

5 min. short drawing test (3min. for test 2min hold up and look at results)
5 min. revision and homework assessment.
5 min new page, draw margin and add title (bottom rh corner)
20 min demo and child practical drawing
5min summary and suggested homework.



[GO TO ... FIRST LESSON](#)

[lesson menu](#)

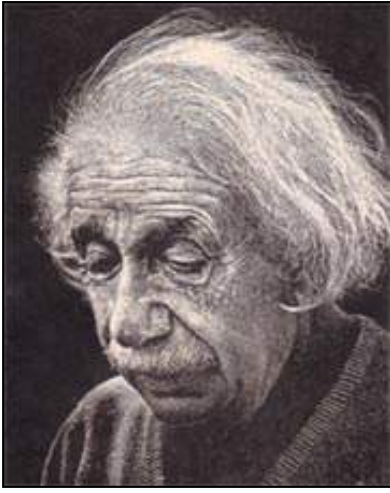

PART 2: LESSON 1 - SETTING UP

TIME:

Allow 40min

Aim:

To establish a new format for freehand lessons and to introduce the 'quick sketch test' to enforce observation and awareness of common day things.

Materials:

The sketch pad, HB and 4B pencil, eraser

Without using the ruler (or any other straight edge) prepare the page with margin and add the freehand boxes as shown.

a) The student should draw the margin lightly (HB pencil), using short lines and when satisfied, firm it in. Allow a good ten minutes for this as some students will be concerned to produce lines of great excellence. This will not be possible at this stage and they could be told to expect as much. The student should be encouraged to keep turning the sketch pad to suit their hand movement, and to use the page edges as guides.



b) When the student is satisfied with the light lines they can be 'firmed in' thus (again using short,

comfortable lines):

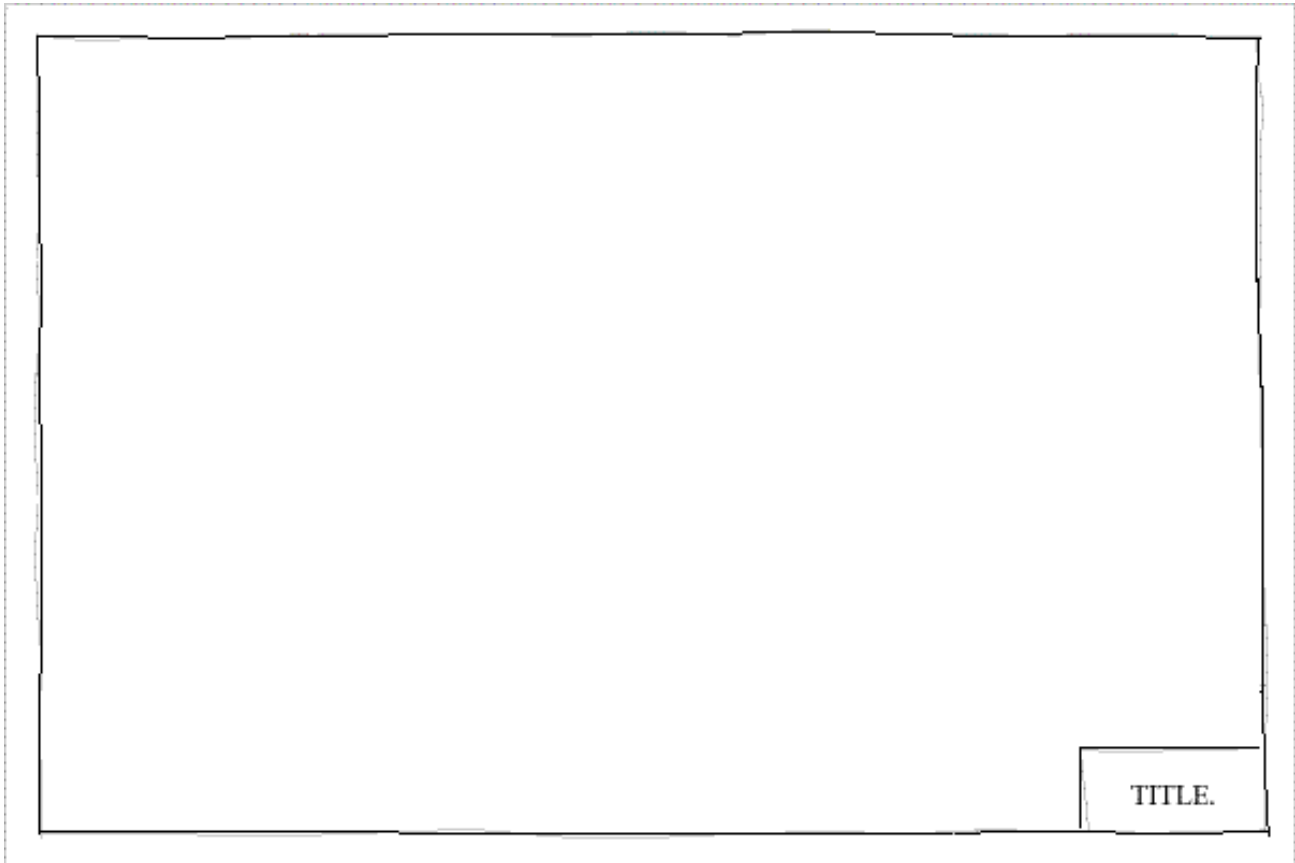

c) Without using a ruler divide the page into quarters using light lines as shown below.

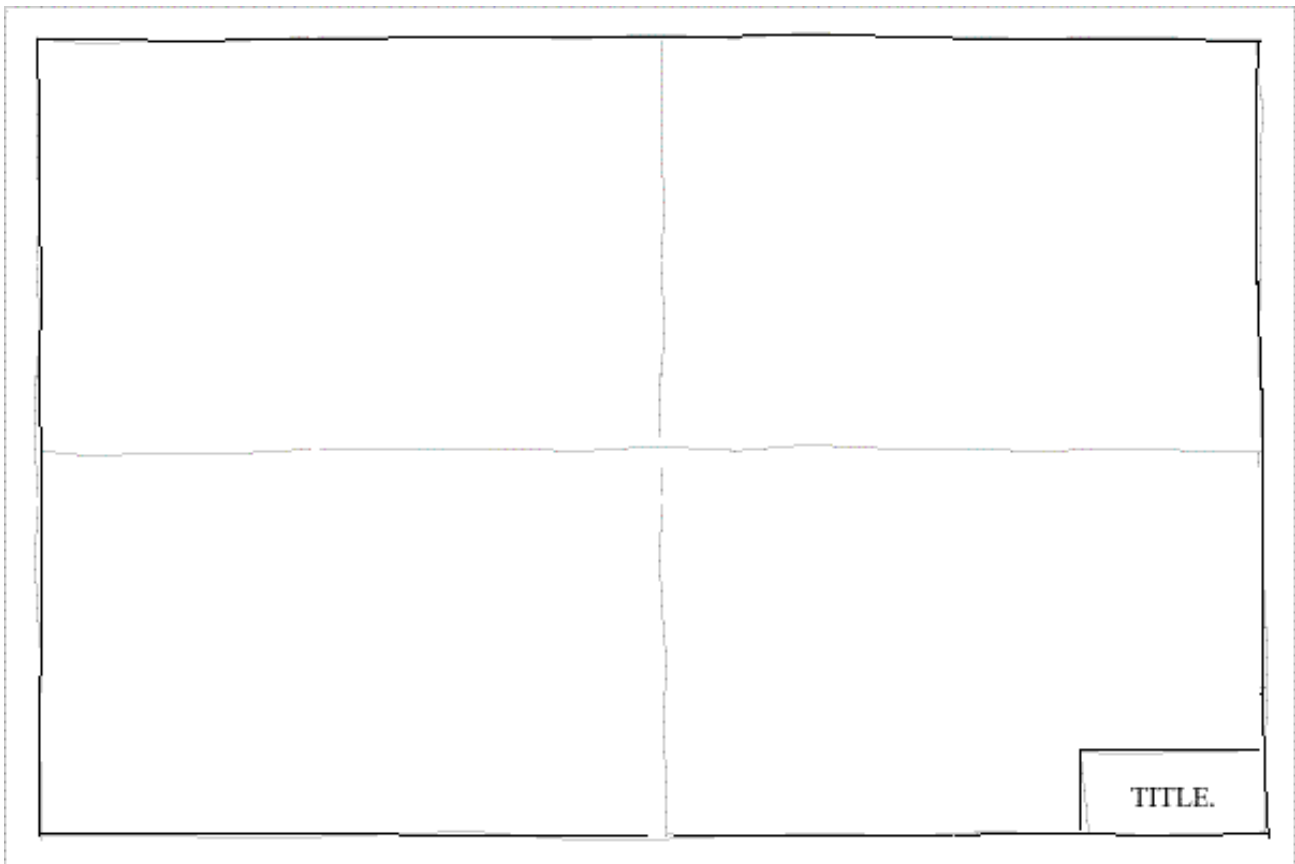

d) Divide again.

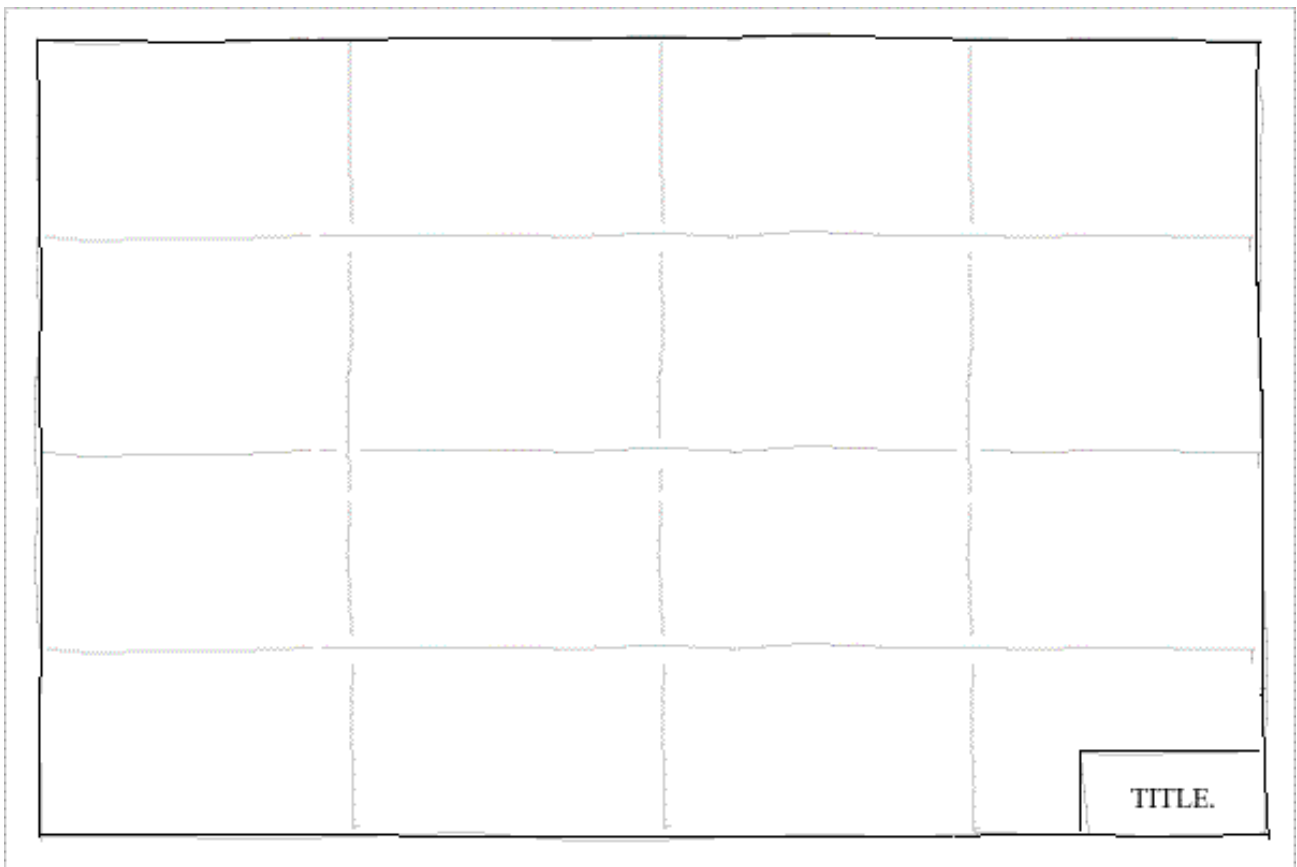

e) And yet again as shown.

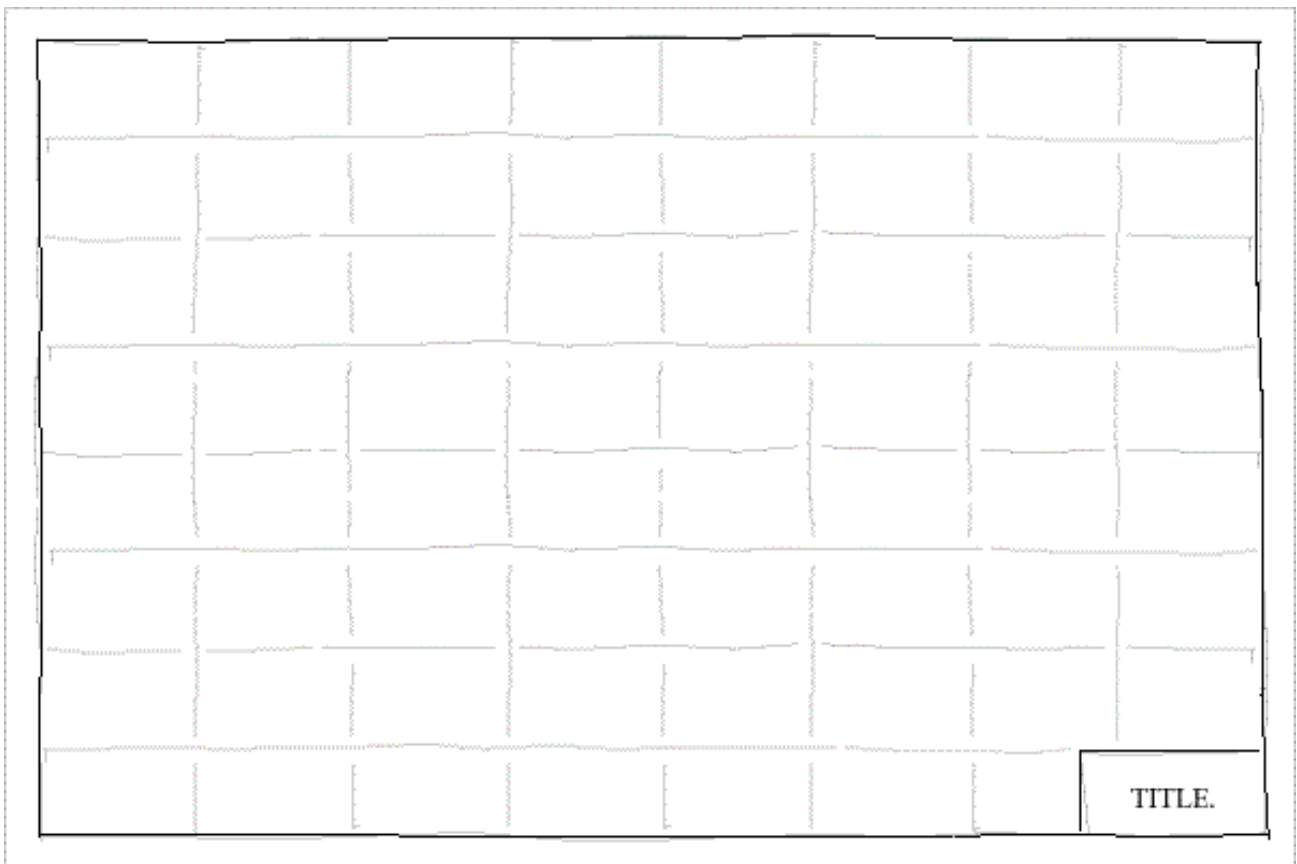

f) And again, so now you have 64 spaces (ignoring the title box).

TWO QUICK SKETCHES

Allow two minutes at the beginning of each lesson for this next exercise.

In the first two little spaces along the top the student is asked to draw their simplest representation of any two commonday objects of choice. They may make them up or use any of the examples listed

on the previous page. It is recommended that the research (practice) for these be set as homework. Then the student will be forewarned and prepared - although any lack of preparation can lead to interesting times ...

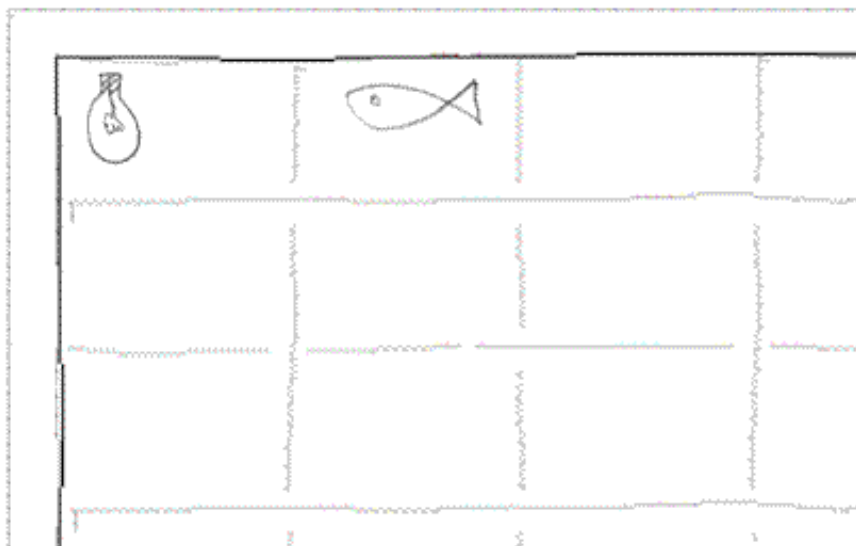

At the completion of the time allowed for this task (can be shortened for future lessons) the student will ask his or her neighbour to guess and write down the names of the articles or objects. If they match the drawings they should remain unidentified (no need for any notation). If not recognized the student should identify them as shown below. The Teacher will be the final arbiter. Be kind!

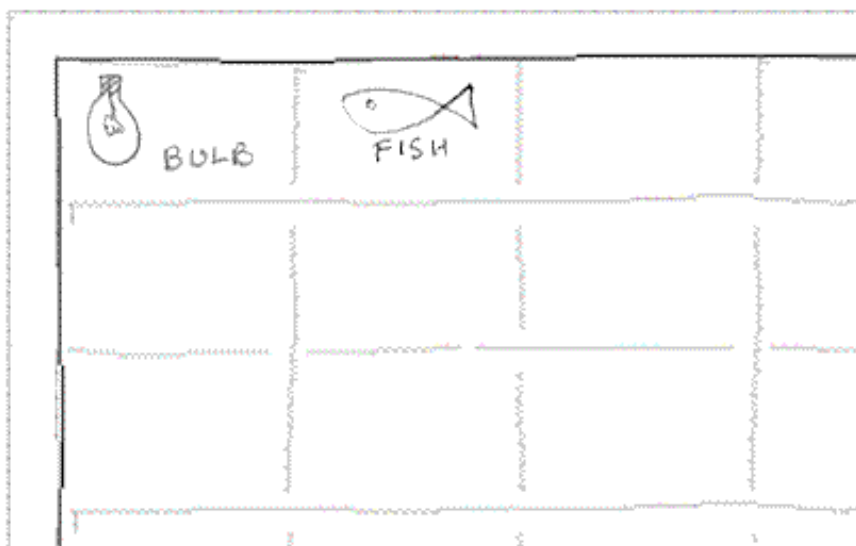

This whole exercise should be treated as fun as the teacher will find the students serious enough and naturally competitive. Do not ridicule any effort yet be constructive where necessary. Praise the good and display the brilliant for the rest of the class to see. Simplicity and effectiveness are the keys. In the example above try and guess what the two unnamed objects are? You will see they are drawn with the maximum economy of line. That what we want from the student.

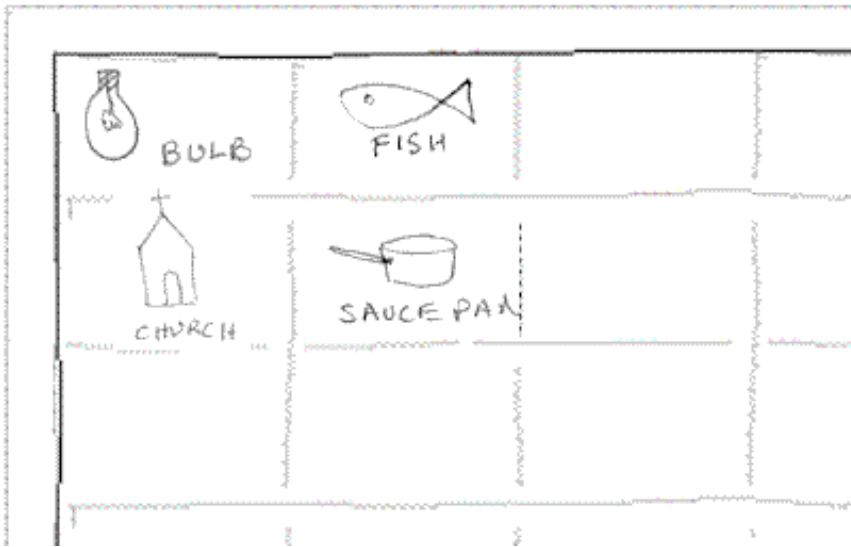

The possibilities for set homework are manifold in these new set of lessons. Page preparation, common object research, completing drawings begun in class etc. Judge the pace according to student level and class performance.

If time remains in the 40min period the student could begin preparing future pages (light lines) with title boxes and freehand borders.



[GO TO ... LESSON TWO](#)

[lesson menu](#)

PART 2: LESSON 2 - SHADING

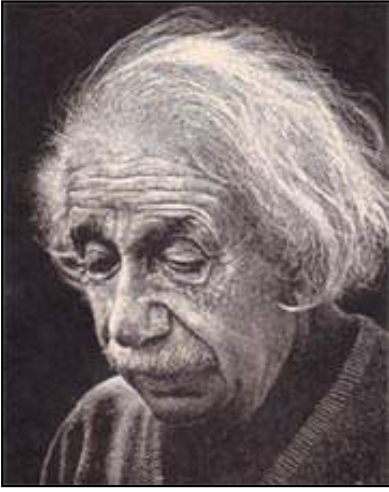

TIME: Allow 40min

Aim: To begin the lesson on shading. This will encompass cross-hatching and other useful methods as well as noting the theory of shading generally.

Materials: The sketch pad, HB and 4B pencil, eraser

Allow five minutes to for the quick sketch test. Two minutes to do and three to mark. Swap, display and title if necessary.

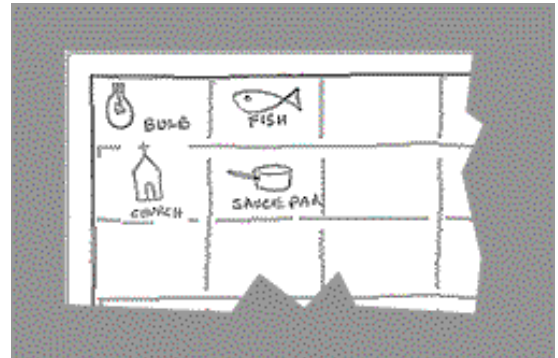

CUPS a) Without using the ruler (or any other straight edge) prepare the page with margin and title boxes then: Make a light freehand sketch of a cup as shown below, then repeat this until four similar cups are made

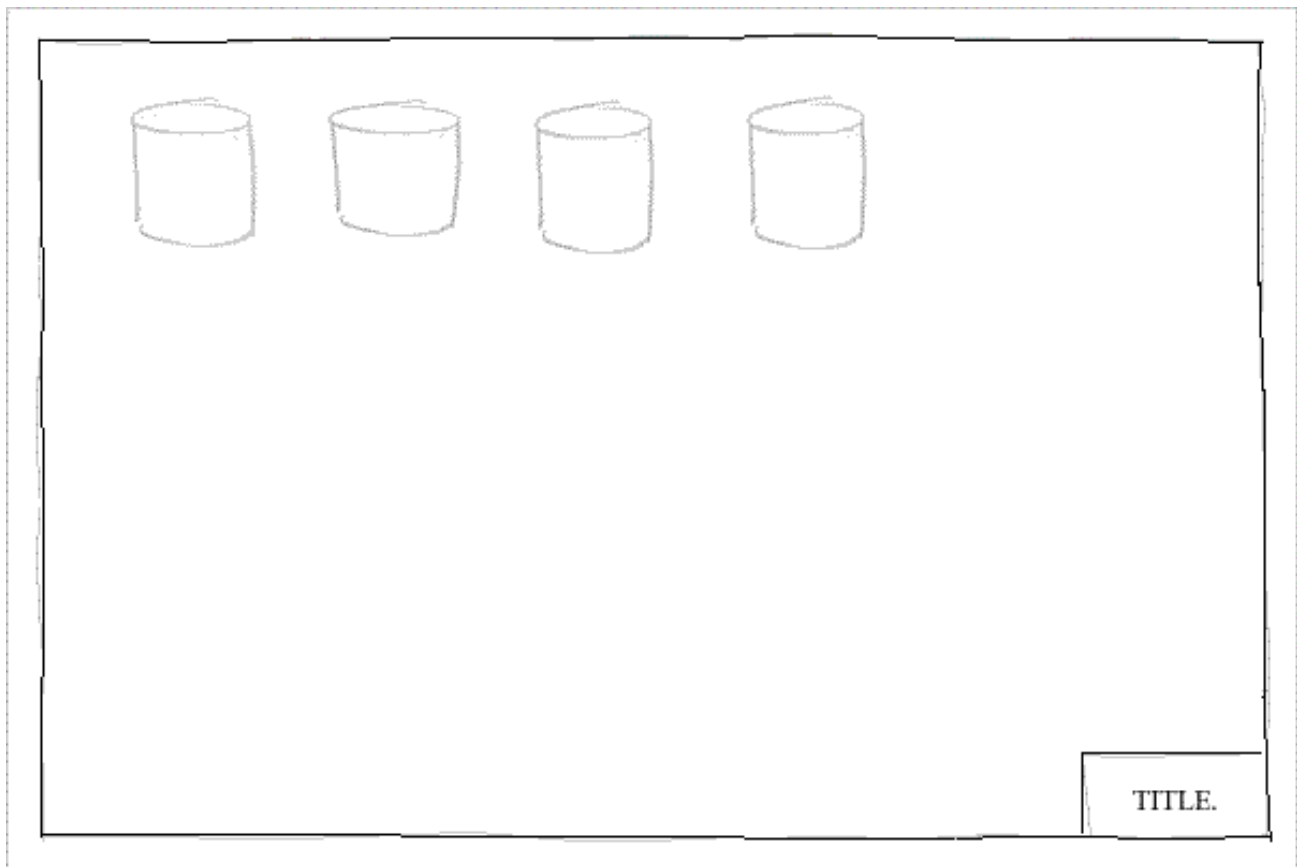

b) Using short strokes firm in cups.

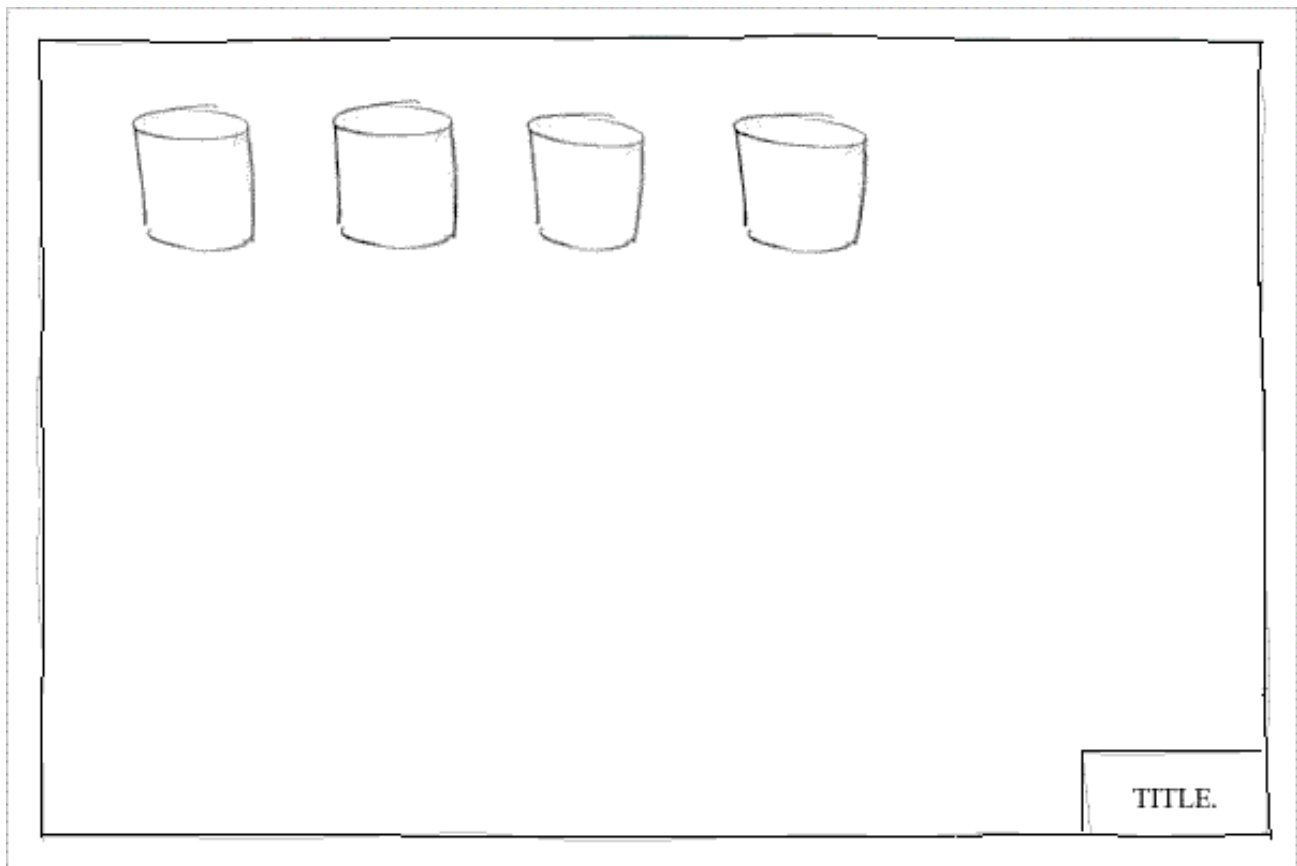

c) Use the 4B pencil and medium pressure 'hatch' a series of parallel sloping lines as shown.

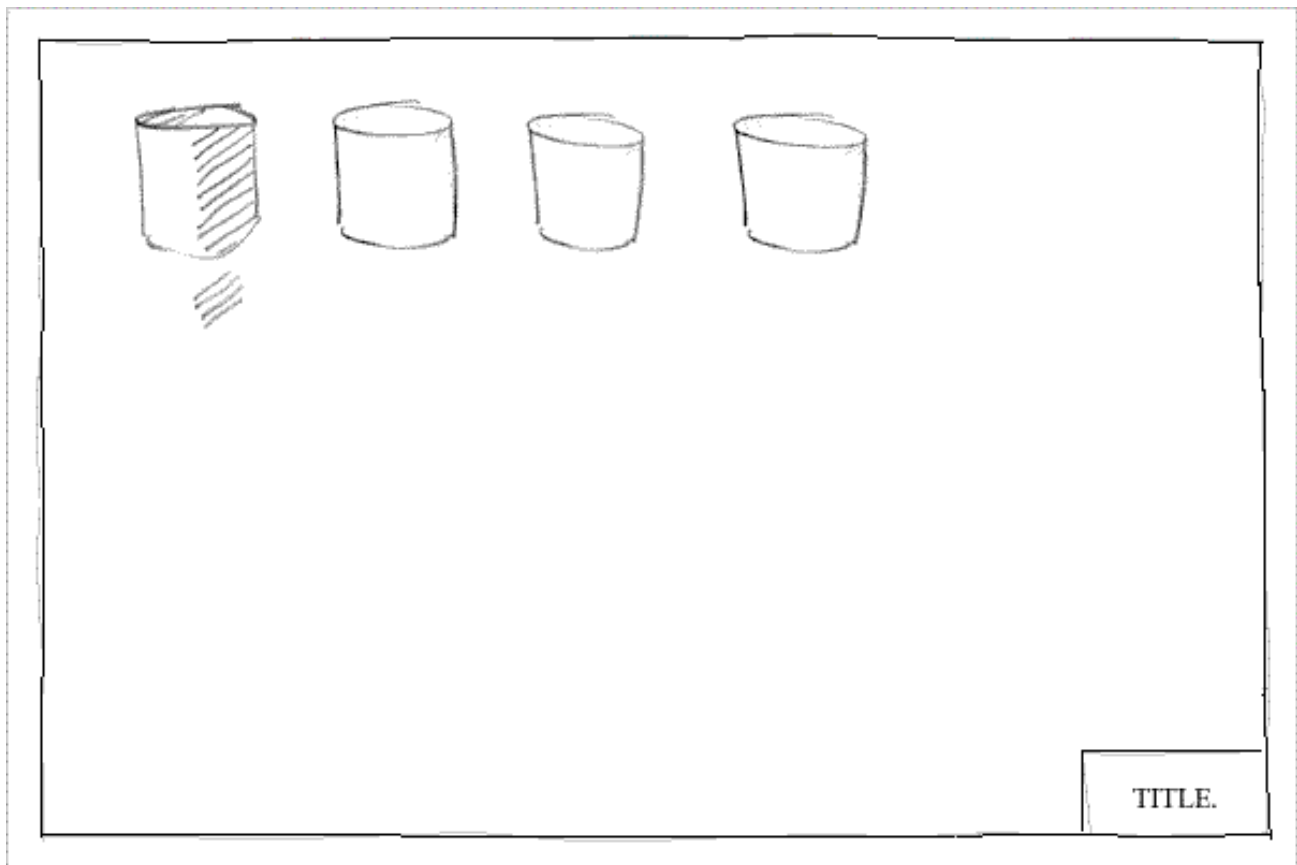

d) Do the same, though with shorter lines, in the other direction. Next use some vertical lines and lastly some horizontal. This method of shading is called cross-hatching and is useful for quick renditions.

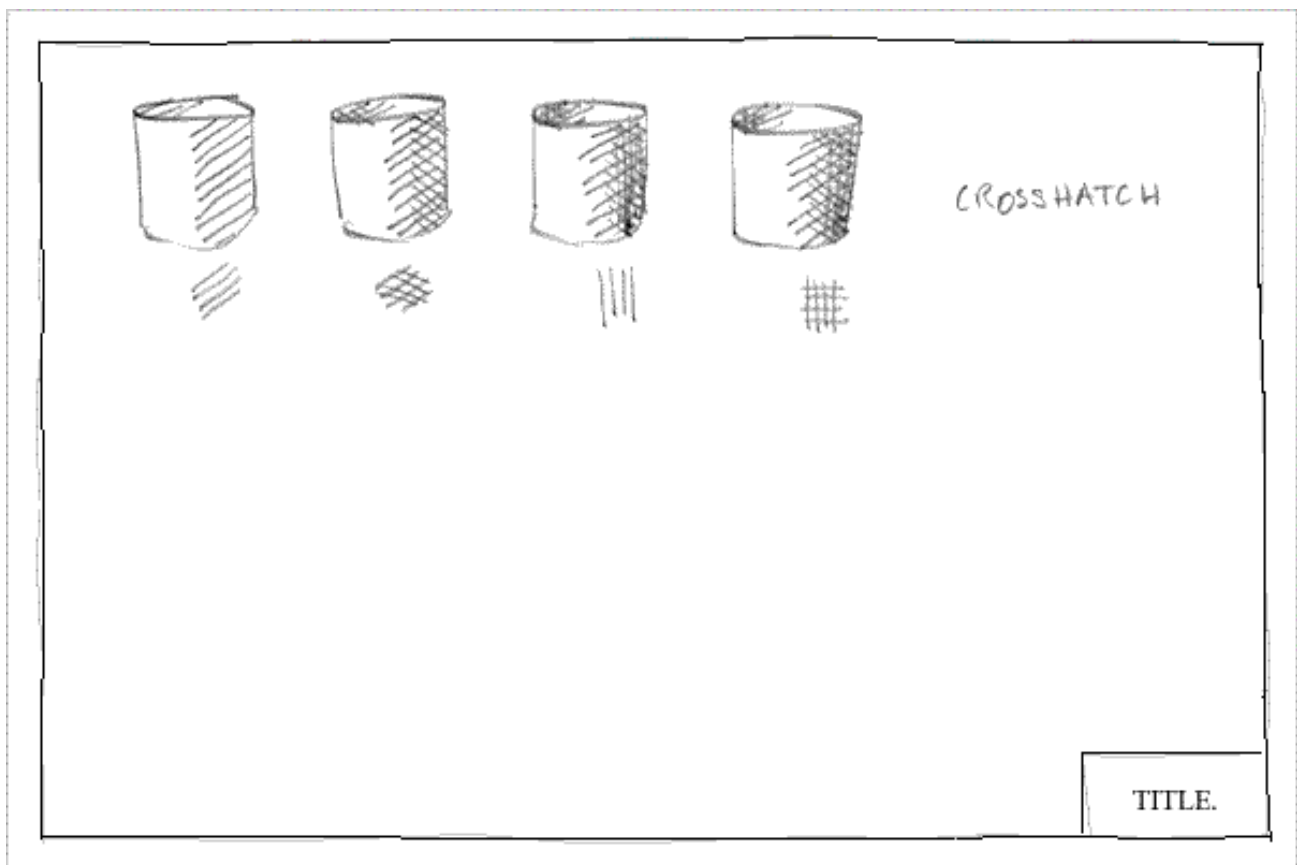

e) Make another row of four cups.

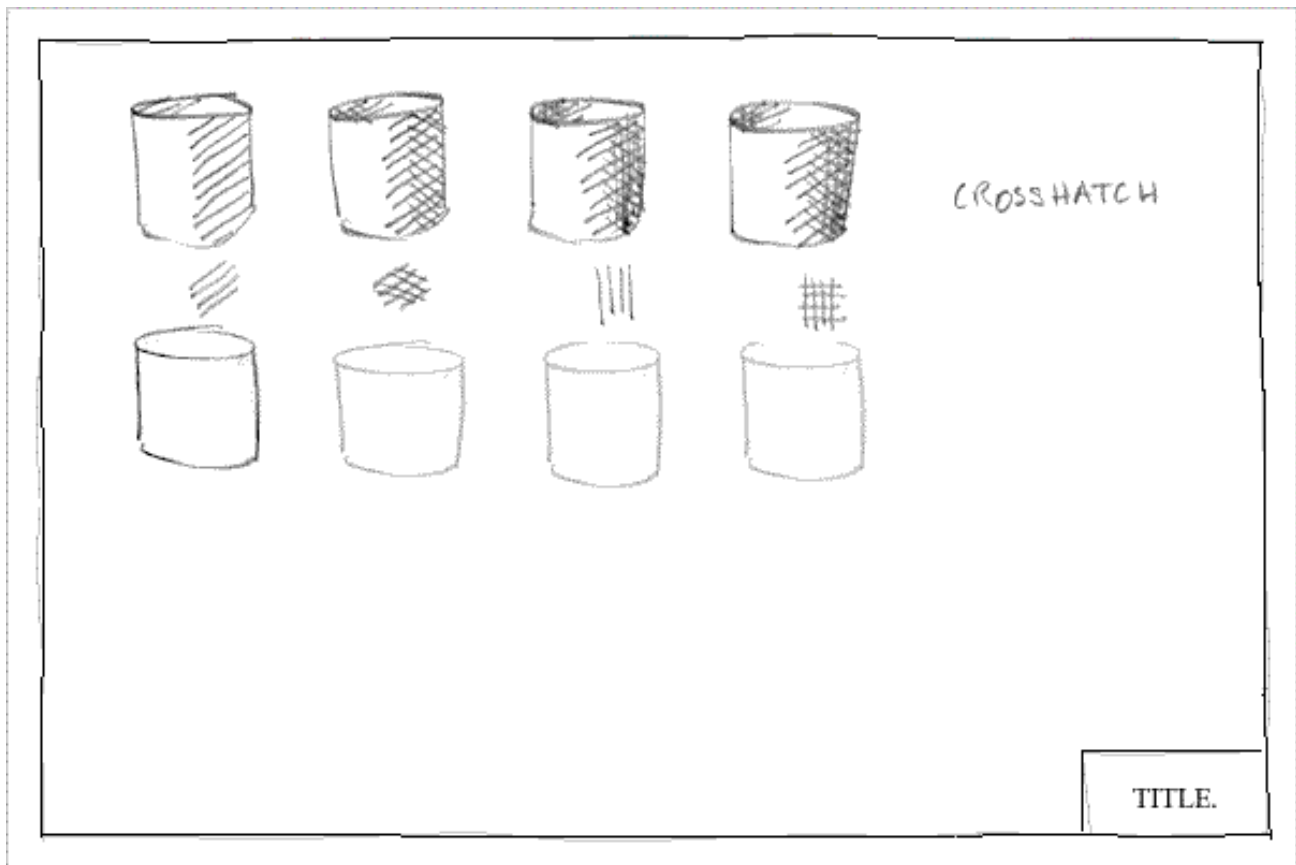

f) This time we will use a 'figure 8' as our shading method. You could use an 'O' or an 'S'. Use your 4B pencil with a 'light weight' or light pressure and draw a series of '8's' as shown. As you near the darker edge of the cup the 8s can 'overlap' and get a little darker. Don't forget the top left 'mouth' of the cup as it too will need to be shaded.

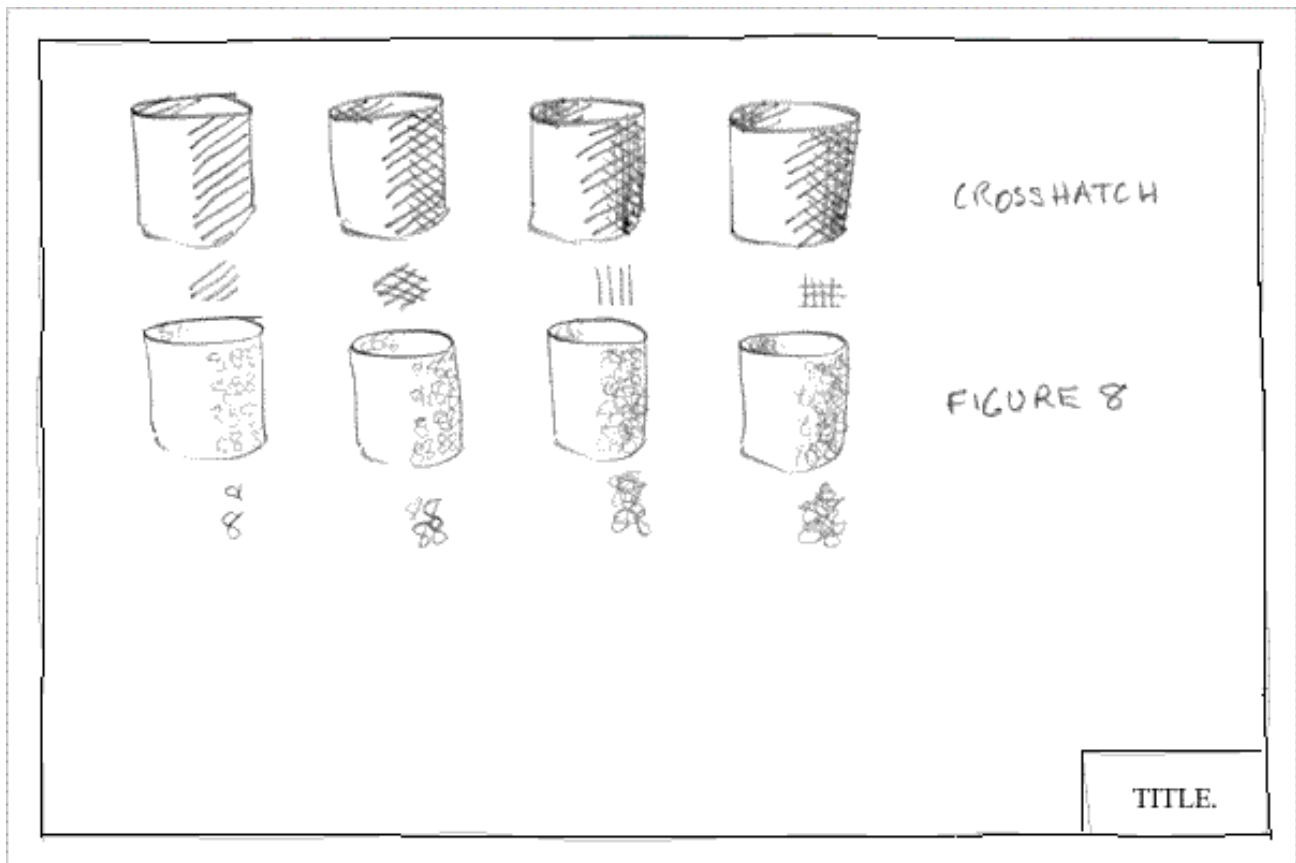

g) Make another row of four cups. Again using your 4B pencil and 'light pressure' make a series of lines using cross hatch or '8's. With the end of your finger rub the pencil lines until they merge together and form a flat even 'smudge'. Try and stay within the edges of the cup. Repeat this and darken as you near the right hand edge of the cup. Again, do not neglect the top lip.

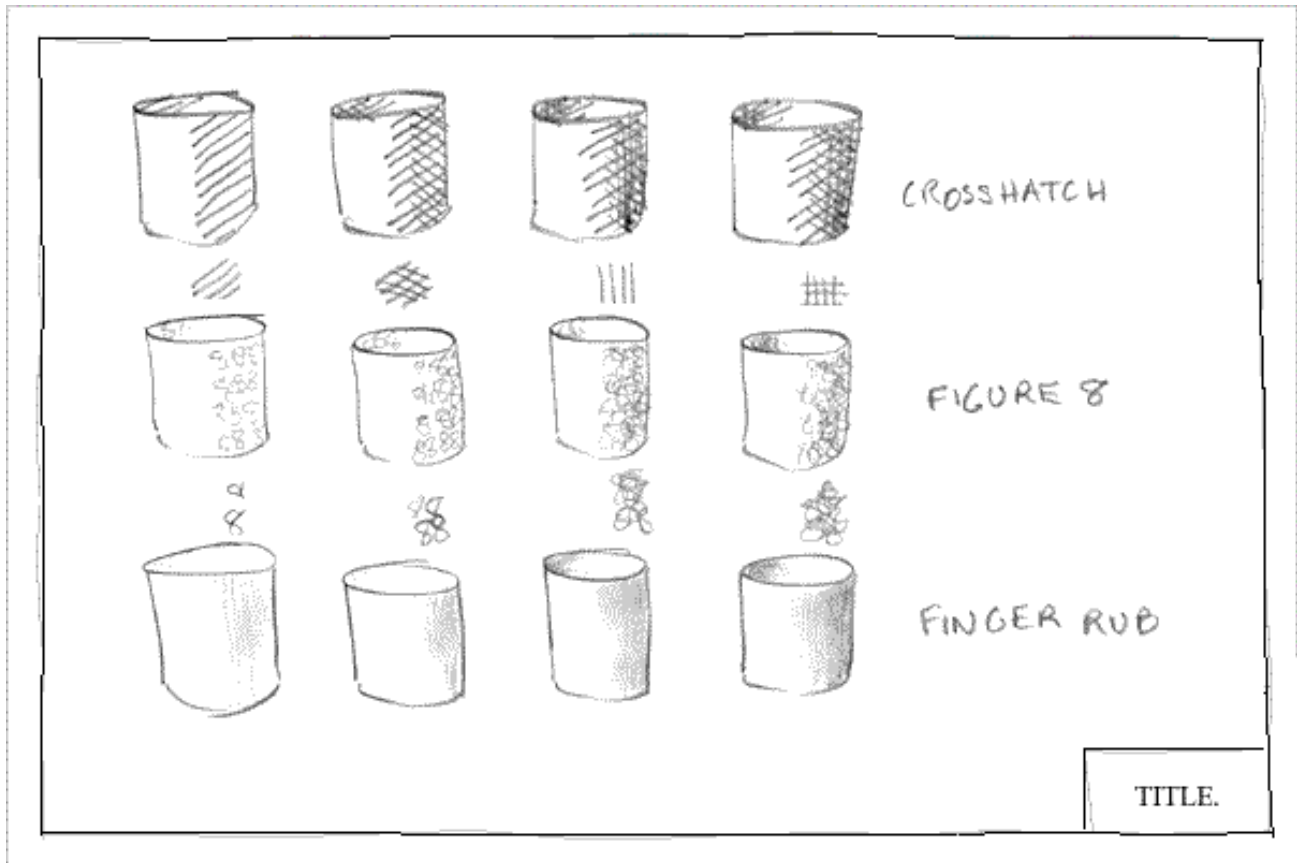

Label the three methods and title the drawing 'shading'.



TENNIS CUPS

[lesson menu](#)

PART 2: LESSON 2 - SHADING

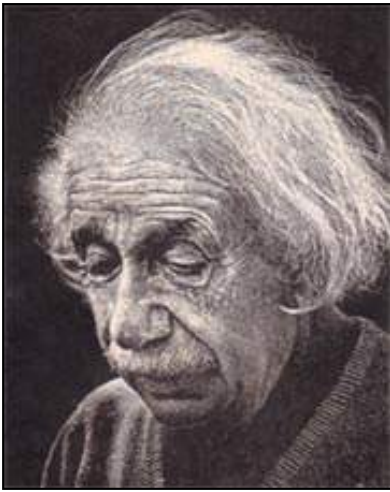

TIME: Allow 40min

Aim: To introduce reflected light and its effect on shadows and shading. To develop the use of shading for a textural effect.

Materials: The sketch pad, HB and 4B pencil, eraser

Allow five minutes to for the quick sketch test. Two minutes to do and three to mark. Swap, display and title if necessary.

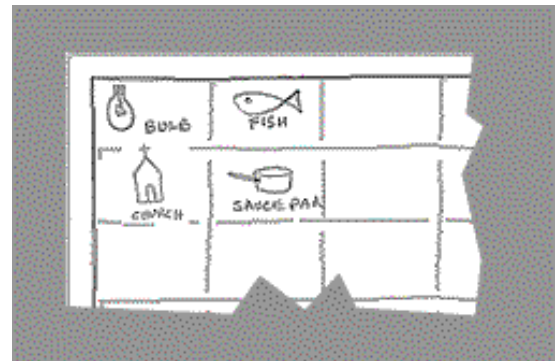

a) Without using the ruler (or any other straight edge) prepare the page with margin and add the freehand boxes as shown previously.

While the students are thus occupied hand out these prepared theory sheets.

Sitting in the garden I asked a person if the shadow cast by a tree would be lighter on a sunny day, than it would, at a similar time, on a cloudy day.

'Does it really matter?' he shrugged, as he poured himself another glass of my most expensive imported red.

'That depends.' I replied, 'one day you might want to paint a shadow.'

'The grisaille legacy'

'I met a man of black and white who had sadly lost his way.

Wringing his hands, he said to me, "but all I see is grey".'

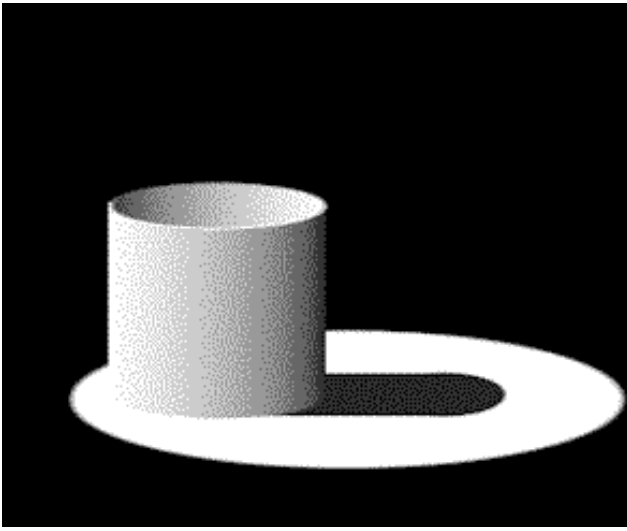

If a cup was placed in a spotlight the shadow it cast would be as black as the surrounding darkness while the shading on the cup should move from a grey at the 'turning point' to a similar blackness.

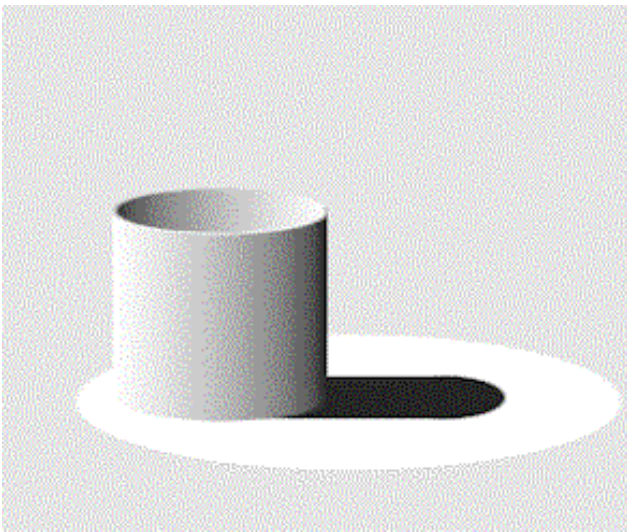

However, if there was some other light in the room the 'black' shadow would look out of place - as shown above. The reason for this is that in our normal life we mostly don't live under spotlights. Usually, there are many sources of 'reflected' light around us. In a room or outside our shadows are rarely completely black as they are modified by the 'general lightness' of the day - or the room.

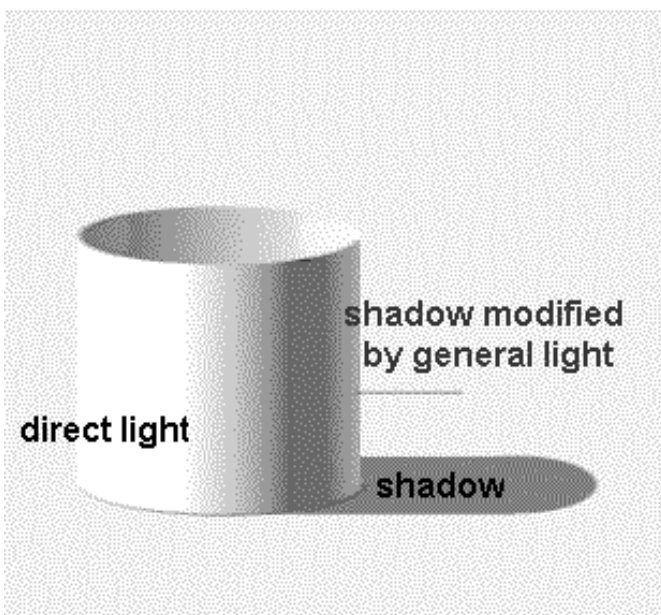

Therefore a more 'realistic' rendition of shading and shadow would be as shown above. This can be

better understood by referring to my general lesson on side light and turning points in the 'painting' section.

b) Lets now go back to our prepared sheet and our lesson for making a quick drawing of a tennis ball.

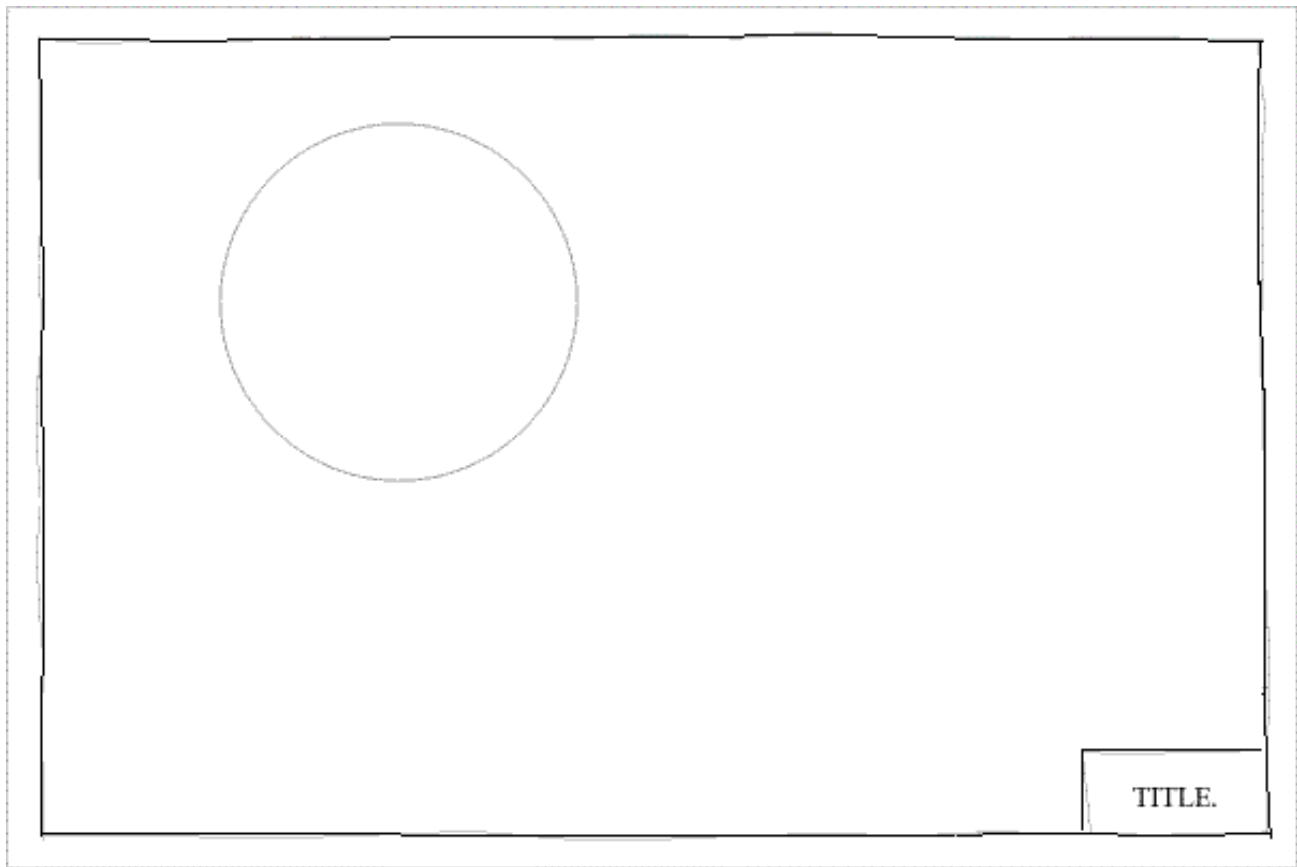

Using the method we learnt in part 1 for making a freehand drawing of a large circle - draw one of the approximate size and position shown.



Employ the figure 8 and smudging method to shade the ball (medium to light weight pressure) ... but leave the two 'S' shaped 'tracks' as shown.

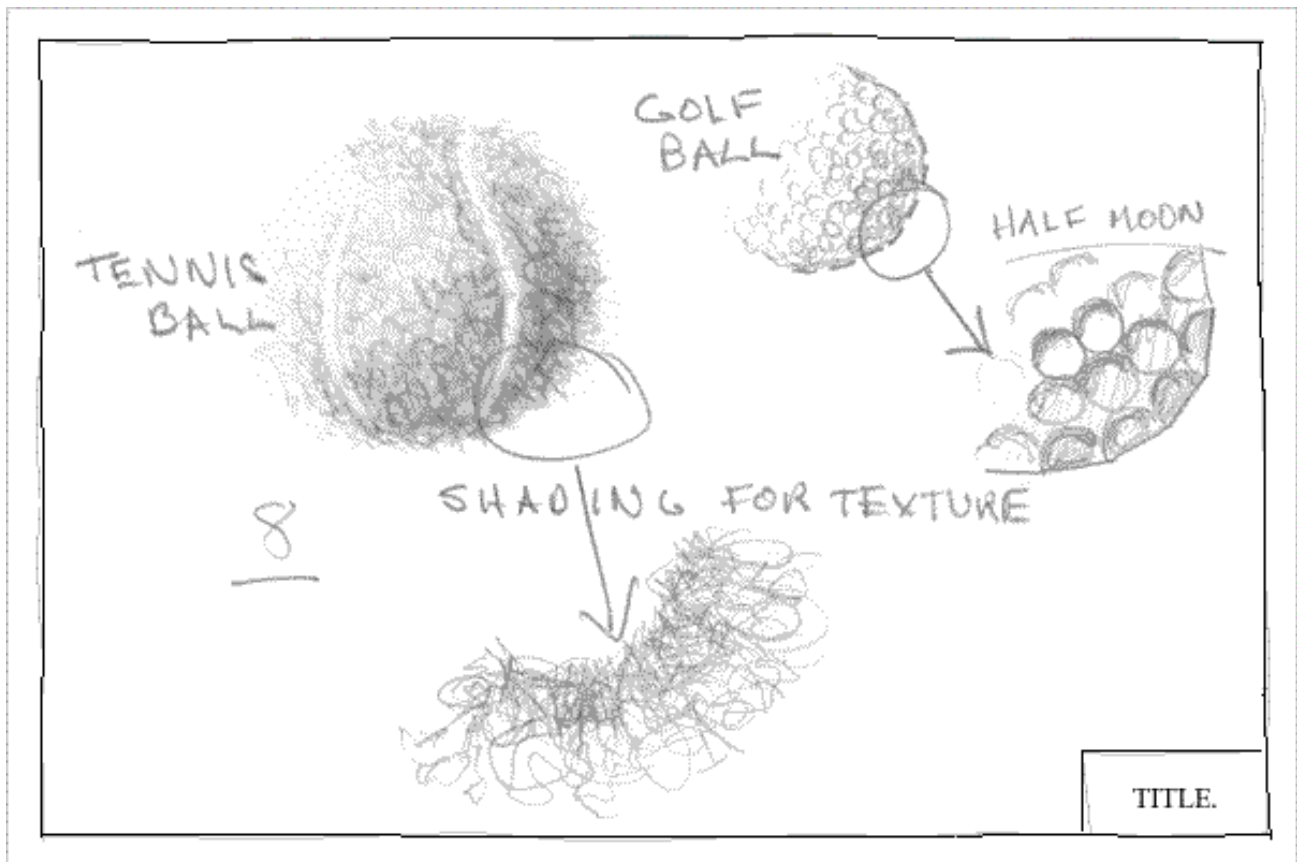

Increasing the pressure with your 4B pencil show some of the 'fluffy' hair at the turning point and at the edges.

HOMEWORK

Find a golf ball, baseball, basket ball or one other and draw it along side the tennis ball. It is

necessary to look up [texture](#) and [advanced texture effects](#) before you begin your drawing assignment.



[GO TO ... TEXTURE](#)

[lesson menu](#)

PART 2: REFERENCE SHEET ON TEXTURE

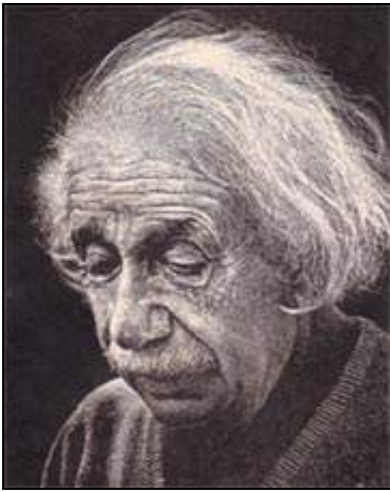

TIME: reference sheet

Aim: At this stage I thought it might be valuable to show how we can combine shading and texture in the one drawing. Later we shall be doing more work on this but for now it is sufficient to show the student what they will be able to do if they apply themselves to the lessons so far. All the techniques are already described.

Scraperboard is a board made of a backing, a layer of compressed whiting/adhesive mix (approx 1mm thick) then covered with a film of black indian ink. An incredibly fine white line is etched with a stylus as it is dragged across the surface. The flat edges of the stylus are sharpened and used to scrape larger areas clean of the ink. The boards can be bought already made as can the stylus and other tools for the scraping process.

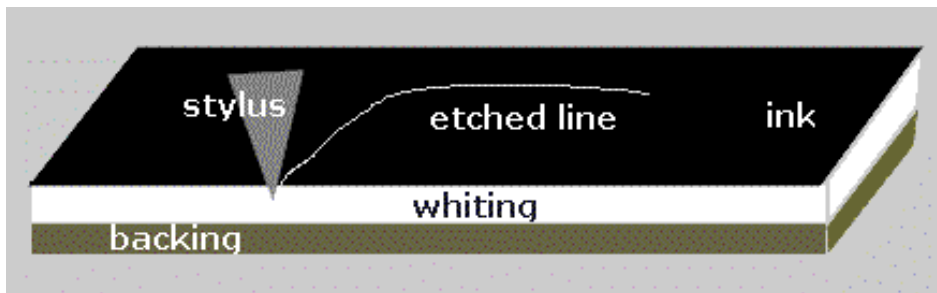

In earlier days, when I was possessed by a steady hand and keen eyesight, I produced an exhibition of 28 scraperboard drawings of which the drawing below is but one example I have scanned from an old exhibition invitation cover.

Alas, none remain in my possession and I needed to search my records for the one shown to scan it and show it to you as an example of 'drawing with texture'.



I used little 'cyphers' or curves(below)for the wollen texture of the pullover(very similar to the furry tennis ball in the previous lesson) and straight lines (single hatching) for the skin texture. There was little opportunity for 'cross hatching in this drawing apart from the hair when a confused tangle is required.

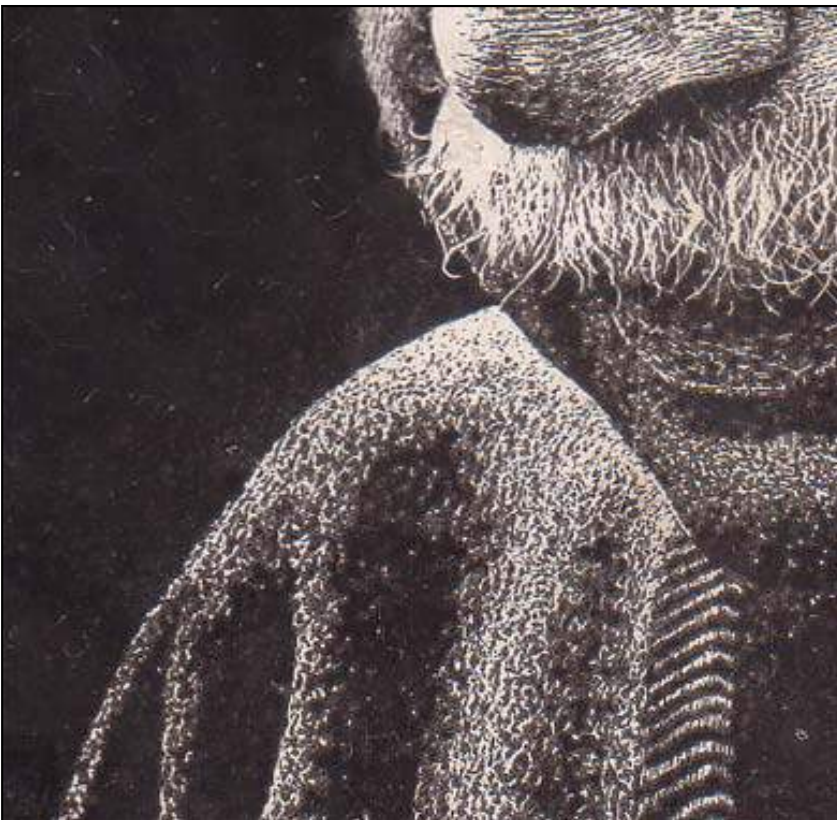

You will note how the skin can be textured either along the folds, as in the forehead, or across the folds as in the nose and cheeks. This produces a 'dynamic tension' that can be used to emphasise roundness or flatness. For those students who decide to advance into painting it is useful to realize this same 'directional line' is the direction the painter would employ with the brush to give the human body appropriate 'dynamic tension'.

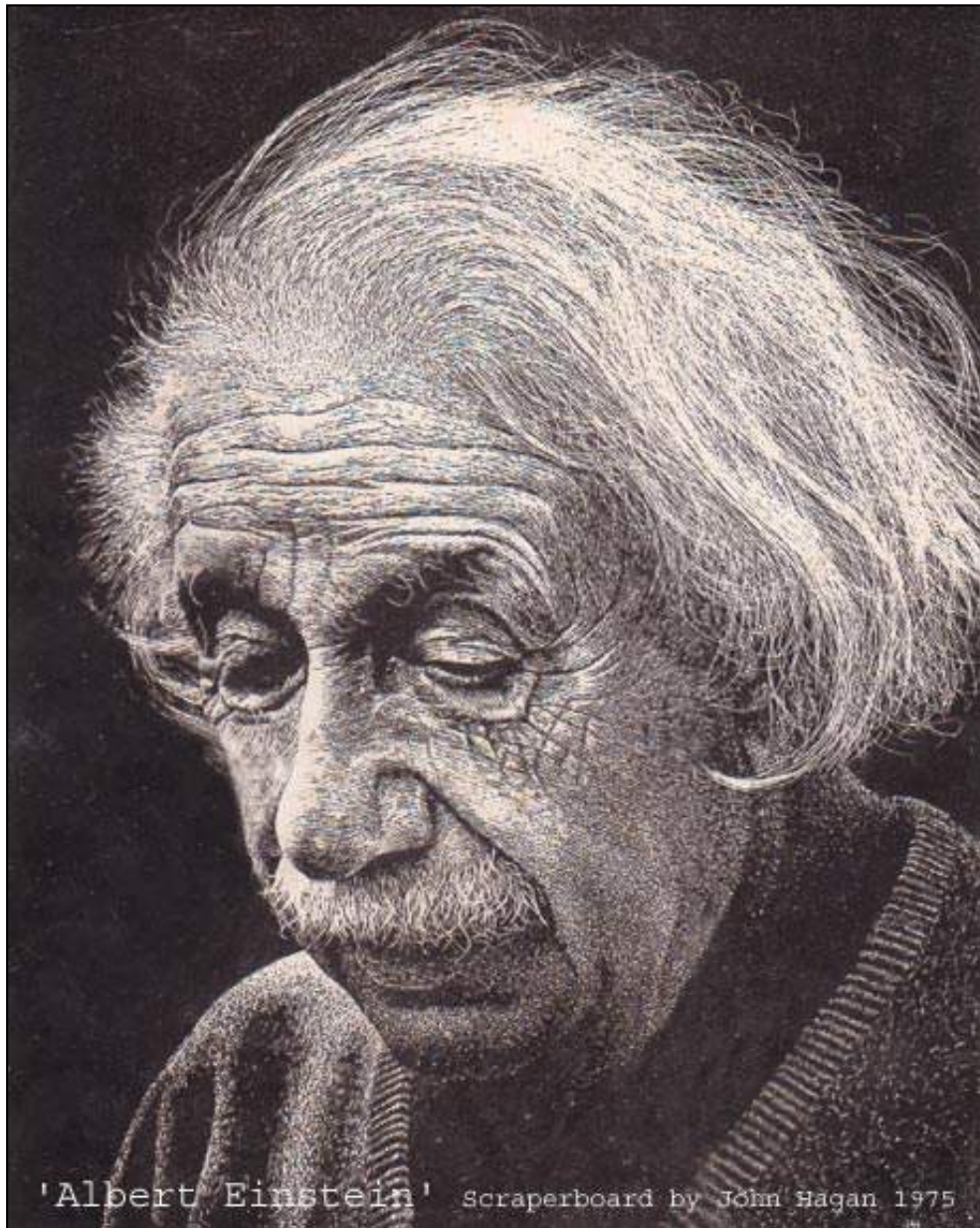

Full size approx 10" by 12" in private ownership (heaven knows where it is now for, at the time, it was purchased by a restaurant owner for \$300 and free meals whenever I was desperately hungry, which was quite often in those days!)



[GO TO ... LESSON THREE](#)

[lesson menu](#)

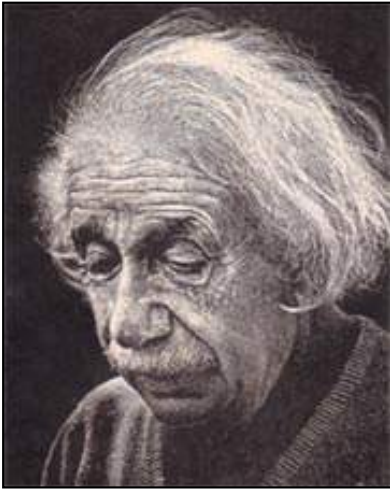

PART 2: LESSON - 3D DRAWING

TIME: Allow 40min

Aim: To introduce the basis of three dimensional drawing and apply to drawing.

Materials; The sketch pad, HB and 4B pencil, eraser, a ruler if need be.

Allow five minutes to for the quick sketch test. Two minutes to do and three to mark. Swap, display and title if necessary.

Draw a little butterfly on your page in approximately the same position as mine.

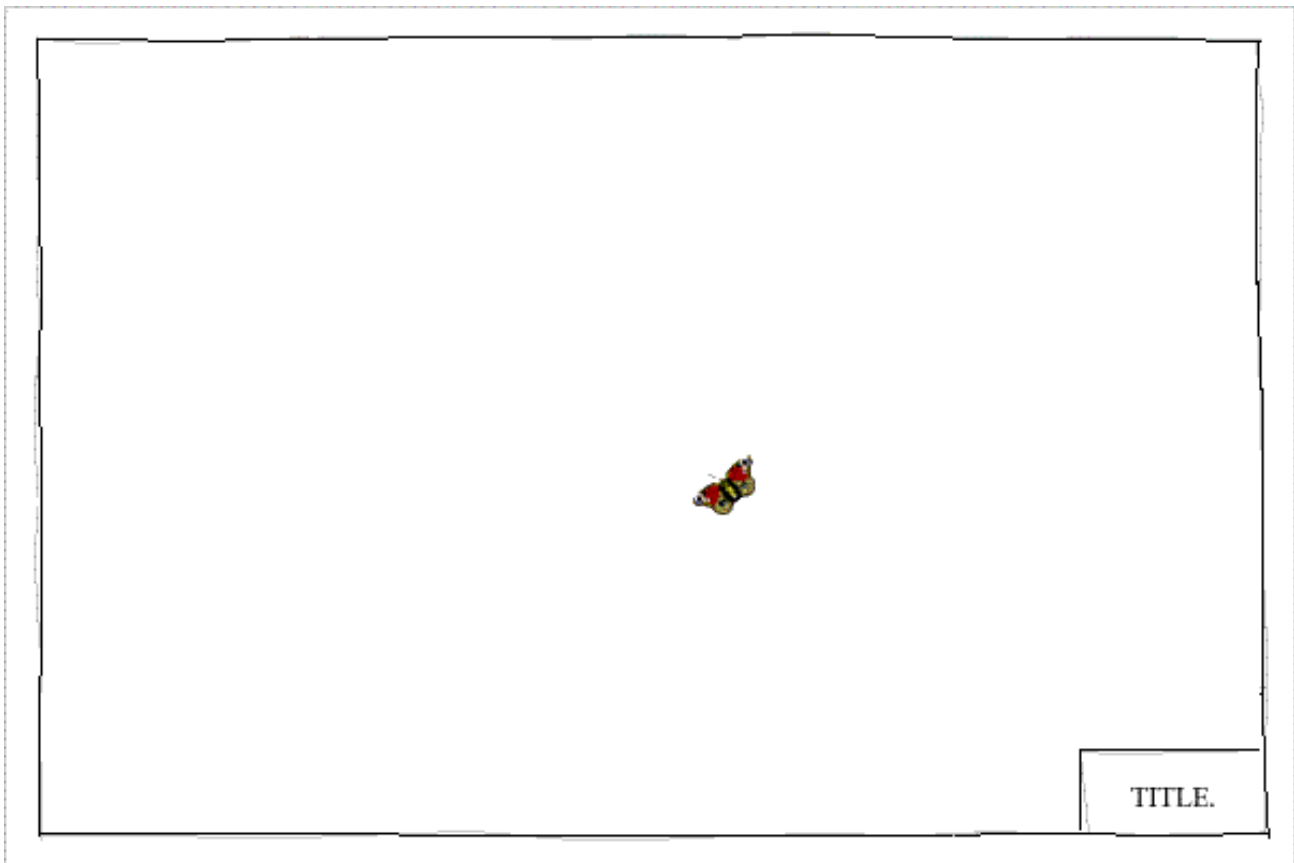

But where exactly is the butterfly? How far from us, how high above the ground? We have no idea until we 'place' our butterfly. To do that we shall put her in a (reference) box or cage. See below ...

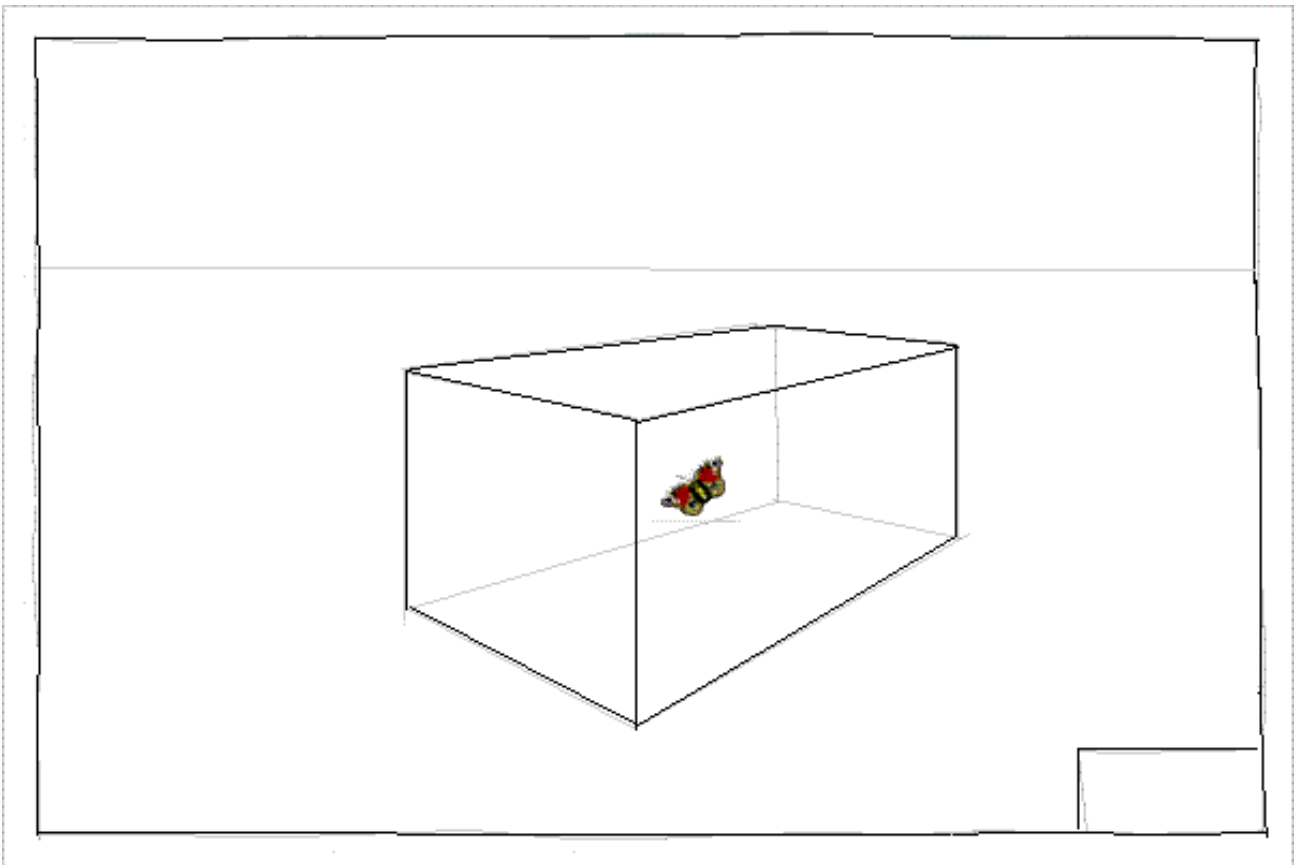

Now we have our reference and we can relate the position of the butterfly to something tangible, specific. Furthermore if we draw a line 'forward' from our butterfly we can decide where we want our butterfly in relation to the front of our box (point 'a')

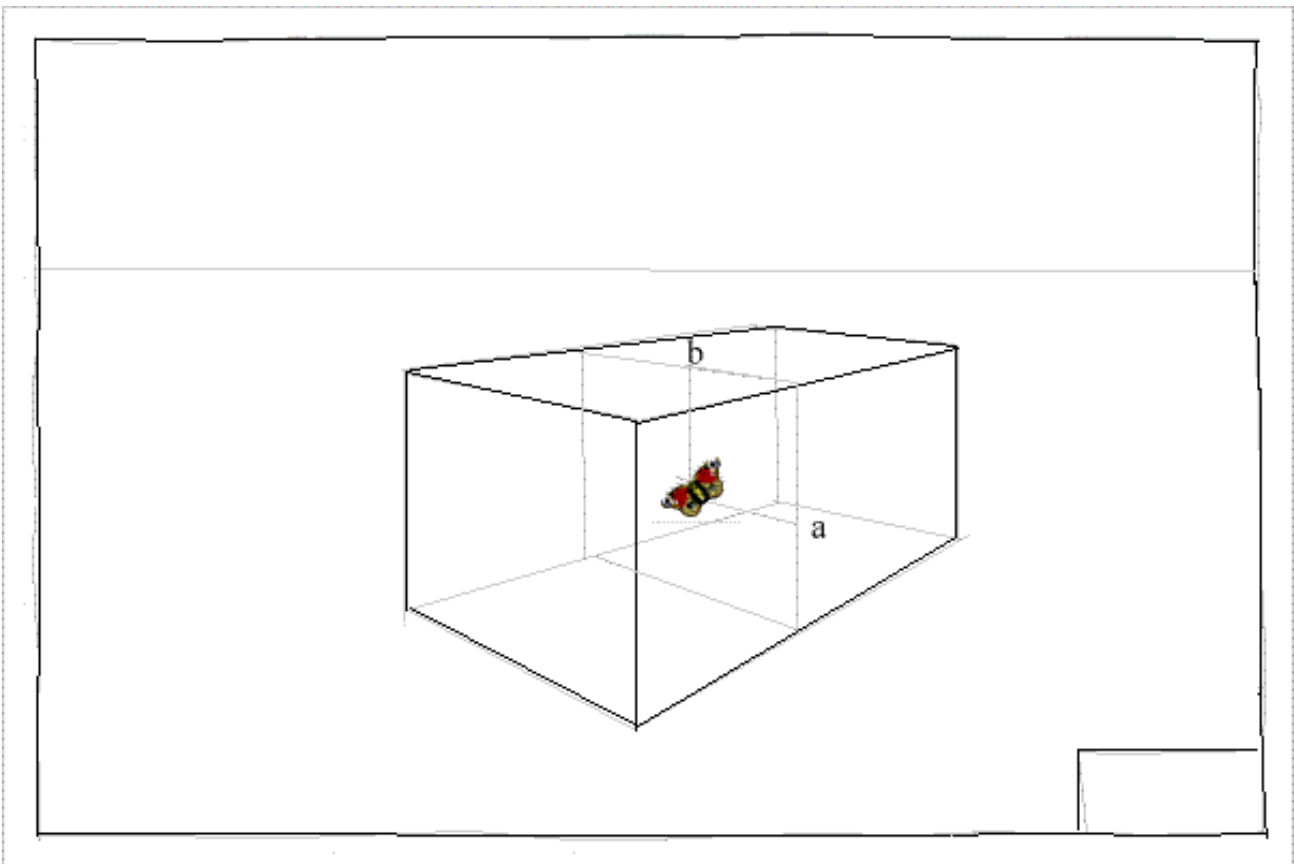

In a similar fashion if we project a vertical line up from our butterfly we can relate the butterfly to the top of our box (point 'b'). But how far up? Since the butterfly is in a set place then point 'b' can be joined by the vertical projection and by the projected line to the left vanishing point. It is as if we sliced through our box and the 'plane' of that slice suddenly cut through the middle of our butterfly.

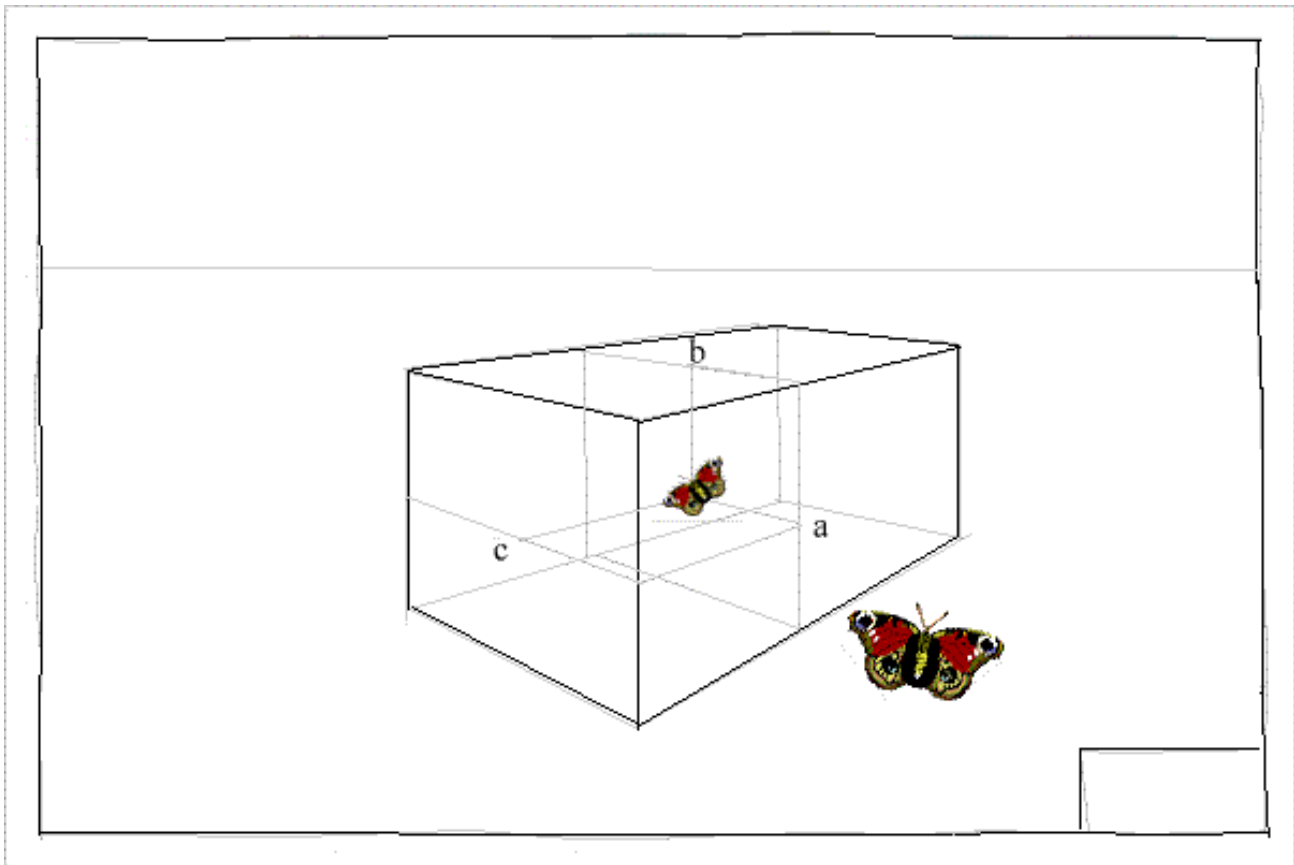

Do this again and locate the butterfly on point 'c' the left hand front surface. Such is the method we can obtain the 'three dimensions' that locate our butterfly in space. Of course we needed to 'reference' the butterfly within a box. Now we have our 'three dimensions'. The bigger butterfly I have introduced is much closer and can be related to the first in a similar manner.

HOMEWORK

Prepare for the next lesson by drawing a 'top view' and 'side view' of a common fork.



[GO TO ... LESSON FOUR](#)

[lesson menu](#)

PART 2: LESSON - DRAWING A FORK

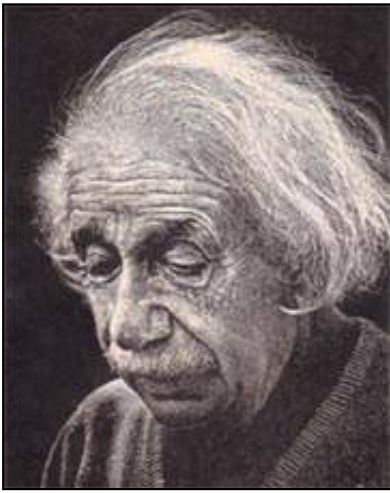

TIME:

Allow 40min

Aim:

To apply in reverse the principles learnt in our previous lesson to drawing objects that have more complicated three dimensional shapes.

Materials:

The sketch pad, HB and 4B pencil, eraser

Allow five minutes to for the quick sketch test. Two minutes to do and three to mark. Swap, display and title if necessary.

Prepare the sheet as usual then using the prepared top and side view of the common fork draw a box of appropriate dimensions as shown.

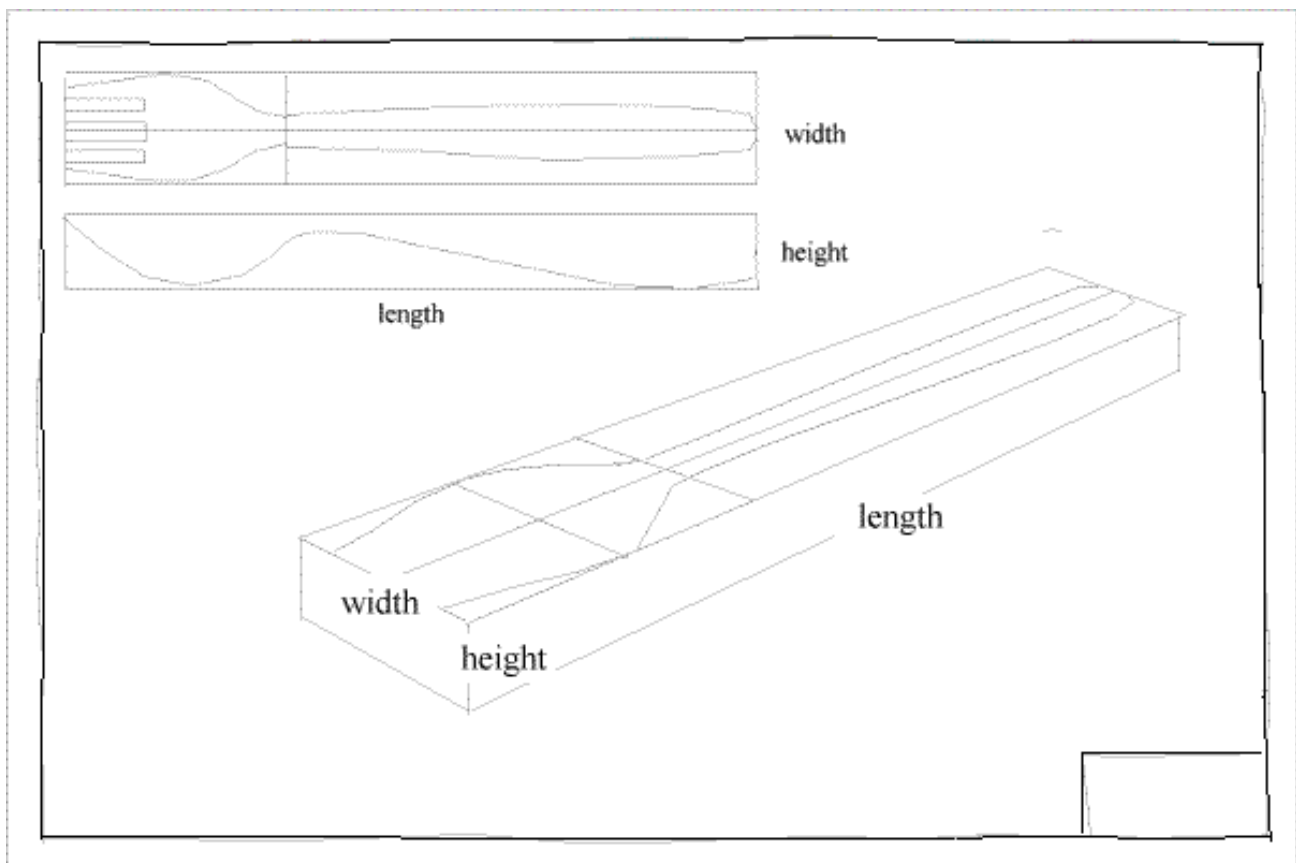

On the top surface draw a 'flat' top view of the fork.

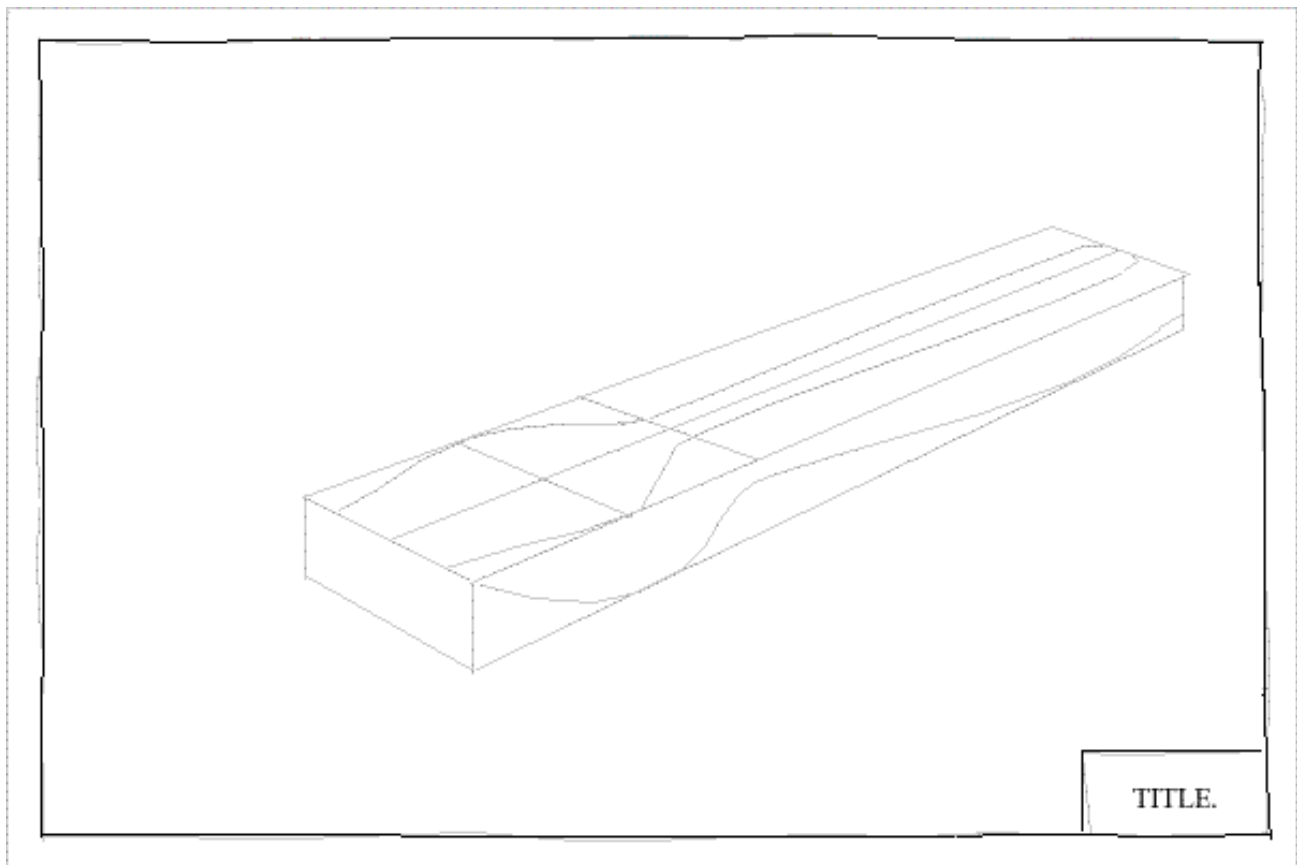

Draw a side view on the front right hand surface as show.

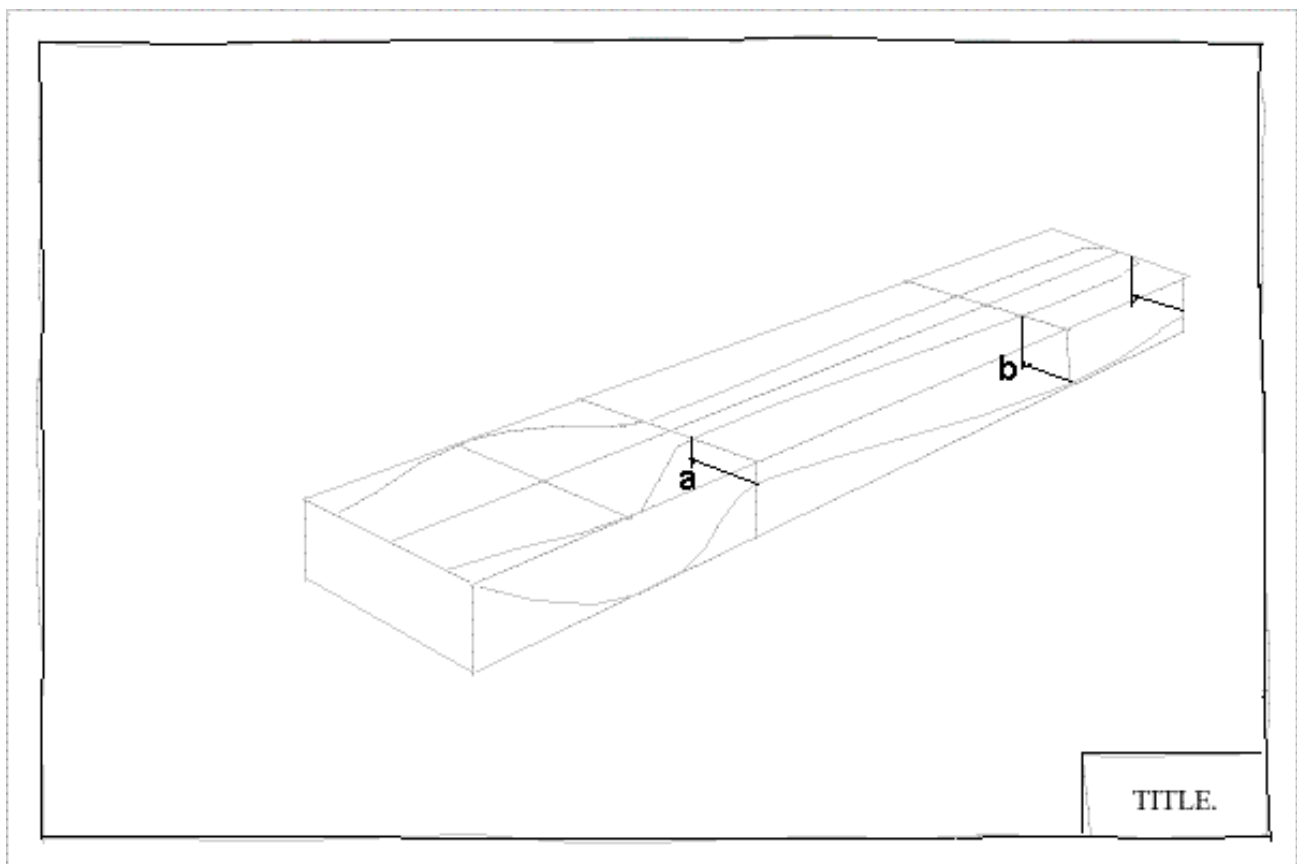

If we now project light lines 'in' from the front view and 'down' from the top we can locate as many points as we like on the edge of our fork ('a' and 'b').

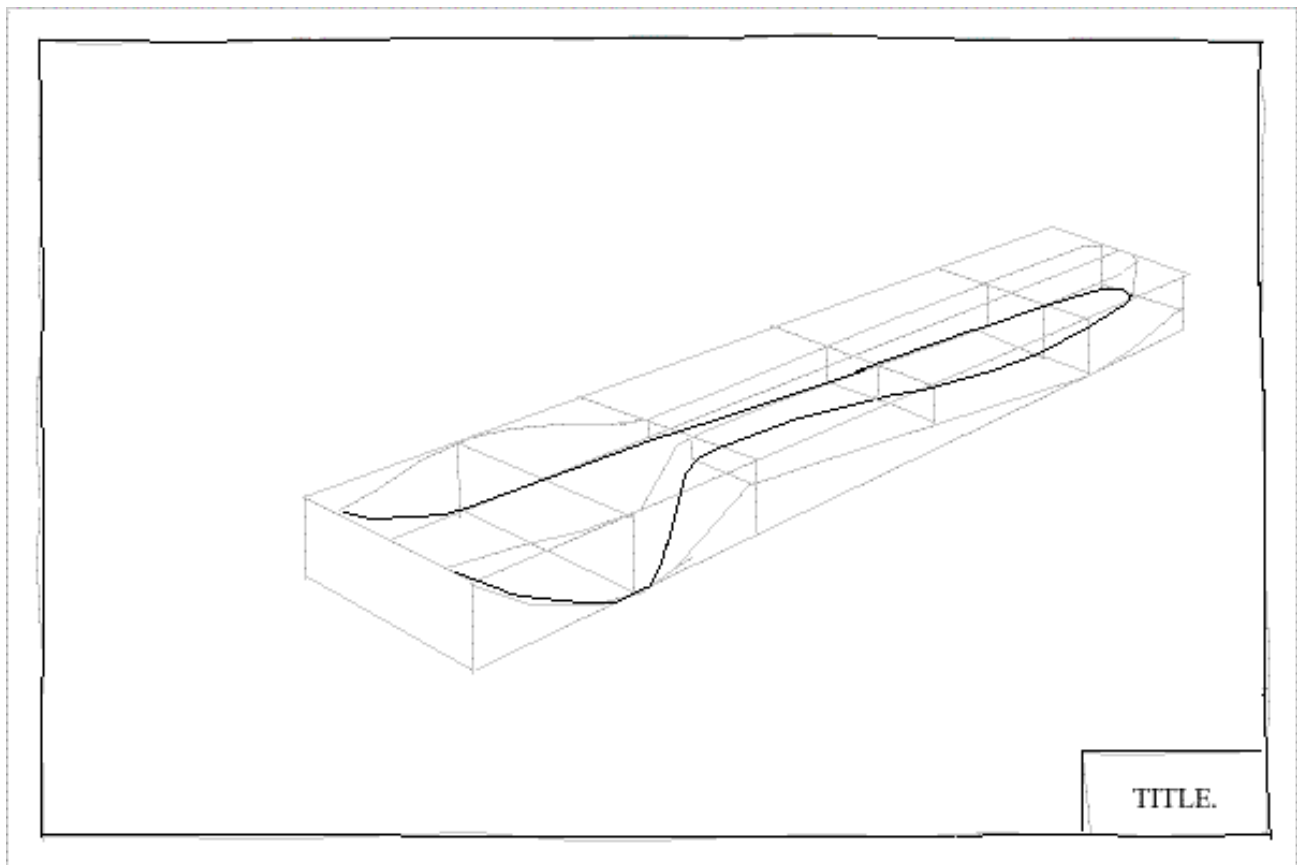

Join all these points up with nice smooth freehand curves as shown.

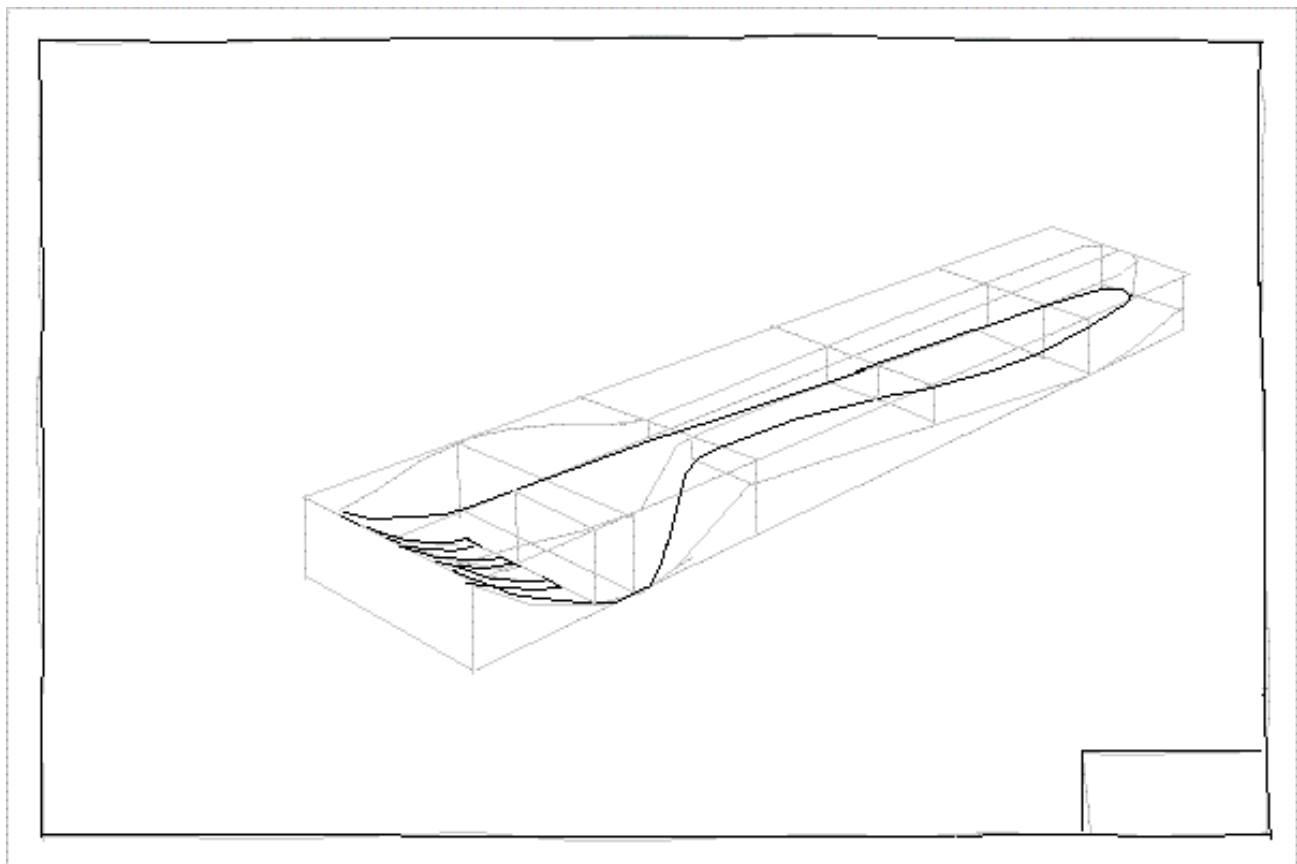

Complete as shown above taking extra care with the prongs.

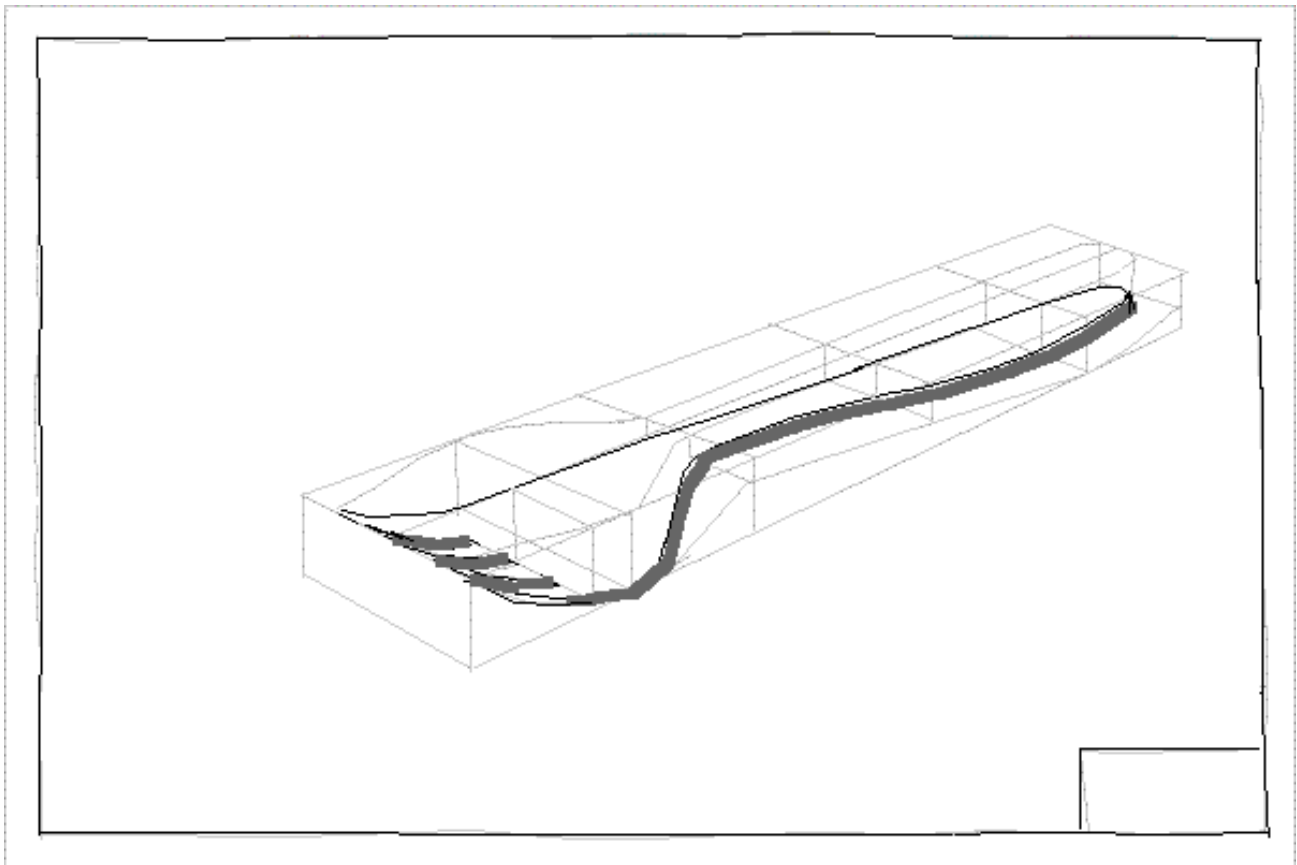

Now let us give our fork a little 'thickness' using shading on the front edge.

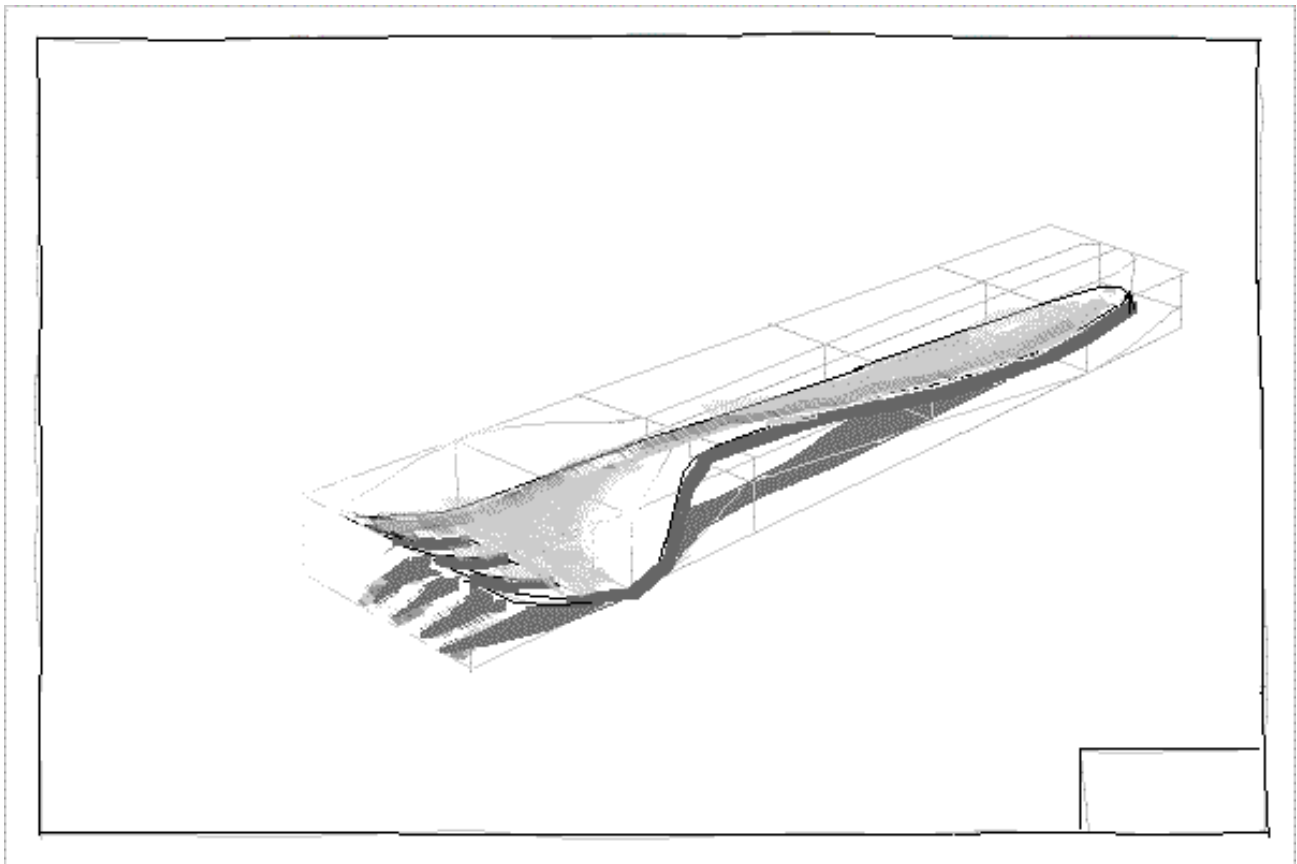

Shade in the rest of the fork and add a shadow where appropriate. If you have a fork with you on your desk you can adjust the shadow as you see it, otherwise just copy mine.



HOMEWORK

Refine the drawing and add a knife.



[GO TO ... PORTRAITURE](#)

[lesson menu](#)

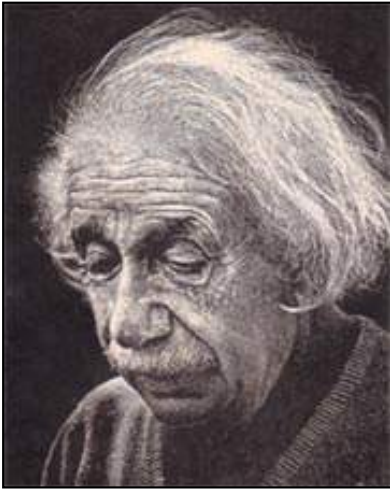

PART 2: LESSON - PORTRAITURE

TIME: Allow 40min

Aim: To study draw a portrait using the 'inside-out' method.

Materials: The sketch pad, HB and 4B pencil, eraser, a ruler for measurements if need be.

Allow five minutes to for the quick sketch test. Two minutes to do and three to mark. Swap, display and title if necessary.

Mostly everything we draw is based on regular solids such as cubes, spheres, cylinders and pyramids ... or a combination of them all. In this lesson we shall be using a sphere, a half-pyramid and a cylinder.

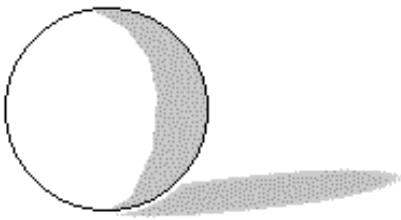

Sphere

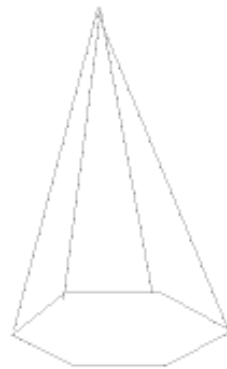

Pyramid

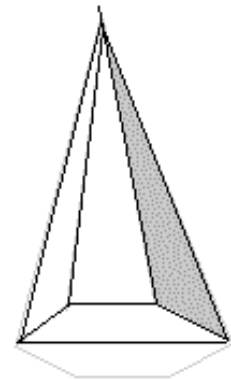

Split pyramid

First we construct a light circle in the approximate position and size shown below.

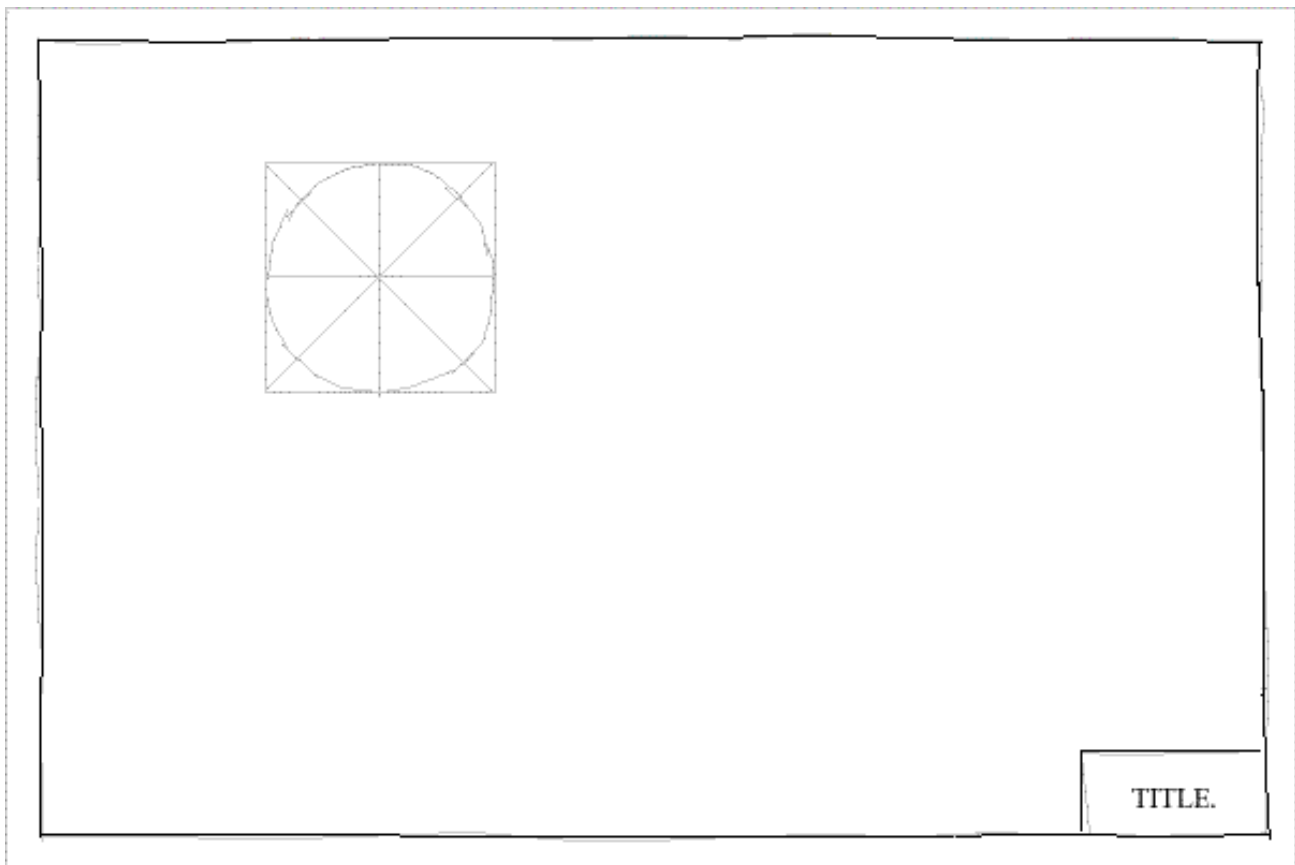

Draw another circle in the position shown (exactly one full circle apart). Using a nice 'sickle moon' arc describe the edges of the shadows that will give the spheres some depth.

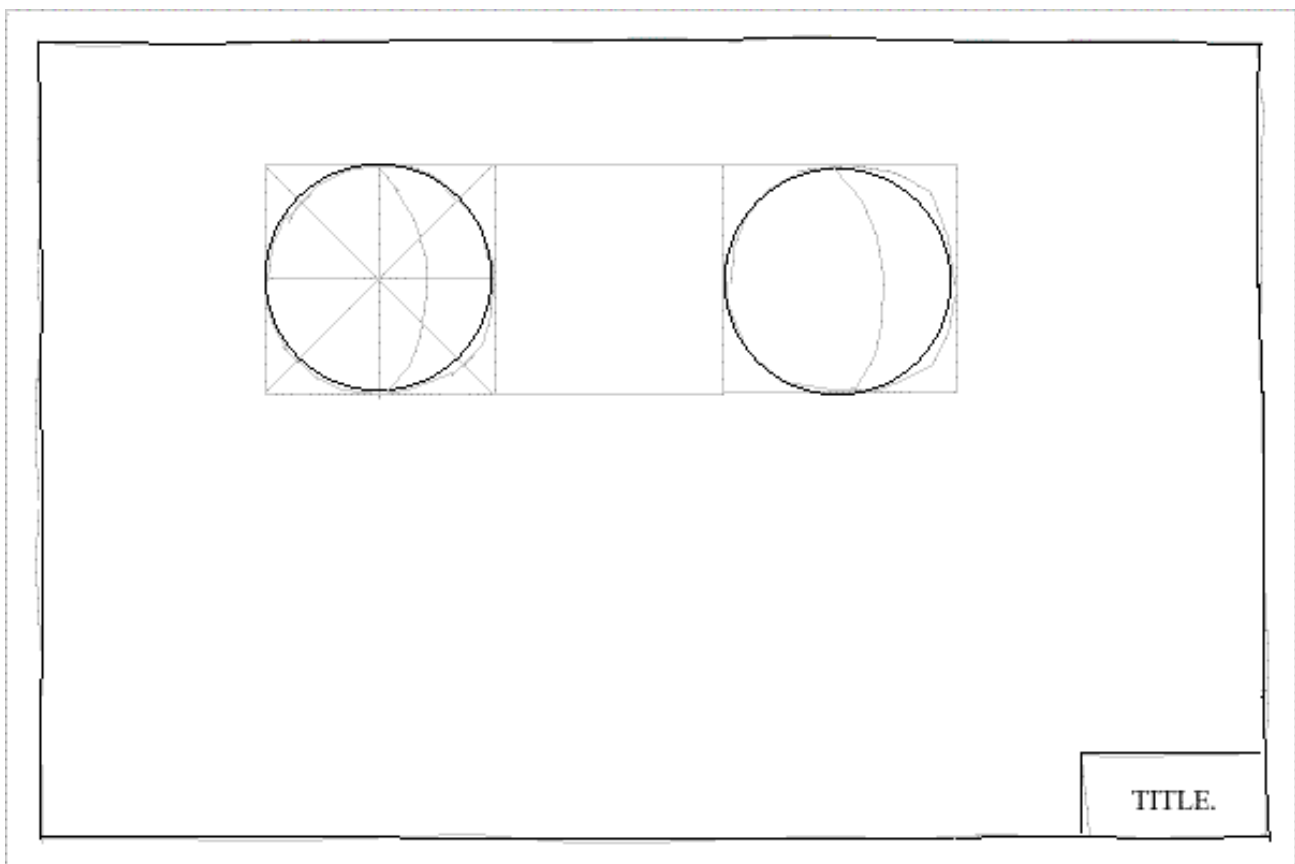

Shade in the shadow parts of the twin spheres.

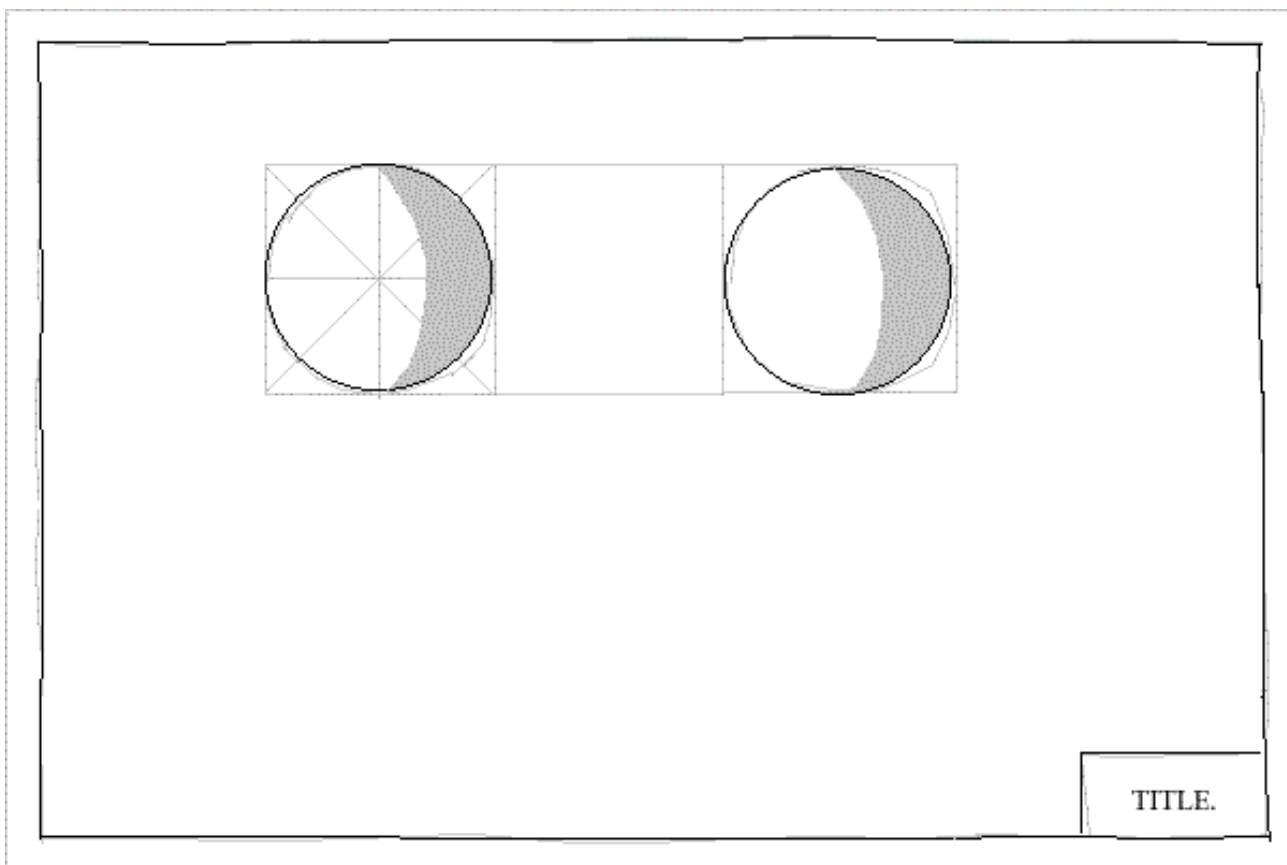

Copy the eye shapes from my drawing being careful to keep them level and sketch the little inside corners as I have done.

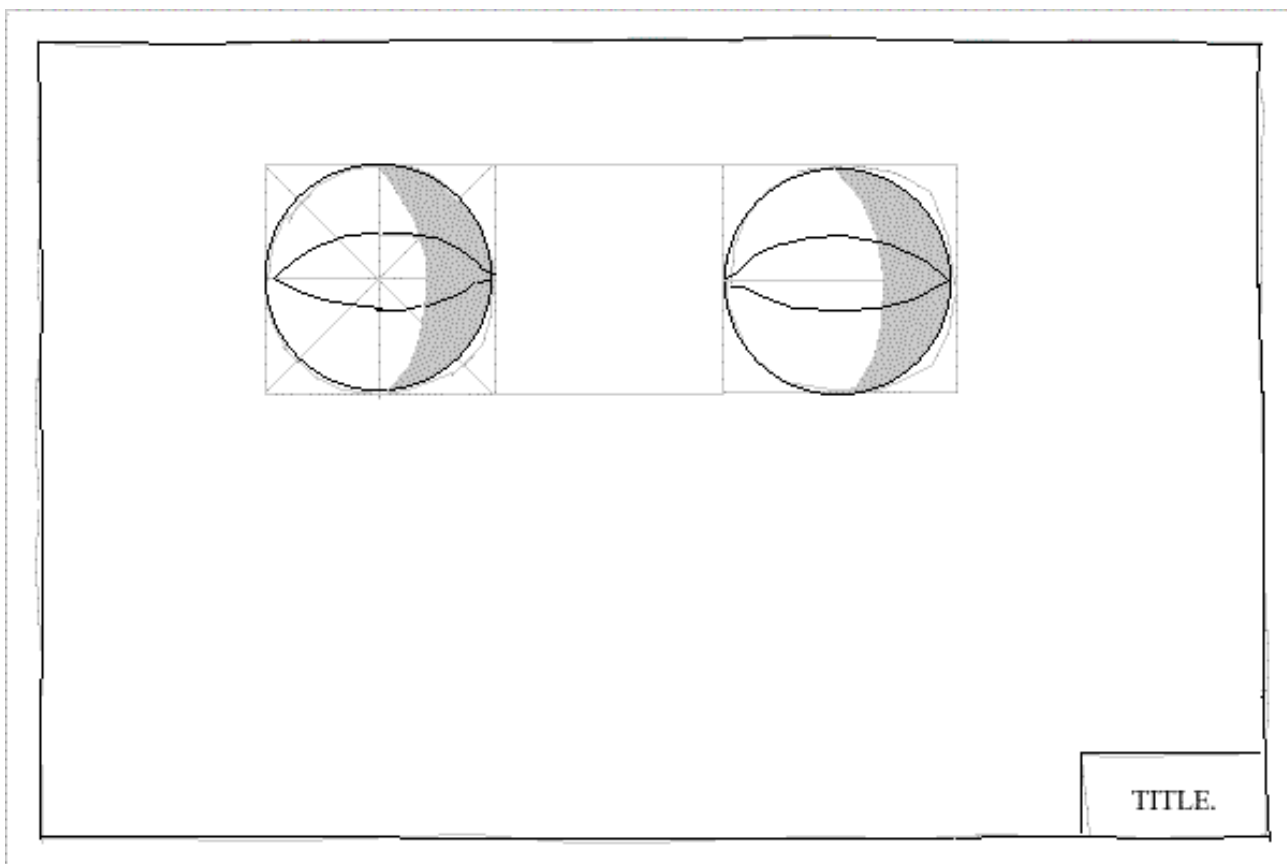

Add the eyelids and circle in the iris and pupils as shown below. To make the eyes look right or left you would position the pupils accordingly.

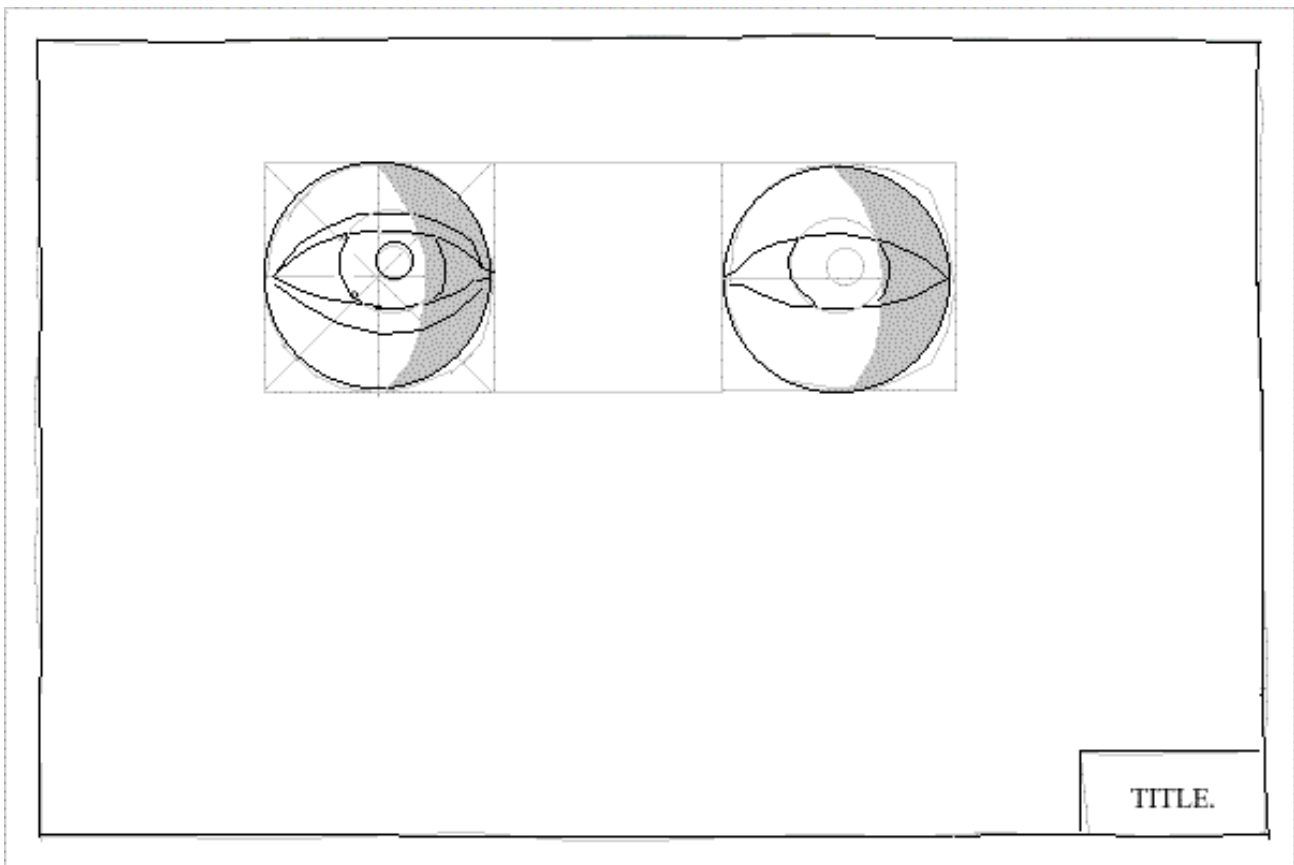

Shade in the pupils and irises. Remember the pupils are actually holes and therefore shadows.

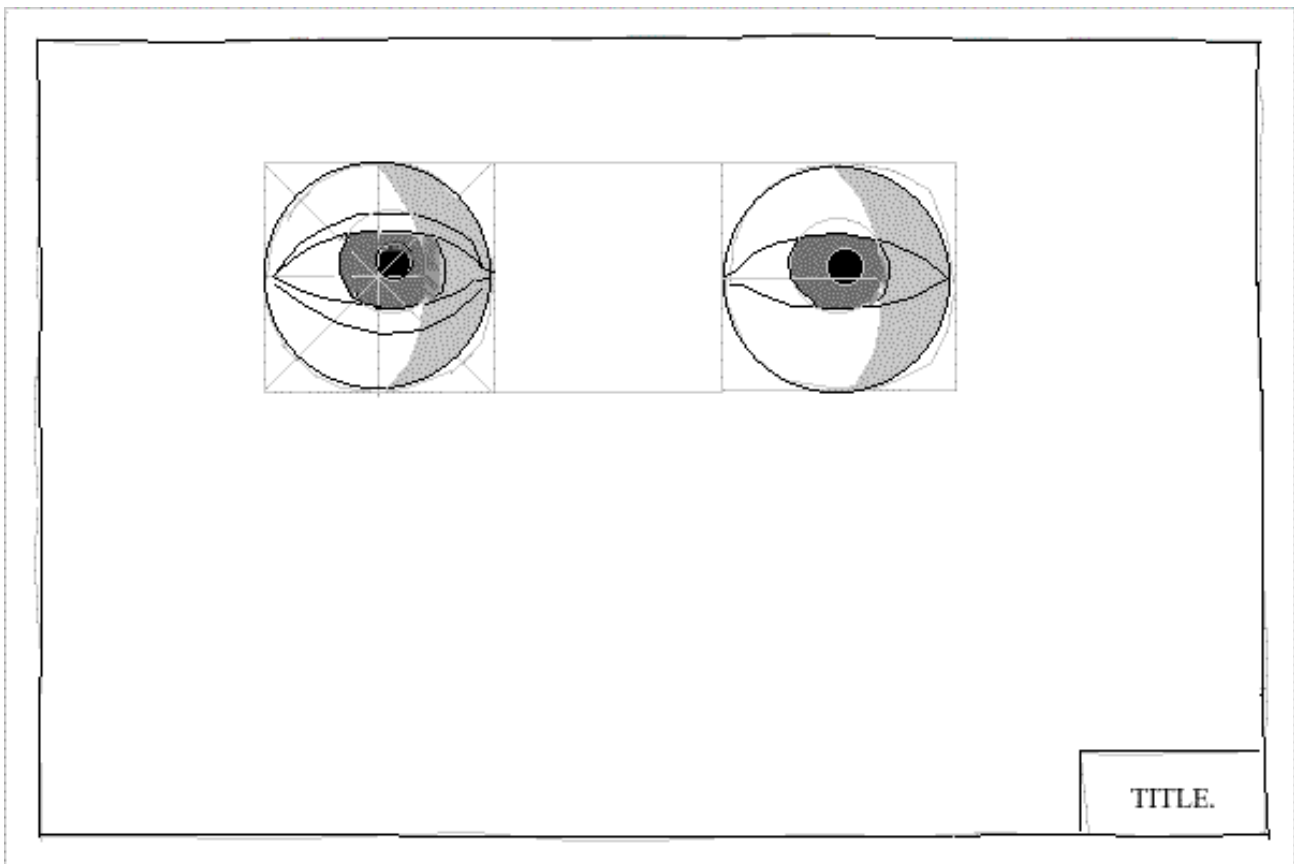

[GO TO ... PORTRAIT \(CONTINUED\) 2](#)

[lesson menu](#)

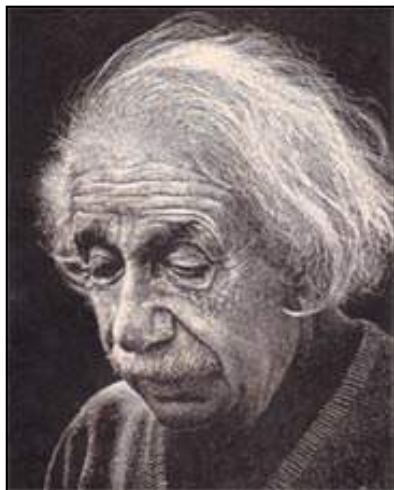

PART 2: LESSON - PORTRAITURE 2

TIME: Allow 40min

Aim: To study draw a portrait using the 'inside-out' method.

Materials: The sketch pad, HB and 4B pencil, eraser, a ruler if need be.

Allow five minutes to for the quick sketch test. Two minutes to do and three to mark. Swap, display and title if necessary.

Using your eraser make the small highlights in the eyes that give them their sparkle. The amount of 'sparkle' should differ from one eye to the other. Sometimes you would 'sparkle' one eye only as the other might be in shade. Careful observation is the key.

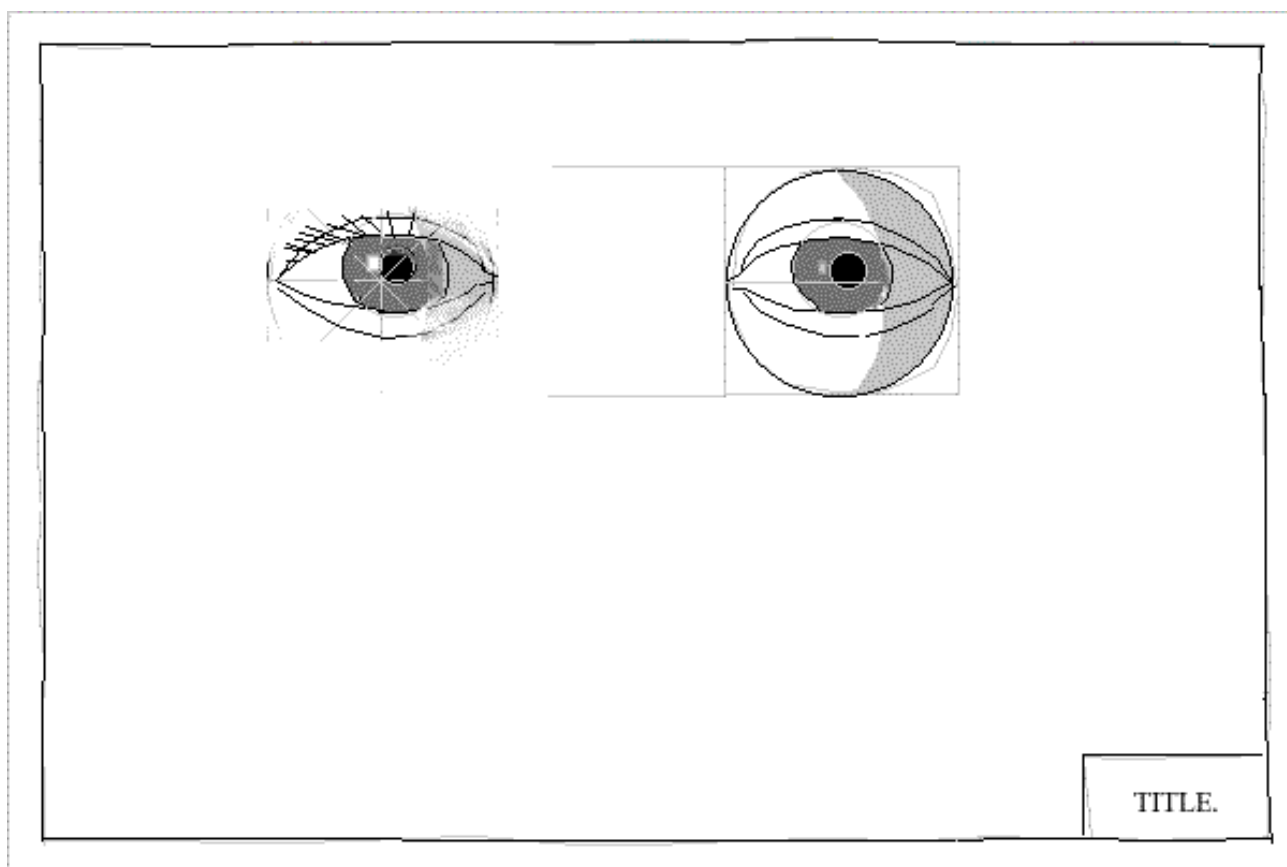

You can suggest some eyelashes at this stage. Next we will construct the pyramid that will give us our 'design' for our nose. All you will need to do in the future is to remember these basic structures when doing your portraits.

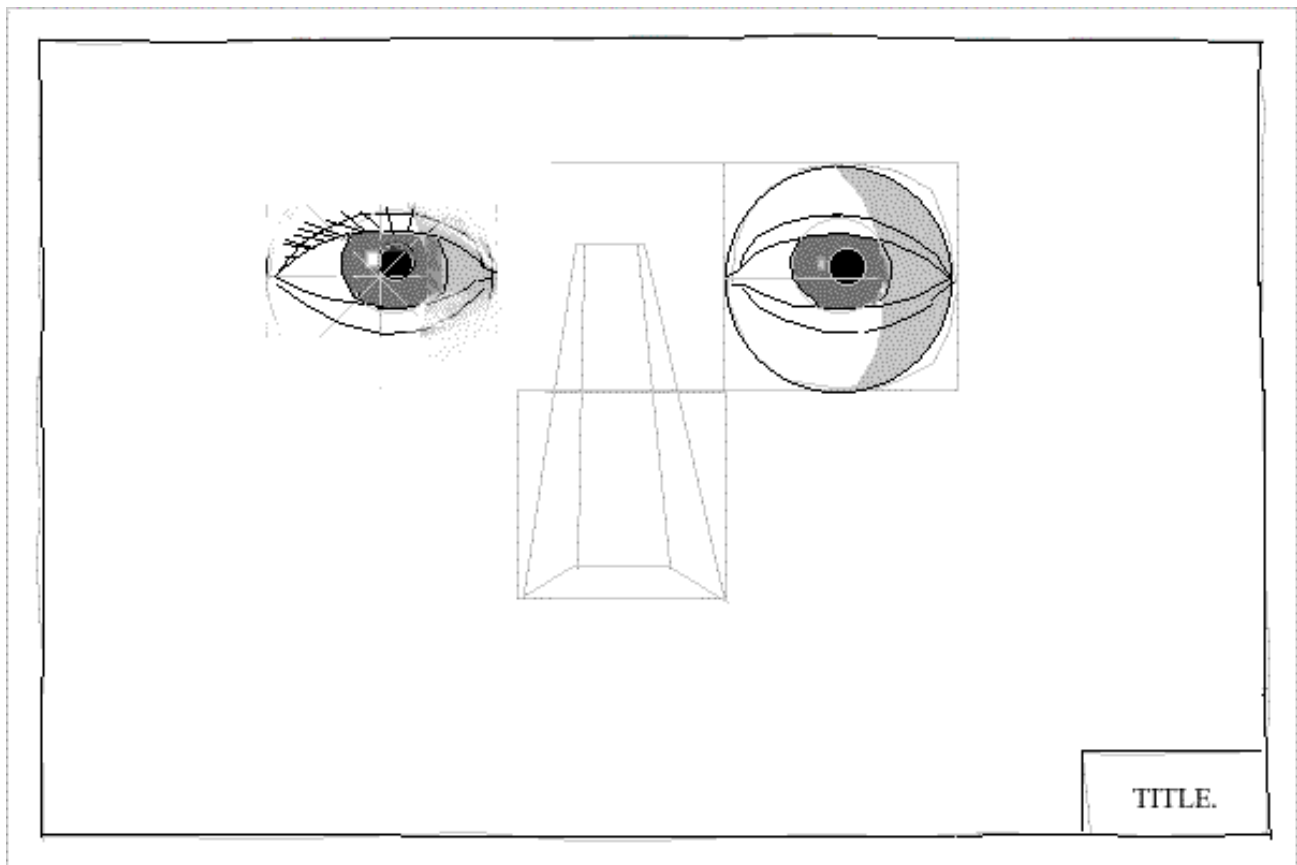

The 'length' of the nose will obviously differ between individuals ... but not too much. The distance between the eyes will often vary slightly as well but once you know the approximate distances as I have given you you can make the minor adjustments yourself.

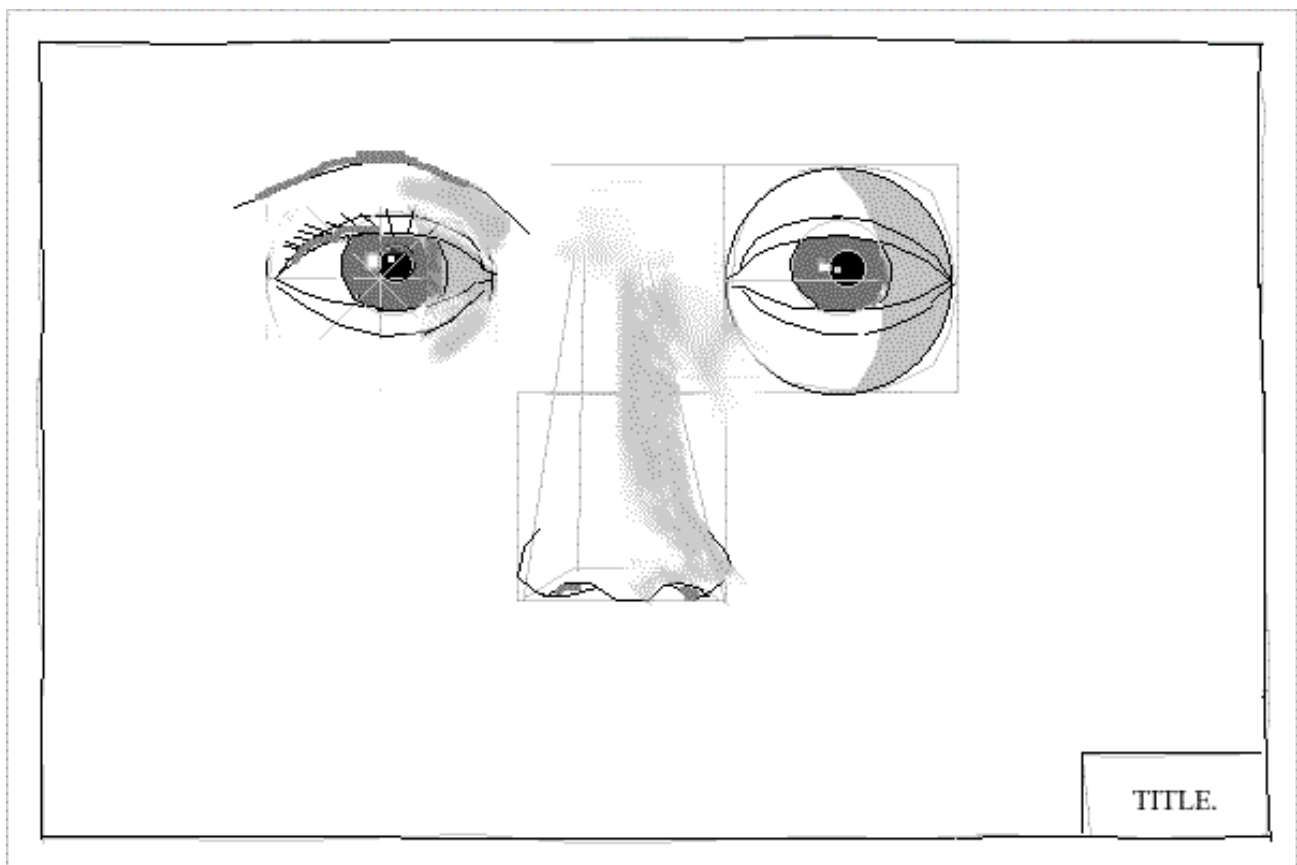

With a little shading and careful edges on the base of the nose you will be able to suggest the shape. Try not to include too many details at this stage. Next we will look at the lips ...

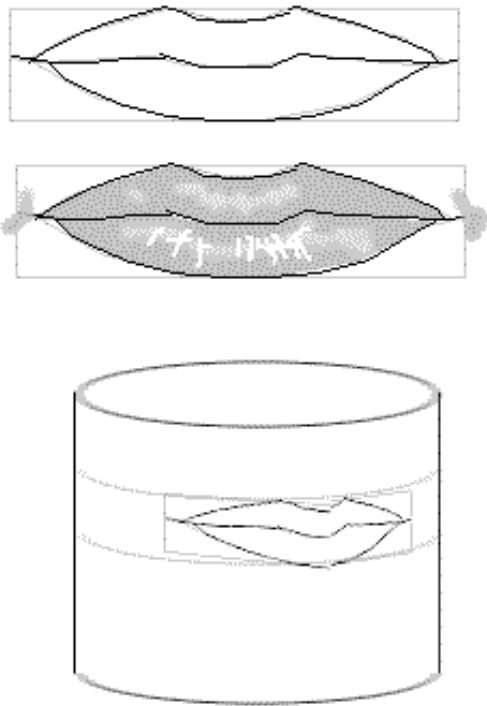

Lips are best visualized as part of a cylinder as they 'wrap around' the face. Here I have down the 'classic' shape with mouth closed. Using similar proportions construct your own as shown below.

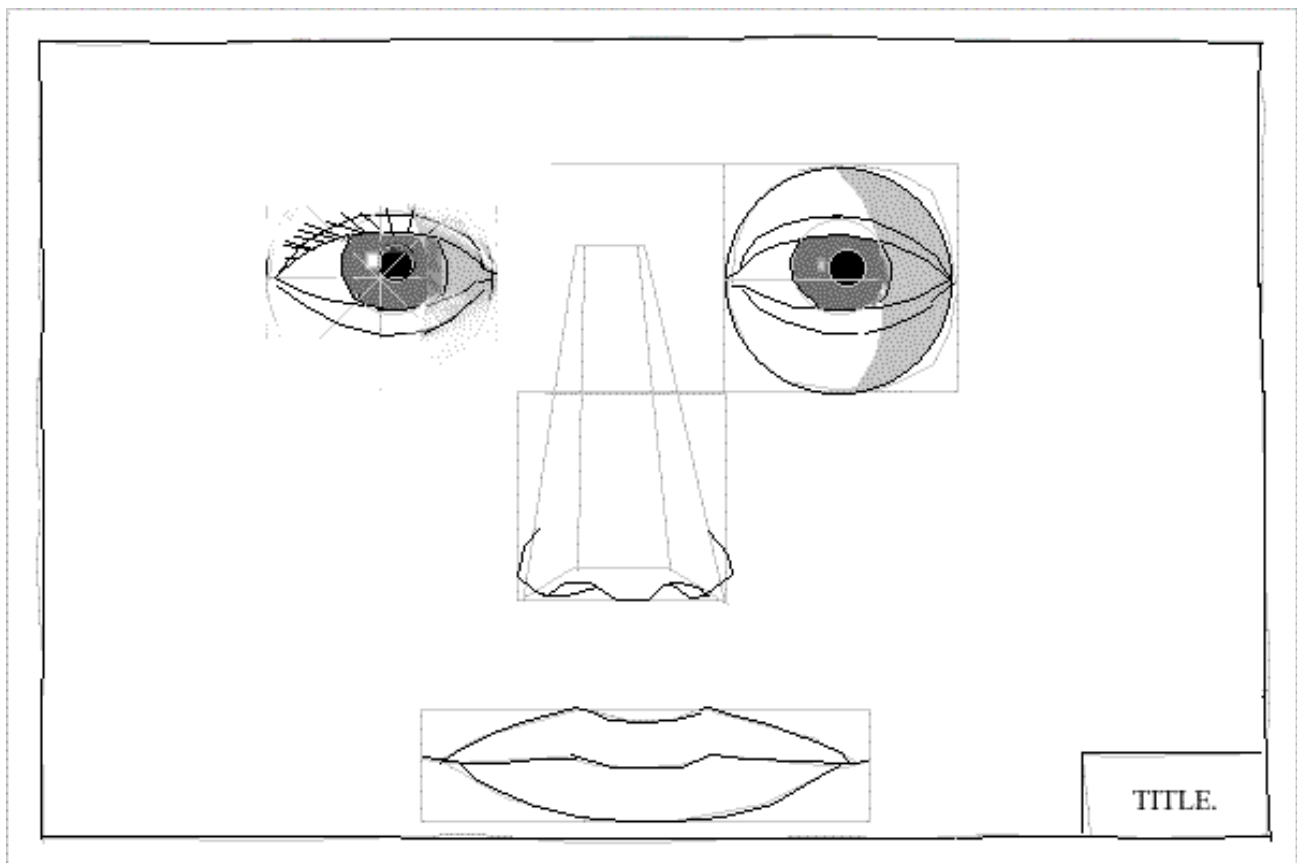

Now add a little bit of shading and complete your drawing as shown.

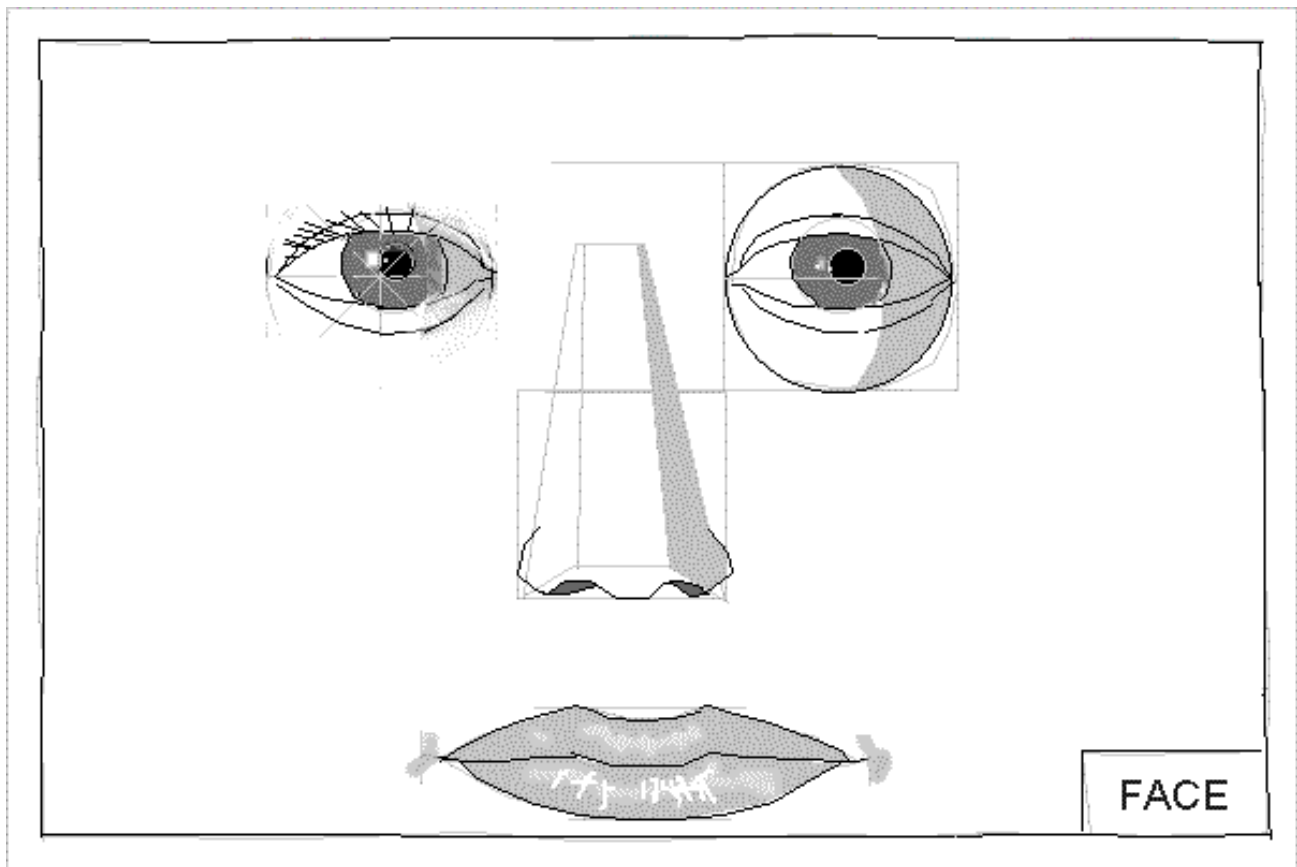

HOMEWORK

Complete both eyes and more shading.



END OF DRAWING BOOK

[back to start](#)



PART 2: LESSON - DRAWING A ROSE

TIME:

Allow 40min

Aim:

This is a project that has two parts. Part one, in this section, is learning to draw a rose and part two is in the general lesson section on making the drawing into a painting.

Materials;

The sketch pad, HB and 4B pencil, eraser.

In addition each student will need a single rose ... either have the student obtain one in preparation or the teacher might decide to provide them in which case one per every two students will be sufficient.

Allow five minutes to for the quick sketch test. Two minutes to do and three to mark. Swap, display and title if necessary.

You will need five sheets for this lesson but have the student prepare them as they need them.

Next have all the students examine the petals on their rose. They should take particular interest in the outside drooping petals where they will observe the following shapes. These they will draw as I have demonstrated below but with their own variations.

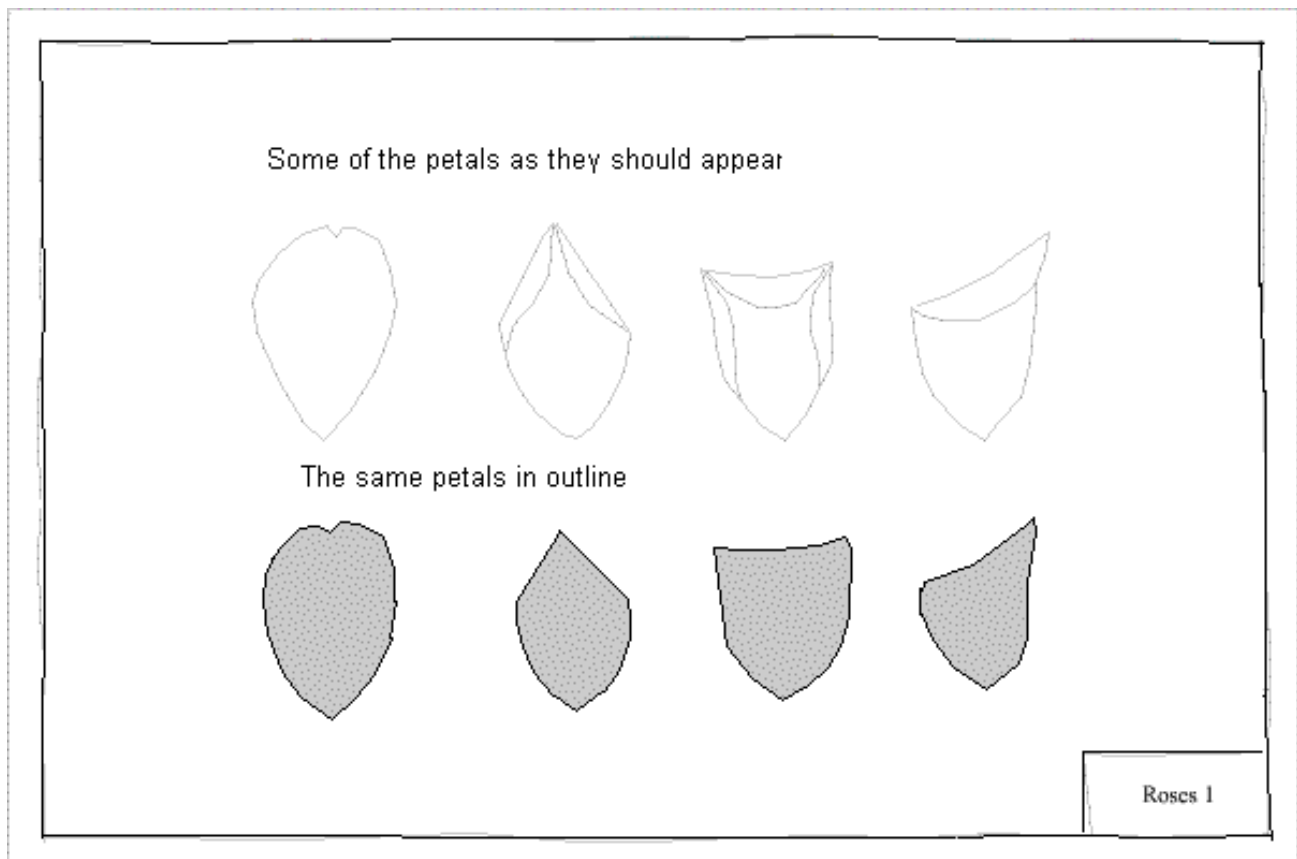

You will note that roses generally have five petals ... inside five petals - inside five petals etc. The petals are offset so that the outside petals don't line up with the adjacent row inside and so on and so forth. Therefore on the next sheet lightly draw a pentagon (five sided figure) as shown in Fig.1. You may use a circle if you like to be more accurate.

Nick the corners as I have shown in Fig.2

Put a vee in the flat sides of the pentagon as this will define the extent of the petals. Fig.3.

Firm in the outline as in Fig.4. as well as defining the petals and the center of the rose. You should now begin to understand the basic structure of the rose as seen from in front.

Complete and label the sheet.

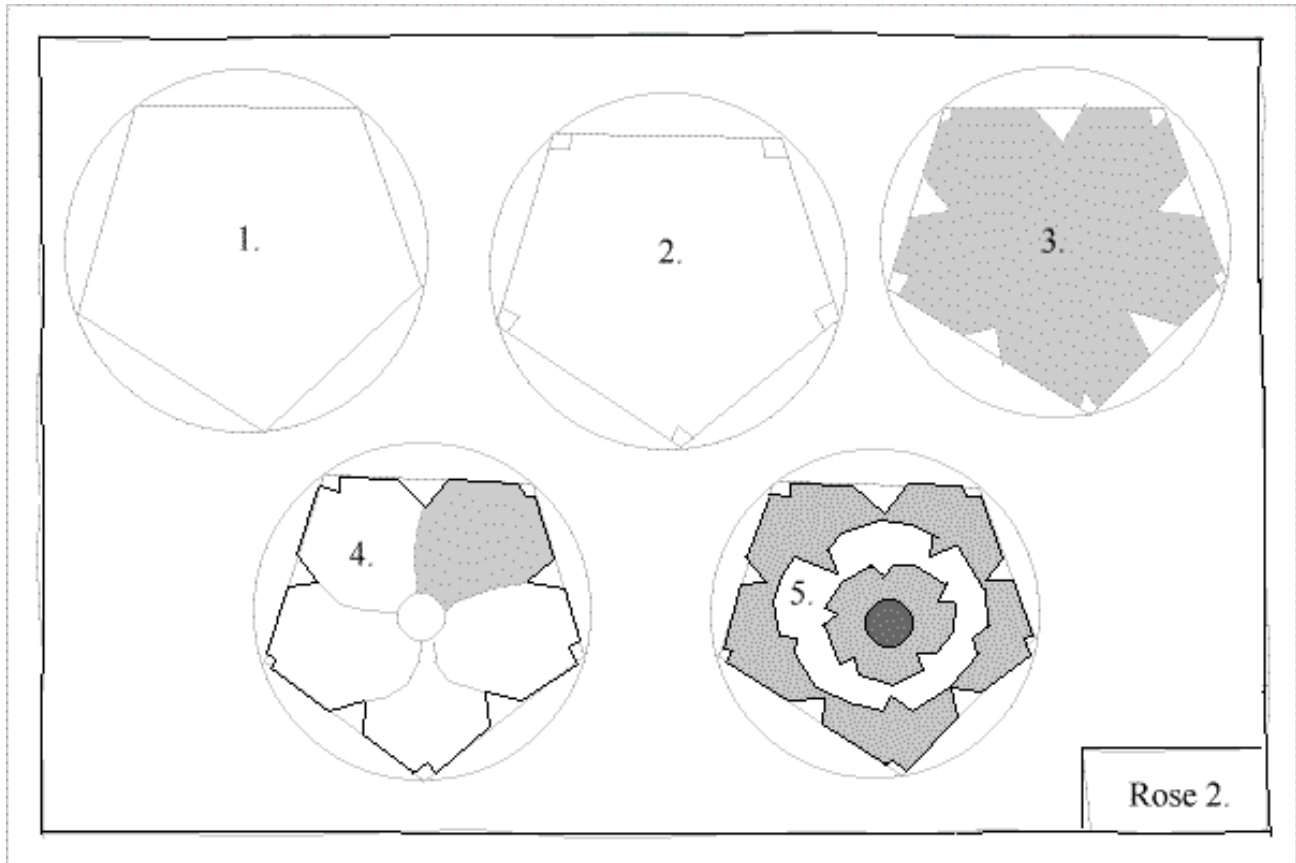

On a new sheet draw the rose as I have done taking particular care to vary the edges of the petals as you discovered in your drawing sheet No.1. Though the structure (pentagon) remains the same the outline gets varied as the petals fold over on themselves hence we get the irregular outline as in Fig.5.

In Fig.6 we will draw the classic 'bell shape' of the internal section of the rose as viewed from side on.

Fig.7 shows the 'bell shape' inserted into the outside petals.

Fig. 8 will be your sketch of the 'rosebud.' Label all these drawings and title the sheet.

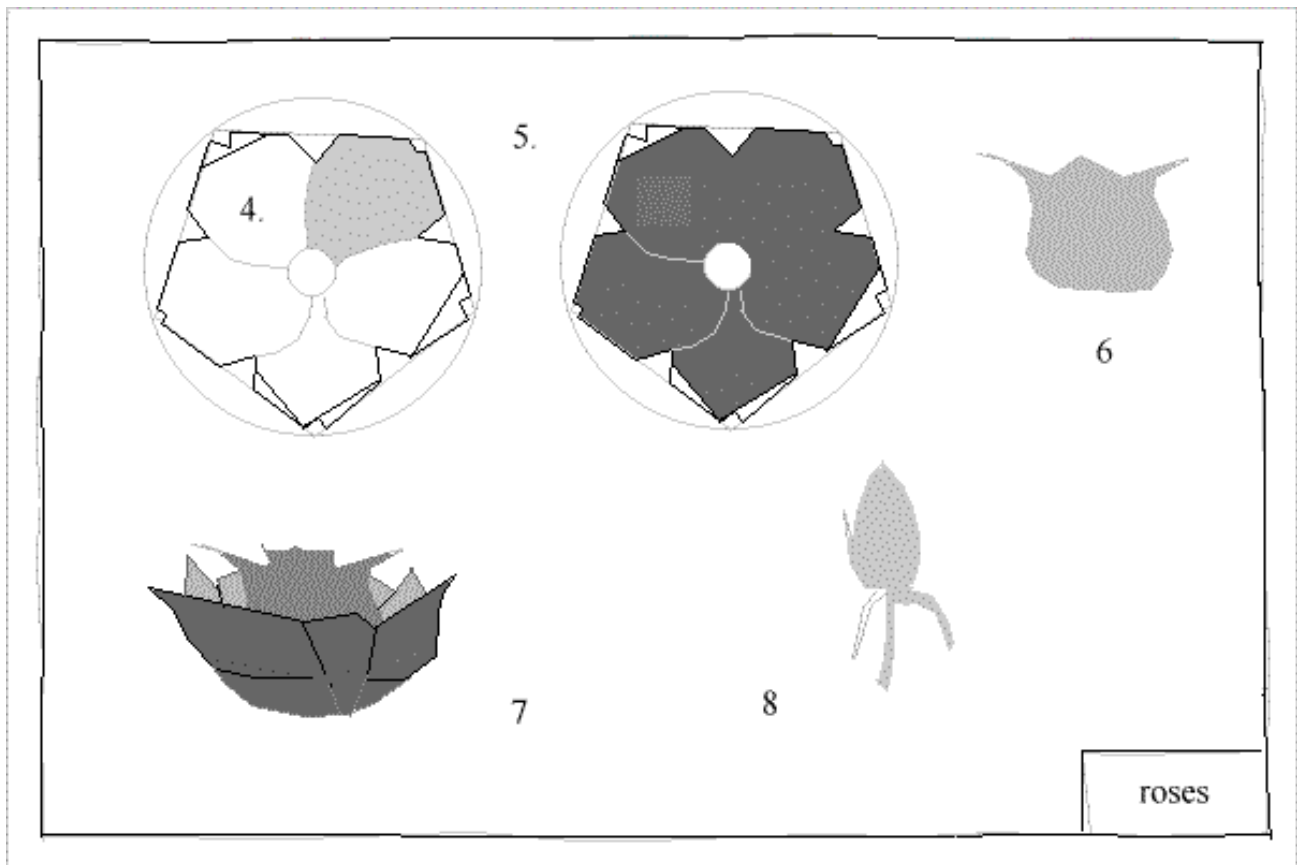

On the next sheet (below) we will draw the front view of the rose from the 'inside' out. Begin with the center as I have in Fig 1 and carefully construct your petals around it getting bigger as they spread out. Shade the deep parts of the petals as I have done until you have the complete 'reference sheet' similar to mine.

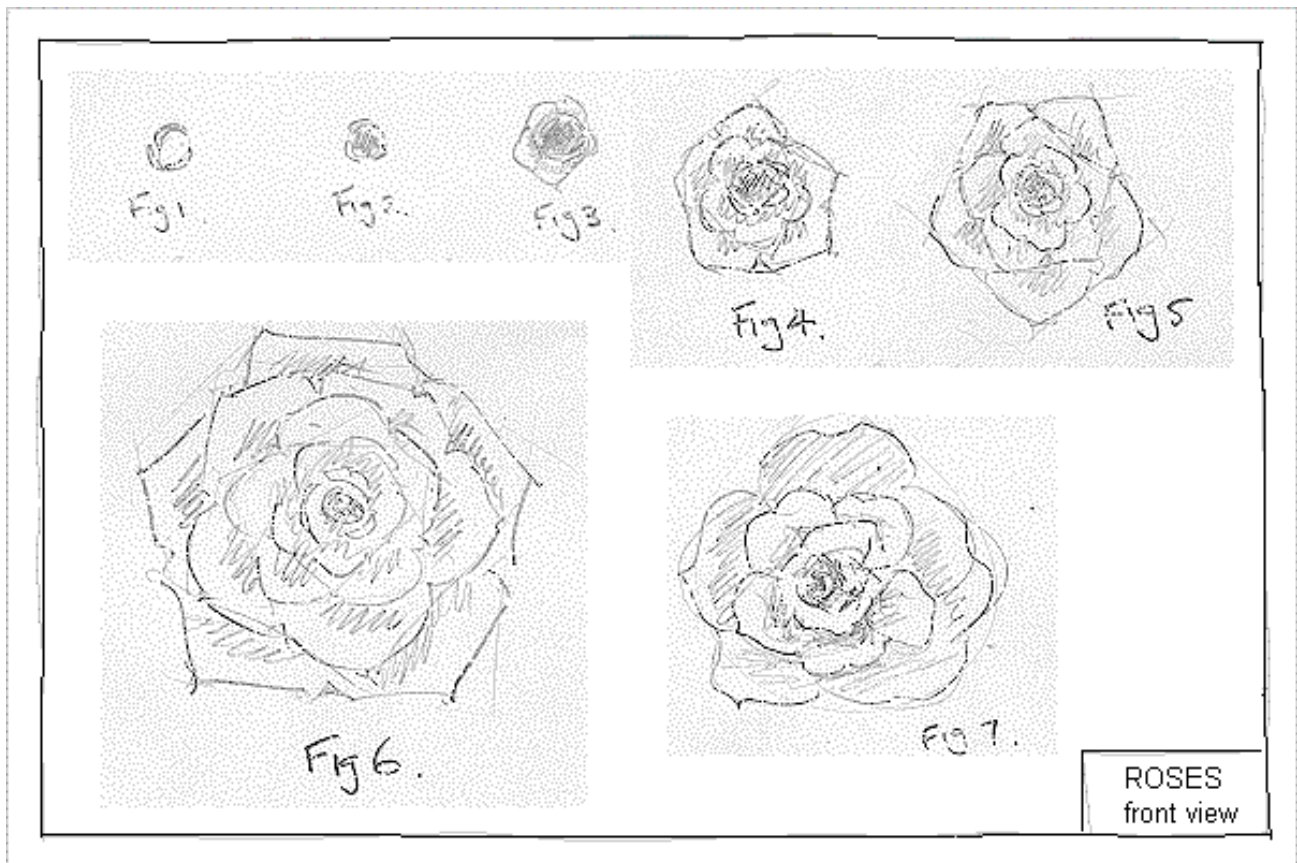

For our final reference sheet we will be drawing the petal again and forming it into side on views of the rose in semi and full bloom. Note the classic 'bell' shape and just concentrate on assembling all the petals. You will note you will only just see the tips of the inside petals though they will mostly appear flat on top as they curl over. They get smaller and stick up more as they get toward the

center of the rose.

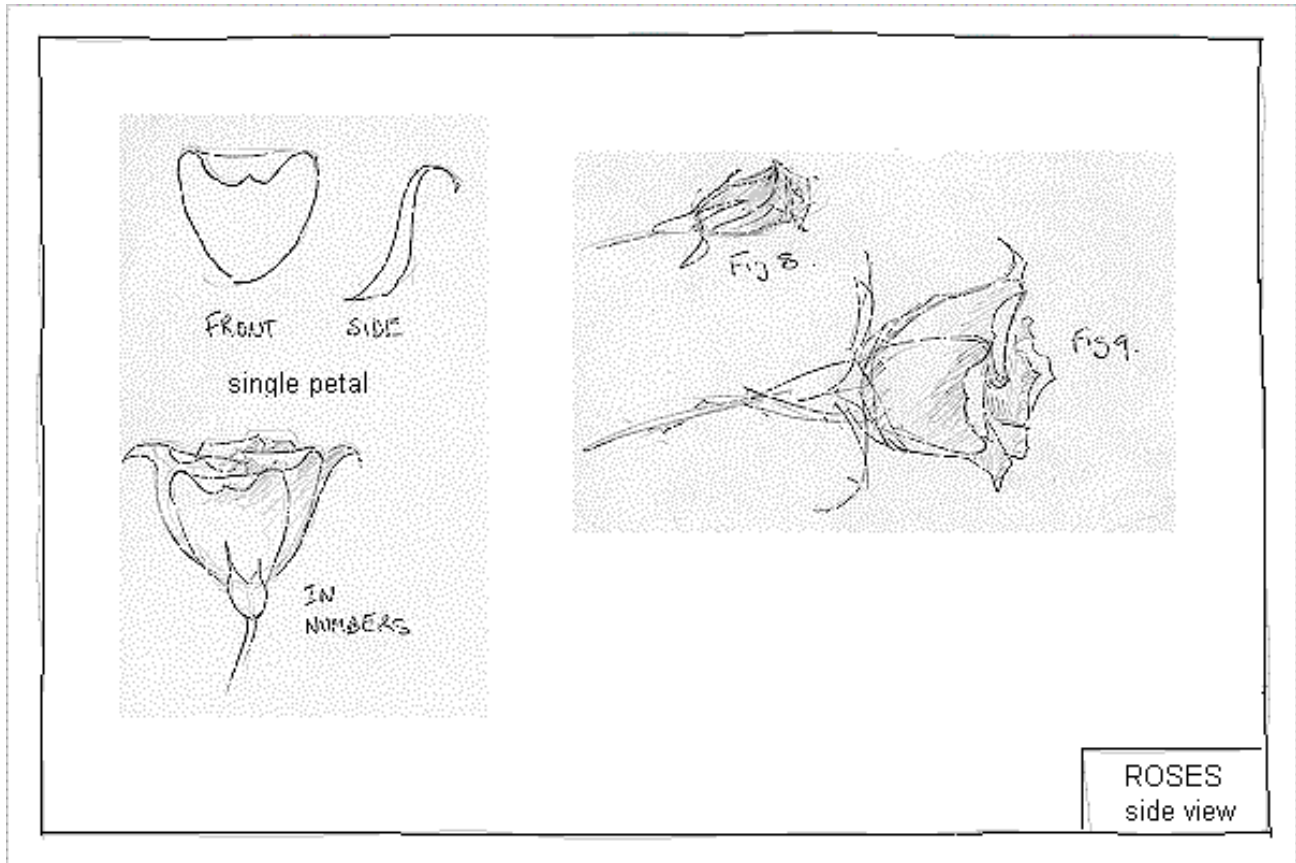

Please note the other 'parts' of the rose and add them as I have. Complete as shown above ... and add the title.

HOMEWORK

Observe and practice until you are comfortable drawing the rose from any angle. Try drawing it from the back!

For those students wishing to see how such a drawing can be converted into an oil painting depicting a vase of roses go to [painting roses](#) in the advanced lesson section.



END OF DRAWING BOOK

[back to start](#)

PAINTING RED ROSES

This lesson is a continuation of the drawing lesson on roses that you should view before attempting your own painting.

I have done the painting in four stages and will attempt describe each stage as they are shown below. The student should try and complete this painting in one session as it is essentially a 'wet in wet' project that relies on the fluidity of the paint.

First of all I covered a primed canvas (16" x 13") in a 'thin' mix of raw umber. Technically this is usually referred to as a 'imprimatura'. When I say 'thin' I mean a mix diluted with turps that spreads like watercolor and dries very quickly. When almost dry I use chalk to draw in the design. For this classic or formal design I place my imaginary 'horizon' about one third up from the bottom and then center the vase. If you prefer you could use charcoal for the drawing.



With the drawing complete I begin painting the centers and shadows in the roses. For this I use 'cadmium red deep' with perhaps a touch of the umber or burnt umber in the very centers. Next you should really load up a half to three quarter inch flat bristle brush with 'cadmium red' and begin to paint between the cadmium red deep with broad singular strokes that will represent the foremost of the petals (see below). Note that your brushstrokes should become a little thinner ... use the edge of your bristle brush for this ... as the petals near the center of the flower.



For the leaves I use a mix of ultramarine blue and yellow ochre. Liven this up with some strokes of deep red. Shadows should never be bland. Where the light strikes some of the leaves you might want to bring them up with a little cadmium yellow and a blue/white mix (see the green highlights above).



Next I would like you to consider the 'negative' space. That is what I call most of the area around the roses, in this case the background, the foreground and the cast shadow. Here you

might mix up a mauve with your cadmium red and ultramarine blue lightened with white and again load up your brush and begin 'cutting in' the outline of the particular blooms that interact with the background. Use a medium if your paint is too dry. It should be creamy and fluid so you will need to recharge your brush after every three or four strokes. You can do a similar thing with the foreground with a mix of raw sienna and white. Spend some time and thought doing this 'cutting in' and if a shape does not appeal rub it off with a rag and try again. Try to achieve a balance between shapes using more one stroke 'concave' shapes for the rose blooms in outline.

DANGER ... do not overwork the brush strokes otherwise the painting will lose its freedom and immediacy. If the hues begin to look too garish you can always tone them down by adding a little raw umber.



Finally you will be left with the water filled glass bowl. This is nothing but a mirror for what surrounds it. Basically you should 'smear the bowl' with all the adjacent colors as I have done and when this looks satisfactory use the chisel-edge of a bristle brush to show some of the rose stems as they are seen through the glass. Add a little 'white' highlight to the glass. Such highlights are best with titanium white/naples yellow mix which gives a better 'glow' than just pure white.



Here is another variation on the same theme on a larger canvas (24" x 16").

[GO TO painting percy the pelican](#)

[Advanced lesson menu](#)

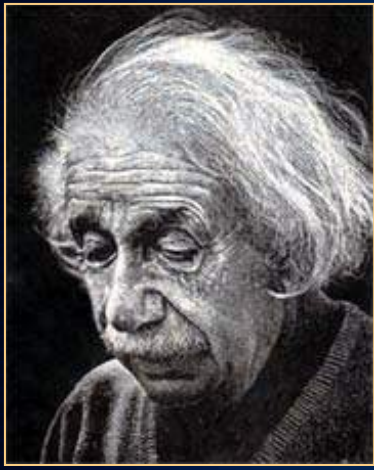

THE MODERN ILLUSIONISTS ADVANCED PAINTING - BEYOND FASHION

... BY JOHN HAGAN

Einstein etching shown (10"x12") by John Hagan (1975)

Perspective

[some advanced perspective](#)

[rivers lakes and ponds](#)

Applications

[the golden mean](#)

[computers and painting \[2\] \[3\]](#)

Painting fur, linen, satin, silk, gauze

[drawing](#)

[texture](#)

[paint application](#)

Color

[what color to use](#)

[hue](#)

[saturation](#)

[psychology and the adjacent effect](#)

[harmony](#)

[color mixing and psychology](#)

Practical painting demonstrations

[The earth, a smaller place? \[2\]\[3\]](#)

[Roses \[2\] \[3\]](#)

NEW [Technology and Painting - the way ahead?](#)

All lesson New CD here

NEW: A view of all works available as prints can be seen by pressing [here](#).

Understanding the aims

[Why Illusion?](#)

Painting metals

[gold and chrome](#)

[silver and copper](#)

What is photo-realism?

[photo-realism](#)

[kissing practice \[2\] \[3\]](#)

[The grape, the cherry and the eye!](#)

[The eye completed](#)

Brushstrokes

[the painterly effect \(Virgil Elliott\)](#)

[Virgil's 'Oil Painters Bible' \[2\]](#)

[the painterly effect \(William Whitaker\)](#)

[Bill's demo \[2\] \[3\] \[4\]](#)

[What makes a masterpiece?](#)

Subscribe to cowdisley technical forum

Powered by [groups.yahoo.com](#)

3-1 CLASSIC ILLUSION AND PHOTO-REALISM



Here we will examine the notion that good paintings can be made by simply copying photographs. To do this we shall return to the latter half of the last century when photography was all the rage and the great debate of the time was whether photography should confine itself to science or also develop as an art form. The perceived danger to painter's incomes was what spawned the impressionists who believed representational art was doomed. Meanwhile it gave the academy painters something to think about - rather like the late 1980's when the champions of computer technology predicted the demise of newspapers and books. It seems they too were a little premature as trees seem in more danger now than then. There is little doubt that Monet, Van Gough, Renoir, Cezanne and others were artists of innovation and that the 'academy' painters such as Bouguereau and Gerome, after Ingre departed this mortal coil, were the next masters of the classic western art technique. I call such painters as Bouguereau and Waterhouse the painter's painters as they combine advanced technique with subtlety to the extent you almost forget the painting is merely a two dimensional illusion. In the fervent battle to maintain a presence against photography it was unfortunate the impressionists were pitted against the academy artists for a shrinking art market. While the impressionists mostly turned to landscape the academy artists concentrated even more on developing a more subtle techniques for figurative and portrait painting.

Iian Neil writes:

'Certainly Bouguereau does have a certain Romantic flavour to his works, but by and large he did not work in the style of Delacroix, David-Freidrich, or Gericault, to name a few exponents of that style. When I look at Bouguereau's work, the overwhelming impression I receive is of Classical polish and perfection, its potential severity softened with aspects of Romanticism.

One must understand that by describing Bouguereau's work as Photo-Idealism one risks classing him amongst those who merely copied photographs. Most critics probably do not realize that Bouguereau, like many of the great "academic" painters, did not rely very heavily on photographs at all -- Bouguereau, like Pietro Annigoni half a century later, preferred to work from life. The fact that his paintings are so extraordinarily verisimilitudinous is due to his enormous technical ability, and not to a slavish attitude towards representing reality "photgraphically".



Iian's drawing

After all, why should we declare Bouguereau to be "photographic"? Is it true that the only *real* reality is to be found in photographs? - that is obviously utter nonsense! The only reality to be found is in reality itself. Bouguereau did not set out to imitate photos, although it is possible he may have spurred himself ever onwards out of the sheer delight of pushing his skills to the limit; nevertheless, he wasn't a parasite or a mediocrity -- he painted from REALITY and not from a faded recreation of reality. After all ... can not the eye capture more of the world's beauty than the photo? Can we not perceive the beauty of movement, the subtleties of colour, and so forth, whereas our cameras struggle to be able to even take adequate photos in poorly lit conditions? We humans don't need to spend hours in the developing room just to see what is out there -- Bouguereau did not need to seek the Truth through photos -- the Truth was already out there.



Now, returning to my initial classification of Bouguereau as a "Classical-Illusionist". It is not my intention to suggest at all that he was an imitator of (or slave to) the camera; I have merely latched on here to the term most familiar to us to describe a representation of reality which is extraordinarily life-like. Bewarned, though - never mistake Bouguereau's supreme illusionistic skill for a barrenness of invention or a servitude to the minutiae (which implies the *irrelevancies*) of reality. Bouguereau stands prominently in the long line of Illusionists who made magic out of the mundane, who distilled the Beauty out of Truth, and who feeds our eyes and our souls on a feast of life-affirming verdor.

Emphasizing the "academism" of the non-Impressionist painters is to do them a disservice. These people didn't just execute works for the state, the Second Empire or whatever. To declare that their 'style' marks them as oppressors of the Impressionists or enemies of "true art" is to make a grave error in judging their importance in art history.

Therefore, I object to them being described as "Pompier" -- I understand that the terms "baroque" and "rococo" also previously had a negative connotation, but if we are try and ressurect the reputations of men like Gerome, Bouguereau and Meissonier, why should we make our task thrice as difficult by referring to them in what we have all acknowledged is a derogatory term? It may be that in the future the term "Pompier art" can be applied with equanimity and fairness by some generation of art historians -- but at the present we would be playing right into their hands by asserting (quite falsely) that Bouguereau and Gerome were merely academics or pedagogues'.

STUDENT ACTIVITY: Use the library or the internet to make a list of 8 impressionist artists of 1890 and a list of 15 academy artists of the same period. Include any Orientalists and the Pre-Raphaelites in the latter group. Also name a painting by each artist listed. Allow 40min.

[GO TO ... the eye, the grape and the cherry](#)
[advanced lesson menu](#)

1-1 THE MAGIC OF PAINTING - INTRODUCTION

'Give me some paint, brushes and canvas and I will give you gold, silver, ruby and pearl. I will give you the greatest treasures you have ever seen. I will show you magic. Artists are the greatest alchemists, the best magicians of all. They can make gold from base metals, they can make you laugh and cry and touch your very soul, and they do that every day - and more ... JH from the 'Modern Illusionists'.



The Magician - A following story will explain how these disciplines can interact and why the word illusionist applies to the master painter as well as the best magicians. Early this century a magician was sent to North Africa to quell a rebellion. He came on stage with a large wooden chest which he placed in the center and asked for the strongest man in the audience to step up. After some coaxing a warrior champion, a lumbering ox of a man was propelled up on stage. The magician told him not to fear but to lift up the simple wooden chest. This the man did this with consummate ease.

Next the magician told the audience he would steal the giant's strength and render him as weak as a kitten. He clicked his fingers and asked the man again to try and lift the chest. Now the strongman strained and pulled but could not move the wooden chest, even an inch, and finally gave up. To prove he had taken away the man's power the magician asked his assistant, a slightly formed young boy, to prove he could lift the chest - which he did.

There was much consternation which the magician stilled by suddenly announcing he could restore the former strongman's strength. Then after asking the audience if that was what they wanted, and with another click of the fingers, he did. Finally, upon ordering the strongman to lift the chest for a third time the man raised it with his former ease.

The chiefs gasped and the rebellion was quelled for who could oppose such power?

Of course a steel plate in the bottom of the chest and an early electro-magnet under the stage was the simple cause of the phenomenon. But what is important is the story. It was the magician's manipulation of the minds of the audience that was the real magic. That is the art of the illusionist. Not the trick. It is the same with a painting or a play. A good painting will make you believe what you are seeing has a reality in time and space even though you know it is an illusion, merely a picture on a wall.

The Application - The techniques of painting silk and satin, gold and silver or diamonds and rubies or anything else for that matter requires the artist to embrace the same three disciplines the magician uses in my story.

1. The artist must understand the nature of the objects or things he or she desires to paint. Just as the magician needed to understand certain principles of electro-magnetism the artist also must be a **scientist**. To create the illusion of gold or chrome the artist must know something of its molecular or crystalline structure, something of light and refraction. In other words some elementary physics and chemistry.

2. The artist must be **philosopher** enough to ask and answer questions regarding the nature of things in their ideal form - a conceptual analysis if you like. The artist must understand how people feel about the things he or she desires to paint. For the magician in my story it was his understanding of people's feelings and their views and prejudices regarding a man's physical

strength that was the key. The concept and knowledge of how people feel about something was - and is - essential for illusion to succeed.

3. Whereas the magician needs the skill and discipline of the actor, **performer** so the artists must similarly have the ability to control the painting in the totality of its parts. The artist needs to be creative and know how best to construct and present his two dimensional painting as a three dimensional illusion. The artist will need to know and apply the techniques that painters use create form and depth (chiaroscuro and perspective).

To summarise then: we have the technical analysis, the conceptual analysis and the presentation technique. When we understand these things about an object or subject we can then paint it.



Many will recall the pearl necklace I made from scratch in a previous lesson - so now let us use that to demonstrate the study necessary to perform the task. Please understand that in this exercise painting without form and depth will produce merely a pale imitation, a sad flat thing that takes us back to kindergarten.



Technical analysis - the physical nature of a pearl.

The pearl's technical characteristics fall under four main headings;

a) Shape - various spherical - round, oval, tetrahedron with no sharp edges.

b) Texture - hard-edge satin, non-oxidising

c) Color - the whole visible spectrum with an underlying milky yellow-orange to blue-grey. Pacific island pearls are yellow orange while artificial Japanese blue -grey.

d) Reflective ability - partially diffuses the light rays with its semi-opaque non -crystalline surface.

Conceptual analysis - The pearl as it exists in the mind of most is usually round, glowing diffused and organic. It's most esteemed color is underlying gold. The pearl is natural and feels benevolent against the skin.

Presentation technique - To take advantage of the pearl's reflective nature I decided to place it in a situation where there was something to reflect. In this case in front of a window on a red table in a brown room with a blue ceiling and an observer between the window and the pearl. A string of pearls is more believable than a single. Use a rich, soft background (prussian blue) that exaggerates the pale, glowing diffused nature of the pearl. That satisfies the form and the depth (perspective) is internal in the reflection.

STUDENT ACTIVITY: Painting the pearls:

- 1) Paint miniature scene as above in a wet medium and allow paint to diffuse.
- 2) Glaze in a semi-transparent mix of white, with a little red and yellow.
- 3) While still wet introduce the faintest touches of as many colors of the spectrum you like.

4) Sharpen the outside edges. Allow 40min.

The greatest illusion of all could be the illusion you never notice. The greatest magic could well be the magic you are never know. A retired spy once said to me ... 'You know, not all magicians wear capes and wave sparkling wands.'

[GO TO ... Painting precious metals](#)

[Main Menu](#)

THE OIL PAINTER'S BIBLE - CHAPTER 5



Master Class - advanced oil painting principles and techniques from the Renaissance to the present by Virgil Elliott, APSC, ASPA
111 Goodwin Avenue, Penngrove, California 94951-8660, U.S.A.
Telephone: (707) 664-8198
E-Mail: VirgilElliott@AOL.com
© 2000 Virgil Elliott. All rights reserved

PRINCIPLES OF VISUAL REALITY

The greatest art is that which moves the viewer in a positive way, which touches perhaps dormant sensibilities inherent in human nature, and awakens and/or fortifies man's better qualities in so doing. Great performances in all the arts accomplish this same goal. A well-written operatic aria, for example, sung brilliantly and with feeling by a virtuoso soprano, can move an audience profoundly, raising the hair on the neck and bringing tears to the eyes, leaving at least some of them gasping and choking back sobs of deeply felt emotion as they try to maintain their composure. Experiencing such profound appreciation for a masterly performance leaves one forever changed for the better. It cannot do otherwise. Great Literature provides many comparable experiences. In painting, it is possible to achieve the same thing.

Great Literature provides many comparable experiences. In painting, it is possible to achieve the same thing. The reader is referred to Rembrandt's "Judas Returning the Thirty Pieces of Silver" for an excellent example. The depth of Judas' remorseful anguish is compellingly conveyed by his body language as well as his facial expression, and the viewer cannot help but be deeply moved upon viewing it.



Compassion and sympathy are called forth as the audience feels the anguish of the subject, so eloquently is it expressed in the painting. Compassion, empathy, sympathy; these are all aspects of man's better nature. To change people for the better—what more noble purpose could an artist be called upon to fulfill? To what higher calling could we aspire?

In each of the examples presented above, the means by which the experience is made possible is

virtuoso performance in an artistic endeavor by a Master of the discipline employed. Whereas the focus of the performance itself is to make the audience feel whatever the artist wants it to feel, it must be stressed that the objective can only be successfully attained through a thorough understanding of every aspect of the art form involved, including the psychological effects produced by each possibility. There is a language to be learned, and mastered, before any great performance is remotely possible. In literature, the language is verbal; in music, it is music theory. In visual art, it is a thorough understanding of the Principles of Visual Reality, coupled with heightened aesthetic sensibility and mastery of drawing and painting techniques. Why the Principles of Visual Reality? Because we live in a world of realistic images. We relate to realistic imagery. We even dream in realistic imagery. Of all the visual possibilities available to a painter, the only way to move our viewers to the utmost is to employ realistic imagery in our work. We may depict things which are not real, but if we render them in accordance with the Principles of Visual Reality, they will read as if they were real, and thus will be able to exert maximum impact on the viewer. It is the language by which we express whatever it is we wish to express, and which our viewers will be able to read and comprehend on the receiving end. Our messages cannot communicate if we speak in a language comprehensible only to ourselves. Thus we must use a language common to everyone who can see. Realistic imagery is that language.

The Principles of Visual Reality are established by the way our vision works. The further one deviates from these principles, the less the work in question will resemble visual reality. In creating the illusion of reality, the artist depends heavily on the indication of the third dimension, which is depth, or spatial recession. Spatial recession is indicated by observing the principles of Geometric Perspective, Atmospheric Perspective and Selective Focus.

GEOMETRIC PERSPECTIVE

Geometric perspective, often referred to as simply perspective, may be defined as the natural law which says the further something is from our eyes, the smaller its image will be. Since there are two types of perspective, the other being atmospheric perspective, it is necessary to distinguish between them by referring to what is normally called perspective as geometric perspective, in reference to the fact that it is a geometric breakdown of a natural optical phenomenon. It is sometimes referred to as linear perspective, as it involves the use of lines in its construction. As simple as it sounds, the problem of how to convincingly render this visual phenomenon had baffled painters for centuries, until a mathematical approach was discovered in the early Renaissance. The painters Masaccio and Uccello, as well as the architect Brunelleschi have each been credited with its discovery. The Roman architect Vitruvius may actually have preceded all of the others named, and may in turn have been influenced in it by someone still earlier, but the discovery does not seem to have reached painters until the early Renaissance. Whichever of these attributions is correct is less important than the fact that the discovery was made, and that it constituted a major breakthrough in illusionistic painting. Once artists learned the system, they could indicate spatial recession more realistically than had previously been possible. The system involves the use of vanishing points; points at which lines intended to depict parallel lines converge. These vanishing points are on the horizon if the lines are level. It is important to note that the horizon is always at the viewer's eye level. When two or more vanishing points are necessary, as in all but the simplest perspective problems, their placement may be worked out following the mathematical system, or, if we are working from life, by simply copying the angles we see and extending them to the horizon. The points at which the extended lines cross the horizon are the Vanishing Points. All lines parallel to the one used to establish the Vanishing Point will converge at that Vanishing Point. If there is any question as to their accuracy, the mathematical system may then be employed to double-check. The mathematical approach must be learned first, and practiced until a point is reached whereby the artist is able to visualize the scene in correct perspective automatically, without the need of actually drawing in the vanishing points and guide lines. The subject is taught to students of architecture, but is not part of the curriculum of fine arts programs in most universities at the time of this writing. It may be that a Fine Arts major could take it as an elective. There are several books on the subject, the best of which are listed in the bibliography. However one chooses to study, whether alone, in an institution, or with a private instructor, the

importance of mastering geometric perspective cannot be stressed too highly. It is imperative that any serious aspiring artist absorb this fundamental principle completely, if he or she is to ever create genuinely Great Art. It must become second nature, so thoroughly assimilated that virtually no effort is required to visualize it correctly. As the subject is so completely covered in Rex Vicat Cole's book, *Perspective for Artists*, there is little point in addressing it in full detail in this book.

Errors in perspective are far too common in modern times. Such an error immediately destroys the illusion of spatial recession, and prevents the viewer from receiving the artist's message.



In the simplest exercises in perspective, one Vanishing Point only is used, and may be placed arbitrarily, on the Horizon. A straight road on absolutely level ground may be indicated by drawing lines from points on each side of the road to the Vanishing Point on the horizon, where they converge. Suppose we want to add a line of telephone poles, or fence posts, running parallel to the road and placed at regular intervals. The spaces between them must diminish as greater distance from the viewer's eye is indicated. The interval between the nearest pole and the second pole is established arbitrarily by the artist. The placement of the base of the third pole may be determined by drawing a guideline from the top of the first pole through the center of the second pole, and extending it until it intersects the line running from the base of the first pole to the Vanishing Point.

A vertical line drawn from the point thus established becomes the third pole. Its height is found by drawing a line from the top of the first pole to the Vanishing Point. The fourth pole is located by drawing a line from the top of the second pole through the center of the third pole and extending it to the line connecting the base of the first pole with the Vanishing Point, and so on. This example is quite simple, and should serve only as an introduction to the geometrical system of indicating three-dimensional depth on a two-dimensional surface. Refer to the insets and accompanying illustrations for solutions to some of the more complex perspective problems.

The system is not quite perfect, as it fails to take into account the curvature of the Earth. It works well because the Earth is so large that in most cases the curvature is not apparent. Its limitations are that it can become quite complicated, and artists are generally not mathematicians, nor are they likely to be interested in approaching the scene from such an analytical, as opposed to intuitive, standpoint. For this reason, many artists, or would-be artists, are weak in their understanding of this fundamental principle. It is imperative that the student, the aspiring artist, apply the discipline necessary to learn the mathematics of the system so well that all awkwardness with its application disappears and ceases to interfere with the creative, intuitive processes so essential to art. Once it is committed to second nature, it becomes a help rather than a hindrance. The artist should then be able to "eyeball" the scene accurately, without having to actually draw the vanishing points and guide lines. Its parallel in music would be the learning of music theory; perhaps no fun at first, but Great Music cannot be created without it.

ATMOSPHERIC PERSPECTIVE

As objects recede in space they not only appear to shrink in size, but tend to lose detail, contrast of values, intensity of color, and their edges appear less distinct the greater the distance from the viewer's eyes. This is the principle of Atmospheric Perspective. Some writers call it "aerial perspective," but this is misleading, as the term, "aerial" usually pertains to flying.

The visual alteration of images over distance is the direct result of "X" amount of atmosphere between the eye and the object or plane in view. The atmosphere contains water vapor and its own density, which renders it somewhat less than totally transparent, adding a certain degree of whiteness to the air. Light renders the atmosphere white. The more air we must look through to view something, the more atmosphere we see between it and our eyes, and the more the image is altered by it. An optical illusion is created by the presence of a semitransparent white between the eye and any color darker than white, which alters the color in question in the direction of blue, as well as lightening the value. This is precisely why the sky appears to be blue. The sky's blue is created by the blackness of space being viewed through a layer of semitransparent white atmosphere. The white is the atmosphere illuminated by the sun.



At night, without the sun's light, the atmosphere is no longer white, and the blackness of space becomes visible. Note that the sky is always lightest just above the horizon. This is the greatest distance we can see at ground level, which is where the atmosphere contains the most (white) water vapor and the greatest density. At the horizon, the density of the atmosphere renders it more opaque, and thus, whiter. As we look up, we look through thinner air, which is less opaque, and the sky is bluer and darker. This is why distant objects and planes appear lighter, bluer, and less distinct. The same phenomenon can be produced with paint. The process is called scumbling and is accomplished by applying a thin veil of white paint semitransparently over a layer of (dry) darker paint. The optical result in paint is the same as in the air. Translucent white over black reads bluish, just as light grey smoke against dark trees reads blue. Note that the same smoke may appear to be brown when a white cloud is behind it, a reverse of the scumble phenomenon. Dark over light increases apparent warmth. This is the principle at work in glazing, that is, the application of darker transparent paint over a lighter passage. Glazing and scumbling are discussed at length in Chapter Six and Chapter Ten.

In painting, atmospheric perspective can be rendered directly, in one step, using opaque paint

exclusively, at least in the distance and middle ground, following the principle, by adding white, and sometimes blue, increasing the white (and blue) to indicate greater distance, softening edges by working wet paint into wet paint, suppressing detail and diminishing contrast between light and shadow to indicate greater distance. The effect can also be gotten, perhaps slightly more convincingly, in a two-stage process whereby the same procedure is used as in the one-step method except that the area of greatest distance is rendered very slightly darker than the desired final effect. The illusion is completed in the second step by scumbling a thin film of white or light grey over the dried paint of the first step in the areas of the greatest distance. The illusion of depth can be further enhanced by painting the deepest foreground shadows, and only these foreground shadows, in transparent glazes over a relatively lighter underpainting or primer. This creates the highest degree of clarity, as would be the case when the least amount of atmosphere is present between the shadow and the viewer's eye, appropriate for the immediate foreground only. The combined, systematic use of glazing, scumbling, and opaque painting allows the painter to create the illusion of depth to the highest degree possible. However, the successful rendering of spatial recession depends even more heavily on observance of the principles of geometric and atmospheric perspective than it does on expert paint handling.

SELECTIVE FOCUS

There is a third principle to be observed when creating the illusion of reality, which is closely aligned with atmospheric perspective. This is the Principle of Selective Focus. It is the phenomenon whereby our eyes, directed by the brain, register the highest attention to detail on whatever we consider most important within our cone of vision. Please note that this process is unique to the natural viewing apparatus. A camera does not operate in the same way. The specific differences will be discussed at length in the chapter on photography. In designing our painting, we must simplify the shapes of lesser importance and render them in softer focus than the areas of primary importance. Hard edges should be used sparingly, and for specific reasons. The use of too many sharp edges destroys the illusion of reality, as it does not correspond to visual experience. Our eyes cannot focus on more than one small area at a time. Everything else appears duller and less distinct. By following this principle, the artist can assign greater importance to key elements in the picture by rendering them in sharper focus and adding more detail, and can arrange things in such a way as to lead the eye from point to point, including areas of secondary and tertiary interest, if desired, to hold the viewer's attention for as long as possible. Areas of secondary and tertiary importance may also be rendered in sharp focus, but must be made less noticeable than the primary subject by their positioning on the picture plane and by arranging things in such a way as to have less contrast of values, lower chroma colors, or whatever other means will render them less noticeable at a distance. Orchestrated in this way, they do not compete with the area of primary importance for the viewer's attention. The main focal point is emphasized not only by sharper focus, but by greater contrast of light and dark, by higher chroma color, perhaps by its juxtaposition with contrasting hue accents, and especially by its strategic placement on the canvas. Other elements in the picture may also point toward it. Thus are the elements of secondary and tertiary interest rendered subordinate, even though they may be rendered in sharp focus in certain instances. Their effectiveness, however, depends on softer focus being used over most of the picture. If one had to choose between painting everything sharp, or everything soft, the soft option would allow for a more convincing illusion of reality. We all, at times, see everything in soft focus, as it takes a certain amount of effort and direction from the brain to focus the eyes on anything. It is not possible, however, to see everything in sharp focus at once; thus, a view painted in such a way clashes with our experiences in viewing the real world. It is easy to fall into the trap of painting this way, for as we move our focus from what we have just painted to what we will paint next, each element appears to us in sharp focus. The temptation to paint it as sharply as we see it when focusing on it is very strong, but must be resisted, or we violate the Principle of Selective Focus, and the illusion of reality of the overall scene will be compromised for the sake of superfluous detail. It is helpful to squint when observing these elements, thereby throwing the eye somewhat out of focus, and then paint them as they appear when squinting. If the painting requires a sharper focus on certain parts of the scene, it is still advisable to begin by squinting, in order to read the larger, more general shapes, and then add whatever

detail is desired after we are certain that the big shapes are correct.



We must not lose sight of how our picture will appear to its viewers at first glance. It must register upon their sense of sight just as the scene itself would, or they will not be drawn in to look at it more closely, and will never see to appreciate the fine work we may have put into the details. A picture must be designed to work as a visual whole. It must be more than a collection of details assembled at random. Elements of lesser importance should be simplified, lest they confuse the viewer as to what the subject, or focal point, of the picture is. If the focal point is rendered in sharper focus, and subordinate areas in softer focus and simplified, confusion is avoided.

This follows precisely the manner in which we view a scene with our own eyes. To see something in sharp focus, the brain must direct the muscles within both eyes to simultaneously adjust their respective lenses to focus on that object, and the muscles guiding the position of each eye to allow them to converge on that same object or surface. This involves a certain degree of effort, thus this action is only triggered by the brain when it deems something of sufficient importance to warrant it. Therefore, by rendering a given object or surface in our painting more sharply, we are indicating to the viewer that this particular thing is important. Thus the term, "Selective Focus."

As artists, we should not just paint what we see, we should paint what we want to show to our audience, selecting only that which is worthy of such special attention, and then presenting it as it appears at its most appealing, or making it more so if it will make a better picture. The viewer's attention is directed where we want it by the use of selective focus. If the visions we paint exist only in our imaginations, so much the better.

By understanding the Principles of Visual Reality, one can render imaginary scenes convincingly real, and perhaps transcend even the limitations of working from life. This is the mark of a Master. This level of ability can only be attained by working from life until the Principles of Visual Reality are thoroughly absorbed. There is no short cut.

THE NATURE OF LIGHT

Of equal importance to the principles governing spatial recession is an understanding of the nature of light and shadow. Three-dimensional form is indicated by the distribution of light. Shadow is, in theory, the absence of light, but in reality there is light in shadow as well. Areas of light are generally illuminated by light rays which have traveled in a straight line from the strongest source, whereas shadows receive their light indirectly, as the rays ricochet off nearby surfaces and bounce in behind objects that block the direct rays, or from secondary light sources weaker and/or farther away than the primary light source. Without secondary light, shadows would read as black. The dark side of the moon is an example. Secondary light is what enables us to perceive form within the shadows.

The shadow is darkest at the just beyond the planes illuminated by the primary (strongest) light source. This area is called the shadow accent (sometimes referred to as the core shadow) of the body shadow. The phenomenon of the shadow accent is best understood in scientific terms. Whenever enough light is present to allow us to see at all, there are light rays coming from many directions, of varying strengths, both reflected and direct, often from more than one source. The strongest light creates what we consider light and middletone areas, whereas the weaker are only visible in shadow. Whatever is blocking the strongest light also blocks a certain amount of secondary light, and the closer the shadow is to the blocking obstacle, the more of the secondary light rays are blocked.

A good analogy is to suppose we are standing under an awning or umbrella in the rain. Our head stays dry, being closer to the awning, umbrella or whatever is blocking the rain. Further down, some rain may reach us, where there is greater distance between a given surface and the awning. If we substitute light rays for rain, it becomes apparent why the shadow accent is darker than the rest of the shadow. Less light means more dark. Beyond the shadow accent, more reflected or secondary light is allowed to enter the shadow area, reflecting off nearby objects or planes, or from secondary (weaker) sources, as the distance from the light-blocking obstacle increases. This light is commonly called reflected light in shadow, although it often includes direct light from weaker or more distant sources as well. Perhaps a more technically correct term would be secondary light. So the shadow accent, also known as the core shadow, is most simply described as the zone of shadow between the primary light and the secondary light.

The shadow accent is a most useful device for describing interior planes, that is, planes within the edges of the object being depicted, by its shape and by how sharply it makes the transition from middletone to shadow. A sharp change in angle will have a sharp transition; a more rounded form would have a softer transition from middletone to shadow. Once the artist understands this principle, he or she will look for the shadow accent, and will use it to good advantage.

The cast shadow follows the same principle as the body shadow (the shadow on the unlit side of the object in question), in that it is darkest at the edge nearest whatever is blocking the light. Its edge is also sharpest at that point, and softens as it recedes from there, due to reflected light from surrounding planes or from secondary sources. The middletone is the area on the lighted side which is far enough from the angle of incidence of the light rays to our eyes that the body color of the object is least altered by the light. Thus the color of a given surface is seen at its highest chroma, or intensity, somewhere in the middletone. This is explained in greater detail in the chapter on color.

The highlight is the point at which the light from the primary light source bounces off the object and to our eyes the most directly. It will contain more of the color of the light source than any other area in the light. The highlight will describe the surface texture of the object being viewed, by the degree of sharpness at its edge, and by the contrast between its value and the value of the middletone. There will be a transition zone between highlight and middletone. The extent of this transition zone, again, depends on the texture and shape of the surface, and on the intensity of the light from the source, striking at the highlight. It is necessary at this point to address the way in which color is affected in the shadow areas. Shadows are areas where the direct light rays from the strongest source cannot reach. If there were but one source of light, and no surfaces nearby to reflect light back into those areas, the shadows would be totally dark, and we could not read shapes within them. However, situations such as that are rare, except in outer space. In reality, there is usually more than one light source, and/or nearby surfaces which reflect

light into shadow areas. The color of the secondary light source affects the color of the shadows. The color of nearby surfaces, which reflect light into shadows, is also cast into the shadows as an inseparable component of the reflected light. The body color of the shadowed surface is also an influence; however, its chroma will be lower (duller) than in the middletone for the same reason that its value is lower (darker). The reason is that there is not enough light in the shadow to reveal the body color at its full intensity.

The strongest influence on the color in shadow is usually the color of a secondary light source. The best example is an outdoor scene on a sunny day. The main light source is direct sun, which is slightly yellowish. The secondary light source is the sky, which is blue. The color of the sky will be the strongest color influence, other than the body color of each surface, in all areas facing it not lit by direct sunlight. The sun's rays, striking directly, are so much stronger than the light of the secondary source (the sky) as to effectively overcome the color influence of the sky in those areas, replacing it in the highlights with its own color plus white. In other words, direct sunlight "eats" the blue. When a cloud obscures the sun, the sky becomes the primary light source, and its color, blue, becomes an influence in the lighted areas, until the cloud moves away and allows the direct rays of the sun to again eat the blue. All areas then in shadow retain the blue influence of the sky, except where the light from the sky cannot reach. In those areas, reflected color will have a stronger influence. For example, the underside of an object surrounded by a green lawn will register a certain amount of green in the shadow areas, whereas the upward-facing areas in shadow will register the blue of the sky. The green is carried with the light from the sun as it bounces off the lawn, reflecting into nearby surfaces. If the object has no color of its own, such as a white or grey statue, this will be more apparent. If the object has its own body color, it will be influenced by the color of the secondary light, but not replaced by it.

After the student has been exposed to these principles, they will become more obvious, as he or she will be on the lookout for them. This is an important step toward becoming an artist. Once the Principles of Visual Reality are completely understood, the artist is freed from dependence on external sources. Nothing the imagination can conjure up will be beyond the artist's ability to depict on canvas. This in itself is still no guarantee, however, that an artist so equipped will be a Master, as he or she must also have something of interest to say. Inspiration is an individual thing that cannot be taught. One finds inspiration on one's own. However, all the inspiration in the world will not help, if the inspired person lacks the vocabulary to express it. An understanding of the Principles of Visual Reality is an extremely important part of that vocabulary.



Detail from "The Songstress" by Virgil Elliott

[GO TO ... Techniques of Painting in Oil](#)

[main menu](#)

KISSING PRACTICE - A DEMONSTRATION PAINTING

'REALISM DEFINED'

One of the most difficult painting tasks is that of actually painting realistic flesh. Nowhere was this excelled but by the French Academy painters of the late nineteenth century or their counterparts across the channel such as Leighton, Waterhouse and Alma-Tadema. Perhaps the most sublime of all these was William Bouguereau whose paintings of people were so convincing it becomes most difficult to distinguish them as mere images. More than anyone Bouguereau made angels as real as the peasant girls he painted as pot-boilers for the more fashionable commercial market. Bouguereau is the professional painter's benchmark for technical perfection in the rendering of flesh.

So how did he do it?

In this lesson I shall demonstrate a technique and provide a brief explanation of how he achieved such results.

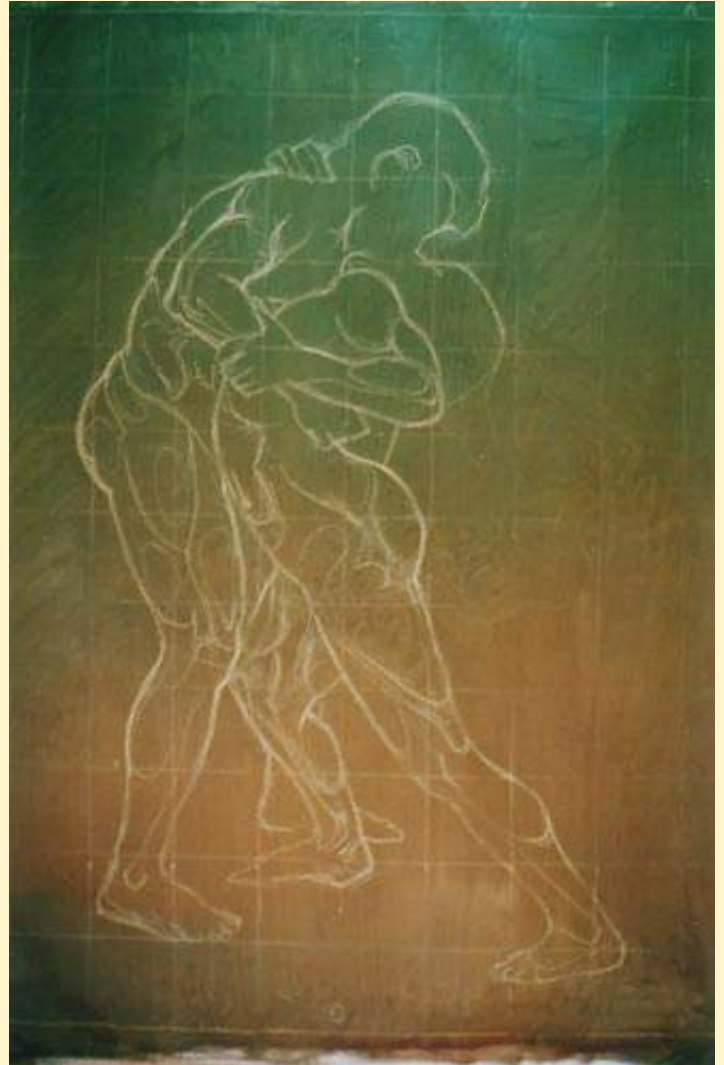

Fig. 1

Preliminary sketch on a small gray board

Fig. 2

Preliminary sketch developed and transferred to canvas

After sketching my forms, in many aspects, and deciding on my general composition, as I have done here in Fig.1 in pencil, I am ready to transfer this to my prepared canvas. In this case it is roughly 52" by 36" and primed with acrylic primer and covered by an imprimatura of umbers and light grays to a value between 4 and 5.

In Fig.3 I have transferred my sketch using the 'grid' method and added some anatomical features. For a painter the study of anatomy is as important a skill as the practicing of scales to a musician or the use of a saw, chisel and drill is to a carpenter. There is no short cut to study and drawing of muscles, sinews and bones if a painter desires to paint the human form. My sketch here is done in chalk for easy removal.



Fig. 3

Looking for shapes that satisfy the eye



Fig. 4

Hinting at a background

To further define my composition, and particular the masses of the forms and how the negative and positive spaces react with each other, I have, in Fig.3, highlighted the background.

In Fig.4 I suggest a background. Here, since the figures will dominate the painting, I place

the horizon low (1/3 up). This will place a high contrast area across the middle of the picture. To further amplify the drama I shall eventually create within this background the three definite distances, far, middle-ground and fore-ground. One of the secrets of creating a super-realism is to allow the eye to be able to comprehend all distances at once. Of course this cannot be accomplished by a camera or by the eye without refocusing.

[GO TO kissing practice No2](#)

[Advanced lesson menu](#)

THE OIL PAINTER'S BIBLE - CHAPTER 6



Master Class - advanced oil painting principles and techniques from the Renaissance to the present by Virgil Elliott, APSC, ASPA

TECHNIQUES OF PAINTING IN OILS

From the earliest days of oil painting to the time of this writing (late Twentieth Century, into the early Twenty-first), a number of oil painting techniques have evolved.

A great deal has been learned through the processes of trial and error and from the experiments of various artists through the centuries. From Jan and Hubert Van Eyck, possibly the first innovators to paint pictures in oils, in the late Fourteenth and early Fifteenth Century, to William Bouguereau, Jean Léon Gérôme, Alexandre Cabanel, Jehan-Georges Vibert and the other French Academic painters in the late Nineteenth Century, technical knowledge developed more or less continuously, as artists of each generation added their discoveries to what their predecessors had learned.



The continuity was interrupted around the end of the Nineteenth Century as a result of the popularity of the Impressionists, who were viewed as a rebellion against the academic style of painting. The emotional reaction to the Impressionists' emergence resulted in a total rejection of the Academy and all it stood for, to the detriment of art instruction throughout the Twentieth Century. The techniques taught at the Academy and the ateliers of the Academics represented the culmination of at least five hundred years of more or less continuous development in representational drawing and painting, dating back to the early Renaissance. This wealth of knowledge included many of the discoveries of the Old Masters, yet it was

suddenly regarded as "old fashioned," "passé," etc., and therefore of no further interest. Technical development essentially ceased at that point. Fortunately, a few of the dedicated students of the Academics carried on in obscurity, and passed what they had been taught on to their students.

There was also enough written documentation of the older techniques to enable this author, and a few other similarly obsessed individuals, to gain some understanding of what was involved, undaunted by the best efforts of several universities' art departments to discourage the pursuit of this knowledge. These written clues made possible a more thorough reading of the paintings themselves, sought out in museums across Europe and the United States over many years. Conservation scientists have also been able to provide a considerable amount of extremely valuable information previously only guessed at, which has helped to unravel the mysteries of the past, as technological advances and ongoing scientific inquiry continue to provide an ever-sounder base of knowledge from which to operate. Only after considerable practice in painting (below) can one fully understand what is there to be read in the paintings of the Great Masters and in the books which attempt to explain the techniques (including this one).



The hope is that this book will prove a little less cryptic (and more accurate) than the old manuscripts which the author was compelled to seek out and decipher in his own quest for knowledge. It is further hoped that it will find its way into the hands of others sharing the same obsession, and help to reestablish a link with the Great Art of earlier times.

THE FLEMISH TECHNIQUE

The earliest oil painting method evolved from the earlier discipline of egg tempera painting, as an attempt to overcome the difficulties and limitations inherent in that medium. As this took place initially in Flanders, the method is referred to as the Flemish Technique. Essential to this method of painting are a rigid surface primed pure white, and a very precise line drawing. The Flemish painted on wood panels primed with a glue chalk ground, which caused the transparent passages to glow with warmth from beneath the surface of the paint. As this method did not easily accommodate corrections once the painting

was under way, it was necessary to work out the idea for the picture with studies done on separate surfaces.

The completed drawing was then transferred to the white panel by perforating the "cartoon", or a tracing of it, along its lines, then positioning it over the panel and slapping it with a pounce bag, or sock filled with charcoal dust. The stencil was then removed, and the drawing finished freehand. Another method for the transfer was to cover one side of a piece of tracing paper with charcoal, or with a thin layer of pigment and varnish or oil, which was then allowed to become tacky, and use it as one might use carbon paper. Once the drawing was transferred to the primed panel and completed, its lines were gone over with ink or very thin paint, either egg tempera, distemper (glue tempera), watercolor or oil, applied with a pen or small, pointed, sable brush, and allowed to dry. The drawing was then isolated, and the absorbency of the gesso sealed, by a layer of varnish. Sometimes a transparent toner was added to this layer of varnish, which was then called an imprimatura. The tone of the imprimatura set the key for the painting, making the harmonization of the colors easier, and allowing for more accurate judgment of values. A field of white primer tends to make everything applied to it appear darker than it is, until the white is completely covered, at which time the darks are sometimes seen to be too light. And when the darks are too light, generally the rest of the tones are too light as well. By toning the isolating varnish (a warm tone was most commonly used), to a tone somewhat darker than white, this problem could be avoided or minimized.

Once the isolating varnish or imprimatura was dry, painting commenced with the application of transparent glazes for the shadows. The paints used by the early Flemish practitioners were powdered pigments ground in walnut or linseed oil. There is widespread speculation regarding whether other ingredients, such as resins, balsams, and/or various polymerized oils were added, and the issue is not yet resolved as of this writing. All opinions on this subject must be understood to be guesswork until scientific analyses have been completed on enough paintings from this era to settle the issue. It is likely, though not definitely established, that the brushing characteristics of the paints might have been altered to a long molecular configuration by the addition of boiled or sun-thickened oils, and possibly balsams such as Strasbourg Turpentine or Venice Turpentine, and/or resins. Strasbourg Turpentine, sap from the firs growing in and around what is today Alsace Lorraine and elsewhere in Europe, is similar to Venice Turpentine but clearer and faster drying. Balsams and polymerized oils add an enamel like consistency to oil paint, changing its structure to a long molecular configuration. Long paint is easier to control than short paint, especially with soft hair brushes on a smooth painting surface, as in the Flemish Technique. Brushes used by the early Flemish oil painters were primarily soft hair rounds. Some were pointed at the tip; some were rounded, and some flat. Hog-bristle brushes were also used for certain purposes, such as scrubbing the paint on in thin layers for glazing and other effects. Painting commenced with the laying in of shadows and other dark shapes with transparent paint. In this method, the painting is carried as far along as possible while the paint is wet, but is usually not finished in one sitting. Large areas of color are applied after the shadows are laid in, and worked together at the edges. These middletone colors may be either transparent, opaque, or somewhere in between, depending on the artist's preference. The highlights are added last, and are always opaque. Several subsequent overpaintings may be applied after the initial coat is dry, if desired. Some Flemish artists also employed an underpainting of egg tempera, or egg oil emulsion paint, to help establish the forms before painting over them in oils.

The Flemish method, in summary, consists of transparent shadows and opaque highlights, over a precise line drawing, on wood panels primed pure white. The painting medium may possibly contain a resin and/or balsam, which increases clarity and gloss, or a combination of a polymerized oil with a raw oil, which takes on the most desirable characteristics of a resin when used together (i.e., sun-thickened linseed or walnut oil, plus raw linseed or walnut oil, mixed together), without the defects of natural resins. The innovations are the use of oil paint and the technique of glazing with transparent color. A glossy varnish is applied at least six months after completion. Paintings are generally limited to smaller sizes, due to the difficulties involved in constructing, priming, and transporting wooden panels of greater dimensions. It had its limitations, but was a vast improvement over egg tempera, both in ease of execution and in the beauty of the final result.

Although it originated in Flanders, word quickly spread of the marvels of oil painting, and it was soon adopted by the German artist Albrecht Dürer, who is known to have traveled to Flanders and to Italy,

and by Antonello da Messina, who studied in Flanders, according to Vasari. Giovanni Bellini then learned it from Antonello, and taught it to Giorgione and Titian. The Flemish painter Rogier van der Weyden, who was adept at painting in oils, came to Italy around 1449 and influenced a number of Italian artists, including Piero della Francesca. The use of oil as a painting medium was adopted cautiously by some, and derided by others, as anything new always seems to create controversy. Michelangelo refused to paint in oils, and reportedly ridiculed Leonardo for adopting it. Titian (Tiziano Vecellio) recognized its merits, and soon added several innovations of his own.

THE VENETIAN TECHNIQUE

Titian and Giorgione are generally credited with originating what became known as the Venetian Method of oil painting. The Venetian Method, or Venetian Technique, shares with the Flemish Method the use of transparent glazes for the shadows, darker darks and for certain special effects, and opaque highlights, but differs from the Flemish method in several important ways.

The method evolved out of necessity, as the church desired large paintings of religious scenes for cathedrals, and wealthy dukes wished to adorn their palaces with large paintings of mythological themes and other subjects. The difficulties of constructing and transporting huge wooden panels influenced artists to seek an alternative. Canvas was soon adopted as the most convenient support for large paintings, as it could be rolled up and delivered, then reattached to the stretcher frame, or another of the same dimensions, at the painting's destination and hung. However, the rough texture of the cloth created a need for certain adjustments in technique and perhaps in the chemistry of the paints. A new primer was also needed, as gesso (gypsum bound with animal glue) and glue/chalk grounds are brittle, and thus unsuitable for use on a flexible support. After years of experimentation, involving the addition of oil or honey to gesso to render it more flexible, white lead ground in linseed oil became the accepted primer for canvas. The canvas was first given an application of weak glue sizing to render it nonabsorbent, as the linseed oil would have otherwise caused the canvas to rot. The glue sealed the absorbency of the canvas and excluded the oil from the linen or hemp fibers.

The gloss inherent in paints formulated for the Flemish Method was found to be objectionable for large paintings, and Titian seems to have made adjustments to produce a less reflective surface. It is likely he eschewed the use of polymerized oils, balsams and resins, all of which increase gloss, and opted instead for simpler paints ground in raw oil only. Thus the paint would have been of a short molecular configuration, rather than the (presumably) long paints of the Flemish. It was found that stiff, hog bristle brushes worked better with the short paint and rough textured canvas.

The combination of large, stiff brushes, short paint, and the tooth of the canvas made the painting of hard edges more difficult. Sharp edges occur quite naturally in the Flemish Technique, with its smooth surface, long paint and soft hair brushes, whereas the stiff brushes and short paint produced soft edges as a normal result on a coarse textured canvas. Titian (or perhaps Giorgione, who died young), however, apparently found the softer edges more to his liking, and used them extensively, as they gave the effect of being slightly out of focus. The edges could be sharpened selectively, where desired, to call the viewer's attention to an area of greater importance, or to describe an object whose edges were actually sharp, such as a starched collar, sword, or piece of paper or parchment, or they could be left soft in the interest of Selective Focus.

The systematic use of soft and hard edges together gave the paintings a more lifelike appearance, and more closely approximated the visual experience than did the overall use of hard edges, as had been the previous practice. Titian was perhaps not quite as accomplished a draftsman as Michelangelo, who is said to have criticized him for it, so he devised a technique which allowed him greater latitude for corrections. This technique involved the use of an opaque underpainting, with the edges left soft and nebulous to allow for later adjustments where necessary. Once the forms were established to the artist's satisfaction, he would allow the underpainting to dry, while he worked on other paintings. When dry, the underpainting could then be painted over in color, beginning with the transparent glazes for the shadow areas, as in the Flemish Technique, and developed further with opaque passages representing the areas of light.

In the Venetian Technique, color is often applied over the underpainting initially as transparent

glazes, which are then worked into, while wet, with opaque pigments. The paint is worked together wet into wet until the desired effect is achieved, or until the paint becomes slightly tacky, at which time it is allowed to dry thoroughly. This process may be repeated as many times as necessary.

At some point, someone, perhaps Titian, discovered that a light, opaque tone, rendered semitransparent by the addition of a bit more oil and/or simply by scrubbing it on thinly with a stiff brush, applied over a darker area produced an effect that could be put to good use. This is what we now call a scumble. It was found that a scumble over a flesh tone would produce the same effect as powder on a woman's face; that is, it made its texture appear softer. This is a useful device when painting women and young people of both sexes. It is also useful for indicating atmospheric density over distance, or atmospheric perspective. See Chapter Five, Principles of Visual Reality. Both glazing and scumbling create optical illusions. As such they effectively expand the capabilities of the limited palette of the early painters in oil. It was imperative that they get the most out of the materials they had.

Glazing is the application of a darker transparent paint over a lighter area. The optical illusion created by the light rays' having passed through a transparent darker layer, bouncing off the lighter surface underneath, then traveling back through the transparent layer to the viewer's eyes, is unique to glazing, and cannot be obtained in any other manner. A warm glow is created, and the color thus produced appears warmer and more saturated (higher in chroma) than the same pigment applied more thickly and opaquely. The effect, in the darker passages, is that of a shadow seen up close, with no atmosphere between the viewer's eyes and itself. The rich, golden glow in Rembrandt's dark browns is produced in this way. Rembrandt was influenced by Titian, and is reported to have at one time owned at least one of his paintings. Glazed darks appear darker than opaque darks, because the light rays are allowed to penetrate more deeply into the paint layer, and are thus subjected to a great deal of filtration before reflecting back out to the viewer's eyes. This effectively expands the value range possible with paints, which are handicapped on the light end of the spectrum by the fact that white paint is not as light as light in Nature. The Old Masters compensated by carrying their darks as far as they could, to create as wide a range of values as possible. This can only be accommodated through the use of transparent paints on the dark extreme. Furthermore, as light contains color, the artist must make the highlights darker than white in order to include color in them. This further limits the value range, and makes necessary the darkening of all tones by a corresponding amount in order to maintain the proper contrast and relationships between each category of light or shadow. Transparent darks allow the expansion of the dark end of the range.

Scumbling is the opposite of glazing. A scumble uses a lighter opaque paint, spread thinly enough so as to become translucent, over a darker passage. The optical effect thus produced is bluer than the paint applied, as the underlying layer is not completely obscured, and exerts its influence on the overall sensation, as has been previously described. It is very effective in softening surface textures, as soft cloth, such as velvet or cotton, or youthful complexions, the surface of a peach, etc., and, as mentioned, for indicating atmospheric haze over distant land planes and in the sky near the horizon. Overcast skies may be scumbled all over, as in Bouguereau's "The Broken Pitcher."

There are still more advanced and sophisticated developments of the Venetian Technique. The "semiglaze", which can be either transparent or semiopaque, or anywhere in between, is a very thin application of color to an area of the same value as the paint being applied. Its purpose is to modify the color of a given area after that area is dry, as in the addition of a tiny bit of vermilion to a cheek or nose, and/or to allow subsequent wet into wet painting over an area in which the paint has dried. It tends to soften unintended too-harsh transitions of tone from the previous sitting, if used properly, and thereby adds a higher degree of refinement to the image. It is applied thinly, by scrubbing it on with a stiff brush, after the addition of a small amount of oil or a painting medium to lubricate the dry surface of the area to be repainted. Titian is reported to have sometimes applied glazes and semiglazes with his fingers, or perhaps he was wiping the excess away after having put too much on with a brush. Stippling with a flat tipped brush is a good technique for applying glazes, scumbles, and semiglazes, though other means work very well in skilled hands. As a further development of the Venetian Technique, the underpainting, or certain parts of it, may be executed in opaque color, rather than totally in neutral greys. One popular variation was Venetian Red and Flake White. The underpainting palette should be limited to lean paints (paints with low oil absorption) which are opaque and/or very high in tinting strength. High tinting strength fat paints (paints with high oil absorption) may be used if mixed in very small quantities with

very lean paints like Flake White. The objective is to keep the underpainting leaner than the layers applied over it. When dry, the color may then be subsequently modified with glazes, scumbles, and semiglazes, or painted over with opaque color. These steps may be repeated as many times as necessary. The highlights are placed last, applied wet into wet with a fully loaded brush. Impasto is often employed in the highlights, to produce the most opaque passages possible, and to ensure that they remain opaque. Oil paints become more transparent with age. Therefore, in order for the highlights to retain their opacity over the centuries, they must be applied heavily. The illusion thus created is that of direct light falling on a solid surface, ricocheting from that surface to our eyes. It is not actually an illusion, as that is exactly what is happening. Juxtaposed with the transparent shadows, the illusion of depth is thus enhanced.

The underpainting, sometimes referred to as a grisaille if done in greys, should have its darkest passages painted somewhat lighter than the desired final effect, or the superimposed colors will lose much of their brightness and depth. Except for certain special effects, as in the technique of Rembrandt, the texture of the underpainting should be as smooth as possible. Any brushstrokes not smoothed out before the underpainting is dry, or scraped down before painting over, will produce a problem area in the next stage. Artists who prefer visible brushstrokes should decide where to place them in the final stages of the painting, as accents.

The Venetian Technique allows the widest range of possibilities of any oil painting method yet developed. Its systematic use of opaque passages, glazes, scumbles and semiglazes stretches the capabilities of oil paint to the absolute limits, and allows the artist the greatest latitude for adjusting the picture at any stage. The employment of the optical illusions created by glazing and scumbling, combined with the control of edges (selective focus), enables the oil painter who has mastered it to indicate three dimensional reality more convincingly than is possible with any other technique.

Among the Old Masters who used the Venetian Technique in one variant or another were Rembrandt, Franz Hals, Nicholas Poussin, Jacques Louis David, Jean Auguste Dominique Ingres, Jean Léon Gérôme, and many other great Masters whose names are not well known today.

It should be stressed that the wonderful results achieved by the Old Masters and other great painters were attributable, in great measure, to the preparations undertaken prior to their beginning work on the final canvas or panel. The concept for the painting had first to be worked out in smaller drawings, sketches and studies done on separate surfaces, to solve all the problems to the artist's satisfaction beforehand. This accounts for the impression most often conveyed by their paintings, of having been executed without the necessity of corrections. In truth, there were many corrections, but the major ones, at least, were most often solved in the study stage before the painting itself was touched. For very large paintings, the usual practice was for the Master to paint the painting first on a smaller scale to work out its composition, and then turn it over to his apprentices to be transferred to the large canvas by means of a grid. Refer to the sidebar for a more detailed description of the grid method of enlarging a design. In some cases, the smaller painting was done without color, to be used by the apprentices as a guide in applying the underpainting to the large canvas, which process the Master would oversee, and usually correct and complete after the students and/or apprentices had done most of the work. Often many supplemental studies were drawn and painted by the Master, either to aid the assistants in painting the large picture, or to solve some of the problems for himself, in the development of the concept for the painting. This practice is as much a factor in the excellent quality of the works these great painters produced as were the actual painting techniques they used so well.

DIRECT PAINTING

The Direct Painting Method differs from the Venetian Technique and the Flemish Technique in that the artist paints in full color from the very beginning, without requiring an elaborate under drawing or underpainting, and without resorting to the use of glazes or scumbles. All paints except the deepest darks are used as if they were opaque, and are usually applied heavily enough as to appear so. The object, ideally, is to paint the entire picture wet into wet, from start to finish. Terms such as *Alla Prima* (Italian) or *Premier Coup* (French) are sometimes used for this technique, indicating that the picture is to consist of one layer of paint, applied all at once, in one sitting. In practice, this is not always possible, and great

pains must then be taken to nonetheless make it appear as if it were done *alla prima*.

The Old Masters employed this technique for sketches only, to be used as visual aids in the creation of larger works executed following the Venetian method or a variant. Franz Hals was the first painter to use direct painting for other than sketches, although the works for which he is famous today may still arguably be called sketches. Hals was proficient in the Venetian Technique as well, and used it for his commissioned portraits. The Direct Painting technique was elevated to legitimacy in the Nineteenth Century by Carolus Duran, the teacher of John Singer Sargent, and then by Sargent himself, among others, most notably Anders Zorn, Cecelia Beaux, and Joachin Sorolla y Bastida.

The range of effects possible with Direct Painting was once much narrower than with the Venetian Technique, but today's wider selection of pigments has expanded its possibilities considerably over what was available in earlier times. The invention of the cadmium pigments and synthetic ultramarine in the Nineteenth Century made Direct Painting a more viable alternative to the Venetian Technique.

Individual approaches vary greatly. Some prefer to begin in charcoal, with a few quick guidelines sketched freehand on the canvas before beginning to paint, while others choose to begin immediately with the brush, and sketch in the shapes initially with thin paint indicating the shadow masses. Some painters tone the canvas beforehand with a very thin transparent imprimatura, to "kill the white", which might otherwise influence them to paint their darks too light a value, and some prefer to paint directly on the white canvas. Others tint the primer to a value darker than white by adding paint or pigment to the final coat of primer to make an opaque tone somewhat darker than white.

A toned ground or imprimatura makes judgment of values a bit easier. Painting on an opaque primer darker than a value seven on the Munsell scale will make the superimposed colors duller, however, and will cause the painting to darken in time. It is better to use a white primer, and add a transparent tone over it to lower the value initially, or add a light opaque tone over the white primer. A transparent toner can be painted into immediately, or allowed to dry before commencing. With the latter practice, care must be taken to avoid violating the "fat over lean" rule.

As with the Flemish and Venetian methods, darks should be applied first, and thinly. The reason for this is that the shapes are indicated reasonably well with just the dark shapes and shadows, and corrections may be made without excessive paint buildup by simply wiping out mistakes with a rag. The early stages are most likely to require correction of shapes, so it is prudent to begin thinly. This also allows a certain degree of transparency in the shadows, which is desirable. Oil paint is most easily controlled by painting wet into wet, from dark to light, systematically. As the reader has surely discovered at one time or another, to attempt to indicate a shape haphazardly, beginning with a middletone or light color soon results in a sea of wet paint into which everything disappears as soon as it is applied. This is called mud. The mud experience has discouraged many would be oil painters over the years. It is simple enough to avoid, if one proceeds methodically, following a logical progression. It is advisable to begin with a very large brush, and block in the large general shadow and other dark shapes first, correcting any mistakes by wiping with cheesecloth, used as an eraser, before adding a second color. The large color shapes in the middletones and lighter shadows should then be blocked in, using another large brush. One may then work back into the shadows and add secondary light, reflected color, and shadow accents, then return to the middletones and add refinements there, saving the lighter areas and finer details for last.

The lights should be painted more thickly than the darks. Large brushes cover more canvas in a given time, hold more paint, and allow the artist to paint much faster. The use of small brushes and the addition of detail should be forestalled as long as possible. Many agreeable effects can be created through expert use of a large brush, especially in areas in which one might be tempted to switch to a smaller one. Facility in this style of painting is developed by the execution of studies painted from life. As they are only studies, there is no pressure to create a masterpiece, and the student is free to experiment. After a bit of practice, the studies become more and more accurate, as the student's ability to perceive value and color is developed to a higher degree, and the initial awkwardness with the brushes and paints is overcome. It is helpful to isolate value in one's first attempts in oils, by working only with white and greys made with Ivory Black and white. Once the student is past the struggling with the paint stage and has learned to understand values, color may be introduced a little at a time, at first adding only Yellow Ochre (or Raw Sienna) and Red Ochre, for use in color sketches of the human head from life. With this palette it is possible to mix what appears to be a full range of colors. It is only effective in paintings with an overall

warm tonality, in which context greys made with Ivory Black and white appear to be blue. Greens are made from yellow and black, or yellow, black, and white, and violets are mixed from black and red, or black, red, and white. An automatic unity is thus achieved, as the cool colors produced in these mixtures are low in chroma, and cannot disrupt the harmony of the warm dominance. The palette is then expanded gradually, as the student becomes familiar with the limited palette, by the addition of Burnt Sienna, Raw Umber, and Cadmium Red, Light. At the appropriate point, Ultramarine Blue is added, and so on, so that no lesson overwhelms the student with too much to learn at once.

It must be stressed repeatedly during the early sketch sessions in oils that only the big shapes should be painted, and large brushes used exclusively. No detail should be attempted until the student is able to judge the correct value, color, shape, and relative proportions of the large shapes of shadow and light accurately. By then, the powers of observation will have been developed highly enough that the rendering of detail will be easier, and, hopefully, bad habits will have been unlearned. By this method of learning, one gains the necessary skills for painting well in oils, in any technique.

The Direct Painting Technique is the one most widely used in modern times. The vast range of pigments available today has, in great measure, narrowed the gap between what is possible with it and with the Venetian Technique. It is also possible to modify the Direct Painting Technique by finishing off with glazes and/or scumbles after the painting is dry, but it then ceases to be direct painting. Some styles of Direct Painting owe their appeal to the painterly looseness obtained when painting very quickly with large brushes. For this type of painting, superimposition of glazes and scumbles would in most cases be inappropriate. In practice, the boundaries between techniques become blurred as artists combine elements of more than one method in pursuit of the desired effect. This is how new techniques are born.

INNOVATIONS OF REMBRANDT

Rembrandt Harmenszoon Van Rijn, whom many consider the greatest artist of all time, learned all that was then known about oil painting while still a very young man, surpassing his teachers very early in his career, and then proceeded to add his own discoveries to the technical knowledge of his time. To this day his best works remain unsurpassed, and serve as inspiration to the rest of us who paint. This being the case, any book on advanced techniques must address Rembrandt separately and at such length as the author's knowledge allows.

What technical information Rembrandt was taught may be discerned by studying the works of his instructors, Jacob Isaacszoon Van Swanenburch and Pieter Lastmann. Such study also immediately shows the genius of Rembrandt by the extent to which he so obviously surpassed them both, and in how early in his career he did so. Nonetheless, his training under them was an important factor in his artistic development, and should not be minimized. Both teachers seem to have possessed a working knowledge of the painting methods in use at that time, which Rembrandt learned from them. This would include the Flemish Technique, the Venetian Technique, and the Direct Painting Technique. Various



examples of his work show that he was not limited to any one of them, but employed them all, the choice depending on which approach best suited the subject in question, and for what purpose the painting was intended. His facility with all three soon led him to combine aspects of one with another, and to add innovations of his own.

Some of his paintings are on wood, executed in what appears to be essentially the Flemish Technique; some small studies on wood panels were done in a variation of the Direct Painting Technique, and some on canvas in both the Venetian and Direct techniques. The primer for the panels is white, the first coat consisting of glue chalk gesso, which was sanded to smooth out the irregularities of the panel's surface, then a layer of white lead in linseed oil, sometimes tinted with black, Raw Umber, and sometimes an earth red, covered with a transparent brown imprimatura, which creates the golden glow characteristic of his work. His canvases are primed with an underlayer of a red earth, perhaps to fill the texture of the canvas, then overlaid with a light, warm grey made from lootwit (lead white with chalk, ground in linseed oil) and Raw Umber, sometimes with a little black and/or earth red, or sometimes with white lead alone.



Rembrandt was an extremely versatile artist, and did not likely follow an unthinking repetition of the same procedure every time. Undoubtedly he thought his way through each painting, from the genesis of the idea to the last brushstroke, never lapsing into a routine approach. From unfinished pictures we know that, at least sometimes, he began in transparent browns, working in monochrome to establish the design of the picture, attending to the masses of dark and light, often using opaque white for the strongest lights in this stage, sometimes referred to as the imprimatura, or later, by the French academic painters, as a frottée, though the term, “frottée” generally referred to a thin brown scrub-in without white, the lights instead being simply indicated by leaving the light ground more or less exposed. This stage was apparently allowed to dry before proceeding further, though there may well have been exceptions. Over the dried brown underpainting color was begun, with Rembrandt working from back to front rather than working over the whole picture at once. He exploited to the fullest the qualities of transparency and opacity, relying on the underglow of light coming through transparent color for many special effects, with opaque lights built up more heavily for the brightly lit areas, their colors sometimes modified by subtle glazes, semiglazes or scumbles, and the arrangement of transparent darks and opaque lights to play

against one another for maximum visual impact and depth. Clues as to his choice of primer may be seen in areas where he has used a sharpened brush handle to scratch through wet paint in order to indicate bits of hair. This is evident in a very early self portrait, now in The Hague, and in many other portraits. The primers and/or imprimaturas thus revealed show that he followed no one single procedure, but varied the choices, based on the effect he was after. The scratching with a sharpened brush handle into wet paint was one of his earlier innovations.

Not long afterward, he began building up the opaque passages in his lights more heavily, and texturing them to take on the physical convolutions of the lighted surfaces of his subjects, most notably the skin textures of male subjects, including himself. The texture was created, or at any rate, can be duplicated, by applying the paint somewhat heavily with large brushes, then gently passing a large, dry, soft hair brush over the surface of the wet paint, back and forth, until the desired texture is attained. Rembrandt began to superimpose glazes of red over these textured passages when dry, then wipe them off with a rag, leaving traces remaining in the low spots to create an even more convincing texture of rough flesh. Someone, at some point, said you could pick up a Rembrandt portrait by the nose.

As he began to expand the effect of glazing over dried impasto to other textures as well, he devised a method employing two whites; one for impasto and one for smoother passages. The impasto white was faster drying, probably made so by the addition of egg (traces of protein, presumed to be from egg, have been found in samples analyzed by conservation scientists), and ground glass, into the formulation. It was very lean, and consisted mostly of white lead with a minimum of binder. He began applying it more and more heavily as the first stage of a two (or more) stage operation which was finished with transparent glazes and wiping, to create fantastic special effects, the most extreme example of which is the man's glowing, golden sleeve in the painting referred to as "The Jewish Bride," in the Rijksmuseum in Amsterdam. The brilliance of this effect cannot be gotten in any other way. He has used the same technique on the bride's costume in the same painting, but here the underpainting is red, which is deepened with a glaze of red lake, probably Carmine (Cochineal). The red carpet on the table in "The Syndics of the Drapers' Guild" (sometimes called "The Dutch Masters"), also in the Rijksmuseum, is done in much the same way. The underpaint appears to have been trowelled on with a knife or some sort of flat stick, then sculpted before it dried.

In Lieutenant Ruytenburch's uniform in "The Night Watch," Rembrandt used this method, but with less heavy impasto, for the ornate brocade work. The wet underlayer was worked with sharpened brush handles and other tools while soft, then allowed to dry before applying the darker glazes. By wiping the glazes off as soon as they were applied, Rembrandt was able to create a bas relief effect of remarkable three dimensionality as the glaze remained in the nooks and crannies. By glazing again, this time with transparent yellows and/or browns, instead of Ivory Black, he gave the textures a rich, golden glow.

Scientific analyses carried out by the National Gallery, London, show that Rembrandt added body to his glaze-like passages by mixing in a bit of chalk, which functions as an inert pigment essentially transparent when mixed with oil, and ground glass, which was probably used primarily to accelerate drying. The glass most likely would have contained lead and/or cobalt, both drying agents.

There has been a great deal of speculation as to what medium or media Rembrandt used, with most of the theories stating that one resin or another had to have been a major component. It now appears that these hypotheses may be in error. Recent studies of paint samples taken from a number of Rembrandt's paintings show no detectable resins. In most of the samples tested, only linseed oil was found, and walnut oil in some of the whites and blues. In some cases some of the oil was "heat-bodied," as in perhaps boiled or sun-thickened linseed oil. It is probable that these were added to the paints in which he wanted a long brushing quality, and in at least some of his glazes. The combination of polymerized oil and raw oil produces a resin-like substance without the undesirable properties of resins. Reinforced with chalk for body, and ground glass for faster drying and perhaps transparency, these appear to comprise Rembrandt's glazing media, as nearly as is discernible by the present level of scientific knowledge, which, it must be noted, is subject to change at any time, as new discoveries are made. For paints intended to be blended smoothly and opaquely, it is most likely that no medium was added, beyond the linseed or walnut oil in which the pigments were ground.

Rembrandt had at least one life size jointed mannequin, on which he would pose the clothes of his sitters. The mannequin, unlike a living person, would remain motionless for as long as Rembrandt needed

to paint the clothing, the folds remaining undisturbed for days, or weeks, if necessary. A live sitter would have to visit the bathroom, eat, sleep, move around, etc., and the folds of the cloth would never be likely to resume their previous shape after any of these activities. The use of the mannequin may or may not have been Rembrandt's innovation, but it was, and is, a good idea regardless.

We cannot expect to be able to rival the great genius of Rembrandt merely by following some of his procedures and using the same tools and materials he used. These are only a small part of his brilliance as an artist. At the core was his intelligence and artistic sense, his ability to constantly strive to improve upon what he had already done without losing sight of the original concept for the painting, to devise techniques, on the spot, which would create the effect he was after. We might hope to achieve the best results by adopting this same attitude towards our own work, rather than by attempting to reduce the methods of a great genius whose works we admire to a simple formula and then following it, unthinking. This is not meant to disparage technique, but to show it in its proper context. The more we know of technique, the more effects we have at our disposal, to serve our creativity and inspiration in the execution of our finest conceptions. If there is anything remotely approaching a formula for creating Great Art, it might be stated as the combination of knowledge and intuition in a single endeavor, plus a lot of work.

This chapter concludes with sections on:

- **THE BISTRE METHOD**
- **THE TECHNIQUE OF WILLIAM ADOLPHE BOUGUEREAU**
- **FRENCH ACADEMIC METHOD**
- **GENERAL PAINTING TIPS**

To place your advance order contact;

Virgil Elliott, APSC, ASPA

111 Goodwin Avenue, Penngrove, California 94951-8660, U.S.A.

Telephone: (707) 664-8198

E-Mail: VirgilElliott@AOL.com

© 2000 Virgil Elliott. All rights reserved

[GO TO ... Painterly effect No2](#)

[main menu](#)

KISSING PRACTICE - A DEMONSTRATION PAINTING - PART 2

'Realism'

In Fig.5 I have brought some of the highlights forward by use of a higher value blue-gray and added some wings. This stage you could call 'molding' the forms or to use its proper terminology you could call it the application of chiaroscuro. This was the method made famous by the Renaissance painter Carravaggio and copied in the north by painters such as Rembrandt, Rubens and Vermeer.



Fig. 5

Adding wings and cool grays



Fig. 6

Scumbling with some highlights

In Fig.6 I have begun to add some warmer tones and some additional compositional props such as the blue swirling cloth, which was a much-loved device by painters to the time.



Fig. 7
Detail of lower torsos.



Fig. 8
Thumbnail of full composition.

Now we get to the technical reason that made Bouguereau paintings so realistic. More than any other painter Bouguereau showed veins and arteries, which we know by our study of anatomy, lie just below the skin and show behind the knee, in the neck, inside the elbow, in the lower abdomen and between the thigh and the torso. There was no need to show them all, yet just sufficient to give the model a defined 'humanity'.

This is a large step away from the 'ideal' toward the 'real' and needs to be handled with the same care a jazz musician might use a discord to amplify a harmony. Not too much that might make it look like a blue road map.

No doubt the display of veins and arteries is not one that would normally attract the viewer BUT in this case it has another purpose. It throws into the mix of the ideal figures and perfect forms something that might otherwise be thought ugly. In Fig.7 you can see where I have shown the veins that occur between the thigh and torso of the female, and the thigh of the male.

Also note in Fig.8 and elsewhere I have reddened hands, feet, knees, elbows and faces as the blood is closer to the surface in these more sensitive areas.

How is this done with paint?

[GO TO kissing practice No3](#)

[Advanced lesson menu](#)

KISSING PRACTICE - A DEMONSTRATION PAINTING - PART 3

'A certain realism'

Now for some technical information regarding technique. I used none other than bristle brushes for this painting to this stage.

OK ... we started with a value 4-5 burnt umber with a blue-gray interior for the figures. The blue gray was molded in the chiaroscuro manner and allowed to settle and dry. A higher value mix of light red/burnt umber and flake white was used to bring the flesh up to a warmth in the secondary areas (or turning point areas) that pointed upwards. The turning point areas that pointed down were left blue-gray (as seen in the background). In certain other areas close to the ground, and reflecting down, a little yellow was added. This took care of most secondary areas.

Working back from the highlights with a flake white, sometimes with a little red added and sometimes with a touch of ultramarine, and using a small bristle (1/4"), cut and blend the highlights into the secondary values. If desired at this stage you can add veins and other secondary areas as well painting wet-in-wet as time permits and adjusting as you wish.





The middle distance is best kept indistinct, yet atmospheric, while the foreground should not detract from the overall design.

[GO TO the eye, the grape and the cherry](#)

[advanced lesson menu](#)

4-2 PAINTERLY 2

William Whitaker writes: 'Like everybody else whose worked at painting a long time, I've tried everything. I've learned that Art Leads, I just go along. I didn't consciously set out to be a certain kind of painter, it just evolved. I don't believe there is any one true way, but I'll tell you what I like best. I start loose and juicy. I rarely paint alla prima anymore and I try to smooth out the paint at the end of a session. I dislike the effect when I paint over a textured layer whose texture is in the wrong places. I have a very old, sharp palette knife (sharpened from years of scraping.) I'll carefully scrape texture off a dried surface with it. If I'm working on a panel, I'll often sand the fuzz, texture and grit off the dried paint surface with wet or dry fine sand paper, sanding wet, before painting the next coat - a technique I picked up from house painters.'



I'm very aware of what I call "wall presence" or the lack of it. A lot of my best buddies were successful illustrators before they became even more successful gallery painters. They all were smart enough to know and understand that the single most valuable characteristic in a painting on display is the spiritual wall presence. It is easier to achieve this quality with oil paint than with other mediums. This is due to inherent pigment strength and natural body.

It is very hard NOT to have texture even when you try. I believe it's best not to worry one way or another. I think it's a kiss of death to be thinking consciously about technique in the middle of the painting process. One must really love to paint, to be driven as it were, to put in the time necessary to really get proficient.

Many people would like to paint, but not enough to paint those endless failures necessary to get to the good work. If it were otherwise, we'd be overrun with painters.

If there is to be texture in my painting, I want it to be in the last layer. I'm aware of the vast range and intrinsic beauty in oil paint. Using thin paint and thick paint, glazes and opaques, one can create a feast for the eye.

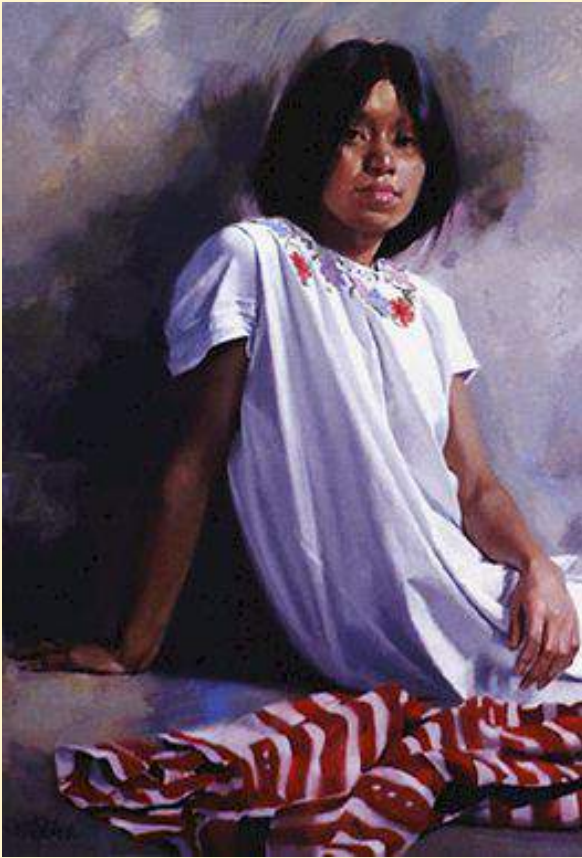

There seem to be a great many folks who are doing high finish (they call it realistic) work out there today. Most of these people paint from the outside in - paint the hair on the dog before painting the dog. Most of the time they are pretty easy to spot. I tell the viewer to check out the following: Do they paint Orange People? Thanks to film, TV and Print, most folks think orange people are realistic! Does everything look like plastic? Enough said about that! What do the broad, quiet passages look like. A poor artist doesn't know how to handle his brush. It shows in the backgrounds.

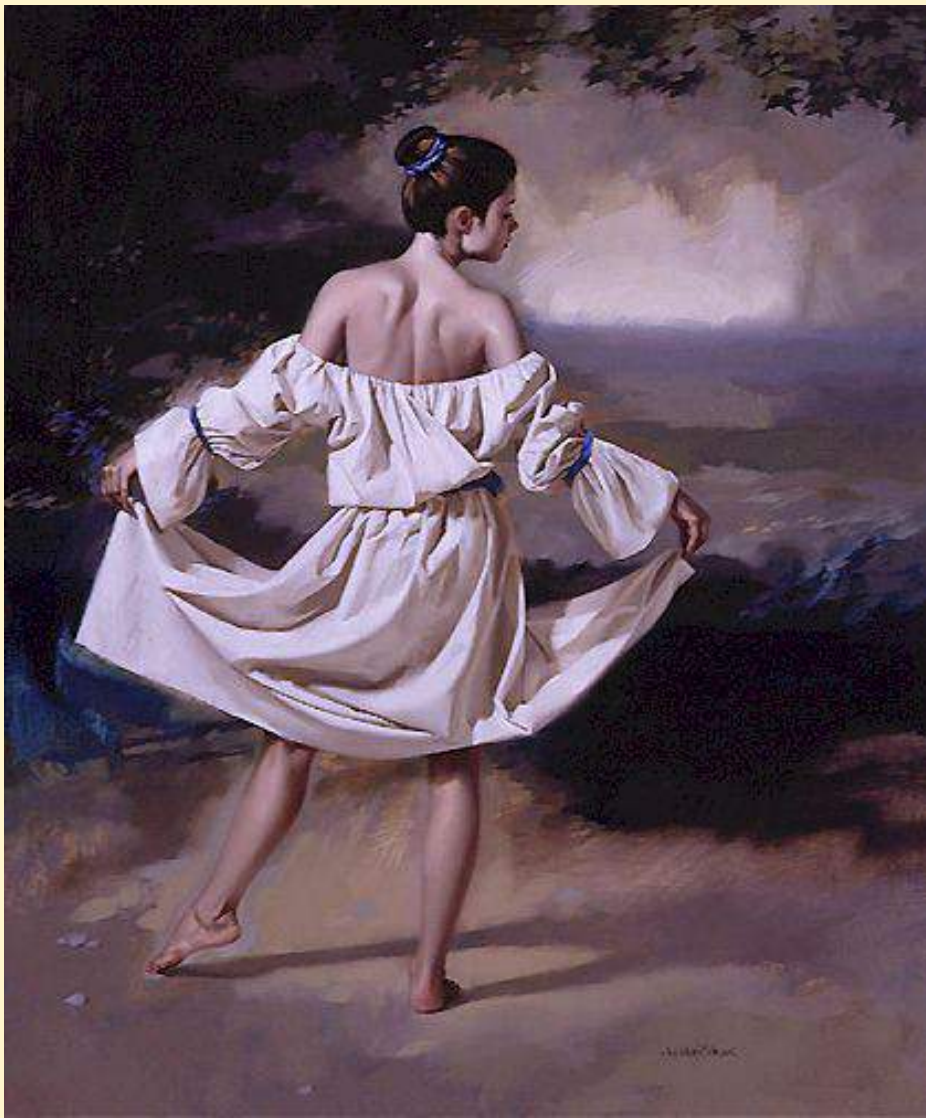

All Paintings on this page are by William Whitaker

STUDENT ACTIVITY: Write a short essay on the relationship between size and wall presence, colors and wall presence, design and wall presence. Give examples of each. Also explain how you think William Whitaker gives his paintings such great wall presence. Allow 40min.

[GO TO ... Bill's demonstration painting](#)
[lesson menu](#)

4-1 THE PAINTERLY EFFECT



In these lessons I do not hesitate to assert that art is about illusion and great art is the total presentation of the greatest illusion. This brings me to the 'painterly effect' or the process of having your brush strokes or knife effects appear on the canvas as you see opposite in the detail from a pink rose I painted 'wet-in-wet' before the blooms could wilt. The full painting is shown below ... JH



Virgil writes:

The "painterly" approach was originally an incidental effect most common in sketches and studies, the sole purpose of which was to help the artist solve some of the problems in the execution of a more refined painting. Titian and Rembrandt became more "painterly" in their later years, when deteriorating eyesight may have hidden the irregularities from them (one hypothesis). Franz Hals painted a number of paintings in the sketch style, probably for his own amusement and/or to cover his bar tab or whatever. He was capable of more refined painting, as is evident in most of his more important commissioned portraits, but employed the faster "alla prima" approach for painting more light-hearted subjects; probably his friends or interesting subjects encountered at the tavern, where no one was likely to pose for very long. Bouguereau has been falsely characterized as disguising his brushstrokes, but his brushwork is actually visible from up close. In reproductions the strokes do not show, because the paintings are generally large, with the main figures life-size, and the brushstrokes are small. He also used palette knife very expertly for certain effects, especially in the vegetation and other parts of the background, but generally did not employ impasto.



The 'painterly' style became more popular with John Singer Sargent, Anders Zorn, and Joachin Sorolla. Sargent actually worked very hard to achieve the effect that he had dashed the picture off effortlessly and accurately all at once. Many passages were scraped out and repainted over and over again until the desired appearance was accomplished. There is a certain charm in this type of painting (see opposite), but its effectiveness depends on the values and colors being registered extremely accurately, or the result just looks sloppy. Sargent's eye was precise enough to make it work. Ironically, he expressed regret, late in life, that he had not carried his paintings to a higher degree of finish. The main trick to painting in this manner is to work fast, with large hog- bristle brushes and large amounts of paint available on the palette. palette knife can also be used for certain effects. A somewhat rougher texture canvas works best for this technique, in my experience. Some subjects are more suited for this approach than others. It is well for artists to be able to paint in more than one manner, and to choose whichever technique best suits the subject at hand.

Regarding impasto highlights, the reason for this is to ensure that they remain opaque far into the future. Oil paint becomes more transparent as it ages, and the thinner the paint, the more transparent it will become. Highlights must be opaque in order to reflect the light which strikes them in the same way as it would reflect from the surface depicted.'

Refined Painting - 'The most advanced concepts go beyond words' ... VE



Rembrandt developed the technique of glazing over dried impasto for a bas- relief effect, wiping the wet glaze off the high spots and allowing it to remain in the nooks and crannies for a heightened three-dimensional effect. Used in this manner, impasto can actually enhance the illusion of the third dimension.

Gerome (below) insisted on a perfectly smooth surface to the painting, and forbade his students to use impasto anywhere.



My first instructor, who happened to be my mother, told me it makes a painting more interesting to the viewer when he or she can detect some of the artist's brushwork from up close. I still adhere to that, to a greater or lesser degree depending on what I feel is most appropriate for the picture in question, but I prefer to only leave a few, in strategic places, rather than leave them everywhere indiscriminately. My usual practice is to have them undetectable from normal viewing distance, and only become barely visible from a few inches away. In my alla prima style, which I seldom employ these days, I may let them show a bit more noticeably in areas where they serve a purpose, as accents. This was generally the practice of most of the Old Masters.

I believe it is best for painters to have command of all possible visual effects, as this opens up the widest range of possibilities, and best facilitates the creation of whatever illusion is desired.' ... Virgil Elliott

left ... detail from Virgil's 'Still Life With Satin'

STUDENT ACTIVITY: Using paint with very little oiliness and half-inch or less hog bristle brushes paint a small 'impressionist style' picture using short thick impasto strokes. Allow 40min.

[GO TO ... Virgil's 'Oil Painter's Bible'](#)
[or lesson menu](#)

3-2 THE GRAPE, THE CHERRY AND THE EYE

A friend once wrote ... 'There is such evident sparkle in the eyes of intelligent people which is often missing in others, but always present to some degree. One of the things that led me to believe this is possible, was when I had the unfortunate experience of having to put one of my cats that had a fatal disease, to sleep. I can't tell you what a horrible experience this was as I loved this animal deeply. As the fatal injection was given, I actually watched the eyes go from sparkling to a dead grey. I have never gotten that image out of my mind.'

In this lesson we are going to examine how to do the reverse ... to put a sparkle back into the eye.

To do this we must look at a white grape and a red cherry and see what makes them appear real. First the grape:

Many artists love putting white grapes in their still life paintings because they have a wonderful transparency which shows up particularly well against a bunch of dark grapes and other items.



Fig 1



Fig 2



Fig 3

Many fruits have a light grey covering on their skin I call 'frosting'. This occurs on the skin of most fresh stone fruit but is particularly noticeable on peaches, plums and grapes. I have added this frosting to **Fig 2** above.

In **Fig 3** I have added a top 'highlight' and a secondary highlight (180 degrees apart) where the ray of light 'emerges' from the grape. This occurs because the grape is semi-transparent allowing some light rays to 'penetrate' the liquid in the grape itself.

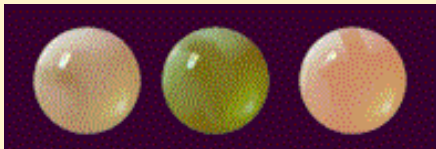

In the examples of the three grapes shown above I have altered their hue slightly to allow for various stages of ripeness. Also, since the 'frosting' is sometimes removed as the grapes are handled or moved about I have cleared certain areas allowing the smooth skin to show through. This has the effect of emphasising the frosted areas even more.

Now all we need do is assemble our bunch in as a convincing manner as possible (see below). This should not be difficult for those partial to eating grapes.

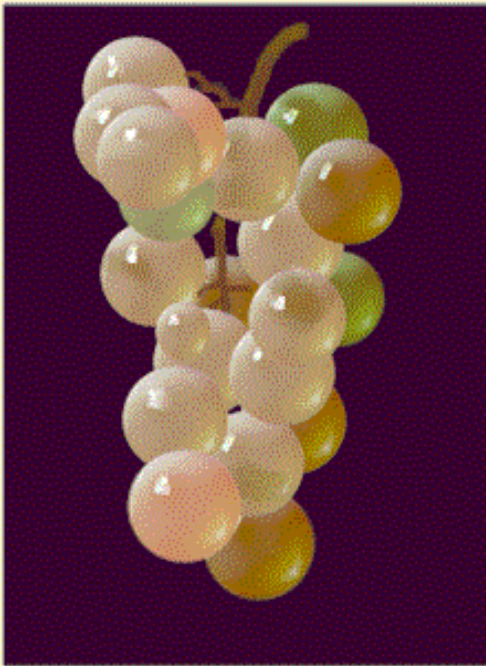

The **cherry** also has similar qualities to the grape though without the transparency.



Fig 1

Fig 2

Fig 3

Fig 4

See above the dark (Fig 1), the frosting (Fig 2), the red (Fig 3) and the highlight (Fig 4). Then ... below they are assembled with a few 'realistic' touches. Most of the frosting is removed and the exposed shiny bright red skin makes the 'highlight' sharper. There is no 'transparency' in the cherry. You will no doubt remember the lesson on the 'pearl' which was an object with similar non-transparency.



With the grape and the pearl (or cherry) we have created the two spheres that together will allow us to understand, paint and add the sparkle we want to the the human eye.

To see how this is achieved you must go to the next page.

[GO TO the eye](#)

[... lesson menu](#)

4-3 WHAT MAKES A MASTERPIECE?

A painting masterpiece is 'a portal or magic window that will draw the imagination.' How is this done and why are we humans drawn to certain paintings like Icarus was to the sun, or flies to fly paper?

Why, because the painter desires the viewer to enter into the painting, and once there, to make them want to dwell awhile. And how do they do this? By imagination and the use of all the means, tricks, skill, subterfuge, and techniques at their disposal.

The techniques include texture, design, color, chiaroscuro, aerial perspective, drawing perspective, form and shape. These skills have been honed over thousands of years and are a proven method to attract the curious and entice even the dullest imagination. They are the basic tools of the painter.



During the previous two centuries a few extra skills have been added to the painters arsenal.

1. Depth of field.
2. Impressionistic use of color
3. Brushstrokes and the viscous use of modern paints.

These also are legitimate tools painters can employ to entice the viewers into their world.

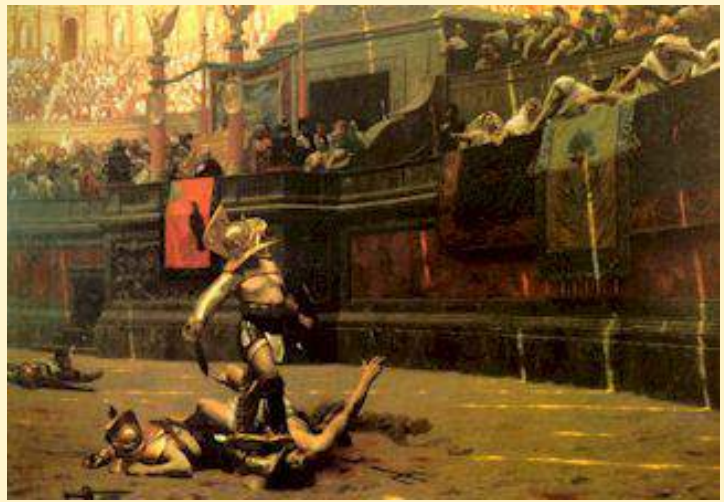

Now that is out of the way we can ask; how do we classify works as masterpieces? Answer; by finding their similarities and judging whether their differences are relevant differences. For this purpose I list below ten pre -1900 paintings I class as masterpieces. This is not to say there aren't others ...

- Giorgione - The Tempest
 - Vermeer - Girl with pearl earring
 - Leonardo - The Mona Lisa
 - Rembrandt - The night watch
 - Caravaggio - Calling St.Mathew
 - Velazquez - Las Meninas
 - Titian - the assumption
 - Watteau - The clown -Pierot
 - Turner - The fighting Temairaire
 - Gerome - Police Versa
- THEY ARE ALL SHOWN ON THIS PAGE



It is assumed that what binds these paintings together is more relevant than their differences. So what binds them? Here we must almost become Taoist in our answer. The artists all 'walked on rice-paper but left no footprints'(ie, more becomes less). In all these works there is mystery, subtlety and a magnetic attraction. The technique is so skilful, so masterful, so seamless, it is unnoticeable. Like the great actor who makes the audience forget

he or she is acting; so does the great painter do likewise for the imagination. That is what requires all the skill and technique.

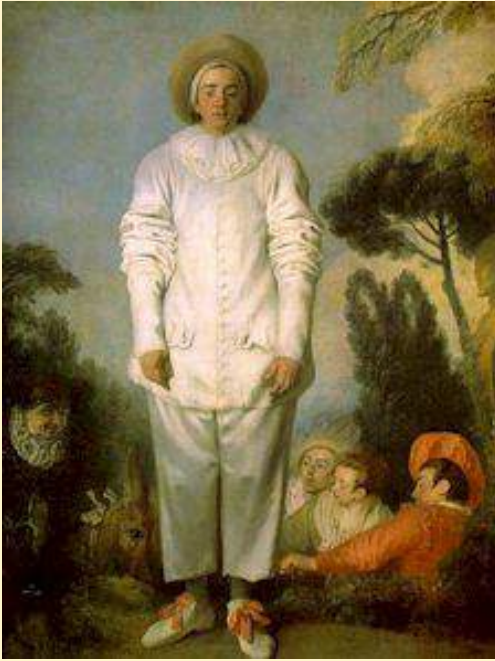

This is not something dependent on the degree of reality of the scene or the portrait, nor is it dependent on the degree of unreality of the same. It is something else.

So, I will list what binds these paintings;

1. They all have an element of mystery
2. They all have a technical mastery that is sufficiently high to make it instantly secondary, unnoticeable.
3. They all visit a moment in time and space that fires the interest and imagination of the viewer.
4. They all pre-suppose the viewer can share a human understanding and common experience with the painter.



So, what does all this prove?

Not much, but I still like to call the process 'the magic of painting', and coming across a masterpiece can take your breath away. It is worth the effort.

STUDENT ACTIVITY: Select your own ten masterpieces and briefly explain why you admire each of them. Allow 40min.

[GO TO ... Advanced perspectivepersp.htm](#)

[... lesson menu](#)

3-3 THE GRAPE, THE CHERRY AND THE EYE

The eye is a ball with the iris (dark part) forming a slight projection like a boss. The pupil is not a color but a dark shadow, a hole that allows light into the eye.

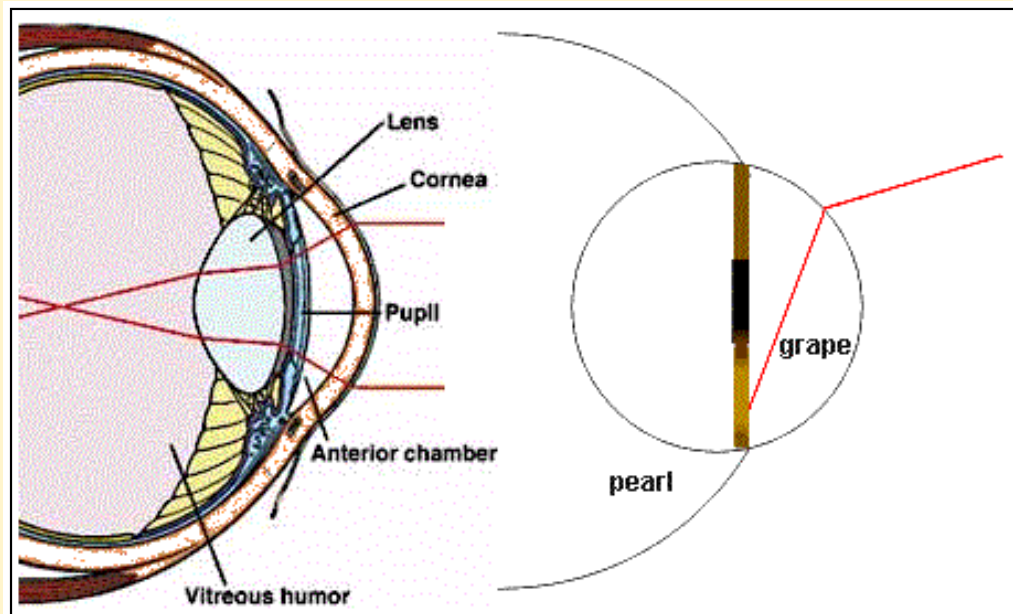

An attribute of the eye is the that it is translucent. This can lead to the following paradox: when the light strikes the iris at an angle the highlight appears to be surrounded by dark even though being round, that side is facing the light.

There are two layers to the outer eye. There is the cornea, and the lens. Light might very easily pass through the cornea, and reflect off the lens causing a highlight at odd locations on the cornea. Both these structures bend light to some extent; the lens obviously bending light more than the cornea. A highlight on the cornea should show up on the opposite side of the cornea as a reflected highlight just as it does in glass.

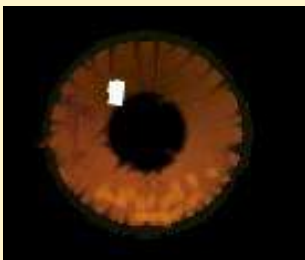

The light that is seen in the iris of the eye opposite the highlight is **transmitted light**, which is seen also in a glass or bottle of wine, or any container of transparent liquid. It works the same with a grape. The iris of an eye is likewise a container of transparent liquid. Light passes through it and reflects off the inside of the back of it, 180 degrees opposite the entry point. The highlight itself is the reflection of the light source from the moist outer surface of the eye. Of course this only occurs when the eye is in the light.

So the side opposite to the highlight often seems lit up, although it is in shadow.

The proper rendering of this effect gives the eye an aqueous and luminous quality, which is not

available in any other way. Indeed it is possible to introduce this effect deliberately by changing the position of the highlight and thus transforming a dull eye into a live one. Often I introduce highlights into the eyes even when it is optically impossible, or when the light source was not even reaching the eye. I consider the employment of such a device to be a legitimate conceit and a method sometimes necessary in portraiture. The fact that, scientifically, the angle is 180 degrees is dependent on the eye being spherical. Unfortunately there are two spheres that contain the surface of the eye which complicates the angle of reflection even more.

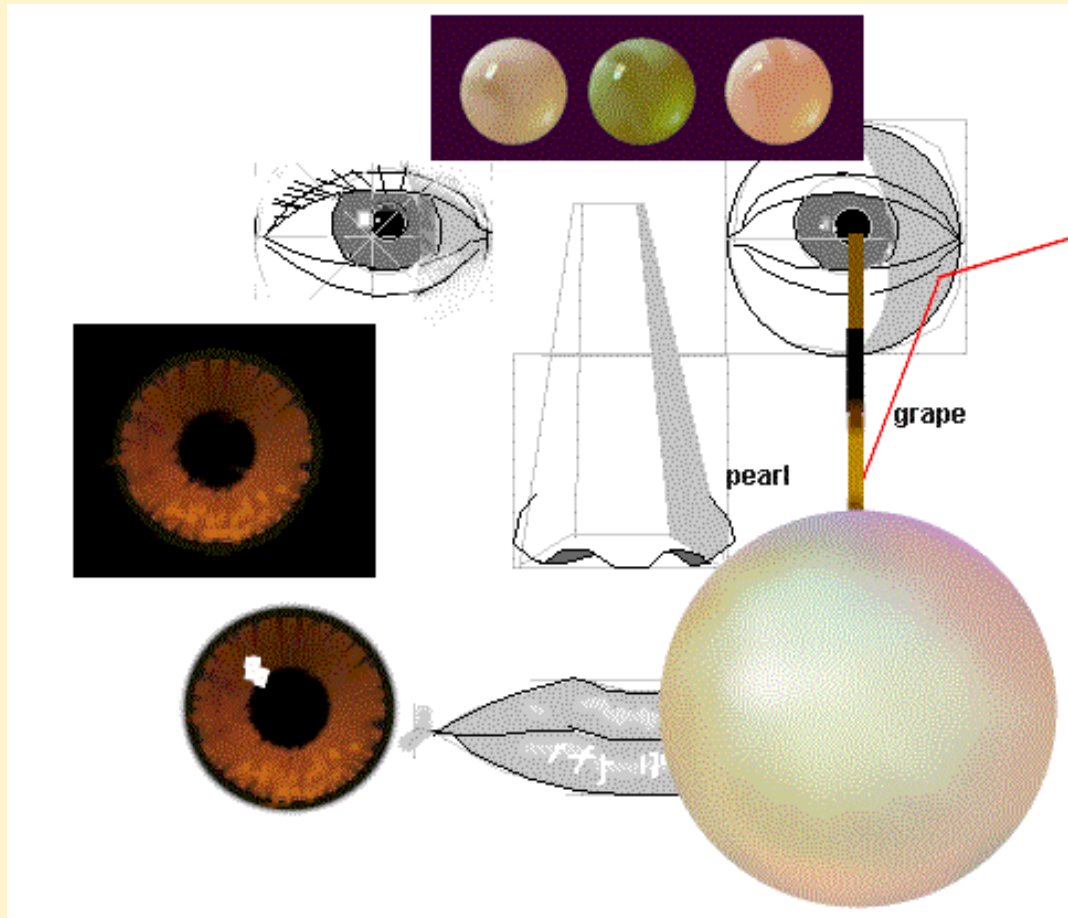

You'd turn a cherry into a grape by adding the transmitted light to the side opposite the light's entry point. A grape is translucent; a cherry is not. Light travels through a grape. You'd also diffuse the highlight a bit more to indicate a less glossy surface. The highlight is the reflection of the light source on the surface, and the degree to which it is diffused indicates the texture of the surface. You might contrast edgy polished metal on the one extreme with soft velvet on the other, for example.

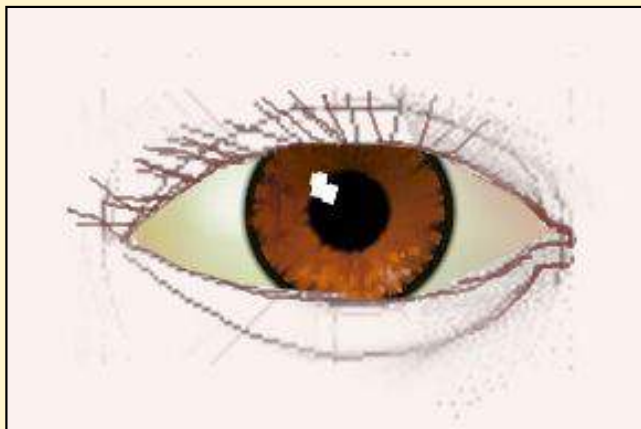

So there we are, mere prisoners of our dermis but with an intelligent sparkle in our eye!

NOTE: Eye conditions and their connection with painting is nowhere better demonstrated than in Peter Bueughel's *'The Parable of the Blind'* where the five beggars are afflicted with five separate but identifiable eye diseases.

[GO TOthe painterly effect](#)

[Advanced lesson menu](#)

COMBINING OIL PAINTING AND TECHNOLOGY

Lesson 1

In this section I shall deal with the future of painting and how it might be affected by technology, computers, advanced printers and scanners.

In this regard I must say, without apology, that in my atelier, as well as all the usual painting equipment, I have a scanner, computer and large format epson 7600 printer that is capable of printing 75year lightfast pigments on canvas. The scanner is a common Cannon LCD (diode) scanner that I cut apart with a hacksaw and re-assembled to allow me to scan paintings of any size and to reassemble them in 'photoshop' without any discernable joining. The scanner is set up on a large grid table, face down has been used to scan 50"x80" paintings with sizes of over 500mg bytes.

Now the good part - should I wish I can print an exact copy of my original then, using my oil paints, treat the canvas inkjet print as a primatura, and begin to paint over it. The final result can be varnished and protected as you would any other oil painting. This again can be scanned...

Of course this allows me to create an endless stream of variations on any of my originals and hence poses the question: What exactly is an 'original'?

I shall leave this for others to decide but let me only say that to this point I am perfectly happy with the integrity of all the processes upon which the final work is constructed.



Now I shall demonstrate some of the processes with my 'Bounty' painting 'Portsmouth 1792', above. The image above is a JPG compressed image made for the purposes of this lesson. The original oil painting was scanned at 360 dots per inch (DPI) in 15 parts. This was joined and color corrected and flattened in Photoshop giving me a 250+ megabyte psd (photoshop) file. The JPEG above was saved from this while the PSD file is the one I manipulated.



Within photoshop I selected a portion of the original and copied and pasted it on to my work area.



Next I 'flipped' it over for the reverse and joined it as close as possible - lining up the particular features that were important for the landscape generally.

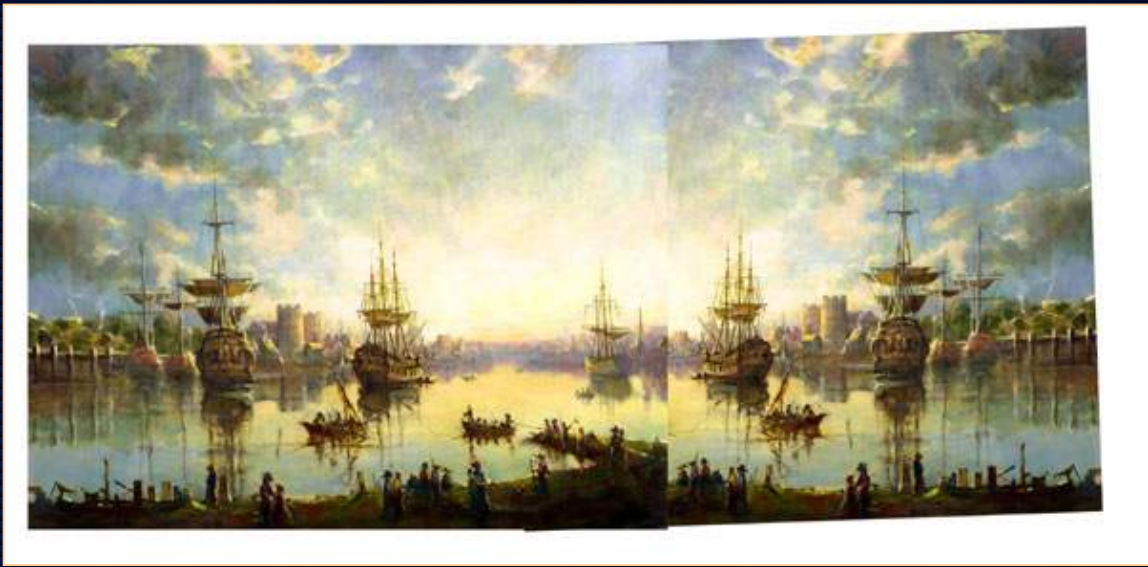

Some further adjustments were needed and some of the details obviously need to be isolated and reformed.

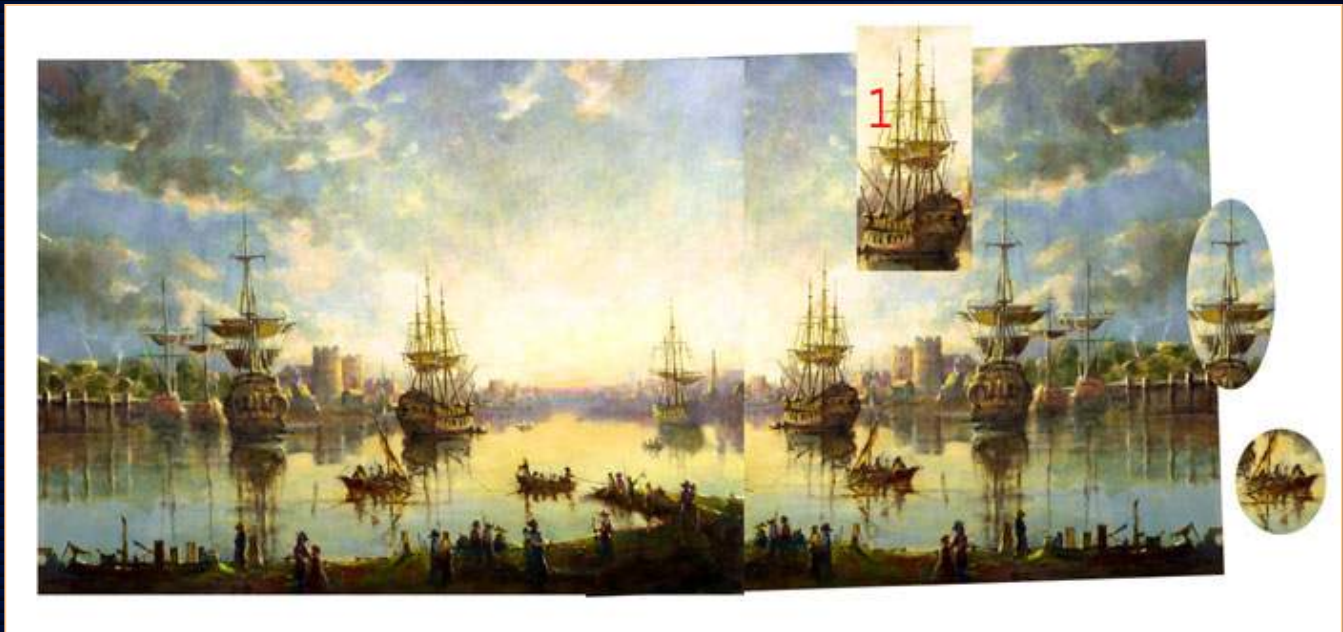

Here I have removed the ship No 1 which will become the major and closest ship. It also need to be tilted a little so the masts line up properly. This is done separately and then the ship replaced into the painting- see below.

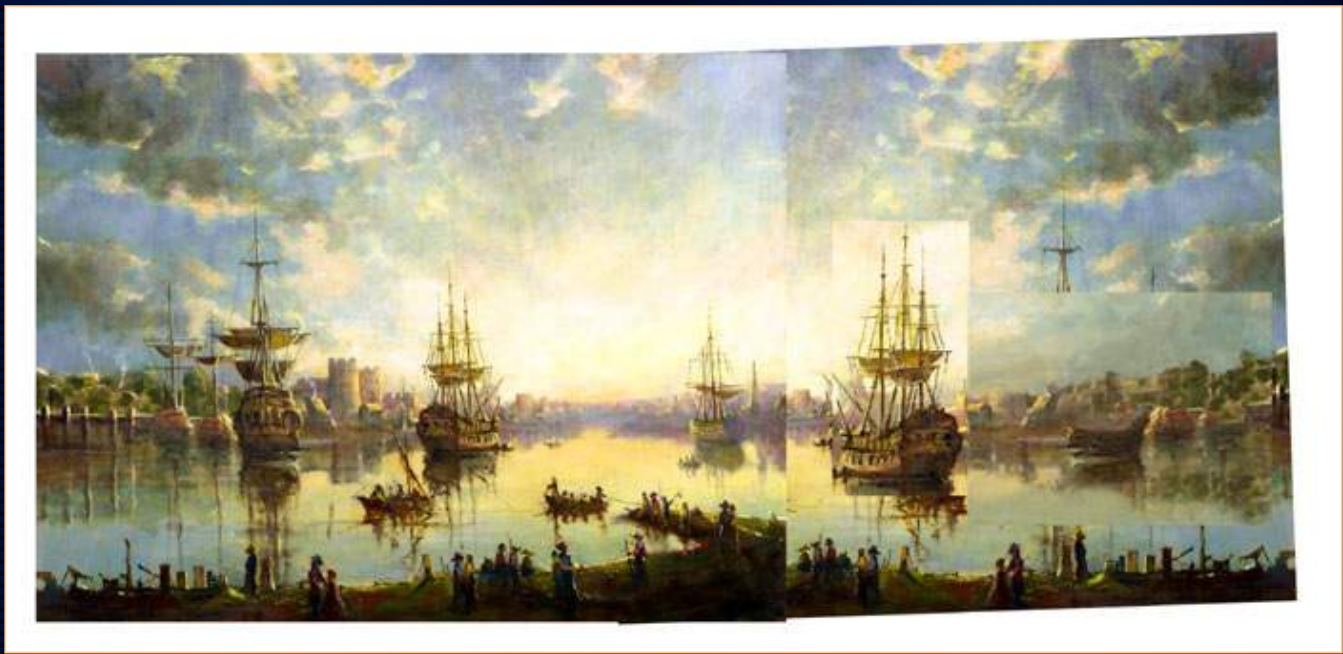

The final stage take more time as many areas are removed, replaced, hidden, healed and joined. The final scan was then printed on canvas 24"x48" allowed to dry. Color correction were made to the print using transparent oils (indian yellow, permanent crimson, phalo blue)in various mixes. More adjustments and details were added using opaque pigments from my standard palette.



This is the final result which I have again scanned into a file and added to my collection. Should any improvements occur I can easily reprint from this larger file. Should I need to use any of the various elements in this painting (the sky for instance), I can easily isolate it and use it as a background for another painting.

[Go to Lesson 2](#)

2-2 SILVER AND COPPER

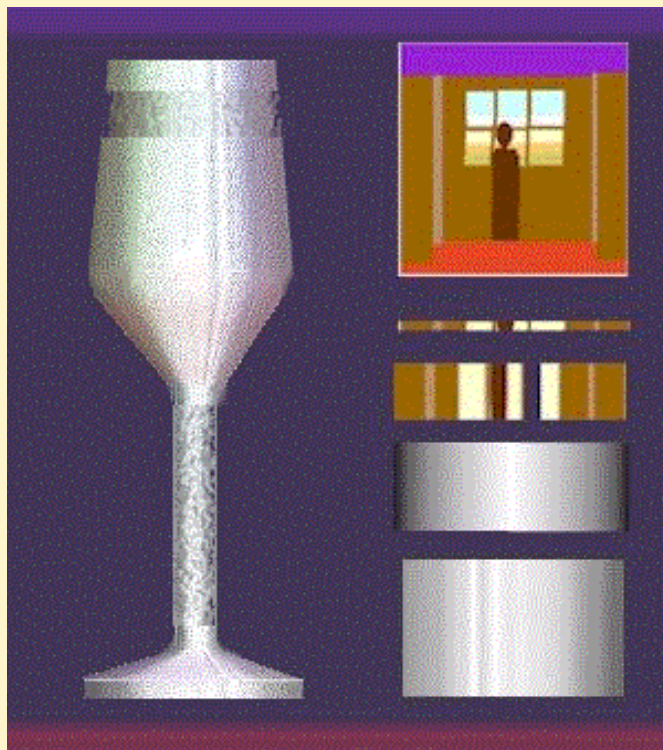

SILVER Technical: Second to gold as most malleable. Oxides are black forming silver sulphide (try egg yolks) - see dark cracks in example. Spitting silver, when silver cools it expels oxygen and spits. Used as an alloy, in photography and for coins. Absorbs most hues equally but seems to reflect minor amounts of most.

Conceptionally : Precious metal with dull lustre. Jewellery, tableware. Combines well with gold and glass and useful for subtle neutral highlights.

Presentation: Always try and understate - against a dark background if possible. As with the pearl, silver can be painted over with a milky rainbow-hued semi-transparent film. Adaptable for use beside objects with strong hues as it will give nice secondary glows. Make colors as subtle as possible.

Painting: First paint in grey as slick and smooth as possible making sure to roughly place the highlights. Allow to dry then glaze with thin quick drying medium. When dry scumble on red blue and yellows in minute milky amounts. When dry glaze again (or else you can apply the colors thinly within a medium). Scumble on colors reflected from nearby objects etc. Place some opaque highlights and merge with surrounding areas until a dull glow is achieved.

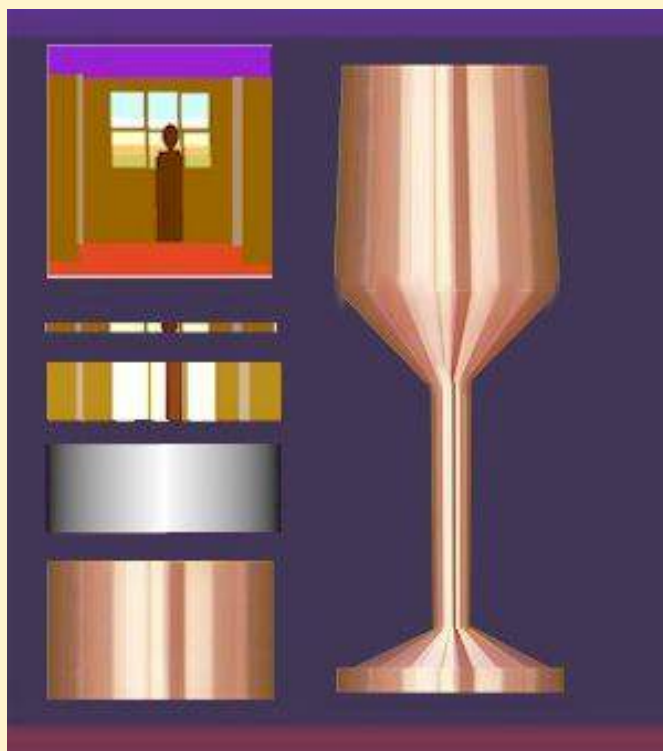

COPPER Technical: Found in pure state and can be beaten into shape when cold. Alloyed with tin gives bronze. Used as plates for engraving and etching. Oxidises a green-blue. Often mined with sulphur which is burnt off in smelting. Great conductor - wide use as cooking utensils. Copper is usually fashioned using a 'ball-pane' hammer which has a rounded face. This gives it that distinctive ripple effect.

Conceptional: Coins, warm brown colors with irregular highlights. Goes in and out of fashion with house utensils etc. Age-old metal easily beaten into relief panels which some years ago were made into stand-alone decorations.

Presentation: Best given the beaten effect - see below. Hints of green in the shadows with subdued red-yellow hues in middle tones.

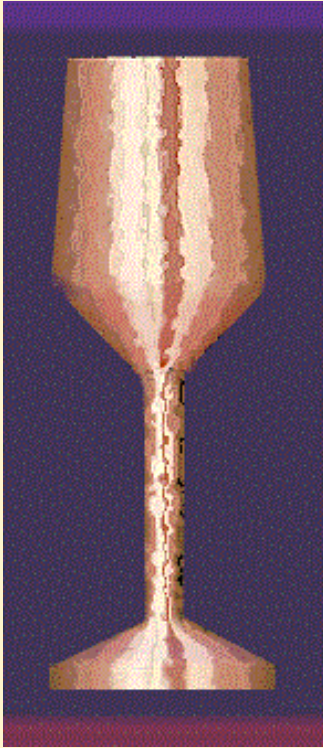

Painting: First use a semi-neutral background color such as raw umber to create forms and shading. Add a little cobalt blue to deepen the forms if necessary. Glaze. Apply mid-tones (I used a thin burnt sienna) feather the edges for a ripple effect but do not blend as with silver. Paint highlights wet in wet keeping edges round but sharp. Glaze when dry.

STUDENT ACTIVITY:For this page and the previous - find your own cylindrical object (cup) and paint it as chrome, gold, silver and copper. Allow 80min.

[GO TO ... photo realism](#)

[... or lesson list](#)

BIRTHDAY ROSES

To me a rose, is a rose, is a rose I have never ever painted a vase of flowers let alone roses. But now I was cornered.

Many years ago I promised a lady I would paint her roses for a particular birthday and promptly forgot about it. Recently I got a call to remind me the birthday was imment ...

There was no way out. I drove off to the flower shop, sorry 'florist', and bought some bunches of roses then searched the house for anything that might be useful as a vase. (All paintings are roughly 24" x 20")



I promised red roses so I decided to warm up with some pink (above). The pink also seemed to be the first to begin to droop, later I was to discover it was necessary to keep them in the refrigerator to prolong their life. The shell was to fill a compositional space as well as reflecting the same hues. It was also a reminder I might be at the beach instead of painting roses.



That seemed ok so I tried the red.



Now I am painting roses expect I should look to their placement. Asking around I find pink blooms are suitable for bedrooms, red for a more formal setting such as a dining room and white and gold anywhere else.

I also discover Cleopatra was said to have filled her rooms with rose petals to welcome Mark Anthony and that the early Christians banned the rose from churches and churchyards because of its connection with pagan rites. This is getting interesting ...

[GO TO roses No 2](#)

[Advanced lesson menu](#)

5-3 IMPROVE YOUR OLD PHOTOGRAPHS

Combining computer technology and principles of painting.

Between painting and writing I sometimes get asked to do little jobs. When I begin I am always somewhat reluctant as the the jobs never seem to rise to my exalted level of 'high art' and I usually moan and complain. This is a good time to take a step or two back and view yourself as the arrogant 'pain in the butt' you are slipping toward. Probably because there is no woman around to bring you back down to earth (not that they ever did) ... anyway, I digress, the job is to fix an old photograph.



The photograph had been torn into four pieces then lovingly stuck back together ... sounds like the normal commerce between loved ones or family members ... then a marker pen was used to repair the rips. I was immediately struck by the blandness of the whole thing, but stick with me here for even the delicious local mud crabs I can sometimes afford are trapped in foul swamps.

For a little more detail ... notice how the marker pen was used on the lips shirt and uniform.



Well I fixed all that using what is called a smudge brush. This allows you to drag surrounding areas over the cracks in whatever 'opacity' you like.

At this point I was feeling rather pleased with myself - job quickly done - another mundane task bites the dust. But I started to think (always a dangerous sign), I asked myself, 'I wonder what sort of life this man had? Which war was he fighting and how do his comrades remember him? Maybe he was a hero? Maybe he was a hero who fought in the trenches and saved the day, or at carried a wounded comrade to safety through a hail of bullets?' So even if he can't pay me perhaps he deserves a little more of my time.

Let's see if I can't make him come alive a little.

[GO TO ... creating color and atmosphere menu](#)

IMPROVE YOUR OLD PHOTOGRAPHS No.2

Combining computer technology and principles of painting.

I quickly separated the major elements of the picture knowing I could always use the smudge tool to put them back together.

Using some color controls (in a graphics programme), I *removed* color from the grey. This has the effect of giving the picture tints of the opposite (complimentary) hues without affecting the contrasts (values). In this operation I applied color theory regarding complements - while keeping the values bright. The reason for this is important. In previous lessons I have talked about the theory of 'subtractive' color and how we use it in painting. The theory I use here is called '*additive color theory*' and is commonly used in photography, film and computer imaging. Simply put the spectrum hues *combine* to produce white light, and the removal of one leaves a predominance of the rest. In other words if we had a red, blue and yellow spotlights and shone them all on a blank screen they would produce white. White then is the sum (additive) of all the colors. If we subtract red then the white spot will turn green, subtract blue and orange will appear etc.



To produce the hues above I started with ovals of white. In the first I subtracted red, the second green and the third blue. This is how what they call 'additive' color, works!

In this manner I applied hue (color) to the hat and uniform, the face and the shirt.

Next I put them roughly back together.

I gave the cheeks and the bottom lip a little extra blush with a computer paintbrush.

This meant I still had a raw figure with no background ...

So I searched for a background that might describe the nature of the war the man fought. I wanted a stark, riveting but an atmospheric scene. I found what I wanted but it was tiny. This was not necessarily a disadvantage as I could repeat some facial and clothing hues in the top half of the background.

I created the background then smudged again with my smudge brush.

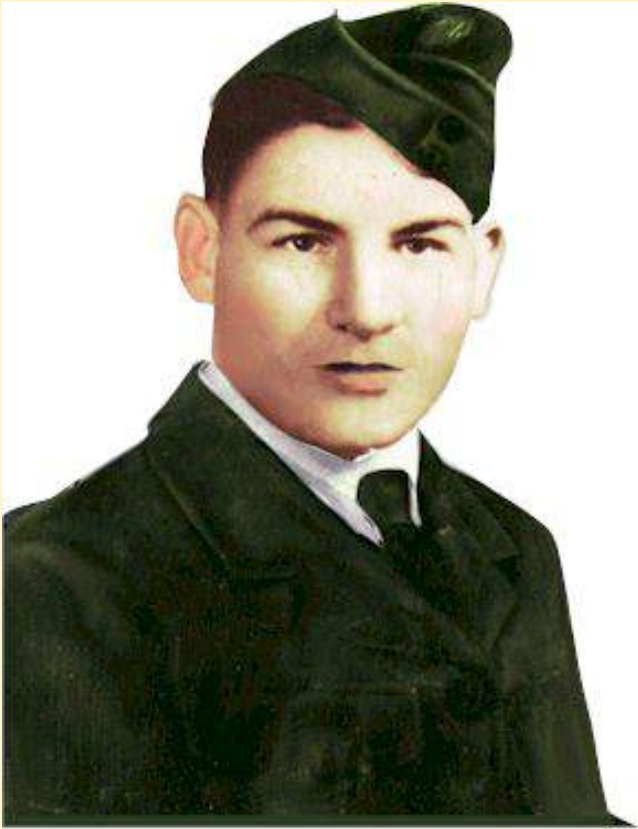

So we went from this ... to ... wait!

Two final touches before cropping

1. Make the eyes come alive with a tiny reflection - my hand slipped a little with the second ...

2. A little highlight as well on the bottom lip.

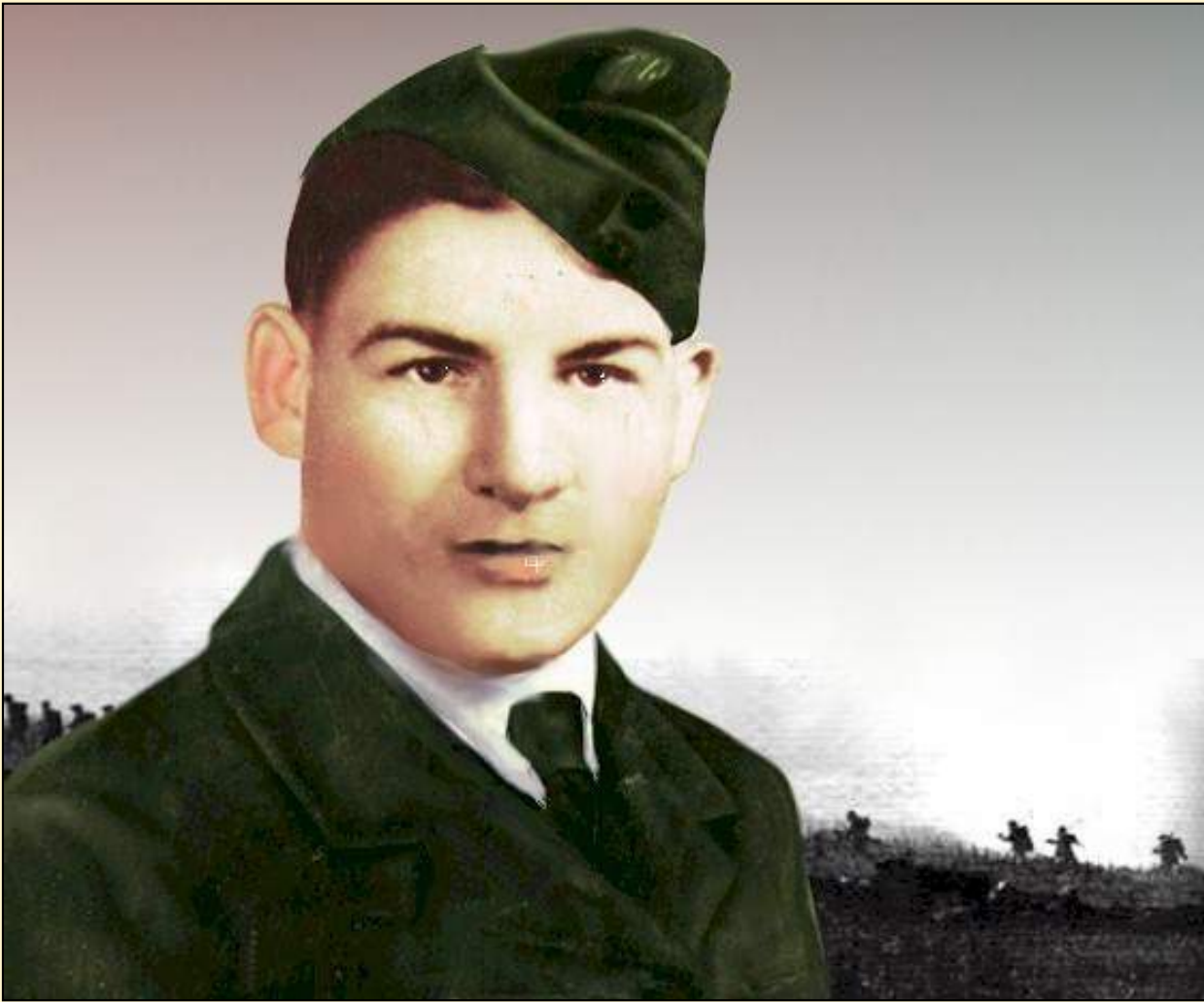

Somehow I hope the man has briefly come alive but as all life surely passes as fast as a summer cloud shades a distant hillside ... anyway sometimes a mundane task can lead to distant thoughts and maybe a little unexpected humanity.

STUDENT ACTIVITY: Paint a color diagram that explains the theory of additive color. Hint ... look in the photography or printing sections of the library. Allow 40min.

This reconstruction was a result of using a very simple computer 'paint' program. To see another reconstruction using the more complicated 'photoshop' program go to the next page.

[GO TO ... another photograph menu](#)

IMPROVE YOUR OLD PHOTOGRAPHS No.3

Combining computer technology and principles of painting.

This is a photograph of a local dignitary that hung on a very light effected wall for twenty or more years. As you can see it is very faded and any blue/green has faded out completely.





The first move was to scan it into adobe photoshop and remove all color. In other words convert it to a 'greyscale' format.

So I searched for a background that might describe the nature of the war the man fought. I wanted a stark, riveting but an atmospheric scene. I found what I wanted but it was tiny. This was not necessarily a disadvantage as I could repeat some facial and clothing hues in the top half of the background.

Next I applied contrast and then converted it back to 'RGB' or a 'color' file since I needed to add color. I added color using 'color adjust' and 'variations'.





Next I used masks and more color controls to vary certain elements. Then I removed the background and applied a diagonal brown/gold color gradient from the top left to the bottom right. I needed to touch up the result by adding a little rouge to the cheeks, sparkle to the eyes, depth to some of the shadows and generally to work the portrait up just as if I were doing a conventional portrait in paint. The result you can see below.

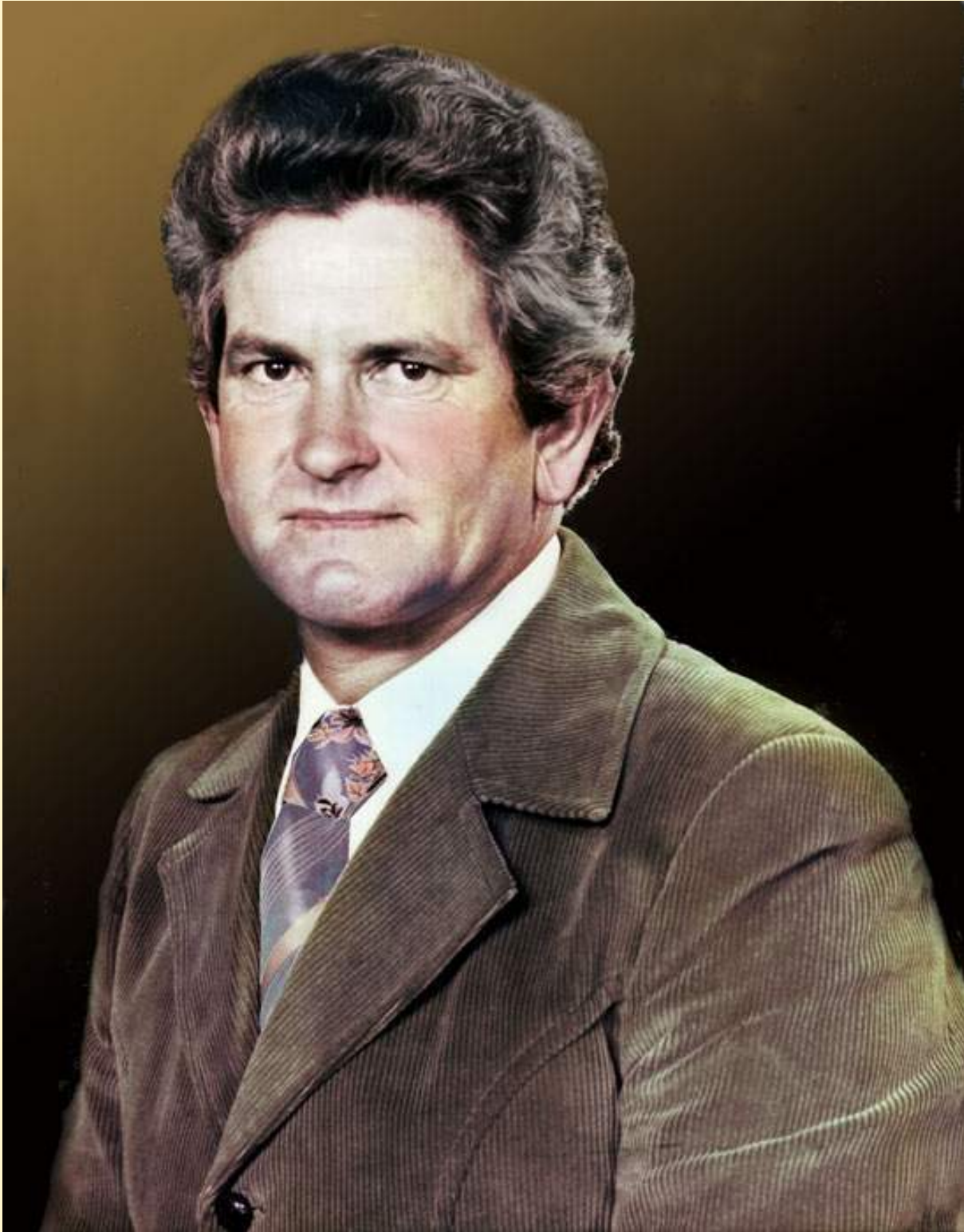

The final print size was 18" by 14", printed with a wide format epon printer, on canvas, with pigment inks and varnished before re-framing and replacing on the wall.

[GO TO painting clothing menu](#)

6-1 PAINTING CLOTHING

The painting of fur, linen, cotton, velvet, silk, satin, gauzes and other diaphanous materials

Drawing the edges and the folds ... the thickness and pliability (softness) of the cloth determines the size and shape of the folds.



Fur and thick wool that is soft yet pliant requires little drawing as it is mainly composed of large gentle contours. It usually dominates the form it conceals.

Thick heavy linen or damask that resists folding will show straight edges and will *stress* at the folds with double or even triple indents (see in the acute angles left). It also will override the shape it conceals. Note the straight lines on the outside of the folds and the triple creases in the folds. Durer, who makes this type of rendition so stylistic it almost becomes his drawing signature, suggests deeper creases within the shadows to



suggest body forms. Note particularly the thigh and leg of Mary.



Light linen or cotton will behave in a similar fashion only the folds and bends will be thinner and closer together. Note the size of the folds and the squareness of the outline. Velvet (the cape) is heavy, yet quite pliable and will show a slight curve and usually turn in single folds. This more flowing style is typical of Botticelli.

Silk and satin are thin and fold easily with narrow and sometimes a chaos of activity where directions alter. They cling to the shape they cover and faithfully follow the contours - be they straight or curved. Here I have simplified a part of a Virgil Elliott painting to show the underlying

structure of the folds.



Gauzes are either thin linen or diaphanous silk in pliability and should be lightly drawn accordingly. A soft shawl will follow a contour while a starched gauze will resist. Below is a starched gauze over a linen dress.



Before you begin drawing a garment observe the broadest and narrowest folds. The complicated folds should be simplified at the drawing stage.



Virgil Elliott is a master painter of silks, satins, and diaphanous gauzes (as well as many other things). He offers the following advice: 'The first thing I do is to arrange the cloth in a way that suits my sense of aesthetics, so that its form indicates what is beneath it, and at the same time adds another element of eye-pleasing shapes to the composition which comprise areas of secondary interest and lead the viewer's eye from the main focal point, around the picture in a graceful pattern (ideally), which ends up back at the main focal point and starts the process again. It should reveal key forms in some places, only suggest them in others, and conceal points of interest in other places (mystery increases interest), while at the same time incorporating its own interesting and/or pretty shapes into the overall. In other words, I usually design the shapes to begin with, before I start to draw or paint, unless by happy accident they have already assumed a pleasing configuration. Often I use a mannequin for this, as models tend to object to having the cloth attached here and there with straight pins, and won't hold still long enough. When I use a live model for the cloth, I draw very quickly to get the shapes noted before she or he has to move for whatever reason, then I follow the drawing, which is generally just a guide sketch at this point, when the model is back from the bathroom or whatever, to rearrange the cloth back the way it was. I then follow the sketch in designing the actual painting, but often deviate from it wherever I see a way to improve the shapes further.'

Does your drawing suggest the pliability of the material? If it does then you need no enhancement in the drawing stage.

[GO TO lesson 2 and texture lesson menu](#)

6-2 FABRIC TEXTURE

2. Texture this is the roughness or smoothness of the material and us usually apparent in two places, the boundaries or edges of the garment or at its general mass where light values change (turning points -basic lesson on texture).

a) Edge : silk obviously can combine the highest degree of smoothness with thinness of material so its edge treatment is the sharpest. Next would be linen or cotton gauze where the edge would appear a thin line. Note - light will often reflect from a cut or bare edge. Fur is the other extreme.

b) Turning points: here texture can be shown as individual weaves, hair, cotton or thread stand proud of the material and cast their own minute shadow. The length of the shadow being determined by the sharpness of the fold (see below). This is where the professional artist makes judicious use of the many brushes at his disposal as well as carefully adjusting the paint to the viscosity necessary for the appropriate effect. Some will paint wet into wet and others paint over dry surfaces. Still others prefer to use glazes, palette knives or a multitude of instruments.

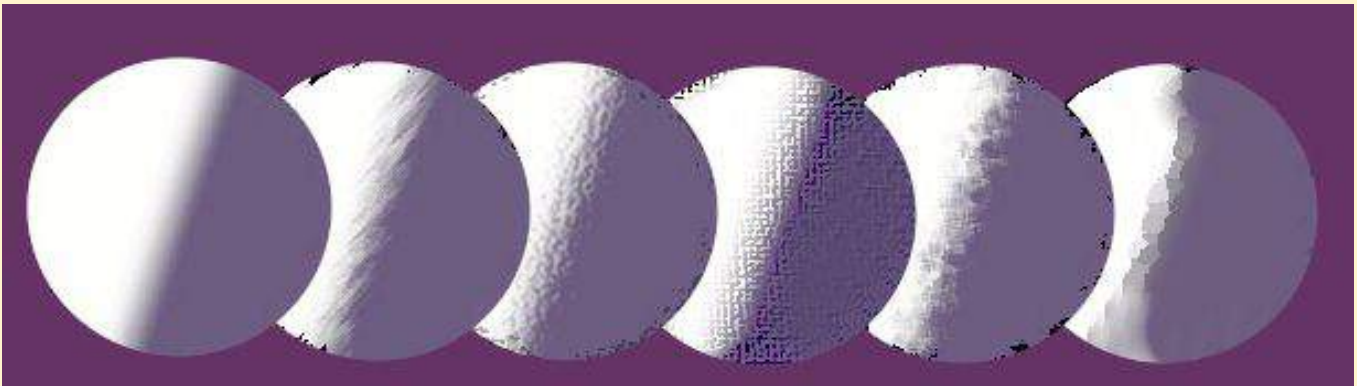

Can you decide from the above examples which is silk, cotton, linen and velvet?

3. Value differences: Tonal - this is the value difference on the grey scale between the highlights and the shadows of the material being painted.

This factor should be approached completely independently of any color considerations and for practical purposes we shall assume one light source and one direction (not backlighting). The artist will usually limit these tonal divisions to a minimum of two and a maximum of four with the following approximations;

Fur and wool - two - with little value difference between highlight and shadow

Flax-linen and heavy cotton - three - values between highlights and middletones closest Satin
- three - values evenly spread (note that highly reflective materials like silk or satin are very prone to secondary surface reflections.)

Silk, taffeta and satin- four - values closer at the highlight end. See blue taffeta dress below.



Gauze and diaphanous silks - two (the third one here is transparency or the form beneath) values between highlights and middletones close.

Virgil Elliott writes: 'The key is to understand that light on diaphanous cloth renders it more opaque, and thereby obscures more of what is underneath, while in shadows it is more transparent, allowing more of what is under it or behind it to show through. Also the opacity/transparency is affected by the angle of the cloth relative to our line of sight. Parallel to the line of sight it is more opaque, and perpendicular to it it is more transparent, with varying degrees in between those extremes.'

Velvet - two + - folds work light a bit differently than other fabrics.

Secondary light - This is the ability of a surface to absorb light rays reflected from another nearby surface (such as the yellow chair below). The artist can then insert complements in the shadows or between the tonal divisions.



Here in this detail from a Goya painting there are secondary and tertiary reflected colors which

provides a richness almost beyond the imagination. Even more so because the initial color of the dress is so bland with only two basic value changes. There are those who will undoubtedly claim they see more.

Virgil Elliott notes ' Whereas it is a popular practice to place complements in shadows, it is not the way light works in reality. The main influence on the color of shadows is the color of the secondary light, which could be any color. Only in highly reflective surfaces like satin or polished metal or glass will reflected color register noticeably in the middletones.'

[GO TO Practical painting](#)
[Back to lesson list](#)

7-1 DECIDING ON COLOR

The basic palette I used for this painting was very simple light red, raw umber and yellow ochre, cobalt blue and prussian blue - one red two yellows and two blues. The overall cast of this painting is blue green. My concern to this stage (above) was to keep everything subdued and to make sure the lights and darks (values) looked correct. I knew I would be adding touches of highly saturated red and yellow hues at a later stage. How did I know this? I remembered a painting by Rembrandt that had a similar color scheme, all I needed were roughly the same percentage of hues - although the values I wanted would be slightly higher. Why did I use this scheme? The narrative involving an ageing Thor demanded clouds and sunset. Since I also knew I would be showing areas of suntanned flesh I therefore resisted using red in the sky and distant landscape. I wanted instead the blue grey of the storm.



When the painting was almost finished I added my touches of cadmium red and cadmium yellow for the highlights, specifically the handle of the hammer and the apprentice's toga. These highly saturated colors have the effect of echoing and unifying all the other reds and yellows. Drawing a parallel to music I could say they act like a pure single high major note, played an octave its harmonic chord. Suddenly you then see all the reds and yellows unified and reverberating about the canvas.



Next we shall embark on a little practical exercise where I hope you will more fully understand some of these terms and principles. I have found a frame for this painting but I will need to color the timber part. What color will I use and why?

STUDENT ACTIVITY:For this page and the following - use two of your own paintings and decide on your choice of their optimum frame . Allow 40min.

Here is my frame

Here is my painting



[GO TO ... the possibilities](#)

[... or lesson list](#)

MORE ON ROSES

Later I will show you how to paint a roses but for now it is important to understand exactly how roses are constructed. It seems they have thorns on the stems, five leaves on the shoots and things called sepals and corollas. This sort of information was not graspingly important to me during my younger years when getting a football over a line or a girl into a backseat were more pressing and roses were stolen from a neighbourhood garden to celebrate grandma's infrequent visits. That's when I first discovered the thorns.



Next I found there are two types of roses; the simple and the complicated. Apparently the simple are the early primitive variety with five petals while the complicated are also known as hybrids, which it seems have more colors and mutations than the livestock around Chernoble.



They can also climb, form a bush and grow from a stick in the ground. They are also named after folk I have never heard of.

There are some positives however and the fact that without roses the English language would be devoid of the excitingly beautiful word 'floribunda' ... and 'tea' would be reduced to a mere beverage. In addition it seems some hardy souls have devoted their lives to grafting miles upon miles of thorny stems together as pleasure, rather than the torture it would seem to normal people.

I must say that since I have had bunches of the things in the studio (for painting purposes only) the general aroma of gum spirit and sweat has lessened. For that alone many are greatfull.

[GO TO how to paint roses](#)

[Advanced lesson menu](#)

Purchasing the John Hagan CD that includes printing information for use in classrooms etc.'

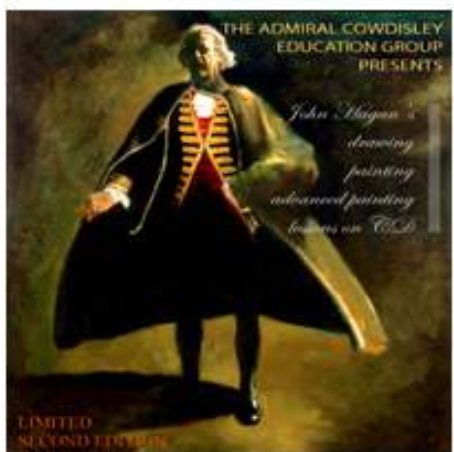

For those folk who have enquired **CDs** of all our drawing, painting' and advanced painting lessons has been produced. This CD is an updated, reformatted for easy printing version so you can create your own reference handbook in your own time or just browse the CD. These CD's we have priced at US \$15 (plus posting) for students and US\$19 (plus posting) for others. The printed files are in pdf format ... but don't despair, you can download the free 'reader' so there should be no difficulty for those who want to print to a work book to store the lessons as hard copy. Teachers will also be able to print the specific lesson or lesson plan they need, when they need it. We have also added extras to the CD such as a few chapters from Virgil Elliott's 'The Oil Painters Bible' (yet to be published). If you are a student and interested in obtaining the CD just send us a [email](#) indicating your university, college, school or if you are a home schooler.

Otherwise you can order directly by the buttons below. Delivery approx 14days.

NEW RELEASE: Third Edition CD
 Since the release of the last CD 15 more lessons have been added and others updated. The Parkhurst Reference Book, Watercolor lessons by David Hagan and a section on Computers and Painting have also been included. Other and better forms of printing have also been formulated. This new THIRD EDITION cd is now available at \$29 plus posting. Ordering is the same as for the first edition. Make sure when you go to CCNow you select the

particular edition you want.

CCNow
 our authorized online retailer

- Secure Online Shopping
- All Major Credit Cards

We have decided to use a Delaware company called 'CCNow.com' for all US and International credit card transactions. They provide a secure and safe transaction base and take all recognized international credit cards. Please make sure the mailing address for sending the CD is correct and can sometimes be different to the billing address. From the buttons below select your preferred payment method. The first button will take you directly to CCNow.

FIRST EDITION



THIRD EDITION

[credit card](#)

[cheque](#)

[other](#)

[BACK](#)

7-2 COLOR POSSIBILITIES

All the values, hues and saturations are taken directly from the painting. This will have the effect of unifying the whole package. The gold on the frame already echoes the yellow of the painting. What color will you ultimately choose? What will be its value, hue and saturation? Try and think of these as a combined choice (ie medium value, green hue, highly saturated)

1. VALUE

Light is absorbed at the back of the eye by cells (cones) sensitive to red, blue and green wavelengths and seem to be responsible for color vision in daylight. In dim light the 'rods' take over, which are more sensitive to blue-green light, and distinguish clearly between values of light and shade. This is why **squinting** helps you determine the **value** of a color.

First: what value (how light or dark)do you prefer?



Medium values - from breastplate



Low and high value - from rocks and sky

2. HUE

Second: what hue (color) do you like?



Blue hues - from sky



Green hues - from sky



Red hue - Thor's neck and flesh

How strongly do you feel about your choices?

[GO TO Saturation](#)

[Lessons](#)

7-3 COLOR POSSIBILITIES No 2

3. SATURATION

Thirdly: saturation level would you pick?



High and low red saturation



High and low saturation from sky



This is an inappropriate example of a non - painting color

In summary ... in your mind you should have pictured the value, the hue and now the saturation. Combine them and what do you get? Is is anything like my choice? Low value (3), red hue and medium saturation.



But if this were to be hung on a blue or green wall my choice would alter considerably. Now you should understand color is about value, hue and saturation ... and how they should be considered separate elements when describing and choosing 'color'. Theoretically this should all be obvious but whenever I am teaching apprentice painters most of their difficulties arise when they grasp a brush. Then they tend to forget completely about color theory and worry about everything else. If this happens the student should be made to work out a separate color design before the painting is begun.

[GO TO The psychology of color](#)

[... or lesson list](#)

7-4 THE PSYCHOLOGY OF COLOR

Psychology is the study of human behaviour ...

What has this to do with color? We must first decide whether there is a genetic or instinctive behavioural element in hue recognition. Then we might ask if there are any environmental aspects that have a universal effect on the human species.

1. Genetic - I have seen no evidence of the first. We are not like bees or birds where the recognition of the hues of flowering plants are somehow passed on from one generation to the next.

2. Environmental - I have seen green associated with health - and with rotting meat, red with luck and danger, blue with pain and tranquillity, yellow with disease or elsewhere intellect. Summing up I know of no universal acceptance of a particular hue or color that has a universal significance across all societies. Movement has more significance for survival purpose for the eye discerns movement before anything else. The eye discerns movement at a span of 180 degrees where hue, depending on its saturation, can be seen only to 140 degrees.

When awareness of red is combined with a sense of heat then we might say the combination is universally one of fire. This and many other instances of combined sensory experiences are manifold but those instancing color alone escape me. I must conclude that singularly hue has no universal behavioural consequences and therefore no psychological implications - unless combined with other senses or hues. Remember there is no universal hue indicating the ripeness of an apple.

This thesis runs a parallel to music where no universal psychological analysis can be made of single notes but when combined with others we can have harmony or disharmony and moods created with various combinations. To take this analogy further it might be argued sensitivity to color is rather like sensitivity to musical notes where some individuals can tune instruments easier than others, some folk dream in color and some remember color easily while others desire to train their color discernment to high levels of sensitivity. Sensitivity to all elements of life is the key that opens the door to happy appreciation. The alternative is to dark to consider.

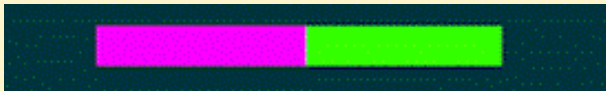
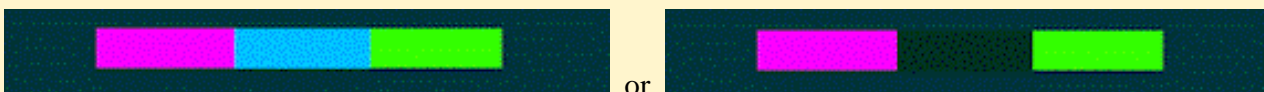
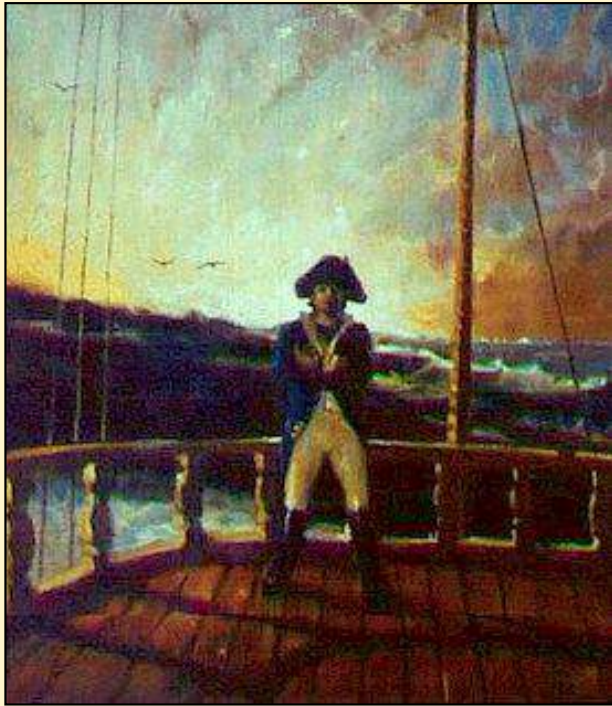

Fig.1

The adjacent effect color residuals of the eye. With musical melodies we have 'progression'. I mean by this intervals of time between notes that allow the brain time to understand the tune. If all the notes were played simultaneously any melody would be incomprehensible. But in painting all colors are played both individually and together, depending on the position of the viewer, and they must work on both levels. As the eye physically moves between adjacent hues, a negative residual interferes with the 'melodic' appreciation. Note the rather sickly Fig.1 combination above. This can be overcome with a transitional or neutral hue as shown below.



As a practical example ...



This painting I did for the 'Bounty' series is a composition in blue and orange. Blue will naturally fight the orange if adjacent so here I separated them as much as possible. Even though the sea line appears blue meeting gold it is a neutral grey-black instead. The hat and coat are separated from the orange clouds by a neutral white. The notion blue always precedes is disproved here.

Like a play in a theatre or an opera a painting is the creation of an illusion - of a painter's particular reality. The dominant hue in the painting below (blue-white) suggests a mid-morning scene.



Here again, in this demonstration piece, it may appear blue is against the yellow - orange of the boat. But where they are strongest they are also furthest apart. This makes the painting easy on the eye and more 'melodic'.

Stained glass windows, the paintings of Mondrian and Roualt are modern examples of strong colors being separated by (black) neutrals. If you feel strongly that poetry should not be element in the style of painting you want to attempt then you can use this information to introduce jarring and suddenly surprising passages to your paintings. I call this the 'Hawaiian shirt effect'. To understand the mechanics of color means that whatever effect you desire can

be realized and whatever you are doing, you are doing it deliberately. Trial and error is no way to pilot a plane or create a masterpiece.

[GO TO ... Psychology and color harmonies](#)

[Lesson list](#)

7-5 COLOR HARMONIES AND PSYCHOLOGY

Using colors and developing a color scheme for your painting is a lot easier than you think. Many more color combinations work than don't work. Let us think more on the music analogy where each note has pitch, force and length - just as in painting each color has hue, value and saturation.

A chord in music is a collection of notes that harmonise. Similar to music I like to think paintings can be composed of color chords. A painting 'chord' could then be thought of as a collection of colors that harmonise. But what causes colors to harmonise?

Below: Colors of similar hue, value and saturation will harmonise just as will musical notes one octave apart. The colors must for they are the equivalent!

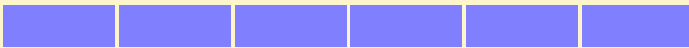

Below: Colors of similar value and hue (but different saturation) will harmonise. Any of these 'harmonies' can be utilised in a painting as either major or minor accents (chords).



Below: Colors of similar value (but different hue and saturation) will harmonise. This would describe a painting of colors with no value difference. No forms would be discernible just hues. We define a high key painting as one with the 'majority' of the painting surface painted with high value colors. Some years ago a particular paint manufacturer produced (modular) colors labeled with their value so artists could more easily harmonise their color schemes!



Below: Colors of similar hue (but different value and saturation) will harmonise. This would be equivalent to a painting done in sepia tones.



In this painting (left) red is the dominant hue. The Dominant hue is the 'base' color that can be slightly varied by adding a little of any of the other colors red, blue, or yellow to slightly modify. Having this 'base' color in all the mixes will unify the painting and can be done at any stage. The deep thinkers usually do this progressively but others (me included) sometimes use a unifying glaze to rescue their problem painting. To be safe a lot of painters add a little of the one hue to every color they use even the highlights! Here (left) light red is the dominant hue. I used light red to unify all the elements even though some of the greys almost appear blue. This painting is simple in that it has just one major scheme(chord) - colors of similar hue. Here the light source is red-yellow therefore the shadows appear of the opposite (complimentary) hue. There is an old adage in



painting which is well worth remembering **'warm light, cool shadows - cool light warm shadows.'**

When considering this scheme also remember the unifying effect of the discordant note. Painters use this is when applying 'spot' compliments (opposites to the unifying hue) which, as in jazz music, has the effect of underlining or exaggerating the unity of the rest. In the painting above I could have done this by making the bird's wings greener (removing all the red from that hue). There is nothing psychological in this, it merely is a practical tool for the painter to employ if the painting seems to lack some vibrancy. Turner was the master of this effect. He would create a huge canvas of reds, oranges and golds then place in a strategic spot of blue - or vice versa. The result can have viewers circling and muttering words like genius, awe-inspiring and unforgettable! From a painter's point of view all it requires is great control and restraint - holding back until that last, final, daub of pure paint. That is the real secret to painting with color - the understated build up, the flat featureless, bland thing that has taken six terrible controlled months to produce then becomes a vibrant masterpiece in the last five minutes.

This brings me back to saturation. This is not, as most painters would have you believe, a post exhibition, or after dark activity. Saturation, sometimes called chroma, is the redness of the red or the difference between a pale blue and a deep prussian blue.

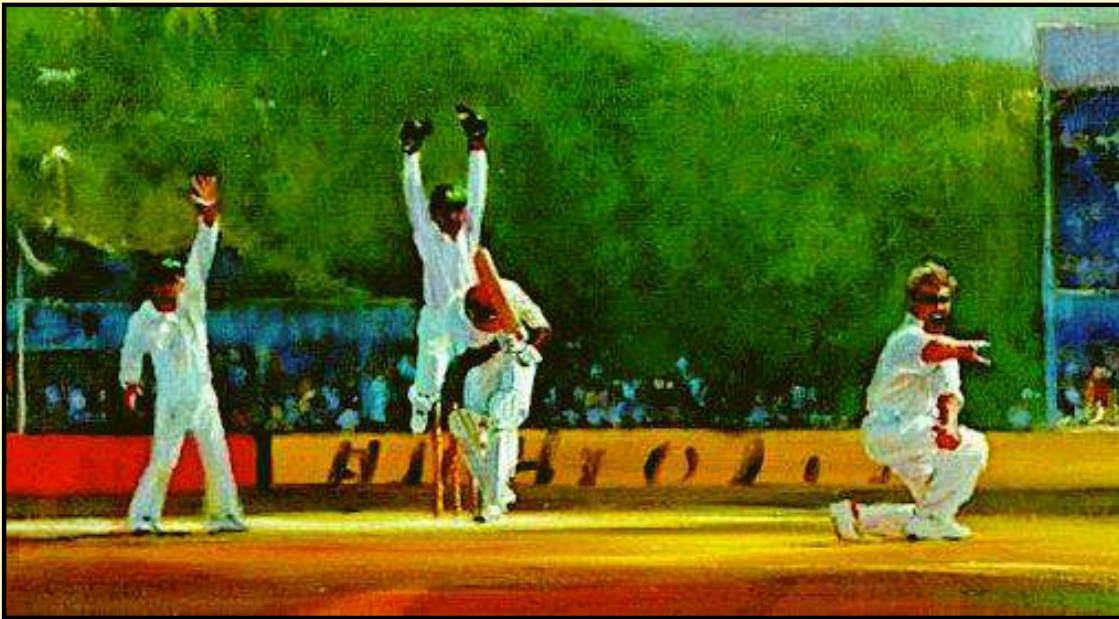

My action painting of cricketers in the West Indies has highly saturated hues (calypso colors) but note how all their values are similar. The red is separated from the dominant green and the white uniforms provide the unifying force. You can get away with a lot if you utilise high contrast neutrals! The major chord (the green, red, blue and yellow hues of similar value) is played again in the white of the uniforms where it is repeated in a 'higher key'.

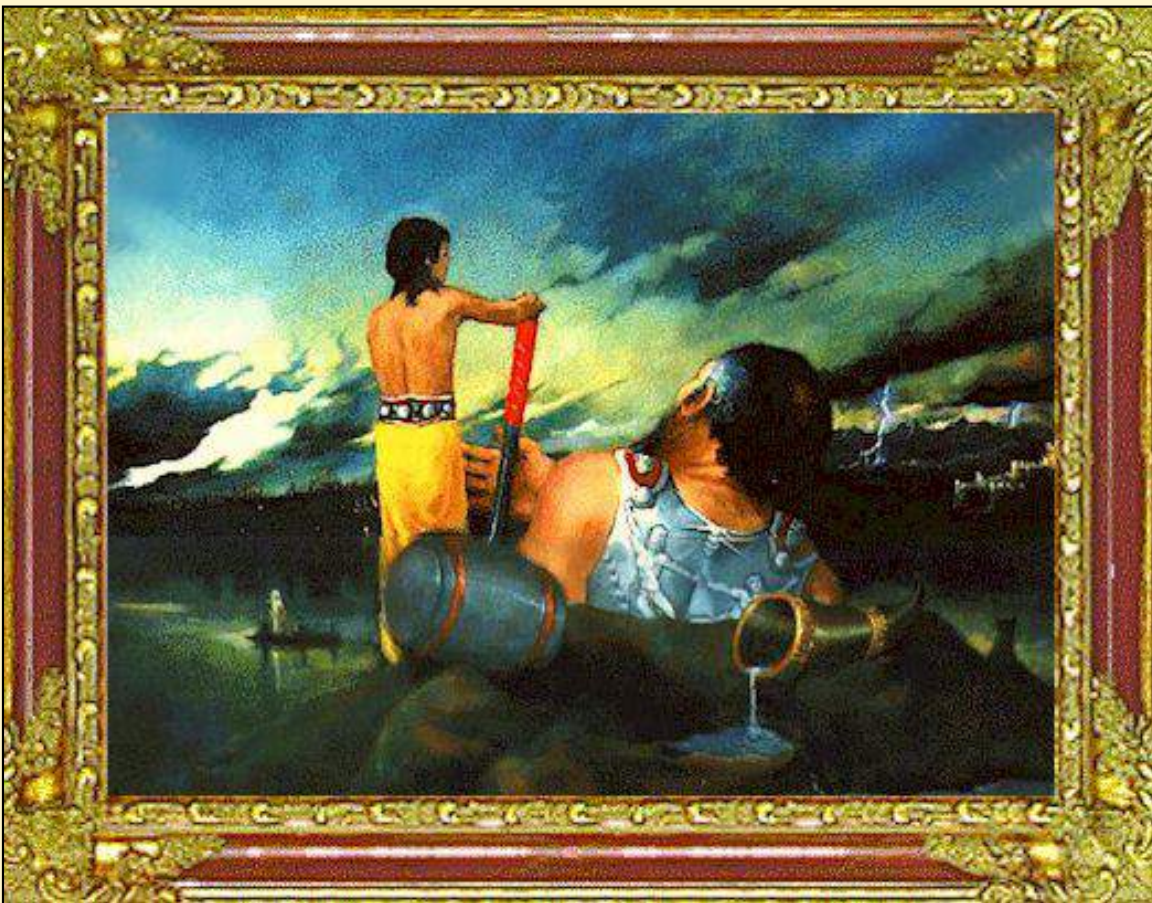

When color becomes highly **saturated** (as in the yellow toga above) it begins to elicit more attention. In this painting 'Thor' I have used colors of similar hues but differing values and saturations. Similar blues appear in the sky breastplate and hammer, yellows in sky water and toga, reds in the flesh and twice in the hammer. These are all minor chords. The major chord is

the green - red combination of similar values.

We cannot talk about saturation without discussing value. Value is what we do when we make drawings and shade them. It is the method we use to define form. If drawing is 'line' then as soon as we shade that line we create value differences, and a third dimension. So the third element, when describing most colors, is value. Value, as stated previously, is the blackness or whiteness of a color (scaled 1-10). Most hues tend to darken with increased saturation.

If you desire to make pleasing two dimensional color compositions you can do so with chords of equal value or similar hues. This is useful and great fun but to make a painting with 'depth' we will also need to match color 'values' therefore we must consider how best to 'mix' the values we want. Would you expect a value five red mixed in equal amounts with a value five yellow to produce a value five orange or a value five red mixed with a value five blue will produce a value five purple?

STUDENT ACTIVITY:I asked: 'Would you expect a value five red mixed in equal amounts with a value five yellow to produce a value five orange or a value five red mixed with a value five blue will produce a value five purple?' Do this on your palette and determine the result. Also do the same with paints of differing values to see whether they 'average' their values. Write up your results. Allow 40min.

[GO TO ... mixing colors](#)

[Lesson list](#)

5-1 ADVANCED PERSPECTIVE No.1

Roll-over perspective



Here is a painting that utilizes a single vanishing point without unduly discomforting the eye. I call this roll-over perspective. My aim in this painting was to paint the total extent of the landscape **beyond** what the camera or the eye would see, and without moving the eye's cone of vision.

As the landscape is essentially flat the illusion needed is one that combines (in the perspective mode) a plan view with an elevation. Also to make the transition as seamless as possible! Secondly the perspective scale must be such that the distance from tee to green should still appear at least 400 yds.

Two essentials must be realised to understand how the illusion is completed.

First: the eye has a natural cone of vision wherein it can focus. This is usually about 30 degrees. Beyond this cone focus is lost - even though movement is discernable up to 160 degrees(wiggle your thumbs and see when they disappear). To look at my painting you will note I trick or force the eye to alter its cone of vision, when it really, is not necessary. It does not have to refocus to see the entire painting, but I make it believe it does. We are forced to look 'down' at the tee and 'up' at the green. The eye will refuse to do otherwise.

Second: the perspective scale is distorted in that I



create the impression that the observer's distance from the tee is defined on one scale and that the distance to the green is on another scale. I do this by placing 'known' objects at strategic points. The tee, the bunker, the trees, the green and the flag are all known objects and placed such as to make the ground appear almost flat. For those students who have already studied my perspective lessons they will know the principle - as congruent objects recede they will be reduced on a proportional scale. They will realise it is this scale I have purposely distorted.

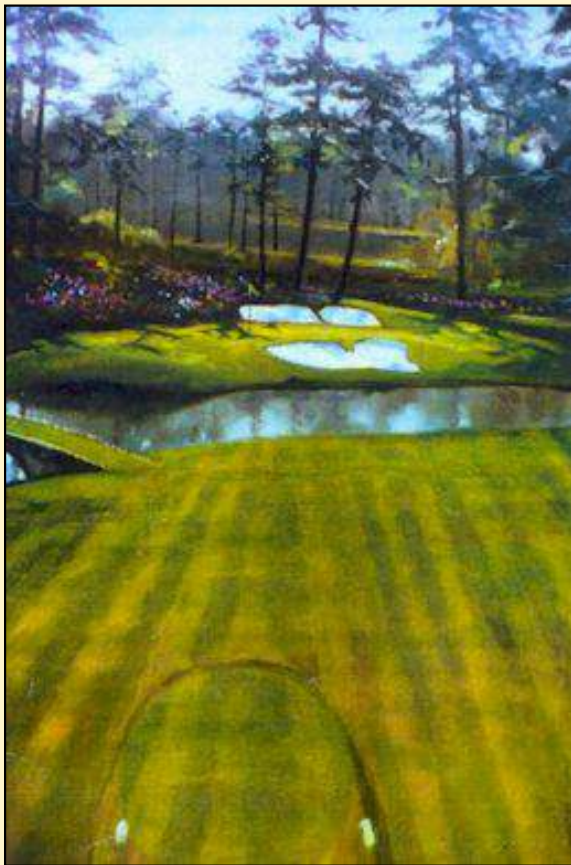

My oil painting shown left is a more familiar example as it is arguably the most famous hole in golf. The tee is on a hill above the green and the length of hole is 155yds. It is a par 3. Again, under normal circumstances, it is impossible for the human eye to focus on both the green and the tee as it is for a camera to satisfactorily render such images. This is still a most beautiful landscape ... even if it is a golf hole and mown grass is merely an earthbound oilslick. If you summarise I refuse to mow the lawn and still play a little bad golf you might well be on the right track!

[GO TO rivers, lakes and ponds](#)

[lesson menu](#)

5-2 RIVERS, LAKES AND PONDS

Robin wrote:

'I've been studying other works and trying to achieve something in the way of great depth to water scenes via multiple layers of thin paint ... mostly transparent due to being so severely diluted with Linseed Oil. It's not quite there, so I'm now thinking of using Marine Varnish, but if that doesn't work, I'll have to trash the whole thing.!)

Don't despair for this is not necessarily a matter of glazes, although they may help in certain instances. If you want to paint something behind something else, you might consider painting exactly that. Depth is achieved in the logical mind of the observer, assisted by the artist providing all the necessary information (clues). This is also demonstrated in my lesson on waves.



Clear water has no color so it cannot be painted. All that can be painted is what is under it, over it, standing in it, or what is reflected upon its surface. After all those things are painted then the water will magically appear.

Some reflections will prevent the transparency

Some will assist

Some will describe the nature of the surface...

To achieve great depth in water scenes you will need to paint in a number of layers simultaneously.

1. The bottom of the lake or water
2. The reflected sky overhead. A little darker than it is.
3. Reflected vegetation from around the shore
4. Perhaps some lilly pads or something else on the surface. Leave a part where the viewer can see to the bottom.

This 'demonstration painting' provides the simplest of examples. Construct it yourself as it will only take moments.



Black white and blue will make a subdued background. The reflection is a value darker than the sky.



Wipe away the center portion and introduce a green bank. The area where the bank is reflected, will be the area that reveals the bottom of the pond. Why? The angle of the main light source, and the shadows of the overhanging bank, prevent the sky reflections. This is where I introduce some color and blend with foreground. You can also paint in some submerged sticks to detail the bottom, as well as some drooping reeds. Don't overdo it! The pond bottom can be any color that suits your purpose - as could the sky. I have used separated opposites.(see lessons on color)

Next, paint in a figure or something else that will enable you to add additional reflections and depth. As I had already used red, yellow, green and blue I used white for the shirt. You can paint thousands of variations on this theme. No glazes are necessary, and the basic theory is presented in an earlier lesson on 'sunrise and sunset'.



[GO TO golden mean](#)

[Main menu](#)

PAINTING PERCY THE PELICAN

Percy the Pelican was the family pet and I was asked to paint him. I said I normally don't do pelicans but then remembered I had a successful painting of a small wave and thought it might be possible to combine the two! (See '[how to paint waves](#)', in a previous section)

I also was reminded just how much pelicans look like old fashioned sailing ships, and I had painted plenty of those.

It did occur to me however, that some of these pelicans can be quite large and intimidating so maybe having them sailing away from the viewer might be the thing to do. It should be a cinch then ...



And so it turned out with the first painting, a great success to all the local pelican lovers. I

called it 'Percy and Pricilla paddle off to find a pilchard'

Flushed with this initial success I decided to do a larger and deeper view - deeper water that is - so I repaired down to the river and observed the ripples and sand. I was also concerned not to let any background material interfere with all the information in the foreground.



This is a larger painting with some improvements on the first with changes made to Pricilla. I called this 'Percy and Pricilla picnic in the pilchard grounds'.

Technically the primatura was a raw umber with a little light red and raw sienna, wiped over with a rag for evenness and quick drying. Next the sand was laid down with much the same mix only with variations and secondary sand ripples. The sky was laid down with the compliment of the sand with the two merging two thirds of the way up the canvas. These constituted the darks of the sky and sand. The next layer was lighter and wet-in-wet, as was all the painting from here on, with the mix getting oilier as we work forward. Some of the lighter ripples are added to the sand and while a lighter gray is added to the sky and worked downwards in 'figure eight

strokes' for the wave forms. This contrasts with the more vertical strokes of the sand reflections. Lastly the figures are painted in with a three quarter inch flat bristle brush.

Subject wise I was now on a roll and decided to add the daughter of the family where Percy was considered the family's pet pelican. They often fed him a ... you guessed it, a herring or a piece of squid. Of course the girl's name was Peggy. The painting was to be rather in the fashion of an intimate portrait, only on water.



I was now becoming more and more convinced that these large birds resembled ships, more particularly man-o-wars, with their gunports positioned along the side looking like black feathers. All they needed was cannon run out ... and smoke and a few feathers ...



So as a final 'Percy the pelican' painting I painted the 'Pelican promontary Wars', a bloody battle between the red beaks and yellow beaks that all started over the fishing rights to the pilchard grounds. You might observe the feathers in the water and one of the redbeaks lost to the deep with only feet showing. That courageous bird Percy was in the van, and was one of the first to break the battle line of the opposition. Though wounded he quickly recovered and spent many an hour on the local shore scratching lines in the sand pointing out to all his mates how exactly the battle progressed, and how the great victory for the yellow beaks was won.

All but the last of the series are being made into prints. The last was done mostly for the benefit of the Cowdisley readers.

[Advanced lesson menu](#)

PAINTING LITTLE WAVES

Remember the first lesson on the importance of really looking at things and studying them? Well this lesson is a reminder of that and will also give you an understanding of how a painter must analyze the smallest things so as to best understand how to paint them in the biggest way. Nothing is more important than understanding this. You might think the figures I put into the following painting are the key. Not so, it is the study of the wave that makes this painting unique.

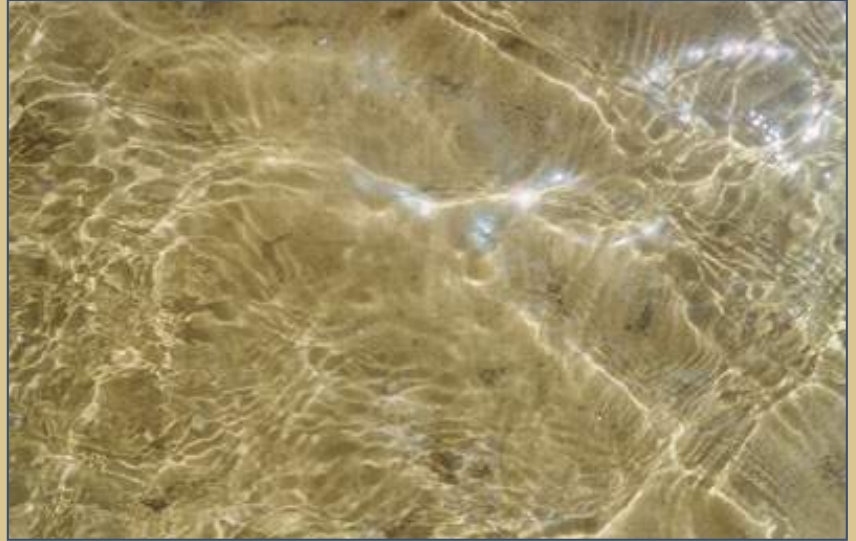

Have you ever wondered how those bright lines on the shallow end of a swimming pool come into being - or when you wade in shallow waters, on a sunny day, how the patterns rippling across the sand are made? Well so did I. So I took myself to the seaside on a sunny day and looked and looked (all in the nature of an artist's everyday grind). Right is a photograph I took so you will can see what I mean. Below is another with an analysis of the reflected light that operates on the surface as the eye is raised.

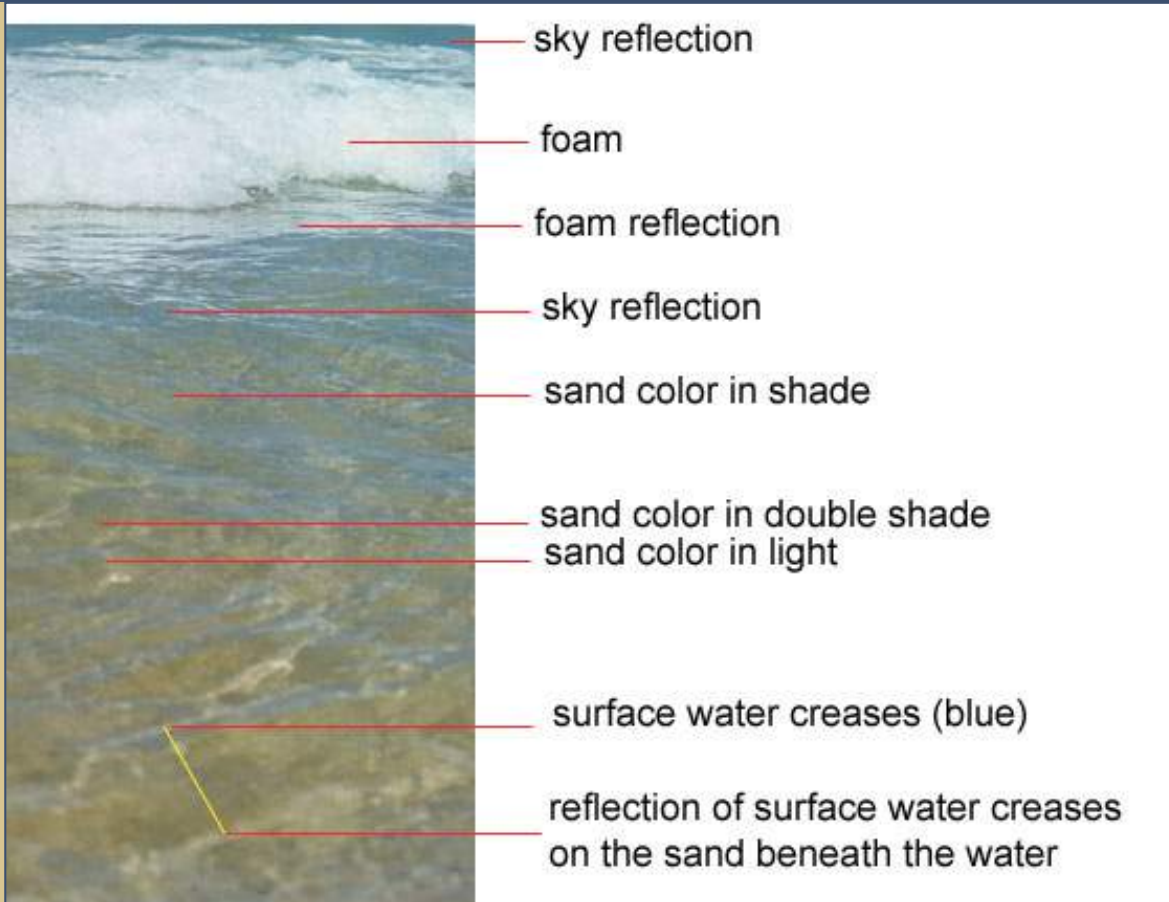

Note the yellow line that shows how the little blue wave top is parallel to the pattern in the sand.

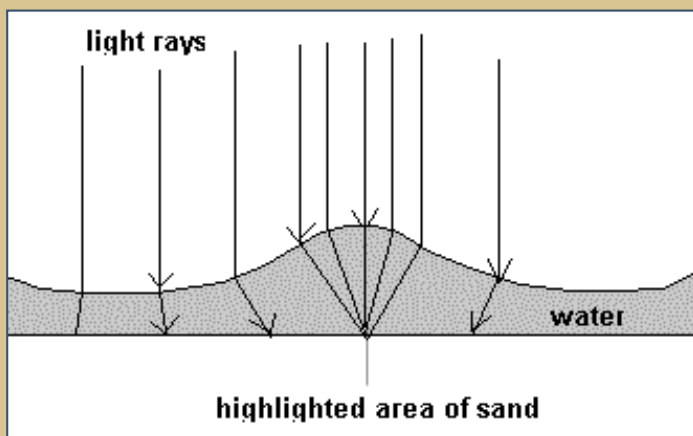

So, how do these bright lines form on the sand? Well they form because the top of the wave is not sharp, but curved like a lens and like a lens, it focuses the light like a lens(see diagram opposite).

Were the wave 'peaked' the difference might occur as shown in the second diagram.

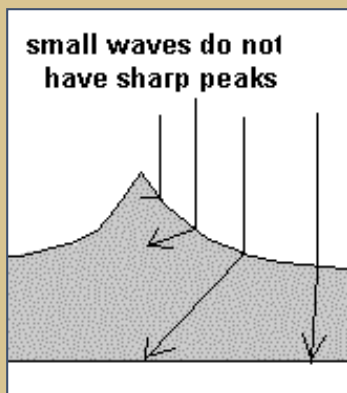

OK, so now we know that small waves are usually rounded. The more scientifically minded might say they were flattened by gravity or that water finds its own level.

Whatever the case I want you to consider the information in the photograph below and understand how the total structure of sand, wave, light and reflected light works and how we might transpose that to any painting we might do of a wave.



deeper water and deeper shadows

sky color reflections

wave pattern configuration

vertical wave surface
let's you see through the wave

wave surface pattern reflected
on the sand below

Let's not waste too much time on the beach (why not!) but get back to the studio and see what we can make from the information we have learnt, gathered and understood.

[GO TO ... waves part 2](#)

[lesson menu](#)

PAINTING LITTLE WAVES No.2

In the detail of the wave shown opposite you may be convinced you are looking through the wave ... but this is mere illusion. My steps in painting were as follows:

1) Paint the whole canvas a thinned mix of dirty sand colored raw sienna mixed with a little raw umber and white. Adjust for a approx value 5 or 6. Let dry to the touch.

2) With a nice runny flake or lead white with a little ultramarine and cobalt blue and using flowing figure eight horizontal hand movements create the wave tops.

3) Add some white to the raw sienna/umber mix and paint the pattern into the verticle wave surface making sure that the lighter more intense pattern is in the shallower wave's forward edge as I have shown.

NOTE: Don't begin the painting until you see the finished article and understand all the steps ... particularly that to make something look as if it were behind something else does **not** necessarily mean painting it that way - as in the sand 'beneath' the wave.



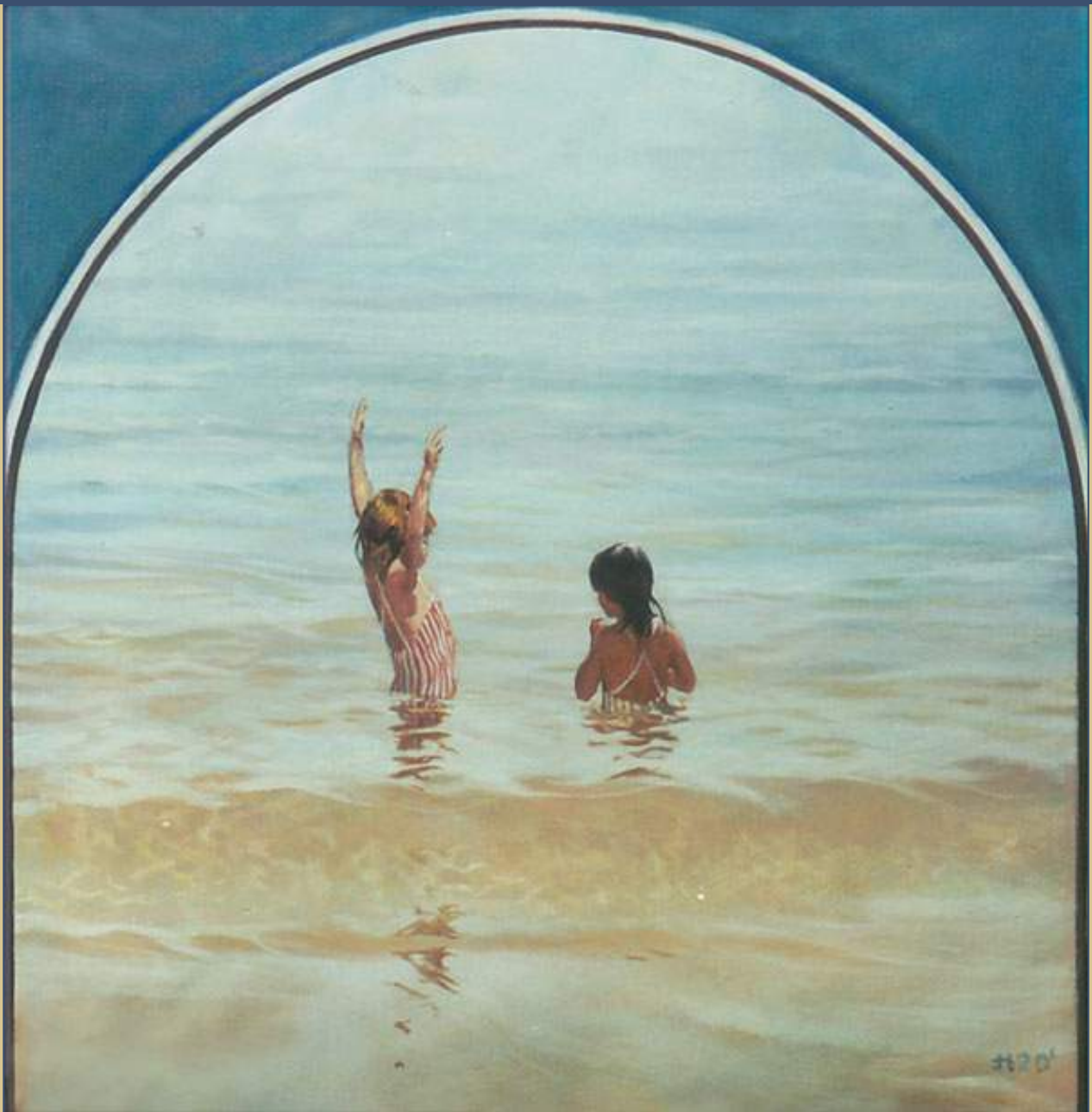

You should now understand the absolute simplicity of the whole scene; though there are a few points to be noted from looking at the painting above.

- 1) The reflected light on the top of the waves gets lighter as it goes back (the angle of incidence with the horizon decreases. In other words the tops of the closer waves are slightly darker in value as they reflect a higher part of the sky.
- 2) The waves get smaller as they recede.
- 3) The almost vertical fronts of the little waves get darker and bluer as the water deepens. In other words the sand color disappears.

Every problem can be solved by a careful study of the photographs shown on the previous page or by another visit to the beach ... which is never a bad idea anyway!



The figures are from sketches I made and I added the swimming costumes and altered there colors and to give a more satisfactory color scheme. (A full view of this painting can be seen by pressing [here](#). It is also available as a quality giclee print.)

STUDENT ACTIVITY: Make your own study (drawing) of some simple natural event or thing such as a clump of grass, part of a grape vine, a fish pond, a pile of autumn leaves or a neglected corner of the garden. Allow 40min. Later you might decide to base a major painting on your particular study?

[Information for new CD releases!](#)

[GO TO other transparencies](#)

[lesson menu](#)

3-3 SHADOW AND TRANSPARENCY

Let us recall our lesson on sunset and sunrise and remember the effect of atmosphere on light rays. Remember how the motes in the sky or mist intercepted the long blue rays and let the red through? Now we will treat that 'mist' as a piece of glass or plastic; a solid yet semi-transparent medium.

In the first example below the reddish pigment particles suspended in the glass are sparsely arranged. As with the earth's atmosphere at sunset the pigment particles in the glass absorb the blue-green light rays ... and this has a dual effect. (Fig 1.)

1. It reflects the red light rays back to the observer making the glass appear red.
2. It allows some of the red rays through to strike the surface behind. Here, that surface (green), absorbs some of the red rays. This tends to slightly neutralize the color. If the green was stronger the shadow would become grey.

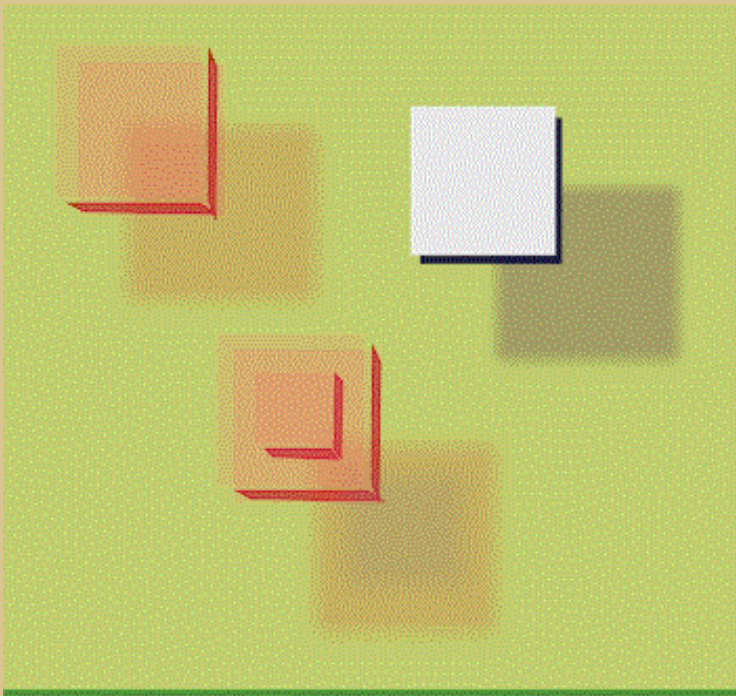

The solid object in Fig.2 blocks out all the light rays and casts a theoretical neutral shadow. Most painters find it useful to paint a warm shadow if the light source is cold and a bluish shadow if the source is warm. In this example the greenish background and reflected side light prevent an altogether neutral effect.

In the third example thicker glass is added to the center. This has the effect of both blocking the light and un-saturating the red. (see previous lesson on saturated color)

The principle regarding transparency is useful when painting with semi-transparent dark paint as the value and depth of the darks can be increased. As opposed to opaque darks, transparent dark allows light to penetrate the surface before reflecting back off what is underneath. This has the effect of filtering out light rays on the way in as well as on the way out thus allowing less of the light rays to escape and for our eyes to read richer, more interesting darks.

Application ...

THE SEMI-TRANSPARENT RED RUBY RING

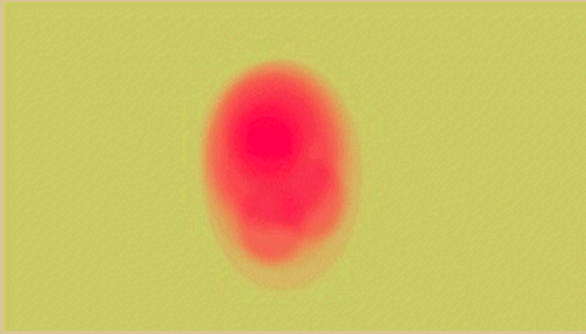

1. Create an oval and smear with shades of red allowing a transparency around the edges. You could do this with a semi-transparent crimson red like alizarin.

The rest is pure fiction and applied logic ...

a) Light source (top left) determines the position of the shadow as well as the position of the reflected light on the stone.



b) The highlight on the stone tells us much. As it is sharply focused we know the stone is smooth and shiny (very reflective). Here it is a window - reflected twice (the second time gives the stone greater transparency). By its position we also know the window is the main light source for the object and a line drawn from the observer to the highlight would reflect at an angle and pass out the window. This tells us that the object's surface is at an angle (round) and that the window is high left. This information should tally with the position of the shadow.

c) The horizontal bands on the ring band define its texture and roundness. The elliptical shadow reinforces this assumption.

Here again this object is not drawn from anything real. It is a pure construction using logic and remembered observation.

STUDENT ACTIVITY: Find examples of gold, silver, chrome and copper and describe them in terms of reflectiveness, edge and color (light hue and dark hue).



[GO TO ... lighting it up](#)

....or back to main [lesson list](#)

PAINTING BEYOND FASHION

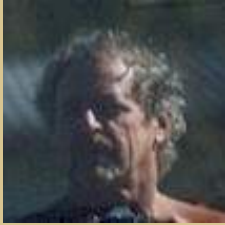

**Basic painting and drawing principles and techniques from the Renaissance to the present
by John Hagan**

TABLE OF CONTENTS

Intro - [Learning to look](#)

1. aerial perspective -6 lessons

[perspective - the basics](#)
[perspective - lets go outside](#)
[veils of atmosphere](#)
[sunrise and sunset](#)
[reverse sunset and night](#)
[clouds, mist and other veils](#)

2. color - 2 lessons

[color the hows and whys](#)
[color a different approach](#)

3. looking harder - 3 lessons

[painting waves](#)[2]
[shadows and transparency](#)

4. light and shade - 4 lessons

[backlight works its magic](#)
[side light and turning points](#)
[front light, and artist's light](#)
[cascading light and shade](#)

5. drawing texture design-6 lessons

[drawing and proportion](#) [2][3]
[pattern and texture](#)
[design and golden mean](#) [2]

6. analysis -5 lessons

[what to paint and why](#)
[analysis of 'girl with pearl earring'](#)
[depth of field](#)
[abstract and texture work](#)
[chaos and disorder](#)

7. practical application -32 lessons

[practical painting](#) [2][3][4][5][6][7]
[portraiture](#) [2][3][4][5]
[demo Alexander](#) [2][3][4][5][6]
[demo nude](#) [2][3][4][5][6][7][8][9]
[framing](#) [2][3]

8. personal paintings used here

[\[press here\]](#)
[advanced art lessons](#)

[*The artist's role and making a living from painting.](#) [2] [3] [4] [5]
[6]

All artork is by John Hagan unless attributed or known pre- 20th century masterpieces!

NEW [Information for new CD release!](#)

LATEST: A fuller view of particular paintings available as prints can be seen by [pressing here](#).

5-3 DESIGN

TRUST YOUR INSTINCTS (and get to the theory later)

Let us assume we are faced with the situation where the following picture must be cropped to fit a particular frame. How should it be done?

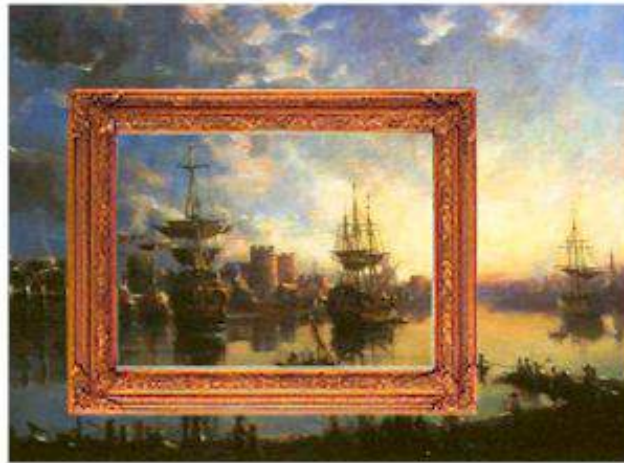

Fig 1



Fig 2

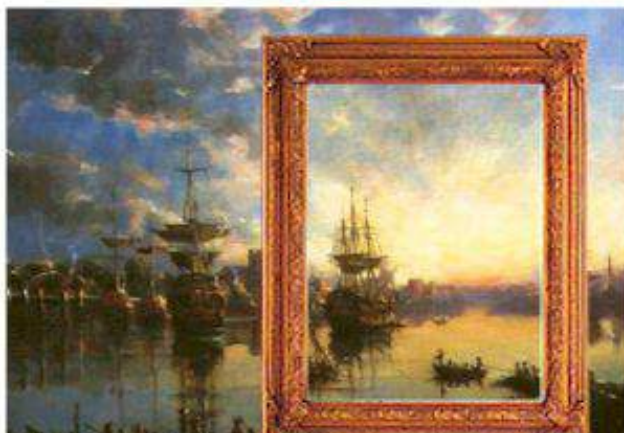



Fig 3

You probably have quite definite ideas about your preferred option ... and if I said I preferred No.2 you may decide I should seek serious counselling or some other form of professional help.

But most paintings do have accents or points of natural interest. Sometimes these are the areas of maximum contrast (lightest against darkest), other times it is a color accent (hue), or in a narrative painting, it could be an area of high dramatic intent - or it may even be a combination of all three. There can, of course, be dominant, secondary and many other minor accents. The question is: where to place them within a defined space so they look right?

Without explaining the complexities of physics, calculus or harmonic proportion (all of which I forgot as soon as I gave up my promising career as a rocket scientist - I ran out of chalk). Still, I have found the following method a helpful starting point for the humble painter.

1. For primary accents - corners of the center rectangle.

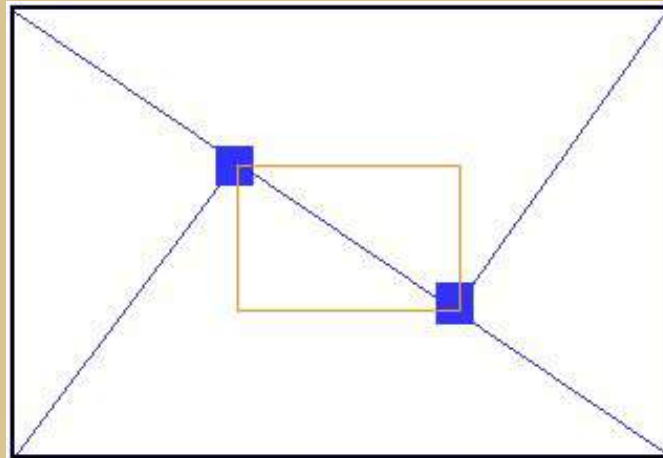

Try and counterpoint a dominant accent with a two secondary or some minor accents (mostly outside the rectangle).

Remember, everything is a balance with the relationship of all the parts to each other as they are to be sympathetic to the whole. Extra accents could lie on the corners of the second rectangle as shown below.

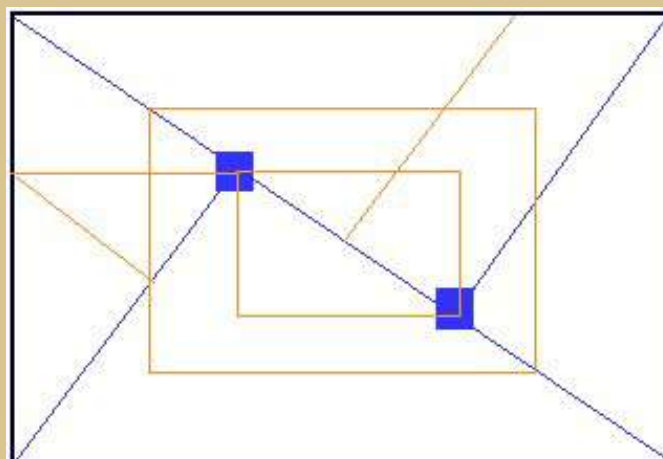

Remember the diagonals are powerful lines in any composition (below).



Later you will see where spirals and curves can also assist in forming the basis of compositions.

An example- one of my most difficult design tasks was to construct a painting to form the frontpiece of my tryptic (a three paneled painting). I was faced with a square to be split down the middle - upon which I wanted to place a single portrait. The problem was I did not want the figure to look as if it were cut in two by an axe.



1. The diagonal forms the main element of the composition.
2. The triangle forces a relief to the diagonal and is the principal construct of the figure.
3. The green and red circles are counterpoint highlights equidistant about the split just like you would balance weights on a seesaw (fulcrum).



With enough counterpoints we can almost create pattern ...

STUDENT ACTIVITY: download or cut and paste into your book a famous painting of your choice. Analyse, showing diagonals and counterpoints and explaining elements that bring the painting into 'balance'. Time:40min.



[GO TO ... the 'golden mean'](#)

.....or [lesson list](#)

7-5 FRAMES AND OTHER DECORATIONS

Historical developments

It is useful to understand the evolution of the picture frame. Frames evolved from painted decorations of architraves and cornices that surrounded frescoes on walls and ceilings (as in the Sistine Chapel below), to actual plaster and timber mouldings used when oil paintings became transportable. Today frames have become 'stand alone' items of mass production.



From the early renaissance architectural fashion has often determined the design of frames. Popular architrave, cornice and skirting designs, often in miniature, formed the frame. If you desired to frame a Watteau painting, if you are lucky enough to possess one or one you painted yourself in the Rococco style, then you should check out the famous houses of the period noting all their architraves and cornices. The great decorators and designers of past eras were usually universally consistent in their style. This approach can be just as valid today so look to architraves and cornice when deciding what frame to use (see below).

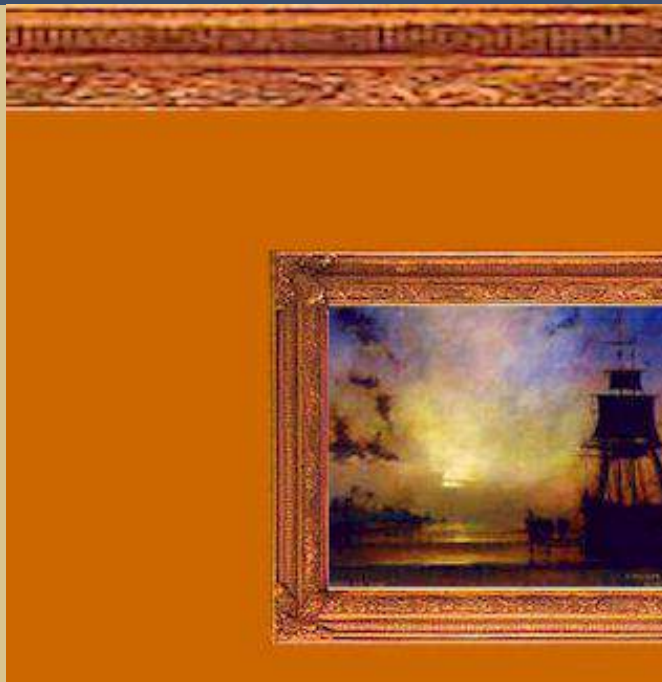

I have sometimes taken to painting decorations or frames on the canvas to achieve a historical effect as in the following example below.



From an artists point of view this allows you to paint a frame before the framer gets his hands on it. Other artists throughout the centuries such as Rubens, Tieopolo and Raphael have done the same often using fruit, leaves vines etc. as decoration. Some might argue it is a tradition worth keeping if only to keep the apprentices active.

With the development of oil painting as a medium and canvas as its ground it became important to protect these new 'mobile' or moveable works of art. Obviously someone had the bright idea to make the frame perform all functions, protection, decoration and finally as part of some intended environment (room). All this has led to much confusion with a minefield of styles, frame mouldings and architecture to negotiate.



So a picture frame can have certain characteristics and many functions;

1. Protect the painting
2. Unify the painting with the architectural style of the room as in repetition of color style or other design elements.
3. Separate the painting from the wall.
4. Tunnel the attention to the painting so it will become the focal point of a room.- or do the reverse.

An artist may require the frame can echo all the qualities of the painting. Accents of similar texture, color, line or shape.

Echoes between painting and frame:

Just as parts of a painting can relate to each other in echoes of texture, color and form so can the relationship between the frame and the painting. This is a relationship the renaissance artists knew well. Some of these relationships I demonstrate in the following example. More can be observed on the following page.



This traditional example (above) only works in isolation and miniature as most elements are fierce. However, texture of frame and breastplate, color values of frame, sky, armour and directional form match. The frame struggles to confine the painting and will only succeed if surrounded by a bland background. The frame is a color compliment of the painting while the gold still echoes the strong yellows.

We are now going to simplify things and examine three elements. The painting, the frame and the background.



[GO TO ... traditional configurations](#)

.....or back to main [lesson list](#)

PICTURE FRAMES

The classic tradition of museum display is that of the Uffizi - deep gold frames on a salmon red background wall. This is a formula often repeated for many renaissance paintings. It is also one I sometimes use in internet galleries - but mostly without the frames. For landscape paintings of high contrast and dark greens the salmon red works well particularly if separated by a neutral (off-white, black) or transit (gold) color.

This is a handy hint for painting as well as framing. When dealing with complementary or opposite colors red-green or blue-orange try and separate them with a transit or neutral color. Even modern minimalist paintings of clashing compliments are often framed to separate them from a colorful wall. Fierce aggressive paintings and color schemes are often impressive and eye catching - but difficult to live with. As with most art the understated is usually more powerful in the long run (less is more - again!) Below we examine three overall elements and their relationships - the wall, the frame and the painting.

IN THE RENAISSANCE
STYLE OF THE UFFIZI



Example 1. Complementary red wall green painting. Frame echoes the painting in color(darks and green-gold) and swirling shapes.

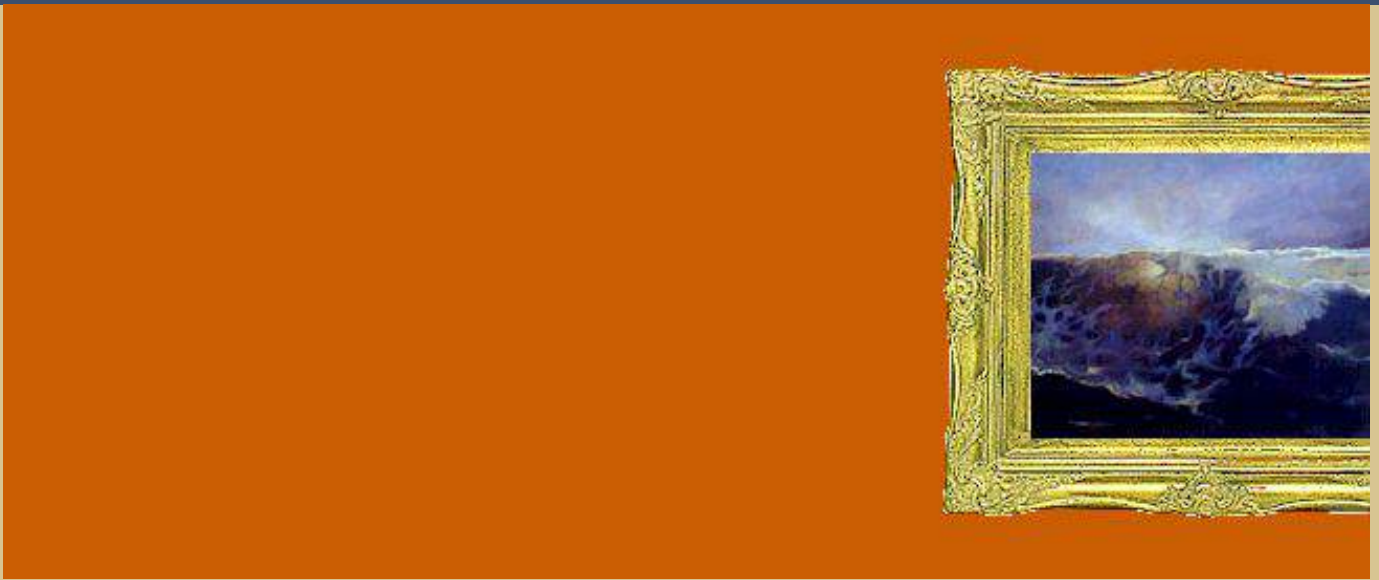

Example 2. Complementary colors of wall and painting with transition light gold between. 1800's style rococo style frame matches swirling wave. The important feature here is the 'value' differences between the frame and the wall and the frame and the painting.



Example 3. Complementary again. Here the frame and the picture provide a unified package where the rust color of the painting is made even more dominant with the matched frame. This allows the wall green to work.

COLOR MATCHING WITH TONAL DIFFERENCES



Example 4. Wall and painting colors are the same and the light gold frame is the complement. Echoes of light and dark from painting to frame.



Example 5. Wall frame and painting colors are the same which allows the small blue and yellow accents. This arrangement gives the painting great depth.



[GO TO ... some aspects of modern framing](#)

... or back to main [lesson list](#)

MODERN FRAMES - ACCENTS AND ECHOES

When the print or painting itself is intended as a decorative item - fashion often dictates the frame. It is perilous in this instance to buy a finished item without checking its intended placement. All sorts of factors such as lighting, wall color, furniture etc. can have their unforeseen effects. In this section I shall concentrate on those principles of framing that confine themselves to the picture and the frame. The principles of modern framing are the same as principles of the past but often with more of a bold fashion statement.

Floating a painting: This is the relatively modern approach of physically separating the painting or print from the frame and/or the wall by the use of neutral or semi-neutral barriers such as mounts, slips or other such devices. The general rule here is to continually vary the widths of the devices and the distances between them.



Texture echos: (also above)This is the repetition of a texture from painting to mount or frame.

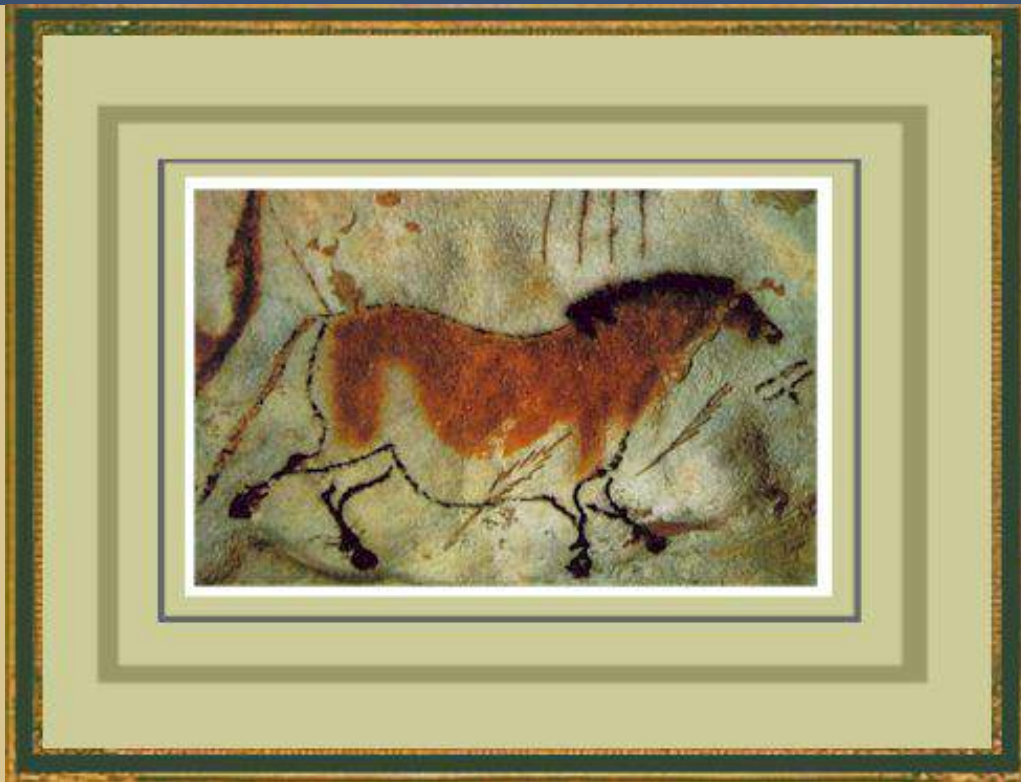

Hue echo or tonal framing: (above) This is the name I give the practice of balancing hue values between painting, mounts, slips and frame.

Borders, lines and bevels: a strong border or dark line is not always necessary as the example below demonstrates.



Size of frame & minimalism: sometimes the simplest is the most effective. Here the print as well as the frame combine to give a three dimensional feel.



[GO TO ... making money from painting](#)

.....or back to main [lesson list](#)

4-3 HOW LIGHT WORKS ITS MAGIC

3. FRONT, PICTORIAL AND AMBIGUOUS LIGHT

1. Front Light - the favorite of photographers, two dimensional artists, children and colorists where emphasis is on color and texture over form and value. Front light can eliminate the need for shading and shadows (which is a pity for they are a great joy and keep many artists from wandering aimlessly about the streets in the dead of night). Front light is also excellent for use in portraits of unremarkable people. Holbein's front light portrait of a Dutch princess eventually caused the schism that resulted in the formation of the Church of England. Like good putty front light can cover-up many faults.

USING THE JMW TURNER FRONTLIGHT PAINTING TECHNIQUE: (From my 'Arrive Timor' (60" by 36") painting from the Bounty series)

1. On a prepared canvas begin with a thin glaze (stand oil/spirit medium) of yellow with touches of red and blue. (blue suggesting the distance, yellow the middle ground and red the foreground). These thin 'washes' serve as a beginning - the overall plan for solving the problems the subject presents.
2. After drying make light compositional drawing with chalk.
3. Lay in the large masses boldly with impasto white/color mixtures and allow to dry.
4. Draw/paint in the forms in greater detail with a light brown (burnt sienna).



5. Begin to add colour using glazes and scumbles. Do not fear adding white to the glazes as this can create a broken light effect. Build thin layers of colour on top of each other maintaining a luminous transparency to the canvas and the textured white below. (note - can be wiped)
6. Apply accents and details including dark local colours as well as impasto white highlights strategically placed to give the effect of glimmering light.
7. Finish the painting in the frame touching up with fresh varnish and using thin brushes to drive paint into

the cracks etc and other areas.

THEORY : In fact this method of painting I used copys Turner but most likely had its beginnings with Rembrant. It gains its effect by glazing over dried impasto to other textures. Rembrant devised a method employing two whites; one for impasto and one for smoother passages. The impasto white was faster drying, probably made so by the addition of egg and ground glass, into the formulation. It was very lean, and consisted mostly of white lead with a minimum of binder (a variation on Step 1 above). He began applying it more and more heavily (Step 3 above) as the first stage of a two (or more) stage operation which was finished with transparent glazes and wiping, to create fantastic special effects, the most extreme example of which is the man's glowing, golden sleeve in the painting referred to as "The Jewish Bride," in the Rijksmuseum in Amsterdam. The brilliance of this effect cannot be gotten in any other way.

By wiping the glazes off as soon as they were applied, Rembrandt and later JMW Turner were able to create a bas relief effect of remarkable three dimensionality as the glaze remained in the nooks and crannies (Step 5-6 above). By glazing again, this time with transparent yellows and/or browns, instead of Ivory Black gave the textures a rich, golden glow (Step 7 above).

STUDENT ACTIVITY: Look up some paint manufacturers or go to your art supplier and find answers to these questions. Name three oils that can be used in oil paint manufacture. What is stand oil? How is sun-dried oil made? Name a non-drying oil. What is a varnish? What is a resin? What is a medium? Which is the most transparent white of those commercially available today? What medium is used for acrylic paints?



APPLIED PICTORIAL AND AMBIGUOUS LIGHT

In the painting above 'Allegory for a time capsule - (detail)' I constructed a sky spanning morning, noon and night. The possibilities of broken light on the ground are immense, but still, within in their particular areas, the scenes must be light consistent. The transition areas, as always, pose the greatest difficulty. Here I used the frame divisions to create artificial boundaries but the changes of pallet (colors) and angled light made the true difference. Note the pyramids are lit from the right, the Venetian castle from above and the skyscrapers from the left.



[GO TO ... Cascading light](#)
.....or back to main [lesson list](#)

OK, now you have learnt your craft and you want to paint paintings that you can sell either the original, or the copyright. This may help you buy your round of drinks at the local tavern and perhaps, at last, put a roof over the heads of your nearest and dearest. You might even have dreams of becoming a responsible member of the community, regain the respect of those outlaws and in-laws who have long since given up on you. How do you do this? Below are some of the methods I have employed that won't leave you feeling like an absolute 'quack'.

- FILLING THE GAPS OF HISTORY
- MAKING ORDINARY THINGS EXTRAORDINARY
- ILLUSTRATING FABLES AND LEGENDS
- RECONSTRUCTING LANDSCAPES OF TIMES PAST
- PAINTING PORTRAITS AND COMMISSIONS
- PAINTING FOR DECORATION

1. Filling the gaps of history

Don't let anyone tell you this is not a legitimate endeavor for a painter. Someone once spoke thus to me...

'How could you paint Shakespeare or Fletcher Christian,' they scoffed indignantly, 'did you ever meet them or see them? You can't just go around doing that! Anyway, they died hundreds of years ago.'

I replied, 'I don't expect Leonardo met the Virgin Mary, nor to my knowledge did Carraviggio meet John the Baptist, or was Michaelangelo ushered into the presence of God for painting purposes...! I also expect neither Rembrant nor Rubens was present when Jesus was lowered from the cross'. And all these things happened over one thousand four hundred years before they were painted.'

In fact it is the artists duty and obligation to do exactly these type of paintings and make them believable. Thus will we enrich history for those coming after us.

First of all let's look at portraits of those folks who were not captured by photography or painters of their time. Perhaps most became notorious well after the event. Anyway here are two examples that have been used on book covers, magazines and in television documentaries from which I gained financially by my agent selling a limited copyright. The originals, of course, I usually retain and will will to my children.

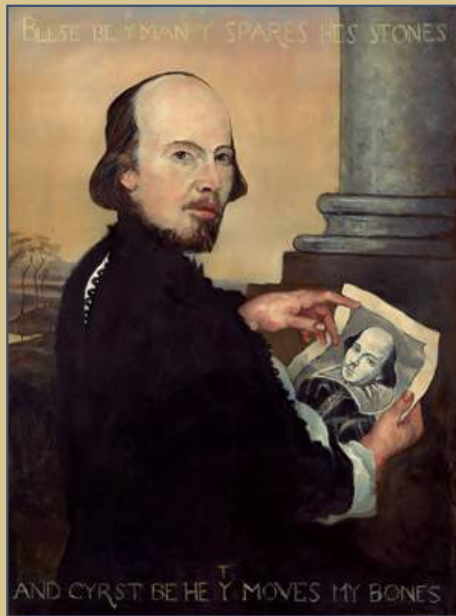

William Shakespeare
who was never painted
in his lifetime



Fletcher Christian



Alexander and the Gordian Knot

These paintings have been copyrighted and used more than once in publications and documentaries and book covers. It shows that any artist still has great scope should he or she wish to properly research and produce a painting that is definitive in its portrayal of some event or person who presently lacks any adequate representation. What other 'gaps' might the 'journeyman' painter tackle? Here is a list off the top of my head:

Milton of paradise lost fame

The philosopher 'Gothe''

Chaucer

A real flesh portrait of Julius Caesar

Sir Francis Drake

John Paul Jones

Christopher Columbus

Sir Francis Drake

Stanley meeting Livingstone

Plato

OK, so you can now see the possibilities should you want to research the subject matter, and have the technical skills to produce a painting that has both feeling, drama and definition. In my atelier my primary duty is usually to give students the skill so they can paint whatever style or method that might suit the period - or otherwise, should they determine something else is required. That is up to them and their reasoning. In this sort of work it is important for future copyright use that the artist refrain too much from 'stamping their personal style' on the work; instead making the painting identify with the time and place or the person and particular event. This sometimes needs much research - but the rewards are great should your portrait or work become the definitive one, as did my Fletcher Christian. You see it was well researched had the benefit of not looking like Mel Gibson, Marlon Brando or Erol Flynn!

Beware that, like the novelist or actor, you might become so attached to some period or person it could almost become obsessional - as I nearly did with my late 18 century era of sail and romanticism.

Finally you need to put these images where folk who need them can see them and this means originally on the web, and perhaps giving them away free (within defined parameters) to educational and other non-profit organizations that require them from time to time.



[GO TO ... Ordinary things](#)

OR ... back to [lesson list](#)

- FILLING THE GAPS OF HISTORY
- MAKING ORDINARY THINGS EXTRAORDINARY
- ILLUSTRATING FABLES AND LEGENDS
- RECONSTRUCTING LANDSCAPES OF TIMES PAST
- PAINTING PORTRAITS AND COMMISSIONS
- PAINTING FOR DECORATION

6. Painting Decorative paintings

When everything else fails... So how do you do formula paintings, and what are the formulas that always sell? In the business we call these 'potboilers' and the problem is not in painting them it is disguising them sufficiently so they seem fresh and new, one off originals instead of formula paintings.

There are of course certain things that have universal appeal and I will show you two variations of them in this lesson. Understand however, this universality needs to be tweaked and adapted depending on the country or other demographics, like your target audience. It is a fact, for instance, that folk in the US and Europe will appreciate more colorful paintings than those living in South Africa or Australia who, no doubt due to an abundance of color and light and the absence of winter grays, appreciate that which they don't get to see a lot ... the more subdued hues.

Here is our first example ... a girl frolicking in a surf on a hot summers day and pelican investigates. A universal desire.



The secret of selling this type of painting is to make it decorative. In other words a fashion item as well as the remembrance of some pleasing experience. To do this I have deliberately made it a 'high key' painting. In other words it has mostly light airy colors - though I do make sure the areas of contrast are there and catch the eye.

So the secret here is mostly presentation. A decent frame matched to the painting in a decorative and unassuming manner (that way it will fit most homes). The painting is not designed to stop people in their tracks, but to create an atmosphere wherein folk are comfortable and relaxed.



To produce this type of painting (above) you will need a basic understanding of the elements of waves and reflections and atmosphere, but it is fairly rudimentary and is well addressed in the lessons so far. Then you will need a camera or sketch pad and a few summer days to sit around the beach ... of course that's the tough part!

Another formula that seems to have a universal appeal is the one with wrought iron fences, balustrades etc. and flowers. In my variation it is best if the wrought iron is painted white and the flowers are climbing roses or suchlike. An abundance of vegetation is also helpful. Again summer and high tones are well placed but make sure there are areas of deep contrast that draw the eye. If you add small children and romantic remembrances of childhood then extra appeal can be added and the clientele and focus groups will not doubt appreciate the effort.

And so in this scenario I have utilized in my 'beauty and the beast' work that you see below. I deliberately evoked the summer Mediterranean feel so as to counterpoint the horrible 'beast'. This of course would prevent otherwise good sales, but then again - is fame and fortune worth all that? In the marketplace this is a dollar each way painting. There could be someone out there who might like both elements.

Well, these paintings are but two variations on good and tested formulas that may make you a fortune if you need one. I have maybe ten other tried and successful 'themes'.



Seriously though folks, if you want to paint for fame and fortune, forget it. I have no personal fortune but I am usually welcomed wherever I go and I get countless invitations to address folk, talk and demonstrate my wares. I can never retire, my financial stability relies not on what I saved but what I may be capable of doing tomorrow. Otherwise I am quite happy with the paintings above. I am not raising the bar so you might be dissuaded from even trying some painting formula, rather you **MUST** do it to learn the basics. I am only warning you against complacency, repetition and false success.

So I no longer paint for the lowest common denominator, though when I was stuck in Brussels, with no money ...



[GO TO ... Advanced lessons](#)

OR ... back to [lesson list](#)

Subscribe to cowdisley technical forum

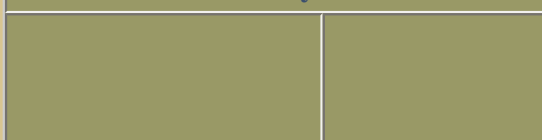

Powered by groups.yahoo.com

- [FILLING THE GAPS OF HISTORY](#)
- [MAKING ORDINARY THINGS EXTRAORDINARY](#)
- [ILLUSTRATING FABLES AND LEGENDS](#)
- [RECONSTRUCTING LANDSCAPES OF TIMES PAST](#)
- [PAINTING PORTRAITS AND COMMISSIONS](#)
- [PAINTING FOR DECORATION](#)

5. Commissions

Due to 50 years of the press showing works of 'art' being made by elephants with brushes held in their trunks, monkeys, guys riding over canvas with bikes, kindergarten children and anyone else with no talent and no training; it is increasingly difficult for any member of the public to believe a professional painter should receive a per hour remuneration that might be similar to what a plumber or an electrician might receive should they spend an equivalent time at a contracted task or job.

This has become the sad lot of painters so the point must be made forcefully and prima facie before any work is undertaken that you expect to be paid on a scale commensurate to your study, skill and experience; at least at a tradesman's hourly rates.

Here I will discuss just a few basic rules for graduated painters who intend to make a career out of commissions.

- Be professional. Make the client aware that your hourly rate should be adequate.
- Define the work: Make sure the size of the canvas, paint, the mounting and frame are all costed and defined. In a lot of instances it is appropriate for the client to agree to pay separately for the frame. This does not preclude a caveat by the artist on the type of frame to be used. I find it useful to make this provision at this stage.
- Take a deposit - at least 10%. More if you are including the frame and mention the cost of artist quality paints, particularly if you intend using any seriously expensive colors such a cobalt blue etc.
- Settle on a completion date with + or - variations for unforeseen circumstance. If it is a portrait this time should run concurrently with the sitting times and the sitters availability.
- Agree on the scene/portrait - general colors and style and if a portrait the mood and props. Don't rush this as it is most important. You should value a happy customer for it is from them you will get a plethora of new clients.
- Be careful the client understands that you will exercise your skills to the fullest but not all paintings turn out to the clients perfect satisfaction. In fact the client should be made aware there are certain risks involved that are separate to actual performance.
- If possible get your signature and your clients on a piece of paper!
- And never, ever, take on more commissions than you can handle. Portraits particularly, can become very demanding whereas commissioned landscapes are usually a joy - particularly in summer.
- Be professional.



[GO TO ... decorative paintings](#)

OR ... back to [lesson list](#)

- FILLING THE GAPS OF HISTORY
- MAKING ORDINARY THINGS EXTRAORDINARY
- ILLUSTRATING FABLES AND LEGENDS
- RECONSTRUCTING LANDSCAPES OF TIMES PAST
- PAINTING PORTRAITS AND COMMISSIONS
- PAINTING FOR DECORATION

4. Reconstructing Historical Landscapes

There is a growing opportunity for painters to make a living by painting historical landscapes using old postcards or photographs as reference material.

I recently experimented with this by taking three old faded, black and white postcards and reconstructing the landscape. They were subsequently scanned and printed and sold in the area they were painted. This could be done in any location should you possess the skill of an adequate landscape painter and a modicum of flair for color and drama.





This painting (24"x36") depicts a flood in a main street of a seaside town in 1892
Taken from the postcard immediately above.





This depicts a dry dock in the same town 1895. I applied a Turner-esque look to the scene.

These paintings were also made into postcards and small prints for which I receive a small income.



Again, the painter should not be so elitist as to spurn such work. Society has, and always will, treasure such efforts should they be atmospheric and definitive. With the right training a painter could always make a good living traveling up and down the coast, or around the country just producing such pieces of work. You might find the local Historical Societies are also interested in commissioning such work - they surely have a wealth of

material you could use!



[GO TO ... Other Commissions](#)

OR ... back to [lesson list](#)

- FILLING THE GAPS OF HISTORY
- MAKING ORDINARY THINGS EXTRAORDINARY
- ILLUSTRATING FABLES AND LEGENDS
- RECONSTRUCTING LANDSCAPES OF TIMES PAST
- PAINTING PORTRAITS AND COMMISSIONS
- PAINTING FOR DECORATION

2. Making ordinary things extraordinary

The idea here is to take something entirely common and paint it in such a way that viewers are forced to look or 'see' the thing in some other way. Just this morning I purchased a packet of beautiful chopsticks. My aim it to one day paint them in in conjunction with a fork or other eating implements. This might just question the process of getting food from dish to mouth.

Anyway painting simple things is also a major obligation of any artist for it promotes lateral thinking and wonder.

Such things might include:

- A footprint in the sand.
- A small wave on the beach with a shell.
- Cooked pasta.
- A map of the world.
- A mailbox.
- Beans and toast.

Look around, walk in the park, go to the seaside, there are thousands of suitable items. Below are a few examples of mine I have found that made successful and saleable paintings.

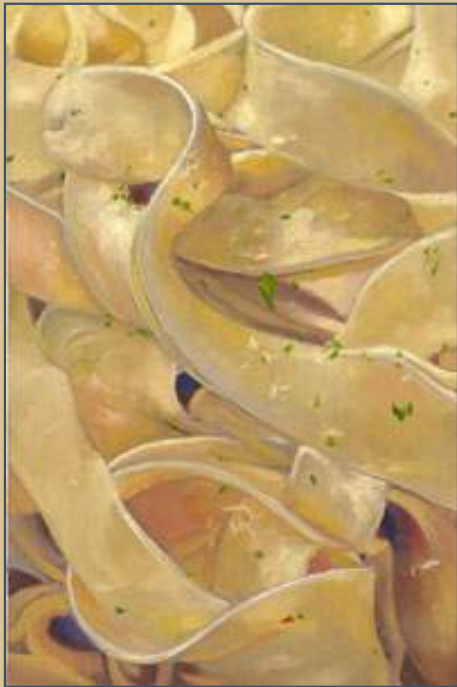

Pasta (36"x24")



Beans and toast (36"x24")



'Landscape'(100"x50") - I intend to follow up this 'world landscape' with another having the map reversed as if looking from inside out; out into the universe. The shapes thus should be vaguely familiar but the 'views' unusual.



[GO TO ... Fables and legends](#)

OR ... back to [lesson list](#)

- FILLING THE GAPS OF HISTORY
- MAKING ORDINARY THINGS EXTRAORDINARY
- ILLUSTRATING FABLES AND LEGENDS
- RECONSTRUCTING LANDSCAPES OF TIMES PAST
- PAINTING PORTRAITS AND COMMISSIONS
- PAINTING FOR DECORATION

3. Illustrating Fables and Legends

Painters have been doing this for ever - from cave painters to artists at the end of the 20th Century. Sadly there is little of it today but... this gives the versatile and patient painter an excellent chance to fill the gap!

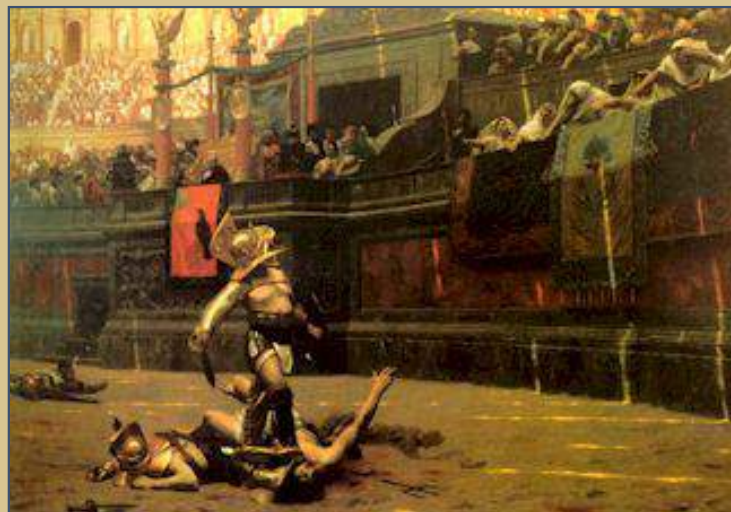

To understand the importance of such paintings as Gerome's 'Police Verso', shown above, one only needs to understand that the whole visual feel and detail of the very successful 'Gladiators' movie was, according to the director Ridley Scott, based entirely around such 1890's work. It is a shame Gerome is not around to claim his legacy. Someone who was however is H R Giger whose paintings and drawings were the inspiration for Scott's 'Alien' movies. These works in turn related back to Goya and Blake's 19th century gothic works.

Others might include:

- Any Shakespearean theme
- St. George and the Dragon
- The Pied Piper
- The Homeric Epics
- The Old Man and the Sea.

- Any of the Myths of the Gods.

You should look toward your imagination and try and paint such paintings or perhaps marrying such legends (St. George) to modern events as allegories as I have done with 'Perils of a Chemical Life' below. It is good practice to be working on one or two of such paintings in the background to your usual commissioned or current work.



Beauty and the Beast (48"x48")



Thor God of Thunder (48"x48")



'Perils of a Chemical Life'(48"x48") - This is a modern day allegory based on the St.George theme where the knight attempts to rescue the heroin stricken maiden who appears as both the serpent and the girl.

Even though this type of painting appears, a first glance, attractive to only a small market the painter should always remember the first rule of selling a painting: that is to produce a painting for the one person who cannot live without and not to paint for that 99 out of 100 people who will think it is OK. This happens regularly as galleries are often seduced to hang bland, mediocre works always attractive for the widest possible range of people. Serious collectors however always favor the definitive, unique work that has obvious craft and value. Should you need to appeal to wider audience this should be done with smaller works with affordable prices rather than quicker large paintings. Remember your small purchaser today will become your collector of tomorrow, so always have some smaller works priced accordingly at any showing.



[GO TO ... Landscapes](#)

OR ... [back to lesson list](#)

6-1 DEFINITIONS

Before you start painting you must decide on your object in learning to paint. There are many styles and methods of applying paint to a surface but there are three main reasons for doing so. After you have looked at these reasons and the examples I have provided you should be able to follow your purpose and utilize the tools of drawing, color, texture and design to your best advantage. The categories are not definitive as many paintings encompass more than a single element - nor is any objective better or worse than any other.

None should ever gain from a painting any dividend in excess of what the artist invests - and if he or she does it is a fool's profit. Sadly so many twentieth century artists hold their public in the same regard a con man would a victim. Even Picasso and Dali made some unfortunate comments in this regard. If we train our senses sufficiently they can evolve to the extent they are able to discern great subtlety. Just as a wine taster or gourmet train theirs so can a visual artist and it is truly a joy.' ...

The categories are:



Fig 2



Fig 3

1. Decoration - I want to paint because I love to decorate.

Fig 1.(above) Here color and proportion are made pleasing to the senses.

Fig 2 Impressionist decoration.

Fig 3 The use of an accent (bright red in a sea of grey) for an eye catching wall decoration

I would have you paint decoration for the appreciation of decoration, paint subtlety for the appreciation of subtlety and paint messages for those looking to pictures for meaning. Why deny people their decoration, why deny the high church their subtlety, why deny the communicators their messages? There is no good reason—still, I would have the artist be all, at the same time. But if you find you cannot, just rejoice in the diversity and do not judge one better than the other.



Fig 4



Fig 5



Fig 6

2. Fine Art - I want to paint to understand and enjoy visual ideas.

Here I will quote a respected food and wine judge, 'In summary less is more. The flavours and fragrances we most enjoy are the ones we only just perceive. More than that, they make us sick. Rose scent is a good example.'

Fig 4 One of the greatest paintings of all time - sublimely subtle. The viewer knows exactly how the artist felt towards the subject. (note the lips slightly apart - a rarity in northern renaissance portraiture)

Fig 5 The mystery, subtlety and the innovation in this painting makes your hair stand on end.

Fig 6 The use of light and landscape in an allegory about painting.



Fig 7



Fig 8

3. Message - I want to paint because I have a message to communicate.

Fig 7. (above) Never has design, contrast and color been so forcefully used in the cause of humanity. A rare feat: no action photograph could ever compete.

Fig 8 There is little decoration or subtlety in this painting titled "Executions at Portsmouth'.

The examples are selected to best illustrate their category by single-mindedly ignoring the other two(ie. in the decorative category the artist has made no attempt at description nor is there any message to be had. In the second category decoration and message are absent whereas the message in the third category swamps everything else.)

To show I am unbiased the last example in each category is one of my own paintings.

STUDENT ACTIVITY: Make you own list of five paintings nominating their categories. Note - some might have more than one category and if so you must name them.



[GO TO ... analysis of a
vermeer](#)

.... or [lesson list](#)

6-2 ANALYSIS OF 'GIRL WITH A PEARL EARING'

What is realism?

The real world, you say? Now that is novel. Perhaps unique. Why would an artist be interested in reality? Of what use is that to the galleries and museums? People don't want an exhibition of the truth. They don't want to see the intestines of a cow nailed to a wall. They never do, and they never did. They want magic and illusion. Magic to make them wonder, and illusion to transport them elsewhere. They want to see pictures that make them laugh and cry they want to see good and evil narratives of honour, and of misfortune, cunning, grand landscapes of history or intimate portraits of seamstresses and blacksmiths. They want the artist to use all the skill, all the tricks, the smoke the mirrors, all the alchemy and all the the magic of painting to make them believe.

They would sweep realism from the wall and stamp it beneath their feet like a cockroach. Realism has an ugly face, you see. No you don't want realism and neither do they. Realism is a poisoned dagger in a dead hand, it is the stuff of body fluids and blackened lungs. No folk want beauty, they want the spectral magic of an angels wings - or to see the dragon twist at the end of St George's lance - and they want to believe!

However the painter's job is not easy. It has a long and ancient apprenticeship and it requires courage and skill. It is to provide the stuff of illusion, the ideals realized. Payment is usually small in coin but large substance when we see the wonder on the face of the child ... or some adult who makes mentions of the image made that dwells in that special place in the mind where people live.

COLOR



Note the extremely limited pallet.- a light red, a cobalt blue and a yellow ochre.
The rest are gradations and mixtures.

Also note the values on the grey scale range from 1-10

PATTERN AND REPETITION

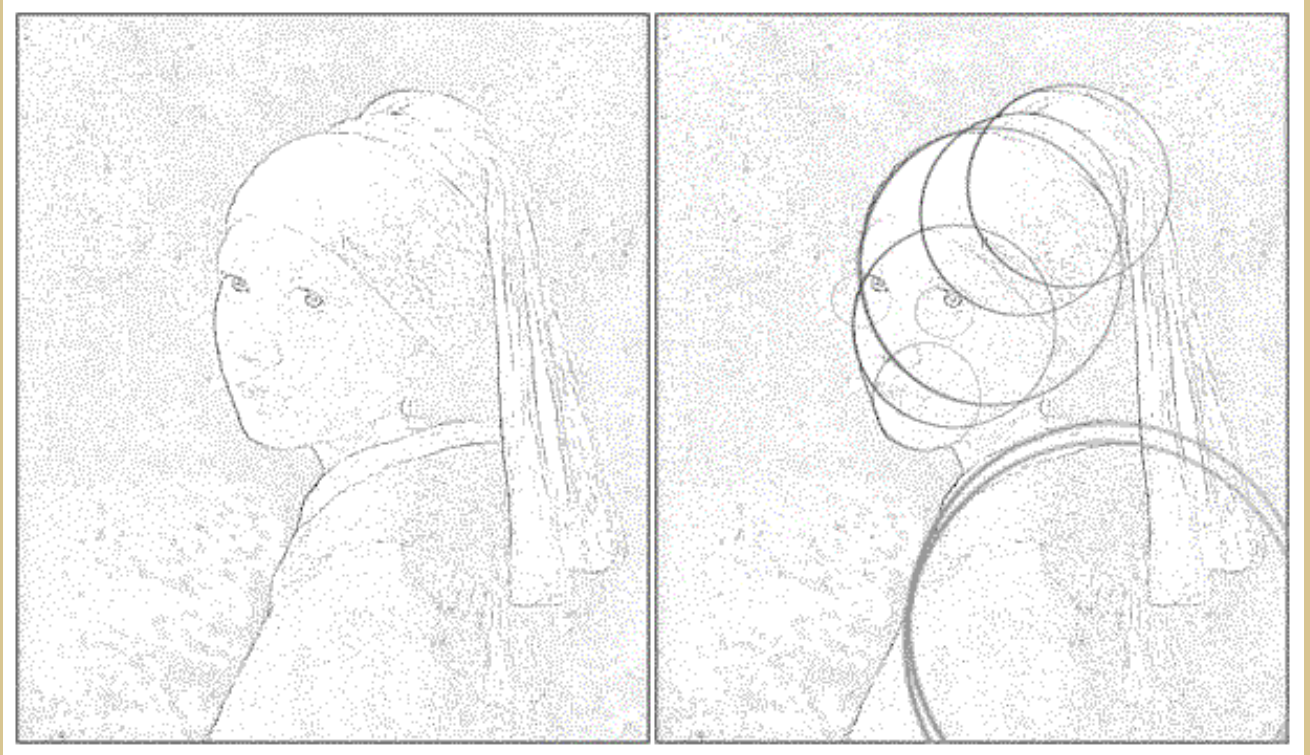

DESIGN

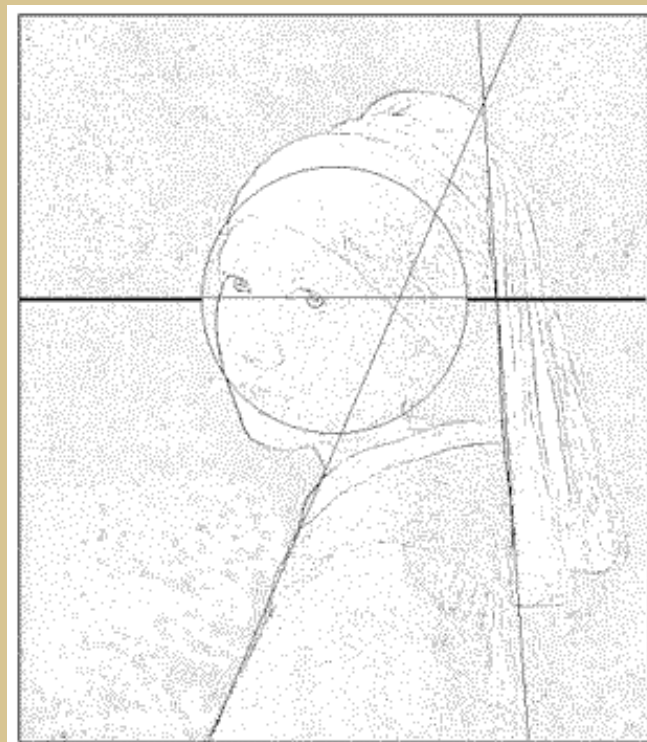

Some of the most effective designs are the simplest. The head is centrally positioned. The horizontal line of the eyes is 'golden' approx 3:5 up the canvas. The two vertical straight lines provide the 'discord' to the circular patterns.

TEXTURE

The hard edges of the pearl (which I think is really a silver ball) eyes, and face make them all equally smooth and spherical. Here again we encounter repetition. The eyes and the pearl, because they are more reflective, have sharper and more defined highlights. The 'pearl' also shows an extra luminosity by its secondary reflection of the white of girl's collar (Fig 3)

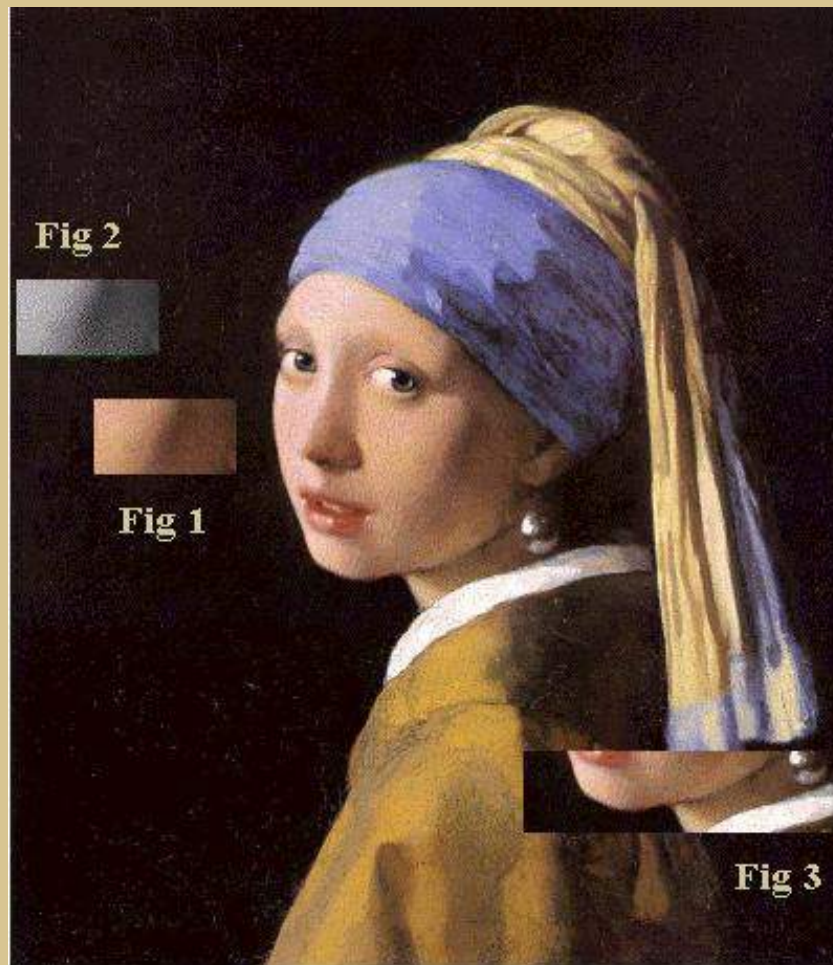

TURNING POINT (Fig 1 and Fig 2)

The transition area from light to shadow is the key to this picture. The transition color between the flesh tones is the background color (Fig 1). The transition values from left to right in Fig 2 are 8-6-4-2-4. The background value ranges between 1-2

EXAGGERATIONS

The reflection of the collar on the girl's jaw shows the artist's skill but does it really exist to the extent shown here? What is the color inside the girl's mouth? Here it is highlighted for effect. These elements show the artist's deliberate and personal touch.

STUDENT ACTIVITY: Pick a painting you like and analyse it by design, texture, pallet and repetition.



[GO TO ... depth of field](#)

...or back to main [lesson list](#)

6-3 DEPTH OF FIELD

The human eye, like the camera, has a limited depth of field. In other words we focus on one level and the objects in front or behind are often blurred. When Deigo Velazquez painted Las Meninas he, along with many artists (pre-photography), painted everything in focus. This was part of the magic of painting as the viewers perception was thereby expanded - rather like a hologram. Today wide angle lens may produce something similar but unless you intend to spend hours in a darkroom it is an all or nothing solution.

There are good lessons to be learned here and this painting by Deigo Velazquez will serve us well as it has a defined foreground, middle ground and background. Let's experiment then ...



First I will separate the fore, middle and back grounds then utilise three focal depths and observe the results.
The essential question I ask is one of choice - what do you like most?



The foreground in focus.



The background in focus (the artist's preferred model?)





The middle ground in focus.- note the exciting change of emphasis.





Ahh... you say - and why not! But don't you find the blurring unsettling? The artist would have.

This particular painting is huge and designed as a feast or as a complete visual experience. I am merely toying with the work and I hereby apologise to the master for doing so. Today we may find no magic in multi-focused paintings but the lessons in design and emphasis are worth considering. The example in the abstract lesson is essentially a similar manipulation. Note: the artist painted so well that the dwarfed figure in the foreground has recently been diagnosed as a victim of congenital syphilis.

STUDENT ACTIVITY: There is a painting to be made by focusing on the girl directly behind the dog as her head and body in this composition is located on a diagonal and in a premier design position. Find a copy of this painting and try it (see lesson on design and proportion for hints).



[GO TO ... abstract](#)
[...or back to main lesson](#)
[list](#)

6-4 ABSTRACT AND TEXTURE PAINTING

Many confuse abstract painting with modern painting or modern 'art' and wars and battles rage in the 'art' world over definitions of what is 'art'.

We are concerned here only with painting.



In truth, an abstract design is one that has no pattern and an abstract painting is one that has no form.

The painting above is not a photograph but its realism is undeniable. It has form but no pattern (repetition).

In a previous lesson I stated 'the human mind does not like to be overloaded with detail, particularly in a painting. It revels in its ability to complete the picture itself. And it must be allowed the latitude (hazy bits) to do this. The degree you allow this will say something about your estimation of your proposed audience. My rule is to always assume they are smarter than you, in other words leave plenty of for the imagination.'

This idea of involving the imagination was the genesis of most post 1850 art movements and experimentations. In the more extreme any cognisant feature became a disadvantage.



When contemplating painting an abstract picture or one with symbolic meaning try and recall no one will gain a dividend from the finished work in excess of your input. So no cheap shots for, to rob your audience is to rob yourself.

Sharpness and smudge the layered effect.



Here I have taken a section from an action painting and blurred it before overlaying it with thin, sharp-edged black and white lines and shapes. This 'depth of field' photographic effect is relatively modern as (excepting Vermeer and a few others) the artists of the past insisted on bringing everything into focus. It must be said their clients often demanded this.

TEXTURE PAINTING

The worth of an artist was once determined by his or her ability to disguise brushstrokes and produce 'magic' surfaces and textures. A few - Rembrant and Titian in their later years - decided paint had a tactile quality itself and sometimes layered the paint to produce a separate effect. Rather like Rodin often left parts of his marble sculptures 'in the rough' to emphasise their other qualities. Mostly they used white as that pigment was the cheapest .It was also the slowest to dry and could be safely applied over the successive layers of dry thin darks.



This use of excessive body in paint took off with the development of cheap mass produced paint in the early and mid-eighteen hundreds. One of the first exponents of this 'impasto' method was Turner and his use of white. Turner would often sculpt some landscape element in heavy impasto, wait for it to dry then coat and wipe with successive transparent galzes. The depressions and cracks would fill and the highlights would realise their sculptured effect. Also the galze over the white would make it glow - even more so if even more galze and white was later applied.

STUDENT ACTIVITY: The ultimate weapon in this texture effect is the pallet knife. If you would like to experiment with this you will get remarkable effects by treating your canvas like a mud heap and shovelling paint around with the knife. Create loose forms if you like. Stop just before the colors completely disappear into a mass of grey mud. Now take some pure color and with the knife gently fold it into the mixture - blending in some areas and in others leaving a few of the edges sharp. Be liberal with your paint but just use a small surface ... Allow 40min.

Then there is the dragged dry brush or scumble effect, mainly in the distant sky (dry the oil out of the paint on blotting paper if you need to).

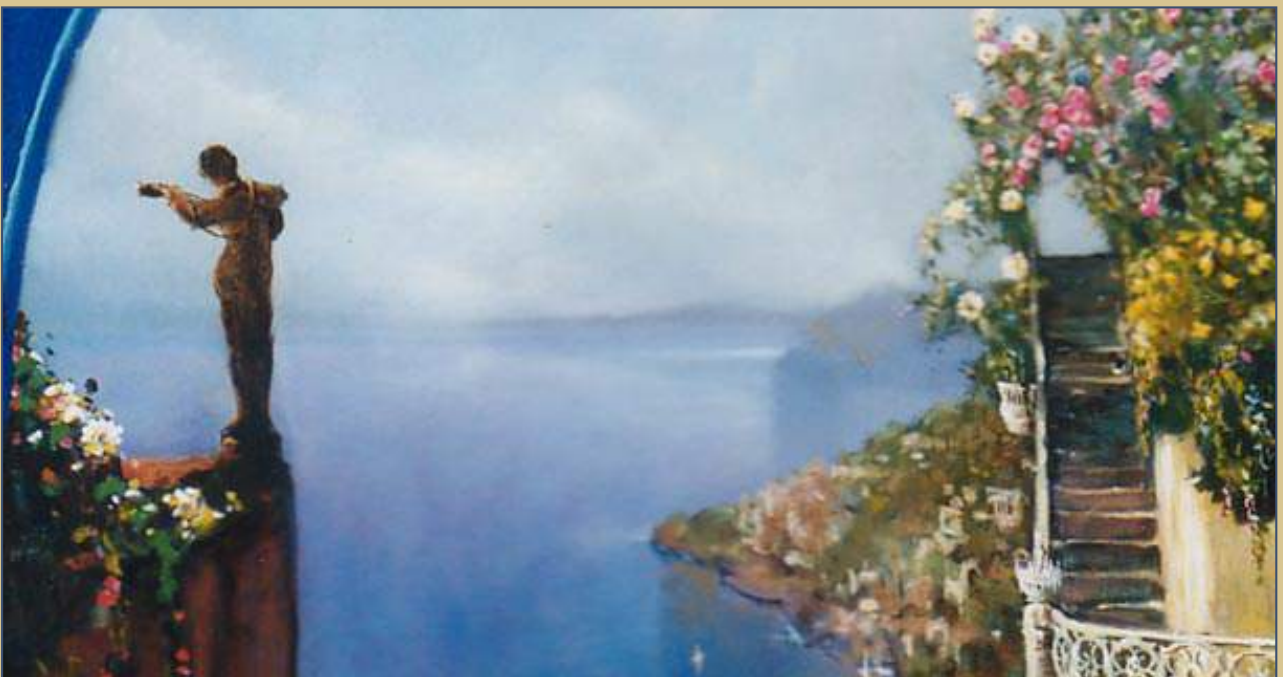

Or the slick oily in the bottom half of my rose painting (adding more oil or medium to your paint).



Experimenting with paint and texture will provide wonderful moments but try not to make this an end in itself. Great paintings have a magic that transcend the sum total of their parts.



[GO TO ... order and chaos](#)

...or back to main [lesson list](#)

6-5 RELATIONSHIPS, CHAOS AND DISORDER

Relationships

We don't just paint 'things' we construct visusl relationships. Now approach a topic of which, in art (relationships) I have some knowledge. Obviously in life it is otherwise - single and thrice divorced. Back to safer ground and painting; every element in a painting can only be considered in its relationship with the other parts. Below in my portrait of Fletcher Christian the parts that draw the eye are usually the areas of maximum contrast.



This portrait has three competing areas of contrast, the forehead the background and the hands. They create a triangle and their relationship is crucial. I am still unsure as to whether the distant light is too bright in relation to the other highlights. Should I dim it and draw the eye more to Christian's face? These are judgements of **relationships**. Above I have used three computer devices to analyse the design.

... AND USING CHAOS

I view it like this:

Let us imagine our life as a room and the room has a partition. On one side of the partition is a continually moving, changing world of disorder and chaos. It is populated by all the creatures of the imagination - and more than a few not invited. It is a world of the surreal, of dreams and nightmares, of anti-logic and senselessness. On the other side of our partition we have order, logic and regular forms. The world of the pyramids, spheres and cubes - the world of habit, pattern and order.

Some people are not comfortable until the partition is forced almost completely to one end of the room (90% order 10% chaos) while others can live in a 50/50 situation. Some will rejoice in the high chaos while others believe it is a factor of age, gender, right and left brain, or potty-training. Some even go so far as to refer to it as the Jeckle and Hyde, Don Quixote or madness syndrome.

I believe we must live with both sides of our existence and recognize the importance of each. We need chaos to think laterally, to be inventive, to associate disparate ideas and concepts. That is the life blood of the creative idea. This is not to underestimate the value of pattern, order and habit. They are the very tools that allow meaning to be drawn from disorder - the foundation blocks of moral and civilized thought and the flame that draws the fluttering moth.

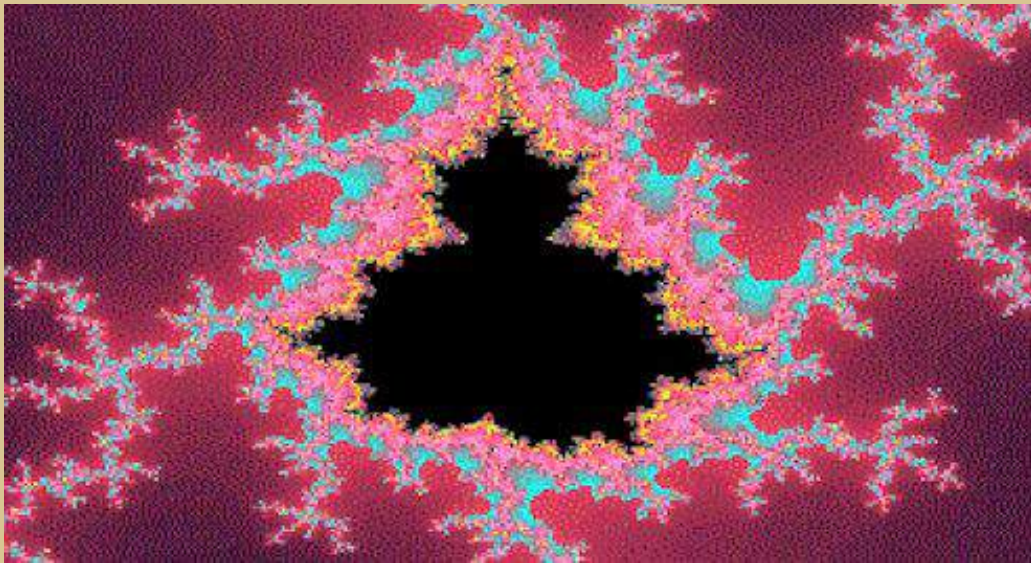

You will note how, up till now, my lessons have dwelt in the rules and order side of the room in an attempt to understand the chaos all about us. For some this may have moved the partition a little to the side of order. Never mind! Just think of what you have learnt so far as your small toolbox with which you can use to disassemble, reassemble and to analyse whatever your imagination demands. And remember, chaos need not be feared, used properly it can be used to pick the problem lock.

Experiments in color, design, form and texture are the basis of most of the art movements in the last 150 years. Whether they were abstract expressionism, impressionism, surrealism or post-modernism they are all attempts at disassembling and re-assembling, of moving into chaos to hopefully discover some new meaning. We should all similarly experiment especially when we find order stifling creativity ... or the present art administration becoming institutionalized and self-absorbed.

A study of fractals is useful when allowing the mind passage between order and chaos.



[GO TO ... practical painting - paint in oils](#)

.....or back to main [lesson list](#)

6-6 BASIC OIL PAINTING



Painting in oils - what you need to know about the paint.

You can liken making paintings with oil paints as making mud pies with different color mud or plaster

Why?

Oil paint usually has 'thickness' so it can be shovelled, spread, pushed, trowelled, brushed and scraped - just like plaster or mud. It can be flattened or piled up ... and much more.

It has all these qualities if mixed correctly. Furthermore it can be made to be spread as thin as gossamer or as thick as clay.

All this depends on just two things:

- a) The thinness or thickness of the paint, called its **viscosity**
- b) The implement you decide to use to push it around - knife, brush, stick, trowel.

So what sort of mud or paint will we make, how dry or how runny?

Oil paint is made up of three main elements.

1. **Pigment** a powder made from ground rock or earth or root anything dry that is intense in color.
2. **Oil** (medium)
3. **A drier** of some sort as oil sometimes takes too long (a thinner)



You can try this:

Go to the kitchen and get a little powdered saffron, powdered red food or cocoa and add a little oil (sunflower, poppy, walnut, safflower, it doesn't really matter which) and mix it up with a knife or spoon. You have now produced a genuine oil paint (and unlike many others, one you could eat it without harm). Find some zinc cream (used as a sunscreen) in the bathroom cabinet and now you have a white oil paint - now some black boot polish and you have a decent black oil paint.

If it is a little thick or hard to mix you may add a little turpentine, thinners or petrol which will obviously cause it to mix easier and dry faster.

Note: it is usually the chemical pigment or the thinners that causes the **extremely poisonous** nature of most commercial oil paints (lead, cadmium and arsenic are old culprits). If the powder you use is unusually strong you might be tempted to add a **filler** to bolster up the mixture. This could be chalk or ground marble or some other neutral powder. Student oil paints usually have more filler than Artists' brands. Filler is cheaper than pigment so you get what you pay for!



OK, so now what do we do with our mixture? If we had two lumps of 'mixture' (paint) say a red and a yellow and made them very oily and put them side by side on a flat surface they would gradually spread out and merge and take ages to get dry.

So more oil will help paint to blend and merge as oil is also the **lubricant** for the pigment and helps it slide around on the canvas.

How can we reverse this and stiffen up the paint?

We could add more pigment or filler, or we could get rid of some of that excess oil.

How do we remove the oil? By putting the mixture on blotting or absorbent paper and waiting. The paper will absorb the oil and a little of the pigment. Obviously to make it more runny we could add more oil and to dry faster and spread thinner we could add turpentine, thinners or petrol.

Get the general idea!



One more thing - we can also add other things that are mixable with oil like certain **resins** and **varnishes** which will make the mixture sticky and shine and maybe dry in a layer like a clear plastic sheet. This might allow what is underneath to shine through. And when we add a little strong pigment to this sheet we can maybe make what is called a '**glaze**'. Then again we could add some egg yolk for a 'matt' type finish.

What now?

Like a potter you have now made you clay, only in your case it is called paint. Instead of water you have added oil and some pigment and, instead of a wheel, you will be putting your mixture on a flat vertical surface, although you will mix it on a bench or pallet. There is no rush with your paint though - it is oil based and will mostly take a long time to dry and this you know you can control adding oil or white spirits.

One main point before you apply your paint; if you first apply a thick layer of paint to your canvas it will take ages to dry because the oil will have to dry out. If you have ever watched oil dry out you could probably also hear you own hair growing. When thick paint dries it shrinks and sometimes cracks. So if your first layer of paint is very thick and you add a thin layers on top of it before it is **totally** dry it will crack all the layers applied thereafter - and as it continues to dry the cracks will get bigger - especially if the color on top is darker.

Painters prevent this by painting the thick slow drying layers last and usually begin with thin fast drying paint - as their background.

'Thick over thin and light over dark' is an old painters saying.

If we don't want to wait we can paint what is called '**wet in wet**'. That means putting wet layers of paint on other wet layers all in the one session (or over the total time it takes the paint to dry). There can still be hours - or days until a 'skin' forms.

This is an important point as many painters would like to finish their painting quickly and are thereby forced to paint 'wet in wet'.

STUDENT ACTIVITY: See next lesson. Using some of the pigments, and oils I have mentioned make up a pallet of colors and paint a small picture. Allow 40min.



[GO TO ... OILS CONTINUED](#)

[... or lesson menu](#)

6-6 BASIC OIL PAINTING CONT.

This lesson is a summation of the practical demonstration I sometimes give to further explain some of the points made in the previous lesson. My purpose is to use common household materials to make an oil painting while my method of teaching this is similar to those cooking shows you see on TV. My desire is to familiarize the students with what 'might' have happened during the 'invention' of oil painting back in the sixteenth century and thus remove some of the hesitation from trying the method themselves. The first thing I do is to search the kitchen and laundry for the materials I need. It is best if this is done without alerting other members of the household as they often don't appreciate your dedication to such an elevated cause.



I describe this lesson as the ultimate alchemy since we are literally going to turn base materials into gold. Of course the 'gold' we paint is sometimes even more valuable than the gold in the ring on your finger which you would discover if you tried to purchase Rembrandt's 'Man with the Golden Helmet'. It would certainly cost more today than the helmet itself.

The main ingredients I will use for this recipe are a linen table napkin, artificial saffron, white zinc cream (prevents sunburn), white shoe polish, black shoe polish, a stick of blue chalk, some sunflower cooking or salad oil, a pack of drinking cocoa and an egg yolk. I will also use the mortar and pestle from the kitchen though a glass bottle would do just as well.



First I find an old frame and stretch the table napkin across the back and staple it in place. Remember to stretch from the center outwards and not from the corners in.

Next I separate the egg keeping the yolk and mix that with some of the saffron. I paint this mixture on to the stretched napkin. This seals the surface and gives a nice quick drying yellow surface. Those who have made mayonnaise will also realize that egg yolk will mix with oil if carefully added and it was most likely this transition that originally led to the development of oil painting anyway.

Next we can grind the colors with our pestle and mortar and mix the powder with the cooking oil making a thick paste. You might like to experiment here with your shoe polish and zinc cream to get variations of the colors you need. You will find that mixing the saffron with the white will quickly give you a rather powerful yellow.

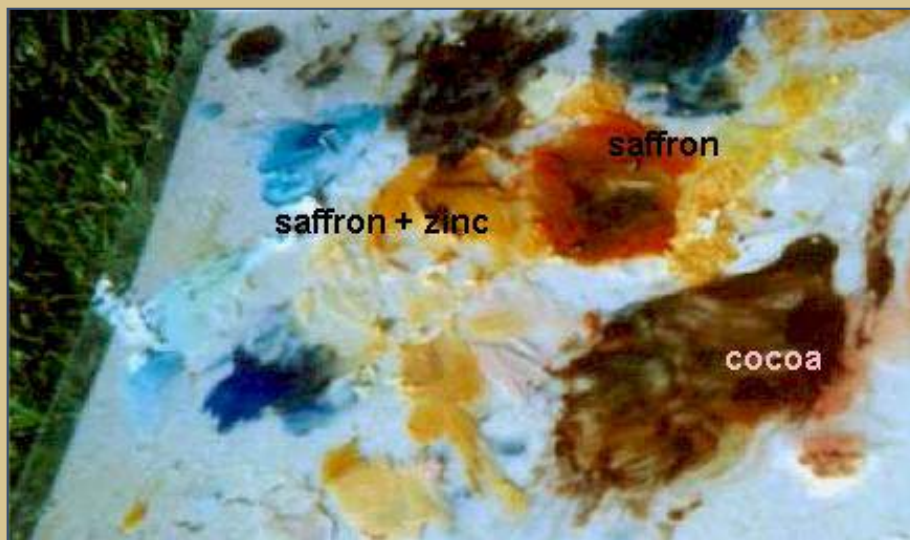

Next I selected a small silver bowl from the china cabinet (as my household is bereft to anything gold) and placed it where I might paint it ... in the meanwhile changing the silver to gold. Below you will observe my efforts. This whole demonstration should only take you an hour at most from making your paints to the finished article while the student can take as long as they like.



You will find the brush a little more difficult to handle as the pigments are much coarser than the commercial alternative. Still persevere and you might manage to amaze your friends if not your own household. After the painting dries you might find it becoming a little dull and lifeless. This is easily fixed with the application of some ordinary furniture polish or wax ... as has been done with oil paintings for centuries!

The palette

When I started painting my palette was - red (light red), yellow (yellow ochre), blue (cobalt) and white. Next I needed some bulk earth colors and purchased burnt and raw sienna and similar umbers. Later I added some cadmium reds and yellows, a crimson, cerulean and ultramarine blue. Finally I purchased some transparent colors like alizarin, Italian pink and thalo blue. I stupidly have many colors I never use.

Surface preparation

I will usually paint on anything that will hold paint but it must be dry, flat, rigid and have a little tooth (roughness). Canvas will also do but it must be laid flat or glued on a board later, otherwise cracking will occur. I like to underpaint the surface with a couple of coats of gesso. I usually use a flat, thick, water based white paint with whiting or some other compatible filler to add body. If it is too thin I will sometimes add PVA glue to bind. If I intend to paint with glazes in the smooth finish traditional manner I will lightly sandpaper the surface. Make sure the surface is completely dry before using oil paints (two or three days).

Underpainting

Called the 'imprimatura' or base coat. Use the cheaper opaque ground colors, umbers ochres and siennas are ideal, and apply thinly with turpentine.

Glazing

Glazes allow light to penetrate the layers and enhance color. They also permit the artist to construct the painting in stages. I use a glaze 'medium' (the liquid to add to the paint) of oil (stand/linseed or the like) varnish (resin/alkyd) and sometimes a little white spirit (turpentine). Modern alkyd lacquers dry rather quickly and may be retarded with more oil or speeded up with the white spirit.

Student Activity: Make a list of other common products you think might be oil based and therefore compatible with oil. Also nominate those common oil based products that are slow drying and those that dry quickly. The student should also place some small pools of various oily substances on a sheet of glass

outside and over a number of days observe the different drying times.

[GO TOPAINTING WITH OILS
CONTINUED](#)



[... or lesson menu](#)

6-7 BRUSHES AND KNIVES AND WET IN WET

Here is a simple little (12"x 14") painting that anyone can do if they have a favourite figure they can plonk on a beach somewhere. I will show you how it is done then you will be able to see what happens when you paint thin over thick.

1. You will note a pinkish underpainting peeking through the waves. This is because I pre-painted the canvas with a mixture of light red and alizarin red with a little white to lift it up. At the time I painted this it was my usual background for seaside studies and I would prepare many such backgrounds all at once. When it was dry I went to step 2.



2. I squeezed out some Cobalt blue/flake white on the top half of the canvas and some yellow ochre on the bottom and using the flat of the pallet knife I sawed the paint back and forward across the canvas. Here and there I added more dollops of white to lighten them but just kept sawing back and forth with the knife. The secret is to blend, blend and when you think you have blended enough ... blend some more.

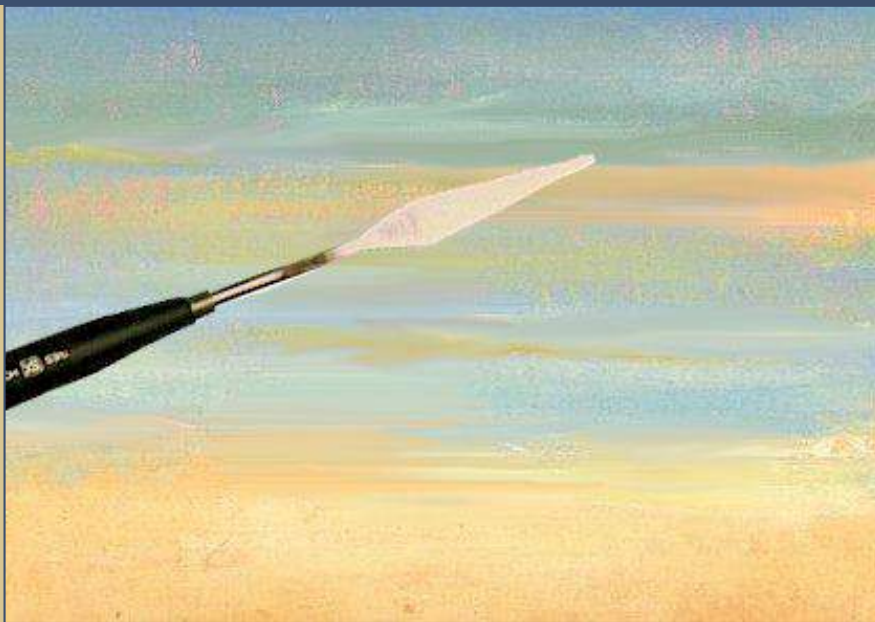

Obviously in some places where I mixed them a lot I made the green you can see, in other places the yellow dominated. I did this fairly haphazardly only lightening the effect towards the center of the painting. Where it gets thin the background comes through and gives us a beautiful mauve tint.

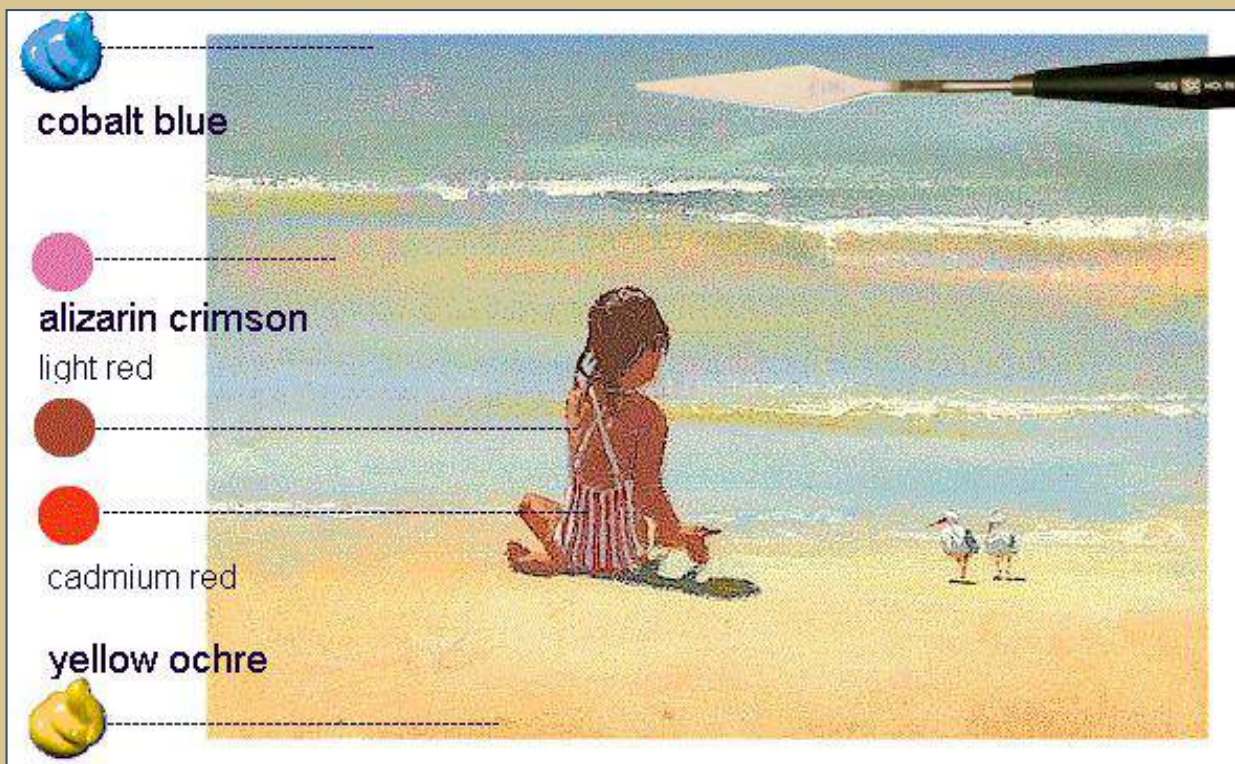

3. At this stage everything was fairly bland but I could begin to see shallow water and deeper water, sandbanks and dry sand, and a shore line. I just needed to define them. Up till now the paint was fairly thick in places and the only painting implement I had used was a knife. Next I loaded up the edge of the knife with white/tint of yellow ochre and dragged it across the canvas tilting it slightly and letting the white be dragged off to form the waves. (See below)

Note: I placed the waves just above the sandbanks and shallow water. Why? Because waves are formed as deep water meets shallow water. Where the sand meets the water it gets a little darker. Observing things like that is what painting is all about. I have probably spent a little too much time observing little things like that instead of



3. For some strange reason I sustained an interruption at this stage of this painting and it was a few days before I returned to it and plonked in the little girl and the seagulls. For this I used a brush and the darker colors you see. So what happened when the paint began to dry? (Below) Well the thin brushed on darks of the girl dried faster than the thicker lights of the background paint. The cracks thus formed allowed the whiter underpainting of the background to show through.

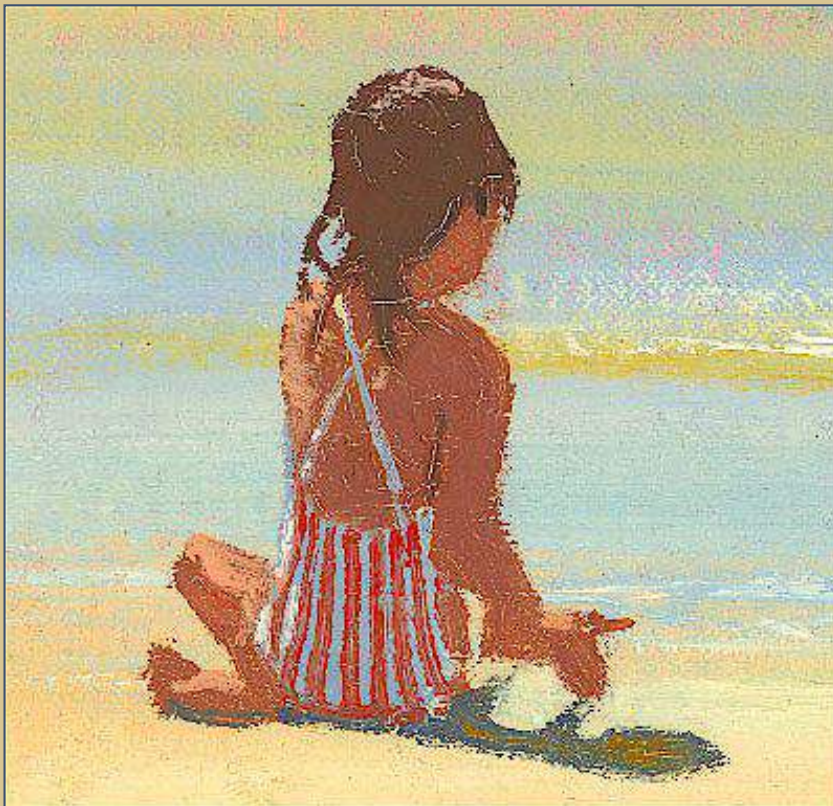

A few artistic points: Note how I painted a cool shadow but warmed up its center to give it a little vibrancy. You can do this with larger shadows. Also the costume colors and stripes I added purely for effect. The cadmium red needed to offset the greens in the water and the cool and warm whites for sparkle.

I have kept this picture to remind me of my stupidity in ignoring a basic principle. It also reminds me of the days I painted many similar paintings using this particular technique. Strangely enough they were quite popular in the colder climes.

STUDENT ACTIVITY: Copy the painting above replacing the figure with one of your choice if you like. Allow 40min.

[GO TO ...LIKE A SCUMBLE](#)



[Lesson list](#)

6-8 LIKELY TO SCUMBLE

As the judge remarked about my life. 'Its like paint ... parts are opaque, parts transparent, and parts somewhere in between, according to how much light is able to pass through the tiny particles of your credibility.'

But he was right about the paint. It can be opaque, transparent, and somewhere in between, according to how much light is able to pass through the tiny particles of pigment. Transparent pigments are like tiny colored crystals, whereas opaque pigments are like little colored (or white) rocks through which light does not pass. Example... Broken china or coal.(opaque) rubies, crushed colored glass.(transparent) Opaque paint reflects light directly from the surface; transparent paint allows light to penetrate beneath the surface,

Opaque paints (siennas, umbers, whites, ochres, and most earth colors generally) give a more convincing illusion of distance, especially when juxtaposed with a foreground which includes transparent passages for the darker darks.



The student might think that in this painting (ABOVE) I used transparent paint for the sky and opaque paint for the foreground... the sea. The reverse is the case. I built up many passages of transparent glazes to create the depth of the foreground waves. The sky is done in a few earth color **scumbles** (great word - sounds like something left after a very high tide or an epithet used to describe the neighbour's children) anyway the 'scumbles' created the milky distance look I desired in the sky. With this understanding, it becomes apparent that transparent paint allows for the deepest darks, because the light does not bounce off the surface, but penetrates deeper before being reflected out to our eyes.

A **scumble** is a thin application of a paint whose basic nature is to be opaque but which is rendered

semiopaque by the physical thinness of the application (scumble) or by the addition of a transparent medium. Its thinness allows the background paint to contribute to the painting. The optical effect of transparent paints or glazes is to retain clarity. The optical effect of opaque paints or glazes is to lose clarity. Scumbling is the method of applying thin layers of opaque paint.

How is it done? In the example right I had all but finished the painting but I wanted to put in some beams of sunlight. I used a dry bristle brush with very little paint and dragged it across a surface that was itself dry. The idea is not to mix (wet in wet) with the underlying paint but to separate the particles of pigment as if they were floating in the sky. This is scumbling.



White, thinned with a little medium is painted over a grey of mid-value to create the pallid blue unhealthy look I wanted in the woman's body here (see below).

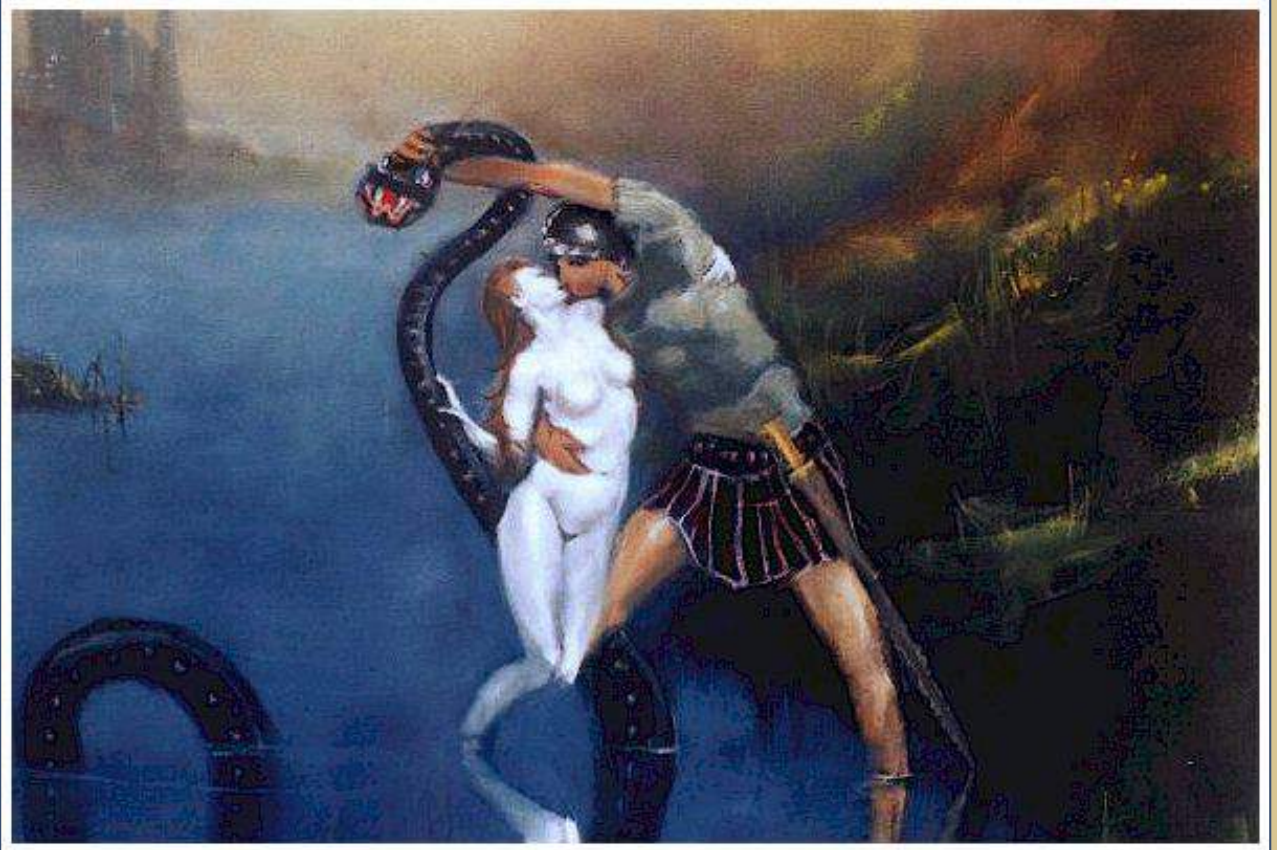

So the uses of scumbling are: To indicate atmospheric haze.
To give an illusion of greater textural softness in fabric.
To create the soft complexions of young women or children in portraiture.

For the the gauze cuffs and



shirtfront in this portrait I used extra thin glazes of opaque white over darker passages underneath - until I got the value I wanted. I used a bristle brush as I wanted a cotton gauze; if I desired a silk then I would have most likely finished with a sable.

The effect on the illusion of atmospheric perspective (below). Transparent passages exhibit greater clarity, an optical sensation peculiar to nearby planes where the least amount of atmosphere is present between our eyes and the plane in question. More distant planes are viewed through more atmosphere, the density of which alters the colors and values to a greater extent the greater the distance involved, reducing clarity.



Example the boat we used in our lesson on aerial perspective.

Here we could use either of three methods to apply the opaque over-paint. We could charge up a large brush and work from the horizon outwards, the mixture thinning as we neared the top or bottom. Alternatively we could just apply it in thin controlled layers waiting for the underneath one to completely dry, trap it with a glaze and then apply the next scumble etc. The third method involves mixing the paint with a fast drying medium that would thin out the pigment particles and apply successive coats.



[GO TO ... Inspiration](#)

.....or back to main [lesson list](#)

6-9 INSPIRATION OR HOW TO GET STARTED

Are you in and artistic Slump?

There are two problems here depending on whether you earn you living as an artist or you do it for enjoyment or other purposes. In the first instance hunger and finding shelter are great motivational tools. In the second you need to be obsessional, like knowing you hid a bottle of Jack Daniels around the house but can't remember exactly where ... and it's 3am ... if only you knew where to start to look?

I suffer both so I find I must plan ahead;

1. Always carry a pair of scissors and be prepared to mutilate any newspaper, magazine or publication that comes within cutting range, and if none do, you must actively give yourself time to seek them out (10 min per day minimum). Be a serial cutter and cut out anything that startles, frightens, causes you to pause, gives you a tightness in the loins or a warm wet feeling, sinks or raises your spirits or any other strong response. It could well be a line or a drawing a pattern or merely a color scheme. Caution ... don't be selective in what you look at- and try not to be distracted by reading any of the articles. Many excellent artists have some difficulty with reading anyway so that is rarely a big professional problem.
2. Put all these cut-outs in a folder.
3. When the folder holds 20 or 30 start a new one. Don't be distracted by trying to catalogue anything ... if you do, then you are probably a better accountant than an artist.
4. Try and forget about the pictures you have kept - but every now and then, as you relax at the bar, open a folder and look again. Not only will this make you incredibly popular it will enhance you artistic reputation.

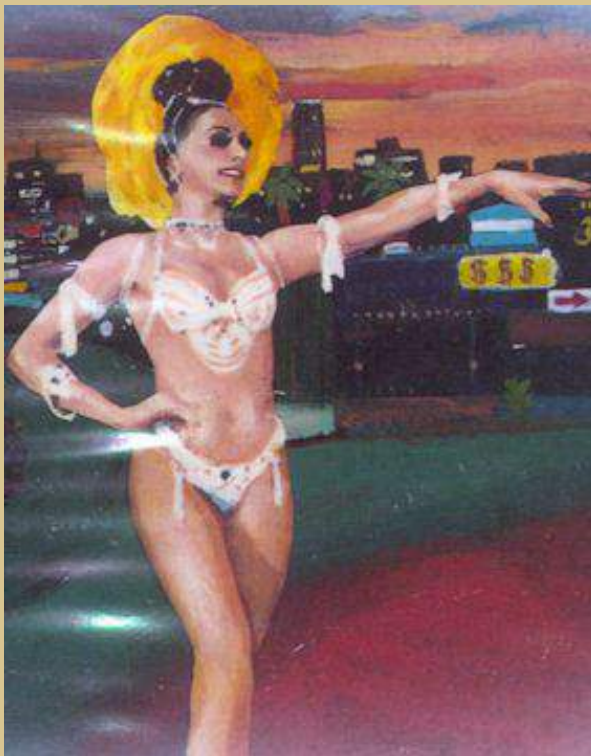

Gradually certain pictures will begin to echo in your mind. They will haunt your existence like bad cholesterol counts and you will know you must do something about them.

Then, your artistic slump will vanish, just in time for your real torment to begin.

Now it becomes what, how, which combination, what is the essence of the feeling and how do I paint (describe) it, how do I start? I had a folder here with great color schemes somewhere ... now which one was that....? How can I encapsulate the feeling, yet be subtle and convincing? What forms/ lines/textures/ patterns/color/ can I apply?

But, just think; when it is all over - and if it all works out brilliantly, you can wildly celebrate, wake up hungover and start all over again.

Now where did I put that red folder with the picture of Englishman on safari in the pith helmet, the Las Vegas showgirl and that picture of the Florida swamp ... and the tree monkey ... actually this is the picture I am painting at the moment.



I reversed the explorer ...

My show girl needed a new face another headress and longer legs



OK, so now I have combined all the elements including a few others hidden in various places

Plus a monkey and an duck ... when you are on a roll don't even hesitate!



[Press for full view.](#)

Now for the fun part ... a name! (but I always had something in mind, you see, for one of my favourite paintings was Giorgione's 'The Tempest' - he died and neglected to name it, and for 400 years art historians

have speculated as to the relationship between the two principal players!)

I toyed with 'Dr Livingstone decides to stay put and continue his African studies' or 'A sporting woman encounters a sporting man and looks away '... but then, like Giorgione, I thought it best not to be too deep.

STUDENT ACTIVITY: Make up and label three folders using your own headings then spend some time trying to fill them.



[GO TO ...Painting glow and light](#)

[... or menu](#)

6-10 PAINTING GLOW AND LIGHT

Glow is essentially a factor of **value** rather than color. How is this achieved? Paint a black canvas and let it dry. On your finger place a little white and with small circular smudging motion apply it somewhere to the canvas. It should now look like a milky smudge. Next take a pinpoint of paint on the end of your finger and touch it once in the middle of the smudge. The result is the essence of glow, total value differential as well as the milky area being a transmission area that will discomfort the eye sufficiently to avoid looking to the point of the light. That is the why we don't want to look directly at the sun. It is discomforting. For great glow or luminosity you must set out to discomfort the eye, that is the secret. To do that the transition (the halo) is the key.

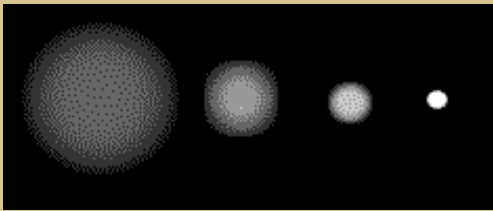

Fig 1. Here are a series of milky smudges

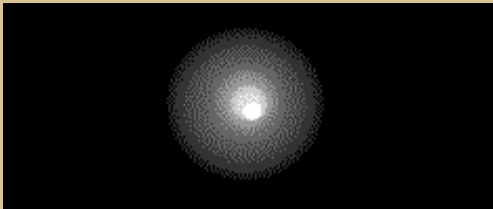

Fig 2. When we combine them we create our glow. Note how I have deliberately offset to white center in an effort to further disturb the eye.



Fig 3. Now I add a little color (any will do) some dark shapes between the spectator and the light and a halo. The halo and spike here are artificial - like the ones made by a camera lens reflection - it is not the same type of halo in the example below.



What discomforts the eye in painting is similar to what discomforts the ear in music. Music is a 'transition' experience in which time is a fixed element (beat). But the eye roves the painted surface in a manner hopefully controlled by the painter. The painter may cleverly force a discomfort in much the same manner a jazz musician will use a discordant note to lay emphasis on a beautiful (intoxicating) chord. What discomforts the eye can be many things, adjacent compliments, illogical form, concave mirrors or, what I mentioned above, unfocused edges. (Rothko used fuzzy rectangles to try and induce a extra translucent brilliance to his plain color areas - it is an old formula).

Why a discomfort? Because the eye naturally avoids looking at bright objects so to paint one the discomfort must be artificially induced. Painting suns and moons was usually referred to as a 'brave exercise' and avoided by all but the most accomplished landscape artists (Turner was accomplished while VanGough experimented). We can never paint surfaces as light as natural light so we must use device and illusion to convince the eye what it is seeing is a light as it should be... that is the fun of illusion!

Painting glow without showing the light source.

Here the principles are the same with the darks superimposed over the lights.



Detail of morning glow from another painting I did for the 'Bounty' series.

STUDENT ACTIVITY: Do the exercise proposed at the start of this lesson. Allow 20min.



[GO TO ... Pearly luminosity](#)

[Lesson Menu](#)

6-11 PEARLY LUMINOSITY

There are two factors to consider here if your aim is to achieve that luminous pearly look that dominate certain landscapes and seascapes. First we must create the 'pearly' look then give it presence and dominance within a framework (painting). It is the nature of that presence that will make it look luminous.

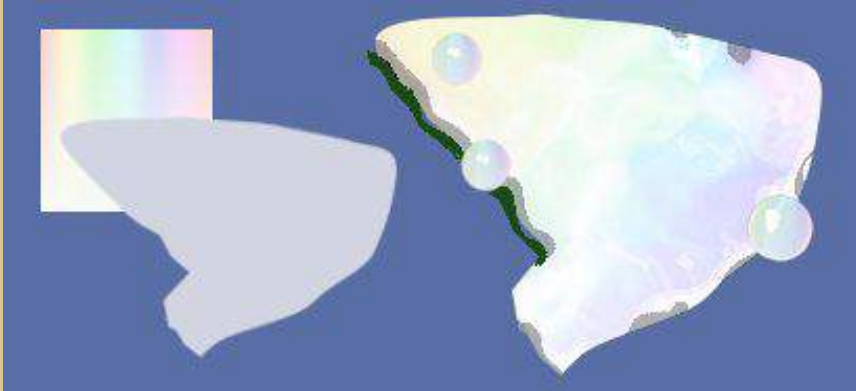

So what makes a mother of pearl shell look pearly? If you look closely it is merely a high value grey-white infused with red, blue and yellow or 'rainbow hues' of equal and similar **values** (above).

To apply this to a painting as I have done below to a sky by Gerome you will see what I mean by a pearly sky. Obviously its use here is unsatisfactory but the principle was one destined to be developed further by the impressionists.



The impressionists did this exercise using short brushstrokes laden with impasto paint which produced a shimmering effect from a distance. You will often notice when people view many impressionistic works in galleries their main concern is their viewing distance - they will usually move back and forth until comfortable. I find it good policy to wear stout shoes when visiting such galleries.



This painting by Monet is an excellent example of an artist employing equivalent value hues, dramatic contrasts, and uncomfortable undefined edges to achieve that shimmering light the impressionists so loved. It is important to differentiate the values in the foreground from the background. While the figure of the woman may seem to almost merge into the sky in fact she is considerably darker. Squint your eyes to better understand the contrast.

Luminosity is achieved by merely pushing the contrasts until the light dominates everything (below). Many artists spend their life trying to make their paintings glow ... mine probably glow most when I throw them on the fire...



... but I never quite give up! Anyway glow isn't everything.

STUDENT ACTIVITY: Collect at least 5 examples of pictures you consider to have 'that glowing quality' and add them to your folder you created in the lesson titled 'Inspiration'. Allow 40min.



[GO TO ... painting portraits](#)

.....or back to main [lesson list](#)

6-12 PRACTICAL PORTRAITURE

A PAGE OF THEORY BEFORE THE PRACTICE



Painting a portrait is quite a personal thing. It demands that the artist make some sort of estimation or judgement. The painting opposite a 'detail' from my portrait of John Morgan.

After deciding on the client (if not the sitter), why the work is commissioned and what scope is the artist allowed - you then ask yourself:

1. What is the essential character of the sitter?
2. How does the sitter view his or her own presence in the world?
3. Is there a pose that seems natural and expressive of the sitter's personality.
4. Are there clothes, uniform, jewellery, favourite pet, room or setting that may contribute?
5. If asked to draw a caricature of the subject what features would best define the sitter?
6. Does the client have any favourite photographs of the sitter (this can be an excellent clue as to expectations - and also to eliminate the unwanted!)?
7. Next you must discuss size. Life size? Head and shoulders with or without hands? Three-quarter or full length? Vertical, semi-reclining or reclining?

After answering all these questions and getting some clear idea into your mind I usually ask if there is any role the sitter might like to play? What historic figure does he or she admire the most? The prospect of painting a man in a plain suit and tie or a woman in a business suit appalls me. Where is the joy in that? Portraiture can have elements of narrative, tools of trade, costume etc. Anything is possible. Painting a portrait of a carpenter (workshop, tools, apron), airline pilot (plane, sky, uniform) or architect (building, drawing board, blueprints) is obvious, but think of the possibilities for an insurance salesman, banker, used car dealer or school teacher. There lies the greater challenge - and the greater rewards. This is where portraiture can, and should, and does transcend photography. The sitter must also be encouraged to imagine ... and believe.

History teaches us a masterpiece makes the sitter famous. We refer to the Mona Lisa, Mrs Siddons or the bust of Madame Houdon often before we nominate the artist. Who were these people? Who was the Mona Lisa and what was her life? Make this point to your sitter or client as it is to future generations that the work will be presented, and it is to them the spirit and life and history of the sitter must be addressed.

Practical considerations:



Physical likeness - for me this is probably the most enjoyable - if you follow some simple rules and ask yourself and others the questions the cartoonist asks himself every day. Silently ask yourself (in the presence of the sitter) what are the most distinguishing characteristics. Then ask yourself the same question later in with the sitter absent. Try and remember some aspect of the person like thick eyebrows, wavy hair, big ears etc.. Also try and remember a mannerism like, a pose, smile or use of hands; finally return to the sitter and experiment with some sketches. If nothing happens don't despair just keep trying and make some more simple sketches to help you. If all this doesn't work start your painting regardless!

The eyes - I make it a point of detailing the eyes (above in the portrait of Fletcher Christian as a young man). The eyes are the gateway to the visual world both for the viewer and the sitter. They must be as fine and detailed as you can achieve (unless the sitter is shy and for some reason seems to avoid looking directly).

A few hints: widen the iris to give a more open and generous face. Add some flesh color to the whites and paint them as if they were pearls. They must appear round. Be subtle with the highlights. One eye is not the exact replica of the other. Make them a little different.

The hair - the hair usually separates the head from the background and should not be overworked. Only some small area showing some individual hair will suffice for an overall hairy effect.

The mouth - if the eyes are the visual gateway, the mouth could be said to be the emotional one - the enigmatic smile for instance. If the mouth does not obviously describe the sitters emotional disposition then the viewer is forced to look to the eyes. It is the trick of the Mona Lisa. Leonardo will not allow the viewers eye to settle. He keeps asking the question. Be careful with the little angles at the corners of the mouth - 45 degrees is the default.



The hands - adding the third element to the 'non-description' of the Mona Lisa are the hands - also in repose. No clue there either.



Note how, in creating substance, Leonardo does not define many edges - neither on the hands or the face.

The costume - sometimes I paint the costume before the hands, face and anything else. Then I save up my joy for later when detailing the folds, jewellery adornments etc. That part is relaxing and doesn't require the absolute concentration needed for flesh.

The background - here you can tell your story or make your narrative. For best practical results try and echo all the colors you have used for the flesh tones and costume in the background - just echoes in hue not value. Use value to make the narrative. See lesson on turning points.

A cautionary tale for the discerning student about two Dutch artists and what was fashion!

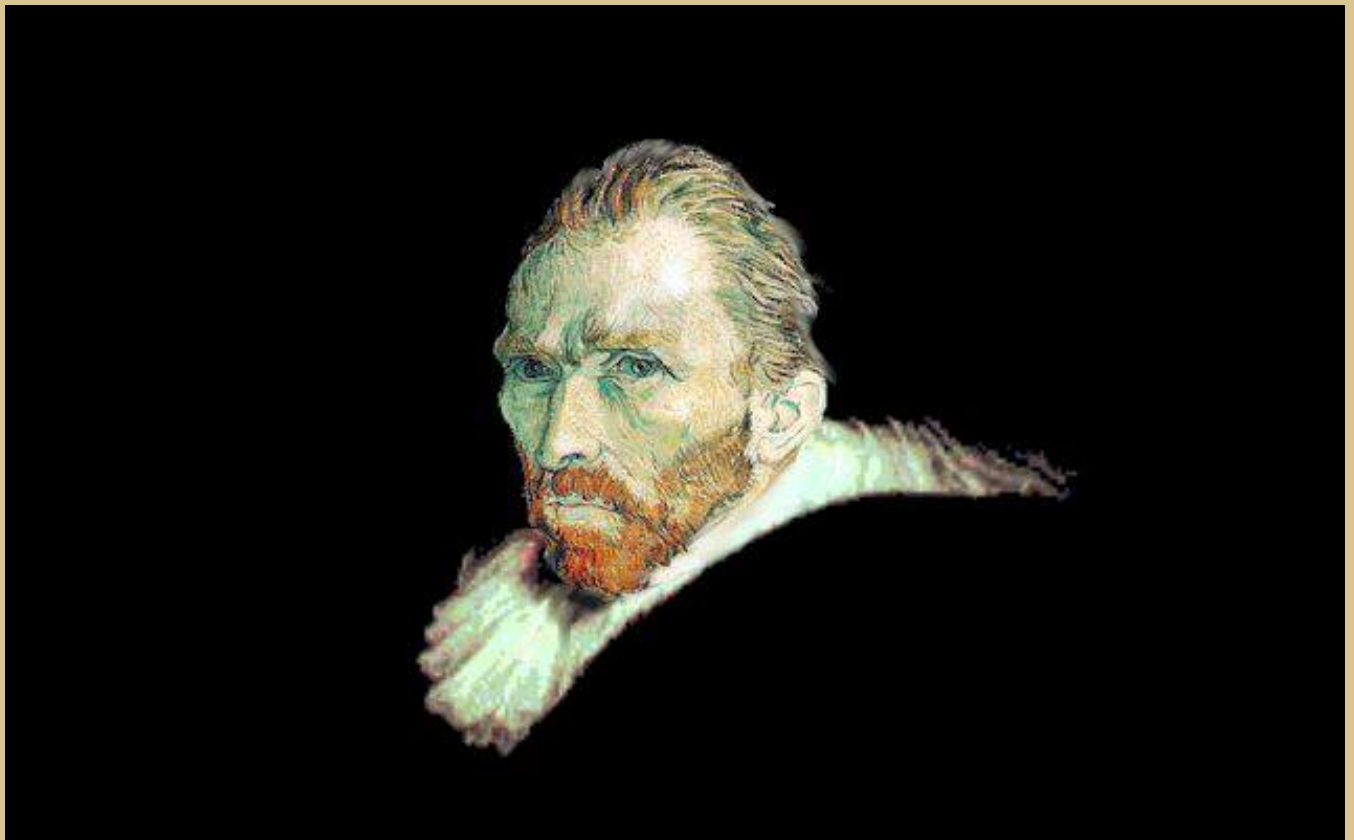

Two brilliant dutch artists born 300 years apart - one whose work was appreciated and the other shunned, one who lived in luxury and the courts of kings while the other lived in poverty, one whose art provided happiness

and security while the others' sent him mad. Who would say one was a better artist? Here I have combined two famous portraits to make the one. I wonder, had they changed places, how then would they have painted?

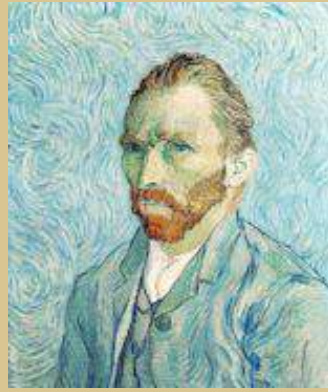

DRAWING WITH PAINT AND THE INSIDE OUT AND OUTSIDE IN TECHNIQUES

Inside out:

When painting a head and shoulders portrait I usually establish the rough proportions of the sitter by way of freehand line. I plan the future positions of the areas of maximum contrast and interest. Next I paint the eyes mouth and nose. In other words I work from inside the overall shapes. As I reach the boundaries I find they often suggest themselves. Some I might like to edge or define while others I let fade away. In general it is appropriate to paint inside out if the figure inhabits more than 50% of the canvas and outside in if it is less.

Outside in - in painting a 'genre' picture or mural (small figures in a large painting) I carefully draw the shapes and figures and fill them in rather like (cartooning) painting an ancient fresco. My drawing in such circumstances must establish a rhythm and place (reality).

STUDENT ACTIVITY: As I used the Mona Lisa to discuss the relationship between hands, mouth and eyes the student should find another example and do the same. Also find the derivation of the word 'cartoon'. Allow 40min.



[GO TO ... Painting hair](#)
[.....or back to main lesson](#)
[list](#)

7-1 PRACTICAL APPLICATION - PAINTING HAIR

Subject: Driving me hairy

John,

Was writing the other day about women's hair. This one (attached) is giving me problems trying to make realistic ... thanks.

My reply; You are not having trouble with hair, you are just overdoing its rendering. In a painting hair is not drawn, it is colored! First decide the general color (try and add a repeat of some deep facial coloring) then block it in as if it were just another part of the face. Add a few individual hairs (not too many) as they fall across the forehead, or as the light highlights them. Let the rest suggest themselves. The mind of a sentient needs only the minimum of clues as too many becomes boring. Any study of Rembrant (in particular his self-portrait 1629) will sufficiently demonstrate the proper balance.

The facial moulding in the picture you sent me is excellent!

Block in the hair as if it were part of the face - not hair! In general try and create a dark side and a light side of the face with a definite turning point (see lesson on analysis - Vemeer), and don't be afraid to alter things to create a feeling in the finished product.

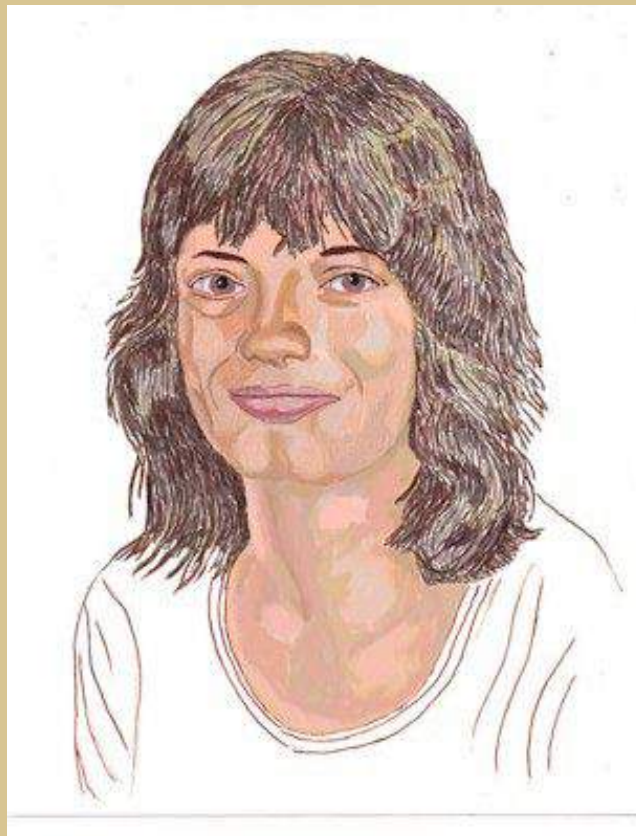

This problem goes to the heart of painting and is better discussed with reference to the lesson called 'The Pearl'. We all know what hair feels like, its texture, its color, its breaking strain, and its usefulness in keeping the sun off our head. We can love it or hate it. We spit it out with disgust when it invades our mouth and admire its lustre and beauty when it cascades the bare shoulders of a beautiful woman. All this has everything, and nothing, to do with painting hair. As I keep pointing out the concept of something must be married with its scientific reality before you can truly paint it.

Before we open our tool box of painting techniques and deal with the problem of the hair let us recall the pearl as it provides us with an example that explains the rules a painter uses to render convincing existence.

Are the pearls real?

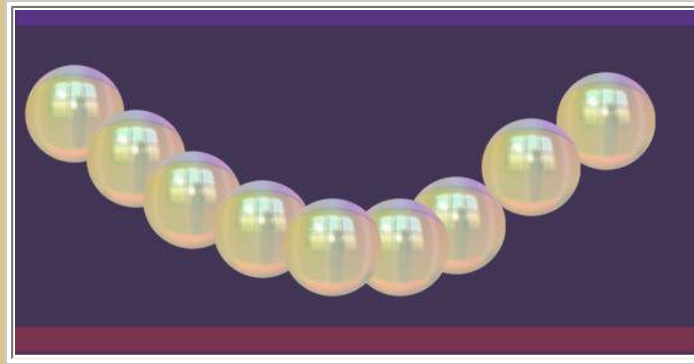

Things only exist as they relate to other things. Without light (place the pearl in a dark room) the pearls will cease to exist. The question is - without light does everything cease to exist? Does an ant need to be a mathematician to know it walks on six legs? If it can only count to five does it mean it must walk with a limp? For the painter the answer is yes. Like Einstein's famous equation light is everything to the artist, the great unifying constant.

In the lesson on the pearl, by beginning with the room, the window, the table, and the observer I first created an environment (for variation I selected objects with both curves and straight lines). It is always useful to create the environment first - either in the imagination or by physical positioning. Since it is semi-reflective the manner the pearl interacts with this environment becomes the 'reality' of the pearl. The painter lives his or her life by investigating relationships between objects under the influence of light. The painter's job is the discovery of the general rules and their employment in creating an imagined reality - that is the joy for the boundaries are endless. But the mortal truth you ask? Who wants the truth? Let us sweep that off the table and crush it like a bug! Dangerous stuff eh? No wonder artists sometimes lose their grip in reality!

Mmm ... so to paint the hair we must create its environment?

There are really only four elements in this picture. The face, hair, background and the light. Unfortunately the face is front lit which restricts any opportunity for secondary light effects or a nicely modulated turning point. First I will slightly smooth the facial contours as they will otherwise compete too much with the hair and background.



Next I create a background echoing all the colors in the face and the darks in the hair. Now you can see the problem. As soon as the background was applied (Fig 4) the hair, although nicely rendered, becomes a foreign object ... and excessively light.



It is not major problem however.

Let us separate the hair and apply a screen tint of a warm dark. Say value 2 at 50% for the more mechanically minded. With paint I would simply use a alizarin - raw umber glaze. Note how the texture is not lost. Saves work later. Next is the favourite part - soften the edges and lose some of the texture.



Explanation: the human mind does not like to be overloaded with too much detail, particularly in painting. It revels in its ability to complete the picture without help, and it must be allowed the (hazy bits) to do this. The degree you allow this says something about your estimation of your proposed audience. My rule is to always assume they are smarter than you, in other words leave plenty of for the imagination.

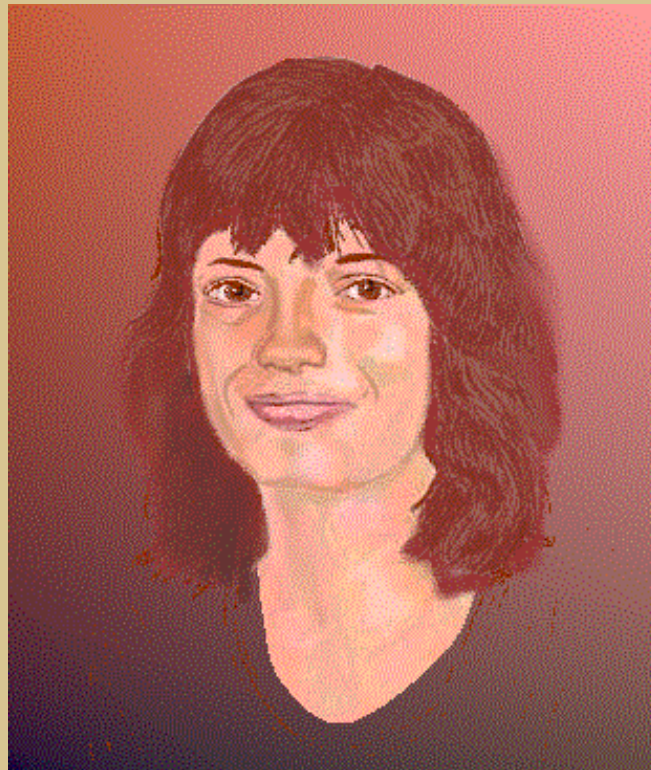

Fade in fade out...

STUDENT ACTIVITY: Find two examples of paintings where detail is overdone and two more where it is insufficient - in your opinion! Allow 40min.



[GO TO ... skin colors](#)
[.....or back to main lesson](#)
[list](#)

7-2 SKIN COLORS OR FLESH TONES

I wrote this lesson in response to a number of letters - to quote but one;

'Some people have difficulty mixing what are called "skin colours." I have seen portraits where no flesh tones were used at all (somewhat like the dutch painter example in your lesson). How do you actually decide what values and hues you will use for a certain person's skin tones? Do you think "cool" and "warm" colours? Do you decide the hue based on the shadowed colours or the colours in the light, or perhaps you use some other method?'

My Reply; The meat of a cooked crab is a delicacy but the environment of the crab itself, and its food, are quite too revolting to contemplate ... which brings me to the skin color or flesh tones of the pale-skinned European and the pallet most suitable for their rendition.

My guide is this: 'find the nearest color matches to the bodily fluids, add the hues of arterial and congealed blood, and the blue of a good deep bruise, line them up carefully and you will have a pallet suitable for the finest of skins'.

Without being too specific yellow ochre, raw and burnt umber, light red, rose madder, cobalt blue and white seem to work well enough. Sometimes a transparent yellow and naples yellow can also be useful. Strangely, this pallet also seems sufficient for African and Asian skin colors.

Painting skin color, throughout history, has been more an exercise in fashion rather than anything else. Today the brown suntanned flesh is attractive to the northern races while the pallid sun-shy color seems desirable among darker skinned people. This may derive as much from envy or our fashion industry as from anything else. For sexual allure the rounded shapes that denote health and vitality are probably far more powerful than the hue - and if they come in pairs even more so.

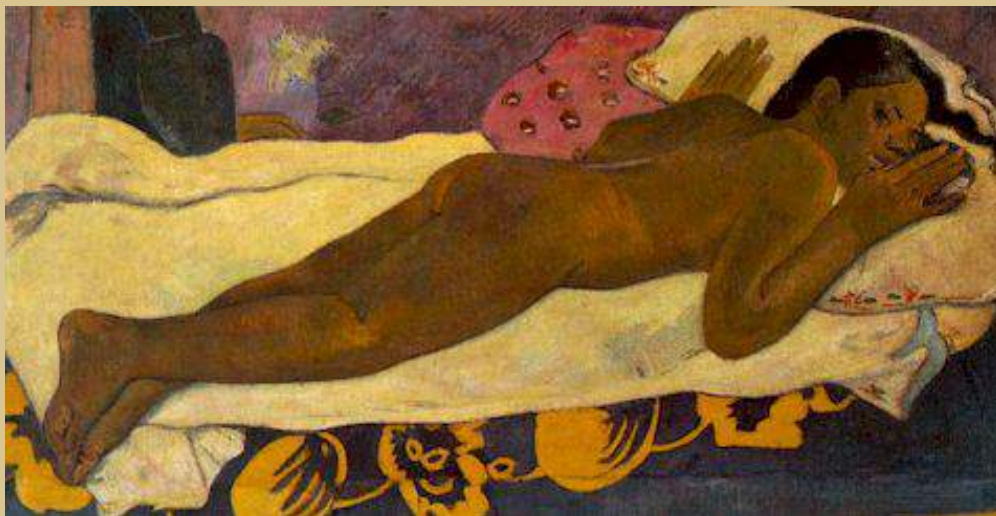

I learned a lot by trying to paint people of various races, and by discerning the similarities as well as the differences. The first thing I learned was that there is no such thing as a formula for skin color. Skin has texture and this can alter if it is wet or dry, male or female, old or young. Skin, glistening under an oily sweat - as say with a 'black' body-builder - could create a totally different look than the skin of a 'white' Scottish damsel reclining under an umbrella in a summer country garden. How do we discriminate? Texture is a product of edge definition and sharpness of the reflected light (see lesson on texture).

Whereas the body-builder may create forms like polished ebony the skin on the damsel may well be bone

colored - but we know they both have the same flesh; the same muscle and tissue structure underneath!

We often use warm and cool tones when painting flesh. The artist's general rule is warm light - cool shadows and cool light - warm shadows. This is an artificial rule often used by professionals to give vibrancy to a painting. Note the cool bluish greys in the facial shadows below.



Goya

OK, let's get specific for the anglo-saxon or white european. Forgetting the light source rose madder was the color the masters used for the cheeks of their feminine subjects. Yellow ochre, the siennas and the umbers were the base and ultramarine was usually the blue. The rest is just modulated tone. These were all mostly all inexpensive pigments. Today rose madder is often replaced by a colorfast alternative. This same formula can be applied to the darker skinned - but with the absence of most of the red hues - a little blue added to the highlights will also assist.

Blood is red. Hold your hand before a powerful light and what do you see? You see a deep glowing cadmium red. A bruise is blue. It is the rupture of blood vessels that turn the captured un-oxygenated blood blue. Both effects are beneath the epidermis which in pale skin is more transparent in the European than in the African. Technically the red 'blush' of the cheeks or elsewhere is the red of oxygenated blood under a semi-transparent layer of skin (epidermis). Very rarely does the artist have an opportunity to use this effect. I did once. I painted a picture where the hand of the subject was directly in the way of the sun. I made the outline white, the secondary outline a bright red and quietly darkened the center (much like a sunset). It created a powerful effect and became the focal point of the painting. So much so I was enticed to forget about everything else. Dear oh dear! One for me and not the client. I must admit the client liked it also and kept it - and I agreed! Professional stupidity in many ways but at the time I needed the money.



The blue of the bruise should not be so powerful as to denote the bruise but rather the shadow shadow of flesh. The same blue you might use for the jaw of a close-shaved jaw. This is the warm and cold. With an alabaster skin tone the hint of the grey-blue is sufficient to make the shadow. See Boucher and other French artists of the 1700's.



Above is an example of my deliberate abandonment of any warm flesh tints. The addicted girl is raised from the mire As a student I was once given white, payne's grey, raw umber and burnt sienna and told to paint a cup and saucer on a white table cloth. Since then flesh colors became less of a problem. Anyone familiar with make-up (scumbling for artists) should have no problems.

STUDENT ACTIVITY: Television has come to make most people believe flesh color is more red/orange that it really is. Why is that? Explain in 200 words.



[GO TO ... painting John Morgan and Grandson](#)
[....or back to main lesson list](#)

6-12 PRACTICAL PORTRAITURE 4

THE PORTRAIT OF JOHN MORGAN AND GRANDSON



John Morgan and his wife Robyn own and operate a large earthmoving and road-making company. John has always been a 'hands on' manager and is often happiest working alongside his men and is attired accordingly. His grandson Sam takes after his Grandfather, whom he follows around whenever he can. He tries to do all those things his grandfather does and is a born mimic in this regard. So much so John bought Sam a battery and gear operated little four-wheeled vehicle of his own. The three-year-old Sam is remarkable in his ability to maneuver his little vehicle 'just like his grandfather'. Needless to say a firm bond exists between the two.

After assembling all my sketches, color notes and photographs of the subjects I set about thinking of how exactly I was going to fit both into the one painting. I finally decided on an arrangement that would combine them by their similar facial expressions that leave no doubt as to their closeness. They are posed to look out of the picture as if challenging the world to view them in their space as they would view the world.



You will note the huge difference in skin-tone between the weather-beaten and tanned John, and the milky fairness of Sam. His skin is very pale, his eyes blue and hair fair. Nevertheless I used the same palette for both.

I began the painting with an imprimatura of raw umber which I allowed to dry. I then drew in my figures using charcoal. Next I worked the deepest shadows with a thin mix of raw umber and cobalt blue with a little light red where I wanted a little temperature variation.

Working up with a slightly thicker mixture I started blocking-in the semi-tones. This is the stage that should take the longest and the painter taking great care to get all the values correct. Keep working them towards the light by adding a higher value color as well as introducing as many interesting tonal variations you can.

Now I can work and blend my shadow planes with a thicker mix of light red, Naples yellow and raw sienna being careful not to bring the highlights up too soon. As I am doing all this I will usually wipe excess paint from my brush on the canvas around the figures.

When I am satisfied with my shapes and planes I will begin to detail some of the features, mouth, eyes, nose and hair with a small brush and a 'long' easy flowing mixture of paint.

Now I will add the highlights to the face glasses and hair. John lost an eye in his 20's therefore the slight difference in the eyes.

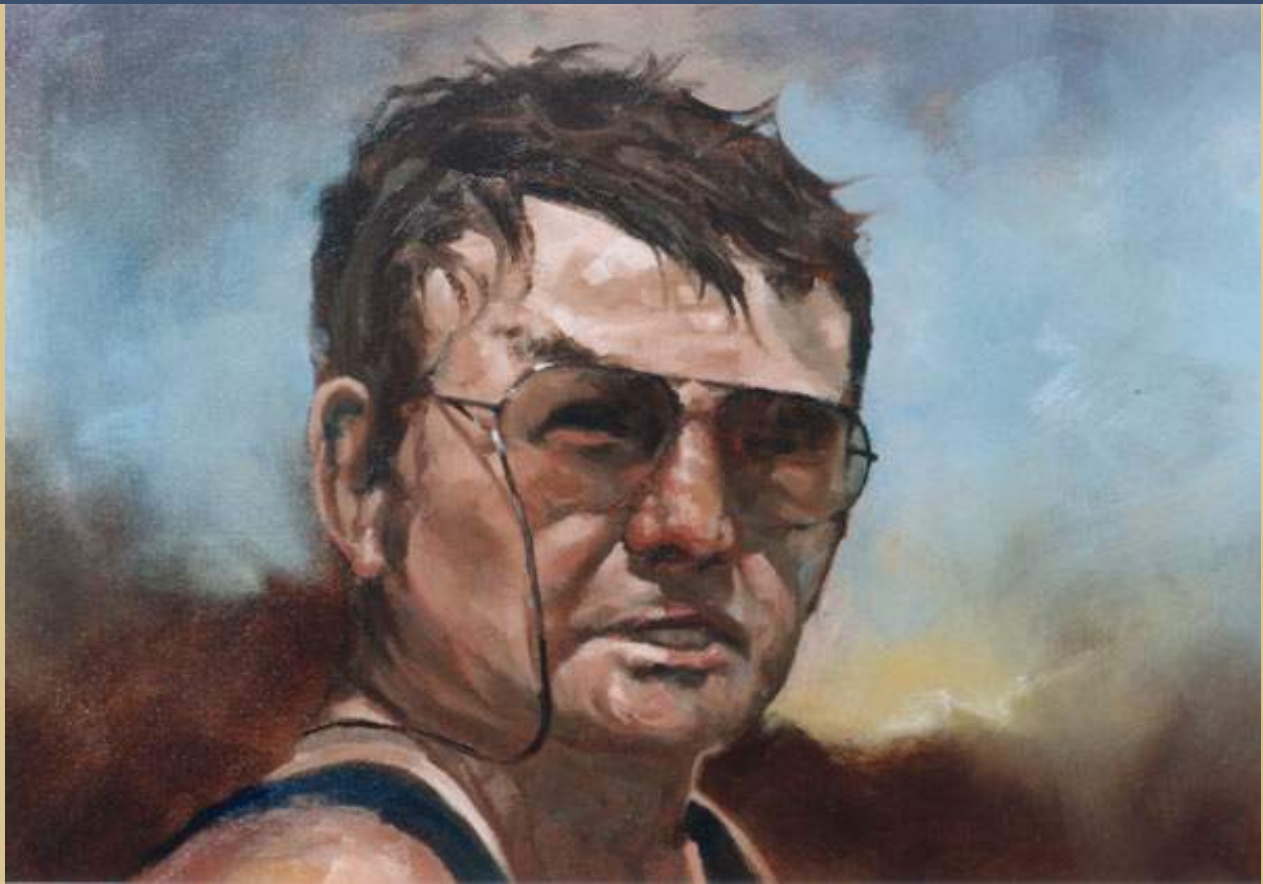

Finally I add the simplest of all backgrounds, an atmospheric mix of light and darks composed entirely of all the colors I have already used. This also generally cleans up my palette nicely.

STUDENT ACTIVITY: Print out a copy of the painting and nominate all the shifts in value by placing a number from 1 to 10 on the specific areas. Refer back to the lesson on colors if you are in doubt as to what is meant by color 'values'.



[GO TO ... Classical portraiture](#)
[....or back to main lesson list](#)

FIRST THE PEARL - A LESSON IN HOW TO LOOK AT THINGS

An apprentice painter might learn how to hold a brush, mix colors or how to use a palette knife, but it matters nothing if the same person does not learn how to 'look' at things, and to look with the eye of someone who wants to explain the world in terms of paint. After many years of learning to 'look' we come to understand the nature of things and how they relate to each other.

This first lesson is an entertaining introduction to give you some idea of what I mean by 'looking'. Don't be too worried if the world I now introduce seems alien at first, because as you progress with the lessons, you will begin to understand that the real joy of painting is not so much occupying your hands, as truly understanding the laws, the lights and shades, and the memories of all the things around you.

OK, I think I remember what a pearl looks like. Ah, its been so long between pearls. I will try to construct one from memory, first principles and logic.

To begin, let us imagine the largest pearl in the world sits on a red table in a room with a blue ceiling. I am the viewer and I view the perl from the front while behind me is a window. Outside it is a fine bright sunny day.

Now if the pearl was someone elses 'eye' we must imagine **what it would see!!**.



It would see me, basic and a little crude - but that dosen't matter at this stage?



The window in the same condition.



Together ...



Add a blue ceiling, some walls and a red table (this is roughly what the pearl would see if it could see). Next we squeeze it into a round shape (with a computer this is easy, in a painting you would work backward.) I am a little disappointed at this stage as it looks rather raw and nothing like a pearl. But, staring failure in the eye, we must proceed (forever faithful to our logic).



So lets us rid ourselves of the black edges. Then, since a pearl is not a perfect mirror, I will blur everything ...



Now we can add a little milky screen (I somehow remember pearls are a little milky, aren't they?)



Still too much saturated color and dark values - so maybe another yellowish screen (glaze) ...



OK ; Now let's cut it out and give it a hard edge ... as it is not made of fur! (later we will look at a lesson on how edge effects texture) ...



That's looks better. Now for the suggested table and ceiling

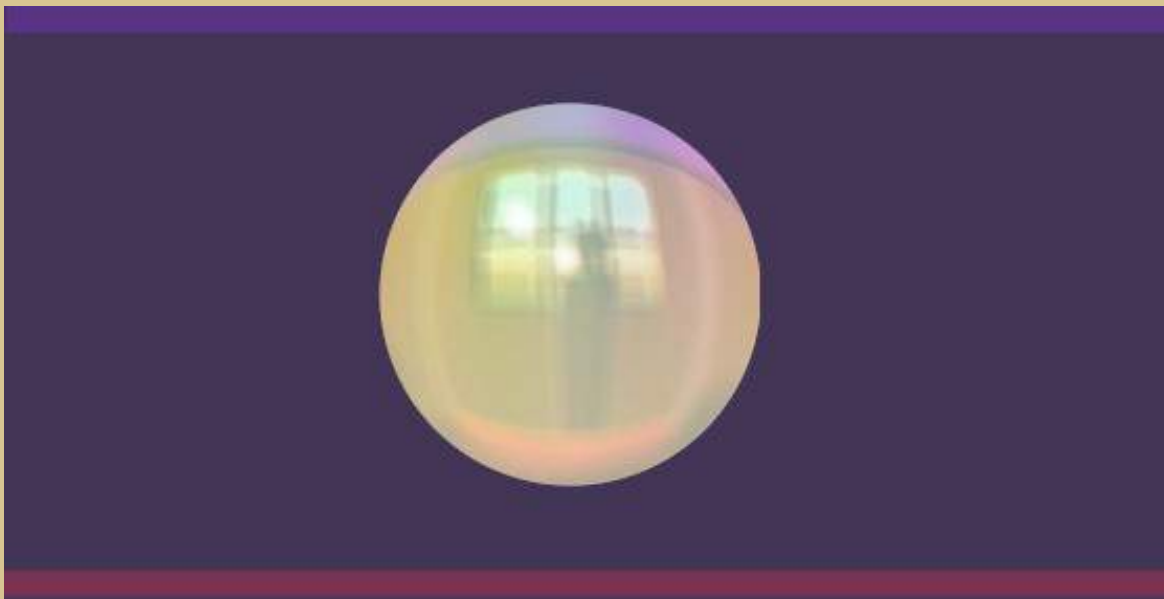

But can't I have a string, seeing I made it myself?

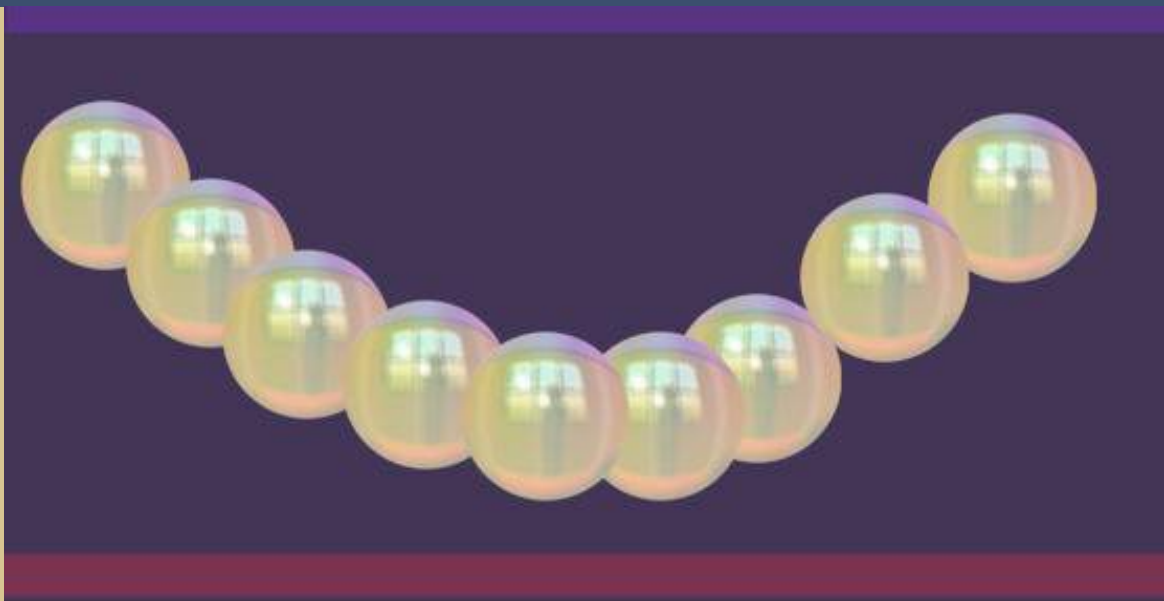

Why, I'm virtually rich! So why can't a pauper have a millionaire's imagination? I expect any artist can always be rich beyond the dreams of mere mortals, the difficulty becomes one of keeping reality in plain view.

PS. I am concerned you may think I am confusing computer graphics with oil painting. I am not as this is a lesson about 'looking'. In either case we must still learn the essence or nature of things before we can make them - using paint or computers. With our 'pearls,' as with the world, that is the starting point, and remember, everything exists in **relationship** to light and other things nearby. The rest is simple logic - either with a brush or computer. OK, lets look some more into the world of the painter.

STUDENT ACTIVITY: Draw and color your own string of pearls using oil pastels or crayons. Hint ... use a toned paper for background. Allow 40min.



[GO TO ... looking into a deeper, deeper world](#)
.....or back to [lesson list](#)