



SEAFDEC/AQD Institutional Repository (SAIR)

Title	Fish farming handbook.
Author(s)	SEAFDEC Institute of Aquaculture
Citation	Southeast Asian Fisheries Development Center. (1980). Fish farming handbook. Tigbauan, Iloilo, Philippines: SEAFDEC Aquaculture Department.
Issue Date	1980
URL	http://hdl.handle.net/10862/1490

This document is downloaded at: 2013-07-02 04:41:25 CST



Fish Farming

HANDBOOK

A handy reference for
farm broadcasters, information writers
extension workers, fishfarmers
teachers and students





SEAFDEC Institute of Aquaculture

Aquaculture Department, SEAFDEC
Tigbauan, Iloilo, Philippines, 5829

P.O. Box 256
Iloilo City, Philippines

Fish Farming

Handbook

1980

SEAFDEC INSTITUTE OF AQUACULTURE

Aquaculture Department, SEAFDEC

Tigbauan, Iloilo, Philippines P.O. Box 256 Iloilo City, Philippines

CONTENTS

FOREWORD	v
GENERAL INFORMATION	1
Pond site selection, design & construction	3
Pond management	13
Harvesting, processing & marketing	39
Pen & cage culture	52
Miscellaneous information	58
MILKFISH	66
Pond site selection, design & construction	68
Fry management	80
Pond management	86
Harvesting & utilization	102
Pen & cage culture	106
Miscellaneous information	110
PRAWN	114
The profitability of raising prawns	116
Pond site selection, design & construction	120
Fry management	132
Pond management	140
Feeding	152
Harvesting, processing & marketing	162
Hatchery & broodstock development	178
Freshwater farming	196

TILAPIA	200
Brackishwater farming	202
Freshwater farming	206
Miscellaneous information	218
MUSSELS & OYSTERS	220
CRABS, OTHER FISHES & AQUATIC PRODUCTS	258
INTEGRATED FARMING	270
ADDITIONAL INFORMATION	292
GLOSSARY	296

NOTE: A detailed table of contents is provided at the beginning of the major sections.

FOREWORD

This handbook is designed to be a source book for workers engaged in bringing knowledge and technology to fishfarmers. It can also serve as a handy reference for fishfarmers themselves.

The articles in this handbook represent 19 months, starting from October 1978, of searching, compilation, editing and cross-checking work by the staff of the Communications/Publications unit of the Institute of Aquaculture. Classified under 7 headings - general aquaculture information, milkfish, prawn, tilapia, molluscs, crabs and other species, and integrated farming - the articles emanate from various sources and contributions. Private aquaculturists, government technologists, researchers and scientific workers, scientists from other research centers and institutions, and the research and technology staff of the SEAFDEC Aquaculture Department themselves have in various forms and manner furnished the materials for the articles found in this handbook. The staff took the liberty of rewriting and reorganizing published or unpublished information with the sole view of making these available in practical and compact form.

The publication of this handbook is one of the initiatives from SIA to develop the fishfarm industry in partnership with the government, the research sector and the aquaculture industry itself.

The handbook will be updated and revised as new information and new findings and experiences occur. We welcome suggestions to improve and make this handbook more meaningful and useful.



JOSEPH C. MADAMBA
Director

GENERAL INFORMATION

POND SITE SELECTION, DESIGN & CONSTRUCTION	3
Make a thorough study before you build a commercial fishpond	3
How to determine what water level is good for fishponds	5
What makes a good nursery pond or semillahan	6
Structures that protect banks and ponds	6
Use low-cost materials to build ponds	7
Use water supply pipe instead of sluice gate	8
Acid sulfate soils — a big problem of fishpond owners	9
The basic differences between sugpo farming and bangos farming	10
POND MANAGEMENT	13
How are modern fish farms managed?	13
Understanding the pond ecosystem better	14
Some reminders for the new year	18
Do's and don'ts in fishfarming	19
Grading of fry or fingerling before stocking	20
Take care of your pond dikes	21
Fishpond operators should replant mangrove areas	22
Have your pond soil analyzed once a year	23
Ways to control fishpond soil acidity	23
Fishpond soils need conditioning	25
Lime is important in pond management	26
Can guano be used as pond fertilizer?	26
Organic fertilizers: how they improve fishpond yields	27
The value of hog manure as fishpond fertilizer	28
Fertilize your fishponds with both organic and inorganic fertilizers	29
Fertilize your fishponds with animal manures	30
Practical ways of destroying fishpond pests	31
Prevent predators from entering your pond	31

Use of organic pesticides urged by progressive fishfarmer	32
How to prevent pollution due to fish wastes	34
How to control oxygen depletion	34
How to identify fish diseases	35
Signs and symptoms of vibriosis in fish and prawns	37
HARVESTING, PROCESSING & MARKETING	39
How to keep fish longer in ice	39
How to prevent fish spoilage	40
Chilled fish offers more advantages than totally frozen fish	41
Making fish balls from trash fish	42
How Panay-Negros fishfarmers package and ship milkfish and shrimps	42
The proper way to pack fish for shipment	44
Some guides in preparing dried fish products	46
Fish marketing in Iloilo, Bacolod and Zamboanga needs some improvement	47
Fish marketing system in Central Luzon mostly benefits middlemen	48
PEN AND CAGE CULTURE	52
Criteria for selecting fish pen site	52
What ails the fish pen industry?	53
Cage culture in Thailand	54
A floating house with fish cages	55
How to eliminate fouling of netpens	56
For better water movement and aeration position your fish cages properly	57
MISCELLANEOUS INFORMATION	58
A bright future for pond culture fishery	58
Conversion guides for fishpond raisers	59
Most Panay fishfarmers follow polyculture	61
Study reveals pond management practices of Panay farmers	62
Instant fishpond in creek yields more than fishponds in Capiz	63
Marine borers — how to protect boats and other marine construction against them	64

Pond site selection, design & construction

MAKE A THOROUGH STUDY BEFORE YOU BUILD A COMMERCIAL FISHPOND

Pay close attention to the layout, design and construction of your ponds. A well-built fishpond means lower costs and better production, says Mr. Leonardo Denila of the Western Visayas Federation of Fish Producers, Incorporated.

Artificially built ponds are subject to natural forces especially waves and flood waters. But with proper design, layout and construction, the harmful effects of flood and waves can be prevented and minimized, Denila said.

Here are the preliminary steps in constructing fishponds.

Observe and note down the tide levels, especially during the months of June, July, November, and December when tides are influenced by heavy rains. The highest and lowest tide levels will affect the elevation of ponds. Also, find out the levels of flood waters from the people in the locality. This information is important in determining the height of your main dike.

Familiarize yourself with the wet and dry seasons and the cropping schedules in the locality as these will help you properly manage the fishponds. For repair of gates and dikes, for stocking and harvesting, you will need extra labor. Schedule them when you can get enough local labor - usually before and after rice planting and harvesting and after the milling season for sugar. Know the local customs and traditions because these will greatly affect labor costs.

Construction costs will also be affected by the kind of plants that had been growing or are growing in your fishpond site and by the type of soil. Sandy clay or sandy loam is best for dike construction because it is hard and does not crack when dry. Don't use soil formed from decayed *bakawan* roots because it easily burns when dry. Also avoid using a completely sandy soil because it is the most expensive to transport. Besides, *lablab* grows poorly with sandy soil.

Meanwhile, your main source of water supply should be noted. Your pond water may come from the sea, rivers or creeks but the presence of a fresh water source is an advantage because it would enable you to have control over the salinity of pond water. Control of salinity is very important for the growth of fish and fish food. See to it that the water is not polluted by wastes coming from such establishments as sugar centrals, distilleries, sawmills, and other factories.

For the layout, design and construction of fishponds, consult with knowledgeable and experienced fish farmers and with the technologists of the Bureau of Fisheries. They can give you useful guidelines so that you won't have to spend so much in building and, afterwards, in making repairs.

Fish farming is not entirely the application of knowledge on how to make the fish survive and grow. Much of the success in the commercial growing of fish lies in the proper application of engineering principles.

SOURCE: "Layout, Design, Construction and Levelling of Fishponds", Leonardo Denila, Readings on Aquaculture Practices, SEAFDEC Aquaculture Department, May, 1977.

HOW TO DETERMINE WHAT WATER LEVEL IS GOOD FOR FISHPONDS

Good water management depends on the water elevation of the fishpond site. Water elevation can be determined by making actual measurements of the height of the water in the site at different stages of the tide and comparing these measurements with the expected heights from the predictions in the tide table. You can obtain a copy of the tide table from the Bureau of Coast and Geodetic Survey, Baranca St., Manila. For example, if the actual height of the water in the site is four feet when the prediction listed in the tide table is four feet, then the elevation in said area is 0. If the area has six feet of water when the prediction is four feet then such an area has an elevation of two feet. On the other hand, if the area has one foot deep of water when the expected tide level is four feet, that area is three feet above 0 datum.

The suitability of an estuarine area for fishpond project based on the water supply can be summarized as follows:

1. Sites with elevation from 0 to 3.5 feet make the ideal elevation for fishponds because they can be watered or drained even under ordinary tidal conditions. Those at elevation from 1 to 4.5 feet are also suitable for fishpond purposes.

2. Areas at elevation 4.5 to 7 feet can be suitable only if they are excavated while areas between -2 feet to -1 foot are suitable only if filled.

3. Areas above 7 feet are unsuitable because they are not watered. Areas below -2 feet are also unsuitable because they are always under water and it would be too expensive to fill them up unless they get elevated by natural forces.

SOURCE: The Philippines Recommends for Bangos 1976.

WHAT MAKES A GOOD NURSERY POND OR SEMILLAHAN

The nursery pond should be prepared at least one month before stocking. This is especially true if fry is to be stocked, after acclimation, direct to the nursery pond.

A good nursery pond should have the following features:

1. It must have a low and level bottom to permit water to flow from the sea or river even at low tide.
2. Its bottom soil should have an organic matter content of at least 16 percent; soil pH must be from 7 to 8; and there must be a good layer of clay in the subsoil to retain water.
3. The pond should have two water gates for easy entry and exit of water from the supply canal to the drainage canal.
4. The pond bottom should be inclined towards one water gate for easier collection and capture of young fish.
5. The pond should have a peripheral canal of at least 15 centimeters deep for fast draining of water while the central portion is being prepared. This canal also serves to catch soil, dirt and other matter falling off the dikes to prevent pollution of the feeding zone.
6. The nursery should have strong perimeter dikes to avoid seepage due to holes caused by crabs or eels and to avoid overflows during heavy rains and typhoons.

SOURCE: Modern Aquaculture for the Philippines by Ceferino de los Santos, Jr., 1978.

STRUCTURES THAT PROTECT BANKS AND PONDS

Waves, water current and wind action can gradually erode dikes and embankments you may not even notice the effect until it is too late. To be sure, build protective structures such as breakers, jetties and barriers.

SEAFDEC engineer Rodolfo Tolosa gives the following means of protecting your pond from strong waves, water current and wind action:

1. *Breakwaters* could be either rubble-mound, or wooden-type, or a buffer zone of mangrove trees. A rubble-mound is made of stones or boulders while a wooden-type one is formed by driving two lines of mangrove piles and filling the space between these piles with branches of trees. A mangrove buffer zone can be established by planting mangrove seedlings in places that have to be protected.

2. Jetties arranged in a zigzag pattern prevent scouring at river bends. Coconut trunks or bamboos may be used. The space between the jetty and the river bank must be filled with twigs and branches. Jetties serve to cushion the impact of onrushing waters on the shore especially at river bends.

3. *Embankment protectives*. Internal waves eat away at embankments unless you set up barriers. Some of these barriers may be made of bamboo wave breakers, worn out rubber tires, and ripraps. A cheap and effective method is to grow creeping or close-growing grasses on embankments.

4. *Screened barriers*. Mouth of pond gates can be clogged by debris. To prevent this, set up a screen barrier before the gates. Bamboo or nylon screens installed at a distance before the mouth of the main gate will collect floating debris.

SOURCE: "Prawn pond engineering," R.T. Tolosa. Technical Consultation on Available Aquaculture Technology in the Philippines (proceedings), SEAFDEC Aquaculture Department, Feb 1979.

USE LOW-COST MATERIALS TO BUILD PONDS

Cheaper and locally available materials could be used in constructing ponds, especially nursery ponds. Although laborious to prepare, they will cost much lower and are just as durable as the ready-to-use but costly materials, according to Flor Apud of the SEAFDEC Leganes brackishwater research station.

For instance, PVC materials which are normally used for distribution line can be replaced with a canal system made of bricks and hollow blocks, Apud said.

Wooden pipes or bamboo poles can be used as inlet or outlet pipes instead of PVC materials. Other usable materials are coconut trunks and big bamboo poles.

USE WATER SUPPLY PIPE INSTEAD OF SLUICE GATE

For prawn nursery ponds, use water supply pipe instead of a sluice gate. This according to SEAFDEC researcher and nursery pond design expert Flor Apud.

Apud says that while a sluice gate is practical and efficient in grow-out ponds or in bigger ponds, its use is impractical in the smaller prawn nursery pond.

Firstly, it is expensive as it requires bigger and more materials. Secondly, its maintenance cost is rather high because you'd have to periodically change the flushboards and parts of sidings which rot easily. And thirdly, water seepage is strong in wooden sluice gates. This problem of water seepage can be easily controlled with the use of small pipes, says Apud.

For a small nursery pond, a wooden pipe or bamboo pole can easily supply and control water and yet it is cheaper and more practical, Apud says.

SOURCE: Design and Construction of a Prawn Nursery Pond by Flor Apud and Madid A. Sheik. In, Readings in Pond Culture and Management. SEAFDEC Aquaculture Department, May 1978.

ACID SULFATE SOILS – A BIG PROBLEM OF FISHPOND OWNERS

Many fishpond owners are getting very low or even zero productivity because their ponds have acid sulfate soils. What are acid sulfate soils?

These are soils that contain a good amount of the mineral called pyrite. Pyrite is iron disulfide in crystal form. A pond site may contain a good deal of pyrite although the acidity of the soil may not be immediately evident because, as long as pyrite is submerged in water, it undergoes very little change. However, upon draining the pond site and excavating the soil, the mineral pyrite comes in contact with air and combines with the oxygen (to undergo a process called oxidation) to form sulfuric acid. When pyrite-containing soil becomes very acidic it is called acid sulfate soil. Acid sulfate soils are not productive and may require a large amount of lime - as high as 20 to 100 tons per hectare -- to neutralize. Acidic soil has also a high phosphate-fixing capacity which means that phosphorous, an essential element for the growth of plants like algae, gets locked in the soil and is not made available to plants.

The acid also attacks other soil minerals to release such minerals as iron, aluminum and manganese in active forms. These minerals in active form limit the availability of other soil nutrients. Hence, you find in extremely acid sulfate soils not even algae growing.

You are advised to have the soil of a proposed fishpond site, especially the subsoil, analysed to find out if you have an acid sulfate or a potential acid sulfate soil. Go down to as deep as one to two meters to obtain your soil sample.

If your site is identified as having an acid or potential acid sulfate soil, decision has to be made as to whether you proceed with its development. Excavating the area to a depth that would take advantage of the tidal fluctuation must be weighed against the cost of excavation as well as the cost of conditioning the pond soil to neutralize the acidic condition. The cost of using a water pump must also be considered if you decide to have a shallow pond bottom. A shallow bottom could avoid getting down into the soil layer where pyrite is found.

Some of the suggested measures to neutralize acid sulfate soils include the following: (a) repeated drying and flushing of the pond soil with seawater; (b) applying burnt lime in sufficient quantities; (c) covering the excavated pond bottom with more suitable soil; (d) good water management which controls the water table in the pond to limit the oxidation of pyrite and acid formation; (e) controlling the erosion of dike soils by planting grasses or shrubs tolerant to acid like African grass and a local *Cynodon* species.

SOURCE: Modern Aquaculture for the Philippines by Ceferino de los Santos, Jr., 1978

THE BASIC DIFFERENCES BETWEEN SUGPO FARMING AND BANGOS FARMING

A profitable combination in fish farming is sugpo and bangos. There are two ways of doing this, according to Mr. Ricardo S. Esguerra, a fish culturist and researcher of the SEAFDEC Aquaculture Department.

One is the traditional method which could yield 1,000 kilograms of bangos and 300 kilograms of prawns per hectare per year. The other, using the improved technique of raising prawns, can yield one ton of prawns and 300 kilograms of bangos in a hectare per year. Here, a much higher profit is expected because of the higher price for prawn.

Esguerra pointed out the need to know the basic differences between bangos farming and sugpo farming. The following are some of these differences:

1. Bangos ponds usually do not need any specific size or shape. Size of rearing pond compartments ranges from 5 to 20 hectares. On the other hand, prawn ponds must be *long and narrow with an area of one to two hectares and arranged in a northeast-southwest direction*. Such an arrangement takes full advantage of wind action for pond water aeration.

2. Because of the extensive nature of bangos fishponds, dikes must measure from 3 to 5 meters at the base and 2 meters in height.

Dikes for prawn ponds are larger: a base of 5 to 7 meters and a height of 2 meters to maintain water as deep as one to one-and-a-half meters.

3. Each milkfish pond requires *only one gate for every ten hectares*, while prawn ponds must have an *inlet gate* and an *outlet gate* to achieve water flow-through.

4. Bangos ponds need *clay-loam* soil suitable for *lablab* growth. Prawn ponds, on the other hand, must have *soft sandy clay soil* so that the prawns could easily dig and seek shelter.

5. Intensive prawn culture requires *aerating devices* such as air blowers and pumps. Bangos farming does not need these except when oxygen level is low.

6. Bangos ponds need *clear water* to produce good lablab growth. For prawn ponds, *green water* is preferable to prevent cannibalism.

7. While bangos pond water has to be changed every two weeks, prawn ponds need *a change of at least one-third of the total volume once a week*.

8. Bangos fry may be stocked directly into the nursery pond in one corner and in an hour the fry would spread out all over the pond. When sugpo are stocked in one corner of a pond, they stay in the same spot so that a predator could easily wipe them out. Sugpo fry should therefore be *distributed in small numbers all over the pond*.

9. Bangos are not susceptible to diseases. Occasionally, parasites attack them during periods of high water salinity. Prawn fry, on the other hand, *are susceptible to fungus and bacterial infections*.

10. Bangos may be *shipped iced or frozen*. Sugpo may be *shipped alive in dry sawdust*. For export shipping, prawns are beheaded, deveined, and blast frozen.

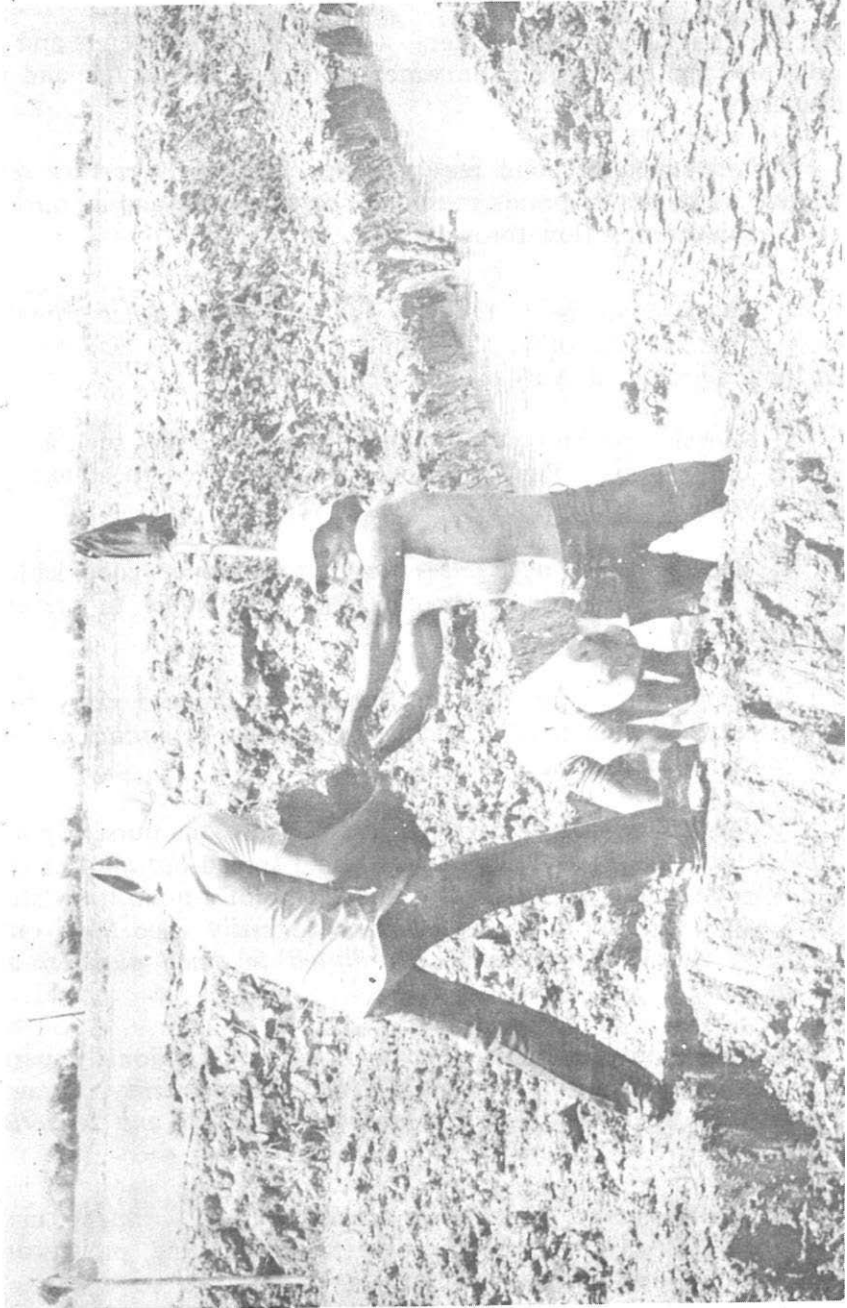

Constructing a pond dike.

Pond management

HOW ARE MODERN FISH FARMS MANAGED?

An Australian fish farming expert, Mr. J.L. MacLean, says that aquaculture or fish farming management aims to get higher yields by preventing the death or depletion of the fish being raised due to the harmful characteristics of the natural environment. MacLean says, the natural environment is hostile and full of dangers to fish life.

Therefore, management aims to control or eliminate as many of these natural dangers to increase the survival rate of fish.

The problems of fish farmers the world over arise from the harmful and the limiting factors imposed by the natural environment. Fish pests and diseases are harmful factors; not enough food for the fish is a limiting factor.

Modern fish farming has developed a management system whose basic components would include a *hatchery*, an *enclosure* such as a pond, a fish pen or a floating cage, *fertilizer*, *feed supplement*, and a system of *water circulation*.

A hatchery eliminates the dangers that cause death of fry. A hatchery prepares the fry or fingerlings for release to the sea or to the fish farm. Left on its own, the fry is very vulnerable. It can easily be killed by the harmful forces in the natural environment. Thus, the hatchery.

The enclosure - a fish pond or fish pen - lessens further the harmful effects of the environment by keeping the fish out of the reach of predators or other animals that prey on them.

Provision of organic or inorganic fertilizers makes the water in the pond more productive. With fertilizers, more organisms that serve as food for the fishes, such as *lablab*, can be grown.

Food - or not enough of it — is a limiting factor. Therefore, providing supplementary food enables you to raise more fish per unit area.

Finally, circulating the water through the fish pond or fish pen would remove the dangers caused by the accumulation of pollutants like wastes. At the same time, it makes available an unlimited supply of oxygen for the fish.

At this level of management, virtually all of the dangers in the environment are eliminated. As a fish culturist or fish farmer, you would then be faced with only one limiting factor - space.

In summary, modern fish culture incorporates the following practices: protecting the fry from natural dangers and preparing them for release to the grow-out ponds or to the sea; protecting the fish from predators; increasing the fertility of the water; adding feed supplement; and removing through water circulation poisonous materials in the water.

UNDERSTANDING THE POND ECOSYSTEM BETTER

Fish farming, especially prawn farming, requires good knowledge of some basic information on how and why changes occur in the pond's conditions. These changes are mainly the result of interactions among the water, soil, air and the various organisms in the pond. Here are some of these information:

1. Soil, water, air and the various organisms in the pond constantly interact. How good or bad the interaction is due largely to available sunlight and weather condition.
2. Water takes in almost all substances -- soils, gases and other

CLIMATE MAP OF THE PHILIPPINES



TYPE 1 - Two pronounced seasons, dry from November to April, wet during the rest of the year.



TYPE 2 - No dry season with a very pronounced maximum rainfall from November to January.



TYPE 3 - Seasons not very pronounced, relatively dry from November to April and wet during rest of the year.



TYPE 4 - Rainfall more or less evenly distributed throughout the year.

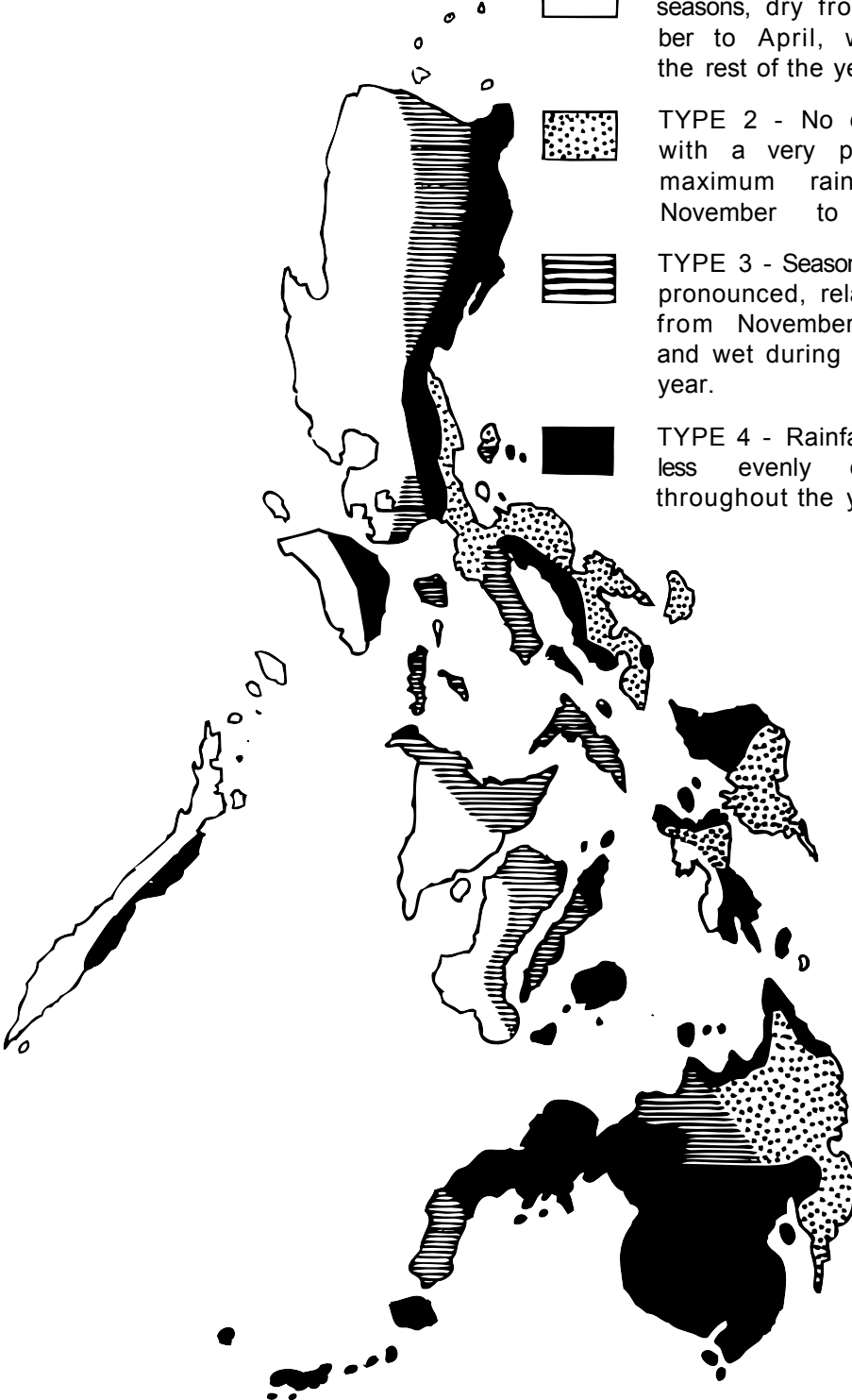

liquids - whether beneficial like nutrients or harmful like chemical pollutants and biological wastes.

3. Salt makes water denser or heavier. The amount of salt is known as salinity and is expressed in parts per thousand or ppt. Seawater's salinity ranges from 32 to 34 ppt while freshwater has zero ppt. Thus, freshwater will float over seawater. During dry months, it is fairly common for fishpond water to reach a salinity of 60 ppt or more.

4. Temperature also affects water density. As temperature rises, the density goes down. Warm water will float over cold water.

5. The ability of water to take in (dissolve) oxygen and other gases is reduced by temperature and salinity. Warmer waters hold less oxygen, as do saltier waters.

6. Although water is composed of hydrogen and oxygen, it is not this form of oxygen which is used by aquatic organisms for breathing.

7. Organic matter in the pond such as decaying plants, animals and uneaten food also use up oxygen and produce harmful products such as ammonia and hydrogen sulfide.

8. Dissolved oxygen in the water can be increased by wind action on the surface, by stirring the water with paddle, or by bubbling air in the water. Letting in new water also increases dissolved oxygen content.

9. Water, to a certain extent, contains free hydrogen and hydroxyl ions. The amount of free hydrogen ions is measured in a scale from 1 to 14 known as pH value. Pure water has equal amounts of hydrogen and hydroxyl ions and has a neutral pH of 7. With a pH below 7, water is acidic. Above 7, it is alkaline. For maintenance of plant and animal life, the pH value should be from 7 to 9.

10. Plants in the pond produce oxygen but just like animals, they breathe and use up oxygen. In the process, plants produce carbon dioxide. In the daytime, plants produce more oxygen than they can consume. At night, they stop producing oxygen but continue to use it up and produce carbon dioxide. In so doing, plants

lower the dissolved oxygen content in the pond sometimes to the point of depletion.

11. Water pH is affected by soil pH and the amount of carbon dioxide in the water. Some pond soils are by nature acidic. Highly acidic soil is usually reddish. Such soil is not favorable for fish farming and therefore has to be treated to lower its acidity.

12. Salinity, temperature, dissolved oxygen and pH vary from one pond to another as well as from time to time. A fish farmer must be able to distinguish short-term changes from long-term changes. Short-term changes are those which occur hour by hour within a day while long-term changes are brought about by seasonal variation and sudden changes such as those brought about by a heavy rainfall.

13. During a 24-hour period the most pronounced change which can drastically affect the fish is the rise and fall of dissolved oxygen content. It is generally at its lowest an hour or two before sunrise. Then it slowly rises to its maximum in the early afternoon and declines as the sun sets until it goes down to the minimum level in the early morning hours before sunrise.

14. Temperature also fluctuates during the day but such changes are not usually serious except in very shallow, less than knee-deep ponds. The rise and fall of pH and salinity during a 24-hour period are also not serious.

15. In a one-year period, however, the most significant change occurs in salinity, particularly in regions with pronounced wet and dry seasons. Salinity will rise to 60 or 70 ppt during the dry season unless freshwater is constantly supplied. On the other hand, during the rainy season, salinity could become so low as to make water almost fresh.

16. The most serious changes are those brought about by heavy rainfall. Such changes could be disastrous. A big flood can suddenly lower pond water's salinity. Run-off from the dikes in ponds with acidic soil could drastically lower the water's pH from 8 to 3 in a short time. After a heavy rainfall, a layer of freshwater is formed over saltwater thus blocking the interchange of gases between air and water. This will easily deplete the oxygen content in the pond water especially when the air is perfectly still.

SOME REMINDERS FOR THE NEW YEAR

For fishpond raisers, here's a checklist of jobs and preparations you may want to do at the start of the year:

1. Repair dikes, gates and other pond structures as well as nets and screens. Inspect your ponds and note where leaks are. You could list down all the needed repair jobs and how much these would cost.

2. Check your water pumps and put them in proper operating conditions. You'll need a reliable pump in the face of the hot summer months.

3. Obtain from the Bureau of Coast and Geodetic Survey a 1980 tidal table. Some calendars being given away by commercial firms also contain the tidal table.

4. Check the pH and fertility of your pond soil to find out if you have to apply lime and fertilizer.

5. You may want to start contacting fry dealers and suppliers. Plan your next year's production scheme in advance; find out where you can obtain fry at a good price and start developing closer business relations with the suppliers or their agents. Your production plan should be able to tell you how much fry you need for the succeeding cropping seasons.

6. Check for signs of erosion around the farm and plant cover crops or install erosion checks. Planting a buffer zone of mangrove trees will go a long way in protecting your land from wave erosion.

7. Start looking into ways you can save on fuel. A smooth-running pump or delivery pick-up saves a great deal of fuel. Also, you may want to look into the possibility of installing some alternative pumping system such as a windmill.

8. See if you can integrate other agricultural operations in your fishfarm. Cattle, hogs, ducks and poultry could be raised profitably with fish. And some crops raised for human food and feed supplement would enable a more efficient use of your land and labor resources.

9. Your workers and farmhands might need some training in new skills and orientation along better pond management practices. See how you can get them to be trained in new and more effective skills.

10. Review your performance last year and see where your management practices and operations can stand some improvement.

DO'S AND DON'TS IN FISHFARMING

Here's a list of what to do and what to avoid in fish farming. These do's and don'ts have been adapted from a list prepared by the Central Inland Fisheries Research Institute in India, whose scientists have successfully developed and promoted what has been called composite culture or polyculture (raising different kinds of fish in one body of water), particularly carps.

What to Do

1. Utilize all cultivable bodies of water for growing fish.
2. Remove weeds from your pond by economical methods
3. Remove all unwanted fishes and predators from the pond.
4. As much as possible, use any plant poison like tobacco dust - to treat your ponds.
5. Stock only after the effect of poisons has disappeared.

What Not to Do

- Do not waste any water area because fish farming is lucrative.
- Do not allow growth of weed because fish will grow poorly and harvesting is made more difficult.
- Do not allow the entry of harmful and predatory fishes into the pond.
- Avoid the use of chemical poisons because they may spoil the pond and leave harmful after-effects.
- Never stock while toxicity is still present in the water.

- | | |
|--|---|
| 6. Fertilize the pond to increase production of fish food. | Do not expect your fish to grow well without enough natural food. |
| 7. Stock at proper rate and ratio. | Do not stock indiscriminately - too low or too high stocking will not give high production. |
| 8. Select healthy fingerlings to get fast growth and lessen predation. | Do not stock with unhealthy and undersized fingerlings. |
| 9. Try to feed the fish with cheap and balanced artificial feed. | Do not expect fast growth rate of fish without proper supplementary feeding. |
| 10. Feed the fish at fixed hours and spots in the pond; observe how the fish consume the feed. | Do not broadcast feed indiscriminately to avoid waste. |

ADAPTED FROM: Central Inland Fisheries Research Institute, Barrackpore, West Bengal.

GRADING OF FRY OR FINGERLING BEFORE STOCKING

Grading of fish to a uniform size before stocking can help fishfarmers get a good estimate of the number of fish in the ponds. Of more importance, you reduce the number of fish that are too small to sell when the stock is harvested.

Sorting tables are commonly used to cull or select fingerlings for stocking. However, use of sorting tables does not avoid careless and rough handling, especially if workers are in a hurry. Fingerlings are usually injured with this method.

A new idea is the use of fish grading panels which are of the same width as the holding tanks. Fish grading panels are placed

in the tank with all the fish concentrated on one side of it. Since the grading panels have slots of predetermined size, the fingerlings smaller than the slots can pass through them. The ones that cannot get through are of the size you want for stocking.

Another way is to use floating grading boxes with panels of metal bars at the sides or bottom. The space between the metal bars determine the size of fish that cannot be retained for stocking. Those small enough to pass between the bars escape. The ones that cannot get through are retained for stocking.

The advantage of this method of sorting fingerlings is that you avoid handling them with dipnets which can injure and cause stress.

TAKE CARE OF YOUR POND DIKES

A good dike is one that does not leak. Leaky dikes are the result of poor dike construction, improper soil used for making the dike, and animals that bore holes through them.

The kind of soil used to build the dike is important. Sandy or silty soil with very low clay content will cause dikes to leak after some time. If no puddle trench is dug during the construction, water tends to seep between the original soil surface and under the dike due to the difference in material consistency. Crabs, eels, snakes and other burrowing animals may bore holes through dikes.

To prevent leak or seepage, always construct a puddle trench at the middle and bottom of the new dike. Build the dike with enough thickness at the base to stand water pressure from either side. Remove all organic matter like roots, twigs, stumps and dead leaves from the soil surface where a new dike is going to be built.

Use clayey soil for diking material. If seepage occurs after some time dig a new puddle trench along the inside of the dike and refill with new clayey soil.

If holes are made by animals, kill the animals inside the holes by placing poisoned bait, putting hydrated lime into the hole, digging the animal out of the hole, and refilling the hole with new

soil. If the dike is too narrow at the base, widen it by constructing a berm or a shoulder.

SOURCE: Modern Aquaculture for the Philippines by Ceferino de los Santos, Jr., 1978.

FISHPOND OPERATORS SHOULD REPLANT MANGROVE AREAS

Fish farming in mangroves or *bakawan* areas can be profitable and fishpond building need not deplete mangrove areas because you can replant the surrounding areas and raise extra income from the *bakawan* harvest as well.

This has been demonstrated by some fishpond operators in coastal and estuarine areas, says Mr. H.R. Rabanal, fishery officer of the South China Sea Fisheries Development and Coordinating Programme based in Metro Manila.

In building fishponds, the operators plant mangrove seedlings in tidal flats around the sites to provide additional buffer area that can protect the fishpond from hard wind and waves, especially during typhoons. Rabanal says that mangrove seedlings planted in a suitable area can provide an effective sanctuary for fish and other aquatic animals. Moreover, an effective nursery area will come up perhaps on the fifth year when the trees reach a half-meter growth. The trees will give the operator a potential income in the future when the trees could then be cut for forest products. One must, however, replant to continue conserving the mangrove area.

According to Rabanal, the most suitable mangrove areas for fish farming are those with elevation below the lower high tides and those that can be drained during the lower tides. He pointed to the cities of Legaspi, Cebu and Davao as most favorable for proper fishpond management.

SOURCE: "Forest Conservation and Aquaculture Development of Mangrove Areas," Herminio Rabanal, International Workshop on Mangrove and Estuarine Area Development for the Indo-Pacific Region -- Proceedings, Philippine Council for Agriculture and Resources Research (PCARR), 1978.

HAVE YOUR POND SOIL ANALYSED ONCE A YEAR

If your fishpond is now in operation, soil sampling and soil analysis once a year is a good practice. When taking soil samples from your pond or your area, be sure to take representative samples otherwise the analysis will not be meaningful.

A composite sample should be taken from each compartment in a fishfarm. In areas with less than one hectare, at least 12 subsamples should be collected at well-spaced intervals. From two to ten hectares, take 25 subsamples.

Each subsample should be a uniform core of soil about ten centimeters long. To prepare composite samples for laboratory analysis each subsample should be well mixed, dried and crushed. Remove shells and other debris from the samples.

Place one kilogram of a composite sample in well marked and clean plastic bags. Be sure to include the date and place of sampling in the markings.

Seek the advice and assistance of the bureau of soils officers in your area. Also, soil laboratories of sugar centrals can provide information on soil pH, lime requirement, organic matter content, nitrogen content and available phosphorous. Their analysis could give you a good indication in planning a fertilization and liming program.

SOURCE: "Fishpond Soils" by Thomas Potter, in Selected Readings in Pond Culture and Management, SEAFDEC Aquaculture Department, May 1978.

WAYS TO CONTROL FISHPOND SOIL ACIDITY

Acidic soils can present serious problems to fishfarmers. Very acidic soils can cause fish kills. Less acid soils, although they may not directly cause death of fish, can limit the availability of soil nutrients and thus prevent the growth of fishfood organisms like

algae and planktons. To insure production, control of soil acidity is important.

One important source of soil acidity in coastal fishponds is the oxidation of soil sulfides. Especially in newly built ponds this can cause severe soil acidity. Problems that result from soil acidity are fish kills, poor utilization of fertilizer, low natural fish-food production, and slow growth of fish.

One way of improving extremely acid soils is by the process called leaching or soil conditioning. Leaching involves establishing a good drainage and then alternately drying and flushing the soil until its acidity is reduced. However, the length of time it takes for leaching to correct acidity is not very well known and may vary according to soil conditions and other factors.

Application of lime can also be an effective treatment for soil acidity but liming could be very expensive due to the amounts needed.

There are three commonly used forms of lime: agricultural lime, slaked lime and burned lime.

Burned lime is the fastest acting form of lime. It is made by heating crushed limestone or seashells. However, because of its cost and difficulty to handle, it has been deemed impractical to use in the Philippines.

Slaked lime which is essentially burned lime with water added also acts rapidly but its cost also limits its widespread use.

The third kind - agricultural lime - is not as efficient as the other two. It is relatively slow acting but due to its lower cost and ease of application, it may be most practicable for long term control of soil acidity.

If you have to apply lime, have your soil analysed to determine how much you have to apply. Knowing the proper rate of application helps increase production and prevents overliming. Also, remember that lime can form insoluble compounds with phosphate. In other words, lime which is calcium will react with phosphorous in the soil and form a compound in which phosphate is locked with the calcium and will not be available for plant growth.

Therefore, you are advised to wait two weeks after liming before you apply phosphate fertilizers.

SOURCE: "Fishpond Soils" by Thomas Potter, in Selected Readings in Pond Culture and Management, SEAFDEC Aquaculture Department, May 1978.

FISHPOND SOILS NEED CONDITIONING

If your fishpond is new or if the site of your pond was once a *bakawan* swamp, you will have to do some soil conditioning. This, according to Mr. Leonardo Denila, a progressive fish farmer and member of the Western Visayas Federation of Fish Producers.

Mr. Denila observes that many fishpond soil in Panay are acidic (they have a low pH). He says that if soil is acidic, lablab would not grow even with the application of as much as two-and-a-half tons of chicken manure per hectare. It is possible that ponds in Zamboanga, Cotabato, and Quezon - particularly those that were once dominated by *bakawan* are also in need of soil conditioning, Denila says.

Conditioning of pond bottoms is done by exposing the soil to sunlight and periodically flushing the bottom with water. It is also achieved by applying lime especially hydrated lime. Have the soil analyzed before applying. Incorporate the lime evenly with the first 15 centimeters of the top soil, Denila advises.

Mechanical conditioning is done when the pond bottom is exposed to air and sunlight. The unwanted elements in the fishpond soil like iron, sulfur, aluminum and acids are exposed to air, or combine with water to form into solids. These are then flushed away.

SOURCE: "Conditioning of Fishponds" , Leonardo Denila, Readings on Aquaculture Practices, SEAFDEC Aquaculture Department, May, 1977.

LIME IS IMPORTANT IN POND MANAGEMENT

Why do you have to apply lime in your fishpond? There are several reasons:

First, lime is a soil conditioner. Lime corrects the soil acidity if applied in proper amounts. It prevents too much accumulation of chemicals poisonous to fish and other water life. Lime hastens the release of nutrients and increases the breakdown of organic matter.

There are plenty of suspended materials in the water which prevent or lessen the penetration of sunlight. Lime combines with these suspended materials to form into solids. Finally, lime reduces the incidence of fish diseases especially gill rot.

Have your pond soil analyzed by the Bureau of Soils to determine the right amount to be applied. Bring to the soils laboratory samples from five different spots in your pond. In taking soil samples, ask for the assistance of the Bureau of Soils or BFAR technicians. The Bureau of Soils should be able to provide you the lime requirement of each pond and the needed amount to correct soil and water acidity. Proper soil and water acidity enhance growth of lablab and other fish food.

To apply lime, *drain* your pond and broadcast the lime or spread it over the pond bottom. Allow one month to elapse after liming before you apply fertilizer.

The most common lime being used in fish ponds is the agricultural lime. Seek the advise of your fisheries technician on the proper application of lime.

CAN GUANO BE USED AS POND FERTILIZER?

"Yes," according to researchers of the SEAFDEC brackishwater aquaculture station at Leganes, Iloilo.

The nutrient composition of guano, or manure of bats and seabirds, varies according to its sources, say researchers Mel Lijauco

and Ely Griño of SEAFDEC. Guano obtained from inland caves normally contain less fertilizer elements than guano deposited in caves near the sea. Guano deposits are mainly phosphatic and the total phosphorous content ranges from 5 to 30 percent. The nitrogen and potassium contents however, are minimal.

A rough guide given by Lijauco and Griño in using guano as fertilizer is to apply from 50 to 100 percent more of it than if you were using chicken manure. For example, if you normally apply chicken manure at the rate of 500 to 1,500 kilograms per hectare, you would have to apply guano at the rate of 1,000 to 3,000 kilograms per hectare.

SOURCES: 1. E. Griño & M. Lijauco, personal communications, Dec. 1979.
2. Philippines Recommends for Fertility Management, 1978 PCARR.

ORGANIC FERTILIZERS: HOW THEY IMPROVE FISHPOND YIELDS

For newly built fishponds or those deficient in organic matter content, the application of organic fertilizer is highly recommended.

The most common organic fertilizer used in fishponds is chicken manure which normally contains 1.5 percent nitrogen, 0.4 percent phosphorous, and 0.37 percent potassium, by volume. Other sources of organic fertilizer are cattle dung (0.49%N; 0.07%P; 0.3%K), pig manure (0.49%N; 0.15%P; 0.5%K), composted rice straw and other plant materials.

Dried chicken manure is applied at the rate of 500 to 1,500 per hectare while other kinds of manure are used at the rate of 1,000 to 3,000 kilos per hectare.

Organic fertilizers give the following benefits: (1) improve soil texture, (2) increase the water holding capacity of the soil, (3) help conserve soil fertility and (4) provide a steady source of major plant nutrients and other minerals.

In fishponds, organic manures help produce more fishfood organisms like *lablab* and zooplankton. Zooplanktons are very tiny animals that are free-floating in the water.

SOURCE: Philippines Recommends for Bangos 1978 (revised edition). PCARR, Los Baños, Laguna.

THE VALUE OF HOG MANURE AS FISHPOND FERTILIZER

As a fertilizer, hog manure contains, by weight, 0.5 percent nitrogen, 0.4 percent phosphorous, and 0.3 percent potassium. It has 25 percent organic matter, about 0.09 percent calcium and about 1 percent of other elements. It of course contains 71 percent water.

Experiences by an Iloilo integrated bangus-piggery operator have shown that application of hog manure in ponds gives (1) a higher percentage turbidity reaction which means that the pond water becomes clearer after application (2) steady increases in the abundance of *lablab* and other natural foods and (3) higher yields.

To prepare hog manure as fertilizing medium:

(a) Mix about 1½ kilos of fresh manure with water in a big 8-gallon plastic pail. Leave the mixture overnight.

(b) Filter the mixture in clean jute bag to remove the big particles.

(c) Use the filtrate - the water that has been filtered - and a small amount of urea added at a rate of 0.3 grams per liter of water as the fertilizing solution. Add this to the pond water.

Dried hog manure can also be applied at a rate of 13.5 sacks per hectare. It has been reported that manure from 20-30 pigs in a year can produce the same fertilizing effect as one ton of ammonium sulfate.

SOURCE: 1. The Philippines Recommends for Bangos 1978 (revised)

2. "Integrated Fish Farming in Thailand" by Soursak Janesirisak, NIFI, Bangkok.

FERTILIZE YOUR FISHPONDS WITH BOTH ORGANIC AND INORGANIC FERTILIZERS

Fishponds should be fertilized with a combination of inorganic and organic fertilizers, according to Atty. Ceferino de los Santos, Jr., a successful fishpond operator in Iloilo.

Apply organic fertilizers first. Chicken, cow or pig manures are applied at the rate of 2,000 to 5,500 kilograms per hectare in new ponds or ponds with little organic mud. Spread the manures after the pond bottom has been drained and dried. Dry and powdered manures should be spread evenly over the surface of the pond by putting them in sacks and letting manure drop out in ribbons as the spreader walks over the pond. If wet, they are poured in heaps at equidistant spots over the pond and then spread out by shovels or spades.

Molasses as organic fertilizer was adopted by Atty. de los Santos after seeing its effectiveness in Taiwan. It's not only a fertilizer but a pesticide as well, he said. Apply it at the rate of 400 kg/ha. Dilute the molasses with pond water. Then pour it into the water gates as water is let into the pond. Maintain water depth at 5 to 10 cm for at least one week under a hot sun, or longer if sunlight intensity is not too great. After two weeks, the pond may be stocked with fish. Water must be raised to the pond's maximum holding capacity. Before stocking fish, make a preliminary test by putting in a few fish. This will determine if oxygen level in the water is high enough for fish to live.

Organic fertilizers should be followed up with inorganic fertilizers like 18-46-0 or 16-20-0. The rate for 18-46-0 is 22 kilograms per hectare. Apply it on platforms when using plankton food. For *lablab* food, apply it by broadcasting first, then by broadcasting again or by platforms. On the other hand, if you use 16-20-0, apply at 50 kilograms per hectare every 14 to 21 days or as needed. You must however be sure that water visibility is maintained between 20 to 30 cm.

SOURCE: Modern Aquaculture for the Philippines by Atty. Ceferino de los Santos, Jr. Iloilo. 1978.

FERTILIZE YOUR FISHPONDS WITH ANIMAL MANURES

Organic manures such as those from chicken, cattle, carabaos and hogs are cheap sources of fertilizers for tilapia production. In fact, some enterprising fishpond operators have put up poultry and piggery projects so that animal wastes are washed off directly to the pond.

Organic fertilizer should be applied particularly on newly constructed fishponds deficient in organic matter content. Here are some of its advantages:

1. Soil texture is improved.
2. Water holding capacity is increased
3. Soil is enriched.
4. There is slow release of the major plant nutrients and other minerals.
5. Enhances the growth of *lablab* and zoo-plankton which are good natural sources of food for fish.

However, one must not spread decomposed organic fertilizer over the whole pond bottom. If you do that, oxygen in the water will be depleted. The required application should be placed in heaps of 20 to 30 kilograms.

Apply dried chicken manure at the rate of 500 to 1,000 kilograms per hectare. Other manures are applied at 1,000 to 2,000 kilograms per hectare.

PRACTICAL WAYS OF DESTROYING FISHPOND PESTS

Atty. Ceferino delos Santos, Jr., President of the Western Visayas Federation of Fish Producers, Inc., suggests the following materials and ways of eliminating fishpond pests:

One - Don't use chemical formulations containing hydrocarbons in ponds because hydrocarbons tend to sterilize or render infertile the pond soil after sometime. Instead, use tobacco dust or other organic materials rich in Retenone or Saponin.

Two - Rice straw may make good compost but takes a long time to decay. It is better to make compost heaps on top of the dikes by mixing rice straw with pond mud and some ammonium sulfate. Cover the compost pile with mud to keep air out of the compost. If available, mix *clostridium* bacteria with the compost. This bacteria thrives under anaerobic condition and hastens the decay of the rice straw.

Finally, use hydrated lime rather than agricultural lime because hydrated lime is faster acting and cheaper. Furthermore, too much agricultural lime will harden the pond bottom.

PREVENT PREDATORS FROM ENTERING YOUR POND

Here are some ways of preventing entry of predators into the pond. Doing these will also prevent the escape of the cultured fish.

Seal the water gates by placing closure slabs in a parallel line starting from the bottom to a height which is at level with the water line desired to culture the fish. Pack mud tightly between the slabs. When using pipes or wooden culverts to take in water, place a pair of slabs cut to fit the pipe or culvert. Then add two more slabs on top. Attach to the pipe a bag of fine mesh nylon net or wire screen by tying them with strings or rubber strips. The net or screen is placed on the pond side of the pipe or culvert. The pond water should be a few inches below the pipe or culvert to

enable the fishfarmer to see the net or screen for cleaning when it gets clogged.

Another way is to make a sleeve-like device, one end tied to the pipe and the other end tied to a bamboo pole inside the pond. The net or screen will prevent the entry of unwanted species, and the escape of the cultured fry or fish. Another method used is to stuff the pipe or culvert with steel wool, a cloth bag filled with coarse sand, or such other materials which are not soluble in water to act as filter.

SOURCE: Modern Aquaculture for the Philippines by Atty. Ceferino de los Santos, Jr. Iloilo. 1978.

USE OF ORGANIC PESTICIDES URGED BY PROGRESSIVE FISHFARMER

Fishfarmers should get rid of pests like Chironomid larvae, polychaete worms, and snails in the pond soil because these animals also feed on *lablab* thereby competing with fish for the food. A serious question in implementing a pest control program is what pesticides to use. Shall we use organic or chemical pesticides'?

Mr. Ceferino de los Santos, Jr., a successful fishpond operator in Iloilo, advises fishfarmers to be careful in choosing and applying chemical pesticides. Most chemicals, he said, leave residual effects which are dangerous to both fish and man. For instance, chlorinated hydrocarbons like DDT, Endrin, Chlordane, Gamma BHC, have long-term residual effects which are suspected to cause soil sterility and poor growth of *lablab* and other natural foods. Chemicals which belong to the organic-phosphate group like Gusathion leaves

a residual effect for two weeks. If the pond is flushed and drained of treated water properly, the chemical - or most of it -- is removed. Its use should be done with extreme caution because animals killed by this poison should not be eaten by people or other animals. Triphenyltin compounds sold as Duter, Brestan, Baylucide, and Aquatin, which are known poison for snails and worms, should not be used for ponds because they also cause soil fertility and may cause stunting in fish.

Instead of chemicals, organic pesticides such as tobacco dust, Derris roots, and other materials containing Saponin and Rotenone, like tea seed cake or Gogo bark should be used, de los Santos said.

Tobacco dust should be applied at the rate of 200-400 kilos per hectare depending on the density of the pests. Spread this material over the pond after it has been drained, dried, and fertilized. You must, however, soak the sacks containing the tobacco dust in water overnight. Then spread them evenly over the pond soil. This will prevent the dust or shavings from being blown away by the wind. Tobacco dust or shavings could also be applied by soaking them in drums of water placed above the water gate. When it is time to let in water into the pond to start the growth of *lablab*, the water is allowed to flow very slowly while you pour the solution of water and tobacco dust into the incoming water. This will save the time and effort of transporting and spreading the material over the whole pond. Water is kept at a maximum depth of 5-10 centimeters in the pond to allow the nicotine to act on the pests for a period of 10 days to 2 weeks. *Lablab* will start to grow during the same period.

The same technique is followed in spreading derris root solution. Apply 40 kilos of roots to one hectare with 10 centimeters depth of water. Reduce the volume of water to reduce the quantity needed. If available, tea seed cake is a good selective poison for pests. It will also kill fish, but not shrimps and prawns. The main problem is that this material is not easily available in large quantities in the country. Its active ingredient is Saponin. One part per million of Saponin will kill fish. Treatment of up to 11 parts per million will not kill shrimp. It works better in high temperature.

HOW TO PREVENT POLLUTION DUE TO FISH WASTES

Fish and other aquatic animals excrete urine and faeces during their growth. These waste matters plus other decomposed matters pollute the pond water. If stocking rate is high, these wastes - called metabolites - may become poisonous causing stress or death in fish.

To avoid this, don't allow your fish stock to remain in one pond for more than a month. Transfer the fish to another pond after one month and drain and dry the vacated pond to eradicate the metabolites.

You cannot, however, do this in prawn ponds because it is difficult to transfer or move prawns due to its habit of hiding in the mud during day time. Instead, prawn raisers drag a chain along the canals in the pond. This will stir the bottom and flush the pond water.

SOURCE: Modern Aquaculture for the Philippines by Atty. Ceferino de los Santos, Jr. Iloilo. 1978.

HOW TO CONTROL OXYGEN DEPLETION

Oxygen depletion is a major hazard in fish farming and may cause the loss of an entire fish population. Routine observations of all ponds should be made at sunrise during the months when this problem is most acute.

Low oxygen concentration is suspected when fish, snails or tadpoles appear at the surface of the water, crayfish come to the margin of the pond or dark streaks appear. Oxygen depletion is accompanied by musty odor or the odor of methane and hydrogen sulfide.

If the oxygen content 18 inches below the surface of the water is 2 ppm or less, the fish start surfacing and showing signs of distress.

The situation can usually be remedied temporarily by partly draining the pond and refilling it with well water or adding large volumes of water from near the surface of an adjacent pond. Fresh water and the reduction of fertility provide the most lasting solution to low oxygen conditions.

If dissolved oxygen content is less than 3 ppm at daybreak and does not rise during a sunny day, it can be assumed that there is either no photosynthetic activity (i.e. no living algae remains) or bacterial decay is using the oxygen faster than it can be produced. At this situation the farmer may apply 25 to 50 pounds of hydrated lime (also called slaked lime or calcium hydroxide) per surface acre to kill bacteria and oxidize organic matter. This may be repeated as often as needed but lime should be distributed uniformly over the pond surface.

If too few algae are present, the addition of ammonium phosphate fertilizers may rapidly restore the bloom.

Fertilizer should not be added if an algal bloom is present.

Fish of all sizes use more oxygen at high temperature than at low temperature.

SOURCE: Second report to the fish farmers, United States Department of the Interior Fish and Wildlife Service, Bureau of Sport Fisheries and Wildlife, Washington D.C. 1973.

HOW TO IDENTIFY FISH DISEASES

Identification of a disease may require laboratory examination by a specialist, but sick fish can easily be recognized by an observant fishfarmer. Four common symptoms are changes in behavior, reduced vitality, failure to feed and the presence of lesions.

1. *Change in behavior* - Fish in good health cannot be seen in ponds except during feeding periods. Should the fish gather in the vegetation near the incoming water supply, or in any particular area of the pond where they can be readily seen, disease should be suspected.

2. *Signs of reduced vitality* - Healthy fish swims quickly away from the disturbances along the bank. If fish do not rush away when the fish farmer approaches, some type of disorder should be suspected. Other symptoms include dropping fins, loss of balance or general sluggishness.

3. *Failure to feed* - Under good water conditions, healthy fish feed vigorously, often taking food immediately after it is provided. Low oxygen concentrations or high water temperatures, as well as diseases, may cause fish to stop feeding, but failure of the fish to accept feed is a positive sign that pond conditions are not good. The farmer should take immediate steps to find out why his fish is not feeding.

4. *Lesions* - Lesions or sores are common in diseases that attack warmwater fishes. The obvious ones are open ulcers or large discolored areas on the body. Others include hemorrhagic areas in the head, body or fins; cysts in the skin, muscles or internal organs; and inflamed areas surrounding a parasite. Presence of any lesion is a positive indication of injury or disease and calls for careful examination.

Correct diagnosis of a disease is the first step toward control. Before any treatment is initiated one should know the water, the fish and the chemical to be used.

SOURCE: Second report to the fish farmers, United States Department of the Interior Fish and Wildlife Service, Bureau of Sport Fisheries and Wildlife Washington D.C. 1973.

SIGNS AND SYMPTOMS OF VIBRIOSIS IN FISH AND PRAWNS

Vibrio anguillarum, an organism responsible for vibriosis in fish, has received an increasing amount of attention over the years. Originally associated with red disease of eels, vibrio is now recognized as a pathogen (cause of disease) in other species of fish. SEAFDEC fish disease researchers have found it to be the cause of mortality in prawn. While it is not clear how vibrio causes diseases in prawn, it is known to cause human gastro-enteritis in Japan and United States.

Vibriosis can occur anytime of the year, reportedly even in water temperatures as low as 4°C. It is most prevalent in the summer months. Outbreaks can be expected when the water temperatures reach 14-20°C.

Signs of vibriosis are not usually evident until the fish have been in saltwater for two weeks. Diminished feeding activity; erratic, spinning swimming patterns and gathering around the edges of the pens could serve as indications to the fish farmer. Diseased fish show hemorrhage around the base of the pectoral and anal fins or a bloody discharge from the vent.

Vibrio disease tend to approach epidemic proportions when water temperature rises.

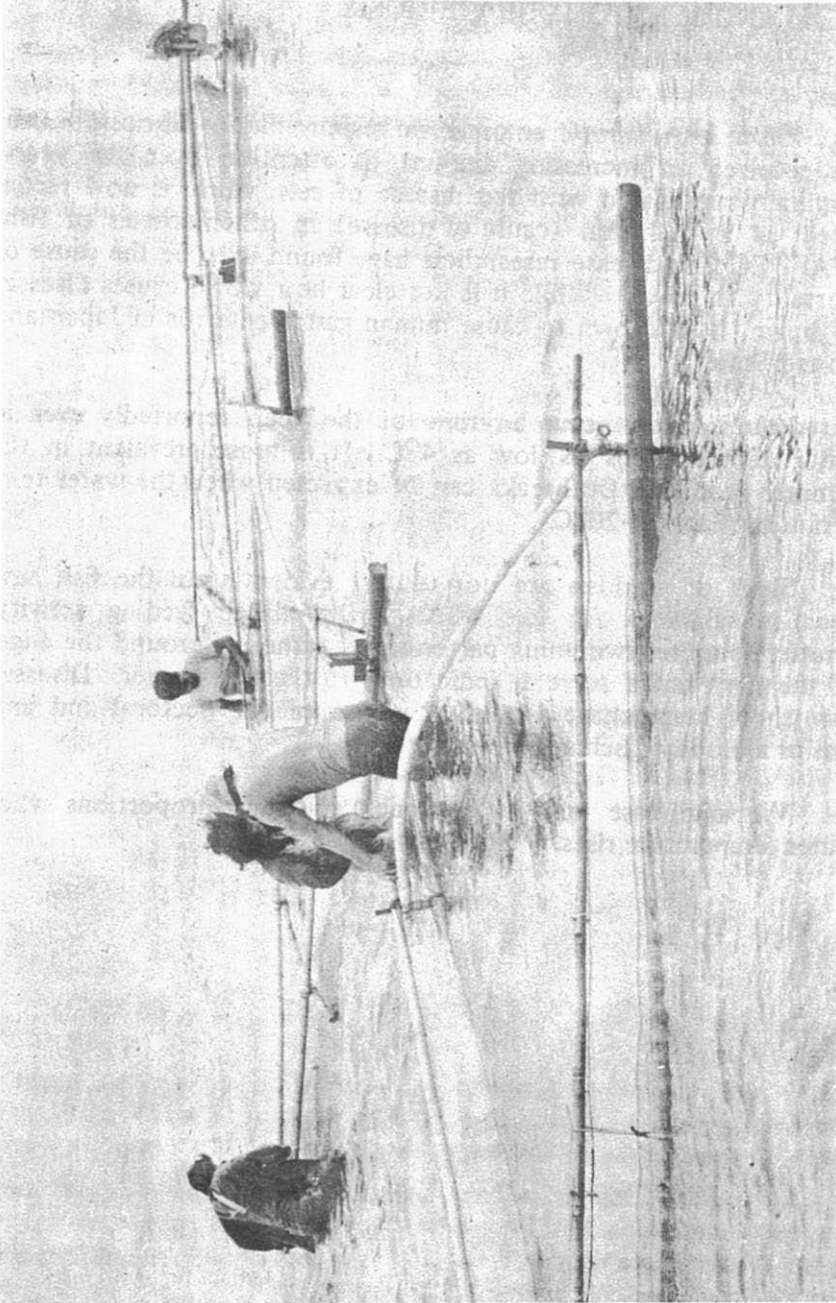

Collection of milkfish fry using scissors net or sakag along Iloilo coast.

Harvesting, processing & marketing

HOW TO KEEP FISH LONGER IN ICE

If you usually sell your fish in ice, here are a few things you must know to keep the fish longer in storage and in transit.

According to a report of the Food and Agriculture Organization or FAO, spoilage of any product, particularly fish, is generally caused by bacteria, by chemical action, or by the action of enzymes of the fish itself. As soon as a fish dies, spoilage begins. However, spoilage can be slowed down by lowering the temperature and the more common way of lowering temperature is by "icing" or storing the fish in ice.

Knowing the storage life of iced fish will help fish producers and merchants minimize losses due to spoilage. Here are some tips on what kinds of fish keep longer and on how to pack fish so that it would not spoil rapidly:

1. Small fish generally do not keep as well in ice as large ones.
2. Fish that have been feeding heavily before harvest spoil more quickly than fish that have not been feeding for some time.
3. Flat fish keep well in ice compared with round fish.
4. Fatty fish spoil rapidly, even in ice. Fifteen percent or more can become unfit for consumption after only one to two days.
5. Insufficient ice or poor method of packing can cause rapid spoilage.

Here's how to properly pack fish in ice:

* Use a plastic foil to line the container. The foil reduces heating up of both fish and ice.

* If it is possible, remove the guts, or the intestines and other internal organs, before packing. This reduces bacterial action.

* Arrange cleaned or gutted fish head down in the container.

HOW TO PREVENT FISH SPOILAGE

Keeping the fish from being spoiled is one of the problems of bangos farmers and traders. The problem becomes more serious as the market becomes farther.

Here are some pointers from a study conducted by the Food Terminal. Incorporated.

1. To transport by boat at a travel time of 24 hours, fish must be chilled prior to packing. For best results, pack them in an insulated one-cubic meter container with drainage outlets at the bottom. This container has wooden dividers to separate *bañeras* of fish from each other.

2. For air transport at a travel time of one hour, chill the fish at zero degree Centigrade prior to packing. Pack them in styrofoam boxes with a net capacity of 60 kilos. You need not put ice, but if you wish, put one kilo of ice for every 20 kilos of fish.

3. For land transport, *bañeras* with holes for drainage of fish fluids and melted ice were found to preserve the quality of the fish and are much cheaper and more durable than styrofoam boxes. However, styrofoam boxes are preferred over *bañeras* when fish which are not pre-chilled are transported by land.

CHILLED FISH OFFERS MORE ADVANTAGES THAN TOTALLY FROZEN FISH

A method of partially freezing fish made its debut in Japan recently. In this new technique the fish is chilled at minus three degrees Centigrade (-3°C). The chilled fish subsequently needs no thawing and its promoters in Japan claim the raw "sashimi" held this way tastes as good as live fish.

The partial freezing technique was developed by the Tokai Regional Fisheries Research Institute of Japan's Fisheries Ministry.

Fish freezing technology had centered previously on quick freezing, at temperatures below -30 degrees Centigrade. However, Mr. Ken Uchiyama, the inventor of the process, was concerned with the loss of protein and flavor in fish held at these low temperatures.

In the chilling or partial freezing method, only about 30 percent of the fish reaches -3 degrees Centigrade. Chilled fish can be used for sashimi after 10 days' storage.

Other advantages include:

- * Cold storage facilities for chilled fish are cheaper than those for very low temperature quick-freezing;

- * Chilled fish is cheaper to transport than live fish; and

- * Partial freezing methods can lead to better utilization of fish, because heads, tails and internal organs can be removed at the original production centers and converted to fish meal.

These advantages had attracted the attention of the inland fishermen's cooperatives in Japan. They have begun supplying chilled carp and rainbow trout to Tokyo since late last year. It is hoped the new technique can also be used with saltwater fish.

MAKING FISH BALLS FROM TRASH FISH

Trash fish and tilapia make good fish balls. This was shown by studies on the gel-forming ability of trash fish and tilapia. Fish balls made of tilapia and trash fish are white with good springiness.

The SEAFDEC Marine Fisheries Research Department based in Singapore recommends ways to make fish balls from trash fish.

1. Behead fish and remove their gut.
2. Separate fish meat from skin and bones.
3. Wash minced meat with water (four times its volume) filtered through a nylon bag.
4. Press out excess water from minced meat. This may be done through a hydraulic press.
5. Bleach minced meat twice with water.
6. Mix bleached minced meat with 2.5 percent sugar and .2 percent preservative in grinder before packing and freezing at -30°C .
7. Roll minced meat into fishballs. Add a little flour to minced meat to keep balls intact.
8. Dip fishballs in water (40°C) before cooking.
9. Deep fry.

HOW PANAY-NEGROS FISHFARMERS PACKAGE AND SHIP MILKFISH AND SHRIMP

Much of the spoilage in transport is the result of improper packaging. Here are some recommended methods of packaging fish or shrimps:

Place newly harvested fish or shrimp into a chilling box to

lower their body temperature and kill them. The usual ratio of ice to fish is two blocks of 300-pound ice to every ton of fish with one more set aside for transport purposes. The chilled fish are then transferred to wooden boxes measuring 12 inches high, 16 inches wide, and 24 inches long while awaiting to be packed.

Icing and packaging for shipment to Manila are done in a big wooden box. The box is 48 inches high, 54 inches wide and 72 inches long. It is built to withstand a content pressure of two tons of ice and one ton of fish or prawn.

For packing of fish or prawn in this box, the general procedure to follow is:

First - Lay out evenly a four-inch layer of crushed ice at the bottom. Compact this layer to lessen melting.

Second - On top of the bottom layer of ice, place the fish with each fish laid on its side and all heads pointing in the same direction. The bellies should also point toward the same direction. Each layer of fish would be about 150 kilos of fish.

Third - Cover the fish layer with a three-inch layer of crushed ice until no fish is visible. Compact the ice.

Fourth - Place alternate layers of fish and ice until you fill the box. A box of this given dimension could hold seven layers of fish.

Fifth - The topmost layer is a five-inch thick ice. Cover this with a plastic sheet to protect it from rain and wind. Nail the cover to further secure the content.

With prawns, you follow the same packing procedure except that a chicken wire should be placed before each layer of crushed ice. This prevents the weight of the upper layer from crushing the prawns underneath.

SOURCE: "Cass studies on prawn culture," Alfredo Lopez. In Technical Consultation on Available Aquaculture Technology in the Philippines (proceedings), SEAFDEC Aquaculture Department, Feb. 1979.

THE PROPER WAY TO PACK FISH FOR SHIPMENT

Fish is highly perishable. Utmost care should be exercised during packing and transporting fish.

1. Sort out the fish as to size and quality if it has not been sorted in the fishpond. Separate the good from the poor quality fish. Good quality fish is silvery white, clean, stiff and fresh, fat with small heads and rounded bellies. Those which are soft, reddish-eyed, large-headed, flat-bellied, discolored or with missing scales are of poor quality.

2. Wash the fish with clean fresh water.

3. Prepare a large box preferably four feet wide, four feet high and eight feet long. This is usually made of wood with flat iron bar reinforcements at all corners. The box may be lined with styropor, lawanit sheets, or nipa leaves.

4. Put crushed ice laid up to 30 centimeters high from the bottom of the box. Use a pallet to tamp them down. Arrange the first layer of fish on top of the ice with their heads aligned to one direction. The body of the fish should be placed with the back downwards and tilted to a 45-degree angle. This will keep the fleshy part of the fish in contact with ice all the time and prevent deforming the fish. Put another layer of crushed ice, about 20 centimeters thick, on top of the fish. Then place another layer of fish on the ice. Repeat the process until the box is filled. But be sure to leave about 30 centimeters of space from the top of the box. There will be 8 to 9 layers of fish in the box.

5. Fill the remaining space on top of the box with crushed ice. Tamp them down with a pallet. Cover the box with, first, some insulating material, then finally with a wooden top which is firmly nailed down along the edges. The box is now ready for shipment.

Shrimps and prawns are packed differently because of their softer body. They are usually packed in styropor or carton boxes with some ice and shipped by air. They are first sorted and carefully washed with fresh clean water and chilled in ice before packing.

However, you could also use the box previously described for

fish. But this time, put the prawns or shrimps in kerosene cans or bamboo baskets. The cans or baskets are then placed on a layer of crushed ice in the box. Allow some space in between cans or baskets so that crushed ice could be inserted. Put a layer of crushed ice on top of the cans or baskets. Repeat the process until about four layers of cans or baskets fill the box. The top layer is of crushed ice which is also covered in the same manner as that used in packing fish.

Some fish farmers who sell direct to consumers do some preliminary processing. The shrimps and prawns are sold headless, skinned and de-veined, or whole. These are usually quick frozen and packed in carton boxes and shipped by air, or in refrigerated boxes by boat. The heads, skin, and other parts of the shrimps and prawns are sold separately to buyers who use them for making shrimp meal or sauce.

Here are some pointers you should always keep in mind:

1. Only good quality fish should be packed and shipped.
2. Pack the fish in layers in order that it will be completely cooled by the ice.
3. Spread out the weight of the fish and ice to avoid crushing the lower layers.
4. Do not use very tall containers.
5. Use coarsely crushed ice for large fish and finely crushed ice for smaller fish.
6. Ship the fish as soon as possible after packing.
7. Upon arrival at destination, if fish could not be sold at once, repack the fish box with enough ice to maintain the cold temperature.
8. If cold storage facilities are available and if the fish can not be sold very soon, it is advisable to keep it in cold storage. However, do not freeze stonehard as it will become soft and will redden at the eyes thereby reducing its sales appeal.

SOME GUIDES IN PREPARING DRIED FISH PRODUCTS

A. Observe Sanitation and Clean Fish Thoroughly

The quality of dried fish depends much on how well you prepared it for drying and how clean you handled the fish during preparation.

Remember: *poor quality fresh fish makes poor quality dried fish.* Drying is often resorted to when there is plenty of unsold fresh fish and the flavor of dried fish may hide somewhat the flavor of stale raw fish. However, poorly prepared fish for drying ends up in a low quality final dried product.

Clean fish thoroughly and see that the utensils, equipment, and drying facilities like racks are sanitary. If possible, chill the fish before drying. The better the product, the less your losses.

B. Tips on Drying Fish

The first step in drying is to keep insects away from the fish. You can reduce drying time by raising the fish off the ground. You can build simple drying racks made of bamboo, wood and other local materials. Have a ready cover in case it rains. A plastic sheet is generally easy to buy, cheap and effective.

Fish for drying are salted to hasten the drying and preserving process.

Heating under the sun can be done with a simple solar drier. It is built in the form of a tent with transparent and black sheets of polyethylene plastic and sticks. A temperature of 45 degrees centigrade can be attained if you position the clear plastic so that it faces the sun and put the black plastic sheet behind. Provide vents at top and bottom. A drying period of 20 hours at 45 degrees centigrade can kill all the stages of the blowfly, the common insect attacking dried fish.

C. Salting Fish for Drying

Salt is applied to fish being prepared for drying to improve the quality and acceptability of dried fish. Salt hastens the removal of water from the flesh and reduces the time for air or sun drying.

Salting is done by splitting the fish and stacking them with dry salt placed between layers, or by immersing fish in brine or salt solution.

With oily fish like sardines, immerse fish for 15 minutes in saturated brine to reduce drying time by half. Prolonged drying leads to discoloration and makes fish rancid.

The other uses of salt are that it controls bacteria and insects like flies and beetles. However, salt in dried fish tends to re-absorb moisture after processing. Hence, you are advised to package salted dried fish properly.

SOURCE: "Postharvest losses of fish" from the book. Postharvest Food Losses in Developing Countries, published by the U.S. National Academy of Sciences, 1978.

FISH MARKETING IN ILOILO, BACOLOD AND ZAMBOANGA NEEDS SOME IMPROVEMENT

Usually, it is not the fish producer who dictates the market price of the fish. Most of the time, he gets the least benefit from fish marketing.

These are some of the findings disclosed by a study of fish marketing in Iloilo, Bacolod and Zamboanga which was jointly conducted by the Bureau of Fisheries and Aquatic Resources (BFAR) and the Bureau of Agricultural Economics (BAEcon).

Big time middlemen like brokers and wholesalers heavily influence price changes and consequently get the biggest slice of the profit, the study noted.

On the whole, fish marketing set-ups in the three cities are not yet fully developed and are beset with many problems. For instance, fish producers are complaining of some government regulations and policies which cut down fish production. Among these are the closure of fishing grounds in Samar, Leyte and Sorsogon and the prohibition on trawl fishing in waters seven fathoms deep or less. To explore new sources of fish beyond these prohibited fishing grounds would entail additional fuel costs resulting in losses to the

fish producers. The study cited the lack of storage facilities as another reason for producers not wanting to catch more fish to avoid possible spoilage and losses.

Recommendations

To improve fish marketing performance in Iloilo, Bacolod and Zamboanga, the study recommended the establishment of the following:

1. Fish farmers' cooperatives similar to the *Samahang Nayon*.
2. Common fish terminal markets to reduce marketing costs.
3. Market assistance centers to keep producers, traders, and buyers informed of prevailing prices of commodities, and other vital market information.
4. Additional cold storage facilities in key areas or, where necessary, refrigerated vans or mobile refrigeration facilities. These will boost transporting of quality fish in fresh form to outlying areas, specially in Iloilo province.

SOURCE: A Survey on Fish Marketing in Iloilo, Bacolod and Zamboanga, Bureau of Agricultural Economics, 1978.

FISH MARKETING SYSTEM IN CENTRAL LUZON MOSTLY BENEFITS MIDDLEMEN

There is no marketing system of fish products in Central Luzon, thus, most of the profits from fishing go to brokers instead of to the fishermen.

The present marketing system is characterized by too many middlemen, large quantities of low-quality fish sold, extreme fluctuations in supply, and poor and inadequate landing and unloading facilities in the markets.

These were based by a study conducted by R.C. Sevilleja and E.W. McCoy, graduate research assistant and associate professor, respectively. Department of Fisheries and Allied Aquacultures and Department of Agricultural Economics and Rural Sociology of Auburn University, Alabama, U.S.A.

As fish pass through many middlemen before reaching the final consumer, more than 80 percent of the profits go to brokers, leaving less than 20 percent to the fishermen, the study noted.

The study found that fish marketing is carried out entirely by private enterprise or individual brokers without any administrative policies or government supervision.

Marketing operations vary in different landing places. Wholesale transactions of fresh fish take place at night or during the early hours of the morning. The fish are landed on the beach and sold to brokers or individuals.

The study also revealed that there are few cold storage and ice making plants in the region. The most common means of transporting fish from landing sites to retail markets are tracks and jeepneys, most of which are not provided with refrigeration equipment. The inadequate transportation system is not a serious problem, however, because most of the fish landed are immediately disposed as fresh fish. Those of less freshness are processed into dried and smoked fish.

There are two main marketing practices followed in the region: 1) auction sales, and 2) the "suki" (buyer-seller relationship) system. In both practices, the honor system of selling without receipts is done. Oftentimes, sales are based on non-economic considerations, such as honesty and integrity of the buyer. The system has given rise to the incidence of bad debts beyond controllable proportions. Under present conditions, however, these two practices offer the quickest way to dispose of the fish catch.

SOURCE: Fish Marketing in Central Luzon, Research and Development Series No. 21. International Center for Aquaculture Agricultural Experiment Station. Auburn University, Alabama, U.S.A. March 1979.

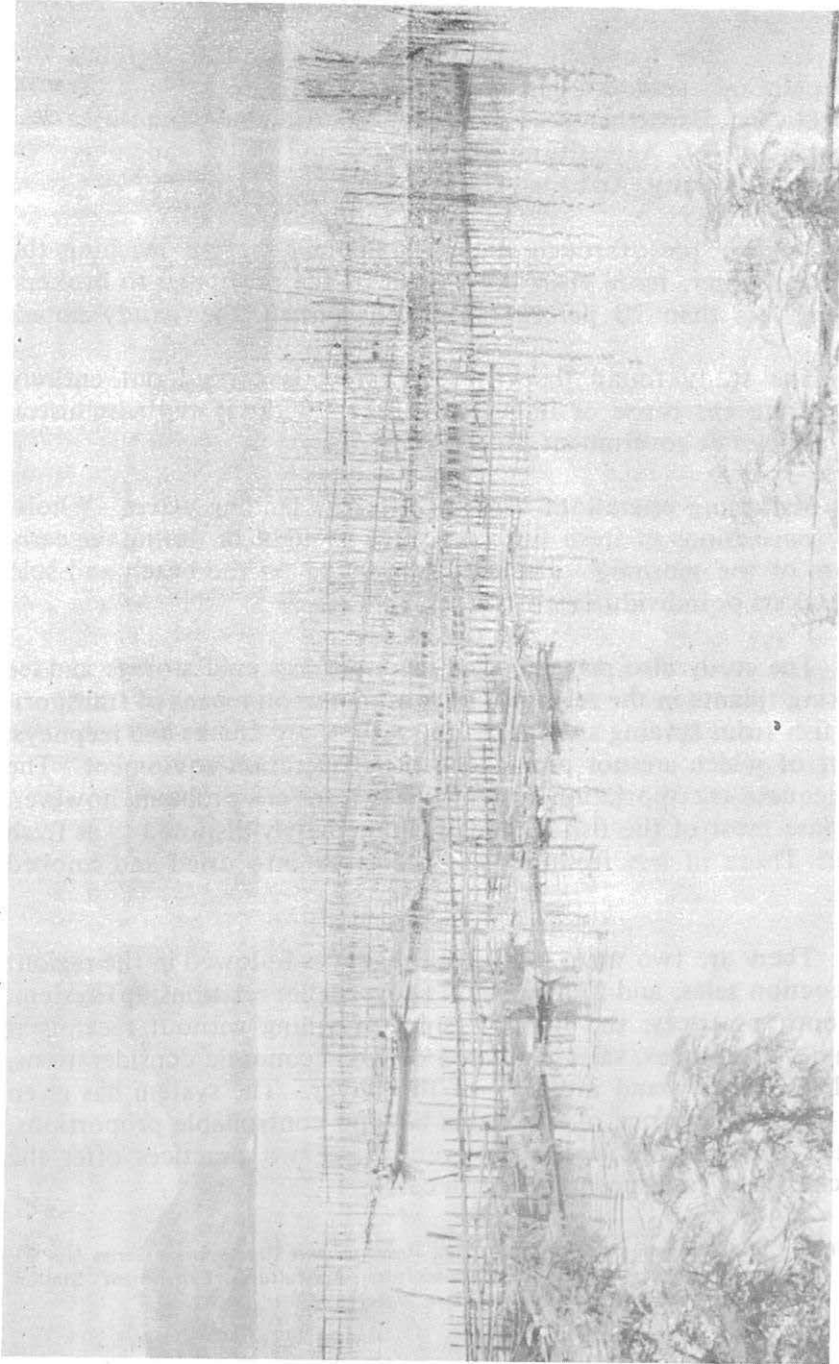

Fishpens and cages at the SEAFDEC Freshwater Fisheries Station in Binangonan, Rizal.

Pen & cage culture

CRITERIA FOR SELECTING FISH PEN SITE

Fish pen farming has been found to be highly profitable with a high and quick return to capital investment. This is especially true with Laguna Lake fish pen owners who raise mostly bangos. It appears that losses only occur when there are typhoons or sometimes fish kills.

Before you go into fish pen farming, however, be sure the following criteria are met:

1. Fingerlings are available.
2. Water depth does not go below one meter during the lowest tide.
3. Current flows moderately.
4. Acidity and alkalinity composition of the water (pH) is stable.
5. Bottom soil is muddy-clay and clay-loam.
6. Cheap labor is available in the locality.
7. Fish pen is sheltered against high winds.

Fish pens may either be made of bamboo screen, locally known as *banatan* or synthetic netting like kuralon, nylon, cremona, tamsi.

The size of fish pens varies from one-fourth to one hectare and can be square or circular in shape. A square pen is, however, more economical and efficient.

The fish raised in pens depends on the natural food present in the lake. However, most farmers give additional feeds which are available in the locality such as rice bran, bread crumbs, corn meal, coconut meal, fish meal, dried shrimps, *lumut*, ipil-ipil leaves and *kangkong*.

The duration of culture depends on the -size of fish and market demand. Bad weather often dictates the time for harvesting. The more common harvesting equipment are drag seine, gill net or cast net. As much as 1.5 to 4 metric tons can be harvested from one hectare of pen per year or 10 times the open water fish catch.

SOURCE: The Philippine Recommends for Bangos 1978. PCARR.

WHAT AILS THE FISH PEN INDUSTRY?

A high ranking official of the Laguna Lake Development Authority has identified the problems which plague the fish pen industry of the Philippines, awareness of which should be helpful to the investor and fishpen aquaculturists. Teodoro Baguilat, LIDA's general manager, mentioned five primary problems:

1) *Typhoons* are the No. 1 killer of the fish pens. Strong winds generating wave action combined with a heavy downpour results in the overtopping of fish nets. Fish escape is a major loss to the fish farmer, although it may be seen as a bonanza to the poor fishermen catching them in open waters.

2) *Fish mortality* results to a recovery rate at harvest time of only about 40-50 percent of the stocking rate, reported Baguilat. A high rate of mortality usually occurs during the fingerling stage, soon after their introduction in the fish pens because of physiological stress. A common phenomenal cause is the so-called "summer fishkill."

3) *Large accumulation of water hyacinth* in between fish pens and in navigation channels create problems of access. During periods of strong winds these accumulations could damage fish pens by pressing against the bamboo barrier. Masses of water plants could in fact increase the extent of typhoon damage to fish pens.

4) Problems of *predators* could be quite serious. Mudfish and catfish are the most important of these carnivores.

5) The fifth is what Baguilat calls the social problem dramatized by the increasing frequency of reported *poaching*. Thirty-eight percent of the fishpen operators reported that they suffered fish losses due to poaching. The LLDA official says it is difficult to define the exact nature of poaching, but he cited reports about net enclosures of the fishpen being slashed below the water line allowing the escape of milkfish which are then caught outside the pens. To prevent poaching many fishpens operators go to the extent of building an extra bamboo fence around their fence or hiring private security forces, according to Baguilat.

SOURCE: "The fishpen industry (of the Phil.): An overview," Teodoro Baguilat, International Workshop on Pen and Cage Culture of Fish, Feb. 11-22, 1979.

CAGE CULTURE IN THAILAND

Cage culture in Thailand started in the early Fifties. Initially, fish were reared in bamboo cages. The cages have been changed to wooden planks and galvanized wire mesh which are easier to handle, inexpensive and durable.

Cages are box-shaped with sizes ranging from 2-3 meters wide and 5-8 meters long by 1.5-2.5 meters deep. Construction cost for a standard cage was approximately 7,000 Baht (about P2,600) with a life span of 6 years before repairs are needed.

Wood cages are built by securing the planks together. Between adjacent planks a space is provided for, usually 2 centimeters to allow water to pass through the cage. A bunch of bamboo poles is used to float the cage.

Five years ago, 722 hectares in Thailand were used for cage culture, containing about 345 cages. Annual production in 1975 was 227 tons worth US \$1 50,000.

Catfish, sand goby, common carp, local carp, Nile tilapia and serpent head are among the species used for cage culture.

Net cages have also been used for the culture of sea bass since the last decade. Most of the culture activities are being conducted in Songkhla Lake, Thailand's largest brackish and freshwater lake.

Net cages are made of nylon net (No. 18) usually 5 x 6 x 3 meters diameter and 3.5 centimeters mesh size. Net pieces are sewed together to form a rectangular shape without a frame. They are made to float in water with depths varying from 1 to 2 meters.

In 1978, the mariculture and seed production staff of Thailand's Marine Fisheries Division also succeeded in the mass production of cuttle fish, mud crab, blue swimmer, striped crab and giant oyster.

However, Thai fish farmers still face the problems of insufficient supply of necessary facilities and equipment, inadequate modern techniques, lack of lead training centers to train farmers who can carry out net cage culture by themselves, and inadequate supply of marine seeds.

SOURCE: "Cage culture in Thailand", Manob Tangtrongpiros and "Net cage culture of Lates calcarifer Bloch and other marine animals in Thailand", Y. Dhebtaranon, S. Maneewongsa and S. Wongsomnuk in International Workshop on Pen and Cage Culture of Fish, February 11-22, 1979.

A FLOATING HOUSE WITH FISH CAGES

A floating house with fish cages for small fish farmers has been proposed by Malaysian fishery experts.

The idea of family unit net-cages was discussed by Prof. Chua Thia-Eng of Universiti Sains Malaysia during the International Workshop on Cage and Pen Culture held at the SEAFDEC Aquaculture Department, Tigbauan, Iloilo from February 12 to 22, 1979.

Chua said such a unit will help fishermen suffering from dwindling catch in inshore waters. Fish cage culture has been found to be more appropriate in certain situation than pond culture. He added that the family unit could train future generations of fish farmers as the family members will be participating in the fish cage culture.

The unit is composed of four rafts each with eight net-cages. In addition to this, a floating house is built to accommodate the family living or working at the fish farm. The area of the house is double that of an 8-cage raft. The 8-cage rafts measure 5.4 x 8.4 meters each while the floating house is 9.6 x 15.6 meters. The unit floats with the use of plastic barrels. The house can accommodate at least a family of four and has a working platform for cleaning, drying or mending the nets as well as space for preparation of feeds.

Both the house and floating cages are anchored to the sea bed by wooden pegs. The whole family unit could be moved and towed away if the environment becomes unfavorable.

HOW TO ELIMINATE FOULING OF NETPENS

A common problem in fish cage culture is fouling of nets. In marine waters, fouling organisms such as barnacles, oysters, mussels, algae, bryozoa, and others rapidly clog up the cage. In freshwater, foulers are mainly algae or freshwater sponges.

Various methods are employed in different countries to prevent fouling. North America and Europe have tried some chemicals but none has proven to be entirely effective. Changing the net at short intervals is one practical solution to the problem. Frequent washing of nets eliminates most algae. In Nepal, *Labeo rohita* is introduced at a rate of 5 fish per 25 cubic meters of water as a biological control for freshwater algal fouling. When nets are changed, vigorous brushing to clean them of algae is also effective.

In Thailand, net cages are painted with chemical and antifouling paints. The paint also prevents rusting of wire cages. In Singapore, nets are hosed with strong jets of water and dried in the sun once a month. Rotating cages to expose out of water the part of the cage blocked by fouling organisms is also practiced in Europe.

To protect the cages from large masses of aquatic weeds and other floating objects, planks may be placed as a shield. Such planks can also deflect timber and logs or small tranches. Or, cages can be simply protected by surrounding them with bamboo poles placed horizontally. In Singapore, an outer net is installed to avoid floatsam.

FOR BETTER WATER MOVEMENT AND AERATION POSITION YOUR FISH CAGES PROPERLY

Oxygen depletion causes large fish losses in ponds. In cage culture fish kills from lack of oxygen also happens, and when they do, loss is usually 100 percent. Fish in ponds can move freely to areas with higher oxygen concentrations, or disperse when dissolved oxygen level drops. However, caged fish cannot escape from the enclosure. Consequently losses are often complete because the closely crowded fish deplete the oxygen faster than water circulation can supply. Good water circulation through the cage is essential for aeration and waste removal. This circulation is greatly dependent on wind-induced water currents, but is aided by the swimming action of the fish. Proper cage positioning greatly affects circulation.

- 1) Cage placement should be such that the longer side faces the prevailing wind.
- 2) The interval between cages should be about 20 feet or more.
- 3) Cages should be positioned over deep water so that solid wastes can sink where water stratification keeps them out of the water where the fish are.

SOURCE: "Second Report to the Fishfarmers," U.S. Department of Interior, Fish and Wildlife, Washington D.C., June 1973.

Miscellaneous Information

A BRIGHT FUTURE FOR POND CULTURE FISHERY

High growth rates, less pollution, vast areas of undeveloped swamps and estuaries, the fact that fish can be cultured all year round and the relative ease in growing natural fishfoods are some of the main reasons why the prospects of pond culture fishery in the Philippines look very bright, brighter in fact than Japan's.

This is the assessment of a Japanese fish culture and ecology expert, Hiroshi Motoh, who has been working for more than four years at the SEAFDEC Aquaculture Department based in Tigbauan, Iloilo, Philippines. Mr. Motoh is the leader of the ecology research project of SEAFDEC.

He gives the following reasons for claiming that pond culture fishery here has a brighter future than in Japan:

1. Fish reared in Philippine ponds attain a higher growth rate because water temperature is continuously high. The warm temperature enables the rearing of fish and shrimps throughout the year.
2. There is less pollution of coastal waters by industrial plants and sewage disposal.
3. There are still vast areas of undeveloped swamps and estuaries and the cost of developing pond areas would be much cheaper here than in Japan.
4. Spawning seasons of useful species are longer in the Philippines than in temperate zones so that more fry could be spawned over a longer period.

5. Water management in ponds can be easily done due to a wide interval between low and high tides. This being so, competitors and predators of cultured fish and shrimp can be easily controlled.

6. *Lablab* - the term for the complex of diatoms and Zoo-planktons - grows naturally in nursery and culture ponds and serves as a cheap supply of food for bangus and other species.

Mr. Motoh says that the price of seafoods in the Philippines is relatively cheap even as the demand is great. The fishpond industry here could be further improved once artificial seed production techniques are successfully applied by the fish farm operators, he adds.

CONVERSION GUIDES FOR FISHPOND RAISERS

Some of the details involved in the daily management of fish ponds are relatively simple. But they can be confusing if instructions involve quantities and measurements which may not be familiar to fishfarm workers. Conversion of units of measures from one system to another could aid the fishfarmer in some of his routinary yet vital pond preparations.

Calculations of the amount of chemicals to be used in fish-farming may involve metric and English units, or combinations of them that may be confusing. Standard units used in fish culture are listed below:

One *cubic foot* of water weighs 62.4 pounds and contains 7.5 gallons. The number of cubic feet in a pond equals the length x the width x the average depth (all measurements in feet).

The volume of water in your pond is *area* multiplied by the average depth of water. One hectare containing water one-half meter deep contains 5,000 cubic meters of water or 50 million cubic centimeters (cc) or milliliters (mL). Or it is about 13,382 gallons.

One gallon (4 quarts or 8 pints) equals 3,800 cubic centimeters (cc). One gallon of water weighs about 8.34 pounds or 3,800 grams.

One pound (16 ounces) equals 453.6 grams and 1 ounce equals 28.35 grams.

Weights are expressed in metric system as grams and kilograms.

A *kilogram* equals 1,000 grams or 2.2 pounds.

Volumes are expressed in *cubic centimeters* (cc) or *milliliters* (mL).

One *liter* equals 1,000 cubic centimeters (cc) or milliliters.

Metric units are frequently used for measuring small amounts of chemicals. Thus, we may apply a certain number of grams of chemicals per gallon, grams per cubic foot, cubic centimeters per gallon or per cubic foot.

In the treatment of fish, it is a common practice to add enough chemicals to the water to produce a desired concentration. Concentrations are generally expressed as parts of chemical per million parts of water or PPM. For example, the addition of one gram of water to 999,999 grams of water gives a concentration of one (1) PPM in a total weight of one million grams of solution.

The amounts of chemical needed to produce one part per million (1 PPM) in each of the standard units of water volume are:

0.0038 gram per gallon
0.0283 gram per cubic feet
1.0 gram per cubic meter

Another method of treatment is the incorporation of a chemical in fish feed. Such treatment is based on the weight of fish. If a standard unit of treatment is given in grams of a chemical per 100 pounds of fish per day; and if 100 pounds of fish are to be treated with terramycin at the rate of 2.5 grams per 100 pounds of fish per day; the amount of feed given each day must contain 2.5 grams of the chemical or the drug. Generally speaking, fish are fed at the rate of about 3 percent of their body weight per day, or 3 pounds of feed to each 100 pounds of fish. For treatment, the feed requires 2.5 grams of terramycin in every 3 pounds of ration. The amount of terramycin per pound of feed therefore is 3 divided by 100 multiplied by 2.5 ($3/100 \times 2.5$) or .075 grams.

What to do with formulations

In these examples, we are assuming that all the chemicals are pure compounds or with a 100 percent active ingredient. However, few of the compounds we use today are pure chemicals. To determine how much of such a mixture is needed, divide 100 by the percent of active ingredient given in the formulation. For example, assume that the chemical to be used contains 25 percent active ingredient; dividing 100 by 25 percent gives you an amount that is four (4) times as much of the formulation as is required of a pure chemical.

One final point: always use the weight of the active chemical when computing for parts per million (PPM).

MOST PANAY FISHFARMERS FOLLOW POLY CULTURE

While Panay fishfarmers follow different rearing schemes almost half are practicing polyculture of bangus and shrimps. This was revealed in a study conducted by Rose Tenedero of the SEAFDEC Institute of Aquaculture for her masteral thesis. The study included some 72 cooperators from Iloilo, Capiz and Aklan who trained in SEAFDEC in 1974-76.

The study also showed that one-third practiced monoculture of bangus while the rest (22%) set aside some ponds for monoculture of bangus and devoted other ponds to the polyculture of bangus and prawns.

At the time of study (1978) milkfish was still the major farm product among these cooperators; it composed from eighty to 100 percent of the pond crop among Iloilo cooperators. Other products were crabs and other shrimps aside from sugpo. Some 37 percent of the cooperators from Iloilo, Capiz and Aklan reported setting aside from one to twenty percent of their total pond area for the production of sugpo. However, almost three-fourths said they were planning to increase the area for prawn.

Also shown in the study is the fairly short experience in prawn culture among the cooperators. Two out of three had less than one

year of experience with prawn and nobody has been in the prawn business for a period longer than ten years. At that time, all the respondents said they had not attended any training program on prawn culture except the one they underwent in SEAFDEC.

SOURCE: Rosita Tenedero, "An evaluation study of the first two years of the SEAFDEC cooperator's program," M.S. thesis (unpub), West Visayas State College, 1979.

STUDY REVEALS POND MANAGEMENT PRACTICES OF PANAY FARMERS

Many of the pond culture practices that Panay farmers had been following closely conform to the recommended techniques, a study of some 72 cooperators from Aklan, Capiz and Iloilo shows. Pond drying has been a widely practiced technique, acclimation of prawn fry has been followed, and frequent change of pond water with the high tide as well as maintaining a water depth of from 30 to 90 centimeters were among the widely followed practices.

Feeding however has been reported to be irregularly done depending on the availability of feeds. And, while Iloilo pond culturists ranked growing of *lablab*, method of stocking and acclimation techniques as the most important part of pond management, their counterparts in Capiz and Aklan considered good dikes, well-kept gates and screened water intakes and outlets as well as acclimation as priority activities.

The cooperators who were interviewed for the study confessed their ponds were not very suitable for prawn culture due to the high elevation of the ponds and a rather high water salinity especially in summer. They said their major problem was the lack of a good freshwater supply.

A significant finding is that many of the fishfarmers stock anytime that fry is available - a reflection of the irregular supply of fry.

SOURCE: Rose Tenedero, "An evaluation study of the first two years of the SEAFDEC cooperator's program," M.S. thesis (unpub.), West Visayas State College, 1979.

INSTANT FISHPOND IN CREEK YIELDS MORE THAN FISHPONDS IN CAPIZ

Most fishermen of Barangay Hipuna, Pontevedra, Capiz used to depend solely from the meager fish harvests they catch from the sea, which sometimes is not even enough for their families' food needs.

But that was before they banded together, formed a cooperative and built an instant fishpond in a creek. The 400-square meter instant fishpond yielded 480 kilos of sugpo and bangos and some *alimango*. This is equivalent to 12,000 kilos per hectare, 60 times the minimum average fishpond yield in Capiz.

This project has provided sufficient income for some 62 farmers and their families in Barangay Hipuna who are members of the Tugbongan-Libakaw Fish Farmers' Cooperative.

Because of the project's success, the cooperative constructed another 500-square meter instant fishpond in the creek.

How did they do it?

According to Nelson Oquendo, a fishpond operator who helped start the project, the instant fishpond is not a new idea in fish farming because this is exactly what fishermen in Laguna de Bay do but in their case they use nylon nets entirely as walling material. In the case of the instant fishpond, they use marine plywood in combination with nylon nets.

The plywood - 3/4-inch thick, four feet wide and eight feet long - was first soaked in coal tar (*alkitran*) for one to three weeks. Wood posts, measuring three inches by four inches and 12 feet long, were also treated with coal tar.

Soaking the plywood and the posts in coal tar makes them last for up to 10 years, said Oquendo.

The posts were then driven eight feet apart, into the creek's bottom. The marine plywood was nailed on them. The plywood was buried one foot deep in the pond soil and was submerged three feet underwater.

Oquendo said that even if the creek dried up, the pond would still have water because of the plywood enclosure.

The top of the plywood wall is lined with nylon net, about three feet wide. This will ensure that every time the tide rises, water inside the pond is changed and becomes fresh again.

SOURCE: Philippine Farmers' Journal, July 1979.

MARINE BORERS - HOW TO PROTECT BOATS AND OTHER MARINE CONSTRUCTION AGAINST THEM

Two general groups of marine organisms attack wood in sea water. One group is related to clams and molluscs and this is where the shipworm and *Martesia* belong. These borers cause heavy damage on wood. The shipworm larvae attack the submerged portion of wood by boring holes. Once inside the wood, the worm bores a tunnel along the direction of the woodgrain. The tunnel becomes larger as the shipworm grows. On the other hand, the *Martesia* is active all year round.

The other group of marine borers are the ones related to crustaceans particularly *Limnoria*. Their damage is limited to the water level.

To protect marine wood against these marine borers, lumber for ships, fishing boats and other marine construction should be pressure-treated. Pressure treatment - particularly the required penetration and retention of treated lumber - should meet the PHILSA Standard No. 104:1975.

Use wood species that possess a natural durability to marine borers. Species not significantly damaged are yakal, manggachapui and yakal-gisok. Tree species with moderate durability are almon, palosapis and guijo. Don't use white lauan as it is prone to heavy damage from marine borers.

SOURCE: Phil. Recommends for Dipterocarps I. Lumber, PCARR. 1977.



MILKFISH

POND SITE SELECTION, DESIGN & CONSTRUCTION	68
What makes a good milkfish farm site?	68
Be sure you have a good water source	70
Cost of developing a milkfish farm	71
Some guidelines in designing a bangos farm	71
Build a strong main gate to prevent overflowing	73
How to build dikes	75
Converting a virgin area into a fishpond	76
Selecting a site for a bangos nursery pond	77
What should you build: an earthen nursery pond or a concrete nursery tank	78
FRY MANAGEMENT	80
March--June is the peak season for bangos fry catching	80
Sources of bangos fry mortality	81
Handle fry carefully	81
Prevent stress in fry	82
Simply ways to check condition of fry	83
How to distinguish milkfish fry from fry of other species	83
Rearing bangos fry to fingerlings	84
Research project aims to end shortage of bangos fingerlings	85
POND MANAGEMENT	86
Blue-green algae (<i>lumut</i>) and diatoms (<i>lablab</i>) are the best natural food of bangos	86
How to grow <i>lablab</i> for high bangos yield	87
How to prepare a nursery pond with <i>lablab</i> as main food	89
Protect <i>lablab</i> from bad weather	90
How to maintain good growth of <i>lablab</i>	91
Control pests of <i>lablab</i>	91
Fully use <i>lablab</i> thru stock manipulation	92
How Taiwan produces 2,000 kilos of bangos per hectare	93
Stock manipulation: one reason for Taiwan's high yield of bangos	94

Preparing the nursery pond with plankton as main food	95
Platform method saves you fertilizer by as much as 40 percent	96
How to tell when fish is under stress	97
Prevent diseases: avoid injuring fingerlings	97
Watch out for bangos kills	98
Bangos kills are bound to occur after heavy rains	98
Watch out for low oxygen level in your ponds	99
How to control pests and predators in bangos ponds	100
HARVESTING AND UTILIZATION	102
For quicker harvest of bangos: construct a chilling tank	102
Harvest bangos the <i>pasubang</i> way	103
Bangos offal can be made into fish meal or silage	103
How to make soft-boned smoked bangos	104
PEN AND CAGE CULTURE	106
Production tips from results of studies on bangos culture in Laguna Lake	106
Tips on raising bangos in cages in freshwater	107
Bangos fry acclimation for freshwater farming	108
MISCELLANEOUS INFORMATION	110
Output and needs of bangos farmers in RP	110
Buy bangos weighing no less than 600 grams and other tips	112

Pond site selection, design & construction

WHAT MAKES A GOOD MILKFISH FARM SITE?

Your choice of a site can immediately spell the outcome of your milkfish farming business. Study the site first before constructing a fishpond. The following pointers will help you choose the right site:

Climate. Milkfish, locally known as bangos, grows faster in warm water above 23 degrees centigrade. However, its growth is retarded when the water salinity or salt content is beyond 45 parts per thousand. The type of climate prevailing in a region is a good indicator. Regions having a short dry season (3 to 4 months) followed by a relatively wet season are well suited for bangos raising than those having an evenly distributed rainfall throughout the year. In the latter, *lablab* - a very good natural food of bangos - will be difficult to grow. The grass green algae or "lumut" will be dominant in such a region but this kind of food can only result in lower bangos yields.

Soil. The best types of soil for bangos ponds are clay, clay loam and sandy clay. Hard mud of the above types is preferable to the soft and loose kind. Hard mud are good for diking and make good pond bottom for the growth of *lablab*. Highly acidic soils should be avoided. This type of soils is characterized by yellowish to reddish particles often becoming reddish when exposed.

Topography. Level marshes and tidal flats are excellent sites. Undulating or rolling areas entail big capital expenses for excavation and levelling. Also, large-scale excavation of uneven surface may expose poor quality soil which requires a long period of conditioning to make the pond bottom productive.

Swampland areas normally have an even surface but some may slope slightly towards the river or coastline. A good knowledge about the lay of the site helps you minimize earthwork and plan your farm layout to fit the natural topography of the site.

Elevation. A bangos fishpond must be in a proper elevation to insure adequate water supply and get it drained when necessary. Such an elevation allows enough water to come into the pond during ordinary high tides and allows draining during ordinary low tides.

Before constructing a pond, find out the tidal characteristics in the area to enable you to determine the ideal pond elevation.

Water Supply. Good quality water should be adequate all year round. It may come from a tidal river, stream or creek or directly from the sea. Salinity or salt content of the water from a tidal river may vary widely depending upon the river's distance from the open sea and the nature of the surrounding area. The river water should also be examined to find out if it is free from pollution.

The availability of a freshwater source is beneficial especially during a long dry season. You'll need it to prevent the rise in pond water salinity.

Vegetation. Thickly vegetated areas should be avoided because you will spend much for labor to uproot the trees and other plants. Afterwards, the area may still be filled with tree stumps.

Socio-economic Factors. Pond construction and management will be easier, cheaper and more effective if skilled labor is available and cheap, if sources of construction materials and production inputs are near the farm site, and if the peace and order situation in the locality is good.

SOURCE: Milkfish Culture in Brackishwater Ponds by M. Lijauco, J.V. Juario, D. Baliao, E. Griño & G. Quintio, SEAFDEC Aquaculture Department.

BE SURE YOU HAVE A GOOD WATER SOURCE

An abundant source of clean, unpolluted tidal water and freshwater is one of the most important need in brackishwater fishfarming. For freshwater, you could dig ground wells, look for artesian wells, or tap from springs, rivers or lakes as long as the water from these sources are clean and uncontaminated by industrial, agricultural and human settlement pollutants.

For seawater, an estuary or coastal water far from sources of pollutants would be an excellent source. Fishfarmers in Taiwan dig shallow wells on the beach at levels lower than the lowest water level to obtain clean sea water. The sand acts as the water filter.

Reservoir. If you don't have good water sources nearby you may have to build a reservoir. The reservoir can be filled to capacity at high tide. To take advantage of the tidal force, provide the reservoir with enough water gates. Water flowing into the reservoir should be screened. You are also advised to fertilize the reservoir water to induce a good growth of algae and phytoplanktons. "Green water" is highly oxygenated. A reservoir should have the capacity to supply the entire water need of the nursery and transition ponds as well as a seven-day supply at 10 percent daily volume of the water requirements in the other ponds. Bear in mind that there are three to four days every two weeks when tidal amplitude is low. This means that during these periods, you cannot take advantage of the tide to bring in fresh seawater. Therefore, you will need the water impounded in the reservoir.

If plankton and algae grow abundantly, stop fertilization. You could even stock the reservoir with some fish - 300 to 500 per hectare -- to avoid excessive growth of algae.

SOURCE: "Milkfish Nursery Pond Management," by Ceferino delos Santos, Jr.

COST OF DEVELOPING A MILKFISH FARM

Bangos farming is a business that involves big investments. But potential income is also big.

To start a one-hectare fishpond, you'd spend P25,000 to P35,000 for earthwork alone - diking, levelling and clearing - using manual labor. Mechanization will cost higher but construction period may be shortened by more than one-half the time it takes for manual labor to finish.

For production expenses, the three major items are fry or fingerlings, hired labor and production inputs such as fertilizers and pesticides. The production cost is estimated to be at 60 to 75 percent of the gross sales from bangos. So, if a kilo of bangos sells at P6.00, you can expect a net income of P1.50 to P2.40 a kilo.

Bangos farms in the Philippines yield an average of about 650 kilograms per hectare per year. The less productive ponds yields as low as 300 kilograms only but the more productive one can yield as much as 1,000 kilograms. Some exceptionally well-developed and effectively managed ponds are able to produce as high as 2,000 to 3,000 kilograms per hectare per year.

A prospective bangos raiser would do well to study proven procedures and techniques before starting to construct a fishpond.

SOURCE: Milkfish Culture in Brackishwater Ponds by M. Lijauco, J.V. Juario, D. Baliao, E. Griño and G. Quinitio, SEAFDEC Aquaculture Department.

SOME GUIDELINES IN DESIGNING A BANGOS FARM

The cost and ease in managing a bangos farm largely depend on how the ponds and the support facilities are laid out. The farm layout should meet the requirements of the type of operation the bangos farmer intends to carry out.

A bangos farmer may engage in either of the following three

operations: 1) purely nursery system; 2) purely rearing pond system; and 3) combination of nursery and rearing pond system.

In the first system, the farm consists mainly of nursery ponds and holding or stunting ponds. Fry are grown into fingerlings which are sold to other fishfarmers.

In the second system, the farm is divided into rearing pond compartments. No nursery pond system is provided. Stunting or holding pond may or may not be present.

A bangos farmer may engage in a complete farming system - a combination of the first and the second systems. The farm consists of nurseries, stunting, and rearing ponds. The operation would therefore involve fry rearing to fingerlings and growing the fingerlings to marketable size.

Aside from the type of farming operations, the layout will be influenced by the size, shape and condition of the site. A rectangular site is ideal since dikes and ponds will be easier to construct than other shapes. Sites which are long and narrow or very irregular in shape will entail higher development costs.

Here are more guidelines in planning the layout of the farm:

1. The main gate is generally located at the lowest portion closest to the source of water, but strategically located as to distribute water effectively into the pond system. Normally, a one-door main gate is sufficient for a 10-hectare project.

2. Enclose the whole area by well-built perimeter dikes and divide the area into small compartments by secondary dikes which are smaller than the perimeter dikes.

3. Provide a system of canals and catching ponds for easy harvesting and effective water management. A section of the main canal immediately in front of the main gate may be used as catching or holding compartment for fish.

4. The ponds should be capable of being operated independently of one another.

5. Put the nursery system close to the stunting or transition pond but centrally located to facilitate transfer of fingerlings within

the farm. In large projects, more than one nursery system may be necessary.

6. Divide the farm symmetrically into regular-shaped pond compartments. Crooked or winding partition dikes are more expensive to construct besides being more prone to wave erosions.

7. Perimeter dikes along rivers, creeks and shorelines should be built 3 to 6 meters within the property boundaries to allow growth of vegetation which will serve as wind or wave breakers.

8. In a combination system, the nursery ponds occupy 3 to 5 percent of the farm area; stunting and transition ponds, 20 to 30 percent; and the rest for rearing ponds, canals, dikes, and other facilities.

SOURCE: Milkfish Culture in Brackishwater Ponds by M. Lijauco, J.V. Juario, D. Baliao, E. Griño & G. Quinitio, SEAFDEC Aquaculture Department.

BUILD A STRONG MAIN GATE TO PREVENT OVERFLOODING

The main gate is one of the most important structures in the bangos farm. If it fails to control water from the source, the whole fishpond could be overflowed since secondary and tertiary dikes are much smaller and lower than the perimeter dikes.

Although the main gate could be made of wood, you'd be more secure if you used reinforced concrete. When building a concrete gate, consider these four requirements: adequate foundation, adequate reinforcement against sidewise pressure, proper mixture and curing, and prevention of undercutting.

Work on the gate starts by enclosing the site with temporary dikes. To ensure a strong foundation, drive bamboo poles one foot apart, center to center, until the hardest soil layer is reached. In addition to this, wooden stakes 2 inches thick, 6 inches wide and 6 feet long should be driven close to one another forming a single line directly below the center of the wall and aprons. This will reduce bottom scouring.

Cover the piles with medium-sized boulders. Then on top of this, place one-half inch diameter steel bars for vertical reinforcement and 3/8-inch bars for horizontal reinforcement. Pour class A concrete mixture 20 centimeters thick. Sprinkle the formed concrete with water or cover with moist sacks.

The sides of the gate should be about one meter apart and should rise vertically to the crown and extend all the way across the dike with the center edge curving outward to form the wings.

Provide three pairs of grooves on the walls: one in the middle for the removable slabs to control water and one on each end for the screen to prevent entrance or escape of fish.

The smaller gates leading to the rearing, transition and nursery ponds are smaller. Ordinarily, they are made of wood painted with coal tar, although they could be made of concrete or hollow blocks. Sizes are proportionate to dikes and the designs vary from the ordinary open sluices type to culvert or monk type. It is useful to provide two pairs of middle grooves 30 centimeters apart for occasional needs to soil seal the gates. Mud packs are held between two sets of slabs.

The gates may or may not have floorings. To reduce scourings, attach 2 feet wide lumber boards directly below the slab grooves in the middle.

For small ponds, pipes can be used instead of the gates. They may be made of wood, asbestos or concrete. Usually, the pipe is about 30 centimeters in diameter, and the length depends on the span of the dike's base. They are provided with slabs, screen or plugs to control water and to prevent entry of predators or escape of fish.

SOURCE: Milkfish Culture in Brackishwater Ponds by M. Lijauco et al., SEAFDEC Aquaculture Department.

HOW TO BUILD DIKES

A bangos farm is made up chiefly of three kinds of dikes: the perimeter or main dikes, the secondary, and the tertiary dikes.

For the main dike

Clear the path of the main dike of trees and grasses including roots and stumps. The cleared path should be 2 to 4 meters wider than the proposed base of the dike. Dig a puddle trench ("mitsa") of about 50 centimeters wide and 50 centimeters deep in the middle of the clearing. Packed with good soil, the trench will help anchor the dike to the subsoil and reduce seepage.

The main dike should be at least one meter higher than the highest flood level at the locality.

The slope of the dike will depend on whether portions of the dike are exposed to strong wind and wave actions. If a dike section is *not* exposed, the slope should be 1:1 ratio, that is 1 unit of horizontal for every 1 unit of vertical rise. If exposed, the ratio should be 1.5:1.

Boulders may be used to reinforce sides that may be subjected to very strong current or wave actions. The crown or top of the dike should be at least 1 meter wide. Some pond owners make it 3 meters or more to allow vehicles to pass through.

The dike is constructed layer by layer of neatly placed mud blocks. Allow each layer to shrink and settle before piling on another. At least, three horizontal layers will form the dike. The final height is determined after allowing 15 to 20 percent for shrinkage and settling.

For secondary and tertiary dikes

The secondary dikes form the large ponds and main water canals while the tertiary dikes make up the nursery pond system.

The crown of the secondary dikes should be about one-half to one meter and with a height of one to one-a-half meters from the pond bottom. The slope usually has a 1:1 ratio.

On the other hand, the smaller tertiary dikes should have a crown width of 0.3 meter, a base width of 0.8 meter and a height of 0.8 meter.

These dikes are constructed in much the same way as the main dikes. Berms or shoulder may be provided if there is a large excess of soil materials inside the compartments.

SOURCE: Milkfish Culture in Brackishwater Ponds by M. Lijauco *et al.*, SEAFDEC Aquaculture Department.

CONVERTING A VIRGIN AREA INTO A FISHPOND

How does one start to convert a virgin area into a productive bangos farm?

This is the question that a prospective bangos pond operator should be able to answer with a well-planned work program.

First of all, you'll have to decide whether you can develop the whole area or only part of it. The area might be too large for you to finance. In this case, you may start developing part of the area and expand as you acquire additional capital. The income you will get from the initial operations could be plowed back to the business to develop the rest of the area.

In general, fishponds are built using mainly manual labor especially if the place is water-logged and cannot be reached by heavy equipment.

First, build the perimeter dikes to control the water level. Without control, water in the job site will rise and fall with the tides and thus hamper the earthwork.

While building the perimeter dikes, start constructing the main gate. At this time too, a benchmark based on the zero datum of the tide must be established. This benchmark will determine the elevation of dikes, gates, pond floors and other facilities of the farm.

A topographic survey of the site would be very helpful especially if the area to be developed is big. An accurate survey can be

done by a licensed surveyor. However, in most cases experienced pond contractors employ practical surveying methods using the water surface as the level to estimate relative differences in land elevations.

While the work on perimeter dike is going on, start building partition or secondary dikes to form pond compartments. You may keep some section of the dikes open to allow passage of flatboats or dozers during clearing, excavation and levelling.

Clearing and levelling may be done immediately after the compartments had been formed. However, you may postpone it until after the trunks have decayed.

Save the rich top soils during the excavation. Pile them up in a large heap. After the excavation, push the top soil back into the pond to form the top layer.

Another way of saving the top soil is by doing strip excavation. Strips of land are excavated alternately after every 3 to 4 meters. The unexcavated areas with its top soil are then levelled and made to fill the excavated strips.

SOURCE: Milkfish Culture in Brackishwater Ponds by M. Lijauco, J.V. Juario, D. Baliao, E. Griño and G. Quinitio, SEAFDEC Aquaculture Department.

SELECTING A SITE FOR A BANGOS NURSERY POND

A very critical step in bangos raising is the management of the nursery pond. It involves the raising of bangos fry to fingerlings. As part of the bangos fishpond system, a nursery pond should be situated properly. Here are the bases for choosing a good site for a nursery pond:

1. There must be an adequate source of unpolluted tidal water;
2. Soil must be clay or clay-loam or sandy-clay and rich in organic matter;

3. You must be able to completely drain the nursery pond compartment in which case its elevation must not be lower than the lowest tide level in you area;
4. The area must be clear and with few vegetation;
5. Bottom must be level; and
6. Nursery pond should be accessible from the rearing ponds.

Nursery ponds, which are normally small and shallow, must be well-kept for growing fry. Locate and built a smaller catching pond ("kulungan") at the lowest part of the pond compartment for impounding and catching fingerlings.

SOURCE: Milkfish Nursery Pond Management, by Ceferino delos Santos Jr. presented at the seminar-workshop on Aquaculture Business Project Development, Evaluation and Management (APDEM), Institute of Aquaculture, SEAFDEC Aquaculture Department, March 3-16, 1980.

WHAT SHOULD YOU BUILD: AN EARTHEN NURSERY POND OR A CONCRETE NURSERY TANK?

Depending on your purpose and location, you can choose from either of two commonly used nursery ponds.

Earthen Ponds. In low areas, earthen nursery ponds would be the most popular to use as construction costs are lower. Pond elevation in relation to tidal amplitude (highs and lows of a tidal cycle) will not require so much expensive excavation work. With a good provision for water exchange the system could be profitable. A good system of water exchange reveals the need for costly pumps.

Concrete tanks. Some farmers prefer to use concrete tanks. Concrete tanks are recommended when the nursery area is far from good sources of fresh and seawater, far from electricity source, far from an access road, and the farmers' main business is selling fingerlings.

Nursery tanks vary in shape and sizes. Freshwater is drawn from ground wells or the local waterworks, but care must be done to avoid water with too much chlorine. Seawater may be obtained from a nearby river or sea or may be transported in tanks. Water filters and recycling systems are usually installed to lessen water consumption. Aquarium aerators are sometimes installed while some use compressors and dry air blowers but these are rather expensive.

Fish are given artificial feeds. Because of the close supervision normally given to nursery tank systems, survival rates are high.

SOURCE: Milkfish Nursery Pond Management by Ceferino delos Santos Jr. Paper presented at the seminar-workshop on Aquaculture Business Project Development, Evaluation and Management (APDEM), Institute of Aquaculture, SEAFDEC Aquaculture Department, March 3-16, 1980.

Fry management

MARCH-JUNE IS THE PEAK SEASON FOR BANGOS FRY CATCHING

The peak season for catching bangos fry is from March to June. So, take advantage of this opportunity. Collect as much as you can for a year-round supply. You can store the fry up to one year in nursery ponds or *kulungan* as a "fry bank" provided supplementary feeding is given.

According to the *Philippines Recommends for Bangos 1978*, the peak season is usually preceded by rainfall and occurs in places where salinity or salt content of the water ranges from 36 to 38 parts per thousand. During the season, the fry is more abundant during full moon and new moon. Catch the fry in the morning during high tides and along the shallow sandy shores. You can use any of the following gears: *saplád* (set fry trap), *sayod* or *sagap* (fry seine), *sakag* (scissors net), bull trawl, or fry dozer.

The Philippines has abundant natural breeding grounds for bangos fry. Known fry grounds are the shallow sandy coasts, tidal creeks and mouths of rivers. These grounds extend up north in the Ilocos and Cagayan Region, along the western coasts of Luzon and the Bicol Region, the Central, Eastern and Western Visayas including Oriental Mindoro and Masbate, to as far south as Mindanao and Jolo.

SOURCES OF BANGOS FRY MORTALITY

More than two-thirds or 65 percent of bangos fry caught in the Philippines go to waste, according to estimates of fishery experts.

Mortality begins right away during fry collection. As fishermen capture the fry from the waters and bring them ashore, some five percent are already killed. When they sort and count the fry for buyers, ten percent more are killed. For careless handling of the fry while holding in containers, the buyer wastes another ten percent. Still another ten percent is lost while transporting the fry to the nursery ponds. The rest of the mortality rate, 20 percent, occurs while rearing the fry to fingerlings in the nursery and transition ponds.

The only way the mortality rate could be reduced is through proper care and handling of the fry.

HANDLE FRY CAREFULLY

Most bangos fry gatherers sell their catch to middlemen who in turn supply the fishpond operators. In the process a big portion of the catch is usually lost due to carelessness.

You could save this wastage and help solve fingerling shortage by being extra careful in handling and transporting the fry.

Bangos fry are better kept in wide-mouth earthen jars or *palayok* of about 20 liters capacity. Half-filled with water, the *palayok* can store 2,000 to 2,500 fry. You can use either saltwater or hard freshwater as long as the change from seawater to totally freshwater is not abrupt.

The fry may be stored in jars for one week. But be sure they are kept in a shaded place to protect the fry from direct sunlight and prevent the water from warming up. Give the fry supplementary feed during daytime at a rate of 3 to 5 percent of the total body weight of the fry stored in the jar, divided into 3 to 4 rations.

The yolk of boiled egg is the common feed of the bangos fry. Crush the yolk finely and mix with a small amount of water. Then sieve the mixture by compressing in an ordinary clean cloth.

Inspect the fry daily and fish out the dead ones. This will help prevent contamination and spread of bacteria to the rest of the stock.

Styrofoam boxes seem to be the best containers in transporting the fry. However, you could also use the cheaper container made of oxygenated plastic bags placed inside the "bayong", a native bag made of woven pandan leaves. The plastic bag is 50 centimeters wide, 83 centimeters long, and 0.0075 centimeter thick. Fill the plastic bag with at least 1/2 to 1/3 full of water from the pond or with ordinary well water. Be sure the fry had been acclimated to freshwater. One bag can hold 6,000 to 10,000 fry.

PREVENT STRESS IN FRY

Sudden changes in temperature and salinity are the most common causes of stress in bangos fry which results in fry mortality.

To avoid salinity stress during transfer or stocking of fry, determine the salinities of the water where the bangos are and where they are to be transferred by using a simple salinometer. You must also decide whether or not a direct transfer would be safe. The simplest way of doing this is by following this procedure:

1. Transfer 2 to 5 bangos fry or fingerlings directly into a large bucket, tub or basin containing water from the pond where the fish are to be transferred.
2. If there is no sign of stress within four hours from the time they were placed in the tub, it is safe to transfer all the fish to the new pond.
3. If stress develops, repeat the test by transferring 2 to 5 fish to a tub containing a half-and-half mixture of the water from where the fish are held and where they are to be stocked.
4. Repeat this procedure as many times as necessary until no stress appears.

SIMPLE WAYS TO CHECK CONDITION OF FRY

Mr. Alfredo Lopez, president of the Organization of Negros Occidental Fishpond Operators, gives the following three simple ways of checking whether the bangos fry you are about to buy is in good condition:

1. Place 1,000 to 2,000 pieces of bangos fry in a porcelain dish. Rotate the water clockwise and observe the fry movement against the water current. Healthy fry will swim vigorously against the current.
2. Move your hand over the dish. If fry is healthy, it will evade your hand by swimming down.
3. In a darkened room, direct a flashlight beam into the water in the dish and observe whether the fry will avoid the direct beam of light. If they do, you're assured of a healthy fry.

SOURCE: Pond Culture and Management - Selected Readings, SEAFDEC-AQD.

HOW TO DISTINGUISH MILKFISH FRY FROM FRY OF OTHER SPECIES

If you are buying milkfish fry, it would be to your advantage to be able to distinguish them. Otherwise, you could get a lot of the wrong fish.

Milkfish fry at 20 to 30 days is tiny, almost transparent and looks very similar to the fry of tarpon (buan-buan) and ten-pounders (bid-bid), both considered undesirable species. Milkfish fry could be distinguished from tarpon fry by its longer body and by the location of the dorsal fin. Dorsal fin of milkfish fry is nearer the tail than those of tarpon fry.

Milkfish fry could be distinguished from the ten-pounder by color and the size of its tail fins. The ten-pounder has a light amber color while the milkfish is almost colorless. Also, the ten-pounder has a longer and wider tail fin than the milkfish.

These distinguishing features are readily picked up by trained eyes or with the aid of magnifying glasses.

One other way to distinguish milkfish fry is the way it swims. It has the tendency to school (swim in close group formation) and swim in a clockwise direction in a circular container. Other fishes do not do these.

Other species like sea bass (apahap) and mullets (banak) are readily distinguished by their color which is black with silver stripes.

Siganids and groupers on the other hand are different from milkfish in that they have short rounded brown bodies (milkfish is elongated) and are slow swimmers.

REARING BANGOS FRY TO FINGERLINGS

A wise bangos farmer buys his one-year fry supply when fry is abundant and cheap. March to June is the best period to do so, although in some areas, a second wave of fry occurs in October to November.

The fry is bought and reared into fingerlings for a period of four to six weeks in a nursery pond. This pond measures from 1,000 to 4,000 square meters.

Nursery ponds must be prepared well to insure the highest possible fry survival rate. Stocking rate varies from 30 to 50 fry per square meter.

During stocking, avoid salinity and temperature shock. The newly arrived fry must be acclimated to pond salinity level if water salinity in the fry container differs widely with that of the pond. Acclimation could be done in plastic basins under the shade for about 4 to 6 hours. Stock the fry during the colder part of the day as in late evening or early morning.

A slightly modified method is the pre-stocking of fry in a small acclimation pond built within the nursery pond proper. The acclimation pond could accommodate 5,000 fry per square meter.

Feed them with patches of *lablab* daily or if fry is visibly weak, with mashed egg yolk. The acclimation pond must be shaded to keep water temperature cool especially during sunny days. After a week, the fry shall have grown larger and developed scales. Release the fry into the nursery pond proper by breaking some sections of the dike.

RESEARCH PROJECT AIMS TO END SHORTAGE OF BANGOS FINGERLINGS

A major constraint among bangos farmers is the inadequate supply of fingerlings. Fish ponds or pens are seldom stocked to their maximum capacity.

This problem may soon be solved by a research whose outcome could pave the way for the establishment of fingerling distribution units around the country to serve the needs of both big and small fishfarms.

An on-going project of the U.P. College of Fisheries Brackish-water Aquaculture Center (BAC) in Leganes, Iloilo is going closer to its goal of establishing a pilot milkfish fingerling distribution unit in Panay.

According to Dr. Arsenio B. Camacho, director of the BAC, the fingerling distribution unit's operation will consist of indoor tanks and reservoirs complete with the necessary life-support units and facilities for fingerling counting, sorting and distribution.

Fry will be collected from the wild and reared to stocking size of 1-2 grams per fish using a total indoor system, he said.

Since 1978, BAC researchers have been conducting feeding trials on fry and hopefully could come up with a feeding program using artificial diets and possibly in combination with natural feed sources.

Camacho reported that tests on artificial diets for fry cultured inside all-glass aquaria gave encouraging results. The diet containing 50 percent protein produced the highest net gain and survival after a culture period of 28 days.

Pond management

BLUE-GREEN ALGAE (*LUMUT*) AND DIATOMS (*LABLAB*) ARE THE BEST NATURAL FOOD OF BANGOS

Four kinds of fishfood organisms are normally found growing in brackishwater ponds - filamentous grass green algae, phytoflagellates, filamentous blue-green algae, and diatoms.

Of these, only the blue-green algae and the diatoms have been found as the most desirable food of bangos of various stages of growth. They are palatable and nutritious and are just right for the way the bangos take their food.

On the other hand, fresh grass-green algae (*Chaetomorpha*) is undesirable for milkfish and for the management of ponds because it grows so much it can crowd the fish, interferes with the process of rotational stocking and harvesting, and it cannot be eaten by young milkfish because it is coarse and fibrous. Only when grass-green algae dies and decays that it becomes palatable to bangos. Its decay will make its protein content digestible to milkfish.

The other group - called phytoflagellates - is harmful for the following reasons:

- 1) a dense growth of phytoflagellates in ponds reduces the grazing activities of milkfish by blinding their eyes;
- 2) it prevents growth of desirable kinds of algae on pond bottom by shutting off sunlight; and
- 3) it can cause fish kills by depleting the dissolved oxygen resulting from decay of a great number of dead flagellates.

These kinds of organisms can be controlled by applying copper sulfate at 2 parts per million (2 ppm) with the chemical kept in suspension in the pond water.

On the other hand, a good growth of *lablab* and blue-green algae would crowd out the growth of undesirable and harmful organisms to provide a better growing environment for milkfish.

SOURCE: "Relative suitability of various groups of algae as food of milkfish in brackish-water pond," Yun-an Tang and Ting-Lang Hwang, in National Bangos Symposium papers and proceedings, 25-26 July 1975, Manila

HOW TO GROW *LABLAB* FOR HIGH BANGOS YIELD

Growing bangos with *lablab* as the major food is still the most popular technique followed in Iloilo where average yield is 1,000 kilograms per hectare - the highest in the country, according to the Fishery Statistics of the Philippines 1974.

Iloilo fishpond owners raise two crops of bangos a year: the first is from March to August, the second from September to February. According to Iloilo fishfarmers' experiences, bangos yield increase depends on a good growth of *lablab*. In turn, *lablab* growth depends on how well ponds are prepared.

Here's how to prepare the pond for the first cropping season:

1. Drain and dry the pond until the ground cracks. It should be hard enough so that when you stand on the ground, your feet will not sink more than one centimeter. Avoid overdrying which reduces the thin surface crust to powder.

2. Enrich the soil with organic fertilizers like rice bran, filter press cake or "mud press" (waste product from sugar factories), and compost plus manures from chicken, pig, cow, carabao or horse. Broadcast these organic fertilizers over the pond bottom. For one hectare, 500 to 1,000 kilograms of low grade rice bran or 1 to 3 tons of the others should be enough.

Fill the pond with water to a depth of 5 to 10 centimeters. Then seal the sluice (passage way for water) and allow water to

evaporate completely. Immediately apply urea or ammonium sulfate after water is let in as this will hasten decomposition of the organic fertilizer. Twenty-five to 50 kilograms of urea or 50 to 100 kilograms of ammonium sulfate per hectare is commonly used. Drain the pond as soon as the water becomes clear and dry the pond bottom again.

3. Let water into the pond for the second time after the soil has dried. Put screens on the sluice to filter the water coming in and when the water reaches 5 to 10 centimeters deep, close the sluice once more.

You will notice a thin mat of *lablab* forming after 3 to 4 days. Broadcast evenly over the pond 50 to 100 kilograms per hectare of 16-20-0 or 18-46-0 inorganic fertilizers. As *lablab* increases in thickness, steadily raise the water up to 20 centimeters. Maintain this water level. In 10 to 15 days, enough *lablab* will have grown to allow stocking of fingerlings.

For the second cropping season, the procedure is:

Dry the pond and prepare it for *lablab* culture during the short dry period that sets in between the change in monsoons. Poison the portions of the ponds that cannot be totally exposed and may contain unwanted fish.

Normally it takes about one to two years before snails reinfest the ponds after the application of chemicals like Aquatin, Brestan 60, Duter and Cercon. If the snails had not previously been controlled, water is allowed to a depth barely covering the areas where the snails are found. Then apply any one of these chemicals at a concentration of 0.3 parts per million which is about 0.3 grams of active ingredients dissolved in one cubic meter of water. Avoid excessive use of these chemicals as fish can't grow well if more than 300 grams of active ingredients are applied per hectare.

Organic fertilizers are seldom used. If any, the quantity is much less than that applied in the first cropping season considering that there is limited time for decomposition and that there may be some danger of oxygen deficiency. A second drying of the pond is not possible.

On the other hand, inorganic fertilizers, usually ammonium

phosphate (16-20-0 or 18-46-0) are broadcast over the pond at 50 to 100 kilograms per hectare after shallow water is allowed. As the *lablab* develops, water is raised gradually. In two or three weeks, the pond is ready for stocking.

SOURCE: "Improved Techniques of Milkfish Farming in Iloilo Province", by Pedro G. Padlan. Pond Culture and Management Selected Readings. SEAFDEC Aquaculture Department.

HOW TO PREPARE A NURSERY POND WITH *LABLAB* AS MAIN FOOD

A nursery pond locally called "semillahan", "pabiayan" or "palakihan" is an essential unit in a bangos farm. Its purpose is to provide the fishfarmer with healthy and stunted fingerlings.

The method of preparing the nursery pond for fry rearing will depend on the kind of natural food to grow in the pond. So far, the most effective food for bangos are *lablab* and plankton. *Lablab* is a film-like substance consisting of small plants and animals, usually brownish, greenish and yellowish in color. As *lablab* grows, additional layers develop on top of one another forming a flabby mat at the pond bottom. Some patches detach and float.

Plankton, on the other hand, is the collective term for all microorganisms suspended in the water. This consists mainly of phytoplankton (plants) and zooplankton (animals).

Both *lablab* and plankton are good sources of food for fry and fingerlings. Presently, most bangos farmers use *lablab*. Here's how to prepare the nursery pond with *lablab* as main food:

Start preparing the pond one or two months before stocking the fry. First, level the pond bottom. Then drain the pond completely and allow to dry for about one to two weeks until soil cracks. Don't overdry. It would make the soil hard and powdery.

Apply chicken manure at two tons per hectare. Then flood to a depth barely covering the pond bottom and apply two to three bags later one bag of 16-20-0 or 1/2 bag of 18-46-0 per hectare.

To hasten breakdown of chicken manure, broadcast urea (45-0-0) at 15 kilograms per hectare.

Increase water depth gradually over a period of 1 to 1-1/2 months - 3 to 5 centimeters each time until the stocking depth of 25 to 30 centimeters is reached. All abrupt increase in water depth causes *lablab* to detach and float. Install fine meshed screens at gates to prevent re-entry of wild fish and predators.

To bolster growth of *lablab*, you may subsequently apply 16-20-0 or 18-46-0 at 1 to 2 weeks interval.

SOURCE: Milkfish Culture in Brackishwater Ponds by M. Lijauco et al., SEAFDEC Aquaculture Dept., 1979.

PROTECT *LABLAB* FROM BAD WEATHER

Heavy rains, strong winds and waves, and lack of sunshine can cause *lablab* to decay in ponds. If unchecked decaying *lablab* could result in fish kills.

What could be done to save *lablab* from these bad conditions?

Offset the harmful effects of rains by freshening the water. During a long period of bad weather, keep the pond water shallow so that sunlight penetrates to the bottom.

To prevent spread of decay, apply hydrated lime over a wide band along the edges of the decayed *lablab*. You could also broadcast up to 400 kilograms of hydrated lime per hectare. This has shown fair results among Iloilo fish farmers.

And to minimize wind and wave action, put up branches and twigs against the wind direction.

SOURCE: "Improved Techniques of Milkfish Farming in Iloilo Province" by P.G. Padlan in Pond Culture and Management Selected Readings. SEAFDEC Aquaculture Department. May 1978.

HOW TO MAINTAIN GOOD GROWTH OF *LABLAB*

Lablab must be provided with adequate nutrition to maintain its growth during the rearing period of bangos.

Iloilo fish farmers do this by occasionally freshening the water or allowing new water to the pond. This new water usually brings with it fresh nitrogen, phosphorus, potash, minerals and other substances needed for good *lablab* growth. Urine and other wastes released by the fish are also sources of nutrients but these may not be enough as the fish consume more *lablab* as they grow bigger.

To be sure, fertilize the pond two weeks after stocking, during sunny days, and preferably in the morning. Broadcast over the pond ammonium phosphate (16-20-0) at the rate of from 25 to 35 kilograms per hectare.

SOURCE: "Improved Techniques of Milkfish Farming in Iloilo Province" by P.G. Padlan in Pond Culture and Management Selected Readings. SEAFDEC Aquaculture Department. May 1978.

CONTROL PESTS OF *LABLAB*

A properly prepared pond for *lablab* growth results in high salinity or salt concentration in the water thus killing practically all unwanted organisms such as snails and marine worms.

However, this does not always happen especially in ponds situated farther inland where the tide waters are diluted by fresh water from rice fields, irrigation canals and creeks. In such a case, eradicating the snails and marine worms is a problem.

From progressive Iloilo bangos farmers, here's how you can control snails and other pests of *lablab*.

To kill the snails and marine worms, use Tri-phenyltin compounds which are sold under the trade names Aquatin, Brestan 60, Duter and Cercon. Apply at a concentration of 0.3 parts per million which is about 0.3 grams of active ingredient per cubic meter. Avoid excessive use of these chemicals as fish can't grow well if more than

300 grams of active ingredients are applied per hectare. A much lower dose could be used if you make the water shallower.

Pests such as tilapia, mosquito fishes, slow-growing mullets should be poisoned with Gusathion A if they have not been killed before the second watering of the pond. The right dosage is about 0.1 cc per cubic meter of water. To prevent reinfestation of the pond, install adequate screens in the sluice.

Infestation of chironomid larvae or "bloodworms" generally occur during the months of June, July and August. These pests are hatched from eggs laid by *gamo gamo* inside the pond. A heavy incidence can cause rapid depletion of *lablab*. To get rid of them without killing the fish, apply Basudin 10 (10 percent diazinon) granules at 0.8 to 1 gram per cubic meter of water. Lindane (6 percent gamma BHC) granules are also effective at 1.3 to 1.5 grams per cubic meter of pond water. These pesticides, however, give offensive odor to the fish. You must, therefore, harvest the fish at least three weeks after pesticides were applied.

SOURCE: "Improved Techniques of Milkfish Farming in Iloilo Province" by Pedro G. Padlan in Pond Culture and Management Selected Readings. SEAFDEC Aquaculture Department. May 1978.

FULLY USE *LABLAB* THRU STOCK MANIPULATION

If you have properly prepared the pond for good *lablab* growth, the next important step in increased bangos production is proper stocking and stock manipulation. You must put the maximum amount of fingerlings at the right time to obtain maximum use of *lablab* in the pond.

Most Iloilo bangos farmers stock their ponds with one size group of fingerlings up to 3,000 per hectare. The size of fingerlings range from 5 to 10 centimeters long, weighing between 2 to 10 grams.

Some farmers, however, stock their ponds gradually in two or more weeks, as follows:

1st stocking - 1,000 to 1,500 fingerlings averaging 80 grams and totalling 80 to 100 kilograms per hectare;

2nd stocking - 1,000 to 1,500 fingerlings averaging 20 grams and totalling 20 to 30 kilograms; and

3rd stocking - 1,000 to 1,500 fingerlings averaging 2 grams for a total of 2 to 3 kilograms per hectare.

The fish are reared in the pond for a period of 45 to 120 days. Harvesting starts when the fish have attained marketable size, about 200 to 500 grams each.

If the fish are consuming the *lablab* too fast, partial harvesting must be done earlier to reduce the stock. Remember that the total weight of the fish must not exceed the food capacity of the pond. This may be between 600 to 800 kilograms per hectare. When this is reached, thinning of the fish stock is done. Harvest from time to time until there is just enough *lablab* left for the remaining fish.

A late batch of fingerlings may be added if food is still adequate and could exceed the need of the old stock at harvest time. These fingerlings will be used as the first stock for the second cropping season.

SOURCE: "Improved Techniques of Milkfish Farming in Iloilo Province" by Pedro G. Padlan in Pond Culture and Management Selected Readings. SEAFDEC Aquaculture Department. May 1978.

HOW TAIWAN PRODUCES 2000 KILOS OF BANGOS PER HECTARE

Three different management techniques - *fertilization*, *pest and predator control*, and *manipulation of fish population or crop rotation* - have combined to raise bangos yields in Taiwan ten times, from 200 to 2,000 kilograms per hectare.

The report, written by FAO inland fisheries expert from Taiwan, Dr. Yun-an Tang, said *fertilization alone* raised yields from 200 to 800 kilograms or 300 percent over yields of unfertilized ponds; pest control further raised production to 1,000 kilograms per hectare or 25 percent more than fertilization alone; and *crop rotation* or what is known as manipulation of fish population improved yields by another 100 percent or from 1,000 to 2,000 kilograms per hectare.

The important feature of the Taiwanese improved pond management techniques are:

1. Fertilization allows growing of desirable algae like filamentous blue-green (lumut) and diatoms (lablab).

2) Pest control and supplemental feeding provides protection and replenishment of the growth of desirable algae. Proper chemicals remove insects and pests while supplemental feeding prevents overgrazing of algae.

3) Proper cropping of fish in rotation enables fishpond raisers to regulate and group compositions of fish populations at the optimum range. This would in turn enable the full and efficient use of fish-food produced by fertilization.

These techniques are not new; the report is contained in the proceedings of the National Bangos Symposium held in Manila five years ago.

STOCK MANIPULATION: ONE REASON FOR TAIWAN'S HIGH YIELD OF BANGOS

Stock manipulation is the key to the high yield of *bangos* ponds in Taiwan, says T.P. Chen in his book *Aquaculture Practices in Taiwan*.

Although Taiwan has a much smaller area for bangos production compared with the Philippines, it has the highest yield per unit area. Taiwan's average yield per hectare of pond was 1,600 kilograms in 1972, while the Philippines' average was only 600 kilograms in 1975.

Stock manipulation allows full use of the food resources, the benthic algae, in the pond. In Taiwan, this is accomplished by the following management technique:

In the early part of April, the pond is stocked with overwintered fingerlings of size varying from 5 to 150 grams in weight. Overwintered fingerlings are either those undersized (less than 150 grams) fish harvested by the fish farmers at the close of the

rearing season and kept in wintering ponds, or those late fry captured from the sea in July and August and stocked in wintering ponds. The number of fingerlings planted varies from 3,000 to 5,000 according to size.

Beginning April, new fry collected from the sea become available. They are purchased and stocked at intervals of two to four weeks. Each time about 1,500 are planted. The following schedule shows the number planted at different times of the year:

Month of Stocking	Average weight of fingerlings planted (in grams)	Number of fingerlings planted
April	5 - 150 grams	5,000
May	0.05	2,500
June	0.06	2,500
July	0.06	2,000
August-September	0.06	3,000
Total number planted		15,000

PREPARING THE NURSERY POND WITH PLANKTON AS MAIN FOOD

Drain the pond completely to eradicate wild species and pests.

Admit water to a depth of at least 65 centimeters, preferably 75 to 100 centimeters. Install fine meshed screens at gates to prevent re-entry of wild species.

Apply one bag of 16-20-0 or 1/2 bag 18-46-0 on a platform. Plankton should bloom after a few days. By then, the pond water has become rich with green plankton and you could see through the water only up to a depth of 15 to 40 centimeters.

If plankton does not bloom, apply fertilizer again. However, if plankton is excessively abundant, so dense that you cannot see more than 15 centimeters through the water, don't apply anymore fertilizer and replace about 1/4 of the pond water with new water. The pond is now ready for stocking.

SOURCE: Milkfish Culture in Brackishwater Ponds by M. Lijauco et al, SEAFDEC Aquaculture Department., 1979.

PLATFORM METHOD SAVES YOU FERTILIZER BY AS MUCH AS 40 PERCENT

There are two methods of applying fertilizer in fishponds. One is by spreading or broadcasting the fertilizer evenly on the pond bottom before the water is let into the pond. The other is by using a fertilizer platform. The platform method saves from 20 to 40 percent fertilizer on the amount required by the other method. It also saves on labor, according to Filipino fish farming specialists who developed the *Philippines Recommends for Bangos*, a publication produced by PCARR for Filipino fish farmers.

A fertilizer platform is a table-like structure made of wood, bamboo or other materials which is placed horizontally about 15 to 20 centimeters below the water level of the pond. Put the platform in easy-to-reach places and fix it by sinking its legs in the pond soil.

Place the required amount of fertilizer on the platform where it will dissolve slowly. The advantage of the platform method is that the fertilizer does not touch the bottom of the pond so that by water and wind action, the nutrients are evenly distributed all over the pond. This method is effective for producing and maintaining plankton growth, the experts say.

Meanwhile, you are advised not to fertilize within two weeks before harvesting the fish.

HOW TO TELL WHEN FISH IS UNDER STRESS

Stress can cause mass killing of young bangos in ponds. Knowing the symptoms of stress would help you prevent the stress from becoming very serious.

You can tell when fish is under stress by the way it moves. A fish under stress breaks away from the group and swims alone. If all are under stress, no group or school will form. Fish under stress swims erratically. It frequently breaks the surface with snout and upper back, it is sluggish and swims weakly, it has difficulty keeping its balance while swimming, it can be seen resting at the bottom or at the surface with little or no movement and often upside down. You will also observe that its breathing becomes either very strong and fast or very faint as indicated by the movement of the gill covers.

A fish under stress will change in appearance. Its body color becomes either very dark, light, or mottled. Bloody-red patches or lines appear in the skin, usually at the base of the fins. Fins are fully extended and stiff.

SOURCE: Modern Aquaculture for the Philippines by C. de los Santos, Jr., 1978.

PREVENT DISEASES: AVOID INJURING FINGERLINGS

Injured bangos fingerlings are easily infected by bacteria and fungus. Dragging a seine over the whole pond to catch fingerlings for stocking purposes, handling them roughly by hand or lifting them in nets out of the water often cause injury.

To minimize losses, Iloilo bangos raisers use the *pasulang* method. They confine the fingerlings in catching ponds or supply canals. The farmers gather them with the use of soft nylon nets and transport them to the stocking pond in plastic bags. If necessary, they use bottled oxygen gas.

SOURCE: "Improved Techniques of Milkfish Farming in Iloilo Province" by P.G. Padlan in Pond Culture and Management Selected Readings. SEAFDEC AQD. May 1978.

WATCH OUT FOR BANGOS KILLS

Fish kills can wipe out all the bangos fingerlings in the pond if you are not quick enough to do some remedial measures.

Fish kills occur immediately after stocking because of failure to acclimate or familiarize the fingerlings with the pond water. It also happens when oxygen is deficient as when no new water is let in for some time. The situation becomes serious when the water has become muddy, has a high salt concentration, a high temperature, and contains poisonous substances.

A heavy rain in the afternoon after a long period of calm or hot days combined with high salinity and deep water cause the fish to surface late in the night following the rain. The fish die in a few hours if no remedial measures are put up.

Taking in new water is the best remedy for oxygen depletion. Otherwise, aeration is done with portable pumps. Hydrated lime applied at 200 to 400 kilograms per hectare has also been found to relieve the fish from stress caused by low oxygen and high carbon dioxide content of the water. Frequent freshening of the pond by letting out some of its water and replacing the quantity with new tide water is done to counteract the effects of whitish waters as a result of decaying *lablab*.

SOURCE: "Improved Techniques of Milkfish Farming in Iloilo Province" by P.G. Padlan in Pond Culture and Management Selected Readings. SEAFDEC AQD. May 1978.

BANGOS KILLS ARE BOUND TO OCCUR AFTER HEAVY RAINS

Following heavy rainfall, bangos kills are bound to happen among brackishwater fishponds.

The probable causes are:

- 1) Water salinity drops suddenly and drastically after prolonged rainfall.

2) Poisonous gases are released when a heavy rainfall accompanied by strong winds stir the pond soil.

3) Pond water is heavily silted from the muddy runoff water and from the disturbed pond soil.

4) Oxygen in pond water is depleted because of lack of sunshine.

5) Water temperature drops as a result of rain and cold weather.

Technologist and pond operators have mainly attributed fish kills to what they call "acid death", which is the result of a drastic change in water salinity. In other words, the water becomes very acidic.

It has also been observed that it is the smaller ponds that are usually affected by "acid death".

As a long-term preventive measure, technologists of the University of the Philippines brackishwater aquaculture center in Leganes, Iloilo suggest applying lime mixed with water to dikes and bottom soil before the start of fish culture.

WATCH OUT FOR LOW OXYGEN LEVEL IN YOUR PONDS

Fish production depends much on adequate and continuous supply of oxygen. A slight deficiency in dissolved oxygen stops fish growth while prolonged depletion causes drastic fish kills.

You must observe the dissolved oxygen distribution in your fishponds. Observe on a 24-hour basis, if necessary.

Some of the most common causes or conditions that lead to the decrease of oxygen level in the water are: high temperature, absence of light, lack of wind action, a lot of mud in the water, heavy pollution with decaying organic matter, rapid growth of zooplankton (or very tiny animals in the water), blooms of what are called dinoflagellates and the abundance of organisms called Zooplanktons, and decay of dead planktons after they bloom.

Young milkfish can tolerate growth deficiency to as low as 1.5 parts per million. However, larger fish or over 200 grams die instantly in brown water ponds if oxygen depletion lasts for more than six hours. To save your fish from drastic kills, be alert to the signs of low oxygen level and immediately move to restore it to normal.

When the pond water loses its clear brownish green color in the morning and does not go back to a light green color in the afternoon, this is a sure sign of lack of oxygen. Abnormal pond water is always clear with the bottom algae growing very well.

"Yellow water" is caused by blooms of dinoflagellates and nannoplanktons. It may not kill fish but it retards their growth. It is brown water that causes drastic fish kills. "Brown water" is caused by an unusually large number of tiny animals called protozoans such as flagellates, phytoflagellates, or rotatoria which lower the oxygen content all the time and completely exhaust oxygen between the hours of 11:00 at night and 5:00 in the morning.

If the water starts yellowing (yellow water) or turning brown immediately move to restore oxygen supply. An effective way to provide aeration is to use pumps which is expensive because of the large area of milkfish ponds. Another way is to let in well oxygenated water from 11:00 o'clock at night to 7:00 or 8:00 o'clock in the morning when dissolved oxygen content is lowest.

SOURCE: "Milkfish Farming in Taiwan, a review of practices and problems," by S.Y. Lin, Taiwan Fisheries Research Institute, Feb. 1968.

HOW TO CONTROL PESTS AND PREDATORS IN BANGOS PONDS

Control of pests and predators is an important activity in fishpond management. This is stressed in the *Philippines Recommends for Bangos*, a set of recommendations that has been developed for Filipino fish farmers by top Filipino milkfish experts.

Here are some pointers on pest and predator control as contained in the *Philippines Recommends for Bangos*.

Against worms and snails, you may apply the following chemicals or materials:

Use *Bayluscide** at a concentration of 0.3 parts per million in pond water or *Shell WL8008* also at a concentration of 0.3 parts per million. If you use *Aquatin*, mix five to eight tablespoonful *Aquatin* in five gallons of water. Sprinkle the solution over a 300 to 500 square meter pond area. Another recommended chemical is *Gusathion A* which should be applied at a concentration of 0.1 parts per million. However, if you use *Gusathion A*, be sure to wash the pond thoroughly because poisonous chemical residues remain for a number of days.

Tobacco dust may also be used to destroy worms and snails. Apply evenly 400 kilos of tobacco dust over one hectare of fish pond.

Rice straw is another material you can use. Place five tons of rice straw in heaps in the fish pond. One good thing about rice straw is that when it rots, it becomes an organic fertilizer. It has been shown that one ton of rice straw increased production by 15 kilos.

For the control of harmful or *poisonous green microscopic plants* apply *copper sulfate* at a concentration of two parts per million. To eliminate *fish predators or food competitors and other unuseful species*, apply the following:

Use *potassium permanganate* in pond water at a concentration of 16 parts per million or *potassium cyanide* at 0.25 parts per million. The poisonous effect of *potassium cyanide* disappears after five days.

Camellia seed meal may also be used. One hectare of fishpond requires 180 kilograms of *camellia seed meal*. However, allow ten days to elapse from application before you stock. After ten days the pond is safe for stocking and the *camellia seed meal* becomes a fertilizing material.

Apply chemicals with extreme care. Do not use them indiscriminately.

*The use of brand names does not imply the named products are being endorsed. Mention of a trade name is only made to show that the product has been used.

Harvesting and utilization

FOR QUICKER HARVEST OF BANGOS: CONSTRUCT A CHILLING TANK

You'll harvest faster, easier and prolong the good quality of bangos by using a chilling or killing tank.

The chilling tank is used to pre-chill the fish in iced water before shipment to markets.

Made either of wood or concrete, the tank normally measures 1 to 2 meters wide, 3 to 4 meters long and about 1 meter high. Construct the tank immediately adjacent to the main catching pond where the harvested fish are temporarily confined.

From the catching pond, the fish are seined, scooped or bailed out and put into the tank containing ice water. This way, the fish die with the least struggle, thus preventing damage to scales and prolonging its good quality.

SOURCE: Milkfish Culture in Brackishwater Ponds by M. Lijauco et al. SEAFDEC Aquaculture Department.

HARVEST BANGOS THE *PASUBANG* WAY

There are five ways to harvest bangos: 1) total drainage, 2) gill netting, 3) electric shock, 4) seining, and 5) water current method or *pasubang*.

Of these five, *pasubang* offers the most advantages. It is very convenient and the fish harvested are clean. *Pasubang* could be used for both partial and total harvesting. It takes advantage of the against-the-current swimming behavior of milkfish.

The method works this way:

Drain the rearing pond partially during low tide. Allow water to enter at high tide so that the fish would swim through the gate and into the catching pond. Close the gate when the fish have been impounded. Depending on the size of the catching pond, the fish could either be scooped, seined or both. Collect the remaining fish in the pond by total drainage.

SOURCE: Milkfish Culture in Brackishwater Ponds by M. Lijauco, J.V. Juario, D. Baliao, E. Griño & G. Quintio of the SEAFDEC Aquaculture Department.

BANGOS OFFAL CAN BE MADE INTO FISH MEAL OR SILAGE

About 20 to 30 percent of the total weight of bangos is offal which is usually disposed off as waste. The offal includes scales, fins and internal organs like the kidney, liver, stomach and intestines. The head and tail are also removed from the fish depending upon the processing method used.

You could make use of the offal and maybe get some income, especially if you are processing bangos in big quantities. The offal can be made into fish meal or silage.

Here's how:

To make into meal, steam the offal for 15 minutes. Then press out the liquid in a screw type pressor. Dry the pressed cake and grind to the desired particle. If the meal is not to be used immediately, it is advisable to mix antioxidants like ascorbic acid. Make a

20 percent solution of the antioxidant in water and soak the pressed cake in the solution for 10 minutes. Drain thoroughly and dry. Pack the dried meal in polyethylene bags and seal.

To make into silage, grind or chop the offal. Prepare a 30 percent sulfuric acid solution and mix this with the offal in an amount equal to 15 percent of the offal's weight. Example: if the offal weighs one kilogram, add 150 milliliter of the 30-percent sulfuric acid solution. Put the mixture in bottles or wooden barrels Stir daily for one month to disintegrate and distribute the acid Don't forget to neutralize the silage before mixing with dry feeds Baking soda may be used to neutralize the silage.

SOURCE: Philippines Recommends for Bangos 1978. PCARR.

HOW TO MAKE SOFT-BONED SMOKED BANGUS

With new improved ways of raising bangos, an oversupply of fresh fish can be expected. When this happens, fishfarmers should venture into fish processing to avoid waste of good fish and even make a bit more money.

One good method is smoking wherein bangos including its bones can be eaten. Here's how it is done:

1. Wash fish. Remove gills and viscera.
2. Wash thoroughly inside and outside of fish.
3. Soak fish in brine which is made up of one part salt and three parts water. Small fish is soaked for 60 minutes; medium-sized fish, 90 minutes; and large fish, 120 minutes,
4. Drain the brined fish. Wrap with aluminum foil or cheese cloth.
5. Pressurize the fish at 10 lbs for 90 minutes for small-sized fish; 120 for medium-size fish, and 150 minutes, for large fish.
6. Remove aluminum foil and arrange the fish in drying trays.
7. Smoke for 30 minutes to 1 hour or until golden brown color is attained using the drum type smoke house. If possible, turn fish every 30 minutes to obtain a more attractive color.

SOURCE: Milkfish (Bangos) as Food. National Science Development Board (NSDB). 1978.



Harvesting bangos.

Pen and cage culture

PRODUCTION TIPS FROM RESULTS OF STUDIES ON BANGOS CULTURE IN LAGUNA LAKE

Following are some of the recent findings on stocking density, rearing of fry and fingerling, and feeding of milkfish resulting from studies done in Laguna Lake by the FFS of the SEAFDEC AQD.

More than one-fifth (or 22 percent) of all the bangos produced in the Philippines comes from fishpens. High production values of as much as 10 tons per hectare of fishpen have been reported. However, the milkfish pen industry has lately been plagued with problems. Here are some results of SEAFDEC studies on a few of the problems.

1. *Cage-reared fry grows faster.* Cage-grown bangos fingerlings grew faster and had a higher survival rate than those reared in improvised plastic-lined ponds. Survival in cages was 66 percent; in plastic-lined ponds 41 percent.

2. *Higher stocking rate.* A stocking rate of as high as 10 fry per square meter was demonstrated possible in tests at Laguna Lake.

3. *Stocking density and supplemental feeding of fry.* Over a 3-week rearing period, fry stocked at 500 per cubic meter cage volume (hapa net cage) with no supplemental feeding gave the most optimal growth in terms of weight and length.

4. *Acclimation of fry.* A gradual and continuous acclimation of fry to freshwater gives a high survival rate (88 percent). This is done by gradually lowering the salinity of the water in which fry are kept through a facility that continuously drips freshwater into the fry basin.

TIPS ON RAISING BANGOS IN CAGES IN FRESHWATER

Bangos grows faster when reared in cages with substrate, according to studies conducted at the SEAFDEC Freshwater Fisheries Station in Binangonan, Rizal. The studies also showed that milkfish grows better - in body weight and length - when stocked at a density of 2 per square meter. Stocking more than this rate would slow down milkfish growth.

RIZAL FISHPEN OWNERS ARE GETTING MORE THAN LAGUNA FISHPEN OWNERS

The bangos fishpens are all in Laguna de Bay but operators from Rizal earn three times as much as those from Laguna.

Why?

It is because Rizal bangos raisers stock more fingerlings per hectare than their counterparts on the southern end of the lake.

This according to a study conducted by Jimmy L. Ramirez for his masteral degree in agricultural economics at the U.P. at Los Baños.

Rizal operators were able to earn an average of P5,226 per hectare compared to the P1,683 per hectare earnings of Laguna fishpen operators.

Surprisingly, Laguna operators spent more to put up their pens than Rizal operators. Laguna operators spent P11,332 per hectare to establish their fishpens while their counterparts from Rizal spent P7,222.

Ramirez also found that smaller pens were more productive than pens of 5 to 10 hectares in size. The smaller pens produced 5,100 kilos per hectare - almost double the 3,161 kilos produced per hectare from bigger pens. The profits therefore in smaller pens were bigger - P8,962 per hectare or more than twice the earnings of bigger pens which averaged only P4,000 per hectare.

Fishpens in Laguna lake can be further expanded profitably, said Ramirez. By adding another hectare to the existing fishpens, the owner will spend about P250 but the extra income it will give would be about P3,206, he said.

Increasing the pens' operating costs would also result in higher profits, Ramirez added. He found that fishpen owners spend an average of 12 centavos on operating costs compared to the added income these expenses bring - P3.25.

However, Ramirez suggests that operators should cut down on expenses for initial capital investment and supplementary feeds.

SOURCE: The Philippine Farmers' Journal, October 1979.

BANGOS FRY ACCLIMATION FOR FRESHWATER FARMING

Acclimation of bangos fry for freshwater farming eliminates the need to grow fry to fingerling size in brackishwater. Therefore, instead of paying for fingerlings at P0.25 each, you can right away obtain fry which only costs P0.08 a piece. These figures were based on 1977 prices.

This has been shown by research conducted at the SEAFDEC Aquaculture Department's freshwater fisheries station in Binangonan, Rizal. Three methods were tested. The first method, gradual and continuous acclimation, gave a high rate of survival - 88 percent. The second, gradual acclimation by partial removal of brackishwater, resulted in 83.6 percent survival. While the third, direct stocking in lake water, gave a poor survival rate of 59.3 percent.

For details, you can write to:

The Program Leader
Freshwater Aquaculture Program
SEAFDEC Aquaculture Department
Binangonan, Rizal

SOURCE: 1977 Annual Report, SEAFDEC Aquaculture Department.

Miscellaneous information

OUTPUT AND NEEDS OF BANGOS FARMERS IN RP

Fishpens earn seven times more than fish ponds. Pesticides increased bangos yield but ironically decreased the net profit of fish farmers. Most members of fish farmers' associations did not get any benefit from the associations.

These are some of the findings in a survey of 1,394 milkfish pond operators and 170 fish pen operators in the Philippines by Dr. Aida R. Librero and Ms. Elizabeth S. Nicolas, program leader and research associate of the SEAFDEC-PCARR Research Program.

Other findings:

1. Fish pens yielded an average gross income of P15,580 per hectare - seven times higher than fishponds'. Consequently, fish pen operators obtained an average net profit of P3,849 per hectare which is about 4.6 times more than what fishpond operators got. The rate of return over operating expenses in fish pen operators was only 32.8 percent due to the big operating costs required. However, the return to pen operators' fixed capital was higher: 50 percent.

2. Using pesticides doesn't necessarily raise the income of bangos farmers. The increase in yield brought about by applying pesticides does not offset the high cost of the pesticides. Those using pesticides spent about P2.60 to produce a kilo of fish compared to P2.20 without pesticides.

3. Fish ponds become more productive and profitable when milkfish is cultured together with other fishes particularly siganid, prawn and crab. Milkfish-siganid farms obtained a yield of 827 kg/ha, 70 percent of which was milkfish and 30 percent siganid. Milkfish-prawn-crab fishponds yielded 740 kg/ha with milkfish comprising 78 percent, prawn 7 percent, and crab 15 percent. Poly-culture farms realized a net farm earnings of more than twice that of monoculture farms. *Milkfish-prawn-crab combination realized the highest net earnings, P2,736/ha.*

4. Fertilizer-using fish farms profited by about 46 percent more than those which did not apply fertilizer.

5. Users of supplementary feeds obtained a net income of P967 per hectare, 27 percent more than that of the non-users.

6. A higher yield is obtained by harvesting the bangos all at one time rather than harvesting them selectively and partially over a number of times. The difference is about 190 kilos of fish.

7. Highest individual yield was 5,813 kilos/ha obtained by a fish farmer in Western Visayas. Ironically, one of the farms in the region got only 20 kilos/ha.

8. Western Visayas is the highest bangos-producing region in the country with an average of 903 kilos per hectare. Ilocos and Central Luzon are second and third with 709 kilos/ha and 611 kilos/ha, respectively. Lowest productivity was registered at Western Mindanao with only 168 kilos/ha.

9. National average production per hectare is 580 kilos.

10. About one-fourth of fish ponds and 41 percent of fishpens were reached by government extension workers.

11. Only a few fishermen's organizations exist. Of the bangos raisers interviewed, only a few were members of an organization. Two-thirds of the members reported they did not get any benefit from the associations.

12. Most operators find the industry wanting of government assistance. According to them, the primary support the government

can give is on credit, control of prices of inputs as well as products and technical assistance.

Consumer Tips

BUY BANGOS WEIGHING NO LESS THAN 600 GRAMS AND OTHER TIPS

Avoid eating bangos which is raw or not well cooked. Bangos is susceptible to *heterophyidiasis*, a disease caused by small flatworms. Men and animals can be infected by eating raw or not well cooked bangos which is infected by the flatworms. In man, the infection may cause mild diarrhea. However, continuous practice of eating not well-cooked infected bangos may result in complications of the heart and internal organs.

Tests have shown that meat yield of bangos increased with round weight up to 600 grams, beyond which the curve levelled off. In other words, avoid buying bangos of less than 600 grams in weight. You get less meat in proportion to the weight. On the other hand, much bigger - and often more expensive on a per kilo basis - bangos do not necessarily give more meat in proportion to the weight.

The internal organs (viscera) of bangos can be made into an easy-to-prepare snack item with the use of flour and eggs. They can also be good ingredients in making kropeck.

SOURCE: Proceedings, Technical Consultation on Available Aquaculture Technology in the Philippines.

PRAWN

THE PROFITABILITY OF RAISING PRAWNS	116	
Why many fishpond owners are going into prawn farming		116
Supgo is not the only good prawn for farming	117	
When supgo fry is short and fungal diseases are prevalent raise hipong puti	118	
Start with a small manageable prawn farm	119	
POND SITE SELECTION, DESIGN & CONSTRUCTION		120
Pointers in selecting a fishpond site	120	
Design and layout of ponds determine how much prawn to stock	121	
Rhomboid ponds with acute corners and aligned with the prevailing wind direction	122	
Considerations for the design and construction of grow-out pond for prawn culture	124	
FRY MANAGEMENT	132	
The right way to count prawn fry	132	
How to transport prawn fry	133	
Stunting -- an answer to fluctuation in fry supply		133
Tips on fry conservation	134	
Acclimate prawn fry before stocking	135	
How to stock prawns	136	
POND MANAGEMENT	140	
Put dried twigs on <i>lablab</i> ponds	141	
How to transfer supgo juveniles from the nursery to the grow-out pond	141	
Water management in prawn ponds	142	
Preparing nursery and grow-out ponds	144	
Water pH is critical for prawn fry	146	
Replenish pond water	146	
Ways to control pond pests and predators	147	
Too much <i>lablab</i> reduces oxygen in pond water		149
FEEDING	152	
Supplementary feed means early harvest and more income	152	
Choosing feed ingredients for supgo	153	
Dry feed is better than fresh feed	155	
How to prepare dry feed for supgo	156	

Some tips on feeding prawns	158	
Ipil-ipil leaves could be used in prawn diets		159
HARVESTING, PROCESSING & MARKETING		162
Quality control - key to high and uniform quality shrimp	162	
Philippine and Japanese requirements for frozen shrimps	163	
The Philippine quality standards and specifications for shrimps	164	
The international and Japanese size standards for first class shrimp	166	
Harvesting, processing and transporting sugpo		167
Frozen shrimp production	168	
Processing prawns for market	169	
Steps in processing shrimps for export		169
Build a processing shed	171	
Handling prawns after harvest	171	
The post-processing steps for export shrimps		172
Saw dust promises to be a good shipping medium of prawns	173	
Why shrimps turn black and spoil	174	
Shrimp kropeck from shrimp heads	174	
"Chitosan" a multi-purpose product from shrimp shells	176	
Tips on cooking sugpo	177	
HATCHERY & BROODSTOCK DEVELOPMENT		178
Build a hatchery for fry production	178	
Choosing a site for sugpo hatchery	179	
Taking care of spawner and eggs	180	
Disinfect prawn spawners	181	
Facilities required for a sugpo hatchery	182	
Eyestalk ablation induces prawn to spawn	183	
Why does eyestalk ablation induce spawning?		184
How are sugpo females differentiated from the males?	184	
What prawns are good for spawning?	184	
When does courtship and mating start among prawns	185	
Always be on guard against prawn hatchery disease outbreaks	185	
FRESHWATER FARMING	196	
How to grow sugpo in cages in fresh water		196

The profitability of raising prawns

WHY MANY FISHPOND OWNERS ARE GOING INTO PRAWN FARMING

More and more fishpond owners have started to raise prawns, particularly the high-priced jumbo tiger prawn, locally known as sugpo. The reason is obvious: there's more money in sugpo than other traditionally pond-raised fish.

There is always a great demand for sugpo from both the local and the foreign markets. This makes the price of sugpo very high. Prices in the local markets now range from P60 to P75 per kilo.

Exporters or their agents have made it a point to race each other to the sugpo grower. Some progressive growers have themselves made arrangements to export their produce.

Last year, the Philippines exported some 3,650 tons of shrimps to Japan. Half of this was pond grown, the rest captured in the sea.

Sugpo has become so popular in Japan for two reasons: lack of supply of spiny lobster, a Japanese delicacy, due to water pollution; and shortage of *Penaeus orientalis* the collection of which has become limited by China's declaration of its 200-mile economic zone. The Japanese has therefore turned to sugpo as substitute for the spiny lobster for social occasions, especially weddings.

Locally, the price of sugpo peaks towards Christmas and New Year. All year round, however, it's seller's market.

SUGPO IS NOT THE ONLY GOOD PRAWN FOR FARMING

Sugpo or jumbo tiger prawn is not the only kind of prawn which could be profitably raised in ponds.

It's true that it is the biggest and most expensive prawn. But it is also the most difficult to raise. It requires low salinity or salt content in the water. You may find that it would be more profitable to raise other prawns in a place where sugpo will be difficult to grow. *Hipong puti*, for instance, does not require low salinity for good growth. Or you may practice crop rotation. During the wet months, grow sugpo and for the rest of the year, other prawns. Depending upon fry availability, it is possible to have one 5-month crop of sugpo and two 3-month crops of other prawns.

The following descriptions of sugpo and the other prawns suitable for pond raising may be used as a further guide:

1. Sugpo (Tagalog term) is also known as *lukon* in Ilongo, *pansat* in Cebuano and *padaw* in Ilocano. It's fast growing. One-gram size juveniles usually grow to 40 to 60 grams in five months. Some grow to as much as 100 grams or more. It grows well and fast in ponds having low salinity - 10 to 25 parts per thousand.

2. *Hipong puti* in Tagalog is known as *putian* in Ilongo, *pasayan* in Cebuano and Ilocano. This prawn has the most abundant natural fry among the prawns recommended for farming. Larval rearing for the production of *hipong puti* fry is considered easier than sugpo. Unlike sugpo, it grows well in pure seawater. Sizes of 20 to 25 grams can be attained in four months when raised at a low quantity together with milkfish. Unlike sugpo, however, it does not tolerate being taken out of water even for short periods such as might be done when transferred from one pond to another.

3. *Suahe* in Tagalog is *pasayan* to Ilongos, Ilocanos and Cebuanos. This is a small prawn and has a low market value. Size at harvest after two to three months ranges from 10 to 15 grams. Fry is naturally abundant and often enters the pond with the tide. It can survive in fairly high salinity.

WHEN SUGPO FRY IS SHORT AND FUNGAL DISEASES ARE PREVALENT RAISE HIPONG PUTI

During the dry season when water salinity is high, you may want to raise *hipong puti* - scientifically called *Penaeus merguensis* and *Penaeus indicus* - instead of sugpo or *Penaeus monodon*. The reason is that sugpo does not grow well in high salinity condition while *hipong puti* does. If you do not have an abundant supply of freshwater during the dry season, you just might do well to raise other prawn species.

Another reason is that fry of *hipong puti* are more abundant than other species. A survey made by Hiroshi Motoh of SEAFDEC has shown that fry of sugpo constitutes only 7 percent of the total catch of wild fry in many areas while fry of *hipong puti* constitutes as much as 60 percent. Furthermore, fry of *hipong puti* costs much less - an average of P2 per thousand - compared to fry of sugpo which usually sells from P80 to P320 per thousand depending on its abundance.

A third reason for switching to *hipong puti* would be the incidence of fungal diseases. The postlarvae of sugpo are prone to stress in high salinity condition and become susceptible to fungus diseases. These diseases often appear during the dry season. While the larvae of sugpo are sensitive to fungus diseases, the other prawn species, however, like *hipong puti* are seldom infected by fungus.

If you can buy sugpo fry, you are advised to stunt them by stocking them in a nursery pond at high salinity, at a high stocking density and fed with supplemental feeds to prevent cannibalism. Wild sugpo fry can be stunted for a few months and readied for the next crop when you go back to raising sugpo. Provide aeration and water flow-through in the concrete nursery ponds.

- SOURCES: 1) "The Present Prawn Culture in the Philippines," a report submitted to the SEAFDEC Aquaculture Department by Hideo Mochizuki, JICA Prawn Culture Expert (May 1979).
- 2) Manual on Prawn Farming by W.G. Yap, F.D. Apud & J.H. Primavera, SEAFDEC Aquaculture Department, 1979.

START WITH A SMALL, MANAGEABLE PRAWN FARM

It is best to start with a small, manageable prawn farm and expand as skills are developed. One should not rush into converting entire milkfish ponds for prawn farming just because prawns command 10 to 15 times the price of milkfish.

You can start by growing prawns as a secondary crop in milkfish ponds. This will hardly need additional investment, except the cost of prawn fry. Growing prawn alone (monoculture) is still new. This requires some revision in the milkfish pond design as well as higher operations costs mostly in terms of feeding and water pumping.

Unless farmed at low density, prawns require much more food than the natural food produced in the pond. In some countries, the use of natural food in pond farming has been completely done away with in favor of total dependence on artificial food. Pond preparation is shortened as waiting for natural food to bloom is eliminated. Preparation is limited to pest eradication and, possibly pH adjustment. One disadvantage might be the higher feed costs.

SOURCE: Manual on Prawn Farming, SEAFDEC Aquaculture Department, May 1978.

Pond site selection, design and construction

POINTERS IN SELECTING A FISHPOND SITE

The location of your pond, its soil, its elevation, and its nearness to a freshwater source are some of the important considerations in choosing a pond site.

Most fishponds used to be mangrove areas. However, not all mangroves are suitable for fishpond development. Look at the kind of mangrove trees growing in a prospective site. A lot of *api-api* or *miyapi* (*Avicennia* species) means it would be a good place for a pond.

Choose a place with suitable soil. Avoid sandy or peaty soil. Soil which can be kneaded into a ball without crumbling even after considerable handling will make good dikes. Some soils are acidic or become acidic once exposed to air. Have the soil of a prospective site analysed to be sure. Ask for analysis of at least the acidity (pH) and organic matter content.

The land elevation is also important. A low area will be difficult to drain except probably during very low tides. On the other hand, an area that is too high will need a lot of excavation work to bring it down to the desired elevation. Or it will need the extensive use of pumps for letting in water.

Ponds with easy access to brackishwater and freshwater will have the advantage of having better control of salinity. See that the water is not polluted from industrial or agricultural pollutants.

For prawn production, areas with Type III climate - a short dry season - and Type IV areas, uniform rainfall distribution, are good areas for sugpo culture. In Type I areas, however, or places

with a pronounced dry season, prawns can be grown effectively only in the wet months. The reason is that during the dry months, the water salinity can increase to as high as 60 ppt which is twice the normal salinity of seawater. Excessive water salinity will stunt the growth of prawns and render them highly prone to stresses.

Type II areas - no dry season - may have acceptable water conditions the year round for prawn growing but have a higher risk from typhoons and floods.

In general, nearness to fry source and to support facilities like good roads, an ice plant, and electricity source are decided advantages in the fishpond business.

SOURCE: Manual on Prawn Farming by Yap, Apud and Primavera, SEAFDEC Aquaculture Department, July 1979.

DESIGN AND LAYOUT OF PONDS DETERMINE HOW MUCH PRAWN TO STOCK

The stocking rate and, consequently, the yield of prawn will depend much on the size, shape, and position of ponds.

For instance, milkfish ponds, no matter how productive they are for milkfish growing, can at best be used only for low-density prawn production. A milkfish nursery pond can accommodate no more than 50 prawn fry per square meter, while a milkfish grow-out pond, can hold only 10,000 prawns per hectare at the maximum.

You can stock more - as much as 4 to 5 times - if the ponds are designed properly and primarily for prawn farming. A good prawn nursery pond can be stocked with 200 fry per square meter, while a grow-out pond, up to 50,000 prawns per hectare.

In a well-designed system, the nursery and grow-out ponds and the pond facilities are laid out in a manner which would allow maximum use of the support facilities. The actual layout will depend upon the topography, water source and access roads.

A good example of a nursery pond capable of accommodating 200 fry per square meter has worked well at the SEAFDEC station

in Leganes, Iloilo. The pond has the following features.

1. Diagonally oriented or positioned along major wind direction
2. Not more than 1,000 sq. m. but not less than 500 sq. m. in size
3. Reservoir pond
4. Above dike concrete supply canal and separate drain canal
5. Separate drain and supply gates
6. Predator barrier series consisting of everted fine mesh nylon net and horizontal sand filter box
7. Water distribution through perforated PVC stand pipes set at corners
8. Aeration system for critical low-oxygen periods
9. Horizontal filter type catching box installed at level to pond bottom

SOURCE: Manual on Prawn Farming, SEAFDEC Aquaculture Department, May 1979.

A new way of building prawn ponds

RHOMBOID PONDS WITH ACUTE CORNERS AND ALIGNED WITH THE PREVAILING WIND DIRECTION

Researchers at the SEAFDEC Aquaculture Department in Tigbauan, Iloilo have come up with a better layout and design of prawn ponds than the usual way of building ponds.

Ponds are usually built in a rectangular shape with the long axis or sides aligned with the prevailing wind direction. In contrast, the new SEAFDEC-designed pond is rhomboid with the acute

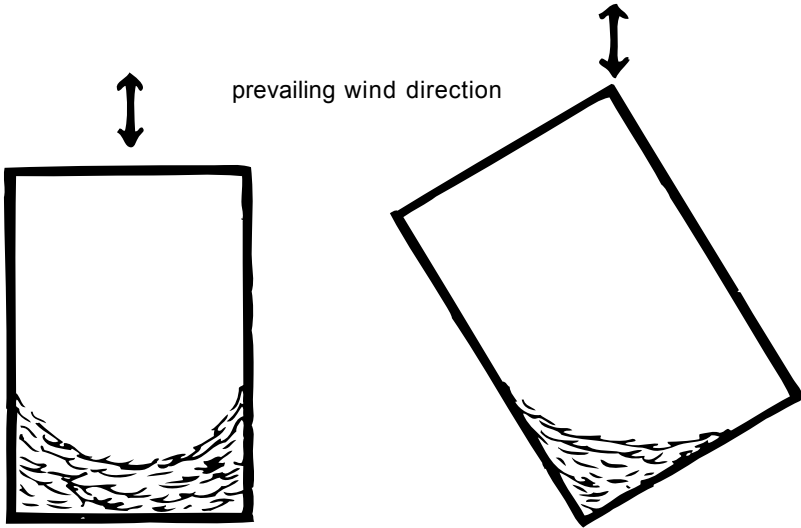

1. longitudinally oriented pond.

2. Diagonally oriented ponds:
lablab accumulates at one end.

Pond orientation according to prevailing wind direction.

corners oriented or positioned along the prevailing wind direction. A rhomboid is a parallelogram having opposite sides and opposite angles equal but with no right angle.

The utmost advantage of the new design is that *lablab* will accumulate only in either of the two acute corners. *Lablab* could then be easily spread out by water action caused by water inlets at the corners. When *lablab* become too thick to be effectively dispersed by water action, collect it by hand before they pile up and decompose.

This advantage is important in nursery operation because of the short duration of the nursery phase. As *lablab* will be present for the duration of the nursery phase, prawns may get entangled in the algal mat and get killed. With the new design, *lablab* can easily be controlled to avoid crowding the prawns.

The researchers also recommend nursery ponds with a size of 1,000 square meters or less. Collecting juvenile prawns is easier in these ponds. However, they warn that small ponds of 200 to 500 square meters may be very convenient but have the disadvantage of having too large an area occupied by dikes. Runoff during heavy rains is higher thus causing water to become acidic and very low in salt content. This could be remedied, though expensive, by using concrete dikes.

SOURCE: Manual on Prawn Farming, SEAFDEC Aquaculture Department, May 1979.

CONSIDERATIONS FOR THE DESIGN AND CONSTRUCTION OF GROW-OUT POND FOR PRAWN CULTURE

A medium density culture system enables a pond owner to stock 2,000 milkfish and 8,000 prawns per hectare. On the other hand, a high density monoculture of prawn allows a stocking rate of 20,000 to 40,000 prawn juveniles per hectare of pond. Regular milkfish ponds when used for prawn production compare poorly; not more than 4,000 prawn juveniles can be stocked per hectare.

To attain medium to high density prawn culture, a grow-out pond should have the following features:

1. It has to be designed along the same lines as the nursery pond: rhomboid with acute corners oriented diagonally along the prevailing wind direction,

2. The pond should be no more than one hectare for easier management.

3. Bottom elevation should be no more than one-half meter, and free from mounds and potholes. The one-half meter elevation makes it easy to flood the pond using tidal fluctuation. Also, a depth of at least 60 centimeters can be maintained without the use of pumps. Making the pond bottom perfectly level facilitates complete draining and drying of the pond.

4. The pond should be provided with separate supply and drain canals with gates placed at opposite sides of the pond. These make it possible to operate a flowthrough system during water change.

5. Water management in medium density ponds is done with tidal action with the help of at least one pump. For high density monoculture, the prawn farmer must use two pumps with a total discharge capacity of 1,000 gpm for a 5 ha area. High density production will also require plenty of supplemental feeding.

6. Allow 500 square meters for nursery per hectare of grow-out pond. Make sure that the nursery and the grow-out ponds are laid out in a manner which would allow for common use of certain facilities.

7. There should be a shed which contains acclimation facilities with airblower or compressor, a sand filter, and one-ton acclimation tanks. These facilities would greatly reduce mortality of young fry during transfer of stocks.

The same shed can also be equipped with facilities for processing marketable prawns. A big blower or compressor with enough capacity to aerate the pond is optional but would be very handy to have.

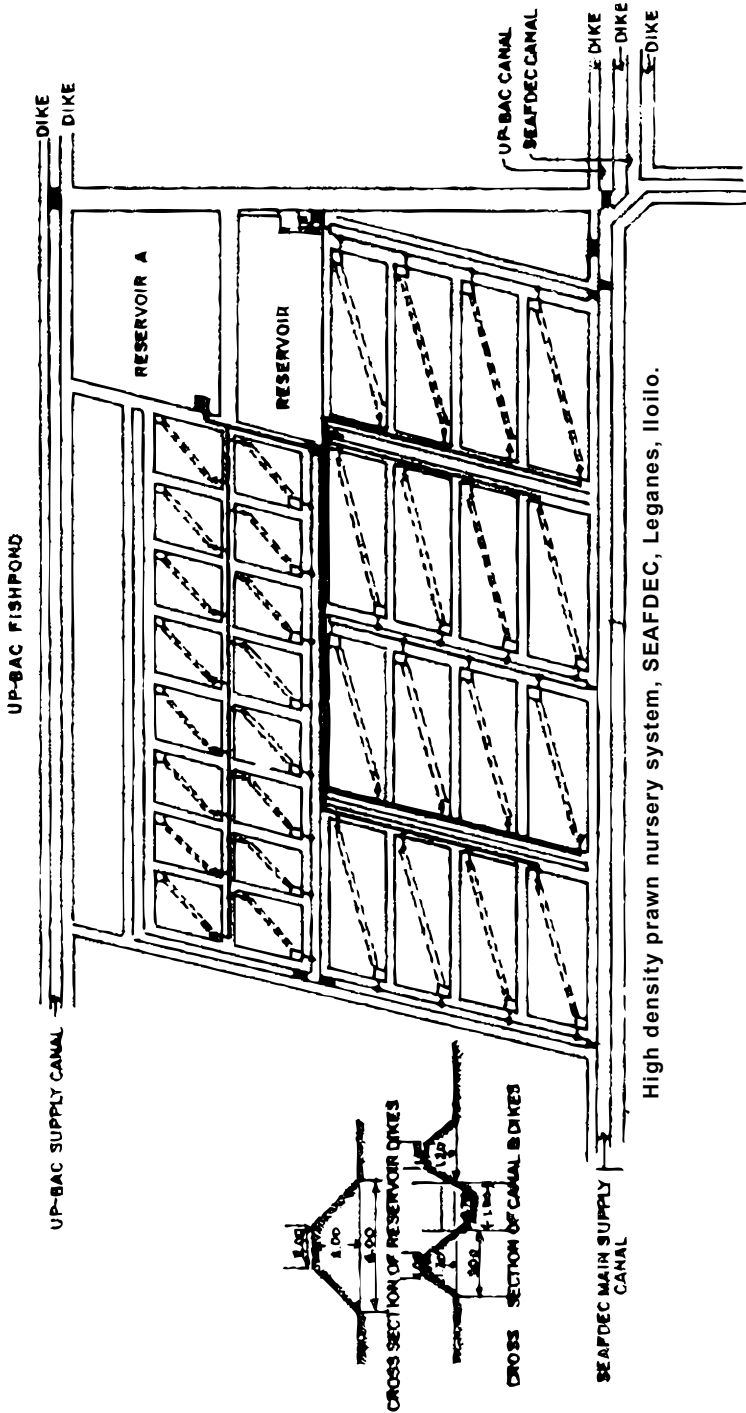

- LEGEND:
- ▬ Wooden pipe
 - # Secondary gate
 - ▣ Control box/monk Type/Outlet pipe/Drainage-harvest box
 - Inlet sprinkler
 - Pump house
 - ▣ Filter box
 - Bottom trench
 - A-1 ha nursery pond system in a diamond shaped design

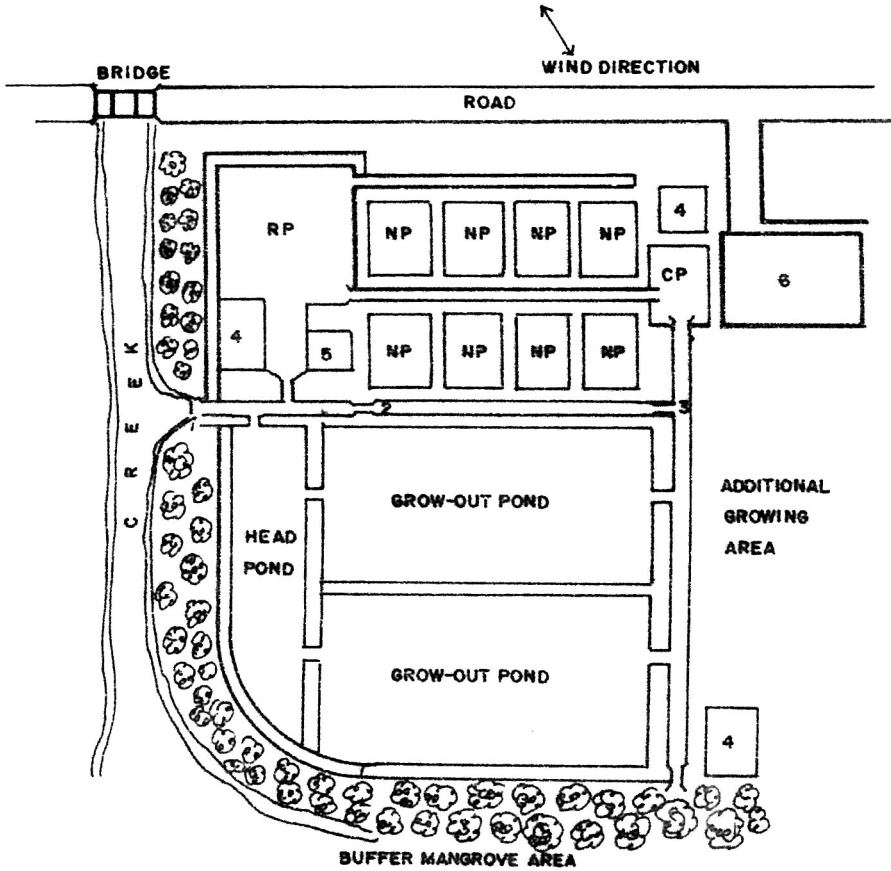

Sample lay-out for a prawn pond system, of 5-10 hectares.

Legend:

- RP -- Reservoir Pond
- NP -- Nursery Pond
- CP -- Catching Pond

- 1 -- Main Gate
- 2 & 3 -- Control Gate
- 4 -- Caretaker's Hut
- 5 -- Main Pump House
- 6 -- Processing Shed

Note: drawn not to scale

Pond sizes:

- Nursery Pond -- 200 -- 500 sq. m.
- Grow-out Pond -- 1.0 -- 1.5 ha.
- Head Pond -- 500 -- 1000 sq. m.
- Reservoir -- 500 -- 1000 sq. m.

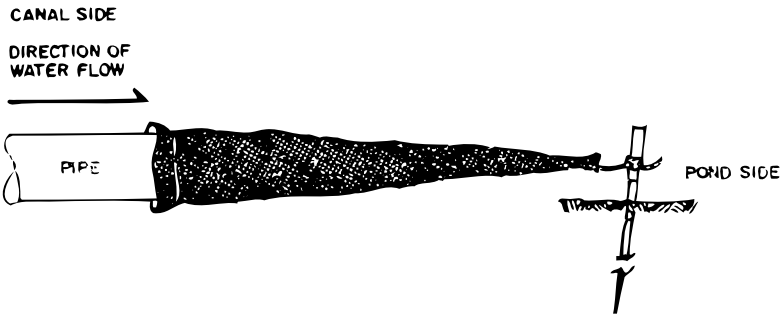

a. Traditional way of using bag net. Silt accumulates inside, causing diminished flow.

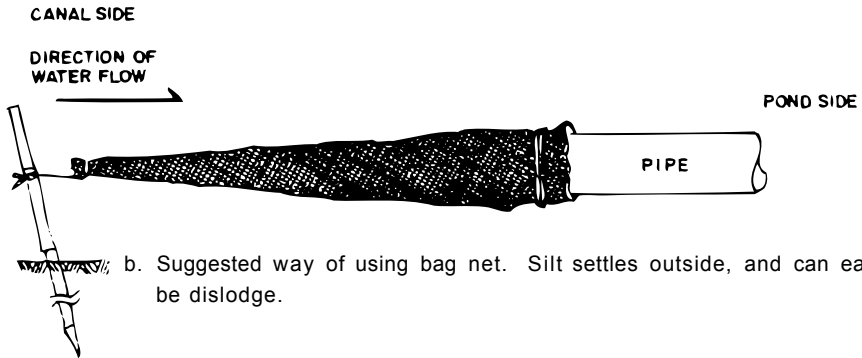

b. Suggested way of using bag net. Silt settles outside, and can easily be dislodged.

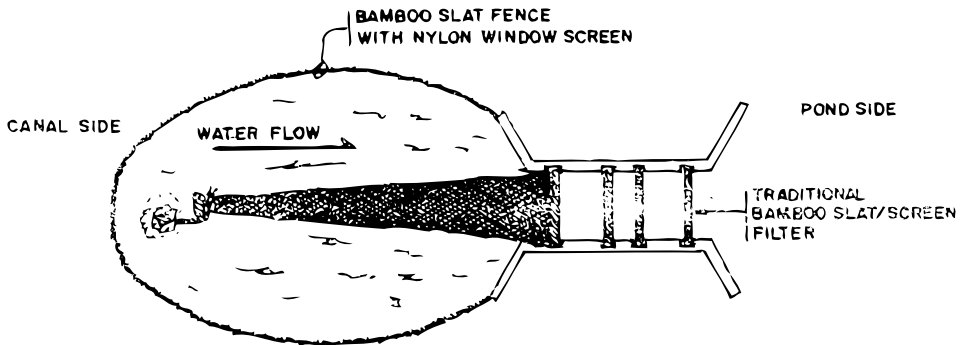

c. Bagnet attached to sluice gate.

Different ways of using filter bag net.

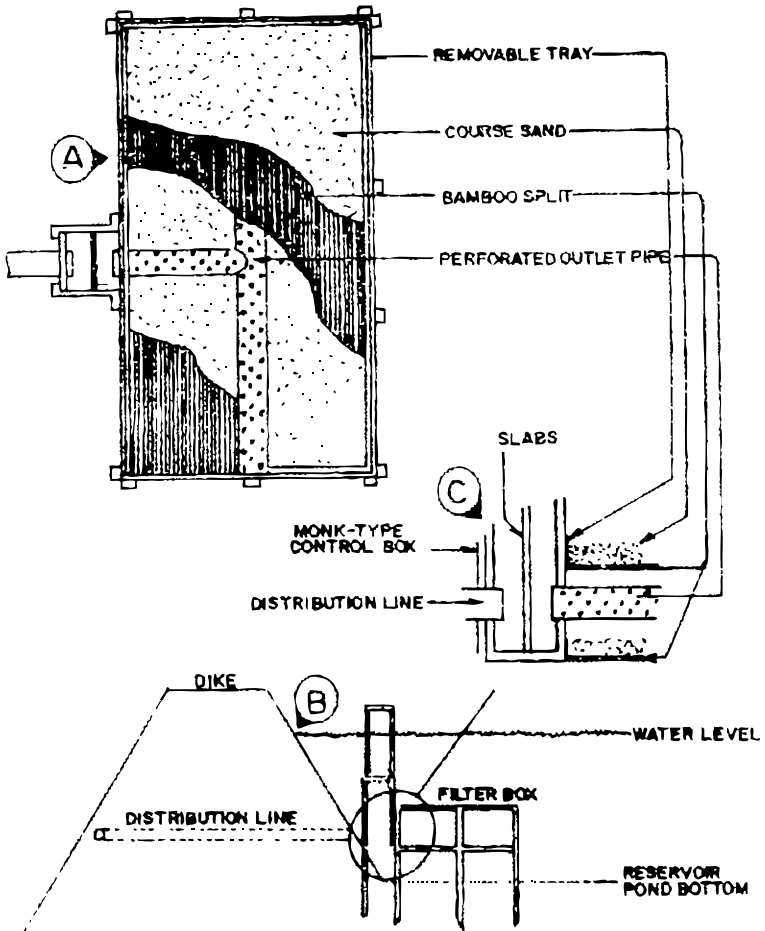

Diagram showing filtration box in reservoir pond. A, Top view showing layers of coarse sand, and bamboo splits, B, Side view of filter box in reservoir pond, C, Inset showing the details inside filter box and drain control box.

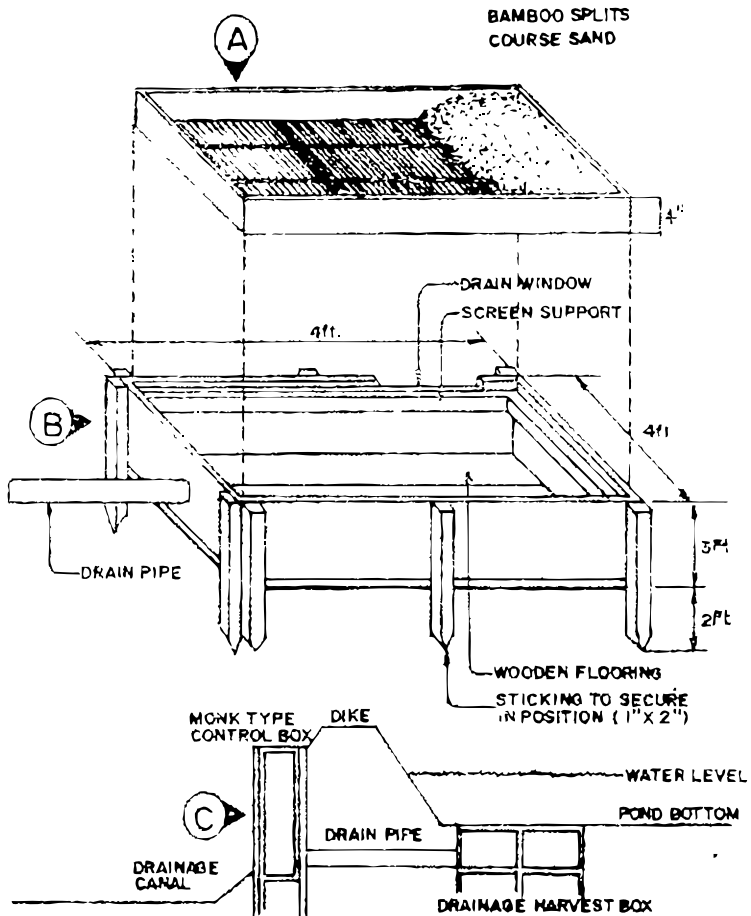
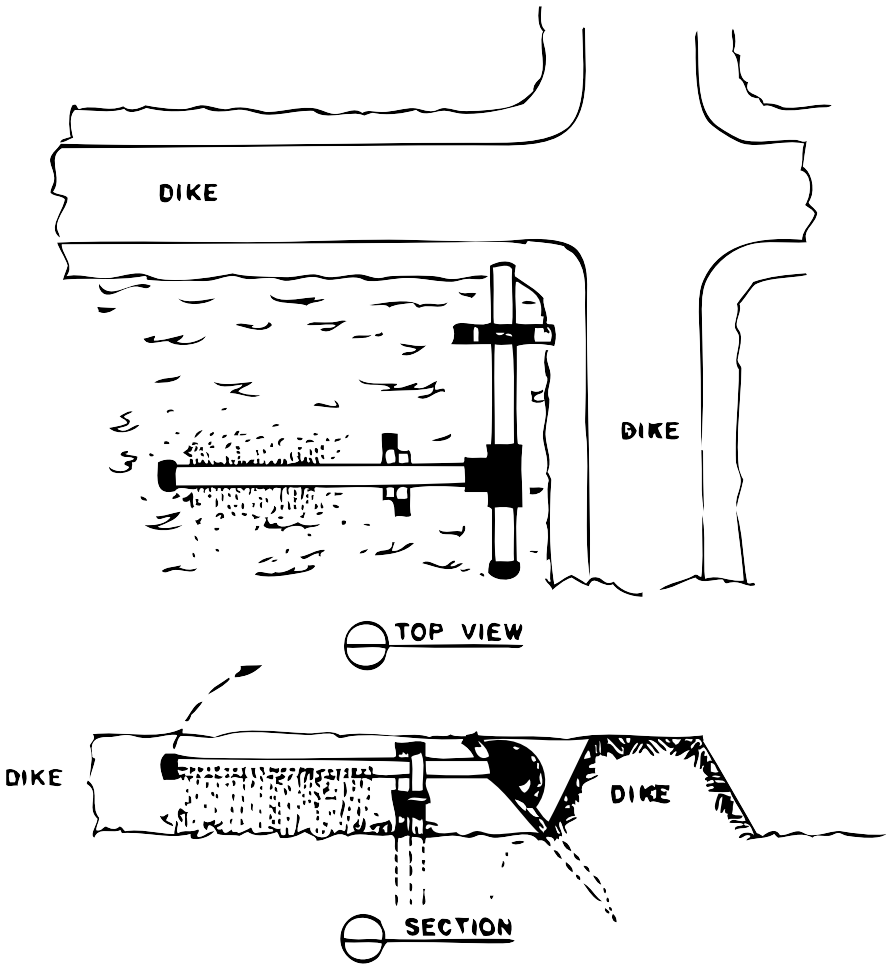

Diagram showing the drainage-harvest box and the monk-type water control box A, Removable screen tray showing parts in detail B, Screen box converted into harvest pit C, Side view of water-control box and drainage-harvest box in nursery pond.



Stand pipe sprinkler system.

Fry management

THE RIGHT WAY TO COUNT PRAWN FRY

Counting prawn fry with the technique used in counting milkfish fry will not give reliable estimates, according to researchers of the SEAFDEC Aquaculture Department in Tigbauan, Iloilo.

Unlike milkfish fry, the fry of prawn do not readily scatter evenly in the counting basin. In counting milkfish fry, a container with its fry content counted individually is used as a standard. The rest of the containers are visually compared with this standard. The contents of these containers are adjusted to equalize, as closely as possible, the standard container's content.

SEAFDEC researchers suggest the following method of counting prawn fry:

Use a 300- or 500-liter circular tank. Fill this tank with a known volume of water and pour the fry into it. Stir the water in an up and down motion using a paddle or plunger. Immediately get a one-liter sample and count the fry content. Do this at least three times. If the water is well stirred, the difference between the three counts should normally be not more than 10 to 15 percent between each other; otherwise, the whole process should be repeated.

The average of the three counts is computed and multiplied by the total water volume in liters to obtain the total estimate of fry.

SOURCE: Manual on Prawn Farming by W.G. Yap, F.D. Apud and J.H. Primavera of the SEAFDEC Aquaculture Department.

HOW TO TRANSPORT PRAWN FRY

Prawn fry can be transported in either of two ways:

1. In plastic bags filled with oxygen capable of holding not more than 10 liters of water. For each liter of water put in 1,000 to 2,000 fry. Pack the bags in styrofoam boxes.

2. In aerated live transport tank with a splash-proof cover. A million fry can be transported in a one-ton tank. A portable blower run by the transport truck's battery aerates the tank.

In both cases, the fry need not be fed during transport. Clean the seawater by filtration before filling the container. Then gradually reduce the water temperature to 22 degrees Centigrade.

When plastic bags in styrofoam boxes are used, place a small bag of ice on top of the container. This will help maintain the temperature. Allow one-third kilo of ice per hour of travel.

SOURCE: Manual on Prawn Farming by W.G. Yap, F.D. Apud and J.H. Primavera of the SEAFDEC Aquaculture Department.

STUNTING - AN ANSWER TO FLUCTUATION IN FRY SUPPLY

Supply of fry fluctuates seasonally. At the same time price of fry may range from as low as P80 per thousand when supply is abundant to as high as P300 per thousand when the catch of wild fry is low.

What you can do is buy as much fry as you can afford during the fry catching season when fry is abundant, stunt them in nursery ponds for a few months, and use the stunted fry or fingerlings as your stock during the times when fry is scarce and expensive.

You can use a concrete nursery pond with sandy mud bottom, according to a Japanese prawn expert who had worked in SEAFDEC.

Stocking density is about 500 fry per square meter of nursery-pond. Feed the stunted fry with mussel meat or artificial feed to prevent them from eating each other.

One private operator in Panay reportedly stocked 57 thousand fry at P-5 -- or five days after postlarvae - in a 100 square meter concrete nursery pond. He gave mussel meat daily to the fry and in three months he was able to harvest around 40 thousand juveniles which he used to stock his rearing ponds.

SOURCE: "The present prawn culture in the Philippines," H. Mochizuki, SEAFDEC Aquaculture Department, May 1979.

TIPS ON PRAWN FRY CONSERVATION

A Japanese researcher at SEAFDEC, Hiroshi Motoh, strongly recommends the ban on the capture of small shrimps. Juvenile or adolescent prawns have poor commercial value anyway, he says.

In his recent survey on the different fry collecting gears and techniques in the Philippines, he observed that fry collectors, after picking out sugpo fry, usually dump on the dry sand the remaining planktonic organisms and debris. These debris still contain plenty of useful prawn fry as well as finfishes and crabs which will grow to edible size if returned to the sea, he said.

To help conserve our fishery resources, Mr. Motoh recommends that these remaining debris and organisms should always be returned to the sea, which is only a meter away from the sorting place.

He also suggests that our cultivable fry, such as *Penaeus indicus* or hipong puti and *P. japonicus*, which are predominant in shore waters, be collected also. This will mean more income for the rural people, Motoh said.

Incidentally, there are 18 types of gear commonly used throughout the Philippines. Seven of these are for collecting sugpo fry and 11 for capturing adult prawns.

SOURCE: Hiroshi Motoh, Fishing for Prawn and Shrimp in the Philippines (Mimeograph).

ACCLIMATE PRAWN FRY BEFORE STOCKING

Prawn fry must be acclimated before stocking to minimize stress.

You must do this as the water condition in the fry transport containers is usually different from that of the pond water. Acclimation will make the transport container water and the pond water conditions closely similar, at least in terms of temperature and salinity.

The steps in acclimation:

For fry transported in plastic bags -

1. Remove the plastic bags from the styrofoam containers.
2. Allow the bags to float on the pond water for at least 30 minutes.
3. Open the bag and take the water temperature with a thermometer or by dipping the hand inside the bag.
4. Then take the pond water temperature.
5. If no difference is felt or if the thermometer reading differs only within one to two degrees Centigrade, proceed with the next step; otherwise, introduce pond water into the plastic bag gradually.
6. If the salinity of the transport water and the pond water is known beforehand to be equal or less than 5 ppt difference between them, the fry can be released immediately once the temperature is equalized.
7. If the salinity difference is great, enough pond water should be introduced very gradually until the salinity difference is reduced to less than 5 ppt. In the absence of a salinity measuring device, gradually diluting the transport water with pond water up to four times its original volume should be sufficient to bring the salinity difference down to acceptance limits.
8. Directly stock the fry from the hatchery into the earthen nursery pond. Stocking in temporary net enclosures such as hapa net causes stress in fry due to overcrowding.

For fry transported in live tanks --

1. A shed is necessary for acclimating a large number of fry when transported in live tanks. The shed should have aeration facilities, a one-ton fiberglass or marine plywood tank, 20-liter plastic pails, and one centimeter plastic hoses.

2. Transfer fry and water in the transport tank to the empty one-ton tank. Allow the fry and water to settle for a few minutes. Then adjust the final volume to one-half the total tank capacity by siphoning through the screen.

3. Allow filtered pond water to flow from an elevated storage tank into the acclimation tank by gravity and through a one-centimeter plastic hose. When the acclimation tank is almost full, the amount of water should already be double the original volume.

4. Install a screened siphon and allow the water to flow at the same rate as the incoming water. Allow the water to flow continuously in and out of the tank.

5. Check temperature and salinity. Fry stocking can be done when the physical conditions have stabilized.

SOURCE: Manual on Prawn Farming by W.G. Yap, F.D. Apud and J.H. Primavera of the SEAFDEC Aquaculture Department.

HOW TO STOCK PRAWNS

Here are some tips to help you stock prawn fry the right way.

1. Stock during any of the following periods:

- * Before 9:00 a.m. and after 6:00 p.m. during sunny days, but preferably in the morning
- * Any time during cloudy days provided pond water temperature is low
- * Any time provided there is admission of fresh tidal water into the pond.

2. Stock only those fry aged P10 to P20 - meaning those fry that have passed 10 to 20 days from the larval stage. With a better water circulation or increased water flowthrough, fry at age P3 to P5 can be stocked.

3. For nursery ponds, you can stock 20 to 30 sugpo fry per square meter. That's about 200,000 to 300,000 pieces per hectare. For rearing ponds, you can stock 5,000 to 20,000 sugpo juveniles per hectare. You may want to raise sugpo with bangos. For every hectare, you can put 5,000 to 10,000 sugpo juveniles and 500 to 1,000 bangos fingerlings.

If you are raising sugpo in a single pond - that is from nursery to rearing - then you should stock one to three fry per square meter or 10,000 to 30,000 fry per hectare.

4. As soon as the fry arrive from the supplier, remove the ice from the styrofoam containers. Select one container for actual head count before stocking. The rest of the containers are for pond stocking.

5. To make an actual or head count, the procedure is as follows:

- a) Get 4 to 5 basins with at least a diameter of 60 centimeters. Put fresh pond water up to about one-half of the basin's capacity.
- b) Remove the plastic bag from the styrofoam container. Open the bag and gradually add pond water to it.
- c) Distribute the fry equally to the different basins.
- d) Start the counting with at least two persons counting and one person recording the count for every basin.
- e) You get the total number of fry by multiplying the number counted for one styrofoam container by the total number of containers.
- f) Once counted, collect and immediately release the fry into the pond.

6. The fry in the remaining containers should be stocked following this procedure:

- a) Remove the plastic bag from the styrofoam containers.
- b) Float the plastic bags in different parts of the pond for at least 30 minutes.
- c) Open the bags and take the water temperature with a thermometer. To make a comparison, also take the temperature of the pond water. If no thermometer is available, dipping one's hand in the water to roughly determine the temperature will do.
- d) If the water temperature in the bag and in the pond is 2 to 3 degrees Centigrade or less, immediately release the fry. Lower the edge of the bag's opening into the water and allow the fry to swim out slowly. Move the bag to scatter the fry.
- e) If the temperature difference is 4 degrees Centigrade or more, gradually add pond water to the bag until the temperature in the bag is almost the same as that of the pond water. Then release the fry into the pond.
- f) Direct stocking of fry in the pond is better than using temporary net enclosures such as the *hapa* for acclimatization. Using the *hapa* usually results in stress followed by cannibalism.

SOURCE: Manual of Operations: Sugpo Pond Culture by J.H. Primavera and F.P. Apud of the SEAFDEC Aquaculture Department, Tigbauan, Iloilo.

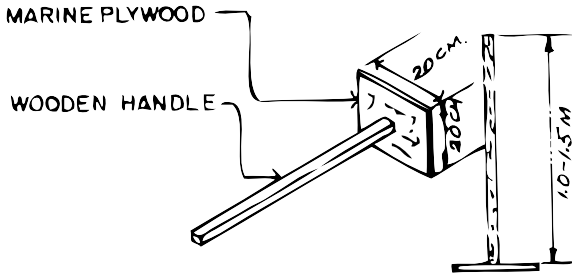

Plunger type paddle to agitate water for counting fry.

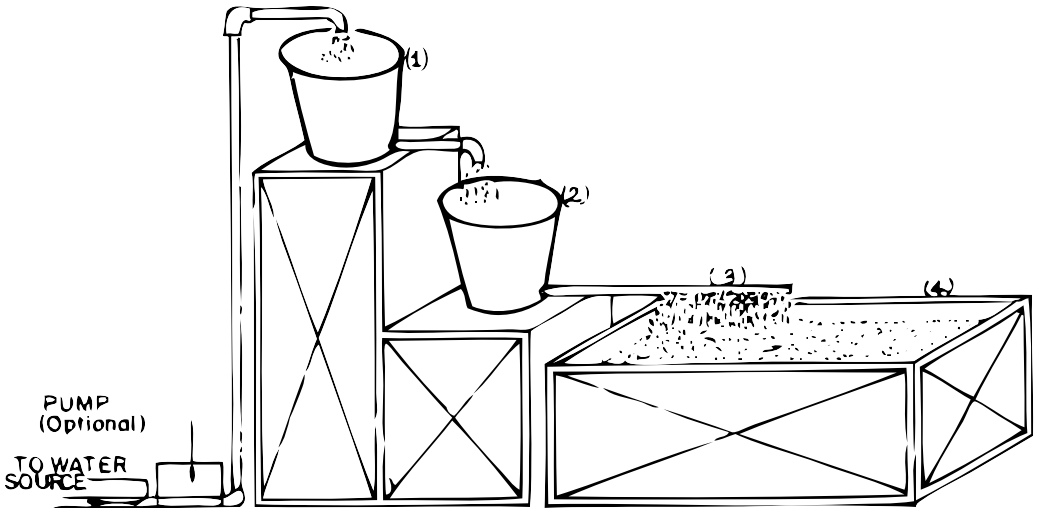

Acclimation facilities.

1. Sand filter using 50 liter plastic bucket.
2. Storage tank, 50 liter plastic bucket.
3. Perforated PVC pipe.
4. Acclimation tank, one to two tons, marine plywood, or fiber glass 50 cm depth.
5. (Optional). Water may be delivered manually by pails.

Pond management

SOME TIPS ON RAISING SUGPO

o Sugpo grows only after molting, a process by which the hard protective shell is shed thereby leaving the animal temporarily vulnerable to predation and cannibalism. You must, therefore, see to it that your pond is well protected from predators. One way of doing this is by applying pesticides before putting in sugpo fry.

o Insufficient food and low level of oxygen in the water result in cannibalism among the sugpo fry. To prevent this, build a peripheral or diagonal canal in the pond to serve as refuge of the fry during the molting period and when water temperature is high. The canal also facilitates water management and harvesting.

o Sugpo grows better in ponds about one meter deep and with low salinities ranging from 10 to 20 parts per thousand. A deeper pond means greater water volume which allows better feeding and care of the stock. At lower salinities, sugpo grows faster because most of the food it takes is converted into flesh and less is diverted into keeping the body's salt-water balance.

o Sugpo can be profitably raised together with *hipong puti*, *bulik*, *suahe* and *bangos*. These species are abundant in Philippine waters.

SOURCE: Manual of Operations: Sugpo Pond Culture by Jurgenne H. Primavera & Florentino P. Apud, SEAFDEC Aquaculture Department.

PUT DRIED TWIGS ON *LABLAB* PONDS

If your pond is built to produce *lablab* as the main food of the prawns, install dried twigs - at least one twig for every 20 square meter area or 500 twigs per hectare. They serve as shelter for the growing prawns and prevent *lablab* from gathering at the sides of the pond.

Place the twigs horizontally in rows perpendicular to the prevailing wind direction. Coconut leaves and bamboo branches can be substituted for twigs.

When reducing the pond water, do it gradually to conserve *lablab*. Do it late in the evening or early morning when water temperature is low.

If the growth of *lablab* decreases to a point that it will not be enough to feed the growing prawns, start giving supplementary feeds.

SOURCE: Manual of Operations: Sugpo Pond Culture by J.H. Primavera & F.P. Apud, SEAFDEC Aquaculture Department.

HOW TO TRANSFER SUGPO JUVENILES FROM THE NURSERY TO THE GROW-OUT POND

Using proper techniques of harvesting and transporting sugpo juveniles greatly reduces mortality. Juveniles are less delicate than fry but they are much more expensive and therefore would demand the same if not greater amount of care.

To harvest juveniles from the nursery pond, drain water to a shallow 10 to 20 centimeters. Place a bag net at the drain pipe or at the gate. When juveniles are concentrated in the bag net, untie the end of the net and collect the sugpo. Repeat the process until most or all of the juveniles are harvested. A mobile net does not cause injury to juveniles but some of them might jump out of the net.

Around 90 percent of juveniles are harvested this way. Pick up the remaining ones from the mud.

Harvest after sunset or before sunrise because direct sunshine harms the juveniles. Don't harvest during a heavy rainfall. Also postpone harvesting if you see plenty of soft-shelled juveniles; soft-shelled sugpo are weak for handling. Mortality at harvest should be minimized at no more than one percent.

Place the harvested juveniles in a hapa net set in another pond until harvest is completed. Then transfer the entire harvest to a transport tank provided with aeration. Bring them to the rearing ponds after counting.

Transporting juveniles. If you transport over long distances, you will have to gradually lower the water temperature in the transport tank to 18°C by using ice. Apply ice after you have put the juveniles in the transport tank.

Check the temperature every hour and maintain it at 18°C to 20°C. Transport juveniles at night because a high air temperature can cause mass mortality.

A safe density during transport is 30 kilograms of juveniles in total weight per one ton water, with aeration for 12 hours. Juveniles can be transported in plastic bags with oxygen similar to the ones used in transporting fry.

SOURCE: "The Present Prawn Culture in the Philippines," a terminal report submitted to the SEAFDEC Aquaculture Department by Hideo Mochizuki, JICA Prawn Culture Expert (May 1979).

WATER MANAGEMENT IN PRAWN PONDS

Water management is a major concern in prawn farming. The kind of system to adopt will depend on the phase and density of prawn farming.

A milkfish nursery pond when used for prawn could hold no more than 50 fry per square meter. This is considered a low density system as against a nursery pond actually designed for prawn production and capable of growing as much as 200 fry per square meter.

A low density system mainly depends on tidal changes. Water replenishment is done during spring tides which occur for 5 to 6 days every two weeks during full moon and new moon periods. In between these periods (first and last quarters), neap tides occur so that replenishment is not possible for a number of days.

To manage the water in a low density system, observe the following:

1. As spring tide approaches, ponds should be partially drained to a certain level where high tide of the day is capable of replenishing the drained water.

2. Avoid draining more than what an expected tide can replenish.

3. Drain the pond late in the evening or in early morning, preferably two to three hours before an expected incoming high tide.

4. Do not drain at daytime, particularly during warm days. You do not only endanger your stock but also release some food nutrients and natural food which float during warm days.

5. Repeat draining and flooding two to three times. Then continuously flood to a desired elevation for the rest of the spring tide period.

6. Soil-seal the pond gate if necessary to prevent leakage when further flooding is no longer possible.

For a high density prawn nursery pond, a flowthrough water management system will be required. This system may be partially dependent on or totally independent of tidal fluctuations.

Water is either allowed to enter during high tide or pumped into the reservoir pond. From the reservoir pond, water is channeled into the culture ponds usually in the morning, 4:00 a.m. to 7:00 a.m., when dissolved oxygen is low and in the afternoon, 1:00 p.m. to 4:00 p.m., when water temperature is high.

With this system, water can be changed even during neap tide. Where supply of fresh water is inadequate, the pond water can be

recirculated, that is the water that is released is pumped back into the pond.

Water System for Grow-out Ponds

The water system for grow-out ponds for prawn and milkfish culture (polyculture) is the same as that method described for the low density nursery system except that water should be maintained at a greater depth (at least 60 cm).

On the other hand, monoculture grow-out ponds will require a water management system similar to that of the high density nursery system. Water pumping costs can be minimized by taking advantage of tidal fluctuation whenever possible such that pumping is purely supplemental.

Draining is done through one of the gates while water enters through the opposite gate to attain maximum water exchange. Pond water depth of at least 60 cm but preferably one meter or deeper must be maintained.

A water pump is primarily used to effect water movement, aerate ponds, replace water losses and, to some extent, replace water after some accidental draining.

SOURCE: Manual on Prawn Farming by W.G. Yap, F.D. Apud and J.H. Primavera, SEAFDEC Aquaculture Department, 1979.

PREPARING NURSERY AND GROW-OUT PONDS

Here are the steps in preparing nursery ponds for growing prawn fry to juveniles:

1. Drain the pond completely and then seal the entry gate with soil or when pipes are used, place a stopper on the inlet pipe.
2. Immediately after draining, apply lime to acid pond bottom and dikes. If needed, apply pesticides and organic manure.
3. Dry the pond bottom for about one week (day 1 to 7-9) until it cracks to eliminate predators which burrow in the mud.

While waiting for the pond bottom to dry, undertake the following:

- a) Repair dikes and canal. The canal should be graded gradually toward the drainage box or gate.
- b) Rake the pond bottom to level and upturn the underlying fertile soil and to hasten oxidation of organic matter.
- c) Fill up potholes on the pond.
- d) Put everted bag nets in all the inlet pipes and entry gates and place filter box screens into the drainage box.

4. Admit initial water at a depth of 5 cm (day 8 to 10). Raise water by an additional 5 cm every three days until pond water depth reaches an average of 20 cm (day 10-19).

5. Allow *lablab* growth to stabilize (day 15-21). However, avoid excessive growth as this may decompose causing foul water. In addition thick *lablab* hampers retrieval of juveniles during transfer.

6. Gradually drain all water from pond. Check for presence of pest species like *Tilapia* which may have survived the initial draining and pesticide application. Any survivors must be eliminated as they will nest and lay eggs in the pond. Refill the pond and drain again 1-2 more times.

7. Make final water replenishment and raise water level to 30-40 cm.

8. Install bamboo branches (one clump per 5 sq m), dry coconut fronds (one clump per 10 sq m), api-api or dried ipil-ipil branches (one clump per 5 sq m) on pond bottom for the prawn fry to cling to.

For grow-out ponds, follow the procedures in nursery and pond draining, drying and other simultaneous activities. However, filter box screens need not be used.

Water management of the grow-out will depend on whether the rearing scheme used is monoculture or polyculture. In monoculture, intensive efforts for growing *lablab* after stocking are not necessary and maybe detrimental. Excess *lablab* decomposes produ-

cing substances poisonous to the prawns. Sugpo shifts to a more carnivorous diet and requires deeper water level as it grows bigger.

For polyculture (sugpo-bangos), use the recommended method of pond preparation for milkfish culture.

SOURCE: Manual on Prawn Farming by W.G. Yap, F.D. Apud and J.H. Primavera, SEAFDEC Aquaculture Department, 1979.

WATER pH IS CRITICAL FOR PRAWN FRY

A Japanese prawn culture expert, Hideo Mochizuki, who had worked with the SEAFDEC Aquaculture Department, says that the pH (acidity or alkalinity) of pond water greatly affects survival of prawn fry. He says that prawn does not take any food under pH 6 (slightly acidic) and begins to die at pH 5.

Poor production in newly built ponds is caused by low pH or excessive acidity of the pond water. He recommends the use of animal manure as fertilizer in new ponds because manure increases water pH while commercial agricultural fertilizers have a low pH and thus tend to make the water acidic.

When rain water runs off from the dike to the pond, pH of pond water goes down, in other words, it becomes acidic. Mochizuki recommends the planting on dikes of acid-tolerant grasses like *Cynodon* species to prevent low pH due to erosion of dike by heavy rains.

Newly built ponds should be limed heavily to stabilize the soil pH. Also, roots of mangrove trees must be removed, Mochizuki advises.

REPLENISH POND WATER

Replenishment of pond water in sugpo ponds is a very important pond management practice.

Pond water is replenished every spring tide. Spring tide is when the tide is at the maximum amplitude or height and it usually occurs during the new and the full moon phases. (This is opposed to neap tide when the tide is at the lowest amplitude or minimum height. Neap tide occurs during the first and last quarter of the moon).

To replenish pond water:

1. Reduce the water level a few hours before incoming tide can enter the pond. Then admit fresh tidal water.
2. Repeat this draining-refilling procedure two or three times. Without draining, admit fresh tidal water until water level reaches the desired height.

Replenishing the water every spring tide takes about five days, three days for draining and refilling and two days for filling.

Water should not be replenished only during spring tide. If signs of stress are observed in your stock, immediately admit new tidal water. This is the reason a standby pump is important for sugpo ponds. If the tide level is low, the pump is the only means to pump in fresh water. During hot days or in the early morning when dissolved oxygen is low, circulate the water by using a pump. Replenishment should also be done after a moderate or heavy rain. Allow water to overflow by draining the top layer of the pond. Immediately replace with fresh tidal water or by means of a pump.

SOURCE: Manual of Operations: Sugpo Pond Culture by J.H. Primavera and F.P. Apud, SEAFDEC Aquaculture Department.

WAYS TO CONTROL POND PESTS AND PREDATORS

Pests and predators of sugpo can be effectively controlled by mechanical and chemical methods.

Here's how you could do it the mechanical way:

1. Drain and dry the ponds two to three times to remove most unwanted fish species like tilapia, gobies, bid-bid, apahap and others.

2. Get rid of edible snails (family *Cerithidae*). You may let other people harvest the snails for free. These snails can be sold at a good price. Snails that concentrate along the water line or in puddles may be shovelled or raked in.

3. See that gates and dikes are in good shape to keep out barnacles and crabs.

4. Install gate screens made of bamboo and nylon, bagnet and other materials to prevent the entry of unwanted species during admission of pond water.

To further check pests and predators, you can apply organic or chemical pesticides or both before stocking sugpo. Throughout a drained but moist pond bottom, uniformly spread any of the following: tobacco wastes such as dust and stalks at 200 to 400 kilograms per hectare or commercial nicotine at 12 to 15 kilograms per hectare; tea seed cake at 150 to 200 kilograms per hectare or commercial saponin at 15 to 20 kilograms per hectare; or quicklime at 100 to 600 kilograms per hectare. For pond conditioning, particularly in acidic ponds, the dosage may be raised to 1,000 to 2,000 kilograms per hectare.

After one to two days, apply dried chicken dung throughout the pond bottom at 1,000 to 3,000 kilograms per hectare. Carabao and horse dung and composted hay can also be used. Allow the organic fertilizers to settle in the soil for 4 to 5 days before you admit initial water at 5 to 8 centimeters deep.

Remaining unwanted fishes and other aquatic animals may be completely eliminated by applying saponin at a little bit less than one-half kilogram per hectare with the water 8 centimeters deep. Also apply 3.2 liters of Bayluscide.

Three days after poisoning, raise water to 15 to 25 centimeters. Change water completely two times and stock the pond after one to two weeks.

TOO MUCH *LABLAB* REDUCES OXYGEN IN POND WATER

Prawn hardly eats blue-green algae so that excess *lablab* accumulates in pond corners. Usually this *lablab* floats on the surface for several days and decays. As *lablab* decays it produces hydrogen sulfide which consumes a great amount of dissolved oxygen. To prevent this, remove floating *lablab* daily. Or, put several bamboo bundles in different parts of the pond and stock some milkfish with the prawns to consume the excess blue-green algae.

SCREEN SNAILS OUT OF PRAWN PONDS

Snails should be eradicated because they compete with fish for the food in the pond. Stop snails from propagating; install window screen at the gate to filter the incoming water. Larvae of snails which can get through the screen are readily eaten by the prawns.

BAD WATER CONDITION PRODUCES SOFT-SHELLED PRAWNS

Those soft-shelled prawns you often complain about are the result of bad water conditions. Prawns are usually cultured in milkfish ponds which are very shallow for prawns. If water cannot be changed during high tides due to the high elevation of the pond bottom, toxic chemicals are formed such as nitrites and hydrogen sulfides. To prevent the production of hydrogen sulfides, place white coral sand in the pond bottom. Coral sand also maintains optimum pH and dissolved oxygen content of the water.

Water depth for prawn should be more than one meter. Pumps or aqua mills for aeration should be used when water cannot be changed by tidal fluctuation, especially in the morning when dissolved oxygen is low.

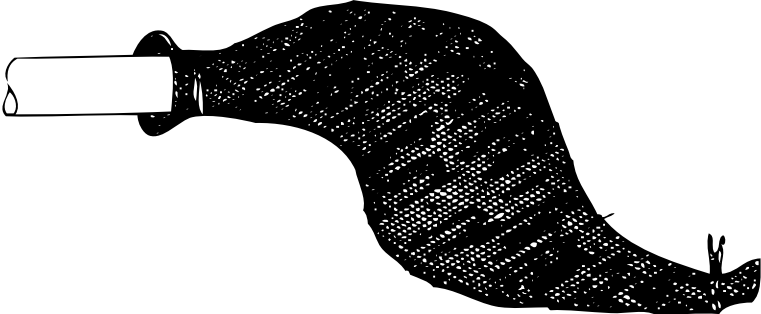

a. Installed at pipe outlet.

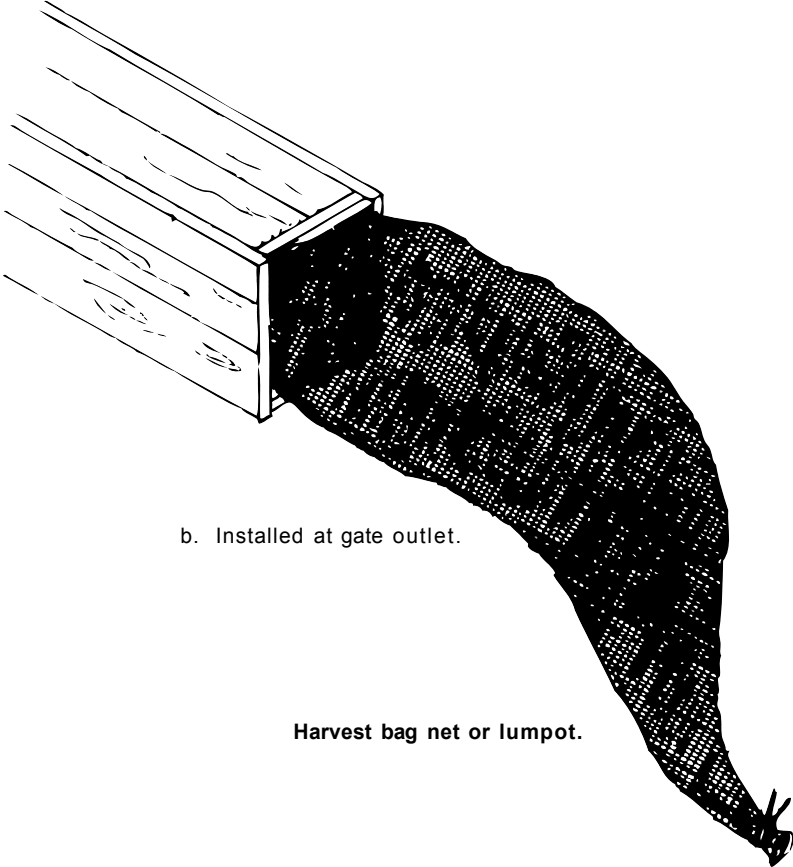

b. Installed at gate outlet.

Harvest bag net or lumpot.

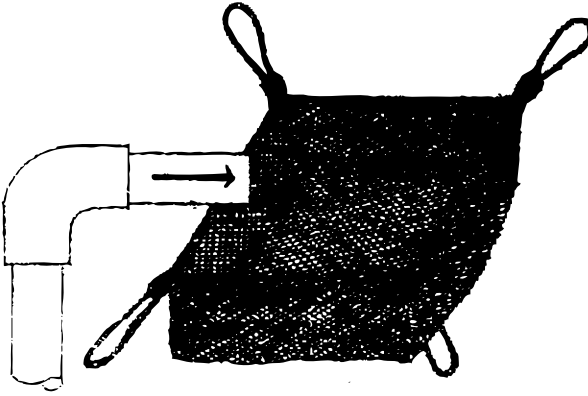

a. Installed at pipe outlet.

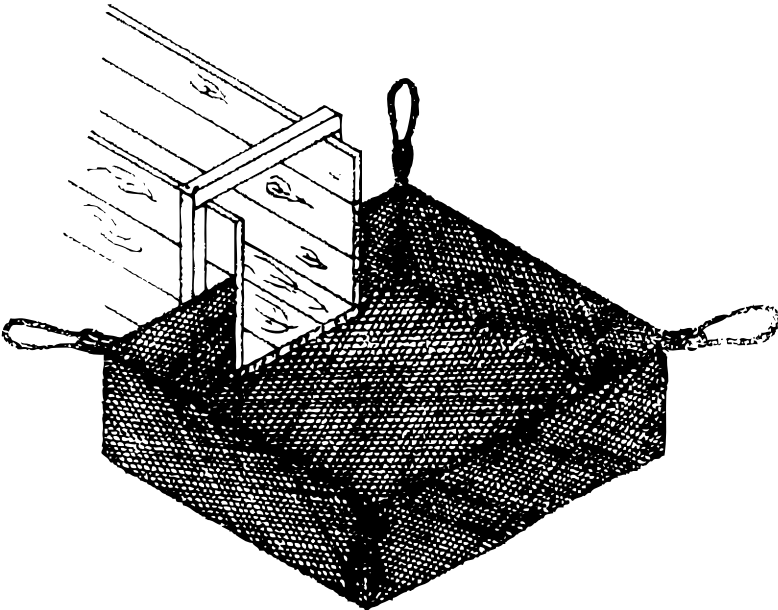

b. Installed at control gate.

Mobile catching facility.

Feeding

SUPPLEMENTARY FEED MEANS EARLY HARVEST AND MORE INCOME

Giving supplementary or additional feed rather than relying only on the natural feed in the pond is more profitable to a sugpo or prawn farmer. With additional feed, more sugpo are harvested over a shorter culture period. It takes only four to five months with additional feed compared with six months without. This allows a farmer to raise more crops per year.

According to Dr. Felicitas P. Pascual, a nutrition specialist of the SEAFDEC Aquaculture Department, additional feed takes up 70 to 80 percent of the total sugpo production cost. However, she estimates that with feed supplement, a sugpo farmer can profit as much as P13,165 per hectare in one harvest. Without feed supplement, the profit will only be around P4,580 per hectare in a harvest, a difference of more than P8,500.

The amount of feed to give is determined by the total weight of the sugpo, said Dr. Pascual. The total weight of sugpo is computed by getting samples of the prawn in the pond and multiplying the sample's weight by the total number of prawns stocked. This is done every two weeks or once a month as the total weight will increase as the sugpo grows bigger. As a rule of thumb, allow for 90 percent survivors for the first month, 80 percent for the second month, 70 percent for the third month, and 60 percent for the fourth month.

When the sugpo post-larvae weigh one to 10 grams, the rate of feeding should be from 8 to 10 percent. Reduce the rate to 3 to 5 percent when the sugpo juveniles weigh more than ten grams.

CHOOSING FEED INGREDIENTS FOR SUGPO

How good a feed diet is is usually measured in terms of feed efficiency or food conversion ratio. It is the amount of feed that will give a unit weight gain in sugpo. For example, if two kilograms of feed produces one kilo of live weight prawn then we say we have a feed conversion ratio of two. The lower the feed conversion rate the better because less feed is consumed per unit weight gained. Also, a good diet must produce sugpo that tastes good to consumers. Prawns should have the bright red color and the delicate flavor that the consumer is used to.

Dr. F.P. Pascual, nutrition specialist of the SEAFDEC Aquaculture Department, gives the following guides in choosing which of the many available feed ingredients are to be combined to make a good feed diet:

1. A combination of two or more protein sources, either of plant and animal source or both of animal source, is better than one source in terms of weight gain. Examples of good ingredients from animal source are fish meal and shrimp head meal while ingredients from plant source are ipil-ipil leaves and soybean meal.
2. Shrimp head meal is not only a good source of protein but also provides the attractant that makes the feed acceptable to the prawn.
3. Tests show that a combination of two parts shrimp head meal and one part fish meal was not only cheap but also resulted in improved weight gain and survival rate of sugpo.
4. Local ipil-ipil leaves soaked in water for 24 hours and added in the diet improved survival rate of juvenile sugpo to about 30 percent.
5. Both the Peruvian and Hawaiian ipil-ipil when included at 10 to 20 percent level in the diet gave good survival rate. Also, the weight gain was similar to a combination of equal parts of fish meal and shrimp head meal.
6. With 30 percent ipil-ipil leaf meal in the diet, the amount of fish meal could be reduced to about 17.5 percent and for shrimp

head meal, 22.5 percent, without affecting growth performance. Fish meal and shrimp meal are some of the most expensive items in the ration; ipil-ipil is much cheaper.

7. While rice bran, corn meal, corn gluten meal, copra meal are considerably high in fiber content, they also contribute protein, fat and carbohydrates in the compounded diet. However, these feeds are poor sources of protein. These feed could be improved by mixing them with animal sources of protein like fish meal and shrimp head meal.

8. The oils, preferably corn oil and fish oil, provide the needed energy and essential fatty acids of the growing sugpo.

9. Bread flour, cornstarch, sago palm starch and agar are good sources of carbohydrates needed for the body energy of growing sugpo. Moreover, they are better binders than cassava flour or sweet potato flour. Unlike fish that gulps or swallows its food, sugpo are nibblers or slow eaters. Thus, a feed pellet must have good binding substance that will last for six or more hours.

10. Vitamin-mineral premix for poultry can also be used for sugpo growing.

THREE TYPES OF DRY FEED FOR SUGPO

Here are three types of feed formulations a sugpo farmer may choose from. The choice will largely depend on the cost and availability of the ingredients involved. The feed ingredients are mixed and made into dry pellets for easy feeding and storage.

These three types of feed formulations were suggested by Dr. Felicitas P. Pascual, a nutrition specialist of the SEAFDEC Aquaculture Department based in Tigbauan, Iloilo. The amount of each ingredient to be mixed is stated in grams per kilogram of feed diet.

<u>Ingredients</u>	<u>Type I</u>	<u>Type II</u>	<u>Type III</u>
Shrimp meal	300	225	275
Fish meal	150	175	275
Soy sauce residue	150	—	—
Ipil-ipil leaf meal	—	300	—
Rice bran	150	—	200
Bread flour	150	100	150
Sago palm starch or corn starch	50	50	50
Corn oil	40	60	40
Vitamin-mineral mix*	9.5	19	9.5
Vitamin C	0.5	1	0.5
Rice hulls	—	70	—
Water	<u>200</u>	<u>200</u>	<u>200</u>
Total grams per kilogram of feed diet	1200	1200	1200

* Allowance has been provided for the destruction of some vitamins during steaming and drying.

DRY FEED IS BETTER THAN FRESH FEED FOR SUGPO

As supplementary feed for growing sugpo, dry feed offers more advantages than fresh or wet feed. Dry feed could be prepared by the fish farmer and stored without costly refrigeration.

This is according to Dr. Felicitas P. Pascual, a nutrition specialist of the SEAFDEC Aquaculture Department based in Tigbauan, Iloilo.

She says that when you feed sugpo with fresh fish and other wet feed you are faced with the problem of proper storage. Without refrigeration facilities, fresh feed easily spoils. Spoiled feed may kill the sugpo stocked in the pond.

Dry feed is a good substitute as long as the diet consists of proper amounts of protein, fats, carbohydrates, vitamins and minerals. A good feed is one that could raise the sugpo to marketable size in the shortest time possible at the least possible cost, Dr. Pascual says.

She gives four factors that must be considered in preparing a good feed diet for sugpo. These are: 1) availability and cost of ingredients, (2) ease of preparation, (3) acceptability and attractiveness to the sugpo, and (4) effectiveness of the diet.

Some common feed ingredients you could make use of are: fish meal (local or imported), shrimp head meal or shrimp meal, ipil-ipil leaves, rice bran (tiki-tiki or fine rice bran), soybean meal, corn meal, corn gluten meal, copra meal, corn oil, fish oil, coconut oil, bread flour or wheat flour, cornstarch, sago palm starch, banana flour, cassava flour, non-poisonous frogs, meat and bone meal, sorghum and vitamin-mineral mixes.

HOW TO PREPARE DRY FEED FOR SUGPO

Dried pellets can be made more economical and nutritious if prepared by sugpo farmers at their home.

From Dr. Felicitas P. Pascual, nutrition specialist of the SEAFDEC Aquaculture Department, here is the list of equipment and the proper way of making dry feed pellets for sugpo.

The equipment needed are: (1) weighing scale or balance; (2) sieves; (3) mixer of 5 to 10 kilogram capacity; (4) meat grinder; (5) corn meal or coffee grinder; (6) steamer or a big cauldron and bamboo basket for steaming; (7) saucepan for gelatinizing cornstarch; (8) drier; (9) wooden ladle; and (10) covered containers for pellets.

The procedure:

1. Use finely ground ingredients of similar size particles. If possible, pass through No. 40 sieve.

2. Mix all dry ingredients thoroughly. If large batches are to be mixed, the dry ingredients can be mixed in a large cake mixer or even in a cement mixer.

3. Add the oil and mix for at least another five minutes.

4. Gelatinize the cornstarch or sago palm starch or bread flour. The procedure is the same as when you gelatinize cornstarch for starching clothes. Usually, one part starch in 4 parts of water is mixed. Fifty grams of starch in 3/4 cup of water for every kilogram of feed will be enough. Suspend the cornstarch in ordinary tap water in half the amount needed for the whole mixture before gelatinizing.

5. Add gelatinized starch to the mixture and mix well. It will result in a stiff dough.

6. Press this dough through a meat grinder with a 1, 2 or 3 millimeter die depending on the size of the prawn that is being fed. For sugpo juveniles weighing around 0.35 gram, 1 millimeter die should be used; 2-gram juveniles, 2 millimeter die; and juveniles weighing 10 grams or more -- 2.5 to 3 millimeter die.

7. From the meat grinder, the dough will come out like noodles. Cut these into one-half centimeter sizes and steam for five minutes. Steaming makes the pellet more stable. Unsteamed pellets break within 30 minutes whereas steamed pellets remain in form up to 12 hours or more.

8. Dry the steamed pellets in an oven overnight at 60 degrees Centigrade. Do not dry under the sun because sunlight destroys some of the vitamins in the pellets. Pellets must be properly dried, otherwise they get moldy. Molds can also cause mass killing due to aflatoxin.

9. Store the pellets in covered cans when dry and cool. Pellets could be made once a week or even everyday depending on the availability of storage space and dryness of pellets.

SOME TIPS ON FEEDING PRAWNS

There are three general types of prawn feed and the amount and frequency of feeding prawns would depend on the growing stage of the prawns and the kind of feeds you are giving.

First, prawns feed on natural food such as pond-grown *lablab* and planktons. A second type of feed is the so-called wet feed consisting of unprocessed materials like "tahong" meat, trash fish, cattle hide, and entrails. These feed supplements cannot be used as the full diet at high density culture systems. However, they may be enough as supplementary feed in extensive and low-density culture to augment the natural foods. A third type is the dry pellet feeds which is still expensive in the Philippines. Some laboratory-tested formulations have shown much promise as supplementary prawn diets but are not yet commercially available, however. SEAFDEC researchers maintain that two to three kilograms of dry feed to produce one kilo of prawn meat - or a 2:1 or 3:1 feed conversion ratio - is an acceptable conversion rate.

While prawns are in the nursery pond, the fry or juveniles are primarily dependent on *lablab*. However, at high stocking densities, you would have to give the prawns supplementary diets.

Also at the nursery stage, the so-called wet feed materials should be given at 100 percent of the estimated total weight of the prawn fry daily for the first two weeks. Reduce the amount of feeding to 20 percent of the prawn fry weight for the rest of the nursery rearing period.

If you have to use dry pellets feeds, feed at 50 percent of the total prawn fry weight - or biomass - during the first two weeks and reduce to 10 percent of the biomass for the rest of the rearing period. Biomass refers to the estimated weight of all the prawns in the pond.

At the grow-out pond stage, the natural food in the ponds might be sufficient for low density culture. But at high densities, you have to feed. With wet feed materials, feed at the rate of 20 percent every week until you get down to 10 percent of the biomass. Maintain this feeding rate until harvest.

For dry pelletized formulations, feed at 10 percent of the biomass daily for the first month and reduce by 1 percent every two weeks until you get down to 5 percent of the biomass. Maintain this feeding rate until harvest.

As to the frequency and methods of feeding, observe the following:

In the nursery, divide the daily ration into three to four lots and feed 3 to 4 times a day. As the prawns grow, feeding frequency can be reduced to twice a day.

In the grow-out ponds, the daily ration is given in two portions, one in the early morning, the second late in the afternoon.

Feed should be scattered all around the pond along the periphery but not too close to the dike.

SOURCE: Manual on Prawn Farming by W.G. Yap, F.D. Apud and J.H. Primavera, SEAFDEC Aquaculture Department, July 1979.

IPIL-IPIL LEAVES COULD BE USED IN PRAWN DIETS

Ipil-ipil (*Leucaena leucocephala*) leaves, used in cattle, poultry and swine feeds, could also be used as a food ingredient in fish diets.

While it contains relatively high amounts of protein, its use is limited because of the presence of mimosine, a substance that can be toxic to fish beyond a certain level.

However, soaking leaves in water is a highly efficient and cheap method for the removal of mimosine, according to Dr. Felicitas Pascual, SEAFDEC nutrition and feed development specialist.

While the amount of water used (250, 500, 750 and 1,000 mL) does not significantly affect the amount of mimosine extracted, more can be extracted with longer soaking time. Approximately 90% of the mimosine can be extracted from the leaves after soaking

for 42 hours. When leaves are soaked for more than 24 hours however, there is a need to change the water to avoid fermentation of the leaves and the presence of a foul odor, Pascual says.

Mature leaves contain less mimosine than immature leaves. However, protein content in young leaves - from 27.5% to 37.75% - is generally higher than in mature leaves - 16.31 to 23.91%. Mixing one part immature leaves with mature leaves, by volume, may help reduce the mimosine content and increase the protein content, Pascual said.

After soaking in water, leaves are air-dried for two days, ground through a Wiley mill and passed through a No. 60 mesh sieve.

A combination of fish meal, shrimp head meal and commercially dried and ground ipil-ipil leaves gives good growth - both in length and in weight - in prawn juveniles.

SOURCE: Pascual, F.P. and N. Tabbu. The extraction of mimosine from ipil-ipil (Leucaena leucocephala) by soaking in water, (Manuscript).



Harvesting, processing and marketing

QUALITY CONTROL - KEY TO HIGH AND UNIFORM QUALITY SHRIMP

Strict observance of control measures in processing helps maintain high and uniform quality products. Food products like fish and shrimps must be bacteriologically sound, that is, safe from disease-causing and spoil-inducing microbes. Shrimps, especially, must be kept chilled continuously from harvest to shipment. Processing time must be kept as short as possible. Good quality is also maintained by keeping the processing area, equipment and utensils constantly clean. Also, workers' health habits must be sound.

Equipment sanitation. Everything that comes in contact with the shrimp from processing tables and containers to tools and machines, should be constantly washed with running water to prevent multiplication of germs. After processing, all items must be washed with fresh water and if possible, exposed to the sun for sterilization. Baskets should be cleaned with special care. You may want to install sterilizing lamps in the processing plant.

Plant sanitation. The building, especially the processing area, should be frequently cleaned up. Adequate and sanitary toilet facilities have to be provided and convenient hand-washing stands must be set up where needed.

Training of workers in sanitary precautions. Train your workers in sanitary precautions and instill in them the need to be personally clean at all times. Hands and nails of workers should be very clean and they should always wear clean clothing while working.

SOURCE: "Marketing aspects of shrimps, quality control, and frozen shrimps production," Protacia R. Sayson, BFAR, Cebu City.

PHILIPPINE AND JAPANESE REQUIREMENTS FOR FROZEN SHRIMPS

For the Philippine market, shrimps have to be frozen hard to the center to a temperature of *minus* 20°C within a period of 30 minutes to three hours, glazed or unglazed and continuously maintained in the frozen state. Japan, on the other hand, requires that the temperature should not be below *minus* 10°C at the center of the product.

For bacterial count, Philippine requirements is that the total plate count shall be below 100,000 colonies per gram of headless sample. Japan requires that total plate count should also be below 100,000 per gram.

The Philippine standard for packaging materials requires hygienic and strong materials; shrimps properly glazed shall be packed in plastic container placed in non-corroding wax-paper boxes. Japan also emphasizes strong hygienic materials that can protect the product from damages caused by outside forces.

As to labelling requirements, the label should contain the following information in bold prints: (1) the words, "PRODUCT OF THE PHILIPPINES," (2) the word "HEADLESS" affixed to the type of shrimp (3) the class of shrimp (4) name and address of distributor; (5) date of inspection; and (6) name and signature of inspector.

Japan, in addition, imposes the following labelling considerations: (1) the net weight of the product should not be less than the labelled one; (2) the labelling shall be true and correct to represent the name and nature of the product; and (3) the size of shrimps shall conform to the size assortment la belled or contracted.

SOURCE: "Marketing aspects of shrimps, quality control, and frozen shrimps production," Protacia R. Sayson, BFAR Region 7, Cebu City.

THE PHILIPPINE QUALITY STANDARDS AND SPECIFICATIONS FOR SHRIMPS

It will considerably get you more headway in marketing your product if you are familiar with and follow strictly the quality standards imposed by the market on that product.

The Philippines has set the following standards and specifications for shrimps. There are four grades (I-IV) and seven criteria for quality. These are: *appearance, color, flavor and odor, tissue and texture, uniformity, presence or absence of undesirable substances, and glaze.*

GRADE I

Appearance. Whole shrimp is in its original form. Shrimp which has the head (carapace) completely removed but still in good form, without being split or broken.

Color. Shrimp which retains the characteristic natural fresh color of the species without any sign of grayish white caused by dehydration or other color change.

Flavor and Odor. Shrimp with good original flavor and free from such odors as hydrogen sulfide, ammonia, trimethylamine and any other odor that is not characteristic of the species.

Tissue and Texture. Shrimp with its flesh reasonably tight and elastic without any sign of a sponge-like or any other abnormal tissue that is not characteristic of the species.

Uniformity. Shrimps for each type and class should be uniform in size and should not be mixed with other species and soft shells.

Undesirable substances. The shrimps should be free from foreign materials such as splintered shells, spines, legs and other foreign substances.

Glaze. For export shrimps, the glaze should be clean, non-poisonous, even, and thick enough to prevent dehydration.

GRADE II

Appearance. Whole shrimp with a fairly good form or only slightly broken. If headless, head is almost completely removed; holds fairly good form and is slightly split or broken.

Color. Shrimps keep fairly good colors or give only the slightest sign of gray white caused by dehydration, or other color change.

Flavor and Odor. Shrimp has a fairly good flavor and is almost free from such odors as hydrogen sulfide, ammonia, trimethylamine or other odors not characteristic of the particular species.

Tissue or Texture. Tissue is fairly tight or elastic and gives only a slight sign of the sponge-like or abnormal tissue that is not characteristic of the species.

Uniformity, undesirable substances and glaze. The requirements under these criteria apply to all grades of shrimp.

GRADE III

Appearance. Whole shrimp not in good form, split or broken. Headless shrimp but which has part of the head unremoved and does not hold good form or is split or broken.

Color. Shrimp has grayish white colors in body or dark colors in tail parts.

Flavor and Odor. Shrimp does not have good flavor or emits such odor as of hydrogen sulfide, ammonia, trimethylamine or other peculiar odors.

Tissue and Texture. Tissue lacks a reasonable or fair tightness and elasticity, or gives signs of the sponge-like or other abnormal tissue not characteristic of the particular species.

GRADE IV

Appearance. Whole shrimp which is deformed conspicuously, or is visibly split or broken. Headless shrimp which has the greater part of the head unremoved, deformed, or split or broken conspicuously.

Color. Shrimp which is discolored conspicuously, or gives a very visible sign of the grayish white color of dehydration.

Flavor and Odor. Shrimp hardly has any flavor, or gives out strongly such odors as hydrogen sulfide, ammonia, trimethylamine or any other smell not characteristic of the species.

Tissue and Texture. Tissue is very soft or soggy; gives a conspicuous sign of the sponge-like or other abnormal tissue that is not characteristic of the species.

Guide to Prawn Exporters:

THE INTERNATIONAL AND JAPANESE SIZE STANDARDS FOR FIRST CLASS SHRIMP

The following table provides the Japanese and the International Size Standards for first class shrimps. Note that the size, which of course influences the weight, of the shrimp is the basic factor that determines the grade of export shrimp. The International Standard Size considers the number of shrimps to a pound while the Japanese Standard Size considers the number of pieces to a kilogram or per two kilograms. The last column provides a guide on how much one piece would weigh to be able to get the corresponding number of pieces per kilogram.

Size No. (per pound)	International Standard Size (No. per lb.)	Japanese Standard Size for 1st Class (No. per kg.)	Japanese Standard Size for 1st Class (No. per 2 kg.)	Weight Per Shrimp (Grams)
8/12	10	23-24	46-48	42.5
13/15	14	28-30	56-60	34.5
16/20	18	38-40	76-80	25.6
21/25	23	47-50	94-100	20.2
26/30	28	57-60	114-120	16.7
31/40	35	65-67	130-134	14.7
41/50	45	95-98	190-196	10.3
51/60	55	117-120	234-240	8.3
61/70	65	140-143	280-286	7.0
71/80	75	162-165	324-330	6.1
81/100	90	195-198	390-396	5.1

HARVESTING, PROCESSING AND TRANSPORTING SUGPO

Harvesting, processing, and transporting are the last three major steps in sugpo farming. Here are some tips to help you carry out these activities:

1. Harvest your stock only when each sugpo weighs 30 to 60 grams. At this weight, there are about 15 to 30 prawns per kilogram. Your stock should be ready for harvest after four to six months in the rearing ponds. You would be able to harvest early if your rearing ponds have low amount of salt content or about 10 to 25 parts per thousand salinity. Sugpo grows poorly with higher salinities.

2. Harvest your stock during three successive days or nights by means of the shrimp trap, bagnet, or catching pond method. Immediately refill the pond with water if you use the bagnet and catching pond methods.

3. On the fourth day, reduce the water down to the level of the peripheral canal. This should allow you to complete the harvest by simply handpicking the remaining prawns.

4. Processing and transporting of sugpo must be done quickly but carefully to preserve quality and to avoid spoilage. Immediately after harvesting, sort the prawns according to size. If prawns are for export, follow the standard size as prescribed by the importers. Remove the heads of the prawns to prevent discoloration and immediate spoilage. You will also save on storage space.

5. Put the prawns alternately with ice in a container two to three feet tall. Containers taller than three feet will accommodate more prawns but at the risk of bruising prawns at the bottom due to the heavy weight of prawns and ice above. Bring the containers direct to the local markets. If for export, bring them to a processing plant for further treatment.

FROZEN SHRIMPS PRODUCTION

The quality of frozen shrimps for export depends greatly on the techniques in handling the product. Any product becomes well-established in the market and can rapidly gain popularity among buyers if it is of consistently high quality and its supply is steady.

With prawns, especially those for export, the quality is of utmost importance.

Mrs. Protacia Sayson, fishery extension specialist with Region 7 (Cebu) of the Bureau of Fisheries and Aquatic Resources, provides the following tips in processing shrimps of high export quality:

First, she says it is easier to maintain freshness of shrimps obtained from a fishfarm since the time lag from catching to factory processing is shorter than those caught in the sea.

Second, newly caught shrimps should be iced or refrigerated immediately and not later than four hours after harvest. Icing should be done in alternate layers of shrimp and ice with a 1:1 proportion. Shrimps should not be stacked in container at a depth of more than three feet to avoid the lower layers from getting squeezed and bruised from the pressure.

Third, beheading shrimps is advantageous because you take out almost one-half of the volume thus reducing the space storage requirements and the amount of ice needed for preserving. Besides, headless shrimps keep much better than whole shrimps.

Fourth, packed shrimps intended for processing should be taken immediately to the processing plant.

*SOURCE: Lecture papers of Ms. Protacia R. Sayson, Fishery Extension Specialist, BFAR Region 7, Cebu City. (These articles on preparing shrimps for export were contributed by Rose Tenedero, trainer, SEAFDEC Institute of Aquaculture).

PROCESSING PRAWNS FOR MARKET

Prawns, especially sugpo, command a good market price. But not if they are unproperly processed and packed.

You would do well to build a post-harvest processing shed. A 50-square meter concrete floor area will do. The shed should have an insulated ice storage closet, a work table designed like a fish market stall with tile or formica top, running water, and good drainage.

Here's the procedure for processing harvested prawns:

1. Bring the newly harvested prawns to the processing shed.
2. Wash prawns in filtered pond water.
3. For local market, pack the prawns whole with crushed ice.
4. For export market, behead the prawns before packing with ice, and sort according to importer's standard sizes.
5. Send beheaded prawns to nearest blast freezing plant for further pre-export processing.
6. Use styrofoam boxes, preferably in wooden or G.I. sheet metal casing, for transport.
7. Don't throw prawn heads. They could be used as an attractant component in feeds. Dry the heads under the sun and store in a cool and dry place.

SOURCE: Manual on Prawn Farming by W.G. Yap, F.D. Apud and J.H. Primavera of the SEAFDEC Aquaculture Department.

STEPS IN PROCESSING SHRIMPS FOR EXPORT

There are six important steps in processing shrimps for export, according to Ms. Protacia Sayson of the Cebu regional office of the Bureau of Fisheries and Aquatic Resources.

These are: sorting, grading, weighing, panning, freezing and glazing.

Sorting. This requires the separation of the good export quality shrimps from the damaged, stale and incomplete ones.

Grading. Shrimps are graded according to their length. If grading is done manually, prepare a gauge for each standard size using a length of bamboo or wood. Paint the gauges with colors different from the grading table. For quicker and more accurate grading, it is better to work in teams to classify shrimps into three major sizes. During grading, shrimps must be kept in ice. Graded shrimps should be stored in containers placed under the grading table. Grading tables are provided with holes beside the fixed gauge so that the shrimps are merely dropped into the container beneath the table. It is also necessary to have the containers in different colors, each color representing a specific grade. As soon as you accumulate about 5 kilos of graded prawn, this should be sent over for the next step in processing which is weighing. Don't keep the shrimps too long in one processing step to keep them fresh. Models or plates representing standard sizes should be displayed or fixed near the grading table to familiarize workers with the standard size of shrimps.

According to international standards, grade of frozen shrimp depends on the number of shrimps per pound. For example, a one-pound carton labelled "8/12" means it contains from 8 to 12 pieces of shrimps, or 10 which is the midpoint of 8 to 12. The closer your packs are to the standards, the higher they will be evaluated according to the international standard.

Weighing. In weighing, remove the finely crushed ice and weigh the specific quantity plus the required extra 5 percent as allowance after thawing. This means that a five-pound pack should weigh five percent more.

Panning. This step must be done carefully but quickly. It involves the following: (a) arrange shrimps in a single layer at the bottom; (b) lay them down with the tail pointing inward so that they would not extend over the sides; tails should not overlap to prevent their breaking during freezing; (c) the second and third layers are arranged at random with each shrimp lying on one side; there should be no spaces between shrimps; (d) the top layer should be arranged in two rows with the tails pointing inward.

Freezing. Fill the pan containing the shrimps with clean cold water. Close the pan and arrange in the freezer. Freeze for 3 to 4 hours at minus 40 degrees centigrade (-40°C). Quick handling and processing as well as uninterrupted chilling with broken ice is very important.

Glazing. The frozen pack of shrimp should be filled again with cold water if the pack is underglazed due to a leak in the pan.

BUILD A PROCESSING SHED

A prawn farm should have a post-harvest processing shed. The processing shed could be constructed in a fifty square meter concrete floor area and fitted with acclimation facilities.

The processing shed should also have the following features:

1. an insulated closet for storing ice.
2. a work table for washing, sorting, beheading and packing which is built like a stall in the fish market and topped with tile or formica.
3. a good drainage
4. a provision for running saltwater.

HANDLING PRAWNS AFTER HARVEST

For high quality prawns, observe proper post-harvest handling procedures.

1. Bring newly harvested shrimps to the processing shed.
2. Wash the prawns with filtered pond water to remove mud and other debris.
3. As soon as possible, remove the head and intestines as it is in these parts that bacterial growth is faster which could bring rapid spoilage of the prawns. For the local market, however, you have

to consider the fact that local consumers are used to buying whole prawns. Similarly, the Japanese market for large prawns prefers whole prawns for aesthetic reasons. But small prawns like the *hipong puti* should be beheaded when prepared for export.

For the local market, pack the prawns whole with ice. For the export market, behead them before packing with ice, and sort according to standard sizes.

Send iced prawns to the nearest blast freezing plant for pre-export processing. Styrofoam boxes in wooden or sheet metal casing for durability are the best containers for local shipment.

Meanwhile, the severed prawn heads would make an excellent component of prawn feed; it is a good attractant. Sun-dry and store these in a cool dry place.

SOURCE: Manual on Prawn Farming by W.G. Yap, F.D. Apud & J.H. Primavera, SEAFDEC Aquaculture Department, July 1979.

THE POST-PROCESSING STEPS FOR EXPORT SHRIMPS

Four steps are involved after processing: cartoning, labelling, storage, and shipment.

Cartoning. Remove the pack of frozen shrimp from the pan by pouring water on the bottom of the pan. Quickly pack the ice-embedded shrimps in polyethylene bags, seal and pack in cartons. Place six to eight of the 3-pound packs or 12 for the 1-kilogram packs in a master carton. Arrange the packs upright similar to the way books are arranged in shelves to make them withstand external shocks in transit. Cartons must be waterproof, corrugated and sturdy.

Labelling. Label according to specifications. The print on top of the carton should be clear. Net weight, name of manufacturer and country of origin should be stated on the box top.

On one side, print all the product types as well as the standard sizes. Use rubber stampers for the "kind" and "size" entries. It is

also necessary to make cartons readily distinguishable from other brands in the market and to be sure that all statements are legible.

Storage. Packed products should be stored and kept at the lowest required temperature which is at least minus 20 degrees centigrade (-20°C).

Shipment. Taking the product out of storage, transporting it to the ship, and loading them should be planned carefully. The waiting period would raise the temperature. To avoid sudden rise in temperature, products should be transported in cold storage vehicles.

SAW DUST PROMISES TO BE A GOOD SHIPPING MEDIUM OF PRAWNS

Prawns command a premium price if shipped alive to foreign markets. This could now be possible by using saw dust to ship prawns alive, according to experiments conducted at the SEAFDEC Aquaculture Department in Tigbauan, Iloilo.

In the laboratory trial, saw dust of white lauan was dried well under the sun. Then it was packed in plastic bags and kept in a refrigerator.

About 10 to 15 grams of sugpo were placed in a plastic basin with aerated seawater. Ice was added gradually to the basin until temperature was lowered to 18 degrees centigrade. The prawns were then packed in the refrigerated saw dust with a temperature of 15 degrees centigrade. These were placed in carton boxes lined with styrofoam board.

Some 300 grams of ice were sealed in a plastic bag and placed on top of the saw dust. The cardboard box was sealed with tape and kept at room temperature - about 28 degrees centigrade - for 24 hours.

When the box was opened the saw dust temperature was found to be about 17.2 degrees centigrade or only 2.2 degrees higher than when it was packed in.

After washing with seawater at a temperature of 18 degrees centigrade, the prawns were again placed in a plastic basin containing aerated seawater at 20 degrees.

It was found that 93 percent of the prawn recovered and started swimming in the basin an hour later.

This experiment was reported by a Japanese prawn expert, Hideo Mochizuki, who had been working at the SEAFDEC Aquaculture Department.

SOURCE: The present prawn culture in the Philippines, H. Mochizuki, SEAFDEC Aquaculture Department, May 1979.

WHY SHRIMPS TURN BLACK AND SPOIL

Spoiled shrimps normally turn black, a characteristic known as "black spot" or melanosis. This is caused by the enzymes in the shrimp. Whole shrimps contain a good amount of enzymes which are mainly found in the head. When the shrimp dies, the enzymes react in the presence of air to oxidize the tissue substances and form melanin - a pigment that imparts black coloration. Chemical processes like enzyme reaction as well as the action of micro-organisms contribute to the deterioration of prawns or fish. Shrimps, particularly, contain high amount of amino acid. These amino acids are believed to be responsible for the desirable and characteristic shrimp flavor, but are also responsible in a way for the hastening of bacterial spoilage in dead shrimp.

SOURCE: "Marketing aspects of shrimps, quality control and frozen shrimps production," Protacia R. Sayson, Extension Specialist, BFAR, Region 7, Cebu City.

SHRIMP KROPECK FROM SHRIMP HEADS

Shrimp heads are considered fish trash and often used as nothing more than an attractant in artificial feeds for shrimps. However, these can be profitably processed into shrimp kropeck, says Aquaculture Department training coordinator and fishery extension specialist Rose Tenedero. Mrs. Tenedero explains:

"Shrimp heads taken as trash from processing plants could start a profitable venture in shrimp kropeck processing and create gainful employment for some people, especially housewives. Instead of using whole shrimps which are expensive, shrimp heads are cheaper raw materials for the making of kropeck, a delicious and nutritious snack."

"Kropeck-making needs ordinary kitchen utensils, a few inexpensive ingredients, and is simple to follow."

Ingredients:

- One (1) kilo shrimp heads
- One (1) ganta rice
- Two (2) tablespoons salt
- One (1) tablespoon "vetsin" or monosodium glutamate
- Five (5) tablespoon limewater prepared by dissolving one
tablespoon lime in one cup water
a pinch of black pepper

Soak rice in water overnight. Grind in a corn meal grinder together with the shrimp which has previously been blanched. The ground mixture should be very fine and semi-viscous. Add 2 tablespoons salt, 1 tablespoon vetsin, the lime water, and a pinch of black pepper for flavouring.

Pour the mixture into a greased steaming pan - an aluminum pie plate can serve the purpose. Steam for two to three minutes. Slice into desired sizes and remove from the pan. Dry the kropeck under the sun for one to two days until it turns brittle.

Fry the dried kropeck in deep fat. Drain in excess oil, cool and pack in plastic bags and seal.

Dried kropeck may also be kept in covered glass container.

"CHITOSAN" A MULTI-PURPOSE PRODUCT FROM SHRIMP SHELLS

Shells of crustaceans like crabs, shrimps and lobsters contain a substance called "chitin". This can be processed into a very useful product known as "Chitosan" which has scores of application in industry from soup thickeners to artificial kidney membrane.

The newsletter, *Indian Seafoods*, published by the Marine Products Export Development Authority of India reports that India has already developed a process for extracting chitin from crustacean shells and in fact has already made trial shipments of this new product to the United Kingdom.

The newsletter says that "Chitosan" is an ingredient in preparations against parasites, blood anti-coagulants, bio-degradable pharmaceutical carriers, wound-healing accelerators, and other medical uses.

Other applications include those in the manufacture of baby food, shoe polish, photographic film, specialty papers, textile finishes, and water soluble paints. Among the latest application of Chitosan are nuclear waste treatment and recovery of rare metals from industrial effluents.

SOURCE: Indian Seafoods Vol. I No. 1, May 1979.

TIPS ON COOKING SUGPO

Sugpo or prawns are more delicious when cooked with their heads on. The natural juices are preserved and the delicate flavor of the prawn may be enjoyed most fully when they are prepared in this method. For attractive serving you may wish to trim the antennae and front claws, but it is not necessary.

Prawns may be cooked in the shell or shelled. However, the meat stays slightly more firm when cooked in shell.

To remove the shell before or after cooking, either snip the shells down the back or grasp the bottom edge where the shell connects with the legs, and peel. The shell should come off easily in large pieces.

Prepare the prawns immediately upon removing them from refrigerator or freezer. Do not allow them to stand at room temperature for extended periods of time.

There are several ways to cook prawns. If you boil prawns, bring the water to a brisk boil before inserting the prawns. From a frozen state, cook the prawns for 5 minutes. If thawed or not frozen, cook for 4 minutes. Bake thawed prawns for 12 to 15 minutes at 350 degrees Fahrenheit, or barbecue 6 inches from heat for 7 to 8 minutes, turning occasionally. Saute prawns for 5 minutes, or broil for 2-1/2 to 3 minutes per side.

SOURCE: [Hawaii Prawn Recipes](#). University of Hawaii et al. 1978

Hatchery & broodstock development

Raise your own sugpo fry

BUILD A HATCHERY FOR FRY PRODUCTION

One of the major problems in the mass production of sugpo (*Penaeus monodon* Fabricius) is how to obtain a constant supply of fry. We cannot depend alone on fry from the coastal waters as there is very little to catch. Although wild prawn spawners (layers) can produce an average of 500,000 eggs per spawning, less than one percent of these eggs ever develop into fry. The rest succumb to the severe conditions in the open sea.

Obviously, the nearest solution is to place the spawners in a hatchery where their eggs will be better taken care of until they become ready for stocking.

The technology to do this has been developed by scientists at the SEAFDEC Aquaculture Department in Tigbauan, Iloilo. And more importantly, they have scaled down the technology to a level which can be adopted by smaller fish farmers with a minimum financial and technical input. The barangay hatchery system consists of small tanks made of marine plywood and designed in modules making them expandable and movable. Fully operational, a basic unit is capable of producing 50,000 fry a month.

The prawn farmers need not also depend much on spawners caught from the wild. SEAFDEC researchers have also developed the technology to induce spawning by eyestalk ablation (pinching or crushing). Since 1977, most of the fry produced at the SEAFDEC Tigbauan hatcheries come from ablated stock in marine pens and concrete tanks.

SEAFDEC has been extending these newly developed technologies to the private sector through seminars, workshops and training courses and through publications.

For the barangay hatchery, SEAFDEC has published a manual titled *Design, Operation and Economics of a Small-scale Hatchery for the Larval Rearing of Sugpo* written by Mr. Rolando R. Platon. For culturing spawners by eyestalk ablation, a guide on *Sugpo Broodstock Development* has been written by Jurgenne H. Primavera, a researcher of SEAFDEC. Other manuals deal with sugpo pond operations. One of these manuals, *Manual of Operations for Sugpo Pond Culture* by J.H. Primavera and F.D. Apud has been translated and published in Ilongo.

CHOOSING A SITE FOR SUGPO HATCHERY

Choosing the site for the hatchery is one critical decision to make, says Mr. Rolando R. Platon, Barangay Hatchery Project leader of the SEAFDEC Aquaculture Department.

Platon stressed that a prospective hatchery operator must carefully evaluate the various criteria for choosing a good site for a hatchery. And these are:

1. *Seawater quality and quantity.* Seawater with minimum seasonal fluctuation in quality is most desirable. The water must not be cloudy and should not be polluted with agricultural and industrial wastes. Adequate volume of seawater should be available when needed.

To determine the suitability of the seawater, conduct preliminary larval rearing experiments using pails or small tanks on the site. A reasonable survival rate of egg to fry in a series of at least three runs would mean better chances of success in actual operations.

2. *Source of spawners.* A hatchery site should be near the source of spawners whether caught from the wild or matured by means of eyestalk ablation in tanks, cages or pens. Transporting spawners over long distances lowers the quality of eggs due to stress.

3. *Road accessibility.* The hatchery should be accessible by road for convenience in transporting supplies and other necessities for hatchery operations. Also, distribution of fry to be stocked in ponds far from the hatchery will be easier.

4. *Availability of electrical power.* Electrical power is vital to the hatchery operations. Although an independent generating unit is desirable as a standby source, it is not worthwhile and economical to operate it on a continuous basis.

5. *Fresh water source.* The need for fresh water is minimal but an adequate supply is advantageous for personal needs and other activities of the hatchery workers.

6. *Availability of technical staff.* The technical expertise necessary for hatchery management at present is still rare. More incentives should be provided for the technical staff.

SOURCE: Design, Operation and Economics of a Small-scale Hatchery for the Larval Rearing of Sugpo by R.R. Platon of the SEAFDEC Aquaculture Department.

TAKING CARE OF SPAWNER AND EGGS

How does one know whether the eggs hatched by a prawn Spawner (layer) are good for growing into fry?

Simply get the hatching rate of the eggs. Eggs with hatching rates lower than 30 percent are not ideal for rearing.

Here are some more pointers to guide you during spawning and hatching of prawn eggs.

Sugpo normally spawn at night. See to it that no light enters the spawning tanks. You could do this by shielding the spawning tanks from light by means of black cloth or some other materials. Provide moderate aeration and keep the water temperature at about 28 degrees Centigrade.

A common evidence of spawning is the appearance of yellow-orange scum on the water surface or on walls of the tank. However,

some spawners do not let out this substance. In this case, take a sample of water in transparent beakers or cups and look for the eggs.

The morning or the day after spawning has taken place, remove the Spawner and clean the water of spawning wastes. Scoop out the wastes by means of a coarse net. Leave the eggs in the tank.

The eggs can be thoroughly washed by continuously running about 100 liters of water into the tank while also siphoning out the same amount of water. Use a strainer to prevent the eggs from being siphoned out. Another way of cleaning the eggs is by transferring them into another tank with fresh clean seawater using a fine mesh net. Aeration should be moderate. You can count the eggs by taking a sample volume.

The eggs hatch 12 to 15 hours after spawning. However, not all eggs hatch at the same time. To determine the hatching rate, the count of the nauplii (newly-hatched) may be made in the morning of the following day. Normally, the hatching rates of eggs from good spawners range from 60 to 98 percent.

DISINFECT PRAWN SPAWNERS

Disinfect prawn spawners or layers for use in the hatchery. They may carry infectious organisms which could badly infect their young.

Use either formalin or furanace for disinfection. Effective doses are 50 parts per million (ppm) for formalin and 3 ppm for furanace. Leave the spawners in the disinfecting solution for 15 to 20 minutes when using formalin and for about one hour when using furanace. A maximum of 5 spawners may be disinfected in a 20-liter volume of solution. Provide aeration during disinfection.

After disinfection, rinse the spawners thoroughly with clean seawater before placing them in the spawning tanks with a capacity of 100 to 300 liters of water. Make sure that the water is clean. Only one Spawner should be placed in each spawning tank to easily determine the fecundity (capacity and tendency to lay eggs) and hatching rate of eggs per spawner.

SOURCE: Design, Operation and Economics of a Small-scale Hatchery for the Larval Rearing of Sugpo by R.R. Platon of SEAFDEC Aquaculture Department.

FACILITIES REQUIRED FOR A SUGPO HATCHERY

A small-scale hatchery for producing sugpo fry must have the following facilities:

1. *Seawater supply system.* A good seawater source has a salinity or salt content of 28 to 32 parts per thousand (ppt). It should also be free from pollution. The water intake could be from an inshore well or right from the sea, but it is necessary to filter from the seawater larger organisms such as fish and jellyfish, as well as silt and mud during heavy runoffs. This is done by using sand filter. The pipes are preferably made of PVC and should be fully exposed for easier maintenance.

2. *Air supply system* Aeration can be provided by a compressor or blower capable of delivering air at an effective pressure of 1.5 meters column of water. Aside from providing oxygen to the water of the hatchery, the air supply also induces air circulation and stirs the water to enable the sugpo larvae to remain suspended at a uniform distribution. PVC pipes are preferred for air distribution lines.

3. *Larval culture tanks.* A 2-ton larval rearing tank may be made of marine plywood shaped into a cylinder with octagonal cross-section and cone-shaped bottom. Use epoxy paint for inside coating. Aeration in these tanks is by means of airstones attached to plastic tubings. The volume of air is controlled by air cocks (regulators) firmly attached to the air supply line.

4. *Algal rearing tanks.* For algal culture, build wooden tanks 60 centimeters deep and having one-ton capacity. Provide these tanks with aeration for efficient circulation and suspension of the algae.

5. *Brachionus culture tanks.* One-ton cubic wooden tanks provided with proper aeration can serve as culture containers for *Brachionus*.

6. *Building.* A roofed structure with walls is necessary to house the larval rearing tanks, the algal starters, and as a monitoring area.

SOURCE: Design, Operation and Economics of a Small-scale Hatchery for the Larval Rearing of Sugpo by R.R. Platon of the SEAFDEC Aquaculture Department.

EYESTALK ABLATION INDUCES PRAWN TO SPAWN

Induced spawning or laying of sugpo (prawn) females by eyestalk ablation (pinching or crushing) has paved the way for the mass production of fry.

Before this technology was developed at the SEAFDEC Aquaculture Department in Tigbauan, Iloilo, fry hatchery operators can only rely on prawn spawners (layers) caught from the coastal waters. The seasonal availability of wild spawners makes it still difficult to mass produce sugpo fry. On the other hand, the use of ablated female prawns for spawning offers two distinct advantages - spawners are cheaper to produce and are available throughout the year since they come mostly from harvests in brackishwater ponds.

Prawns should be ablated only when hard-shelled, never when newly molted (soft-shelled) or ready to molt (whitish spots on shell). The procedure is as follows:

1. Hold the prawn gently but firmly with one hand. Check the sex of the prawn as only the females should be ablated.
2. Ablation could be done either on the left or right eye. However, an already infected or damaged eye should be the one ablated to leave one good eye.
3. To ablate large numbers as in marine pens, simply pinch off the eyeball and crush the eyestalk between the thumb and forefinger.
4. To ablate small numbers as in tanks, make an incision on the eyeball using a sharp blade or scissors to allow a free flow of fluids, then squeeze the eyeball contents outward between forefinger and thumb. Crush the eyestalk two to three times to destroy the tissue.
5. As much as possible, ablation should be performed quickly and underwater to minimize stress.
6. After ablation, immediately release the females in the pen or tank. No antibiotics are applied. If done properly, the ablated eye heals in a week. Other ablation techniques include cutting,

tying with a nylon string, and burning of the eyestalk, with or without antibiotic application.

WHY DOES EYESTALK ABLATION INDUCE SPAWNING?

Found in the eyestalk of sugpo females are ovary-inhibiting hormones which prevents the maturation of ovaries. Eyestalk ablation eliminates or at least reduces these hormones to a level where full maturation of the ovaries can take place.

Maturation of the ovaries follows a few days to a few months after ablation. Spawning may occur as quickly as 7 days after ablation. However, three weeks is the average period between ablation and spawning, and in some cases, it may stretch to 2 to 3 months.

Unlike sugpo, other commercially important prawns such as *hipong puti* and *pasayan* are able to mature and spawn in captivity without undergoing eyestalk ablation.

HOW ARE SUGPO FEMALES DIFFERENTIATED FROM THE MALES?

At same age, females are generally larger than the males. Females have a flattened thelycum located between the bases of the last pair of walking legs or periopods where the spermatophores (sperm-containing sacs) are deposited. In contrast, males possess a paired petasma that aids in sperm transfer ampoules (protruberances containing the spermatophores) between the bases of the fifth pair of walking legs.

WHAT PRAWNS ARE GOOD FOR SPAWNING?

To be able to produce good quality eggs after eyestalk ablation, pond-reared females should be: at least one year old, weighing at

least 90 to 100 grams, and with carapace length of 52 to 56 millimeters.

For mating purposes, male prawns should be at least 50 to 60 grams and with carapace length of 40 to 45 millimeters.

WHEN DOES COURTSHIP AND MATING START AMONG PRAWNS?

The courtship and mating process starts when the newly molted female attracts one to three hard-shelled males who follow her as she makes brief upward swimming movement over distances of 50 to 80 centimeters. Eventually, one male is able to position himself directly below the female. The pair engages in parallel swimming movements during which the male turns to an upside down position, trying to attach his underside to that of the female. If successful, the male quickly turns around to a position perpendicular to the female, curves his body in a U-shape around her and flicks head and tail at the same time. It is probably during this time or shortly afterwards that the sperm sacs are inserted inside the thelycum - the female receptacle.

ALWAYS BE ON GUARD AGAINST PRAWN HATCHERY DISEASE OUTBREAKS

In a prawn hatchery, the potential for disease is always present but the outbreak can be prevented by keeping the larvae healthy through adequate feeding and good water management. This is a basic premise in prawn hatchery management, according to SEAFDEC prawn researchers Jurgenne H. Primavera and Fred Yap.

At the SEAFDEC Aquaculture Department hatcheries, studies have been done to control various disease-causing microorganisms using different chemical agents. Primavera and Yap cited the trials that have been conducted by the Department fish pathologists. One of the newer techniques developed is the disinfection of prawn spawners before these are used in the hatchery. The herbicide (plant killer) Treflan-R has been found, among many so-called

chemotherapeutic agents screened for effectivity and toxicity to prawn larvae, to be effective in preventing the occurrence of the most prevalent larval diseases caused by the fungi *Lagenidium* and *Sirolopidium*. This technique is much cheaper and easier than treating the water for larval rearing, a practice done in other prawn hatcheries.

Following is a list of diseases of larvae of *Penaeus monodon* or sugpo that have been encountered and identified at the SEAFDEC hatchery in Tigbauan, Iloilo as reported by SEAFDEC fish diseases specialist Rogelio Gacutan:

(a) *Fungal diseases*: *Lagenidium callinectes*, *Sirolopidium*, and *Haliphthoros* - these are major disease problems and most virulent but whose occurrence can be prevented or minimized by disinfection of spawners with Treflan-R.

(b) *Bacterial diseases*: *Leucothrix mucor*, *Vibrio*, and *Aeromonas* - these are minor disease problems whose treatments have not been established for *Penaeus monodon* under local conditions but against which are employed antibiotics in other hatcheries.

(c) *Protozoans and algae*: *Zoothamnium*, *Vorticella*, *Epistylis*, *Gregarina*, *Ephelota gemmipara*, and *Licmophora abbreviata* - these have not been observed to be lethal in local hatchery.

SOURCE: "Status and problems of broodstock and hatchery management of sugpo (*Penaeus monodon*) and other penaeids," J.H. Primavera and W.G. Yap, paper presented at the Symposium Workshop on Fish Hatchery/Nursery Development and Management, PCARR, Los Baños, Laguna, 27-29 September 1979 (mimeograph).

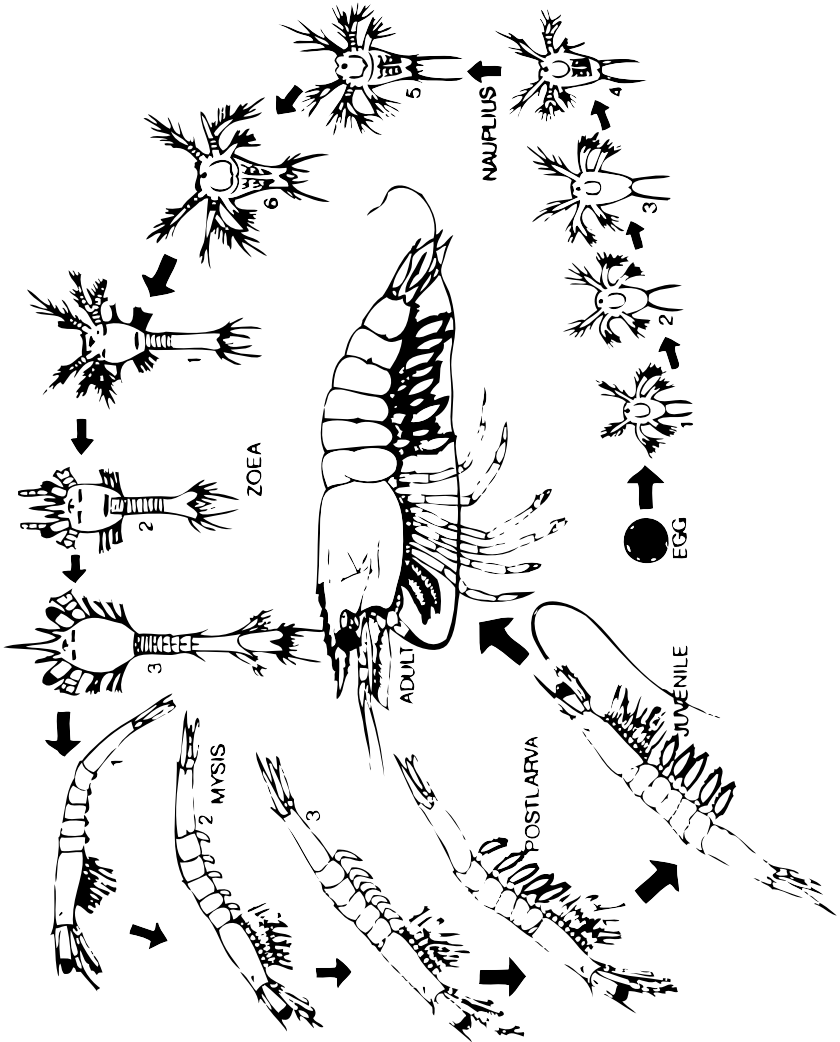

Life cycle of *P. monodon*

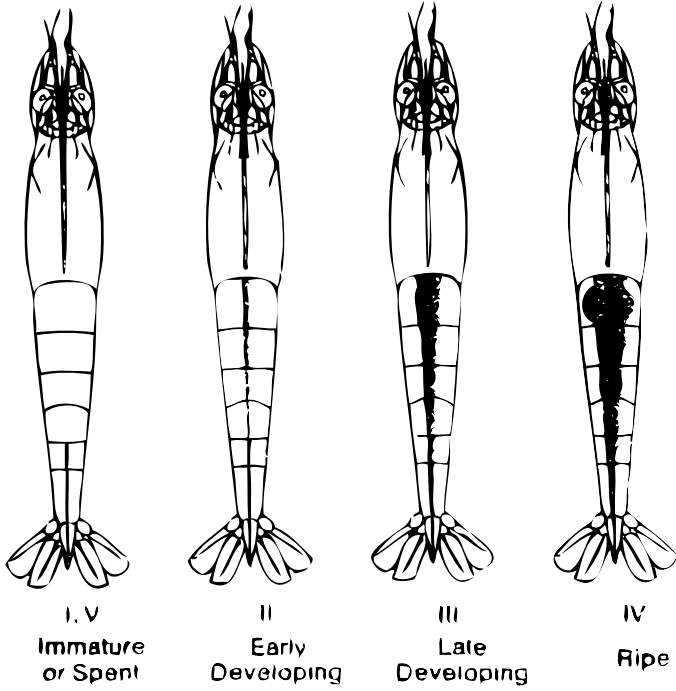

The appearance of the ovarian mass at the different stages of maturity.

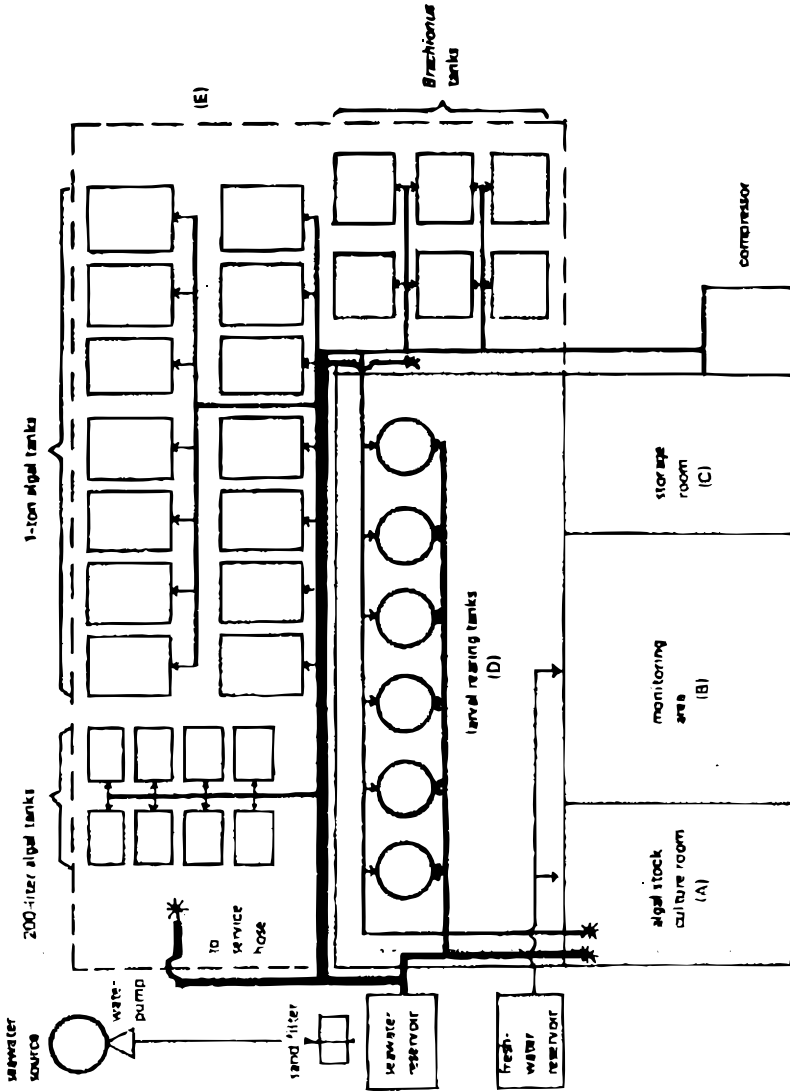

Layout of a small-scale hatchery system.

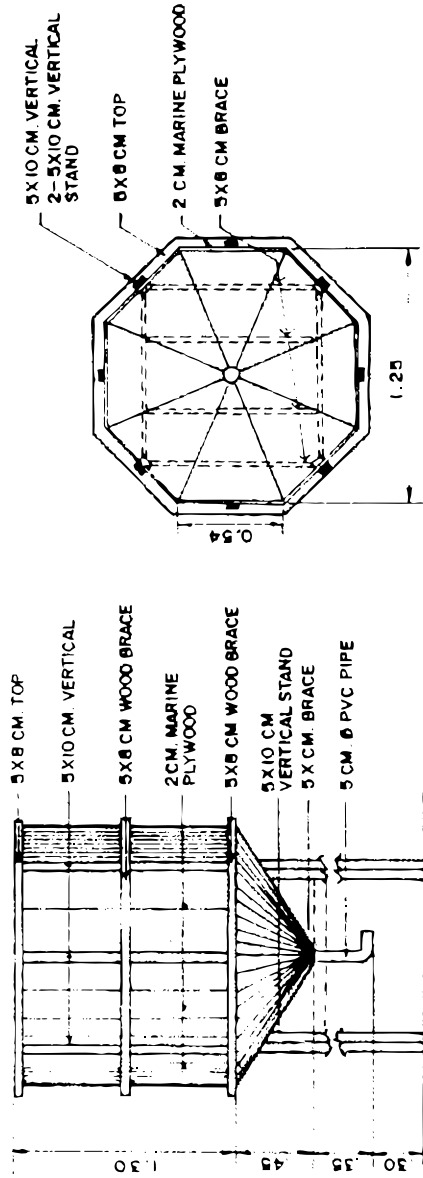

Specifications of a 2-ton conical-bottom wooden larval rearing tank.

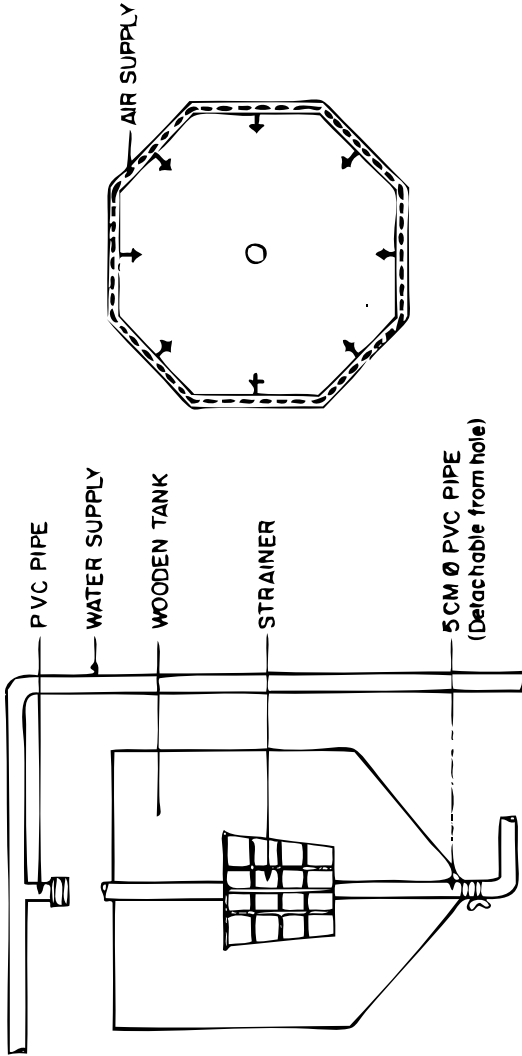

SYSTEM OF PIPE ON WOODEN TANK

WOODEN TANK and STRAINER

Details of the larval rearing tank showing the strainer and the supply lines for water and air.

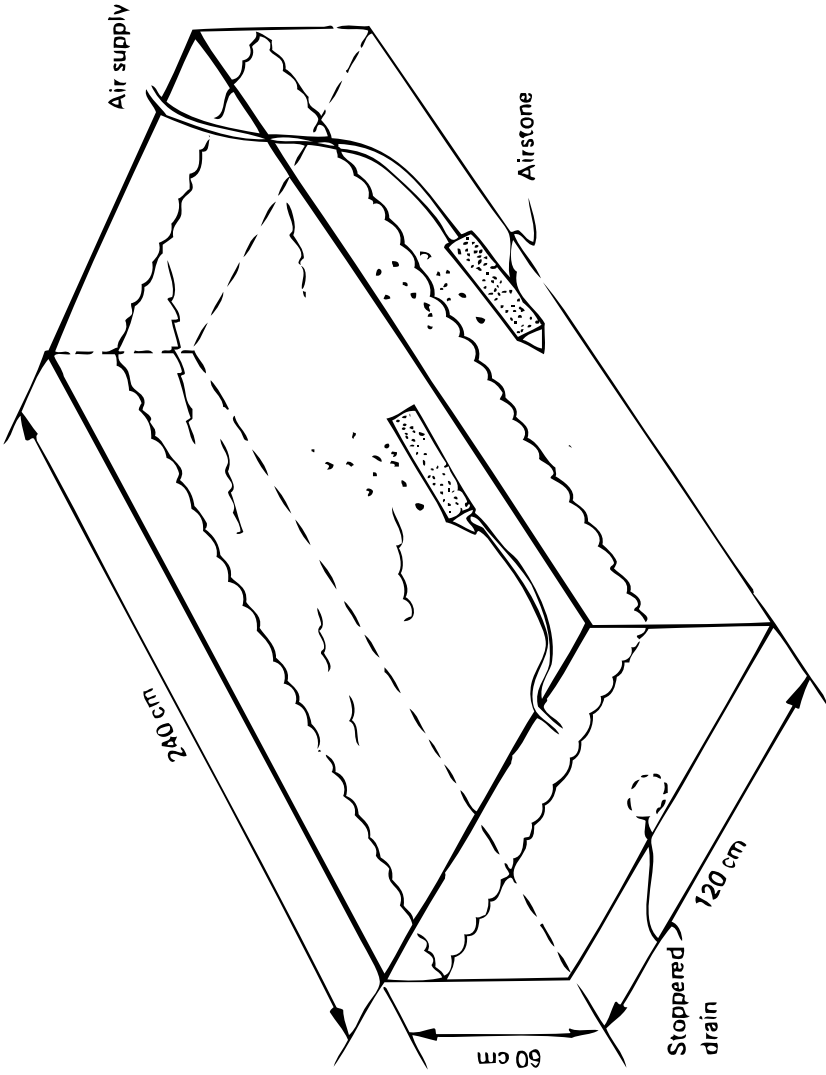

One-ton wooden algal culture tank.

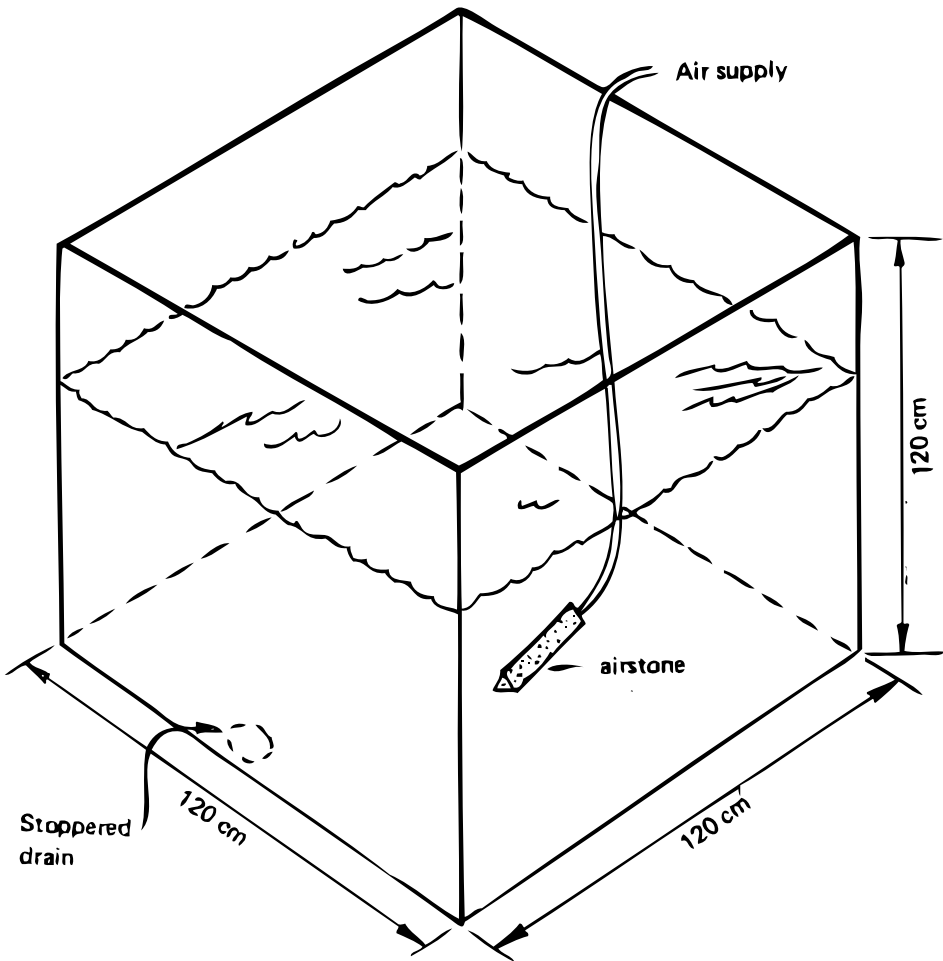

One-ton wooden *Brachionus* culture tank.

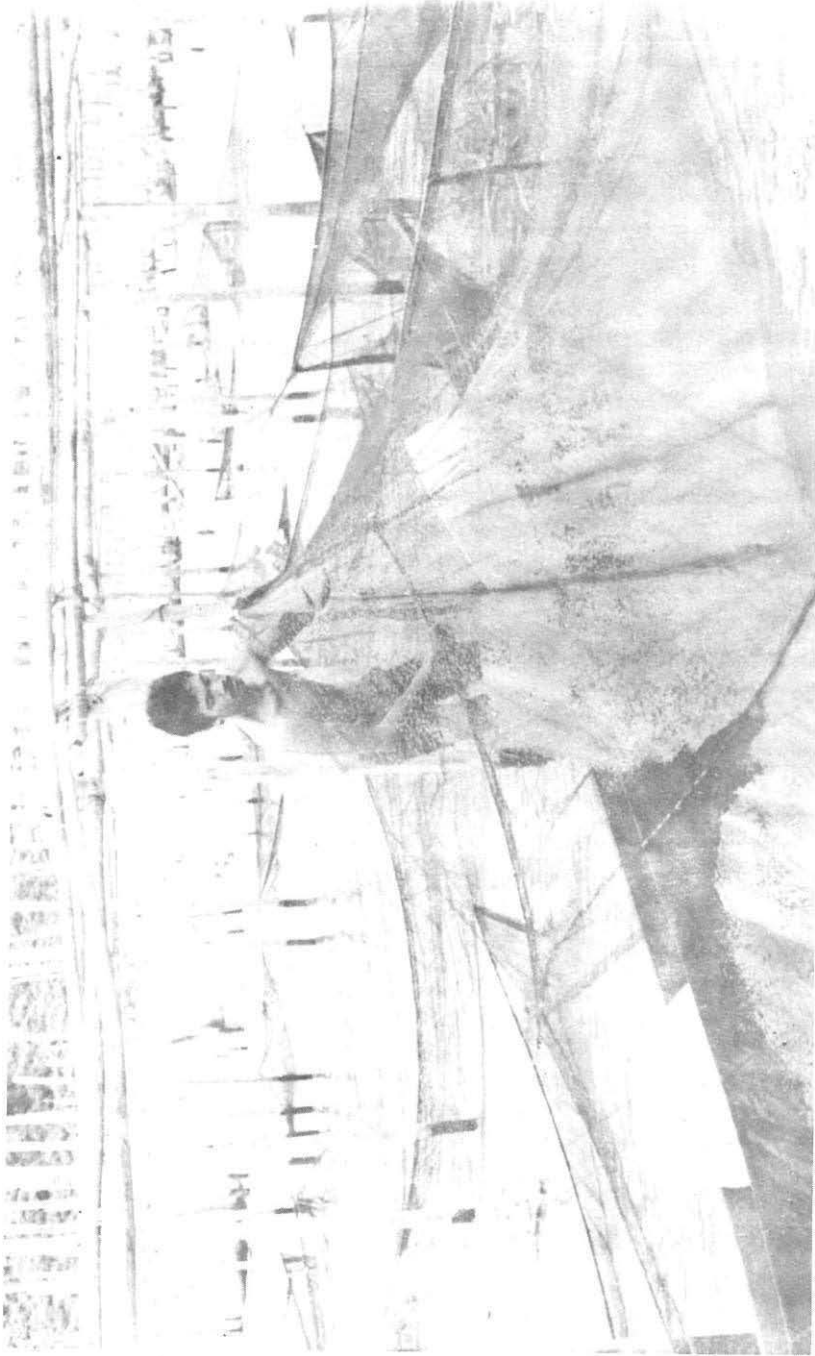

Feeding prawns in cages at the SEAFDEC Freshwater Fisheries Station in Laguna Lake, Binangonan, Rizal.

Freshwater farming

HOW TO GROW SUGPO IN CAGES IN FRESHWATER

Don't be surprised if one of these days, you buy Jumbo Tiger Prawn or Sugpo grown in Laguna Lake.

This expensive sea food item - known only to grow in salt-water, brackishwater and marine -- can at last be grown in freshwater.

Proof of this is the pilot sugpo farm of the SEAFDEC Aquaculture Department Freshwater Fisheries Station in Binangonan, Rizal. Occupying a one-half hectare area in a placid cove in Laguna Lake, the farm consists of 19 hapas and 35 B-net cages. From July to September this year, the farm is expected to yield around 1.7 tons of sugpo averaging 40 grams a piece. Researchers of the station report an estimated net profit of P47,000 or 117 percent return to investment from their expected harvest.

Interestingly, the lake-cultured sugpo turned golden brown upon harvest. This should enhance the export value of sugpo, according to SEAFDEC researchers at Binangonan.

Natural food found in the lake was the primary source of feed for the sugpo. However, supplemental feed in the form of pellets was also given. The prawns had a feed conversion ratio of two kilos of feed per kilo of prawn meat. Ingredients for the feed pellets also came from raw materials found in Laguna Lake. A kilogram of this feed is estimated to cost around P4.00.

There are three important stages in sugpo cage farming in freshwater: 1) transport and handling of fry; 2) acclimation of fry from brackishwater to freshwater; and 3) rearing of the prawns in cages.

Transport and Handling of Fry

Obtain sugpo fry from hatcheries or from dealers who get them from fry gatherers. Get those fry which are about 35 days old from the start of the larval stage. At this age, the fry are about 30 to 40 millimeters long.

Place the fry in polyethylene bags filled with oxygen. The number of fry to be placed inside the bag should be around 1,000 fry every eight liters of brackishwater. Or - 125 fry for every liter of brackishwater. Put seaweeds or eel grass in the bags to serve as substrate.

Place the bags in an inverted position in the transport container. For short distances, bags made of *buri* are commonly used. However, for long distances, styrofoam boxes cooled with ice should be used. Place enough ice to maintain the temperature at about 21 degrees centigrade.

Acclimation to Freshwater

Upon reaching your farm, check the salinity or salt content of the water in the bags where the fry are contained. To quickly determine the salinity, use a refractometer.

Allow the fry to rest for 1 to 2 days in brackishwater with the same salinity which is usually 12 to 18 parts per thousand. The brackishwater is contained in a marine plywood tank. Aerate the water moderately.

Stock the fry in the tanks containing the brackishwater at a density of 20 fry per liter of water.

Feed the fry with blended meat or "tulya" once daily at about 10 percent of the total body weight of the fry.

For acclimation, you can use a big plastic basin or tub fitted with a faucet. Mount this on top of an aquarium or a tank made of marine plywood. Put tap water and lake water at a 50:50 ratio into the basin and adjust the opening of the faucet so that the flow of water is continuous.

The rate of flow should be enough to enable freshwater to

entirely but gradually replace the saltwater in the tank after three days.

From the acclimation tanks, transfer the fry to hapa nets in the lake. The dimension of the hapa net is 5 meters long by 5 meters wide and is 3 meters deep. The net should touch the bottom of the lake for better growth of prawn.

Stock 40 fry for every square meter of the hapa net. One hapa net, which is 25 square meters in area, should therefore be stocked with 1,000 fry.

Rearing of the prawns

On the first month there is no need to give supplemental feeds. But on the second month, feed the fry with a combination of FFS algae cake (developed by the SEAFDEC Freshwater Fisheries Station) and trash shrimp at 5 percent of the body weight. The algae cake for this period is a starter feed which contains 40 percent protein.

Give one-third of the ration in the morning and two-thirds in the afternoon. Continue giving this feed combination until the third month.

After that, the young prawns should have grown to about 80 to 120 millimeters long. They can now be transferred to B-nets. The mesh size of a B-net is 55 millimeters. The B-net is 10 meters long by 5 meters wide and is 3 meters deep.

Cover the cages to prevent escape of prawn and entry of enemies and set them in the lake so that the bottom is submerged in the mud.

Reduce stocking density to 30 per square meter. This means that one B-net cage with a total area of 50 square meters would accommodate 1,500 prawns.

On the fourth month, switch to grower feed which contains 30 percent protein. This is the FFS algae cake finisher which contains 20 percent protein and should also be fed in combination with trash shrimp at 5 percent of the body weight.

On the fifth month, feed the prawns with a finisher feed. This is the FFS algae cake finisher which contains 20 percent protein and should also be fed in combination with trash shrimp at 5 percent of the body weight.

At the end of the fifth month, prawns should be large enough for harvesting. At this point, they ought to weigh about 40 grams a piece.

Choosing the site

A module is the most efficient way of setting up cages in the lake. One module contains a series of net cages.

The site for sugpo cage farming should not be exposed to strong waves; the lake bottom soil should be silt-loam or clay-loam; and the water should at least be two meters deep. The farm area has to be relatively free from pollution.

An ecological survey indicates that the following sites in Laguna Lake are desirable for prawn farming. These are in Talim island on the Binangonan side; off Los Baños town in Laguna; around the town of Pila, also in Laguna; and further up to Pililla in Rizal.

For more information on cage farming of prawn in Laguna de Bay write to:

The Program Director
SEAFDEC Freshwater Fisheries Station
Binangonan. Rizal

TILAPIA

BRACKISHWATER FARMING	202	
Select a good fishpond site	202	
Experts foresee great demand for tilapia fingerlings		203
Some ways to produce tilapia fingerlings	204	
Proper handling of fry produces vigorous fingerlings	205	
FRESHWATER FARMING	206	
Cage farming of <i>Tilapia mossambica</i>	206	
How to construct a floating cage for the Nile tilapia		206
The proper way to stock Nile tilapia in cages	207	
Growing tilapia in cages in lakes	209	
Tilapia cage farming in Laguna de Bay	211	
New improved techniques in tilapia farming	212	
Low-cost feed for Nile tilapia in cages	212	
Supplemental feed makes tilapia grow faster, more nutritious	214	
Some tips on tilapia farming in freshwater	214	
For bigger tilapia, control their population	215	
Tilapia reared during warmer months reach market size rapidly	216	
Tilapia sold live brings a higher price	217	
MISCELLANEOUS INFORMATION	218	
Tilapia raisers need more government attention		218
Fishpond in the forest	219	

Brackishwater farming

SELECT A GOOD FISHPOND SITE

For successful fish farming choose a good location for your fish pond.

Fish farming experts say that fishponds can be constructed almost anywhere. However some sites are much better and can be developed more economically. This is contained in the *Philippines Recommends for Tilapia* developed for Filipino fish farmers by fisheries scientists of the Philippines.

In selecting a proper site for and in building a fishpond, consider the following:

1. Be sure there's an adequate water supply. Water should be enough all year round. For fishponds along the coast, the source of good quality water is the tide which brings in either salt or brackish water. To avoid the destructive effect of wave action and tidal waves, locate your pond at a minimum of one kilometer away from the seashore. Make use of river and canal systems for waterways.

2. Site should be easily drained whenever necessary. Good drainage is necessary to dry the pond bottom and get rid of undesirable fish and water plants. In brackishwater ponds, the elevation of the fishpond should be above that of the low tide level. Otherwise you will need pumps to dry the ponds.

3. A good fishpond soil is clay, clay loam, or sandy clay. Hard mud is preferable to the soft and loose kind of soil. Avoid sandy, rocky or gravelly soils. If possible do not put up ponds in areas with thick deposits of organic or decaying matter.

4. Level marshes, swamplands or tidal flats are preferred sites. Uneven terrain needs a lot of levelling which requires more expenses.

5. Areas with plenty of big rocks and thickly rooted plants should be avoided. Rocks cause leaks that are difficult to seal while decaying roots along dikes serve as source of water seepage. Thick rooted plants are costly to remove.

6. Sites which are usually flooded and exposed to strong waves should not be selected. If your area is near a foot hill, dig a canal around your ponds to divert run-off water.

7. Your fishpond site should be near market outlets and good transportation facilities.

8. Finally, it would be desirable if the locality has plenty of available low-cost and properly trained labor as well as production and construction materials.

EXPERTS FORESEE GREAT DEMAND FOR TILAPIA FINGERLINGS

Rice-fish culture has passed from the experimental stage to the field trial stage. It has been proven successful and profitable at the field trials conducted by the Freshwater Aquaculture Center. Thus, the government recently launched a campaign to promote rice-fish (particularly Tilapia and carps) culture among the nation's farmers.

However, there is one problem: the supply of fry and fingerlings may not meet the requirements of a nationwide adoption of the technology.

Consider these facts. The Philippines has 1.4 million hectares of irrigated ricelands. Experts estimate that if all these lands are somehow devoted to rice-fish culture, we would be needing from 4,200 million (or 4.2 billion) to 8,400 million (8.4 billion) fingerlings in one cropping alone. One cropping is 80 to 100 days or about three months. The estimates do not even take into account the fingerling requirements of existing and yet-to-be developed tilapia or carp fishponds and fish cages.

Considering these estimates, the potential for the fish seed (fry and fingerling) production aspect of the industry looks good indeed.

This is one reason, the rice-fish program being handled by the Freshwater Aquaculture Center for the government has included the training of farmer-cooperators on *fish hatchery* management.

SOME WAYS TO PRODUCE TILAPIA FINGERLINGS

1. *Enclosure or "bitinan"*. This is the simplest way to breed Java and Nile tilapia. An inverted mosquito net or "bitinan" made of nylon netting is used. The net is suspended and supported in a pond by means of four poles. Stock three to five females for every male breeder per square meter of "bitinan" area. Grow plankton in the pond to serve as tilapia food.

Collect the fry from the "bitinan" once a month and transfer them to another enclosure or to a nursery pond for holding.

2. *Trench method*. A trench or canal one-half to one meter wide and 20 to 40 centimeters deep is dug along the side of the dike of a rice paddy with a good water supply. Stock Java or Nile tilapia breeders at a ratio of 3 females to 1 male for every two square meters of trench. For zillii tilapia, stock at a one-to-one male-female ratio per two square meters. The fry are caught with a dip net or a scissor net. See that the rice field is free of predators and harmful chemicals.

3. *Pond method*. A pond is used to raise fingerlings. When male and female tilapia are mixed in a pond at 10,000 to 20,000 per hectare, a large number of fry can be recovered after three to four months. Collection of fry is done by partially draining the pond and separating the adults with a coarse-meshed net and then scooping the young with a fine-meshed seine.

PROPER HANDLING OF FRY PRODUCES VIGOROUS FINGERLINGS

To get a high survival rate of vigorous stocks, tilapia fry must be handled properly. A very practical and inexpensive way of holding fry or fingerlings for future use is by using the net enclosure or "bitinan."

Put in from one thousand to two thousand fry per square meter of enclosure or 5,000 to 1,000 fingerlings. Fish seeds may also be stocked in fertilized nursery ponds at densities of 100,000 fry per hectare or 50,000 fingerlings per hectare. Guard against predators like mudfish (dalag) and "bid-bid."

SOURCE. Philippines Recommends for Tilapia 1976, PCARR, Los Baños, Laguna.

Freshwater farming

It's getting popular

CAGE FARMING OF *TILAPIA MOSSAMBICA*

Tilapia farming in floating cages has been found to be profitable in Lake Bunot, San Pablo City and has spread in Laguna de Bay, Lake Pacay and Pantabangan Reservoir.

The commercial floating cage used in Lake Bunot for raising *Tilapia mossambica* is constructed of locally available materials such as bamboo, wood and nylon netting with 12.7 millimeter mesh. A cage farmer could get as much as P25,000 from each cage in six months.

Lake Bunot fish farmers stock as much as 100,000 fingerlings of *T. mossambica* per cage. Fingerlings weigh 5 to 10 grams each on the average. The fish grow mainly on the natural food available in the lake. Rice bran is occasionally given as supplemental feed. As much as 10 to 15 tons per cage is harvested every six months. Marketable weight of tilapia is 100 to 150 grams.

HOW TO CONSTRUCT A FLOATING CAGE FOR THE NILE TILAPIA

With only a few pesos, one can start growing Nile Tilapia (*Tilapia nilotica*) in floating cages. You can do it in rivers, lakes, reservoirs, swampy areas and ponds with flowing water as long as the water is at least four feet deep.

According to Dr. Rafael D. Guerrero III, dean of the college of inland fisheries at Central Luzon State University, one can con-

struct a fish cage at a cost of only P40 to P70 depending on the source and kind of materials. This cage measures 1 x 1 x 1 meter or one cubic meter.

The cage is made of wooden frames enclosed by 3/4 inch mesh size synthetic (polyethylene) netting. It has three main accessories: a hinged lid or cover, two styrofoam floats, and a feeding box.

The lid should be lunged with a non-metallic material like old rubber tire strips to avoid corrosion. As the lid will always be exposed to sunlight, you may use 1/4-inch mesh G.I. screen instead of synthetic netting. It's more durable than the synthetic net which can only last up to six months. Synthetic nets in the other parts of the cage which are kept underwater remains useful for over two years with normal care.

You need two styrofoam floats measuring 100 to 15 x 7.5 centimeters each. Attach these floats with G.I. straps on opposite sides of the upper part of the cage.

The feeding box measures 1 x 0.5 x 0.5 meter with four sides enclosed by fine mesh netting. It is suspended inside the cage.

You can further strengthen the cage by doubling the netting with a 1.5 meter wide net. Stretch one piece of this net to enclose the bottom and two opposite sides of the cage. This would make the bottom stronger. Attach the netting to the frame by nailing bamboo splits over it. Paint the wooden frames with coal tar.

THE PROPER WAY TO STOCK NILE TILAPIA IN CAGES

Nile tilapia is most desirable for cage culture. It grows fast and big in cages.

Depending on the size, fingerlings will cost from ten to twenty centavos a piece.

Using a cage measuring 1 x 1 x 1 or one cubic meter, you may stock from 250 to 1,500 fingerlings depending upon the water conditions, size of fingerlings and management.

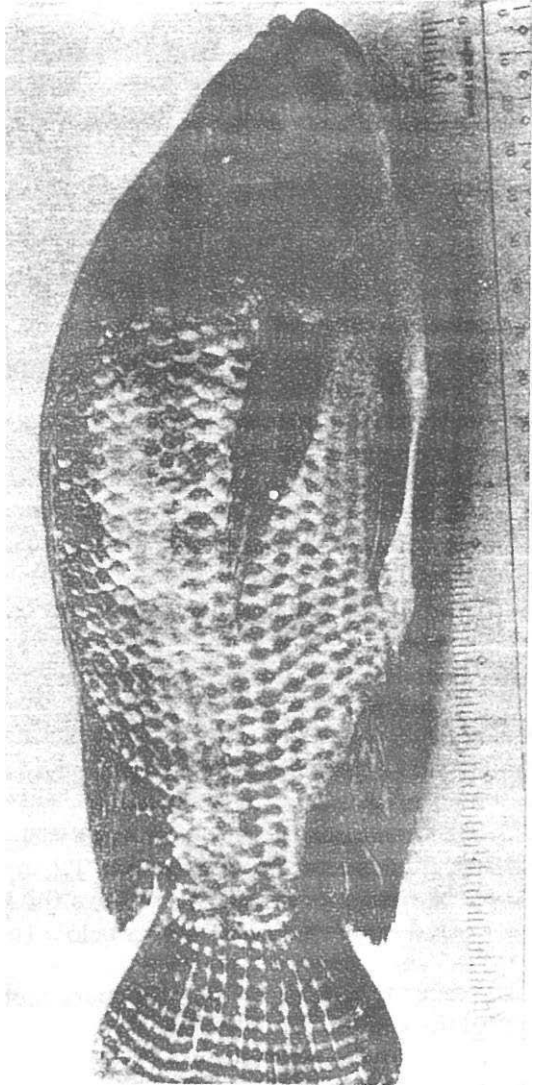

Adult tilapia

In a lake, reservoir or swift-flowing river, you can stock as high as 1,000 to 1,500 pieces per cage. In bodies of water with slow to moderate moving water, 500 to 1,000 fingerlings are recommended.

If you intend to grow tilapia in large sizes which is from 100 to 200 grams reduce the stock to 250 per cage. Reduce it further to 100 to 200 fingerlings if supplemental feeding only is done. High stocking densities require feeding with artificial diets for efficient growth.

To grow large Nile tilapia, the fish are manually sexed after two months of culture. Only the faster-growing males are kept in cages for further growth. Male tilapia can be distinguished from the female by their bigger size and the presence of only one opening in their genital papilla. The female papilla has two openings.

GROWING TILAPIA IN CAGES IN LAKES

Lake-grown tilapia raised in pens similar to milkfish pens would burrow under the bottom of the fence net and escape. This problem has been remedied by using floating cages such as those in Lake Bunot in San Pablo City and lately, in Laguna de Bay.

Tilapia cages in Laguna de Bay are built like a fishpen except for the net flooring which prevents fish from burrowing into the mud bottom and escaping. The net resembling an inverted mosquito net is tied to the bamboo poles staked firmly on the lake bed.

The frame for the cage is of bamboo poles braced together by lashing bamboo horizontally at about one and-a-half meters above the water level. The net is made of nylon or polyethylene materials and has a mesh size of 0.5 to 2.5 centimeters. The upper rim of the net is tied to each bamboo pole one meter above the water level and the bottom line is tied about 30 centimeters below the lake bottom.

Sizes of fish cages range from 50-200 square meters and are set in clusters (or modules) of two to 20 units.

They must be located in areas sheltered from strong winds and with the water not shallower than two meters.

SOURCE: "Cage Culture of Tilapia in Laguna de Bay," A.M. Mane, Technical Consultation on Available Aquaculture Technology in the Philippines (proceedings), SEAFDEC AQD, Feb. 1979.

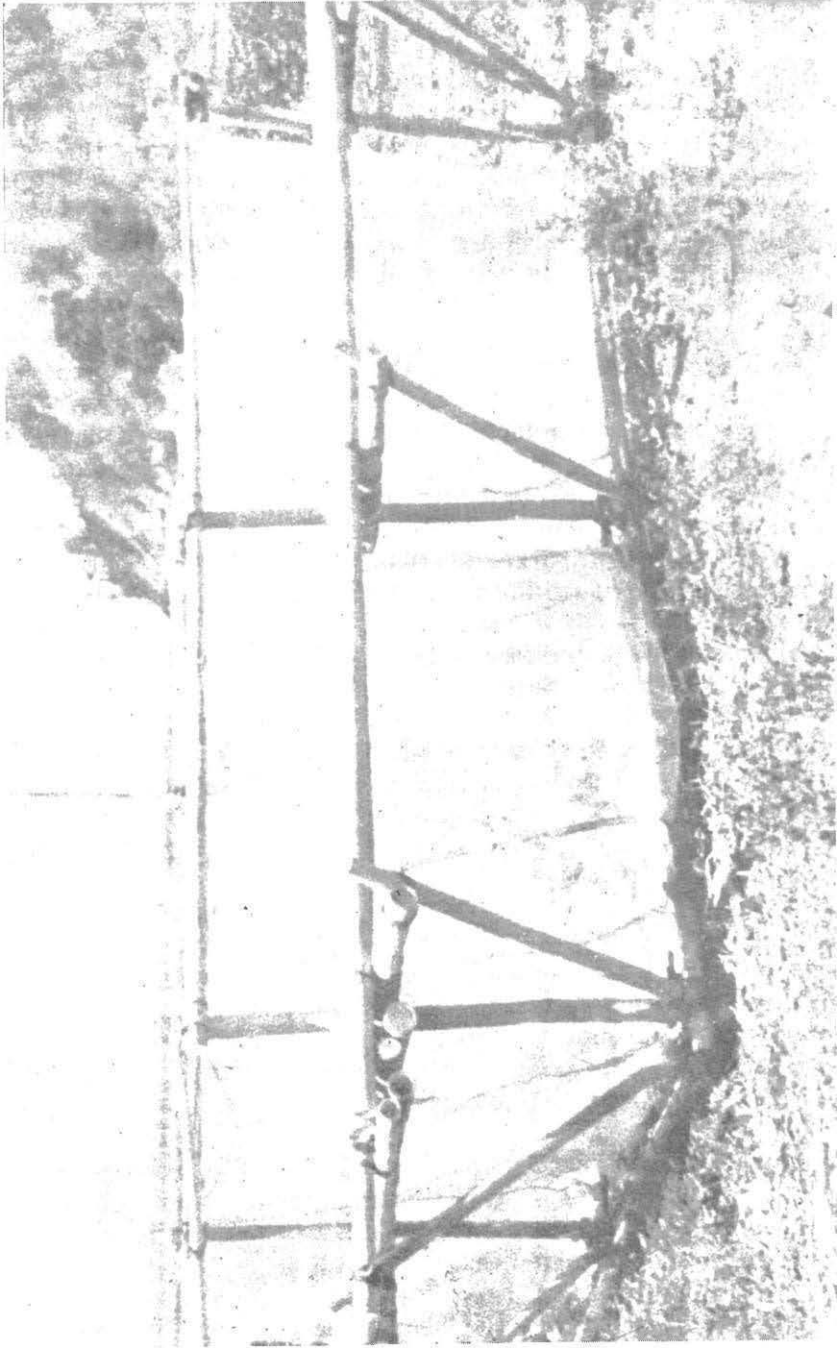

Floating cages for rearing of cultivable fish species

TILAPIA CAGE FARMING IN LAGUNA DE BAY

Small fishermen around Laguna Lake can now raise tilapia in cages. The SEAFDEC Aquaculture Department Freshwater Fisheries Station in Binangonan, Rizal is developing tilapia farming in the lake. It requires a very small capital and the technology is simple.

Here are the features of the tilapia cage farming technology:

A fish cage that can be easily made using locally available material costs about one thousand pesos (P1,000). The dimensions of the fish cage is 20 meters by 10 meters by 3 meters, large enough to be stocked with 10 thousand (10,000) fingerlings. You can produce one thousand kilos of marketable tilapia in five months. This should give a gross income of around six thousand pesos (P6,000).

These are the simplified steps as developed by the SEAFDEC Freshwater Fisheries Station:

Obtain *Tilapia nilotica* breeders, composed of 30 females and 15 males, weighing about 150 grams each. Place the breeders in cages of 3 x 3 x 2 meters dimension and feed them with tilapia pellets at 10 percent of the body weight. The tilapia pellets are known as *FAS* Tilapia pellets.

Tilapia will spawn after two to three weeks. Observe the appearance of fry on the surface of the water. Scoop the fry and transfer them to another cage of the same size which is 3 x 3 x 2 meters. Put 10 thousand fry in the cage and feed them with pellets at 10 percent of the body weight. In one month, fry will reach fingerling size or about two to three inches long.

Stock the fingerlings in rearing cages of 10 x 20 x 3 meters. Place the rearing cages in deeper portions of the lake with the net touching the bottom. Feed once a day at 10 percent body weight. Harvest tilapia after five months.

Write to the Head of the Freshwater Fisheries Station, Binangonan, Rizal for printed materials giving the details of the tilapia cage farming technique.

NEW IMPROVED TECHNIQUES IN TILAPIA FARMING

Tilapia's potentials for large-scale farming are so great that aquaculture researchers are now giving more attention to its development.

The SEAFDEC Freshwater Fisheries Station in Binangonan, Rizal has been conducting several studies to improve Tilapia farming.

Here are some of the recent findings in the station:

1. A hatchery and nursery system for *Tilapia nilotica* in cages in Laguna Lake can be built out of low-cost materials. The system can be easily adapted and financed by small operators to ensure them of continuous supply of fingerlings. The hatchery is capable of producing 250 fry per spawner every three to four weeks. Stocking rate is 6 to 7 adult Tilapia per cubic meter at a sex ratio of three females to one male. Harvested fry are sorted and reared in hapas until they become ready for transfer to grow-out cages.

2. Tilapia fry can be reared in hapas for one to two months at 500 fry per cubic meter without supplemental feeding. But with complete feeding using SEAFDEC-formulated algae cake, stocking density can be doubled to 1,000 per cubic meter.

3. A new Tilapia breed - SEAFDEC 2000 - has been developed from a cross of red tilapia from Taiwan and *Tilapia nilotica*. The new breed produces progenies that are uniform in size, with fast growth rate, and a very high survival rate. Mass production of this breed is being undertaken by the SEAFDEC Binangonan station for distribution to interested Tilapia cage farmers.

LOW-COST FEED FOR NILE TILAPIA IN CAGES

For high yields, Nile tilapia in cages should be given supplementary feed especially if the water's natural food productivity is poor. The feed does not have to be costly.

One such feed has been formulated at the Central Luzon State University. Its ingredients are locally available and cheap. It costs P1.20 to P1.50 per kilo. It is efficient - giving an average feed conversion of 2.5. That is, you spend 2.5 kilos of feed to produce one kilo of fish.

The feed consists of 75 percent fine rice bran (cono) and 25 percent local fish meal. It is prepared and fed to the fish in moist pellet form.

To prepare 10 kilos of the feed, 2.5 kilos of fish meal are mixed thoroughly with 7.5 kilos of fine rice bran. Store the feed in gunny sacks or plastic bags in a cool, dry place.

Moist pellets are produced by mixing enough water with the mashed feed to form moist balls. The moist balls are then pressed into an ordinary meat grinder with 1/4-inch die to produce the noodle-like moist feed. When fed to tilapia, the noodles are broken into pellets.

The daily feeding rate varies from 3 to 5 percent of total fish weight depending on the size of the fish. For fish weighing 50 grams or less, the feeding rate is 5 percent; 4 percent for fish ranging from 50 to 100 grams, and 3 percent for fish weighing more than 100 grams. Younger fish utilize feed better than older ones.

How do you determine the amount of feed needed in a day? First, compute the total fish weight in the cage. Simply multiply the number of fingerlings by the average weight of the fingerlings. For example, a cage stocked with 1,000 fingerlings weighing 20 grams each will have a total fish weight of 20 kilos. With a feeding rate of 5 percent, the amount of feed to be given is one kilo per day.

Two feedings a day are done. One-half of the total feed for the day is given in the morning between 6 and 8 o'clock and the other half in the afternoon between 4 and 6 o'clock.

SUPPLEMENTAL FEED MAKES TILAPIA GROW FASTER, MORE NUTRITIOUS

Tilapia mossambica grows faster and are more nutritious if given supplemental feeds. The supplemental feed need not be expensive.

This according to researchers of the SEAFDEC Aquaculture Department's Freshwater Fisheries Station in Binangonan, Rizal.

Ingredients for the supplemental feed are available locally. It is composed of 60 percent rice bran, 20 percent ipil-ipil leaf meal, and 20 percent fish meal. Given this feed, tilapia stocked at 75 pieces per square meter in floating cages in Laguna Lake grew faster and were found to have a higher protein content. Moreover, the feed conversion is better - you will need only four kilograms of the feed to produce one kilogram of tilapia flesh.

With this performance, the recommended feed is far better than other supplemental feeds such as the one consisting of 30 percent chopped snails and 70 percent rice bran. However, giving no supplemental feed at all results in much lower growth rate.

SOME TIPS ON TILAPIA FARMING IN FRESHWATER

From studies conducted at the Freshwater Aquaculture Center of Central Luzon State University (CLSU) in Muñoz, Nueva Ecija, here are some tips on tilapia farming:

* The larger the fingerlings stocked the greater the recovery and total production. The study showed, for instance, that 5-gram fingerlings had an average recovery of only 49 percent and average yield of 67.5 kilograms per hectare while 13-gram fingerlings had an average of 84.3 percent recovery and an average yield of 188 kilograms per hectare. It is also interesting to note that the stocking size of 19 grams attained the harvestable size of 50 grams after 69 culture days.

* Japanese snail meal can replace two-thirds of the fish meal in the ration of Nile tilapia. Another good substitute, horse meat meal, gave better weight gain and feed conversion when given as a complete replacement of fish meal.

* All-male Nile tilapia can be grown together with milkfish without affecting the growth and production of milkfish because there is no competition for food between milkfish and Nile tilapia. Stocking of Nile tilapia at 2,000 fingerlings per hectare with milkfish at 5,000 per hectare and mudfish at 100 per hectare gave the highest gain in weight of fish. Mudfish is stocked to control possible increase of tilapia due to reproduction in the event that manual sexing would not result to 100 percent male.

* Addition of supplemental feeds like rice bran and copra meal increased the net production in a polyculture system involving milkfish and all-male Nile tilapia. It is suggested that in places where an agricultural by-product is abundant and cheap, its use as a supplemental feed should be tried.

SOURCE: Inland Fisheries Project - Philippines, Technical Reports No. 12 & 13.

FOR BIGGER TILAPIA, CONTROL THEIR POPULATION

Large tilapia always fetch a better price and sell faster. Get good yields of big tilapia by controlling their population in the pond or cage. Tilapia can reproduce very rapidly that if you don't keep down their population, all you can harvest are plenty of small fish.

A practical way to control tilapia reproduction is to harvest before they breed or lay eggs. This is done two months after stocking of fry in the case of Java tilapia and three months for Nile tilapia. This method applies well for Nile tilapia as the species reaches market size (at least 50 grams) before it lay eggs. However, this method is practicable only for small-scale production.

A new technique has been developed - artificial sex reversal - which manipulates the sex that the small and still sex-less tilapia

will finally assume by feeding them with male hormone. The synthetic male hormone is fed to the fry during the stage of their life when they are still without sex. This hormone directs the would-be females to become males. Hence, no reproduction in the group occurs.

This method requires some training on the techniques as well as a fair amount of capital investment on the facilities needed to work it out.

SOURCE: Philippines Recommends for Tilapia 1976, PCARR, Los Baños, Laguna.

TILAPIA REARED DURING WARMER MONTHS REACH MARKET SIZE RAPIDLY

February and March are good months to stock tilapia fingerlings, according to former fisheries commissioner Andres Mane, a tilapia farmer himself. Fingerlings stocked during these months reach market size -- about 10 pieces to a kilo - in four to five months, said Mr. Mane. However, if the rearing period goes through the colder months of December and January, the fish would need seven to eight months to grow to the same size.

Mane provides the following tips for the cage rearing of tilapia:

Transport fingerlings (3-5 cm long) from nursery ponds to fish cages in oxygenated plastic bags or tin tubs (bañera) of 500-liter capacity. Stocking rate is 20 to 25 fingerlings per square meter. You can double the stocking rate to 50 per square meter with supplemental feeding. Stock during the early morning or late afternoon hours.

To a great extent, lake grown tilapia in cages feed on the natural foods in the lake. However, you may have to give fine rice bran and kangkong leaves if natural food is scarce. Scatter the rice bran in small amounts in the morning. Place kangkong leaves in patches inside the cages. Replenish the feed supply when much of it has been eaten.

TILAPIA SOLD LIVE BRINGS A HIGHER PRICE

Live tilapia commands higher price. This according to a veteran tilapia raiser, former fisheries commissioner Andres Mane of Los Baños, Laguna. Tilapia marketed alive usually sells for twice as much as dead tilapia, he says.

To harvest tilapia so that they can be kept alive longer, Mr. Mane recommends the following procedure:

Concentrate fish ready for harvesting in one corner of the cage. This is done by pulling up the net after it is detached from the bamboo frame.

Scoop the fish with a long-handled scoop net into the container which is usually a tin tub (bañera) or a styrofoam box filled to one-fifth its capacity with fresh water.

Cover the container with net or wood to keep the fish from jumping out. Change the water in the container very often. In this condition you can keep the fish alive for as long as four to six hours after which they gradually weaken and die.

Miscellaneous information

TILAPIA RAISERS NEED MORE GOVERNMENT ATTENTION

The tilapia industry needs more government support, according to a SEAFDEC-PCARR study of the 1974 operations of 131 tilapia pond operators in the Philippines mostly in Luzon specifically Cagayan, Isabela, Central Luzon, and Southern Luzon.

The study revealed that while bangos farms averaged about 11 hectares, tilapia farms were mostly below one hectare. Furthermore, most tilapia farmers raised the fish as part-time job. They spent about 1.5 months in the fishpond with most of their time spent in other occupation in order to supplement the food requirement of the family and earn additional cash income.

Most tilapia farmers interviewed agreed that the government could help the industry through credit and technical assistance. They cited as major problems improper construction of pond gates and dikes, flood and water pollution, low supply of fingerlings, credit unavailability, red tape in processing loan applications, insufficiency of capital, and high cost of inputs.

Raising tilapia with other fishes was found to be more profitable than monoculture, or raising tilapia alone. Tilapia-carp farms obtained a profit of P942 per half-hectare compared with P402 per half-hectare in monoculture farms.

Fertilization is not a common practice in tilapia ponds. Only 30 percent in monoculture ponds and 47 percent in polyculture ponds practiced fertilization. Of these, the majority fertilized the pond only when needed, the rest did so before stocking or regularly once a month. The usual practice is to apply chicken manure every 20-30 days.

The study showed that fertilization and supplemental feeding proved to be advantageous. Fertilization increased average yields in monoculture farms to 677 kilos per half-hectare or four times that obtained in non-fertilized ponds. Fertilized tilapia-carp fishponds yielded an average of 599 kg, or three times as much as non-fertilized ponds.

Both monoculture and polyculture farms which applied supplemental feeds netted more than five times the amount obtained by non-users of supplemental feeds.

FISHPOND IN THE FOREST

In the forests of Pagbilao, Quezon, *Tilapia nilotica* is being successfully raised in fishponds built at the sides of creeks.

This was reported by M.L. Generalao and P.R. Garcia of the Forest Research Institute's Agro-Forestry Research Center in Pagbilao, Quezon.

The scheme is simple and inexpensive, Generalao reported. At a cost of not more than P300, a farmer can put up a fishpond with an area of 300 sq m and a depth of 1 to 1-1/2 meters. The design is similar to the "loong," built by fishermen near a river. The only difference is that, in the forest, this fishpond is at a higher elevation while the "loong," as the term is used in Southern Luzon, is at a lower elevation.

Although other fishes such as bangos, dalag, hito and shrimps can also be grown, Generalao and Garcia, said that BFAR technicians in Quezon have recommended Tilapia because it thrives well. A young tilapia grows 30 to 40 cm in a year and feeds on the natural food found in the mountain streams. Another advantage of tilapia is that it multiplies rapidly, spawning 5 to 6 times a year, according to the agro-forestry researchers.

The encouraging initial experience with the Pagbilao fishpond has prompted the Forest Research Institute to expand the project in connection with its agro-forestry research and development program, Generalao reported.

MUSSELS & OYSTERS

- Tahong and talaba; easy to raise and highly profitable **222**
- Places where mussels and oysters can be farmed **223**
- You can transplant mussels and oysters for future farming **224**
- Two ways to grow mussels **225**
- Cleansing oysters and mussels **227**
- Choosing a site for a mussel farm **228**
- Modernize your system of producing mussels, grow them in rafts **230**
- Cost of putting up a mussel raft **231**
- How to construct a mussel raft **232**
- The right materials for collecting mussel spats **232**
- Tips on maintaining a mussel raft farm **235**
- When to hang mussel collector ropes **237**
- How to transplant young mussels to growing ropes **243**
- How to make collector ropes and growing ropes for mussel raft farming **244**
- Protect the mussels from predators, parasites, pests and silt **245**
- How to harvest mussels grown by tulos and rope-web methods **246**
- Harvesting and transporting mussels **247**
- How to clean and preserve mussel **248**
- Try these novel mussel recipes **249**
- Oyster farming methods **252**
- Oyster shells collect more spats than coconut shells **253**
- Harvesting talaba **254**
- Southern Tagalog oyster farmers have the edge **254**
- Pangasinan fish farmer turns river into an instant oyster and prawn farm **256**

TAHONG AND TALABA: EASY TO RAISE AND HIGHLY PROFITABLE

Green mussels and oysters, known locally as *tahong* and *talaba* offer anyone with keen interest and small capital a highly profitable business venture. Farming these two popular delicacies is relatively simple. It does not require too much skill. Fertilization and other rigorous operations required in most other farming ventures are not needed in tahong and talaba farming. All you do is "plant," let them grow, harvest and get as much as three to five times every peso you invest.

According to the *Philippines Recommends for Mussels and Oysters 1977*, mussel farming can give a return per peso investment of P2.25 to P5.00 Oyster farming can enable a farmer to earn as much as P3.15 to P5.55 for every peso he spends.

Based on 1976 prices, a one-half hectare mussel farm using the *tulos* or stake method can yield a gross income of P240,000 during the first year of operation. This comes from the sale of 40,000 gallons of mussels sold at P6 per gallon. Using *buho* bamboos staked at half-meter apart, the estimated expense is small - around P65,000. The resulting net farm profit, therefore, is quite substantial - P175,000 or a return per peso investment of P3.70. The farmer can get more in the succeeding years of operations since he will not have to spend anymore for the initial equipment, such as the motorized banca and diving equipment. By that time, he must have also paid his loans and interest from his first year's income. He should therefore get a net income of as much as P189,000 or P4.70 per peso invested.

A one-hectare oyster farm is projected to yield a net income of around P154,000 based on 1976 prices. This means a return per pesos investment of P3.48. The oyster farmer can get more in the next cropping season as he will be using the same plot.

Interested persons who wish to have more knowledge on the proper culture of mussels and oysters may consult with the Director, Bureau of Fisheries and Aquatic Resources (BFAR) in Intramuros, Manila or with the BFAR regional offices based in most cities of the country. The BFAR has demonstration farms for mussels and oysters which you could visit and observe such as those in Cavite, Pangasinan, Cagayan, Sorsogon, Cebu City, Roxas City, Samar, Tangub City, Ozamis City and Cagayan de Oro City.

PLACES WHERE MUSSELS AND OYSTERS CAN BE FARMED

At present, there are only a few areas in the country where mussels (*tahong*) and oysters (*talaba*) are commercially farmed. Mussels are abundantly produced in Bacoor Bay in Cavite, Sapián Bay in Capiz, and Maqueda Bay in Samar. Oysters are successfully farmed along the coasts of Cavite and Bulacan; Aringay, Sto. Tomas in La Union; Abucay, Bataan; Buguey, Cagayan; Negros Occidental and Banate, Iloilo.

However, there are a lot more places where *tahong* and *talaba* can be commercially grown, according to the *Philippines Recommends for Mussels and Oysters* 1977. These are in the following sites: 1) Lingayen Gulf and Binloc, Dagupan in Pangasinan; Masinloc in Zambales; Balayan Bay in Batangas; Batangas Bay; Tayabas Bay in Quezon; Makato in Aklan; Panguil Bay; Northern Leyte coast; Catbalogan, Western Samar; Sorsogon; Calauag Bay, coast of Alabat Island and coast of Polilio Islands in Quezon.

A good indicator for a farm site is the intensity of mussels and oysters found clinging to structures like *baklad* or fish corrals. Mussels and oysters grow and spawn in brackish to salty waters of coves, bays and estuaries. Favorable water salinity is from 27 to 35 parts per thousand for mussels and 17 to 35 parts per thousand for oysters. The mussel needs to be under water at all times even during low tide. A good site should have a somewhat hard and sticky bottom. A muddy-sandy substratum usually gives a high production of mussels. Mussels and oysters do not survive well in shifting bottoms or solid rocks. The site should not be heavily polluted with industrial and agricultural wastes such as pesticides.

YOU CAN TRANSPLANT MUSSELS AND OYSTERS FOR FUTURE FARMING

Mussels and oysters can be transplanted in new breeding areas to serve as new sources of seeds for the next cropping season.

Transplanting is normally done in sites that have conditions similar to the collection or farming area. The most common practice is to transfer the whole collector with the seeds intact. Seeded collectors are transported by means of raft or *balsa* for short distances, or by bancas, provided the seeds are not submerged in water.

You must handle the seeded collectors with care to avoid seeds from detaching from the collector. Long exposure to sunlight should also be avoided. Mussels die easily from high temperatures.

The method of transplanting depends upon the type of farming used. For the *bitin* and *tulos* methods, the whole seeded collectors are gathered and replanted.

For the broadcast type of farming, separate or cull the clusters to reduce the number of shells at a maximum of three per cluster. This will minimize competition for space and food within a cluster and allow the juveniles to grow to marketable size in a shorter period. The bivalves are then scattered evenly on the substratum.

The collection site and the plot called *pabiayan* should be near each other to effectively transplant mussel juveniles. Detache clusters of *tahong* entirely from the bamboo collector without cutting the beard or byssus. Then drop the clusters carefully to the substratum. When the *tahong* are big enough, dredge the bottom during harvest time by means of a wire scoop net.

In some places, seeded poles are cut into the desired lengths and packed carefully in *pandan* baskets or *bayong* for transport to distant places. To transplant, hang the seeded poles in prepared plots by strong wire. These serve as substrate for growth of the seeds into breeders that will produce new spats for the next spawning season.

TWO WAYS TO GROW MUSSELS

The *tulos* or stake method and the rope-web method are the two most widely used methods of mussel farming in the Philippines. The *tulos* uses bamboo poles while the rope-web uses synthetic rope as mussel collectors. Both methods are effective. However, the *tulos* is easier to start with because you can get bamboos at a low price. Synthetic ropes for rope-webs are more expensive but they can be used over a much longer time than bamboos.

The Tulos or Stake Method

Aside from bamboo, you could also use palm and mangrove trees as materials for the *tulos* method.

To facilitate staking and prevent the poles from floating, punch some holes at the upper end of each bamboo segment. This will allow water to fill the hollow portion of the bamboo. Sharpen the basal end of the bamboo pole by making a diagonal cut. Stake the bamboo poles at one-half to one meter apart. Since mussels need to be submerged at all times, it is not necessary for the tip of the poles to protrude above the low water line after staking. However, the boundary poles should extend above the high water line. Reinforce the bamboo poles with horizontal traces if the current in the area is strong.

Experience at Bacoor Bay has shown that mussels settle along the entire length of the submerged bamboo stake. An average of 2,000 to 3,000 seeds per meter length has been observed to adhere at these levels.

After staking, the plot should be inspected regularly to observe the growth of mussels and to control organisms that may destroy the crop. Fouling organisms such as algae, corals, seaweeds, sponges and other pests should be scraped off.

The Rope-Web Method

The rope-web system was first tried in Sapijan Bay in Capiz and has been found effective and durable. The webs can be used again and again provided they are cleaned of dirt, algae or *lumut* and other fouling organisms before using.

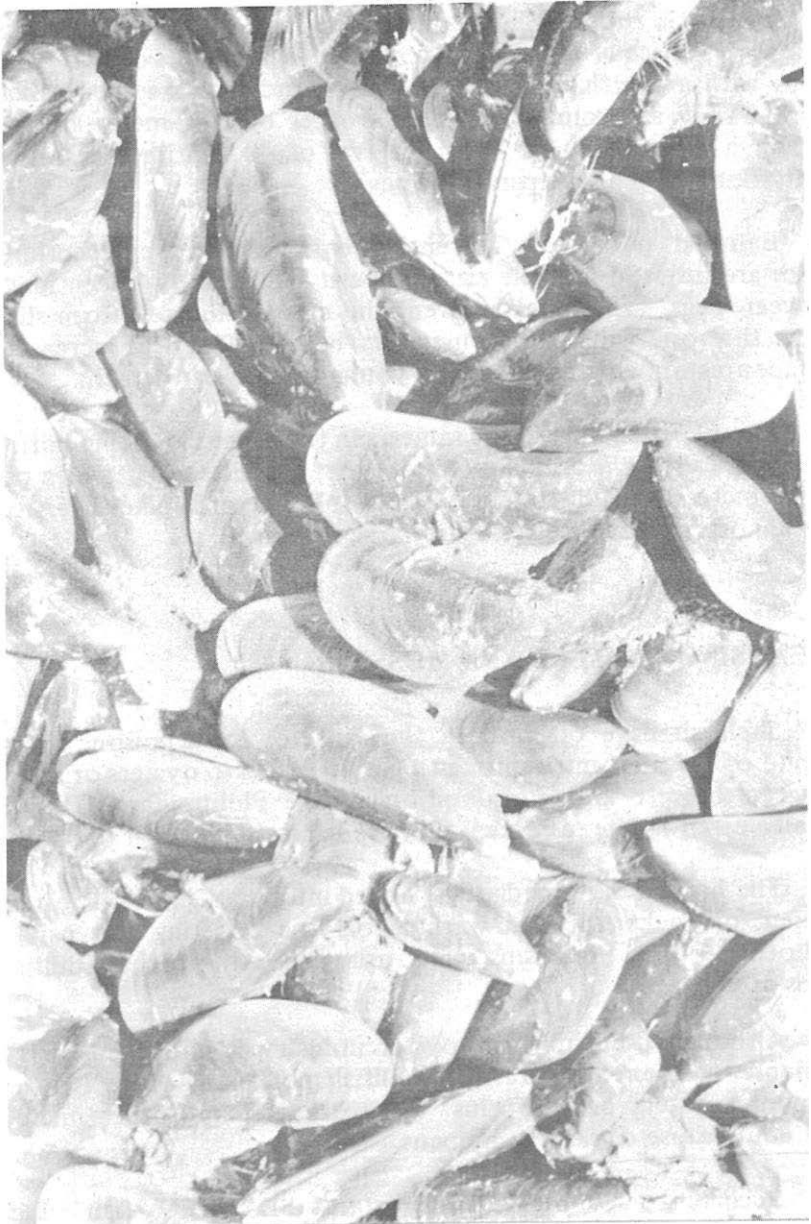

Freshly harvested green mussels.

Synthetic ropes with a diameter of 12 millimeters are made into webs tied vertically to bamboo poles. A web consists of two parallel ropes with a length of five meters each and positioned two meters apart. They are connected to each other by a 40-meter long rope tied in a zigzag fashion at an interval of 40 centimeters between knots along each of the parallel ropes.

Bamboo pegs with 20-centimeter length and one-centimeter width are inserted into the zigzag rope at a spacing of 40 centimeters between pegs. These pegs prevent the mass of mussels from sliding down the rope when it becomes very heavy. The pegs increase the surface area on which the spats or young mussels can attach.

The plot structure is the same as in the stake plot using horizontal braces called *bila* and *baral* except that the distance between posts is five meters. A full stretched rope-web collector is placed vertically to the posts at three meters apart along the rows.

CLEANSING OYSTERS AND MUSSELS

Shellfish have often been the cause of food poisoning cases. In spite of this, not much processing is accorded to oysters or mussels between harvest and consumption in the Philippines. They are usually eaten in the same day they are harvested for fear of spoilage.

The harvest is immediately packed into wooden boxes, bamboo baskets or sacks without washing off the adhering soil particles and other fouling organisms. In transit, the oysters gather additional loads of microbes.

Although the Philippine oyster industry is not faced with the immense problem of paralytic shellfish poisoning, there is a need to purge oysters of coliforms, Enterobacteria and other microbes that could cause diseases in humans.

According to Rogelio Gacutan, SEAFDEC fish disease specialist, the depuration process is relatively simple. Depuration is allowing a shellfish to flush itself of impurities and microorganisms.

Clean seawater is pumped into large holding tanks and the load of impurities is quantified. The proper amount of chlorine is then

added and allowed to evaporate. Mussels or oysters are then placed on rocks in the tanks and the purified water is slowly pumped over for 48 hours. The now clean oysters or mussels are placed in bags, are sealed, tagged and rinsed. Draining takes three hours. When properly depurated, the samples should keep for three days.

In Australia, depuration plants are widely used. The plant is equipped with 10 shallow fiberglass tanks in two stacks of five, supported by galvanized iron pipes. The oysters are held in a single layer on black plastic trays, three trays to a tank, half-a-bag of oysters per tray, or a total capacity of 15 bags.

Each 48-hour purification cycle requires 700 liters of seawater, which is circulated at a rate of 20,000 liters per hour. Overflow from the tanks is collected, temperature adjusted to about 20°C, filtered and pumped through an eight-lamp ultra-violet sterilizer before being recirculated over the oysters.

In the Philippines, mussels are sometimes processed into a "bagoong" kind of preparation. Raw mussels are shucked, placed in bottles and salted for a fermentive process that assures improved flavor and more importantly freedom from disease causing organisms.

SOURCES: "Post-harvest processing of oysters and mussels," Rogelio Gacutan in Technical Consultation on Available Aquaculture Technology in the Philippines, Feb. 8-11, 1979.

Australian Fisheries, November 1979.

CHOOSING A SITE FOR A MUSSEL FARM

The first important factor in choosing a site for mussel farming is the presence and abundance of spats or young mussels in the area.

Most successful mussel farms in the country are located in areas where mussel spats are abundant, like in Bacoor Bay in Cavite and Sapián Bay in Capiz.

Other factors to consider in choosing a site for mussel farming are:

1. The site should be protected from strong winds and waves.
2. The tidal range in the site should be enough to enable complete and frequent change of water. The greater the tidal exchange the better. More food is brought to the suspended mussels and wastes more easily flushed.
3. The water should contain enough food for the mussels. Water with greenish color indicates sufficient food.
4. The tidal currents should be strong enough - no less than two centimeters per second. Weak or slow water movements result in poor growth of mussels due to the slow replenishment of food. Also, weak currents promote the setting of harmful organisms in the water.
5. The site should be enclosed enough to enable young mussels to settle on spat collectors. In offshore and exposed areas, spats are carried to the sea before they have a chance to settle on collectors.
6. The water should be relatively deep, at least two meters during low tide.
7. The site should not be too far upriver as to be subject to a drop in salinity during rainy season.
8. The market or at least the road should be near the site for easy marketing.
9. The site should be free from pollution and sewage wastes. Discharges from fishponds using pesticides specially snail killers are deadly to mussels.

SOURCE: Manual on Mussel Farming by W.G. Yap et al, SEAFDEC Aquaculture Department.

MODERNIZE YOUR SYSTEM OF PRODUCING MUSSELS, GROW THEM IN RAFTS

SEAFDEC Aquaculture Department mussel culture experts recommend floating rafts - instead of bamboo stakes - for growing green mussels (*tahong*);

You can get more income from these rafts which are easier to operate and maintain and last longer than the traditionally used bamboo stakes.

Although mussel culture using bamboo stakes is cheaper to set up, it has many disadvantages such as the following:

- * bamboo poles do not last longer than two years;
- * the stakes provide a good access for predators like drills and other harmful gastropods, starfishes, crabs and sea urchins. Some species of crabs which nest inside submerged bamboo poles have been seen to topple bamboo stakes more than six months old in the water;
- * maintenance and inspection of the stakes can be done only when the tide is sufficiently low to permit easy diving;
- * mussels crowd over certain portions of the stakes only;
- * difficulty of timing staking operations to coincide with spat-fall.

On top of these, silt piles up faster in areas occupied by mussel stake farms. Bamboo stakes hinder the flow of the water allowing organic and inorganic matters to settle in the area. As siltation increases the area becomes shallower. As a result, mussels' growth is retarded and when they develop in very thin shells, they become easy prey for crabs and fishes.

Mussel farming using rafts or other floating structures has several advantages. Mussels grow faster; regular thinning can be done; rafts can be moved around to prevent siltation; rafts can be constructed out of durable materials capable of lasting several years; predation is minimized; and production per unit area is more.

A mussel raft farm, the experts say, is easy to maintain due to its independence from the tide. The most important thing you have to watch for is timely laying of spat (young mussel) collectors. Once the mussel spats have settled on the collector ropes, maintenance of the farm consists only of thinning and transplanting the young mussels to growing ropes, protecting the mussels from predators, parasites, pests and silt, adding buoys when mussels become heavy, and replacing pegs when necessary.

SOURCE: Manual on Mussel Farming by W.G. Yap et al, SEAFDEC Aquaculture Department, 1979.

COST OF PUTTING UP A MUSSEL RAFT

A mussel farm need not be large. Unlike other forms of aquaculture such as pond culture of milkfish or prawns, one need not think in terms of hectares. The size can be scaled down to fit a farmer's financial capability.

Using rafts made of bamboo, styrofoam buoys and polypropylene ropes is much better than using bamboo stakes. A meter of rope attached with coconut husks produces 5 to 15 kilograms of mussels. Thus a raft measuring 6 meters wide and 8 meters long and with 800 meters of rope collectors can yield 4,000 to 12,000 kilograms of mussels.

On the other hand, a 100-square meter mussel farm using 50 bamboo stakes can at most produce only 1,000 kilograms. And bamboo stakes do not last very long.

A mussel raft will cost more to put up but in the long run will provide higher net income per year to the farmer. A mussel raft can provide a net income of about P4,930 for the first year and about P7,700 for every succeeding year.

The cost of putting up a 6-meter by 8-meter mussel raft is estimated at around P3,070. Only portions of the bamboo raft need be replaced every other year and the cost will be only about P300 or 10 percent of the initial investment.

HOW TO CONSTRUCT A MUSSEL RAFT

A mussel raft consists of two compartments: 1) a rigid framework or lattice structure from which the ropes are hung; and 2) buoyant objects to keep the framework afloat.

For the framework, bamboo or lumber could be used. Although bamboo breaks easily, it is cheap and widely available. Except for the hardwood variety (those used for bridges and piers), lumber will not last long in the sea. If lumber is to be used, treat the wood with marine anti-fouling paint.

Bamboo, metal drums, plastic drums, styrofoam blocks, and ferro-concrete blocks may be used as buoys. The choice should be based on availability, durability, and cost.

Bamboo poles may be lashed together with either monofilament nylon or galvanized wire to form the lattice or framework of the raft. Buoys should be lashed securely to the bamboo framework and distributed evenly.

Rafts may be tied together then laid out in a series 3 to 4 meters apart with an anchor at each end of the line. In shallow areas the rafts may be moored to stakes.

The whole series of rafts should be laid out parallel to the direction of the current. They should be laid out so as not to obstruct navigation or fishing.

SOURCE: Manual on Mussel Farming by W.G. Yap *et al.*, SEAFDEC Aquaculture Department.

THE RIGHT MATERIALS FOR COLLECTING MUSSEL SPATS

Mussel farming depends largely on the efficiency of collecting spat or young mussels.

Aside from knowing where and when to place spat collectors, one should use the right collecting materials.

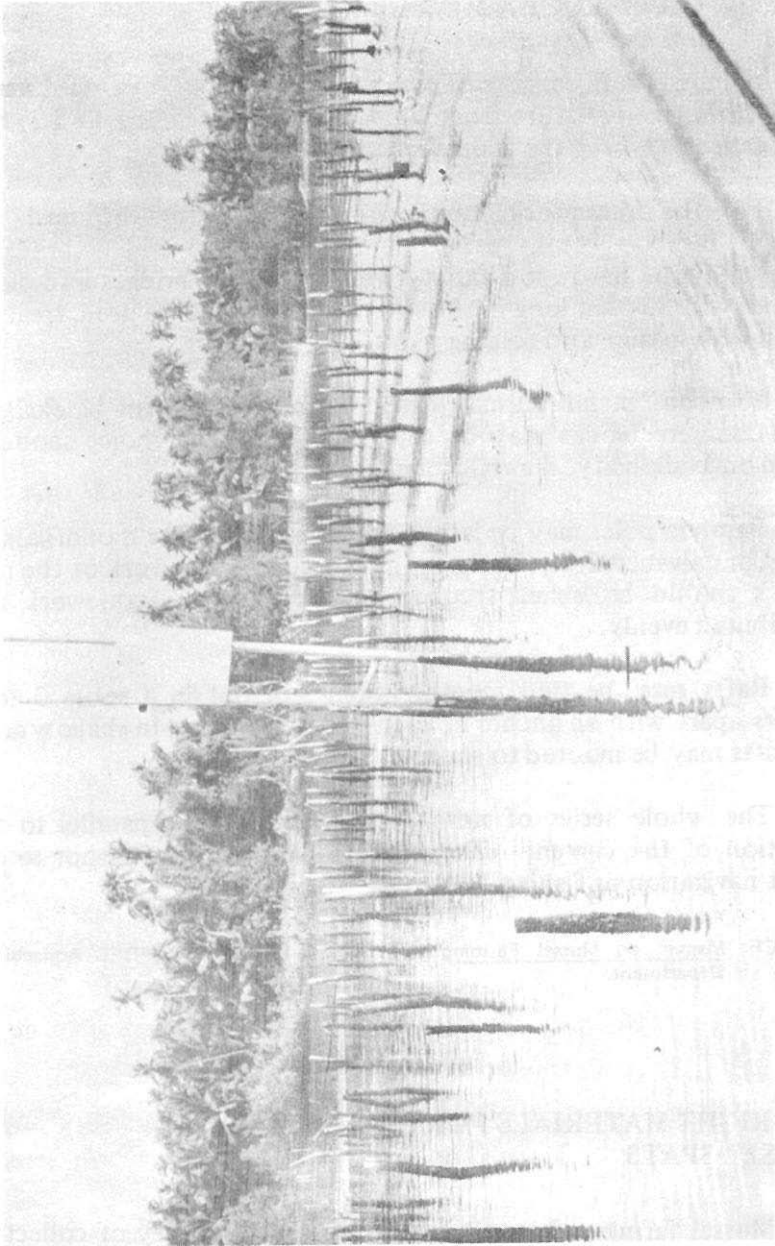

The traditional stake method of culturing green mussels.



Bamboo rafts for mussel culture. These were set up by the SEAFDEC Aquaculture Department in Himamaylan, Negros Occidental.

The following must be considered in choosing the type of materials for collecting mussel spats:

1. The collector should be attractive to the mussel larvae. Mussel larvae settle on filamentous objects and later move on to more solid substrates.
2. The collecting materials should be easily available locally.
3. It should be easy and inexpensive to prepare.
4. It should be durable - should last till harvest at least.

So far, the only material satisfying almost all of the above criteria is coconut husk. Its hairy, fibrous composition makes it attractive to mussel spats. The only difficulty with coconut husk is that it does not last long in the water, so that usually the mussels will have to be re-laid or transplanted for growing to marketable size.

Other suitable materials are cabo negro, and old frayed ropes.

TIPS ON MAINTAINING A MUSSEL RAFT FARM

As mussels grow, the ropes become heavier. When they become too heavy, the raft will go down below the water's surface forcing the ropes to sink to the bottom mud. That will make your mussels easy prey to harmful organisms. Also, the mussels will contain mud which will lower their quality.

To avoid this, inspect your mussel raft regularly and put additional buoys to keep the raft afloat.

Bamboo pegs which are inserted into the lay of growing ropes to prevent the mussels from slipping off should be inspected regularly. Decayed pegs should be replaced. If necessary, add pegs to support exceptionally large mussel clusters.



A close up of the floating raft. Note ferrocement buoys used as floats.

WHEN TO HANG MUSSEL COLLECTOR ROPES

A mussel farmer would do well to know the right time to set out spat collectors.

If the spat collectors are set out very much earlier than the spawning period, large numbers of barnacles and other harmful organisms will attach to the collectors and make the collectors unattractive to mussels. On the other hand, if the collectors are set out too late, only very few spats will be collected.

Farmers learn by observing when spatfall occurs. Thus in Bacoor Bay in Cavite, farmers generally lay their collectors before April and again in November. In Sapián Bay in Capiz, the period of highest spatfall intensity usually occurs from February to March and again in September to October. In Himamaylan River (Negros Occidental), the best spatfall period has been observed to occur in March while another spatfall period comes in November, although lesser in intensity.

In general spat collectors should be installed not earlier than February but not later than March to catch the first spatfall, usually the heavier one. For the secondary spatfall, collectors should be laid during September and November.

The most accurate way of forecasting spatfall period, however, can be done by monitoring mussel larval abundance in the water daily. This could be done by trained technicians using special equipment. In other countries, this type of service is provided by a government agency.

In the Philippines, a spatfall forecast system or network has not yet been established. However, a pilot project in mussel and oyster spatfall forecast has been started this year in Himamaylan, Negros Occidental under the auspices of the SEAFDEC Aquaculture Department.

SOURCE: Manual on Mussel Farming by W.G. Yap et al., SEAFDEC Aquaculture Department. 1979.

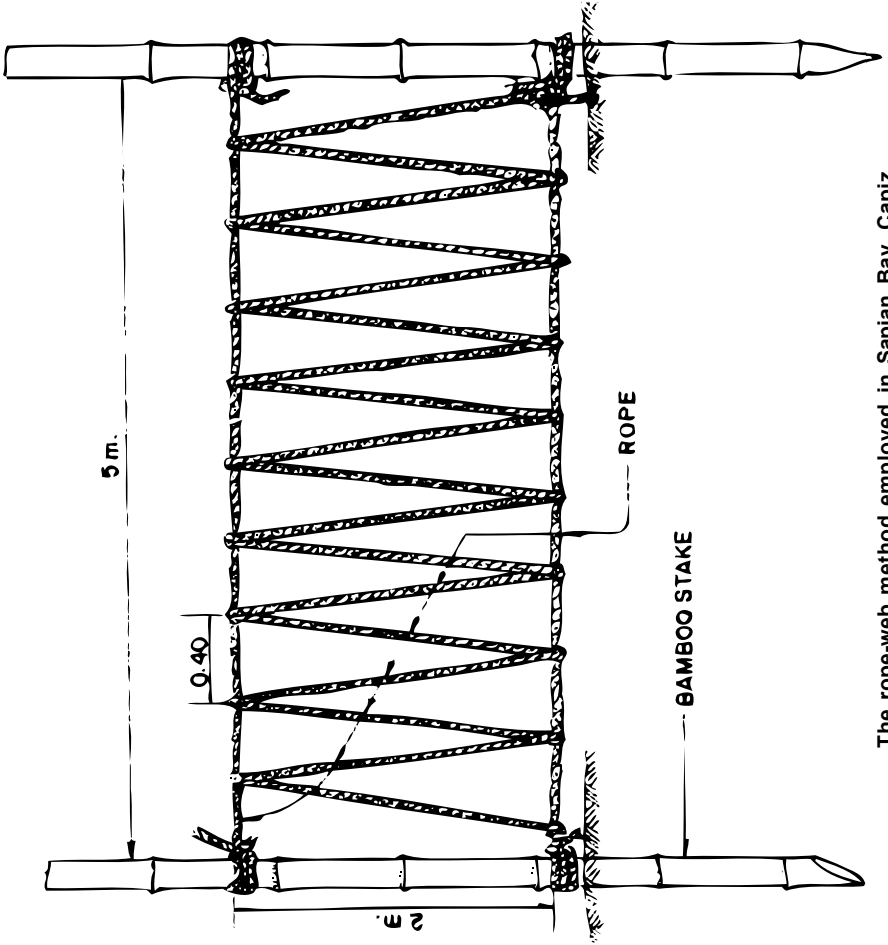

The rope-web method employed in Sapien Bay, Capiz.

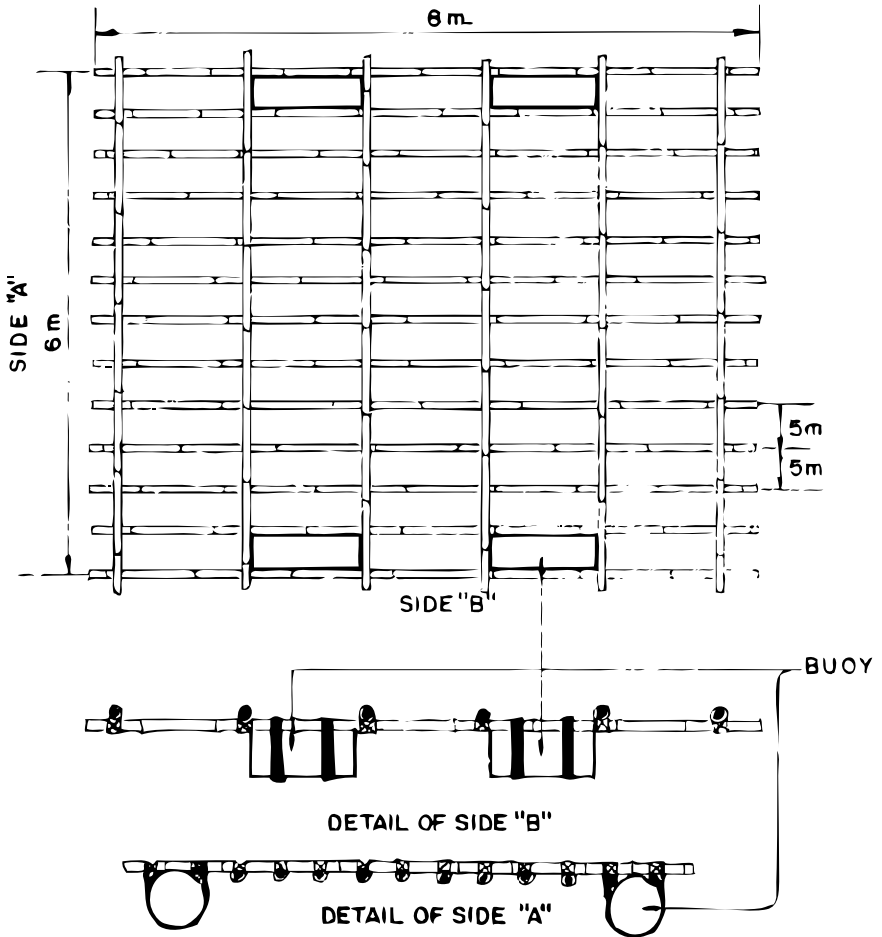

Construction detail of a mussel raft using bamboo framework and floats.

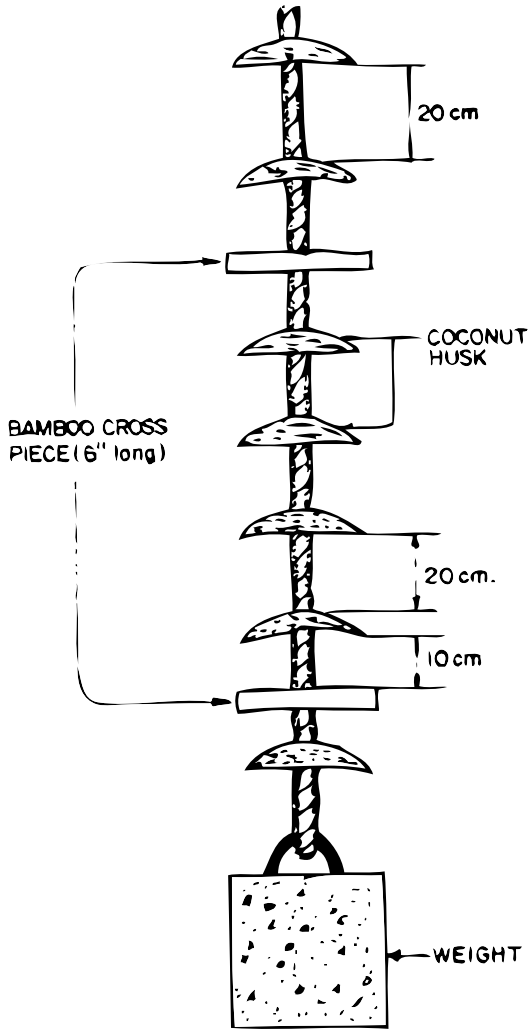

Detail of one (1) growing rope (2.0 m. long).

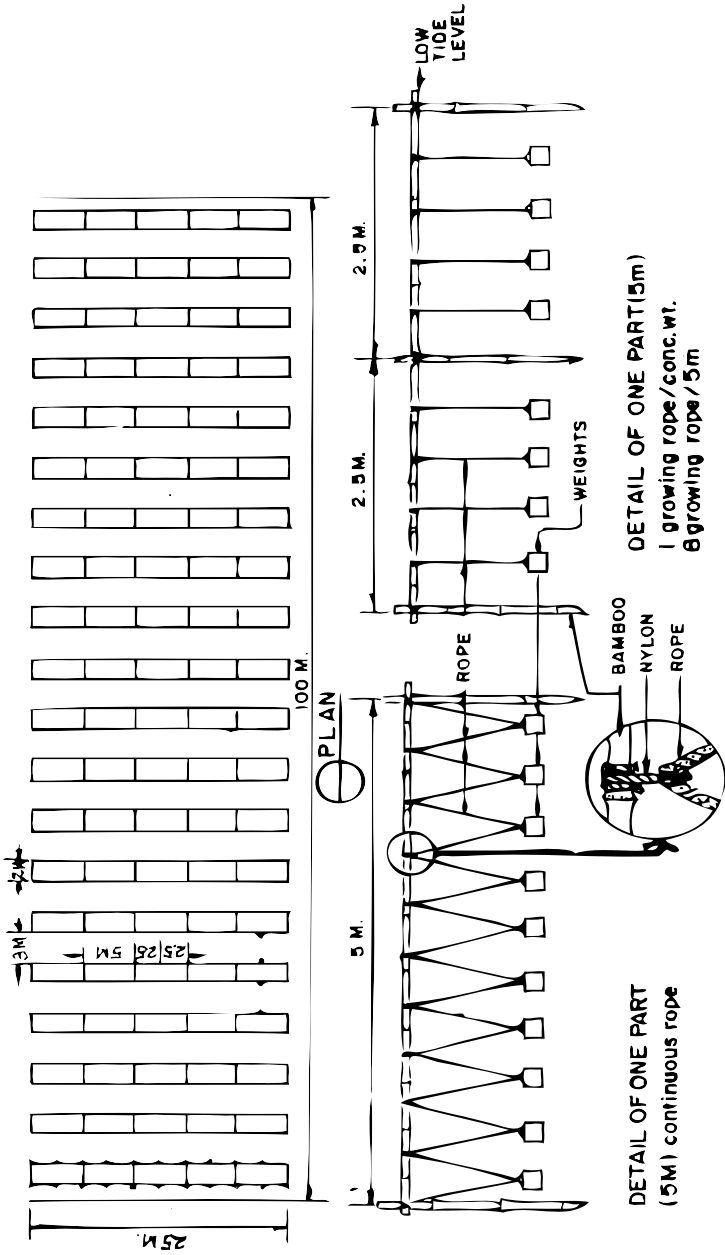

Fixed structure mussel farm using bamboo plots.

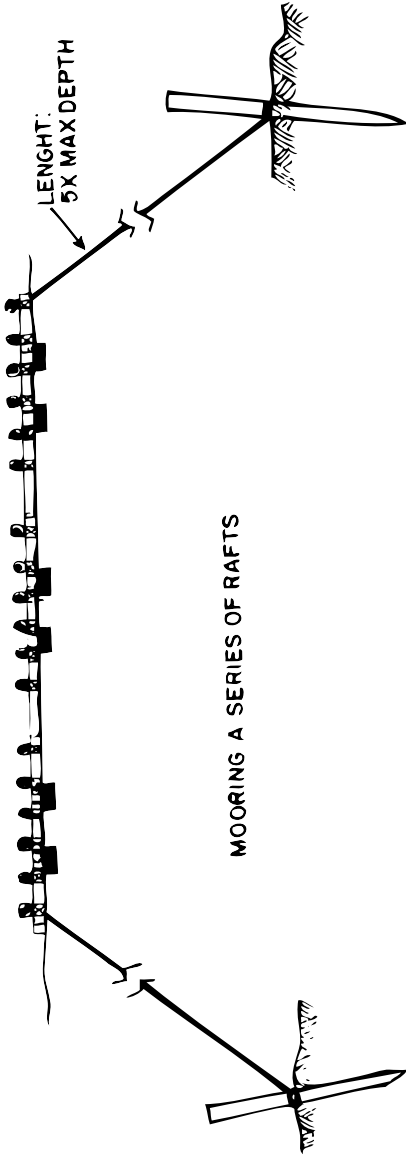

MOORING A SERIES OF RAFTS

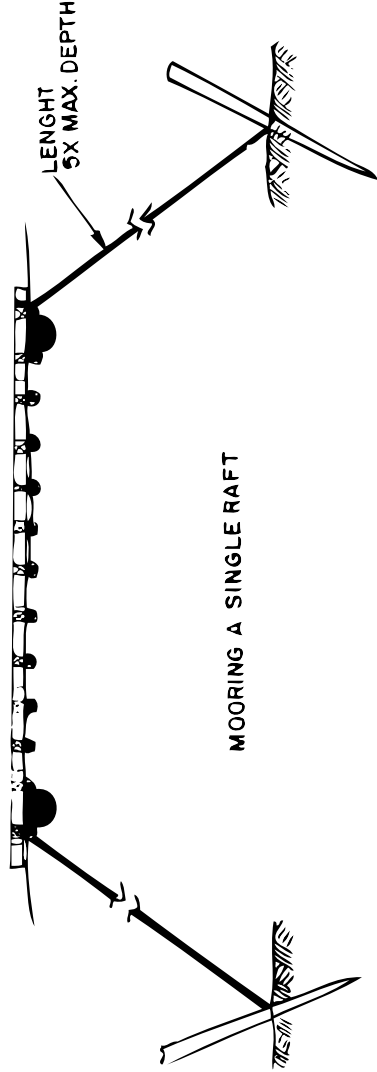

MOORING A SINGLE RAFT

Methods of mooring a single raft or a series of rafts.

HOW TO TRANSPLANT YOUNG MUSSELS TO GROWING ROPES

You have two choices when you grow mussels in rafts. One is to use only one kind of rope - the growing rope - for both collecting spats or young mussels and growing them to marketable size. The other is to use two ropes: a collector rope for collecting spats and a growing rope for transplanting the spats and growing the mussels until they reach marketable size.

Here's the procedure in thinning collector ropes of mussel spats and transferring them to growing ropes.

Thinning the collector rope should be done when spats have grown to a length of 10 to 15 centimeters. Gently break the clump of mussel spats attached to each coconut husk collector. The mussels should be in small clusters each with 10 to 20 mussels.

To transfer the small clusters of mussels to the growing rope, two persons -- one on each end - must stretch the rope while another person is fixing or binding the clusters to the rope. The clusters could be attached to the rope by means of a thin cotton string or abaca twine. However, you may use strips of cotton gauze in place of string when the mussel clusters are small or the spats are loose.

Avoid crowding the mussels in a rope. Put not more than 300 mussels in a meter of rope.

Thin and transplant before the coconut husk collector start to decay. During transplanting, protect the mussels from the heat of the sun and the wind while they are still out of the water. A convenient way of doing this is by building a small hut on your raft.

SOURCE: Manual on Mussel Farming by W.G. Yap et al., SEAFDEC Aquaculture Department, Sept. 1979.

HOW TO MAKE COLLECTOR ROPES AND GROWING ROPES FOR MUSSEL RAFT FARMING

There are two methods of growing green mussels (*tahong*) in bamboo rafts. In the first method, two kinds of ropes are prepared: *collector ropes* and *growing ropes*. Young mussels or spats are collected with collector ropes and later re-laid or transplanted to growing ropes.

In the second method, only the growing rope is used; spats are collected and grown in the same rope.

Collector ropes are shorter and thinner than growing ropes. You can use either polypropylene or polyethylene ropes with a diameter of 5 millimeters.

At 50 to 60 millimeter intervals, insert pieces of coconut husk into the lay of rope. Tie a heavy object to the end of each rope to keep it weighted down. Stones wrapped in pieces of old netting or small blocks made of cement may be used for weights.

Hang the collector ropes about one-half meter apart. Spats collected on collector ropes must be thinned to prevent over-crowding once they have grown to a length of 10 to 15 millimeters. Transplant these mussels to the growing ropes where they are reared until ready for harvest.

For growing ropes, you may use either cabo negro, abaca, polypropylene or polyethylene ropes with a diameter of 12 to 20 millimeters. As in collector ropes, tie a heavy object to the end of each rope.

A Very important part of growing ropes are the pegs made of thin bamboo pieces about 25 centimeters long and 1.5 centimeters wide. Insert these pegs into the lay of the rope at 30-centimeter intervals.

The bamboo pegs prevent the heavy toad of rapidly growing mussels from slipping off the rope. This is likely to occur during bad weather, during the lifting of the rope for regular inspection, or during harvest.

Growing ropes could be treated with tar for added strength and longer life. If you will do this, insert the pegs into the lay of the rope before treatment.

In contrast to collector ropes, growing ropes should be hung at least one meter apart. Hanging growing ropes too close to each other results in slower growth of the mussels. It also promotes siltation. Length of the rope depends on the depth of low tide. In deep waters (3 to 5 meters), the ropes may be suspended individually from the bamboo frame.

If you wish to collect and grow mussels on the same rope, the ropes may be prepared as for growing ropes. Additionally, however, insert coconut husk pieces into the lay of rope about 15 centimeters apart. The rope should be spaced as for growing ropes - at least one meter apart.

SOURCE: Manual on Mussel Farming by W.G. Yap et al., SEAFDEC Aquaculture Department, Tigbauan, Iloilo, September 1979.

PROTECT THE MUSSELS FROM PREDATORS, PARASITES, PESTS AND SILT

Inspect your mussel farm regularly and remove predators, parasites, pests and silt. Predators such as crabs and sea urchins can be driven off or pried loose by a stick. Scrape off with a knife harmful organisms growing on the mussel shells and on the ropes. Also, you may expose the mussel-filled ropes for a short period during the early morning or late afternoon when sunshine is not too intense.

Pests and other foulers growing on the mussels or on the ropes reduce yield by crowding or smothering newly settled spat and slowing down movement of water and food for the mussels. These organisms and silt add to the weight of the mussels and ropes thus forcing you to add buoys which would add to your expenses.

Silt should be shaken off the ropes regularly.

Poachers or thieves could be your greatest profit-stealers. As the raft method of culture allows for easy harvest, by the same

token, it can be easily stolen. You must guard the farm vigilantly especially when the mussels have grown to marketable size.

SOURCE: Manual on Mussel Farming by W.G. Yap *et al.*, SEAFDEC Aquaculture Department, Sept. 1979.

HOW TO HARVEST MUSSELS GROWN BY *TULOS* AND ROPE-WEB METHODS

Mussels can be harvested six to ten months after the stakes or the rope-web plots are set. At this time, the mussels should be about five to ten centimeters long. Harvest at low tide, during daytime, and when the sea is calm.

Prepare your harvesting equipment such as a banca or raft (*balsa*), face masks or goggles and flippers for diving. You could make flippers out of marine plywood to save money.

To harvest mussels raised in the *tulos* method, pull up the mussel-laden stakes and load them in the banca. Remove the mussels with the use of an iron rod or any rigid object. Use gloves to avoid cutting your fingers.

Clean the mussels of dirt and mud. Put them in a nylon net bag and shake them in sea water. Pile the clean mussels in one corner of the banca. To shed off the barnacles (*talipitip*) that have attached to the mussels, vigorously beat a half-filled bag of mussels against the side of the banca. Then dip and shake the hag in sea water.

You will find it difficult to harvest a stake with a dense growth of mussels having different sizes. If there are more small mussels or spats, postpone harvesting until most of the crop attain marketable size. However, you could also harvest partially. Pull up only those stakes which have dense growth of harvestable mussels. For stakes having more small mussels, the diver can gather only the bigger ones and leave the stakes posted.

In rope-web method, harvest the mussels by untying the rope-webs from the poles and lifting them to the banca or raft. Manually detach the clusters from the ropes. Cut off the "beard" from the

mussels with a sharp knife. Load the mussels in big bamboo-woven baskets (*kaing* or *takuyan*) and dip them repeatedly in sea water. Once cleaned, pack them in synthetic sacks for marketing.

You could use the rope-webs for many more croppings. Scrape off the dirt and dry under the sun.

SOURCE: Philippines Recommends for Mussel and Oyster 1977.

HARVESTING AND TRANSPORTING MUSSELS

Most consumers prefer medium or "bite-size" mussels hence mussels should be harvested before they grow too big.

Also, the mussel's meat should be fat, not thin. A fat meat is full-bodied and attractive; males have a rich, creamy appearance while females are filled with bright-orange eggs in almost every part of the body. The flesh of fat mussels shrinks only slightly after cooking.

In contrast, the flesh of thin mussels is watery and transparent and shrinks to less than half of its original size when cooked.

Mussels cultured on ropes attached to rafts grow faster and taste better than those grown in stakes. Stake-grown mussels usually contain mud.

Here are some more pointers in harvesting mussels:

While detaching mussels from the rope, care must be taken not to injure them by seeing to it that their byssus threads ("beard") are not pulled out. These threads are very important part of their bodies. The mussels die within a few hours if these threads are so violently pulled out as to include the muscular supports.

For this reason, the mussels should be scraped off with a sharp knife or bolo and should never be pulled off the ropes. Or, the mussels may be detached from the ropes by grasping their byssal attachment rather than the mussels themselves when pulling them off the rope.

Harvest and transport the mussels in clusters to effectively conserve moisture and keep them alive longer. Removing clustered mussels from the rope is relatively easy as the cluster readily slips off.

During transport to market, the mussels should be kept in moistened jute sacks protected from the heat of the sun. Break up the mussel clusters just before they are displayed for sale, again with a sharp knife or a pair of scissors.

Leave at least 10 to 15 percent of the mussels after harvest to serve as breeding stock to produce spats for the following season.

SOURCE: Manual on Mussel Farming by W.G. Yap *et al.*, SEAFDEC Aquaculture Department, 1979.

HOW TO CLEAN AND PRESERVE MUSSEL

Premium price is usually obtained for clean uncontaminated mussel meat. In addition, mussel sold shucked (meat has been removed from the shell) would command a better price.

The first step in cleaning mussels is to purify them. Purification is a process in which the mussels are allowed to cleanse themselves of pollutants in clean sea water for a number of hours. Remember that mussels exposed to low tide are liable to be contaminated with microorganisms. And since they feed by straining the water in their system, chances are they have a high concentration of harmful microorganisms. Therefore they have to be purified.

Clean mussels by scrubbing the shell with stiff brush under running water. Scrape off the byssus or the "beard". Continue washing the mussels until they are free of sand and grit.

To separate the meat from the shell steam or boil the clean mussels for five to ten minutes or until the shells open. Boiling is better because the meat shrinks less. To prevent mussel meat from getting tough, cool the boiled meat immediately by spraying with cool water.

Meat is then removed from the open shells, usually by hand. Also remove the remaining beard and then wash the meat in clean water. Avoid oversoaking.

Mussel meat spoils easily and cannot be kept fresh - even in ice -- for more than 24 hours.

You may further process the meat by freezing, bottling, smoking, and canning.

Freezing. Store the meat at minus 29 degrees Centigrade. The meat will be in excellent condition for at least 9 months.

Bottling. Meat is bottled in brine in the liquor from cooking or in a spiced vinegar.

Tahong could also be jellied and bottled. Pour a gelatine jelly mixed with spiced vinegar over tahong which have been previously pickled in vinegar.

Smoking. Soak the cooked meat in brine for 5 minutes. Then dip in edible oil and place in wire meshed trays for smoking. Allow to dry for 25 minutes. Smoke at 71 degrees Centigrade for 25 minutes. Finally, pack the meat in jars or cans.

Canning. Tahong meat could be canned in brine, oil, or sauce. Heat processing is required. The meat shrinks during processing with weight reduction of up to 16 percent.

SOURCE: Mussel Culture in the Philippines, a Manual prepared by BFAR and the SEAFDEC Aquaculture Department.

TRY THESE NOVEL MUSSEL RECIPES

Mussel can be prepared in so many ways, the simplest of which is boiling or baking. But mussel meat can be "adoboed" or prepared into a mouth-watering omelet.

Mussel Adobo: Marinade mussels in vinegar, minced garlic, pepper and soy sauce for thirty minutes. Boil the marinade for

about three minutes. Remove from fire. Fry the mussel meat in hot cooking oil until it turns light brown. Serve with marinade mixture.

Mussel Omelet: Steam 2 dozen small mussels until shells open. Remove meat from shell and heat for one minute in 2 teaspoon butter. Make two 3-egg omelet. Before you fold the omelet put 12 mussels in the center of each and slide the omelet into a heated flame-proof serving dish. Brush the surface with melted butter, sprinkle with a little grated cheese and place the platter under the broiler to melt and brown the cheese. Surround the omelets with tomato sauce and one-third cup sliced cooked mushrooms.



Freshly harvested oysters.

OYSTER FARMING METHODS

The method to use in oyster farming depends upon the substratum and composition of the soil and sub-soil.

If the substratum is muddy and soft enough for the posts to be easily planted to the bottom at a minimum depth of one-half meter, then you should use either the *tulos* or the *bitin* method. For hard bottoms, the broadcast method would be more applicable and practicable. However, the substratum should be one that is not exposed to strong currents.

Place the oyster spat collectors in the spatfall areas during the spawning season to entrap oyster spats before the barnacles adhere to and crowd the collectors. The spawning seasons of oysters are in January to February and July to September.

Oysters spats grow to marketable size of six centimeters or larger in eight to 12 months from the time of setting. As in mussel farming, cropping is timed several days before the beginning of the spawning season.

Tulos or Stake Method

The stake method used in mussel farming can be applied in oyster farming. The only difference is in the height of the stakes. The tip of the stake should extend above the low water mark by about one meter.

Oyster spats are usually abundant at a depth of 84 centimeters from the surface. They cling to the bamboo poles at 15 to 120 centimeters from the lowest tide. They are totally absent at depths of 140 centimeters or deeper in Bacoor Bay.

Bitin or Hanging Method

Aside from the stake method, you may also use the hanging method. Hang strings of oyster shells or coconut shells on a bamboo plot or raft at 25 centimeters intervals.

The oyster or coconut shells with holes punched at the middle are strung together with synthetic rope. Attach the shells to the

string at a uniform spacing of 10 centimeters with the use of bamboo tubes or knots or loops made on the string. Each string should measure from one to two meters depending upon the height of the water. *The lower end of the line should not touch the bottom.*

Hang the strings in a series of horizontal braces called *bila* and *baral* which are suspended in stakes posted at two meters apart in a straight row. Horizontal bamboo supports (*bila*) are fastened or tied at or near the tip of the posts in each row. The opposite posts of the parallel *bila* rows are connected by short horizontal supports (*baral*), forming rough bamboo squares. The entire series of squares form the whole plot. The *bila* and *baral* should be slightly above the water level during mean low tide.

In deep waters where other methods are not possible, the hanging method can be done with a raft or *balsa*. Five to six horizontal bamboo poles (*bila*) are laid side by side and tied together to the short horizontal braces (*baral*). The raft is moored to four-corner posts with enough space to allow the raft to float at different water levels. Hang the string collectors to the braces at 30 to 60 centimeters apart. They should not touch the bottom even during low tide.

The Sabog or Broadcast Method

The *sabog* or broadcast method is an age-old system of oyster farming. Oyster shells, stones, gravels, tin cans, or any piece of hard object are scattered at the bottom where spatfall is known to occur. This method is applicable in areas with a maximum depth of two meters for easy gathering. The substratum should range from hard to semi-hard, sandy or rocky and non-shifting. The farm is usually located in shores or banks near the farmer's house.

OYSTER SHELLS COLLECT MORE SPATS THAN COCONUT SHELLS

Oyster shells are better than coconut shells as collectors of oyster spats, according to a study conducted by SEAFDEC researchers in Banate, Iloilo. On the average, oyster shells collect 3.72 times more spats than coconut shells do.

SOURCE: Research Highlights, '78, SEAFDEC Aquaculture Department.

HARVESTING *TALABA*

Oyster grows to marketable size of six centimeters or larger in eight to 12 months from the time of setting. The way to harvest depends upon the kind of culture used.

To harvest *talaba* raised in the stake or *tulos* method, swim under water and pry off the clusters of oysters from the *tulos* with a mallet or any hard object. When the basket is full, swim back to the banca to unload the crop. Wash the basketfull of oysters by dipping and shaking it vigorously in sea water. Sort out small oysters from the harvest and grow them to marketable size through the *sabog* or broadcast method.

In the hanging or *bitin* method, detach oyster-laden strings or hangings from their hooks and haul them to the raft or banca. Cut the oyster hangings into clusters which are then separated from each other by knocking. Put them in baskets and wash by dipping and shaking in water.

To harvest oysters grown in the *sabog* method, simply rake or dredge them in with a wire scoop net. Eliminate dirt, mud and other foreign matter by shaking the scoop net vigorously in water. Throw back into the water the small oysters.

SOURCE: Philippines Recommends for Mussel and Oyster 1977.

SOUTHERN TAGALOG OYSTER FARMERS HAVE THE EDGE

A wide gap exists in the earnings of Southern Tagalog oyster farmers and their counterparts in other regions of the Philippines. Southern Tagalog farmers get an average gross income of around P10,000 per farm in a year which is 17 times more than what Cagayan Valley farmers get: P585. Western Visayas farmers grossed P2,820 while Ilocos farmers, P713.

This was reported by Dr. Aida R. Librero and Ms. Elizabeth S. Nicolas, program leader and research associate of a SEAFDEC-PCARR Research Program.

Included in the study were 163 oyster farmers - 99 from Ilocos, 6 from Cagayan Valley, 48 from Southern Luzon and 10 in Western Visayas - and 30 mussel farmers from Bacoor, Cavite.

Southern Tagalog farmers produce more oysters per unit area and get a very high price for every oyster sold. Obviously, the most favorable factor on their side is their nearness to Metro Manila where the demand for oysters is high, the researchers said. Oysters sell for as much as P11.54 per can (about 19 liters) in the Southern Tagalog area while farmers in other regions sell their produce at a much lower price. In Western Visayas, for instance, the price is P3.94 a can.

Moreover, Southern Tagalog farmers produced 820 cans per farm, the highest productivity in the country. Western Visayas is second with 715 cans per farm, followed by Cagayan Valley with 292 cans, and Ilocos, 165 cans.

Staking or "tulos" is used by most oyster and mussel farmers. However, the method used in oyster farming varies among the regions. Up north, Cagayan Valley farmers adopted the broadcast method while in Ilocos, both the stake and lattice methods are popular. Southern Luzon farmers use the hanging method where empty shells are suspended in nylon twines collectively called cultches. The stake method is more popular in Western Visayas.

Oyster and mussel farming appear to be easy. Only a little more than one month (1.1 month) in a year is spent by a farmer. The rest of the year is devoted to other occupations, usually fishing where farmers get an average income of P2,386.

Although many farmers complained of predators in their farms, most of them seemed to make little effort to eliminate them. Only about eight percent do it through the catch-and-kill method.

Most of the farmers cited the popularity and profitability of the business when asked why they engaged in oyster/mussel farming.

PANGASINAN FISHFARMER TURNS RIVER INTO AN INSTANT OYSTER AND PRAWN FARM

A Pangasinan fishfarmer has turned a river mouth near Lingayen Gulf into an instant farm for oysters and prawns.

From this farm, he was reportedly able to harvest at one time P48,000 worth of sugpo. Also, he has set up some 50,000 oyster ropes. One rope filled with harvestable oysters can fill a kerosene can which sells at P10 a can which means a potential income of P500,000 from oysters alone.

The enterprising farmer is Binmaley vice mayor Samuel Bautista. His farm was recently visited by SEAFDEC researchers/trainors and some 100 trainees of the on-site training course on milkfish and prawn culture and management conducted by SEAFDEC in Binmaley.

According to the SEAFDEC training team, the instant fish farm was formed when the mouth of the river became blocked with a sand bar which prevented the water from flowing to the sea. On the other side of the sand bar, high sand dunes protect the farm from sea waves.

Mr. Bautista told the researchers and trainors that the farm is not likely to be flooded because the highest flood that has occurred in the area did not affect the river. He said he started developing the river as an oyster farm using the hanging method; attached under the bamboo bridges surrounding his pen are 50,000 ropes of one meter length each. A rope can yield as much as one kerosene can of oysters. At P10 per can, he has a potential income of P500,000 from oysters.

Mr. Bautista said he parcelled out portions of the oyster farm to his workers and encouraged other people to put up their own.

Later, he set up pens for sugpo and siganid. Having had no training in aquaculture, he had to rely only on what he had read about prawn farming, he said. He experimented first with 75 gravid spawners he bought from trawler operators, placing them in cages in the river. However, this initial attempt ended up in failure because of the low salinity of the river.

Undaunted, Bautista bought another batch of gravid spawners, put them in cages, and this time, placed the cages in the sea. Success came one night when he saw that the prawns were vigorously swimming in the cages. The next morning, he saw what he described as yellowish scums which turned out to be eggs attached along the sides of the cages. These "scums" hatched into fry which Bautista used to start his prawn stock. He scooped and transferred them to his pens only a few meters across the sand dunes and reared them to harvestable size. For this effort, he claimed he was able to harvest about 8 tons from which he realized P48,000.

SOURCE: Report of the SEAFDEC-SIA Training Div. on the In-Situ Training program held in Aparri, Cagayan & Binmaley, Pangasinan from Aug. 13 to 22, 1979.

CRABS, OTHER FISHES & AQUATIC PRODUCTS

CRABS, OTHER FISHES	258	
From Taiwan: Tips on growing crabs		260
Monoculture of crabs	261	
Crabs hatch eggs more than once		262
New ways of cooking crabs	263	
Hatcheries for carp culture	264	
The potentials of hito	264	
Trepang is also an export item		265
How to extract agar from seaweeds		266
How to make the tasty squid ring		267
Water hyacinth can be a good livestock feed		268

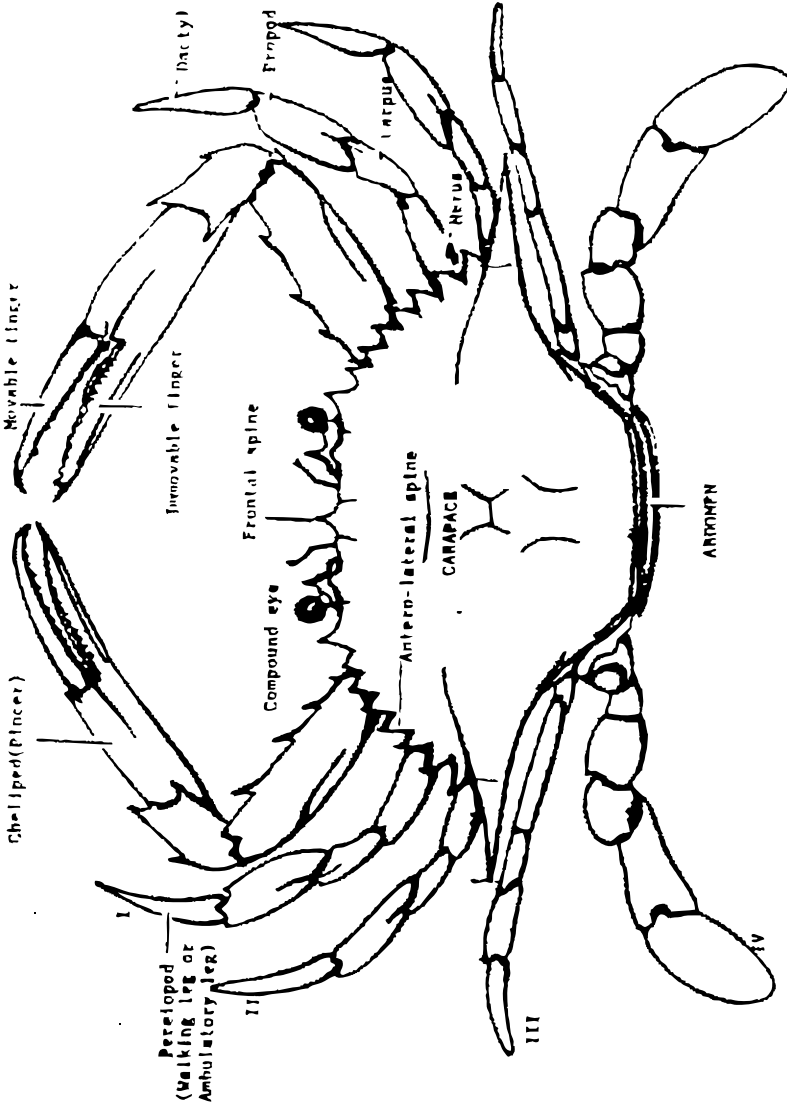

External Morphology of Crab

FROM TAIWAN: TIPS ON GROWING CRABS

Alimango, known scientifically as *Scylla serrata*, is an expensive food item. Because of its scarcity in the market, raising crabs is highly profitable.

In Taiwan, most farmers raise crabs in brackishwater ponds with shrimp plus either or both milkfish and *Gracilaria*, a seaweed. Generally, their ponds range from one-half to two hectares in size with bamboo or plastic fences erected on the mud dikes to prevent escape of crabs. Ponds with concrete dikes are sometimes used.

The baby crabs planted are either those whose carapace (the hard case on the back) are 1.5 to 3 centimeters wide or larger ones of less than 60 grams in weight. They are harvested when they attain a carapace width of 12 centimeters or a weight of 220 grams.

Taiwanese farmers usually stock not more than 10,000 per hectare. The purpose of the culture is primarily for growth, so both males and females are planted.

The feeds usually given are snails, trash fish, internal organs of fish, and almost any kind of food. Soft-shelled snails, mostly freshwater, are preferred over hard-shelled snails because the latter need to be cracked first before they are fed.

The quantity of feeds given daily is equivalent to five percent of the total weight of the crabs. Feeds are given once daily - in the later afternoon - since the crabs usually feed after dark. More feeds are given if the crabs are found to be actively searching for food.

The crabs generally reach marketable size in five to six months. The survival rate is about 50 percent in those cases when small baby crabs are stocked and about 70 percent if larger crabs are stocked. Most of the crabs that have had many copulations have very little meat and bring a very low price. In Taiwan, this is often the case after September. To avoid this, farmers usually harvest their crabs before that time.

MONOCULTURE OF CRABS

Monoculture of crabs or raising crabs alone in the pond is practised by Taiwanese farmers. Their main purpose is to rear only female crabs to maturity with fully ripe gonad (sex gland) to get a better price.

Here's how they do it: Raise female crabs that have just had copulation for a period of one to two months. Because only a few post-copulation females can be obtained at one time, you should provide a number of small ponds to hold the different batches of crabs which are collected at intervals.

For the crab farm, choose a site in the estuarine areas or mouths of rivers where the tidal difference is great to facilitate change of water. Be sure the water salinity or salt concentration is from 15 to 30 parts per thousand. Also, choose a site with sandy bottom as this will be easy to clean.

Build a pond about 350 square meters in size. Or divide a large square pond into four smaller square ponds. Construct a concrete tank of about 1.5 square meters in the center to serve as a water inlet for all the four ponds. When the water is let in, the crabs will congregate in this tank and can be caught there.

The walls of the pond should be about one meter high and should be preferably made of brick or concrete with protruding lips to prevent escape. Just inside the wall, put a layer of bricks on the bottom to form a sloping surface on which feeds can be placed. If walls are made of mud, install bamboo screens obliquely towards the inside of the pond to prevent escape.

Stock the seed crabs anytime between April and September. The stocking rate is generally three crabs per square meter, varying in accordance with the water exchange capacity of the pond. The size of the crabs stocked varies from 7 to 12 centimeters in carapace width.

Snails, trash fish, fish internal organs, and almost any kind of animal food could be used as feeds. However, feed plenty of snails as these have been found to induce the maturation of the crabs. The quantity of feeds given daily is about five percent of the total weight

of the crabs (about 35 kilogram per 1,000 crabs). Feed the crabs once a day and in late afternoon since they usually feed after dark. If the crabs appear to be actively searching for food, add more feed.

SOURCE: Aquaculture Practices in Taiwan by T.P. Chen.

CRABS HATCH EGGS MORE THAN ONCE

Crabs are available throughout the year but most plentiful from May to September. During this period, the price of crabs goes down. The rest of the year, as catch goes down the price goes up.

Nobody knows how long crabs live. But it is not true that mother crabs or spawners immediately die after only one hatching activity.

According to a study conducted by the crab research group of the SEAFDEC Aquaculture Department, one mother crab lived for six months more after hatching about seventy percent of her egg load or about two million larvae. This mother crab died only because the researchers killed and used her for further experiment. Moreover, mother crabs hatch eggs more than once. The other mother crabs in the study showed signs of spawning or rematuration within 30 to 40 days after the previous hatching activity. This spawning occurred without the help of the male crabs.

SOURCE: Originally from the PCARR Handbook for Farm Broadcasters; updated November 1978 by Ms. Alice Laviña of the SEAFDEC Aquaculture Department.

NEW WAYS OF COOKING CRABS

Many good cookbooks contain excellent recipes for cooking crabs. All are useful, one or two being unusual. It seems, however, that there is a lack of information on cleaning crabs. Here are two new ways of preparing crabs for the table:

1. Preparing hard crabs

- a. Cook the crabs either by boiling in a large pot with 1/3 full of water added with a pinch of salt, sliced celery stalks, a dash of vinegar to enhance the flavor or steamed with salt, seasoning, and vinegar.
- b. Allow the cooked crabs to cool.
- c. Pick the edible portions by:
 - 1) Breaking off the legs and the claws and discarding the legs.
 - 2) Loosen the top shell with the use of a thin knife.
 - 3) Remove and discard the feathery gills.
 - 4) Remove the mouth parts and rinse out the contents of the stomach. Break the body into two lengthwise, and pick out the meat from the body compartments.

2. Preparing soft crabs

Cleaning soft crabs is done by removing the inedible portions before cooking. Here's how to prepare soft crabs:

- a. Pull out the apron away from the body with the use of sharp scissors.
- b. Cut off the mouth parts behind the eyestalks.
- c. Pull up the pointed end on one side of the top shell and cut off the gills. Repeat on the other side.

- d. Insert finger and remove the stomach from behind the mouth area, then rinse crab thoroughly. After cleaning, soft crabs may be sauteed, deep-fried or baked.

SOURCE: Successful Crabbing by Ernest S. Cottrell et al. Camden, Maine: International Marine Publishing Co. 1976.

HATCHERIES FOR CARP CULTURE

Carp culture is fast gaining popularity in the Philippines due to some of its desirable qualities such as faster growth rate, herbivorous food habits and their general acceptability by the consumer public.

Different types of carp hatcheries are in vogue depending on the financial capability of the fish breeder. The ones generally used are made of a series of double hatching hapa fixed to bamboo poles in ponds. The inner hatching hapa is made of mosquito net cloth and the outer one is made of close meshed linen cloth. Outdoor hatchery consists of circular cemented hatching pools, either singly or multi-chambered and provided with diagonally-installed pipes at the bottom of the pools for constant circulation of water. Portable hatching jars are also used for incubation.

Indoor hatchery consists of a series of hatching jars made of glass, plastic or fiberglass provided with a continuous flow of water. The jars are cylindrical at the top and cone shaped at the bottom. They are open at the top and have a small hole with a nozzle at the bottom through which a rubber tubing is fitted. Water enters through a beak fitted at the top of the jar. In some instances, sieve-cloth funnels or plastic funnels are used instead of jars.

SOURCE: "Status and problems of carp hatchery and nursery management," H. Chaudhuri, paper presented at the Symposium-Workshop on Fish Hatchery/Nursery Development and Management, PCARR, Los Baños, Laguna, 27-29 September, 1979 (mimeograph).

THE POTENTIALS OF HITO

Hito or catfish thrives in all freshwater lakes, rivers, streams, irrigation canals, ricefields and pools.

Hito culture, however, has not developed as rapidly as milkfish culture in spite of high local and export demands, probably because its culture involves heavy stocking and intensive feeding.

Hito feed consists of 90 percent meat protein and 10 percent rice bran. It can also be fed with ground fish, trash fish, worms,

insects, chicken entrails, dried or freshwater shrimps and fish offals. If these feeds are in short supply, substitute feeds could be used such as, boiled ground rice or rice bran mixed with fishmeal or ground meal.

Efficiently managed ponds can produce as much as 100 metric tons per hectare, considering that hito can grow at the rate of 35 to 40 grams per month and can weigh as much as 175 to 200 grams in six months, according to Ponciano Gutierrez, BFAR Supervising Fishery Biologist. Hito presently sells at P15 a kilo.

Aside from the high local demand, hito combined with *tanguingue* has high export potentials. In 1977 the U.S. imported 830,000 kilograms valued at US \$990,640 while export to Japan was 542,278 kilograms valued at US \$247,803. Other potential markets include Hongkong and the US Trust Territories.

SOURCE: "The prolific hito," Julieta R. Agcaoili, Fisheries Today, Volume II, No. 2, May 1979.

TREPANG IS ALSO AN EXPORT ITEM

Sea cucumber, locally called *trepang* is a delicacy in many countries and rising consumption in China, Singapore and Japan has increased the export demand for this product.

Trepang is usually consumed in processed form, i.e., salted, dried, smoked or cooked and serves as an ingredient for chopsuey, pancit and soup. Used mainly in the manufacture of pure, high grade seafood delicacies it can also be soaked, boiled and dried, then mixed with salt and sodium bicarbonate.

Major exporting countries are Japan and Australia. In 1978, production increased from 226,000 kilograms valued at P2.5 million (1977) to 646,000 kilograms valued at P6.9 million.

Its price in the local market ranges from P10.00 to P14.00 a kilo, depending on supply. It is more abundant during summer than during rainy months.

SOURCE: "The exotic trepang," Antonio Ramos, Fisheries Today, Vol. II, No. 2 May 1979.

HOW TO EXTRACT AGAR FROM SEAWEEDS

Red algae is abundant in the coastal waters of our country. Many of these seaweeds are good sources of agar - or more familiarly recognized as gelatin. Agar is a gelatinous substance extracted from such seaweeds as *Gelidium*, *Gracilaria*, *Gelidiella* and *Eucheuma*.

Eucheuma farming has become a profitable seafarming venture in some places like Zamboanga.

While the agar is not soluble in cold water it can be dissolved and extracted in boiling water.

Here are some ways to extract agar from seaweeds:

1. Gather the appropriate seaweeds and dry and bleach them under the sun.

2. Soak dried-bleached seaweeds overnight.

3. For every 100 grams of dried seaweed, add 3 liters of water and a little acetic acid or ordinary vinegar and boil for one hour.
4

4. Filter the boiled seaweeds through a cheese cloth and pour the liquid agar in a wooden mold.

5. Allow the agar to gel (solidify) at room temperature.

6. Cut the solidified agar into bars and freeze for 5 days.

7. Thaw the frozen agar bars in running water.

8. Dry the bars under the sun.

9. Weigh dried bars and pack them well in plastic bags.

The pulp from the first extraction still contains a good amount of agar and can be boiled again for a second extraction. What to do with the pulp from which agar has been extracted? Try it for fertilizers. Agar, in the form of a sweetened and flavored gel, is a popular item in diets and refreshment preparations.

Note: These recommendations were submitted by Rose Tenedero, a senior training coordinator of the SEAFDEC Aquaculture Department.

HOW TO MAKE THE TASTY SQUID RING

That crispy, crunchy, delicious squid ring which is popular but getting to be rather expensive is a fast-selling product of Iloilo. Although the squid ring makers of Iloilo claim that the quality of their product is due to some trade secrets, you may want to try making your own homemade squid rings. The ingredients are few and the recipe is not that complicated to follow. The following squid ring recipe was contributed to *Fish Farm News* by Mrs. Rose Tenedero, a senior training coordinator of the SEAFDEC Aquaculture Department.

Ingredients are medium sized squid, baking soda, egg and flour mixture, and cooking oil. Fresh squids are preferable.

Procedure:

1. Remove head and internal organs of squids and wash cleaned squid thoroughly with water;
2. Cook the squid in a little water and salt to taste;
3. Slice cooked squid into rings of the desired thickness;
4. Prepare soda water which is done by dissolving two (2) teaspoons baking soda in three (3) cups water. Soak rings in this soda water solution for 30 minutes;
5. Dry the squid rings under the sun for 4 to 6 hours;
6. Roll the squid rings in the egg and flour mixture;
7. Fry in deep fat. Drain the excess oil from the rings;
8. Cool and pack your squid rings in plastic bags and seal tightly.

WATER HYACINTH CAN BE A GOOD LIVESTOCK FEED

Water hyacinth is often considered as a useless and troublesome aquatic weed. This weed however can be a good livestock feed.

According to a report contained in the November 1978 issue of *Asian Livestock*, water hyacinth is being used as livestock feed in many Asian countries. In Indonesia, pigs are fed rations containing water hyacinth. In China, swine raisers boil chopped water hyacinth with vegetable wastes, rice bran, copra cake and salt to make a suitable feed. In Malaysia, fresh water hyacinth is cooked with rice bran and fish meal and mixed with copra meal as feed for pigs, ducks and fish in ponds.

Aquatic weeds such as the water hyacinth contain ten to twenty-six percent crude protein when dried. This is equal to or even higher than that of forages. The low fiber content of aquatic weeds also makes them potential substitute for hay and other roughages eaten by grass-eating animals. As a roughage, the water hyacinth is satisfactorily digested by animals.

However, despite these potentials, many attempts to feed aquatic plants to animals have failed, the report said. One reason is that the hyacinth used was not in the right stage of growth. Also, the hyacinth was not properly prepared before feeding to animals.

The report suggested the following ways of preparing water hyacinth as feed:

1. Don't use hyacinth or other aquatic weeds covered with sand, silt and carbonates.

2. Choose lush, succulent, tall-stemmed hyacinth.

3. To reduce moisture and mineral content of aquatic weeds, chop and press them lightly before feeding directly to the animals. You can dry them in the sun to make hay or further dry them up using hot air so that they will not get moldy when stored. They could also be ground into meal or pelleted for easy handling.

4. You can also make water hyacinth into palatable, nutritious and digestible silage which will be readily accepted by cattle and sheep.

INTEGRATED FARMING

- INTEGRATED FARMING 270**
- More income from integrated fish-livestock-crop farming **271**
 - You can practice and succeed in integrated fish farming **272**
 - Rice-fish culture: a new hope for farmers **273**
 - More tips on rice-fish culture **277**
 - Rotation of rice and fish — an alternative to rice-fish culture **278**
 - Tilapia fingerlings can be grown in rice paddies **279**
 - Fish-livestock farms gave highest rate of farm income **279**
 - Rice, fish, and frogs: 3-in-1 project **280**
 - Piggery and bangos farming go together **281**
 - Small and big farms alike can make good use of biogas **282**
 - Expert cites benefits from multi-commodity farming **283**
 - Tips from Malaysia on integrated fish-livestock crop farming **284**
 - "Farm of the future" **286**
 - Duck-fish farming **287**
 - Gabi — a versatile and profitable "extra" crop **288**
 - Gabi raised with fish can be profitable **289**
 - Fish-pig combination ups fish yield by more than four times **289**
 - Rice-vegetable-fish one-hectare farm grosses P25,000 a year **290**

MORE INCOME FROM INTEGRATED FISH-LIVESTOCK-CROP FARMING

Fishfarming combined with either or both livestock and crop production can enable a farmer who is cultivating a small area to earn more.

According to an article contained in the October 1978 issue of *Asian Livestock*, several combinations of livestock-fish-crop farming are possible. Among these are: *rice and fish in irrigated rice fields*; *rice-fish-vegetables*; *swine-chicken-fish*; *swine-fish-rice-forage-other crops*; *duck-fish*; and *fish-goat-raising*.

Raising fish in rice fields is an old practice widely adopted in several countries in Asia. For a while, this type of farming met some difficulties when modern rice cultivation was introduced. The new technology requires the use of insecticides, some of which are poisonous to fish. However, this problem was solved when insect-resistant rice varieties were developed.

In the Philippines, one hectare of irrigated rice land can yield from 100 to 200 kilograms of carp or tilapia in addition to about 3,500 kilograms of rice. Farm income is further boosted if the farmer grows vegetables like eggplant, onion, tomatoes, beans, or even banana plants on the widened dikes.

In swine-fish-chicken combination, the animal manure is used to produce feed for the fish. About 20 to 30 kilograms of pig or chicken manure can produce one kilogram of carp. The manure from 15 to 25 pigs can sufficiently supply feeds to a one-hectare fish pond. Moreover, this system controls pollution as animal wastes go directly to the fish.

With a small capital, integrated swine-fish-rice-forage crop farming can be achieved. In this case, animal wastes go to a digester which produces methane gas. The effluent water from the digester flows into an algae pond where chlorella is grown to provide feeds for poultry and swine. The surplus water is then channeled to a fish pond where fast-growing species can be cultured in the plankton-rich water. Water drained from the pond is further used for irrigation of rice crops and leguminous fodder which can be fed back to the animals.

Another simple but profitable combination is duck-fish farming. Ducks make use of the pond water surface and aquatic food in the shallow parts of the pond while the fish thrive on the droppings of the ducks which fertilize the pond. It is estimated that 500 ducks kept in a one-hectare pond would give 36 tons of manure in a year sufficient to yield 1,800 kilograms of fish.

Raising goats on fishpond dikes is another possibility. Goats could keep down the grass growth on the pond dikes while providing milk and meat to the fishfarmer. This, however, has to be studied adequately, the article mentioned.

YOU CAN PRACTICE AND SUCCEED IN INTEGRATED FISH FARMING

Integrated fishfarming offers many advantages. For instance, manure from hogs, poultry, cattle, goats, or ducks enrich the pond water. For a fishpond operator, this would mean free fertilizer besides getting additional income from livestock products.

Take the case of Mr. Ernesto Jamandre, Sr. of Iloilo. His 1,200 heads of hogs give enough manure to supply nutrients to the chlorella ponds which feed tilapia. Furthermore, the digested manure goes to his milkfish and prawn ponds. Not satisfied with this, he has added a few heads of Brahman cattle to his complex. With an abundant supply of manure, Jamandre has even acquired a cheap source of energy. He has installed biogas generators.

Another good example is Mr. Ceferino de los Santos, Jr., also of Iloilo. He is manufacturing high grade table and industrial salt from brine which is concentrated from high saline water coming from his fishponds. Salt making is done through the boiling method. He uses open pans over furnaces fueled by sugarcane bagasse, cane trash, coconut husks and firewood. Nothing seems to be useless for this enterprising pond operator -- he uses the ash recovered from the furnaces as soil conditioners to rice and sugarcane fields.

Mr. de los Santos is surprised that the country yearly imports some 150,000 metric tons of salt when almost anyone can make salt through solar and wind evaporation or by boiling concentrated brine. The Philippines, he said, abounds with sea water which is the inexhaustible source of salt.

He pointed to ponds which are not productive during dry months of the year - January to May - due to very low tidal amplitude. These ponds could be made productive through salt making, he said.

SOURCE: Modern Aquaculture for the Philippines by Ceferino de los Santos, Jr. 1978. Iloilo City.

RICE-FISH CULTURE: A NEW HOPE FOR FARMERS

Rice-fish culture can increase the country's fish production by 20 percent, according to Dr. Catalino dela Cruz, director of the Central Luzon State University freshwater aquaculture center. Our country now has some one and one-half (1.5) million hectares of irrigated rice land which can be used to produce about 300,000 tons of *Tilapia nilotica* or a combination of *Tilapia nilotica* and common carp. This quantity is more than two-and-one-half times the present production in fishponds, he said.

The fisheries expert says that fish culture in paddies planted to high yielding rice varieties require very little change in land preparation and rice culture techniques. In other words, it does not conflict with the present practices of fish farmers.

An average fish yield of 204 kilograms per hectare per crop was obtained from the rice-fish farming field tests. About 10 percent or P677 per hectare was added to the rice farmer's income. The net income was arrived at after deducting all expenses which included six cavans of rice amounting to P330 representing the reduction in rice yield as a result of using part of the field for fish trenches.

The main requirements for a *palay-isdaan* are fingerlings and labor. Rice bran - a feed supplement - could be given but even without supplementary feeding, fish can grow at the rate of more than one-third (.37 gram a day).

Considerations for the Farm Layout

There are six factors to consider in designing the rice-fish culture area. These are: *site selection, size of paddy, trenching, water supply, dikes, and screens.*

First, the area should be free from flooding, far from source of insecticide contamination, and must provide better control of water. For good water control the land must have a clayey soil to lessen excessive escape of water by soil penetration. Also, drainage by gravity could be done whenever needed.

Second, each rice paddy should be independent of each other so that one paddy can be drained or filled with water at will. Paddy size may vary from 100 to 2,500 square meters, as long as there is even flooding and enough number of trenches are dug. At the Freshwater Aquaculture Center, the size of individual paddies is 200 square meters.

Third, paddies are provided with trenches running through the area where water can be held. Trenches serve both as a refuge for fish when water falls to a very low level and as a passageway for the fish in moving around the paddy. Trenches also make it easy to harvest the fish; when the water level is lowered at harvest time, the fish collect inside the trenches and can be easily harvested from there.

One can dig peripheral trenches (dug along the perimeter of the paddy) or place them so that they cross the center of the paddy either running across or lengthwise. However, for a 200 square-meter paddy, the researchers have found out that a peripheral trench wastes some 30 percent of the land area. At the Freshwater Aquaculture Center, a single trench running lengthwise at the center has proven to be sufficient for a 200 square meter area. This kind of trench uses up only 10 percent of the land area. It was further shown that the 10 percent reduction in space did not significantly reduce the rice yield compared to an equal area without trench.

Paddies more than 200 square meters in area would need more than one but properly spaced trenches. Spacing between trenches should be approximately 10 meters, the researchers recommend.

The fourth consideration is water supply. Water entering into the paddy should be free from unwanted animals or fish species, free of poisonous materials, and does not contain excessive amount of silt. They suggest that if communal irrigation water is used, you should test the water by filling a pail with it and putting live fish to enable you to observe if the fish die or live.

The fifth consideration involves the dikes. Dikes in paddies to be used for rice-fish culture should be higher than dikes normally used for rice culture alone. It should be strong enough to retain water at a minimal loss. Considered satisfactory is a dike some one-half meter or 50 centimeters wide at the base, 40 centimeters high, and about 30 to 40 centimeters wide at the top. Grasses and weeds at the dikes should be trimmed as they provide hiding places for rats and other pests.

The last consideration in farm layout or design is the screen. Place a screen in every water intake gate and drainage gate to prevent unwanted fish from getting washed into the paddy. The screens can be placed at a certain height so that during heavy rains, excess water can spill through.

Fish Culture in a Rice-Fish Farm

What to raise? Three types of fish can be successfully raised in the rice paddies: *Tilapia nilotica*, monosex *Tilapia mossambica* and common carp. You may raise them singly (monoculture) or in combination (polyculture).

Never allow mudfish and catfish to enter the rice paddies. These fish species are difficult to contain in the paddies and may cause you poor harvest.

How much to stock. The number of fish to stock in a given area depends on the size and the species to be grown and availability of food. Without supplemental feeding and if to be grown alone (monoculture), you may stock one hectare of rice paddies with 5,000 tilapia fingerlings or 3,000 to 4,000 common carp fingerlings. If tilapia is grown with carp (polyculture) the rate of stocking should be 4,000 tilapia and 2,000 carp per hectare.

Provide a nursery pond to hold young Tilapia which you could use for the next cropping season. To ensure steady supply of fry, maintain a breeding pond where fry could be continuously produced.

Fingerling size. Fish must be able to attain harvestable size by the time rice is to be harvested. Hence, the size of the fingerlings to be stocked will depend on how long the rice matures after transplanting. The culture period of the fish varies from 80 to 100 days.

Care of fingerlings. Prior to stocking, the fingerlings should not be left out of the water for a very long period of time. Avoid overcrowding them in transport containers. Also, see to it that the water is good. Transfer the fingerlings slowly to the paddies. Allow several minutes to pass so that the water temperature in the transport container and in the paddy are almost equal.

Rice Culture in a Rice-Fish Farm

Use the latest IRRI varieties that are resistant to insects and diseases. Traditional varieties are not good because they are susceptible to insects and diseases, give low yields, take longer periods to grow, and do not respond well to fertilizers.

In general, the techniques recommended by government technicians on rice farming should be followed. However, fertilization and water management will have to be slightly altered for rice-fish culture.

The use of fertilizer. Part of the fertilizer applied in the rice paddies goes to the production of plankton and other organisms which serve as natural fish food. Apply the usual requirement for growing rice alone. However, avoid using acid forming types such as ammonium sulfate which is toxic or poisonous to fish. The usual practice at the Freshwater Aquaculture Center is to do basal fertilization prior to transplanting at the rate of 150 kilograms 16-20-0 and 75 kilograms urea per hectare. After 40 to 60 days from transplanting, another 75 kilograms of urea per hectare is applied.

Water management. Water must be kept in the paddy at all times while the fish are there. When fish and rice are still small, keep the water shallow, about 2 to 5 centimeters deep. As the rice grows, increase the water depth to 10 to 15 centimeters.

Place a screen in every water intake gate to prevent entry of mudfish, catfish and other unwanted species. Also place a screen in every drainage gate to prevent stock from escaping.

SOURCE: "Design/layout considerations in a freshwater rice-fish culture farm in the Philippines" by R.G. Arce and C.R. dela Cruz, Technical Publications of the Freshwater Aquaculture Center, Volume I FAC, CLSU, Muñoz, Nueva Ecija, 1978.

MORE TIPS ON RICE-FISH CULTURE

Recommended Varieties

The following IRRI-developed rice varieties are recommended for rice-fish culture because of their resistance to insects: IR 26, IR 30, IR 32, IR 36, IR 38, IR 40 and IR 42. The culture period of these varieties is from 110 to 145 days.

Use Carbofuran pesticides

Trials so far indicate that carbofuran insecticides are not poisonous to fish. And that no chemical residue is left on the fish, which is thus safe for human consumption.

Recommended stocking densities

Recommended species are *Tilapia mossambica*, *Tilapia nilotica* stocked at 3 thousand to 4 thousand per hectare or common carp (*Cyprinus carpio*) at 3 thousand to 4 thousand per hectare. In mixed or *polyculture*, stocking rates are 4 thousand tilapia and 2 thousand carp per hectare. Culture period for the fish is 80 to 110 days.

Profitability

Results from 19 field trials conducted by the Freshwater Aquaculture Center in 1977-1978 at farmer cooperators' ponds showed an average yield of 116 cavans of palay (50 kilos per cavan) and 204 kilograms of fish per hectare per cropping. This yield corresponds to an average net income of about P5,210 per hectare - around P677 more than one can normally get from rice culture alone.

ROTATION OF RICE AND FISH - AN ALTERNATIVE TO RICE-FISH CULTURE

Fears have been expressed on the dangers of uncontrolled use of chemicals leading to contamination of fish in rice-fish culture where both are grown in the same paddy at the same time.

An alternative to this system is rotational cropping of rice and fish, revealed a rice-fish culture researcher Dr. C.R. dela Cruz of the Freshwater Aquaculture Center of the Central Luzon State University. Rotational cropping entails the growing of rice and fish in separate areas or in the same area but at different times.

It offers the following advantages:

1. There is less chance of pesticide build-up in fish tissues since rice fish are grown in separate areas or at different times. By the time rice is harvested, the chemicals may have degraded so that the fish is safe.

2. Pest of rice can be controlled more effectively because the life cycle of the pest is disrupted with the culture of fish.

3. Both rice and fish crops are benefited; left-over fertilizer from the fish paddies can be taken up by the next rice crop while the decaying rice stubble during fish culture enhances growth of natural fish food.

4. Decreased cost of producing rice with the possibility of zero tillage (no cultivation). After harvesting the fish, the paddy bottom can be directly planted to rice. If some weeds or algae grow, a single harrowing could eliminate them.

5. Less construction cost of fish paddy in comparison to a regular fishpond with deeper water and taller and wider dikes.

With rotational cropping, the paddy dike is alternately converted into a rice field and a fishpond. This method, dela Cruz says, would be suitable in irrigated areas and in places within the typhoon belt. Fish instead of rice may be raised during the typhoon months, dela Cruz advised.

TILAPIA FINGERLINGS CAN BE GROWN IN RICE PADDIES

Nile tilapia or *Tilapia nilotica* fingerlings could be successfully produced in rice paddies, according to studies conducted at the Freshwater Aquaculture Center of Central Luzon State University (CLSU) in Muñoz, Nueva Ecija.

Here are some tips gathered from the results of the CLSU-FAC studies:

1. Stocking breeders at a sex ratio of 1:4 - one male for every four females - produced more young fish than the male to female ratios of 1:2 and 1:3.

2. Average gain weight of Nile tilapia breeders decreased as the stocking density was increased from 2,000 to 6,000 breeders per hectare.

3. Breeders fed with rice bran produced more fingerlings than the non-fed breeders. An average of 3,074 fingerlings per 200-square meter plots were produced when breeders were fed with rice bran as against the very low average of 179 per plot of non-fed breeders. This means that fingerling production in rice plots could be viable only if the breeders are fed with rice bran.

SOURCE: Inland Fisheries Project - Philippines, Technical Report No. 12 & 13.

FISH-LIVESTOCK FARMS GAVE HIGHEST RATE OF FARM INCOME

Integrated fish-livestock farms gave the highest rates of farm income, an economic study of integrated farming in Taiwan revealed.

Reported in a paper at the seminar on integrated crop-livestock-fish farming held at PCARR (The Phil. Council for Agriculture and Resources Research) in Los Baños late last year, the Taiwan study said that fish-livestock farming gave a higher production efficiency and farm income than other integrated enterprises. The types of

farms analysed comparatively in the study included three independent enterprises (crop, fish and livestock) and four integrated systems (crop-fish, crop-livestock, fish-livestock and crop-fish-livestock). A representative sample of 20 to 25 farm households for each type of farming was taken. The study was done in 1979 in the Southern area of Taiwan.

Crop farms showed the lowest rate of farm income while crop-livestock fish farm systems gave the second highest rate, next to fish-livestock farms. Integrated farming increased not only the overall agricultural output but also the farm income, the study noted.

SOURCE: "An Economic Analysis of the Integrated Crop-Livestock-Fish-Farming in Taiwan," Chaur Shyan Lee, Research Institute of Agric'l Economics, National Chung Hsing University, Taichung, Taiwan.

RICE, FISH, AND FROGS: 3-IN-1 PROJECT

A rice farmer in Pangasinan is getting more than rice from his four-hectare farm. He also harvests giant tilapia and edible frogs.

Faustino Romoa, a farmer-leader in Barangay Sumabnit, Binalonan, Pangasinan, calls his farm a "three-in-one project."

During the planting season, he plants palay in the fields, and lets out tilapia fingerlings and tadpoles of the edible frog locally known as *tukak* in the water.

At harvest time, or after four months, he reaps the rice and gets the giant tilapia and frogs from his field. In the process, he earns three times more than if he planted only rice.

The tilapia fingerlings and the *tukak* tadpoles are nourished in a breeding pond for a month. Then they are separated, transplanted and sown in the rice paddies. To make harvesting easier, Romoa dug small canals in the center of each paddy where fish and frogs can be collected as soon as the paddy is drained.

Romoa's farm is a natural environment for the rice, the fish and the frogs. The growing palay serves as shade for the finger-

lings; and the frogs feed on almost all insects, thus also helping in the control of plant pests.

For fish food, Romoa discovered that bamboo and hill termites are good additional feeds, aside from *darak* (rice bran) and bread crumbs. He also uses harmless fertilizers such as the 16-20-0 variety, and urea, which stimulates the growth of *lumot* - another essential fish food.

A motor pump draws water from a well and supplies enough freshwater needed by the tilapia. Romoa does not use irrigation water because of the pesticides it contains.

Another interesting feature of Romoa's farm is that 500 cavans of undried rice stalks are left to rot right in the field. In three months, he will have fertilizer out of this heap of decayed stalks for free. By summer, the system will include other crops like mungo, Taiwan catfish - a variety which breeds rapidly - and giant frogs.

SOURCE: Philippine Farmers' Journal, March 1979.

PIGGERY AND BANGOS FARMING GO TOGETHER

Our country could easily save some P178 million worth of fertilizer if the animal wastes - which are rich in organic nitrogen - are used.

Hog manure, for instance, could be used to fertilize bangos ponds. This is exactly what progressive Iloilo bangos raisers do. They raise about 15 hogs to supply fertilizer to a one-hectare farm. The combined farming gives them increased bangos yield and higher return to investment.

Here's how hog manure is made into fertilizer:

Mix one-and-a-half kilogram of hog manure with water in a big 8-gallon plastic pail. Leave the mixture overnight. Filter in a clean jute bag to remove the big particles. The filtered manure plus a small amount of urea - added at a rate of 0.3 grams per liter of water - is then poured into the pond water. This serves as the fertilizing solution.

Dried hog manure can also be applied to the fishpond at a rate of 13.5 sacks per hectare.

The use of hog manure as pond fertilizer enhances growth of *lablab* and other natural foods.

SOURCE: Philippines Recommends for Bangos 1978. PCARR.

SMALL AND BIG FARMS ALIKE CAN MAKE GOOD USE OF BIOGAS

Small farms as well as big ones can diversify operations and make full and effective use of the biogas generated from the manures of pigs and poultry.

A small-farm of only 1.6 hectares in Santa Barbara, Pangasinan raises fruit trees, vegetables, pigs, broilers and fish. Manure from 16 sows and 1,600 broilers is fed into a digester for biogas production. The liquid sludge from the digester - said to be a better fertilizer than fresh manure - is then used to fertilize the orchard, the vegetable plots, and the fishpond. Entrails of dressed chicken from the farm, chopped banana stalks and vegetable scraps are cooked in the farm's biogas-fired stoves. The cooked mixture is fed to the pigs. Biogas is also used for various farm and household purposes. This 1.6-hectare farm is owned by Manuela Maramba of Sta. Barbara, Pangasinan.

On the other hand, the 24-hectare Maya Farms complex in Antipolo, Rizal has installed a biogas plant and efficiently uses the sludge and the biogas product. The Maya Farm integrates hog raising with slaughtering, meat processing and canning, as well as feed mixing and crop and fish production.

The farm's biogas plant serves to eliminate the odor of the manure from 10,000 pigs; the biogas is used in cooking at the canning plant, in heating the scalding tanks at the slaughterhouse, running gas refrigerators, water heaters, water pumps, and the corn grinder as well as other farm machinery. In turn, the sludge from the digester is settled in lagoons, recovered, dried, and processed into feed materials. The water from the lagoon is then channeled to the fields planted to sweet corn and vegetables. It serves as a

liquid fertilizer to the corn and vegetable plots. Also, the liquid fertilizer along with sweepings from the pigpens are used to fertilize the farm's fishponds which yield about 2 tons of tilapia per hectare in three months.

EXPERT CITES BENEFITS FROM MULTI-COMMODITY FARMING

A rapidly growing population, more and more fragmented small farms and the high cost of energy have combined to make more urgent and to favor the practice of integrated multi-commodity farming or simultaneously growing in one area more than one food commodity. This according to PCARR fisheries research director Elvira O. Tan in a paper she presented in a recent scientific conference on integrated crop-livestock-fish farming.

Dr. Tan said the growing population demands a sustained increase in production; the land reform program which limits ownership of land to 7 hectares as well as the eventual subdivision of land parcels among children of a farm family calls for the fullest use of farm resources; and the energy crisis requires that we become self-reliant in the production of food as well as energy source.

All these can be answered by integrated farming which makes very efficient use of food production resources in farms, she said.

The following articles, which were reviewed and reported by Dr. Tan in her paper, illustrate various proven experiences as well as promising trials on integrated farming in the Philippines.

ILOILO FARM INTEGRATES PRODUCTION OF FISH, PIG, CATTLE, AND COCONUT

A 120-hectare milkfish brackishwater pond in Iloilo province started producing higher yields when the operator started applying raw sewage from pigpens. The Jamandre Farm, owned and operated by Ernesto Jamandre, has two piggery units. One supplies clear water effluent from a digester to the nursery ponds while the other

unit - which has a four-compartment treatment tank - supplies sludge through plastic hoses to the farm's grow-out ponds.

Jamandre reported a total pig stock of around 1,200 including 134 sows and eight boars of pure breeds.

His farm also includes about 35 heads of cattle which are made to graze on the six-meter wide principal dikes and on a 16-hectare coconut area in which grass is growing. The coconut area adjoins the fishponds.

Jamandre also raises shrimps and some tilapia in his fishponds.

SOURCE: "The Phil. experience in integrated crop-livestock-fish farming systems," Dr. Elvira O. Tan, PCARR, Nov. 1979.

TIPS FROM MALAYSIA ON INTEGRATED FISH-LIVESTOCK-CROP FARMING

A. *Fish and Pig Culture*

A case study conducted in Penang, Malaysia on fish and pig culture showed that a yield of around 3,260 pounds of fish per acre per year was attained. This yield is equivalent to about 3,655 kilograms per hectare per year. Fish stocked in the pig manure-fertilized fish ponds included grass carp, common carp, silver carp and tilapia.

In the fish-pig culture, waste water from the piggens is channelled directly into the ponds. Pigs are fed with a soft diet consisting of boiled succulent vegetable feeds. Usually given are tubers and succulent stalks of sweet potato, cassava leaves and tubers, chopped banana stem, kangkong, and other succulents. These crops, you may note, are grown both for human food and animal feed.

B. *Fish and Chicken Culture*

Trials done at the Malaysian Agricultural Research Development Institute station in Malacca has shown the great possibility of rearing chickens above a freshwater pond stocked with the giant freshwater

shrimp (*Macrobrachium rosenbergii*) and a mixture of other freshwater fishes.

In the experiment, a poultry shed was built above the fishpond. At the end of four months some 242 kilograms per acre (equivalent to 598 kilogram per hectare as 1 acre is about 0.4 hectare) of shrimp and the same amount of fish were harvested. The chicken attained weights of from 1.2 to 1.8 kilos each. A hundred chicken can keep one acre (0.4 hectare) of fishpond in constant productivity, reports from Malaysia indicate.

C. *Fish and Duck Culture*

Disused mining pools in Malaysia are utilized for the culture of fish consisting of grass carp, silver carp, and bighead carp. Vegetables are planted next to these pools where pigs are reared and ducks are kept. Malaysian Agricultural Research Development Institute tests have shown that polyculture of freshwater prawn and fish and duck is feasible. In the experiments, the fish were not given supplementary feed.

The recommended stocking rate of ducks is 100 per acre to be grown in four months. This is equivalent to 250 ducks per hectare. Two crops of ducks can be raised in one year.

The stocking rate of fish is as follows: 5,000 freshwater shrimp, 250 grass carp, 120 bighead carp, and 100 Indonesian carp. This rate is on a per acre basis. Fish is going to be harvested in nine months and a conservative estimate of one-half ton of fish per acre (or 1.25 tons per hectare) could be attained.

In addition, short term crops like cassava, kangkong, banana and other short term fruit crops like papaya could be integrated into the system.

It was reported that 2,000 ducks can provide 30 tons of droppings annually.

D. *Fish-Pig-Crop-Culture*

The recommended stocking rate in this three-commodity integrated farming system - as reported in Malaysia - is 12 pigs per acre

or 30 pigs per hectare. For a growing period of about 6 months, one can grow two crops of pigs in one year.

For fish, the rate on a per acre basis is 50 grass carp, 200 big head carp, 100 silver carp and 500 common carp or 850 fish per acre (equivalent to 2,125 fish per hectare. Fish is harvested in nine months.

Here, the average weight of each pig after 6 months of rearing is about 214.5 kilos, the report claimed.

Crops recommended for integration are those which are usually grown for both human food and swine feed such as cassava, sweet potato, gabi, banana, and kangkong.

SOURCE: "Tricommodity Integrated Farming in Malaysia" presented by Mr. Ali Bin Ismail at the symposium on Agribusiness System for Integrated Crop-Livestock-Fish Farming held in PCARR, Los Baños, Laguna, Phil., 19 to 25 Nov 1979.

"FARM OF THE FUTURE"

A good model of integrated crop-livestock-fish farming has been put up in 1977 by Central Luzon State University (CLSU).

Called the "Farm of the Future," it produces rice, tilapia (the *Tilapia zillii* type), and 15 other crops for a net income of more than P11,600 per year.

The university uses the farm for economic studies and demonstration. It has the following components:

1. Four tilapia nursery and breeding ponds occupying almost seven hundred square meters;
2. Five rice-fish paddy fields with a combined area of about 8,800 square meters;
3. Several elevated 3 to 4-meter wide dikes for vegetable beds that occupy a total area of around 2,400 square meters;

4. An underground channel along the main farm dike for distributing irrigation water;
5. A pumphouse; and
6. A farm house made of brick.

The farm was developed at a cost of some P57,500 including the farmhouse which cost almost P12,000.

Recently, the farm has been renovated with a few more additions such as the two double-decked poultry houses that can each house 100 broilers. The poultry houses directly deliver chicken manure to a tilapia breeding pond and a tilapia nursery pond. The other improvement comes in the form of a duck house with seven Muscovy ducks for the other nursery pond. Finally, a swine house with four pigs delivering manure to the other tilapia breeding pond has been built. To complete the picture, three small mushroom beds measuring 1 by 2.5 meters each were set up behind the farm house.

SOURCE: "The Phil. experience in integrated crop-livestock-fish farming," Dr. E.O. Tan, PCARR, Nov. 1979.

You can give this a try:

DUCK-FISH FARMING

A report contained in the May 1978 issue of the British magazine, *Fish Farmer*, suggests the profitability of raising ducks and carps in one pond. The ducks make use of the pond water surface and aquatic food in the shallow parts of the pond while the fish thrive on the droppings of the duck which fertilize the pond.

Written by Alex Behrendt of Two-Lakes Fisheries, the report says that ducks kept in open carp ponds should be able to get about one-third of their food needs in the pond. They would therefore only be given half of the usual protein needed to fatten to the desired weight. Ducks can control water weeds and loosen the pond soil bottom for the benefit of the carp. They also eat many under water creatures which the carp do not eat.

An average figure for stocking is 300 ducks per hectare of pond while the carrying capacity may be raised to 500 or more two-year old carps to a hectare.

There are important things to observe, among which are the following: duck-fish farming should be carried out in ponds which can be completely drained; it should not be attempted in gravel pits and ponds which cannot be drained because dangerous infection could set in. Water depth should not exceed one meter. Ducks don't feed to a depth more than one meter. Water with very few underwater weeds should not carry more than 100 ducks per hectare. Oxygen levels in the water must be constantly checked.

An additional production of one kilo of carp for every duck can be expected. This additional fish production is reared at no extra cost, the report mentioned.

GABI - A VERSATILE AND PROFITABLE "EXTRA" CROP

Gabi (aba or aua in Ilocos, abalong, dagmuai or gaway in Visayan, linsa or natong in Bicol) is a versatile and profitable crop that is now being highly recommended for integrated crop-fish-livestock farming.

It commands a good price and one can make use of practically all its parts - the leaves, petiole or stalk, and the corns or fleshy edible roots.

Gabi grows in lowland and upland soils and with or without much soil preparation. It can even tolerate saline (opposite of acidic) soils. Lowland gabi also grows in soils where rice is grown. And in dry upland areas, gabi can grow well, planted mostly in backyards but usually along some drainage canal.

In recent field trials, gabi has been planted at the bottom of paddy dikes in rice-fish culture fields. Farmers in Cavite and other provinces have long been planting gabi in between (intercropped) rows of pineapple or lowland rice.

Aside from being a nutritious food crop, gabi can be a cheap supplemental feed for livestock.

GABI RAISED WITH FISH CAN BE PROFITABLE

At the Central Luzon State University experimental farm, gabi or taro (*Colocasia esculenta*) is being grown simultaneously with tilapia in rice paddies. One trial plot has elevated plots for the gabi plants and trenches for the tilapia. Another system has the entire pond planted to gabi at a spacing distance similar to rice culture.

According to the report, if gabi sells at one peso per plant, a 200 square meter paddy containing 1,000 plants would gross one thousand pesos. This would be a more profitable proposition than the expected 3 cavans of palay that can be produced from the same area but which would be worth P150 only.

FISH-PIG COMBINATION UPS FISH YIELD BY MORE THAN FOUR TIMES

Results of preliminary trials on fish and pig production at the Freshwater Aquaculture Center of the Central Luzon State University have shown that yields of 5,850 kilograms of fish per hectare in 270 days can be obtained. This is more than four times the production from fish alone using the same fish stocking density and with the application of inorganic fertilizer only.

The combination used was 60 pigs and 20,000 fish per hectare. The fish was composed of 17,000 *Tilapia nilotica*, 2,800 *Cyprinus carpio* or common carp and 200 mudfish or snakehead (*Ophicephalus striatus*). Mudfish was added to control too much reproduction of tilapia.

In another trial brackishwater ponds containing 4,000 milkfish and 2,000 tilapia per hectare were supplied directly with pig manure

washed from pens built over the ponds. The system produced an average of 252 kilos of milkfish and 180 kilos of tilapia.

SOURCE: "The Phil. experience in integrated crop-livestock-fish farming systems," Dr. Elvira Tan. PCARR, Nov. 1979.

RICE-VEGETABLE-FISH ONE-HECTARE FARM GROSSES P25,000 A YEAR

A one-hectare farm in Nueva Ecija where the integrated production of rice-vegetables and fish is being done earns a yearly gross income of P25 thousand. This was reported in a paper presented recently at an integrated farming conference by Dr. Elvira Tan, director for fisheries research of the Philippine Council for Agricultural and Resources Research (PCARR).

The farm, owned by Francisco Carbonel of Nueva Ecija, includes the following features:

1. A tilapia breeding and nursery pond of about 1,000 square meters;
2. Rice-fish paddies of around 9,000 square meters;
3. Slightly raised paddy dikes with a width of 1.5 to 2 meters occupy a combined area of 1,000 square meters; and
4. An independent and reliable water supply with underground channels runs along the dikes to the points of delivery.

The farm dikes are planted to vegetables like eggplant, pechay, native onion, tomatoes and beans as well as fruit bearing plants like citrus and bananas. Gabi are also planted at the base of the paddy dikes.

Rice, however, is still the major crop.

Mr. Carbonel invested some P12,000 for the project which has increased his gross farm income from P10,000 to P25,000 per year.

ADDITIONAL INFORMATION

Warning to prospective fishpond operators:

BEWARE OF ACID SULFATE SOILS

If you're looking for a fishpond site, be sure the soil is not acidic or potentially acidic. All your investments may go down the drain if you build your fishponds in such areas.

Fishponds with acid sulfate soils yield low harvests or none at all because of fish mortalities and poor growth of fish.

According to Dr. Virendra Pal Singh, an Indian scientist working at the U.P. Brackishwater Aquaculture Center (BAC) in Leganes, Iloilo, fish hardly grow or survive in acid sulfate soils because of low pH, the poisonous effects of iron and aluminum, poor growth of fish food especially algae and other microscopic plants, and poor physical condition of the soil.

Many fishpond operators in the Philippines could be incurring losses due to acid sulfate soils in their ponds. Singh cited a 1976 survey which revealed that six out of ten fishponds in the Philippines are affected by acid sulfate soil conditions. This, he said, maybe one of the reasons why our country's average milkfish production is low.

Singh reports that acid sulfate soils or potential acid sulfate soils cover over 15 million hectares of land in the tropics nearly 5 million hectares of which are in South and Southeast Asia. Of the 15 million hectares only about 2 million are cultivated. In the Philippines, the extent of acid sulfate soils has not been precisely established although Singh estimates that 15 to 20 thousand hectares of the lands are not being cultivated in the island of Panay alone.

What are acid sulfate soils?

Acid sulfate soils arise from sediments deposited in coastal areas and on land belts bounded by rivers and the sea. When dried and exposed to air, these sediments become acidic due to the oxidation (reaction with oxygen in the air) of sulfides. Sulfides are mainly in the form of a substance called pyrite. When the pyrite is oxidized it leads to the formation of sulfuric acid. Acid sulfate soils contain quantities of aluminum and iron that are poisonous to plants. The pH of acid sulfate soils is as low as 3.5 (very acidic) in some layers in the upper 50 centimeters of the soil profile and less than 4 in the lower layer.

When submerged in water and not exposed to air, acid sulfate soils are nearly neutral (pH value is slightly less than 7) but when the water recedes or the land is drained, the pyrites react with oxygen to form sulfuric acid resulting in an extremely acidic soil.

Most brackishwater fishponds in Southeast Asia are built on mangrove areas. Mangrove swamps and similar areas are known to provide conditions that favor the formation of acid sulfate soils.

In acid sulfate soils, nutrients especially phosphorus are locked in the soil and thus cannot be availed of by plants even if the nutrient is in abundant quantity in the soil. This condition results when the soil is highly acidic and has a high concentration of aluminum and iron. The high concentration of these two elements limits the availability of phosphorus to plants. Thus, even with the application of phosphate fertilizer, phosphorus still cannot be availed of by plants (such as algae and other fishfood) because of the so called binding effect of phosphorus by excess aluminum.

How to improve acid sulfate soils

Investors are advised to proceed cautiously with the development of mangrove areas for fishponds. A detailed soil survey should be conducted first before deciding on whether to push through a project or not. While acid sulfate soils could be improved, the cost of doing so has not been well established, says Singh.

Leaching, liming, and proper fertilization can improve acid sulfate soils. Citing the work at the University of the Philippines Brackishwater Aquaculture Center in Leganes, Iloilo, Singh says

they had to till the pond soil to hasten oxidation. They also subjected the soil to tidal flushing and washing by rain to leach away undesirable sulfates and metals like aluminum and iron. The ponds were then treated with lime which, at different treatment levels, gave noticeable improvement in fish yield compared with the untreated ponds. Applying chicken manure further improved fish production, Singh reports.

He also cited the case of a big fishpond project in Carles, Iloilo where he serves as consultant. Because of extremely acidic soil, the fishpond project had not been productive until remedies were taken to remove the acidity caused by the acid sulfate soil. The pond bottom was tilled two times to speed up oxidation. After levelling and flushing several times with seawater, the pond soil acidity was significantly reduced. Soil pH rose from a very acidic 3.7 to an almost neutral 6.25.

The dikes were also leached by pumping with seawater to wash away the acids. If this were not done, the acidic soil of the dikes would render the pond bottom also acidic after subsequent rains. Chicken manure applied at 5 tons per hectare gave a good indication of *lablab* growth, Singh adds.

Singh gives the following pointers which could help reclaim acid sulfate soils:

One is to limit the oxidation of pyrite and try to render inactive existing soil acidity by constantly maintaining a high water table. This method, however, provides a temporary relief only. The problem is likely to occur again.

The other and more effective approach is to drain the pond intensively to oxidize as much pyrite as possible and then flushing away the oxidized pyrite. According to Singh, the quantity of pyrite present in any acid sulfate soil is not unlimited. Therefore, if these acids by any means can be removed or neutralized, the soil should become neutral in time.

The pond bottom and the dikes should be periodically dried and flushed with seawater. This should be followed by liming and proper fertilization.

To further improve acid sulfate soils, observe the following: liming, covering the acidic soil with a more suitable material like filter mud press — a waste product from sugar mills, covering pond dikes with vegetation to check erosion, lining the dikes with limestone, and good water management and pond fertilization.

Nitrogen and phosphorus can raise primary productivity of fishponds with acid sulfate soils

A study conducted at the University of the Philippines Brackishwater Aquaculture Center has shown that nitrogen and phosphate can raise the primary productivity of fishponds with acid sulfate soils. Primary productivity means the ability of the soil to support fishfood organisms like algae.

Dr. Singh, one of the study leaders, stressed that both nitrogen and phosphorus must be applied in combination and in correct ratios. Applied alone, neither nutrient would give any benefit, he said.

In the study, eight combination of treatments of different levels of nitrogen and phosphorus were applied every two weeks to the experimental fishponds. It was found that the experimental ponds that received 120 kilograms of nitrogen per hectare and 30 kilograms phosphate (P_2O_5) per hectare gave the highest growth of algae. This was followed by the treatment with 60 kilograms nitrogen plus 30 kilograms phosphate per hectare.

As part of the study, the dissolved oxygen content in the water was monitored throughout the duration of the study. It was found that the lowest dissolved oxygen content was recorded in the ponds that received no fertilizer and in those that received 30 kilos of nitrogen per hectare only. On the other hand, the highest dissolved oxygen content was recorded for the treatment of 120 kg N/ha plus 30 kg P_2O_5 per ha.

The application of phosphorus alone or nitrogen alone gave no better result than the control ponds which received no fertilizers at all. This shows that if phosphorus is limiting in the soil, hardly any benefit can be derived from the application of nitrogen alone or potassium alone.

The study also showed that the *ratios of nitrogen and phosphorus are more important* for algae production than the absolute amounts in which they are applied.

SOURCE: "Management of Fishponds with Acid Sulfate Soils," lecture paper presented by Dr. Virendra Pal Singh at the SEARCA-SEAFDEC seminar-workshop on Aquabusiness Project Development and Management (APDEM), Tigbauan, Iloilo, March 2-16, 1980.

GLOSSARY

- Acid — a compound, usually having a sour taste and capable of neutralizing alkalis and reddening blue litmus paper, containing hydrogen which can be replaced by a metal or an electro positive radical to form a salt.
- Acclimatize — to acclimate, or to habituate or become habituated to a new climate or environment.
- Absorb — to swallow up the identity or individuality, to suck up or drink in liquids as a sponge absorbs water.
- Aerate — to charge or treat with air or a gas, especially with carbon dioxide or oxygen.
- Aerobic — organisms or tissues requiring, or not destroyed by the presence of free oxygen.
- Algae — freshwater and marine chlorophyll-bearing plants ranging in size from a few microns to many meters in length.
- Alkaline — pertaining to or having the characteristics of an alkali, or containing an alkali, a compound of hydrogen and oxygen with one of the elements lithium, sodium, potassium, rubidium, and cesium, or ammonium radical.
- Alluvial — pertaining to or composed of earth deposited by water.
- Aquaculture — fish farming, or culture of commercial species of plants and animals in inland bodies of water like ponds, rivers, streams, lakes or reservoirs.
- Assimilation — transformation of digested nutrients into an integral and homogenous part of the organism.
- Available phosphorous — that portion of the phosphorus in the soil that can be readily absorbed and assimilated by growing plants, and in case of fishponds for exchange with water.
- Biology — the science of life and of the origin, structure, reproduction, growth, and development of living organisms.
- Biota — combined fauna and flora of any geographical area.

- Biotic — pertaining to life.
- Brackishwater — any mixture of sea and freshwater with salinity less than 30 parts per thousand.
- Brine shrimp — a small crustacean which is reared for food for young stages of fish and shellfish. Scientific name - *Artemia salina* L.
- Buoyant — having the property to float.
- Carnivore — flesh eating animal.
- Chlorophyll — the green nitrogenous coloring matter contained in the chloroplasts of plants. There are two forms, bluish-green chlorophyll - A, and yellowish-green, Chlorophyll - B.
- Crustaceans — a large class of arthropod animals, like crabs, lobsters, shrimps, etc.
- Culture — the practice of cultivating, as of soil or water, and raising plants and animals for consumption.
- Datum — the point from which any reckoning or scale starts.
- Datum level — the horizontal plane from which heights and depths are measured.
- Degradable — capable of being reduced from a higher to lower type, or capable of deterioration.
- Demersal — found in deep water or on the bottom of streams, pools or oceans.
- Density — mass of a substance per unit of its volume, compactness.
- Deoxygenation — reducing or removing oxygen.
- Detritus — a mass of disintegrated materials
- Diurnal — happening in a day, occurring every day.
- Ecology — the study of the relations of organisms to their environment.
- Ecosystem — the total environmental conditions of a geographic area and the interactions therein.
- Equilibrated — well balanced, a condition of balance among the forces acting within the body or material system.
- Food chain — transfer of food energy through a series of organisms in many stages of eating or being eaten.
- Foreshore — the intertidal beach zone between high and low water marks.
- Gravid — pregnant or ripe, ready to spawn.
- Habitat — the natural environment.

- Hapa net — a rectangular net, like an inverted mosquito net, used to contain fry or fish seeds at initial stocking in nurseries.
- Hatchery — a place for artificial spawning and hatching of fish or shellfish.
- Herbivore — plant eater.
- Inorganic — inanimate, not being animal or vegetable, not the result of living or organic processes.
- Intertidal zone — area on the foreshore lying between low water spring tides and high water spring tides.
- Invertebrates — lower animals without backbones.
- Juveniles — young stages of animals, between postlarval stage to the time they mature sexually.
- Lablab — the name used in the Philippines for the complex growth of aquatic plants and small animals like the algae, bacteria, protozoans and diatoms.
- Larvae — an immature stage of an animal.
- Liner — material, like polythelene sheets, applied to soil or sand surface to retain water and prevent seepage.
- Levee — a natural or artificial embankment constructed to contain water as in a pond.
- Mariculture — sea farming of plants and animals.
- Metamorphose — change of shape, transformation as when the larvae of prawns change from nauplius to mysis to postlarva.
- Molluscs — animals with soft body coverings with limey shells.
- Morphology — that branch of biology which treats of the form and structure of plants and animals, forms of organisms apart from function.
- Moult — to shed the outer covering, like the exoskeleton of shrimps and crabs.
- Mysis — the last larval stage of crustaceans before they transform to young juveniles.
- Nauplius — the first larval stage, usually characterized by unsegmented body and a few appendages.
- Neap tide — tide of minimum amplitude or height occurring during the 1st and last quarter of the moon.
- Niche — a position specially adapted to its occupant.
- Noxious — causing or tending to cause injury to health, pernicious
- Nutrient — something that nourishes

- Organic — pertaining to or of the nature of animals and plants, pertaining to the use of compost, manure, peat moss, and other natural fertilizers.
- Optimum — condition or degree producing the best result.
- Omnivore — eating all kinds of food both animal and vegetable.
- Pelagic — oceanic, living on or near the surface of the ocean
- Peripheral — pertaining to the outer surface, distant from the center, circumference.
- Pesticide — chemicals to kill pests.
- pH — the negative logarithm of the hydrogen ion concentration in grams per liter of a solution: used in expressing relative acidity and alkalinity.
- Photic — those underwater regions which are penetrated by sunlight.
- Photosynthesis — the process by which plants form carbohydrates from carbon dioxide and water thru sunlight acting on chlorophyll.
- Plankton — tiny plants and animals growing in water.
- Phytoplankton — tiny plants which drift with the water current.
- Postlarva — the condition past the larval stages of growth, when the juvenile resemble the adult except for some characteristics.
- Predation — the act of an animal eating another.
- Putrescible — liable to putrefy, decay or decompose.
- Raceway — a long narrow pond where water inlet and outlet are at opposite ends.
- Rotenone — a white crystalline substance, $C_{23}H_{22}O_6$, effective principle in insecticides and fish poisons obtained from the roots of plants specially an Amazonian tree (Genus *Lonchocarpus*) and the Indian derris.
- Run-off — stream or surface water from rain flowing from a catchment area.
- Salinity — saltiness of water expressed in parts per thousand (‰).
- Saponin — one of the several nearly white amorphous glycosides characterized by their ability to form emulsions and soapy lathers.
- Sedimentation — accumulation or deposition of sediments.
- Sluice gate — a structure with a gate or closure for regulating flow of water.

Solvent	— a liquid or substance capable of dissolving other substances.
Soluble	— capable of being uniformly dissolved in a liquid.
Specific gravity	— the ratio of the mass of the body to that of an equal volume of some standard substance, water in case of solids and liquids, and air or hydrogen in case of gases.
Specific heat	— the amount of heat required to raise the temperature of a given substance by one degree.
Species	— category of animals or plants subordinated to a genus but above a breed, race or strain.
Spring tide	— tide of maximum amplitude or height occurring during new and full moon.
Stratification	— to form in layers or strata
Stress	— to put into difficulties or distress.
Sublittoral zone	— shallow, inshore sea with depths of 200 meters or less.
Substrate	— material or substance acted upon by an enzyme or ferment, a substance in which something takes root.
Toxic	— poisonous, due to or caused by poison or toxin.
Translucent	— capable of transmitting light, allowing light to pass thru but not permitting a clear view of the object.
Transparent	— the quality of being transparent, admitting passage of light and clear view of objects beyond.
Turbidity	— the cloudy condition of water caused by impurities.
Unicellular	— single celled.
Up-welling	— the turn over of water by which bottom water is brought up near the surface.
Vertebrate	— higher animal with backbone.
Viscera	— internal organs, specially those of the great cavities of the body as the stomach, lungs, heart, etc.
Viscosity	— state, quality, property or degree of being imperfectly fluid.
Volumetric	— pertaining to measurement of substance by comparison of volume or by volumetric analysis.

- Wavelength — the distance measured along the line of propagation, between two points representing similar phases or two consecutive waves.
- Wind breaker — anything that protects from or breaks the force of the wind.
- Zoea — the larval stage of arthropods, like shrimp and crab.
- Zooplankton — tiny animals which drift with the water current.
- PPM — parts per million.
- PPT — parts per thousand, sometimes written as ‰.



Give a man fish
And you feed him for a day
Teach a man to grow fish
And you feed him for a lifetime

