

Short introduction into

# Analytical Chemistry

by Prof. Dr. Manfred Sietz  
and Dr. Andreas Sonnenberg  
(PowerPoint slides)



# What is Analytical Chemistry?

- study of methods for determining the composition of substances
  - qualitative („what?“)
  - quantitative („how much?“)
- see also:  
*[http://en.wikipedia.org/wiki/Analytical\\_chemistry](http://en.wikipedia.org/wiki/Analytical_chemistry)*, the free encyclopedia



# Overview

Clinical analytical chemistry  
e.g. analysis of blood or urine

Environmental analytical  
chemistry e.g. heavy metals  
in soil or water

Analytical Chemistry

Forensic analytical chemistry  
e.g. comparison of DNA codes  
or trace analysis of clothings  
(„guilty or not?“)

Quality control  
e.g. analysis of vitamin  
content in food samples

# 10 steps of chemical analysis

1. Sampling (sampling errors!)
2. Sample naming
3. Sample preparation
4. Analysis
5. Signal recording
6. Signal processing
7. Evaluation of analysis results (correctness, exactness, reproducibility)
8. Plausibility check
9. Certification
10. Filing



# Instruments for Analysis

## Components of a typical instrument

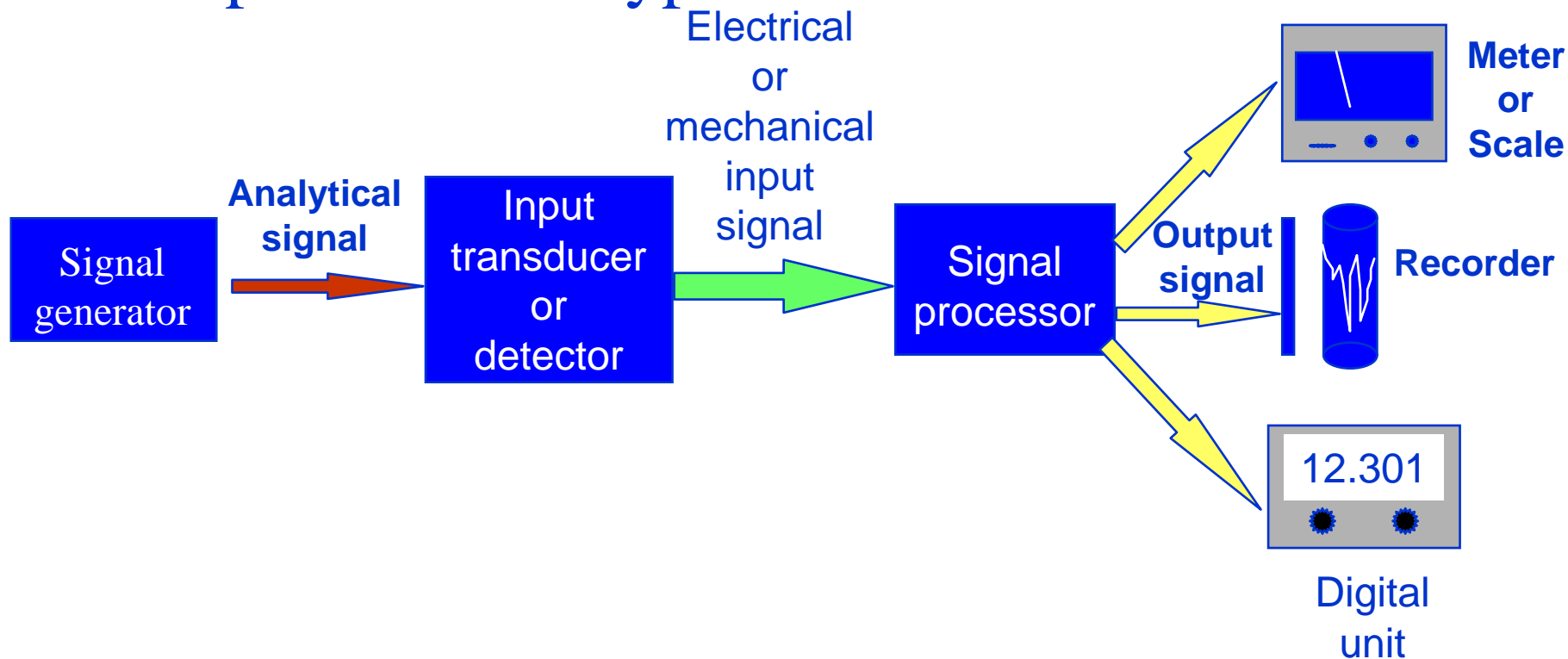

Dr. S. M. Condren

# Evaluation of analysis results

The average value  $\bar{x}$  of all single results in a series of measurements is to be calculated by following formula:

$$\bar{x} = \frac{x_1 + x_2 + x_3 + \dots + x_n}{n} = \sum \frac{x_i}{n}$$

and  $\sum_{i=1}^n$  ; n = number of single results.

The precision P of an analysis is determined by the range of standard deviation S

$$S = \left[ \frac{1}{n-1} \cdot \sum (x_i - \bar{x})^2 \right]^{1/2} \quad \text{und} \quad P = \frac{S}{\bar{x}}$$

# Types of errors

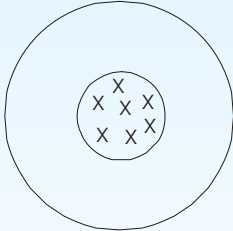
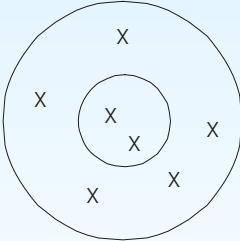
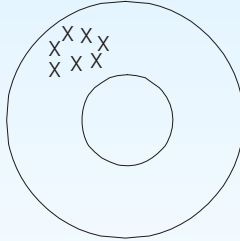
type of error		coincidental error	biased error	gross error
				miss
precision	optimal	bad	good	-
correctness	optimal	good	bad	-

# Extend of correctness and precision

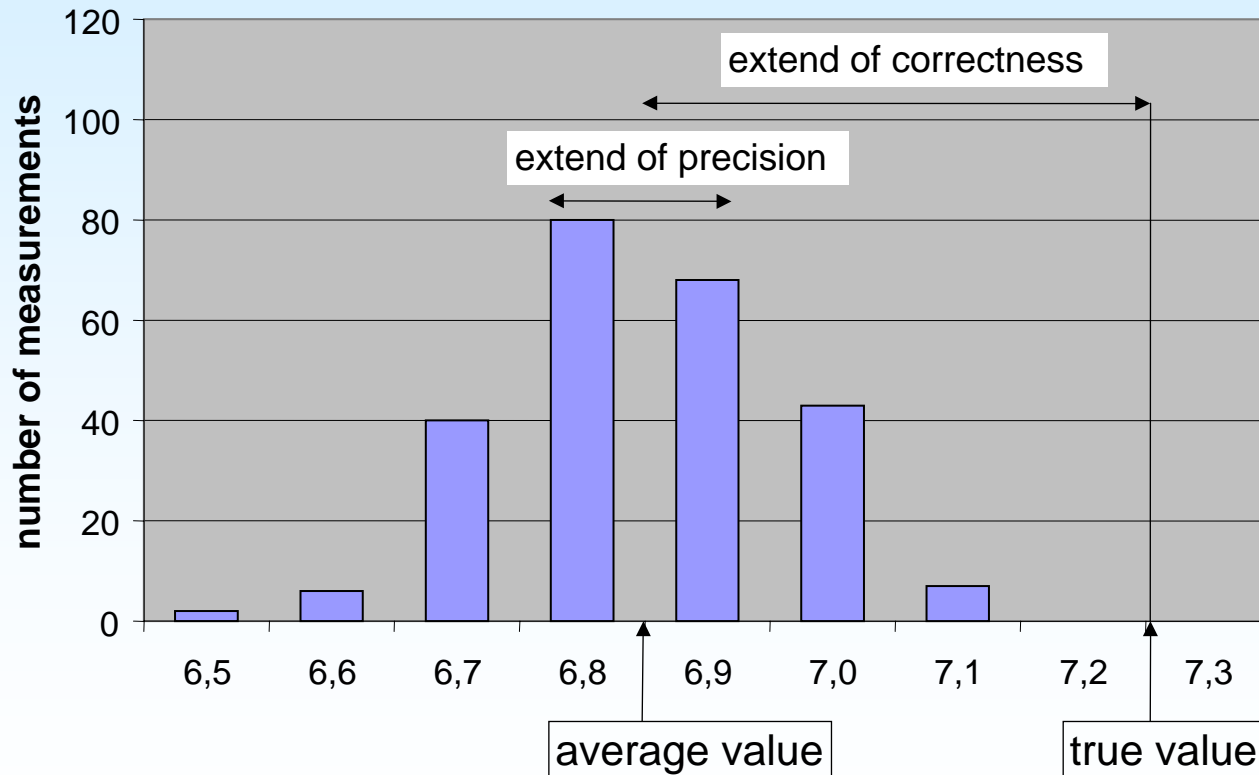



# Concentration units

- A one molecular solution contains 1 mole of a material solved in one liter of solvent (e.g. water). The unit is mole per liter.
- Example: A one molecular saline solution contains 58,44 g common salt NaCl solved in one liter water. 1 g NaCl solved in 1 liter water would correspond to 1000 ppm; 1 mg NaCl solved in 1 L would correspond to 1 ppm.
- One liter water with 25 degree Celsius weighs 1000 g or 1.000.000 mg; 1 mg NaCl in 1.000.000 mg water means, that the water contains 1 ppm NaCl; 1ppm = 1 mg per litre

# Detection limit

Minimum concentration or weight of analyte that can be detected at a known confidence level



# Applicable Concentration Range

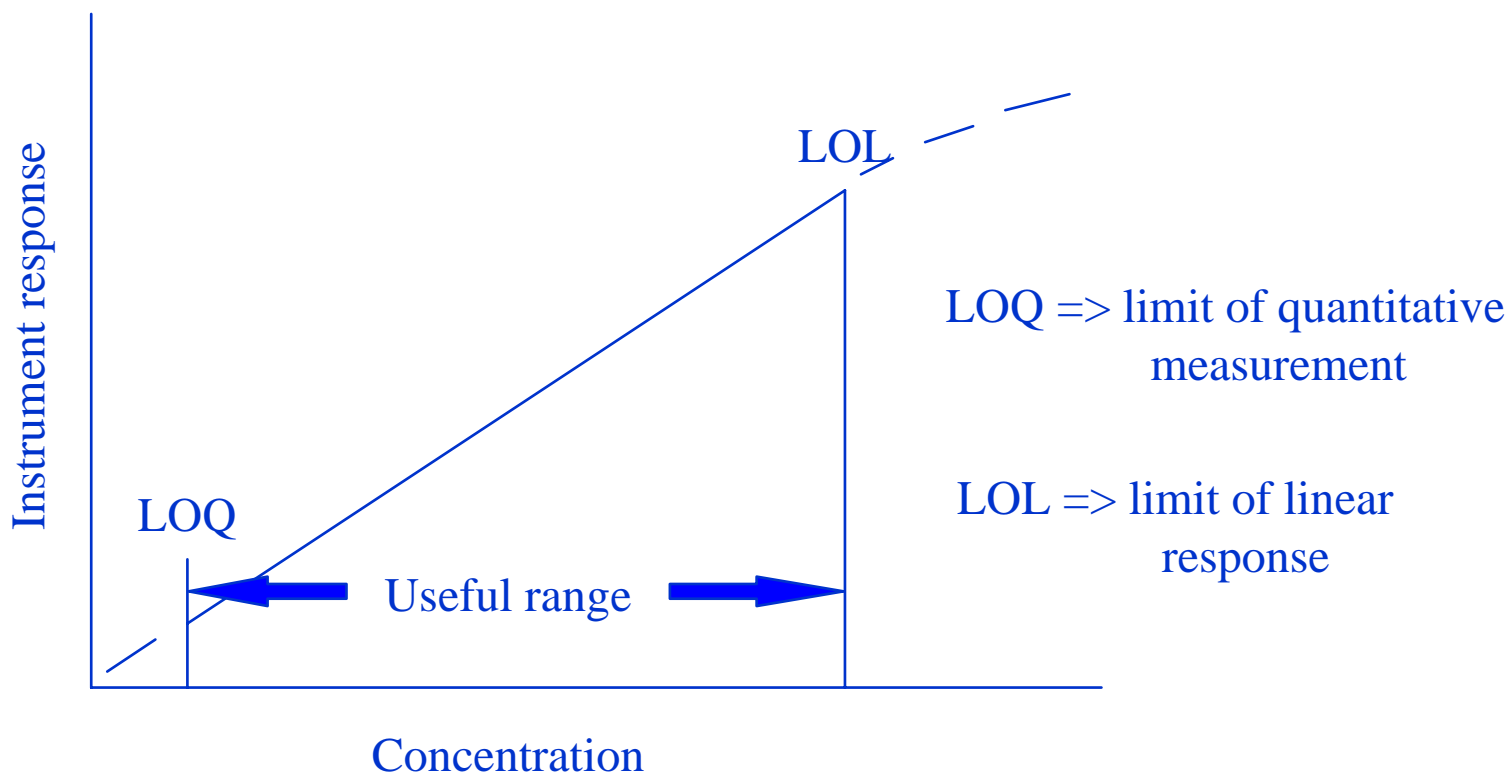

Dr. S. M. Condren

# Limit of determination, detection limit and blank value

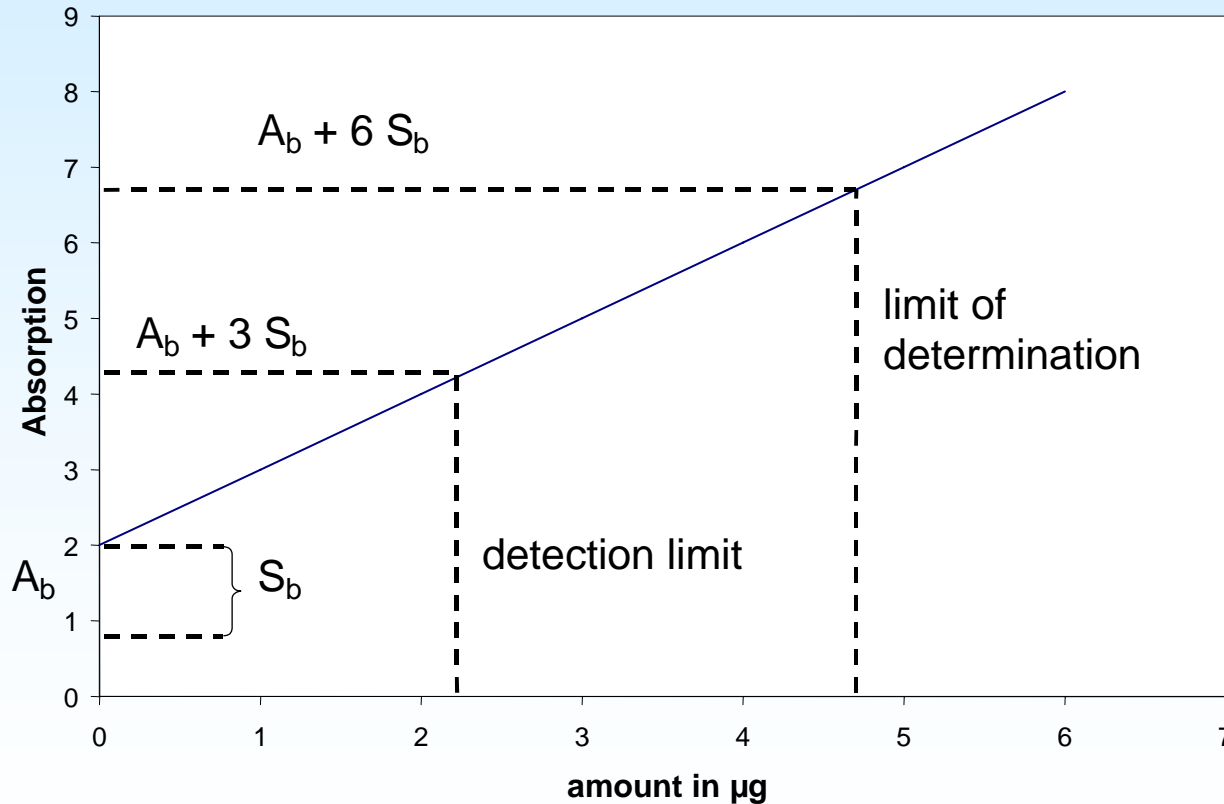

S = standard deviation, b = blank value

# Typical methods for quantitative analysis

- of heavy metals in soil, water or waste water is **ATOMIC SPECTROSCOPY**
- of solvents in soil, air, water or waste water is **GAS CHROMATOGRAPHY**



We start with

# CHROMATOGRAPHY



## THIN LAYER CHROMATOGRAPHY, A SEPARATION METHOD

## Example: Qualitative analysis of green grass

We take some green grass, add a little amount of a solvent and press and stir the mixture until it gets a dark green color. We take a small portion of that green liquid by a capillary glass and put a liquid spot on a thin layer of white  $(\text{Si-O-})_3\text{Si-OH}$  („stationary phase“). We let the solvent dry.

Then we put the plate into some different solvent („mobile phase“) and let the solvent ascend.



# Mechanisms I



M ↑

The component ▲ stays mainly at the surface of the stationary phase (adsorption) resp. in the stationary liquid phase (distribution), while the component ○ stays mainly in the mobile phase.

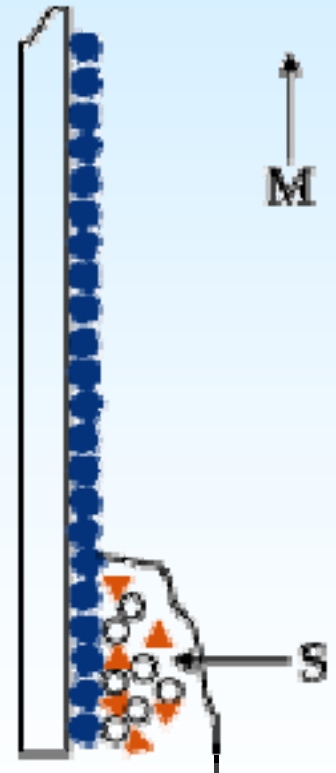

M ↑



# Mechanisms II



As soon as new mobile phase flows, the components staying in the mobile phase are being transported. They get in contact with unallocated solid or liquid stationary phase. The stationary phase mainly adsorbs or dissolves the component ▲.

Adsorbed resp. in liquid stationary phase dissolved molecules ● trespass in the mobile phase and are being transported further more.

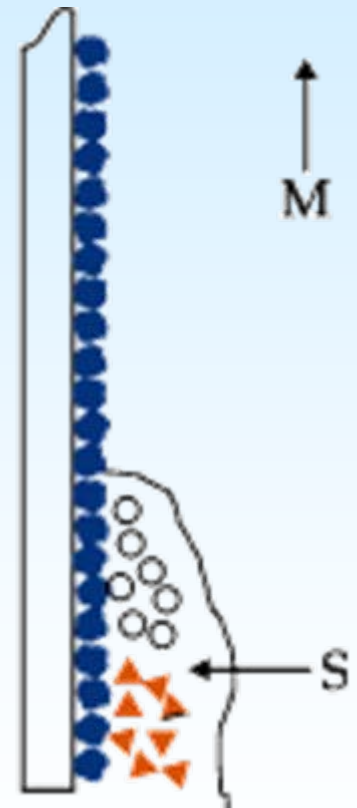

# Mechanisms III

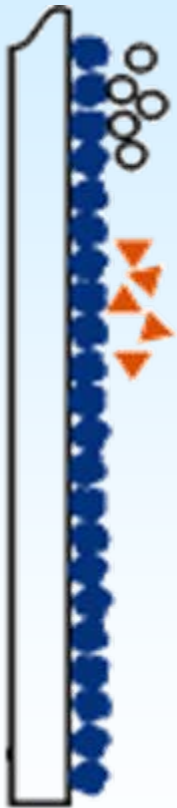

M

After multiple repetition of the above mentioned processes, the two components are being separated. The molecules  $\bullet$  mainly stay in the mobile phase and obviously move faster than the molecules  $\blacktriangle$ . In other words: the  $R_f$ -value of  $\blacktriangle$  is smaller than the value of  $\bullet$ .

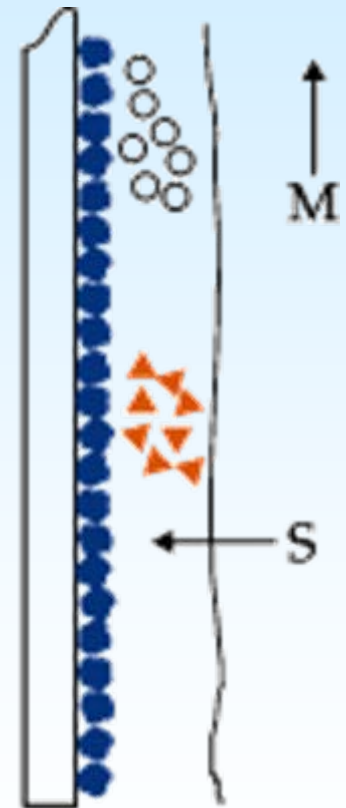

M

S

# The Retentionfactor $R_f$

Definition:  $R_f = \text{Distance start-substance} / \text{Distance start-mobile phase}$

A: the  $R_f$ -value

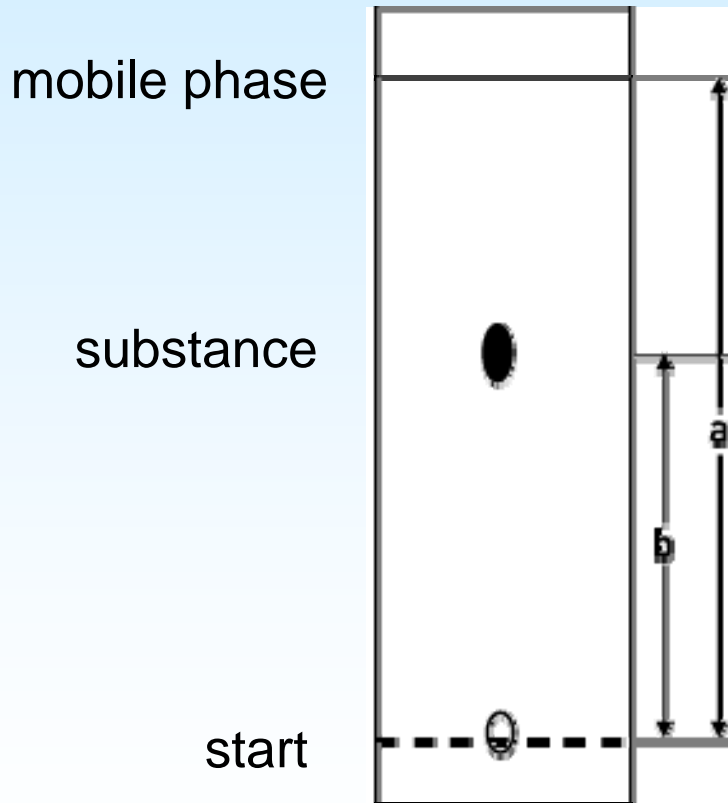

B: the  $R_{st}$ -value

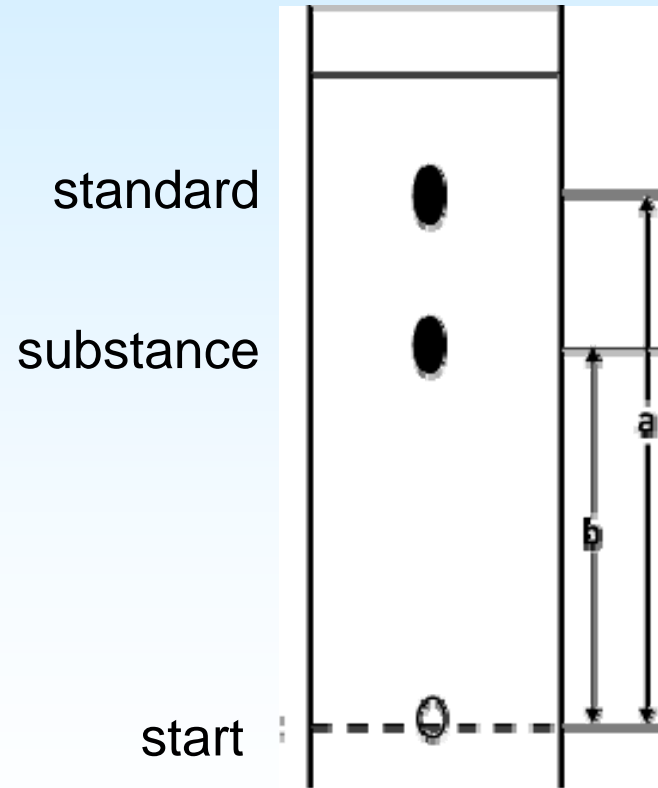

$$R_f = b/a = \text{dist. substance} / \text{dist. mob. phase} \quad R_{st} = b/a = \text{dist. substance} / \text{dist. standard}$$

Thin layer chromatography is a qualitative separation technique.

The substances are separated by their solubility in the mobile phase and their affinity towards the stationary phase.

The balanced distribution of a substance is described by:

$$c_{\text{stationary phase}} / c_{\text{mobile phase}} = K_T$$

$c$  = concentration of a substance

$K$  = constant (depending on temperature)

# Separation of chlorophyll

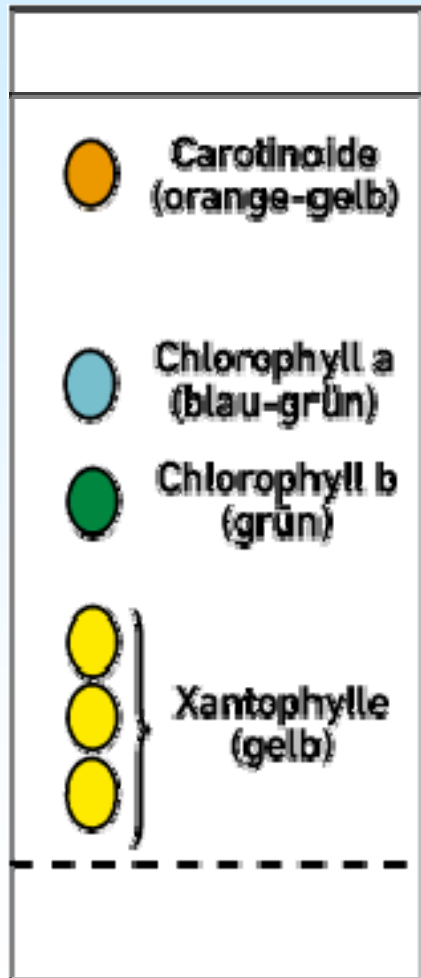

mobile phase

start, ca. 1 cm high

# Molecular structure of chlorophyll a and b

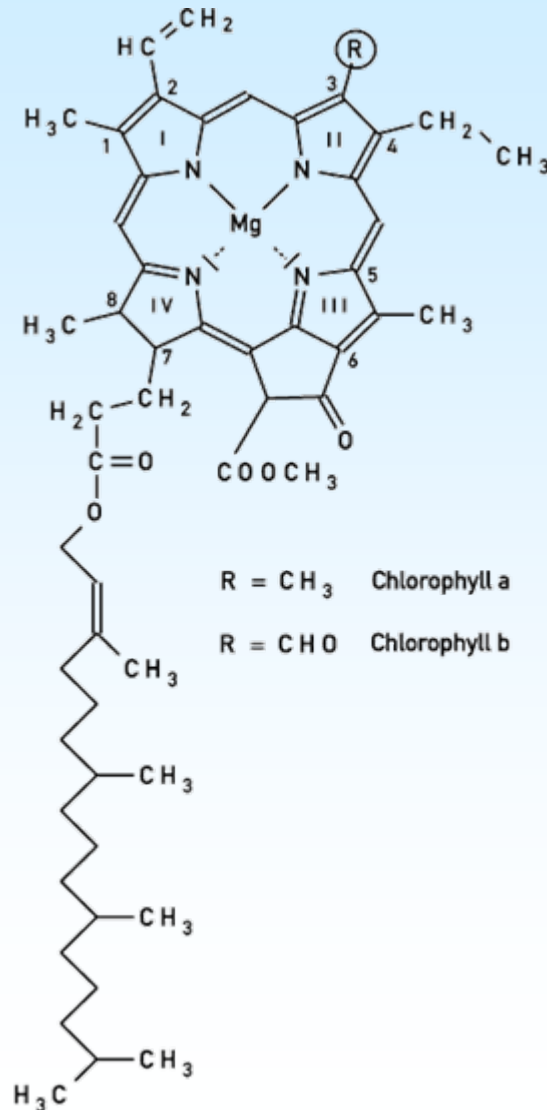

# Molecular structures of $\beta$ -Carotene and Lutein

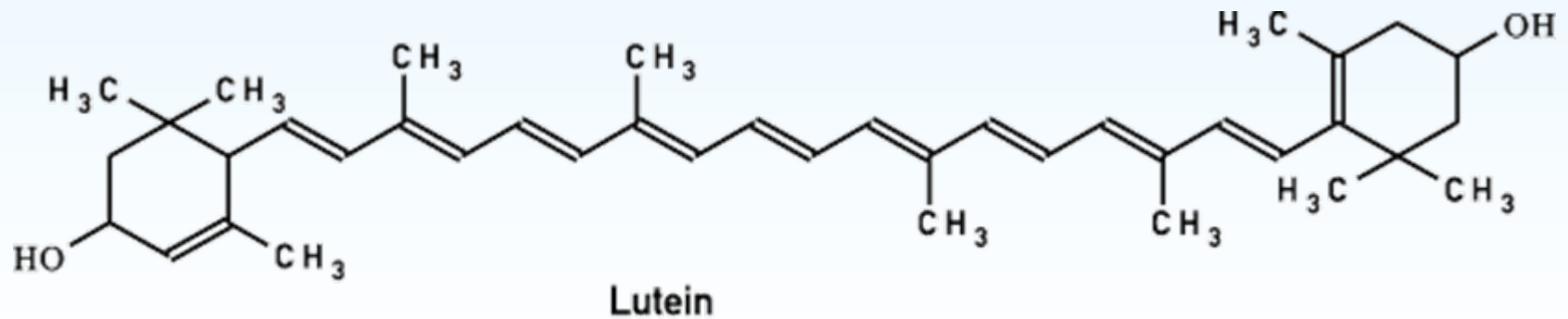
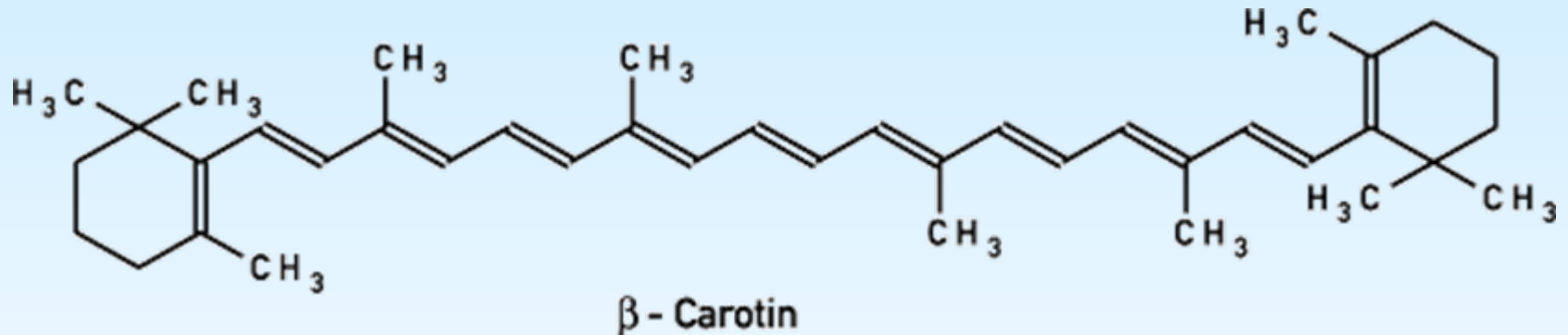

# Absorption spectra of chlorophyll a and b

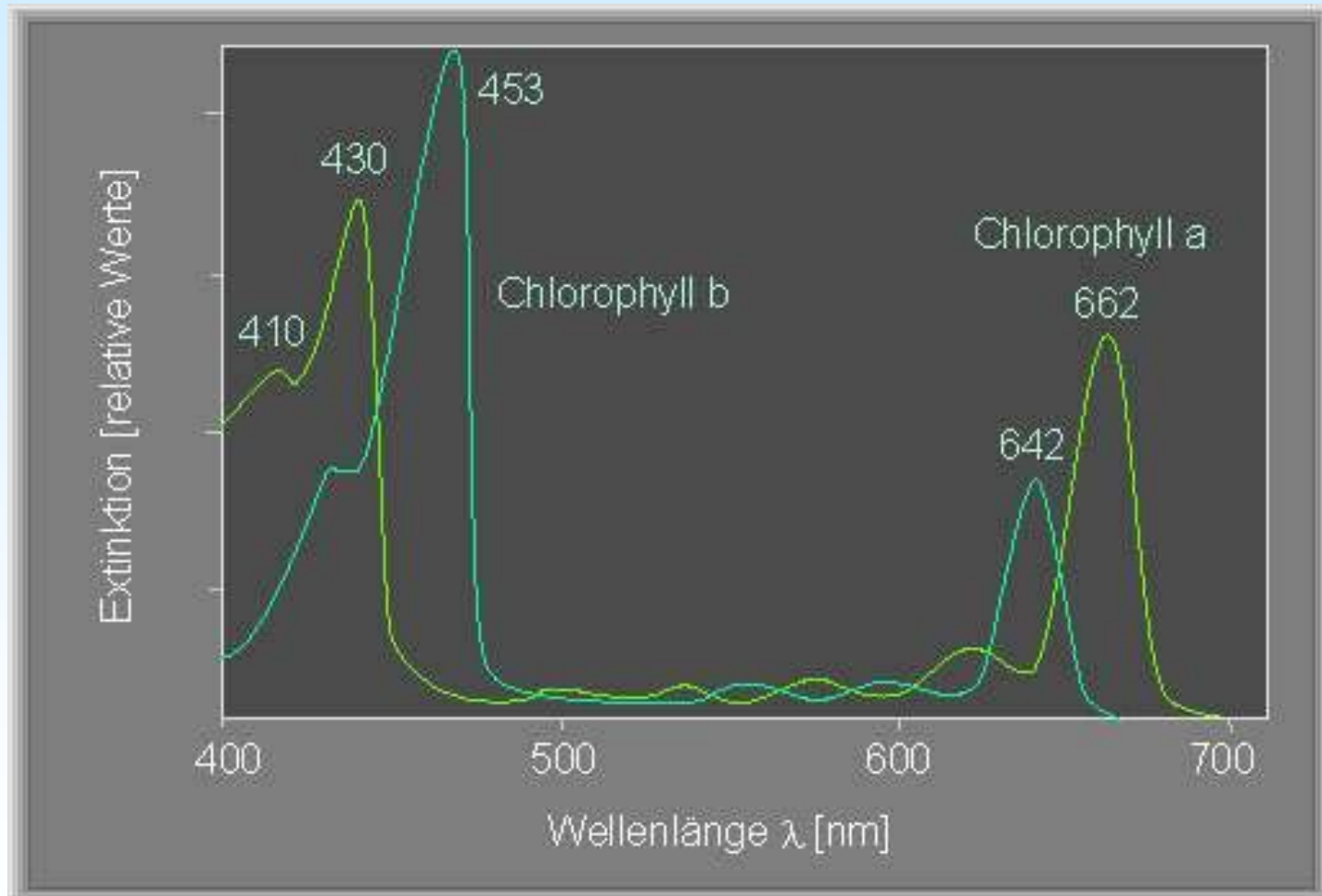



# Effective spectrum of photosynthesis

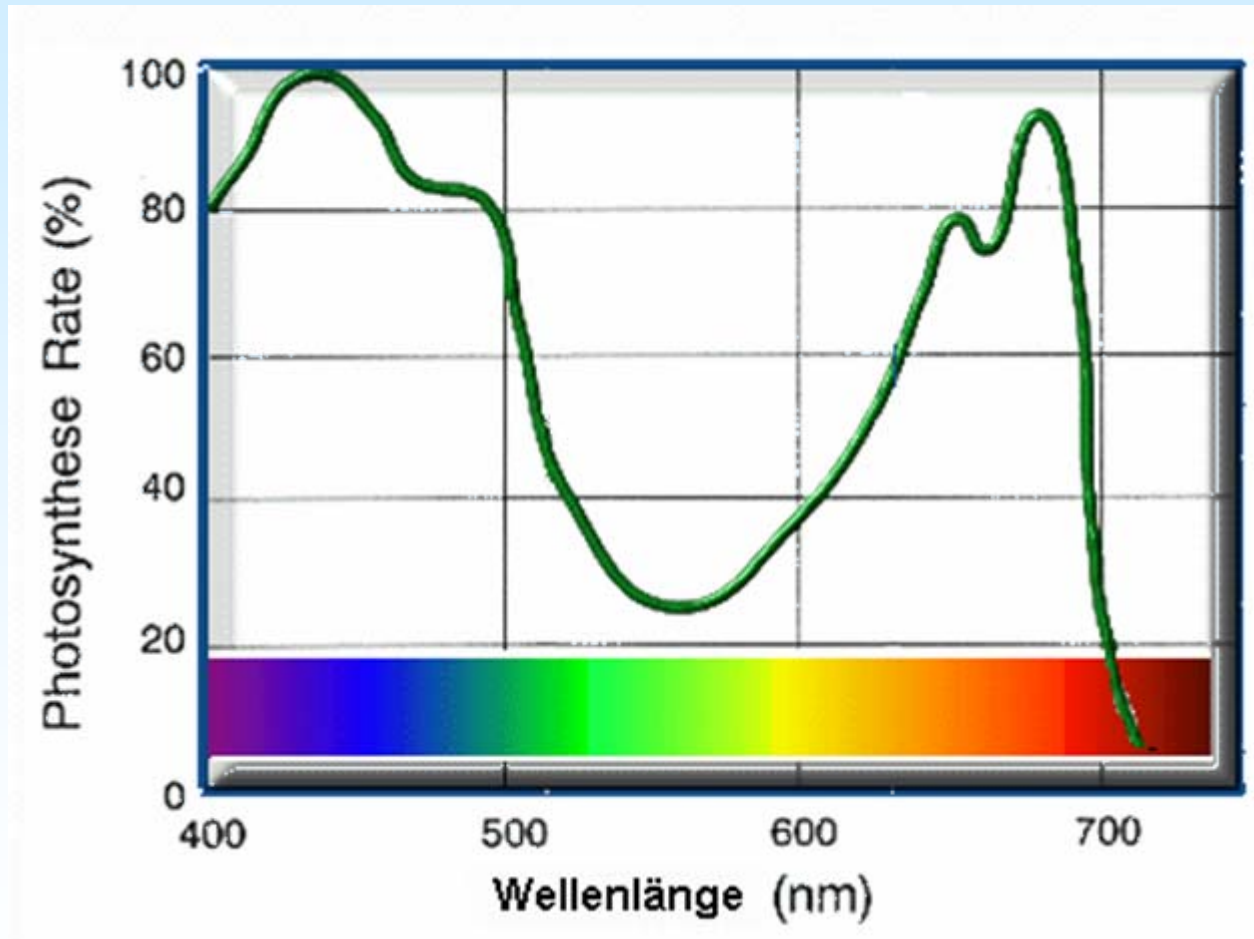

Different chemical substances have different chemical properties (polarity, solubility etc.)

They are separable by different  $R_f$ -values in a thin layer chromatogram („TLC“).

The TLC-method shows in a simple, quick and cheap way, how to analyse the composition of a natural substance like green grass.



Now we change the thin layer by a metal column, filled with  $\text{Si(OH)}_n$  and we change the mobile phase from a solvent into a gas:

# GAS CHROMATOGRAPHY

see also:

<http://www.gaschromatography.com/basic.asp>



# Gas Chromatography

- separation by partition between gaseous mobile phase and liquid stationary phase supported by inert packing
- developed in 1941 by Martin and Synge
- applications did not come till 1950s

# Principles of gas chromatographic separation

mixture of 3 components

actual signal

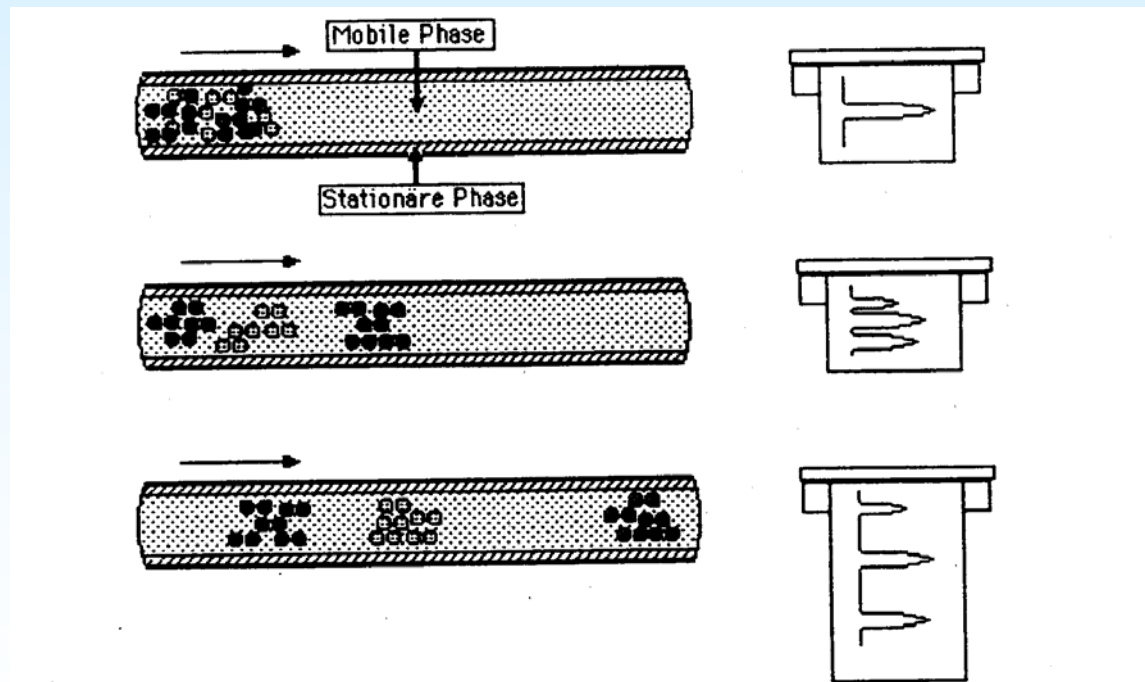

# Assembly of a Gas Chromatograph

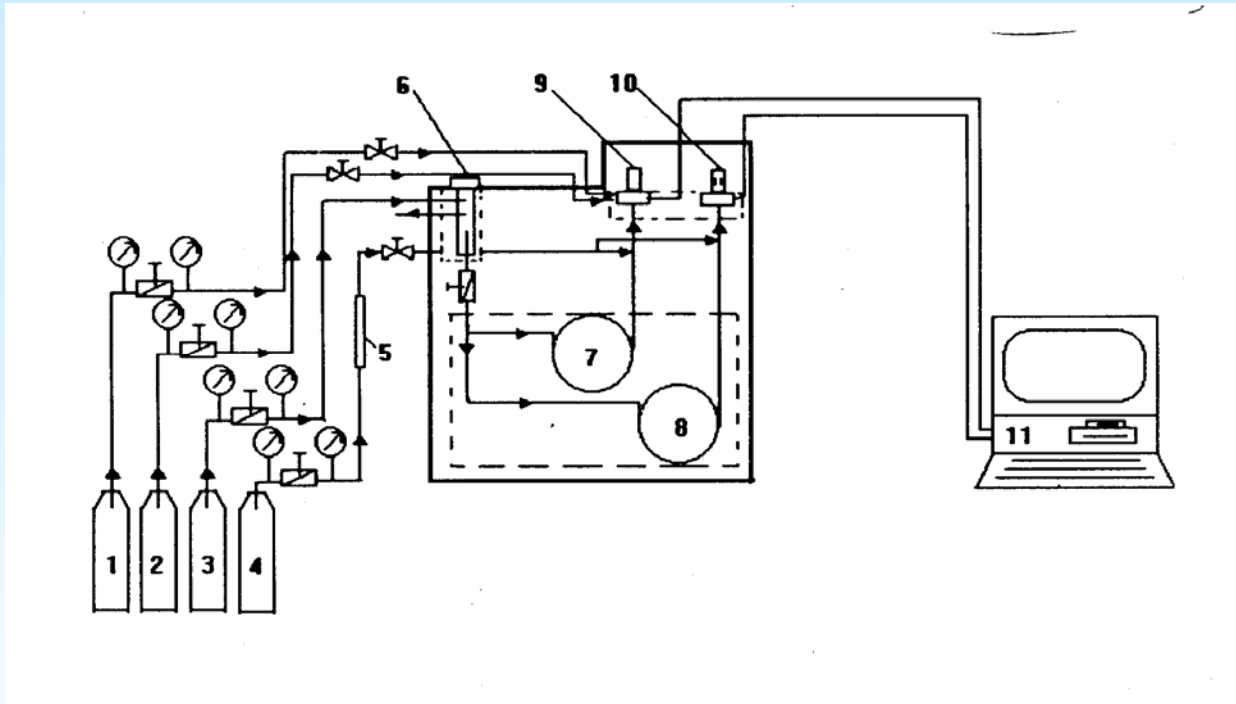

1 H<sub>2</sub>

2 synthetic air

(1 and 2 burning gases for FID)

3 He (mobile phase)

4 N<sub>2</sub> (cheap possibility to dilute  
the mobile phase)

5 Cleaning column for N<sub>2</sub>

6 Injector

7,8 capillary separation columns

9,10 detectors

11 workstation (signal recording)

“Cross-sectional view  
of a microflash  
vaporizer direct  
injector.”

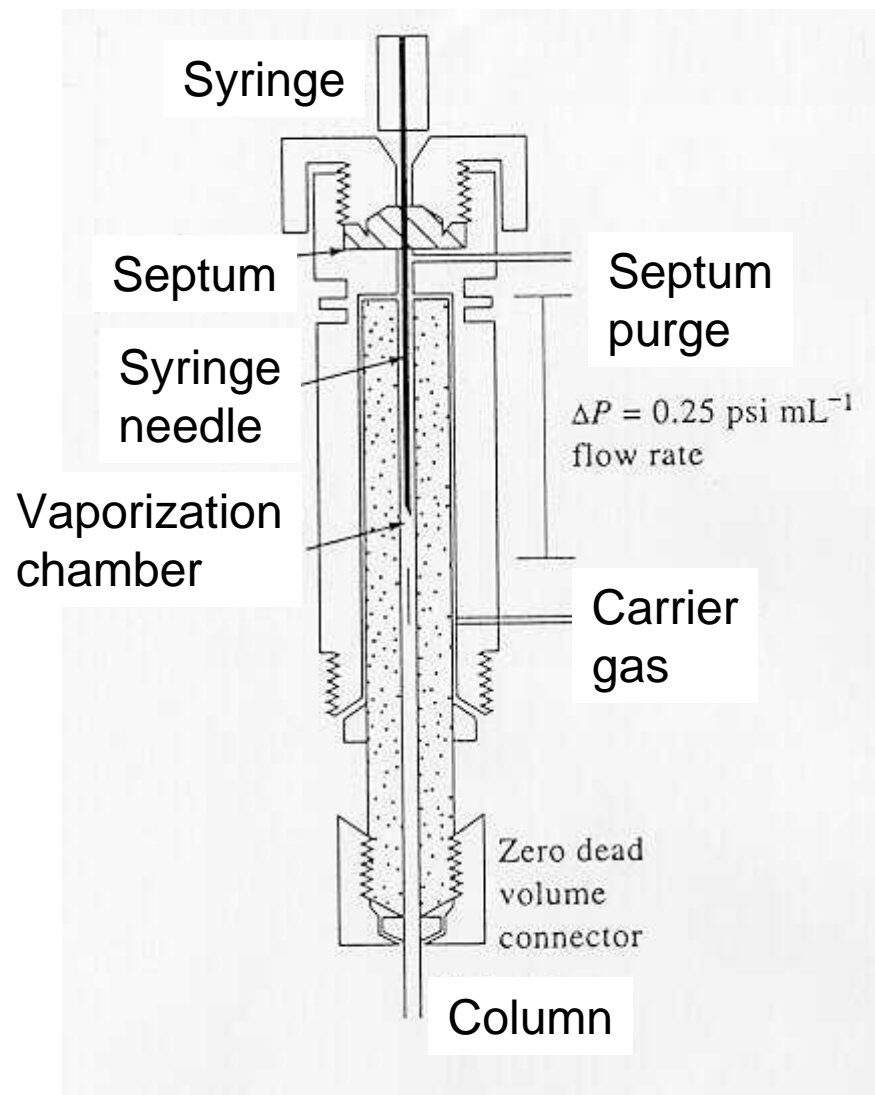

Dr. S. M. Condren

# Apparatus

## Column Thermostating

### temperature:

- slightly below or equal to av. b.p. of components
- allows for  $t_R$  between 2 and 30 min
- programmable



“Effect of temperature on gas chromatograms: (a.) isothermal at 45°C; (b.) isothermal at 145°C; (c.) programmed at 30°C to 180°C.”

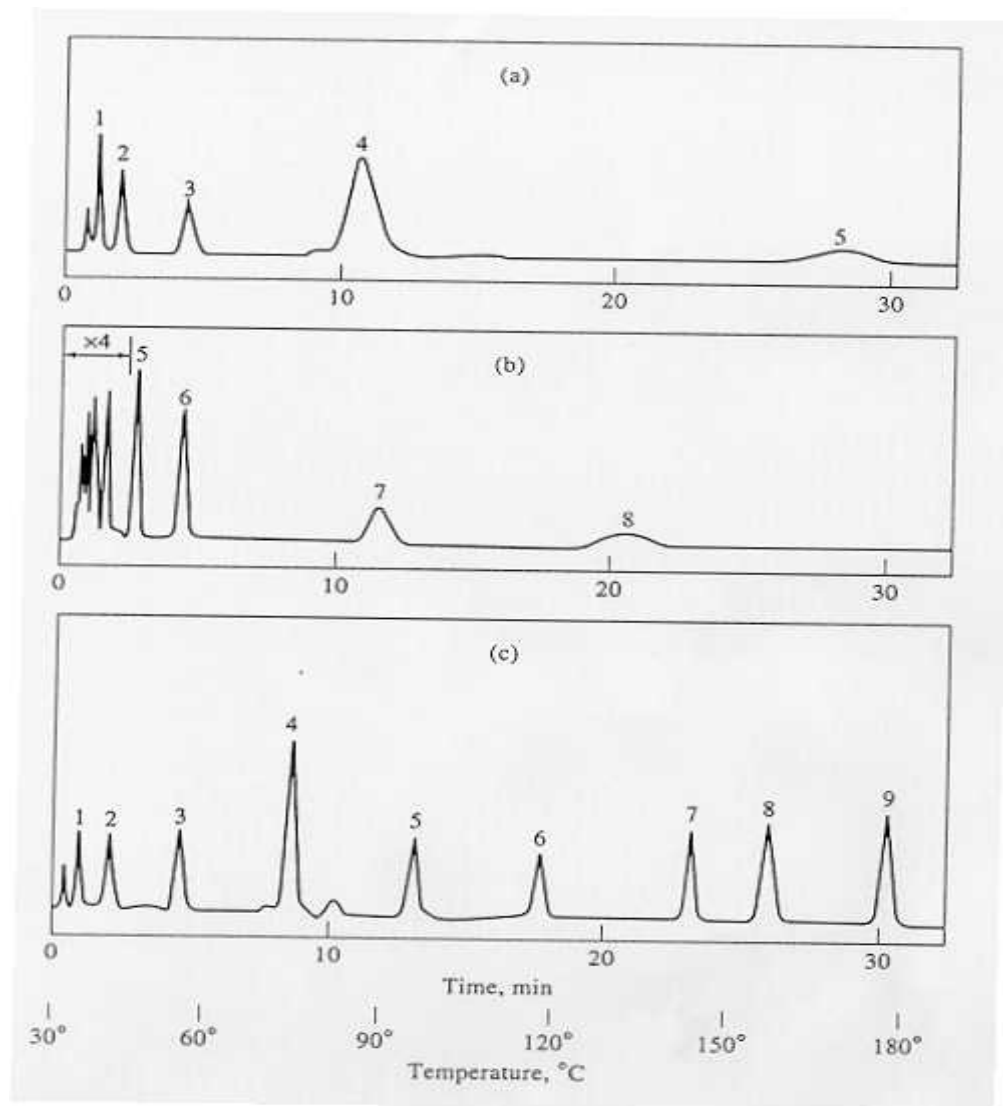

Dr. S. M. Condren

# Apparatus

## Detectors

- **Flame Ionization Detector (FID)**
  - sample burned in H<sub>2</sub>/air flame
  - sample must be combustible
  - must use electrometer
  - flame resistance  $10^{12}\Omega$
  - ppm sensitivity
  - destructive

“A typical flame ionization detector”

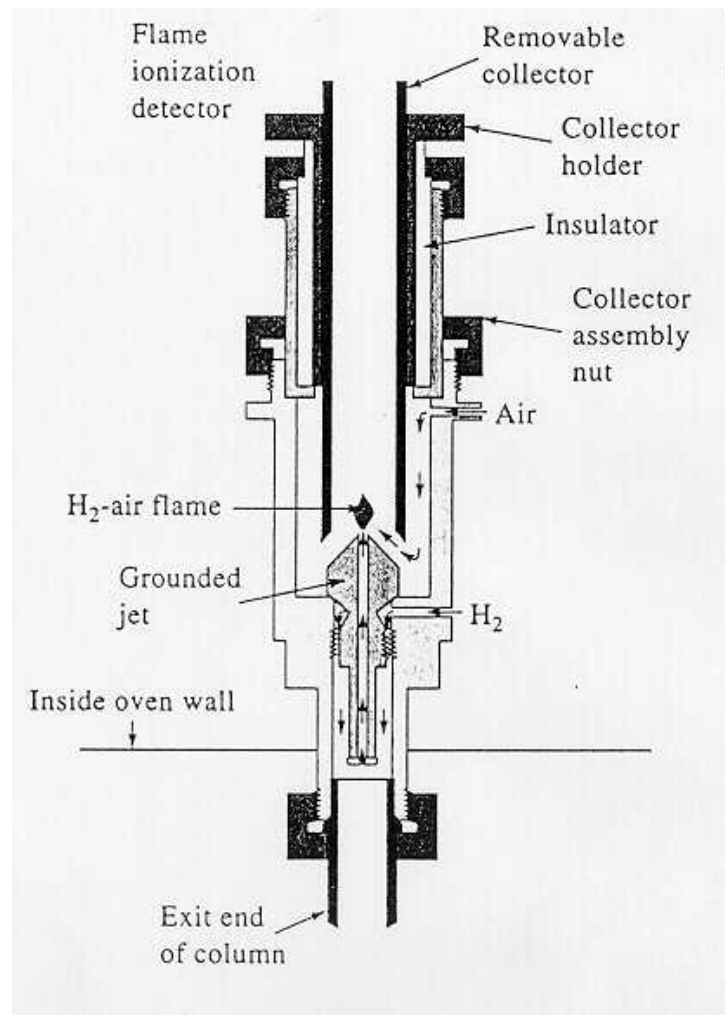

Dr. S. M. Condren

One typical application for gas chromatography is the pesticide analysis of fruits and drinking water.

Each pesticide correspond with an electric signal („peak“), whereas the **retention time** since injection of the sample is equivalent to a single type of pesticide.

The **peak area** shows the amount of pesticide in the sample.

But how to be sure?



Filename: TR14  
Operator:

Sample: Test Sample 2  
Channel: NPD GV1701  
Acquired: 31-03-85 5:44  
Method: MAXENT2VPE09-F4  
Comments: ORGANOPHOSFOR PESTICIDI E TRIAZINO

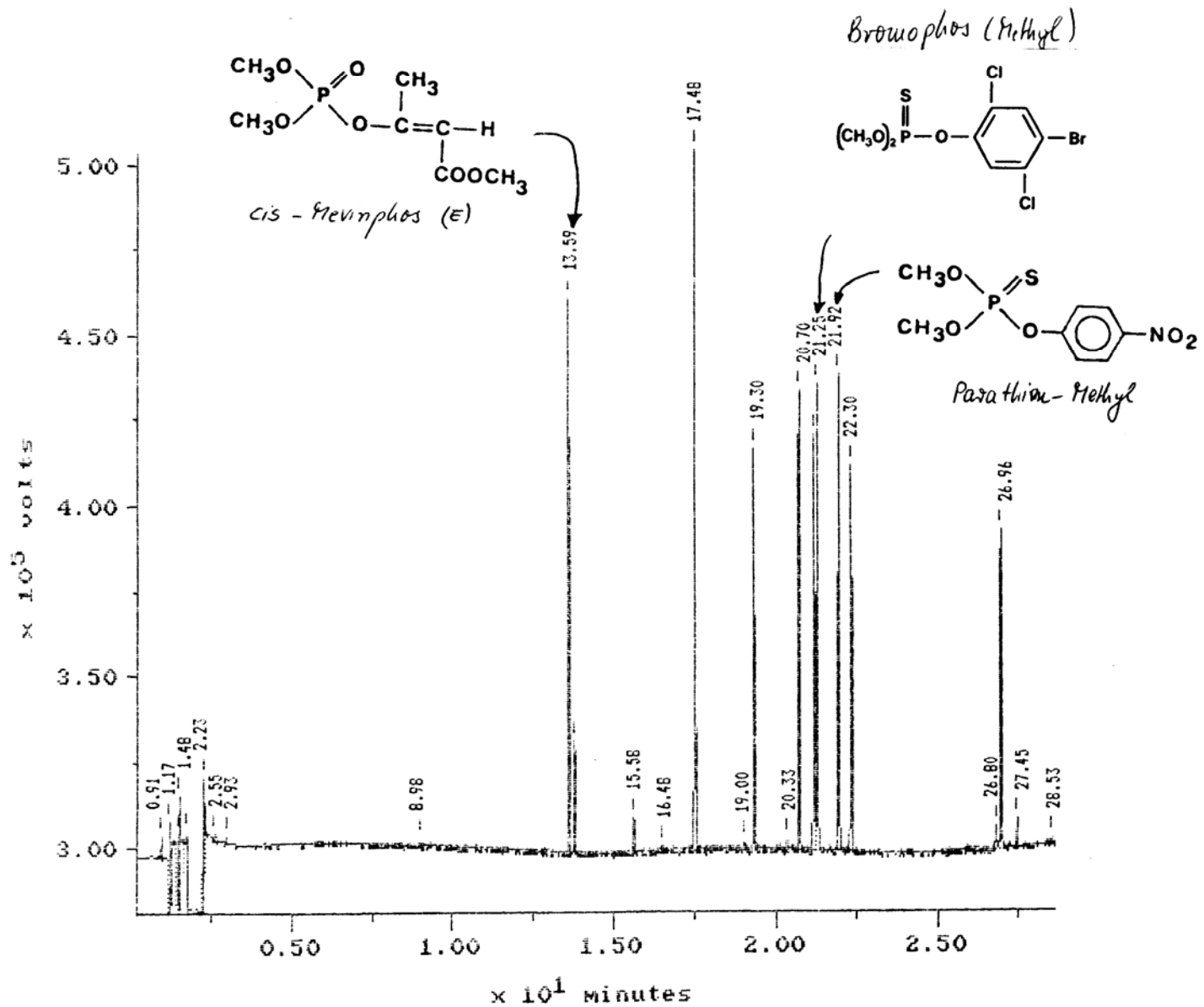

Filename: TRIA  
Operator:

Sample: Test Sample 2  
Channel: MFD 001701  
Acquired: 31-OCT-85 9:44  
Method: Y:\DATA\2\PROG-P4  
Comments: ORGANOPHOSPHORIC PESTICID: E TRIAZINO

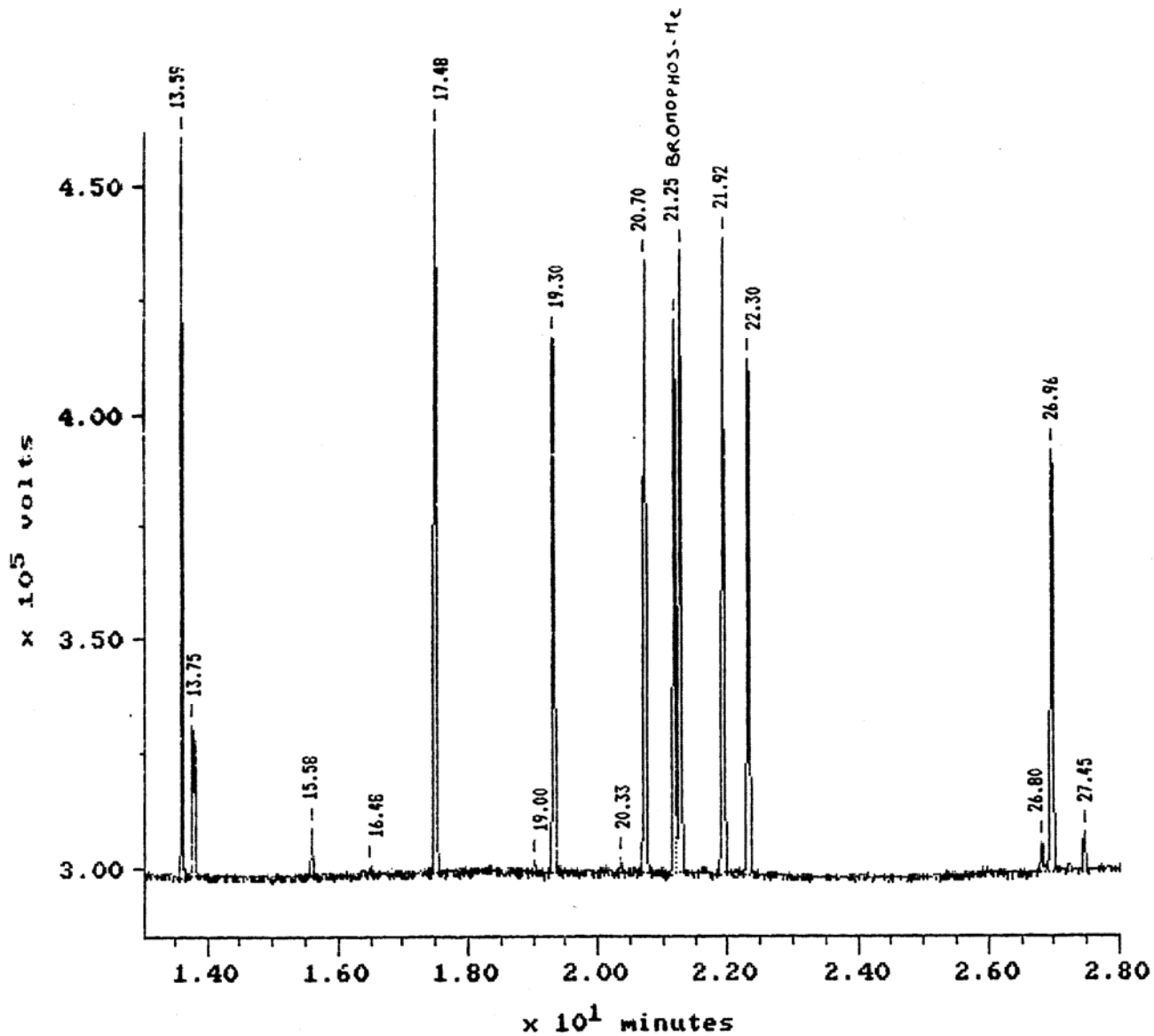

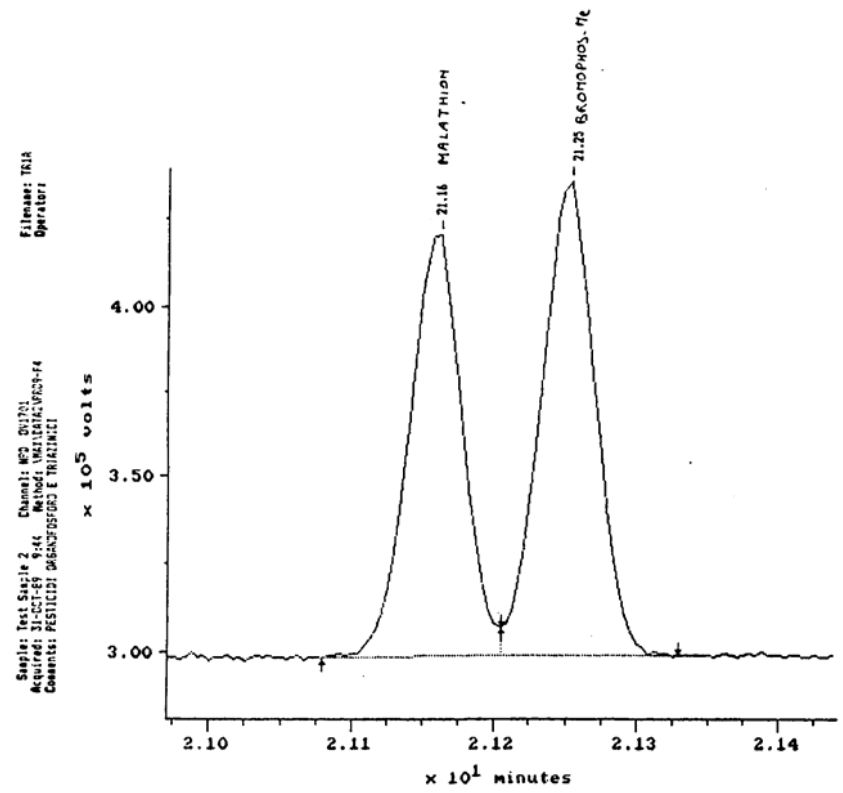
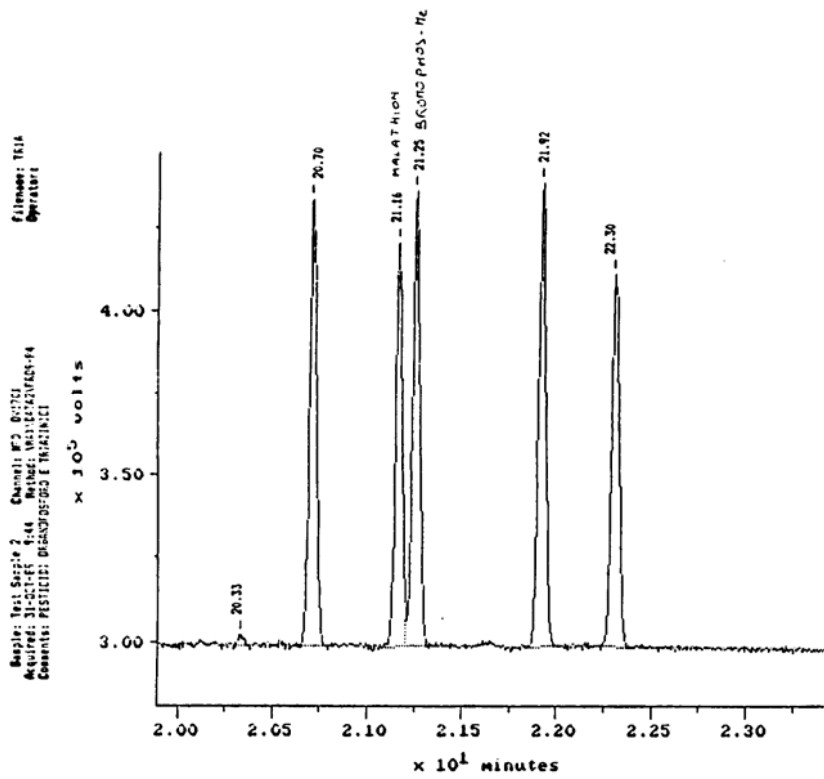

Filename: TR1A  
Operator:

Sample: Test Sample 2  
Channel: NFD GV1701  
Acquired: 31-OCT-89 9:44  
Method: MAX/DATA/PROG-P4  
Comments: PESTICIDI ORGANOFOSFORO E TRIAZINICI

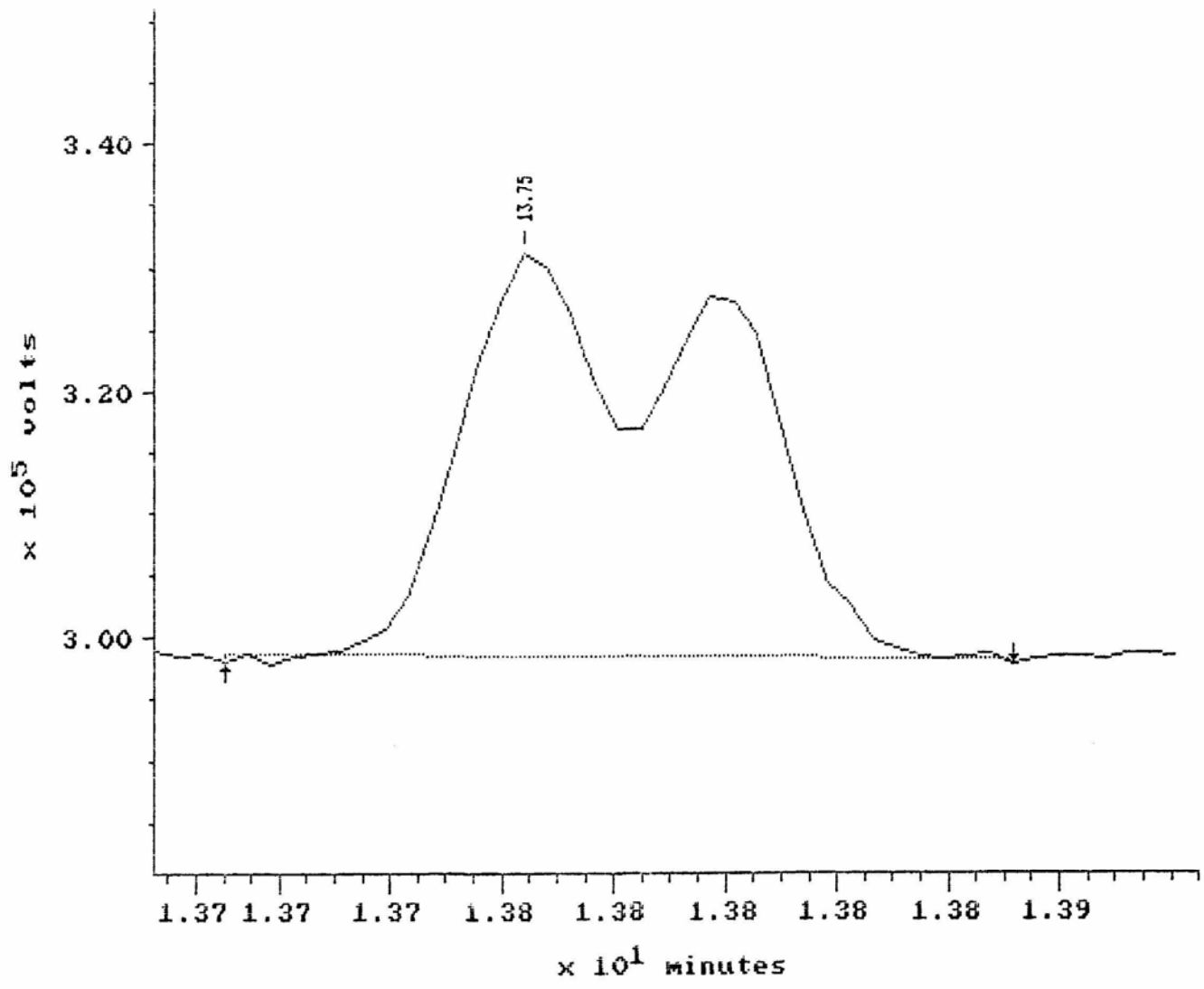



Filename: TR1A  
Operator:

Sample: Test Sample 2 Channel: NPD DVI701  
Acquired: 21-OCT-89 9:44 Method: LMAI\DATA\NPG9-F4  
Comments: PESTICIDI ORGANOFOSFORO E TRIAZINICI

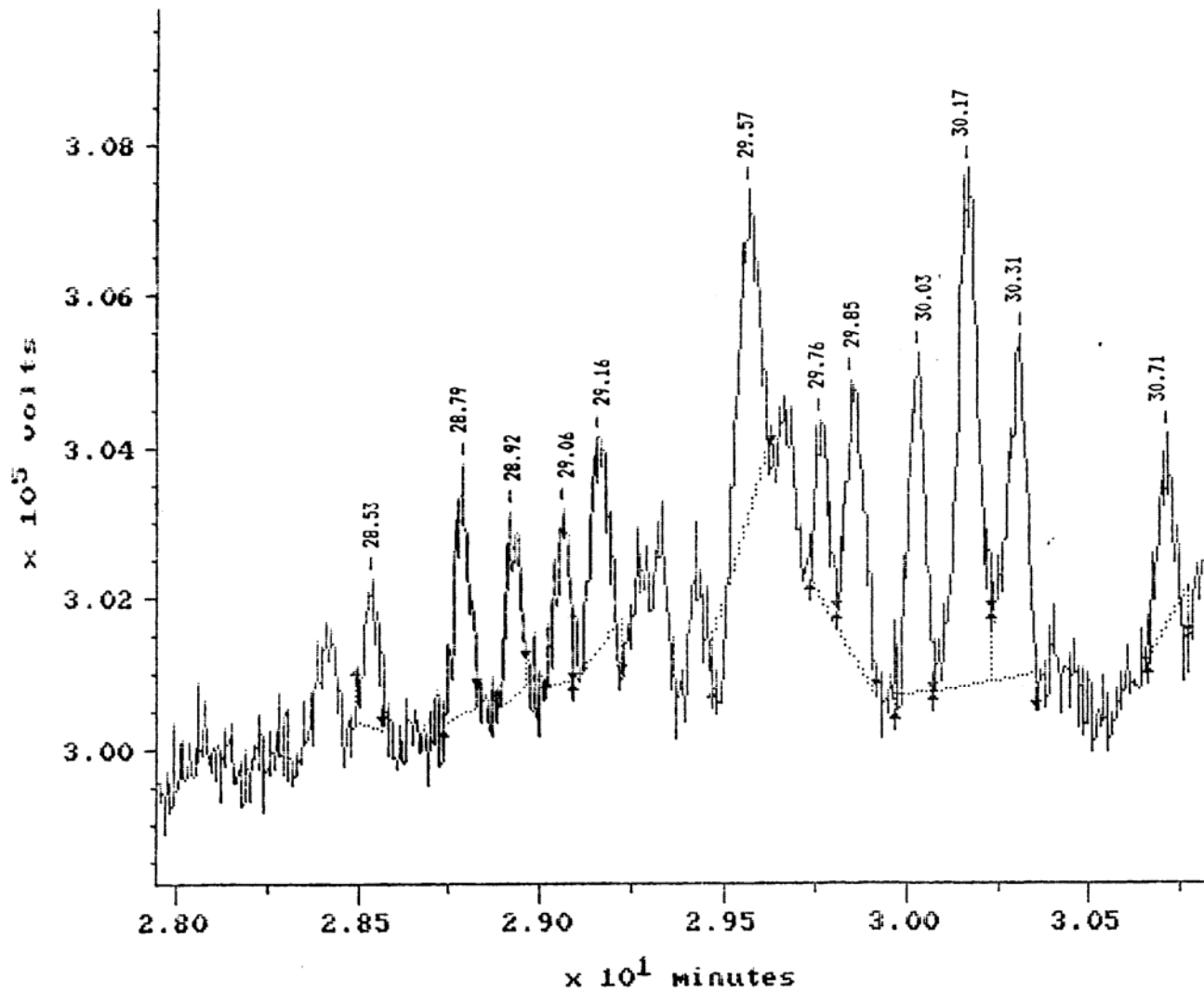

## MAXIMA B20 CUSTOM REPORT

Printed: 16-OCT-1989 15:16:34

SAMPLE: M2088

04 in Method: PESTICIDI CLORURATI  
 Acquired: 12-OCT-1989 10:45  
 Rate: 4.0 points/sec  
 Duration: 41.000 minutes  
 Operator:

Type: UNKN  
 Instrument: HRGC/ECD 1  
 Filename: M2088  
 Index: Disk  
 Injection Volume: 1.0

DETECTOR: ECD 1 OV225

Retention Time (minutes)	Relative Time	Peak Area	Peak Response	Solution Conc <i>ppb</i>
3.000	0.103	130483378952		
3.171	0.109	2262284056841		
3.350	0.115	108157114750		
3.829	0.131	12819768949		
5.775	0.198	9078682850		
8.742	0.300	47667778831	0.6730	390.30
8.896	0.305	8444340322		
9.171	0.315	19088092370	0.2695	326.46
9.296	0.319	53459116010	0.7548	433.37
9.725	0.334	85060609408		
9.842	0.338	528529962849	528529962849.0026	
10.850	0.372	73410283768		
11.204	0.385	11325629289		
11.329	0.389	42835629544	0.6048	412.21
11.642	0.400	24049285733	24049285733.1707	
13.804	0.474	46905584320	0.6623	428.61
14.508	0.498	33663814422	0.4753	436.00
14.742	0.506	20276758180		
29.133	1.000	70826124001	70826124000.5109	500.00
TOTAL		3568366011387		2426.94

Because of the rapid development of computers connected to analytical systems, a few problems arise. Nowadays, measurement results are automatically transferred to analysis reports. The reports are signed by the laboratory head and are sent to the customer. So there is not always enough critical review concerning the plausibility of analysis results. Still, the laboratory is responsible for the results and has to assume liability.



# Atomic Spectroscopy

see also:

<http://shsu.edu/~chemistry/primers/AAS.html>



# Atomic Spectroscopy

These methods deal with the **absorption** and **emission** of radiation by atoms.

The methods deal with **free atoms**.

**Line spectra** are observed

Specific spectral lines can be used for elemental analysis - both **qualitative** and **quantitative**.



AAS: The temperature of a Bunsen burner flame is high enough to excite e.g. sodium atoms from common salt to „shine“.

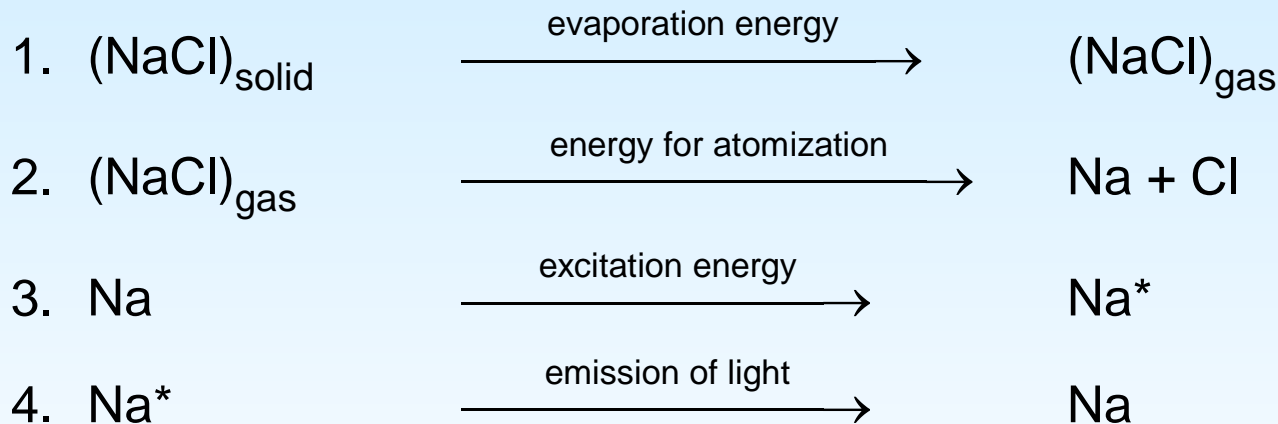

The excitation in the third step is connected with different electron „jumps“, which take place all at the same time.

Therefore the emission of light in step four is connected not only with the emission of **one** spectral line, but with an emission of a complete line spectrum.

# Atomization Techniques

“Processes occurring during atomization.”

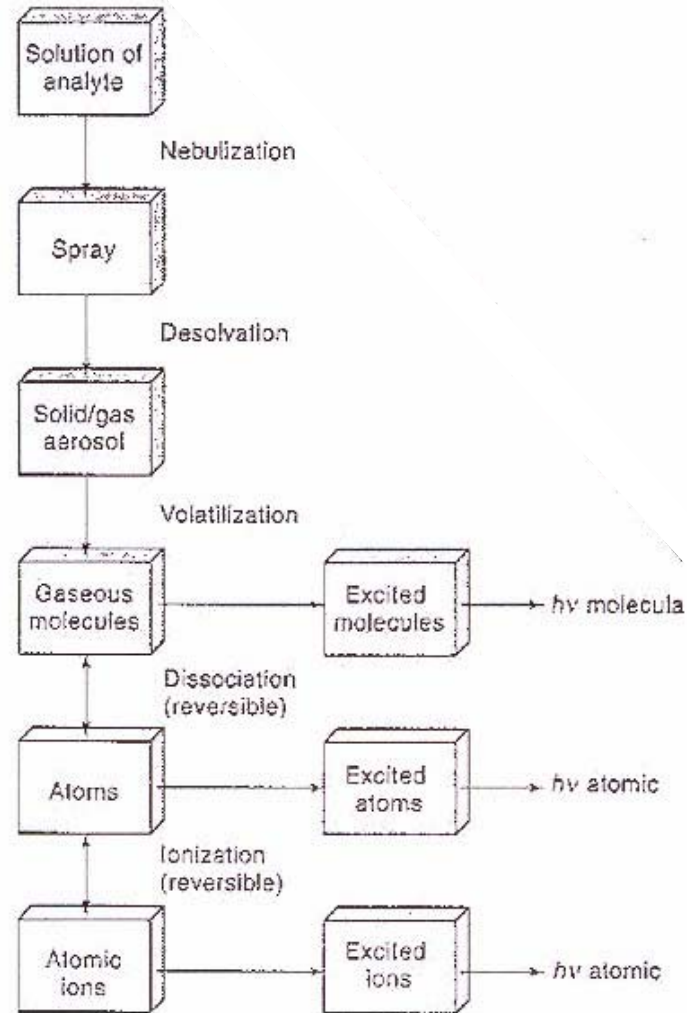

Dr. S. M. Condren

# Flame Atomizers

"A laminar flow burner."

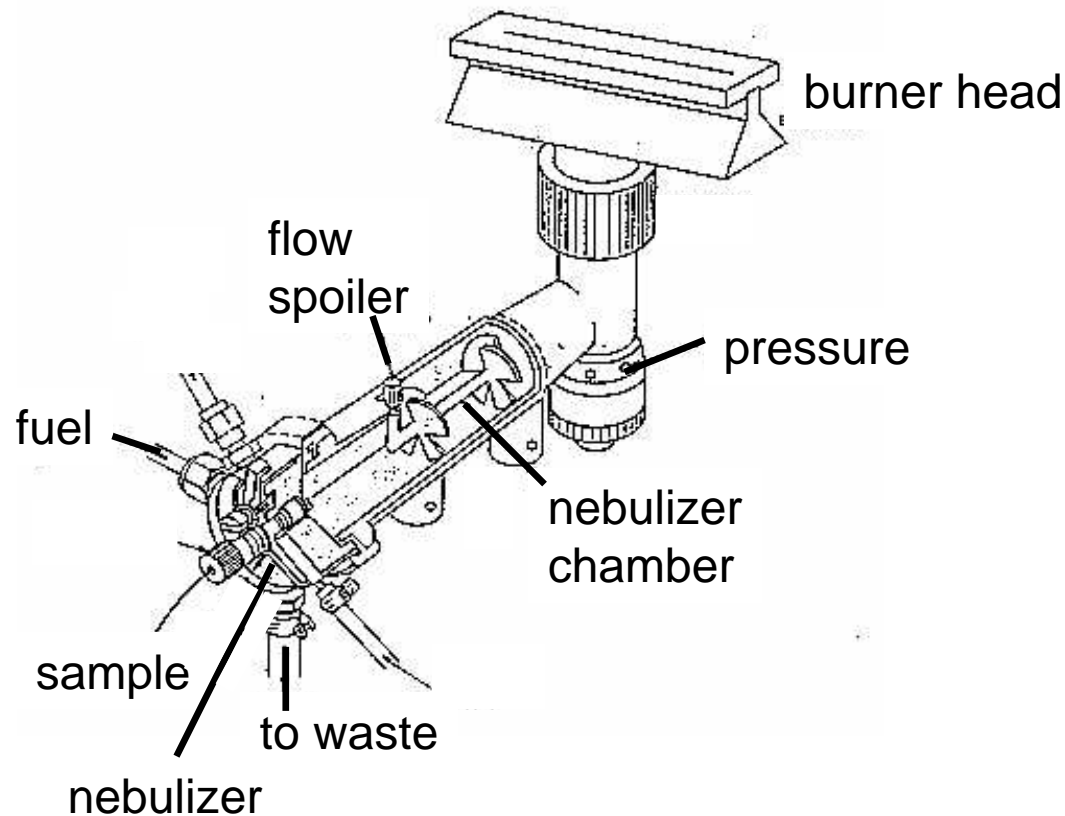

Dr. S. M. Condren



# Excitation sources

The method of flame excitation is of relative low temperature.

Air/H <sub>2</sub>	2100 °C
O <sub>2</sub> /H <sub>2</sub>	2700 °C
N <sub>2</sub> O/C <sub>2</sub> H <sub>2</sub>	3050 °C

This results in only a very small percentage of atoms being ionized (< 1%). One option to go to higher temperature is the Plasma emission.

# Emission and Absorption

## Emission:

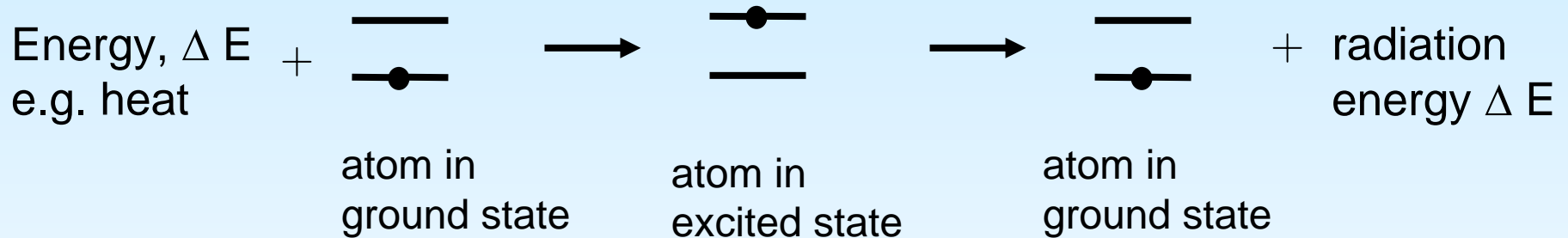

## Absorption:

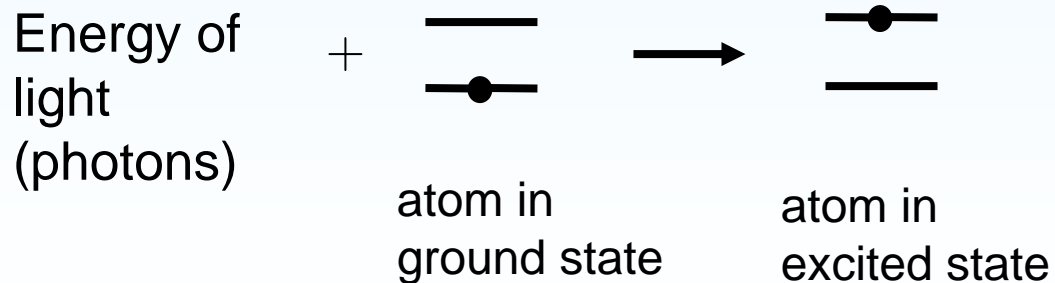

# Term diagram of sodium

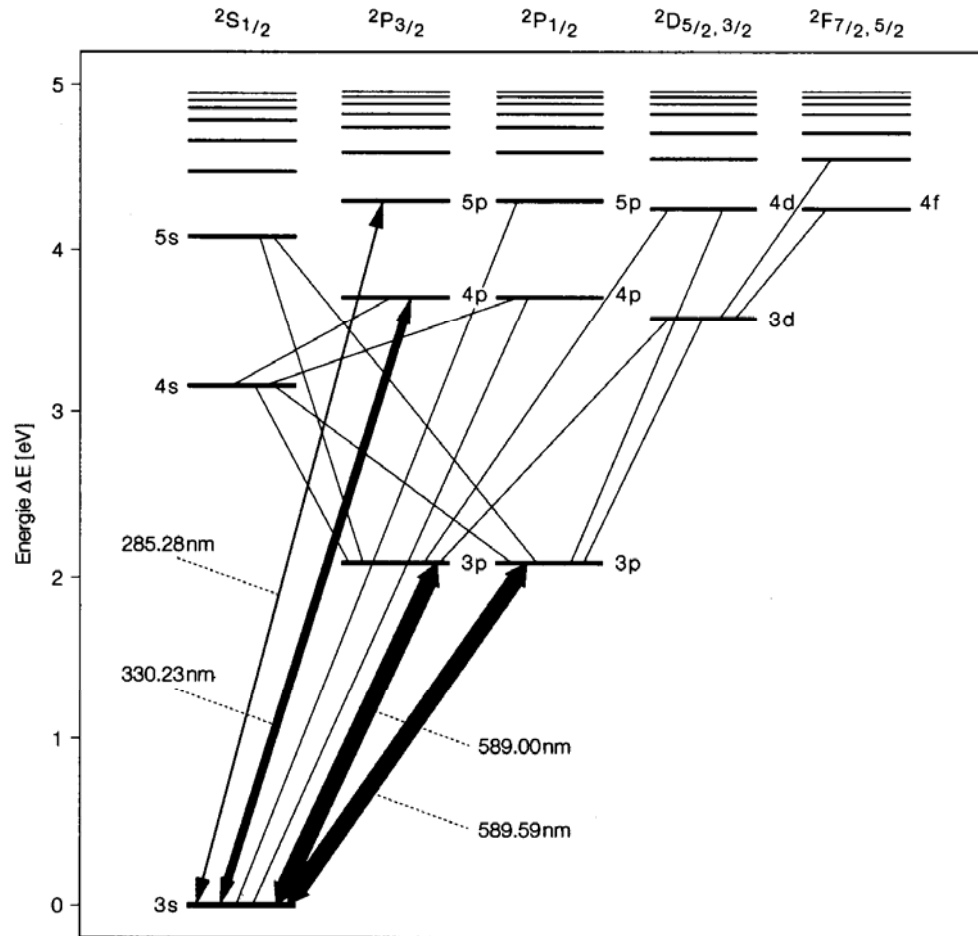

**Fig. 4-10** Termschema des Natriums. Die Dicke der Pfeile deutet die Intensität der entsprechenden Linien an. Die vom Grundniveau ausgehenden Linien heißen Resonanzlinien.

# Band spectrum

Energy-level diagram for a sodium atom showing the source of a line spectrum

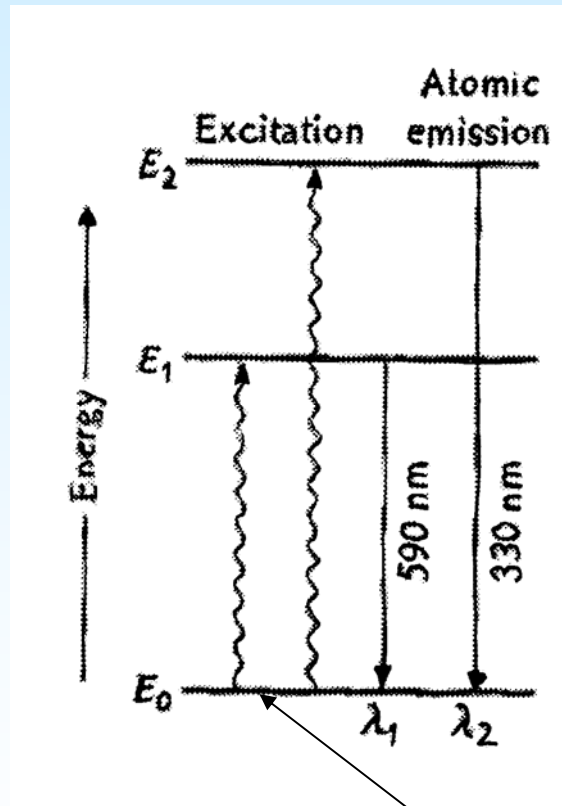

Thermal or electrical energy

# Atomic emission

Methods rely on the presence of specific emission lines

Element	Major emission line, nm
---------	-------------------------

---

Ag	328.1
Cu	324,8
Hg	253,7
K	344,7
Zn	334,5

# Components of Optical Instruments

## Flame Atomic Absorption Spectrometer

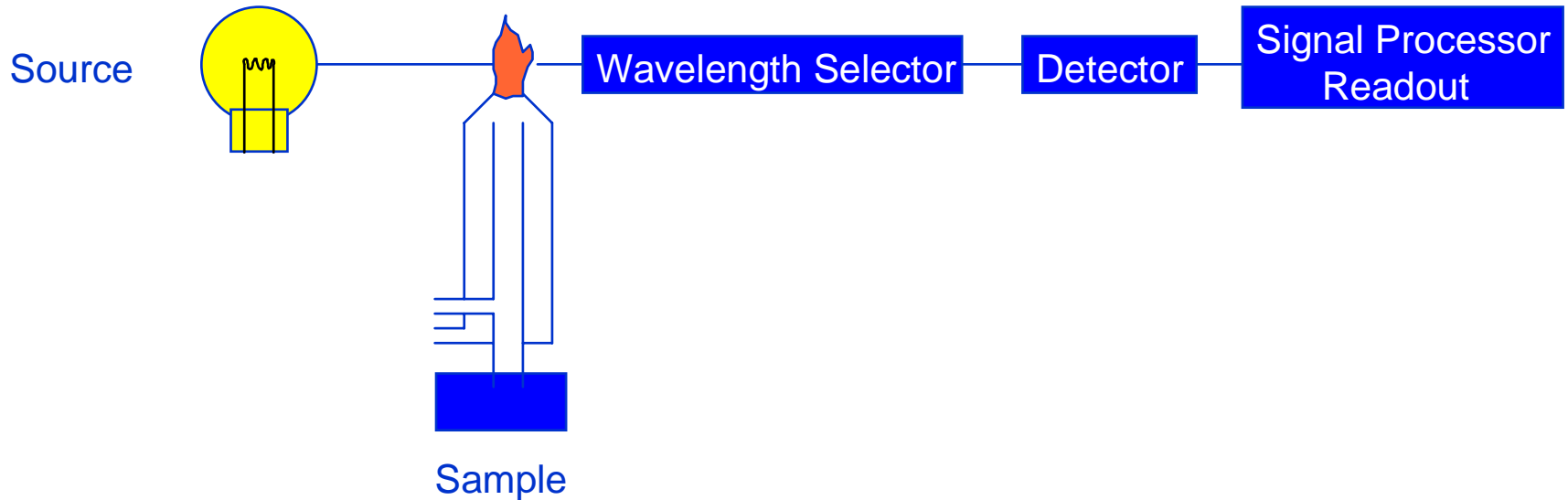

Dr. S. M. Condren

# Measurement principle I

A line emitter, e.g. a hollow cathode lamp sends out the emission spectrum of one chemical element. In the flame, the concentration of this atomized element is equal to the proportion of absorbed radiation on the resonance line. In the monochromator, the resonance line is selected and all other lines are faded out. Therefore the detector only sees the resonance line, whose attenuation is finally registered.

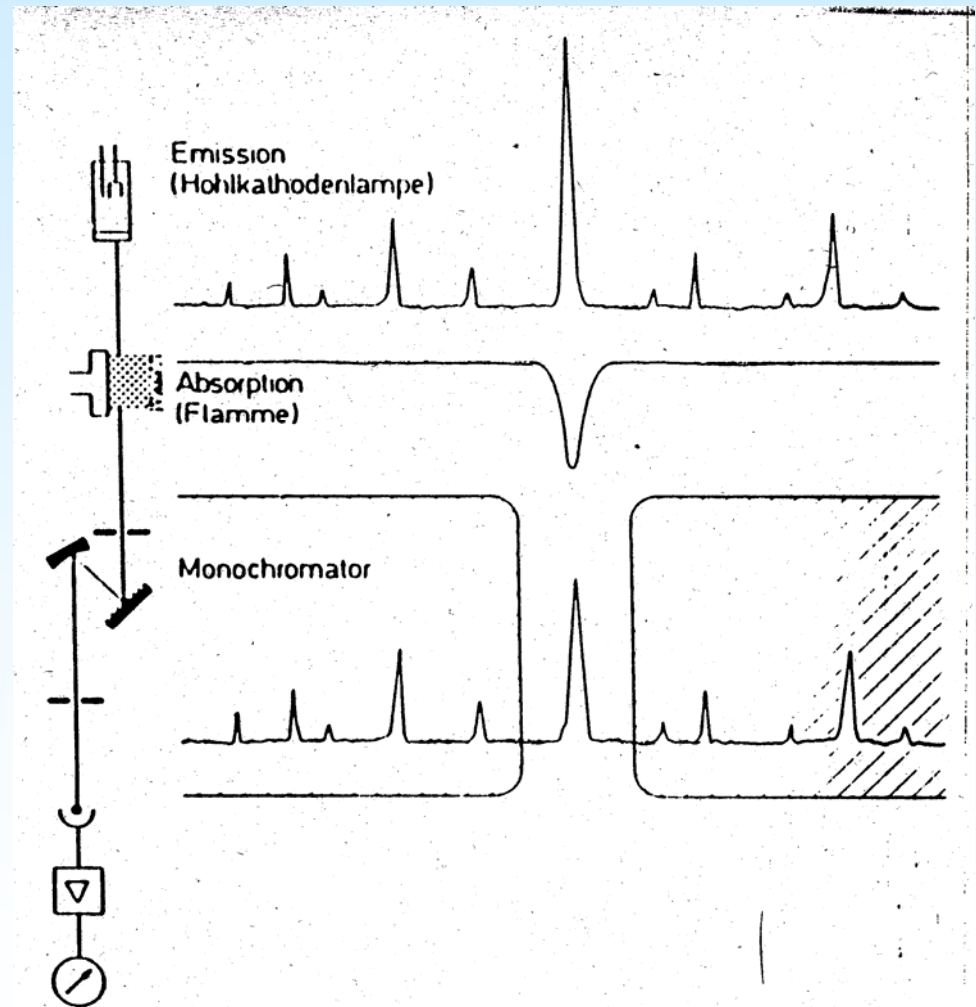

# Measurement principle II

Light attenuation is proportional to amount of metal atoms in the flame:  
 $I/I_0 \sim c$

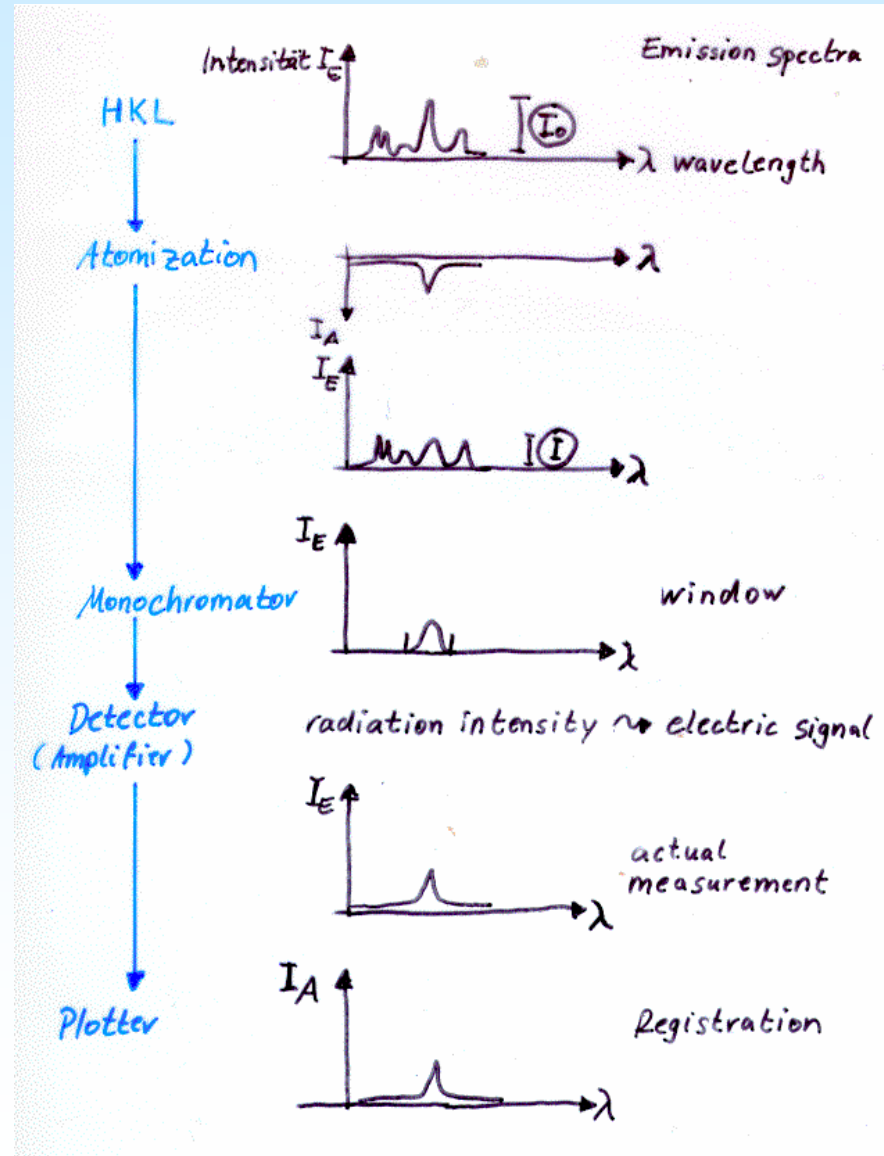



# Hollow Cathode Lamps (HCL)

Fig. 9-11, pg. 215 "Schematic cross section of a hollow cathode lamp."

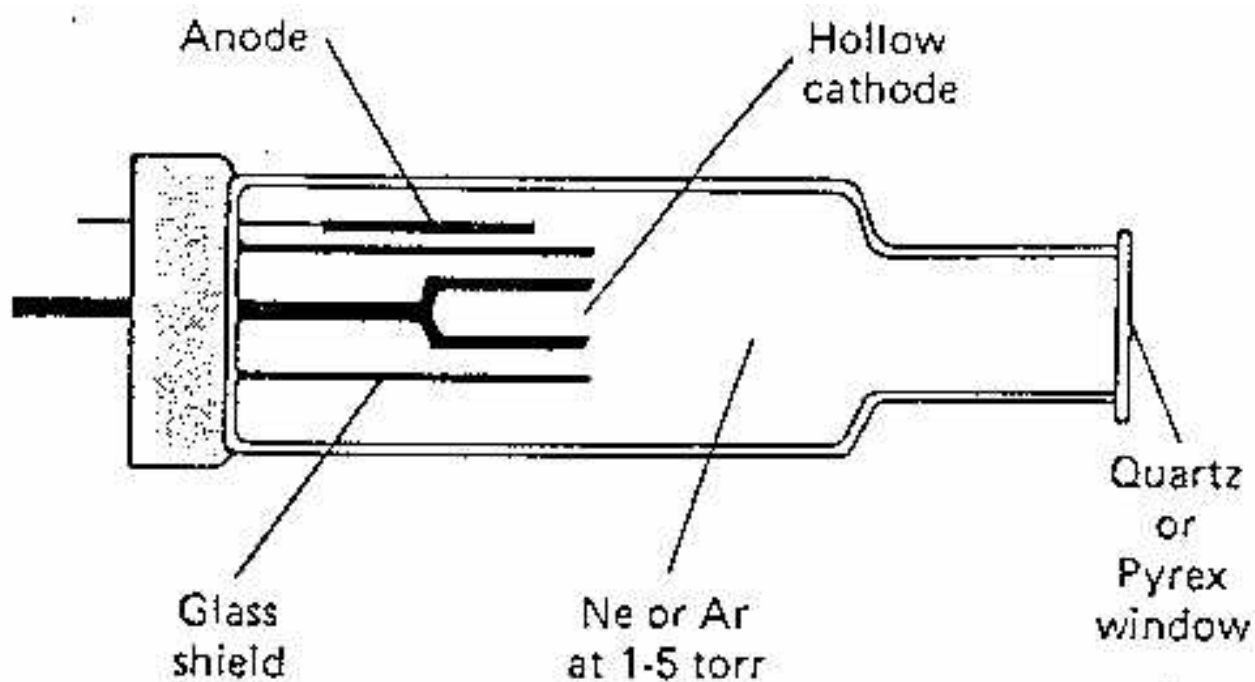

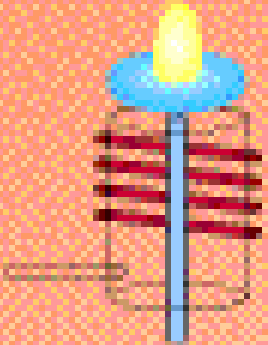

## Hollow cathode lamp

An HC lamp will only produce the emission lines for the cathode element.

Multi-element HC lamps are available but are limited.

Not all metals will make suitable cathodes

- Metal is too volatile

- A good cathode can't be produced

- The metal may not be good conductors

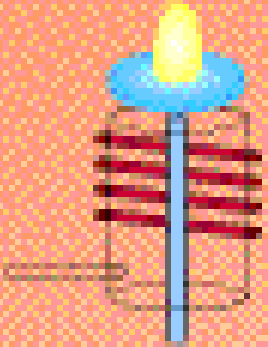

## Hollow cathode lamp

This source produces emission lines specific for the element used to construct the cathode.

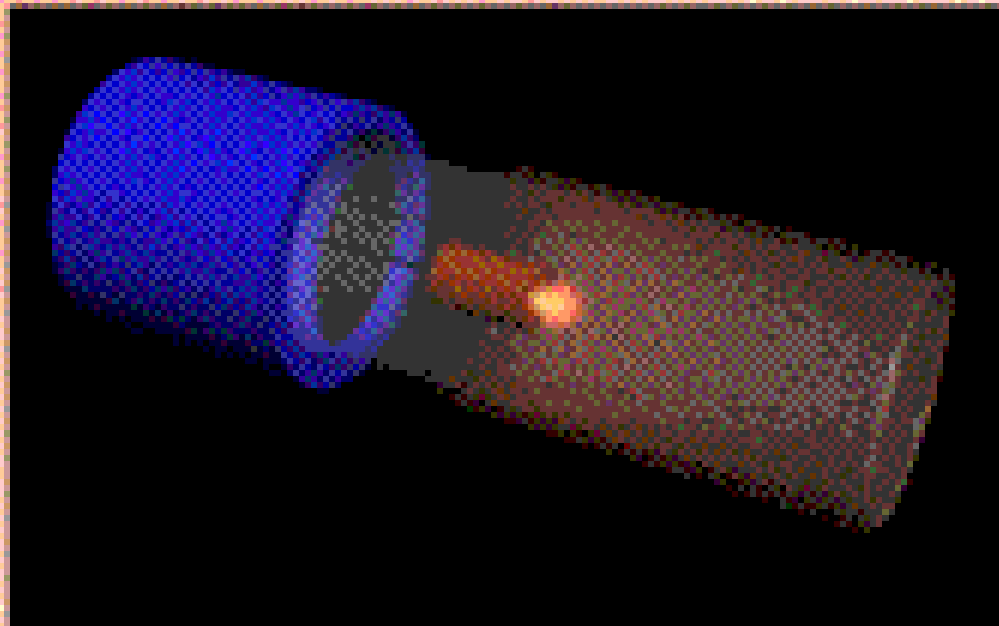

The cathode must be capable of conducting a current for it to work.

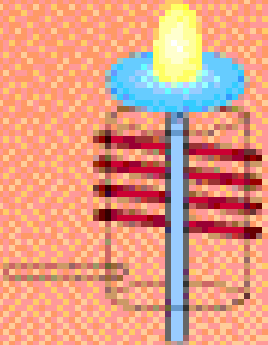

## Hollow cathode lamp

The lamp is filled with an inert gas like argon or neon. When a potential is applied, it causes the gas to become excited and it is driven towards the cathode.

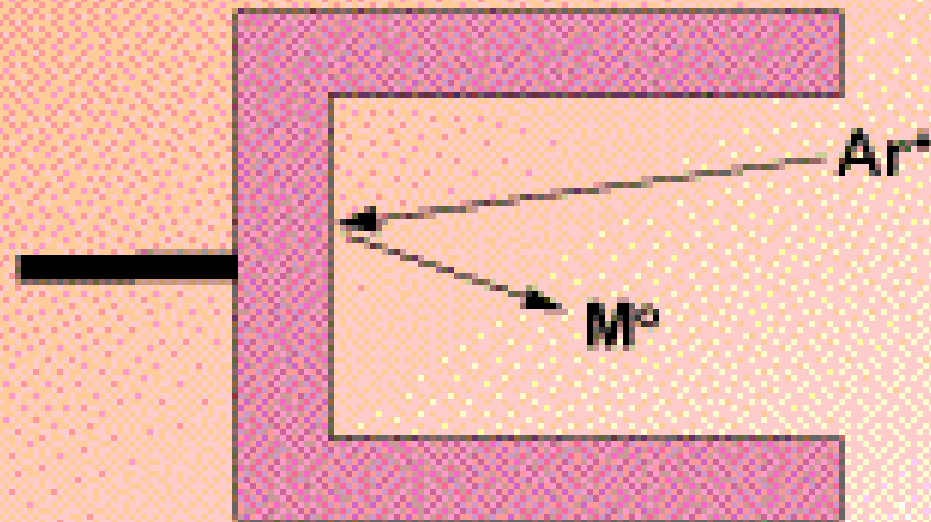

Metal atoms are then sputtered off the surface of the cathode.

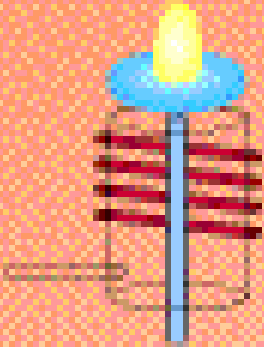

## Hollow cathode lamp

Repeated bombardment of the metal atom by the gas causes it to be excited. It ultimately relaxes, producing specific atomic emission lines.

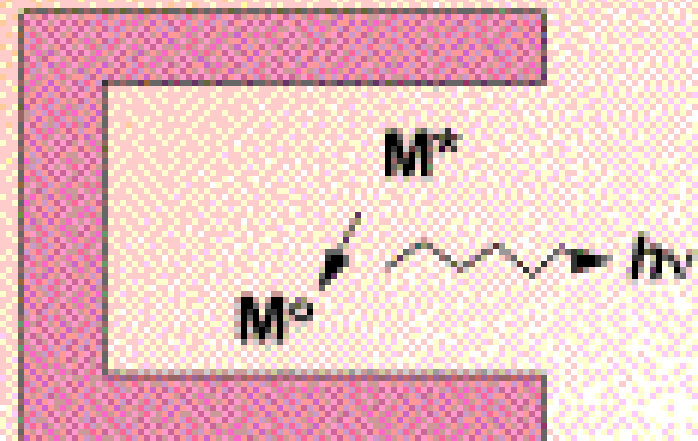
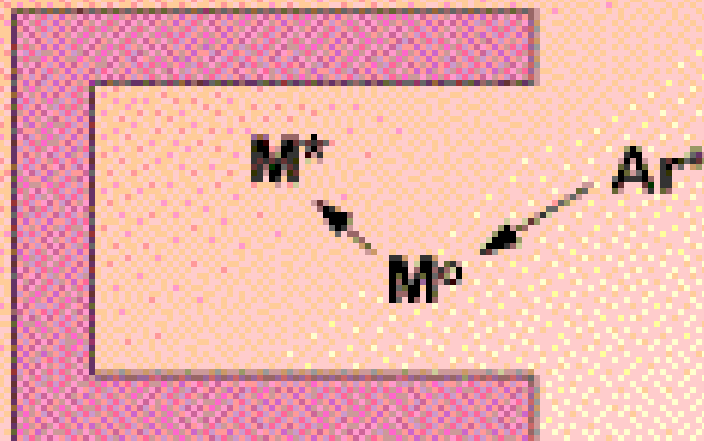

# Analysis of total chromium and hexavalent chromium (Cr(VI)) in leather

Leather goods are considered to be pure natural products. Keeping in mind that during treatment of animal skins about 250 different chemicals (e.g. aldehydes, phenols, pesticides, acids, caustic solutions, heavy metals, solvents, softeners, coloring agents, plastics, oils and fats) are used, it appears not correct to title leather as „natural products“.

These chemical treated leather products can set different chemicals free, as soon as they get in contact with the human skin. These chemicals may display a dangerous potential for the consumers health.



Therefore migration experiments were accomplished, which simulated the release of chromium and carcinogenic Cr(VI) from leather by the application of artificial sweat solutions.

The results of the coincidentally selected 29 leather samples were frightening:

It was shown under the chosen conditions, that approx. 1/2 of the samples released hexavalent, carcinogenic chromium in the simulated sweat.





# Total chromium of 29 leather samples of 5 different categories

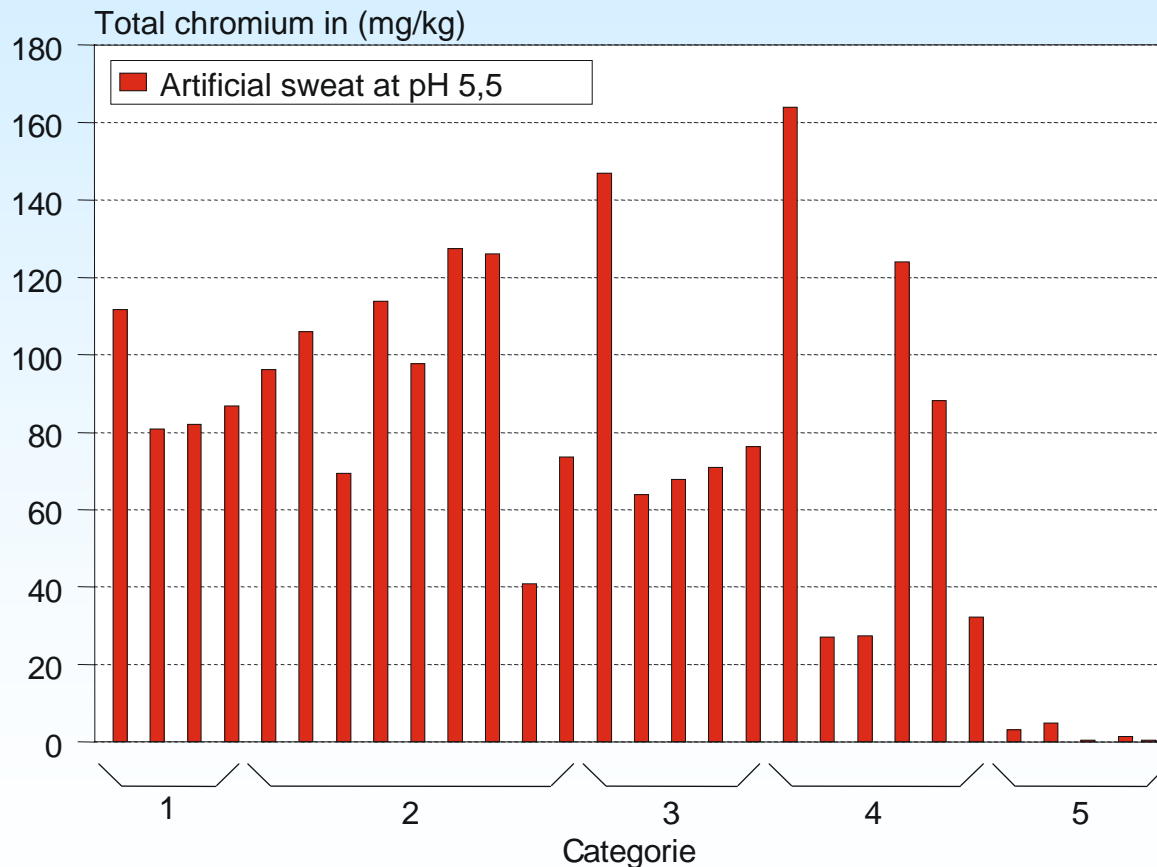

# Concentration of Cr(VI) in 29 leather samples of 5 different categories

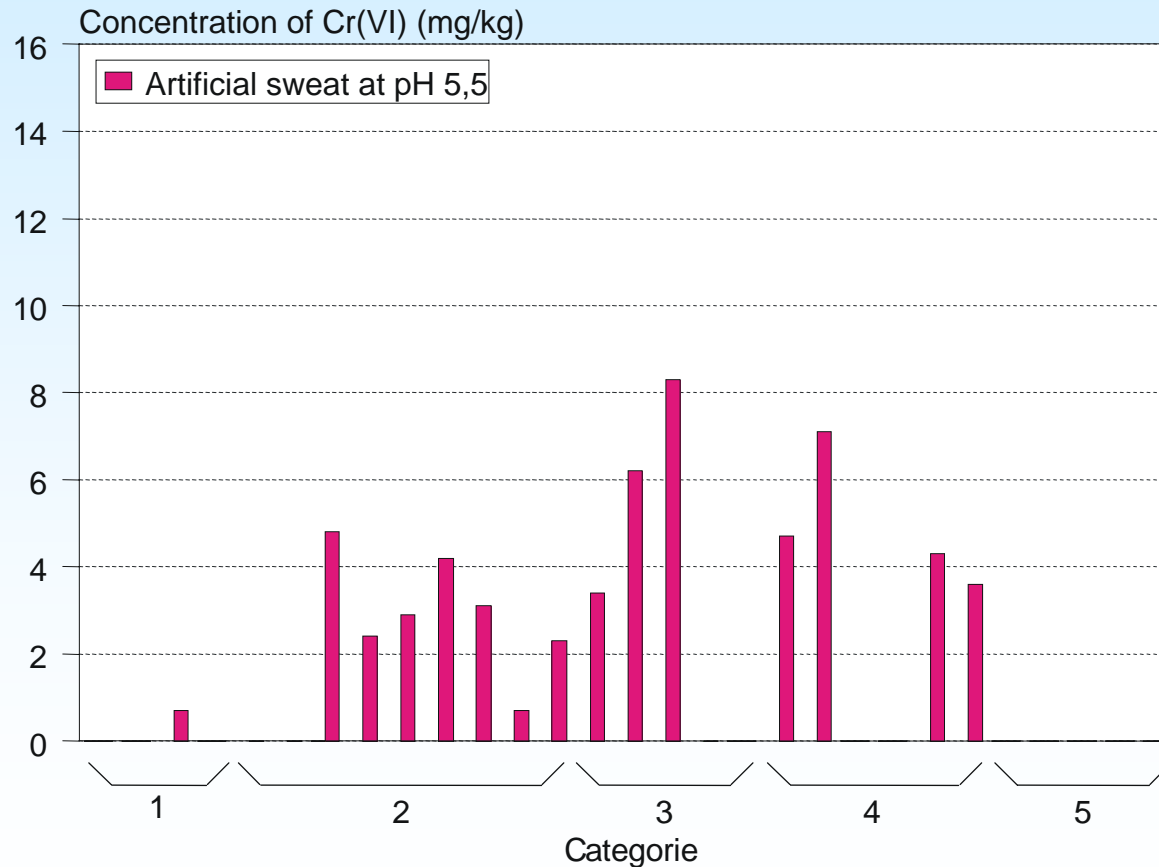

Thank you for your attention

