

Industrial Design Project- 3

# TRANSFORMABLE FURNITURE

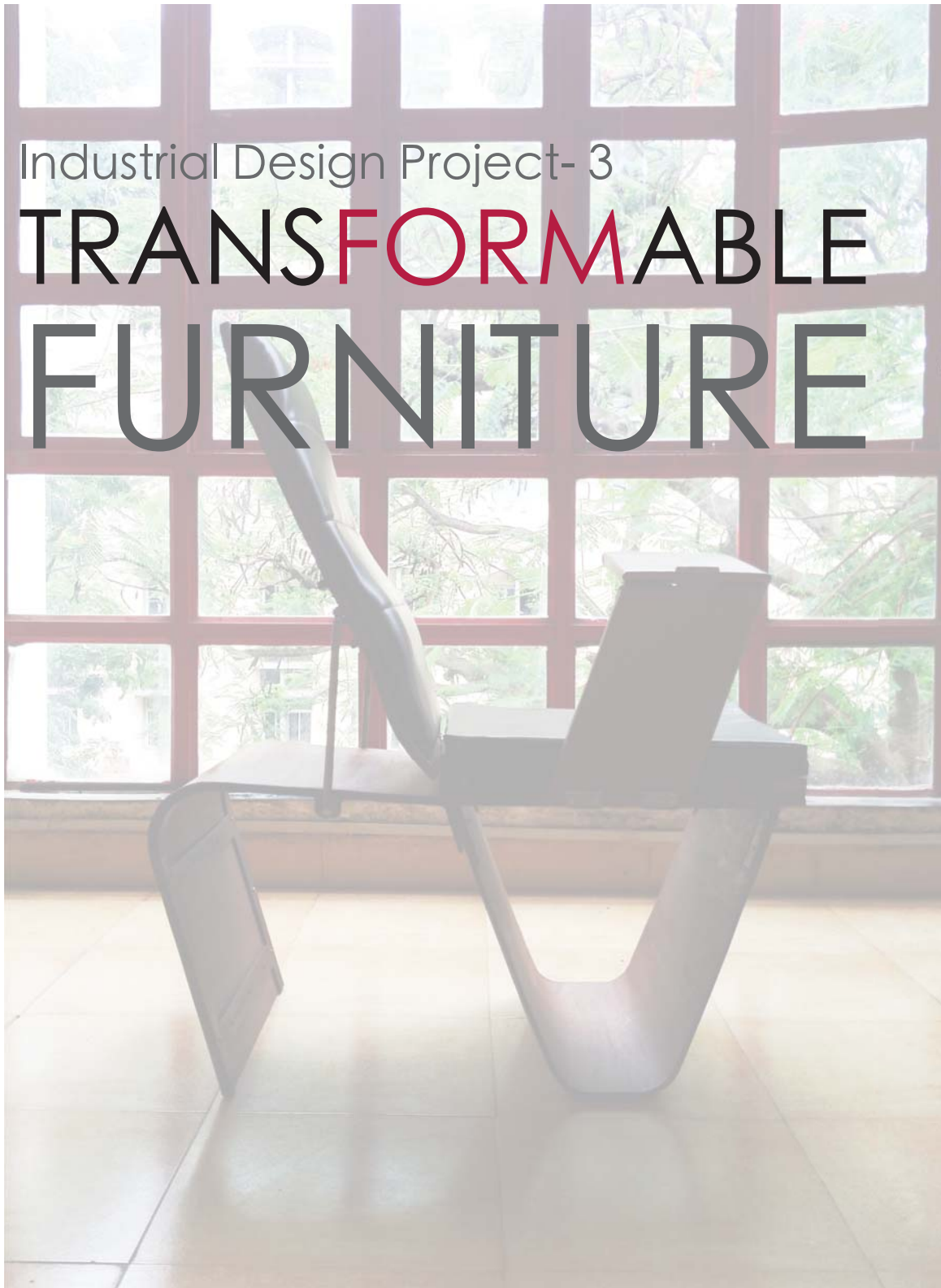

Ibynta B Tiewsoh

10613005

Guide:

Professor Purba Joshi

Co. Guide:

Professor N. Sadhu

## What is transformable furniture?

- Multi functional
- The user gets more out of a small space
- Interactive
- Playful
- Layout looks mundane after a certain point of time, transformation takes away the 'boring' factor

Study

Design  
process

Final  
concept

- Why transformable?  
(need and opportunity)
- Focus group
- User studies
- Scenario
- Inference

## Why transformable? (Need and opportunity)

- Young people cannot afford to equip an apartment or room enough necessary furniture, and this means that some objects will have to be multifunctional.
- Breathing space is needed
- Not that interested in mundane activities like cleaning every other day, so low maintenance is required.
- There is currently a lack of an organiser of sorts, which leads to so much clutter.
- Low height furniture or mats are used, especially for eating, sitting, sleeping
- Need a better system, most importantly when entertaining family, friends or colleagues.

## Focus group

- The current scenario in cities is that a lot of young professionals just starting off with their careers come from various corners of the country.
- Initially a large disposable income is not available
- It is unnecessary to buy large quantities of furniture serving different purposes if the need to move arises.
- Crave a lifestyle or aspire to live comfortably and better living.
- A measure to establish their independence to support themselves and the way they live.



## User studies

- Questionnaire
- Mood board options
- Timeline study for weekdays and weekends
- Scenario study

## Scenario

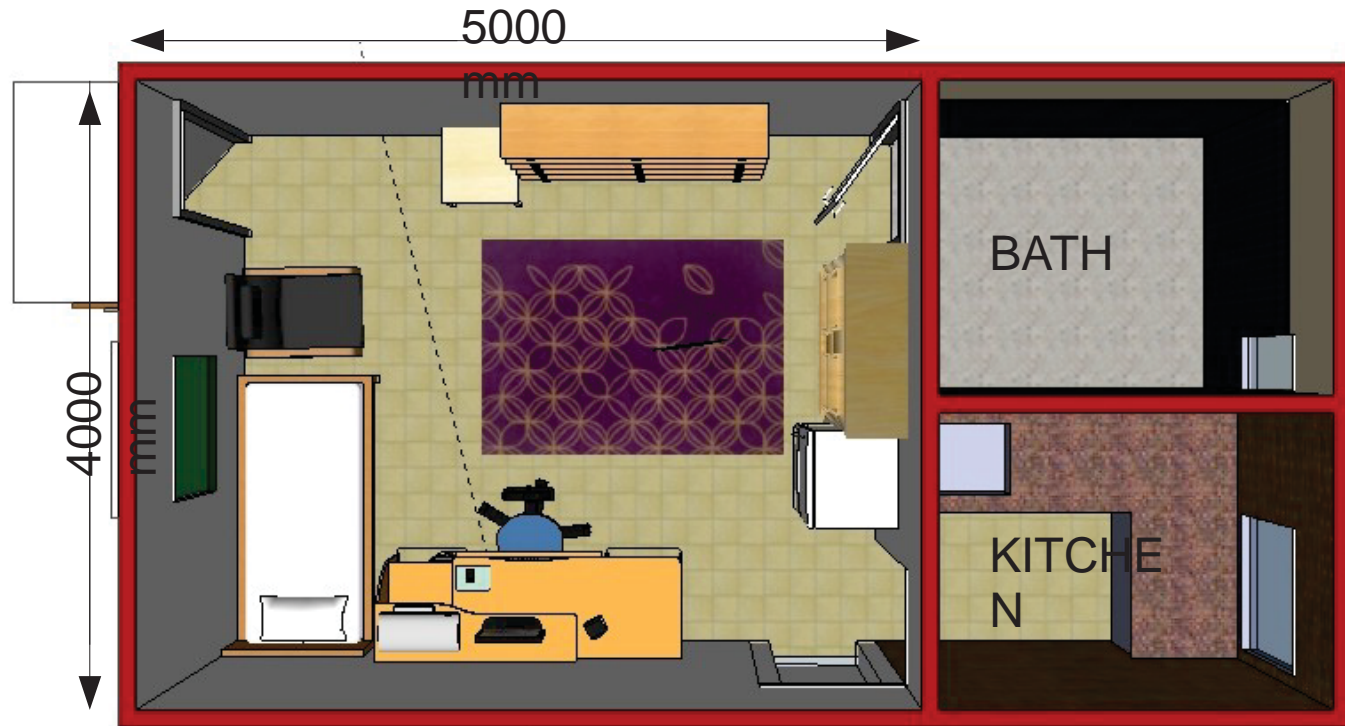

- The above plan is of an one room apartment i had studied. Its 5m x 4m in area with an attached kitchen and bath.

- The main room is used for sleeping, working, dining, entertaining friends and storage purposes.

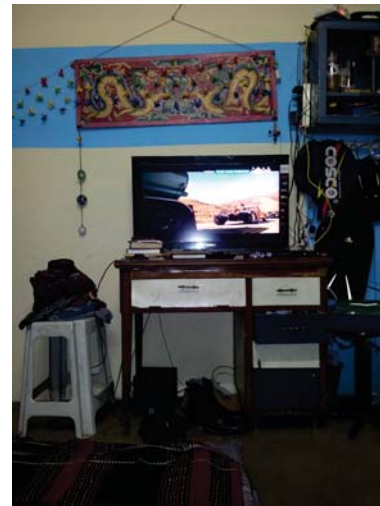

## Inferences

From the activities performed in the regular routine, the following was observed to be more frequent:

- Need for a chair while watching tv or entertaining people
- Lounge chair for reading and taking short naps
- A work unit to write on or to place laptop
- A dining unit to spread the plates and food

*The human posture regarding all these activities change and thus require adjustments in the type of furniture needed.*



Study

Design  
process

Final  
concept

- Scope of the project
- Design Brief
- Explorations
- Possible materials
- Possible mechanisms
- Design ideations
- Form explorations  
(sketches and models)
- Rig testing of concepts
- Evaluation



## Scope of the project

- To design a work/ study unit
- To design for eating/ dining
- To design for leisure/ reading/ relaxing

## Design brief

- The furniture should transform for different posture seating functions like for study, lounge, dining, reading.
- Product should have –
  - Lumbar support
  - Leg rest
  - Adjustable backrest
  - It should be easily handled by one person

# Exploration

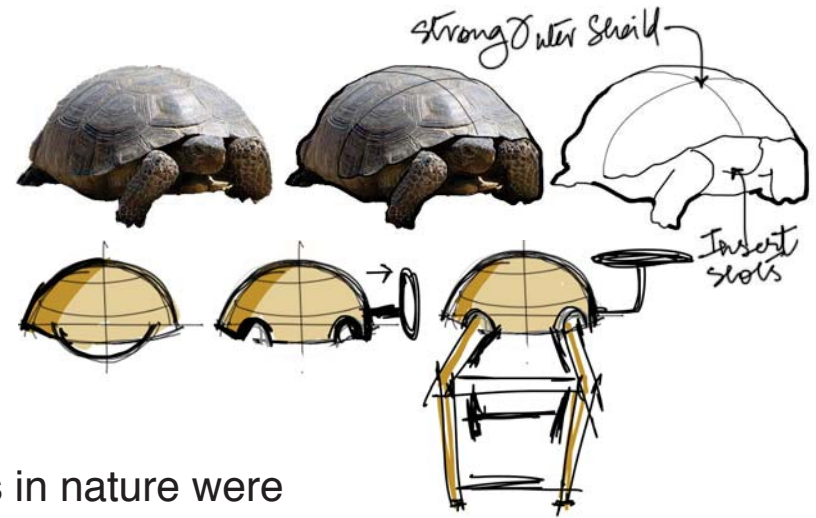
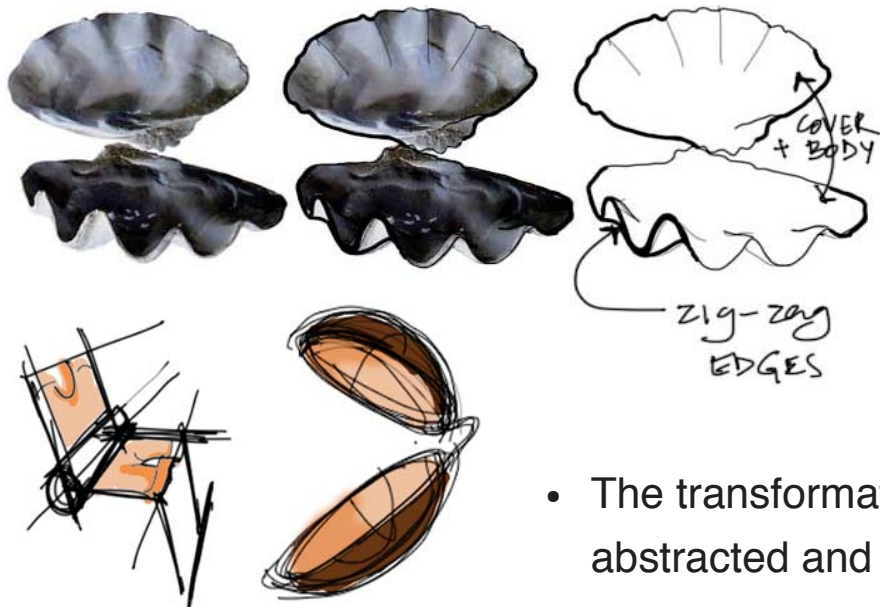

- The transformations in nature were abstracted and analysed.

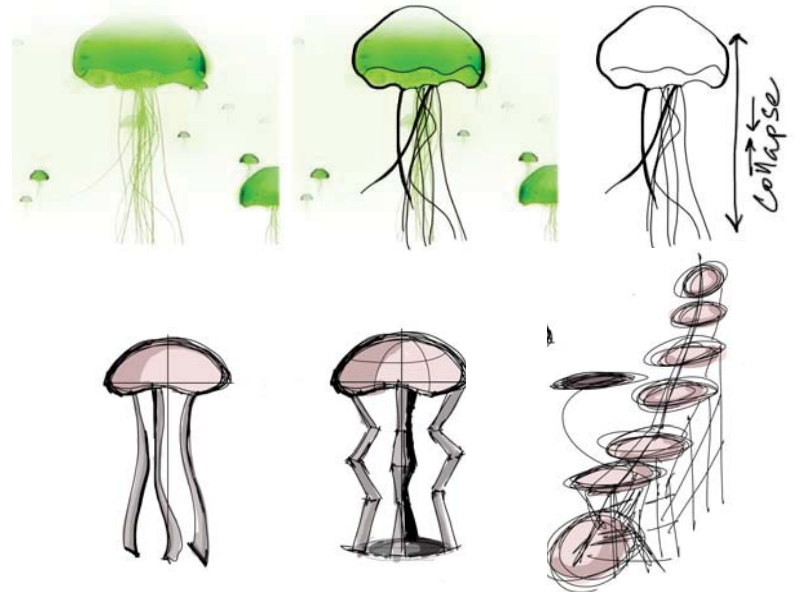
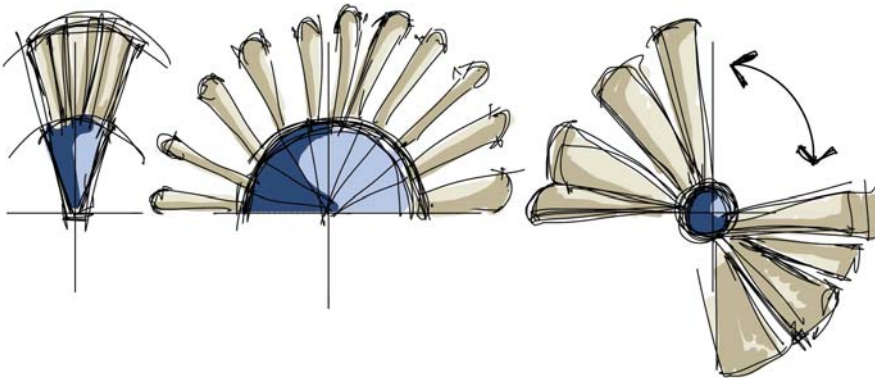

# Exploration



modular  
units  
folding

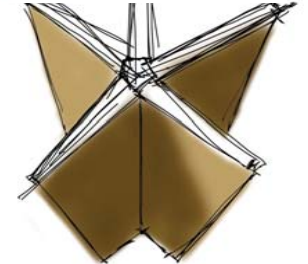
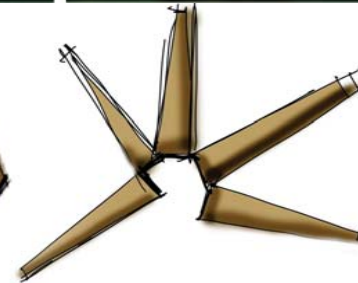
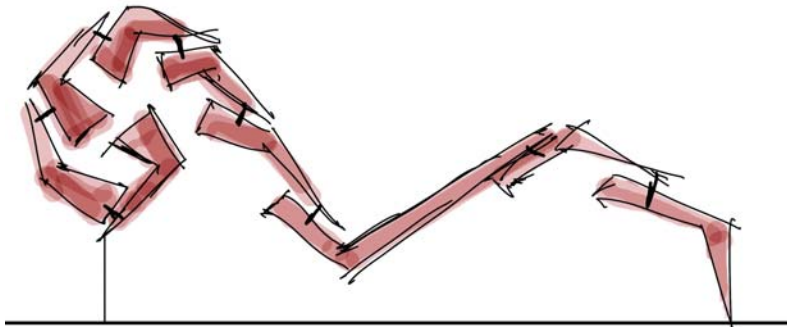
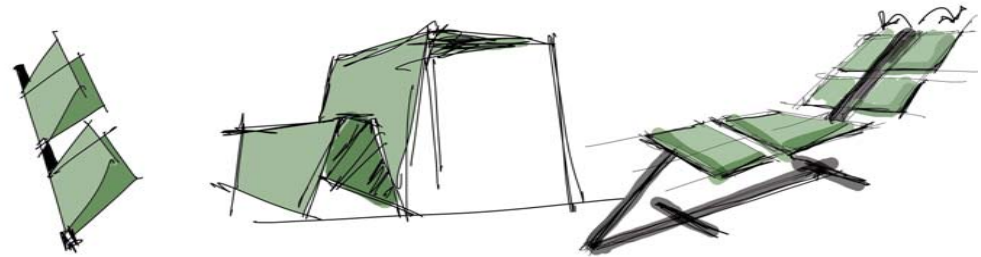
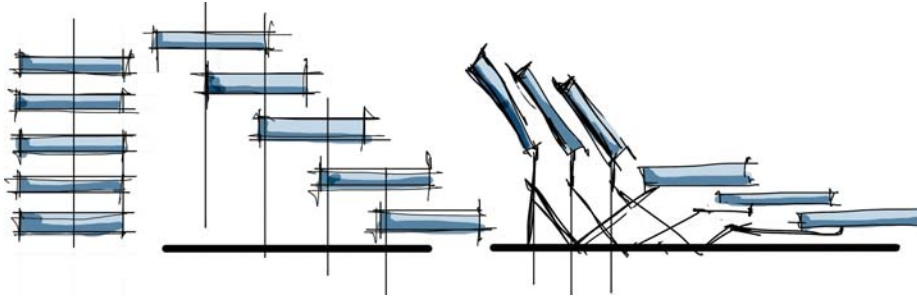



Possible materials



Foam



Polypropylene



Stainless steel



Plywood



Cane and bamboo



Cork sheet



Possible mechanisms



Hinge

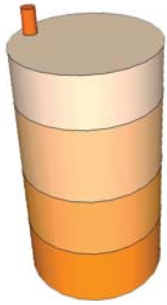

Pivot

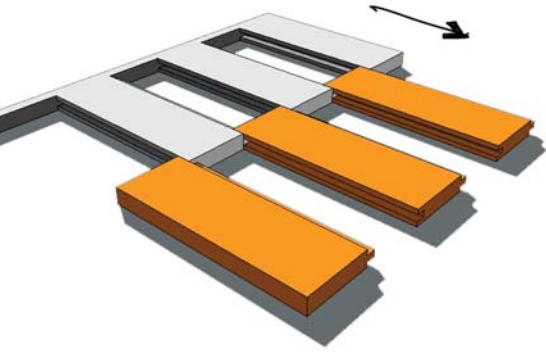
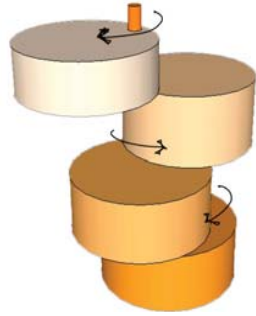

Slide out

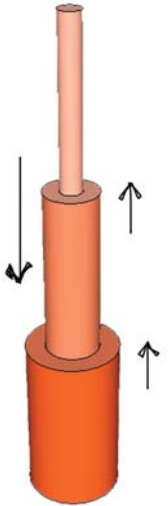

Parallel alignment

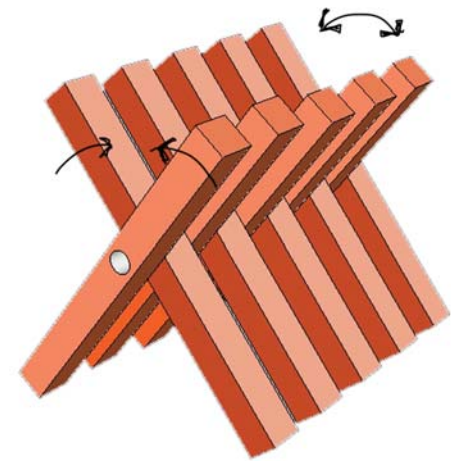

Alternate fold



Recliner



Hook

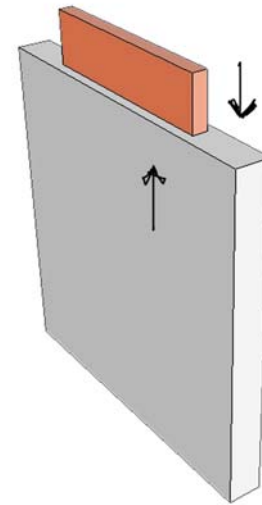

Slot insert

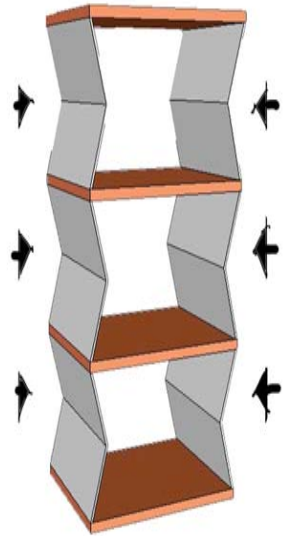

Expand & contract



## Design ideation



- It has a flap mechanism, supported by a hinge which snaps shut the back support and the leg support.
- The low table underneath is provided wheels for easier handling.
- The seat cushions in the dining unit overlaps one another.
- Possible materials for this is mixture of a wooden framework and PU foam for the cushions



## Design ideation

- The furniture will be having a snap fit mechanism or a hook mechanism where the cushion hooks itself on the cushion below it.
- This way the cushions do not move but they stay in place.



## Design ideation

The design idea is the result of three components, the framework, seat and backrest. The back rest can collapse into the seat, making it easy to move around the house.

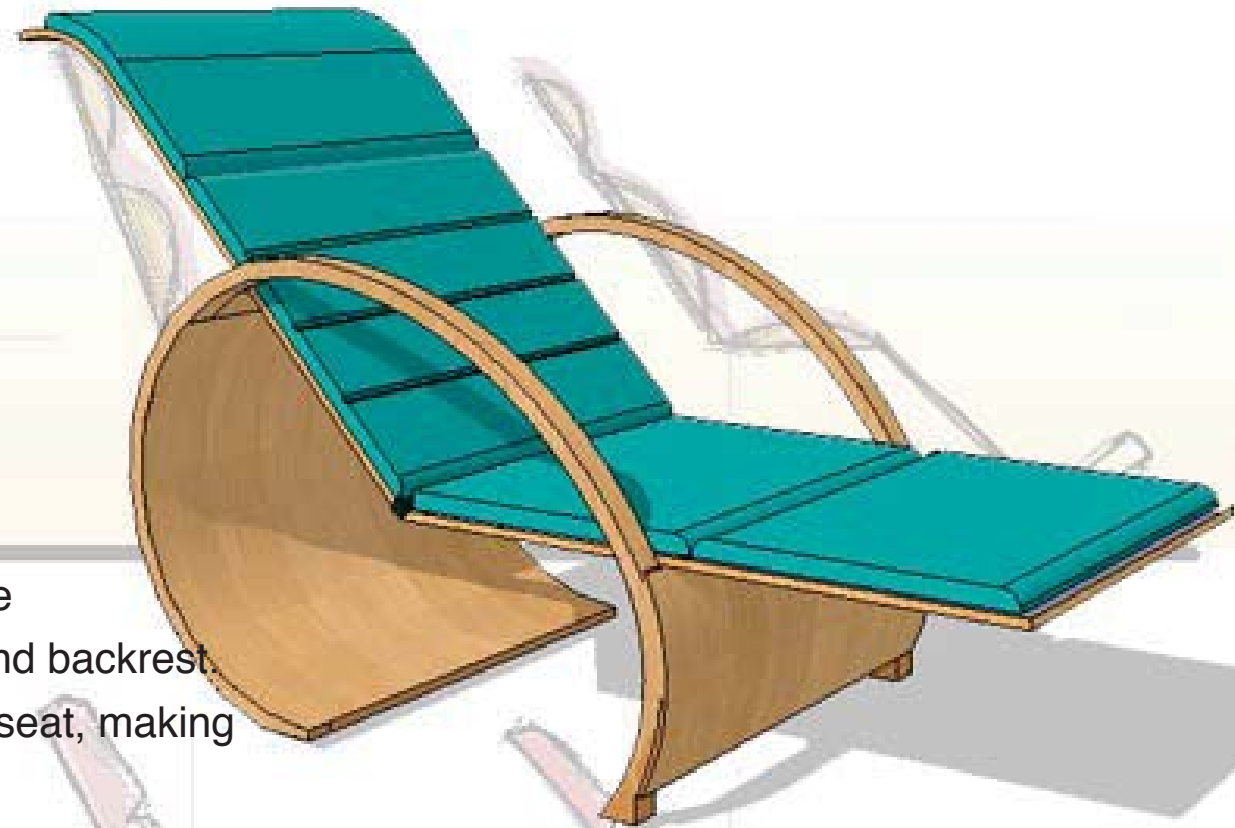

## Design ideation

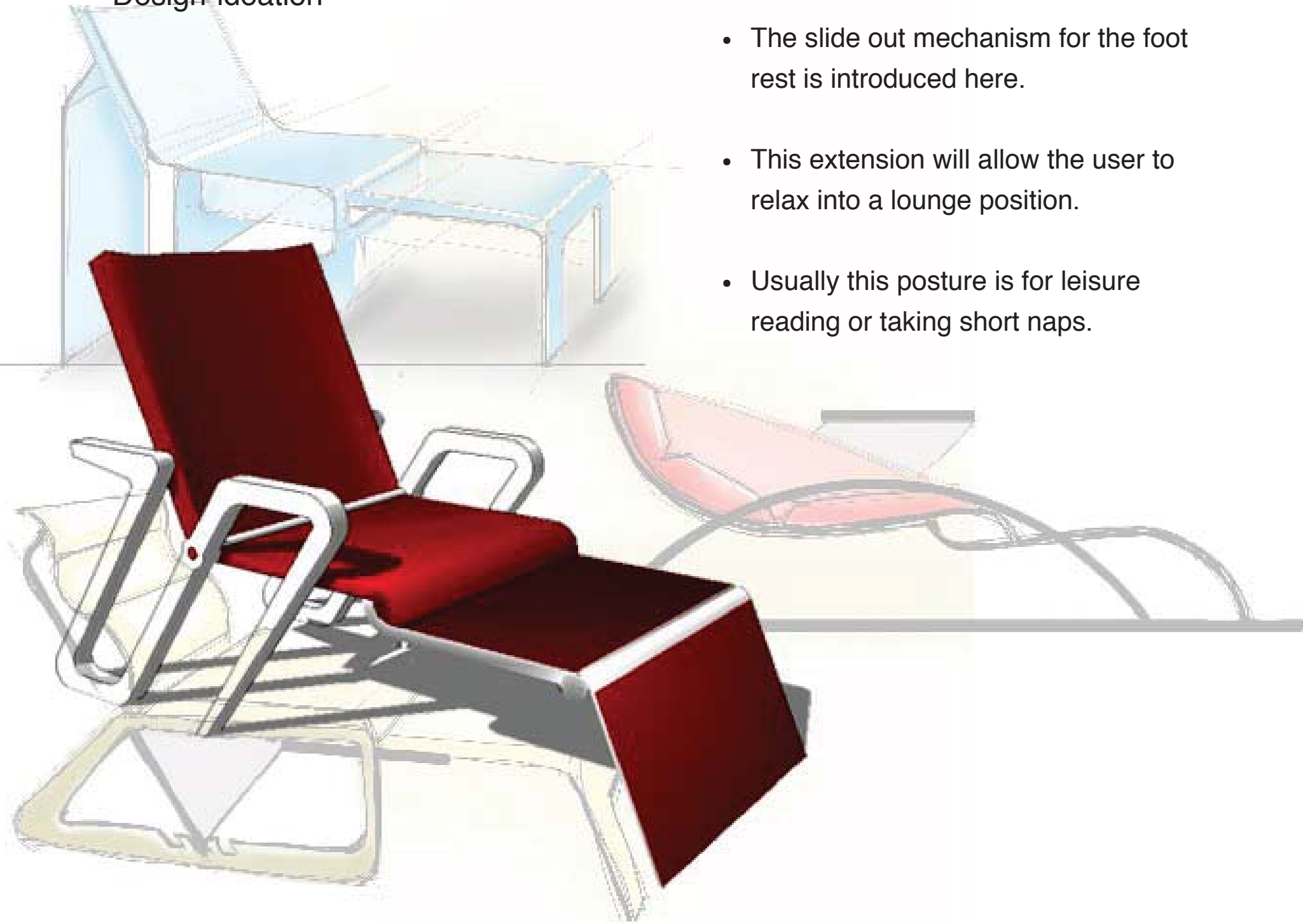

- The slide out mechanism for the foot rest is introduced here.
- This extension will allow the user to relax into a lounge position.
- Usually this posture is for leisure reading or taking short naps.

## Design ideation

- The backrest is adjusted by having cut out parts of it being pushed out and inserted into slots of a framework placed behind the back.
- The slots supporting the cut out correspond to the angle needed for different posture seating.

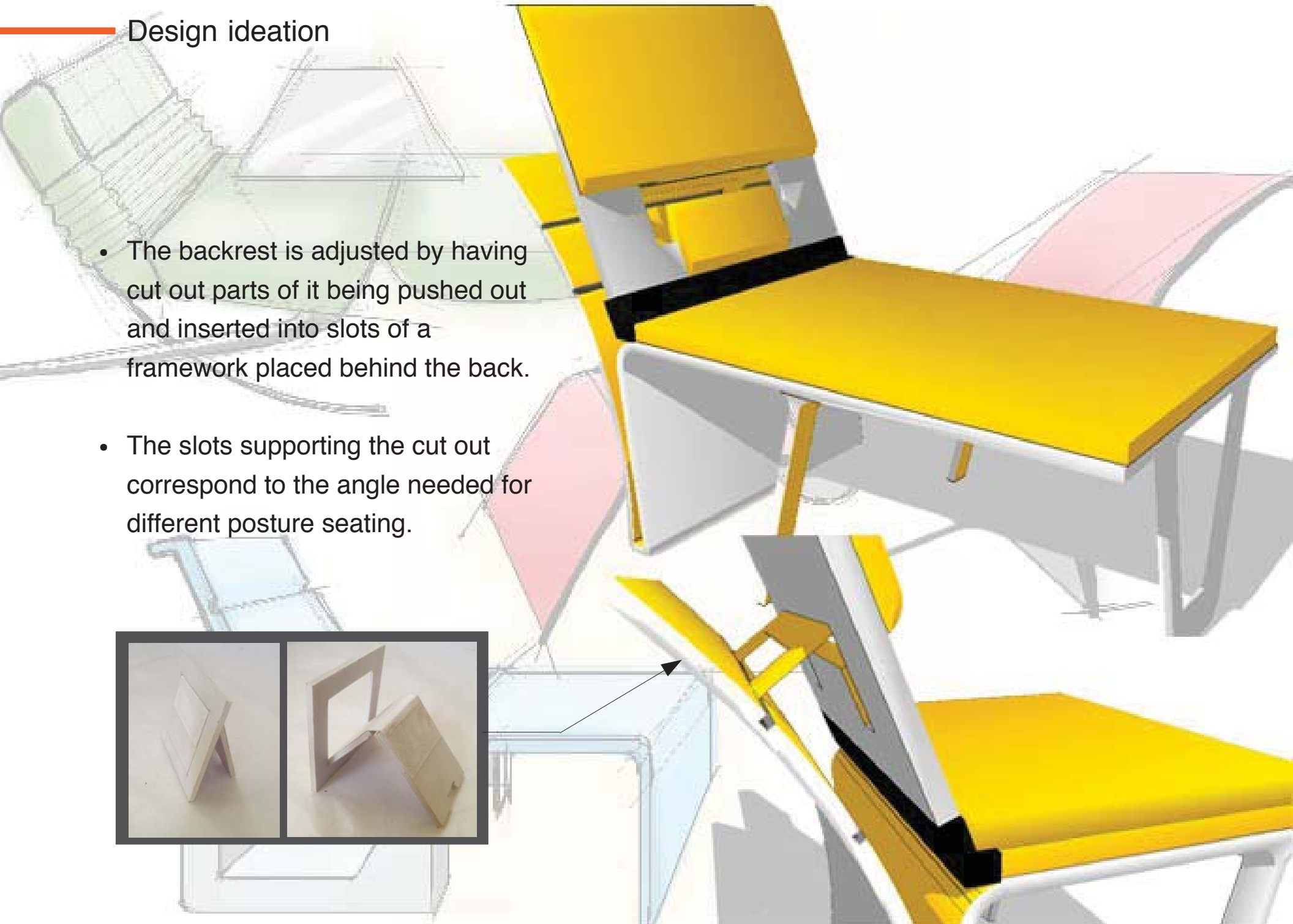
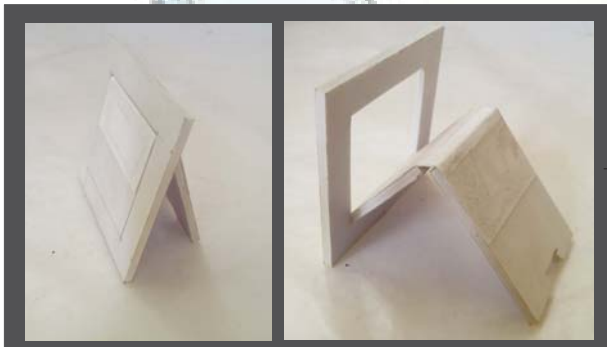

## Design ideation

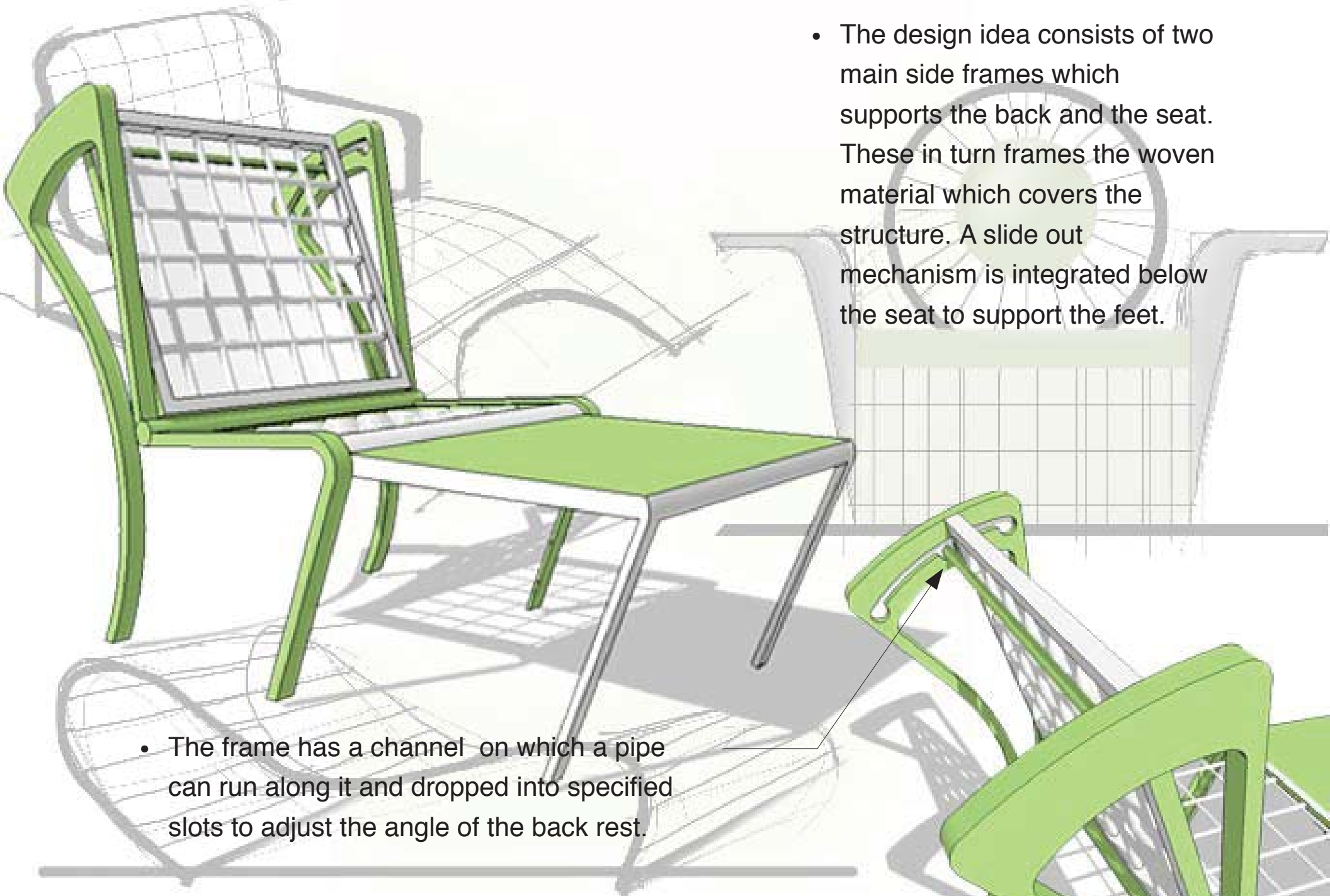

- The design idea consists of two main side frames which supports the back and the seat. These in turn frames the woven material which covers the structure. A slide out mechanism is integrated below the seat to support the feet.

- The frame has a channel on which a pipe can run along it and dropped into specified slots to adjust the angle of the back rest.



## Design ideation

- The adjustment in the back rest is done by pulling the arm rest forward or back depending on the angle.
- The hook runs along the channel and slot on the arm rest.

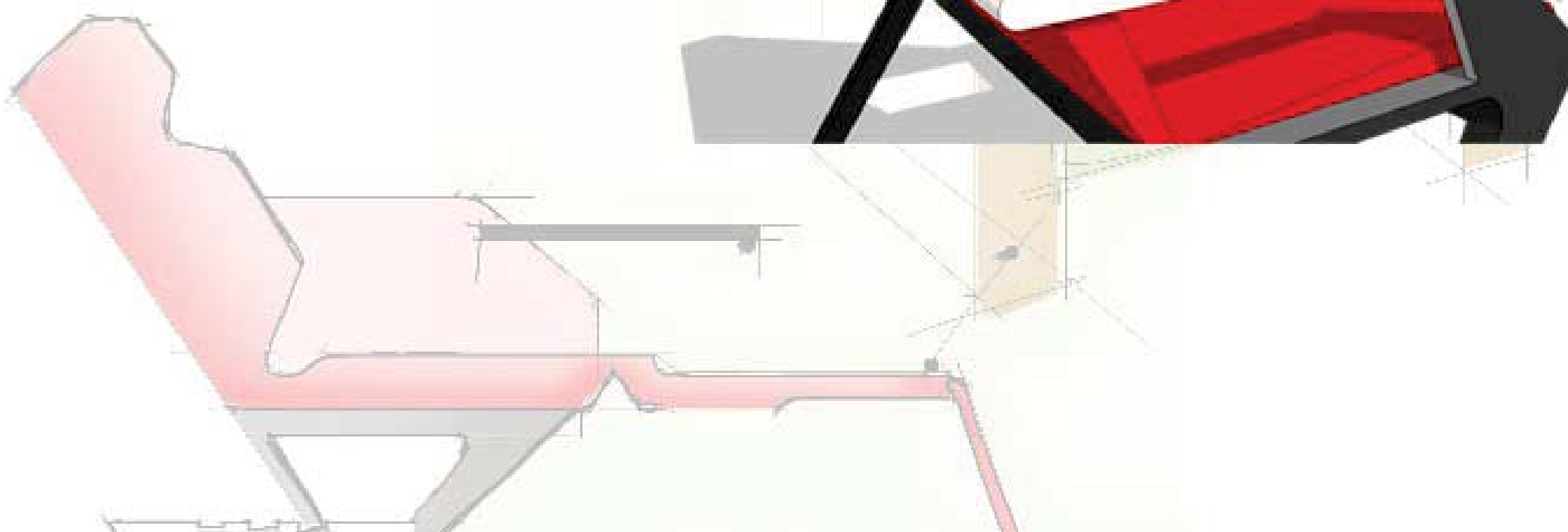

Design ideation

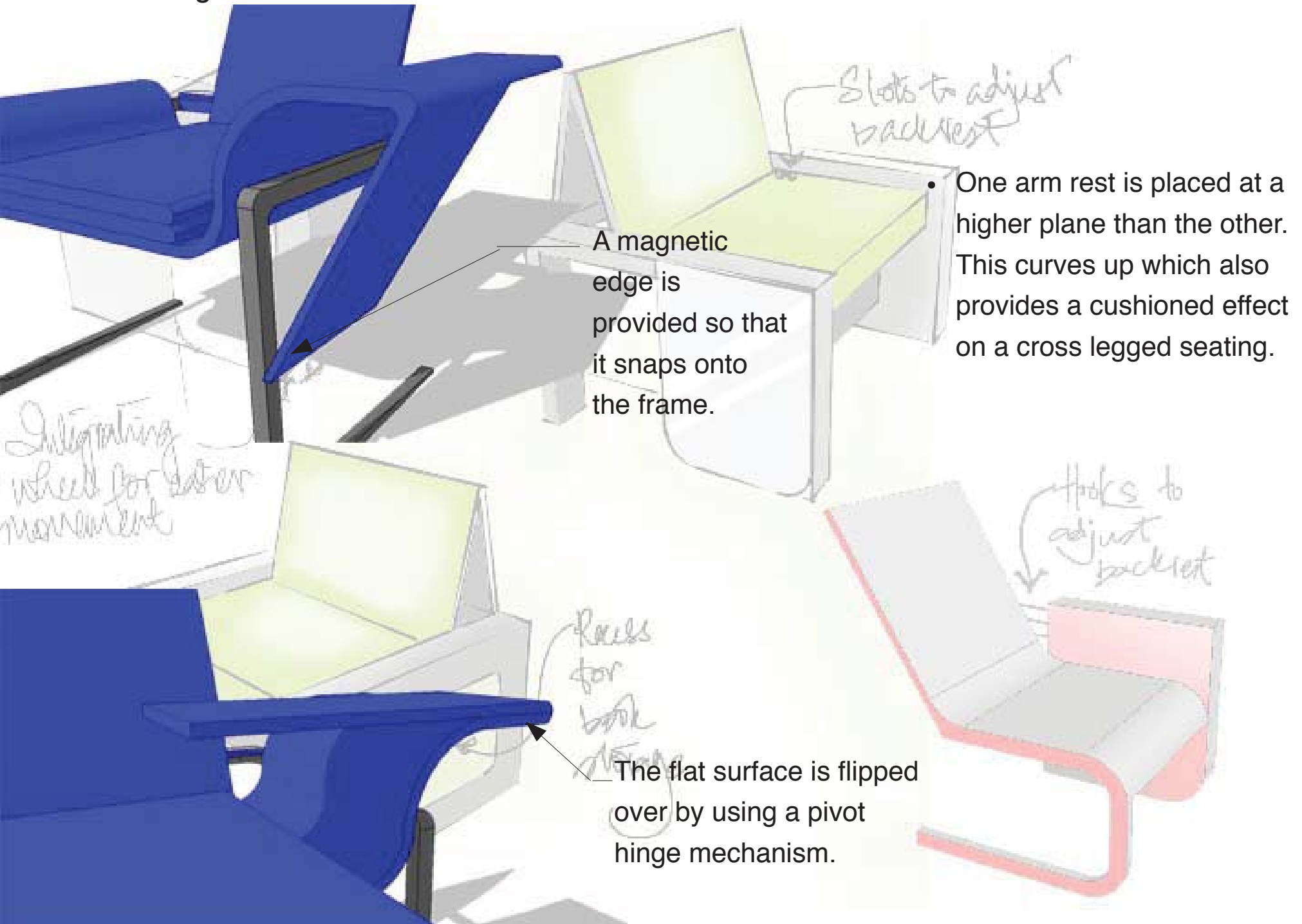

Rig testing of concept # 1

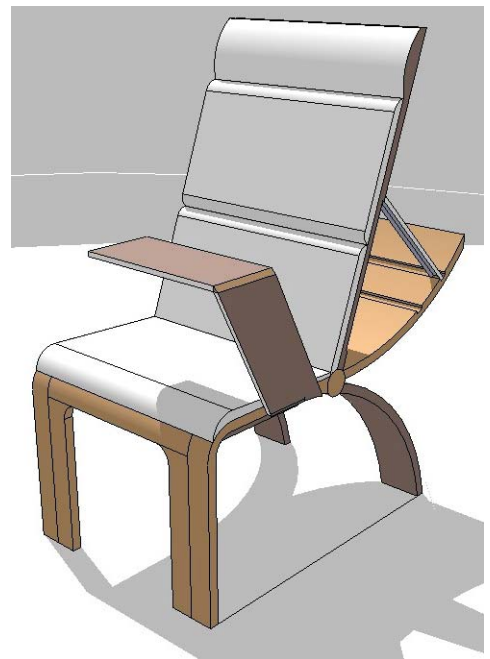
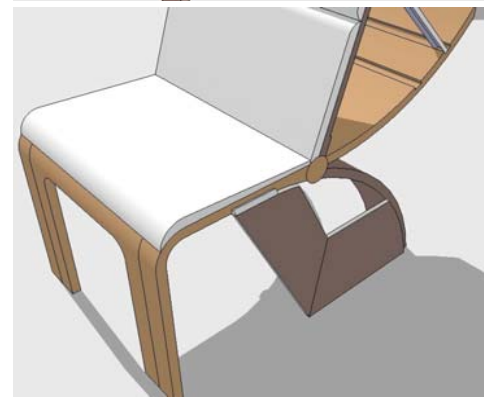

- Playing with curves, one support at the base, the other to support the backrest
- Backrest held by hooking the back along the channels.





## Rig testing of concept # 1

- The height and width of the rig was satisfactory
- Need a head rest to handle leisure activities
- When reclined without the hook, the angle felt more like lying on a bed

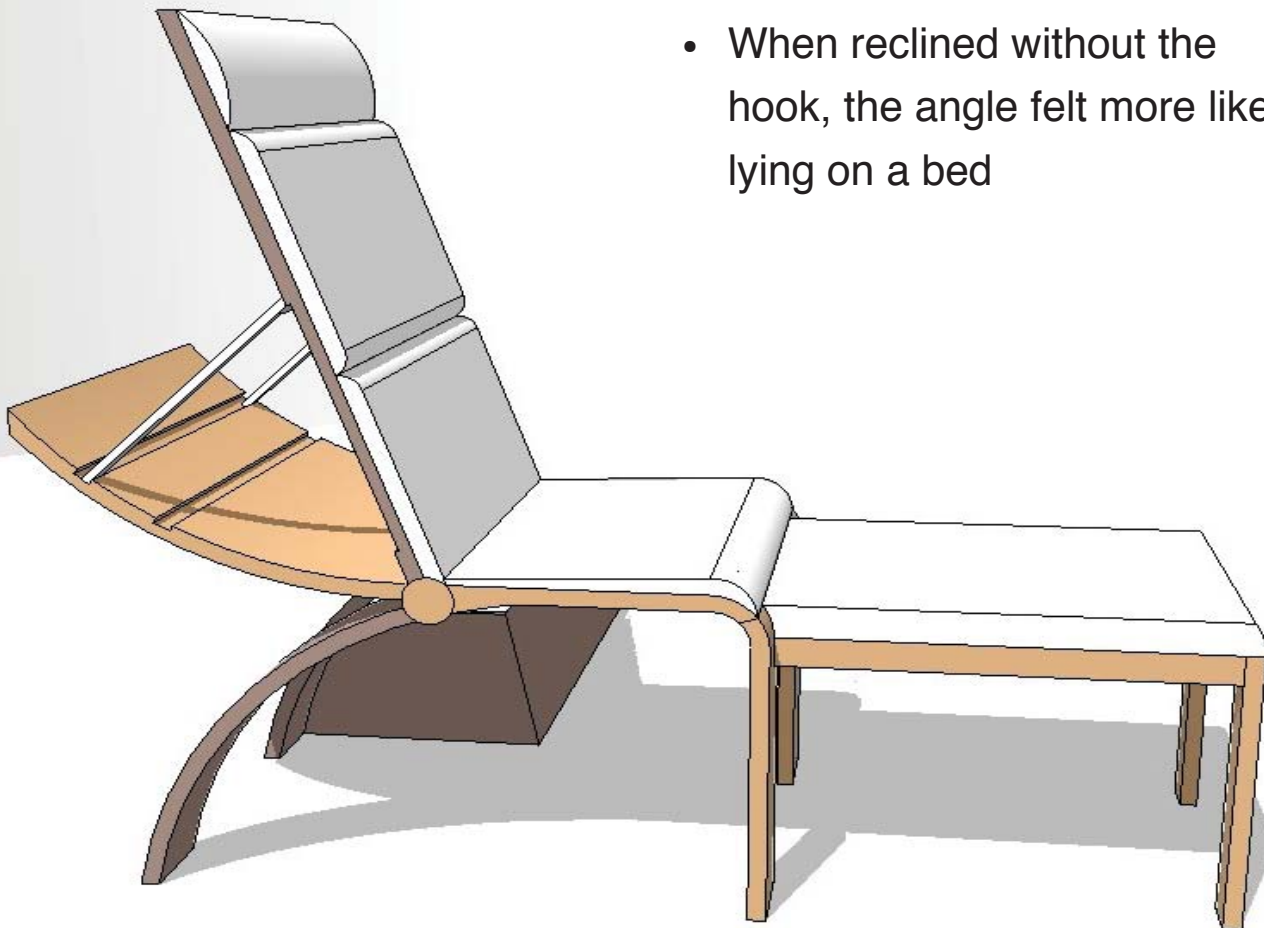

## Rig testing of concept # 2

- Has wheels at the front for easier portability
- When user needs to move the chair, all that is required is to lift and pull.
- Can change into a work unit by lifting up the work top which snaps to the side

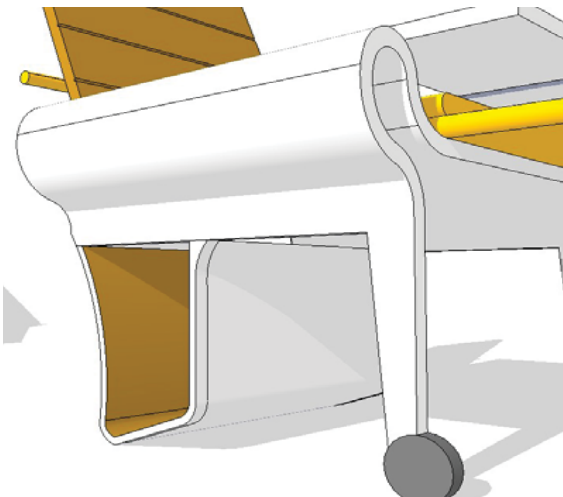
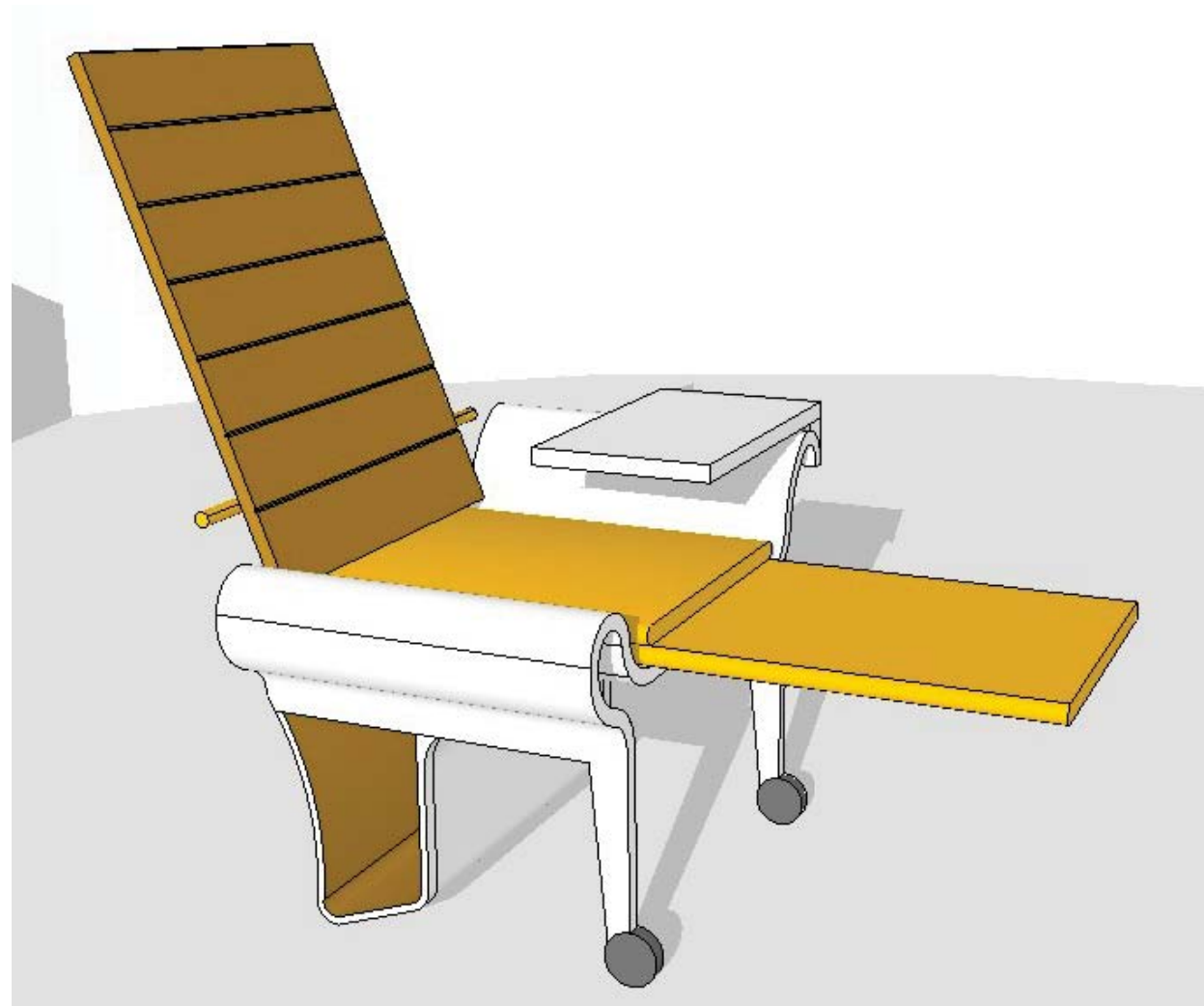

## Rig testing of concept # 2

- Becomes more effortless with wheels
- The handle member supporting the back is stable, and provides strong support to the backrest.
- The load of the chair is reduced when pulling it around





Rig testing of concept # 3

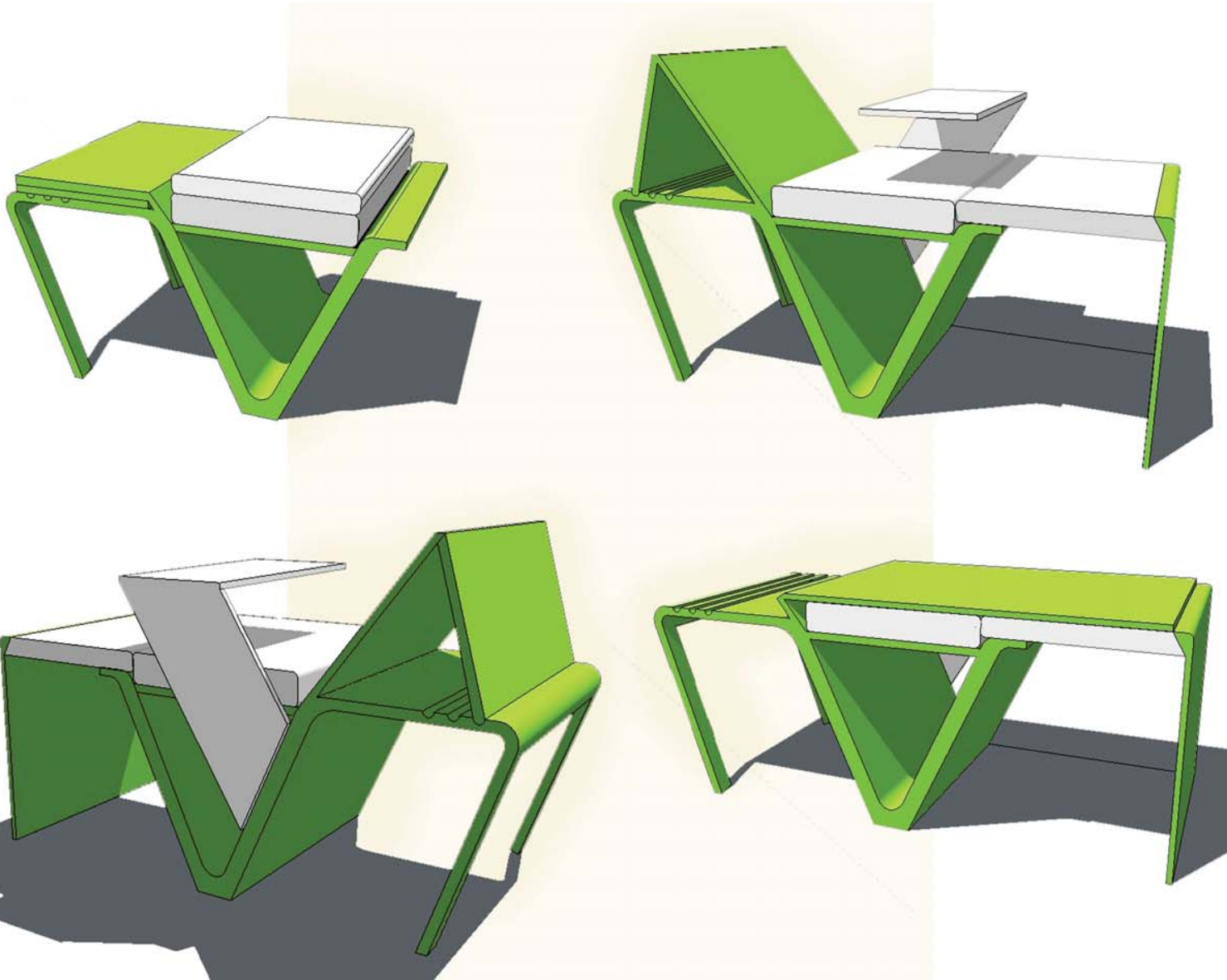

- Single sitting
- Work unit
- Extended recliner
- Double sitting plus coffee table
- Storage for books, magazines..

## Rig testing of concept # 3

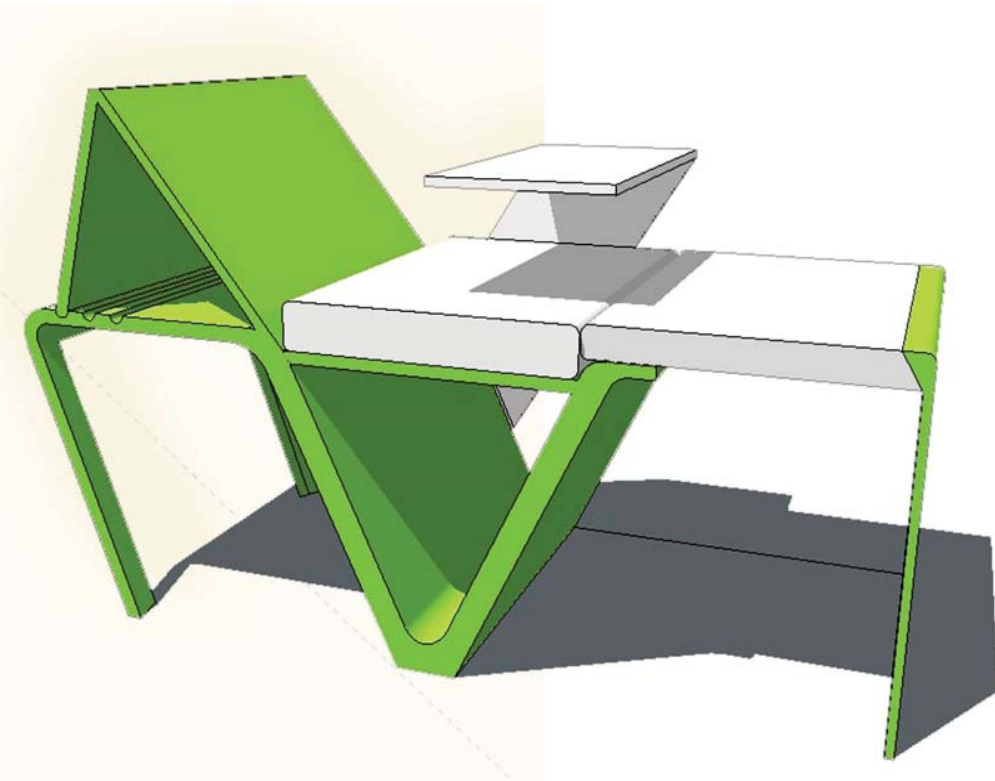

- Various sitting postures were tested out.
- Support to the head was needed.
- When double sitting was tried out, the only problem is that the users do not face each other



# Evaluation

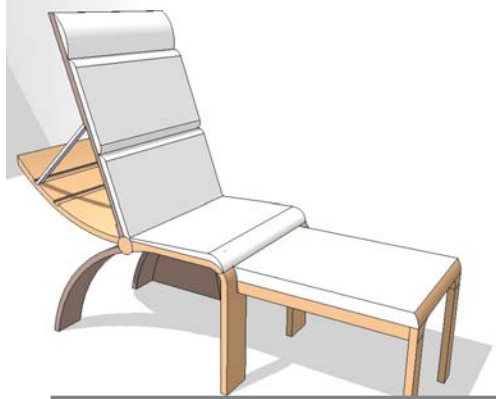

Work unit	Dining unit	Lounge	Reading	Storage	Lumbar support	Leg rest	Utility
✓	For 1 person	✓	Not so comfortable	✗	Comfortable	✓	<ul style="list-style-type: none"> <li>•Sitting 1 person</li> <li>•Relaxing</li> <li>•Working</li> <li>•Dining</li> </ul>



✓	For 1 person	✓	Comfortable	✓	Comfortable	✓	<ul style="list-style-type: none"> <li>•Sitting 1 person</li> <li>•Relaxing</li> <li>•Working</li> <li>•Dining</li> <li>•Storage</li> <li>•Portable</li> </ul>
---	--------------	---	-------------	---	-------------	---	--

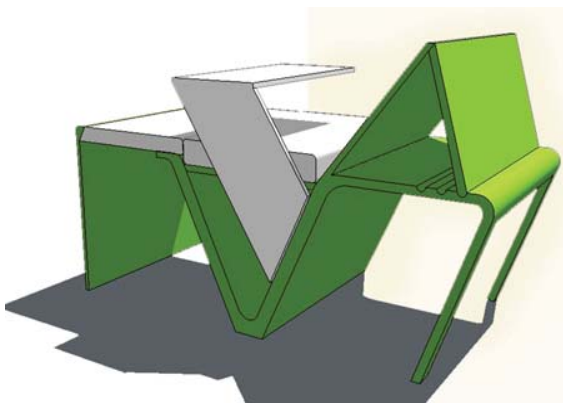

✓	For 2 people	✓	Comfortable	✓	Comfortable	✓	<ul style="list-style-type: none"> <li>•Sitting 2 people</li> <li>•Relaxing</li> <li>•Working</li> <li>•Dining 2 people</li> <li>•Storage</li> </ul>
---	--------------	---	-------------	---	-------------	---	--

Study

Design  
process

Final  
concept

- 
- Final concept
  - Dimensions
  - Manufacturing process
  - Bill of materials/ Costing
  - Scenario
  - Detailing + Safety features
  - Form and aesthetic
  - Realisations after the process





Final concept

- SEAT:** The cushions are double layered.
- HEAD REST:** has extra foam to support the head
- SEAT:** can flip out to extend and support the legs stretched out.
- HOOKS:** are strategically placed for angle adjustment
- CURVED SUPPORT:** for better lumbar support.
- STORAGE:** for books or magazines which are currently being used.
- SEATING:** for two people with the backrest being transformed to a TABLE





## Dimensions and Anthropometry

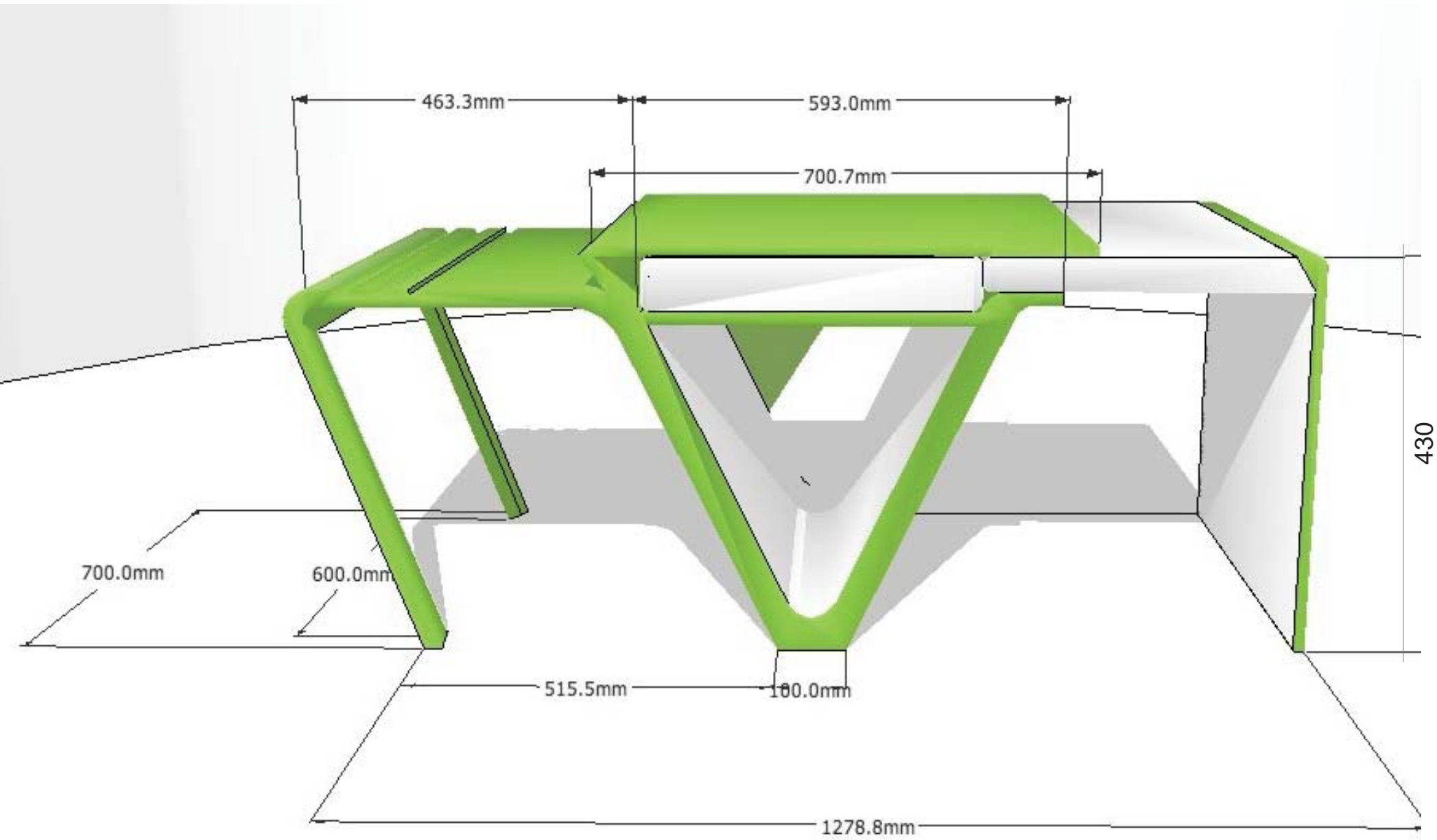

# Manufacturing Process: custom piece



**1. Making the mould:**

Tongue and groove joint



**2. Adhesive bonding of ply:**

A generous amount of fevicol is applied all over the surface of the ply and another is stuck over it.



**3. Getting the curve:**

The plywood is curved along the profile of mould and nailed to the wood. Clamps are added for better bonding.





## Manufacturing Process: custom piece



### 4. Making the mould:

Fixtures were pulled out after 24 hours and the ply is set to the desired form.



### 5. Additional support:

Frame fabrication is done in mild steel to support the structure.



### 6. Rubber mat at the base:

A mat is stuck at the base to protect the plywood.



## Manufacturing Process: custom piece



### 7. Finish:

Spirit polish is applied to the plywood.

The upholstery is done up with rexine over foam.





## Manufacturing Process: Large scale



### **PREPARATION:**

Selecting and cutting the plywood



### **PRESSING:**

The wood is formed by using pressing machines



### **CNC:**

The pieces are sanded to the required size.



### **FINISHING:**

Stained, oil treated or lacquered final products can be used accordingly.

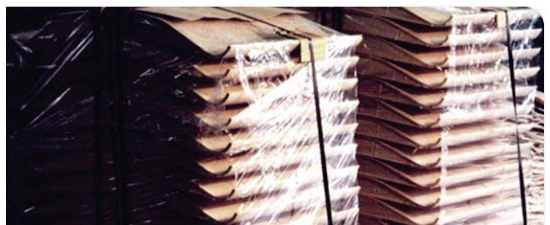

### **PACKAGING / DELIVERY:**

The pieces are then stacked and packed, ready for delivery.

## Bill of materials



### FLEXIBLE PLYWOOD

Process: Cutting, Bending



### MILD STEEL FRAME

Process: Cutting, welding, fabrication



### FOAM

Process: Cutting and pasting on plywood.



### REXINE FABRIC

Process: Cutting, stitching, nailing to the plywood.

- **Carpenter fee** – Rs. 5000 for 7 days
- **Upholstery fee** – Rs. 1500 for 2 days
- **Welding** – Rs. 700 (Rs. 100/ kg.)
- **Hardware (Screws, adhesive)** – Rs. 500

- **Flexible plywood** – Rs. 3000 (2 sheets)
- **Foam** – Rs. 250
- **Rexine** – Rs. 900 (1.5 meter)

**Total cost of the product = Rs. 12,350 /-**

Scenario



Sitting



Work unit



Scenario



Relaxed posture



Scenario



Short afternoon naps

Scenario



Entertaining

## Detailing + Safety features

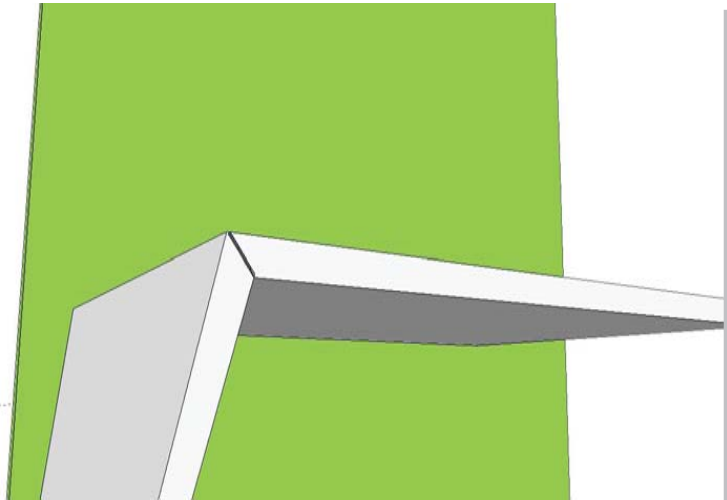

### FOLDING WORK TOP

Cut at a 45 degree angle at the edges

Would rest at a perfect 90 degrees

Magnetic snap is provided when folded backward.

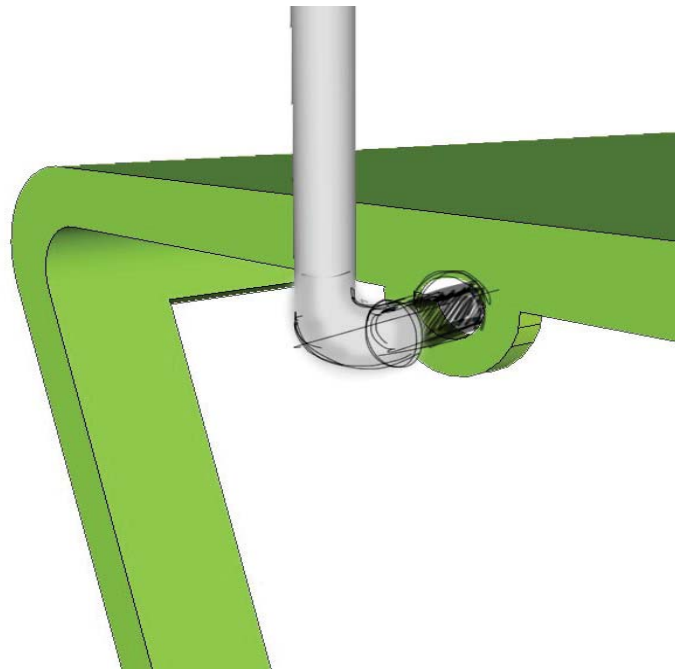

### HOOK for backrest

A rod is provided below which snaps onto the hook which holds the backrest.

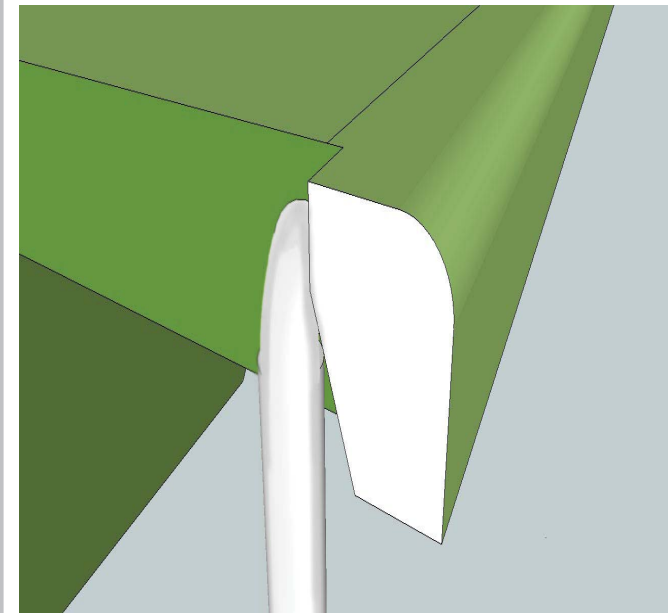

### STAND

The edge of the extended surface needs to jut out, so as to stop the stand from collapsing.



Form and aesthetic



The profile suggests a continuous flowing linear form

Form and aesthetic





## Realizations during the process

- Should have used more layers of plywood for better strength.
- Would not have needed the steel frame members.
- Foam can be a little thinner at the lumbar support to even the plane when the backrest is folded.

The back stand instead of curving inwards should curve outwards for better support



The height of the seat in the model is quite high. Total height should be 430 mm.



## References

<http://www.moldedplywood.eu/en/technology.html> On 14<sup>th</sup> June 2012

<http://www.wikihow.com/Bend-Plywood> On 14<sup>th</sup> June 2012



———— Thank You! ————