

## INORGANIC CHEMISTRY 201 COURSE NOTE (Pearson International Edition)

### Chapter 1 Elements- Periodic Table arrangement, Physical Properties

**Matter consist of** - Elements (simplest form of matter)

There are 117 elements known for now e.g. H, Na, Cl, O<sub>2</sub>, N, C etc.

All known elements are arranged in increasing atomic number in the Periodic Table

All elements are represented by a symbol (abbreviation that is used to represent element

Symbols consist of one or two letters – H, Na, N, Ca

**Element:** are made up of atoms

**Atoms** are the smallest particle or basic unit of an element that can take part in a chemical reaction

- Has same characteristics as the element
- Each element has its own characteristic atom different from those of other elements
- Atom is from the word ATOMOS – minute particles
- Atoms are tiny particles not visible to the naked eyes but can be viewed by powerful microscope such as Scanning Tunneling Microscope (STM)
- For example, 1.0 g of Na and 16 g of Oxygen contain  $2.6 \times 10^{22}$  atoms and  $6.02 \times 10^{13}$  atoms respectively
- Then the mass of one atom of Na is  $3.8175 \times 10^{-23}$  and that of oxygen  $2.66 \times 10^{-23}$
- These measurements were made with highly precise instruments such as a mass spectrometer and nuclear reaction energies

#### Atomic Mass Scale

- The mass of an atom is in the range of  $1.0 \times 10^{-23}$ . This is so small that it may not be useful or convenient in normal laboratory scale
- Physical scientist and chemist devised a relative scale which is more suitable for calculating atomic masses. This scale is called the **atomic mass scale (ams)**
- Atomic masses are measured relative to a reference element that is arbitrarily chosen for convenience sake and assigned an arbitrary number.

- The unit used for this scale is called the **atomic mass unit (amu)**
- Earlier Chemist chose naturally occurring isotopes of oxygen as the reference element and defined **amu** as 1/16 of the average mass atoms of isotopes of oxygen:  $^{16}\text{O}$ ,  $^{17}\text{O}$ ,  $^{18}\text{O}$
- Earlier Physicist chose the predominant isotope of oxygen:  $^{16}\text{O}$  and defined **amu** as 1/16 of the mass of an atom of  $^{16}\text{O}$
- In 1961, and international consensus (SI unit) chose isotope of carbon-12 (**C-12**) as the reference element and arbitrarily assigned the value of 12 amu
- Therefore, **1 amu = 1/12 of mass of C-12 atom**
- Mass spectrometer gave the real mass of one atom of C-12 as  $1.9927 \times 10^{-23}\text{g}$
- Hence **1 amu =  $1/12 \times 1.9927 \times 10^{-23}\text{g} = 1.6606 \times 10^{-24}\text{g}$**
- If mass spectrometer or other precise methods measures the mass of one atom of any element (e.g. one atom of Na weighs  $3.8176 \times 10^{-23}\text{g}$ ), one can then convert this to its equivalent on the **amu scale**
- On **amu scale**, the mass of one atom of Na will be  $3.8176 \times 10^{-23}\text{g}/1.6606 \times 10^{-24}\text{g} = 22.9892 \text{ amu}$
- **The Biologist uses the Dalton scale which is 1 amu = 1 Dalton**
- **This is how the atomic masses of all elements are calculated and recorded in the periodic table**
- A simple way to explain the concept of **amu scale** is to consider a basket full of 20 cubes of sugar. Each cube of sugar has different weights. If we randomly choose one of the cubes (labeled X with mass 20g) as our reference cube to which the masses of all other cubes in the basket is calculated
- We also assign an arbitrary unit of 12 to cube X
- If we pick cube Y with mass 40g, we can calculate the relative mass of cube Y on our arbitrary scale as  $= 40/20 \times 12 = 24 \text{ amu}$
- We can calculate the relative masses of other cubes of sugar in the basket in the same way
- **In practice, the average mass of isotopes of elements is used in calculating is relative atomic or atomic masses**

- For practical purposes, **the gram-atomic mass unit** is used in laboratory calculations
- **The gram-atomic mass is the amu expressed in grams** and is defined as the **molar mass of that element**
- For example, the amu of Na= 23, the gram atomic mass (molar mass of Na) = 23g
- **Example: The average relative mass of magnesium atoms is  $4.03065 \times 10^{-23}$ g. Calculate its atomic mass if one atom of C-12 has a mass of  $1.9927 \times 10^{-23}$ g and an atomic mass of 12.0 amu**
- **Answer: First step is to compare the relative atomic mass of magnesium atoms with that of 1/12 of C-12**

$$1 \text{amu of C-12} = 1/12 \times 1.9927 \times 10^{-23} \text{g} = 1.6606 \times 10^{-24} \text{g}$$

**Therefore, the atomic mass of the magnesium ions will be =**

$$4.03065 \times 10^{-23} \text{g} / 1.6606 \times 10^{-24} \text{g}$$

$$= 24.505 \text{ amu}$$

## Periodic Table

History- 1800 – scientist noticed that some elements looks and behave alike

- 1872- Mendeleev and Meyer arranged 60 elements known then according to their properties and increasing atomic masses
- Today, we have 117 elements arranged according to increasing atomic properties or similarities in their electron distribution in their valence shells (s and p orbitals, orbitals that hold the electrons involved in bonding)
- For example, Oxygen, O([He]  $2s^2 2p^4$ ) and Sulfur, S([Ne]  $3s^2 3p^4$ ) have same number of electrons in the valence shell and hence, have similar properties as well as some other differences (O is a colorless gas while S is a yellow solid both at room temperature)
- 1915- Moseley found that X-ray frequencies of elements increases with increasing atomic weight
- He assigned the X-ray frequencies (whole numbers) of each element and called it atomic number which he assigned to the number of protons in a nucleus of an atom

- The atomic weight increases as the atomic number increases and he arranged the atomic number in increasing order as seen in the periodic table
- This arrangement lead to two trends in the periodic table: the **period** which is the horizontal row of the table and the **Group**; the vertical rows in the periodic table
- There are 7 periods (top to bottom) and 18 groups (left to right) in the Periodic Table (PT)
- **Period:** 1<sup>st</sup> period- 2 elements (H and He)
- 2<sup>nd</sup> Period – 8 elements, Li – Ne
- 3<sup>rd</sup> Period – 8 elements, Na – Ar
- 4<sup>th</sup> Period – 18 elements, K – Kr
- 5<sup>th</sup> Period – 18 elements, Rb- Xe
- 6<sup>th</sup> Period – 32 elements, Cs – Lu
- 7<sup>th</sup> Period – 31 elements, Fr- Lr
- Lantanides (period 6) and Actinides (period 7) are placed at the bottom of the table so that everything can fit into a page
- **Group:** Groups 1, 2, 13 - 18 are called representative groups (Initially called groups 1A, 2A, 3A - 8A)
- Center – Transitional Group, 3-12 (old name 1B to 8B)

### Classification of Groups

- Some groups have special names
- Grp. 1A – Alkali metals , Li, Na, K, Rb and Cs
  - Physical properties – soft, shiny metals, good conductors of electricity and heat, low melting point, reacts violently with water, forms white substances with oxygen to form oxides
  - Hydrogen is placed on top of this group but is not a metal
- Grp. 2A – Alkaline Earth metals, Be, Mg, Ca, Sr, Ba, Ra. Shiny metals but less reactive compare to Grp 1A

- Grp. 7A(17) – Halogens, F, Cl, Br, I, At. Very reactive (especially F and Cl) and forms compounds with most elements
- Grp. 8A(18) – Noble gases, He, Ne, Ar, Kr, Xe and Rn. Unreactive

### Metals, Metalloids and Non metals

- There is a zig zag line that runs from grp. 13 to grp. 17.
- The line separates elements into Metals (on the left, except H) and non metals (on the right)

#### 13 14 15 16 17 - Group

- B
- Si
- Ge As
- SbTe
- PoAt

- **Metals**- shiny solids at room temperature except mercury, can be stretched (ductile) and flattened (malleable), good conductors of heat and electricity, high MP than non metals. Metallic character increases from right to left and top to bottom of the PT
- **Non Metals**- not really shiny and some are liquids or gasses, poor conductors of heat and electricity, not malleable or ductile, low MP
- **Metalloids**- Elements located along the zigzag line- B, Si, Ge, Te, Po, At (except Al), can be metal or non metal and will display characteristics of both but not as good as either of the two, often called Semiconductors (can be modified to conduct or insulate)
- **Transitional Elements**- Elements in between metals and non metals (Grps. 3 -12)

### Physical Properties of Elements in the Periodic Table

Effective Nuclear Charge: electrons are negatively charged and hence are attracted to the nucleus. Properties of atoms depend on how their electrons are strongly attracted by the nucleus and also on the electron configuration. Coulombs law says that the strength of the force between two charges depends on the size of the charges and the distance between them. Hence the force

of attraction on an electron by the nucleus depends on the net charge on the electron and the distance between the electron and the nucleus

$F = Z/r$  ( $z$  is the total charge and  $r$  the distance). The larger the  $r$  the less is  $F$

In another way we can view each value of  $r$  as describing the shell in which the electrons reside. The force that keeps the electron in its orbit is

$F = mv^2/r$  (mass of electron,  $v$  its velocity and  $r$  the radius of the orbit) (1).

The Kinetic energy of each electron is described as,  $KE = \frac{1}{2} mv^2$  (2)

From (2)  $v^2 = 2KE/m$  and

substitute in (1)  $F = m(2KE/m)$

Therefore,  $F = 2KE/r = K/r$  (where  $K = \text{constant} = 2KE$ )

Hence, force of attraction on the electron varies with  $r$  i.e. it decreases with increasing  $r$  or vice versa. This variation determines how the physical properties of elements vary across the PT.

In a multiple electron atom, the electrons experience both attractive force by the nucleus and the repulsive forces by the other surrounding electrons. On the average, each electron will experience the net electric field in the environment created by the nucleus and other electrons around it. We view the net electric field as if it resulted from a single proton in the nucleus and is called the **Effective nuclear charge ( $Z_{\text{eff}}$ )** but in reality  $Z_{\text{eff}} < Z$

### Physical Properties

- Ionization Energy: Low ionization energy which decreases as we go down the group
- Electron Affinity: decreases down the group
- Atomic size or radius: Increases down the group
- Metallic bonding: Because of the large size and limited number of valence electrons, the metallic bonds between the atoms of these metals are not that strong. This also accounts for the low density, melting point and hardness.

Table 1. Alkali Metals

<b>Property</b>	<b>Li</b>	<b>Na</b>	<b>K</b>	<b>Rb</b>	<b>Cs</b>	<b>Conclusion</b>
Density g/cm <sup>3</sup> @ 20 <sup>0</sup> C	0.53	0.97	0.86	1.53	1.87	Increasing
Melting Point	179	97.8	63.7	38.9	28.3	Decreasing
Hardness	0.6	0.4	0.5	0.3	0.3	Decreasing
Electrical Conductance	17.4	35.2	23.1	13	8.1	Decreasing
Flame Color	Carminc	Yellow	Violet	Bluish red	Blue	

**Chapter 2** Nature of Atoms and Electrons, Bohr's Postulates of Electrons

## Dalton's Atomic Theory

In the 1900's, Dalton improved on Democritus' postulate that matter can be divided into small indivisible particles. He proposed the following

- All matter is made up of tiny particles called Atoms
- All atoms of the same element are identical and different from those of other elements e.g. atoms of Na are different from those of oxygen
- 2 or more atoms of different elements combine together in a fixed ratio to form a new substance
- The combination is called a chemical reaction which consists of rearrangement, separation, combination, and formation processes.
- Atoms are never created nor destroyed (Law of conservation of matter: Matter is never created nor destroyed. It is converted from one form to another)

## Structure of Atom

In 1897, **J.J. Thomson** suggested that atoms can be divided into subatomic particles.

- He applied electricity to a glass tube (cathode ray tube) containing a positively charged electrode
- He observed that some particles were attracted to these positive electrodes and called them cathode rays
- He concluded that these particles must be negatively charged because they are attracted to a positive electrode and therefore called them **Electrons**
- Since an atom is neutrally charged, he also suggested that there will be an equal number of positively charged particles in the atom which he called **Protons**
- He finally suggested that the structure of an atom is like a "pudding" with the electrons forming a cloud and the protons randomly scattered in the cloud

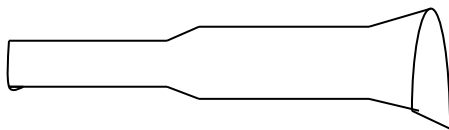

**Rutherford**: tested Thomson's atomic structure model

- He assumed that if a positively charged particle is passed through Thomson's atom, it should pass through it undeviated



- In his alpha particle scattering experiments, He passed positively charged particle through a thin gold foil
- He observed that some particles were slightly deviated, some moderately, some severely and then some totally reflected in the opposite direction.
- This observation contradicts Thompson model
- He also observed that this positive particles are heavier than the electrons and 10,000 times smaller in size than atomic diameter
- He concluded that for the deviations and reflections to occur, there must be a concentration of positive charges of the gold foil that repels these particles as pass near or through it. The extent of closeness of these positively charge particle to these concentrated centre will determine the extent of deviation or reflection
- The positive center he called **nucleus**.
- He then suggested a model of a positive nucleus surrounded by negatively charged particles (electrons)

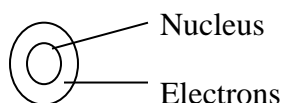

**Chadwick** also concluded that atoms have some particles that have **mass but no charge**. These particles are called **neutrons**

**Subatomic Particles:** In summary, an atom is said to contain a proton and neutron (called nucleons) that resides in the nucleus and surrounded by clouds of electron(s).

- The proton and the neutron have about the same mass
- Both are about 1840 times heavier than an electron.

Details of the properties of each of these particles is described below

Electron ( $e^-$ ): is negatively charged (-1). Mass =  $5.486 \times 10^{-4}$  amu or  $9.109 \times 10^{-28}$  g, negative charge of  $-1.602 \times 10^{-19}$  Coulombs.

Proton (p): positively charged (+1). Mass = 1.0087 amu or, positive charge of  $+1.602 \times 10^{-19}$  Coulombs

Neutron (n): neutrally charged. Mass = 1.0087 amu or  $1.6748 \times 10^{-24}$  g

Particle	Abbreviated Notation	Mass (amu)	Mass (g)	Relative Charge	Charge (Coulombs)
Electron	e	Negligible ( $5.486 \times 10^{-4}$ )	$9.109 \times 10^{-28}$	-1	$-1.602 \times 10^{-19}$
Proton	p	1	$1.6748 \times 10^{-24}$	+1	$+1.602 \times 10^{-19}$
Neutron	n	1	$\sim 1.6748 \times 10^{-24}$	0	0

### Arrangement of Subatomic Particles

#### Rutherford's Planetary Model

From experiments the following conclusions were reached about the structure of an atom

- Electrons resides outside the nucleus in shells of certain energy level
- Electrons moves randomly in an orbit around a positively charged nucleus and sustained in their orbit by both centripetal and centrifugal forces
- The nucleus contains only the protons and neutrons
- All atoms are neutrally charged and contains the same number of protons and electrons
- A neutron has no charge
- The mass of an atom is determined by the mass of the nucleus, that is, the mass of the proton and the neutron
- Isotopes of the same element occurs because of differences in the number of neutrons in the nucleus of its atoms

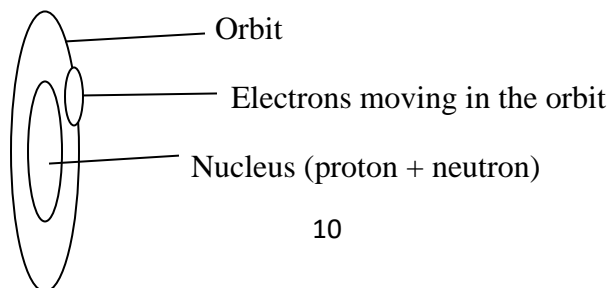

## Atomic Number/Atomic Mass

- All atoms of the same element have the same number of protons and electrons
- This number is called the **Atomic number (Z)**
- The periodic table is an arrangement of elements in increasing atomic number
- The mass of all atoms is the mass of its nucleus and is called the **Atomic Mass (A)**.  $A = Z + n$
- The **atomic mass** is written at the **top left corner** of the symbol that represents the element while the **atomic number** is written at the **left lower corner e.g.**
- $_{11}^{23}\text{Na}$
- Example: X is an element having 11 protons in its nucleus. Given that the relative atomic mass of this element is 23.

(a) Find

- Mass number
- Number of electron and
- Number of neutron the atom of the element

(b) Draw a simple illustration of the arrangement of the subatomic particles

(c) Write the symbol of the element indicating mass number and the atomic number

Answer: (i)  $A = 23$

(iii)  $A = Z + n$  therefore,  $23 = 11 + n$

(ii)  $Z = 11 =$  the number of the protons

$n = 23 - 11 = 12$

(b)

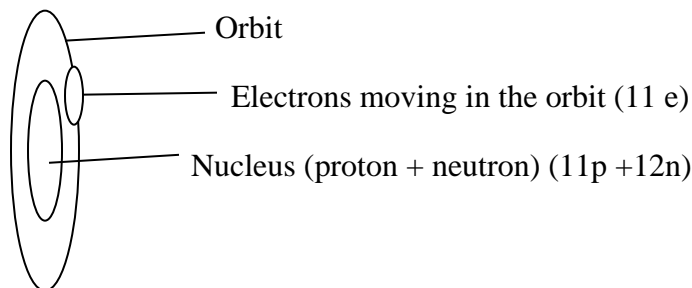

(d)  $^{23}\text{Na}$

11

### Arrangement of Electrons in Principal Energy Levels

**Neil Bohr's Postulate**— Postulated that electrons moves in a circular orbit or shell around the nucleus

- The orbits are at a fixed distance and energy level from the nucleus
- Electrons arrange themselves in this orbit or shell
- The energy level increases as orbit distances increases from the nucleus
- There is an energy value associated with each orbit or shell
- Electrons in a specific energy state have a specific energy and is in an “allowed” state
- Electrons in an allowed state does not radiate energy and therefore will not spiral into the nucleus
- Energy is emitted or absorbed by an electron only as the electron changes from one allowed energy state to another. This energy is emitted or absorbed as a photon,  $E = h\nu$
- The maximum number of energy level for a known element is seven are is called the **principal energy (quantum) level with a symbol n**
- The principal energy level is labeled 1-7 or alphabetically from K to Q (KLMNOQ)
- Each energy level have a maximum number of electrons that can occupy it and is defined as  $2n^2$  as shown in the table below

### Number of Electrons in Principal Energy Levels

Principal Energy level	Alphabetical Label of Energy Level	Maximum Number of Allowed Electrons
1	K	2
2	L	8

3	M	18
4	N	32
5	O	50
6	P	72
7	Q	98

### Electronic Configuration

Electronic configuration of an atom is written in accordance to the number of electrons found in each energy level available in the atomic structure of an element starting with the energy level numbered 1 or K

For example  ${}_{11}\text{Na} = 2, 8, 1$

Example: Show diagrammatically how the subatomic particles are arranged in the following atoms. Also show the electronic structure for each of them.

(a)  ${}_{11}{}^{23}\text{Na}$  (b)  ${}_1{}^1\text{H}$  (c)  ${}_8{}^{16}\text{O}$

(b) State the electronic configuration and the principal energy levels at which the outermost electron can be found in each atom, then calculate the maximum number of electron allowed in this principal energy level,

### Sublevels and Arrangement of Electrons in Sublevels

All electrons possess an amount of energy which is represented by the following factors

- (1) The quantum number (n): indicates the size of the orbital
- (2) (i) The sublevels: indicates the shape of the orbitals. There are four sublevels (s, p, d, f). s orbital does not have degenerate level while the remaining three sublevels have degenerate orbitals. (ii) **Degenerate orbitals: are orbitals with the same energy but different spatial orientation.** (iii) Each degenerate sublevel have a maximum number of electrons it can contain: s- 2e, p-6e, d-10, f-14e.

Table 2 Sublevels and Number of Degenerate Orbitals

Sublevels	Max # of Electrons/sublevel	# of Degenerate Orbitals	Designation of a filled Orbital
-----------	-----------------------------	--------------------------	---------------------------------

S	2	1	$s^2$
P	6	3	$p^6$
D	10	5	$d^{10}$
F	14	7	$f^{14}$

The exact location of an electron cannot be identified. A region where there is a high probability of finding an electron is called an atomic orbital. This region of space is three dimensional and results into a specific shape for each type of orbital as shown below.

s-orbital: the shape is spherical and the probability of finding an electron at the nucleus is high

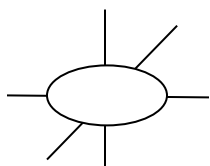

p-orbital: consist of two adjacent spherical lobes positioned at opposite sides of a nucleus. The three degenerate p-orbitals lie along the 3-dimensional axes ( $p_x$ ,  $p_y$ ,  $p_z$ ). The probability of finding an electron at the nucleus is zero. The **nucleus of the p orbital** is called a **node point**

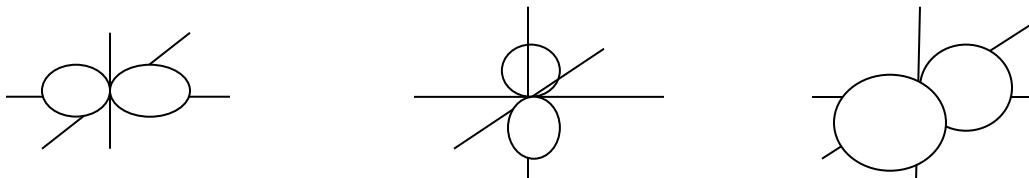

-The regions on both sides of the node points is assigned + and – signs. These signs do not represent ionic charges. The s orbital is assigned the + sign because it has no node point.

The shapes of the d and f orbitals are complex and cannot be easily represented

The five d degenerate orbitals are :  $d_x$ ,  $d_y$ ,  $d_z$ ,  $d_{xy}$ ,  $d_{xz}$ , or  $d_{yz}$

The seven f degenerate orbitals are:  $f_x$ ,  $f_y$ ,  $f_z$ ,  $f_{xy}$ ,  $f_{xz}$ ,  $f_{yz}$ ,  $f_{xyz}$

Electrons are arranged in an orbital by three principles, viz:

- (1) Aufbau or building principles: electrons are filled into orbitals in order of increasing energy-  $1s < 2s < 2p < 3s < 3p < 4s < 3d < 4p < 5s < 4d < 5p < 6s < 4f < 5d$  etc
- (2) Pauli's exclusion principle: Electrons spins on its axis and hence generates magnetic and electric fields. Electrons in the same degenerate orbital repels each other and therefore will have opposite spins number to be able to reside in the same orbital. Hence Pauli formulate the following rules: (i) The maximum number of electrons in a degenerate orbital is two (ii) the two electrons in a degenerate orbital have opposite quantum spin number (+/-). Each spin is represented by half headed arrows ( $\uparrow\downarrow$ ). (iii) no two electron have all four principal quantum numbers the same
- (3) Hund's rule (the principle of maximum multiplicity): degenerate orbitals are singly filled before pairing up. As a result, an atom tends to have as many unpaired electrons as possible, In order words, electrons avoid repelling each other by seeking out empty shells to fill up instead of pairing up.

**Electronic diagram and Configuration:** The shorthand form of representing the arrangement of electrons in orbitals can be in form of a diagram or in a specified configuration.

For example, carbon has 6 valence electrons and can be represented thus:

Electronic Configuration:  $1s^2 2s^2 2p^2$

Electronic Diagram: 

1s	2s	2p

Another way of writing electronic configuration is to use the **Abbreviated format**. This involves using the configuration of noble gas preceding the desired element and filling the remaining valence electrons in the next principal quantum level

For example, Sodium has 11 valence electrons:  $1s^2 2s^2 2p^6 3s^1$ . The nearest noble gas before sodium is Neon with electronic configuration:  $1s^2 2s^2 2p^6$  which is one electron shorn of sodium configuration. Hence sodium configuration can be written as:  $[\text{Ne}]3s^1$  which is the condensed or abbreviated format of sodium configuration.

## Chapter 3 Electromagnetic Radiation

### O Lord, How wonderful thou art..... Ps 8

The universe has many types of radiations:

- UV, IR, visible light, gamma, microwave etc.
- All are forms of electromagnetic radiations (EMR) with similar characteristics
- EMR possesses energy which it carries through space, it is called **radiant energy**
- All EMR can be described as a wave or as a particle
- All EMR moves through vacuum at the speed of light,  $3 \times 10^8$  m/s (c)

### The Wave Nature of EMR

All EMR can be described as a wave. The characteristics of a wave is as follow”

- Each wave is a packet of energy with high and low points

-



- For example – when a stone is dropped in a pool of water or a boat is travelling on water, we observe some continuous ripples moving through the water. These ripples occur as a result of the energy transferred to the water by stone or by the movement of the boat on the water. The energy moves through the water and is reflected as the ups and down movement seen as ripples.

- The **high point** of a wave is called the **Peak (Crest)** and the low point is a trough (inverted peak)

- **The height of the peak is called the Amplitude**

- The amount of energy possessed by a wave determines how high a peak will be

- The **distance between two successive peaks or trough is called the wavelength ( $\lambda$  called lamda). The unit of wavelength is cm, m etc**

-

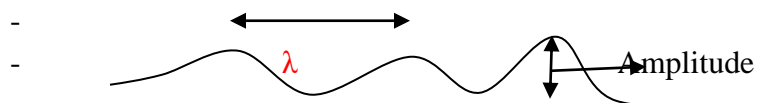

- The **number of wavelength or cycles that passes through a specific point per second is called the Frequency ( $\rho$  called nu). The unit of frequency is Hz or  $s^{-1}$**

- All EMRs has electrical and magnetic fields

- The periodic oscillations of the intensities of both the electrical and magnetic fields results into the various characteristics of EMR waves

- The speed of water waves varies depending on the amount of energy input when it is created but that of EMR's are the same and equal to the speed of light



- Hence, there is a direct relationships between EMR parameters such as wavelength, energy, frequency etc For example, (i)  $c = \lambda \nu$  (ii) if wavelength is long, the frequency is short (fewer cycles passing a point per second) and vice versa)
  - The differences among EMR's is in their wavelengths
  - We can arrange the different EMR's according to increasing wavelength. This forms what can be described as a **continuous spectrum** and is called the **electromagnetic spectrum**
- 

**Table 3 Common Wavelength Units for EMR**

Unit	Symbol	Length (m)	Type of Radiation
Angstrom	$\text{A}^0$	$10^{-10}$	X-ray
Nanometer	Nm	$10^{-9}$	UV-Visible
Micrometer	$\mu\text{m}$	$10^{-6}$	Infrared
Millimeter	Mm	$10^{-3}$	Microwave
Centimeter	Cm	$10^{-2}$	Microwave
Meter	M	1	TV, radio
Kilometer	Km	1000	Radio

- The EMR spectrum is very wide. Gamma rays is similar to the size of an atomic nuclei while that of Radio waves may be longer than a football field
- Human eyes can see in the visible light region of the EMR spectrum. However, this region is very narrow (400-700 nm)

Example Two EMR waves are represented as shown in the figure below



(b)



(i) Which wave has the higher frequency (ii) If one wave represents the visible light and the other infrared radiation, which wave is which?

Answer: (i) Wave (b) has a longer wavelength (distance between two peaks or troughs) and hence will have the lower frequency, while wave (a) has a shorter wavelength, hence the higher frequency

(ii) From the EMR spectrum the visible light has a shorter wavelength than the Infrared. Hence, wave (a) is the visible while wave (b) is the Infrared

Assignment: The yellow light given off by sodium light used in public lighting has a wavelength of 589 nm. What is the frequency of this radiation?

Answer:  $c = \lambda \nu$  (1) hence  $\nu = c / \lambda$  (2).

Therefore,  $\nu = (3 \times 10^8 \text{ (m/s)} / 589 \text{ nm})(1 \text{ nm} / 10^{-9} \text{ m})$

$= 5.09 \times 10^{14} \text{ s}^{-1}$

Assignment: The yellow light given off by sodium light used in public lighting has a wavelength of 589 nm. What is the frequency of this radiation?

Answer:  $c = \lambda \nu$  (1) hence  $\nu = c / \lambda$  (2).

Therefore,  $\nu = (3 \times 10^8 \text{ (m/s)} / 589 \text{ nm})(1 \text{ nm} / 10^{-9} \text{ m})$

$= 5.09 \times 10^{14} \text{ s}^{-1}$

## Quantized Energy and Photons

Not all interactions of atoms and EMR can be explained by the wave theory. It cannot explain the following phenomenon: (i) emission of light when an object is red hot (black body radiation) (ii) emission of electrons from the metal surfaces of which light shines (photo electricity) and (iii) emission of light from excited gas atoms (emission spectra)

Max Planck: Solids emit radiation when heated. For example, metals glow red (kitchen stove) or emit white light (tungsten light bulb). A white hot object is hotter than a red hot object.

Planck explained these phenomenon's by saying that energy is released or absorbed by atoms in discrete amount or in minimum size. This amount is called "QUANTUM" of fixed amount. He related energy to radiation as:

$$E = h\nu$$

(h is Planck's constant =  $6.626 \times 10^{-34}$  joule second,  $\nu$  = frequency and E = energy of radiation)

- Each stair is regarded as an allowed action and therefore quantized energy levels are allowed energy states
- In summary, Planck is saying that energy is absorbed or released in multiple's amount of  $h\nu$ ,  $2h\nu$ ,  $3h\nu$  etc.
- If we go up a ramp, there is a gradual increase in potential energy ( $pd$ ) while going up a stair case requires stepping on a stair one at a time which requires a fixed amount of energy (a fixed amount of  $pd$  rise per stair case, quantized) for each stair climbed.

### The Photoelectric and Photons: Behavior of EMR as a Particle

Albert Einstein Theory:

- When light shines on a metal surface, the metal surface emits some electrons. This is called the photoelectric effect
- There is a minimum frequency of light required to cause this emission for different metals
- For example light with frequency  $> 4.60 \times 10^{14} \text{ s}^{-1}$  will cause Cesium to emit light. Anytime less than this frequency will have no effect on Cesium.
- Einstein explained the observation as follows: Each stream of light behaves as a packet of energy or as a particle called photon
- Each photon has an energy  $E = h\nu$  which is quantized and can be absorbed by electrons on the surface of the metal.
- Electrons are held together by attractive forces in the bulk of the metal and needed a minimum amount of energy called the work function to overcome these attractive forces.
- So, if the photon energy is greater than or equal to this work function, electrons will be emitted from the surface of the metals as observed with photoelectric effect. Excess photon energy will be converted to kinetic energy for the electrons
- A burst of light might be intense but if its frequency is less than the work function, it will not cause electron emission

Assignment: (a) A laser light emits light with a frequency of  $4.09 \times 10^{14} \text{ s}^{-1}$ . What is the energy of one photon of the radiation from the laser? (b) If the laser emits a pulse of energy containing  $5.0 \times 10^{17}$  photons of this radiation, what is the total energy of the pulse? (c) if the laser emits  $1.3 \times 10^{-2} \text{ J}$  of energy during a pulse, how many photons are emitted during this pulse?

Answer

$$(a) E = h\nu = (6.626 \times 10^{-34} \text{ J}\cdot\text{s})(4.09 \times 10^{14} \text{ s}^{-1}) = 3.11 \times 10^{-19} \text{ J}$$

$$(b) \text{ Total energy} = 3.11 \times 10^{-19} \text{ J} \times 5.0 \times 10^{17} = 0.16 \text{ J}$$

$$(c) \# \text{ of photons} = 1.3 \times 10^{-2} \text{ J} / \text{Energy of one photon} = 1.3 \times 10^{-2} \text{ J} / 3.11 \times 10^{-19} \text{ J} = 4.2 \times 10^{16}$$

### Line Spectra and the Bohr Model

- A source of radiant energy may possess a single wavelength like a laser light. This type of radiation is called **monochromatic ray of light**.
- In nature, many radiant light like electric bulb, the sun, moon, and the stars emit light with many wavelengths
- A **continuous spectrum** is produced when these wavelengths are separated into individual components. For example, if a light from a bulb is passed through a glass prism, the white light will be separated into its individual wavelength which appears as different colors that fades into each other
- Similar thing happens when the sun rays pass through rain drops in the atmosphere, the ray of light will be divided into different wavelengths which appears as different colors called the **Rainbow**
- When electric current is passed through a tube containing different gases at reduced pressure, each gas emits different colors characteristic of such gases.
- Similar thing happens to some metals. For example, Na emits yellow light; Neon emits red-orange color used as street lights etc.
- If these lights are passed through a prism, few distinct color lines are seen instead of a continuous spread of colors. **These lines represent different wavelengths and are called line spectrum of those metals or gases**
- For example, the hydrogen atom shows 4 lines: violet (410nm), blue(434nm), blue-green(486nm), and red (656nm). Other lines were also found in the UV and IR region of the hydrogen spectrum
- These lines fit into Balmer's series or the Rydberg's equation
 
$$1/\lambda = (R_H)(1/n_1^2 - 1/n_2^2)$$

$$\lambda = \text{wavelength, } R_H = \text{Rydberg's constant } (1.096776 \times 10^7 \text{ m}^{-1}), n_1 \text{ and } n_2 \text{ are integers with } n_2 > n_1$$
 This explains why there are line spectra, that is energy is quantized

## Bohr's Model

- Rutherford suggested the planetary motion of electrons around the nucleus
- Classical physics says that such electrons will emit EMR and therefore will lose energy and therefore spiral down into the nucleus.
- Such phenomenon is not observed with atoms of any element
- Bohr suggested the following reasons for the electron not spiraling into the nucleus: (1) Only certain orbits of specific radii and with specified amount of energy are allowed for the electron of an hydrogen atom (2) An electron in an **allowed** energy state has a specific energy and is in a **allowed** energy state.
- An electron in an allowed state will not absorb or radiate energy
- An electron will absorb or radiate energy only if it moves from one allowed state to another allowed energy state.
- This energy is emitted or absorbed as a photon,  $E = h\nu$
- Bohr's postulate is only true for Hydrogen atoms and not for other atoms because electrons behave as a wave and it is supposed to spiral down into the nucleus if it behaves as a wave (will lose energy)
- Bohr calculated this energy with the equation
$$E = (-hcR_H)(1/n^2) = -2.8 \times 10^{-18} \text{J}(1/n^2)$$
 [h = plank's constant, c = speed of light and  $R_H$  = Rydberg's constant, **n is an integer = 1 - infinity = principal quantum number**]
- n = 1 is the **lowest energy level (ground state of hydrogen)** and as its value becomes larger, E, also becomes less negative and larger
- For  $n \geq 2$ , the energy states are called **Excited states**
- **When  $n = \infty$  (infinity),  $E = 0$  (zero energy)** the electron will be removed from the orbit at this stage to another one (absorption or emission of energy)
- The value of the absorbed or emitted energy is equal to the difference in energy between the two states.  $\Delta E = E_2 - E_1 = h\nu$
- Hence, it is only radiant light with frequency =  $\nu$  that can be absorbed or emitted by an atom
- **Since  $\nu = c/\lambda$ ,**
$$\text{then } \Delta E = h\nu = hc/\lambda = -2.8 \times 10^{-18} \text{J}(1/n_f^2 - 1/n_i^2)$$
 then
$$\lambda = hc/\Delta E$$
where  $n_f$  = final principal quantum state and  $n_i$  the initial principal quantum state
- If  $n_f < n_i$ , then  $\Delta E = \text{negative}$  and hence energy is released (emission). The reverse will result into absorption.

**Assignment:** If  $E = (-hcR_H)(1/n_f^2 - 1/n_i^2)$ , prove that  $1/\lambda = (R_H)(1/n_f^2 - 1/n_i^2)$  where

$\lambda$  = wavelength,  $R_H$  = Rydberg's constant  $n_1$  and  $n_2$  are integers numbers equivalent to the principal quantum numbers?

Answer

$$E = (-hcR_H)(1/n_f^2 - 1/n_i^2) \text{ and } E = hc/\lambda \text{ therefore,}$$

$$E = hc/\lambda = (-hcR_H)(1/n_f^2 - 1/n_i^2) \text{ hence,}$$

$$1/\lambda = (-hcR_H)(1/n_f^2 - 1/n_i^2)/hc = (R_H)(1/n_f^2 - 1/n_i^2)$$

### Limitations of Bohr's Model

- Bohr's model is only true for hydrogen atom
- It cannot explain why electrons do not spiral down into the nucleus if electron behaves like a wave. He just assumes it will not happen

### Wave Nature of Matter

- De Broglie said that an electron moving round a nucleus behaves like a wave because it has a certain wavelength associated with it
- The wavelength  $\lambda = h/mv$  where  $h$  = Planks constant,  $m$  = mass and  $v$  the velocity of the electron
- He proposed that any **moving matter or particle** have the same **characteristic wavelength and a momentum,  $mv$**

Example: (a) What is the wavelength of an electron moving at a speed of  $5.97 \times 10^6$  m/s? (mass of electron =  $9.11 \times 10^{-31}$  kg). (b) In which region of the EMR can we find this wavelength?

Answer:  $\lambda = h/mv$

$$\lambda = (6.626 \times 10^{-34} \text{ J-s}) / (9.11 \times 10^{-31} \text{ kg})(5.97 \times 10^6 \text{ m/s})$$

Since  $1\text{J} = 1 \text{ kg m}^2/\text{s}^2$

$$\text{Then } \lambda = (6.626 \times 10^{-34} \text{ J-s})(1 \text{ kg m}^2/\text{s}^2/1\text{J}) / (9.11 \times 10^{-31} \text{ kg})(5.97 \times 10^6 \text{ m/s})$$

$$\lambda = 1.22 \times 10^{-10} \text{ m} = 0.122 \text{ nm} = 1.22 \text{ \AA}$$

(b) The wavelength is in the X-ray region

- De Broglie postulate was proved experimentally by passing a beam of electron through a crystal. The electrons were diffracted.
- This led to the **development of electron microscope** which can **magnify objects 3 million times** more than a visible light can achieve

## The Uncertainty Principle

- If a ball is rolling down a ramp, we can accurately calculate its position, speed and direction at any time. But for an electron that behaves like a wave (wave extends into space) and a particle, its exact location (x) and momentum (mv) at a point in time cannot be determined simultaneously with certainty. This is what is called **Heisenberg Uncertainty principle**. It is only applicable to subatomic particles. (if you know the exact location of an electron with certainty, you cannot determine its momentum (speed, v) with certainty)
- He expressed the uncertainty as
$$\Delta x \cdot \Delta(mv) \geq h/4\pi$$
 where x position and mv= momentum of the particle
- $\Delta x \geq h/4\pi \Delta(mv)$ . The only measurement with uncertainty is the speed of the electron (v) hence,  $\Delta x \geq h/4\pi (m\Delta v)$ .
- If we use  $9.11 \times 10^{-31}$  kg as the mass of a hydrogen electron and its speed as  $5 \times 10^6$  m/s and uncertainty of 1% in its speed.
- Then ,  $\Delta x \geq (6.626 \times 10^{-34} \text{J-s})/4(22/7) (9.11 \times 10^{-31} \text{ kg})(0.01 \times 5 \times 10^6 \text{ m/s})$ .
- $\Delta x \geq 1 \times 10^{-9} \text{m}$  which is greater than the size of an atom
- Hence, we have no idea of where the electron is - is the kernel of Heisenberg's Uncertainty principle

## Schrodinger Equation

- Proposed an equation that incorporates the wave and particle nature of electron together which helps us to understand electronic structure better than before. He applied the equation to a hydrogen atom
- This opens a new way of dealing with subatomic matters and is known as **Quantum or wave mechanics**
- **The Hydrogen Atom:** A guitar string produces a standing wave when vibrating. Similarly, Schrodinger considered a hydrogen electron as a standing circular wave around the nucleus.
- Guitar standing wave produces waves with basic frequencies and also overtones (higher frequencies, harmonics). Similarly, electron produces lowest-energy and higher energy waves
- **Solution to Schrödinger's** equation gave several mathematical expressions called **wave functions**

- **Wave functions** describes the location of an electron in an atom and is represented by the Greek symbol  $\Psi$ (psi).  $\Psi$  has no physical meaning but  $\Psi^2$  tells us the location of an electron when in its “allowed energy state”
- The allowed energy state are the same as in Bohr’s model – electron moving in an orbit of fixed radii around the nucleus
- But in Wave mechanics, the exact location of an electron is uncertain if the momentum is known with certainty (uncertainty principle) and vice versa
- So, what we are sure of is that we cannot literally locate an electron in an atom, but we can speak of **a chance of locating it within a certain boundary** (probability) at a point in time. This probable space region is described by  $\Psi^2$  in Schrödinger’s equation.
- $\Psi^2$  is called the **probability or electron density and is called the Orbitals**
- **Each orbital (wave) have specific energy and shape (particle)**
- For an s-orbital,  $\Psi^2$  is **spherical**, p-orbital (figure 8), d and f-orbitals are **diffuse**
- Bohr’s model uses one quantum number (n) to describe an orbital
- while the wave mechanics uses three quantum numbers to describe an orbital: (i) principal quantum number (n= 1, 2, 3 etc), (ii) angular momentum quantum number (l describes the shape of an orbital, l = from 0 to (n-1) for all values of n. For example if n = 2, l = 0, 1, l is represented by s, p, d, f and its values of l are 0, 1, 2, 3 respectively) (iii) magnetic quantum number  $m_l$  which describes the orientation of the orbital in space and can take values of -l to +l including zero ( for example if n = 2, l will be equal to 0 and 1 and  $m_l = -1, 0, +1$ , for every value of l, there are (2l+1) possible allowed values of  $m_l$ )



**Table Relationship between n, l and m<sub>l</sub> for n = 4**

n	Possible value of l	Subshell Designation	Possible values of m <sub>l</sub> (2l + 1)	Number of orbitals in a subshell	Total number of orbitals in a subshell
1	0	s	0	1	1
2	0	2s	0	1	4
	1	2p	-1,0,1	3	
3	0	3s	0	1	9
	1	3p	-1,0,1	3	
	2	3d	-2, -1, 0, 1, 2	5	
4	0	4s	0	1	16
	1	4p	-1, 0, 1	3	
	2	4d	-2, -1, 0, 1, 2	5	
	3	4f	-3, -2, -1, 0, 1, 2, 3	7	

## Chapters 4: Molecular Orbital Theory: Names and Structure of Simple Covalent Compounds.

### Lewis Structure

Lewis symbol of an element is made up of the chemical symbol surrounded by a number of dots. The symbol represents the inner core of the element (the nucleus and the inner electron shells) and the dots the outermost or valence electrons. For example, the Lewis structure for Silicon (atomic # = 14; [Ne] 3s<sup>2</sup>3p<sup>2</sup>) can be represented as shown below

:Si: where the pair dots represent the 3s<sup>2</sup> pair of electrons and the two single dots represent the 3p<sup>2</sup> electrons.

Lewis structure can also be represented as 4 single dots around the silicon atom and can be made to represent essentially covalent bonding in substances. Structures representing transfer or sharing of electrons between 2 or more elements is called the Lewis structure.



### Rules about Lewis structure

1. All valence electrons in a Lewis structure must be accounted for
2. All atoms in a Lewis structure acquires the octet configuration (duplet for H)
3. All electrons in a Lewis structure are paired
4. Each atom in a bonded pair contributes equal # of atoms or sometimes only one atom donates the pair of electrons.
5. Double or triple bonds are sometimes represented with Lewis structure.
6. Sometimes an element has more than one Lewis structure. It is then possible to represent the element with either one single Lewis structure or a hybrid structure called a *resonance*.
7. Start by identifying the central atom and then draw plausible Lewis structure using the rules stated above (duplet and octet rule must be obeyed)
8. Central atoms is the least electronegative and should be able to form multiple bonds with other atoms (atoms like H, F etc form single bonds and may not be a central atom in many structures whereas atoms like N, O, S, Si etc can form multiple bonds and are hence plausible central atoms)
9. Count all non bonding electrons as belonging to the atom on which it is found and count bonding electrons by dividing them equally between the bonded atoms
10. Use concept of formal charge to assess the plausibility of a suggested structure. (formal charge = valence electrons in an isolated atom minus the # of electrons assigned to that atom in a Lewis structure).
11. The structure with a formal charge of Zero is the most plausible structure.

Example: Write a plausible Lewis structure for the molecule hydrazine, N<sub>2</sub>H<sub>4</sub>?

**Answer: Total valence electrons is 14 (2N= 10 and 4H= 4)**

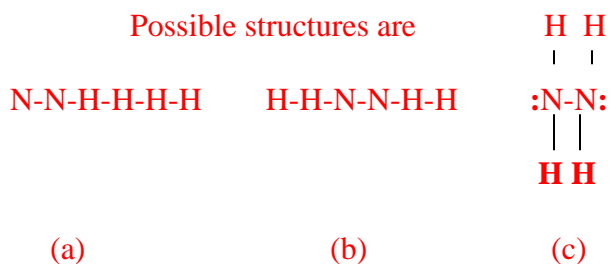

Structures(a) and (b) are not possible because the total electrons around the H atoms is more than 2 which is the allowed valence electrons for Hydrogen atoms and also H can only form single bonds. Nitrogen is a better central atom and can form multiple bonds around itself. Hence, structure (c) is better structure to represent hydrazine

**Formal Charges:** Assign formal charges for the atoms in H- C $\equiv$ N:

<b>Answer:</b>	<b>H</b>	<b>C</b>	<b>N</b>
<b>Valence electrons</b>	<b>1</b>	<b>4</b>	<b>5</b>
<b>Electron assigned</b>	<u><b>1</b></u>	<u><b>4</b></u>	<u><b>5</b></u>
<b>Formal Charges</b>	<b>0</b>	<b>0</b>	<b>0</b>

**Resonance:** The Lewis structure of the molecule of SO<sub>2</sub> can be written in two forms as shown below.

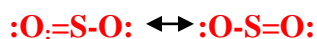

phenolic compounds, minerals, soluble dietary fiber Both structures are correct and at the same time are the same. Each structure has one single S-O bond one double S-O bond. The true structure is not known but is assumed to be a hybrid of both structures. This representation of the structure of SO<sub>2</sub> is called resonance

### Assignment

**Write the Lewis structure and shapes for the following molecules or ion (1)NO<sub>3</sub><sup>-</sup> ion. Hint: The Oxygen atoms are all bonded in the same way to the Nitrogen atom**

**Answer: The structure we are seeking must contain 24 valence electrons (5 from N and 18 from the 3 oxygen atoms, plus one extra electron for the net charge -1)**

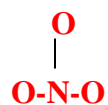

(a)

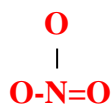

(b)

Structure (a) is incorrect: it leaves the Nitrogen with incomplete octet. Option (b) produces a plausible structure with all atoms having an octet shell but does not obey the rule in the hint that all O are connected in the same way to the central atom, N.

Therefore, the true structure of the Nitrate ion is a hybrid of the three structures shown below

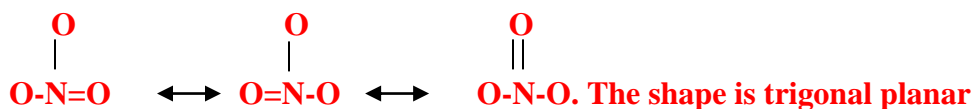

2.  $\text{N}_2\text{O}$  3.  $\text{SO}_4^{2-}$  4.  $\text{SF}_6$  5.  $\text{PCl}_5$  6.  $\text{NO}$  7.  $\text{PCl}_3$

### Exceptions to the Octet Rule

**Odd-Electron Species:** If the total # of electrons in a Lewis structure is an odd number, then two conclusions about the structure is that: 1) there must be an unpaired electron somewhere and 2) at least one atom will lack a complete octet of electrons. A good example is the molecule of  $\text{NO}_2$  with 17 electrons and  $\text{NO}$  with 11 electrons. Because of the presence of the unpaired electron, odd electron molecules are said to be **paramagnetic** and the even one with all the electrons paired to be **diamagnetic**. However, nature provides surprises like oxygen molecule with 12 electrons being paramagnetic. The explanation is that the Lewis structure indicate that the oxygen molecule have multiple bond character.

### Incomplete Octet

There are situations in which the outermost shell of an atom does not have a complete octet of electrons in its Lewis structure. A good example is  $\text{BF}_3$  and some other atoms that participate in coordinate bonding. These molecules react with Lewis base to form a coordinate complex. For example  $\text{BF}_3$  reacts with  $\text{NH}_3$  to form the  $\text{BF}_3\text{NH}_3$  complex.



## The Expanded Octet

Phosphorus forms two chlorides,  $\text{PCl}_3$  and  $\text{PCl}_5$ . The  $\text{PCl}_3$  Lewis structure obeys the octet rule for all atoms. But in  $\text{PCl}_5$ , the P has 10 electrons in its outermost shell which is more than the octet rule allows. This situation is called an **Expanded Octet**. This phenomenon occurs with atoms with available d-orbitals that can accept extra electrons for covalent bonding.  $\text{SF}_6$  is another example. In general, elements in period 3 and higher behave in this way because of the availability of orbitals that can accommodate extra electrons.

**Conclusion:** Lewis structures can help us understand the composition, bonding and properties of compounds.

## Chapter 5 Bond Theories

### Shapes of Molecules

- Lewis structures can help us understand the composition, number and type of bonding, and properties of compounds but not its shapes or molecular architecture.
- Molecules have shapes and sizes determined by the bond angles and distances between the nuclei of components that make up the molecule
- Properties of compounds depend on their shape, size, bond polarity and strength. This is profoundly demonstrated in many biochemical reactions and substances produced by living species e.g. the Yew tree produces Taxol which is used in treating breast cancer
- There is a relationship between 2-D Lewis structure and 3-D molecular shapes
- The covalent bonds (lines) used in Lewis structure tell us the type of orbitals used by molecules in bonding and subsequently help to understand the behavior of molecules (physical and chemical properties)
- Lewis structure of carbon tetrachloride is 2-Dimensional (lying in the same plane) and it just indicates that 4 chlorine atoms are attached to a central carbon but the 3-D structure indicates that the chlorine atoms are located at the corners of a tetrahedron structure with bond angles of  $109.5^\circ$
- Bond angles (angles made by lines joining nuclei of components of the molecule, C-Cl in  $\text{CCl}_4$ ) and bond length ( $1.78 \text{ \AA}$  in  $\text{CCl}_4$ ) determine the shape and size of a molecule.

- Consider molecules with the formula  $AB_n$  (A the central atom and B the atoms attached the central atom, n the number of B atoms), the shape of the molecule is determined by the value of **n**.
- For molecules of  $AB_2$  type, the general shape is either linear (bond angle of  $180^\circ$ ) or bent (bond angle  $< 180^\circ$ )

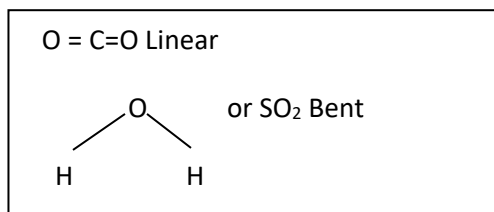

- For  $AB_3$  molecules, the common shapes are T shape, trigonal planar (A and B atoms lies in the same plane) or trigonal pyramidal (A lies in the plane above the B atoms)

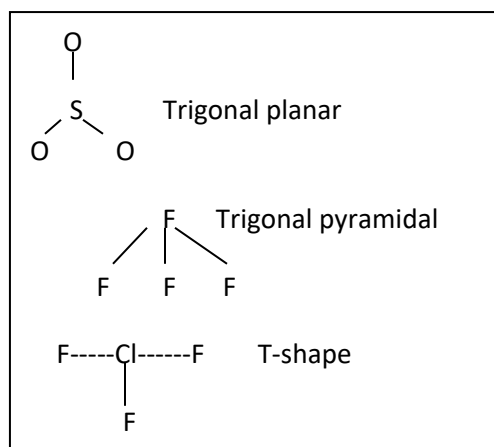

- Other common shapes of  $AB_n$  molecules are tetrahedral, Trigonal bypyramidal and octahedral
- When A is an element from the s and p block, the shape of the molecule will be one of the above mentioned shapes. This observation can be explained by the Valence-Shell Electron Pair Repulsion model (VSEPR)

### Valence-Shell Electron Pair Repulsion model (VSEPR)

- A pair of electron forms a single covalent bond between 2 atoms. A **bonding pair** of electron describe the region where those pair of electrons can be found and is called the **electron domain**.

- A **non bonding pair** (lone pair of electron) of electron is found in the region located on one atom and that region is also referred to as an electron domain
- Each multiple bond in a molecule is also called an electron domain
- 
- For example O<sub>3</sub> structure is O-O=O. It has 3 electron domains: single and double bonds and one lone pair of electrons on the central oxygen atom
- VSEPR model looks at electron domain as negatively charged domain and therefore will repel each other.
- The best arrangement of **n** number of electron domains is the one that present the minimum repulsion between them.

Table 4 Electron Domain Geometry

# of Electron Domain	Arrangement of Electron Domain	Electron Domain Geometry	Predicted Bond Angles
2	B-A-B	Linear	180°
3		Trigonal Planar	120°
4		Tetrahedral	109.5°
5		Trigonal bipyramidal	120/90°
6		Octahedral	90°

- Arrangement of electron domains around the central atom is called the **electron domain geometry (VSEPR)**. By knowing the # of bonding and non bonding pairs of electrons we can predict the geometry of a molecule
- Arrangement of atoms around the central atom in a molecule is called the **molecular geometry**. Non bonding pairs of electrons are not part of the description of molecular geometry
- For example,  $\text{NH}_3$  has 3 bonding pairs and one non bond pair of electron and its electron domain geometry is tetrahedral. However, its molecular geometry is trigonal pyramidal because the non bonding pair is not part of the molecular geometry
- When all electron domain arises from bonds, the molecular geometry and the electron domain geometry are identical e.g.  $\text{BF}_3$ , shape is trigonal pyramidal (3 bonding domains). But if there are 2 bonding domains and one non bonding domain, the electron domain geometry is trigonal pyramidal and the molecular geometry is bent e.g.  $\text{NO}_2^-$

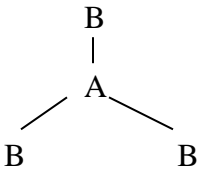
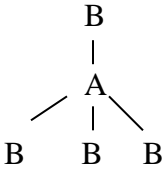
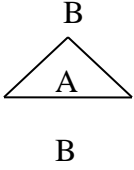
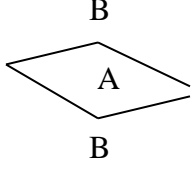
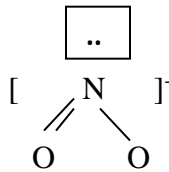

- Knowing the electron domain geometry allows us to predict the molecular geometry
- In summary, the procedure of using the VSEPR model to predict the shape of molecules or ions are as follow:
  - (1) Draw the Lewis structure of the molecule or ion and count the total # of electron domain around the central atom. (all non bonding pair, single, double or triple bonds, count as electron domains)
  - (2) Arrange the electron domains around the central atom to give a structure with the minimum repulsion among the electron domains. This gives the electron domain geometry of the molecule or ion
  - (3) Use the arrangement of the bonded atoms only to determine the molecular geometry of the molecule or ion



Assignment: Use the VSERP model to predict the molecular geometry of 9i)  $O_3$  and  $SnCl_3^-$

Answer: The Lewis structure of  $O_3$  are (distribute 18 electrons)

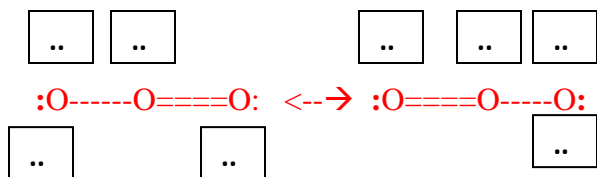

The two resonance structures are of equal length. There are 2 bonding and one non bonding electron domains. The electron domain structure is trigonal pyramidal. The molecular geometry uses only the 2 bonding electron domain to form its shape, so the shape of the molecule is bent.

(b)  $SnCl_3^-$  Lewis structure is shown below (distribute 26 electrons)

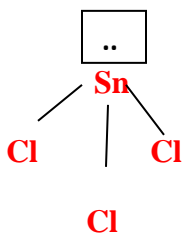

The electron domain geometry is Tetrahedral (3 bonding and one non bonding electron domains). The molecular geometry is trigonal pyramidal (3 bonding electron domains)

Modifications to VSERP Model

**(a) Effect of Non Bonding and Multiple Bonds on Bond Angles**

- The ideal geometry of molecules or ions (as shown in table above) are sometimes distorted because of the presence of non bonding pairs of electrons or multiple bonds in their electron domain geometry.
- Bonding electrons are attracted by both nuclei of the bonding atoms while non bonding pairs are only attracted by the nucleus of the atom on which the electrons reside. Hence there is less restriction on the influence of the electron domain of the non bonding pair is larger than that of bonding pairs (larger size). This leads to the non bonding electron domain exerting more repulsive forces on nearby electron domain.

- The repulsive forces will push nearby electron domains closer to each other, hence, reducing the bond angles. The more non bonding electron domains present in a molecule or ion, the more the bond angles are reduced.
- Multiple bonds have larger electron densities and hence will have larger electron domain repulsive influences on nearby electron domains, hence will reduce bond angles just like the non bonding electron domains
- For example, if we look at the bond angles of  $\text{CH}_4$  ( $109.5^\circ$ ),  $\text{NH}_3$  ( $107^\circ$ ) and  $\text{H}_2\text{O}$  ( $104.5^\circ$ ), there is a decrease in the size of the bond angles as the number of non bonding electron domain increases. (as electron affinity of the central atom increases or moving across a period, the bond angle decreases)
- Another example is the molecule phosgene ( $\text{COCl}_2$ ). It has 2 bonding and one non bonding electron domains. The prediction is a trigonal planar with a bond angle of  $120^\circ$ , but the bond angle is  $111.4^\circ$ . This implies that the double bond in the structure of phosgene act more like a non bonding pair with more repulsive influences on other electron domain around it, hence reducing the bond angles of phosgene.

**(b) Molecules with Expanded Valence Shells**

- The central atom in a molecule from the third period and above may have more than four pairs of electrons around it. That is, they may have valence shells that do not obey the octet rule. Such molecules or ions may have 5 electron domains around (trigonal bipyramidal structure) or 6 electron domains (octahedral structure) around it.

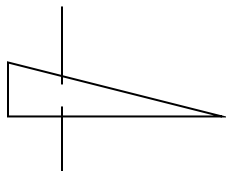

- The basic electron domain geometry (most stable) for a 5 electron domain molecule is trigonal bipyramidal. This indicates 2 electron domains in axial positions (top/down,  $90^\circ$  to the equatorial plane) and 3 electron domains in an equatorial position (plane of a triangle,  $120^\circ$  bond angles).
- If there are non bonding pairs in the electron domains, they lie in the equatorial planes hence changing the molecular geometry as its # increases (see table below)

- The most stable electron domain geometry for a 6 electron domain molecule or ion is the octahedral geometry (2 tetrahedron joined together)
- The octahedron has 8 faces (8 equilateral triangles) and 6 vertices (a central atom with its 6 electron domains pointing in 6 directions)

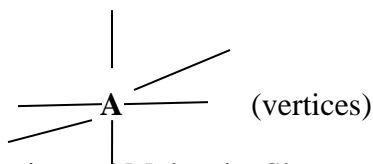
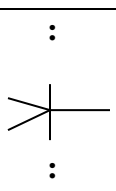

Table 5 Electron Domain Geometries and Molecular Shapes of 5 and 6 Electron Domain Around the Central Atom

Total Electron Domain	Electron Domain Geometry	Bonding Domains	Non Bonding Domains	Molecular Geometry	Example
5	Trigonal bipyramidal	5	0	 Trigonal bipyramidal	PCl <sub>5</sub>
		4	1	 Seesaw	SF <sub>4</sub>
		3	2	 T shaped	ClF <sub>3</sub>
		2	3	 Linear	XeF <sub>2</sub>
6	Octahedral	6	0	 Octahedral	SF <sub>6</sub>
		5	1	 Square pyramidal	BrF <sub>3</sub>

				pyramidal	
		4	2	 : : Square planar	XeF <sub>4</sub>

- All bond angles in an octahedron is  $90^\circ$  and all vertices are equivalent

- The non bonding electron domains can be placed along any of the vertices, hence changing the molecular geometry as the number increases (see table below)

Assignment: Use the VSEPR model to predict the molecular geometry of (i) SF<sub>4</sub> and (ii) IF<sub>5</sub>

Answer: Lewis structure of SF<sub>4</sub> is shown below (34 electrons distribution)

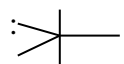

It has 5 electron domains (4 bonding and one non bonding). Hence the molecular shape is seesaw

(ii) The Lewis structure of IF<sub>5</sub> is shown below

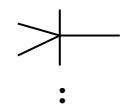

It has 6 electron domains (5 bonding and one non bonding). Hence the molecular shape is square pyramidal

### Molecular Shape and Molecular Polarity

**Bond Polarity:** is a measure of how electrons are shared between the atoms that forms the bond. As the difference in electronegativity of the two atoms in the bond increases so also is the bond polarity.

**Dipole moment:** is a quantitative measure of the amount of charge separation in a molecule which affects both its physical and chemical properties (melting and boiling points etc). The polarity and geometry (shapes and orientation) of molecules affects the value of its dipole moment. Bond dipole is the dipole moment between two atoms that forms a bond.

Bond dipoles and dipole moments are vector quantities and hence, for a polyatomic molecule or ion, the overall dipole moment of such molecules or ion is the vector (magnitude and direction) sum of all its bond dipoles. The two C-O bond in a molecule of CO<sub>2</sub> are polar, equal in magnitude but opposite in direction, hence they cancel each other and therefore makes the dipole

moment of CO<sub>2</sub> to be zero. We can then say that CO<sub>2</sub> is a non polar molecule. **It is evident in this example and others that the geometry of a molecule dictates the overall dipole moment of a molecule.**

If we consider water, H<sub>2</sub>O, the shape is bent. It has two identical H-O bonds with equal dipole moments but their directions are not opposite each other. Therefore, the dipole moments will not cancel each other out, which make water to be a polar molecule ( $\mu = 1.85\text{D}$ )

**Assignment: Predict whether the following molecule are polar or non polar (a) BrCl (b) SO<sub>2</sub> (c) SF<sub>6</sub>**

**Answer:** (a) the molecule contains two atoms with different electronegativity, hence it will be polar. Chlorine is more electronegative than Br, hence it will carry the partial negative charge.



- (b) The O-S bonds are polar but the VSEPR predicts the resonance hybrid of SO<sub>2</sub> to be bent, hence it will be polar. Oxygen is more electronegative than S, hence it will carry the partial negative charge
- (c) The S-F bonds are polar but the VSEPR geometry of SF<sub>6</sub> is octahedral. All the S-F bonds are identical and the octahedral geometry is symmetrical. Hence all the SF bond dipoles cancel out. Therefore, SF<sub>6</sub> is non polar

### Covalent Bonding and Orbital Overlaps

- VSEPR helps to predict the shapes of molecules but it does not explain why bond exist between atoms
- Quantum mechanics have been used to explain theories of covalent bonding
- The question is: how can we use atomic orbitals to explain chemical bonding and the geometries of molecules?
- Lewis electron pair bonds and the idea of atomic orbital's have been combined together to form what is called the **Valence-bond theory**
- Lewis theory suggests that atoms share electrons to form a chemical bond. The chemical bond is a concentration of electrons between the two nuclei of the participating atoms
- The valence bond theory suggests that a chemical bond is formed when a valence atomic orbital of one atom overlaps or shares space with the valence atomic orbital of another atom. The shared space or the overlap domain can only

contain two electrons of opposite spin. The nuclei of both atoms will at the same time attract the pairs of electrons, hence holding the atoms together forming a covalent bond.

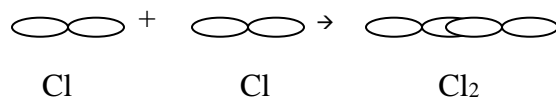

- Orbital overlap can occur between atoms of the same element or atoms of different elements. For example the  $1s^1$  electron of H can overlap with the the  $3p^5$  orbital of chlorine to form the HCl molecule

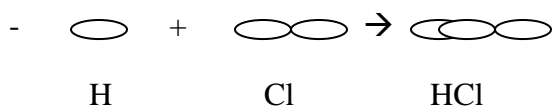

- There is an optimum distance between the two nuclei in a covalent bond. The variation of the potential energy with the distance between the two nuclei of a covalent Hydrogen bond is shown below

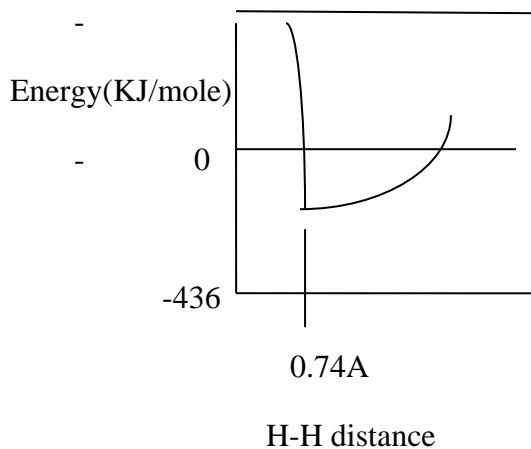

- At infinite distance from each other, the H atoms do not feel each other, hence their PE approaches zero. As the atoms approach each other, the overlap of the  $1s$  orbital's increases increasing the electron density between the nuclei. The result is a decrease in PE of the system and the bond strength increases. There is a minimum distance between the nuclear after which, there is a sudden sharp increase in PE energy due to electrostatic repulsion between the nuclei. This minimum distance is the distance at which the attractive forces between the two nuclei is balanced by the repulsive forces between them. The distance is called the bond length of the covalent bond.

## Hybrid Orbital's

- VSEPR theory explains the shapes of molecules but does not explain filling and shapes of atomic orbital's
- For example, how does VSEPR explain formation of tetrahedral structure of methane from the shapes and orientation of carbon 2s and 2p atomic orbital's with that of 1s atomic orbital's of hydrogen.
- How can we relate overlapping of orbital's with molecular geometries?
- To explain these, it is assumed that the atomic orbital's of the central atom mixes together to form new types of orbital's called **Hybrid orbital's**
- This process is called **Hybridization**.
- Shapes of hybridized orbital's are different from any of its parent orbital
- The number of hybridized orbital's formed is equal to the number of orbital's that formed the hybridized orbital's
- Examples of hybridized orbital's are: sp (2 orbitals), sp<sup>2</sup>(3 orbitals), sp<sup>3</sup>(4 orbitals)
- For example, BeF<sub>2</sub> is predicted to have a linear structure with two identical BeF bonds by the VSEPR theory.
- The EC of F is 1s<sup>2</sup>2s<sup>2</sup>2p<sup>5</sup> which indicates that it has an unpaired 2p electron
- The EC of Be is 1s<sup>2</sup>2s<sup>2</sup> with all electrons paired which shows that in its ground state, it is incapable of forming bonds with the fluorine atom. The Be atom can promote one of its 2s electrons to its 2p orbital so that it has a 2s and 2p unpaired orbital with which it can form bonds with F. To form the linear structure predicted for BeF<sub>2</sub>, the Be 2s and 2p orbital's hybridized to form 2 sp hybridized orbitals. The sp hybridized orbital's have two lobes, one small and one big with the big ones pointing in opposite directions.
- Be uses the sp orbital's to form identical bonds with F atoms pointing in opposite directions. This result into a linear structure.

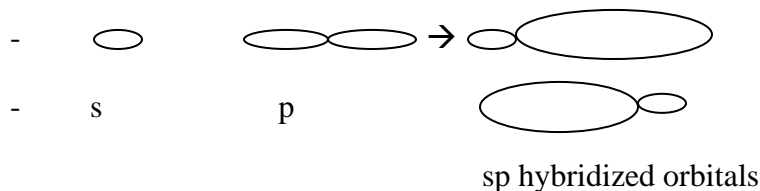

- $sp$  orbitals – 2 equivalent hybridized orbital's opposite to each other -  $180^\circ$  linear
- $sp^2$  –  $120^\circ$  – 3 equivalent hybridized orbital's pointing in different directions but lying in the same plane- trigonal planar shape  $BF_3$

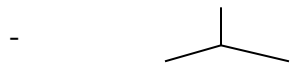

- $sp^3$  – 4 equivalent orbital's pointing in different directions with the large lobe pointing towards the vertices of a tetrahedron e.g  $CH_4$

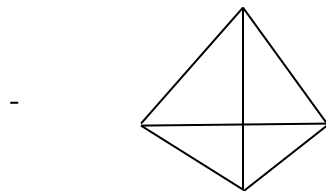

- $sp^3d$  – 5 equivalent hybridized orbital's with each orbital directed at the vertices of a trigonal bipyramid

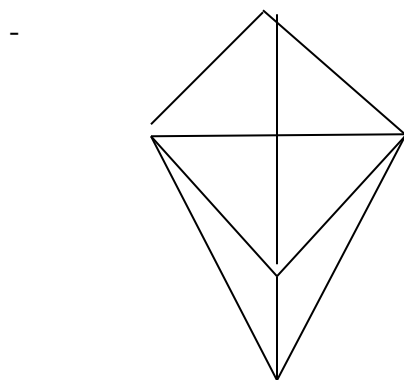

- $sp^3d^2$ - 6 equivalent hybridized orbital's with each orbital directed at the vertices of an octahedron

**Multiple Bonds-** The hybrid orbital's described above involves electron densities formed between two nuclei. The electron densities is said to lie along internuclear axis and are called **sigma bonds ( $\sigma$ )**.

When two p orbital overlaps, they form a bond that is different from a sigma bond and is called a pi ( $\pi$ ) bond. This bond is also a covalent bond that is perpendicular to the internuclear axis with regions above and below the internuclear axis. There is no chance of finding electrons along the internuclear axis in a pi-bond because it overlaps sideways (not facing each other). The overlap is less and hence results into a bond that is weaker than a sigma bond.



Multiple bonds in a molecule can be a double bond (one sigma and pi bond) or a triple bond (one sigma and 2 pi bonds). Examples of molecules with multiple bonds include ethane ( $C=C$ ), carbon dioxide ( $O=C=O$ ), acetylene ( $C\equiv C$ ) etc.

### Resonance Structures, Delocalization and $\pi$ Bonding

The sigma and pi bonds described above are formed between two nuclei and hence it is called a localized bond because we associated the bonding electrons to a pair of nuclei

For molecules that have resonance structures with one or more pi bonds, we cannot particularly associate electron density with a particular atom. The electrons are **delocalized** all over the atoms in that molecule. A good example is benzene with two resonance structures. Benzene has 6 carbon atoms with each one of them attached to 2 other C atoms and a hydrogen atom ( $\sigma$  bonds). Each C atom also has a 2p orbital with one electron, perpendicular to the plane of the molecule and arranged in a cyclic fashion to form pi bonds.



Delocalized electrons give molecules stability and rigidity in its geometry

**Assignment:** Which of the following molecules or ions will exhibit delocalized bonding: (i)  $SO_3$  (ii)  $SO_3^{2-}$ , (iii)  $H_2CO$ , (iv)  $O_3$  (v)  $NH_4^+$

### Molecular Orbital Theory (MOT)

Lewis structure, VSEPR and valence bond theories help to understand some aspects of bonding but not everything. For example, they do not explain why elements give different colors when they absorb light. The molecular orbital theory can explain some of these phenomena.

Electrons in orbitals can be described by wave functions called atomic orbitals. Likewise, electrons in molecules can be described by wave functions called molecular orbitals (MO). MO has similar characteristics as an atomic orbital: can only hold 2 electrons at a time, its electrons have opposite spins, it has energy etc. However, the MO is associated with the entire molecule not with individual atoms.

### Hydrogen Molecule

When two atomic orbitals overlap, they produce two molecular orbitals: (i) **the bonding molecular orbital ( $\sigma$ )** which is lower in energy relative to the two atomic orbitals from which it is formed (parent atomic orbitals). It concentrates the electron density between the nuclei of its atoms, and hence forms the covalent bond that holds the molecule together and (ii) **the antibonding molecular orbital ( $\sigma^*$ )** which is of higher energy than its parent atomic orbitals.

This MO excludes electron density in the region where a bond is supposed to be formed and concentrates electrons on opposite sides of the nuclei (electrons repel each other in the bonding region). This MO configuration is therefore, unstable than its parent atomic orbital's (higher energy).

For the Hydrogen molecule formed from two 1s orbital's, the MO is represented as shown below and is called the energy-level or molecular orbital diagram

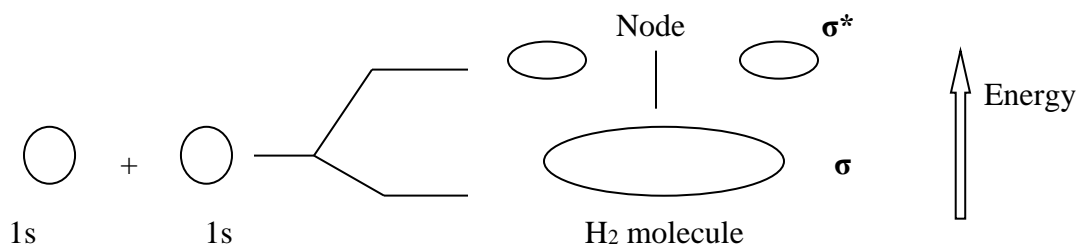

The electron configuration of H<sub>2</sub> molecule can also be written as  $\sigma^2$  similar to atomic orbital configuration.

### Bond Order

Bond order determines the stability of a covalent bond. It is determined as

$$\text{Bond Order} = \frac{1}{2} (\text{number of bonding electrons} - \text{number of antibonding electrons})$$

Single bond = 1 bond order, Double bond = 2 bond order, Triple bond = 3 bond orders

For odd number molecules, fractional bond orders ( $1/2$ ,  $3/2$ ,  $5/2$  are possible)

**Example: What is the bond order for the ion He<sub>2</sub><sup>+</sup>**

**Answer: The He<sub>2</sub><sup>+</sup> has 3 electrons to distribute in its MO's. Two electrons goes into the bonding MO and one into the antibonding MO's**

$$\text{Hence Bond order for He}_2^+ = \frac{1}{2} (2-1) = \frac{1}{2}$$

### Molecular Orbital's for Li<sub>2</sub>

The Electronic Configuration for Li is  $1s^2 2s^1$ . The MO diagram will look as shown below

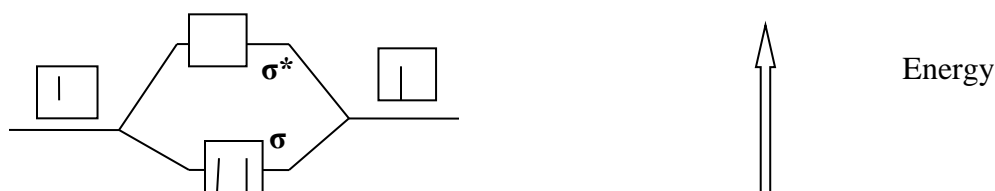

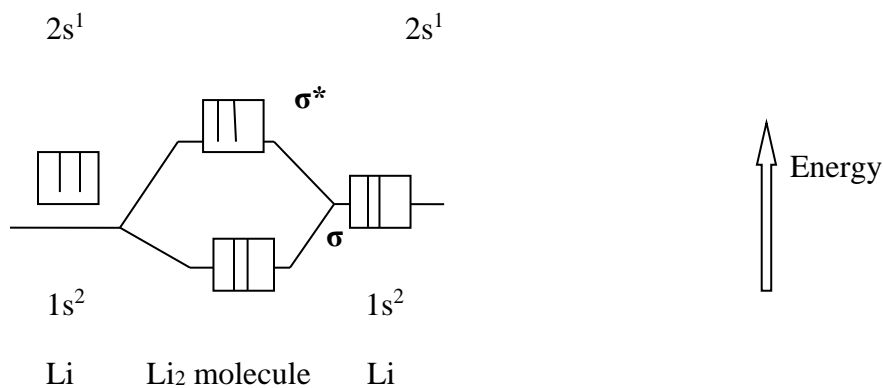

### Molecular Orbital's for Elements with p-Orbital's (B<sub>2</sub>- Ne<sub>2</sub>)

Elements in this period have both 2s and 2p atomic orbital's and the energy diagram is as shown above. Conclusions from the energy diagram are as follows"

The 2s bonding and antibonding MO are lower in energy to the MO's formed by the 2p- orbital's

The overlap of the 2p<sub>z</sub> orbital is greater than that of the 2p<sub>x</sub> and 2p<sub>y</sub>.  $\sigma_{2p}$  MO's is lower in energy than the  $\pi_{2p}$  MO's. The  $\sigma_{2p}^*$  is of higher energy than the  $\pi_{2p}^*$  MO's

Both  $\pi_{2p}$  and  $\pi_{2p}^*$  are doubly degenerate

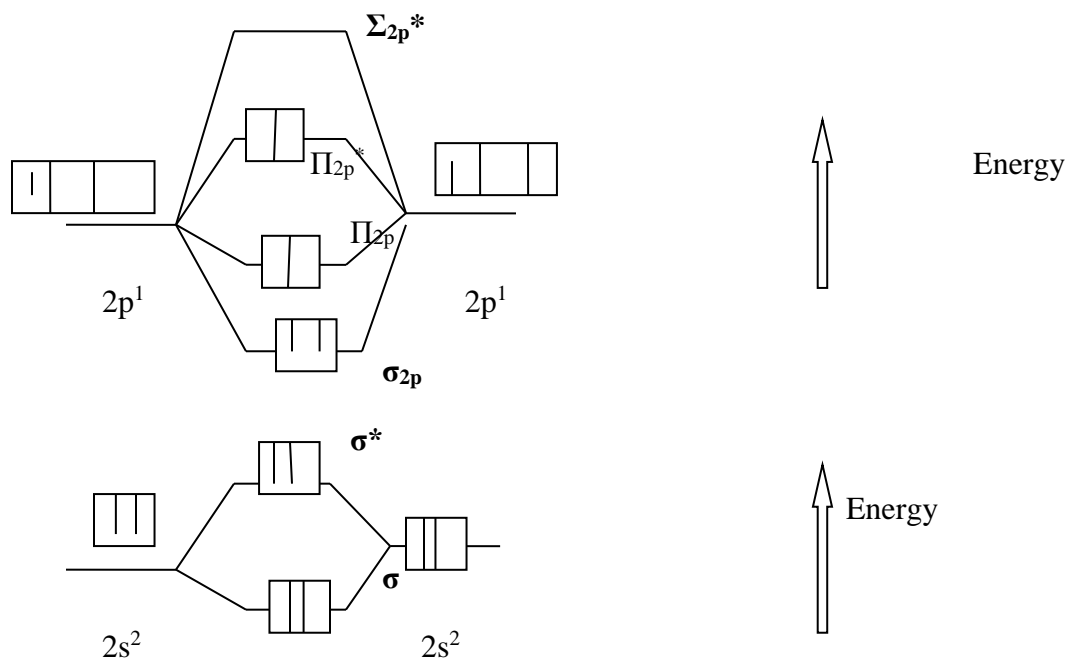

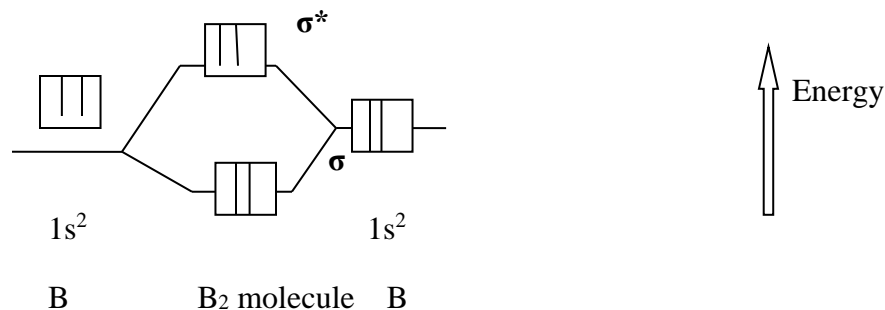

## Chapter 6 Acids and Bases

### Acid

- **Arrhenius Acid:** A substance that dissolves in water to give  $H^+$  ions  
 $HCl \leftrightarrow H^+_{aq} + Cl^-_{aq}$   
**Naming of Acids:** Acids dissolve in water to give  $H^+_{aq}$  ions and a negatively charged ion which is a non metal ( $Cl^-_{aq}$ )
- The word **hydro** is placed before the name of the non metal and ends with the suffix 'ic' acid. For example, HCl is called hydrochloric acid,  $H_2SO_4$  is called sulphuric acid
- Acids turns litmus paper red and phenolphthalein colorless
- Acids are sour to taste
- **Brønsted Acids:** is defined as a substance that donates protons.  $H^+$  ion does not exist freely in water. It attaches itself to a molecule of water to form the hydroxonium ion:  $H^+ + H_2O \rightarrow H_3O^+$

### Bases

- **Arrhenius Base:** a substance that dissolve in water to give a cation and a hydroxide ion. For example,  $NaO \rightarrow Na^+_{aq} + OH^-_{aq}$ . Most Arrhenius bases are groups 1A and 2A substances e.g Na, K, Be, Li
- Bases like  $Ca(OH)_2$ ,  $Al(OH)_3$ ,  $Fe(OH)_3$  are strong but insoluble in water
- Arrhenius bases are sour to taste and slimy to touch. They turn litmus blue and phenolphthalein pink

- **Naming of Bases:** The name of the metal is ended with the word hydroxide. For example NaOH is called sodium hydroxide.
- **Brønsted Base:** is a substance that accepts a proton. For example, water accepts a proton to form the hydroxonium ion, hence water is a base in this reaction. Another example is the reaction:  $\text{NH}_3 + \text{H}^+ \leftrightarrow \text{NH}_4^+$ ,  $\text{NH}_3$  is proton acceptor and hence it is acting as a base in this reaction

### Conjugate Acid and Base

- **Brønsted- Lowry:** Conjugate pairs such as A-B are molecules or ions that gain or lose  $\text{H}^+$  ions
- Every acid-base pair have two conjugate pairs in the forward and backward direction: Conjugate acid/base pair

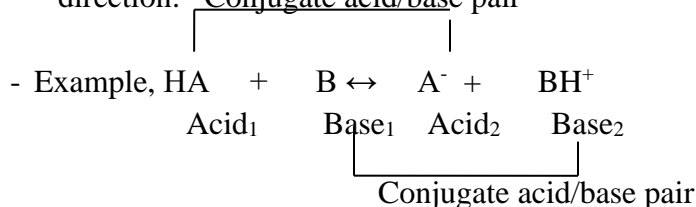

- :

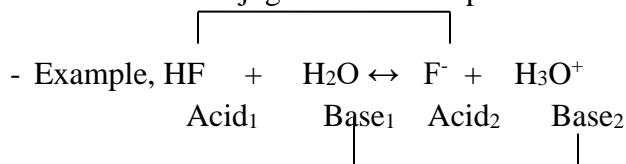

Conjugate acid/base pair

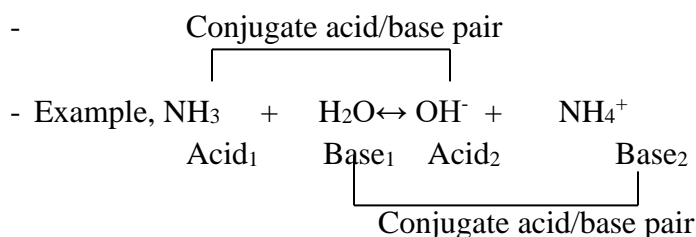

### Strength of Acids and Bases

- Strength of acids and bases is the number of moles of  $\text{H}_3\text{O}^+/\text{OH}^-$  per mole of acid/base replicates
- Strong acids and bases dissociate completely in solution:  $\text{HCl} \leftrightarrow \text{H}^+ + \text{Cl}^-$
- while weak acids and bases dissolves sparingly in solution:  
 $\text{CH}_3\text{OH} \leftrightarrow \text{CH}_3\text{O}^- + \text{H}^+$

## Chapter 7 Inorganic Chemicals: Application in Chemistry, Agriculture, Medicine and Industry

**Inorganic Elements:** Inorganic elements abound in nature. Examples include Na, K, Ag, Au etc.

- Inorganic compounds are compounds that do not have Carbon in its composition:  
 Example includes:  $\text{H}_2\text{O}$ , HF, HCl etc
- Exceptions include:  $\text{CO}_2$ ,  $\text{H}_2\text{CO}_3$ ,  $\text{NaCO}_3$

**Chemical Industry:** Inorganic elements and their compounds are very useful in many chemical industries.

- They are useful in the following area
- (i) Steel (iron and charcoal), golf clubs (titanium), Light bulbs (tungsten filament)
- (ii) Dairy product (fortified with Calcium), antacids ( $\text{CaCO}_3$ )
- (iii) Smog (NO- deleterious to health), Gold (precious metal), Silver (ornaments), Mercury (thermometer),
- (iv) Titanium (filaments, toothpaste, paints), Paints (lead), Advertising (neon lights)

- (v) Noble Gases: Helium is used as carrier gases in Gas Chromatography analysis (GC) and fill balloon, Argon in forming plasma plume in analytical experimentations, Neon is used to fill lighting bulbs
- Divers: Mixes oxygen and nitrogen for breathing in deep waters. If oxygen is not mixed with nitrogen, nitrogen may be absorbed by blood cells at this high pressure region and cause disorientation. A mixture of helium and oxygen may be used instead of nitrogen to prevent disorientation
- Oxygen- Breathing- is essential to life. Used by living cells for respiration
- CO<sub>2</sub>- used by plants to manufacture their food and in fire extinguishers, used as dry ice in cryogenic refrigeration
- Cu<sub>2</sub>O is used to prevent growth of algae on plants. Fe[III] chromatinins are found in yellow pigments in plants
- Space Shuttles: Astronauts uses LiOH to remove CO<sub>2</sub> from the air in their cubicles
- Bleach: hypochlorite is used to remove stains from clothing materials and wood pulp. Chlorine is used in cleaning water to produce portable drinking water
- Analytical Chemistry: Silica is used in separation science as the stationary material for gas and liquid chromatography columns. It also use in the manufacturing of glass materials

### Health Industry (Medicine)

Electrolytes: are present in body fluids and cells of plants and animals. Essential in metabolic processes in the body (respiration, fluid regulation, cardiac cycle etc)

### Ions in the Body and Food

Ion	Occurrence	Function	Source	Hypo	Hyper
Na <sup>+</sup>	Outside the cell 135-145 meq/L	Regulate body fluid	Salt, tomatoes	Hyponatremia Cardiac failure	Hypernatremia Little urine, throat edema
K <sup>+</sup>	Inside the cell	Regulate cell function 3.5 -5.5 meq/L	Bananas, nuts juice, orange	Hypokalemia Lethargy, muscle	Hyperkalemia Irritation, nausea,

				weakness, neurological dysfunction	arrhythmia
--	--	--	--	--	------------

### Ions in the Body and Food Cont'd

Ion	Occurrence	Function	Source	Hypo	Hyper
Ca <sup>+</sup>	Outside the cell	Tone/muscle function 8.5 -10.5 meq/L	Milk, dairy products	Hypocalcemia Tingling of toes and finger tips, muscle cramps, osteoporosis, deep bone pain	Hypercalcemia
Mg <sup>+</sup>	Outside the cell	Enzyme/muscle control 1.5-2.5 mEq/L	Spinach	Hypomagnesia, Disorientation, hypertension, tremors, slow pulse	Hypermagnesia, drowsiness
Cl <sup>-</sup>	Outside the cell	Gastric fluid regulation. 95-105 mEq/L	Salt	Same as Sodium	Same as sodium
P	Outside	2.5-4.0 mEq/L			

**Casting:** CaSO<sub>4</sub> used in orthopedics (plaster of Paris, POP)

**Antacid:** Tums contain about 40% calcium to regulate acids in stomachs and prevent gas formation

**Breathing:** Oxygen is used in breathing therapy and LiOH is used to remove CO<sub>2</sub> from air in space shuttle cubicles

**Hot and Cold Compress:** Cold pack: Bag contains water and NH<sub>4</sub>NO<sub>3</sub> in separate compartments. When the bag is squeezed, the ammonium nitrate mixes with the water and an endothermic reaction occurs where 330J/g of energy is consumed per gram of ammonium nitrate.



The temperature drops and pack becomes cold. The cold compress reduces edema, inflammation, hemorrhaging and heat at the point of injury to promote healing.

Hot pack: Bag contains water and  $\text{CaCl}_2$  in separate compartments. When the bag is squeezed, the  $\text{CaCl}_2$  mixes with the water and an exothermic reaction occurs. Temperature of the bag increases and pack becomes hot. The hot compress reduces edema, relax muscle, and expand the capillary vessels which allow blood flow to the point of injury and promote healing.

**Dental Surgery:** Anesthesia: uses dinitrogen dioxide to numb nerves in the mouth.

**Blood Gases:** consist of  $\text{N}_2$ ,  $\text{O}_2$ ,  $\text{CO}_2$ ,  $\text{NH}_3$ , and water vapor,  $\text{HCO}_3^-$  which takes part in fluid regulation and respiration and controls blood pH value.

**Electrolytes:** takes part in fluid, metabolic (kidney) and respiration regulation

**Arterial Blood Gases (ABG):**

Electrolyte	ABG Values
$\text{HCO}_3^-$	24-26 mEq/L
$\text{CO}_2$	35-45 mEq/L
pH	7.2- 7.45
Sat % (oxygen)	95%
$\text{PaO}_2\%$	80-100%

**Hyperbaric Treatment:** High pressure treatment that increases the ability of the blood to absorb more oxygen which helps in the treatment of some infections of cancer patients

**Water:** is 60% of adult human body and 78% in infants. Carries nutrients to the cells and remove cell wastes.

**Kidney:** takes part in metabolic and respiratory regulation, secret acidic or alkaline urine and Hydrogen ions, reabsorbs  $\text{NaHCO}_3$ . Salts of Ca/Mg are stored in kidney and are called Kidney stones. Kidney stones are a very painful sickness.

**X-ray/ CT-scan/MRI** may use dyes for better viewing of images of body organs (barium sulfate)

**Enema:** may use barium sulfate as an enema for constipated clients

**Agriculture:** necessary to sustain life

Green House: helps to trap heat needed for plant growth ( $T = 18^{\circ}\text{C}$ ). Green house gases include  $\text{CH}_4$ (1%),  $\text{CO}_2$ (76%), Dinitrogen dioxide (laughing gas), CFC (Chlorofluorocarbon)

**Fertilizers:** essential minerals needed for plant growth. It increases productivity and yield of annual crop. There are different types: (1) artificial or synthetic fertilizers: inorganic, non biodegradable (ii) Macronutrients fertilizers: contains 6 elements essential for plant growth: primary macronutrients- N (green growth) and Phosphorous (strong root/abundant flowers)

Potassium- prevent diseases; Secondary macronutrients: Ca, Mg, sulfur.

Others: iron, Mn, B, Cu, Molybdenum, Ni, Cl, Zn. Deficiency hampers growth

**Alum:** repels fly. **Arsenic:** poison to kill pests and vermin's

**Pesticides: Alum and ammonium nitrate**

**Radiation of Foods (fruits, juices):** used to kill germs and bacteria (salmonella, Listeria, E. coli). May use Co as radioactive material which produces gamma rays used in killing germs and bacterial in foods

## Chapter 8 Redox Potential and Application.

Oxidation and reduction are complementary simultaneous reactions that occur naturally in nature. The abbreviation for the process is called REDOX (Reduction- Oxidation). Redox reaction is an equilibrium reaction. Examples of redox reaction include: (i), a piece of nail will rust within 2-3 days when exposed to the weather –  $2\text{Fe} + 3/2\text{O}_2 \rightarrow \text{Fe}_2\text{O}_3$  (ii) Biological cells undergo oxidation (Cancer cells) (iii) as part of the process of production of NaCl (Down's process) (iv) Galvanic cells: reaction that occurs in galvanic cells to produce electric current

**Oxidation:** can be defined in 3 different ways: (1) loosing of hydrogen ions ( $\text{H}_2\text{CO}_3 \rightarrow \text{H}^+ + \text{HCO}_3^-$ ) (ii) gaining of oxygen ( $\text{C} + \text{O}_2 = \text{CO}_2$ ) (iii) loosing of electrons ( $\text{Cu} \rightarrow \text{Cu}^{2+} + 2\text{e}^-$ )

**Reduction:** May be defined as (i) gaining of hydrogen ( $\text{H}_2\text{O} + \text{Cl}_2 \rightarrow \text{HCl} + \text{HOCl}$ ) loosing of oxygen  $2\text{H}_2\text{O}_2 \rightarrow 2\text{H}_2\text{O} + \text{O}_2$  (iii)  $\text{Cu}^{2+} + 2\text{e}^- \rightarrow \text{Cu}$

Other Examples:  $2\text{Mg} + \text{O}_2 \rightarrow 2\text{MgO}$

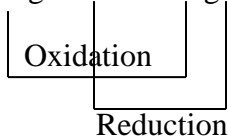

## Half Reactions

Involves expressing oxidation and reduction as separate equations

$2\text{Mg} + \text{O}_2 \rightarrow 2\text{MgO}$  is equal to 2-half reactions:

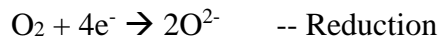
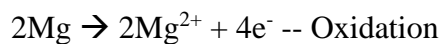

**Reducing Agent:** Mg is losing electrons to reduce oxygen, hence it a reducing agent

**Oxidizing Agent:** Oxygen is accepting electrons from Mg to oxidize Mg, hence it is an oxidizing agent

### Oxidation State (Number)

- An ionic state achieved by an element (atom) either by gaining or losing electrons
- It is a convenient way of expressing a reaction process going on at a point in time
- The oxidation state of an element is zero irrespective of whether the element is an atom (ne), a molecule ( $\text{O}_2$ ,  $\text{H}_2$ ) or a lattice (Si)
- In assigning an oxidation state (#), homonuclear bonds are ignored while heteronuclear bonds are considered. For example, In  $\text{H}_2\text{O}_2$ , the O-O bond is homonuclear and is not used in determining the oxidation state of oxygen in this compound. The heteronuclear bond, H-O, is considered in determining the oxidation state of H or O in this compound

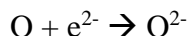

- Oxidation process involves increase in oxidation number of an atom while reduction process involves decrease in oxidation number of an atom

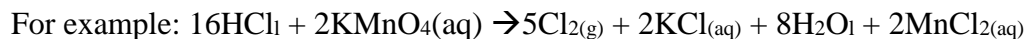

Half Reactions for this reaction is as shown below

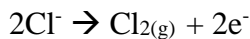

Oxidation: -1            0

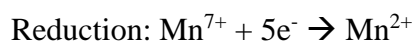

Reduction    +7                            +2

- The net charge of ox/red process must be zero

### Half Cells/Galvanic Cells

- A simple electrochemical reaction cell consists of: (a) a metal strip dipping into a solution of one ions (Cu strip in Cu salt solution). There will be no chemical reaction in this set up.
- We may represent such cells as half cells:  $\text{Cu}^{2+}(\text{aq}) + 2\text{e}^- \leftrightarrow \text{Cu}_\text{s}$
- We can put two such half cells together to form an electrical circuit.
- If there is a potential difference between the 2 half cells, hen a reaction will occur e.g. Daniel Cell
- Daniel Cell: consist of 2 half cells –  $\text{Cu}^{2+}/\text{Cu}$  and  $\text{Zn}^{2+}/\text{Zn}$

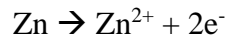
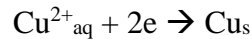

- When the two cells are connected by a salt bridge (gelatin impregnated with KCl or  $\text{KNO}_3$ ), ions pass from one cell to another
- The two cells gradually mixes together while Redox reactions takes place

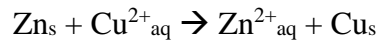

- This arrangement result into a Galvanic cell
- An electrical work is done in this type of cell to allow the mixing to occur
- The potential difference,  $E_{\text{cell}}$ , between the two half cells is measured in volts (V) with a voltmeter
- $E_{\text{cell}}$  is related to change in Gibbs energy for the cell reaction and is also called the Standard cell potential under standard condition.

$\Delta G_{\text{(Gibbs energy)}} = -ZFE^0_{\text{cell}}$ <p><math>Z = \#</math> of moles of <math>\text{e}^-</math>'s transferred per mole of reaction. <math>F =</math> Faradays constant = 96485 C/mol, <math>E^0_{\text{Cell}}</math> potential difference in Volts. <math>\Delta G = \text{J/mol}</math></p>
---

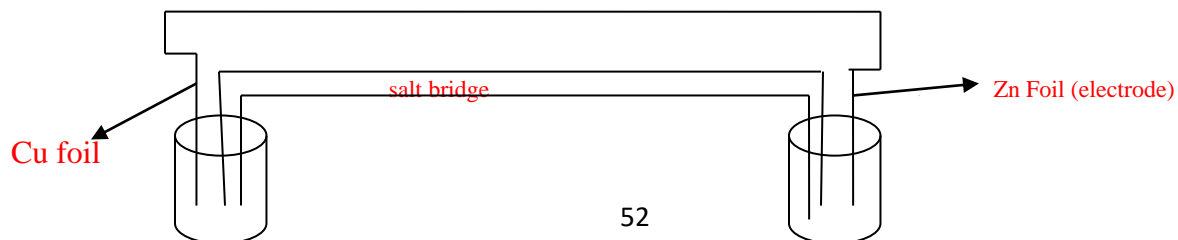



### Galvanic Cell

#### Standard Conditions for an Electrochemical Cell for Single Electrodes

The conditions are as follow: - Unit activity for each cell (for dilute solutions-activity is equal to the concentration of the solutions)

- Pressure of any gaseous component is 1 bar ( $10^5$  psi)
- Temperature is  $298^{\circ}\text{C}$
- The solid component must be in its standard state

#### The Gibbs Energy and the Equilibrium Constant

- Redox reaction is an equilibrium reaction,
- It has an equilibrium constant which is related to Gibbs energy
- $\Delta G = -RT \ln K$  and

$$\ln K = - \Delta G / RT = ZFE_{\text{cell}}^0 / RT \quad R = \text{molar constant} = 8.314 \text{ J/kmol}$$

For a cell reactions that is thermodynamically favorable,

$E^0$  must be positive and  $\Delta G$  must be negative and  $K > 1$

#### Defining and Using Reduction Potentials ( $E^0$ )

Tabulated values of  $E^0$  are available and it refers to  $E^0$  of  $\text{Cu}^{2+}/\text{Cu} = +0.34 \text{ V}$

It is impossible to measure  $E^0$  of a single cell by itself, hence it is measured relative to the  $E^0$  of a hydrogen electrode

-a standard hydrogen electrode consist of:

Pt electrode in  $\text{H}^+$  ( $1 \text{ mol/dm}^3$ , unit concentration)

$\text{H}_2$  gas at 1 bar

$$E^0 = 0$$

$2\text{H}^+ + 2e \rightarrow \text{H}_{2g}$ - this half cell is combined with another half cell to determine its

$E^0 = E^0$  reduction -  $E^0$  oxidation, the value gives the sign of the Cell  $E^0$

Example:  $\text{H}^+_{\text{aq}}/\text{H}_{2\text{g}}//\text{Zn}^{2+}_{\text{aq}}/\text{Zn}_{\text{s}}$  galvanic cell

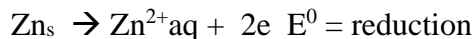
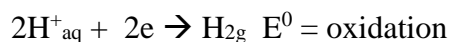
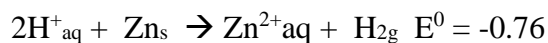

$$E^0 = E^0_{\text{red}} - E^0_{\text{ox}} = (0 - 0.76) = -0.76\text{V}$$

Standard electrode table is arranged such that the most positive  $E^0$  is at the bottom of the table (most powerful oxidizing agent, Fluorine and the one at the top is the most powerful reducing agent)

The following 2 half cell reactions correspond to 2 half cells that as combined to 2 half cells to form an electrochemical cell

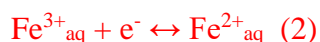
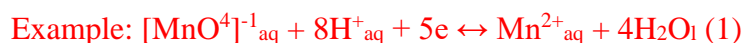

(a) Which cell will be the spontaneous cell reaction? (b) Calculate the  $E^0_{\text{cell}}$ ?

Answer: Check the  $E^0$  for the half cells



$E^0_{\text{Mn}^{7+}/\text{Mn}^{2+}} > E^0_{\text{Fe}^{3+}/\text{Fe}^{2+}}$ , hence the  $\text{Mn}^{7+}/\text{Mn}^{2+}$  is a more powerful oxidizing agent than the  $\text{Fe}^{3+}/\text{Fe}^{2+}$  hence, it will be the spontaneous reaction cell. So the cell reaction will be



$$E^0 = E^0_{\text{red}} - E^0_{\text{ox}} = 1.15 - 0.76 = 0.74\text{V}$$

$\Delta G$  value is a better parameter to use in determining the spontaneity of a reaction than the  $E^0$  values

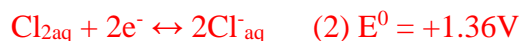

Each of the Fe cell is connected to the  $\text{Cl}_2$  half cell to form a galvanic cell

Cl<sub>2</sub> half cell is more positive than the two Fe half cells, hence its reaction is more spontaneous than the two Fe half cells (more powerful oxidizing agent), hence the galvanic cells will be



From the E<sup>0</sup> cell values, E<sup>0</sup> Fe<sup>2+</sup>/Fe (1.80V) > E<sup>0</sup> Fe<sup>3+</sup>/Fe, should be the most spontaneous half cell. But if the ΔG values are calculated, the reverse is the case

$$\Delta G = -zFE^0$$

$$\Delta G \text{ Fe}^{2+}/\text{Fe} = -2 \times 96485 \times (1.8) = -347 \text{ KJ/mole and}$$

$$\Delta G \text{ Fe}^{3+}/\text{Fe} = -6 \times 96485 \times (1.4) = -810 \text{ KJ/mole}$$

$$\Delta G \text{ Fe}^{3+}/\text{Fe} \text{ per mole will be } -810/2 = 405 \text{ KJ/mole (balanced equation)}$$

$$\Delta G \text{ Fe}^{2+}/\text{Fe} = -347 \text{ KJ/mole per mole}$$

Hence, the Fe<sup>2+</sup>/Fe is the spontaneous cell reaction and more thermodynamically favorable.

#### Dependency of Reduction Potential on Cell Conditions

Usually, laboratory experiments are not done at standard cell conditions. A change in condition can change the ability of a reagent to act as an oxidizing or reducing agent.

For example, if the concentration of the half cells is not unit concentration (0.1 mole/dm<sup>3</sup>), the Nernst equation is used to calculate the cell potential

$$E = E^0 - \left\{ \frac{RT}{zF} \ln \left[ \frac{\text{reduction}}{\text{oxidation}} \right] \right\}$$

R = molar gas constant, T = temperature in K, F = Faraday's constant, z = # of electron transferred

## Chapter 9 Complex ion Formation

Complex ions are formed by coordination of ligands to ions in aqueous solutions

Ligand means to “bind”

In a coordination complex we have the following

A central atom (ion) coordinated by ligands (ion or molecule) and act as a Lewis acid

Ligand (ion or molecule) act as a Lewis base

A ligand: act as a Lewis base (donate electrons to central atom)

Forms bonds with the central atom/ion

Are either anionic or neutrally charged specie

The central atom acts as a Lewis acid and receives electrons from the ligand (Lewis base)

Examples of Coordination Complexes: are formed by (1) d- block metal ions e.g Co (ii) p-block species e.g.  $[\text{BrF}_4]^-$



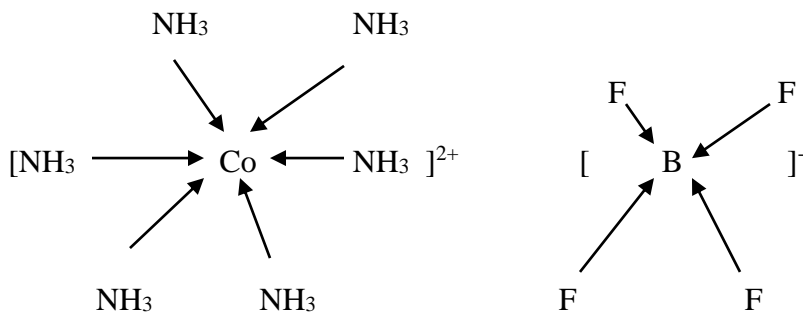

Arrow is used to show the donation of pair of electrons by the neutral ligand to an acceptor e.g  $\text{Co}(\text{NH}_3)_6$

A line is used to denote the interaction between an anionic ligand and the acceptor atom

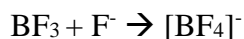
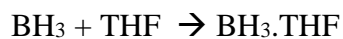
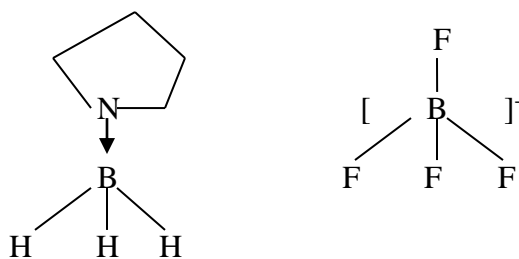

A Lewis acid + Lewis base = Adduct (complex ion). The formation of the adduct is represented by a dot (.) as shown above with THF.

### Investigating Coordination Complex Formation

The following methods can be used to investigate formation of complex ions

- (a) testing the change in chemical properties (not that reliable)
- (b) All reactions are equilibrium reaction; hence, determining equilibrium constant is a more reliable investigative tool

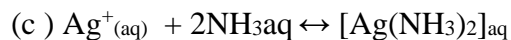

$$K_{\text{eq}} = \frac{[\text{Ag}(\text{NH}_3)_2]_{\text{aq}}}{[\text{Ag}^+_{(\text{aq})}][\text{NH}_3_{\text{aq}}]^2}$$

- (d) Physical methods – Electronic or vibrational spectroscopy – more reliable technique

### Application of Stability Constant

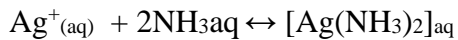

$$K_{\text{eq}} = [\text{Ag}(\text{NH}_3)_2](\text{aq}) / [\text{Ag}^+(\text{aq})][\text{NH}_3(\text{aq})]^2$$

(a) If  $\text{Cl}^-$  ion is added to the solution, no precipitate is observed. This suggests that all the  $\text{Ag}^+$  is binded or  $K_{\text{Ag}/\text{NH}_3} \gg \gg K_{\text{Ag}/\text{Cl}}$  complex, hence no  $\text{AgCl}$  is formed or the little one formed is soluble

If  $\text{I}^-$  is added, precipitate is observed, this implies that  $K_{\text{Ag}/\text{Cl}} \ll \ll K_{\text{Ag}/\text{I}}$

(b) Extractions: Neutral ligand are sparingly soluble in aqueous media but soluble in organic media. For example  $[\text{Fe}(\text{acac})_3]^{3+}$  is red in color and insoluble in aqueous media. It can be extracted into Benzene or Chloroform (acac= acetyl acetone or pentane dione)

### Stability Constant of Coordination Complexes

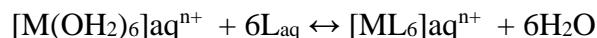

The formation of the complex  $[\text{ML}_6](\text{aq})^{n+}$  from  $[\text{M}(\text{OH}_2)_6](\text{aq})^{n+}$  involves a stepwise displacement of the water molecule by the ligand. Each step has a characteristic stability constant  $K_1 \dots K_6$ . The overall stability constant is represented by  $\delta_6$  such that

$$\delta_6 = K_1 \times K_2 \times K_3 \times K_4 \times K_5 \times K_6$$

$$\log \delta_6 = \log K_1 + \log K_2 + \log K_3 + \log K_4 + \log K_5 + \log K_6$$

$$\text{and } \delta_6 = [\text{ML}_6](\text{aq})^{n+} / [\text{M}(\text{OH}_2)_6]^{n+} [\text{6L}]^6$$

### Gibbs free energy

$\Delta G^0 = -RT \ln K$  (R= molar gas constant =  $8.314 \times 10^{-3}$ , T = temp in K and k = equilibrium constant).  $\Delta G^0$  can be calculated from each step of the complex formation

### Determination of Stability Constants

If concentration of the central atom/ion ( $\text{M}^+$ ) and the ligand is known and only the complex ion is formed, then, the stability constant,  $\delta_n$ , can be determined by:

(i) polarography and potentiometry (if the reaction is reversible) (ii) pH (if the ligand is a conjugate of a weak acid) (iii) ion exchange (using spectrophotometer- Beer-Lambert law) (iv) NMR and (v) DFT theory

## Thermodynamic Consideration of Complex Formation

Ligands can have more than one donor atoms in its structure. The number of donor atoms is called the **Denticity** of the ligand:

One donor atom – mono dentate

Two donor atom – bidentate

Greater than one – polydentate

**Chelate Ring:** Coordination of a polydentate ligand to the central atom ion results into a chelate (crab claw). The presence of adduct and highly charged ligands increase the entropy ( $\Delta S$ ) and enthalpy ( $\Delta H$ ) which makes  $\Delta G$  to be more negative. This makes the formation of the complex more feasible.

**Example:**  $\text{Co}_{\text{aq}}^{2+} + \text{EDTA} \leftrightarrow [\text{Co}(\text{EDTA})]^{2-}$  (EDTA = ethylene ditetraacetate)

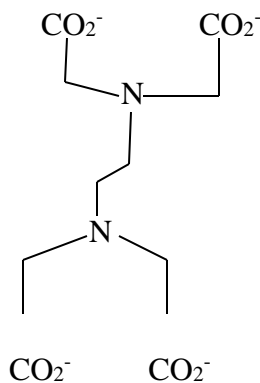

When chelates are formed a 5 or 6 membered ring is formed. 3 or 4 membered ring is not stable because of ring strain. Thermodynamically, formation of bidentate or polydentate chelates are favored over mono dentate chelate complexes. For ions/atoms that are not d-block atom/ion e.g. lanthanides, the stability of the complex adducts decreases with increasing atom/ion size and increases with increasing ionic charge i.e.  $\text{Ca}^{2+} > \text{Sr}^{2+} > \text{Ba}^{2+}$  (increasing size) and  $\text{Li}^+ < \text{Mg}^{2+} < \text{Al}^{3+}$  (increasing ionic charge)

## **Chapter 10. Chemistry of group 5, 6 & 7 Elements**