

# *Origami*

(Collection near 300 models from Internet)

“Curious things, habits. People themselves never knew they had them.”

*Agatha Christie*

# Two Fold Angelfish by J.C. Nolan (Jan '95)

© '95

Beginner (Pureland)

Fold from a square of paper colored the same on both sides. If two-color paper is used start with the colored side down for a predominantly white model. A 4" piece of paper produces a model 4" high.

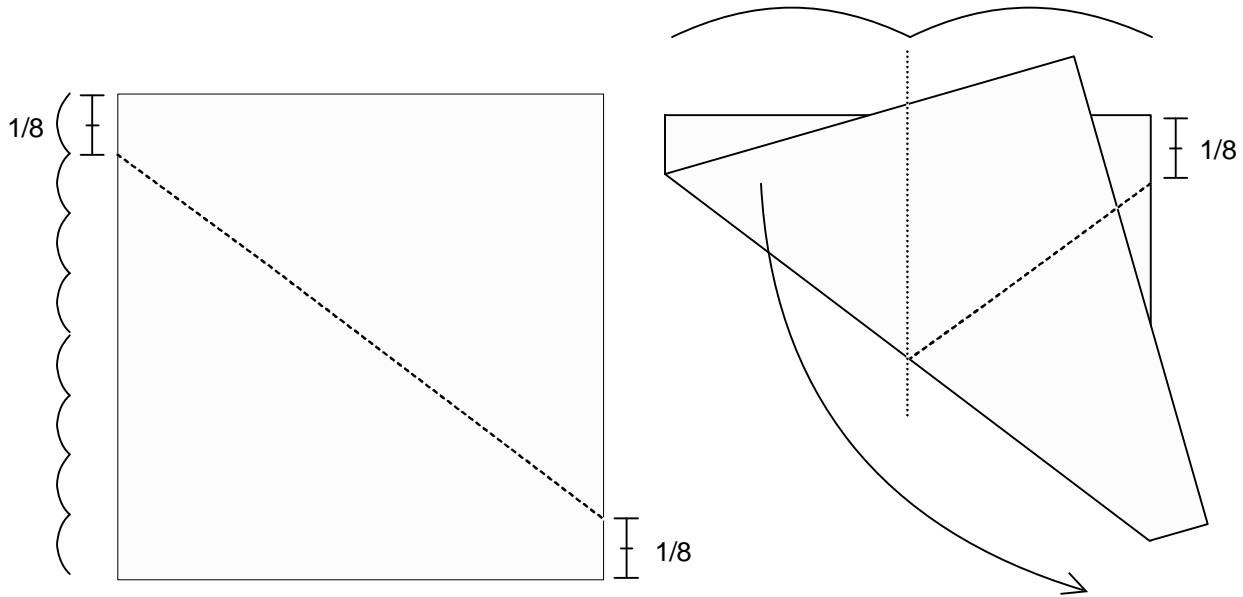

1. Please note, the extra symbols are for those who prefer having landmarks. Feel free to estimate.

2. Please note, see previous note.

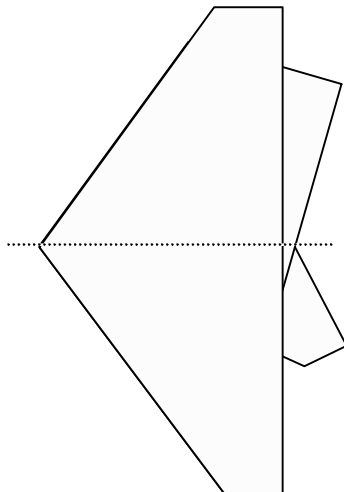

3. The dotted line is to help show how things line up.

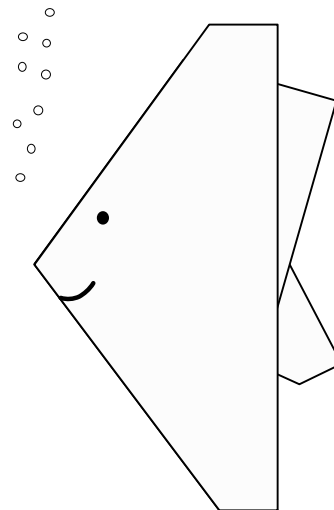

4. Complete the model with a smiley-face.

# 8½ by 11 Turtle

Or what to make with typing paper

By Perry Bailey 1997, 1999 ©

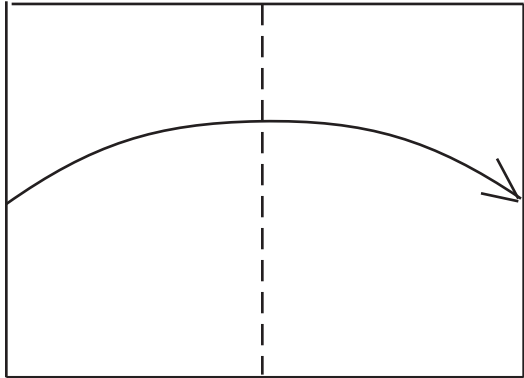

1. Fold paper in half lengthwise.

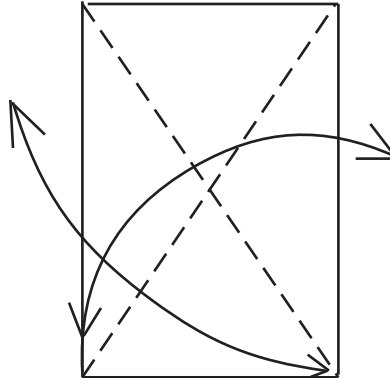

2. Fold in half or at least from corner to corner both directions and then unfold.

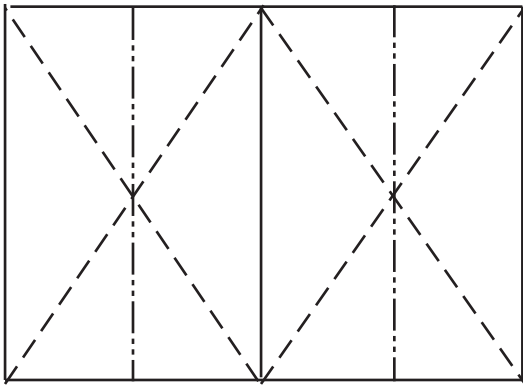

3. Fold 2 almost water bomb bases along the lines shown. The two bases will both leave a little bit of paper sticking out, in the next diagram you can see one set the other is hidden.

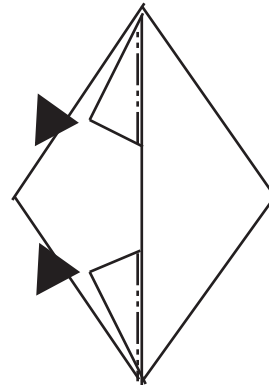

4. Reverse fold both sets of flaps into the model.

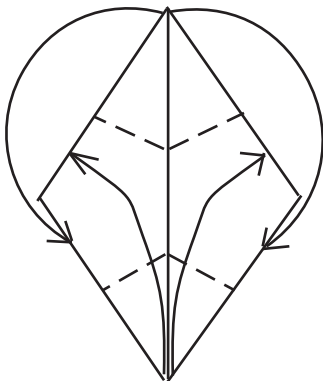

5. Pull the flaps out to the outsides of the model, so that they all lay flat.

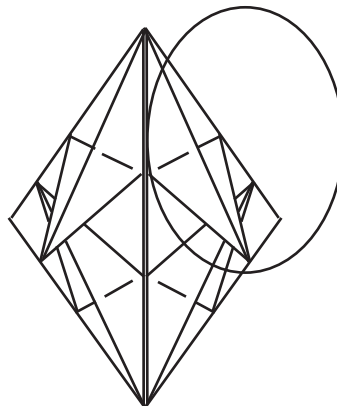

6. At this point we will magnify the circled part of the diagram in the next step.

7. Squash fold the flaps outward along the lines shown.

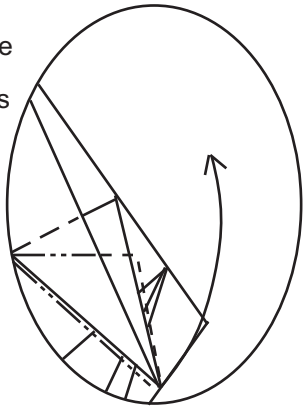

8. Fold down the top set of flaps along the lines shown in the diagram. Valley fold the sides in towards the center, then fold the bottom flaps upwards as shown.

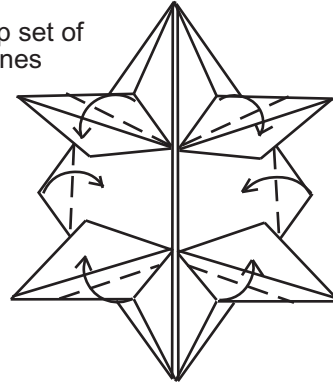

9. This what you should have at the end of step 8.

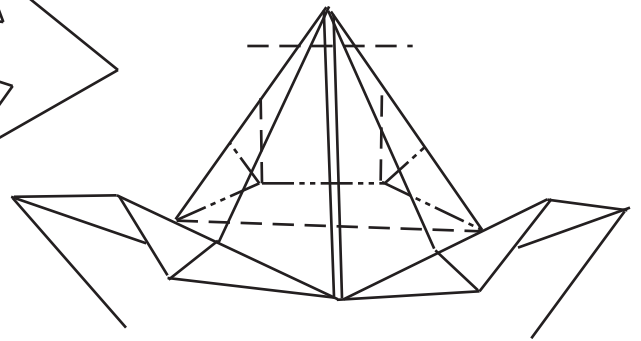
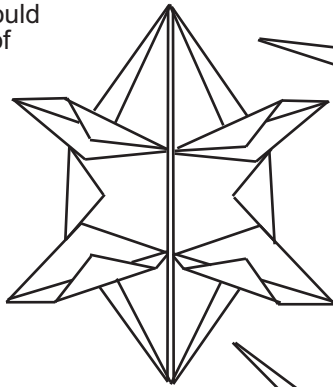

10. Fold the top down along the fold lines as shown, to create the head.

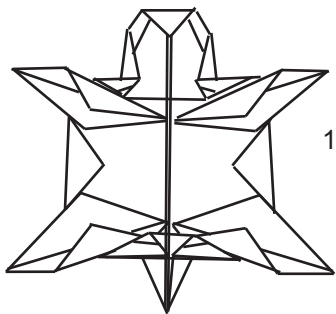

12. Finished model from the bottom view.

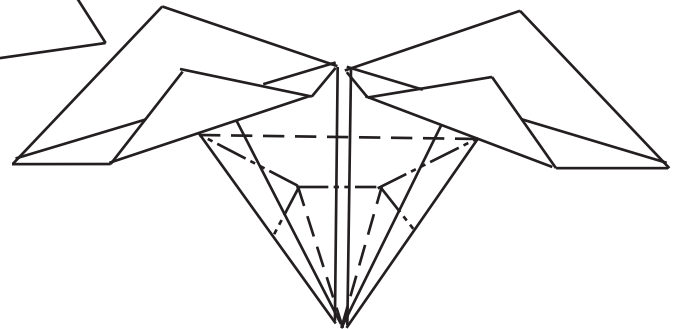

11. Fold the the tail upwards along the lines shown in the diagram

13. The finished model from the top.

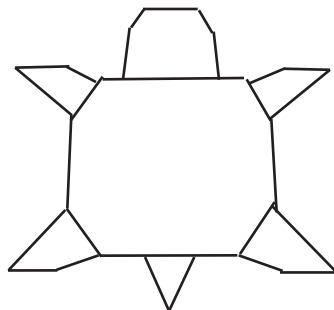

# Acroanthosaurus

Begin with a square, white side up, with both diagonals precreased.

1.

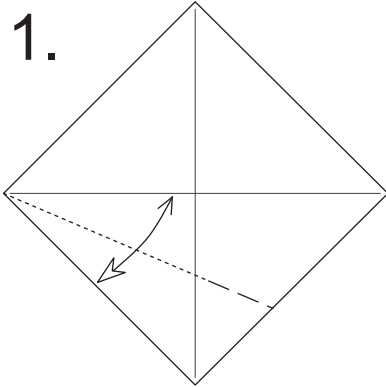

Valley fold the lower left side to the horizontal center line, bisecting the angle on the left corner, but crease only where the fold intersects the lower right side. Unfold.

2.

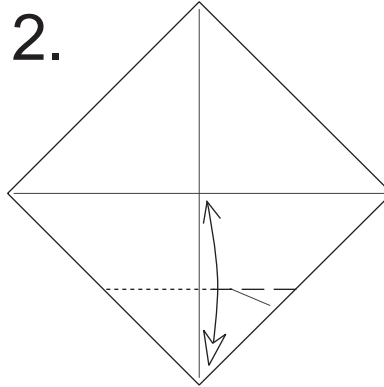

Valley fold the bottom corner to the center of the square, again creasing only on the right side. Unfold.

3.

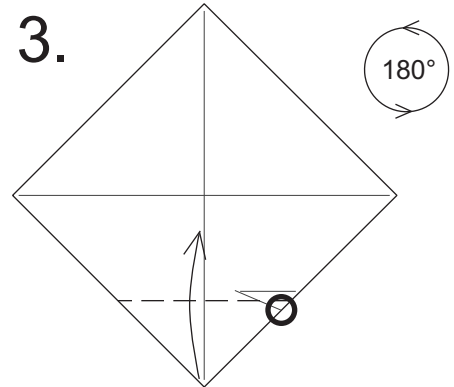

Valley fold the bottom point up so that the intersection of the edge of the paper and the angle bisector from Step 1 lays on the crease line from Step 2. Rotate the paper 180°.

4.

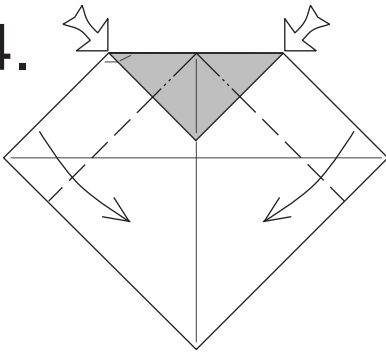

Reverse fold the top sides in to the center line, creating a small preliminary base at the top. The next diagrams are enlarged.

5.

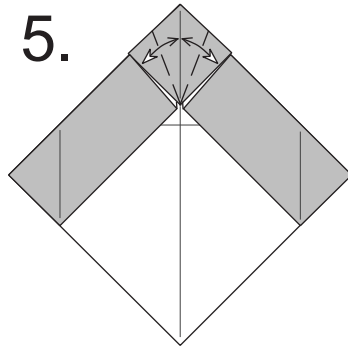

Valley fold the sides of the preliminary base at the top to the center line and unfold.

6.

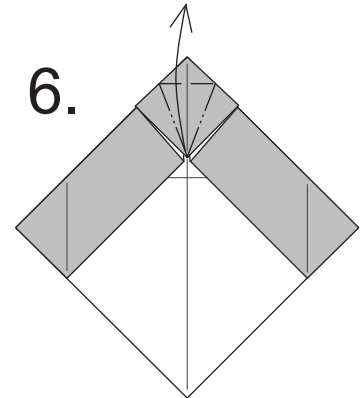

Petal fold on the creases from Step 5.

7.

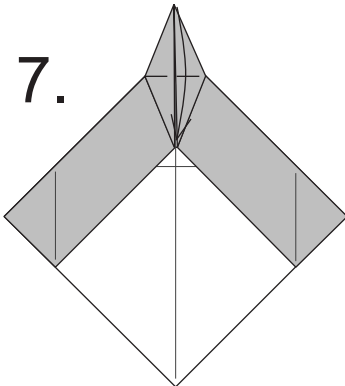

Valley fold the petal back down.

8.

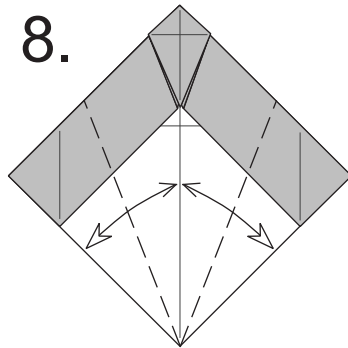

Valley fold the lower edges to the center, bisecting the lower point on each side, and unfold. Because of the proportions used in Steps 1-3, the side corners of the paper should lie right at the lower tip of the petal fold at the top when the edges are at the center line.

9.

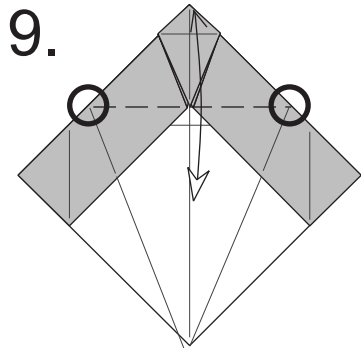

Valley fold the top point (including the bird base assembly) down along a line that connects the tops of the angle bisectors from Step 8. This crease should go across the very tip of the petal fold. Unfold.

10.

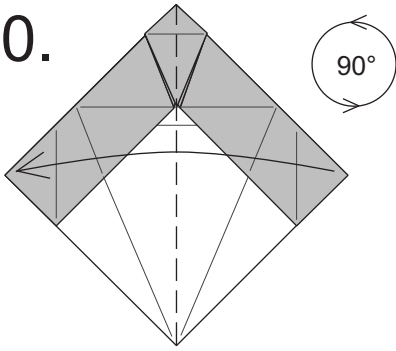

Valley fold the entire model in half, right side over left. Rotate the model 90° counterclockwise (the thick point including the petal fold will be on the left).

11.

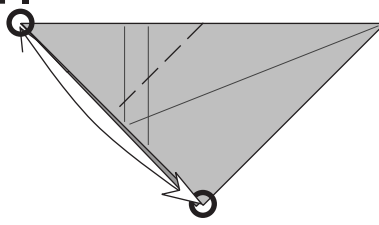

Valley fold the thick point at the left down to the bottom point and unfold.

12.

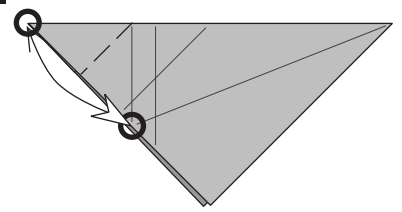

Valley fold the thick point at the left down to the intersection of the edge and the angle bisector from Step 8 and unfold.

13.

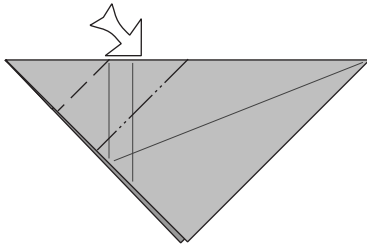

Double reverse fold the thick, left point inwards on the crease from Step 11 and back out on the crease from Step 12.

14.

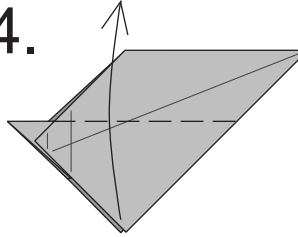

Valley fold the upper part of the paper (including the upper part of the thick, petal folded assembly inside) as far upwards as it will naturally fall.

15.

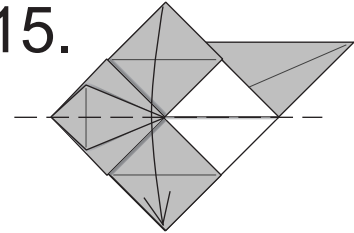

The result. Unfold the top flap back down.

16.

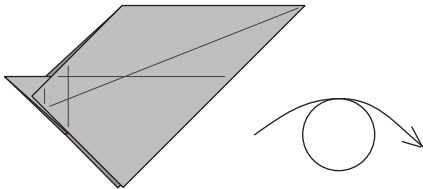

Turn the paper over from side-to-side.

17.

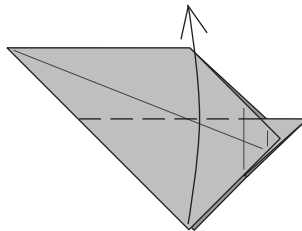

Fold the top flap up again, as in Step 14.

18.

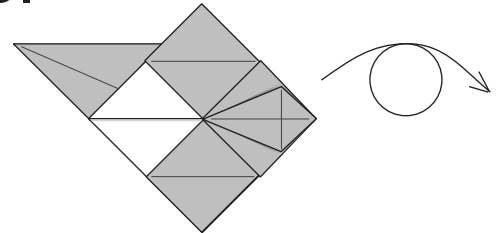

Turn over from side-to-side. The next diagrams are enlarged.

19.

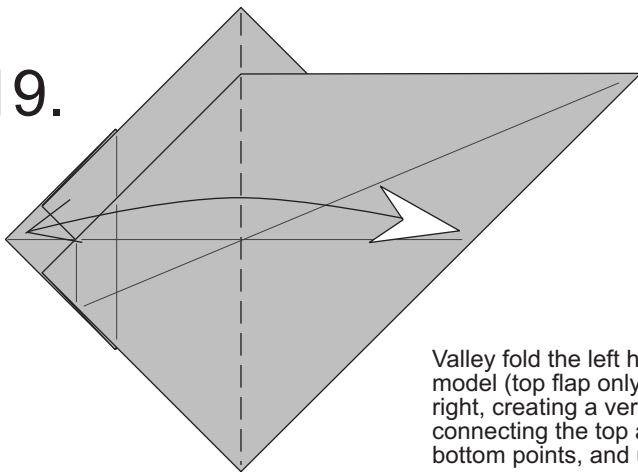

Valley fold the left half of the model (top flap only) over the right, creating a vertical line connecting the top and bottom points, and unfold.

20.

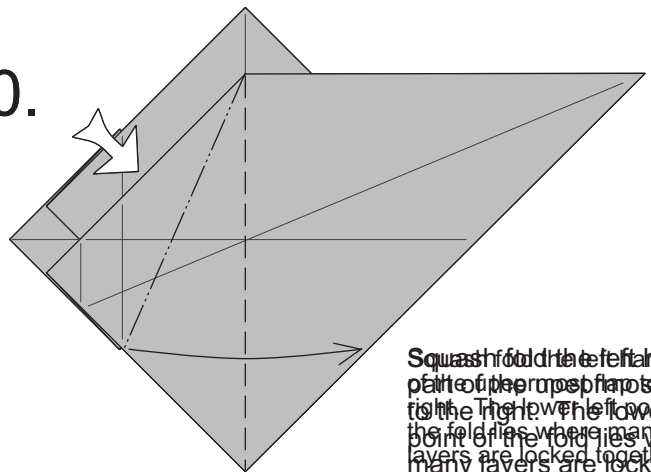

Square fold the left half of the model over the right, locking many layers together. The lower left point of the fold lies where many layers are locked together.

21.

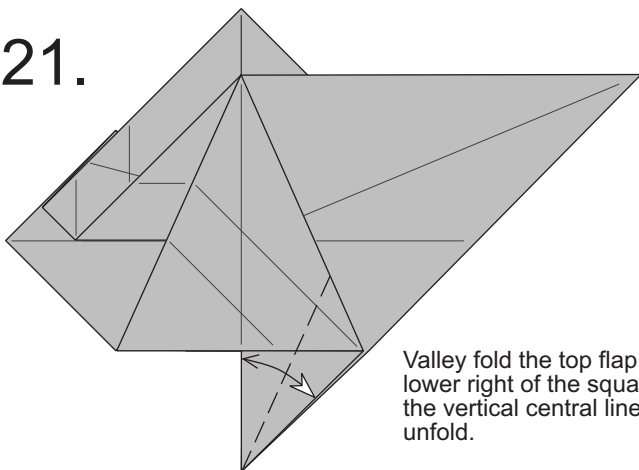

Valley fold the top flap at the lower right of the squash to the vertical central line and unfold.

22.

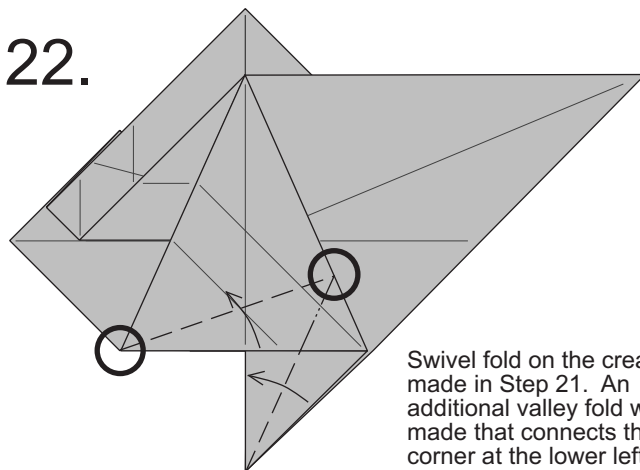

Swivel fold on the crease you made in Step 21. An additional valley fold will be made that connects the corner at the lower left and the upper end of the crease made in Step 21.

23.

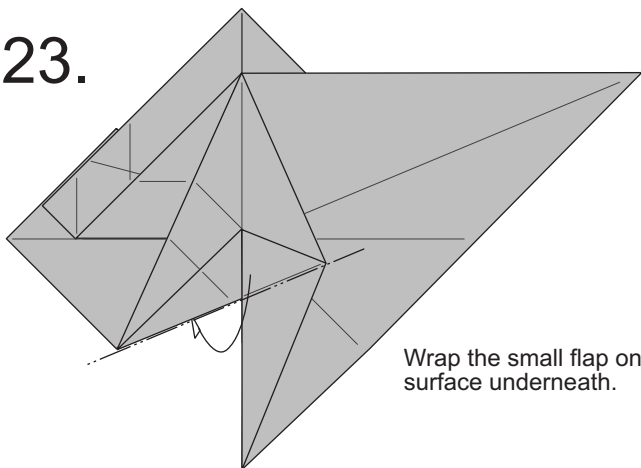

Wrap the small flap on the surface underneath.

24.

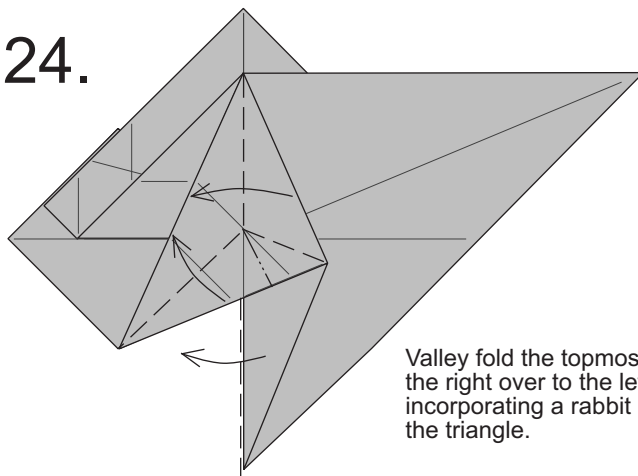

Valley fold the topmost flap on the right over to the left, incorporating a rabbit ear in the triangle.

25.

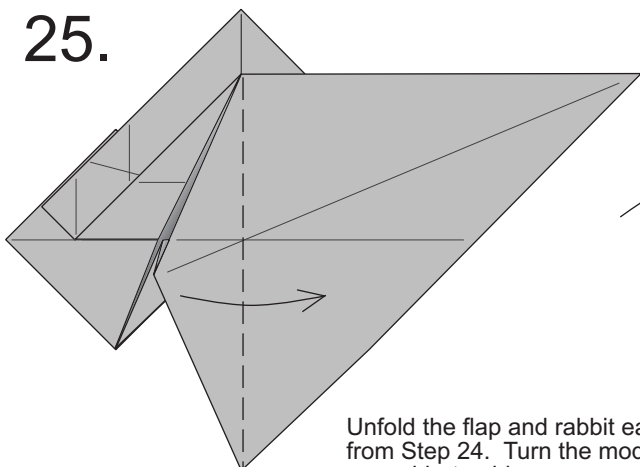

Unfold the flap and rabbit ear from Step 24. Turn the model over side-to-side.

26.

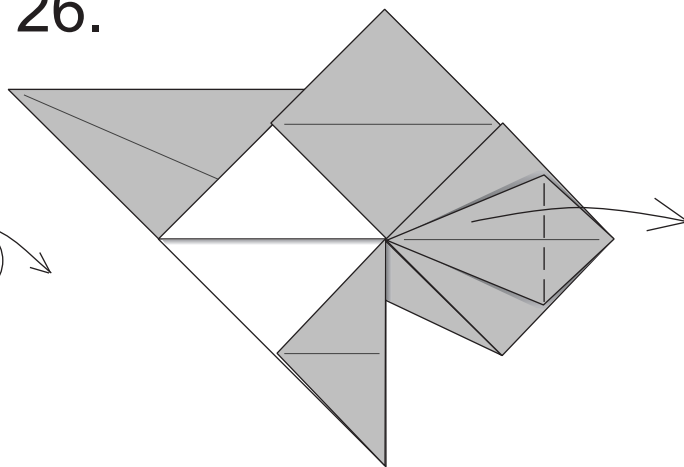

Fold the petal at right back up along the existing crease.

27.

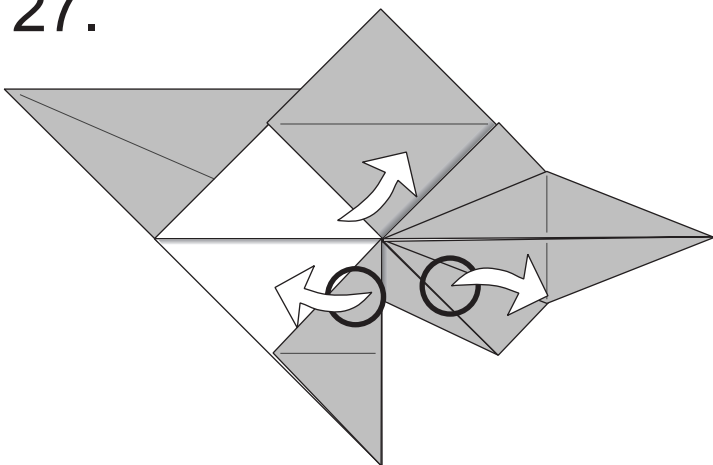

The loose colored triangle that lies on top of the point at the bottom is connected to some paper that is currently trapped inside the model. Grabbing the circled points, pull them gently apart and away from each other to expose it; in doing so, the upper half of the model will also swing up.

28.

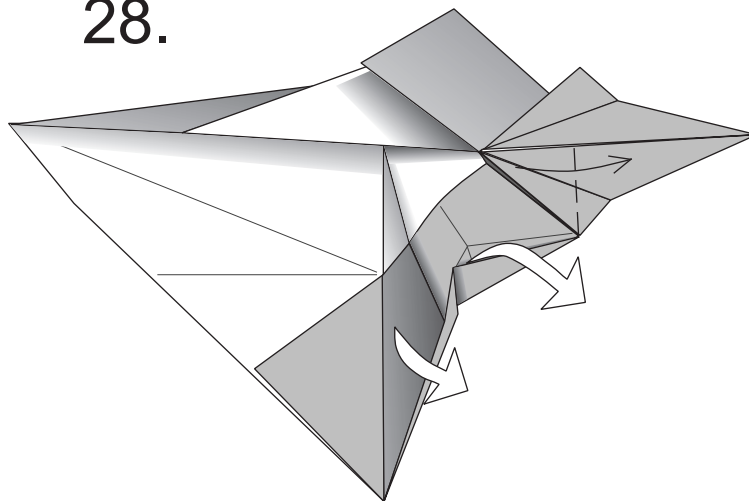

Pull out the trapped layer of paper, wrapping it around the raised edge at the lower right (this is a diamond-shaped layer of paper when unfolded; as you do this, or unfold it, unwrap the paper, and refold it). The freed paper at the bottom of the petal fold at right will swing up. This is a difficult move.

29.

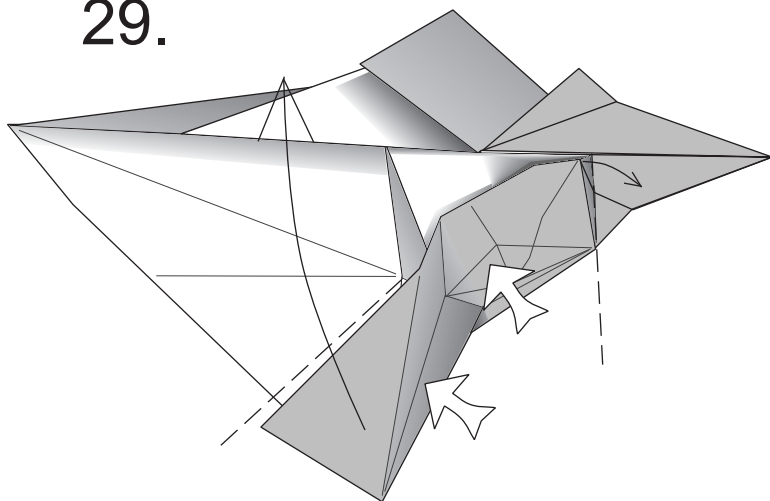

Now the rectangle of paper is free, and sticking up in this diagram. Flatten the model by pushing the freed flap and the points to which it is connected down. The point at right that is connected to the petal fold goes the left, and the larger point at the bottom valley folds up and to the left on a new crease.

30.

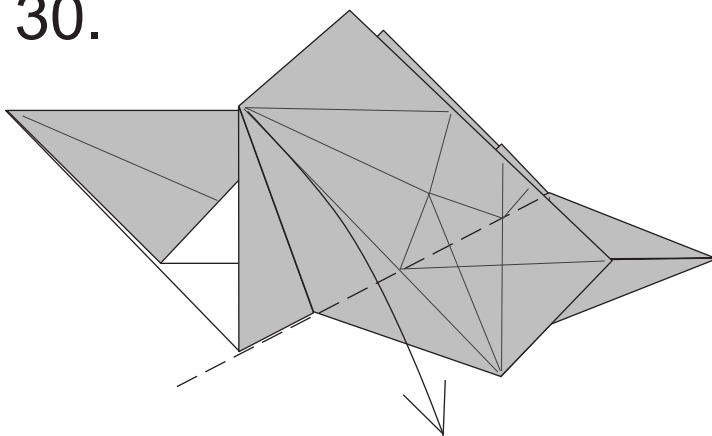

Valley fold the top flap down and to the right.

31.

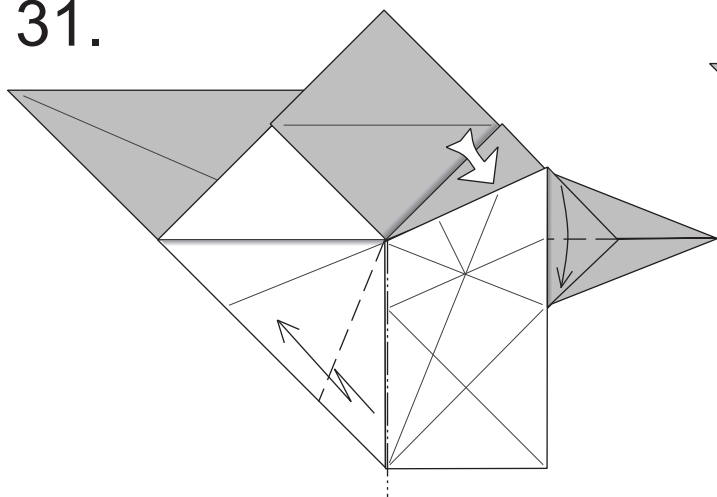

Swivel the flap to the left. The valley fold at right and the vertical mountain fold are on existing creases. The right portion of the flap swivels downwards, and the left side swivels up and to the left.

32.

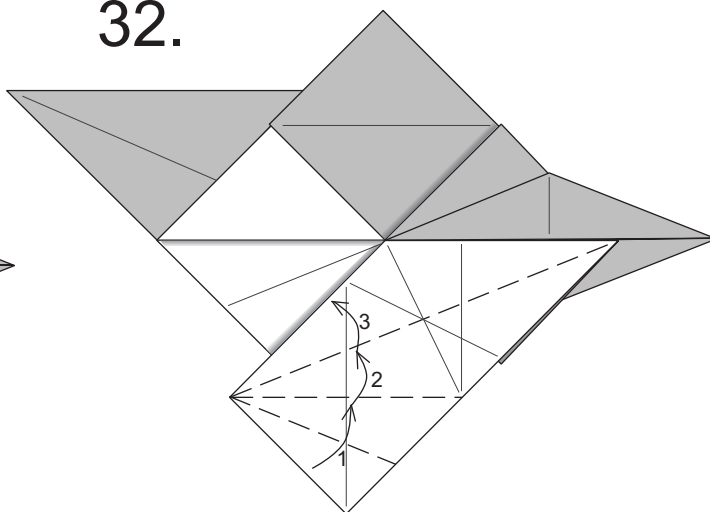

Valley fold over and over three times to narrow the white flap. Only the first crease is new.



33.

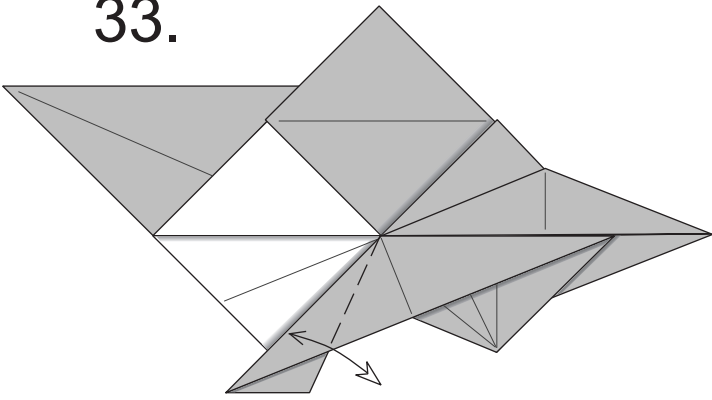

Valley fold the narrow flap and point at the bottom over to the right and unfold.

34.

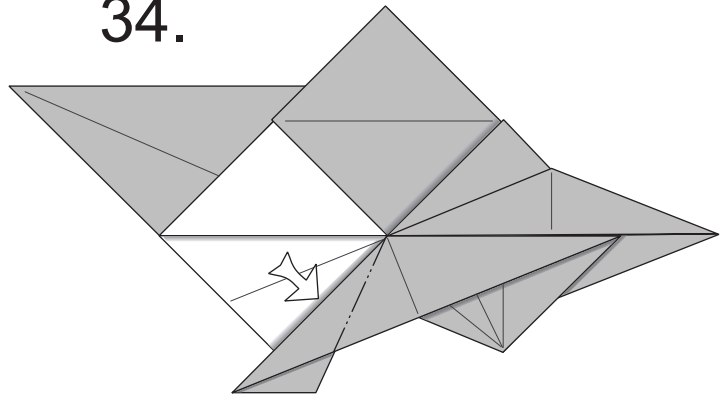

Reverse fold the flap through on the crease from Step 33.

35.

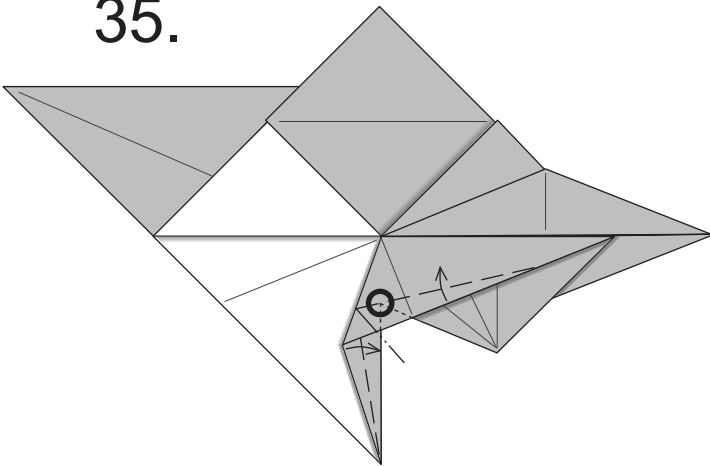

Narrow the colored flap with two swivel folds. One narrows the flap covering the large point at the bottom; the other narrows the colored point to the right, but note that it does not continue all the way to the tip of the point. Note that the swivel should go through the intersection (circled) of the flaps beneath (indicated by the x-ray lines).

36.

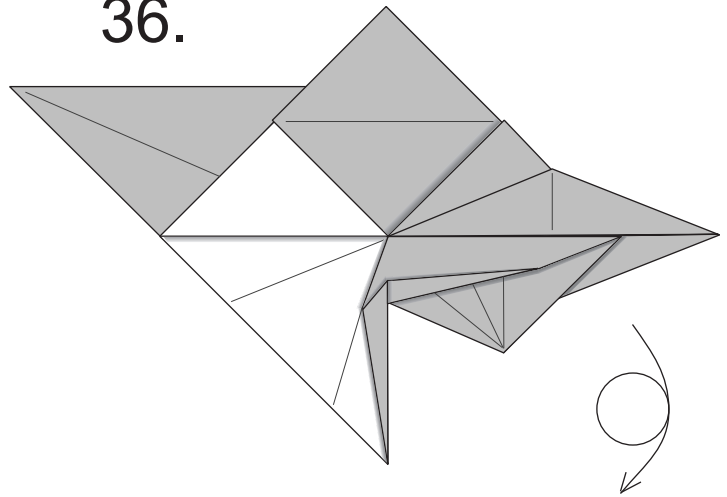

The result. Turn the model over from top-to-bottom.

37.

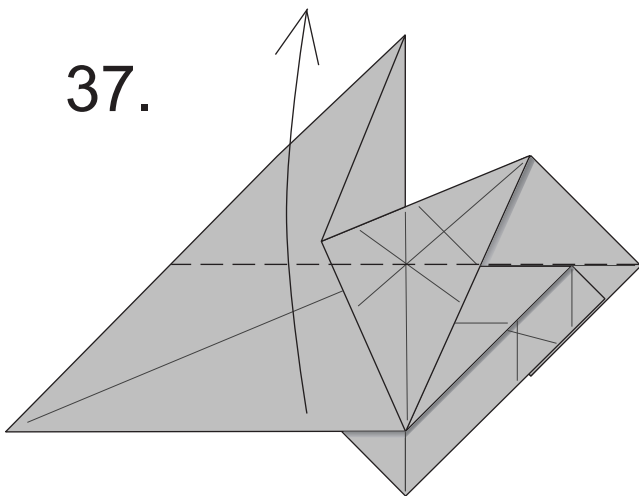

Valley fold the large flap at the bottom up as far as possible.

38.

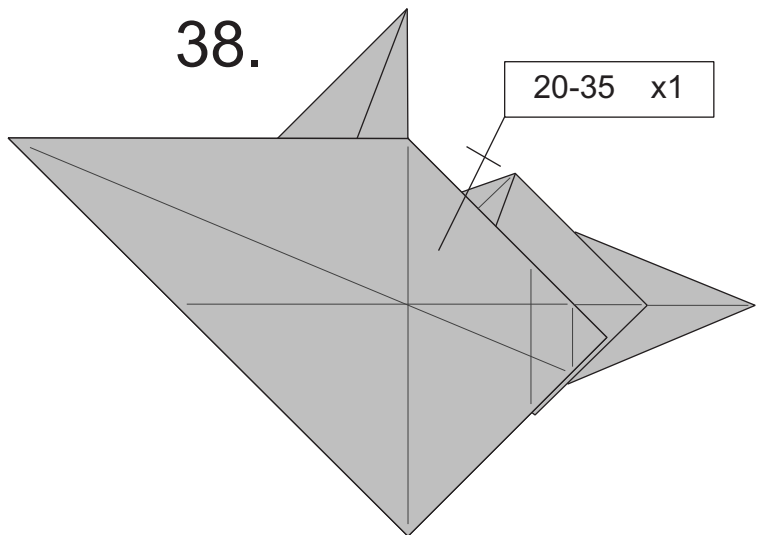

Repeat Steps 20-35 in mirror image on this side.

39.

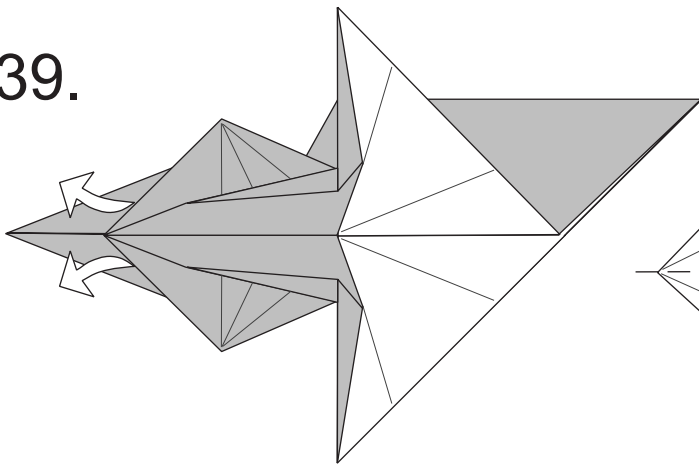

Pull out paper under the two broad points at left, unfolding the petal fold and associated paper.

40.

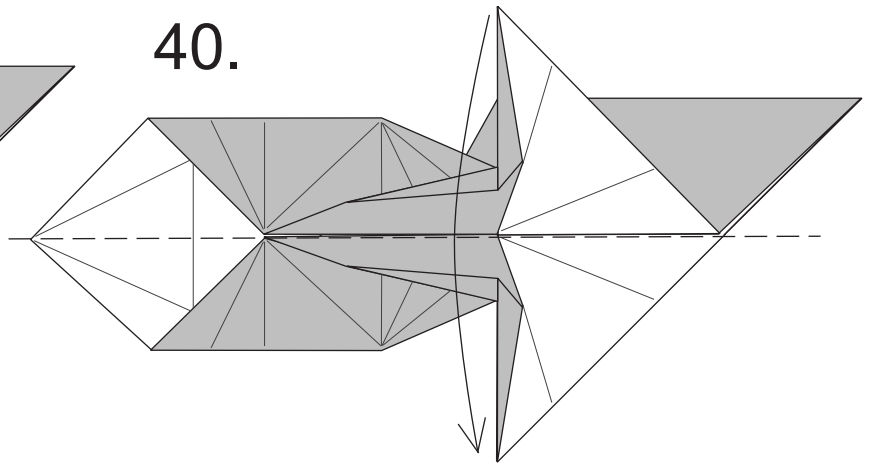

Fold the model in half, bringing the top portion down over the bottom. The next series of diagrams are reduced in size.

41.

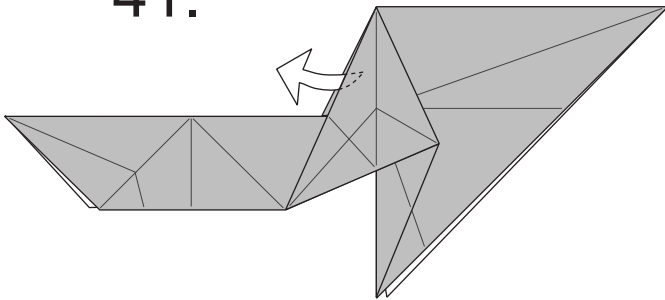

Unsink the chevron-shaped paper from between the layers.

42.

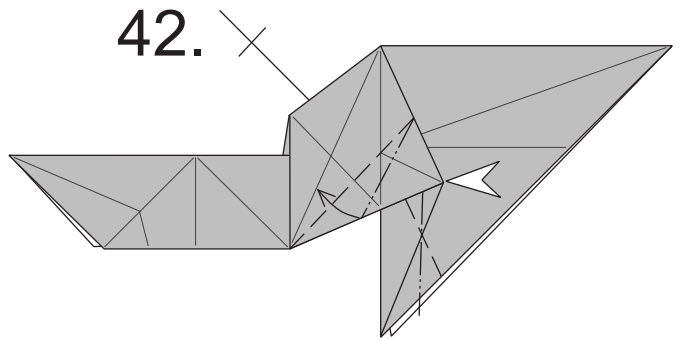

Spread squash the angled layer in the center. The valley fold on the top layer is on an existing crease. Repeat behind.

43.

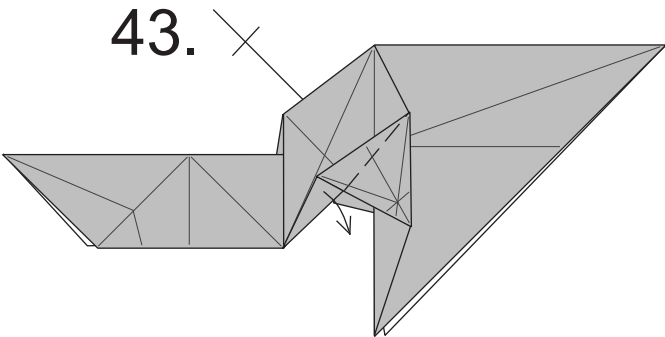

Valley fold the narrow flap at the left back down. Repeat behind.

44.

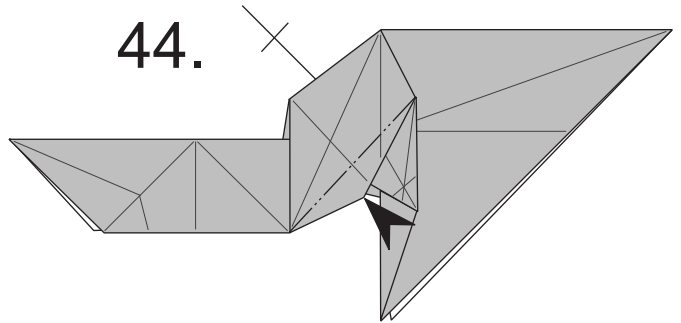

Closed sink the flap inside. This is not easy because it's difficult to reach inside the model at this point without unfolding a lot of the model. Repeat behind.

45.

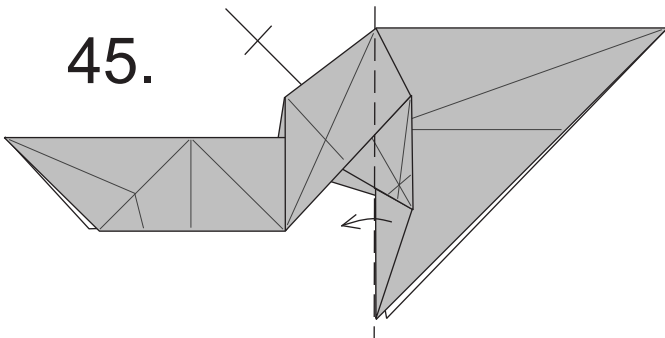

Valley fold the tall, narrow flap at right over to the left; repeat behind.

46.

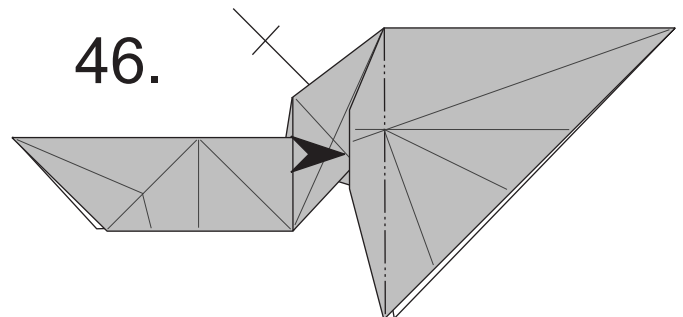

Closed sink this flap inside, as well. Repeat behind.

47.

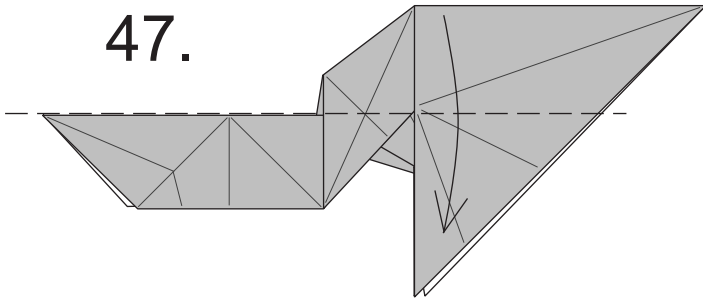

Valley fold the upper half of the model down along a line even with the top of the point at left.

48.

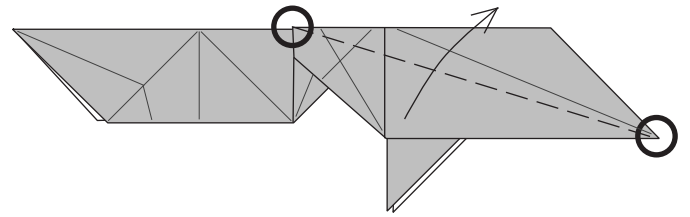

Valley fold the flap up at an angle. The fold line connects the very tip at the right with the point along the top edge at left.

49.

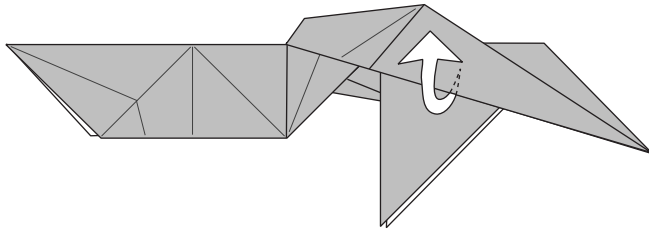

Bring a layer from underneath the fin flap to the surface. This is something like unsinking a layer. This need not be repeated behind; in fact, this move will return symmetry of the layers to the model.

50.

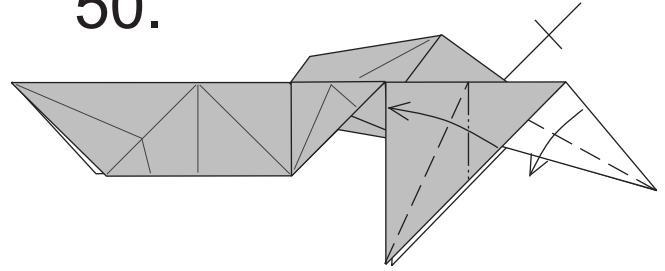

Swivel fold the top layers to narrow both the leg and the tail. Note that while the leg is folded along an angle bisector, the tail is not, and the flap goes further down than its present lower edge. Repeat behind.

51.

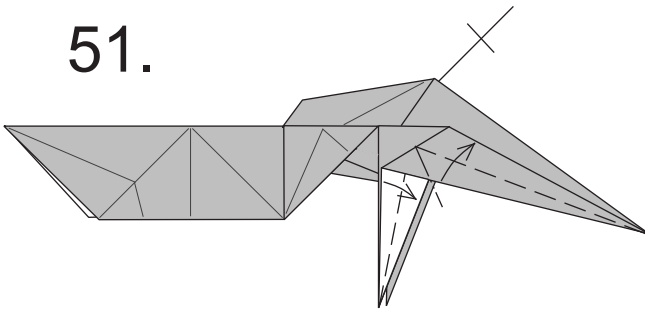

Swivel fold the top layers of the leg and tail again. As before, the leg flap gets bisected; the tail flap should line up with the edge beneath. Repeat behind.

52.

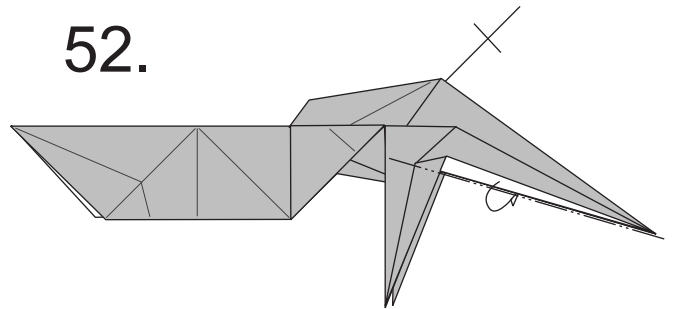

Fold the narrow, white flap on the bottom of the tail inside. Repeat behind.

53.

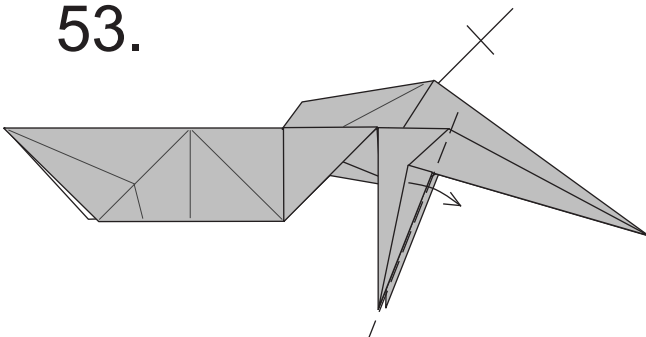

Valley fold the narrow flap on top the leg over to the right; repeat behind.

54.

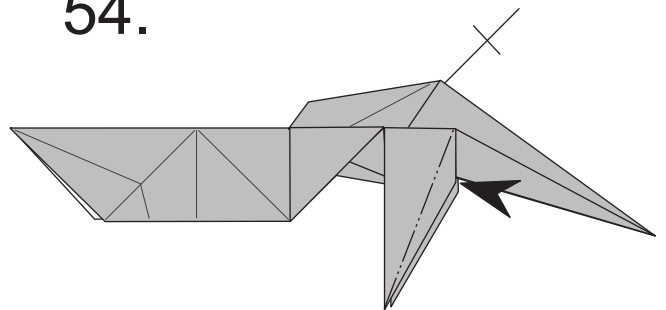

Closed sink the flap inside to narrow the leg. Repeat behind.

55.

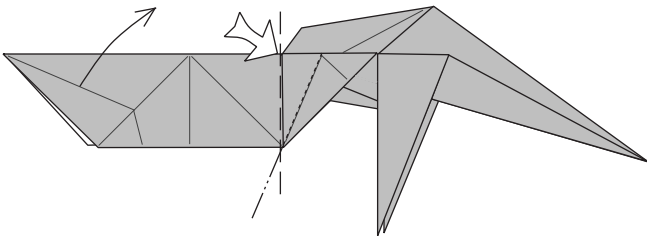

Double reverse fold the point at left up. The first reverse fold is hidden beneath the triangular points and is indicated by the x-ray and mountain fold lines; the second reverse fold is indicated by the vertical valley fold line.

56.

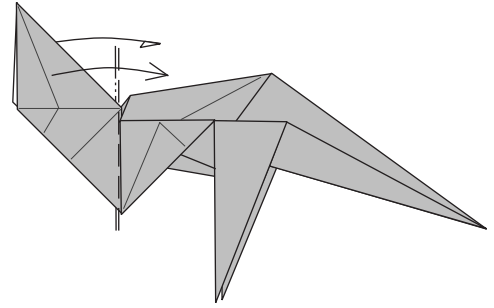

Outside reverse fold the flap on the right along the edge of the arm points below. This occurs on an existing crease. The next diagrams are enlarged.

57.

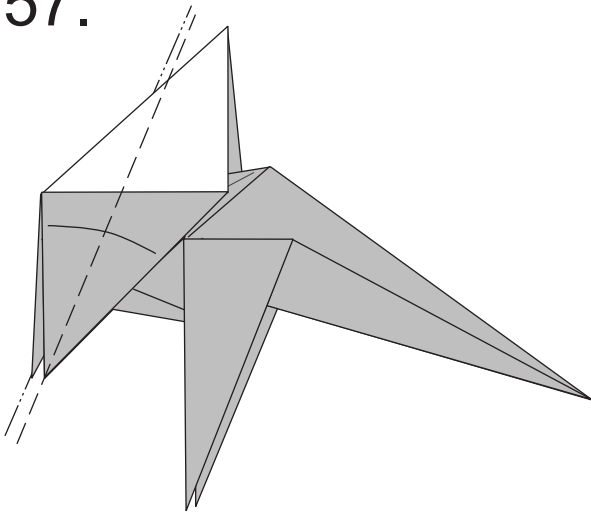

Outside reverse fold the flap again, bisecting the arm (lower) points.

58.

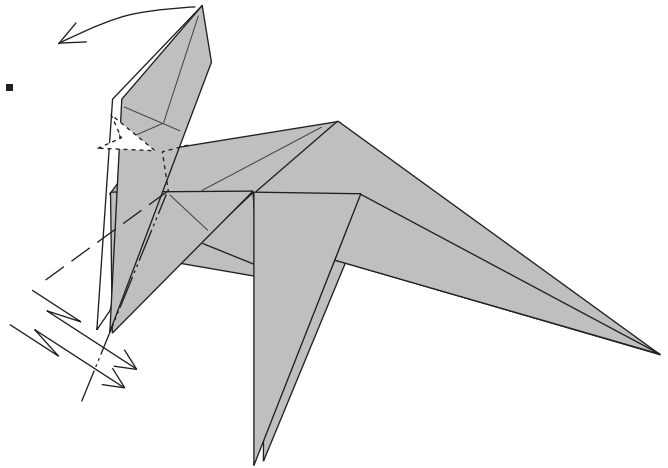

Inside crimp the arms in half, bringing the head down a bit. In order to do this effectively and without ripping the paper, you will have to push in (like an open sink) the bit of the hump on the back that is hidden inside the neck (indicated by the x-ray line).

59.

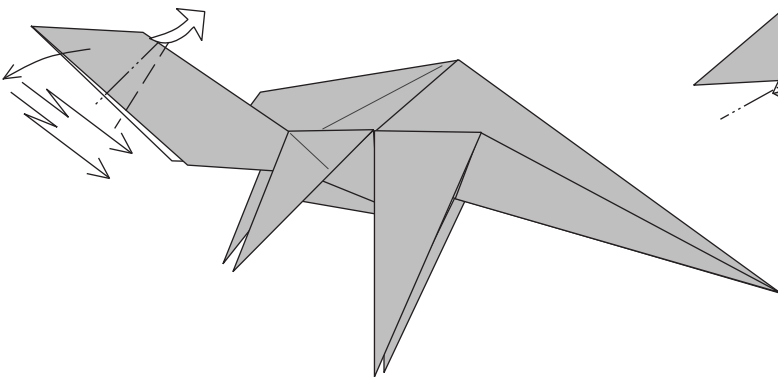

Outside crimp the head down. Note that the crease lines for the crimp do not meet on the top of the neck — you'll have to spread some paper and push out a bit from the inside to do this.

60.

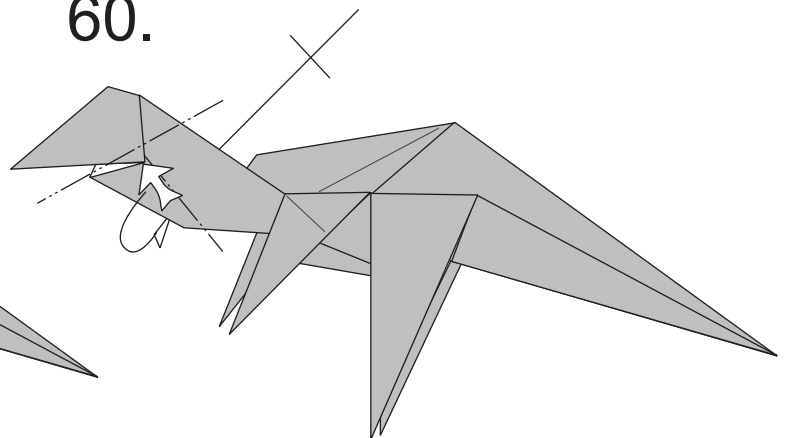

Narrow the neck by mountain folding some of the flap in front inside; as you do this, a small bit of the bottom of the head will be squashed into a gusset inside. Repeat behind.

61.

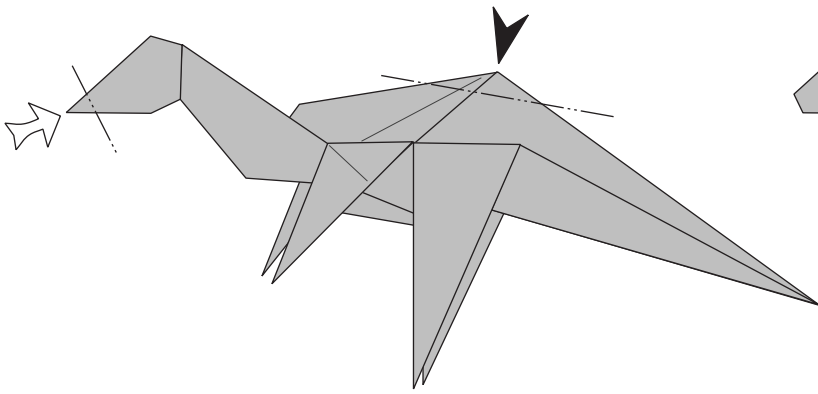

Reverse fold the tip of the snout. Closed sink the point on the hump on the back to make the hump roughly of equal height along the back (it will still get shorter along the tail).

62.

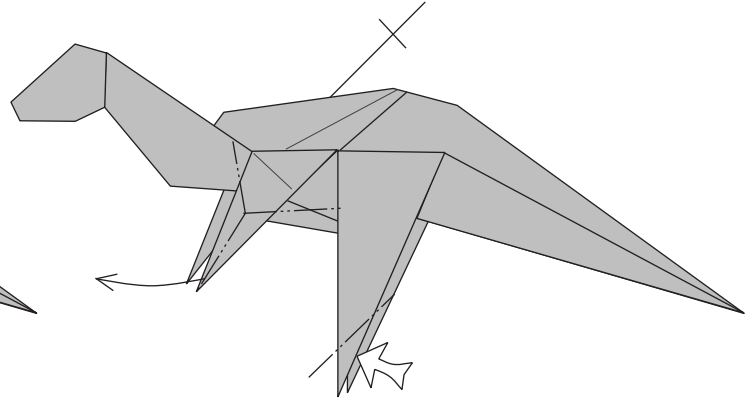

Rabbit-ear the thick arm points and swing them upwards. Reverse fold the tips of the leg points to form feet. Repeat both folds behind.

63.

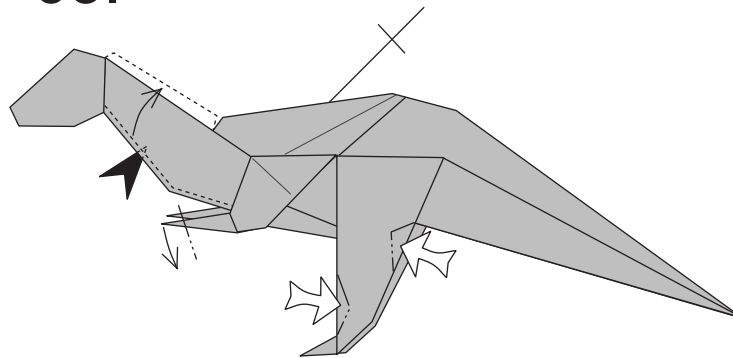

Fold hands down at the ends of the arms. Dent in some of the paper on the legs to shape the knee and ankle. Repeat behind. Inside the neck, closed sink some of the middle layer upwards to form a continuation of the hump on the back on the top of the neck.

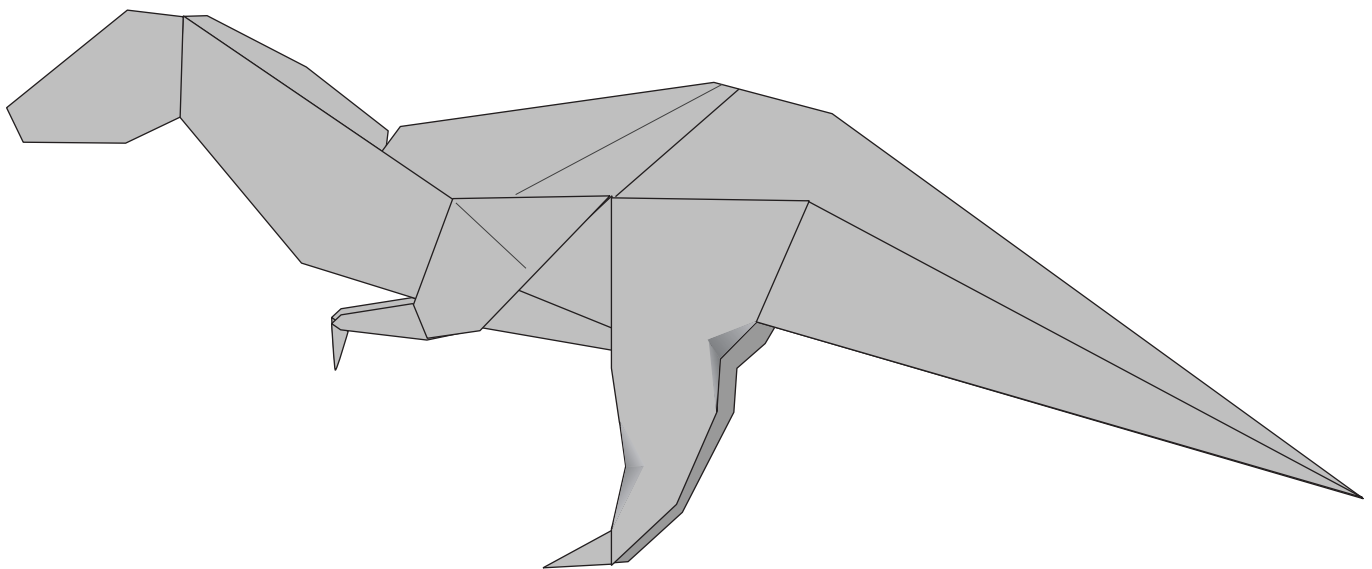

Finished Acrocanthosaurus

---

# Alien

Fernando Gilgado

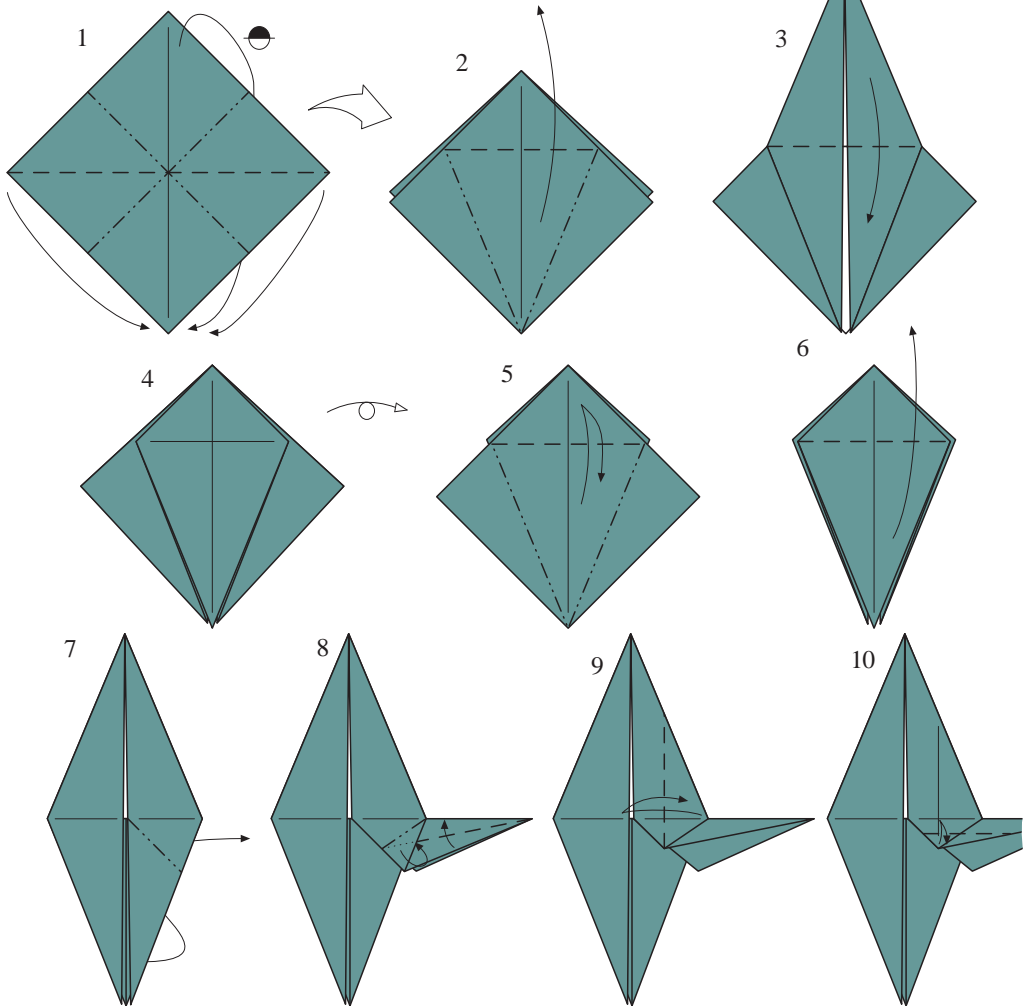
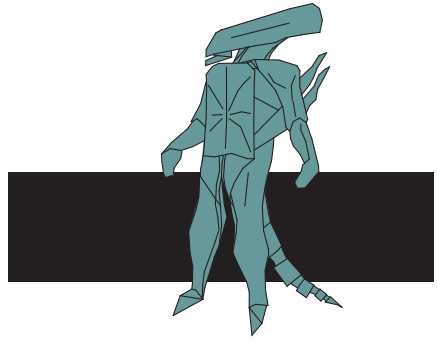

ASOCIACIÓN ESPAÑOLA DE PAPIROFLEXIA

APTDO. DE CORREOS 13.156 - 28080 MADRID

CORREO ELECTRÓNICO: [aepinet@publinet.com](mailto:aepinet@publinet.com)

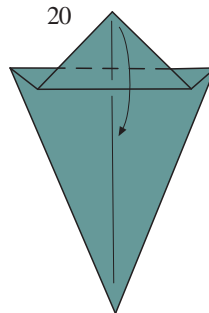
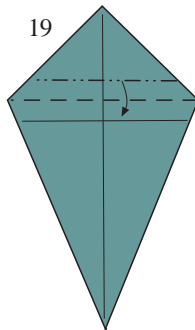
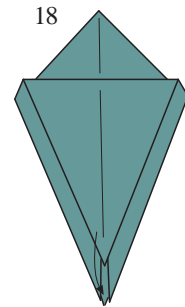
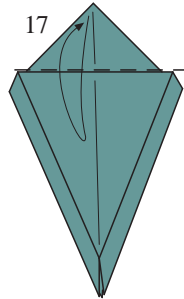
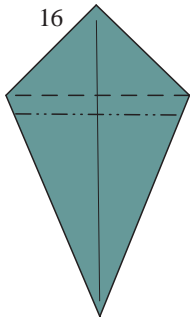
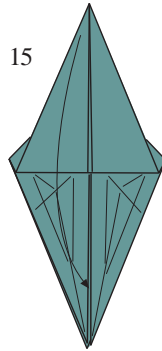
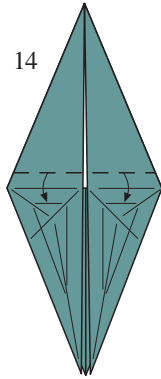
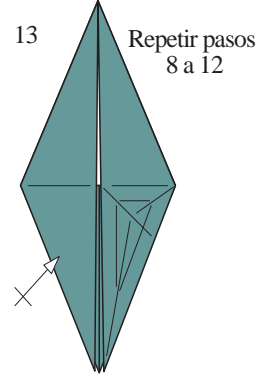
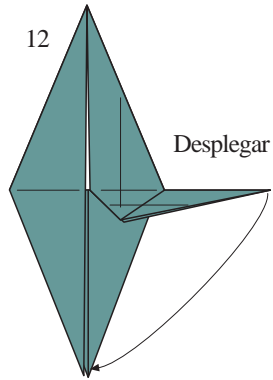
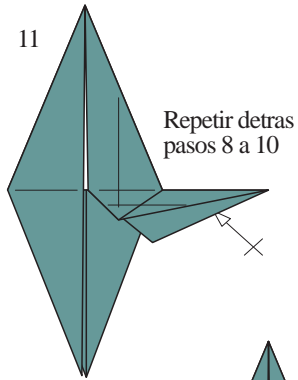

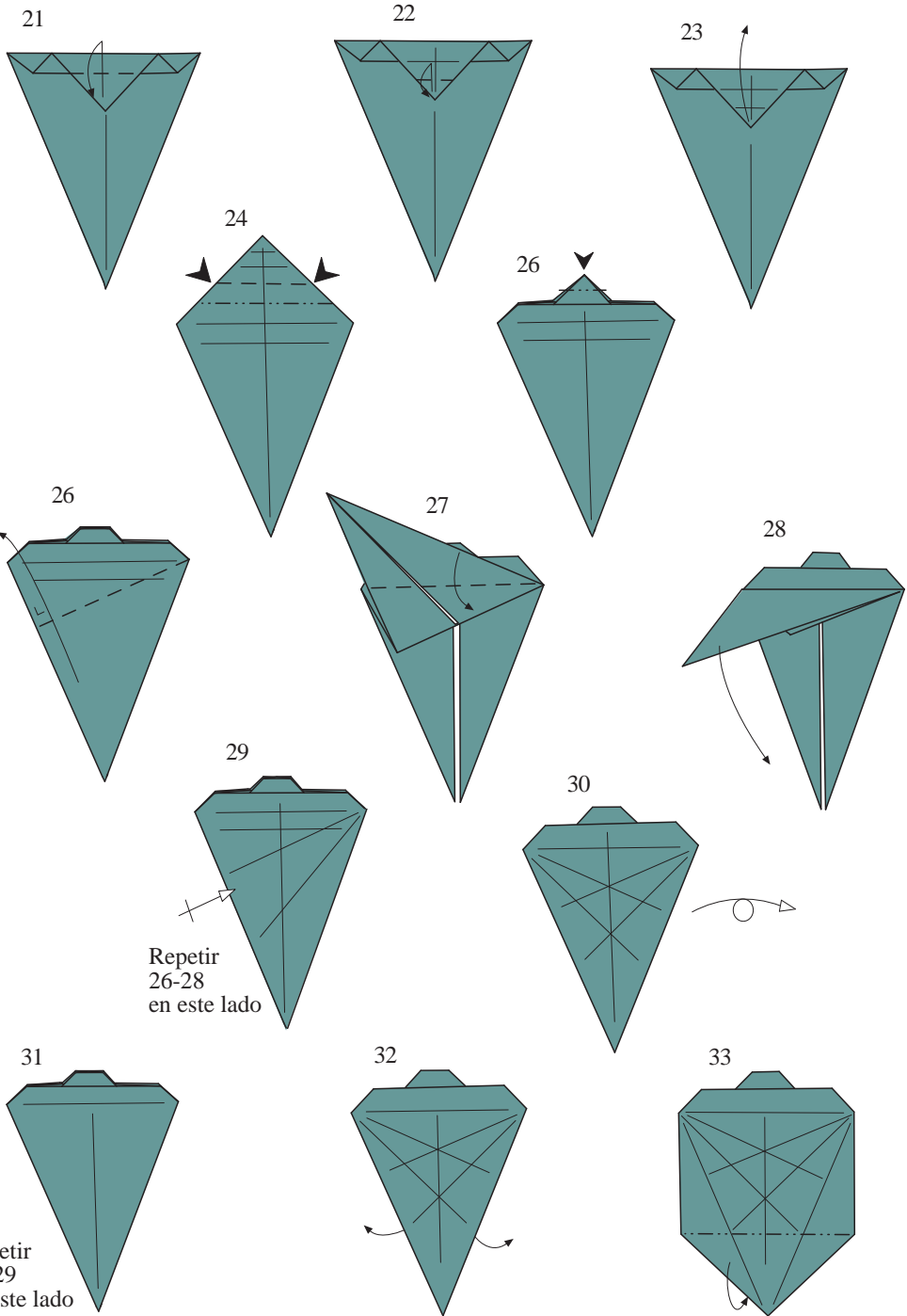



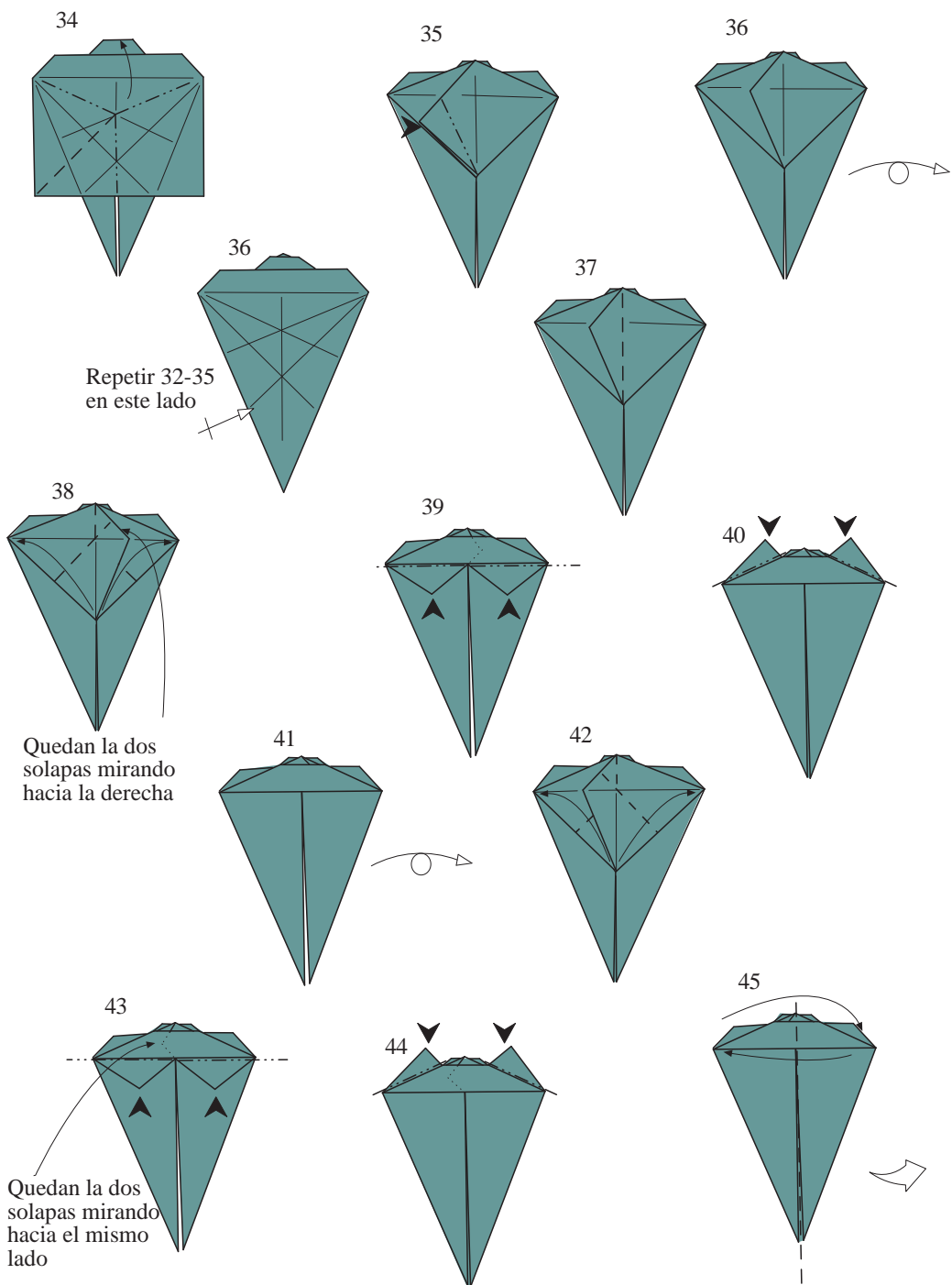

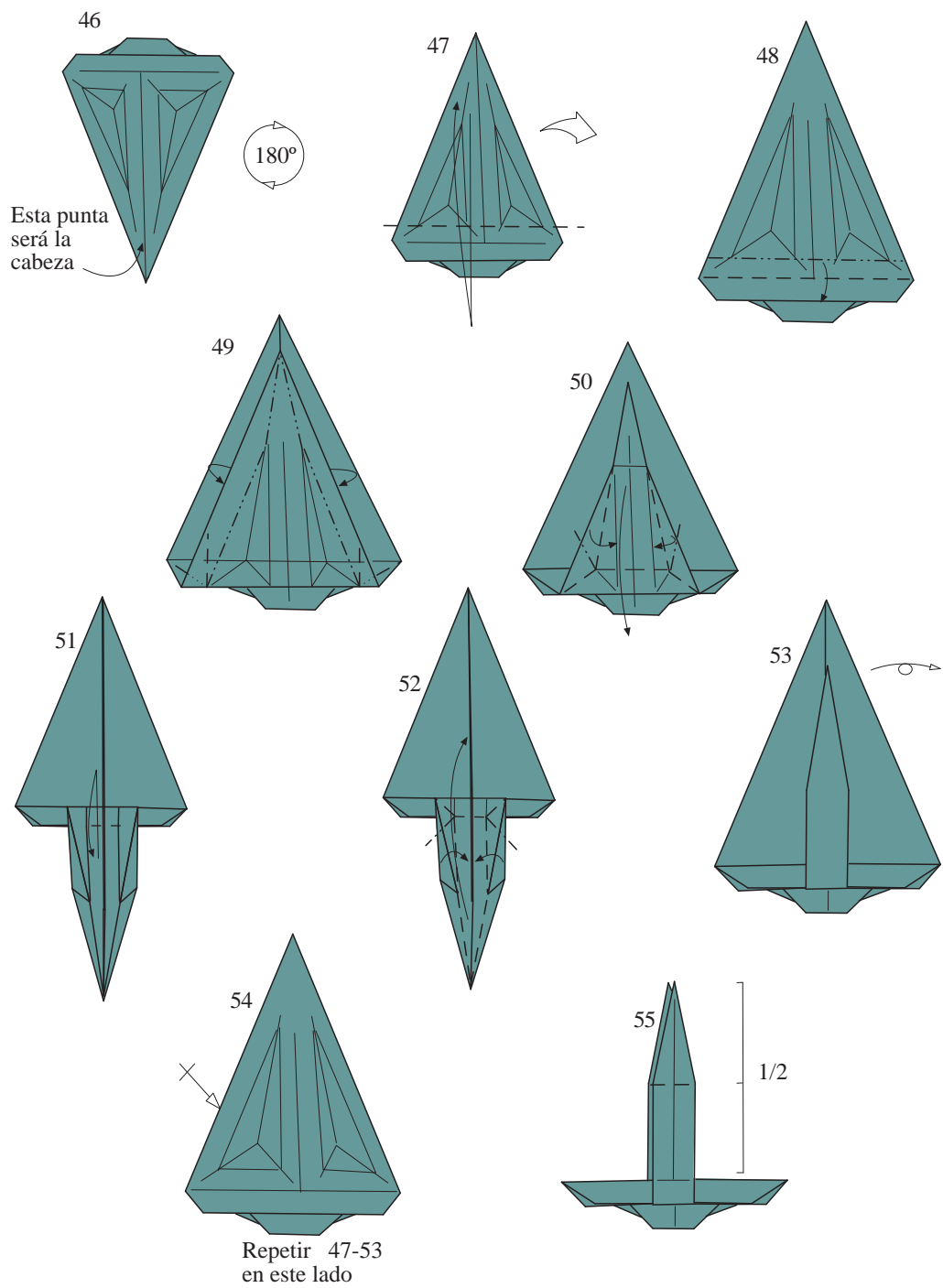

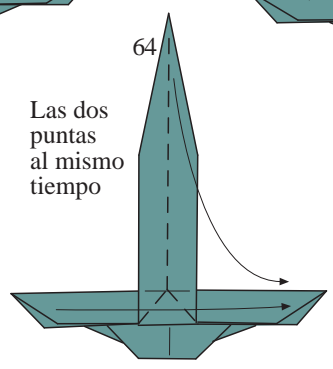
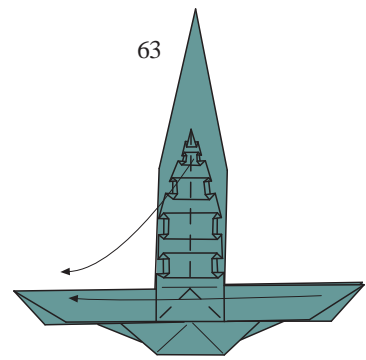
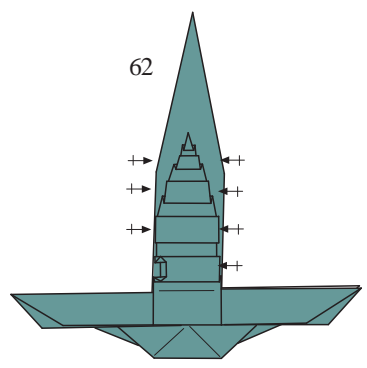
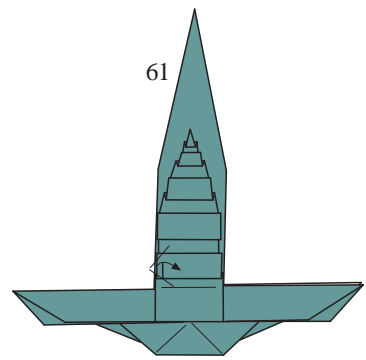
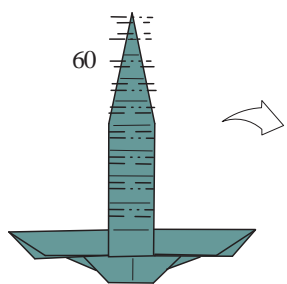
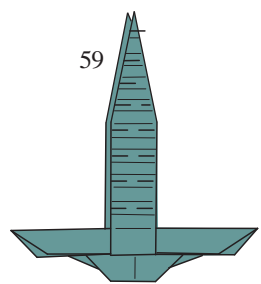
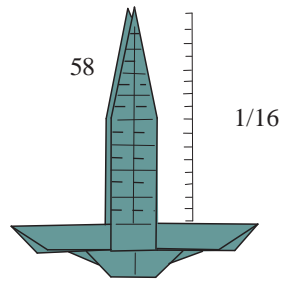
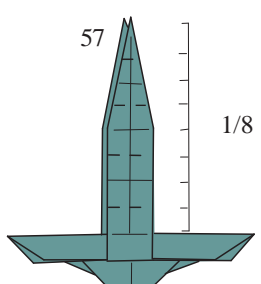
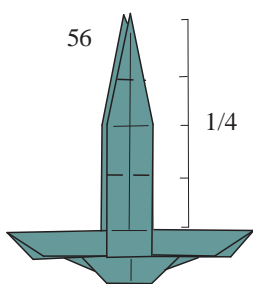

Las dos  
puntas  
al mismo  
tiempo



---

65

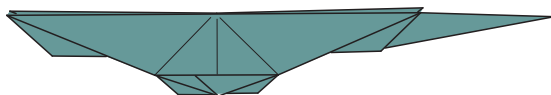

66

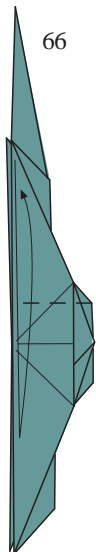

67

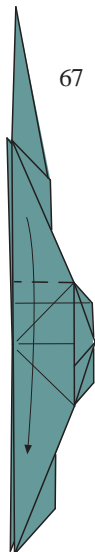

68

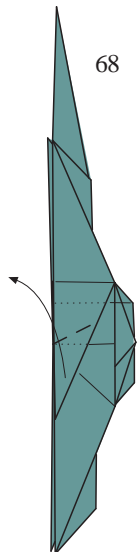

69

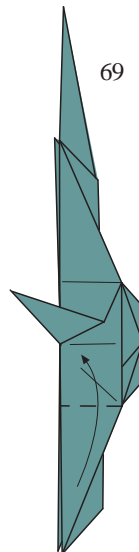

70

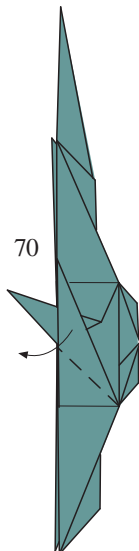

71

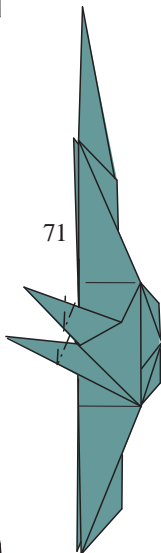

72

Repetir  
66-71

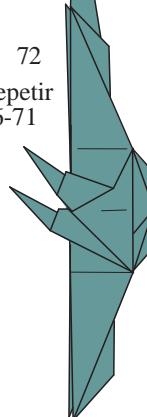

73

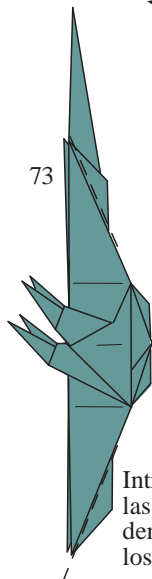

74

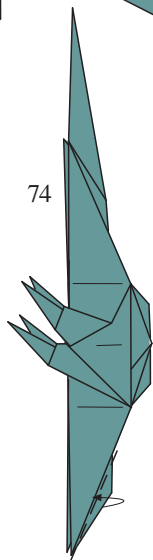

75

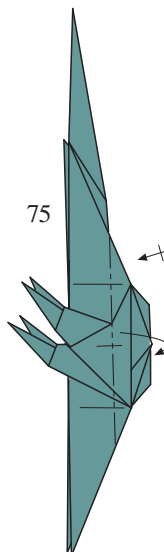

76

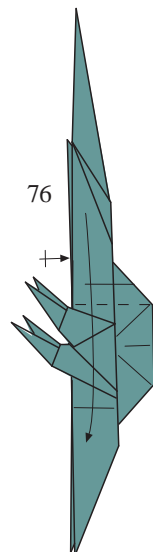

Introducir  
las solapas  
dentro de  
los bolsillos



ASOCIACIÓN ESPAÑOLA DE PAPIROFLEXIA

APTDO. DE CORREOS 13.156 - 28080 MADRID

CORREO ELECTRÓNICO: [aepinet@publinet.com](mailto:aepinet@publinet.com)

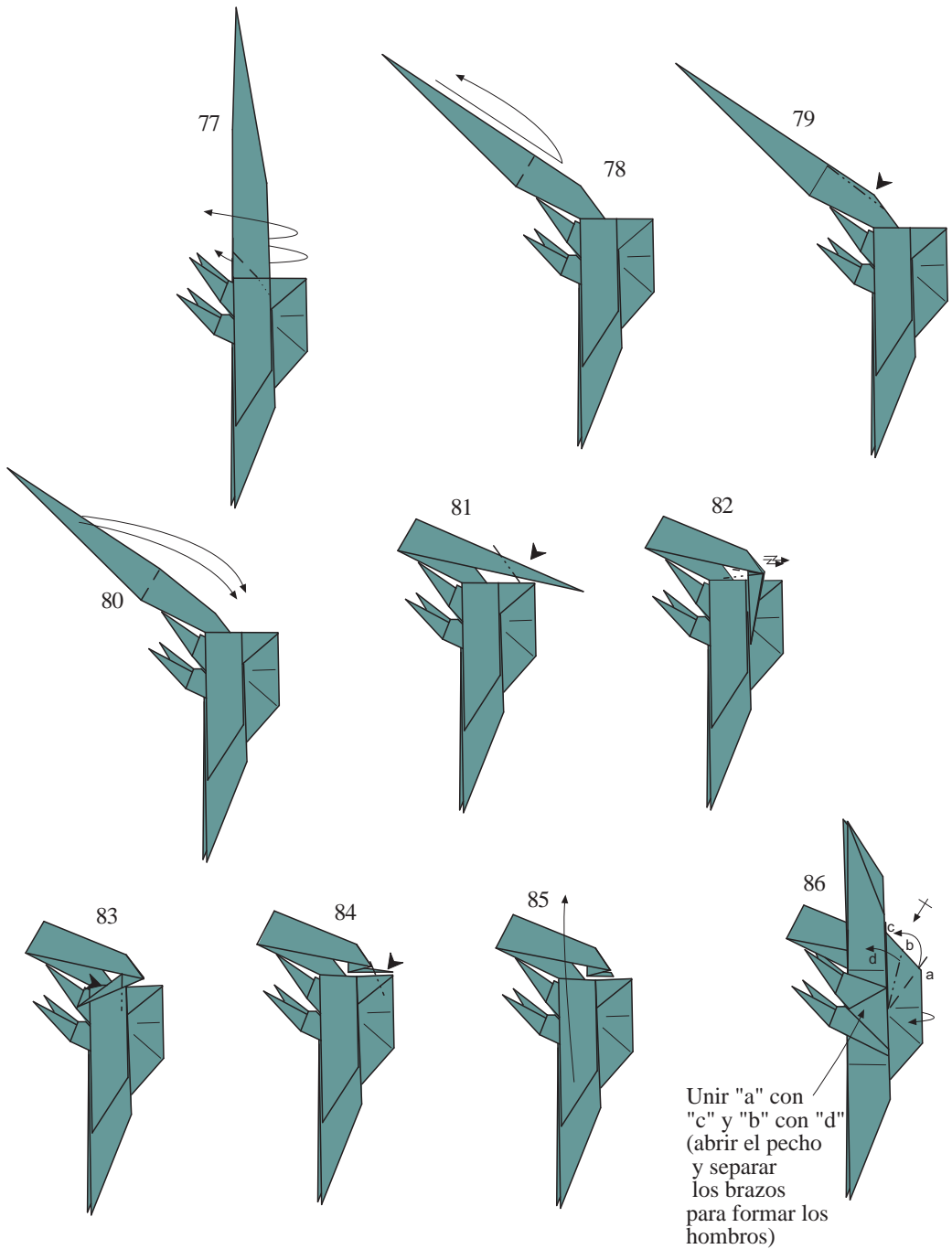

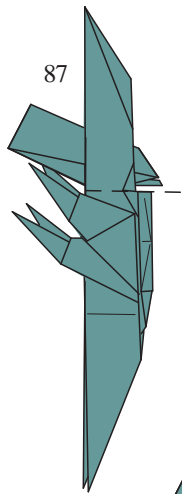

87

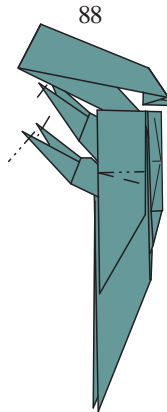

88

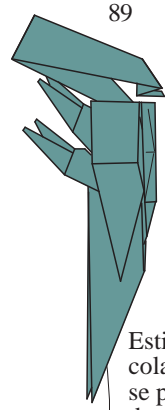

89

Estirar la cola lo que se pueda (se despliega parte del modelo)

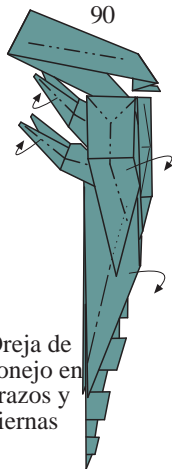

90

Oreja de conejo en brazos y piernas

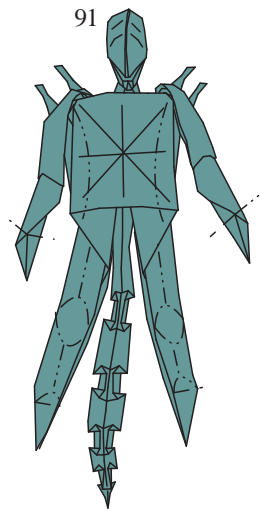

91

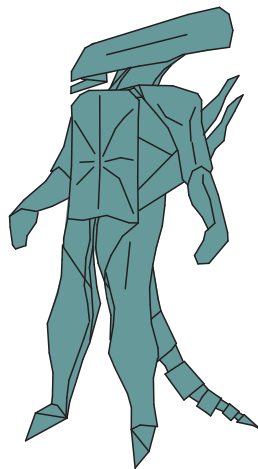

# Angel

Maarten van Gelder

© 1986 Sep

This angel has coloured wings and a white face and dress. When folded from soft coloured paper you may create a nice mobile for Xmas.

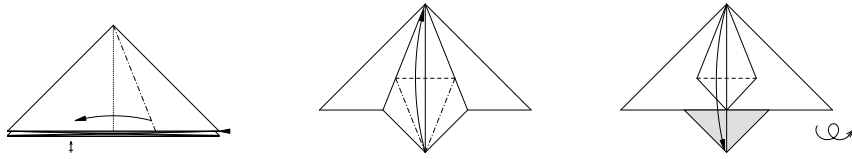

1 Start with waterbomb-base (color inside).

2

3

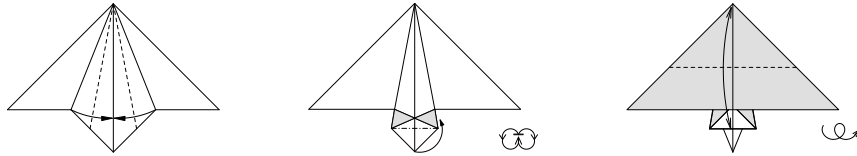

4

5 Fold point backwards. After that turn model inside out. See diagrams 6 and 7 for the result.

6

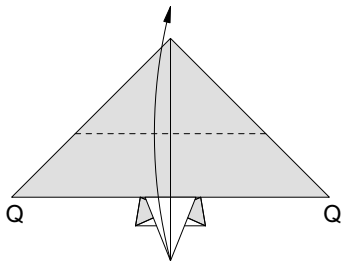

7 Fold white point (head) up. Points Q will raise. Don't push flat; they will flatten automatically in diagram 11..13!

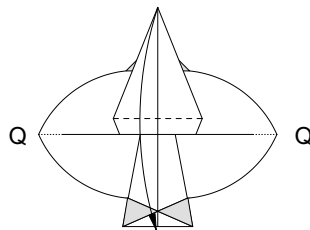

8 Fold point down. Points Q stay up.

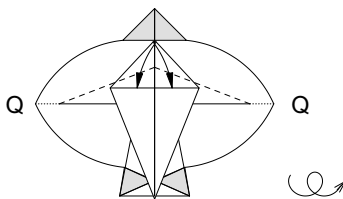

9 Fold two flaps so that they will overlap. See diagram 14 for the position of the wings. Turn model over.

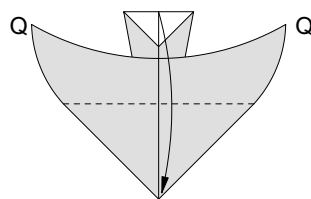

10

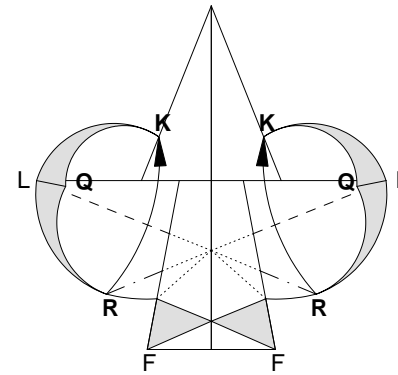

11 Fold points R to K. Points Q flatten automatically.

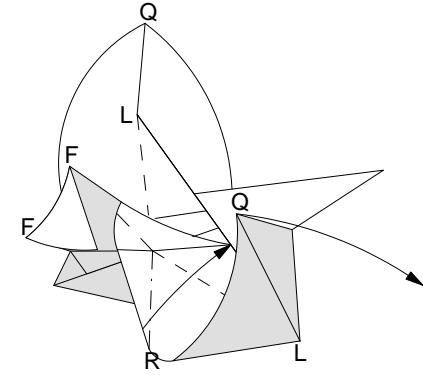

12 Raise flap F. The mountain fold through R is only in one layer.

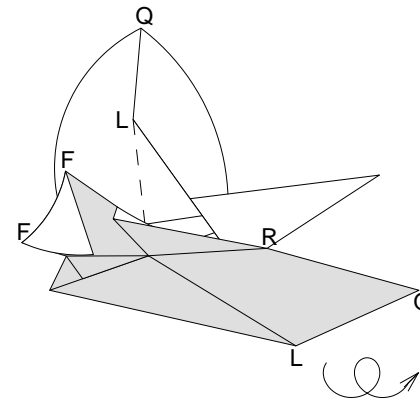

13 Repeat on left side. Turn model over.

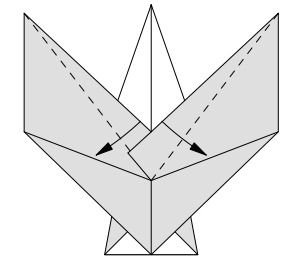

14

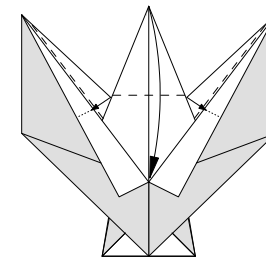

15 Fold upper edges of the wings between the layers. Fold point down.

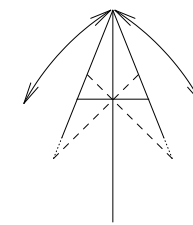

16 Detail: head

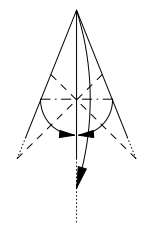

17 Fold like the preliminary fold.

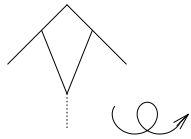

18

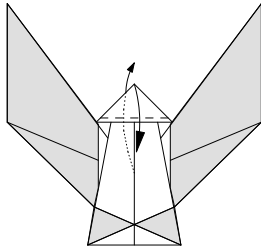

19 Front: Turn head flap over to the front.

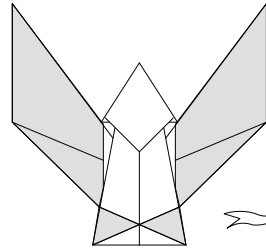

20 Unfold the head back to diagram 16. Keep front up.

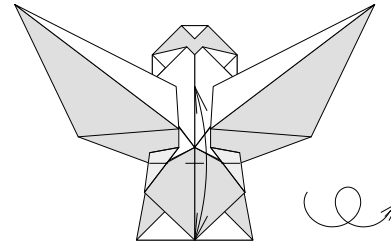

26

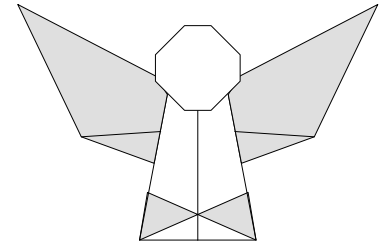

27 Curve the wings to get a nice result.

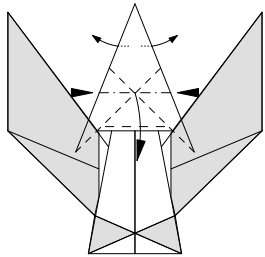

21 Push sides of head in. Folds in the front of the head remain as they are, folds on the back turn from valley to mountain and vice versa. Top will become 3D. Push flat to diagram 23.

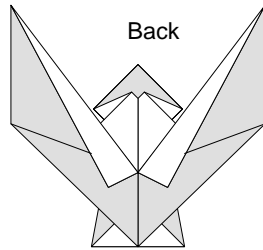

22

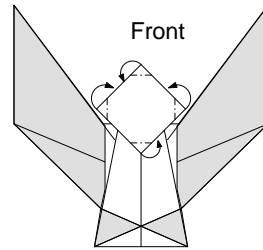

23

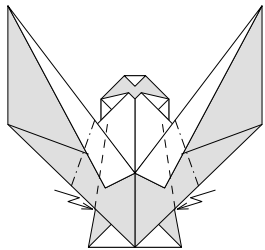

24

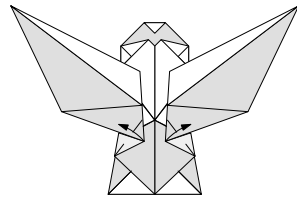

25

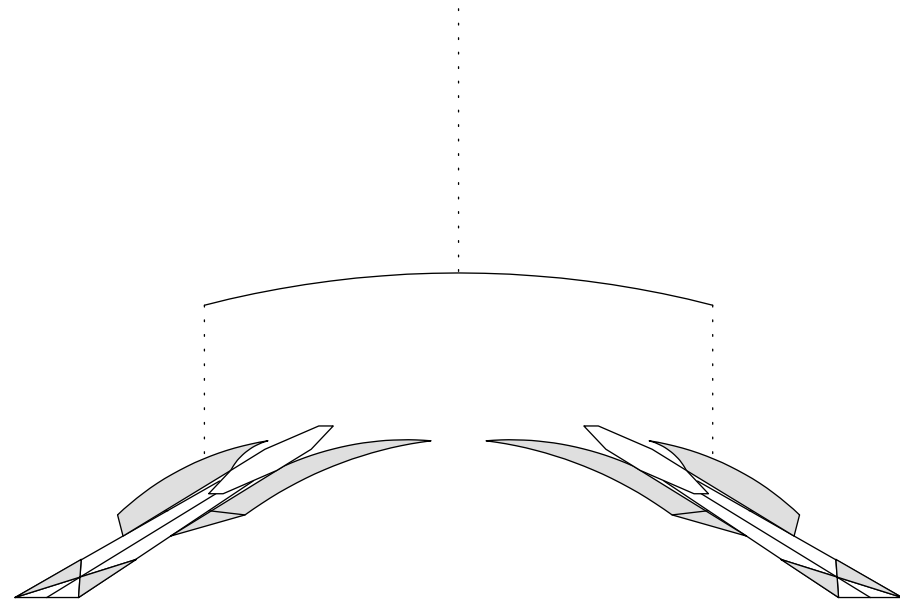



This angel has coloured wings and a white face and dress. When folded from soft coloured paper you may create a nice mobile for Xmas.

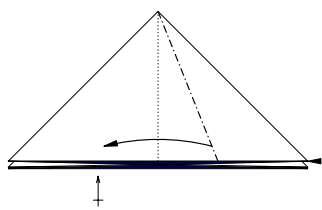

1 Start with waterbomb-base (color inside).

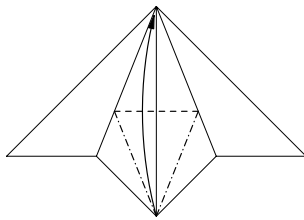

2

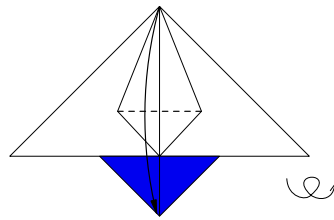

3

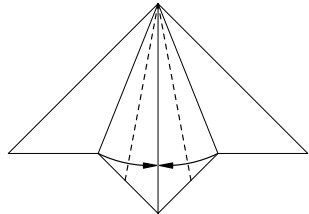

4

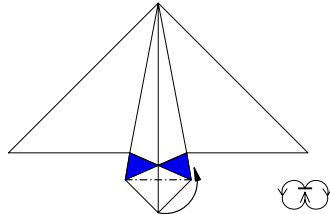

5 Fold point backwards.  
After that turn model  
inside out. See diagrams 6 and 7 for the result.

6

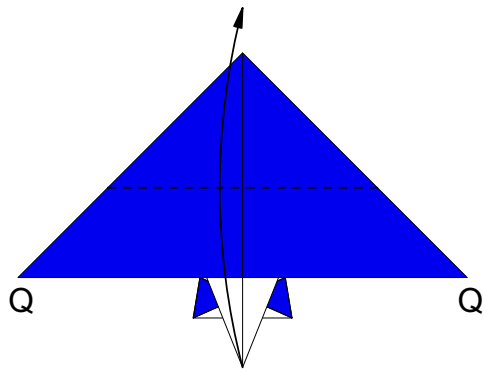
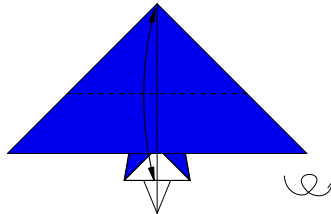

7 Fold white point (head) up.  
Points Q will raise. Don't  
push flat; they will flatten  
automatically in diagram 11..13!

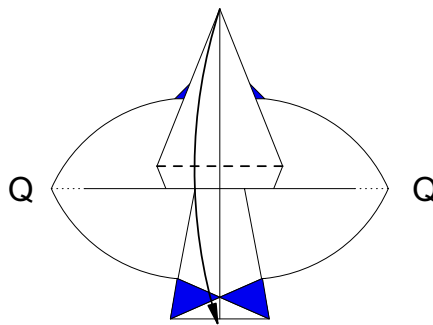

8 Fold point down.  
Points Q stay up.

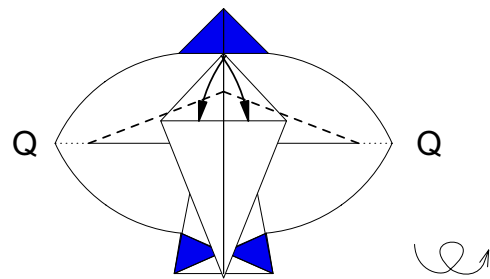

9 Fold two flaps so that they  
will overlap. See diagram 14  
for the position of the wings.  
Turn model over.

10

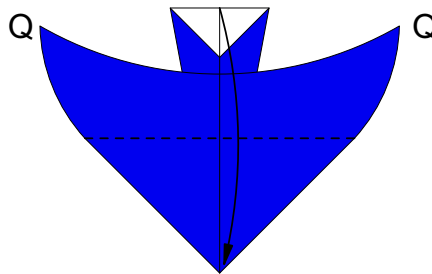

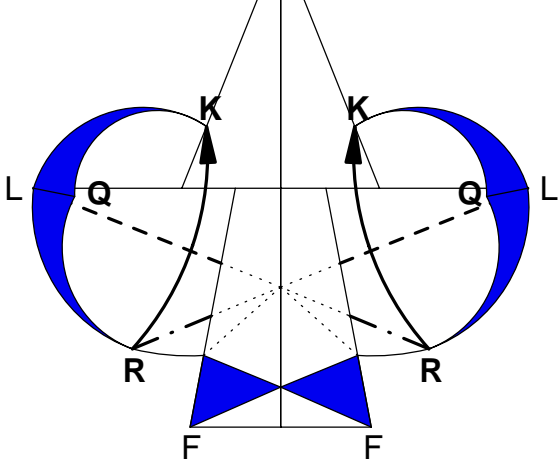

11 Fold points R to K. Points Q flatten automatically.

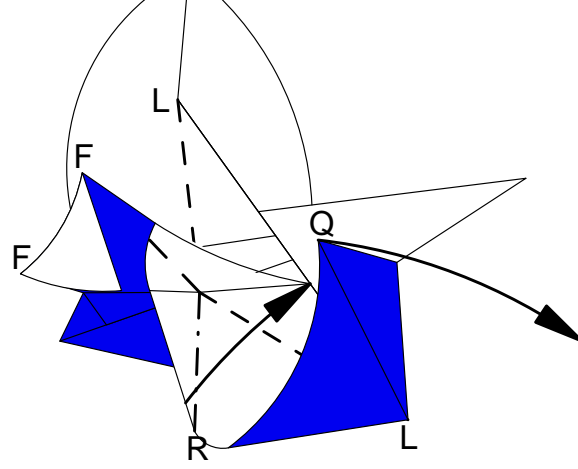

12 Raise flap F. The mountain fold through R is only in one layer.

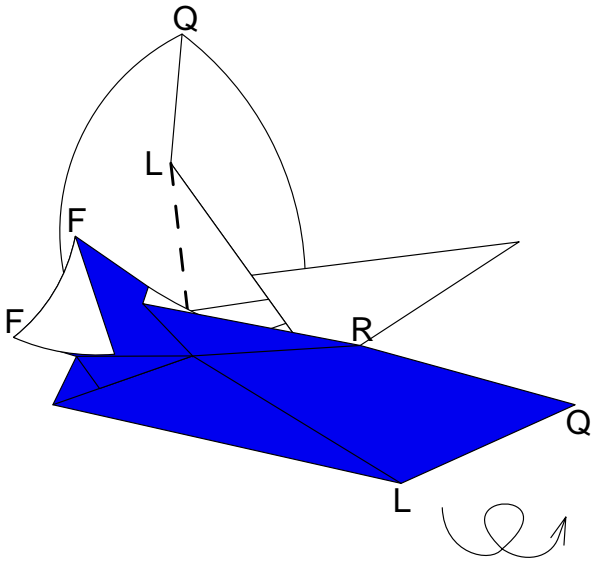

13 Repeat on left side. Turn model over.

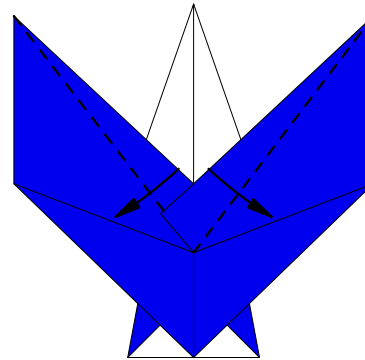

14

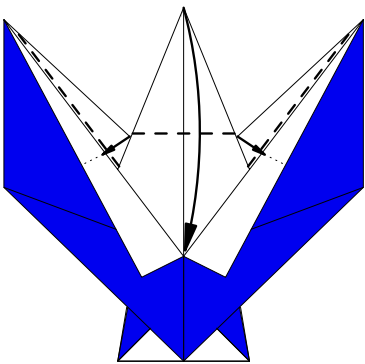

15 Fold upper edges of the wings between the layers. Fold point down.

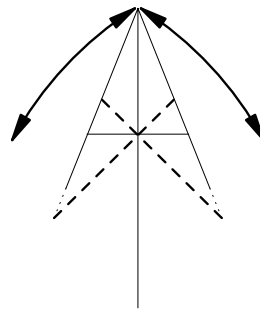

16 Detail: head

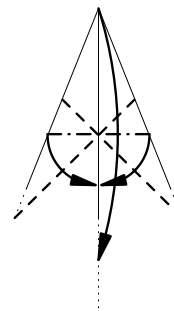

17 Fold like the preliminary fold.

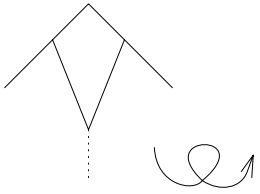

18

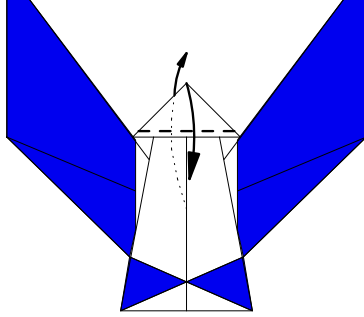

19 Front: Turn head flap over to the front.

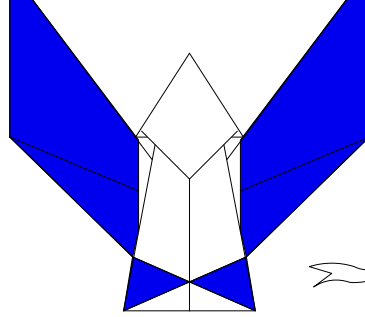

20 Unfold the head back to diagram 16. Keep front up.

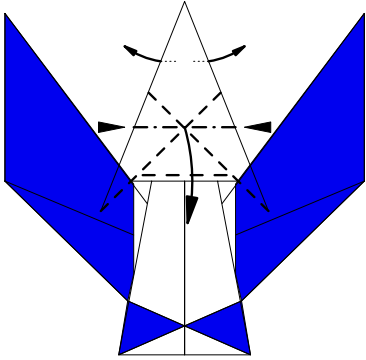

21 Push sides of head in. Folds in the front of the head remain as they are, folds on the back turn from valley to mountain and vice versa. Top will become 3D. Push flat to diagram 23.

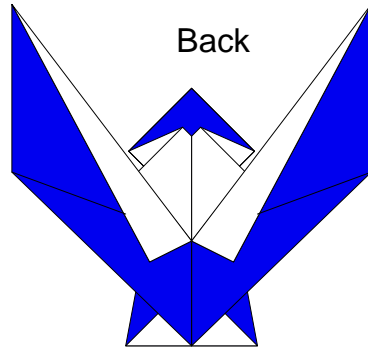

22

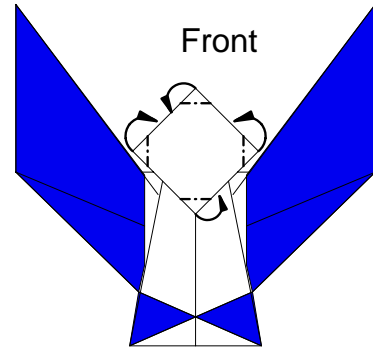

23

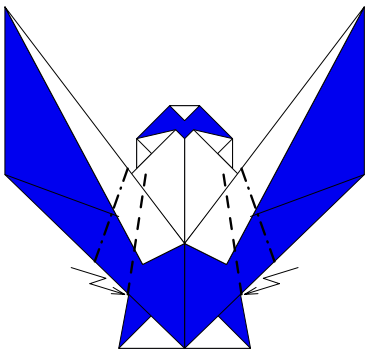

24

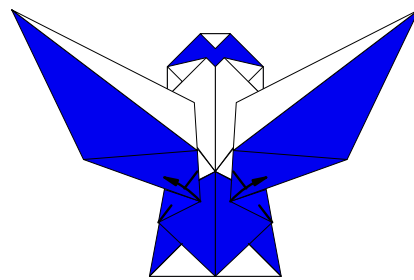

25

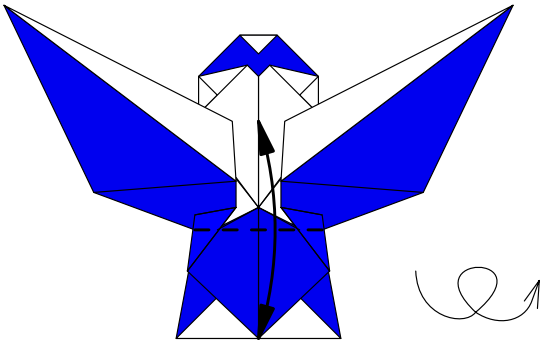

26

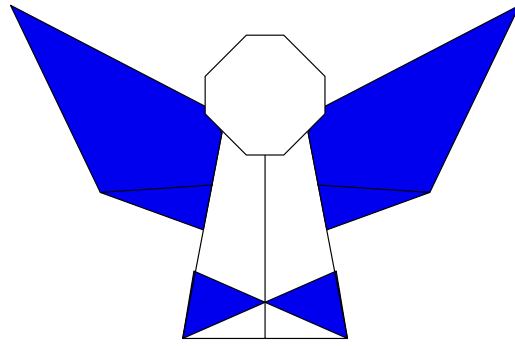

27 Curve the wings  
to get a nice result.

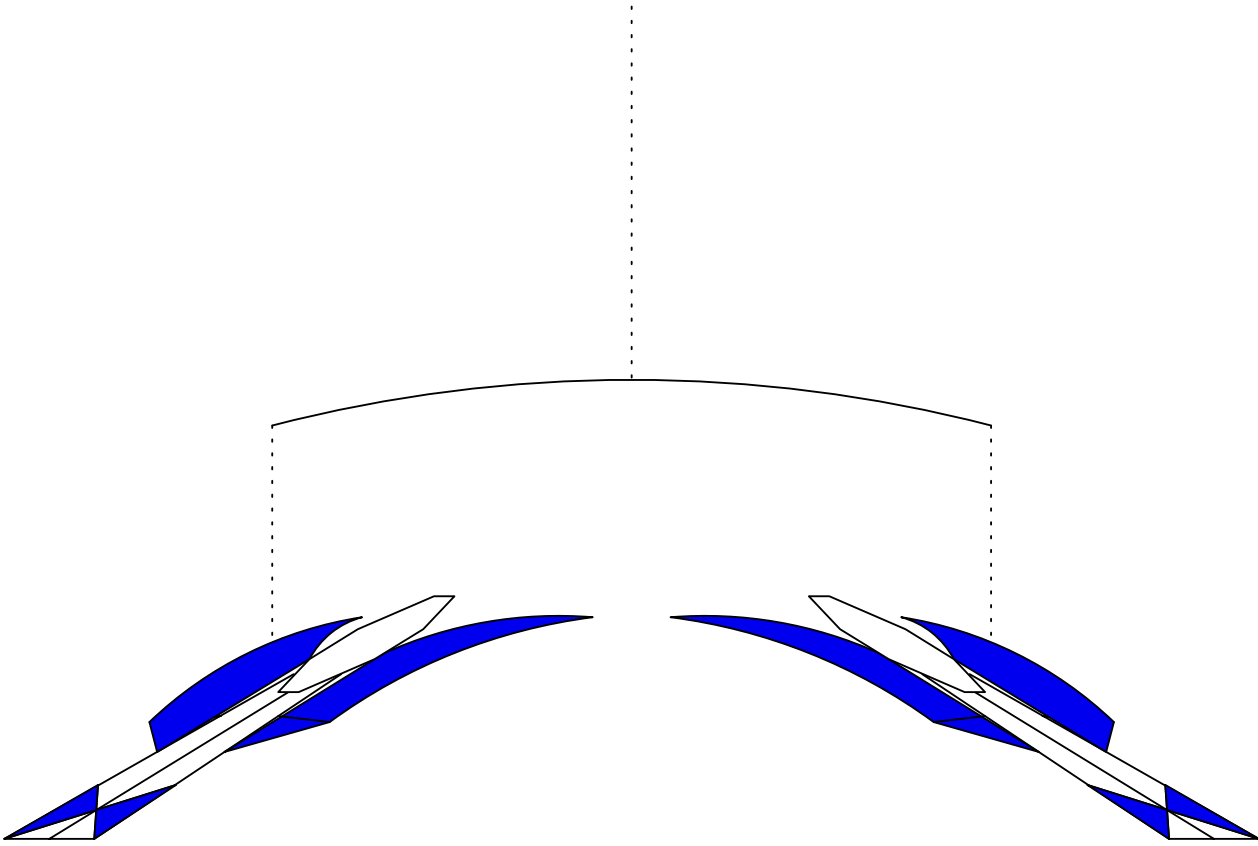

# Angel

created & diagrammed by Alec Fehl

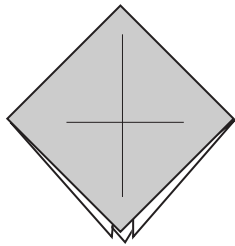

1] Colored preliminary fold.

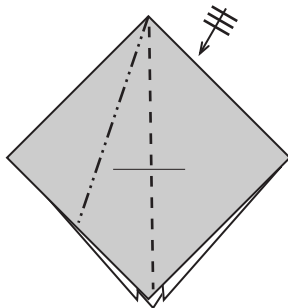

2] Squash fold. Repeat on back and sides.

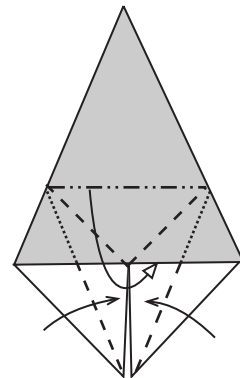

3] Inside petal fold. (Petal fold, then tuck the triangle underneath.) Repeat on sides. DO NOT repeat behind.

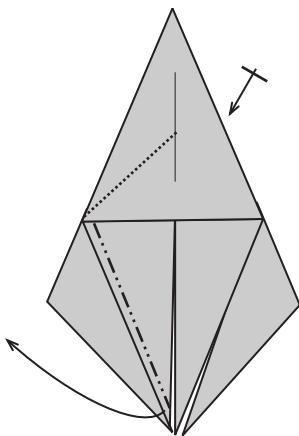

4] Reverse fold point up. Repeat on right.

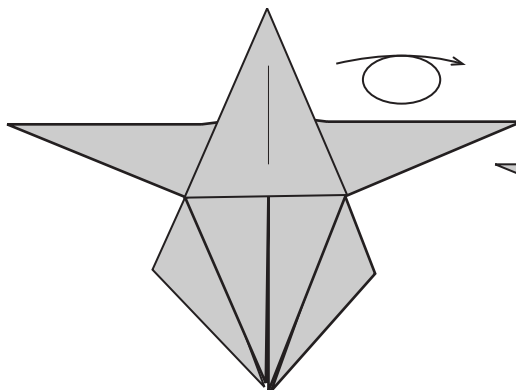

5] Turn over.

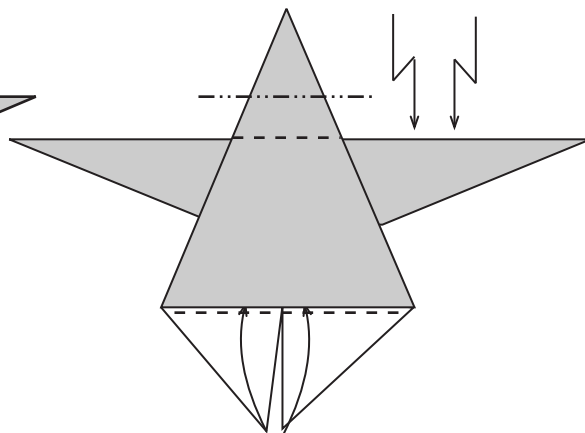

6] Tuck bottom flap inside. Crimp head.

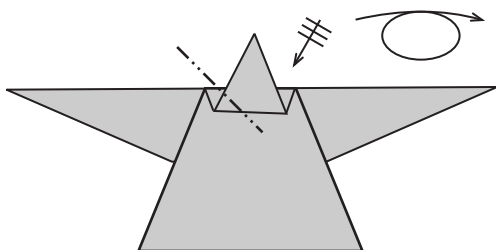

7] Tiny reverse fold at base of head. Repeat on right and behind. Turn over.

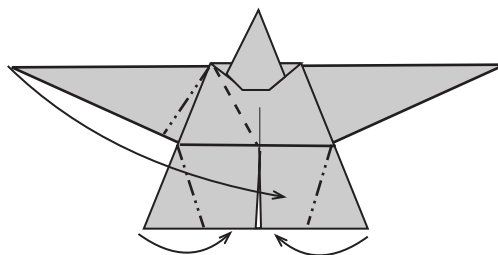

8] Reverse fold bottom corners. Squash fold the wing.

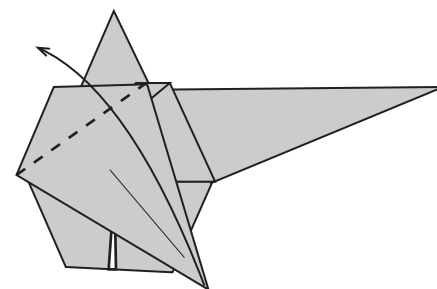

9] Valley fold wing over.

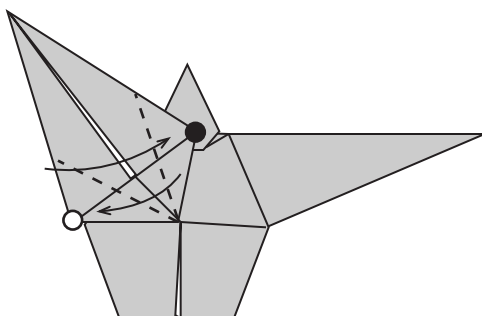

10] Valley fold side of wing to the left. Fold other side to the right. They will overlap. Tuck one flap into the pocket to lock the wing. (Tuck flap ● into pocket ○.)

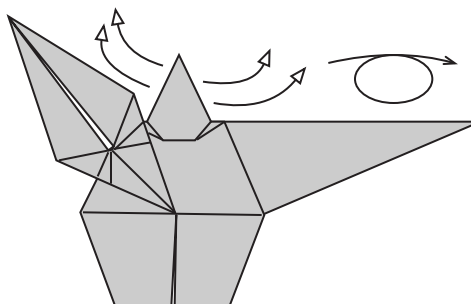

11] Repeat 8-10 on other wing. 3-D head by pulling out 4 trapped ridges. Turn over.

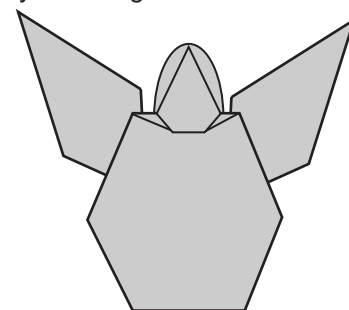

The completed angel



# Ankylosaurus by Ronald Koh (Singapore)

Complex This is a deceptively difficult model, watch the diagrams carefully! Fold from a large sheet (at least 20") of Japanese foil. The model can also be wet folded with good results. A 20" sheet of foil can be easily created by carefully taping four 10" sheets together. This doesn't "count" as taping because you are still working from a square.

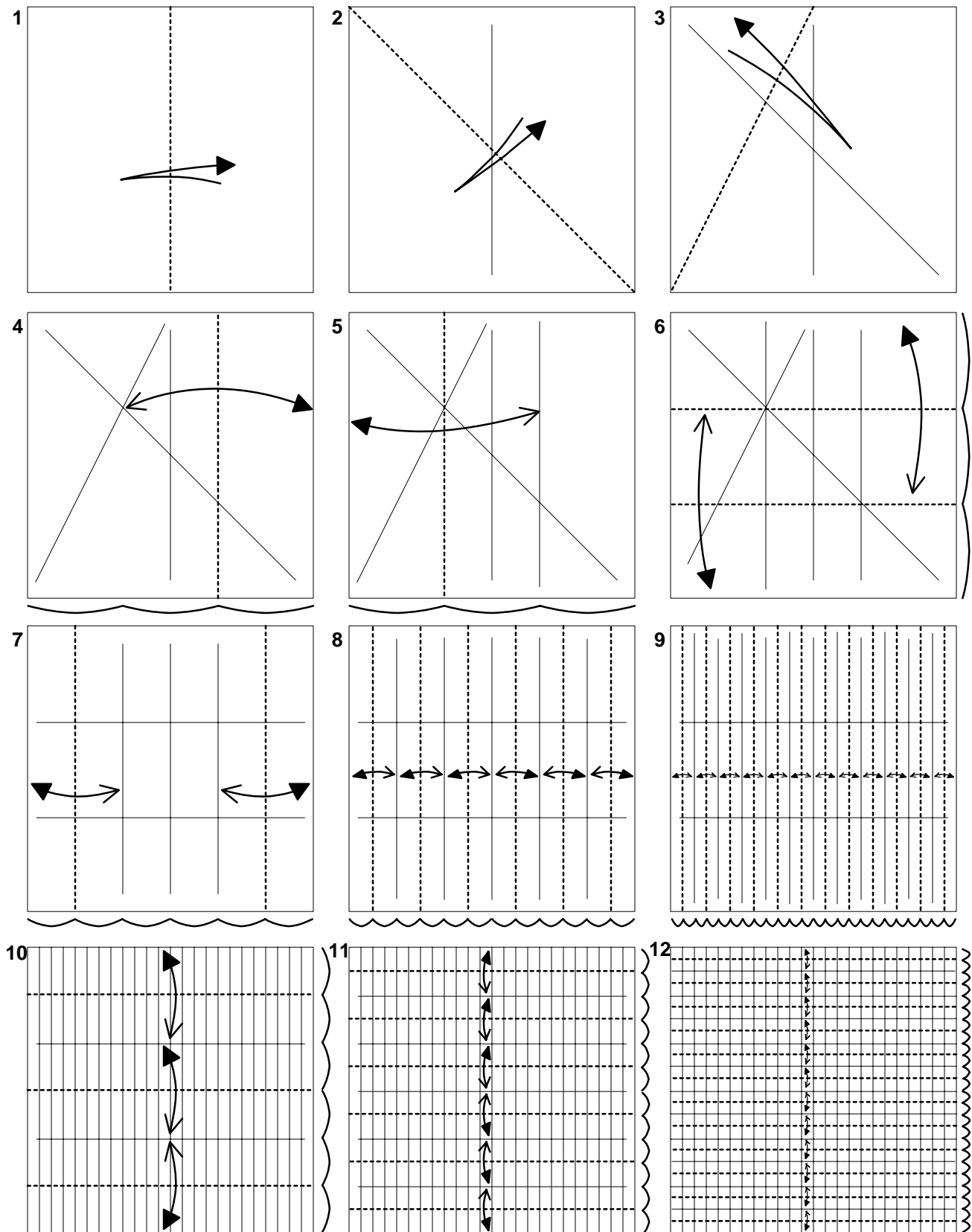

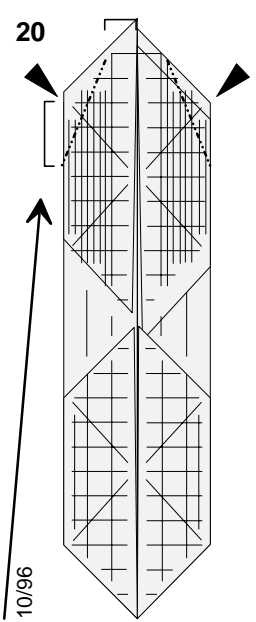
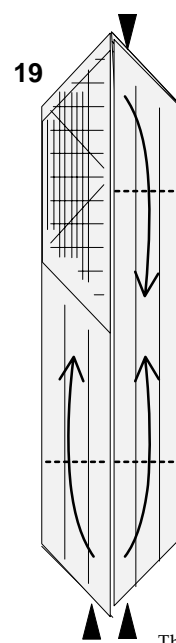
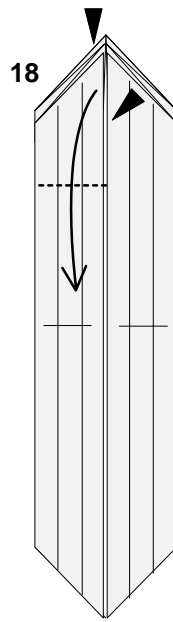
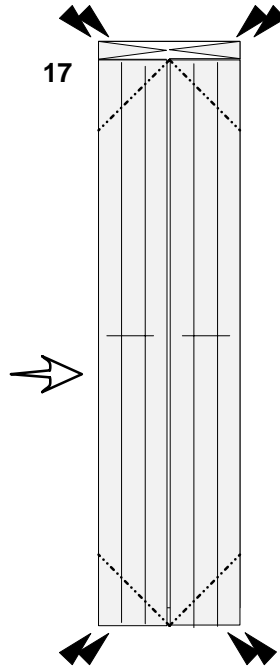
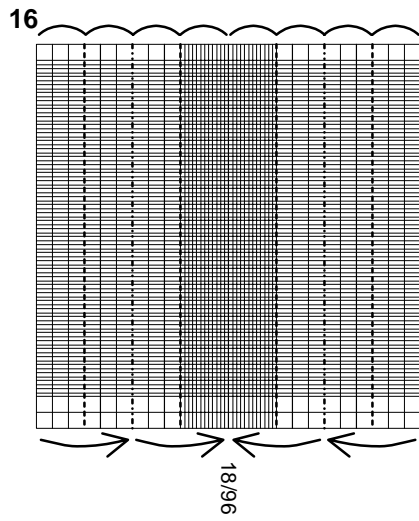
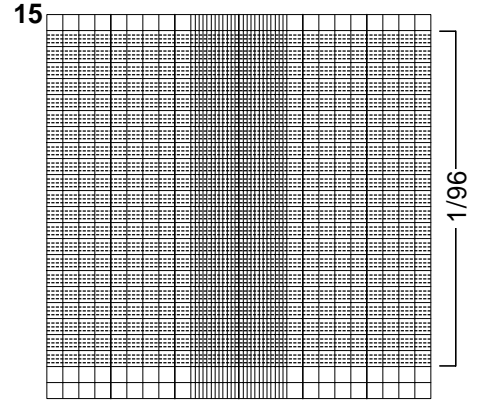
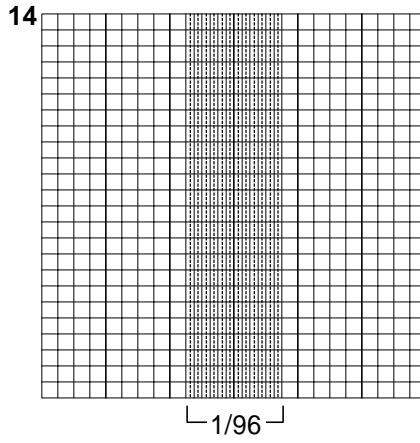
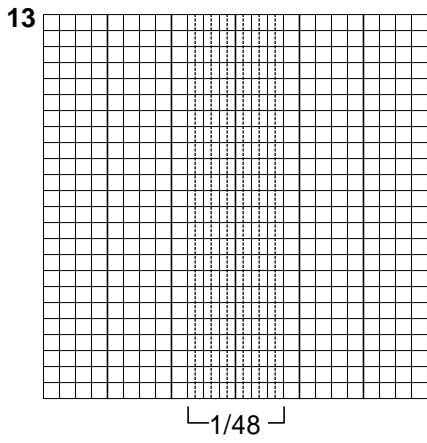

These distances are extremely important, 5 & 22 blocks each. Check the other side to verify landmarks.

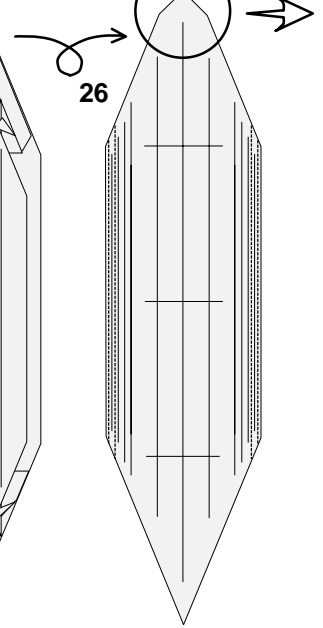
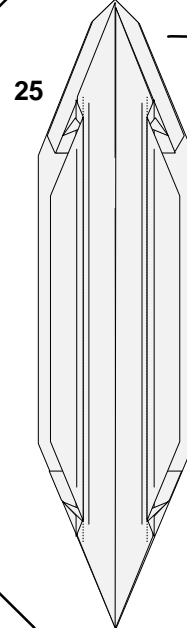
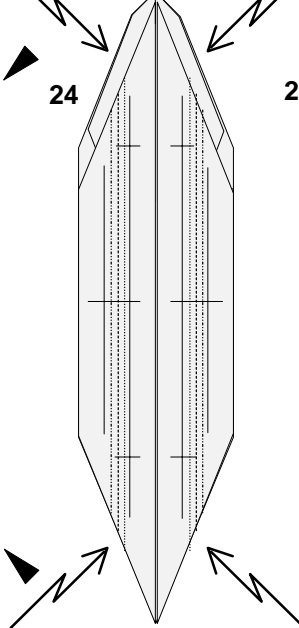
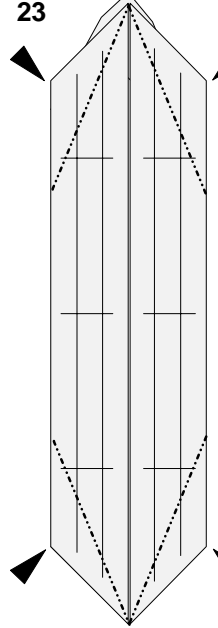
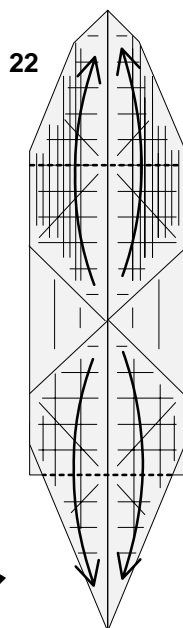
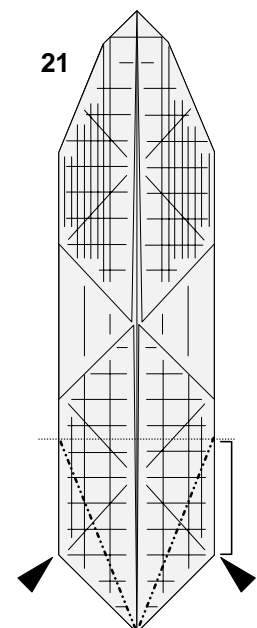

Crimp @ 1/96, causes a spreadsquash. Use the underlying layers to show where to fold.

Crease 1/192 through two outer 1/96ths.

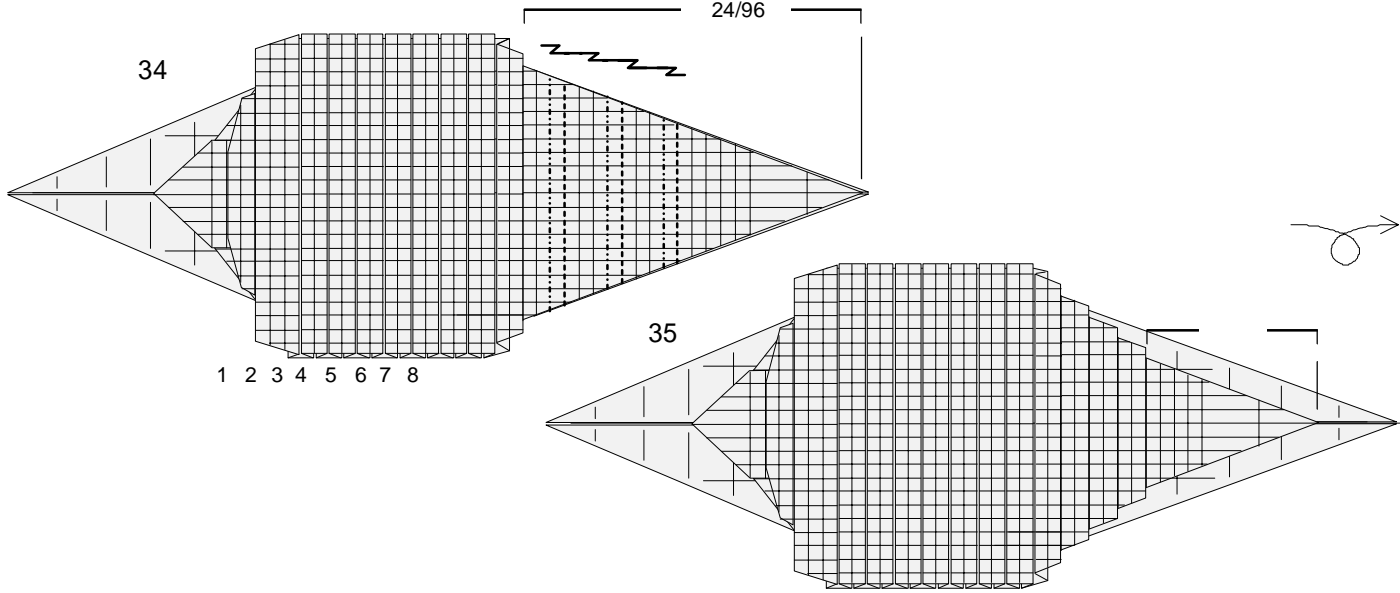
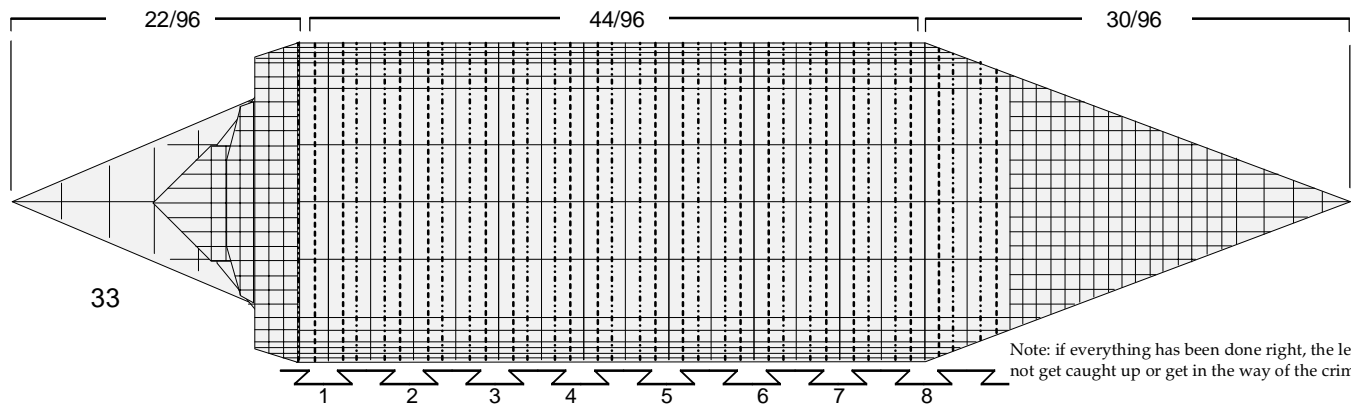
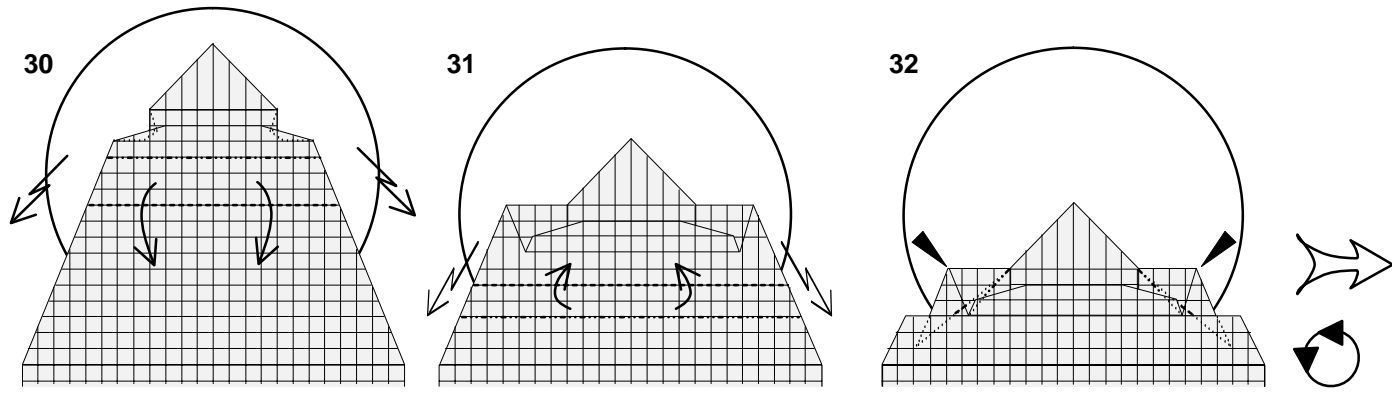
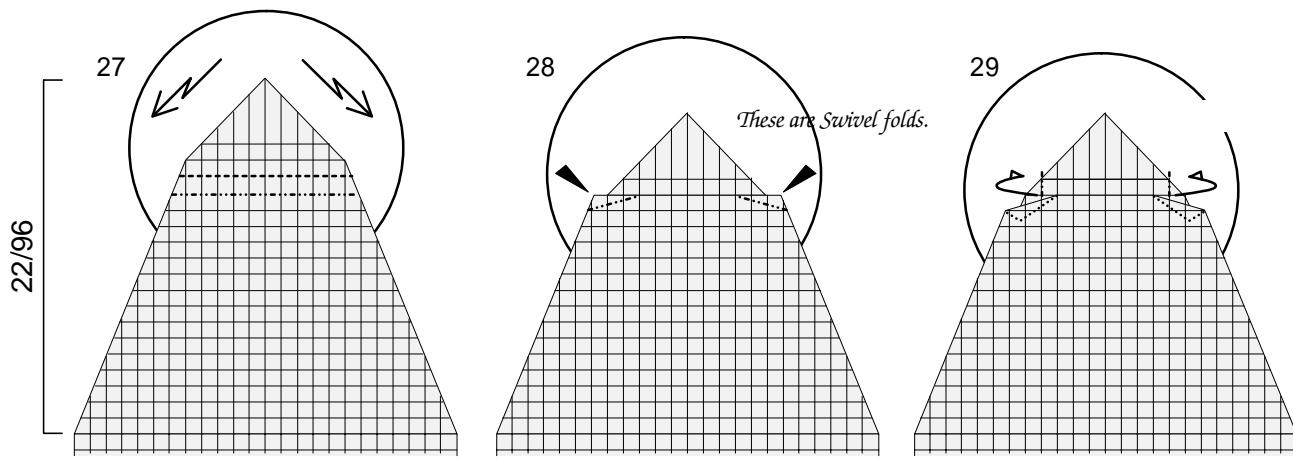



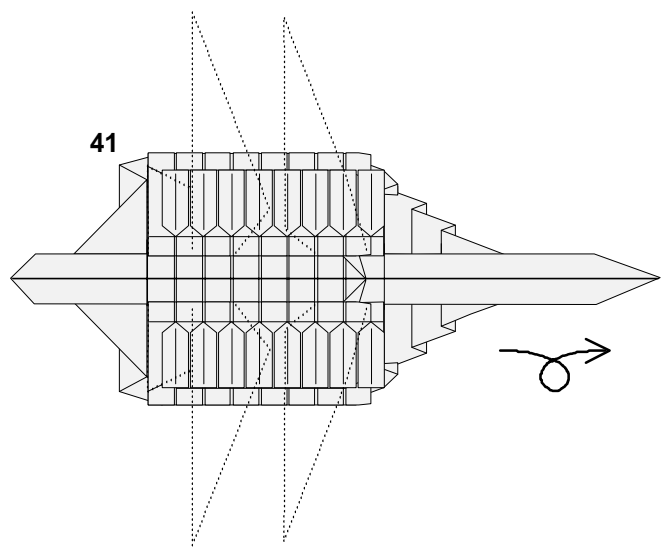
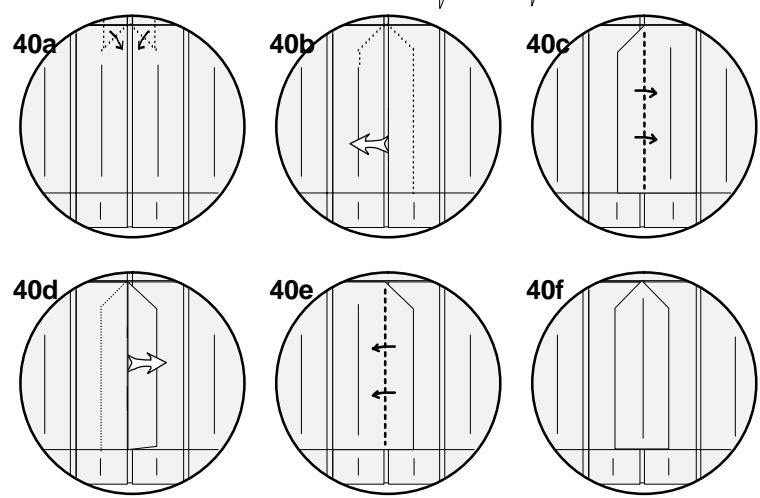
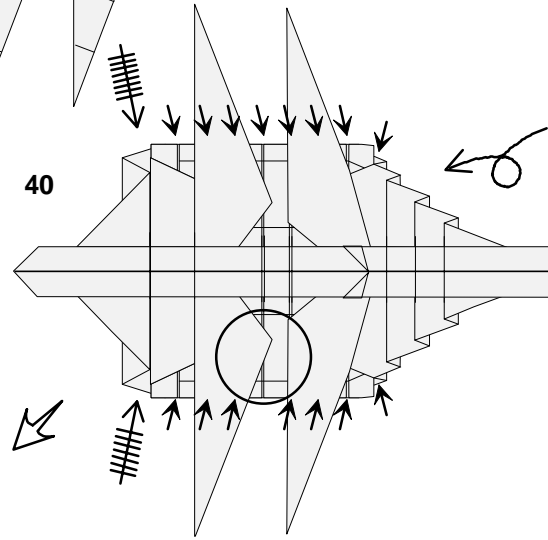
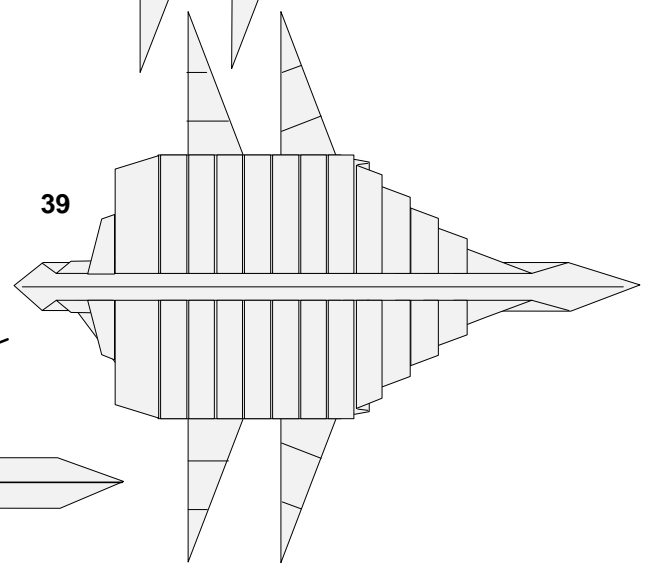
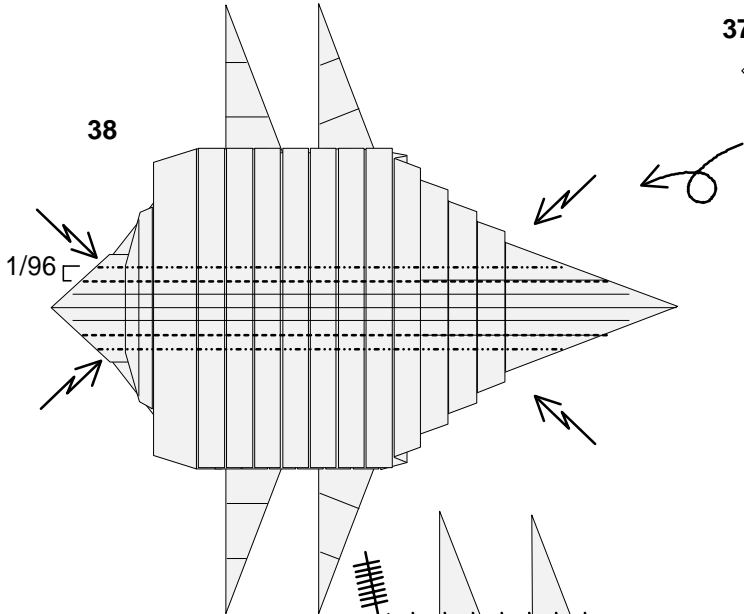
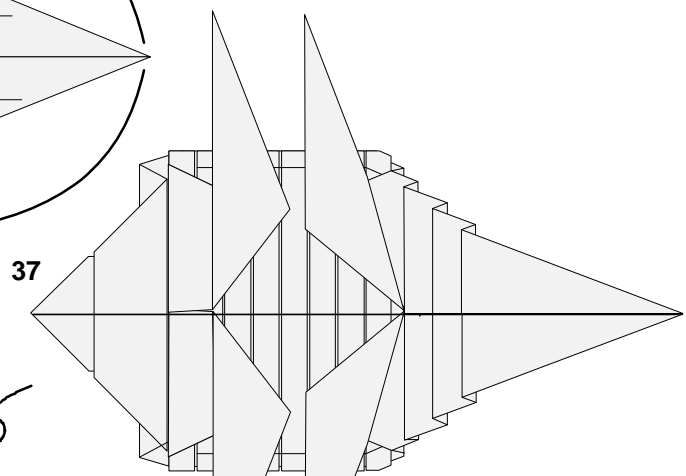
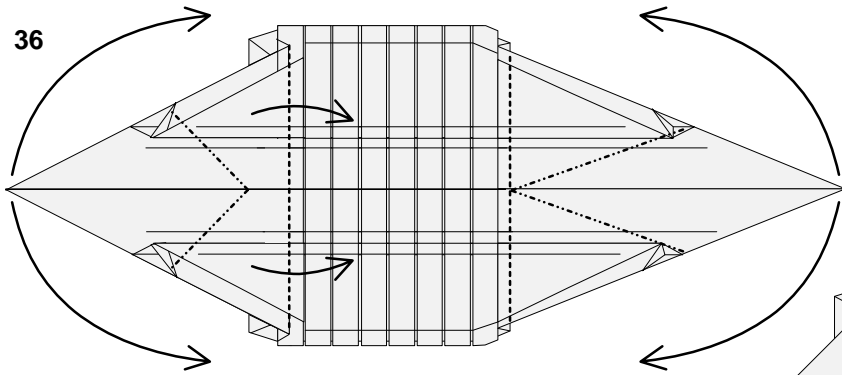

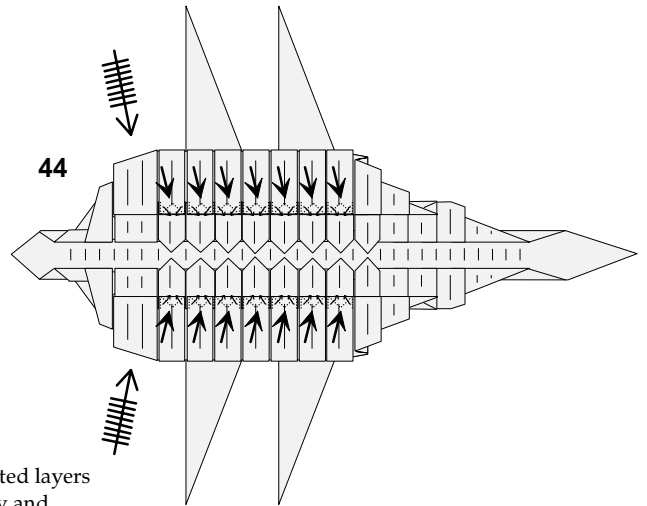
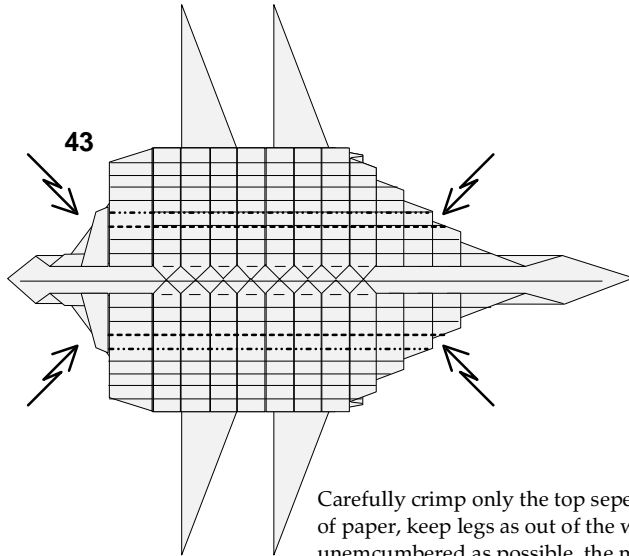
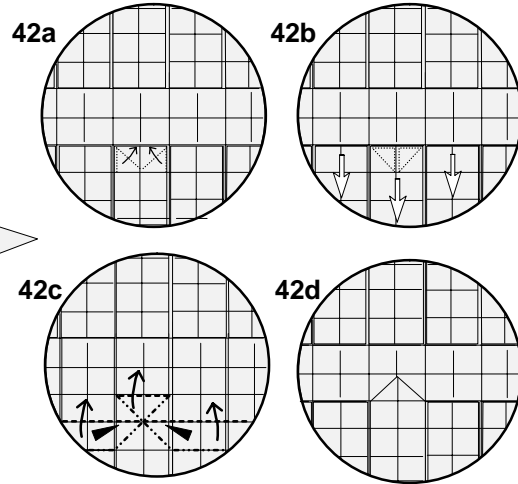
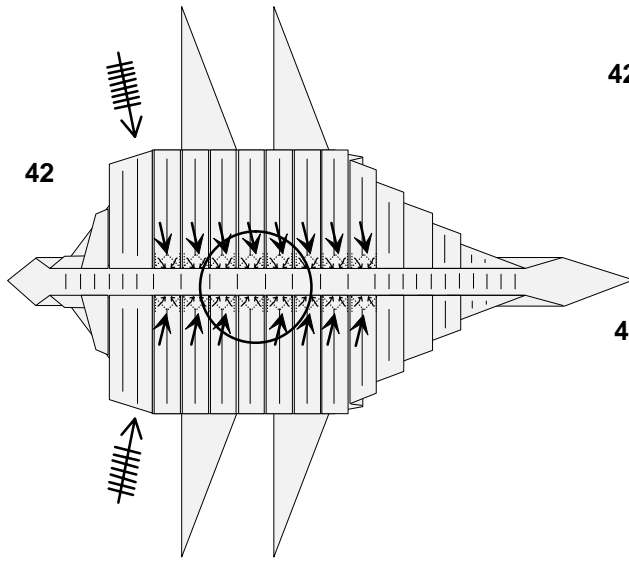

Carefully crimp only the top separated layers of paper, keep legs as out of the way and unencumbered as possible, the model will be thinner that way. Do not crimp the head, make adjustments as necessary.

Repeat steps 40a through 40f seven time s on each side on the new crimp.

This is easier than it looks! Do the crimp first, & then petal fold. Be careful that the points at the bottom (on the other side) stay sharp and do not move.

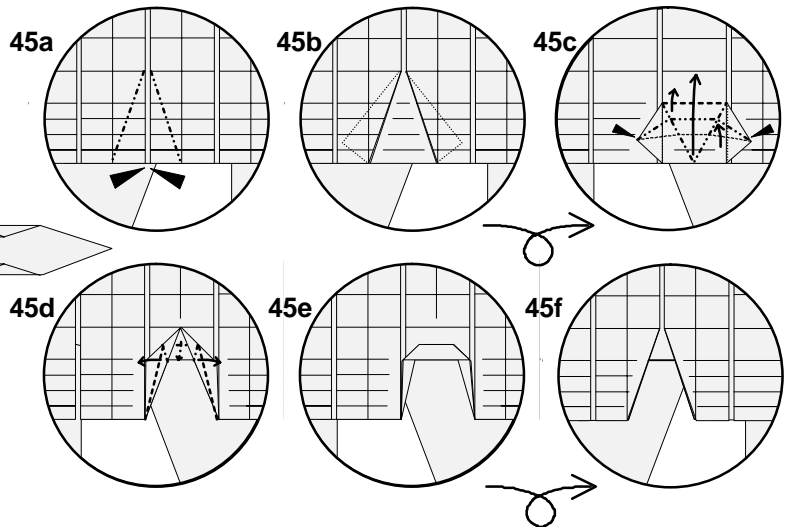
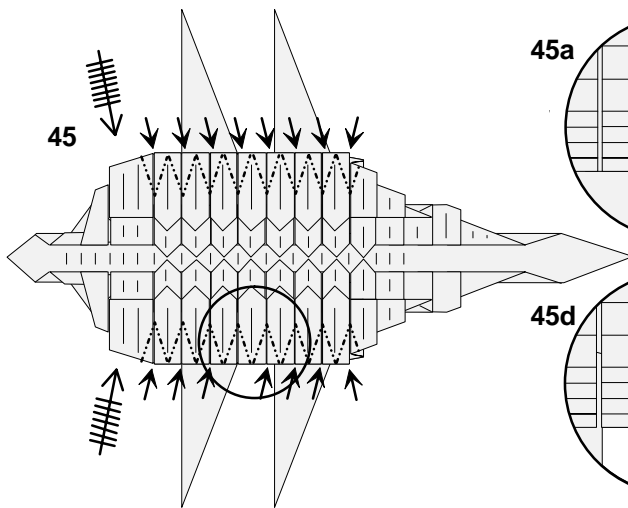

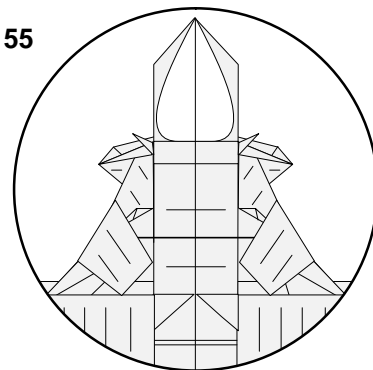
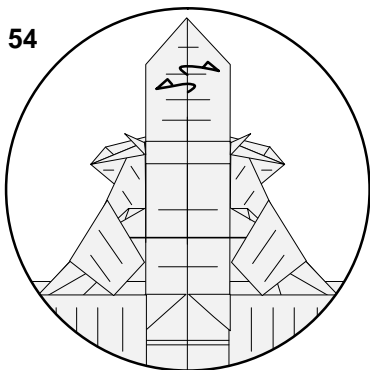
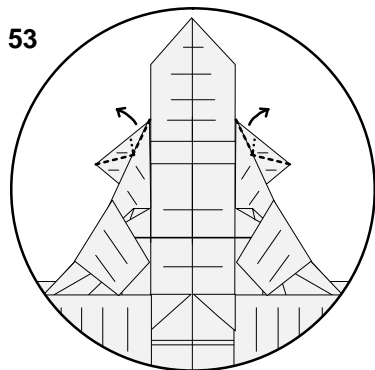
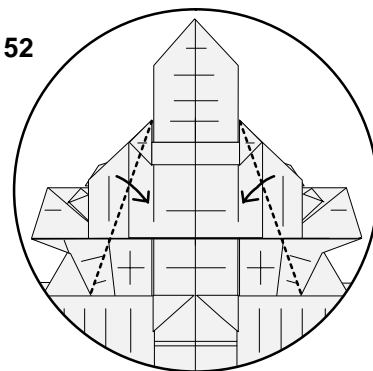
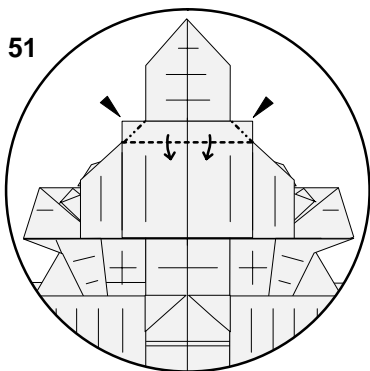
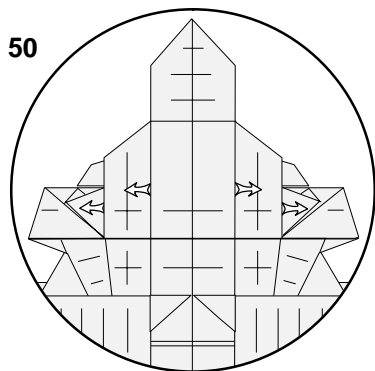
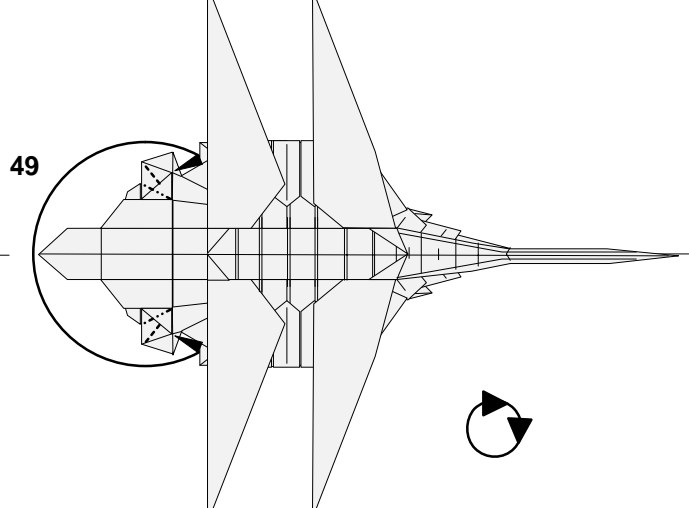
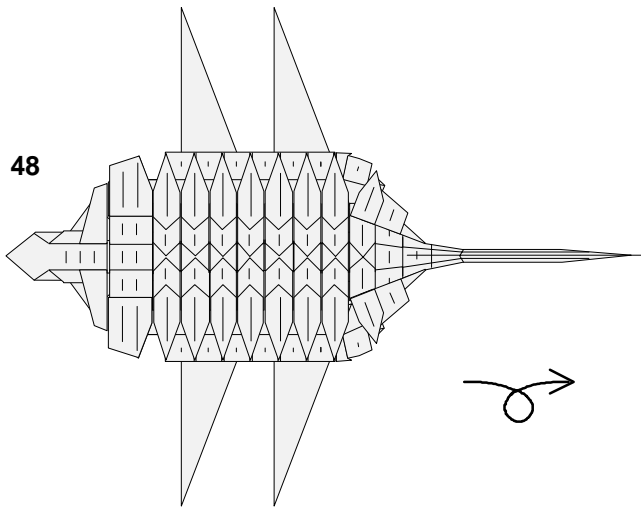
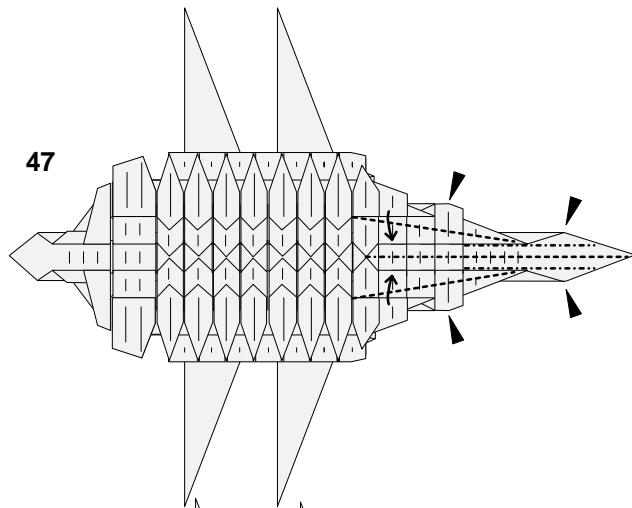
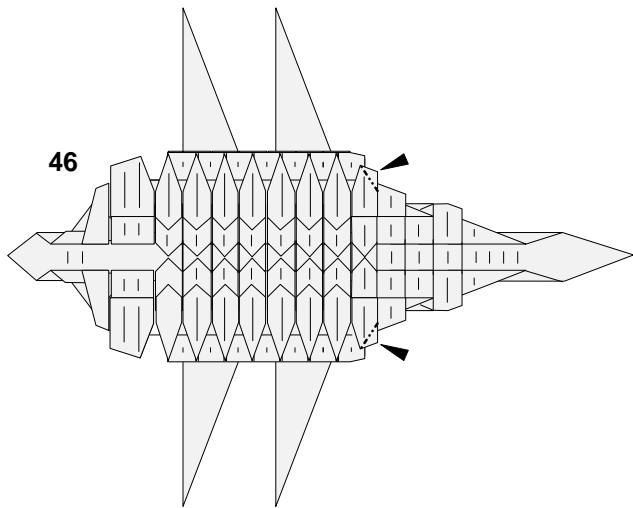

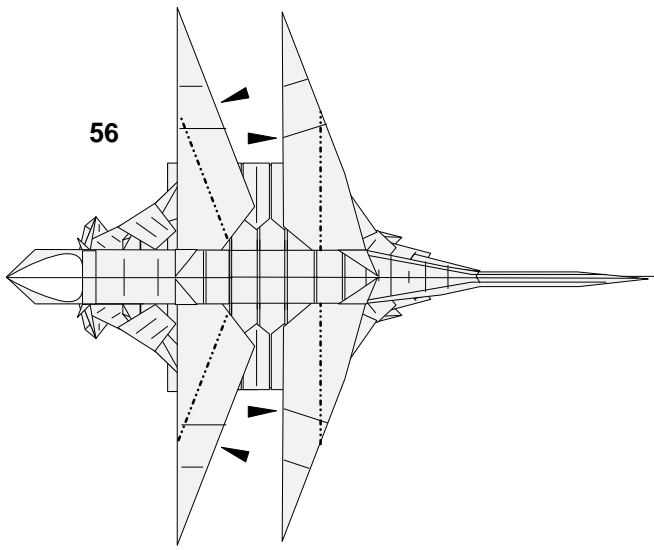

56

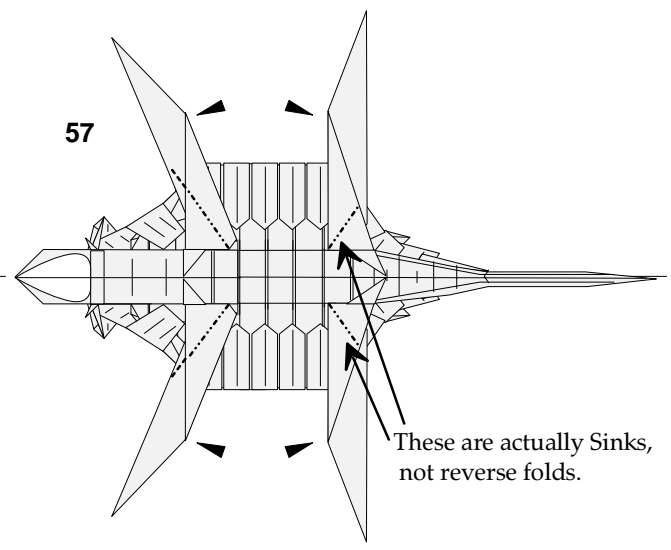

57

These are actually Sinks, not reverse folds.

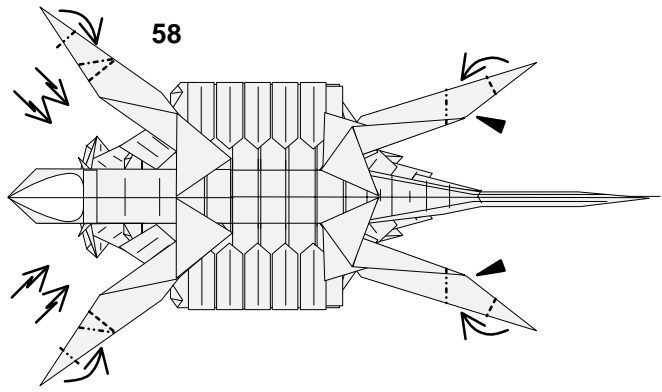

58

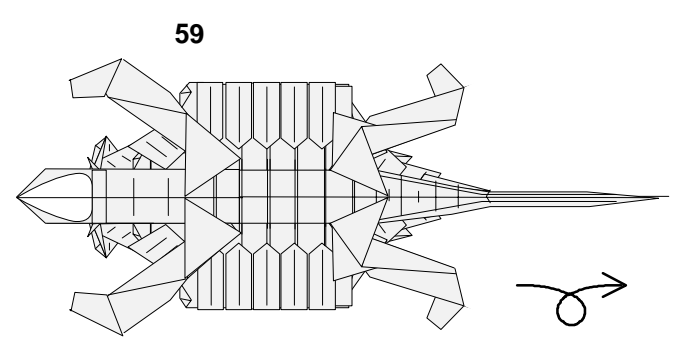

59

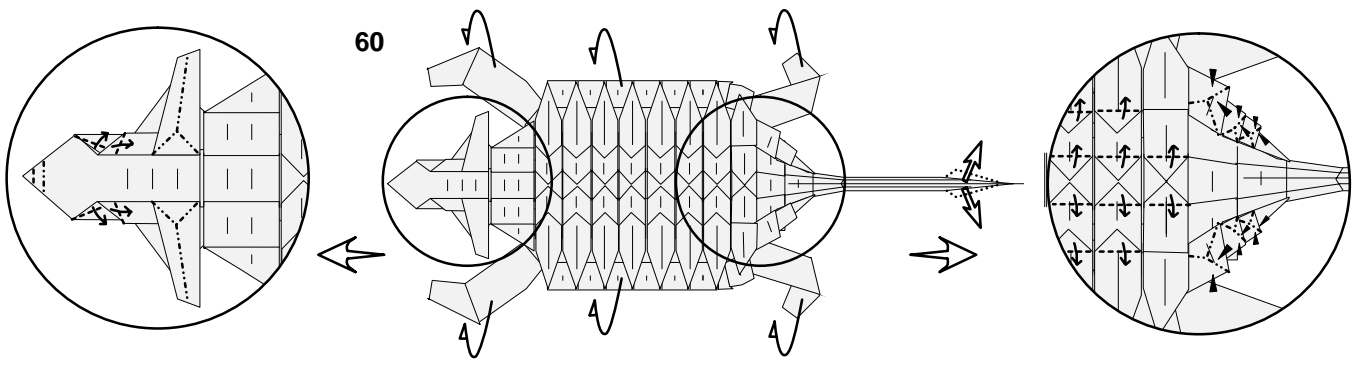

60

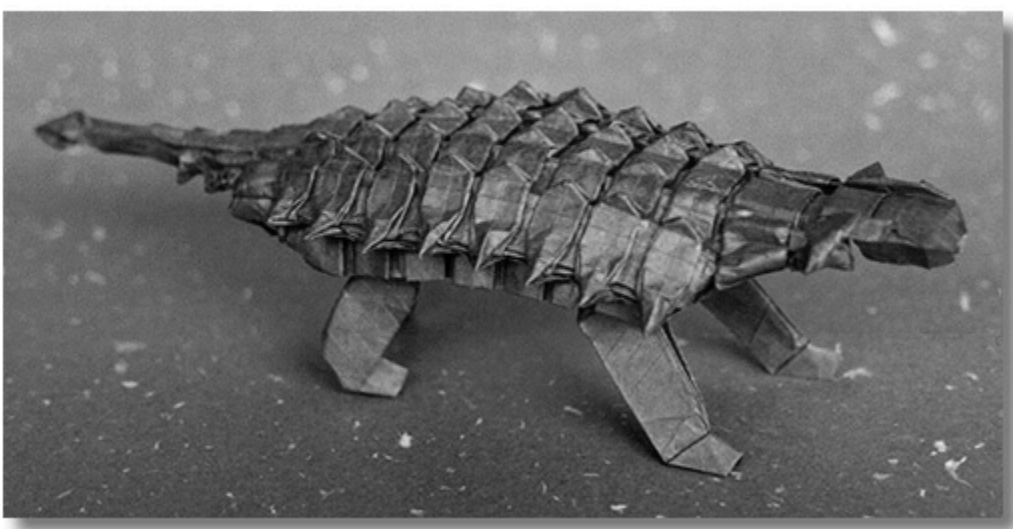

# Spined Ant

©Hans Birkeland 1997  
Use foil-backed paper

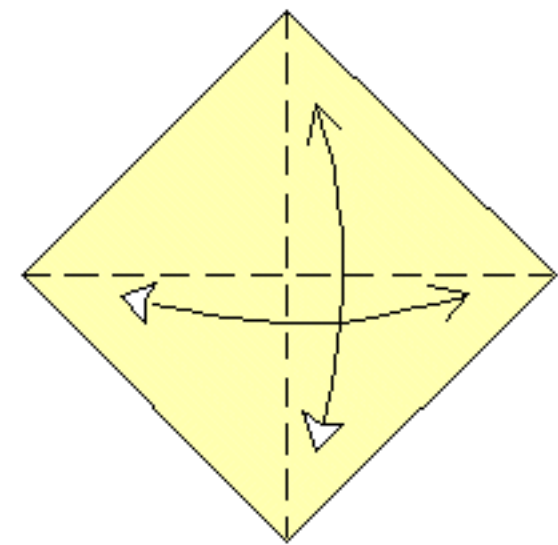

**1** Begin with the white side up. Fold and unfold the diagonals.

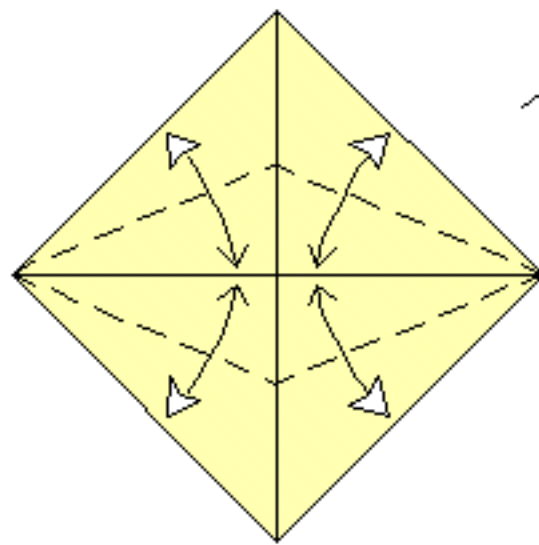

**2** Fold and unfold the angle bisectors. Turn the paper over.

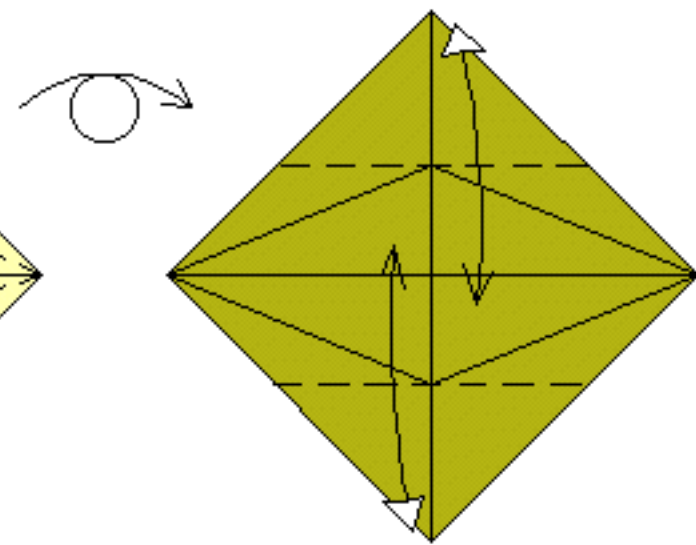

**3** Fold and unfold.

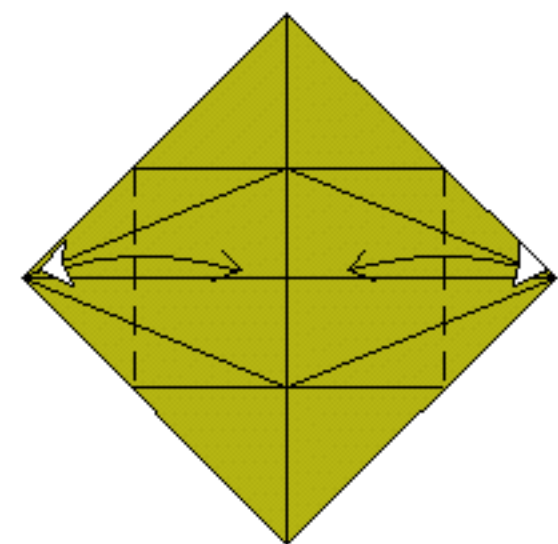

**4** Fold and unfold.

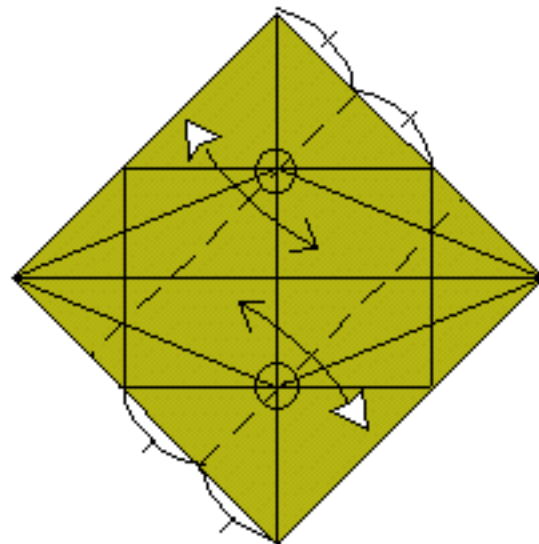

**5** Fold and unfold.

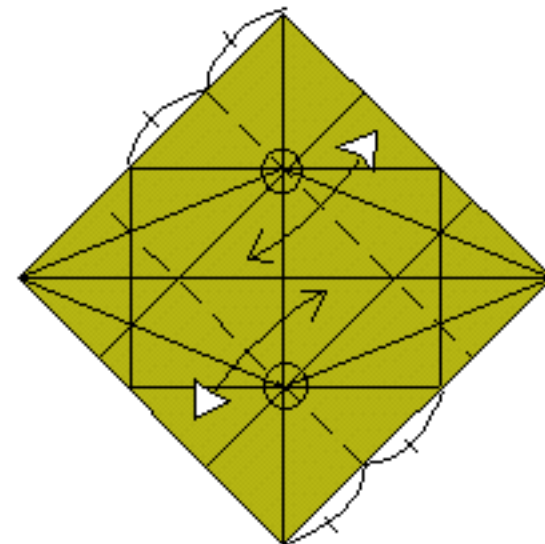

**6** Fold and unfold.

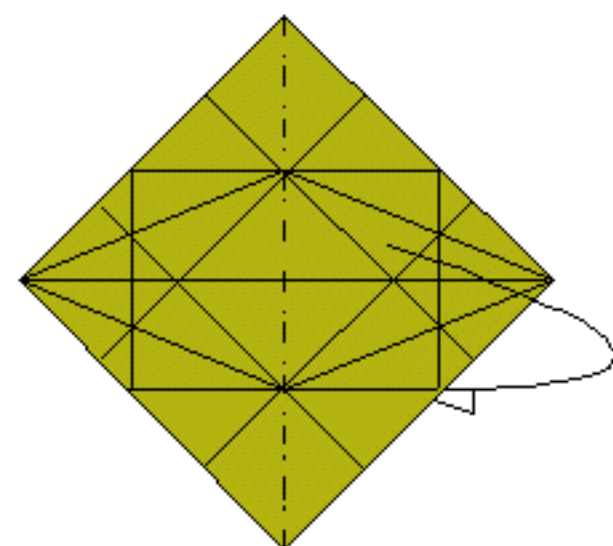

**7** Mountain-fold behind.

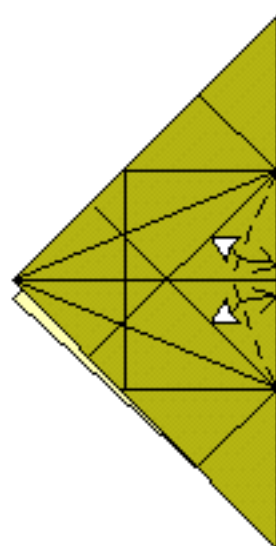

**8** Fold and unfold the angle bisectors through both layers. Unfold to step 7.

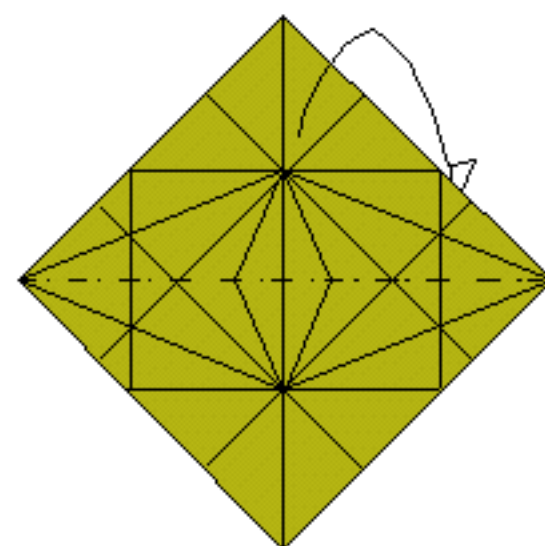

**9** Mountain-fold behind.

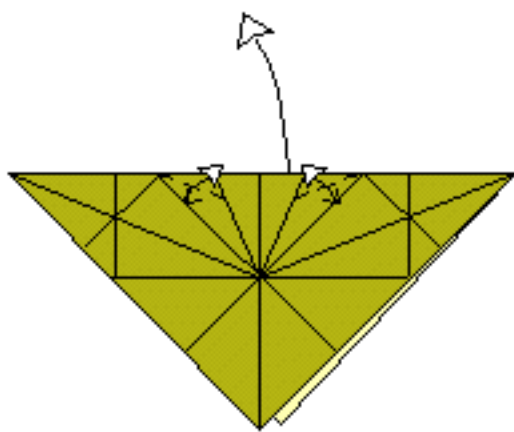

**10** Fold and unfold the angle bisectors through both layers. Unfold.

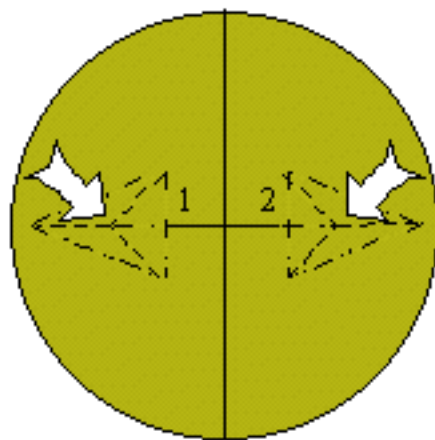

**11** Enlarged view. Make the two vertical mountain-folds and then start pushing in the area within the triangles (see next step).

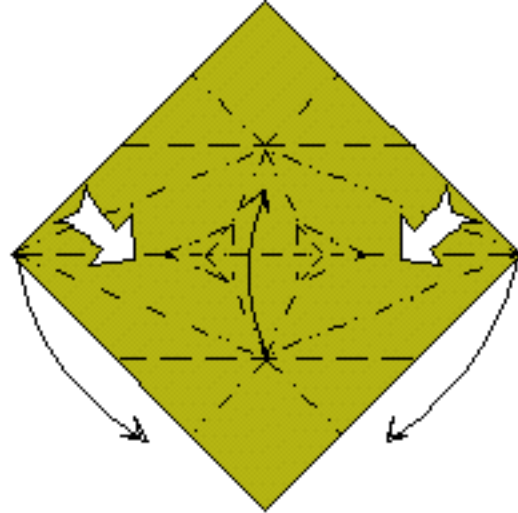

**12** Collapse on existing creases. Next step shows this step seen from the side.

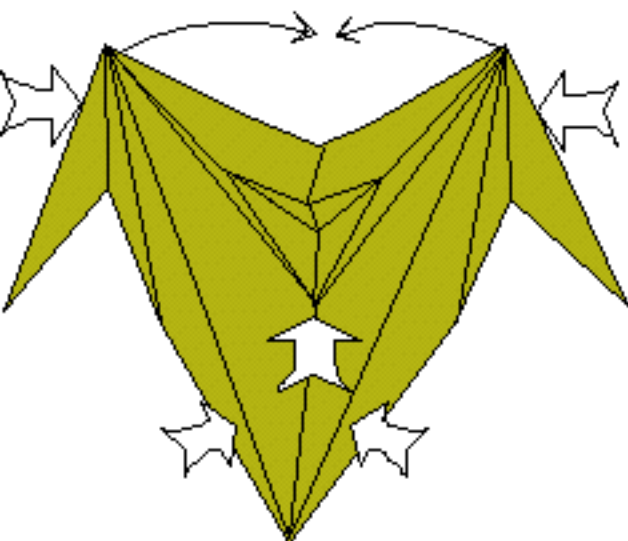

**13** Step 12 seen from the side, partially collapsed.

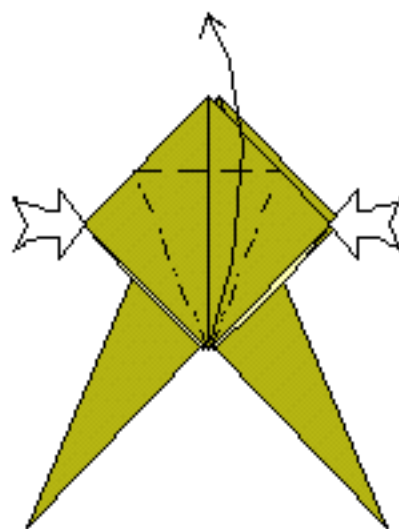

**14** Petal-fold. Repeat behind.

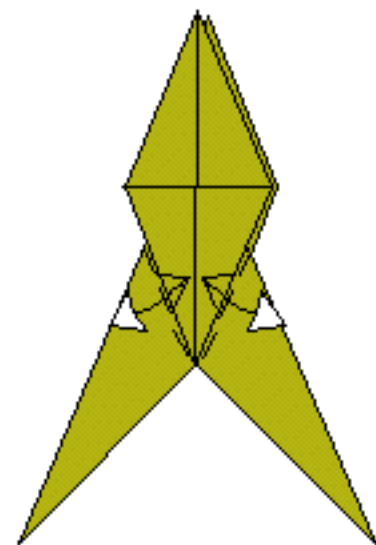

**15** Fold and unfold through all layers.

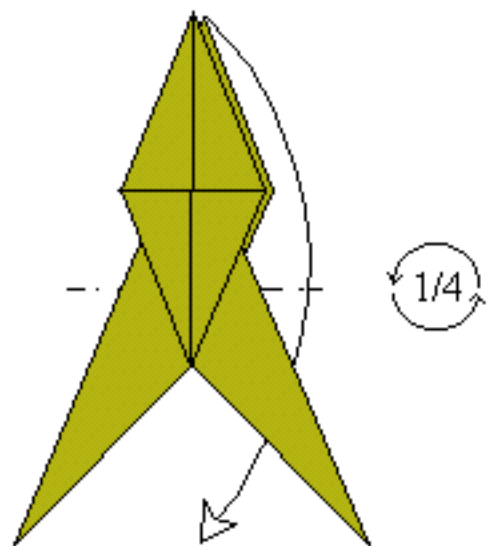

**16** Fold the flap at the back down as far as it will go. Rotate the model.

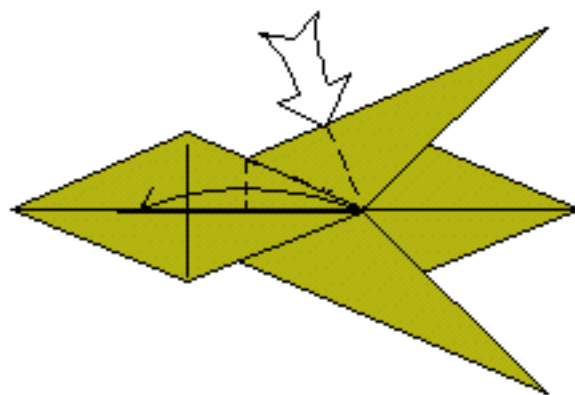

**17** Swivel-fold. Repeat on the right, thus being able to squash flat (see next step).

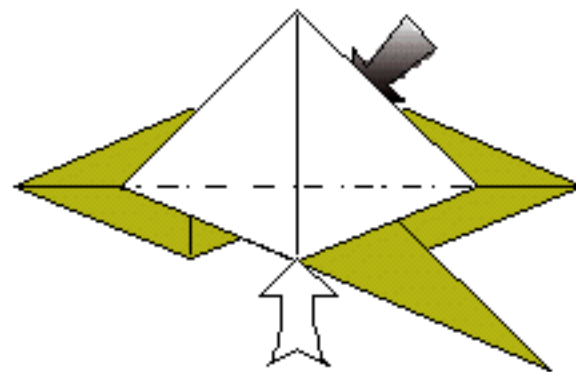

**18** Like this. Closed-sink the lower triangle upward.

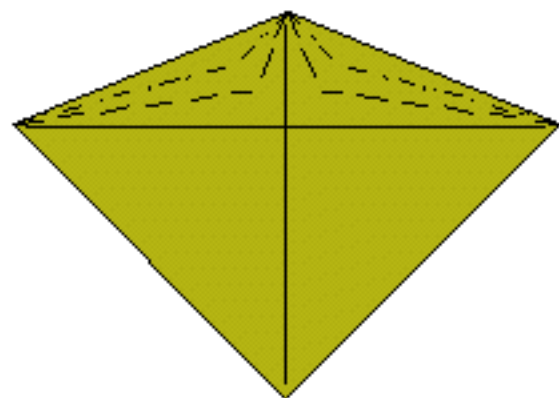
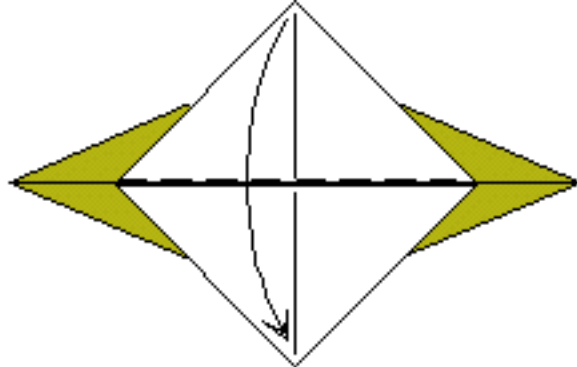
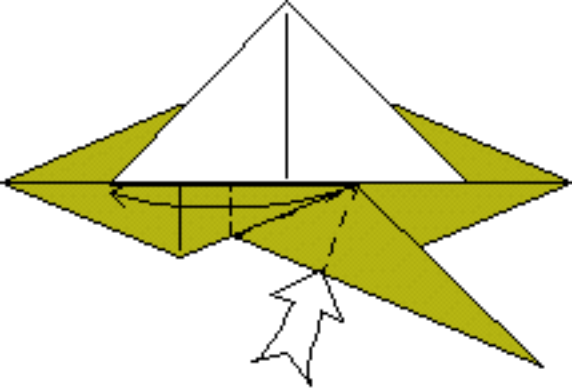

**19** Repeat steps 17-18 on the lower flap.

**20** Fold the upper flap down.

**21** Enlarged view of the center flap. Pre-crease the upper part, dividing in thirds. Then unfold to step 20.

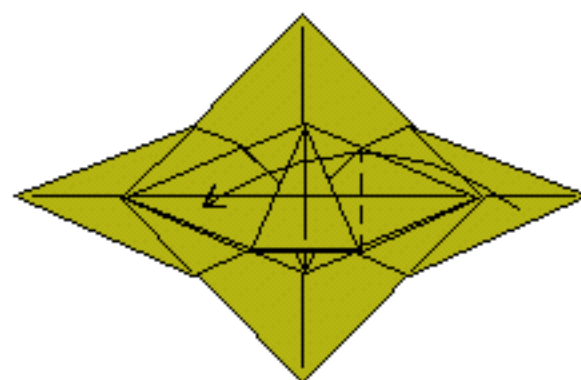
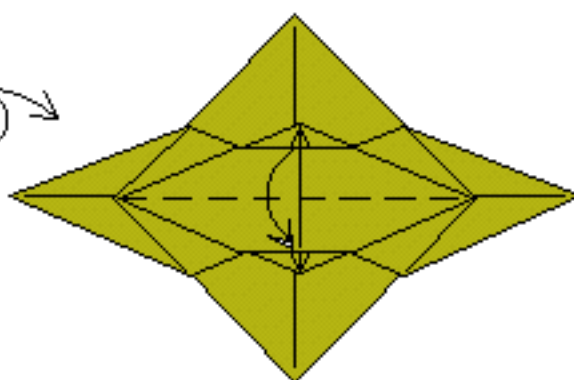
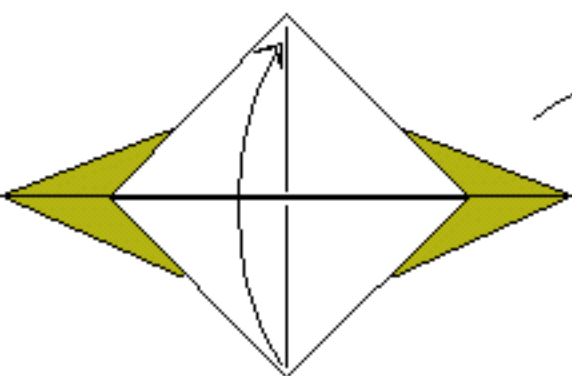

**22** Repeat steps 20-21 on the lower flap. Turn the model over.

**23** Valley-fold one edge down.

**24** Fold the right flap to the left as far as it will go.

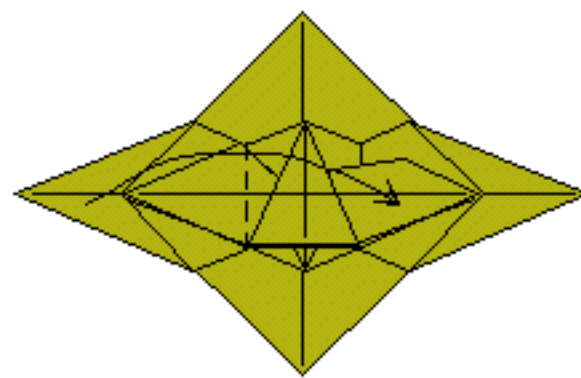
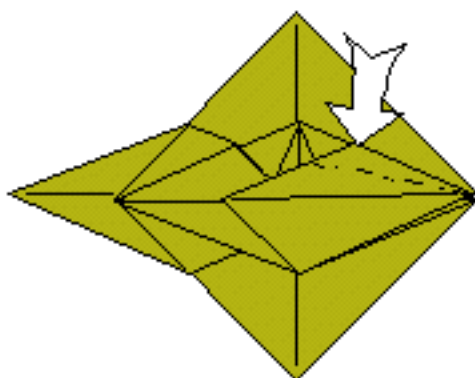
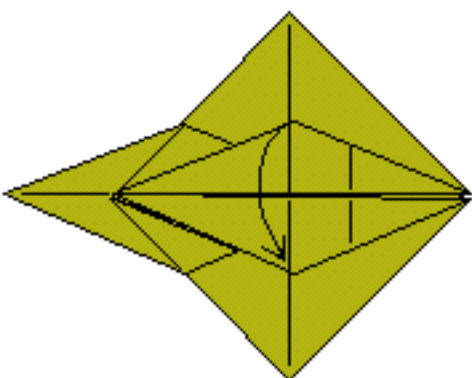

**25** Fold down one layer.

**26** Open-sink the edge on the angle bisector. Then refold to step 24.

**27** Repeat steps 24-26 on the top left.

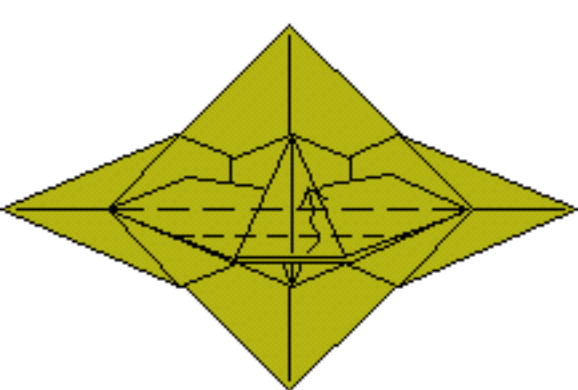

**28** Fold over and over.

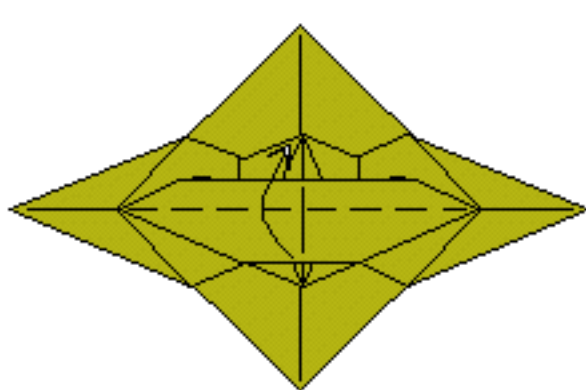

**29** Repeat steps 23-28 below.

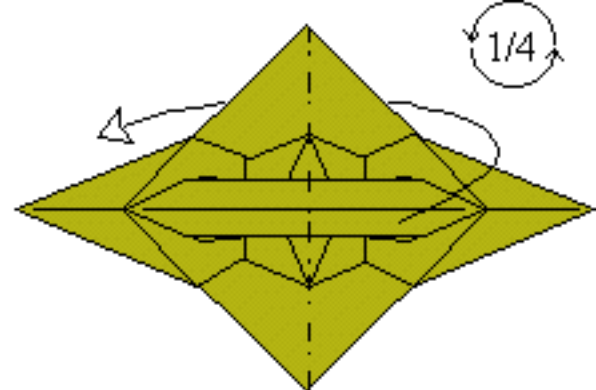

**30** Mountain-fold in half. Rotate.

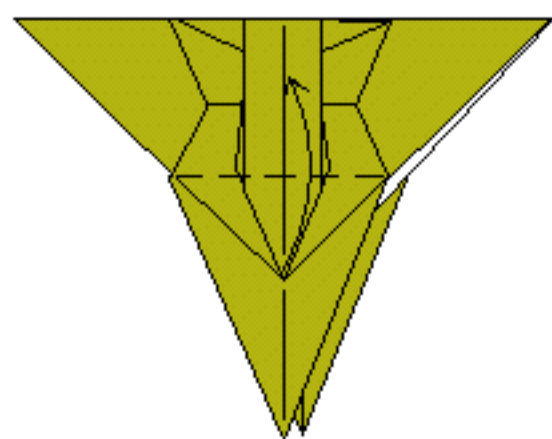

**31** Valley-fold.

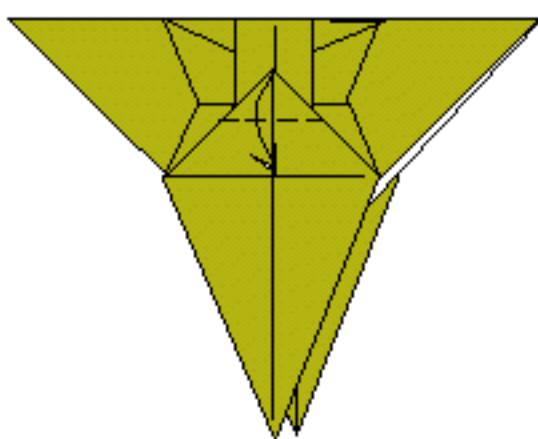

**32** Valley-fold.

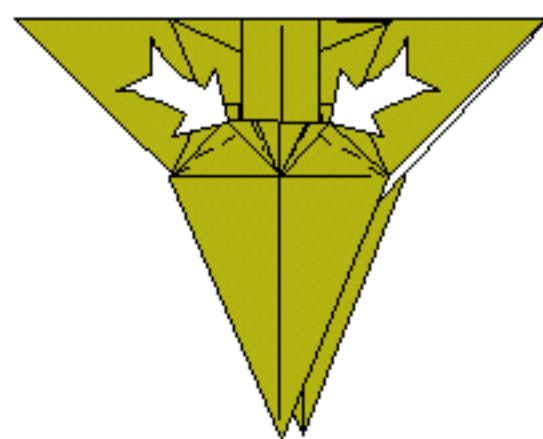

**33** Swivel-fold.

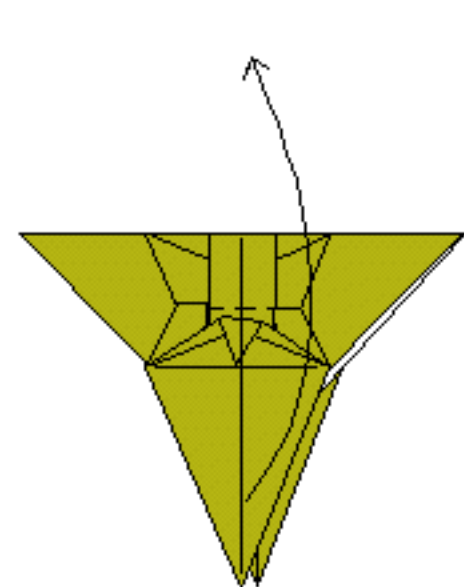

**34** Valley-fold.

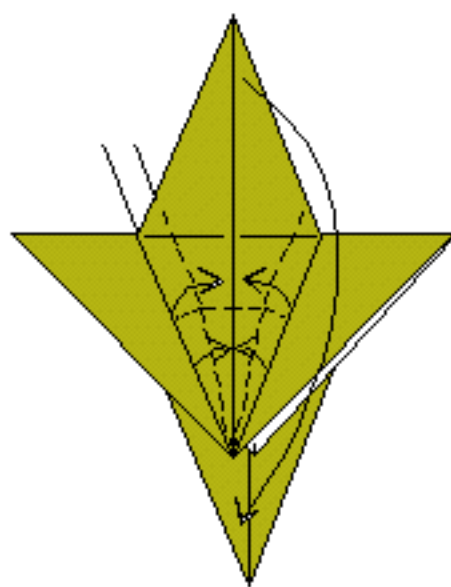

**35** Fold in the edges as the large flap is folded down. See next step.

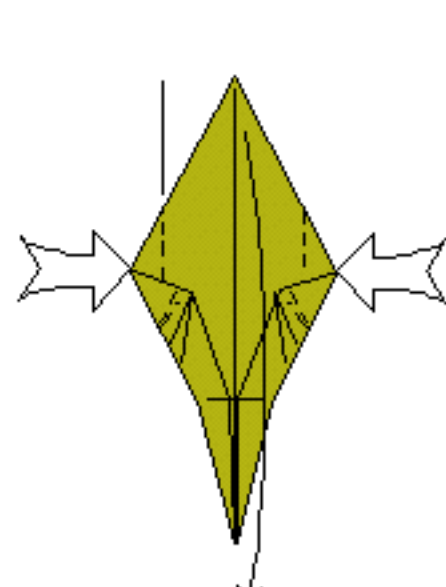

**36** In mid-air. Swivel-fold. Continue folding the flap down.



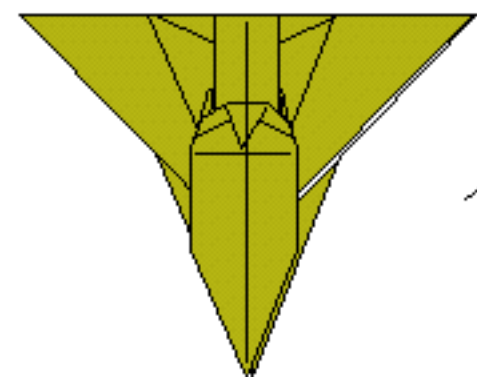

**37** Turn the model over.

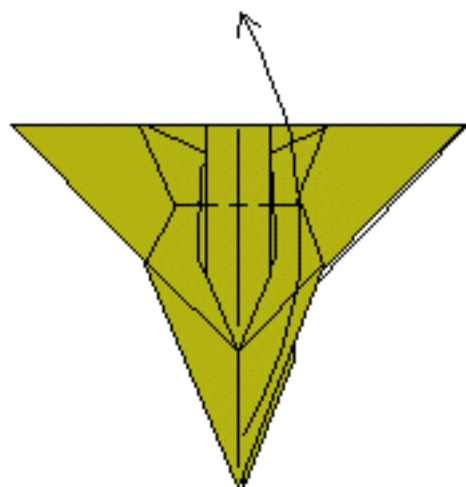

**38** Valley-fold.

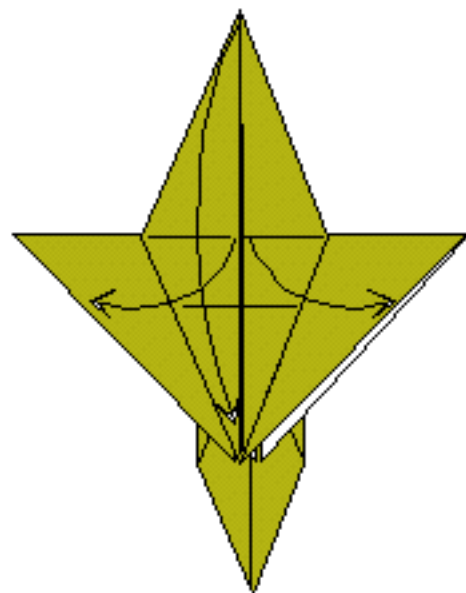

**39** Unfold the petal fold.

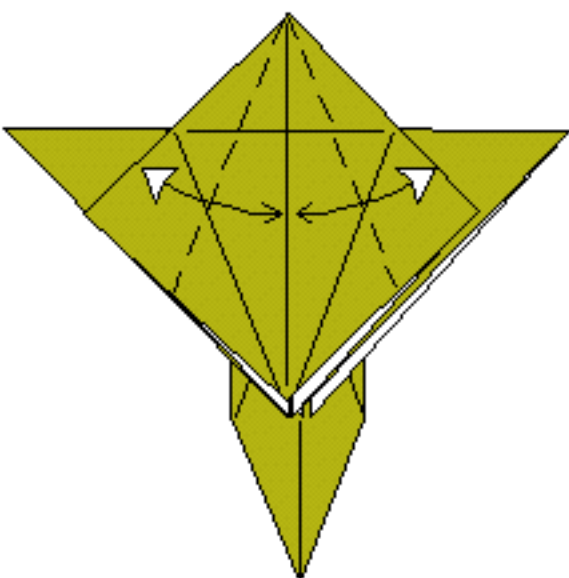

**40** Fold and unfold.

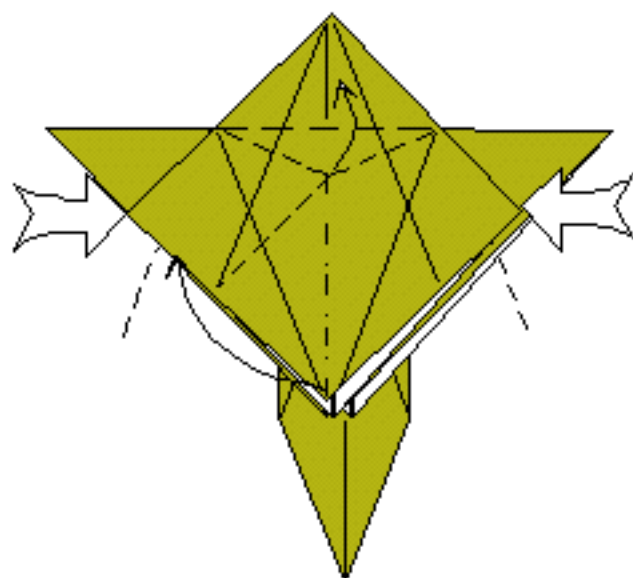

**41** Squeeze the sides together and swing the bottom flap over to the left. See next step.

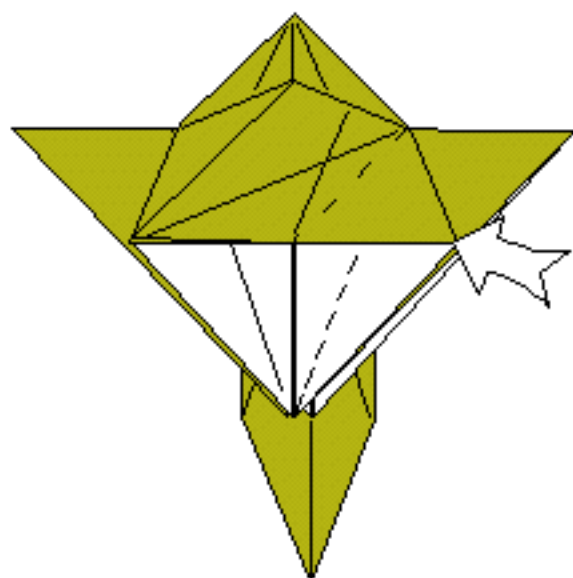

**42** Reverse-fold.

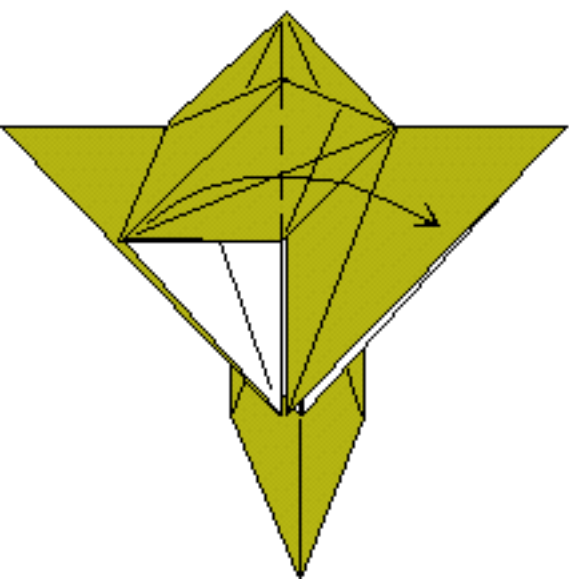

**43** Valley-fold the center flap to the right, and repeat step 42 on the left side.

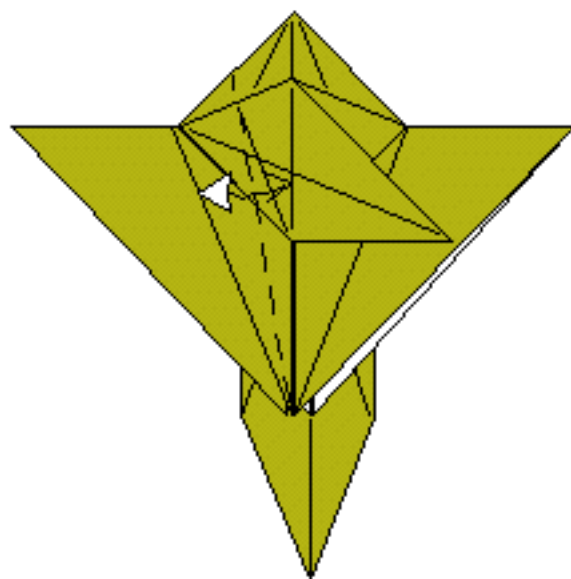

**44** Fold and unfold.

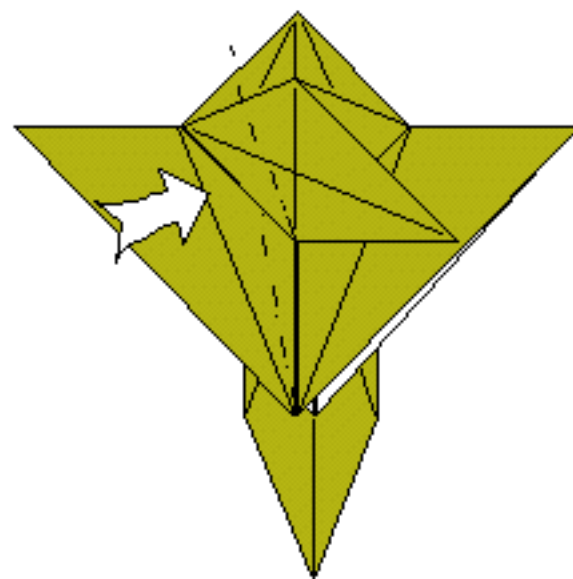

**45** Open sink.

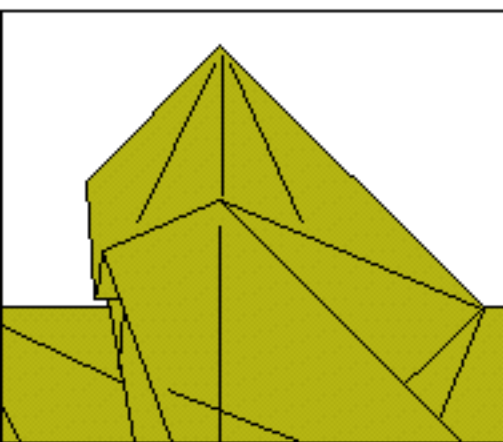

**46** Detail of sink. Repeat steps 44-45 on the left side.

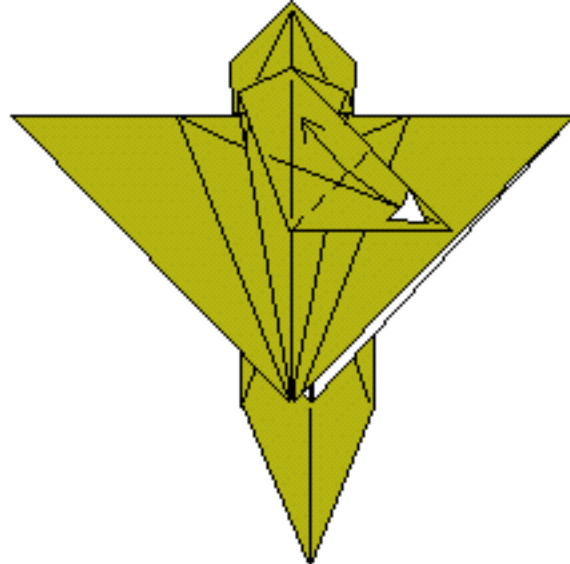

**47** Fold and unfold the angel bisector.

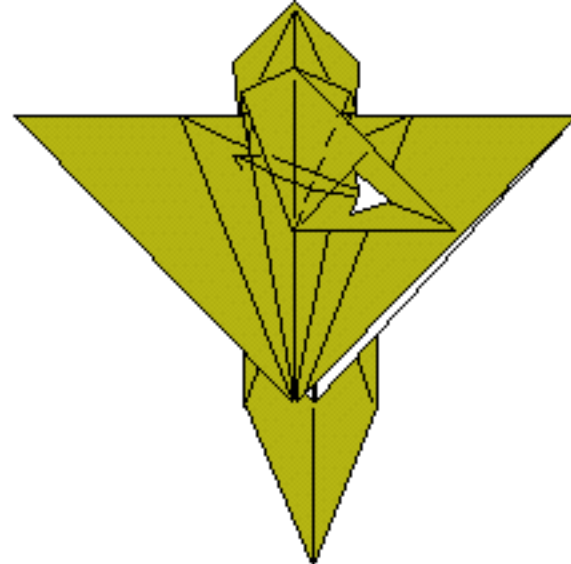

**48** Fold and unfold the angle bisector.

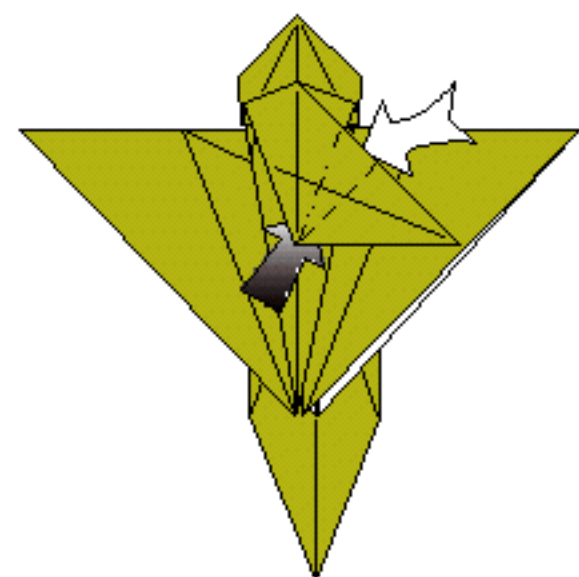

**49** Reverse-fold in and out.

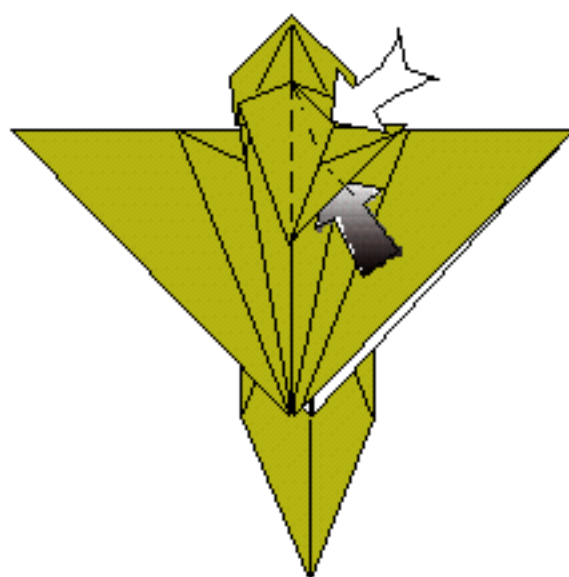

**50** Spread-squash.

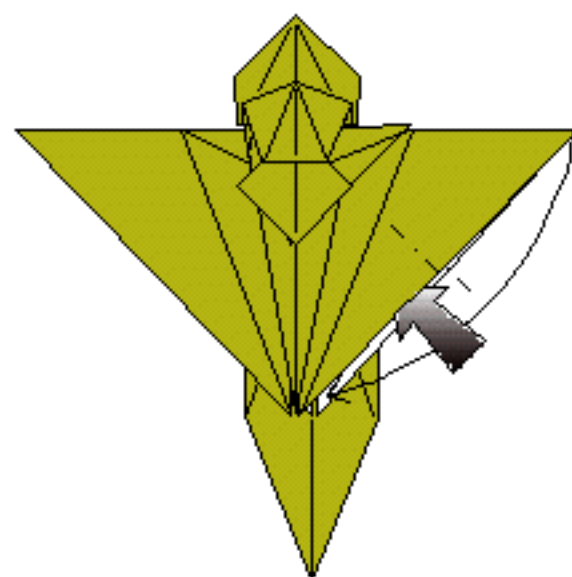

**51** Reverse-fold.

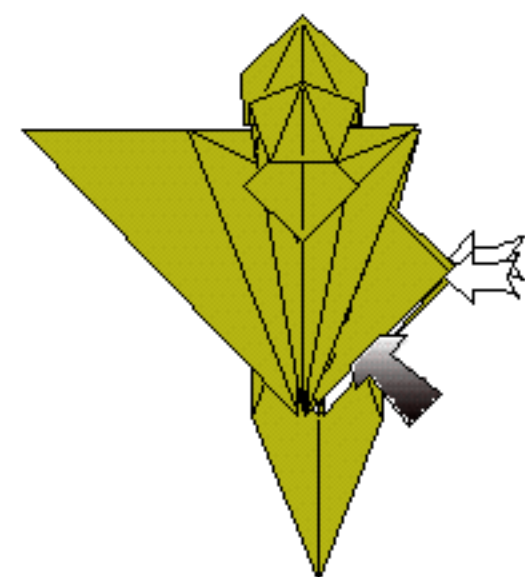

**52** Reverse-fold two edges. Then unfold.

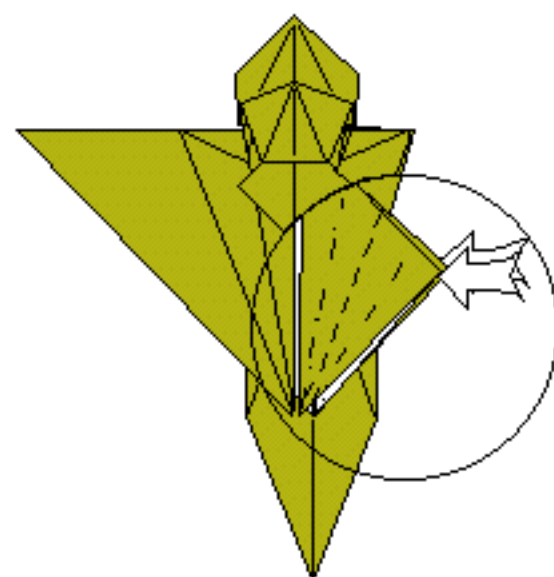

**53** Cut-away view. Reverse-fold each edge three times. The valley fold is on the crease made in step 52.

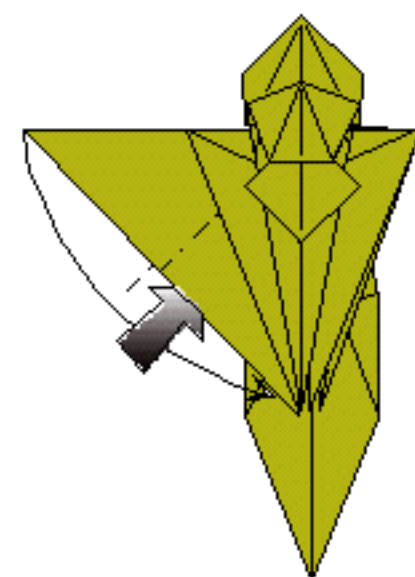

**54** Repeat steps 51-53 on the left flap. This is easier if the right flap is unfolded during the process.

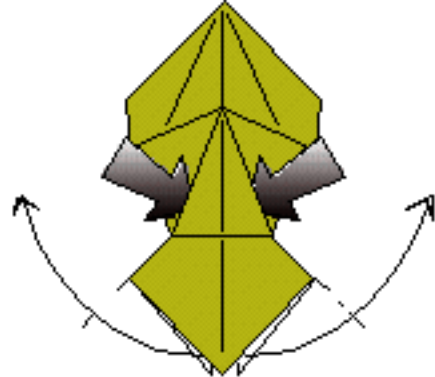

- 55** Enlarged view of the head. Reverse-fold the antennae to each side as far as they will go.

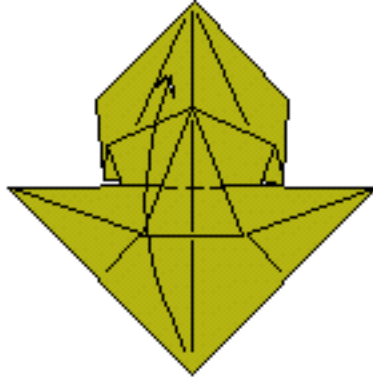

- 56** Lift the flap upward without pressing flat.

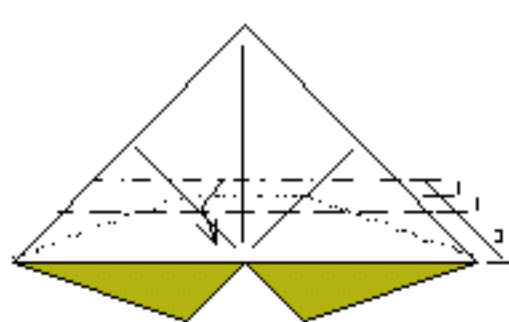

- 57** Pleat-fold. The divisions, using the edge behind, are approximate.

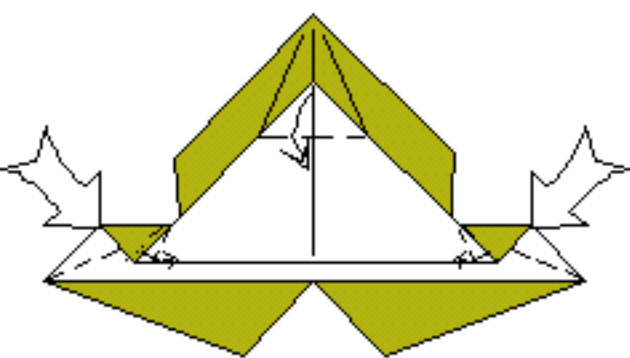

- 58** Swivel-fold the sides. Valley-fold the top corner.

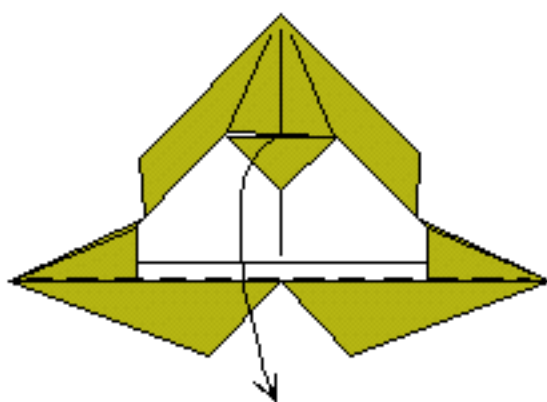

- 59** Fold down.

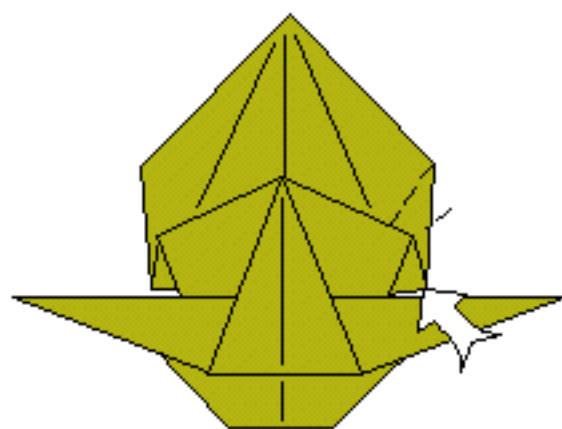

- 60** Reverse-fold. Repeat on the left side.

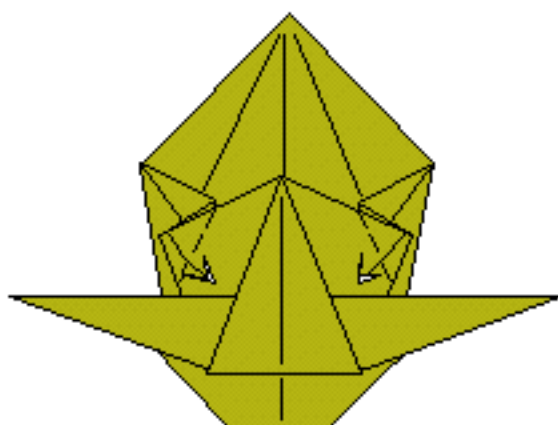

- 61** Valley-fold.

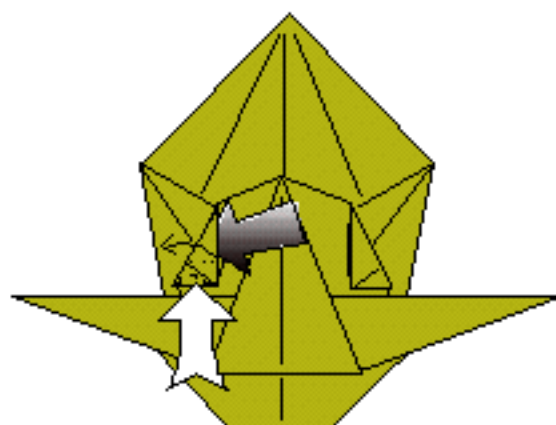

- 62** Open up the eyes and squash flat.

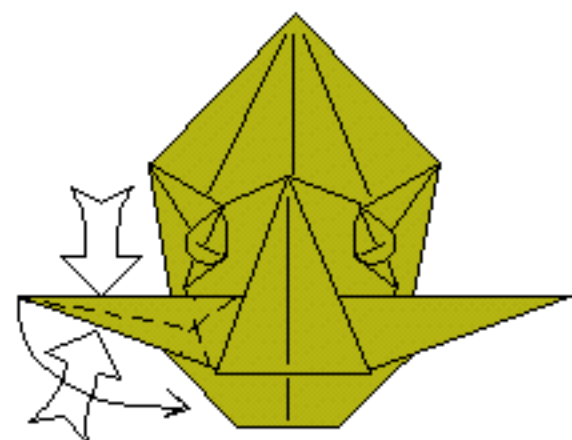

- 63** Rabbit-ear the antennae so that they point straight out toward you.

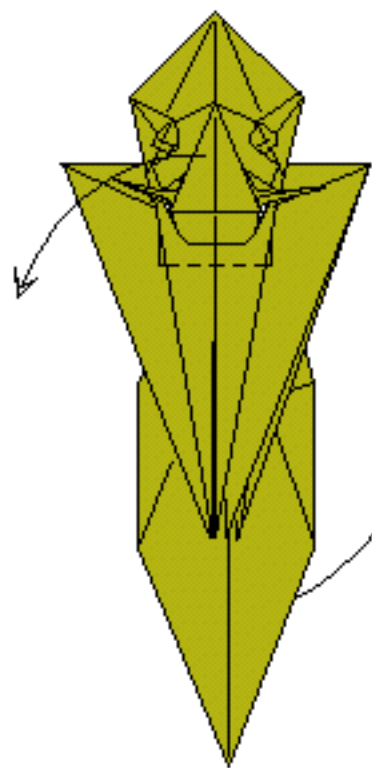

**64** Lift the flap at the back and fold the head to the front. Next view from the right side.

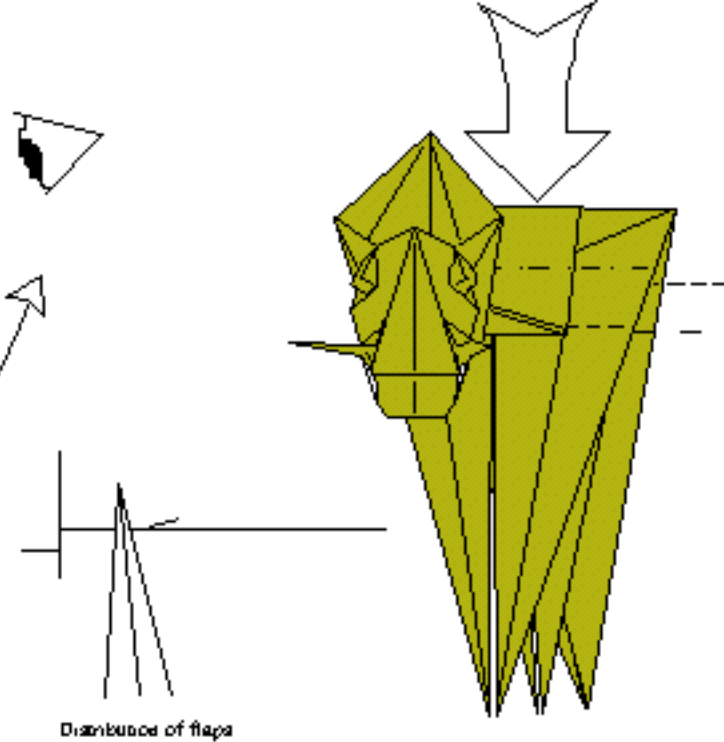

**65** The back-body is not shown. Squash the thick edge flat.

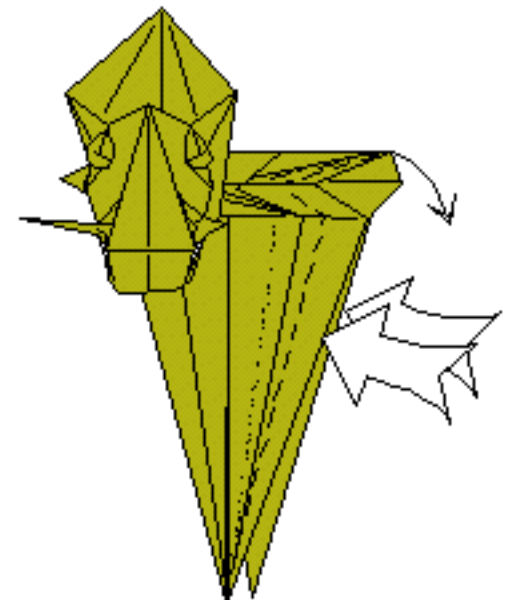

**66** Collapsing on the creases made in step 21, put the two edges inside the nearest pockets. The resulting point will point slightly downward. Repeat behind.

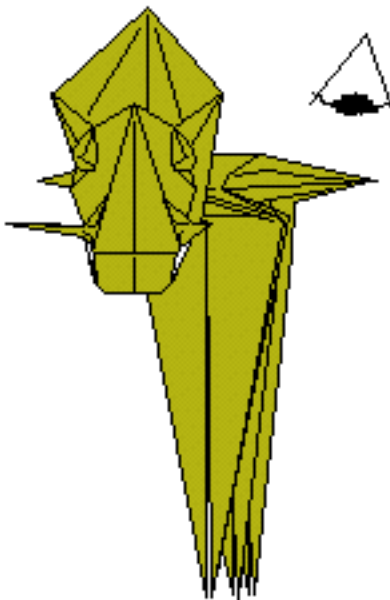

**67** Like this. Next view from top of back-body.

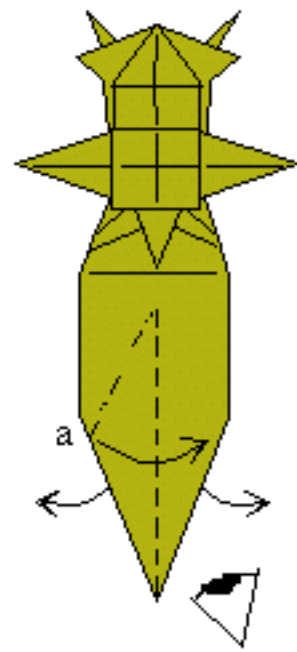

**68** Open up the edges below and fold corner **a** over to the right. The body becomes 3-dimensional.

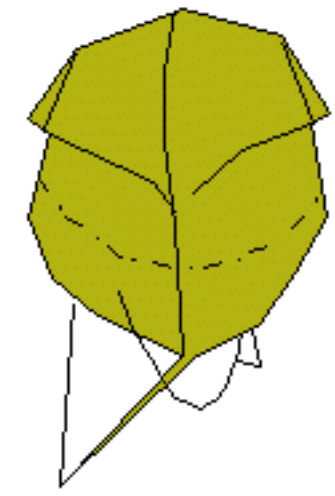

**69** View from behind. Fold the edge inside.

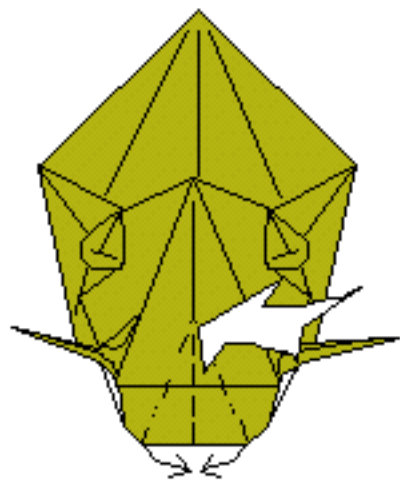

**70** Detail of head. Push in where indicated. Press the jaws together and fold the resulting edge to the left at the back-side. Next view from behind the jaws.



**71** Squash-fold.

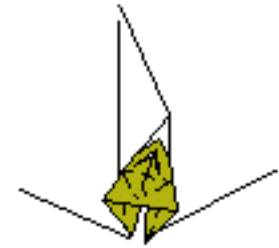

**72** Petal-fold.

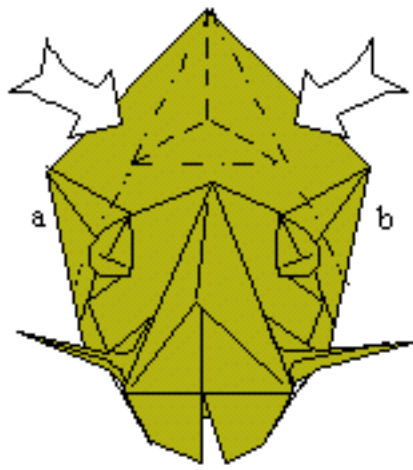

**73** Collapse to make a point partly on existing creases. Edge **a** and **b** will point straight backward.

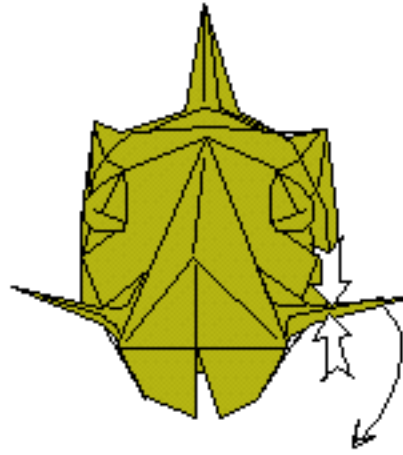

**74** The head is now 3-D. Pinch and form the antennae.

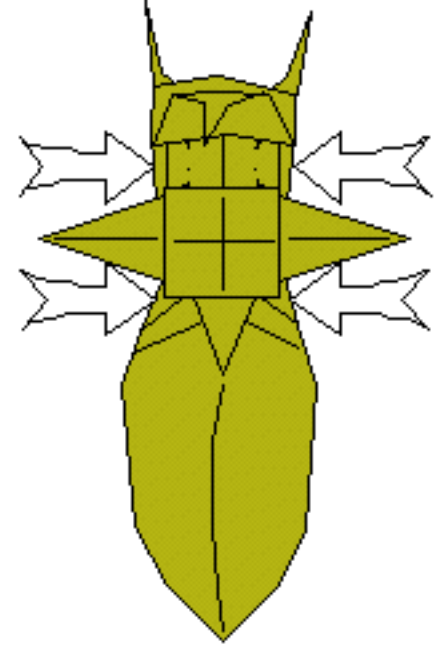

**75** Pinch between the head and mid-body, and between the mid-body and back-body.

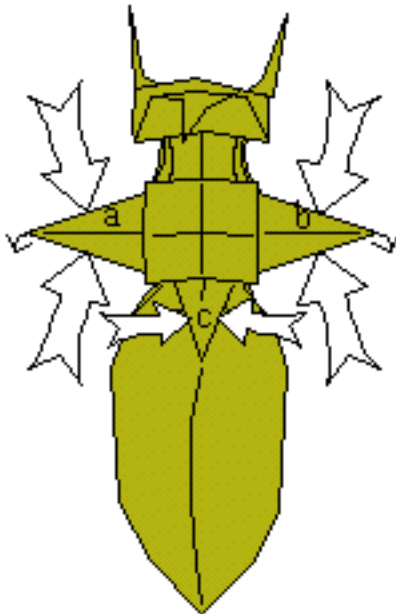

**76** Pinch points a, b and c. Point c should be slightly raised.

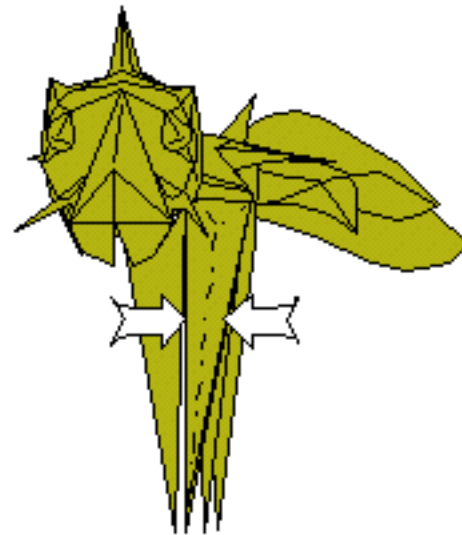

**77** Pinch the two front pairs of legs with mountain folds, and the third pair with valley folds. Then curve and form the legs to make feet etc.

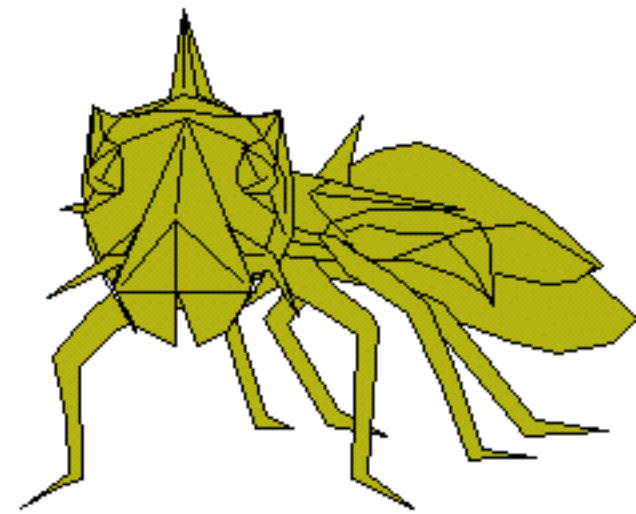

**78** The finished Spined Ant.

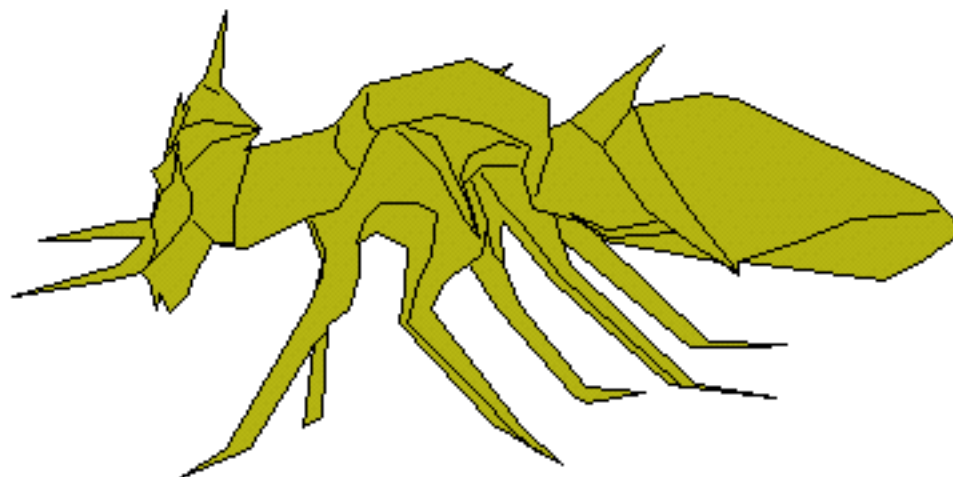

Side view.

# APATOSAURUS

by Hans Birkeland (Norway) ©1993

Design: 03.10.93

Diagrams: 07.11.93

Begin with the white side up.

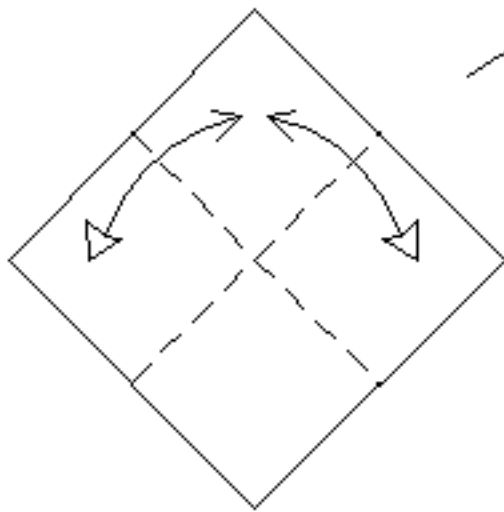

**1.** Fold and unfold.  
Turn the paper over.

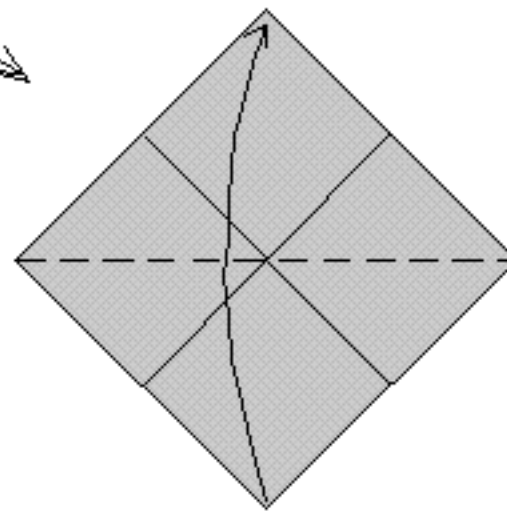

**2.** Valley-fold in half.

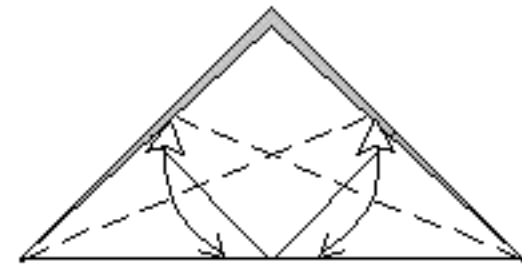

**3.** Crease the angle bisectors. Repeat behind.

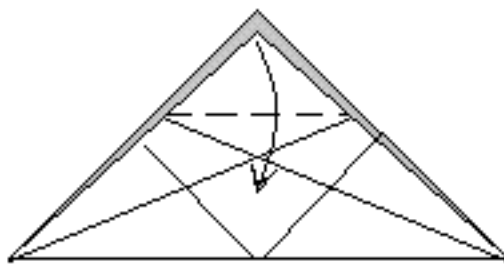

**4.** Valley-fold the corner down.  
Repeat behind.

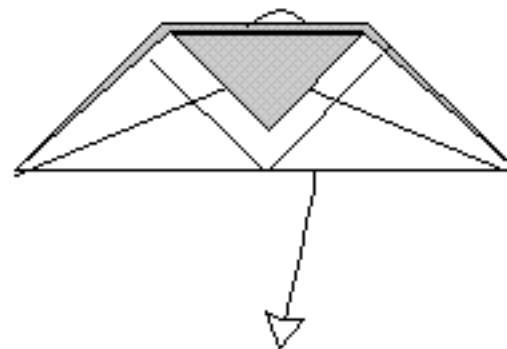

**5.** Unfold.

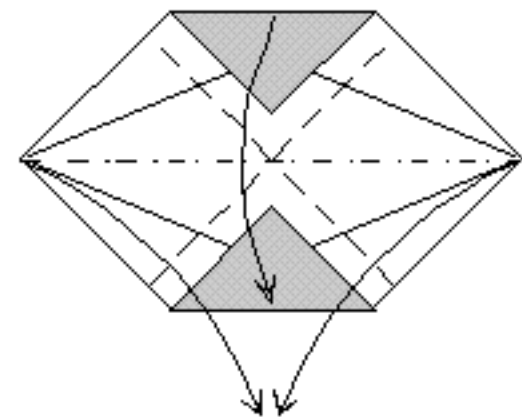

**6.** Collapse on existing creases.

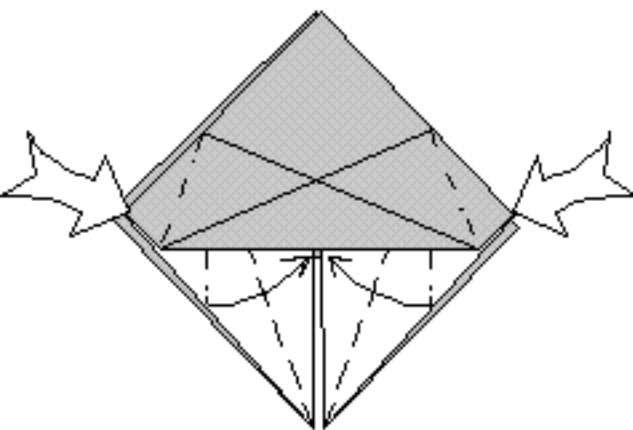

**7.** Swivel-fold the sides.  
Repeat behind.

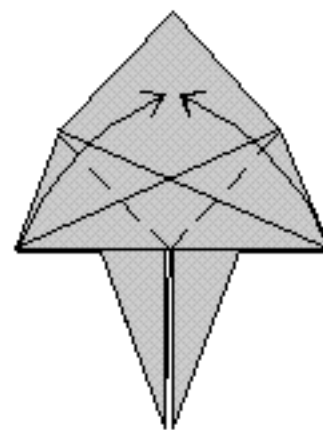

**8.** Valley-fold the flaps upward as far as they will go. Repeat behind.

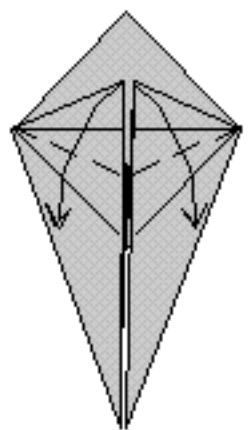

**9.** Valley-fold the flaps down along the angle bisectors. Repeat behind.

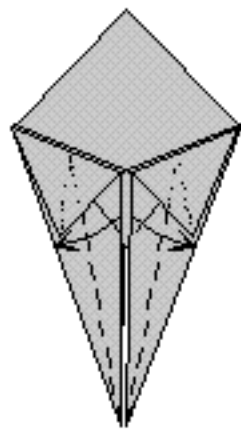

**10.** Reverse-fold the raw edges so that they are parallel to the outer edges. Repeat behind.

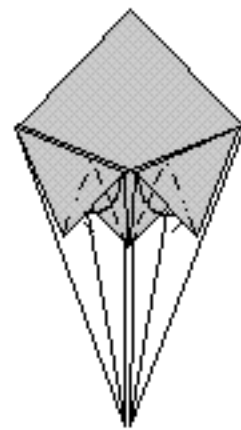

**11.** Swivel-fold. The mountain fold is on an existing crease. Repeat behind.

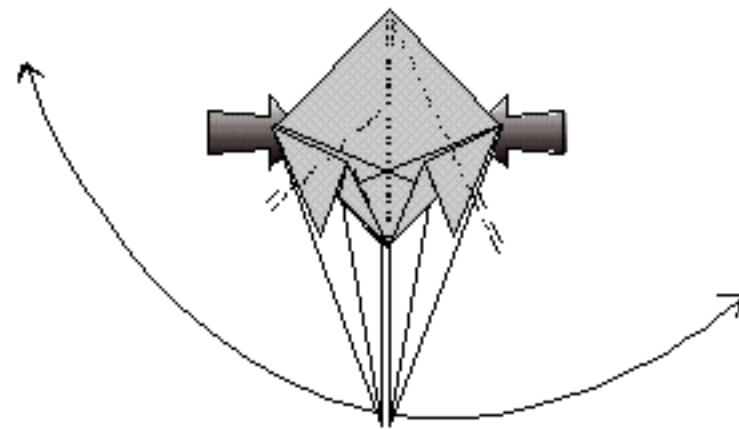

**12.** Reverse-fold the neck and tail. The upper edge of the tail should reach slightly beyond the back.

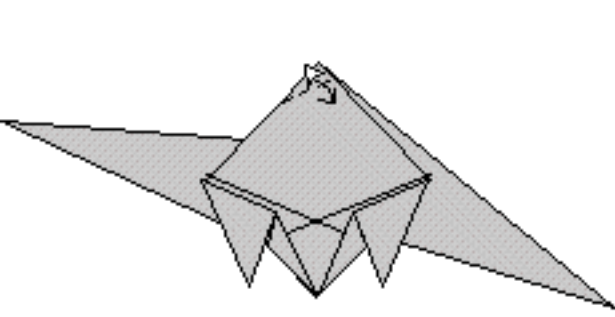

**13.** Fold and unfold.

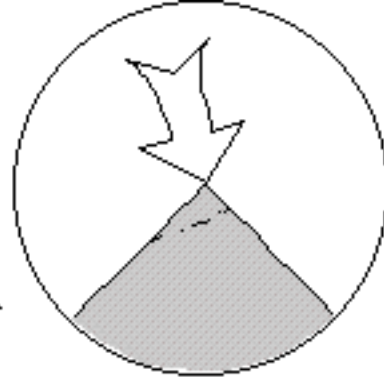

**14.** Closed-sink.

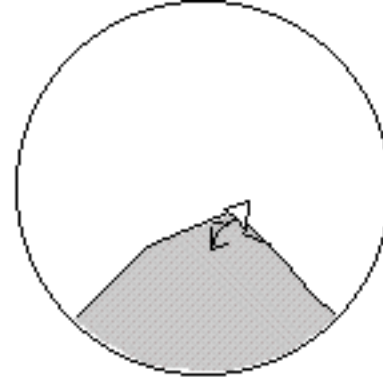

**15.** Fold and unfold.

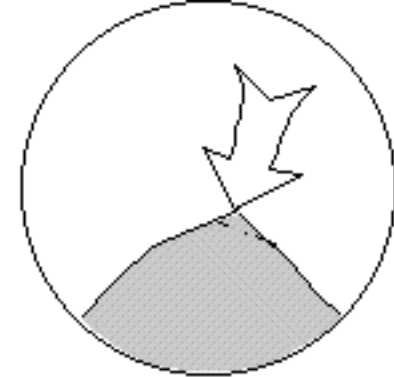

**16.** Closed-sink.

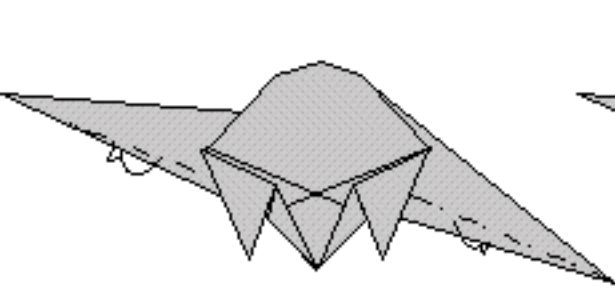

**17.** Mountain-fold the edges inside. Repeat behind.

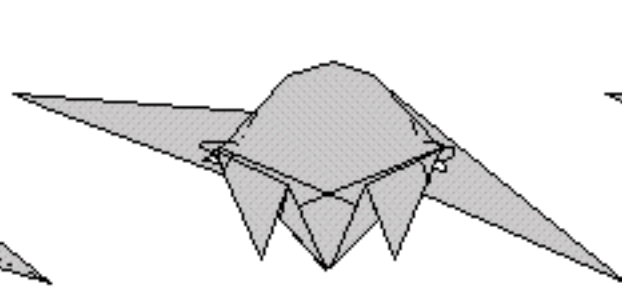

**18.** Mountain-fold the edges inside. Repeat behind.

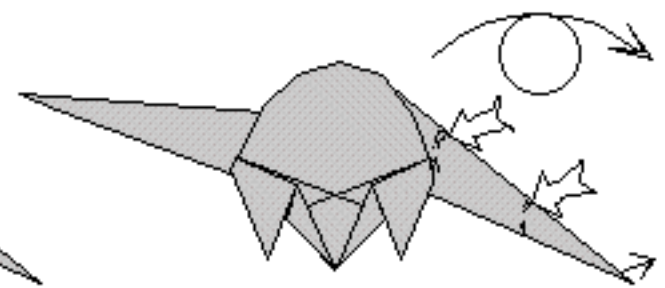

**19.** Make two 3-dimensional crimps, rounding the tail. Turn the model over.

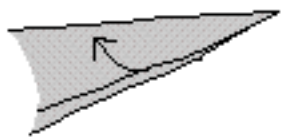

**20.** Enlarged view of the head. Open out the nearest edge.

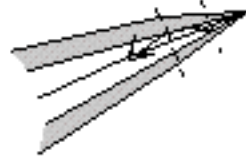

**21.** Crimp.

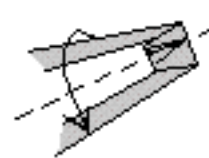

**22.** Close again.

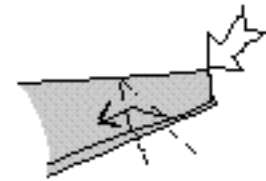

**23.** Crimp symmetrically.

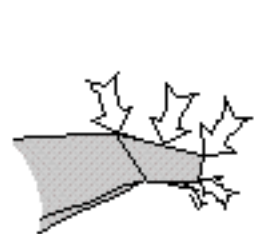

**24.** Pull out the lower jaw and round the head.

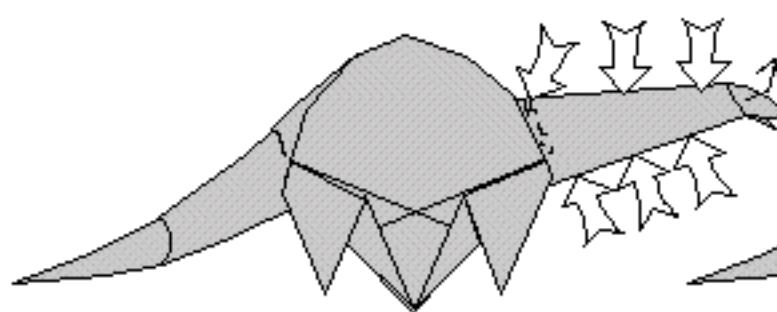

**25.** Make a 3-dimensional crimp at the base of the neck, rounding the neck.

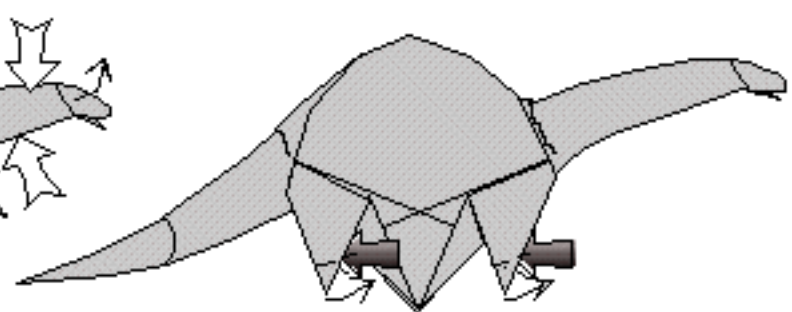

**26.** Crimp the feet symmetrically. Repeat behind.

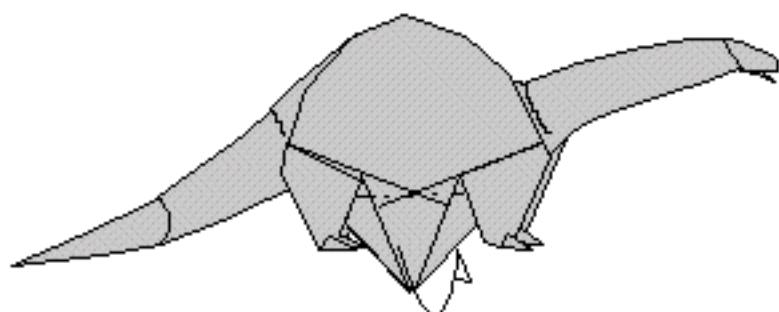

**27.** Mountain-fold the flaps of the belly inside. The body will now be 3-dimensional. Make the body a bit rounder to finish the model.

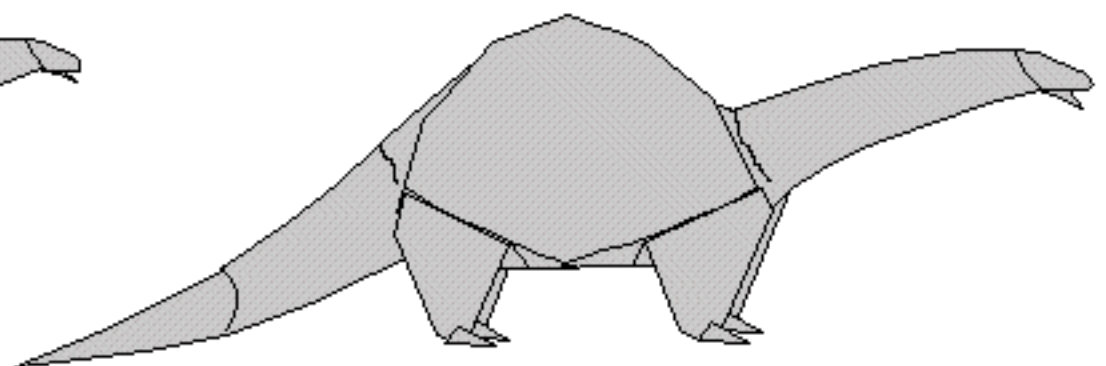

**28.** APATOSAURUS

---

# Bebé Parasauropus

---

Fernando Gilgado Gómez

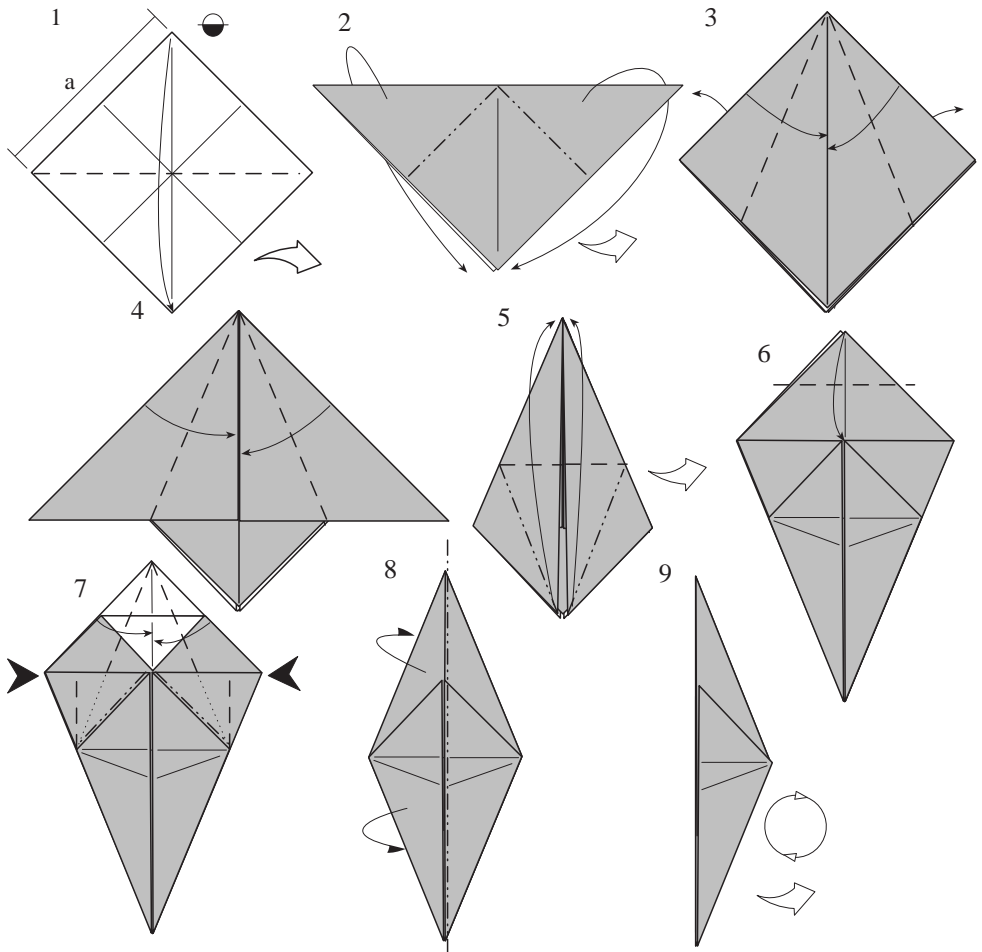
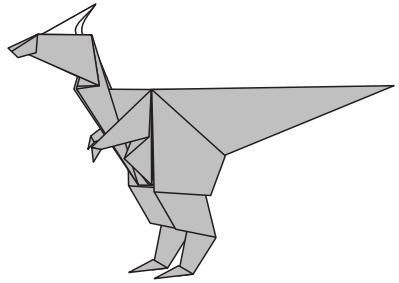



---

10

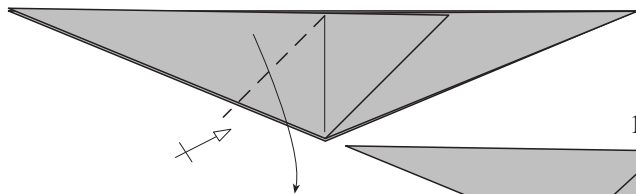

11

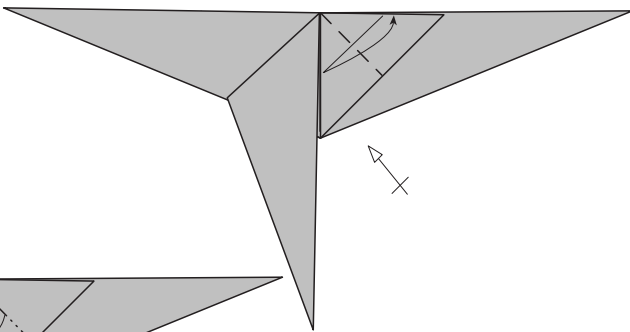

12

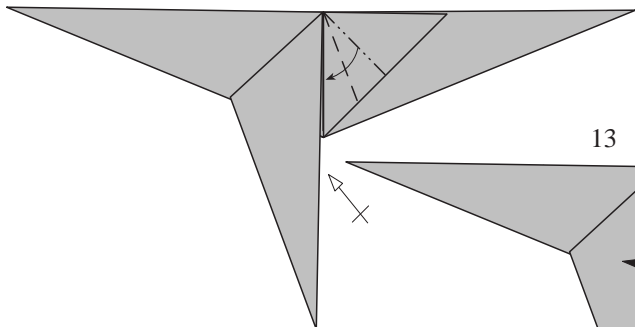

13

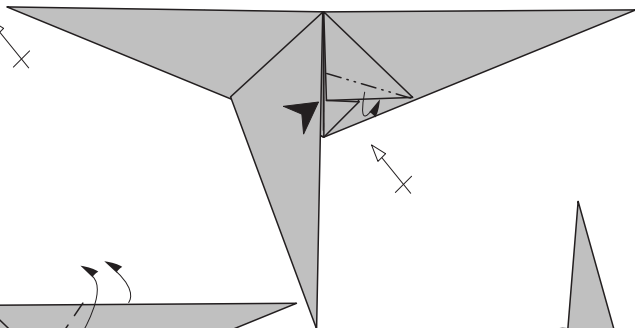

14

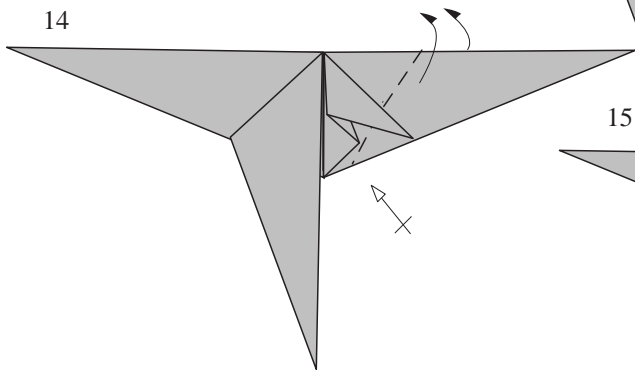

15

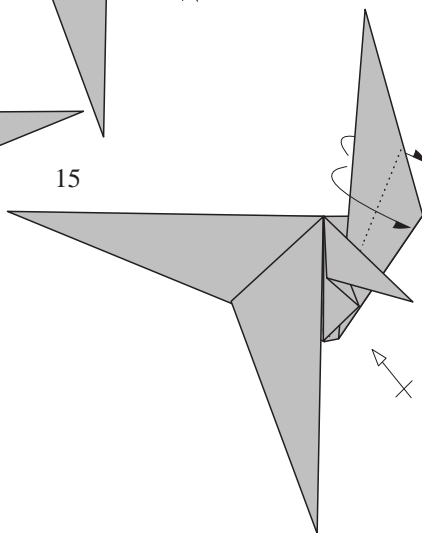

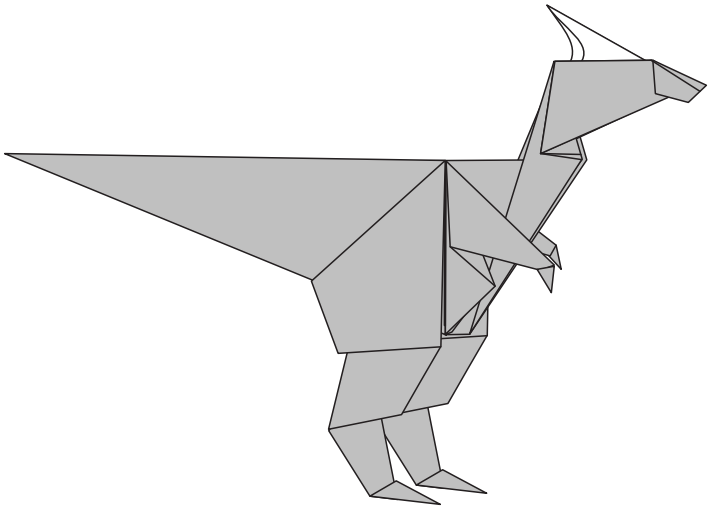
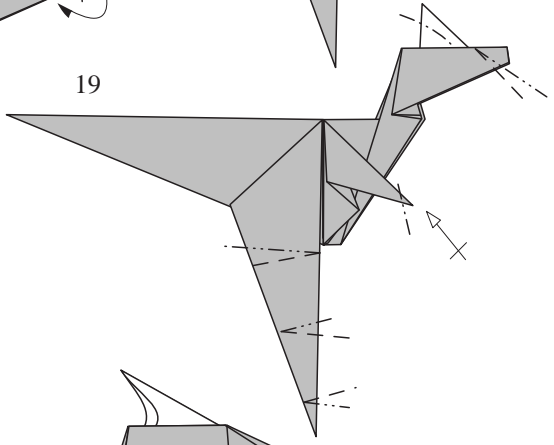
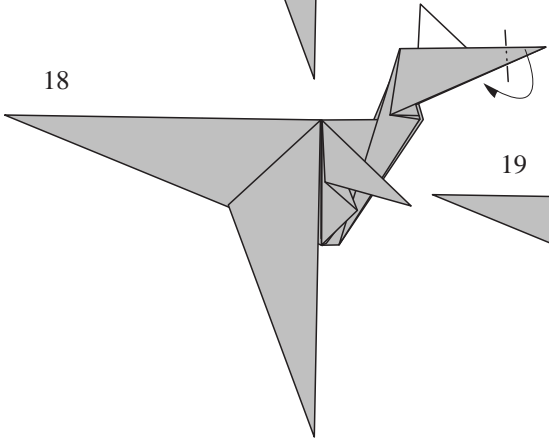
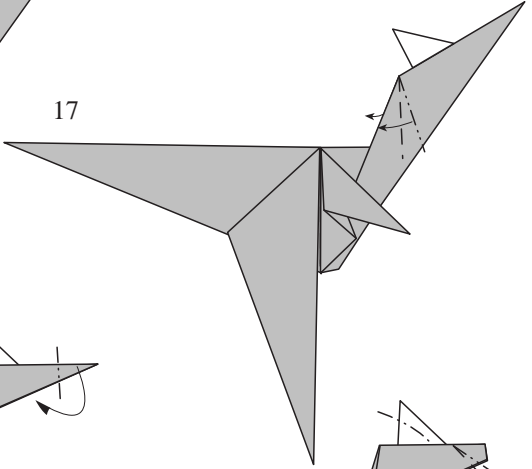
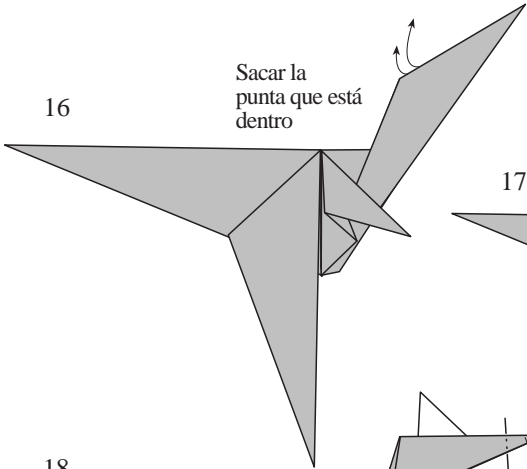

# Three-Banded Armadillo ©1993 by Joseph Wu

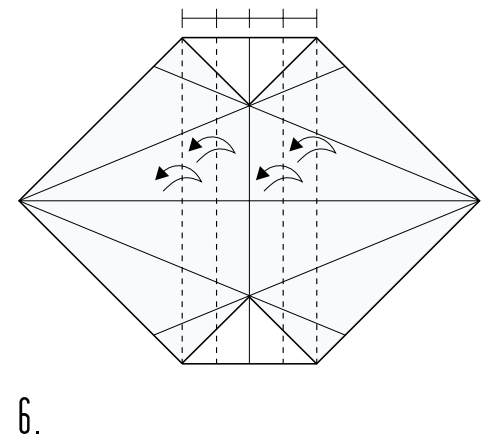
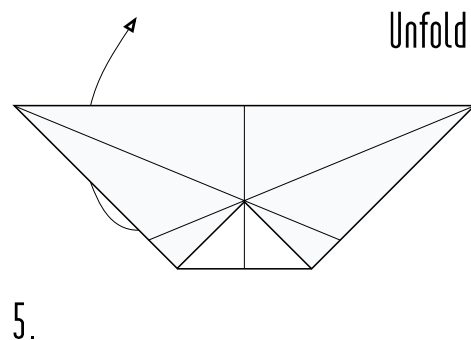
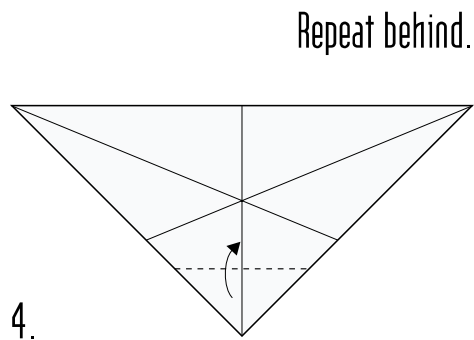
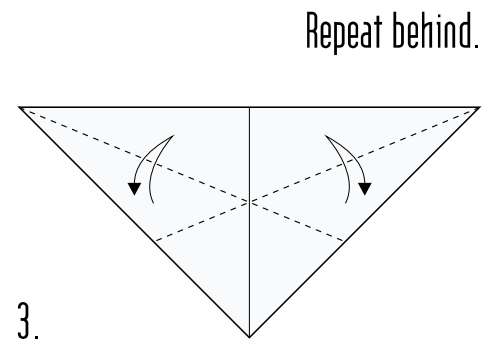
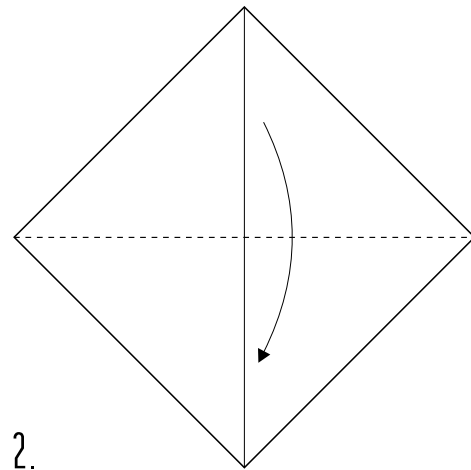
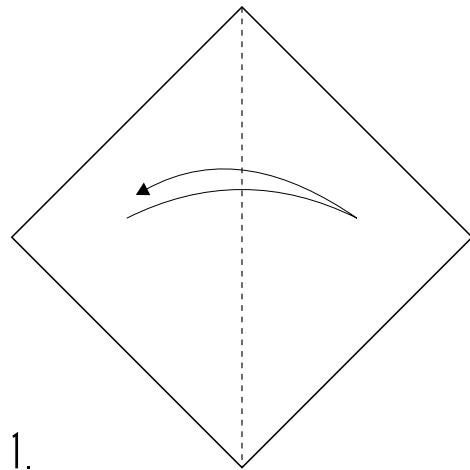

# Three-Banded Armadillo ©1993 by Joseph Wu

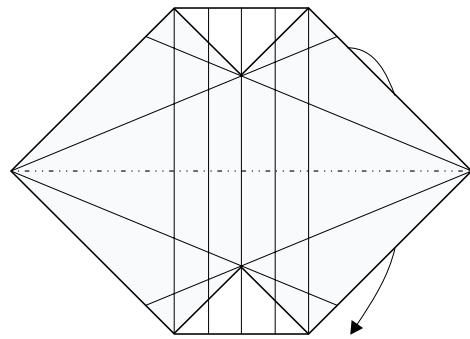

7.

Inside reverse folds.

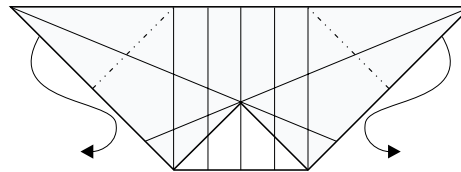

8.

Unfold.

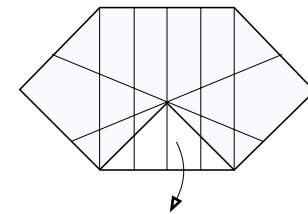

9.

Squash fold. The valley fold is on an existing crease.

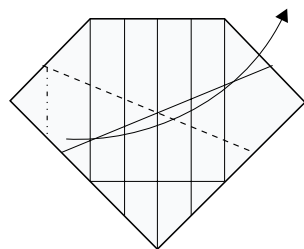

10.

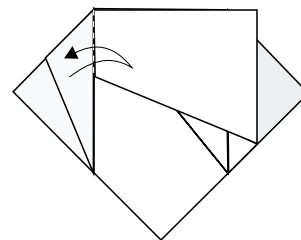

11.

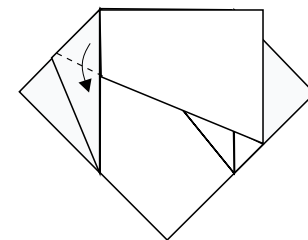

12.

Repeat steps 10-12 three times:  
on the right and on the back.

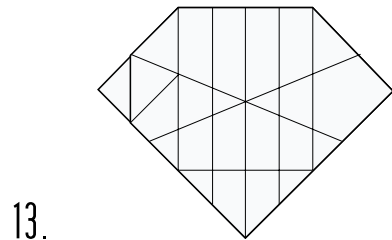

Repeat behind.

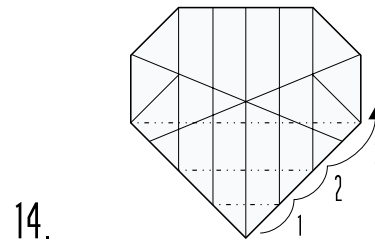

Repeat behind.

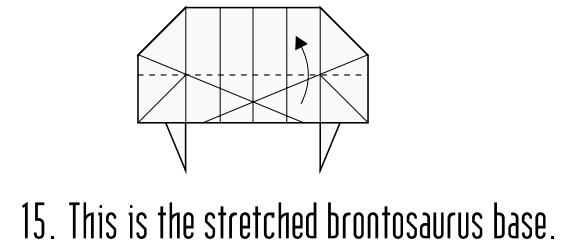

Repeat behind.

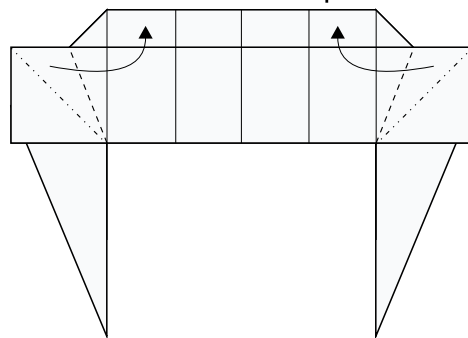

Repeat behind.

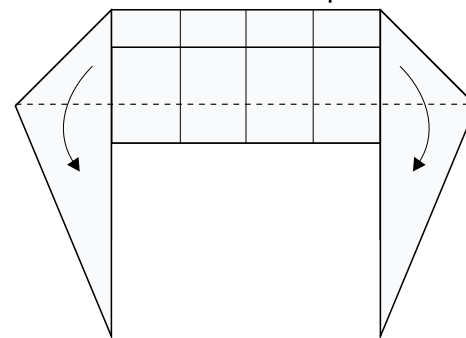

Unfold. Repeat behind.

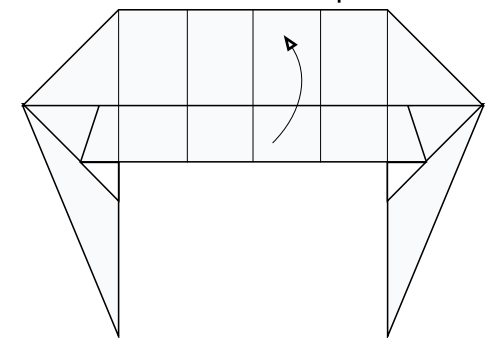

# Three-Banded Armadillo ©1993 by Joseph Wu

Fold middle inside and up.  
Repeat behind.

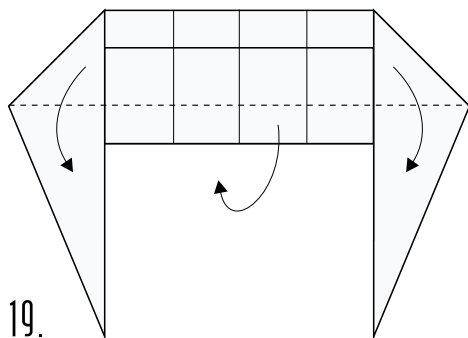

Fold and unfold on both lines.

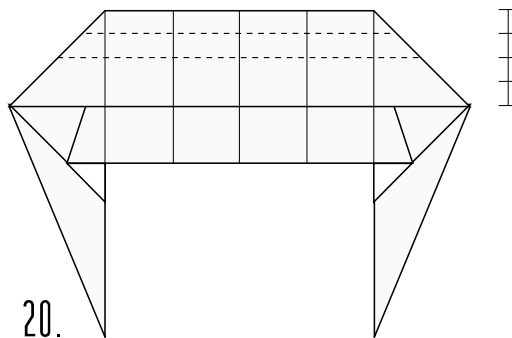

Sink down and up.

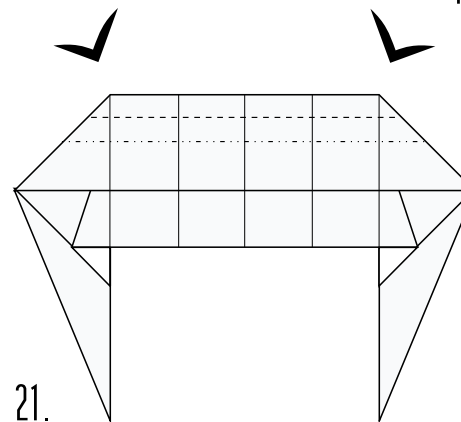

Repeat behind.

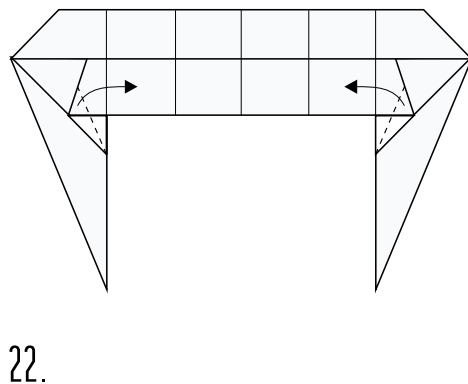

Repeat behind.

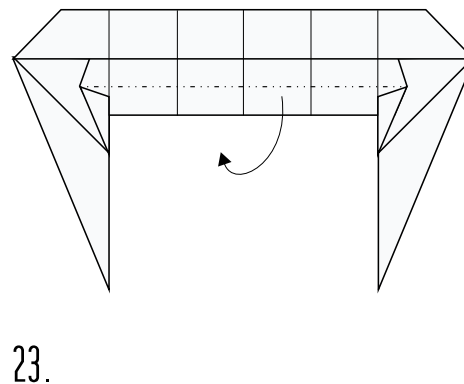

Repeat behind.

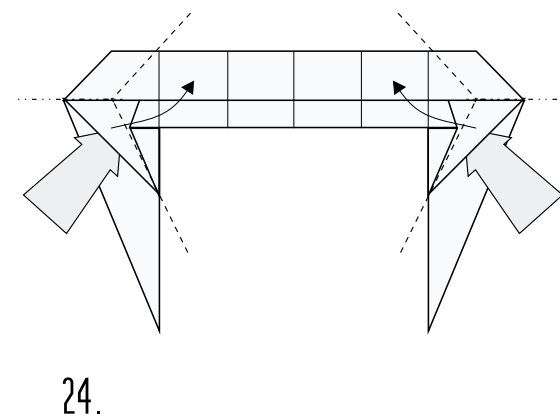

# Three-Banded Armadillo ©1993 by Joseph Wu

Repeat behind.

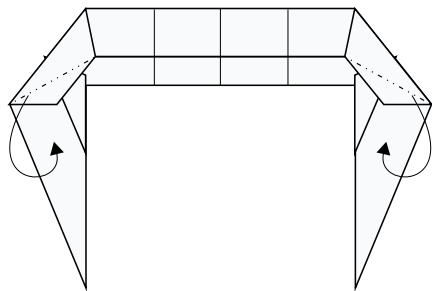

25.

Repeat behind.

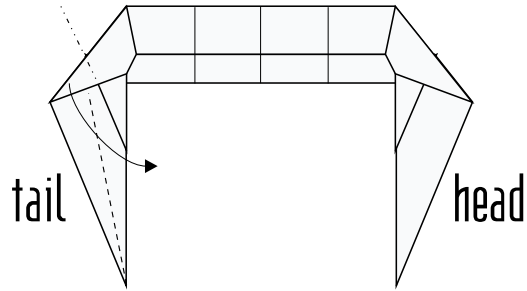

26.

Inside reverse folds.

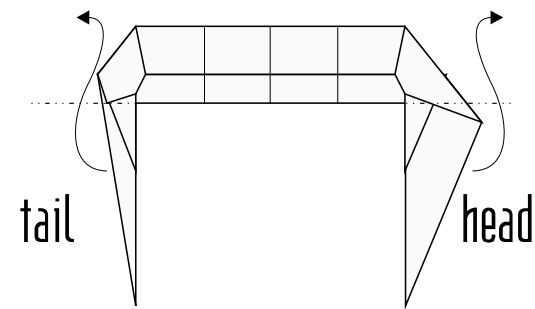

27.

1. Inside reverse fold.  
2. Outside reverse fold.

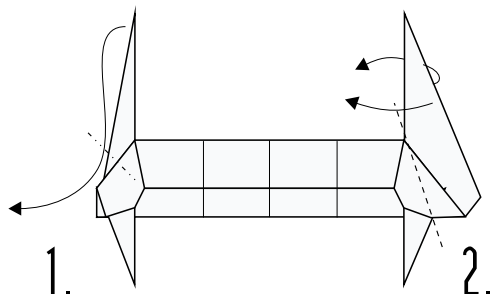

28.

1. Fold both sides down.  
2. Outside reverse fold.

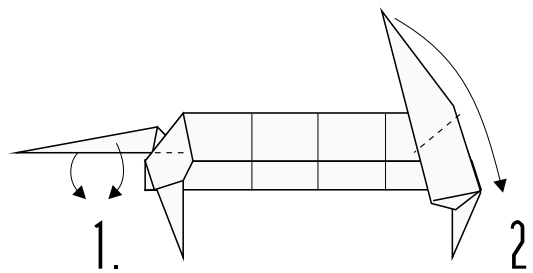

29.

Crimp folds.

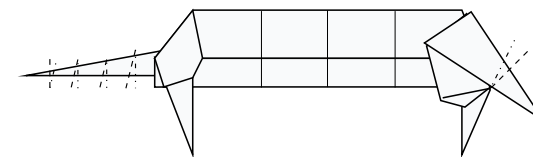

30.

# Three-Banded Armadillo ©1993 by Joseph Wu

1. Reverse fold.  
2. Swivel fold. Repeat behind.

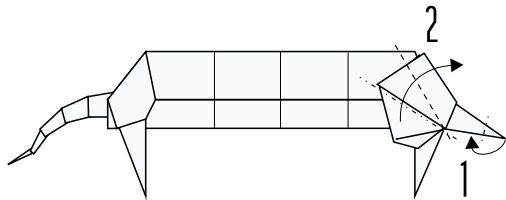

31.

Inside reverse folds.  
Repeat behind.

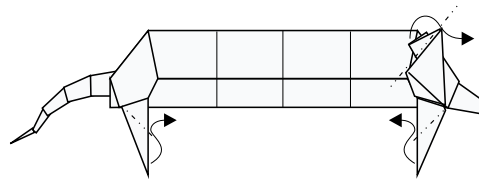

32.

Inside reverse fold front legs. Bend ears down slightly. Repeat behind.

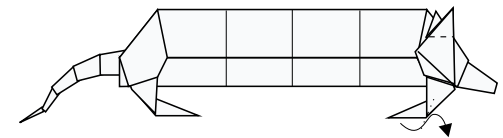

33.

This is the result of the folding so far. The final steps are involved with making the model three-dimensional.

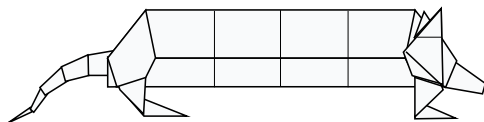

34.

Spread the bottom of the model so that the extra layers of paper made in step 21 are exposed.

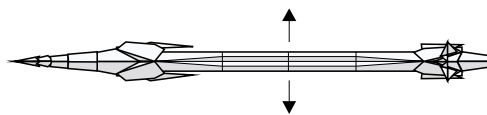

35. Top view.

Pleat the resulting dome shape. Note that the middle crease is crooked at the ends.

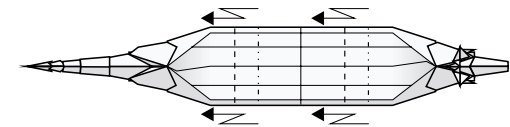

36. Top view.



# Three-Banded Armadillo ©1993 by Joseph Wu

This is the result of the pleating.

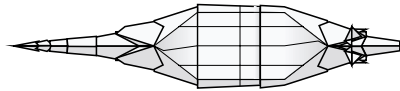

37. Top view.

Lock the pleats into place  
(hidden layer inside).  
Repeat behind.

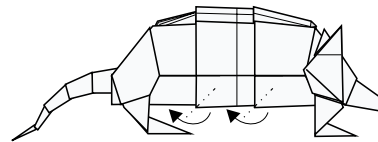

38. Side view.

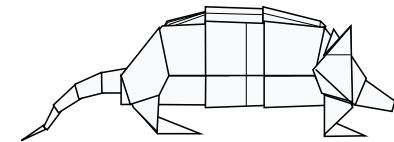

39. The completed armadillo.

## Notes:

1. The head does not look very "animal-like" when compared to the heads of other origami animals, but I have tried to recreate as accurately as possible the distinctive shape of the armadillo's head.
2. This model is the result of a challenge made to me by a friend (a non-folder) in November 1992. The breakthrough in the creation of this model occurred in April 1993 when I decided to modify Montroll's "brontosaurus base" as a starting point. The model was completed in May 1993.

# Badger

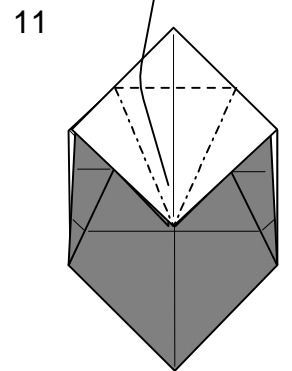
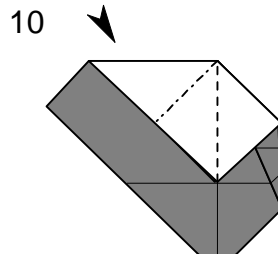
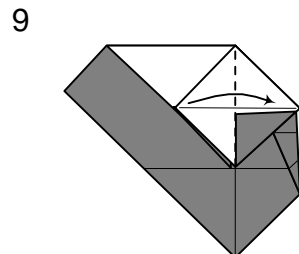
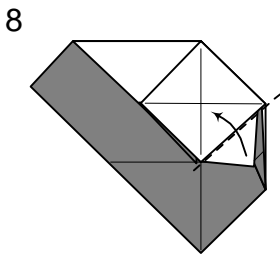
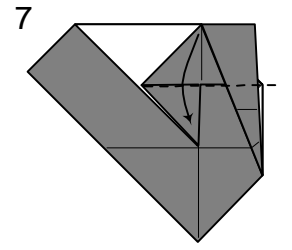
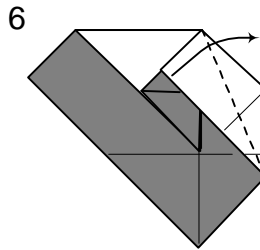
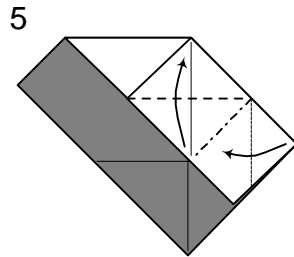
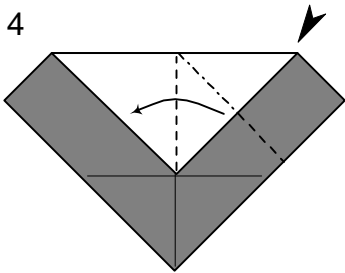
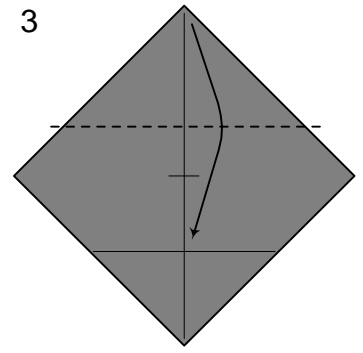
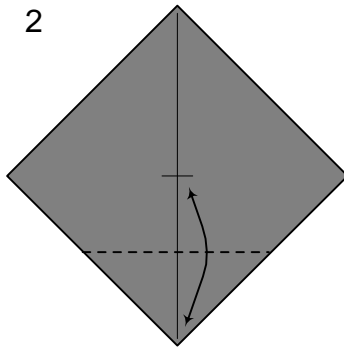
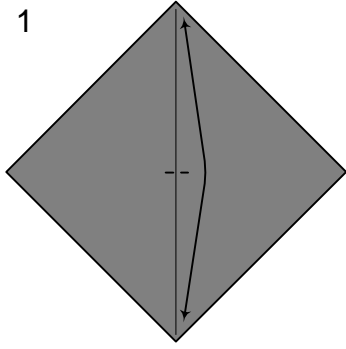

Repeat steps 4 to 9 on the left side

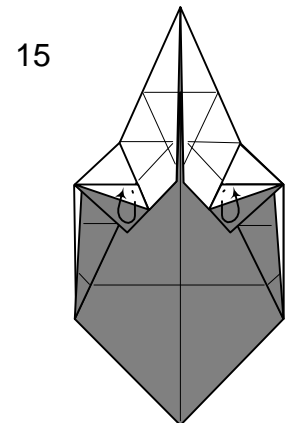
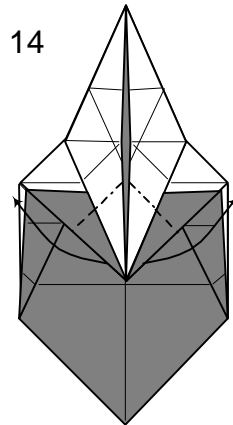
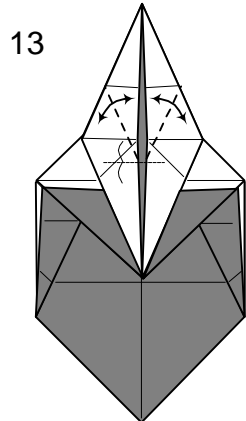
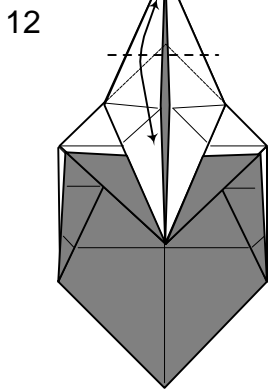

Crease tip down just a little below the point behind

Crease a single layer down to half way between the two horizontal creases

Inside reverse folds

Wrap one layer to the front (colour change)

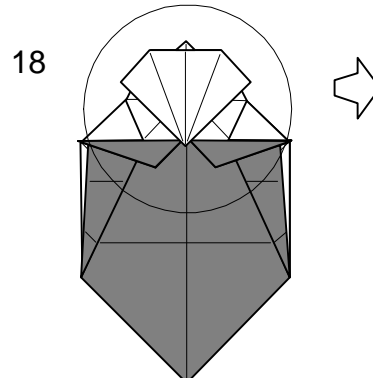
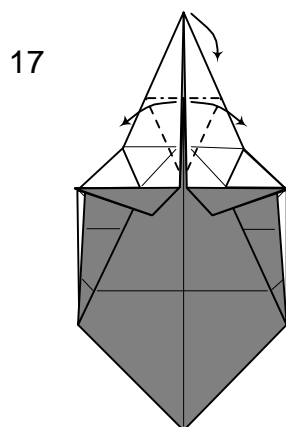
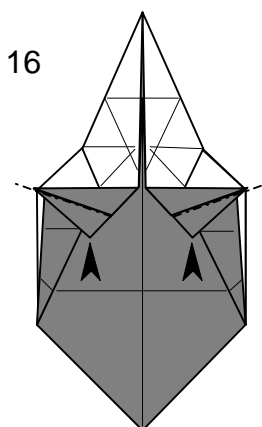

# Badger

19

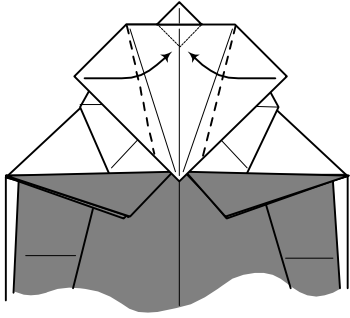

Fold sides towards the base of the 'imaginary' square

20

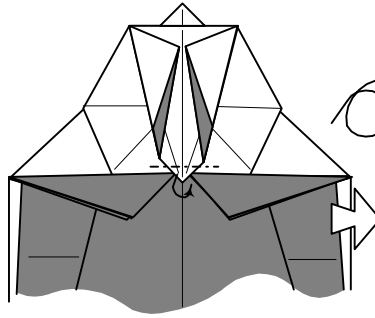

21

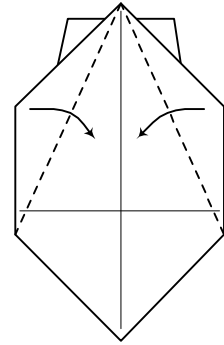

22

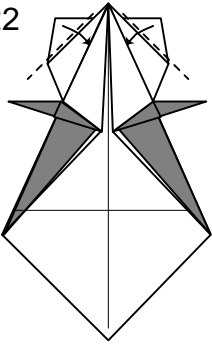

23

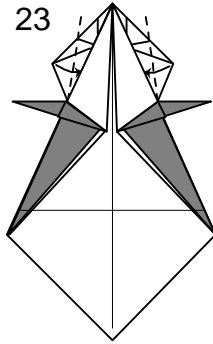

24

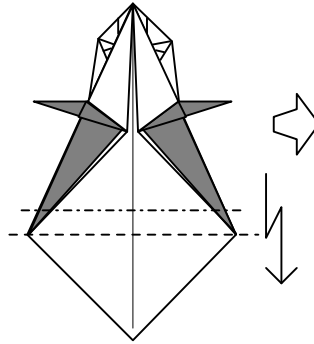

25

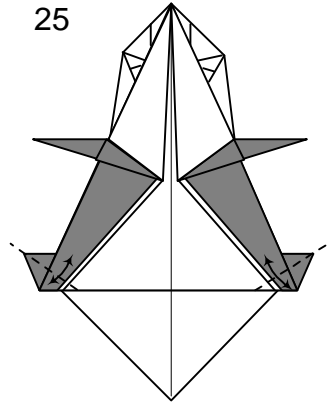

26

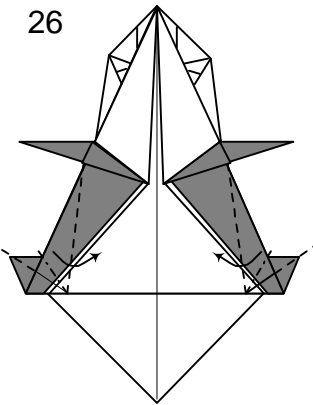

27

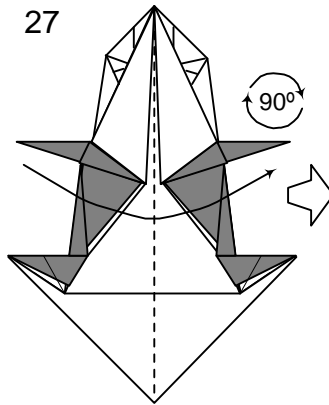

28

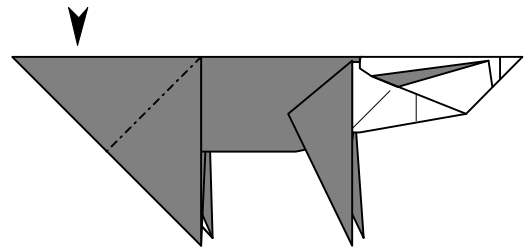

29

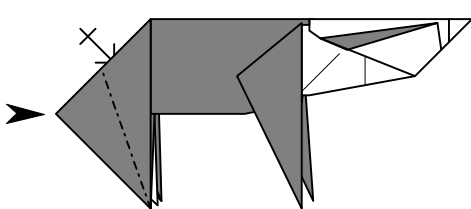

30

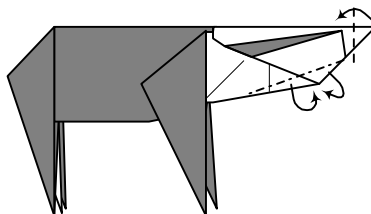

31

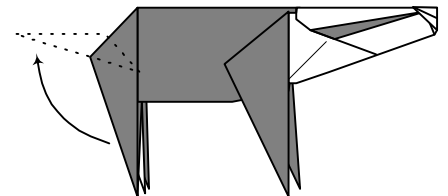

32

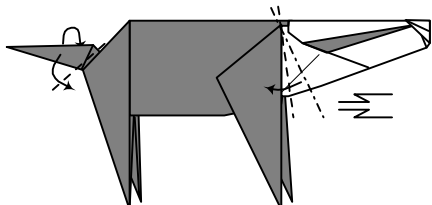

33

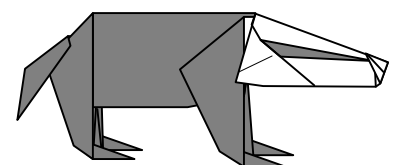
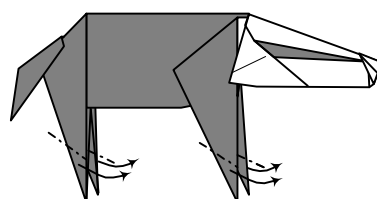

Make 4 inside reverse folds

# Ballerina

Maarten van Gelder

© 1998 Mar

The Ballerina is a variation on my Human figure. Use a light color for both sheets. Start both parts coloured side as shown to get a complete white figure. Created on the way to St. Petersburg. The daughter of Sergei Afonkin was on the ballet school and figured in the theatre.

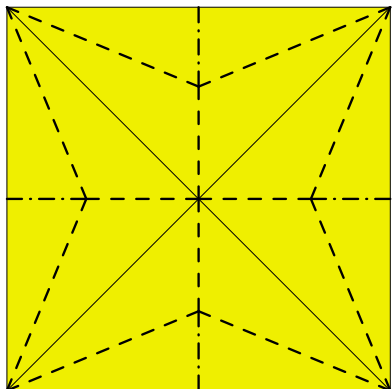

1 Top part of body

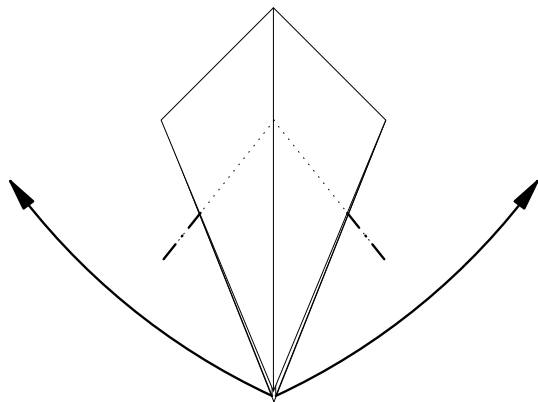

2

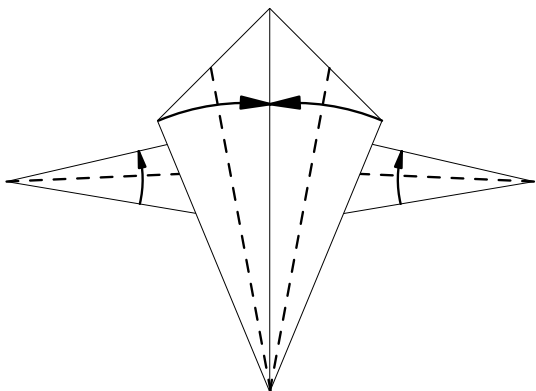

3

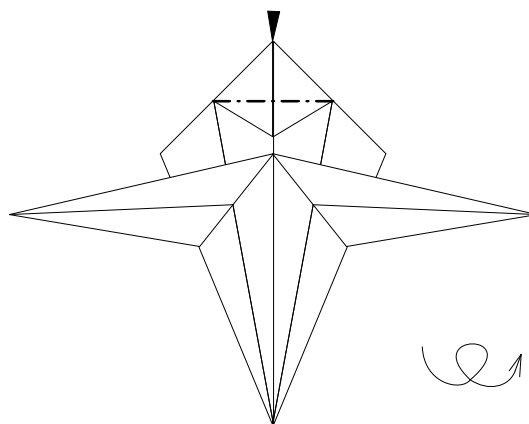

4

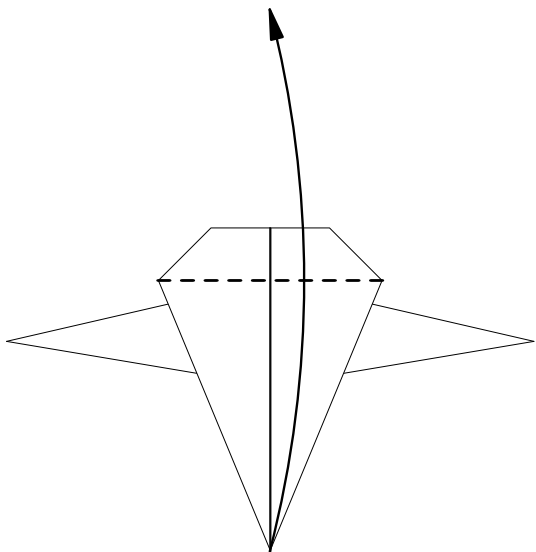

5

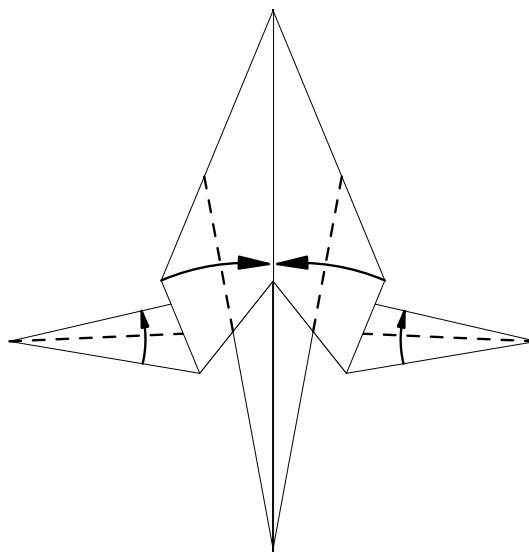

6

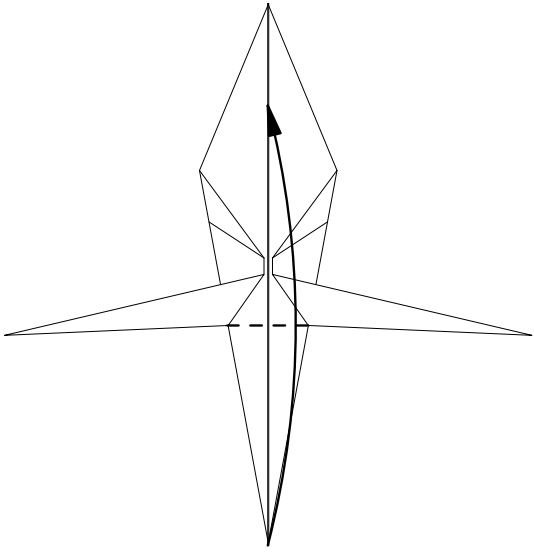

7

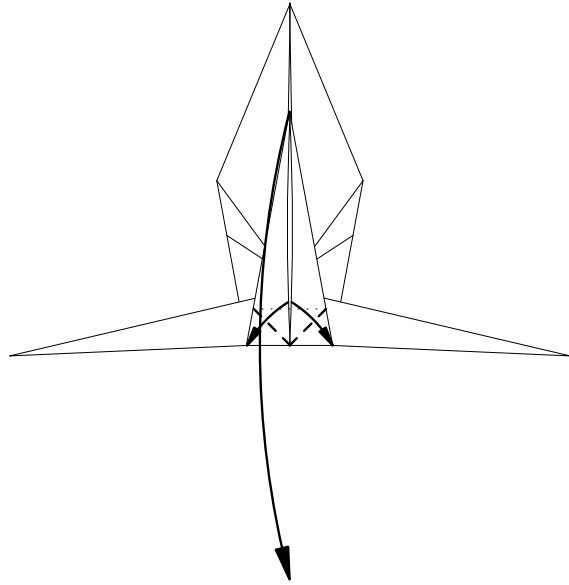

8

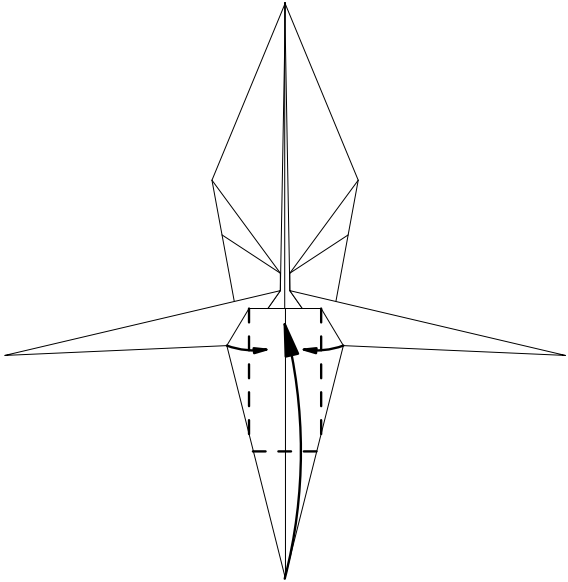

9

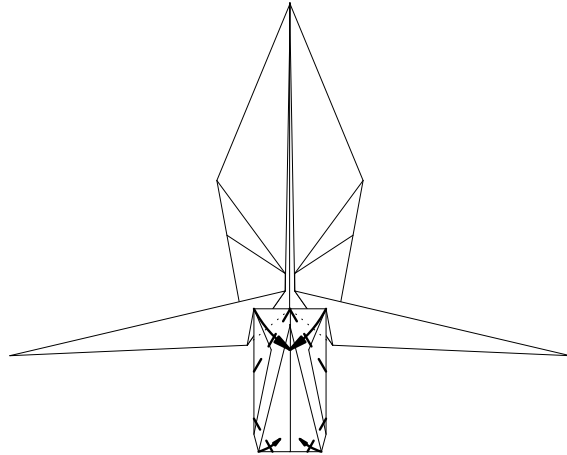

10

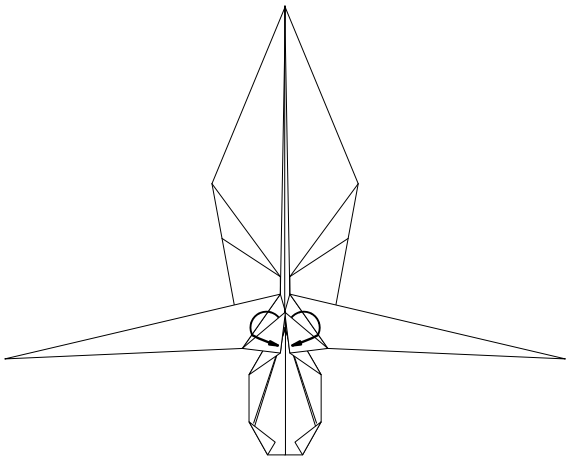

11 Pull hidden flap and fold over

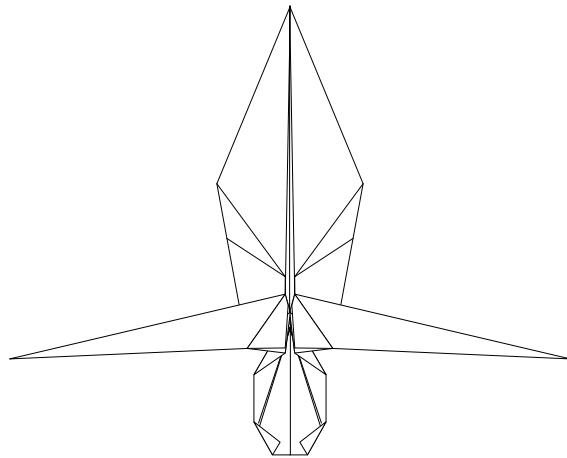

12 Top part of body finished

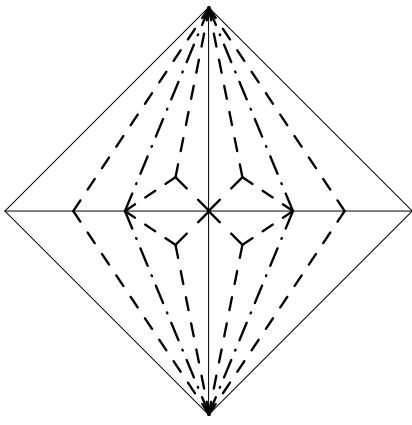

13 Bottom part of body;  
precrease

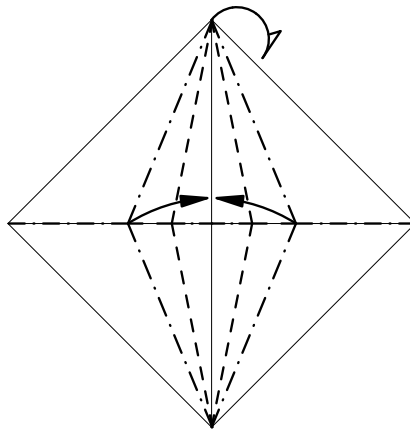

14

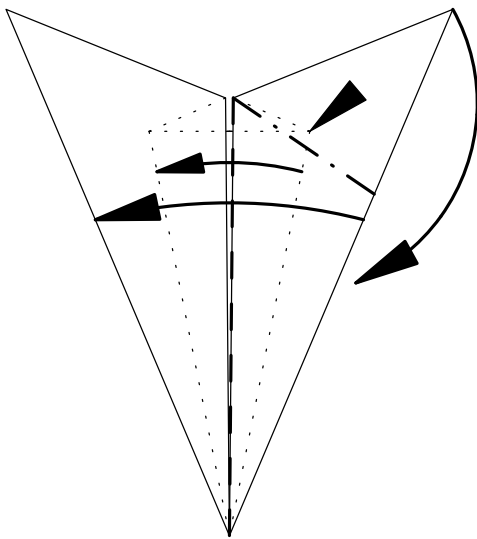

15

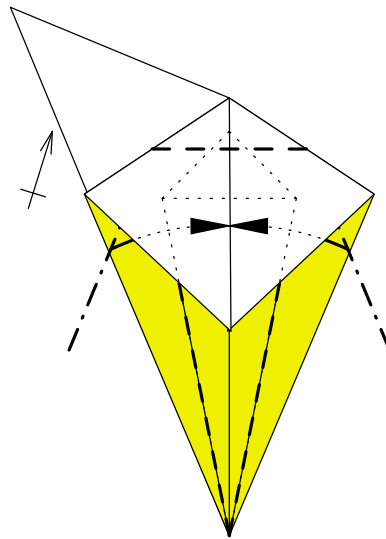

16

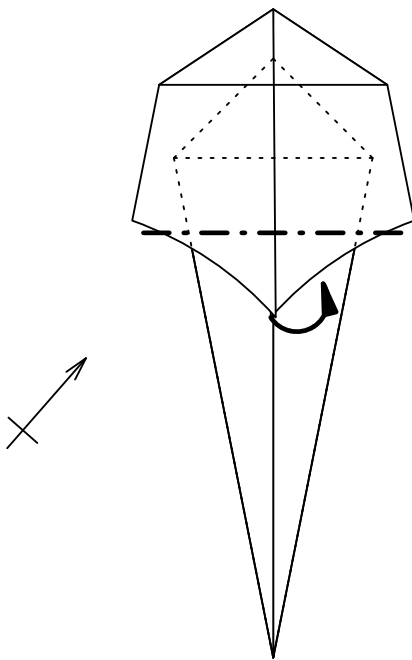

17 Tutu is now 3D

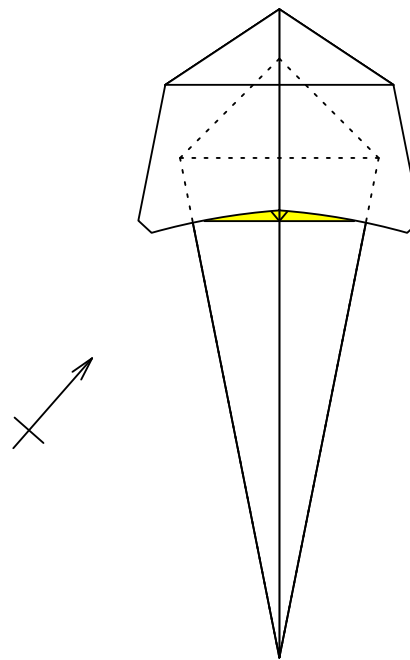

18 Bottom part finished

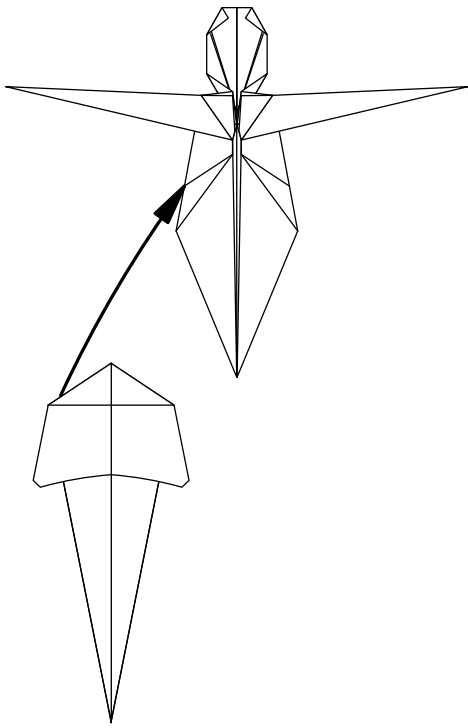

19 Insert bottom part in top part in sink of diagram 4

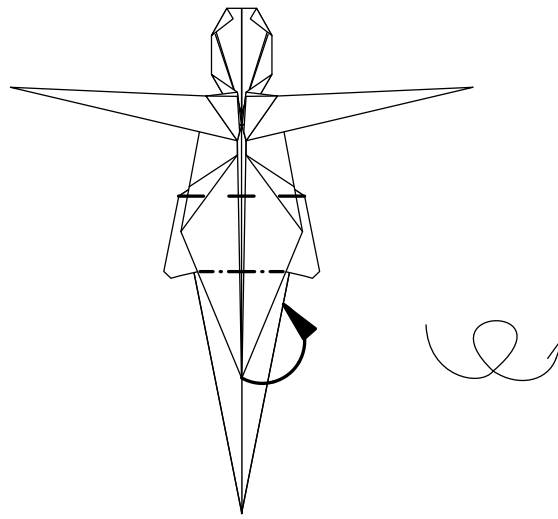

20 Lock parts by folding tip inside bottom part

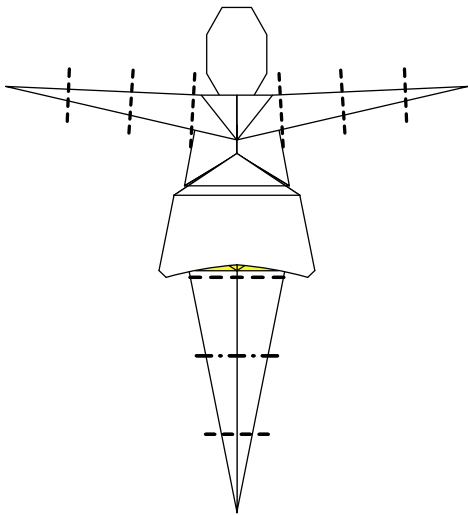

21 Form arms and legs

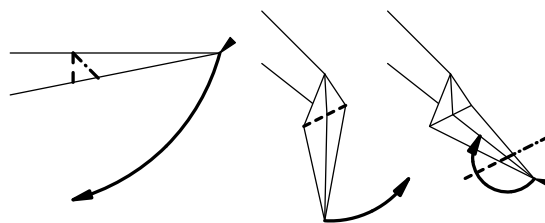

22 Form hands

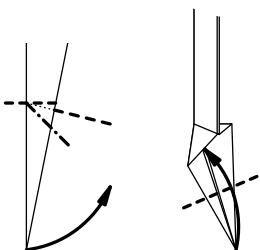

23 Form feet

# Dollar Bill Basket (Part 1 of 2)

Model Created and Diagrammed by A. Anselmo 12/93

anselmo@thermsa.eng.sunysb.edu

Found, I'm sure, by others...

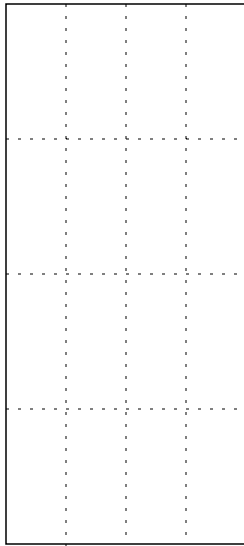

1) Fold the bill in fourths in both directions. This is mainly for marking purposes.

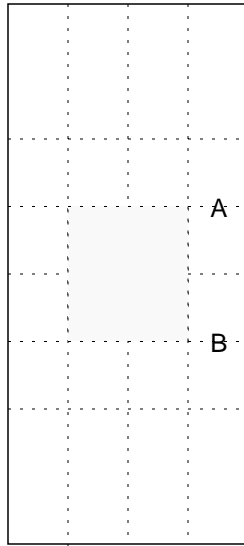

2) Now, make the valley folds at A and B. The shaded area is the bottom of the basket.

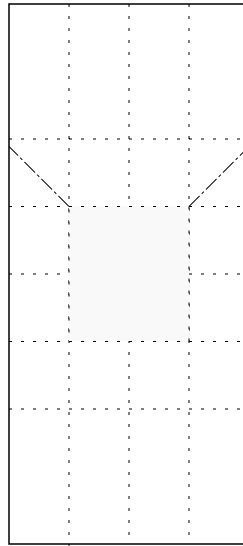

3) Make small mountain folds where indicated, at a 45 degree angle. Fold inwards, as the model becomes three-dimensional.

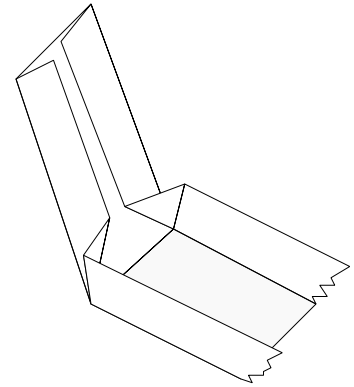

4) This is what you are aiming for.

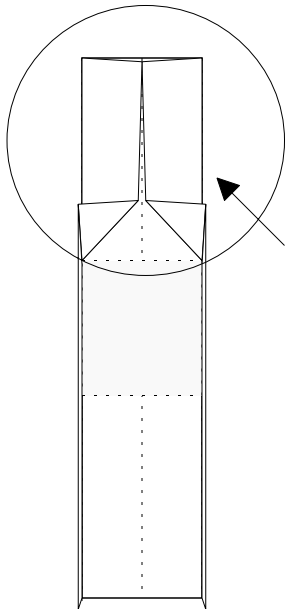

5) The zoomed in area will become the basket handle.

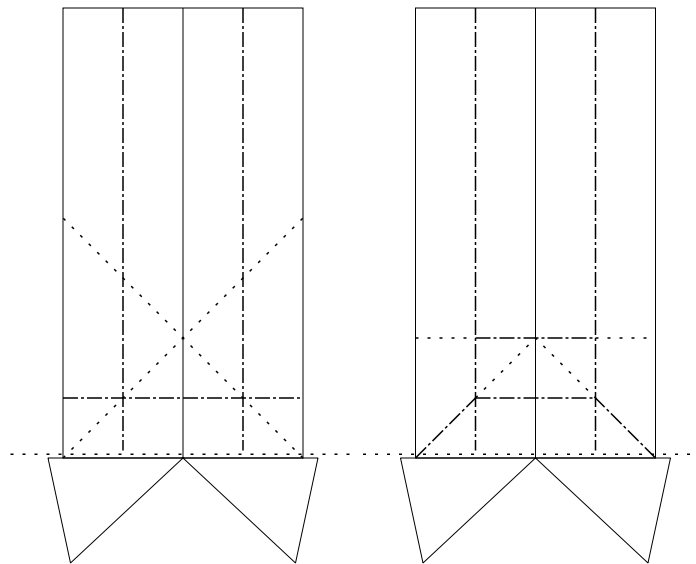

6) Valley fold the diagonals, and then the mountain folds. Where they cross, make another mountain fold.

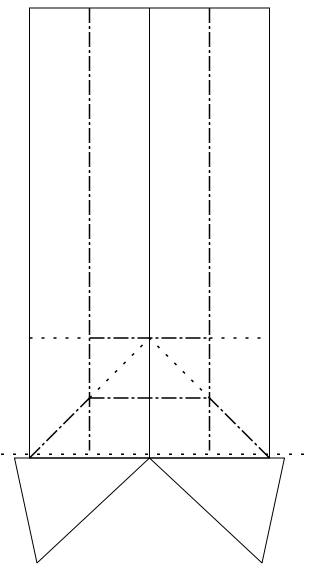

7) The fold lines for the next step are shown above. If you squeeze the top of the bill, you will see this fold develop.



## Dollar Bill Basket (Part 2 of 2)

Model Created and Diagrammed by A. Anselmo 12/93

anselmo@thermsa.eng.sunysb.edu

Found, I'm sure, by others...

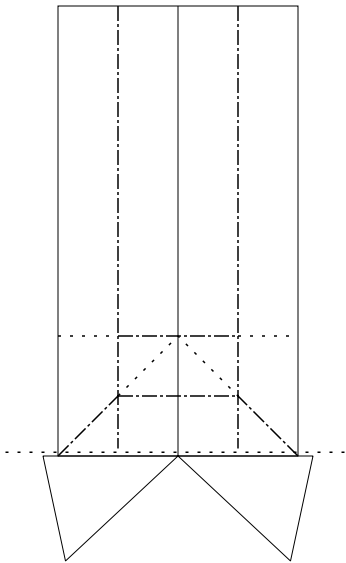

7) From before...

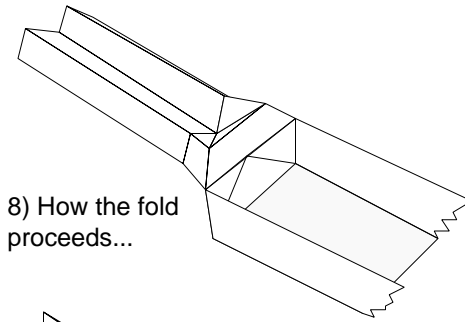

8) How the fold proceeds...

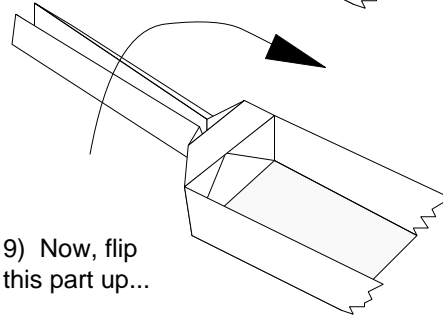

9) Now, flip this part up...

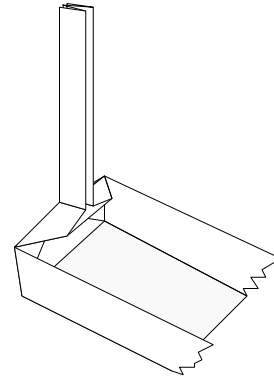

10) So it looks like this. Now, repeat steps 3)-9) on the other side.

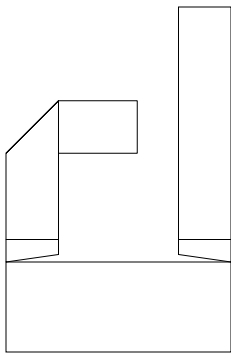

11) Inside fold the two handles, and interlock them by sliding the handles together. Here, one side is shown folded.

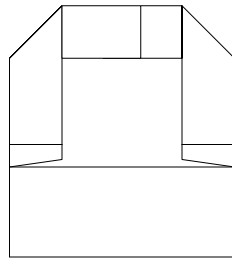

12) The finished model. If the handles don't overlap enough, you should make the bottom of the box smaller, which means folds A and B in step 2) should be closer together.

# Bee

by Marc Kirschenbaum

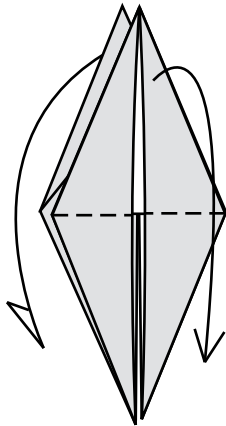

1. Begin with a bird base, colored side out. Fold the top flaps down.

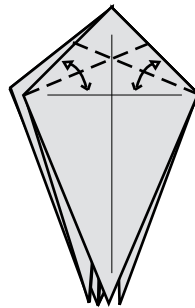

2. Precrease the top.

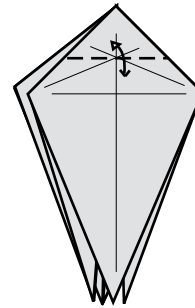

3. Precrease through the intersection of creases.

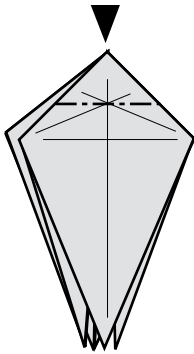

4. Sink the top.

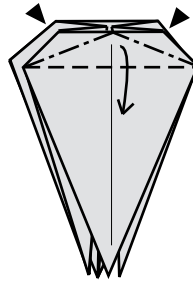

5. Spread squash.

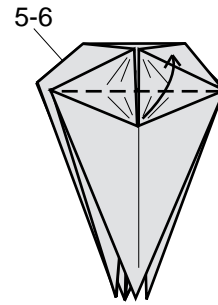

6. Flatten. Repeat steps 5-6 behind.

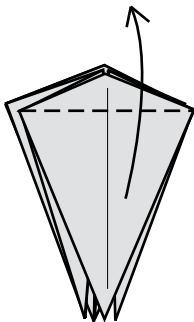

7. Swing the front flap up.

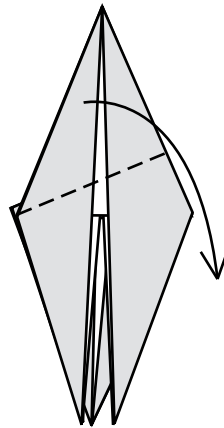

8. Valley down.

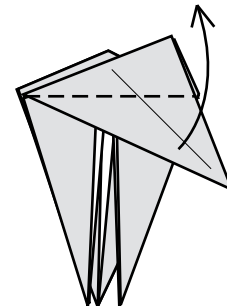

9. Valley up.

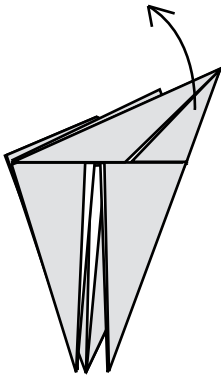

10. Unfold.

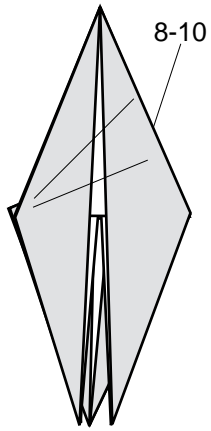

11. Repeat steps 8-10 in mirror image.

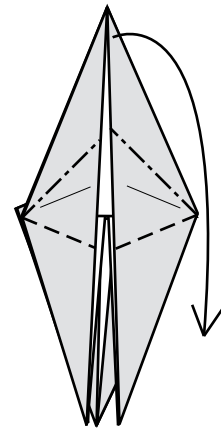

12. Swing down while spreading out the top layers.

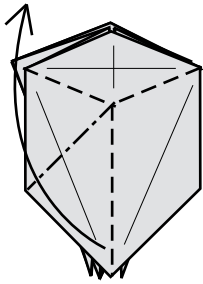

13. Rabbit ear.

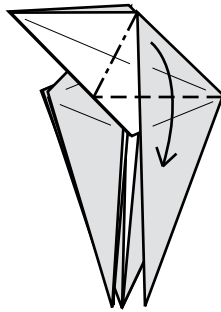

14. Squash.

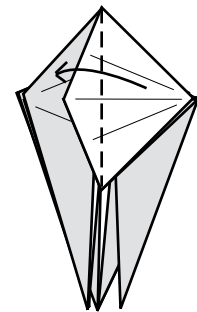

15. Valley over.

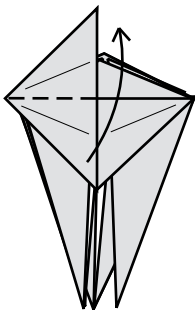

16. Swing up.

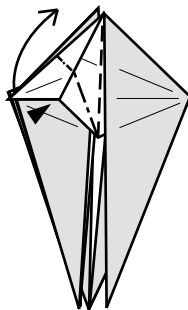

17. Spread squash.

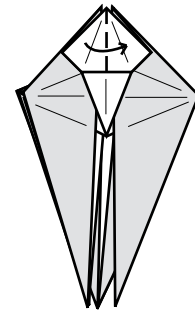

18. Swing over.

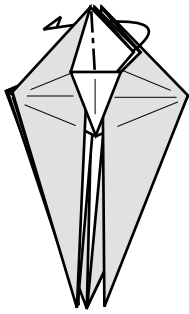

19. Pull the flap through.

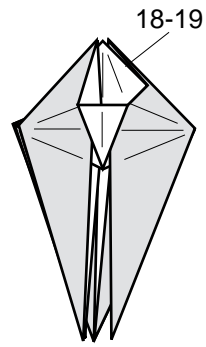

20. Repeat steps 18-19 in mirror image.

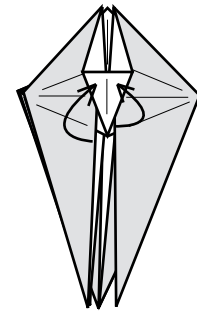

21. Bring the colored layers to the surface.

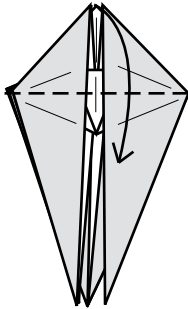

22. Swing down.

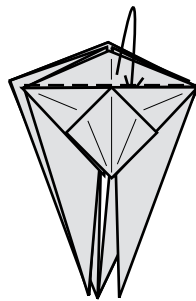

23. Tuck flap into pocket.

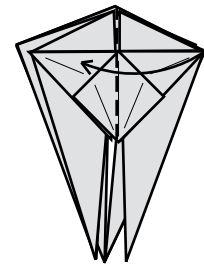

24. Swing the large flap over.

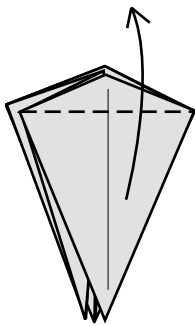

25. Carefully fold flap up, releasing the trapped layer.

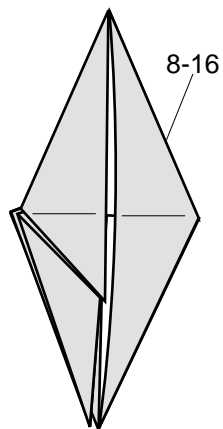

26. Repeat steps 8-16 on this flap.

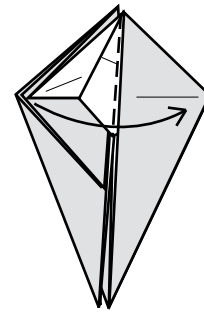

27. Swing over.

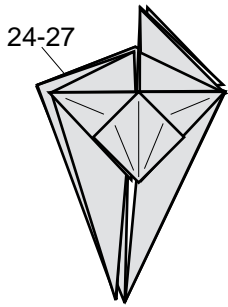

24-27 Repeat steps 24-27 in mirror image.

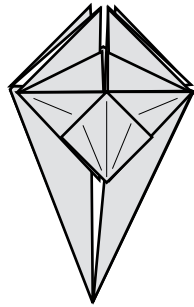

29. Turn over.

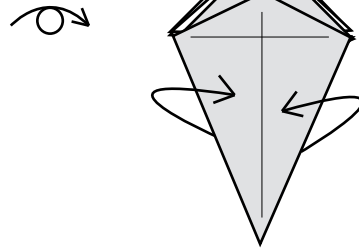

30. Wrap a single layer around each side.

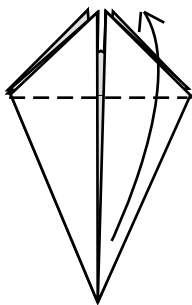

31. Valley up.

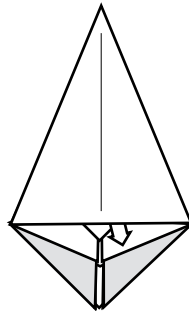

32. Unsink.

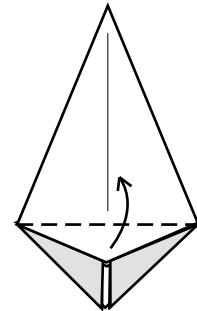

33. Valley up.

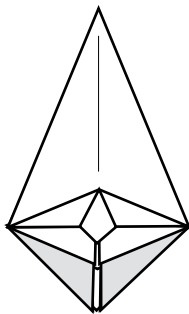

34. Turn over.

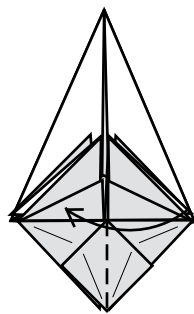

35. Swing everything over.

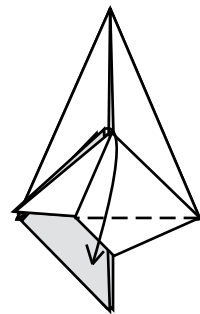

36. Swing down two flaps.

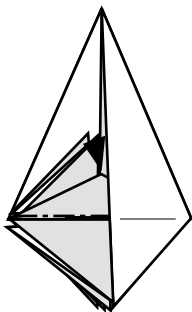

37. Closed sink.

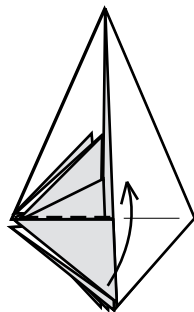

38. Swing one flap up.

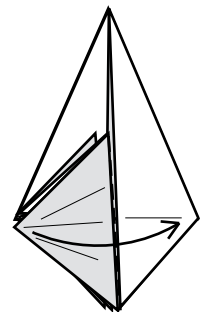

39. Swing the large flaps back.

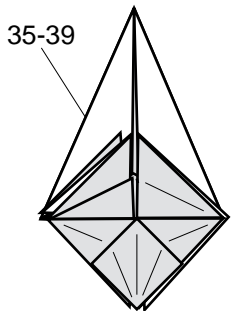

40. Repeat steps 35-39 in mirror image.

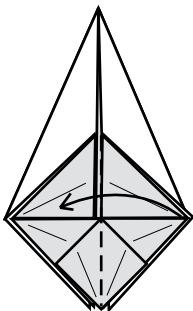

41. Swing one flap over.

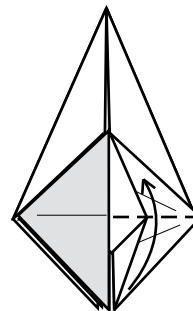

42. Swing one flap up (a portion of the fold is hidden under the colored region).

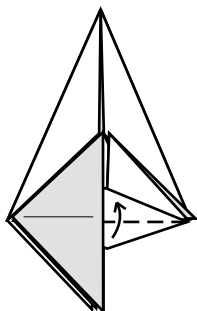

43. Swing up again.

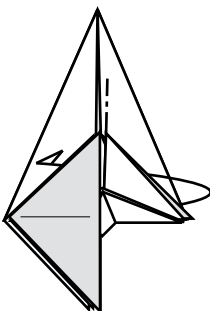

44. Swing the flap through.

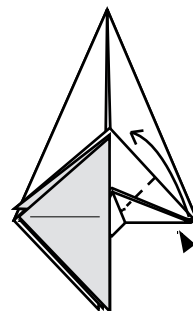

45. Reverse fold.

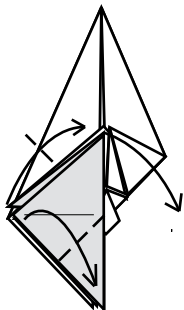

46. Rearrange the flaps as indicated.

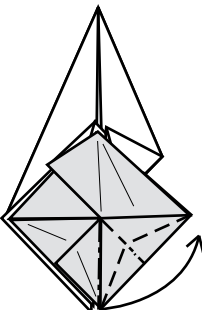

47. Swing up while incorporating a reverse fold.

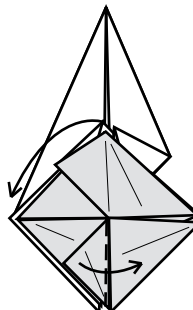

48. Swing over bottom flap. Stretch top flap outwards.

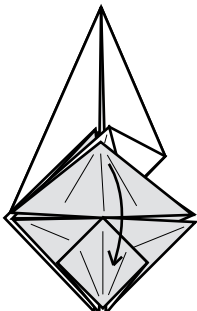

49. Swing down two flaps.

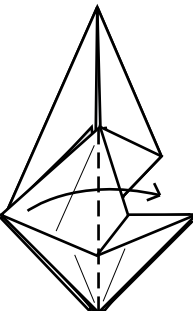

50. Swing over one flap.

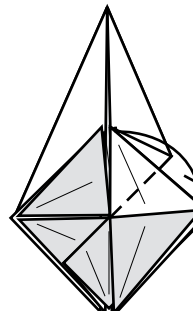

51. Valley corner down.

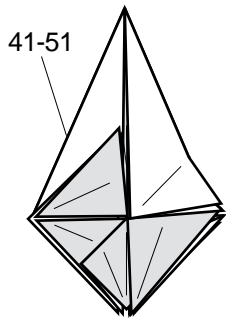

52. Repeat steps 41-51 in mirror image.

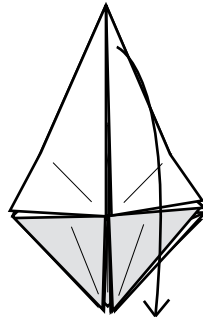

53. Swing down.

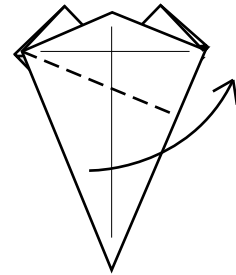

54. Valley up.

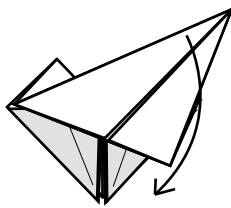

55. Swing down.

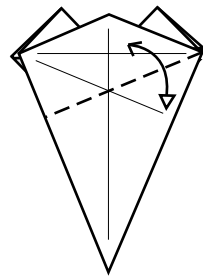

56. Precrease in opposite direction.

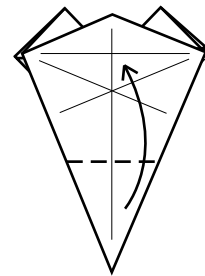

57. Valley to horizontal crease.

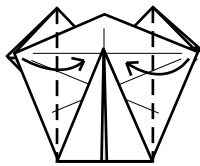

58. Valley to center.

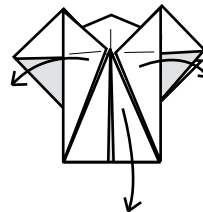

59. Unfold.

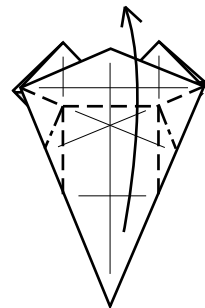

60. Swing up while swiveling in sides.

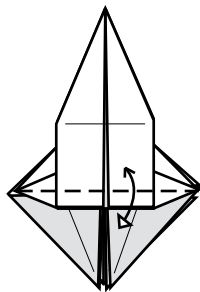

61. Precrease.

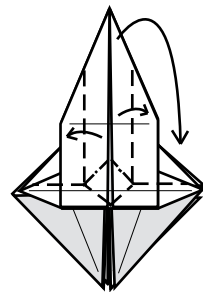

62. Valley the top single layers outwards while folding the tail upwards. The tail will not lie flat.

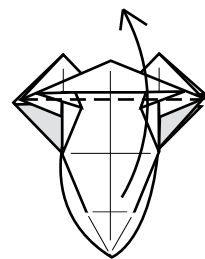

63. Valley the tail up.

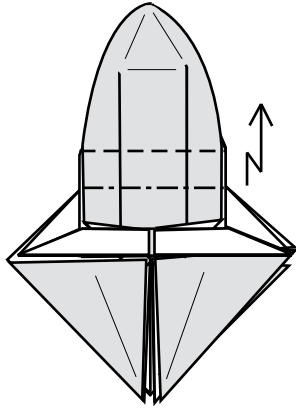

64. Pleat the tail. The valley fold lies along an existing crease. The mountain fold is midway from the valley fold to the white portion.

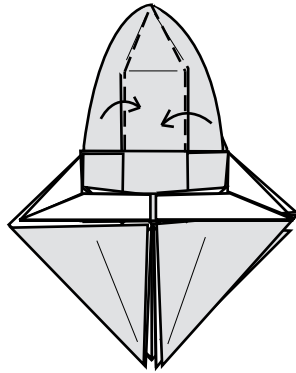

65. Fold the sides back to the center. A swivel will form underneath the pleat.

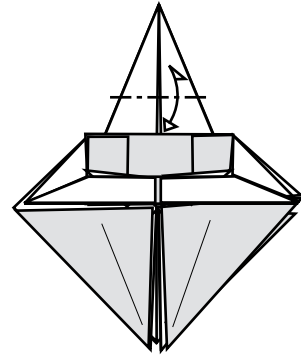

66. Precrease. The resulting width should be about as wide as the colored section below.

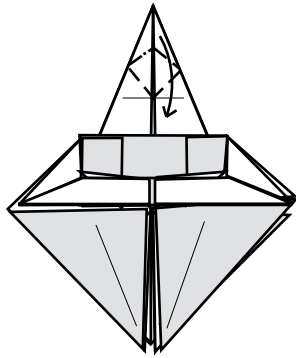

67. Squash the tip.

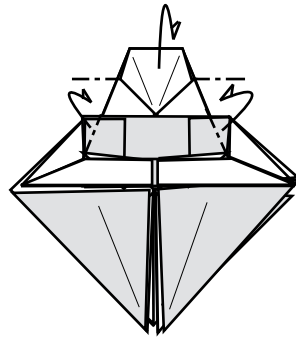

68. Swing the top back to reveal the colored triangle. Mountain back the excess paper at the base of the tail.

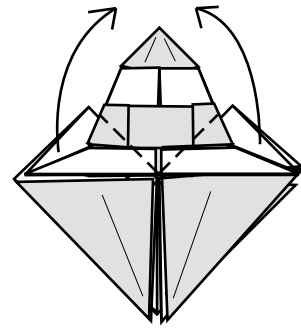

69. Valley upwards; do not crease sharply.

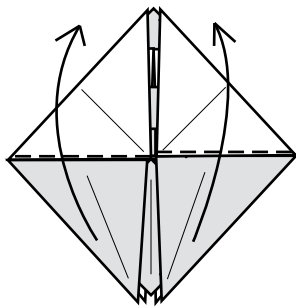

70. Swing the top flaps up.

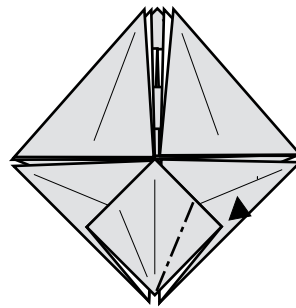

71. Reverse fold.

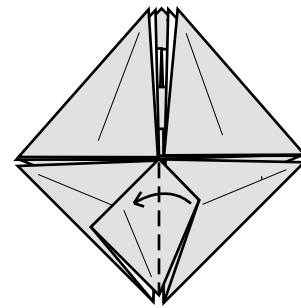

72. Swing over.



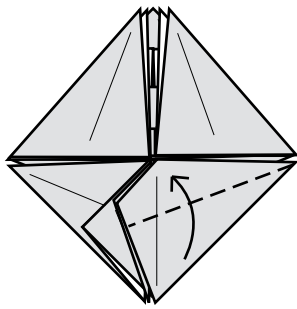

73. Valley up.

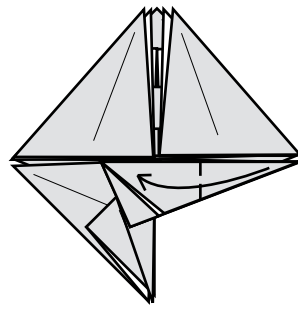

74. Swing over.

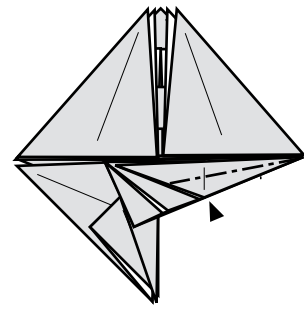

75. Sink.

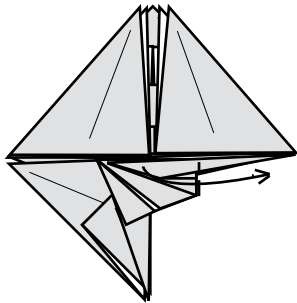

76. Swing back.

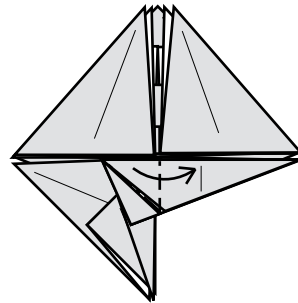

77. Swivel over.

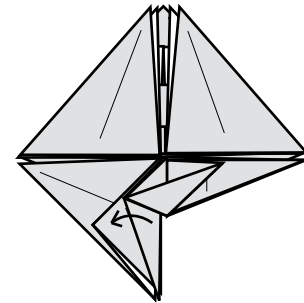

78. Pull out single layer.

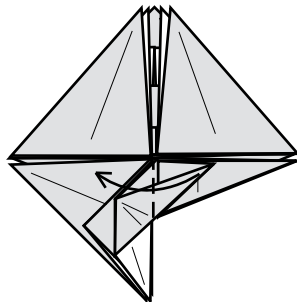

79. Swing over.

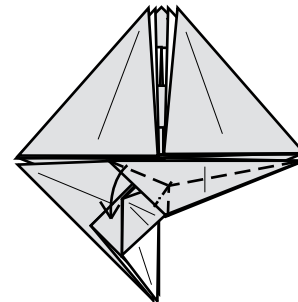

80. Rabbit ear.

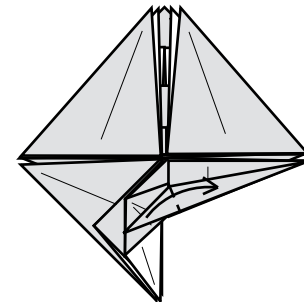

81. Swing over.

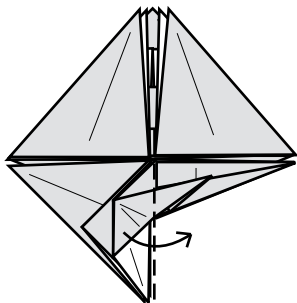

82. Swing over.

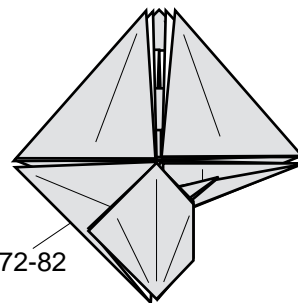

83. Repeat steps 72-82 in mirror image.

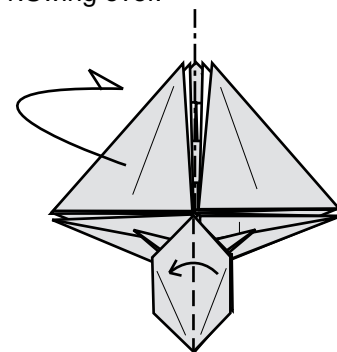

84. Lightly fold the model in half.

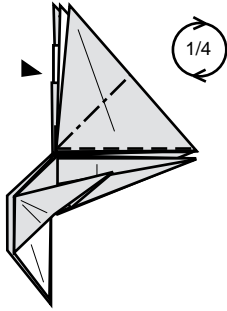

85. Squash flap, being sure to distribute the inner layers as evenly as possible. The tiny hidden flap should go towards the head. Rotate.

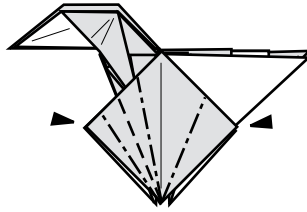

86. Reverse fold one half into angle quadsectors. Reverse the other half along the angle bisector.

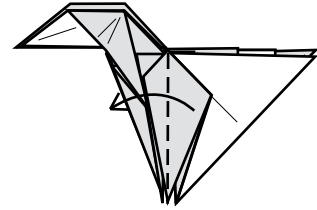

87. Swing over.

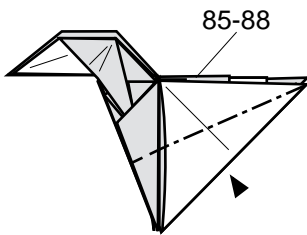

88. Squash fold. Repeat steps 85-88 behind.

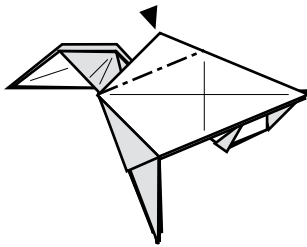

89. Reverse fold.

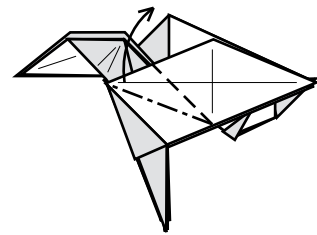

90. Swivel up. Make the valley fold as light as possible.

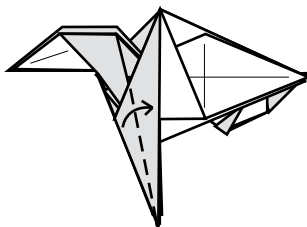

91. Valley fold.

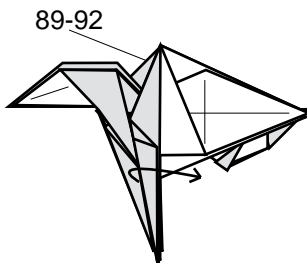

92. Swing over two flaps. Repeat steps 89-92 behind.

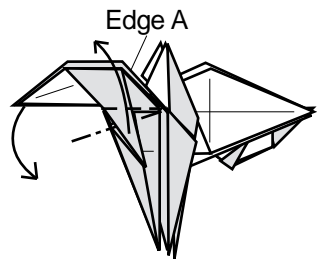

93. Crimp the head into the body so that edge A lies straight. Allow the antennae to swing up.

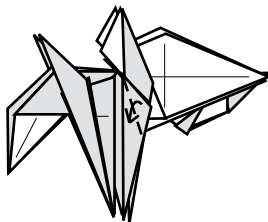

94. Valley fold.

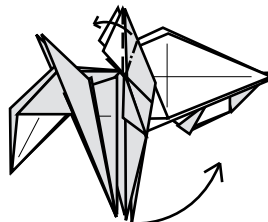

95. Pull out back leg while swiveling at top.

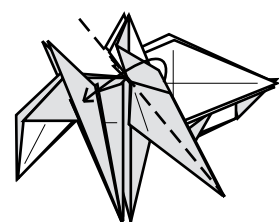

96. Valley down.

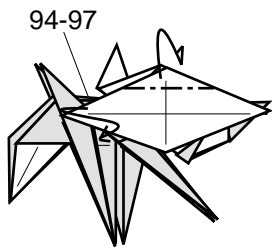

97. Tuck the tip of the wing into the pocket. Shape the wing. Repeat steps 94-97 behind.

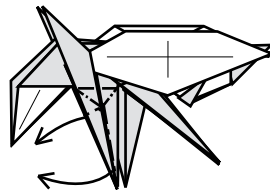

98. Rabbit ear the front legs. Due to the thickness, they will stick out slightly.

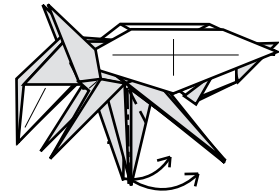

99. Crimp the middle legs in half.

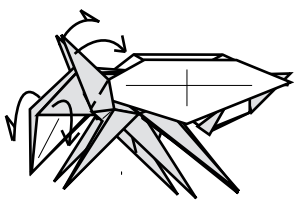

100. Pull the antennae back and outside reverse fold the head around them.

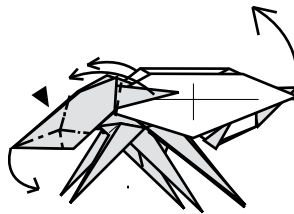

101. Curl the antennae around the head. Double rabbit ear the head. Pull tail upwards.

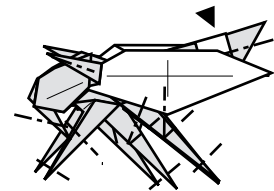

102. Crimp the legs. Curl the antennae and the tip of the head. Round out the abdomen, and curl the wings around it.

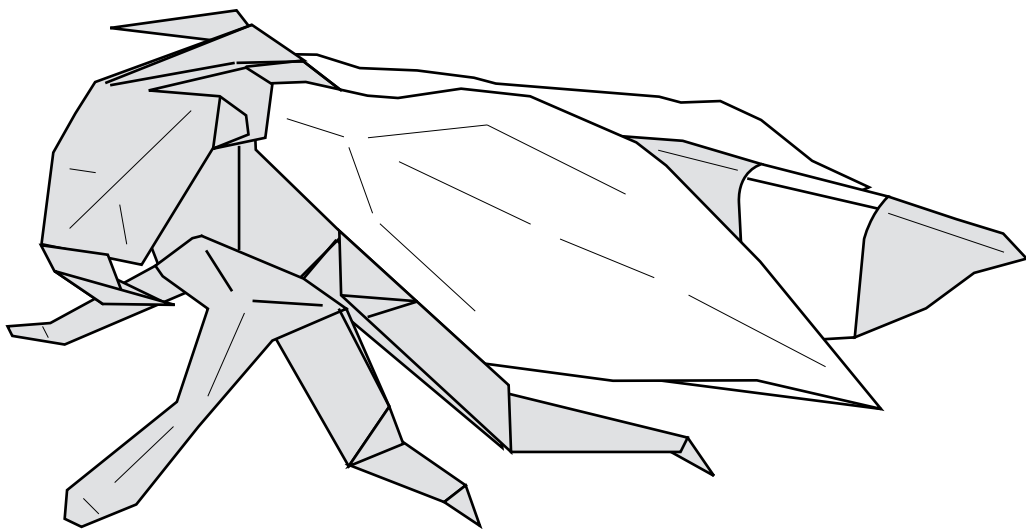

103. Completed Bee  
©1994 Marc Kirschenbaum

Атлетический медведь  
Athletic Bear  
by Eugeny Fridrikh,  
RUSSIA

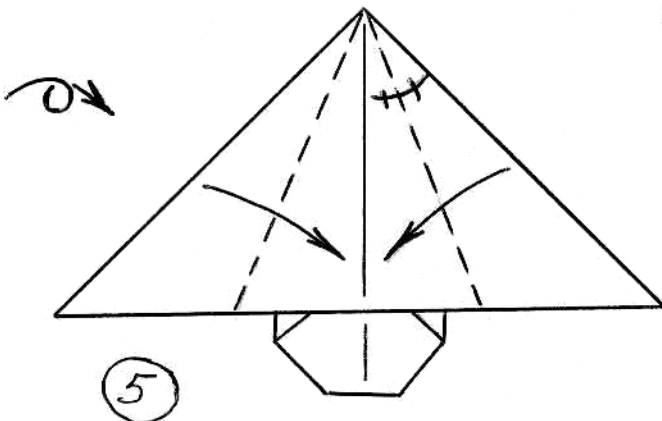
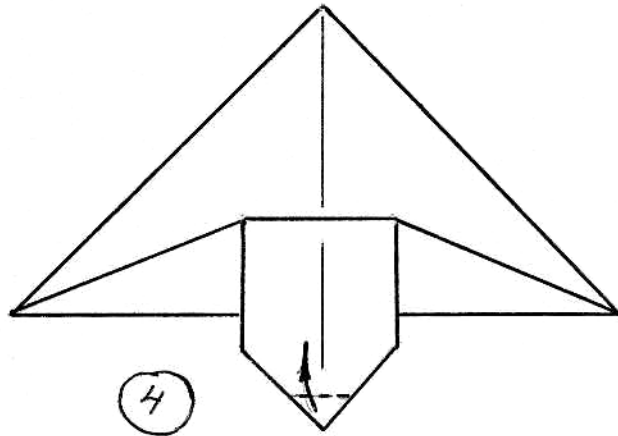
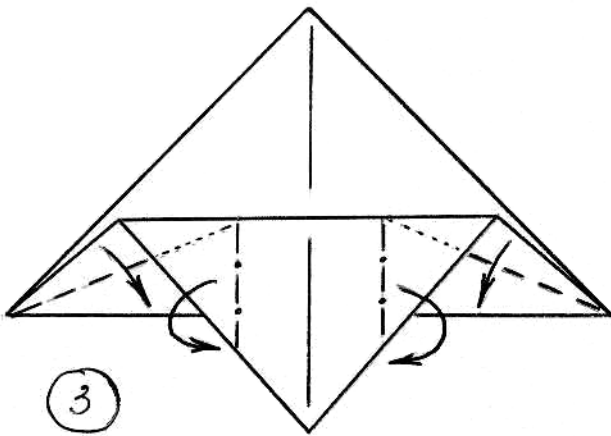
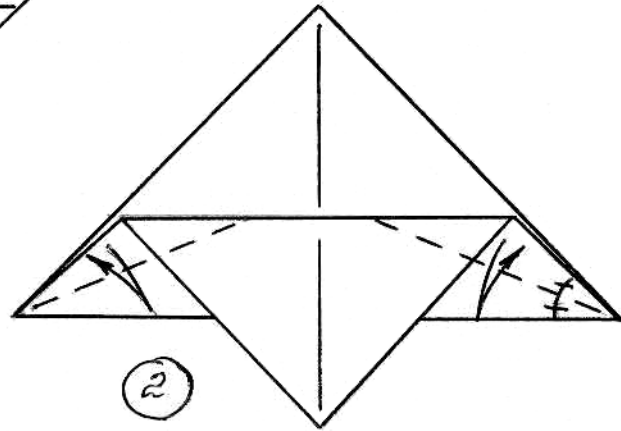
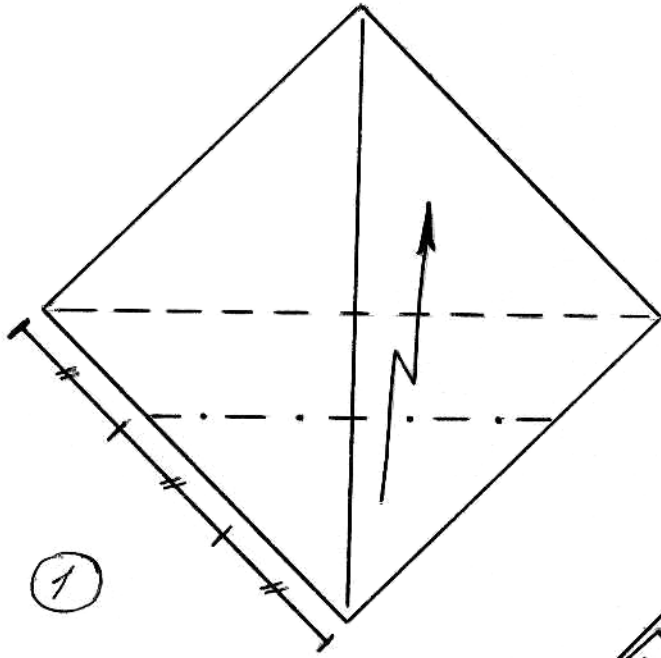

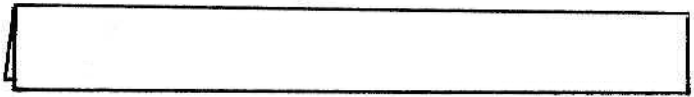
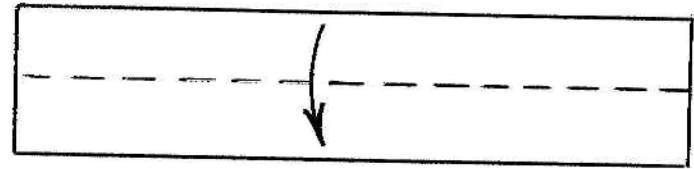
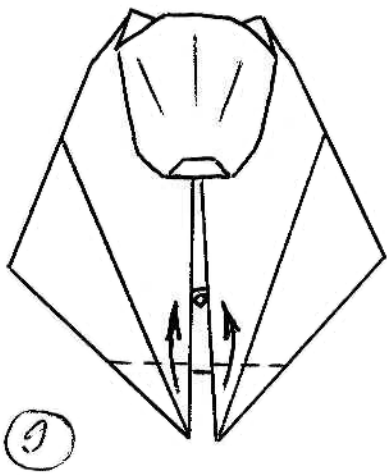
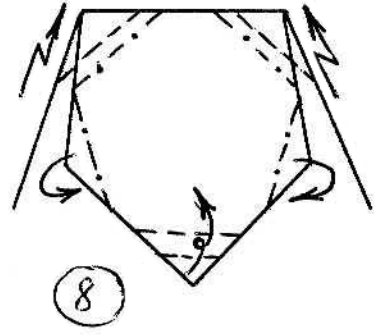
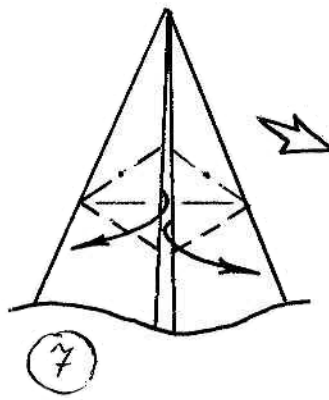
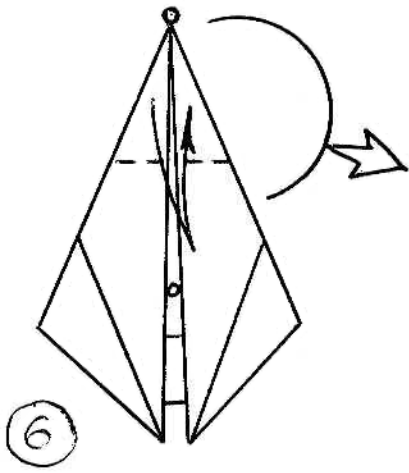

10

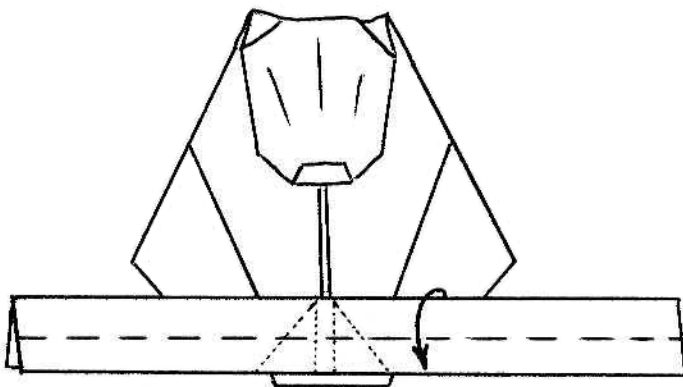

11

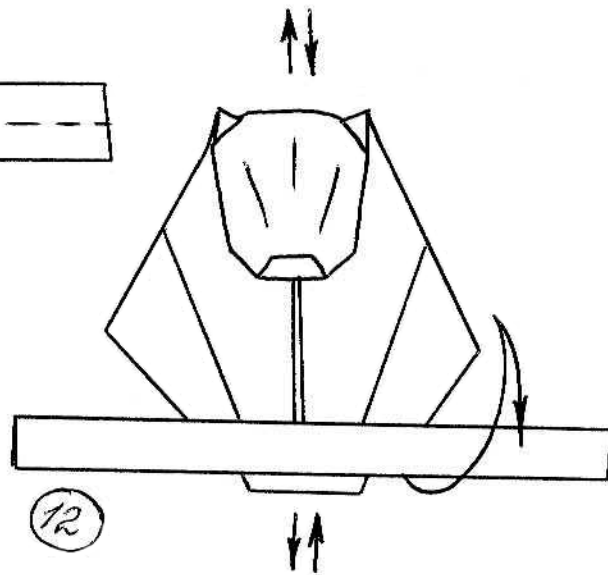

12

# Beetle

Created by Marc Vigo Anglada  
April 1994

Beetle, Page 1 of 3

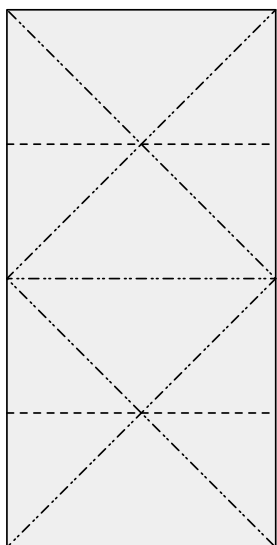

1 Begin with a 2x1 rectangle  
Fold two waterbomb bases

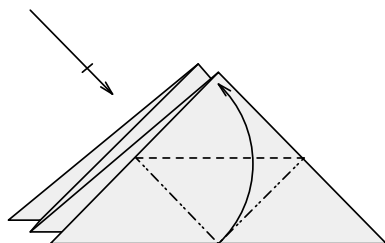

2

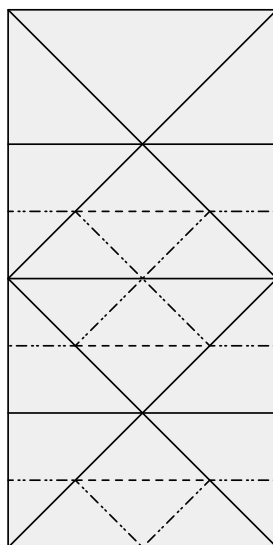

3

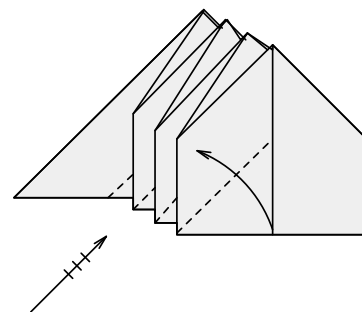

4 Valley fold front layer, reverse  
fold the rest, as shown in figure 5

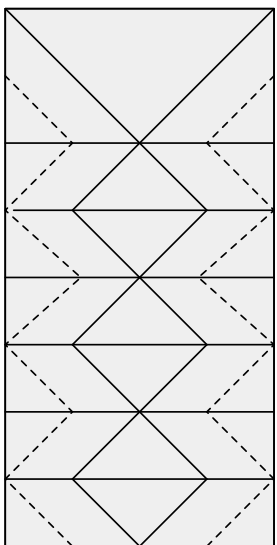

5

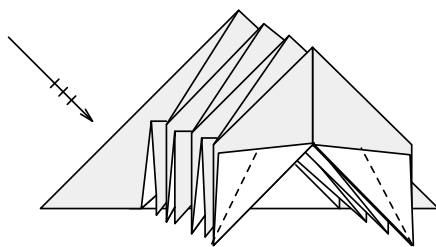

6 Valley fold front layer, reverse fold  
the rest. Repeat on the right side

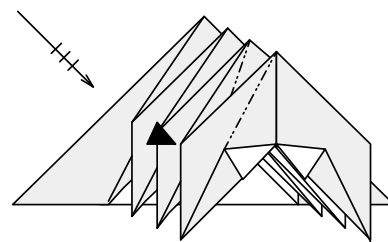

7 Sink three corners  
Repeat on the right side

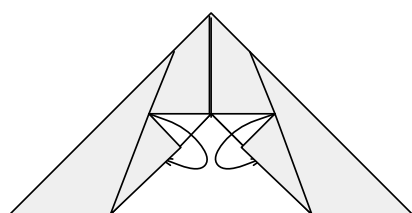

8 Front view. Mountain fold inside  
Repeat on the right side

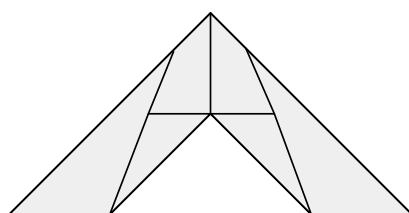

9 The result should look like this  
Turn the model over

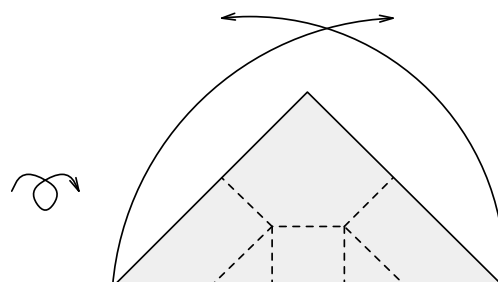

10 Raise the corners. All oblique pleats  
are at 45 degrees.

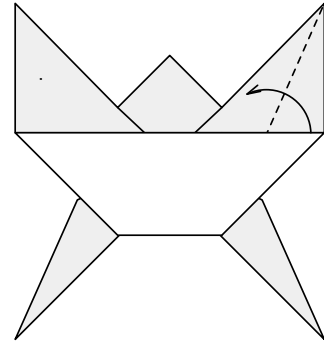
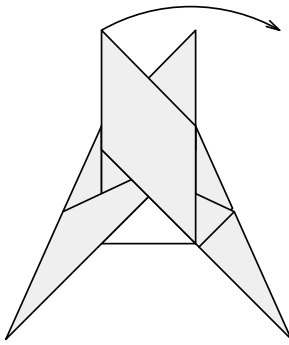
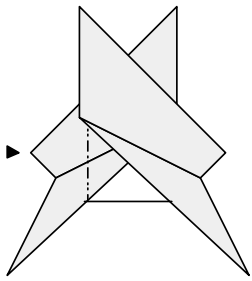

11 Sink. Repeat on the right side

12 Turn the flap to the left  
Repeat on the right side

13 Valley fold front layer,  
reverse fold the second.

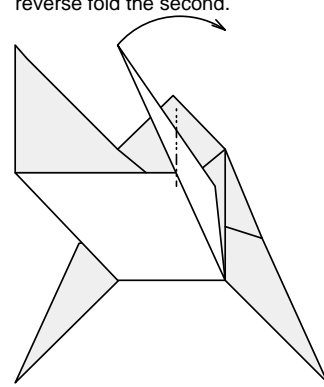
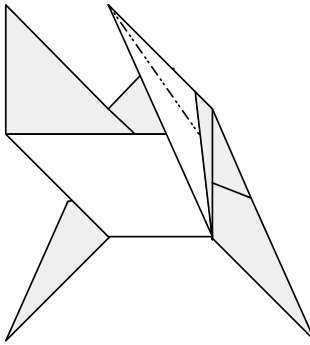
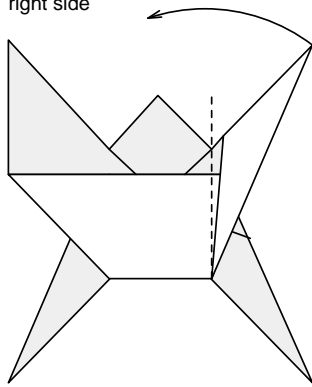

14

15 Mountain fold first layer,  
valley fold the second

16 Reverse fold

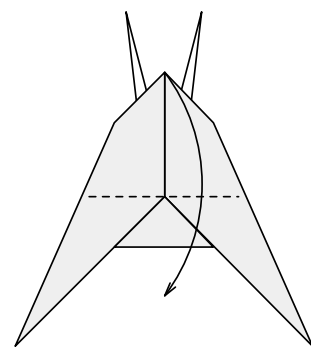
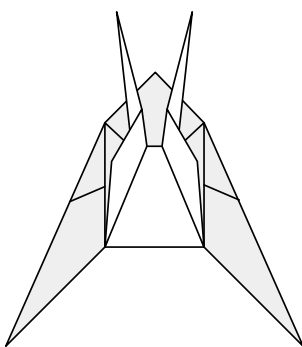
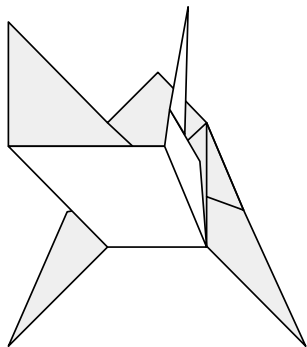

17 Repeat steps 12-15  
on the left side

18 Turn the model over

19 Mountain fold  
two layers

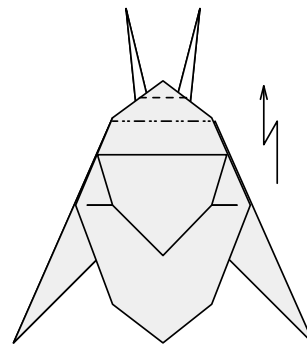
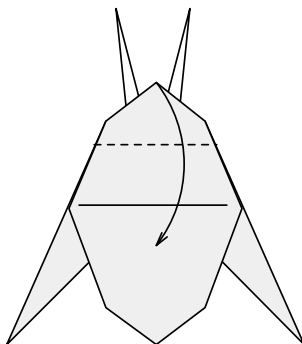

20

21 Pleat fold to form  
the head

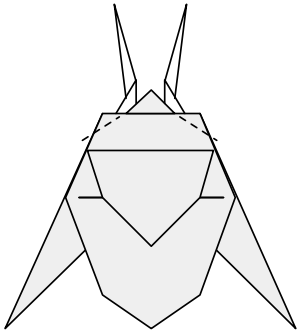

22 Valley fold the eyes

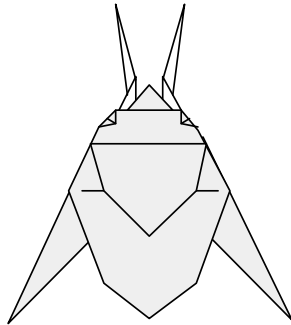

23 Turn the model over

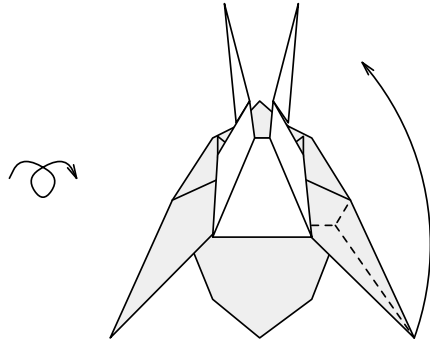

24 Rabbit ear the first pair of legs

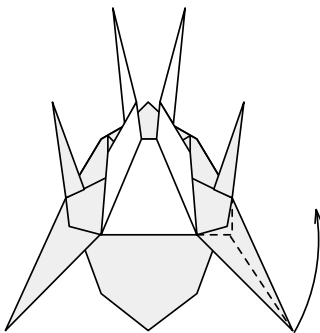

25 Rabbit ear the second pair of legs

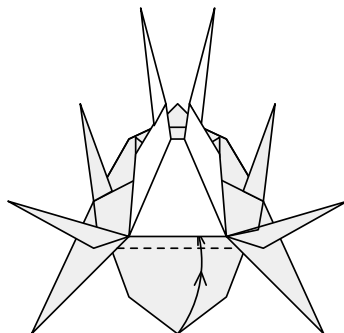

26 Valley fold one layer to lock the model

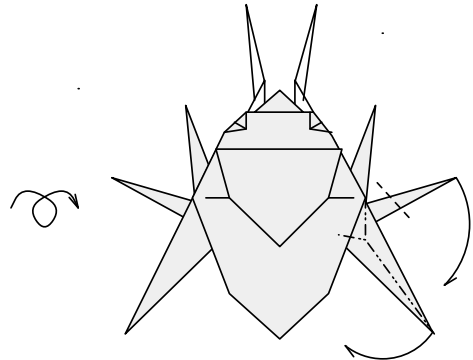

27 Reverse fold middle legs  
Rabbit ear third pair of legs

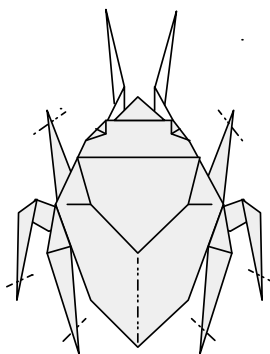

28 Crimp fold tip of legs  
Mountain fold in half to  
mark wings

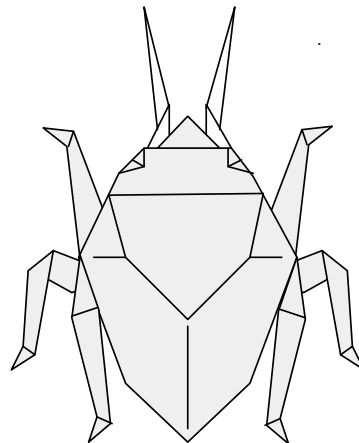



# Beetle

By Hans Birkeland (Norway) ©

Model : 93.05.04

Diagrams : 93.05.11

Use paperbacked foil coloured black, gold or silver.  
A 25 cm square will produce a finished model about  
8 cm long. Begin with the white side up.

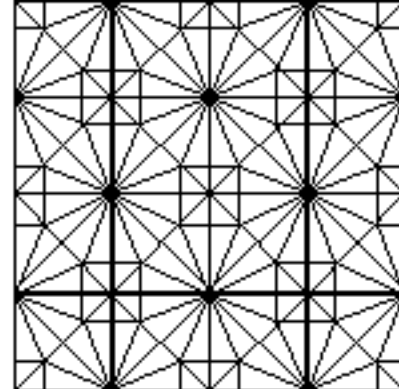

1

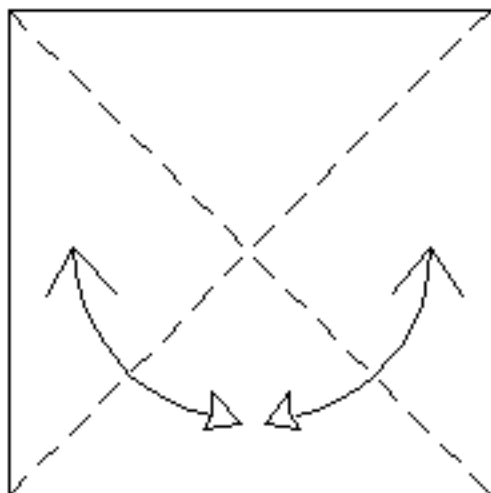

Fold and unfold.

2

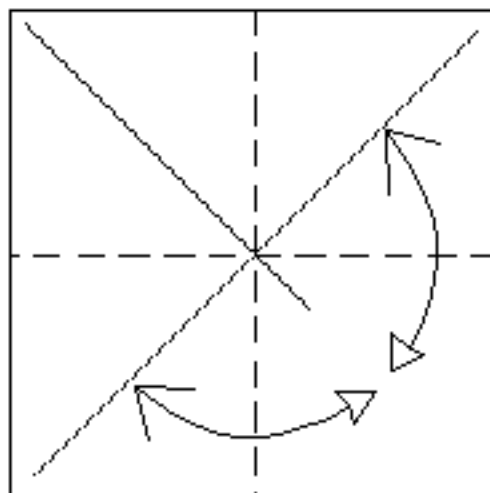

Fold and unfold.

3

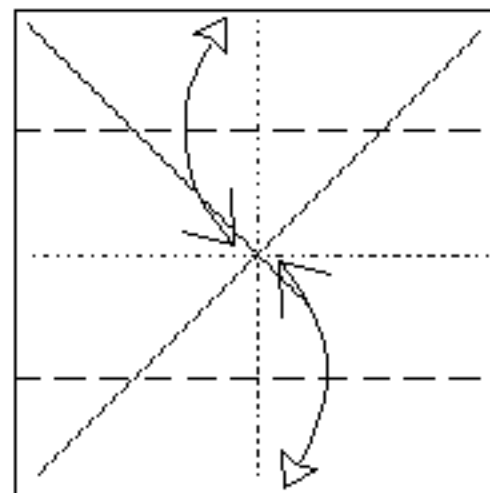

Fold and unfold.

4

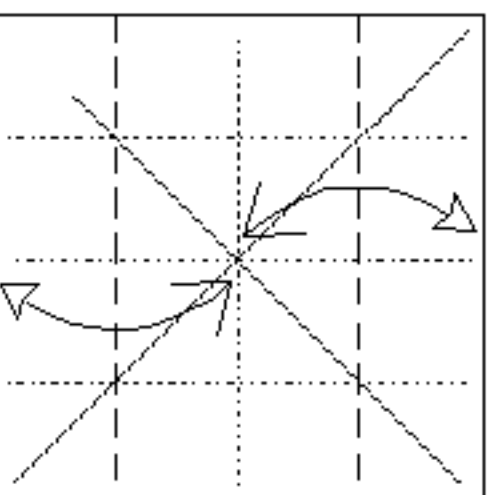

Fold and unfold.  
Turn the paper over.

5

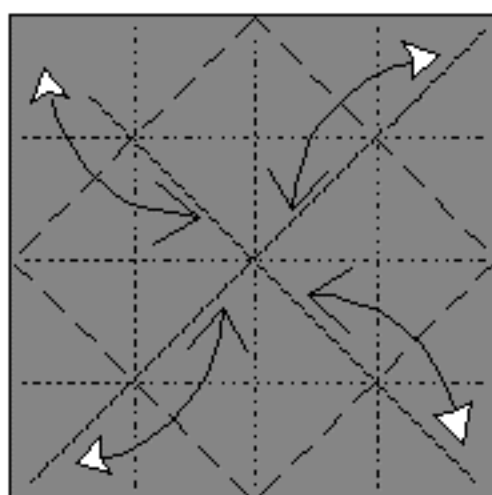

Fold and unfold.  
Turn the paper over.

6

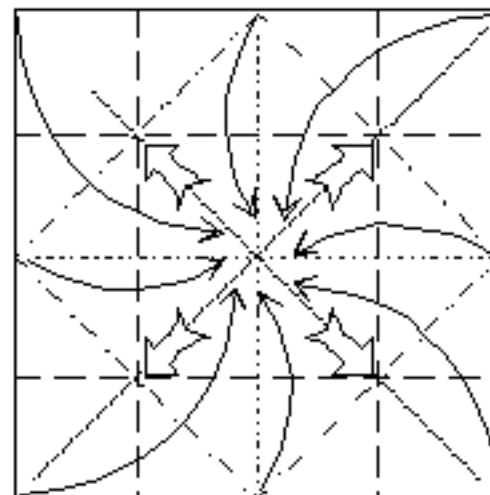

Push at the intersections and  
collapse the sides to the centre.

7

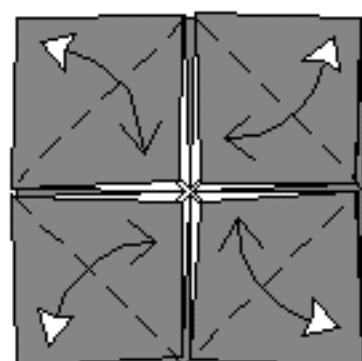

Fold the corners to the  
center and unfold.

8

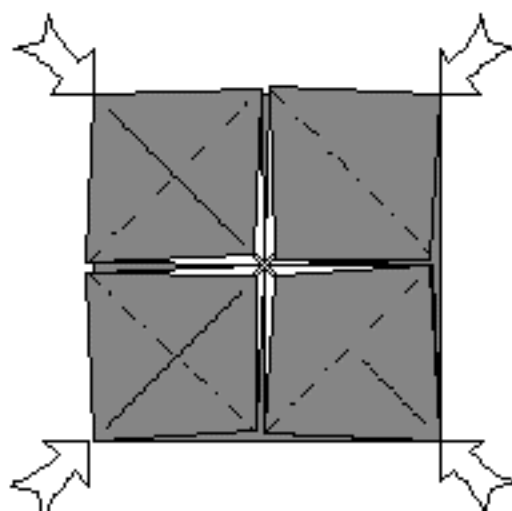

Sink the corners.

9

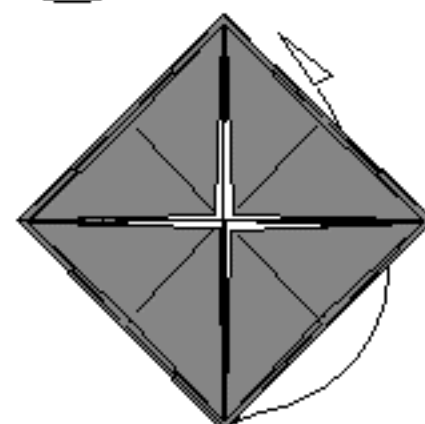

Mountain-fold the  
model in half.

10

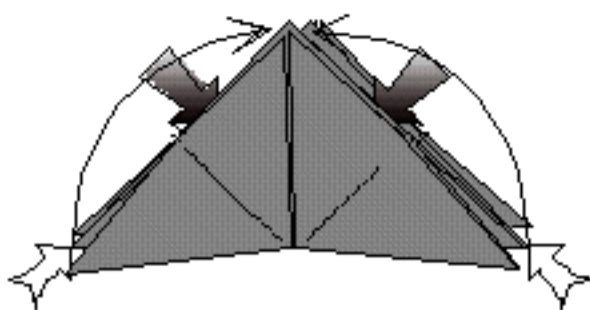

Reverse-fold the center flaps up.

11

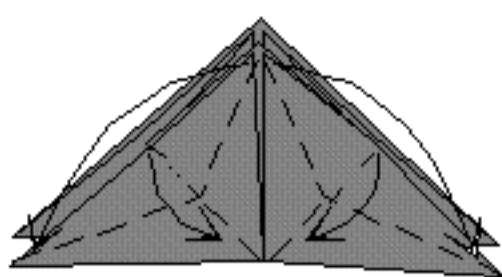

Fold one flap down on each side, incorporating a reverse fold.

12

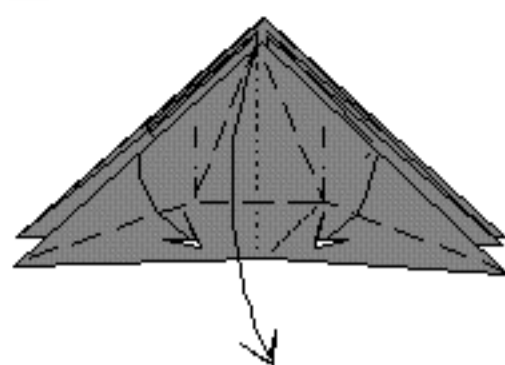

Pre-crease the valley-folds and then fold the flap down, forming a petal-fold in the process.

13

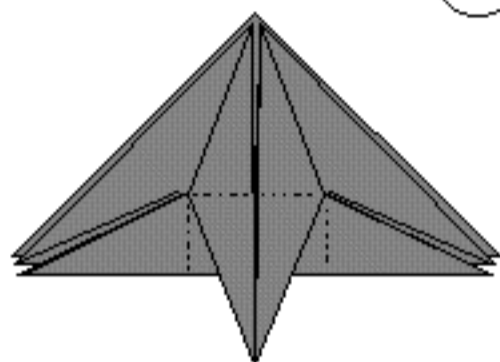

Like this. Turn the model over.

14

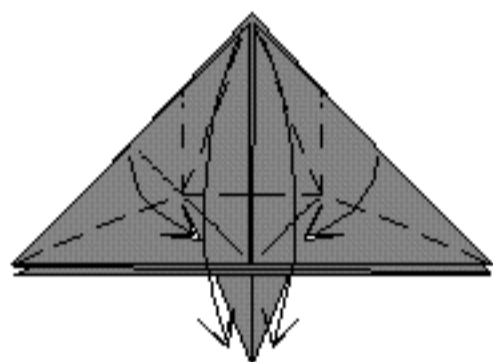

Repeat step 12. The only difference is that the flap is divided in two.

15

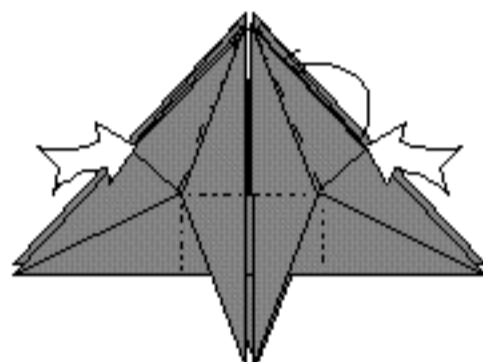

Reverse-fold.

16

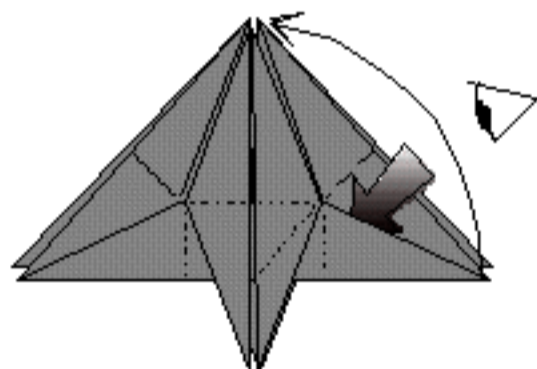

Reverse-fold. The edge inside should be folded to the left. Next view from the right side.

17

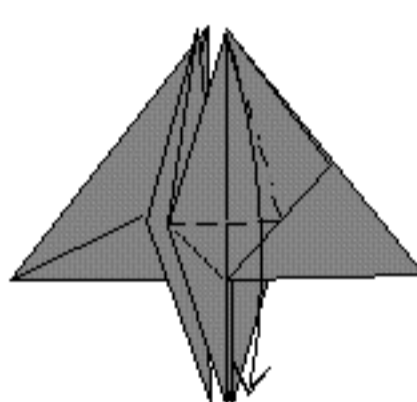

Make a half petal-fold.

18

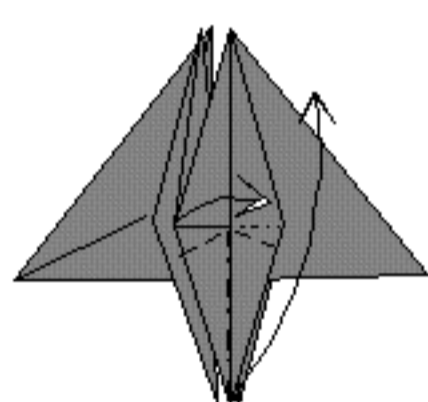

Reverse-fold the point up and flatten.

19

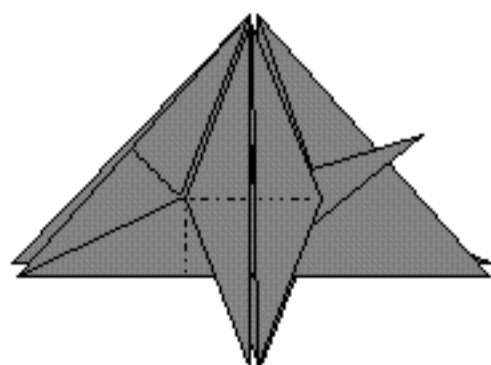

Repeat steps 16-18 on the left side.

20

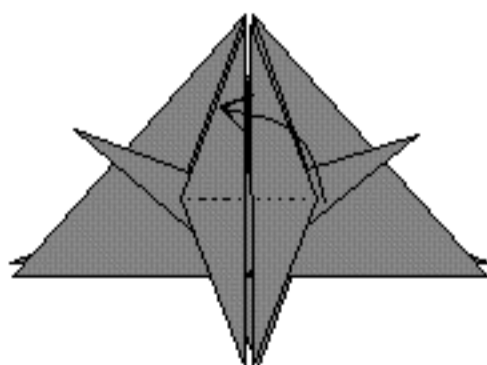

Lift the point.

21

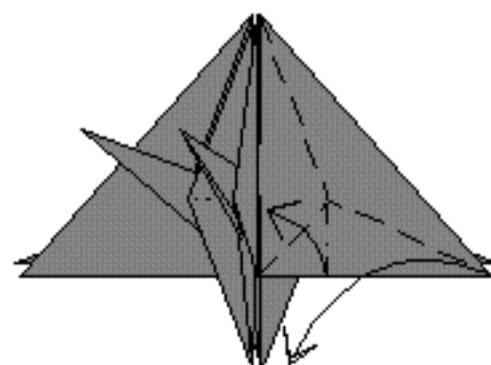

Form a rabbit ear. Fold through both points as if they were one layer. Then flatten the model.

22

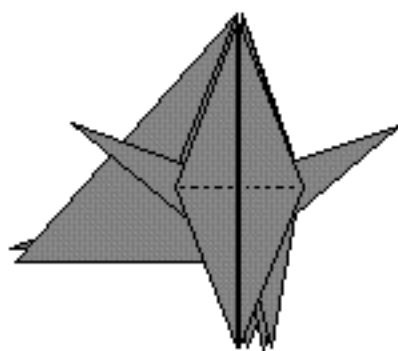

Repeat steps 20-21  
on the left side.

23

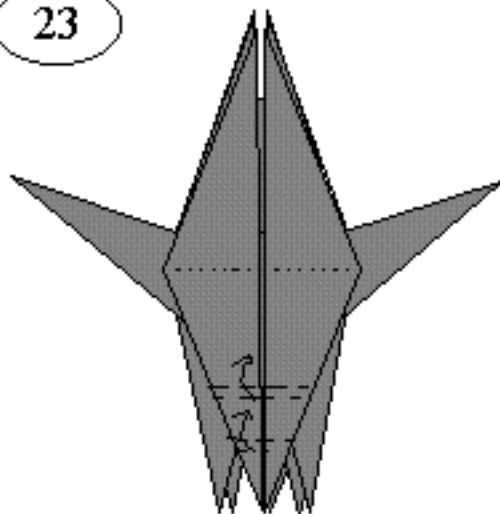

Crimp the two points  
as if they were one.

24

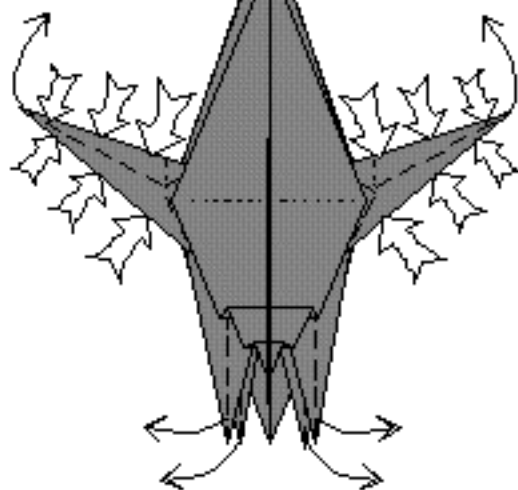

Narrow the two front legs with rabbit ears.  
Repeat on the four back legs.

25

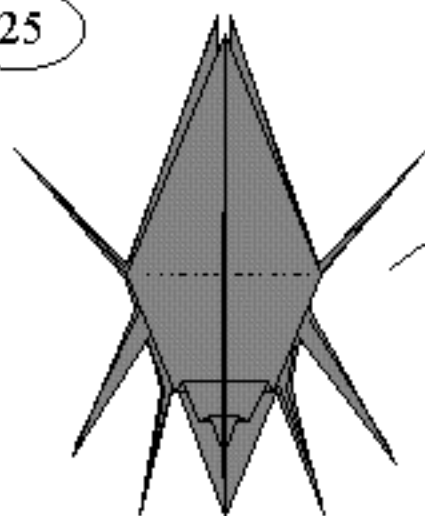

Like this.  
Turn the model over.

26

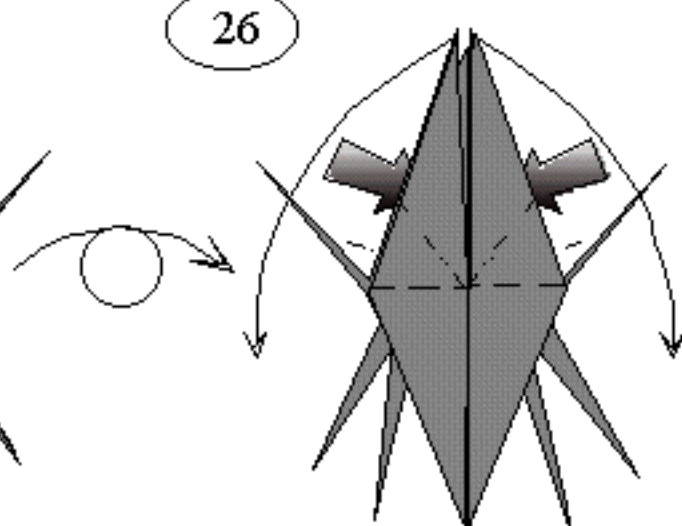

Swivel-fold the wing-  
cases downward.

27

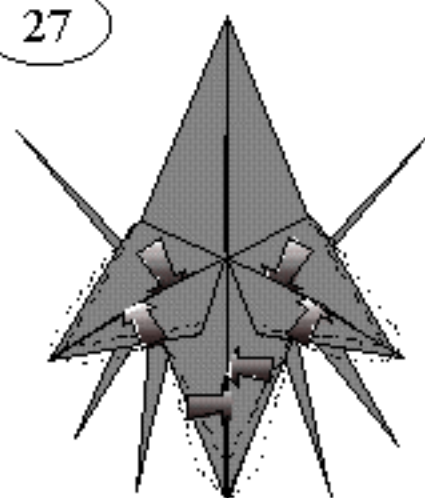

Broaden the wing-cases and the  
wing-flap by pushing out the upper  
layers. Partly unfold the swivel-fold  
to make this easier. The wing-cases  
can be pushed a bit to the front (up-  
ward) so that the paper doesn't tear.

28

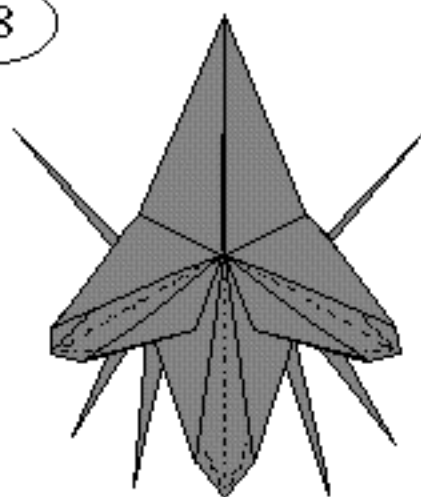

Like this.

29

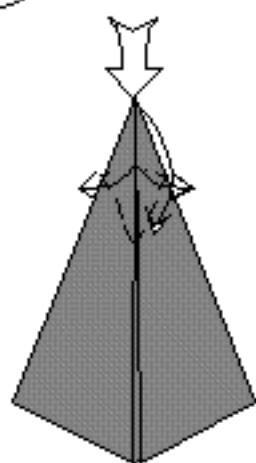

Make a petal-fold on the head.

30

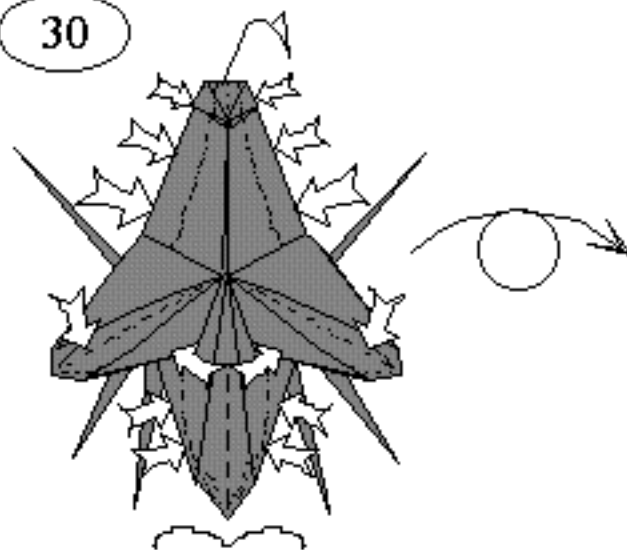

Round the neck and head. Bend the head a bit toward  
the ground. Round the sides of the wing-flap and  
round the wing-cases. Turn the model over.

31

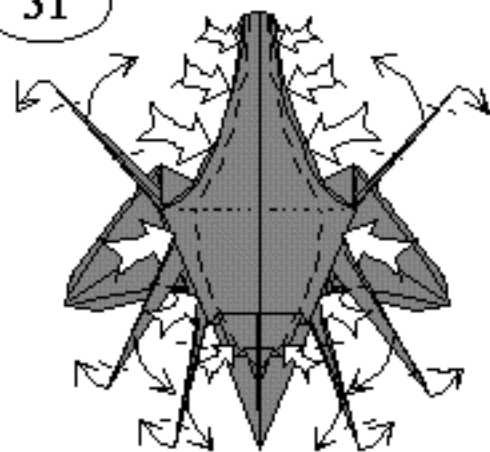

Round the edges toward the center.  
Curve the legs with mountain- and  
valley-folds. Turn the model over.

32

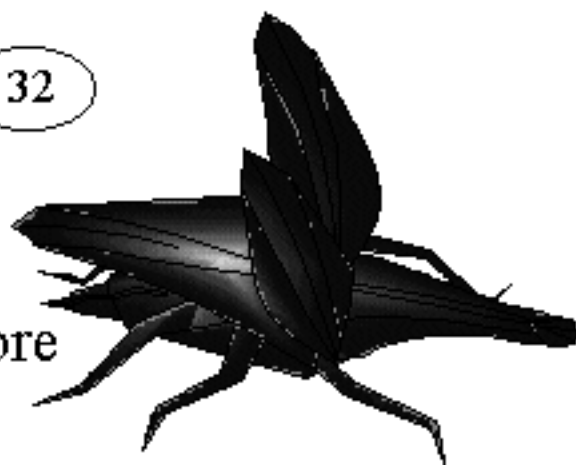

**Coleoptera d'amore**

# Dollar Bill \$

Model Created and Diagrammed by A. Anselmo 12/93  
 (although I'm certain someone has done something like it.)  
 anselmo@thermsa.eng.sunysb.edu

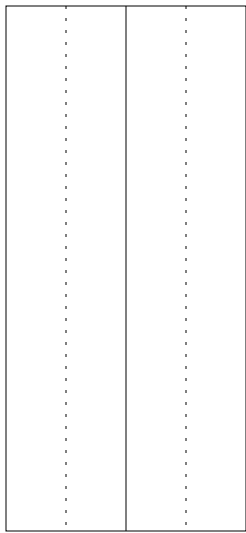

1) Fold the bill lengthwise, and unfold. Fold edges in to the middle.

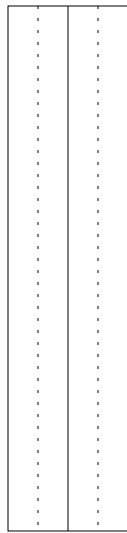

2) Fold edges towards the middle again.

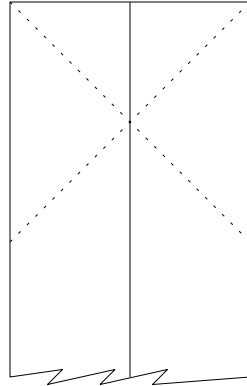

3) Fold along the indicated lines.

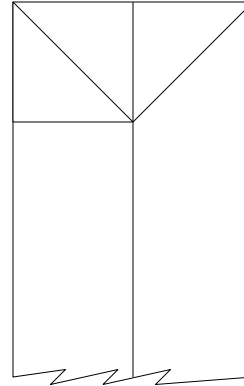

4) Unfold the left side. The object of the next few folds is to create a locking mechanism.

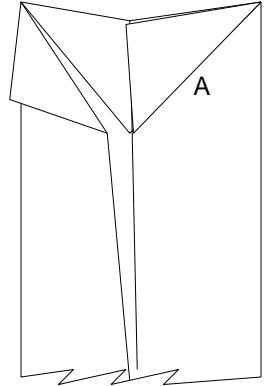

5) Keep the right hand side together, and fit the pocket forming at "A" into the shaded tab.

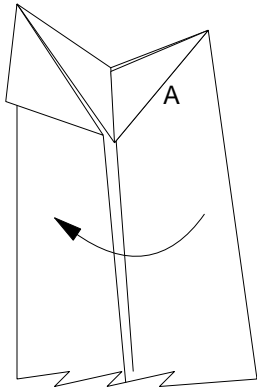

6) How the fold progresses.



7) This should be locked by now.

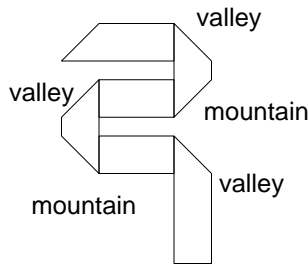
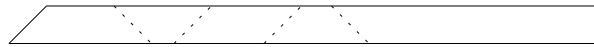

8) Lay the fold sideways, and make it into a reversed "S" shape with a series of valley and mountain folds. Of course, when looking at it unfolded, all the folds appear as valley folds. The reverse "S" here is shown a bit more "open" than I usually make it. The tighter the "S", the more of a tail you will be left with to make the vertical line that goes through the "S". Take note!

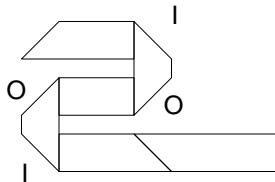

9) Unfold the last valley fold. Make the folds "I" inside reverse folds, and "O" outside reverse folds, so the reverse "S" shape will not come apart.

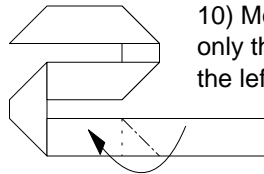

10) Mountain fold only the top flap to the left to achieve...

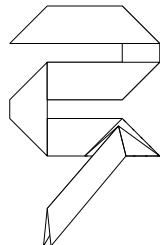

14) Now you should have this. Fold this long flap to the left.

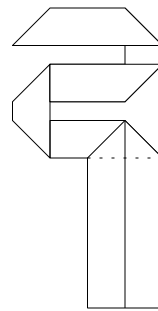

11) This. Valley fold upwards at the indicated point.

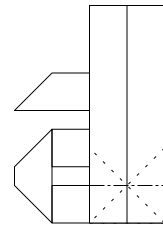

12) Valley fold and mountain fold so this last piece can collapse towards you.

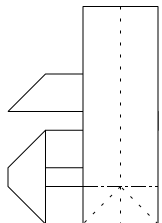

13) You should only follow the indicated folds to collapse this section.

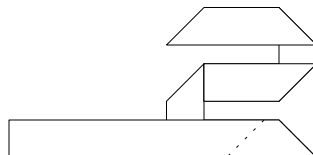

15) Valley fold the flap so it hangs downwards.

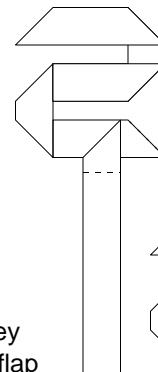

16) Valley fold upwards, under the middle and over the top.

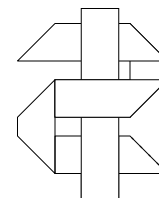

17) You should have this now. Flip it over, and you have a "Dollar \$" !

Note: This model appears best after sitting in your wallet for a few hours, since the creases have time to set.

# Biplane II

by Marc Kirschenbaum (NY)

©1996

Complex

A 10" square makes a model with a 4" wingspan

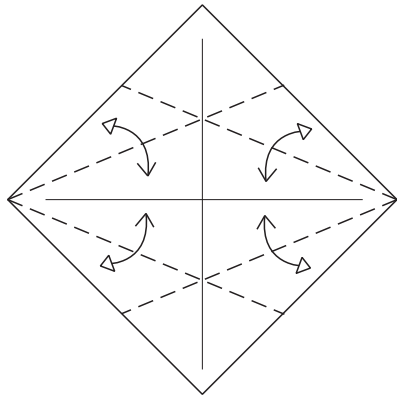

1. This will be the color of the body. Precrease along angle bisectors.

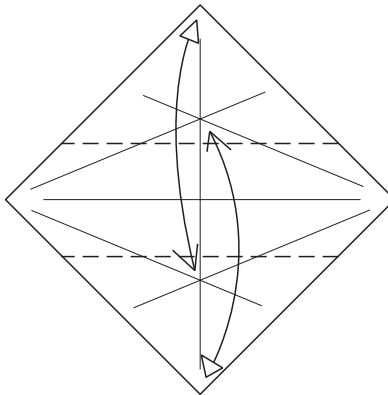

2. Valley the corners to the intersections of creases and unfold.

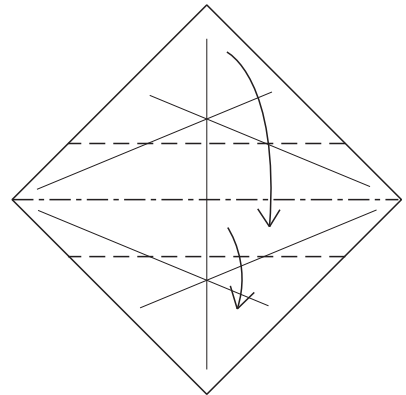

3. Pleat along existing creases.

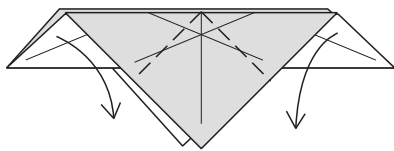

4. Valley to center.

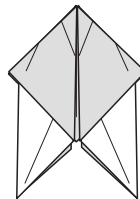

5. Turn over.

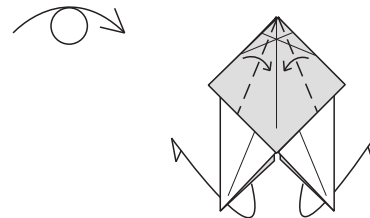

6. Fold sides to center, allowing flaps to swing outwards.

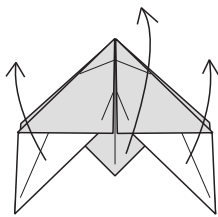

7. Unfold entirely.

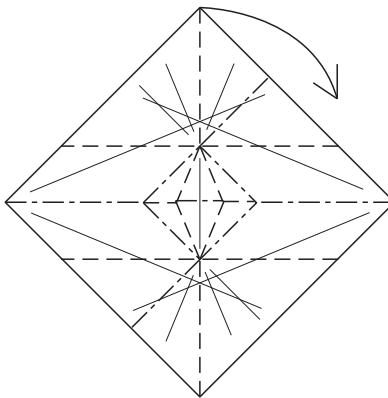

8. Collapse.

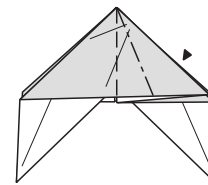

9. Squash the center flap.

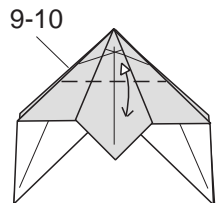

10. Valley down as far as possible and unfold. Repeat steps 9-10 behind.

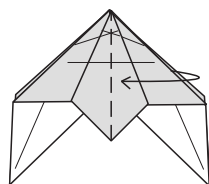

11. Spread open to reveal small flap.

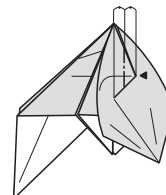

12. Sink triangularly halfway.

12-13

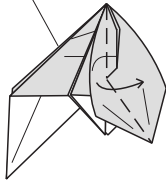

13. Close back up. Repeat steps 12-13 on the other side.

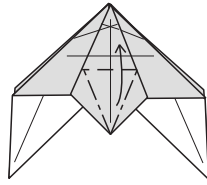

14. Petal fold.

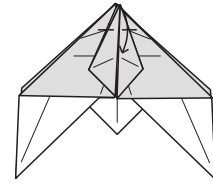

15. Valley to intersection of creases.

14-16

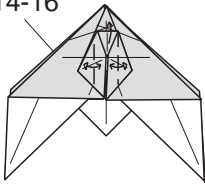

16. Precrease sides of flap and then open up. Repeat steps 14-16 behind.

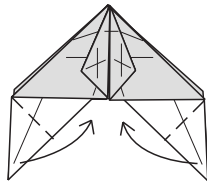

17. Valley corners. Turn over.

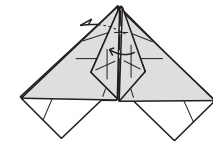

18. Swing a flap over, front and back.

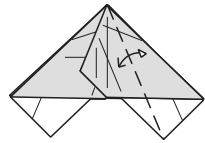

19. Precrease through all layers.

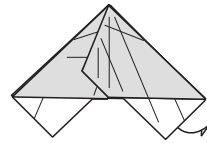

20. Unfold bottom flap.

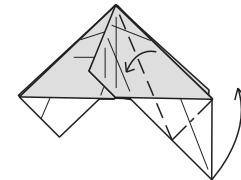

21. Squash. Do not flatten completely.

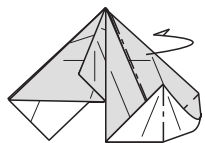

22. Wrap around to make symmetrical.

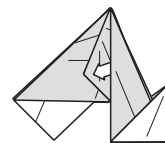

23. Pull out single layer.

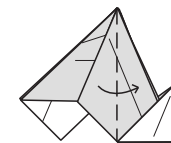

24. Valley over.

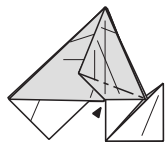

25. Reverse fold.

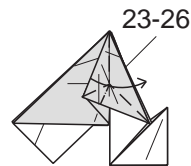

26. Swing over flap while incorporating a reverse fold. Repeat steps 23-26 behind.

18-26

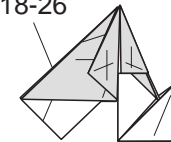

27. Repeat steps 18-26 in mirror image.

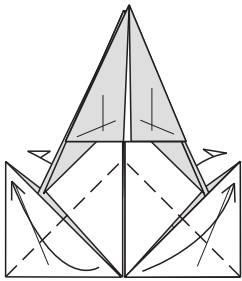

28. Valley up corners.

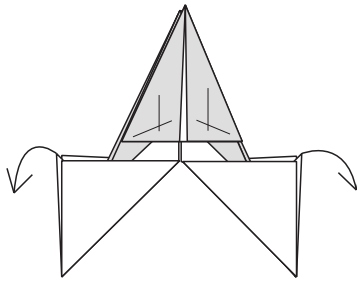

29. Pull out hidden corners.

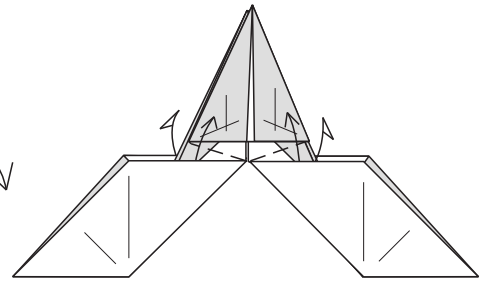

30. Pull out hidden points.

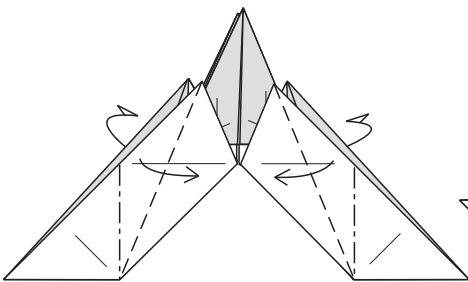

31. Crimp sides.

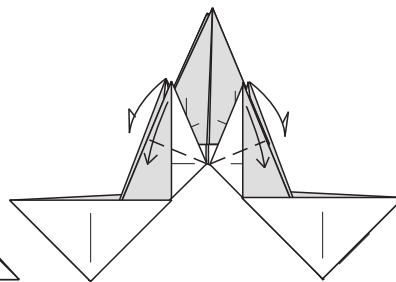

32. Valley down four points.

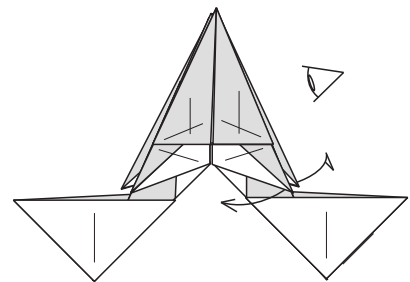

33. Stretch apart sides.

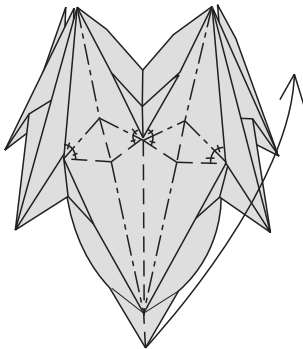

34. View from step 33. Double-crimp upwards and flatten.

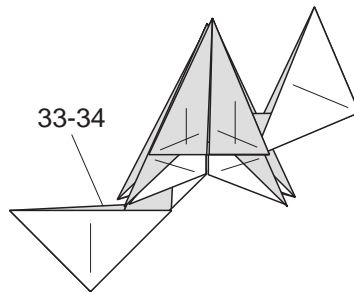

35. Repeat steps 33-34 on other side.

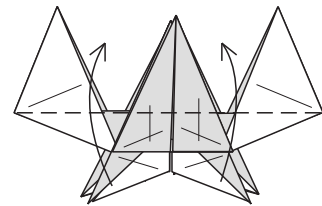

36. Lightly swing up top section.

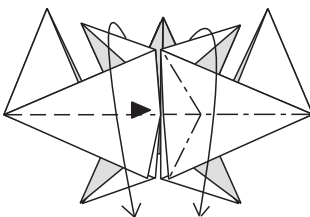

37. Swing back down while collapsing the top single layer outwards.

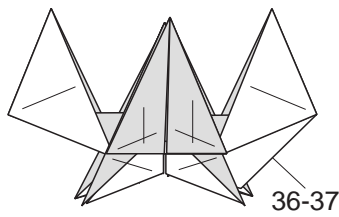

38. Repeat steps 36-37 behind.

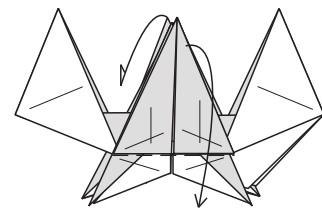

39. Swing down flaps.

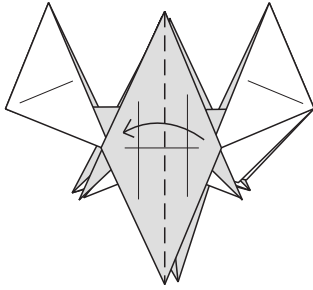

40. Swing over a layer, undoing reverse fold. Repeat behind.

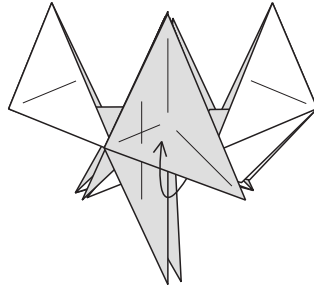

41. Wrap around a single layer. Repeat behind.

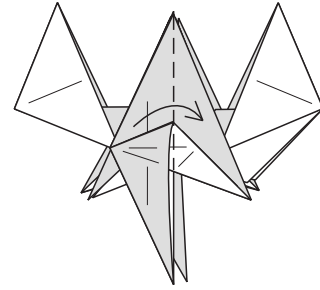

42. Swing back. Repeat behind.

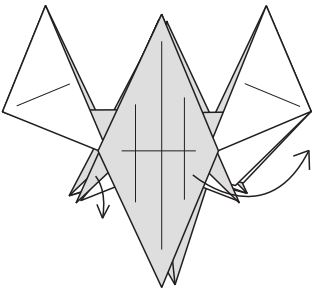

43. Pull flap out, releasing layers at left. Repeat behind.

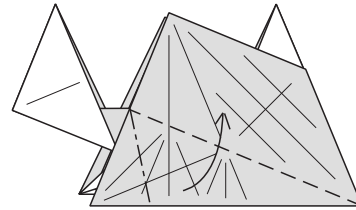

44. Asymmetrical squash. Repeat behind.

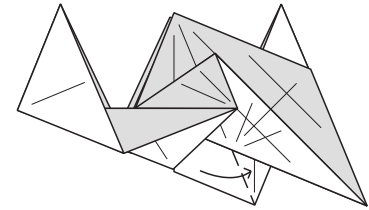

45. Valley layer through. Repeat behind.

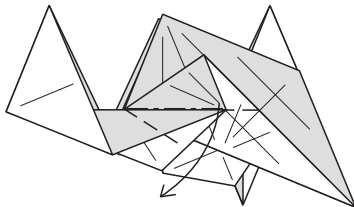

46. Swivel down. Repeat behind.

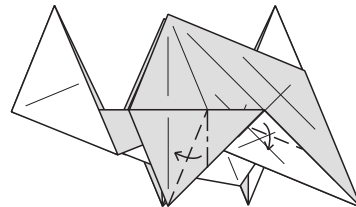

47. Swivel over. Repeat behind.

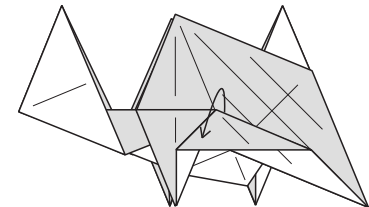

48. Bring single layer to surface (closed sink). Repeat behind.

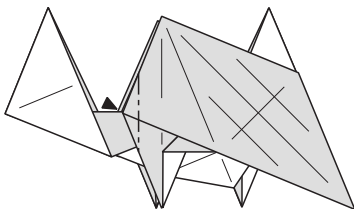

49. Sink triangularly, so as to match up with the folded edge in the middle. Repeat behind.

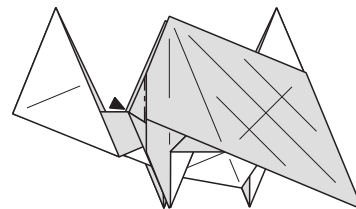

50. Sink triangularly again. Repeat behind.

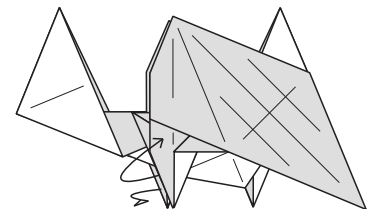

51. Wrap around a single layer. Repeat behind.



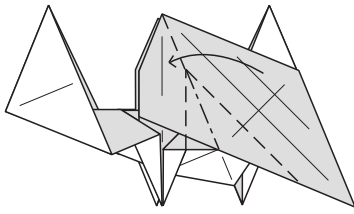

52. Swing flap over while incorporating a reverse fold along existing creases.

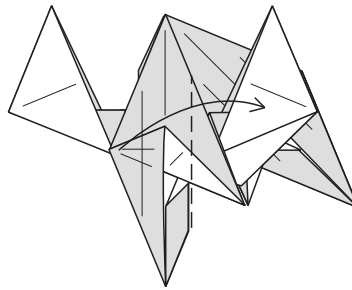

53. Swing over two layers. Model will not lie flat.

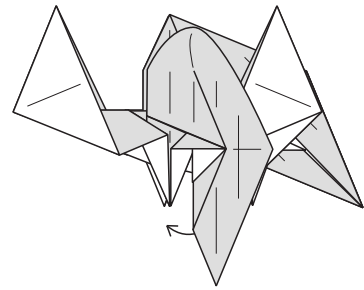

54. Pull out single layer from behind.

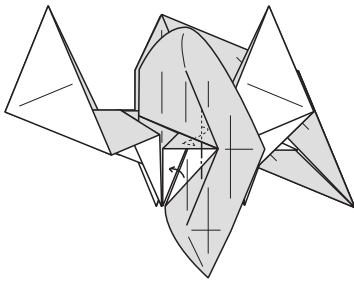

55. Swivel under.

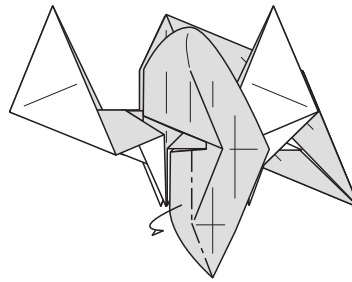

56. Swing single layer back.

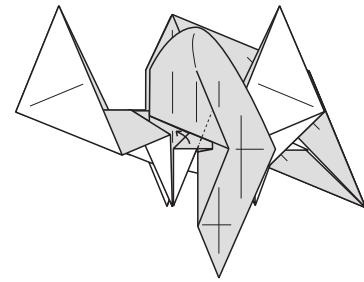

57. Swivel up.

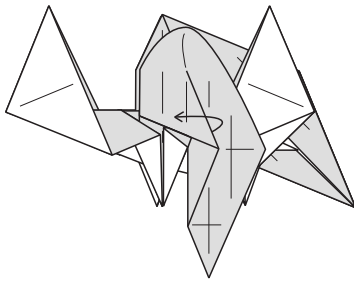

58. Wrap single layer around (closed sink).

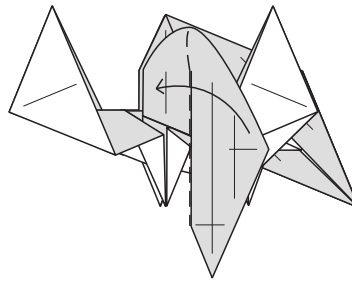

59. Close model back up.

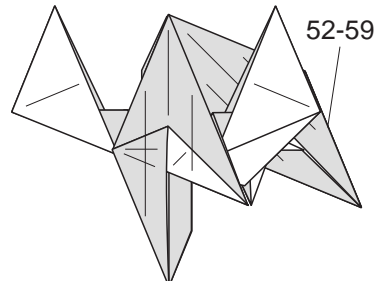

60. Repeat steps 52-59 behind.

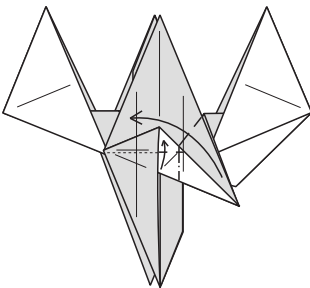

61. Swing over flap while pulling up a layer through the pocket. Repeat behind.

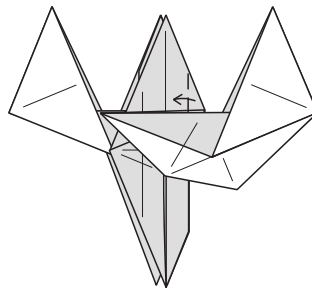

62. Valley along existing crease. Repeat behind.

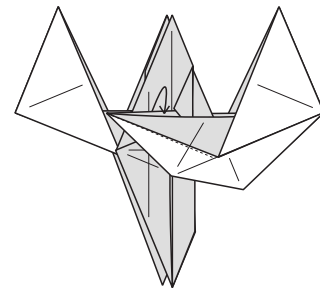

63. Swivel down hidden middle layer into pocket. Repeat behind.

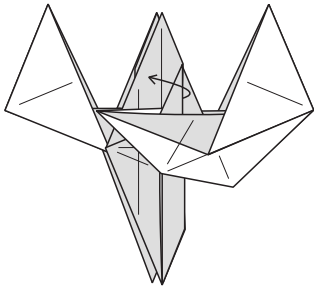

64. Bring single layer to surface (closed sink). Repeat behind.

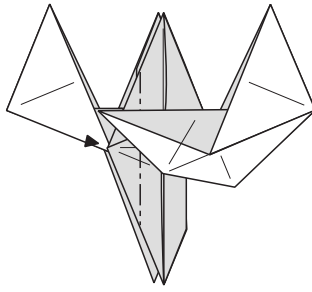

65. Closed sink along existing crease. Repeat behind.

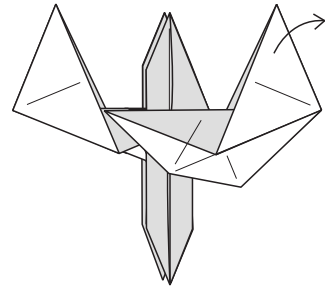

66. Pull point outwards.

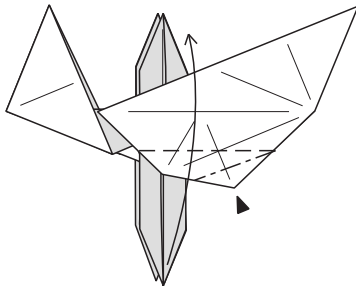

67. Bring the bottom points to the top, allowing the corners to spread sink.

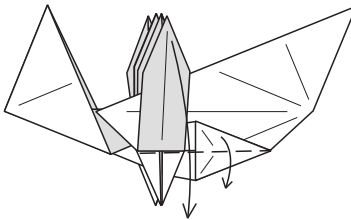

68. Swing down.

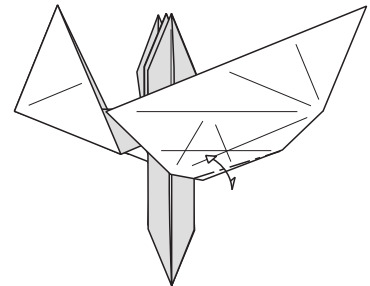

69. Precrease. Repeat with adjacent flap.

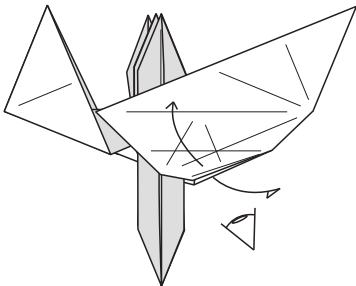

70. Spread apart.

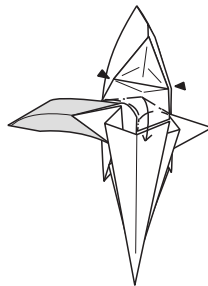

71. View from step 71. Sink single layer through from behind, using the creases from step 69.

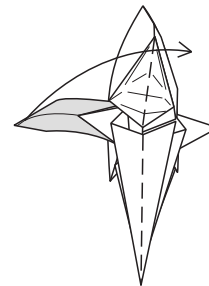

72. The edges of the wing should now be flush. Close the model up.

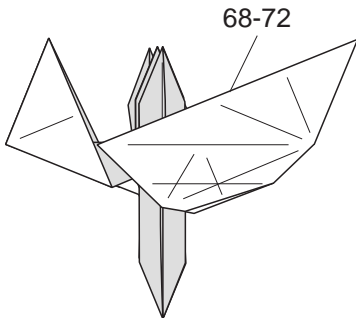

73. Repeat steps 68-72 behind.

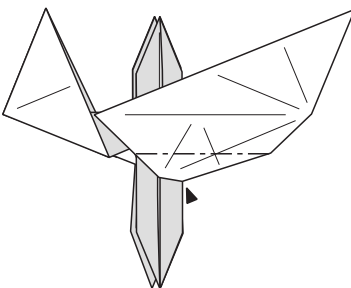

74. Sink triangularly along existing crease. Repeat behind.

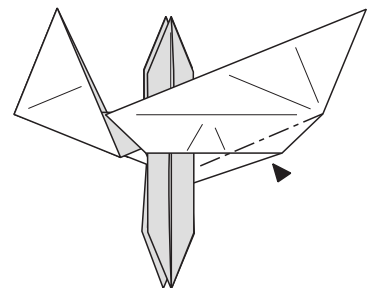

75. Closed sink along existing crease. Repeat behind.

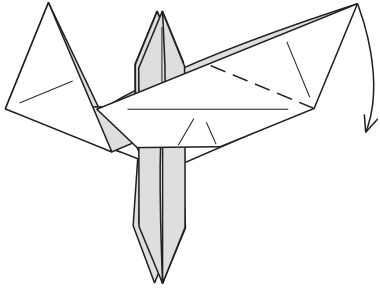

76. Outside reverse fold along existing crease.

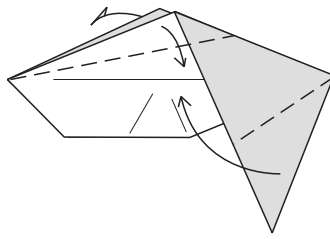

77. Detail of tail. Valley along angle bisectors.

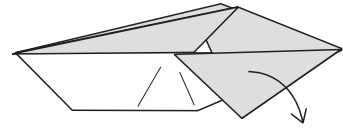

78. Unfold.

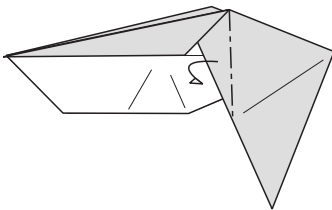

79. Swivel fold. Repeat behind.

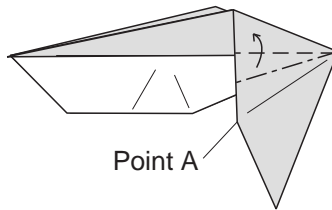

80. Crimp upwards, so point A meets colored raw edge.

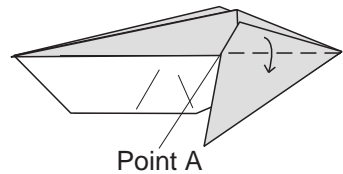

81. Valley down. Repeat behind.

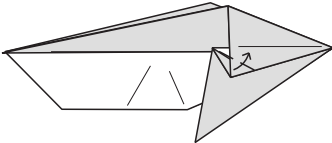

82. Valley along angle bisector. Repeat behind.

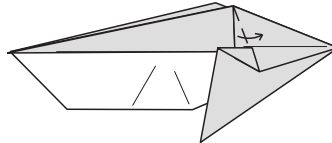

83. Swivel over. Repeat behind.

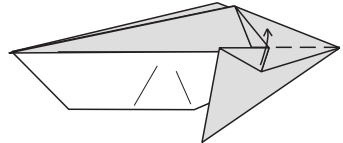

84. Valley up. Repeat behind.

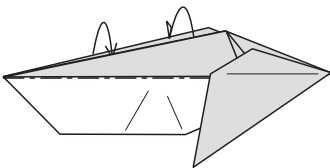

85. Mountain top flaps into pocket.

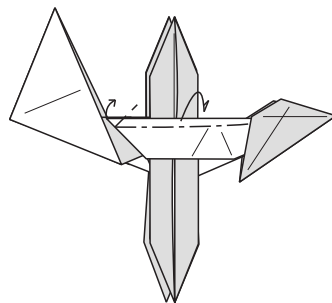

86. Mountain the double layer about 1/4th the width. Towards the tail, the fold will terminate at an angle, and at the other end, a swivel will form. Repeat behind.

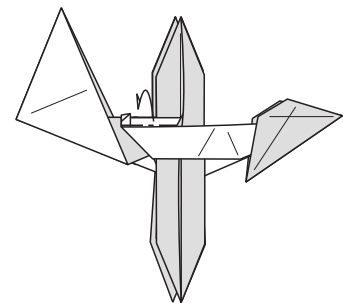

87. Reverse fold back. Repeat behind.

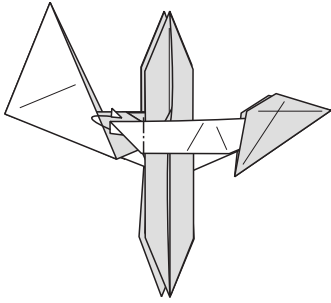

88. Mountain behind wing.  
Repeat behind.

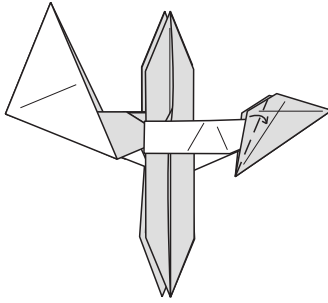

89. Valley to existing crease.  
Repeat behind.

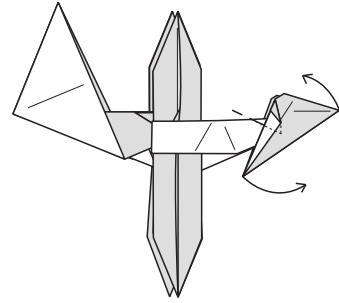

90. Crimp the tail section. See  
step 91 for positioning.

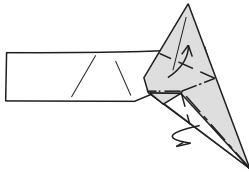

91. Collapse upwards.

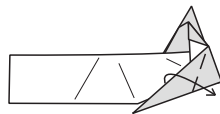

92. Outside reverse fold.

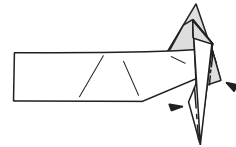

93. Sink the indicated regions.

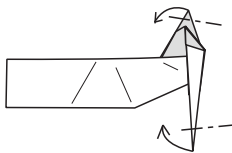

94. Reverse fold the indicated  
areas.

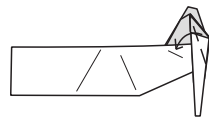

95. Valley over a single layer.  
Repeat behind.

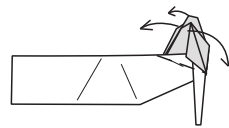

96. Pull the center flap forwards  
while pulling the side flaps  
outwards.

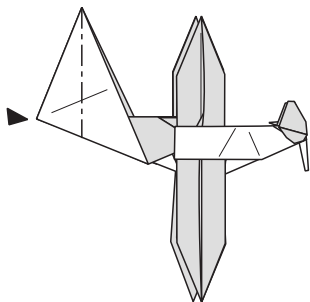

97. Open sink.

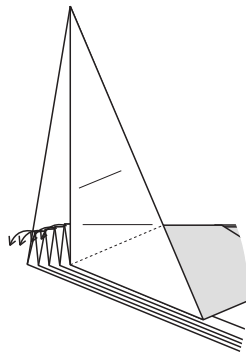

98. Reverse the four hidden  
corners down.

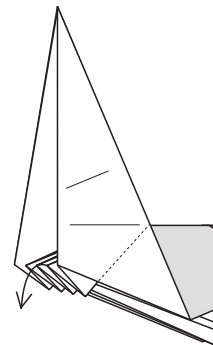

99. Reverse the first of the three  
points down. Note how the  
bottom five layers are  
distributed.

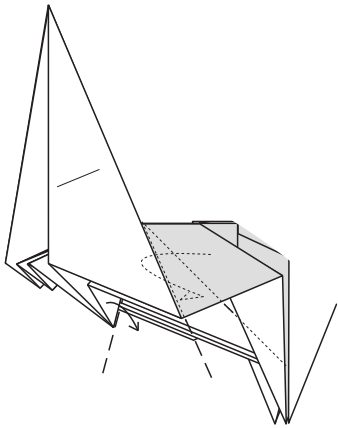

100. Swivel.

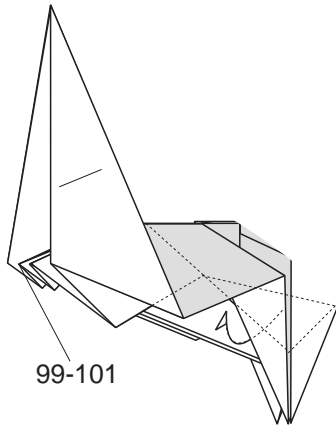

101. Reverse into pocket.  
Repeat steps 99-101  
behind.

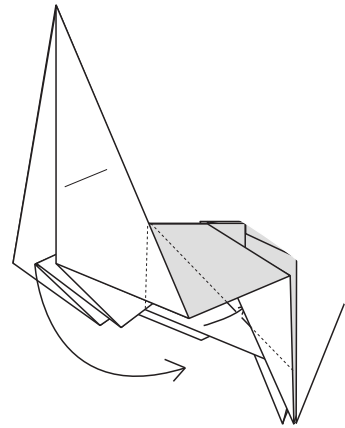

102. Swivel.

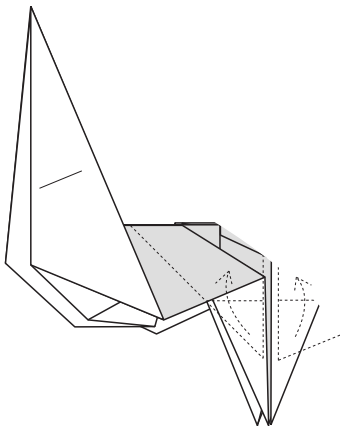

103. Tuck the bottom hidden  
points into the center of  
the model.

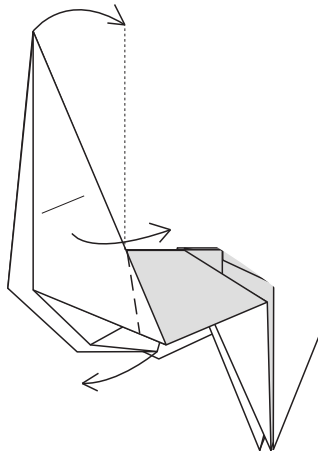

104. Spread apart the flap flat,  
while pulling it into an  
upright position.

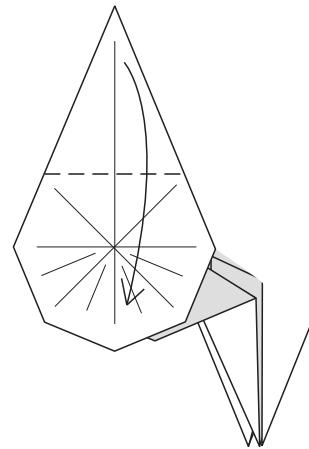

105. Valley down.

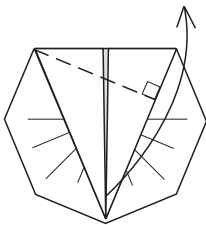

106. Valley up.

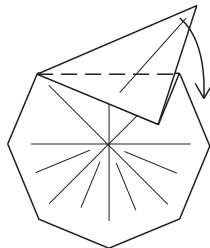

107. Valley down.

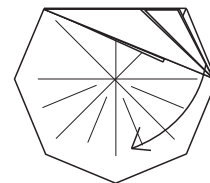

108. Undo pleat.

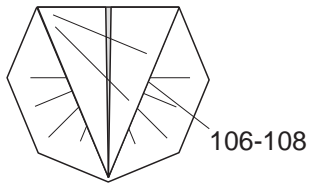

109. Repeat steps 106-108 in mirror image.

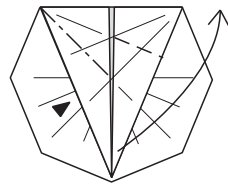

110. Asymmetrical squash.

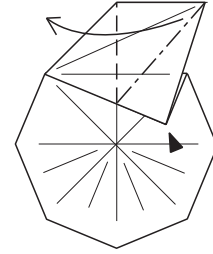

111. Squash.

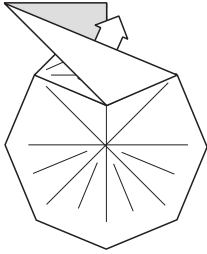

112. Pull out single layer.

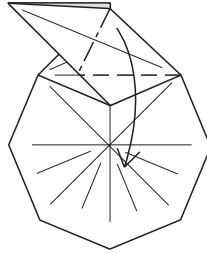

113. Squash.

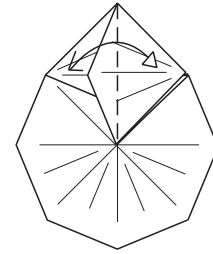

114. Precrease.

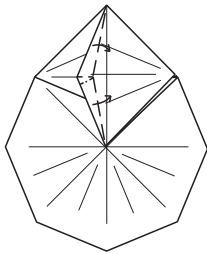

115. Rabbit ear.

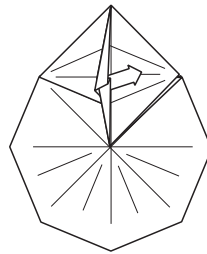

116. Unsink.

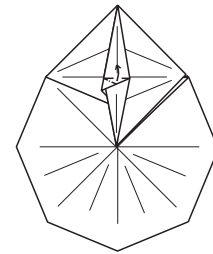

117. Swivel up.

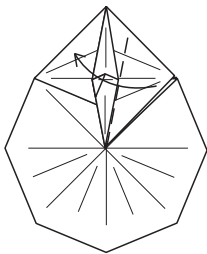

118. Valley over.

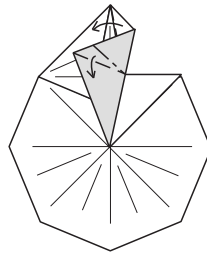

119. Swivel.

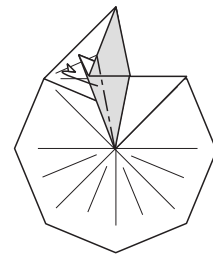

120. Mountain behind.

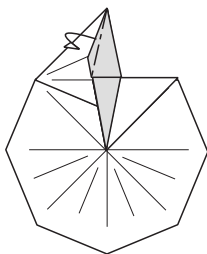

121. Mountain behind.

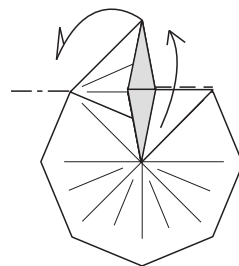

122. Flip the points.

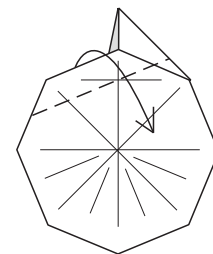

123. Valley through intersection of creases. See step 124 for positioning.

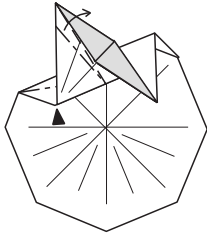

124. Spread squash.

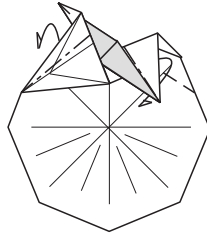

125. Swivel at each side.

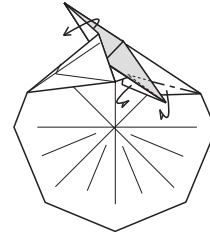

126. Swivel at right. Bring colored layer to surface.

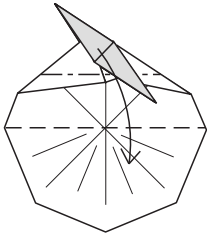

127. Pleat downwards.

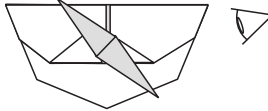

128. Completed propeller.

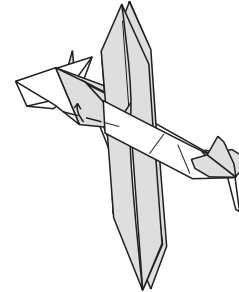

129. Valley up (there are no reference points).

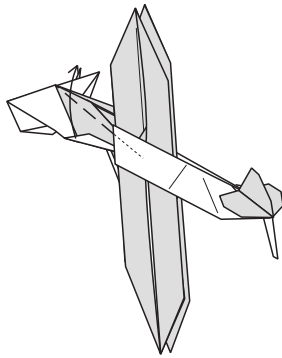

130. Pull the single layer up as far as possible.

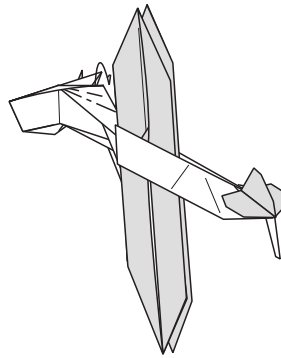

131. Pleat the excess into the center pocket.

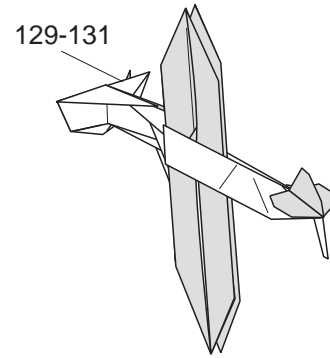

132. Repeat steps 129-131 behind.

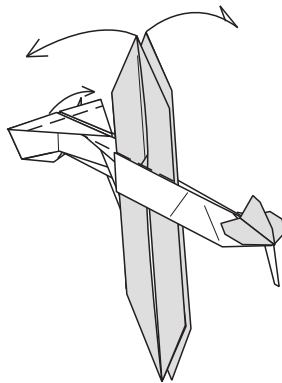

133. Spread the wings apart, allowing the front to spread apart too. To flatten, fold the top of the cowl over.

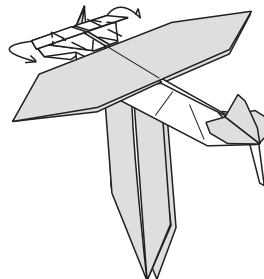

134. Collapse the sides inwards at 90°. You can trim the sides to taste with mountain folds.

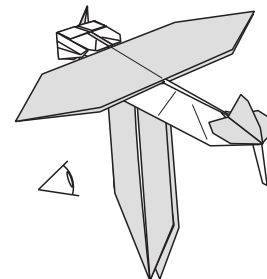

135. Completed cowl.

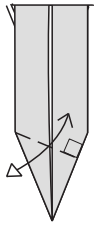

136. View of lower wing. Precrease.

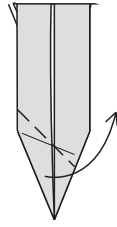

137. Valley at 45° through intersection of precrease and center.

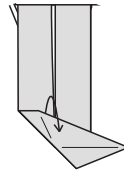

138. Wrap a single layer around.

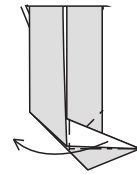

139. Squash over.

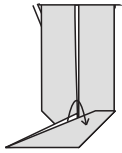

140. Wrap a single layer around.

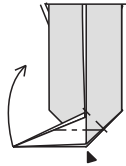

141. Spread squash.

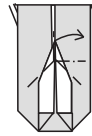

142. Rabbit ear the tip of the strut.

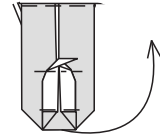

143. Raise the wing and strut, tucking its tip into the pocket on the upper wing. Repeat steps 136-143 on other wing.

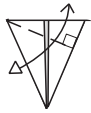

144. Detail of landing gear. Precrease.

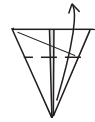

145. Valley up.



146. Pull out a single layer from each side.



147. Valley down while incorporating reverse folds.



148. Shape with mountain folds.

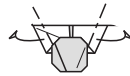

149. Round off with mountain folds.



150. Completed wheel. Repeat steps 144-149 behind.

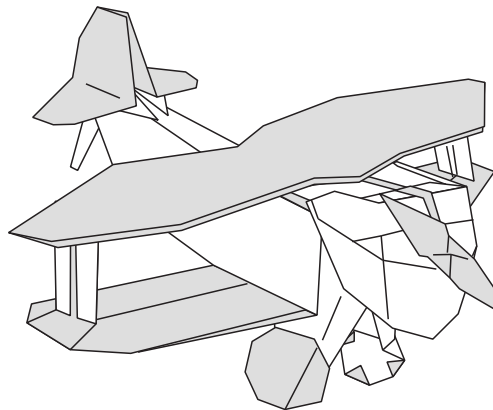

151. Completed Biplane II  
©1996 Marc Kirschenbaum





# Bird

Designed and diagrammed by Andy Carpenter 1998.

Use a square of thick paper or foil backed paper. An 11 inch square will produce a model approximately 8.5 by 3 inches.

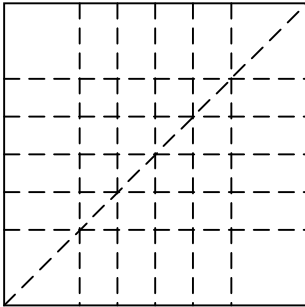

1. Precrease with a diagonal valley fold and divide the sides into 1/8's.

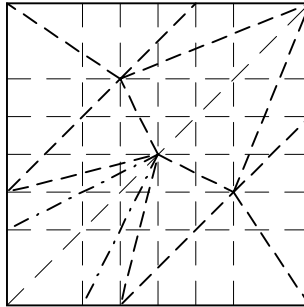

2. Continue precreasing.

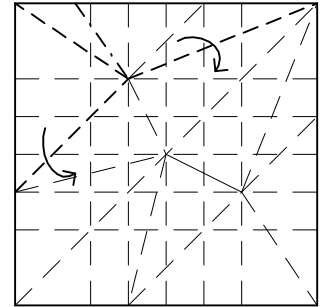

3. Fold left side of model over as shown. The new mountain fold should be placed such that the paper folds flat.

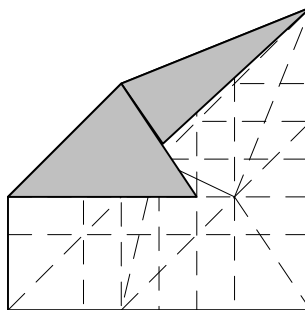

4.

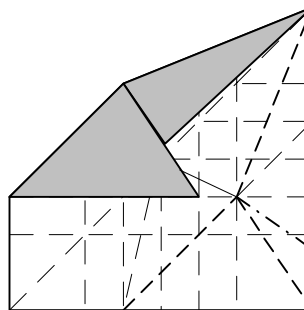

5. Repeat step 3 on right side of paper.

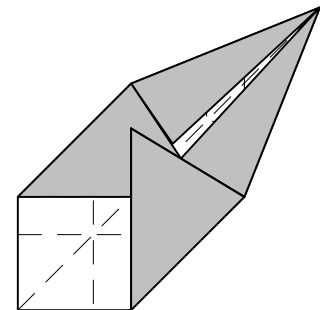

6.

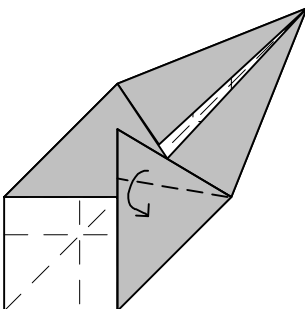

7. Valley fold downwards to form a flap. The paper should lay flat.

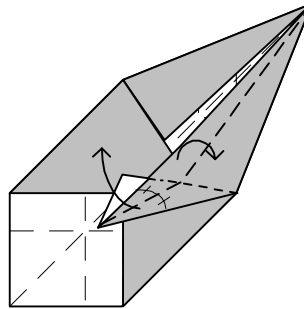

8. The valley fold at the bottom bisects the angle. Lift the flap back upwards to form a triangle.

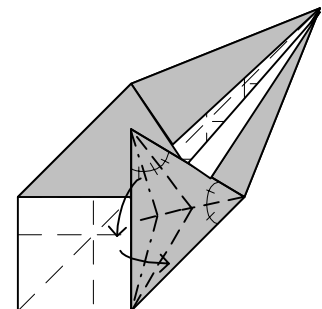

9. Folds at the top and bottom trisect the angle. The fold on the right bisects the angle.

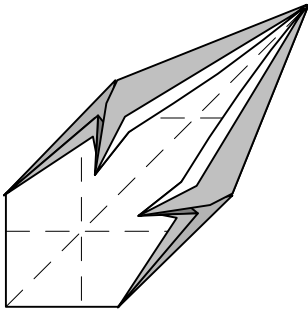

10. Repeat steps 7 - 9 on the left side of the paper. The model will not lie flat after this.

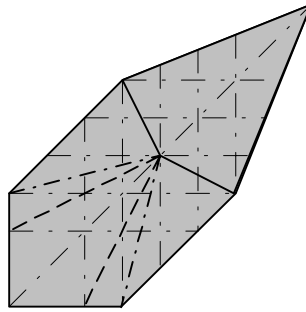

11. Turn the paper over and make the folds shown. The folds were formed in step 2.

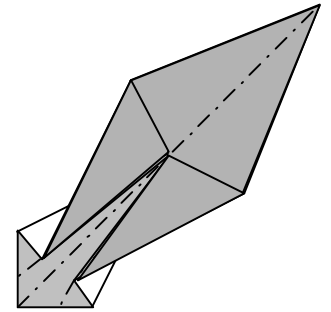

12. First mountain fold the paper behind at the bottom to form the tail. Then mountain fold the paper in half.

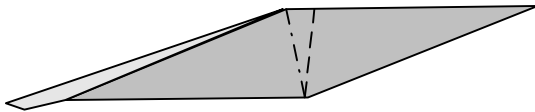

13. Side view of bird. Crimp the paper.

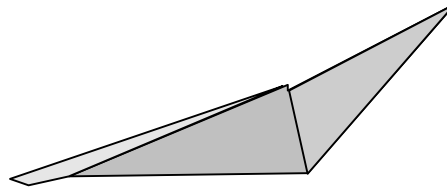

14. Turn the paper over to see it from the underside.

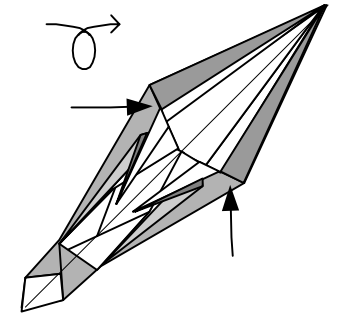

15. Pull the paper out where the arrows are.

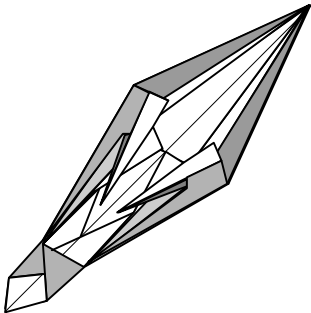

16. The paper should look like above (or at least similar).

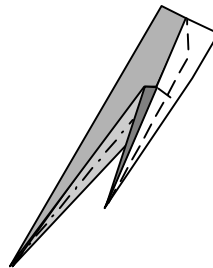

17. Enlarged view of left leg from 16. Thin legs by valley folding top half and sink folding lower half. Leg should stand up. Repeat on the right leg.

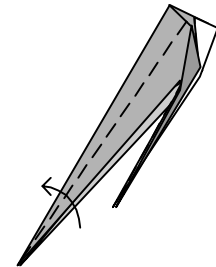

18. Enlarged view of left leg. Valley fold the leg over from right to left. Repeat on other leg.

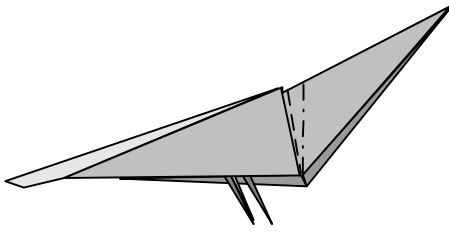

19. Crimp the neck.

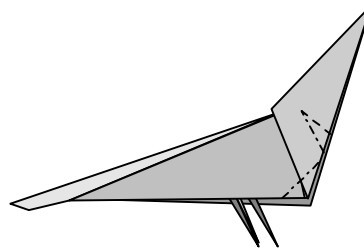

20. Shape the head as above.

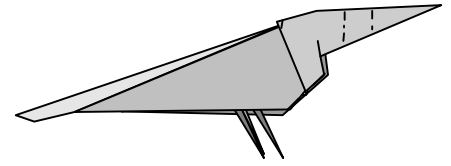

21. Form the beak.

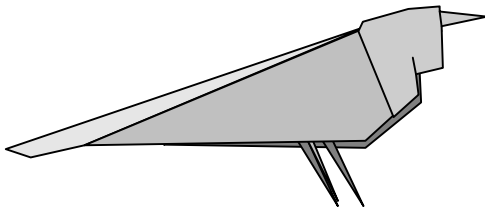

22. The model should look as above.

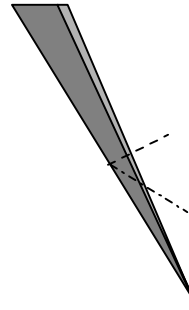

23. Enlarged view of one of the legs. Crimp the leg and repeat on other leg.

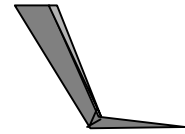

24. Spread out the paper on the foot as much as possible.

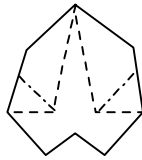

25. Enlarged view of spread out foot from the underside. Fold to form three claws. Tweezers may help here. Repeat on other foot.

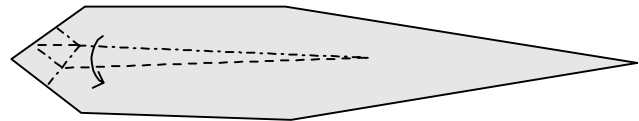

26. Enlarged view of tail area only. Fold to shape tail feathers.

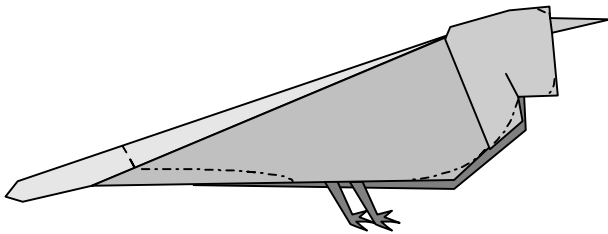

27. Fold to shape bird as shown.

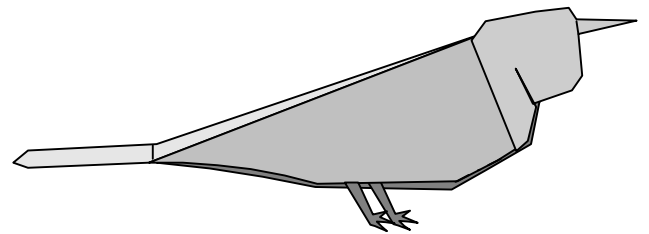

28. The completed bird. With some manipulation of the tail and feet it should be possible to balance the bird on its feet.



# Bird

© Hans Birkeland

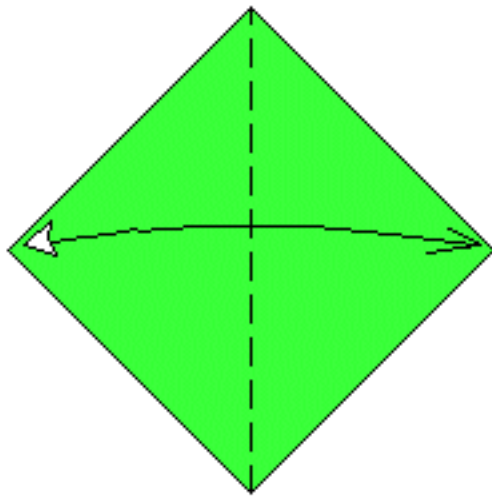

**1** Begin with the white side up. Fold and unfold.

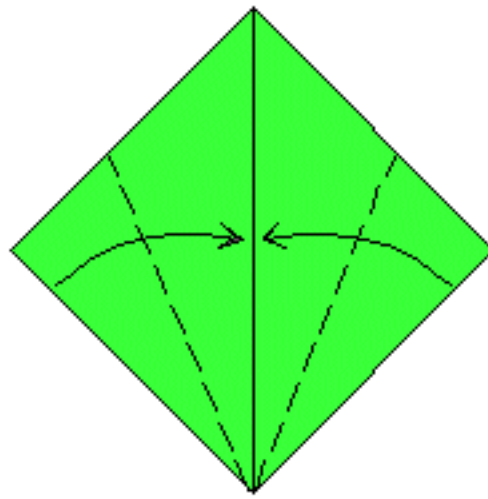

**2** Fold a kite-base and unfold. Turn the paper over.

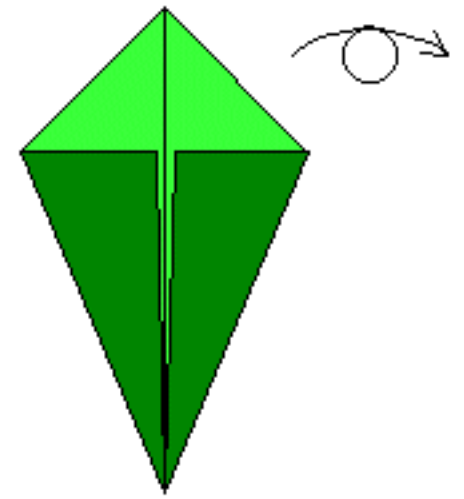

**3** Fold and unfold.

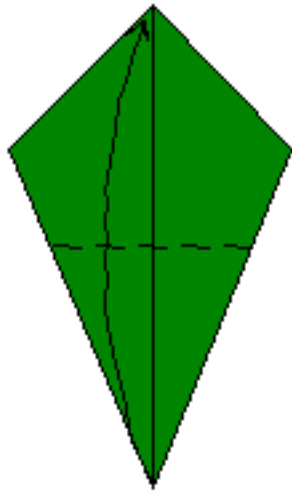

**4** Valley-fold.

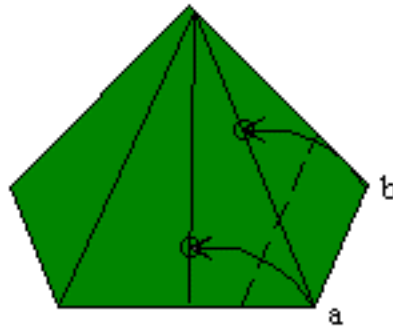

**5** Collapse on existing creases.

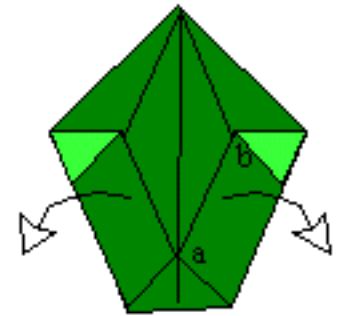

**6** Fold and unfold.

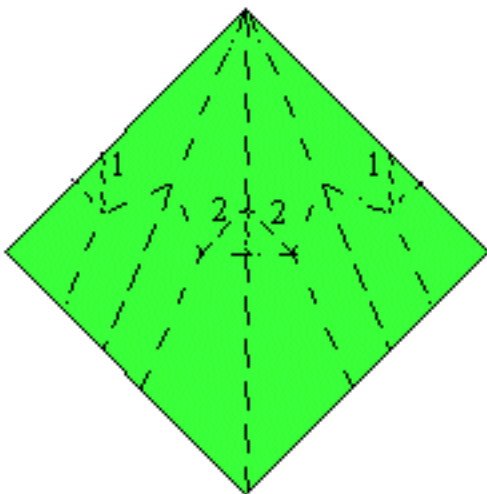

**7** Reverse-fold.

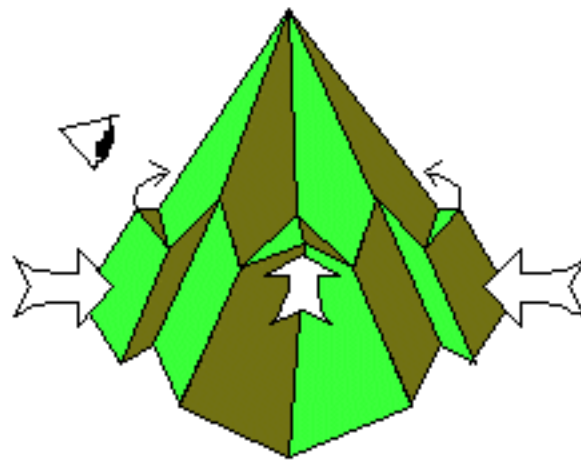

**8** Swivel-fold. The valley-fold is on an existing crease. Repeat behind.

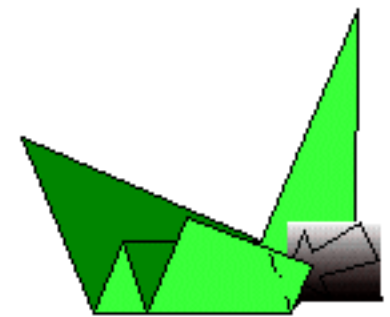

**9** Valley-fold. Repeat behind.

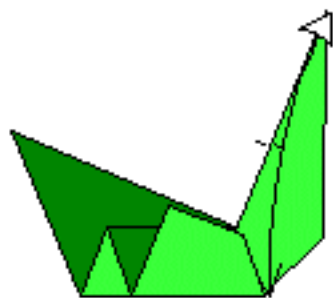

**10** Fold and unfold, making a mark at the edge.

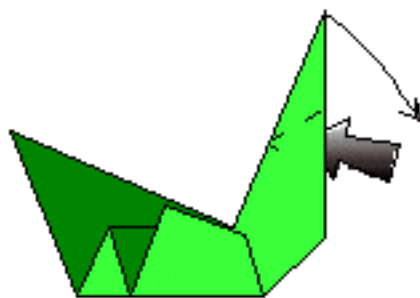

**11** Reverse-fold.



**12** Open at the top and valley-fold. Next view from the top.

---

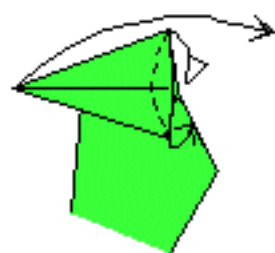

**13** Make a rabbit ear.

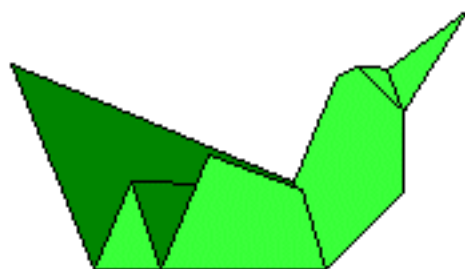

**14** Finished bird.

---

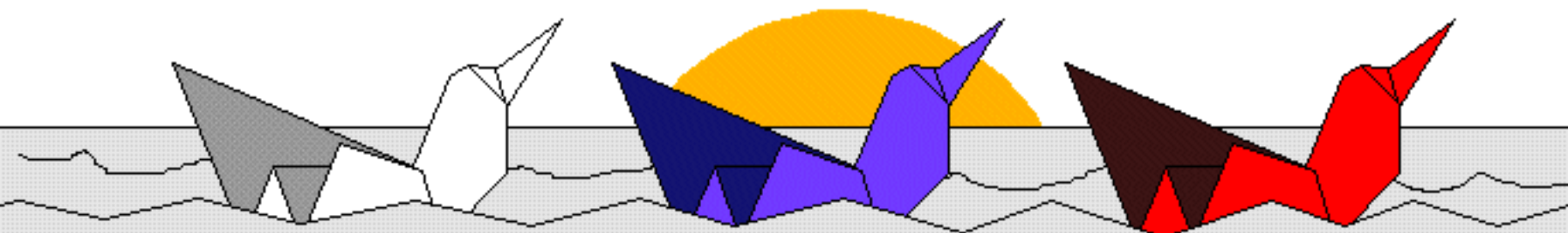
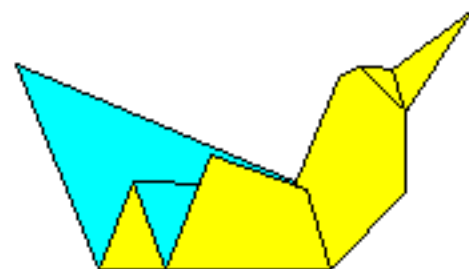

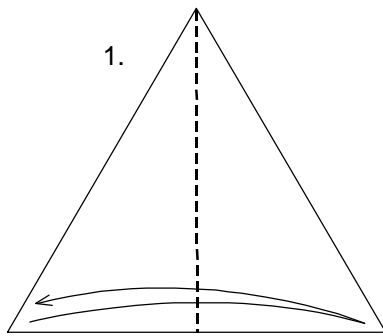

1. Begin with an equilateral triangle, about 15 cm to each side. Fold and fold.

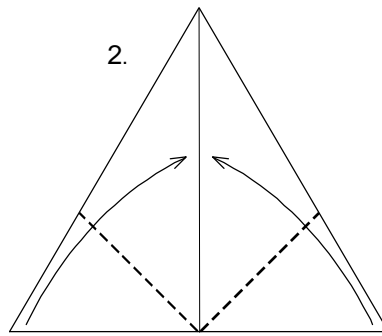

2. Fold to the crease line in the centre ...

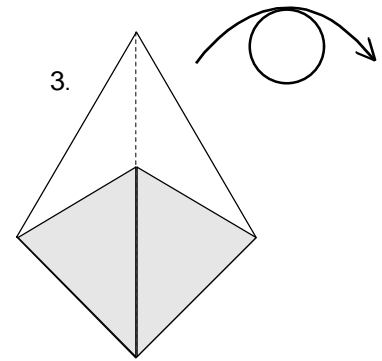

3. ... and turn paper over.

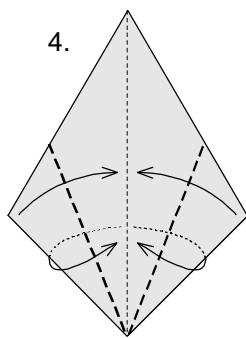

4. In this step, only the top layer is folded. Bring the lower edges to the middle.

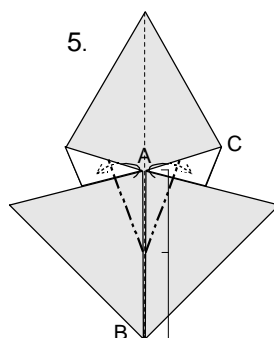

5. Mountain fold each of the corners under as shown, at the mid-point between A and B and parallel to line B and C.

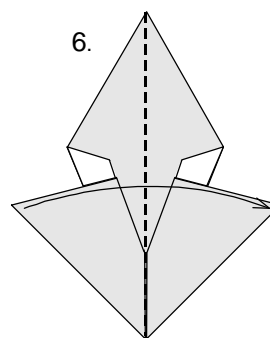

6. Fold in half.

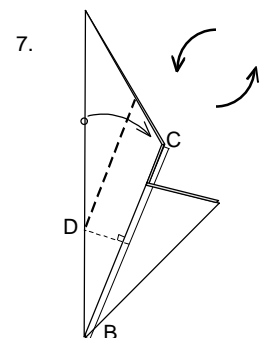

7. Imagine BCD as an isosceles triangle. Valley fold as illustrated and crease well.

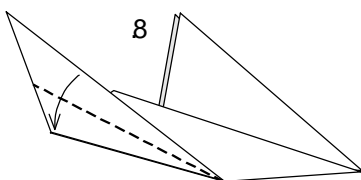

8. Fold down and crease well ...

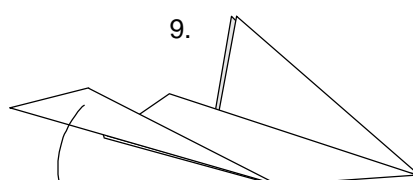

9. ... then unfold Steps 7 and 8.

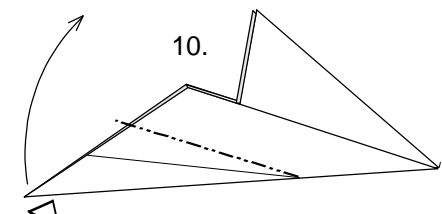

10. Reverse fold along the crease lines made in Step 7.

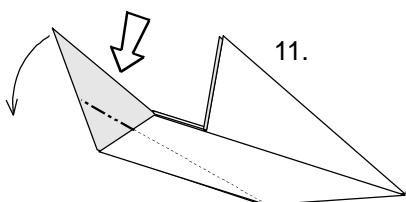

11. Reverse fold again along creases made in Step 8.

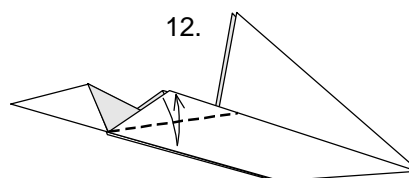

12. Fold and unfold, creasing firmly ...

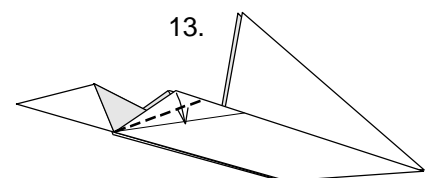

13. ... then valley fold to the crease made in Step 12.

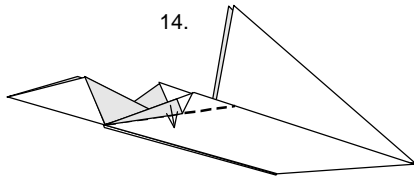

14. Fold over ...

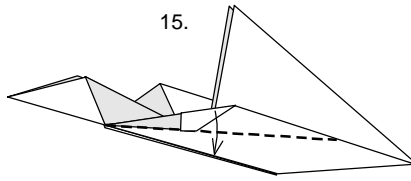

15. ... and over.

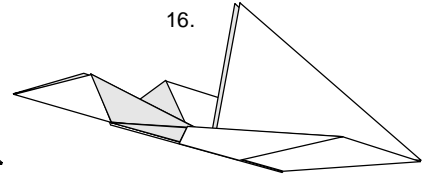

16. Repeat Steps 12 to 15 on the other side.

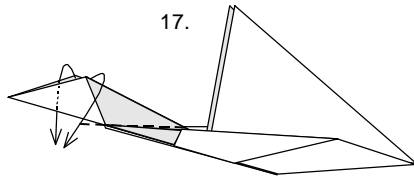

17. Outside reverse fold on the left ...

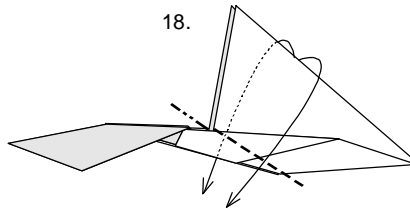

18. ... and then the right, at the angle as illustrated.

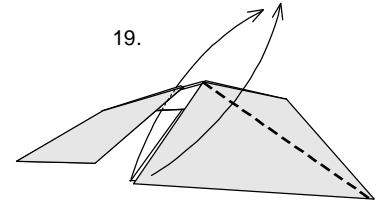

19. Fold up the top and back pieces as shown.

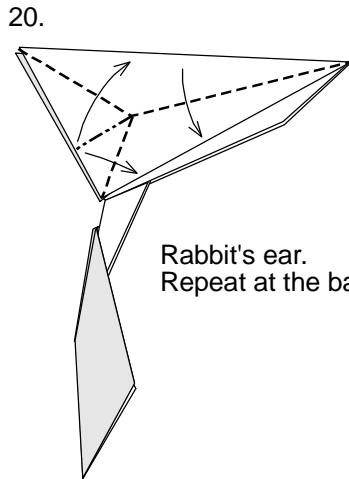

20. Rabbit's ear. Repeat at the back.

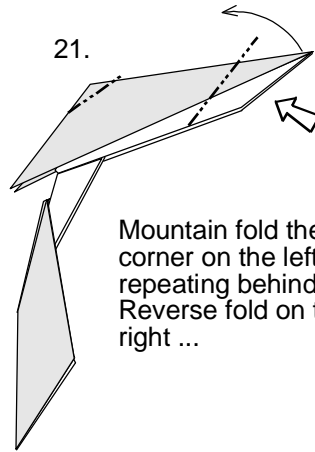

21. Mountain fold the corner on the left, repeating behind. Reverse fold on the right ...

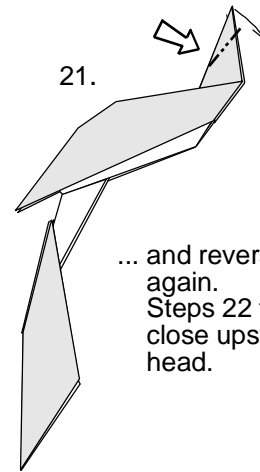

21. ... and reverse fold again. Steps 22 to 24 are close ups of the head.

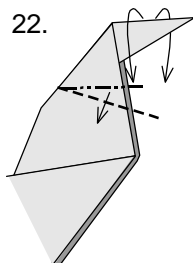

22. Outside reverse at the top while crimp folding below ...

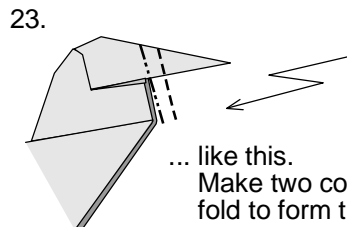

23. ... like this. Make two consecutive reverse fold to form the beak ...

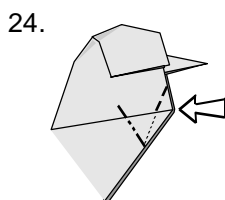

24. ... then crimp fold here to finish.

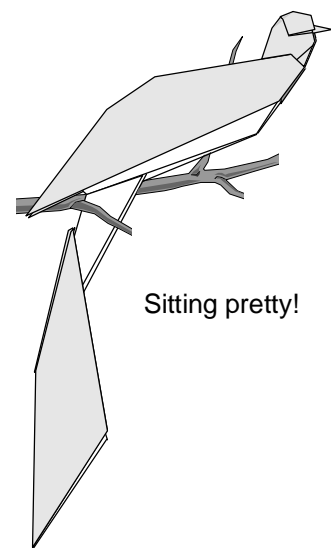

Sitting pretty!



# Flor

## Bloom

Use um quadrado de papel.  
Use a square of paper.

Criação e Diagramação:  
Rita Foelker

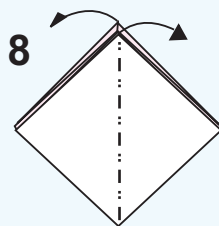
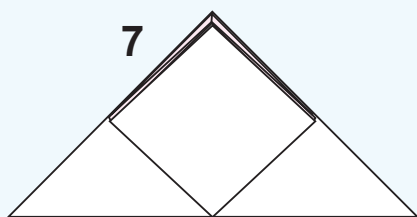
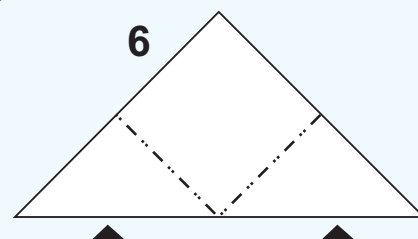
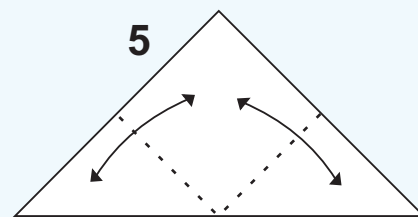
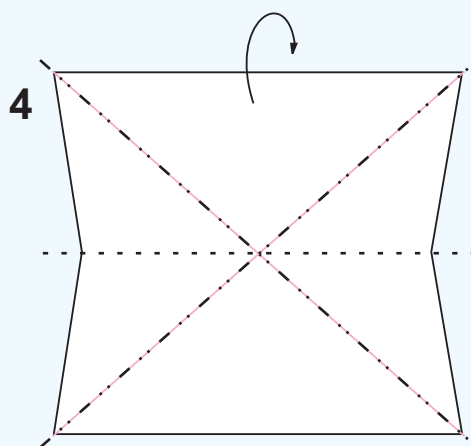
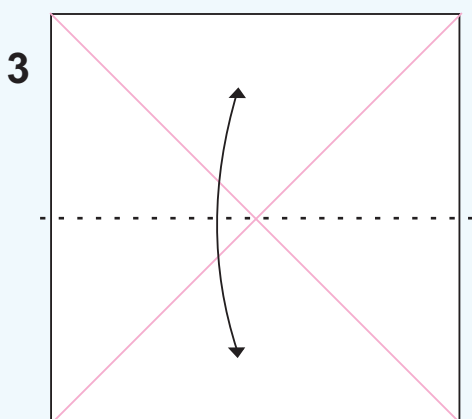
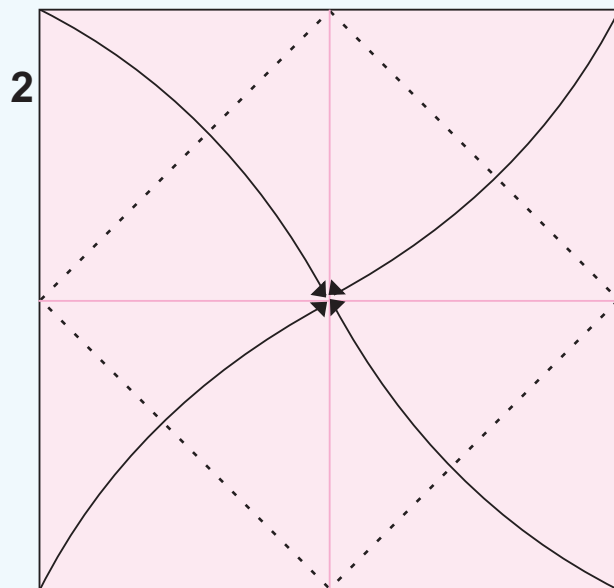
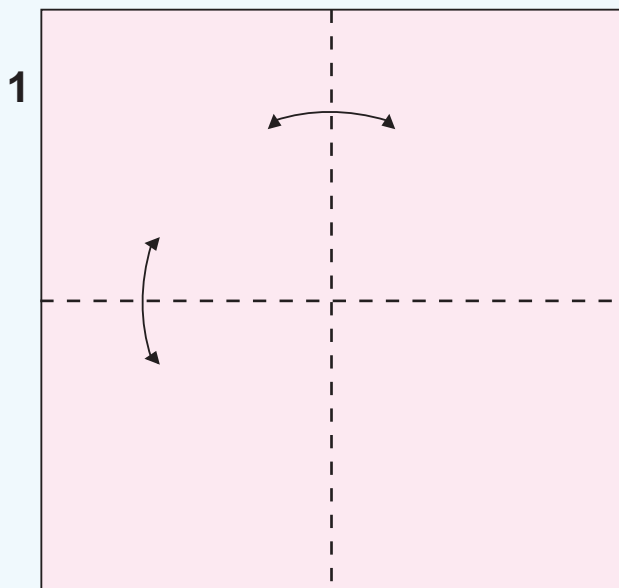

Passos 5-6: Repita na parte de trás.  
Steps 5-6: Repeat on the back.

Dobra de montanha só  
na primeira e na última camadas.  
Mountain folds only  
in the first and last layers.

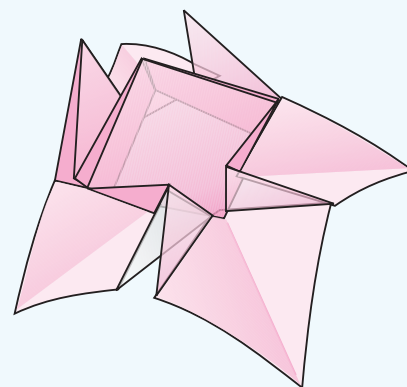
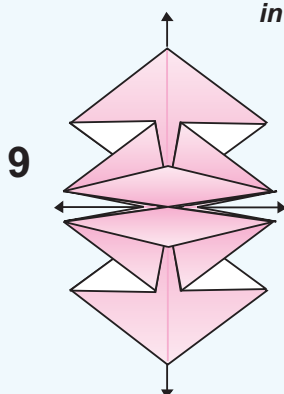

Se desejar, coloque o caule, introduzindo  
um pedaço de arame ou palha no orifício embaixo.  
If you want, put the stalk in it, by inserting  
a piece of thin wire or straw into the down hole.

# Blue Crab / Rock Crab by Marc Kirschenbaum (NY)

©1989

Use a large foil-backed square.

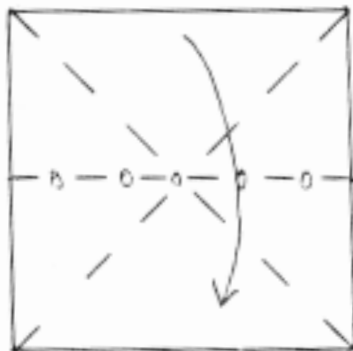

1. White side up:

Form a waterbomb base.



4. Unfold. Repeat steps 3-4 folding to the opposite side.



2. Precrease where indicated. Do not repeat behind.



3. Valley fold top corner to the intersection of creases.



5. Mountain fold through intersection of creases. (Valley fold first and convert to a mountain fold.)

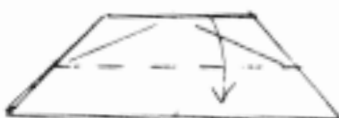

6. Valley fold the top edge to the bottom edge.



7. Unfold the pleat.



8. Unfold sides.

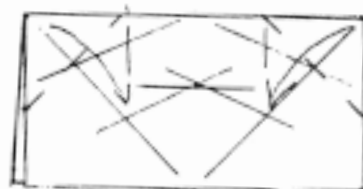

9. Valley fold where indicated.

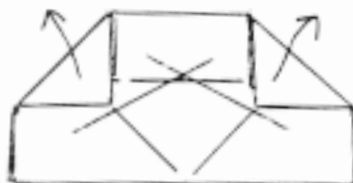

10. Unfold the two flaps.



11. Valley fold where indicated.

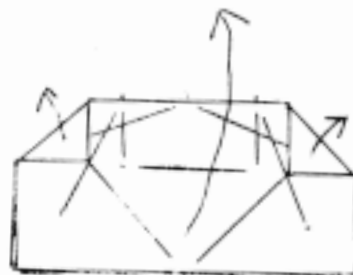

12. Convert folds from Step 11 into mountain folds, and then open up model entirely.

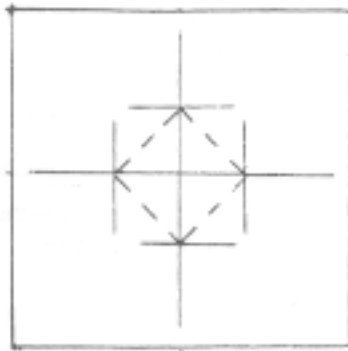

13. Precrease where indicated. Return to the waterbomb base position, being sure to keep the precreases from Step 2 in front.



14. Sink along crease from Step 5.



15. Swing down flap while squashing corners. Repeat behind and then turn over

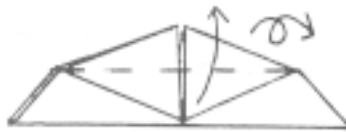

16. Swing flap up; do not repeat behind. Turn over.



17. Swing flap over.



18. Swing flap over while reverse folding on existing creases. Repeat Steps 17-18 on the other side.

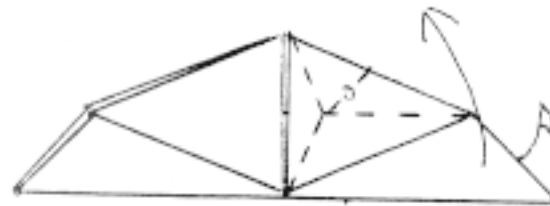

19. Model enlarged:

Rabbit ear large flap along existing creases. The two single layers in this flap will separate as a result.

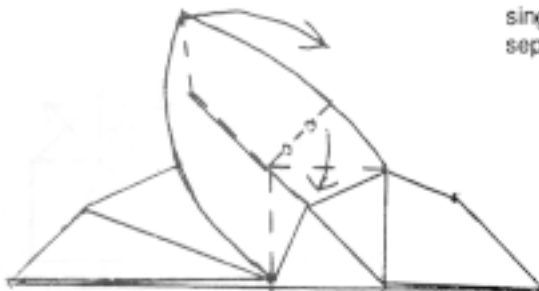

20. Swing the large flap over while bringing its single layered sides together. This is essentially a rabbit ear.

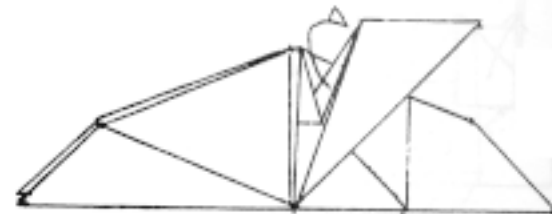

21. Wrap this layer around. The flap will have to be unfolded slightly.

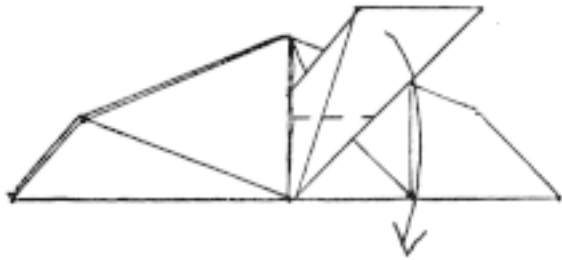

22. Swing down flap; model will not lie flat.

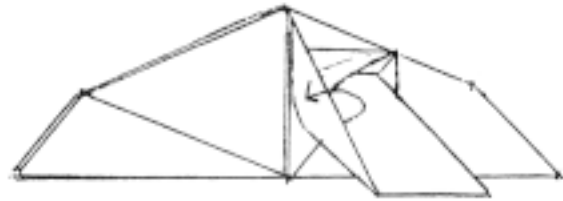

23. Pull section out and to the surface. This is essentially undoing a closed sink and then flattening.

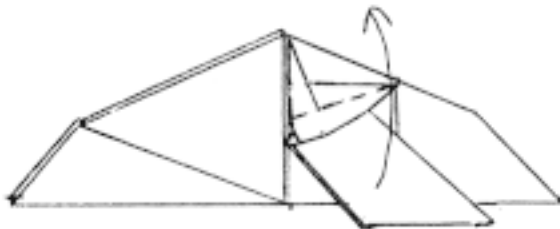

24. Step 23 completed. Swing flap back up to flatten model.

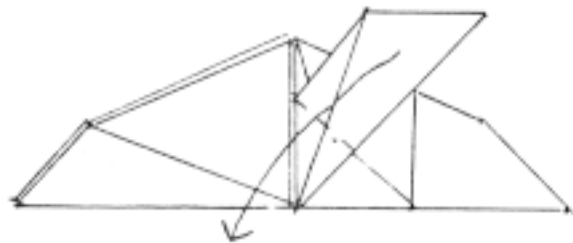

25. Swing flap across. Ensure that the layers of this flap stay together.

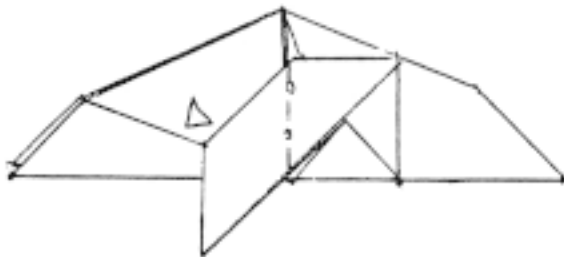

26. Closed reverse fold the flap.

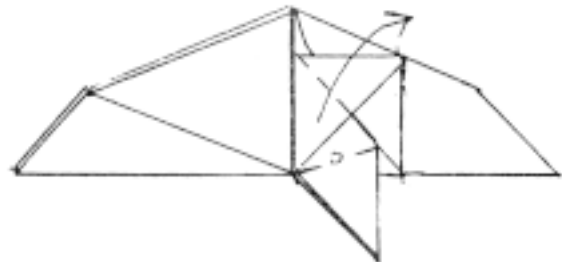

27. Squash fold the flap.

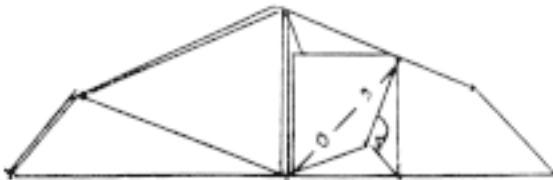

28. Mountain fold the excess paper. Repeat Steps 19-28 on the other side.

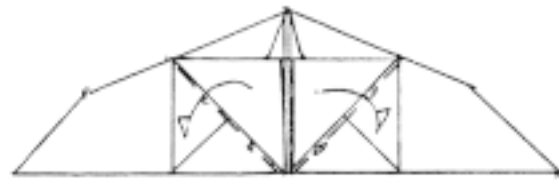

29. Mountain fold the top single layers into the model. Do not do this step if you want to make the Blue Crab.

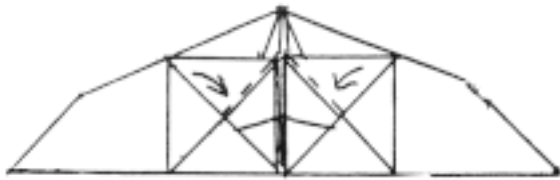

30. Swing a flap down from each side.

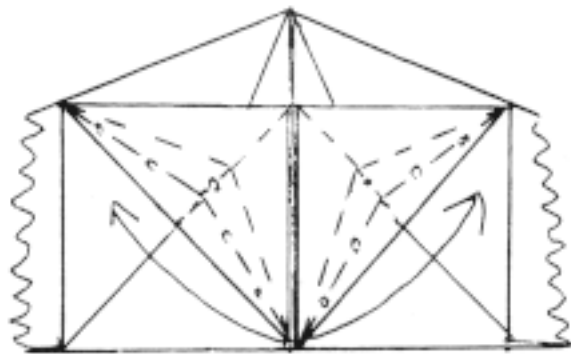

31. Detail of legs:

Swing flaps back up again, reverse folding up and then down. For Blue Crab, do not reverse fold down.

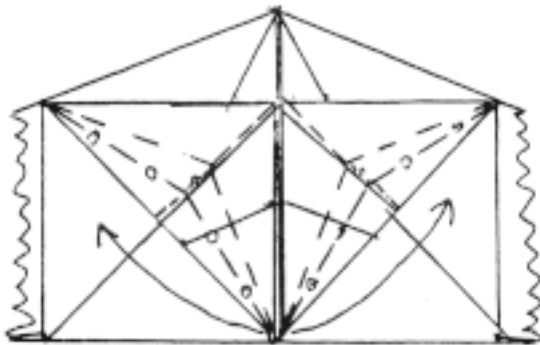

32. Same as previous step, but on a thicker flap. This time do not omit the mountain folds.

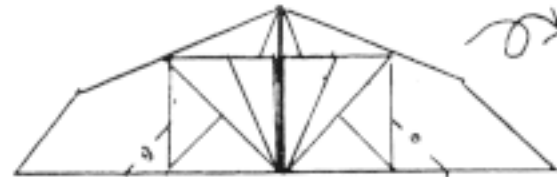

33. Precrease using the existing fold as a guide. The mountain fold should not extend to the top. Turn over.



34. Valley fold top down as lightly as possible.

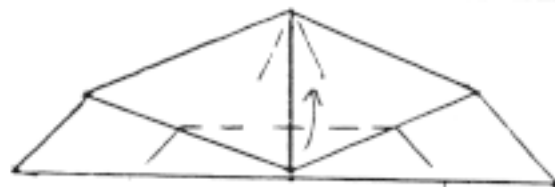

35. Valley fold flap up so that it intersects with the creases shown.



36. Pull single layer to the surface (similar to a closed sink). Do not flatten.

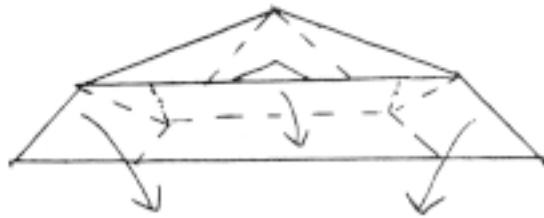

37. Simultaneously fold the sides in on existing creases while folding down the edge created in Step 36 as far down as it will go (it will not touch the bottom).



38. Turn model over.

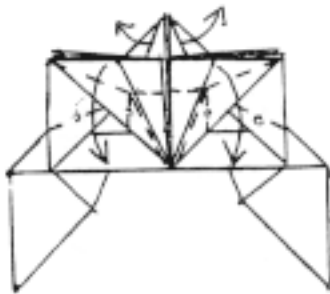

39. Pull out paper at the top of the model. At the same time, swing the legs down while collapsing the paper connecting them.

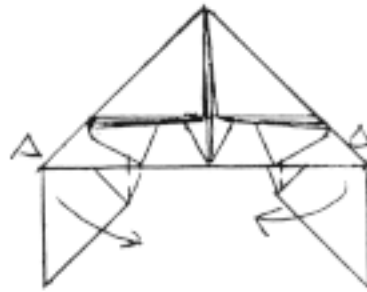

40 Reverse fold sides.

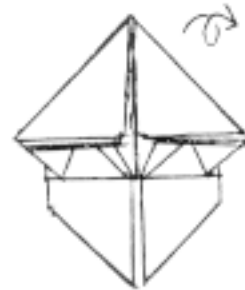

41. Turn over.

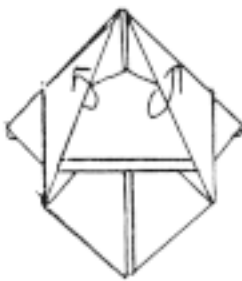

42. Bring sides to the surface (similar to undoing a closed sink).

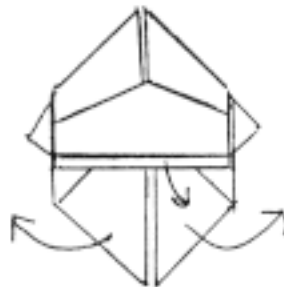

43. Spread out sides and pull out single layer; model will not lie flat.

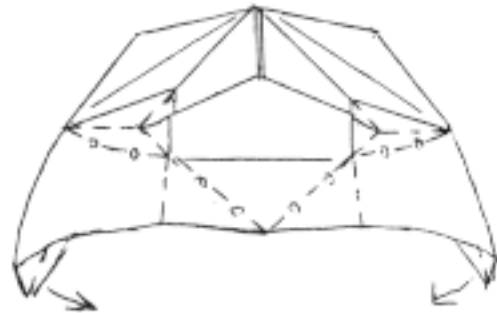

44. Collapse as shown. Please note that not all of the folds are shown; they are either partially formed or will form naturally. Also, avoid getting the legs tangled in between the layers.



45. Valley fold flap up.

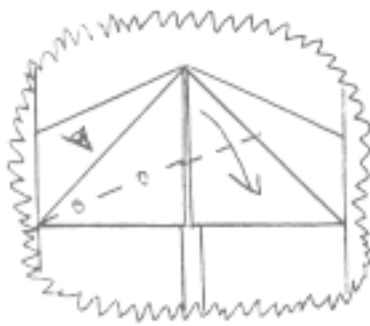

46. Enlarged view of flap for eyes:

Squash fold one side of the triangle folded up in the previous step.

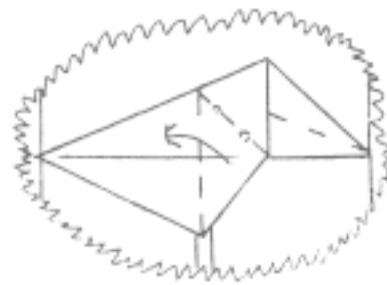

47. Form 'half' of a petal fold by swinging the small center flap over.

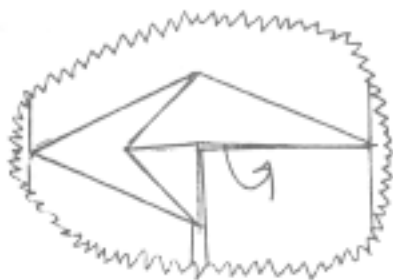

48. Pull out single layer of paper and flatten out.

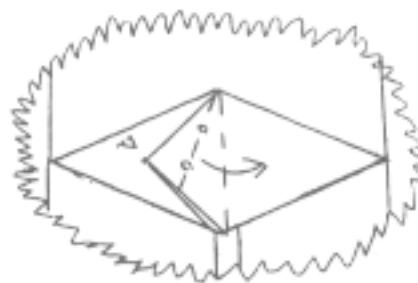

49. Squash fold flap.

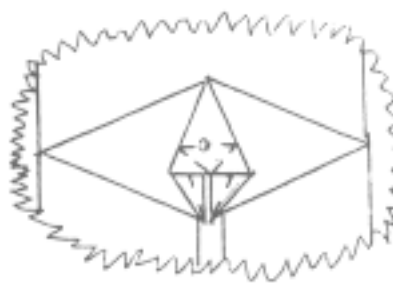

50. Fold sides in while tucking in the resulting petal fold underneath. Model should be opened up slightly to do this.

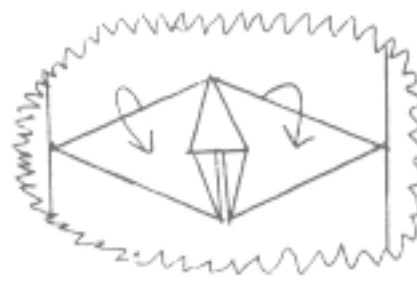

51. Pull single layer of paper over top half of eye assembly. This is essentially a closed sink.

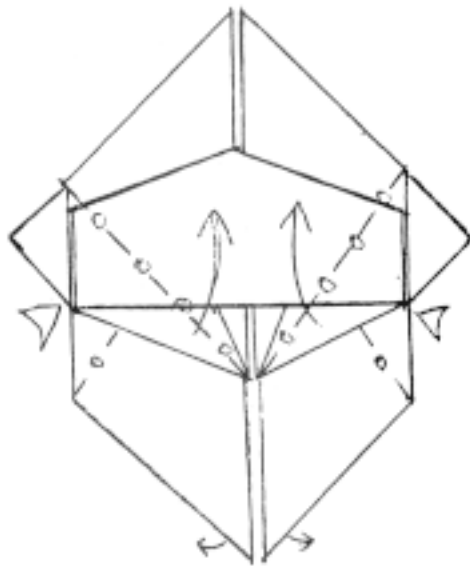

52. Sink sides. Do not flatten. Note that in the next diagram the claws move away from each other, and the raw edges on the claws do not meet the center of the model.

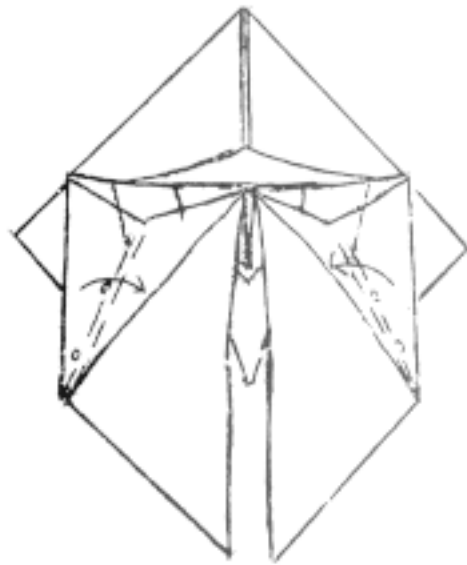

53. Make the concave sides flat by forming the tiny crimps where indicated. To accomplish this, you will first have to puff out the concave single layer from underneath.

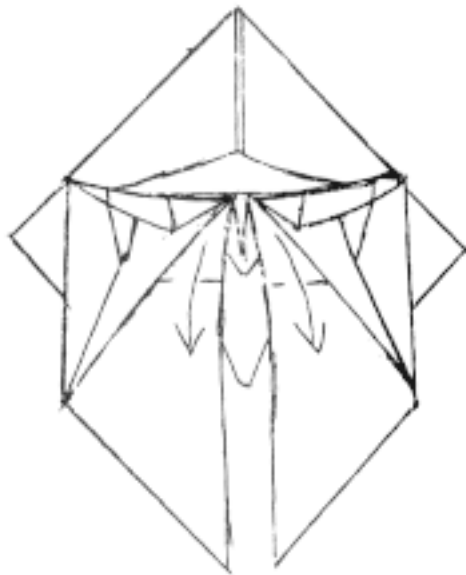

54. Flatten model. Keep in mind that the raw edges of claws do not meet center of model, and the folded edges of claws should meet the folded edges of the crimps formed in the previous step.

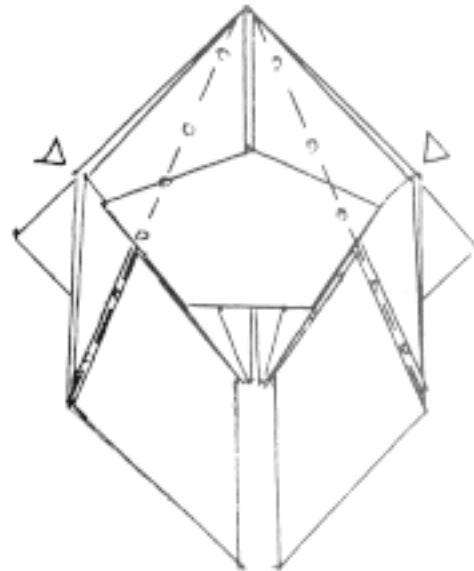

55. Closed sink where indicated. Note that model does not lie entirely flat due to tensions created by the reference points I chose.



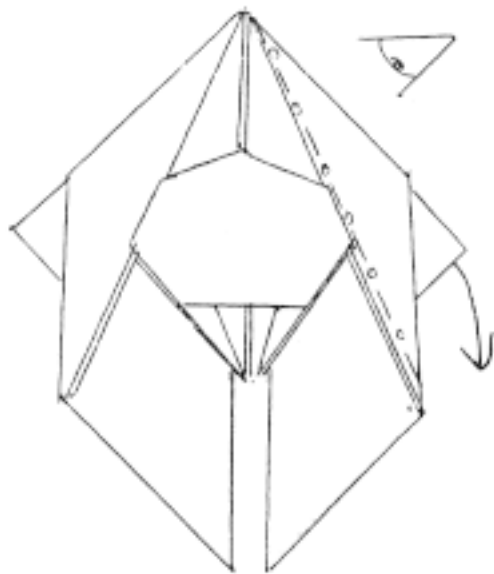

56. Open out side along indicated mountain fold. Model will not lie flat.



57. View from Step 56:

Collapse claw using folds indicated.

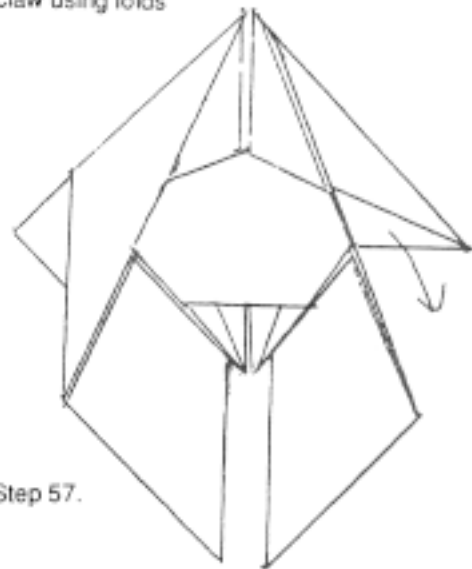

58. Complete. Return to Step 57.

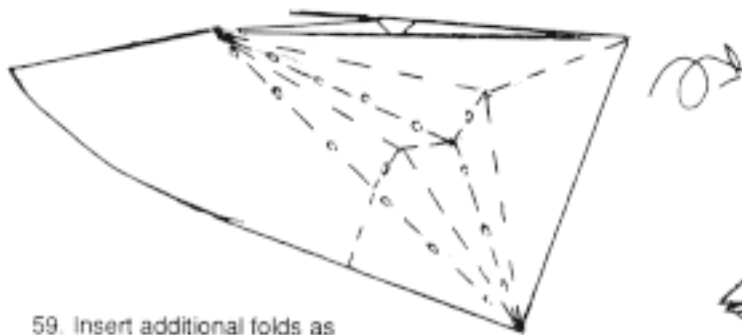

59. Insert additional folds as indicated. Completed fold will still resemble Step 58. Repeat Steps 56-59 on the other side. Turn over.

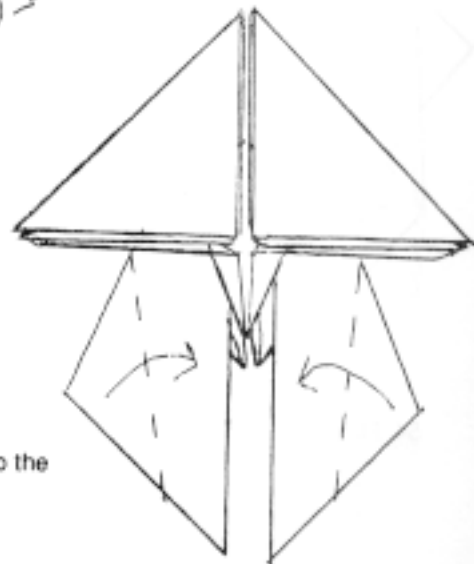

60. Valley fold corners to the nearest edge.

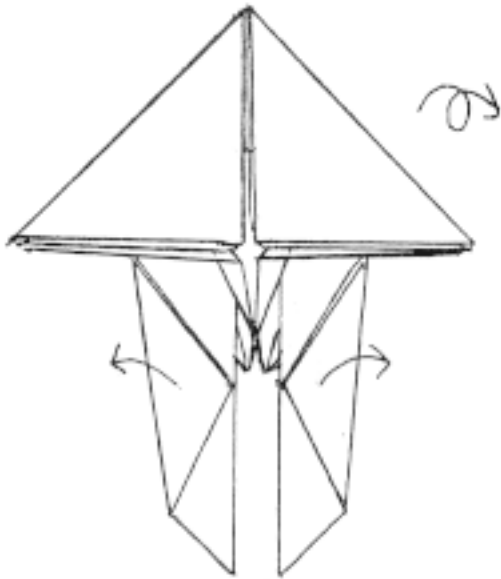

61. Unfold. Turn model over.

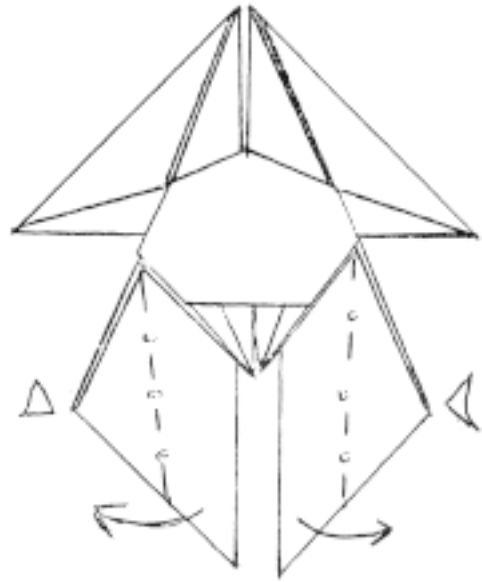

62. Sink claws while pulling them out.

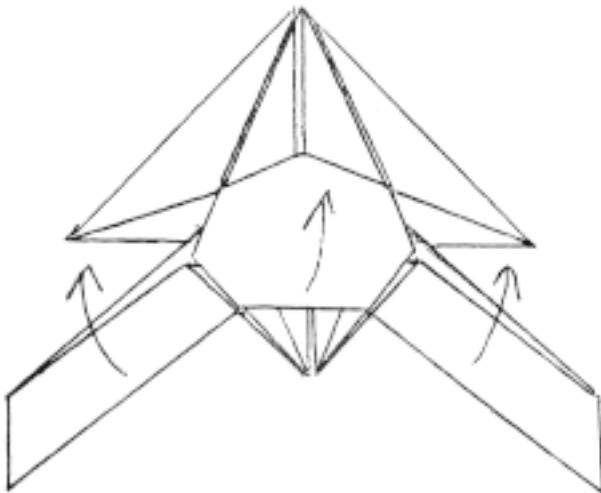

63. Raise the top layer.

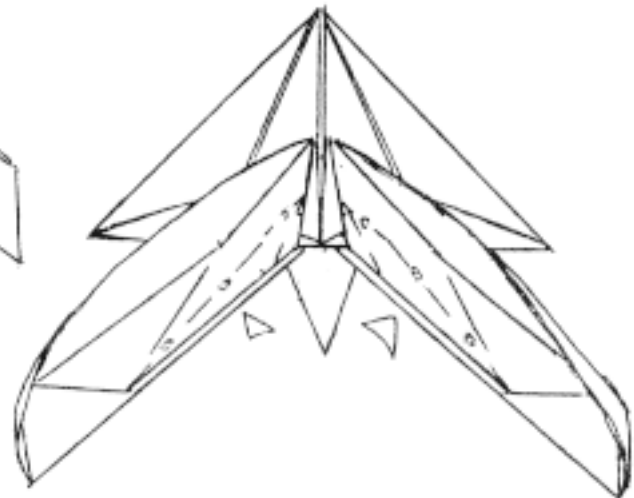

64. Sink top layer halfway towards the nearest creases.

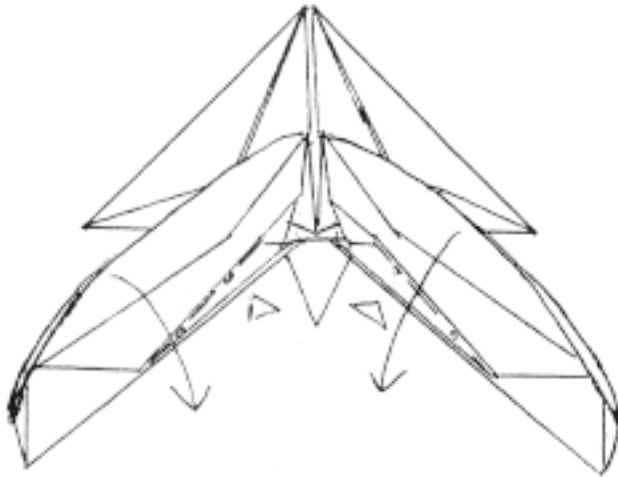

65. Closed sink the next layer down so that it lines up with its neighboring layers. Flatten model to position of Step 63.

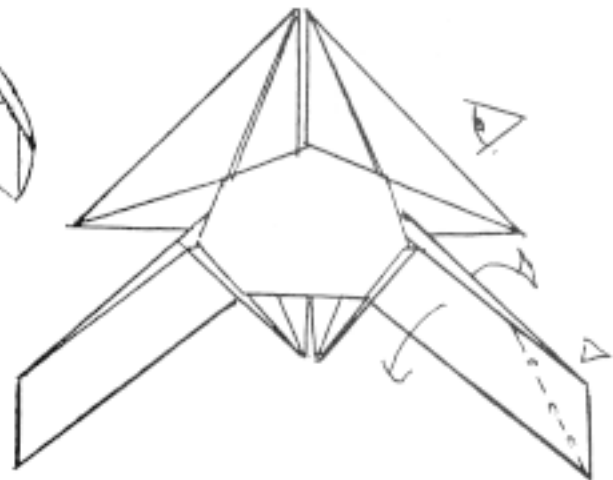

66. Spread squash the claw.



67. View from Step 66:

Unsink paper from the claw. Pull out paper from the sides of claw until its sides are straight. This will cause the claw to tilt downwards.



68. Only claw is shown:  
Mountain fold.

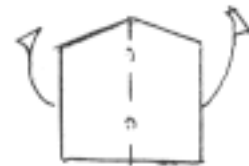

69. Flatten the claw and its arm by folding the claw in half. See the next step for the positioning of the claw.

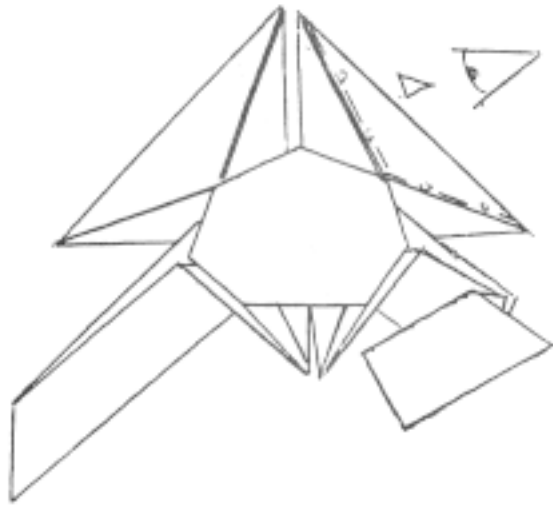

70. Repeat Steps 66-69 on the other claw. Spread apart the 'web' between the legs.

71. View from Step 70:

Insert the long valley folds in between the mountain folds and crimp the leg. The way the other folds are formed is not important. Repeat this with the other leg and then turn the model over.

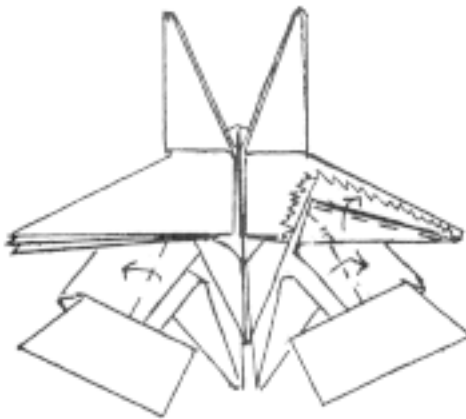
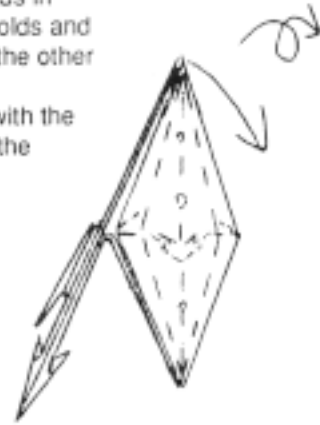

72. Swivel the bottom layer of the leg over the bottom thickness of the legs. The valley folds along the claws should lie against the thickness of pleats below them. For the Rock Crab, use a reverse fold instead; that is, use a mountain fold along the length of the legs instead of a valley fold.

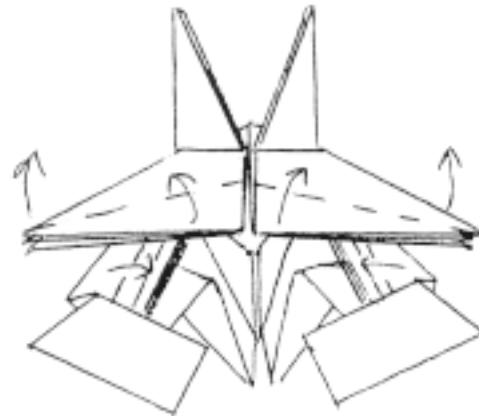

73. Valley fold the entire leg assembly in half while spreading the legs apart. The bottom single layer on the front leg should stay in place. Fold in the top layer for each of the claw's arms.

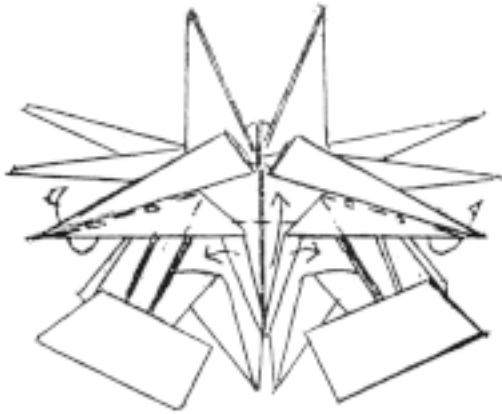

74. Squash the center flap upwards while wrapping the single layers from the legs behind. For the Blue Crab, wrap the single layers forward.

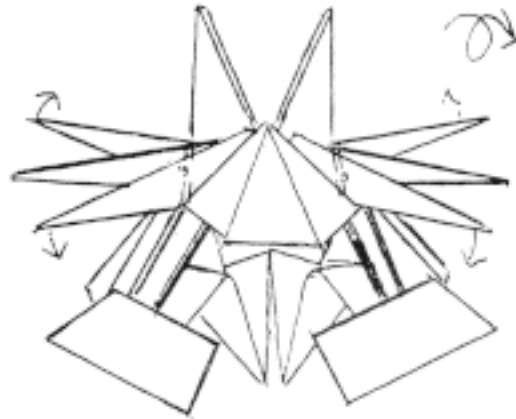

75. Completed step. Spread out legs farther, putting a slight crimp in them where they meet the body. Turn over.

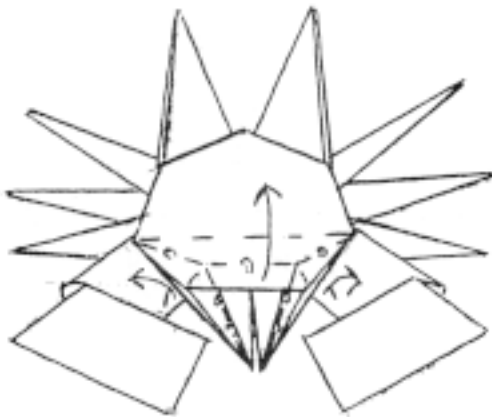

76. Squash the eyes up as indicated. The horizontal mountain fold should be made as lightly as possible. The bottom single layer of the eyes simply gets reverse folded outwards, with the fold extending down to the arms of the claws.

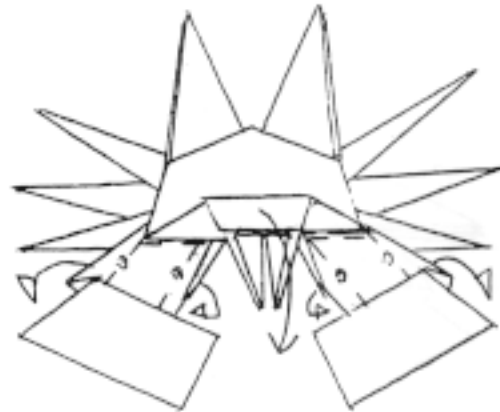

77. Fold back down the front of the shell. Pull out the eyes slightly while doing this to add to their length. Shape the arms of the claws by mountain folding them where indicated as far as possible.

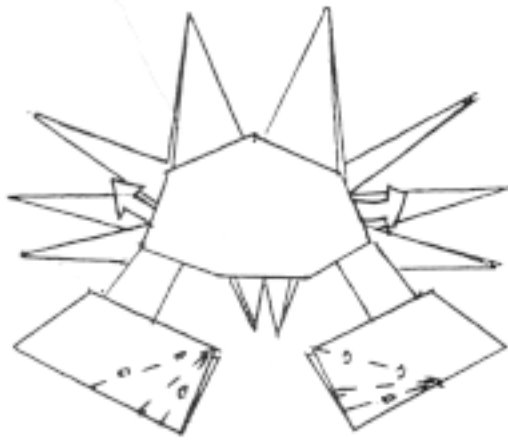

78. Reverse fold the claws in and out 3 times with each reverse fold being half the width of the previous. Pull out paper from the sides of the shell. For the Blue Crab, pull out as much as possible.

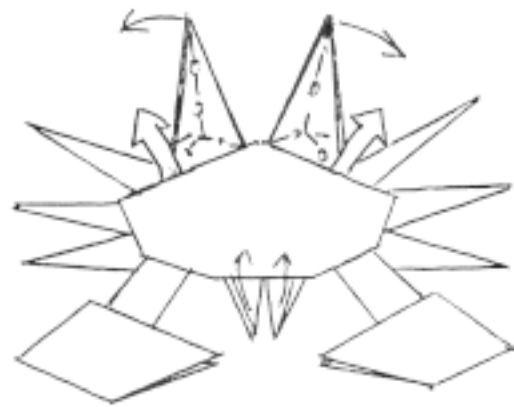

79. Pull out paper from the back of the shell. Pull out less for the Blue Crab. Rabbit ear the back legs outwards. Pinch and fold the eyes up. See the appropriate final diagram for the appropriate final shaping.

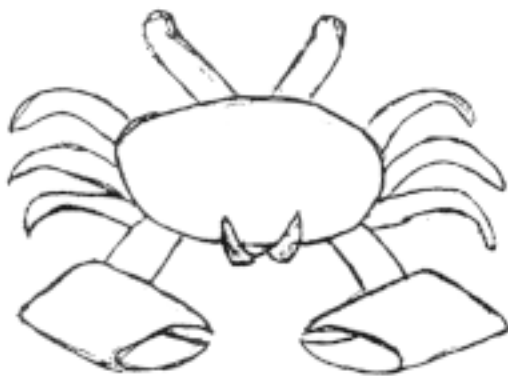

80. Completed Rock Crab:



81. Completed Blue Crab:

This model was inspired by Robert Lang's Freshwater Crab as seen in the 1986 Convention Program.

# Boat (traditional)

Diagrammed by: František Grebeníček (1999)

[www.origami.cz](http://www.origami.cz)

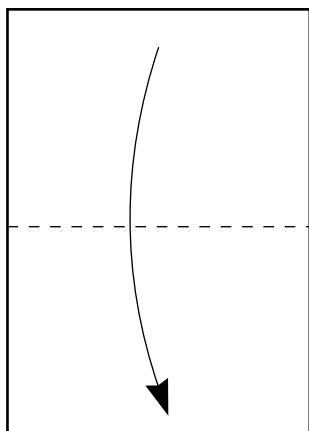

(1) Start from a rectangle (e.g. A4).  
Fold in half.

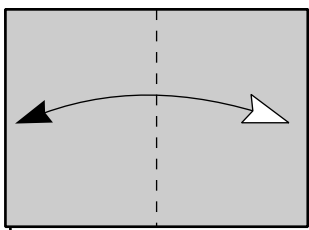

(2) Fold in half and  
unfold.

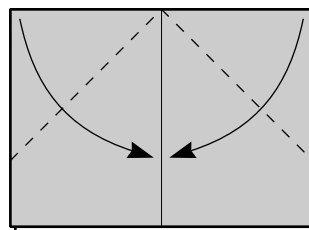

(3) Fold to the center.

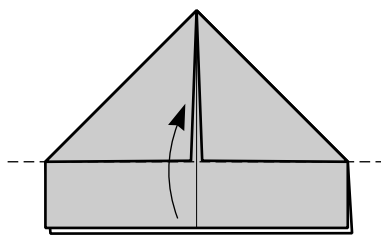

(4) Fold the overlap-  
ing strip upwards.

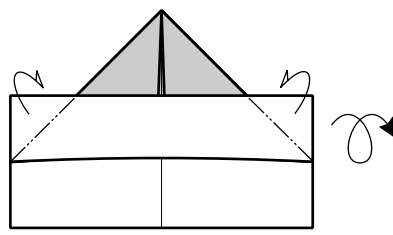

(5) Fold corners  
backwards. Turn over.

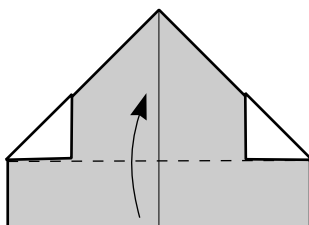

(6) Fold strip upwards.

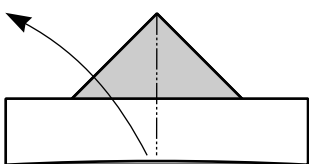

(7) Open.

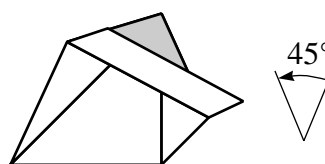

(8) Opening in progress.

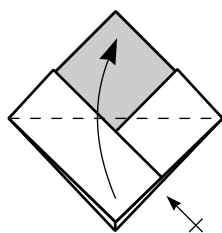

(9) Fold triangle upwards.  
Repeat behind.

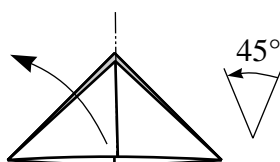

(10) Open (like  
in the steps 7 and 8).

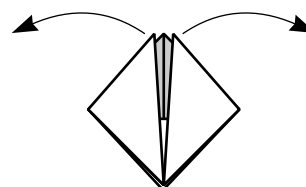

(11) Take upper  
corners and stretch out.

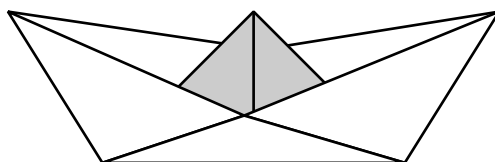

(12) Finished boat.

# Boat II

Designed and diagrammed in 4/97;  
Idea came from Fujimoto box variation

©1997 Sy Chen

1. Start from square with boat color up; Make creases

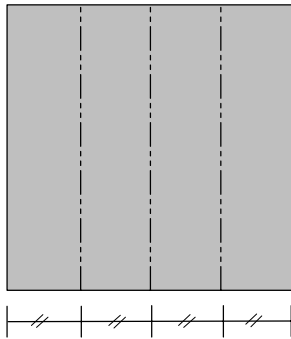

2. Right edge meets the 1st left crease

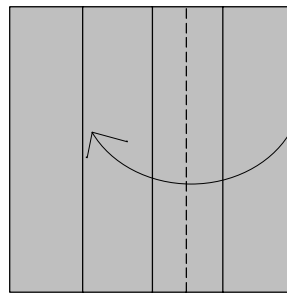

3. Enlarged; Fold 3 corners

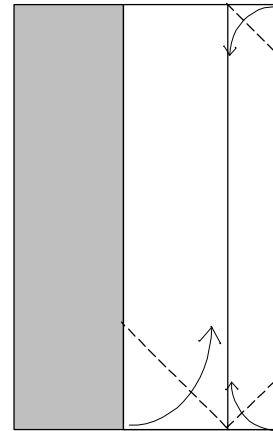

4.

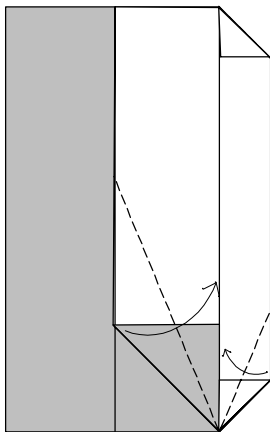

5.

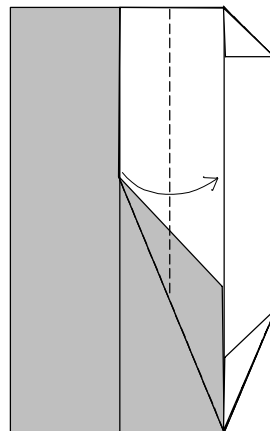

6.

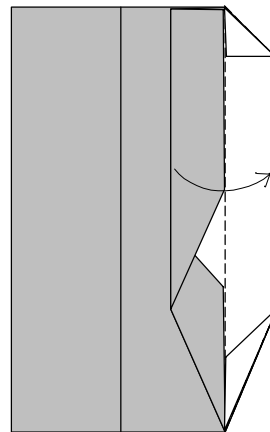

7. Repeat steps 2-6 for left hand side

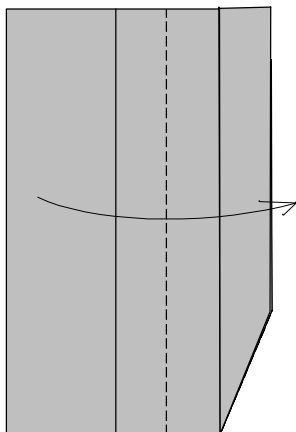

8. Open to form 3D

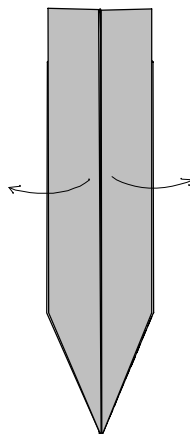

9. Finished

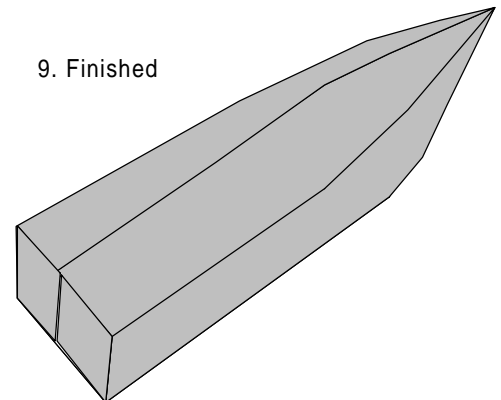



# Boat III

© 1997 Sy Chen

Designed in 4/97 and diagrammed in 5/97;  
A variation from Sy's Boat II but effectively  
taking advantage of rectangle shape

1. Start from rectangle (3x4, A4,  
letter-size, or most of the magazine  
papers) with boat color up; Fold  
right side; Fold and unfold left side

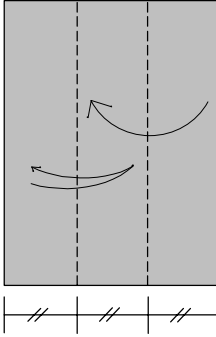

2. Enlarged; Fold and unfold

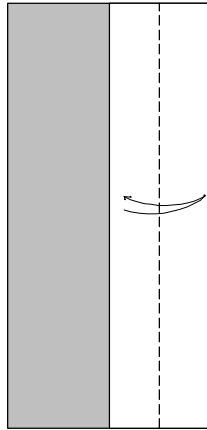

3. Fold 3 corners

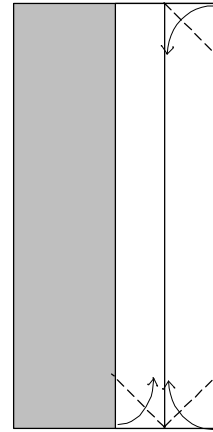

4.

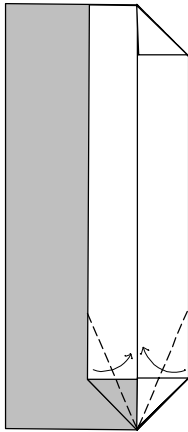

5.

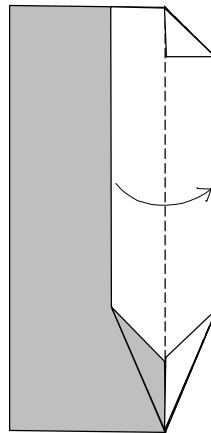

6. Repeat steps 2-5 for left  
hand side

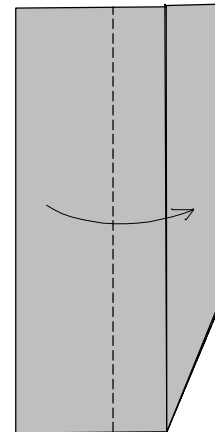

7. Open to form 3D

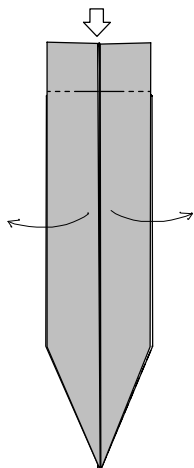

8. Finished

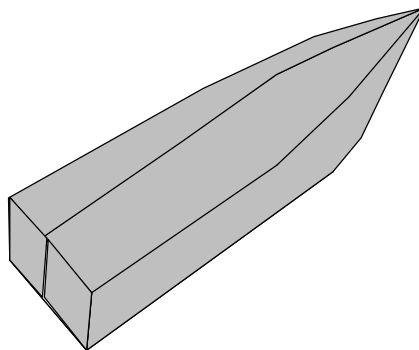

\* Ready for variation? Try to make this  
one.

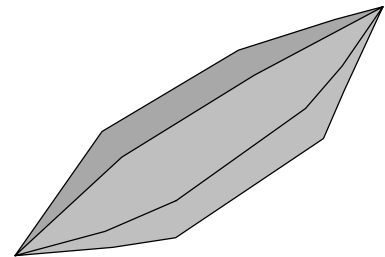

# book 1

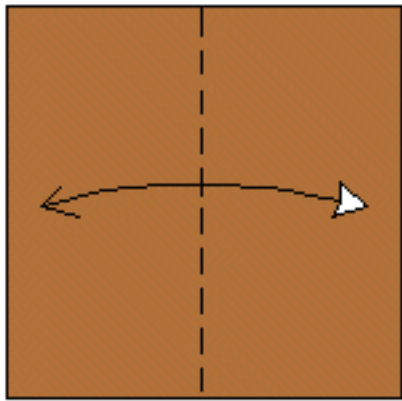

**1** Fold and unfold.

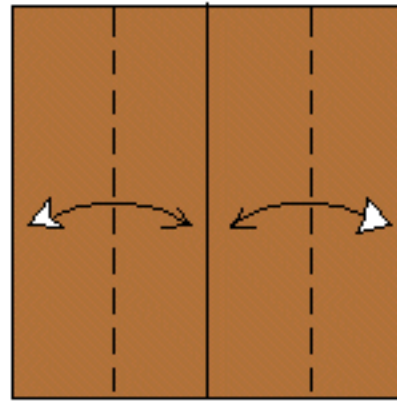

**2** Fold and unfold.

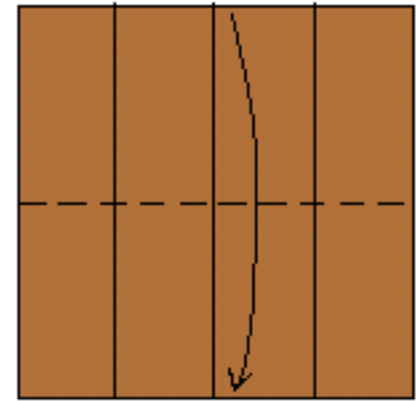

**3** Fold the upper edge down.

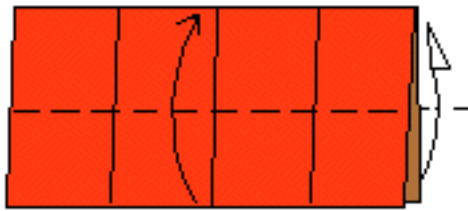

**4** Valley-fold the bottom edge up. Repeat behind.

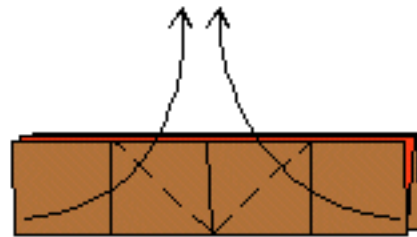

**5** Fold through all layers.

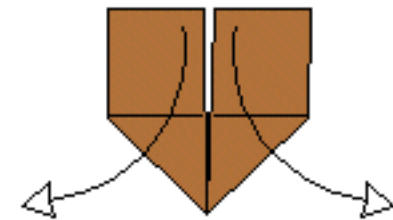

**6** Like this. Unfold to step 4.

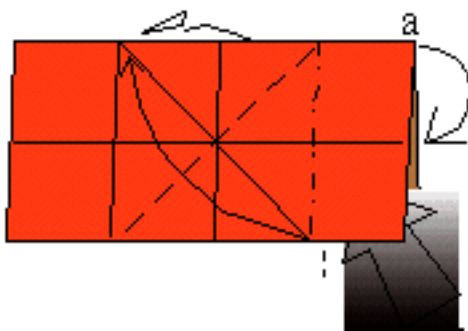

**7** Open up between the bottom layers and twist corners  $90^\circ$  clockwise.

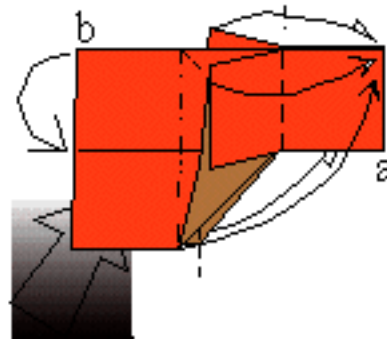

**8** Repeat step 7. The small side-flaps are valley-folded to the right.

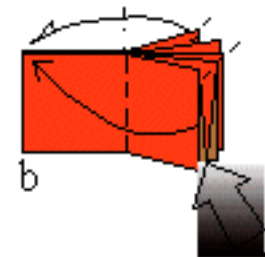

**9** Book-fold one layer to the left so that the next edge is squashed flat. Repeat behind.

# book 1

---



**10** Book-fold.



**11** Book 1 is finished.

---

# book 2

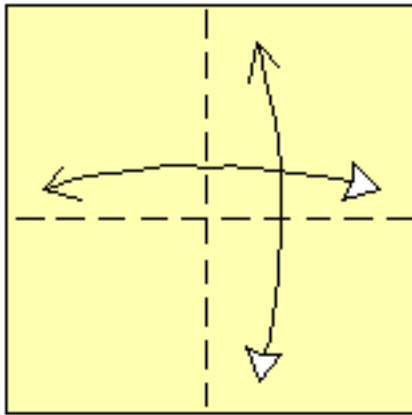

**1** Fold and unfold.

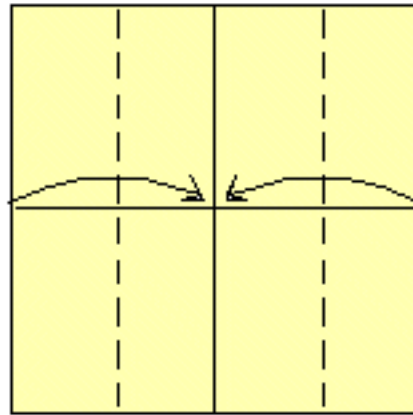

**2** Fold the edges to the midline.  
Turn the model over.

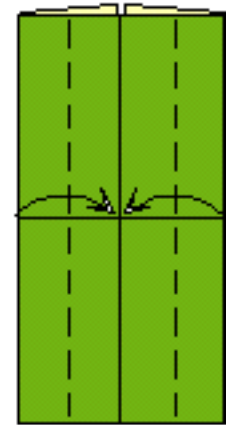

**3** Fold the edges to the midline, folding through all layers.

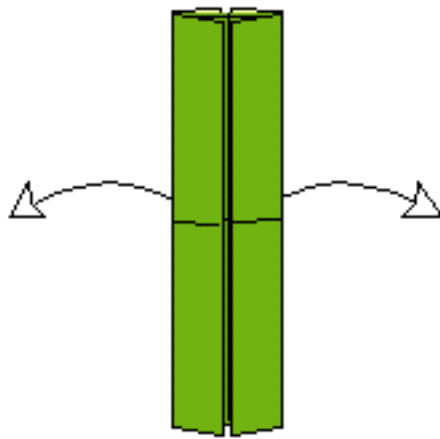

**4** Unfold completely.

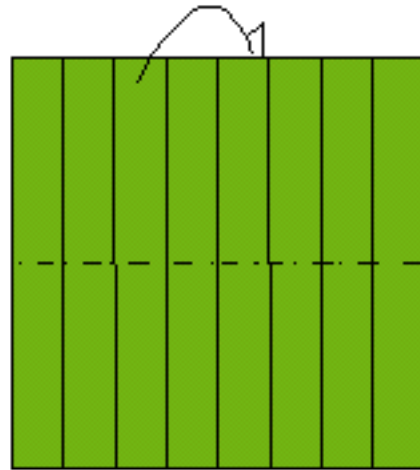

**5** Mountain-fold the upper edge behind on an existing crease.

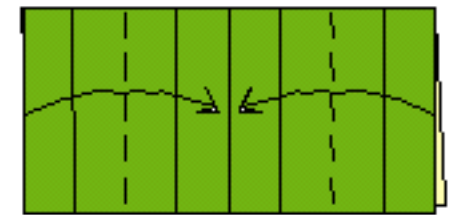

**6** Fold the edges to the midline.

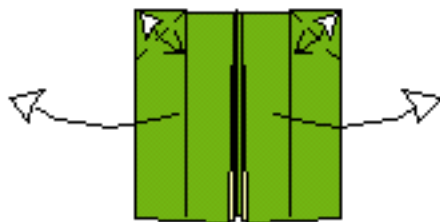

**7** Fold and unfold the corners using existing creases as guidelines. Unfold to step 2.

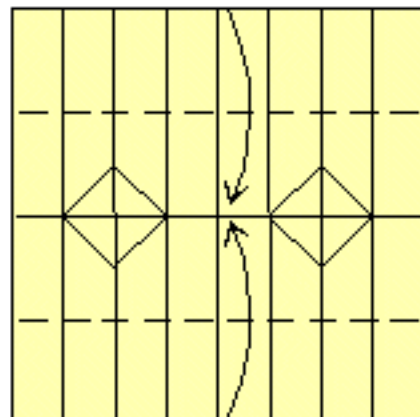

**8** Fold the upper and lower edges to the midline.  
Turn the model over.

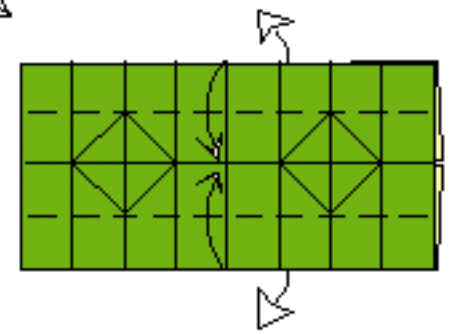

**9** Fold the upper and lower edges to the midline without creasing the back layers.

# book 2

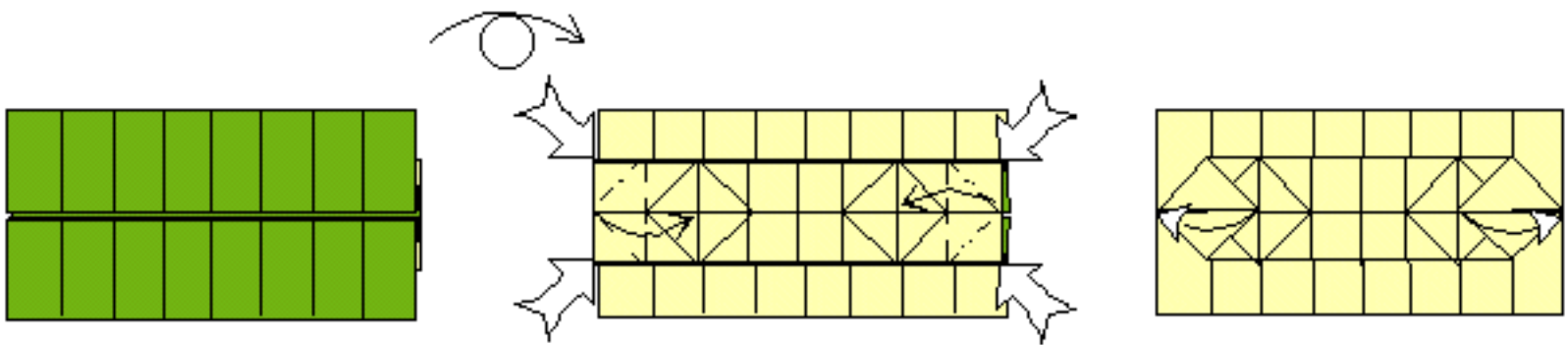

**10** Like this.  
Turn the model over.

**11** Petal-fold.

**12** Unfold.

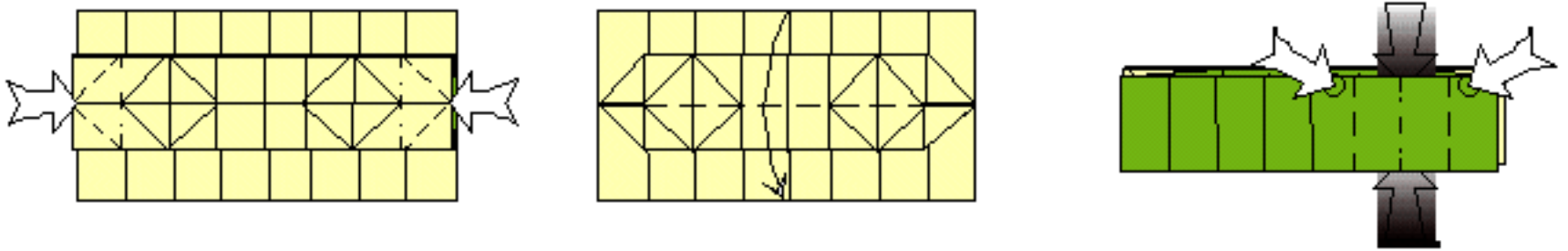

**13** Inside-petal-fold on  
existing creases.

**14** Valley-fold in half.

**15** Push together and push  
down the middle layer on  
the top, using existing  
creases. The model is 3-D.

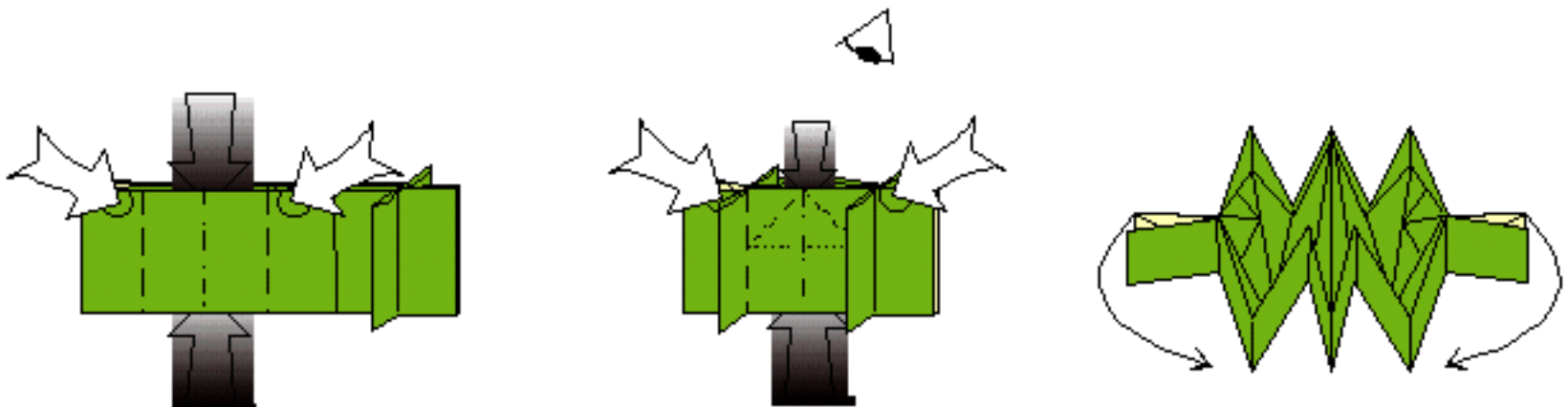

**16** Repeat step 15  
on the left.

**17** This step resembles the last one. Open  
up between the first and second layer  
on the top. Simultaneously push up the  
closest of the two hidden edges at the  
bottom and push the sides together.

**18** View from above.  
Book-fold the two pages  
on each side toward you  
and press together.

# book 2

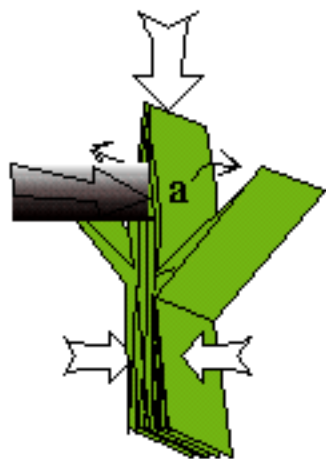

**19** Keep the bottom layers together. Push in the middle of the five edges at **a**, and press the whole flap flat.



**20** Open up between the layers and distribute the spare paper from last step outward. Simultaneously the hidden edge is shifted from **1** to **2**.



**21** The flap is now nearly 50% longer! Repeat on the other similar flap.

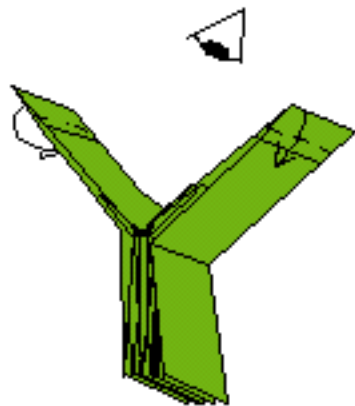

**22** Fold in some of the spare paper on the cover.

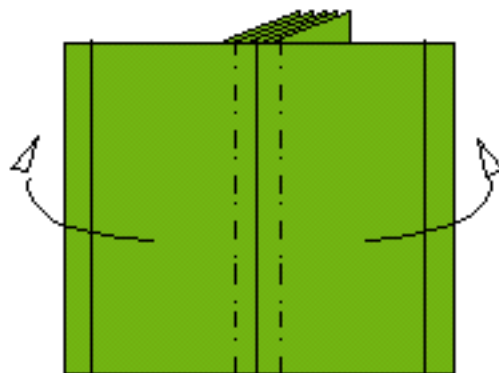

**23** Back view. Close the book with mountain-folds.

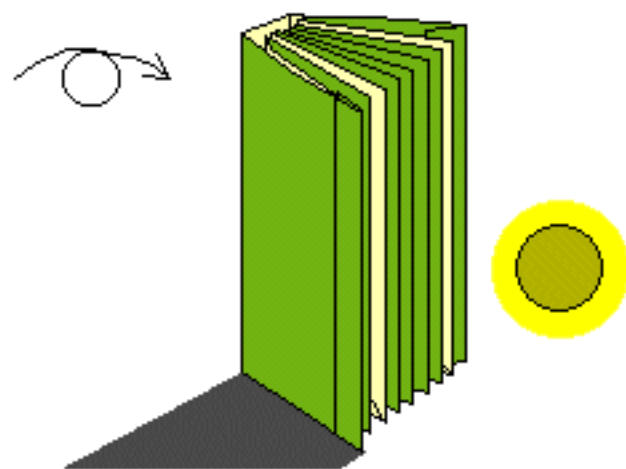

**24** Book 2 is finished!

# Book (36 pages)

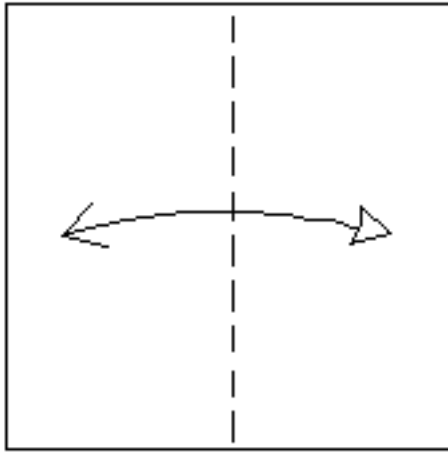

- 1** Use a large piece of tissue-foil. The height of the model will be 1/9th of the side of the square. Start with the white side up. Fold and unfold.

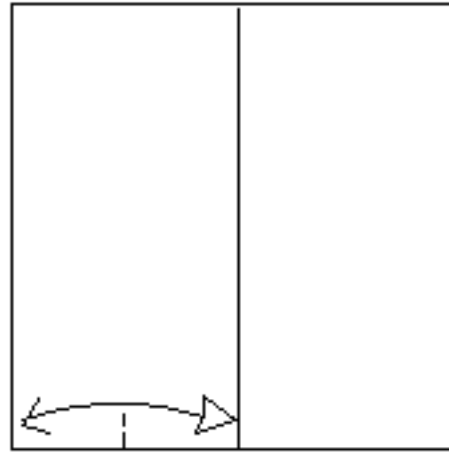

- 2** Fold and unfold.

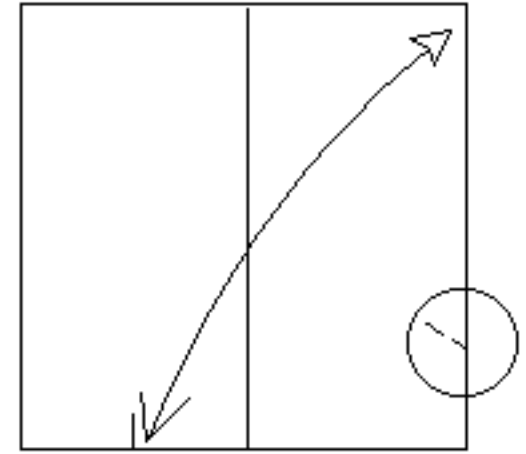

- 3** Fold the upper right corner down to point A, making the crease sharp only where it hits the right edge. Unfold.

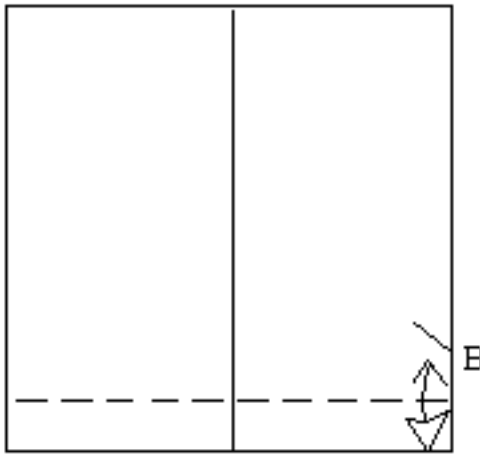

- 4** Fold the lower edge up to point B and unfold.

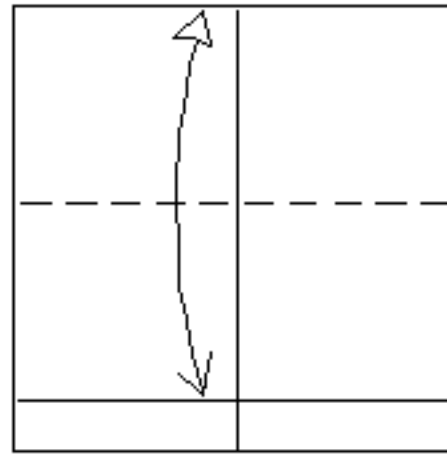

- 5** Fold down to the crease from last step and unfold.

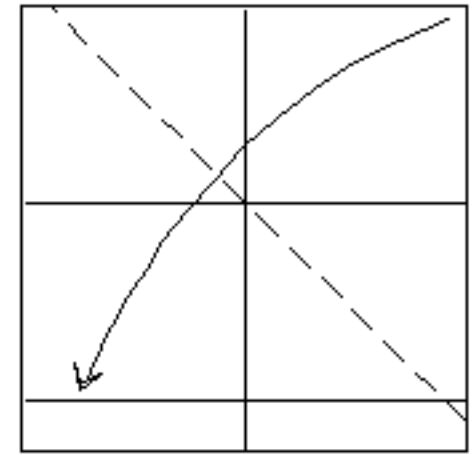

- 6** Valley-fold through the center.

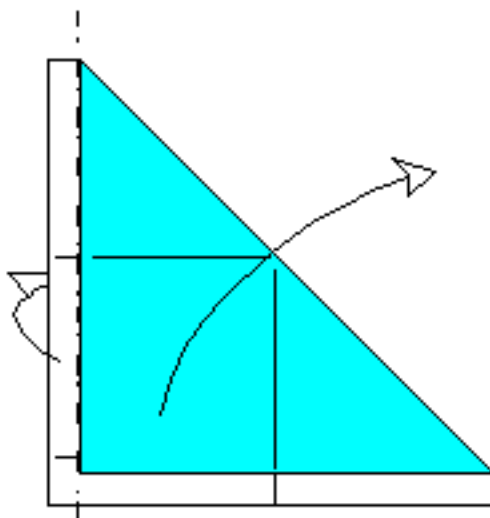

- 7** Mountain-fold the edge. Then unfold the large flap.

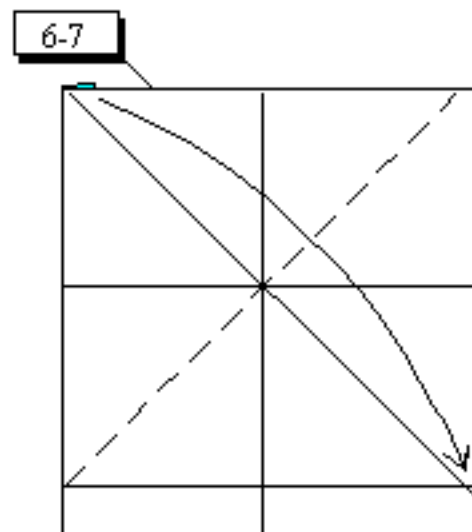

- 8** Repeat steps 6 - 7.

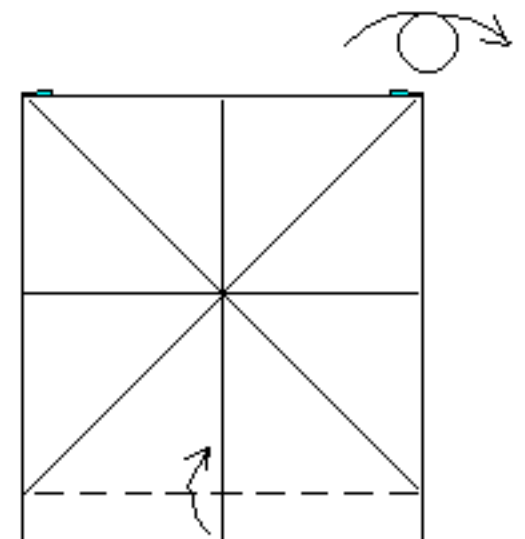

- 9** Valley-fold on the existing crease. Turn the model over.

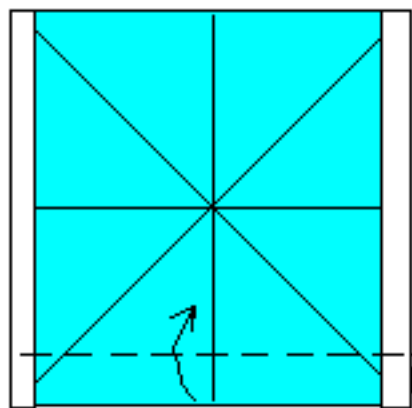

**10** Valley-fold, using the edge behind as a guide.

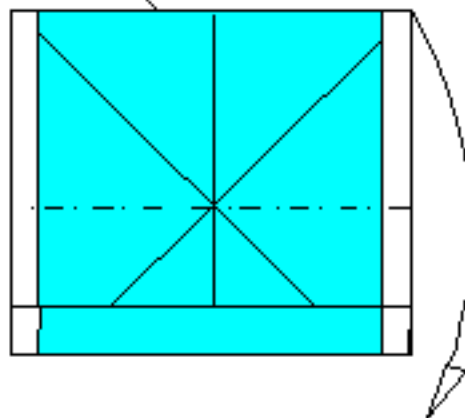

**11** Repeat steps 5 - 7 of Book (26 pages).

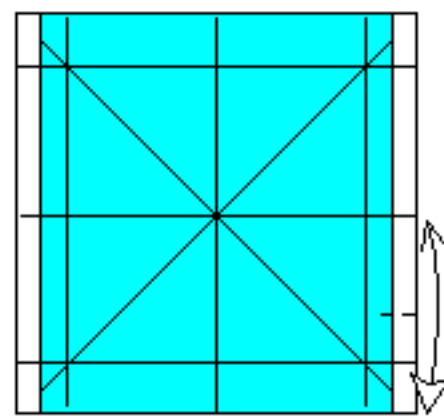

**12** Fold the bottom edge up to the midline and make a crease. Unfold.

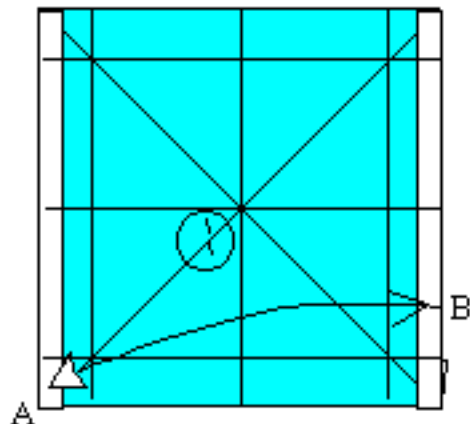

**13** Fold corner A to point B and make a mark where the fold hits the diagonal.

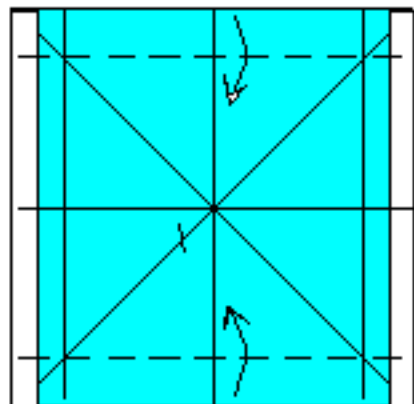

**14** Valley-fold on existing creases.

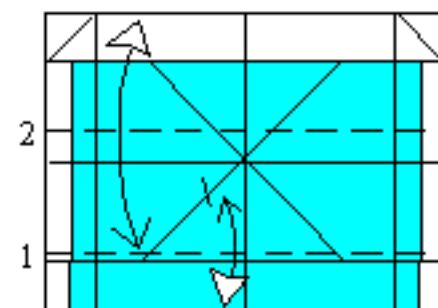

**15** Fold the bottom edge up to the mark from step 13 and unfold. Then fold the upper edge down to the new valley crease and unfold.

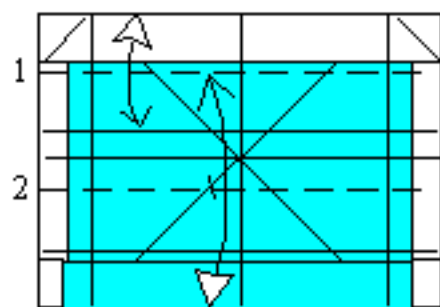

**16** Fold and unfold. Unfold to step 14.

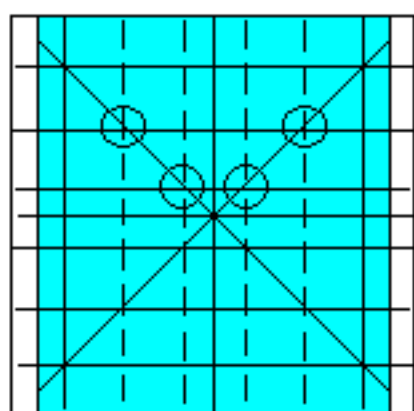

**17** Add valley folds similar to those in steps 15-16, using the crease crossings as a guide. Turn the paper over.

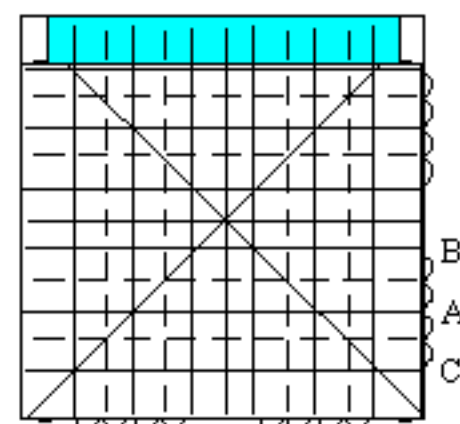

**18** Add 8 valley folds. This is easily done by folding crease A (existing mountain crease) up to crease B and down to crease C. Then repeat 3 other places.



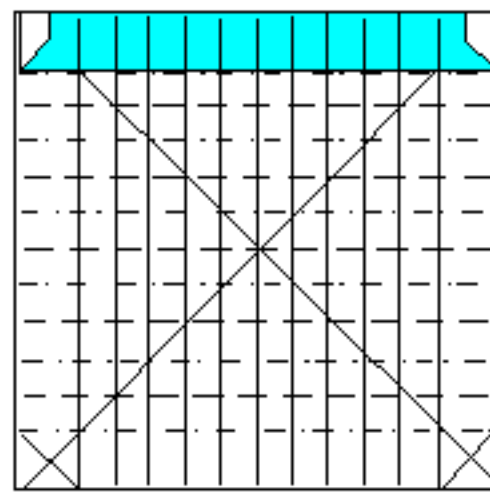
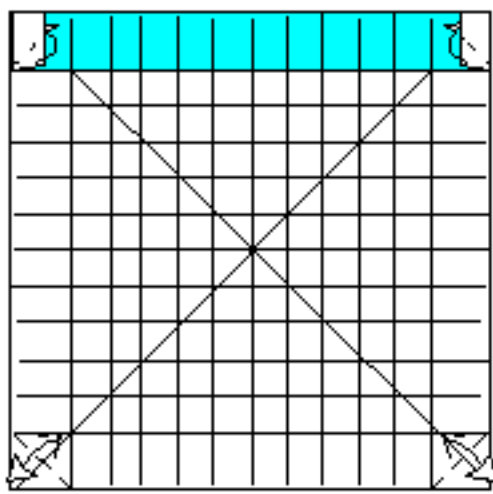

13-17 of Book (26pg.)

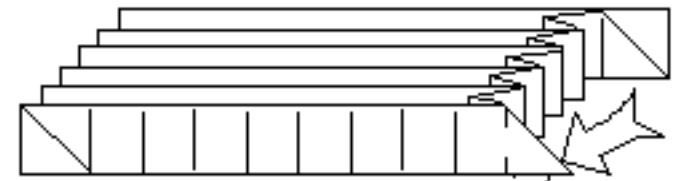

18-23 of Book (26pg.)

**19** Mountain-fold the small corners at the top inside. Fold and unfold at the bottom.

**20** Repeat steps 13-17 of Book (26 pages). See next step for the result.

**21** Repeat steps 18-23 of Book (26 pages), but do not repeat behind in step 20. In step 23 there will be no middle edge to squash.

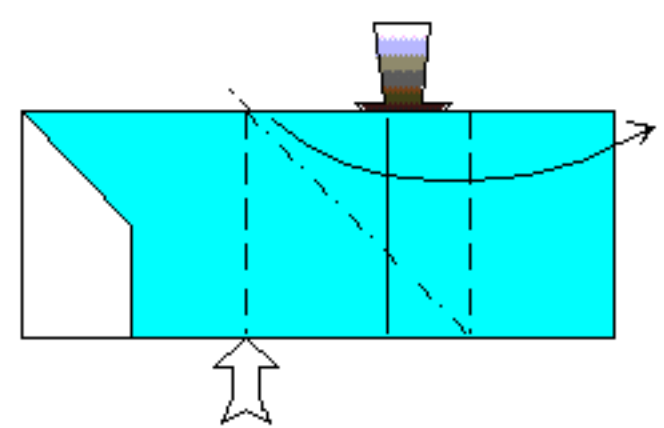
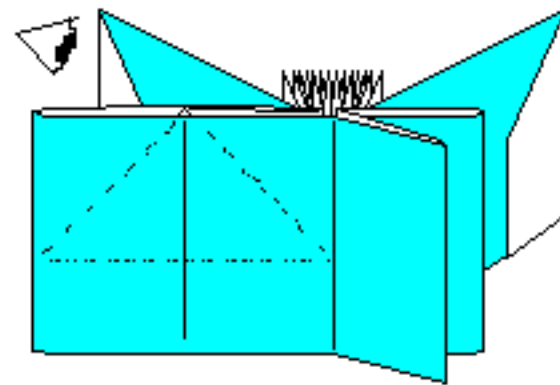
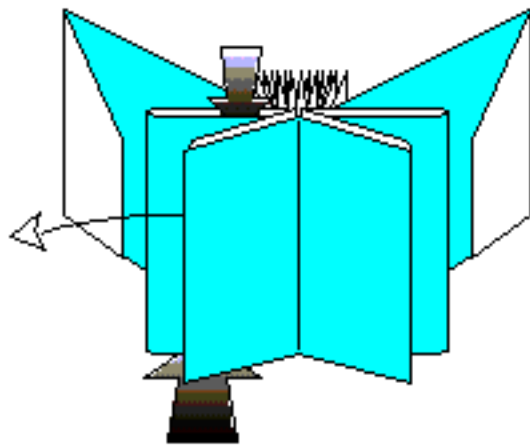

**22** Open up from the bottom between the two thick edges and pull out a single layer of trapped paper, squashing an edge inside it from the top.

**23** Like this. The dotted line indicates the squash. Next view from the left side.

**24** Open up between the nearest layers at the top and squash the bottom edge, swivel-folding to the right. A new valley fold is made at the right.

22-25

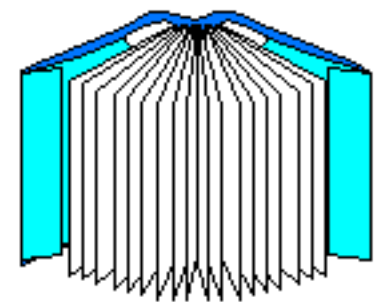
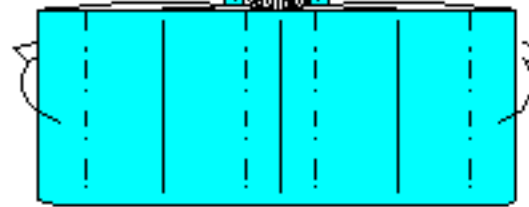
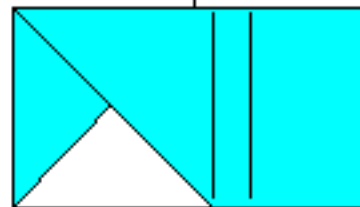

**25** Book-fold one layer to the left.

**26** Like this. Repeat steps 22-25 on the far side. Next view from the back.

**27** Mountain-fold some paper at the edges of the cover. Pinch through the thick layers to form the back. Turn the model over (upside-down).

**28** Finished book.

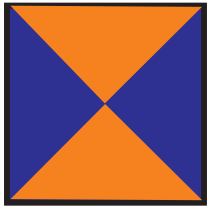

Start with Specially Made 2 toned paper.

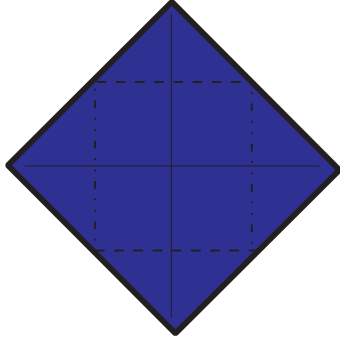

Or Make your own by mountain and valley folding.

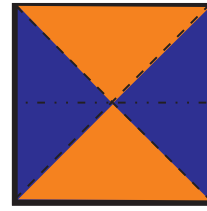

1) Crease on inticated lines.

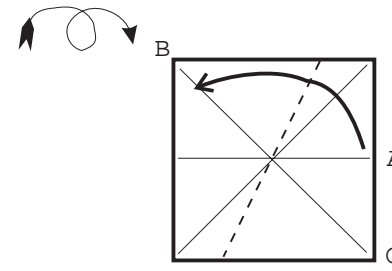

2) Fold so point A lies on line BC

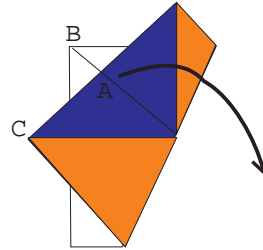

3) Unfold

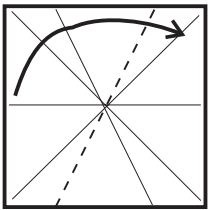

4) Repeat 2 & 3 symytrically on the left side.

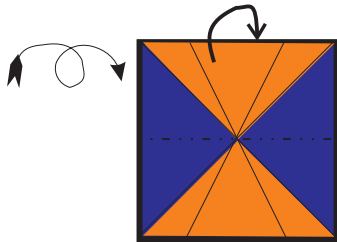

5) fold top back.

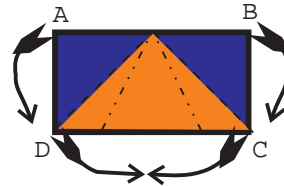

6) grasp points A & B and swing down so piont C & D meet.

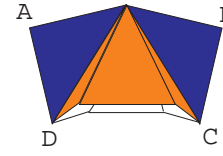

Midway through step 6.

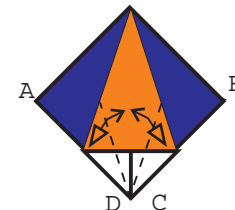

7) Fold and Unfold.

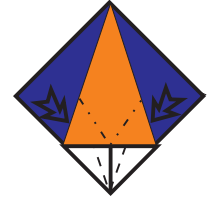

8) Inside Reverse.

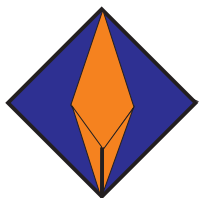

9) The result. turn over.

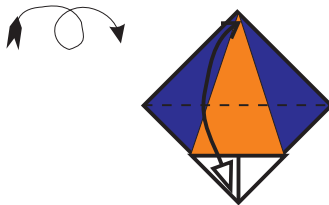

10) Fold and Unfold

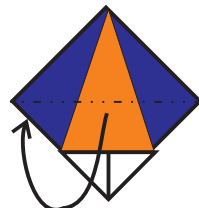

11) fold under and tuck in pocket.

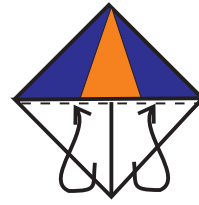

12) Tuck the two triangles into the pocket, do not tuck in pointer underneath.

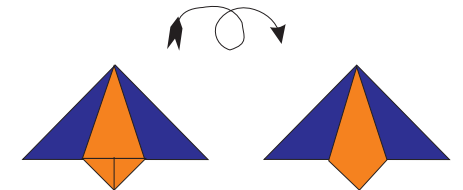

Back Side.

Front Side.

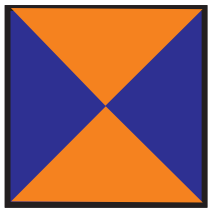

Start with Specially  
Made 2 toned paper.

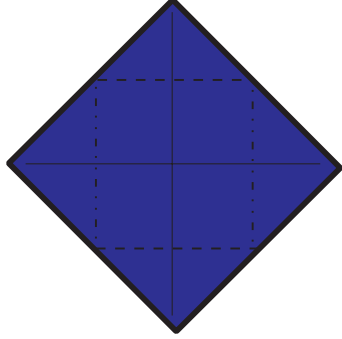

Or Make your own by  
mountain and valley  
folding.

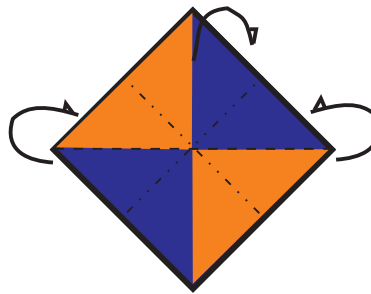

1) Make a preliminary  
fold.

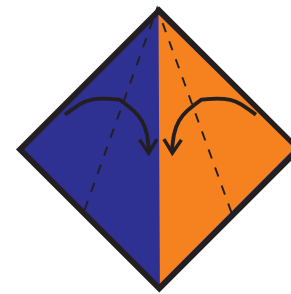

2) Valley fold front  
layer only.

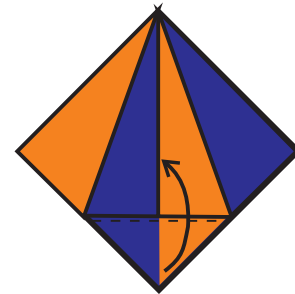

3) Valley fold front  
layer only.

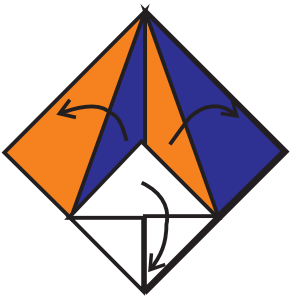

4) Unfold to step 2.

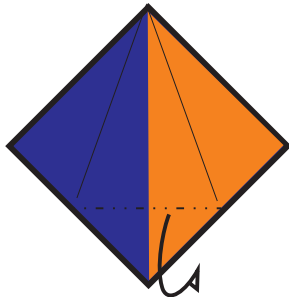

5) Tuck underneath.

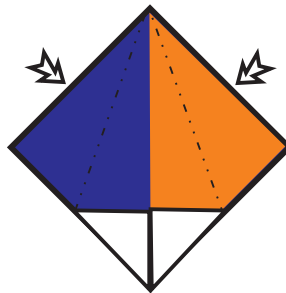

6) Two reverse folds.

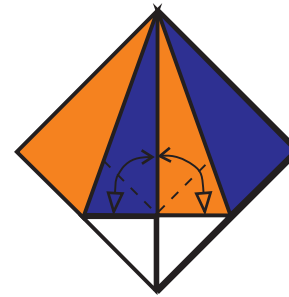

7) Fold and unfold.

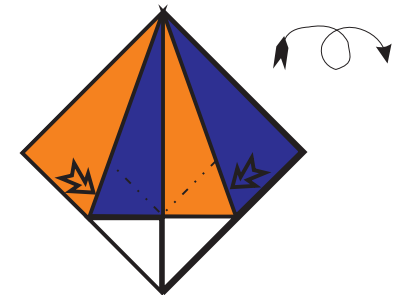

8) Two reverse folds.

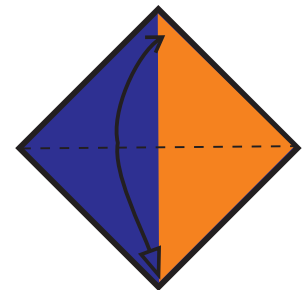

9) Fold and unfold.

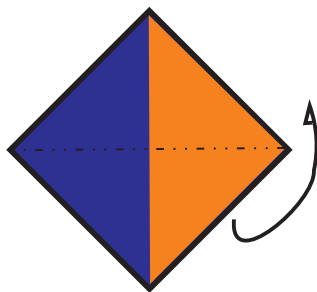

10) fold under  
and tuck in  
pocket.

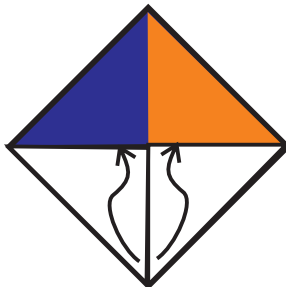

11) Tuck the  
two triangles  
into the pocket,  
do not tuck in  
pointer underneath.

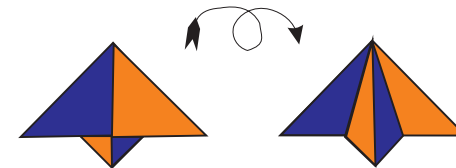

Back Side.

Front Side.

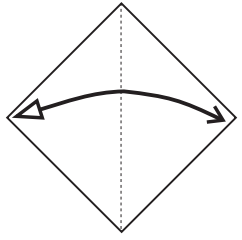

1) Crease diagonal

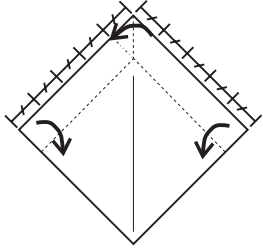

2) Rabbit ear  
One-fifth of  
the way in.

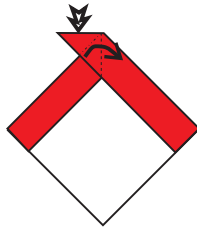

3) Squash fold

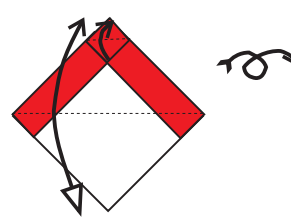

4) Valley fold  
small flap and  
crease diagonal

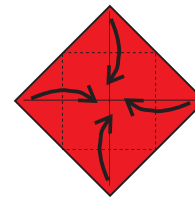

5) Turn over  
and blintz.



6) collapse  
along the  
creases.

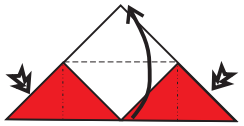

7) A type of  
petal fold.

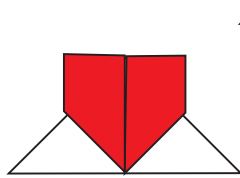

8) Like this.  
Turn over.

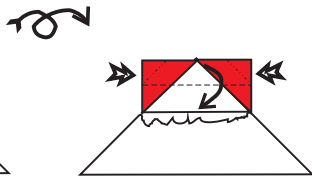

9) (Top of front  
cut away) Make  
another odd  
petal fold.

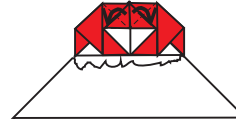

10) Two valley  
folds.

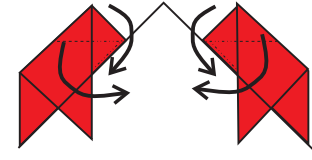

11) (Top portion  
only shown)  
Two swivel folds.



12) Tuck in  
Pockets below.

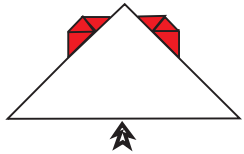

13) Open up pocket  
on the bottom.



14)

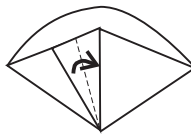

15) Step 14  
and 15 are to  
secure pocket.

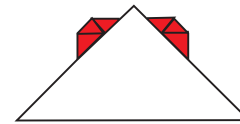

Back

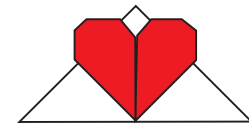

Front

# Heart Bookmark by Kim Best

Inspired by the Heart  
Models by Francis OW

email -- [Kim.Best@m.cc.utah.edu](mailto:Kim.Best@m.cc.utah.edu)

# Simple Box

Copyright 1998 Stephen Hecht. All Rights Reserved

A 10cm x 14cm sheet produces a model 3cm x 3cm base and 4 cm high

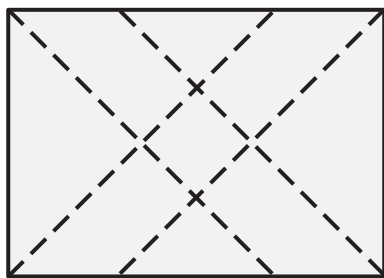

1. White side up. Valley crease at 45 degrees.

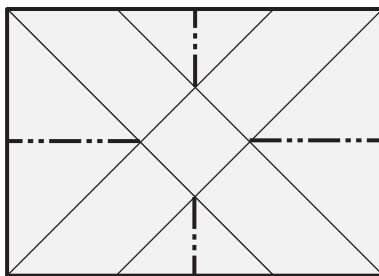

2. Mountain crease (try not to crease center square).

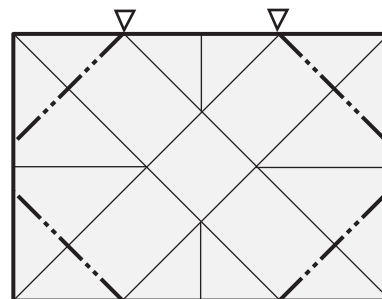

3. Mountain crease at 45 degrees (flaps do NOT meet at center line).

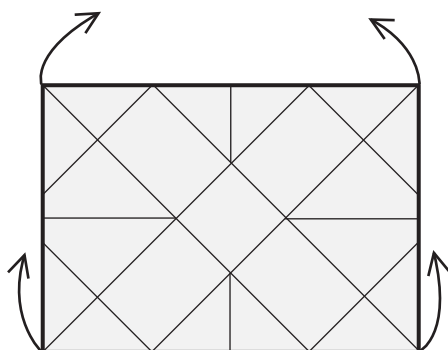

4. Creasing finished. Lift four corners, using creases from steps 1 & 2.

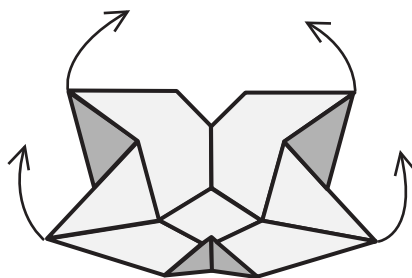

5. In progress.

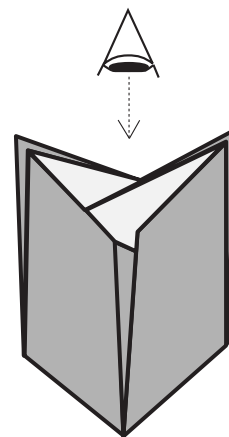

6. 3-D box-shape. All triangular flaps inside.

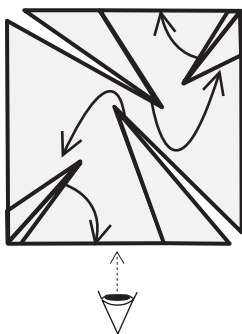

7. Top-view. Push small triangular flaps against wall, then large flaps. Tips of large flaps need to be folded a bit.

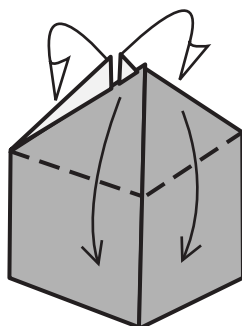

8. Side view. Valley down on creases from step 3. You may need to flatten the box slightly to avoid tearing.

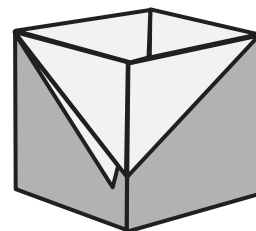

9. Done.

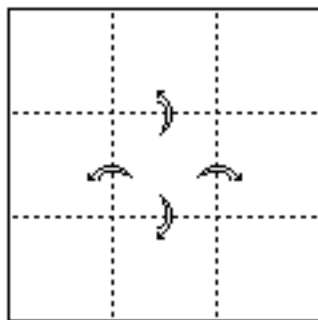

Divide in thirds  
and turn over.

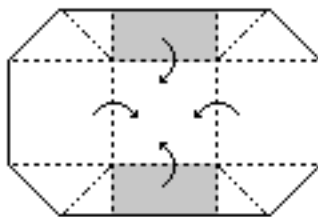

Collapse along existing  
creases, allowing  
corners to move inside.

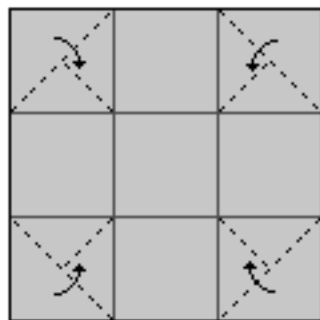

Pre-crease parts of  
diagonals and valley-  
fold all corners.  
Turn over.



Ends should look  
something like  
this inside.

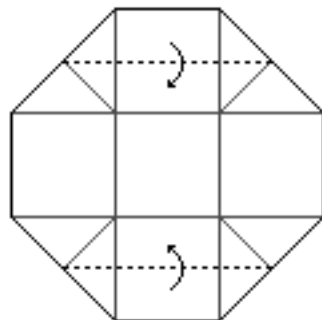

Valley-fold two sides.

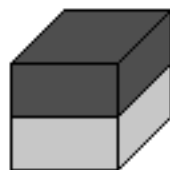
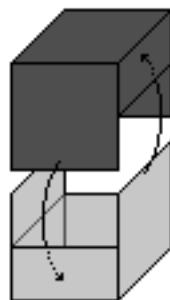

Fold two elements and  
combine them as shown.

# Braided Paper - J.C. Nolan 2/13/92

High Intermediate difficulty level. A 10" piece of paper produces a 3 3/4" model.

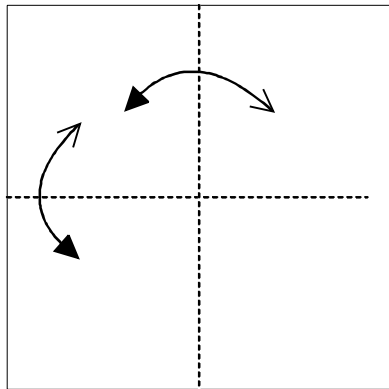

1. Fold and unfold laterally.

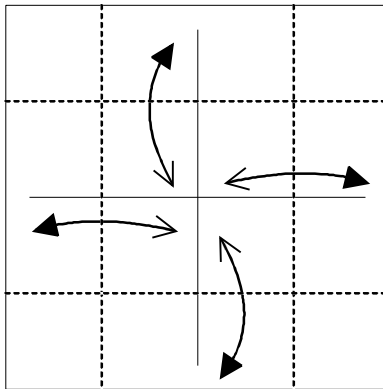

2. Fold and unfold in fourths. Turn over.

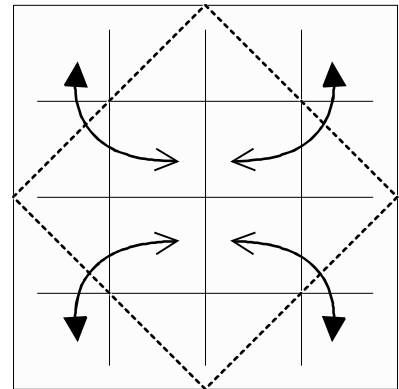

3. Fold and unfold. Turn over.

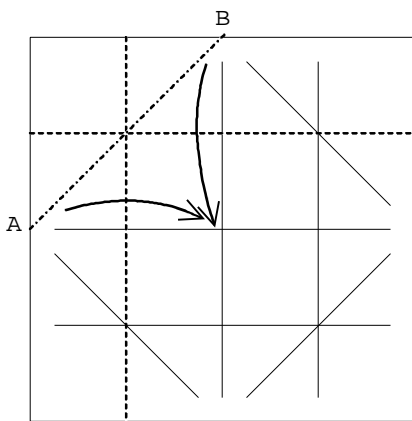

4. Following the existing creases, start to fold a windmill base, bringing points A and B to the center.

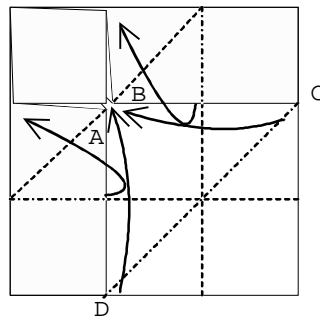

5. To complete the base, do the same with C & D.

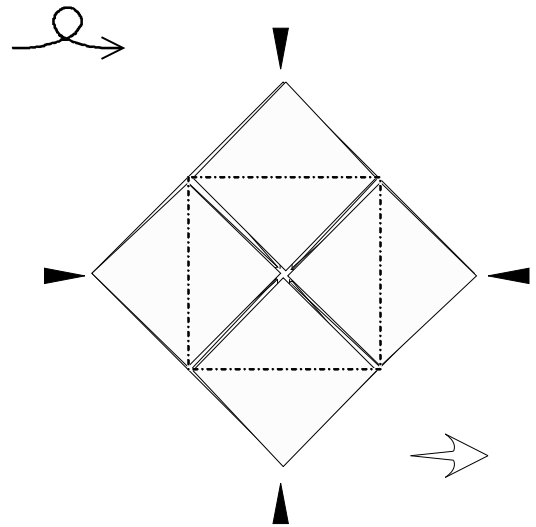

6. This is a completed windmill base. Sink all four corners.

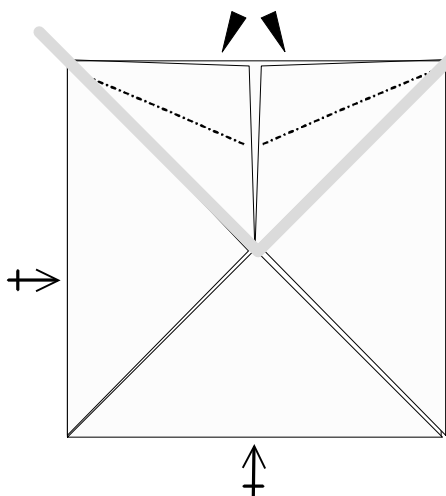

7. X-Ray view, reverse fold the two flaps. Repeat on other three sides.

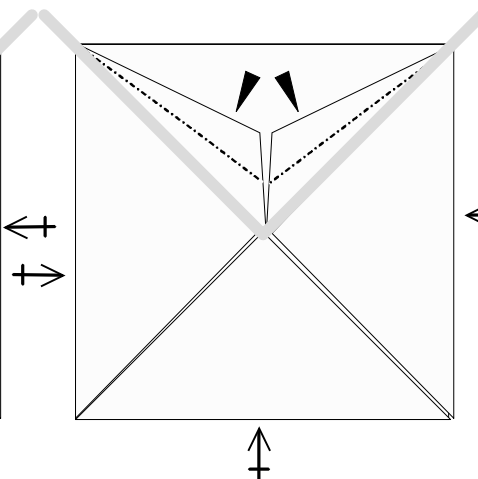

8. Pleat sink the two flaps. Repeat on the other three sides.

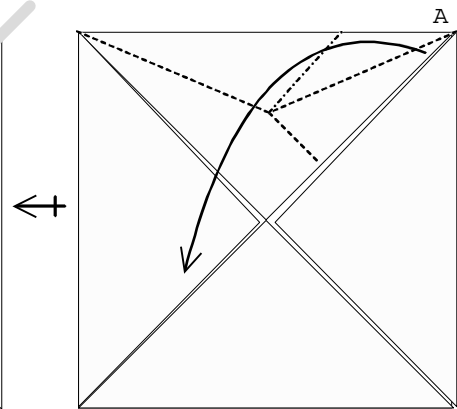

9. No longer an X-Ray view. Pull point A all the way down as far as it will go, thinning the diagonals as you fold.

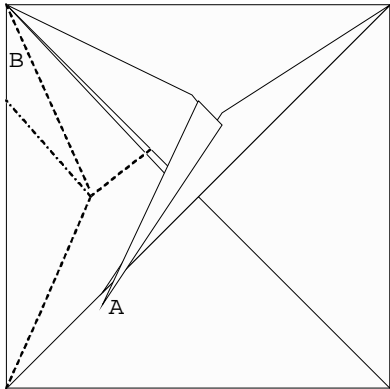

10. Repeat on the next flap. Point A will become covered.

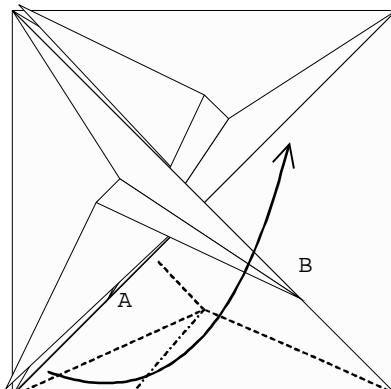

11. Repeat on the next flap.

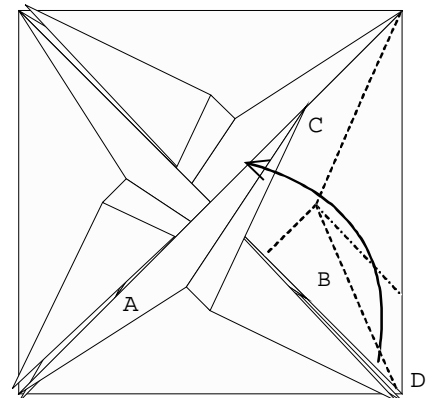

12. Repeat on the last flap, tucking the end inside when done.

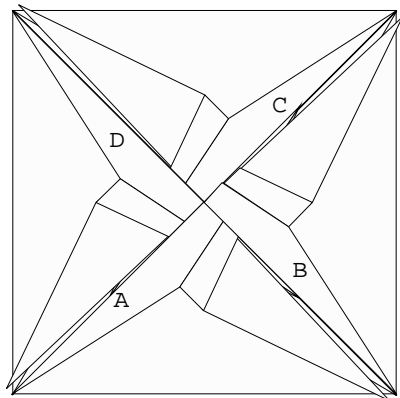

13. The first level is complete.

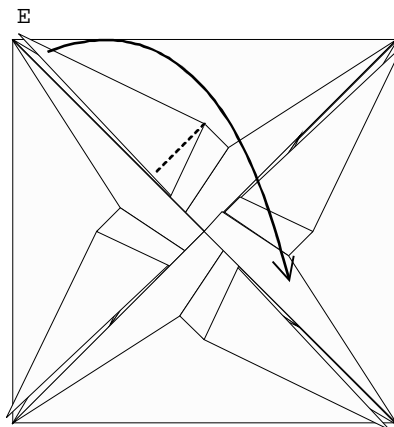

14. Fold the next flap down.

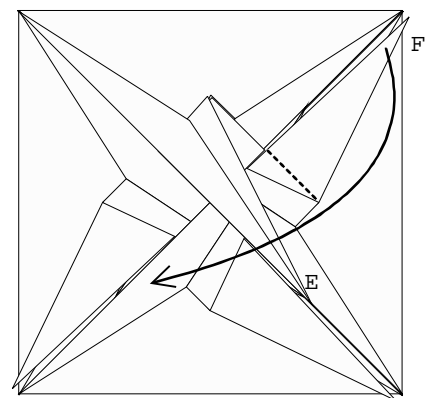

15. ...and the next flap...

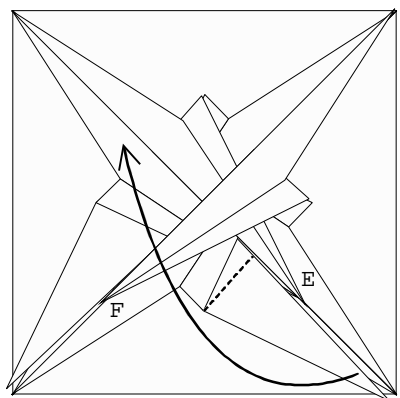

16. ...and the next flap...

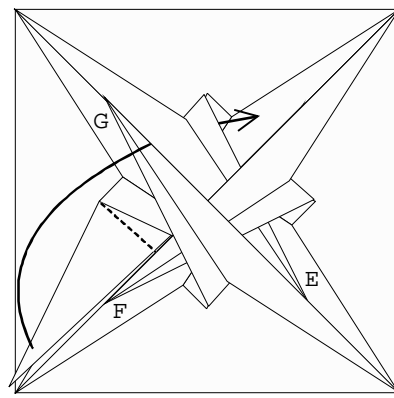

17. ...and the final flap, folding over the first flap, under the next, and out the other side.

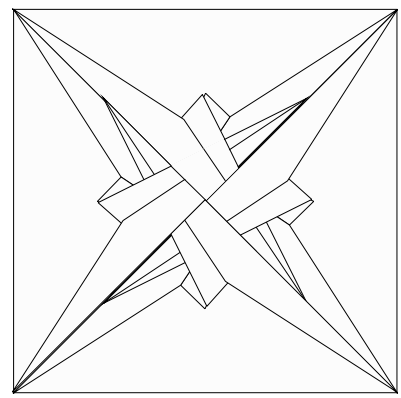

18. Completed model.



# Buck The Bunny

By Perry Bailey ©1998/1999

①

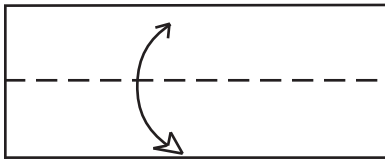

Take a dollar bill or a piece of paper around the same dimensions, fold it in half the long way, then unfold. I am using a dollar bill, starting front side up crease it then turn it over.



②

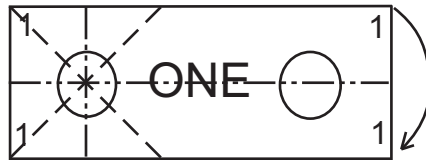

Make a Water bomb base while folding model in half.

③

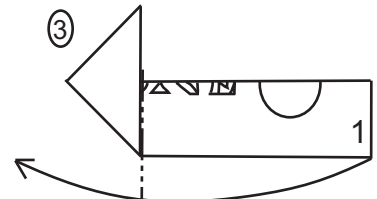

Reverse fold the entire bill out side of the WB base.

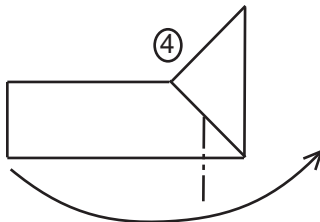

Inside reverse fold the length of the bill back from about the half way mark of the top or bottom of the WB base.

⑤

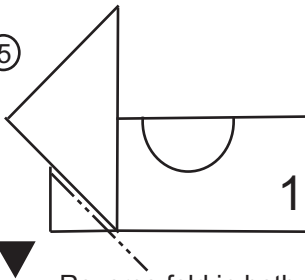

Reverse fold in both corners, (one to a side).

⑥

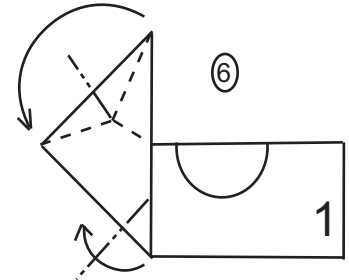

Reverse fold the bottom flap up to form front paws, Make a Rabbits ear fold on each side of the head.

⑦

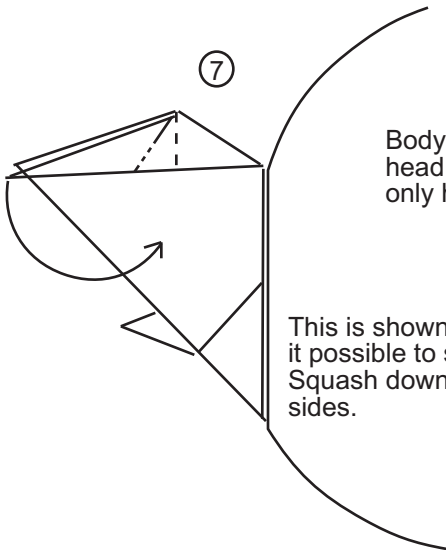

Body not shown head and front only here.

This is shown enlarge to make it possible to see the fold lines. Squash down the ears, on both sides.

⑧

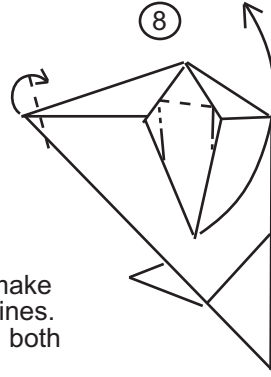

Body not shown head and front only here.

Still in enlarged mode, Reverse fold the front to make a nose, the top part of the nose will co-operate if you force it to, much like a small child or an ex-spouse. Do an uneven double rabbits ear fold along the lines shown to finish the ears. Then we shrink the picture back down.

⑨

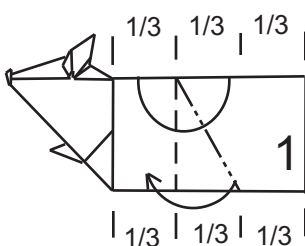

Now crimp fold the rear part of the bill from about 1/3 from the front on top, to about 1/3 from the back on the bottom.

⑩

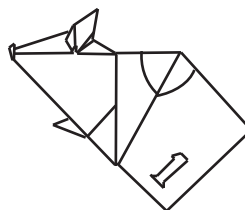

You should come out something like this. Now we need to work inside the model so the next view is interior of the model.

⑪

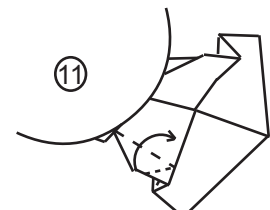

We make an uneven rabbits ear to get excess paper up inside of the model, do both sides.

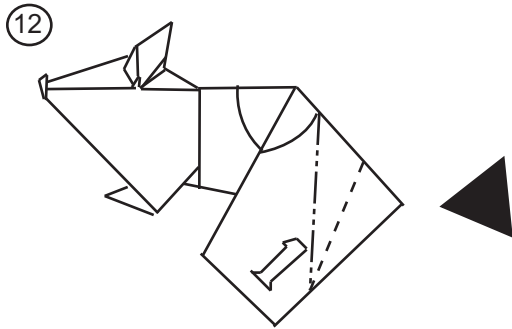

This is how it should look after our thinning the model out with the preceding fold. Now do a double inside reverse fold to form the haunches.

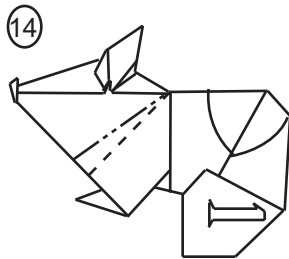

Crimp fold the head downwards, so it is even on both sides. Then open up the model to lock the head in to place. (See next diagram)

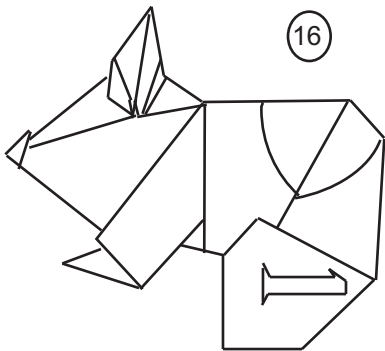

Just for continuity here is the finished model still in the attitude you started with.

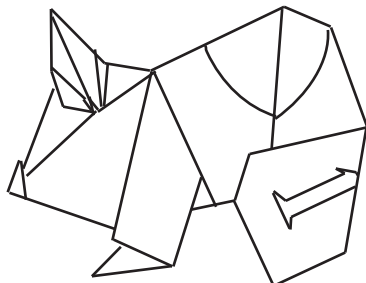

It just might tend to have the nose a little close to the ground.

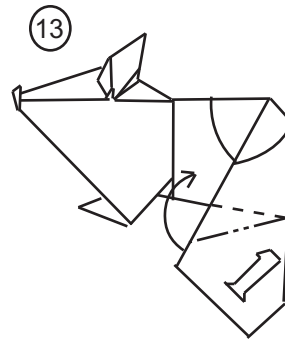

Swivel fold up the legs on each side. I used the back of the bill to give you helpful reference points.

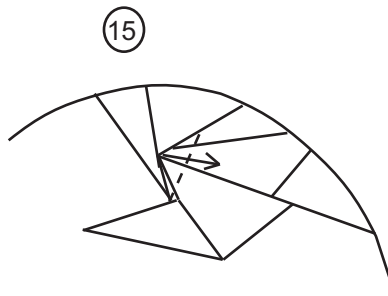

This is inside the model and magnified, to lock the head in to place just use a simple valley fold on the tip of the crimped material. Then you are done!

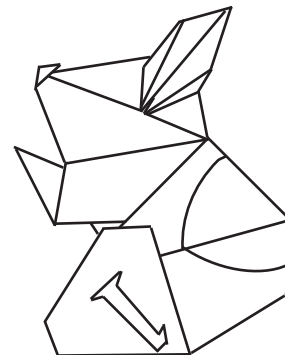

While I designed it to sit up, it can go on all fours.

With any luck at all your rabbits will all look a little different, each time you make it! Almost all the folds can be altered to make each bunny unique.

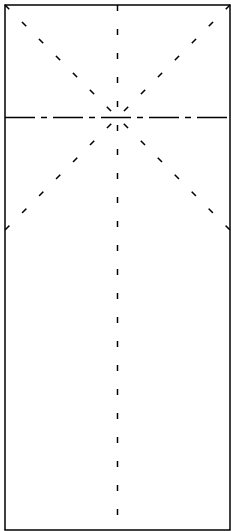

1) Preliminary base at top of bill, fold lengthwise as well.

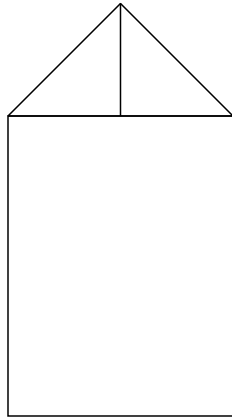

2) You will get this.

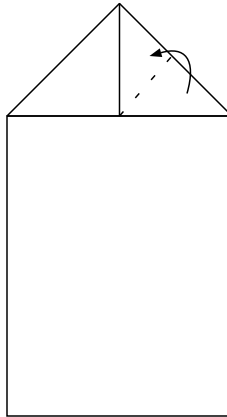

3) Take one flap from base and fold upwards.

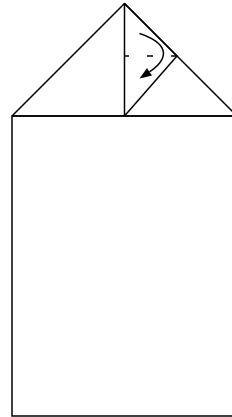

4) Fold downwards.

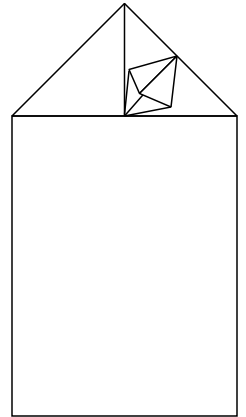

5) Unfold steps 3 and 4, and squash the fold to get...

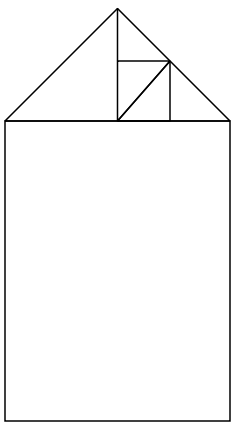

6) this.

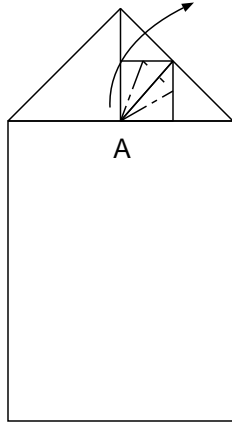

7) Bring the tip at A upwards, as in the bird base.

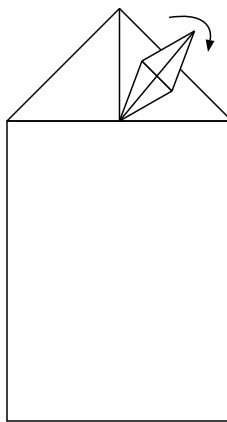

8) You will get this. Fold the top half of this structure down.

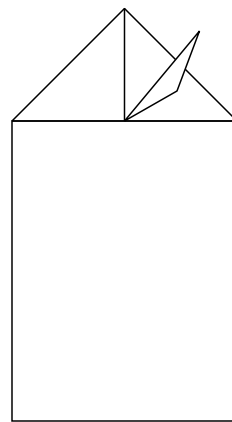

9) After step 8, you should have this.

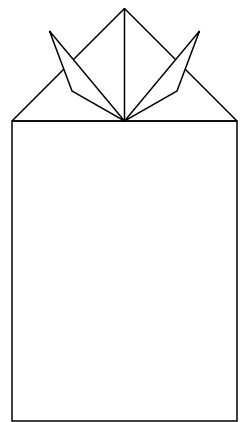

10) Repeat steps 3-9 on the other side.

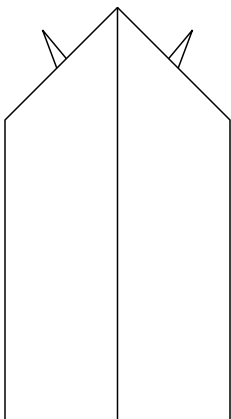

11) Flip the model over.

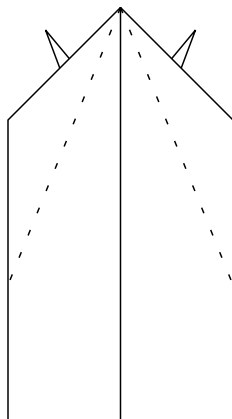

12) Fold the top edges of the paper to the center.

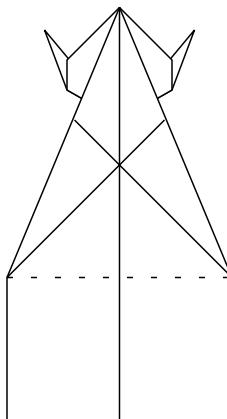

13) Fold the bottom of the model up.

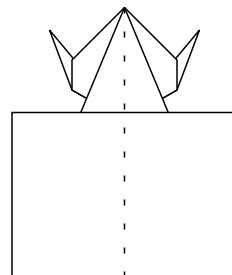

14) Valley fold along the middle.

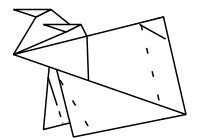

15) The basic model. You can make fore legs and hind legs by the simple folds, as shown.

# \$ Butterfly

Copyright 1998-99 Stephen Hecht. All Rights Reserved

A dollar bill makes a model 55mm long with a 65mm wingspan. For your first attempt, begin with a 3x7 rectangle larger than a dollar bill.

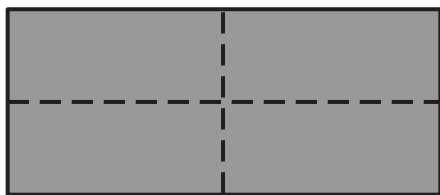

1. Begin black side up. Valley-crease, the horizontal not too sharply. Turn over.

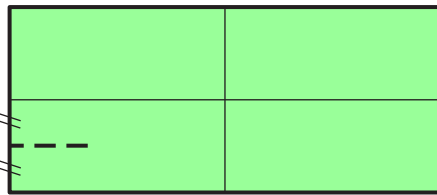

2. Crease halfway, making a mark.

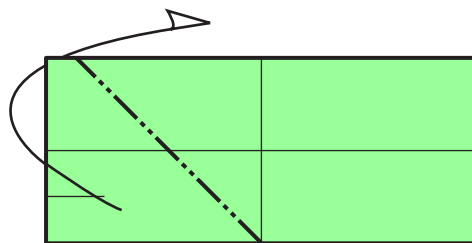

3. Soft mountain-fold on 45-degree line.

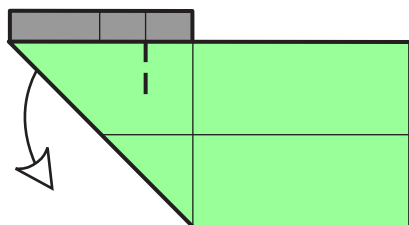

4. Pinch where mark from step 2 hits edge. Unfold.

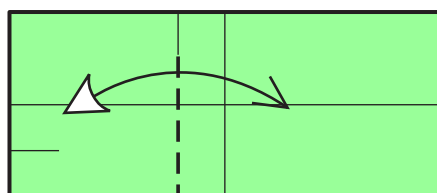

5. Use mark from previous step to make this valley-fold. Unfold.

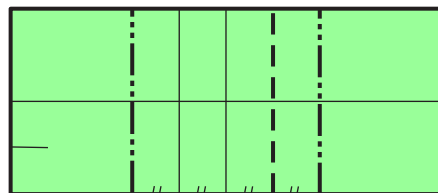

6. Use the 2 existing creases to add 3 more.

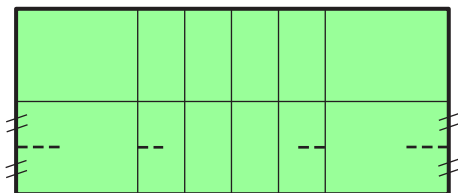

7. Pinch halfway marks where indicated.

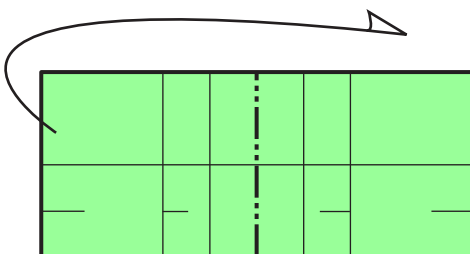

8. Mountain in half.

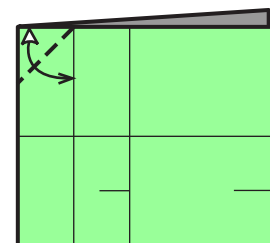

9. Crease and unfold.

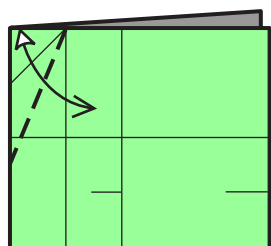

10. Crease and unfold, bisecting. Crease from previous step will align with vertical crease.

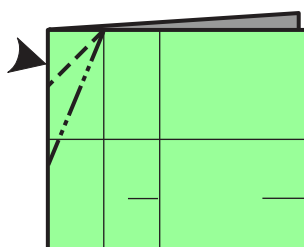

11. Reverse-fold, in-and-out.

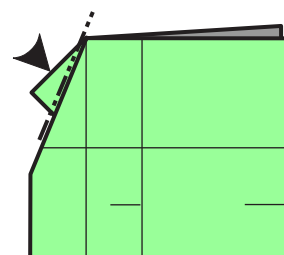

12. Reverse-fold.

# \$ Butterfly (continued)

Copyright 1998-99 Stephen Hecht. All Rights Reserved

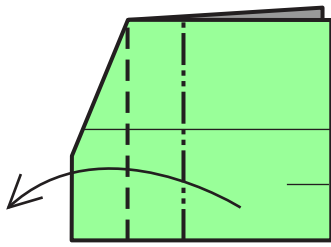

13. Pleat top layer on existing creases.

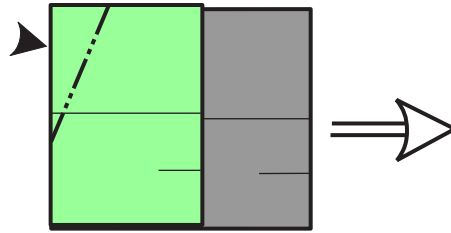

14. Reverse-fold, following the hidden edge. Unfold to step 13.

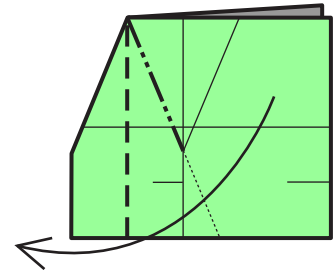

15. Pleat top layer, softly on the dotted line.

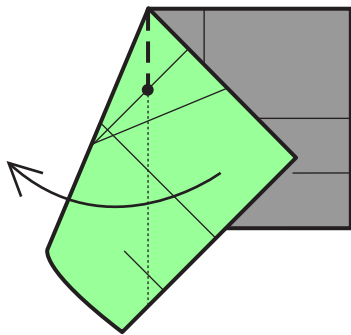

16. Follow hidden vertical edge. Softly on dotted line.

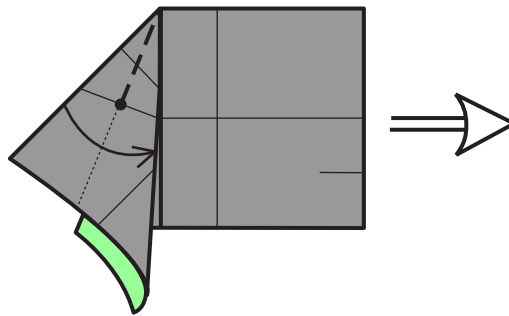

17. Bisect angle. Softly on dotted line. Unfold to step 13.

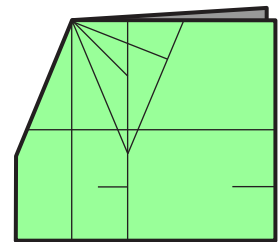

18. Creases exist as shown.

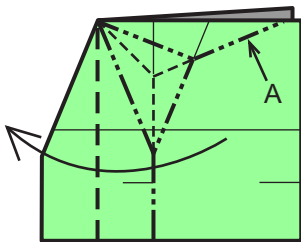

19. Collapse on the creases. First close up the mountain-fold triangle, pinching the tiny new valley-fold. Then flatten to form mountain-fold "A".

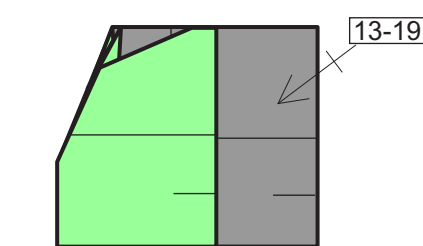

20. Note that "A" does not reach corner. Repeat 13-19 on rear flap.

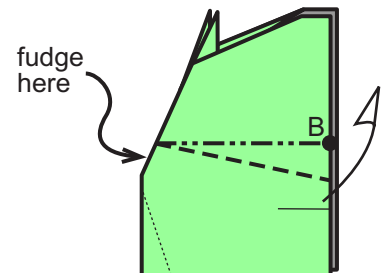

21. Pleat. Mountain-fold is the existing half-line. For the valley, bring the 1/4-mark to lie under "B". The dotted line is a hidden mountain-fold caused by shifting paper.

# \$ Butterfly (continued)

Copyright 1998-99 Stephen Hecht. All Rights Reserved

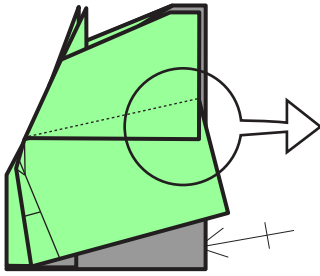

22. Note shifted creases in fudged area. It needn't be precise, it will be hidden later. Repeat 21 behind.

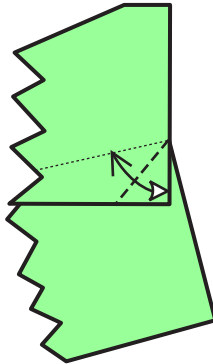

23. Close-up of right edge. Fold and unfold to hidden edge (hold model up to the light).

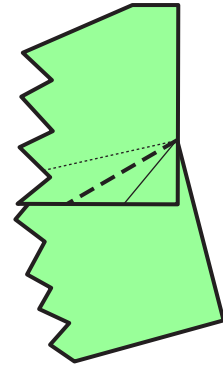

24. Fold and unfold (bisection), aligning previous crease with hidden edge.

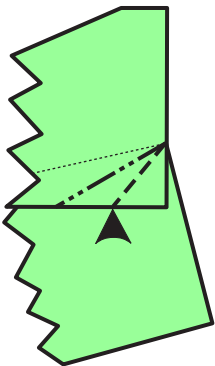

25. Reverse-fold, in-and-out.

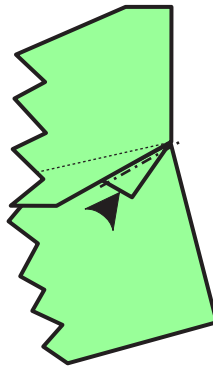

26. Reverse-fold. These steps are similar to 9-12. Turn over.

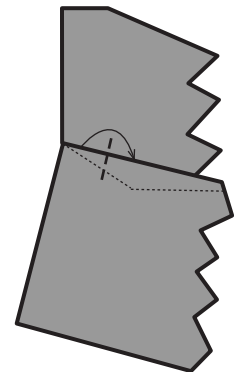

27. Fold and pinch, where limited by most recent reverse-fold.

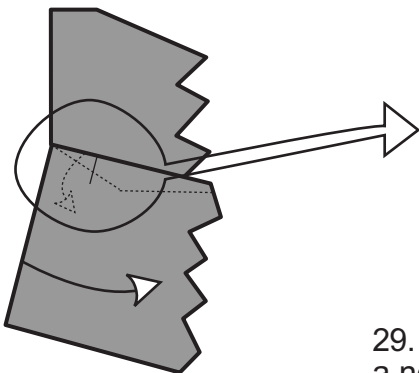

28. Undo the reverse-fold from step 26. Then spread the area towards the right.

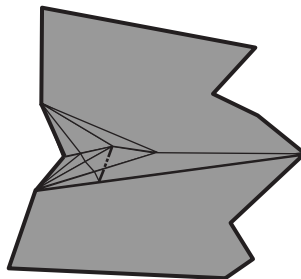

29. Push from behind and create a new mountain-crease linking the base of the reverse-folds to the pinch mark of step 27.

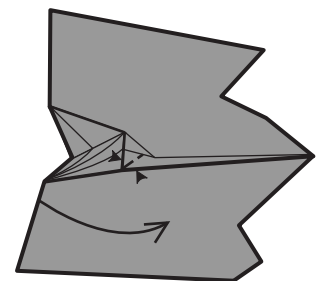

30. Begin to flatten by pinching where shown. Swing the standing edge to the right.

# \$ Butterfly (continued)

Copyright 1998-99 Stephen Hecht. All Rights Reserved

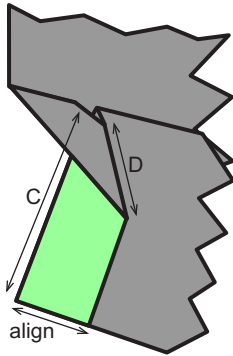

31. To flatten, first align bottom edges. Then flatten "C", then flatten "D". Careful of tearing due to imprecision.

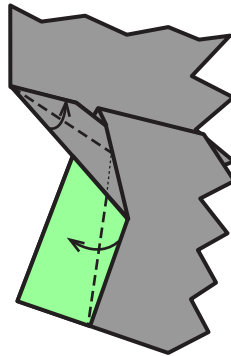

32. Swivel. The upper crease partially exists. Use it to start the swivel and locate the end of the vertical crease.

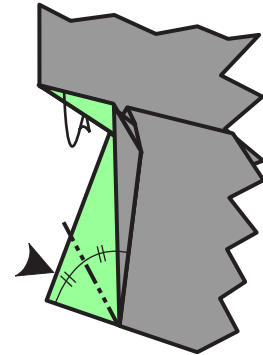

33. Wrap top layer around to the inside. Reverse-fold corner, noting the bisected angle.

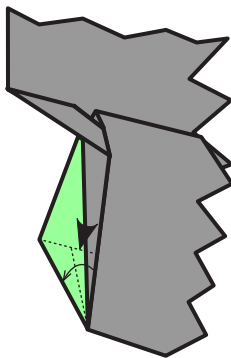

34. Reverse-fold hidden corner, bisecting. Then unfold it.

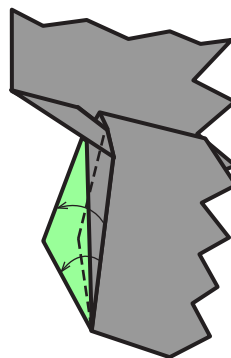

35. Crease and unfold. Lower crease bisects. Upper crease aligns vertical edges.

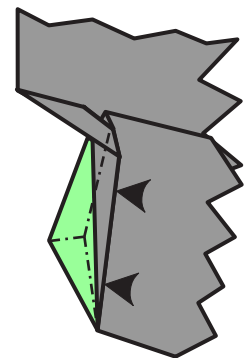

36. Reverse the two creases just made and add the tiny mountain-fold, pushing edge towards the left (model not flat).

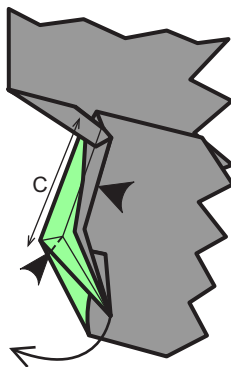

37. Still pushing towards the left, also push in at the tiny valley-fold, swinging the point down to align with edge "C".

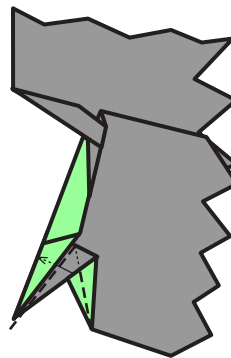

38. Model is flat again. Swivel on existing creases and tuck between layers.

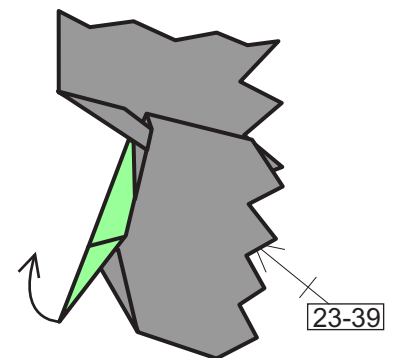

39. Curve the tip towards you a bit. Helps keep together. Repeat steps 23-39 on the other wing.

# \$ Butterfly (continued)

Copyright 1998-99 Stephen Hecht. All Rights Reserved

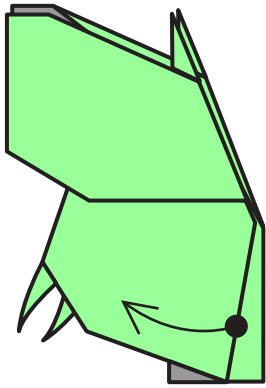

40. Entire model again. Spread upper layers a bit.

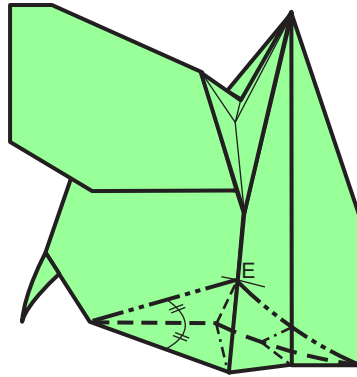

41. "E" is the mark made in step 7. First make the long mountain-folds. Then make the left valley (an exact bisection). Then make the right valley (not an exact bisection), closing up the model.

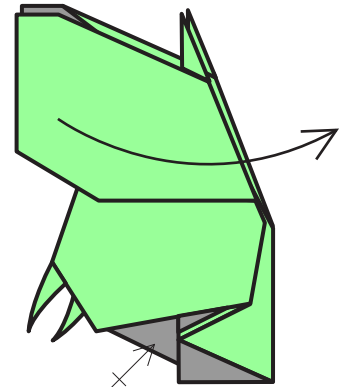

42. Thus. Repeat 40-41 on other side. Then open model out.

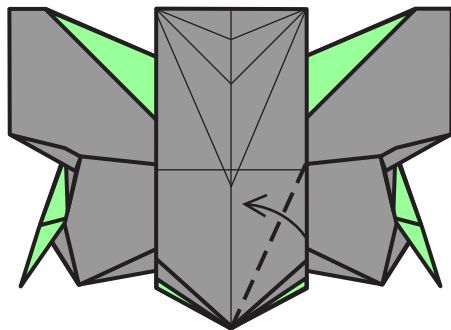

43. Valley-fold, limited by the folds of step 41. If you have been accurate, it will hit the bottom corner. Unfold.

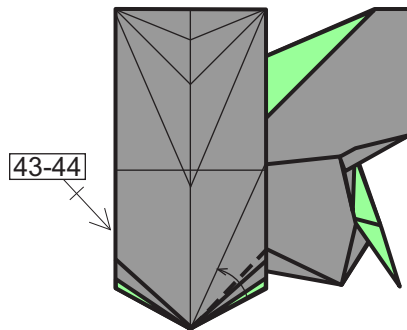

44. Valley to previous crease and unfold. Repeat 43-44 on the left. Close up the model again.

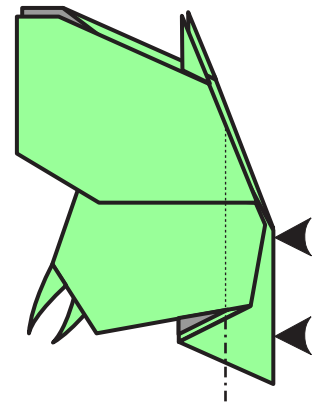

45. Closed-sink central ridge halfway.

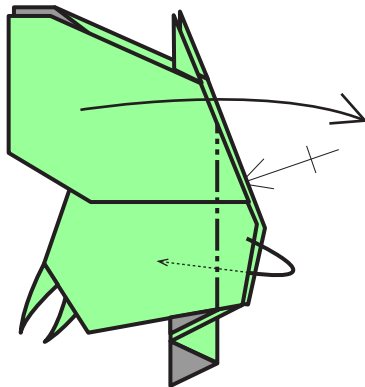

46. Tuck into sink, creasing sharply. Repeat behind. Then open model again.

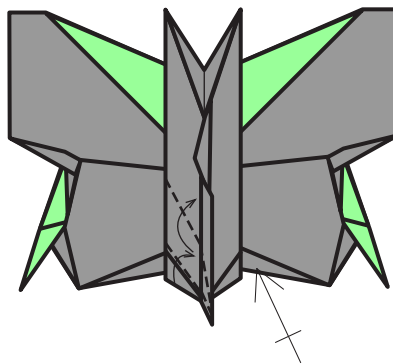

47. Reform valley-folds from 44, then valley folds from 43. Close up model, adding new mountain folds.

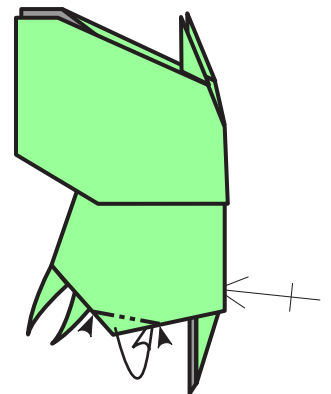

48. Mountain to shape wing. Reverse-fold at overlaps to help secure. Repeat behind. Bottom half is now done.



# \$ Butterfly (continued)

Copyright 1998-99 Stephen Hecht. All Rights Reserved

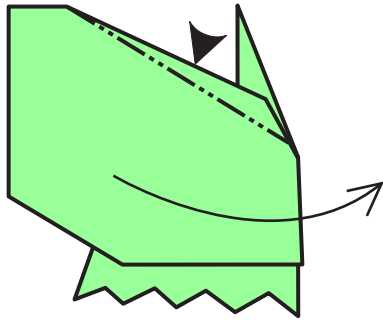

49. Top of model. Closed sink (limited by paper at right). Then lift wing.

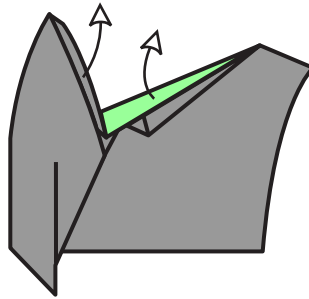

50. Lift the single-ply "reverse-fold", exposing the underside of the sink.

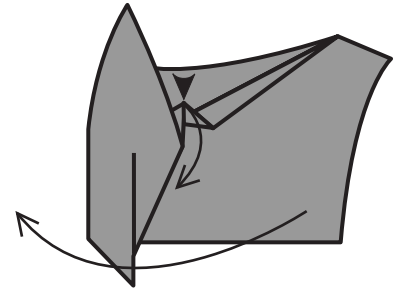

51. Reverse-fold the small corner, and close up the model. This distributes the layers of the sink more evenly.

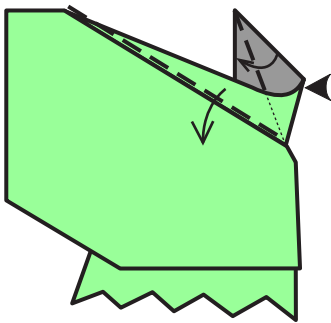

52. Squash the flap lifted in step 50, on existing creases.

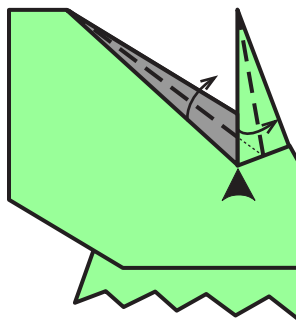

53. Squash again.

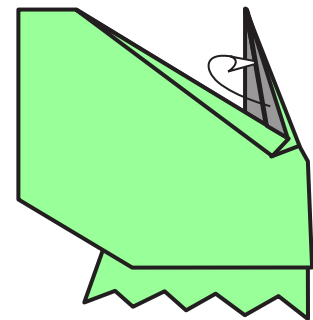

54. Wrap raw edge to the inside.

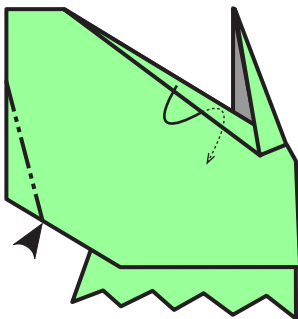

55. Tuck long flap into sunken pocket. Mountain-fold to shape wing. Reverse-fold at overlap to help secure.

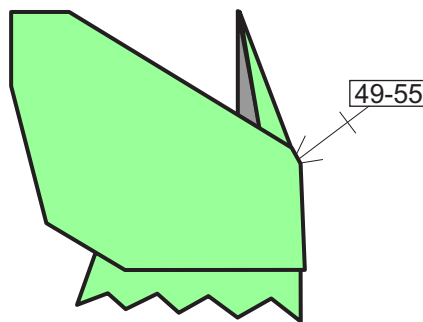

56. Like so. Repeat 49-55 on other wing.

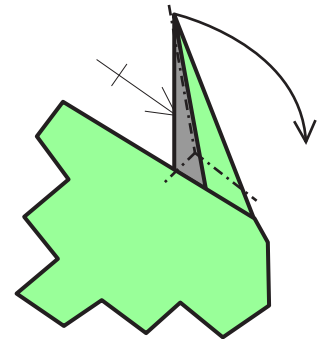

57. Double-rabbit-ear the point to form antenna. Repeat behind. Distribute layers evenly.

# \$ Butterfly (continued)

Copyright 1998-99 Stephen Hecht. All Rights Reserved

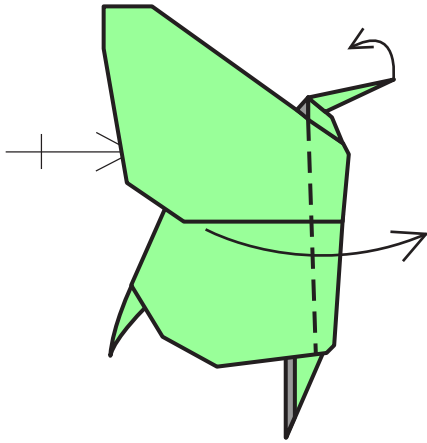

58. Curl antenna. Fold wings, not too sharply, where limited by body. Repeat behind.

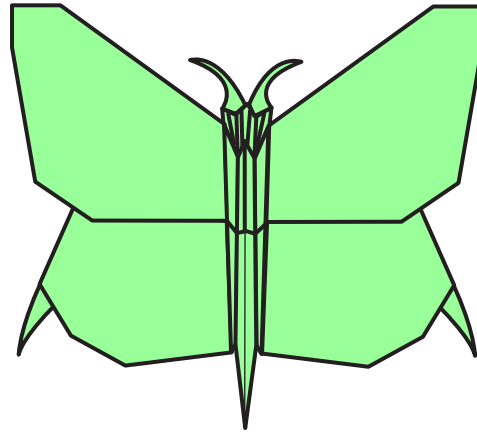

59. Finished.

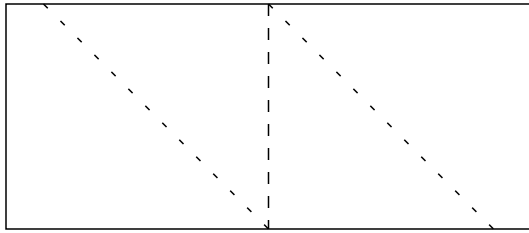

1) Mark the center of the bill with a valley fold, and then fold diagonally to this mark.

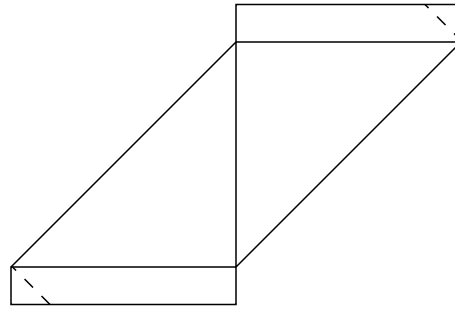

2) Flip the model over, and fold the small corners so that the remaining paper can be tucked into the model.

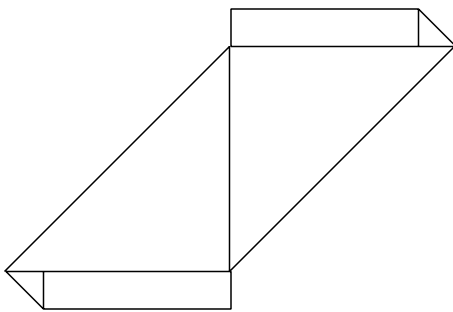

3) Now, fold those flaps into the model.

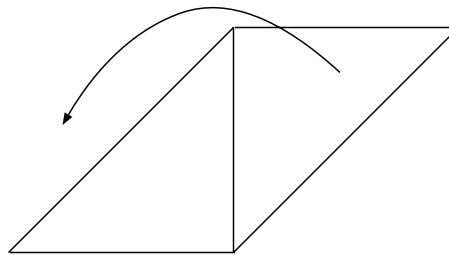

4) Mountain fold the right hand side of the model so you get...

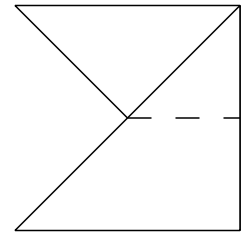

5) this. Valley fold in the middle, where shown.

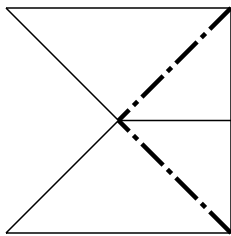

6) Mountain fold along the heavy lines.

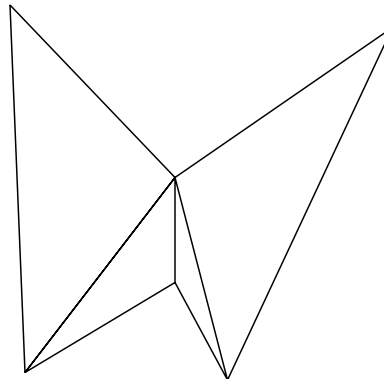

7) The model will now be able to stand on a flat surface.



Valley fold in half. Then valley fold both top edges down to center. **TURN OVER**



Valley fold corners in. Valley fold both lower flaps up along bottom raw edge. Tuck inside. **TURN OVER.**



Valley fold center raw edges to outside edges and unfold. This fold will be used later on in the model. Again **TURN OVER.**



Valley bottom raw edges to outside edges. Fold top flap only and only to center. See next photo.



Half way there... Keep lifting center and fold right half over left half. This is a natural collapse of the model along the existing folds. See next photo.



Lift top flap to right and flatten. See next photo.



Reverse fold two lower points.



Twist and pull both points that you just made down to make the tails. See next photo.



Pulling helps elongate tails. **TURN OVER.**

10



Bend triangle flap up and squash fold.

11



Inside reverse to narrow body.

12



Crimp head and tuck inside. Narrow body more by folding edges under. See next photo.

13



Mountain fold in half along center.

14

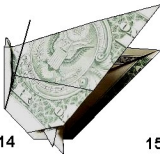

Valley fold following angle of lower body (see photo), and repeat behind.

15



Valley fold following side lines of body and repeat behind.

16



Crimp fold top wing down over existing landmark fold from step 3 (approx. 1/8 in.)



**Completed butterfly**

**This butterfly was originally designed for a 2-1 rectangle by Dokuohtei Nakano. It's featured on page 36 in the book "Complete Origami" by Eric Kenneway. This is a very good book with over 100 projects. If you get a chance take a look at it.**

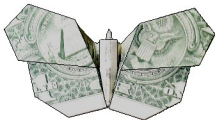

**Variation of butterfly**

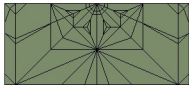

**Folding pattern**

**The original design did not have top and bottom wings and did not have tails. The extra paper from the dollar allows for the addition of tails. Just these two additions make for a dramatic difference in the look of the finished model.**

**Butterfly adapted for a dollar by Joe Gilardi, all rights reserved. You may use this design for personal or non-profit. If used for commercial or profit, I request only a copy of the publication. Enjoy!! If you would like to share any comments, designs, variations or just want to say hi... Papajoe@chorus.net**

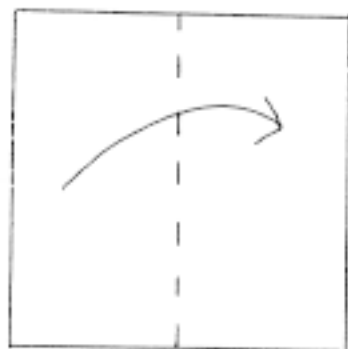

1. This will be the color of the body. Fold in half.



2. This will be the color of the wings. Fold corners, and remove fold from step 1.

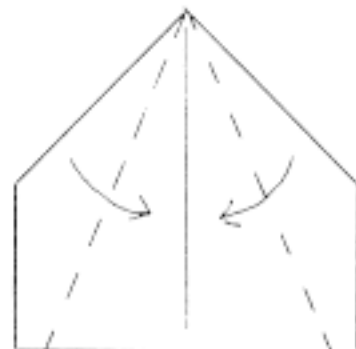

3. Fold to center pulling flaps from behind.

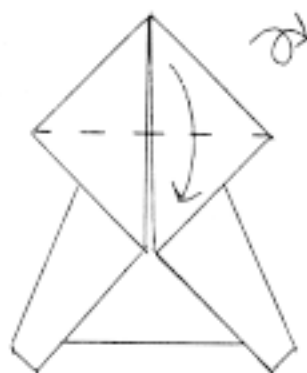

4. Valley fold top. Turn over.



5. Rabbit-ear bottom, using the intersection of folds on back as a guide.



6. Precrease.

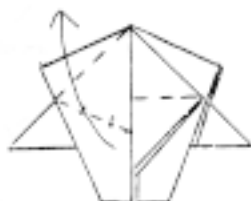

7. Form an asymmetrical squash fold.



8. Valley-fold flap. Repeat steps 6-8 on the other side.



9. Squash fold the center flap.

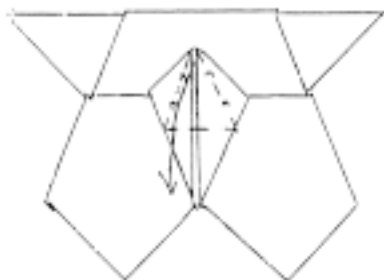

10. Petal fold flap downward.

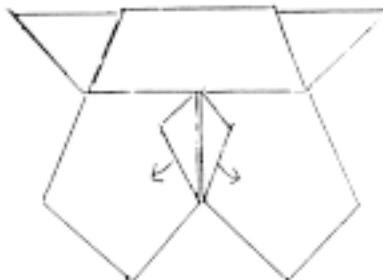

11. Pull out a single layer from each side.

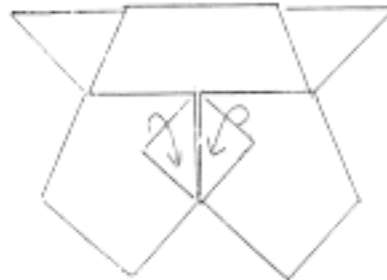

12. Hide the center square by pulling a layer of paper from behind each side.

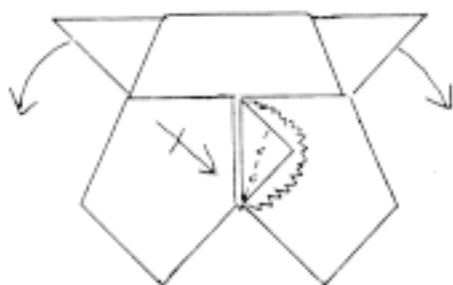

13. Reverse fold the hidden flaps. Pull out top corners, undoing the crimp. Turn over.

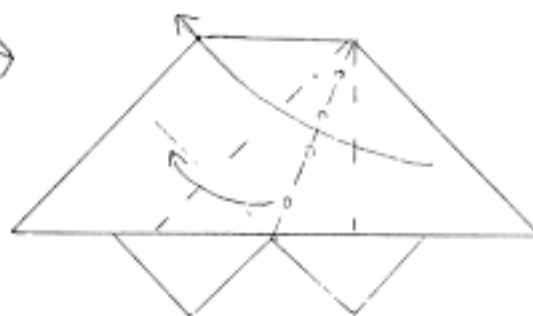

14. Swing flap up while crimping; note the intersections.

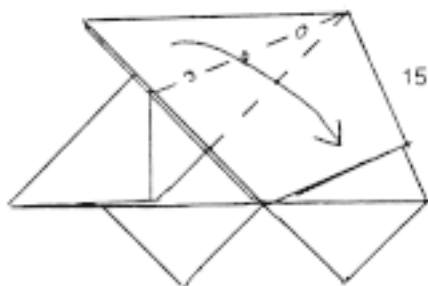

15. Valley fold flap down and then squash it.

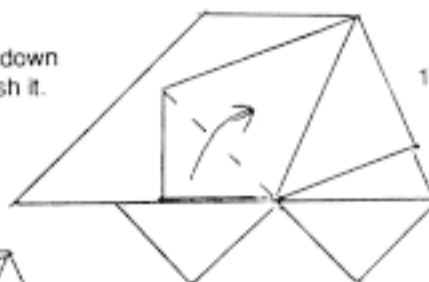

16. Valley fold the corner up.



17. Fold up, spreading out the inner layers.



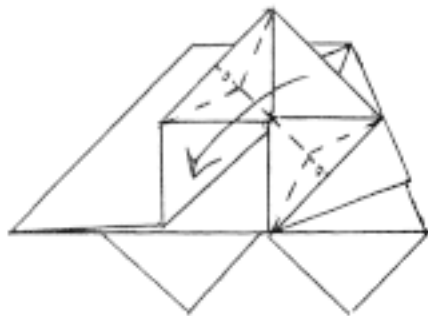

18. Fold down while reverse-folding the sides.

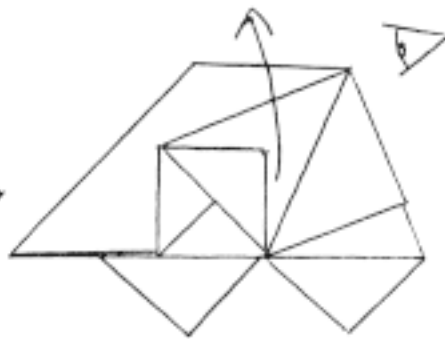

19. Open out one side.



20. View from 19: Collapse by inserting valley folds between the existing creases, working from the inside towards the outside. Note: this is Aaron Einbond's favorite step.

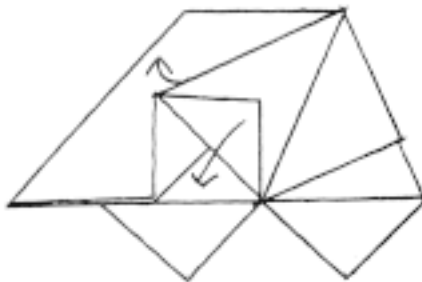

21. Fold down the corner and undo one of the side reverse folds.

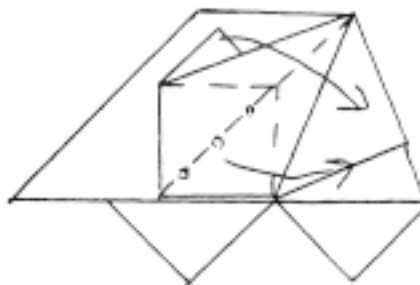

22. Fold flap over while reverse folding the bottom single layer. Repeat steps 14-22 on the other side.

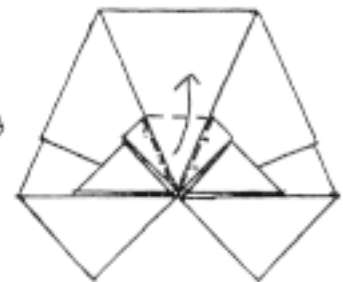

23. Petal fold the center flap.

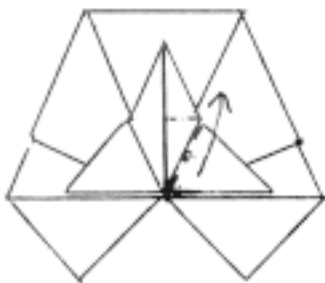

24. Squash fold one of the sides.

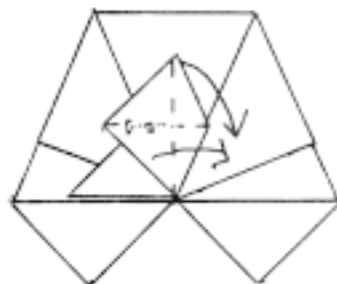

25. Fold the single-layered triangle over and then fold in half downwards. Repeat steps 24-25 on the other side.

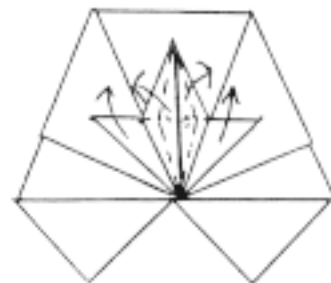

26. Fold flaps up while reverse folding the top center layers outwards.



27. Right "triangle" shown only; Reverse fold. Repeat on the other side.



28. Reverse fold. Repeat on the other side.



29. Fold the sides of the top layer to the center. Repeat on other side.



30. Reverse fold. Repeat on the other side.

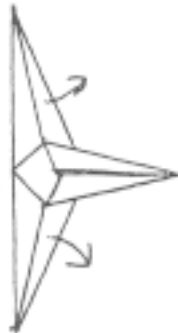

31. Carefully pull out the top layer from each side. Repeat on the other side.

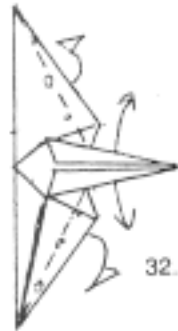

32. Mountain fold the just pulled layer around as many layers as possible. Open out the top to a preliminary fold formation. Repeat on the other side.



33. Reverse fold along existing creases. Repeat on the other side.

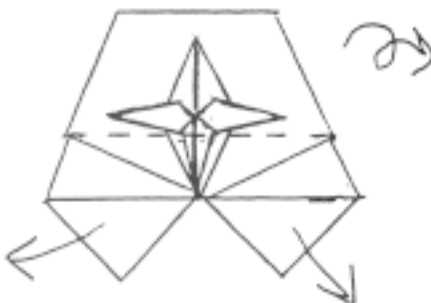

34. Precrease first. Open out the front and turn over.

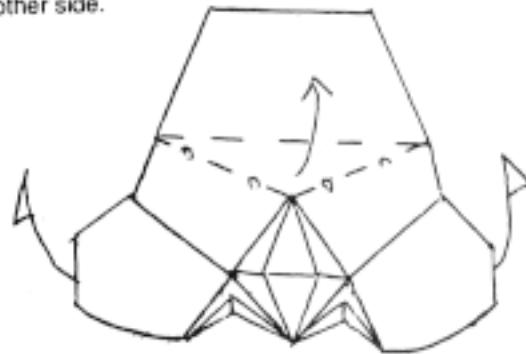

35. While retaining the folds from steps 9-13, pull the center portion up, and flatten the model by swinging the wings to the back.

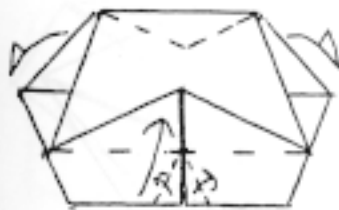

36. Valley fold bottom corners. Fold the bottom up while swinging the back down. Precrease top as indicated.

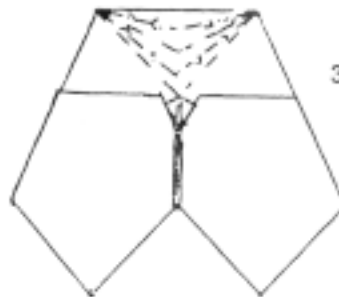

37. Insert additional precreases by forming a series of reverse folds and opening them up.

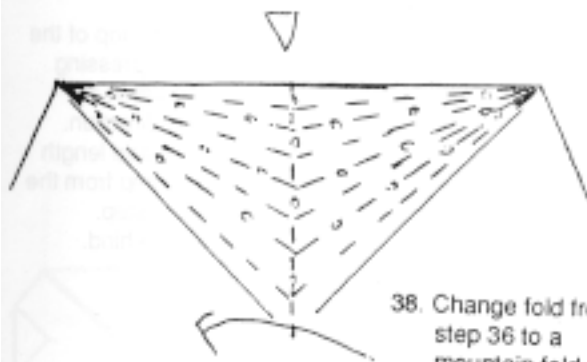

38. Change fold from step 36 to a mountain fold, and insert valley folds in between the existing mountain folds working towards the outside. These are all essentially reverse folds.

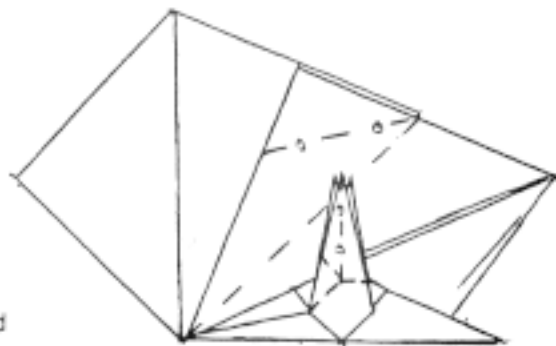

39. Model Rotated: Fold the center leg down as indicated. Crimp the thickness on the wing. Repeat all steps behind.

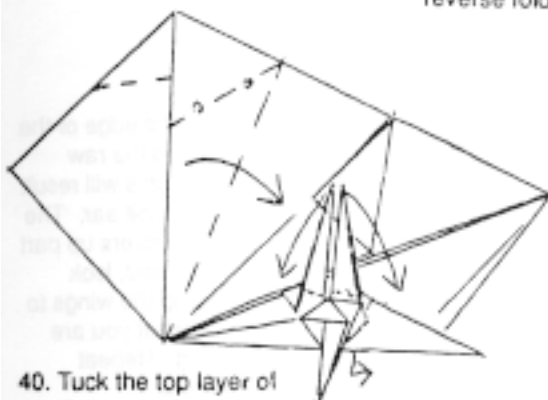

40. Tuck the top layer of the center leg into the pocket beneath it. Reverse fold the other legs down. The layers will not be distributed evenly. Squash where indicated on the wing. Repeat all steps behind.

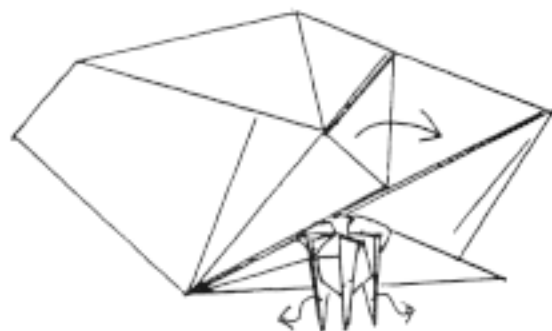

41. Tuck in the top layers of the outer legs into their respective pockets underneath. Unfold the triangular flap on the wing. Note how its tip touches the creases from the previous squash. Repeat all folds behind.

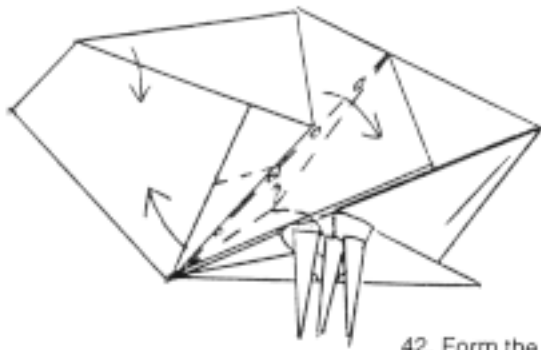

42. Form the long valley fold on the top single layer only. This will cause the model to be 3-D. Flatten the antenna by crimping it upwards. Repeat behind.

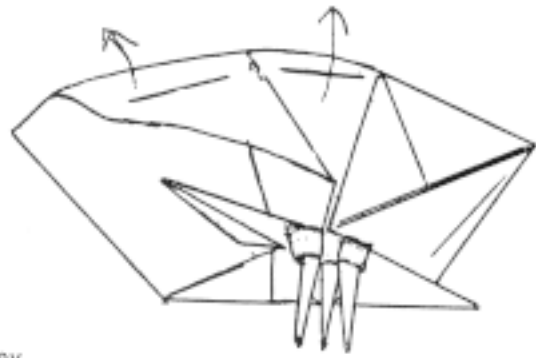

43. Flatten the top of the wings by pressing the top flat in an upward direction. This will add length to the crimp from the previous step. Repeat behind.

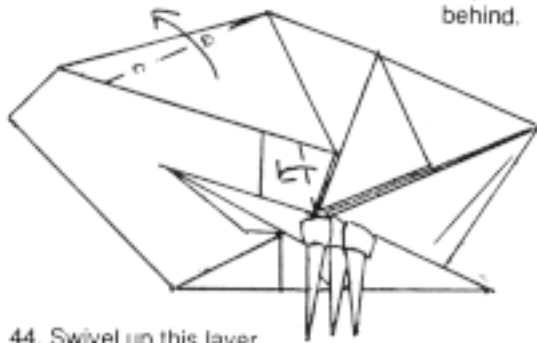

44. Swivel up this layer so that its raw edge is parallel to the lower raw edge at the wing. Repeat behind.

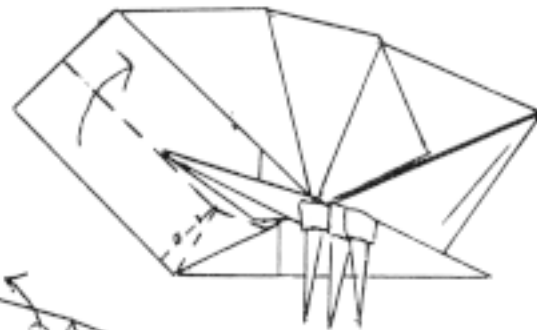

45. Fold the edge of the wing to the raw edge; this will result in a rabbit ear. The head covers up part of the fold, look behind the wings to see what you are doing. Repeat behind.

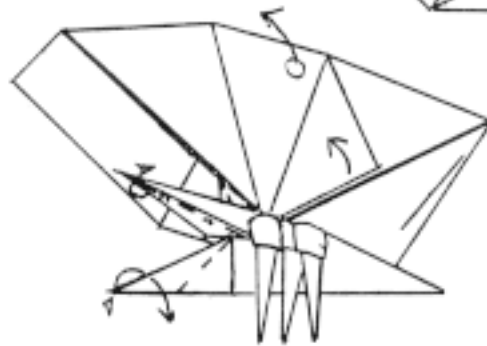

46. Thin the antennae using reverse folds. Outside-reverse fold the head. Pull the wing sections apart from where indicated by the circle. Repeat behind.

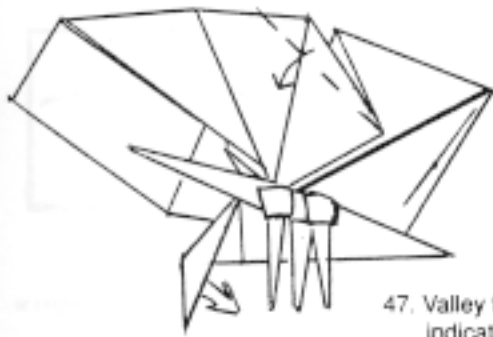

47. Valley fold where indicated on the wings. Repeat behind. Pull out a single layer of paper from the head. You will have to open the head to accomplish this.

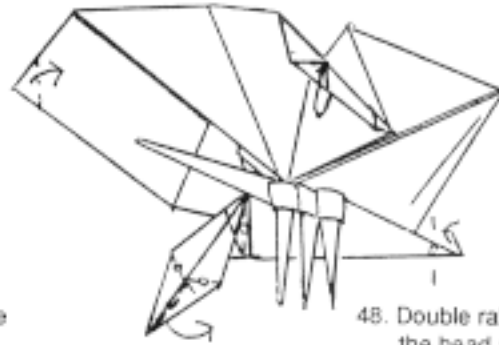

48. Double rabbit-ear the head and curl the top. Crimp the head into the body. Shorten the tail. Close and sink the flap folded in step 47. Repeat behind. Shape the legs and the antennae.

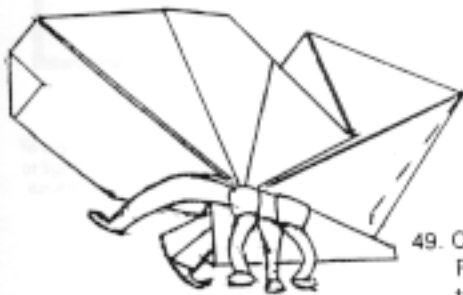

49. Completed body. Fold the wings down to the completed model.

50. Completed Butterfly.

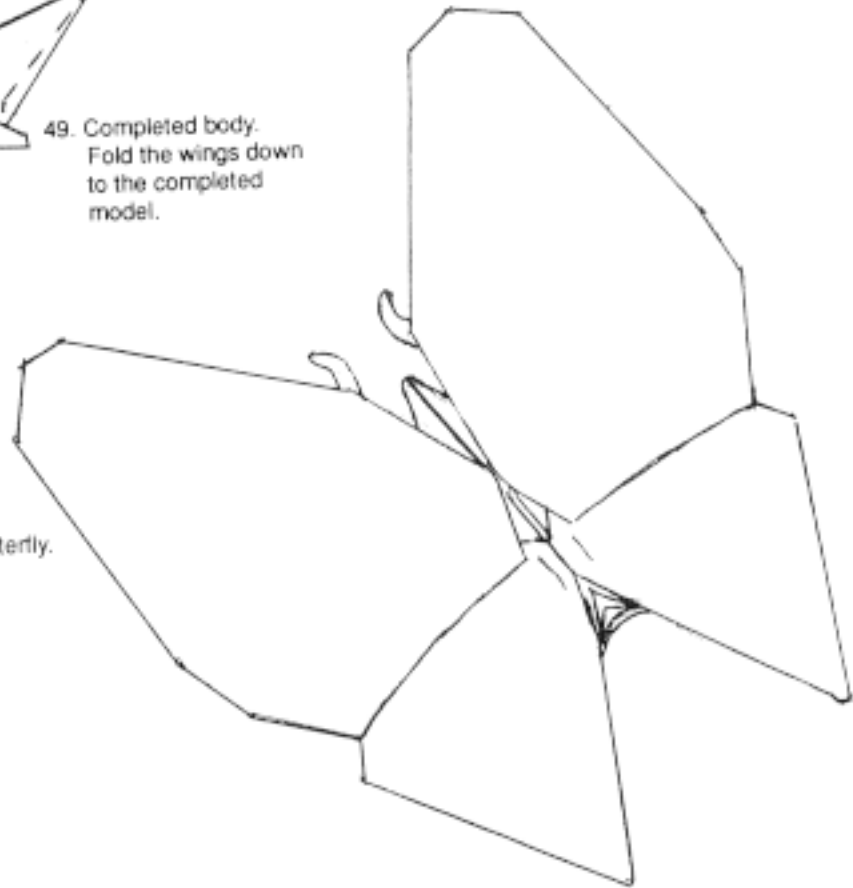

# 3 butterfly 3

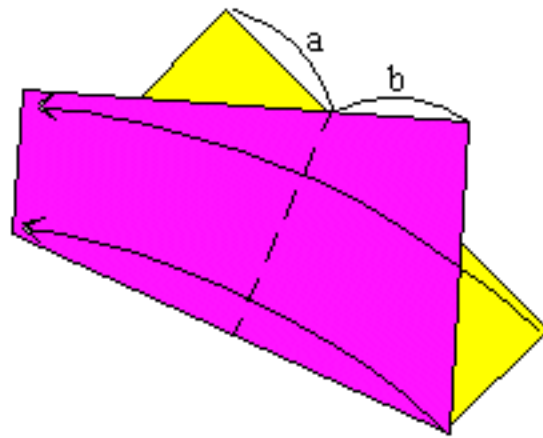
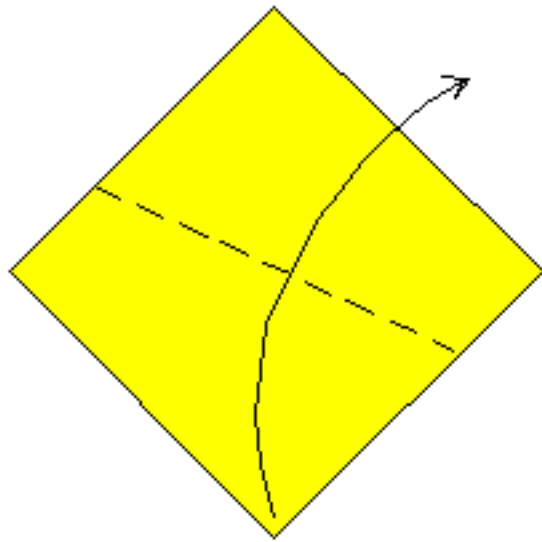

1/8

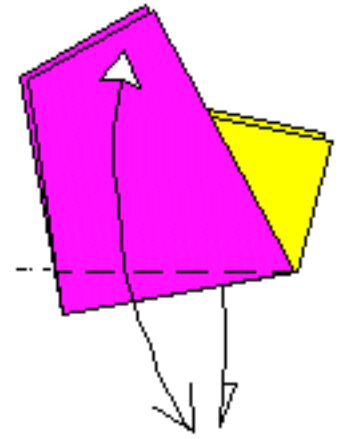

**1** Valley-fold. See next step before you press flat. (different angles in this step will give different butterflies.)

**2** What 's important is that a and b are equal. When they are, press flat. Valley-fold in half. Rotate the model.

**3** Valley-fold and open up. Repeat behind

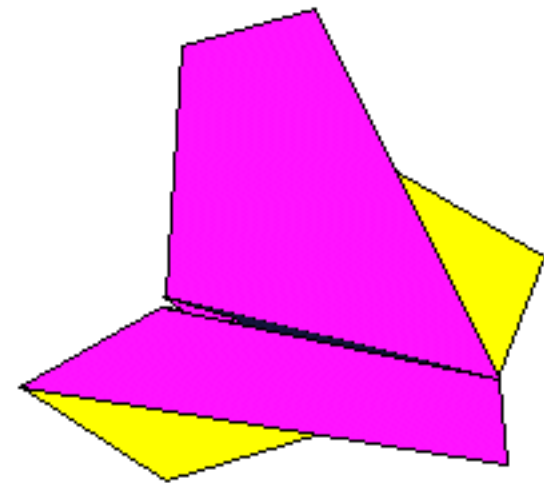
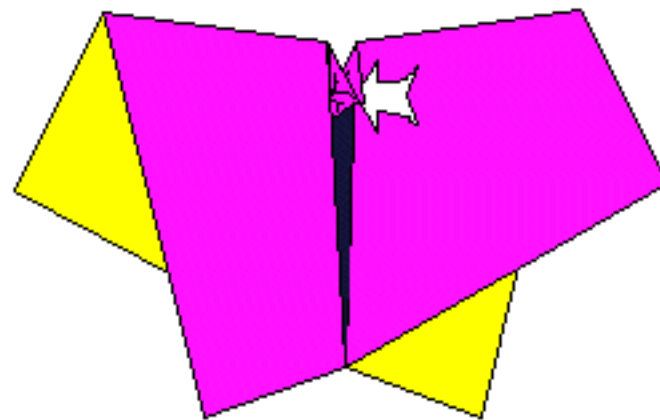
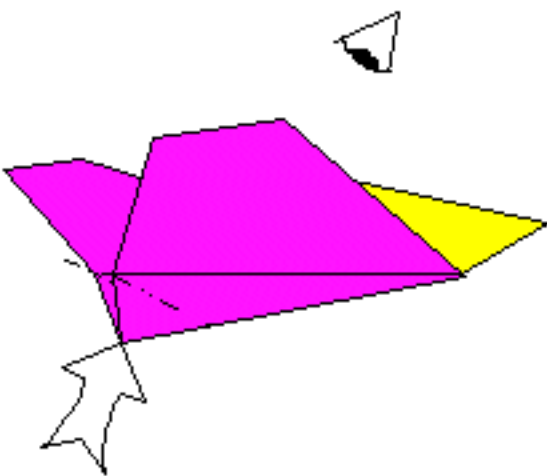

**4** Reverse-fold. Next view from above.

**5** Valley-fold the little edge into the pocket at the left.

**6** Butterfly 1 is finished. Also try variant 2.

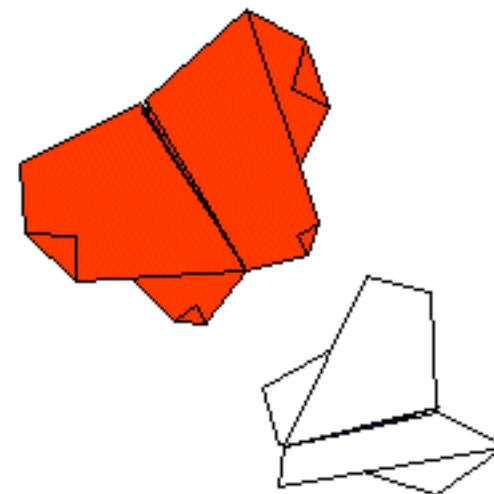
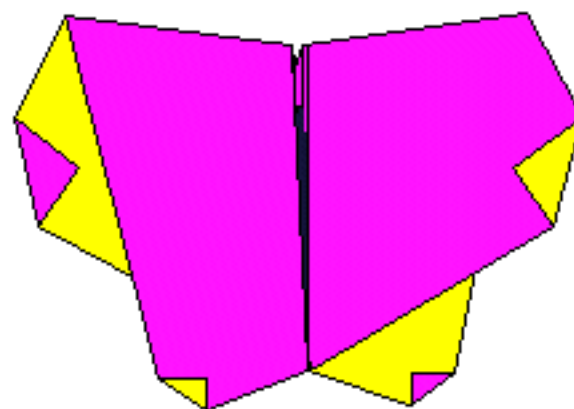
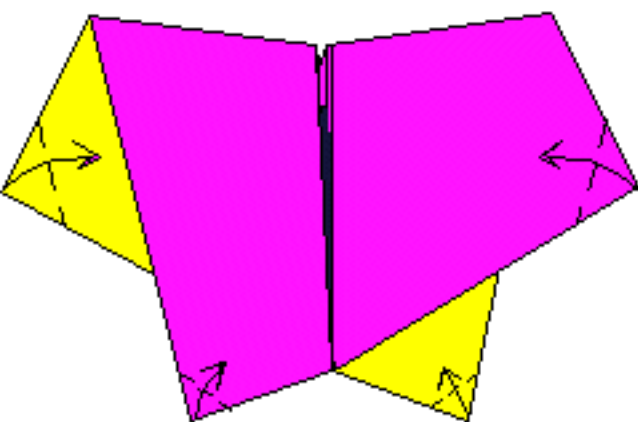

**7** Variant 2: Valley-fold the corners.

**8** Butterfly 2 is finished.

The butterfly made with single-colored paper.

# Butterfly - Collin Weber

Use a 2x1 rectangle with a different color on each side.

Start with the side with the color you want to be the wings. The other color will be the head and body.

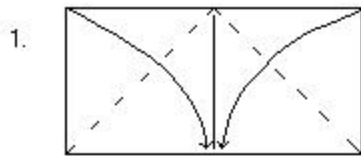

1. 2 valley folds to the center

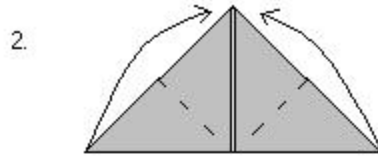

2. 2 valley folds and unfold

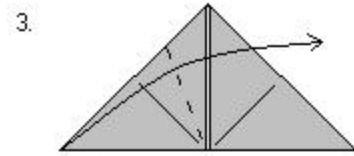

3. Valley fold to the right lining up the crease made in step 2 with the center line.

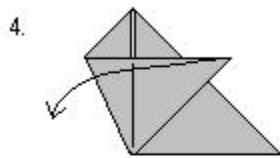

4. Unfold  
Repeat steps 3 and 4 on the right

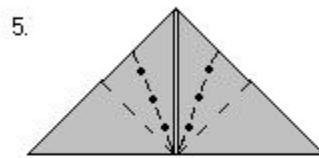

5. Reverse fold in and out on each side

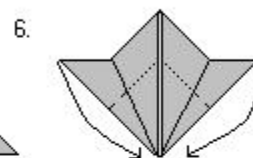

6. 2 reverse folds

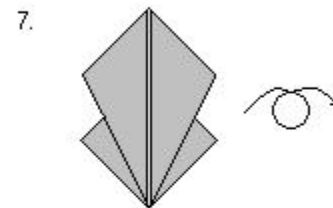

7. Turn over

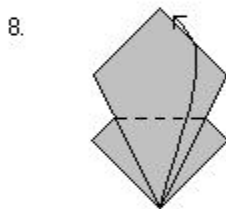

8. Fold the point up to the top like a petal fold

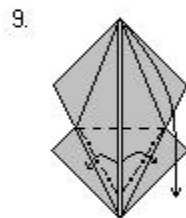

9. Fold the point back down while sliding some paper out on each side

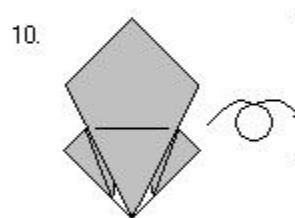

10. Turn over

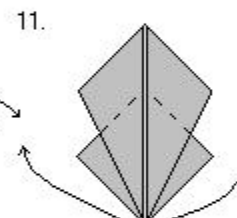

11. Fold the 2 points up

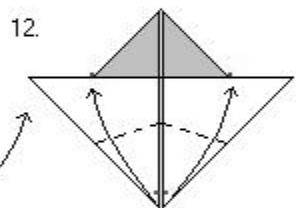

12. Valley fold the 2 bottom points up so that the dots line up

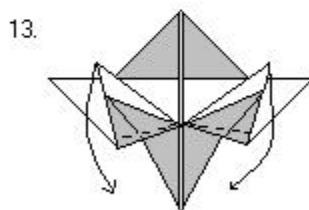

13. 2 valley folds

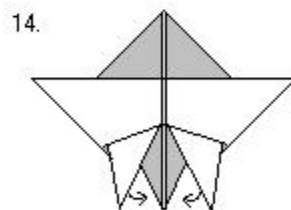

14. Pull some paper out on each side

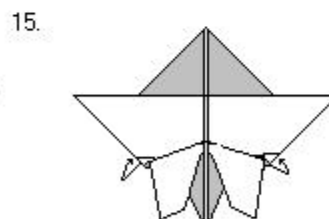

15. 2 mountain folds

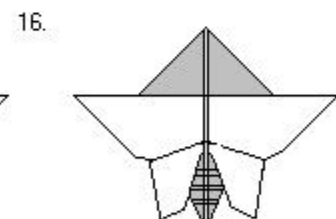

16. 3 pleats on the body

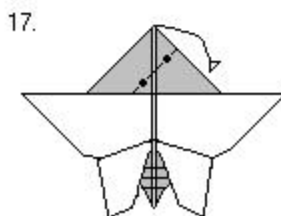

17. Fold behind

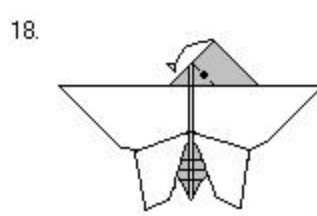

18. Fold behind

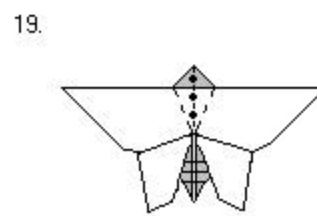

19. Add these folds to finish the head

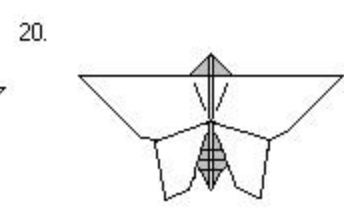

20. BUTTERFLY

# A Butterfly for Alice Gray by Michael LaFosse

©'92

Intermediate Fold from a small sheet of duo paper. Try varying the proportions in steps 4 & 11 to create variations. A 5" square produces a 3 1/2" model.

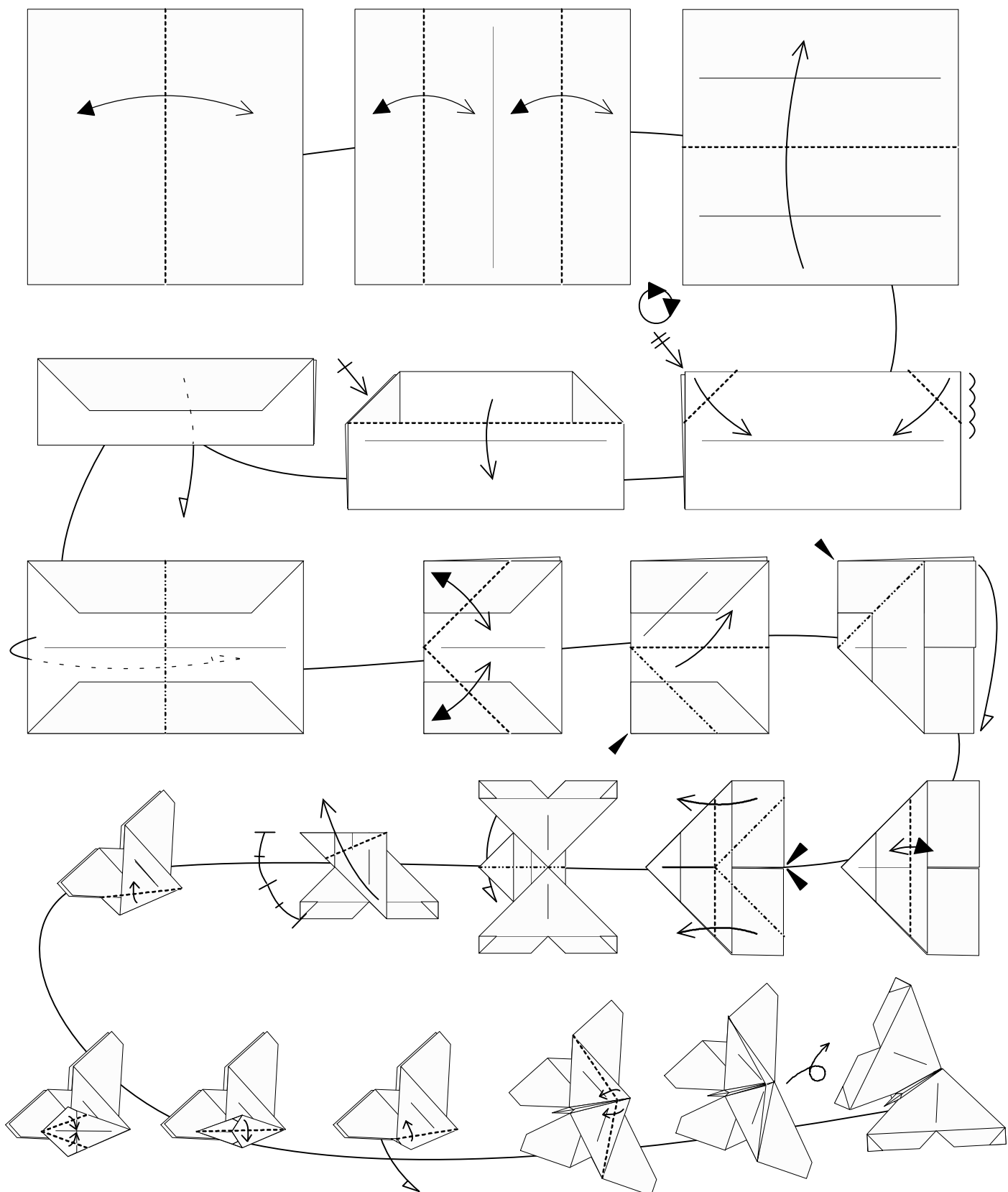

Diagrammed by J.C. Nolan - Sept.'94



# Butterfly

©Hans Birkeland 1998

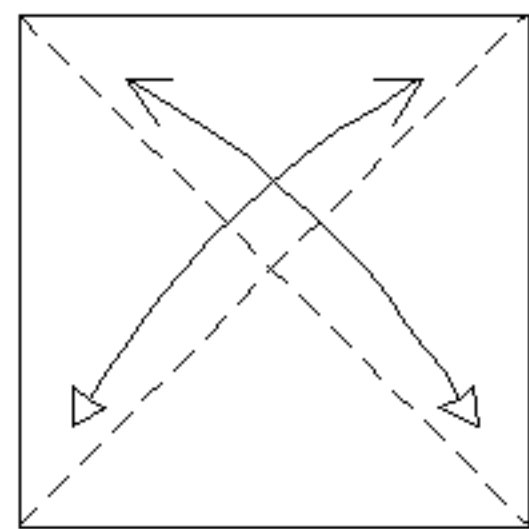

**1** Start with the white side up. Fold and unfold. Turn the paper over.

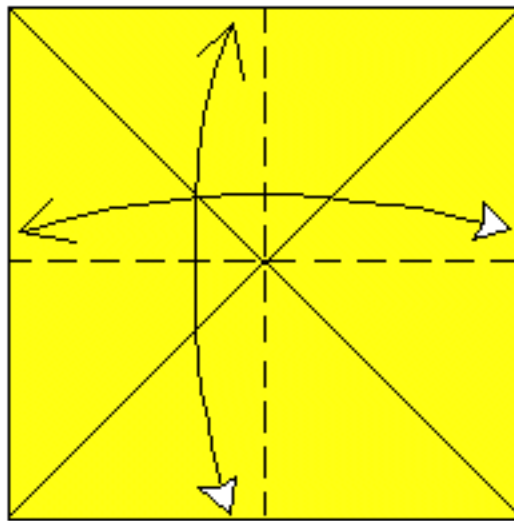

**2** Fold and unfold.

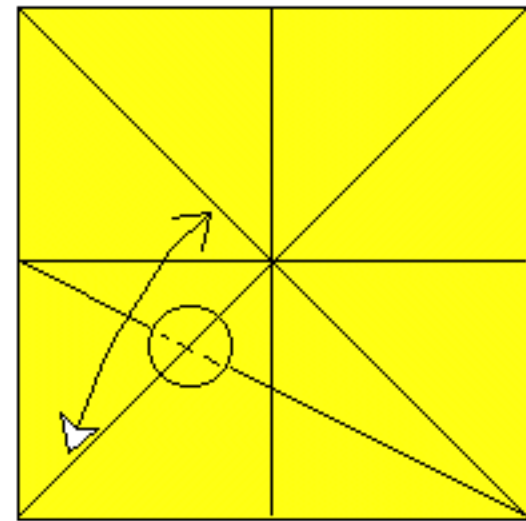

**3** Fold and unfold, only pressing flat where the crease hits the diagonal.

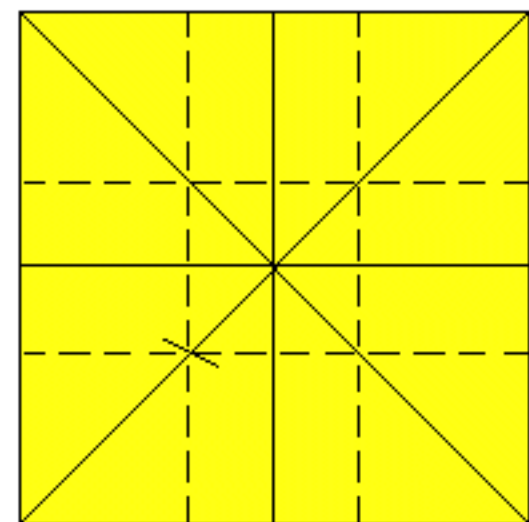

**4** Fold and unfold, dividing the paper in thirds. Turn the paper over.

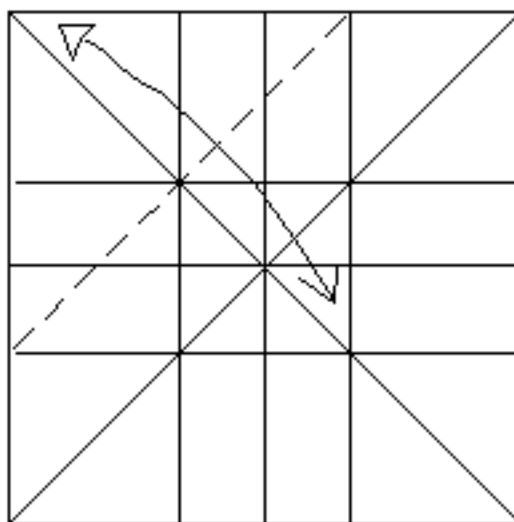

**5** Fold and unfold. Repeat with the three other corners.

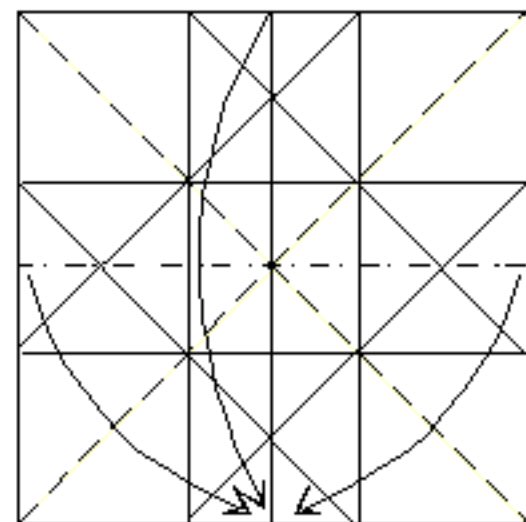

**6** Make a coloured waterbomb-base.

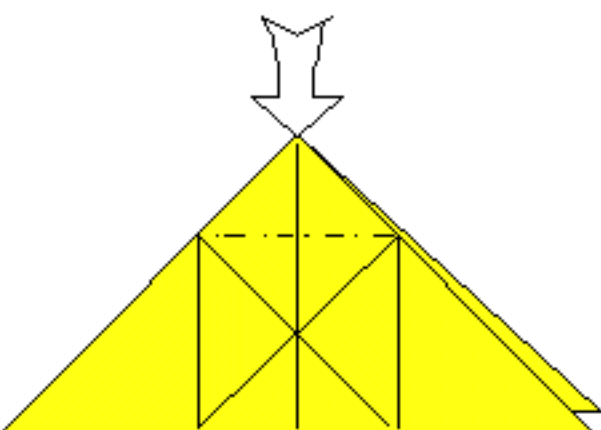

**7** Open-sink.

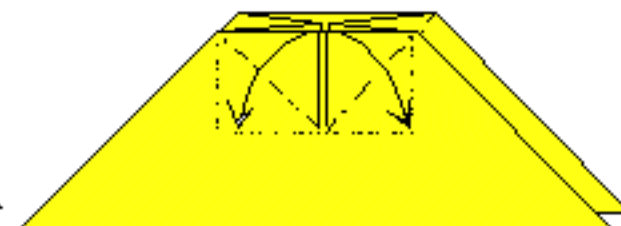

**8** Reverse-fold the hidden corners on existing creases.

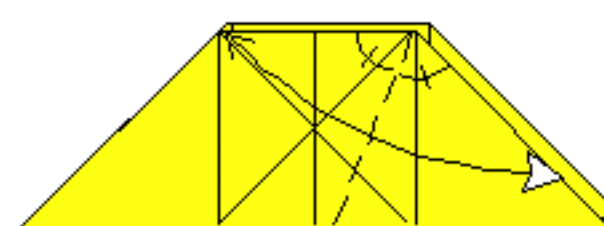

**9** Fold and unfold the angle bisector. Repeat on the left and behind.

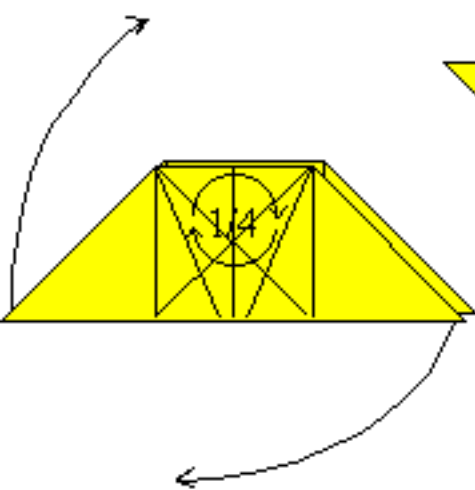

10 Rotate the front layers clockwise.

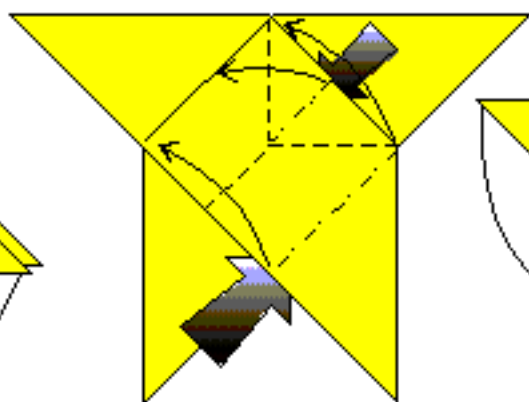

11 Open up between the layers and squash flat. Repeat behind.

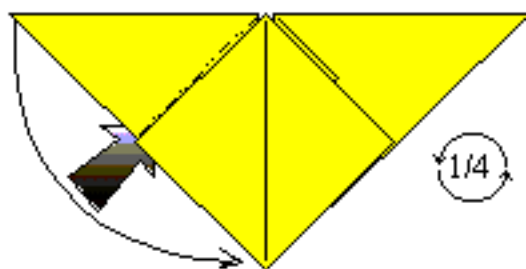

12 Reverse-fold the left flap. Rotate the model.

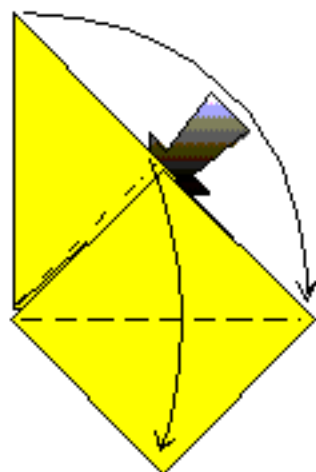

13 Squash-fold.

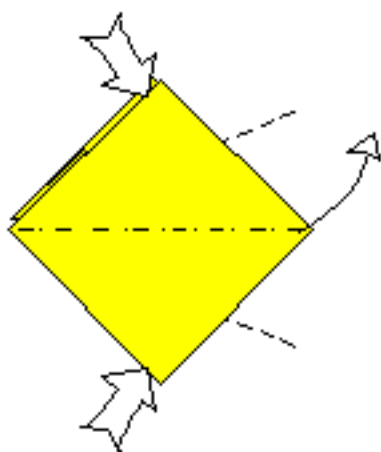

14 Lift and press together on existing creases, the resulting flap is folded upward. Repeat behind.

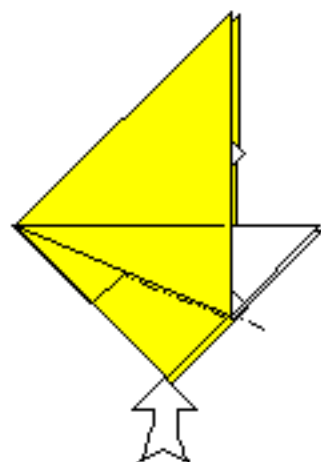

15 Reverse-fold. Repeat with the three similar edges.

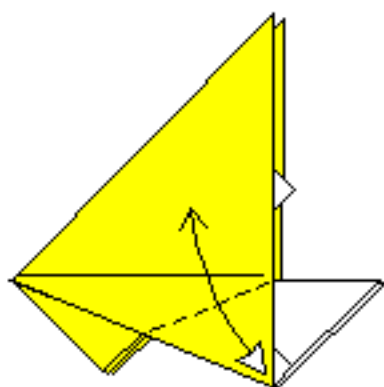

16 Fold and unfold the nearest flap.

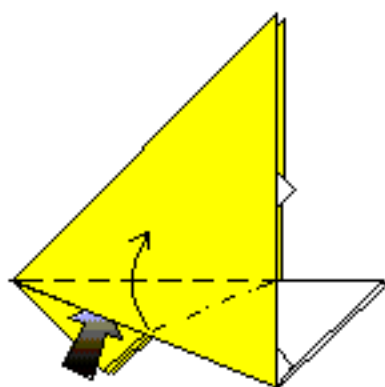

17 Open up the nearest pocket and spread-squash, folding the resulting flap downward.

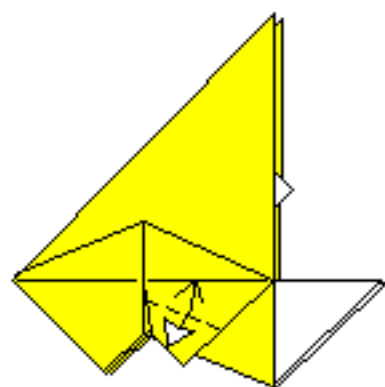

18 Like this. Fold and unfold the angle bisector.

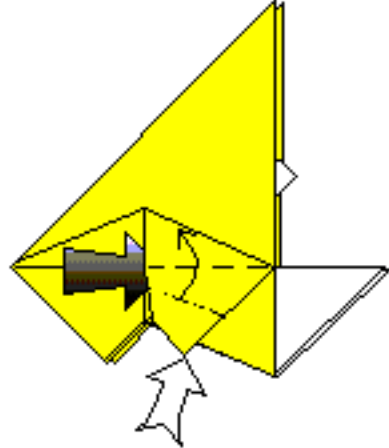

19 Open up where indicated and spread-squash.

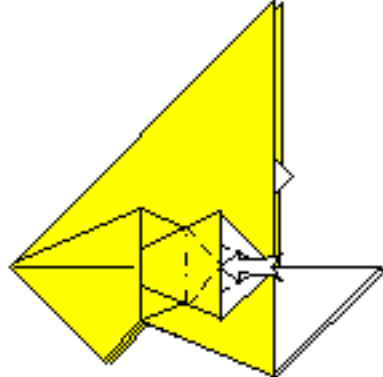

20 Inside-petal-fold.

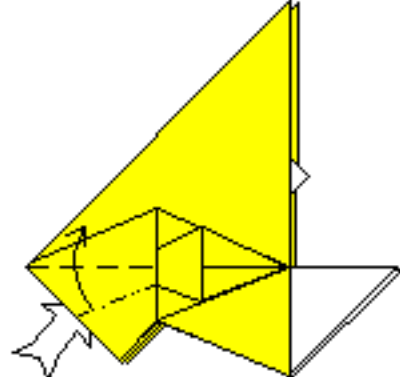

21 Squash-fold.

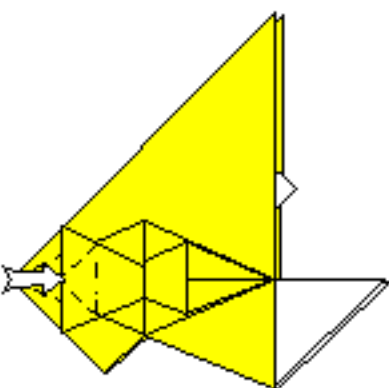

22 Inside-petal-fold.

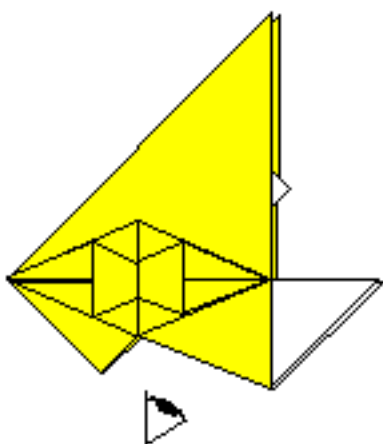

23 Repeat steps 16-22 on the back and on the top and then steps 16-19 on the bottom. Next step seen from below.

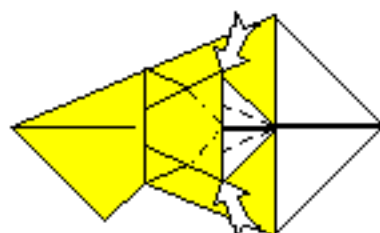

24 Reverse-fold. Repeat with the three similar edges.

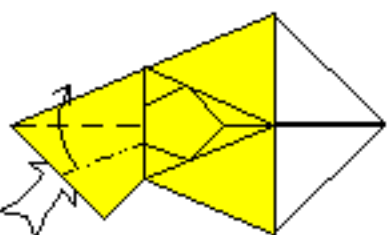

25 Squash-fold.

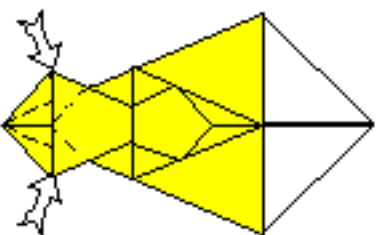

26 Reverse-fold. Then close the sides again.

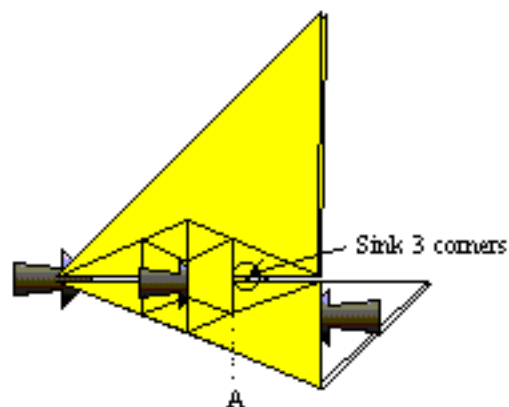

27 Open up where indicated and sink the part of the hidden corners that is on the right side of line A. Repeat behind.

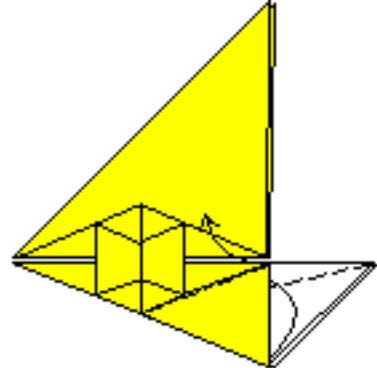

28 Reverse-fold the nearest edge. Repeat with the edge behind it.

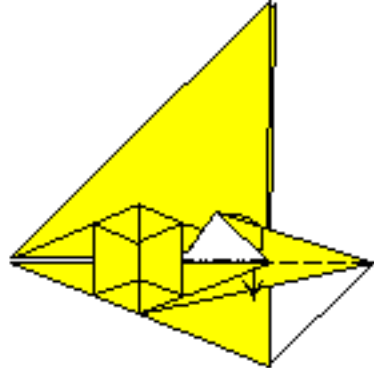

29 Reverse-fold. Repeat behind.

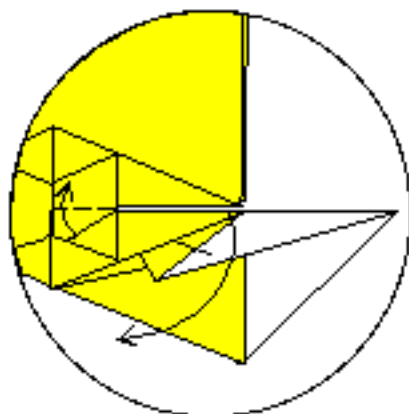

30 Swivel-fold. Repeat behind.

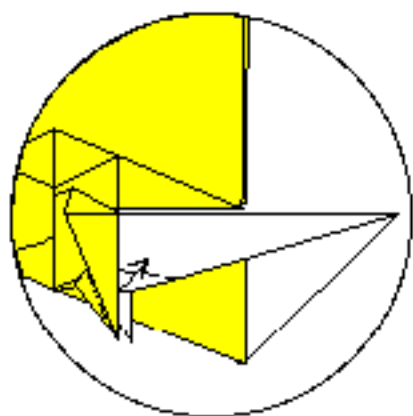

31 Swivel-fold. Repeat behind.

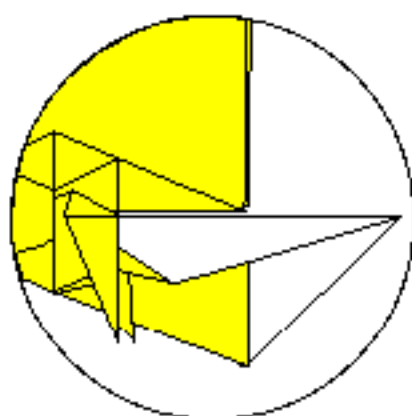

32 Inside-petal-fold.

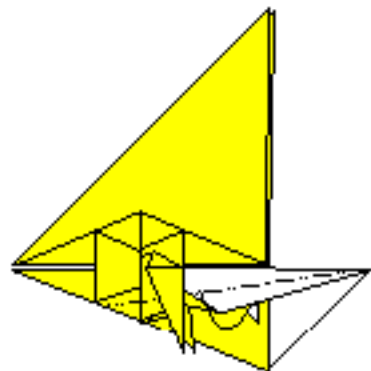

33 Fold the edge inside. Repeat behind.

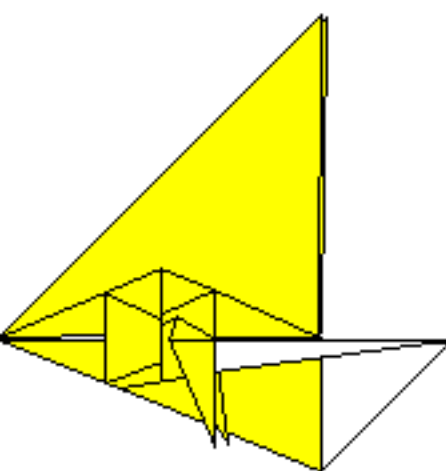

34 Repeat steps 28-33 on the flap behind.

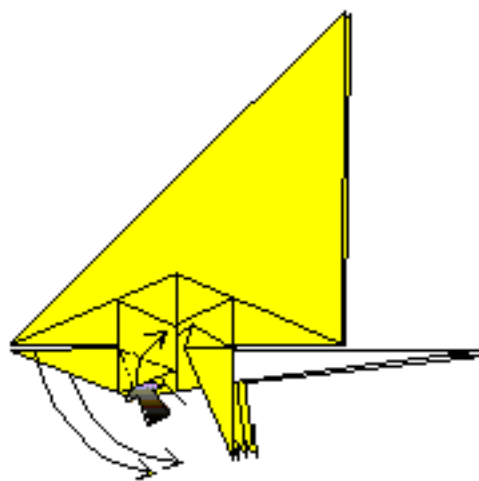

35 Swivel-fold both hind legs at the same time, turning the back body downward in the process.

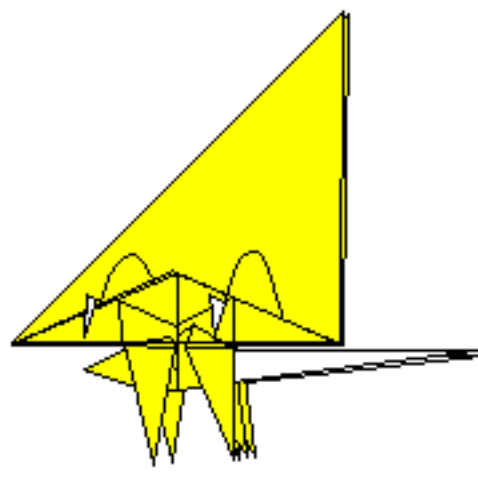

36 Wrap a layer to the front. This is the same as closed-sinking the indicated edges into the wing. Repeat on the back of the wing and then twice on the other wing.

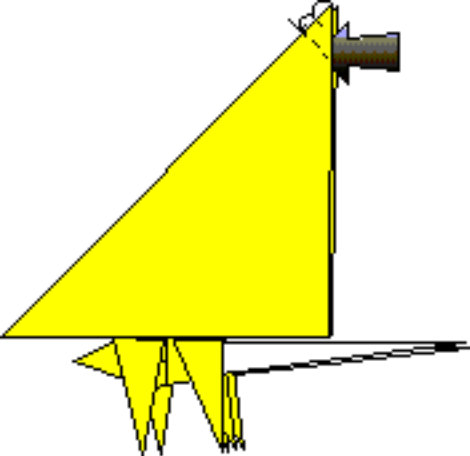

37 Open up and fold the tip of the wing over and over. Repeat on the other wing.

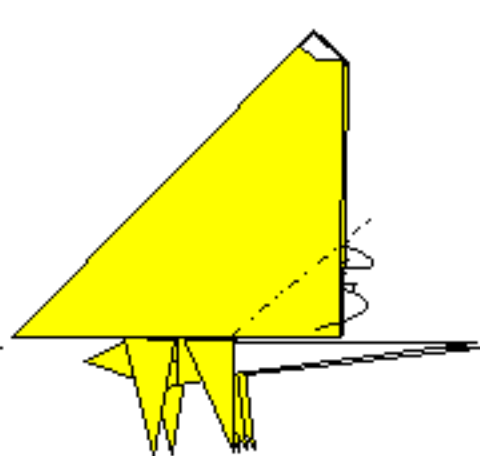

38 Fold the edges inside. Repeat behind.

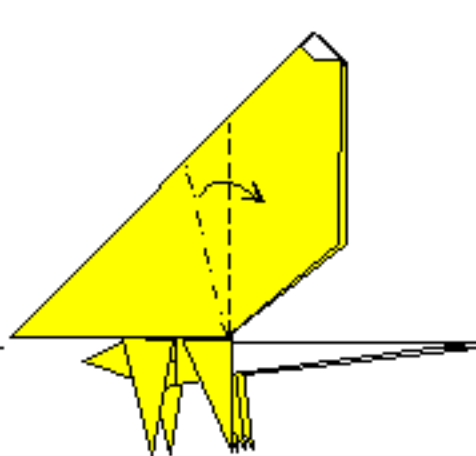

39 Crimp-fold. Repeat behind.

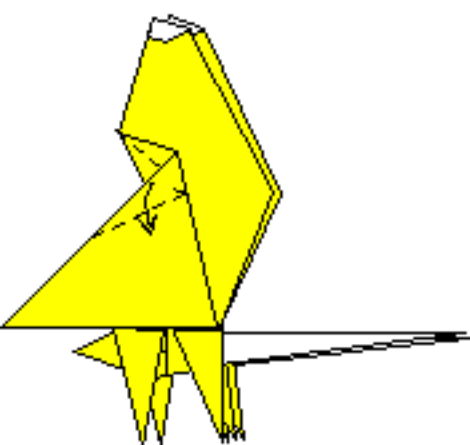

40 Swivel-fold. Repeat on the other wing.

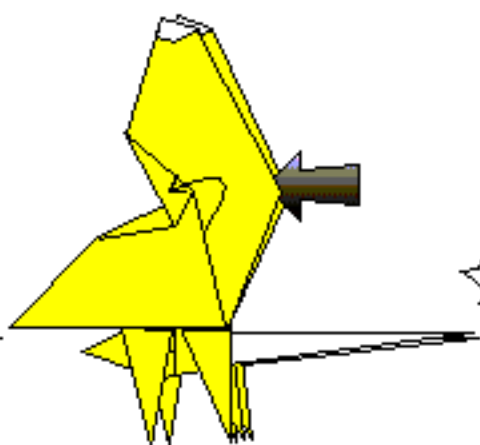

41 Wrap to the front. Repeat on the other wing.

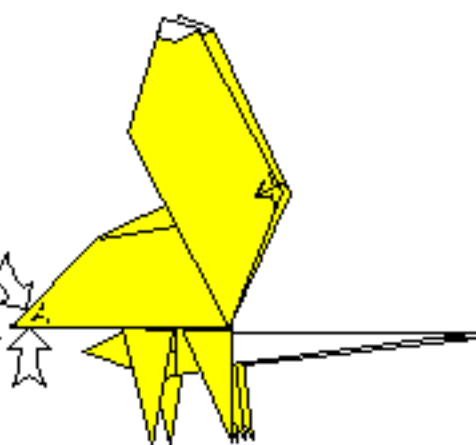

42 Valley-fold the double edge as one. Slightly rabbit-ear the tip of the wing. Repeat on the other wing.

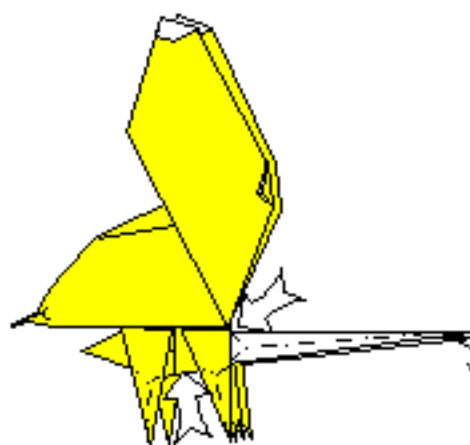

43 Rabbit-ear the antennae and make them as thin as possible. Sink some spare paper above the head. Rabbit-ear and spread the legs. Make the body round. Spread out the wings.

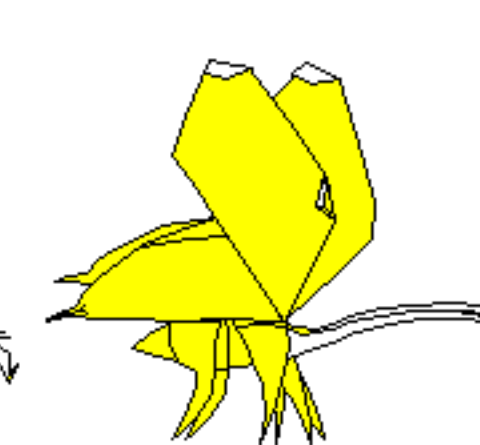

44 The finished butterfly.

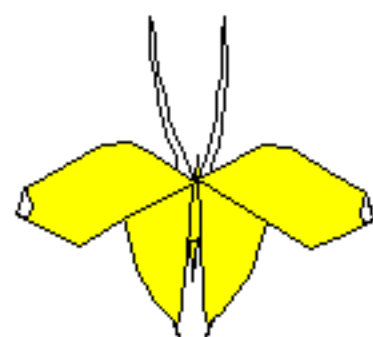

Use a darkly colored full-backed square. The length of the completed model is one-half the length of the original square's diagonal measurement.

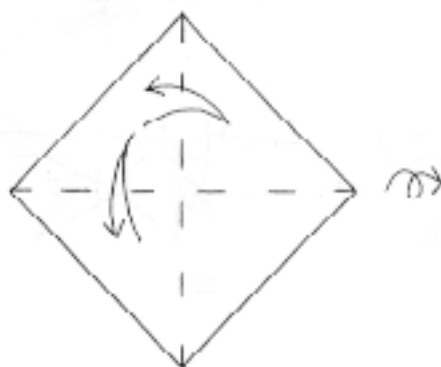

1. White side up. Precrease and then turn over.

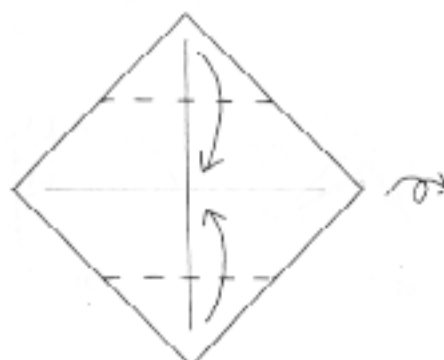

2. Fold the top and bottom corners to the intersection of creases. Turn over.

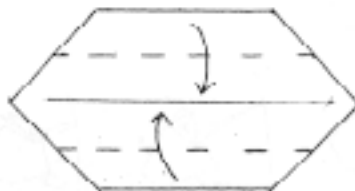

3. Fold the edges to the center while bringing forward the flaps from behind.



4. Fold the corners to the center.



5. Precrease using mountain and valley folds where indicated.



6. Fold multiple swivel folds as indicated, working from the center outwards.



7. Same as in the previous step, but this time form a rabbit ear on the original corner. Repeat steps 6-7 on the other side.

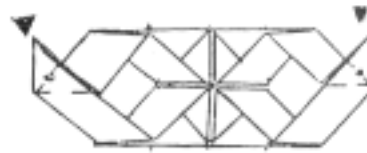

8. Squash fold the two end points.



9. Flip the top section up. Turn over.

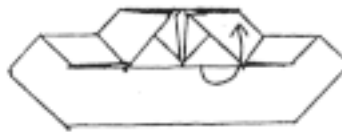

10. Bring the single layer to the surface. This is basically a closed sink.

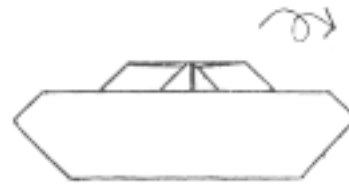

11. Completed step. Turn over. Repeat steps 9-11 on the bottom.

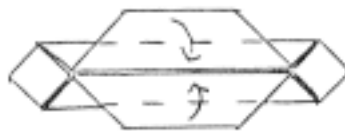

12. Valley-fold the sides to the center, bringing the triangular flap from behind to the surface.

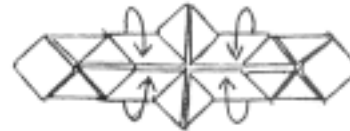

13. Bring the single layers to the surface; this is basically a closed sink.

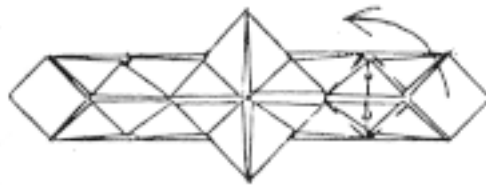

14. Fold the long flap over to the center while reverse-folding two layers where indicated.

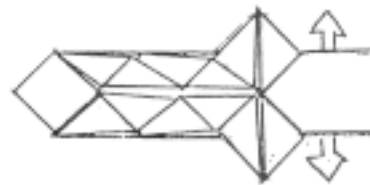

15. Pull out a single layer from each side. This is basically undoing a reverse fold.

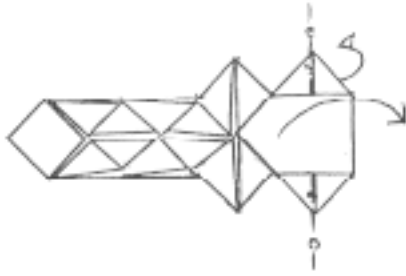

16. Flip the flap as indicated.

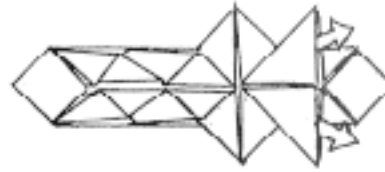

17. Un-sink the indicated regions. The model will have to be opened up to facilitate this. Repeat steps 14-17 on the other side.

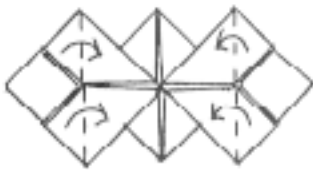

18. Valley-fold the four newly formed flaps.



19. Bring a single layer to the surface where indicated. Rotate model 90 degrees.

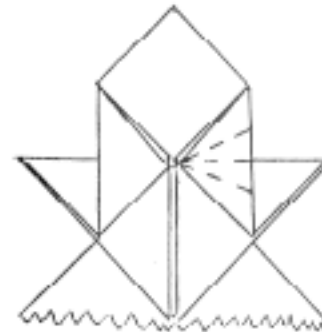

20. Top shown only. Precrease using valley folds.

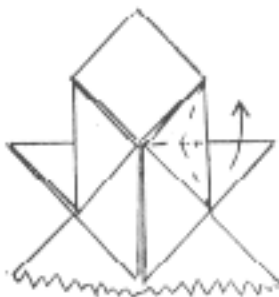

21. Flip the single flap up while reverse folding.

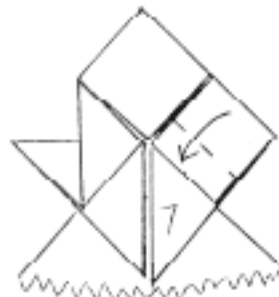

22. Lightly valley-fold the flap across as far as possible.



23. Again valley-fold lightly while pulling out paper where indicated.





24. Squash the single layer.



25. Valley-fold the top layer of the square over lightly, while spreading out the layer under it, and while stretching the indicated region. The flap folded in step 22 should stick up at a right angle.



26. View from step 25. Fold the flap down while reverse-folding. This is the flap you folded up in step 22.



27. Bring flap down while reverse folding. Repeat steps 20-27 on the other side.

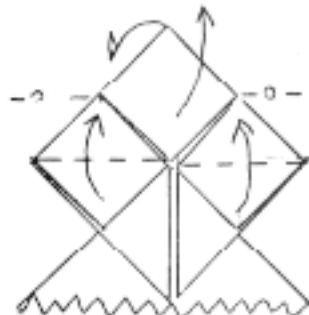

28. Swing the top back. Bring the two thick side flaps up.

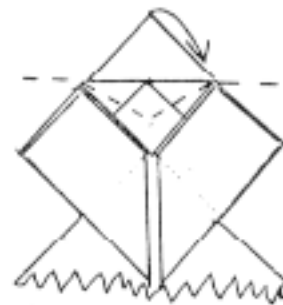

29. Precrease where indicated. Flip the top back to the front. Repeat steps 20-29 on the other end.

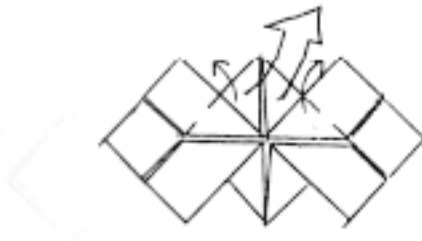

30. Open out the top.

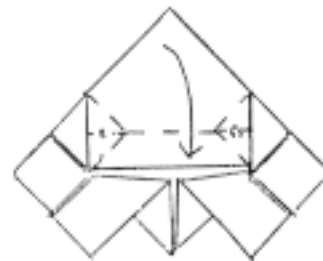

31. Swing flap down while reverse-folding the sides.

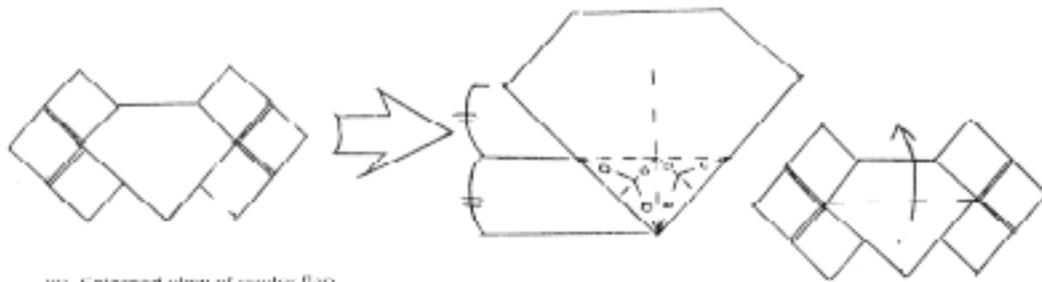

32. Enlarged view of center flap. Collapse using the indicated folds (model will not lie flat). Unfold.

33. Valley-fold the single layer up.



34. Fold the two small flaps to the center.

35. Flip up as much as possible; the top center flap will fall back naturally. Repeat steps 30-35 on the bottom.

36. Precrease by reverse-folding with the indicated folds and unfolding.

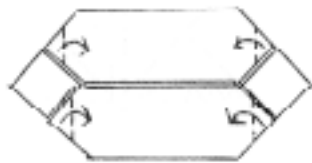

37. Valley-fold each of the four flaps halfway.

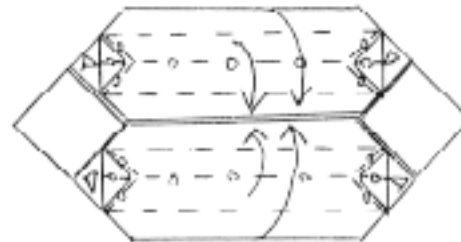

38. Bring the sides in while forming the pleat in the top single layer. You will have to reach inside to accomplish this.

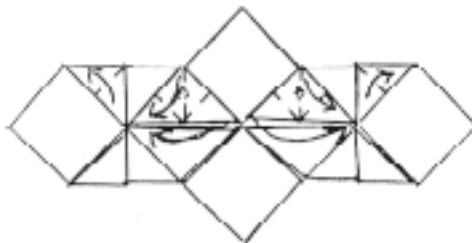

39. Make the set of multiple swivel folds as indicated.

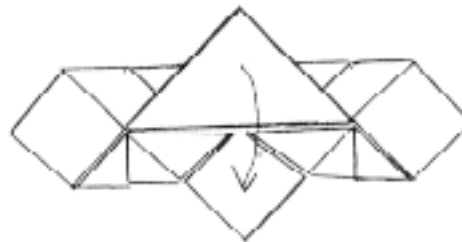

40. Repeat step 39 on the bottom. Swing the top flap down.



41. Sink halfway.

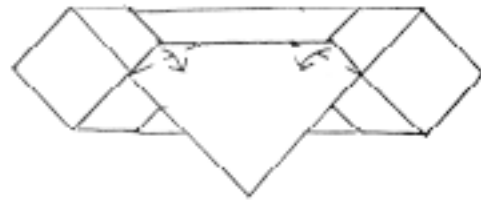

42. Valley fold where indicated; the edges will naturally spread out.

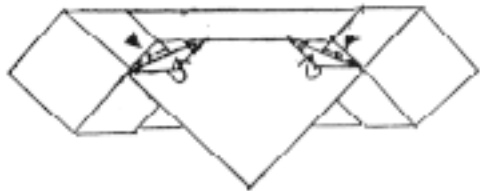

43. Pull single layer to surface of flaps folded down in previous step; i.e., closed sink. Reverse-fold the corner flaps.



44. Valley fold where indicated.

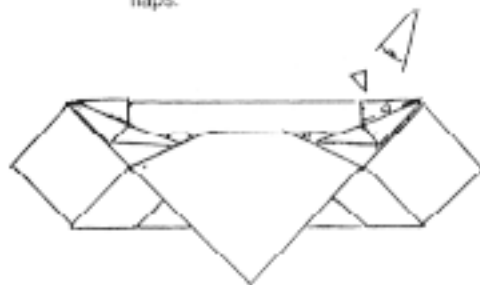

45. Reverse fold where indicated. Do not flatten.

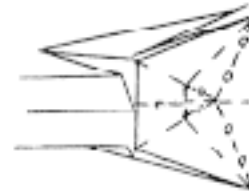

46. View from step 45. Reverse-fold the single layer up and then down. The fold on the interior should form naturally. Repeat steps 45-46 on the other side.

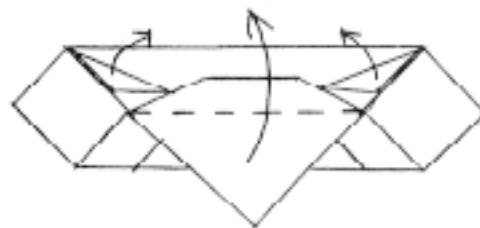

47. Valley fold. Repeat steps 30-47 on the bottom.

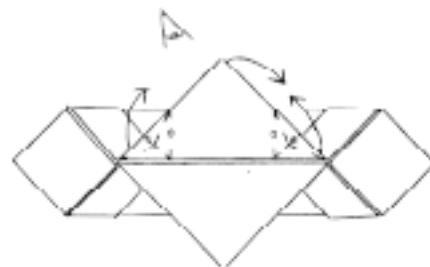

48. Lift the top flap at 90 degrees and reverse-fold the sides. The model should no longer be flat.

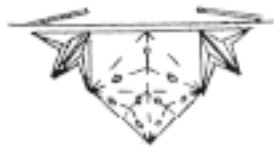

49. Partial view from step 48. Using the folds from step 32, collapse as indicated.

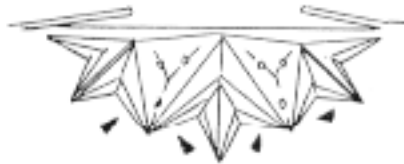

50. Pinch the indicated regions, pulling down the five legs into an equidistant formation.



51. Complete. Repeat steps 48-50 on the other side.

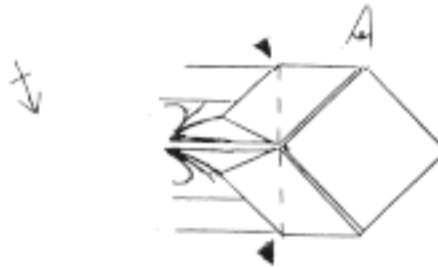

52. Partial view from step 51. Sink the areas indicated; the triangular regions will pop out. Repeat on the left side.



53. View from step 52. Reverse-fold the indicated region. Pull down the legs and open out the end by pulling on the original corner. Repeat all steps behind and on the other side.



54. Collapse the legs as indicated, stretching them into an equidistant formation. Swing over the top flaps as indicated into this formation. Repeat everything on the left.



55. Complete.



56. View from step 55. Mountain-fold. Do not repeat behind.



57. Rabbit-ear to form the legs.

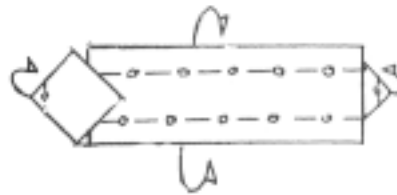

58. View from step 57. Round the body as indicated. Pull each of the legs out slightly at an angle from the body while positioning them.



59. Completed cankerworm.

# CAR (VW BUG)

by: Charles Esseltine (2001)

I know that it is not an exact likeness. But so many people called this a Bug that I have bowed to their will.

Begin with a preliminary base colored side out for a colored car. White side out for colored wheels. I think foil is the best for this model. But it can be done from any material.

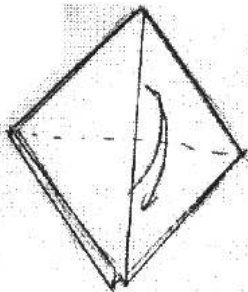

1.) Fold and unfold the top layer.

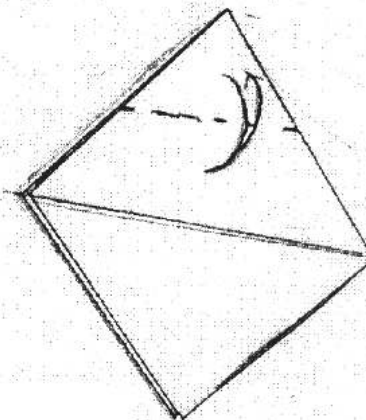

2.) Fold the top to meet the center. Then unfold.

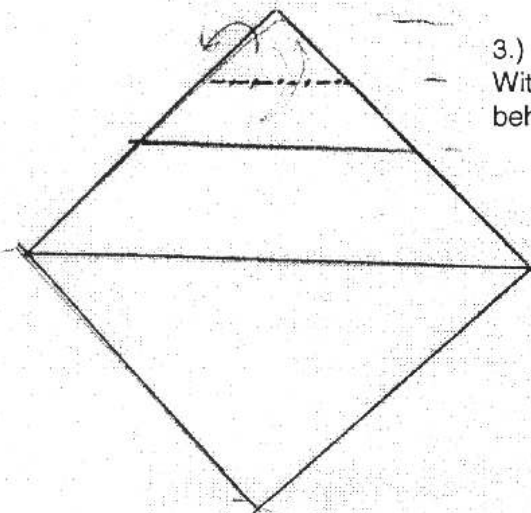

3.) Fold the top in half. With the point going behind the model.

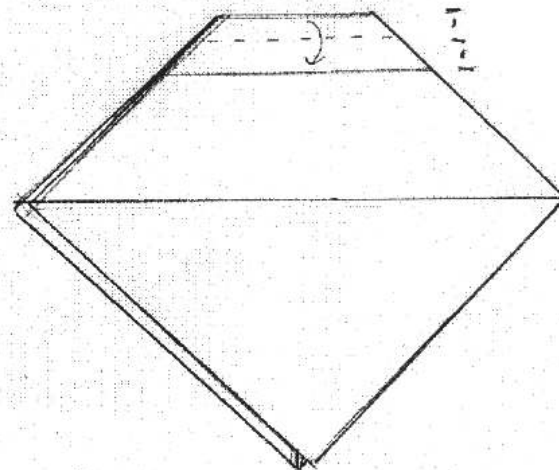

4.) Fold down the new edge. This brings the top to the front.

5.) Unfold the layers.

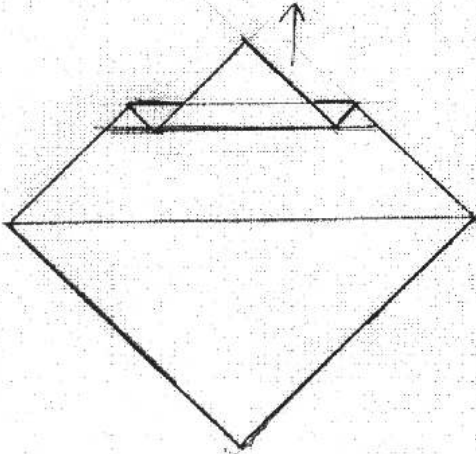

6.) Pleat sink the center with the point up. Partially opening the model is necessary.

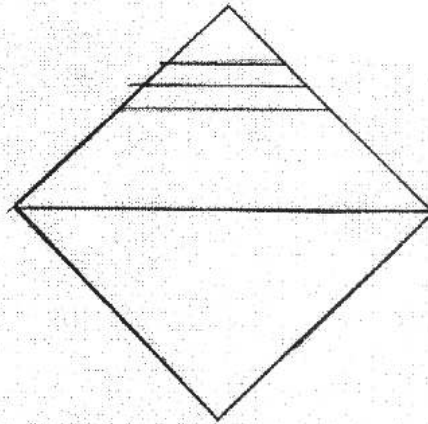

7.) Fold up the sides.

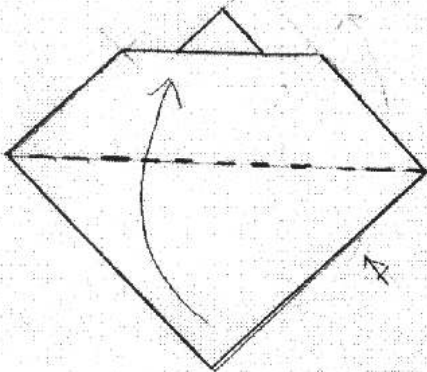

8.) Open up the side, and refold the model so that the primary colors is on the outside.

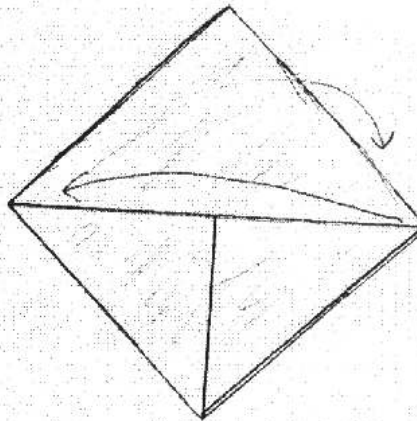

9.) Fold up the remaining sides.

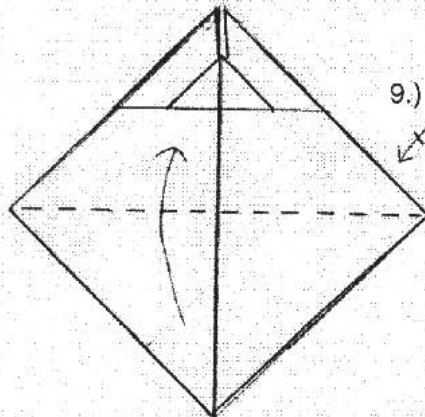

10a.) Inside reverse fold the interior points down to meet the bottom edge.

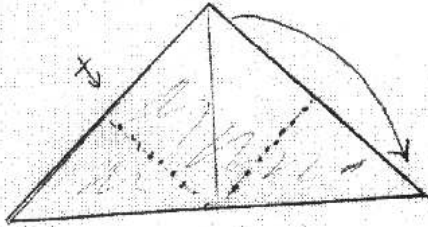

10b.) This is how the bottom will look like when done.



11.) Fold the top 3 layers to the centerline. This will pull up one layer from point (X). Fold it down to meet the bottom line.

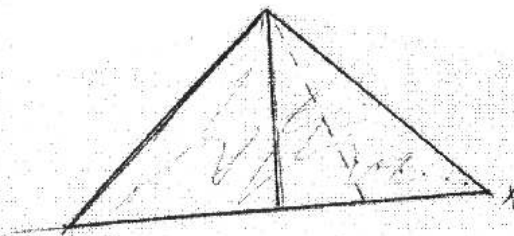

12.) This is how it will look. Repeat on the other 3 sides.

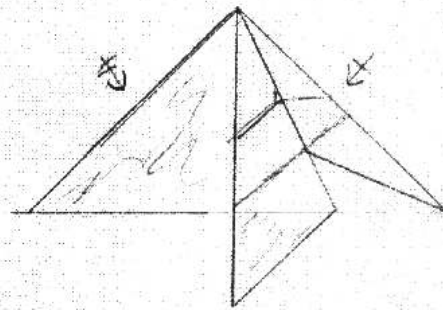

13.) Open out the 2 middle sections with out unfolding the ends.

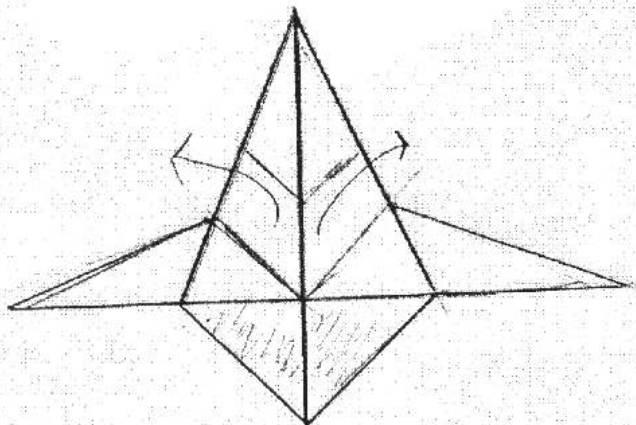

14.) Fold the first layer down from point (A) to point (B).

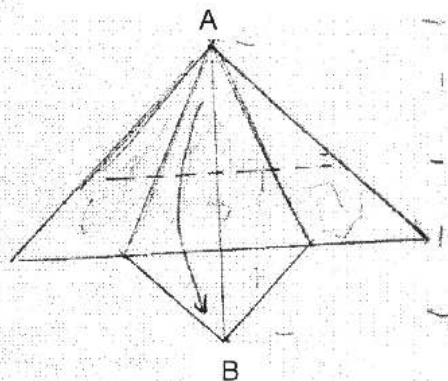



15.) Fold the sections back along the existing lines.

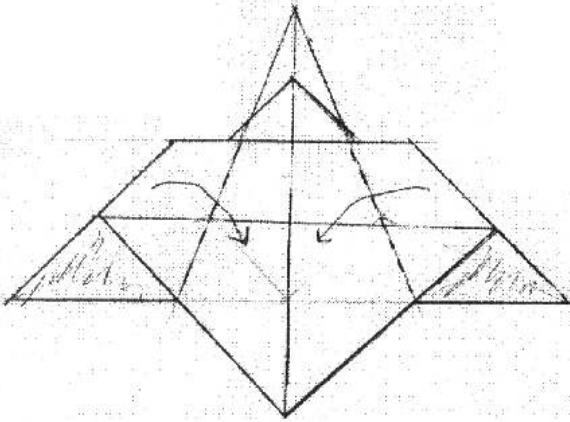

16.) Repeat steps 13-15 on the back.

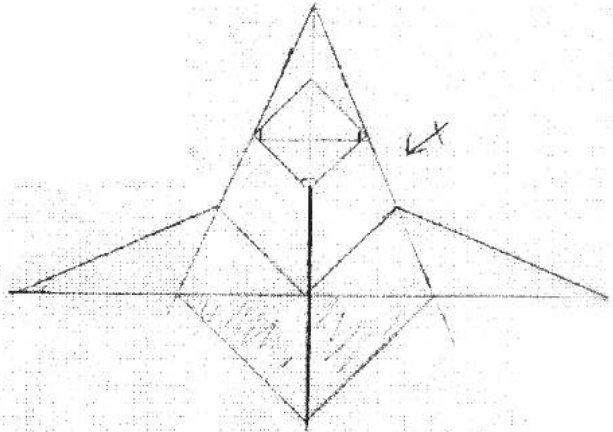

17.) Fold & unfold the bottom layers.

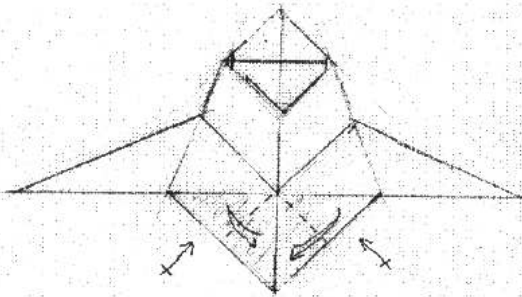

18.) Squash fold the the bottom sections. Repeat behind.

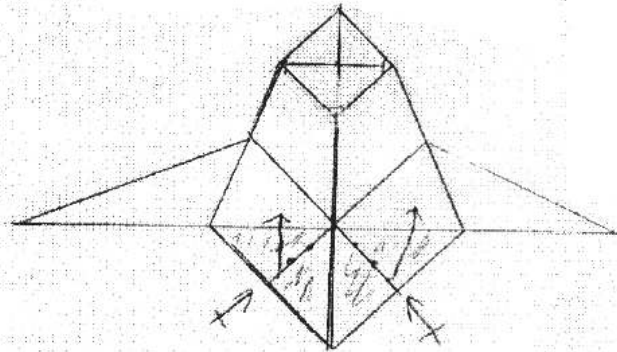

19.) Fold the edges inward (just a little bit) parallel to the centerline.

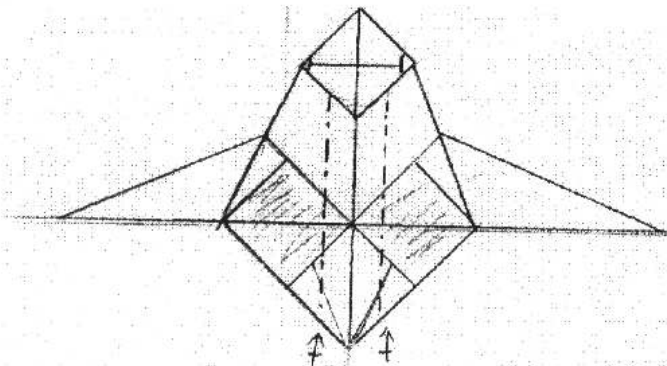

20.) Fold in the points on the outside, and top of the wheels.

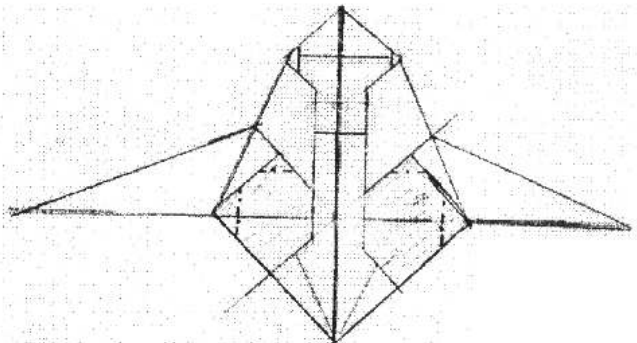

21.) Open the bottom and form the roof. At point (X) open out the hood and trunk of the car by spreading the layers and pulling them down to the sides. The layers that form the hood, and trunk will flatten into points at the front and back of the model.

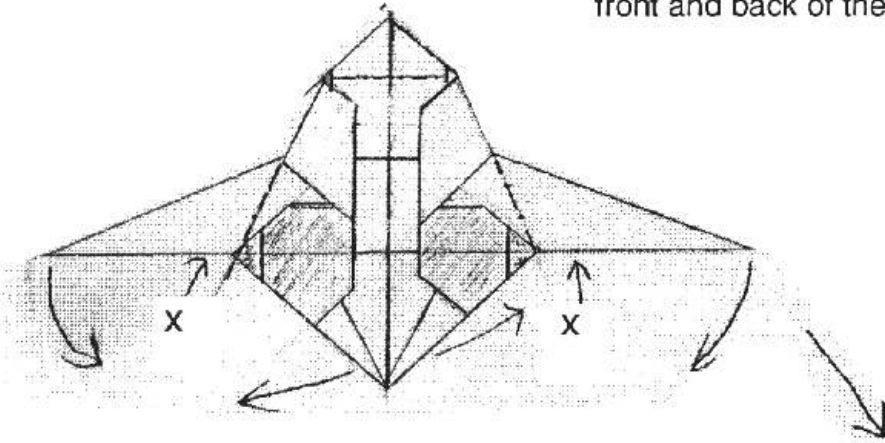

23.) Looking inside the model, fold the inner layer from the points marked (X) to the points marked (J). (Thank my friend Joe Powers for locating point (J)) Repeat on the other wheels.

22.) Fold the inner layers inside the model.

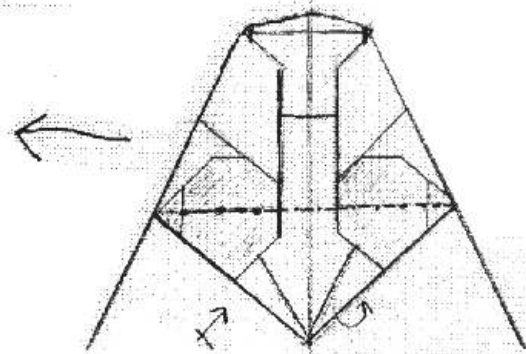
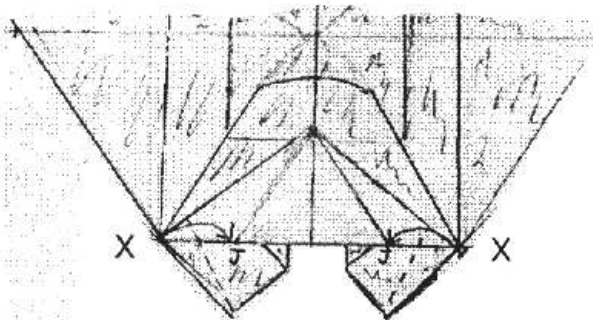

Repeat behind.

24.) Fold in the bottoms of the wheels. Note: The larger the model, the more you can round the wheels.

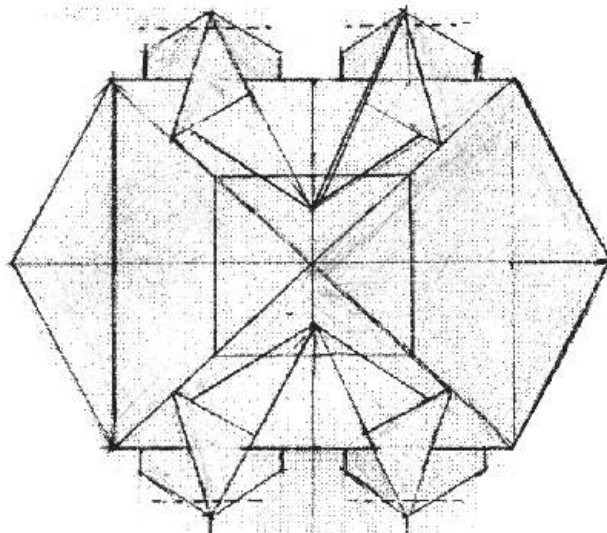

25a.) On each side pull in layer (A) only. Line  $\overline{CD}$  will arc inward, and the sides ( $\overline{CC'}$  &  $\overline{DD'}$ ) will move towards the centerline, and the outer layers (B) will move outwards.

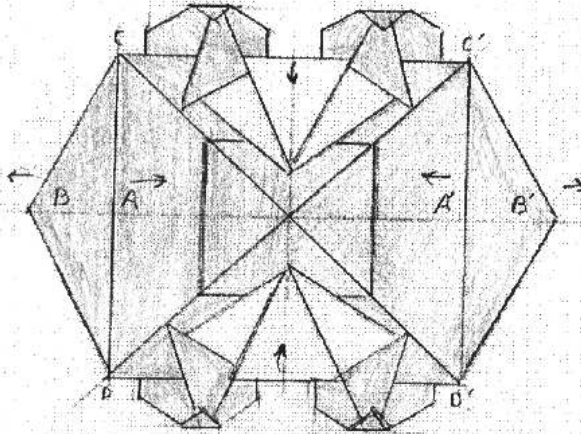

25b.) The model should look like this.

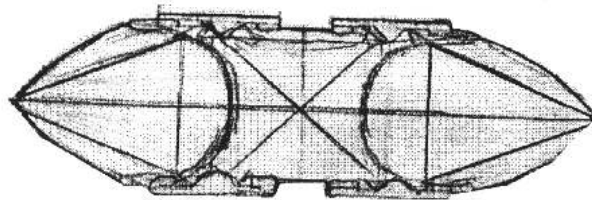

Bottom View

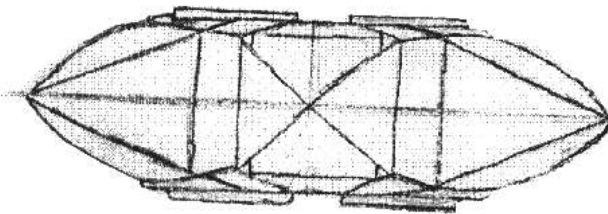

Top View

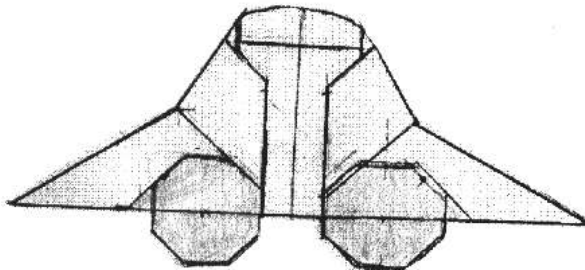

Side View

Now for the tough part. Choose which side is the front!

26.) Flatten one side, making creases parallel to the centerline.

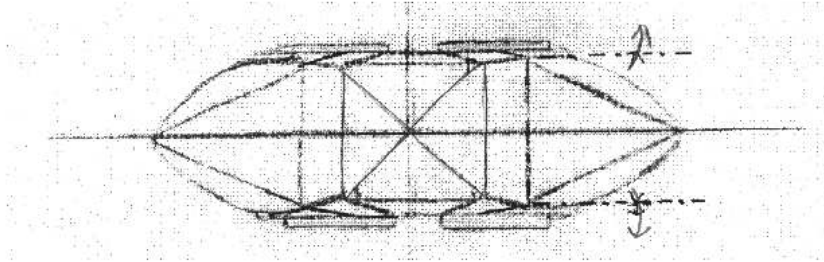

27.) This looks harder than it is. About 2/3 of the way down the edge of the hood, make a soft crease. Pinching the corners so that the front points straight down.

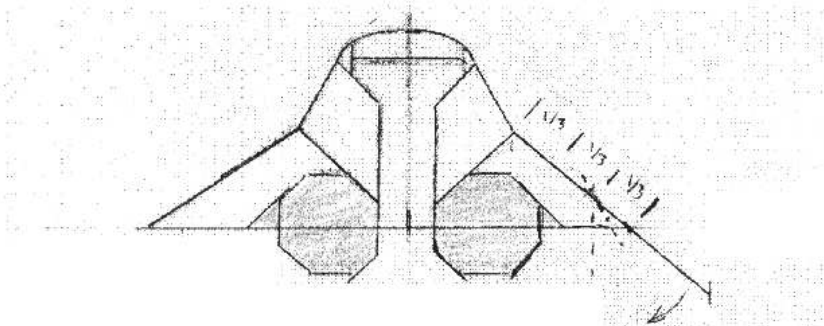

Same step, different view.

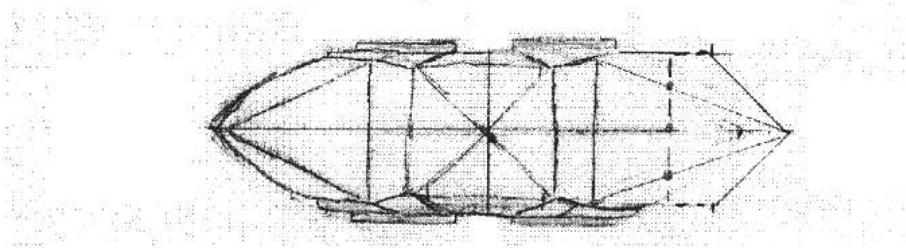

28.) Fold the tips inward, so that they are flat against the front.

29.) Fold the bottom up as far as it will go.

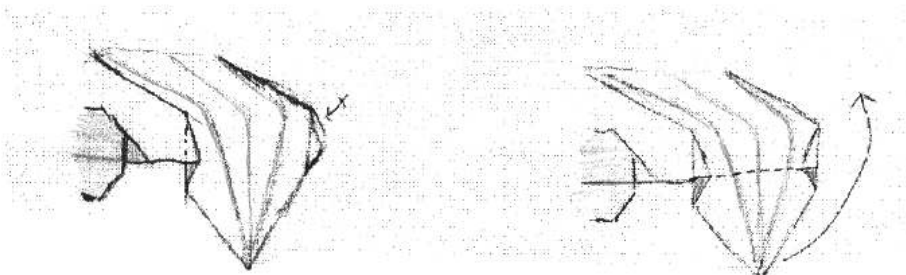

30.) Now fold it down a little bit shy of the top of the hood.

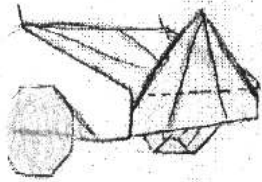

31.) To finish the head lights, just tuck the remaining paper under the edge.

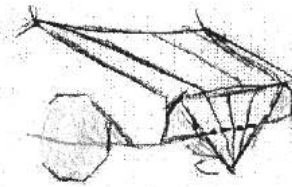

32a.) Now for the trunk. Make an arbitrary fold parallel to the back windshield's edge. (Note: The Beetle has a round back, so make this fold as close as possible to the windshield.) And reverse the creases as indicated. A soft crease will form on each side of the trunk.

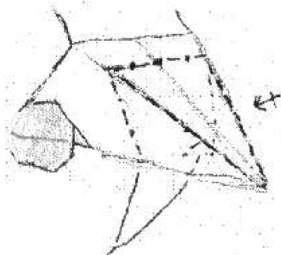

32b.) This will be the result. You'll know its right if the bottom edge is straight across.

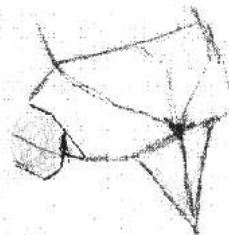

These two points will meet in the middle of the back.

33.) Fold the point up from the bottom edge.

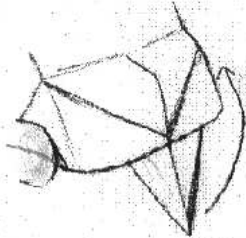

34.) Using the edges as a guide. Fold, and unfold a line where they meet.



35.) Fold the tip to meet the marker fold.

36.) Tuck the flap inside the edges to lock the trunk.

(O.K. I got the trunk to lock. Now I need to find out how to unlock the doors!)

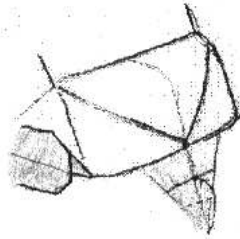

The trunk and license plate are done.

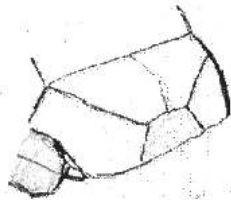
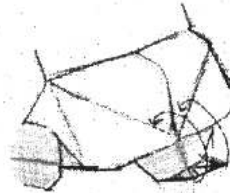

And so is the car!

Drive safely!

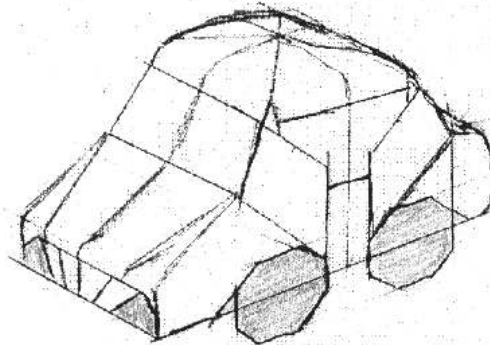

# CAT

by HERMAN VAN GOUBERGEN

USE HALF A SQUARE OF WHITE PAPER (PHOTOCOPY PAPER WORKS WELL)

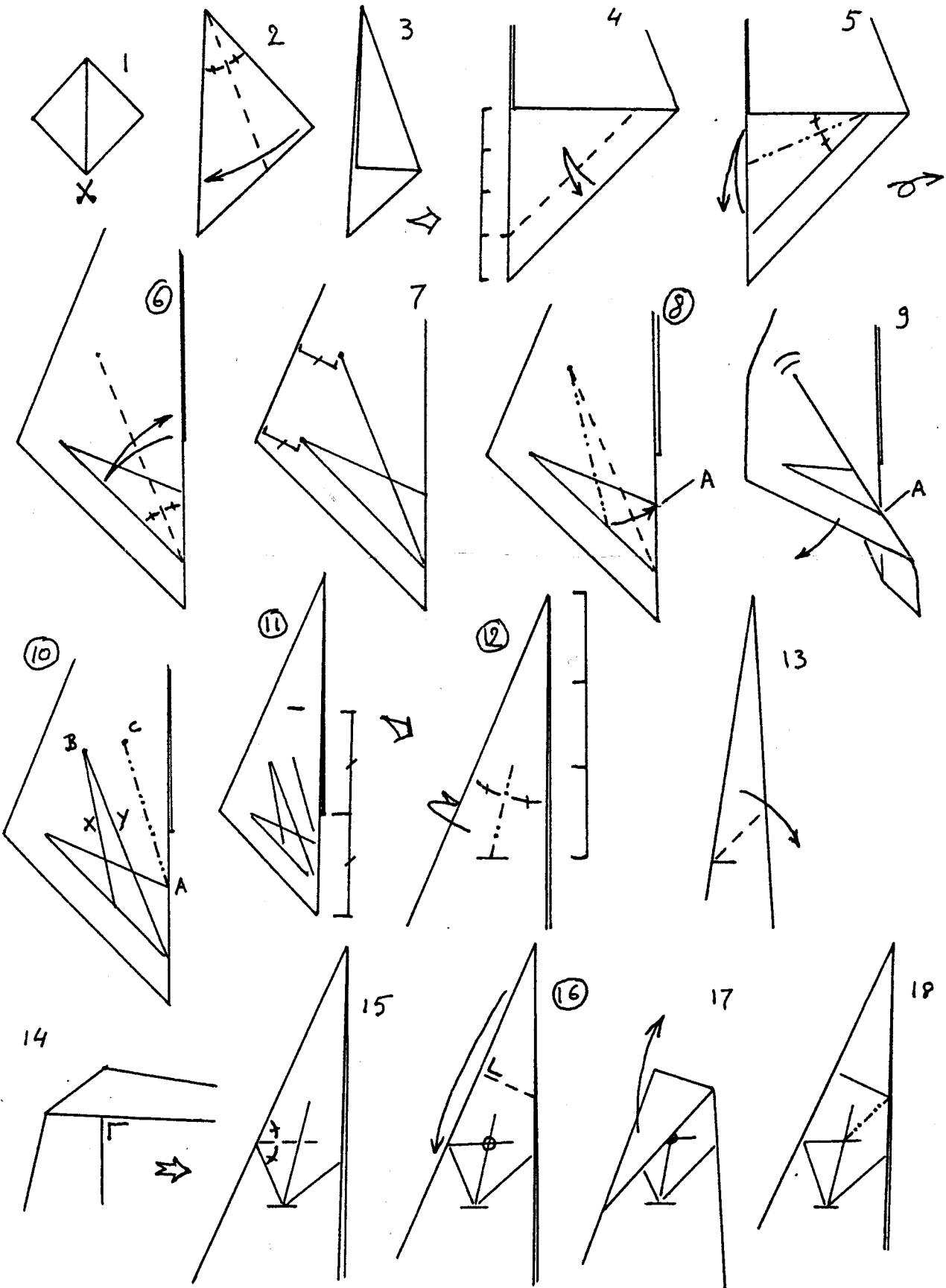

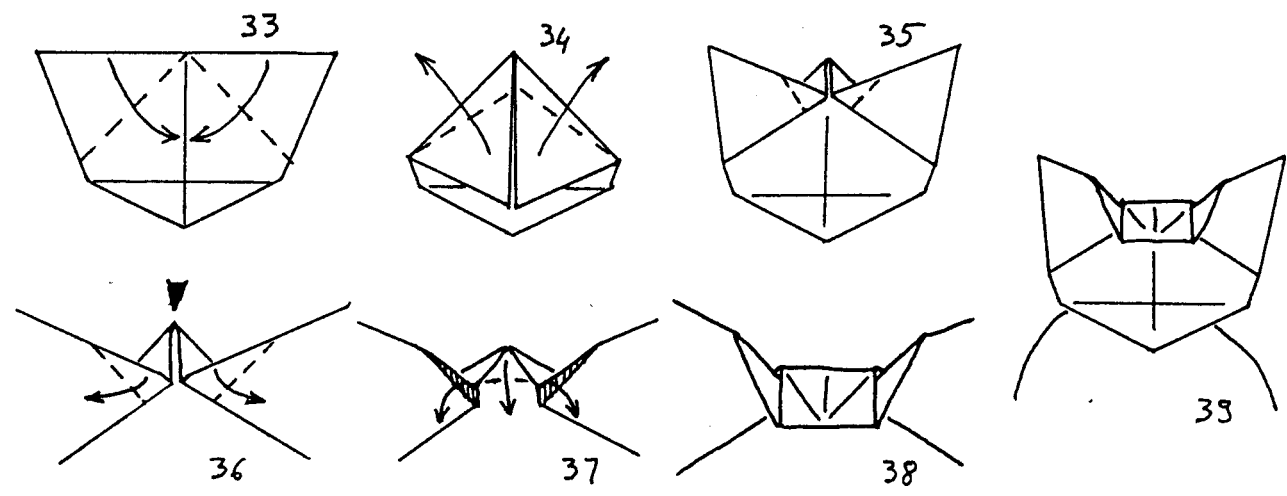
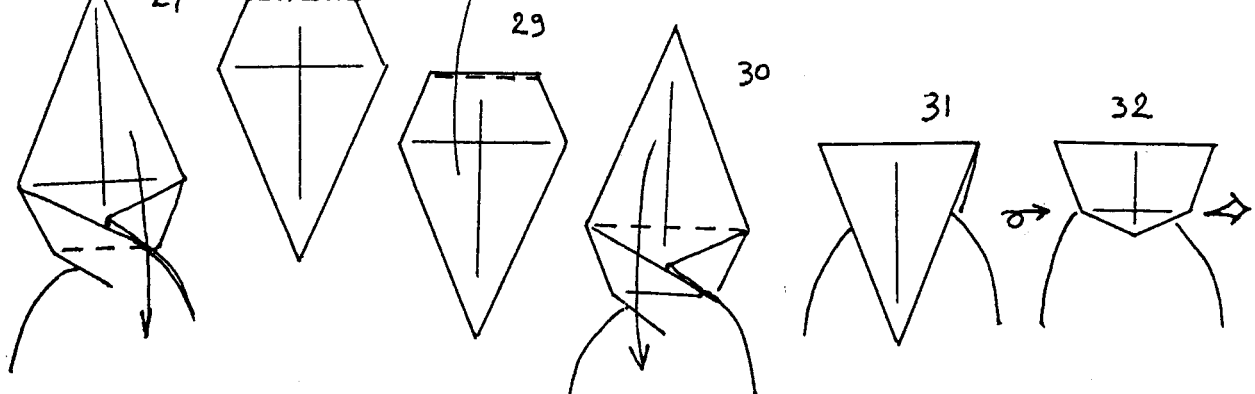
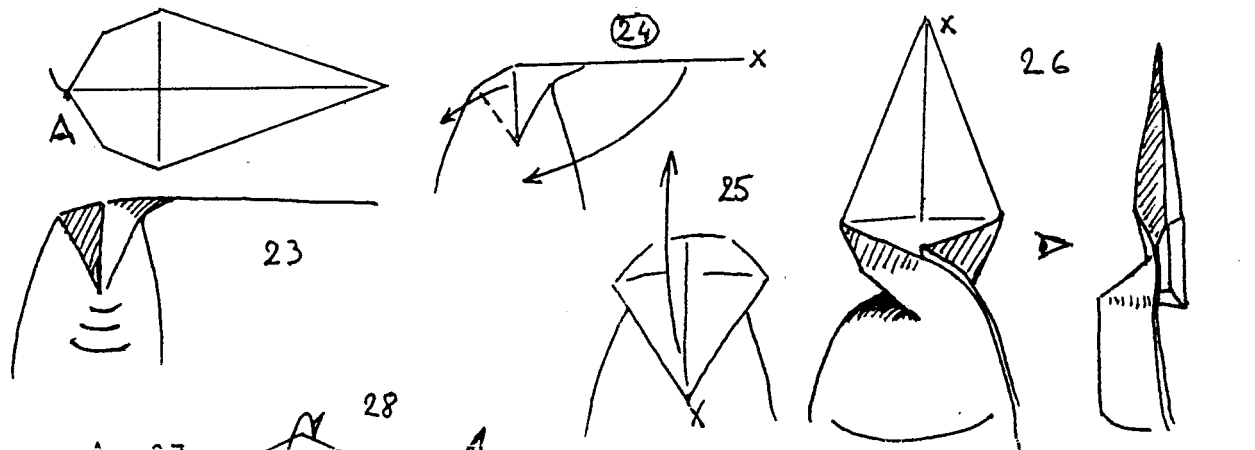
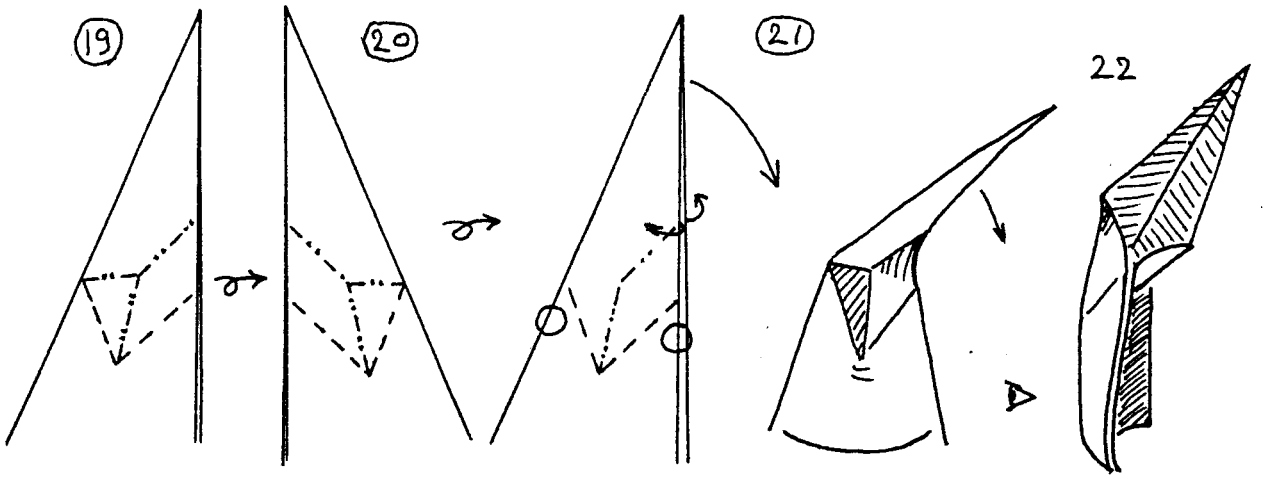



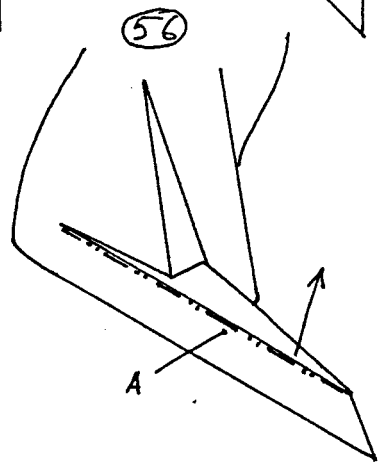
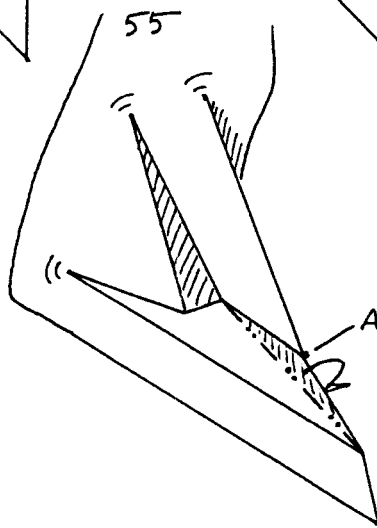
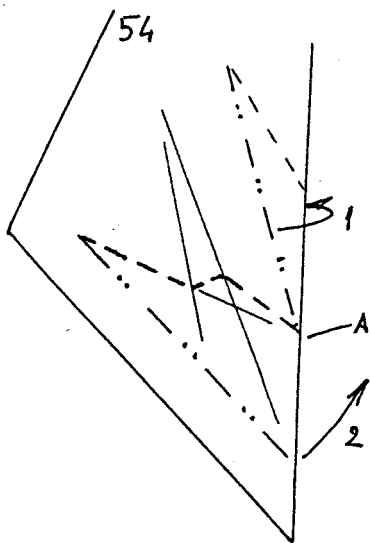
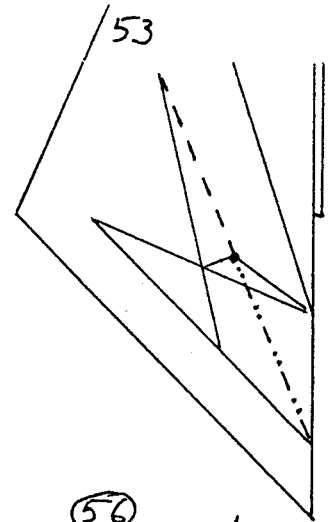
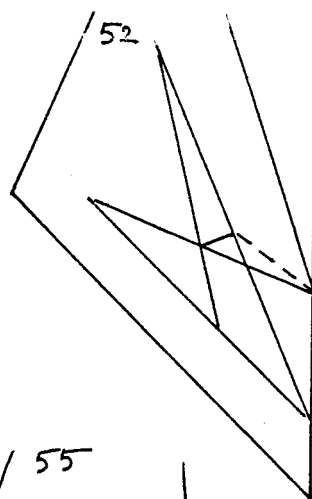
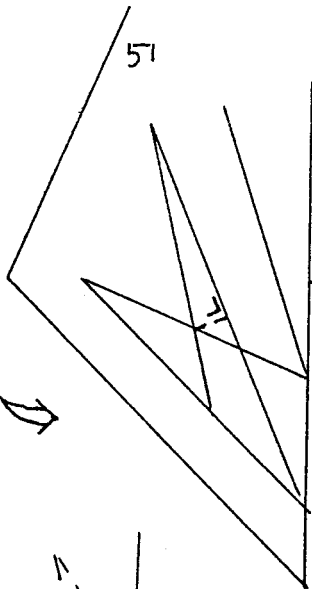
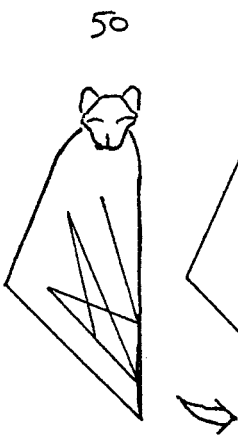
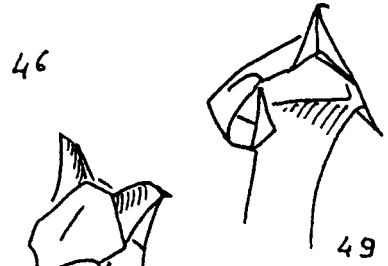
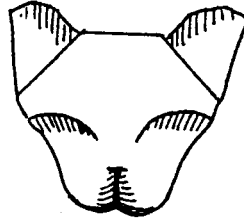
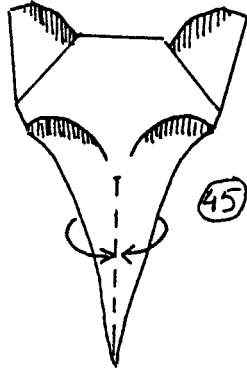
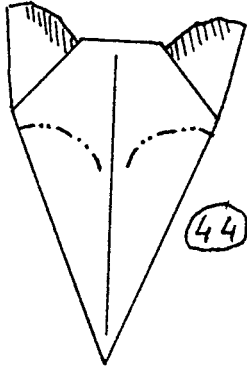
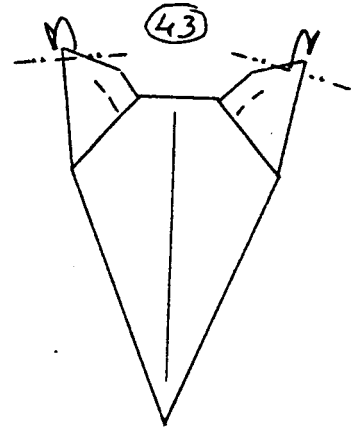
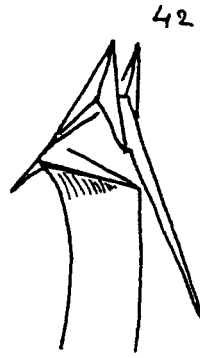
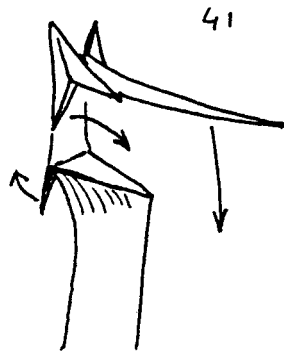
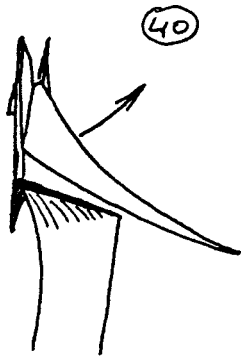

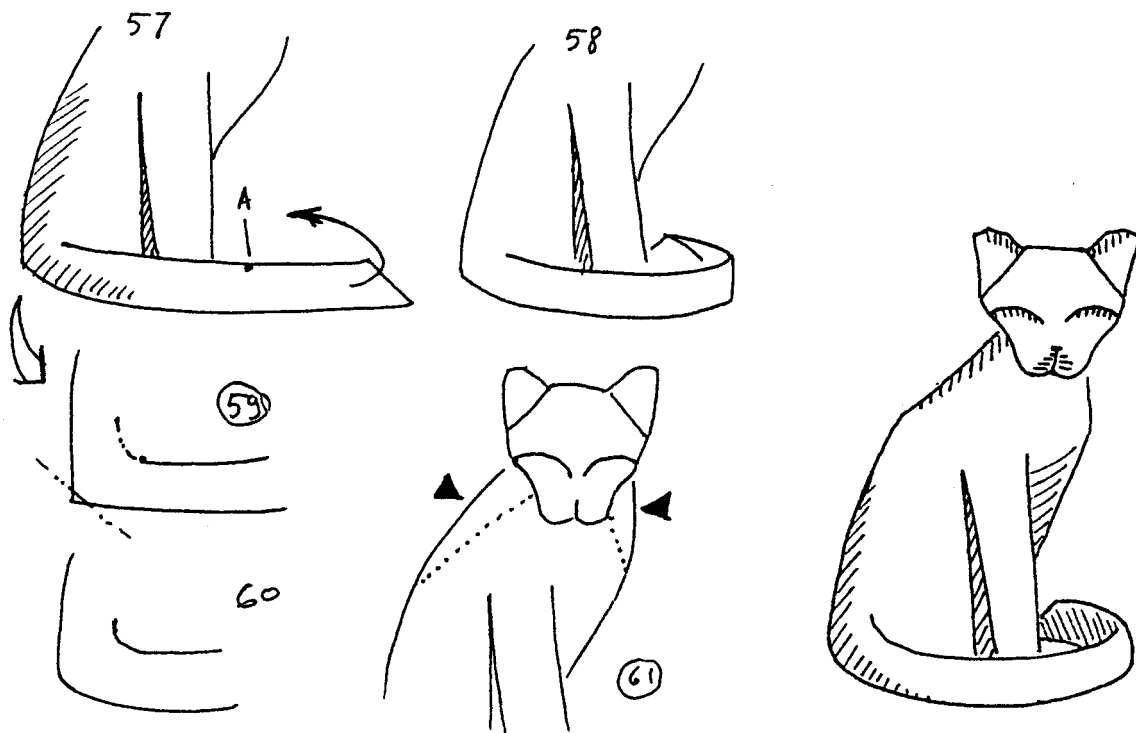

© HERMAN VAN GOUBERGEN 96

A circled number step number on the diagrams means there are written instructions for that step. Please read them before folding. The folding sequence seems very mathematical. In reality most location points are not that critical: It's just a way of minimizing free folding.

6. Fold the bisector. Step 7 indicates the position of the endpoint.
8. Crimp on an existing valleyfold. The mountainfold starts at the endpoint of that valley and Step 9 indicates its angle. Avoid creating the bottom border.
10. Mountain fold starting at A, nearly parallel to Y but widening slightly towards the top. Endpoint C is just a fraction higher than B.
11. Make a tiny mark with your fingernail in the centre of the point.
12. Fold the bisector, starting from the mark in 11. Fold only the bottom third of the point.
16. Fold the point so that its edge crosses the circled point.
19. & 20. Rearrange existing folds on one layer of paper only.
21. Pinch *both* layers of paper at the indicated spots and move your hands together, curving the paper in between (make a bump, not a hollow.) The top point should open out and move down.
24. Twist the top point to the front, wringing the cat's neck.
40. Side view. Pull apart the two layers of the ears.
43. Gently curve the ears, the paper wants to do this anyway.
44. Curved 'eyebrows'. Practice this in a separate sheet first.
45. Inside reverse fold. Don't fold the edges, only curves here.
47. Side view. Get rid of the point by folding it up into the head.
56. Make sure flap A is folded into the tail.
59. Run your thumbnail along the tail furrow and extend it, curving upwards.
61. Gently curve back the paper along the dotted lines.

The final model will need a support to stand.

Copyright © 1996 Herman van Goubergen, all rights reserved.  
 PDF version 1999 by Sebastian Marius Kirsch <skirsch@t-online.de>.  
 Distribution for noncommercial purposes is free. Please contact the author  
 if you want to use this model for commercial purposes.

# cat

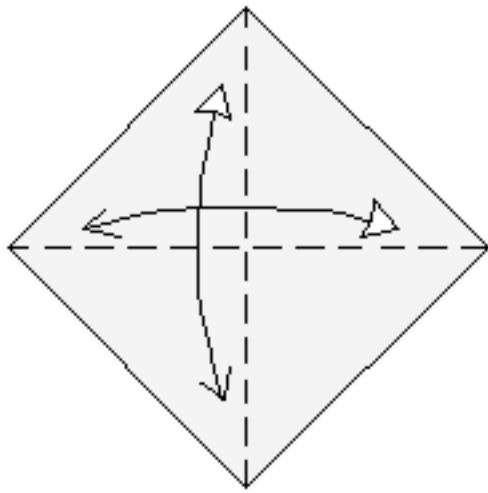

**1** Begin with the white side up. Fold and unfold the diagonals.

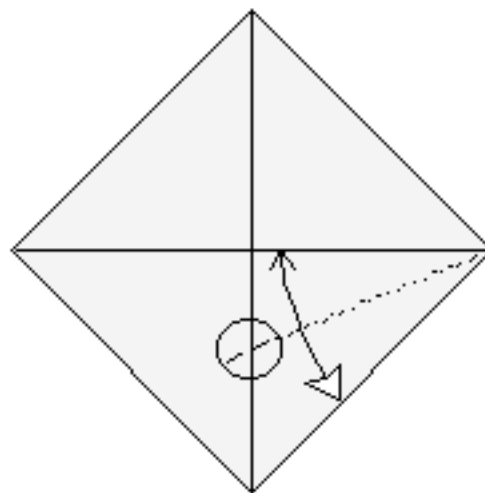

**2** Make a mark where the angle bisector crosses the vertical diagonal.

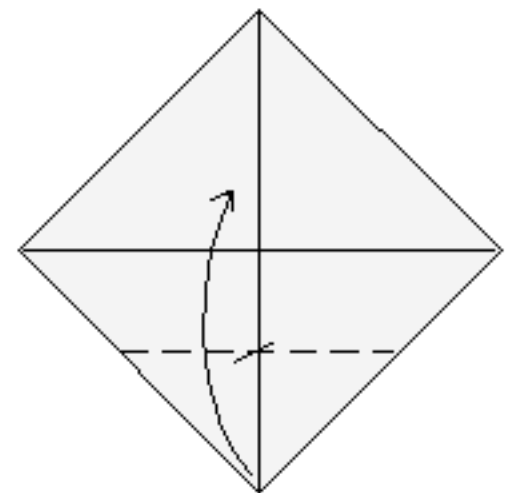

**3** Valley-fold.

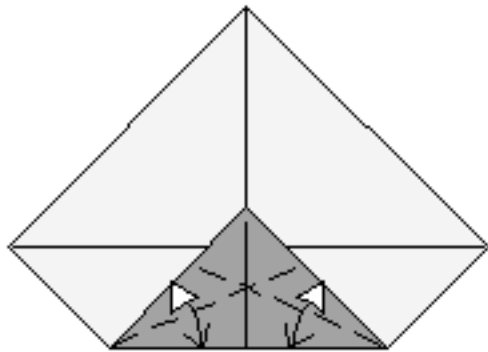

**4** Fold and unfold the angle bisectors.

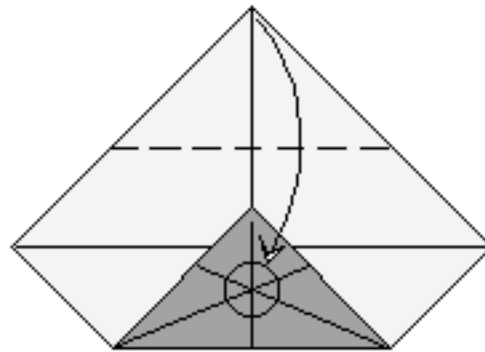

**5** Valley-fold the corner to the crossing of creases.

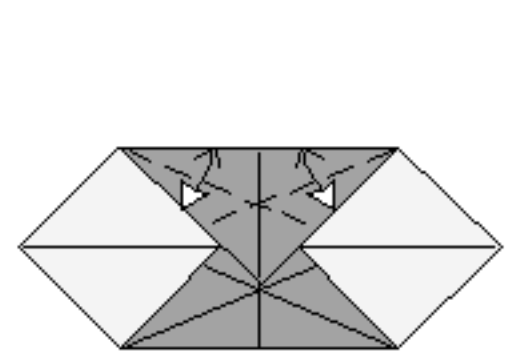

**6** Repeat step 4.

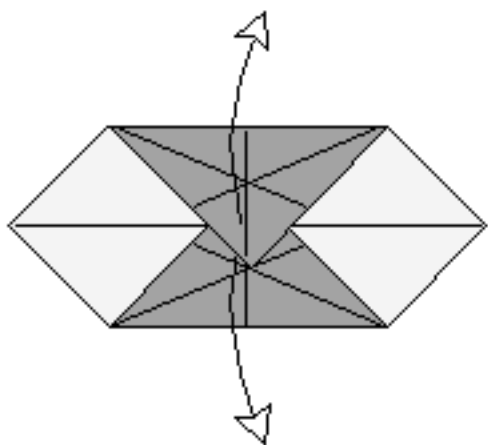

**7** Unfold.

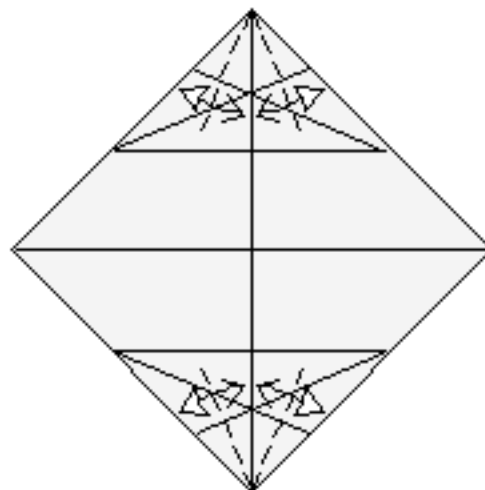

**8** Fold and unfold the angle bisectors where indicated.

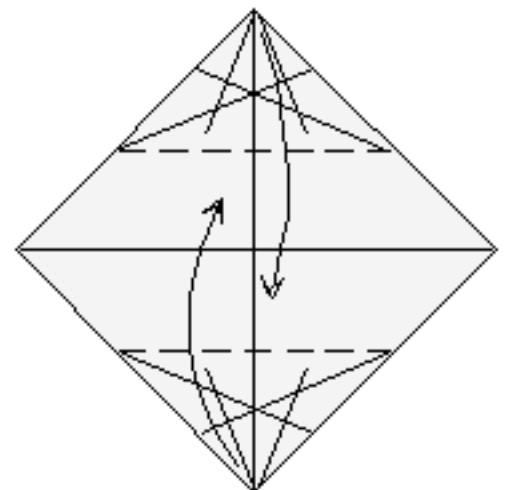

**9** Re-fold on old creases.

# cat

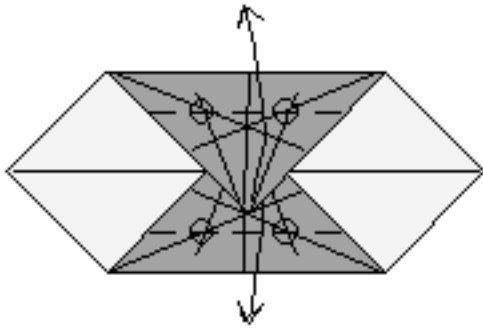

**10** Valley-fold.

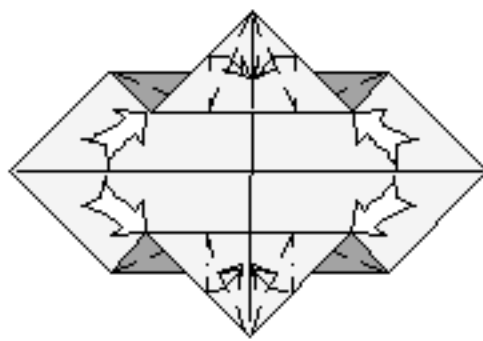

**11** Swivel-fold.  
Rotate the model.

1/4

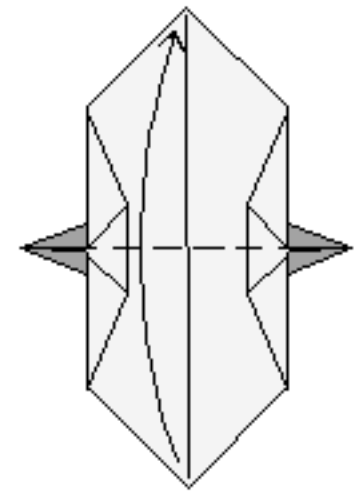

**12** Valley-fold.

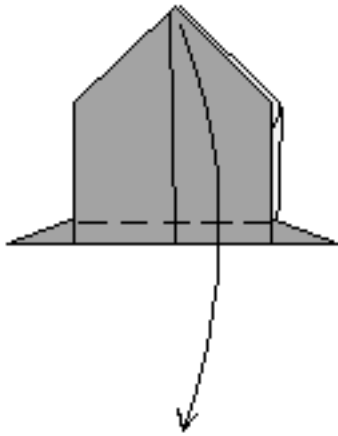

**13** Fold and unfold  
the angle bisectors.

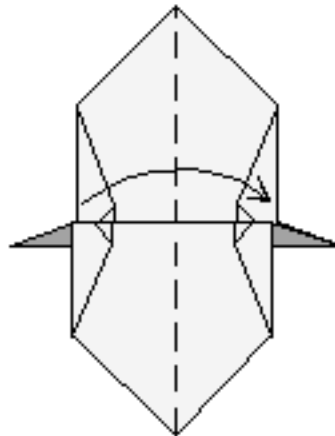

**14** Book-fold.  
Rotate the model.

1/4

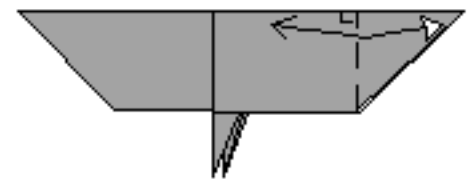

**15** Fold and unfold.

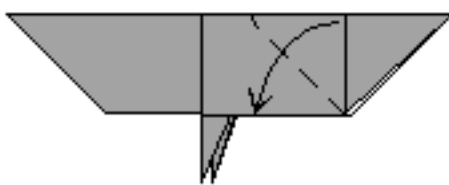

**16** Valley-fold.

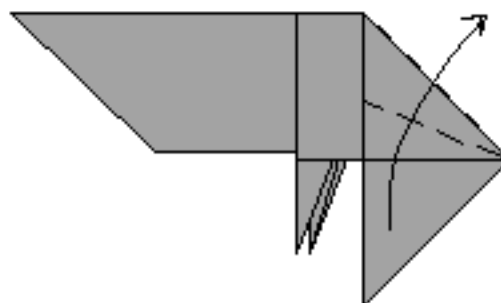

**17** Valley-fold the  
angle bisector.

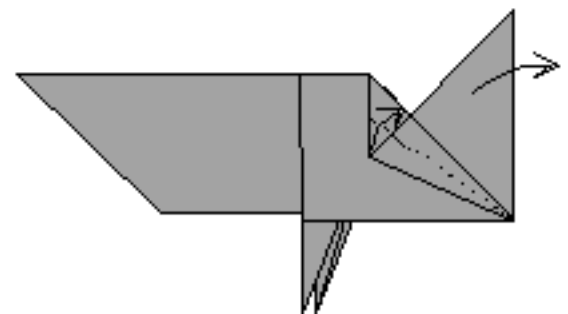

**18** Fold the angle bisector by  
swiveling the flap clockwise.

# cat

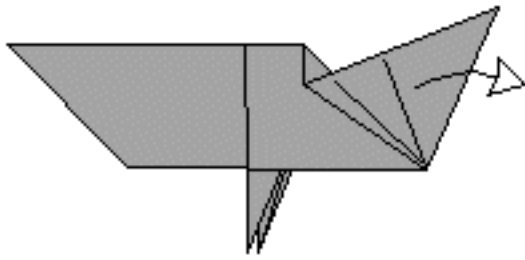

**19** Unfold.

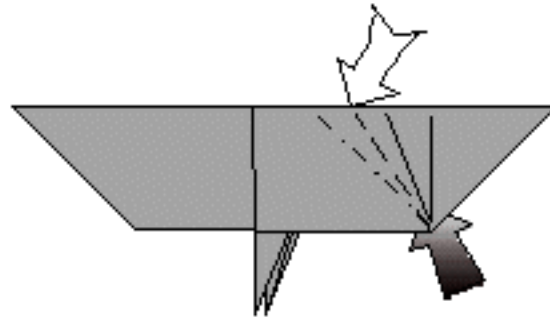

**20** Crimp symmetrically.

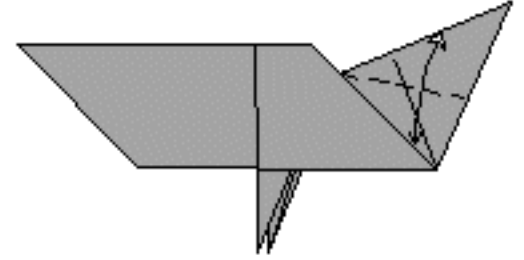

**21** Fold and unfold the angle bisector.

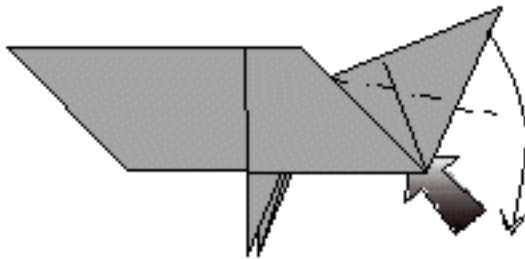

**22** Reverse-fold.

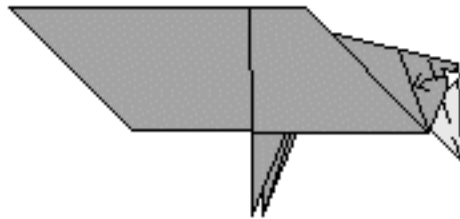

**23** Fold and unfold. The right corner should touch the old crease. Repeat behind.

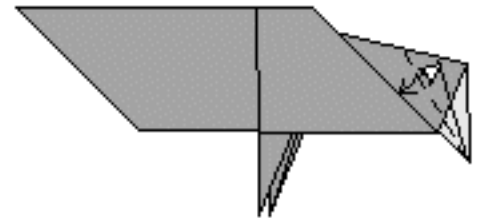

**24** Fold and unfold the angle bisector. Repeat behind.

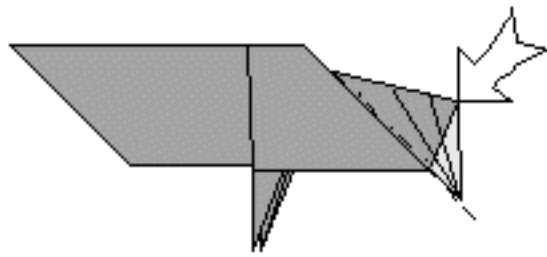

**25** Reverse-fold.  
Repeat behind.

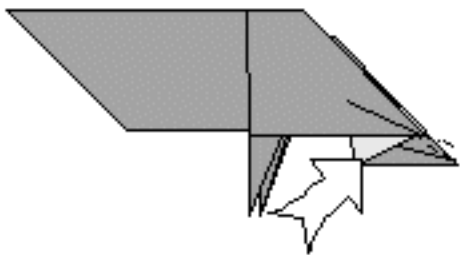

**26** Reverse-fold.  
Repeat behind.

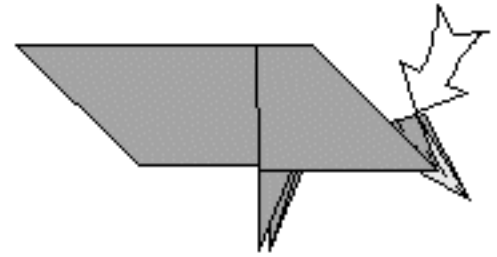

**27** Reverse-fold.  
Repeat behind.

# cat

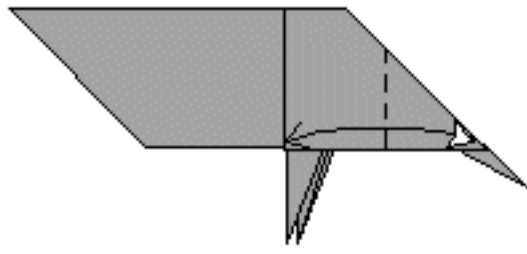

**28** Fold and unfold.  
The top of the valley-fold starts at a hidden corner.

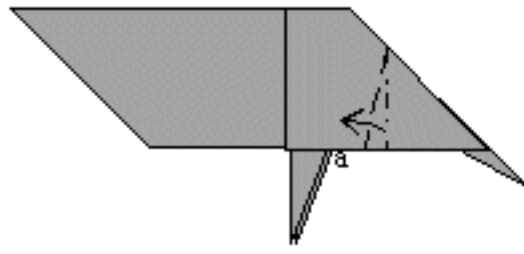

**29** Crimp symmetrically.  
The mountain-folded edge should point at corner **a**.

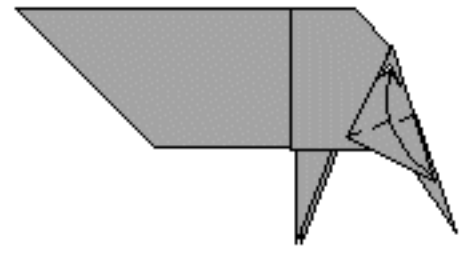

**30** Valley-fold the corner upward. Repeat behind.

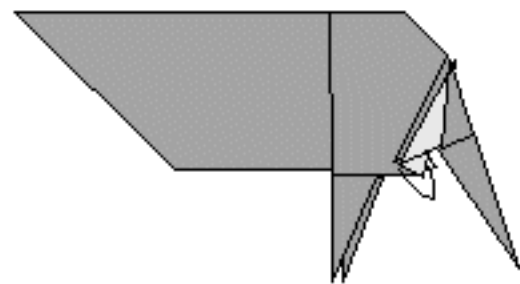

**31** Mountain-fold the corner inside. Repeat behind.

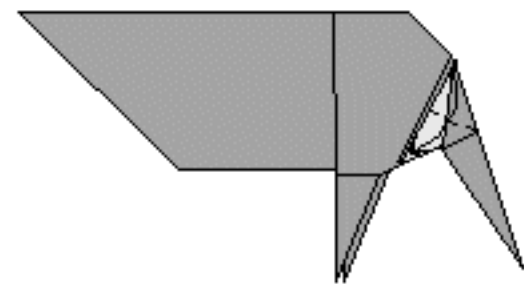

**32** Valley-fold. Repeat behind.

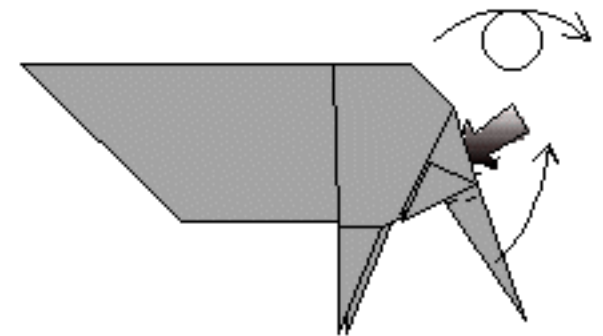

**33** Crimp the tail upward. Turn the model over.

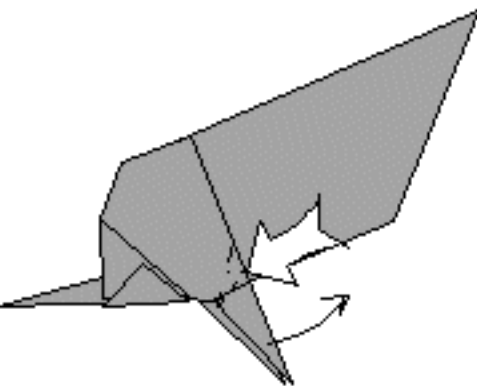

**34** Crimp the leg with two reverse-fold. Repeat behind.

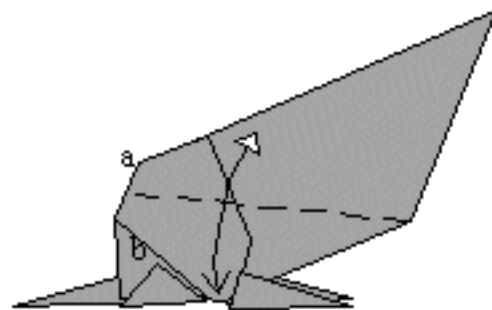

**35** Fold and unfold. Corner **a** should touch edge **b**.

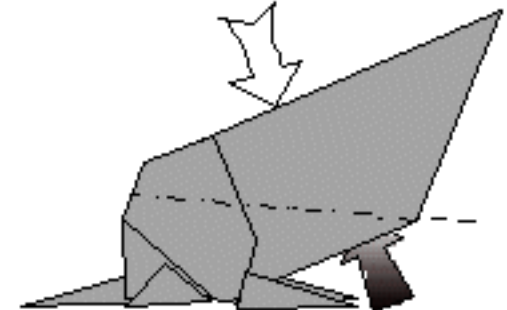

**36** Closed-sink.

# cat

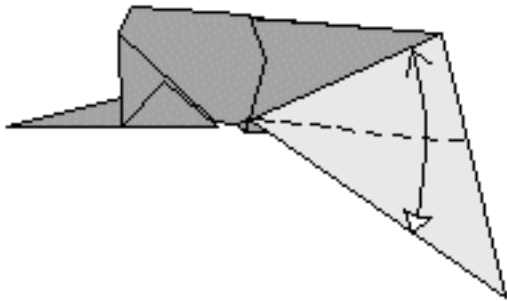

**37** One front leg is not shown.  
Fold and unfold.

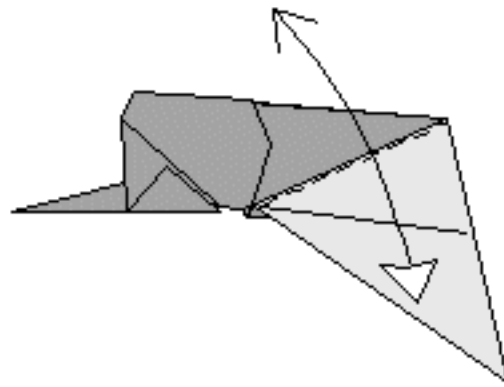

**38** Fold and unfold.

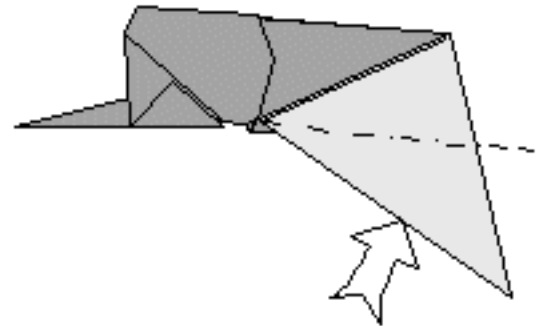

**39** Reverse-fold.

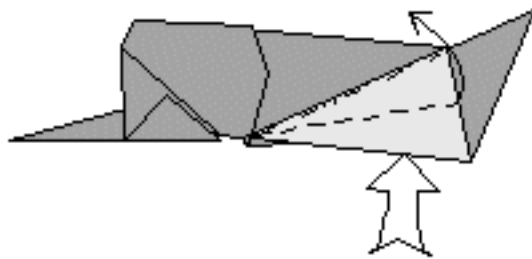

**40** Crimp symmetrically.

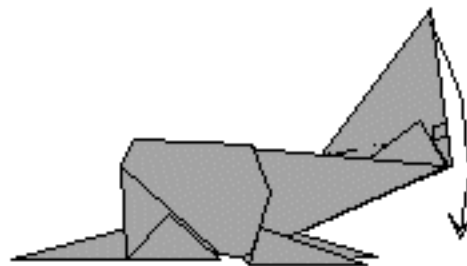

**41** Reverse-fold.

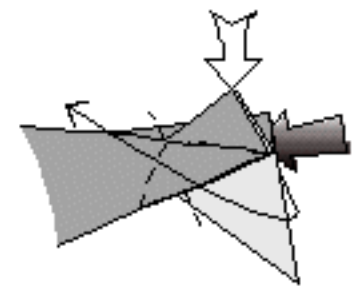

**42** Swivel-fold. The model  
will not lie flat.

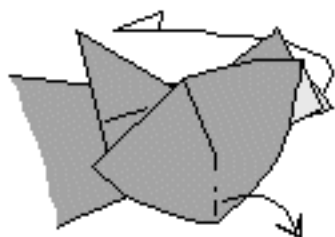

**43** Repeat step 42 behind. In the  
process, the corner pointing  
outward is outside-reversed,  
and the model becomes flat.

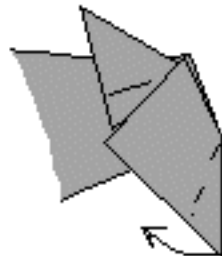

**44** Reverse-fold.

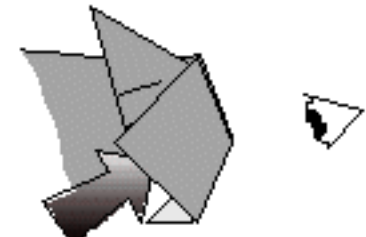

**45** Open up.  
Next view from  
the front.

# cat

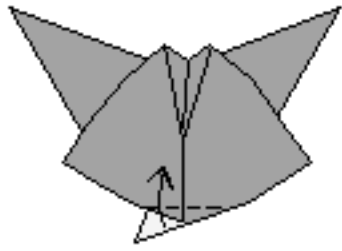

**46** One front leg is not seen.  
Fold and unfold.



**47** Keep the edges together  
and sink where indicated.

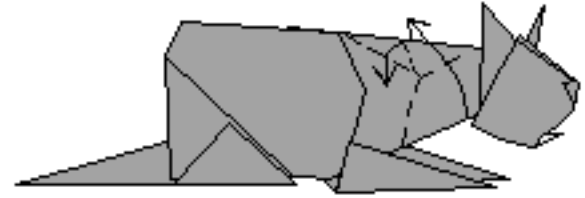

**48** Rabbit-ear the neck  
to turn the head.

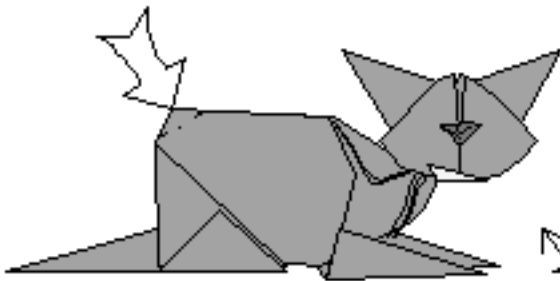

**49** Closed-sink the corner.

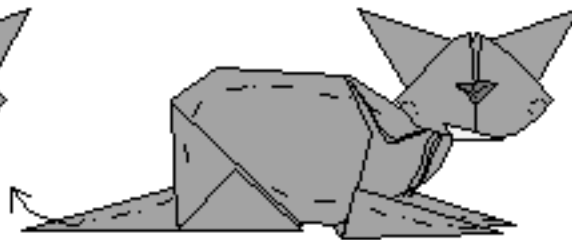

**50** Make the body 3D and  
give the cheek a dent  
on each side.

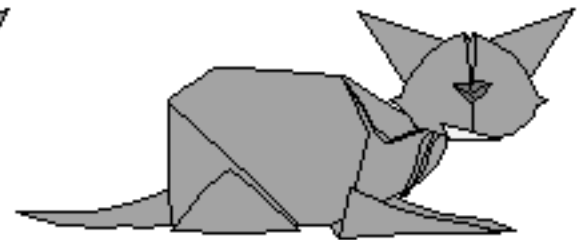

**51** The finished cat.



**52** Alternative cat.  
Make ears shorter  
by mountain-folding  
the edges inside.



**53** Like this.  
Also try to put the head in  
different positions, give the  
head different shapes etc.



---

# Gato

---

J. Aníbal Voyer

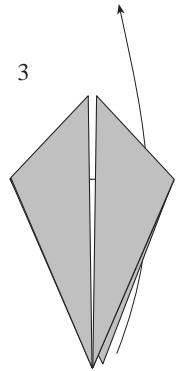
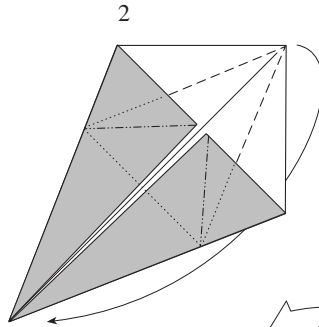
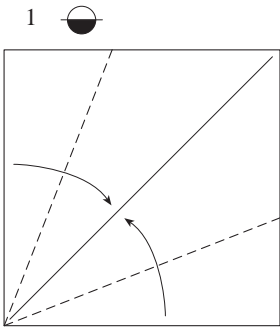
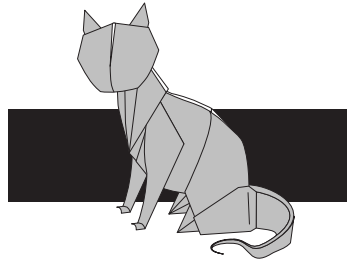

4 Base Pez

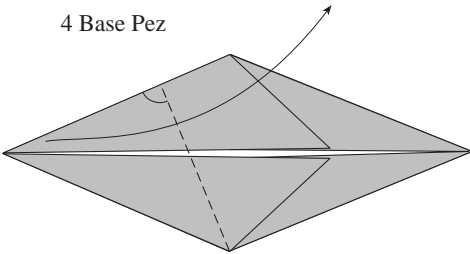

5

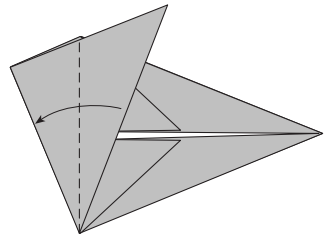

7 Repetir 4 y 5  
al otro lado

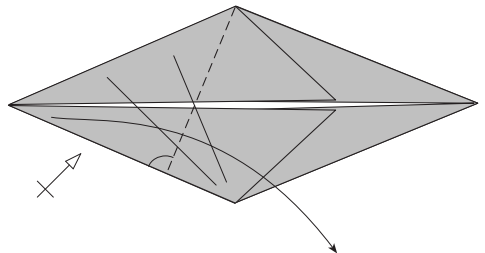
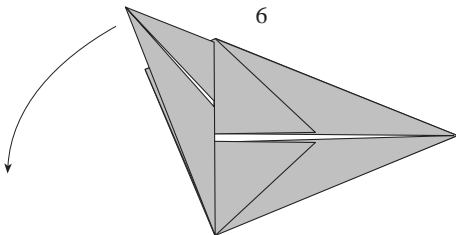

---

8

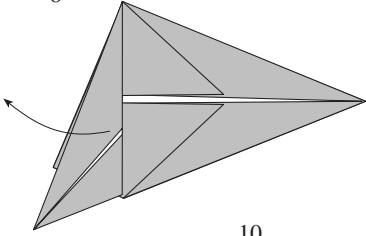

9

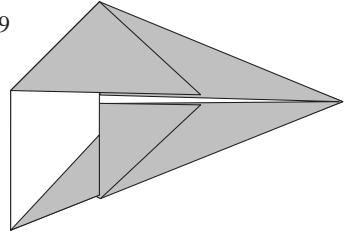

10

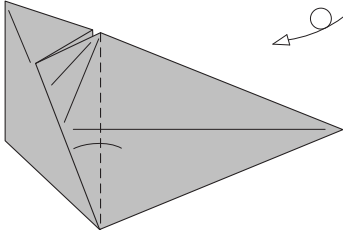

11

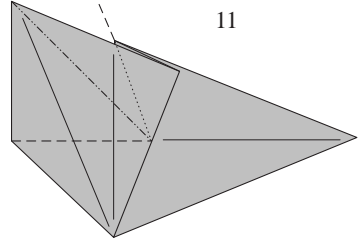

12

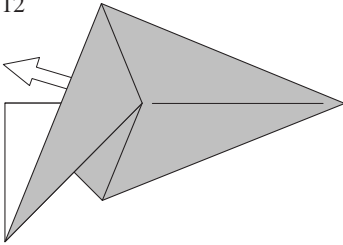

13

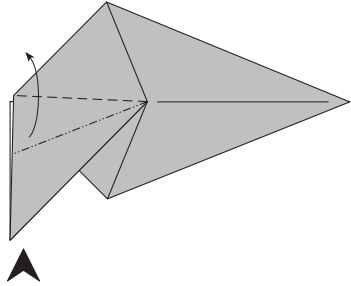

14

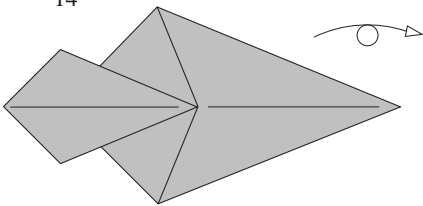

15

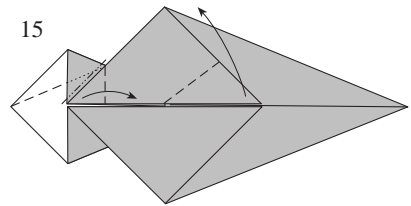

16

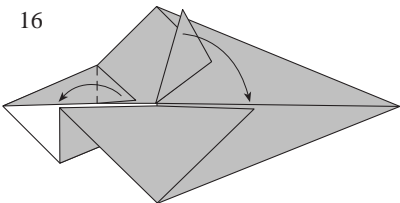

17

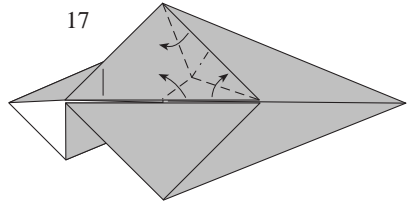

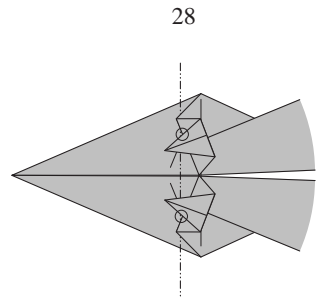
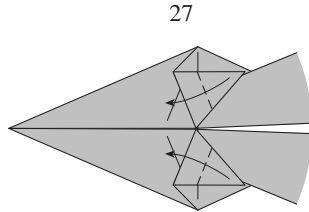
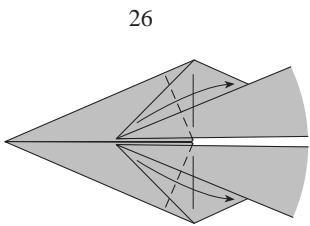
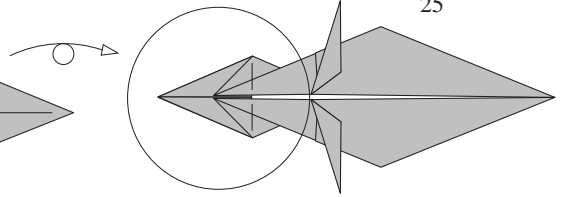
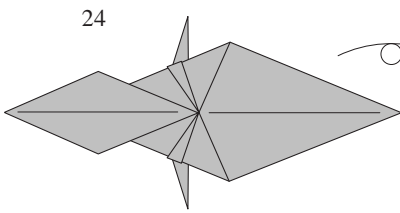
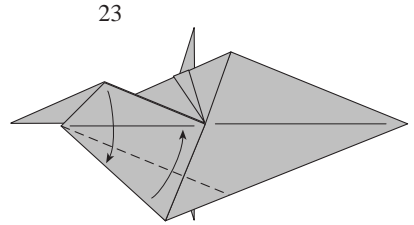
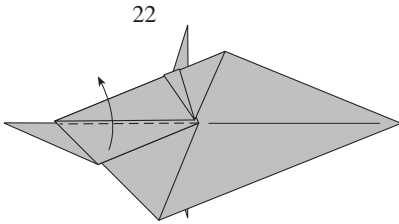
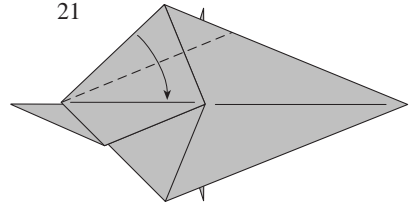
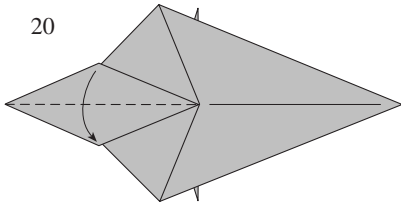
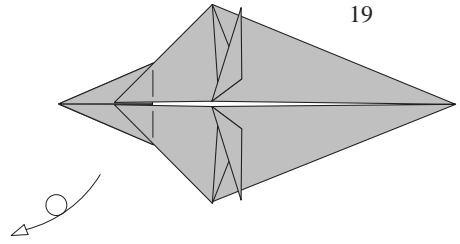
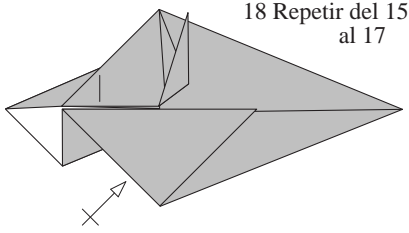

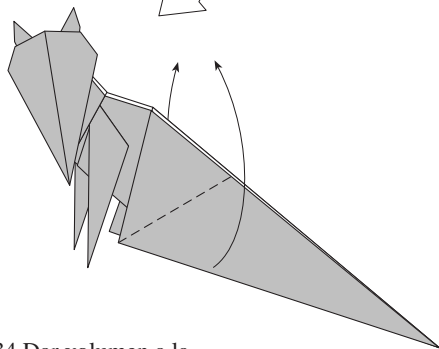
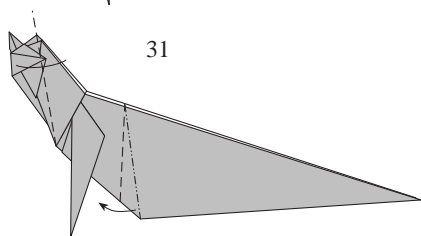
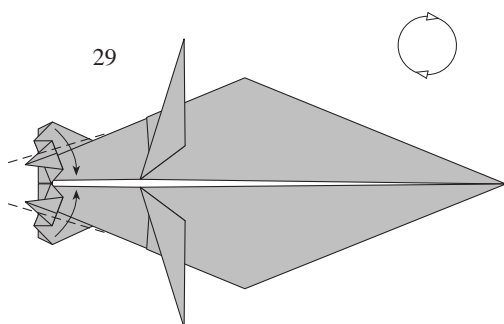

34 Dar volumen a la cabeza y al cuerpo

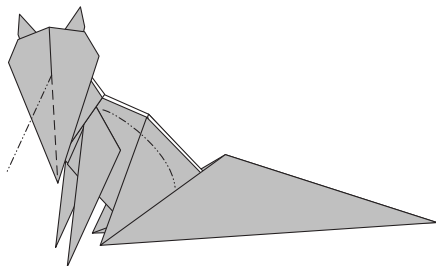

35 El paso de la cola solo se puede plegar si se ha dado volumen al cuerpo

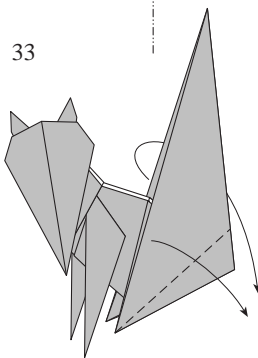
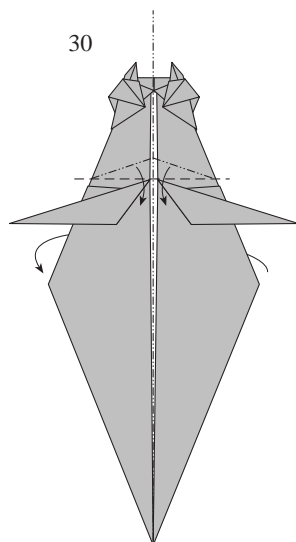
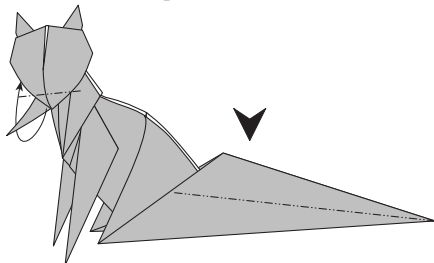

33

36 Adelgazar la barriga del gato

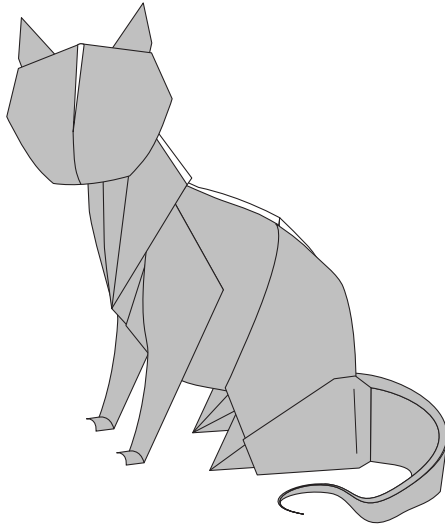
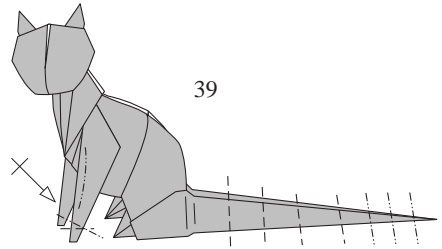
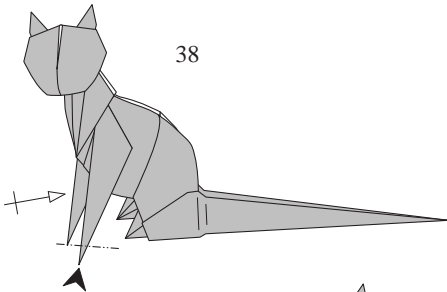
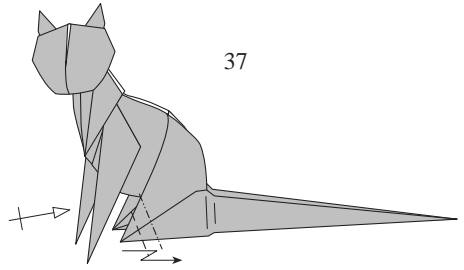
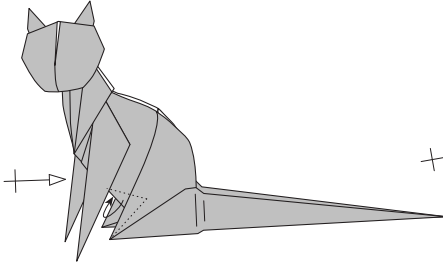

# Catamaran

Maarten van Gelder

© 1987 May

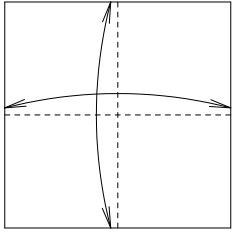

1

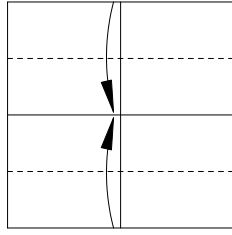

2

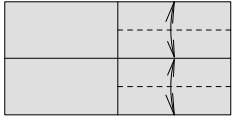

3

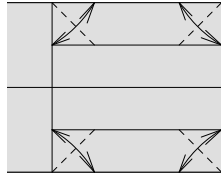

4

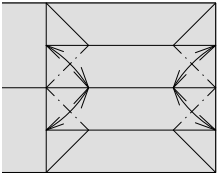

5

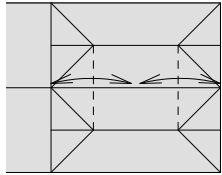

6

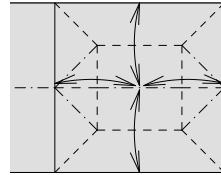

7 The right half becomes the double boat. The left half is only folded double.

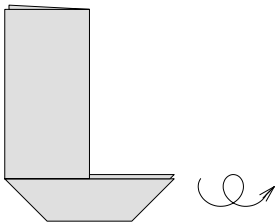

8

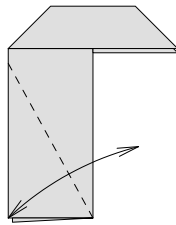

9

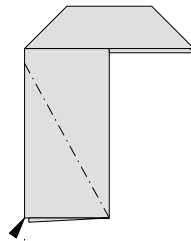

10

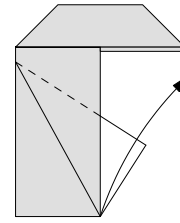

11

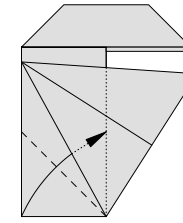

12 Fold tip of foresail between both layers.

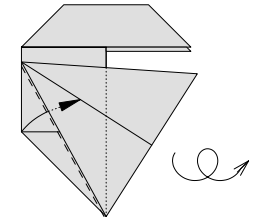

13 And again

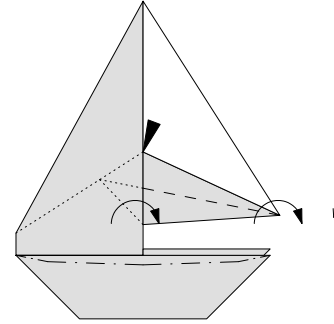

14

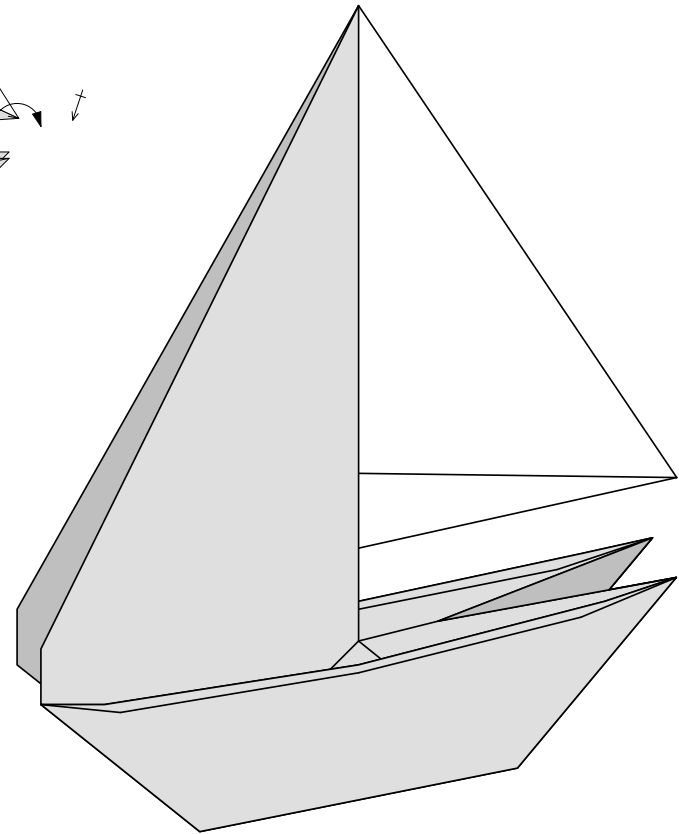

Use a strip of paper 8 x 1 (24 x 3 inch or 20 x 2.5 inch will do), both sides same color. Shorter than 8 x 1 is possible, but not as nice. You may first try with a strip of 3 x 1. The diagrams are drawn as if folded of a 3 x 1 strip. Only the finished model is drawn as if folded from a 8 x 1 strip.

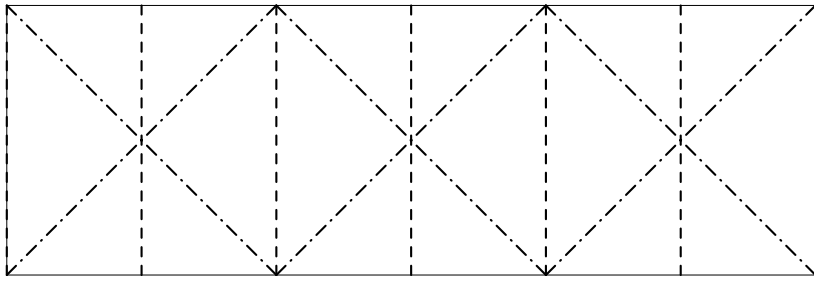

1

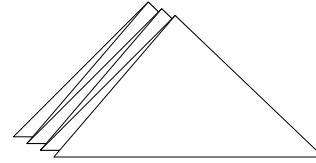

2

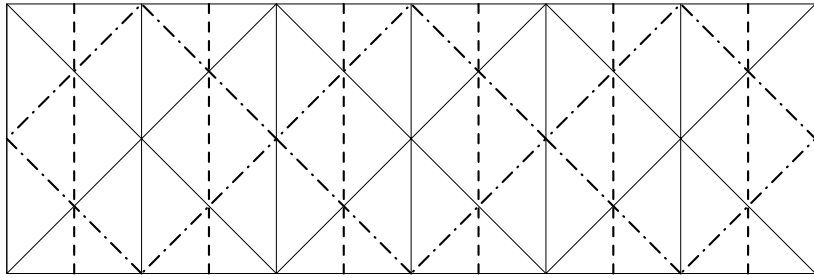

3

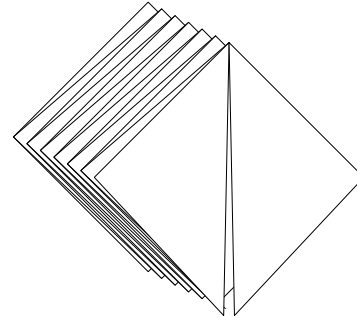

4

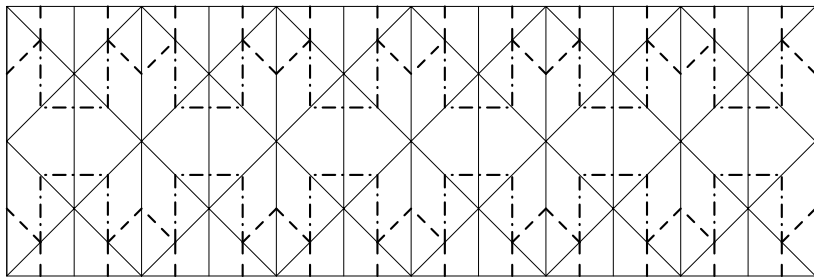

5

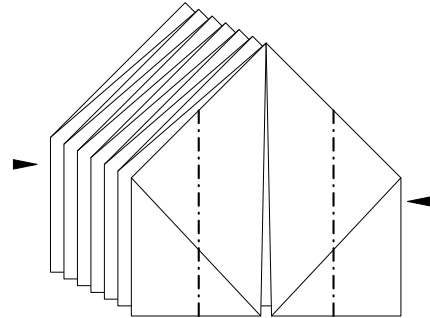

6

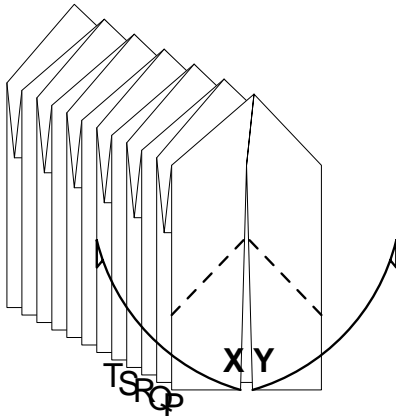

7 Reverse fold whole length

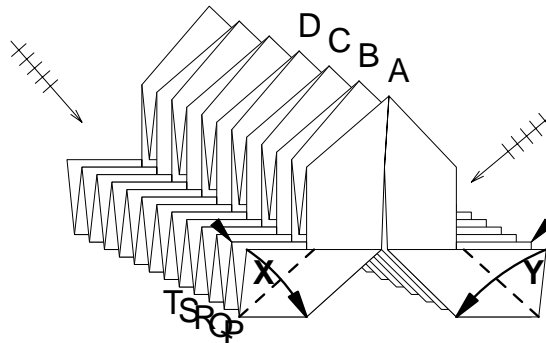

8 Reverse fold: all tips

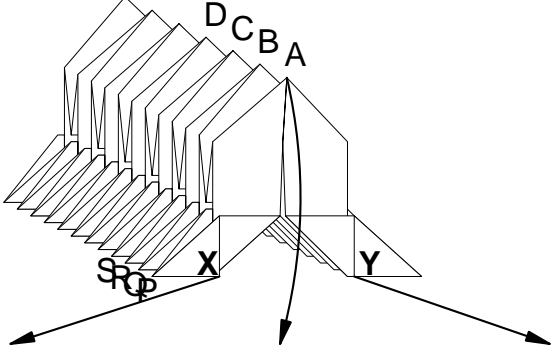

9 Unfold front flap. See 10, 11 and also finished model for position of points P, Q, R and S

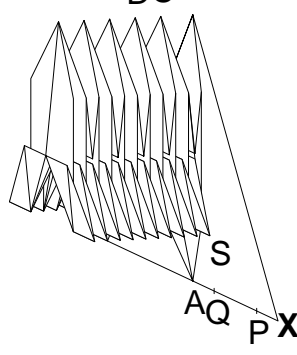

10

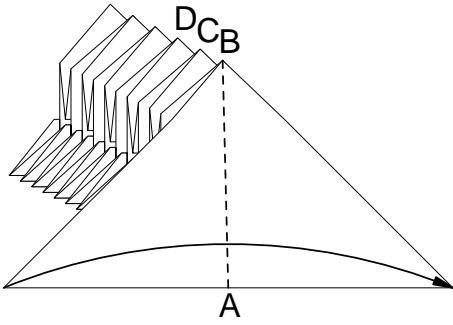

11

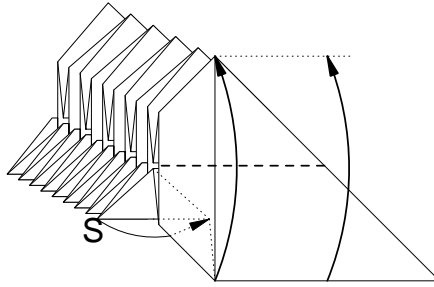

12 Only upper flap; don't push flat  
Point S swivels automatically

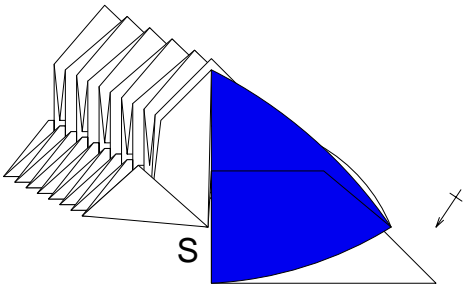

13 Fold the flaps back to diagram 10 and repeat 11-13 on the right side

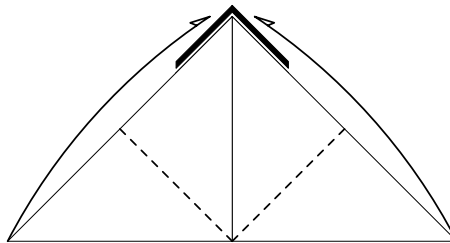

14 Outside reverse fold

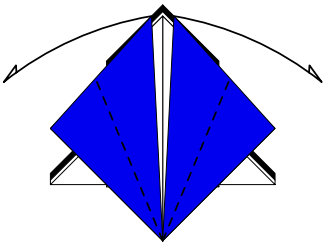

15 Outside reverse fold

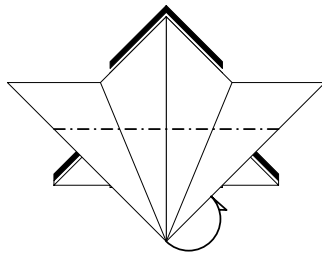

16

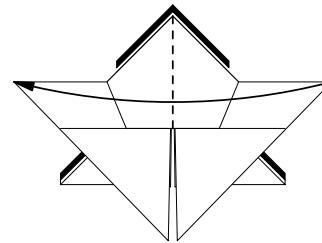

17



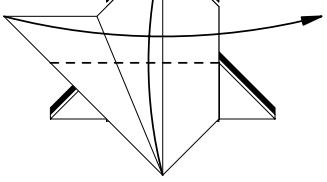

18

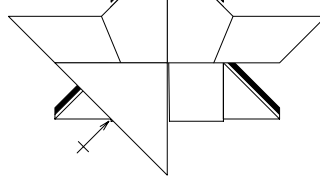

19 Repeat 13 and 14

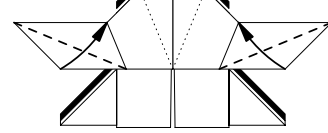

20

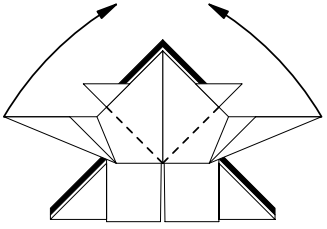

21

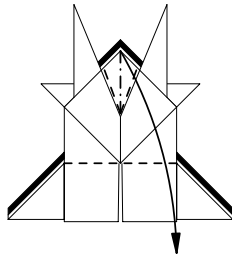

22 Fold head down  
Reverse fold in 'nose'

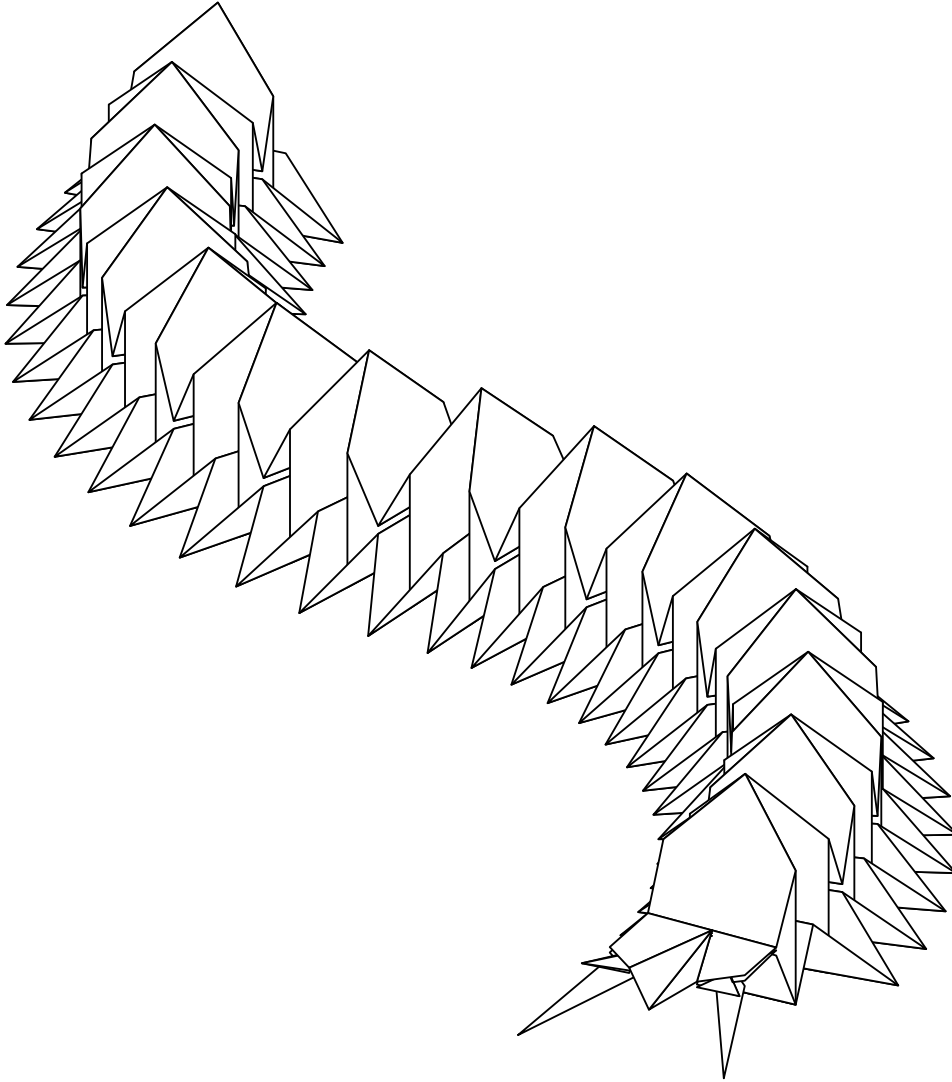

# Caterpillar

Maarten van Gelder

© 1984 Dec

Use a strip of paper 8 x 1 (24 x 3 inch or 20 x 2.5 inch will do), both sides same color. Shorter than 8 x 1 is possible, but not as nice. You may first try with a strip of 3 x 1. The diagrams are drawn as if folded of a 3 x 1 strip. Only the finished model is drawn as if folded from a 8 x 1 strip.

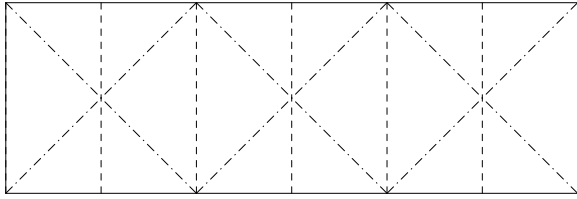

1

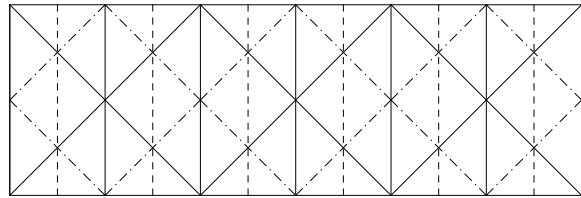

3

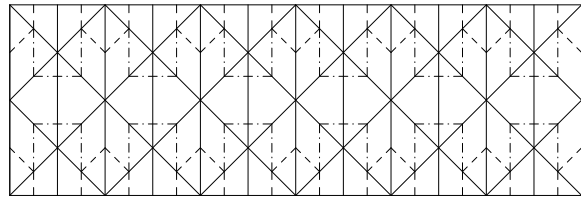

5

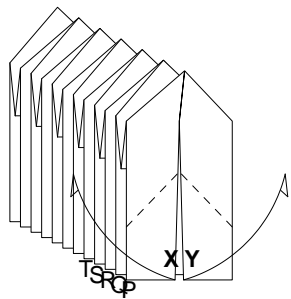

7 Reverse fold whole length

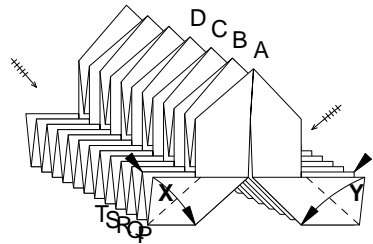

8 Reverse fold: all tips

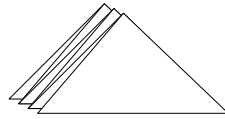

2

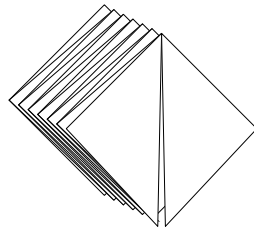

4

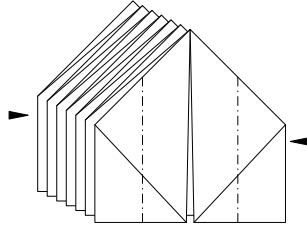

6

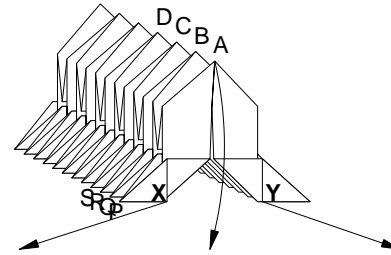

9 Unfold front flap. See 10, 11 and also finished model for position of points P, Q, R and S

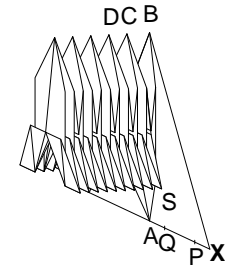

10

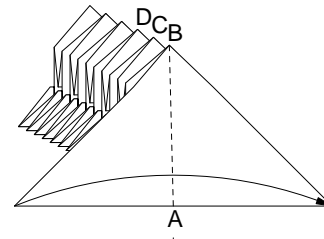

11

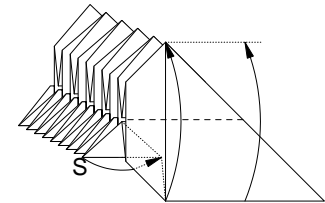

12 Only upper flap; don't push flat Point S swivels automatically

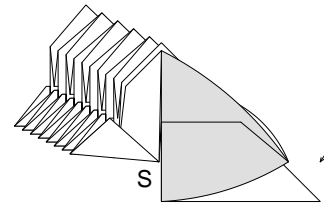

13 Fold the flaps back to diagram 10 and repeat 11-13 on the right side

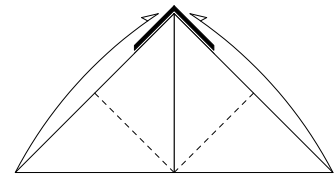

14 Outside reverse fold

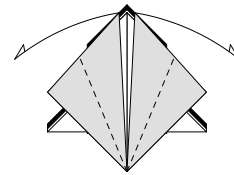

15 Outside reverse fold

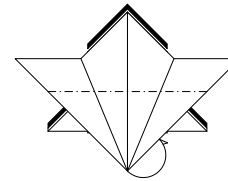

16

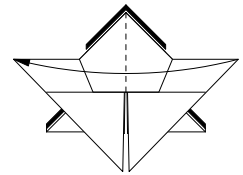

17

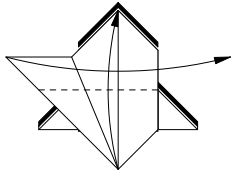

18

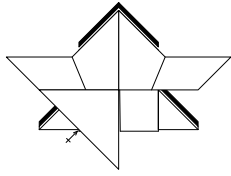

19 Repeat 13 and 14

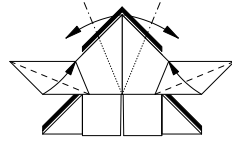

20

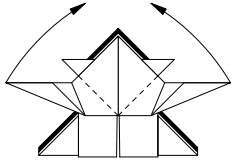

21

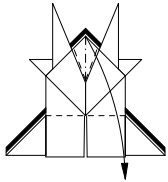

22 Fold head down  
Reverse fold in 'nose'

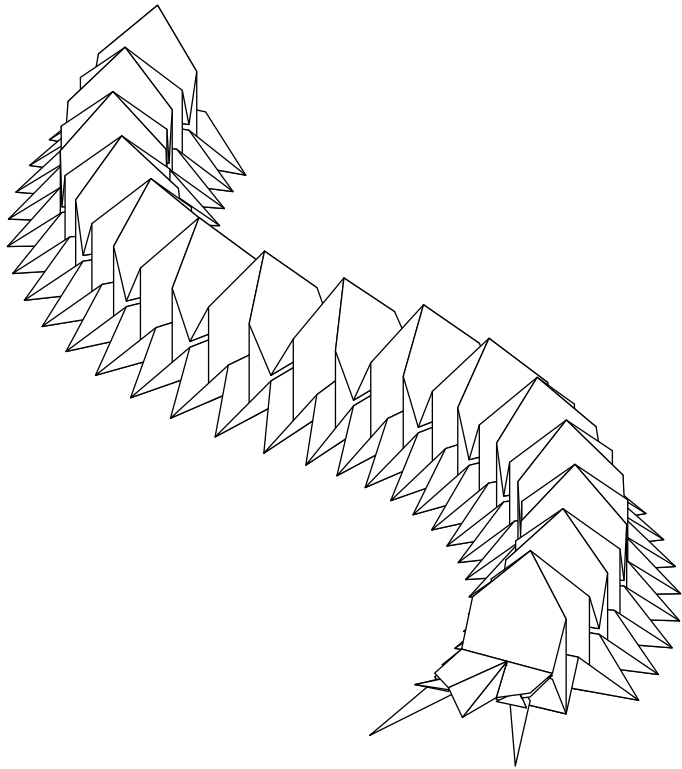

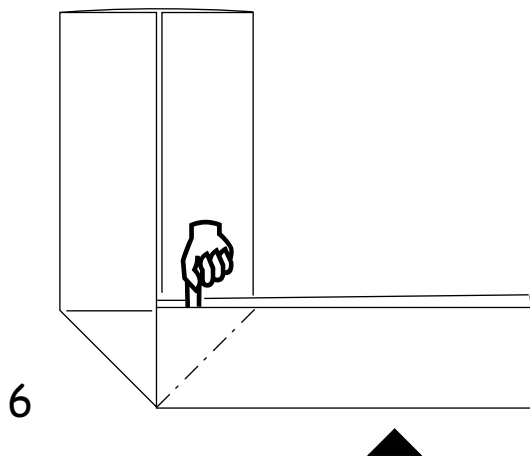
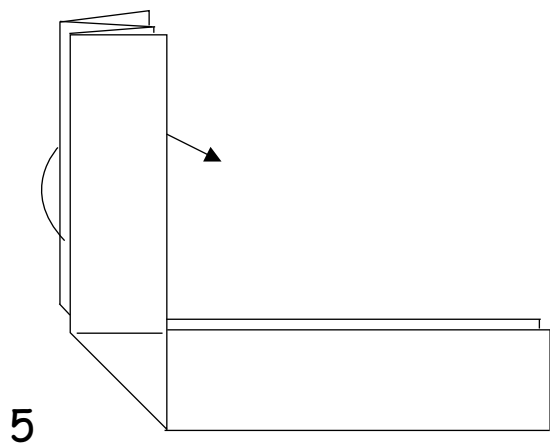
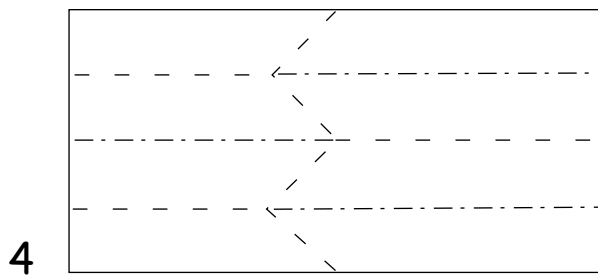
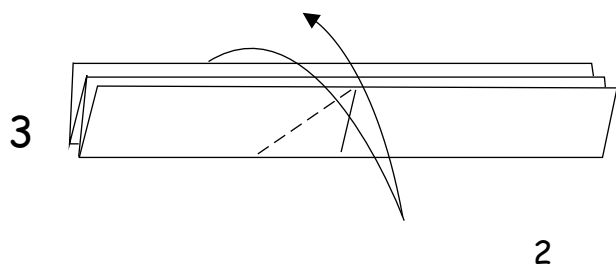
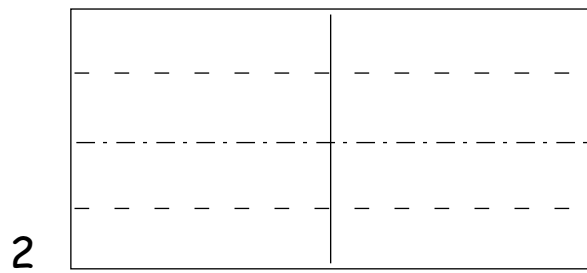
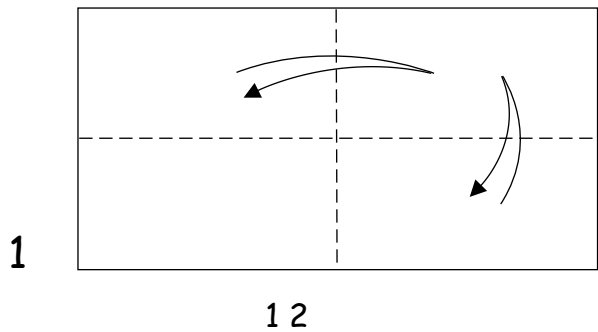

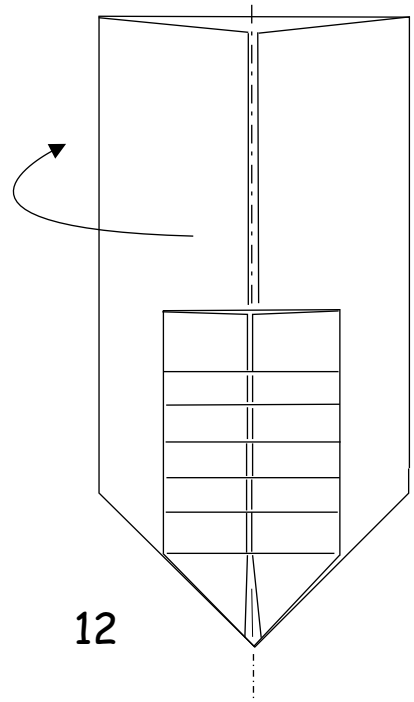
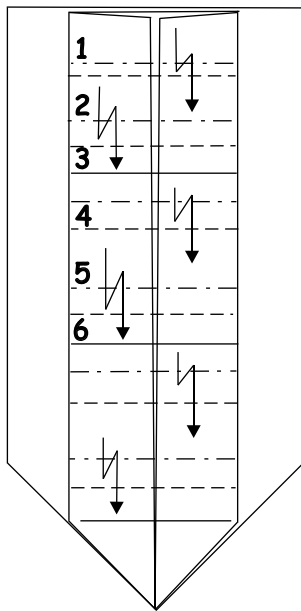
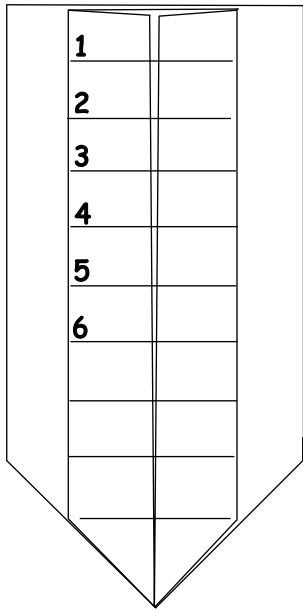
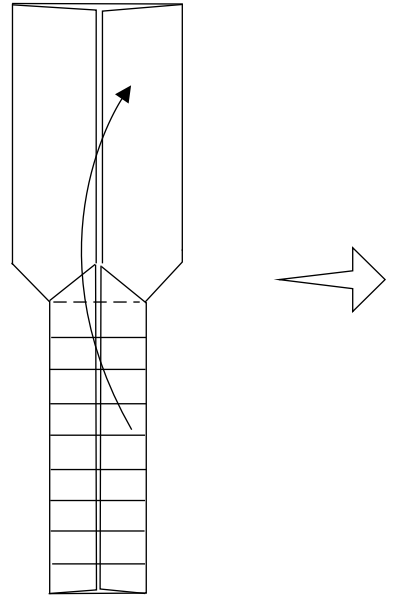
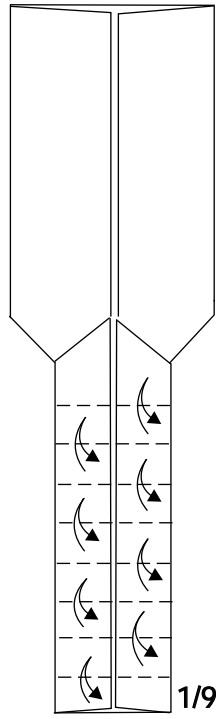
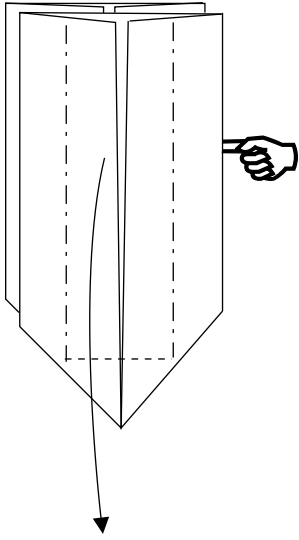

1

1/9

12

11

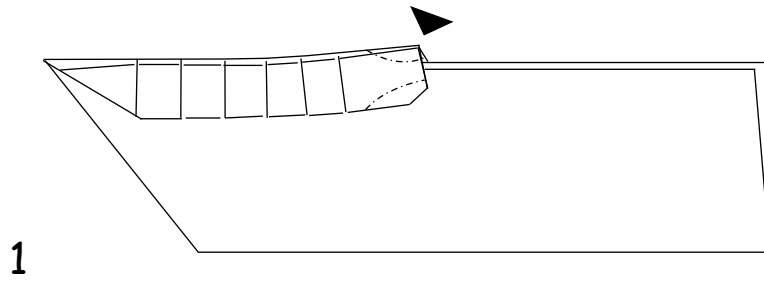
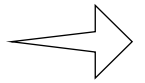
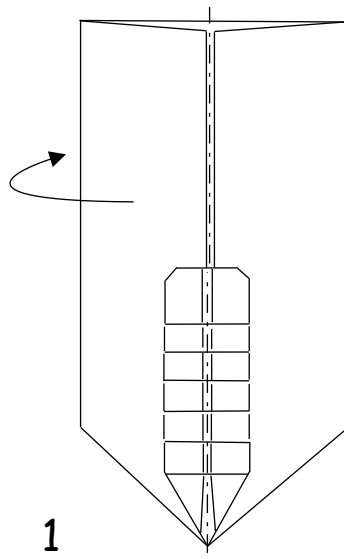
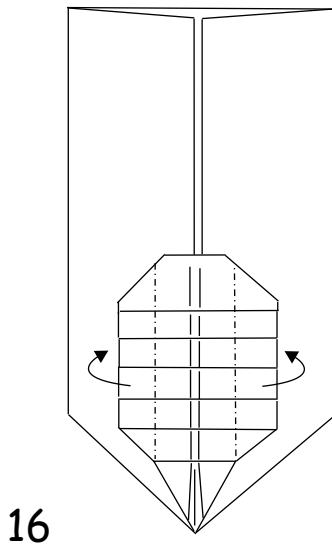
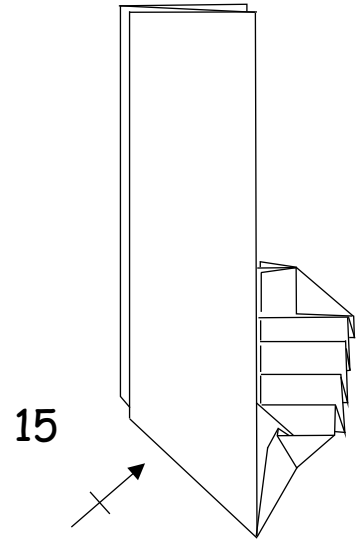
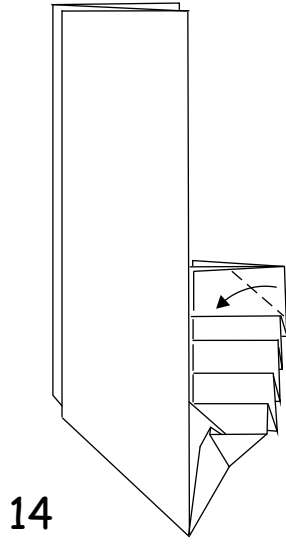
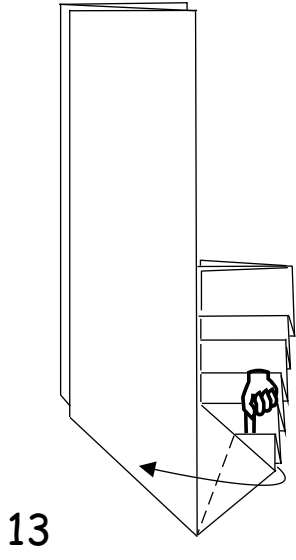

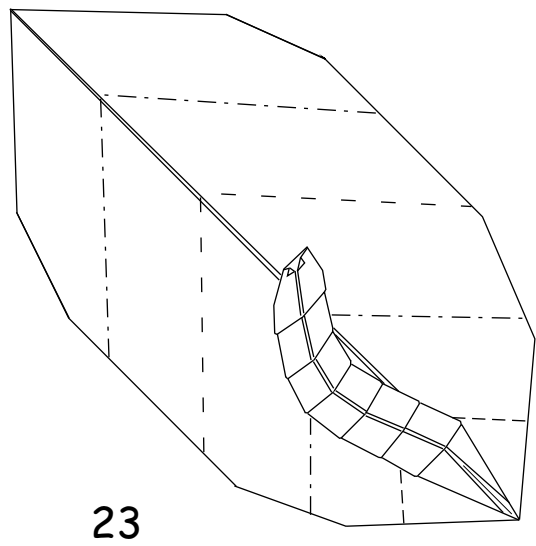
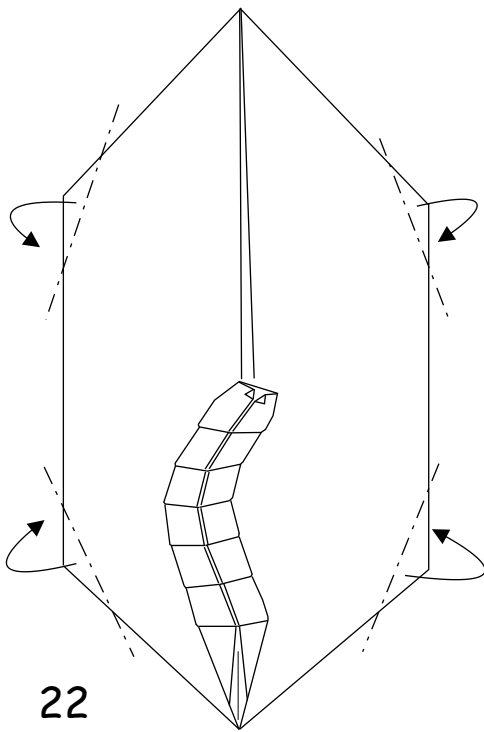
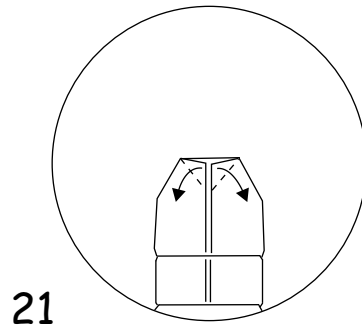
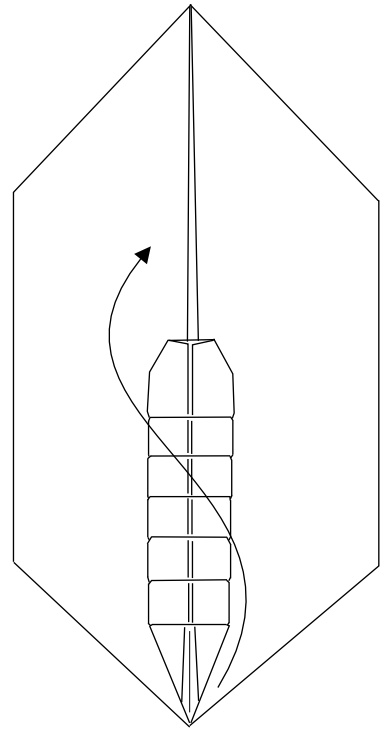
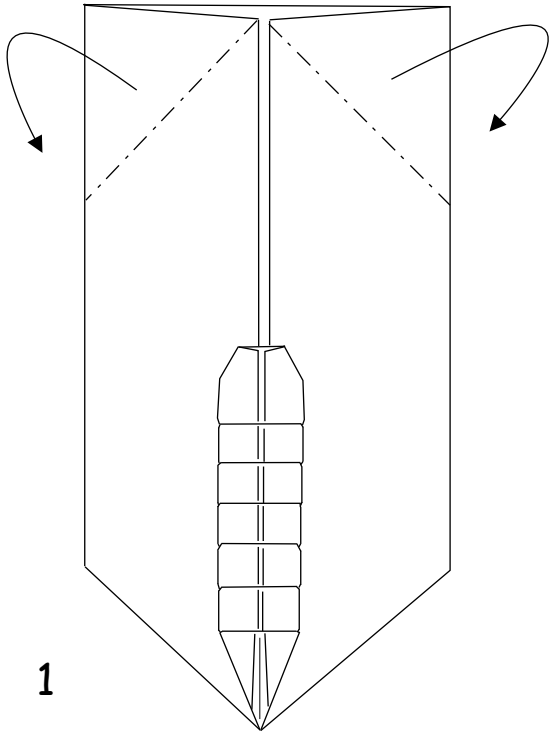

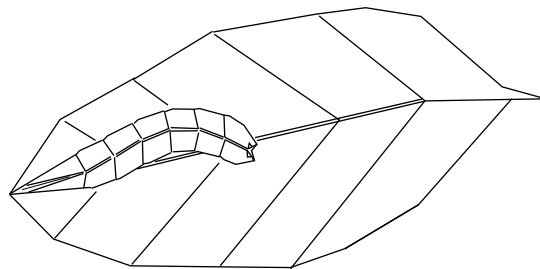
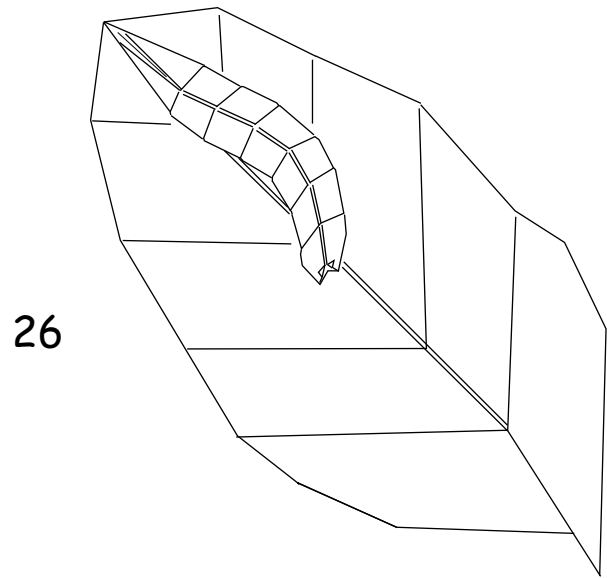
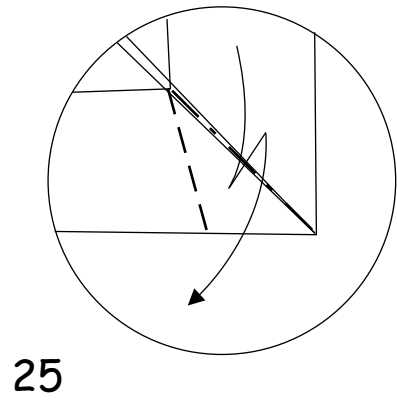
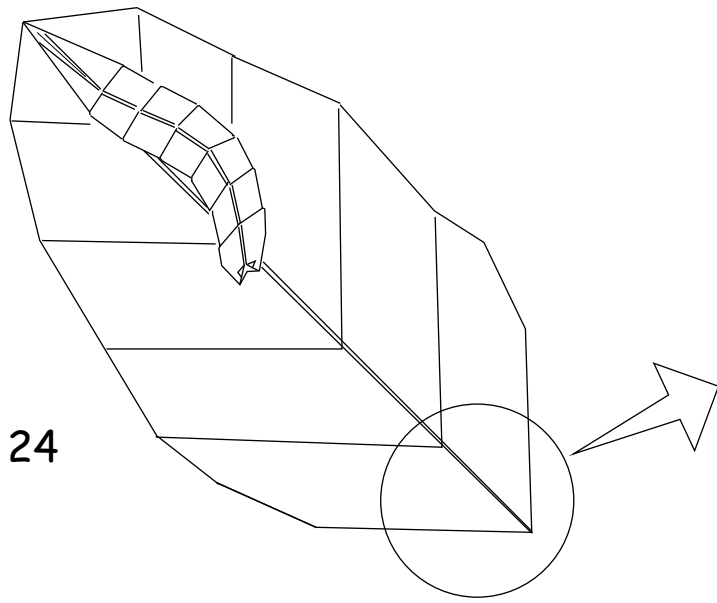



Simple chain unit for fast folding. With this we won the Novelty competition at Nottingham 1998.

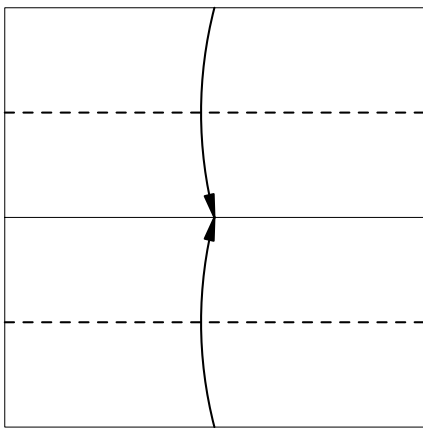

1

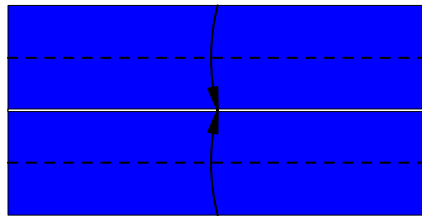

2

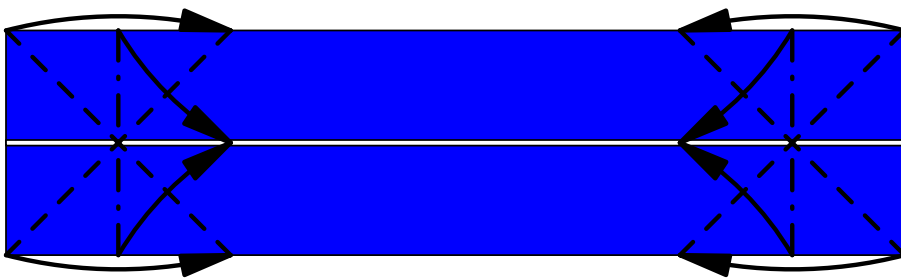

3 Make waterbomb bases on both ends

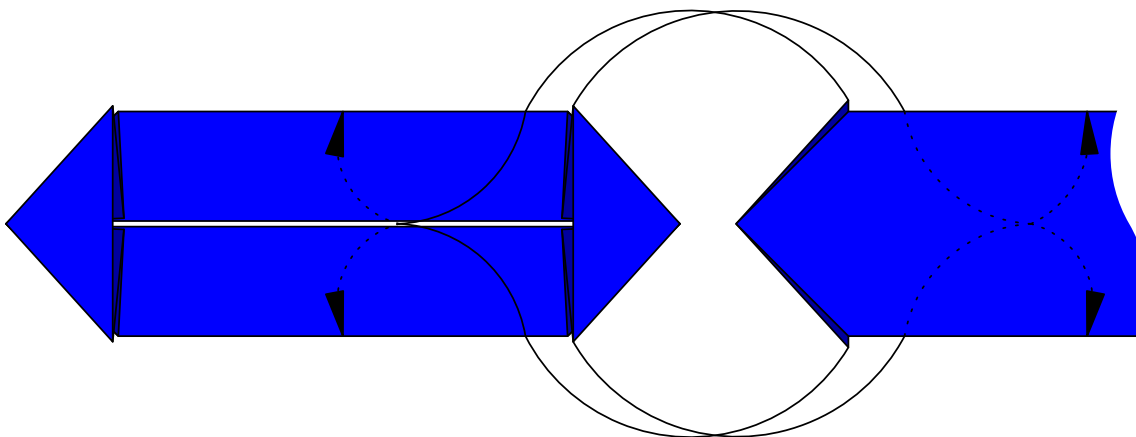

4 Connect: hook flaps of waterbomb basis in other unit and vice versa



This unit is somewhat stronger than version 1.  
Take a rectangle. A4 is ok.

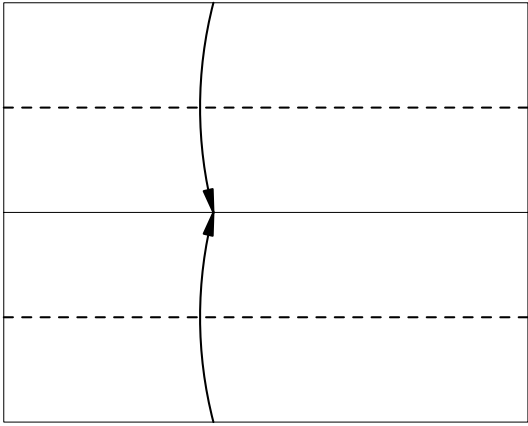

1

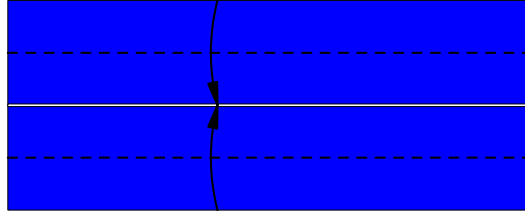

2

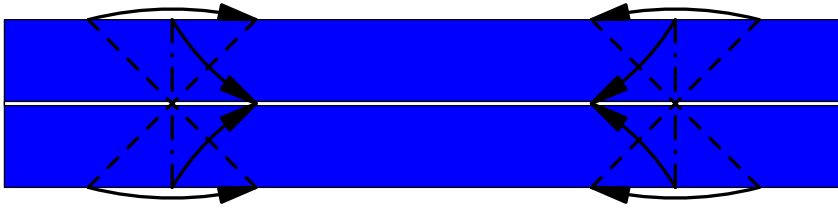

3 Make waterbomb bases on both ends

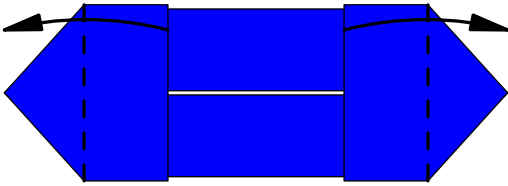

4

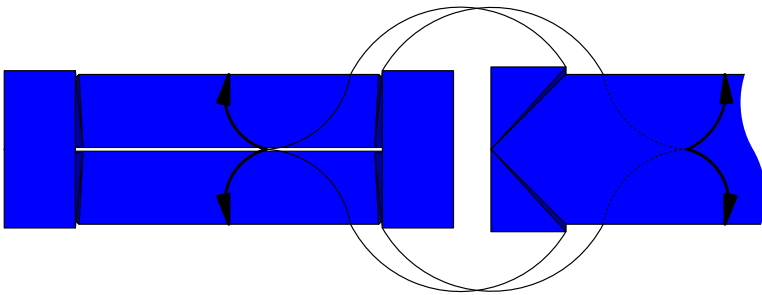

5 Connect: hook flaps of waterbomb basis in other unit and vice versa



Start with a square, white side up.

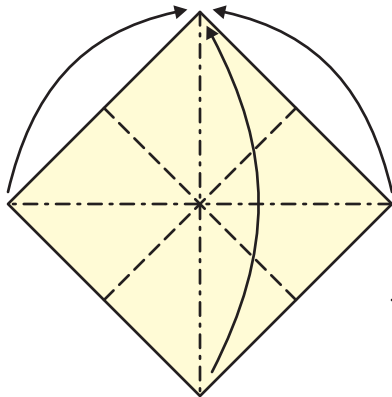

1. Preliminary fold.

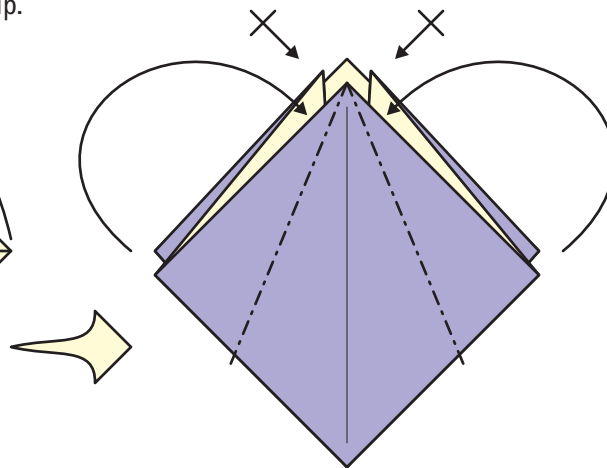

2. Inside reverse folds.

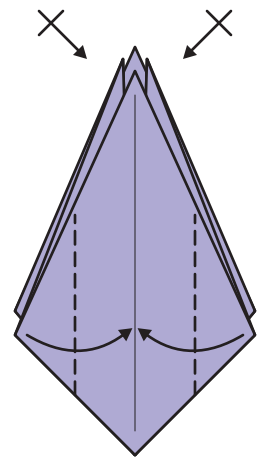

3. Valley folds to the centre.

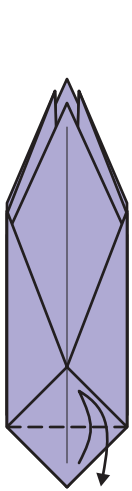

4. Fold and unfold.  
Knight and Rook  
start here.

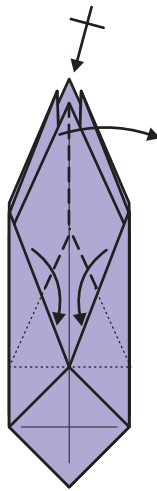

5. Rabbit-ear.  
Repeat behind.

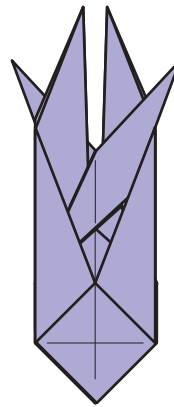

7. "Minor miracle".

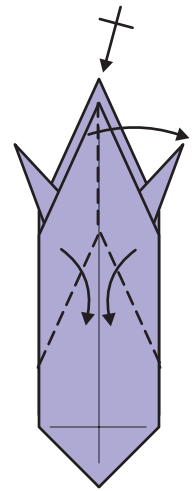

8. Rabbit-ear.  
Repeat Behind.

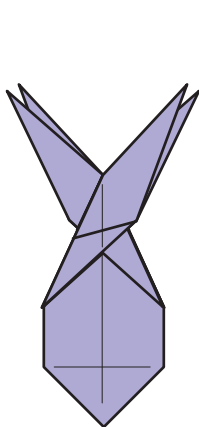

9. After step 8.

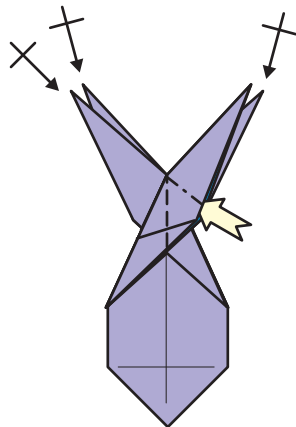

10. Squash each  
flap downward.  
Pawn and King  
start here.

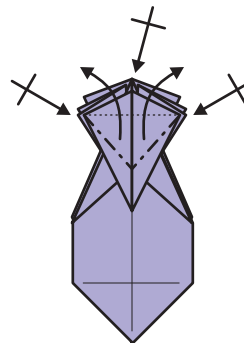

11. Squash each  
flap upward.

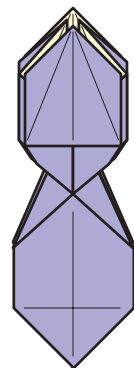

12. After step 11.  
Bishop and Queen  
start here.

Pawn: Start after step 10 of page 1.

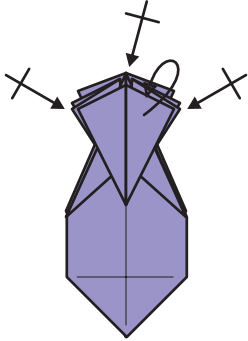

1. Flip each flap inward.

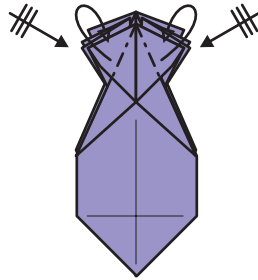

2. Mountain fold all eight flaps into the model.

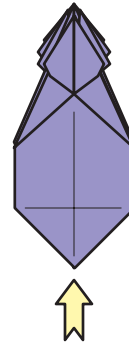

3. Inflate the bottom to form a square base.

Bishop: Start after step 12 of page 1.

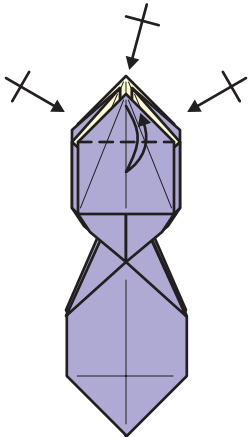

1. Fold and unfold all flaps.

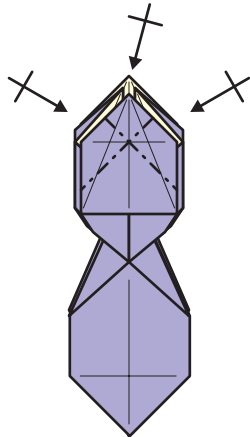

2. Fold and unfold all flaps.

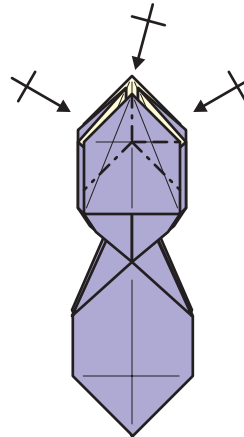

3. Rabbit-ear all flaps.

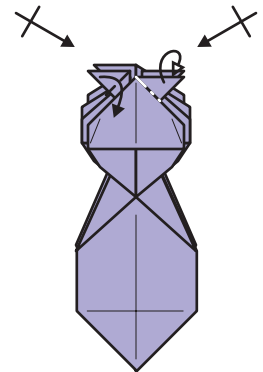

4. Fold all corners over the next flap.

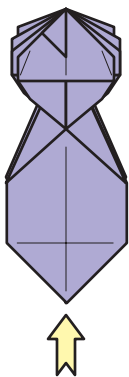

5. Inflate the bottom to form a square base.

Knight: Start after step 4 of page 1.

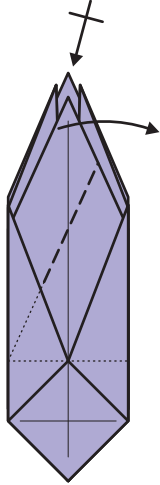

1. Fold front and back flaps over to one side.

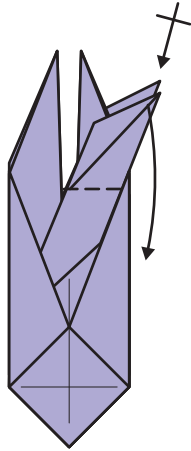

2. Valley fold down.

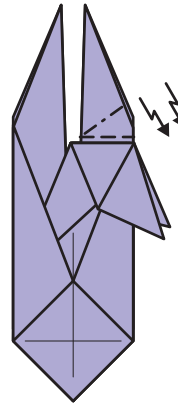

3. Crimp.

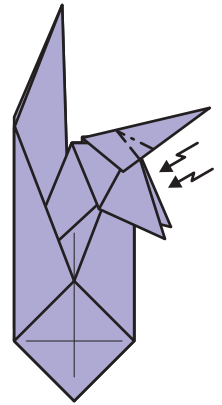

4. Crimp.

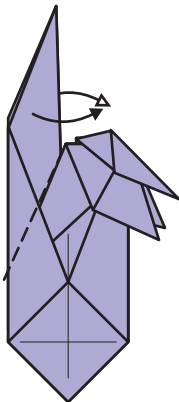

5. Outside reverse fold.

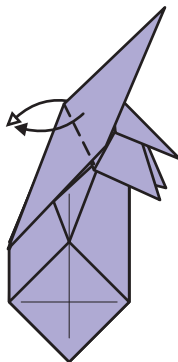

6. Outside reverse fold.

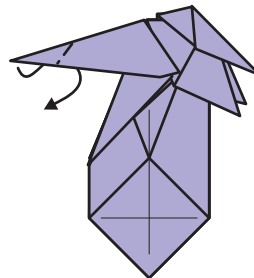

7. Inside reverse fold.

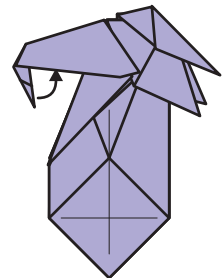

8. Outside reverse fold, and tuck inside.

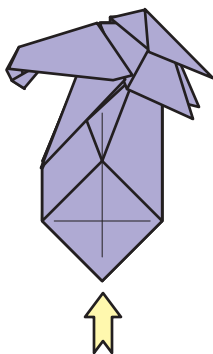

9. Inflate the bottom to form a square base.

Rook: Start after step 4 of page 1.

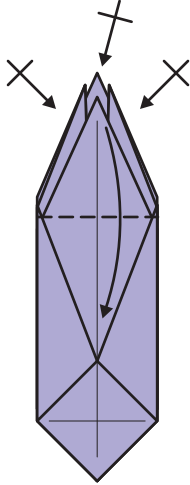

1. Fold all flaps down.

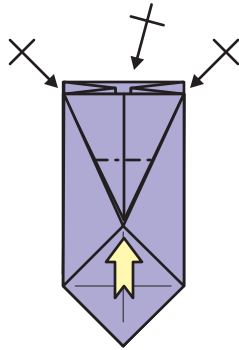

2. Sink the tips of all flaps in half.

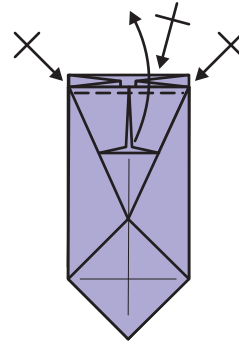

3. Fold all flaps up

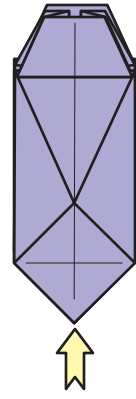

4. Inflate the bottom to form a square base.

Queen: Start after step 12 of page 1.

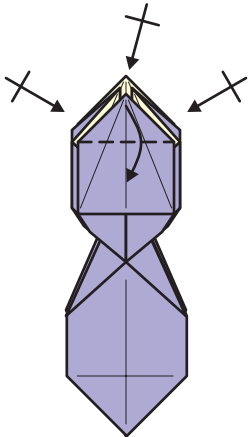

1. Fold all flaps down.

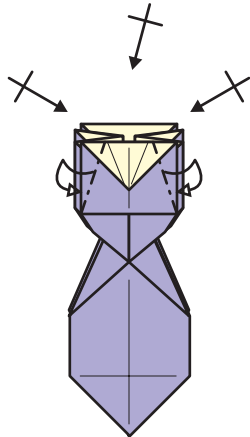

2. Fold and unfold the corners of all flaps along existing creases.

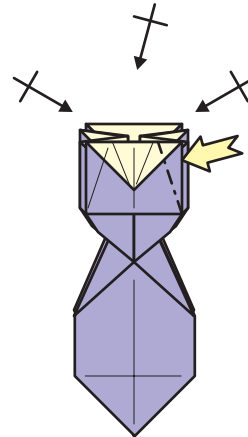

3. Inside reverse fold the right side of each flap.

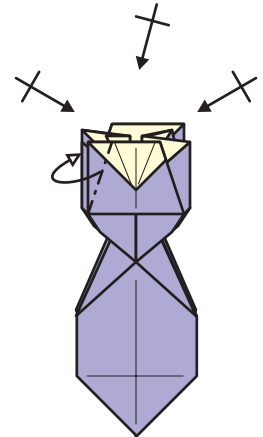

4. Tuck the left corner of each flap into the pocket of the next flap.

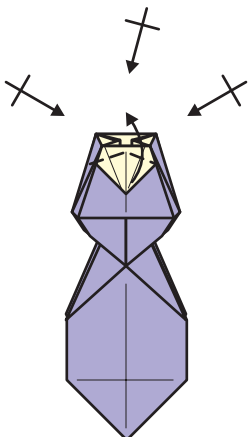

5. Valley fold tips up to form the crown. The tips will not lie flat.

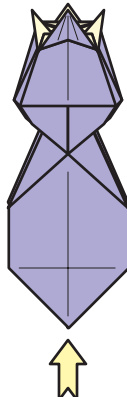

6. Inflate the bottom to form a square base.

King: Start after step 10 of page 1.

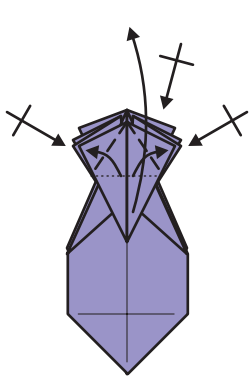

1. Squash fold each flap upward.

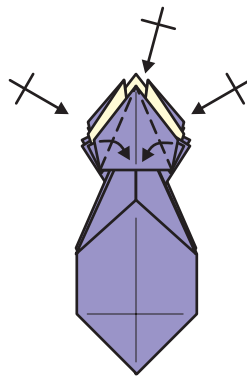

2. Narrow each flap with valley folds.

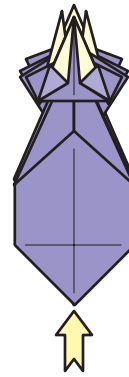

3. Inflate the bottom to form a square base.

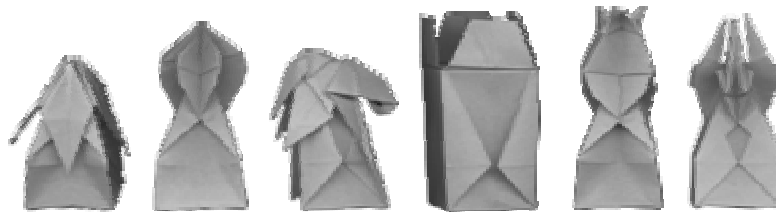

The completed chess set. From left to right, the pieces are the pawn, the bishop, the knight, the rook, the queen, and the king. Actually, the pawn shown in the photo is an older version that did not have the long flaps tucked inside the model. The premise behind this series of chess pieces was to design a chess set that (a) could be folded from the same sized squares, (b) were 3D, and (c) were easily distinguishable. The first piece to be designed was the knight, followed by the pawn, the bishop, and the queen. The king caused me all sorts of problems, and I'm actually still not happy with its look. The rook came almost as an afterthought.

# chess board (4-piece)

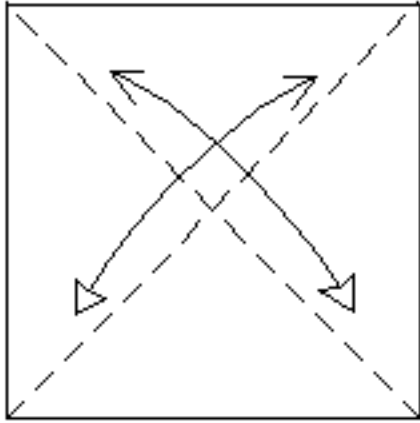

**1** Model based on chess board by John Montroll. Begin with the white side up. Fold and unfold.

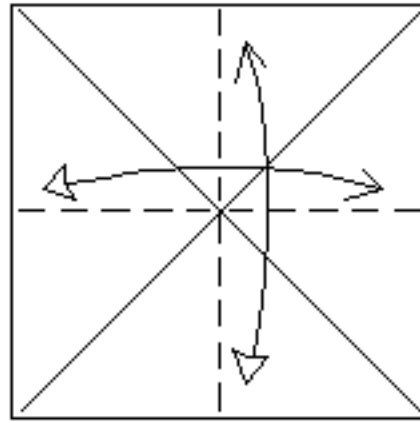

**2** Fold a kite-base and unfold. Turn the paper over.

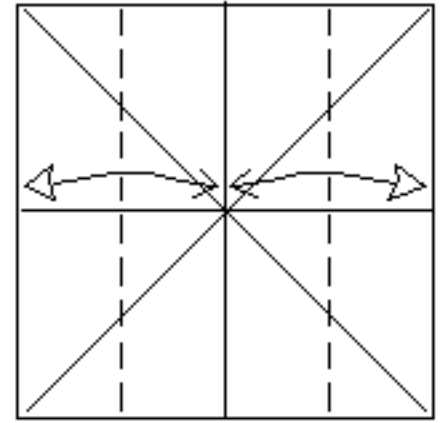

**3** Fold and unfold.

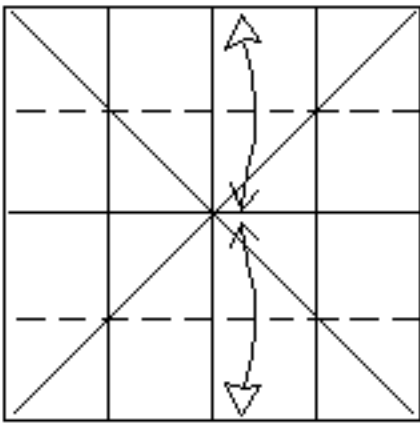

**4** Valley-fold.

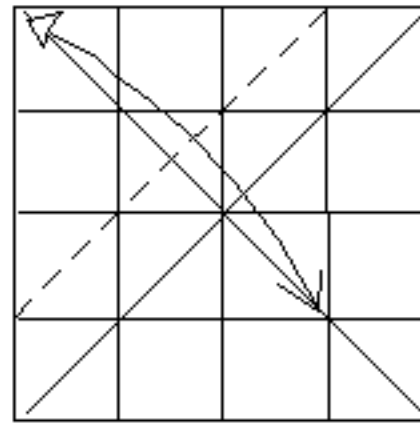

**5** Collapse on existing creases.

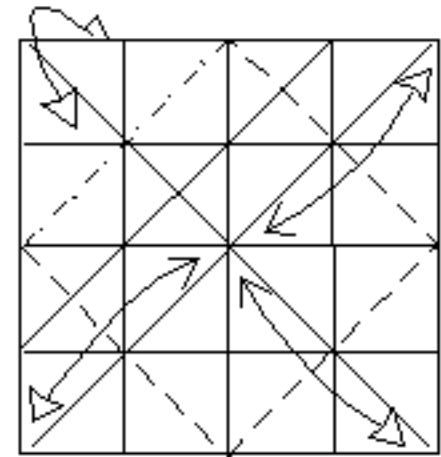

**6** Fold and unfold.

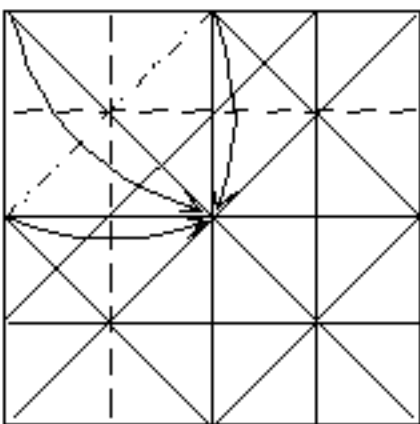

**7** Reverse-fold.

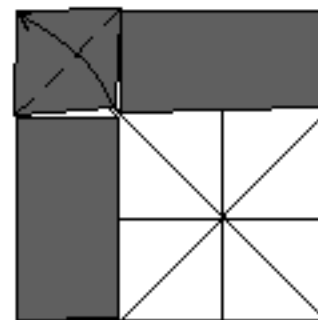

**8** Swivel-fold. The valley-fold is on an existing crease. Repeat behind.

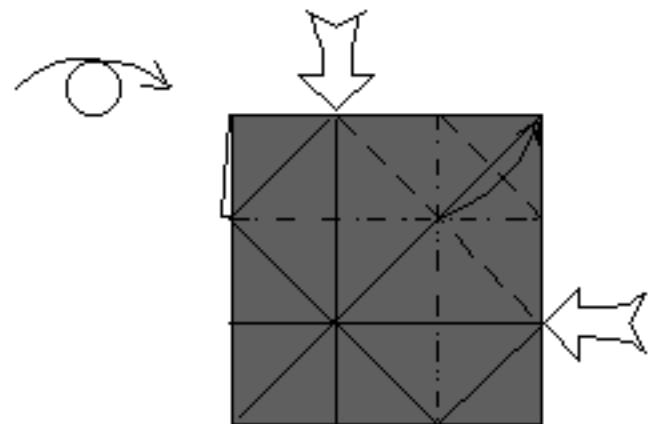

**9** Valley-fold. Repeat behind.



# chess board

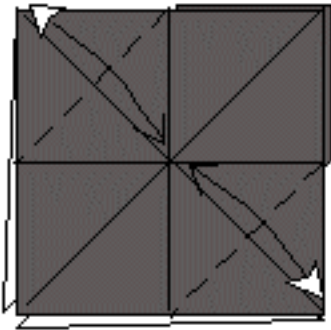

**10** Fold and unfold

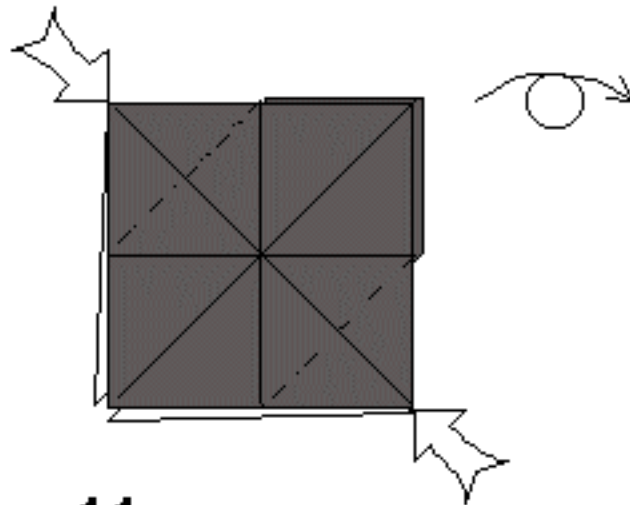

**11** Reverse-fold.  
Turn the model over.

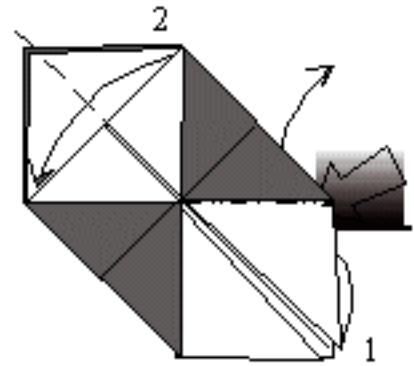

**12** Reverse-fold the right flap upward. Then book-fold a corner down to the left.

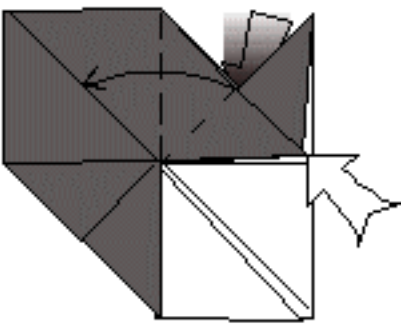

**13** Open up behind the point and squash-fold toward the left.

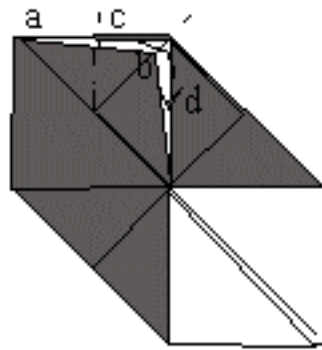

**14** Swivel-fold a to b and c to d.

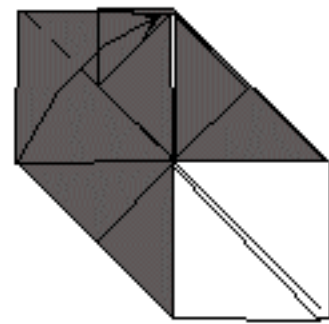

**15** Book-fold the corner up toward the right.

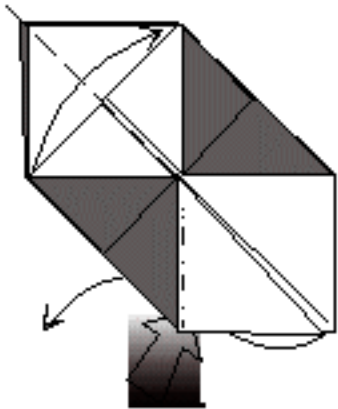

**16** Repeat steps 12-15 on the left.

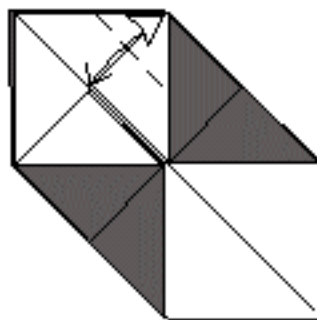

**17** Valley-fold one layer to the middle and unfold.

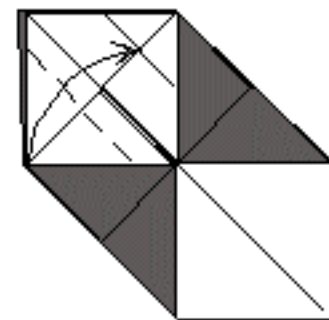

**18** Fold to the old crease and unfold.

# chess board

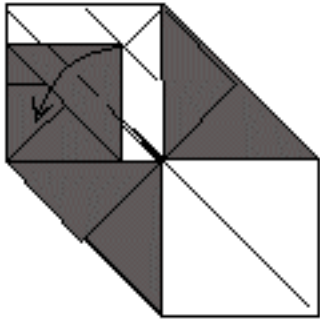

**19** Valley-fold along the midline.

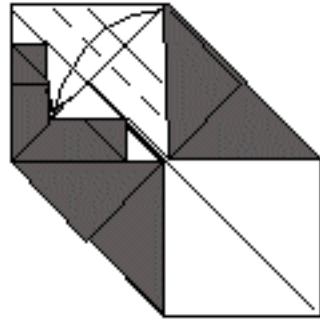

**20** Repeat steps 18-19 on the upper flap.

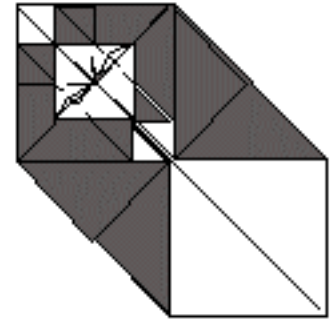

**21** Valley-fold.

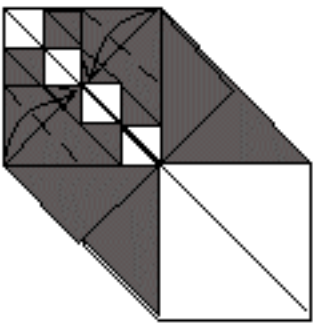

**22** Fold the corners (one layer) to the center.

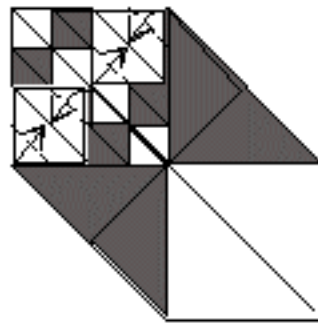

**23** Valley-fold.

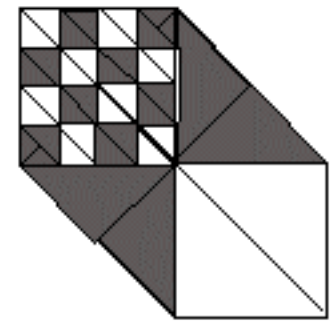

**24** Modul 1 is finished.  
Modul 2 : repeat steps 1-12 and continue with step 25.

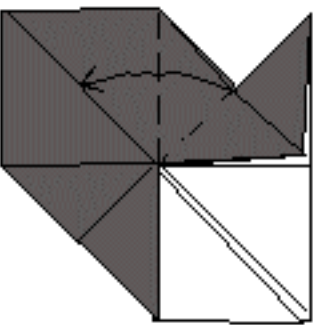

**25** Crimp-fold to the left.

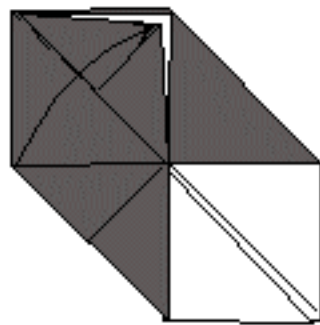

**26** Fold one layer to the right.

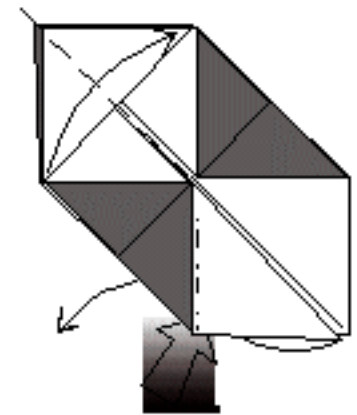

**27** Repeat step 12 + steps 25-26 on the right.

# chess board

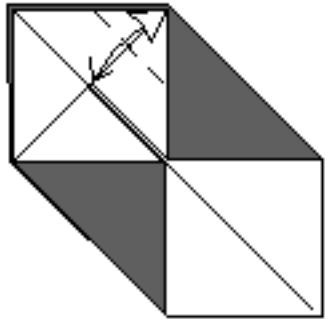

**28** Repeat steps 18-24.

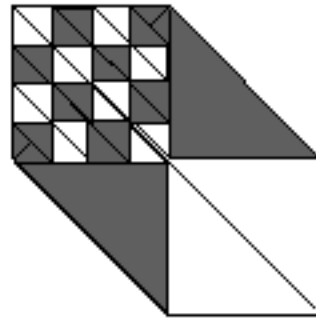

**29** Module 2 is finished. Module 3 and module 4 : repeat module 2, but start with the black side up!!

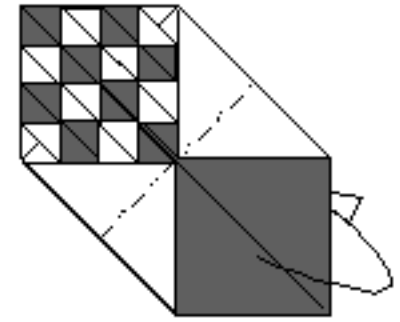

**30** This is how module 3 and 4 looks like. Mountain-fold on both modules.

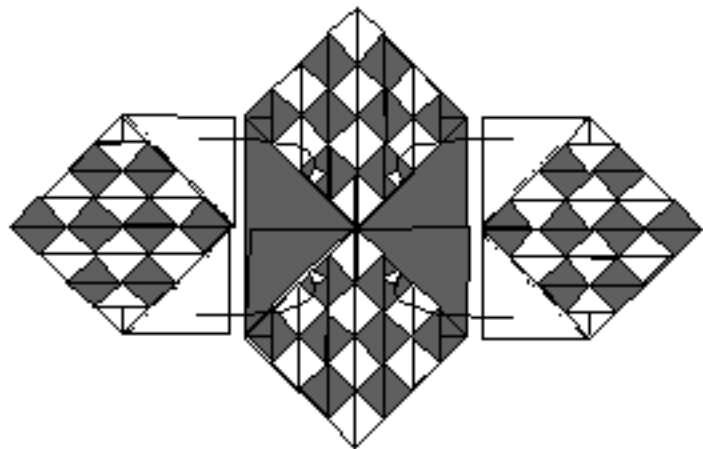
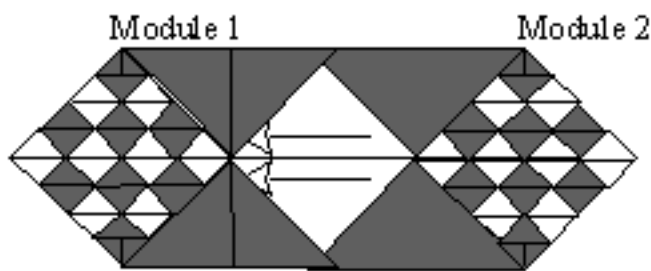

**31** We are now ready to assemble the modules. Start by pushing module 2 into the pocket on module 1. Rotate the model.

**32** Like this. Lock module 3 and 4 by putting their extra flaps into the pockets on each side of the model.

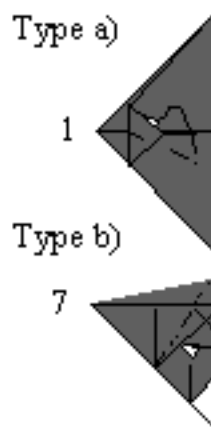
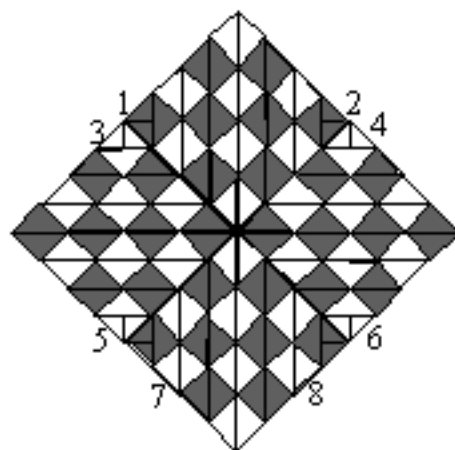

**33** Like this. Mountain-fold the hidden edges inside their respective pockets to lock the layers together. Lock 1-4 are type a) and 5-8 are type b).

**34** X-ray of locks. The lock should not be visible on the outside. Lock 5 and 6 are made on the underside of the model.

**35** Chess board is finished.

# Coot

By Perry Bailey Copyright 2000

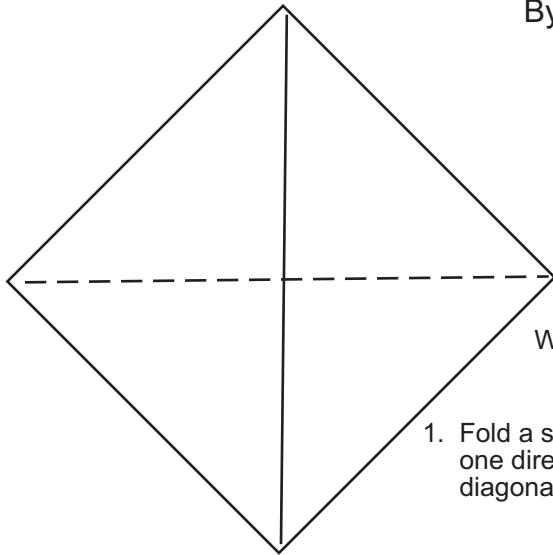

White side up

1. Fold a square in half on the diagonal one direction then fold in half on the diagonal the other way.

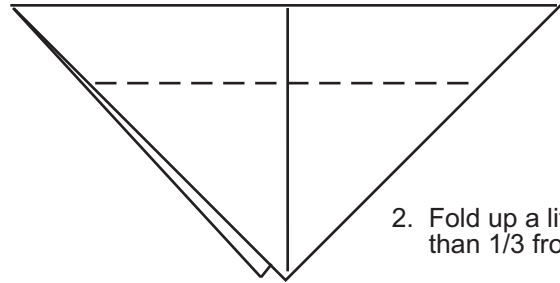

2. Fold up a little less than 1/3 from the top.

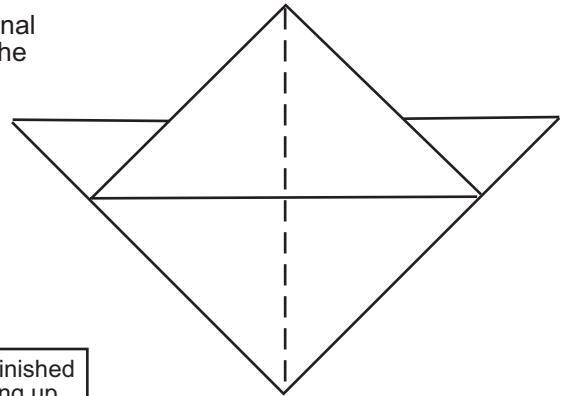

3. Fold the model in half, and turn 90 degrees.

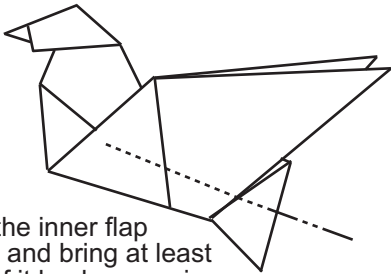

10. Grab the inner flap again and bring at least part of it back up again. This time it doesn't have to go the length of the flap.

NOTE: When the model is finished there should be a flap sticking up inside of the model you can fold over to lock the body together.

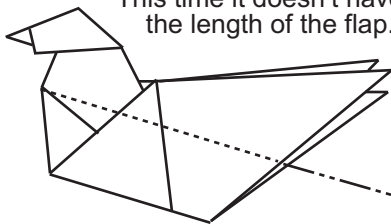

9. Grab the inner flap and reverse fold that puppy all the way to the end of flap, so it comes down even with the bottom of the model.

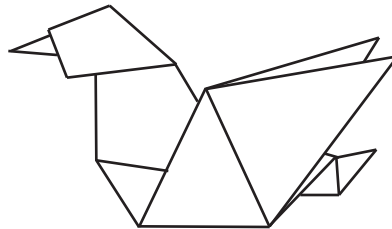

The finished Coot!

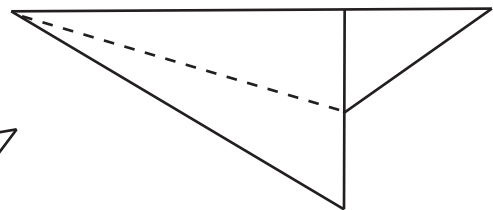

4. Fold the long edge up to the top on each side.

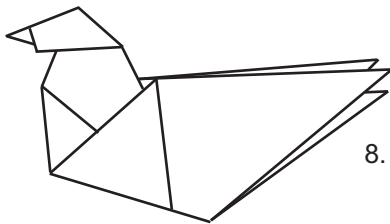

7. Pleat the beak in a little for that waterfowl look!

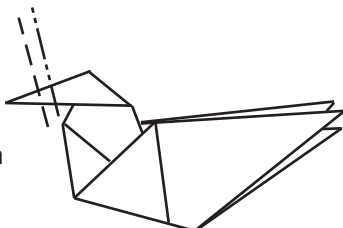

8. Just taking a break here to say to mention how far the tail sticks out all depends on step 2.

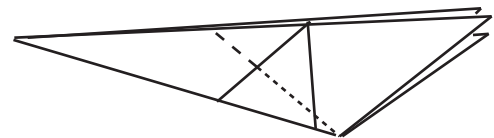

5. Reverse fold up the neck, part of neck is inside the body, you know the neck is right when it touches at the underlying layers in the front.

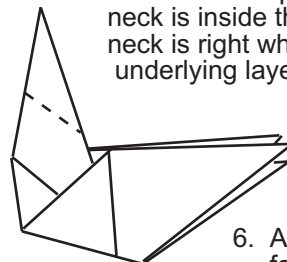

6. Another outside reverse fold for the head.

# Fiddler Crab

By Hans Birkeland (Norway) ©1993

Model : 93.06.06  
Diagrams : 93.06.18

Use paperbacked foil (covered with tissue paper).  
A 25 cm square will produce a finished model  
about 7.5 cm long. Begin with the white side up.

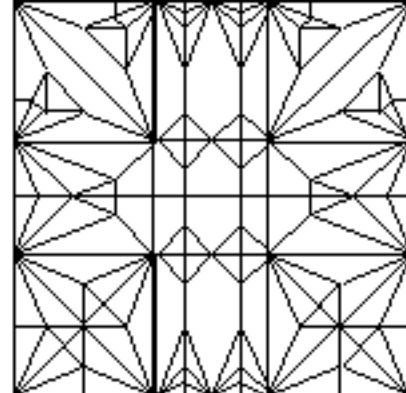

1

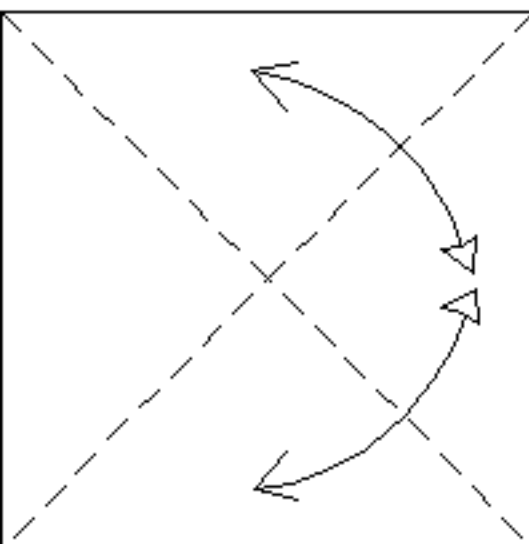

Fold and unfold.

2

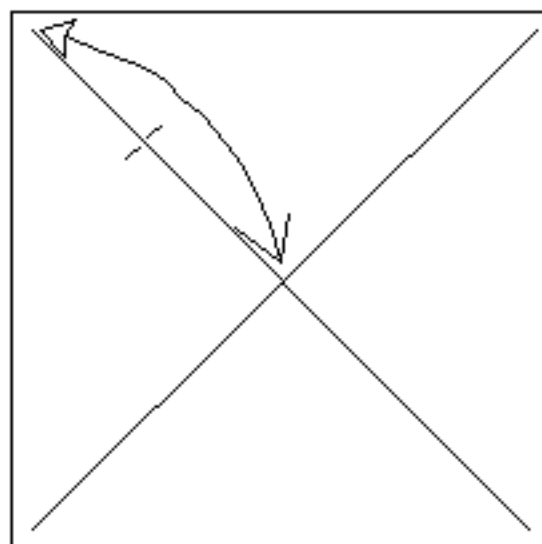

Fold and unfold. Just make a mark.

3

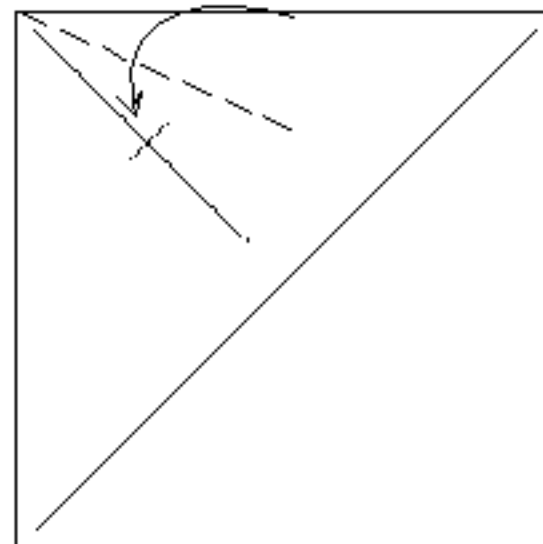

Fold the edge down softly,  
without making a crease.

4

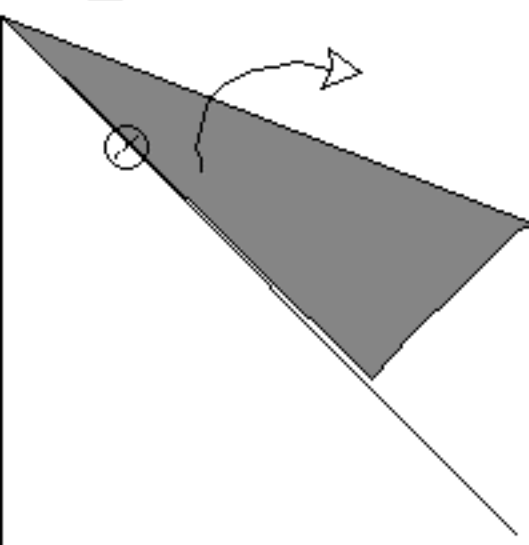

Make a mark where the edge  
touches the old mark. Unfold.

5

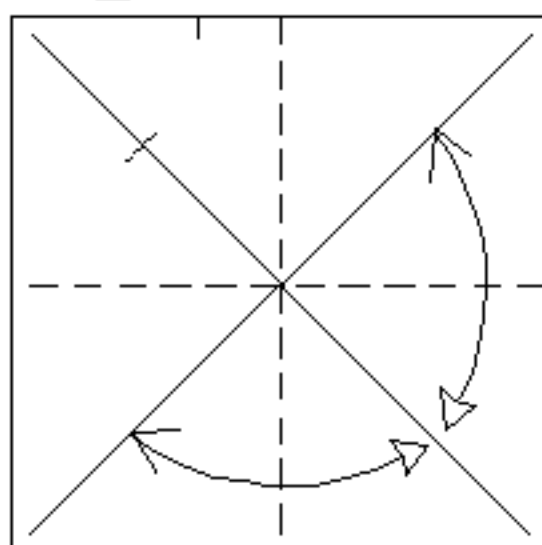

Fold and unfold.  
Turn the paper over.

6

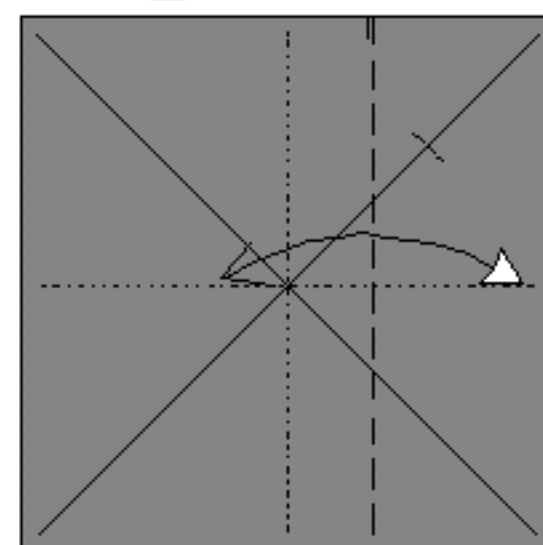

Fold and unfold. The valley-  
fold touches the upper mark.

7

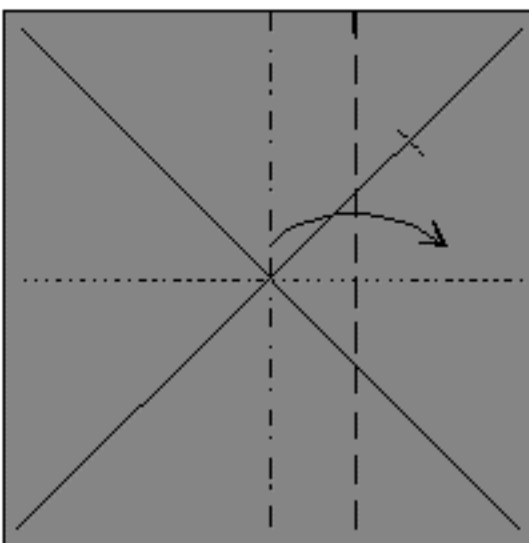

Pleat on existing creases.

8

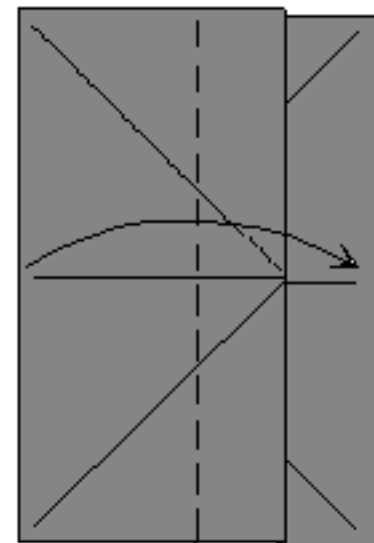

Fold the left side over to the  
right. Unfold completely.

9

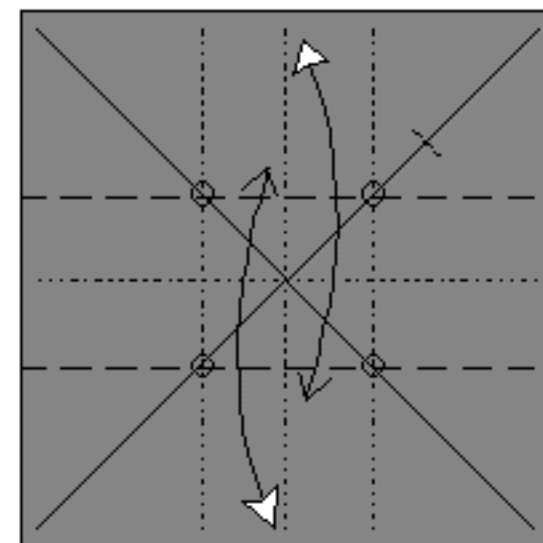

Fold and unfold.

10

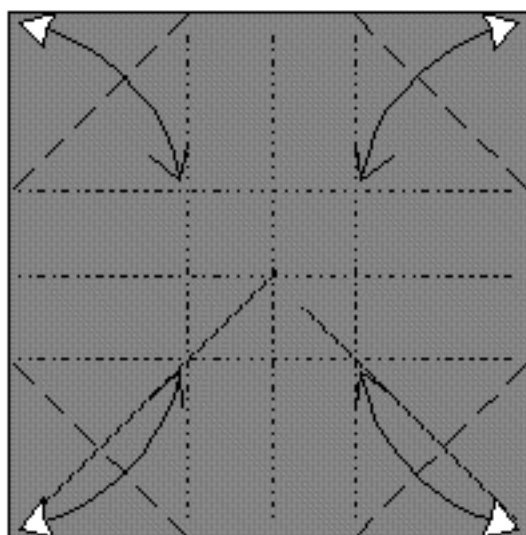

Fold and unfold.  
Turn the paper over.

11

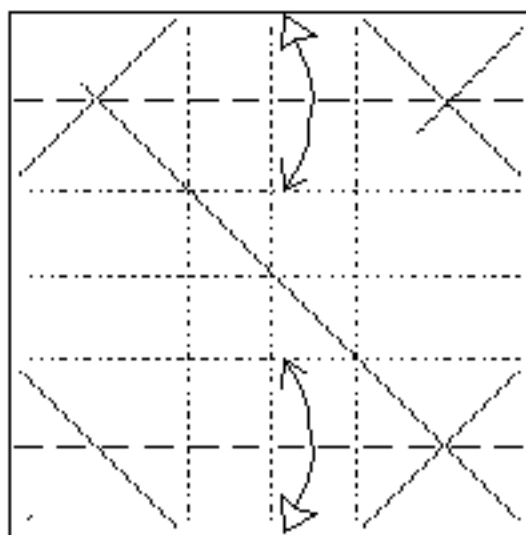

Fold and unfold. Rotate the  
paper 1/4 turn clockwise.

1/4

12

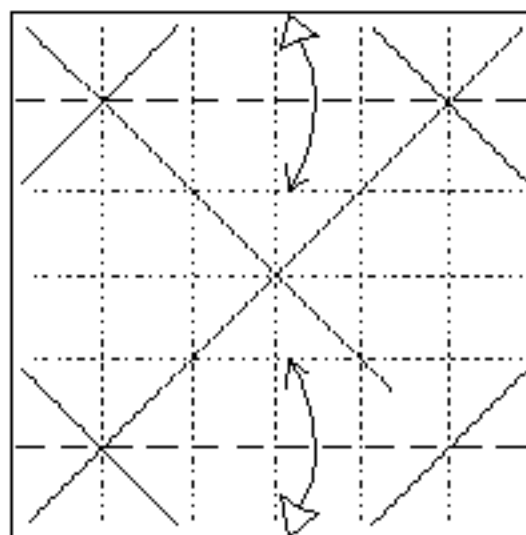

Fold and unfold.

13

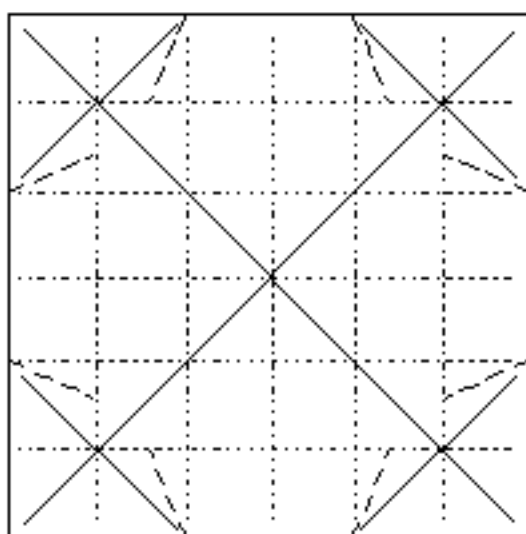

Fold the angle bisectors. The crease  
should stop at the nearest crease-line.  
This step isn't really necessary, but it  
makes the folding easier later on.

14

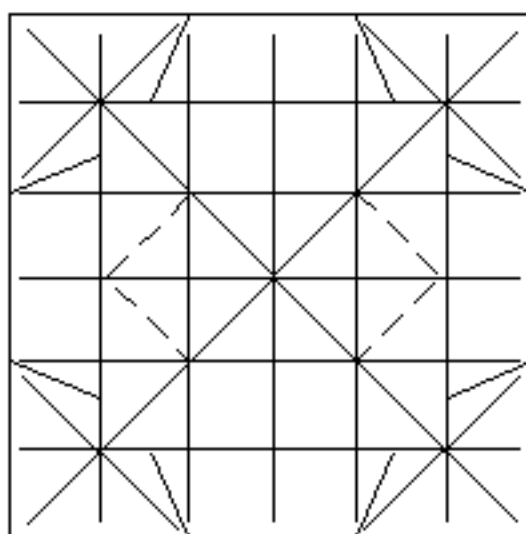

Fold the angle bisectors. Note  
that the creases do not reach the  
outer vertical crease-lines.

15

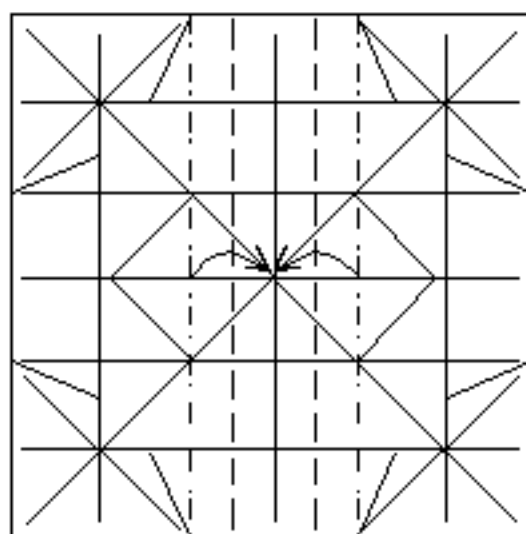

Pleat. The mountain-folds  
are on existing creases.

16

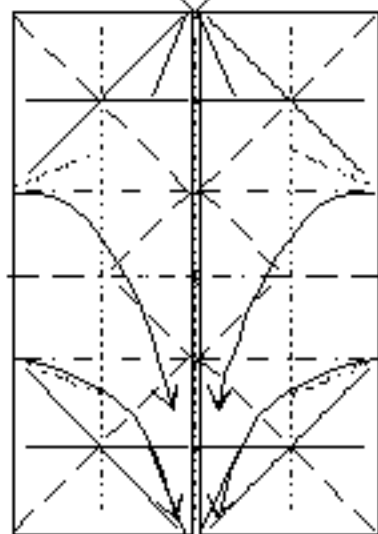

Collapse on existing creases.

17

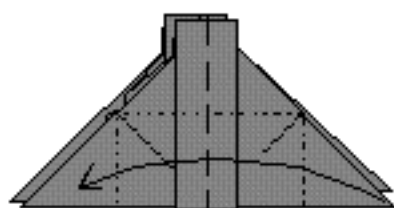

Like this. Book-fold  
one flap to the left.

18

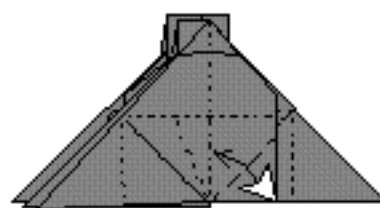

Fold and unfold.

19

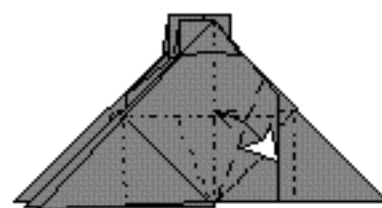

Fold the angle bisector  
and unfold.

20

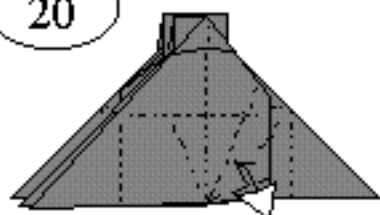

Fold the angle bisector  
and unfold.

21

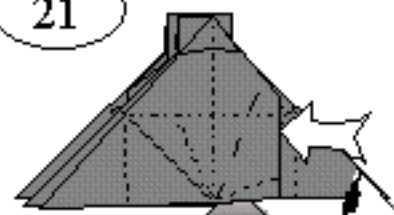

Reverse-fold/sink on  
existing creases.

22

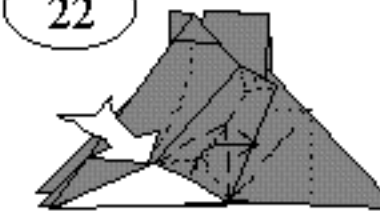

In the process, reverse-fold  
the paper to the right on  
existing creases.

23

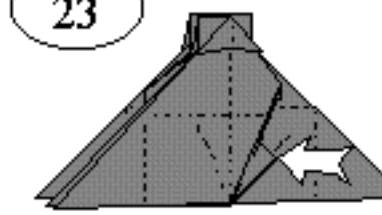

Reverse-fold on  
existing creases.

24

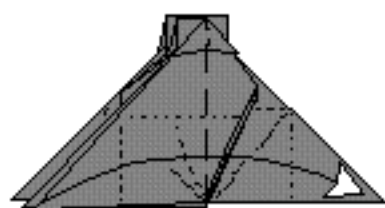

Book-fold one flap back to the right.

25

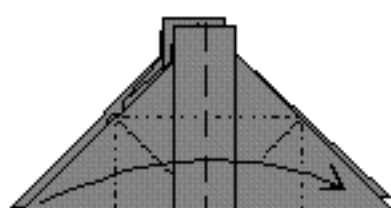

Repeat steps 17-24 on the left side.

26

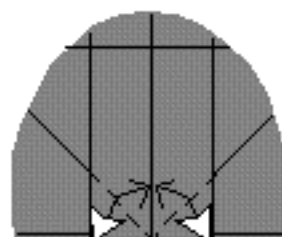

Enlarged view of the center. Fold and unfold.

27

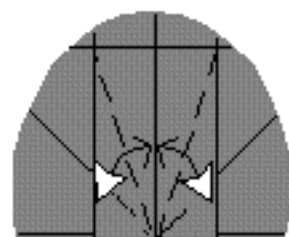

Fold the angle bisectors and unfold.

28

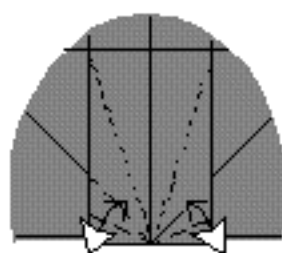

Fold the angle bisectors and unfold.

29

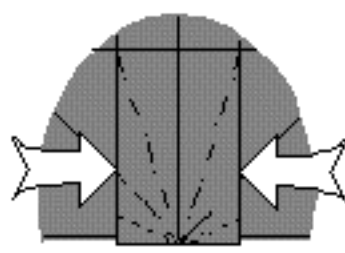

Repeat steps 21-23 on the small flaps.

30

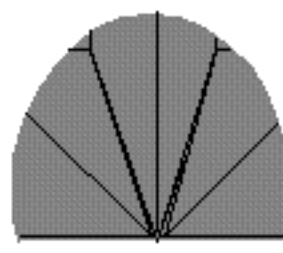

Repeat steps 26-29 behind.

31

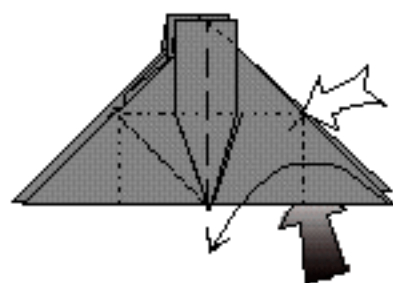

Lift one flap and squash-fold it symmetrically. Only press flat on the upper part.

32

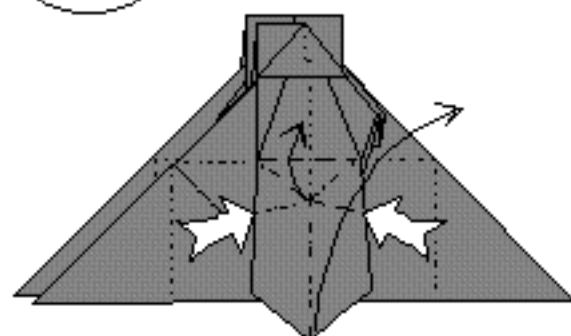

Pinch the lower edges of the squash fold together and swing the flap up to the right.

33

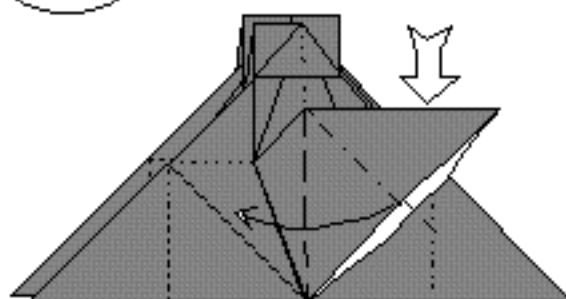

Squash-fold.

34

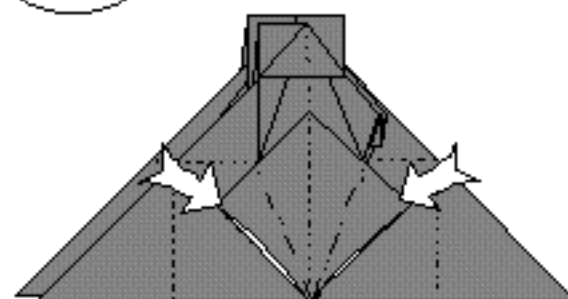

Reverse-fold.

35

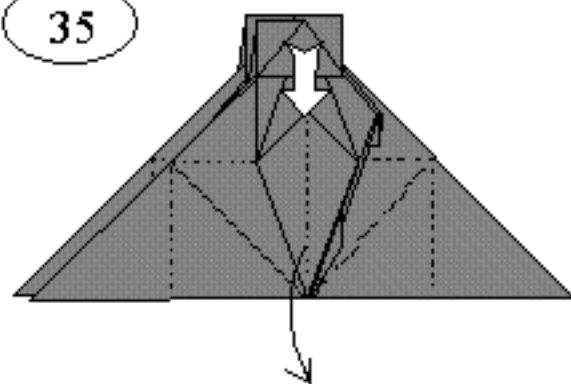

Pull the flap as far down as it will go, making a Stretched Bird Base.

36

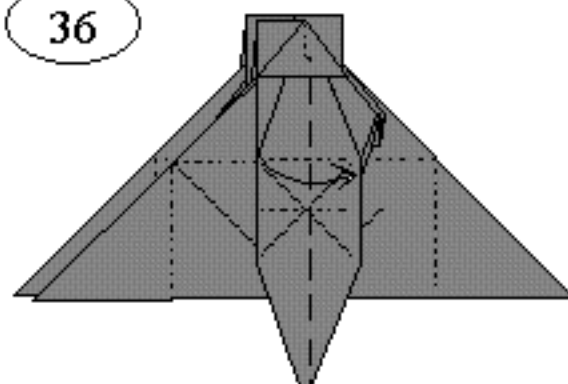

Book-fold two edges to the right.

37

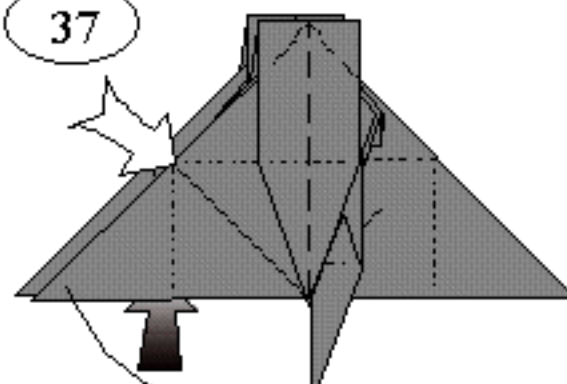

Repeat steps 31-36 on the left.

38

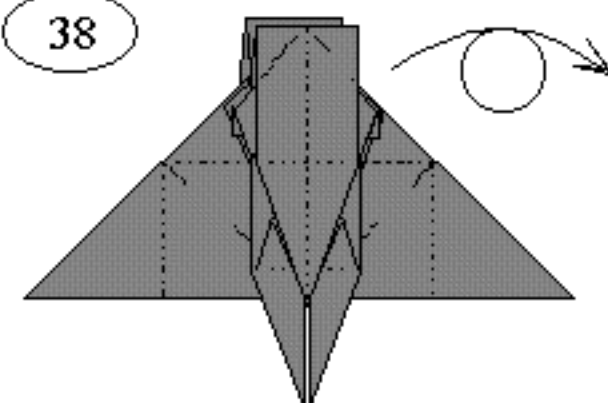

Turn the model over.

39

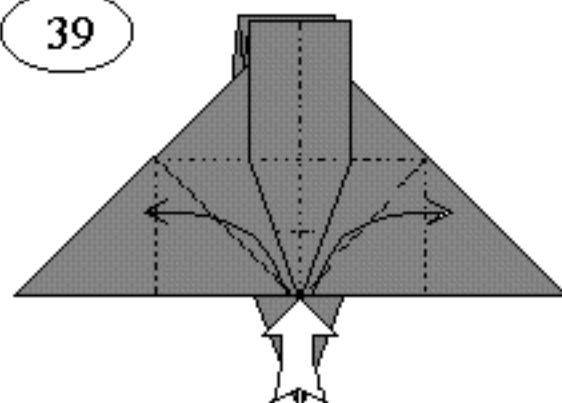

Pull the edges to each side and sink the center flap upwards as far as it will go.

40

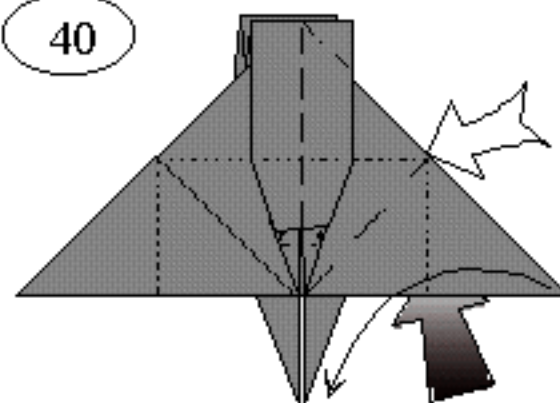

Repeat steps 31-37, but omit step 35.

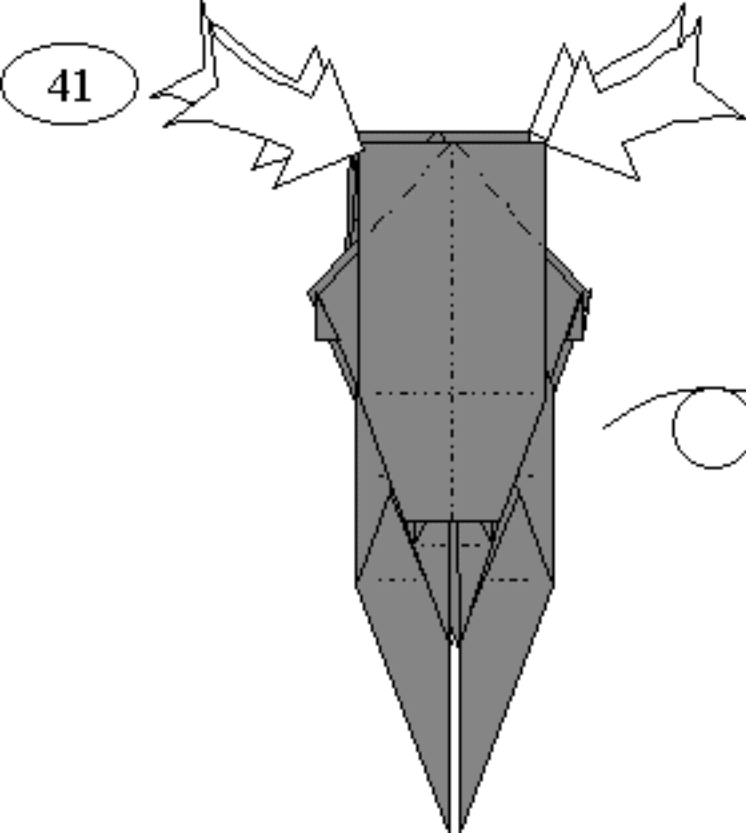

Reverse-fold the four corners.  
Turn the model over.

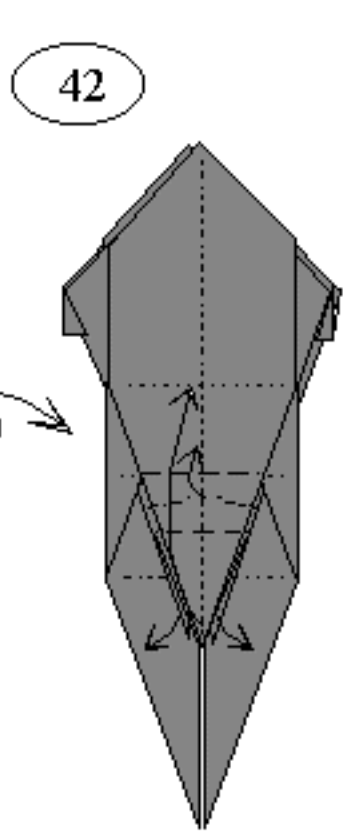

Pleat the flap and pull the  
antennae a bit out to each side.

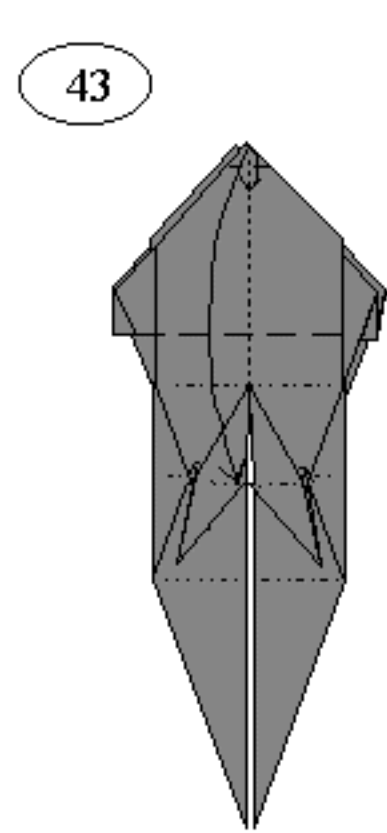

Round the upper corner and  
then fold one thick flap down.

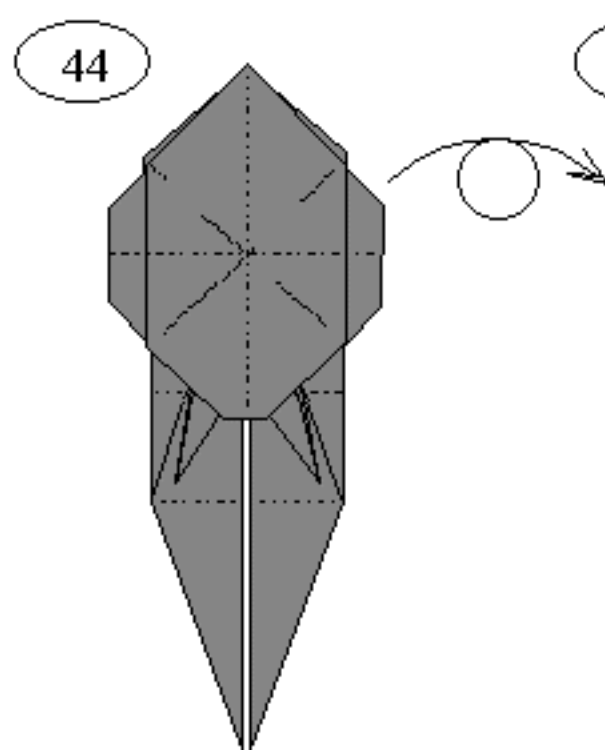

Turn the model over.

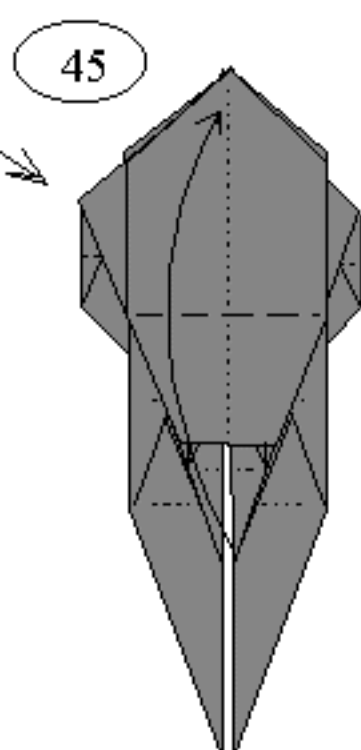

Fold one flap up.

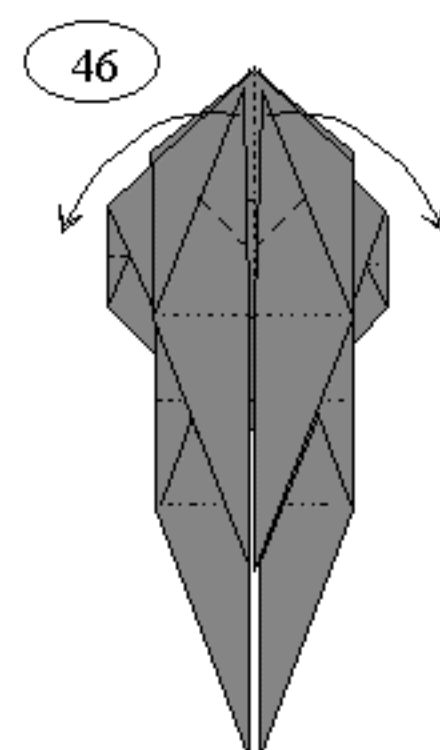

Valley-fold the two  
points to each side.

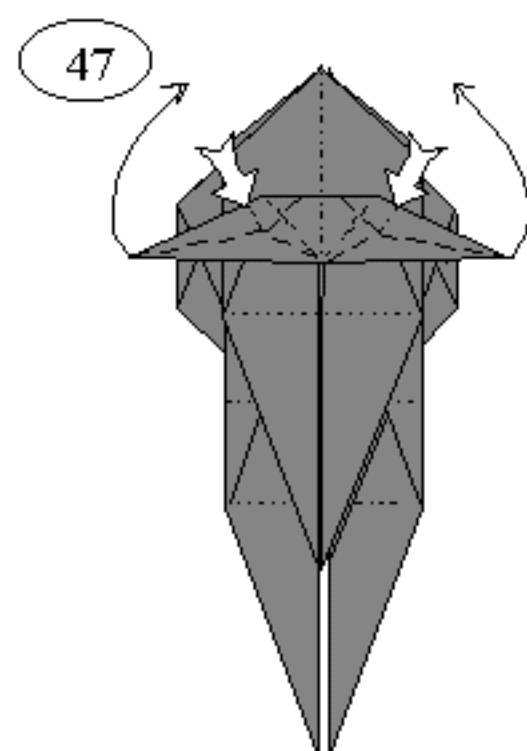

Rabbit-ear each point.  
These are the back legs.

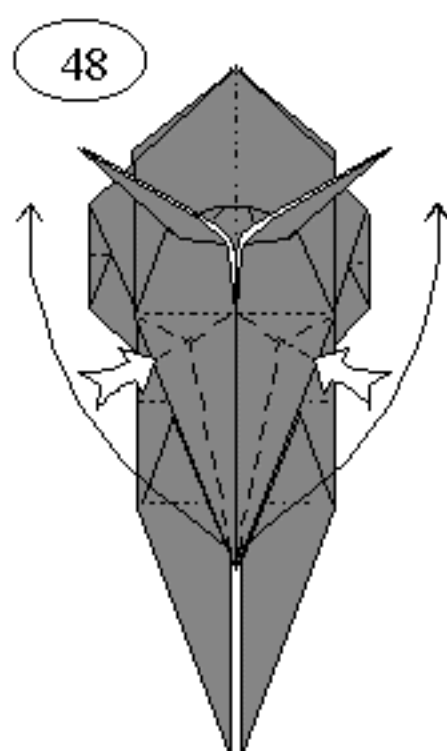

Rabbit-ear the next  
pair of points.

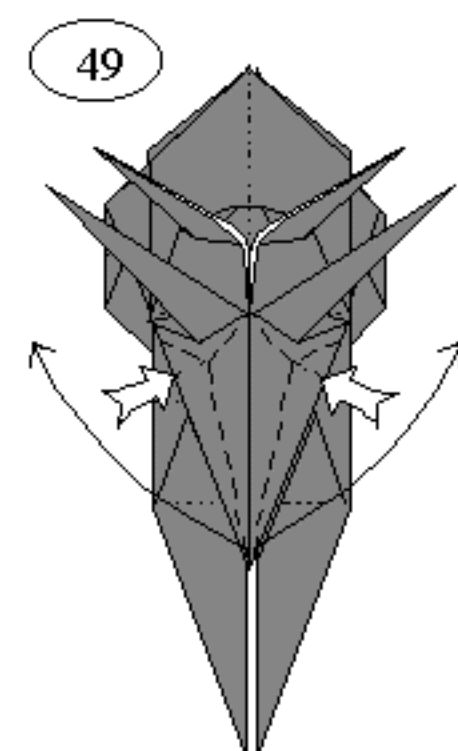

Rabbit-ear the next  
pair of points.



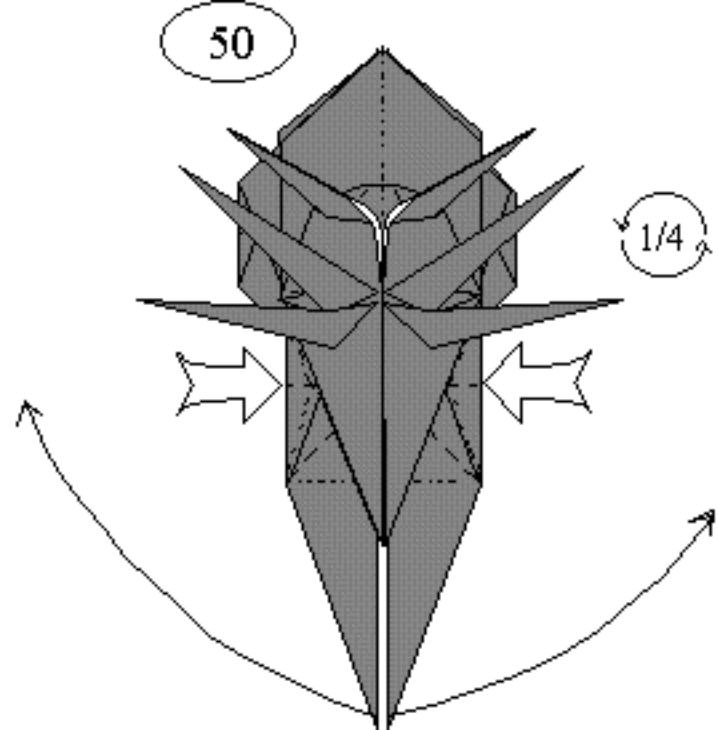

50  
Push in the sides symmetrically and move the long points 90° in each direction. Turn the model 1/4 counter-clockwise.

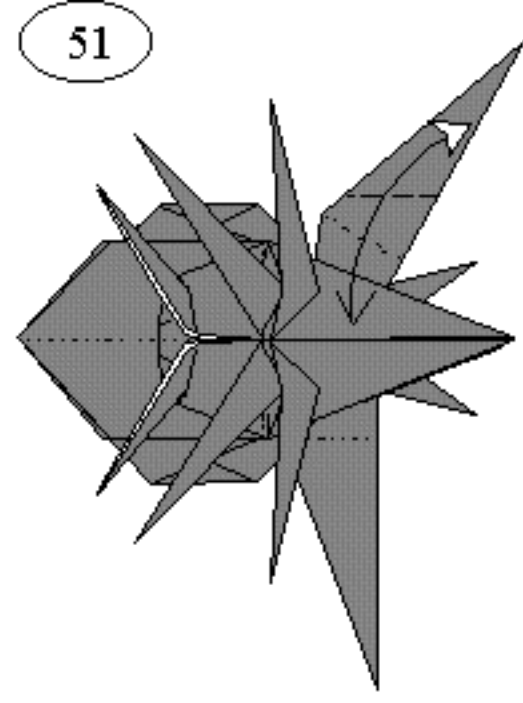

51  
Fold and unfold.

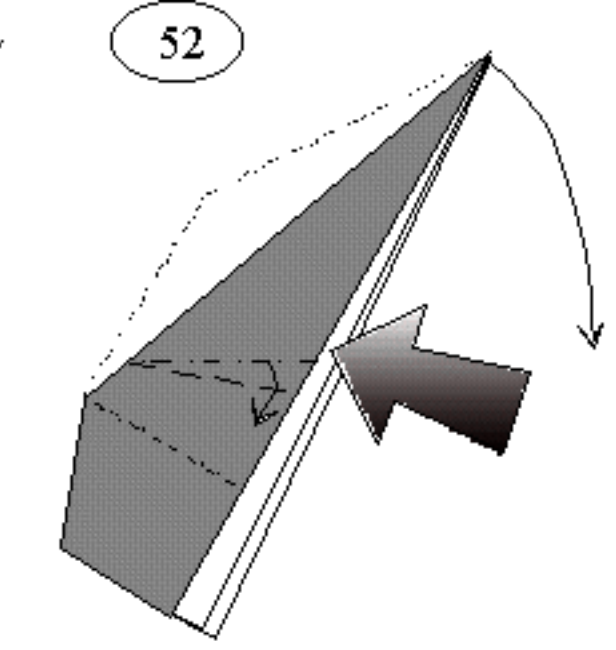

52  
Enlarged view. Push in the middle edge and crimp symmetrically.

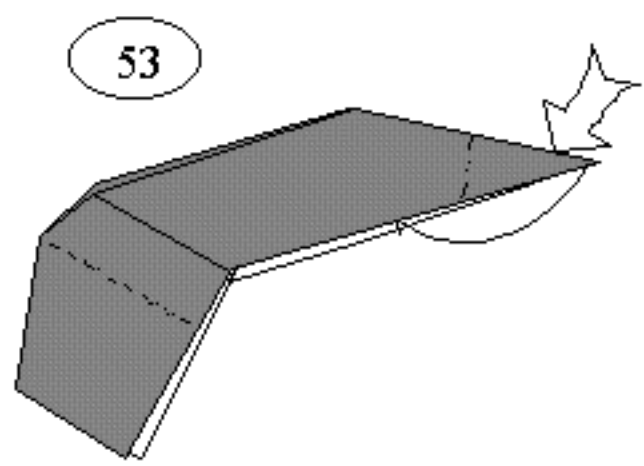

53  
Reverse-fold the tip.

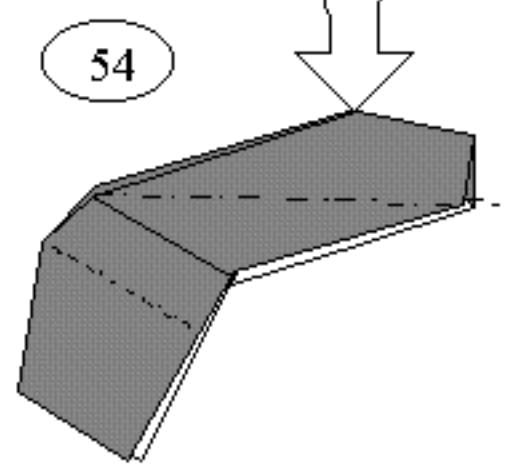

54  
Closed-sink.

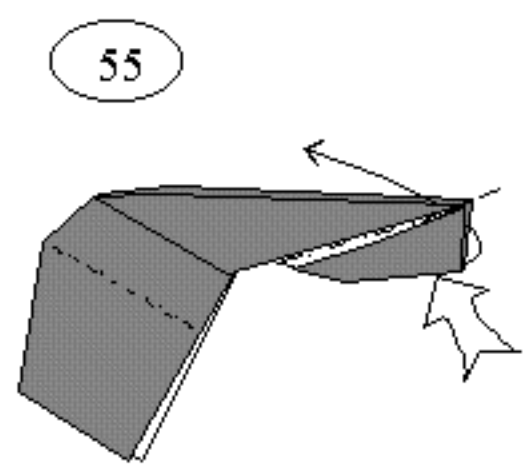

55  
Reverse-fold.

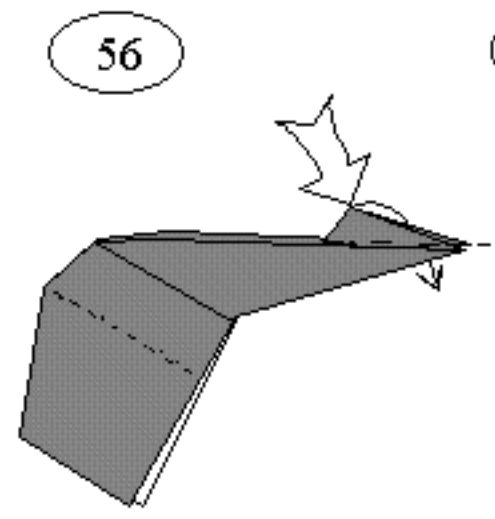

56  
Reverse-fold.

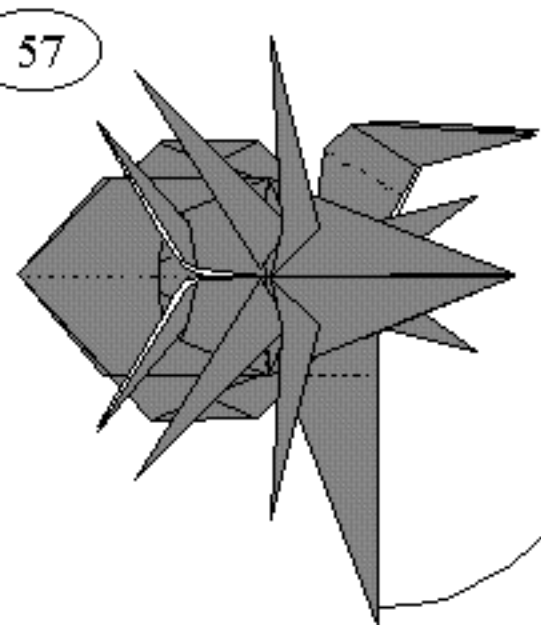

57  
Unfold to the position in step 50.

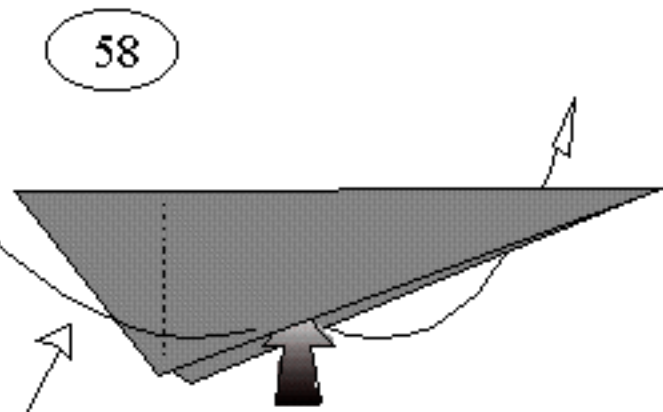

58  
Enlarged view of the lower claw. Open flat.

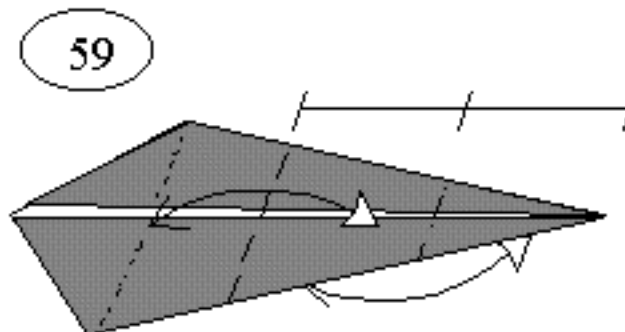

59  
Fold and unfold.

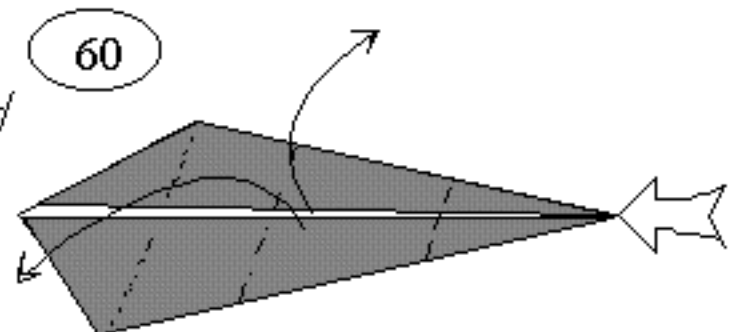

60  
Open up and double-sink on existing creases.

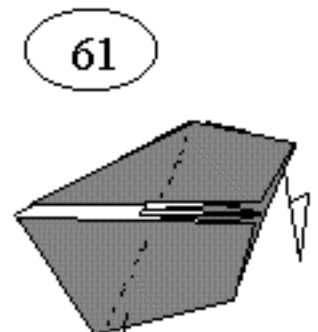

61  
Like this. Refold the flap to the position in step 57.

62

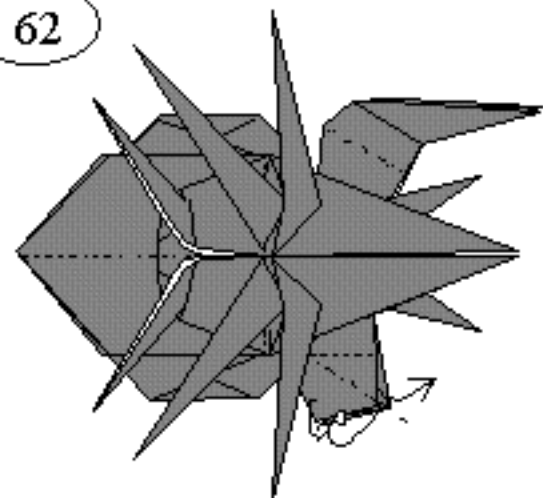

Narrow the claw, folding the corners inside. Pull out the hidden point.

63

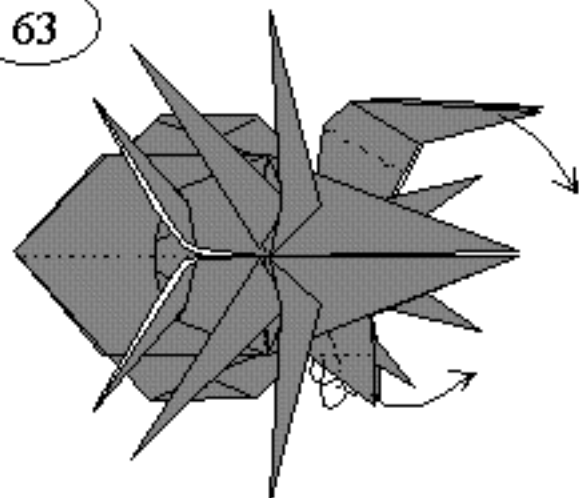

Swivel both claws to the front, and then narrow the small claw further.

64

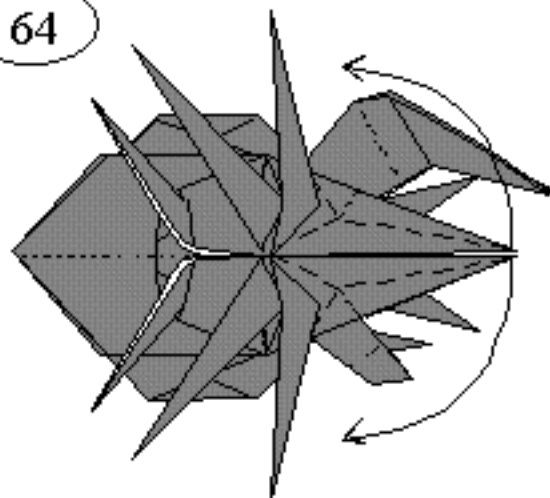

Rabbit-ear the front legs. Make them as long as possible.

65

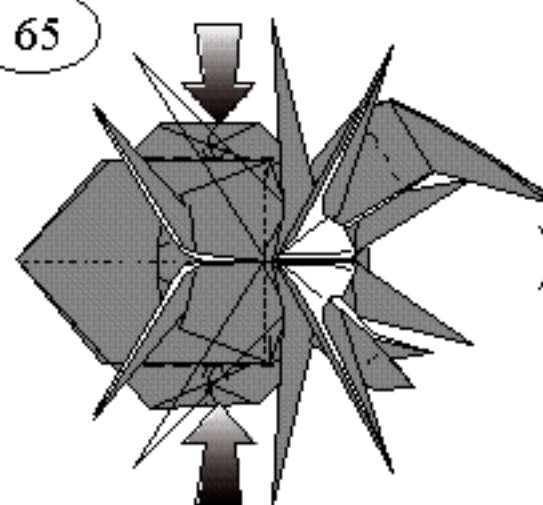

Valley-fold the edges and tuck them inside.

66

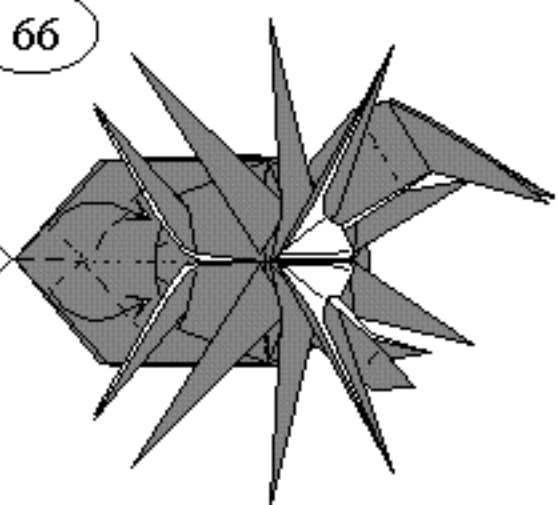

Make a rabbit ear.

67

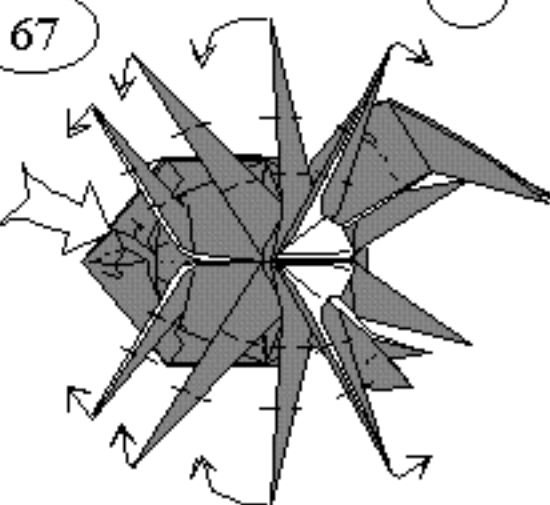

Squash-fold the indicated flap. Curve the legs with valley-folds. Turn the model over.

68

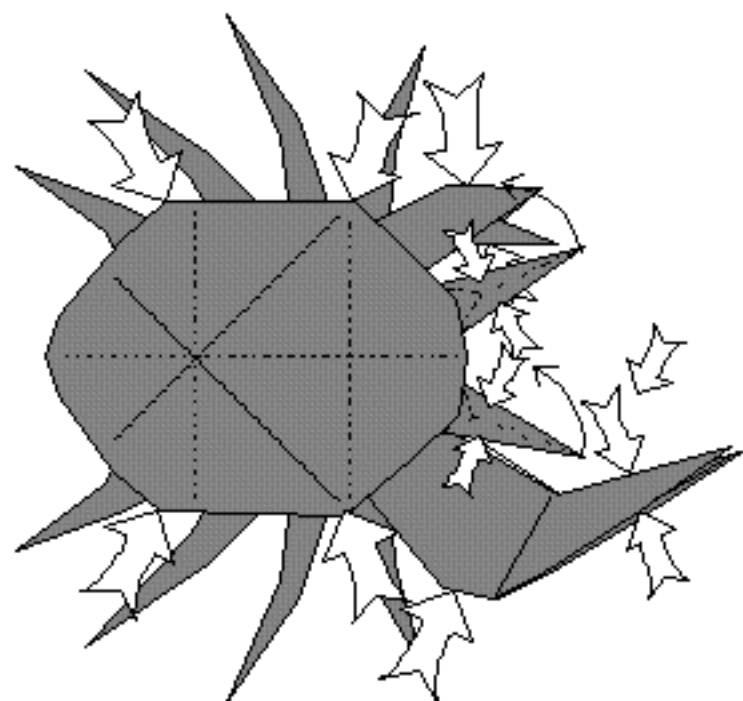

Narrow the antennae. Round the claws and shell.

69

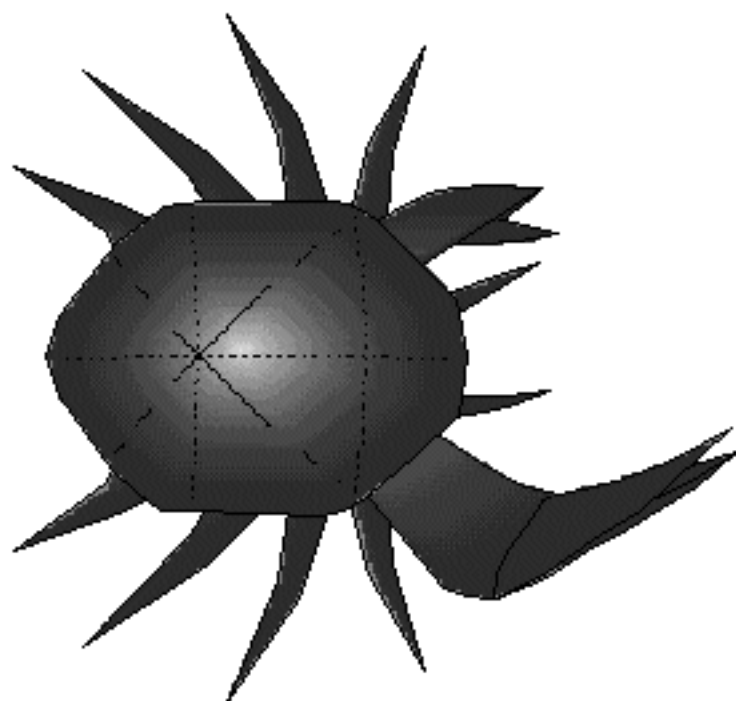

Fiddler Crab

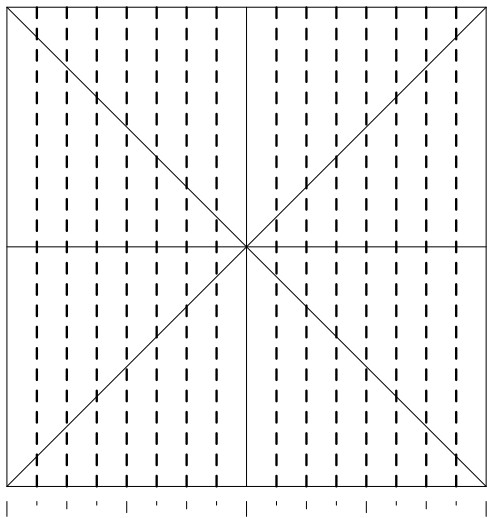

1

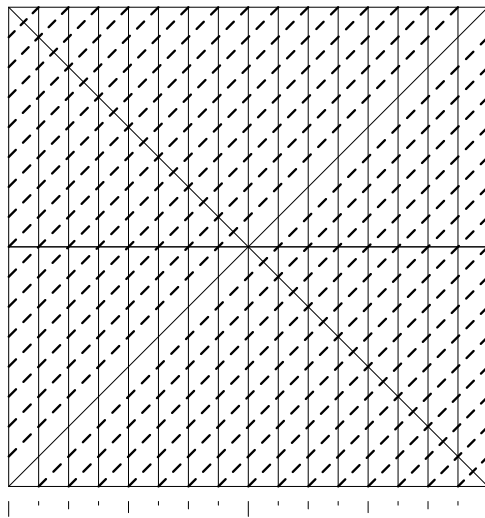

2

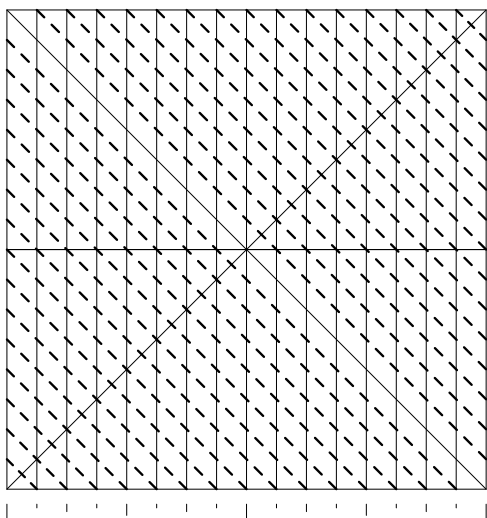

3

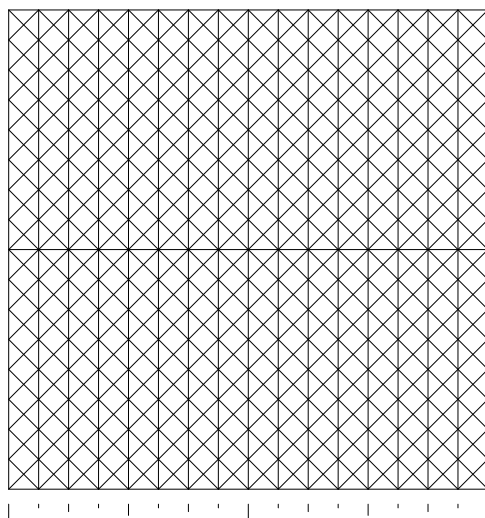

4

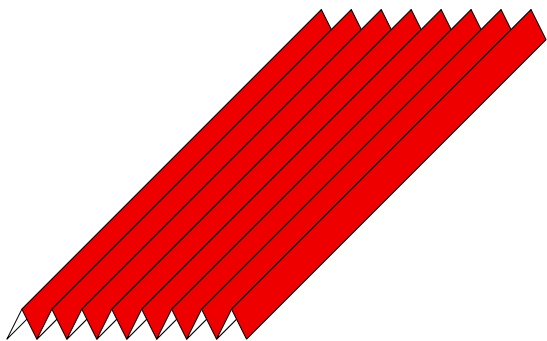

5

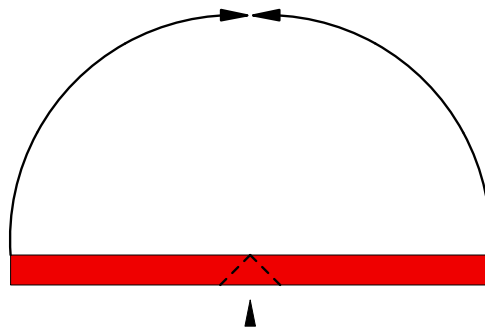

6A Reverse fold in the center to fold both ends up

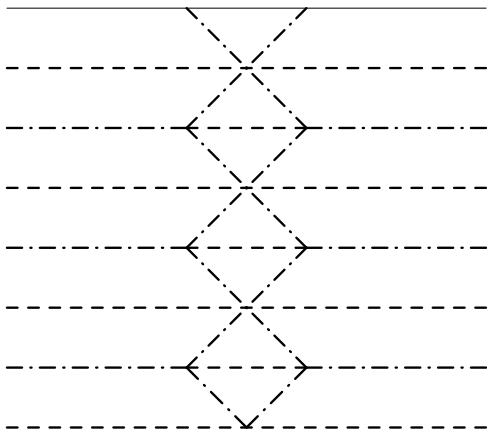

6B Crease pattern  
seen from bottom

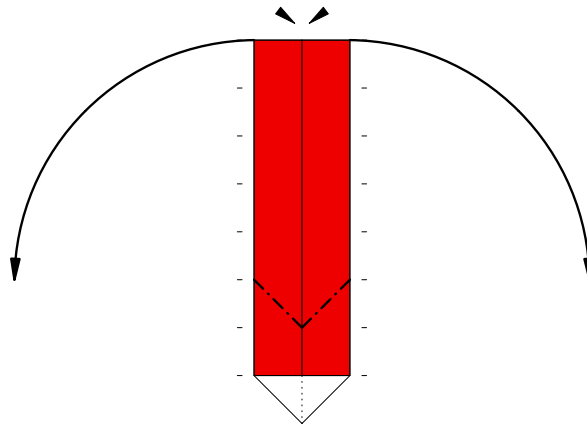

7 Fold ends out via  
zigzag reverse folds

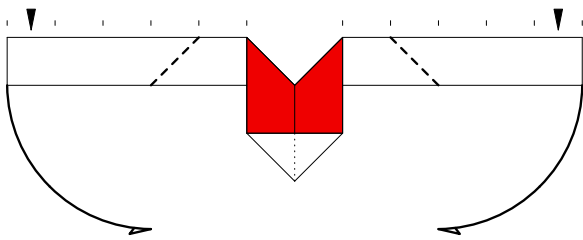

8

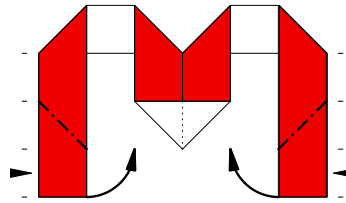

9

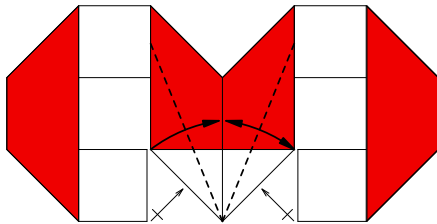

10

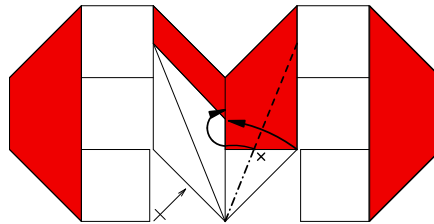

11 Right flap to the left;  
point X between flap

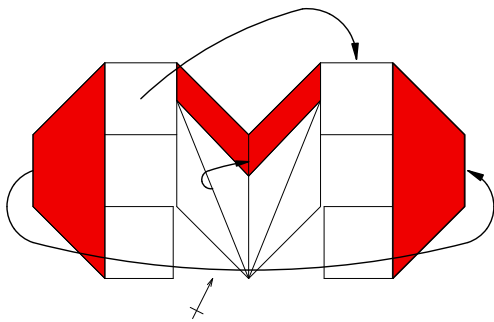

12 Center: left flap behind right flap.  
Left end overlaps right end for 2/16.  
Repeat behind; very difficult

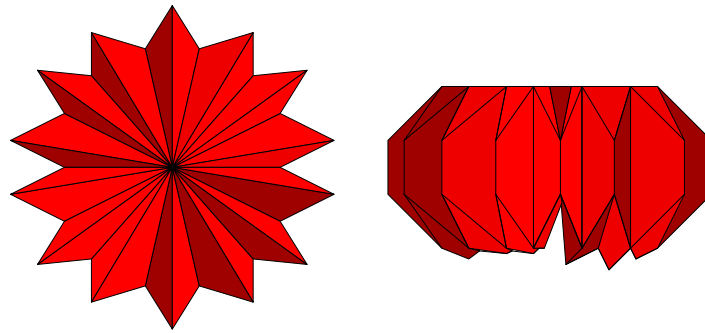

13 Finished: top view and side view

# The Little genetically manipulated Devil

Design: 11.94 by Hans Birkeland (Norway) ©1994

Use a large sheet of thin paper or foil. [To get colour-changed eyes with a one-coloured paper, you can just paste a piece of golden foil at the top corner of the square, as shown in step 14.]  
Begin with the coloured side up.

The Little Devil

The Little genetically manipulated Devil

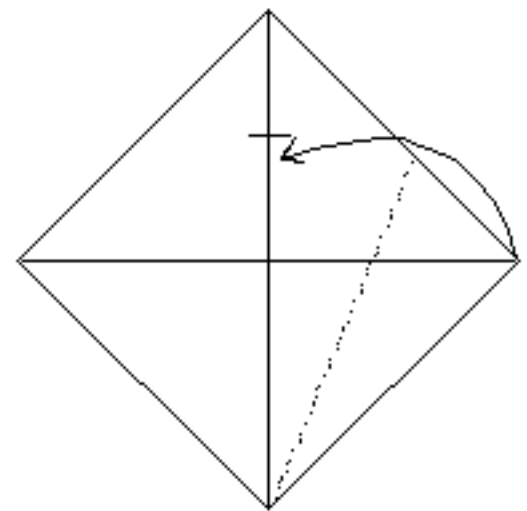
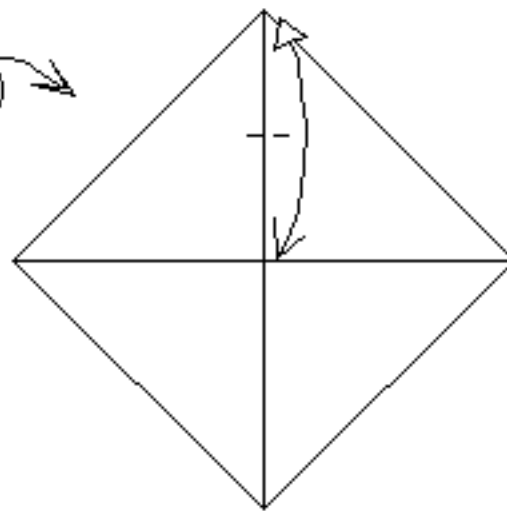
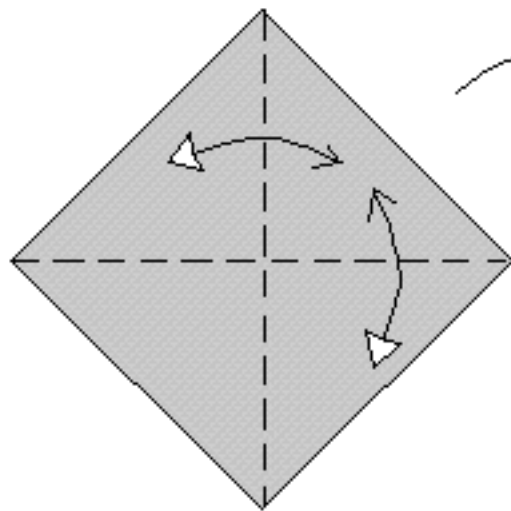
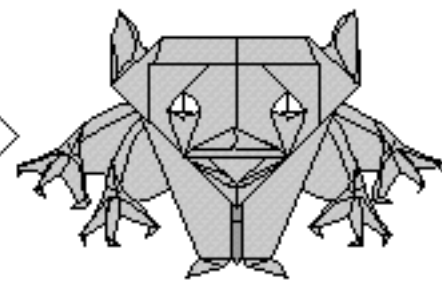
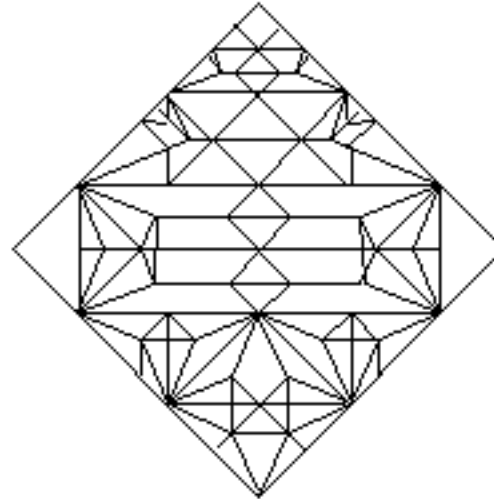
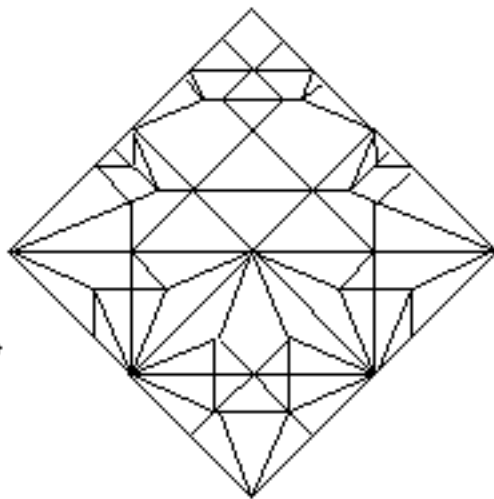
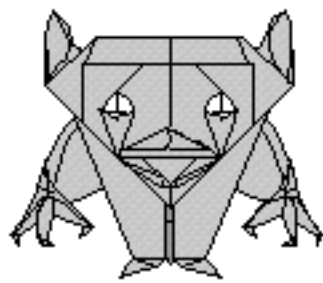

**1** Fold and unfold.  
Turn the paper over.

**2** Make a mark.

**3** Fold the edge to the midline  
without making a crease.

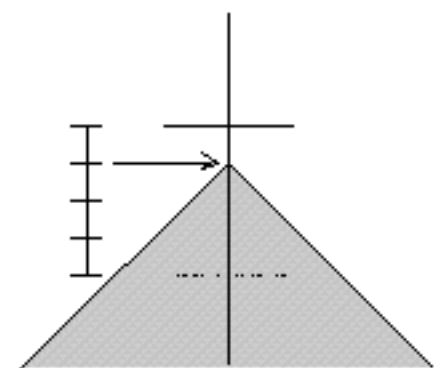
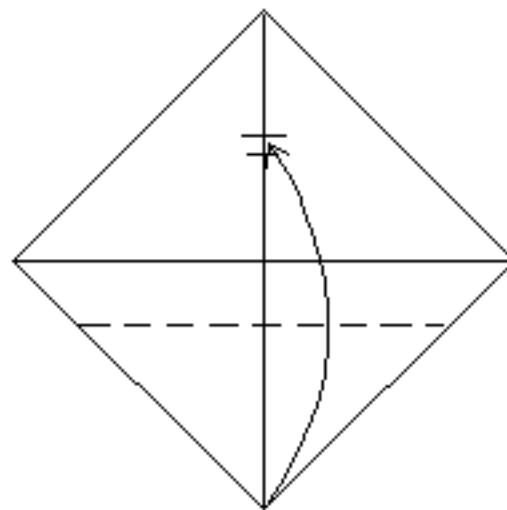
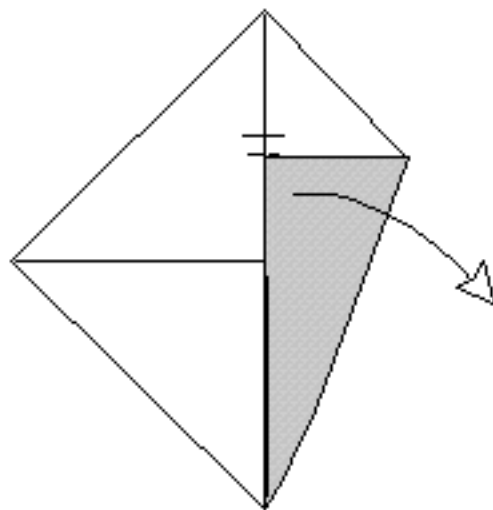

**4** Make a mark with your nail  
where the coloured edge  
hits the vertical diagonal.  
Unfold.

**5** Valley-fold the bottom corner  
to a point about 3/4  
between the two marks.

**6** Enlarged view.

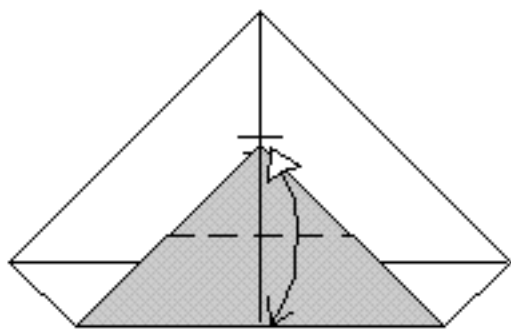

**7** Fold and unfold.

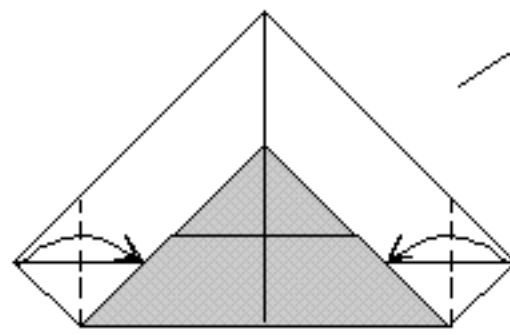

**8** Valley-fold the corners.  
Turn the model over.

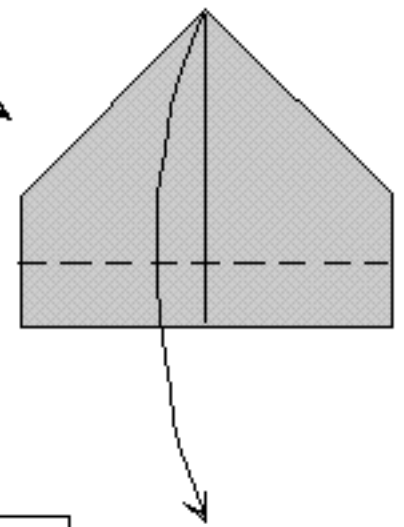

**9** Valley-fold down on  
an existing crease.

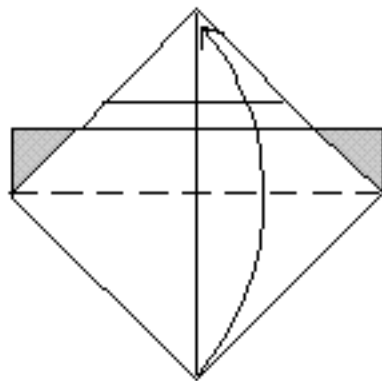

**10** Valley-fold.

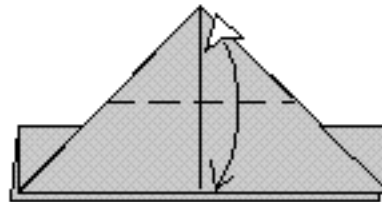

**11** Fold and unfold.

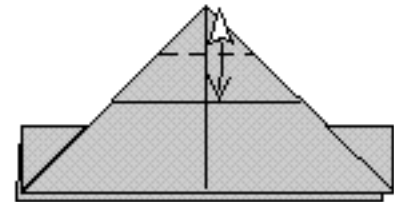

**12** Fold and unfold.

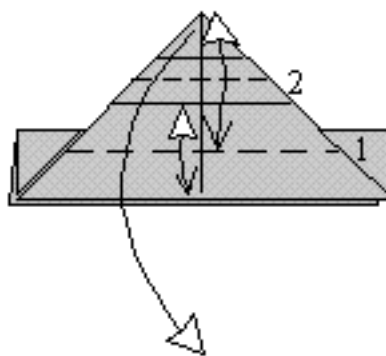

**13** Fold and unfold in the  
indicated order. Then  
unfold the whole flap  
downward.

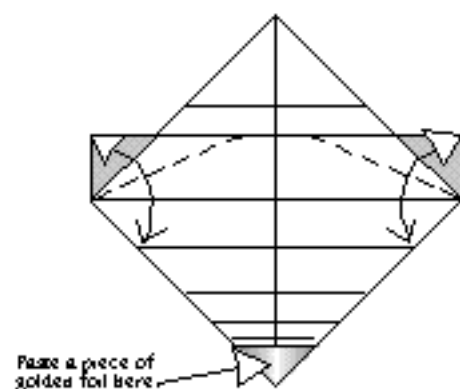

**14** Fold and unfold, making  
angle bisectors. The foil  
is optional.

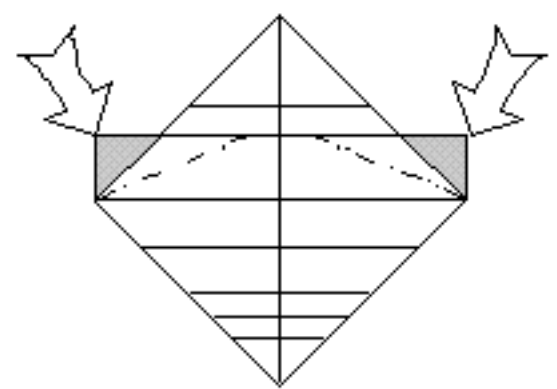

**15** Reverse-fold.

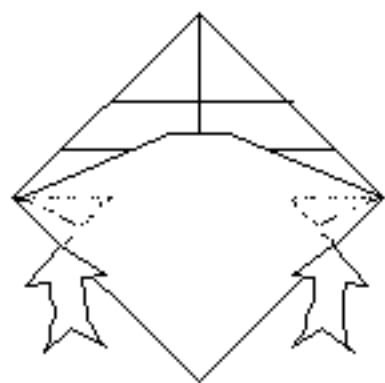

**16** Reverse-fold the two hidden edges upward.

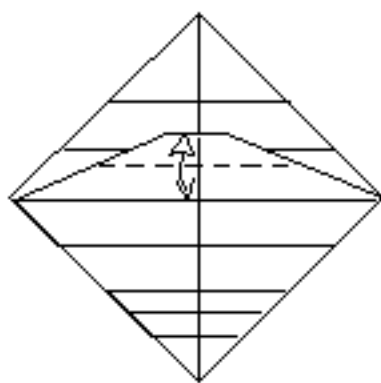

**17** Fold the edge down to the centerline and unfold.

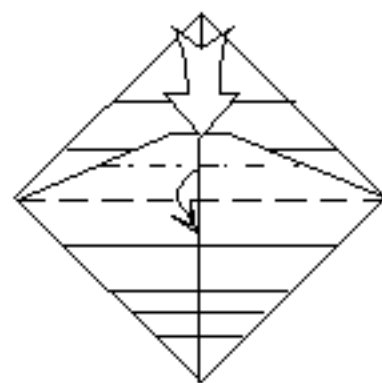

**18** Spread-squash on existing creases.

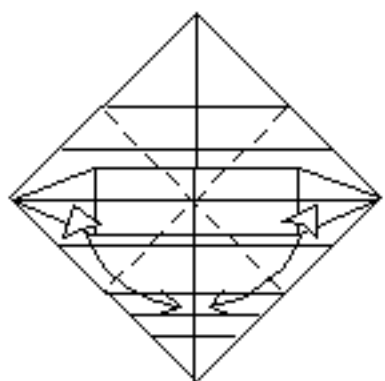

**19** Fold and unfold.

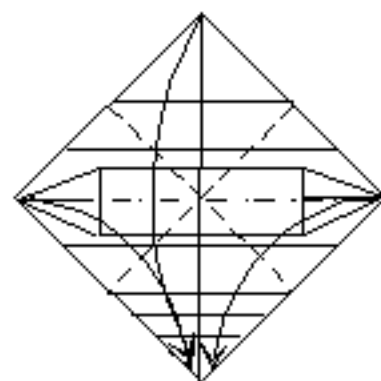

**20** Make a preliminary fold.

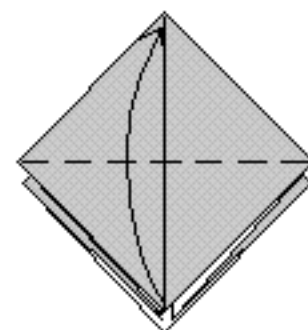

**21** Valley-fold one layer upward on an existing crease.

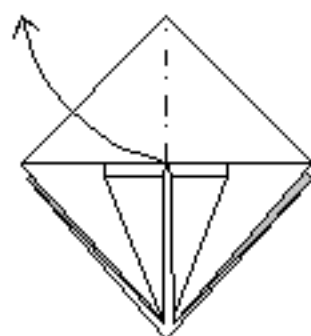

**22** Open out the edge to the left.

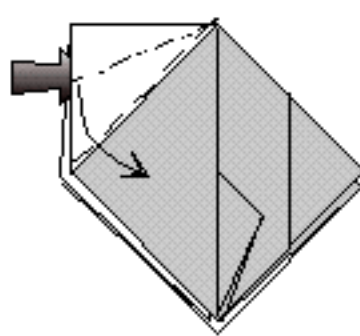

**23** Squash-fold.

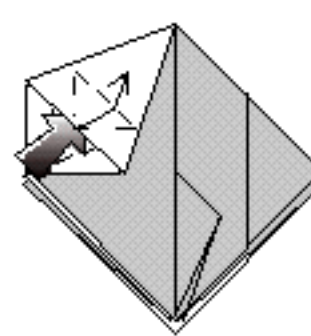

**24** Petal-fold.

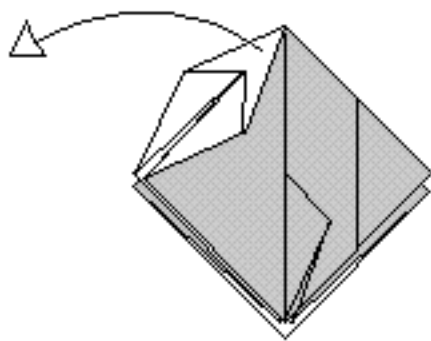

**25** Unfold the flap completely.

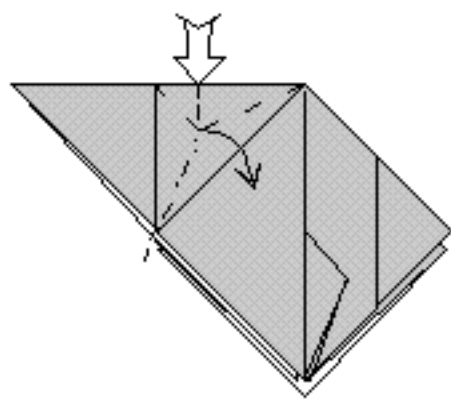

**26** Collapse symmetrically on existing creases.

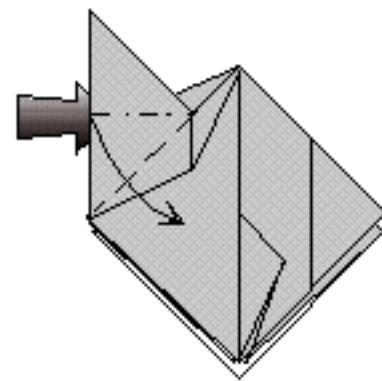

**27** Squash-fold on existing creases.

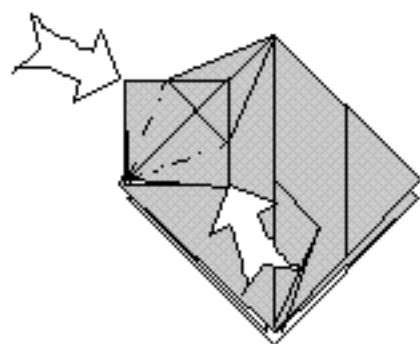

**28** Reverse-fold the edges on existing creases.

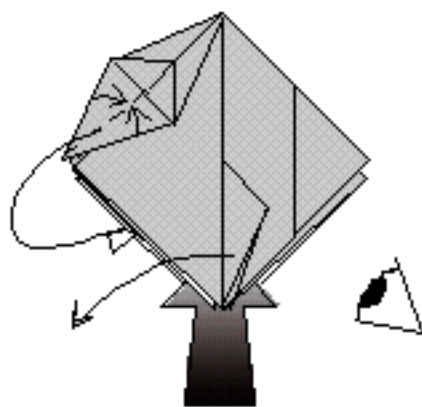

**29** Press together only the nearest layers and swivel the flap around its axis and into the interior of the model. Next view from the interior.

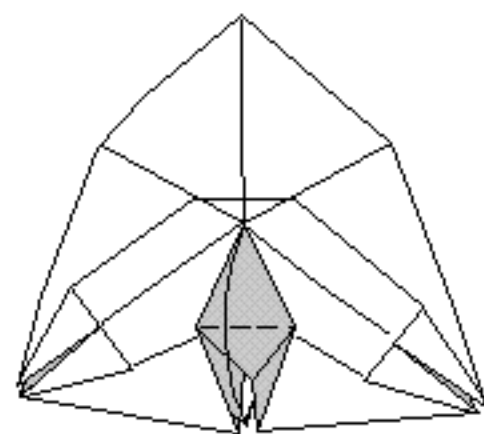

**30** Valley-fold the flap down.

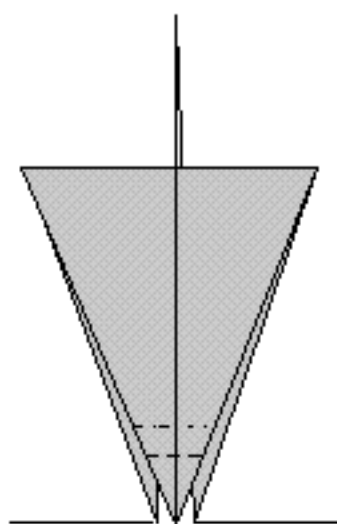

**31** Enlarged view. Make a pleat.

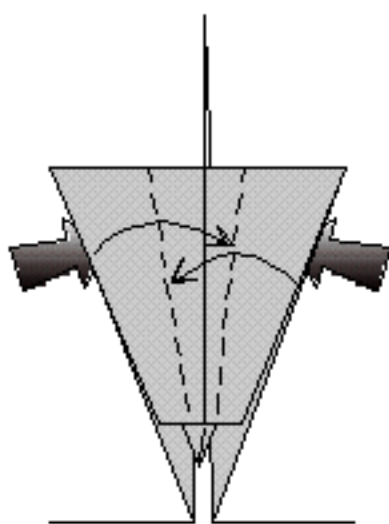

**32** Valley-fold the edges past the mid-line, dividing in thirds. There will be squash-folds at the top and bottom of each edge.

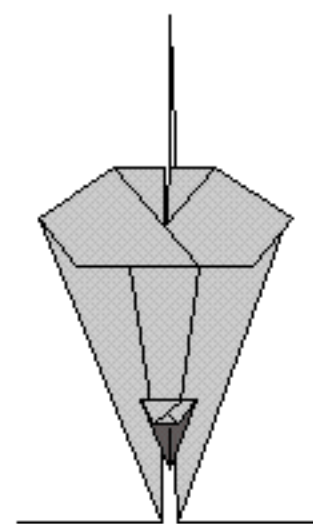

**33** Bring the two dark edges to the front.



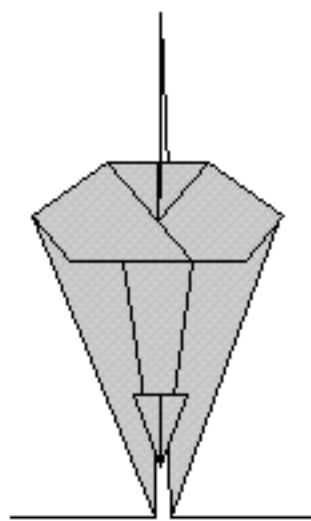

**34** Like this. Now close the model to the position in step 29 without pressing flat where the tail is.

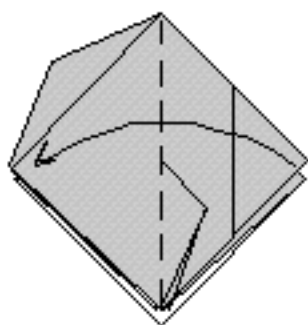

**35** Book-fold one layer to the left.

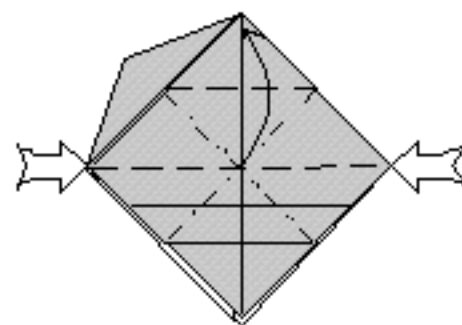

**36** Collapse on existing creases.

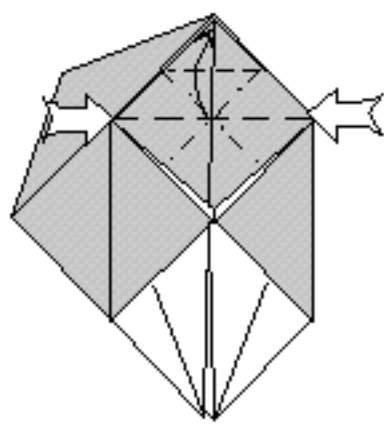

**37** Collapse on existing creases.

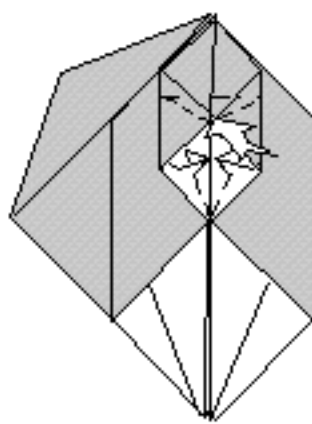

**38** Swivel-fold. Notice that the loose corner of the little square disappears into the pocket that is formed.

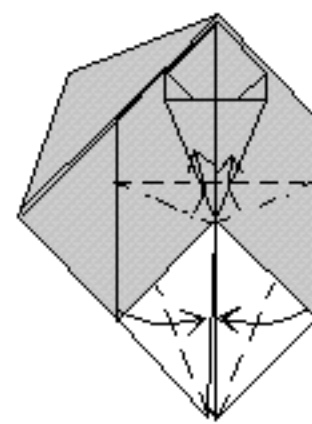

**39** Swivel-fold.

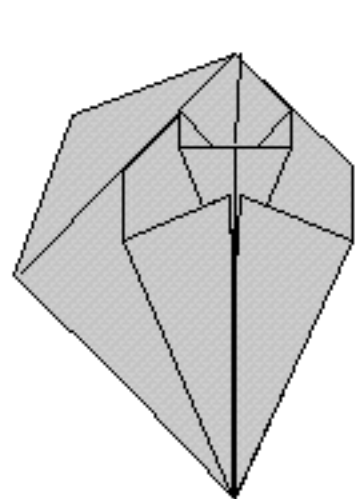

**40** Turn the model over.

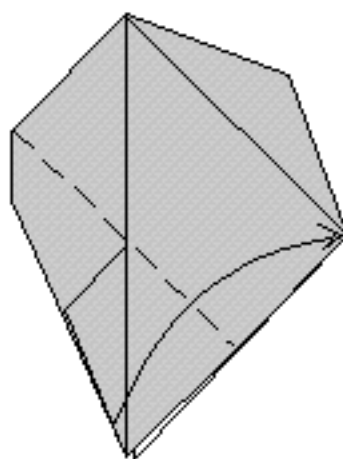

**41** Valley-fold the upper layers so that two bottom corners meet the right corner.

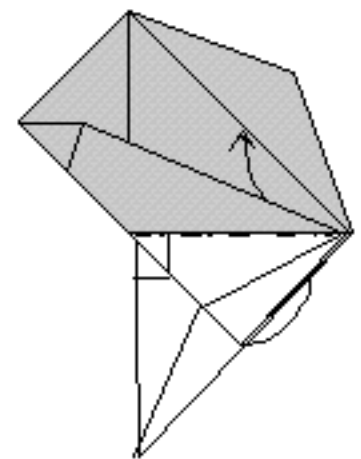

**42** Reverse-fold.

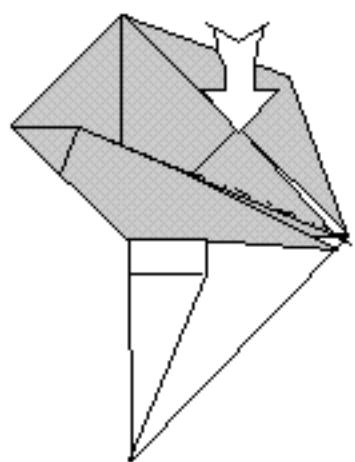

**43** Reverse-fold.

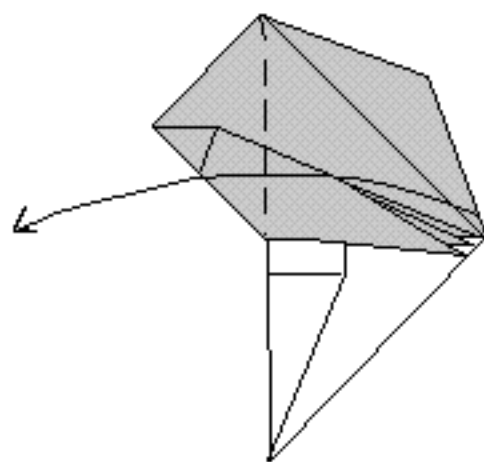

**44** Book-fold the whole assembly to the left.

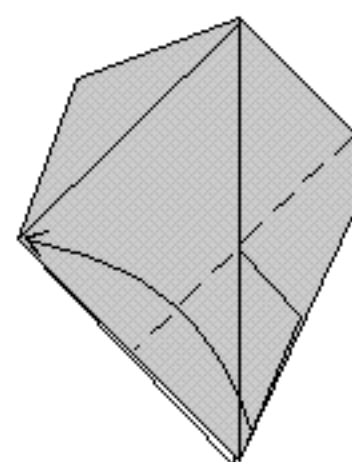

**45** Repeat steps 41-43 on this side.

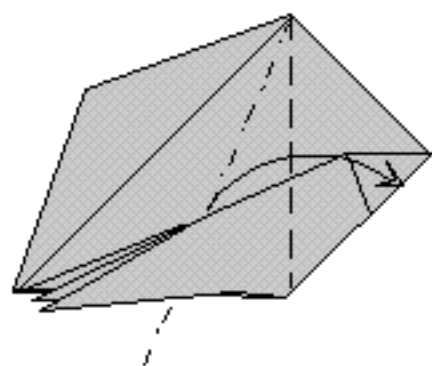

**46** Open up between the middle layers and squash-fold the model symmetrically.

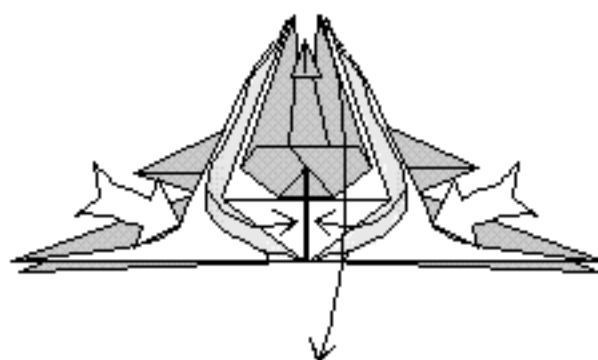

**47** An intermediate step. Fold the inner edges to the midline before the model is pressed flat.

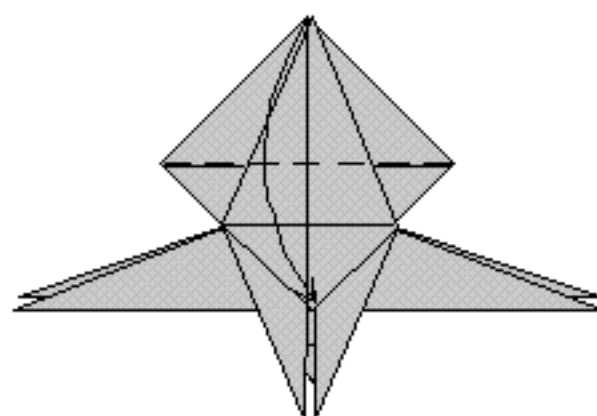

**48** Valley-fold downward through all layers.

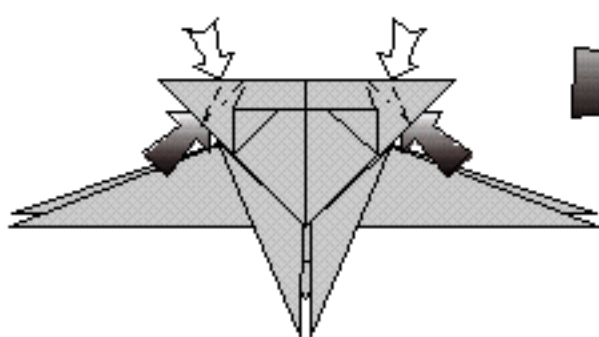

**49** Open up and crimp the ears (there will be two edges in front).

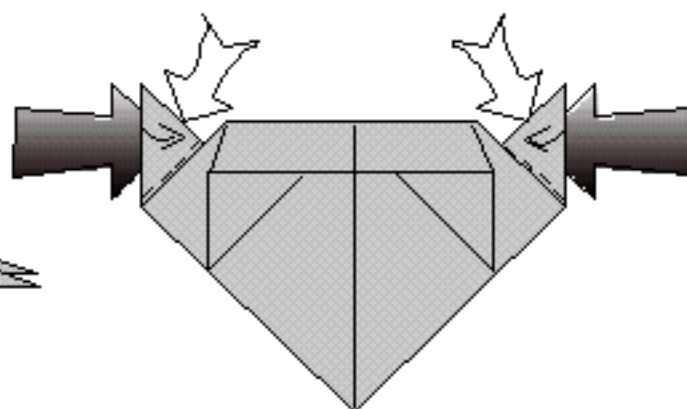

**50** In the next steps only the head is shown. Form the ears by opening up the nearest layer.

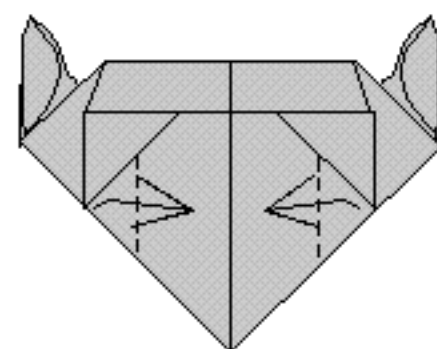

**51** Valley-fold.

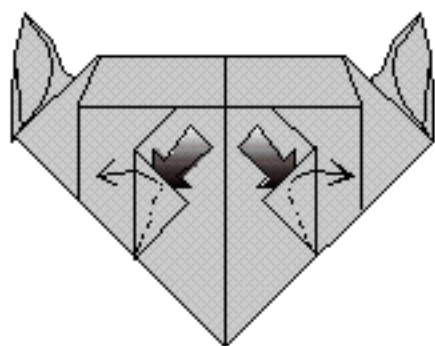

**52** Squash-fold the eyes.

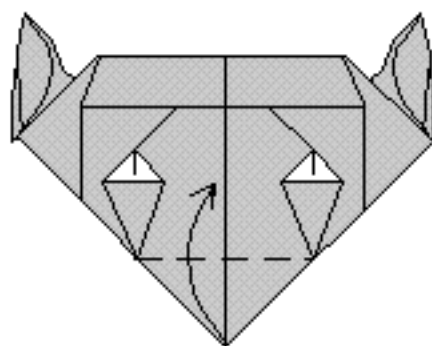

**53** Valley-fold one layer.

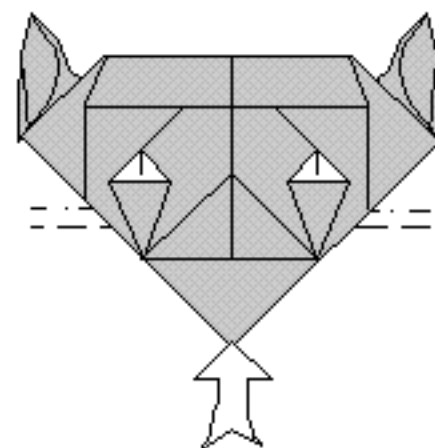

**54** Push the next corner a bit upward and press flat, thus forming an internal pleat.

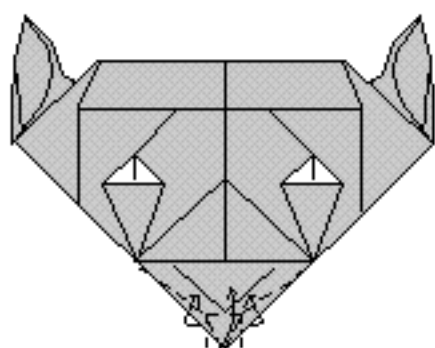

**55** Swivel-fold the edges as you fold the lower corner upward, placing it behind the tongue.

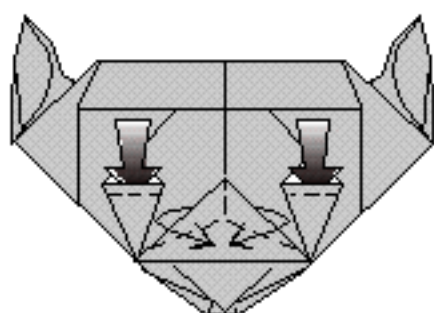

**56** Rabbit-ear the nose. Then open the eyes.

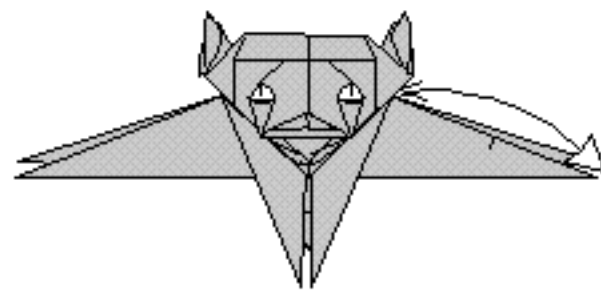

**57** The head is now finished. Make a mark on the upper edge of the nearest right arm.

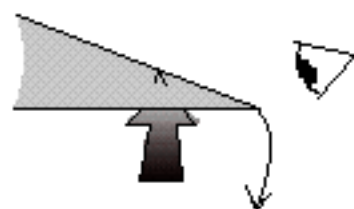

**58** Spread the bottom layers and push up the middle edge, making a mountain crease connecting the marks on the two upper edges.

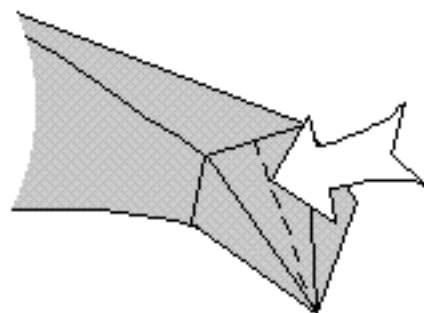

**59** In progress. Close the open area and press flat when there's a 90° angle between the bottom edges.

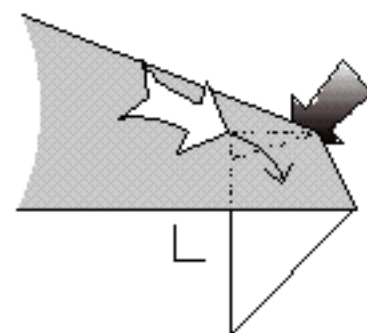

**60** Like this. Reverse-fold a part of the hidden edge.

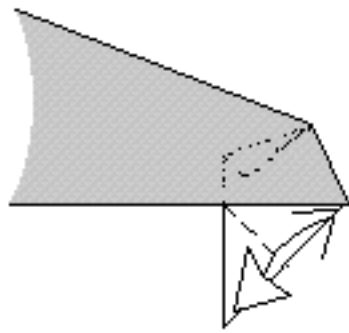

**61** Fold and unfold.

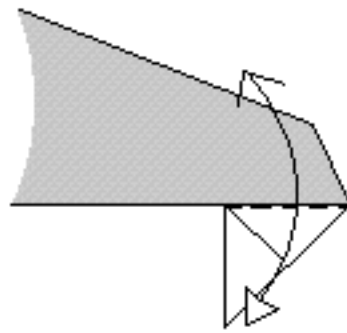

**62** Fold and unfold.

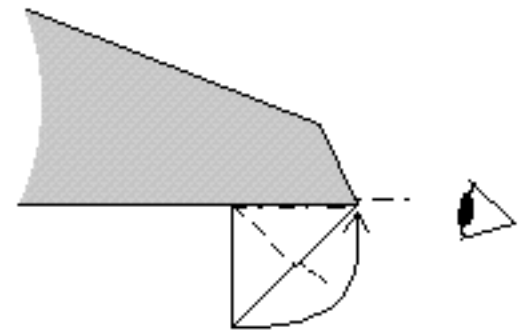

**63** Crimp on existing creases.

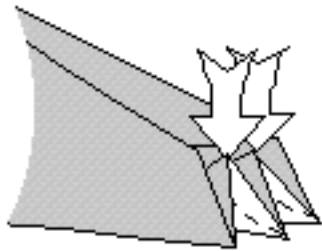

**64** Reverse-fold two edges.

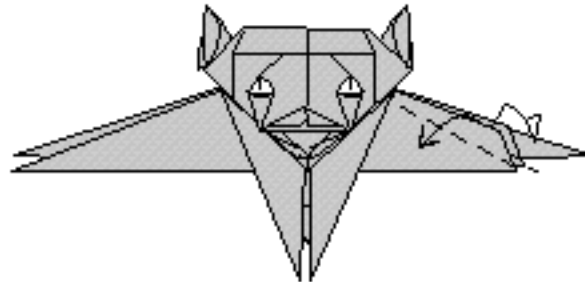

**65** Valley-fold the edges downward, making an angle bisector.

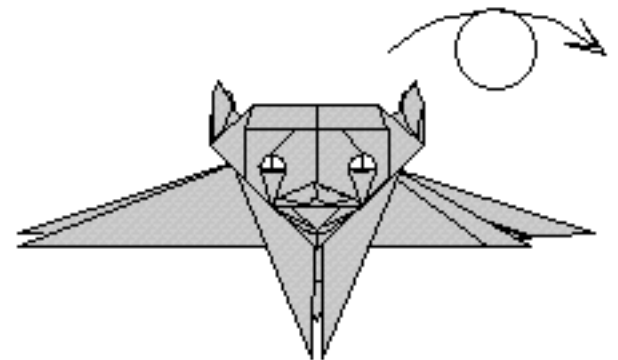

**66** Repeat steps 57-65 on the three other arms. Then turn the model over.

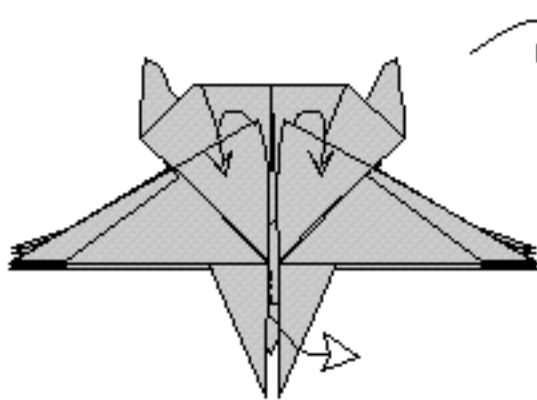

**67** Pull out the tail and pinch it slightly. Curl the wings outward. Turn the model over.

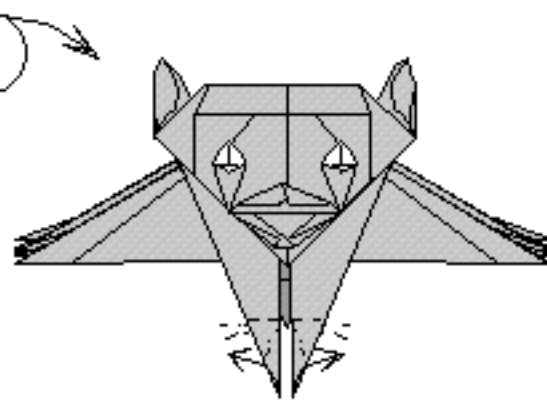

**68** Swivel-fold the legs to make feet. They should point forward and have small heels pointing backward.

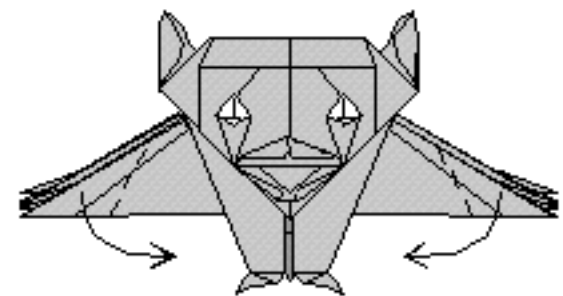

**69** Curl the arms forward and spread the fingers.

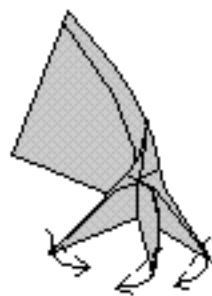

**70** Valley-fold the tip of the fingers to make claws.

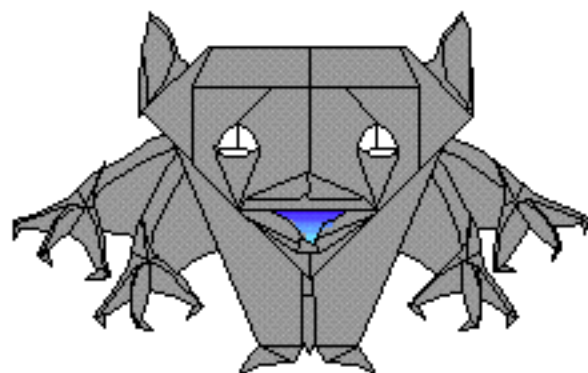

**71** The Little genetically manipulated Devil.

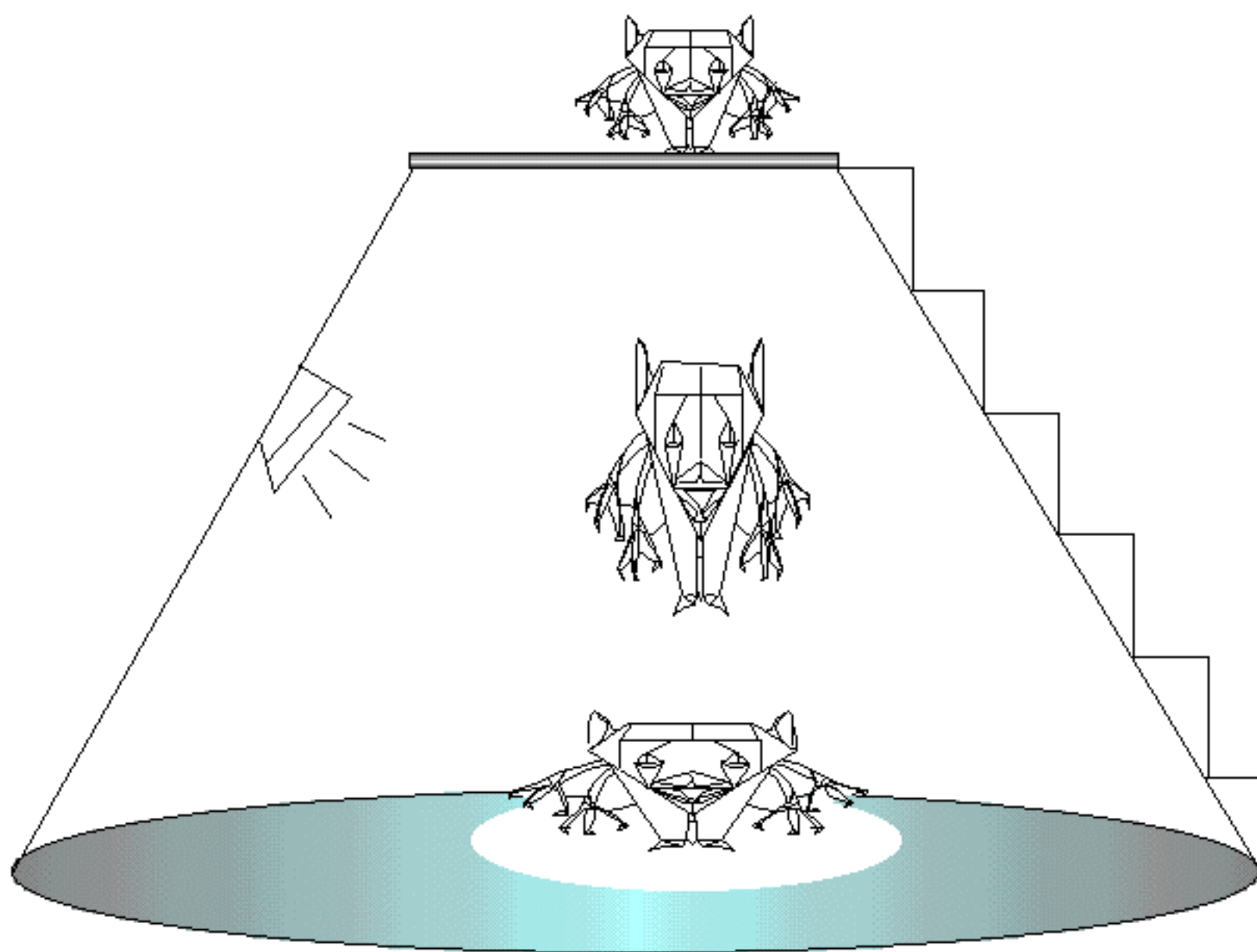
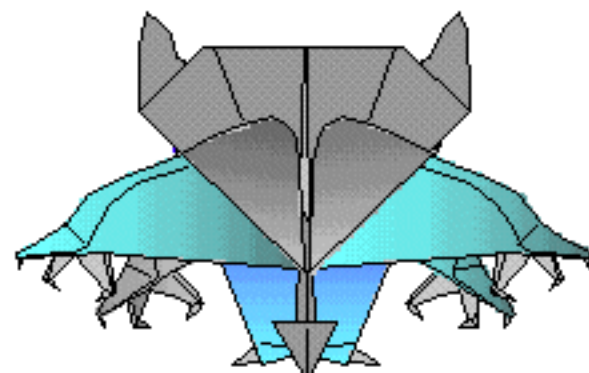

# the little genetically manipulated devil 2

Design: 06.95 by Hans Birkeland (Norway) ©1995

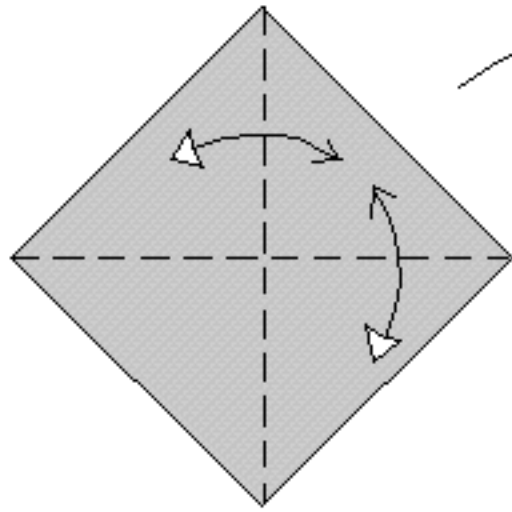

**1** Begin with the coloured side up. Fold and unfold the diagonals. Turn the paper over.

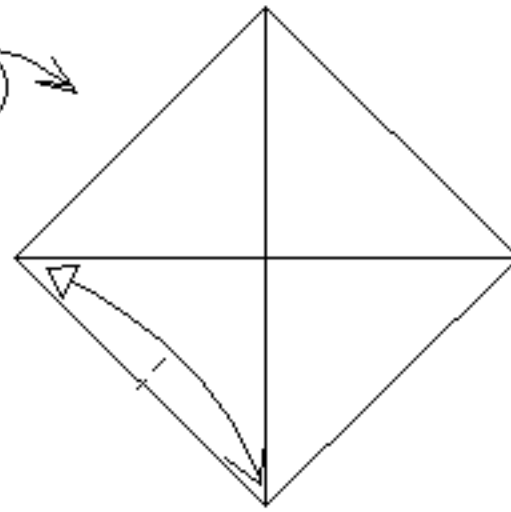

**2** Make a mark.

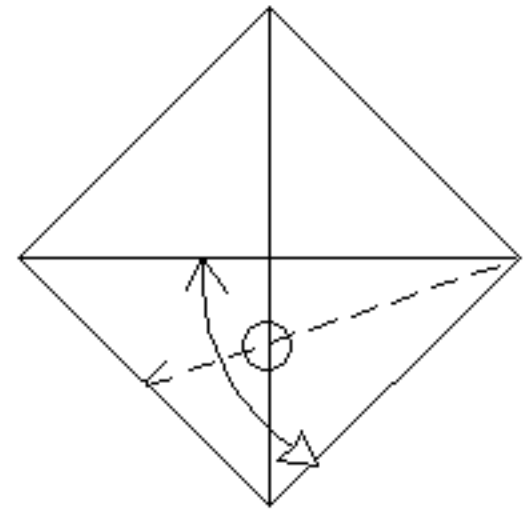

**3** Fold and unfold, only pressing flat where the crease hits the diagonal.

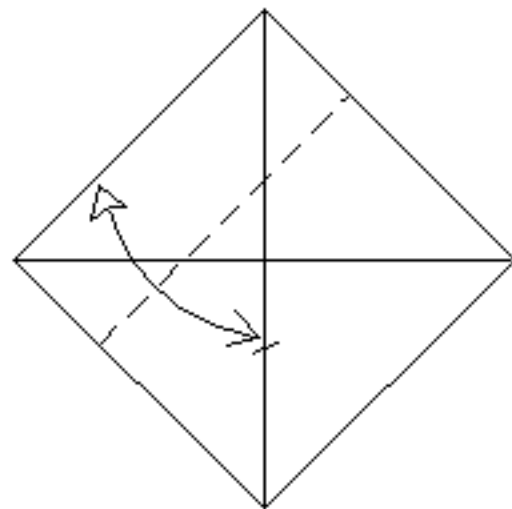

**4** Fold and unfold.

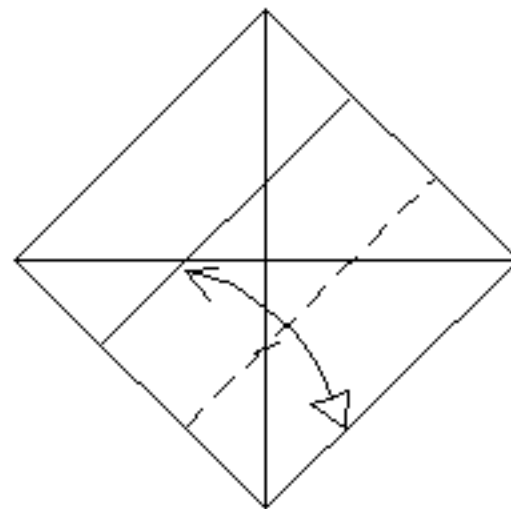

**5** Fold and unfold.

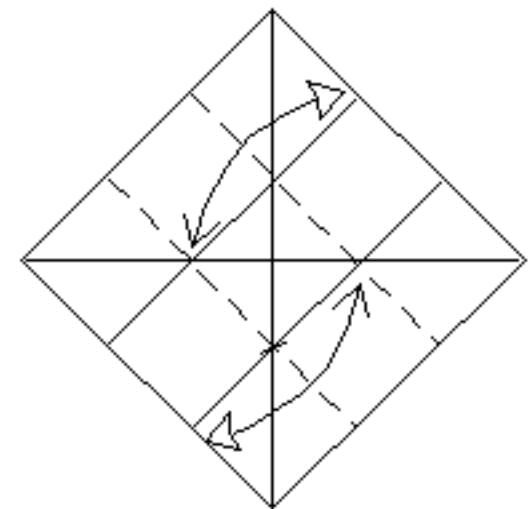

**6** Fold the edge to the midline without making a crease.

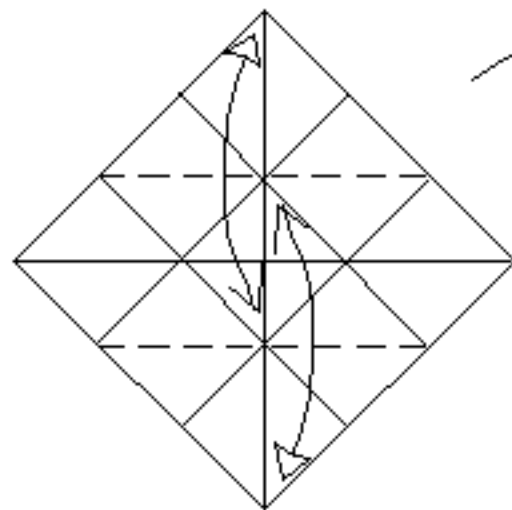

**7** Fold and unfold. Turn the paper over.

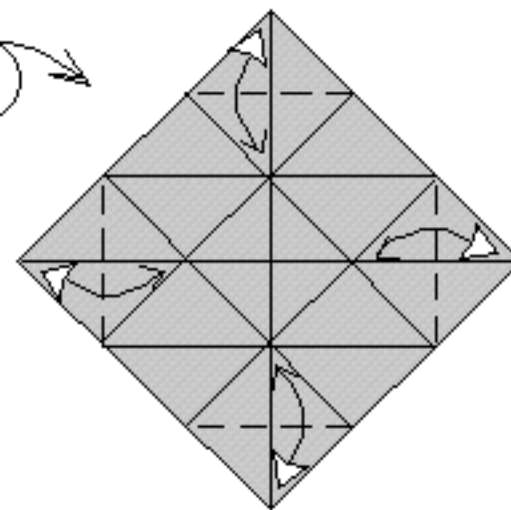

**8** Valley-fold the bottom corner to a point about 3/4 between the two marks.

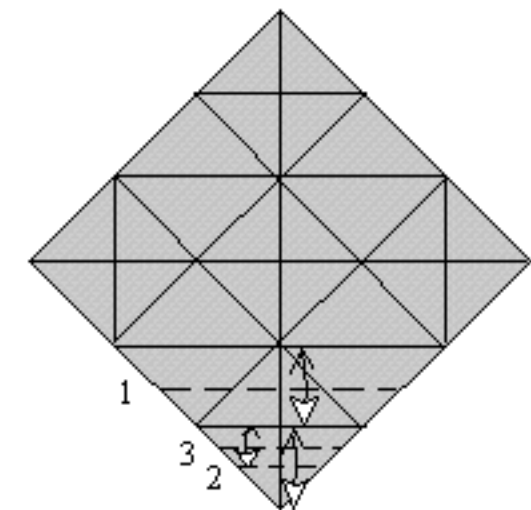

**9** Fold and unfold.

# the little genetically manipulated devil 2

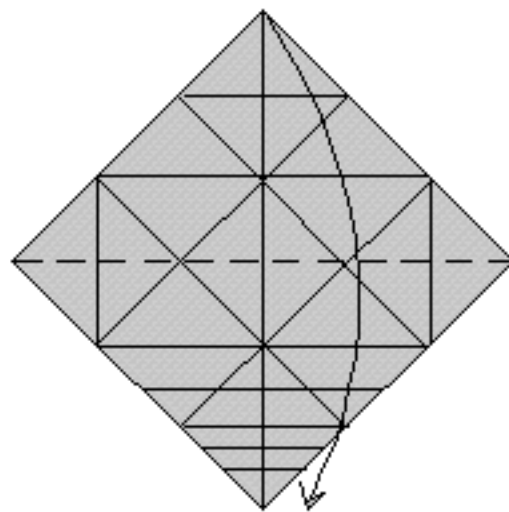

**10** Fold in half.

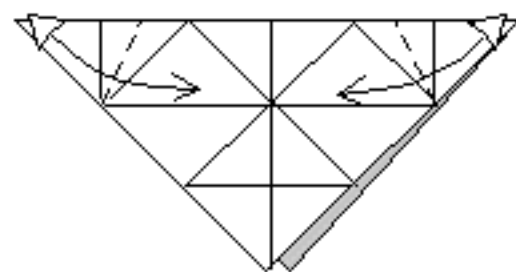

**11** Fold and unfold.

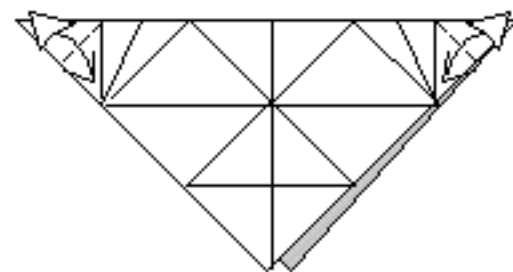

**12** Fold and unfold.

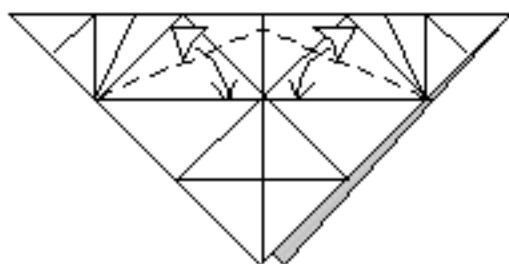

**13** Fold and unfold.

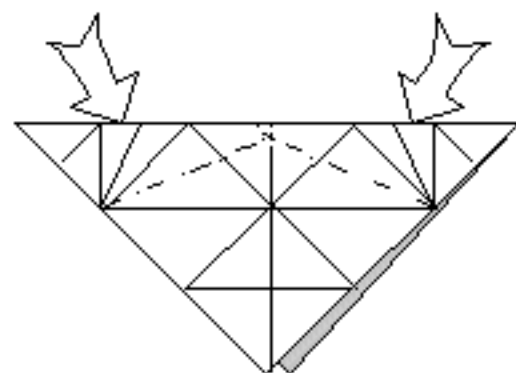

**14** Sink.

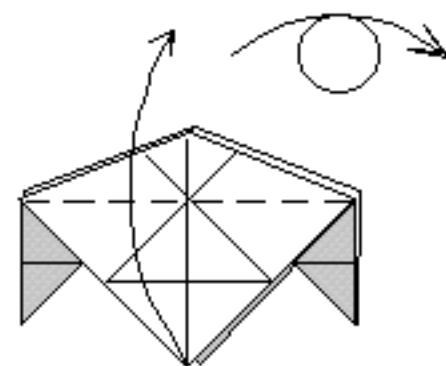

**15** Fold the nearest flap upward on an existing crease. Turn the model over.

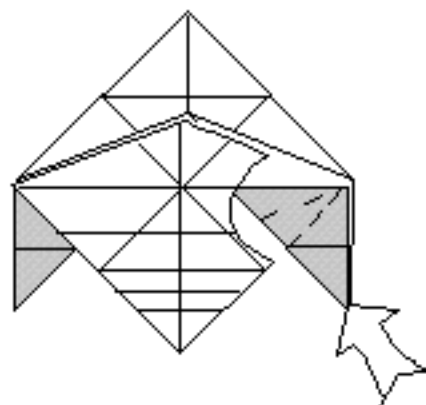

**16** X-ray view. Crimp the right flap on existing creases. Repeat on the left.

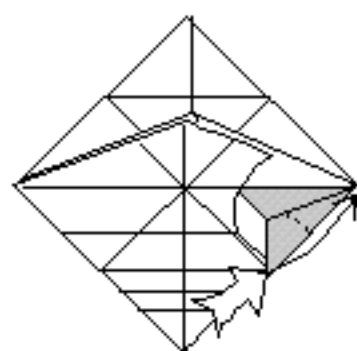

**17** Reverse-fold on an existing crease. Repeat on the left.

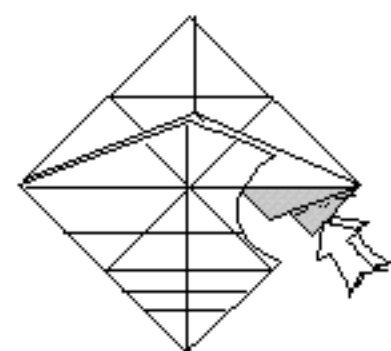

**18** Reverse-fold the two edges on the right. Repeat on the left. Continue with step 18-71 of the 4-arm version. This model will have 6 arms.

# The Little Devil

Design: 09.94 by Hans Birkeland (Norway) ©1994

Use paper that's coloured on one side and golden on the other. (To get the colour-change effect you can just paste a piece of golden foil at the top corner of the square, as shown in step 8a.)  
Begin with the golden side up.

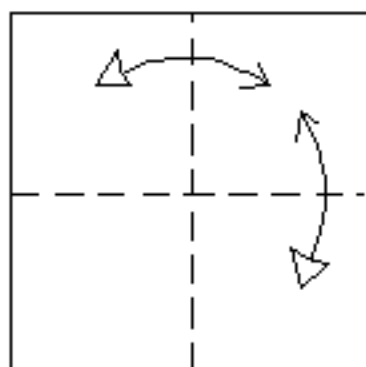
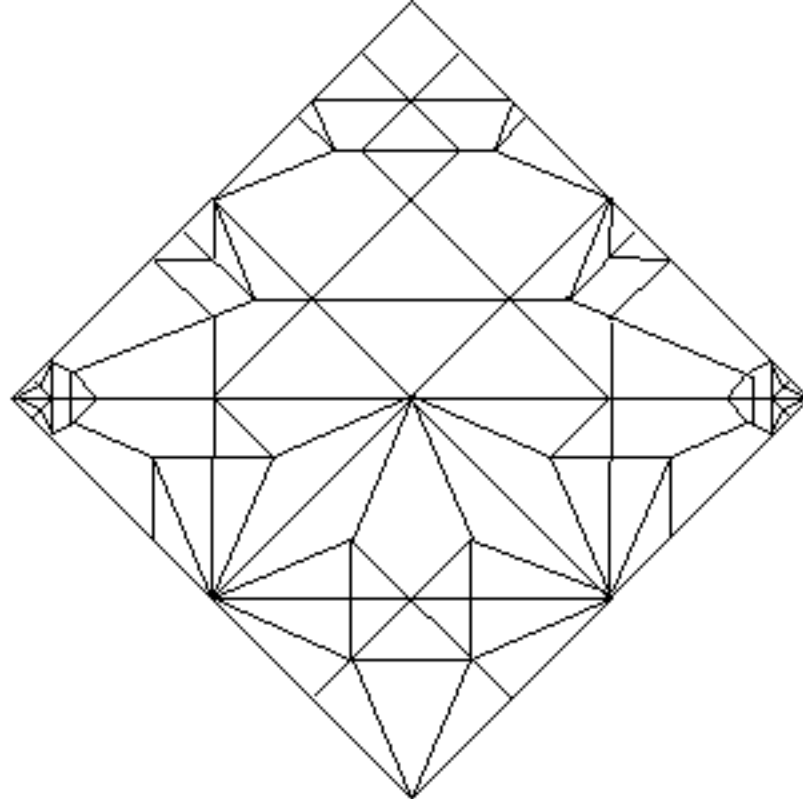

**1** Fold and unfold.

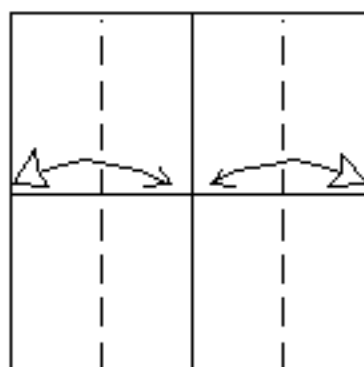

**2** Fold and unfold.

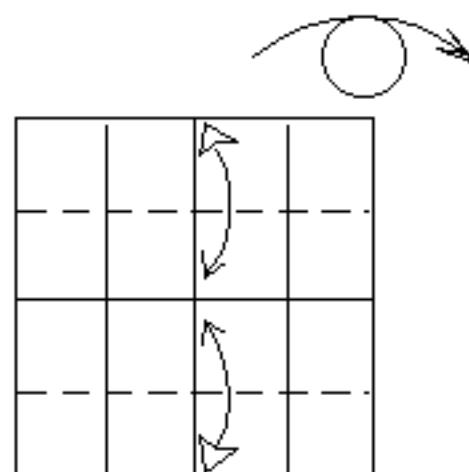

**3** Fold and unfold.  
Turn the model over.

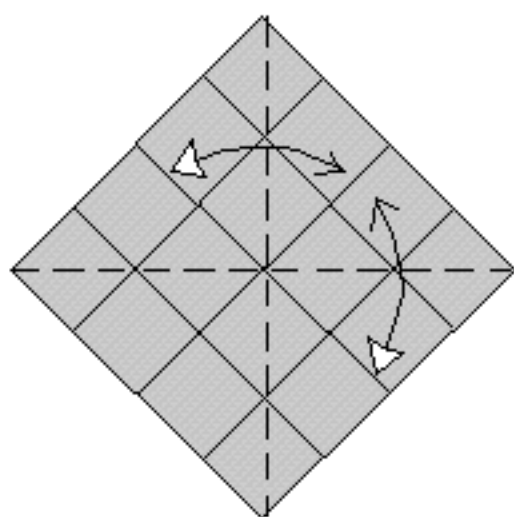

**4** Fold and unfold.

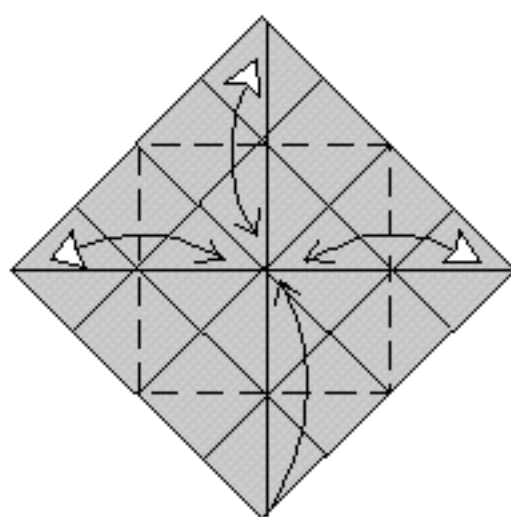

**5** Fold and unfold.

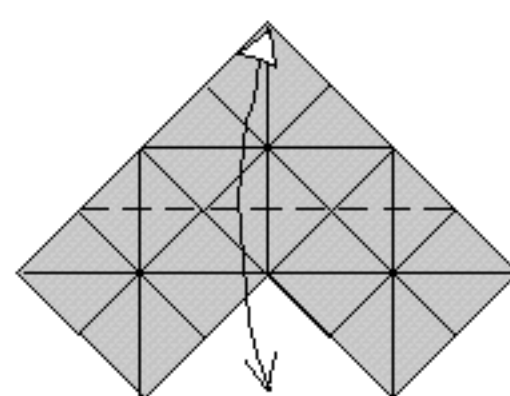

**6** Valley-fold.



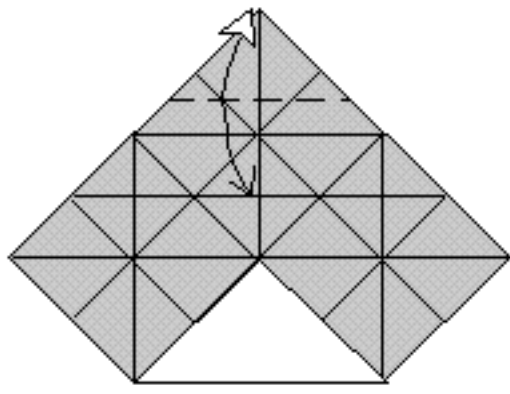

**7** Fold and unfold.

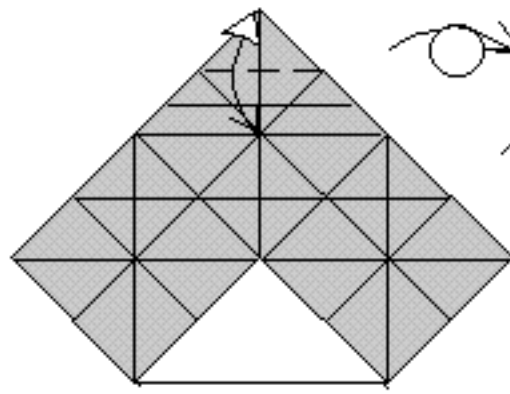

**8** Fold and unfold. [If you have used a one-coloured paper, turn around and do the next step.]

**8a** Place a piece of golden foil here.

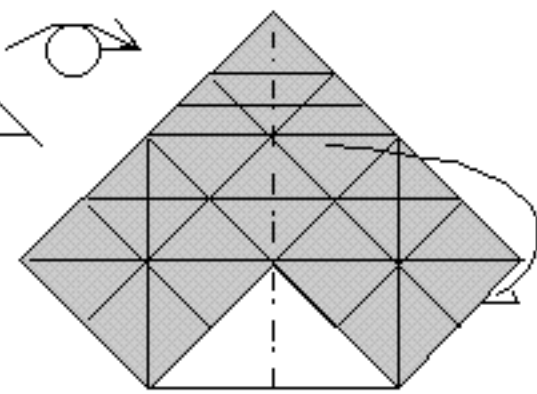
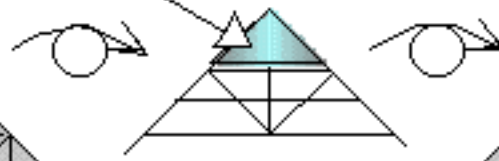

**9** Mountain-fold in half.

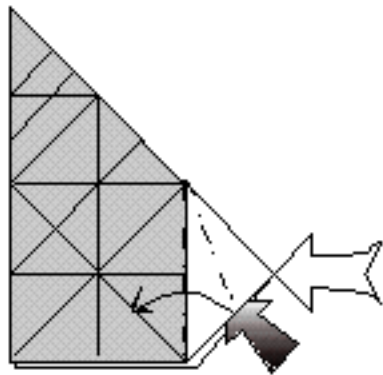

**10** Squash-fold.

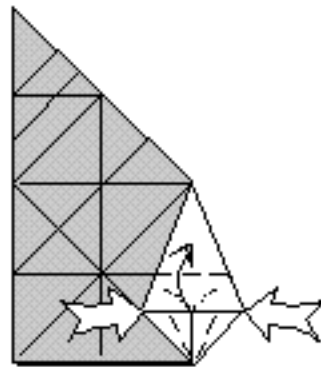

**11** Fold and unfold.

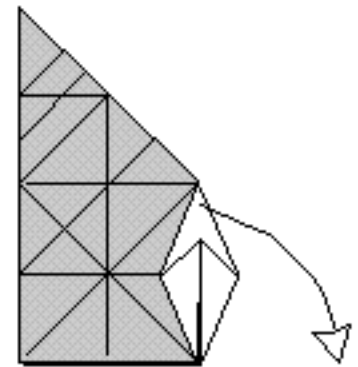

**12** Unfold.

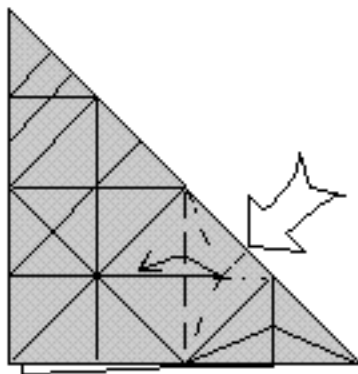

**13** Collapse on existing creases.

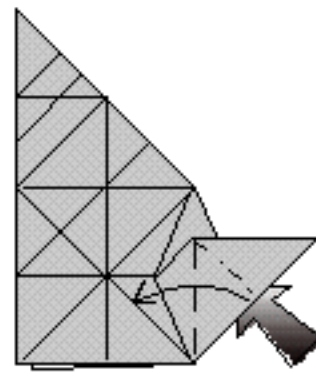

**14** Squash-fold.

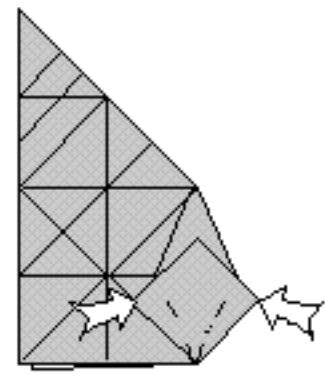

**15** Reverse-fold the edges on existing creases.

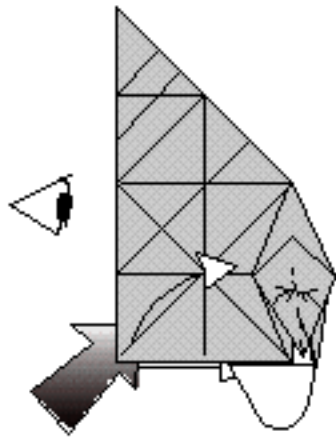

**16** Press together only the nearest layers and swivel the flap around it's axis and into the interior of the model. Next view from the interior.

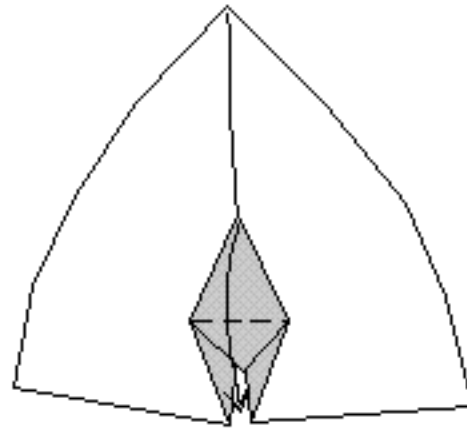

**17** Valley-fold the flap down.

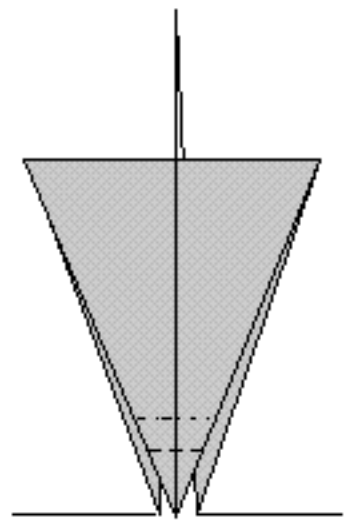

**18** Enlarged view. Make a pleat.

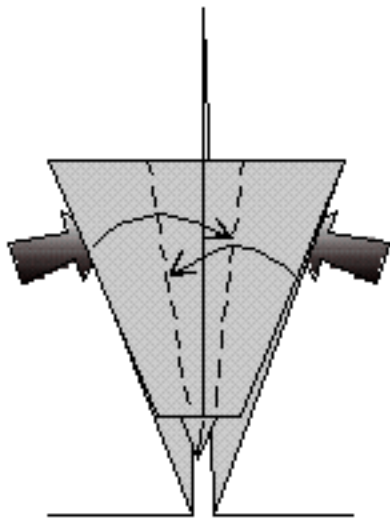

**19** Valley-fold the edges past the mid-line, dividing in thirds. There will be squash-folds at the top and bottom of each edge.

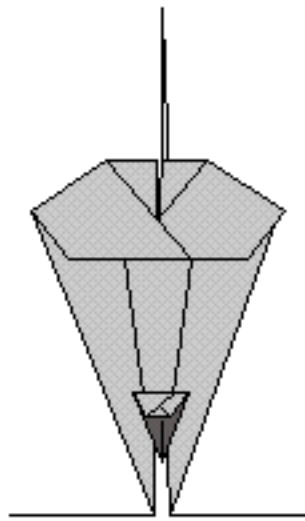

**20** Bring the two dark edges to the front.

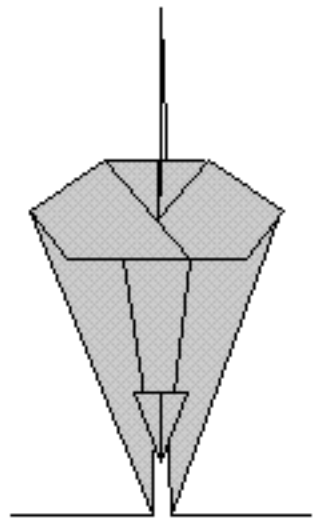

**21** Like this. Now close the model without pressing flat where the tail is.

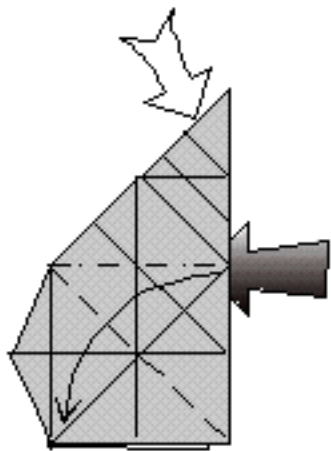

**22** Squash-fold.

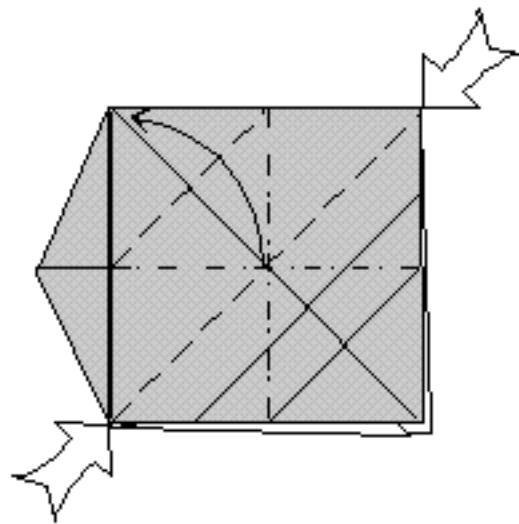

**23** Collapse on existing creases. This step is similar to a petal fold.

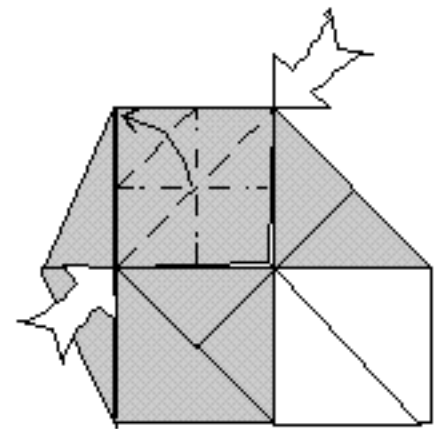

**24** Repeat last step in a smaller scale.

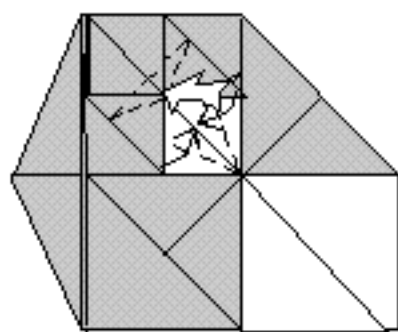

**25** Swivel-fold. Notice that the loose corner of the little square disappears into the pocket that is formed.

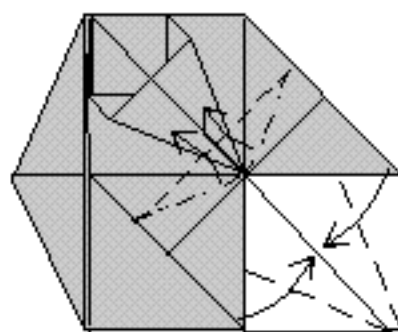

**26** Swivel-fold.

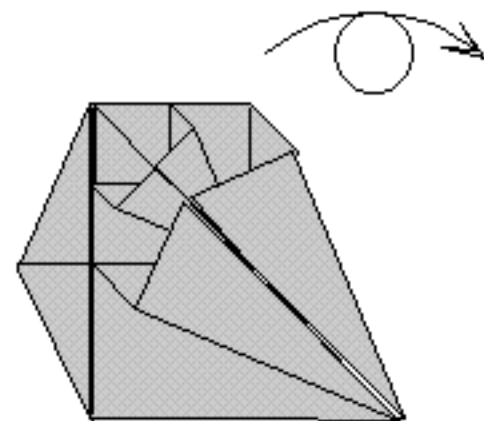

**27** Turn the model over.

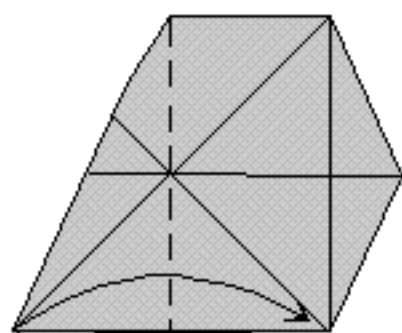

**28** Valley-fold the upper layer on an existing crease.

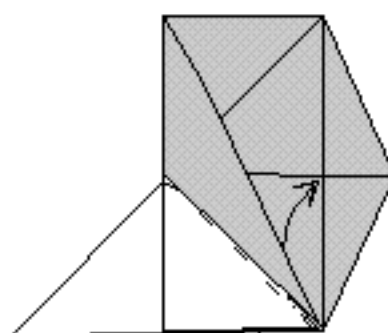

**29** Reverse-fold on existing creases.

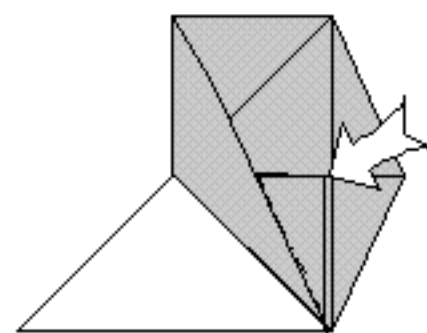

**30** Reverse-fold.

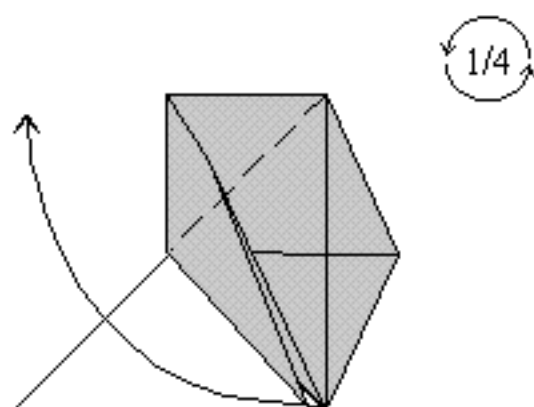

**31** Valley-fold the whole assembly upward and rotate the model 1/4 turn anti-clockwise.

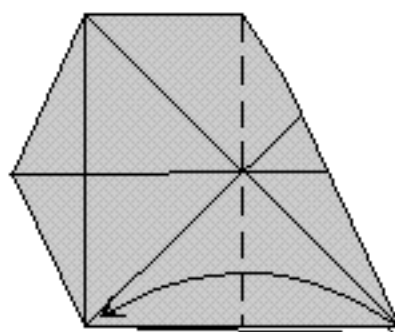

**32** Repeat steps 28-30 on this side.

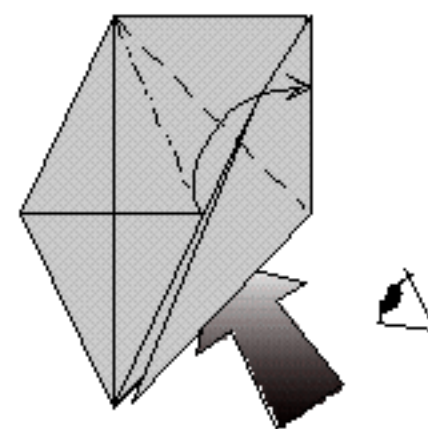

**33** Open up between the middle layers and squash-fold the model symmetrically.

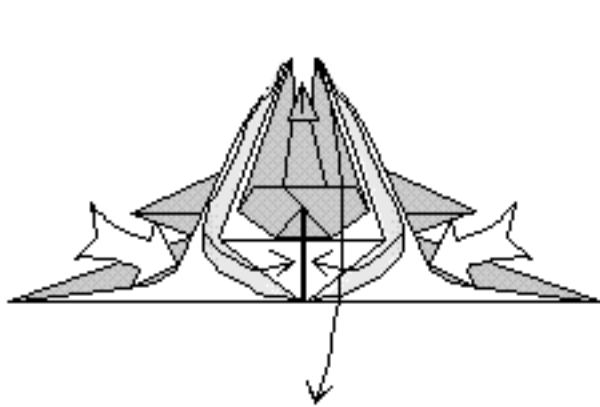

**34** An intermediate step. Fold the inner edges to the midline before the model is pressed flat.

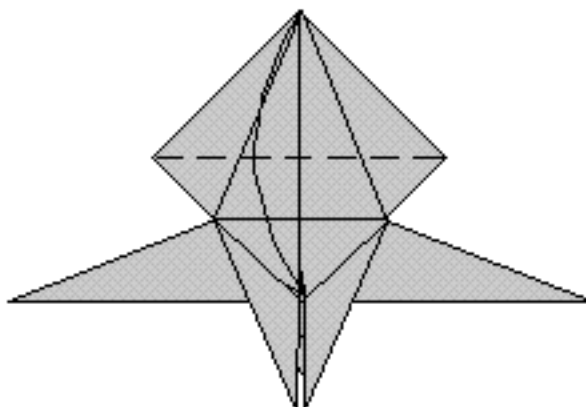

**35** Valley-fold downward.

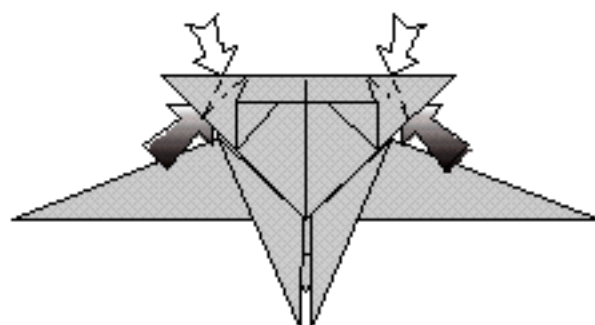

**36** Open up between the middle layers (there will be two edges in front) and crimp the ears.

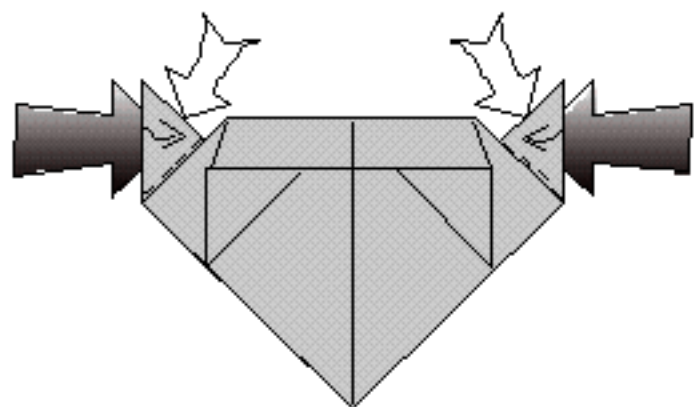

**37** In the next steps only the head is shown. Form the ears by opening up the nearest layer.

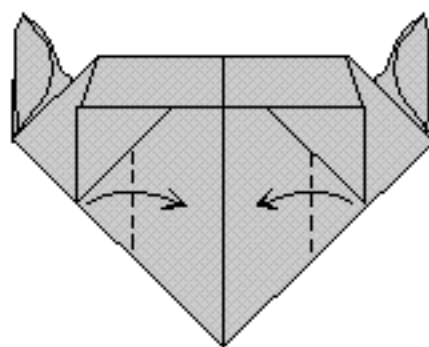

**38** Valley-fold.

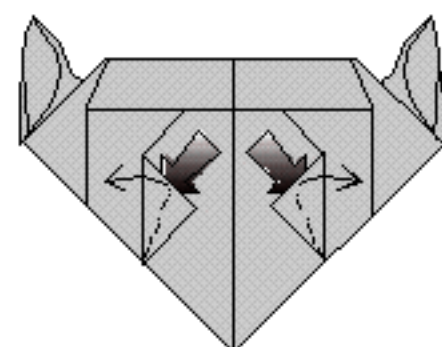

**39** Squash-fold the eyes.

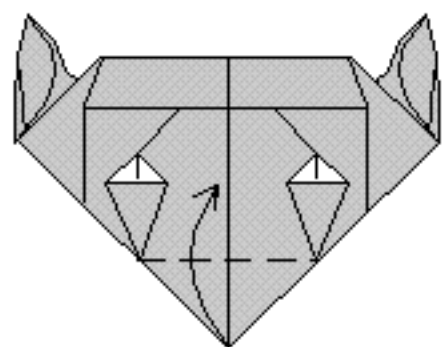

**40** Valley-fold one layer.

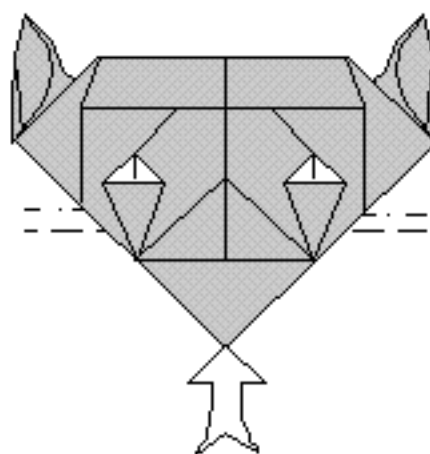

**41** Push the next corner a bit upward and press flat, thus forming an internal pleat.

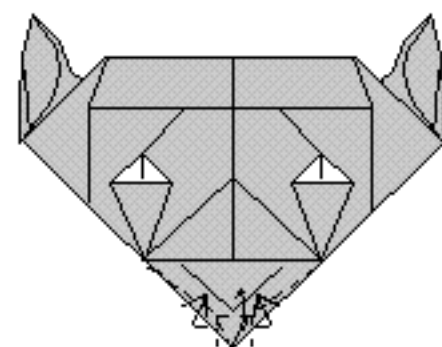

**42** Swivel-fold the edges as you fold the lower corner upward, placing it behind the tongue.

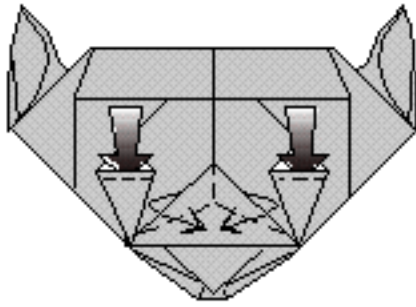

**43** Rabbit-ear the nose.  
Then open the eyes.

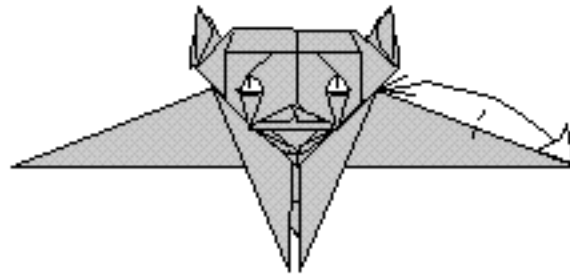

**44** The head is now finished.  
Make a mark on the upper  
edge of the right arm.

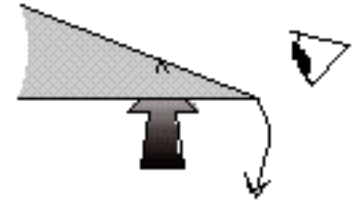

**45** Spread the bottom layers and  
push up the middle edge, making  
a mountain crease connecting the  
marks on the two upper edges.

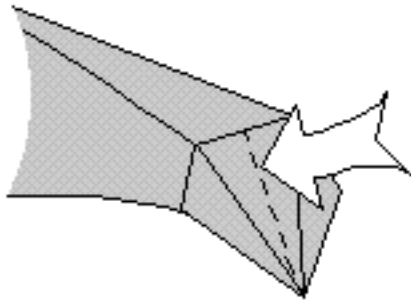

**46** In progress. Close the  
open area and press  
flat when there's a  
90° angle between  
the bottom edges.

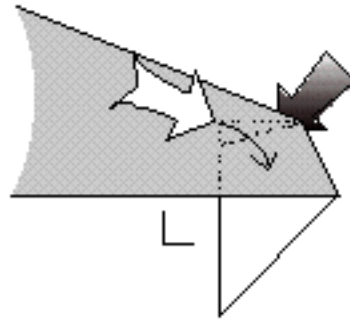

**47** Like this.  
Reverse-fold a part  
of the hidden edge.

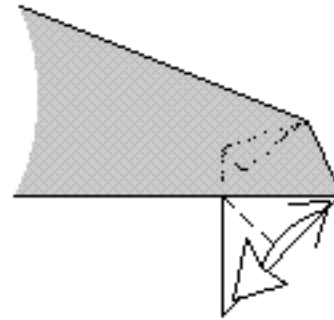

**48** Fold and unfold.

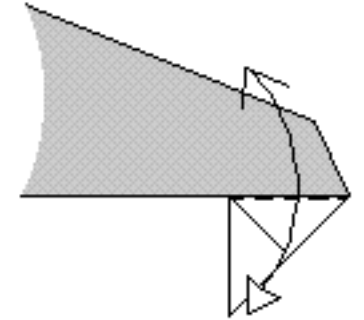

**49** Fold and unfold.

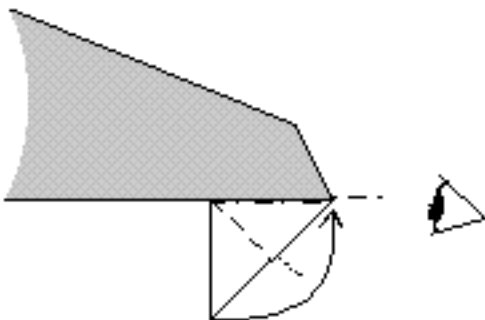

**50** Crimp on existing creases.

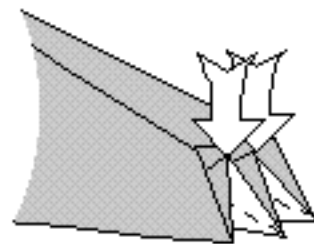

**51** Reverse-fold two edges.

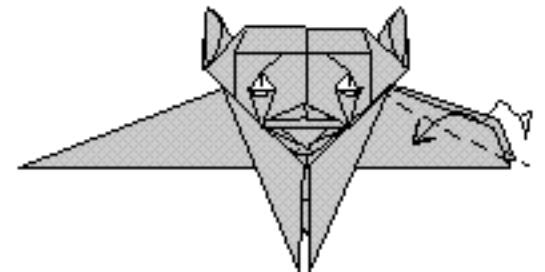

**52** Valley-fold the edges  
downward, making an  
angle bisector.

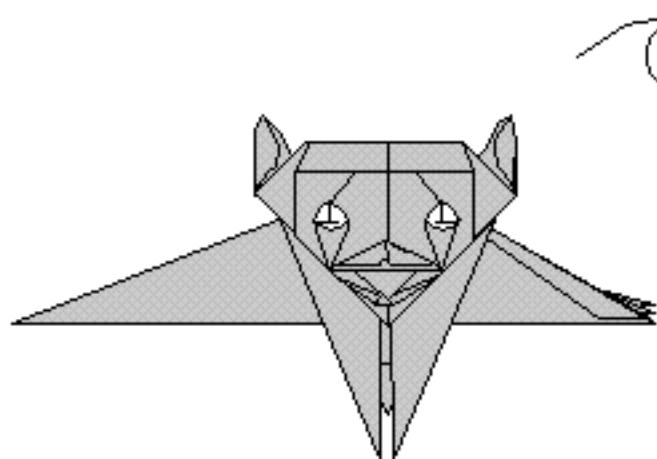

**53** Repeat steps 44-52 on the left arm. Then turn the model over.

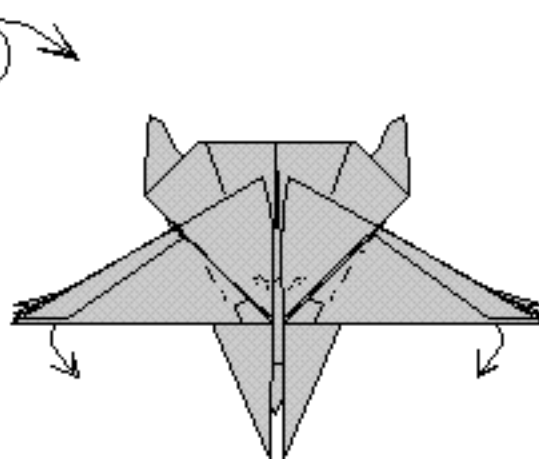

**54** Crimp the arms, putting the edges into the pockets above.

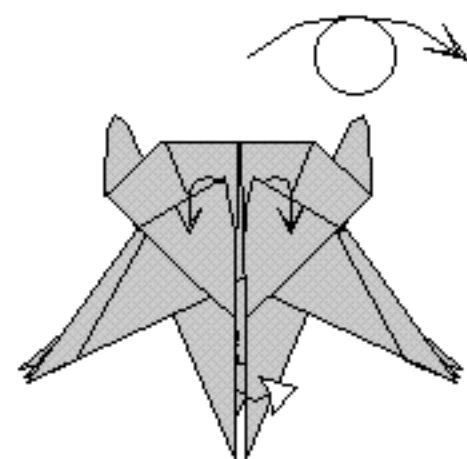

**55** Pull out the tail and pinch it slightly. Curl the wings outward. Turn the model over.

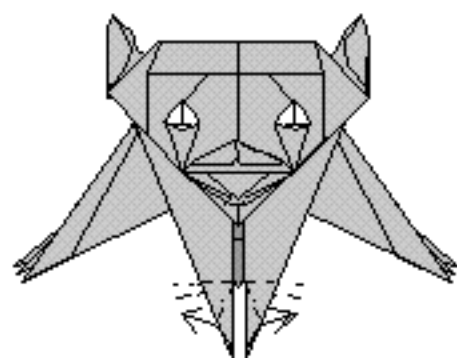

**56** Swivel-fold the legs to make feet. They should point forward and have small heels pointing backward.

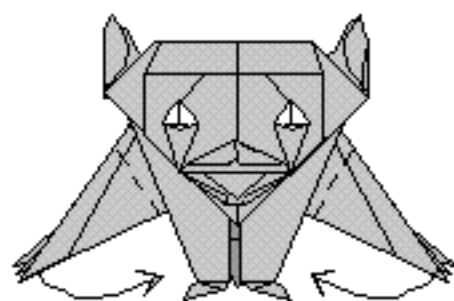

**57** Curl the arms forward and spread the fingers.

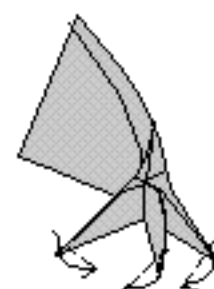

**58** Valley-fold the tip of the fingers to make claws.

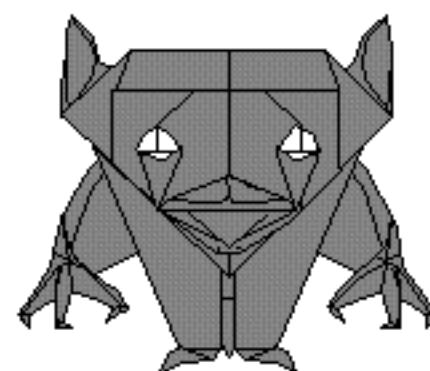
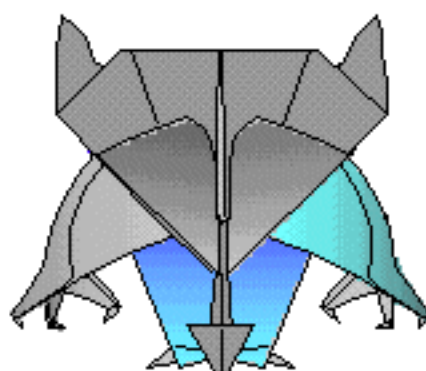
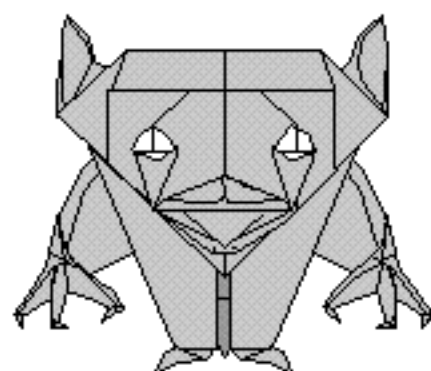

**59** The Little Devil.

# baby dino

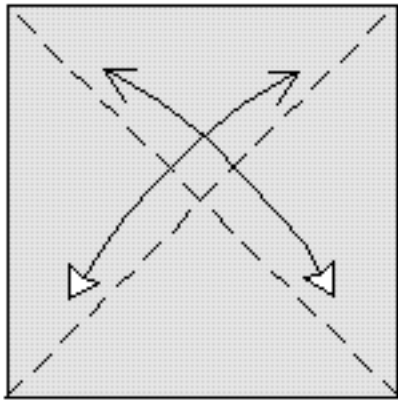

**1** Begin with the white side up. Fold and unfold.

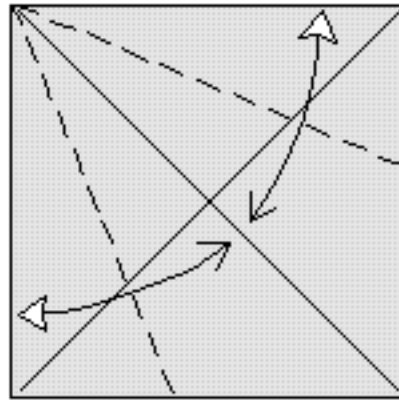

**2** Fold a kite-base and unfold. Turn the paper over.

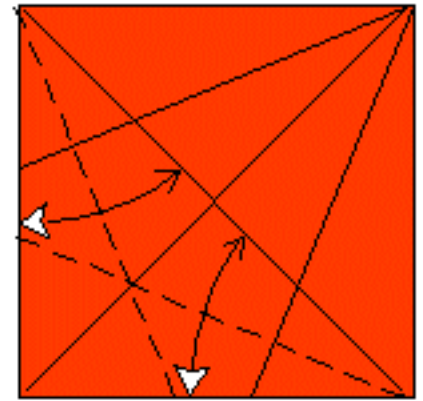

**3** Fold and unfold.

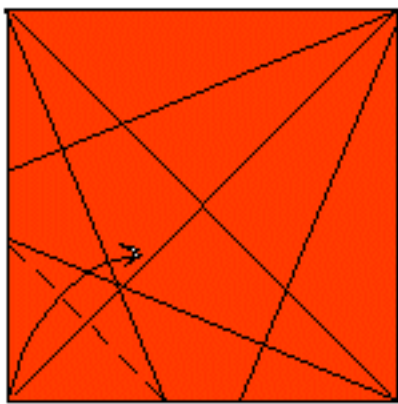

**4** Valley-fold.

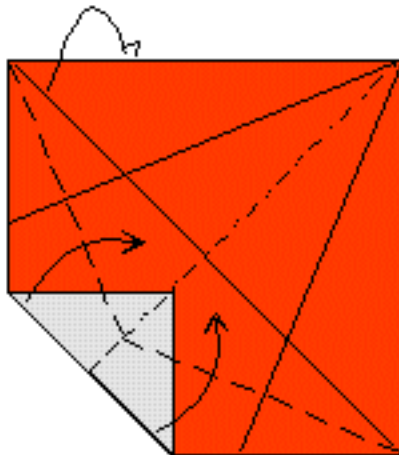

**5** Collapse on existing creases.

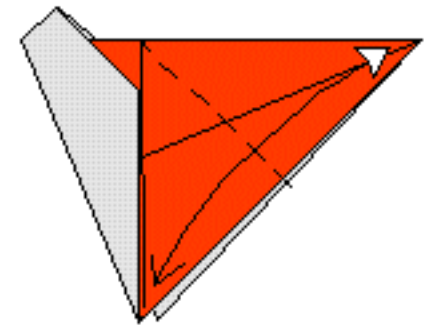

**6** Fold and unfold.

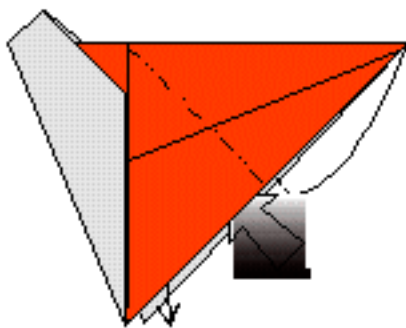

**7** Reverse-fold.

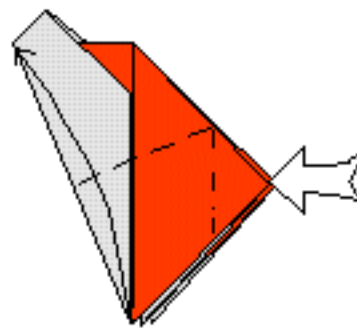

**8** Swivel-fold. The valley-fold is on an existing crease. Repeat behind.

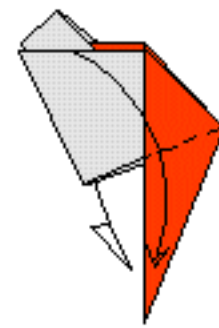

**9** Valley-fold. Repeat behind.

# baby dino

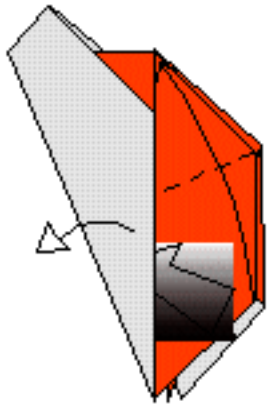

**10** Open out the left edge and repeat step 8. The model will not lie flat.

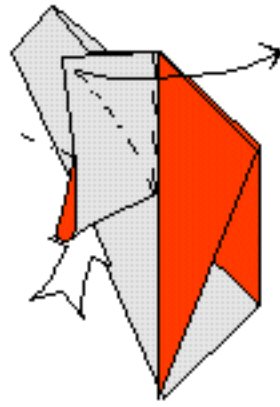

**11** Push up the partially hidden edge so that the flap can be swivel-folded to the right. The model is still 3-D.

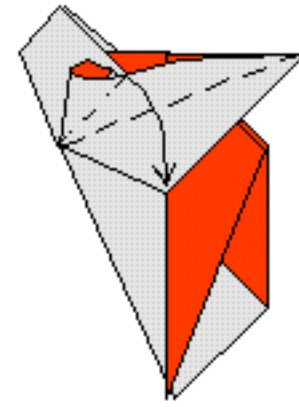

**12** Valley-fold the upper edge down on an existing crease.

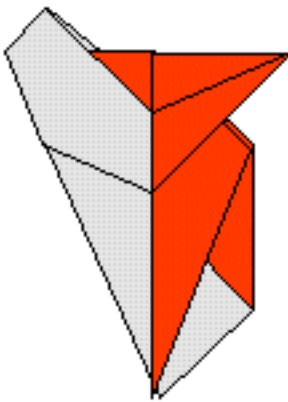

**13** Like this. Repeat steps 10-12 behind.

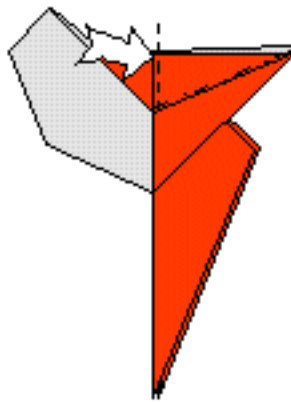

**14** Reverse-fold. Repeat behind.

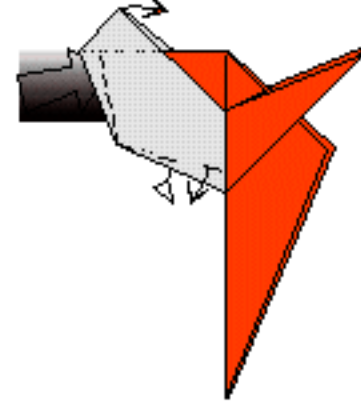

**15** Open up between the layers on the top left and shift the paper in a clockwise direction.

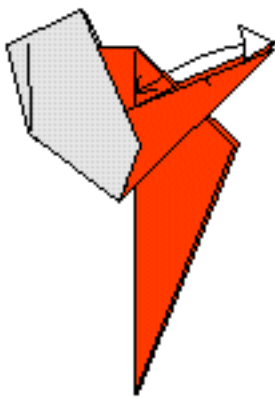

**16** Fold the tip of the point to its upper edge base and unfold, making only a small mark.



**17** Spread the bottom layers and push up the middle edge, making a mountain crease connecting the marks on the two upper edges.

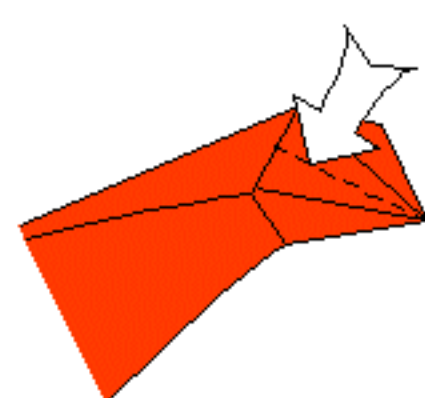

**18** In progress. Close the open area and press flat when there's a 90° angle between the bottom edges.



# baby dino

---

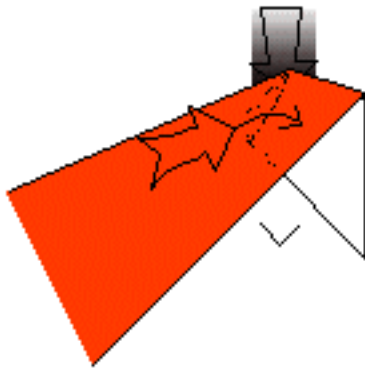

**19** Like this.  
Reverse-fold a part  
of the hidden edge.

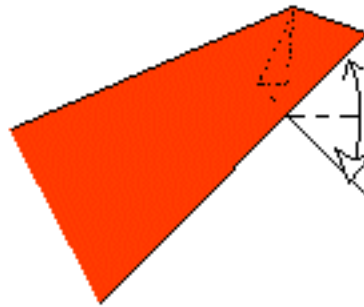

**20** Fold and unfold.

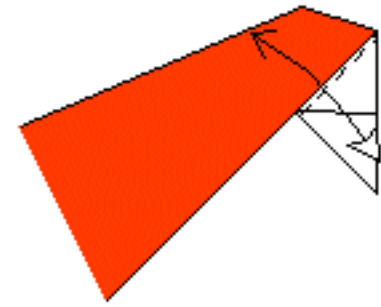

**21** Fold and unfold.

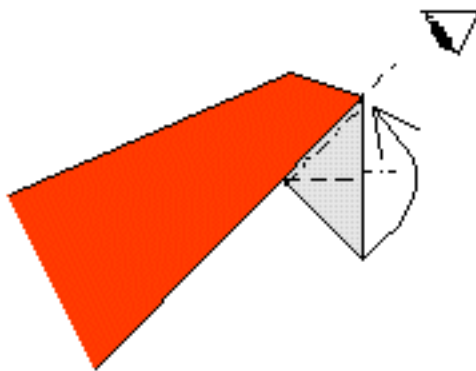

**22** Crimp on existing creases.



**23** Reverse-fold two edges.

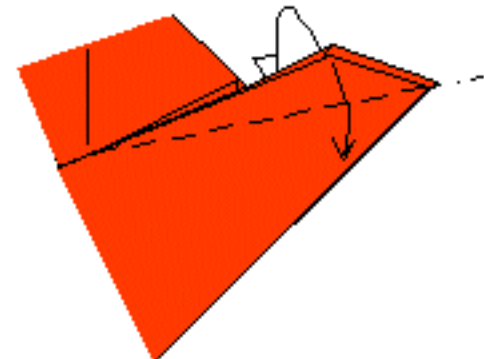

**24** Fold the edges down  
on each side.

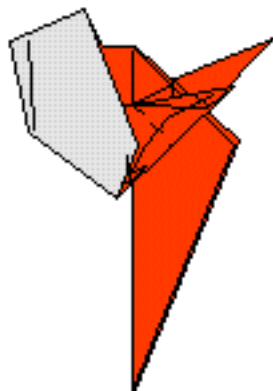

**25** Valley-fold the arm down  
as far as it will go.

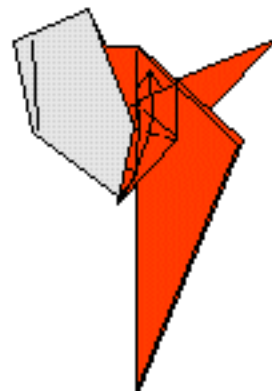

**26** Valley-fold the arm upward  
so that the left edges are  
on top of each other.

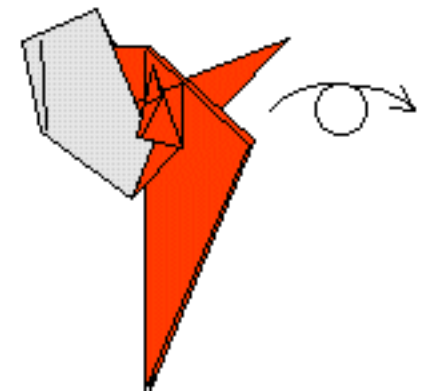

**27** One arm is finished. Turn  
the model over and repeat  
steps 16-26 on the back.

# baby dino

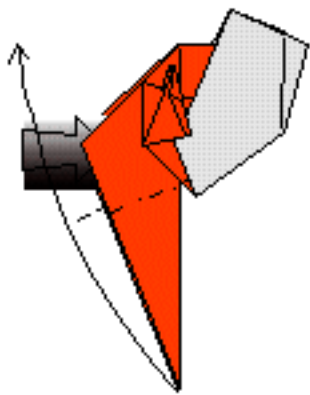

**28** Reverse-fold the long point and rotate the model clockwise.

1/4



**29** Form the nose and mouth with two outside reverse folds (the flap is divided in thirds).



**30** Open up between the two hind layers and reverse-fold the whole corner inside.



**31** Make eye and nostril. Repeat behind.

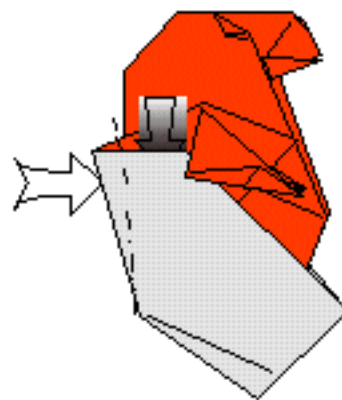

**32** Open between the closest layers and reverse-fold the two edges inside. This step resembles step 30.

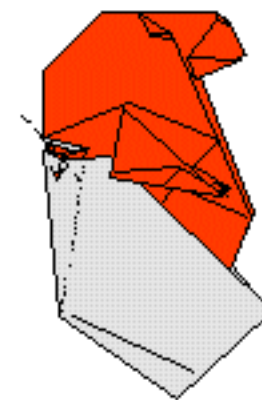

**33** Lock the hidden layers with a valley-fold.

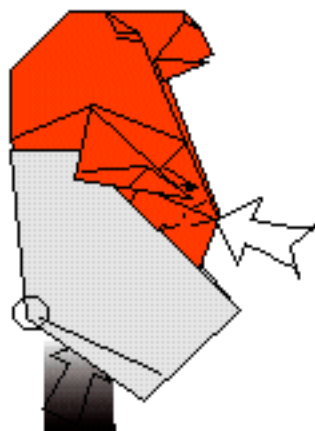

**34** Hold the model where indicated. Open up from the bottom and sink a part of the stomach so that the body becomes 3-dimensional.

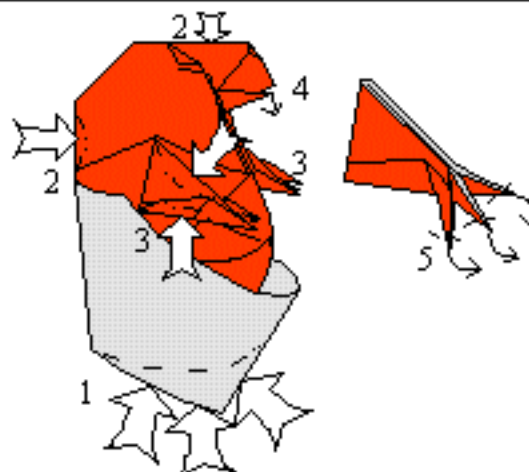

**35** 1. Push in the bottom of the egg.  
2. Push in the neck and forehead.  
3. Pinch the arms.  
4. Open the mouth.  
5. Spread the fingers and make claws.



**36** Baby Dino.

# Diplodocus

M.J.van Gelder

© 1986 Sep

Use paper size 4 x 1 (p.e. 12 x 3 inch)

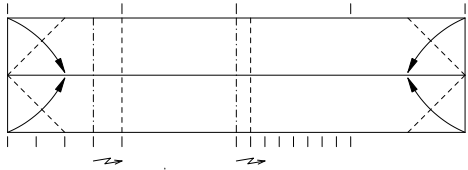

1

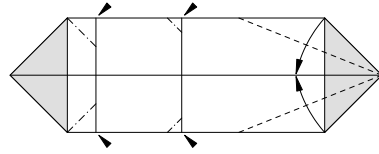

2

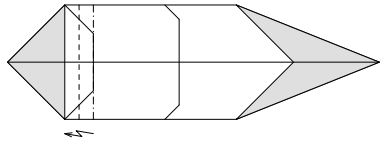

3

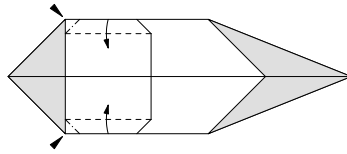

4

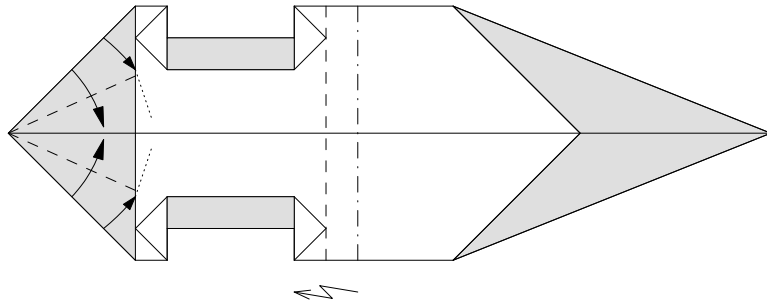

5

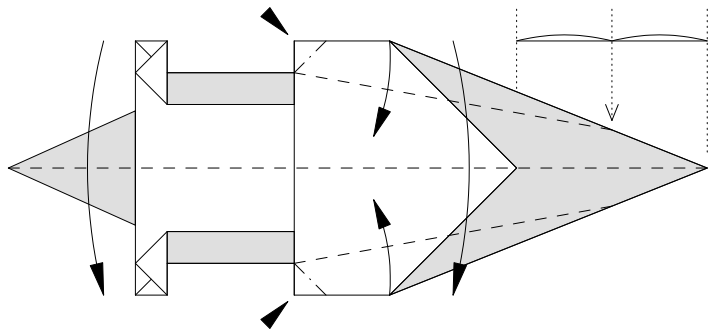

6

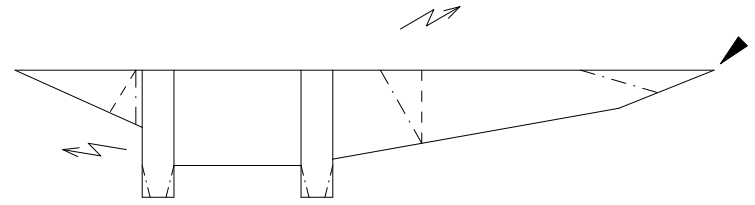

7 Colour shade omitted

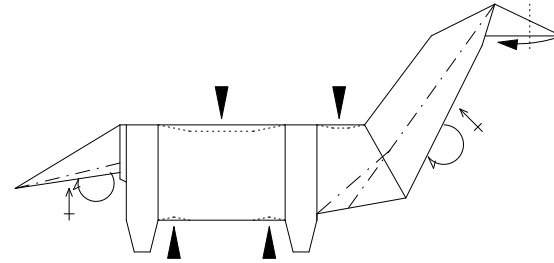

8 Narrow tail inside to make it bend  
Push in back, begin of neck and belly somewhat to make the  
Diplodocus 3D

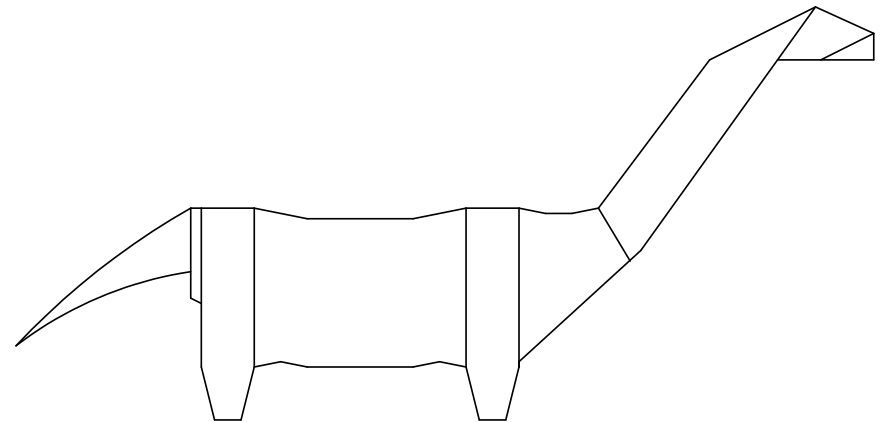

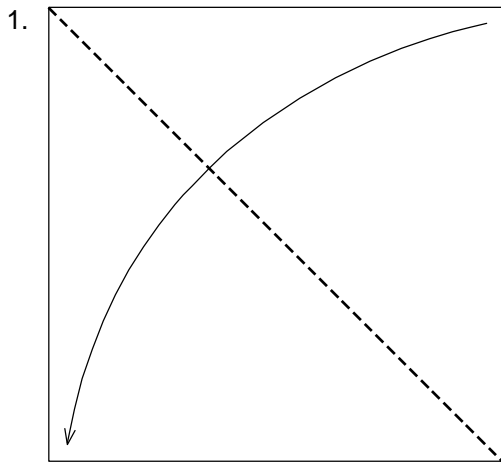

Begin with a square of between 15 and 20cm, with the white side faced up. Fold diagonally in half.

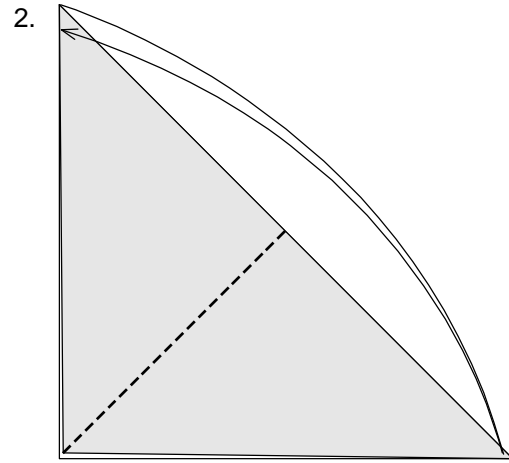

Fold diagonally in half again, crease firmly, and unfold.

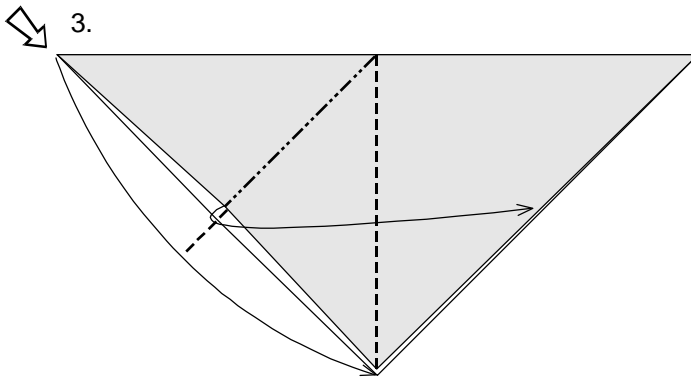

Separate the two vertical edges on the right and squash fold.

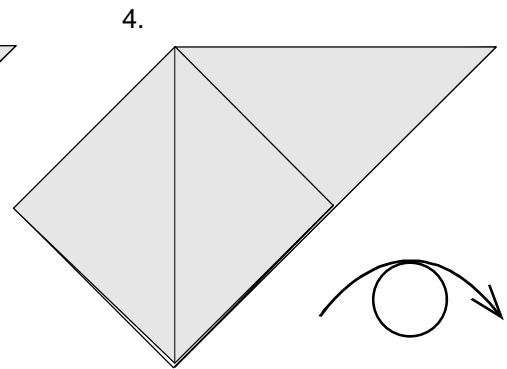

Turn the model over ...

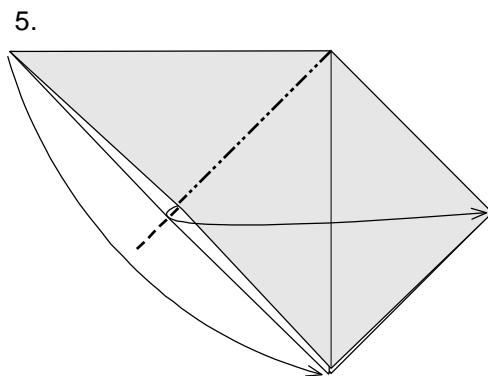

... and repeat Steps 3 and 4 on this side.

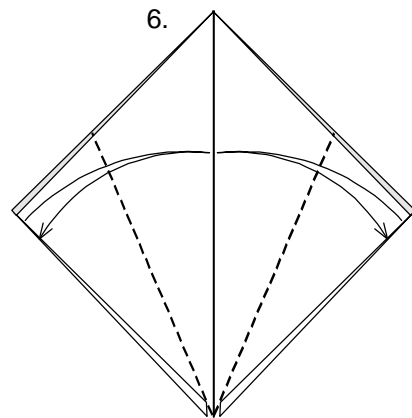

Fold the lower diagonal edges to the centre, crease firmly, and unfold.

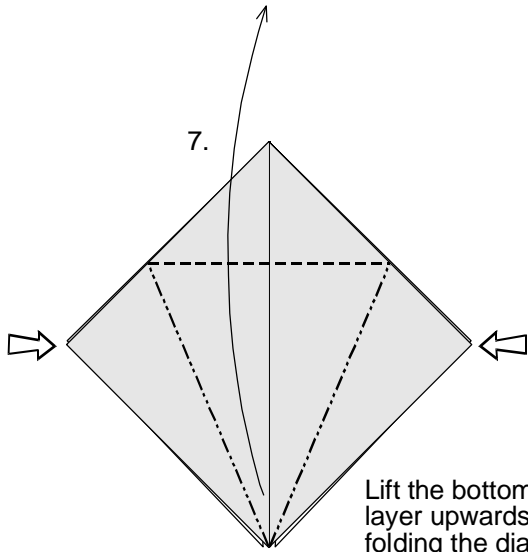

7. Lift the bottom corner of the first layer upwards while reverse folding the diagonal sides along the crease lines made in Step 6.

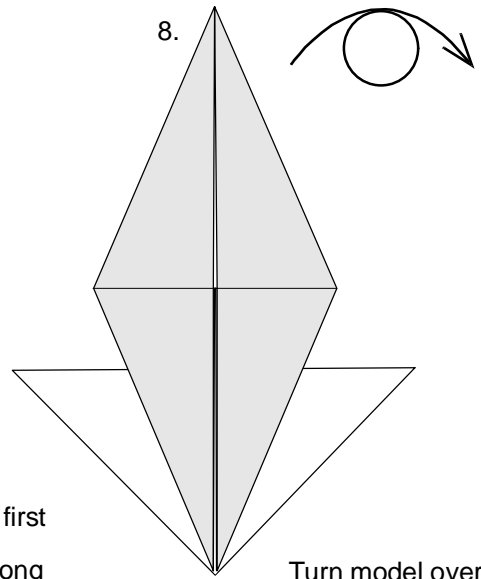

8. Turn model over

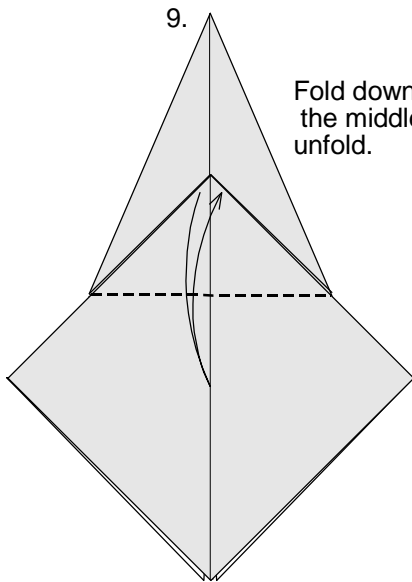

9. Fold down the triangular piece in the middle, crease firmly, and unfold.

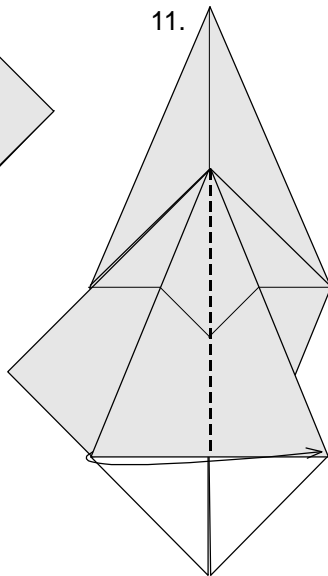

11.

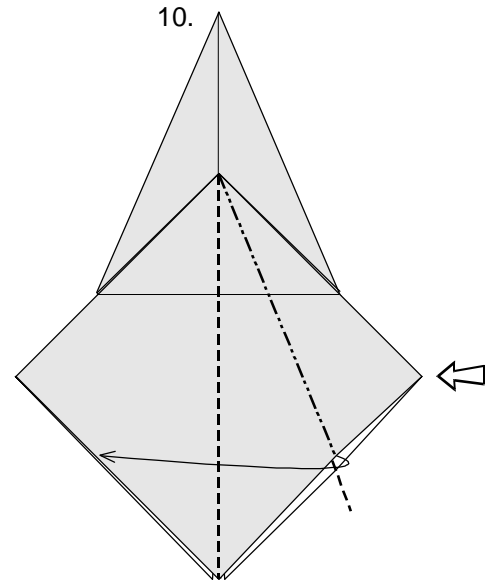

10. Separate the two diagonal edges on the right and squash fold ...

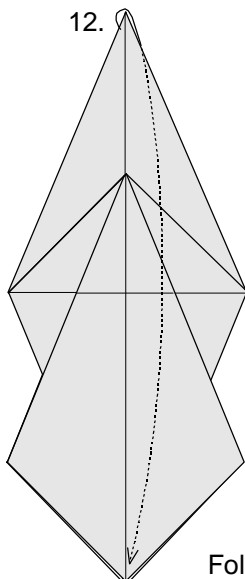

12.

12. Fold down the flap at the back.

... then swivel the first flap on the left to the right, and repeat Step 10 on the second flap on the left.

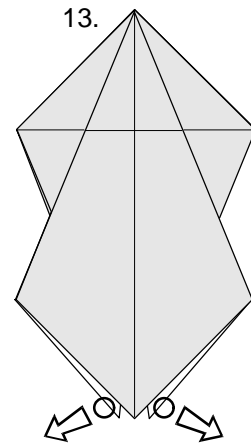

13.

13. Grasp the paper at the circled positions and pull apart ...

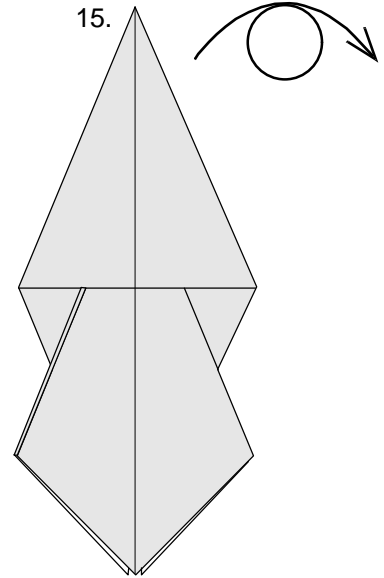
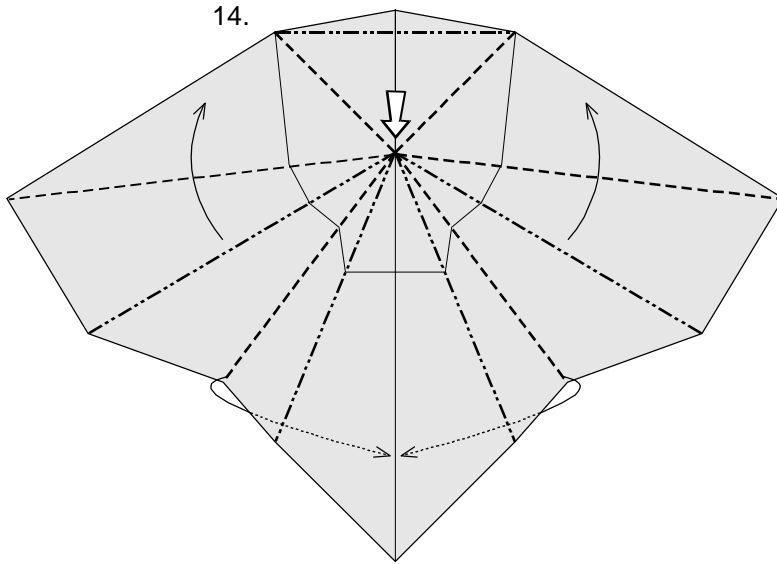

... then push in the centre where the diagonal creases intersect and collapse the paper again along the existing mountain and valley fold lines.

Your model should now look like this. Turn model over.

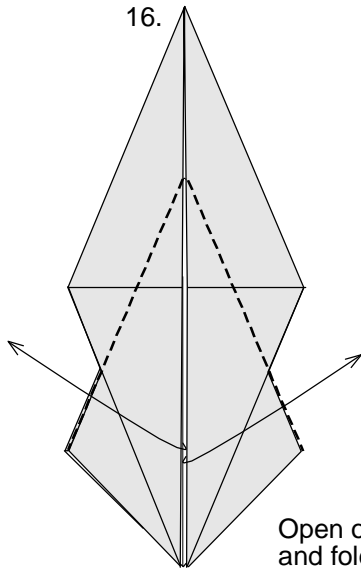

Open out from the centre and fold the first two layers to each side.

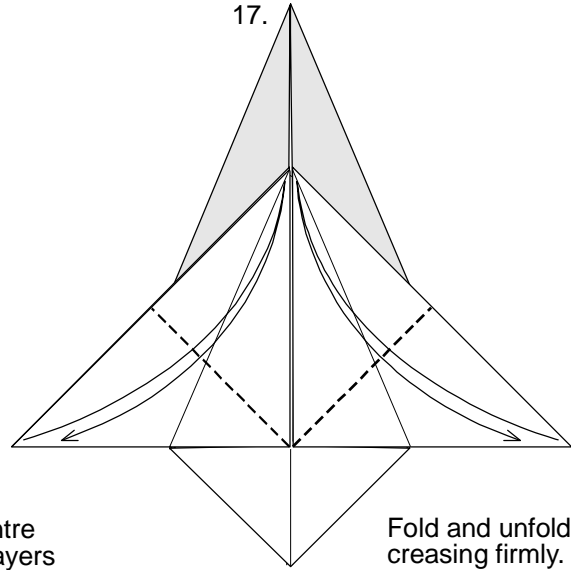

Fold and unfold, creasing firmly.

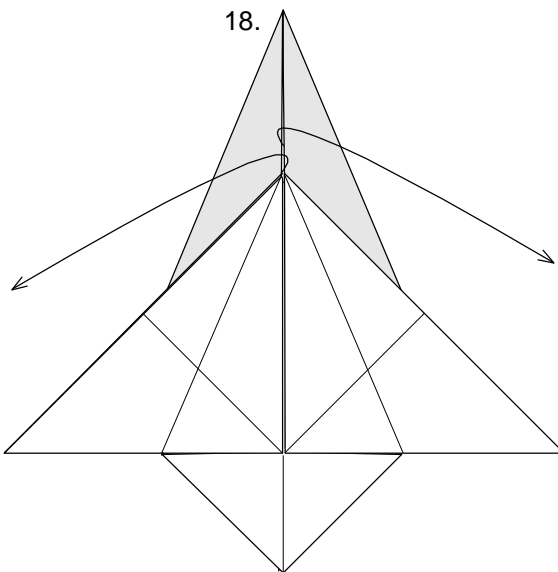

Unfold model completely.

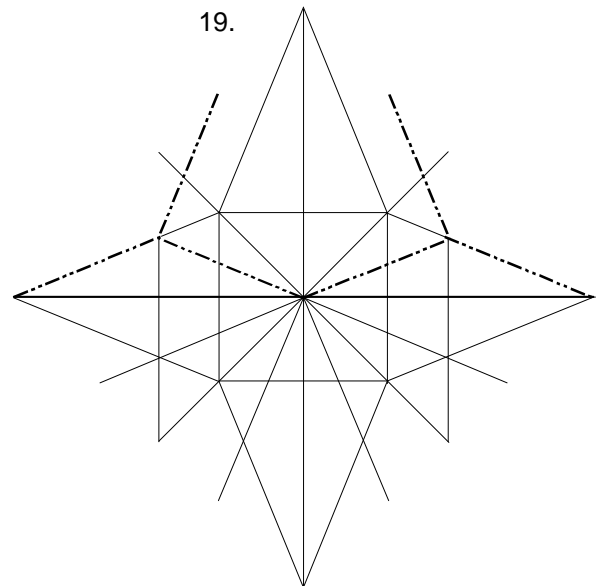

Recase the indicated valley fold lines as mountain folds. This will make Step 20 easier.

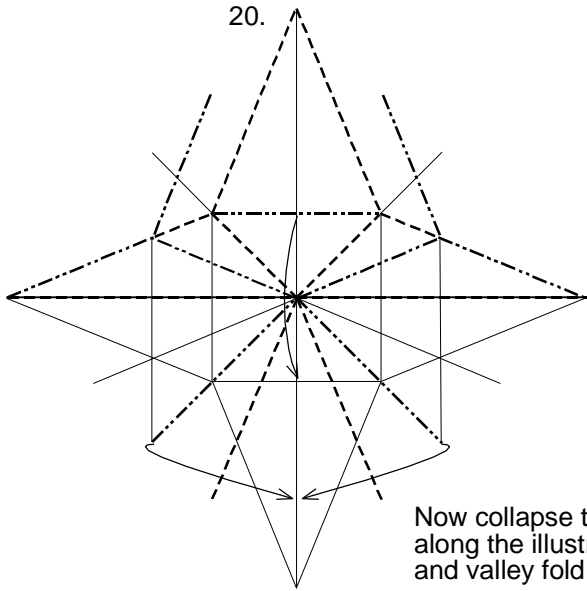

Now collapse the paper again along the illustrated mountain and valley fold lines ...

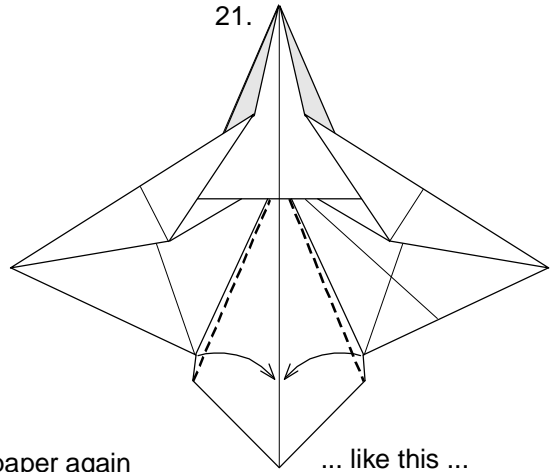

... like this ...

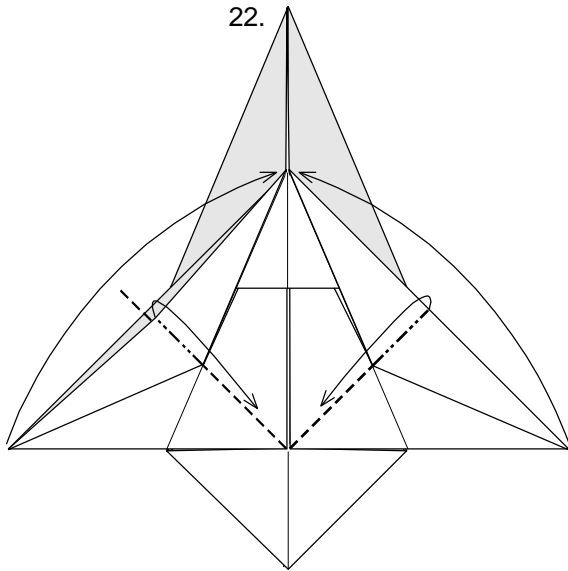

Separate and draw the diagonal edge of the first layer of the flaps on each side towards the centre, then fold the corners at the sides to meet the top corner of each triangle.

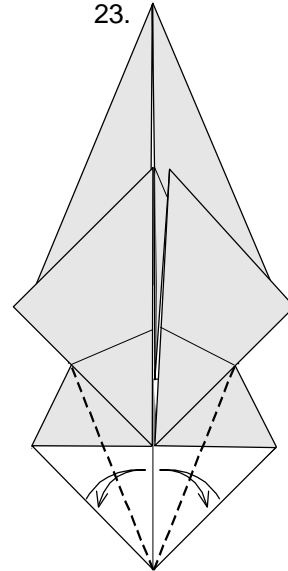

Fold as shown, crease firmly, and unfold.

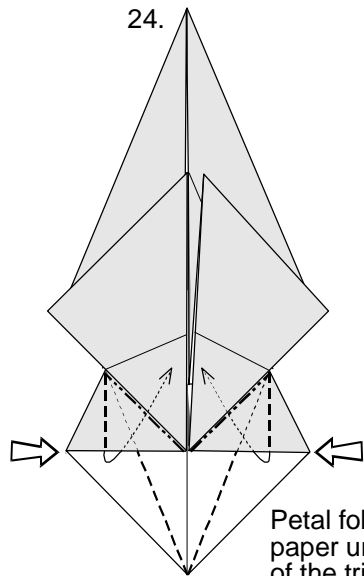

Petal fold, tucking the excess paper under the lowest corner of the triangular pieces above.

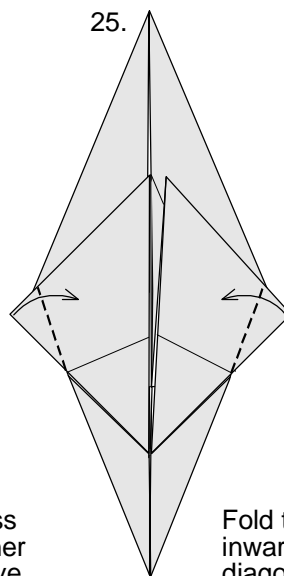

Fold the excess corners inwards, in line with the diagonal edge at the bottom.

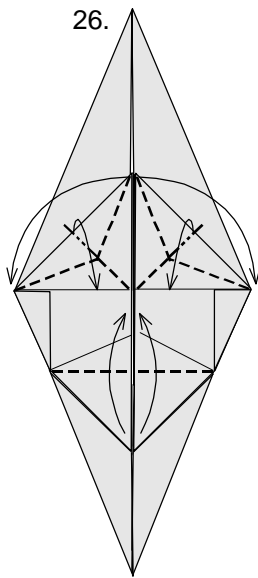

26. Fold up the lower triangular flaps and rabbit's ear fold the upper pieces ...

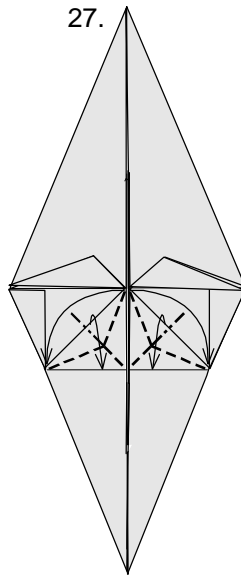

27. ... then rabbit's ear fold the lower pieces ...

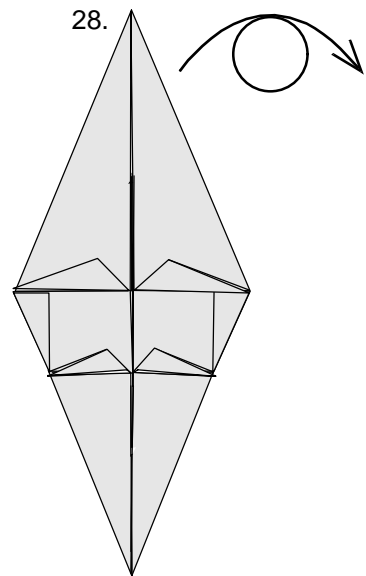

28. ... like this. Now turn the model over.

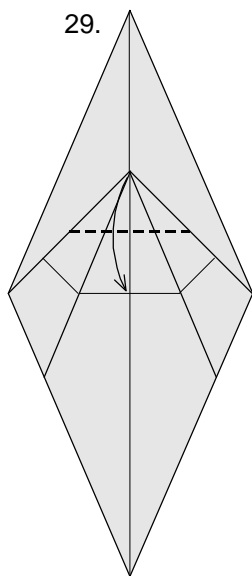

29. Fold the tip of the triangle to the intersecting crease lines as shown ..

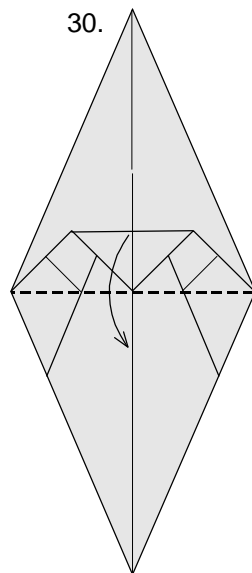

30. ... then fold this piece all the way down from the horizontal mid-point of the model.

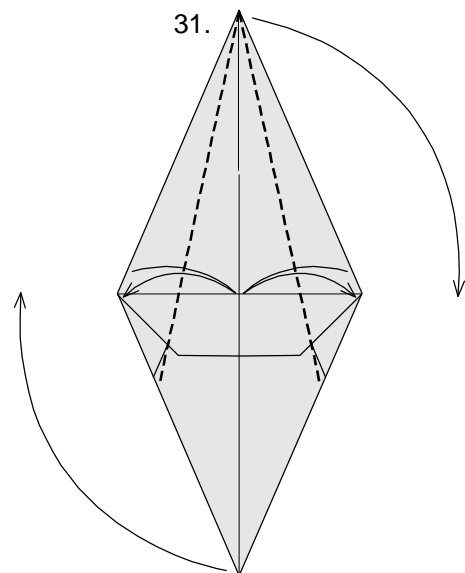

31. Fold the upper diagonal edges to the centre, crease firmly, and unfold, then rotate the paper clockwise through 90 degrees.

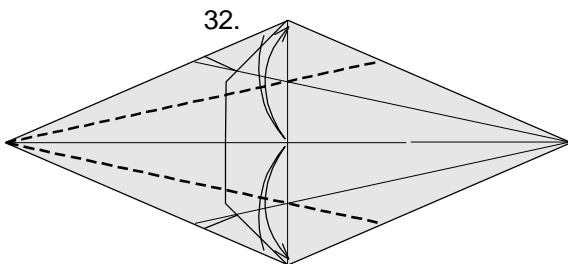

32. Fold and unfold on the left, as in Step 31.

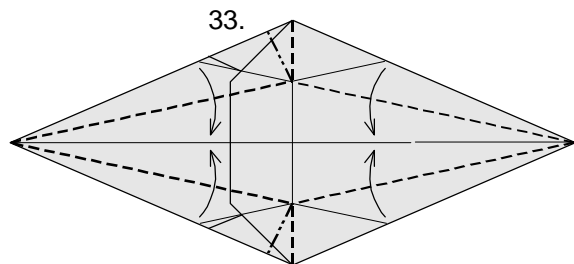

33. Now bring the four diagonal edges to the centre as illustrated, Note the crimps in the centre.



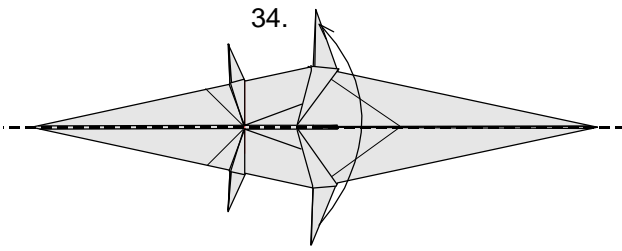

34.  
Fold the model horizontally in half

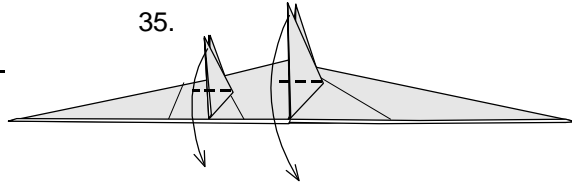

35.  
The four vertical pieces will form the legs. Fold down the two on this side and repeat at the back.

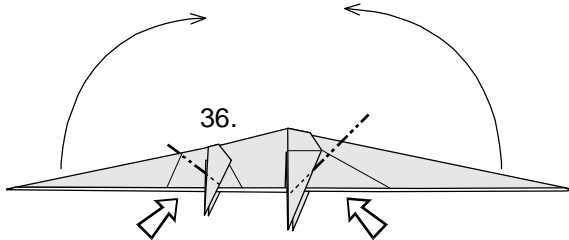

36.  
Reverse fold on the right and left.

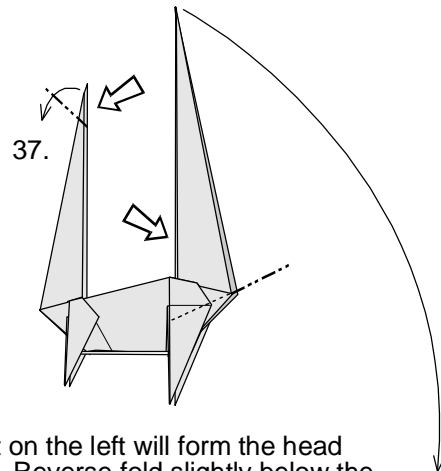

37.  
The point on the left will form the head and neck. Reverse fold slightly below the tip, then reverse fold again at the base of the tail piece on the right.

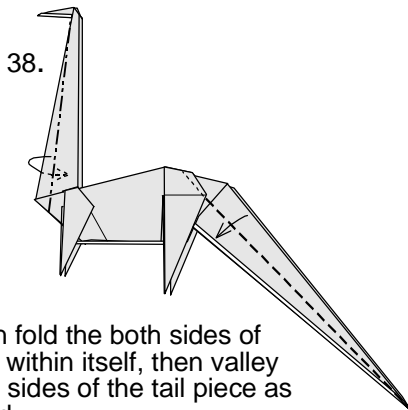

38.  
Mountain fold the both sides of the neck within itself, then valley fold both sides of the tail piece as illustrated.

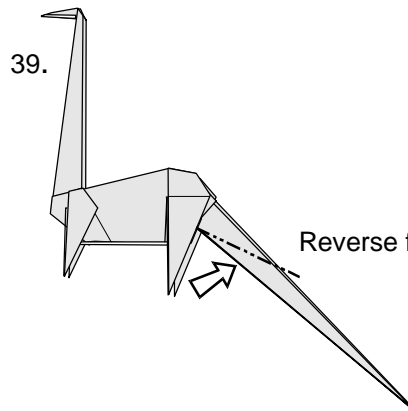

39.  
Reverse fold the tail again.

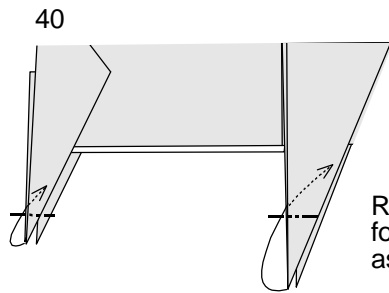

40.  
Reverse fold the tips of all four legs within themselves as illustrated.

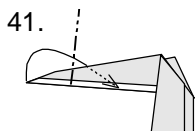

41.  
Now for the head. Inside reverse fold ...

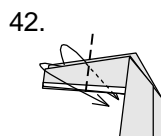

42.  
... then outside reverse fold ..

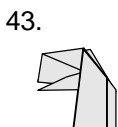

43.  
... like this, and the diplodocus is done.

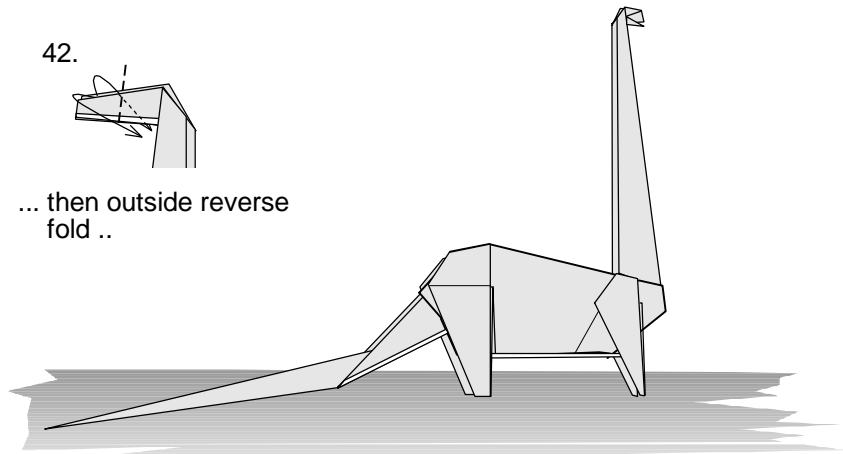

# Bebé Diplodocus

Fernando Gilgado Gómez

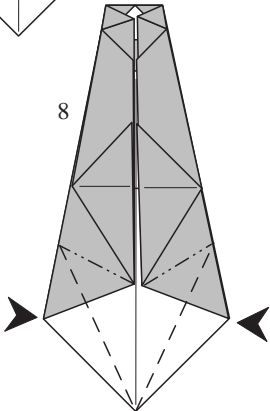
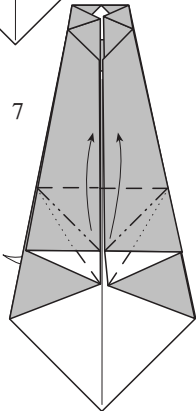
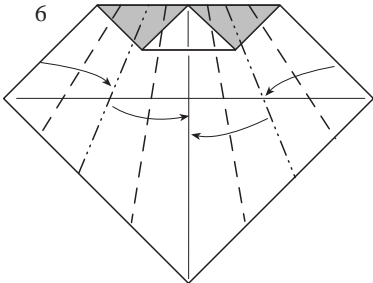
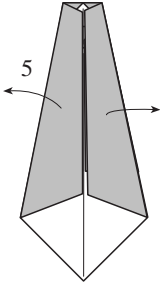
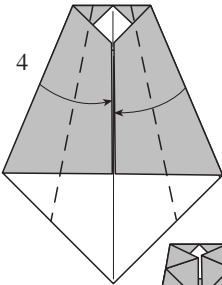
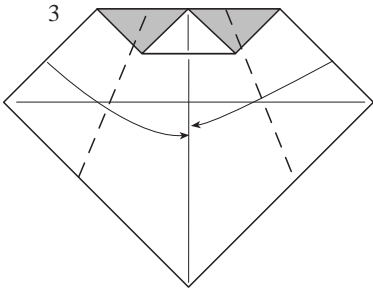
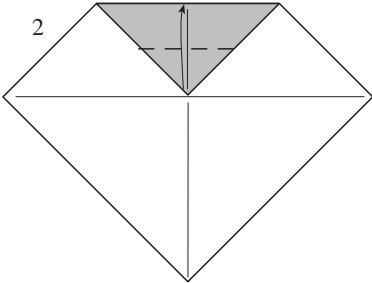
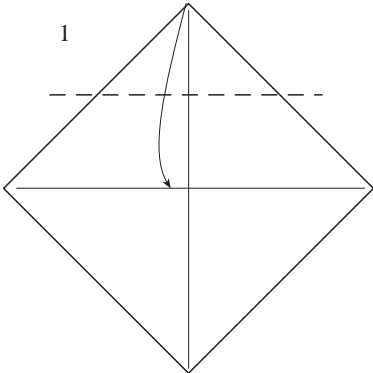
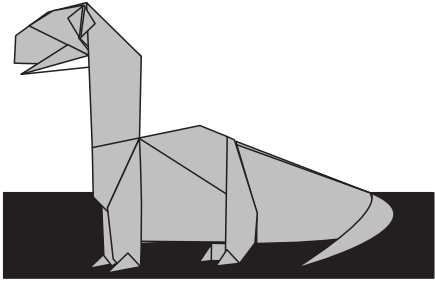

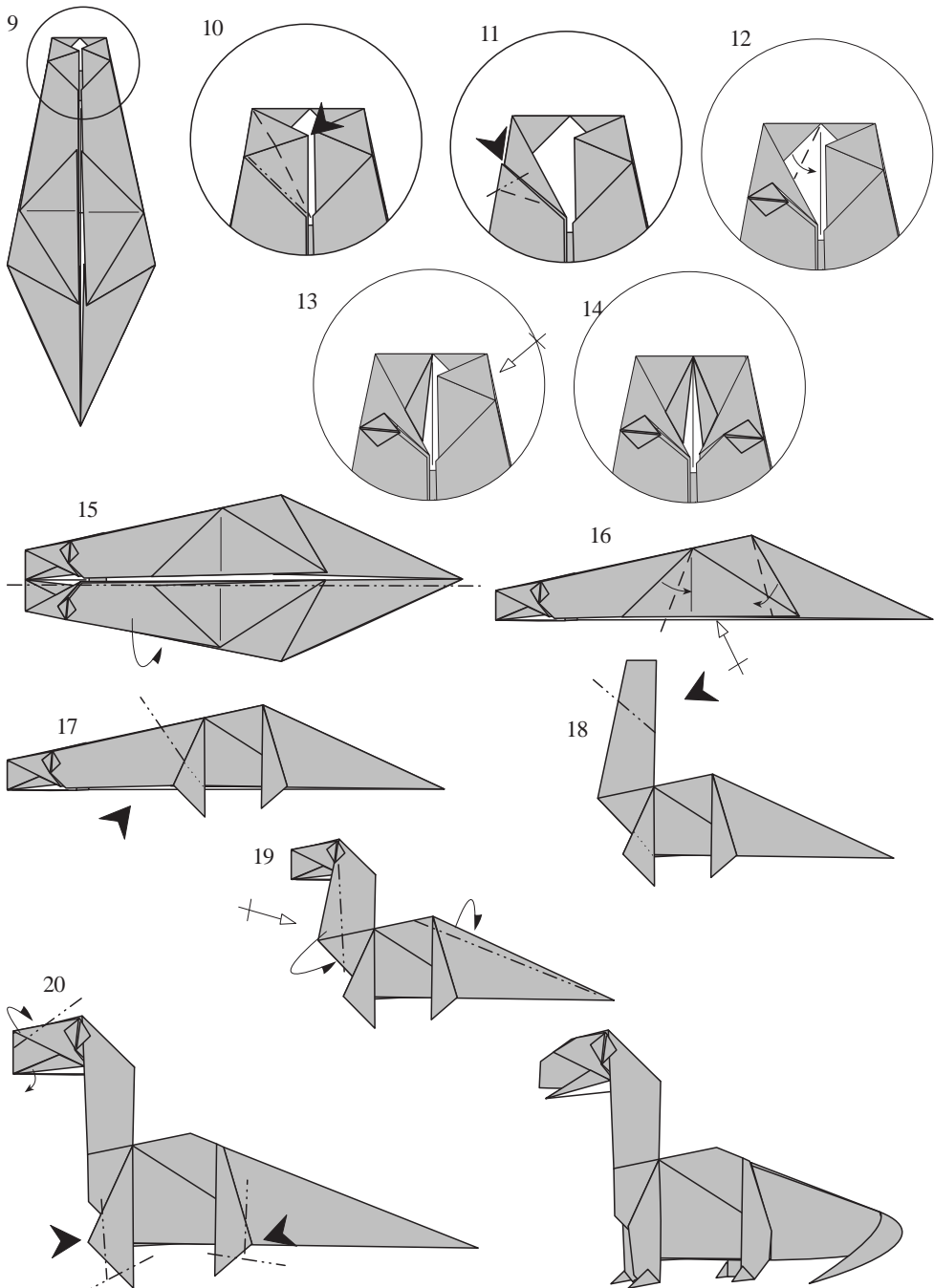

# \$ Tip Basket

by Kalei Anne Lundberg  
copyright 1991

I developed this back in the good old days when a dollar and some change was a pretty good tip for a cup of coffee and a piece of pastry. Smile. The model is presented for personal use. For any other applications please contact me at [klundber@mnsinc.com](mailto:klundber@mnsinc.com) ... thanks.

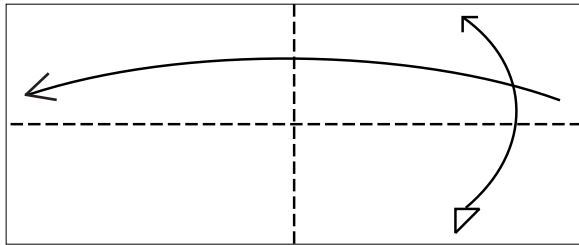

1. Fold and unfold along the long side.  
Valley fold in half.

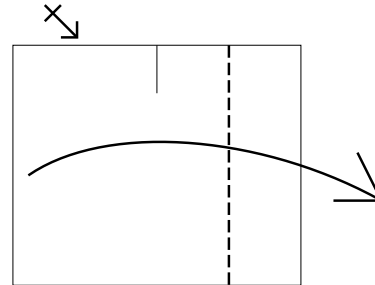

2. Pinch the top flap at the half way point to find the landmark and valley fold at the quarter mark. Repeat behind forming an accordion pleat.

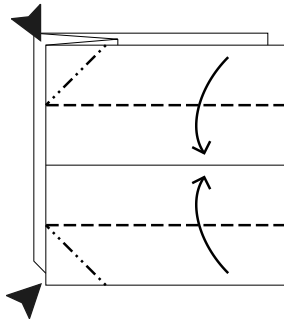

3. Valley fold the raw edges to meet at the center line opening and squash folding the corners.

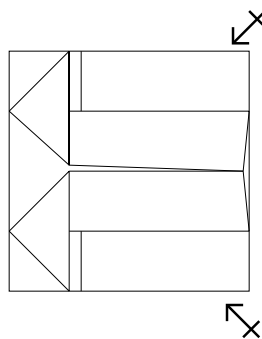

4. Note that the squash fold will not line up exactly with the upper edge. Repeat step three on the other side and turn upright.

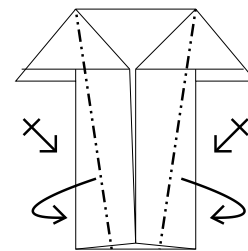

5. Mountain fold the edges under. The idea is to reduce the width of the handle by about one third. These creases fold all the way down into the corners of the pockets formed by the accordion pleat. Repeat behind.

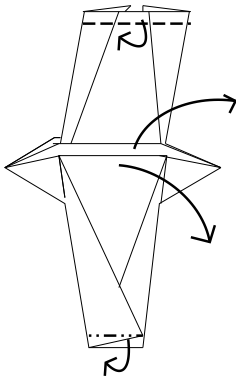

6. Because step 5 is a judgment fold one side of the handle will be larger than the other. Unfold the larger side and valley fold the top edge down. Mountain fold the still folded edge behind. These folds will lie about on the line of the border of the bill. Open up the basket and square off the bottom.

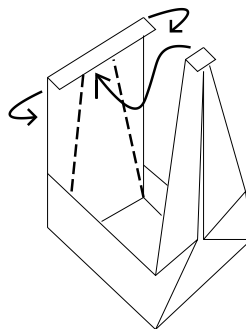

7. Slip the tab of the folded side underneath the tab of the other and wrap around following the creases to lock in place.

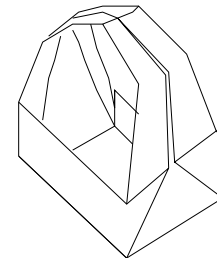

8. Tah Dah!!! Fill the basket with change and give to your favorite wait person. If the bill is old roll the top edge of the basket over a bit to the inside so it can be lifted without the change falling out.

# Dolphin

Note: Drawings are not drawn to scale.  
Follow the written directions in the first few steps closer than the diagrams.

1.

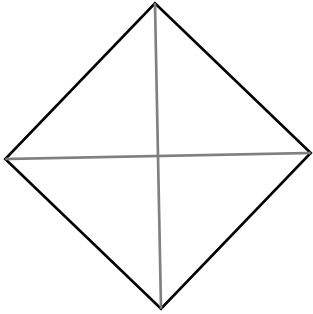

Begin with a square,  
same color on both sides.  
Crease the diagonals.

2.

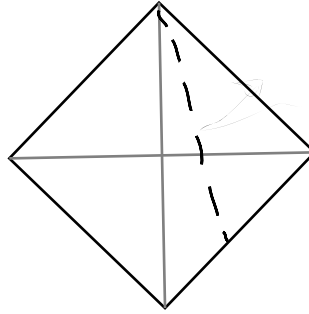

Fold to center and unfold.  
Rotate 90 degrees clockwise.

3.

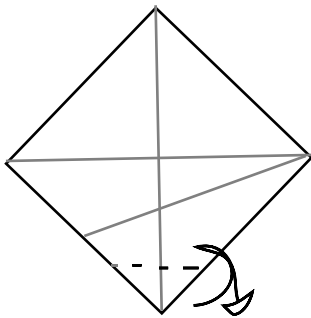

Fold up to intersection  
and unfold.

4.

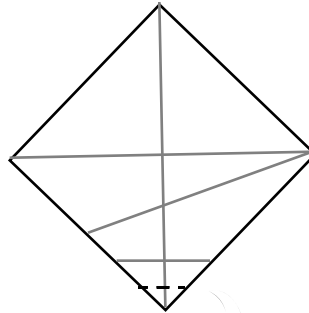

Fold up to the crease you just  
made. Unfold.

5.

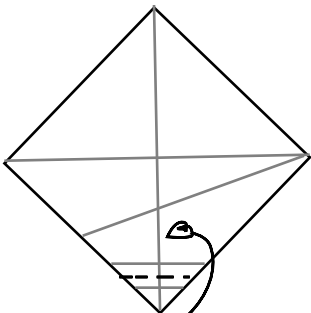

Valley fold so that the  
crease made in step 4  
lies slightly above the  
one made in step 3.

6.

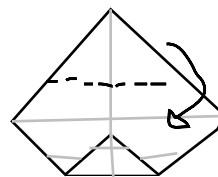

Like so. Valley fold the top  
corner to meet the bottom one.

7.

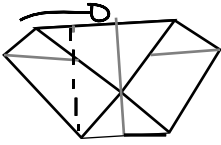

Valley fold the left so that  
a) The edges on top line up.  
b) The fold creates a 90 degree angle on bottom.

8.

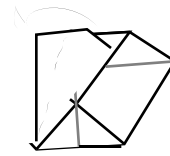

Valley fold to bisect lower angle.  
Unfold steps 7 and 8, and repeat them on the rights.

9.

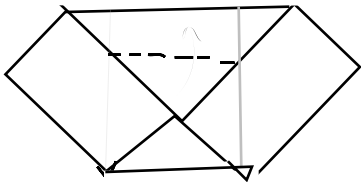

Valley fold the flap so that the edges of the fold intersect the fold made in step 7 at a right angle.

10.

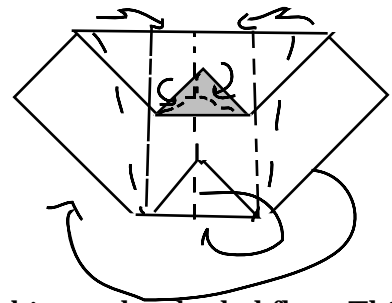

Rabbit ear the shaded flap. This is the dorsal fin, so it's best to leave it pointing straight up. Fold the bottom flap underneath. Refold steps seven and eight. Mountain fold entire model in half lengthwise.

11.

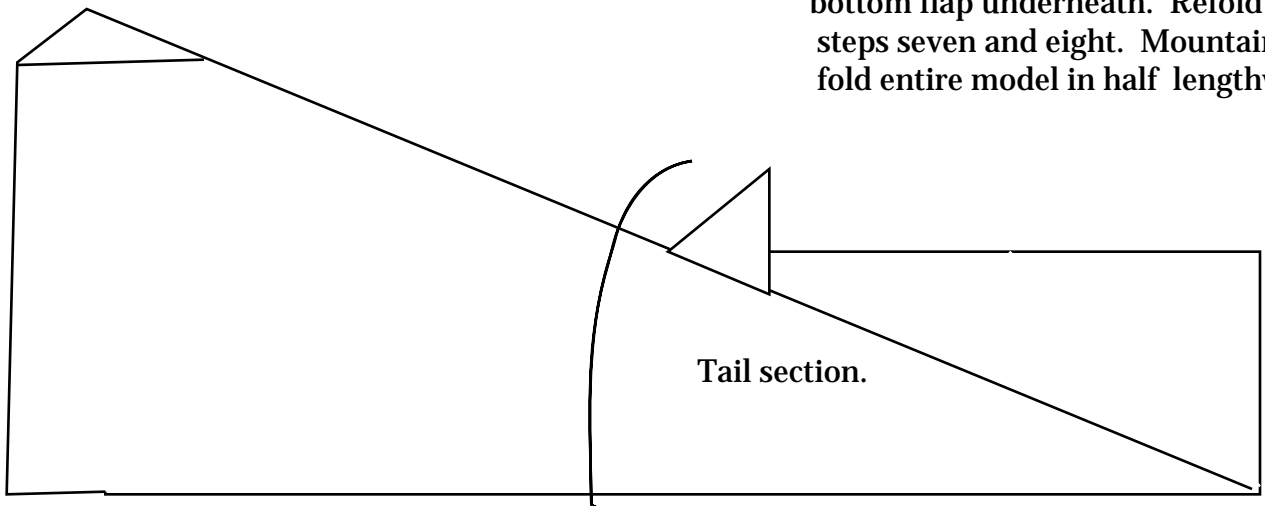

Your model should look something like this. The next few steps will deal with the tail.

12.

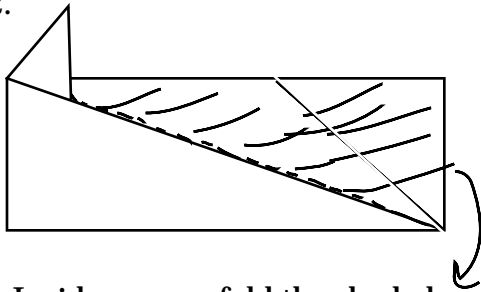

Inside reverse fold the shaded area down. There is a little triangle pointing up inside the dorsal fin. Reverse fold this along with the rest.

13.

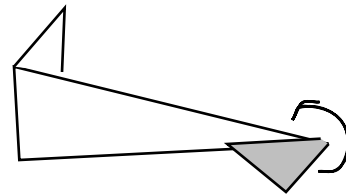

Inside reverse fold the shaded flap up.

14.

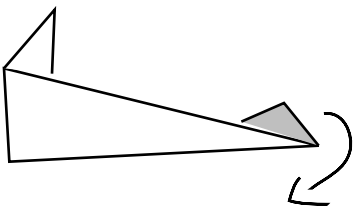

Inside reverse fold the shaded flap down.

15.

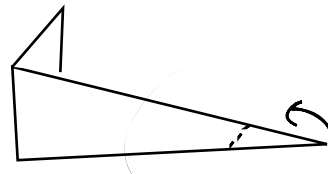

Reverse fold the tail, repeat behind.

16.

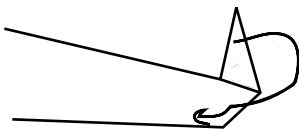

Squash fold to form tail, repeat behind.

17.

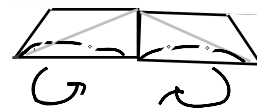

Top view of tail. Gently mountain fold to curve the ends.

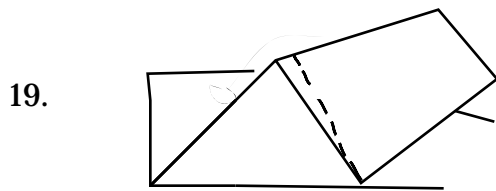
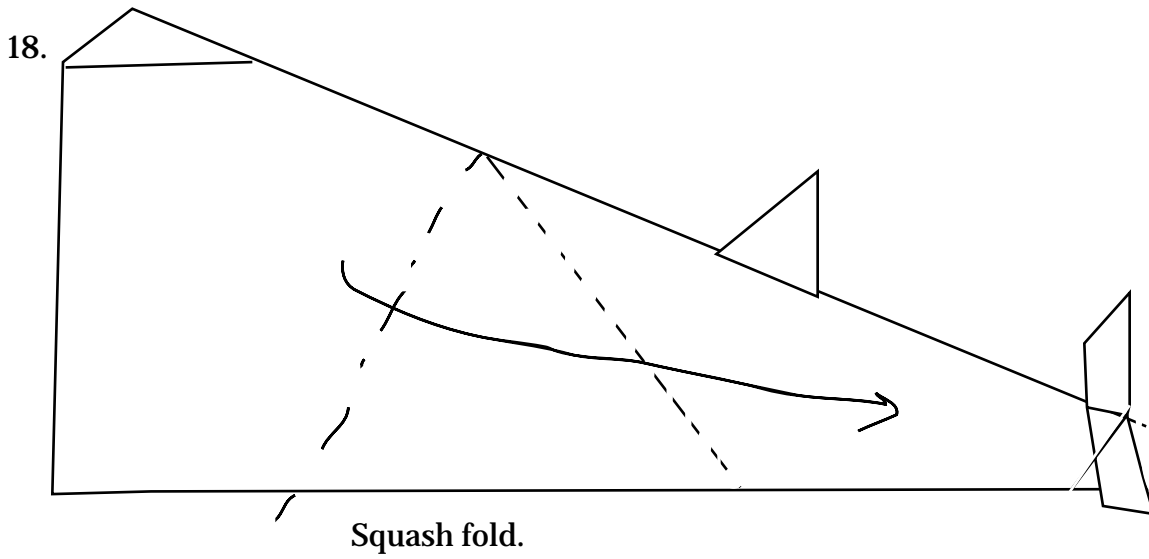

Only the first and middle layers are shown.  
Valley fold down.

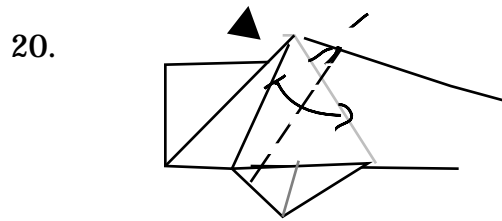

Dorsal fin is not shown. Spread sink; the top of the spread should lie along the top edge of the middle of the model.

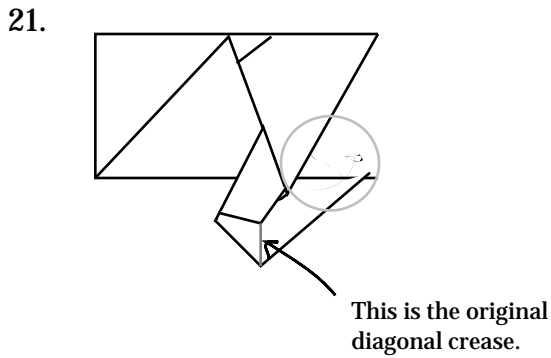

Reverse fold a single layer up.  
There are no guidelines for this fold.

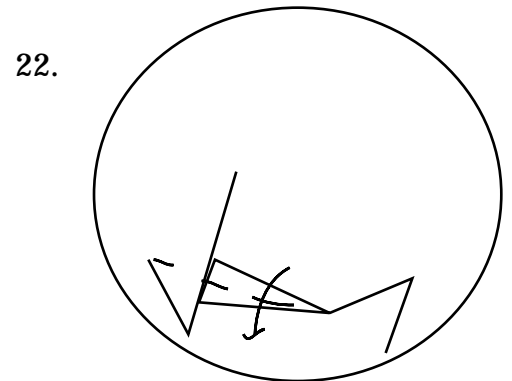

Bisect the corner of the flap you just folded up with a reverse fold.  
Steps 21 and 22 help separate the fin from the body.



22.

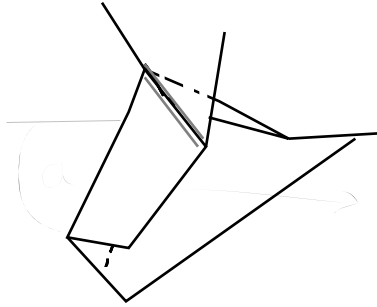

Details of the fin.  
This is a judgement fold.  
The grey line is a mountain fold  
which lies along an edge.  
Swivel until angle "a" is about  
80 degrees wide.

23.

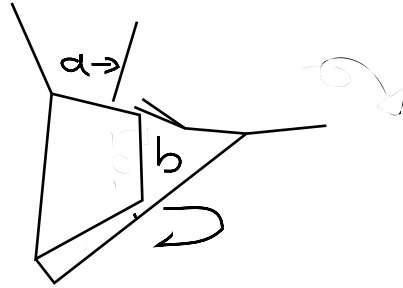

Inside reverse fold flap "b"  
to line up with edge "a".  
Mountain fold "c". Turn  
over.

24.

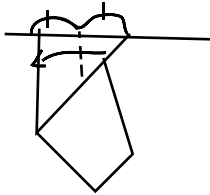

Reverse fold.

25.

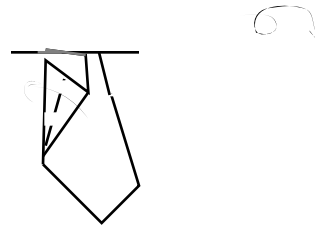

Swivel in half. The gray  
is a mountain fold that  
lies on an edge. Turn over.

26.

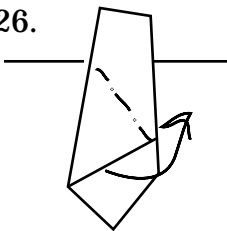

Reverse fold. This  
fold IS assymetrical.

27.

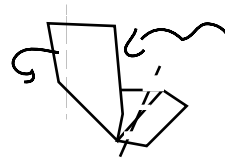

Fold over and tuck  
into fin. Closed-sink  
the other end to narrow it.

28.

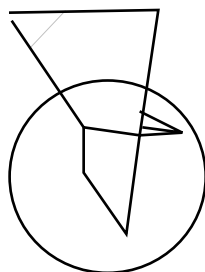

Completed fin. Repeat steps 18-27  
behind.

29.

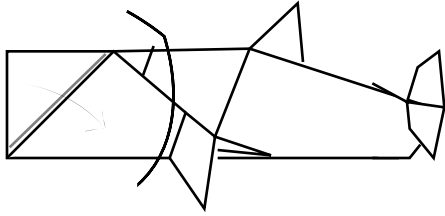

Your model should look something like this. The grey line is a valley fold. Tuck the triangle inside.

30.

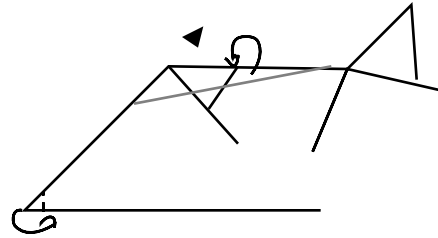

Another judgement fold; When the model is completed, you may adjust this step to taste. Sink the center and fold the side layers into the sink. Reverse fold the tip.

31.

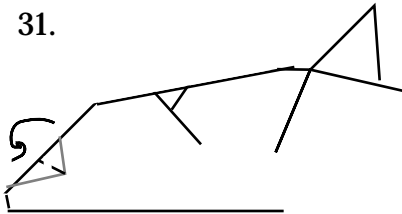

Now we're going to shape the head and make it three dimensional. The grey lines are mountain folds, the dotted line is a valley fold. Sink the top of the head into the bottom; the sides will puff out and the snout will form.

32.

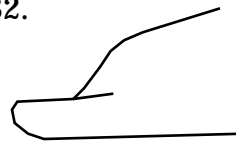

The head should look something like this.

32.

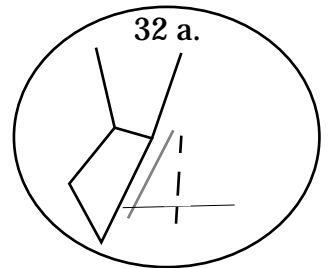
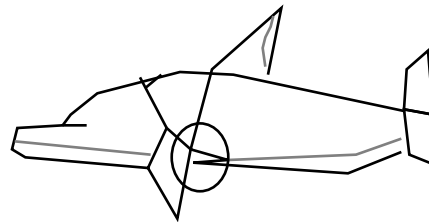

The grey lines are mountain folds.  
32 a: Crimp the paper right by the fin to puff out and curve the body. The crimp should extend about half way up. You may want to sink the crimp in between the first and middle layer.  
32: Shape the bottom of the body and the dorsal fin with gentle mountain folds. Repeat behind.

33.

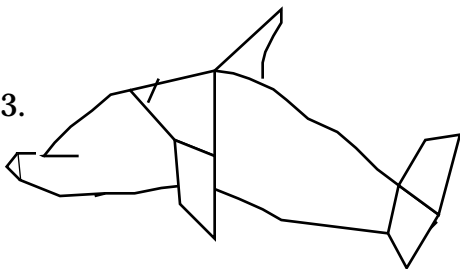

Completed dolphin.

# Flapping Dove

by Eugeny Fridrikh

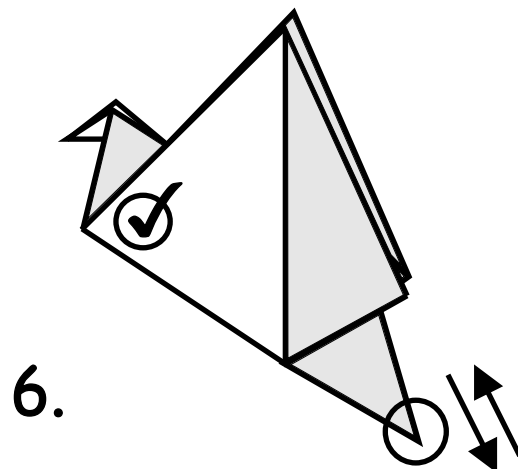
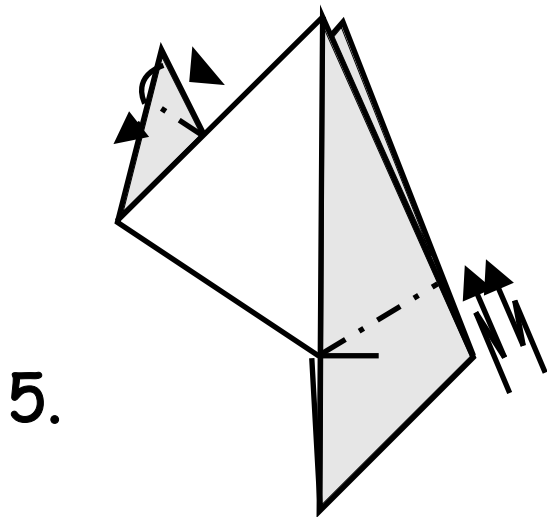
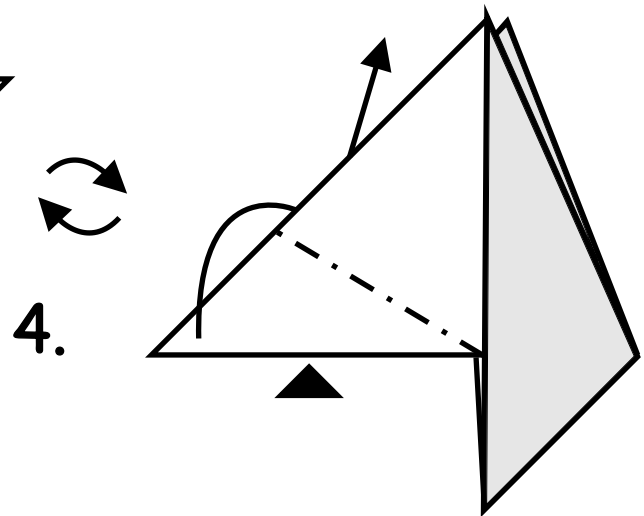
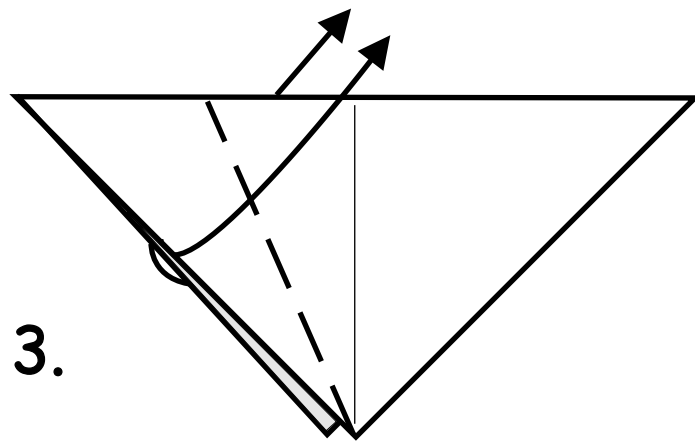
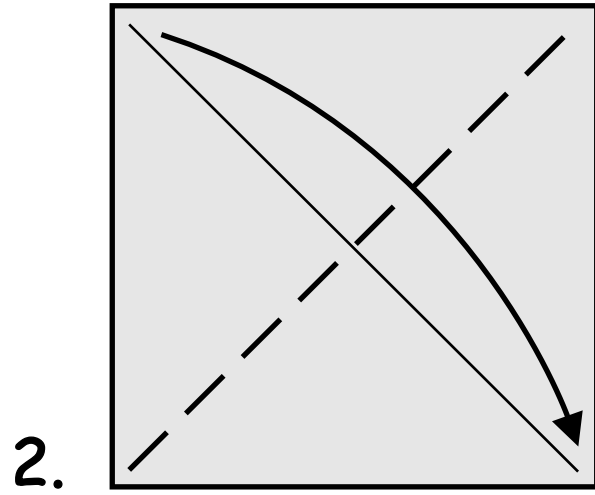
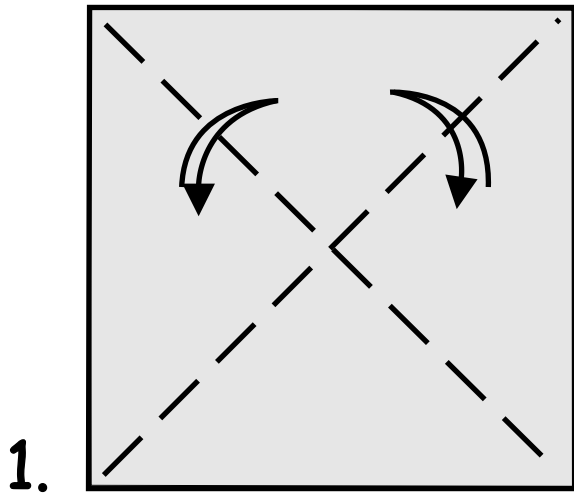

# Dragon

(c) 1993 K. Weidner

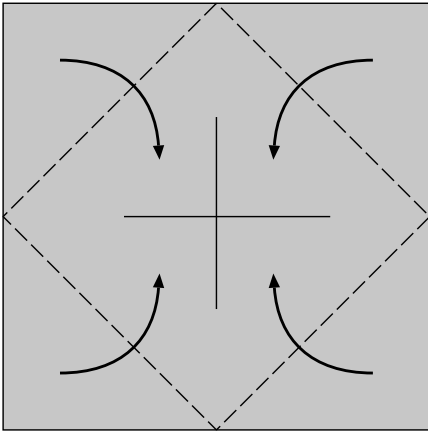

1. Blintz-fold, the colored side is inside.

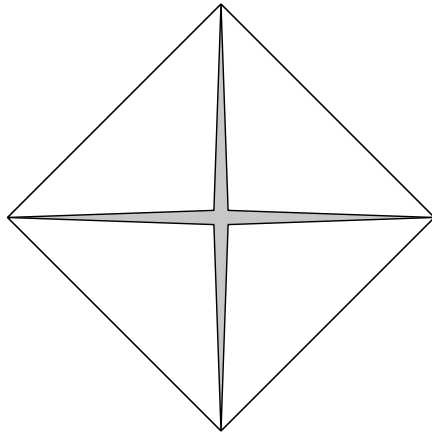

2. Turn the paper over

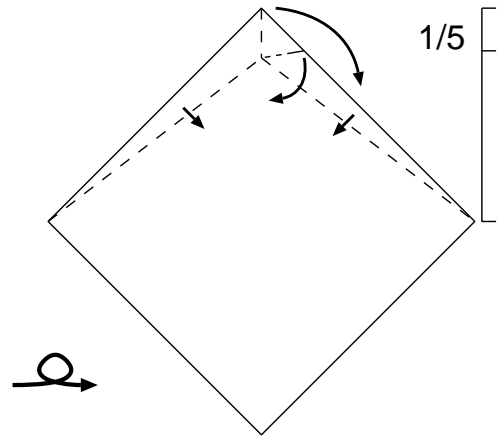

3. Fold a small rabbit ear.

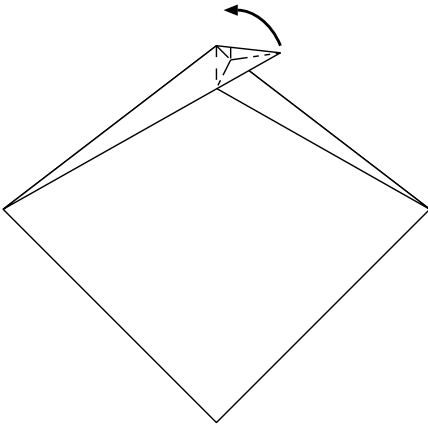

4. Petal-fold the small flap

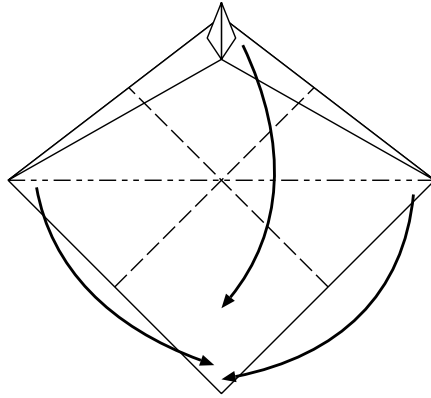

5. Preliminary fold, just like a bird base.

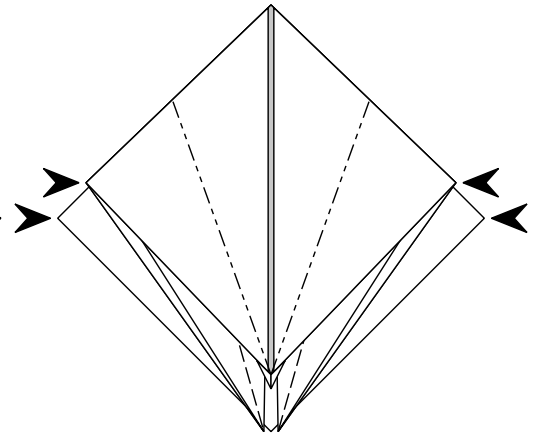

6. Reverse-fold the corners.

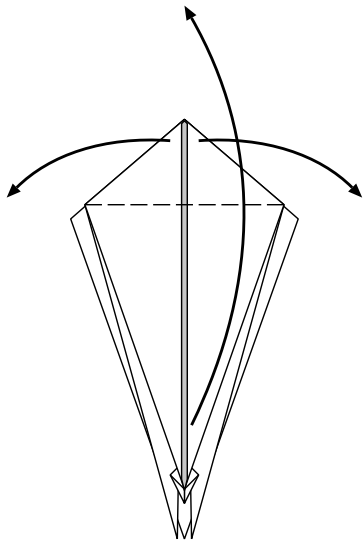

7. Pull out the loose paper while folding up the tip. Repeat behind.

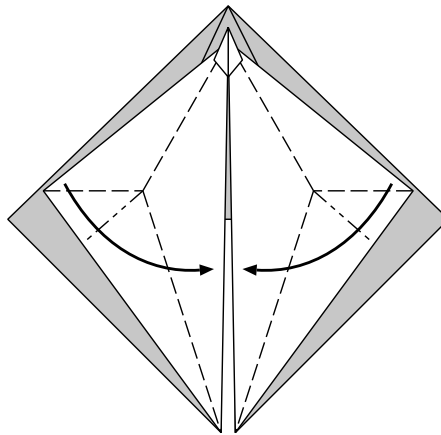

8. Fold rabbit ears, repeat behind.

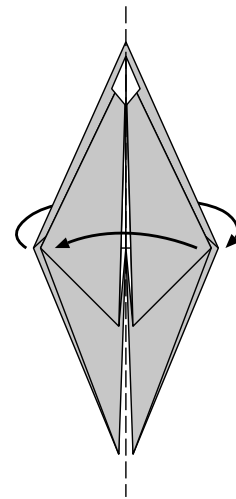

9. Fold two flaps to the left, repeat behind.

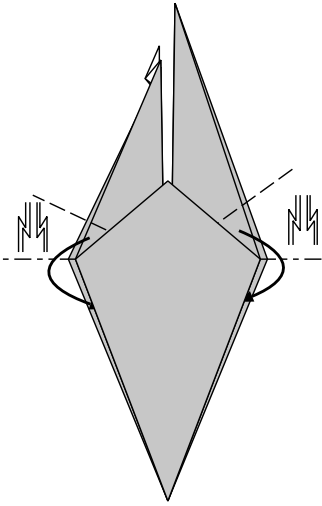

10. Crimp-fold.

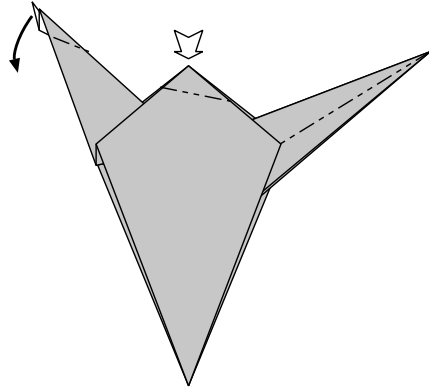

11. Sink the center, narrow the tail, inside reverse fold the head.

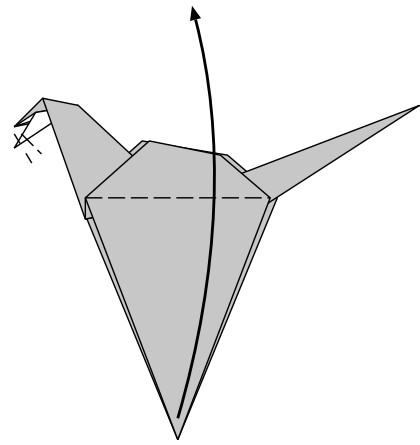

12. Fold up both wings, reverse fold the jaw.

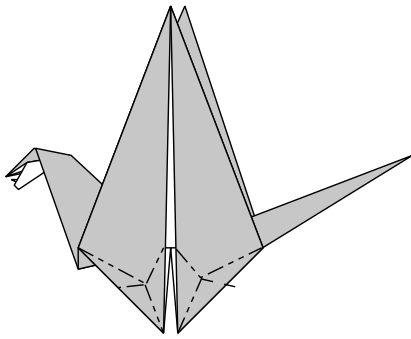

13. Double-rabbit-ear all four legs.

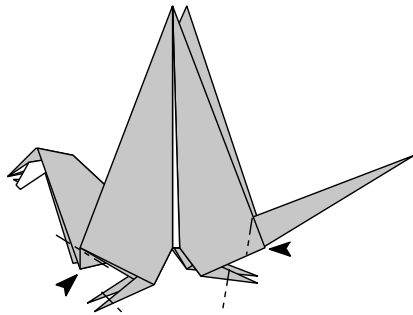

14. Reverse-fold the legs and sink the corners.

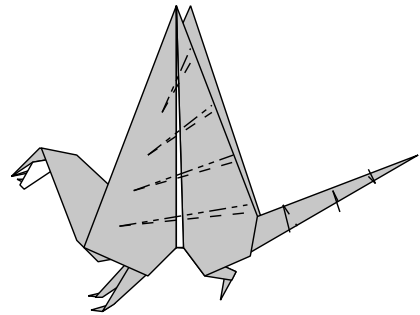

15. Shape the wings and tail.

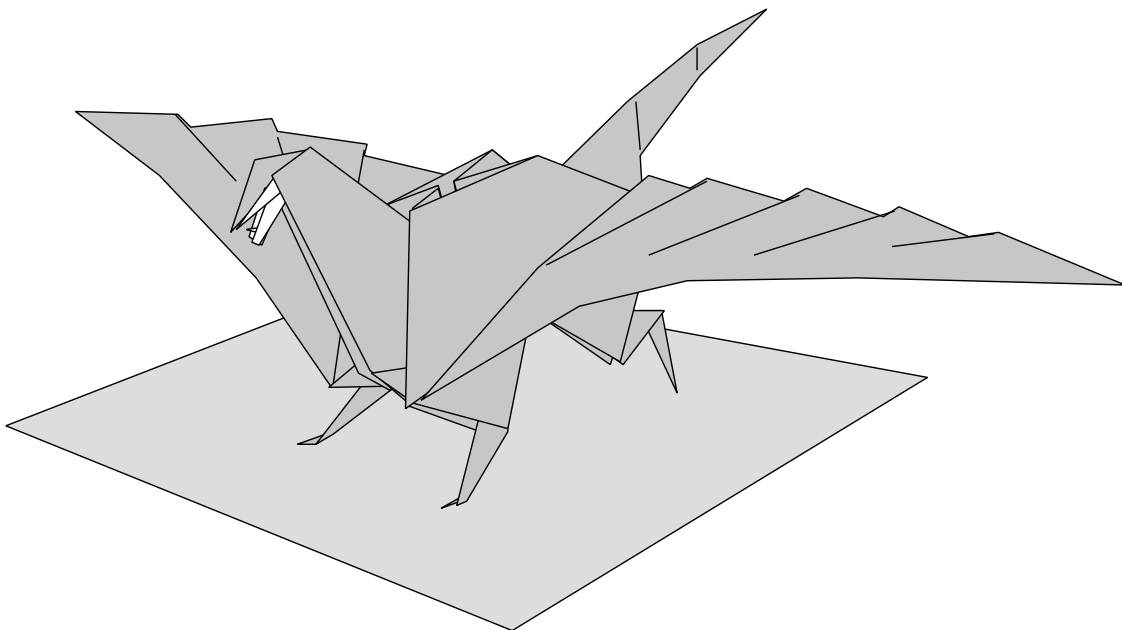

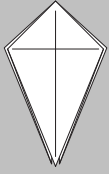

Autor: J. Anibal Voyer

Dificultad: 

Proporción:  $h = \frac{1}{2} a$

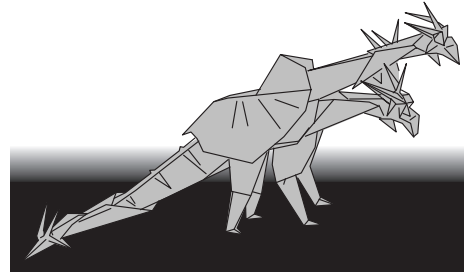

# Dragón de 3 cabezas

1 

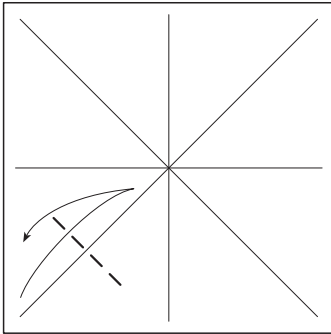

2

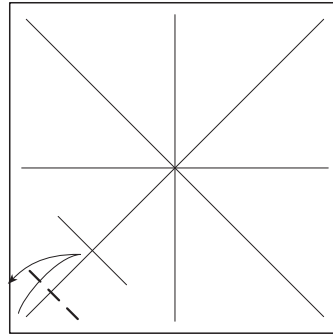

3

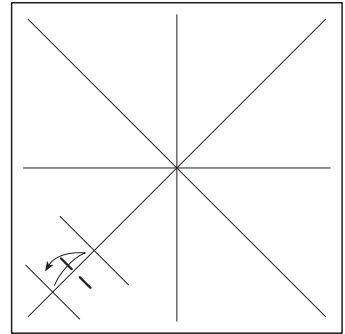

4

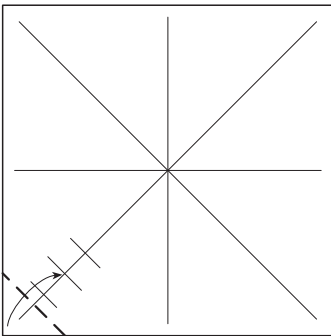

5 Repetir en las  
otras 3 esquinas

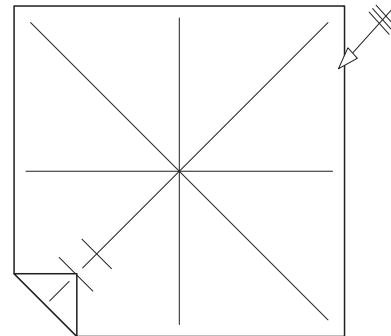

6

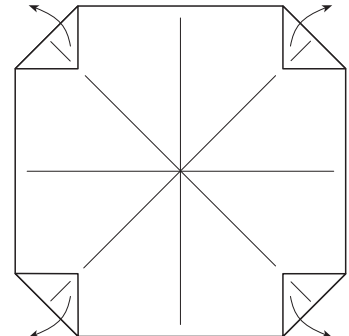

7

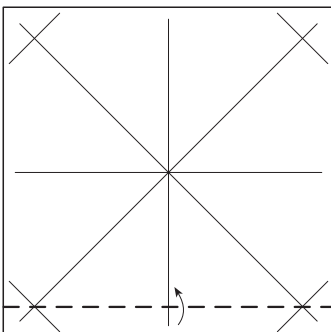

8

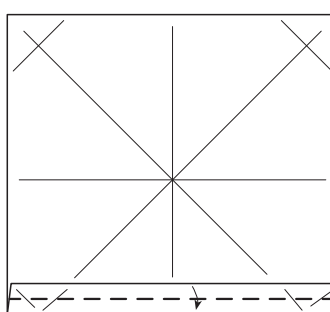

9

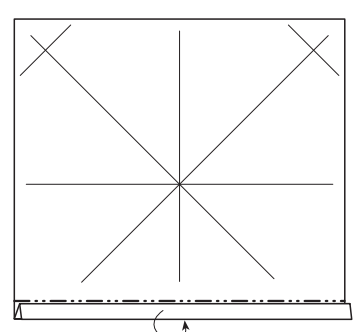

10

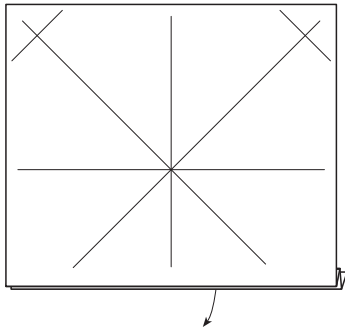

11 Repetir en los otros 3 lados

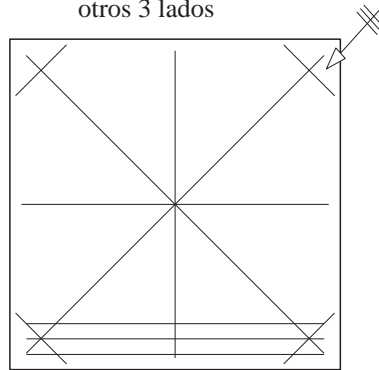

12

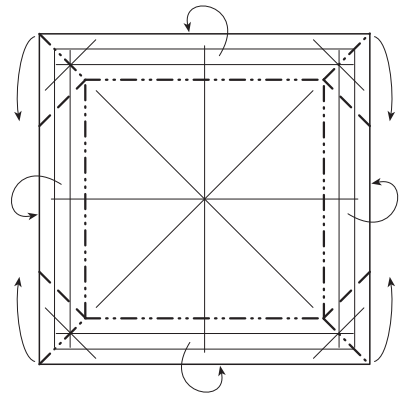

13

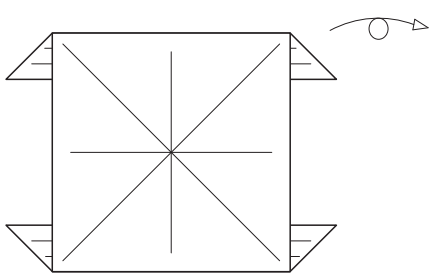

14

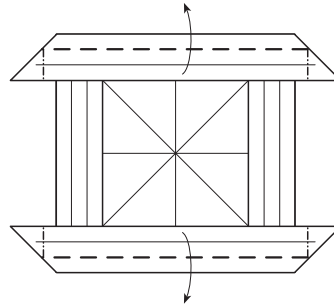

15

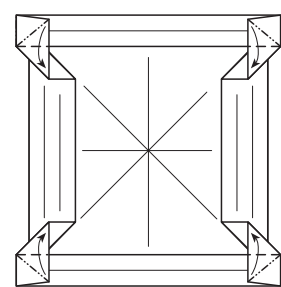

16

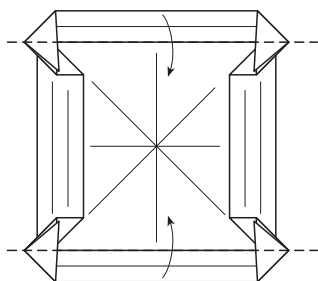

17

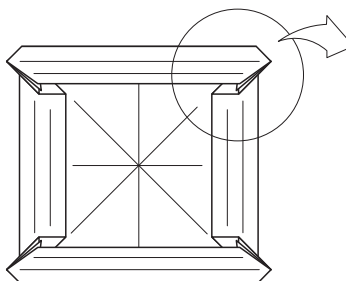

18 Hay que hacer estos pasos simultaneos en las 4 esquinas

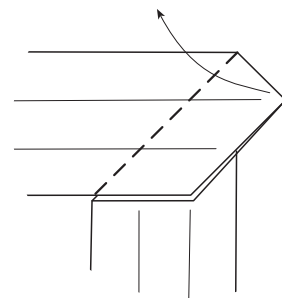

19

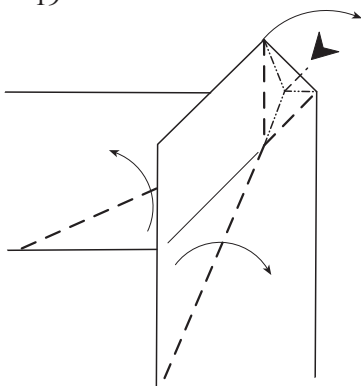

20

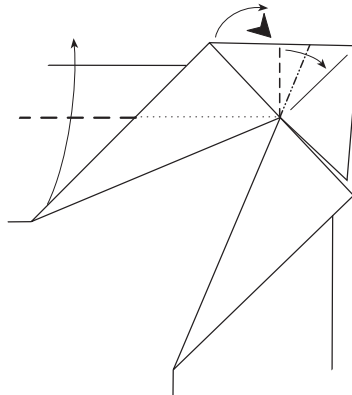

21

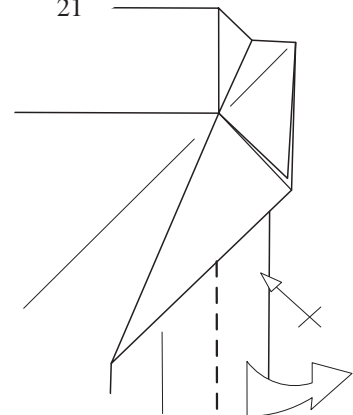

22

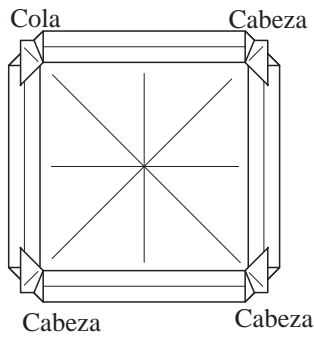

23 Plegado de las cabezas

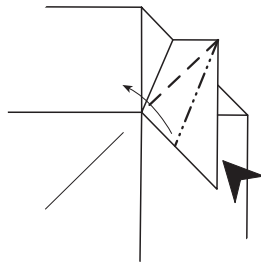

24

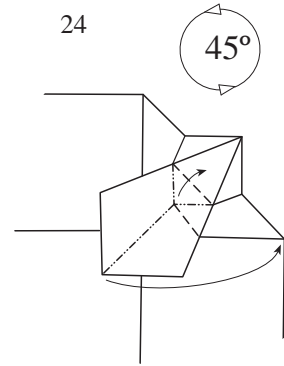

25

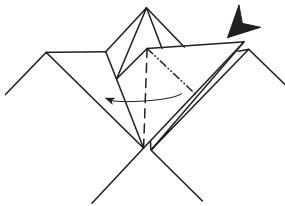

26

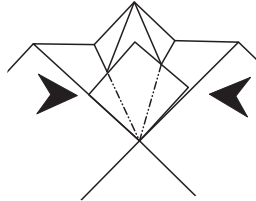

27

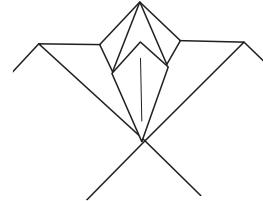

28 Plegado de la cola

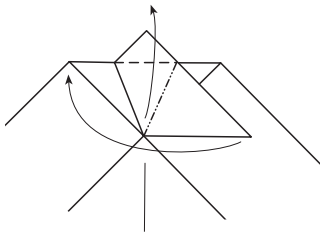

29

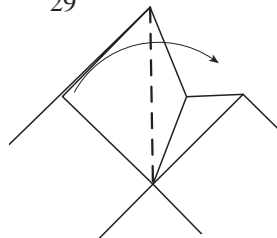

30

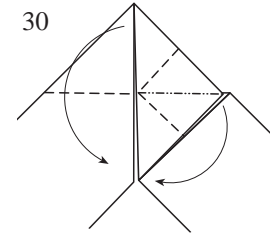

31

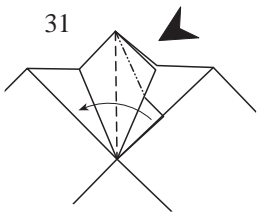

32

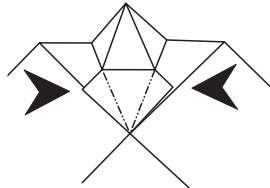

33 Hay que plegar a lo largo de todo el lado (se hace igual con las cabezas)

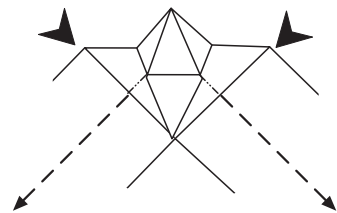

34 Repetir en las cabezas

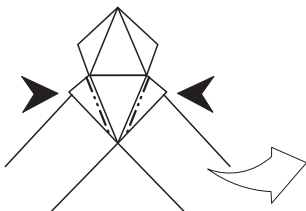

35 Solo se pliega en la cola

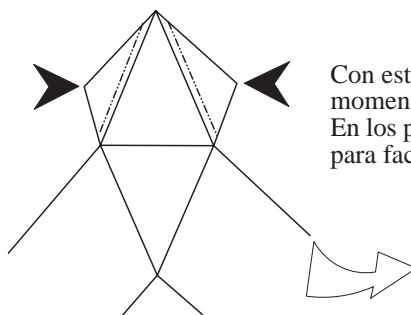

Con esto hemos terminado, por el momento, con las cabezas y la cola. En los proximos pasos no las dibujare para facilitar los dibujos.



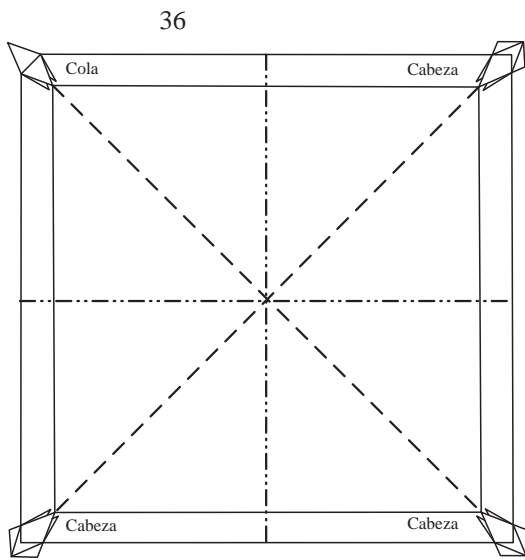

37 Las cabezas hacen que no se pueda doblar hasta la punta debe quedar como en el paso 39

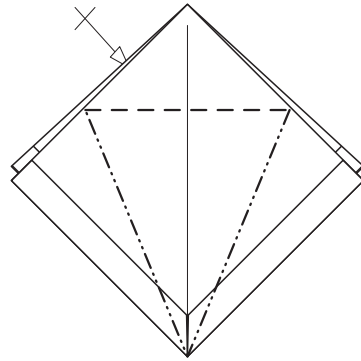

38 Cabeza vista desde dentro

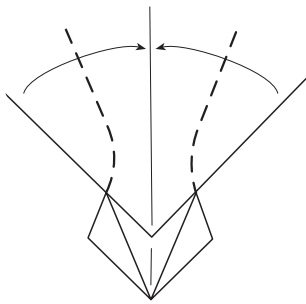

39

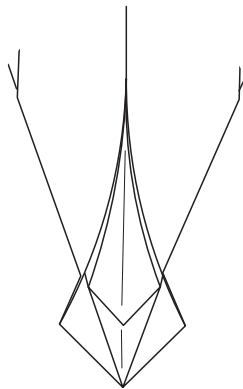

40

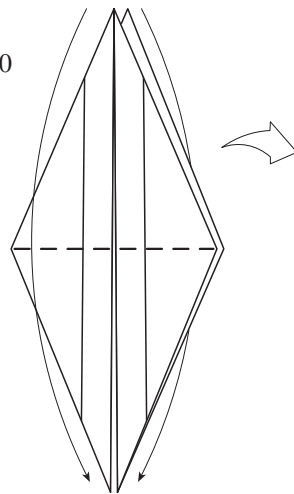

42 Desplegar hasta el paso 37

41

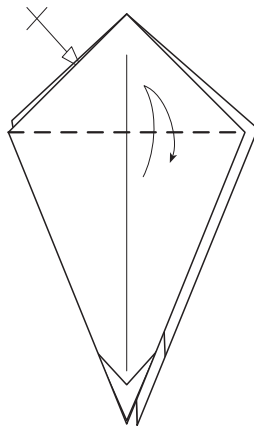
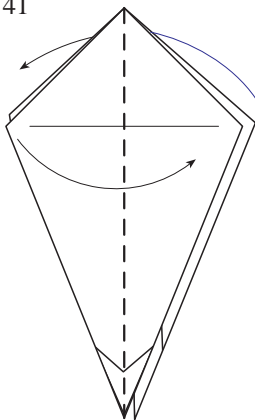

43

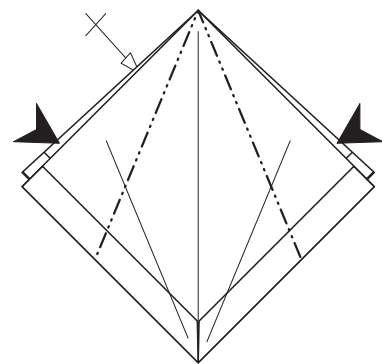

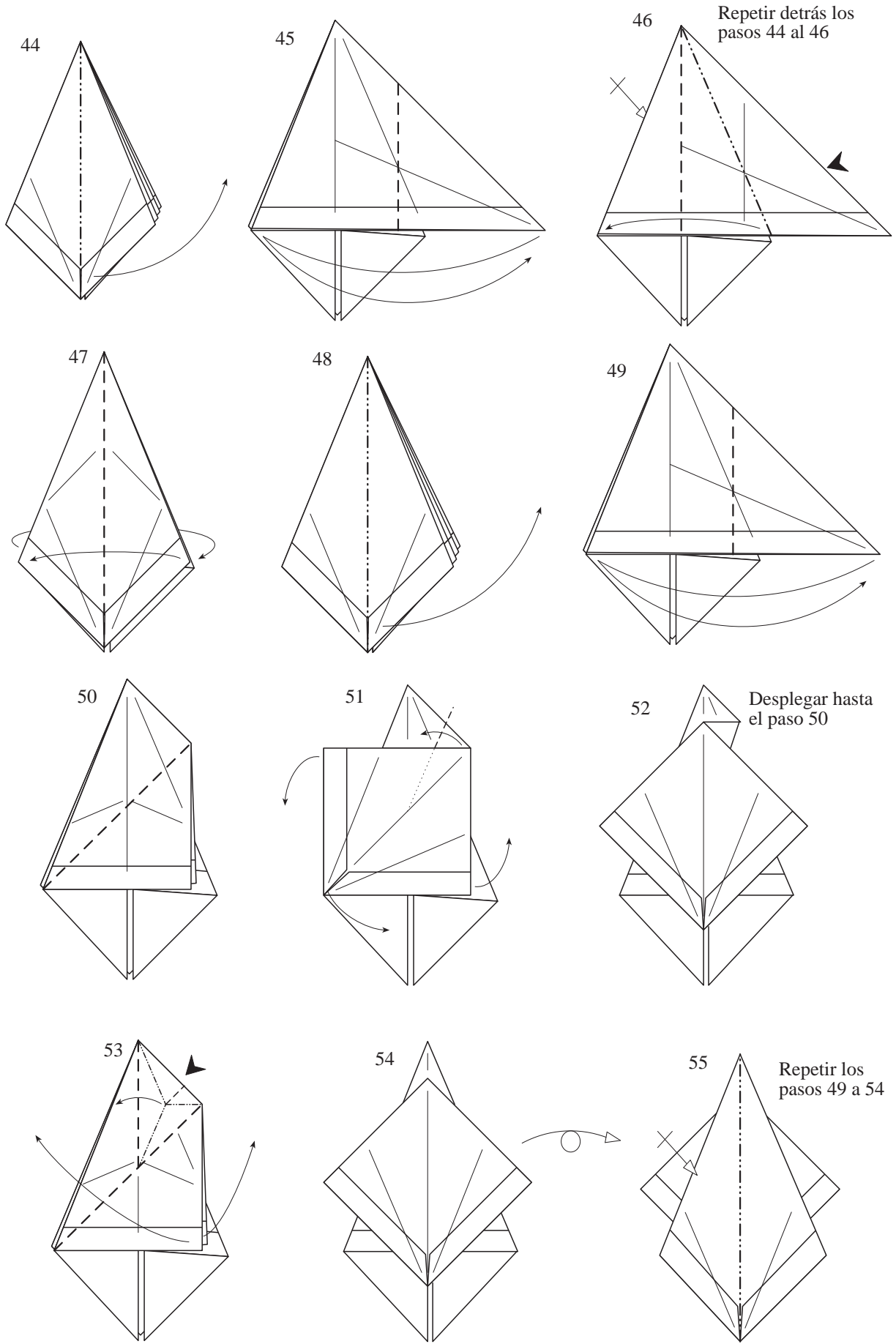

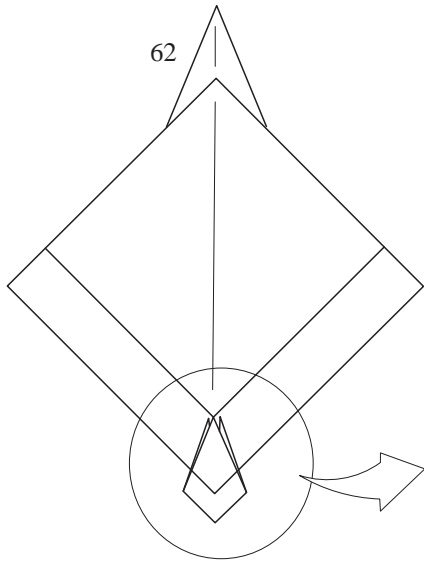
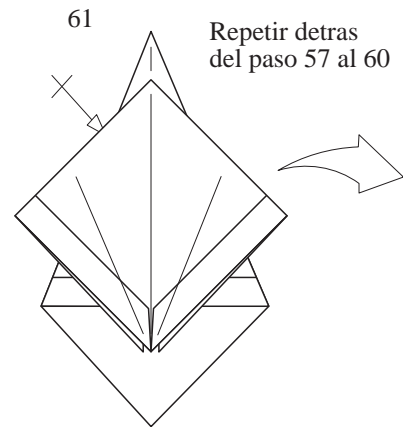
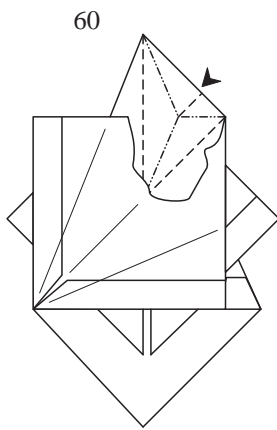
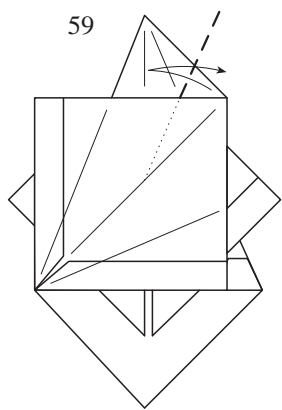
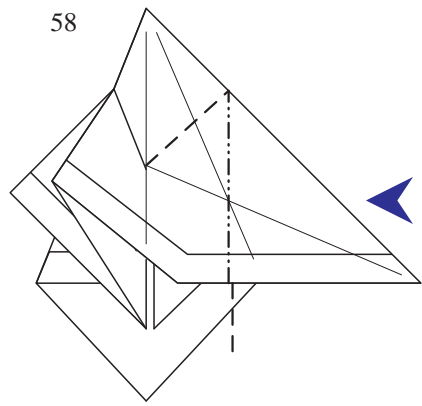
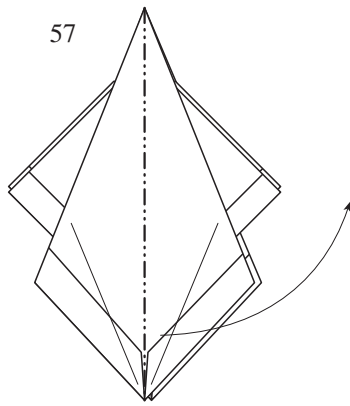
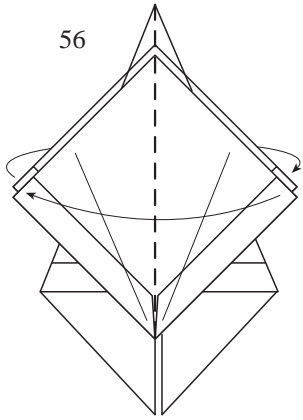

63 Continuemos con las cabezas

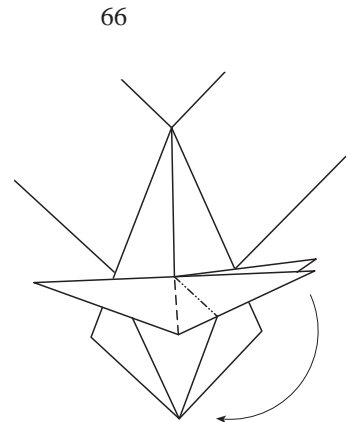
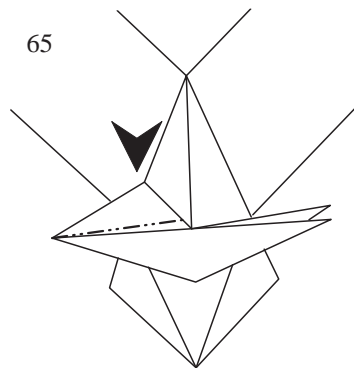
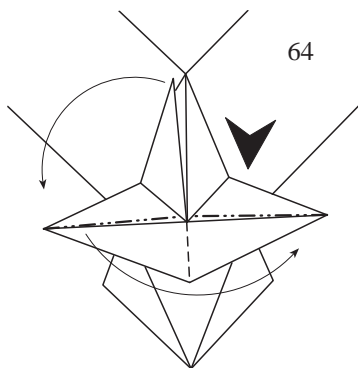
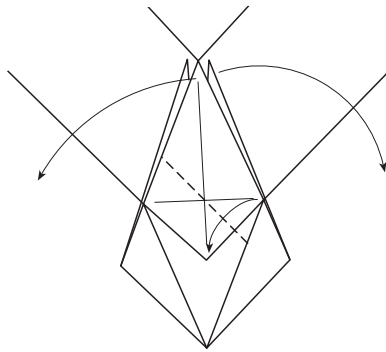

67

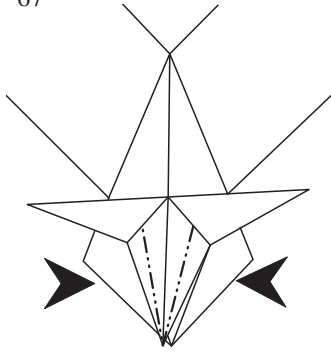

68 Los pasos 63 a 68 hay que repetirlos en las 3 cabezas

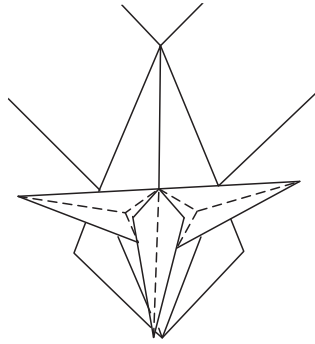

69 La Cola

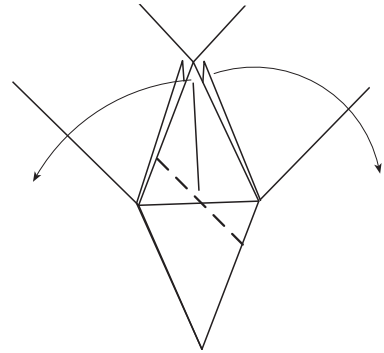

70

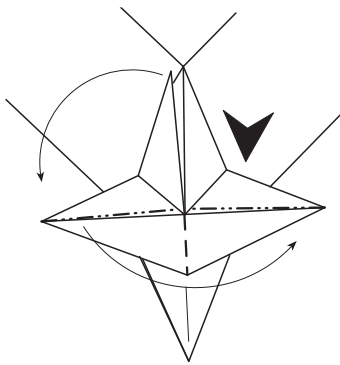

71

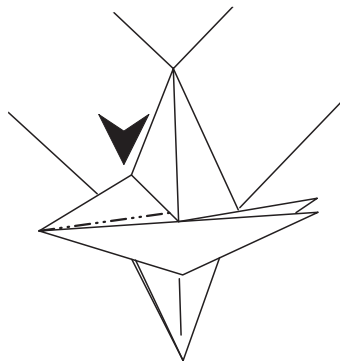

72

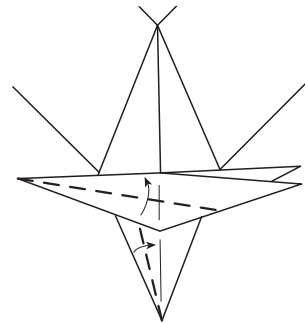

73

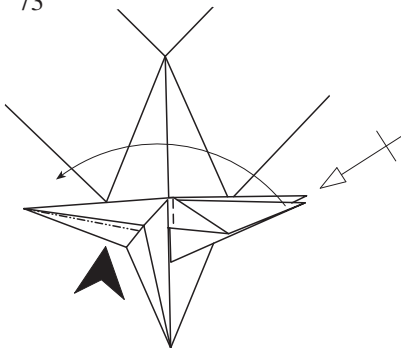

74

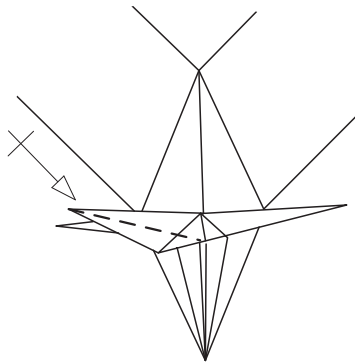

75

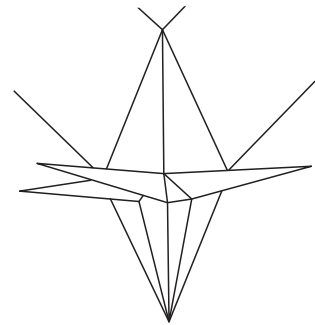

76 No dibujo las cabezas y la cola para simplificar los diagramas

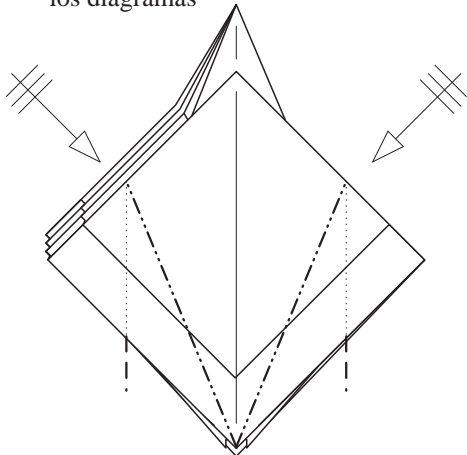

77

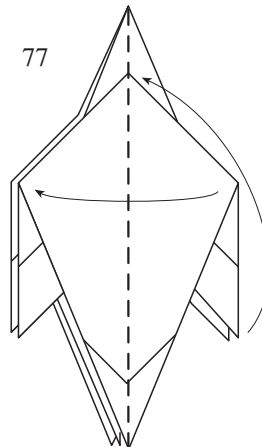

78

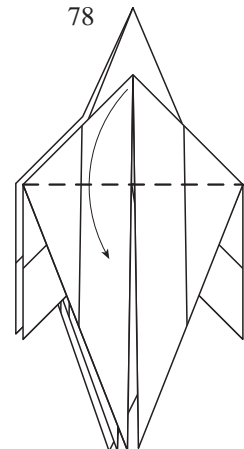

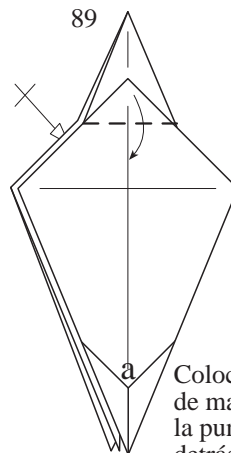
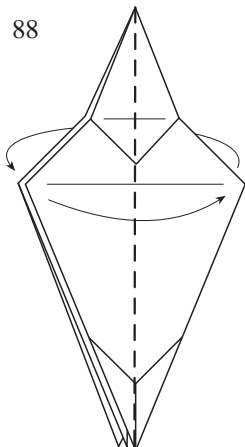
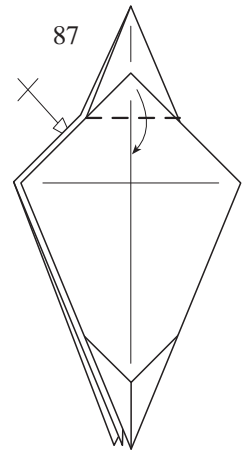
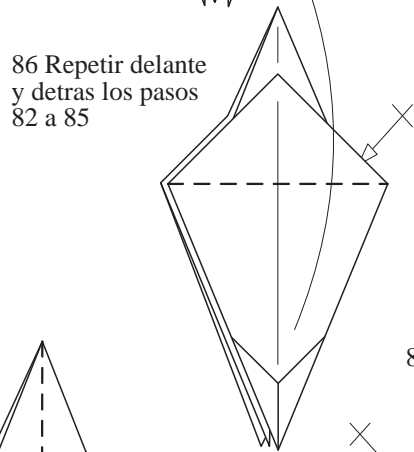
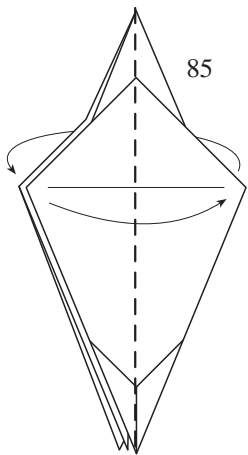
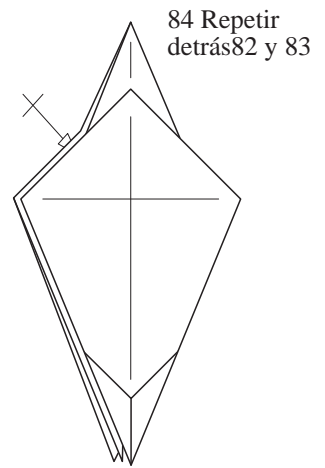
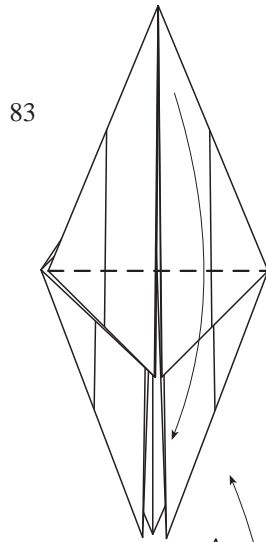
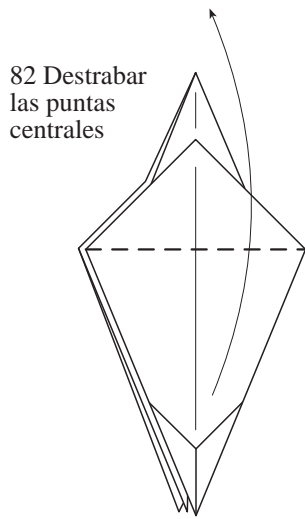
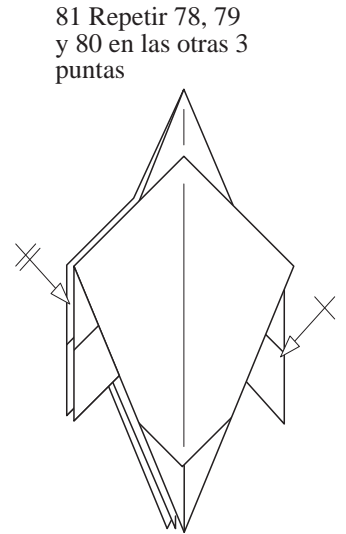
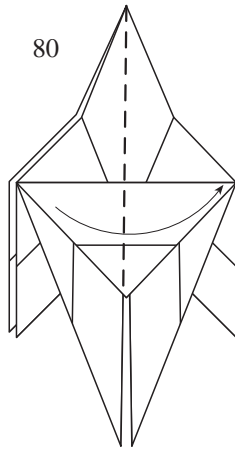
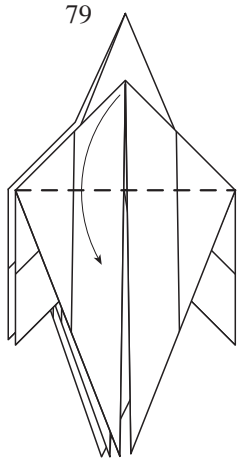

Colocar el modelo de manera que tanto la punta a como la de detrás sean cabezas

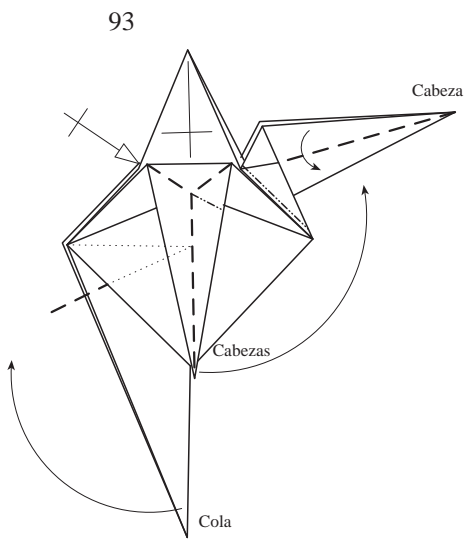
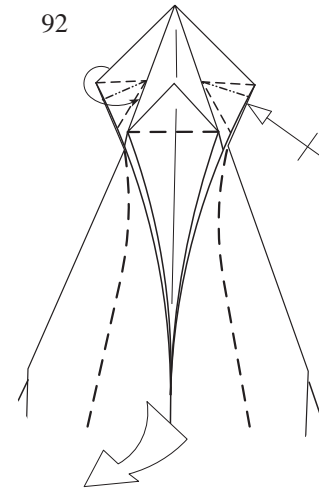
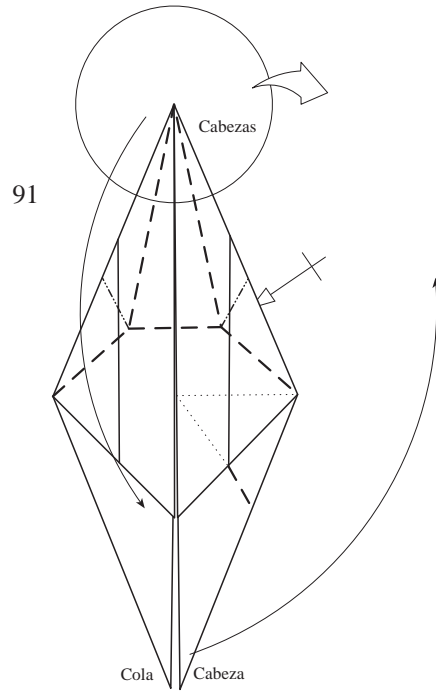
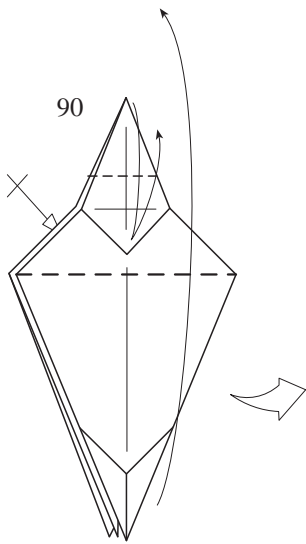

94 Detalle de las cabezas

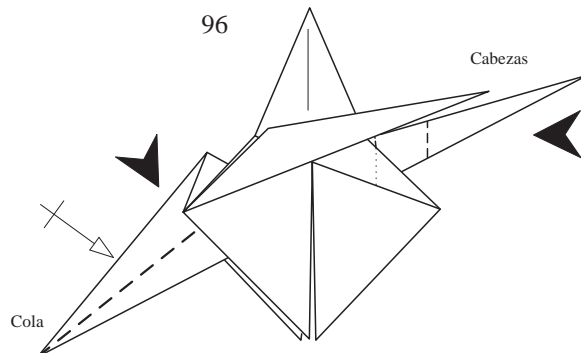
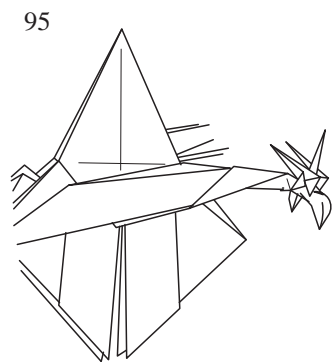
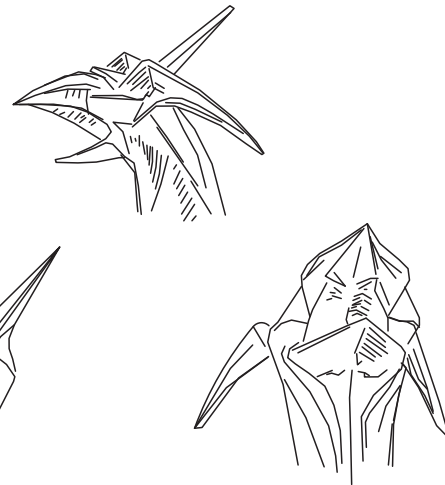

97 Detalle de la cola



98

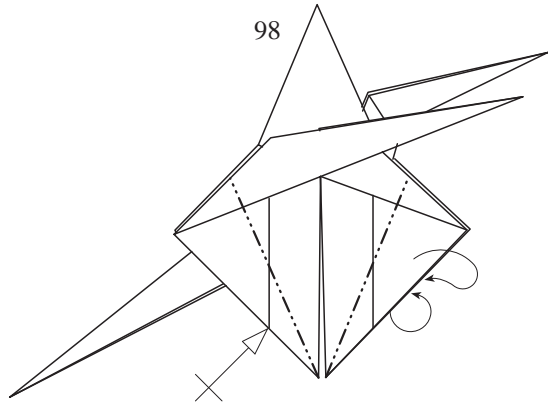

99

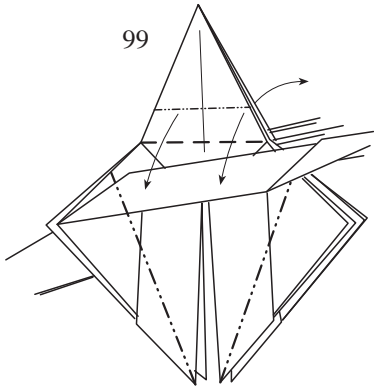

100

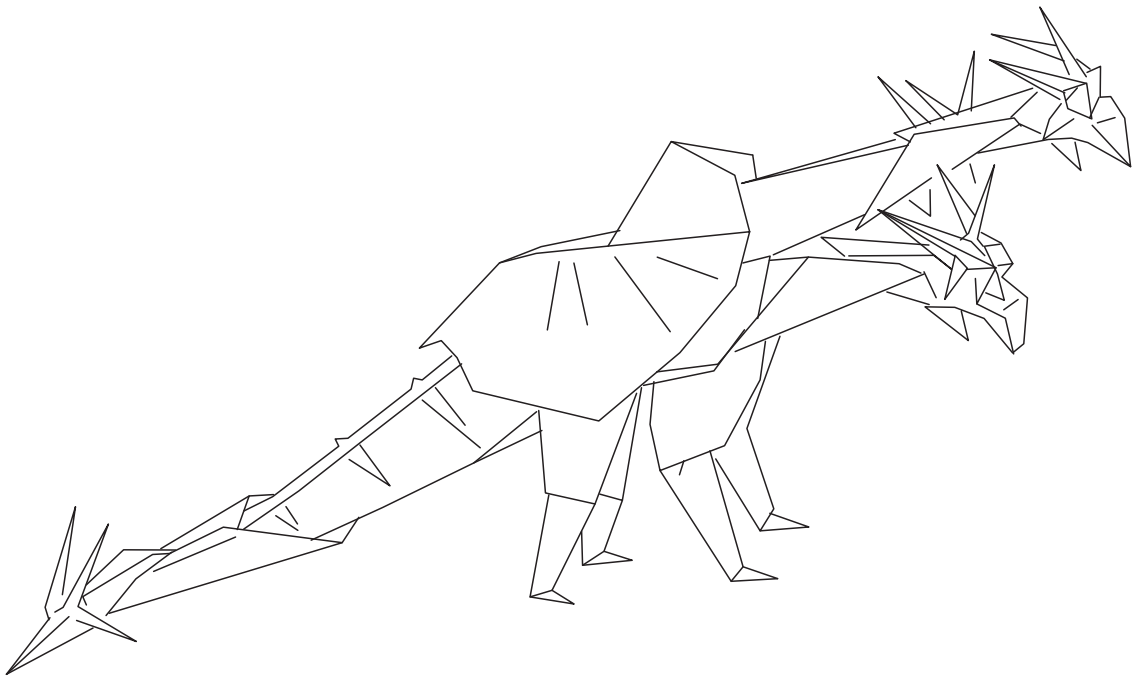
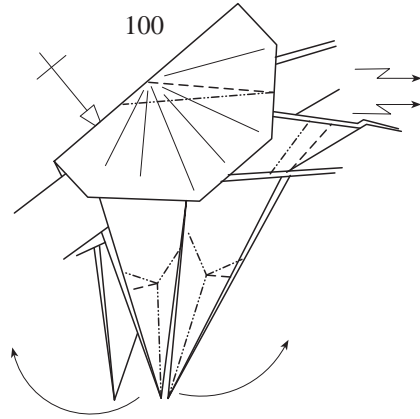

# Candy Wrapper Dragon

A. Anselmo  
January 1999

----- Valley fold  
----- Mountain fold

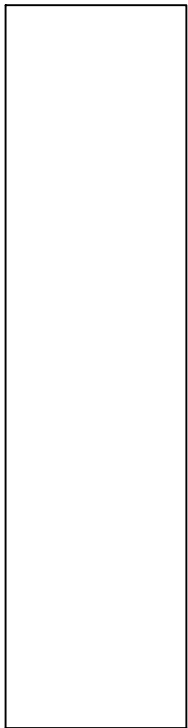

1) White side up, 1x4.

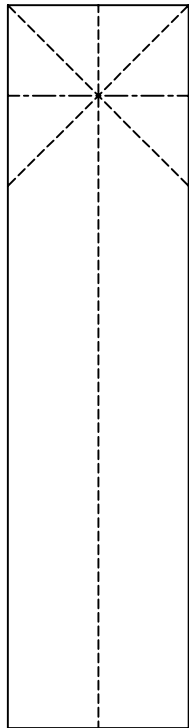

2) Valley fold in half, and fold a waterbomb base at the top.

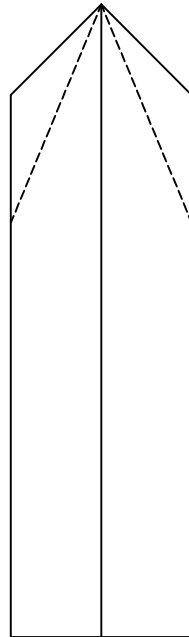

3) Turn the model over, and valley fold the top layer.

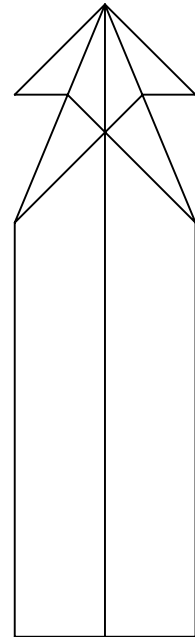

4) You will get this.

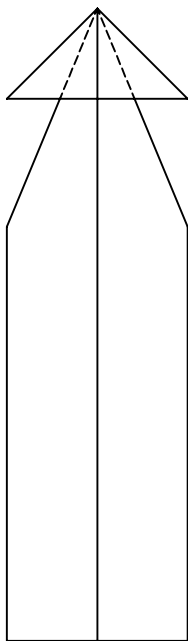

5) Valley fold along the lines indicated.

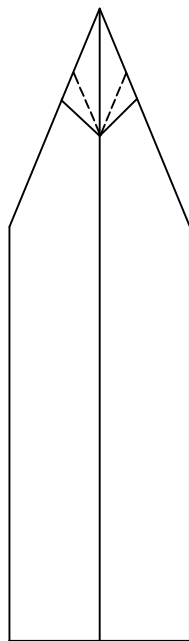

6) Valley fold the horns inward.

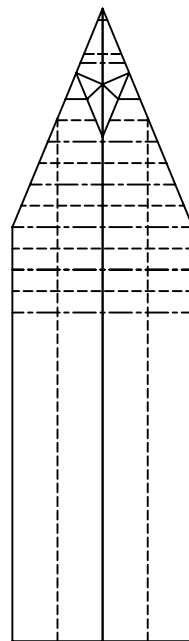

7) Accordion fold as shown. Pleat fold the nose and tip of the nose.

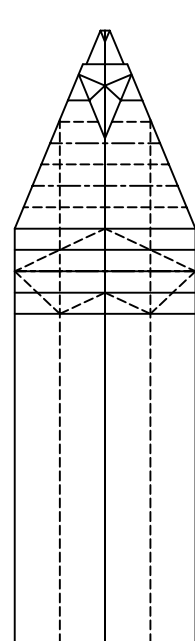

8) Valley fold as shown, using the accordion folds as a guide.



# Candy Wrapper Dragon

A. Anselmo  
January 1999

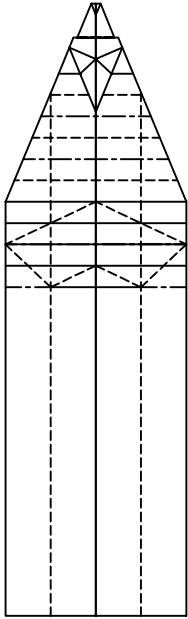

9) Accordion fold again, but only part of the way.

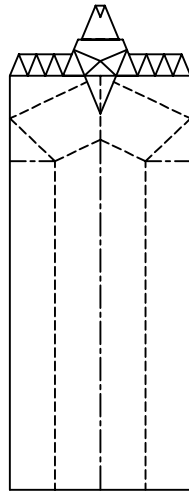

10) Accordion fold only as shown. Note the key folds. Fold inwards. This may be tricky.

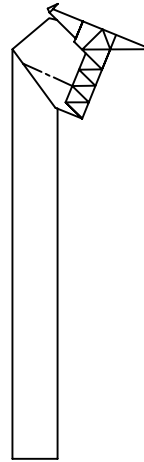

11) You should get something like this.



12) Tuck in the excess paper in the head.

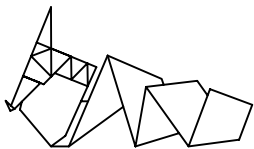

13) Turn sideways, and fold the tail as desired.

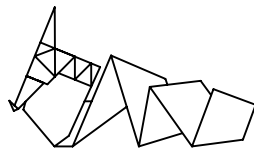

14) Reverse fold and outside reverse fold the folds from the previous step, so the model does not easily unfold.

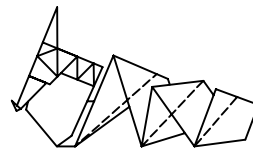

15) On both sides of the model, fold back the bumps on the back as shown.

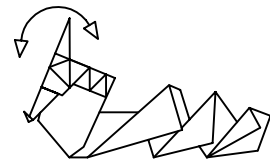

16) The finished dragon. You can move the head, and fold the tail differently as desired.

# Dragon In Flight (Version 2.5)

By Charles Esseltine.

I suggest that you should use a large (9 inch or larger) piece of foil (Florist foil is the best in my opinion.), for your first model. You can make the model from just about any paper (Kami, Washi, waxed, plain, etc...), but the model will tend of suffer paper spread. So foil is the best. And Florist foil is very forgiving. If you make a mistke, I mean mistake, it can be undone, and most creases can be pressed out. Begin the model white side up.

1.) Fold and unfold.

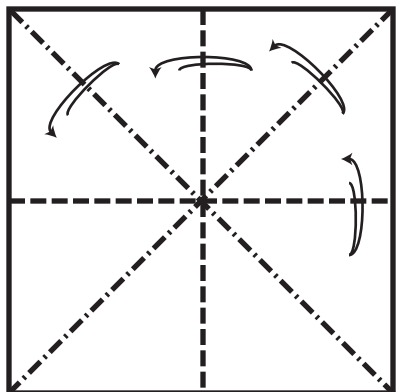

2.) Fold and unfold just the corners.

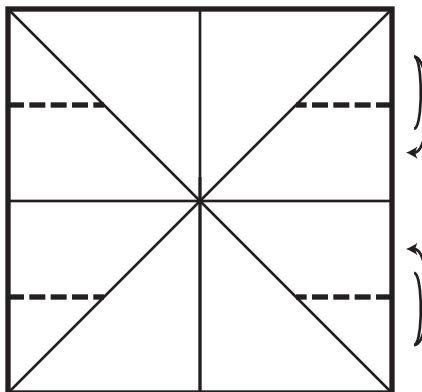

3.) Fold and unfold just the corners.

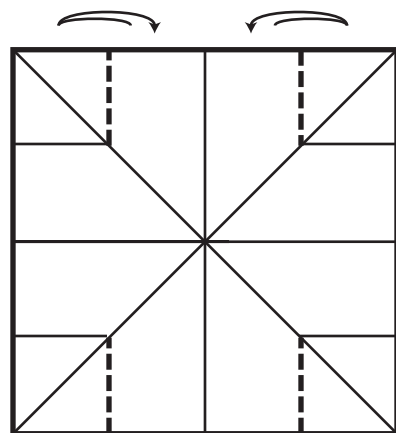

4.) Fold and unfold.

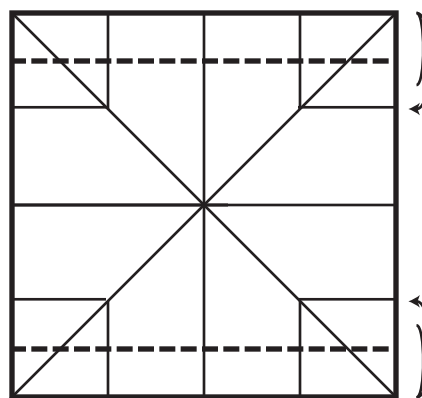

5.) Fold and unfold.

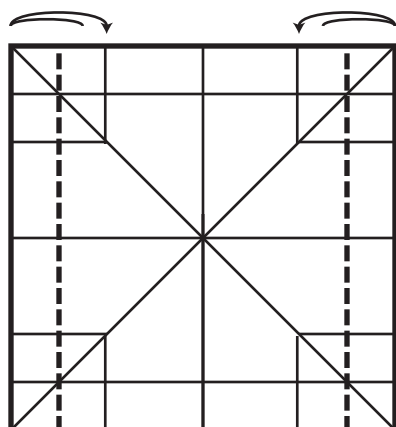

6.) Flip over

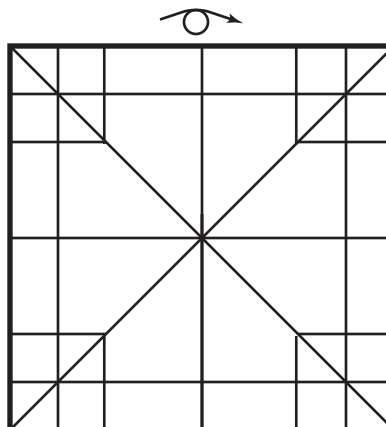

7.) Fold and unfold. Then flip over.

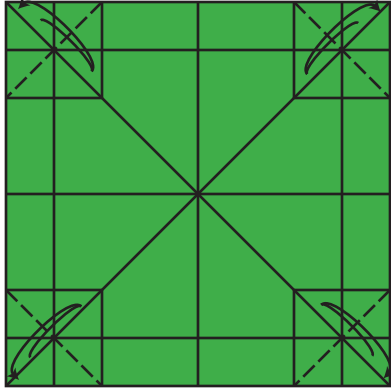

8.) Fold the sides in. The corners will form mini-preliminary bases.

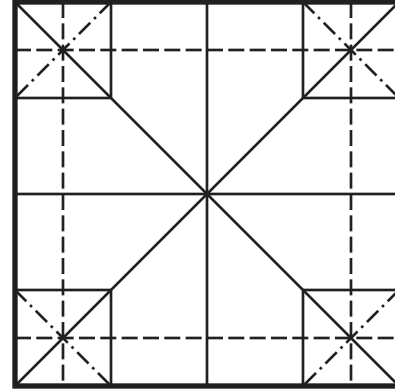

9a.) Choose one corner for the head.

9b.) Fold the flap to the tip.

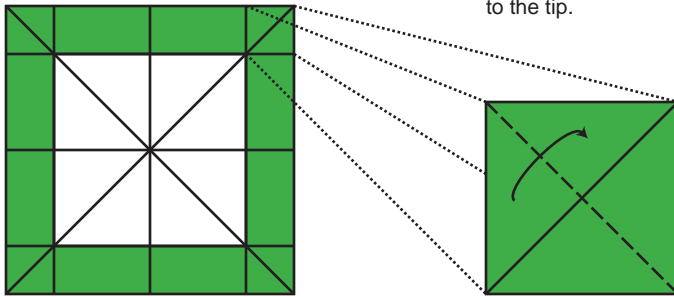

10.) Fold into the center line.

11.) Unfold one flap.

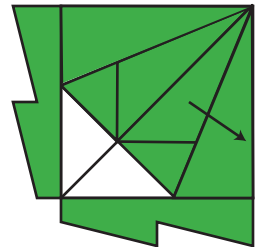
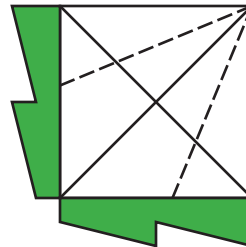

12.) Squash fold.

13.) Fold it back.

14.) Repeat steps 11 - 13 on the other side.

15.) Petal fold.

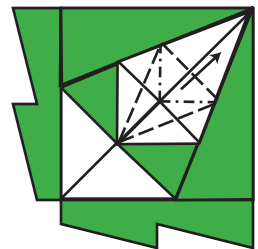
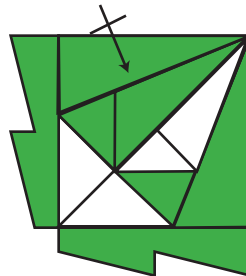
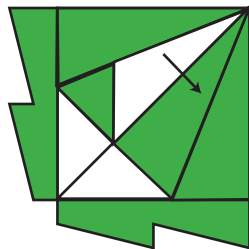
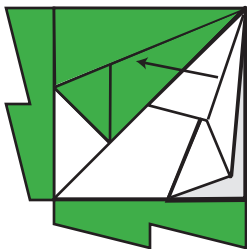

16.) Fold the flap back and forth.

17.) Unwrap the outer layers. You will have to partially unfold it to do so. Refold the bottom.

18.) Squash fold.

19.) Petal fold. Now you have a small Bird Base.

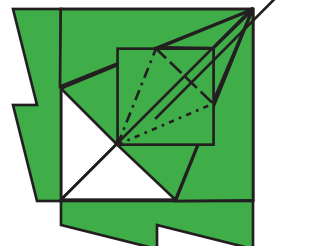
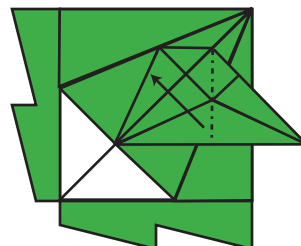
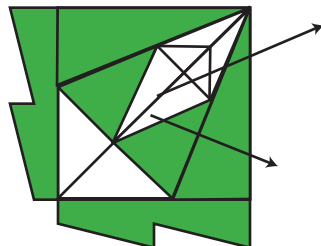
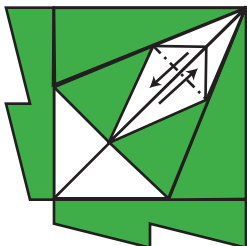

20.) Fold the other three corners as shown.

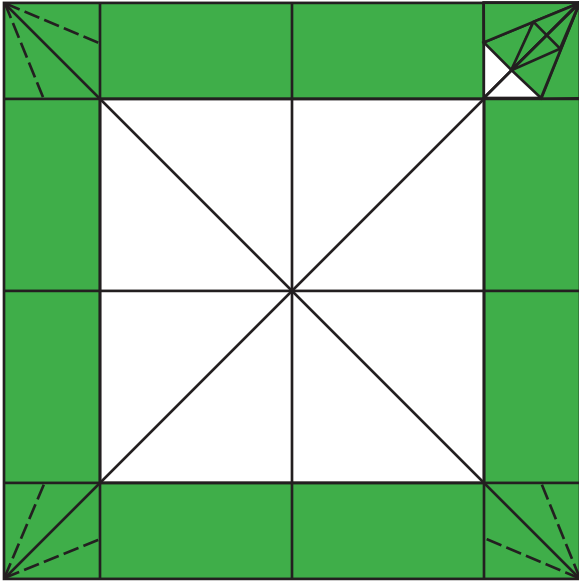

21.) Fold into a preliminary base. Watch the X.

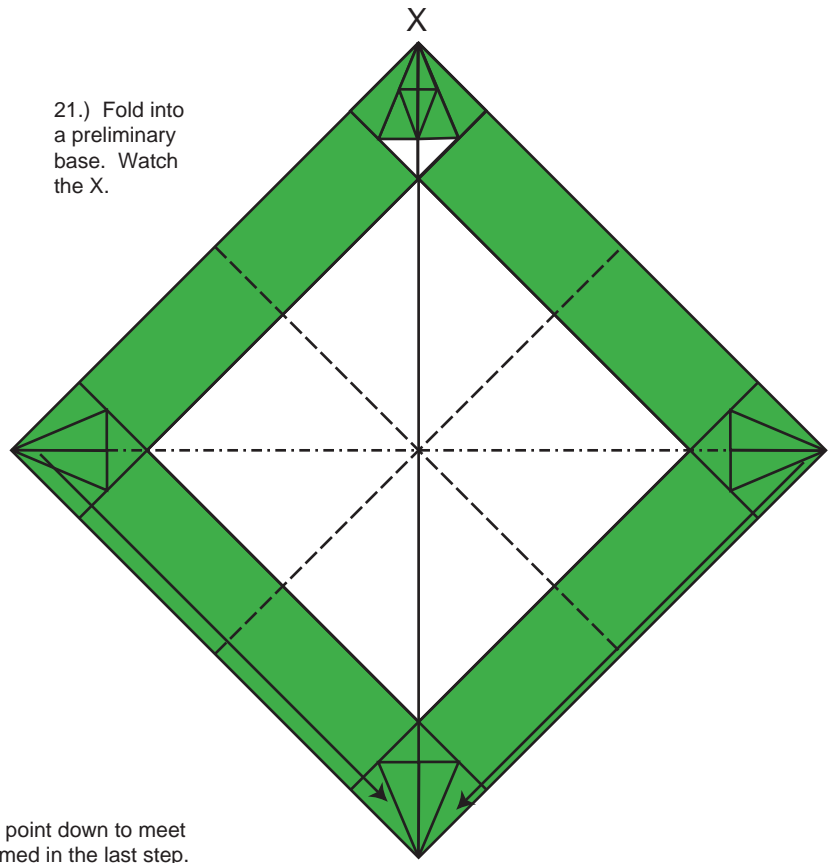

22.) With the X layers in front, fold the sides to the center line. Repeat behind.

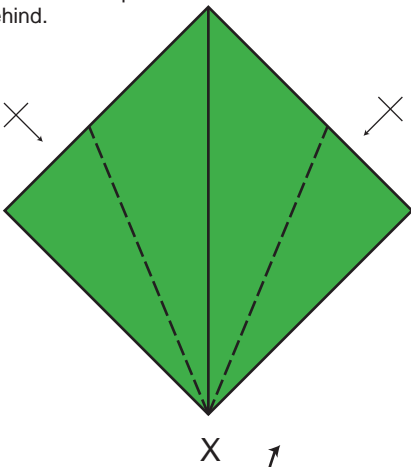

23.) Fold the point down to meet the edges formed in the last step.

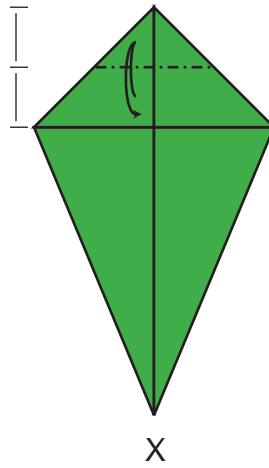

24.) Sink the tip on the line created by the last fold. If you partially unfold it, it will be much easier.

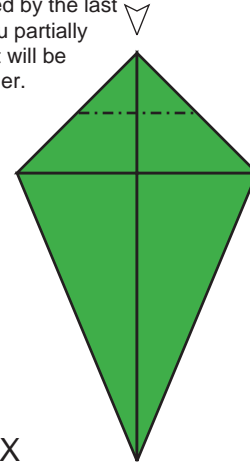

25.) Open up the sides.

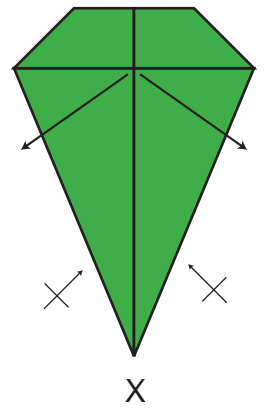

26.) Petal Fold Front and Back

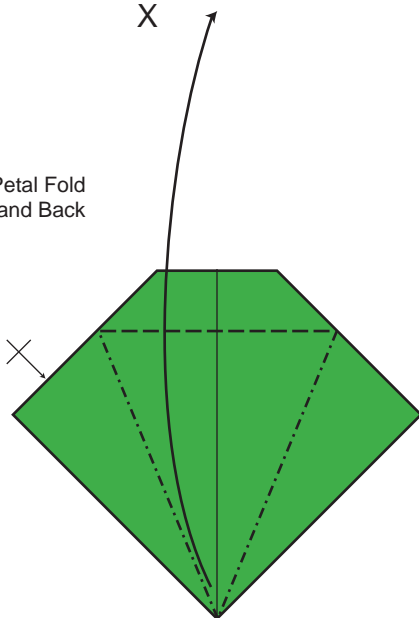

27.) Pull out the inner edges. Taking care not to unfold the head (X) Press flat.

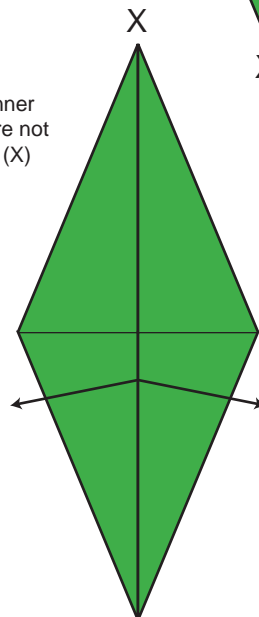

28.) Repeat on the back, but unfold the tail as well. Flip over.

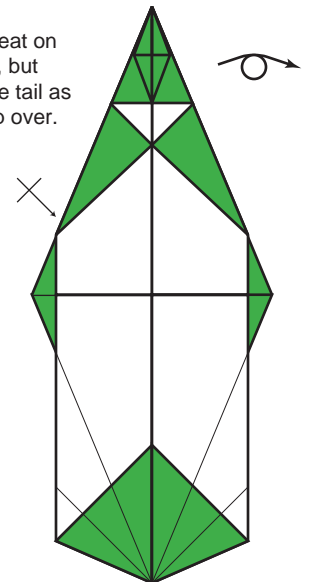

29.) The tail should look like this. Flip over.

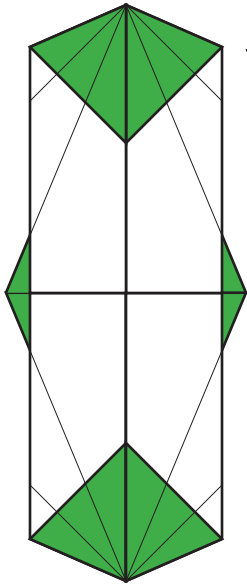

30.) Fold the layers of the head together.

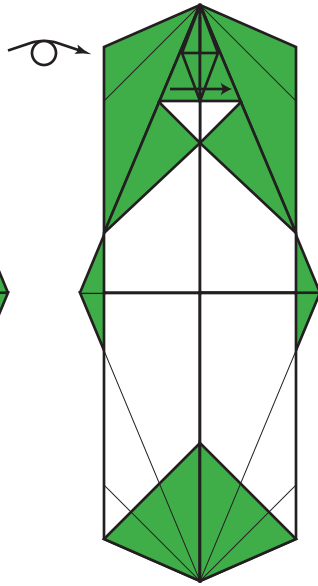

31.) Fold the top layers to the center. Then unfold.

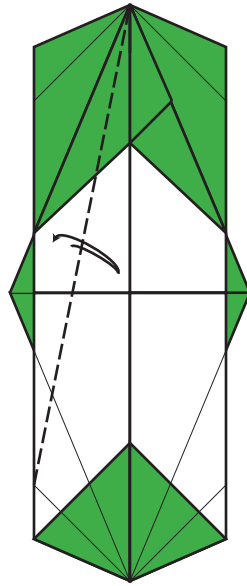

32.) Squash fold

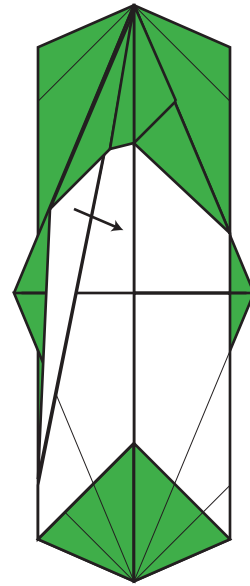

33.) Flip this layer back.

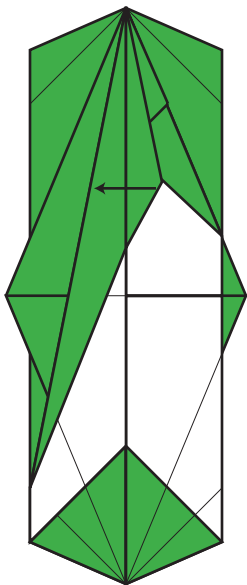

34.) Flip all of the layers of the head, to the other side.

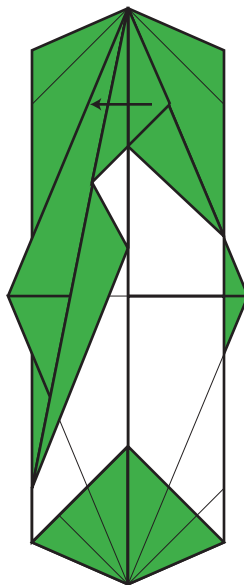

35.) Repeat steps 31 through 33 on the other side.

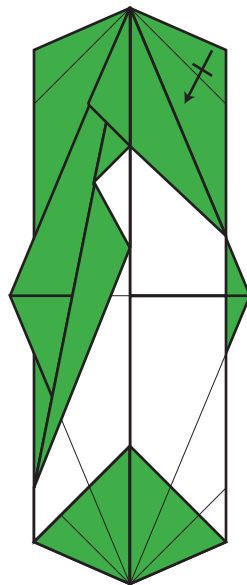

36.) Open the layers of the head,

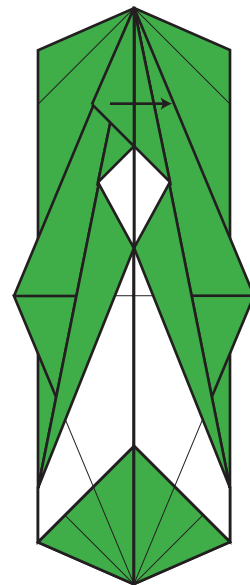

37a.) Fold the edges into rabbit ears.

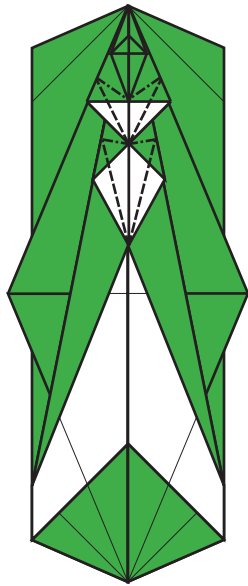

37b.) The completed folds. Now flip over.

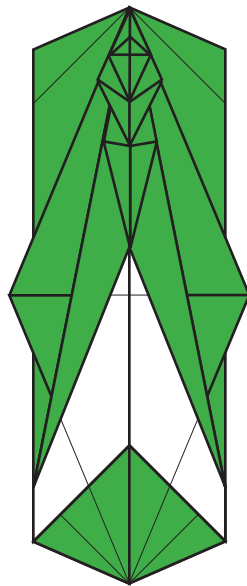

38.) Using the other side as a guide for these folds. Make a rabbit ear.

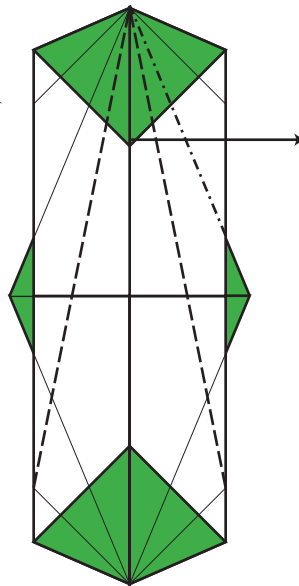

39.) Squash fold.

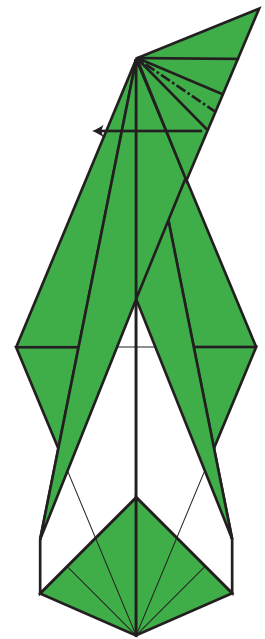

40.) Petal fold the tail.

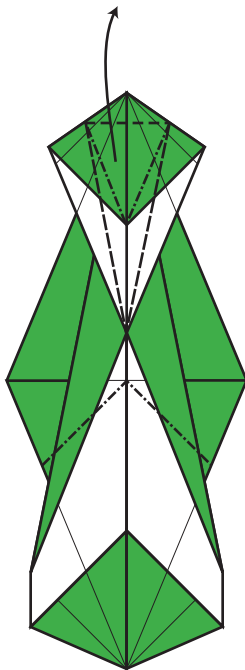

41.) Inside reverse fold the wing outward. Opening the wingtips as you do. The leading edges will line up with line AB

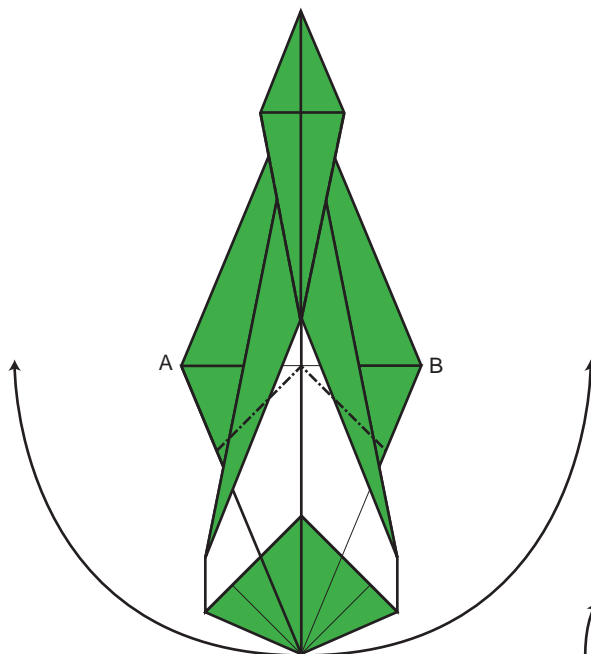

42.) Fold the inner layer up on the front and back of each wing.

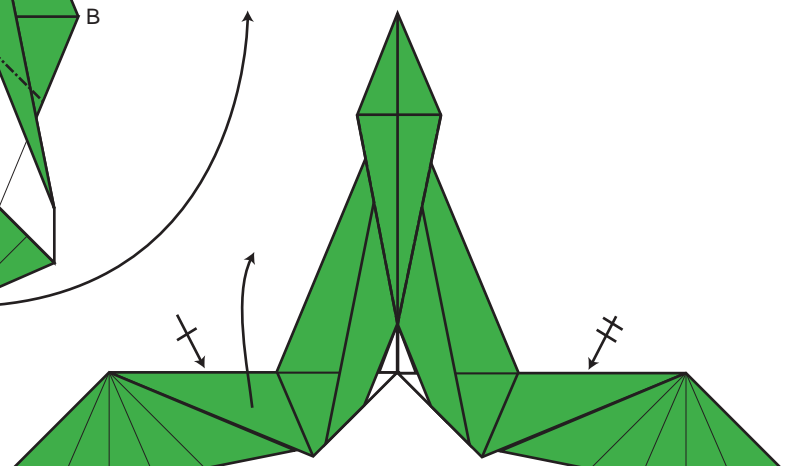

43.) Fold down the front and back layers.

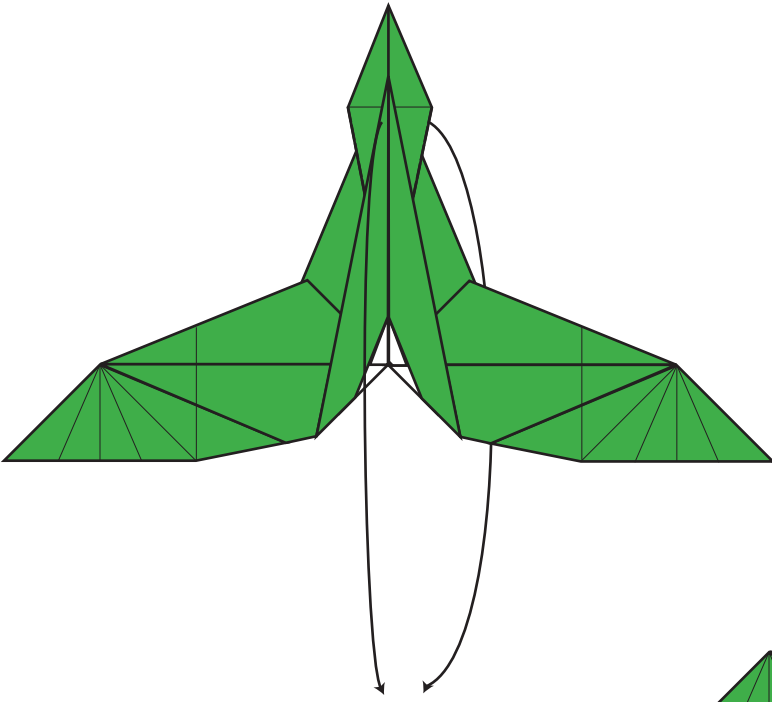

44.) Do a combination fold. Bring the top edge into the centerline. This will lift up the top layer of the wing. When the fold is complete, this edge will lie along the leading edge of the wing. Repeat this on the other three sides.

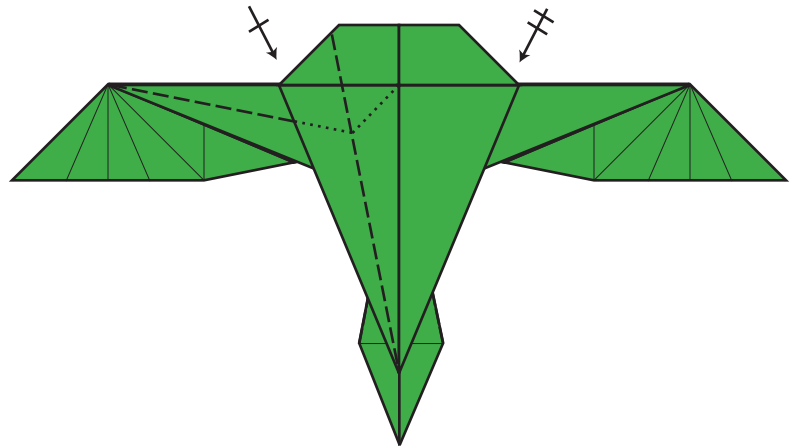

45.) Now open one side.

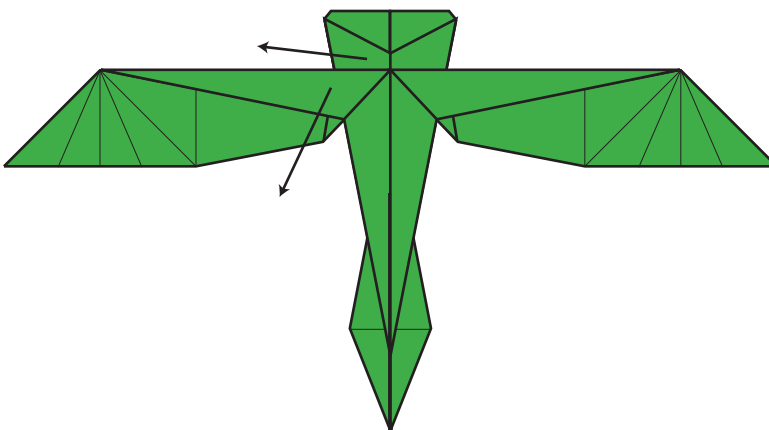

46.) Now we get to the fun part! First bring the Far edge (A) to meet the unfolded edge (B). This will bring the first bisector fold (C) to the center line (D). This will bring the wing's leading edges up as well. Fold the same as with the body, bringing the valey fold (c) to meet the leading edge (d). When the folds are complete the model will not lie flat. In fact the two edges will be at right angles to the rest of the model.

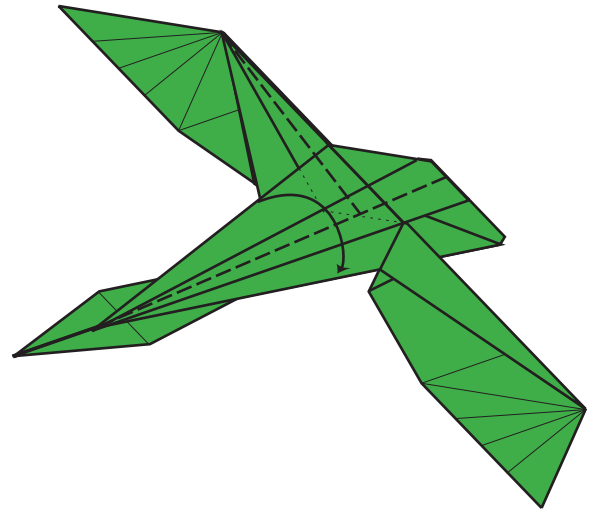
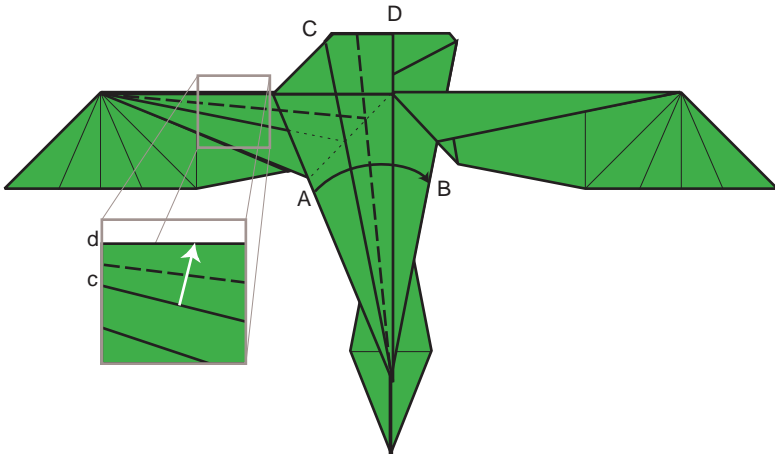

47.) Now fold the standing layers down.

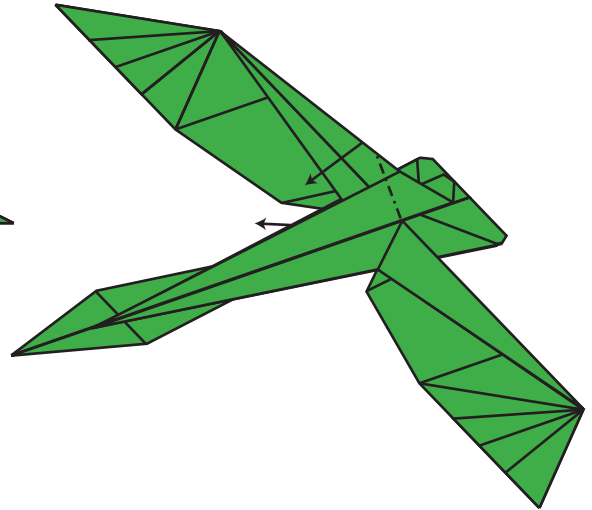
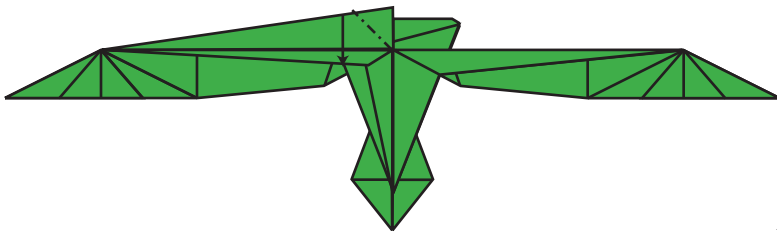

48.) Compound fold the remaining layers along the same lines as in step 43. The model will now lie flat.

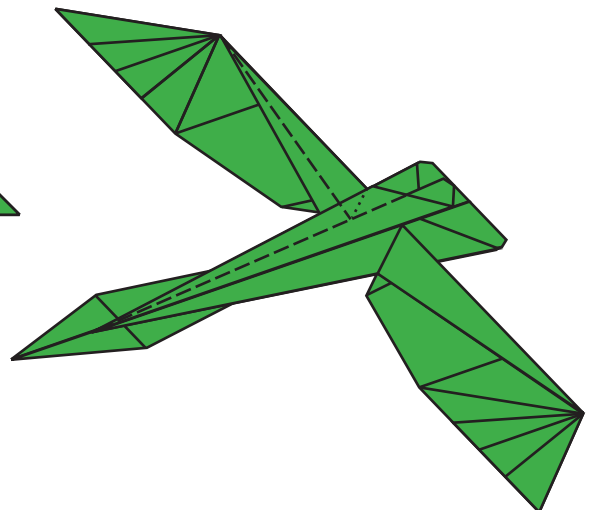
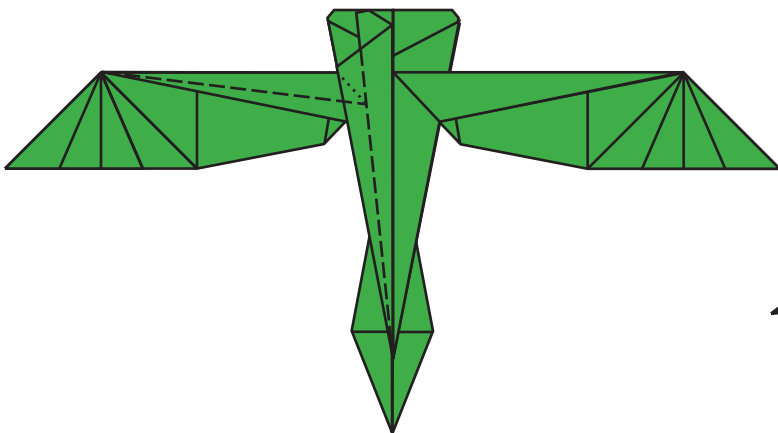



49a.) Now repeat steps 45 - 48 on the other sides.

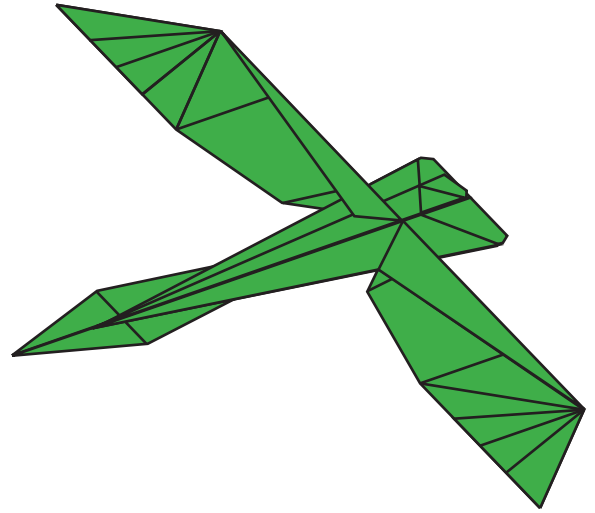
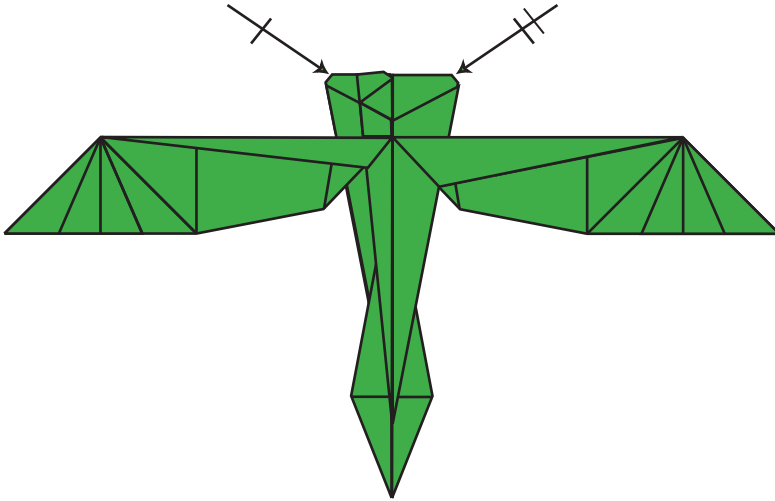

49b.) The model should look like this. This is also a good time to flatten the dragon as much as possible. Make all of the creases as sharp as you can. Here is where a hard flat surface comes in handy. You can also use a rolling pin, if one is handy.

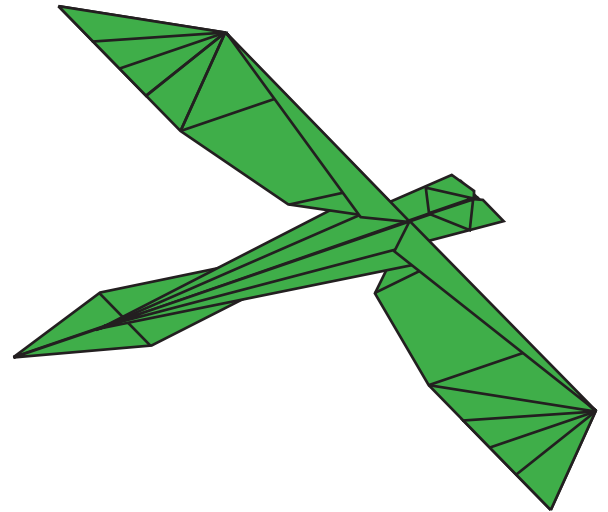
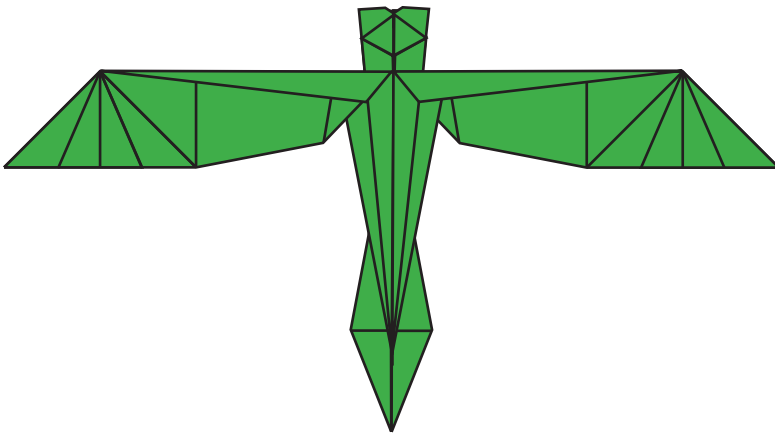

50.) Open out the model. Pulling the head and tail sections out, so that they lie flat, with the center section above the wings standing perpendicular to the rest of the model. This easier done than said. You'll see what I mean, by looking at the next step.

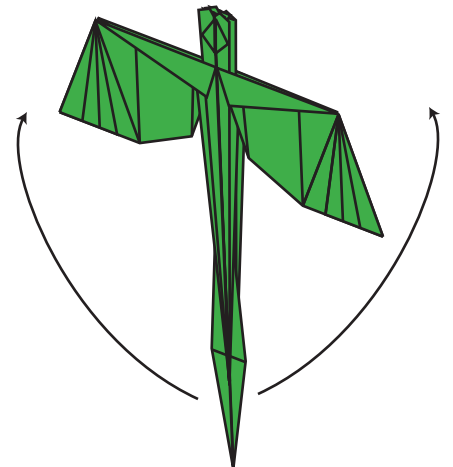
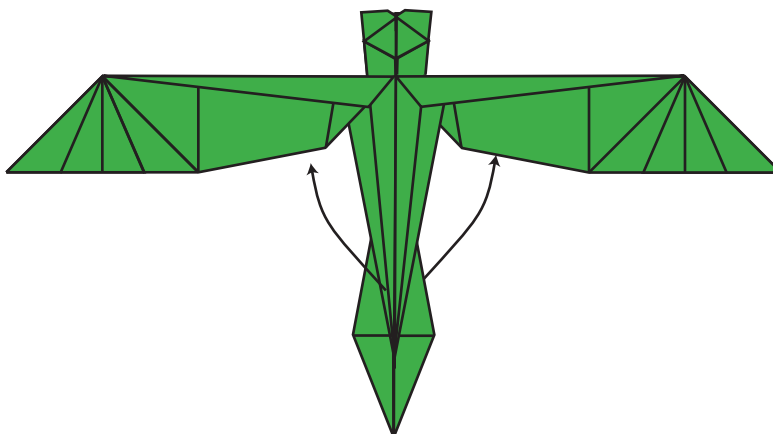

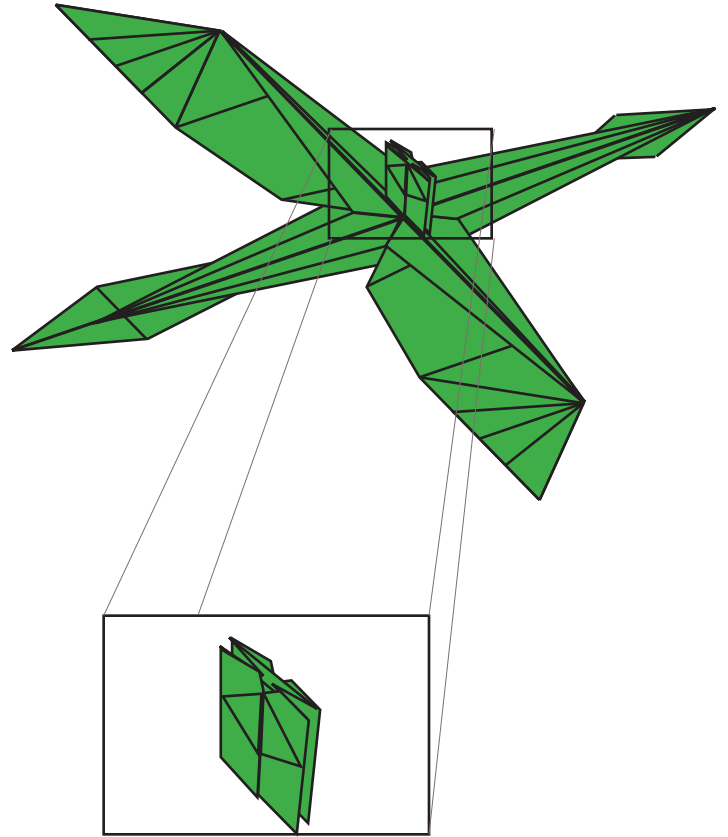
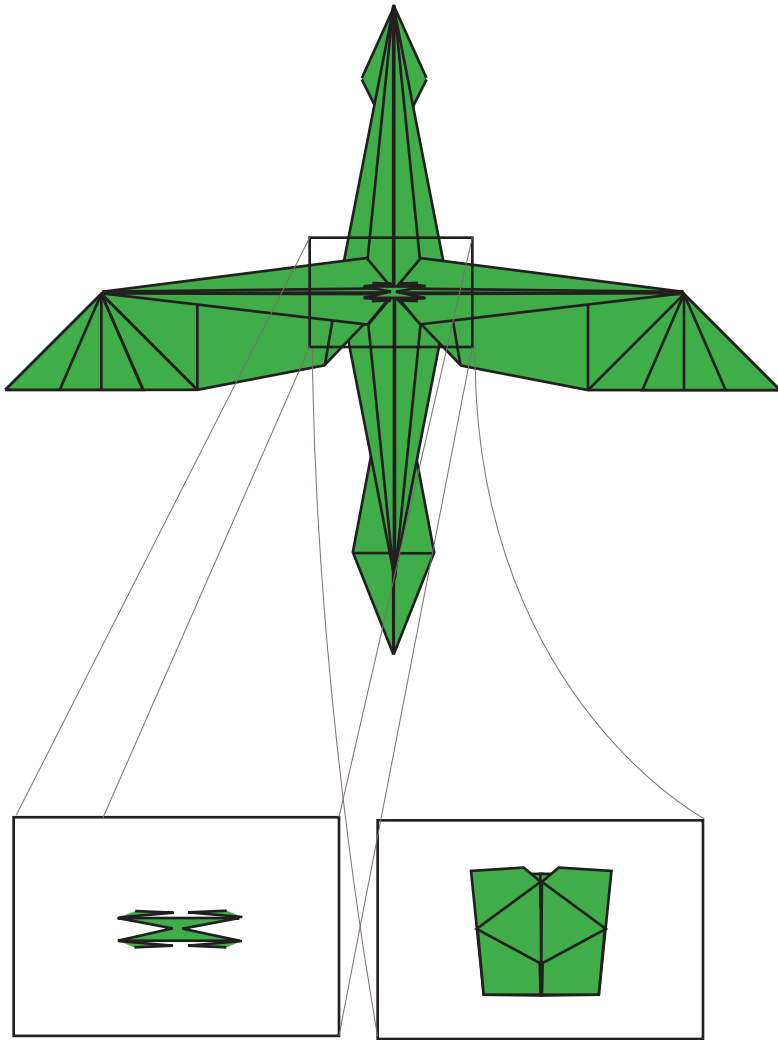

51a.) The next few steps deal with the center section. First open the middle. Spreading as you go.

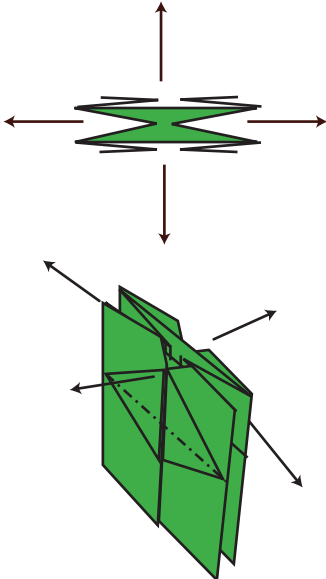

51b.) As the bottom spreads out it will form a square box.

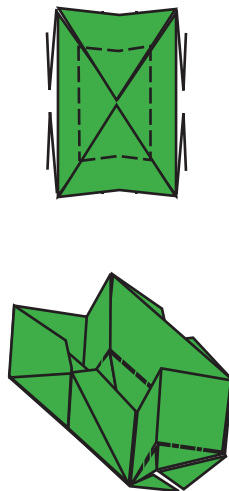

51c.) Finished. The edges don't have to be sharp, but it helps.

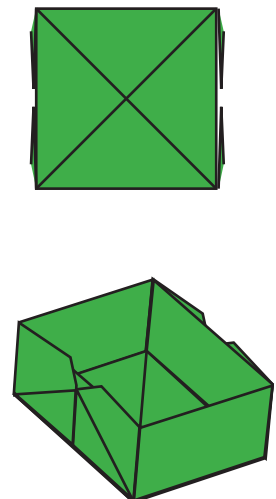

52a.) Bring in the sides, while you pull the front and back outwards. Flatten the model.

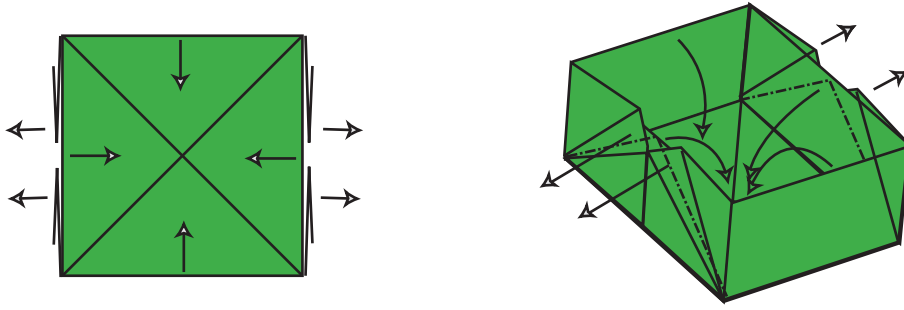

52b.) It will look like this when done.

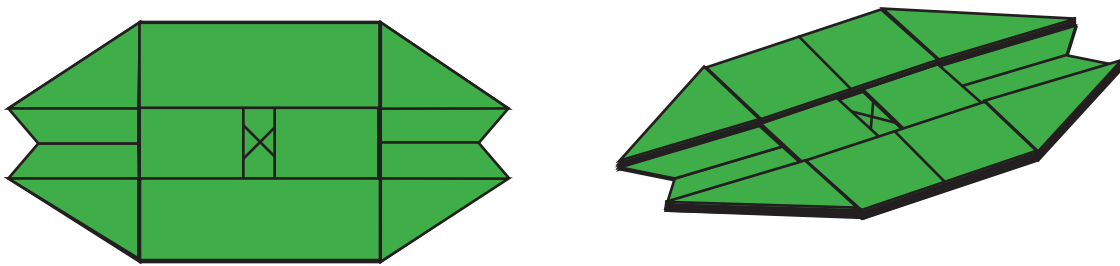

53.) Flip over.

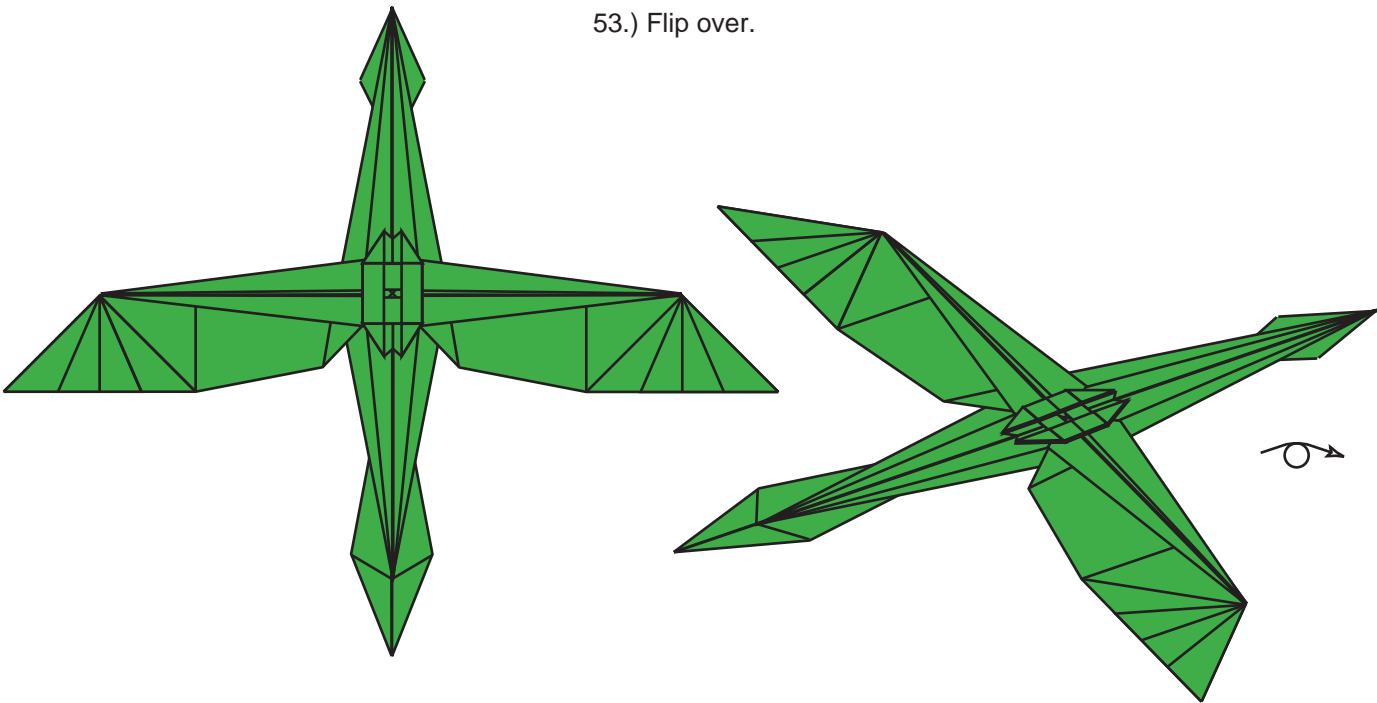

54.) Fold the head and tail sections to one side.

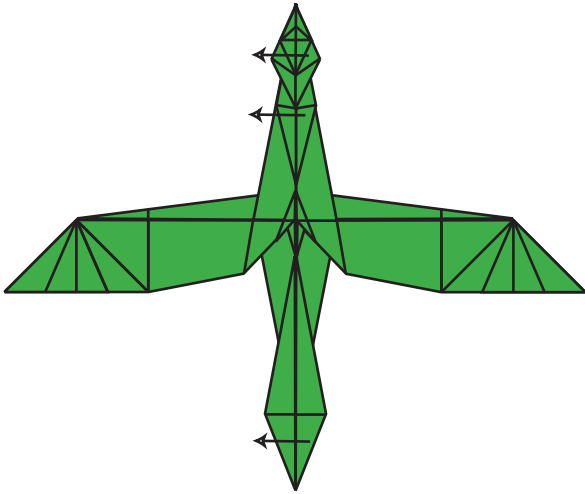

55.) Fold the edge into the center, shaping the wing as you go.

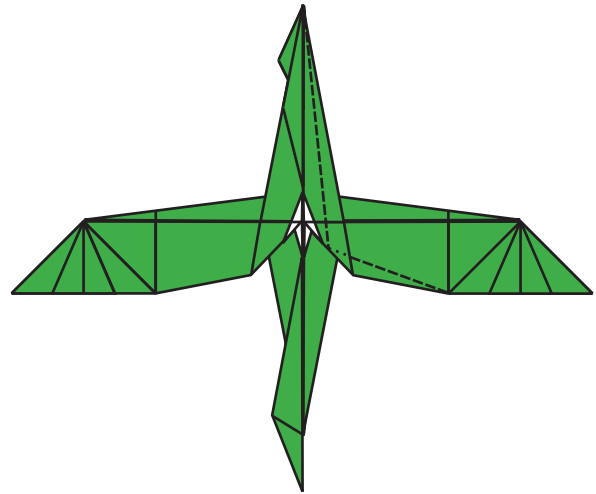

56.) Flip both layers of the wing forward.

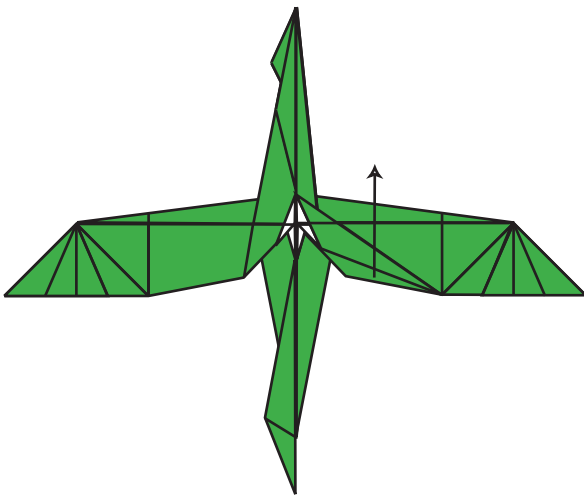

57.) Repeat step 55 on the back.

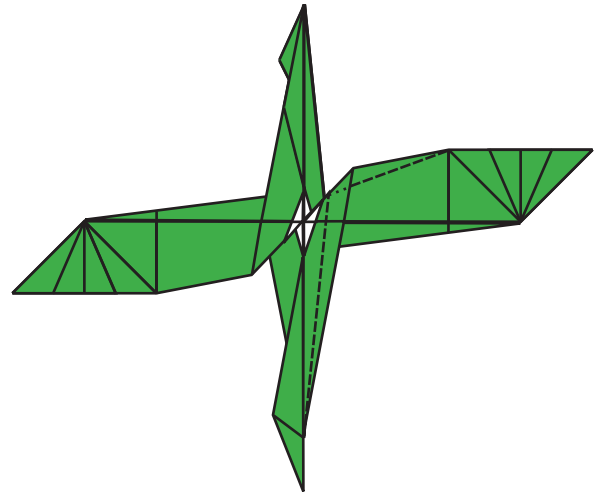

58.) Flip the wing, head, and tail over.

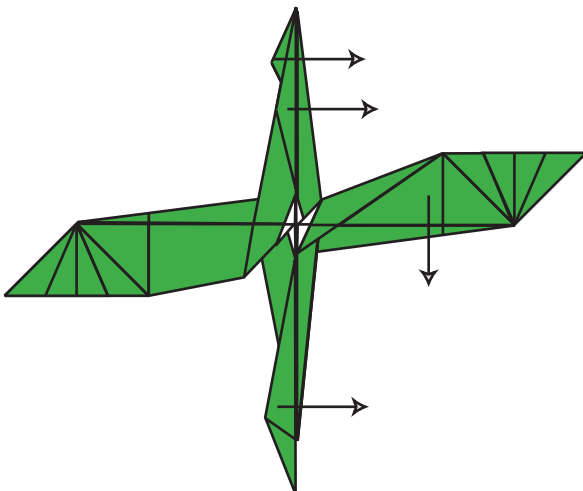

59.) Repeat 55-57. And return the wing to its' starting position

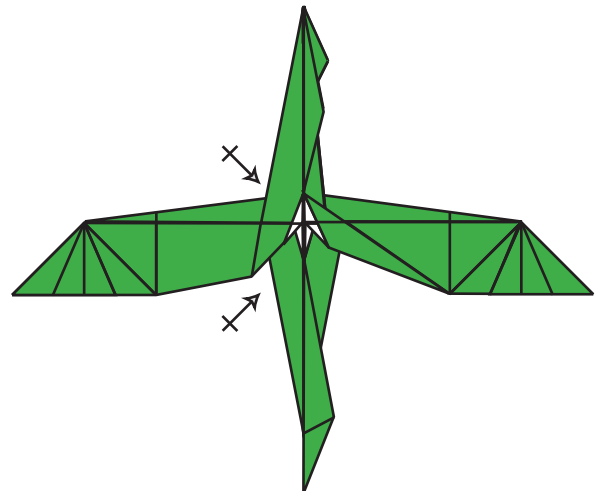

60.) It's starting to look like a dragon, isn't it?  
Rotate 90 degrees.

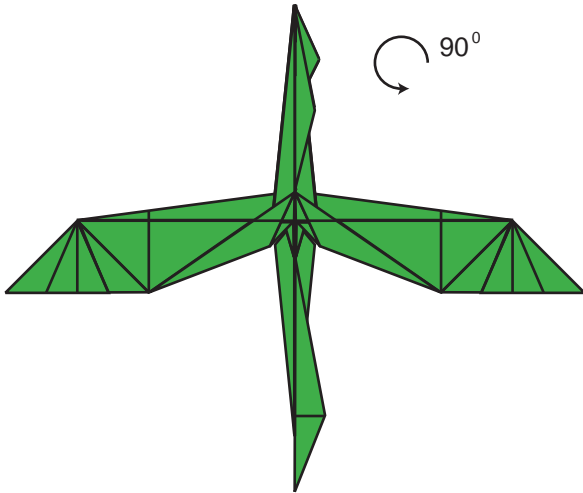

61a.) Fun Time! No we fold the model ALMOST in half. The center section is rather THICK. So we fold the head and tail in half (a), but the bottom is to be folded in a U shape (b) with the bottom almost flat.

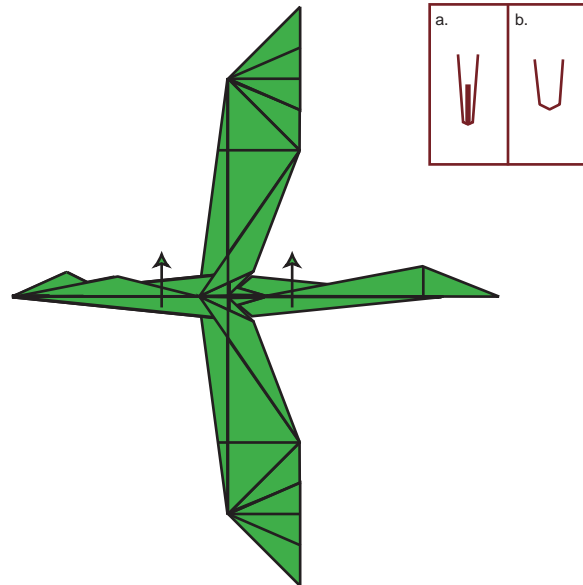

61b.) The wings should be between 30 and 90 degrees depending on what pose you want the dragon to have. For the next steps we zoom in to the legs.

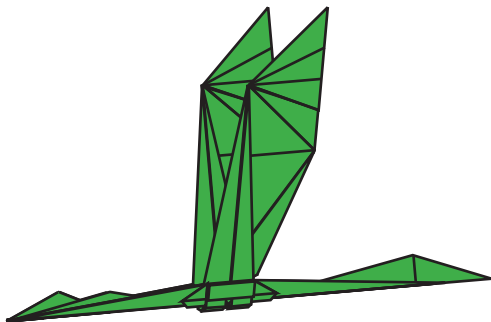

62.) Roll the leg down as far as it will go.

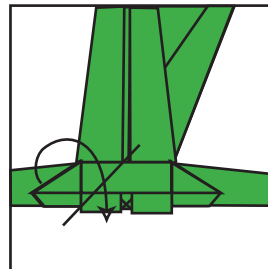

63.) Pinch the tip.

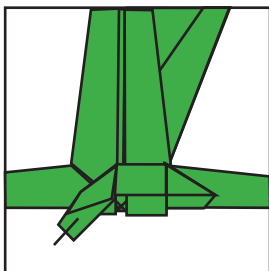

64a.) Repeat steps 62 & 63 for the other legs.

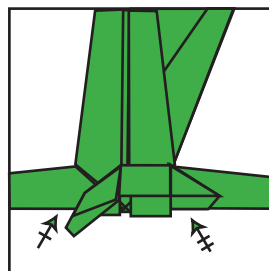

64b.) The legs are done. Let's move on to the wings.

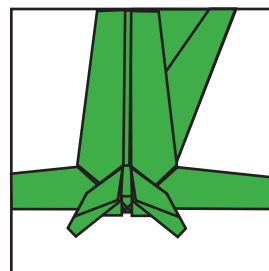

65.) Fold the leading edge back. This will cause the wings to move forward. The model will not lie flat.

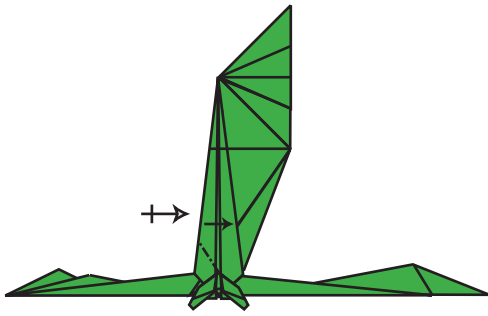

66a.) From the marker fold, unfold all the layers. This causes the wing to take on a curve. You can adjust this fold to reflect different wing positions.

Then curve the wingtip along the existing lines.

Repeat on the other wing. Shaping them to taste.

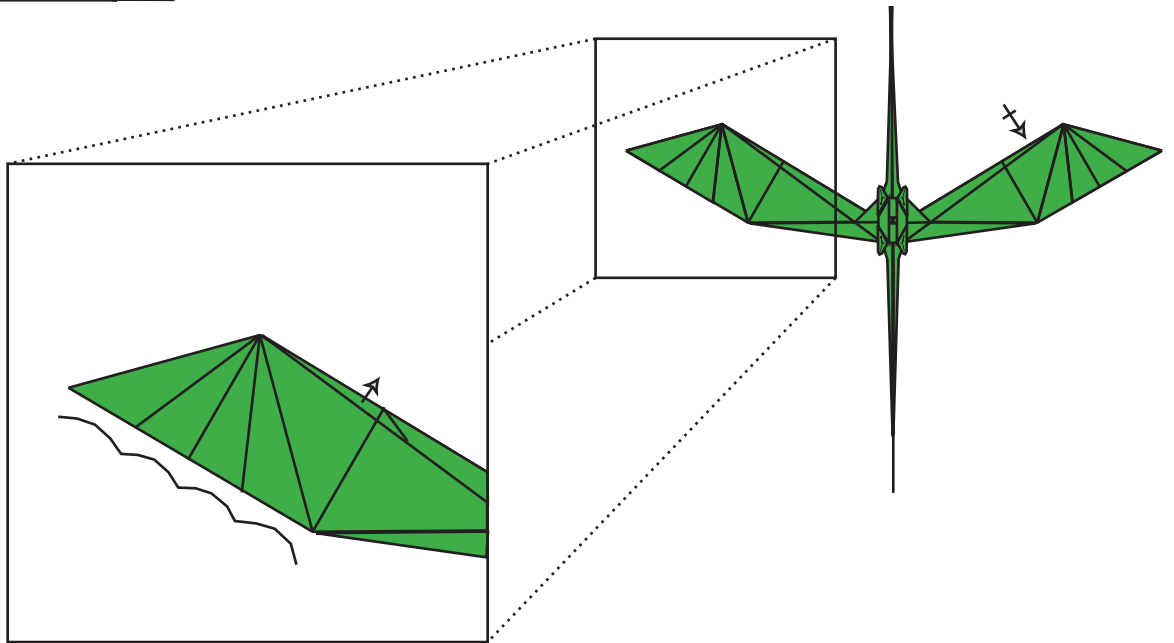

66b.) The wings are done.

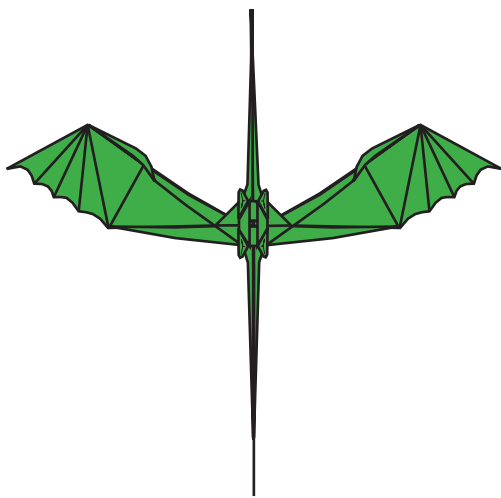

67.) Wrap the sides of the tail fin over the tail.



68.) With a soft crease, curve the tail fin.



69.) Outside reverse fold all layers of the head as shown.

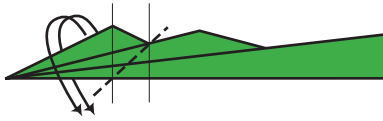

70.) Fold the first layer to the top to make the eyes.

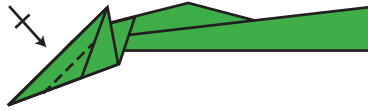

71.) Inside reverse fold down the mouth. You don't have to pull it all the way down. Do the mouth to taste.

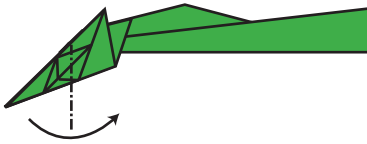

72.) Inside reverse fold the teeth.

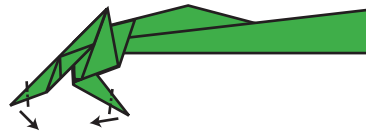

73.) With a pencil, or a similarly pointed object, open the eyes.

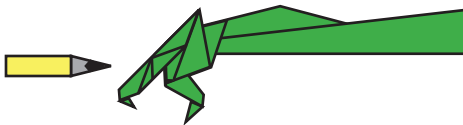

74.) Spread the ears slightly.

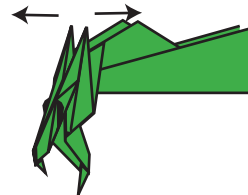

75.) Daragon done!

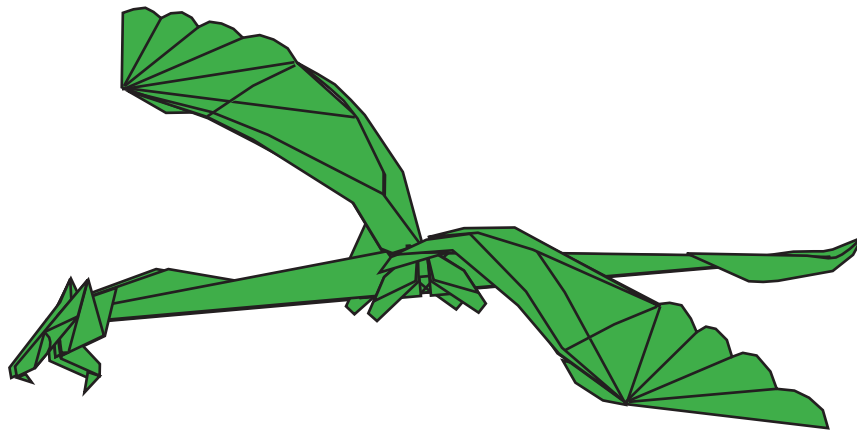

# “Китайский дракон”

Автор: Питер Будаи (Венгрия)

Для этой модели рекомендуется мокрое складывание или использование бумаги на основе фольги. Из листа со стороной 80 сантиметров получается модель длиной 19 сантиметров.

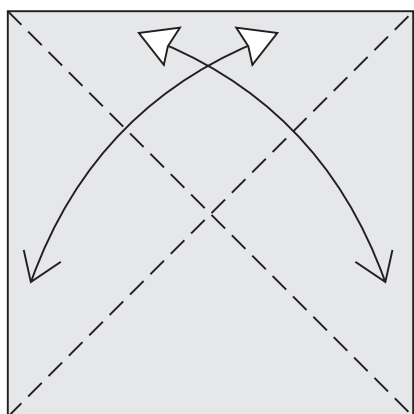
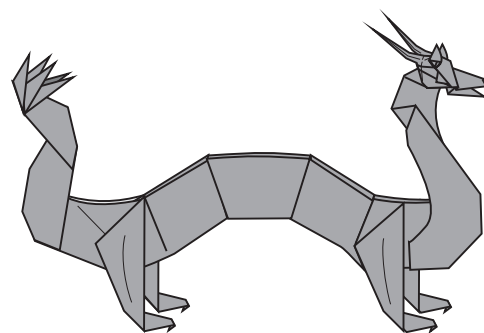

1. Перегните квадрат по диагоналям.

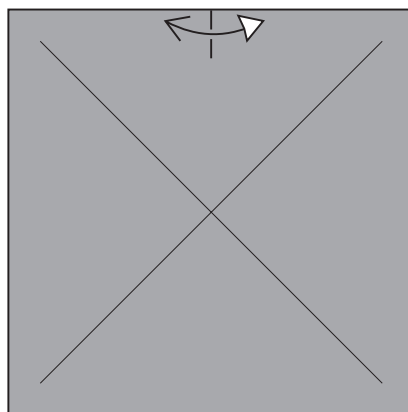

2. Перегните верхнюю сторону посередине

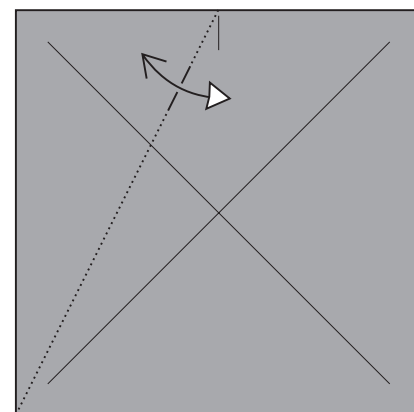

3. Перегните ещё раз

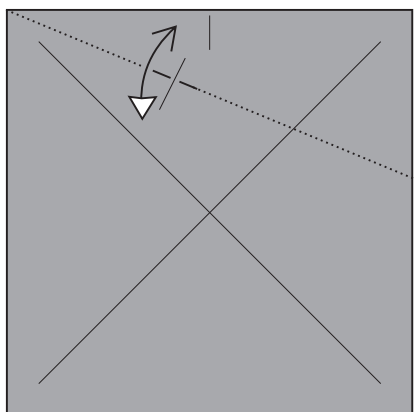

4. Сделайте ещё одну засечку

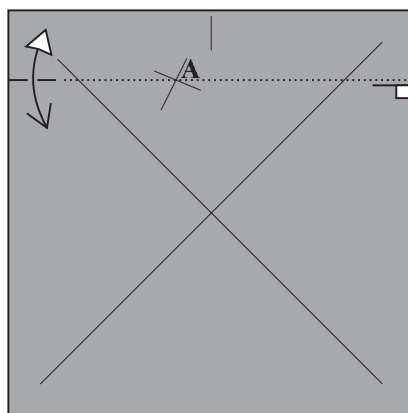

5. Перегните квадрат по линии, проходящей сквозь точку А.

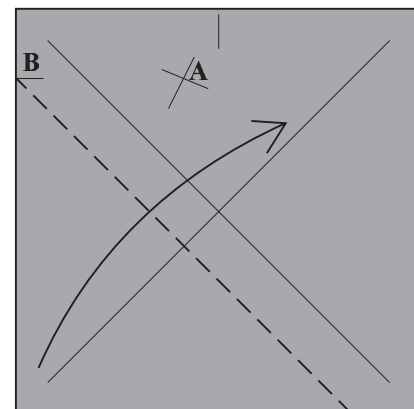

6. Глубинный сгиб через точку В



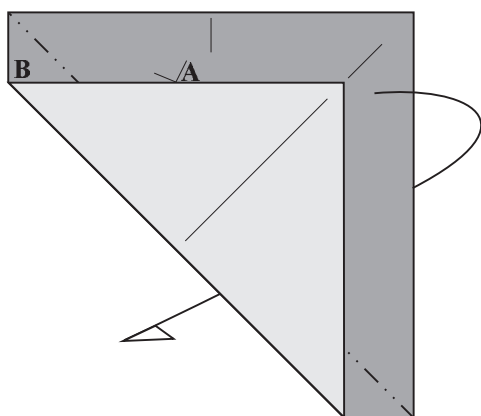

7. Горный сгиб по диагонали

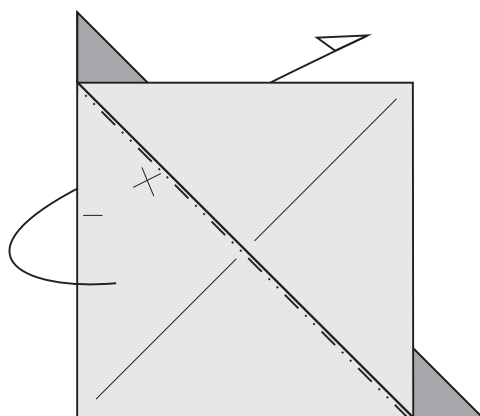

8. Обратная складка. Углы должны совпасть.

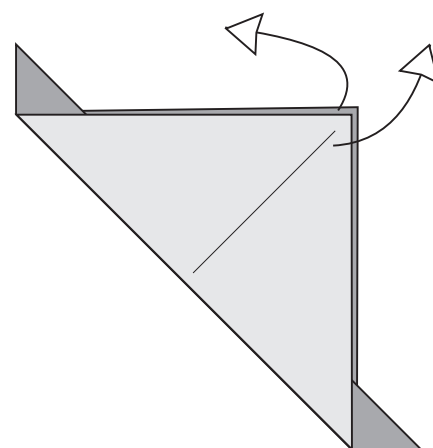

9. Разогните.

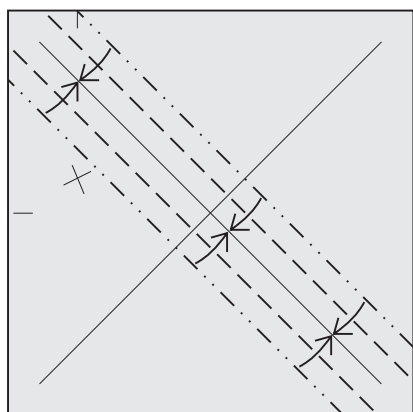

10. Используя намеченные линии, согните две складки-молнии к диагонали

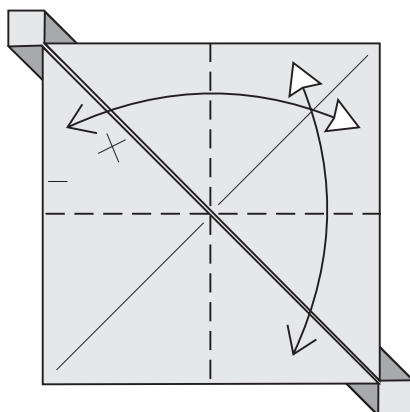

11. Сделайте два глубоких сгиба.

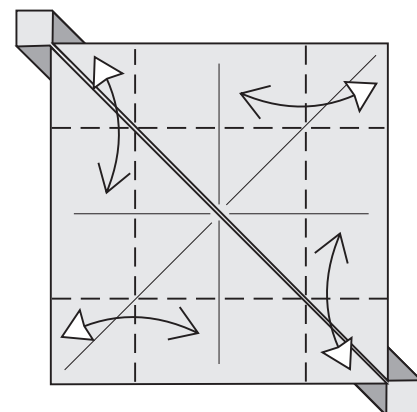

12. Ещё несколько сгибов.

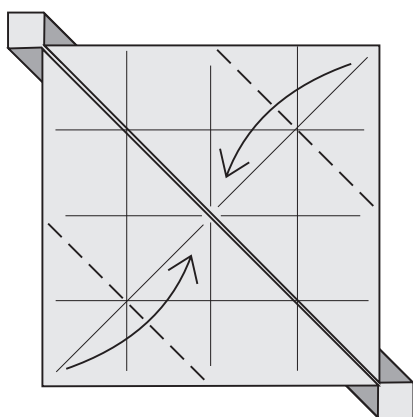

13. Согните углы к центру.

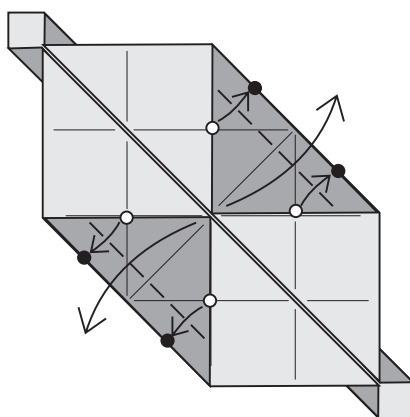

14. Отогните углы в стороны так чтобы белые контрольные точки совпали с чёрными.

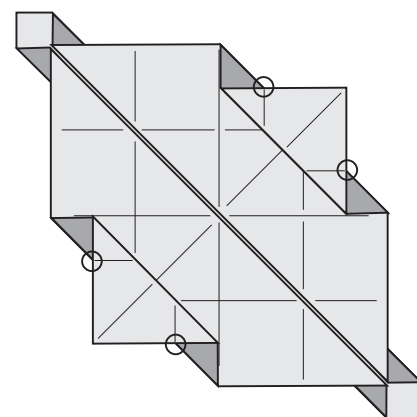

15. ... вот так.

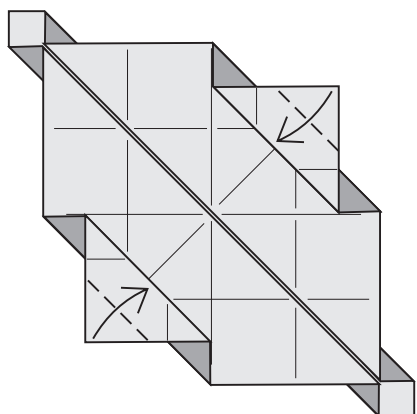

16. Всего лишь пара глубинных сгибов...

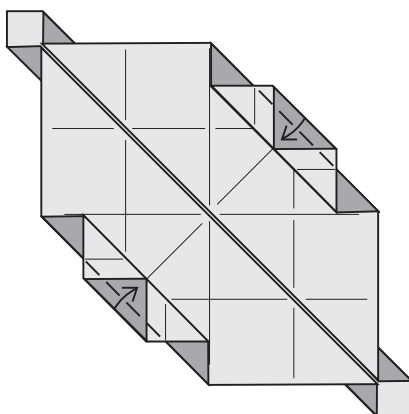

17. Снова глубинки.

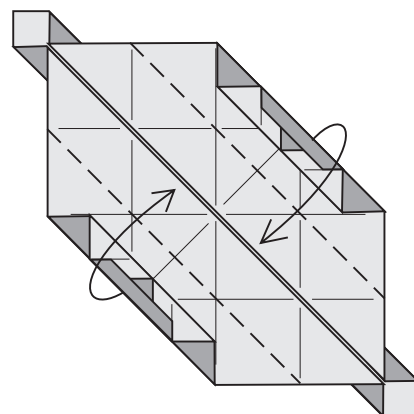

18. Согните обе стороны к диагонали.

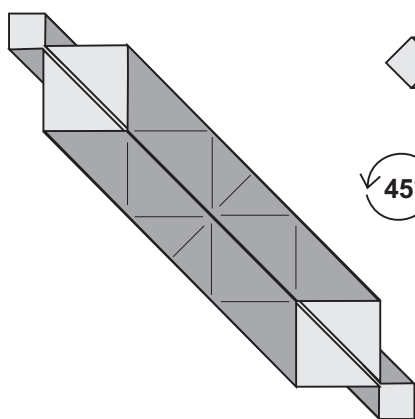

19. Поверните фигуру на 45 градусов.

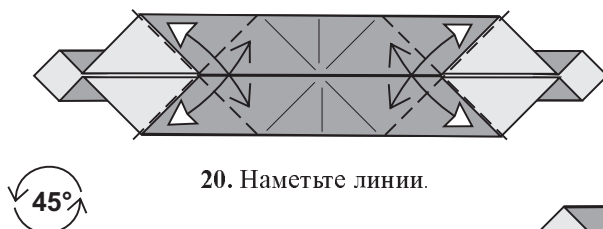

20. Наметьте линии.

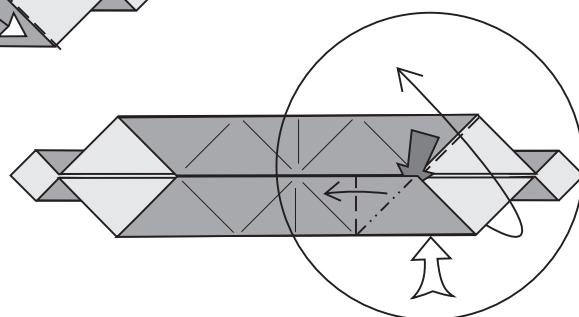

21. Сдвигаем складку. Последующие шаги (22-44) показывают именно эту часть фигуры.

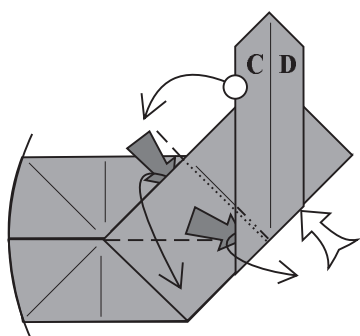

22. Сдвигаем снова. Вниз.

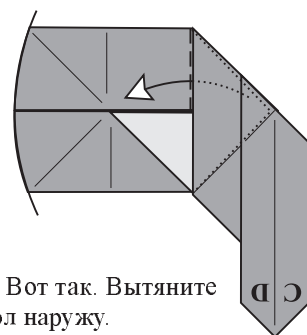

23. Вот так. Вытяните угол наружу.

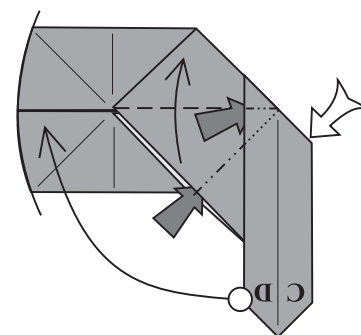

24. Раскройте карман.

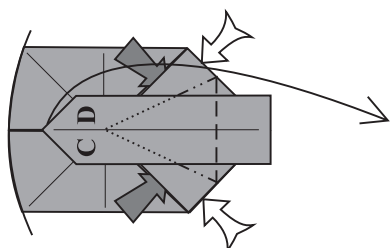

25. Затем выполните лепесточный сгиб.

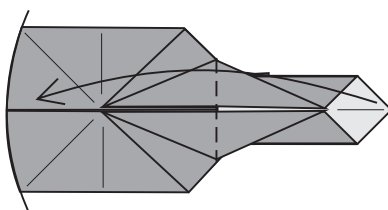

26. Согните выполненную складку пополам.

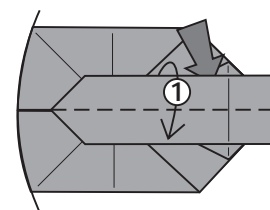

27. Отогните один слой вниз. Не проглаживайте!

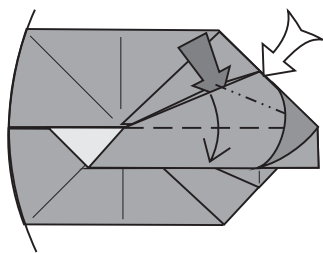

28. Раскройте карман, расправляя складку

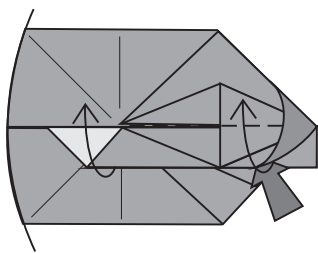

29. Закройте складку

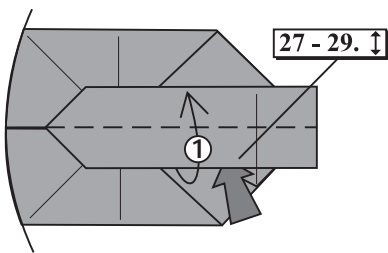

30. Повторите шаги 27-29 в зеркальном отражении

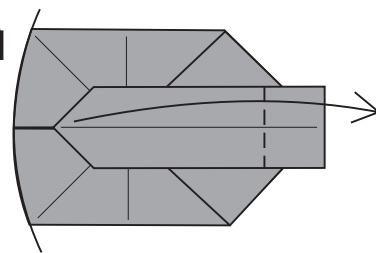

31. Растяните складку

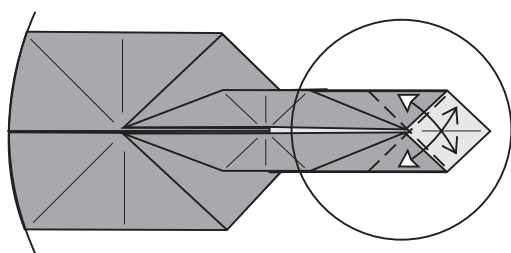

32. Глубинные складки.

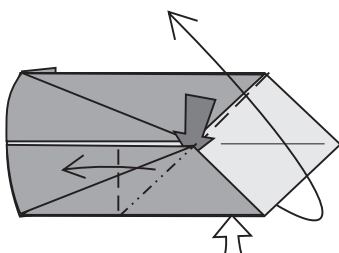

33. Правая часть фигуры крупно. Сдвигаем слой по указанным линиям.

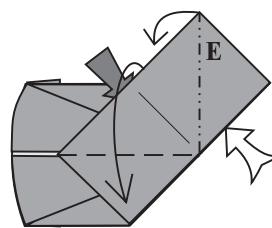

34. Сдвигаем ещё раз.

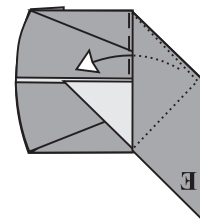

35. Вытащите угол наружу.

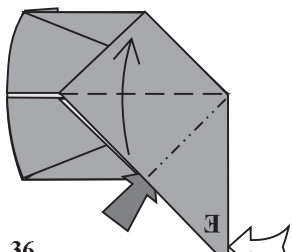

36. Раскройте карман

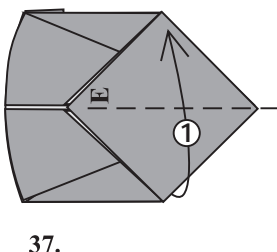

37. Отогните один слой вверх.

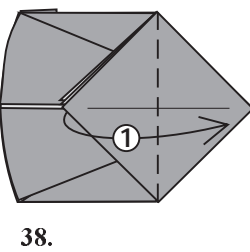

38. Отогните слой в сторону.

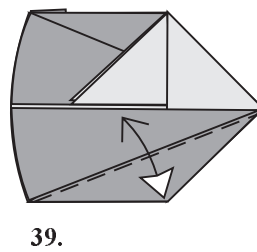

39. Перегните.

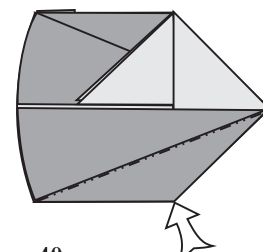

40. Вогните угол внутрь, раскрывая складку.

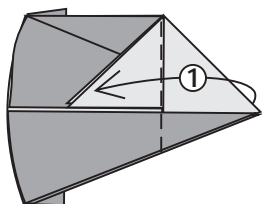

41. Согните слой назад.

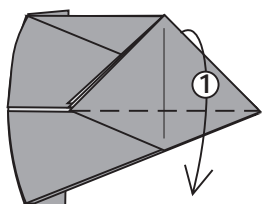

42. Отогните вниз.

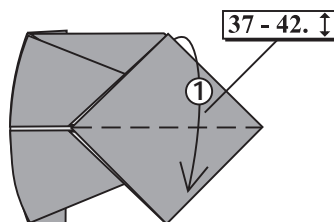

43. Повторите шаги 37-42 в зеркальном отражении.

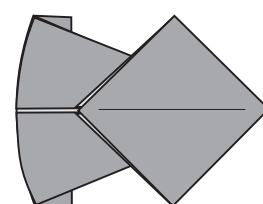

44. Правая сторона готова.

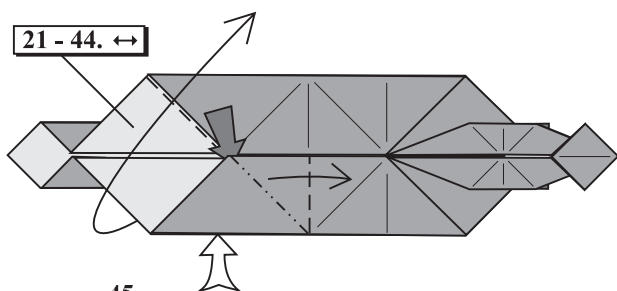

45. Повторите шаги 21-44 в зеркальном отражении.

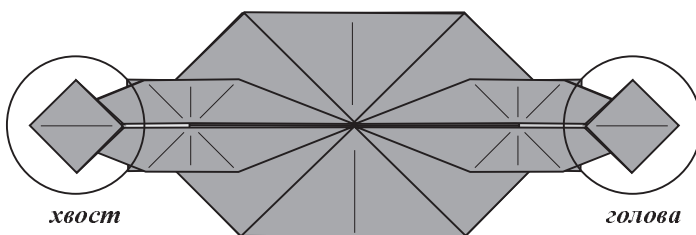

46. Шаги 47-64 относятся к голове, а 65-68 - к хвосту.

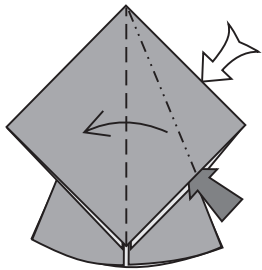

47. Голова. Раскройте карман.

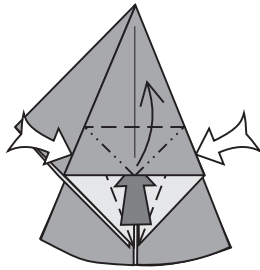

48. Лепесточный сгиб.

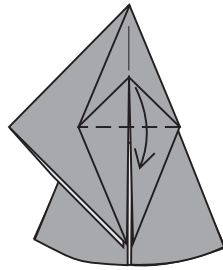

49. Отогните угол вниз.

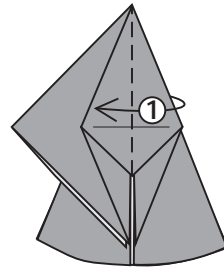

50. Перелистните только ОДИН слой.

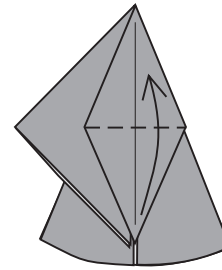

51. Отогните вверх.

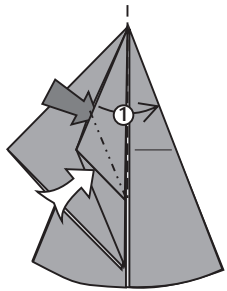

52. Расправьте складку.

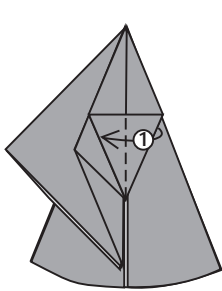

53. Глубинный сгиб.

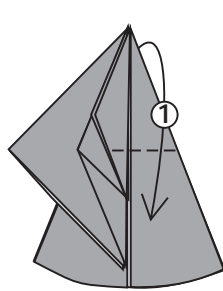

54. Согните вниз, расправляя складки.

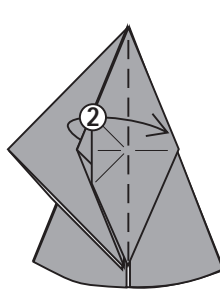

55. Отогните ДВА слоя.

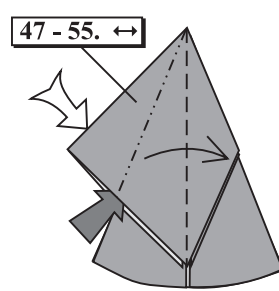

56. Повторите шаги 47-55 в зеркальном отражении.

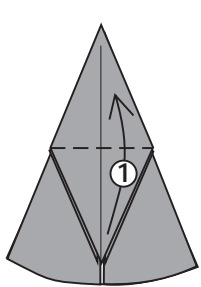

57. Отогните один слой вверх.

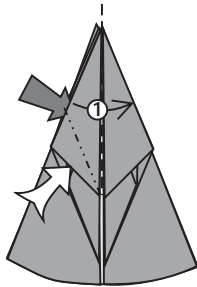

58. Расправьте складку.

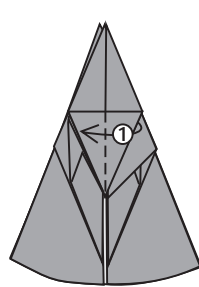

59. Отогните обратно.

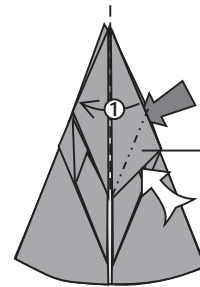

60. Повторите шаги 58-59 в зеркальном виде.

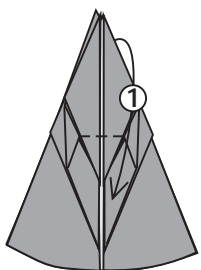

61. Расправьте складки.

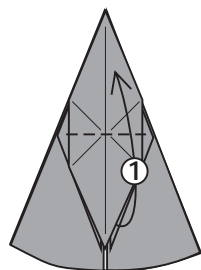

62. Отогните ОДИН слой вверх.

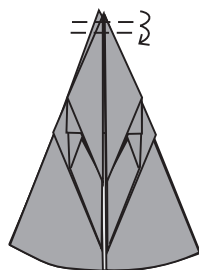

63. Заверните верхний угол.

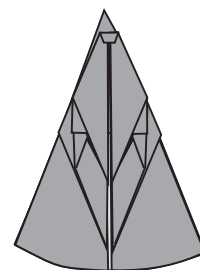

64. Основа для головы готова.

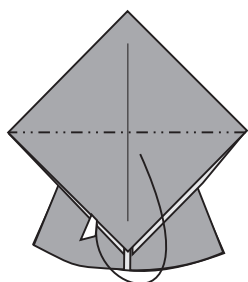

65. Хвост. Горный сгиб.

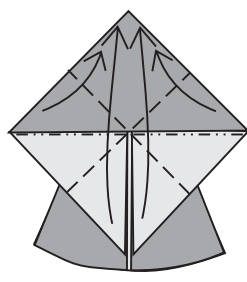

66. Сложите базовую форму "квадрат"

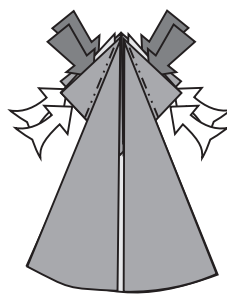

67. Вогните 4 треу гольника внутрь.

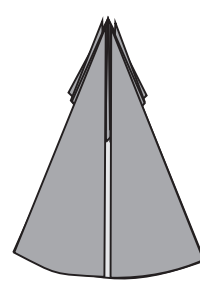

68. Основа для хвоста готова.

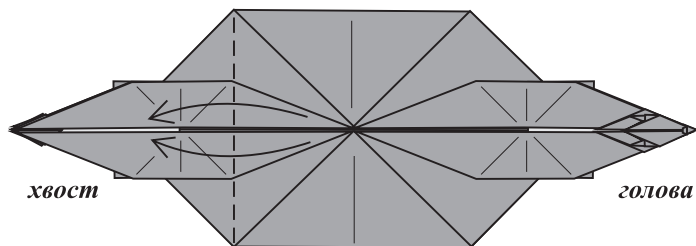

69. Согните два угла к хвосту.

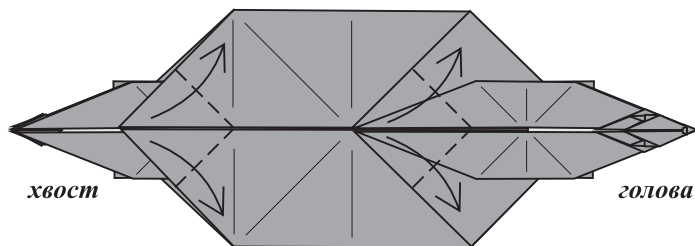

70. Четыре глубинных сгиба.

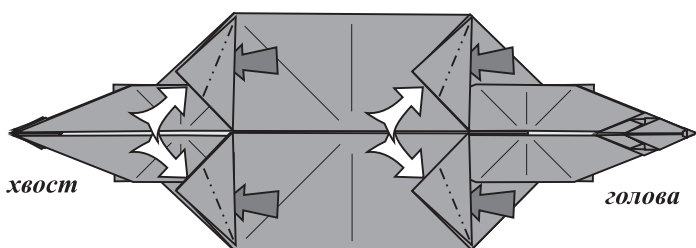

71. Внутренние горные сгибы.

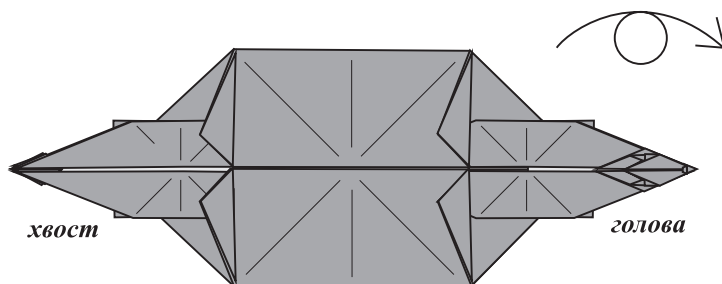

72. Переверните на другую сторону.  
Следите за положением головы и хвоста.

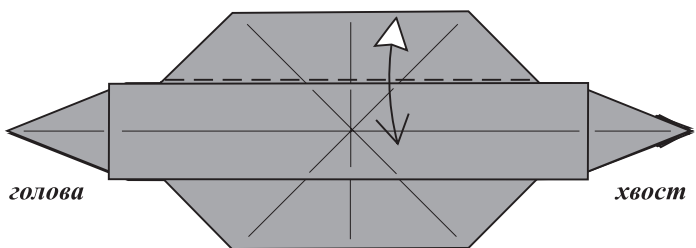

73. Перегните.

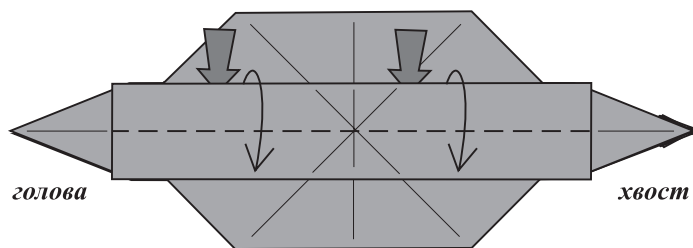

74. Отогните слой вниз.  
Не проглаживайте!

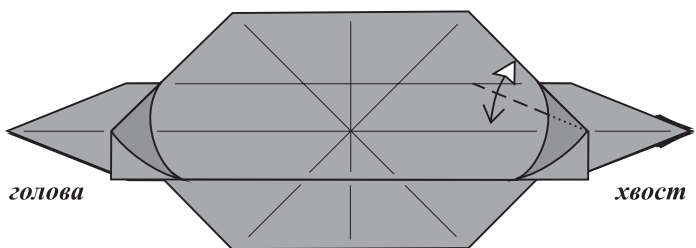

75. Перегните только верхний слой.

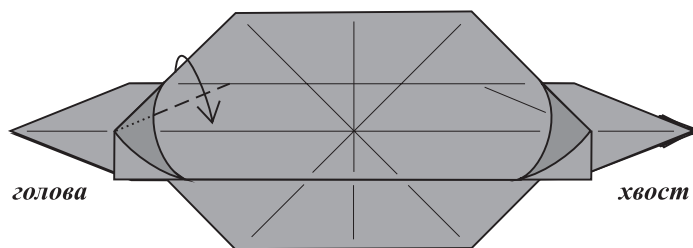

76. Согните вниз верхний слой  
на стороне головы.

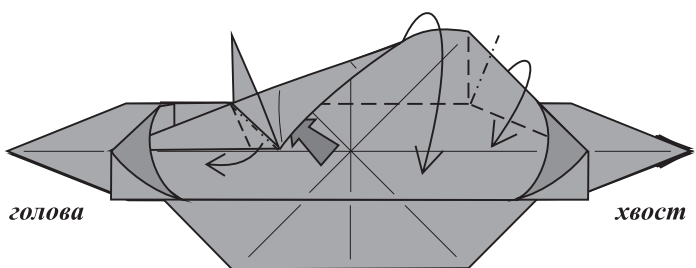

77. Закройте складку, складывая  
по указанным линиям.

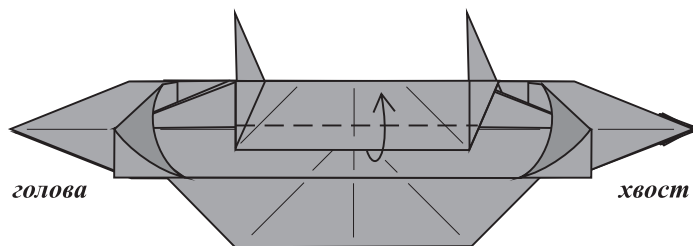

78. Отогните выступающий край.

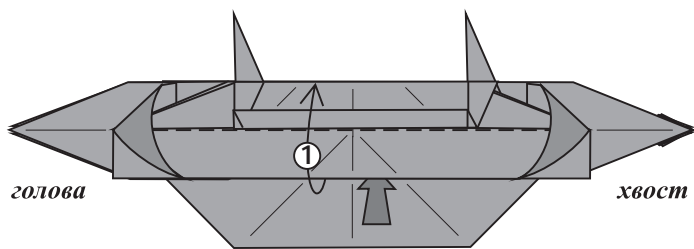

79. Накройте складку.

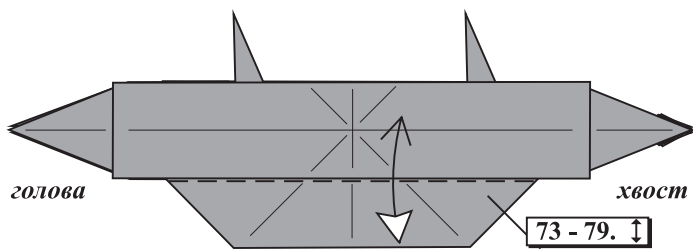

80. Повторите шаги 73-79 в зеркальном виде.

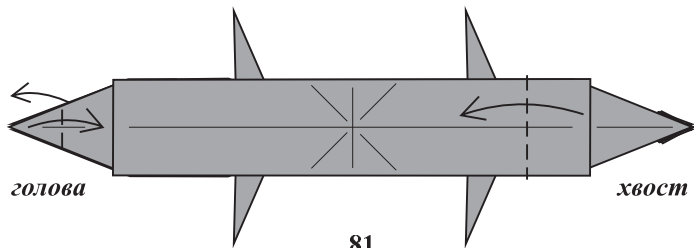

81.

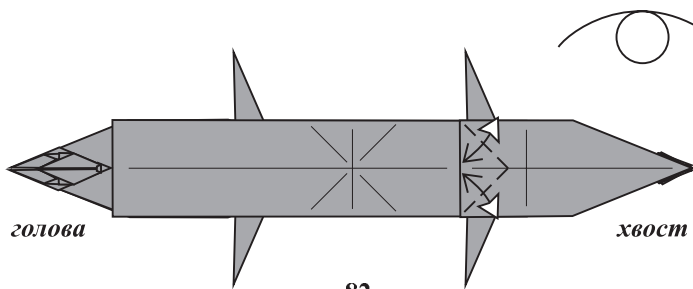

82.

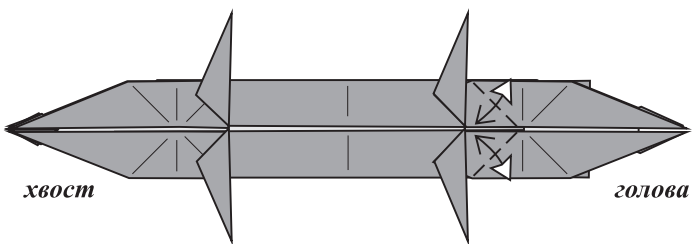

83. Перегните.

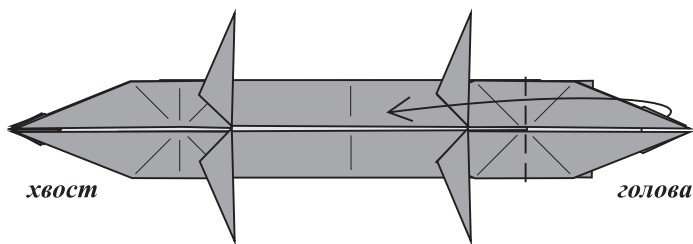

84. Согните голову к центру.

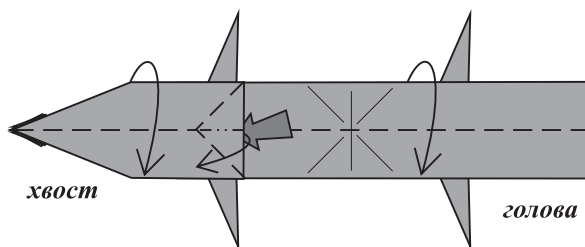
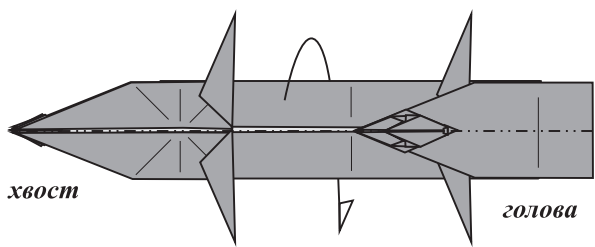

85. Согните фигуру пополам.

Рисунок справа показывает что происходит на другой стороне в это время.

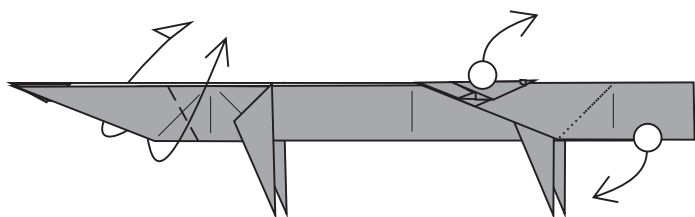

86. Выгните хвост. Поверните шею дракона на 90 градусов, используя сгибы, сделанные в шаге 83.

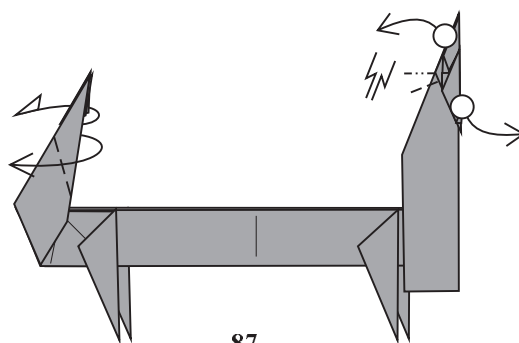

87.

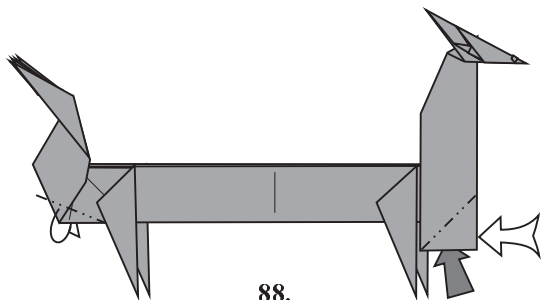

88.

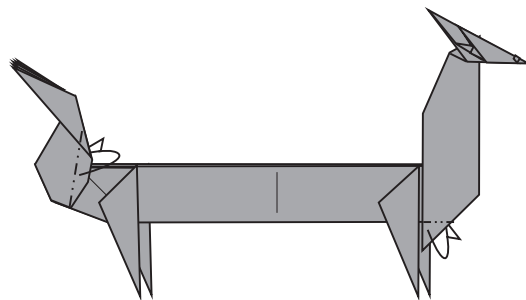

89.

Горные сгибы на шее и хвосте. Повторите с другой стороны.

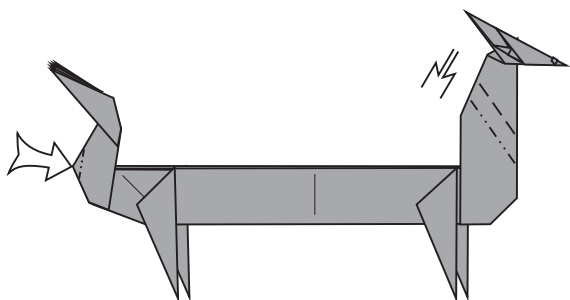

90.

Вогните часть хвоста внутрь и сделайте складку-молнию на шее.

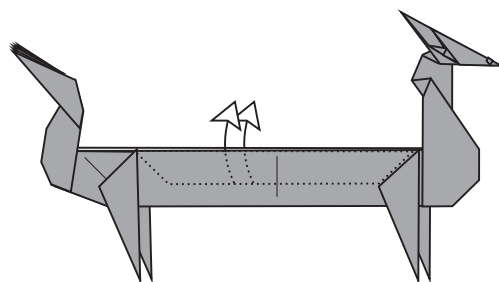

91.

Вытащите наружу слой, сложенный в шаге 17. Повторите с другой стороны.

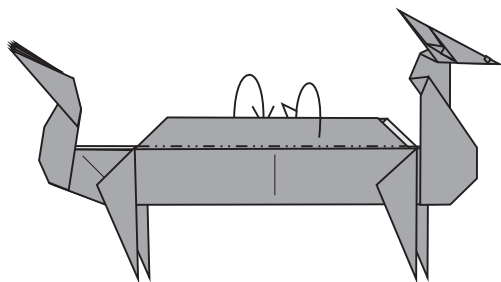

92.

Согните бумагу, чтобы накрыть белый цвет.

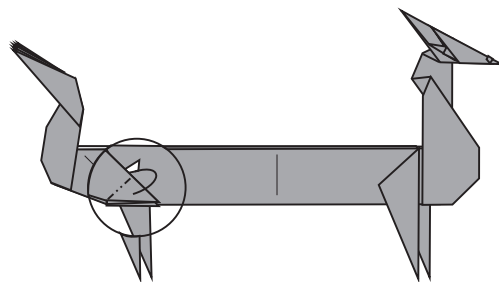

93.

Взгляд изнутри. Согните два угла, чтобы фигура не раскрывалась.

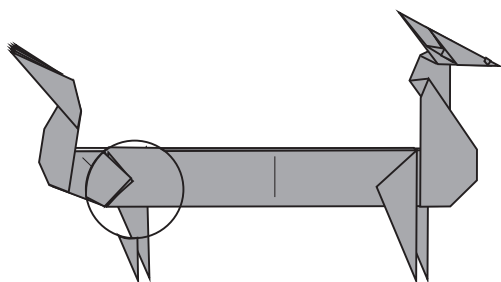

94.

Вот так. Теперь задние ноги не будут разбегаться в стороны.

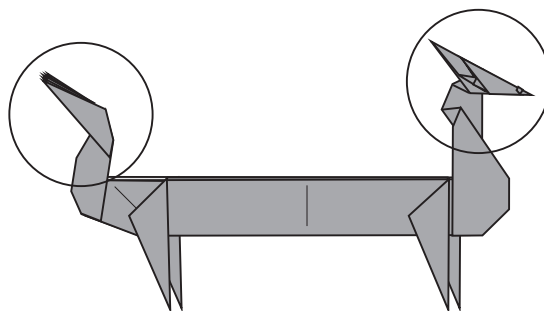

95.

Шаги 96-99 касаются хвоста, а 100-1007 - головы.

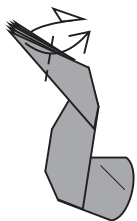

96.

Хвост. Внешняя складка. Повторите с другой стороны.

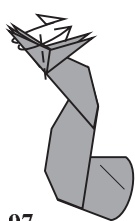

97.

Снова глубинные складки.



98.

Внешняя складка.

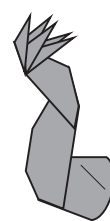

99.

Хвост готов.

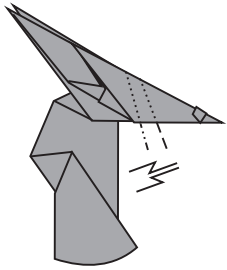

100. Голова. Складка-молния.

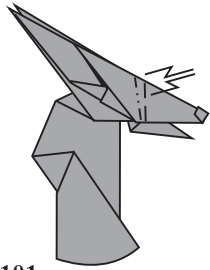

101. Маленькая складка-молния в верхней части.

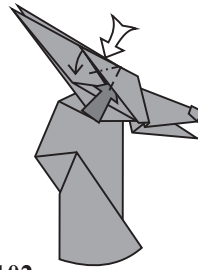

102. Раскройте карман. Повторите с другой стороны.

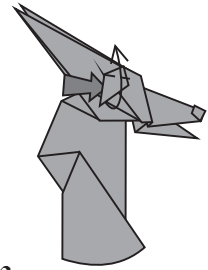

103. Сложите ухо. Повторите с другой стороны.

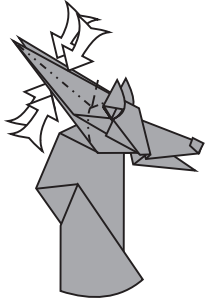

104. Делаем рога.

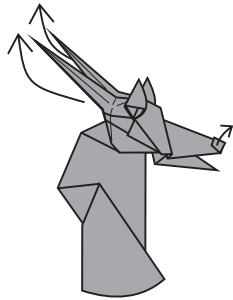

105.

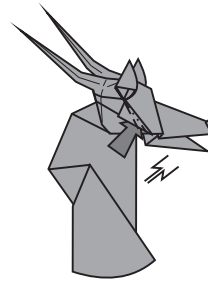

106. Складываем глаза.

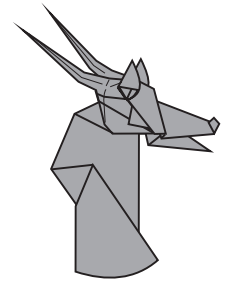

107. Голова готова.

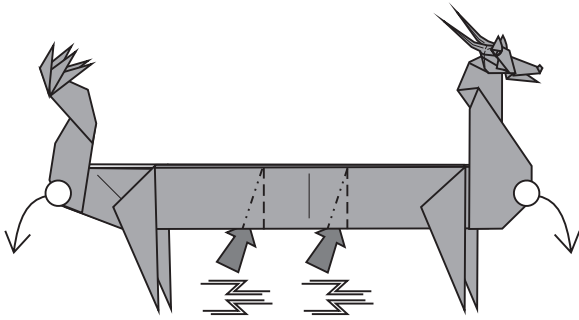

108. Изогните туловище дракона, делая складки-молнии..

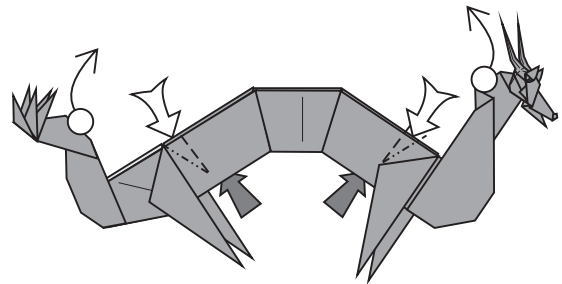

109. Продолжаем сгибать туловище.

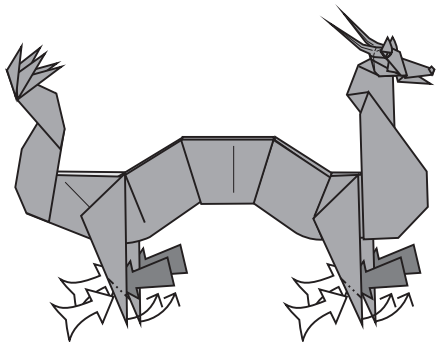

110. Складываем лапы дракона.

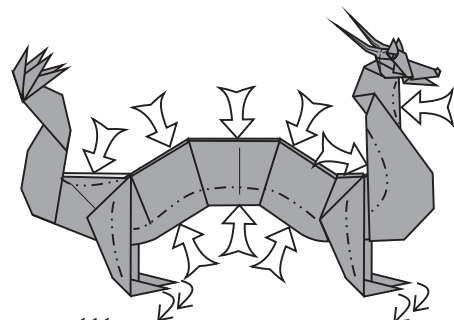

111. Придайте модели мягкие очертания. Сделайте когти на лапах.

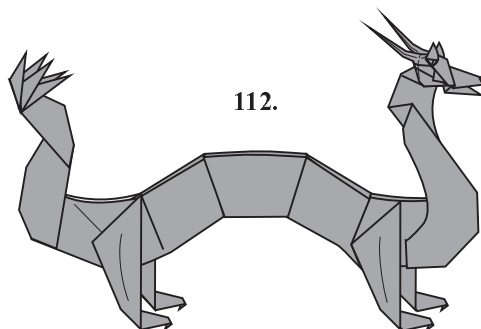

112.

Каких-то 112 сгибов и Дракон готов!



# Compact Dragon

By Perry Bailey Copyright 1999 (Barely)  
With thanks to the work of Samuel Randlett

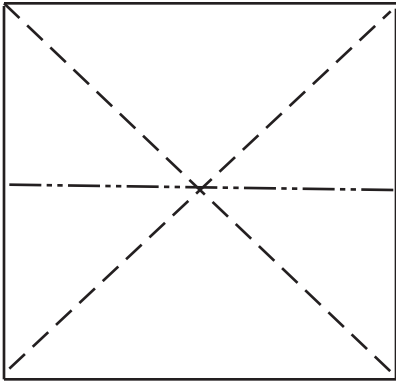

1. Fold a water bomb base with the white side facing up.

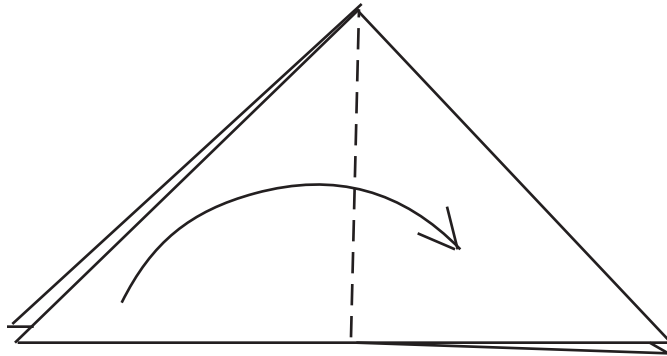

2. Fold one flap over so there are three flaps on one side and only one on the other.

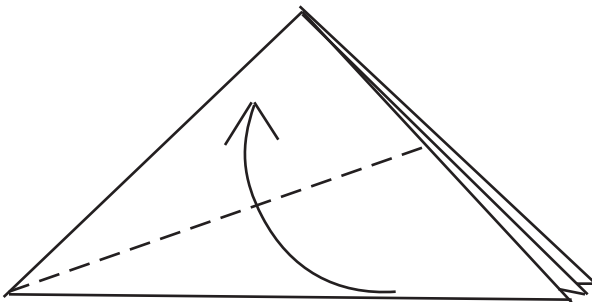

3. Valley fold up the top layer of paper only, this will leave you with a flap sticking up.

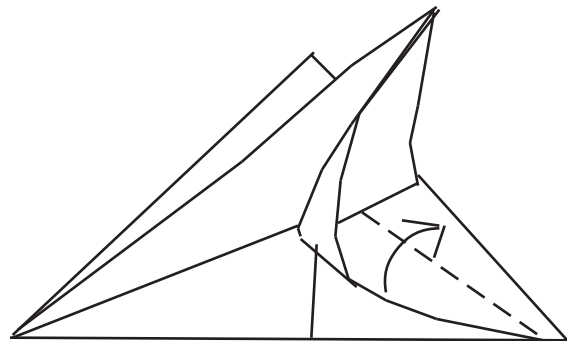

4. Take that flap that is sticking up and fold it over to the edge of the model and then flatten the model.

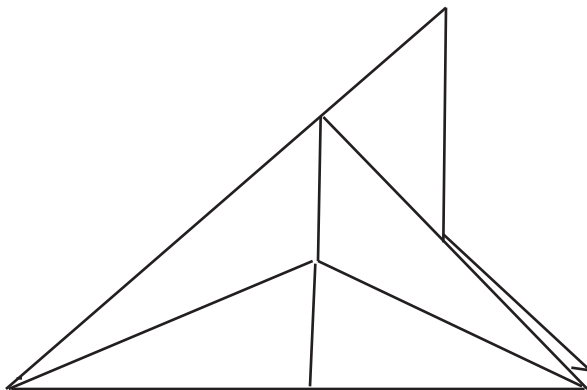

5. You should have something that looks like this. If you do repeat 3 through 4 on the other side.

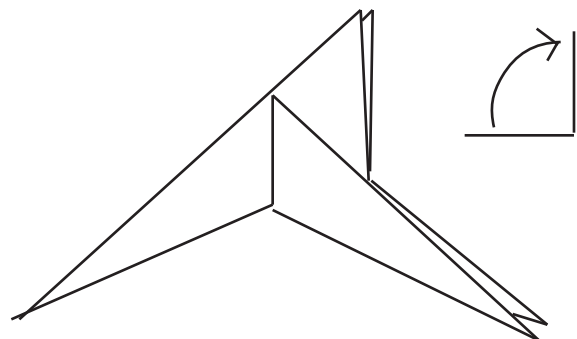

6. Which should have given you something like this, with one flap one side and 2 flaps on the other, and 2 above. Turn the model 90 degrees to the right.

7. Arguably this diagram isn't a true 90 degrees to the right but I doubt yours was perfect either! ( you there with compass bad, bad person, sit in the corner and make this into a flapping bird instead!) Fold the top flap all the way over.

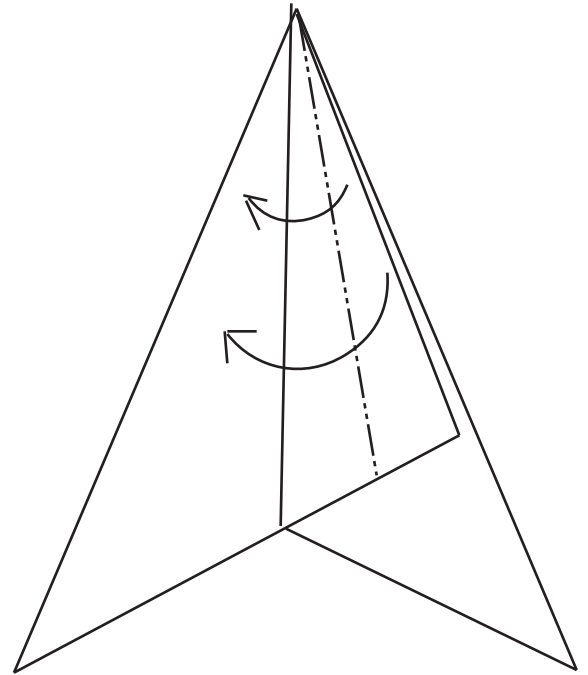
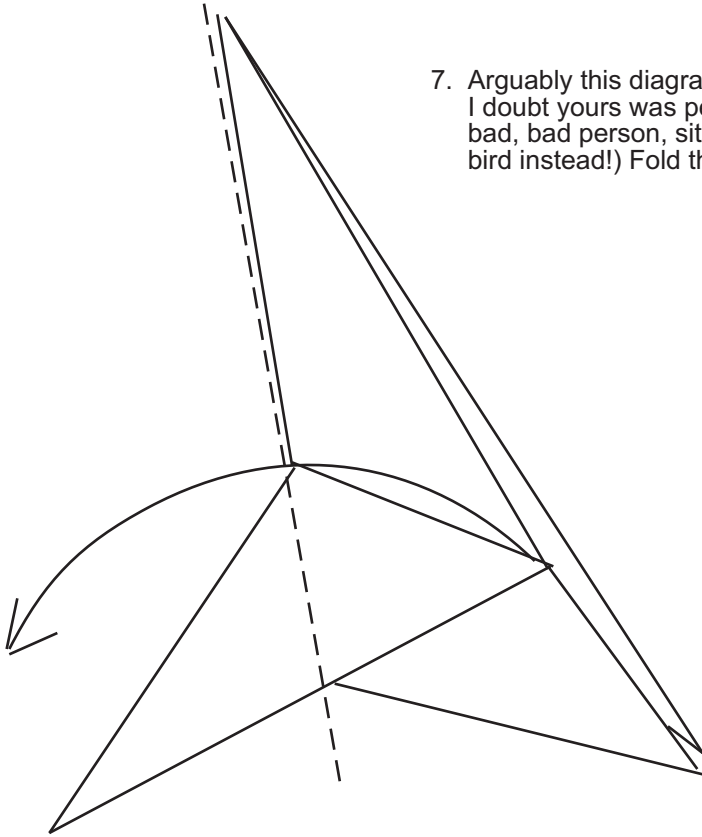

8. Now if all you want was a trekkie pin you can quit now, for the rest of you prepare to be confused. As you can see this appears to be a squash, and it is sort of, if you don't mind messy.

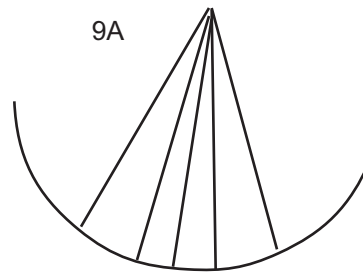
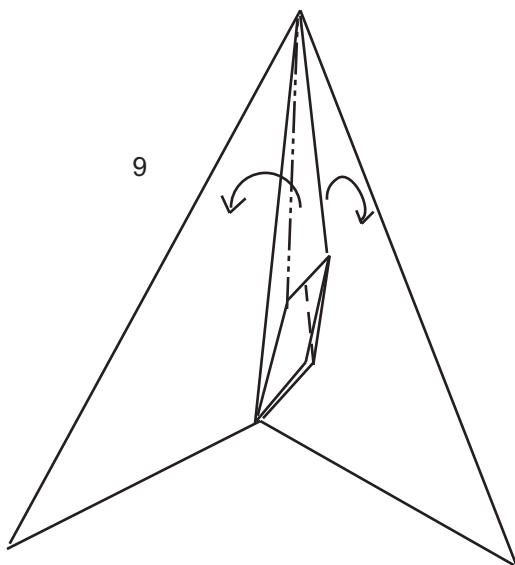

9. OK now as you can see I have blown a page or two on this in an effort to make some sort of sense out of it. You have to start this at the top of the model and to do that you may have to reach in behind to start it. Note it will not go all of the way to the bottom of the model in a normal manner, as there are too many layers of paper so when you reach the bottom of the squash stop and go to the next page.

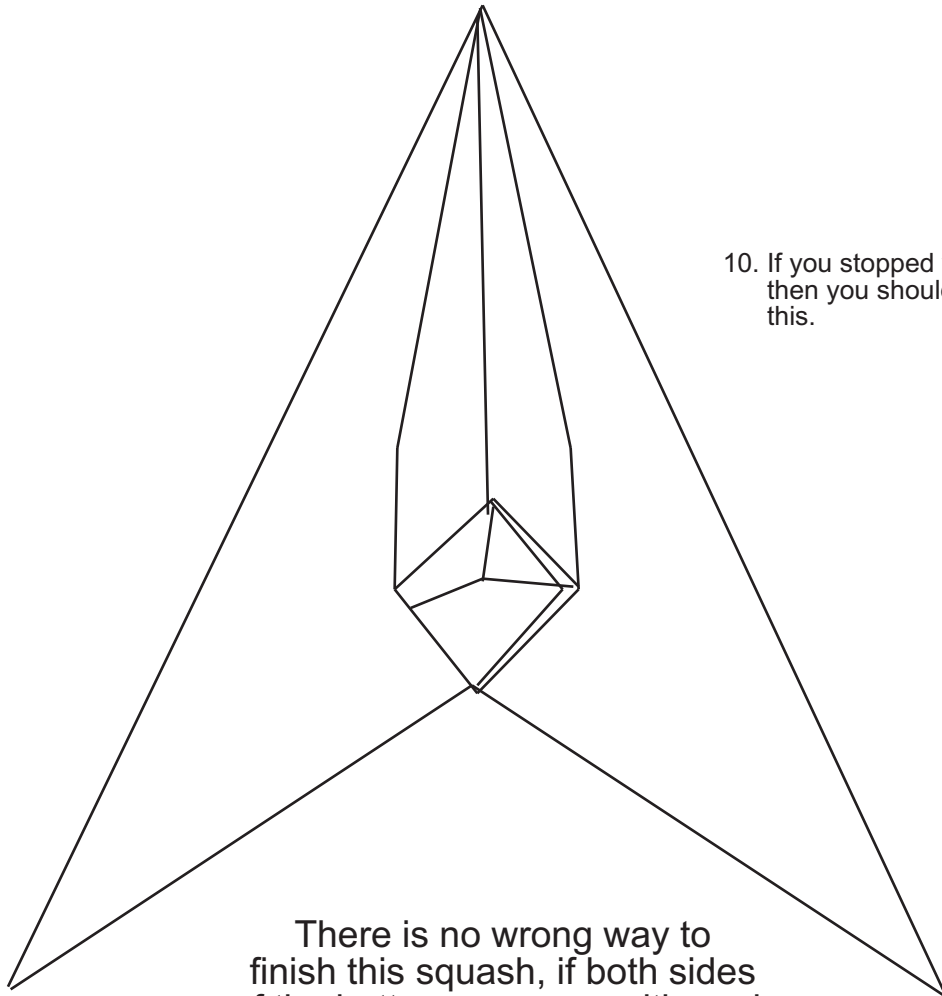

10. If you stopped when it started to get strange then you should have something sort of like this.

There is no wrong way to finish this squash, if both sides of the bottom are even with each other, you got it right!

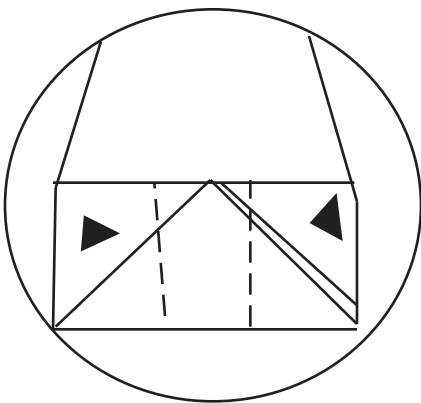

11. In close up you see the model can not fold flat, but we don't need it to if you pinch the center of it together then you can proceed.

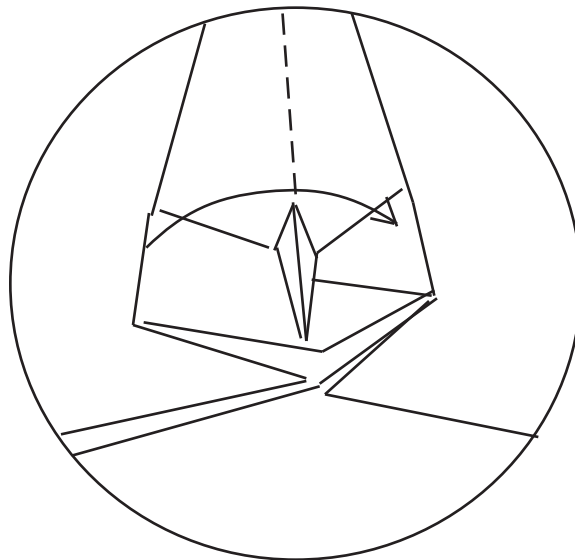

12. To fold it back together again back to step 7 or a near equivalent which should be flat. If That doesn't come out well just smash it down flat and get on with it!

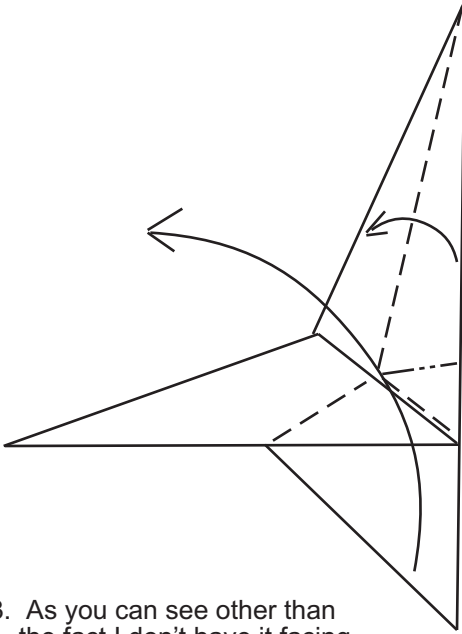

13. As you can see other than the fact I don't have it facing quite the same way it does resemble step 7 and is flat.. Now fold on the upper flap one layer over will folding the lower flap up to create the wings. Repeat on the other side.

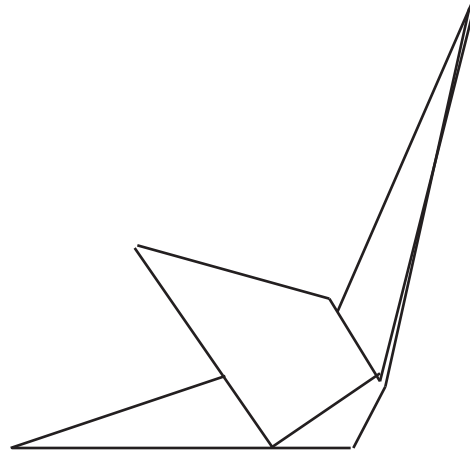

14. In theory anyway you should be here. Note the rounding of his tummy was brought about by the odd squash we did earlier, unless of course you went for the bird option in which case you should be happily flapping away!

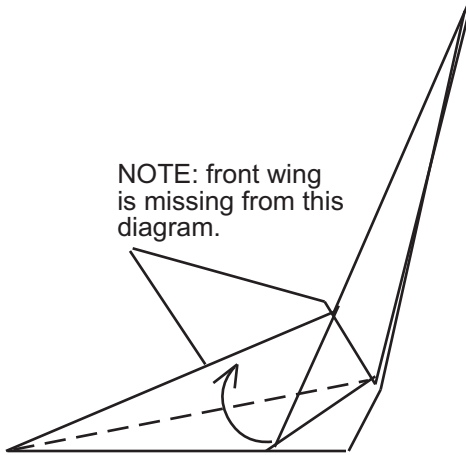

15. Fold the flap up on both sides, note that you will be folding this up inside of the wing it's self. Repeat on other side.

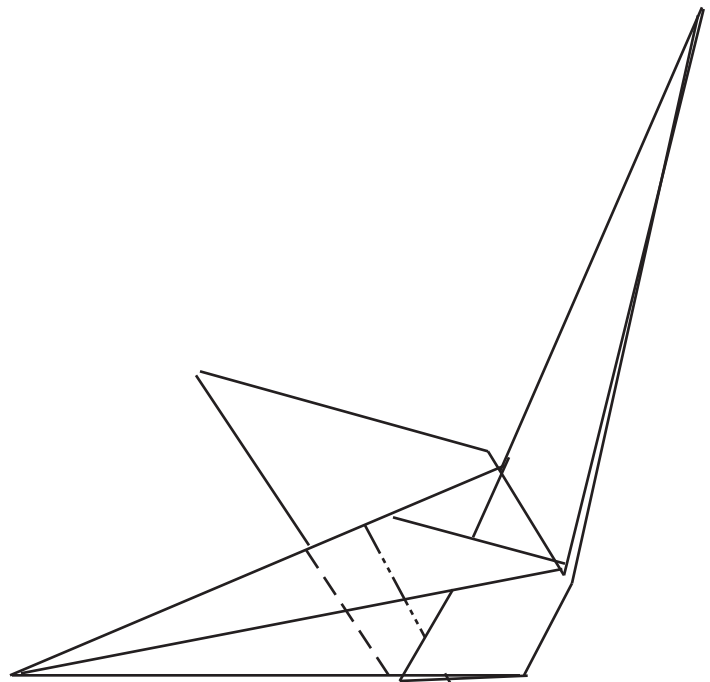

16. Fold the tail in and back out using 2 reverse folds. Still in x-ray mode.

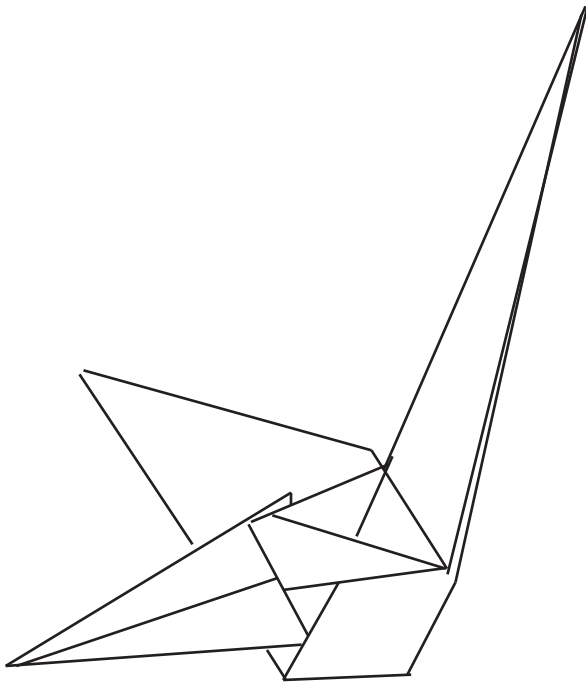

17. You should have something like this if the front wing were missing.

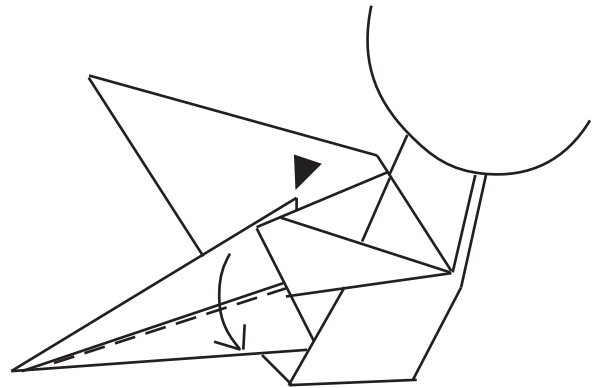

18. Now lets start on the tail, fold down the upper layers on both sides while sinking the inside corner. Please note this should create a color change on the tail.

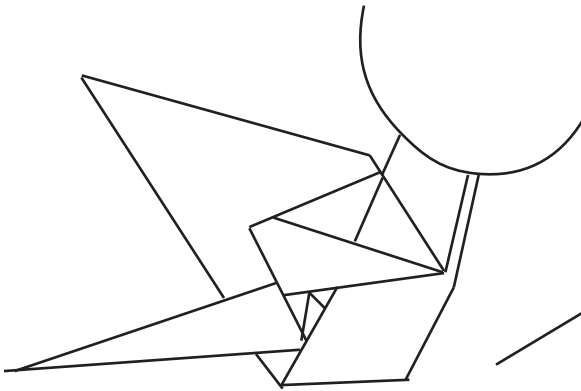

19. Should come out like this.

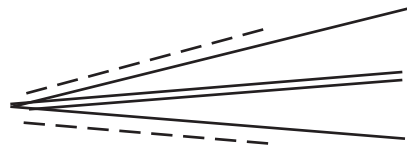

20. Now if you open the tail up from the top and then looked at it from the bottom it should resemble this. Now open out the bottom layers part way.

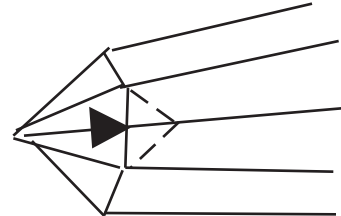

22. This is very inaccurate but the best I could do, pull the center layer inside while flattening the model.



23. If everything worked out just right it ought to bear at least a passing resemblance to this. This finishes the tail, well all but a tiny thing, we do at the end of the process. Again note a little bit of color change at the bottom of the flare in the tail.

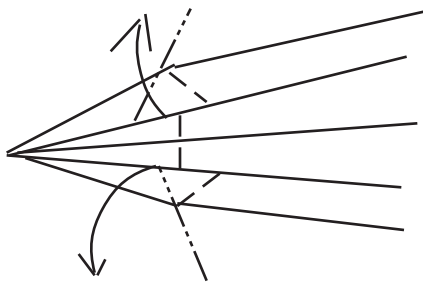

21. Then if you fold it up as you pull out the last layers it should give you lots of material to make a barb for the tail.

24. Now if we give the poor beastie back it's wing it should look like this! Now form the neck using a series of pleat folds to suit your tastes!

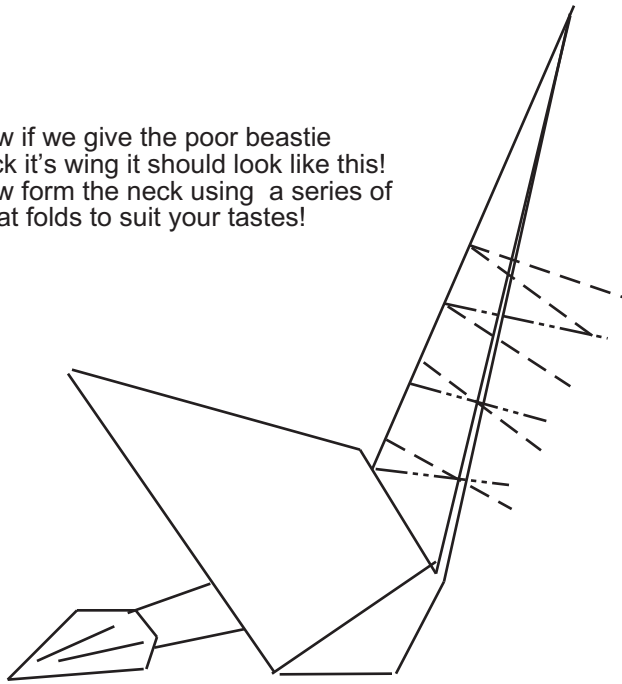

25. I always seem to go for necks that go both directions, of course that's up to you, but all the same I think I will finish the diagrams with it done in my preference. Now to form the head start by using a crimp fold.

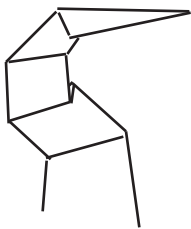
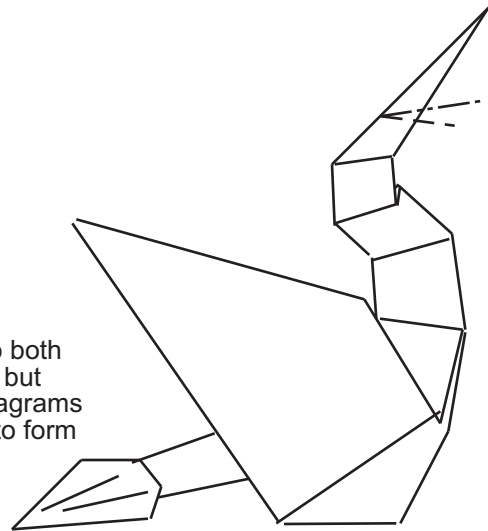

26. To make this easier when you go to pull out the two layers on each side let the head come unfolded. Grab the outer 2 layers underneath the head on each side and pull.

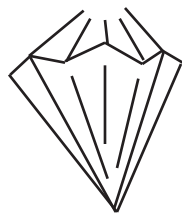

27. Sort of looks like this or it should! Then with all the new layers showing fold it back flat.

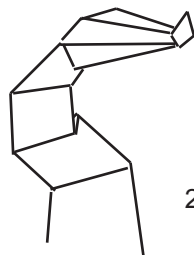

29. Might look like this complete with snout or maybe better, if you work it right, you can make it seem to have eyes. The top 2 thirds of the head are color changed.

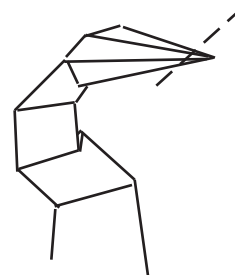

28. anything vaguely reassembling a head at this point is good, feel free to fold a snout, or not.

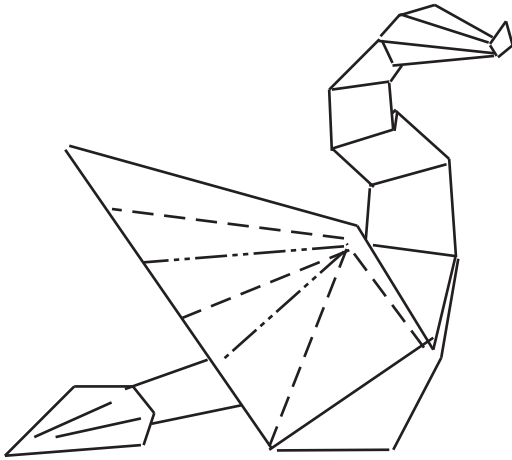

30. Now lets fold them wings up, as you might have noticed, just some simple pleats and we are almost done.

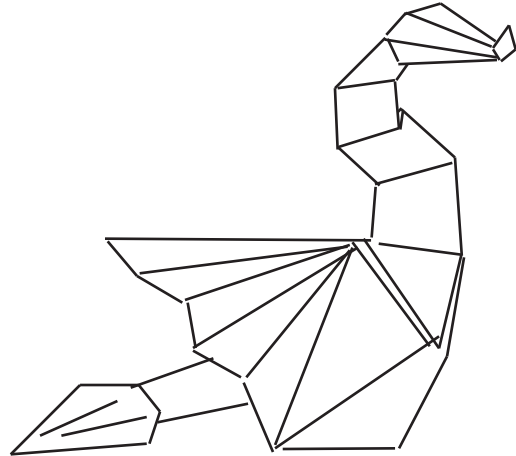

31. Or if you are not the finicky type you could say it was done! But there is this one little bit that sort of helps I think.

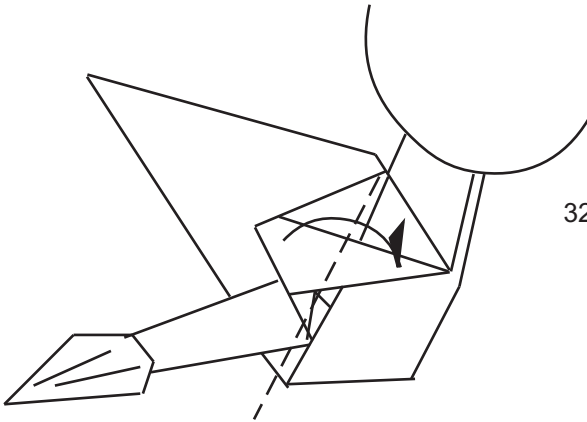

32. Us finicky types would look at this and say, oh! be jabbers! But that critter has a big behind! Not compact at all so we go back to x-ray mode beneath the wing and you can see where we tuck that bit inside of the wings to finish it up and tighten it down as it were!

33. Now we are finished, unless your feeling especially clever and then you can go back to steps 8 through 12 and instead of all that mucking about just sink the inner layer which would let you make a nice neat perfect looking squash fold, except then you might need to add a couple of folds to round out the tummy.

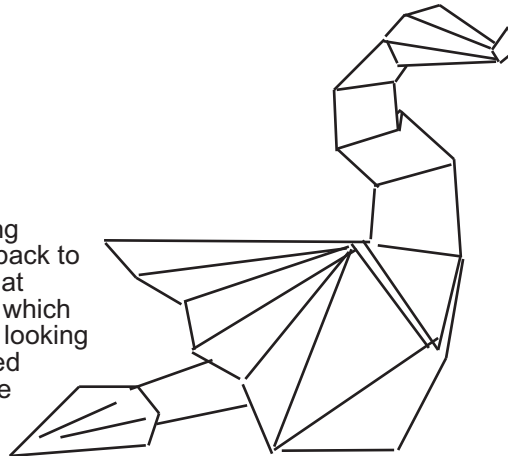

# \$ Dragonfly

Copyright 1998-99 Stephen Hecht. All Rights Reserved

This model's design borrows from Robert Lang's dragonfly in *The Complete Book of Origami* (Dover, 1988). A dollar bill makes a model 45mm long with a 63mm wingspan. For first attempt, begin with a 3x7 rectangle larger than a dollar bill.

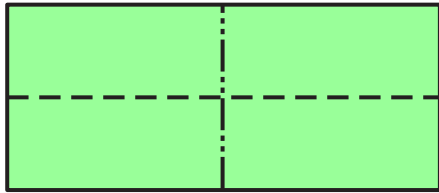

1. Begin green side up. Valley-crease the long way, mountain-crease the short way.

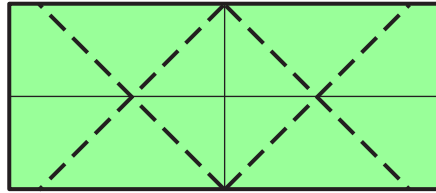

2. Bisect the middle 4 right angles with valley-creases.

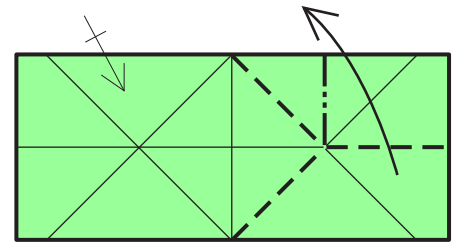

3. Rabbit-ear. Repeat on left.

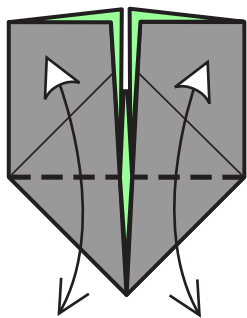

4. Fold and unfold. Turn over and rotate 1/4 turn.

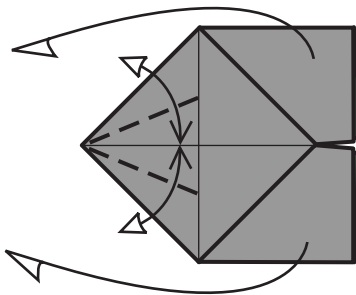

5. Crease bisectors, stopping where shown. Then swing flaps around.

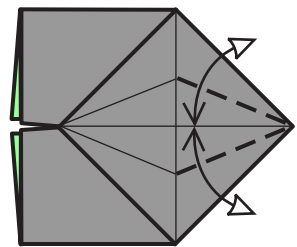

6. Crease bisectors.

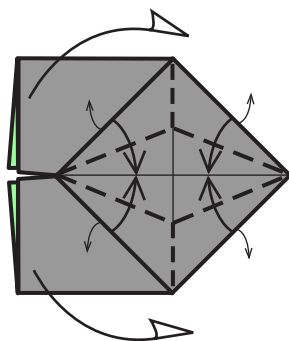

7. Collapse. A layer swings out from behind at the 4 tiny arrows, and the long flaps stand straight up.

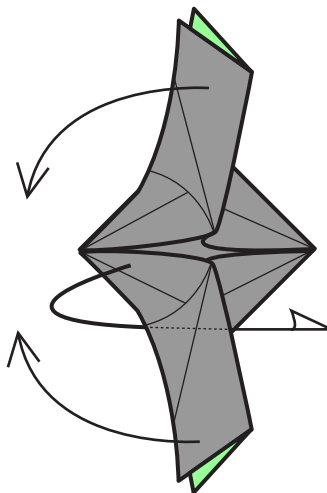

8. Swing the left half of the central diamond under the right half; the standing flaps fall to the left. No new creases. Rotate.

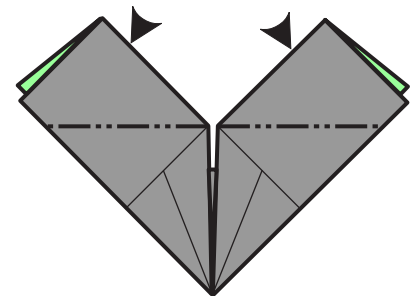

9. Reverse-fold on existing creases.



# \$ Dragonfly (continued)

Copyright 1998-99 Stephen Hecht. All Rights Reserved

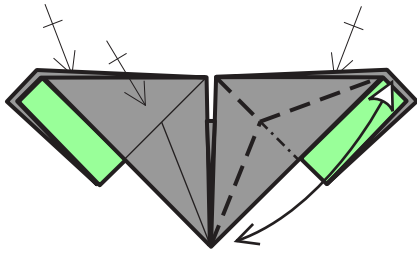

10. Flip one layer down, incorporating a reverse-fold. Unfold. Repeat on left, and twice behind.

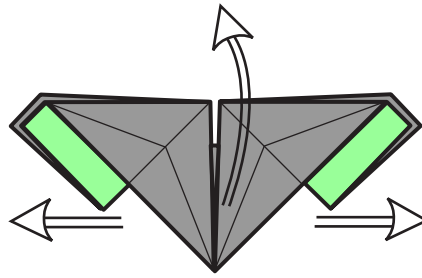

11. Lift bottom point, opening paper completely.

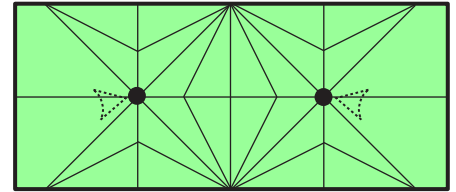

12. The central diamond-shape sticks up. The indicated points are concave. Push them up from behind to invert them.

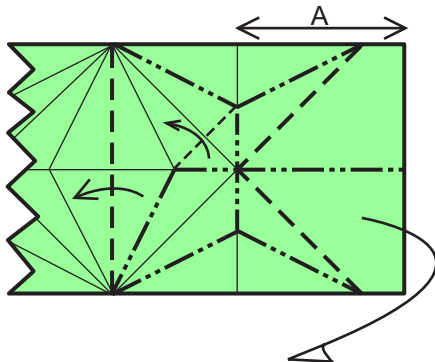

13. Pinch together all the edges in the range "A", swinging them under. Meanwhile, divide the central diamond. Only the tiny valley fold is a new crease.

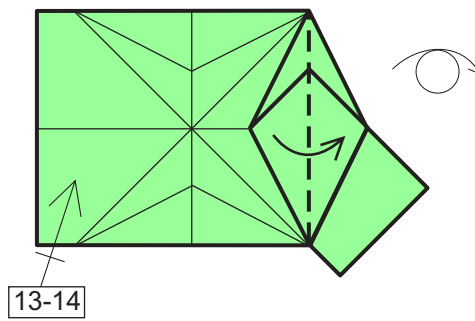

14. Flip one flap to the right. Repeat 13-14 on the left. Turn over.

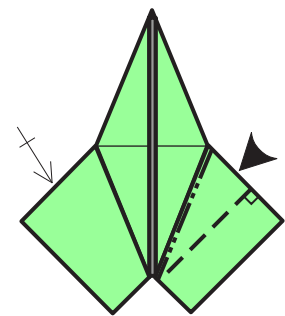

15. Reverse-fold, in-and-out. Repeat on left.

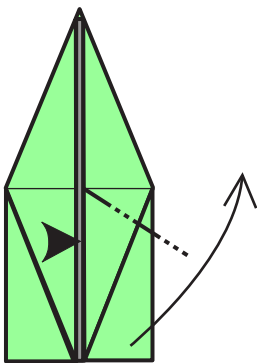

16. Reverse-fold, 1 layer over 2. See next diagram for positioning.

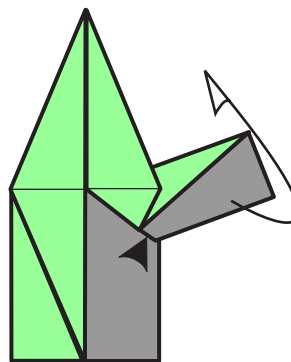

17. Flip the (single-ply) rectangular section behind and upwards. This is a reverse-fold.

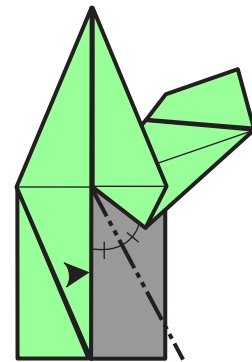

18. Reverse-fold, 1 layer over 2. Note bisected angle.

# \$ Dragonfly (continued)

Copyright 1998-99 Stephen Hecht. All Rights Reserved

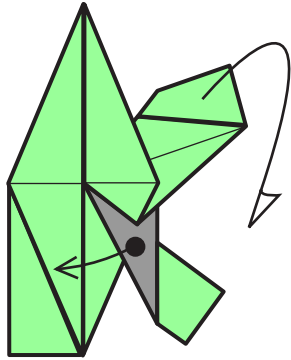

19. Pull single-ply black triangle to the left. This will drag the single-ply rectangular piece of the upper wing downwards.

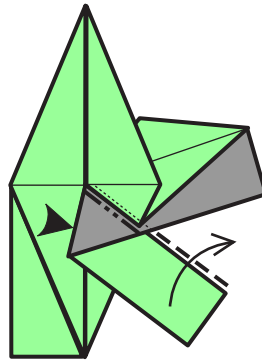

20. Reverse-fold, flipping the single-ply over. Sharpen all creases.

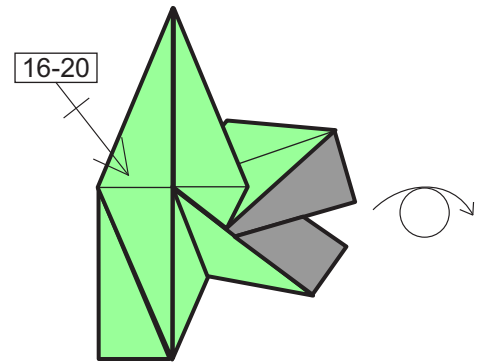

21. Repeat 16-20 on left. Turn over.

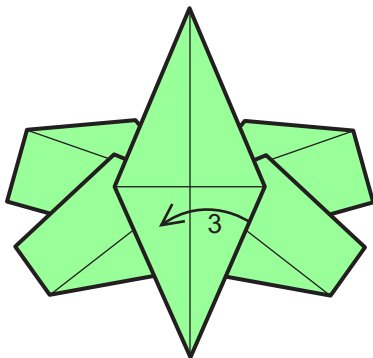

22. Flip 1 flap over, and pull the next 2 flaps towards the left. Model won't lie flat.

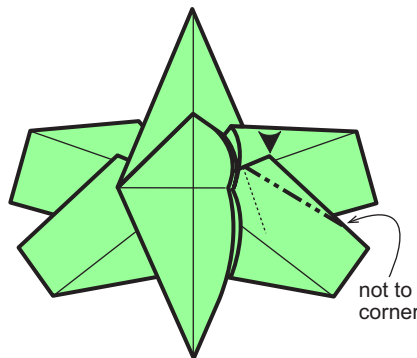

23. Exposed wing: reverse-fold top edge. Rear half is an angle-bisector. Let go of one of the stretched flaps.

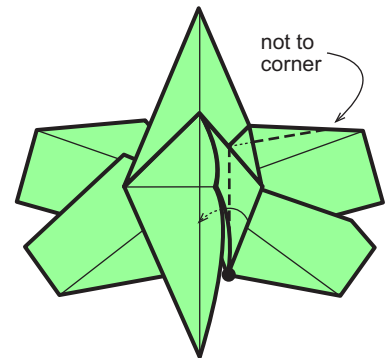

24. Model still not flat. Bisect lower angle, swiveling at the upper edge. Release the stretched layer.

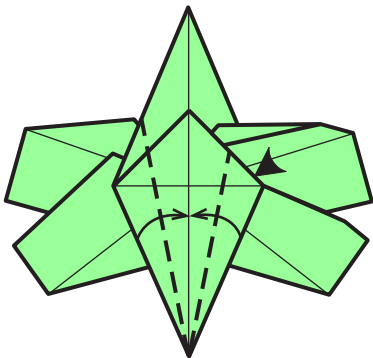

25. Model now flat. Fold left flap to center line. Spread-squash right flap to center line.

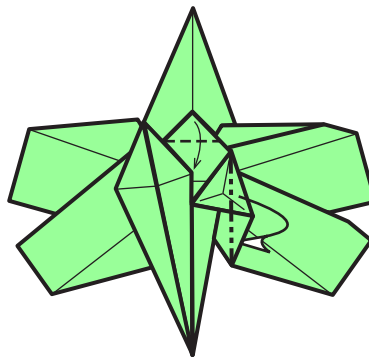

26. Valley tip of central triangle fold down where limited. Tuck right edge of spread-squash behind.

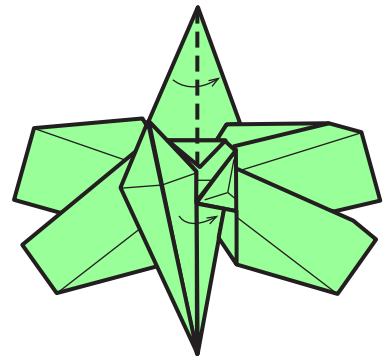

27. Flip one flap over from the left.

# \$ Dragonfly (continued)

Copyright 1998-99 Stephen Hecht. All Rights Reserved

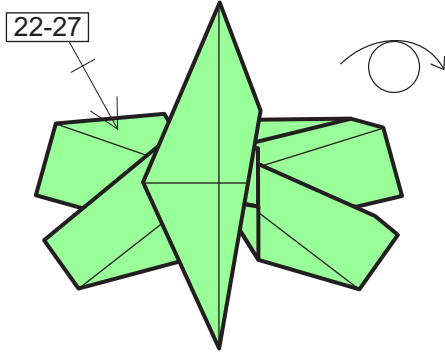

28. Repeat 22-27 on left. Turn over.

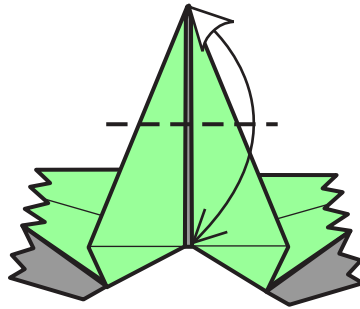

29. Detail of top point. Fold and unfold tip down to base of triangle.

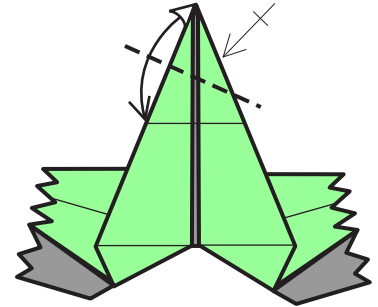

30. Fold and unfold. Repeat on right.

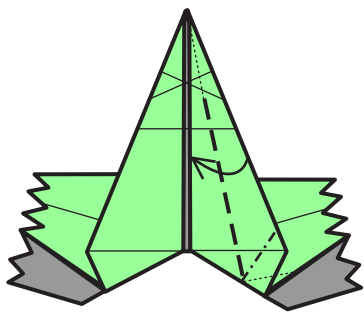

31. Bisect, swiveling at the bottom. Don't make the crease sharp all the way to the point.

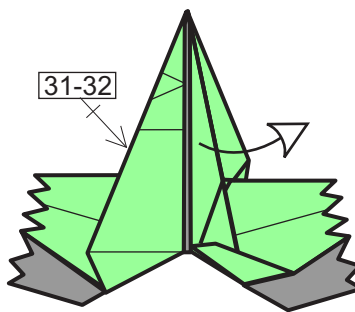

32. Note where the mountain-fold wound up. Unfold previous step. Repeat 31-32 on left.

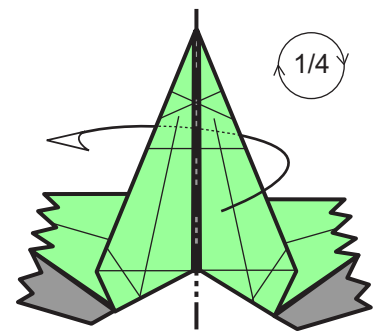

33. Mountain-fold entire model in half. Rotate 1/4 turn.

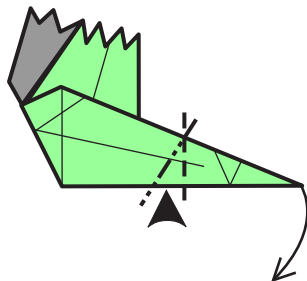

34. Detail of head. Reverse-fold twice. The valley-fold is the crease from step 29.

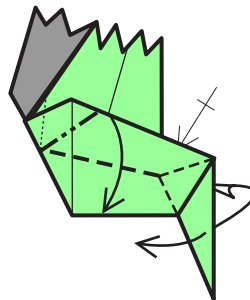

35. Note that front edge is vertical. Reform swivels from steps 31-32, spreading front of head perpendicular.

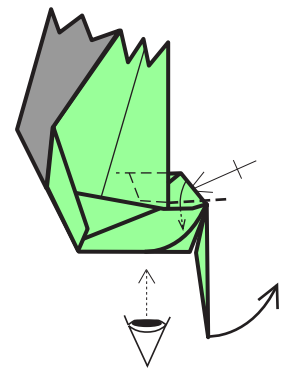

36. Tuck protruding edge down, limited at the left by thickness (sort of a reverse-fold). Repeat behind. Swing tip up slightly.

# \$ Dragonfly (continued)

Copyright 1998-99 Stephen Hecht. All Rights Reserved

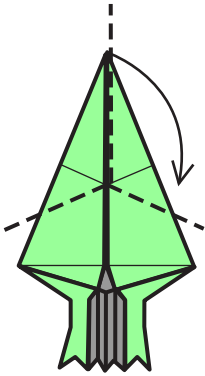

37. Rabbit-ear on existing creases from step 30.

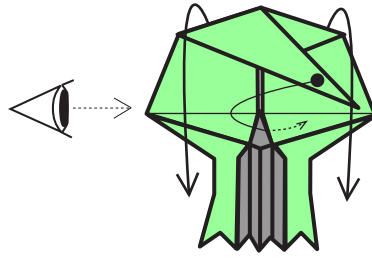

38. Tuck point of rabbit-ear inside crimped layers as you close the head back up. Tweezers help.

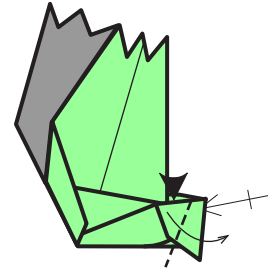

39. Spread eye to the right, opening and rounding. Repeat behind.

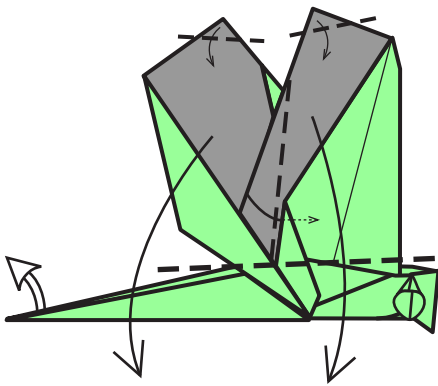

40. Final details:  
Valley-fold rear edge of front wing, tuck behind swivel fold.  
Blunt tips of wings.  
Fold the wings down.  
Repeat all behind.  
Open tip of tail, form a rounded flat area.

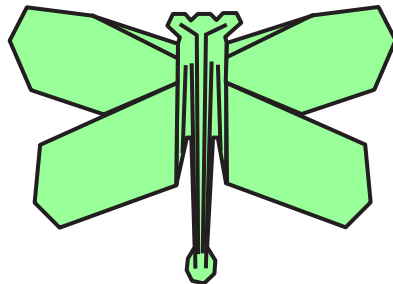

41. Completed dragonfly.

# \$ Dragonfly, version 2

Copyright 1998-2000 Stephen Hecht. All Rights Reserved

This model's design borrows from Robert Lang's dragonfly in *The Complete Book of Origami* (Dover, 1988). For your first attempt, begin with a 3x7 rectangle considerably larger than a dollar bill. A dollar bill makes a model 45mm long with a 63mm wingspan, and requires tweezers.

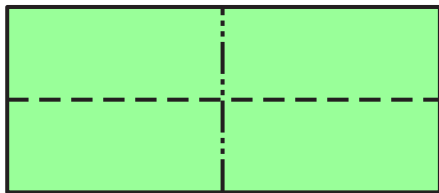

1. Begin green side up. Valley-crease the long way, mountain-crease the short way.

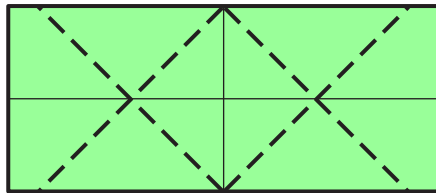

2. Bisect the middle 4 right angles with valley-creases.

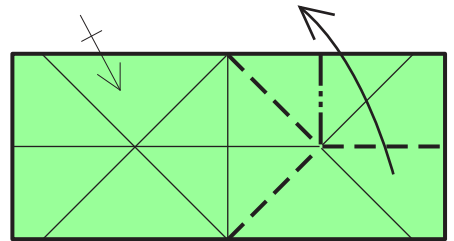

3. Rabbit-ear. Repeat on left.

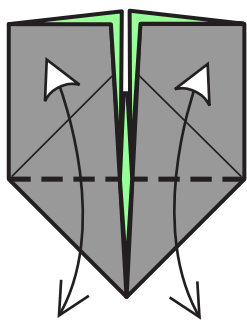

4. Fold and unfold. Turn over and rotate 1/4 turn.

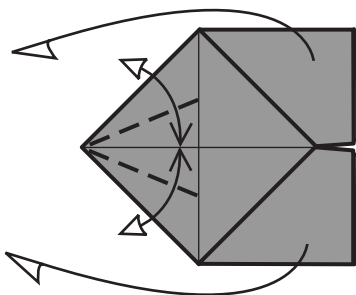

5. Crease bisectors, stopping where shown. Then swing flaps around.

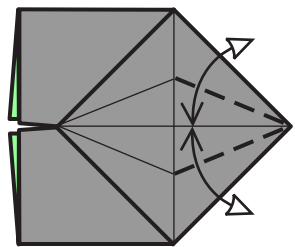

6. Crease bisectors.

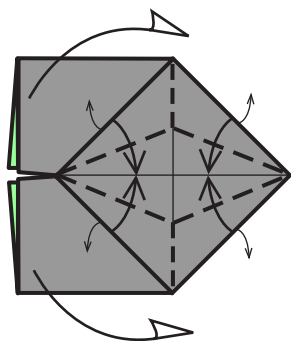

7. Collapse. A layer swings out from behind at the 4 tiny arrows, and the long flaps stand straight up.

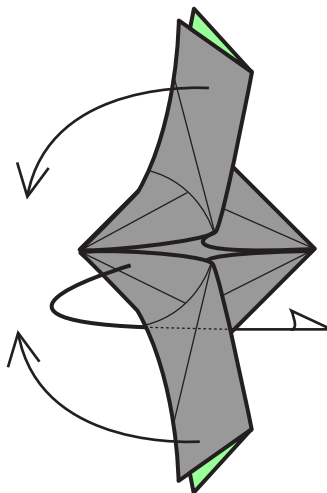

8. Swing the left half of the central diamond under the right half; the standing flaps fall to the left. No new creases. Rotate.

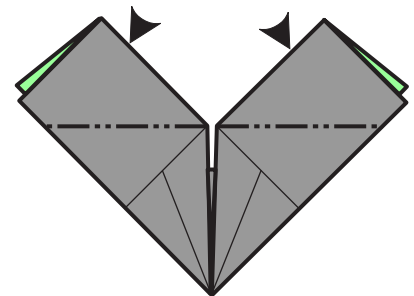

9. Reverse-fold on existing creases.

# \$ Dragonfly, v2 (continued)

Copyright 1998-2000 Stephen Hecht. All Rights Reserved

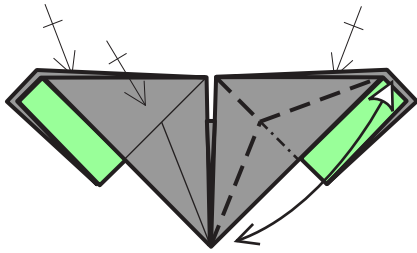

10. Flip one layer down, incorporating a reverse-fold. Unfold. Repeat on left, and twice behind.

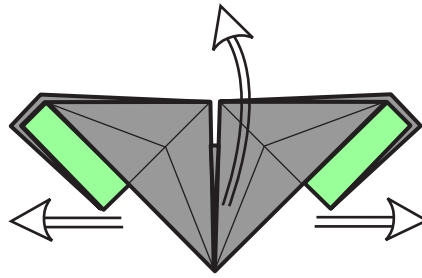

11. Lift bottom point, opening paper completely.

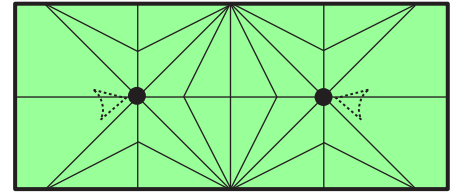

12. The central diamond-shape sticks up. The indicated points are concave. Push them up from behind to invert them.

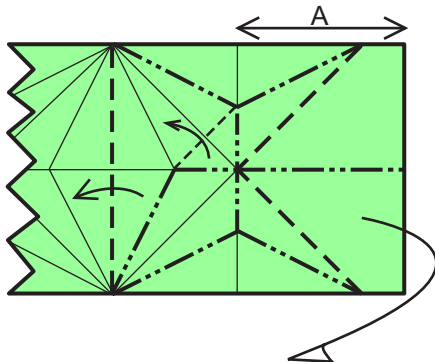

13. Pinch together all the edges in the range "A", swinging them under. Meanwhile, divide the central diamond. Only the tiny valley fold is a new crease.

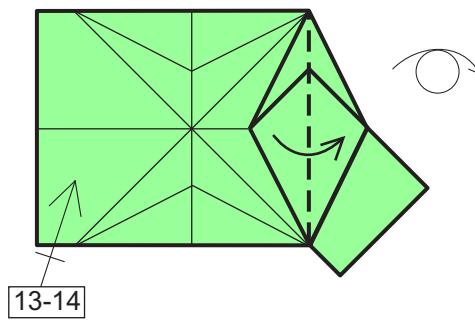

14. Flip one flap to the right. Repeat 13-14 on the left. Turn over.

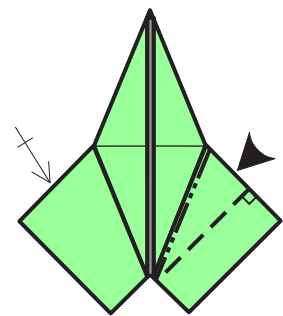

15. Reverse-fold, in-and-out. Repeat on left.

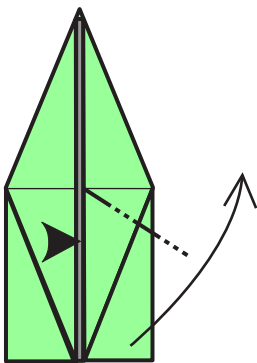

16. Reverse-fold, 1 layer over 2. Crease only the front half sharply. See next diagram for positioning.

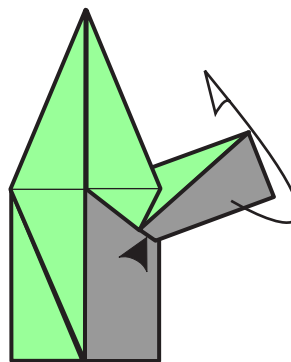

17. Flip the rectangular section behind and upwards. This is a reverse-fold. Do not crease sharply.

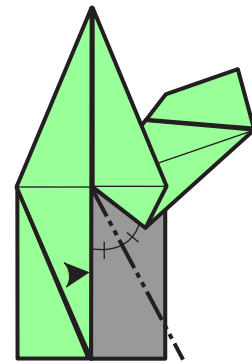

18. Reverse-fold, 1 layer over 2. Crease only the rear half sharply. Note bisected angle.

# \$ Dragonfly, v2 (continued)

Copyright 1998-2000 Stephen Hecht. All Rights Reserved

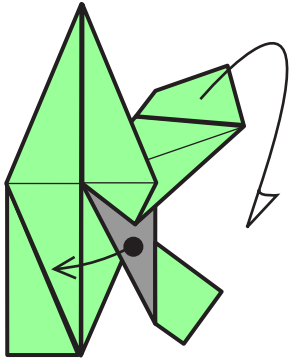

19. Pull single-ply black triangle to the left. This will drag the single-ply rectangular piece of the upper wing downwards. Don't crease.

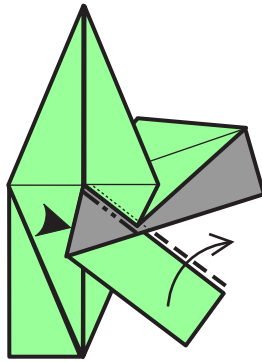

20. Reverse-fold, flipping over the rectangular single-ply. Press flat and sharpen all creases.

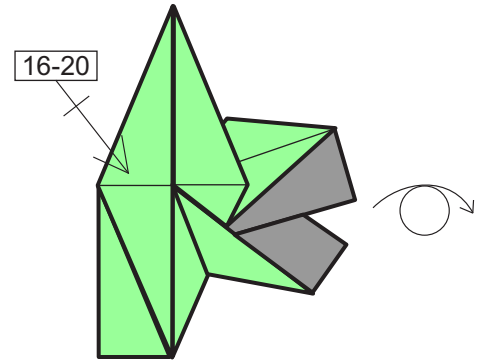

21. Repeat 16-20 on left. Turn over.

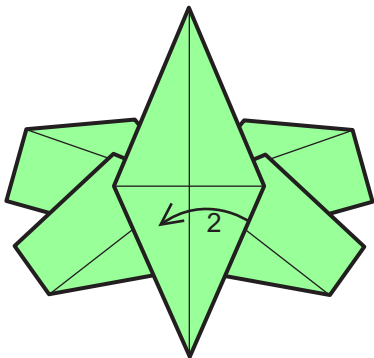

22. Flip 1 flap over, and pull the next flap towards the left. Model won't lie flat.

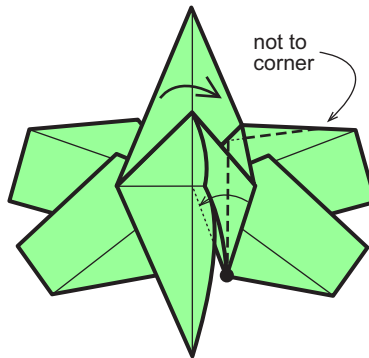

23. Bisect lower angle, swiveling at the upper edge. Release the stretched layer, and flip the long flap back to the right.

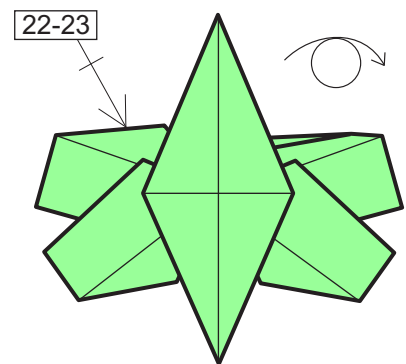

24. Repeat 22-23 on left. Turn over.

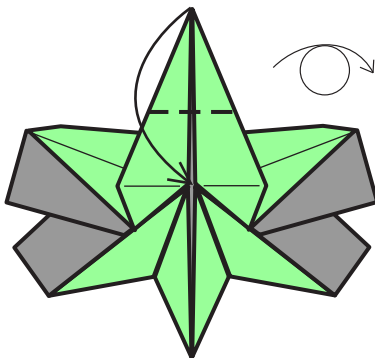

25. Fold top point to center. Turn back over.

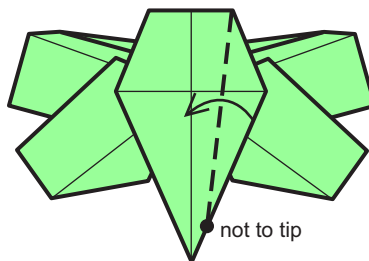

26. Valley fold, creasing sharply.

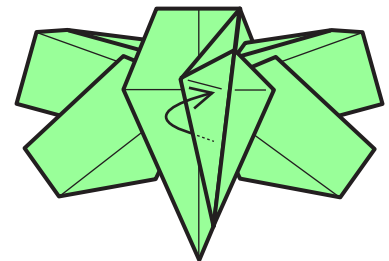

27. Bring one layer to front (closed sink).

# \$ Dragonfly, v2 (continued)

Copyright 1998-2000 Stephen Hecht. All Rights Reserved

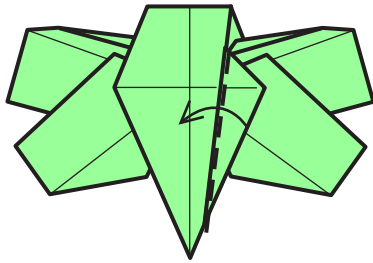

28. Valley-fold next flap over on the sink line (stretching at the wing). Unfold it.

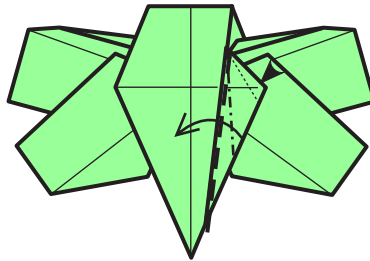

29. Fold over again, spread-sinking assymmetrically. The x-ray line is the other side of the spread.

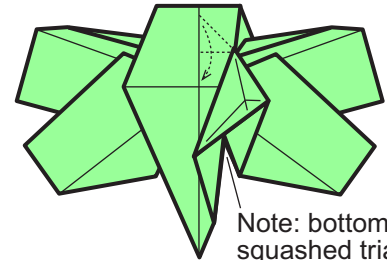

Note: bottom of squashed triangle crosses point where wing meets body.

30. Reverse-fold (symetrically) tip of tiny hidden waterbomb base, as far as possible. (Temporarily unfold point from step 25.)

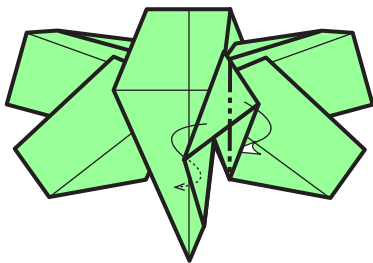

31. Tuck left edge into the sink. Mountain-fold right edge behind the edge under it (creasing sharply).

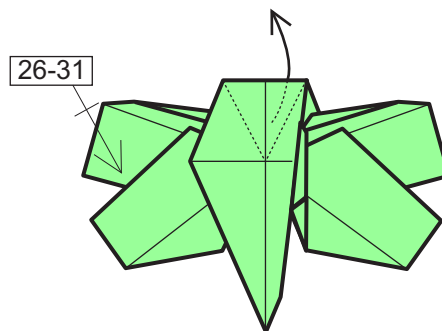

32. Repeat 26-31 on left side. Unfold point from step 25.

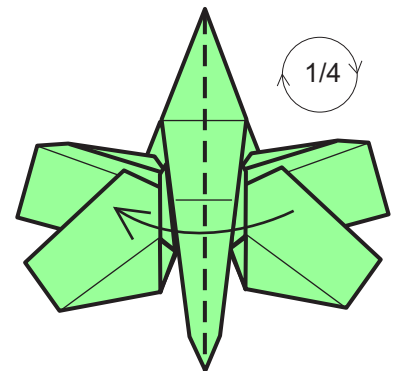

33. Fold model in half. Rotate 1/4 turn.

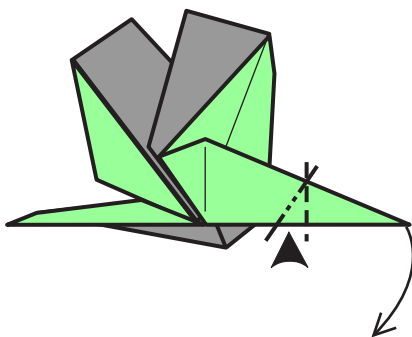

34. Reverse-fold twice. The valley-fold is the crease from step 25.

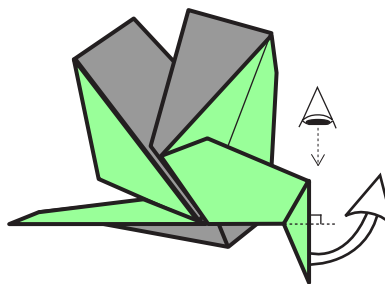

35. Note: front of head is vertical. Unfold the crimp and spread the 4 ridges along upper edge of head.

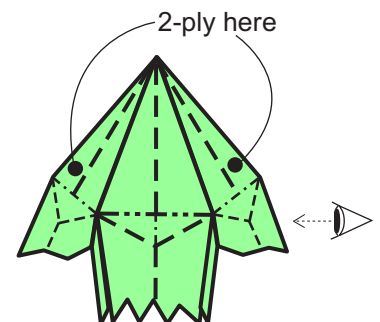

36. Triple-crimp along existing creases.



# \$ Dragonfly, v2 (continued)

Copyright 1998-2000 Stephen Hecht. All Rights Reserved

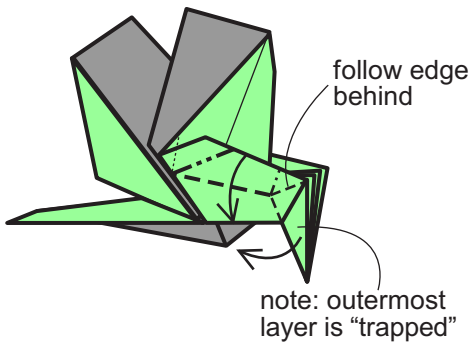

37. At wing, swivel. At head, flip over a layer, incorporating a reverse fold.

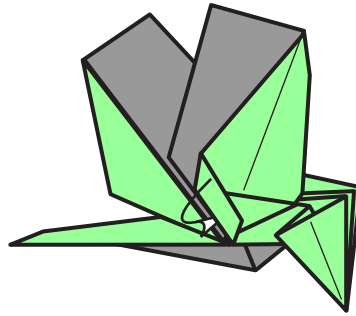

38. Wrap swivelled layer around (sort of a closed-sink).

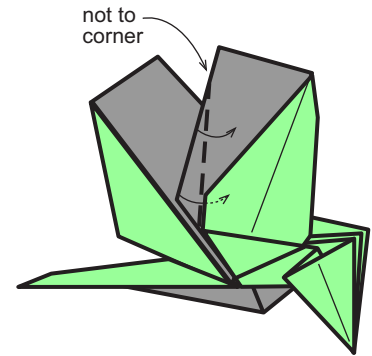

39. Valley-fold along edge of the wrap. Tuck under where it overlaps the front of the wing.

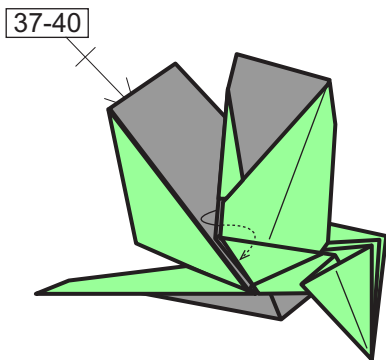

40. Tuck back of wing into the wrapped bit from step 38 (locking wing). Repeat 37-40 on other side.

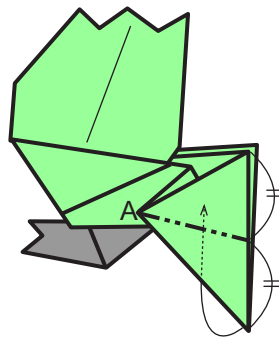

41. Detail of head. Sink as shown. If opened flat, this would be a mountain-fold joining point "A" with its counterpart.

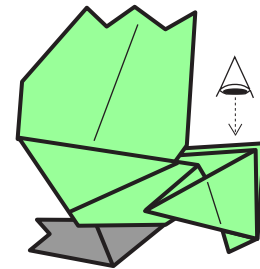

42. Like so. Spread top of head apart a bit.

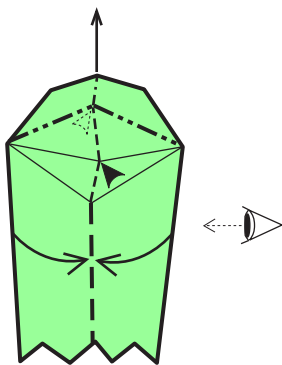

43. Top-view of head. Push down the crimp, unsinking the front of the head, and close back up.

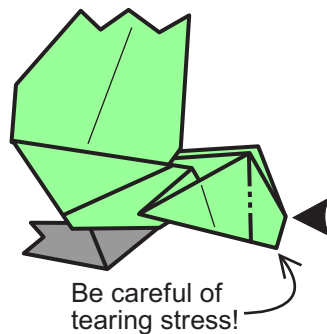

44. Closed-sink along existing crease.  
Optional: underneath the head, twist the extra sunken material towards the rear.

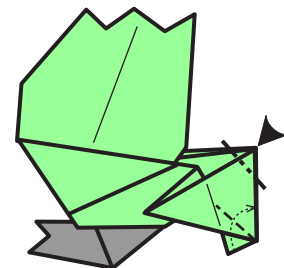

45. Dent the top corner of the head. Tuck in at bottom. Head is now locked.

# \$ Dragonfly, v2 (continued)

Copyright 1998-2000 Stephen Hecht. All Rights Reserved

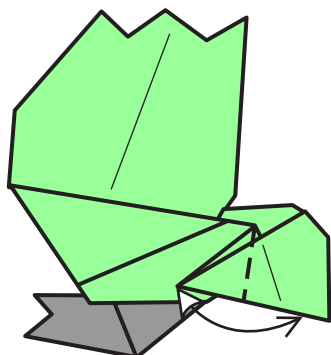

46. Fold and unfold eye-flap where naturally limited. Then lift it perpendicular.

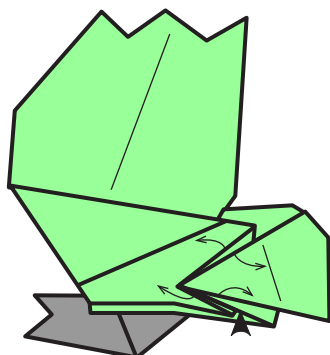

47. Half-squash the lower middle edge shown. Spread lower and upper outer edges.

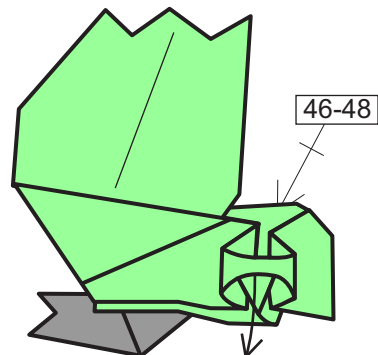

48. Like so. Round the eye further, pulling down the lower edge. Repeat 46-48 behind.

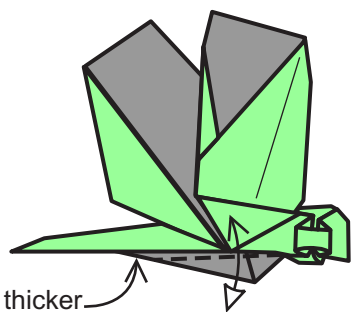

49. Fold and unfold only the front "belly" flap. The crease dips away from the body where the extra thickness begins.

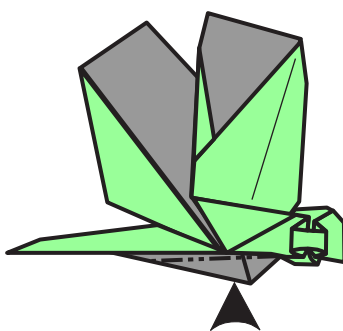

50. Closed-sink the front flap along the crease just made.

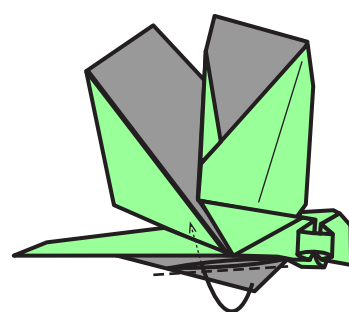

51. Fold the far "belly" flap over the middle ridge, and tuck it into the sunken pocket; crease sharply, as this is the belly-lock.

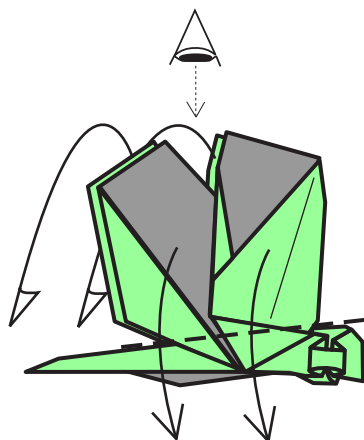

52. Bend down (very thick) the wings to 90 degrees, along the upper edge of the body.

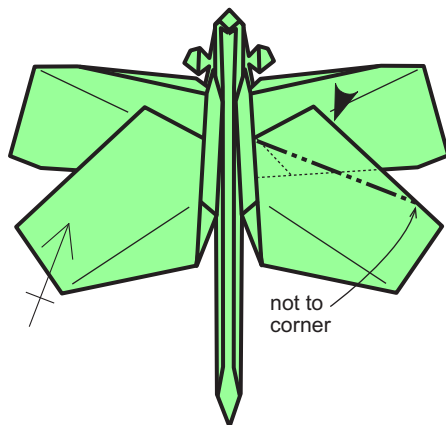

53. Reverse-fold. Rear half is "maximum extent".

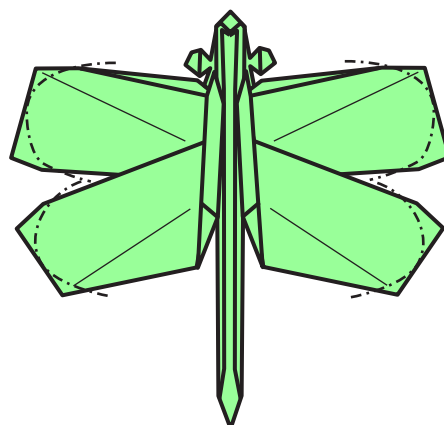

54. Shape wings with mountain folds.

# \$ Dragonfly, v2 (continued)

Copyright 1998-2000 Stephen Hecht. All Rights Reserved

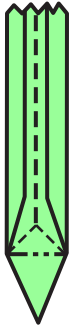

55. Detail of tail. Pinch tip of tail and flatten.

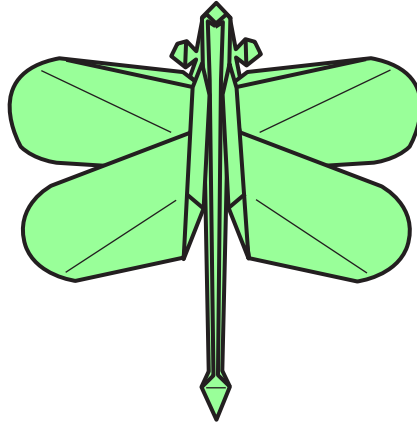

56. Completed dragonfly.  
(Re-shape the eyes if they've become mangled.)

# Dragon in the Water

By Perry Bailey 1997

Inspired by the work of  
Yoshihisa Kimura,  
who reminded me that  
there is more than 1 way  
to cut a square in half.

1. Cut a Square in half Diagonally.  
Then fold it in half and unfold as shown.

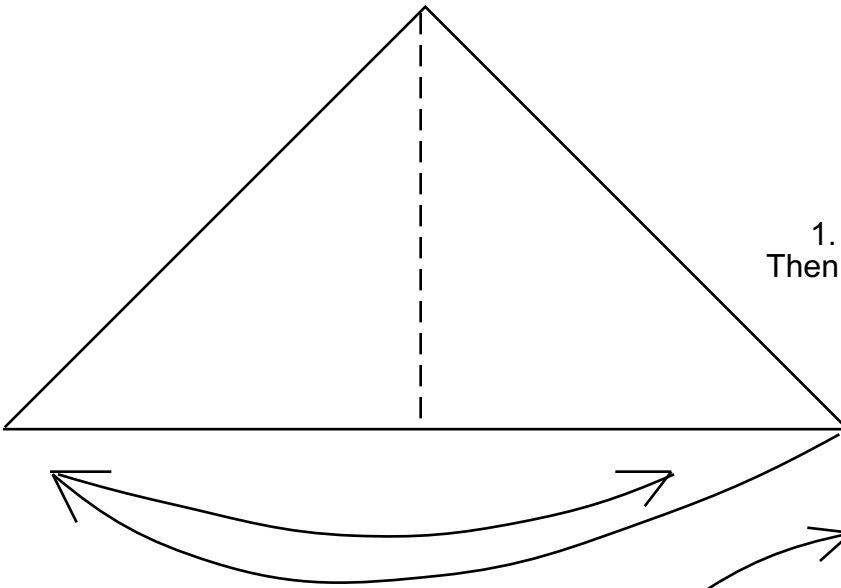

2. Valley fold up the flaps  
on each side of the model.

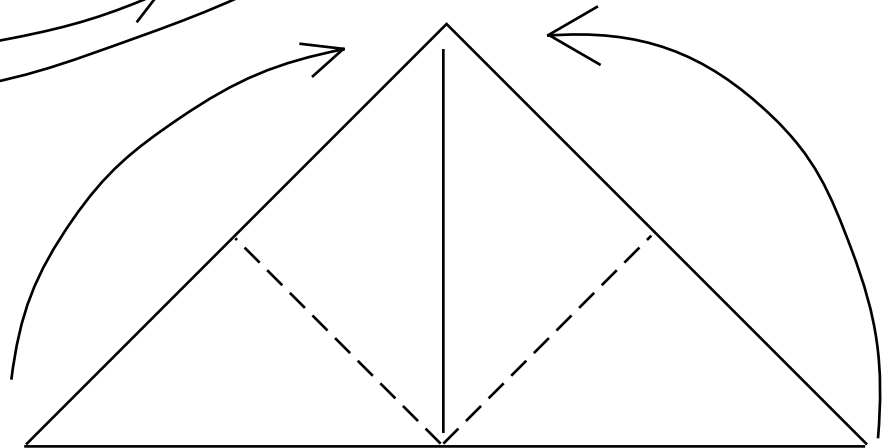

3. Turn the model over  
from left to right.

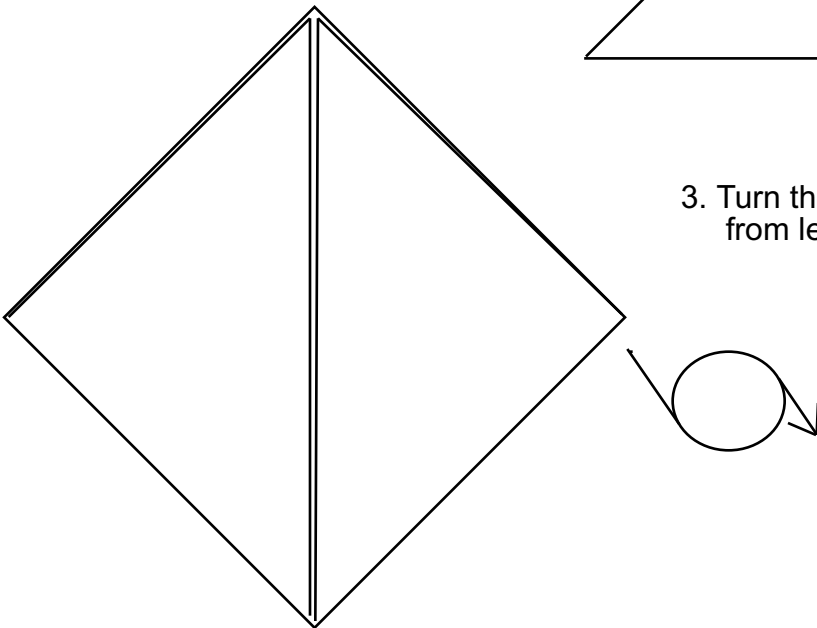

4. Fold both side in to the center,  
folding only the top layer on each side.

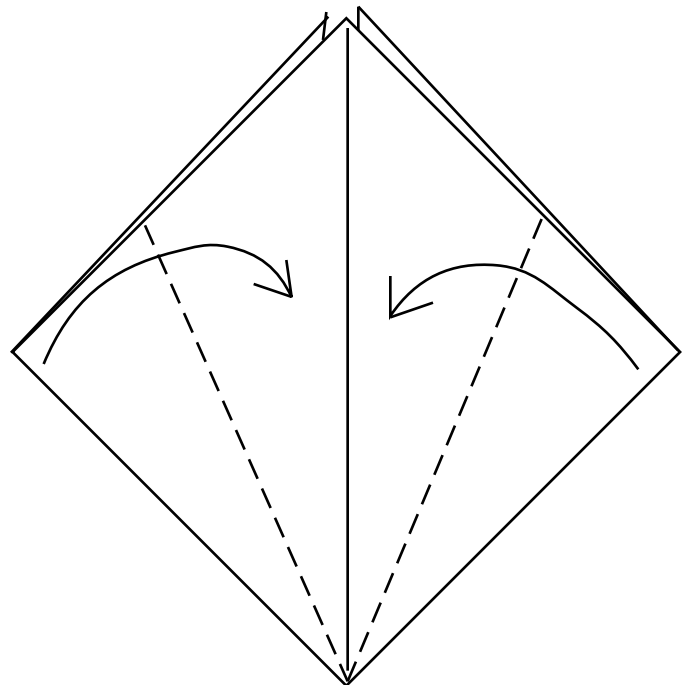

5. Fold up the side edges to the center

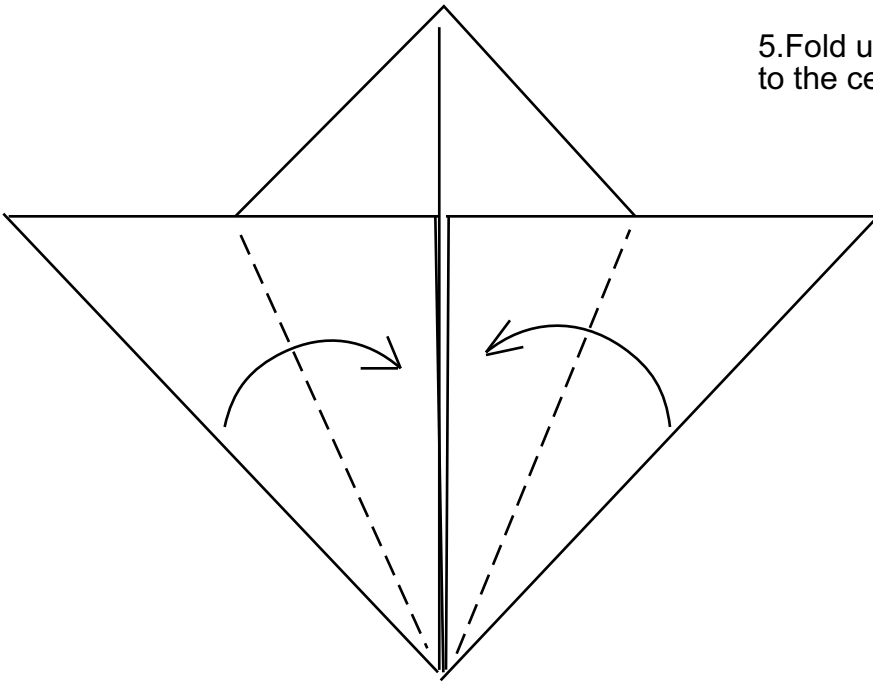

6. fold edges in on both sides then valley fold up the entire bottom of the model and unfold.

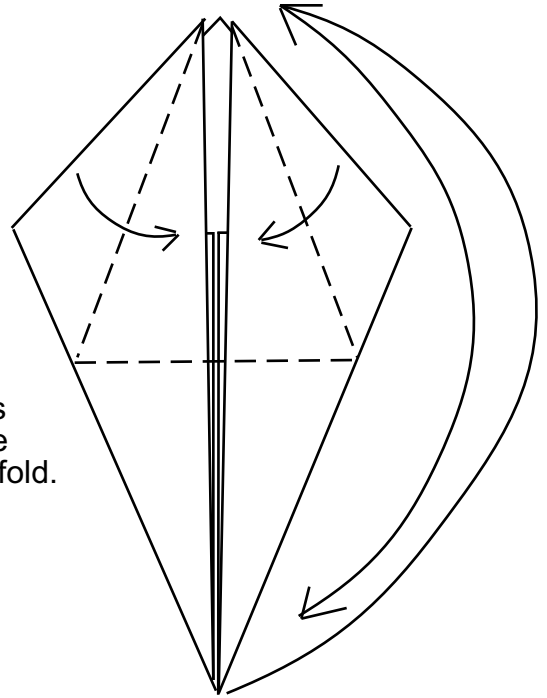

7. This is just making a simple rabbits ear fold downwards.

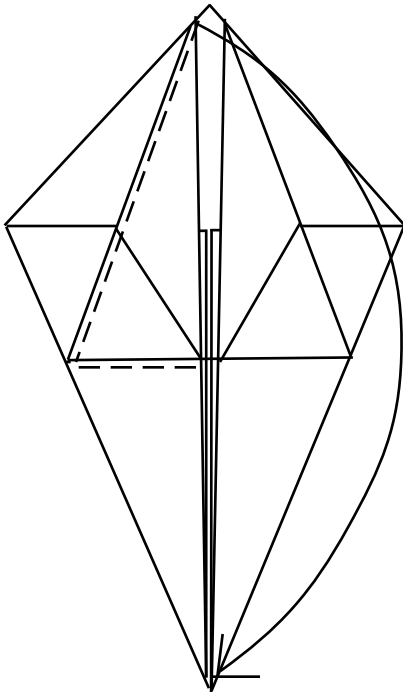

8. Repeat on other side.

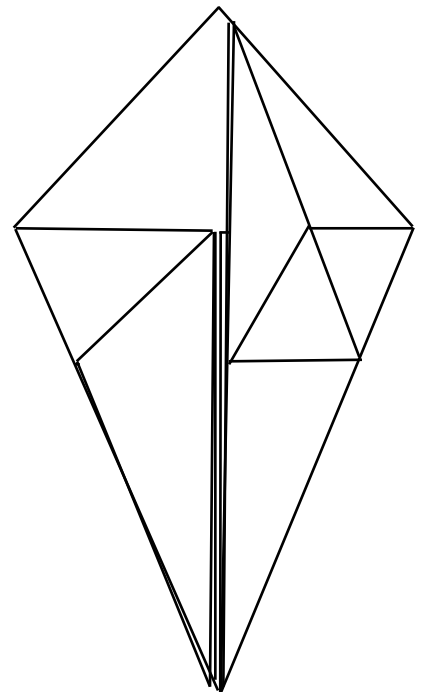

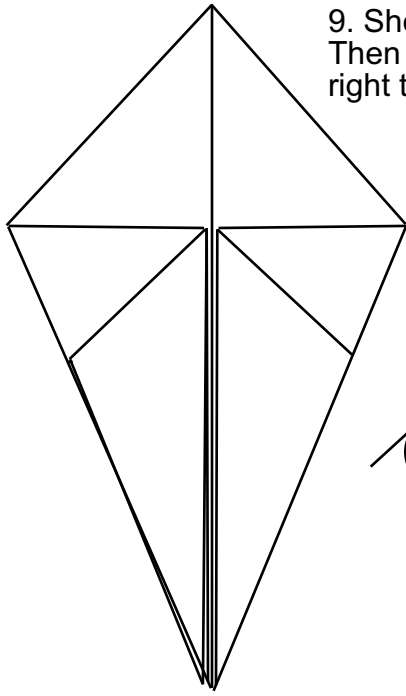

9. Should look like this. Then turn over model, right to left.

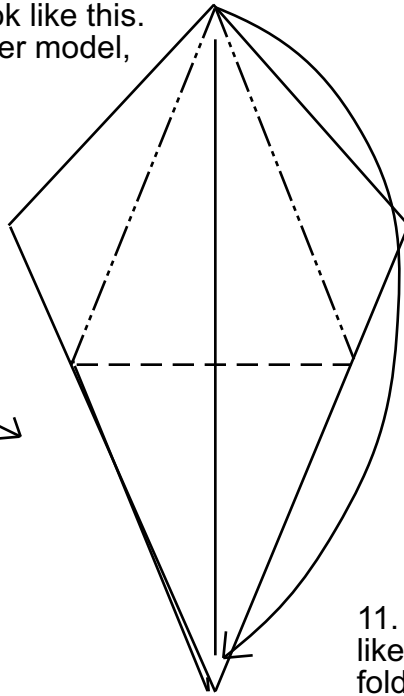

10. fold the top half down as in the bird base.

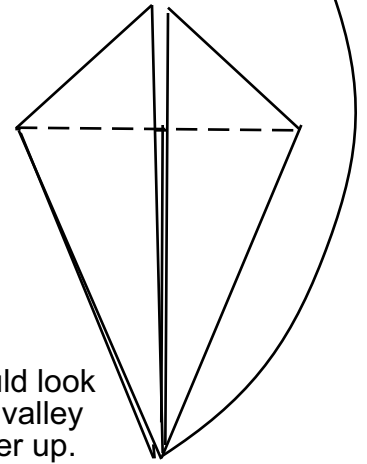

11. Model should look like this. Then valley fold the top layer up.

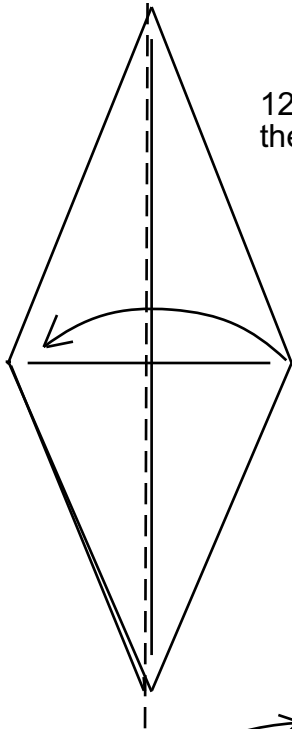

12. Fold entire model in half, then rotate to right.

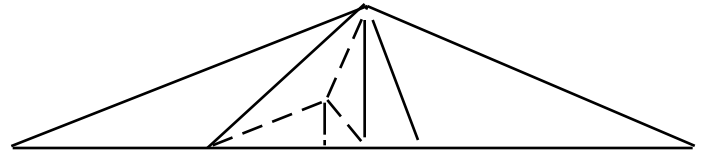
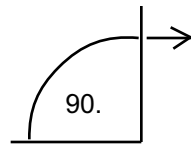

13. make a rabbit ear fold from the small flap on each side.

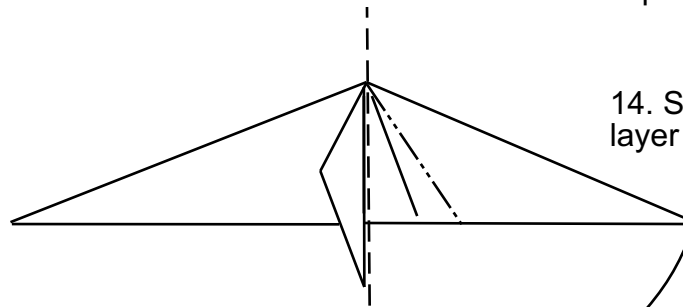

14. Squash fold the outside layer on each side.

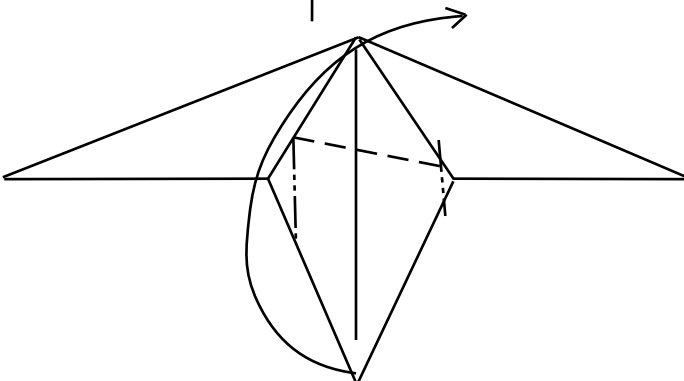

15. Fold the wings up as shown on both sides.

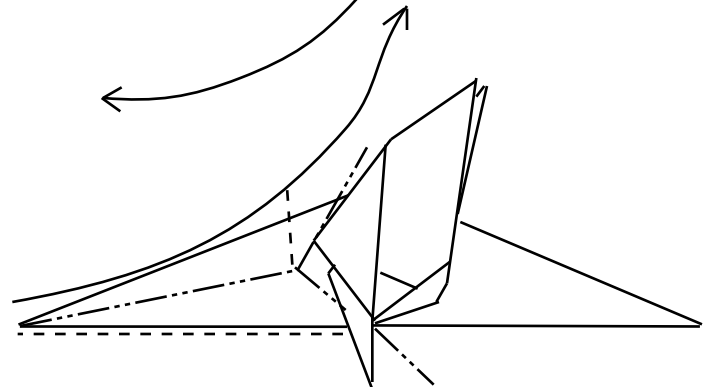

16. To form the neck you actually sort of squash the flap down on both sides then fold it up. This takes care of any thinning needed for the neck.

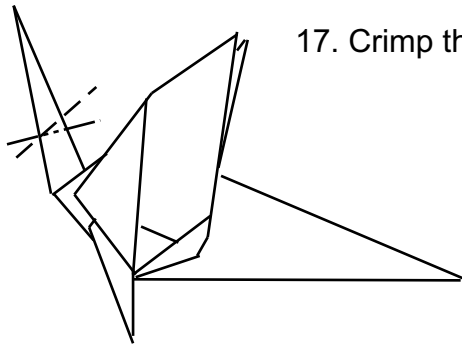

17. Crimp the Neck back.

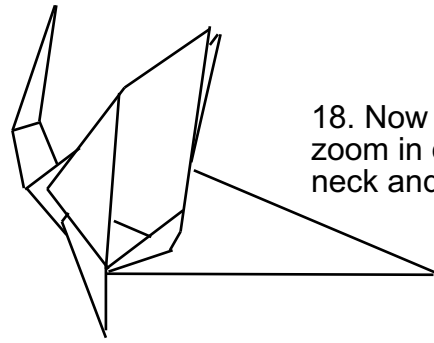

18. Now we will zoom in on the neck and Head.



19. First crimp down to form the head.

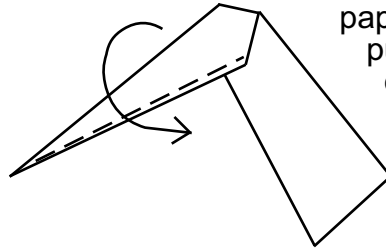

20. Now there is a double layer at the top of the head reach in and bring out the doubled layer on each side of the head, one side at a time. Be careful not to tear the paper at the back of the head, as you pull out the layers and bring them down. The head will not lie flat.

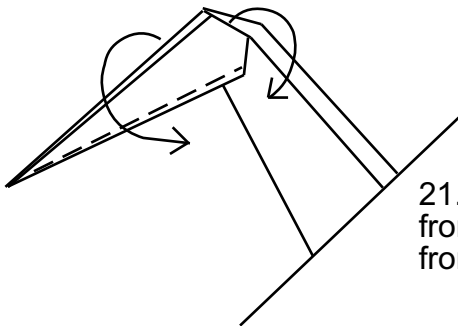

21. Part of the head comes from layers brought out from behind the neck.

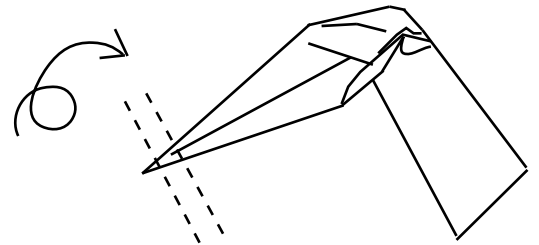

22. The effect should be something like this, then valley fold the tip of the nose over twice to finish the head.

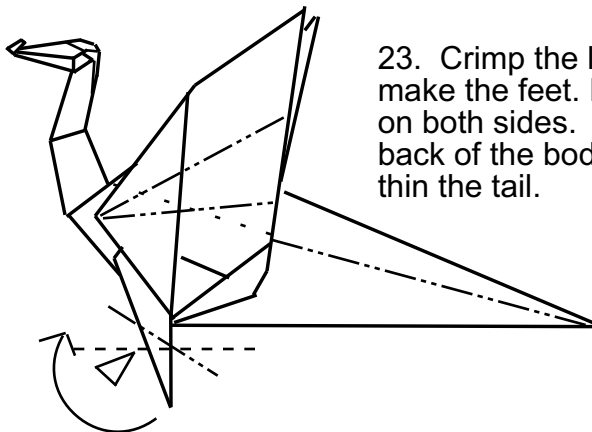

23. Crimp the legs in to make the feet. Pleat fold the wings on both sides. Fold the entire back of the body inwards to thin the tail.

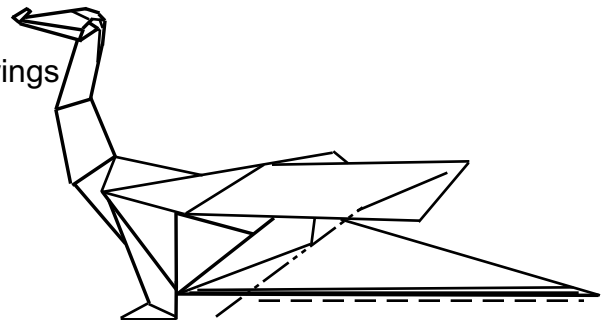

24. Reverse fold the tail up.

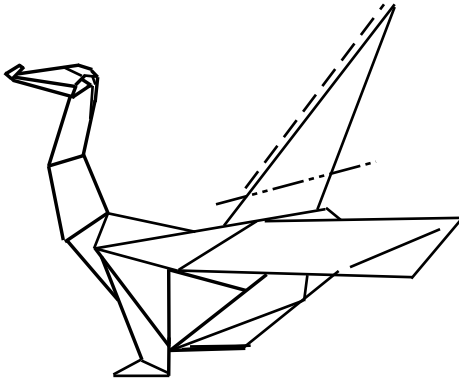

25. Reverse fold the tail down.

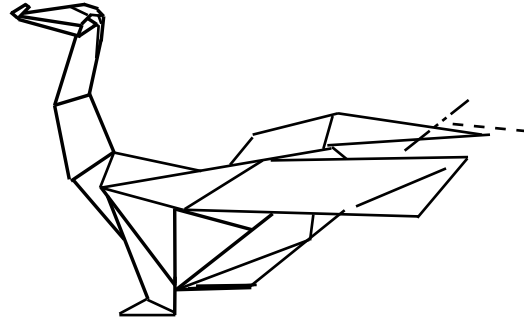

26. reverse fold the tip of the tail up.

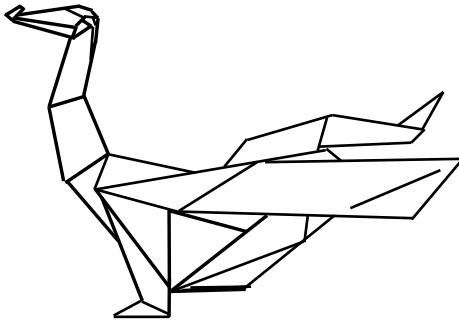

27. Now spread the wings outwards with a curl at the outer tips and it is finished.

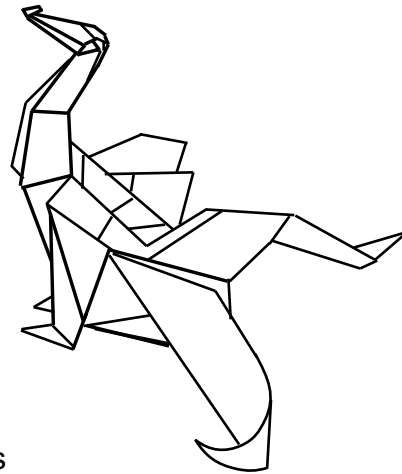

28. The theory being that the dragon is either taking off or landing in the water. Please believe me it looks better than my drawing. Thankyou



# \$Fan Tailed Dragon

By Perry Bailey Copyright December 1999

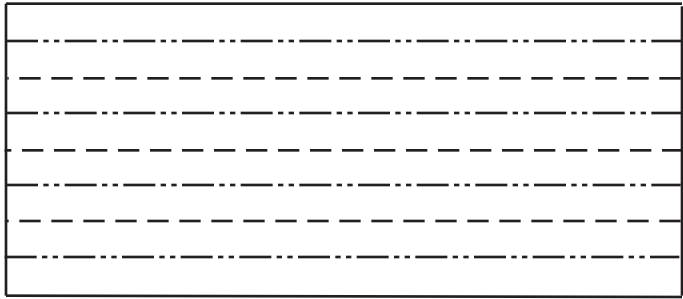

1. Fold the bill into eighths lengthways face down.

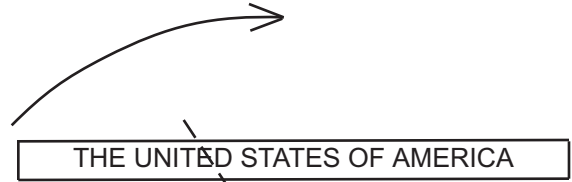

2. Reverse fold all layers.

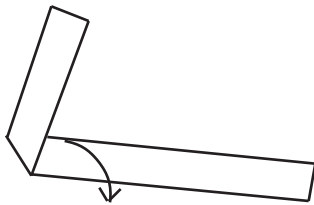

3. Pull out three layers on each side of the model.

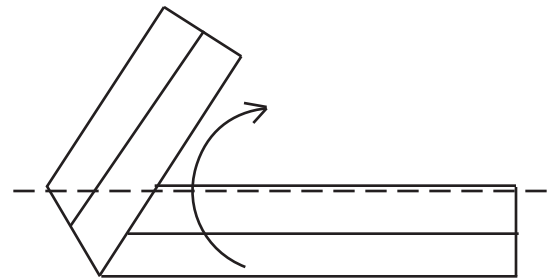

4. Open up the bottom of the model.

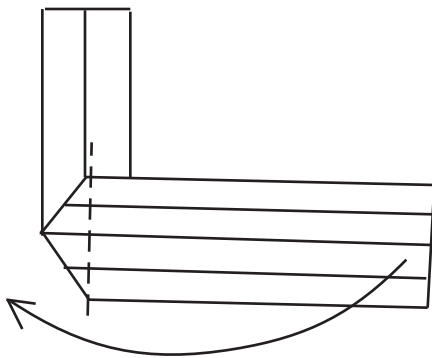

5. Valley fold the bottom of the model over.

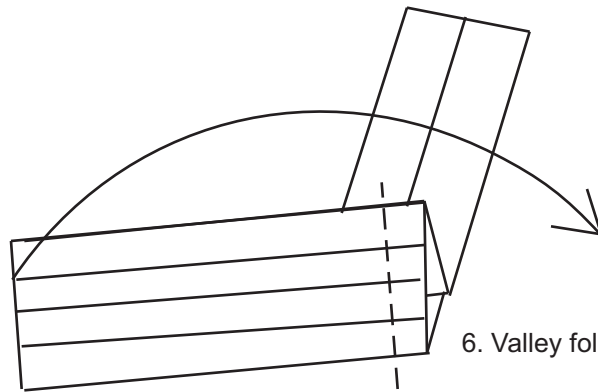

6. Valley fold over.

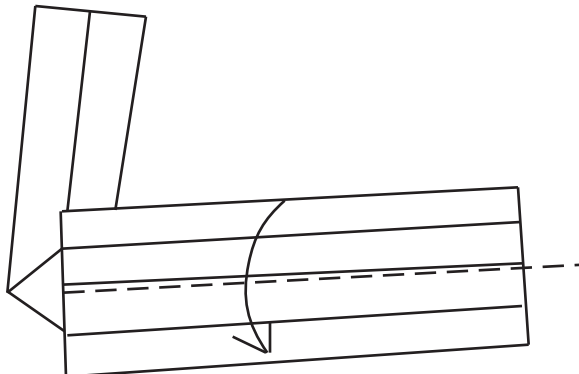

7. Fold the bottom of the model back down.

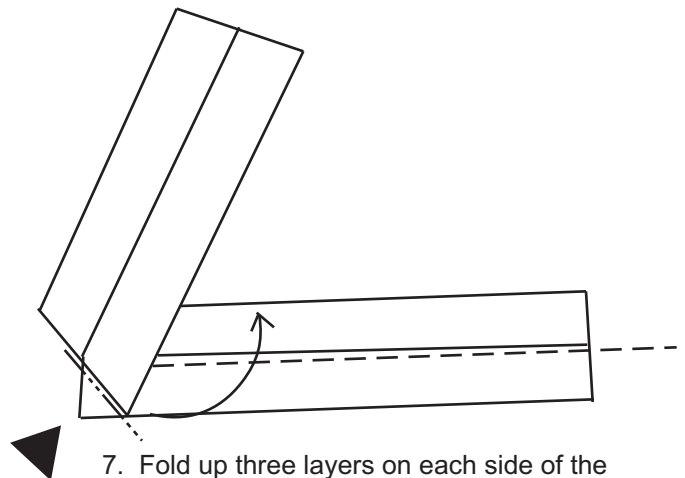

7. Fold up three layers on each side of the Model, while pushing in and folding up the bottom corner.

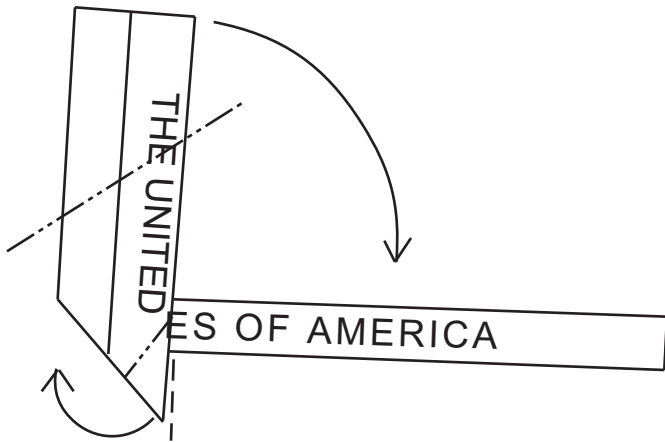

8. Reverse fold the entire top down till it touches the main body. Then use another reverse fold to make the feet (repeat on other foot).

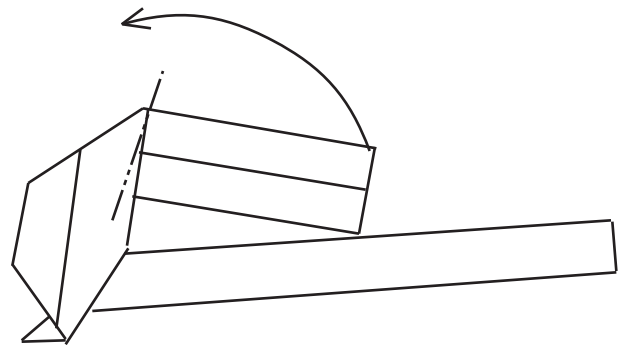

9. Reverse fold the flap back to the front.

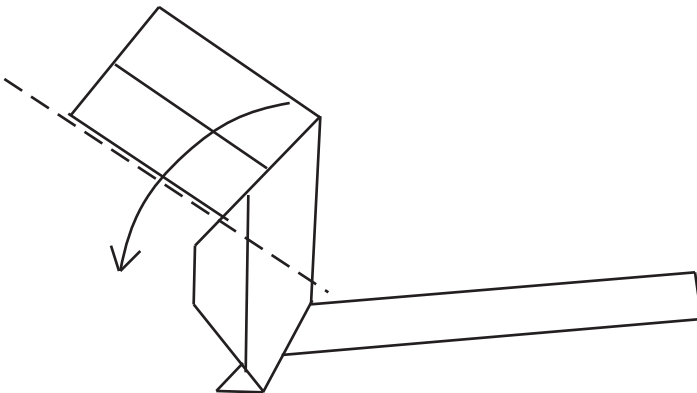

10. fold down the top flap of the model.

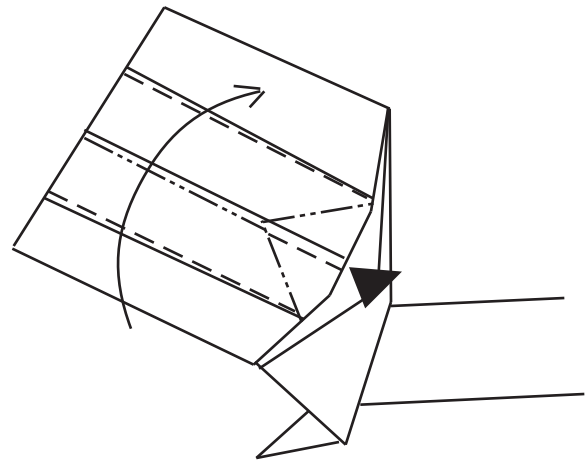

11. Bring up the middle layer by collapsing the center of the model upwards while refolding the top back together, you will have to sink the back of the top flap into it's self into the model.

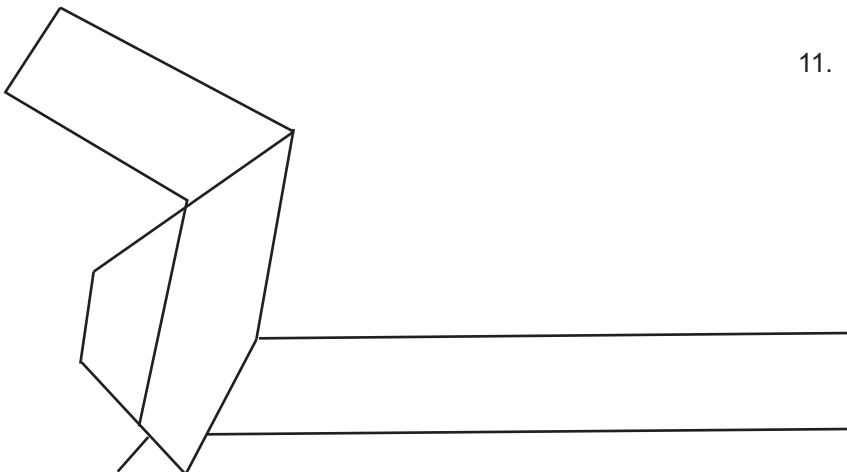

12. The results should be like this in shape.

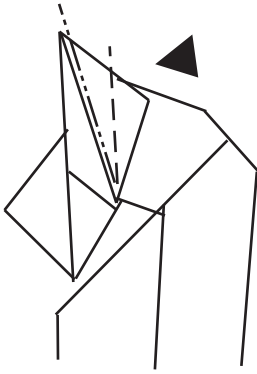

18. Fold over the flaps to form the horns.

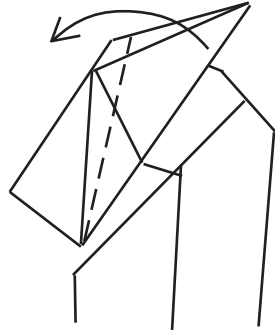

19. Rabbit ear the flap into it's self to finish the horns Curl to taste.

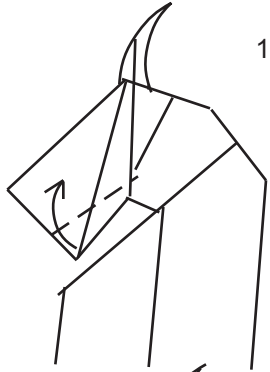

20. Fold up the tips to make the fangs.

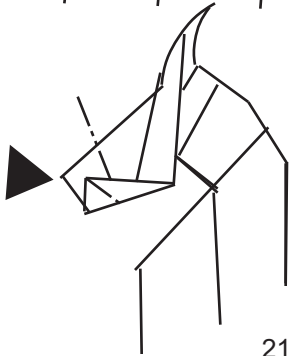

21. Sink the excess paper to finish the head.

### HEAD FORMATION

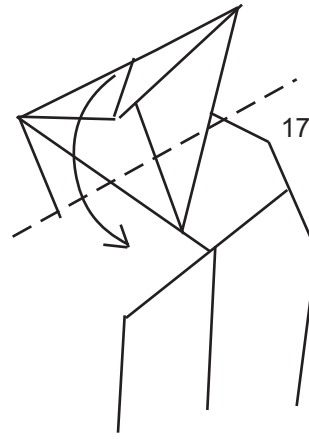

17 Fold down bothsides evenly this will involve a partial reverse fold.

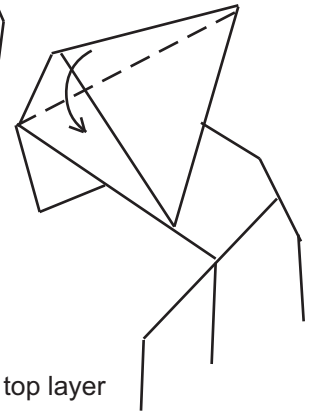

16 Fold down top layer each side.

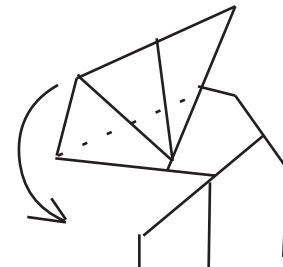

15 Pull down inner layer.

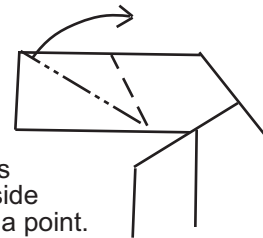

14 Fold up 2 layers so that the outside layer comes to a point.

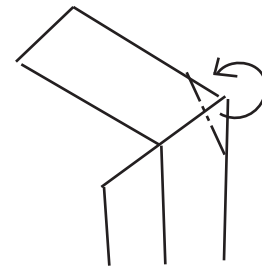

13 Fold in a little at the back of the neck.

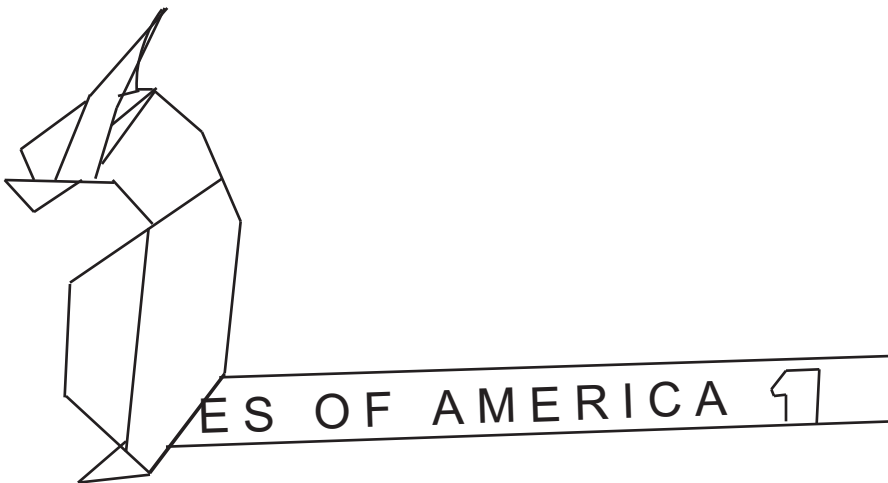

22. Now we can start on the end of the beast!

Minus Head

23. Open up the body.

4 of 5

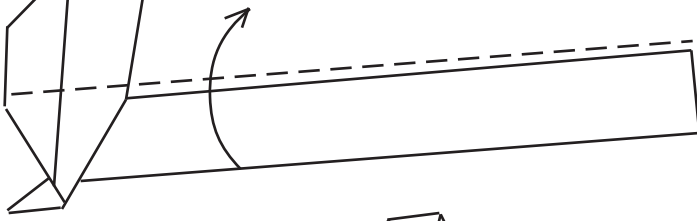

Head and neck not shown.

24. Fold the body up to the point of the neck

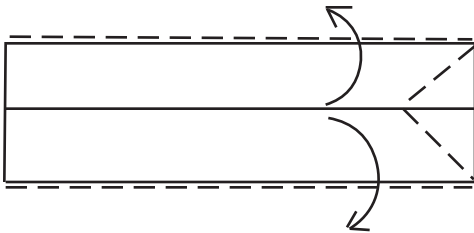
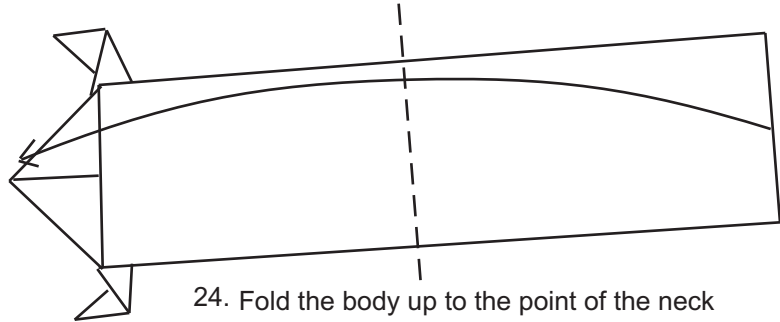

25. Partially unfold the bottom and wrap one layer of paper over on each side.

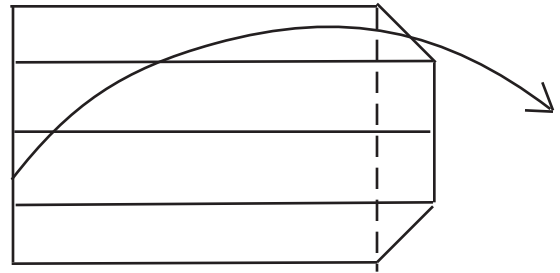

26. Fold the bottom back over.

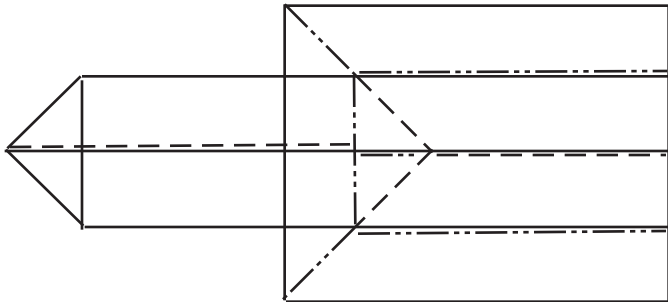

27. Colapse into shape.

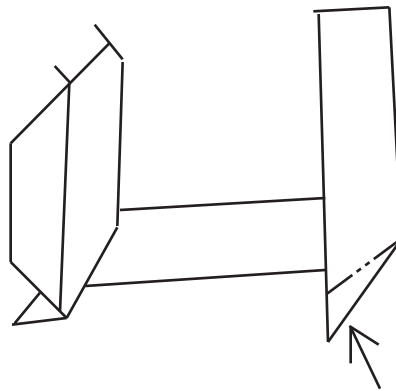

28. Reverse fold up to form the back feet.

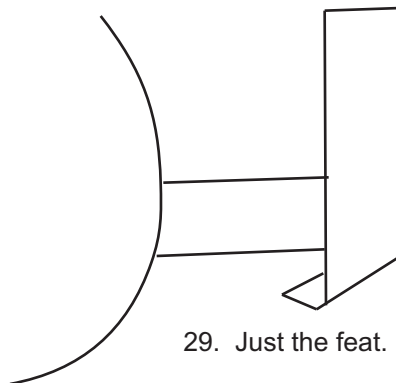

29. Just the feet.

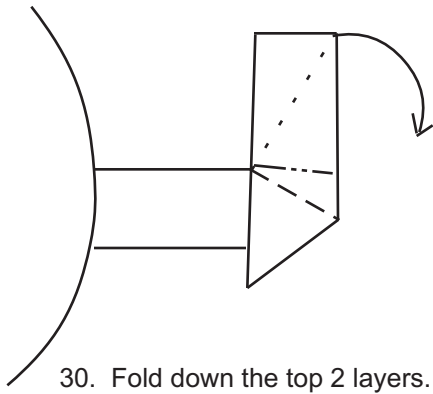

30. Fold down the top 2 layers.

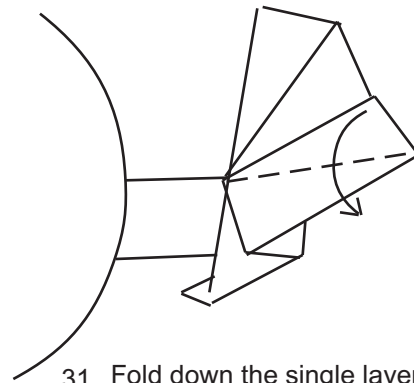

31. Fold down the single layer to finish the tail, then repeat the sequence on the other side.

### Alternate head sequence

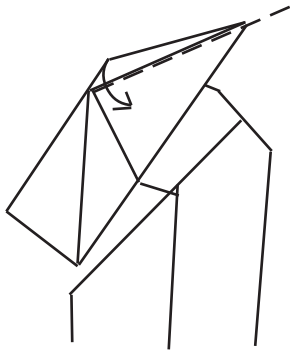

18. Fold down top section on both sides.

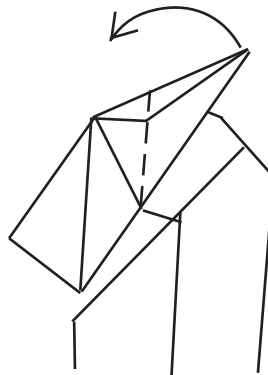

19. fold over to form the horns.

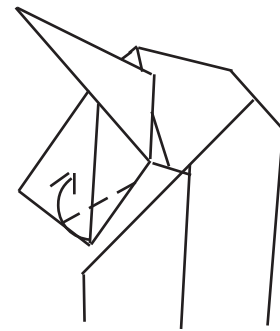

20. Fold up to form jaw then go to step 21.

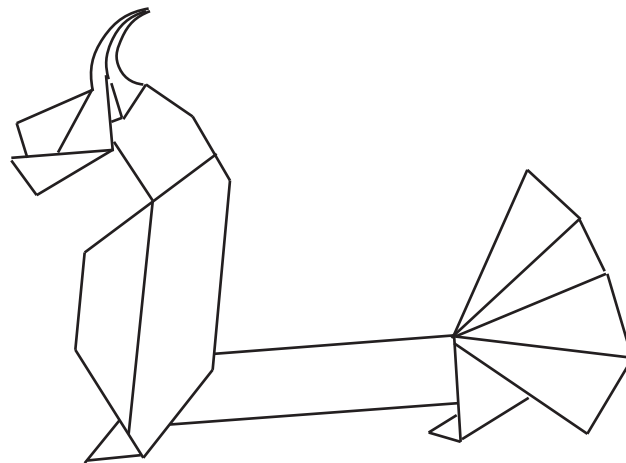

32. Finished! now you can fan the tail out a bit and even puff out the chest a little if you like and put a final curve to the horns!

# Flapping Dragon

Eileen Tan  
eileen@tristan.tn.cornell.edu  
January 31 2001

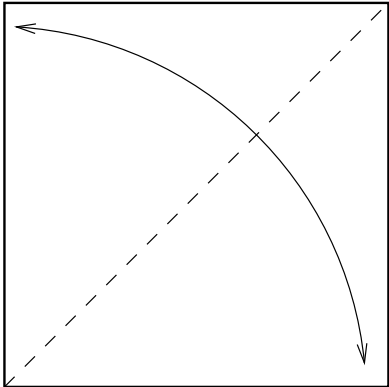

1. Crease diagonally.

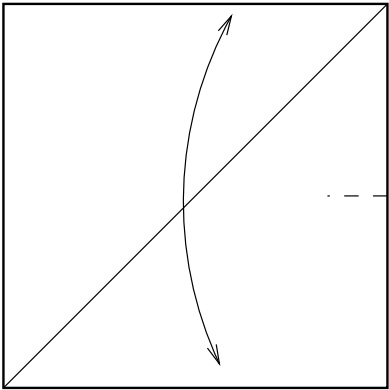

2. Make a pinch mark halfway down.

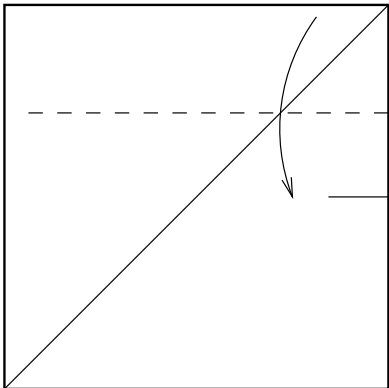

3. Fold the top edge down to the pinch mark.

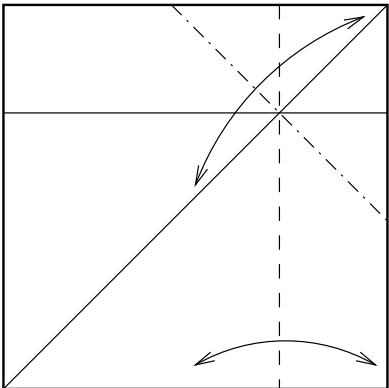

4. Fold and unfold.

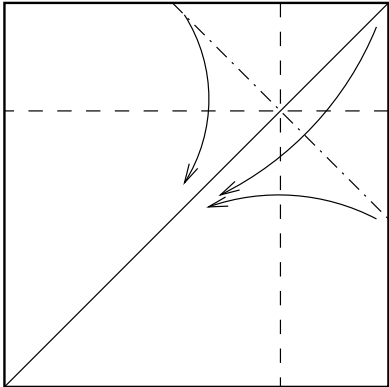

5. Fold a preliminary base on the existing creases.

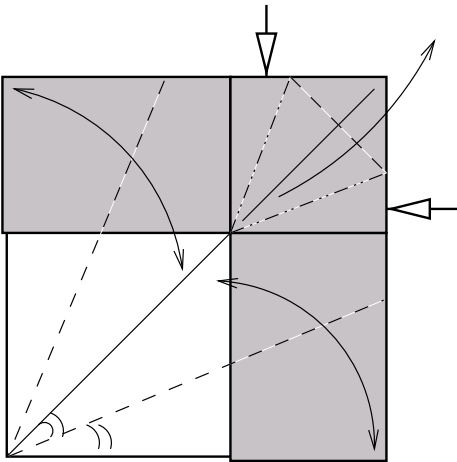

6. Petal fold the preliminary base. Crease the sides.

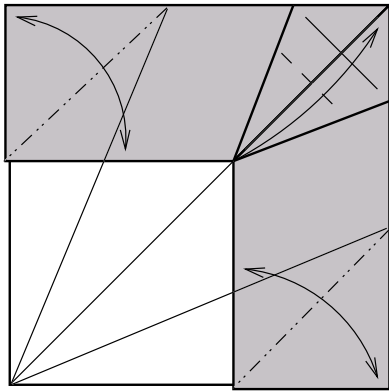

7. Valley fold the tip up.  
Fold and unfold the two corners.

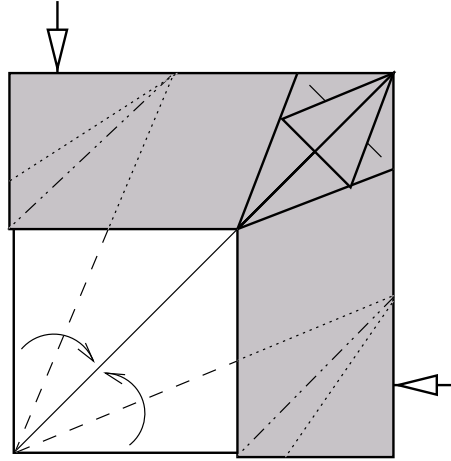

8. Reverse fold the sides in.

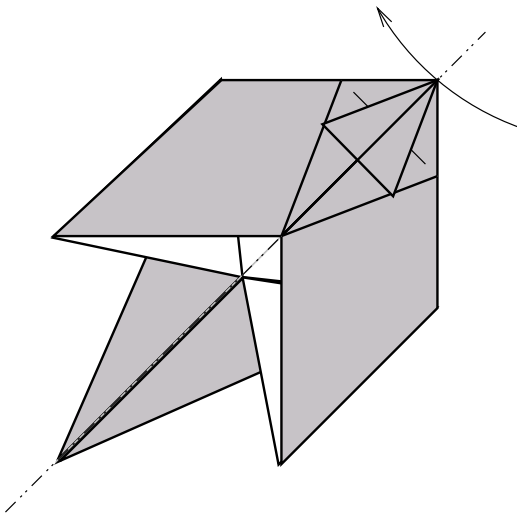

9. Mountain fold the entire model in half.

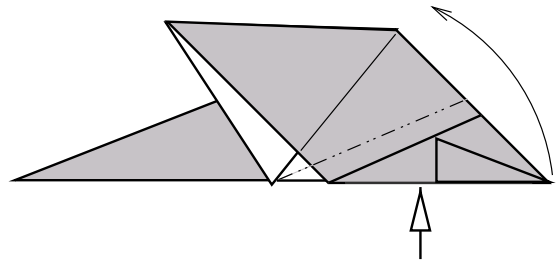
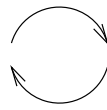

10. Reverse fold.

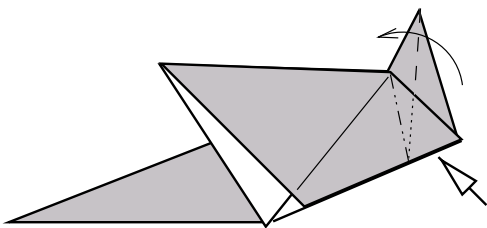

11. Reverse fold; repeat behind.

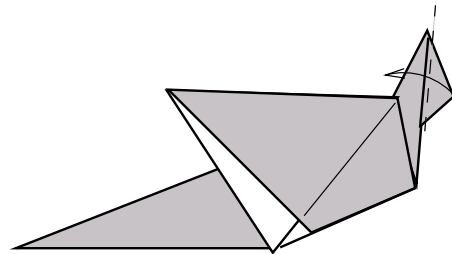

12. Valley fold the topmost flap;  
repeat behind.

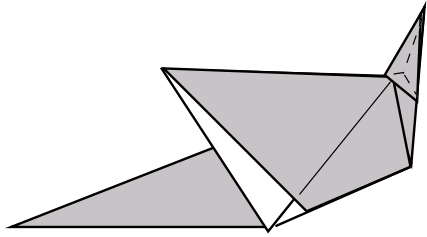

13. Rabbit ear fold the topmost flap; repeat behind.

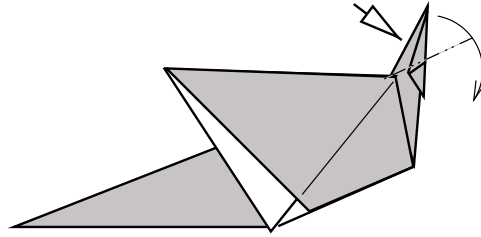

14. Reverse fold the head down. The paper is thick here, so do this fold slowly.

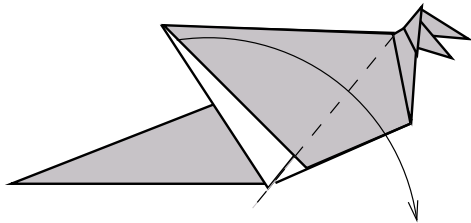

15. Valley fold the wing down; repeat behind.

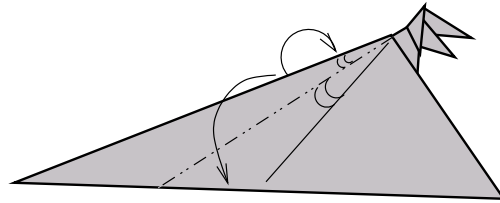

16. Outside reverse fold.

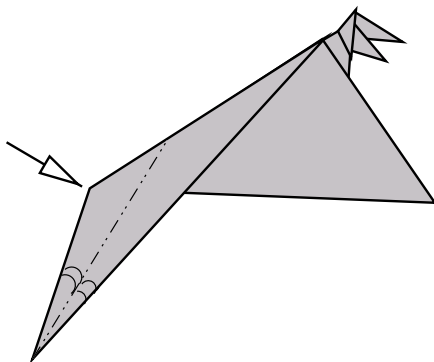

17. Open sink.

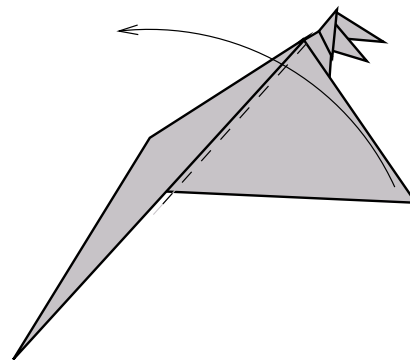

18. Valley fold the wings back up; repeat behind.



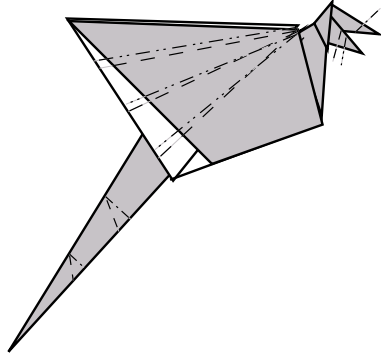

19. Crimp the wings and the tail; repeat behind. Reverse fold the tip of the head. Reverse fold twice to form the mouth.

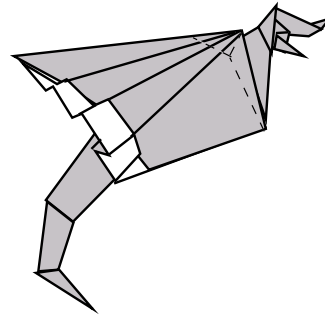

20. Rabbit ear fold the wing to form a claw; repeat behind.

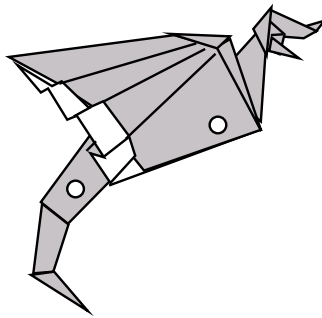

21. Finished Flapping Dragon  
Hold at the two circles, and pull apart to make the wings flap!

# Eastern Dragon © 1998 by Joseph Wu (Designed ca. 1992. Diagrammed 98-8-26 to 98-10-09.)

The Nippon Origami Association's (NOA) magazine, *Origami*, No. 149 (January, 1988), included diagrams for a dragon by KITAMURA Keiji. The head was subtle and beautiful, but the body was awkward and clumsy. The model also required two 2x1 rectangles. I took the head design and grafted it onto a longer rectangle to create this eastern dragon.

Start with a 5x1 rectangle, coloured side up. (You can use any integer ratio of 4x1 or longer. My longest dragon started with a 12x1 rectangle.)

1. Precrease into squares (all valley folds).

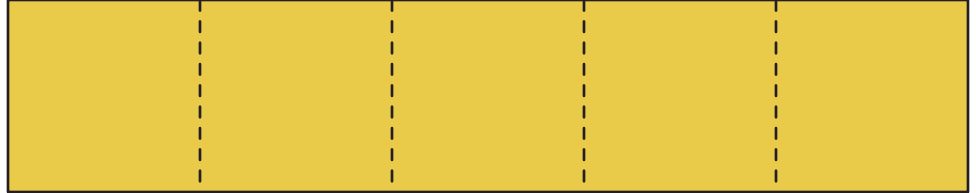

2. Precrease into half squares (all valley folds).

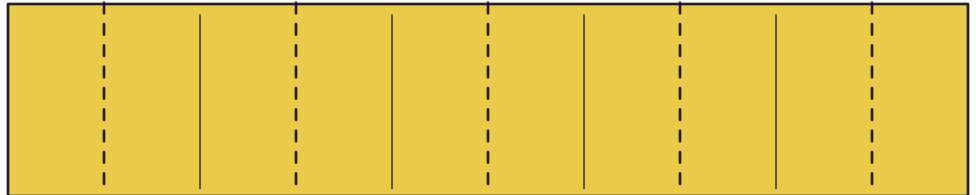

3. Precrease into quarter squares (all valley folds).

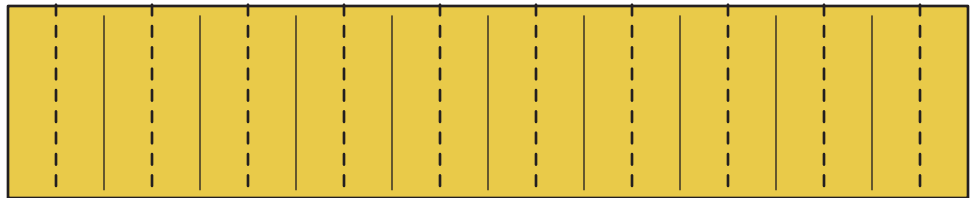

4. Precrease into eighth squares (all valley folds).

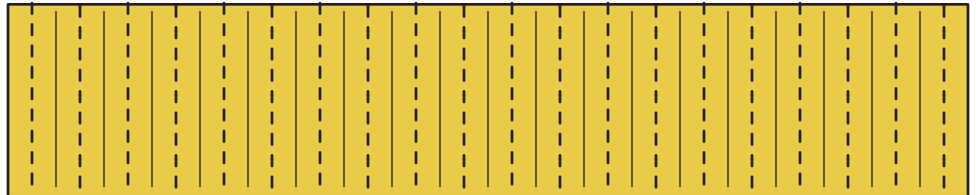

5. Precrease in half.

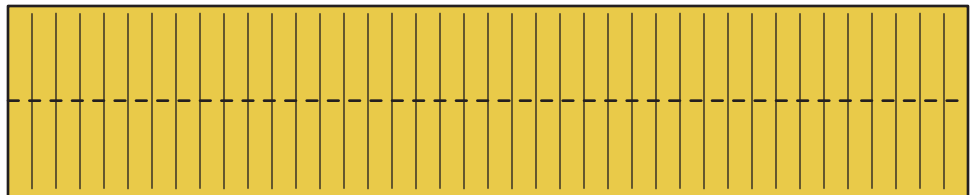

6. Precrease into quarters (all valley folds).

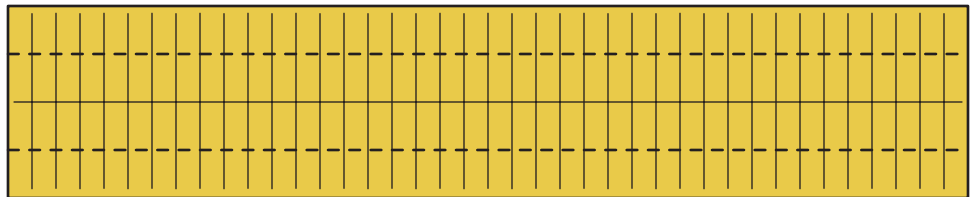

7. Precrease outer quarters into eighths (all valley folds).

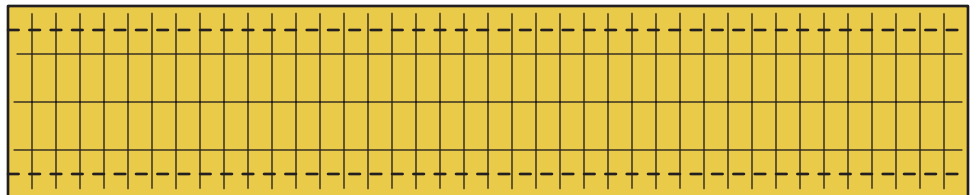

8. Precrease outer eighths into sixteenths (this time, *mountain folds*).

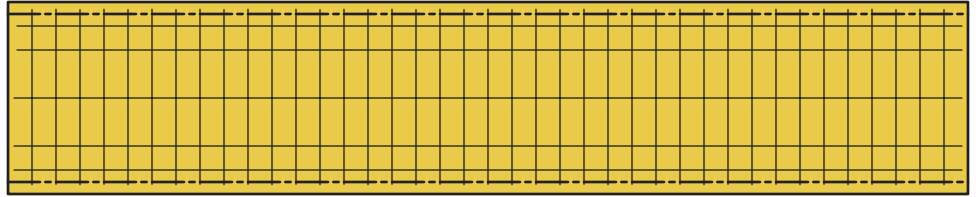

9. Precrease first eighth into sixteenths (again, a *mountain fold*).

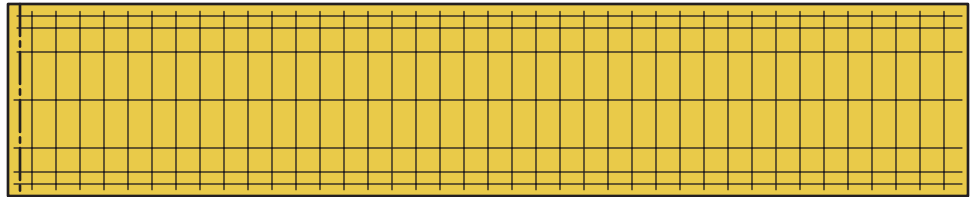

10. Precrease diagonals of the first square (again, *mountain folds*).

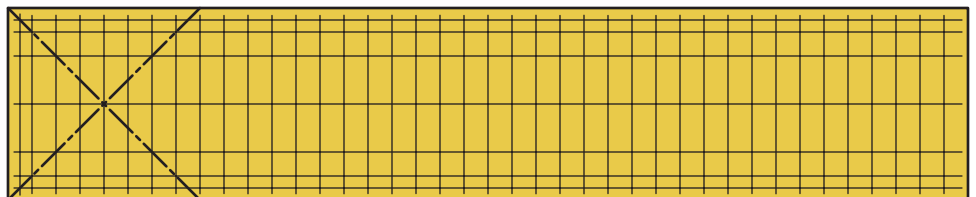

11. Collapse the outer edges using existing creases, forming the dragon's "horns" at the corners.

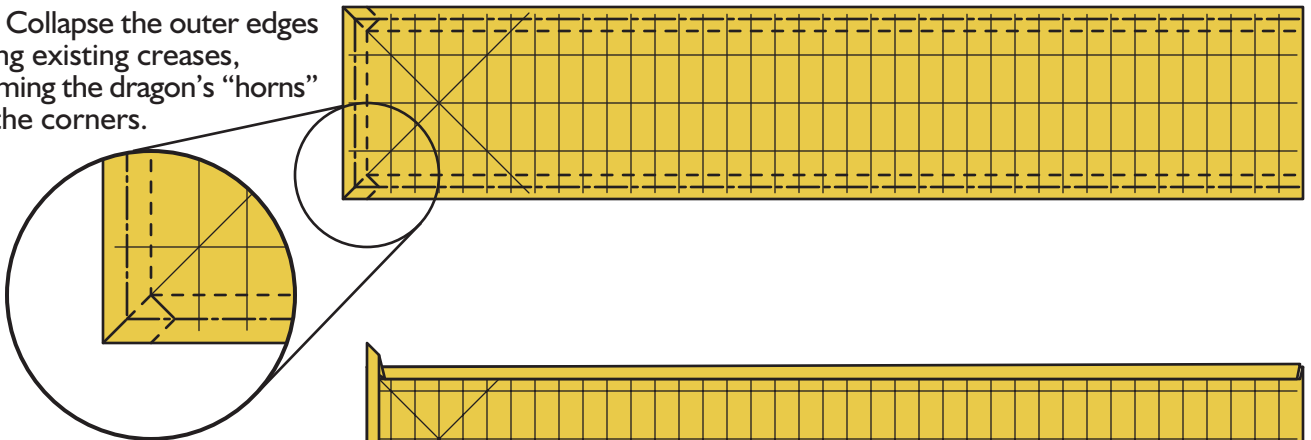

12. Turn the model over.

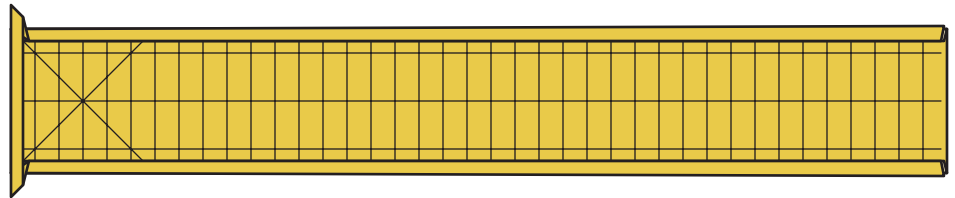

13. Precrease.

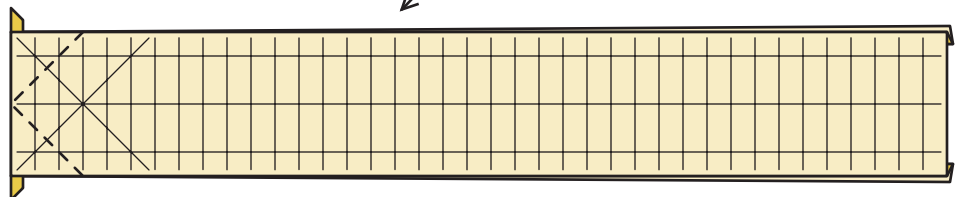

14. Precrease.

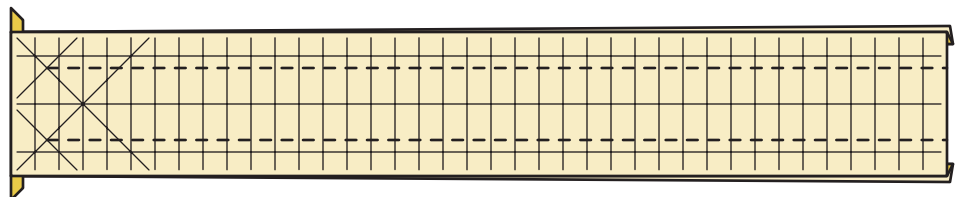

15. Collapse into rabbit ears.  
 Do *not* crease the horns!

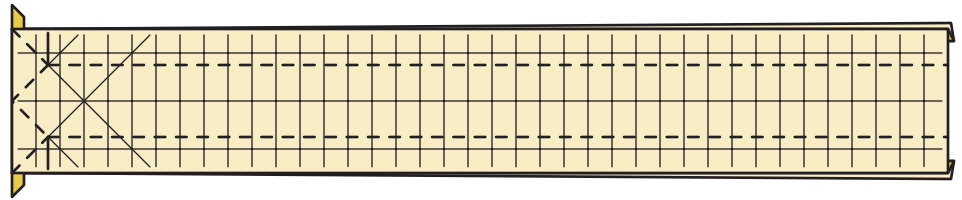

16. Precrease. Pay close attention to which segments are the landmarks.

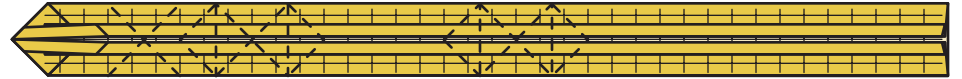

17. (Enlarged view.)  
 Precrease. Pay close attention to which segments are the landmarks.

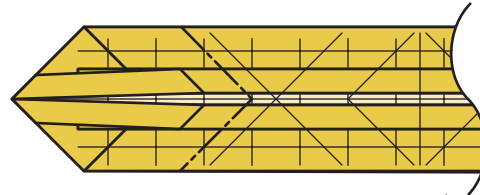

18. Fold up the tip of the nose.

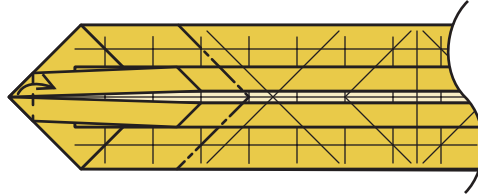

19. Form a waterbomb base using existing creases.

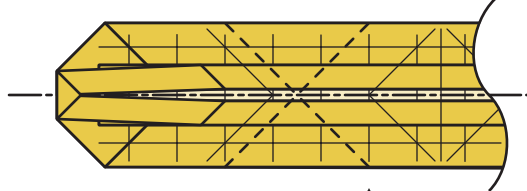

20. Inside reverse fold on existing crease.

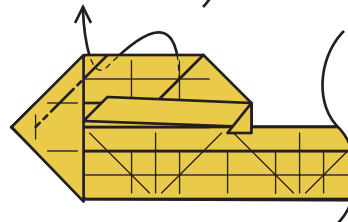

21. Outside reverse fold.

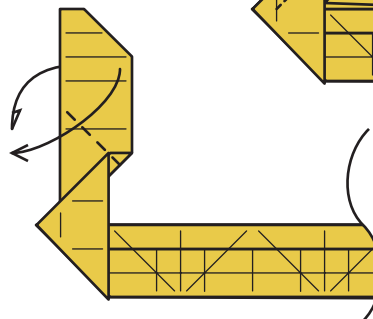

22. Fold up the sides of the head to form the eyes. Tuck under the horn.

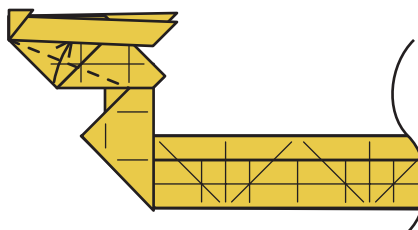

22. Head complete.

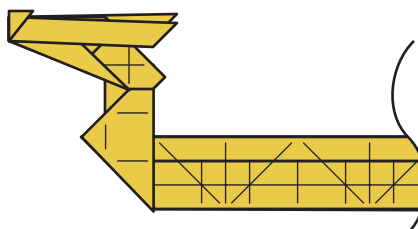

The colour change can be performed at this point by flipping this raw edge under itself.

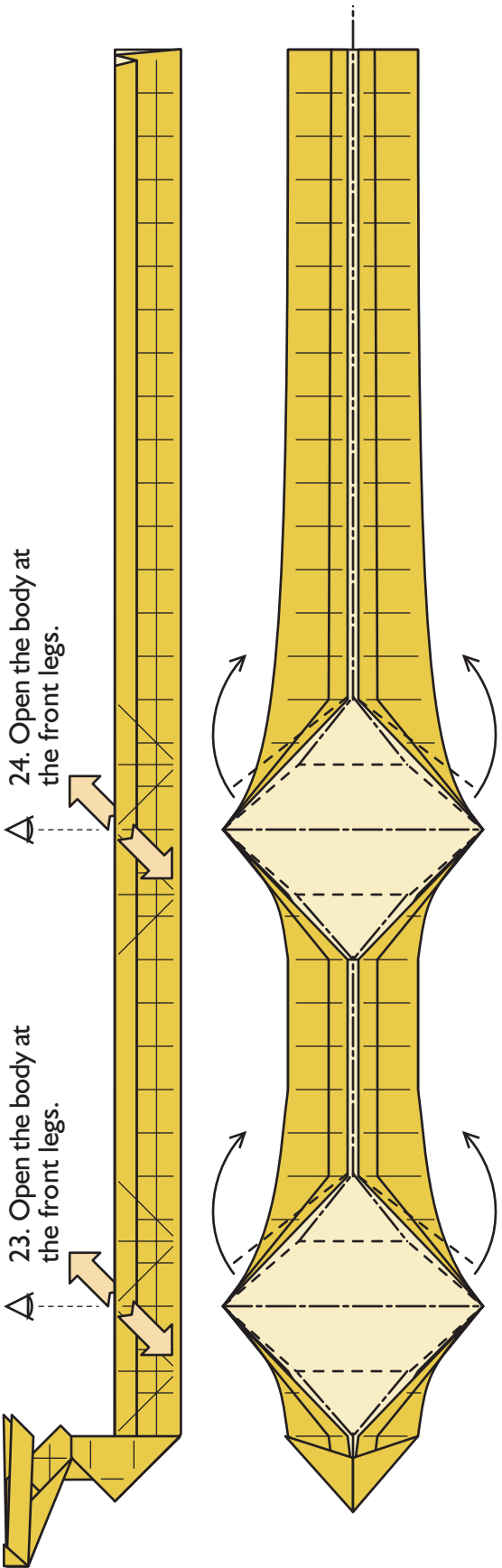

23. Open the body at the front legs.

24. Open the body at the front legs.

23a. View from the top (head not shown). Collapse on creases shown, and fold the two points toward the tail.

24a. View from the top (head not shown). Collapse on creases shown, and fold the two points toward the tail.

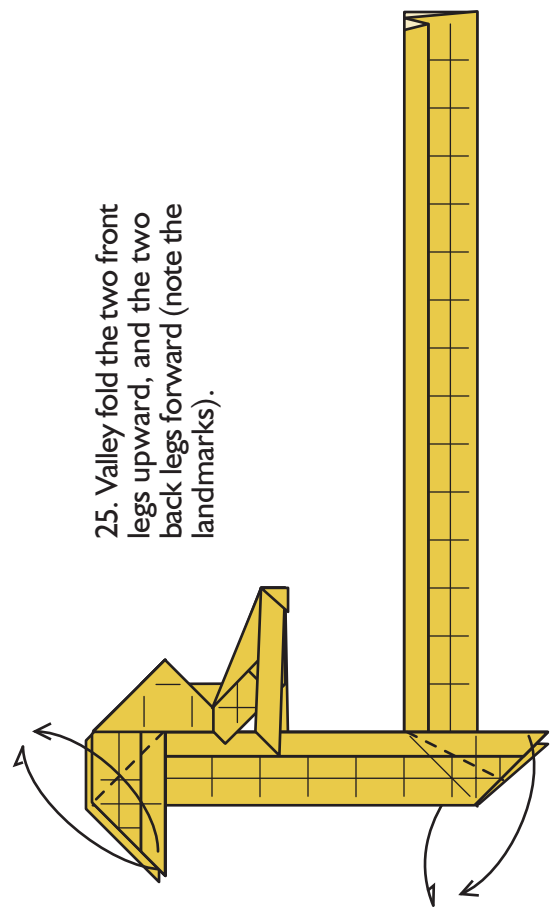

25. Valley fold the two front legs upward, and the two back legs forward (note the landmarks).

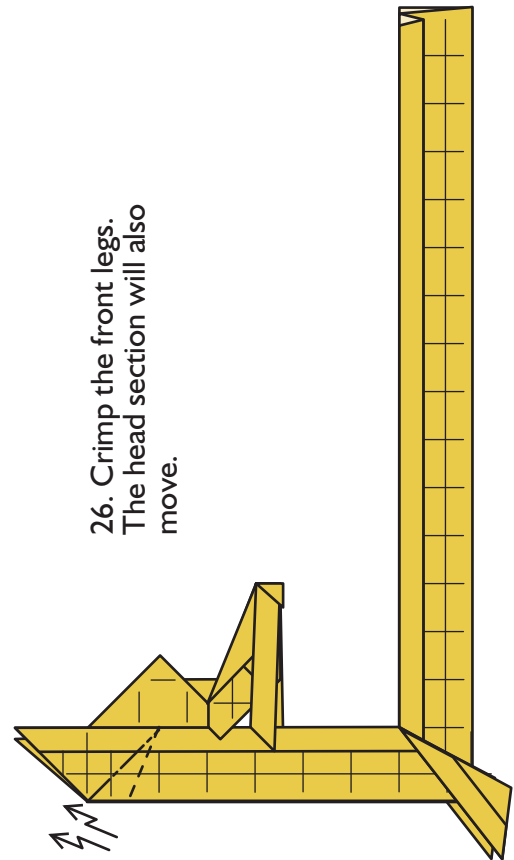

26. Crimp the front legs. The head section will also move.

28. Fold the bottom edges of the tail into the middle using the existing crease (both sides of the tail).

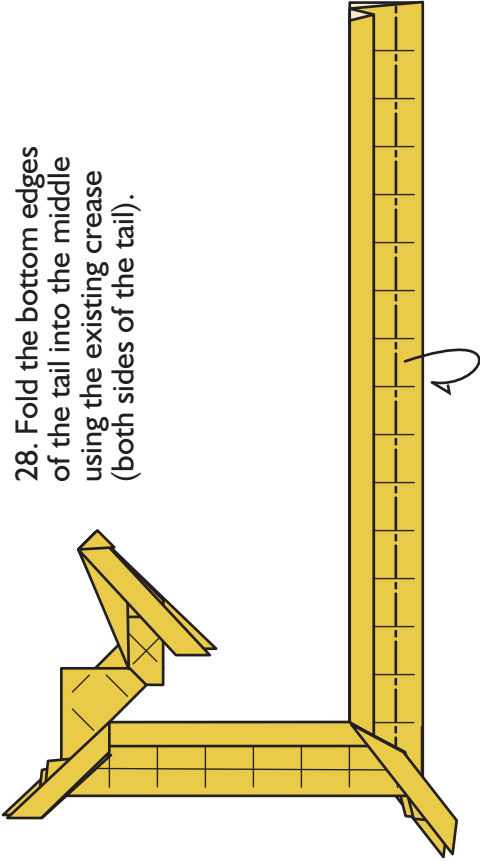

27. Inside reverse fold the back corners of the four legs. A corner will stick out.

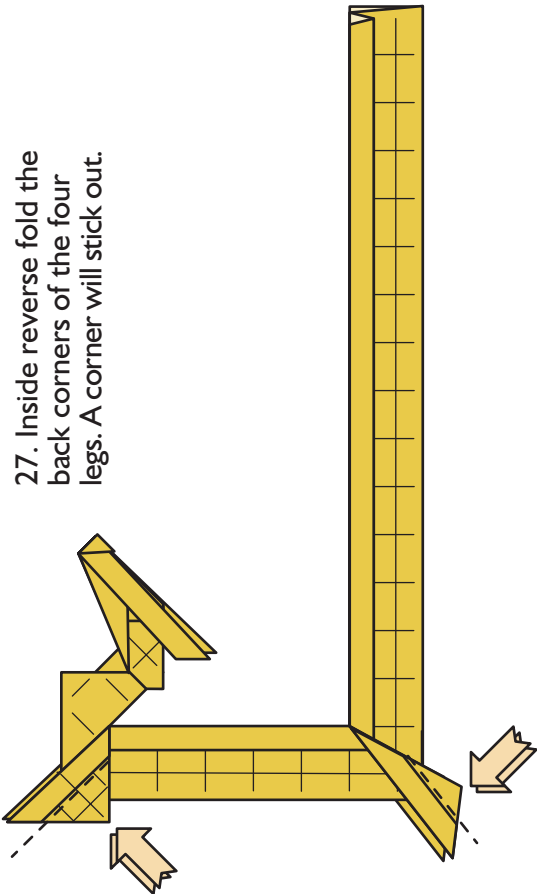

29. Crimp the body and the tail as shown. The marked crimps are outside crimps, and the rest are inside crimps. (Outside crimps must be opened up to be formed, much like outside reverse folds.)

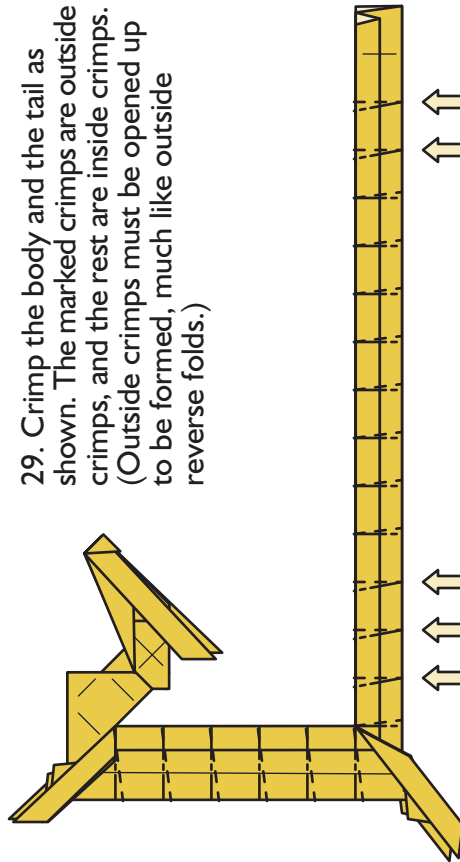

30. Fold the feet forward.

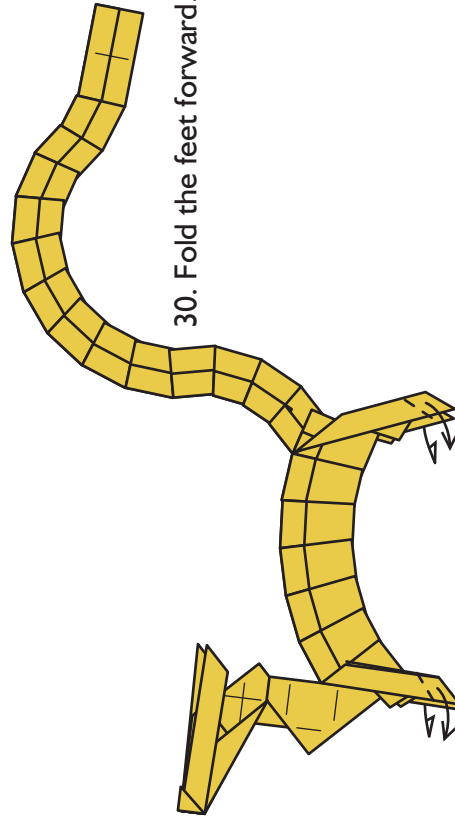

31. Pull out some paper from the tail.

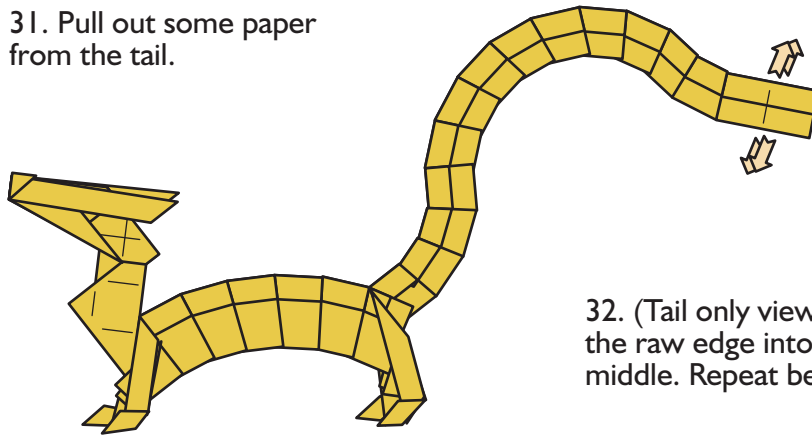

32. (Tail only view.) Fold the raw edge into the middle. Repeat behind.

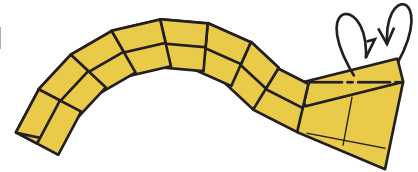

33. Inside reverse fold the front layer only.

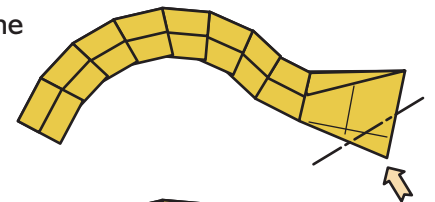

34. Fold the back layer up and tuck it into the pocket formed in the previous step.

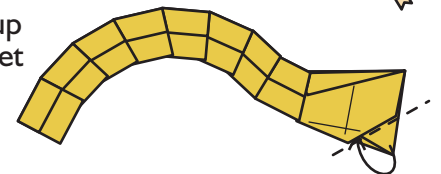

35. Fold the front two layers into the middle.

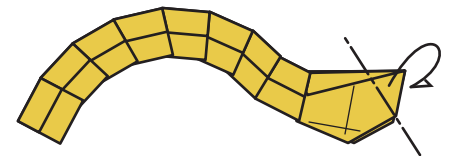

36. Fold the back layer into the middle.

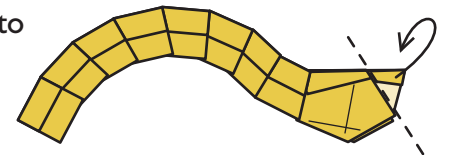

37. The finished dragon.

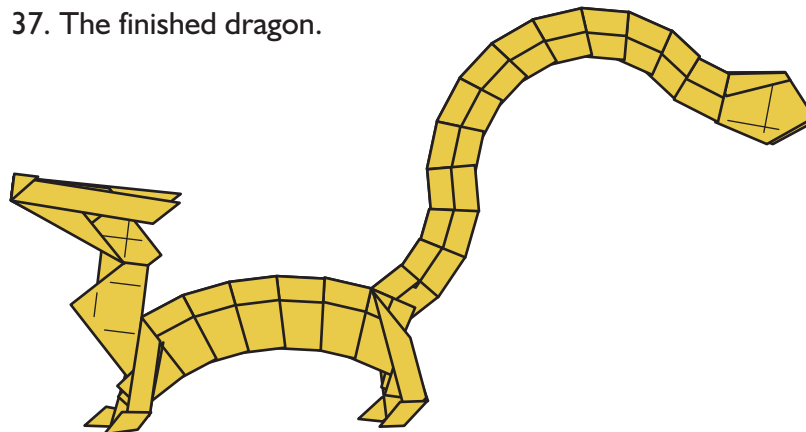

This fold is useful as a drip catcher on a bottle (of wine).

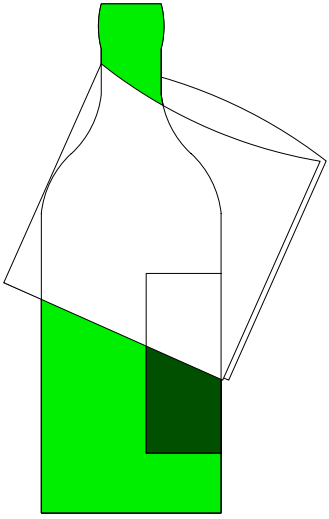

1 Put the napkin around the bottle like this

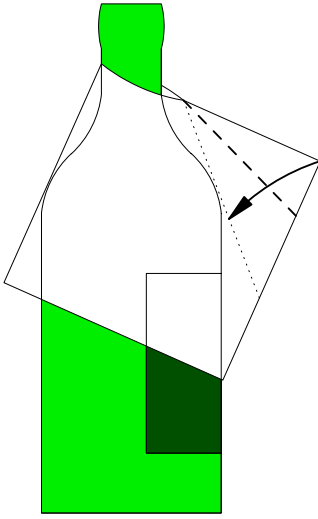

2 Fold together

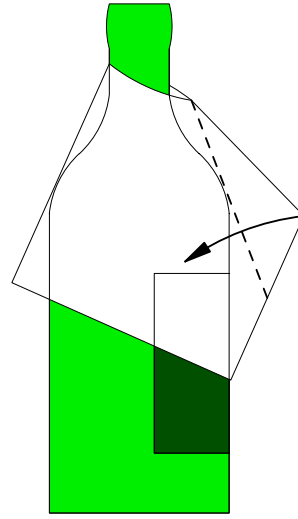

3 And again

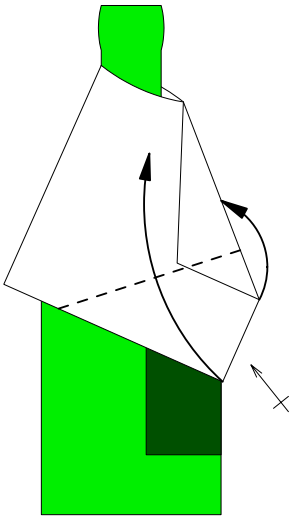

4 Fold both sides together

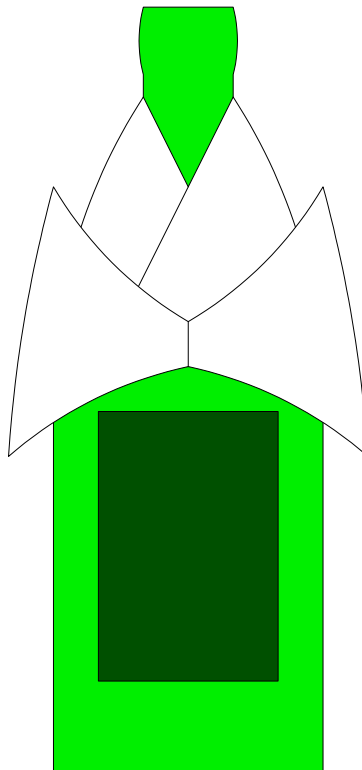



Start with a coloured frog base.

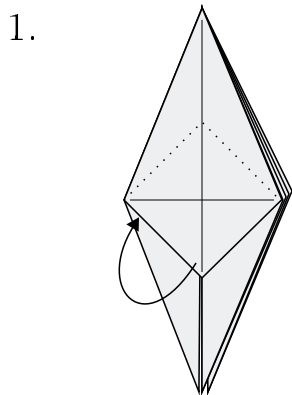

Tuck inside.  
Do NOT repeat behind.

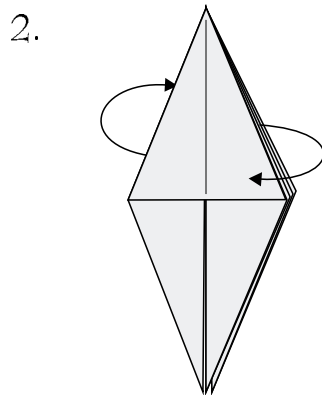

Fold two layers to the left  
on the front and two layers  
to the right on the back.

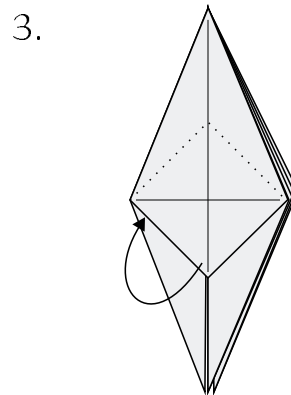

Tuck inside.  
Do NOT repeat behind.

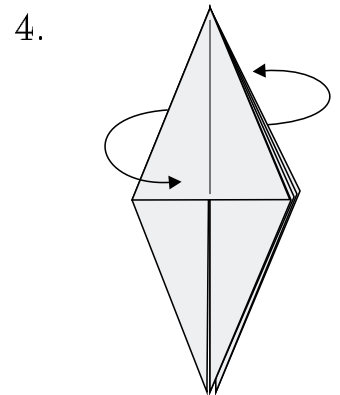

Fold one layer to the right  
on the front and one layer  
to the left on the back.

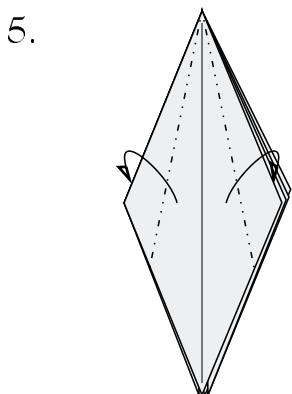

Mountain fold top layers.

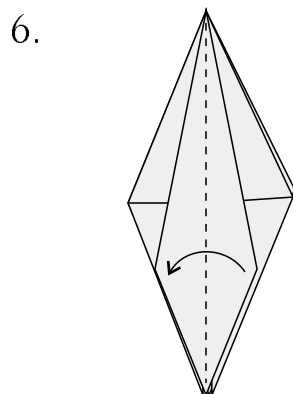

Fold one layer left.

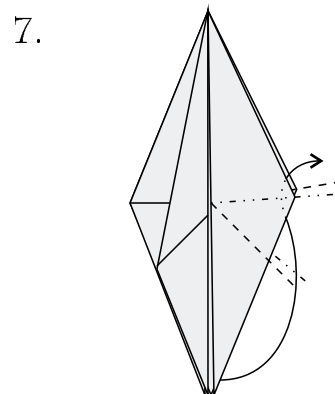

Crimp (reverse fold up and  
reverse fold back down).

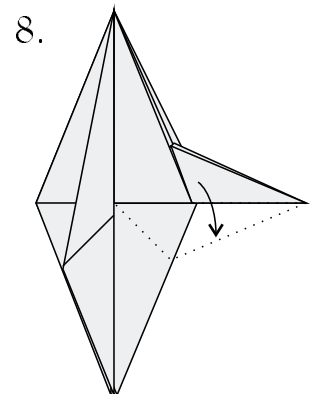

Pull out top layer.

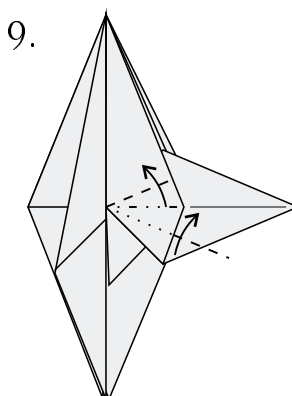

Swivel.

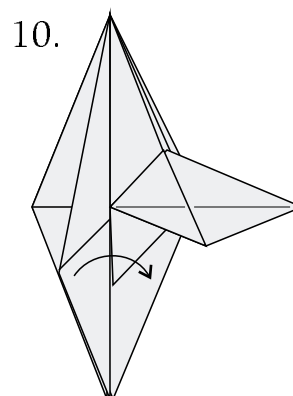

Fold one layer back right.

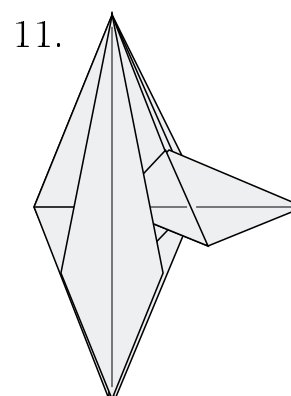

Repeat steps 6-10 on left side. Turn model over.

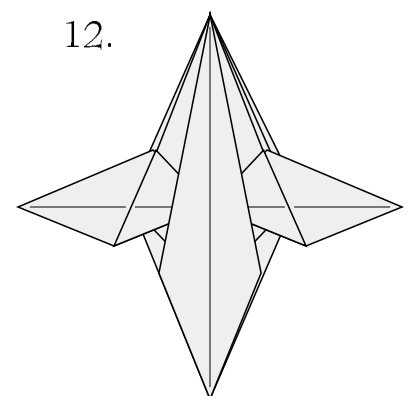

13.

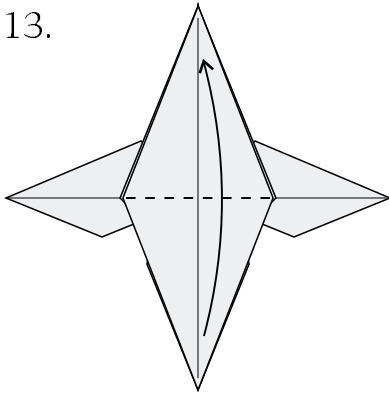

Fold top flap up.

14.

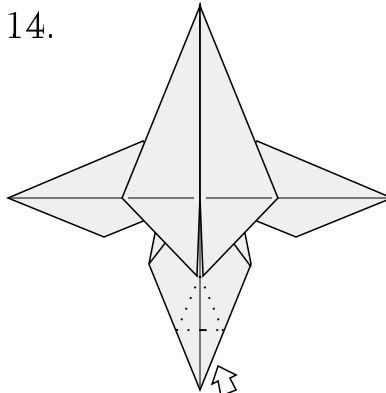

Sink the tip of the tail.

15.

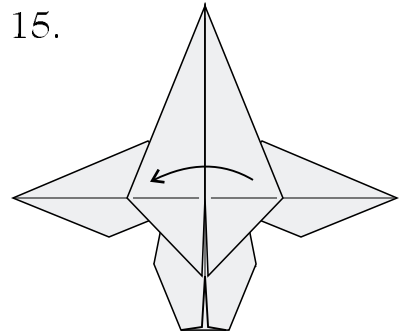

Fold one layer left.

16.

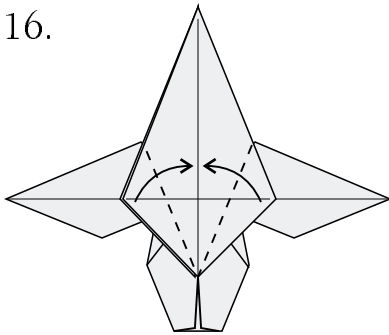

Valley fold to centre.

17.

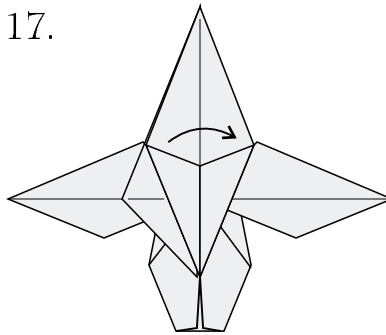

Fold one layer back right.

18.

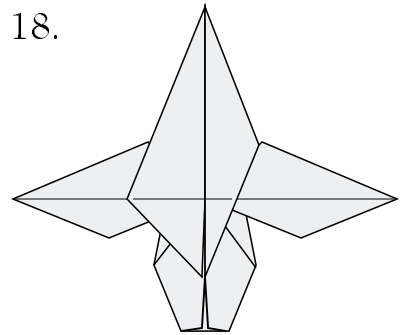

Repeat steps 15-17 on left side.

19.

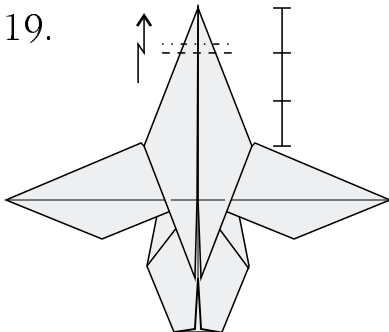

Pleat the beak.

20.

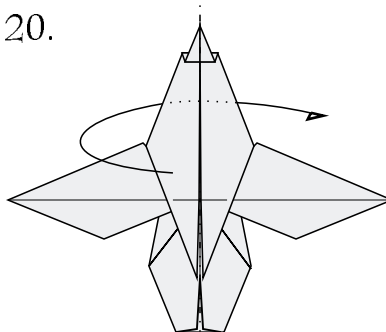

Mountain fold model in half.

21.

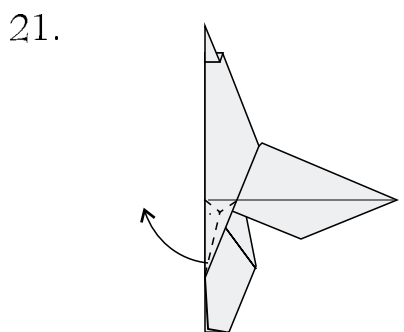

Rabbit's ear the legs.

22.

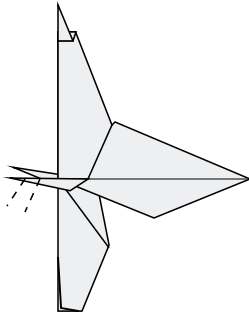

Bend legs to form claws.

23.

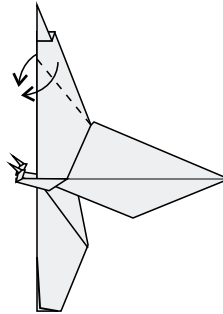

Reverse fold head.

24.

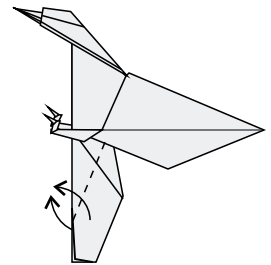

Reverse fold tail.

25.

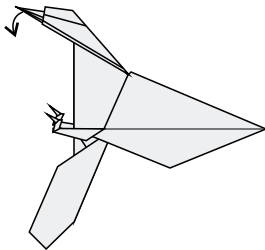

Open beak.

26.

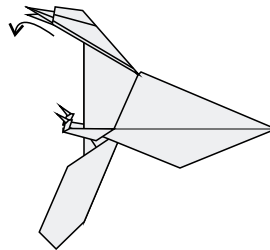

Curve tip of beak.

27.

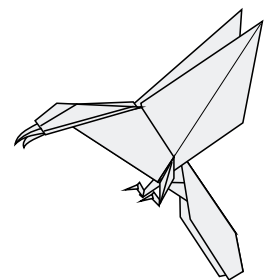

The eagle completed.

### Notes:

This model was created on January 13th, 1994, after a frustrating attempt at folding an eagle made of three sheets of paper that was created Bazza (Brian) Ewins. Anyway, I decided to try my hand at creating an eagle and this was the result. I am fairly pleased with the look of this model, especially since it is one of the few frog-base models that I have ever created.

I have tried to make the diagrams as clear and understandable as possible, but, of course, I might not have achieved this goal. If you have any suggestions as to how I could make these diagrams more understandable, please let me know.

I would rate this model as "intermediate" (or perhaps "high intermediate"), but of course I am biased. Please help me to assign a rating to this.

Thanks for trying out my new model!

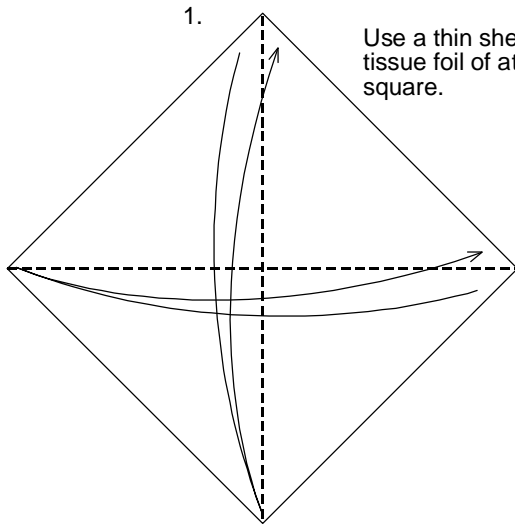

Use a thin sheet of paper or tissue foil of at least 15 cm square.

Fold diagonally in half from left to right, crease well, and unfold. Repeat by folding in half from top to bottom, and unfold.

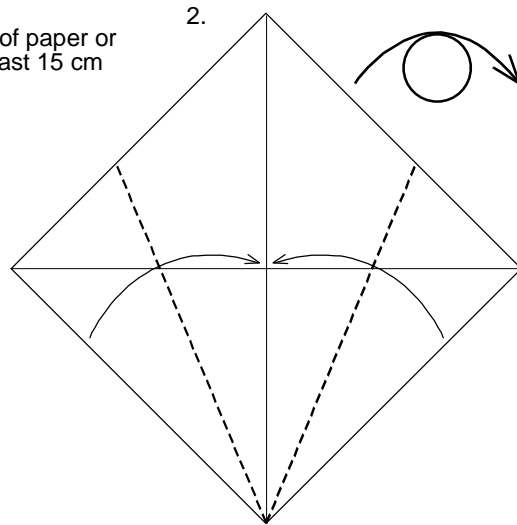

Valley fold the lower diagonal edges to the crease line in the centre and turn paper over.

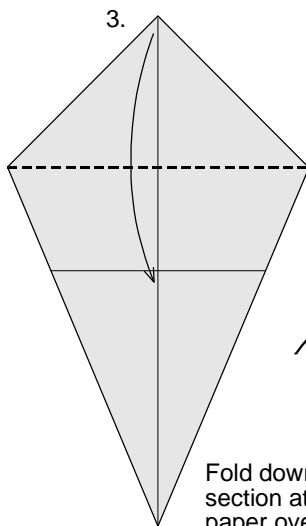

Fold down the triangular section at the top and turn paper over.

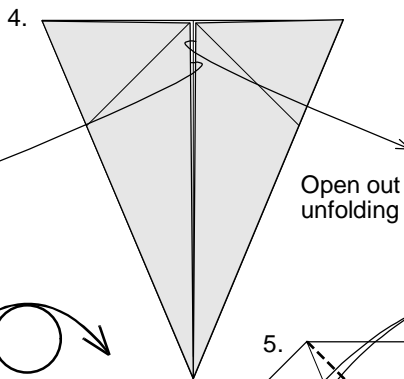

Open out to the sides, effectively unfolding Step 2.

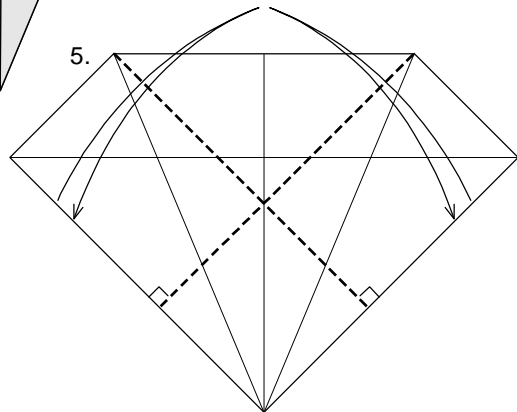

Make two diagonal folds as illustrated, in line with the edge of the triangular layer underneath. Crease firmly, and unfold.

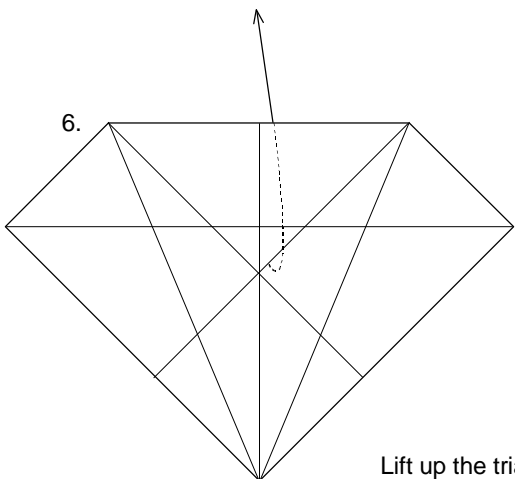

Lift up the triangular piece from behind.

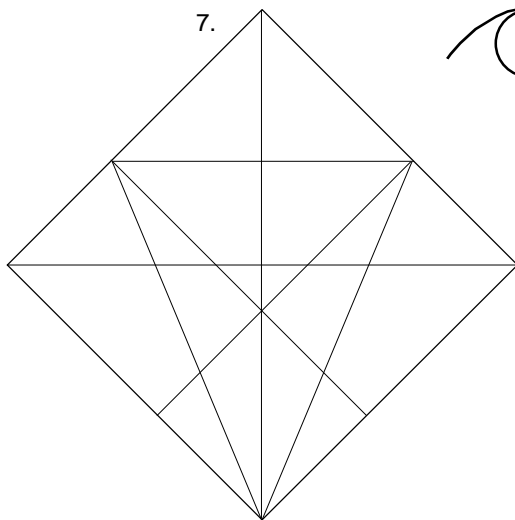

Repeat from Step 2 on the lower half of the paper, then turn the paper over.

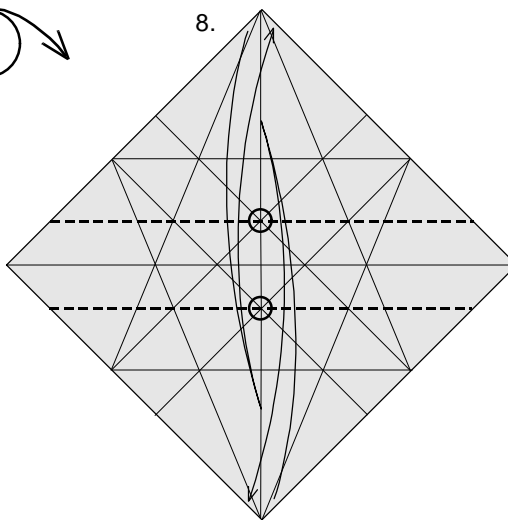
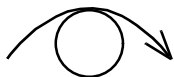

Valley fold through the circled intersecting crease lines, crease firmly, and unfold.

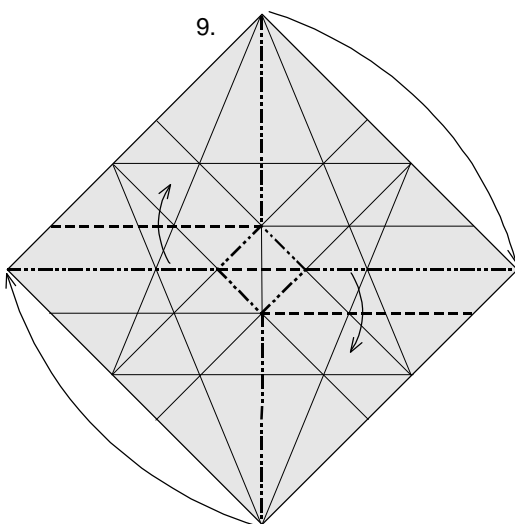

Collapse the paper along the illustrated mountain and valley folds ...

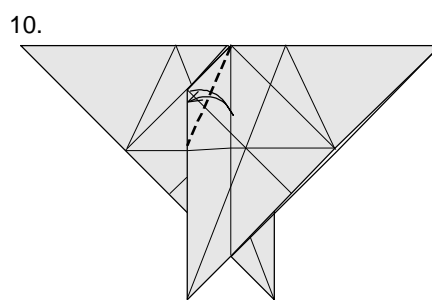

... like so. Now fold the diagonal edge in the middle to the vertical crease in the centre, crease firmly, and unfold. Repeat on the other side.

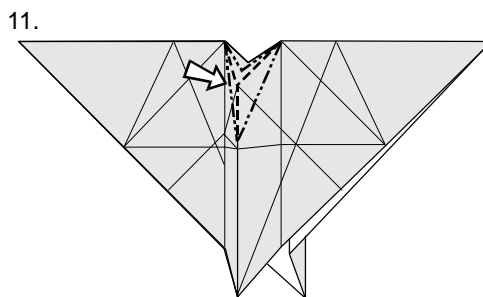

Pull the flaps on each side slightly apart and sink fold. You may need to stick a finger through the underside to guide the sink fold precisely along the crease lines made in Step 10. Repeat on the other side.

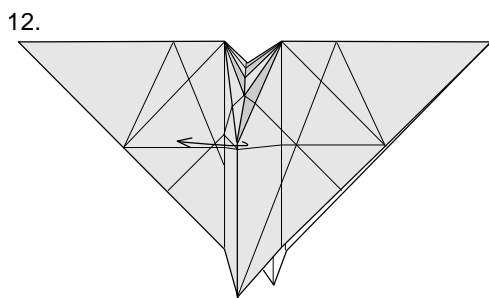

Flatten the rest of the model to the position at Step 10.

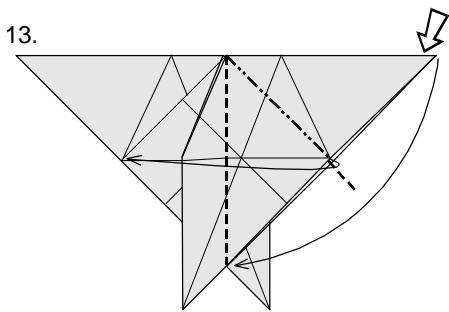

Separate the two diagonal edges on the right and squash fold. Repeat behind.

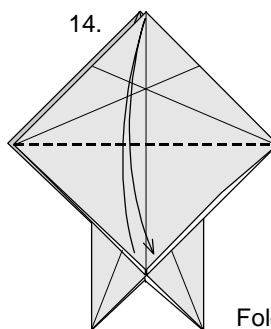

Fold the bottom corner to the top, crease well, and unfold.

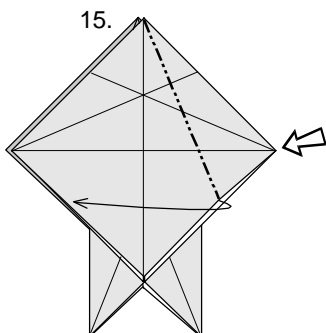

Separate the two diagonal edges and squash fold again.

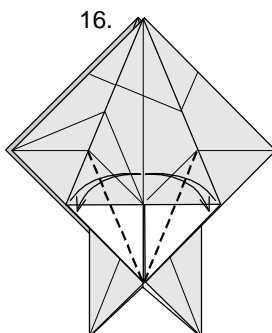

Fold and unfold, creasing firmly ...

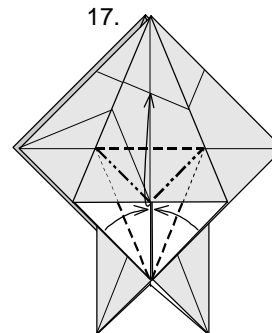

... then petal fold.

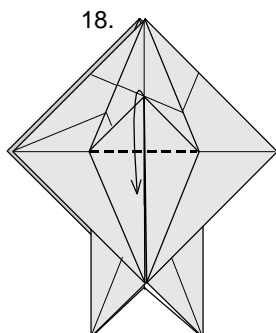

Fold the triangular flap down ...

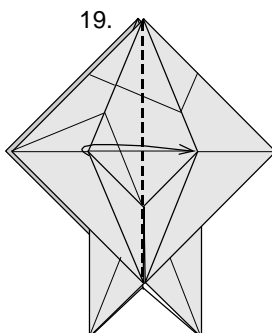

... then fold the flap on the left to the right. Repeat from Step 15 on the next flap on the left.

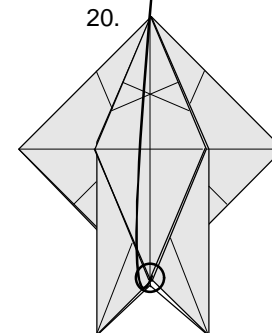

Grasp the circled point and gradually pull the flap upwards as far as it can go, opening out and flattening the layers beneath ...

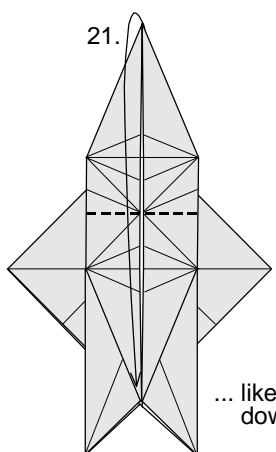

... like this, before bringing down the flap again.

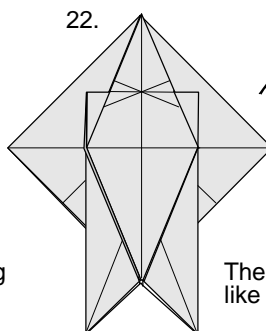

The model should now look like this. Turn the model over.

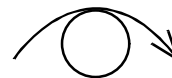

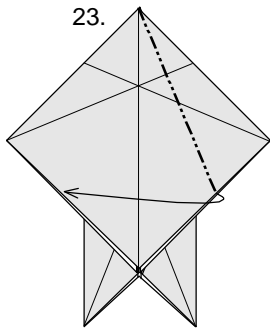

Repeat Step 15 on the right, and then on the left.

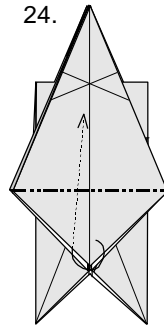

Mountain fold the triangular portion of the uppermost layer under and against itself.

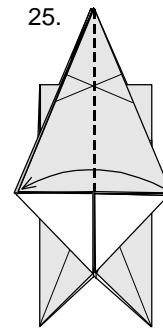

Fold the first flap on the right to the left.

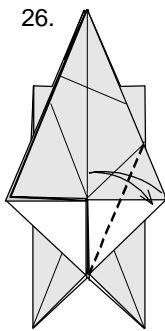

Fold and unfold, creasing firmly ...

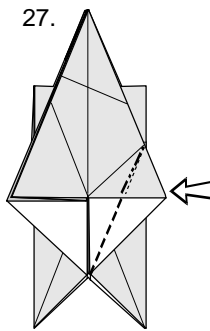

... then reverse fold.

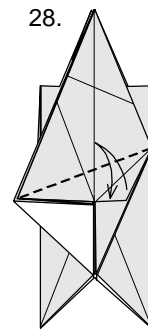

Fold and unfold again, from the left corner to the corner on the right.

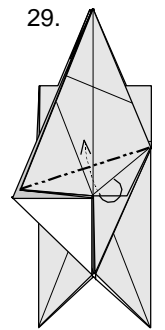

Now mountain fold the excess paper under as well ...

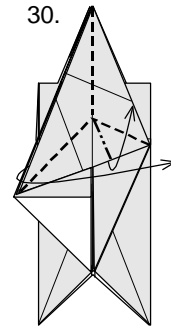

... then close up with a rabbit's ear fold.

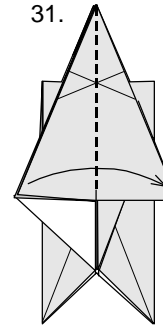

Fold the flap on the left to the right and repeat from Step 26 on the other side.

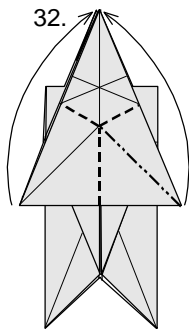

Bring the corners from the sides to the apex.

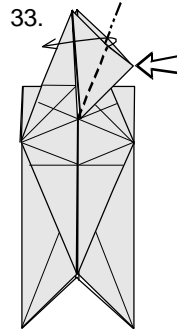

Squash fold ...

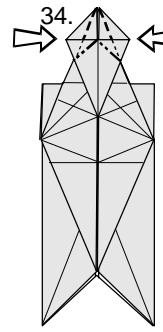

... and then petal fold, as you did in Steps 16 to 18.

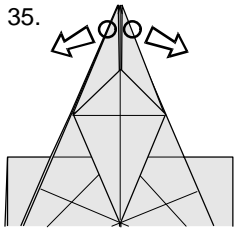

35. Grasp the flaps at the circled area and pull gently apart, ...

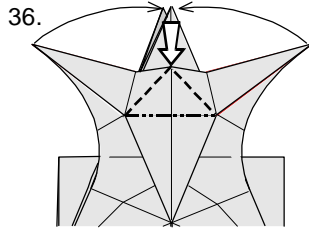

36. ... then reverse fold to hide the triangular tab beneath.

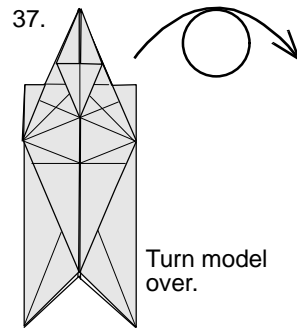

37. Turn model over.

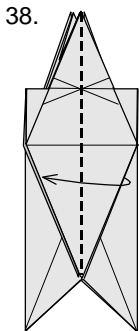

38. Swivel both layers to the left, ...

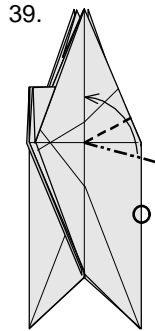

39. ... grasp the paper at the circled area and make a crimp fold while drawing the paper, slightly beyond midway, towards the top ...

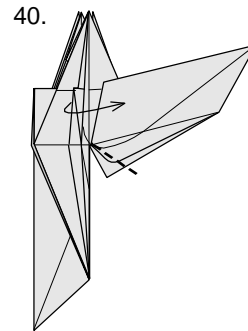

40. ... like this. Return the two layers folded in Step 38 to the right and flatten out.

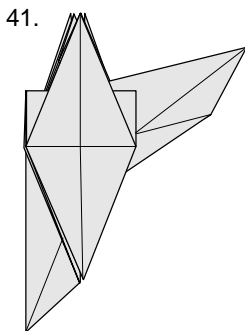

41. The model should now look like this. Repeat Steps 38 to 40 on the left side of the model.

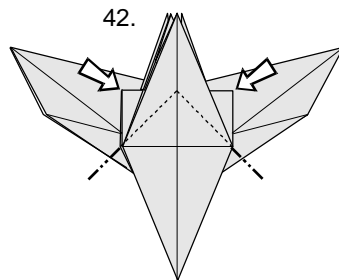

42. The pieces on each side, which will form the wings, should be symmetrical. Reverse fold each of the tabs on the sides ...

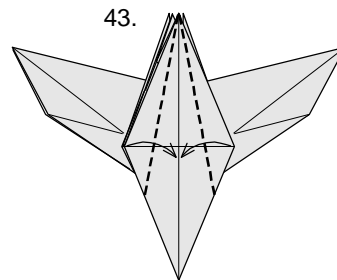

43. ... then valley fold the sides of the top layer to narrow.

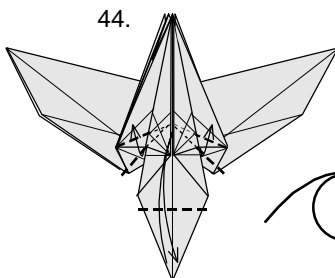

44. Valley fold the tail piece upwards, crease firmly, and unfold. Next crimp fold the layer at the base of each wing as illustrated, then turn model over.

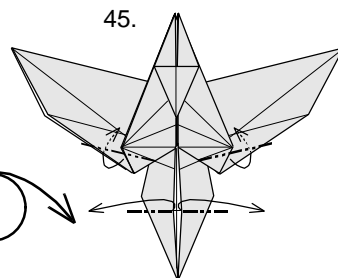

45. Mountain fold the first layer at the bottom corner of the wings within itself, then separate and draw the central vertical edges of the tailpiece to the sides ...

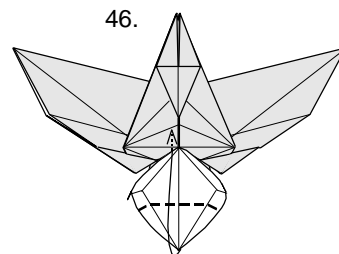

46. ... and reverse fold to hide the lower portion of the tailpiece within the opening ...



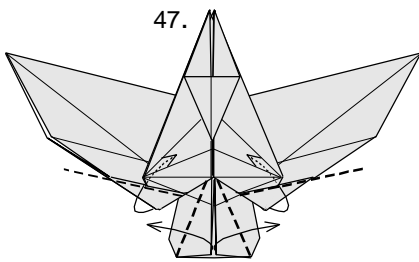

... like this. Now valley fold the corners of the second layer of the wing within itself, and widen the tail by folding out the overlapping tabs in the middle.

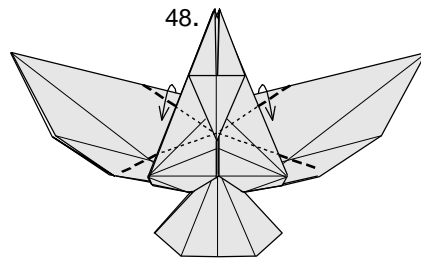

Crimp fold the front of the wings as illustrated.

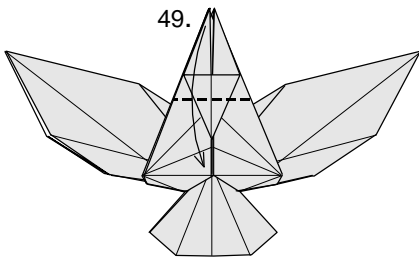

Bring down the uppermost flap with a valley fold, ...

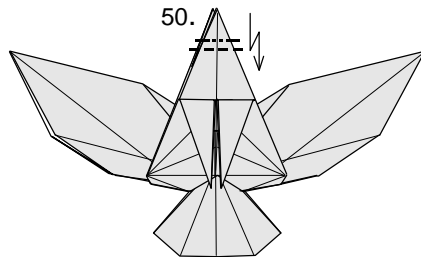

... crimp fold through all remaining layers at the top to form the head ...

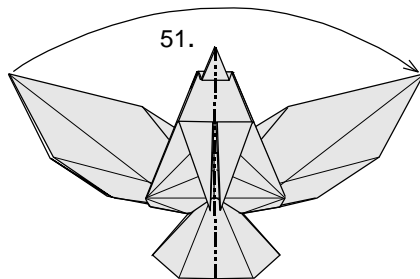

... and mountain fold the model vertically in half

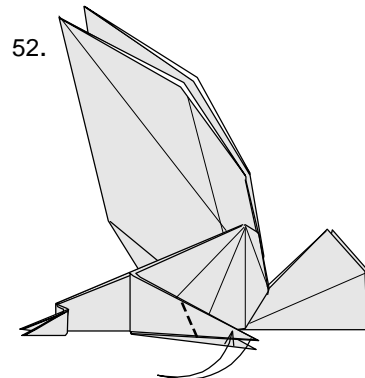

Now to form the left claw. First, fold and unfold ...

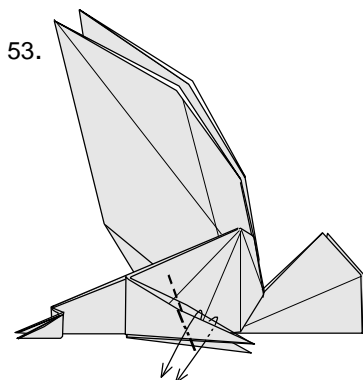

... then do an outside reverse fold using the crease lines made in Step 52. You will need to open out the layers temporarily to do this.

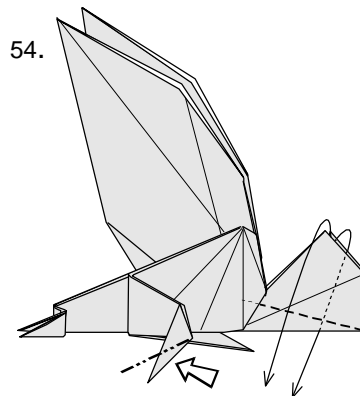

Inside reverse fold the claw, then outside reverse fold at the tail.

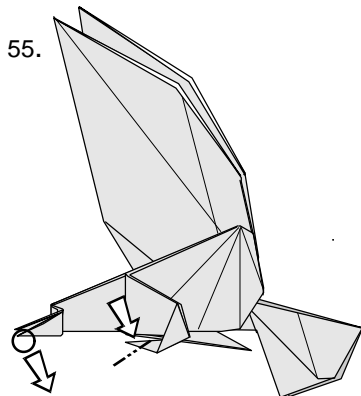

Pull down the lower beak just a little. Reverse fold the tip of the left claw once more as illustrated, then repeat from Step 52 on the right claw.

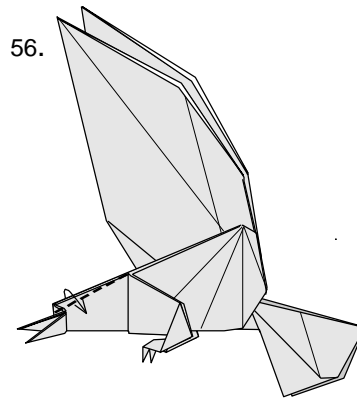

Valley fold both sides of the head and neck area as illustrated.

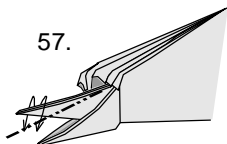

Outside reverse fold the tip of the beak ...

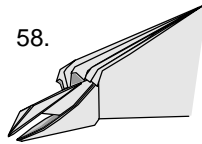

... like this.

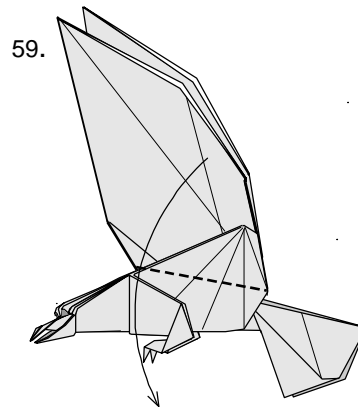

Fold down the wing on this side ...

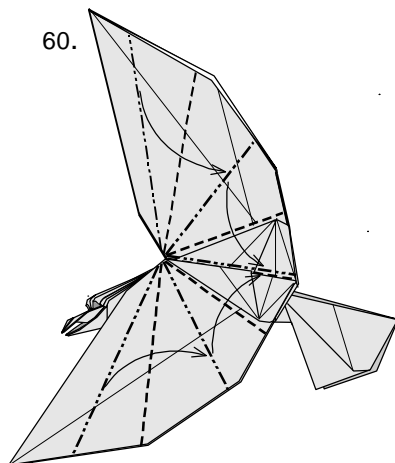

... then crimp the wing with a series of mountain and valley folds as illustrated. Repeat from Step 59 on the other wing.

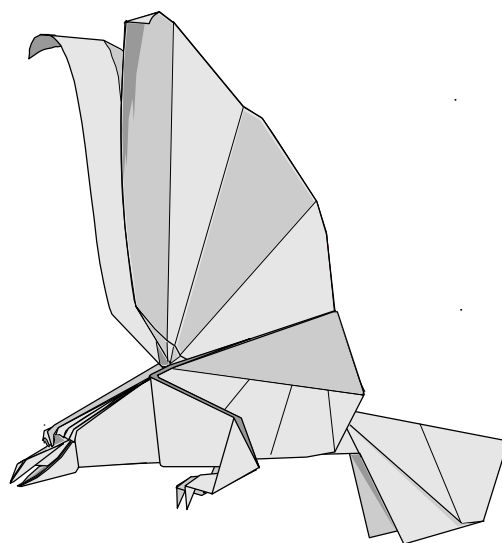

Finally, spread out and curve the wings for greater realism.

**EAGLE**  
 (c) Brian Ewins 1993

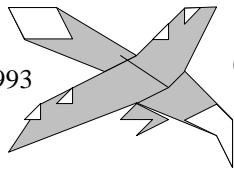

(Roughly)

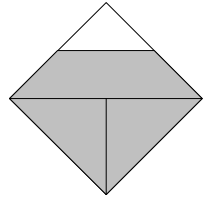
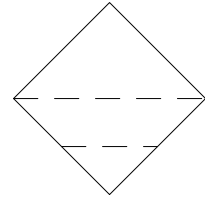
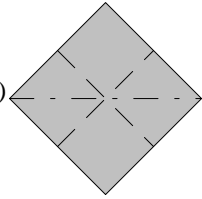

Preliminary Fold... (enlarged) front and back... base complete.

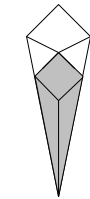
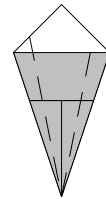
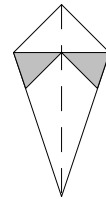
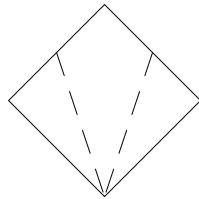
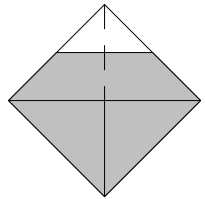

Tail...fold right to left...kite, fold left to right...repeat on left...fold sides front and back.

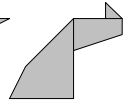
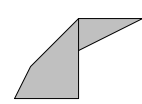
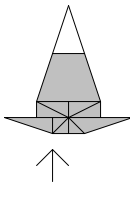
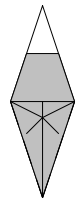
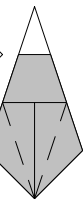
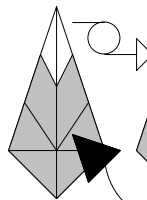
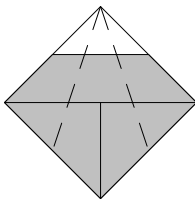

Leg... inside reverse folds. body points -->

tail will fit in here.

Body... fold in sides (both layers)...repeat at bottom,

Fold legs out, then in at mark so they stick up.

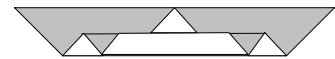
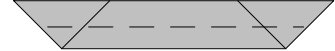
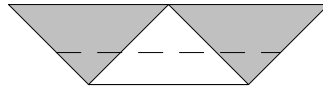
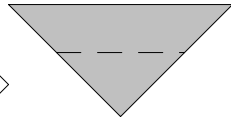
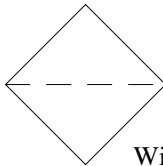

Wing... keep folding in half as shown.

... unfold this.

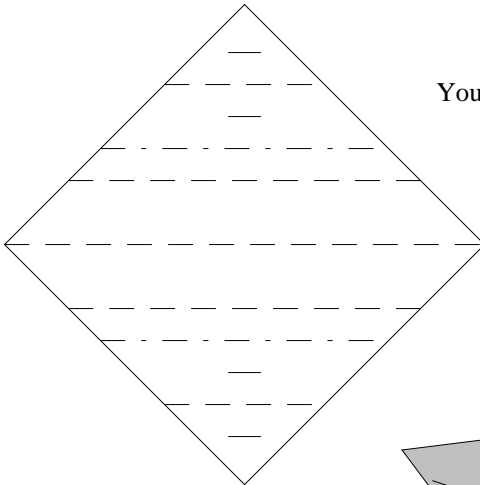

You should see 11 folds.

use only the 7 shown,

other 4 marked as guides.

Pleat a triangle, centre shown as guide.

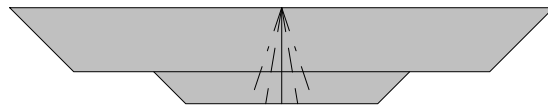

Result is like this.

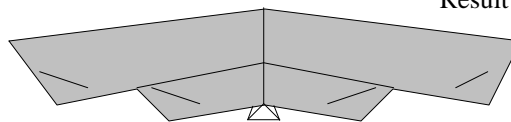

fold corners to make white wingtips.(repeat below)

triangle under wings goes inside body, then tail acts as peg to hold it all together. Make a beak on the head.

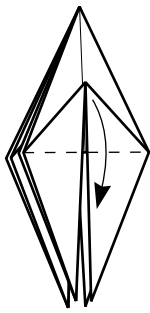

a) Begin with the frog base.

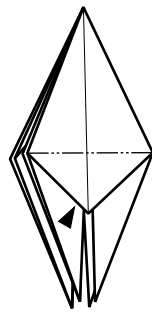

b) Tuck inside.

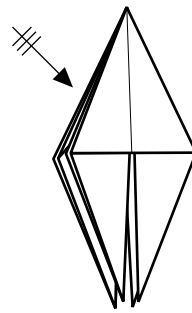

c) Repeat on other three corners.

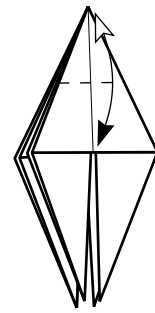

d) Make a crease.

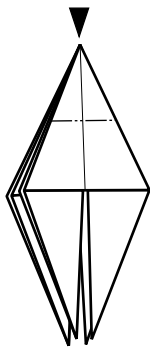

e) Sink carefully,

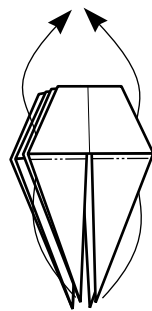

f) Reverse-folds.

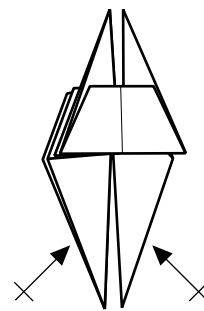

g) Repeat behind.

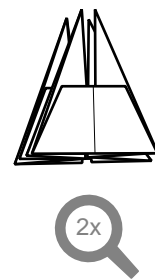

h) Double zoom.

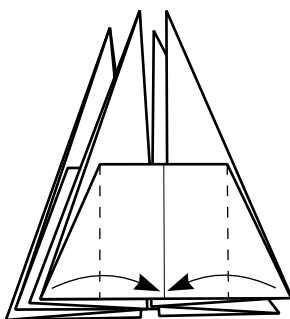

i) Fold to the center.

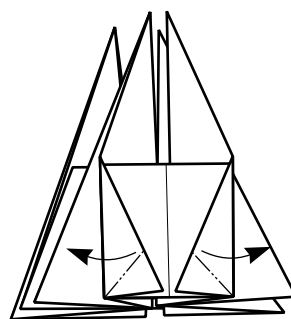

j) Squash-folds.

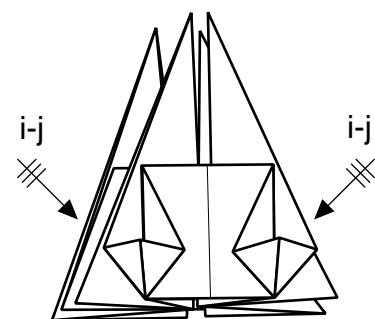

k) Repeat the last two steps on the remaining corners.

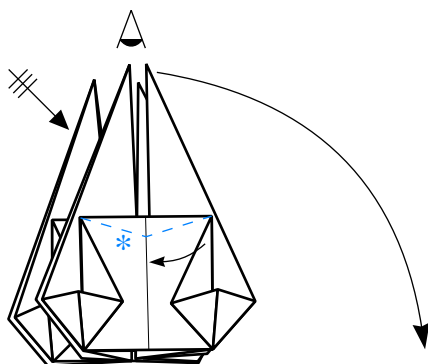

l) Open petals. Make the model to be 3D.

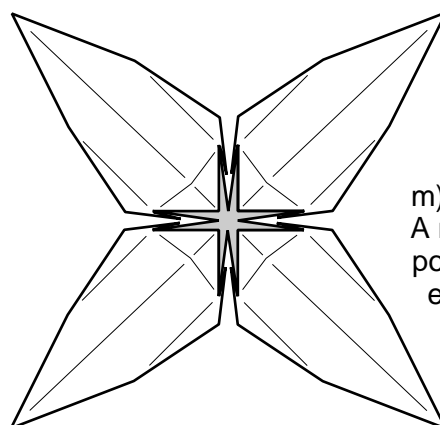

m) Ground plan. A modification is possible making eight reverse-folds (\*).

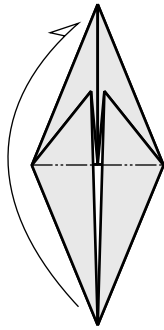

a) Begin with the fish base. Fold behind.

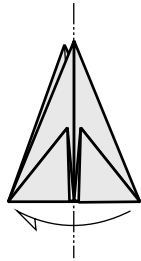

b) Fold behind.



c) Pull out the inside fold.

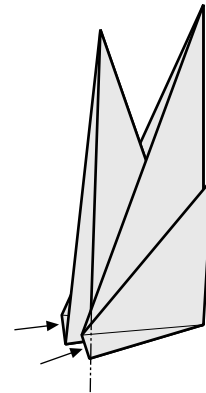

d) Fold the tips.

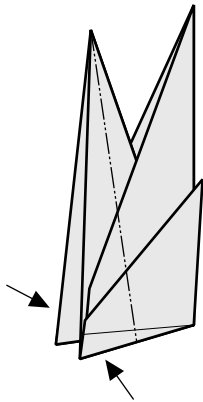

e) Fold inwards and lock together.

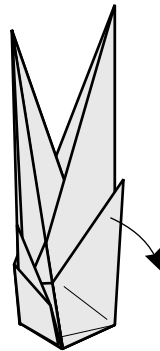

f) Shape the leaf. Repeat behind.

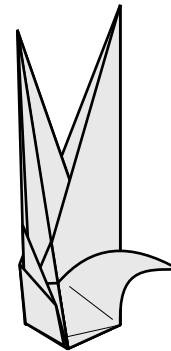

g) Fold two other stems.

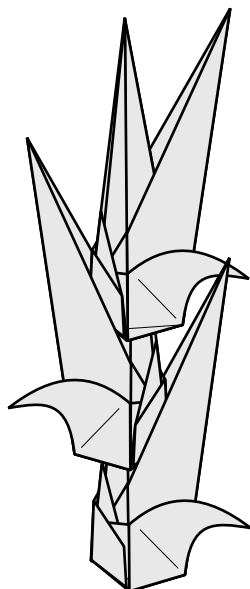

h) Put stems together and append two blooms.

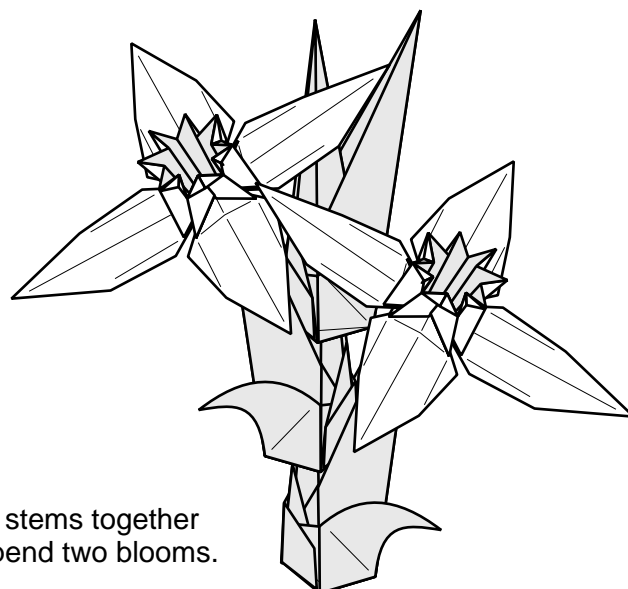

# Appendix - frog base

---

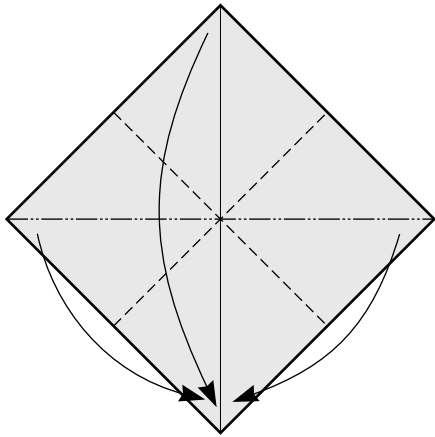

(i)

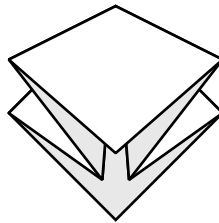

(ii)

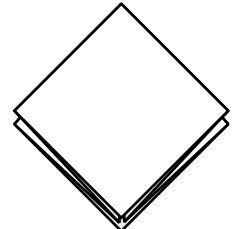

(iii) PRELIMINARY FOLD.

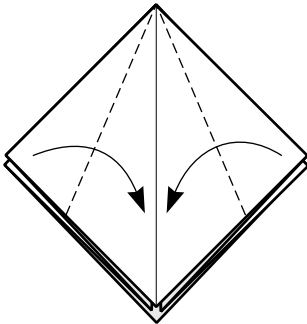

(1)

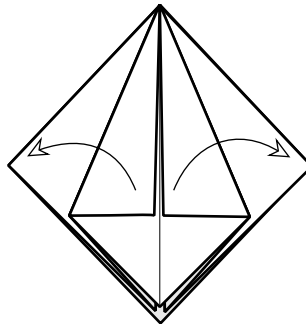

(2)

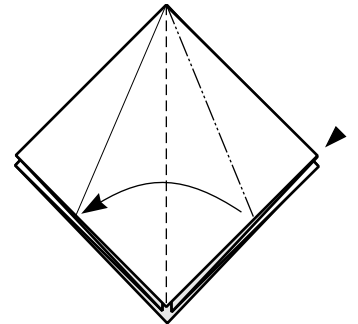

(3)

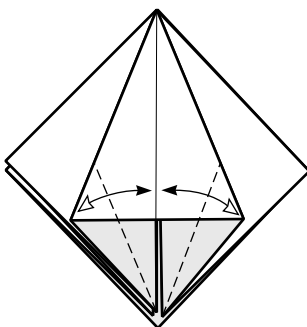

(4) Squash-fold.

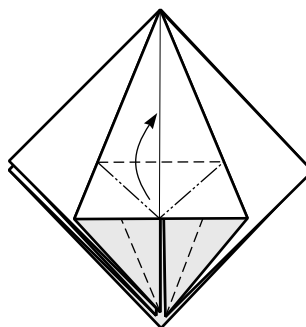

(5)

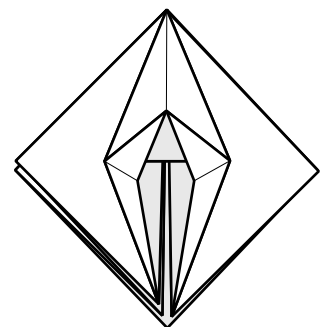

(6) Petal-fold.

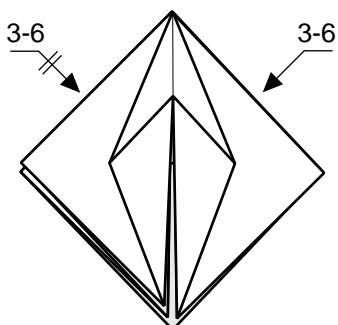

(7)

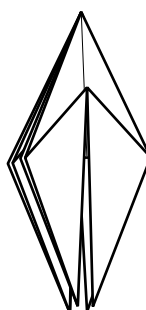

(8) FROG BASE.

## Appendix - fish base

---

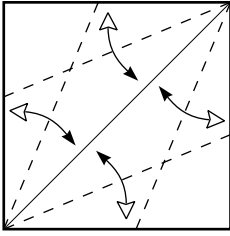

(1)

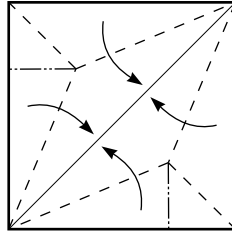

(2)

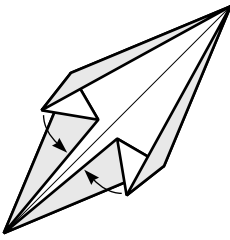

(3)

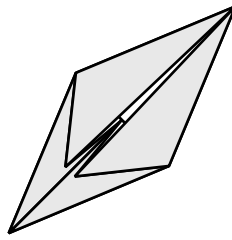

4) FISH BASE.

# Eiffel tower

1

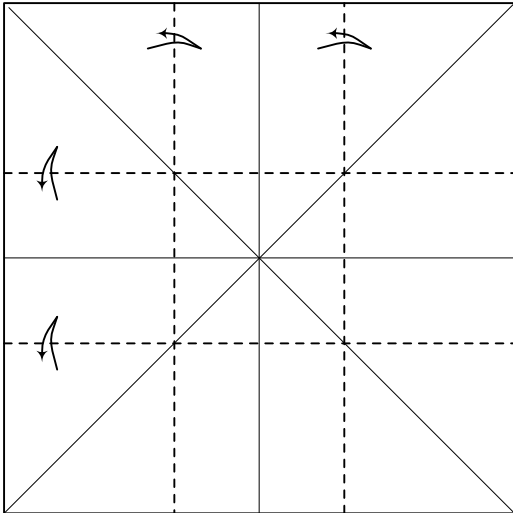

Crease into thirds

2

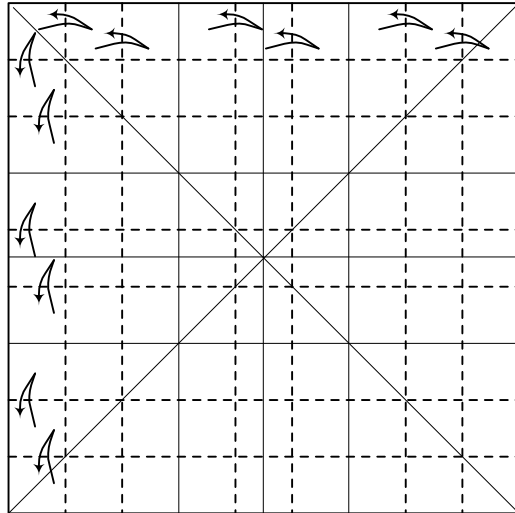

Crease into 3rds again to make 9ths

3

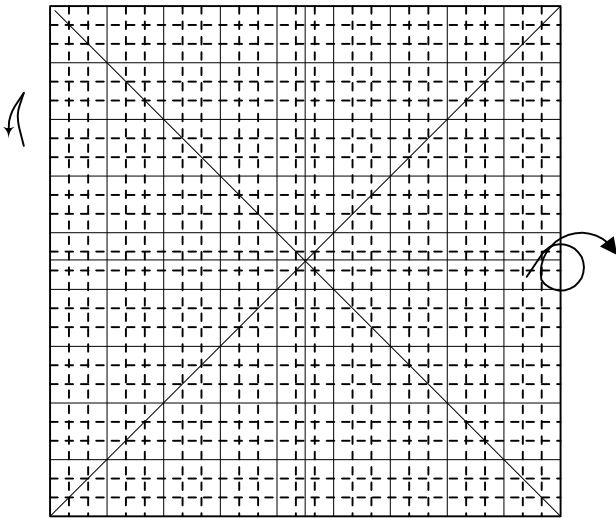

Crease into 3rds once more to make 27ths

4

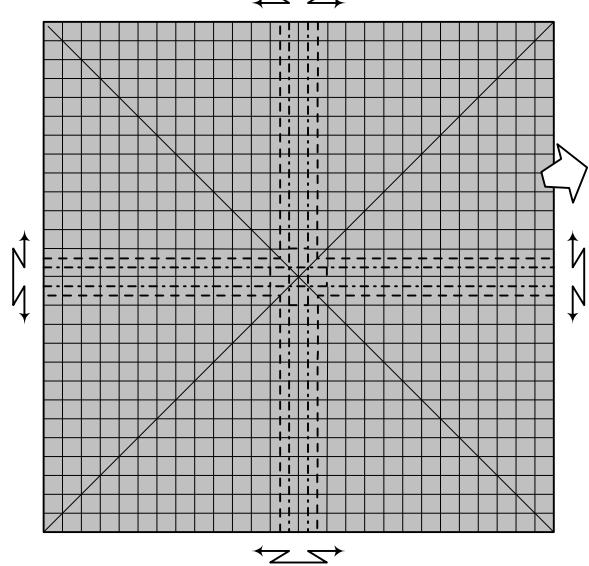

Form a small box in the centre of the paper

5

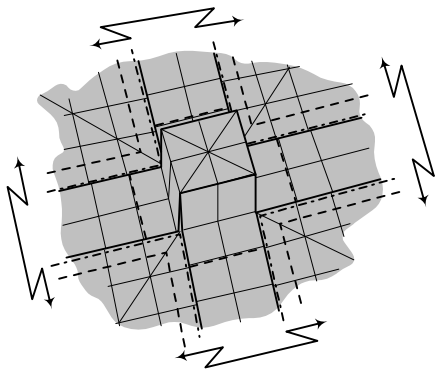

Repeat the procedure in step 4 to make the box taller

6

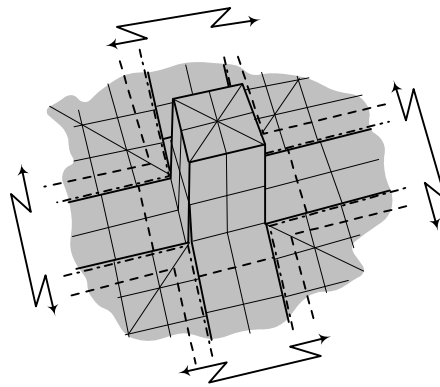

Repeat step 5 again to make the box 3 segments tall



# Eiffel tower

7

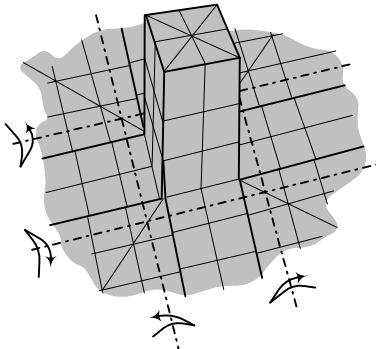

Make sharp mountain creases bisecting the first flat segment at the base of the tower

8

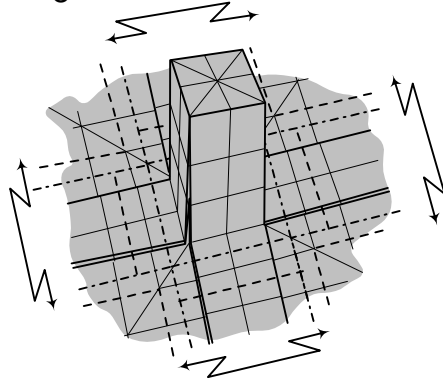

Make another step starting half a segment from the tall stack

9

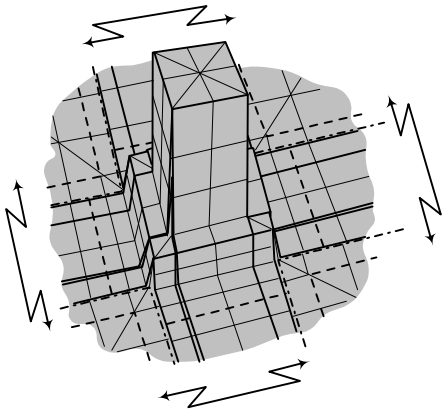

Make the step 2 segments tall

10

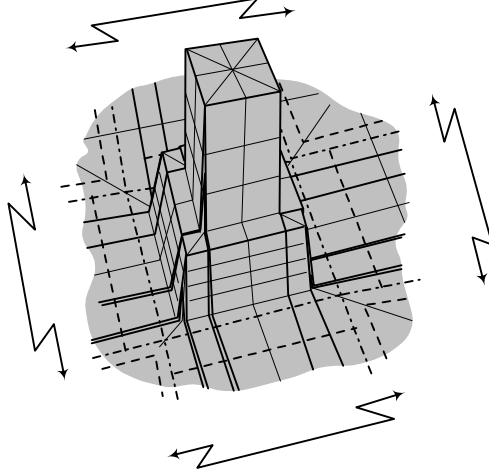

Add another step

11

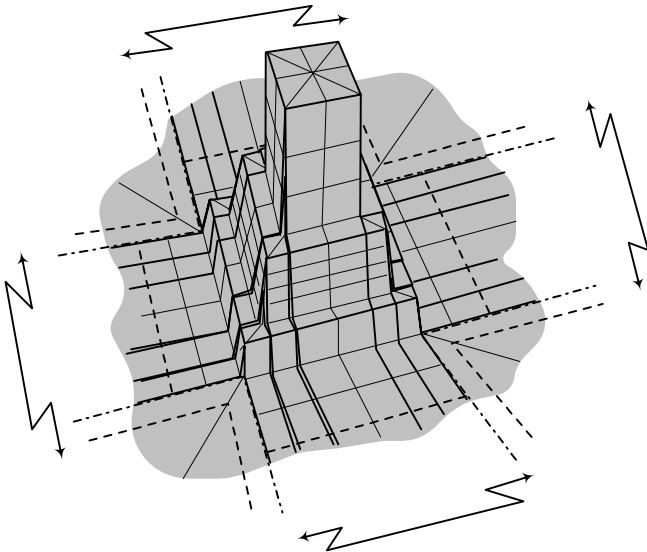

Make this step 2 segments tall

12

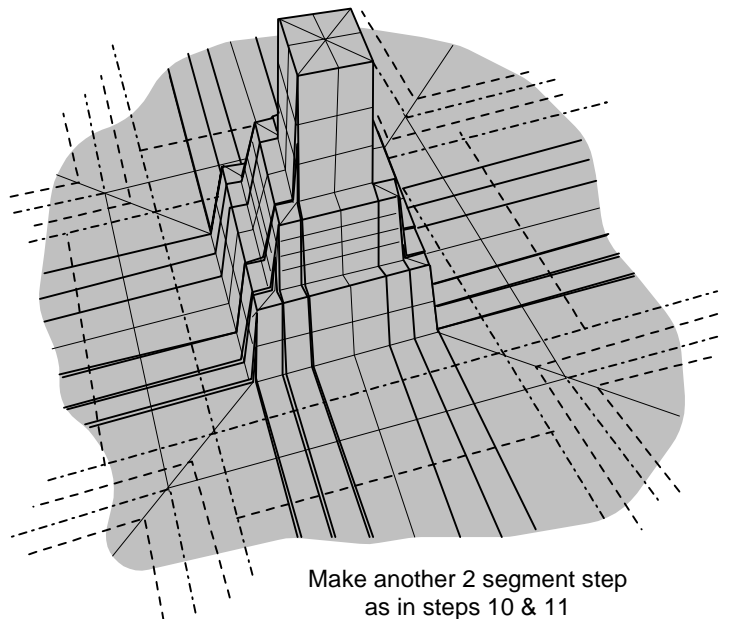

Make another 2 segment step as in steps 10 & 11

# Eiffel tower

13

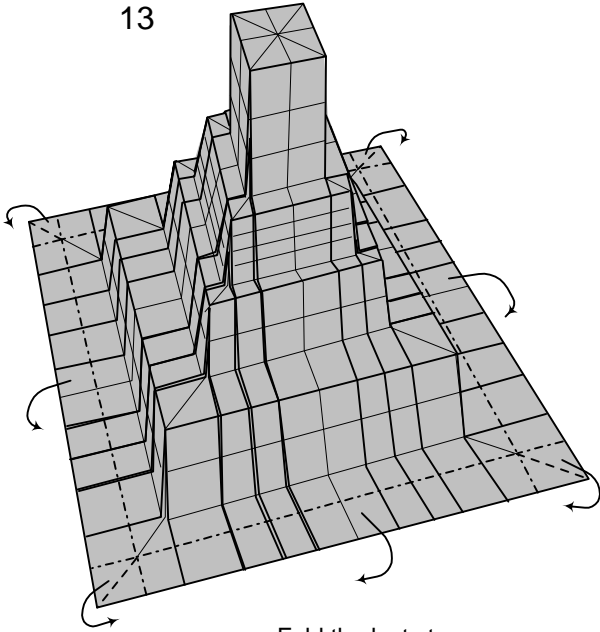

Fold the last step

14

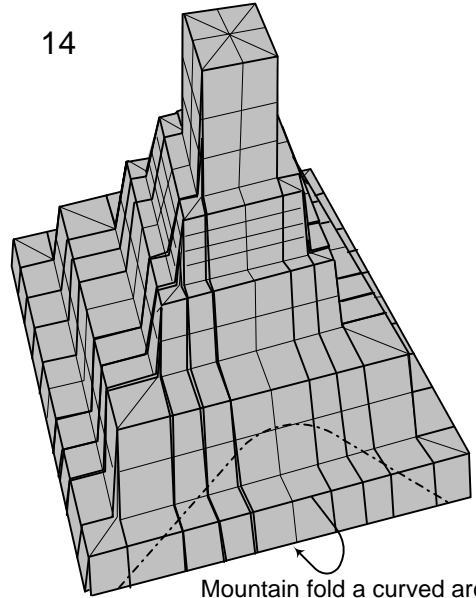

Mountain fold a curved arch while 'fanning' the layers inside the model

15

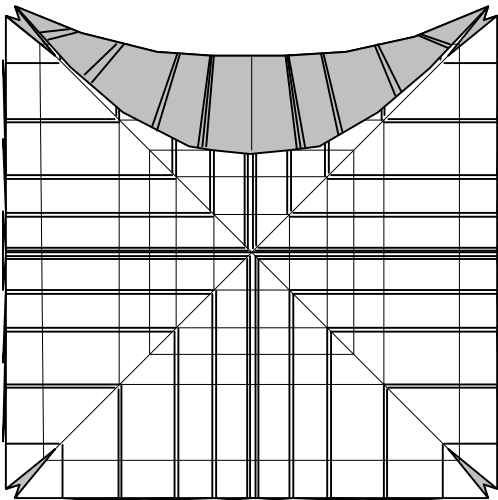

View from underside showing 'fan'

16

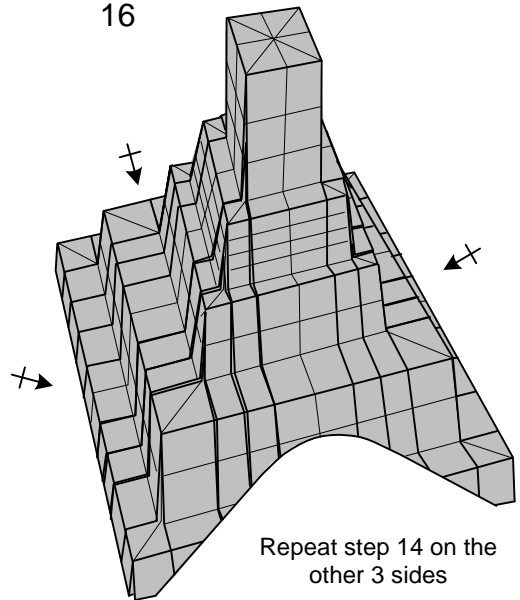

Repeat step 14 on the other 3 sides

17

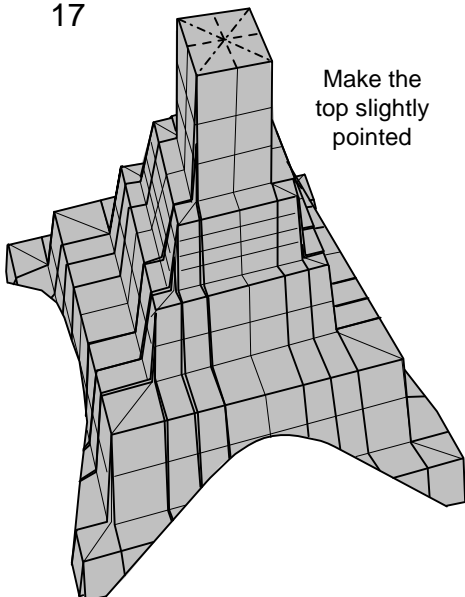

Make the top slightly pointed

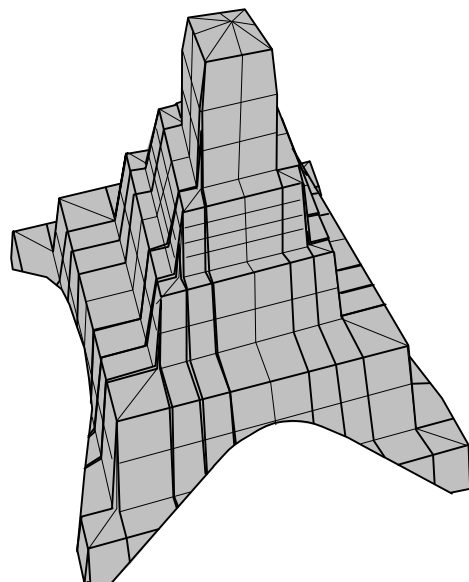

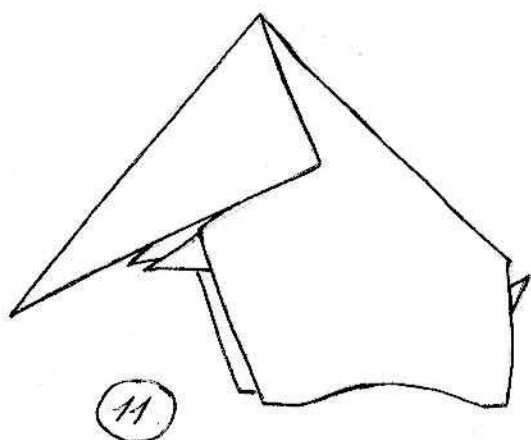
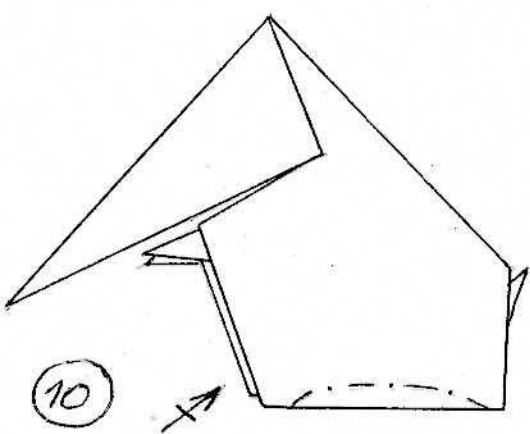
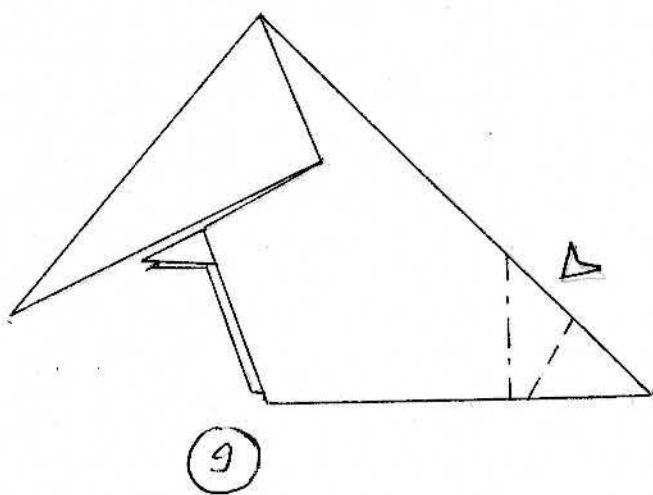
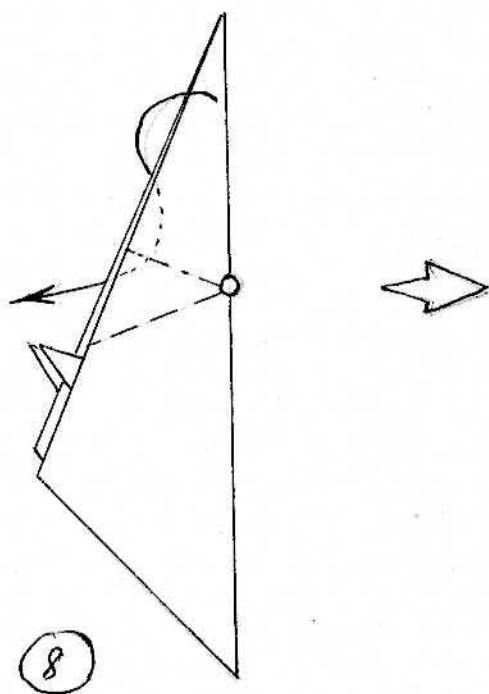
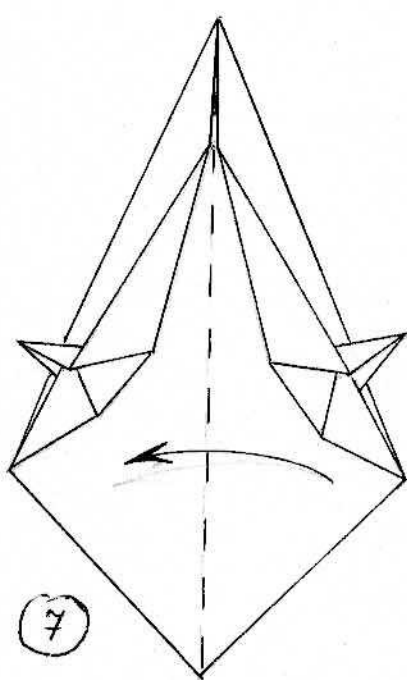
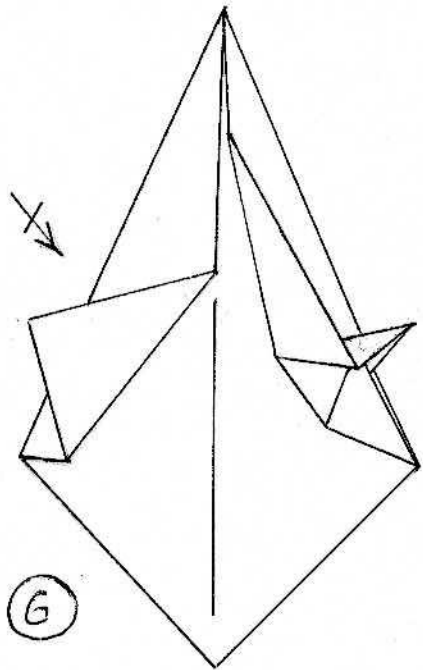

# Volney's Elephant

By Perry Bailey Copyright 1972 + 1997

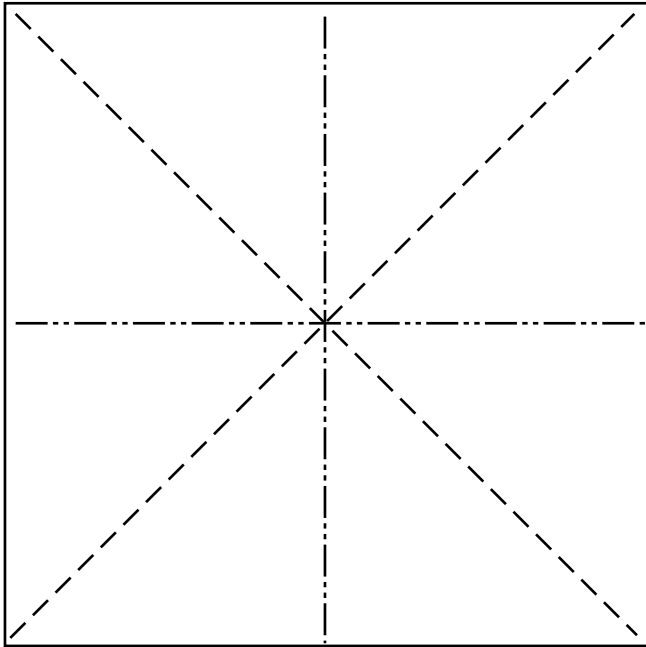

1. Colored side up.

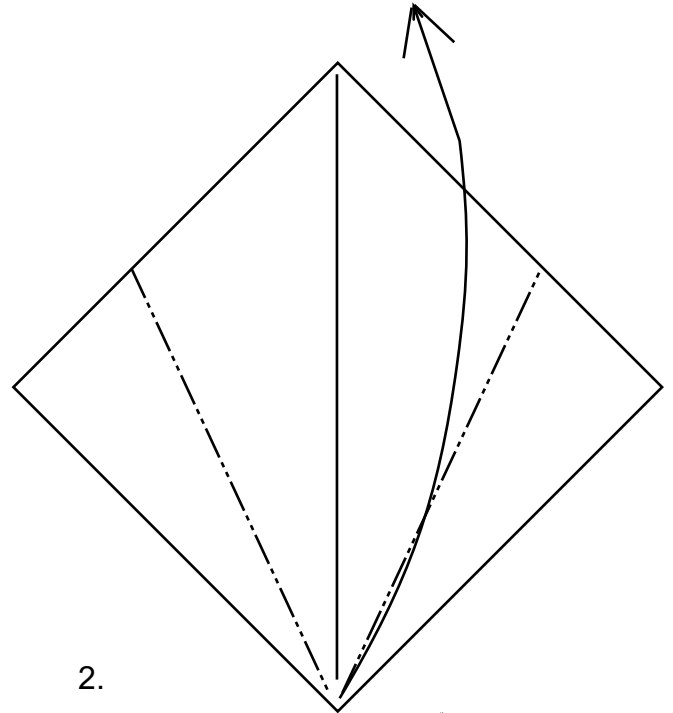

2.

As you can see this model is based on the traditional bird base.

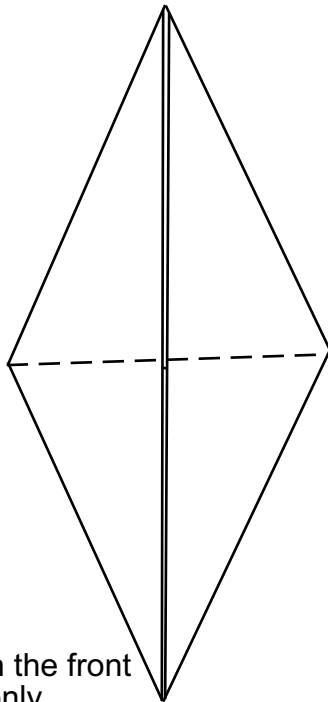

3. fold down the front flap, only.

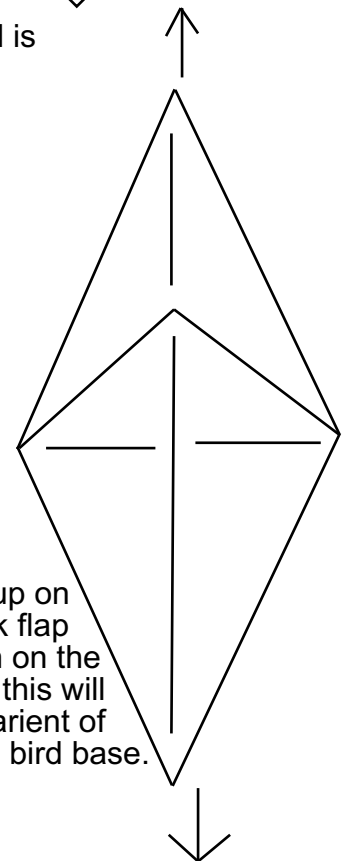

4. pull up on the back flap and down on the front flap, this will make a variant of the stretched bird base.

pbailey@mtayr.heartland.net

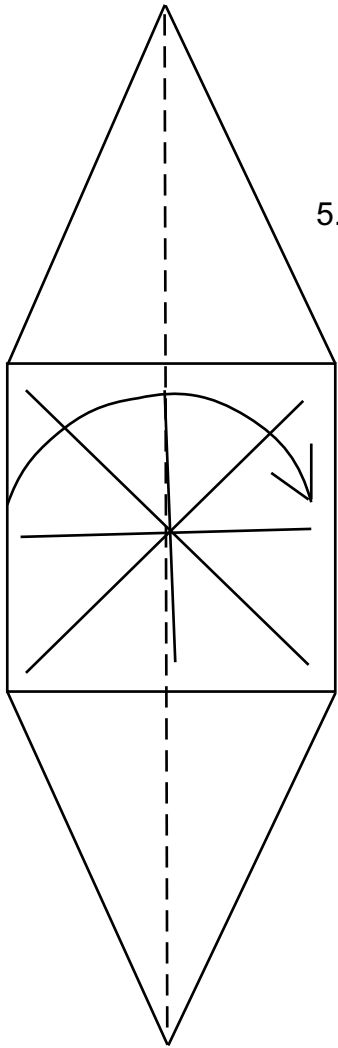

5. Fold the model in half.

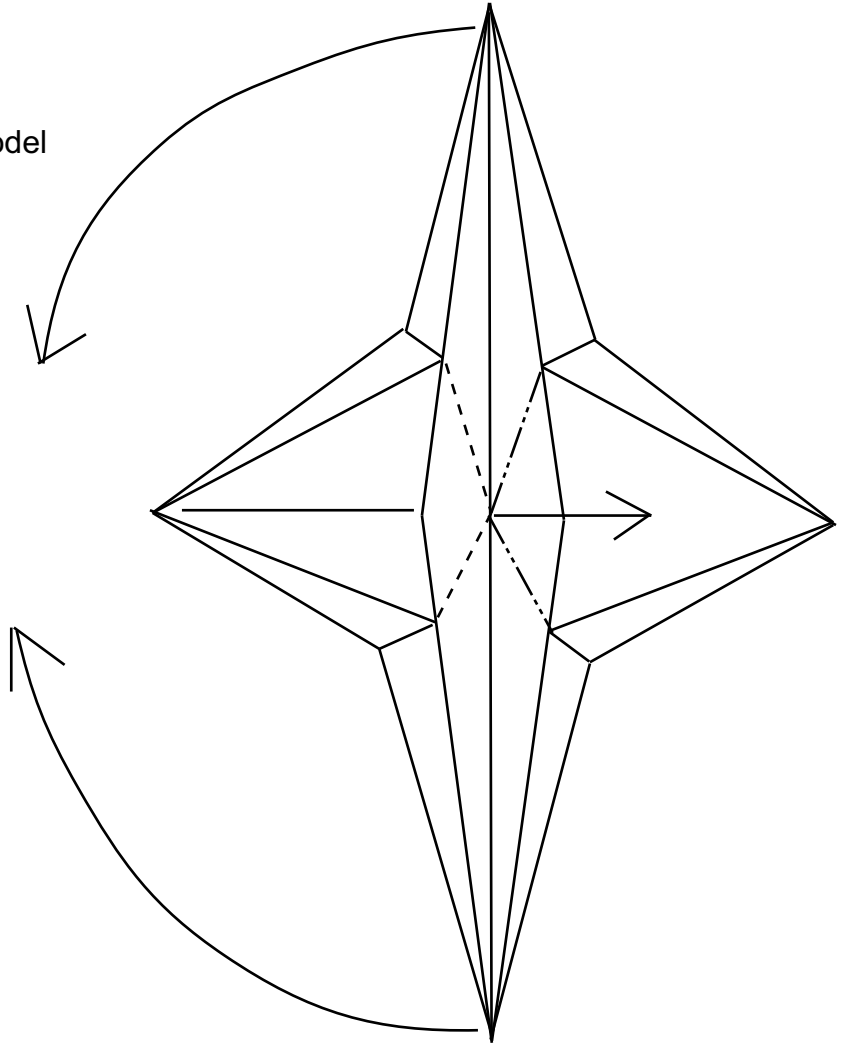

6. The two outside points come down, while the center of the model folds to one side as shown.

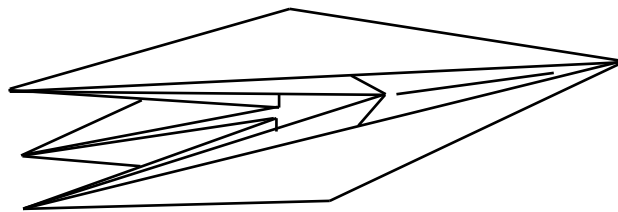

7. as you fold the model together in the previous step, it should look something like this, as it goes together.

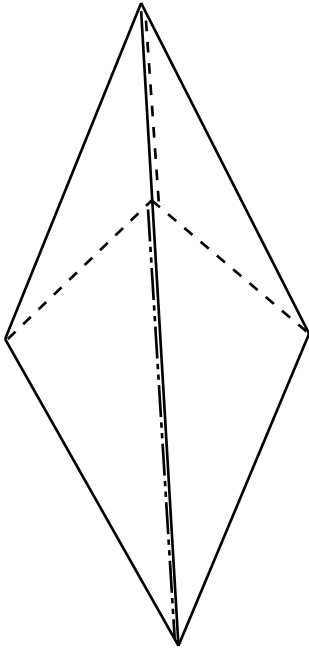

8. This move is actually not all shown here as while you fold along the inside point you also reach behind and open up the triangular flap in the back

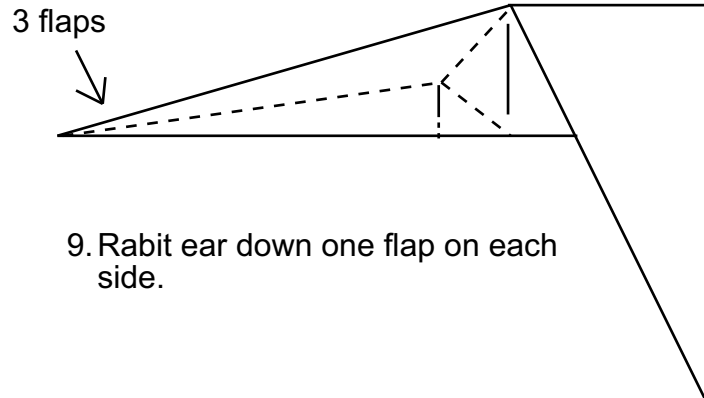

9. Rabbit ear down one flap on each side.

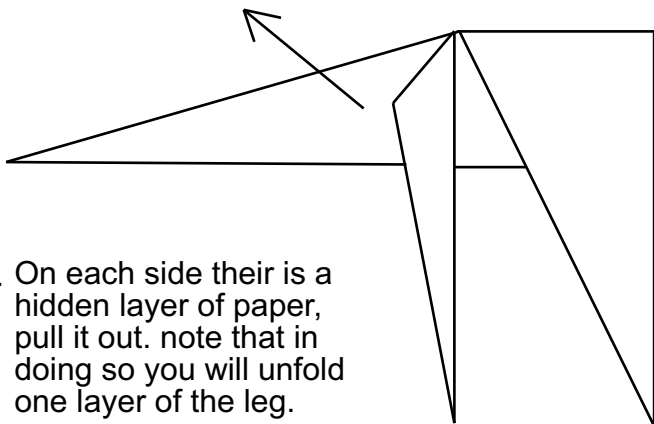

10. On each side there is a hidden layer of paper, pull it out. note that in doing so you will unfold one layer of the leg.

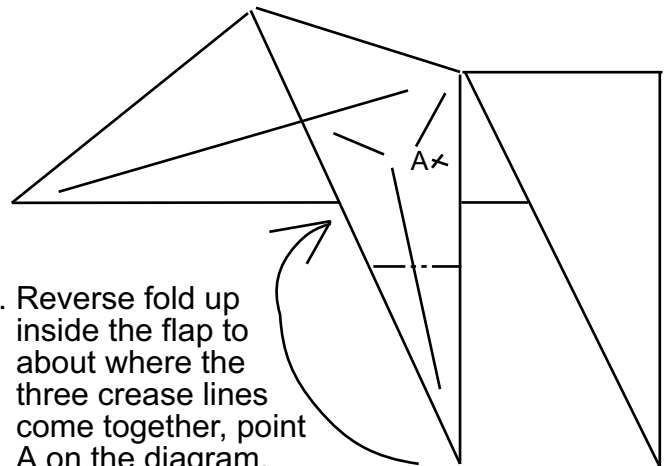

11. Reverse fold up inside the flap to about where the three crease lines come together, point A on the diagram. Repeat on other side.

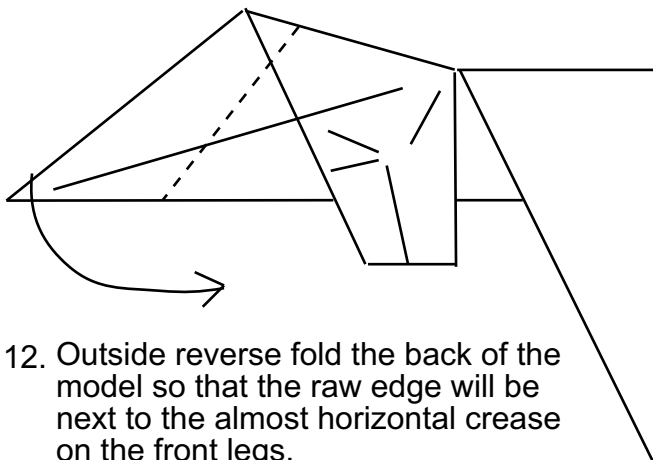

12. Outside reverse fold the back of the model so that the raw edge will be next to the almost horizontal crease on the front legs.

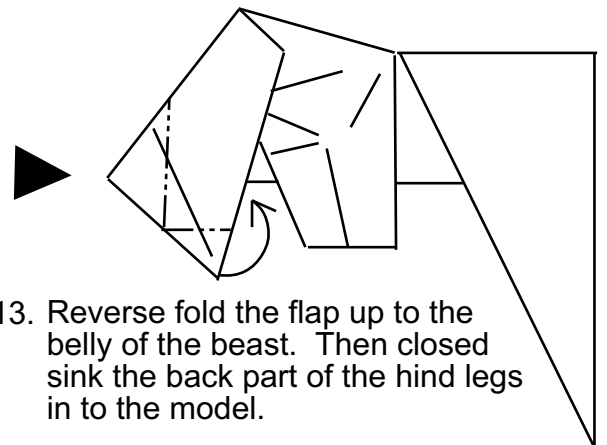

13. Reverse fold the flap up to the belly of the beast. Then closed sink the back part of the hind legs in to the model.

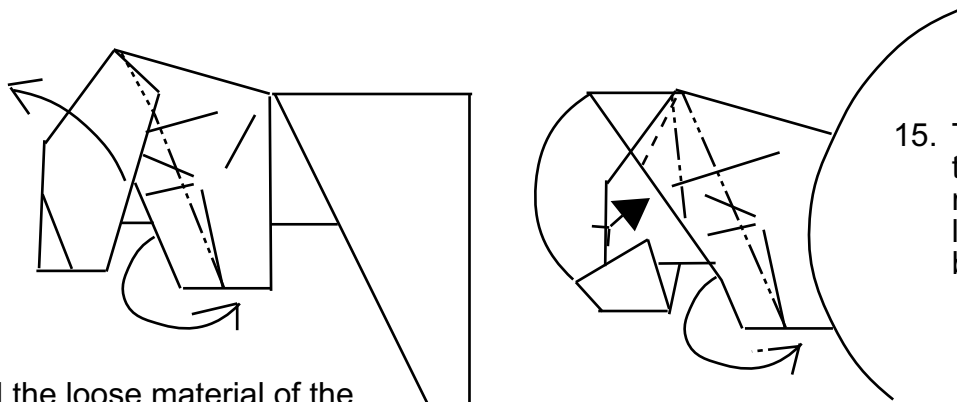

15. This allows us to thin down the front legs so that they match up better with the back legs. While keeping the back legs on the top layer.

14. Fold the loose material of the front legs behind the leg, and insert the bottom edge into the pocket formed by the reverse fold made in folding up the legs. Note when you do this you will also have to make 2 more minor folds not shown as they are under the rear flap, so lift the rear flap up out of your way. To see these folds look at the next diagram.

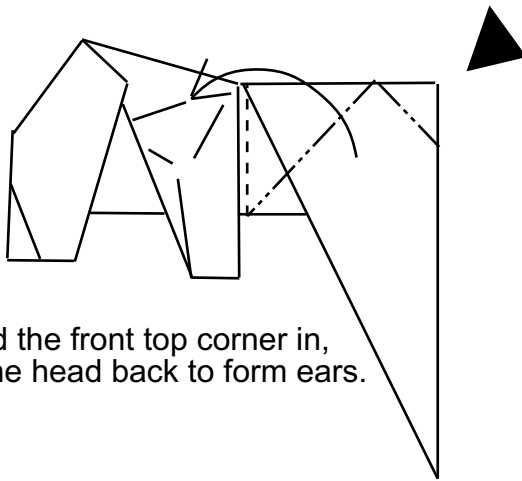

16. Reverse fold the front top corner in, then pleat the head back to form ears.

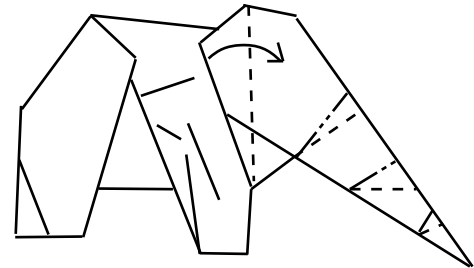

17. Reverse fold the top of the head inwards, then pleat the head back to form the ears then pleat the trunk upwards three times.

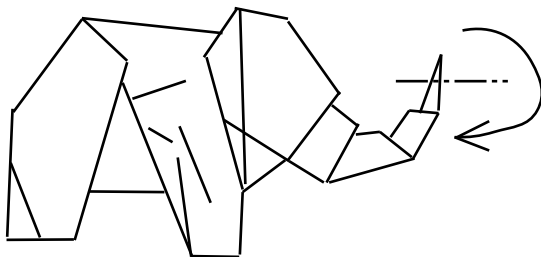

18. This is the final step, reverse fold the tip of the trunk in.

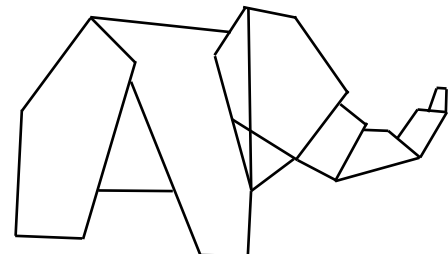

The finished elephant!  
I like making him out of foil best, but any paper will do!

# **BABY ELEPHANT WITH THREE LEGS**

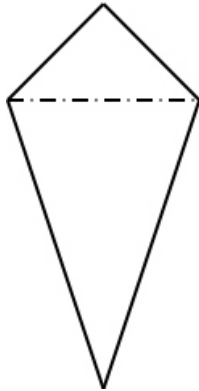

1. Start with a bird base. Sink.



2. Reverse-folds.

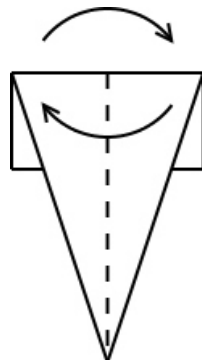

3. Fold one layer to the left unfolding step 2. Repeat behind. Repeat step 2.

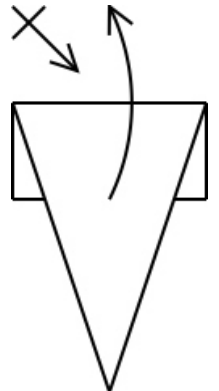

4. Pull up. Repeat behind.

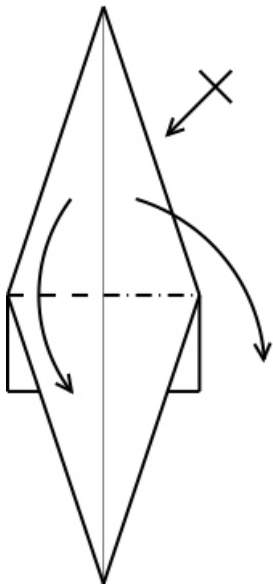

5. Pull down while opening the flap on the right. Repeat behind.

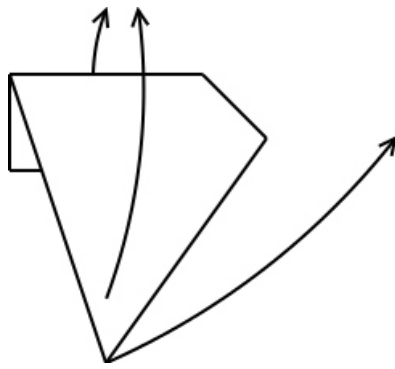

6. Open.

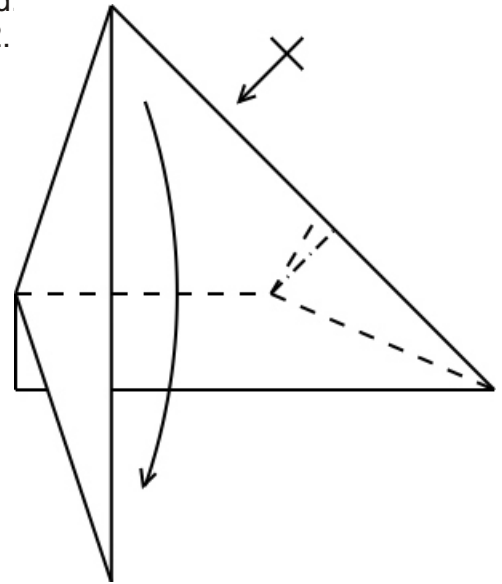

7. Fold down. A new crease will appear. Repeat behind.

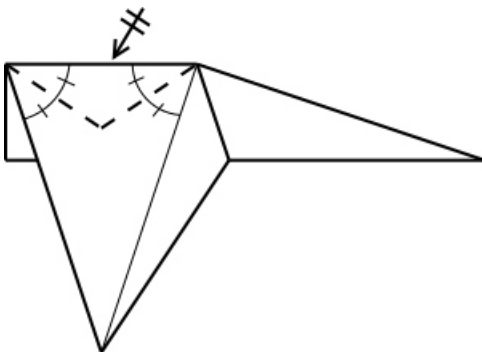

8. Crease bisectors. Repeat behind.

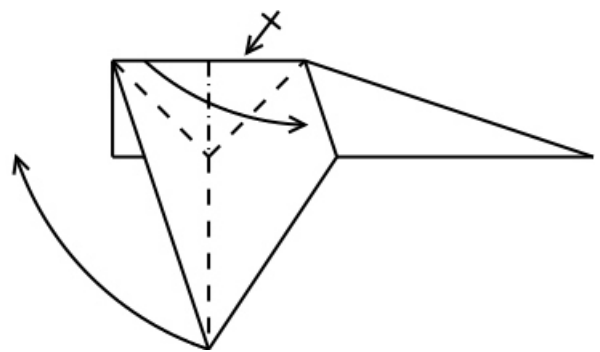

9. Fold to the right while pulling the inner layer up.



# BABY ELEPHANT WITH THREE LEGS

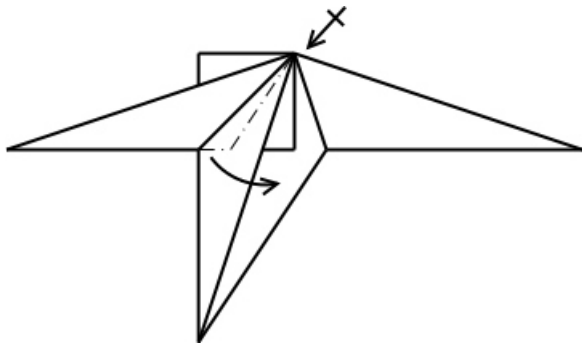

10.  
Gently pull the leg back using the creases made in step 8. A new crease will be necessary in the back leg.  
Repeat behind.

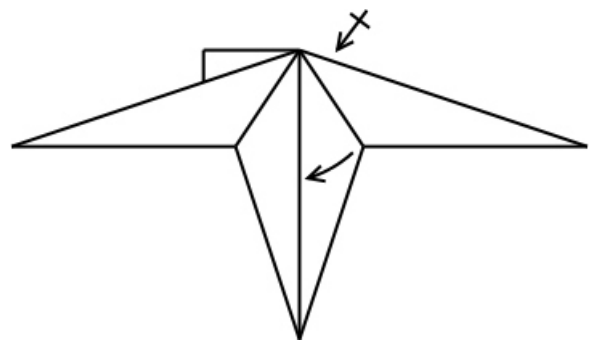

11.  
Inside reverse-fold to perform the leg.  
Repeat behind.

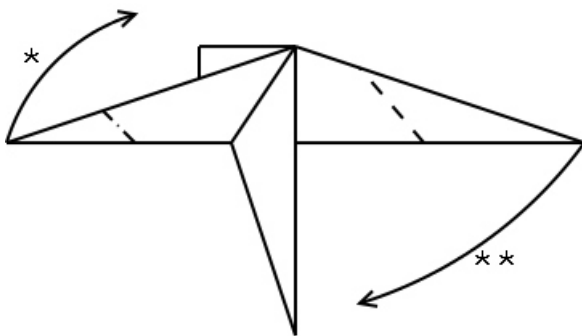

12.  
\* Inside reverse-fold.  
\*\* Outside reverse-fold.

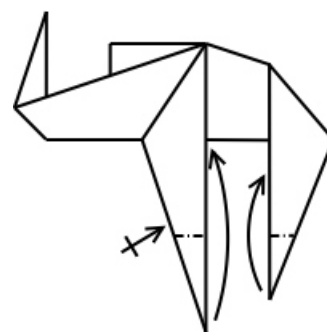

13.  
Inside reverse-fold the three legs.

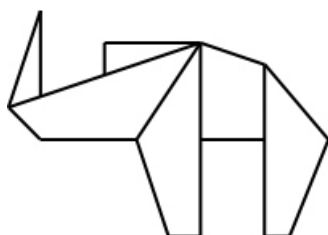

14.  
Done!  
Baby elephant with three legs.

# \$Elephant

Copyright 2000 Stephen Hecht. All Rights Reserved

A dollar bill makes a model 55mm x 35mm. For your first attempt, begin with a 3x7 rectangle larger than a dollar bill.

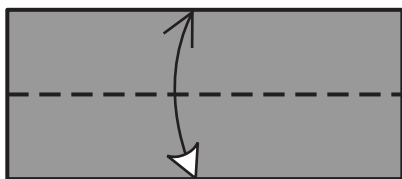

1. Black side up (for green model). Valley-fold in half and unfold.

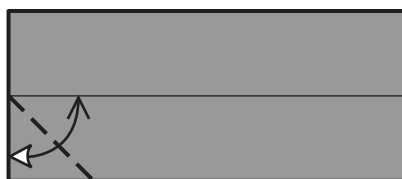

2. Softly valley-fold to center line; crease sharply where it hits the bottom edge. Unfold and turn over top-to-bottom.

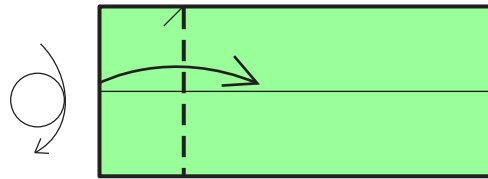

3. Valley-fold at mark just made.

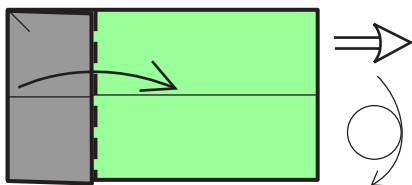

4. Valley-fold. Then unfold model and turn over, top-to-bottom.

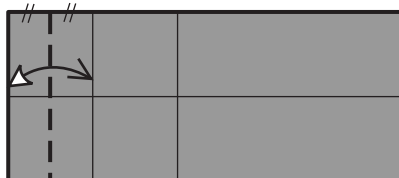

5. Fold and unfold.

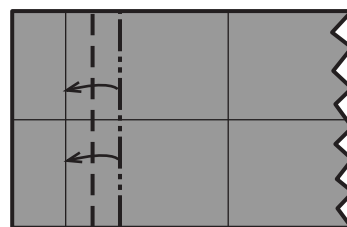

6. Pleat. Mountain-fold is the existing crease.

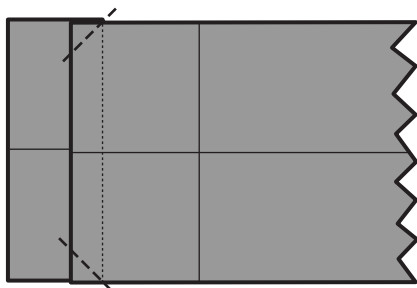

7. Valley to hidden edge and unfold.

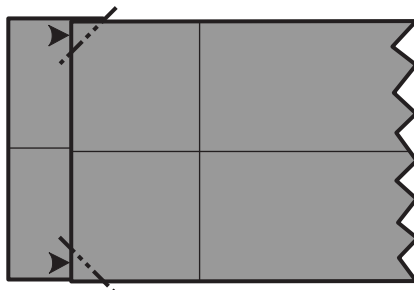

8. Reverse-fold on previous crease.

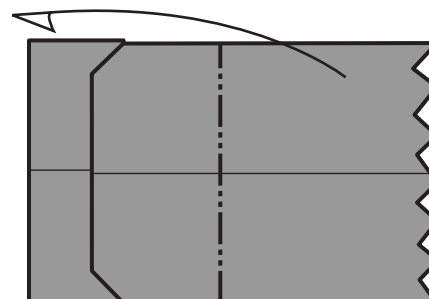

9. Mountain-fold on existing crease.

# \$Elephant (continued)

Copyright 2000 Stephen Hecht. All Rights Reserved

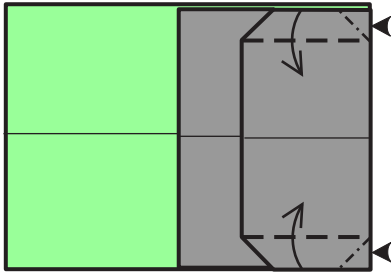

10. Squash right corner. Valley-fold is horizontal. Repeat above.

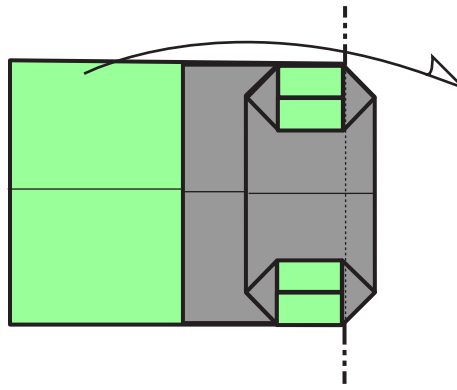

11. Mountain-fold the large rear flap.

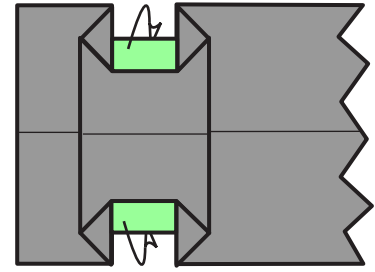

12. Swing small flaps around to the back.

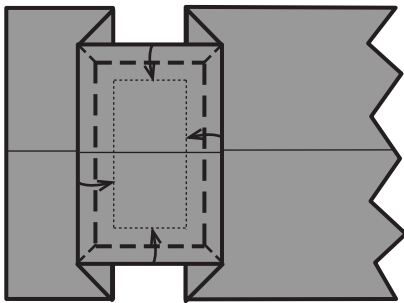

13. Valley-fold to the underlying edges, forming rabbit-ears at the four corners. The vertical creases needn't be sharp.

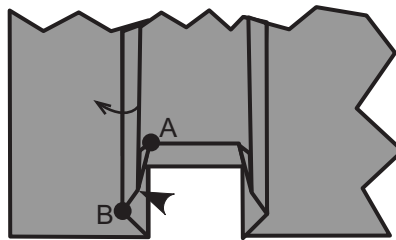

14. Detail of bottom. Hold down at points "A" and "B" while unfolding the vertical edge, and spread-squash.

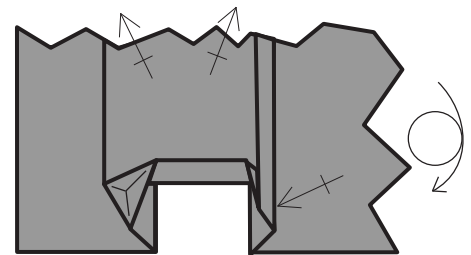

15. Like so. Repeat 3 times. Turn over top-to-bottom.

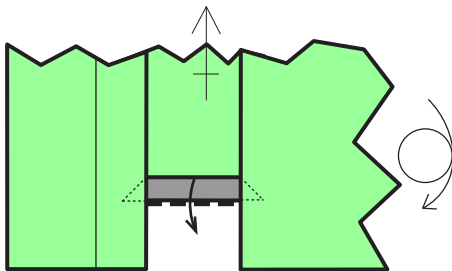

16. Fold down the nested flap. Repeat above. Turn over top-to-bottom.

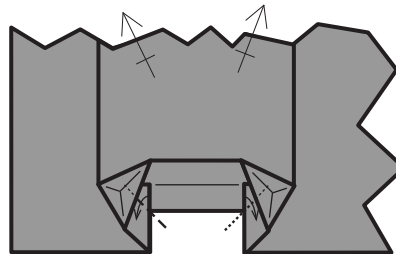

17. Valley-fold the little triangles down. Repeat twice above.

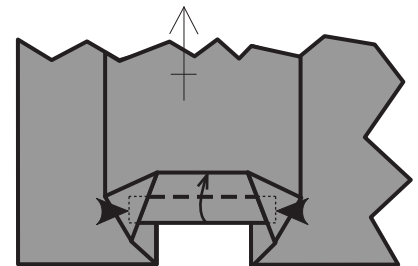

18. Valley up on existing crease, squashing hidden corners on existing creases. Repeat above.

# \$Elephant (continued)

Copyright 2000 Stephen Hecht. All Rights Reserved

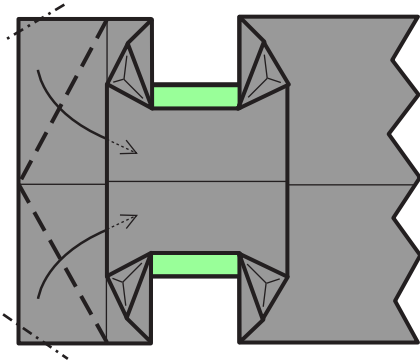

19. Valley-fold corners and tuck under. Corners are nipped a bit.

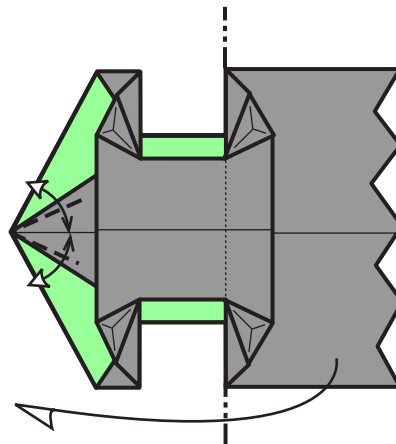

20. Valley to center line and unfold. Don't crease too far. Then swing large flap to the left.

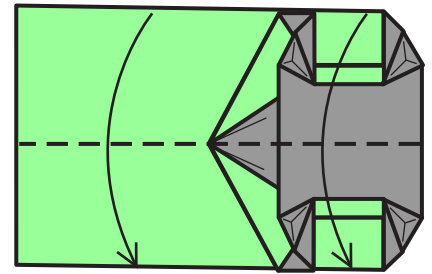

21. Fold model in half.

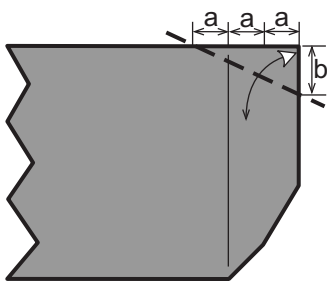

22. Right end of model: fold and unfold. Length "b" is a little bit more than length "a".

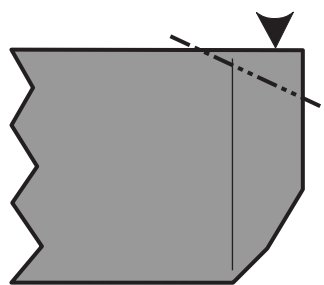

23. Reverse-fold on the crease just made.

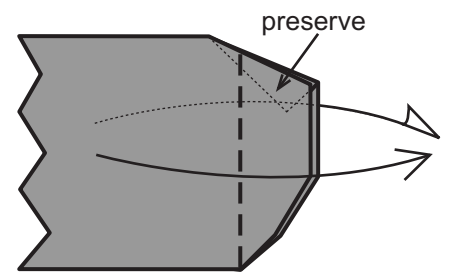

24. Outside reverse-fold large flap to the right, on the existing crease, preserving the small reverse-fold in the layers beneath.

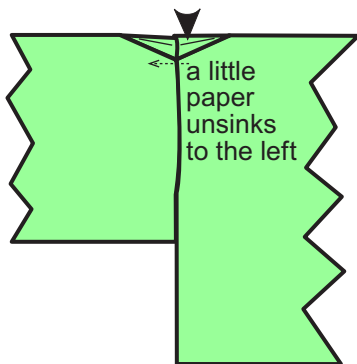

25. Enlargement of unresolved area. Push down and flatten on existing creases.

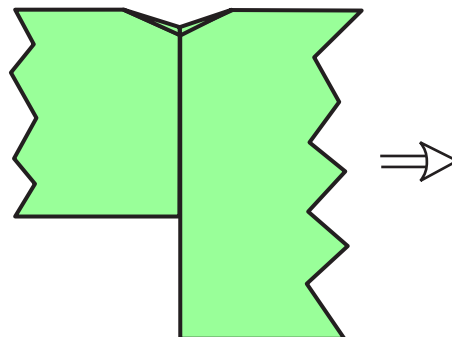

26. Model is completely flat again. Unfold to step 20.

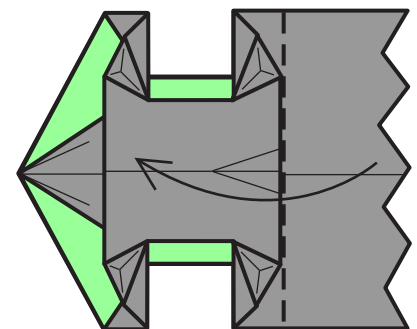

27. Valley-fold along the folded edge.

# \$Elephant (continued)

Copyright 2000 Stephen Hecht. All Rights Reserved

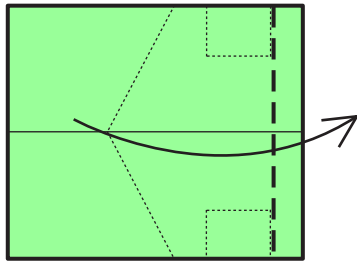

28. Valley-fold along hidden edge of the "legs". Don't crease too sharply.

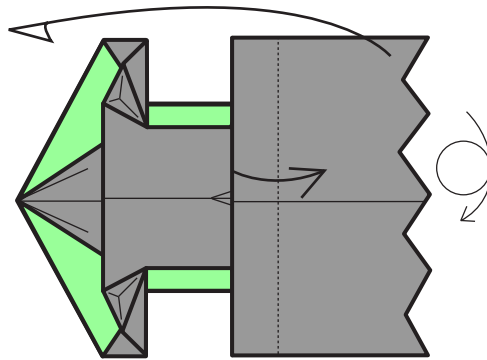

29. Swing large flap behind, undoing the valley-fold of step 27. Turn over top-to-bottom.

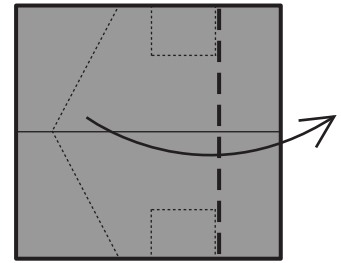

30. Valley-fold along same hidden "leg" edge as before, sharply this time.

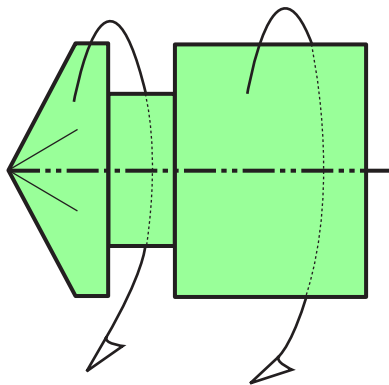

31. Mountain-fold model in half.

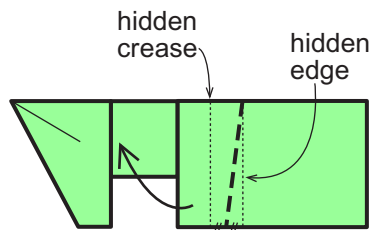

32. Pivot large rectangular flap back and up. The valley-fold is on the lowest layer of paper (on each side of the model).

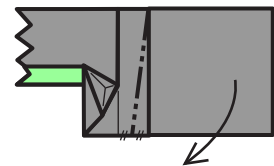

33. Inside view of rear half of model.

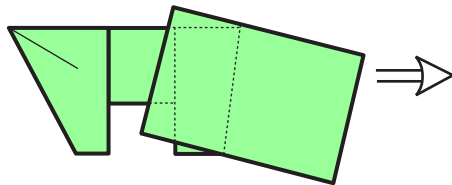

34. Like so. Unfold again to step 20.

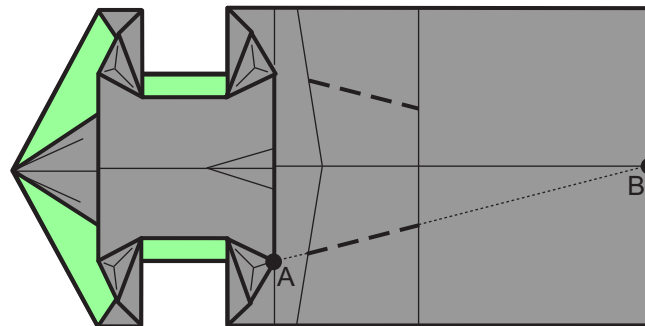

35. Valley-fold along the lines connecting points "A" and "B", sharply only between the vertical creases indicated. Repeat above.

Technique:  
 1. make soft mountain-fold between A and B, sharpen between vertical creases;  
 2. convert to sharp valley-crease;  
 3. use it to locate the other valley. (even easier: mark with a ruler!)

# \$Elephant (continued)

Copyright 2000 Stephen Hecht. All Rights Reserved

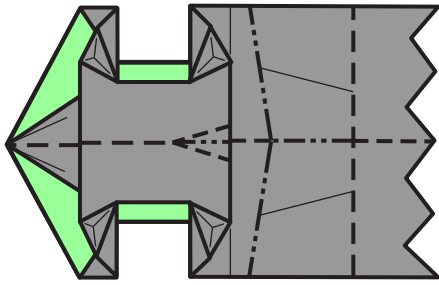

36. Refold to step 34, also reforming the "shoulder divot" made in steps 22 to 26.

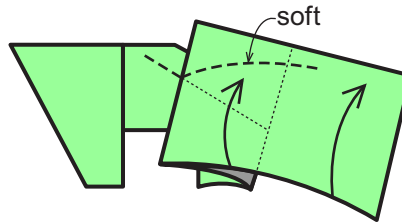

37. Lift top layer, valley-folding the middle layer on the crease made in step 35. Paper will stretch and model will not be flat.

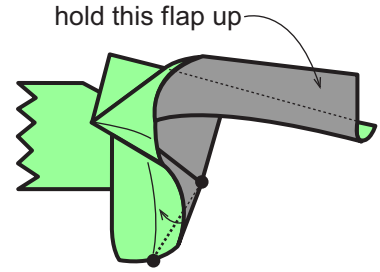

38. Rear half of model not shown. Begin to squash by pressing a valley-fold between the points shown.

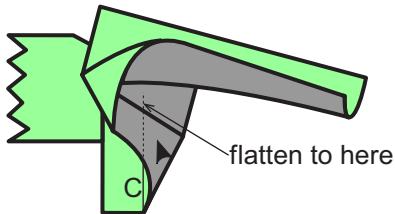

39. Flatten where shown from right to left, stopping at the hidden vertical crease "C".

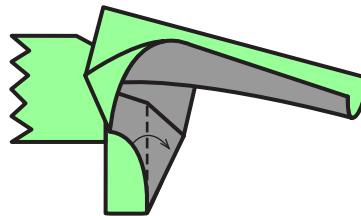

40. Valley-fold the lower standing flap to the right along that same vertical crease.

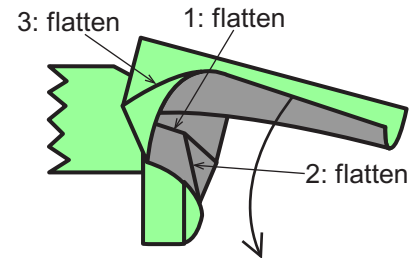

41. Flatten three edges in the order shown, closing up the model.

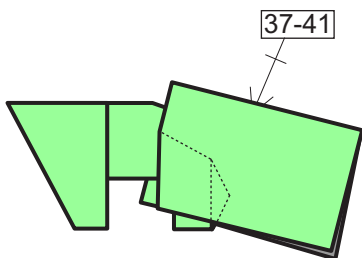

42. Entire model shown. Repeat 37-41 on far side. Try to keep model symmetric.

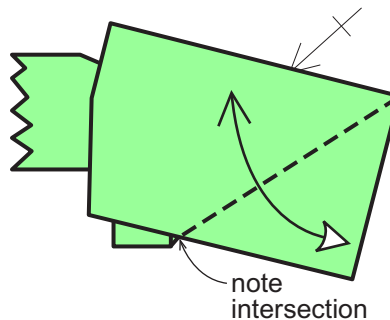

43. Valley fold and unfold, corner to intersection shown. Repeat behind.

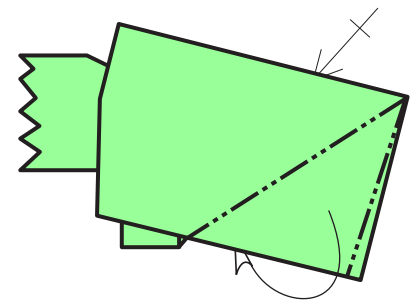

44. Mountain-fold on same crease. If necessary to make it fit inside, fold a little of the edge. Repeat behind.

# \$Elephant (continued)

Copyright 2000 Stephen Hecht. All Rights Reserved

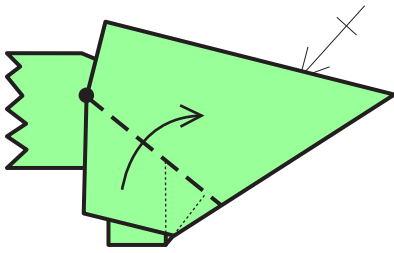

45. Valley-fold. Left end is at the corner shown. Right end is as far as possible without stretching/tearing the paper. Repeat behind.

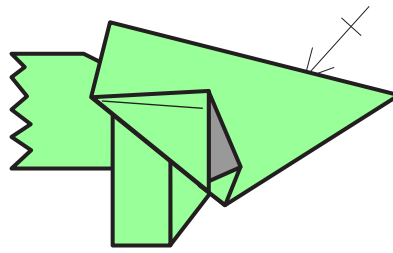

46. Unfold. Repeat behind.

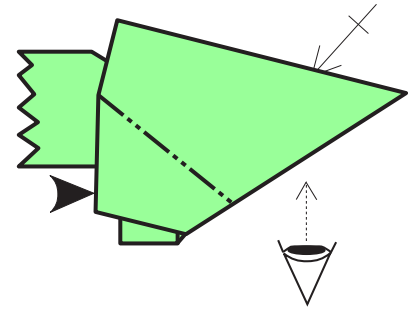

47. Reverse-fold (symmetrically) on the crease just made. Repeat behind. Then spread apart sides a bit.

easier to form mountain-folds while tucking in

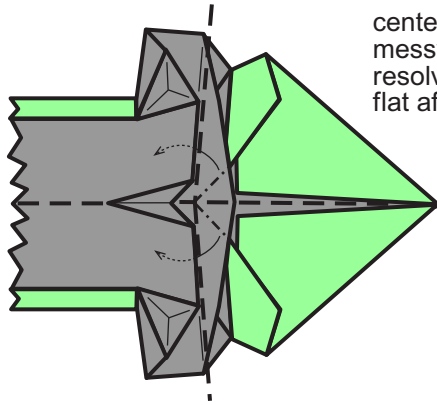

center of crimp is messy from tension; resolve by pressing flat after closing up

48. Crimp the narrow flap and tuck it inside the legs: do top half; undo it; do bottom half; close model while re-doing top half.

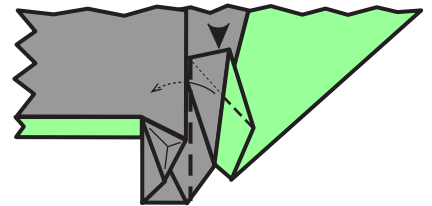

49. Inside view of rear half: squash and tuck into leg. Repeat on near side.

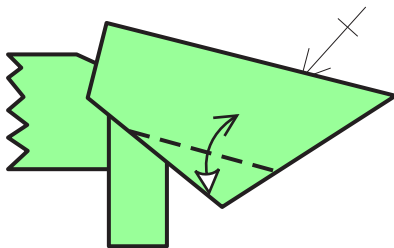

50. Side view: valley-fold and unfold along the underlying raw edge. Repeat behind.

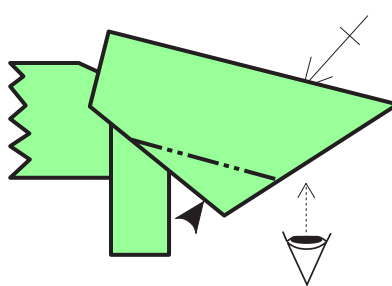

51. Reverse-fold along the crease just made. Repeat behind. Then spread apart sides a bit.

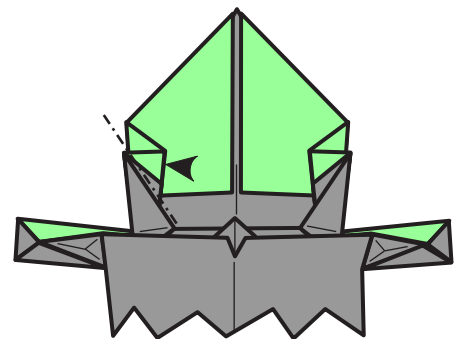

52. Reverse-fold the tusk symmetrically; the result will not lie flat. It helps to pre-crease first.

# \$Elephant (continued)

Copyright 2000 Stephen Hecht. All Rights Reserved

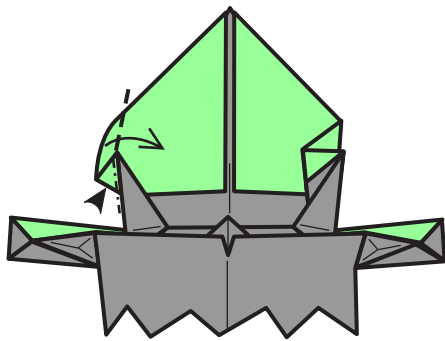

53. Reverse-fold and flatten. You may need to slightly adjust the previous reverse-fold to get a clean tusk.

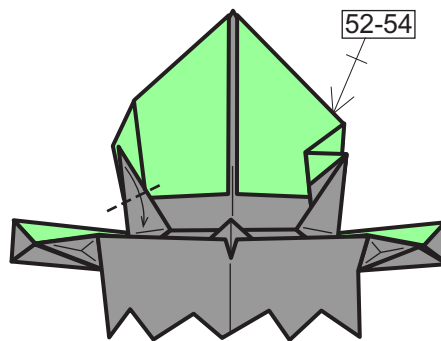

54. Fold down the tusk where naturally limited. Repeat 52-54 on the right. Close up the model.

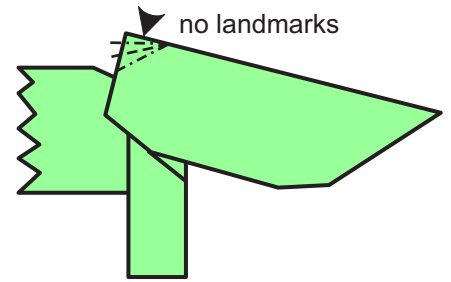

55. Side view: reverse-fold 3 times to shape the back of the ears.

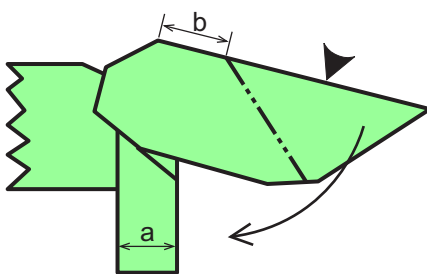

56. Reverse-fold (pre-crease first). Length "b" is slightly longer than length "a". The reversed edge becomes vertical.

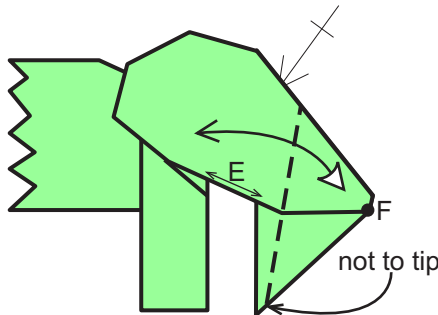

57. Valley-fold one layer. Point "F" will lie on edge "E". Repeat behind. Unfold.

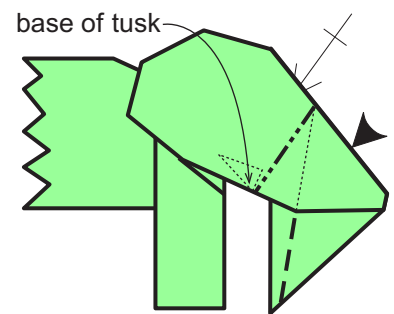

58. Reverse-fold. Valley on the crease just made. Repeat behind.

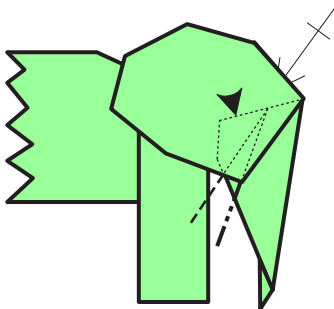

59. Reverse-fold back out. The tusk should be "released". Repeat behind.

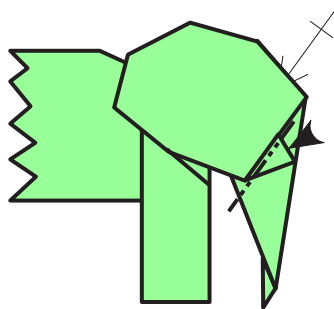

60. Reverse-fold back in again. Repeat behind.

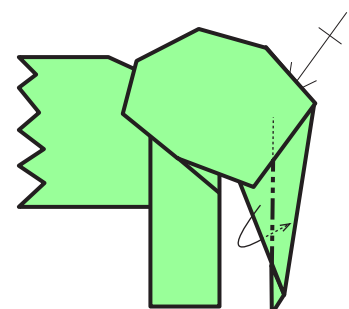

61. Mountain-fold and tuck inside trunk. Repeat behind.



# \$Elephant (continued)

Copyright 2000 Stephen Hecht. All Rights Reserved

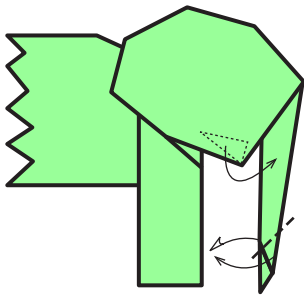

62. Outside reverse-fold the trunk. Pull out the tusks. Because of some judgement folds, they may need some forcing.

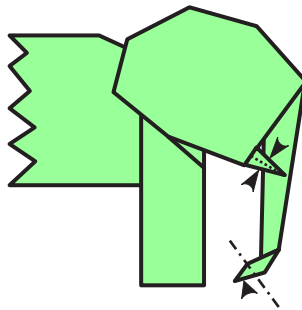

63. Pinch and curve the tusks. Reverse-fold the tip of the trunk.

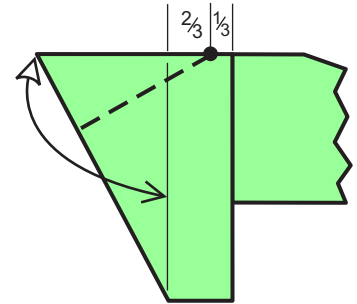

64. Tail and hind legs: pivot at point shown, bring corner to vertical crease. Unfold.

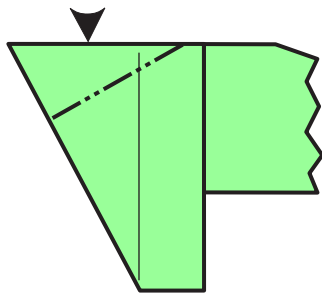

65. Reverse-fold on the crease just made. Distribute the layers symmetrically.

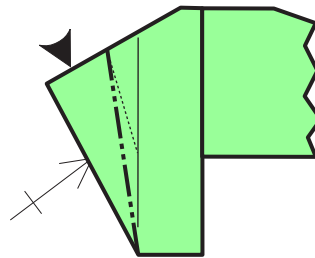

66. Reverse-fold. Rear half is on the crease made in step 20. Crease the front half softly. Repeat behind.

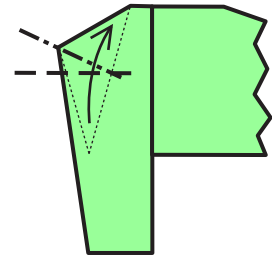

67. Inside-crimp the tail upwards.

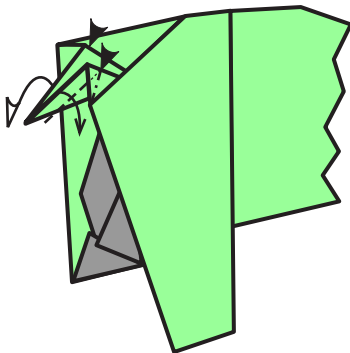

68. Outside reverse-fold the tail, while making two tiny reverse-folds where shown.

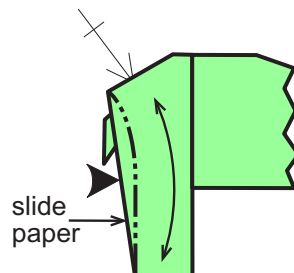

69. Push in the backs of the legs. Bow the legs a little bit.

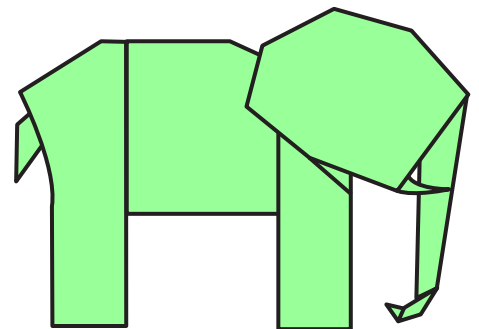

70. Finished elephant.

# envelope

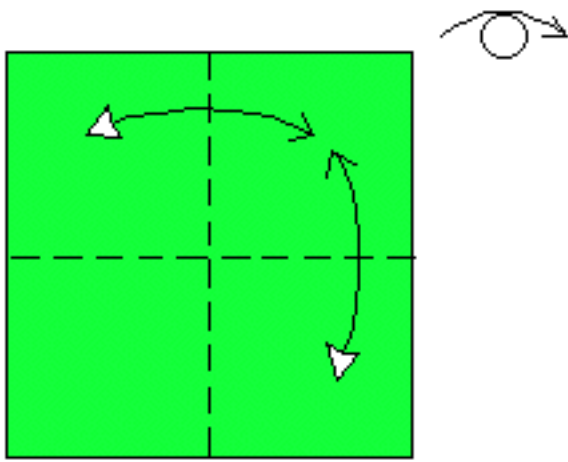

- 1** Start with the dark side up. Fold and unfold. Turn the paper over.

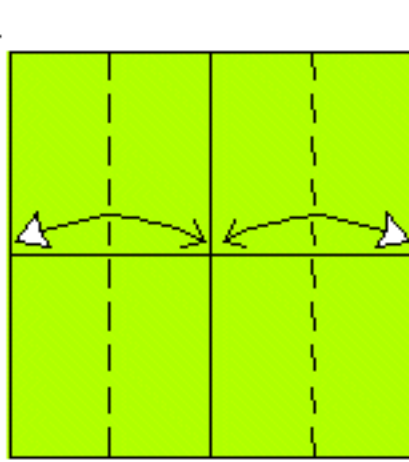

- 2** Fold and unfold.

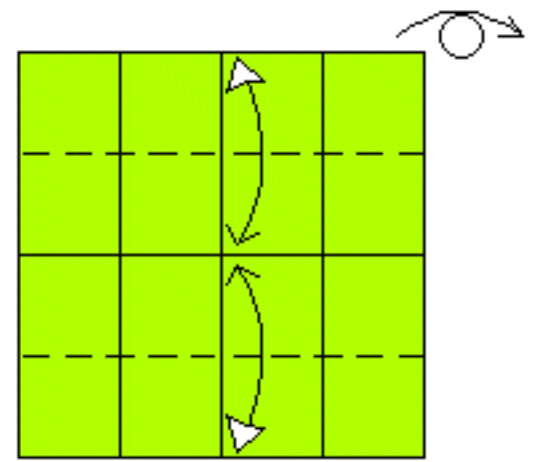

- 3** Fold and unfold. Turn the paper over.

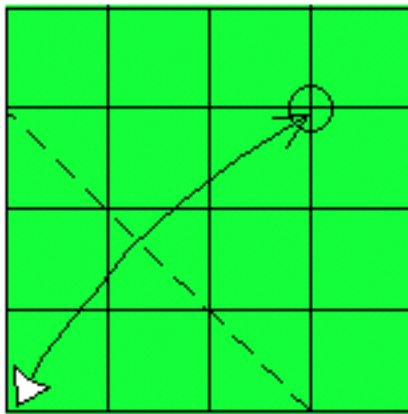

- 4** Fold and unfold as indicated. Repeat on the other three corners.

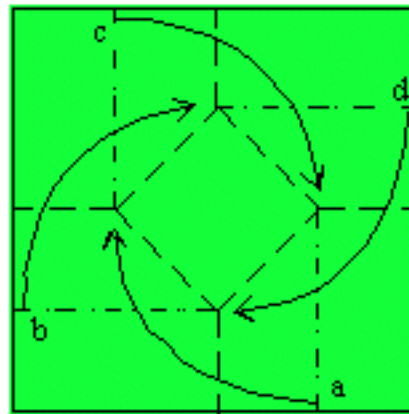

- 5** Collapse on existing creases. The mountain folds **a**, **b**, **c** and **d** should move clockwise as in a spiral before pressing flat.

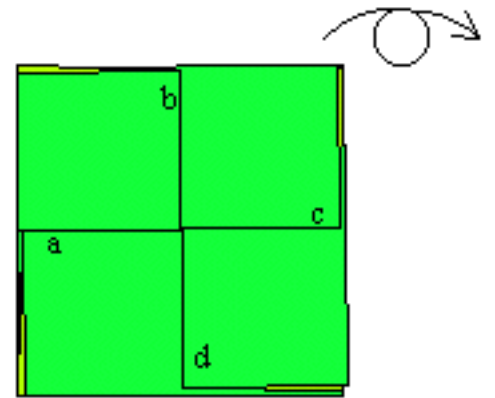

- 6** Finished twist-fold. Turn the model over.

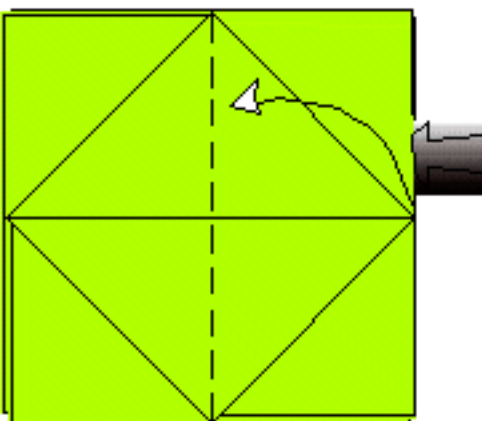

- 7** Lift one layer at the right side.

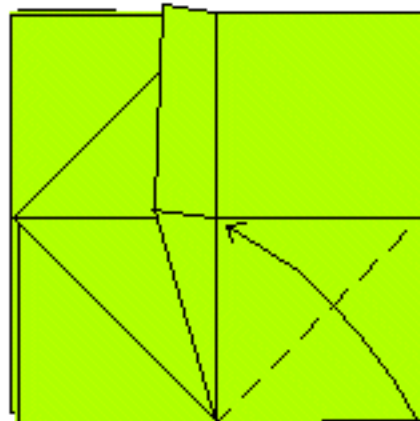

- 8** Valley-fold two layers.

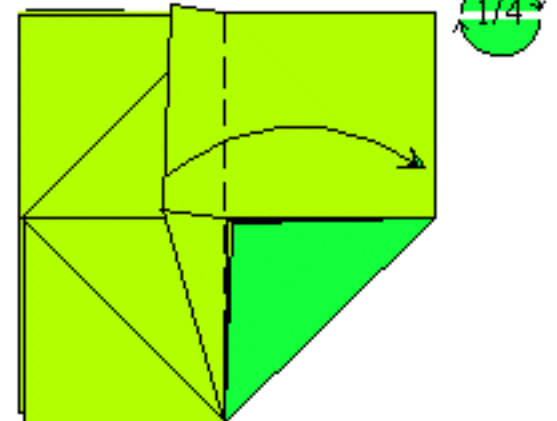

- 9** Fold the edge back. Rotate the model.

# envelope

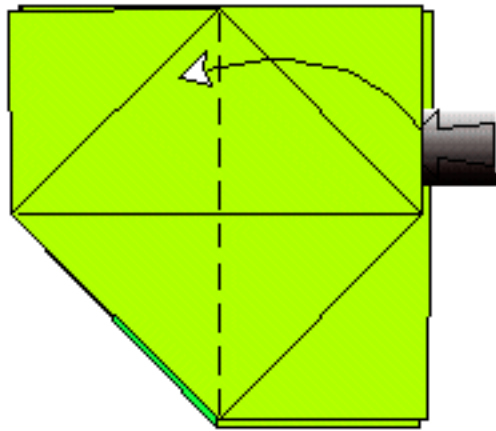

**10** Repeat steps 7-9 on the next two corners.

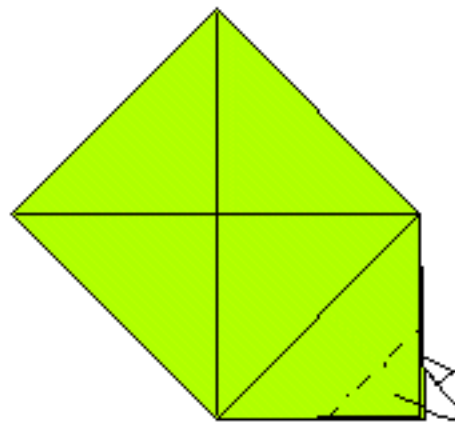

**11** Mountain-fold the last corner.

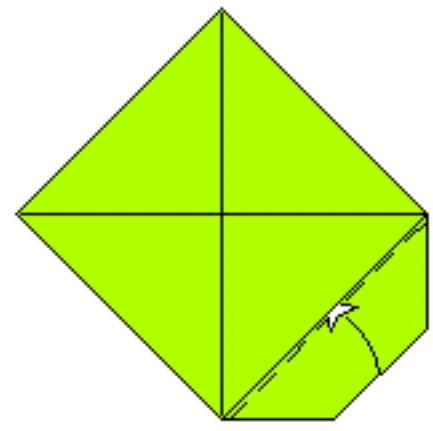

**12** Put the edge into the pocket.

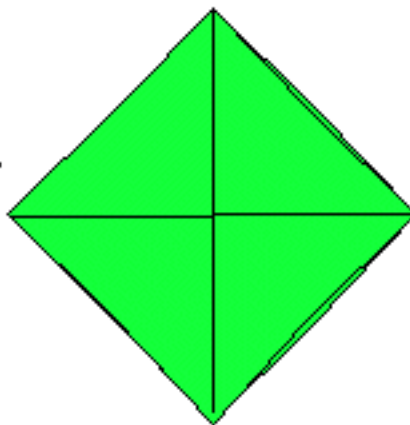
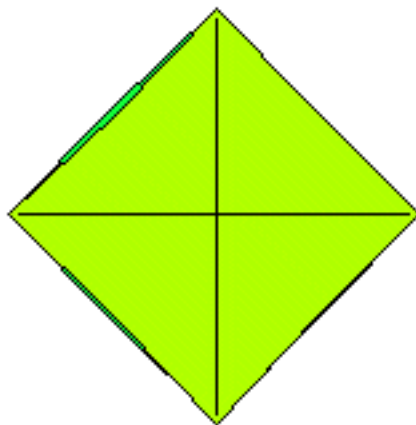

**13** Finished envelope. To open it up, find the corner from step 11 and pull out.

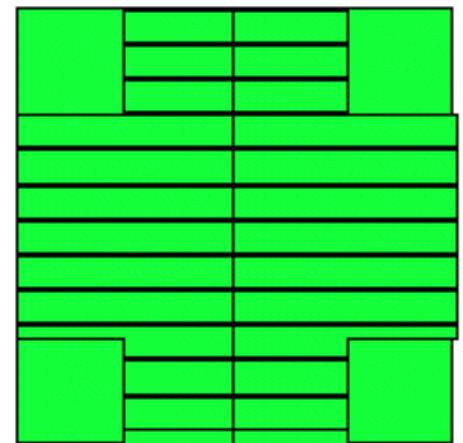

The indicated area on the dark side can be written upon.

# Fire Lizard

By Perry Bailey Copyright 1997  
Inspired by The works of  
Anne McCaffrey

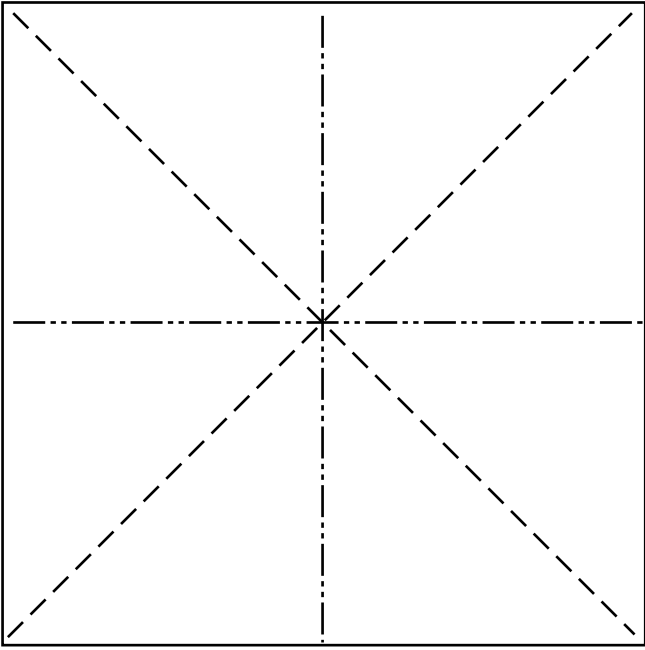

1. Colored side up.

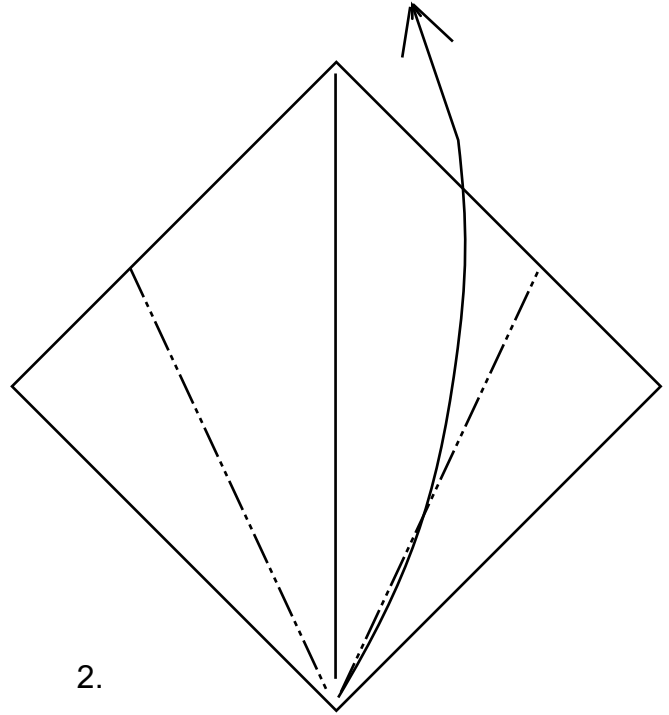

2.

As you can see this model is based on the traditional flapping bird base, and yes it will flap its wings!

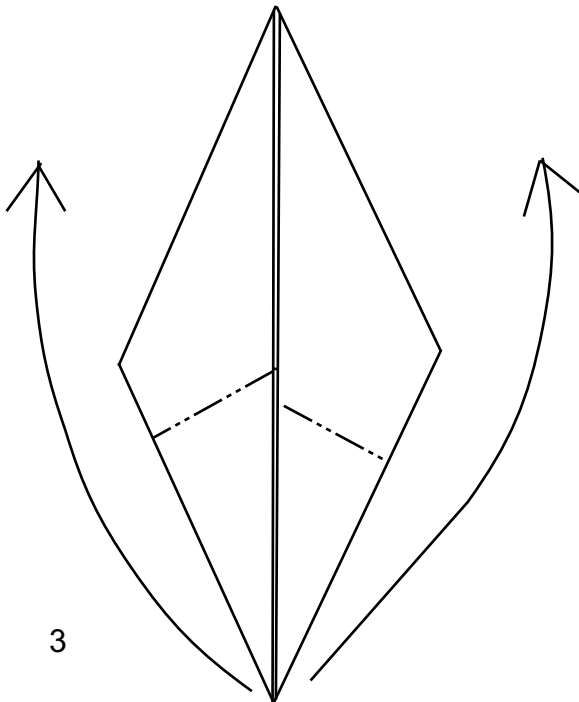

3

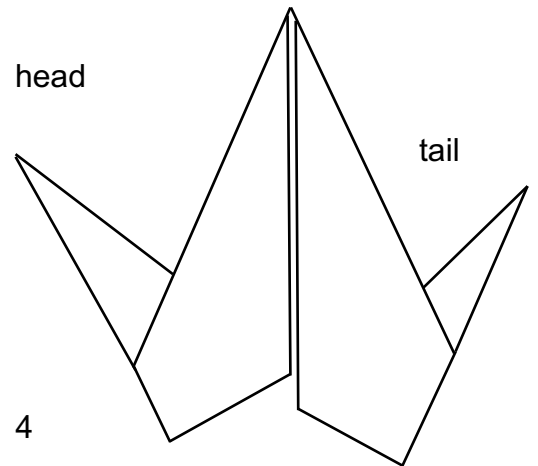

head

tail

4

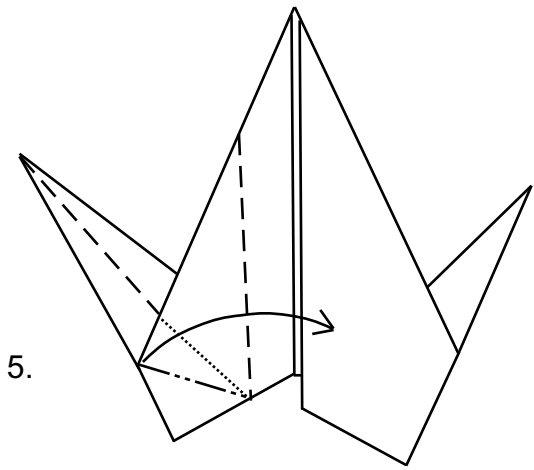

Thin the neck down by folding over the flap to the upper edge of the neck, while at the same time folding back the flap to the point where the center hump meets the edge of the wing. Repeat on the other side.

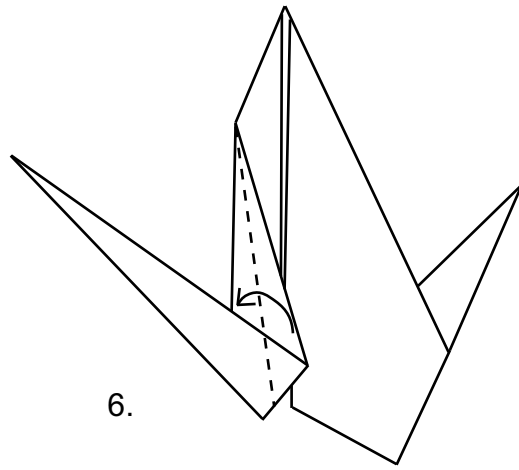

Fold over flaps on both sides to form the front legs.

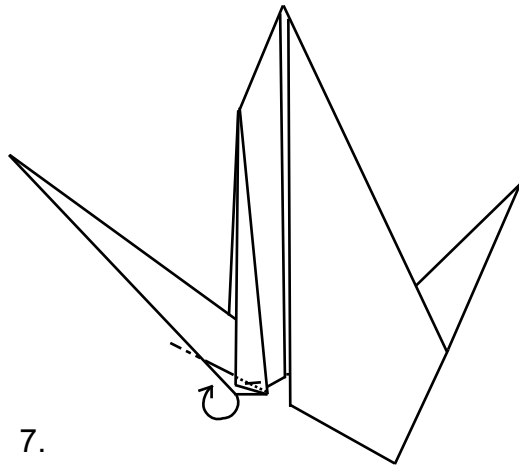

Mountain fold the base of the neck inside of itself with out folding the out side flap that makes up the front leg. Repeat on other side.

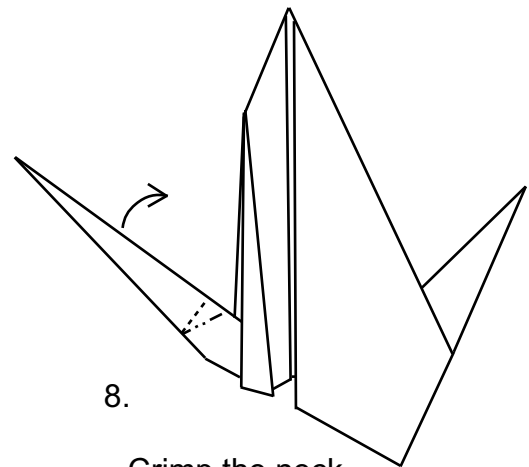

Crimp the neck back towards the wings.

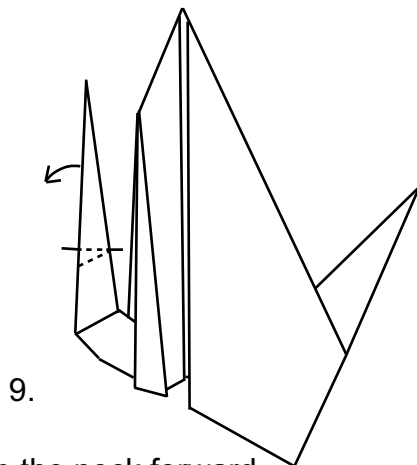

Crimp the neck forward again.

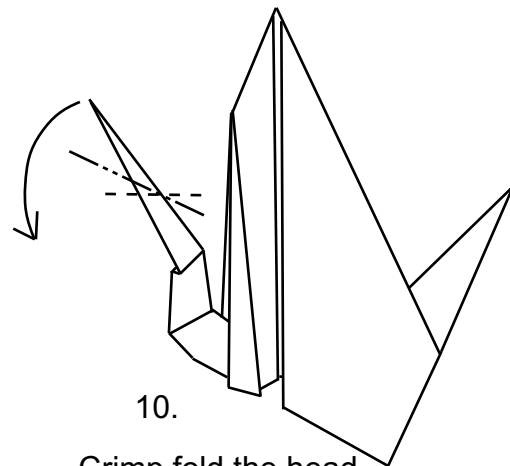

Crimp fold the head down.

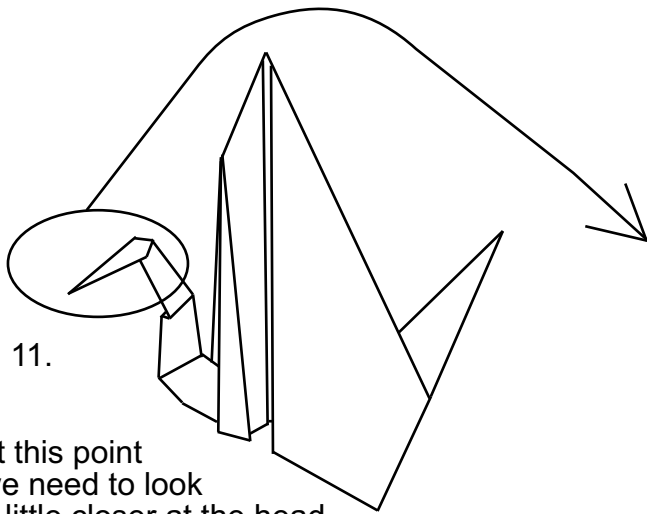

11.

at this point we need to look a little closer at the head so we will enlarge it in the next frame.

Now there is a double layer at the top of the head reach in and bring out the doubled layer on each side of the head, one side at a time. Be careful not to tear the paper at the back of the head, as you pull out the layers and bring them down. The head will not lie flat.

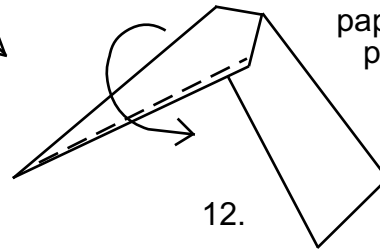

12.

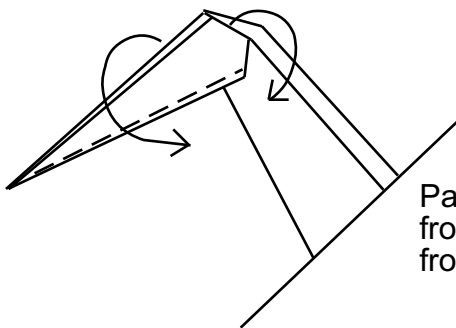

12b.

Part of the head comes from layers brought out from behind the neck.

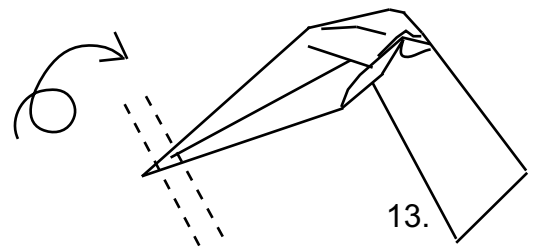

13.

the effect should be something like this, then valley fold the tip of the nose over twice to finish the head.

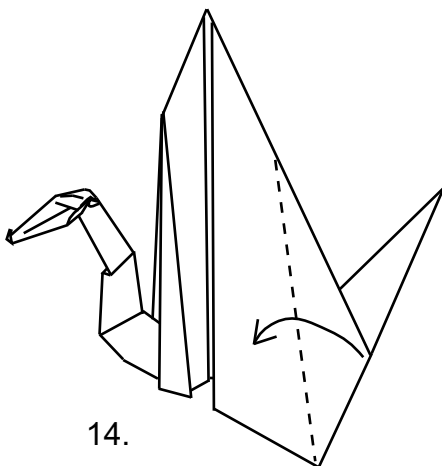

14.

14. Now fold the flap at the back of the wing over from the bottom point up towards the upper third or so of the wing, both sides.

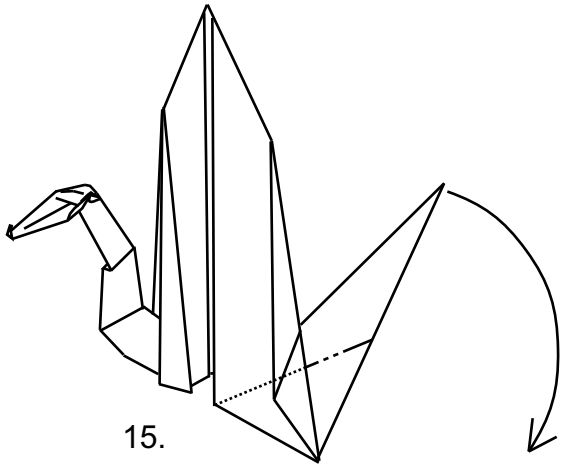

15.

Reverse fold down the tail to its base, bringing it down to about the half way mark at the back.

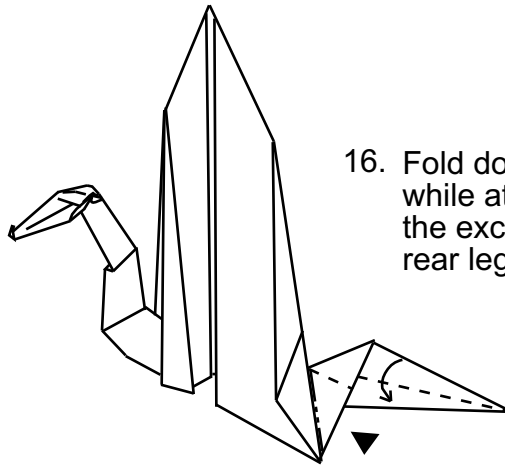

16. Fold down the tail to thin it out while at the same time folding the excess material behind the rear leg. Repeat other side.

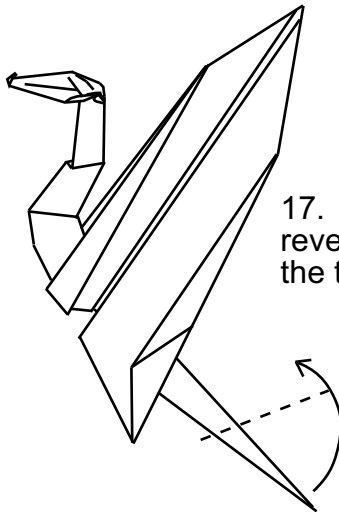

17. reverse fold the tail up.

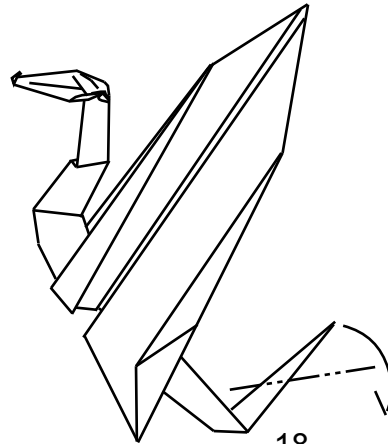

18. Do it again, but down this time.

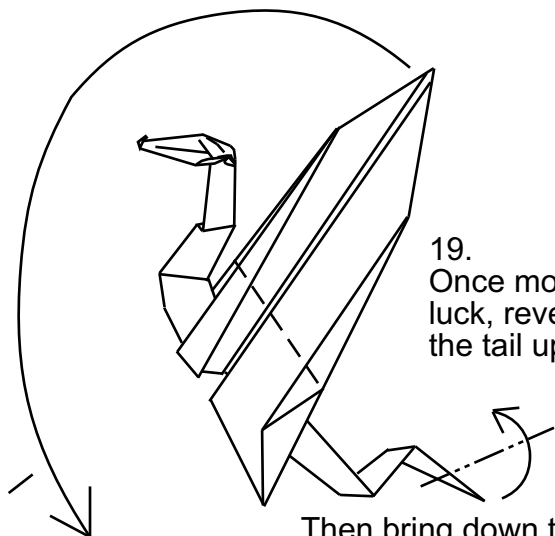

19. Once more for luck, reverse fold the tail up.

Then bring down the wings on each side as far as you can.

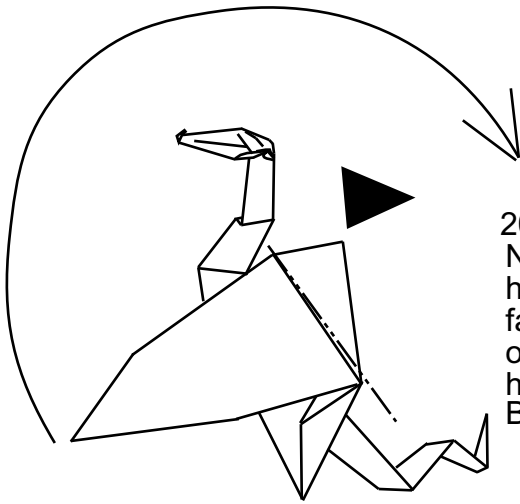

20. Now sink the center hump in a triangular fashion, with the point of the triangle at the head and tail spread apart. Bring the wings back up.

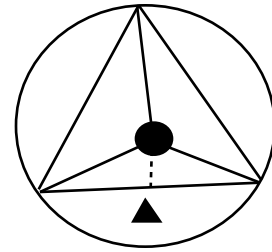

20A. Push in at the center to sink the hump then push in at back to fold sink flat.

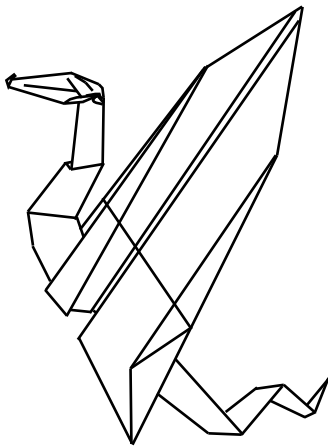

21. You should at this point be about here. The next picture will be a blow up of the wing.

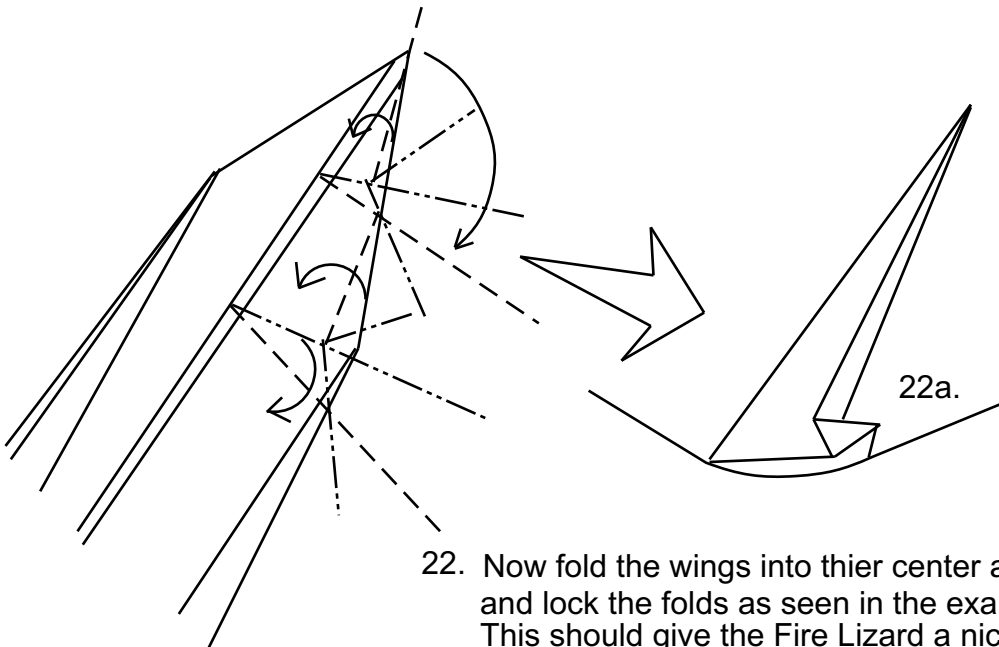

22. Now fold the wings into thier center as shown and lock the folds as seen in the example 22a. This should give the Fire Lizard a nice curve to its wings, folded properly it should be able to stand on it hind legs as shown in the finished model.

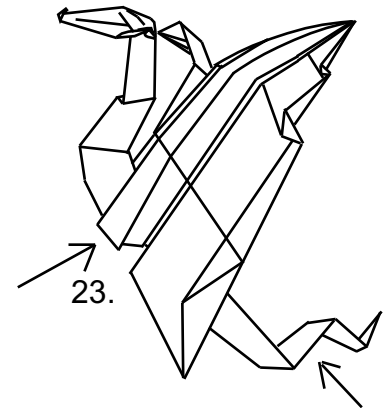

Finished. hold the front legs and pull the tail, he will flap his wings.



# \$ Flower

Copyright 1998-99 Stephen Hecht. All Rights Reserved

A dollar bill produces a model 100mm long with a bloom of 40mm diameter. The bloom is adapted from Herman Lau's Flower-in-a-Pot. That bloom can also be used here, resulting in a shorter stem and a smaller bloom diameter (but with 8 petals, not 6).

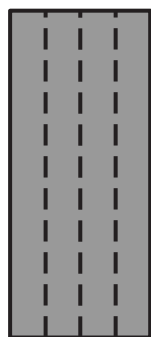

1. Valley-crease at quarters. Turn over.

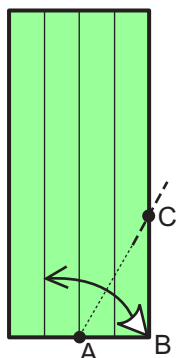

2. Pivot at A, bring B to 1/4 line, marking only at C.

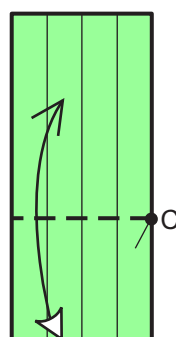

3. Valley-fold and unfold at C.

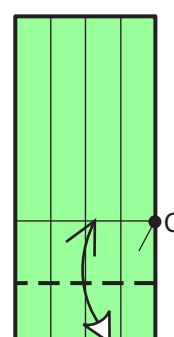

4. Valley-fold and unfold halfway to C. Turn over.

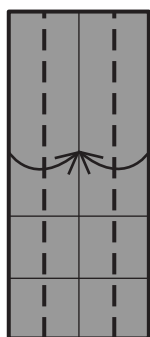

5. Swing in sides.



6. Swing up on existing crease.

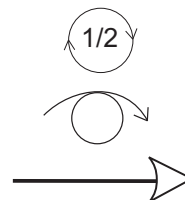

7. Valley and unfold through all layers of the upper flap. Unfold completely. Rotate half turn. Turn over.

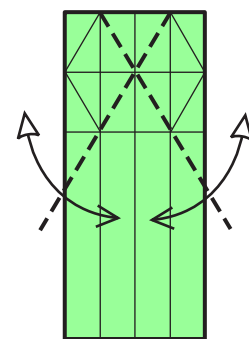

8. Valley on existing creases, extending to edges.

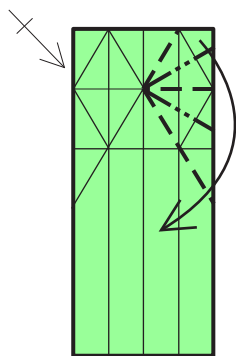

9. Use existing valley-creases to squeeze in mountain-fold angle bisectors. Repeat on left.

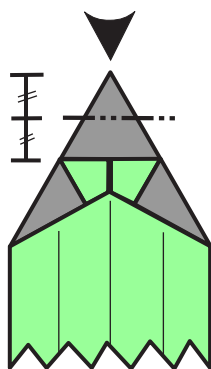

10. Sink hexagonally halfway. (Open out to find landmarks.)

Alternate method, using Lau's 8-petalled flower:  
 1. Crease at quarters.  
 2. Water-bomb base at one end.  
 3. Squash the 4 triangular flaps of the water-bomb base: two loose flaps in front, two flaps attached to the rest of the bill in back.  
 4. Octagonally sink tip halfway.

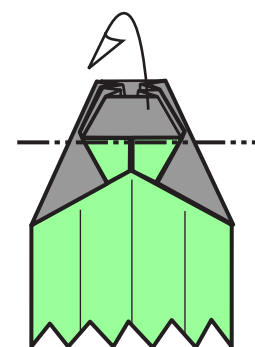

11. Mountain-fold entire top and unfold.

# \$ Flower (continued)

Copyright 1998-99 Stephen Hecht. All Rights Reserved

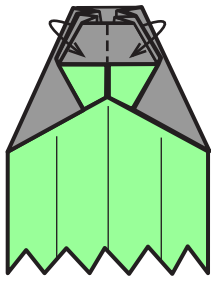

12. Gather up 4 edges perpendicularly.

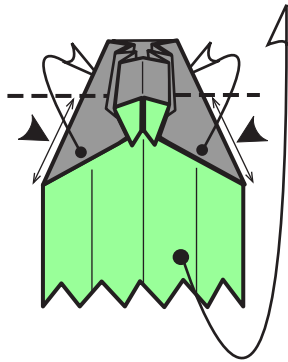

13. Wrap edges. Reverse below valley-fold (where indicated). Entire bottom of bill swings behind and up.

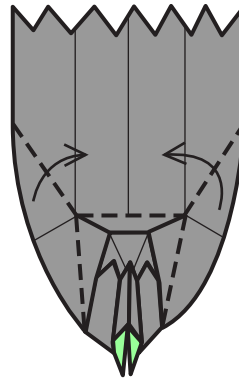

14. Continue collapsing on existing creases.

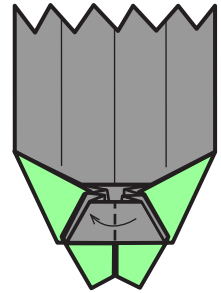

15. Note that the sunken assembly has remained fixed. Swing one flap to the left.

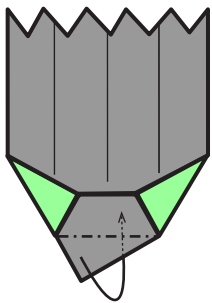

16. Mountain-fold on existing crease, tucking inside.

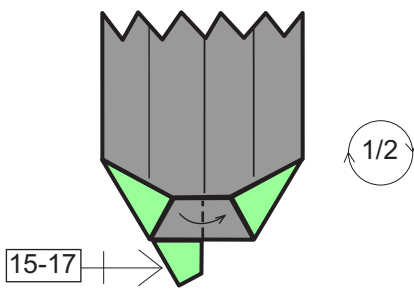

17. Swing flap back to the right. Repeat 15-17 on left. Rotate half-turn.

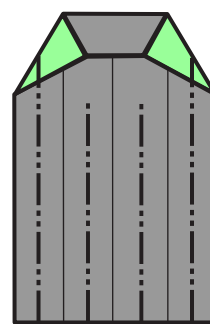

18. Add mountain-creases halfway between existing valleys. Inner ones don't have to go all the way up.

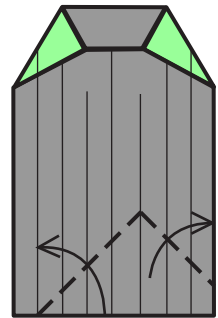

19. Crease forwards and backwards. Make the longer fold first, then use it to help locate the shorter.

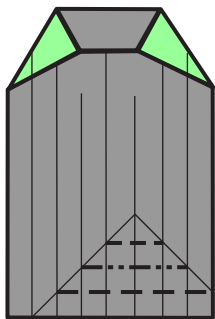

20. Add more creases. Turn over.

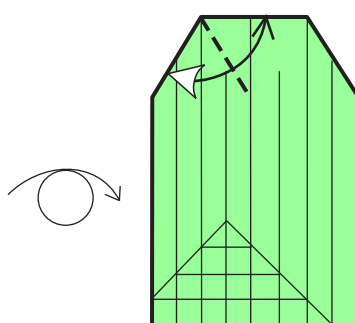

21. Crease angle-bisector, to center-line. Repeat on right.

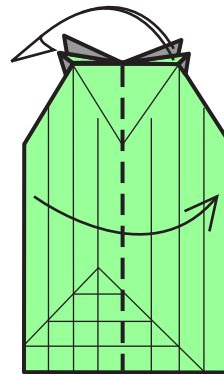

22. Fold model in half, swinging 2 small flaps to the left behind at the top.

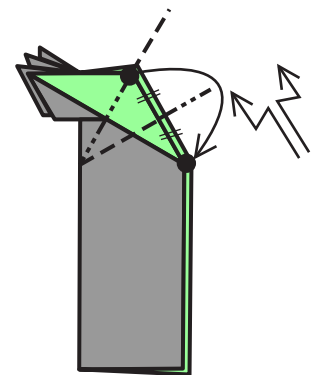

23. Outside crimp. Mountain-folds exist, valley-folds are new.

# \$ Flower (continued)

Copyright 1998-99 Stephen Hecht. All Rights Reserved

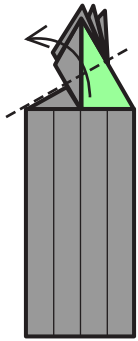

24. Lift one flap.

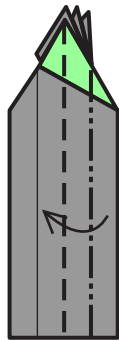

25. Pleat on existing creases.

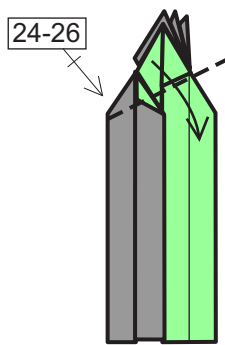

26. Swing flap back down. Repeat 24-26 behind.

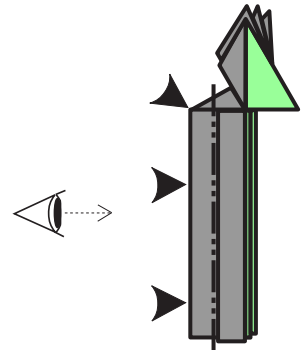

27. Sink long edge. Closed-sink and keep together at the top.

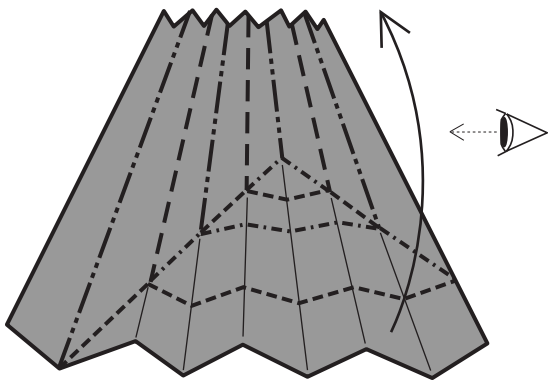

28. Spread pleats, reform creases from 18-20, Elias-stretching.

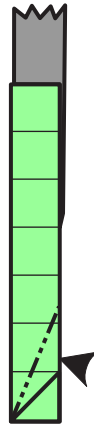

29. Closed sink upper layer on angle-bisector.

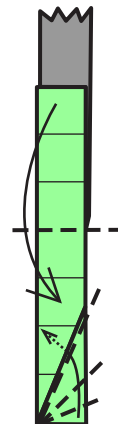

30. Roll and tuck inside sink. Swing flap down.



31. Closed-sink. Not quite an angle-bisector.

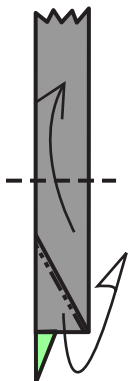

32. Mountain a single ply, flush with sink. Swing flap back up.

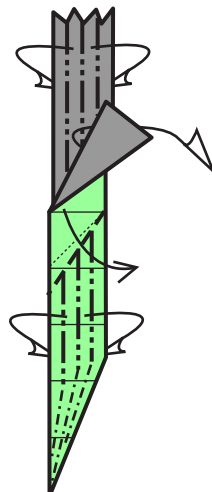

33. Outside reverse fold the leaf (valley is single-ply, mountain on dotted line). At the same time, mountain the stem in quarters, forming a tube. Where leaf joins stem, form tiny gussets to avoid tearing.

Tuck loose paper at tip of leaf inside, behind the sink from step 31. Curve and shape leaf.

Rabbit ear stem where it joins the bloom.

# \$ Flower (continued)

Copyright 1998-99 Stephen Hecht. All Rights Reserved

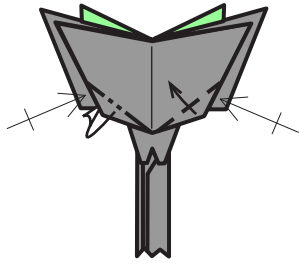

34. This is the view between the two thinnest petals. Valley and mountain the lower corners of the 4 "loose" petals, locking the base of the bloom.

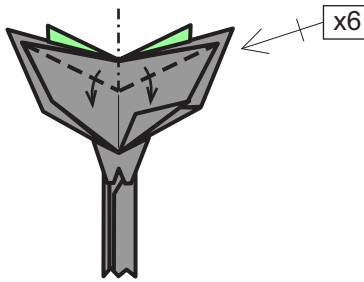

35. Reverse-fold top edges of all 6 petals (about 1/3 of the angle). Don't flatten.

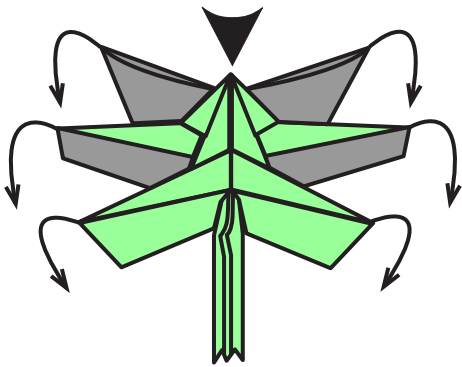

36. View from above the bloom. Pull down tips of petals, while gently flattening the center.

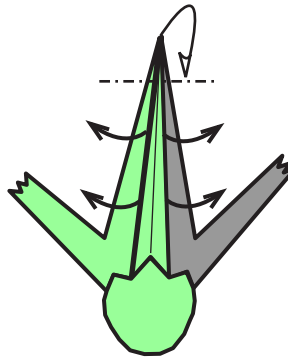

37. This is a single petal. Open and round the sides of the petal, and mountain the tip behind. Flatten the underside of the petal, especially the thick petals adjoining the stem.

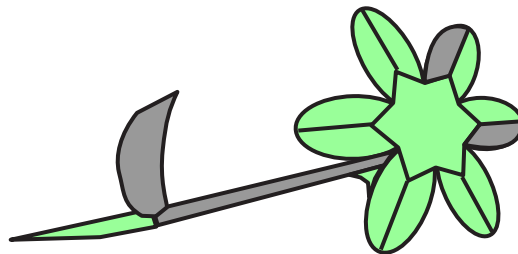

38. Finished. (Ok, so it's a generous picture, but you get the idea.)

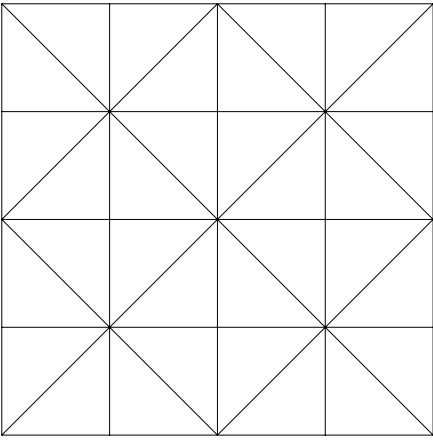

1 Precrease all lines

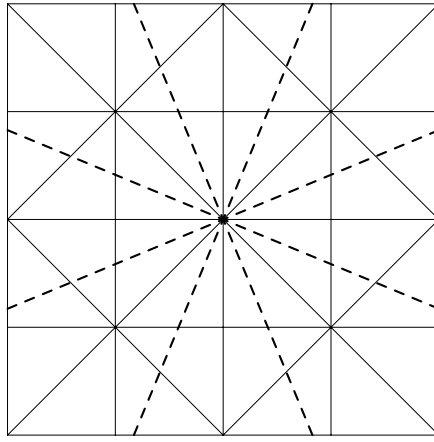

2

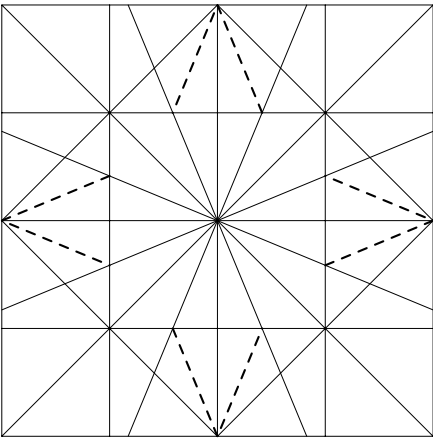

3

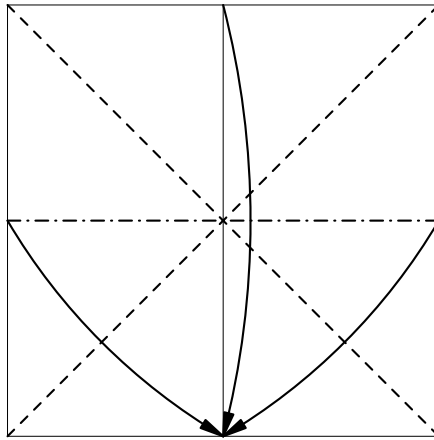

4

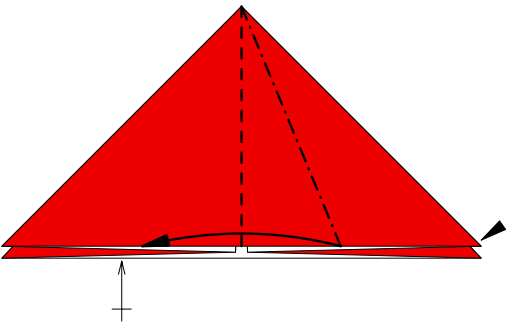

5

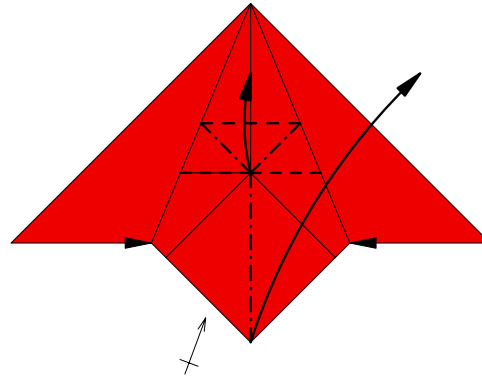

6

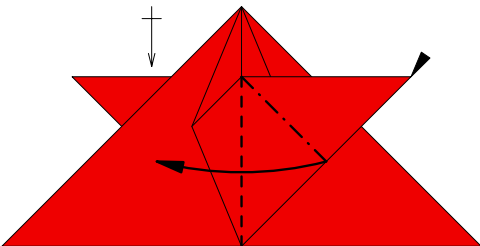

7

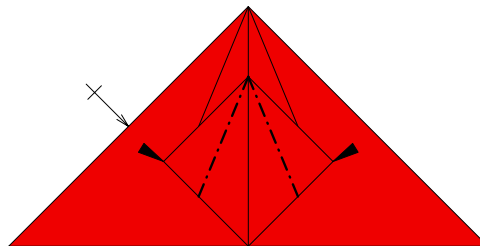

8

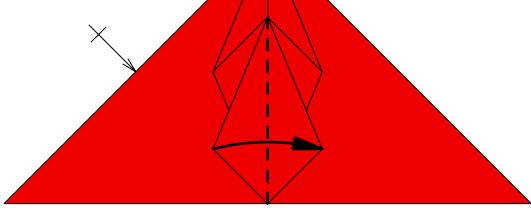

9

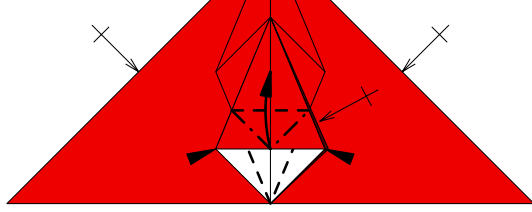

10

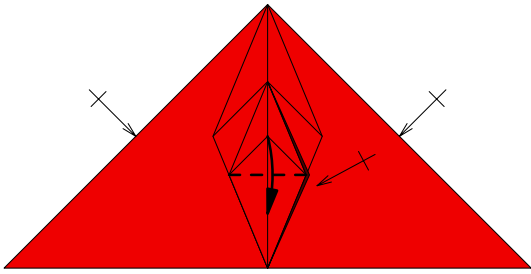

11

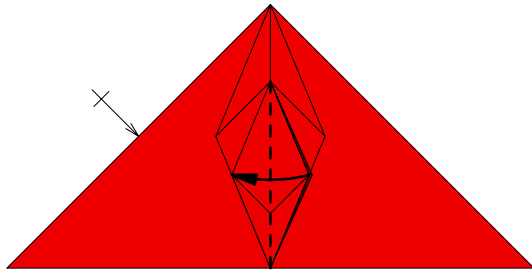

12

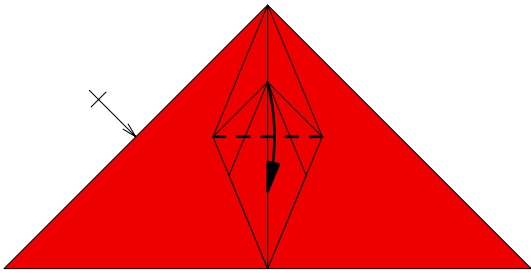

13

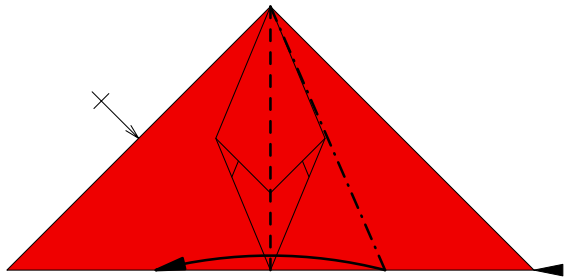

14 Repeat diagram 6-14 on other points

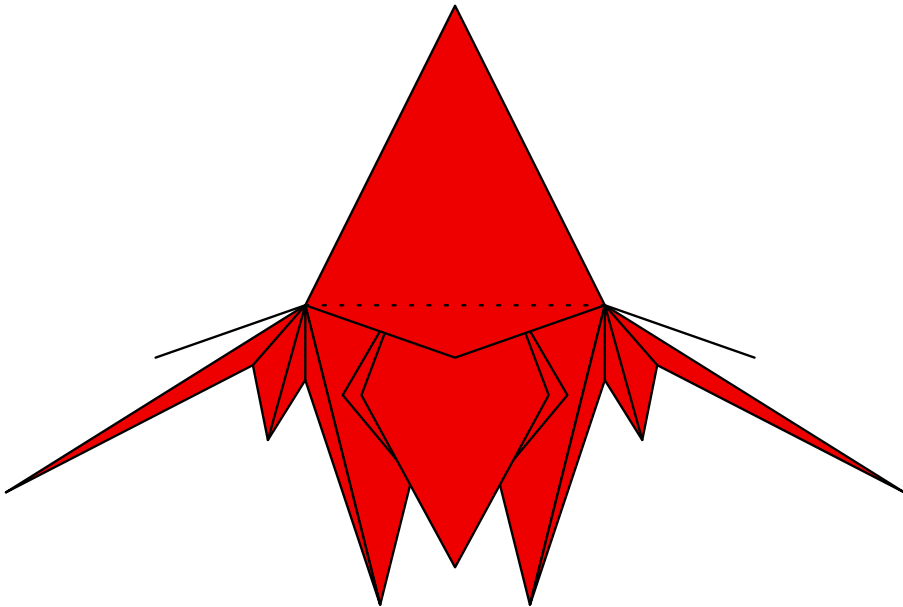

# Virág levelekkel

## Flower with leaves

Model: Peter Budai © 1997.  
Diagrams: Peter Budai © 1998.

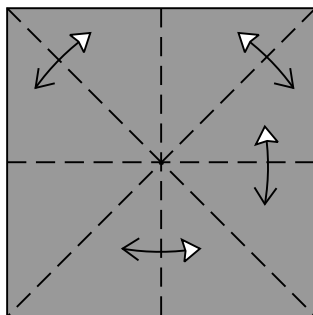
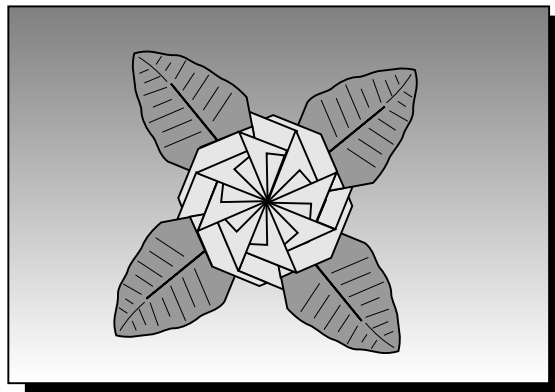

1. Oda-visszahajtások átlósan és a felezők mentén.  
*Fold an unfold diagonally and in half.*

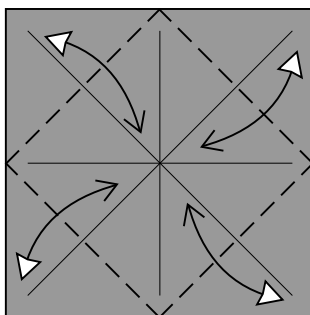

2. A sarkokat középre hajtjuk, majd vissza.  
*Fold the corners to the center and unfold.*

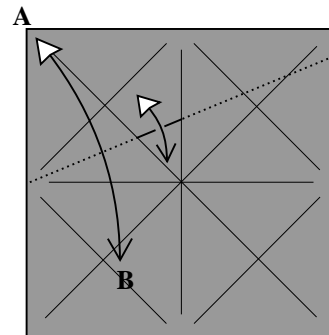

3. Az "A" sarkot a "B" vonalra hajtjuk, majd vissza. **Csak középen élzünk!**  
*Fold corner "A" to line "B" and unfold. **Crease only the middle.***

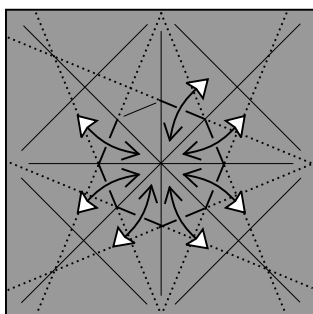

4. Oda-visszahajtások úgy, mint az előző lépésben.  
*Fold an unfold alike to the previous step.*

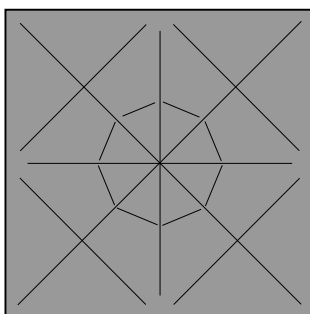

5. Középen kialakult egy nyolcszög. Fordítsd meg a papírt!  
*An octagon is born in the center. Turn the paper over.*

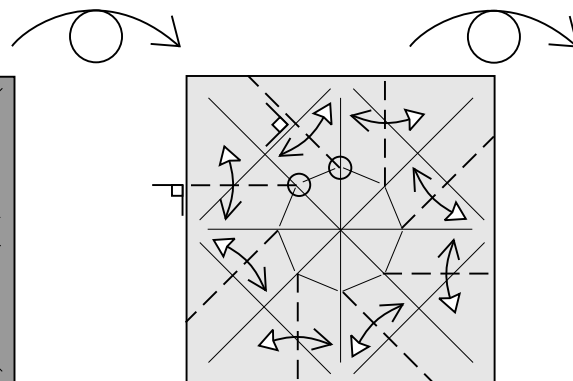

6. Oda-visszahajtások a rajz mintájára. Fordítsd meg!  
*Fold and unfold as shown. Turn the paper over.*

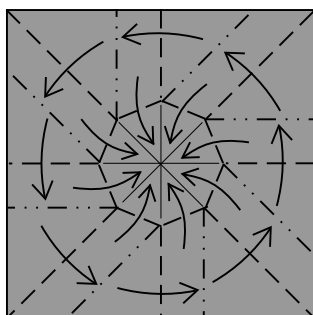

7. Összehajtjuk a már kész élek segítségével.  
*Collapse using existing creases.*

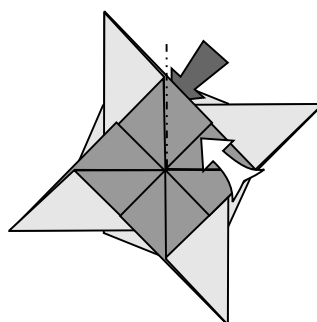

8. Váltóhajtás a sarkon.  
*Reverse-fold the corner.*

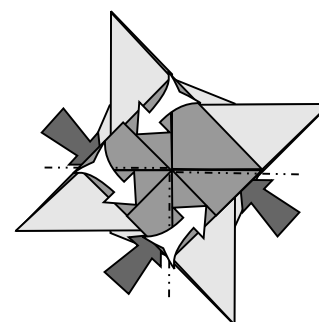

9. Váltóhajtás a maradék három sarkon is.  
*Reverse-fold the remaining three corners as well.*

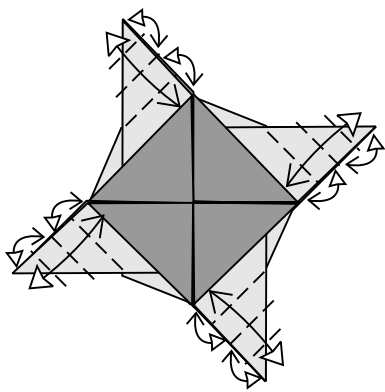

**10.** Negyedelőnk mind a négy fülön.  
*Divide into fourths on all four flaps.*

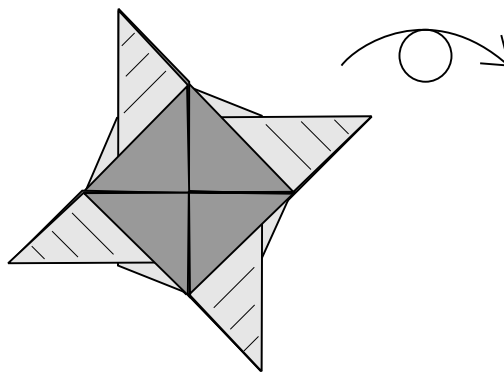

**11.** Fordítsd meg a modellt!  
*Turn the model over.*

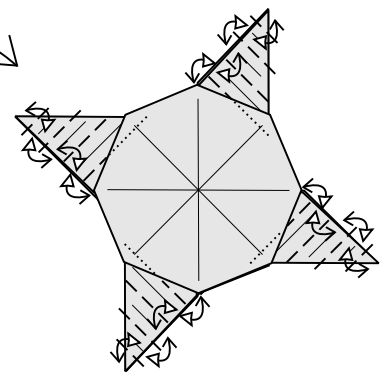

**12.** Tovább felezzük (nyolcadokra).  
*Divide further into eights.*

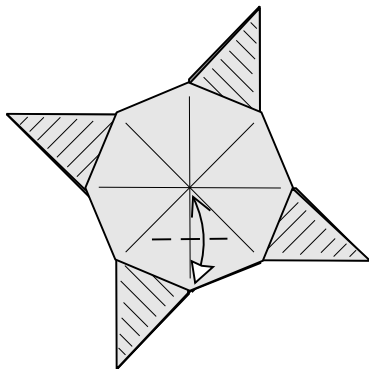

**13.** Oda-visszahajtás a felső rétegen.  
*Fold and unfold the top layer.*

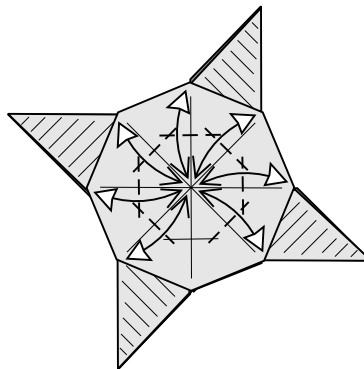

**14.** Oda-visszahajtjuk a többi hét csúcsot is.  
*Fold and unfold the remaining 7 points.*

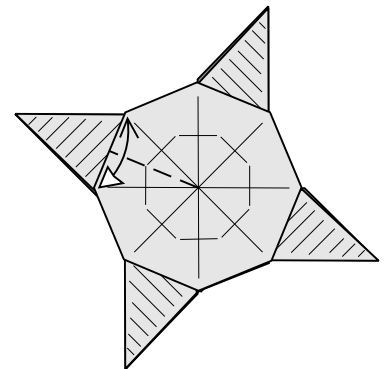

**15.** Oda-visszahajtás ismét.  
*Fold and unfold again.*

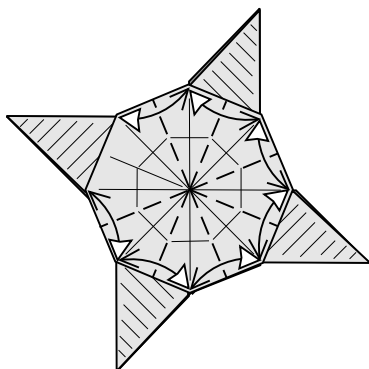

**16.** Oda-visszahajtunk a maradék hét helyen.  
*Fold and unfold at the remaining 7 places.*

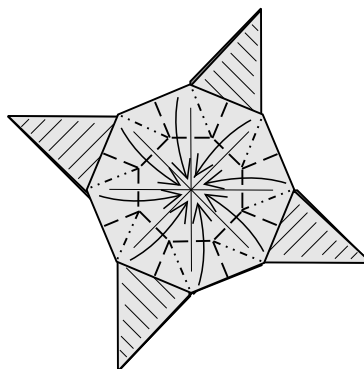

**17.** Összehajtjuk a már meglévő élek felhasználásával.  
*Collapse using existing creases.*

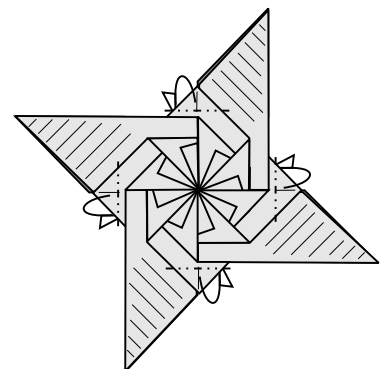

**18.** Hátrahajtunk négy sarkot.  
*Mountain-fold four corners.*

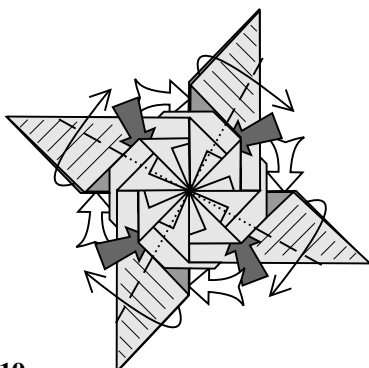

**19.** Váltóhajtás (csak egy réteget) a középponttól a harmadik hajtásélig.  
*Reverse-fold one layer. The fold goes from the center to the third crease.*

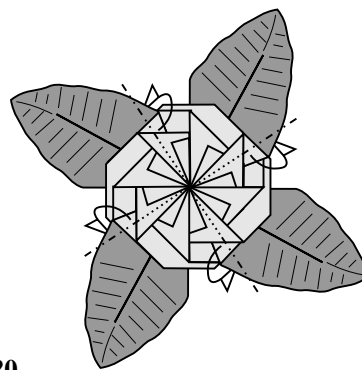

**20.** A modell nem lapos. Hátrahajtunk.  
*The model does not lie flat. Mountain-fold.*

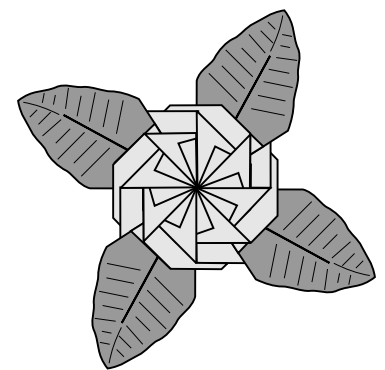

**21.** Kész a virág.  
*Finished flower.*



Complex

An 18" square makes a model 6" high

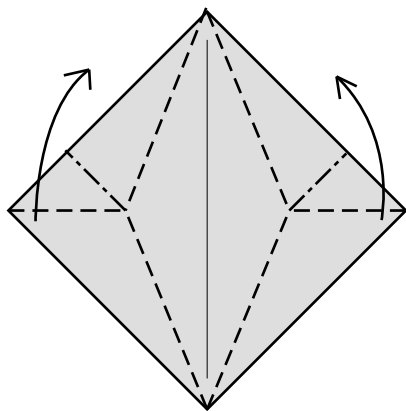

1. With darker side up, form rabbit ears on both sides.

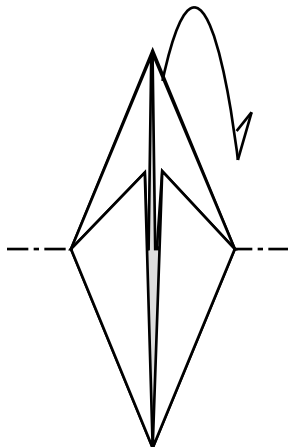

2. Swing back.

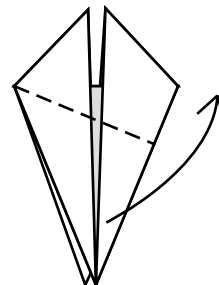

3. Valley up.

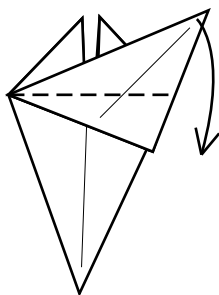

4. Valley down.

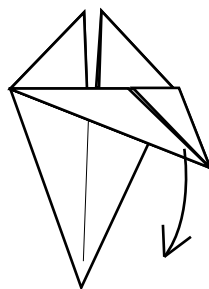

5. Unfold.

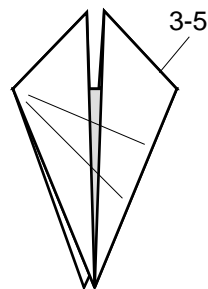

6. Repeat steps 3-5 in mirror image.

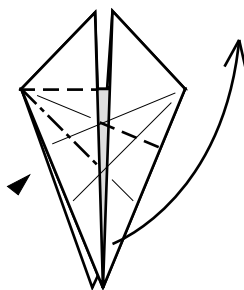

7. Asymmetrical squash.

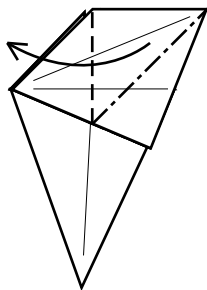

8. Squash.

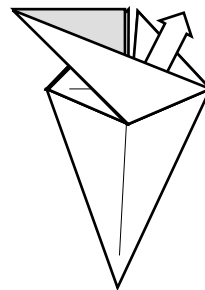

9. Pull out single layer to make symmetrical.

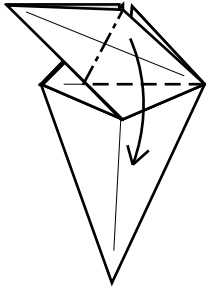

10. Squash.

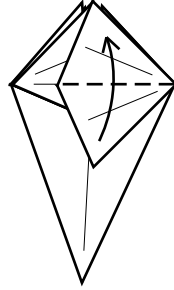

11. Valley up.

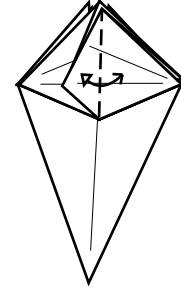

12. Precrease.

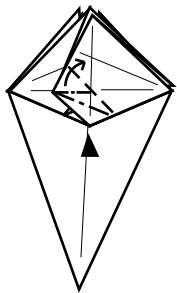

13. Form valley fold, allowing squash to form at bottom.

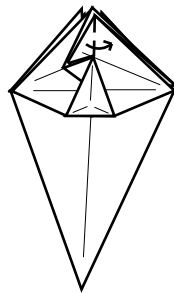

14. Pull one layer through.

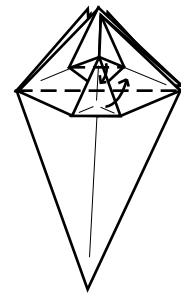

15. Valley folds.

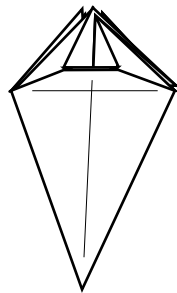

16. Turn over.

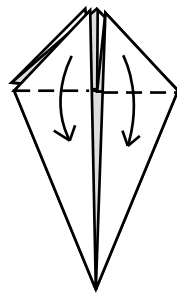

17. Swing down.

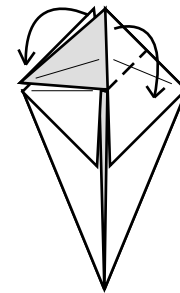

18. Open out top.

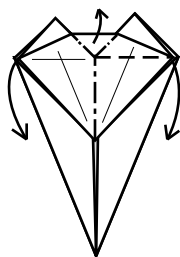

19. Collapse into rabbit-ear formation.

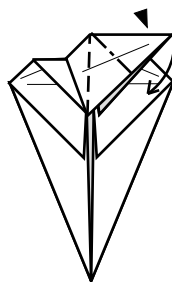

20. Squash.

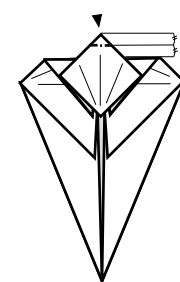

21. Sink halfway.

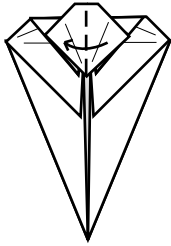

22.Swing over.

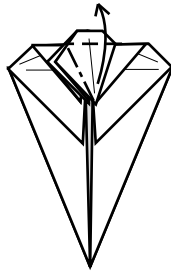

23.Petal up.

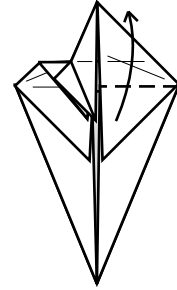

24.Swing up.

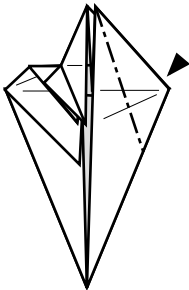

25.Sink triangularly.

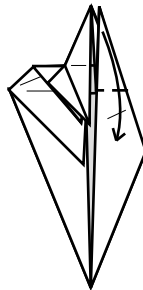

26.Swing down.

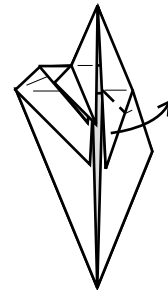

27.Valley outwards.

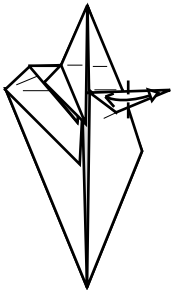

28.Precrease flap halfway.

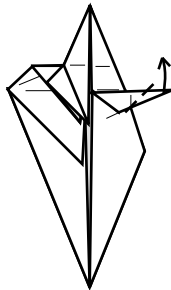

29.Valley along precrease.

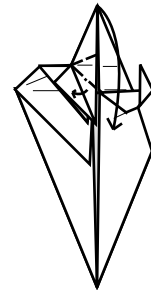

30.Valley down point, while swinging out top single layer.

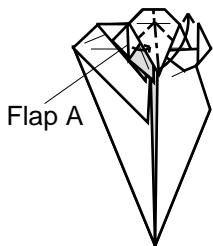

31.Swing over flap A, while incorporating a reverse fold. A gusset will form where flap A meets the point.

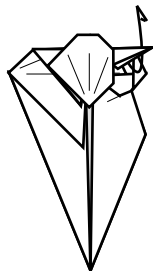

32.Pull up the thick set of layers

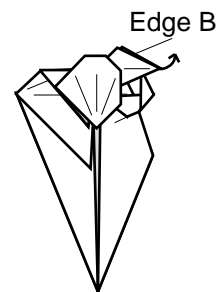

33.Pull up edge B, so that it is parallel with the base of model.

22-33

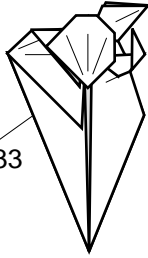

34. Repeat steps 22-33 on the other side.

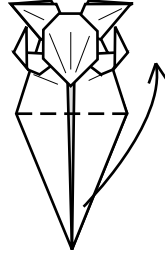

35. Valley. Rotate model.

1/2

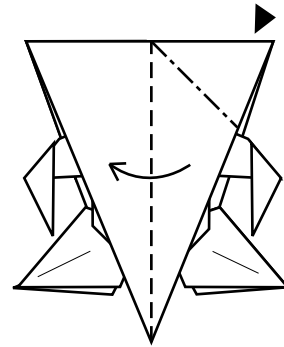

36. Squash.

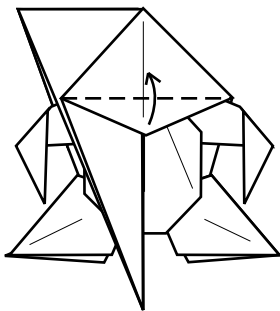

37. Valley up.

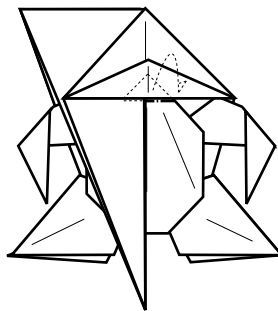

38. Mountain fold the single layer to match up with folded edge above.

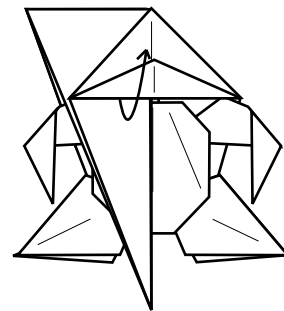

39. Pull out single layer from underneath.

36-37, 39-40

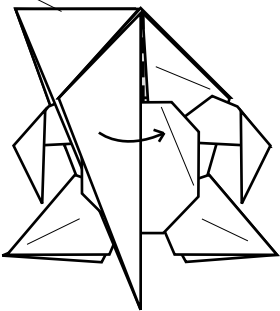

40. Swing over. Repeat steps 36-40 on other side, skipping step 38.

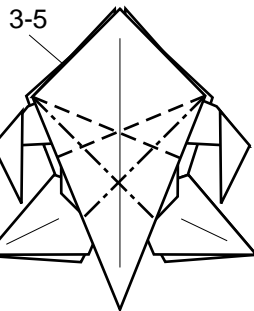

41. Repeat steps 3-5 on the top flap.

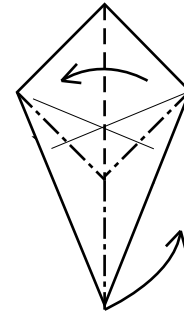

42. Top shown only. Fold in half, while outside reverse folding.

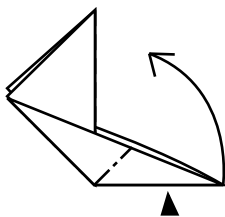

43. Reverse fold.

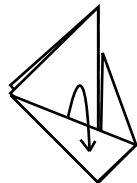

44. Pull around single layer from underneath.

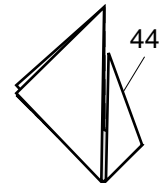

45. Repeat step 44 behind (it is easier to first swing the small flap to the other side to accomplish this).

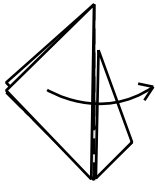

46. Swing one flap over.

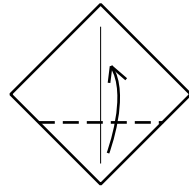

47. Valley up; see next step for positioning.

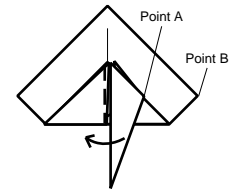

48. Note that points A and B are on the same plane. Swing over.

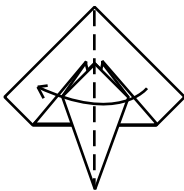

49. Swing over.

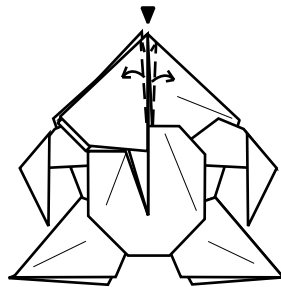

50. Fold out top edges a small amount, allowing tip to squash.

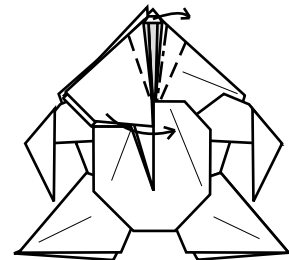

51. Swing over head while swiveling out the ear. Form mountain fold first. Center of ear should lie at 45 angle.

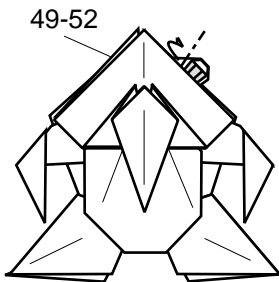

52. Mountain edge of ear to make it symmetrical. Repeat steps 49-52 on other side.

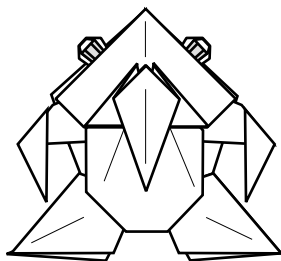

53. Turn over.

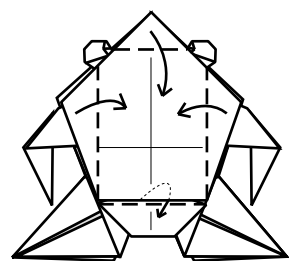

54. Fold sides in. Pull out tiny flap from bottom pocket.

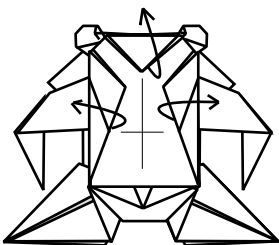

55. Pull single layer to surface (closed sink).

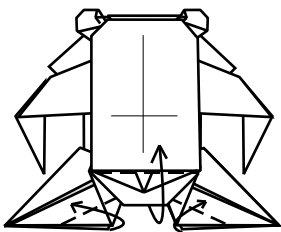

56. Stretch the bottom upwards. Valley the lower edges of the legs to the center.

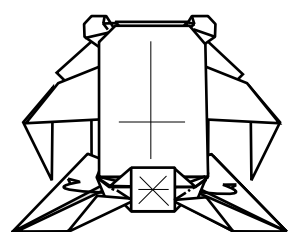

57. Swivel the material from the legs behind.

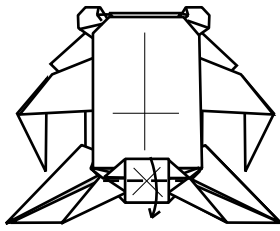

58. Swing down.

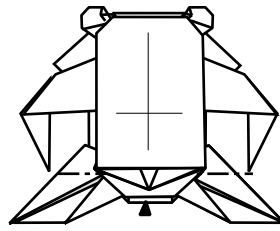

59. Closed sink.

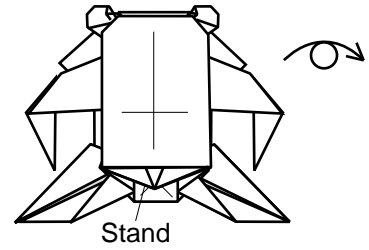

60. Note flap for stand. Turn over.

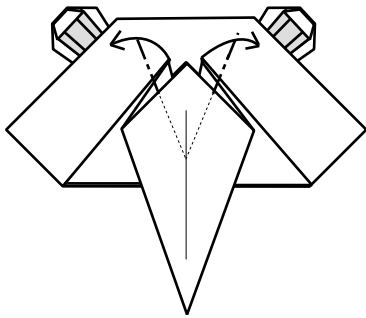

61. Reverse fold.

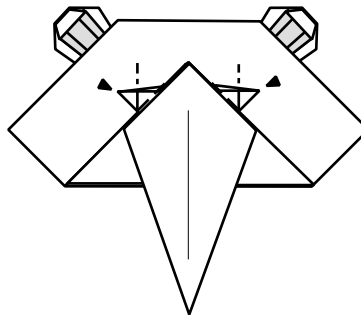

62. Squash points.

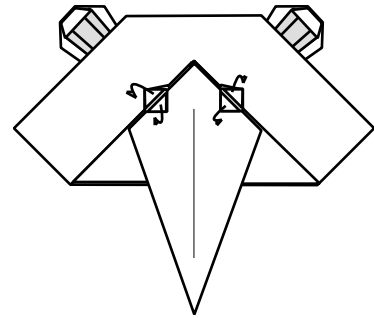

63. Wrap a single layer around to color change.

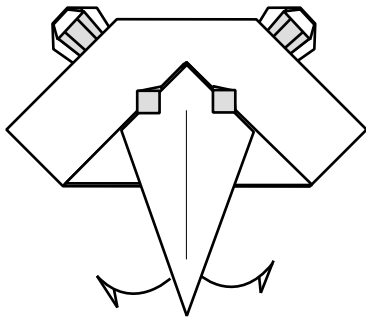

64. Spread out tip of nose.

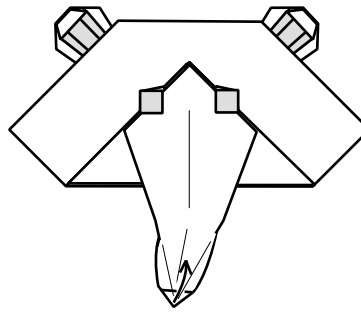

65. Valley up tip.

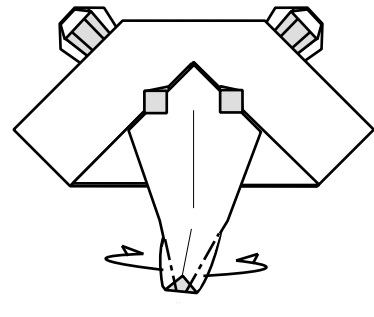

66. Fold side layers of nose back in.

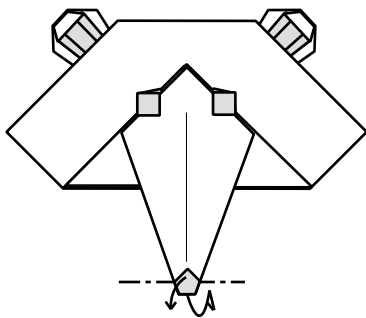

67. Flip single layer of nose down.

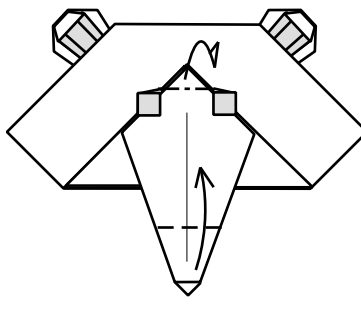

68. Mountain top of muzzle. Valley nose up.

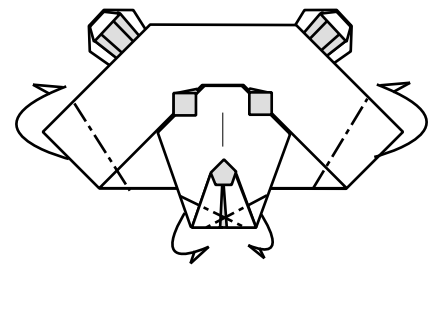

69. Shape head to taste.

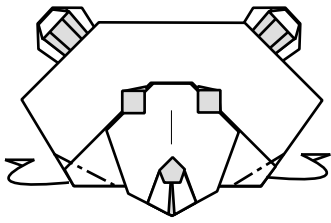

70. More shaping.

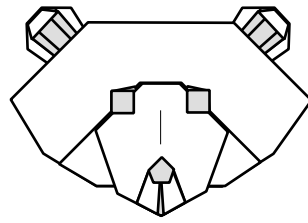

71. Completed head.

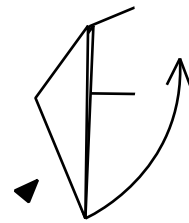

72. Squash arm.

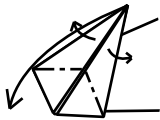

73. Swing down while spreading out layers.

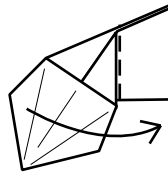

74. Valley over.

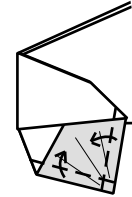

75. Valley edges in (bottom one first).

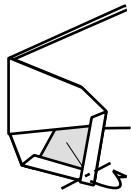

76. Mountain tip.

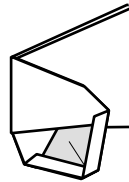

77. Completed arm. Repeat steps 72-76 on other arm.



78. Mountain side of leg to match bottom edge.



79. Pull out layers from sides to make leg 3-D.



80. Wrap corner over.

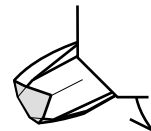

81. Completed leg. Repeat steps 78-80 on other leg. Stretch the stand (see step 60) down. Stretch legs forward and round model to taste.

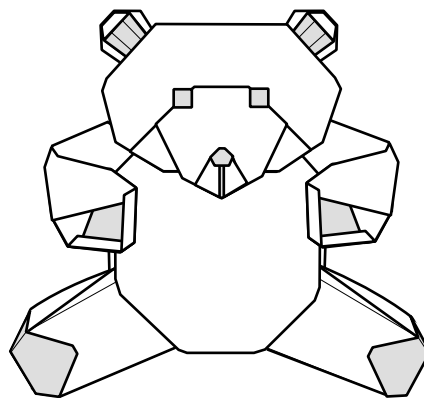

82. Completed Fluffy  
© 1994 Marc Kirschenbaum

# 1/n Fairytale Forest

©Hans Birkeland 1999

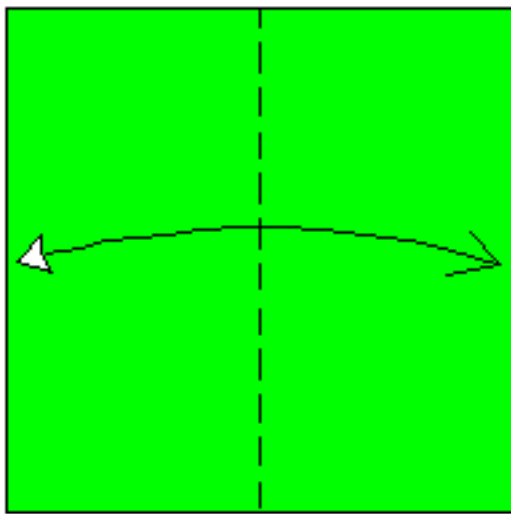

**1** Use green tissue-foil for best result. Start with the coloured side up. Fold and unfold.

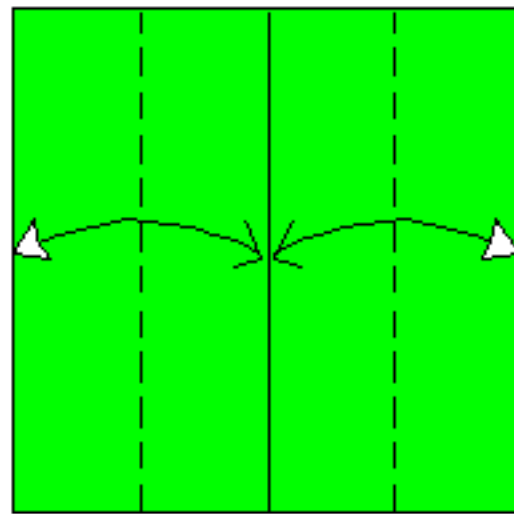

**2** Fold and unfold. Turn the paper over.

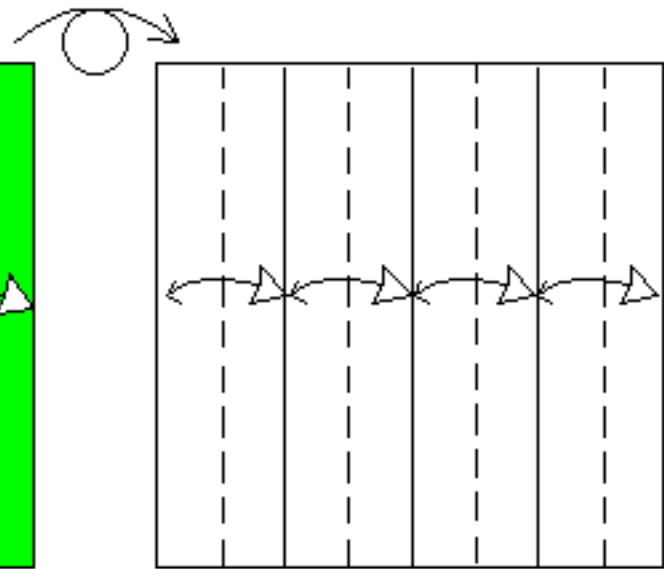

**3** Fold and unfold. Unfold completely.

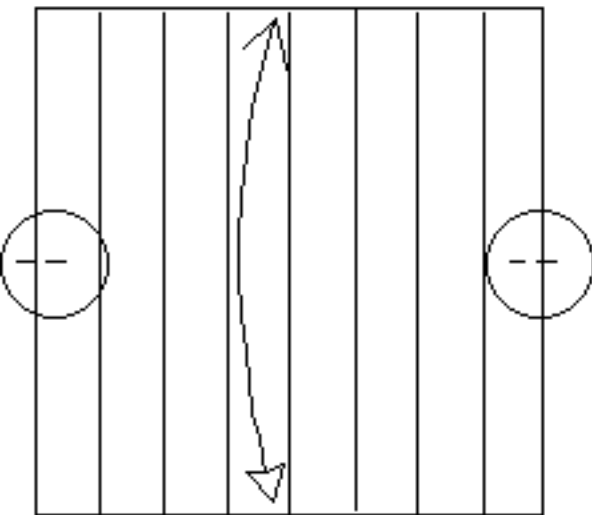

**4** Fold and unfold, only pressing flat where indicated.

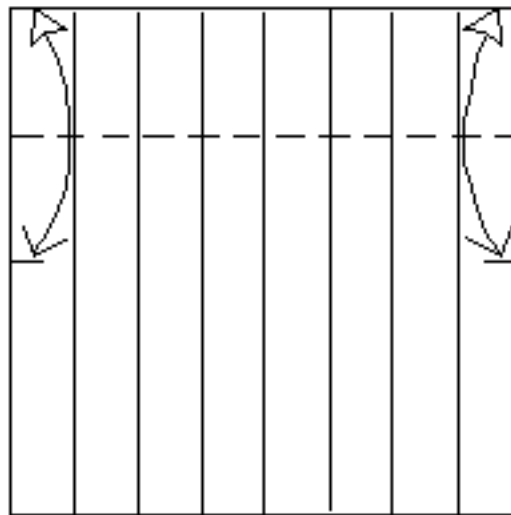

**5** Fold and unfold.

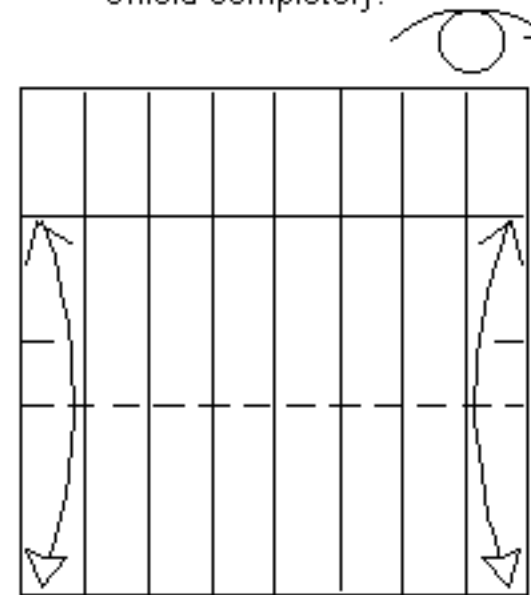

**6** Fold and unfold. Turn the paper over.

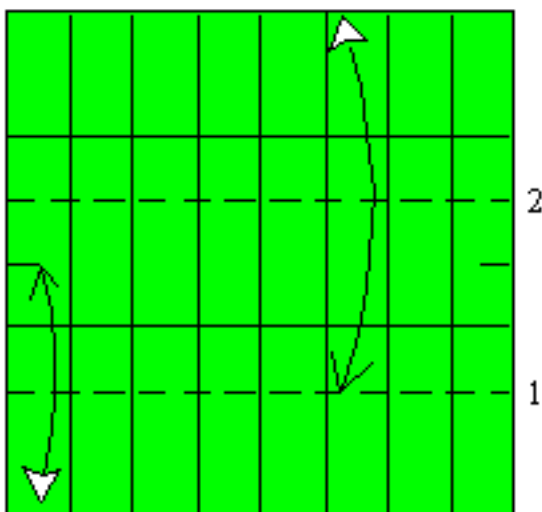

**7** Fold and unfold two places.

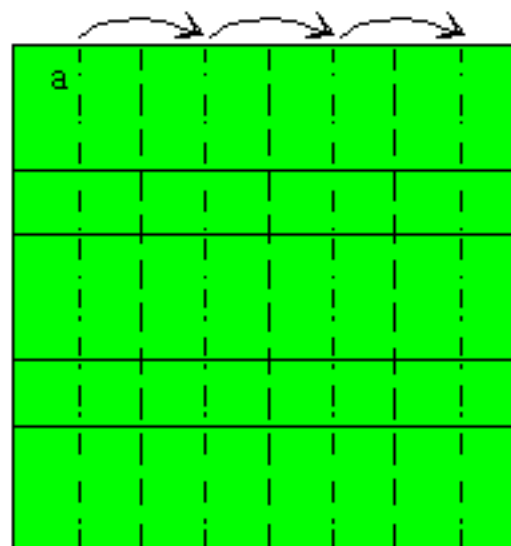

**8** Collapse on existing creases.

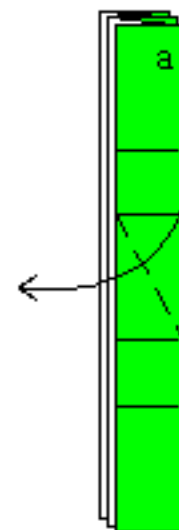

**9** Valley-fold through all layers.



# 1/n Fairytale Forest

©Hans Birkeland 1999

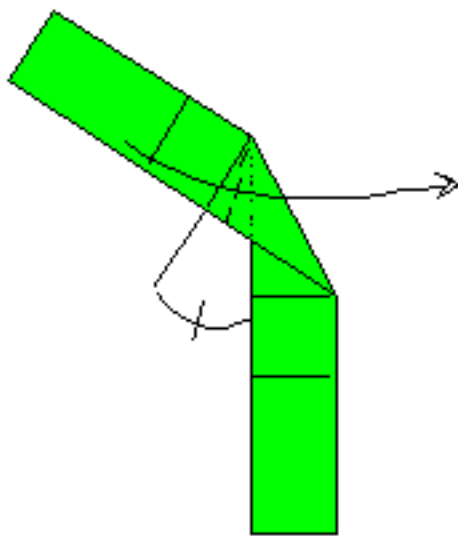

10 Valley-fold.

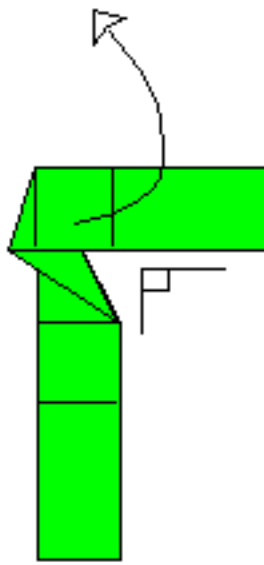

11 Unfold to step 9.

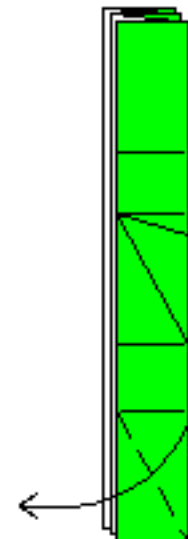

12 Repeat steps 9-11.

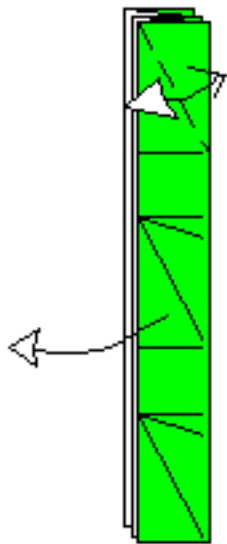

13 Fold and unfold through all layers. Then unfold completely.

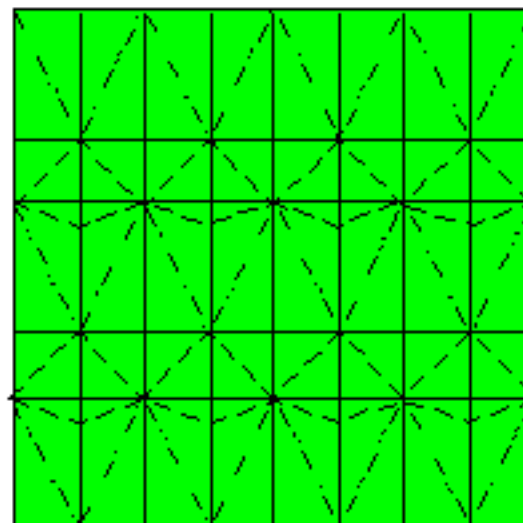

14 Turn the creases to valley- and mountainfolds following this pattern.

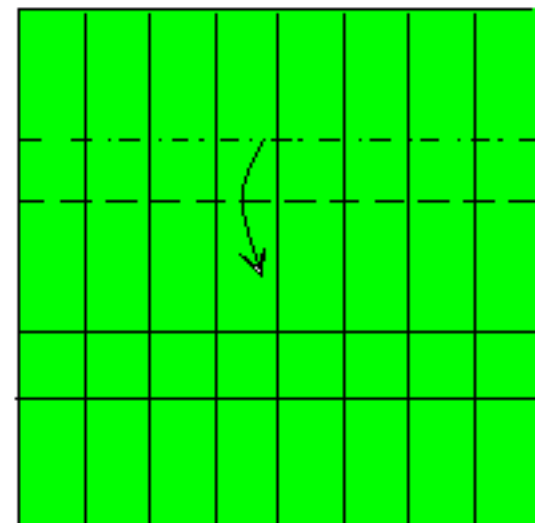

15 Fold down on existing creases.

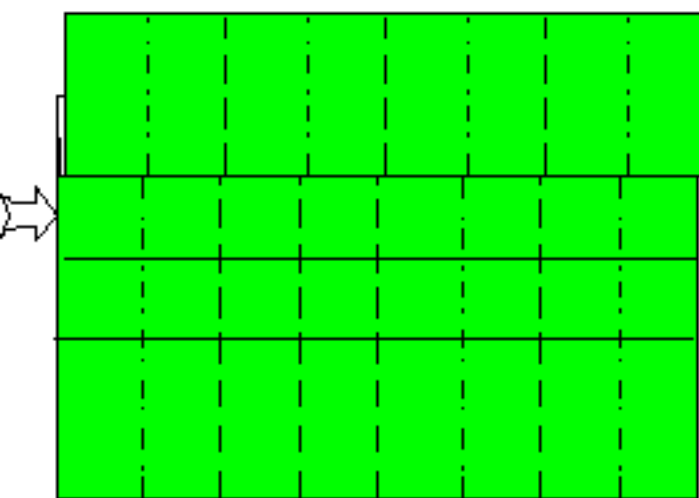

16 Push together on existing creases and then open up slightly.

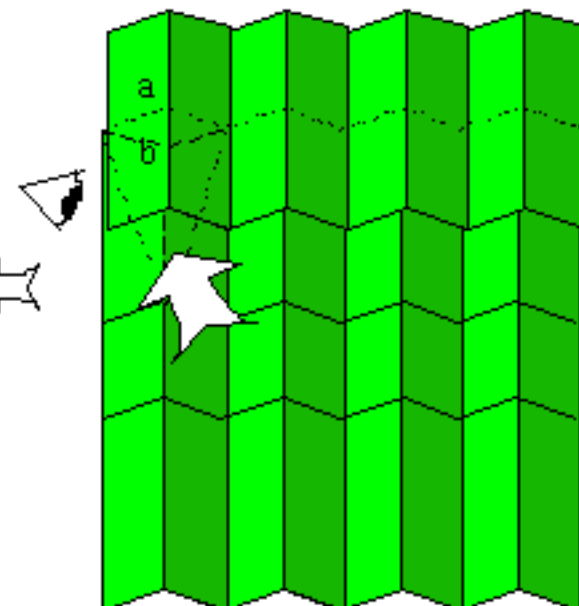

17 Push in where indicated, using existing creases. The hidden edge will change from **a** to the existing crease at **b**.  
Next view from the left.

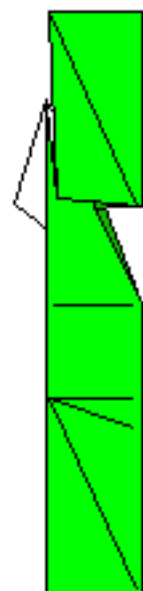

18 Like this.

# 1/n Fairytale Forest

©Hans Birkeland 1999

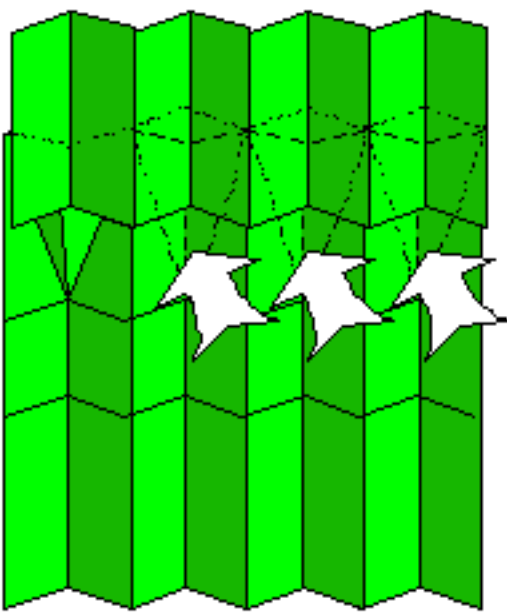

19 Repeat step 17 three other places.

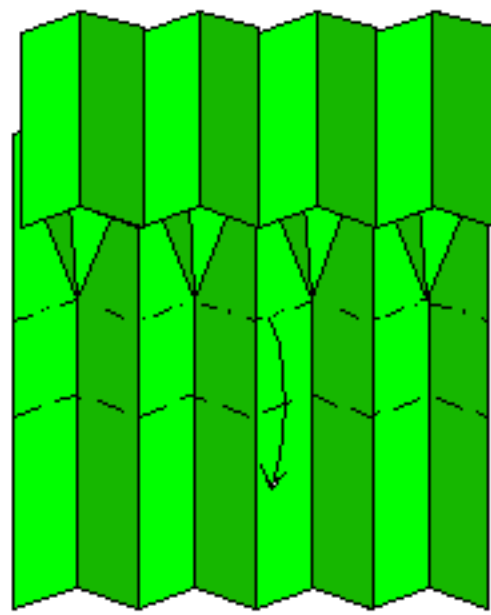

20 Repeat steps 15-19 on the lower part.

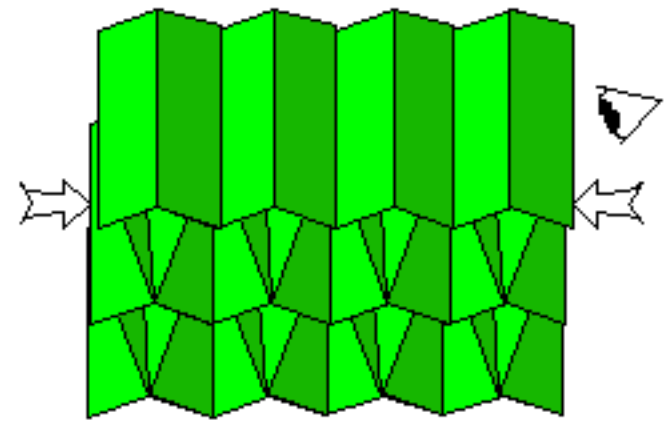

21 Like this. Press together, collapsing on old creases. The model becomes flat. Next view from the right.

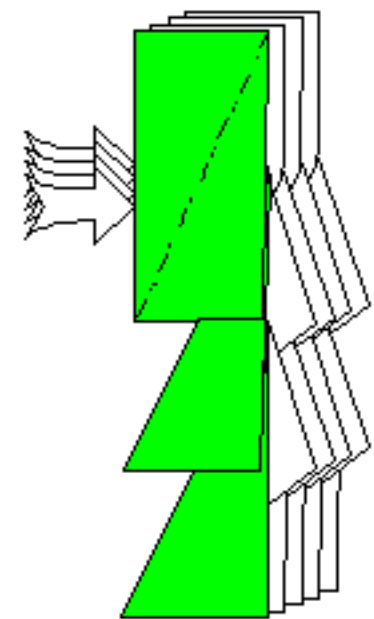

22 Reverse-fold on existing creases.

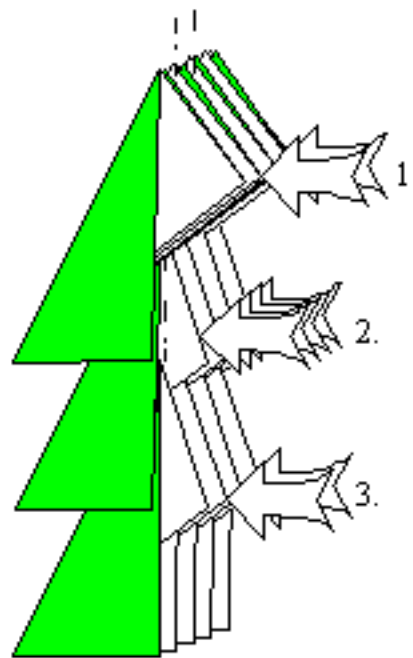

23 Start by mountain-folding the top two middle edges inside. Then fold all four middle edges inside, and then the two middle edges at the bottom.

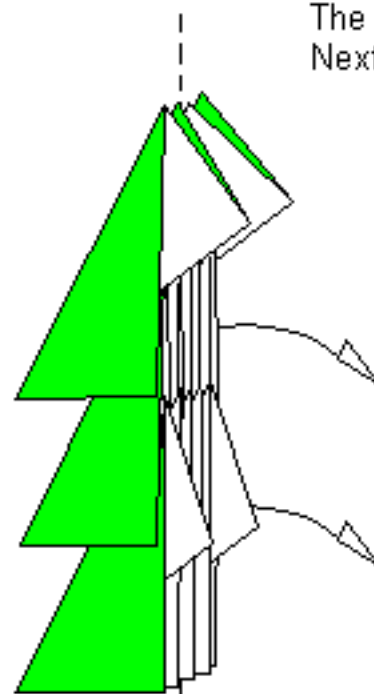

24 From behind, book-fold two layers to the right.

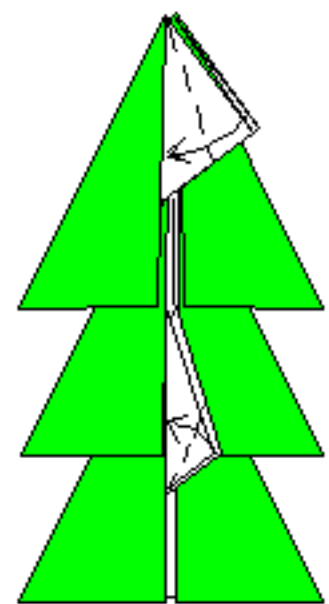

25 Valley-fold two layers as one.

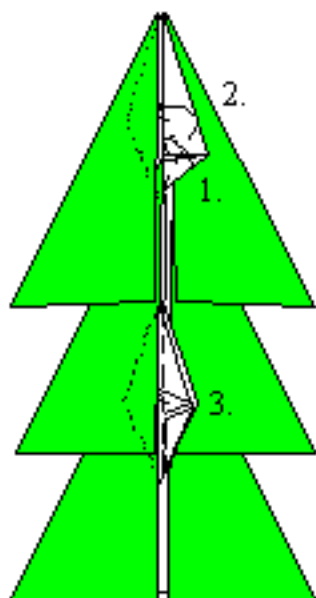

26 Valley-fold the upper edge once more and then fold both protruding edges to the left, hiding them underneath the coloured layers. This locks the layers together.



27 Spread the four layers to point north, south, east and west.

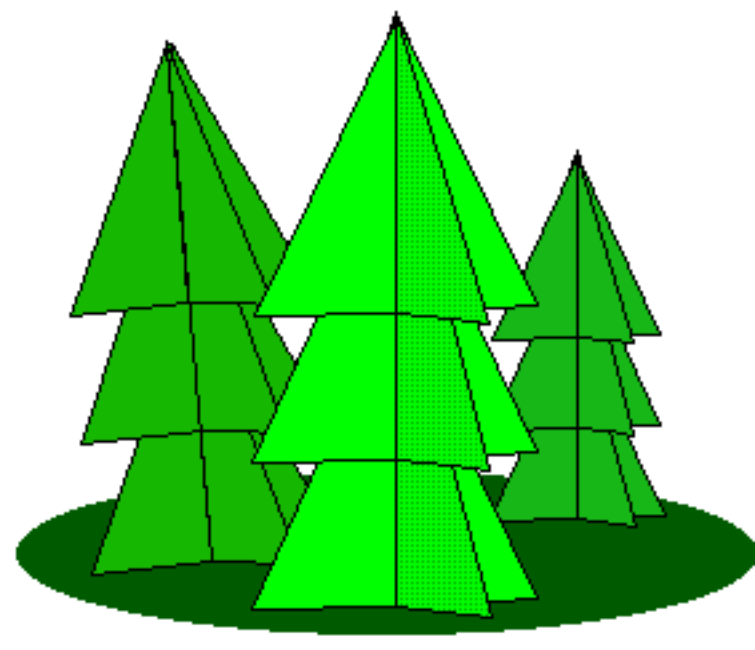

28 First chapter of the fairytale forest is finished.

# foxmask

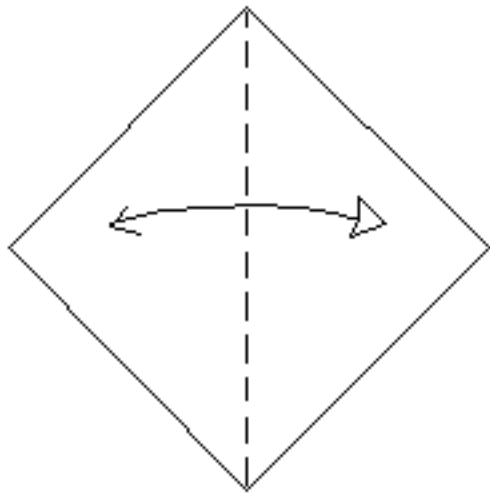

**1** Start with the white side up. Fold and unfold.

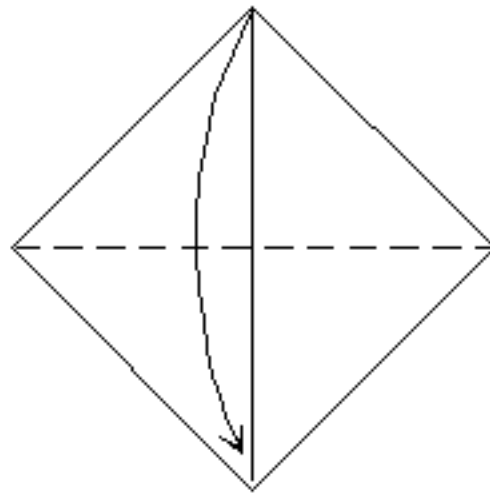

**2** Valley-fold.

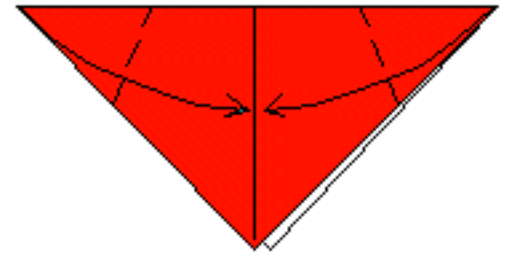

**3** Valley-fold the corners to the midline so that their lower edge is horizontal.

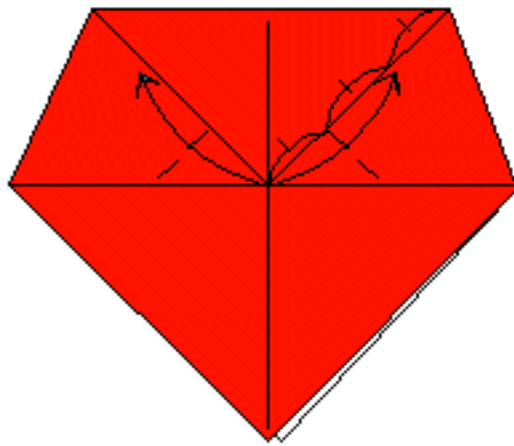

**4** Valley-fold about 1/3th.

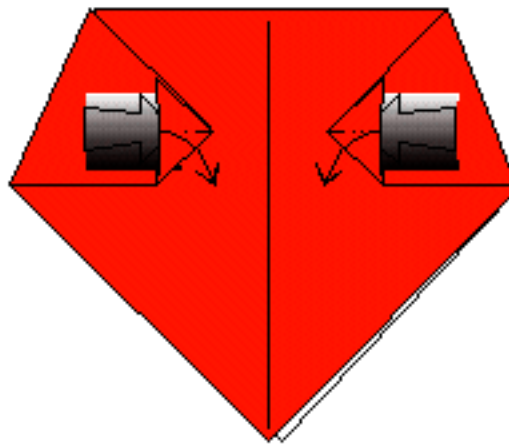

**5** Squash-fold.

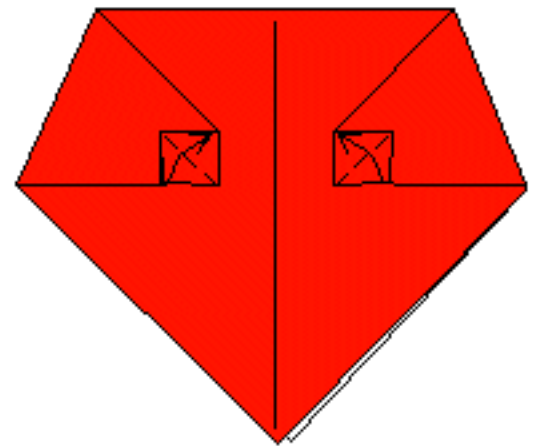

**6** Valley-fold.

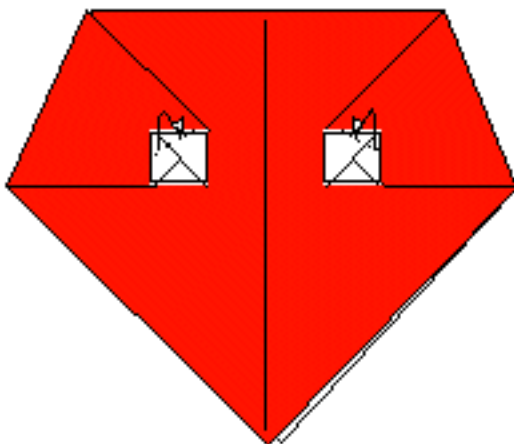

**7** Mountain-fold the edges.

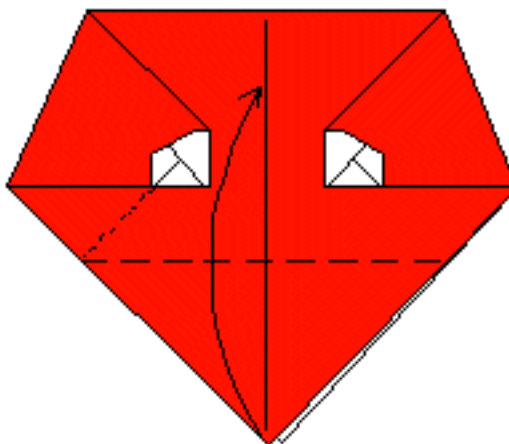

**8** Valley-fold one layer.

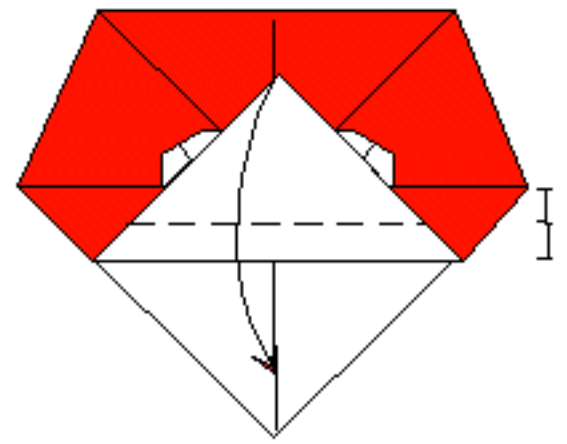

**9** Valley-fold.

# foxmask

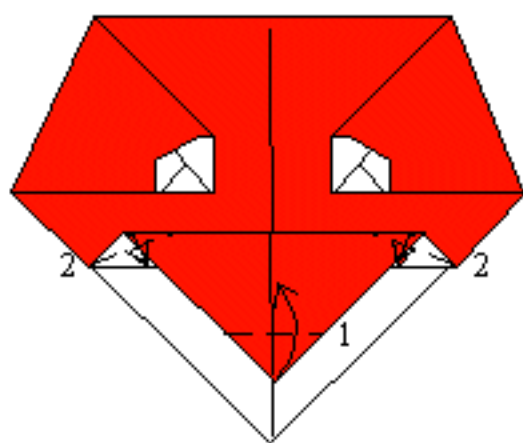

**10** Valley-fold.

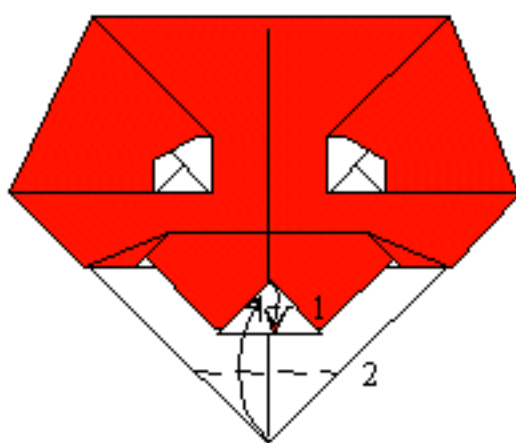

**11** Valley-fold.

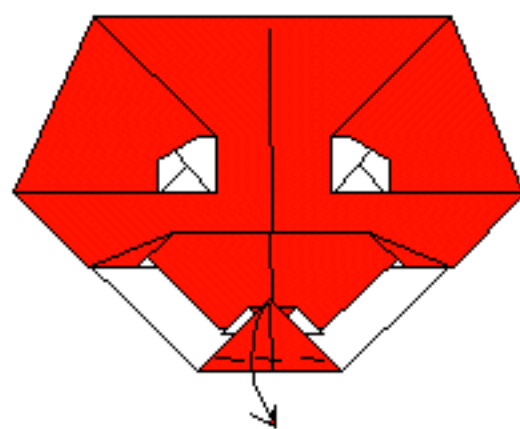

**12** Valley-fold.

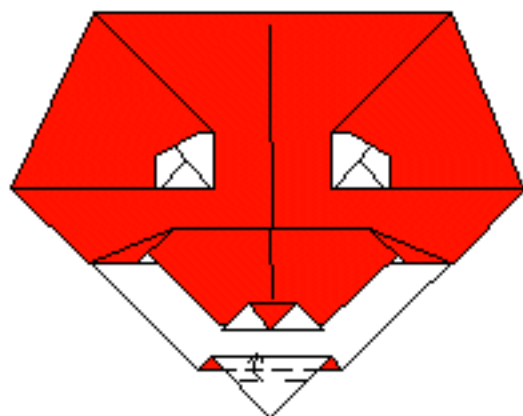

**13** Crimp-fold.

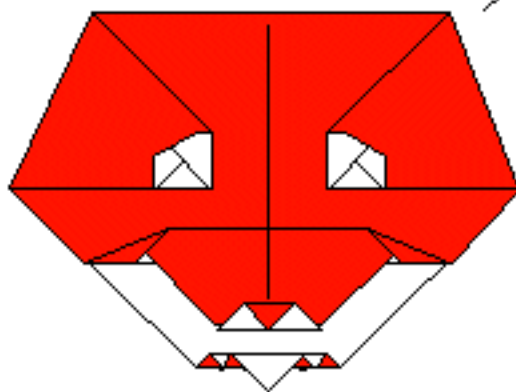

**14** Like this.  
Turn the model over.

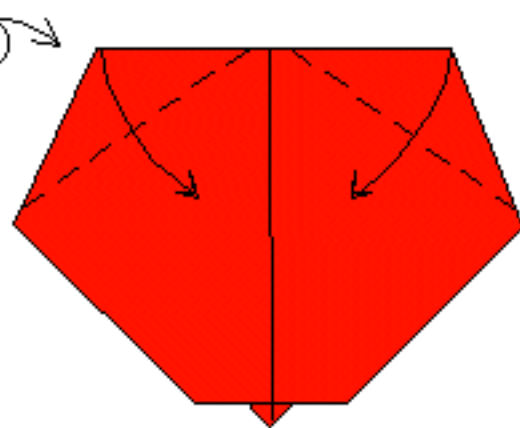

**15** Valley-fold.

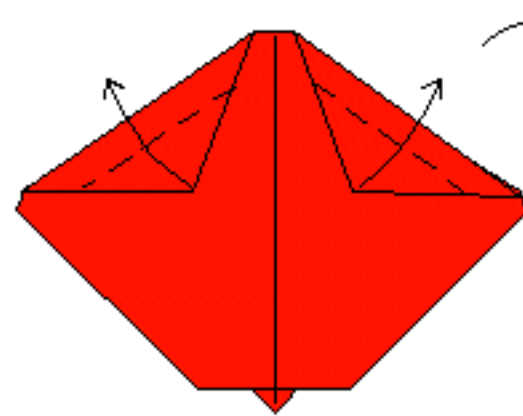

**16** Valley-fold.  
Turn the model over.

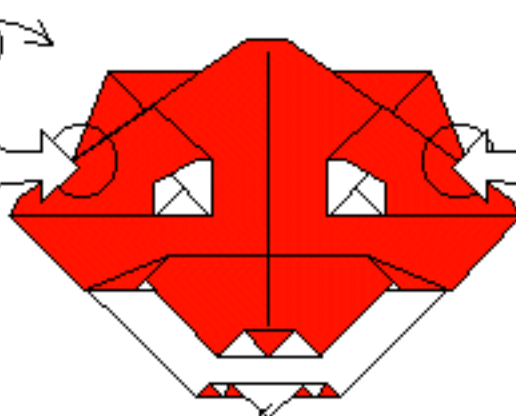

**17** Finished foxmask.  
Press together where indicated,  
and the fox will open its mouth.

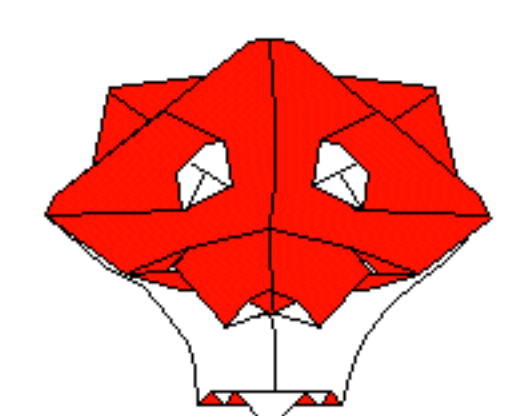

**18** Waff!

Use a piece of paper green on both sides. Precrease in all four directions.

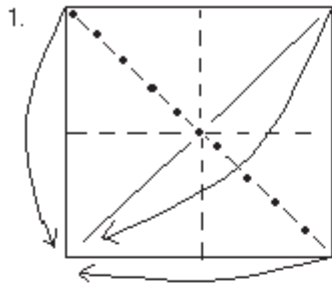

Collapse into preliminary base  
Rotate

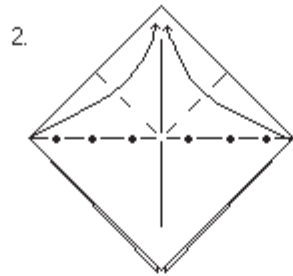

Swing the left and right corners up to the top

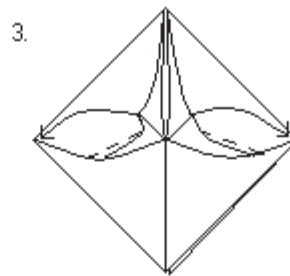

Spread the 2 points out to the sides leaving the central flap where it is

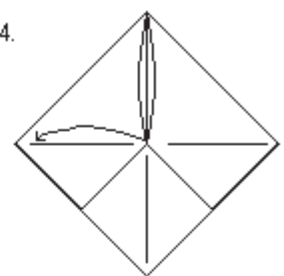

Fold the central point to the side

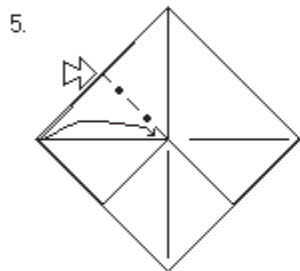

Squash fold the central point

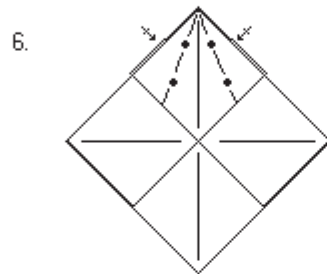

2 reverse folds  
Repeat on the 2 similar flaps inside the model

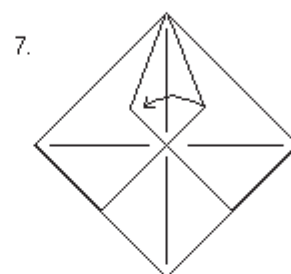

Valley fold one layer over

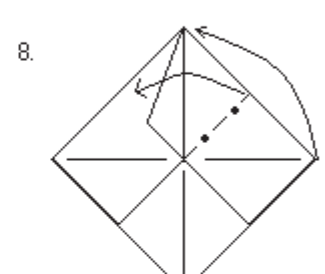

Swing the right corner up to the top

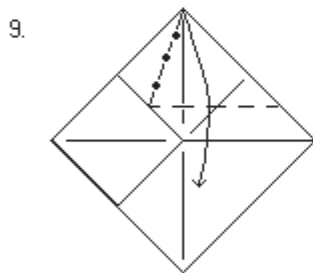

Half petal fold

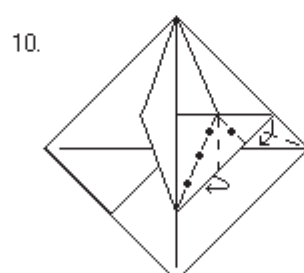

Swivel the paper behind

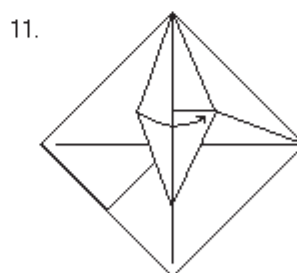

Fold 2 layers back to the right

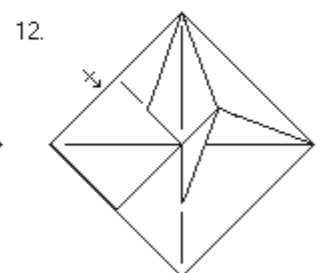

Repeat steps 7-11 on the left side

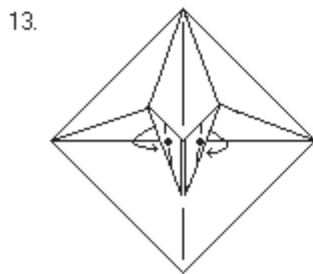

Thin the back legs with mountain folds

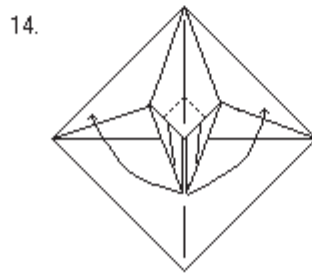

Reverse fold the back legs up at a right angle

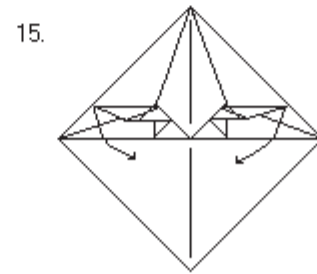

Reverse fold the legs down

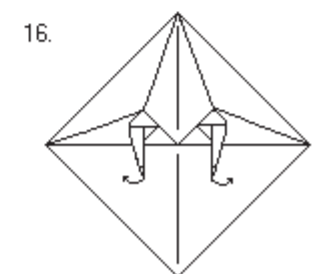

Reverse folds to form feet

17.

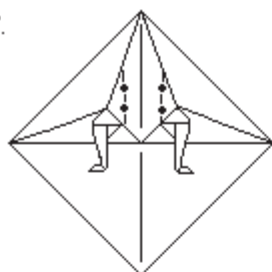

Thin the body with mountain folds

18.

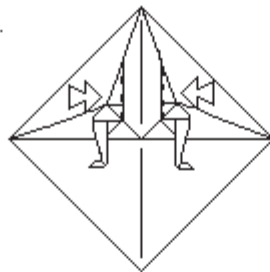

Sink on both sides

19.

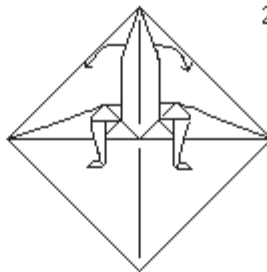

Reverse fold the front legs down

20.

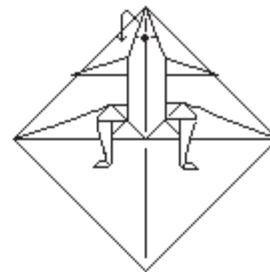

Fold behind

21.

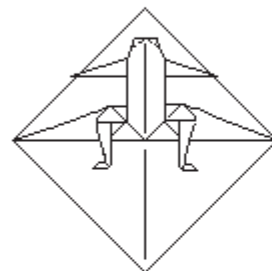

2 valley folds to make eyes

22.

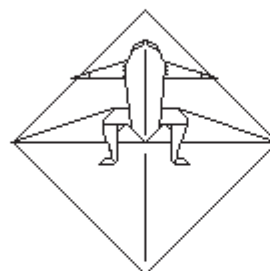

Make mountain folds on the legs so that the frog stands up on his front legs  
2 valley folds for feet

23.

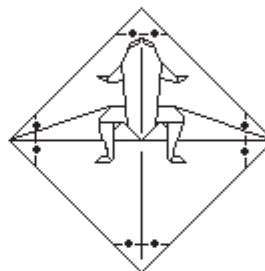

Mountain fold all 4 corners

24.

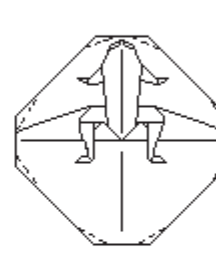

Round off the lily pad with mountain folds

25.

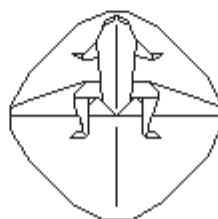

FROG ON A LILYPAD

Simple unit to make a garland.  
Start with a rectangle 1:3 or longer.

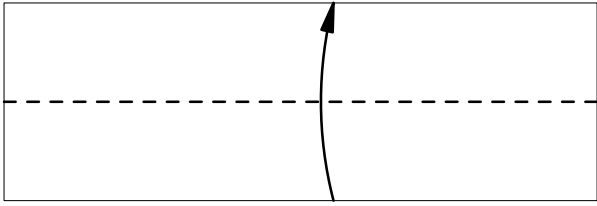

1

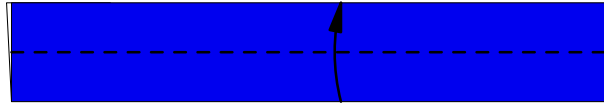

2

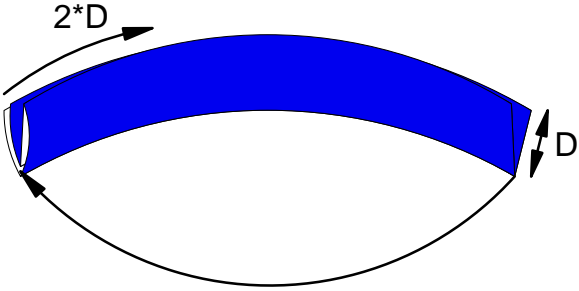

3 Put right end inside left end  
in V shape.

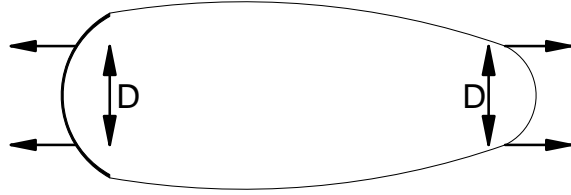

4 Fold on two places in  
overlap section.

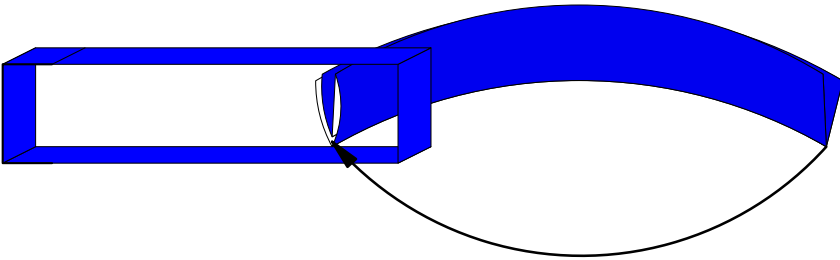

5 Close next ring through previous one.

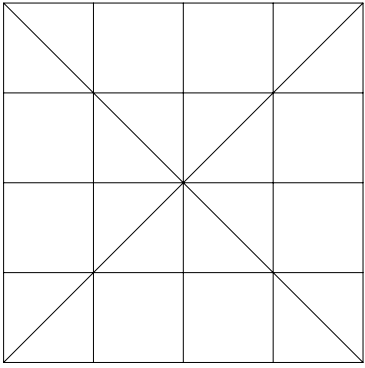

1

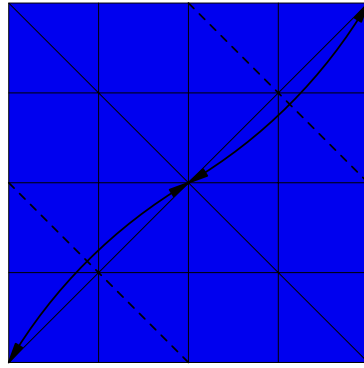

2

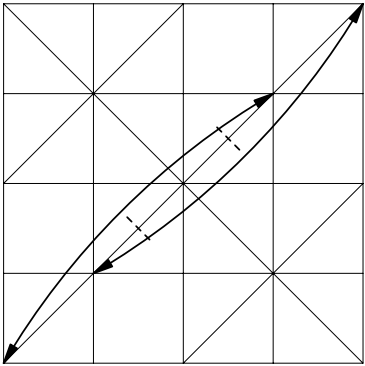

3

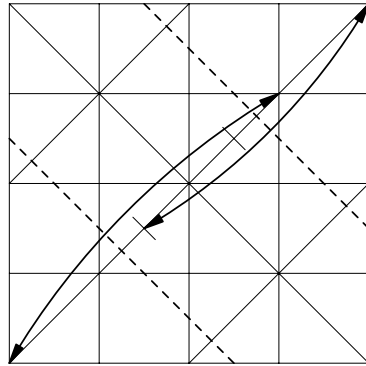

4

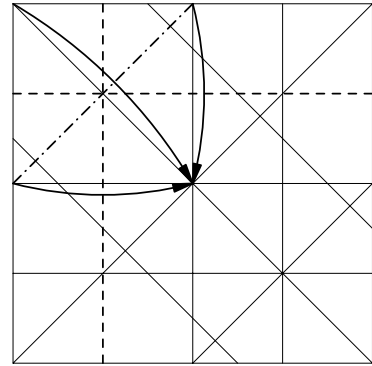

5

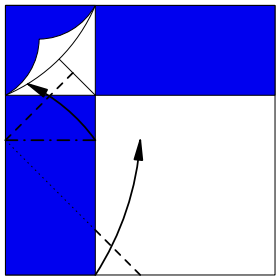

6

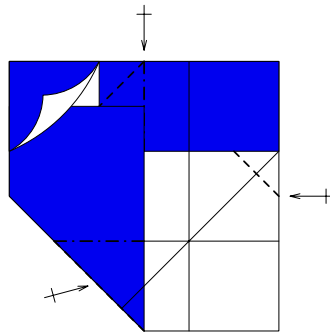

7

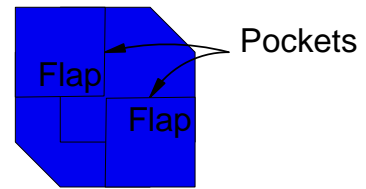

8 Couple units:  
flap in pocket

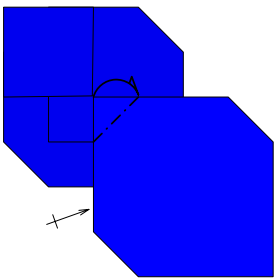

9 Lock

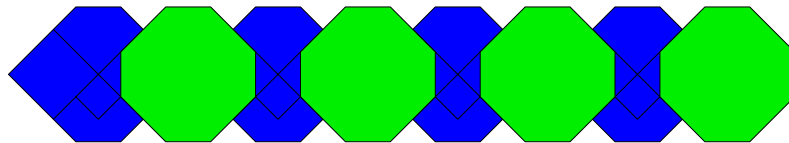



# Gecko and Fly on a Wall

by Herman van Goubergen

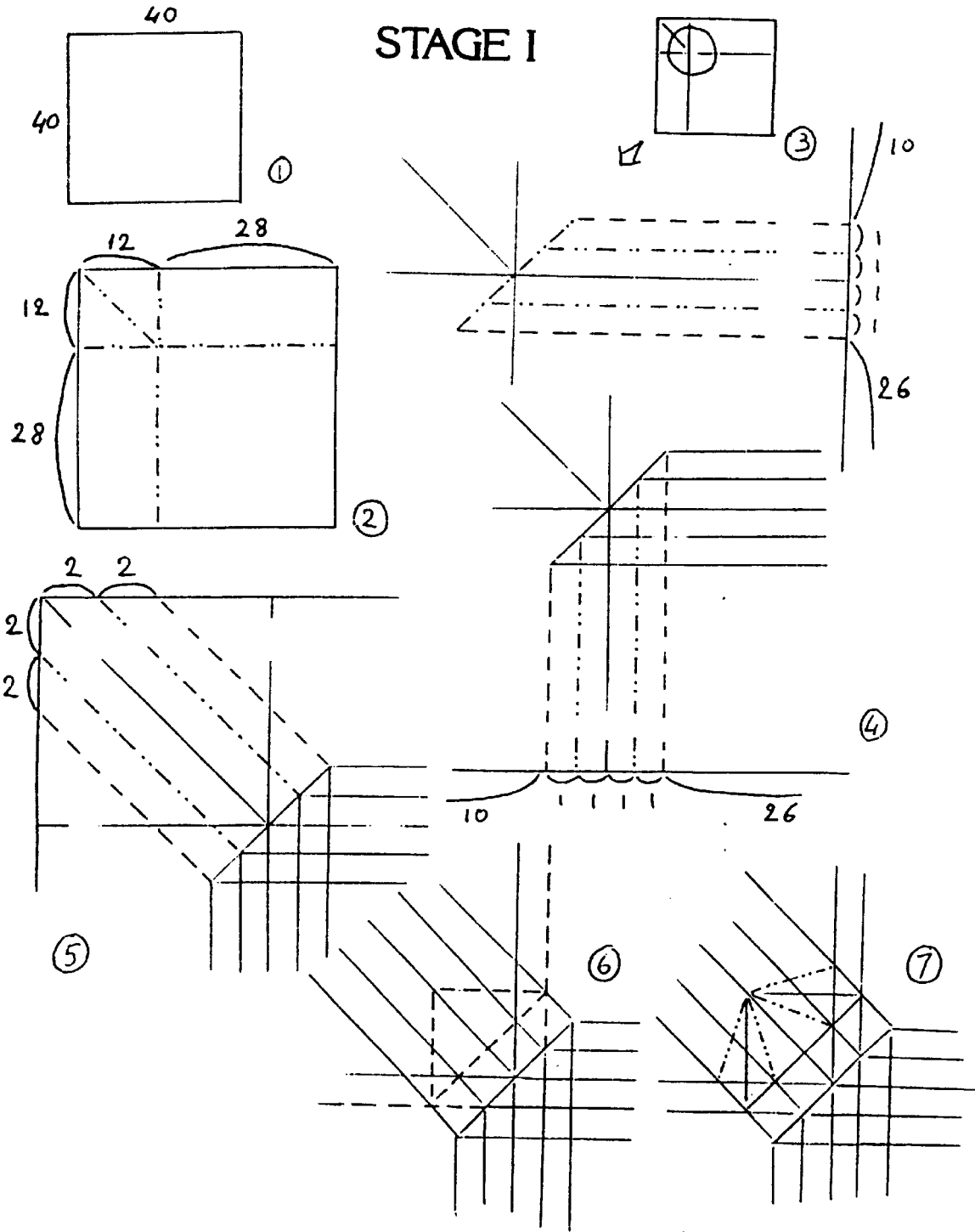

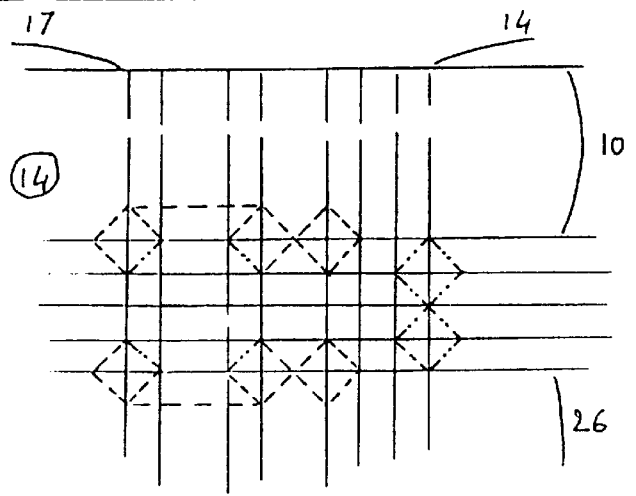
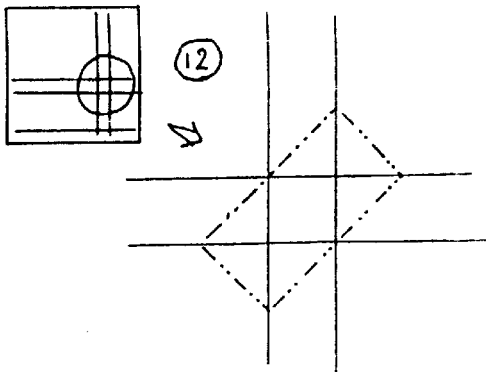
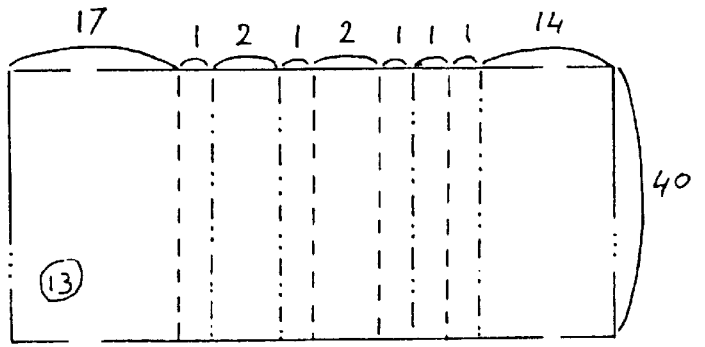
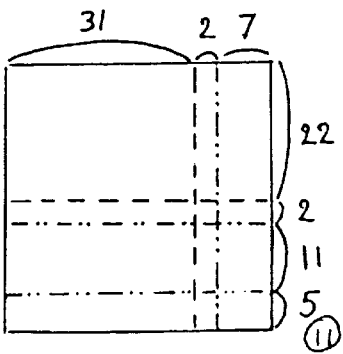
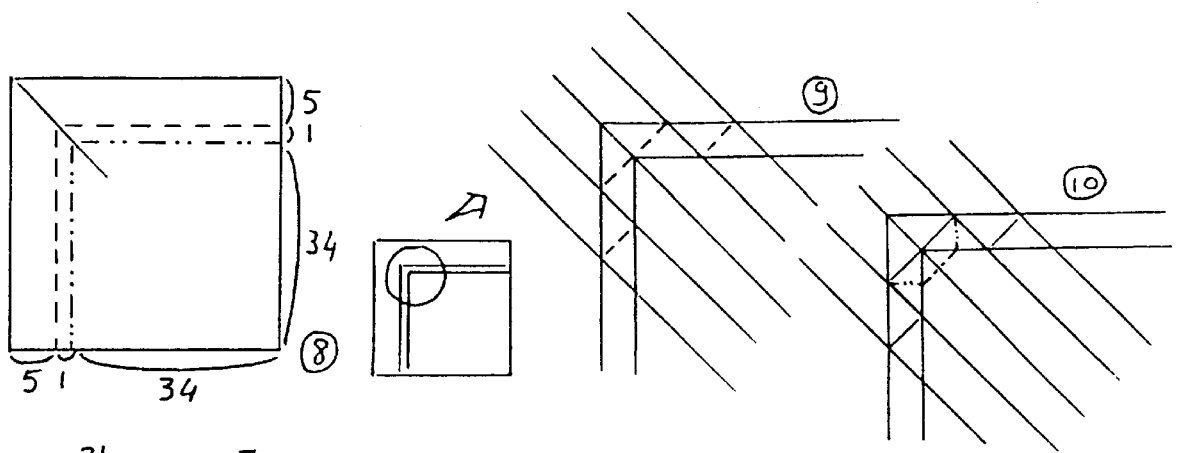

STAGE II

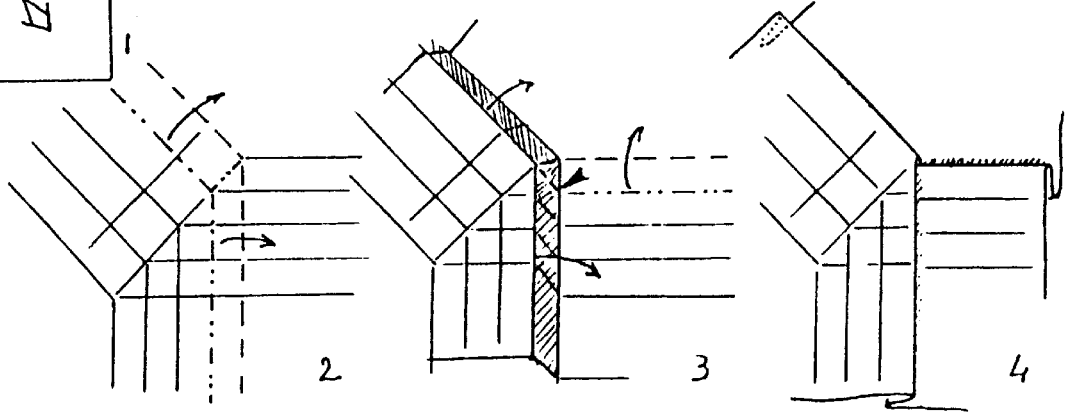
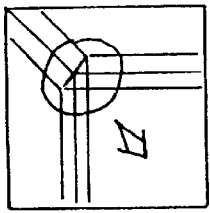

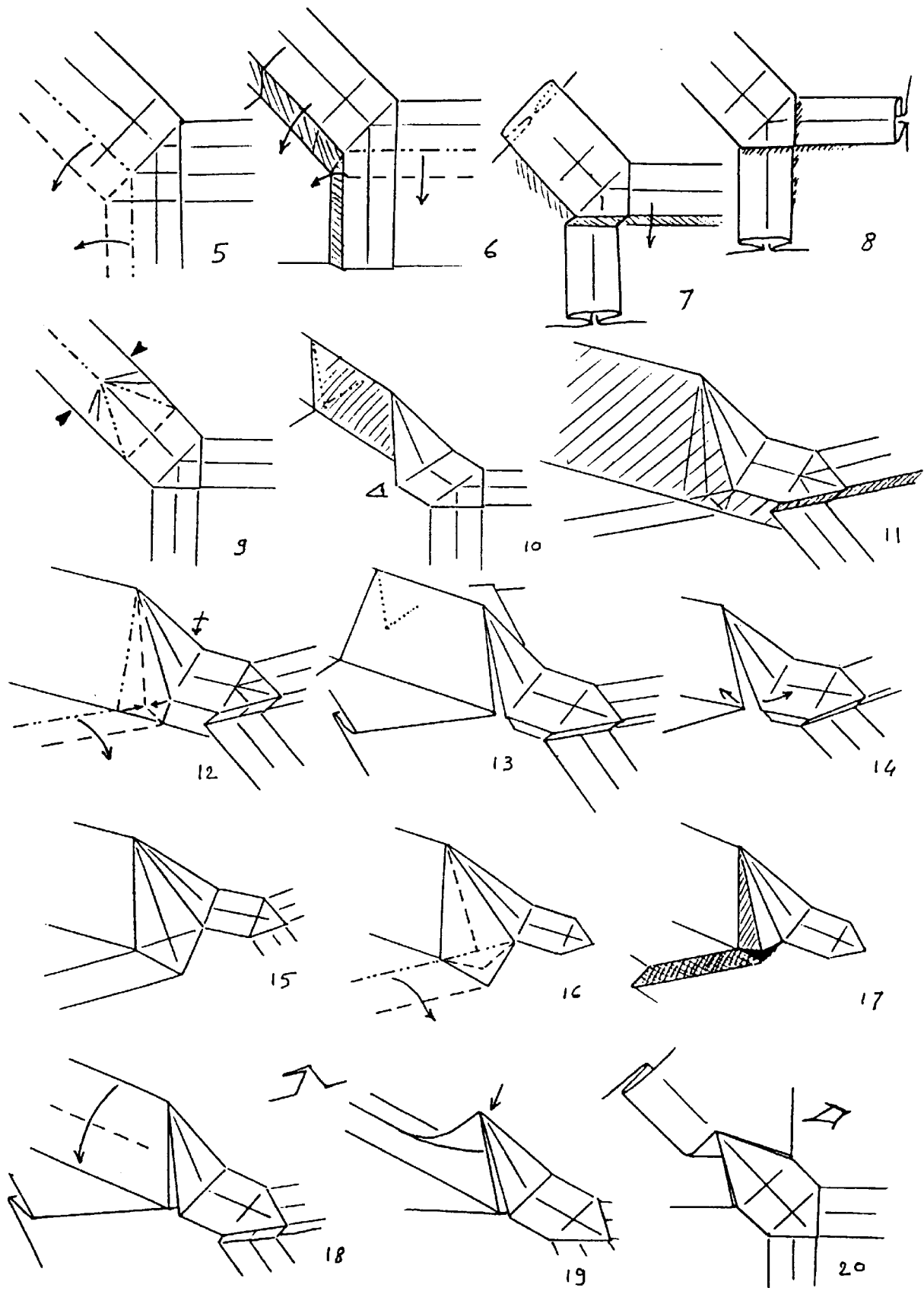

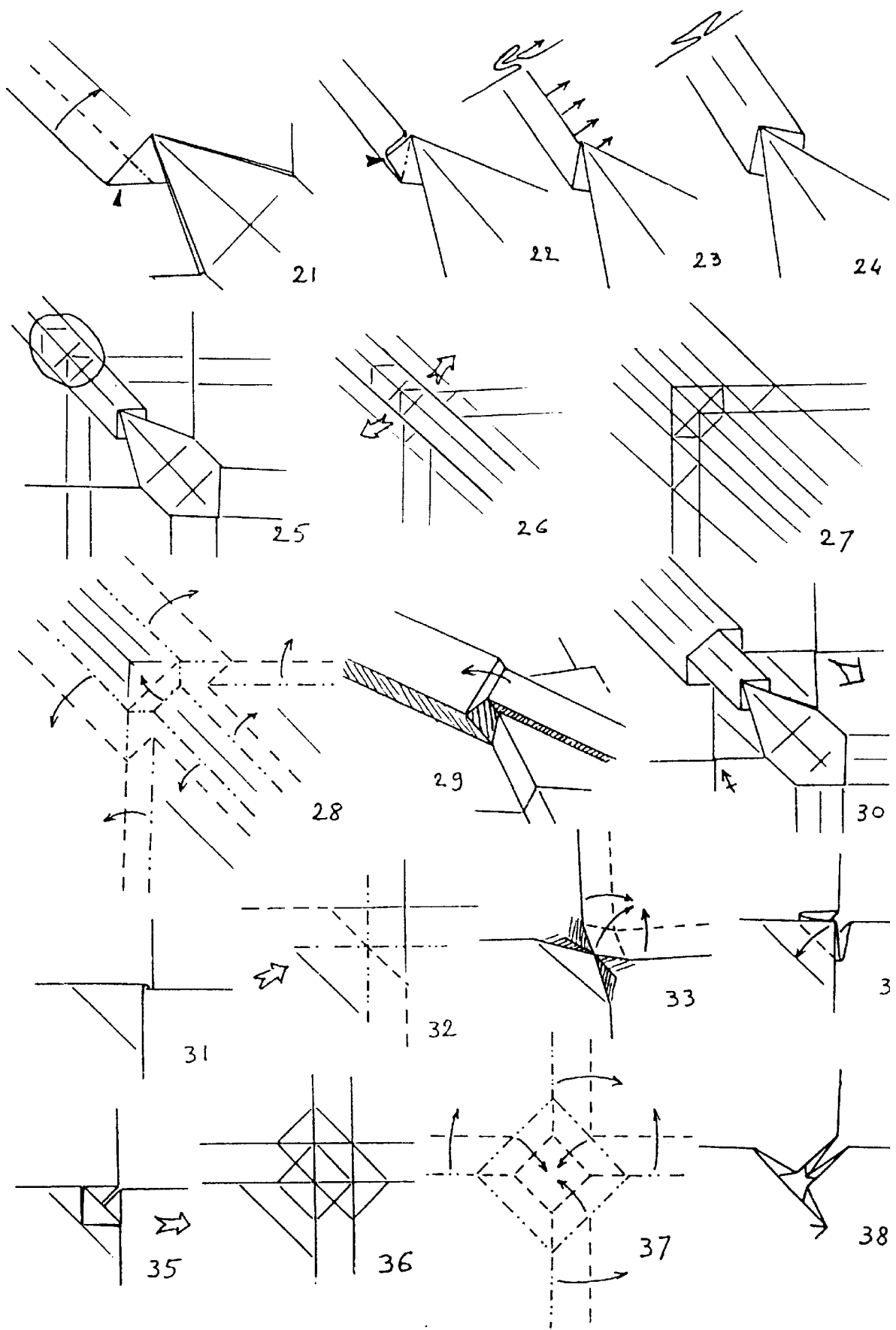

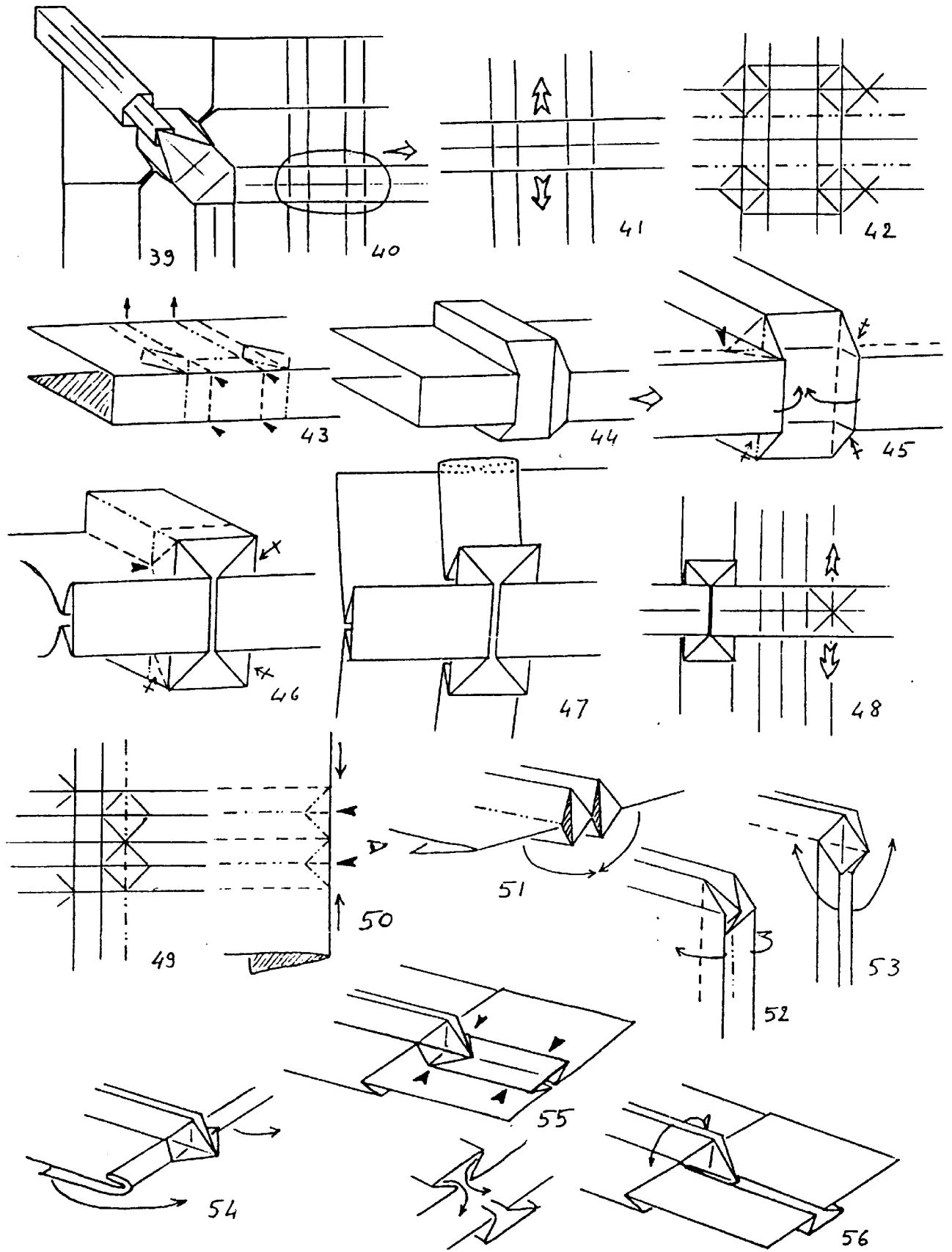

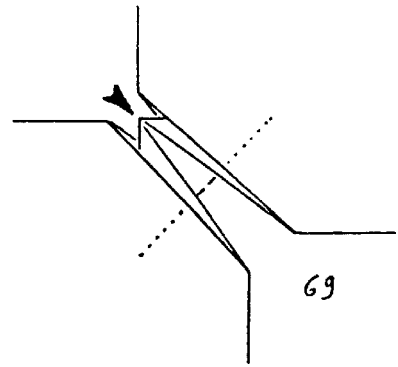
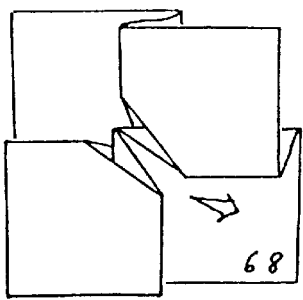
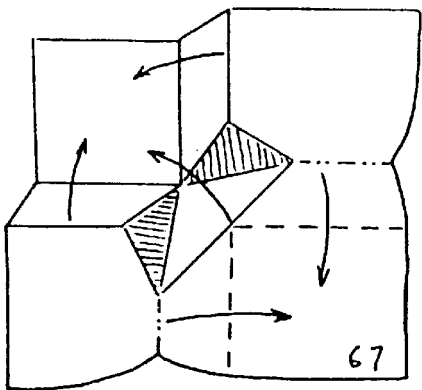
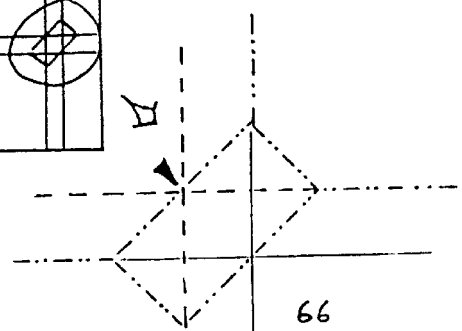
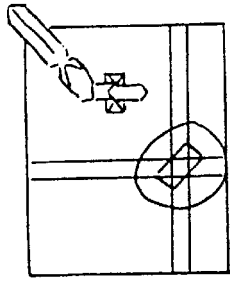
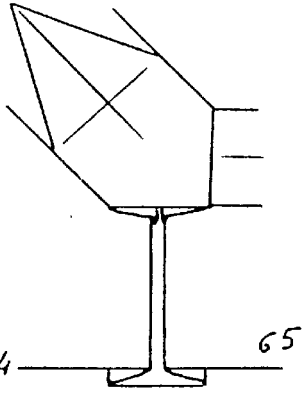
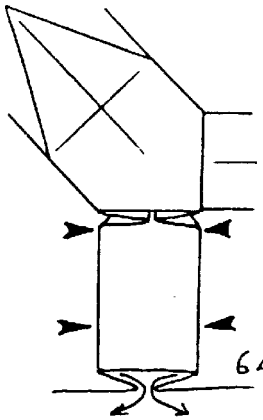
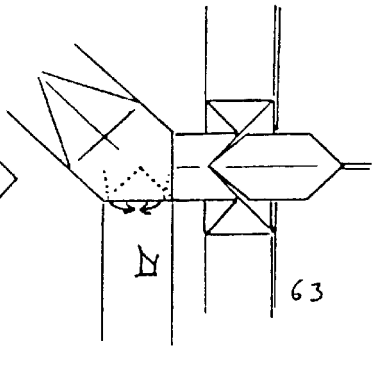
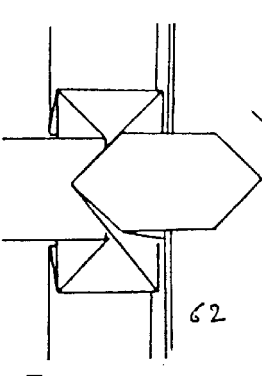
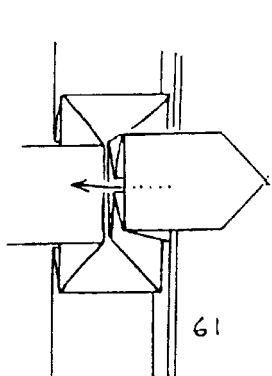
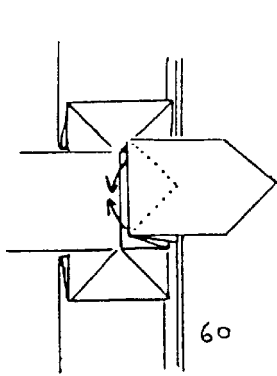
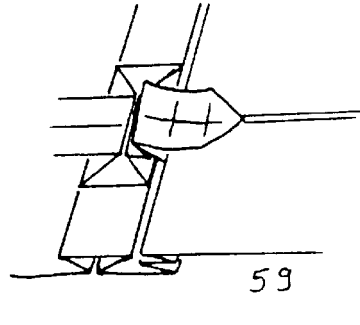
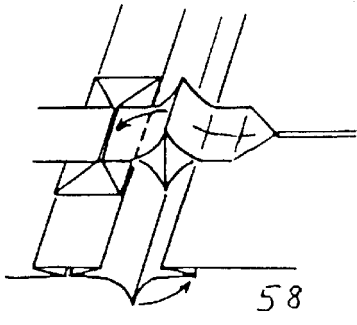
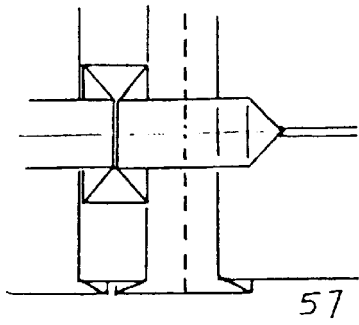

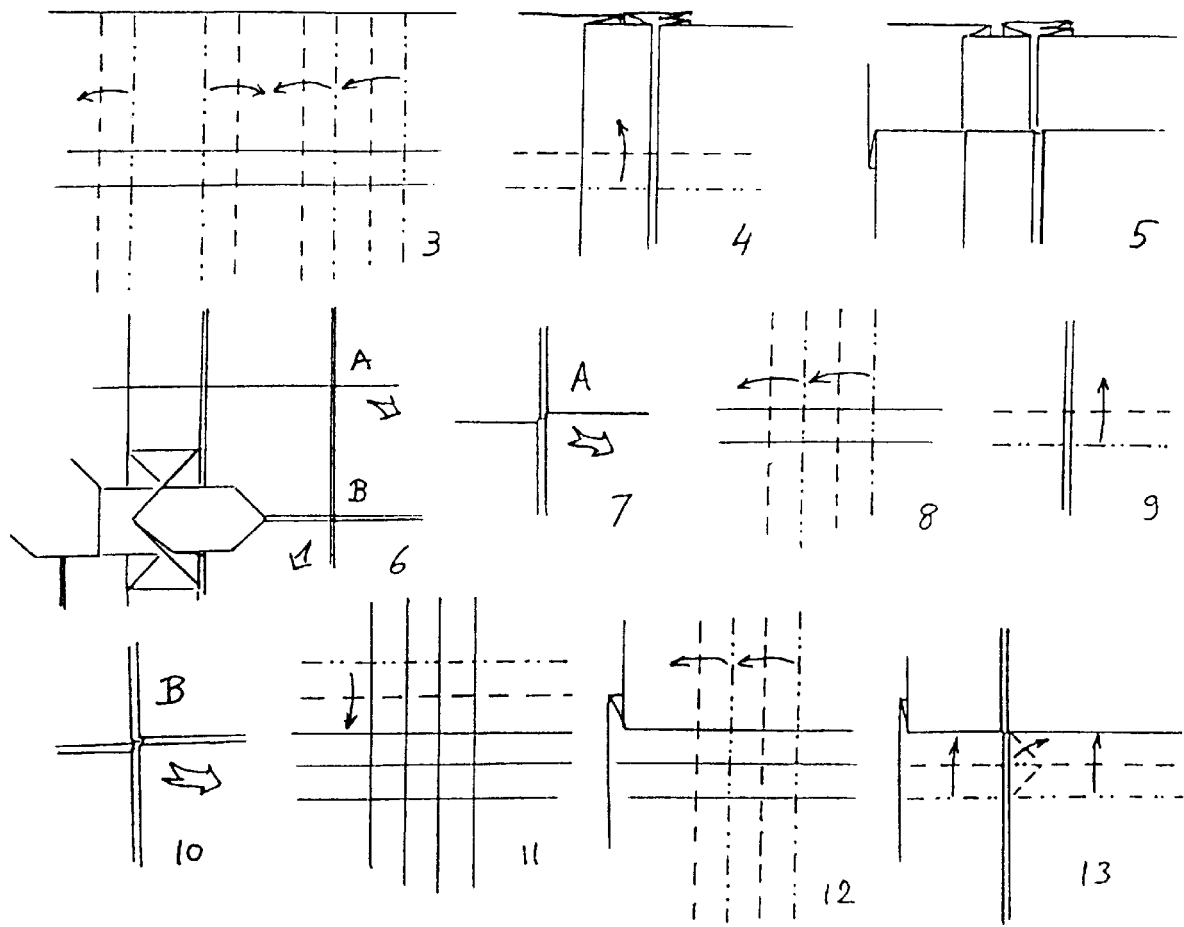
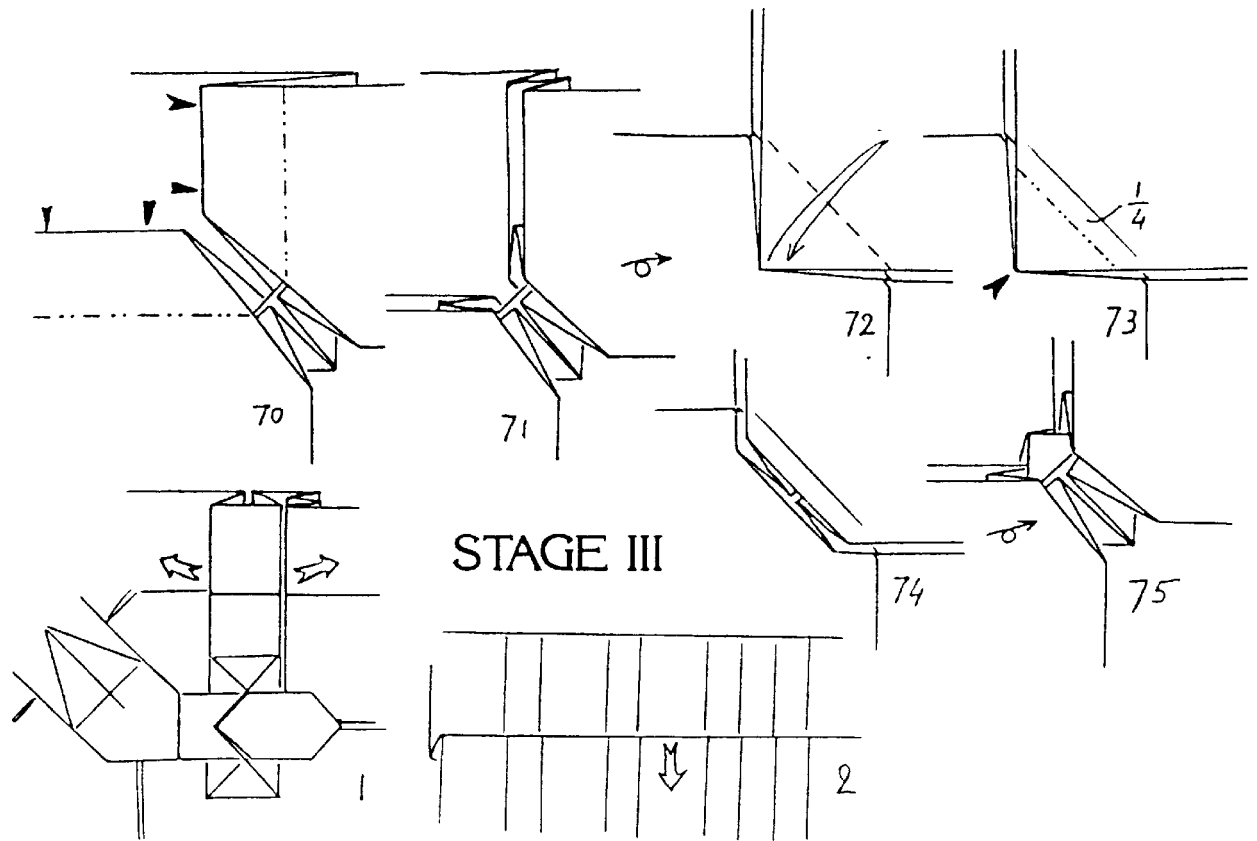

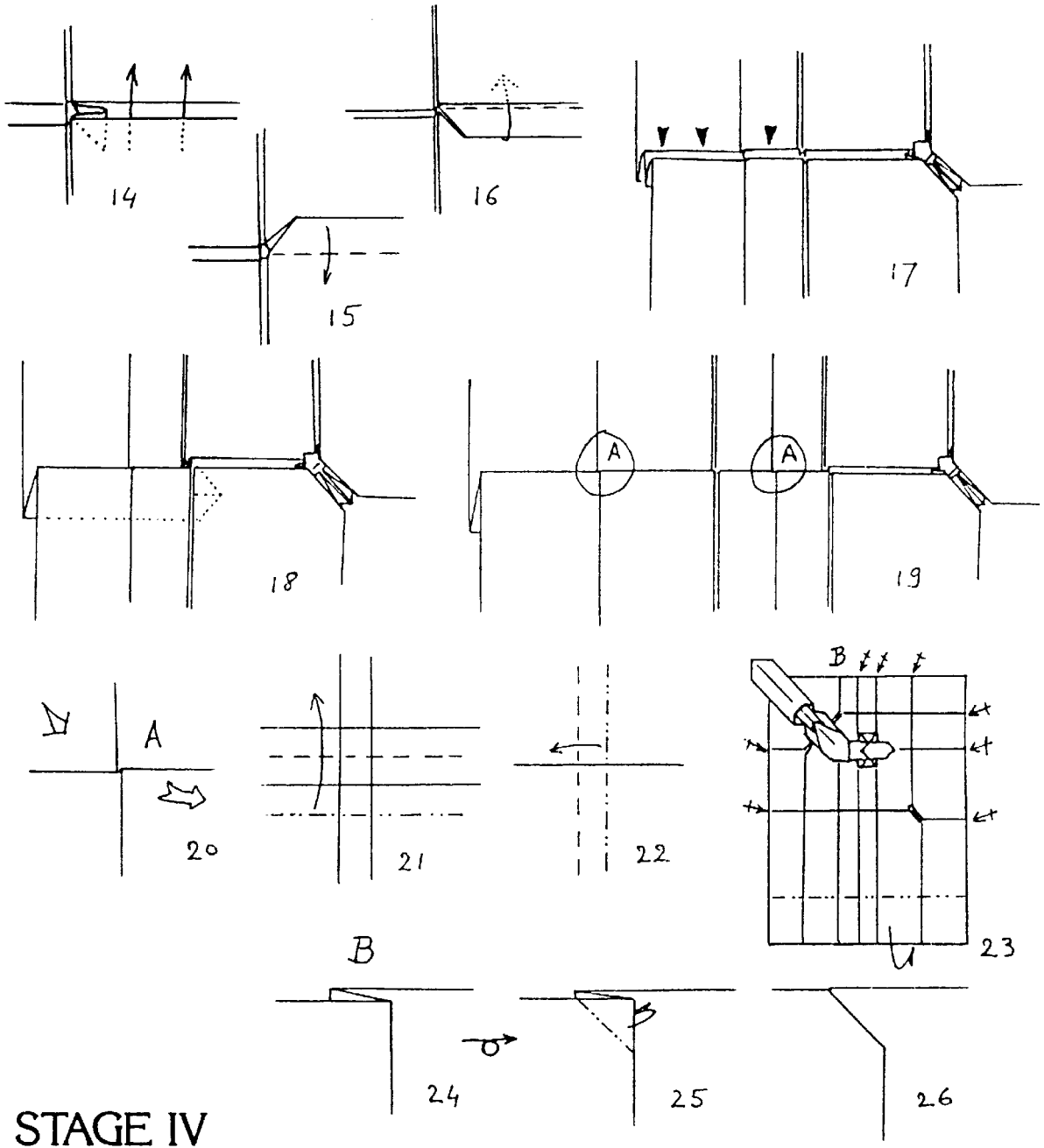

**STAGE IV**

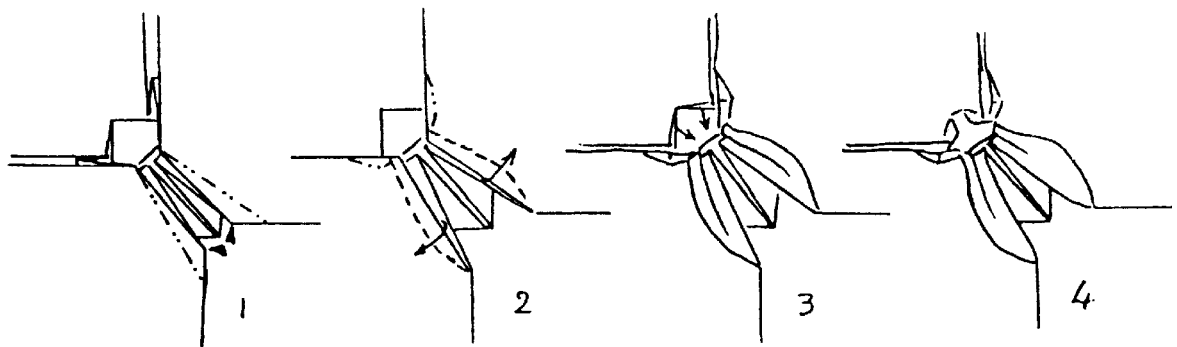



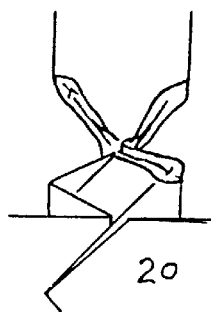
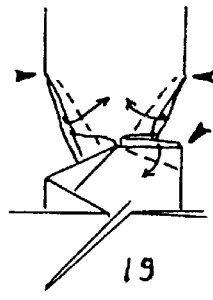
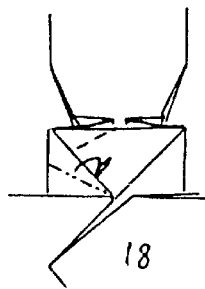
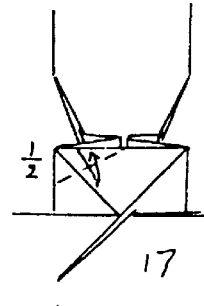
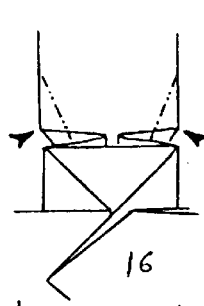
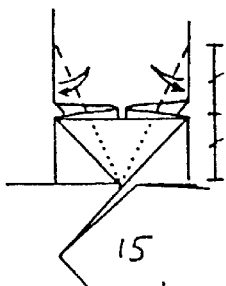
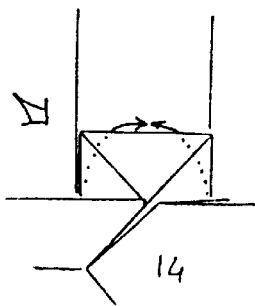
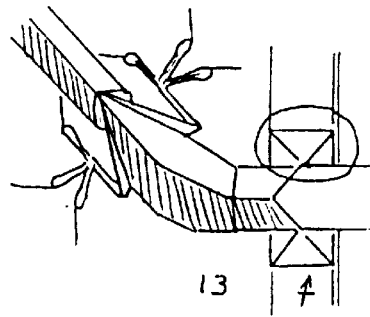
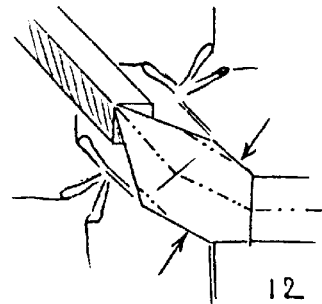
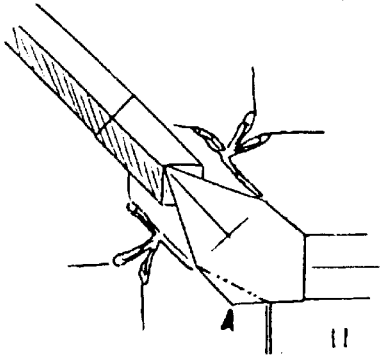
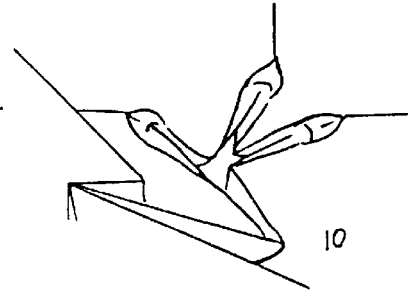
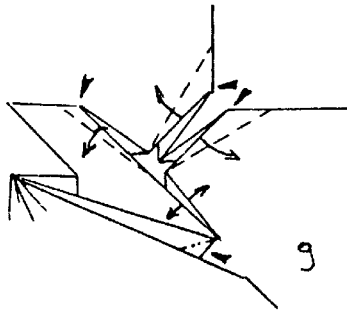
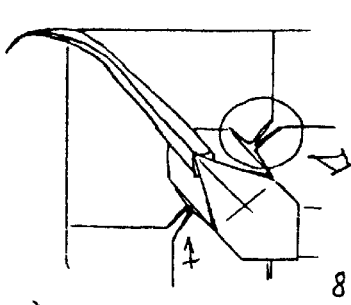
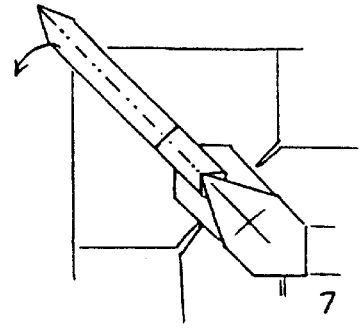
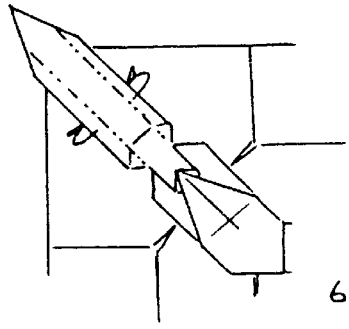
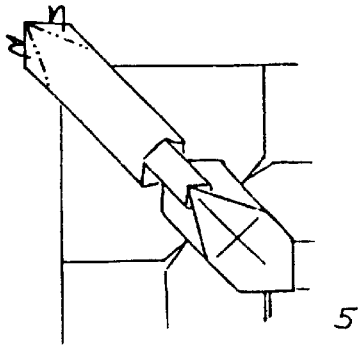

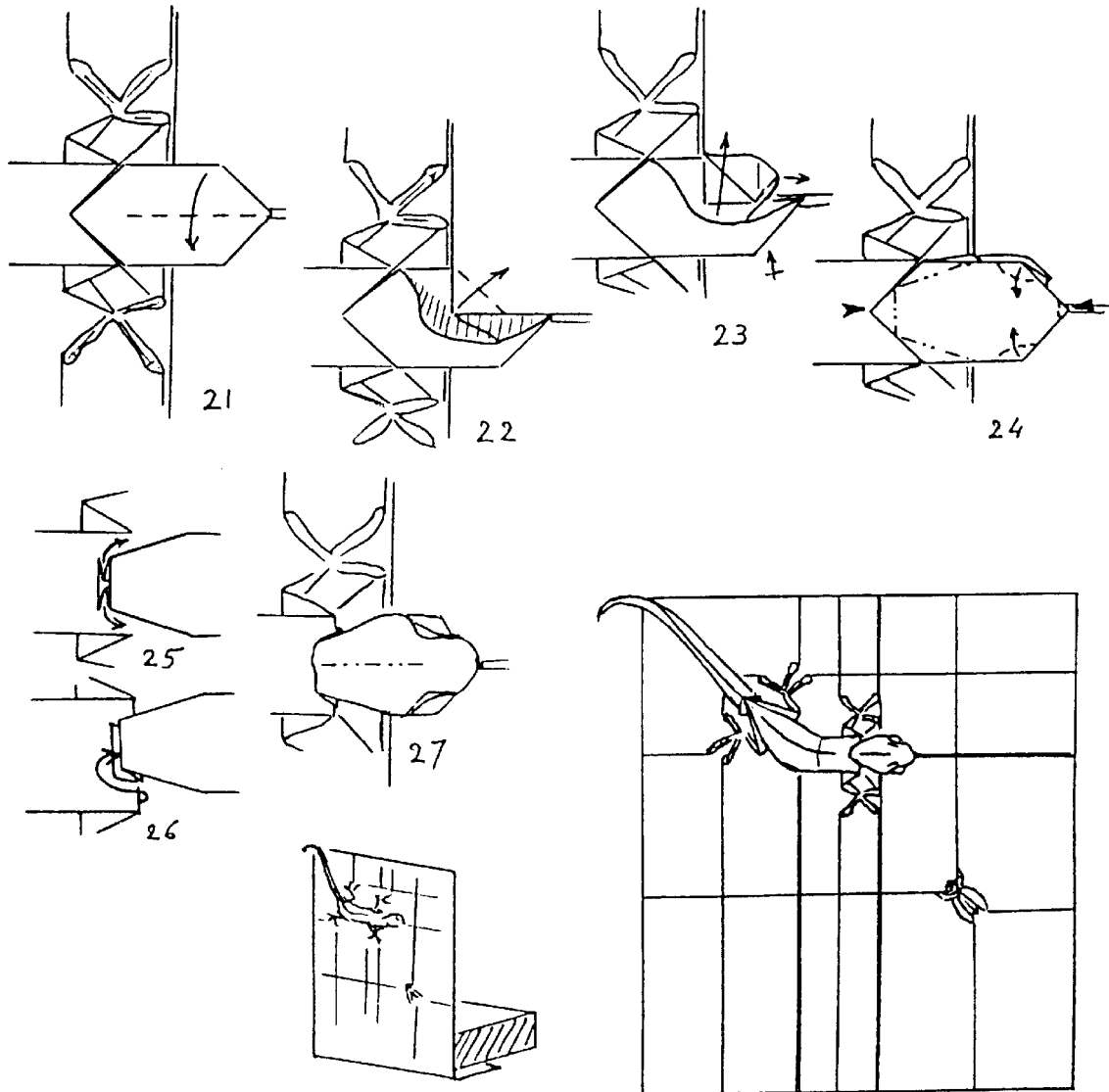

© HERMAN VAN GOUBERGEN 93-94

## Instructions

Use a large square (I use a 30×30 cm piece of Kraft paper).

The distances around the edges of the paper are measured in units of 1/40th of the side of the square. The final model is 22 by 25 units.

**stage 1:** precreasing. Measure the correct position for the long folds and draw them on the back of the paper before folding.

**stage 2:** collapsing. To do some manoeuvres, you may have to undo previous folds.

**stage 3:** rearranging. Where the long pleats cross,

they tend to open out. To avoid this, the pleat sequence is rearranged locally to lock the pleats. After this stage (or after stage 4) it is a good idea to put some heavy books on the 'wall' portions of the model and leave it overnight to get a nice flat background.

**stage 4:** final modelling. Fold the details and 3D the lizard. Give it a nice curved shape.

You can either stand the model as indicated in the drawing (if the paper is stiff enough) or hang it on the wall.

Copyright © 1993–1994 Herman van Goubergen, all rights reserved.  
 PDF version 1999 by Sebastian Marius Kirsch <skirsch@t-online.de>.  
 Distribution for noncommercial purposes is free. Please contact the author if you want to use this model for commercial purposes.

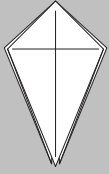

Autor: J. Anibal Voyer

Dificultad:

Proporción:  $h = \frac{1}{2} a$

# Fantasma

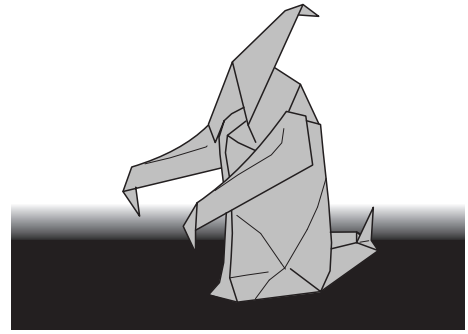

1

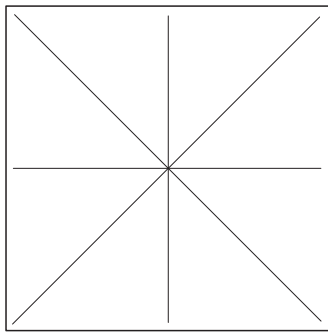

2 Repetir en las cuatro esquinas

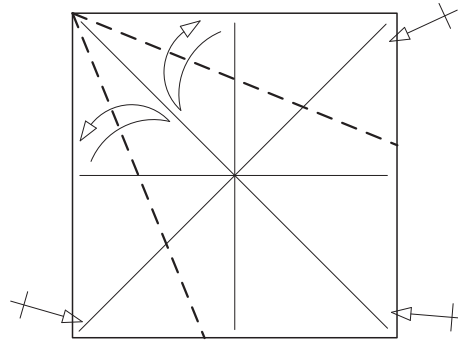

3

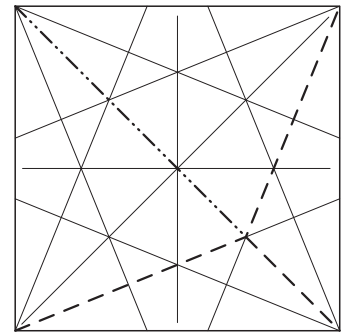

4

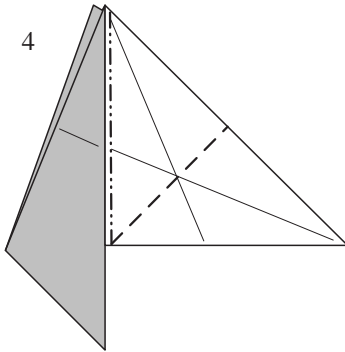

5

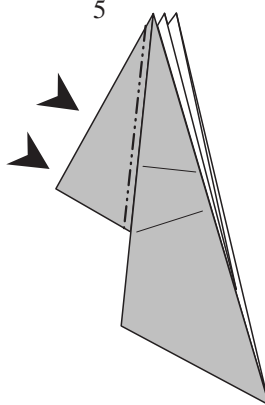

6 Repetir detras

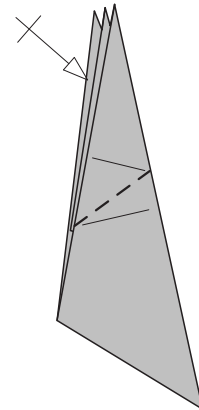

7

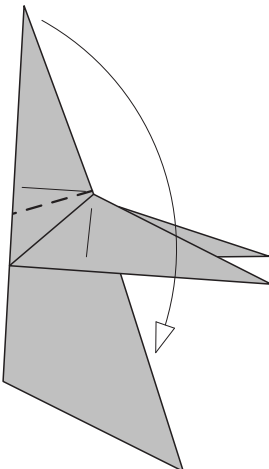

8

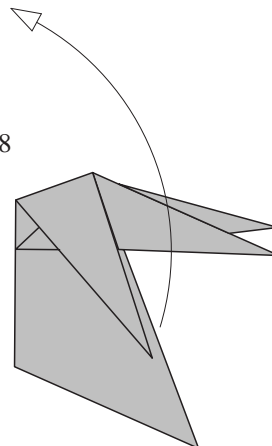

9

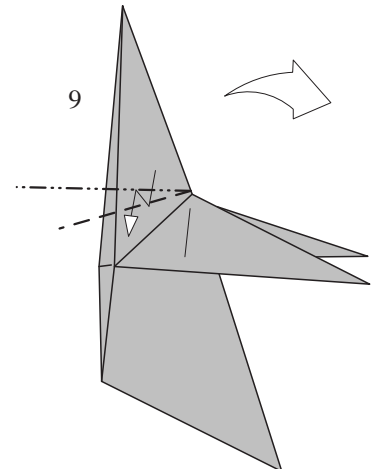

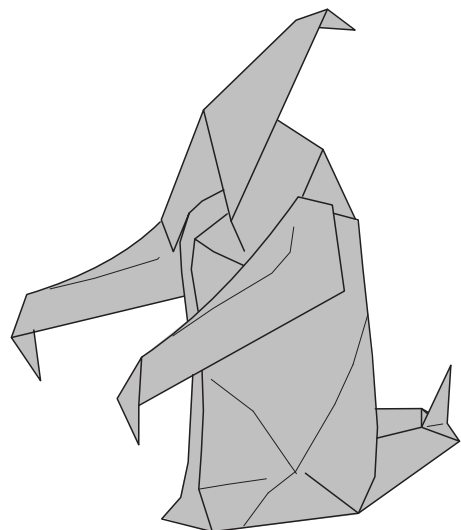
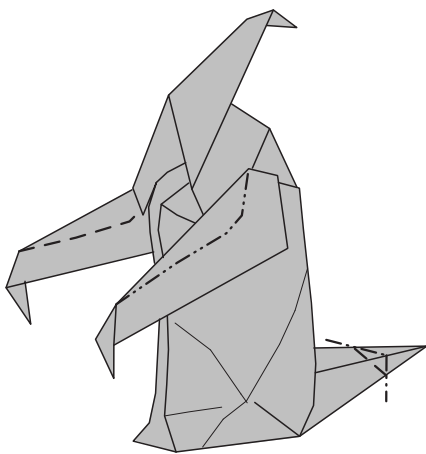
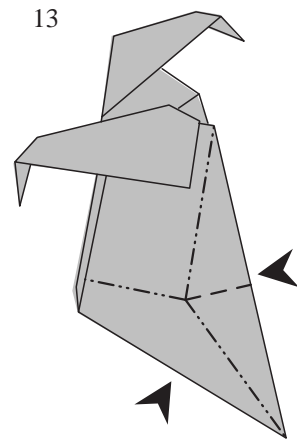
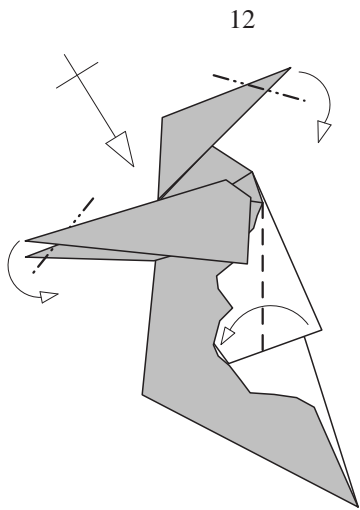
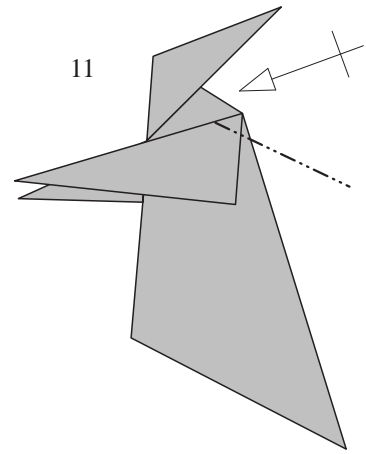
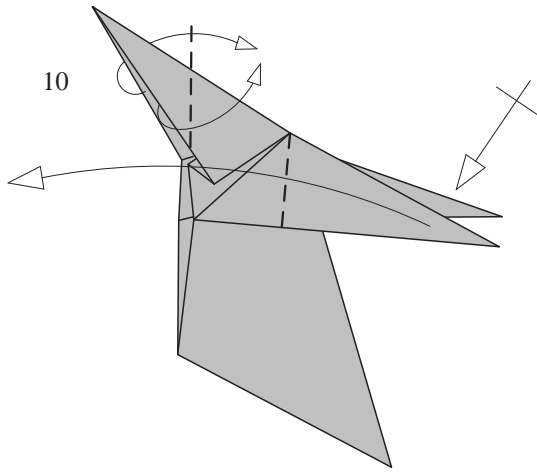

# GHOST

Design: 31.01.94

Diagrams: 02.02.94

Begin with the dark side up.

by Hans Birkeland (Norway) ©1994

**Folding pattern :**

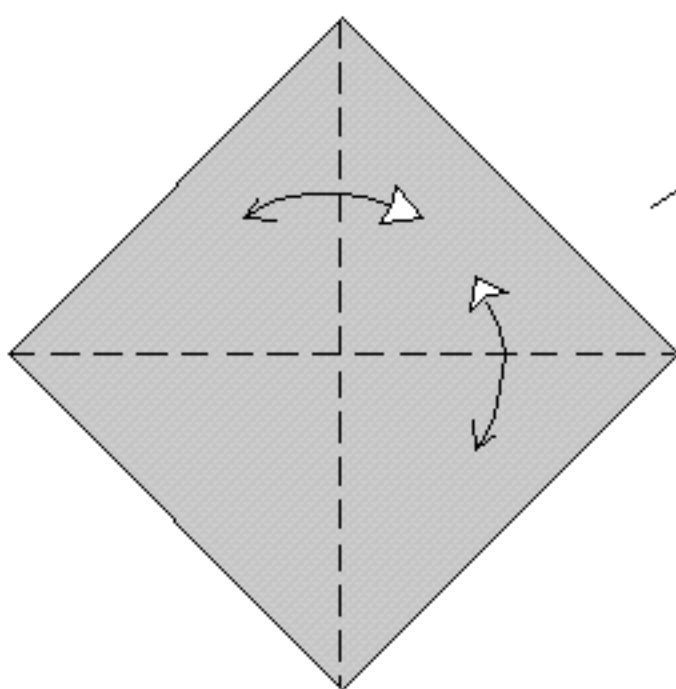
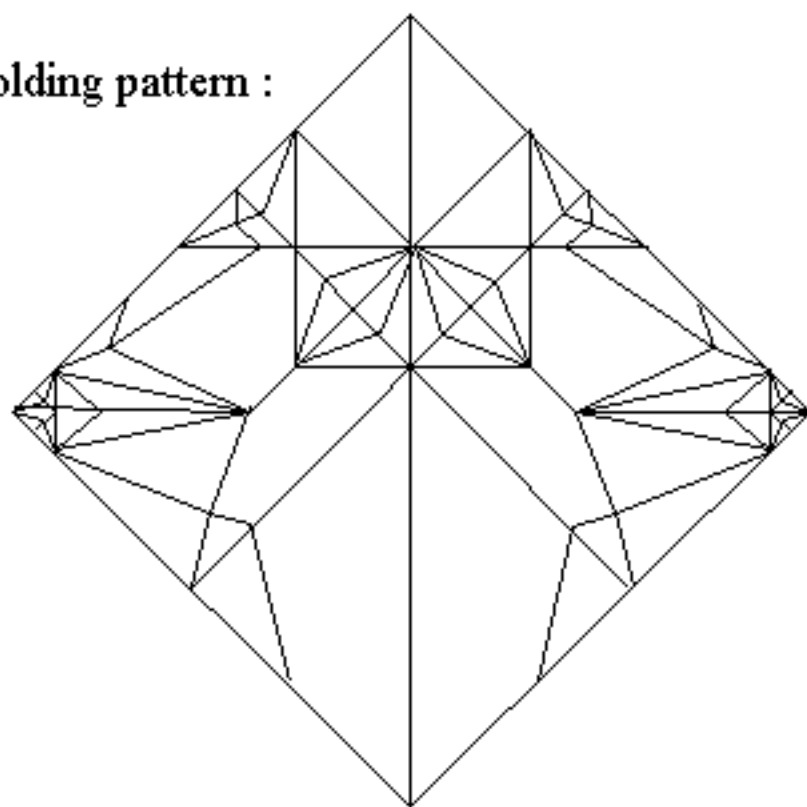

**1.** Fold and unfold.  
Turn the paper over.

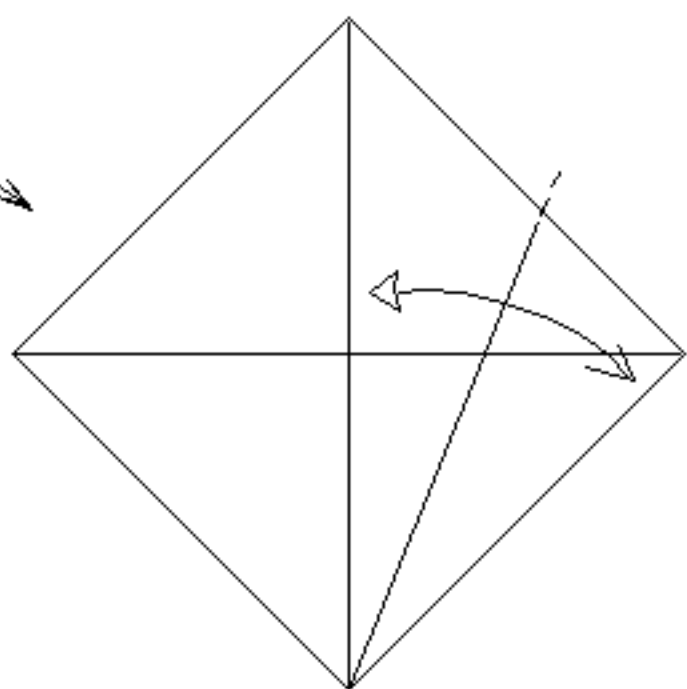

**2.** Fold and unfold.  
Just make a mark.

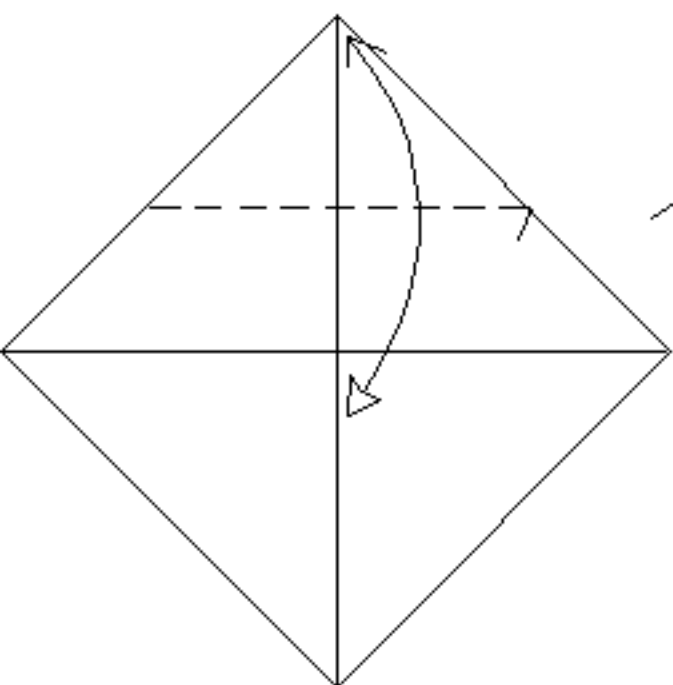

**3.** Fold and unfold.  
Turn the paper over.

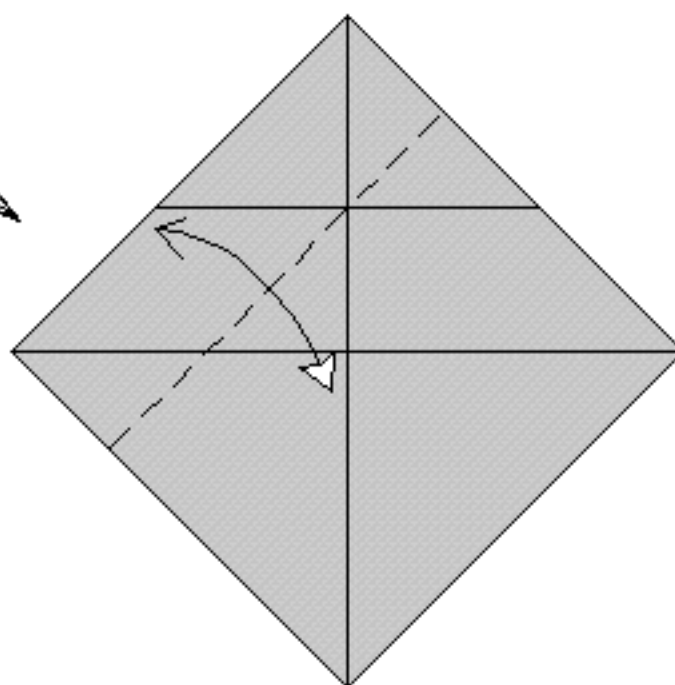

**4.** Fold and unfold.

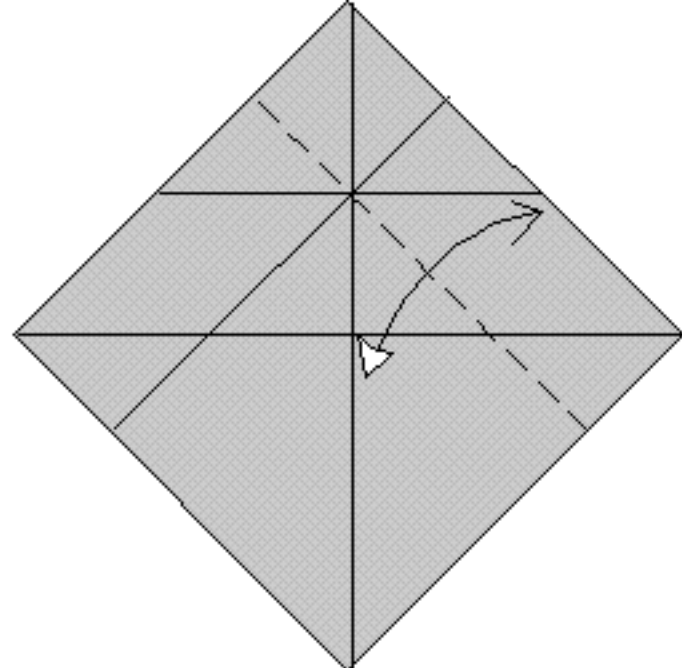

**5.** Fold and unfold.

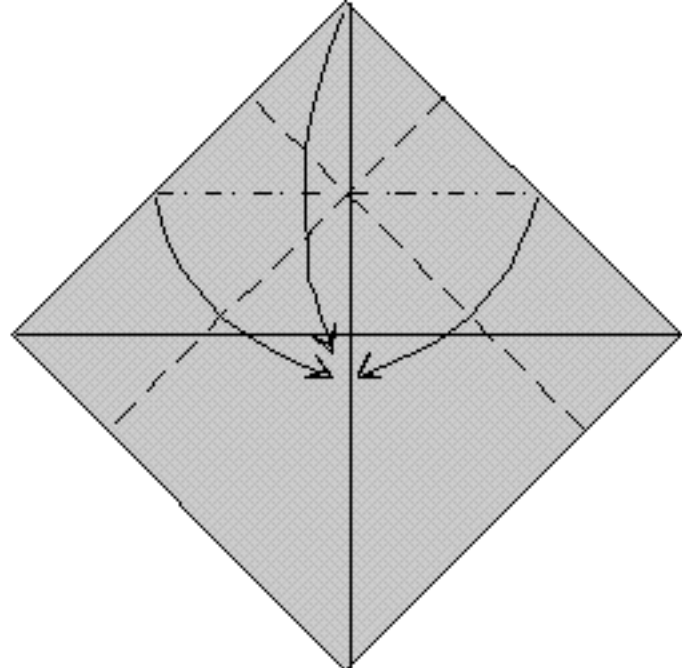

**6.** Collapse on existing creases.

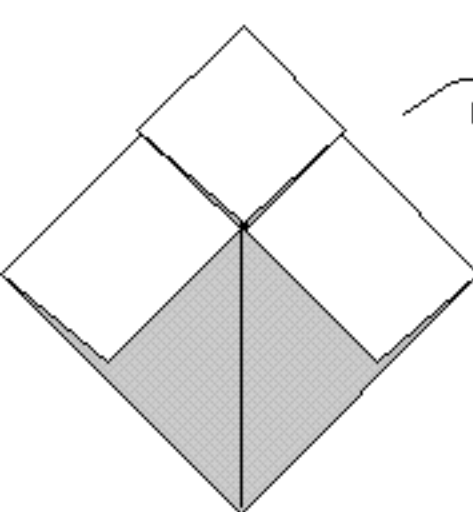

**7.** Turn the model over.

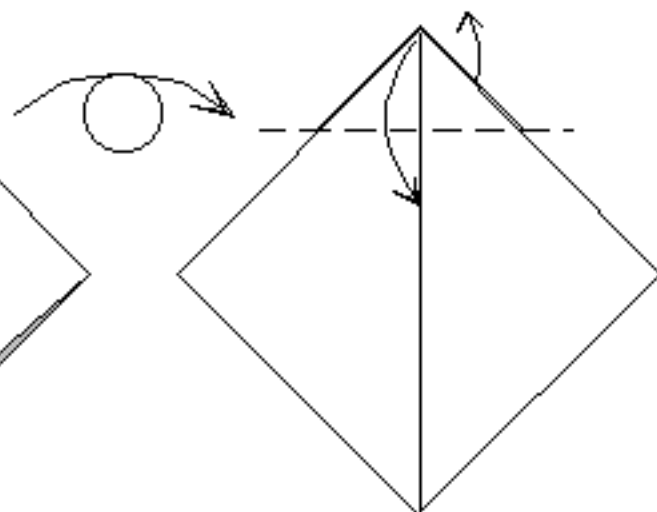

**8.** Valley-fold the corner down, letting the flap on the back come up.

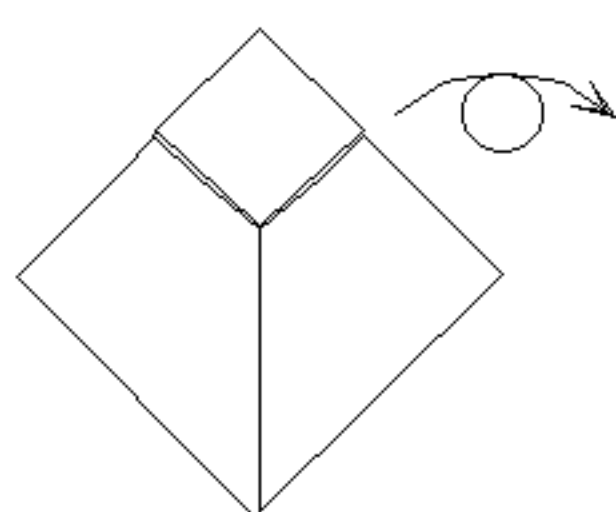

**9.** Like this. Turn the model over.

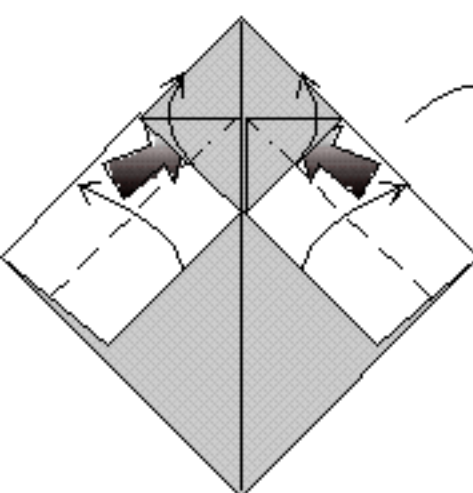

**10.** Squash-fold. Then turn the model over.

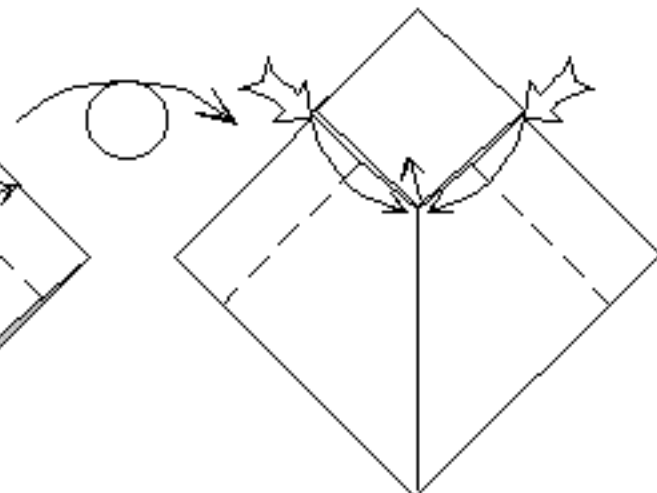

**11.** Reverse-fold the nearest edge on the left and on the right.

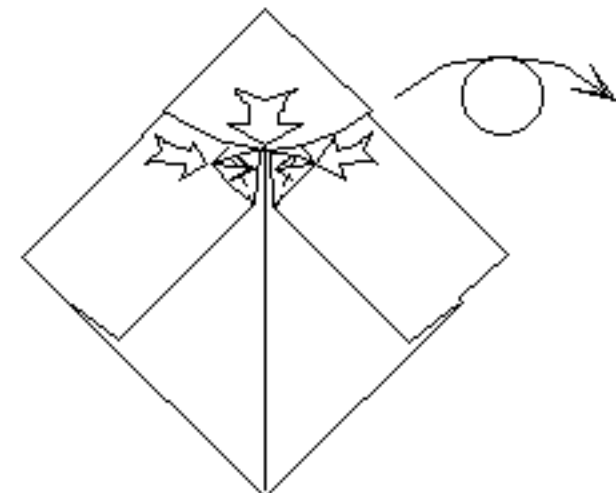

**12.** Reverse-fold the edges on the little "preliminary fold" and flatten. Turn the model over.

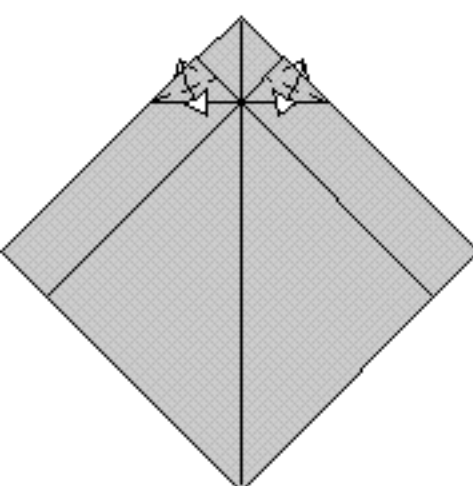

**13.** Fold and unfold.

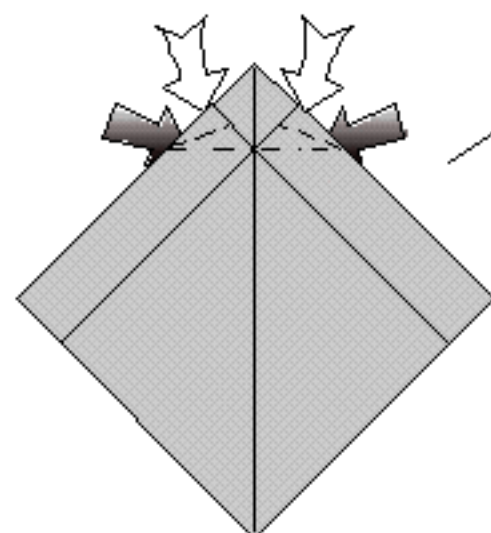

**14.** Reverse-fold down and up on existing creases. Turn the model over.

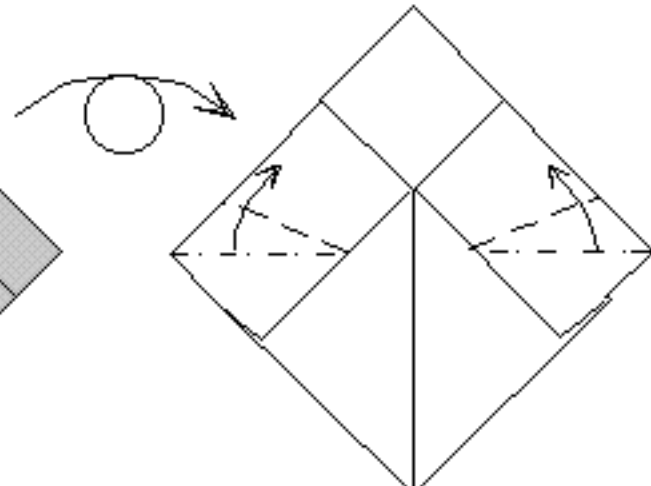

**15.** Swivel-fold so that the new edges are parallel to the edges of the little square.

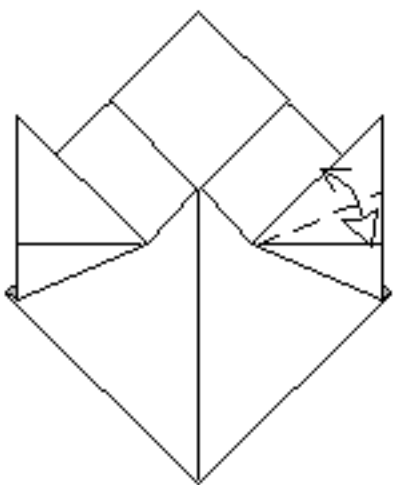

16. Fold and unfold.

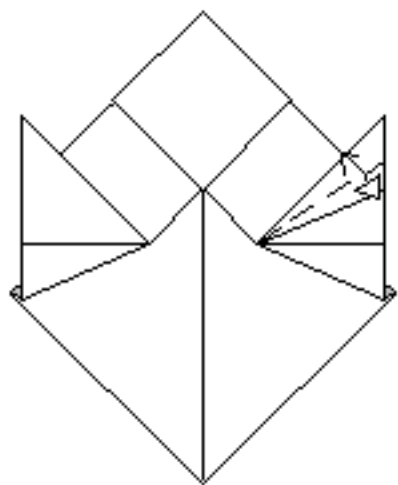

17. Fold and unfold.

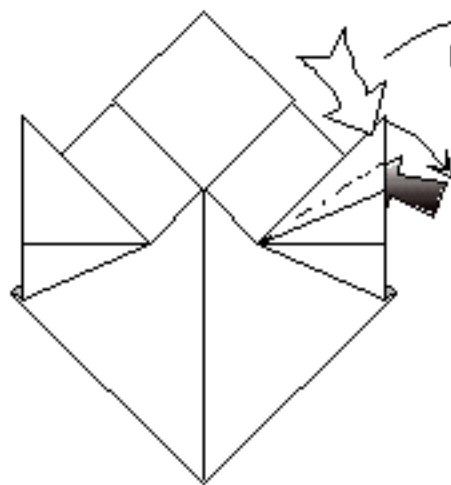

18. Reverse-fold on the existing crease. Turn the model over.

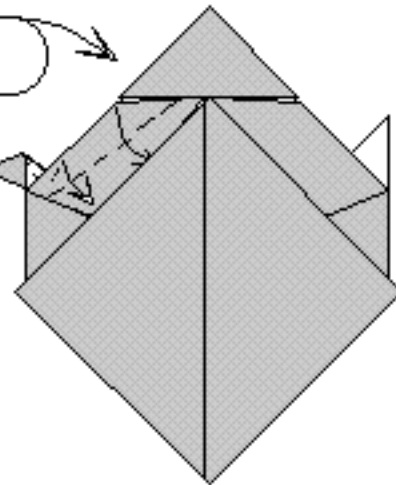

19. Swivel-fold the edge and put in underneath the edge below.

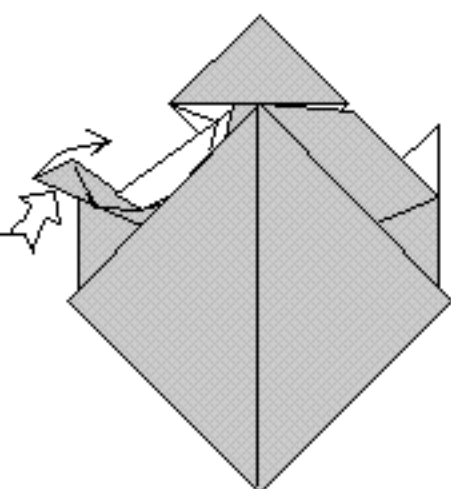

20. Reverse-fold.

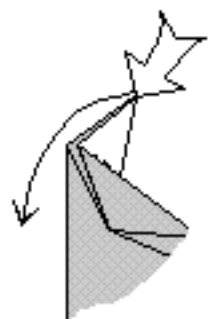

21. Reverse-fold.

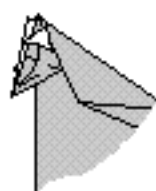

22. Fold and unfold.



23. Fold and unfold.



24. Reverse-fold.

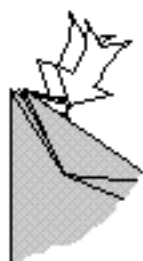

25. Reverse-fold the two small edges.

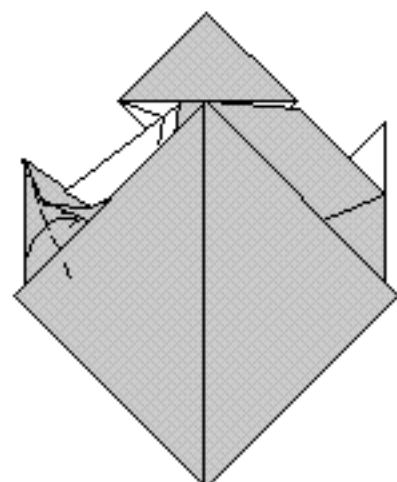

26. Valley-fold part of the left edge underneath the edge above it. The model will not lie flat.

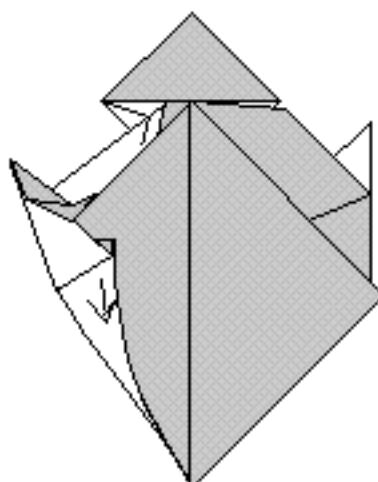

27. Swivel-fold until the new edge meets the corner. Then flatten.

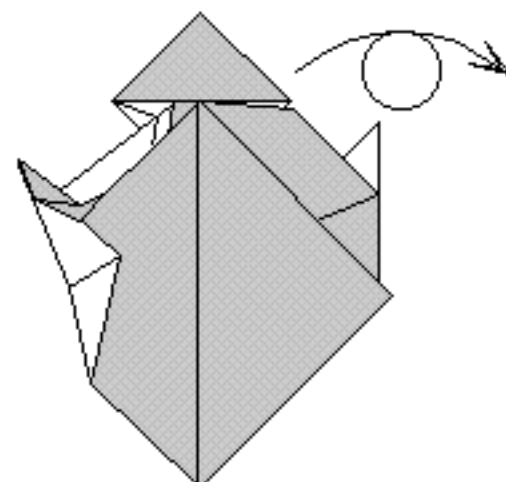

28. Like this. Turn the model over and repeat steps 16 - 26 on the left side.

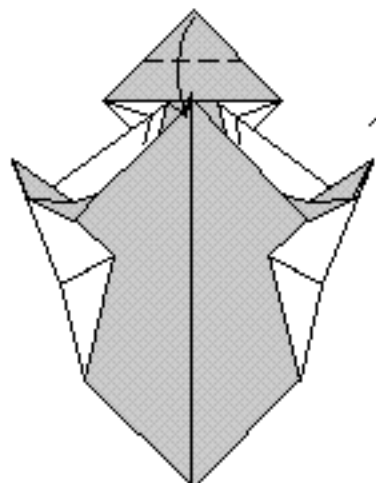

29. Fold the top corner down, a bit past the horizontal edge. Turn the model over.

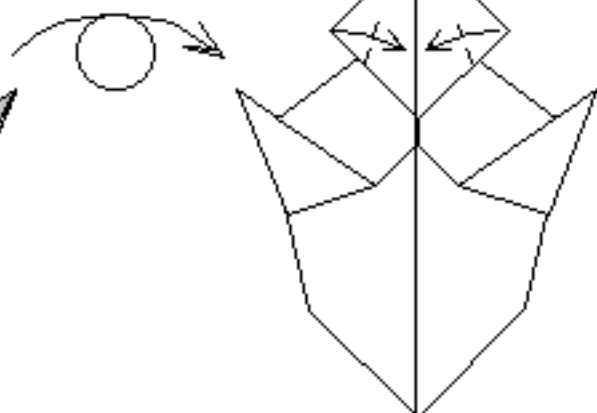

30. Fold the corners almost to the center. Flatten only where indicated.

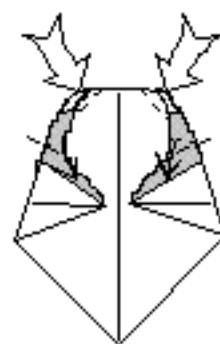

31. Swivel-fold so that the top edges will lie parallel to the center-line, thus making small eye-flaps. The model is now flat.

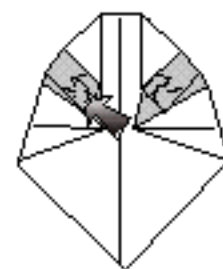

32. Like this. Open up the eye-flaps and squash.

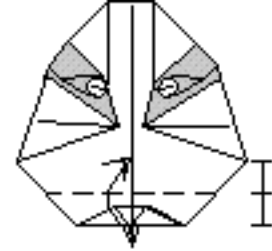
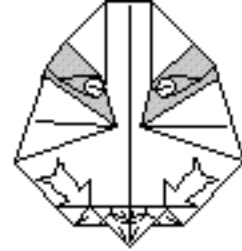
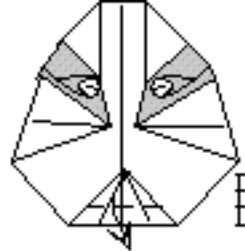
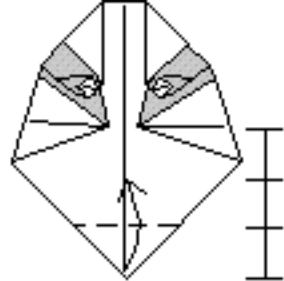
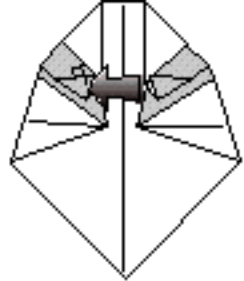

**33.** Open the eyes and make them round. They will now be 3-dimensional.

**34.** Valley-fold the corner upward.

**35.** Valley-fold the corner downward.

**36.** Swivel-fold.

**37.** Valley-fold the lower jaw upward.

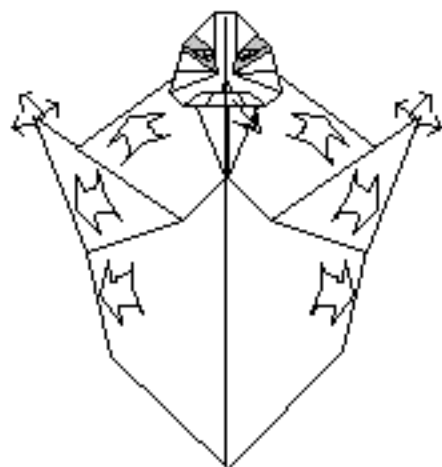

**38.** Round the edges of the body towards the back, spread the fingers and pull the lower part of the head a bit out from the chest.

**39.** Ghost 1.

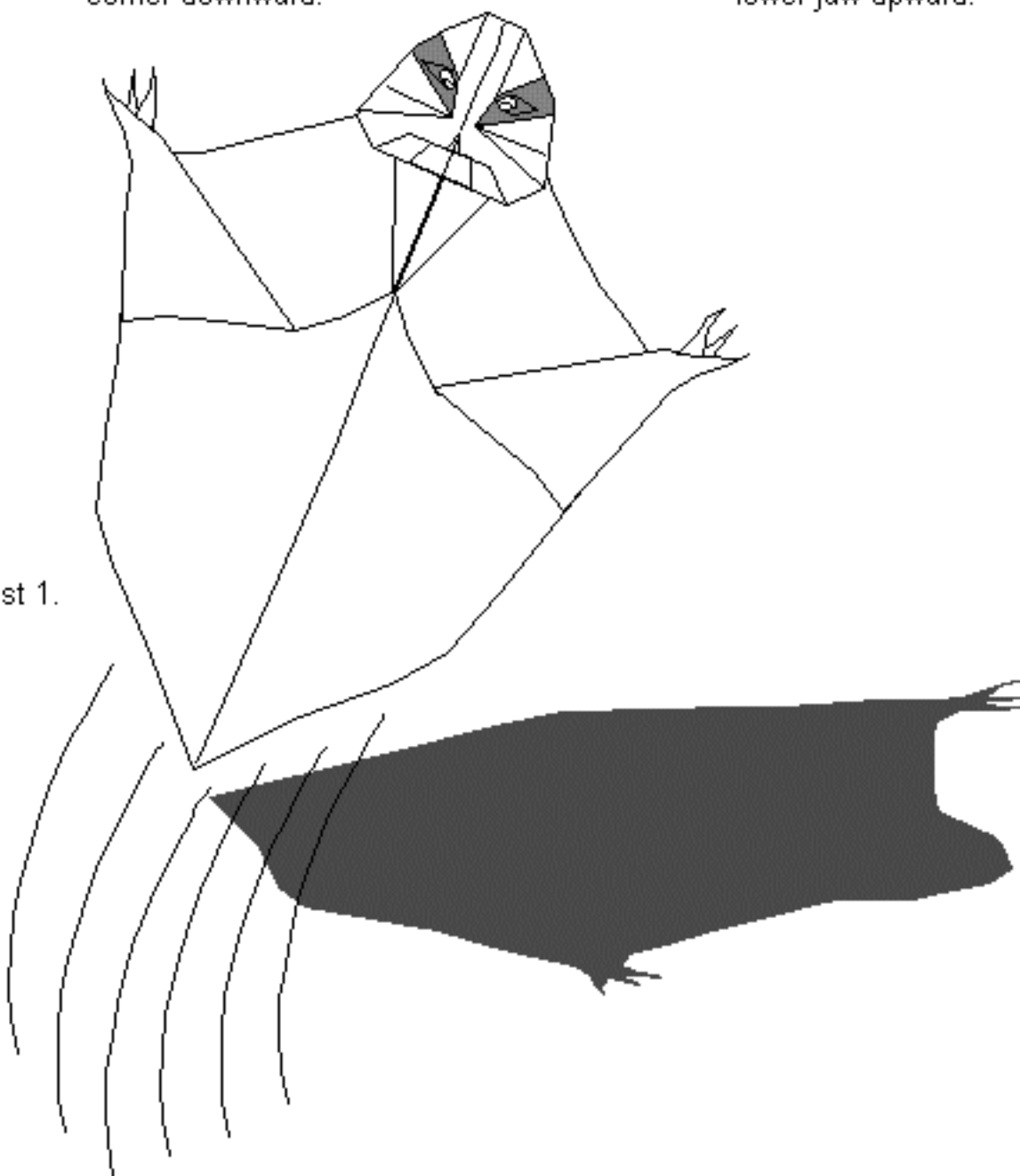

## Ghost 2 :

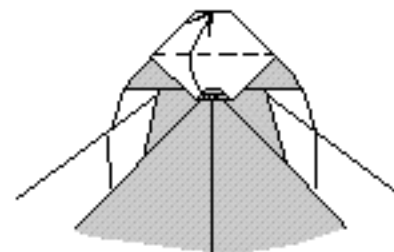
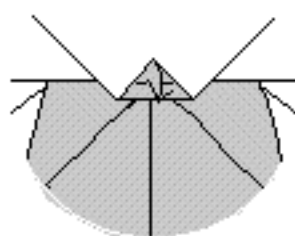
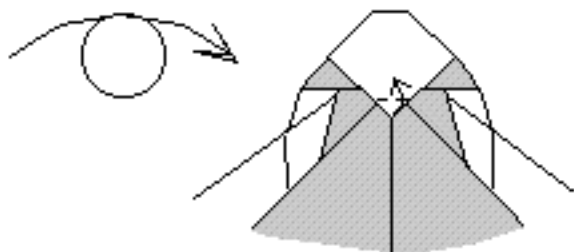
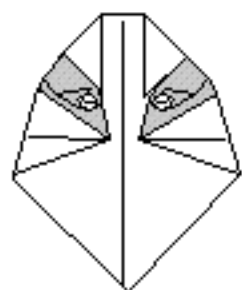

**34.** Turn the model over.

**35.** Valley-fold the corner upward..

**36.** ...and downward.

**37.** Valley-fold.



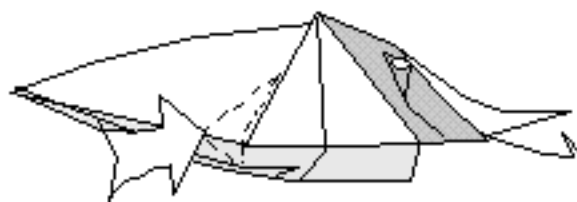
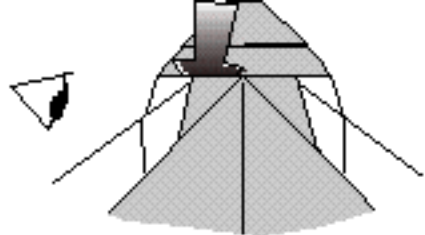

**38.** Put one finger inside the pocket. Next view from the left.

**39.** Make a crimp to make the head 3-dimensional. Repeat on the other side. Finish like Ghost1, step 38, but now curve the body like a U upside-down.

**40.** Ghost 2.

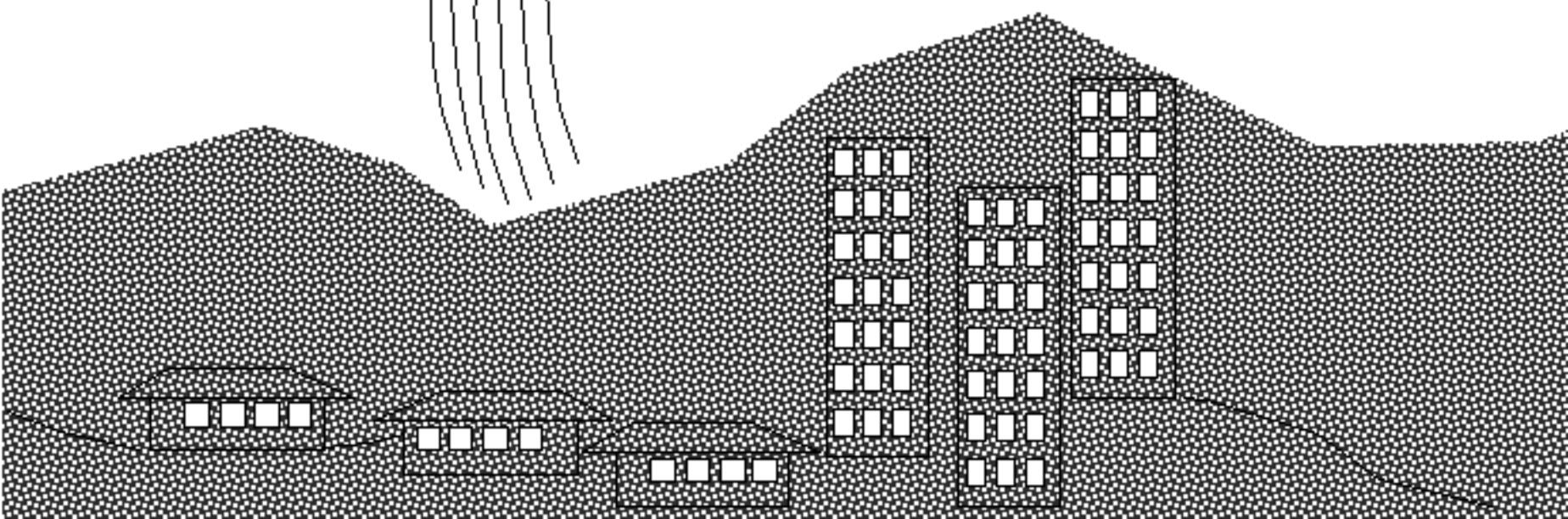
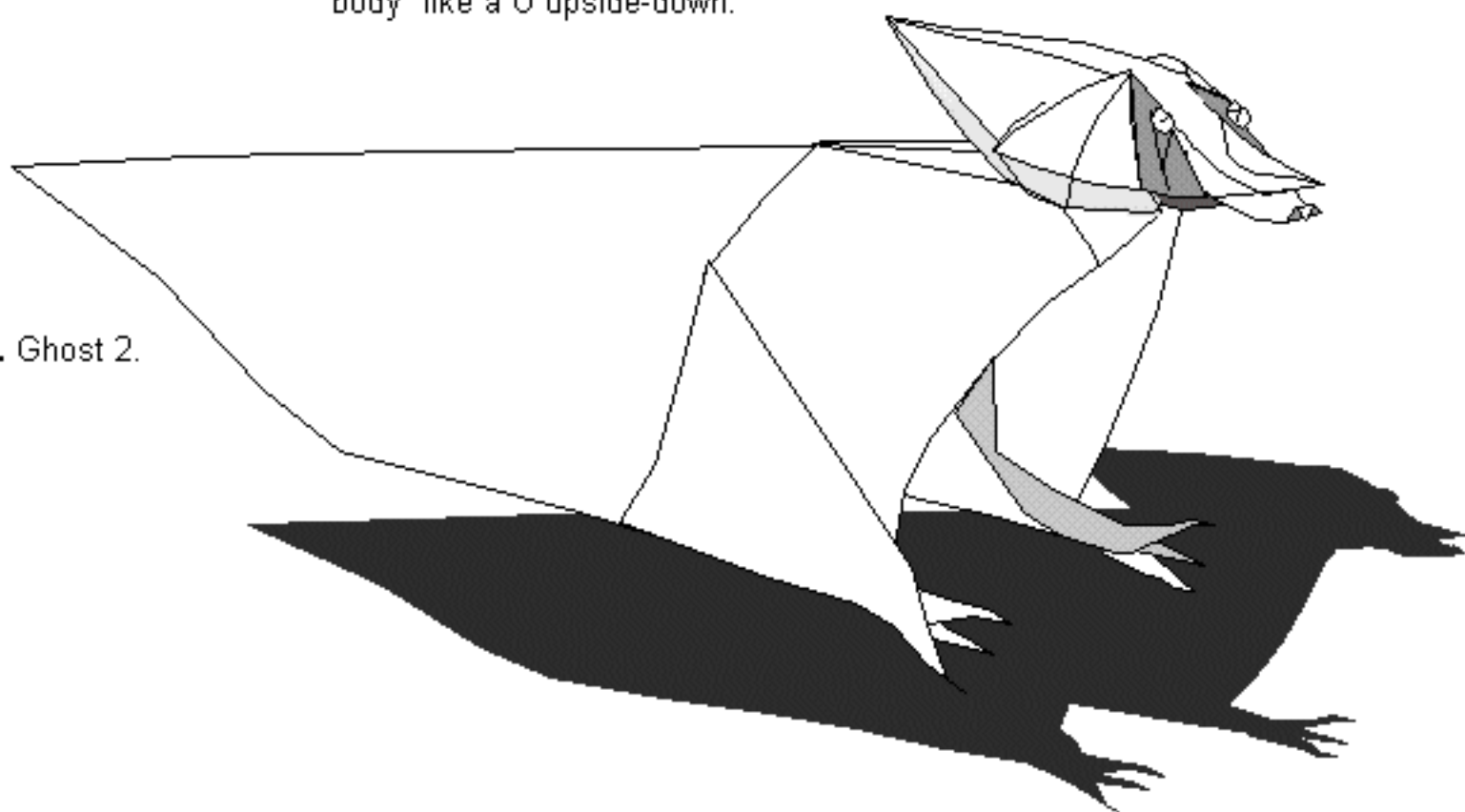

# Gift Box

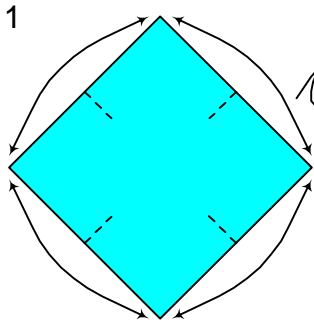

1 Pinch the half way points

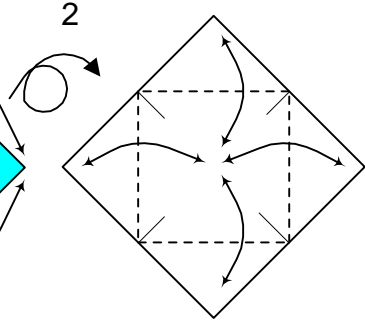

2 Fold the corners to the middle using the pinch marks as a guide

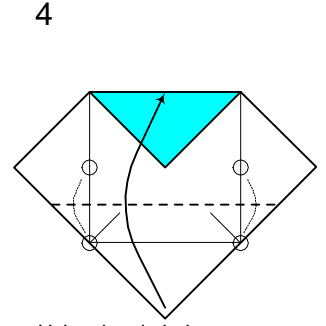
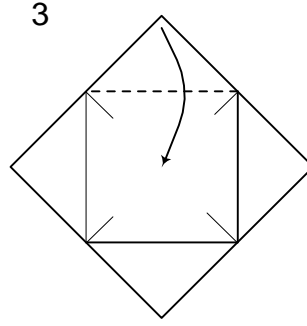

4 Using the circled areas as a guide valley fold the bottom corner up to the top edge

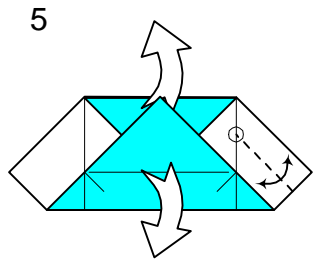

5 Crease as far as the marked point then unfold completely

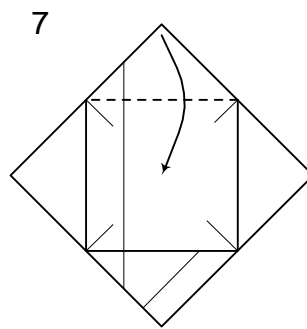
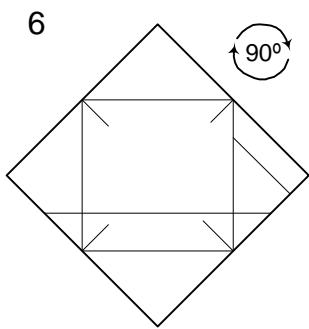

7 Repeat steps 2-6 on the other 3 corners

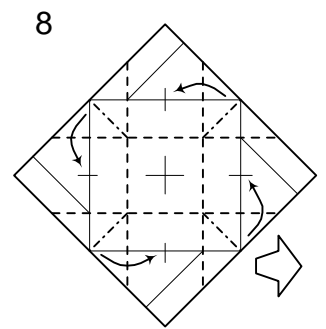

8 Begin to form a box

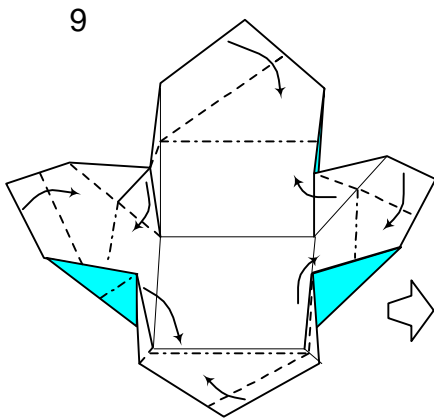

9 Continue to collapse the box, incorporating the creases from step 5

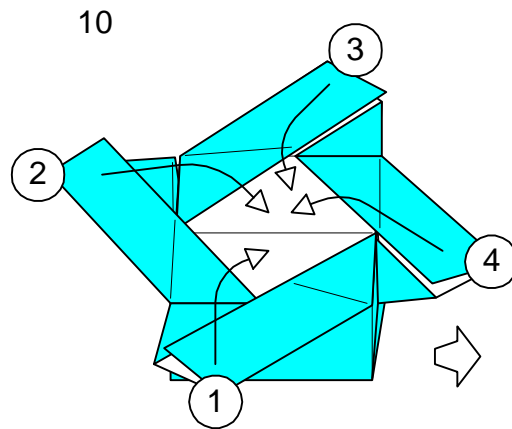

10 Finished box. Close by folding each flap to the middle in the order shown.

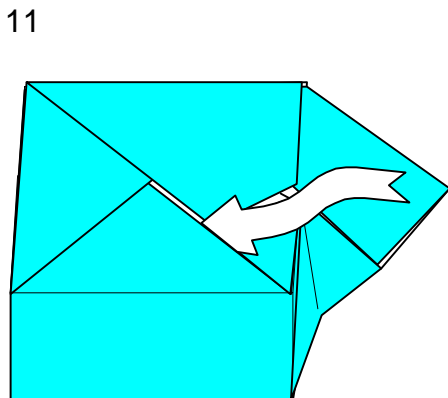

11 Tuck the last flap under to lock the box

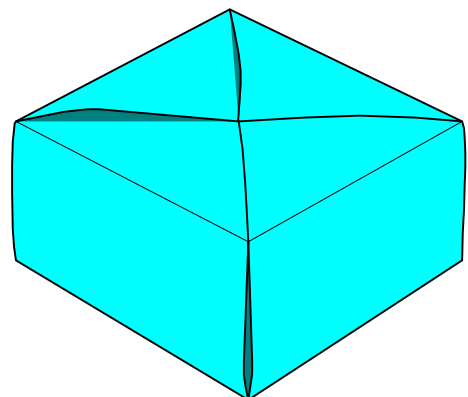

# Gigi the cat

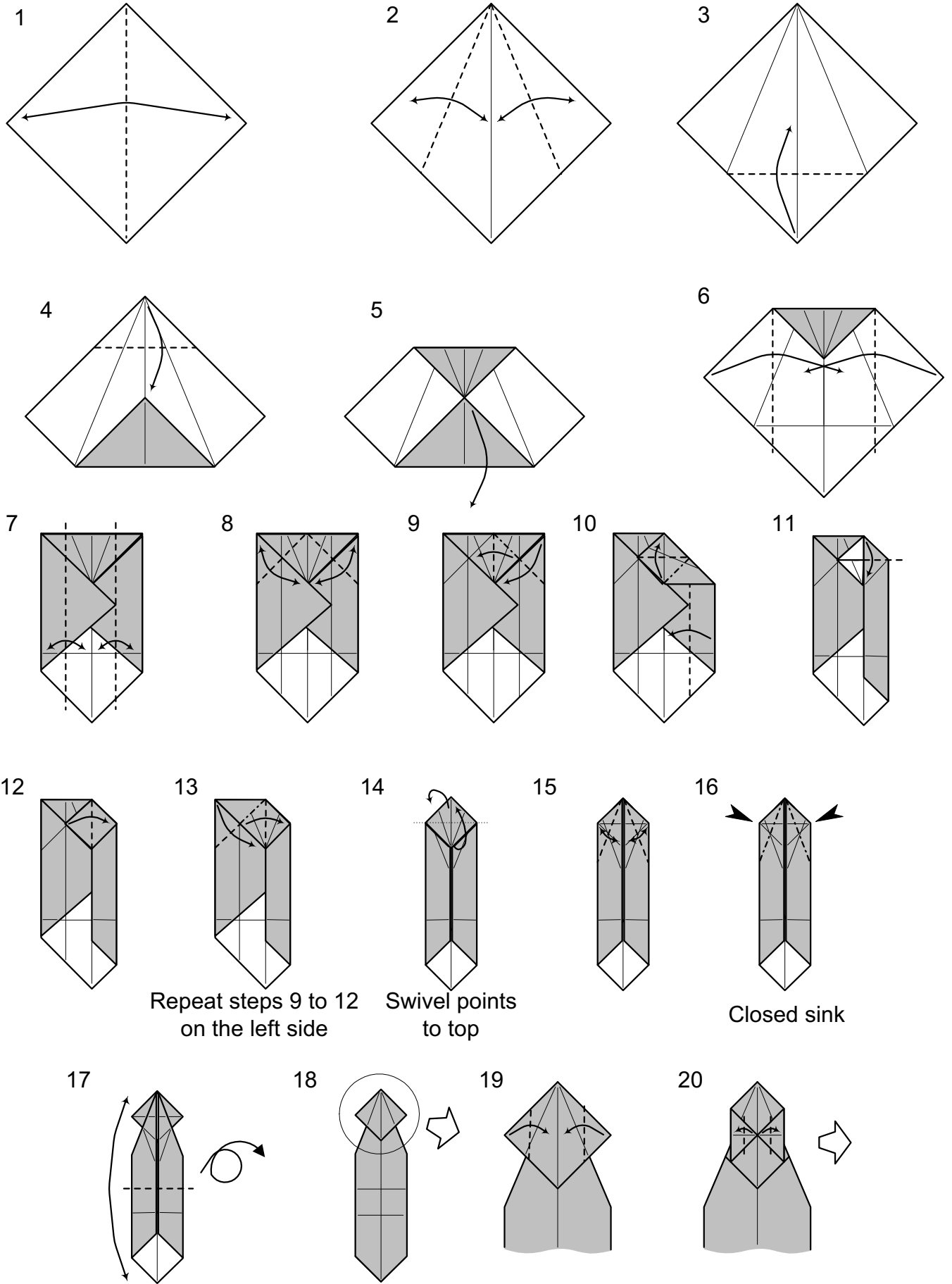

# Gigi the cat

21

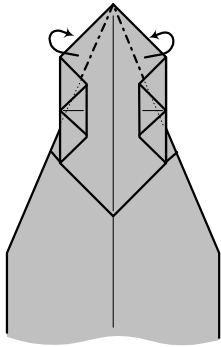

Fold 1 layer behind

22

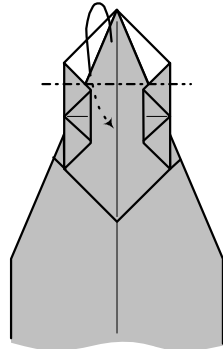

Fold point down  
inside model

23

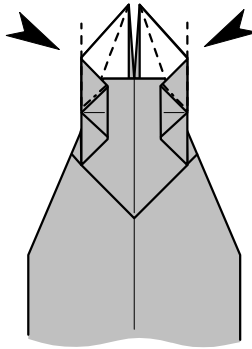

24

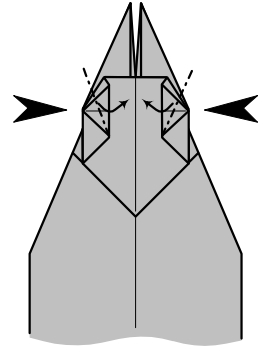

Squash folds

25

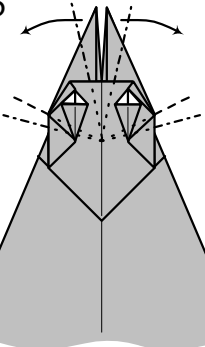

Swivel the ears  
(keeping double layer  
at the front)

26

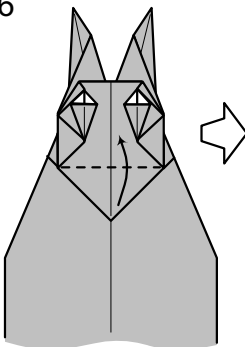

27

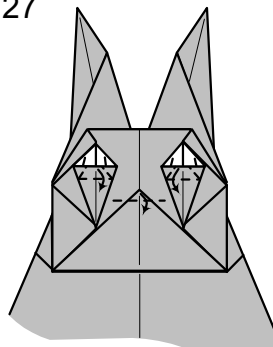

Fold tip of nose.  
Make 'soft' petal folds  
to form eyes.

28

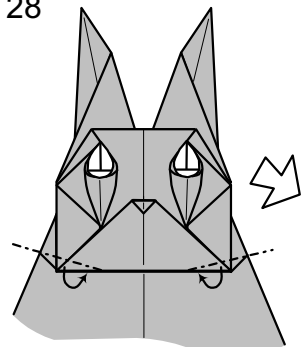

29

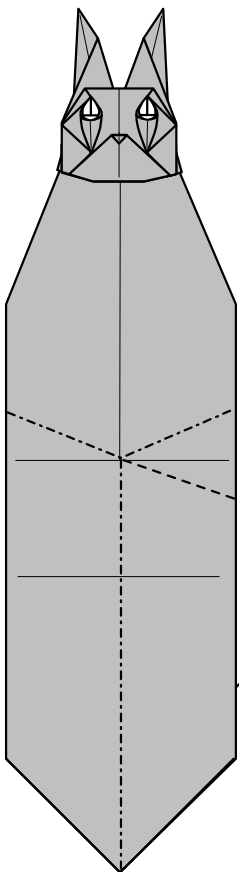

Rabbit ear

30

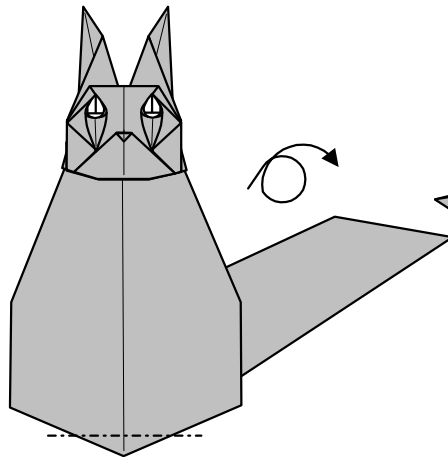

32

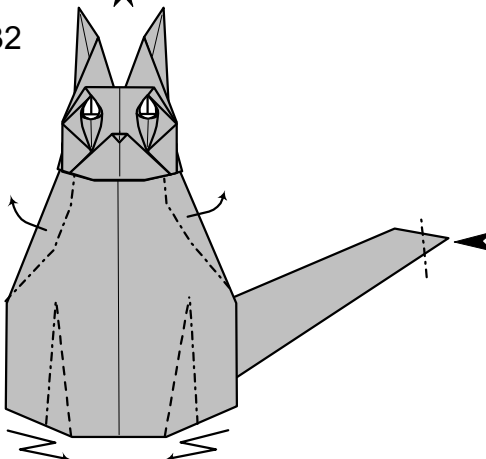

31

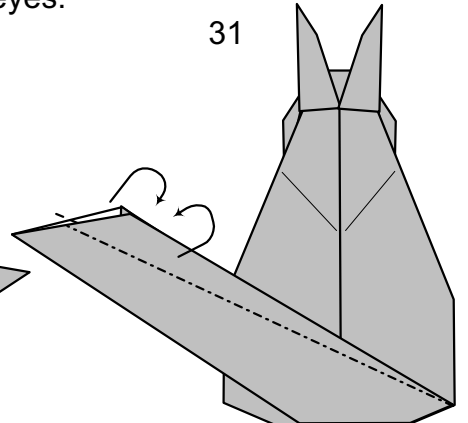

# Ranchu (Ornamental Goldfish)

© Ronald Koh - 1994

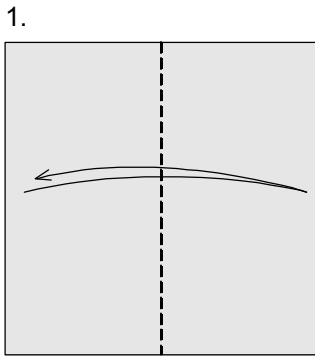

1. A 12 to 15 cm square of paper will do nicely. Fold in half and unfold.

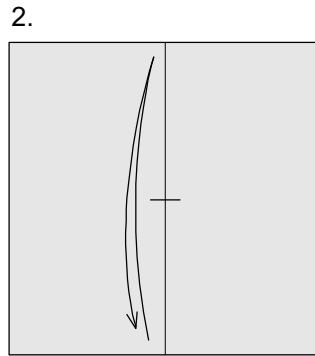

2. Fold and unfold vertically, creasing the centre only.

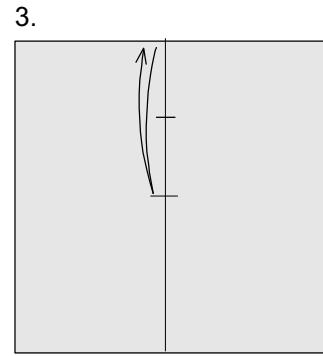

3. Fold to the mark made in step 2 and unfold, creasing in the centre only.

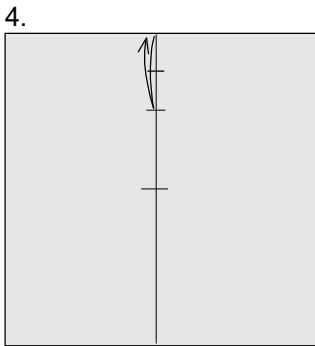

4. Fold and unfold again as shown. This marks an eighth of the height.

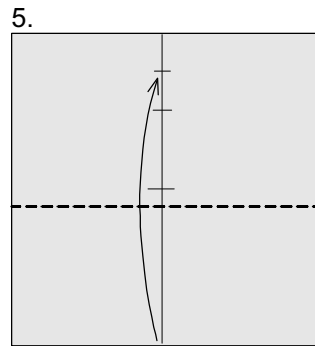

5. Bring the bottom edge of the paper to the crease made in step 4 ...

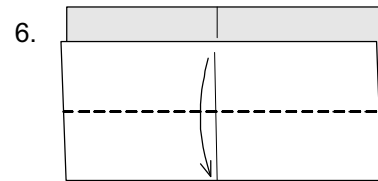

6. ... then fold down again.

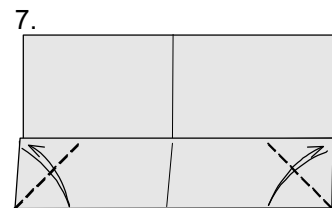

7. Fold and unfold each corner, creasing well.

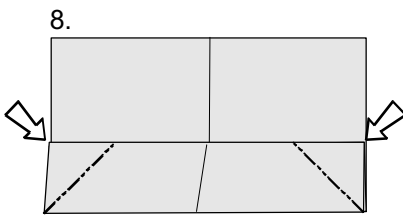

8. Inside reverse fold along creases made in step 7.

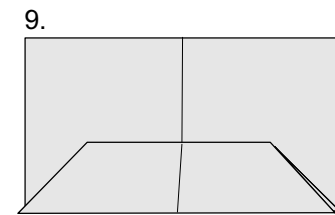

9. Turn paper over.

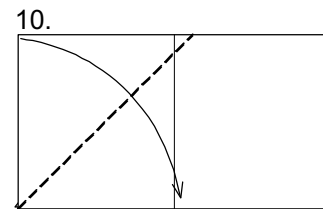

10. Fold down ...

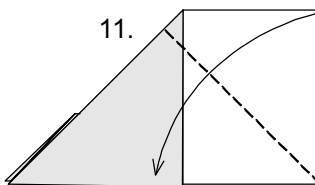

11. ... and again on the right.

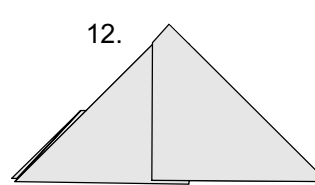

12. Turn over again

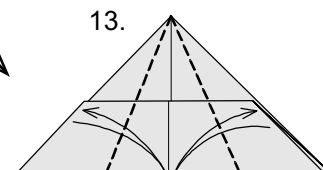

13. Fold the diagonal edges of the paper to the line in the middle, crease firmly, and unfold.

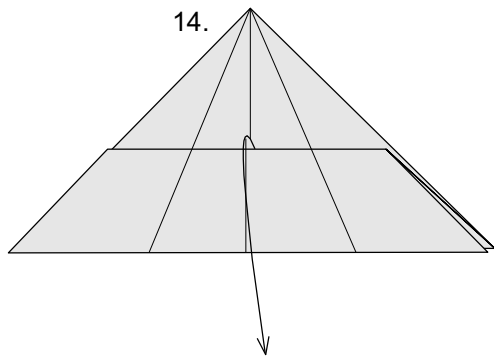

14. Bring down this layer ...

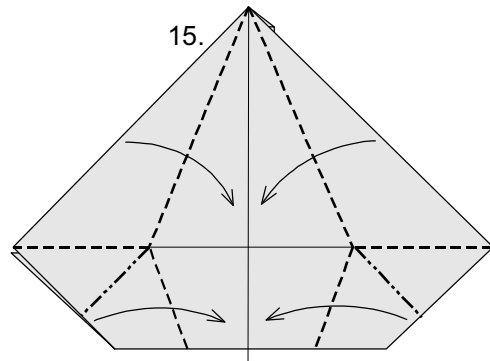

15. ... like this, then rabbit,s ear both sides along creases made previously.

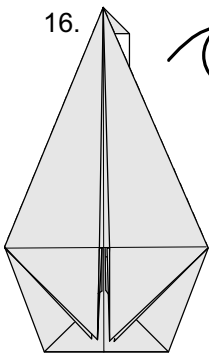

16. Turn over.

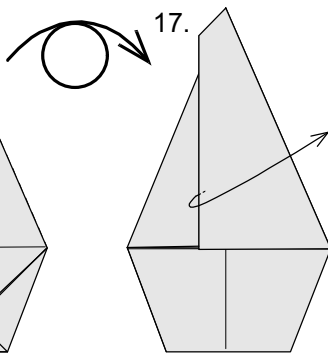

17. Open out this layer to the right.

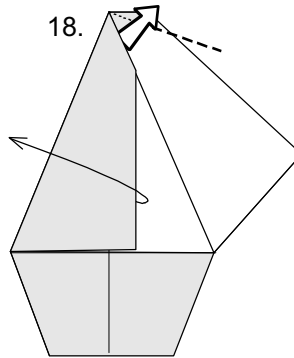

18. Lift out the hidden paper at the top, then open out the layer on the left.

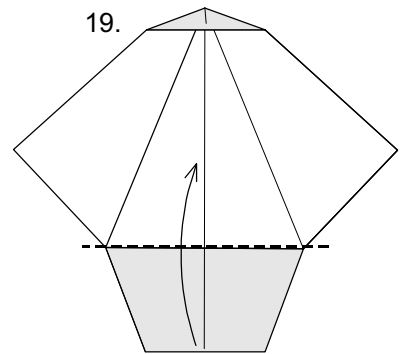

19. Fold up the lower portion of the assembly as shown.

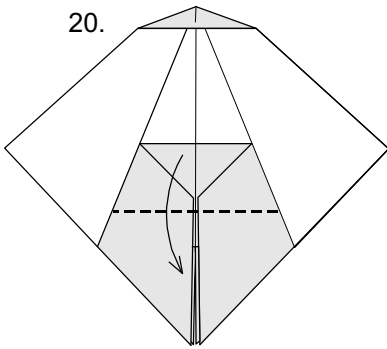

20. Valley fold ...

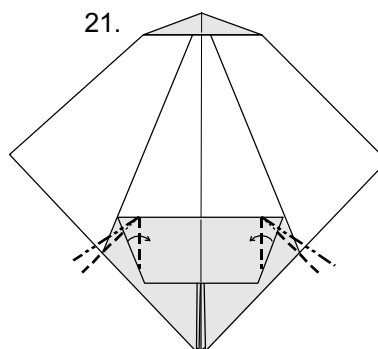

21. ... then crimp fold each side.

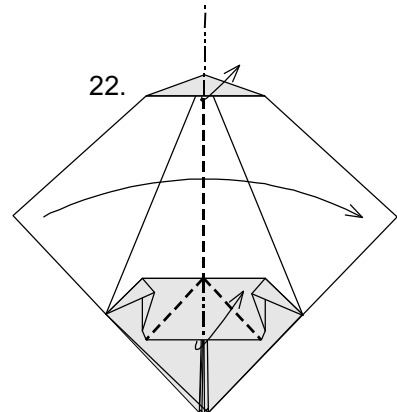

22. Fold assembly in half while lifting out the layer at the top and a triangle at the bottom ...

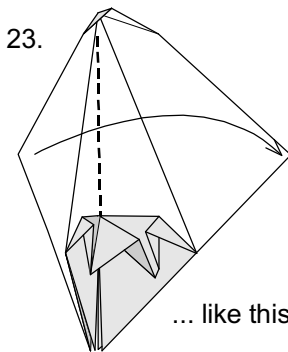

23. ... like this ...

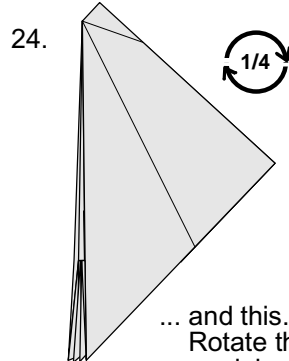

24. ... and this. Rotate the model

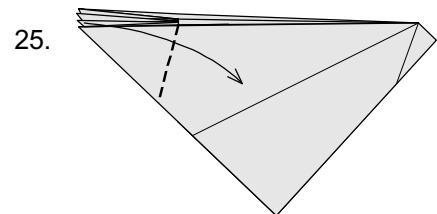

25. Fold the first two flaps to the right, and crease firmly.

26.

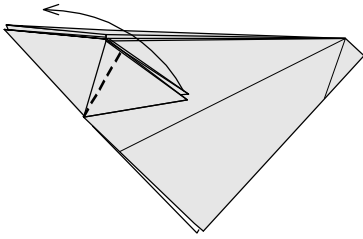

Now valley fold ...

27.

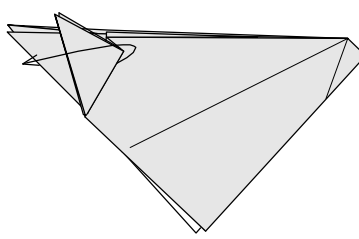

... then unfold Steps 25 and 26.

28.

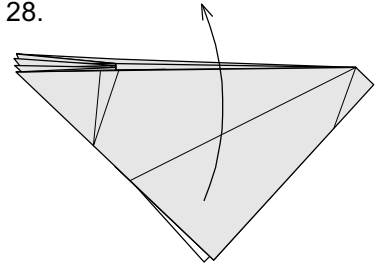

Lift up the first layer ...

29.

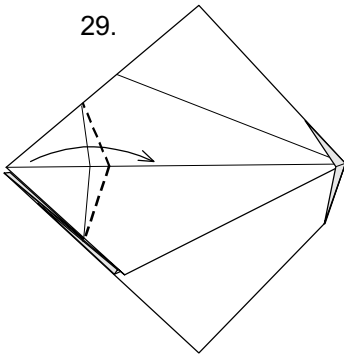

... then fold in the left corner along creases made in Step 26.

30.

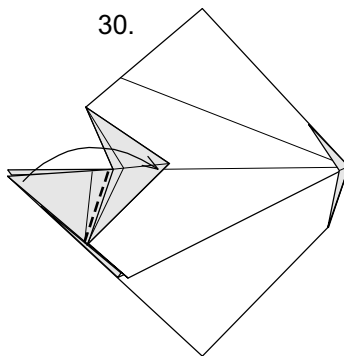

Fold the next layer on the left to the right as illustrated ...

31.

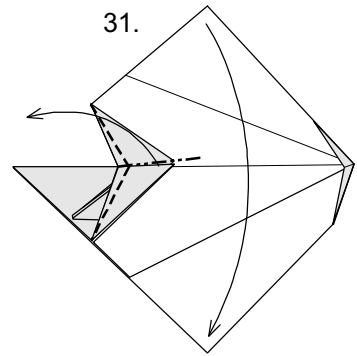

... then bring down the top flap as you valley fold the assembly on the left along creases made in Step 25 ...

32.

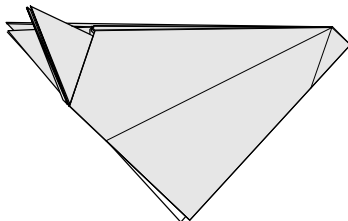

... like this. Repeat Steps 25 to 31 on the other side.

33.

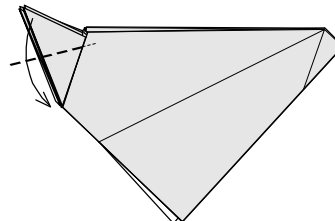

Fold down the first layer ...

34.

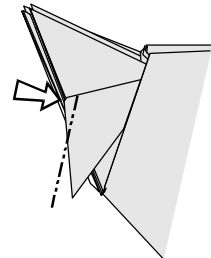

... then reverse fold the resulting corner as shown.

35.

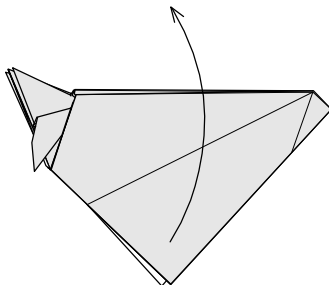

Bring up the top layer again ...

36.

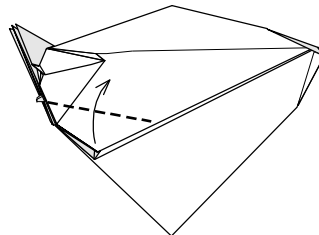

... then valley fold the next layer ...

37.

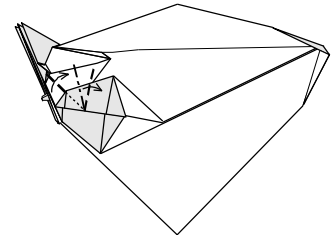

... and then valley fold again and crimp as illustrated.

38.

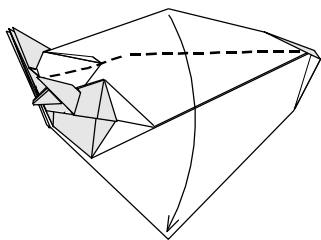

Now bring down the layer at the top again and repeat Steps (?) to 37 on the other side.

39.

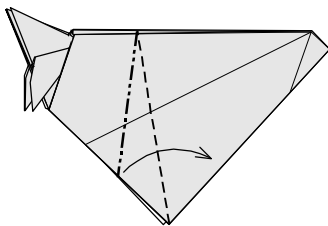

Crimp fold according to diagrammed proportions, crease firmly ...

40.

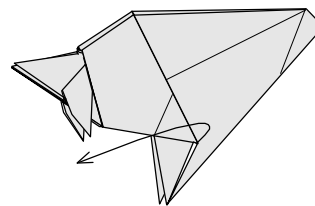

... and unfold.

41.

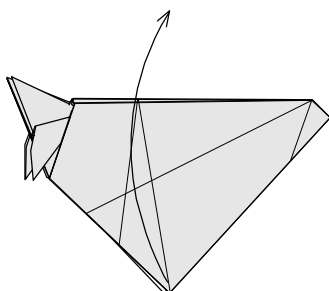

Bring up the top layer again.

42.

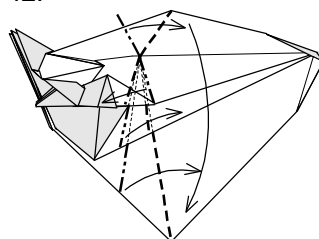

Crimp fold each of the four layers separately as shown, then close the assembly by bringing the top layer down again.

43.

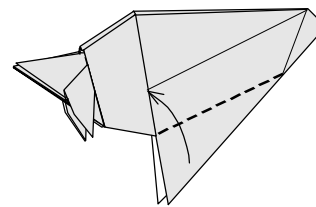

Fold up as shown ...

44.

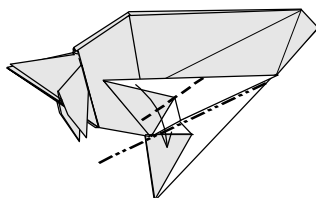

... then down again. Repeat at the back from here through Step 47 ...

45.

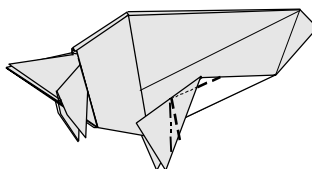

... then crimp fold as illustrated.

46.

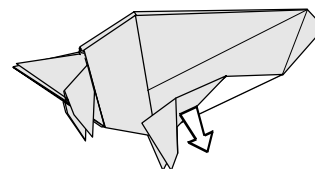

Now open out to unfold Steps 43 to 45.

47.

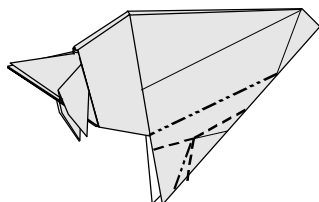

Collapse the assembly under the body as shown, using crease lines made previously.

48.

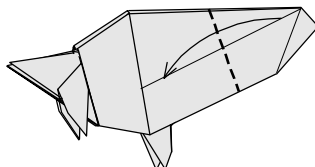

Your model should now look like this. Valley fold, creasing firmly ...

49.

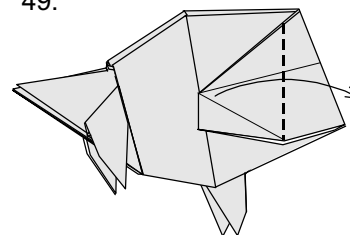

... and yet again. The illustration is slightly enlarged from here on.



50.

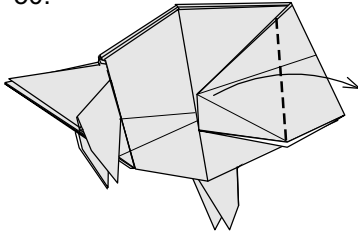

... and yet again.

51.

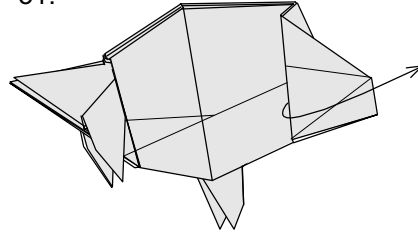

Now unfold Steps 49 and 50.

52.

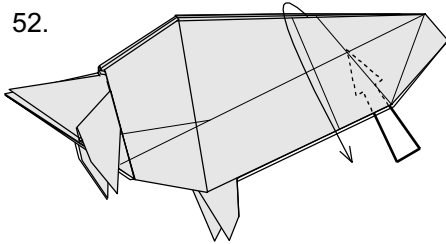

53.

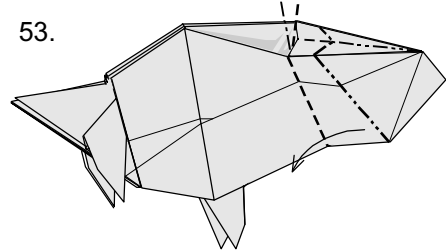

Hidden between the external body layers are two narrower pleated layers. Push up from the bottom to open out the pleat of the hidden layer nearest to you, while simultaneously separating the first and second layers at the top ...

... like this.  
Now crimp fold both sides of the head along creases made previously while bringing out the top of the head ...

54.

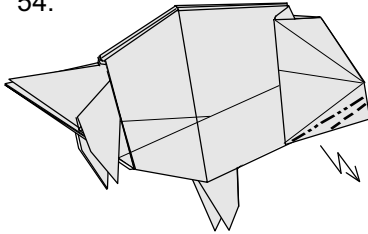

55.

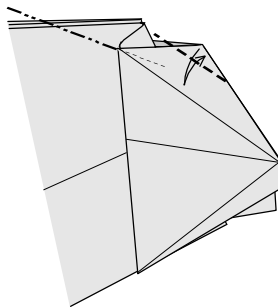

56.

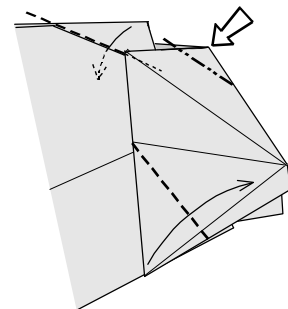

Crimp fold both sides of the model to form the mouth.

Fold and unfold at the top of the head, creasing firmly. Mountain fold at the base of the neck.

Now sink at the top of the head, then continue folding as illustrated.

57.

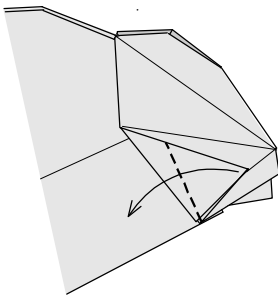

58.

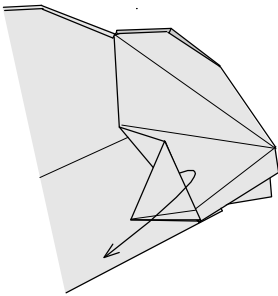

59.

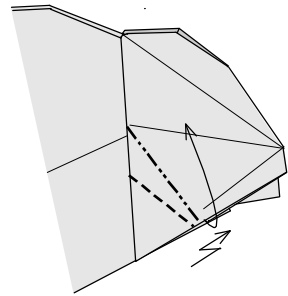

Valley fold to the left again ... ... then unfold Steps 56 and 57.

Separate the two layers of this flap and crimp fold along creases made previously.

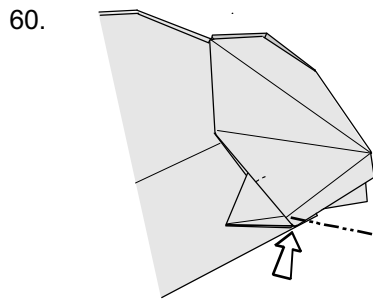

Sink the little corner at the bottom.  
Diagrams 61 and 62 shows a close up of this part of the model.

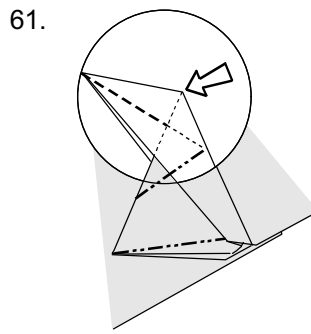

Mountain fold twice as illustrated.  
The upper fold should automatically form a hidden gusset.

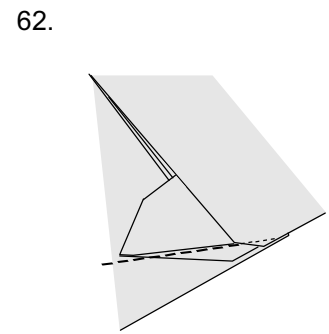

Valley fold the next layer.

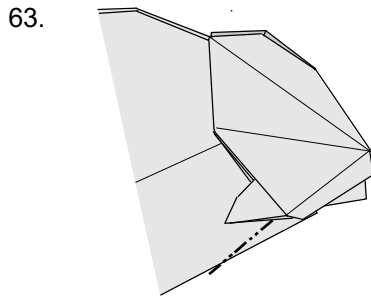

Mountain fold under and repeat from Step 56 on the other side of the head.

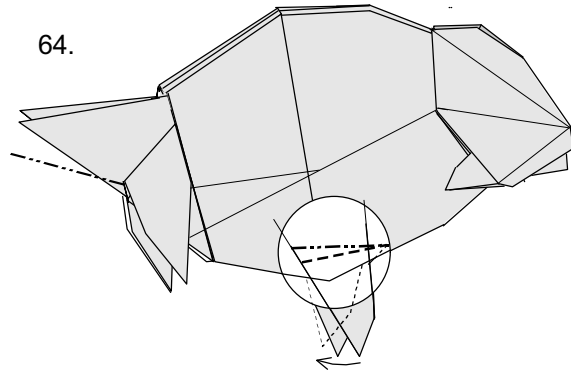

Crimp fold each of the two fins to bring them a little further to the back.  
Shape the central area of each side of the tail as illustrated.

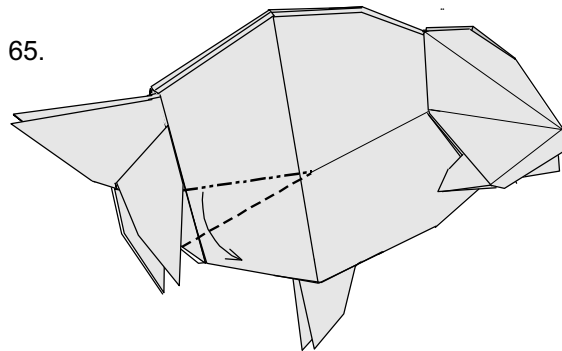

Finally, crimp fold both sides of the body along creases made previously, making sure that the body convexes outwards.

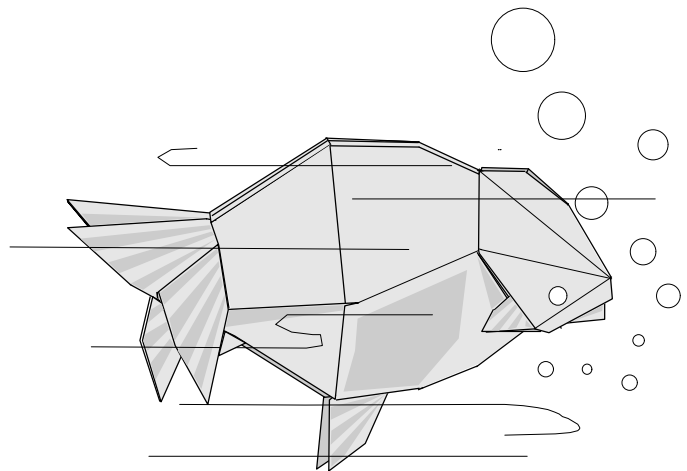

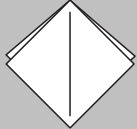
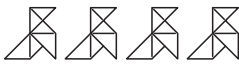
	<i>Autor:</i> J. Anibal Voyer
	<i>Dificultad:</i> 
	<i>Proporción:</i> $h = \frac{1}{2} a$

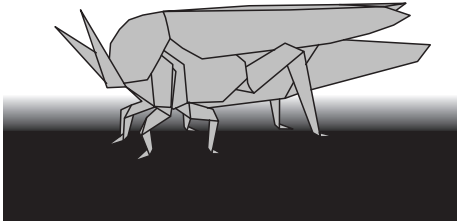

# Saltamontes

1 

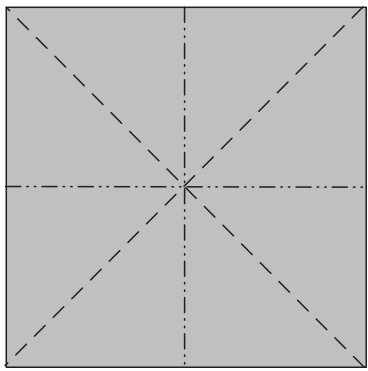
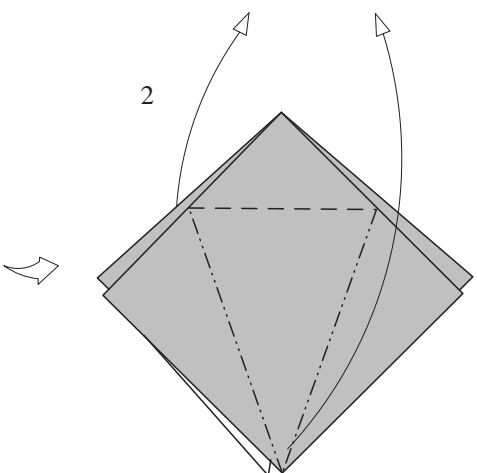
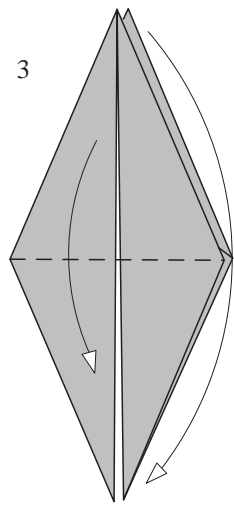
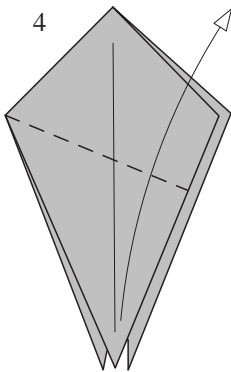
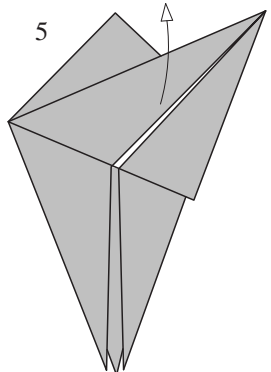
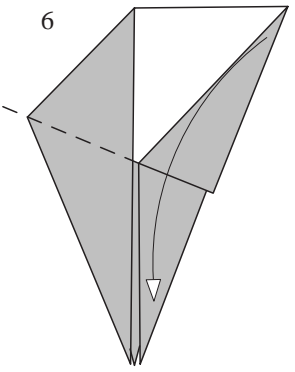
7 Repetir a la derecha

10 Repetir del  
paso 4 al 9

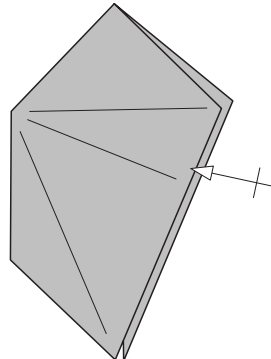
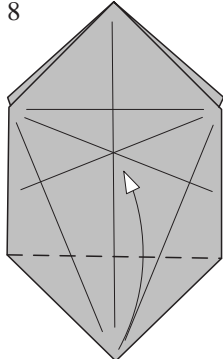
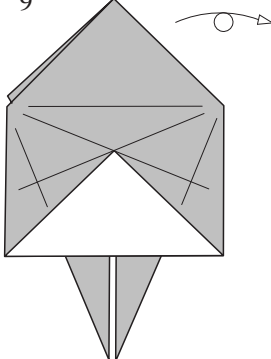

11

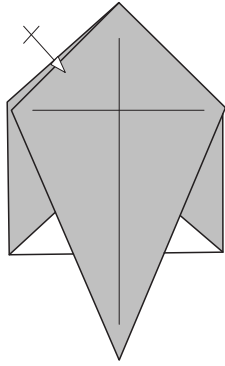

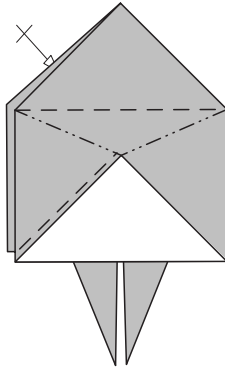
12

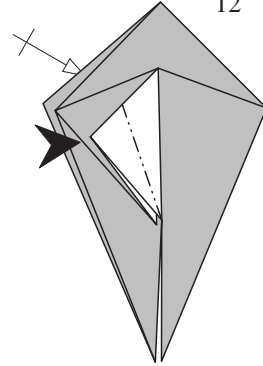

13

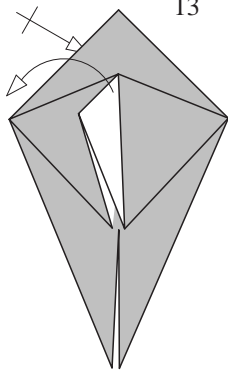

14

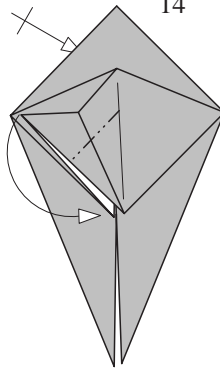

15

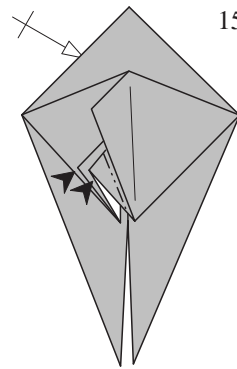

16

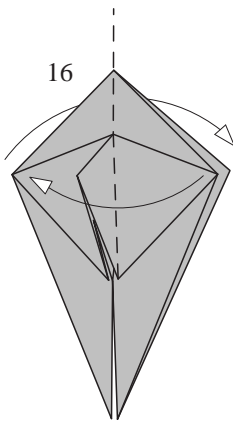

17 Repetir  
de paso 4 al 8

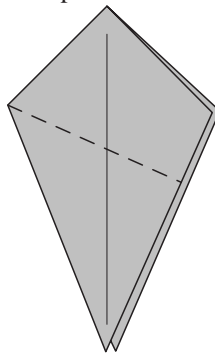

18

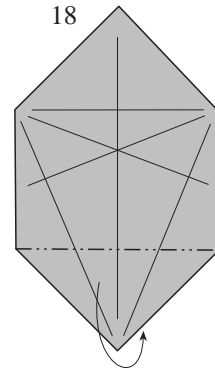

19

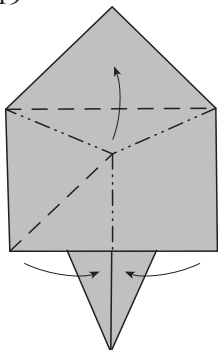

20

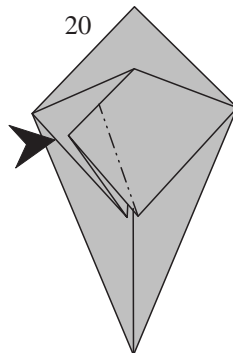

21 Hundir los  
picos plegando  
en 4 partes

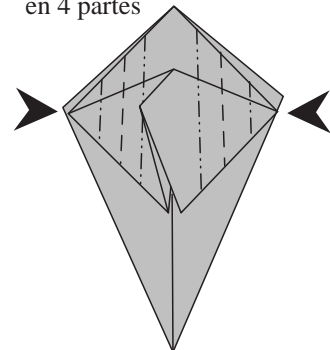

22

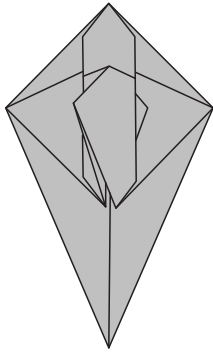

23 hundir los picos

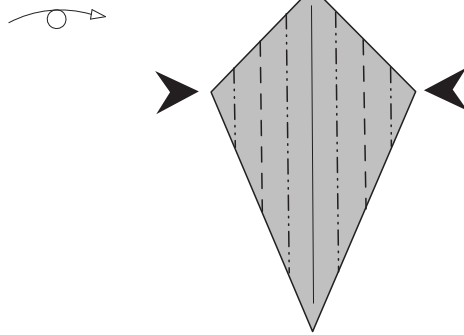

24

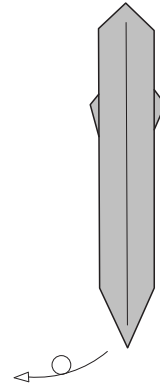

25

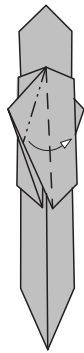

26

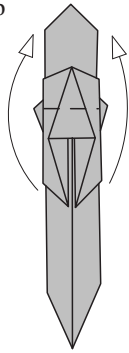

27

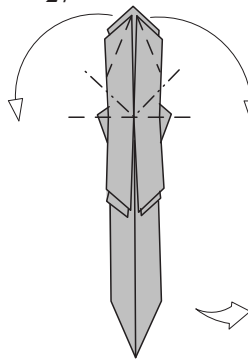

28

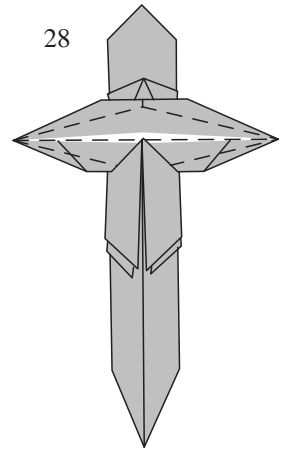

29 Hay que subir dos puntas de la dercha y dos de la izquierda

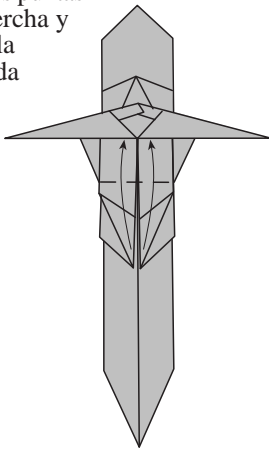

30

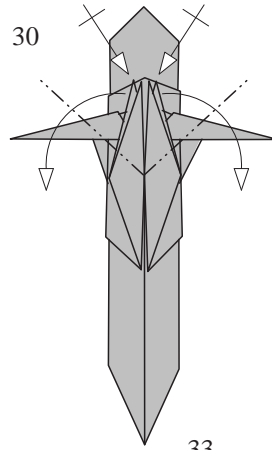

31

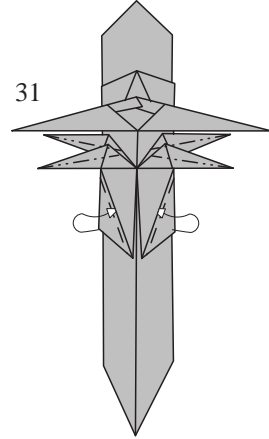

32

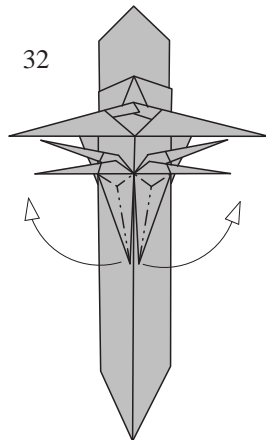

33

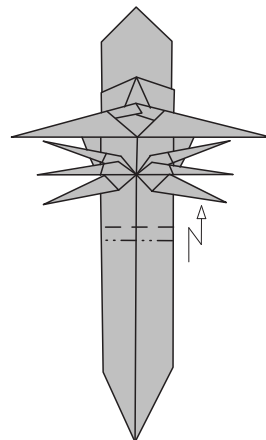

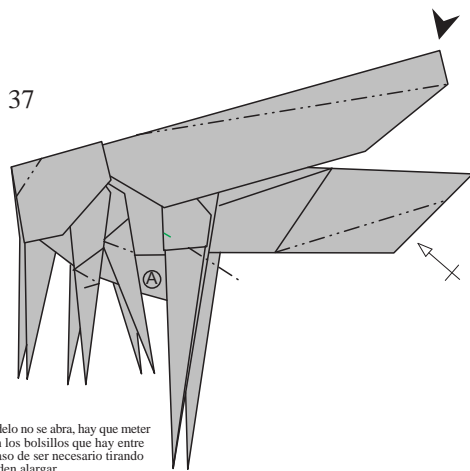
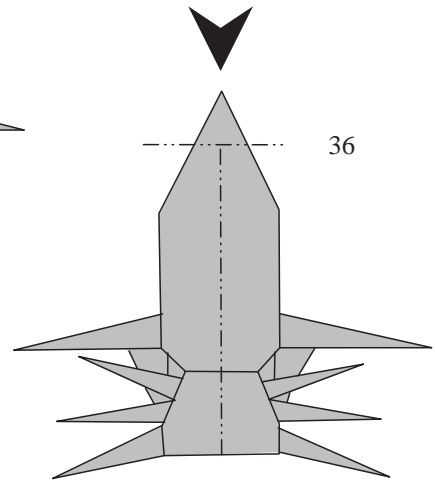
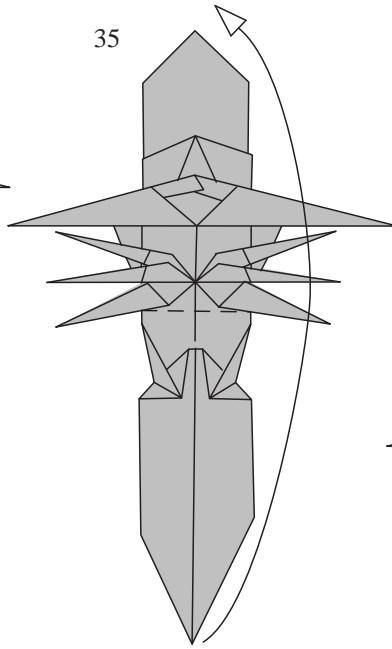
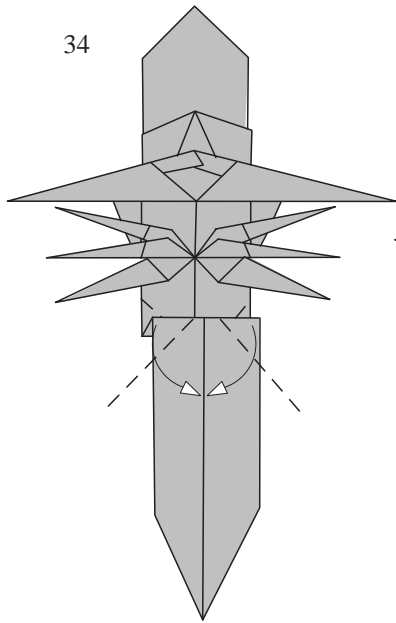

Para que el modelo no se abra, hay que meter las puntas A en los bolsillos que hay entre las patas. En caso de ser necesario tirando de ellas se pueden alargar

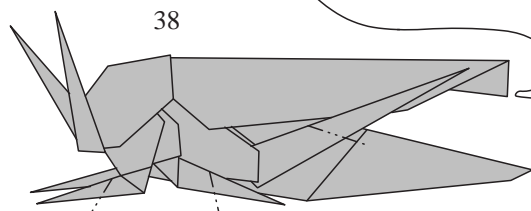
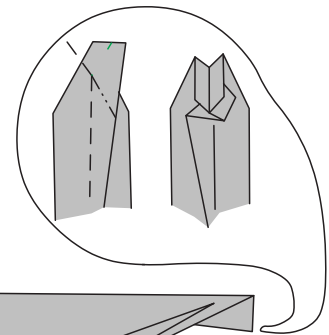

PLEGADO DEL EXTREMO DE LAS ALAS VISTO DESDE EL INTERIOR

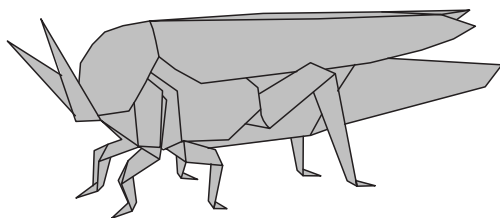

When completed, this modular design has a lot of open area and is amazingly sturdy.

Please send any comment to <winson\_chan@spectrumsignal.com>.

Feel free to make copies and distribute.

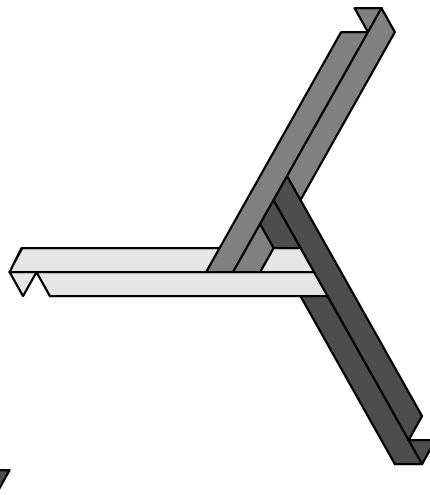
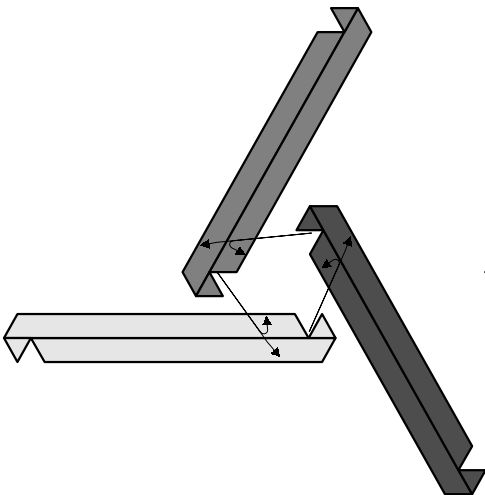
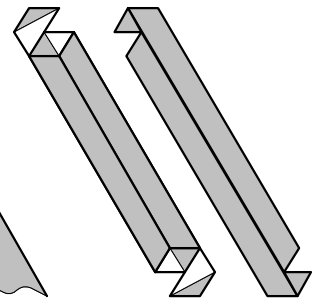
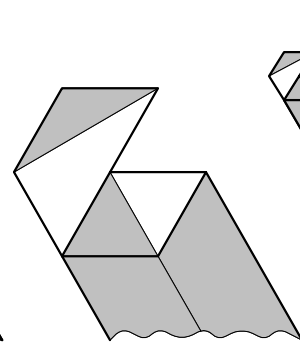
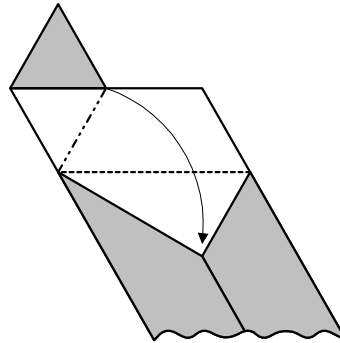
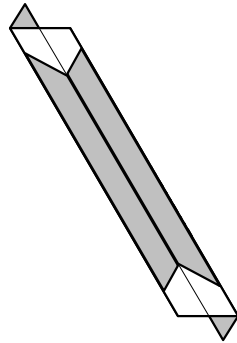
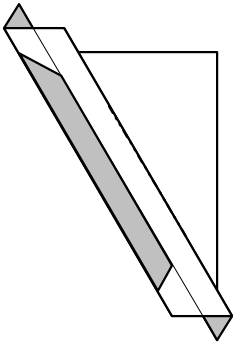
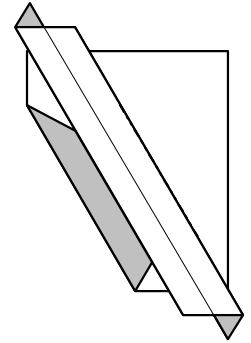
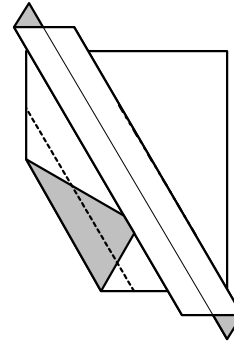
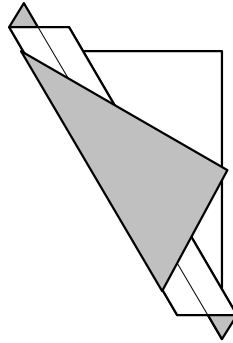
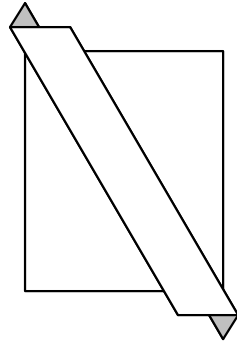
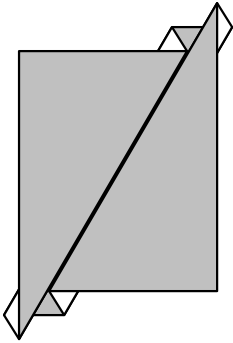
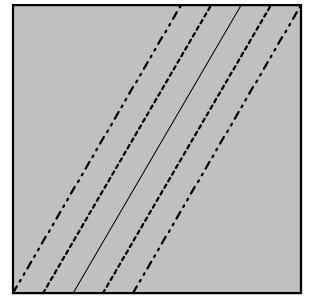
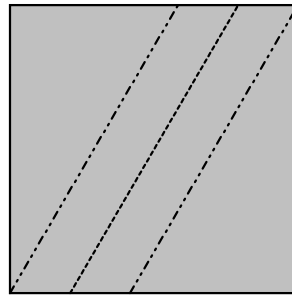
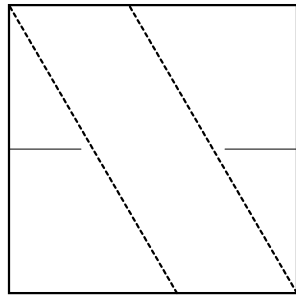
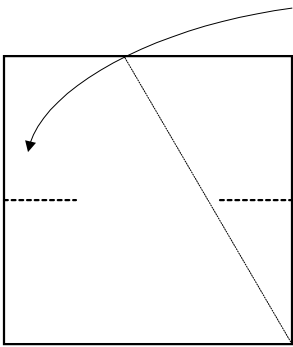

30 units required to make the structure shown below.

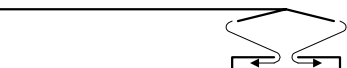
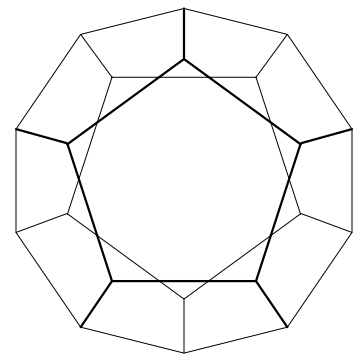

Angled Modular (Hacky Sack)	1/1
Designer: Winson Chan	
Diagrammed by: Winson Chan	
Revision: 1.0	Date: 5/15/96

# Grandfather's hat

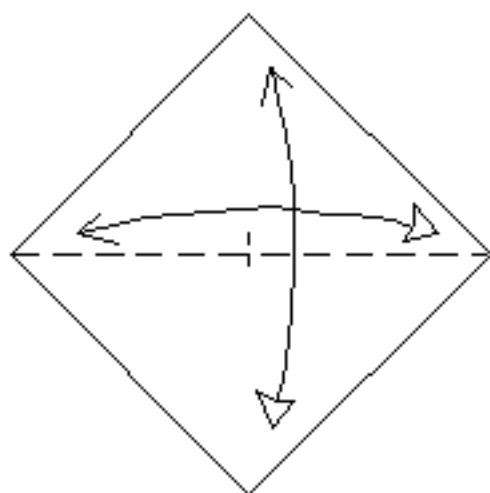

**1** Fold and unfold. Make a mark at the middle.

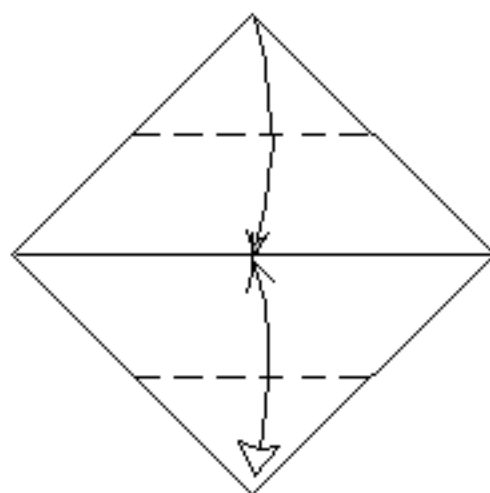

**2** Valley-fold to the center.

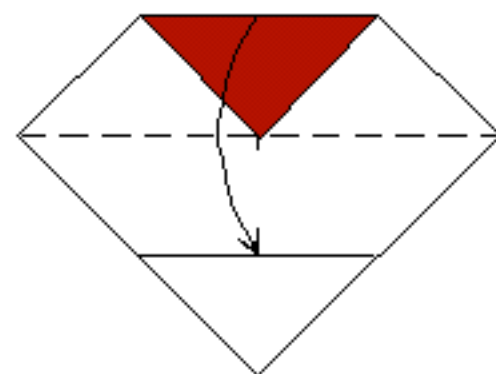

**3** Valley-fold.

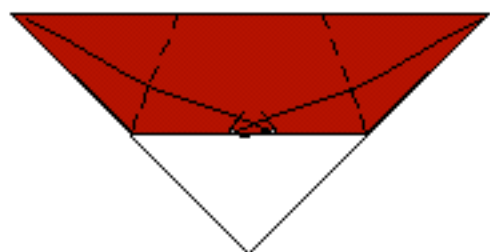

**4** Valley-fold.

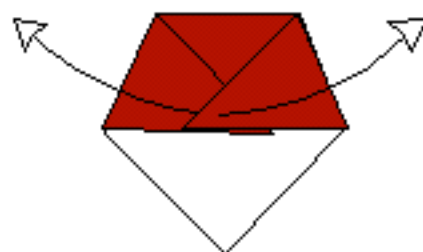

**5** Unfold.

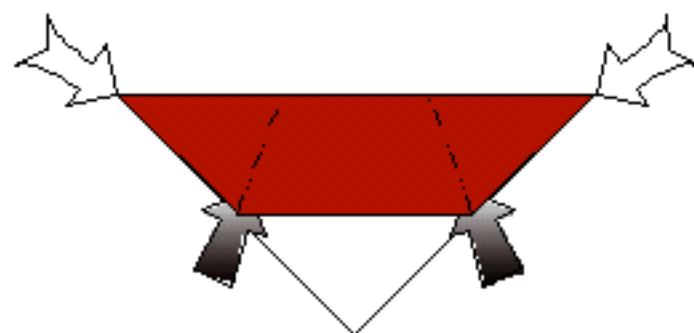

**6** Reverse-fold.

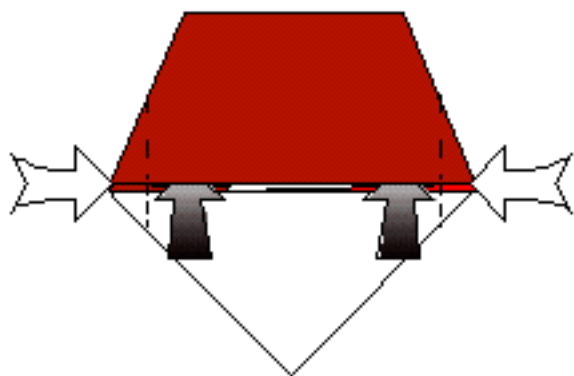

**7** Reverse-fold.

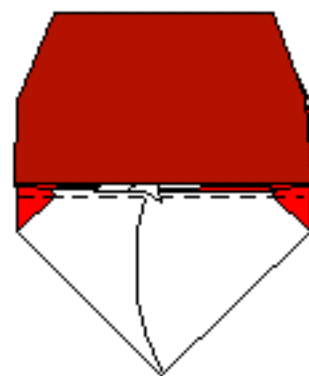

**8** Valley-fold into the pocket.



**9** My grandfather's hat.



This heart is the largest fully symmetrical heart you can make from one square piece of paper.

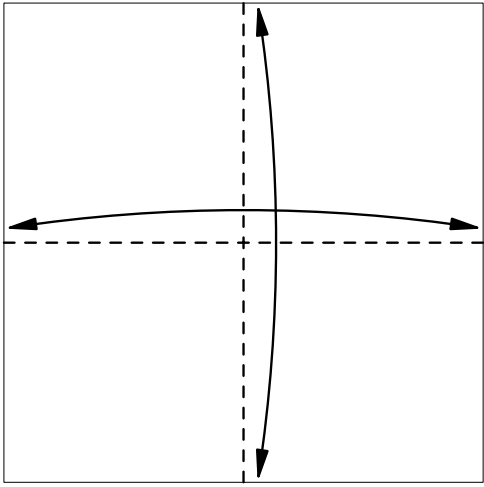

1

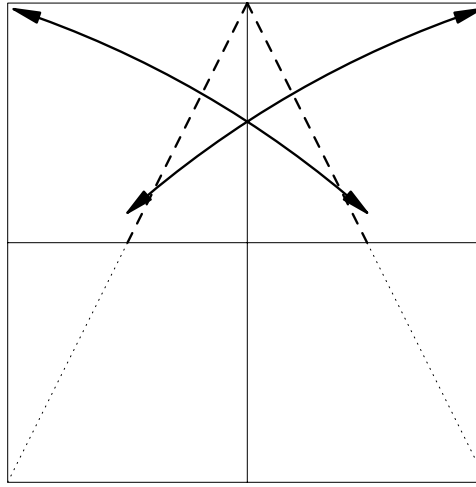

2

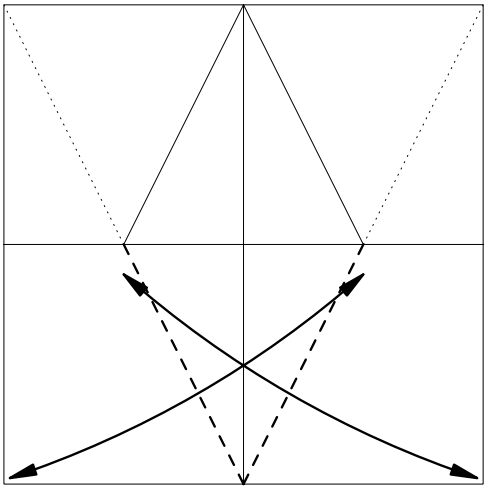

3

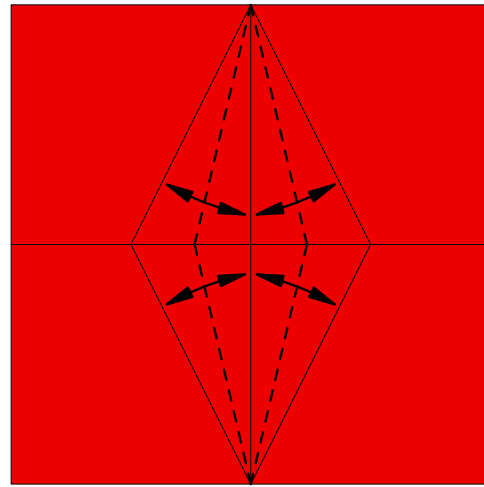

4

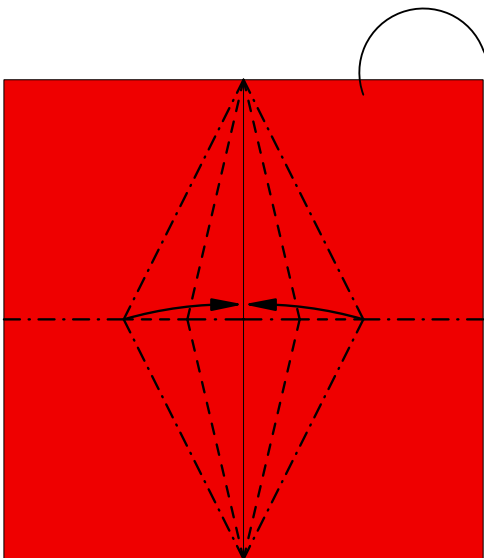

5

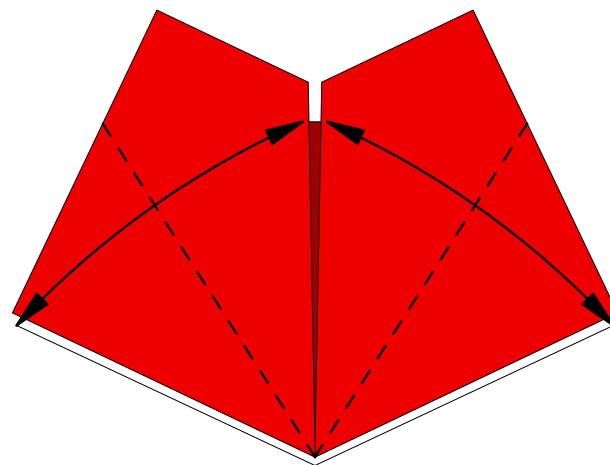

6

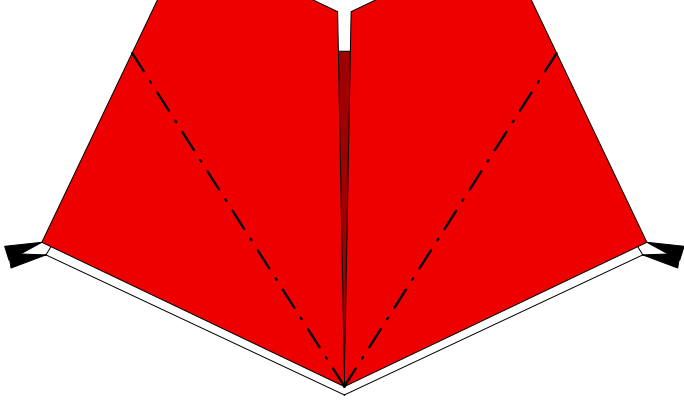

7

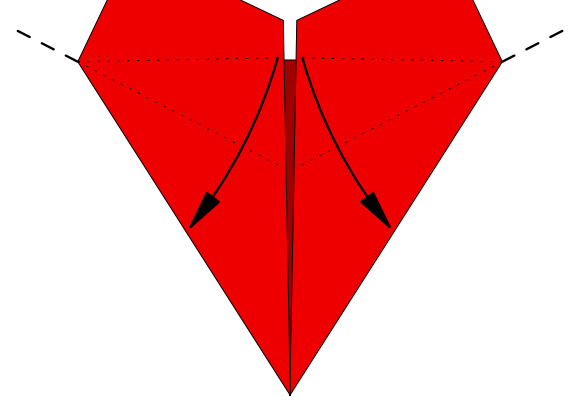

8 Fold inside flaps to interlock.

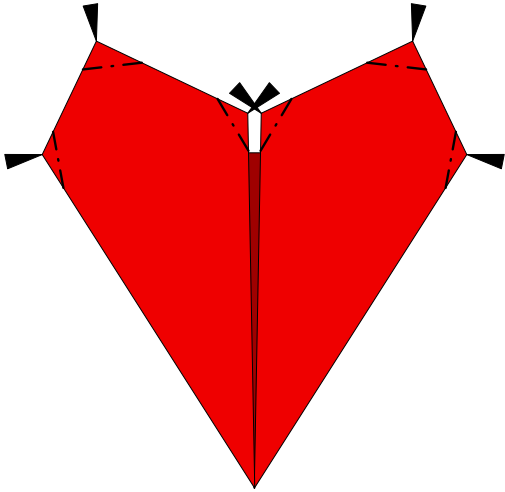

9

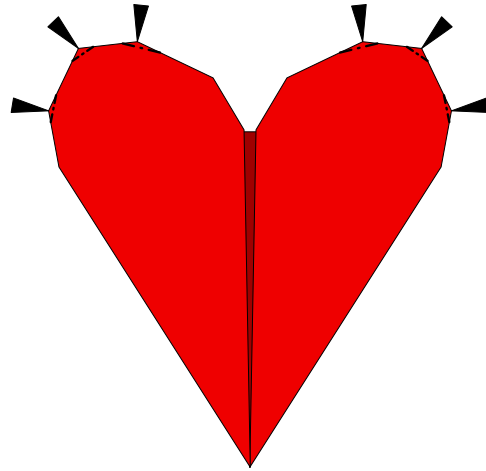

10

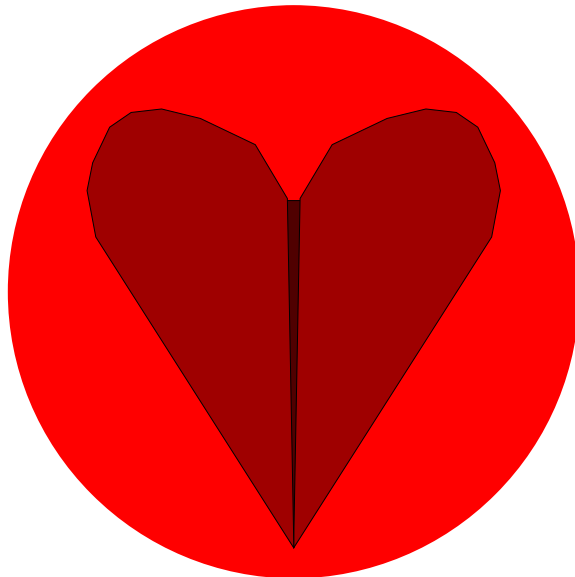

# Heart

Maarten van Gelder

© 1991 Apr

This heart is the largest fully symmetrical heart you can make from one square piece of paper.

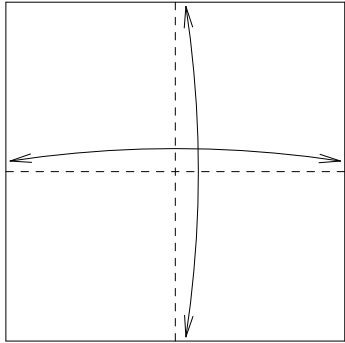

1

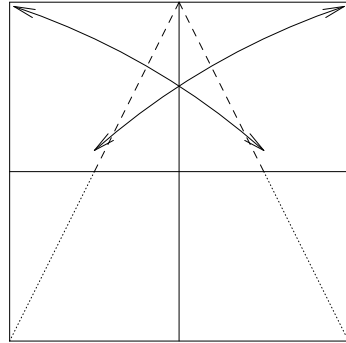

2

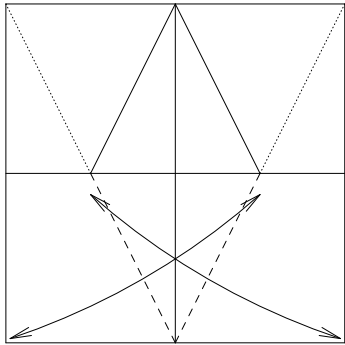

3

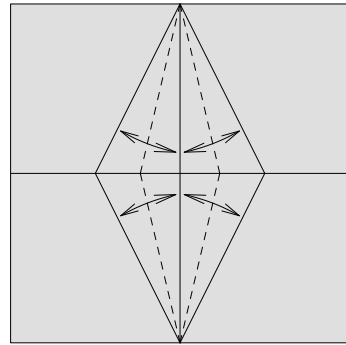

4

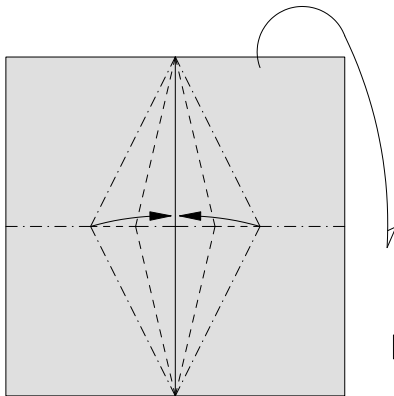

5

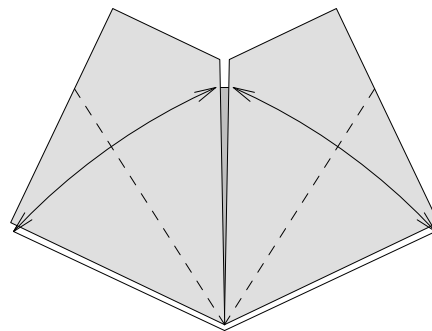

6

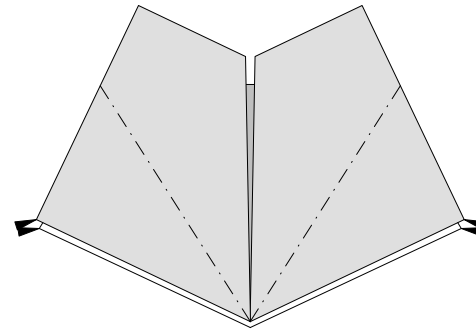

7

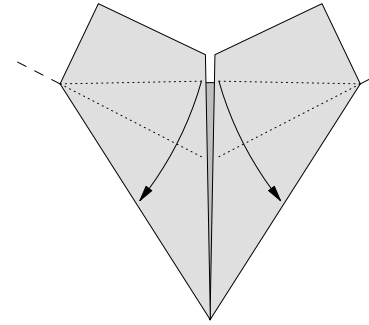

8 Fold inside flaps to interlock.

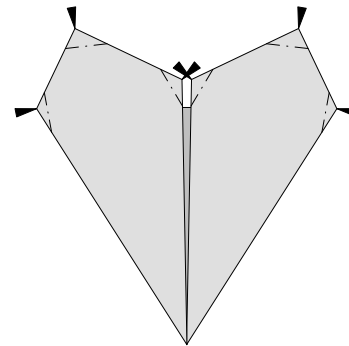

9

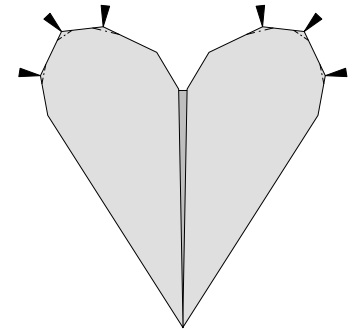

10

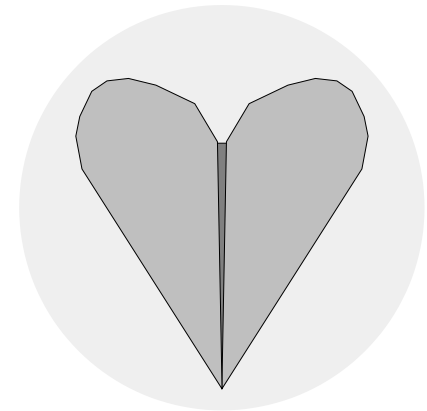

# PARA GUARDAR EN TU CORAZON

José Tomas Buitrago Molina  
Colombia (c) 1997

Papel tamaño carta (8½"x11" / 21.6x27.9 cm)

Color abajo. Tamaño final 5½" (14.5 cm)

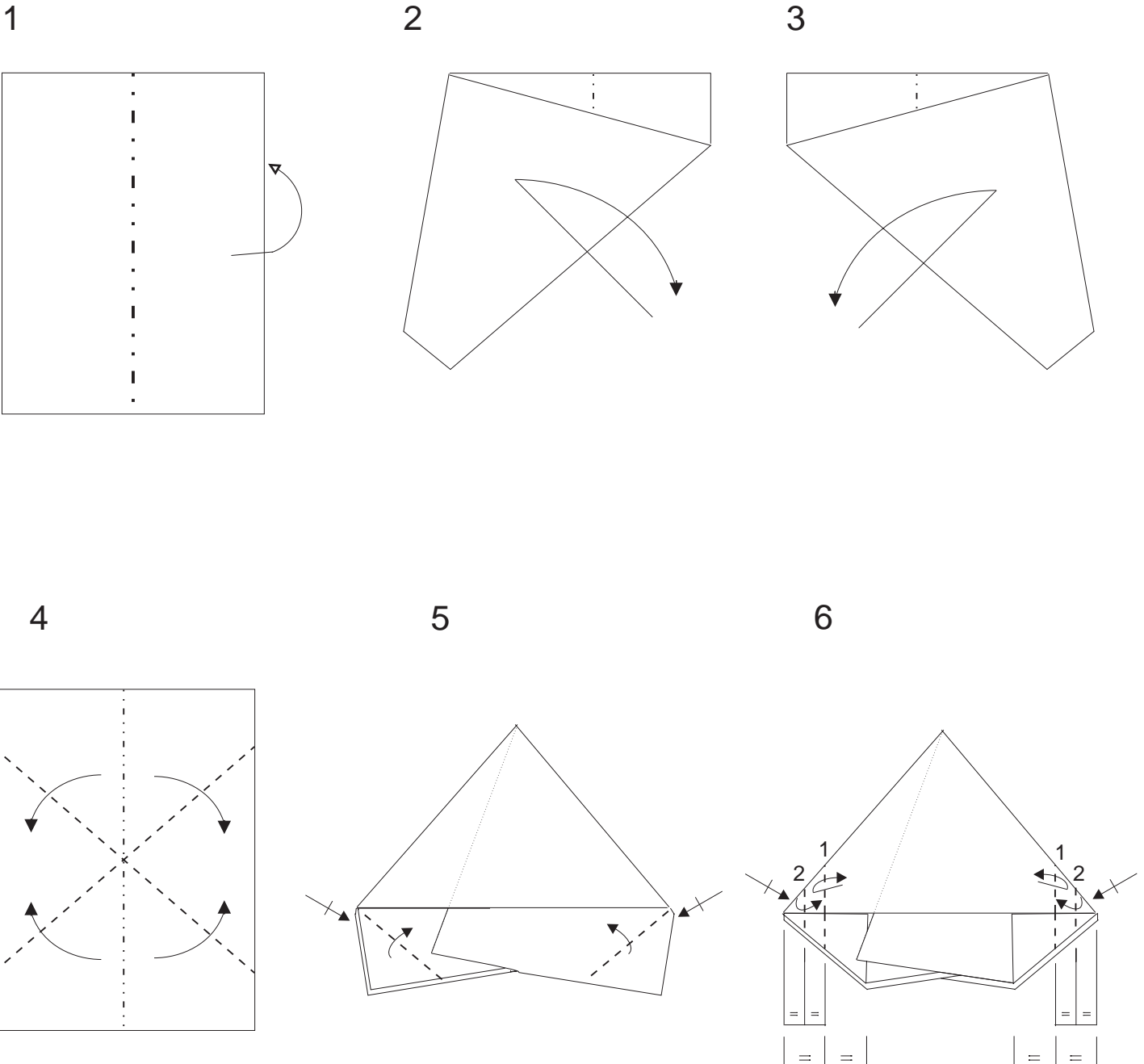

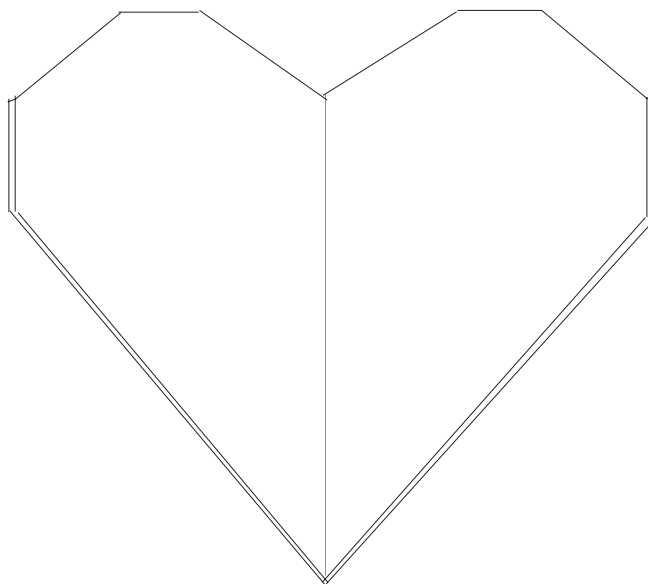
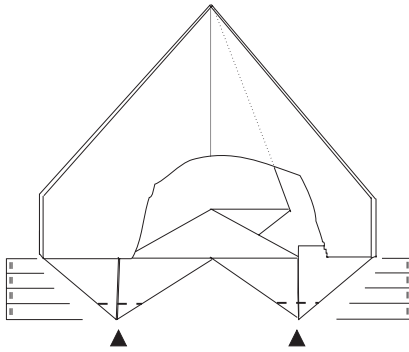
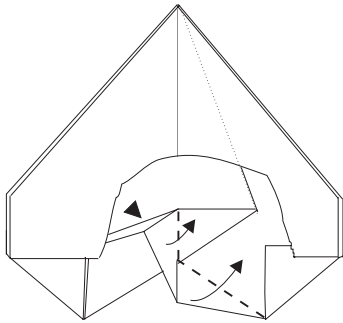
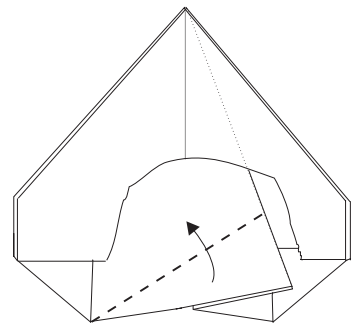
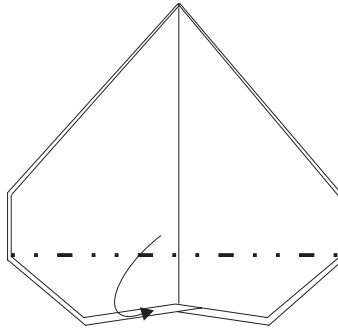
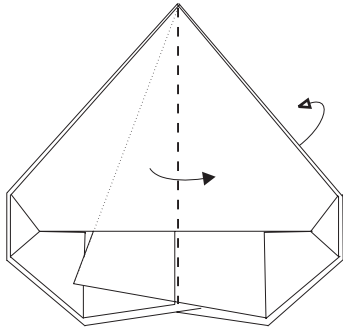

# Heart I

designed by **Sy Chen** (6/1996)

diagrammed by **Sy Chen** (6/1996)

© 1996 Sy Chen

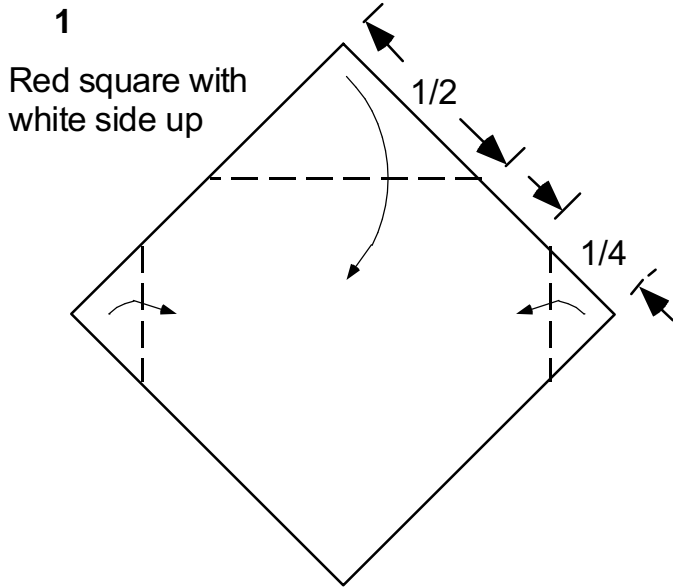

2 Pleat and make center part downward (concave). Heart won't stay flat anymore.

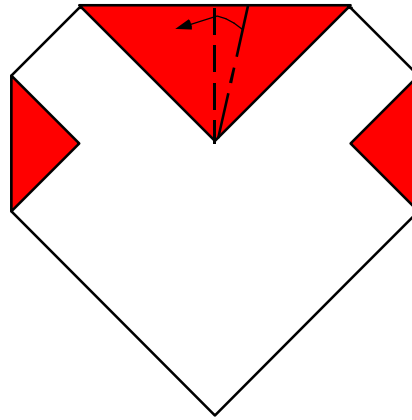

4

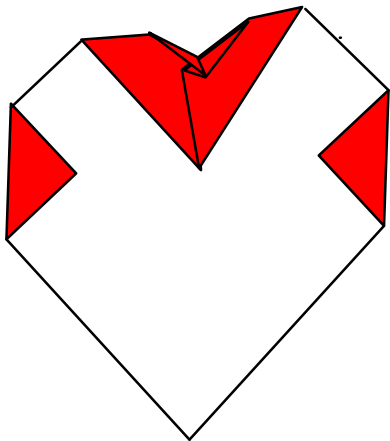

3 Fold them at the same time

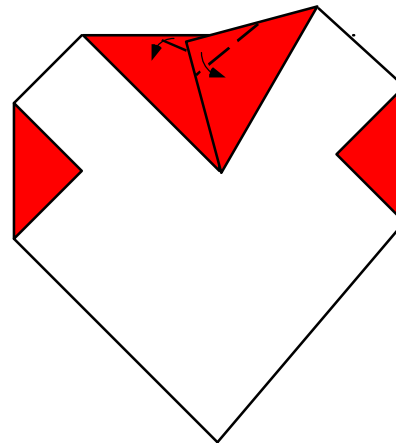

Turn over

5

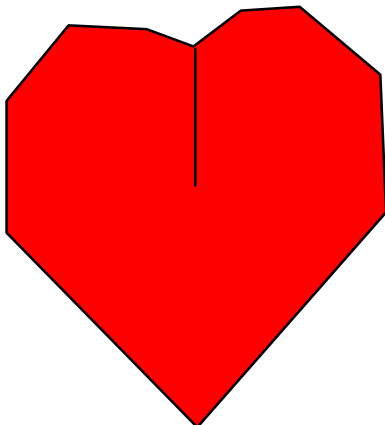

**Judgement:** Adjust crease size or angle in step 2 or 3 to add your own taste

**Challenge:** Can you make a bigger heart out of a same sized square?

# \$ Heart-and-Arrow

Copyright 1999 Stephen Hecht. All Rights Reserved

A dollar bill makes a model 30 mm x 45mm. For your first attempt, begin with a 3x7 rectangle larger than a dollar bill.

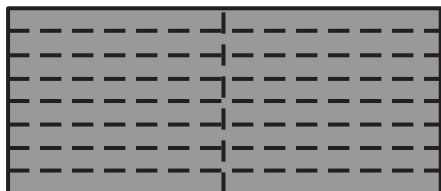

1. Either side up. Crease at eighths horizontally, halfway vertically. Flex all creases both ways.

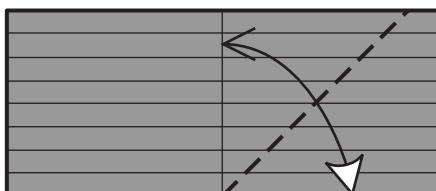

2. Make this crease sharp only where it crosses the center horizontal line.

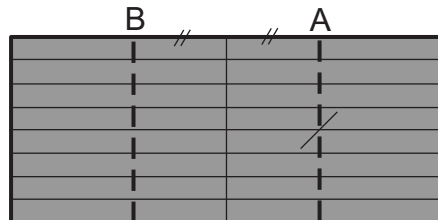

3. Use the mark to make crease "A". Then use "A" and the center vertical line to make crease "B", at the same distance. Flex both.

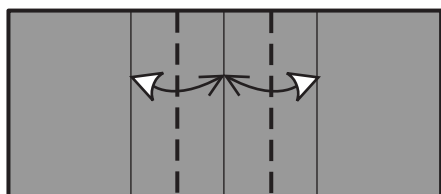

4. Horizontal creases not shown. Bisect the rectangles.

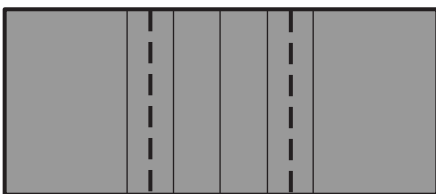

5. Bisect the outer rectangles.

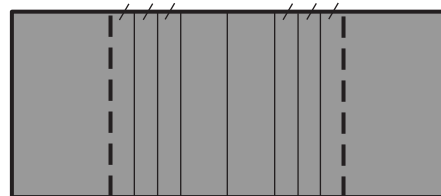

6. On each side, use the outer 2 creases to add another.

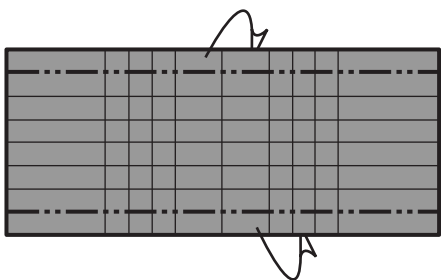

7. All creases shown. Mountain the top and bottom eighths behind.

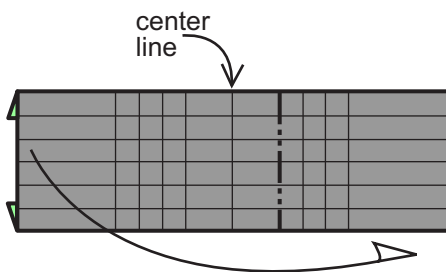

8. Swing behind on the indicated crease. Turn over.

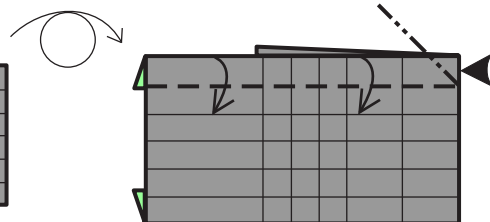

9. Flip down the top eighth, squashing the corner at the right.

# \$ Heart-and-Arrow (cont.)

Copyright 1999 Stephen Hecht. All Rights Reserved

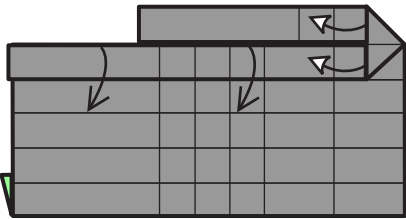

10. Pull out paper from under the squash, flipping down the long edge.

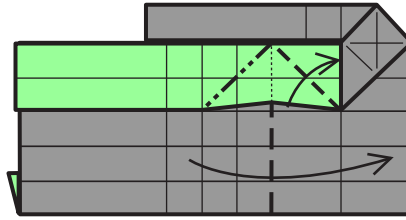

11. Swing over the long flap, while pulling up the triangle shown.

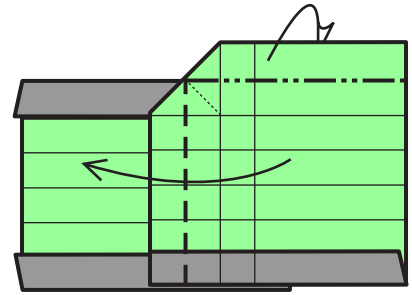

12. Swing flap back on existing crease, while flipping down the top eighth and squashing a tiny diagonal.

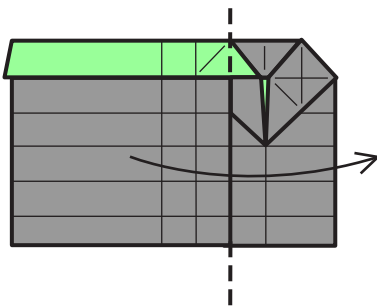

13. Swing back. Both sides of model will then look similar.

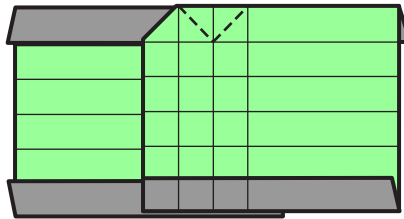

14. Crease.

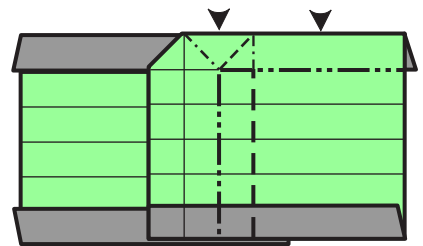

15. Pleat and sink on existing creases.

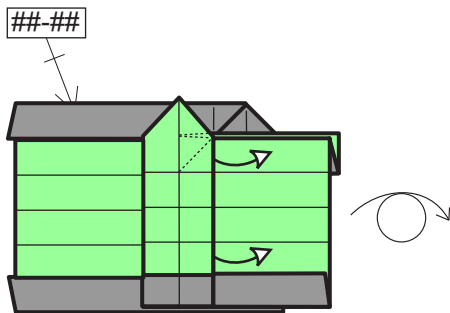

16. Undo last step. Turn over and repeat 14-16.

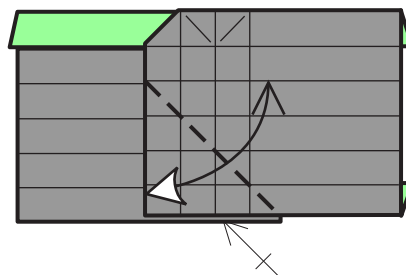

17. Crease top flap. Repeat behind.

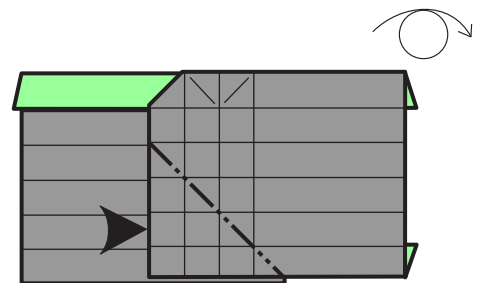

18. Reverse-fold on existing crease. Turn over.



# \$ Heart-and-Arrow (cont.)

Copyright 1999 Stephen Hecht. All Rights Reserved

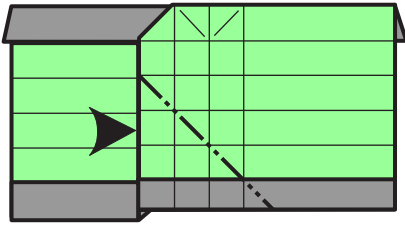

19. Reverse-fold on the crease; rear-half is double thickness.

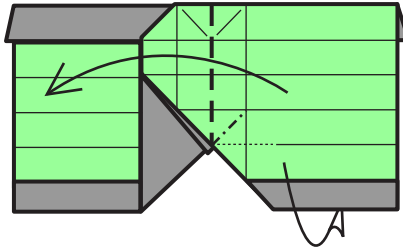

20. Swing flap to left on existing crease, squashing only the tiny diagonal indicated. The X-ray line is a hidden valley fold.

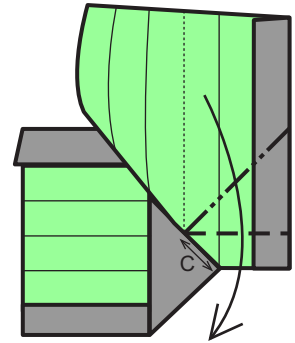

21. Segment "C" is the new crease. Swing back down on existing crease, squashing the diagonal shown. The X-ray line is a hidden valley fold.

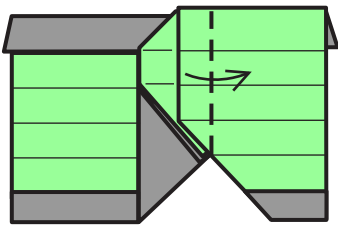

22. Fold the new flap to the right.

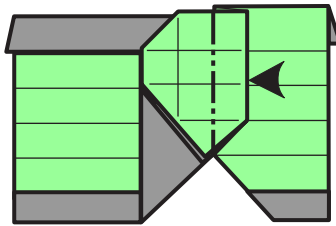

23. Reverse-fold at the top, closed-sink at the bottom.

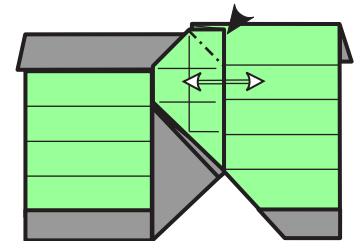

24. Pull gently open at the top, and reform the sink from step 15.

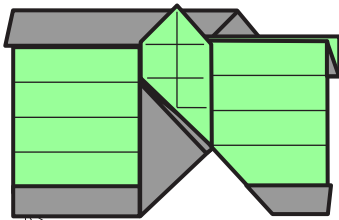

20-24

25. Repeat 20-24 behind.

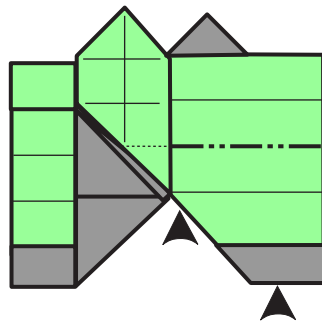

26. Reverse-fold. At the left end, only the embedded layer is reverse-folded.

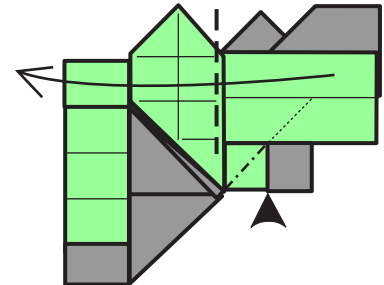

27. Swing flap to the left, squashing the corner behind it.

# \$ Heart-and-Arrow (cont.)

Copyright 1999 Stephen Hecht. All Rights Reserved

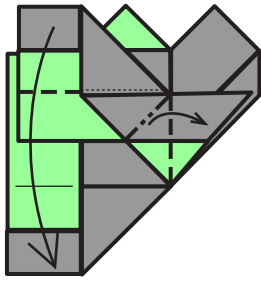

28. Swivel again. Note the tiny squash (mountain-fold).

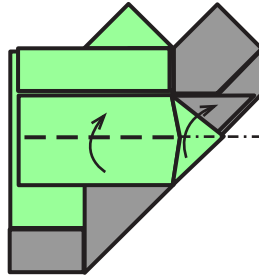

29. Flip up an edge, opening the triangular pocket.

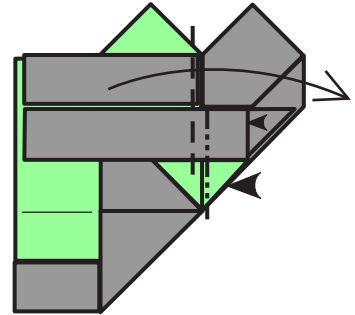

30. Closed-sink the small two-toned trapezoid. Then swing the pleated flap to the right.

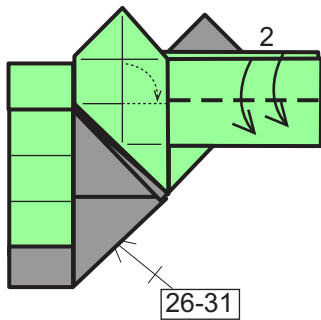

31. Swing down 2 edges, swiveling under the sunken area. Repeat 26-31 behind.

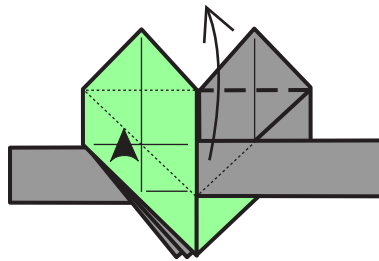

32. Swing the large, hidden triangular flap upwards, reverse-folding the left side.

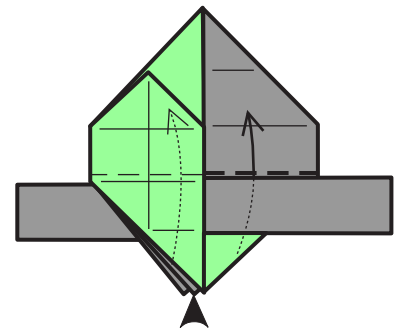

33. Reverse-fold the middle triangle upwards.

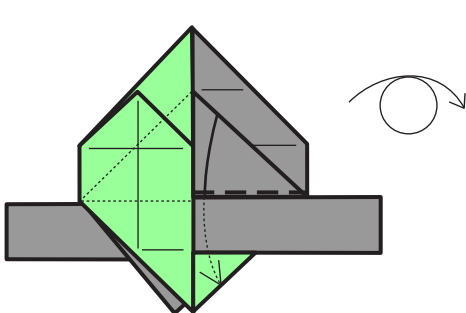

34. Valley-fold it back down, into the pocket immediately in front of it (a tight fit, even if accurate). Turn over.

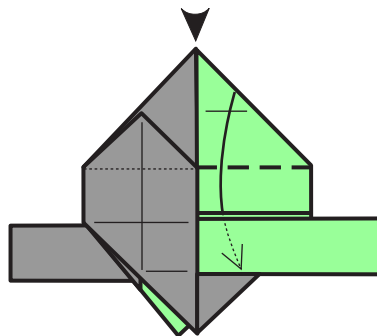

35. Reverse-fold the top point down, tucking the tip into the pocket immediately in front of it.

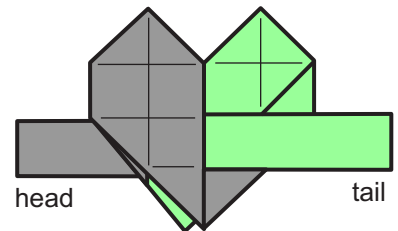

36. Like so. Now we begin on the tail of the arrow.

# \$ Heart-and-Arrow (cont.)

Copyright 1999 Stephen Hecht. All Rights Reserved

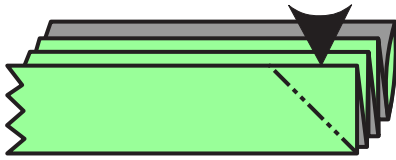

37. Tail: notice pleats are not perfectly symmetric. Reverse-fold.

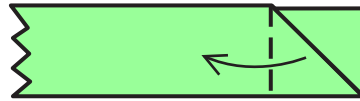

38. (Not all edges shown.) Swing over.

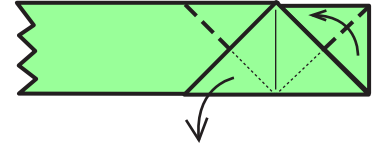

39. Rotate.

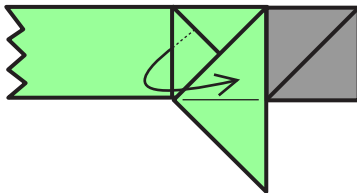

40. Bring one layer to surface (a closed-sink).

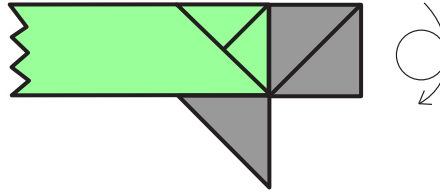

41. Thus. Turn model over top-to-bottom.

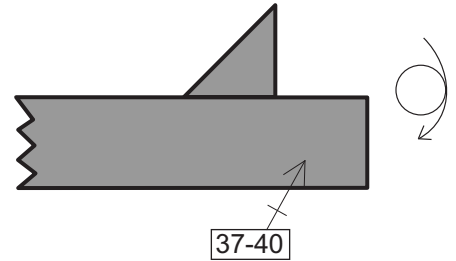

42. Repeat 37-40, treating the double-thickness as one layer. Turn back over (top-to-bottom).

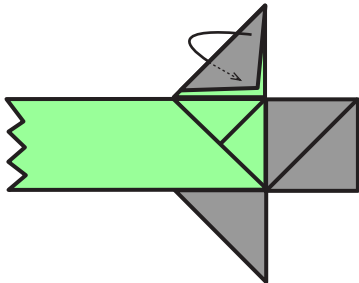

43. Tuck in the loose triangle.

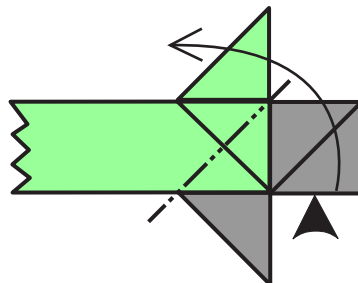

44. Reverse-fold protruding edges as if they were a single edge.

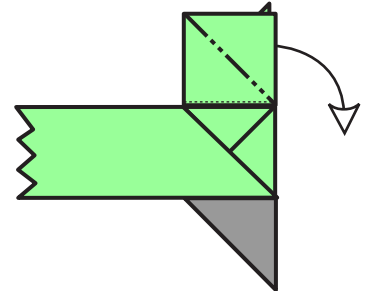

45. Pull out paper and swivel down the front edge. The X-ray line is a horizontal valley-fold that becomes a vertical mountain-fold flush with the right edge of the model.

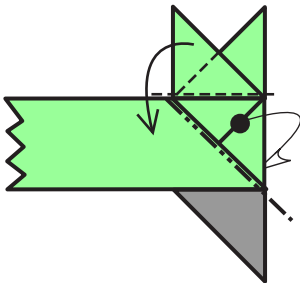

46. Swing the middle triangle down and behind, dragging the upper triangle.

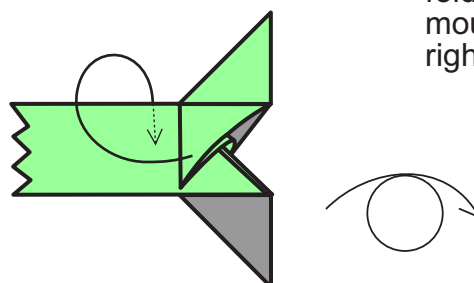

47. Tuck the loose triangle into the second pocket (between pleats, not into the sink). Tail complete. Turn over side-to-side.

# \$ Heart-and-Arrow (cont.)

Copyright 1999 Stephen Hecht. All Rights Reserved

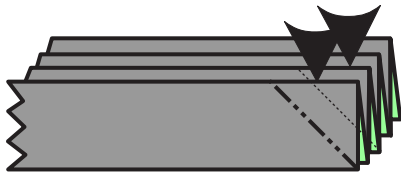

48. Head of the arrow.  
Pleats are symmetric.  
Reverse-fold first 2 corners.



49. (Not all edges shown.)  
Swing 2 flaps to the left.

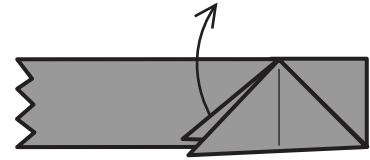

50. Pull out corner.

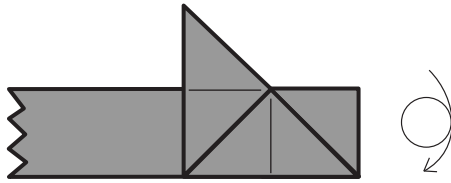

51. Like so. Turn over top-to-bottom.

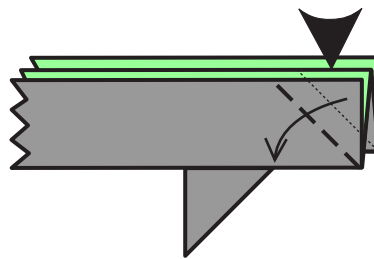

52. Valley-fold top corner.  
Reverse-fold next corner.

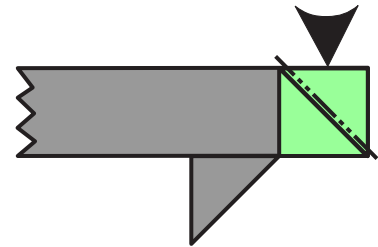

53. Reverse-fold the remaining corner; its rear half is smaller than its front.

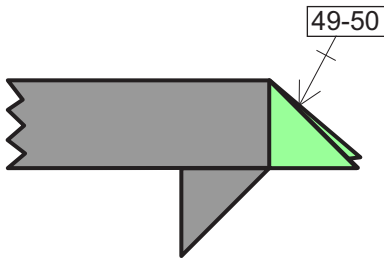

54. Repeat 49-50.

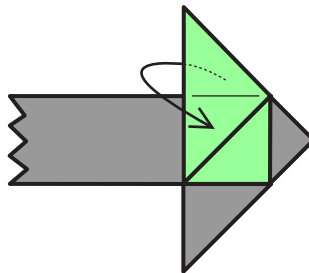

55. Swing rear half of large triangle to front.

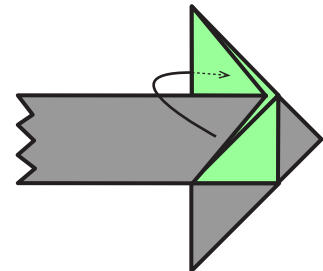

56. Tuck new flap into pocket behind. Front edges of arrowhead are now both closed.

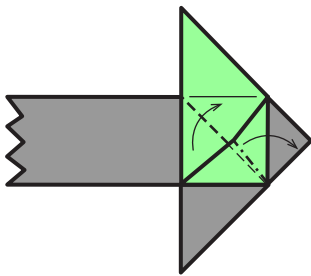

57. Squash. Turn over top-to-bottom and repeat on the other side.

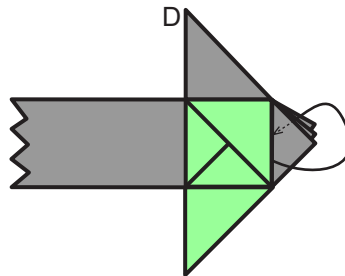

58. There are now 3 tiny triangular flaps at the tip. Wrap the top layer of the front triangle to its back. Very hard! Unfold point D and 3 pleats of the shaft while executing.

# \$ Heart-and-Arrow (cont.)

Copyright 1999 Stephen Hecht. All Rights Reserved

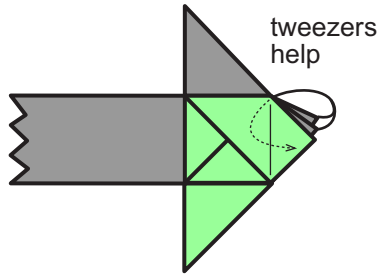

59. Tuck the middle and rear points inside the front point (sequentially or nested). Arrowhead complete.

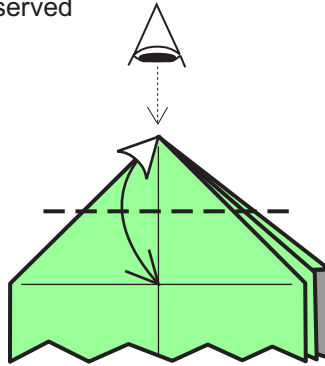

60. Left upper point of the heart. Crease and flex. Then open out the tip into a 3-sided pyramid, the 2 front right edges kept together.

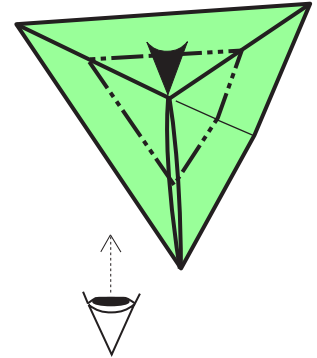

61. Top view. Sink the tip on the crease just made (keeping the double-edge together).

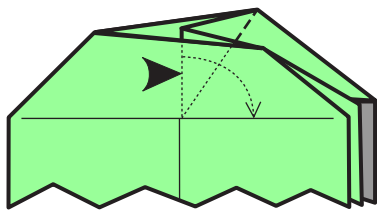

62. Back to a front view. Reverse-fold nested corner down.

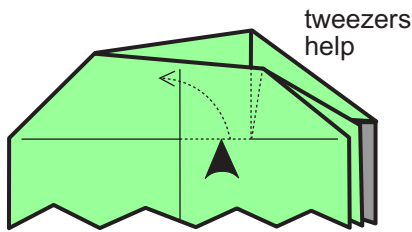

63. Reverse-fold the corner back up, tucking into the tiny pocket. These steps achieve a closed sink more easily. Repeat 60-63 on the right point of the heart.

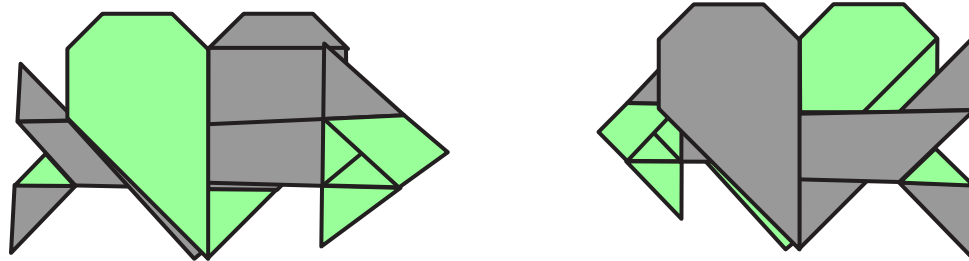

64. Model complete. Bend arrow head and tail outwards where they emerge from the heart.

There are unfortunately 2 separate points at the bottom of the heart, but this does help the model stand up a little better. And though I regret the two-tone harlequin-esque finish, it's not as glaring with a real dollar bill as in these diagrams. (I regard these shortcomings as the price of achieving my self-imposed goal: the arrow shaft emerges from under the planes of the heart.)

# Heart Card V

Designed on 7/5/97 and diagrammed in 11/97;  
6" square produces 3" square

©1997 Sy Chen

1. Start from duo-color square with heart color side down

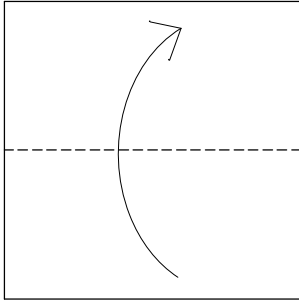

2. Enlarged; upper right to bottom edge;  
judgement fold upper left corner;  
inside reverse lower left corner

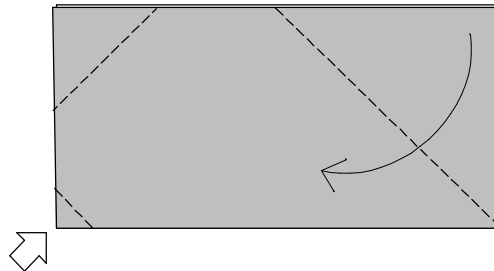

3. Mountain fold to shape upper heart part;  
Inside reverse indicated corner;  
Make  $AB=CD$

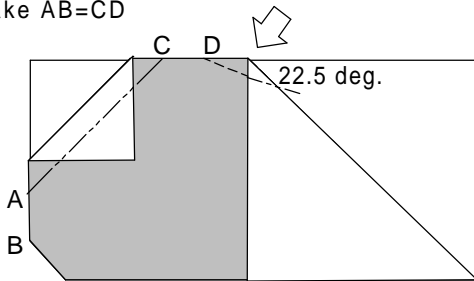

4.

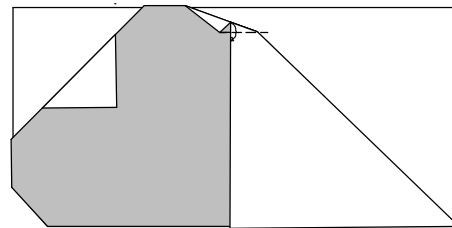

5. Close card

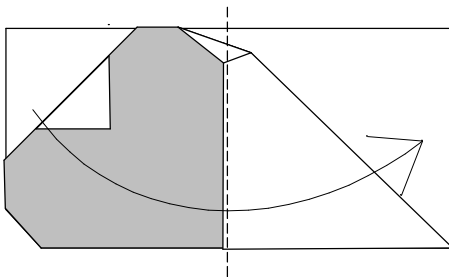

6. Finished. Ready for open

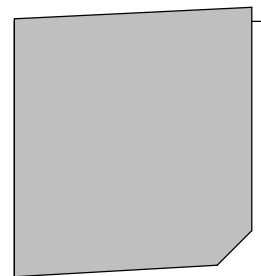

# Heart for Alida

Maarten van Gelder

© 2000 Mar

This heart is the largest fully symmetrical heart you can make from one square piece of paper.

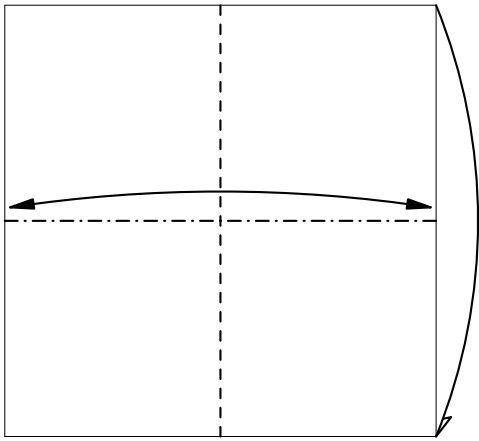

1

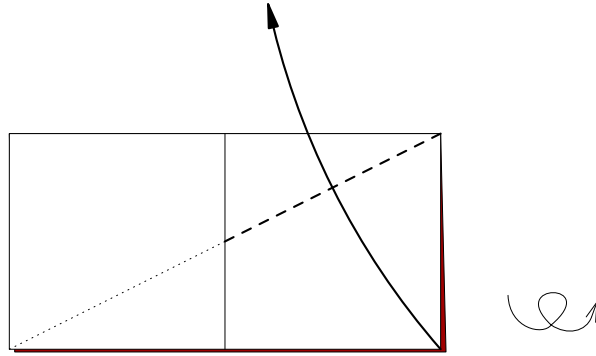

2

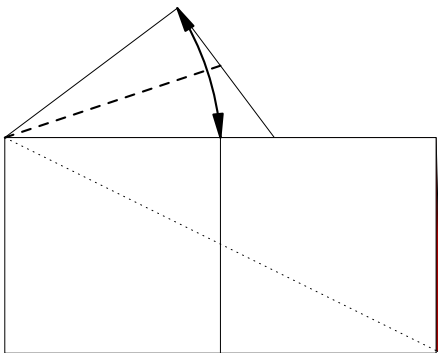

3

→ 1

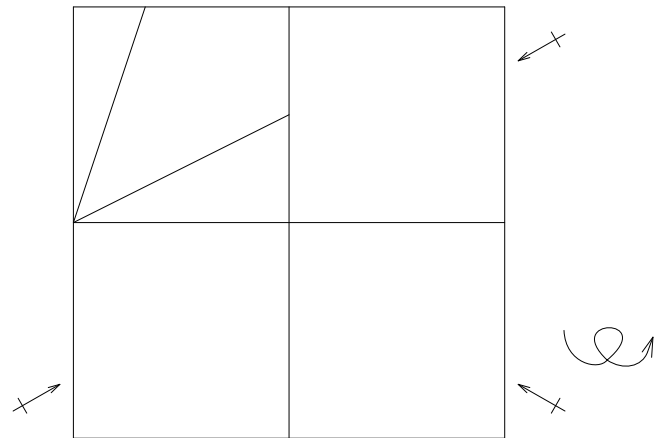

4

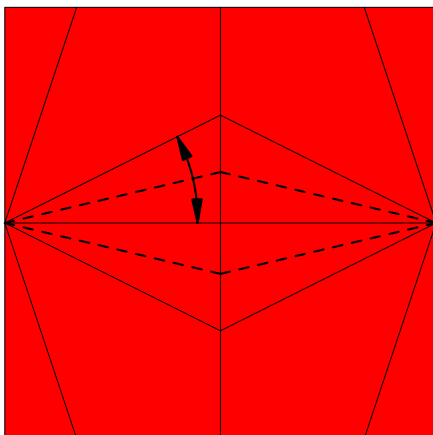

5

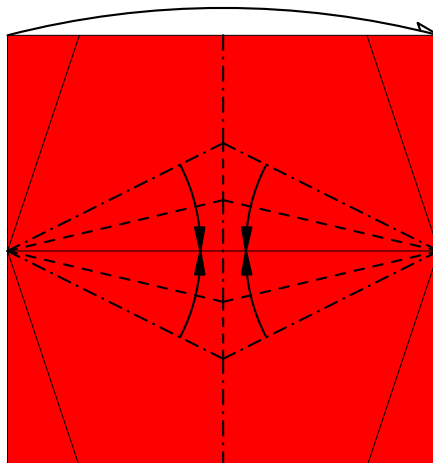

6

90

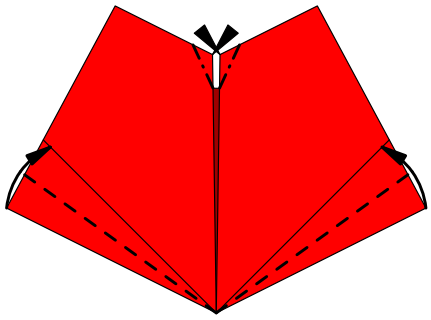

7

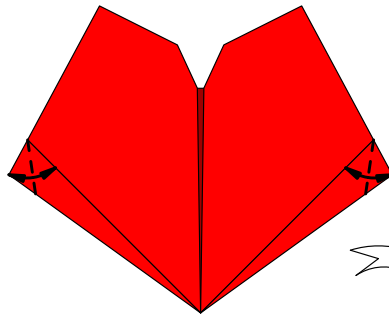

8

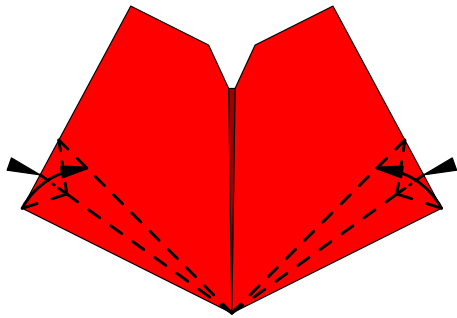

9 One layer

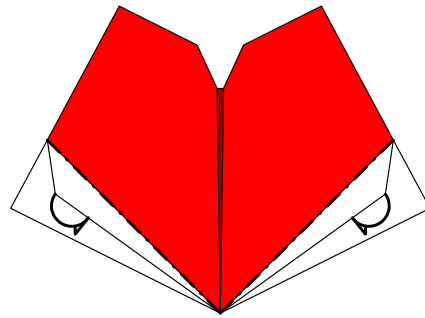

10

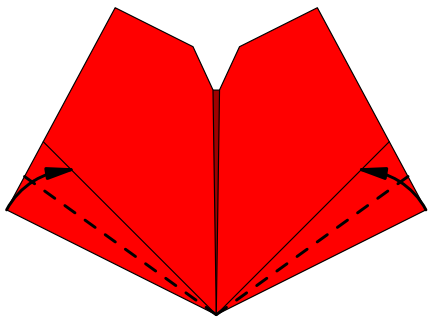

11

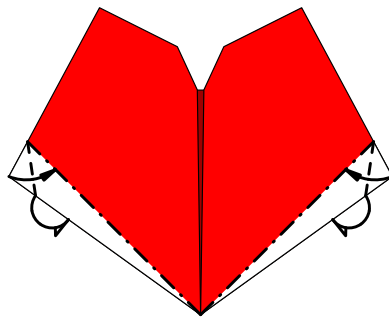

12 Put in pockets

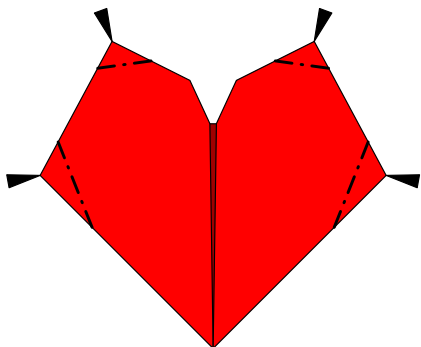

13

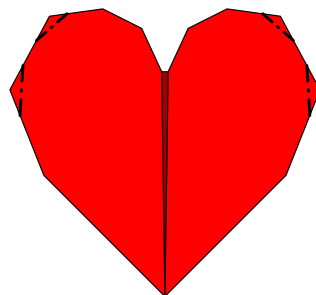

14 Make flaps and pockets as in 9-12

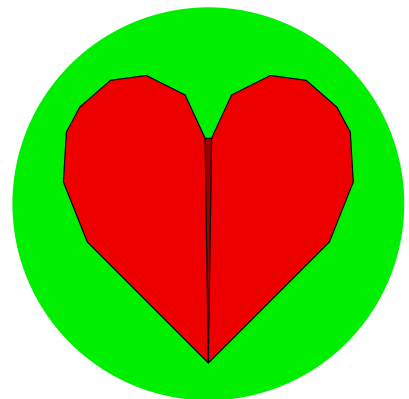



# hen on an edge

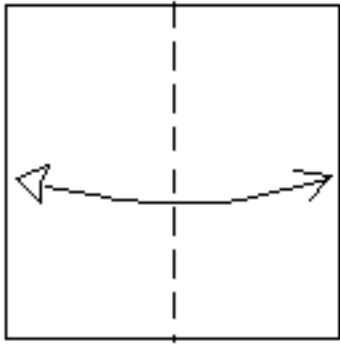

**1** Begin with the white side up.  
Fold and unfold.

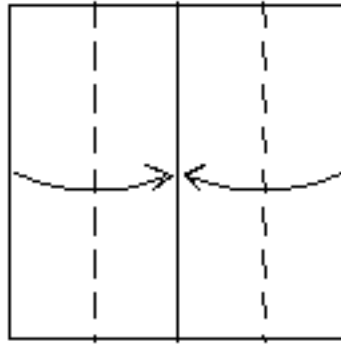

**2** Valley-fold.

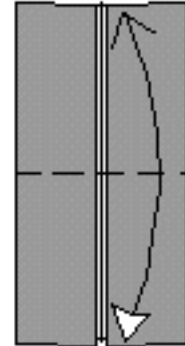

**3** Fold and unfold.

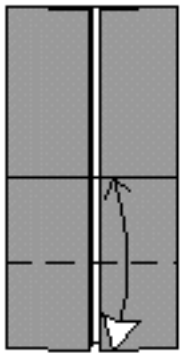

**4** Fold and unfold.

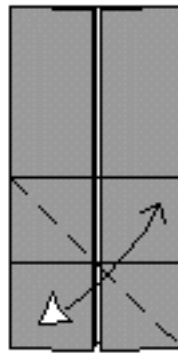

**5** Fold and unfold.

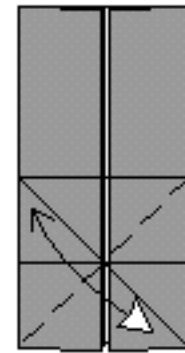

**6** Fold and unfold.

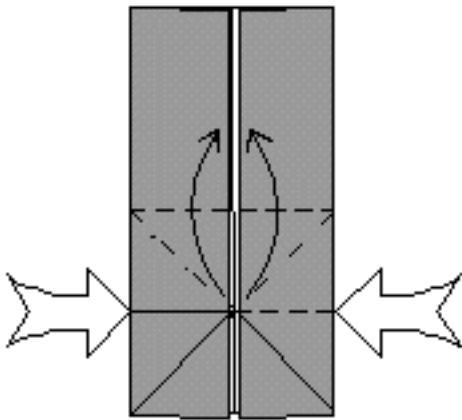

**7** Squash-fold the lower part of the model.

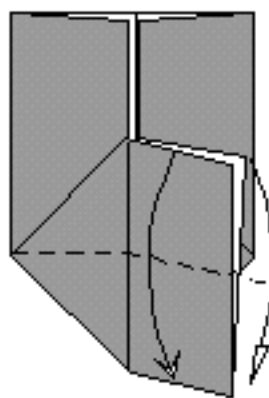

**8** Fold the two flaps down.

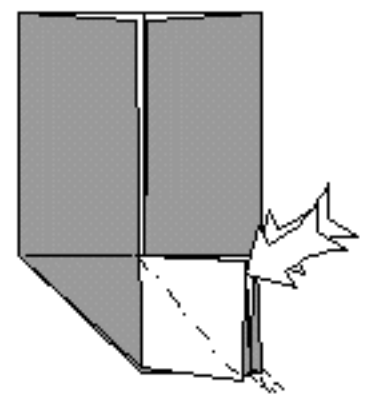

**9** Reverse-fold two edges.

# hen on an edge

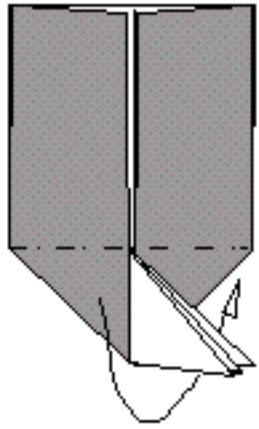

**10** Mountain-fold.

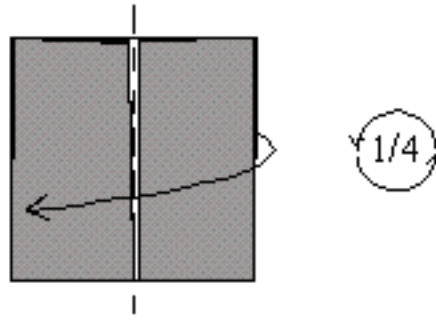

**11** Book-fold one edge to the left. Rotate the model.

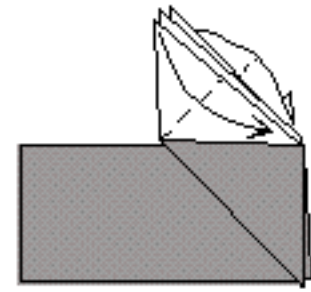

**12** Fold one flap down on an existing crease. Repeat behind.

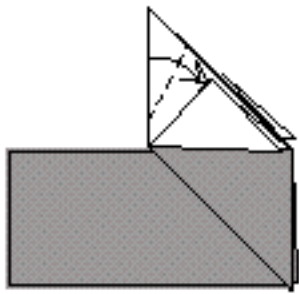

**13** Valley-fold.

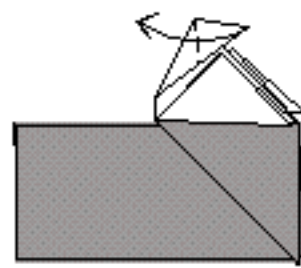

**14** Valley-fold.

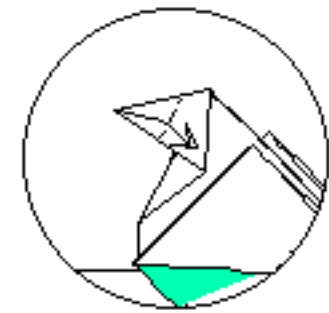

**15** Valley-fold.



**16** Valley-fold.

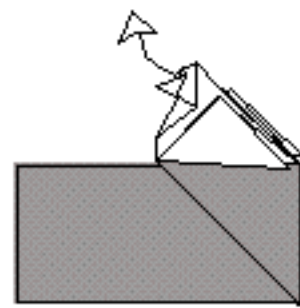

**17** Unfold to step 13.

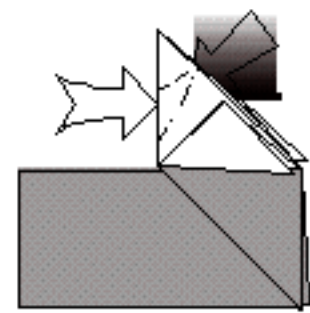

**18** Crimp on existing creases.

# 3 hen on an edge 3

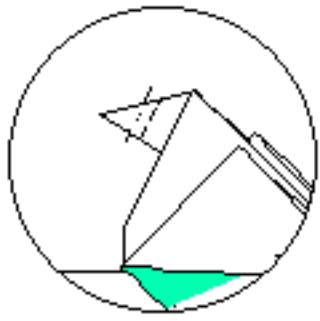

**19** Crimp the beak on existing creases.

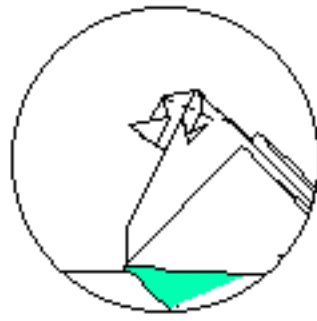

**20** Valley-fold the edge down. Repeat behind.

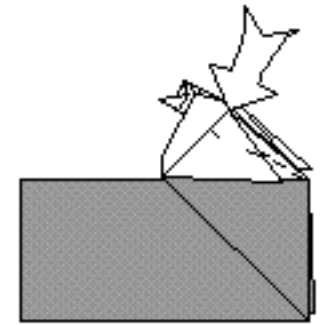

**21** Reverse-fold asymmetrically. Repeat behind.

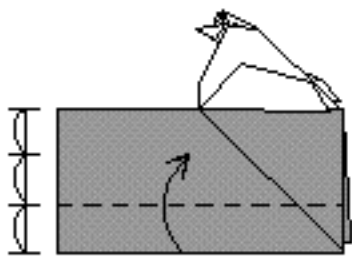

**22** Valley-fold the lower edge upward. Repeat behind.

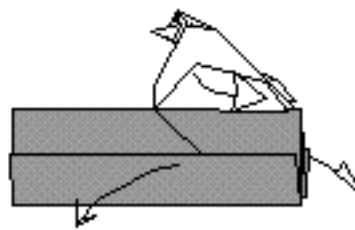

**23** Adjust the long flaps so that the model will stand. Curl the wings.

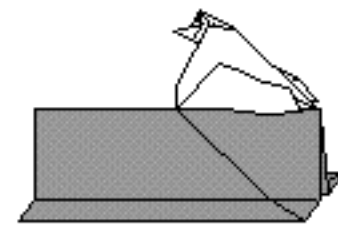

**24** The model is finished.

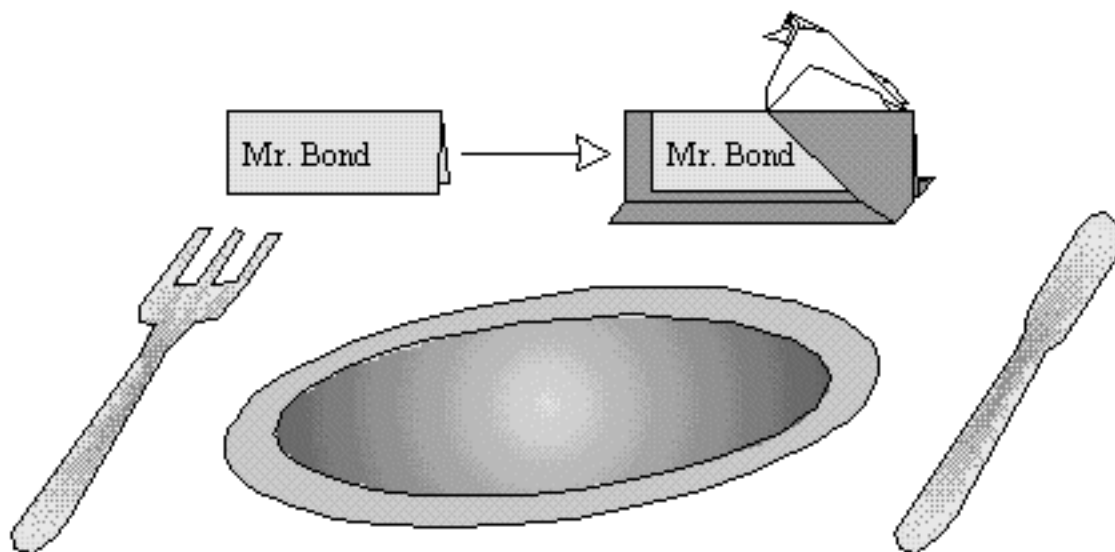

Try using it as a table card, inserting a name tag underneath the hen.

# Heron by Gabriel Willow (ME)

Complex    Fold from a colored bird base. A 10" piece of paper produces a model 6" high.

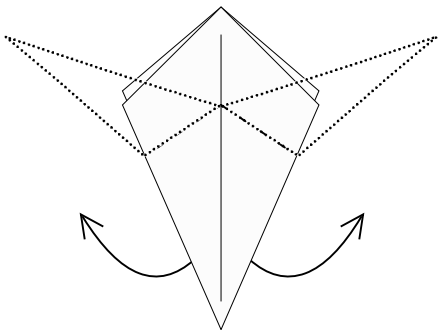

1. Reverse fold both flaps above the horizontal so that the points rest as shown.

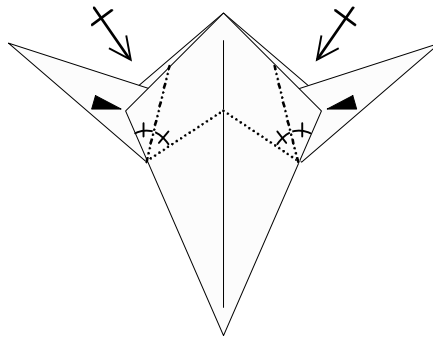

2. Sink triangularly using the hidden landmarks. This will leave two small flaps sticking out.

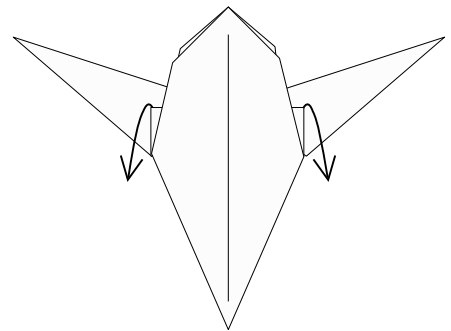

3. Reverse fold the two flaps. **DO NOT** repeat behind.

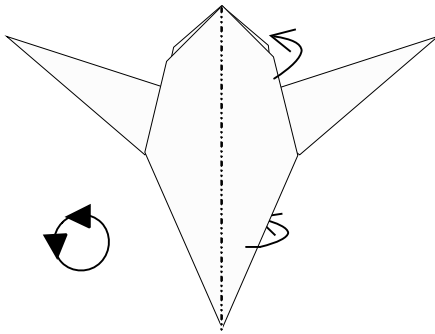

4. Fold in half & rotate 90 degrees.

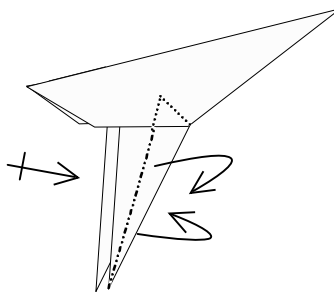

5. Thin the legs by folding them inside.

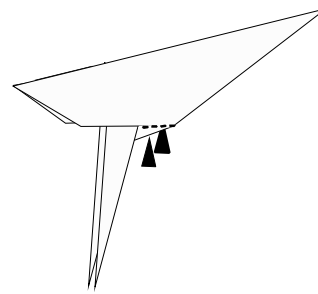

6. Reverse fold the two flaps.

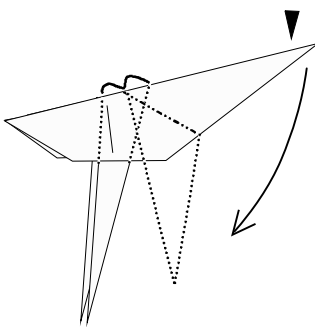

7. Reverse fold. Note location of landmarks.

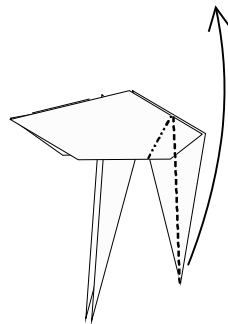

8. Double rabbit ear back up.

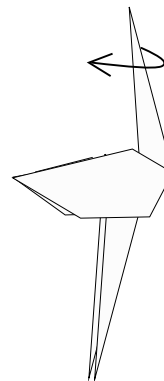

9. Open the model out, but do not crease.

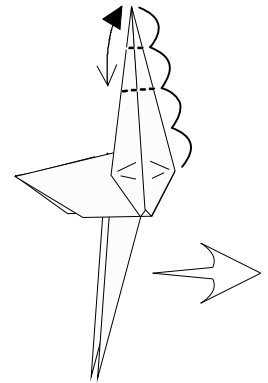

10. Crease the top fourth.

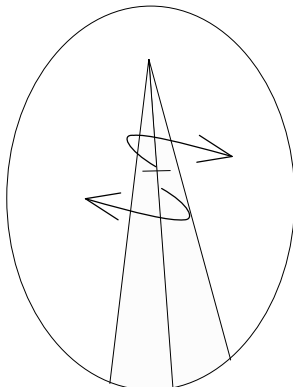

11. Close-up view. Carefully open the two layers on each side.

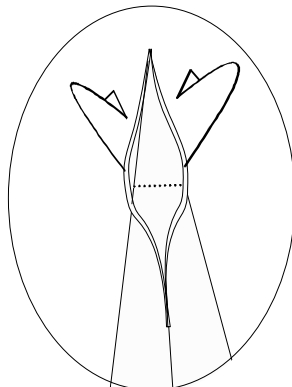

12. Wrap only the outer layer behind on the 1/4th mark made in step 10.

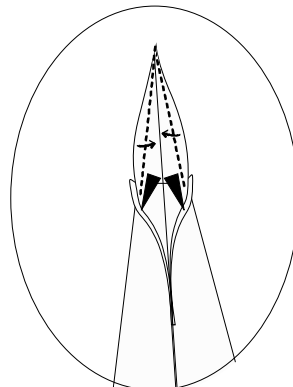

13. Fold the inner layers back in. Flatten out the outer layers.

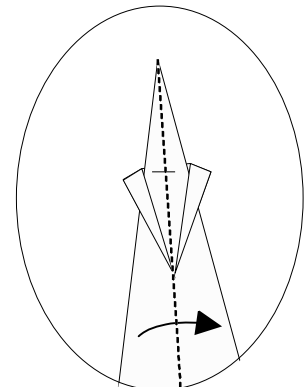

14. Close the flap back up.

*Diagrammed by J.C. Nolan - Feb. '95*

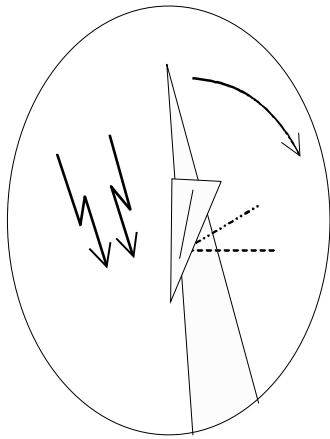

15. Move the head into position with a crimp.

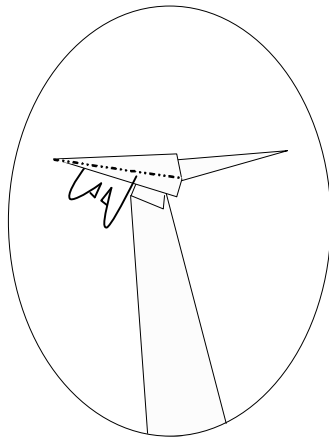

16. Thin the comb by tucking the flaps inside.

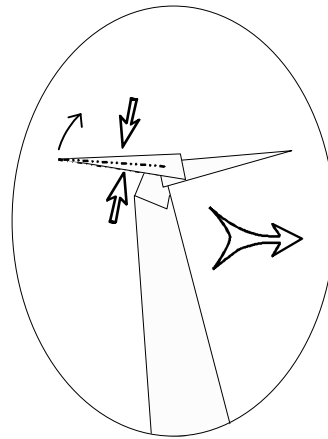

17. Pinch and curl the comb into its final shape.

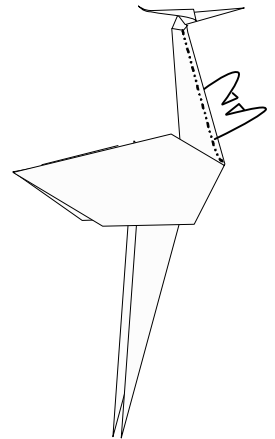

18. Thin the neck. Note that the folds curve.

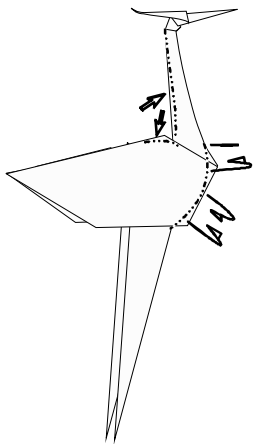

19. Continue to shape the neck and body.

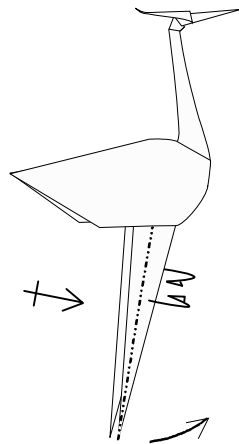

20. Thin both legs by folding the flaps to the inside of each leg.

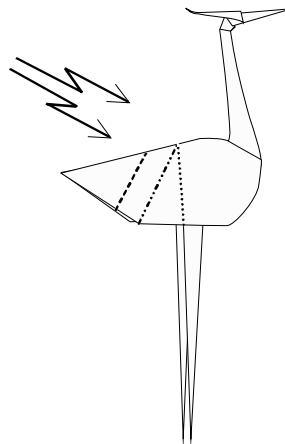

21. Crimp, using the hidden landmark, to form the tail.

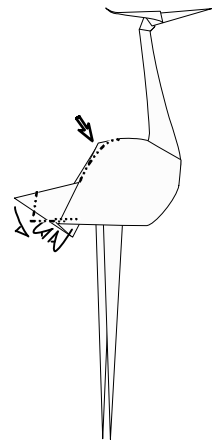

22. Shape the tail and body further.

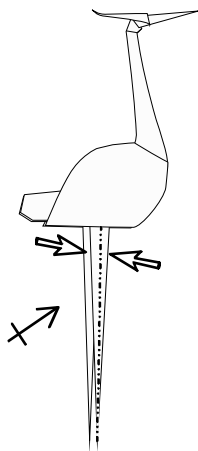

23. Thin the legs by pinching in front and behind.

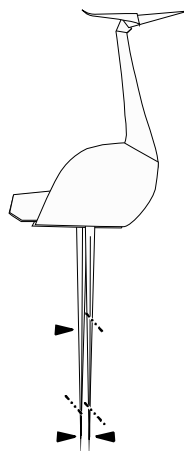

24. Move the legs into final position.

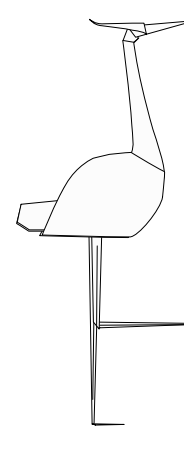

25. Completed Heron.

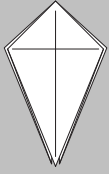

Autor: J. Anibal Voyer

Dificultad:

Proporción:  $h = \zeta? a$

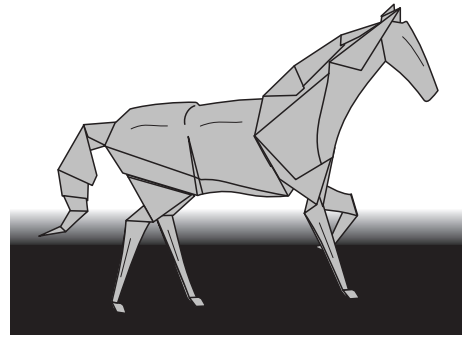

# Caballo

1

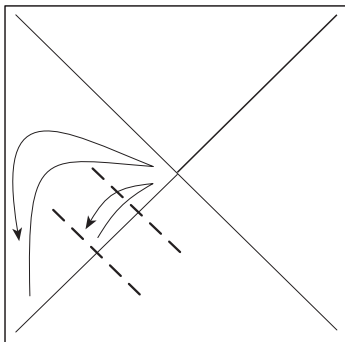

2

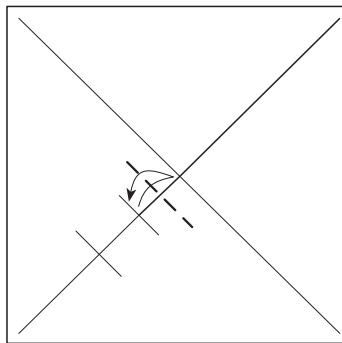

3

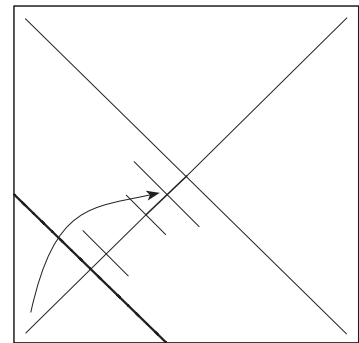

4

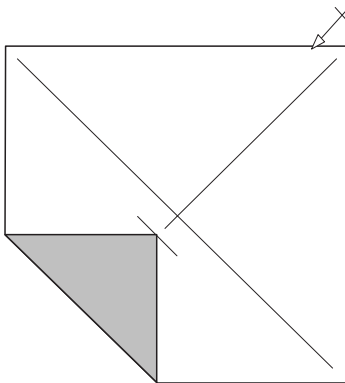

5

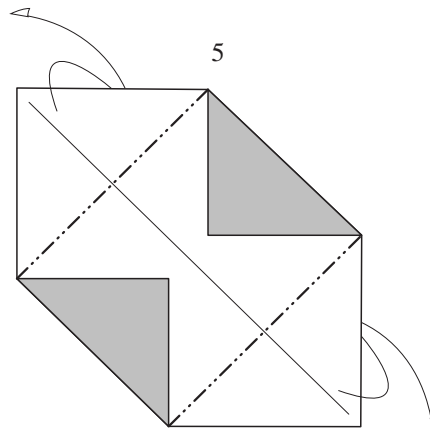

6

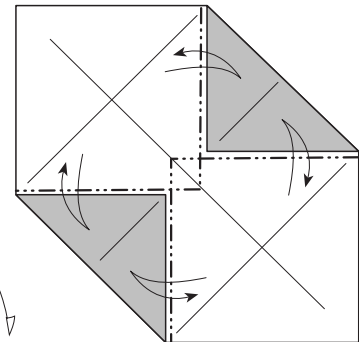

7

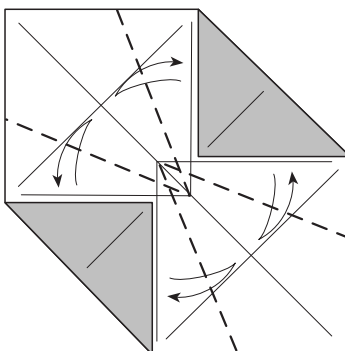

8

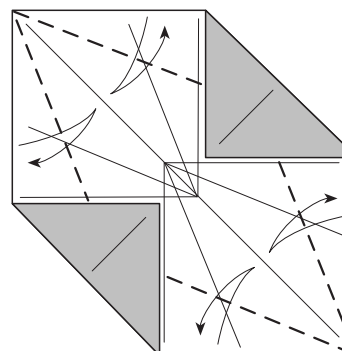

9

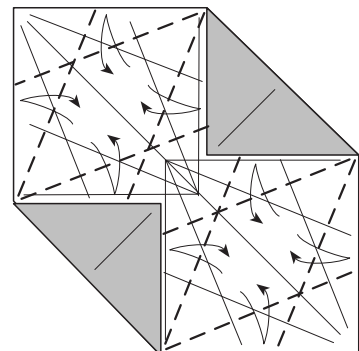

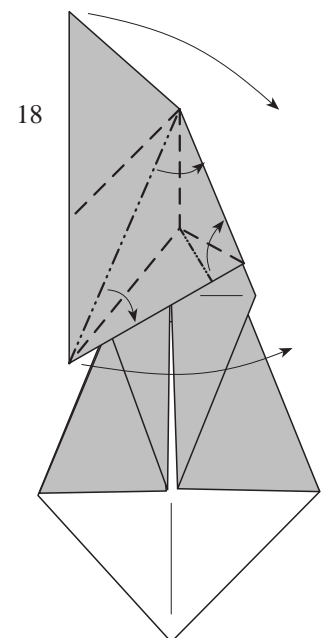
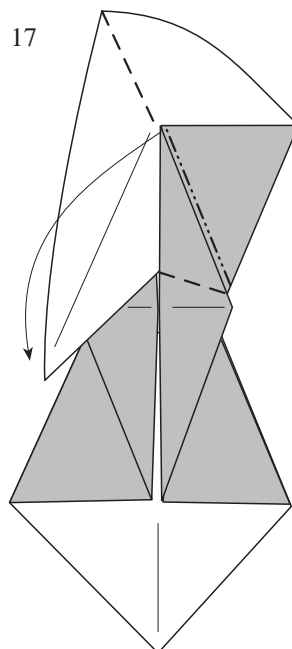
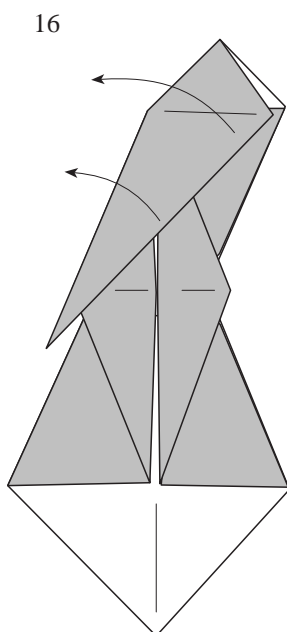
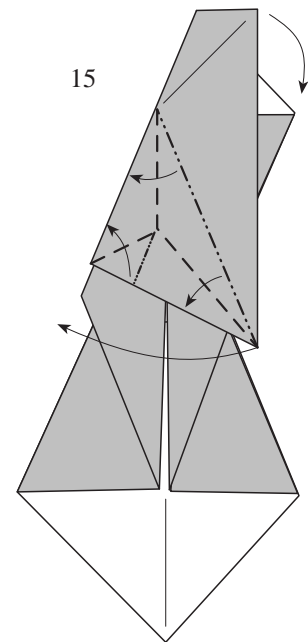
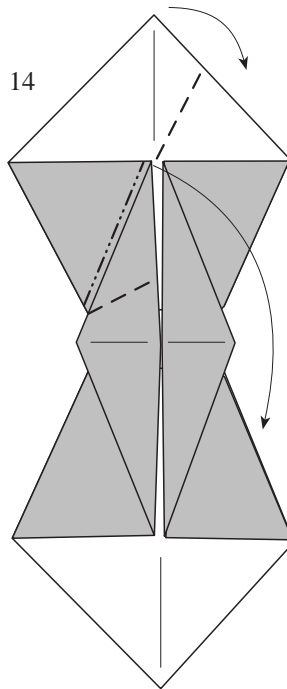
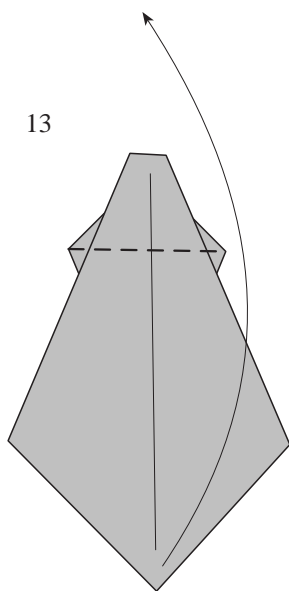
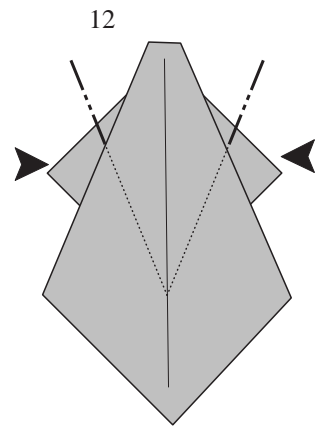
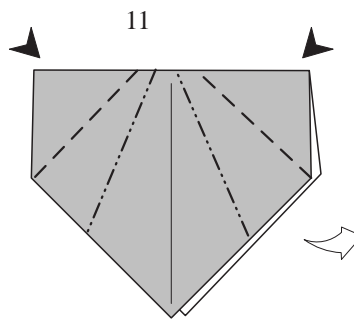
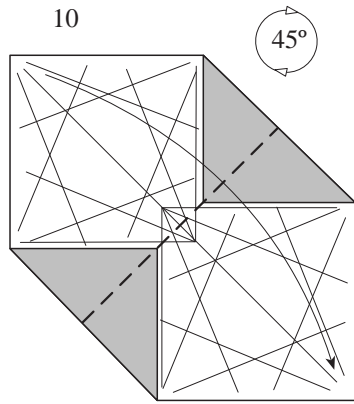

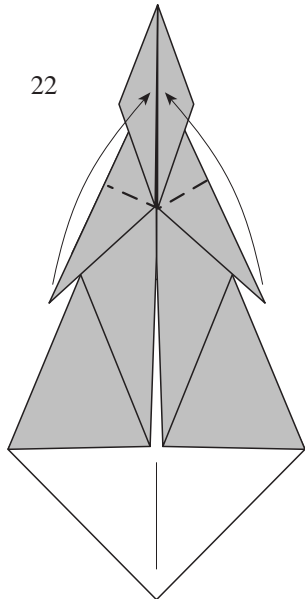
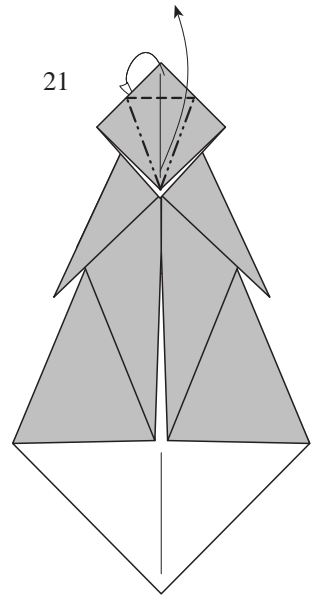
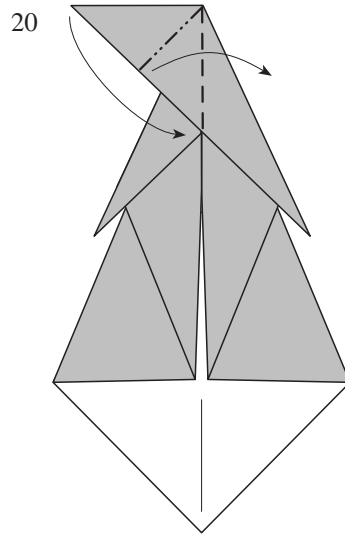
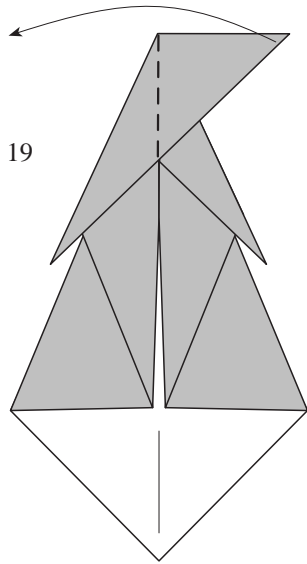

23 Repetir del  
paso 14 al 20

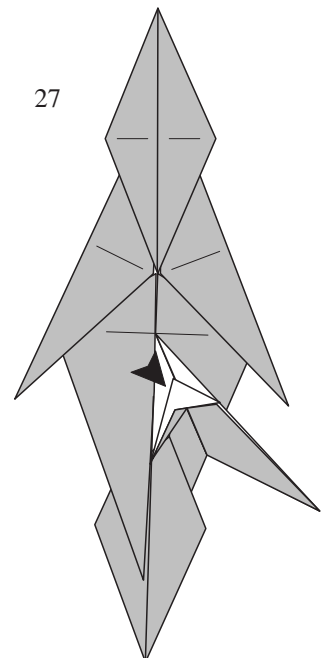
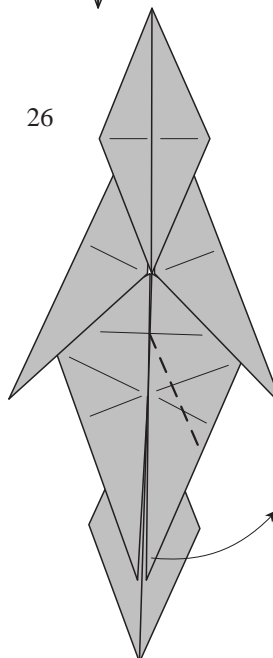
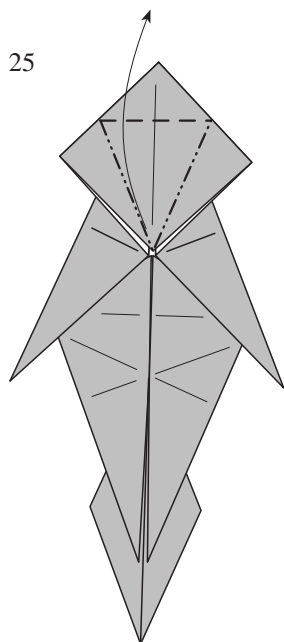
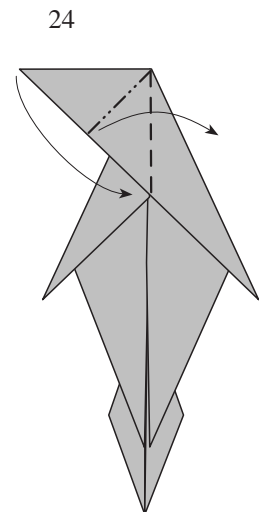
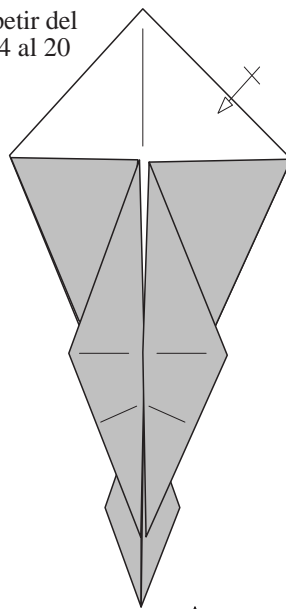



28 Repetir a la izquierda los pasos 26 y 27

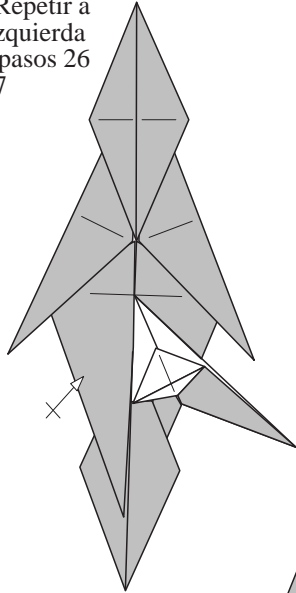

29

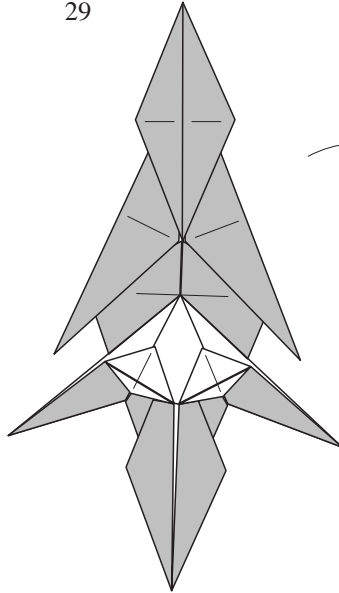

30

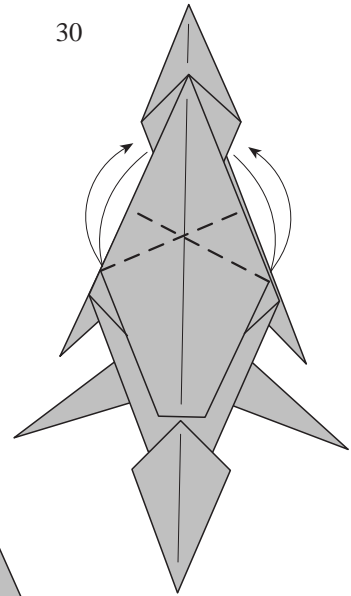

31 Este paso debe hacerse simultaneamente delante y detras

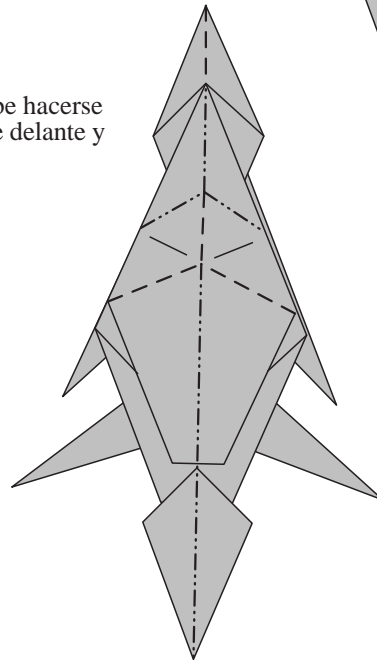
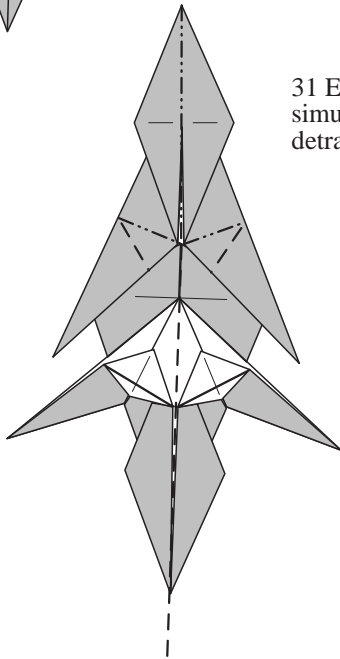

32

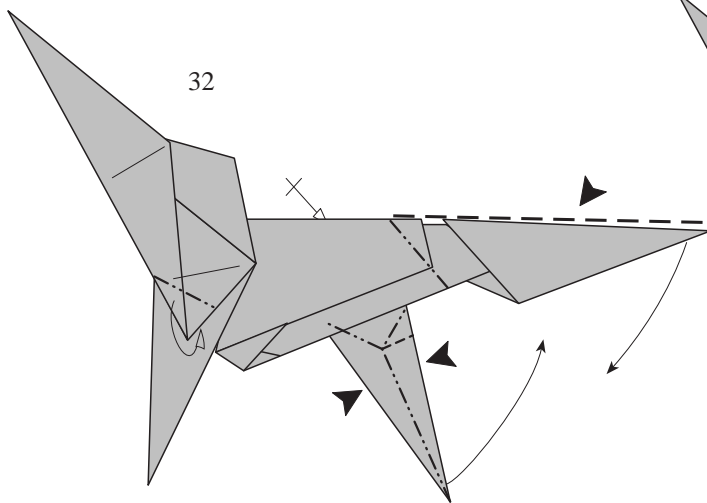

33

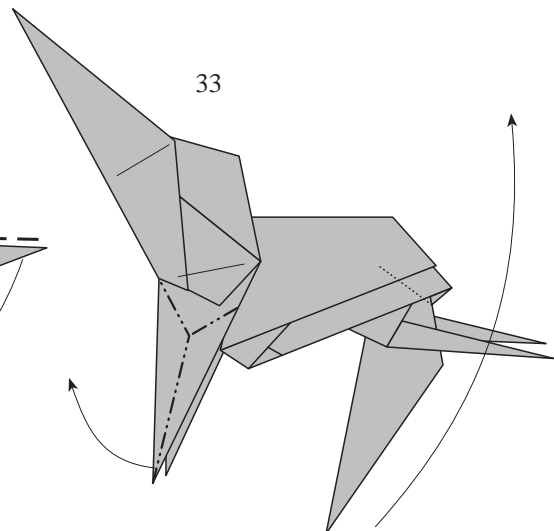

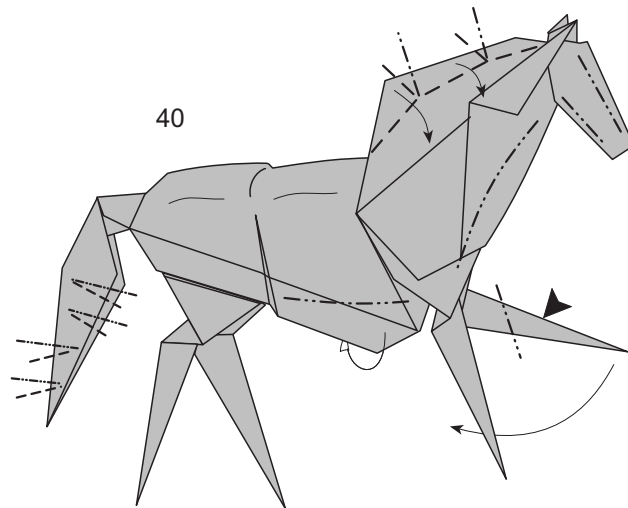
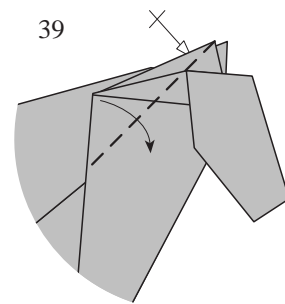
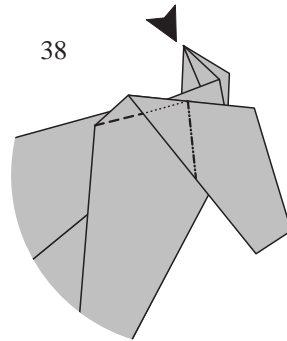
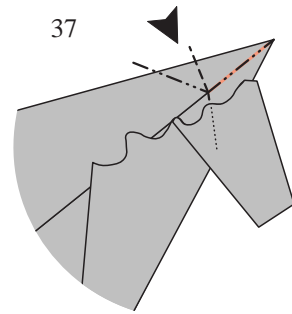
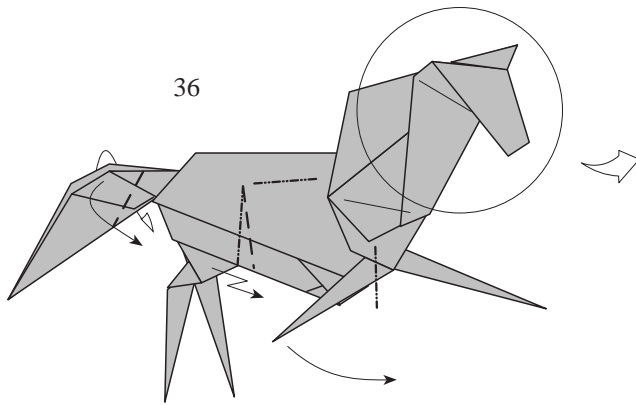
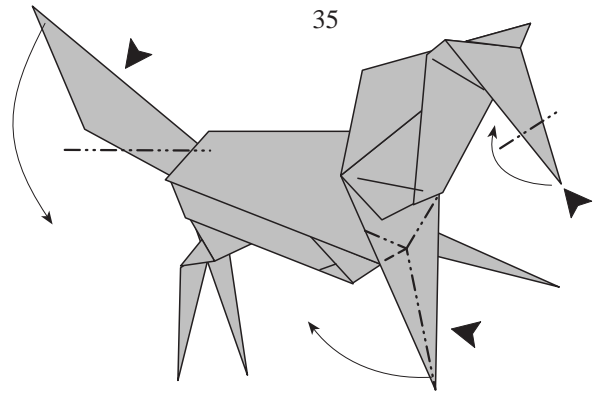
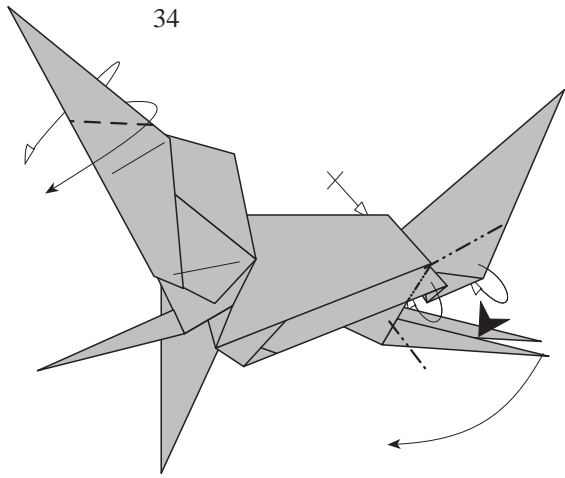

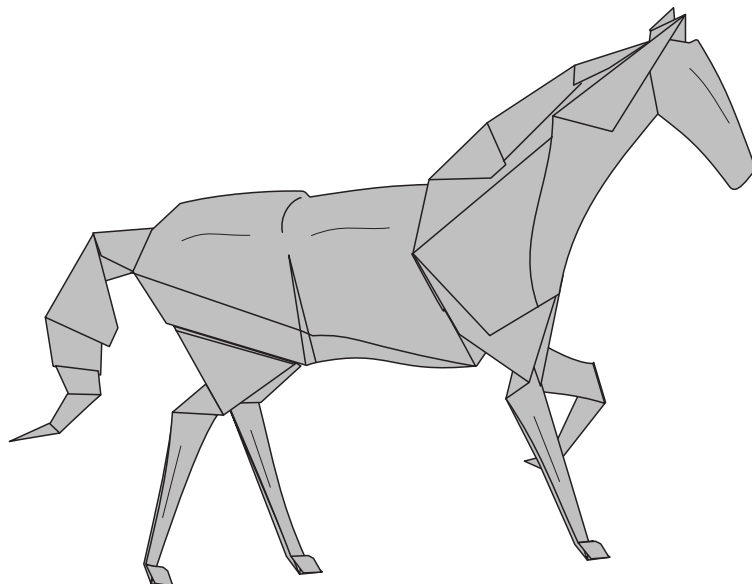
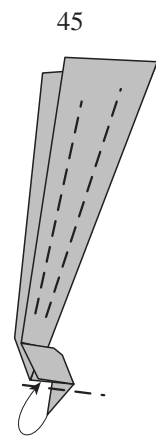
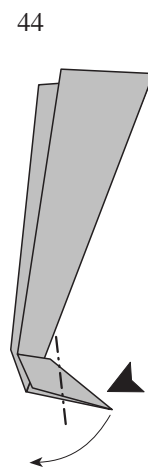
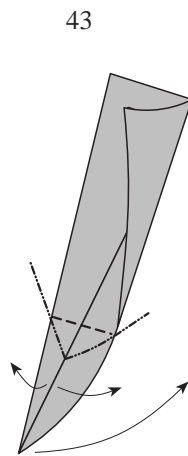
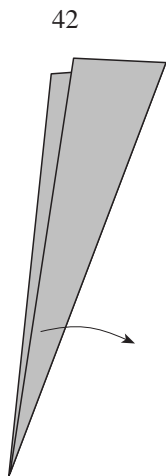
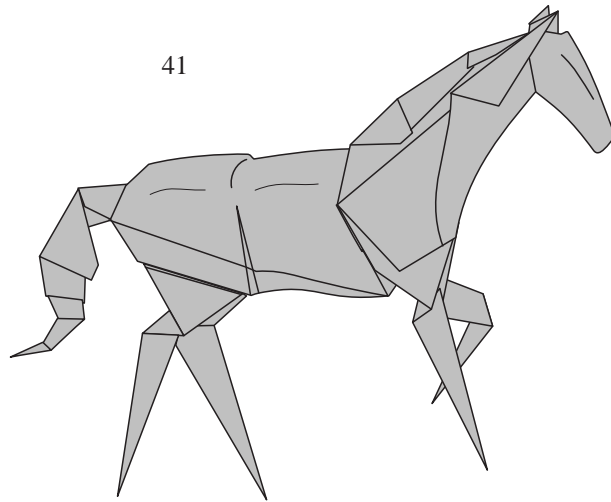

# “Арабский скакун”

## Автор: Роберт Ланг (США)

то о на из о ле ни мо еле оберта анга ри лана е иально ля итателе ибиряка .  
о ороного оня таки оэтом е ли не ели обза е ти ь тали маном л а  
ре та ил я. эта а и горя и раб ки еребе ора ет а оими гра иозн ми ормами.  
о и кам не о ет брать я за эт голо оломк озмо н тра м а ро ем ела те то  
отите озмо но рез льтате ме то коня а и р ка ока ет я то то оинтере не

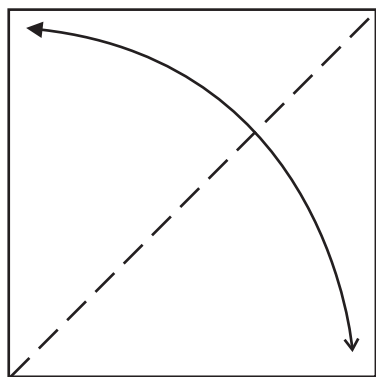

**1** Возьмите большой квадрат (со стороной не меньше 25 см.) и перегните его по диагонали

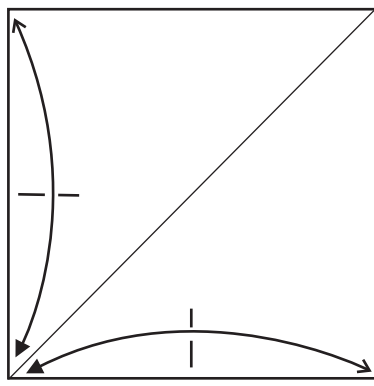

**2** Перегните две стороны квадрата посередине

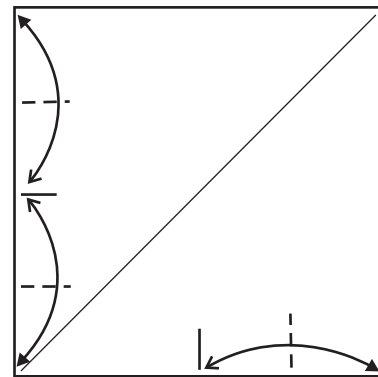

**3** Сделайте ещё три “насечки” на сторонах

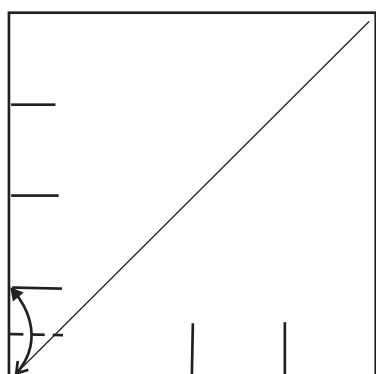

**4** Ещё одна “насечка”

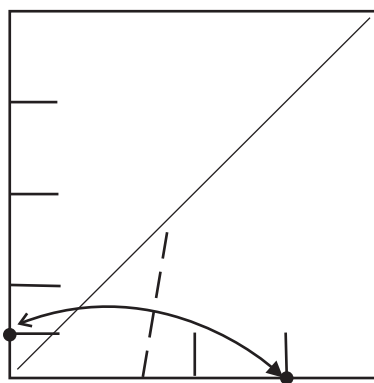

**5** Перегните квадрат так, чтобы линия сгиба проходила между отмеченными точками

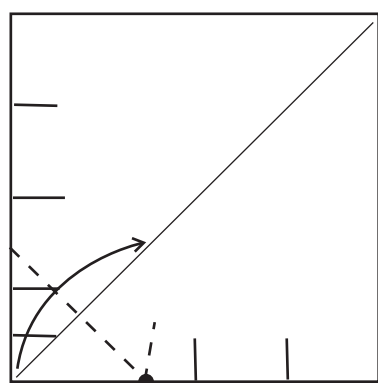

**6** Согните угол квадрата вверх вдоль диагонали, так чтобы линия сгиба проходила через “насечку”, сделанную в предыдущем шаге

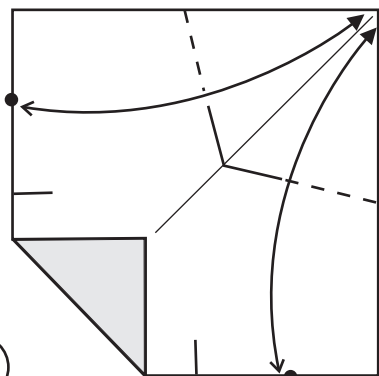

**7** Согните верхний правый угол к указанным точкам и сделайте “насечку” на верхней и правой сторонах квадрата

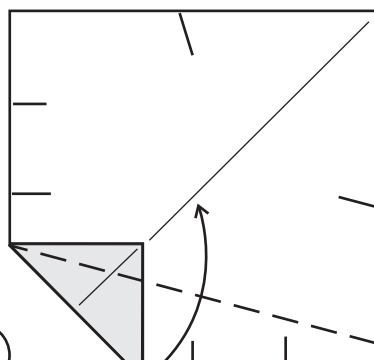

**8** Согните нижний угол вверх так, чтобы он совпал с диагональю

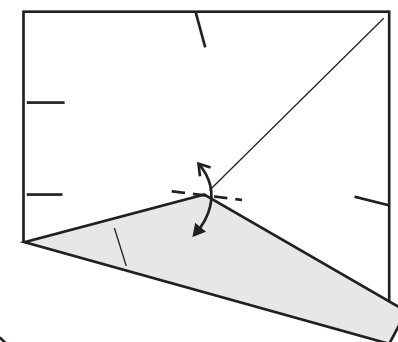

**9** Сделайте “насечку” через точку, около угла, касающегося диагонали

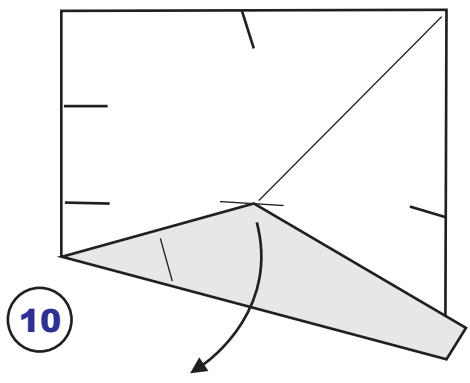

10

Отогните слой бумаги

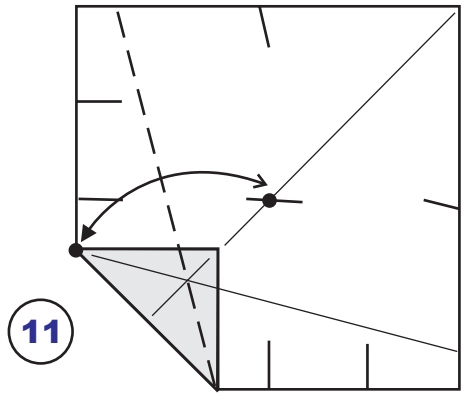

11

Согните угол к отмеченной точке, и отогните

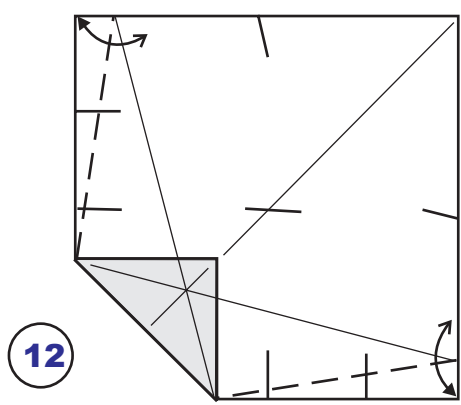

12

Наметим линии

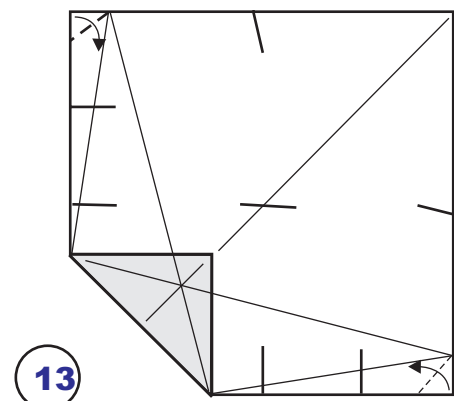

13

Сложите уголки к линиям, которые вы только что наметили

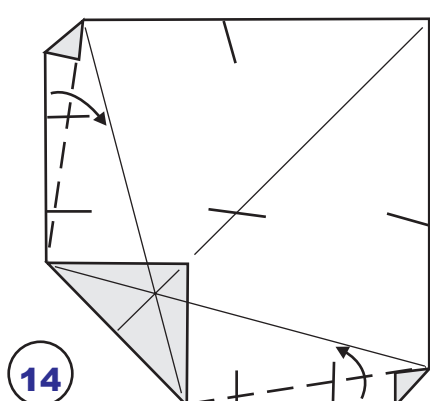

14

Снова сделайте сгибы, которые вы делали в шаге 12

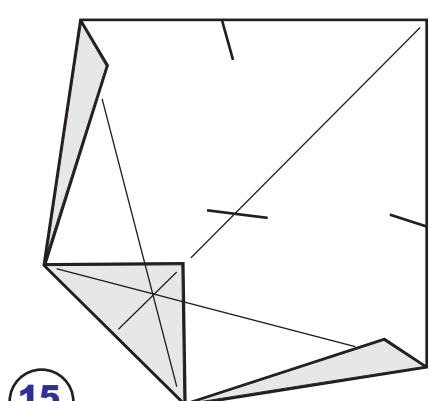

15

Проверьте результат и переверните фигуру на другую сторону

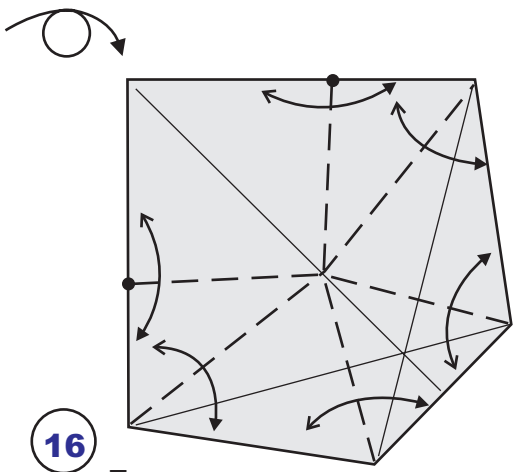

16

Перегните складку по указанным линиям. Все сгибы сходятся к диагонали в точке, отмеченной в шаге 9

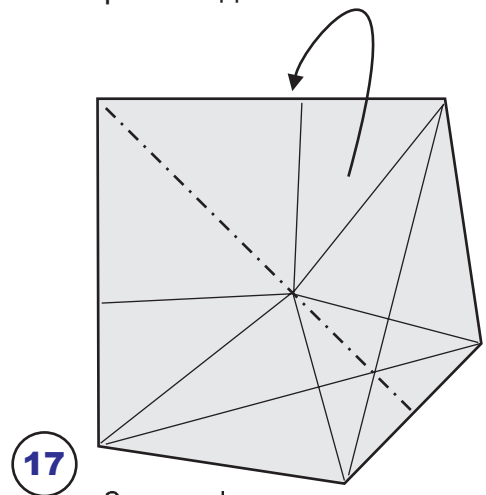

17

Согните фигуру по диагонали "горой"

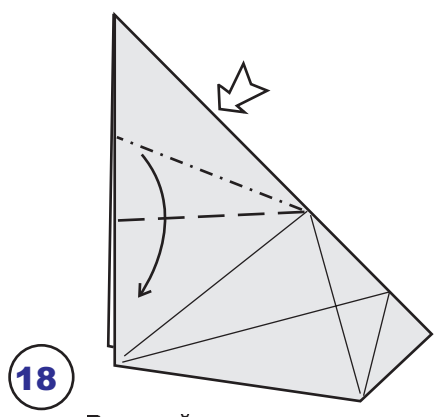

18

Раскройте симметрично карман. Глубинная складка проходит по уже намеченной линии

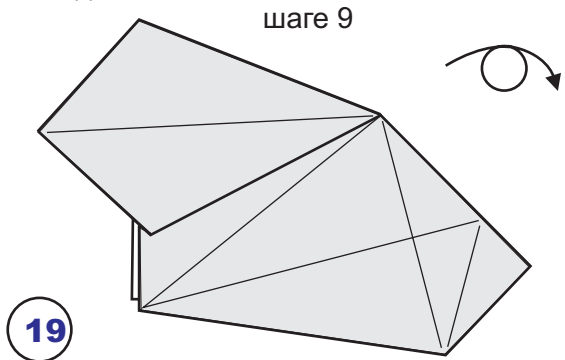

19

Проверьте, что получилось и переверните фигуру, при этом повернув её на 90 градусов

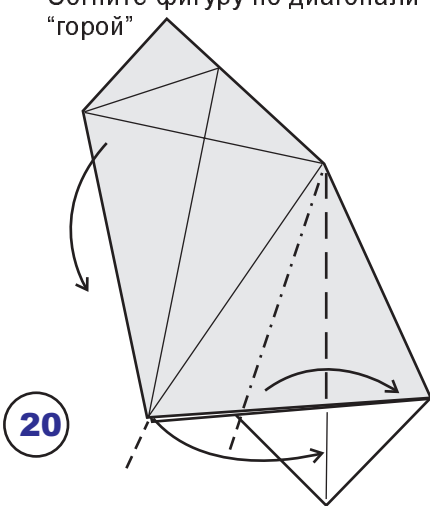

20

Сдвиньте слои так, чтобы два угла совпали с вертикальной линией

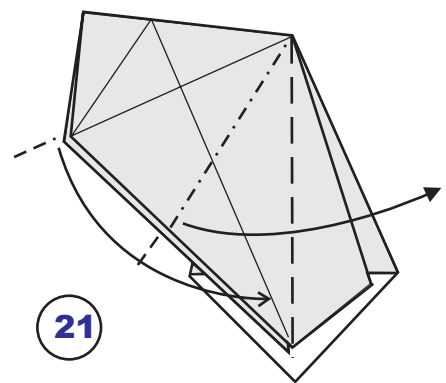

21

Ещё раз сдвиньте слои, чтобы следующие два угла коснулись верикали

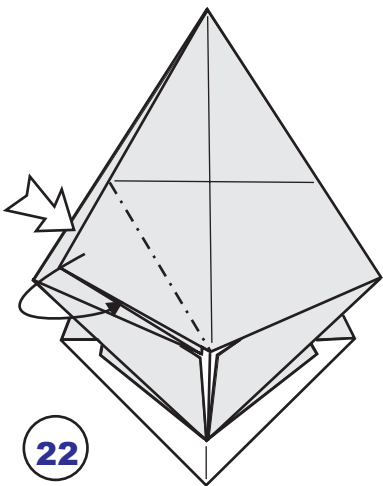

**22**

Вогните угол внутрь по намеченной линии

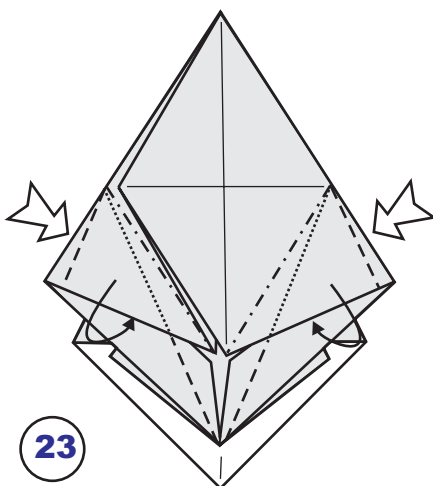

**23**

Вогните углы на обеих сторонах

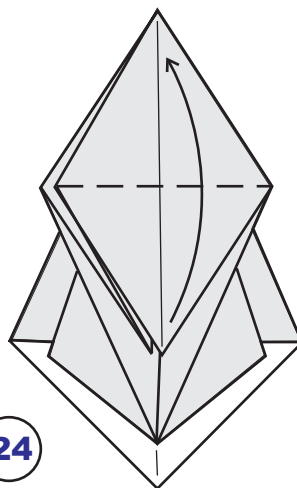

**24**

Согните верхний слой вверх

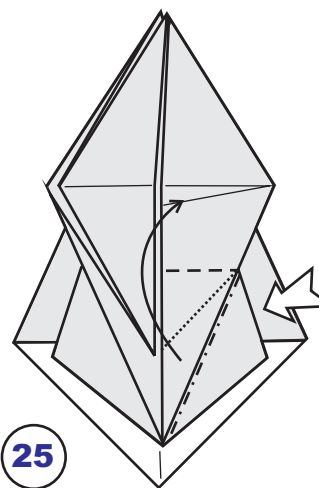

**25**

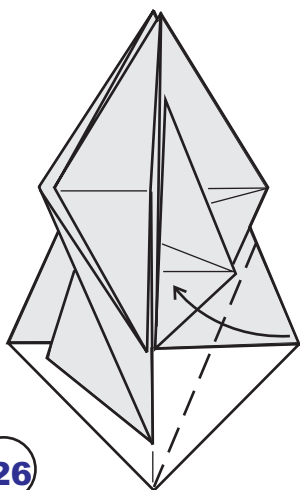

**26**

Согните правый угол к середине

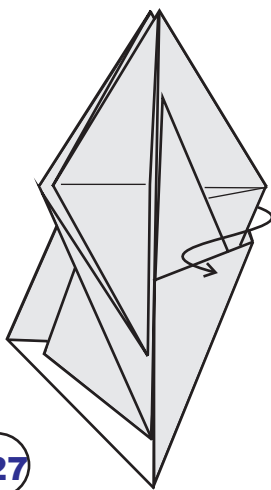

**27**

Переместите закрытые слои вперед

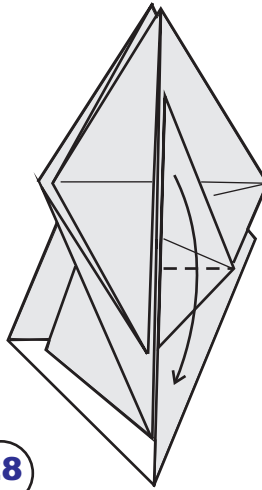

**28**

Отогните один слой вниз

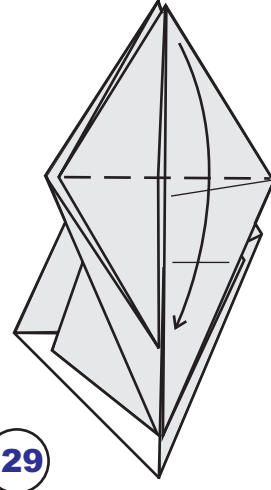

**29**

Отогните следующий слой

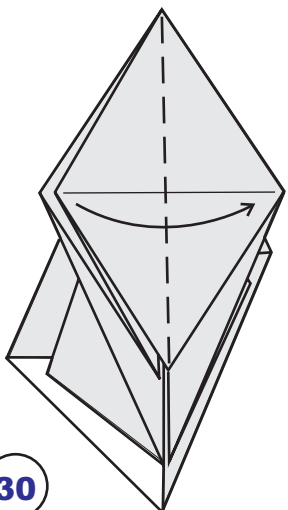

**30**

Перелистните один слой слева направо

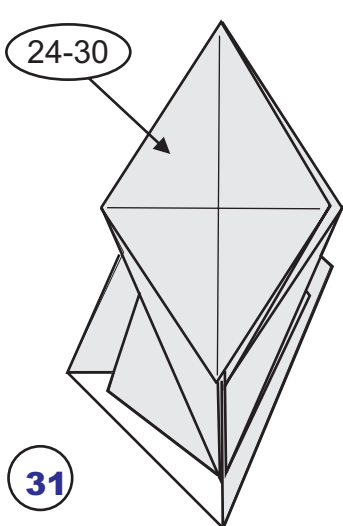

**31**

Повторите шаги 24-30 слева

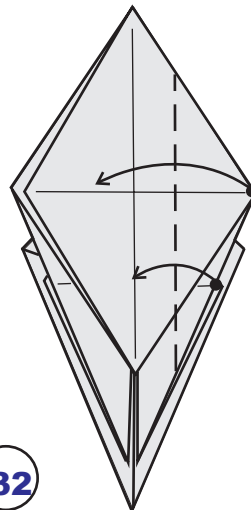

**32**

Согните два угла каждый к указанной линии

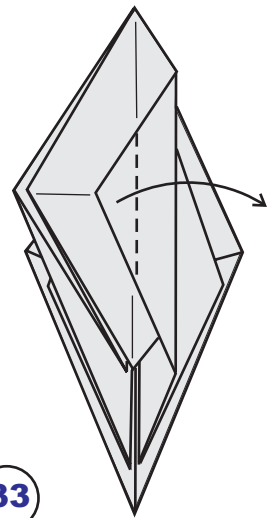

**33**

Отогните уголок обратно вдоль вертикальной складки

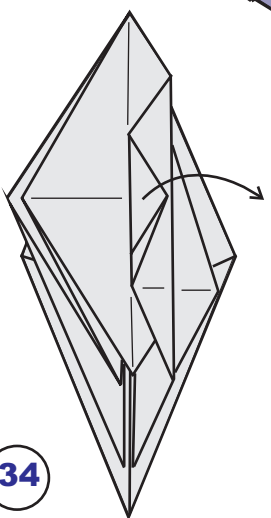

**34**  
 Разверните складку

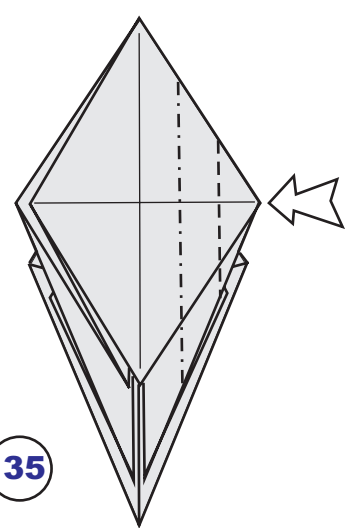

**35**  
 Вогните правую часть  
 фигуры загогом по намеченным  
 линиям, при этом нужно будет  
 практически полностью раскрыть  
 складку

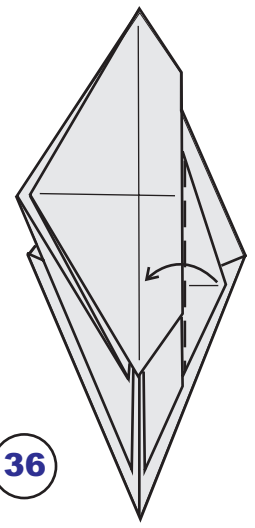

**36**  
 Согните следующий  
 слой вверх

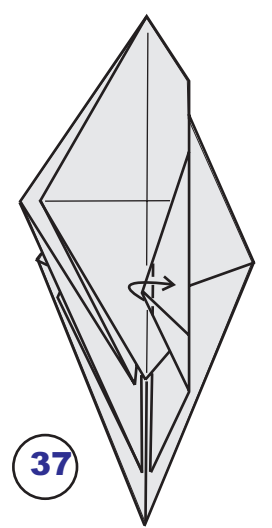

**37**  
 Отогните уголок  
 вправо вдоль  
 вертикальной линии,  
 потом разверните  
 всю складку

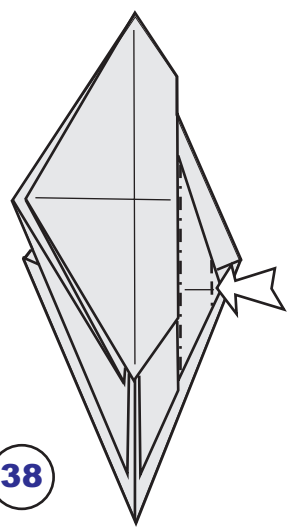

**38**  
 ...и повторите операцию  
 в духе шага 35

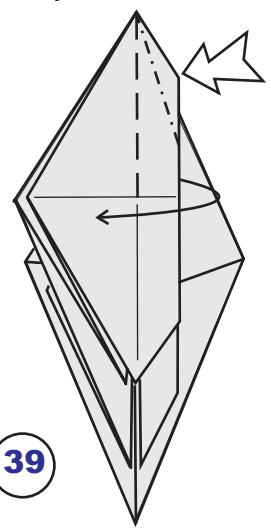

**39**  
 Отогните верхний слой,  
 при этом расправится  
 складка в верхней части  
 фигуры

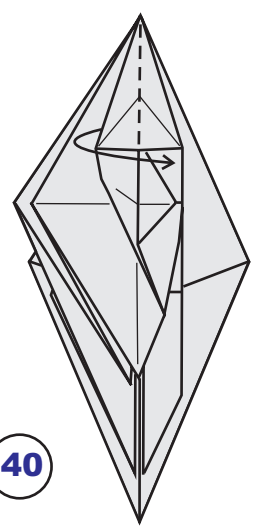

**40**  
 Закройте складку

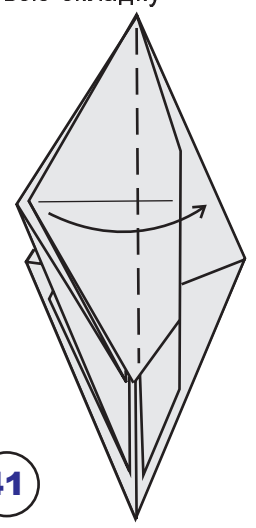

**41**  
 Перелистните слой  
 слева направо

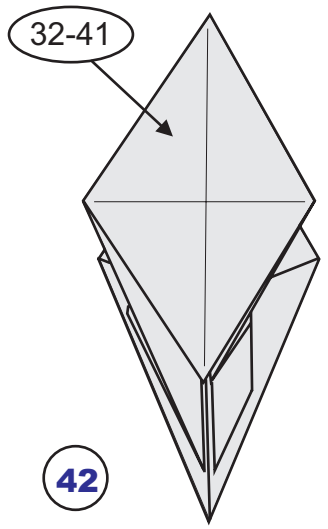

**42**  
 Повторите операции  
 32-41 слева

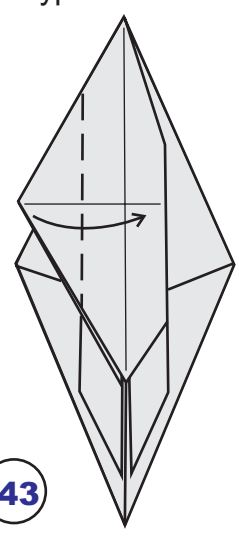

**43**  
 Согните оставшийся слой  
 вправо вдоль нижней  
 складки

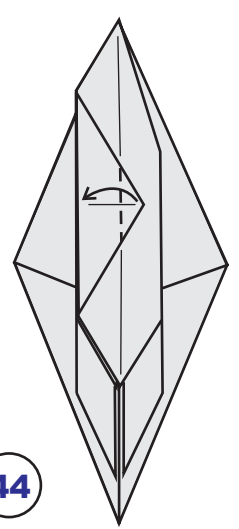

**44**  
 Отогните уголок  
 и раскройте складку

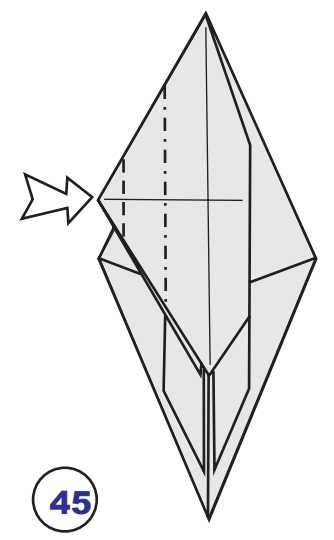

**45**  
 Вогните и выгните складку,  
 используя намеченные линии,  
 как вы это уже делали ранее

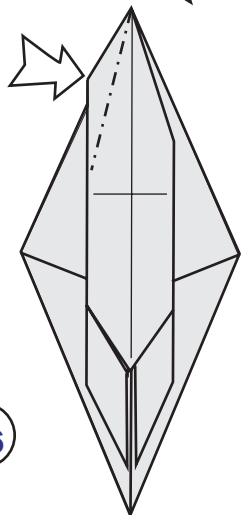

46

Вогните внутрь угол, как вы это делали в шаге 39

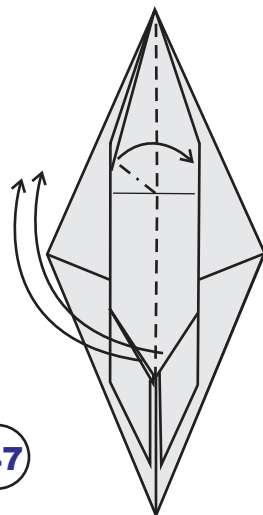

47

Разверните слои в верхней части фигуры, одновременно поднимая два угла вверх, перпендикулярно к плоскости фигуры

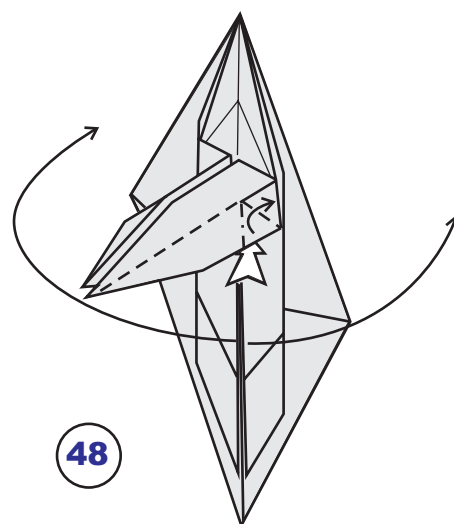

48

Согните пополам сегменты, затем отогните в разные стороны

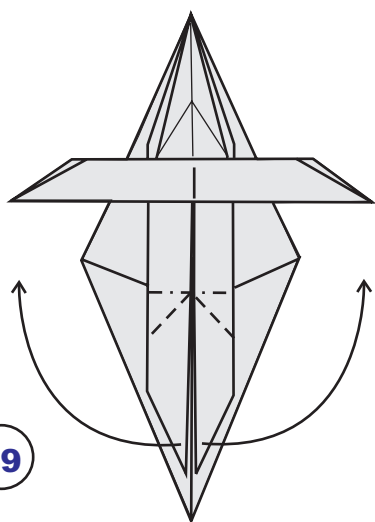

49

Отогните вторую пару сегментов в разные стороны

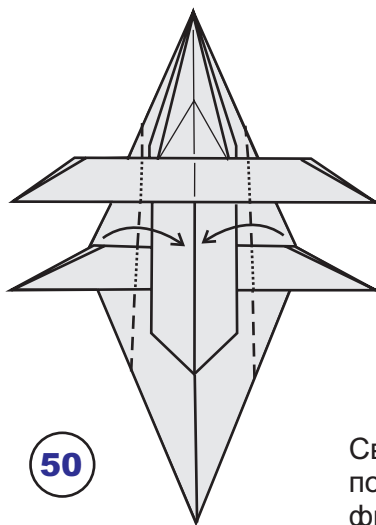

50

Согните произвольно боковые стороны к середине

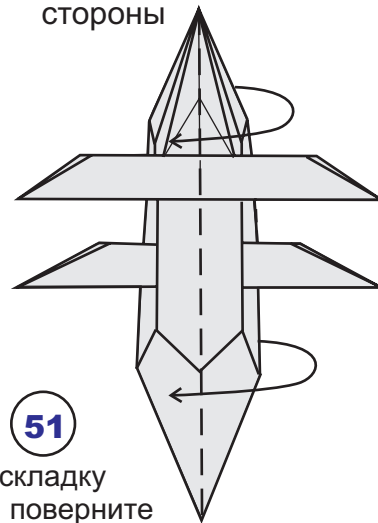

51

Сверните складку пополам и поверните фигуру на 90 градусов против часовой стрелки

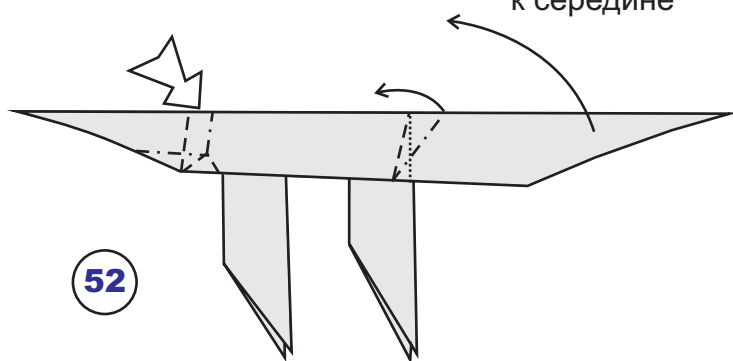

52

Отогните шею и сформируйте складку для хвоста

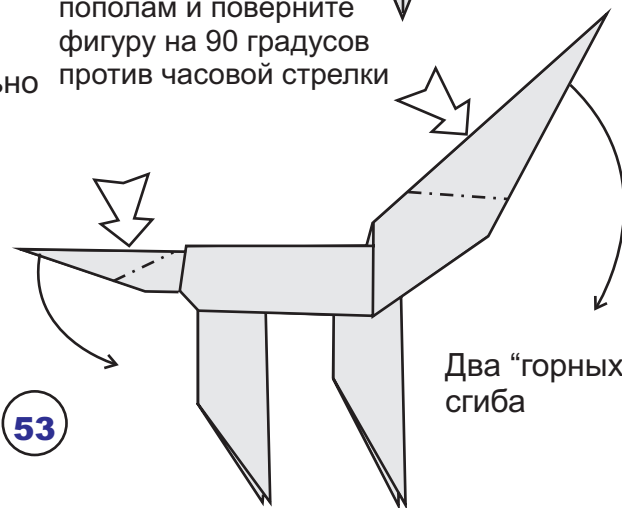

53

Два "горных" сгиба

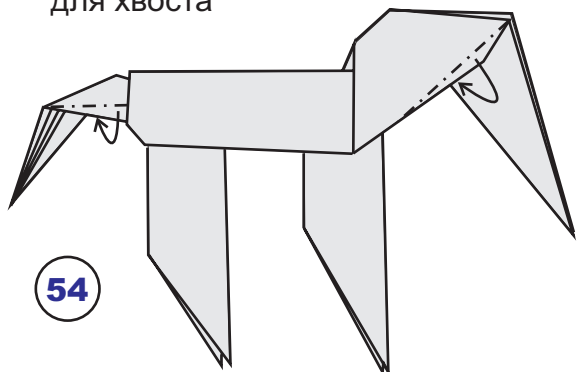

54

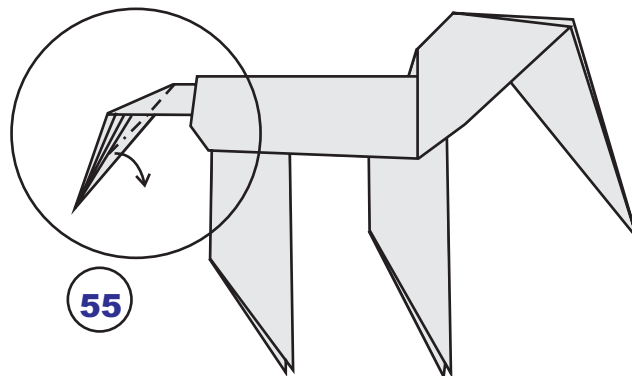

55

Вытяните один слой вниз



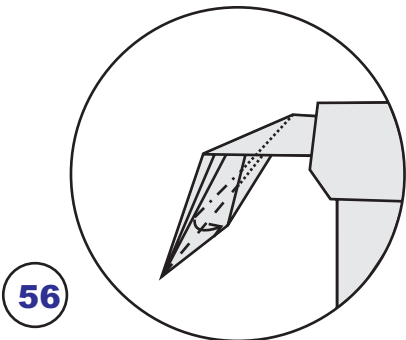

56

Вытяните ещё один слой

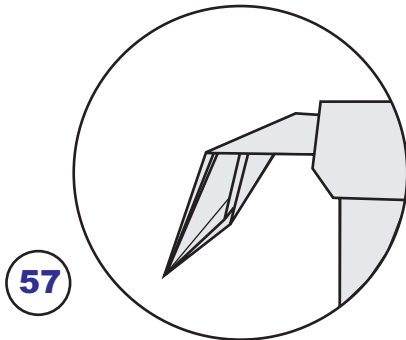

57

Повторите ту же операцию дважды

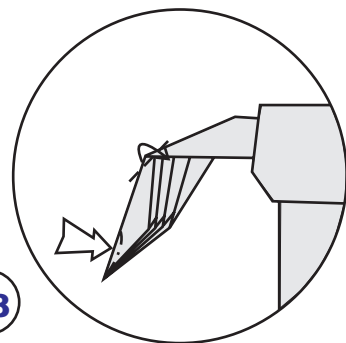

58

Глубинная складка сверху  
Изогните кончик хвоста

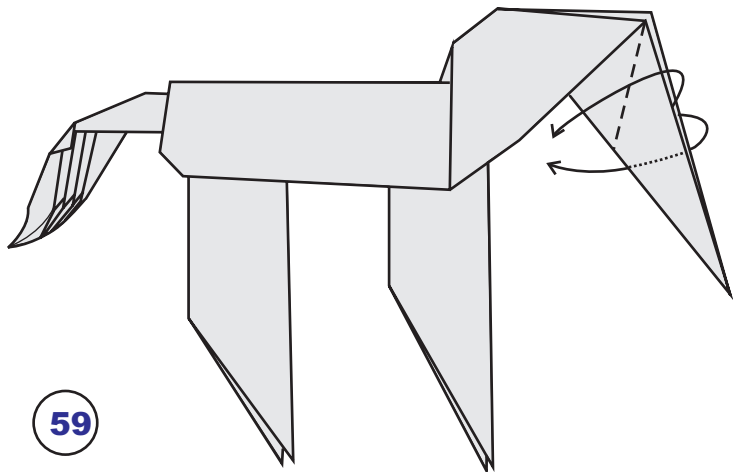

59

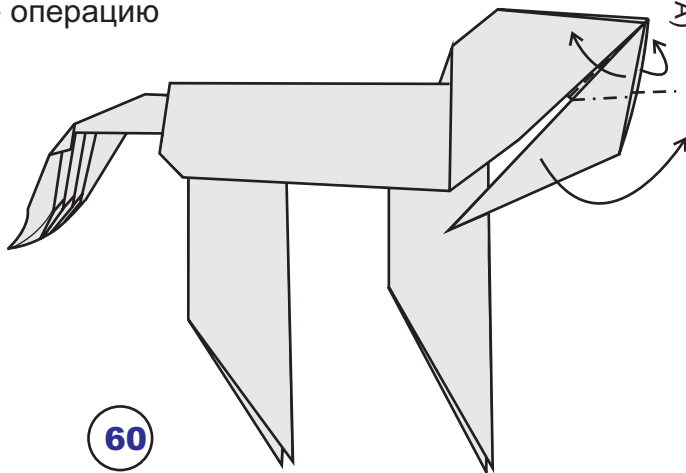

60

Поднимите правую часть фигуры  
вверх, формируя основу головы

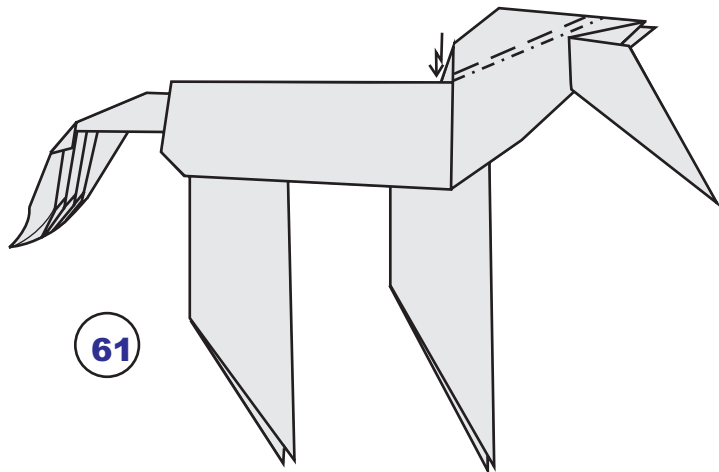

61

Обычный зигзаг для гривы

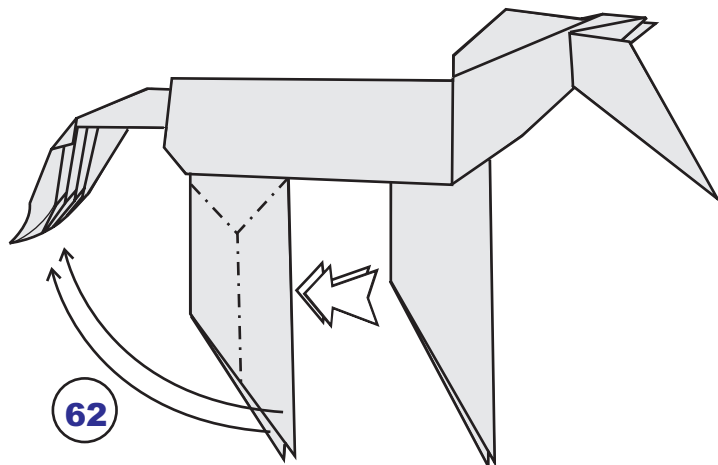

62

Дважды сложите "ухо кролика"

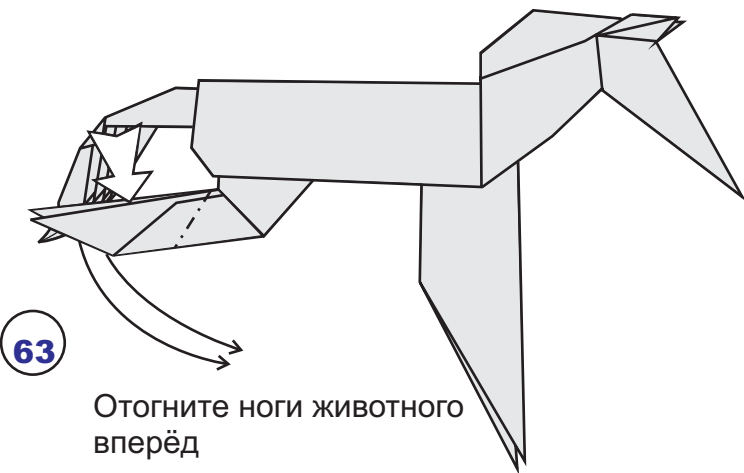

63

Отогните ноги животного  
вперёд

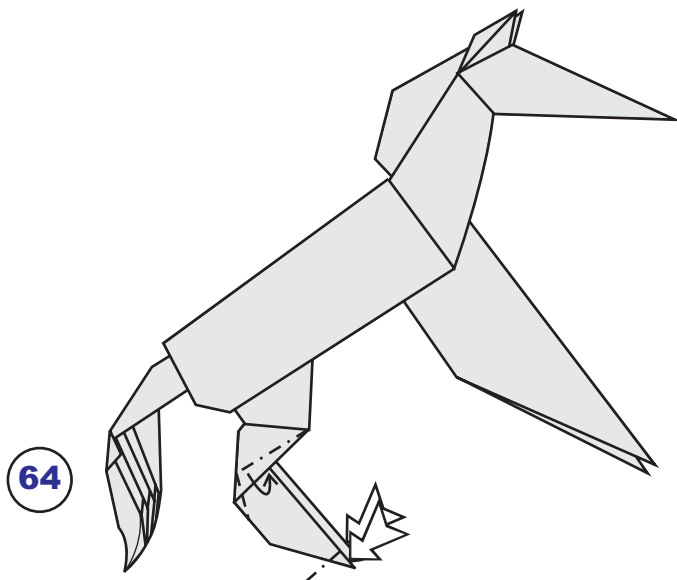

64

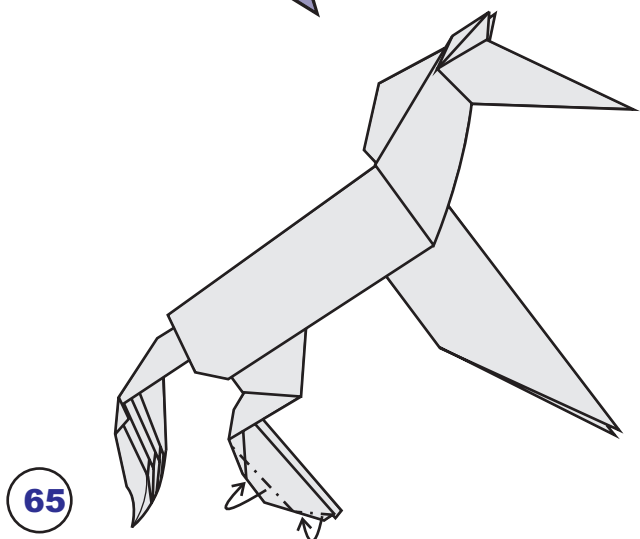

65

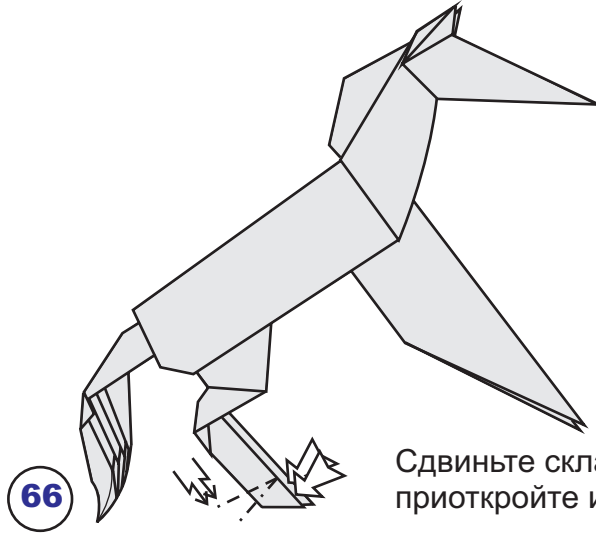

66

Сдвиньте складки и приоткройте изнутри

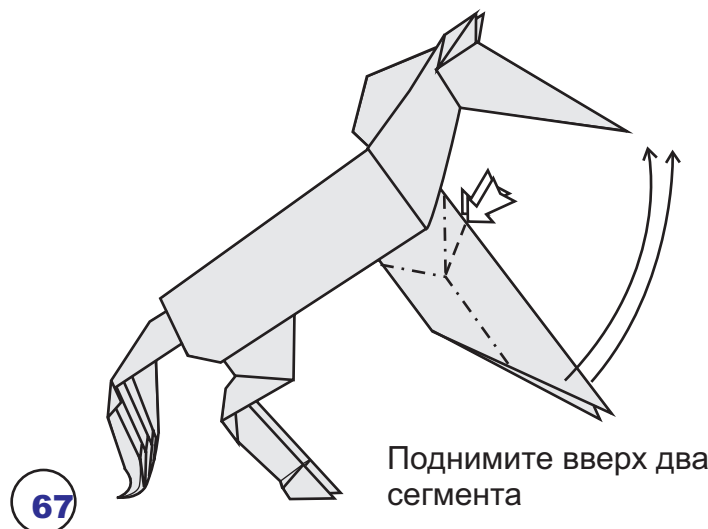

67

Поднимите вверх два сегмента

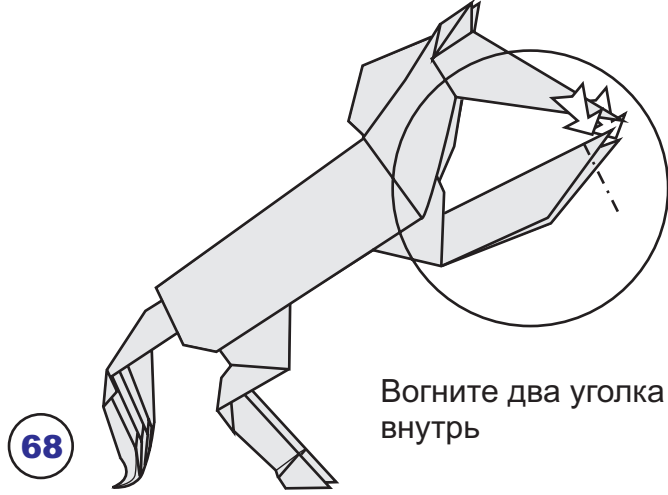

68

Вогните два уголка внутрь

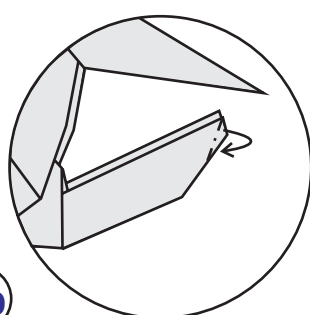

69

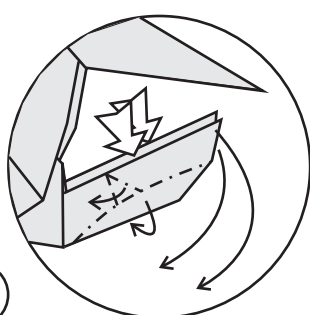

70

Складывайте по всем указанным линиям одновременно

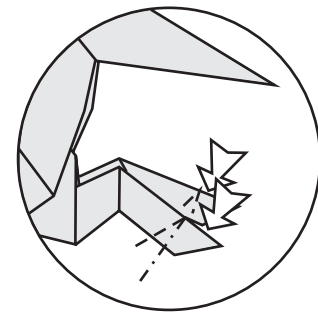

71

Вторая пара копыт абсолютно идентична первой!



72

Сдвиньте складки по бокам. Доведите до конца складывание головы коня. Горными и глубинными складками сформируйте гриву.

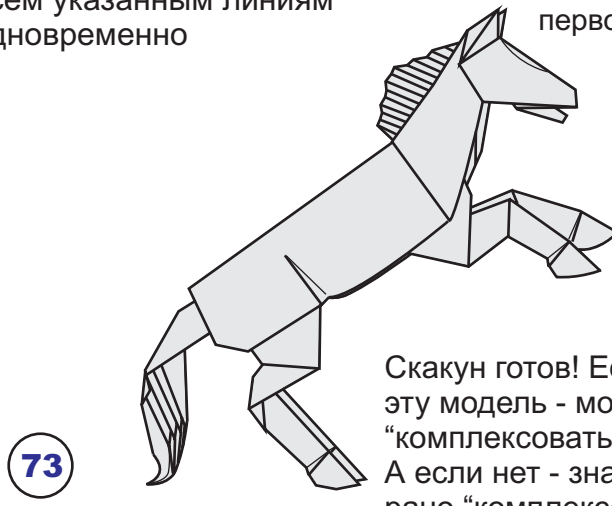

73

Скакун готов! Если вы осилили эту модель - можете "комплексовать" и дальше. А если нет - значит, вам ещё рано "комплексовать"!

# “Вариации на тему головы лошади”

Автор: Дэйв Брилл (Англия)

Наступающий год по восточному календарю- год Лошади. Как в таком случае нам не сложить символ 2002 года - голову этого замечательного смелого и трудолюбивого животного? При этом стоит отметить, одна голова - хорошо, а три - намного лучше!

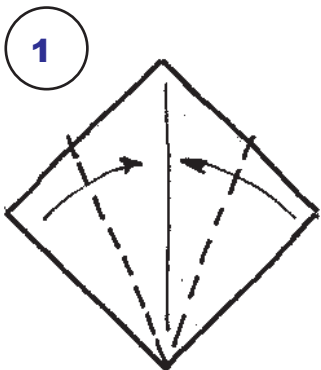

1  
Make a kite base from a 6" square

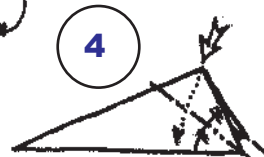
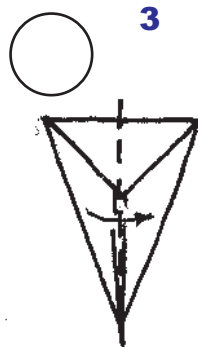
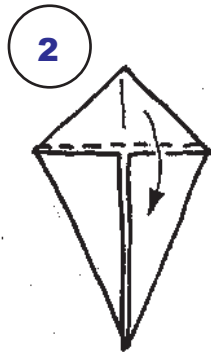

4  
reverse fold to form the earflaps

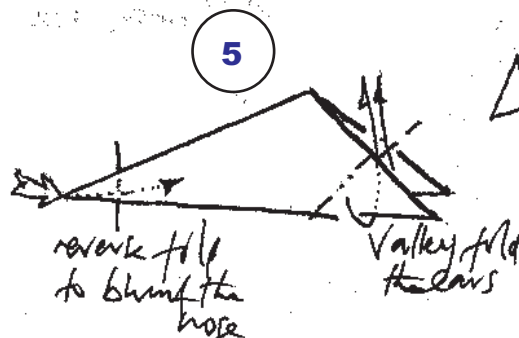

5  
reverse fold to blind the nose

valley fold the ears

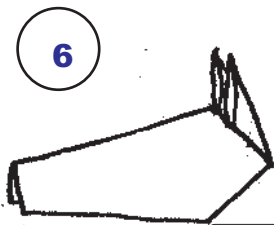

6  
Вариант 1

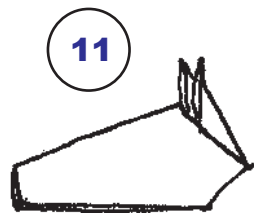
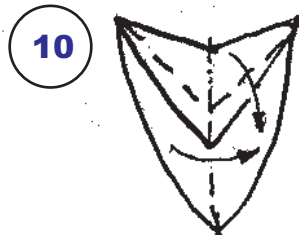

11  
Вариант 2

reform the head & ears:

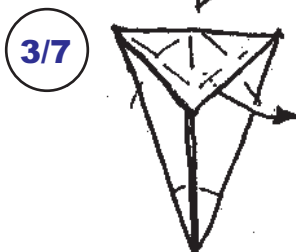

3/7

open up back to step 3 above, then pull out one hand edge

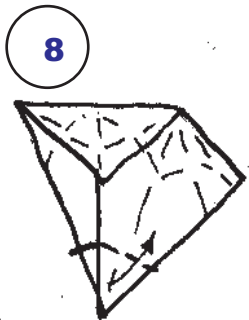

8

valley fold along existing nose creases

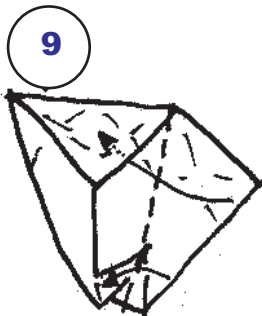

9

replace the raw edge to lock the nose

5/13



fold another square to step 5, then open up to step 3, & turn over.

13

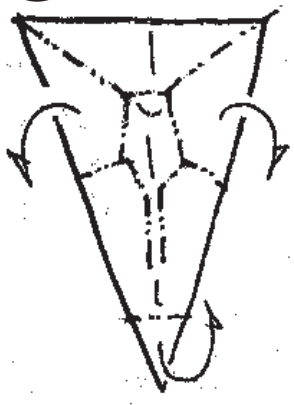

Squeeze in these new mountain folds

14



reform, encouraging volume.

Add nose, eyes & ears.

15

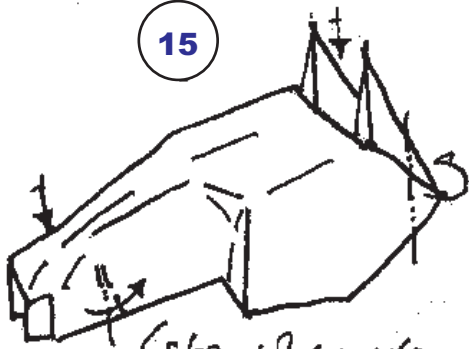

(stop when you want!)  
Crimp nose & narrow the ears

16

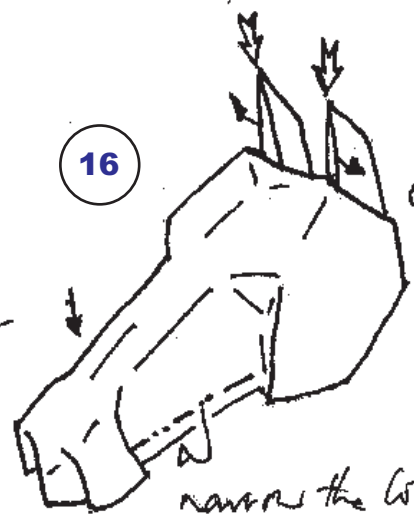

open the ears

narrow the lower edges

17



Вариант 3

© Brill '97.

This heart is the largest fully symmetrical heart you can make from one square piece of paper.

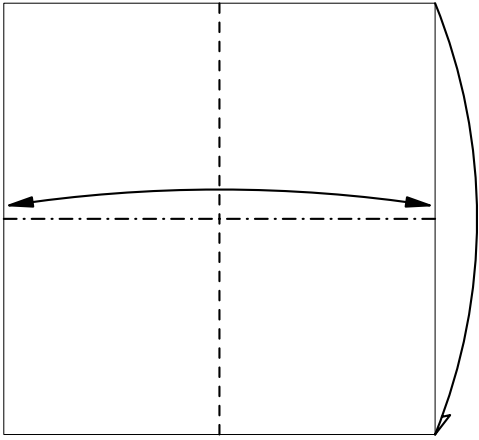

1

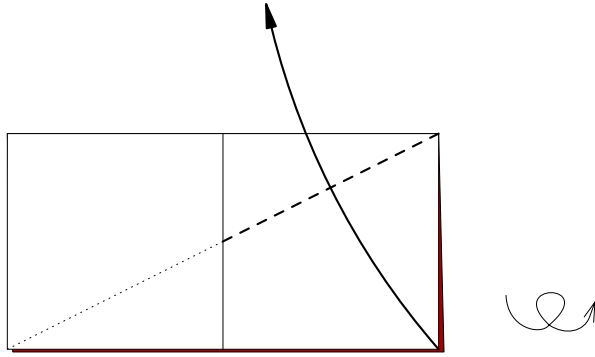

2

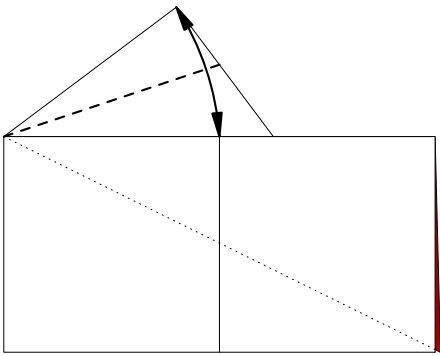

3

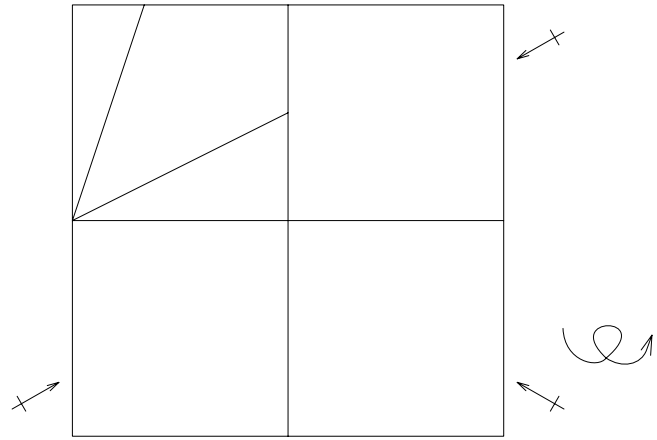

4

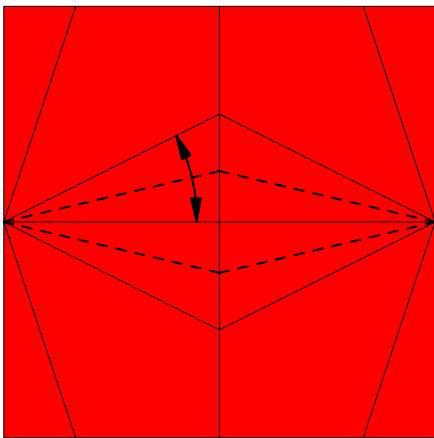

5

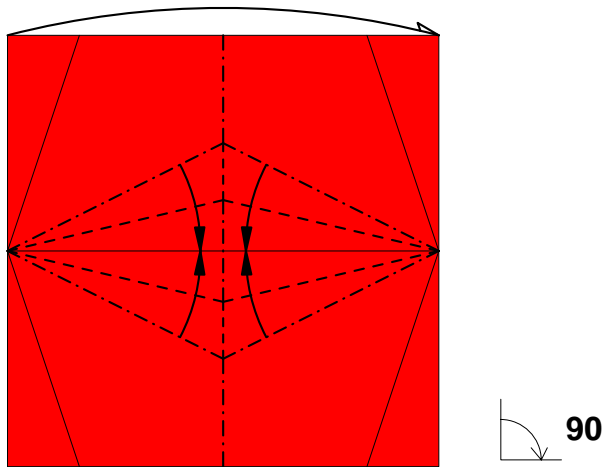

6

90

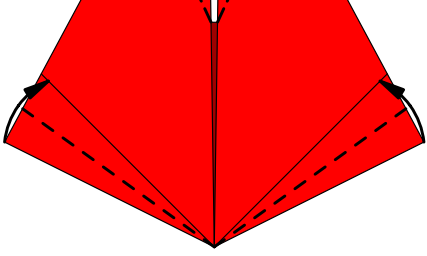

7

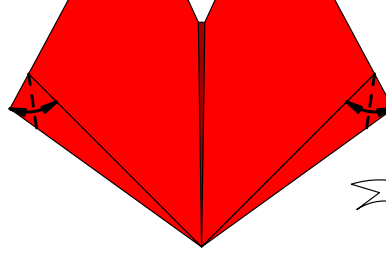

8

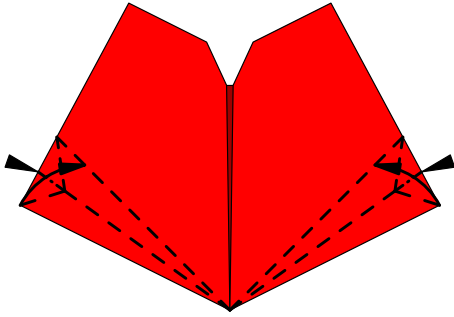

9 One layer

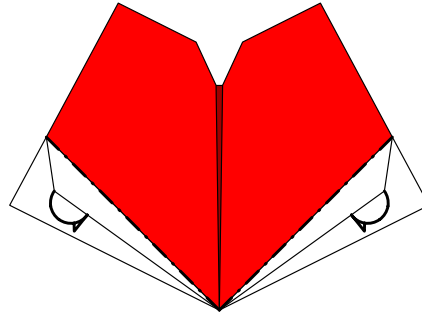

10

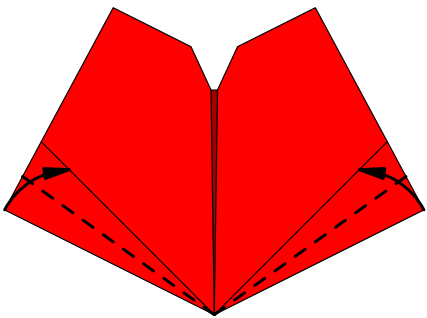

11

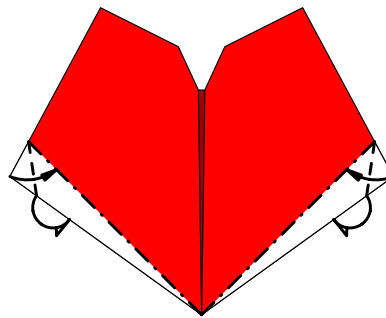

12 Put in pockets

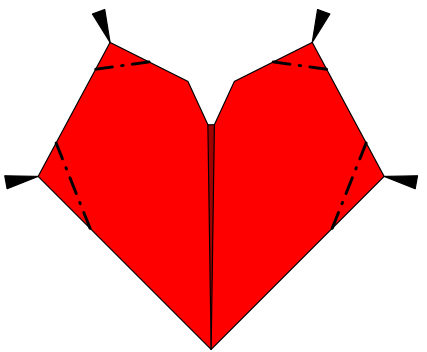

13

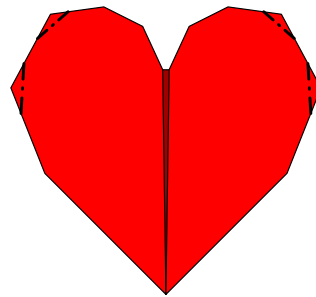

14 Make flaps and pockets as in 9-12

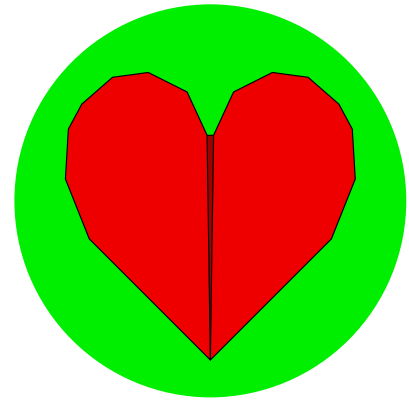

This human figure consists of two sheets  
The top part of the body should start white side down to get a white 'shirt'  
The bottom part should be color down to get colored trousers  
Designed because I needed two white/black dressed people to my wheelchair

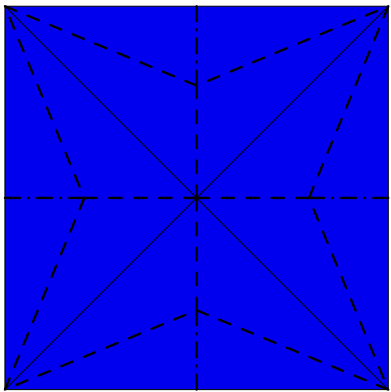

1 Top part of body

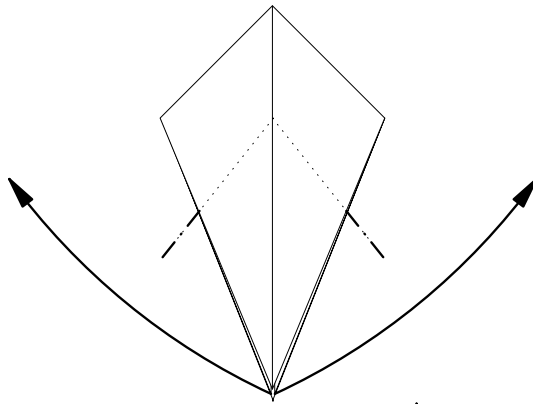

2

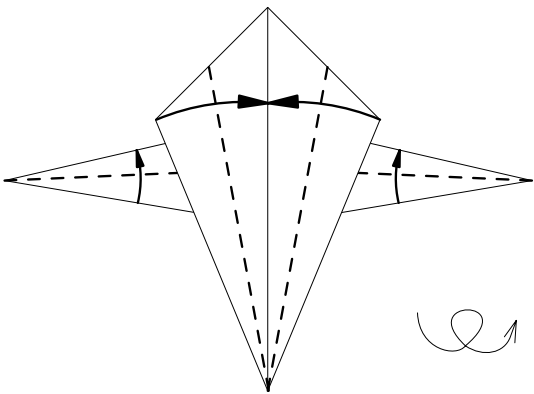

3

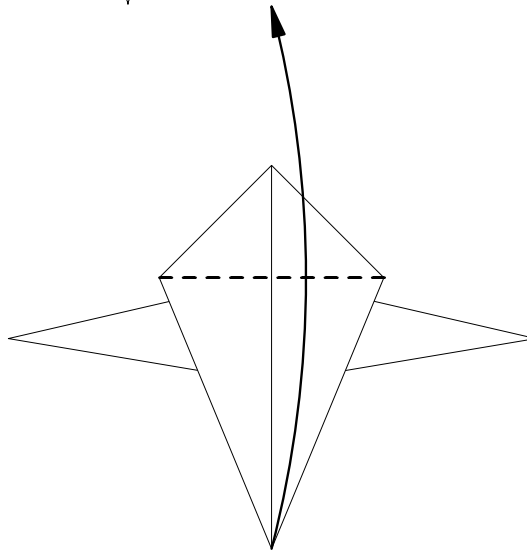

4

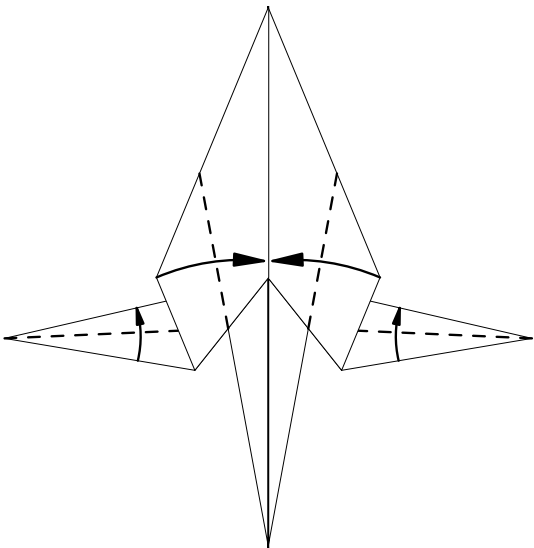

5

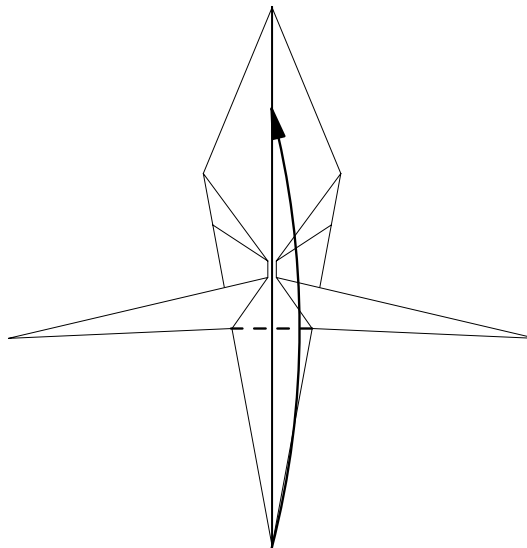

6

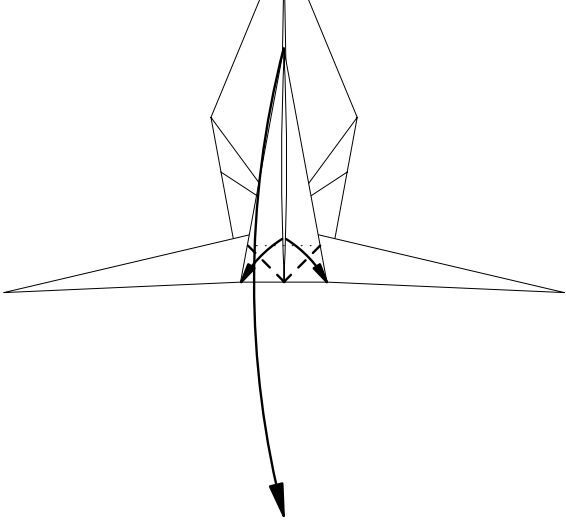

7

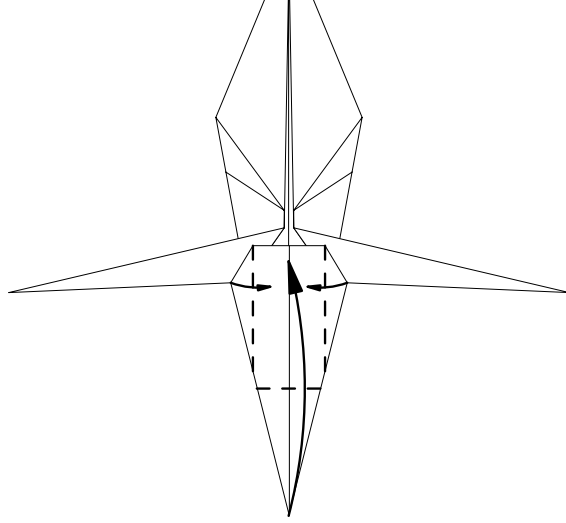

8

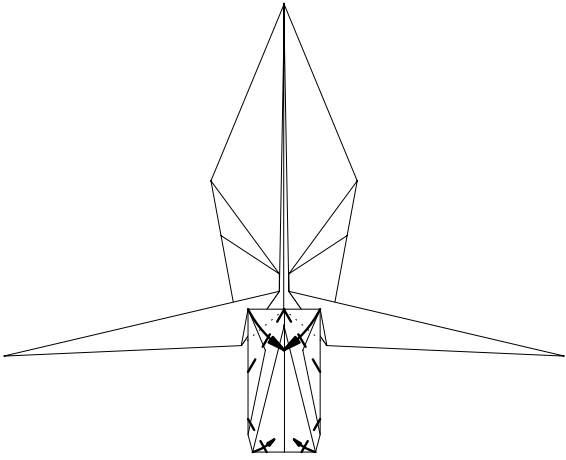

9

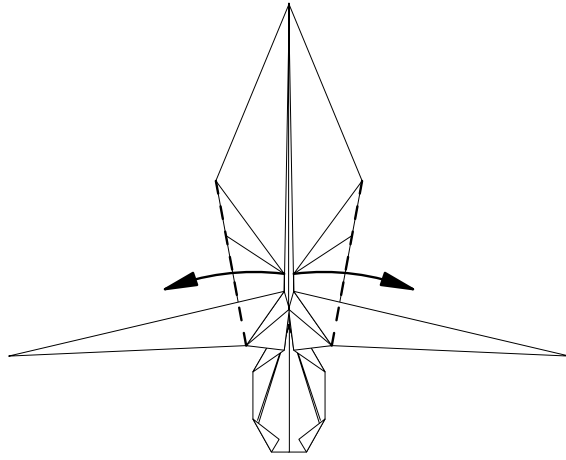

10

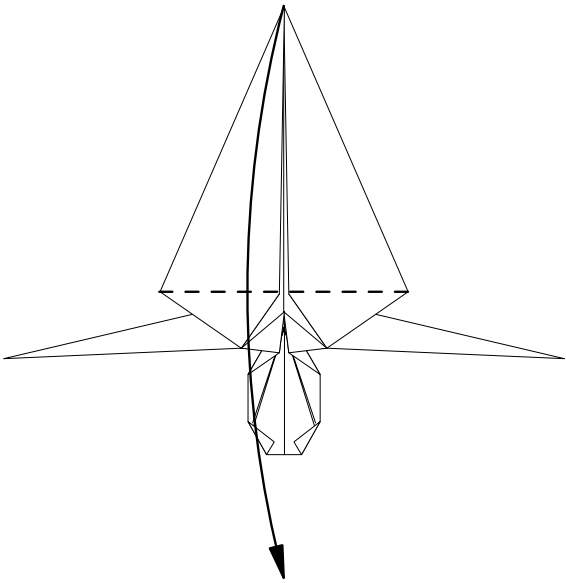

11

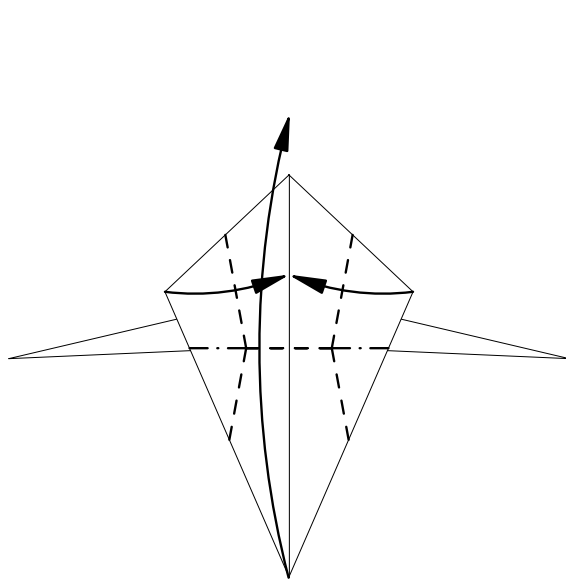

12



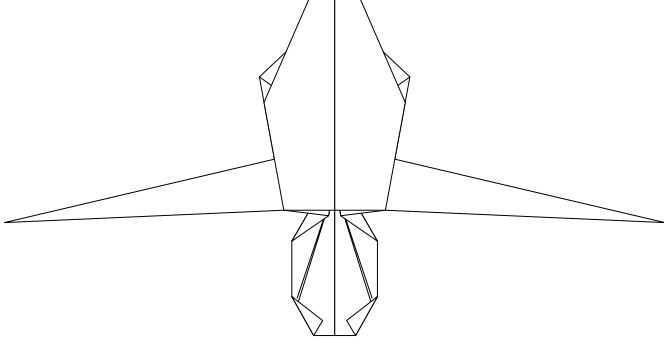

13 Top part of body finished

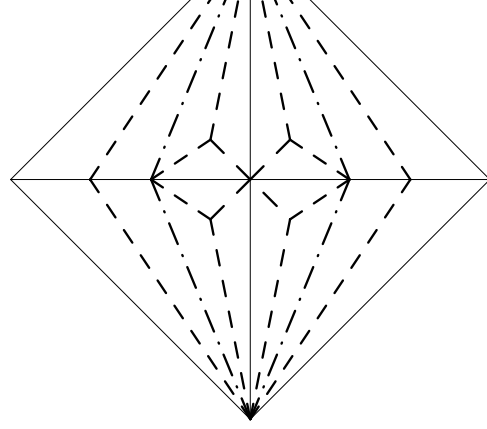

14 Bottom part of body; precrease

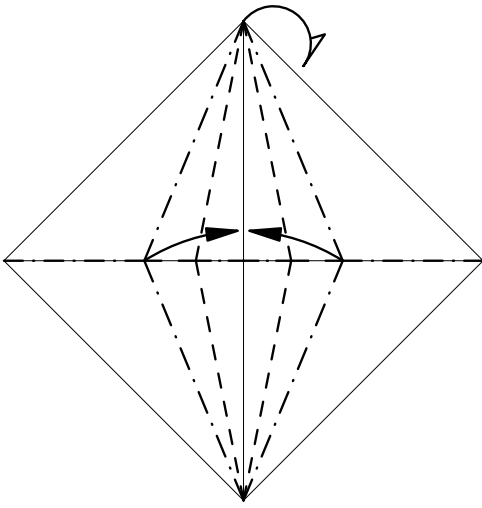

15

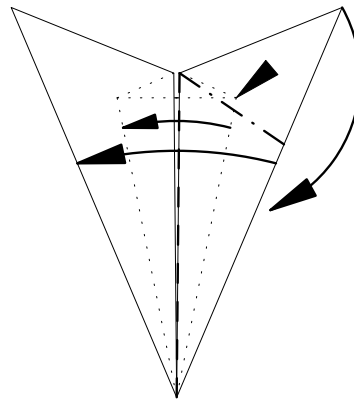

16

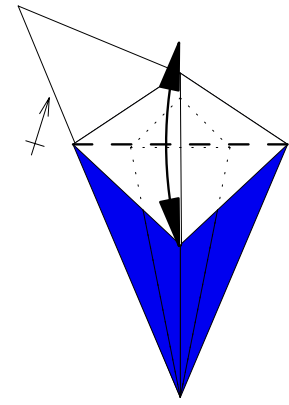

17

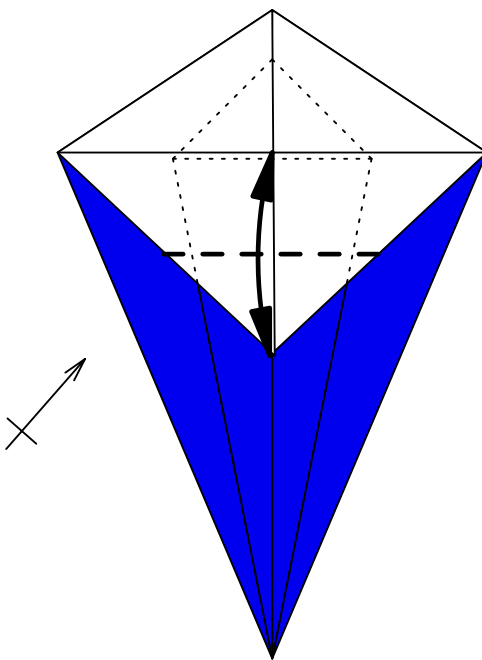

18 Bottom part of body finished

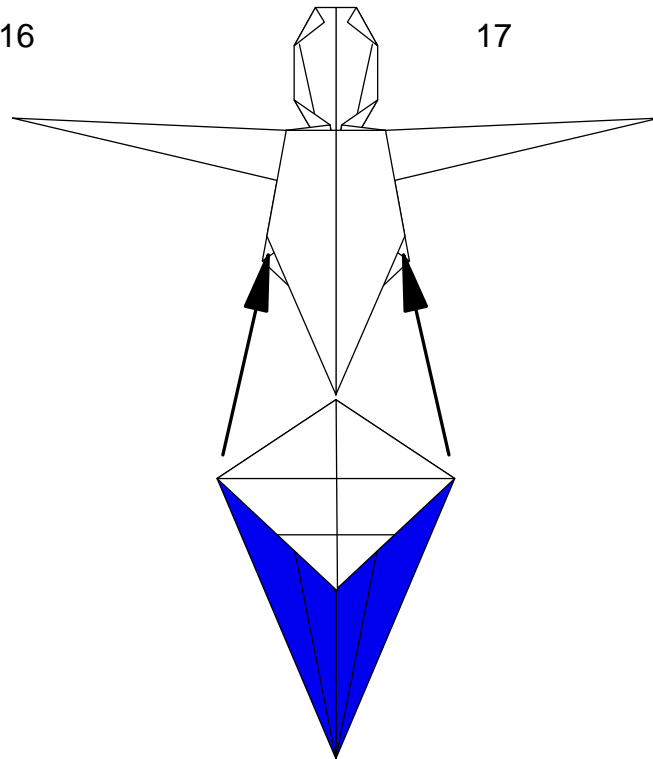

19 Insert bottom part in top part

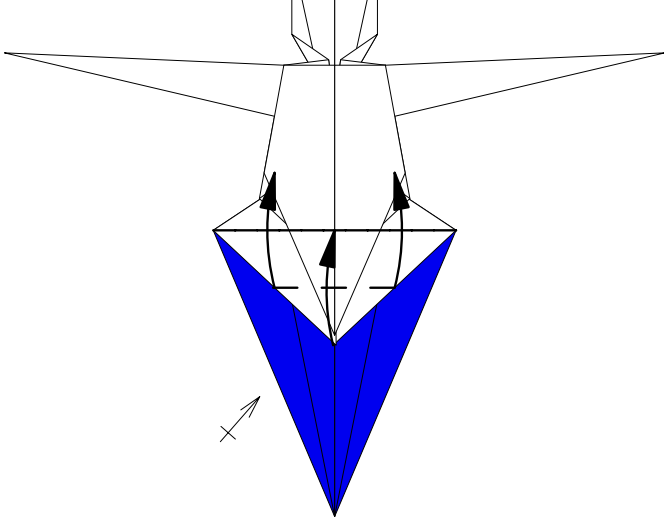

20

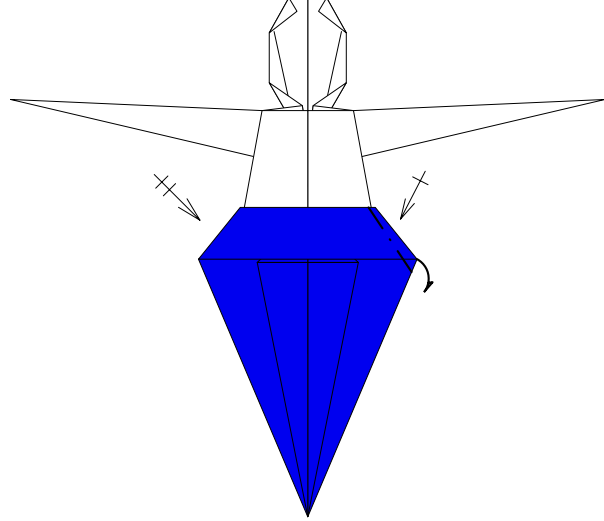

21

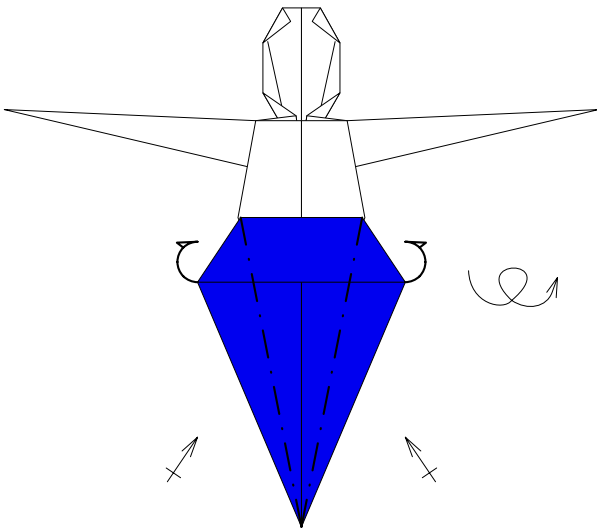

22 Fold inside

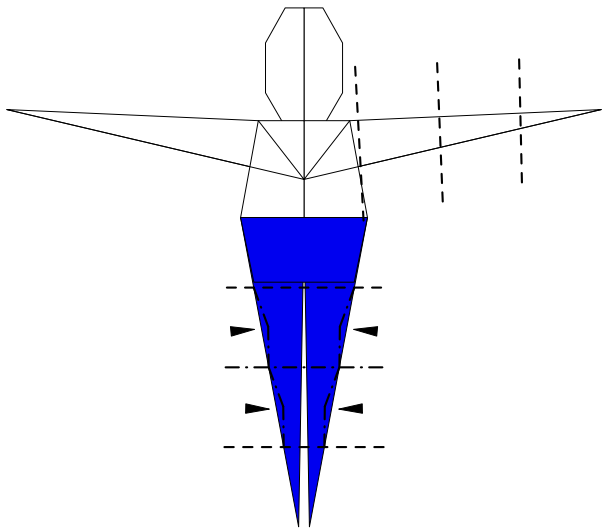

23 Form arms and legs

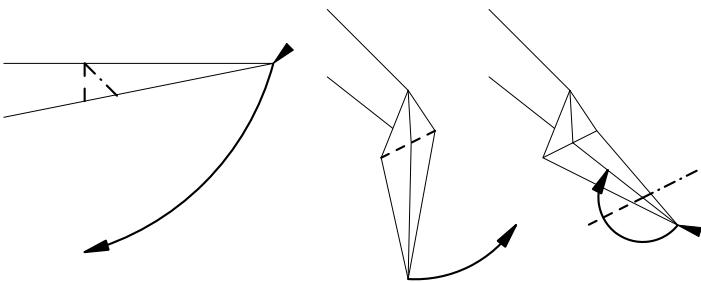

24 Form hands

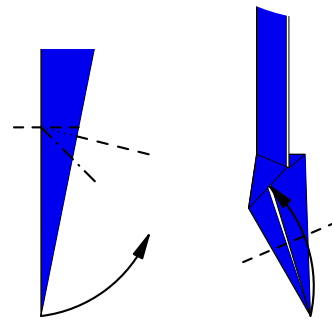

25 Form feet

# Black Belt in Origami

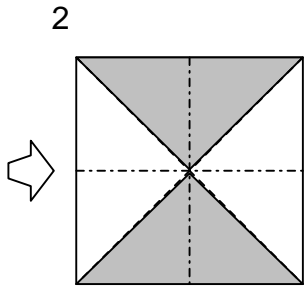
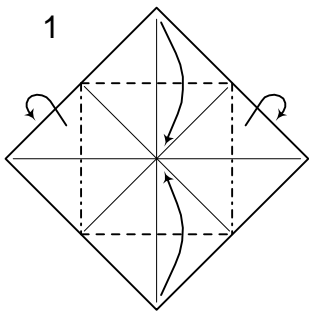

Preliminary fold

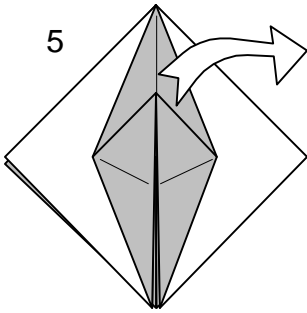
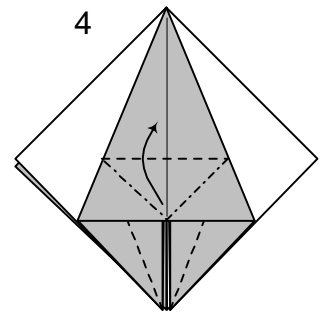
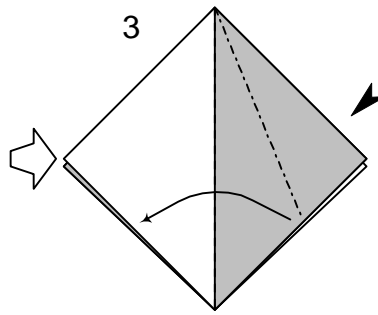

Pull out the loose paper (it helps if you unfold to step 4 first)

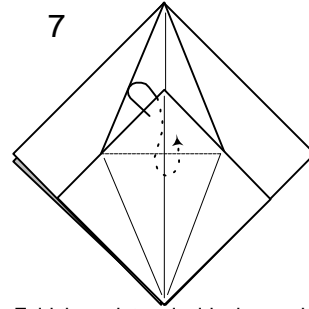
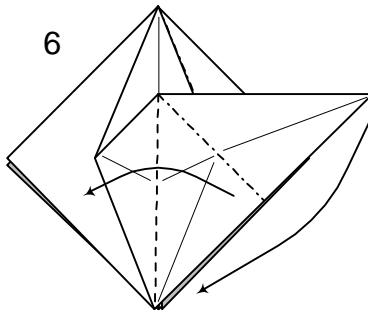

Fold the point up inside the model (you need to pull the model apart to do this)

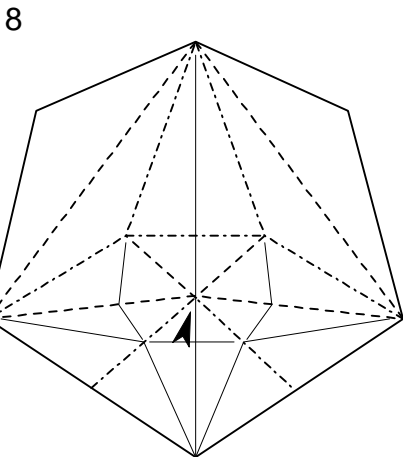

This is the half way stage

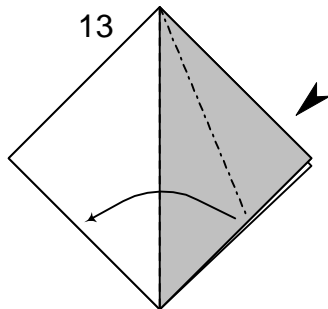
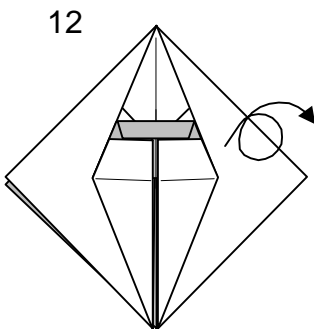
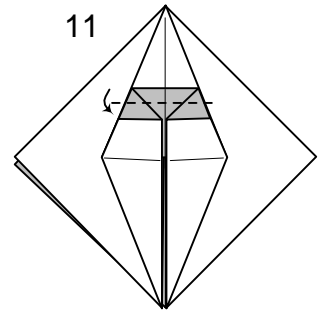
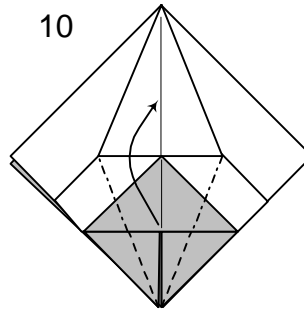
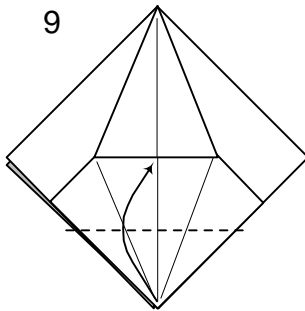

Repeat steps 3-8 on this side

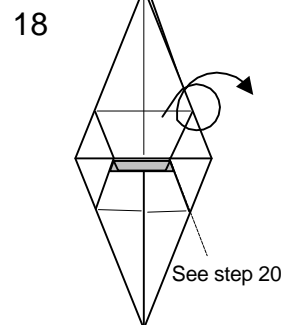
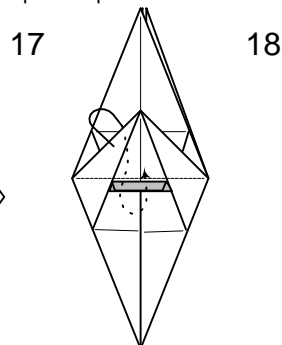
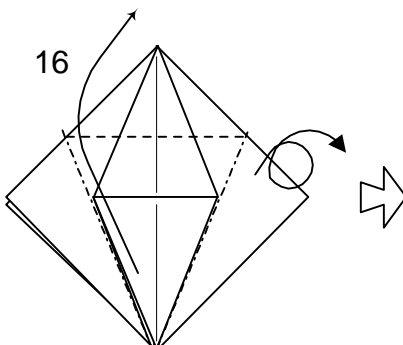
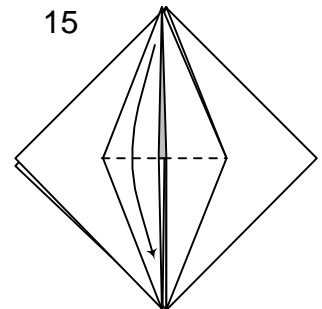
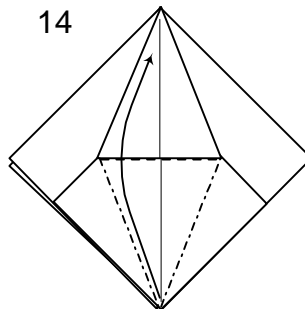

See step 20

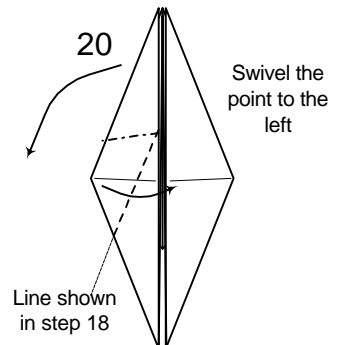
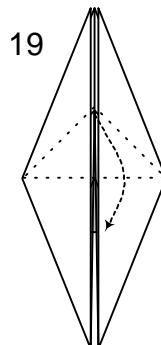

Swivel the point to the left

Line shown in step 18

Fold the point up inside the model (much harder than step 7!)

# Black Belt in Origami

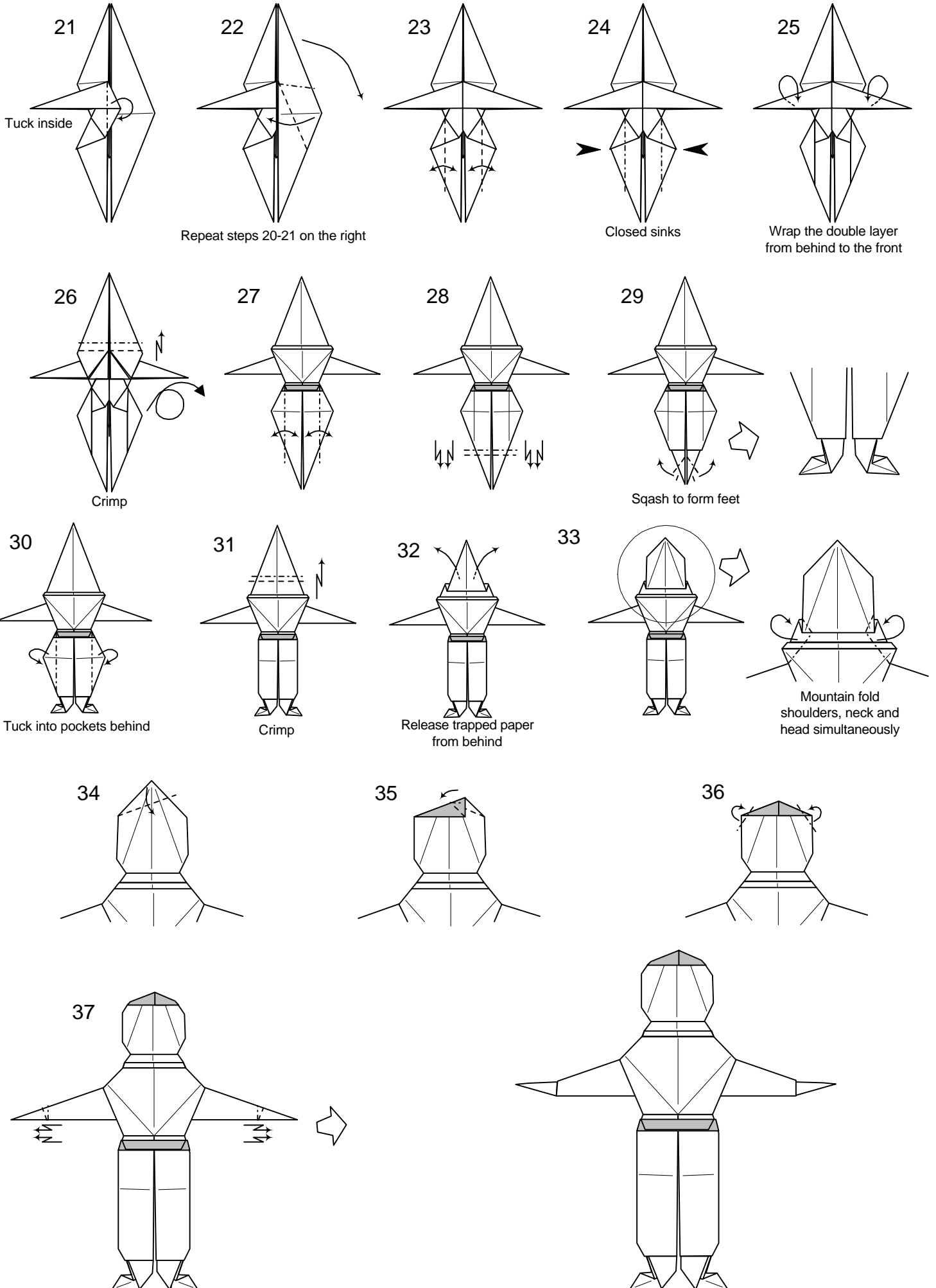



**Clapping Monk** by Eugeny Fridrikh,  
Russia, West Siberia, 1994

1.

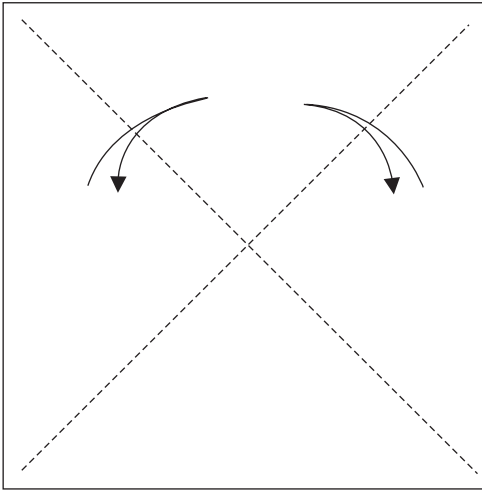

2.

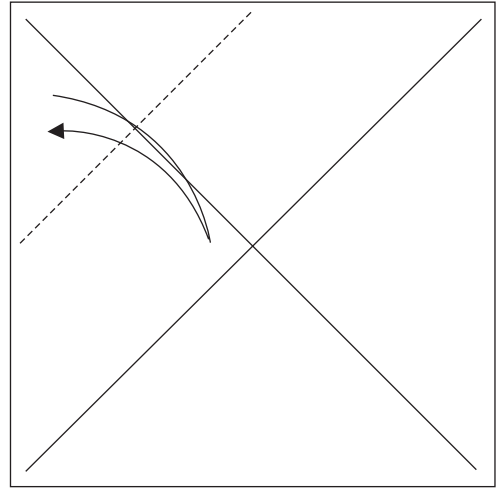

3.

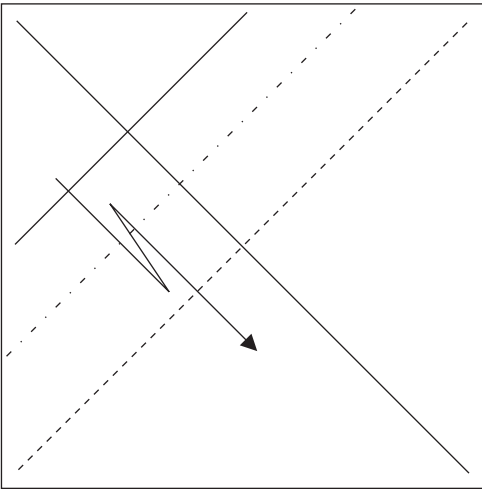

4.

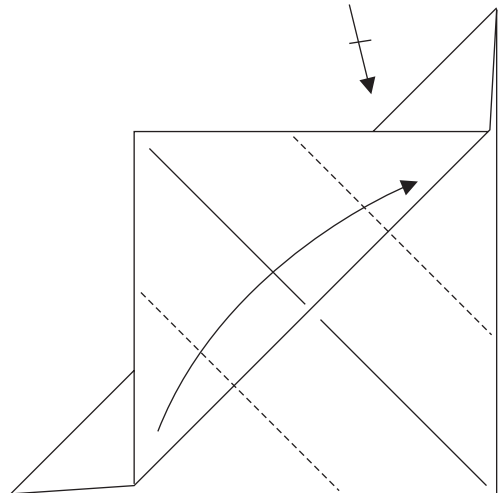

5.

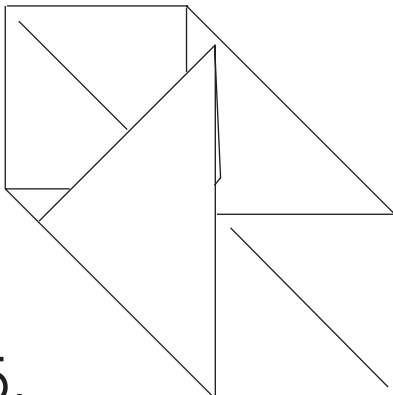

6.

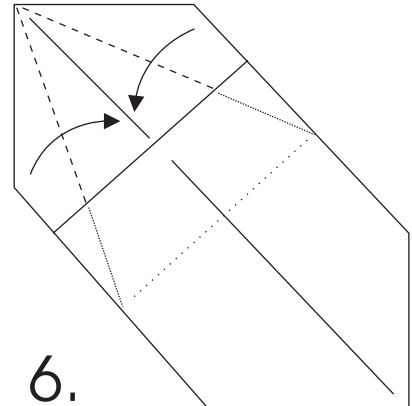

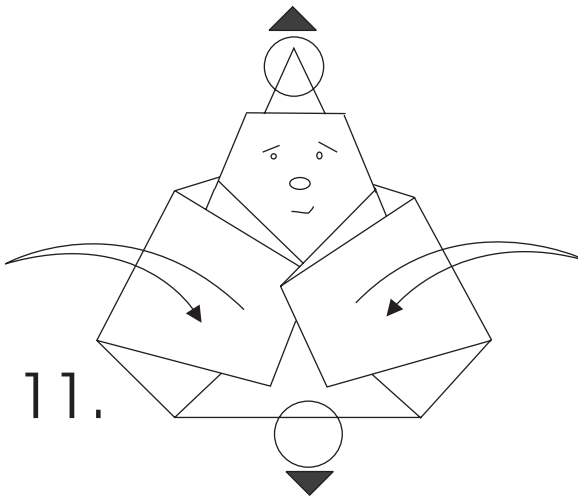
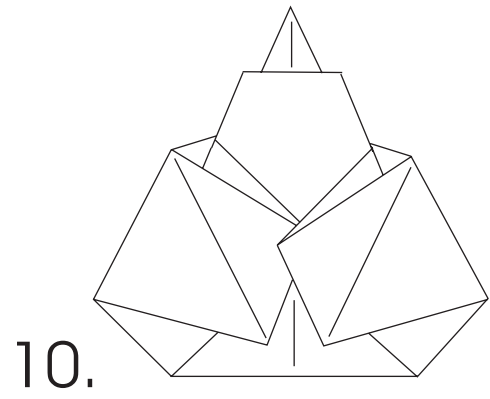
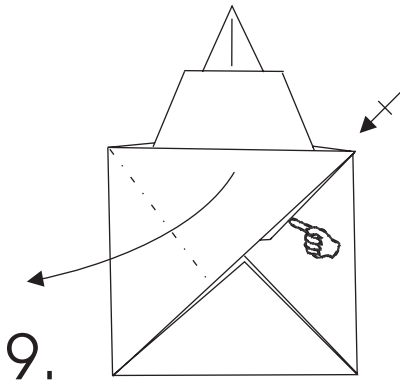
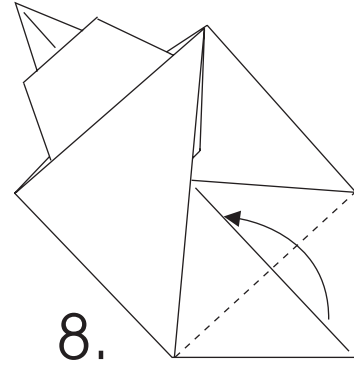
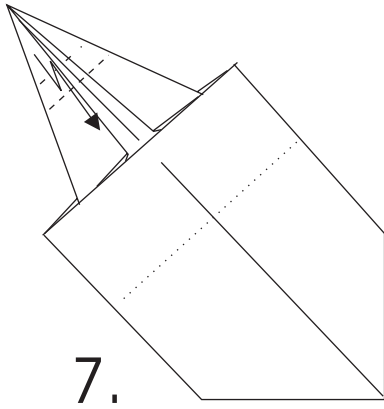

# Pregnant Woman

created/diagrammed by Alec Fehl 5/14/99-5/15/99

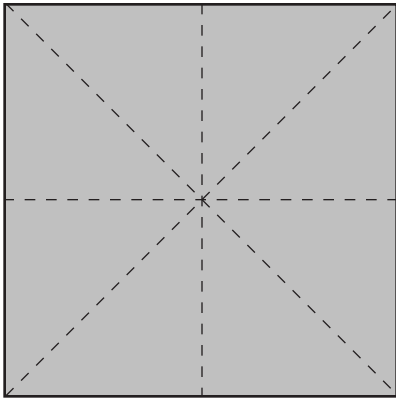

1] Crease.

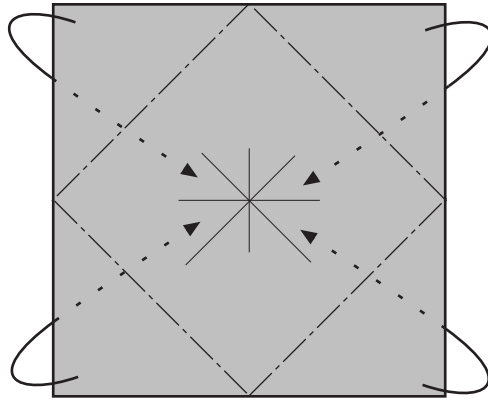

2] Blintz fold behind.

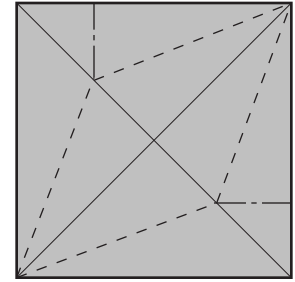

3] Rabbit ears.

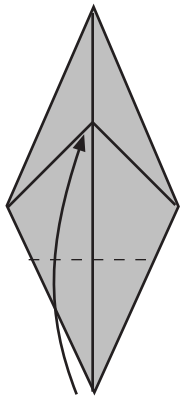

4] Fold bottom tip to small tips.

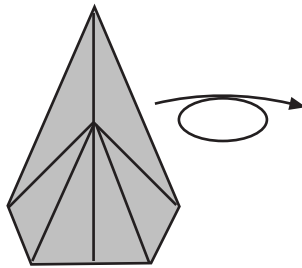

5] Turn over...

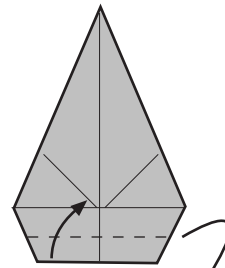

6] Fold bottom edge to crease and allow back triangle to swing out.

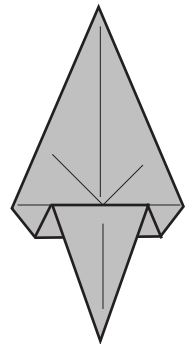

7] Enlarge...

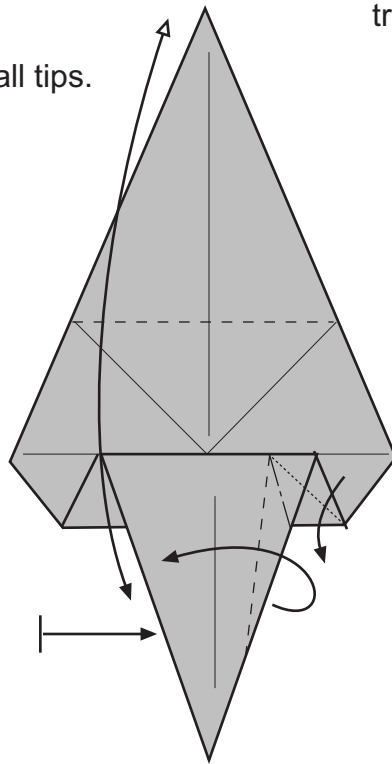

8] Swivle to thin leg. Repeat on other side. Crease body. Note location of valley fold.

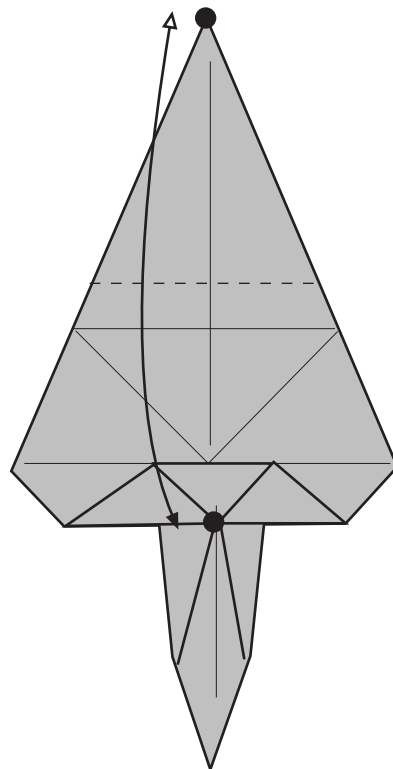

9] Crease from dot to dot.



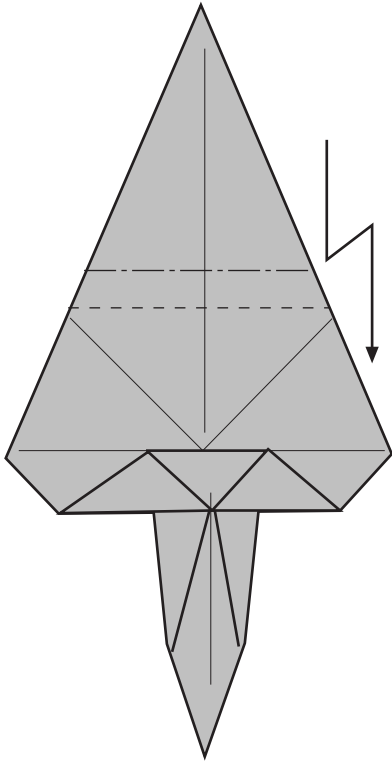

10] Pleat on folds from previous 2 steps.

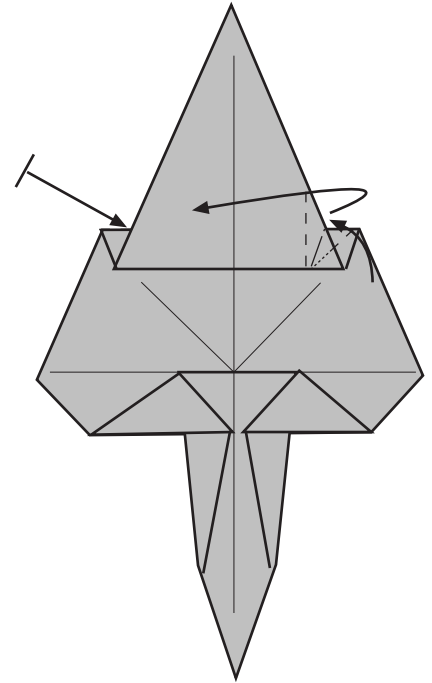

11] Swivle to thin head. Repeat on left.

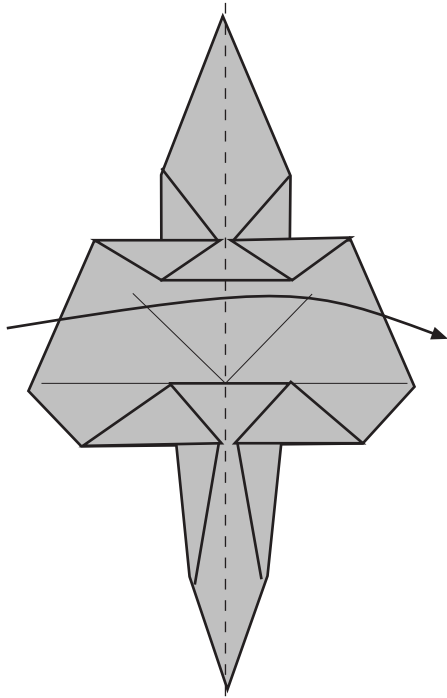

12] Fold in half.

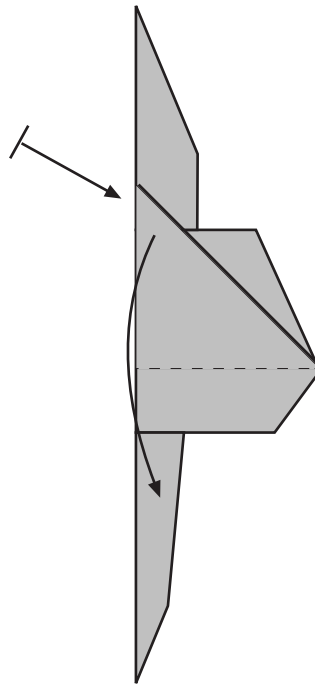

13] Swing flap down. Repeat behind.

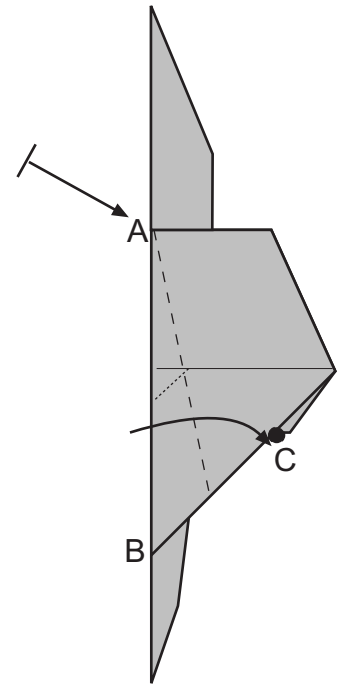

14] Fold so line AB lies atop point C. A tiny gusset will form. Repeat behind.



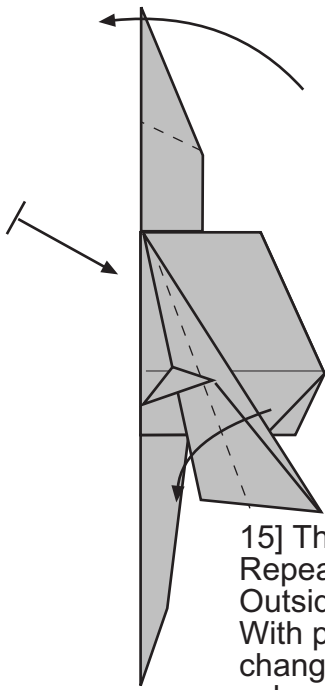

15] Thin arm.  
Repeat behind.  
Outside reverse fold head.  
With practice, you can color  
change the head to give hair  
color.

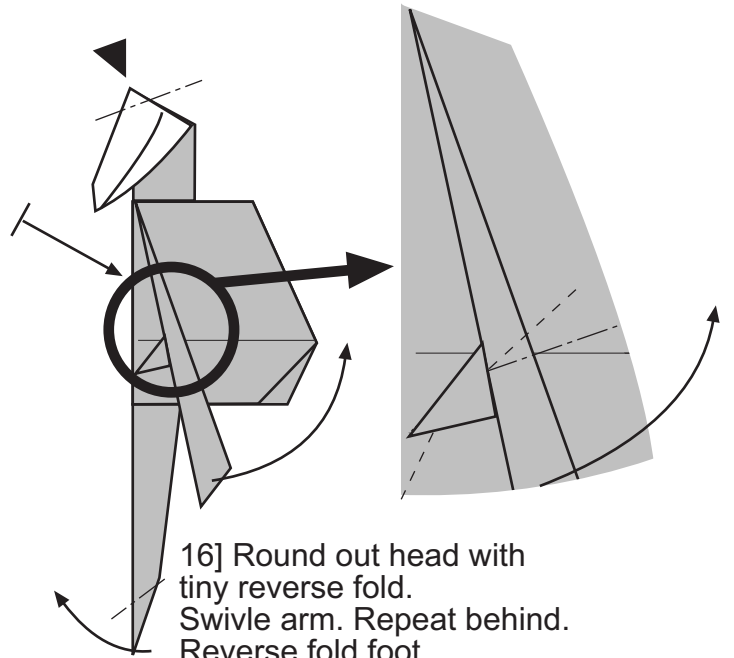

16] Round out head with  
tiny reverse fold.  
Swivle arm. Repeat behind.  
Reverse fold foot.

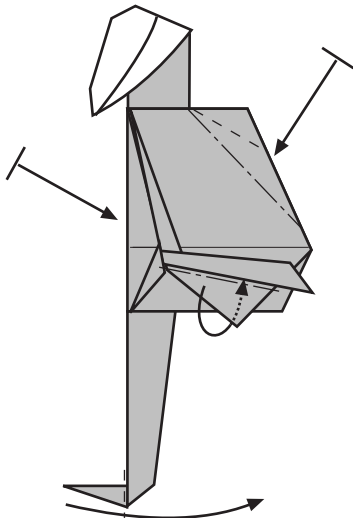

17] Reverse fold foot.  
Tuck under extra paper  
below arm. Repeat behind.  
Pleat to form breast. Repeat  
behind.

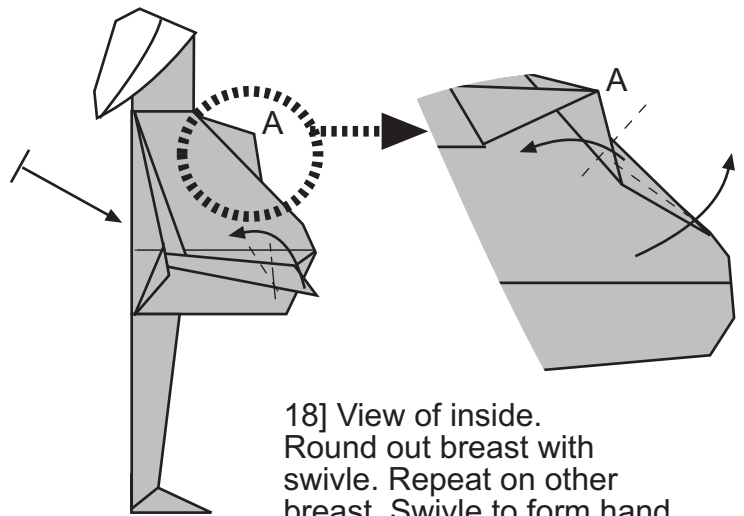

18] View of inside.  
Round out breast with  
swivle. Repeat on other  
breast. Swivle to form hand.  
Repeat behind.

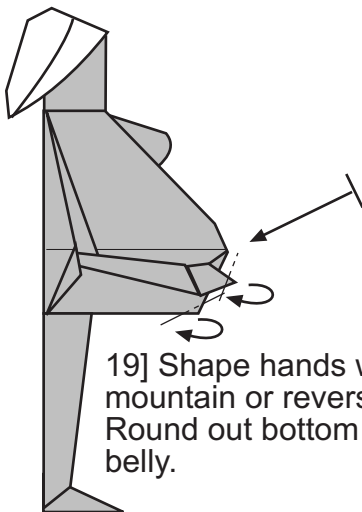

19] Shape hands with  
mountain or reverse fold.  
Round out bottom of  
belly.

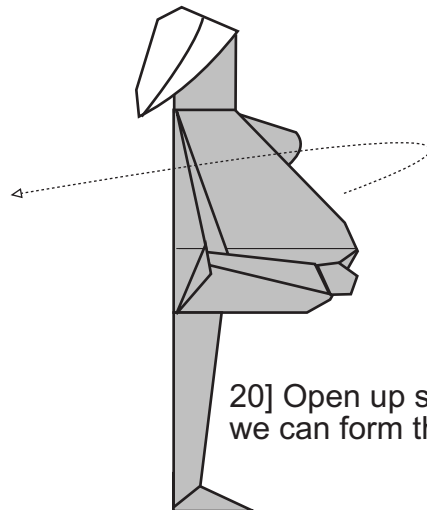

20] Open up so  
we can form the lock.

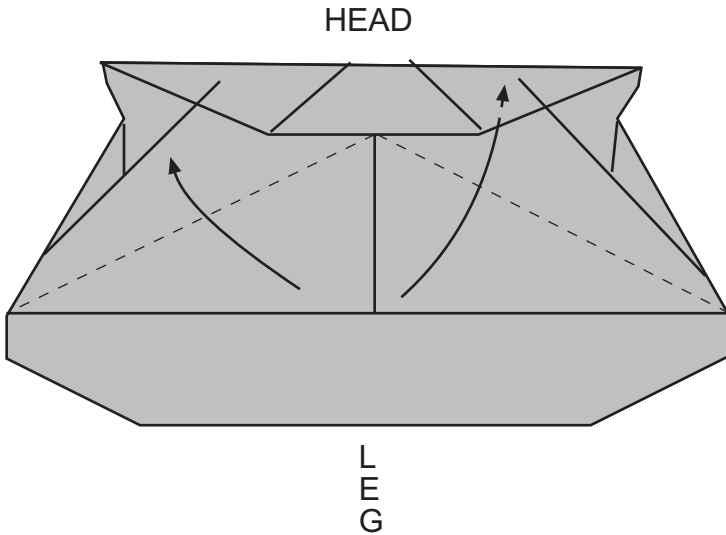

21] NOTE: Head and leg not shown.  
Valley fold flaps (from the blintz in step 2).  
Tuck the right side under.

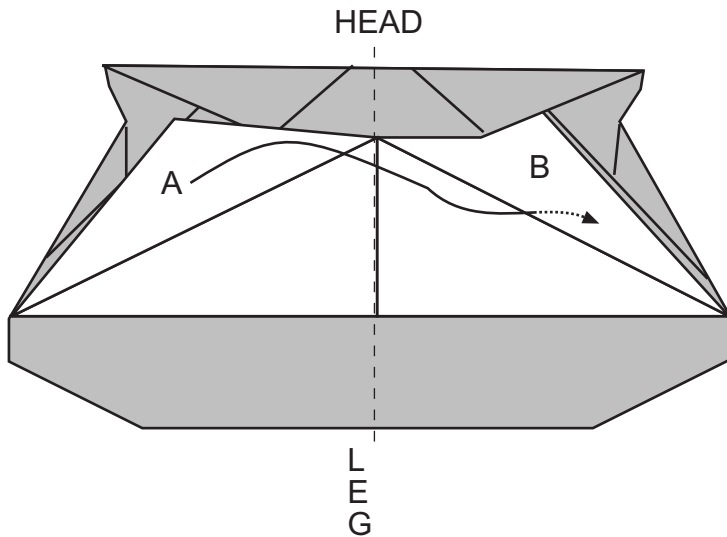

22] NOTE: Head and leg still not shown.  
Close up model while tucking flap A under flap B.

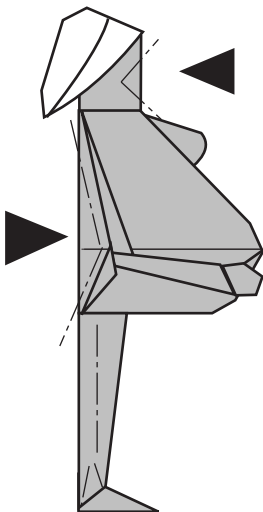

23] Model is locked.  
Shape face with mountains.  
Shape leg with mountain pinch.  
Form butt and arch back with a semi-sink.

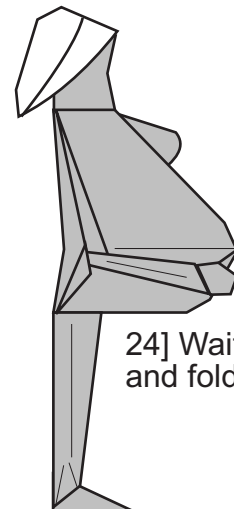

24] Wait 9 months and fold a baby.

# Coat

Created by Marc Vigo Anglada

June 1995

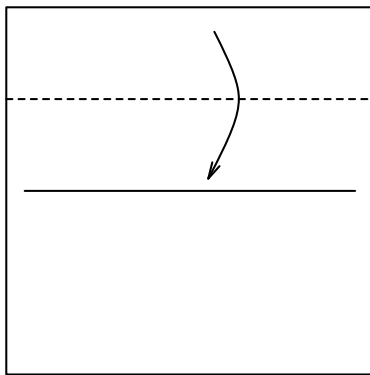

1. Start with a square paper. Valley fold the top fourth

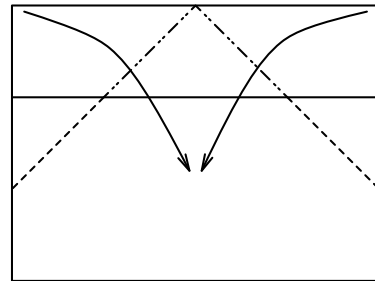

2. Reverse folds.

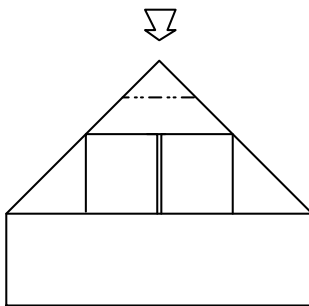

3. Sink the top vertex.

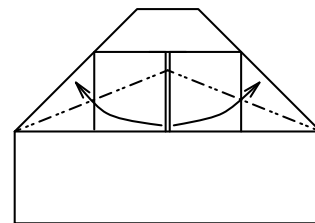

4. Reverse folds.

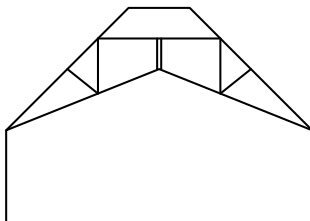

5. The result should look like this. Turn the model over.

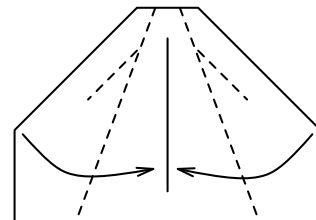

6. Valley folds. The sleeves fold straightforward.

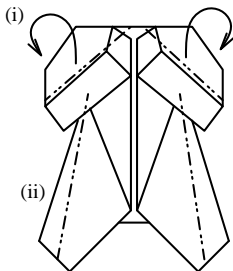

7. (i) and (ii) Mountain fold behind.

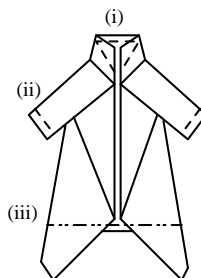

8. (i) Valley folds.  
(ii) Outside reverse fold.  
(iii) Fold inside.

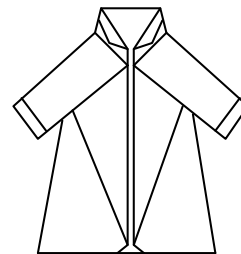

9. Finished coat.

1.

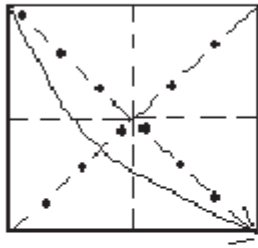

Preliminary fold

2.

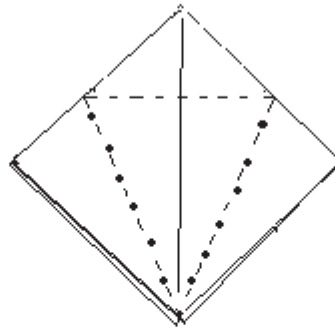

Petal fold  
Repeat behind

3.

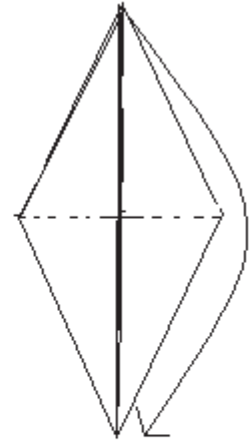

Valley fold the point back  
down to form the bird base  
Repeat behind

4.

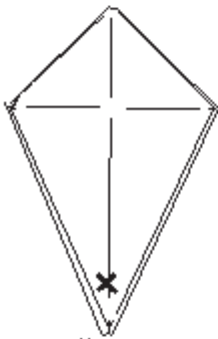

Hold the front flap by the "X"  
and repeat behind.  
Pull the flaps away from each  
other stretching out the central  
triangle. This forms what is  
called the stretched bird base.

5.

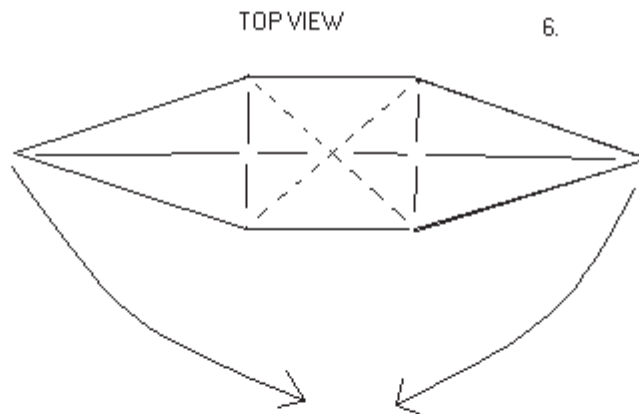

Reverse fold the 2 side points  
down to reform a bird base  
shape with different internal  
layering

6.

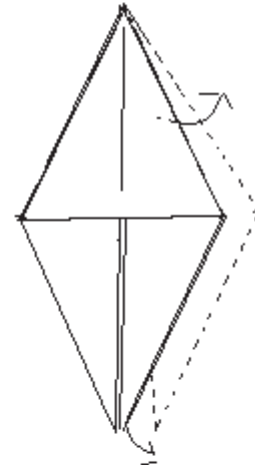

Stretch the paper out to fill in  
the dotted lined area and widen  
the triangle on top. This moves  
the point on the right slightly  
off center  
Repeat behind  
Skip this step if you  
like.

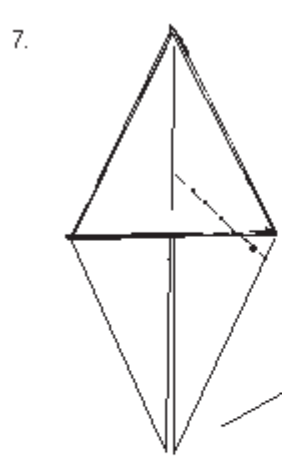

Reverse fold one point up.

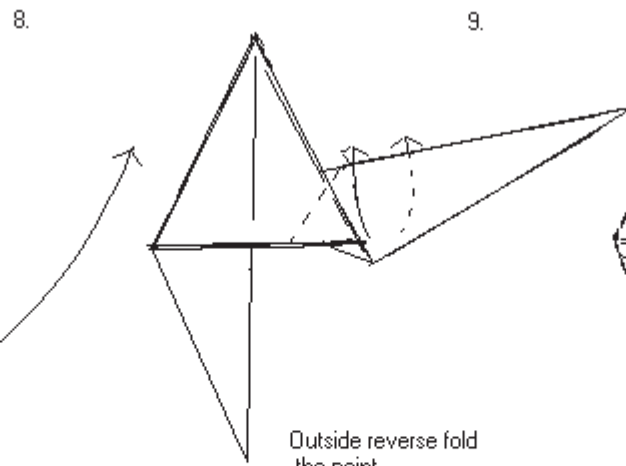

Outside reverse fold the point

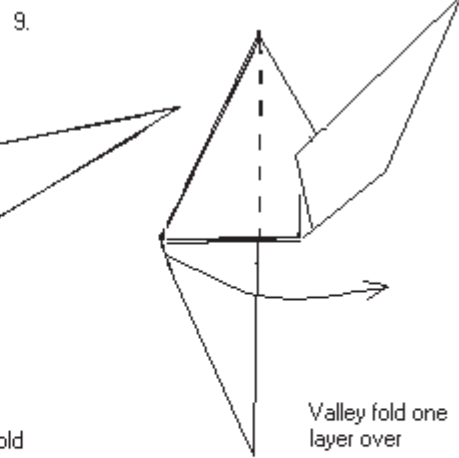

Valley fold one layer over

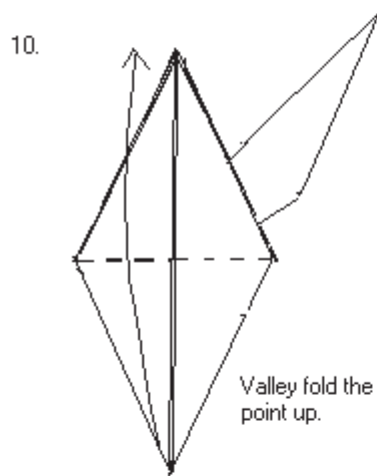

Valley fold the point up.

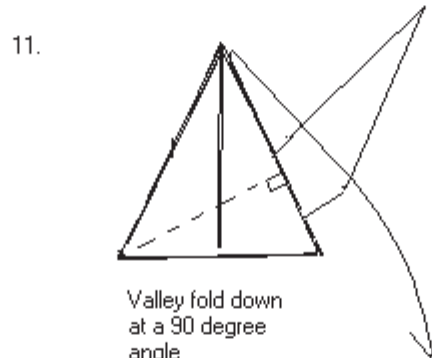

Valley fold down at a 90 degree angle

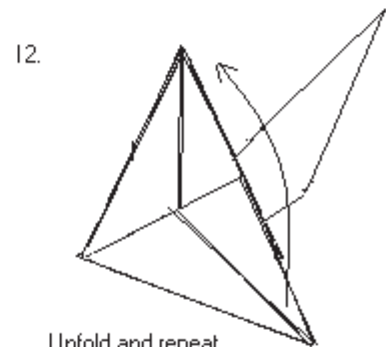

Unfold and repeat step 11 in the other direction

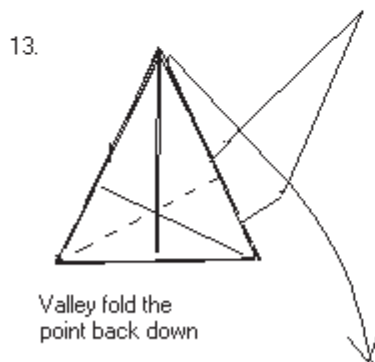

Valley fold the point back down

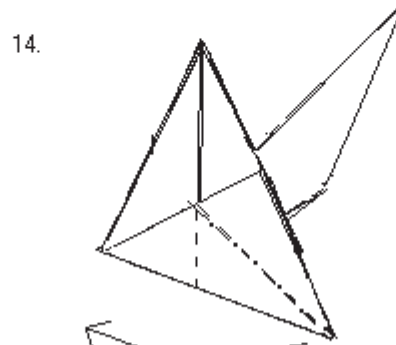

Swing the point over and squash down

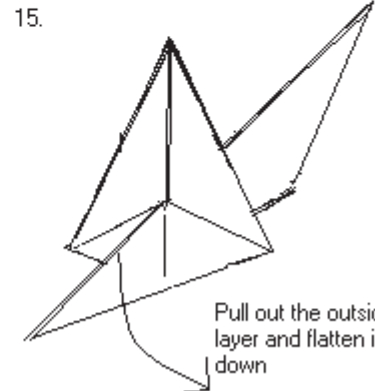

Pull out the outside layer and flatten it down

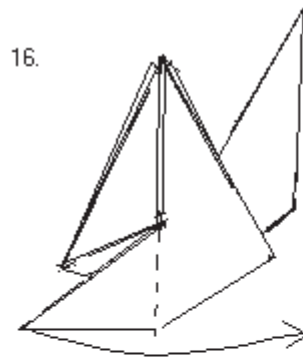

16. Valley fold the triangle over

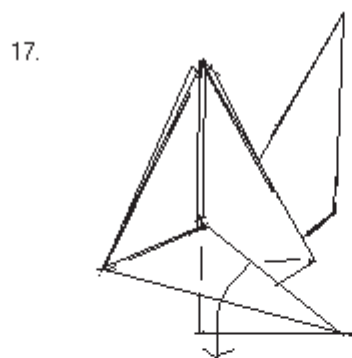

17. Pull out the paper on this side

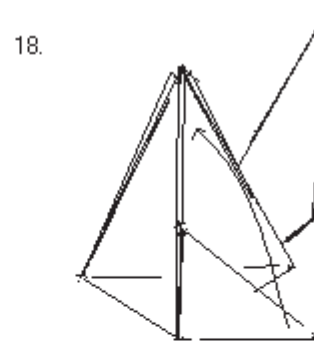

18. Fold the paper up while spreading it out

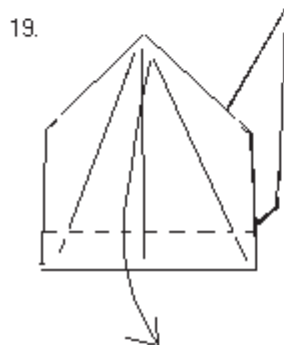

19. Valley fold the flap down

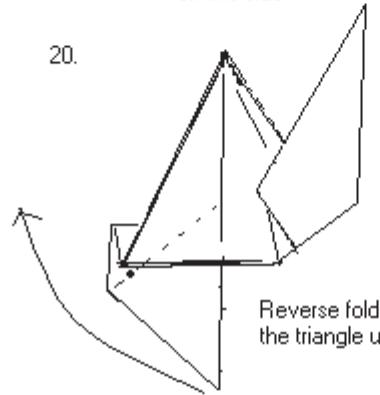

20. Reverse fold the triangle up

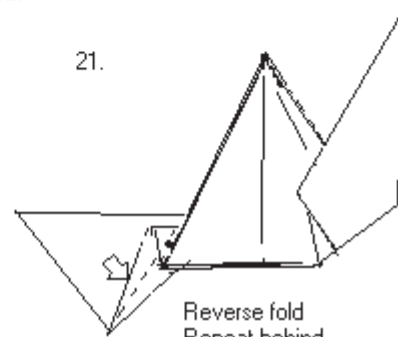

21. Reverse fold Repeat behind

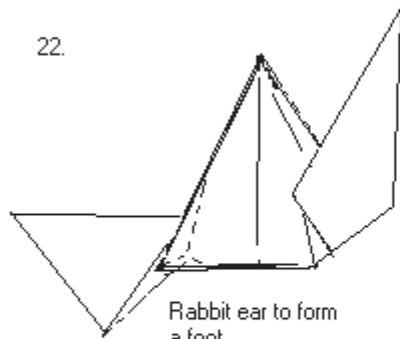

22. Rabbit ear to form a foot Repeat behind

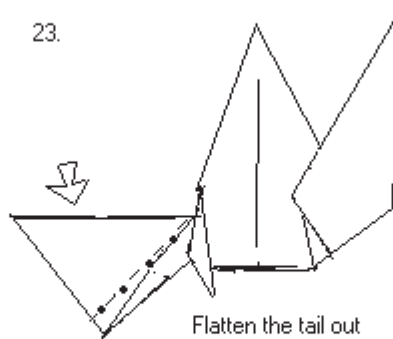

23. Flatten the tail out into a square shape

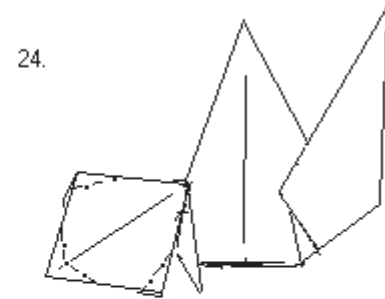

24. This is the tail turned to the side Round off the tail with mountain folds

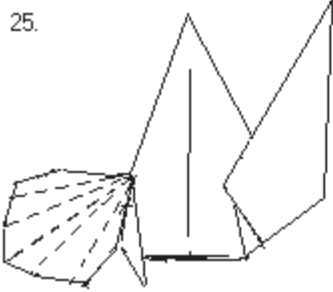

25. Make these folds and unfold to make fan-type creases. Curl the tail around

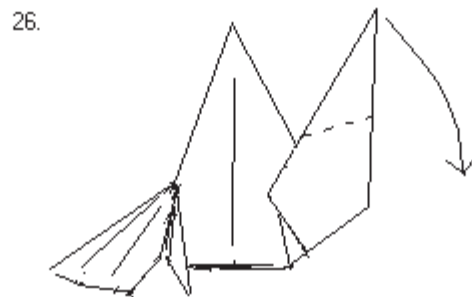

26. Outside reverse fold the head down

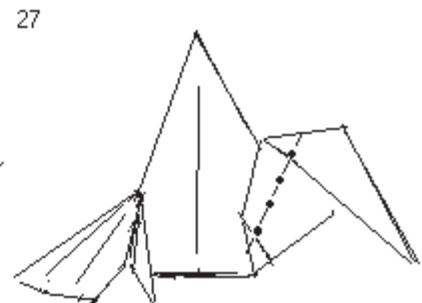

27. Mountain fold Repeat behind

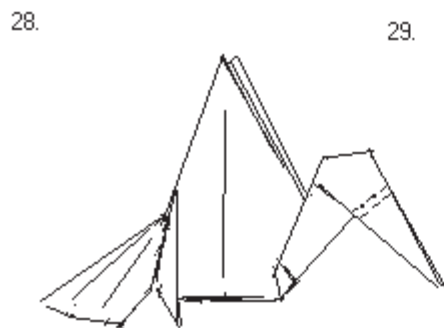

28. Crimp fold to form the beak

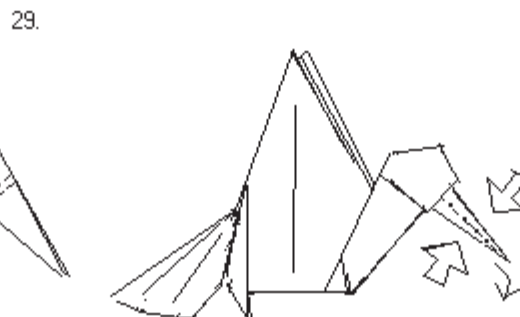

29. Pinch the beak and curve it

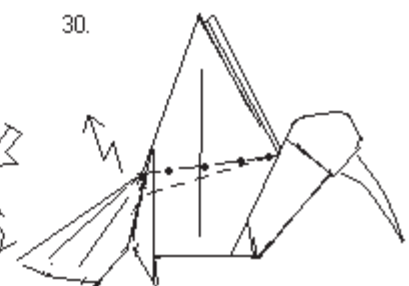

30. Pleat the wing repeat behind

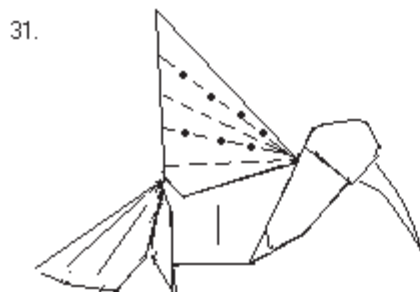

31. Fold the wing like a fan and unfold Repeat behind

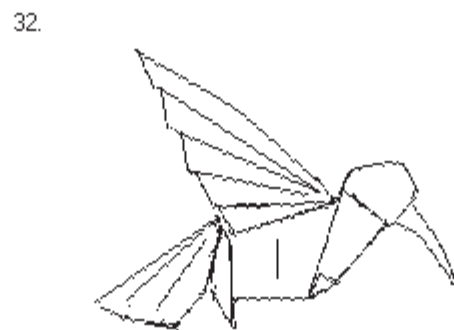

32.

# White Ibis (*Eudocimus albus*) by Gabriel Willow (ME)

High-Intermediate

Start with a white bird base folded from red paper. A 10" piece of paper produces a model 5" in length.

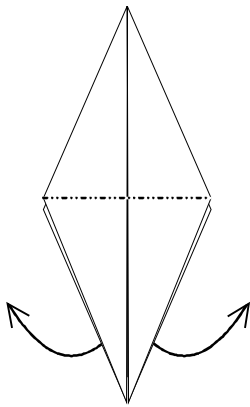

1. Reverse fold the two points.

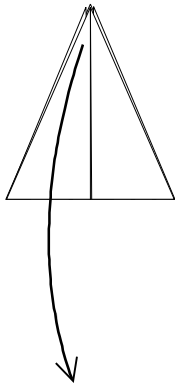

2. Fold the front point down.

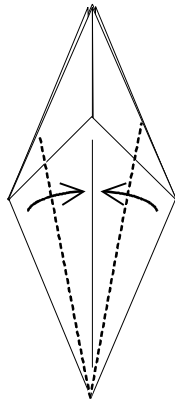

3. Fold the edges inward.

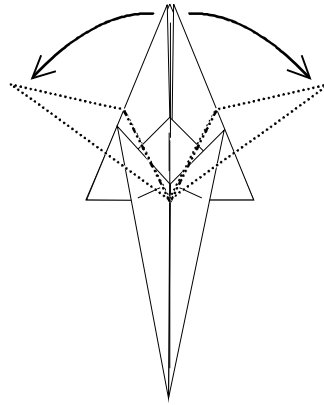

4. Reverse fold the points.

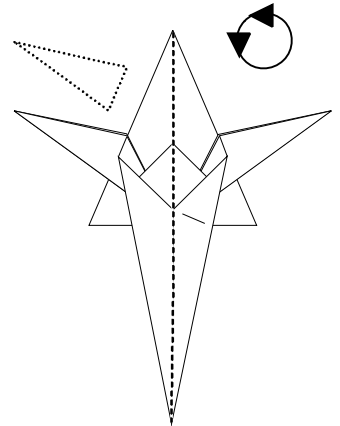

5. Note that each point forms an isoscles triangle. Fold the model in half and rotate 90 degrees.

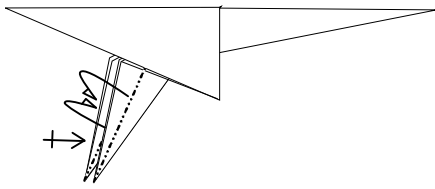

6. Fold the flaps inside each leg.

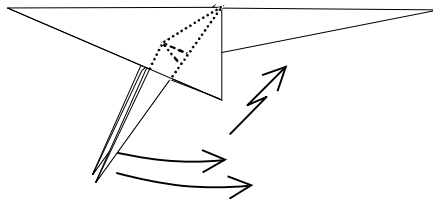

7. Crimp the legs forward so that they are parallel to the front of the body.

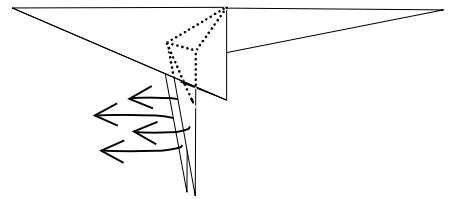

8. Carefully slide the paper back as far as it will go on both sides of both legs.

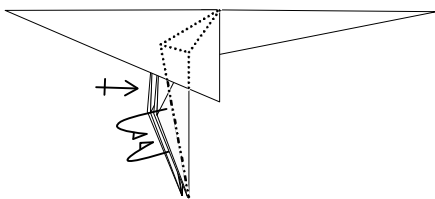

9. Fold the colored flaps inside. Note that part of the leg will still be white. Repeat behind.

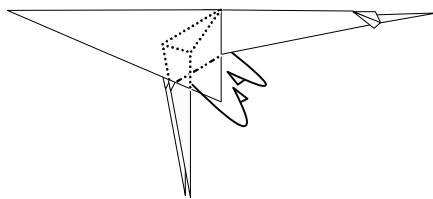

10. Fold both flaps inside.

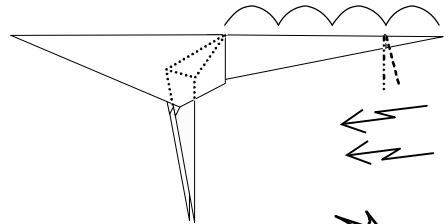

11. Crimp the neck at 1/4.

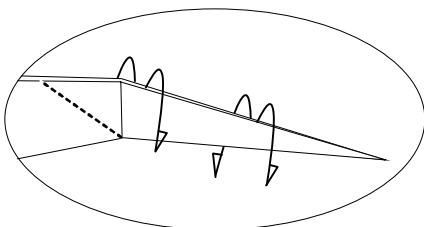

12. Carefully pull the flaps down.

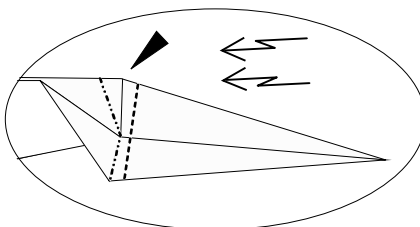

13. Crimp/sink the point. See step 14 for correct positioning.

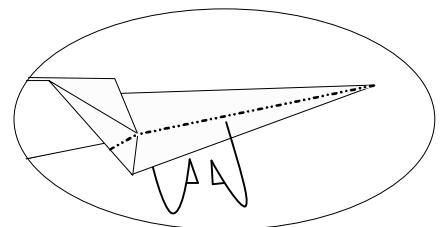

14. Fold the flaps inside.



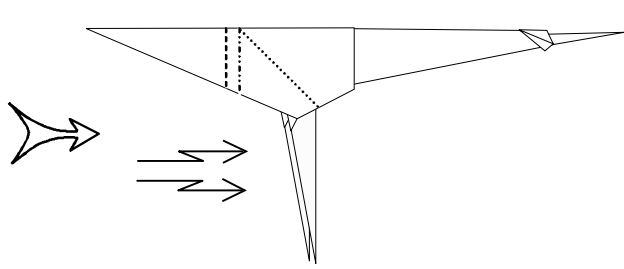

15. Crease the tail.

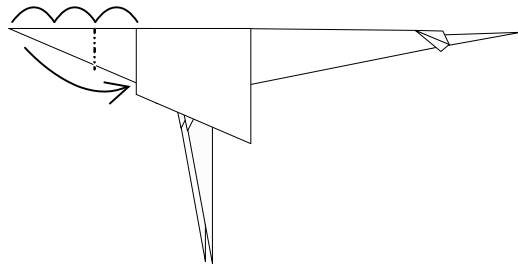

16. Fold inside.

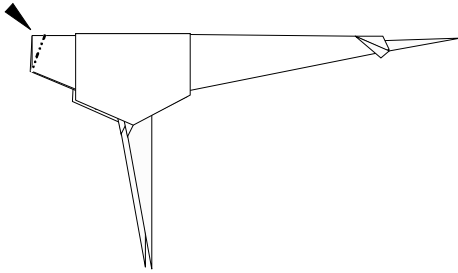

17. Reverse fold.

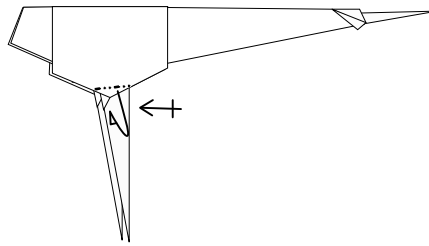

18. Fold both flaps inside.

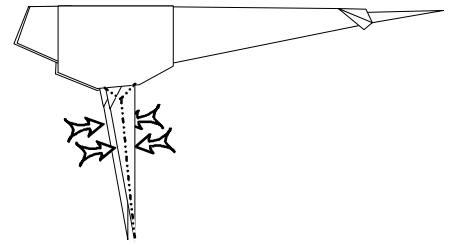

19. Shape the legs.

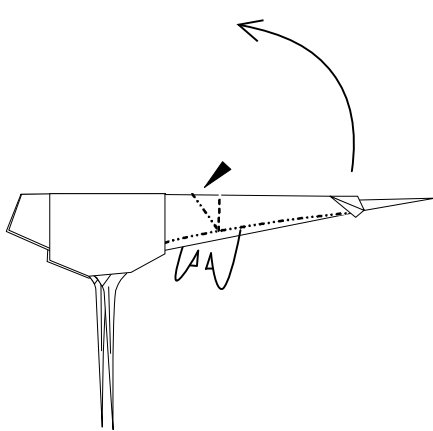

20. Crimp the neck while thinning.

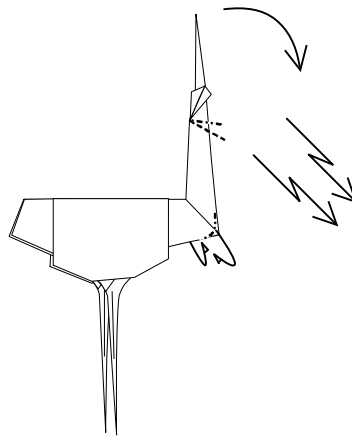

21. Shape the bottom & crimp again.

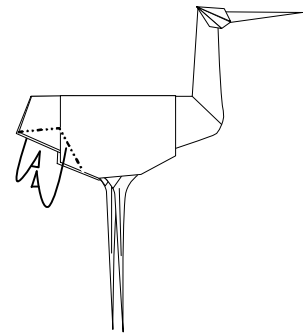

22. Fold the flaps inside.

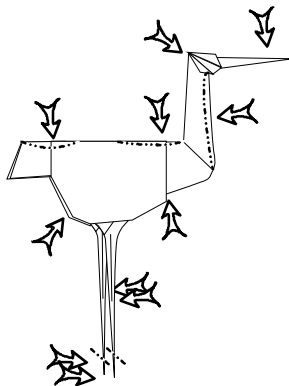

23. Soften into final shape.

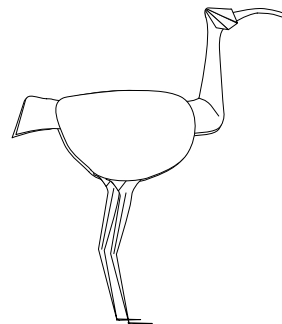

24. Completed model.

start white side up

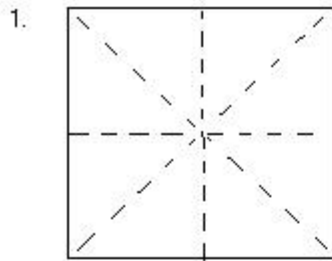

1. Precrease the paper in half in all 4 directions

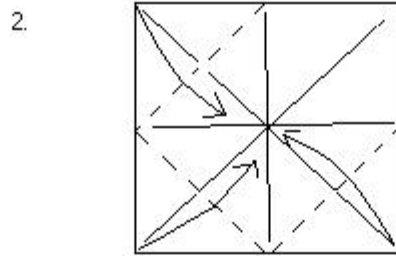

2. Fold three of the corners into the middle

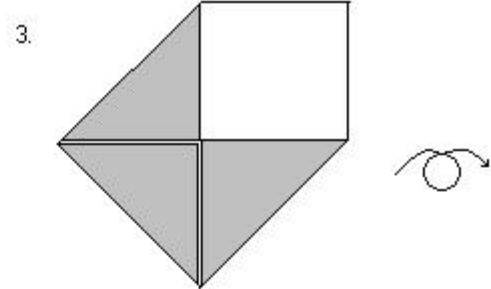

3. Turn over and rotate

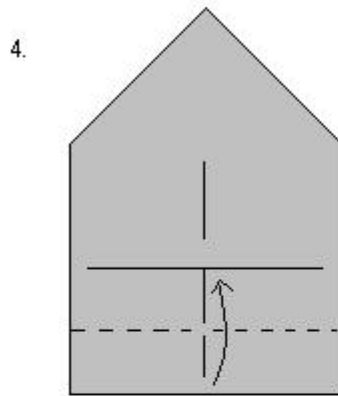

4. Fold to the center

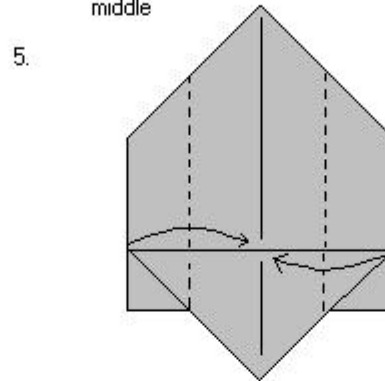

5. Fold to the center

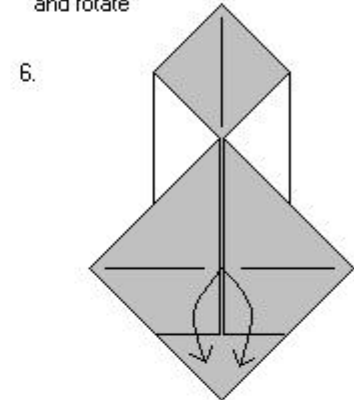

6. Pull out the 2 points

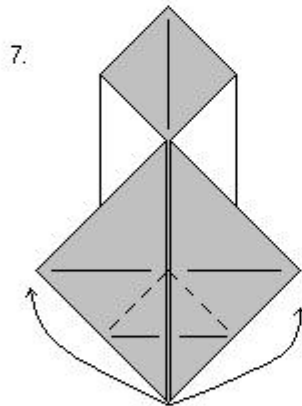

7. 2 valley folds

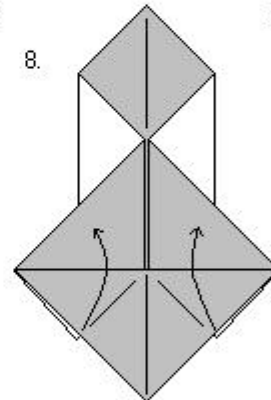

8. Reverse fold the 2 triangles out from inside

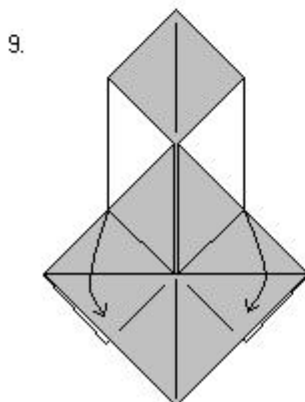

9. Fold the flaps down

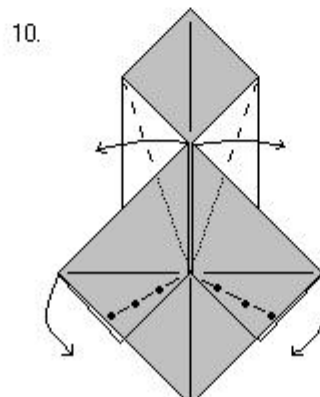

10. Squash folds

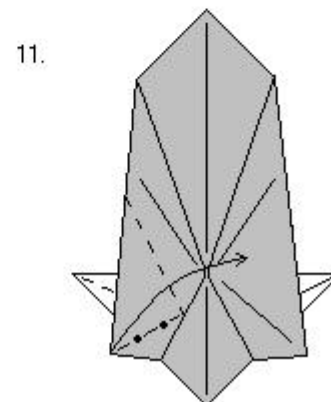

11. Similar to half a petal fold

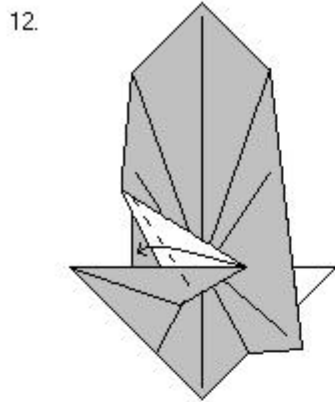

Valley fold to line up on the inner edge

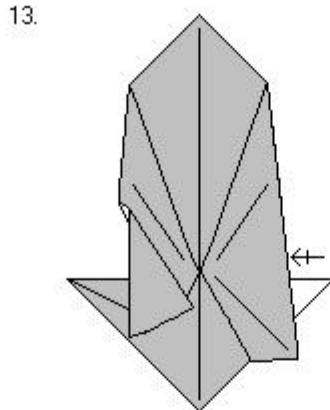

Repeat 11 and 12 on the right side

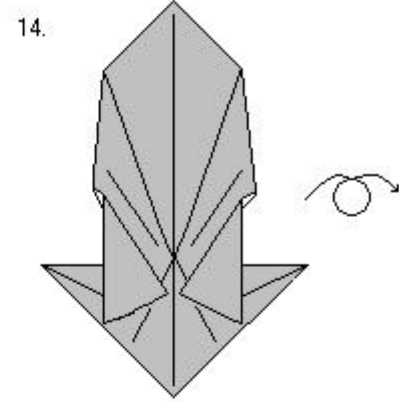

Turn over

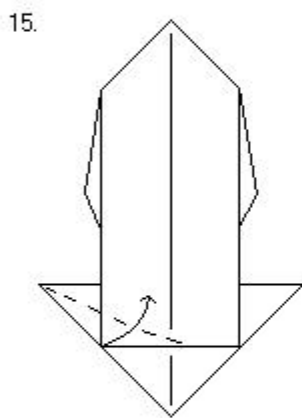

Valley fold

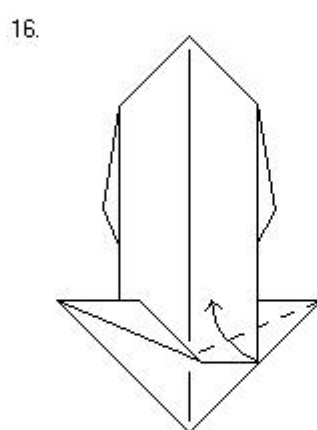

Valley fold

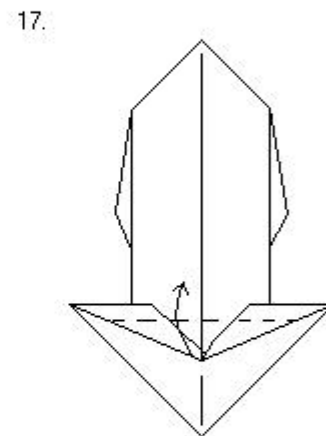

Valley fold the thick layer 2/3 of the way up

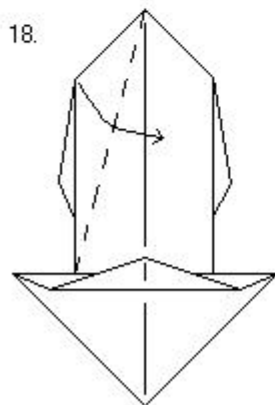

Valley fold

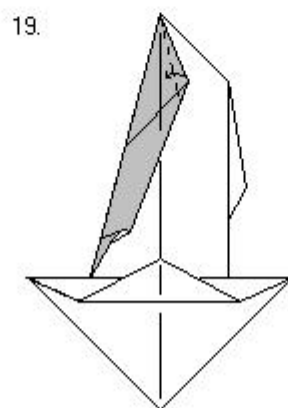

Valley fold to the center

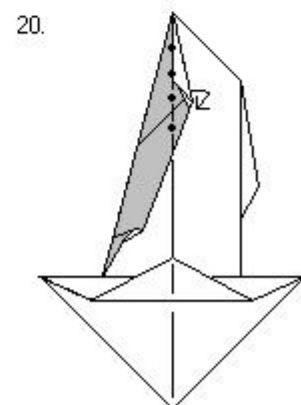

Mountain fold this portion inside

21.

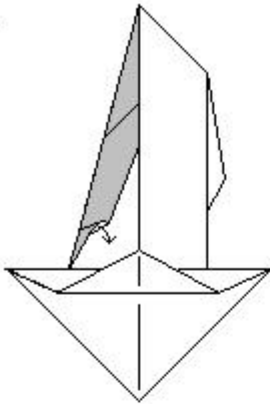

Squash fold

22.

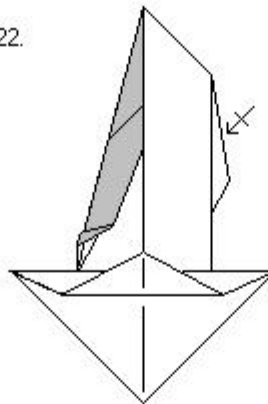

Repeat steps 18-21 on the right side

23.

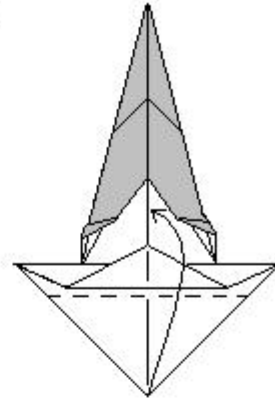

There are no guidelines for this fold

24.

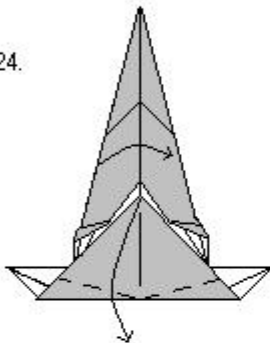

Reverse fold the point out while folding the model in half

25.

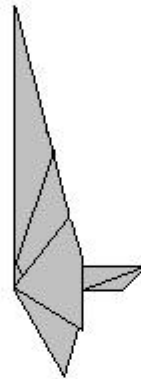

Rotate by 90 degrees

26.

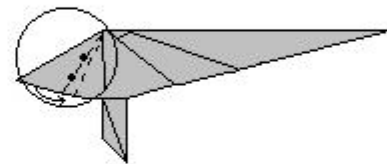

The top layer is not shown inside the circle  
Crimp to form the tail

27.

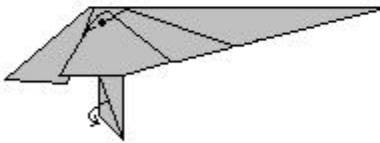

Mountain fold the top to the wing  
Thin the leg with a mountain fold  
Repeat both behind

28.

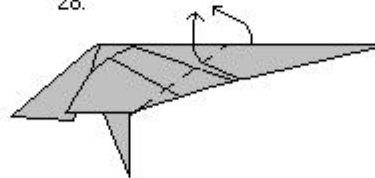

Outside reverse fold the neck

29.

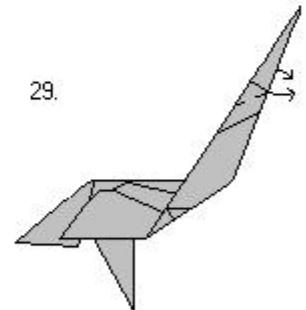

Outside reverse fold the head

30.

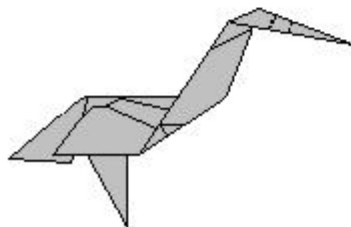

Crimps to form the beak

31.

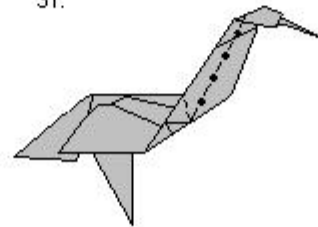

Crimp the neck while making it thinner

32.

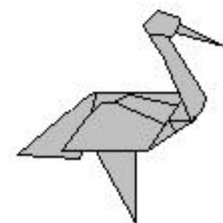

Curve the bill

33.

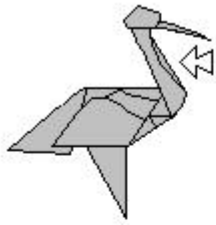

Curve the neck

34.

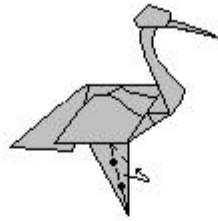

Thin the leg with a crimp  
Repeat behind

35.

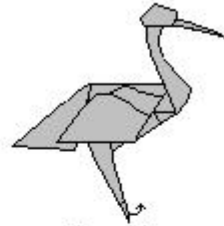

Form a foot  
Repeat behind

36.

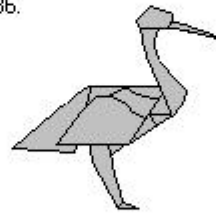

IBIS

# Blintz Icosidodecahedron by Tung Ken Lam

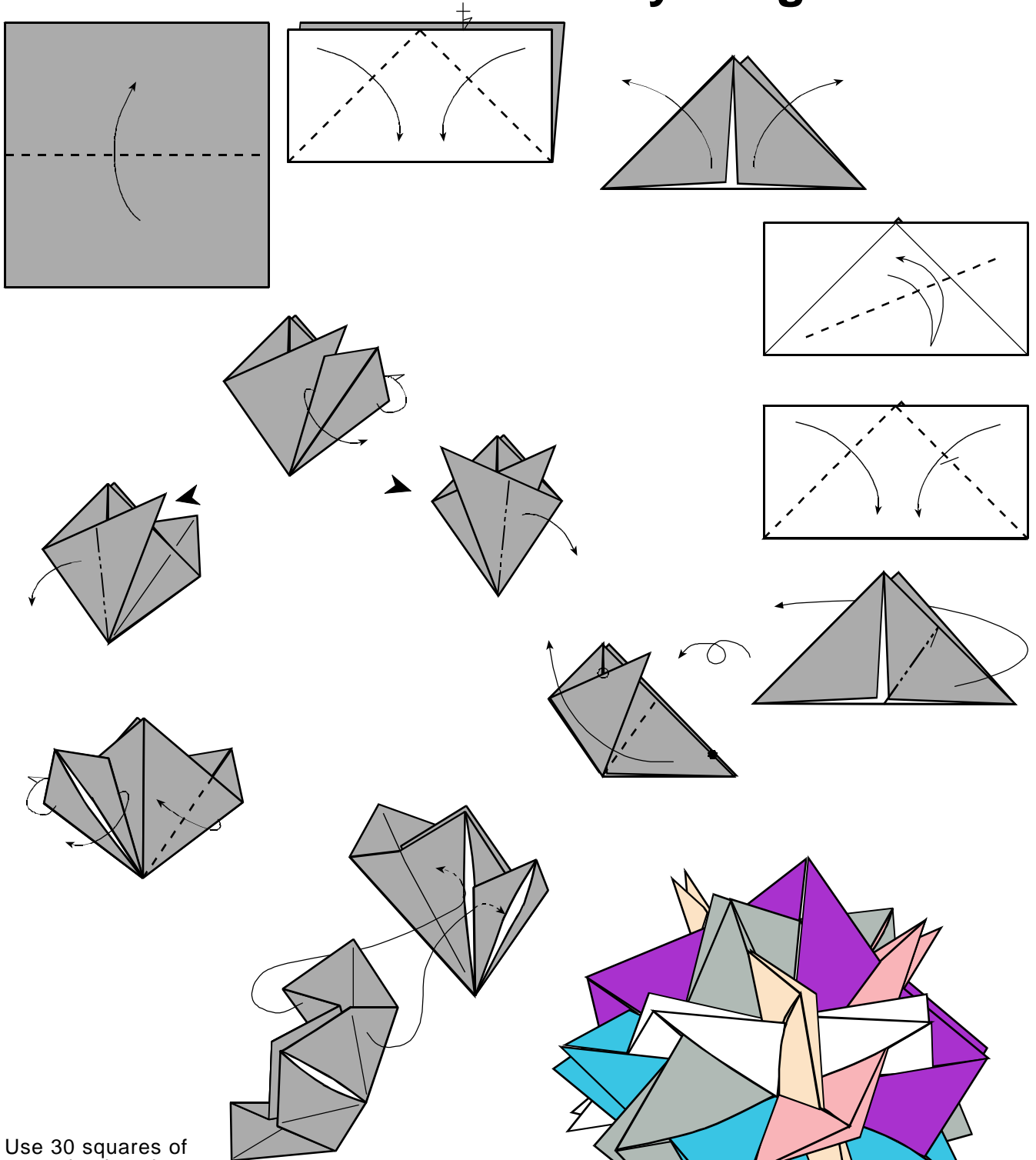

Use 30 squares of paper in six colours.

Initially assemble a ring of five units in different colours. Then add to one unit to each face to form a three-sided pyramid.

Add the remaining units so that they appear to form planes that intersect each other.

x30

Model and diagrams:  
Copyright Tung Ken Lam 2000. All rights reserved.

# Inflation

by Marc Kirschenbaum

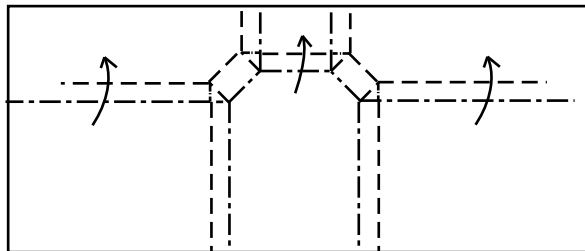
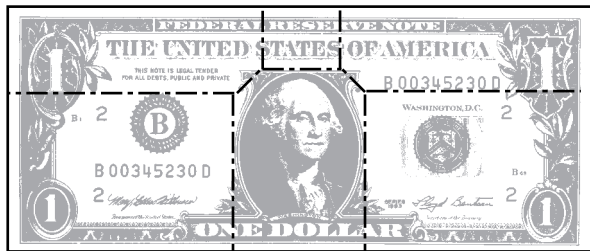

1. Precrease where shown; all folds are mountain folds. Note where the folds are formed: Horizontal creases lie over "B" and "Washington D.C." Form the larger folds first.

2. Markings are eliminated for clarity. Pleat upwards using folds made in step 1. Guidelines: Horizontal mountain folds should meet bottom of "The United States of America," and the top of Washington's head should meet "Federal Reserve Note." Note that horizontal valley folds do not completely extend towards the edge.

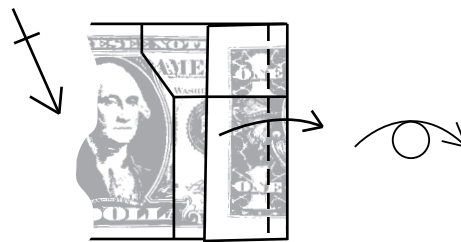
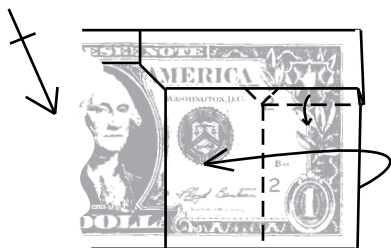

3. Swivel fold, using tip of "A" as a guideline. Repeat on the other side using end of "T" as a guideline.

4. Valley as far as possible. Repeat on the other side. Turn over.

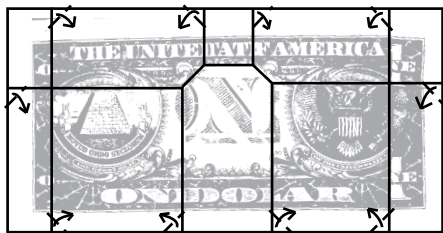

5. Valley fold to lock pleats. Iron flat and turn over.

6. Completed Inflation  
©1987 Marc Kirschenbaum

I. PRECREASES.

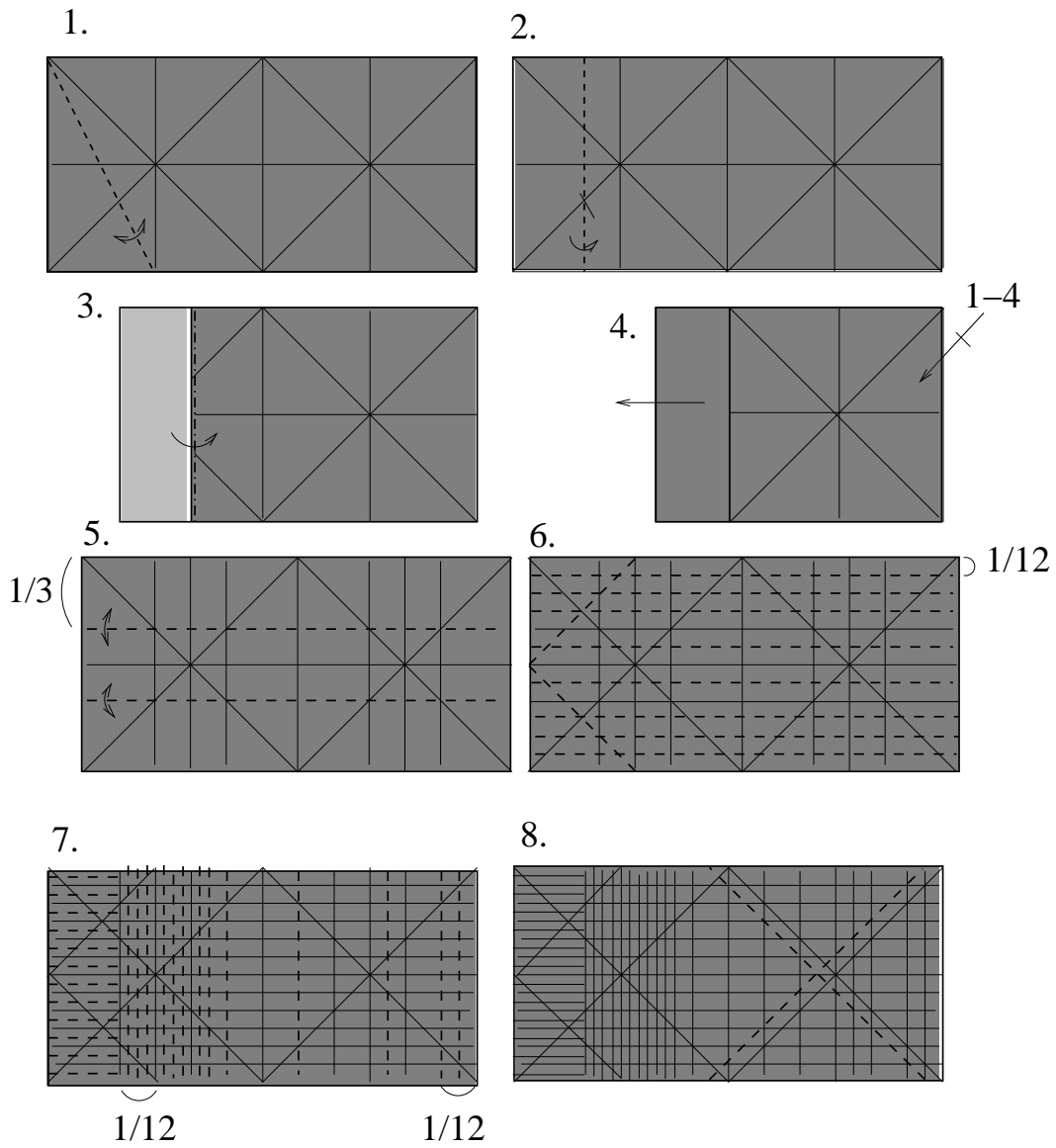



II. THE LID.

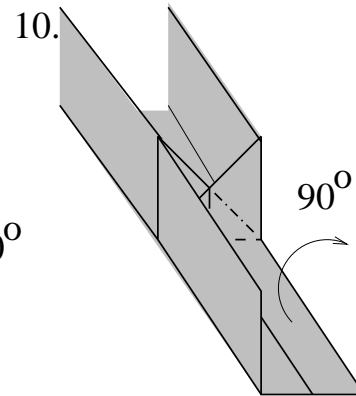
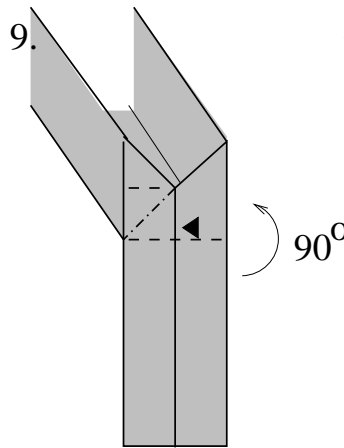
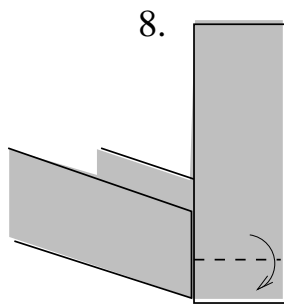
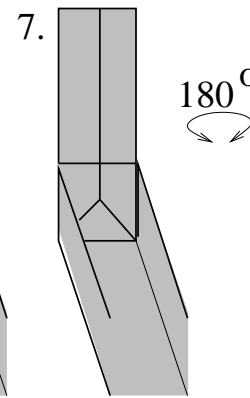
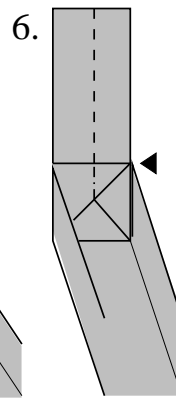
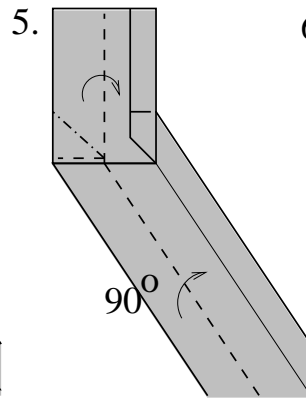
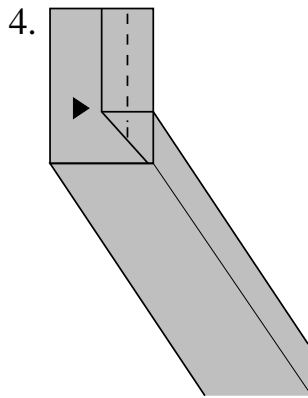
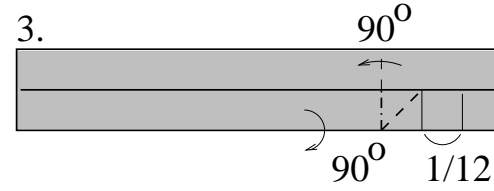
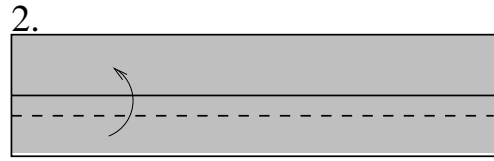
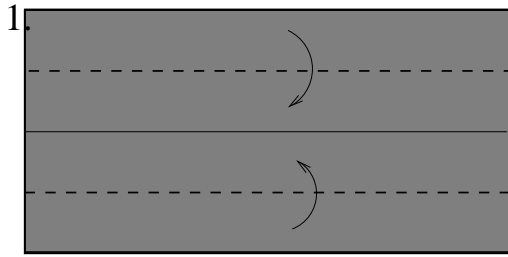

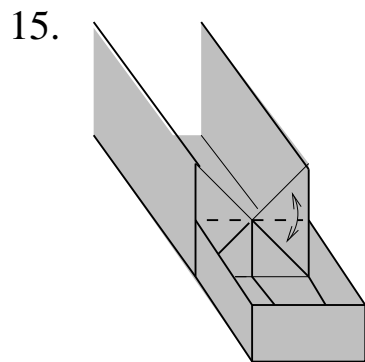
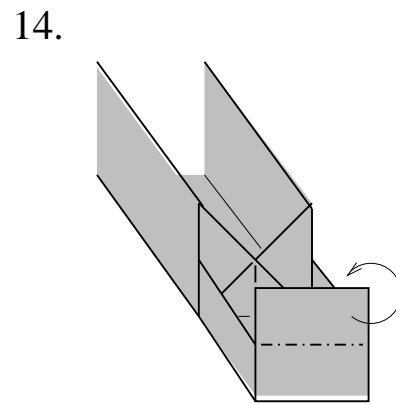
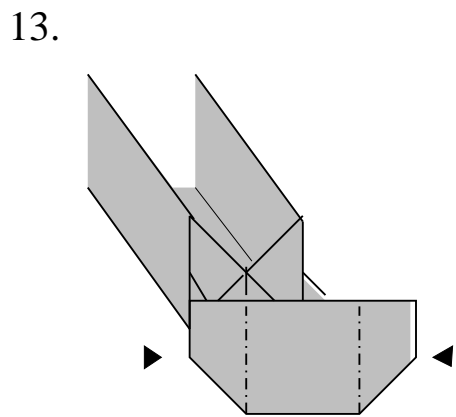
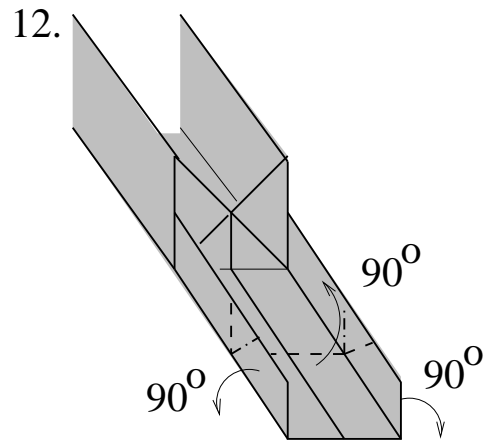
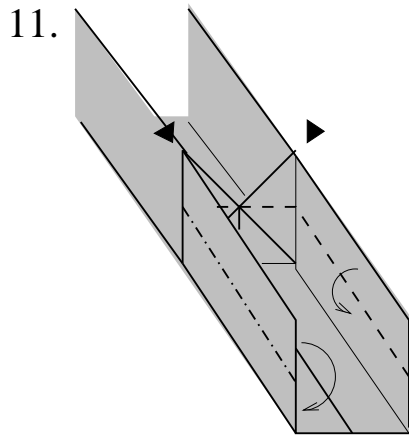

### III. THE BOX.

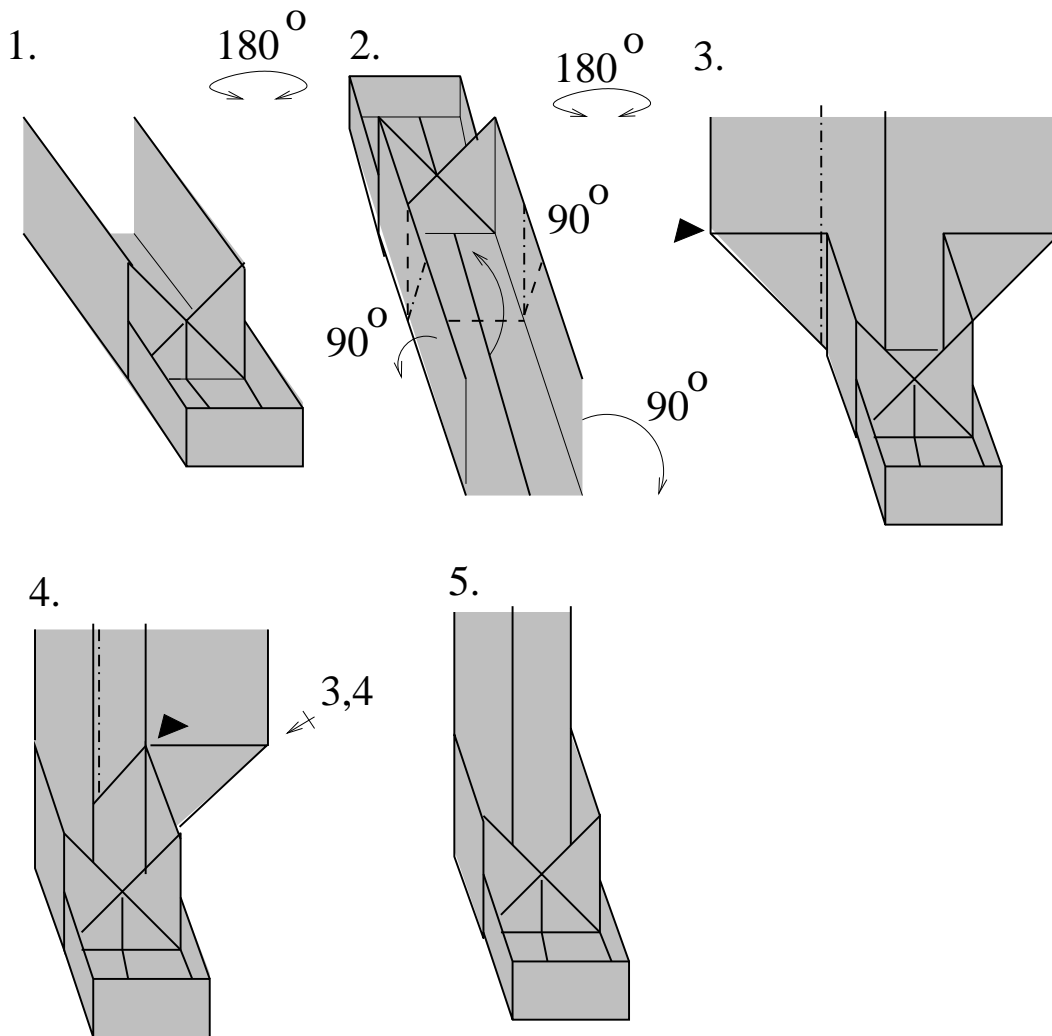

### IV. THE SPRING

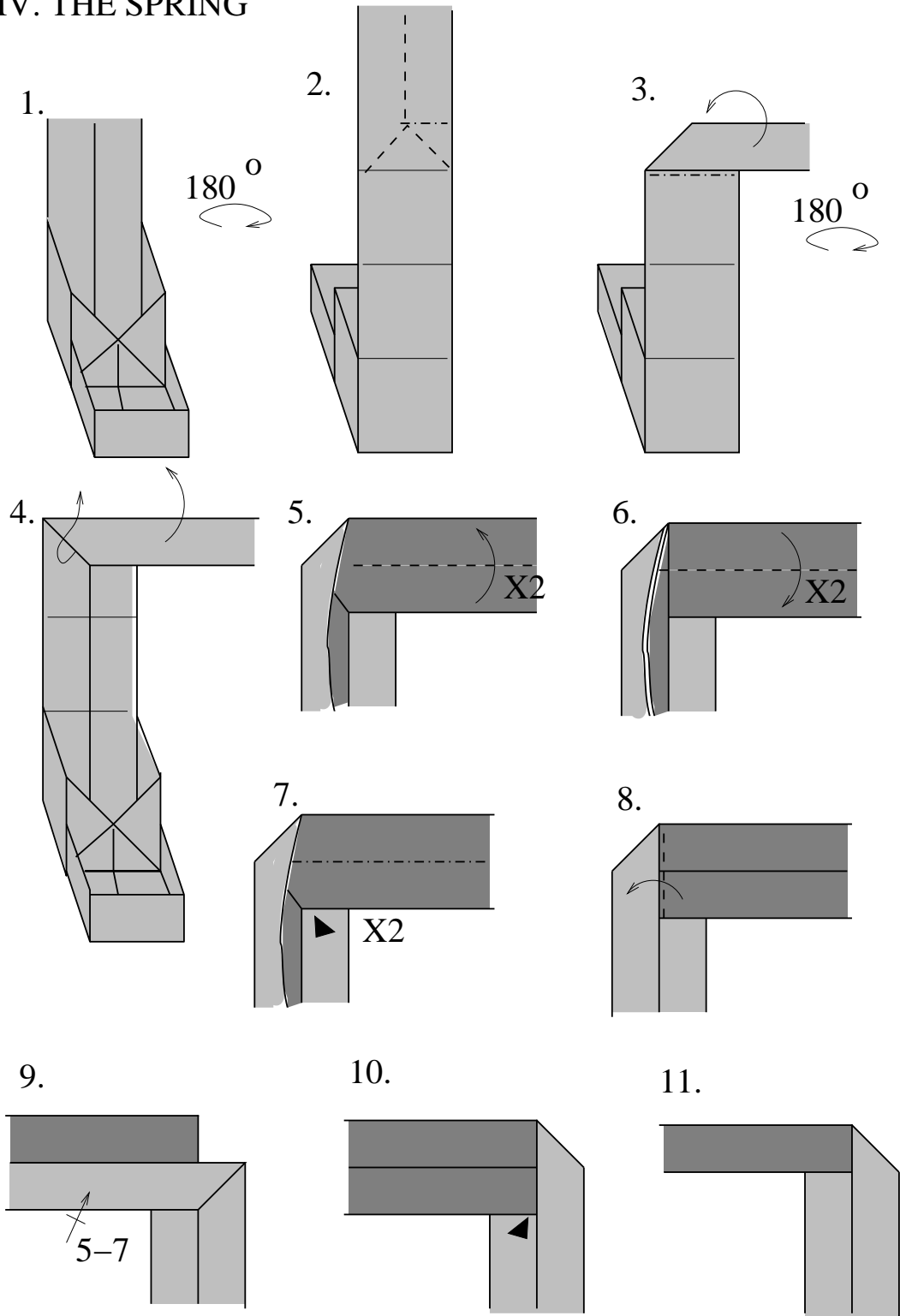

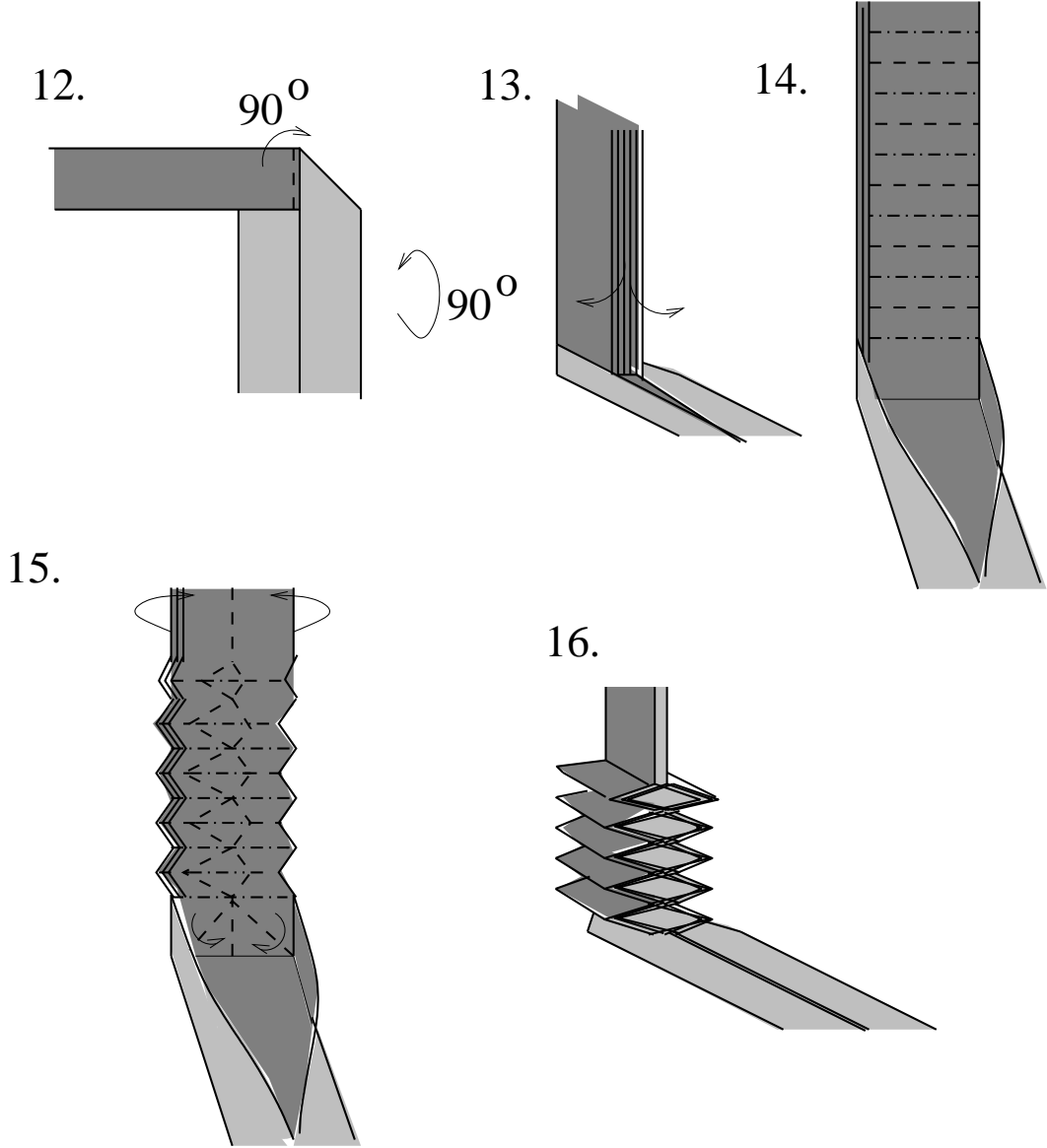

V. JACK!

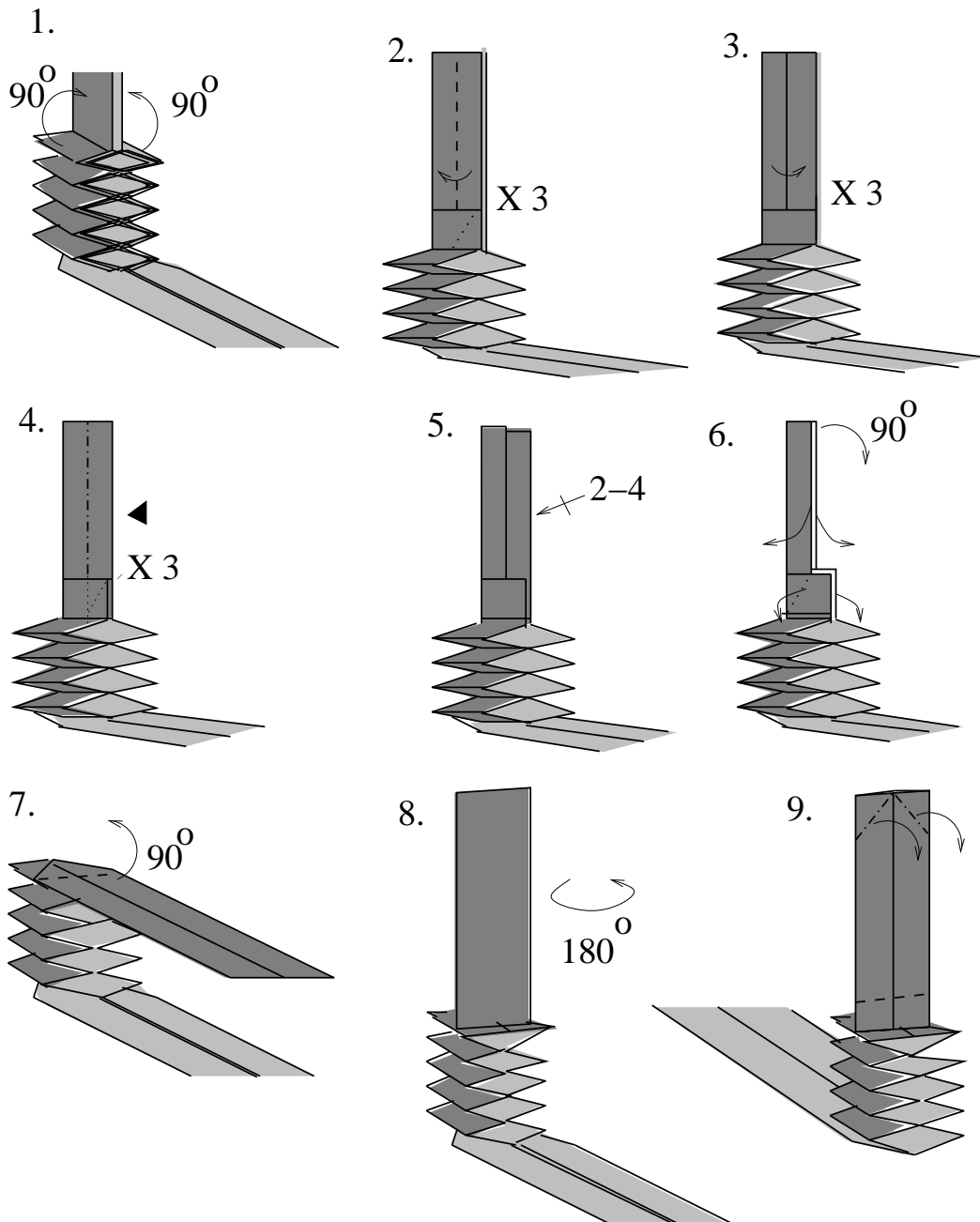

9.

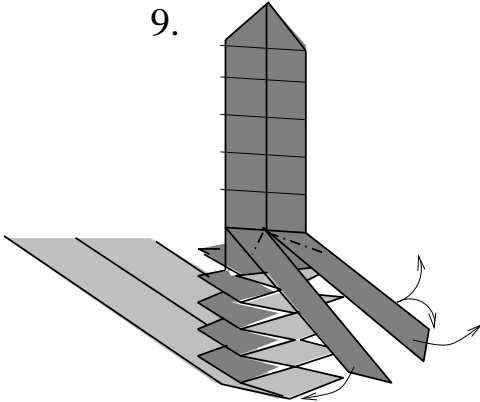

10.

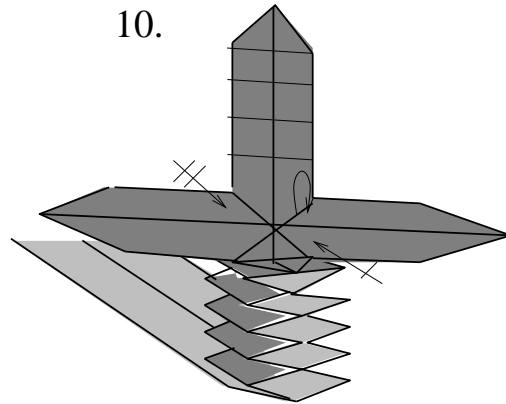

11.

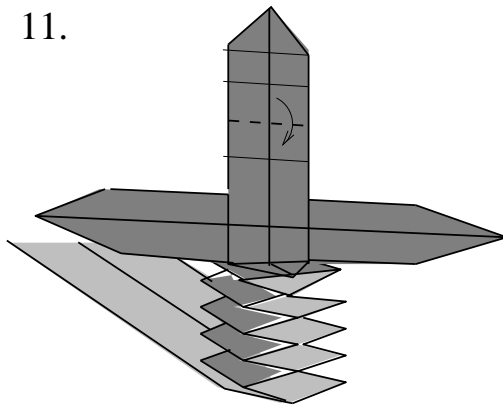

12.

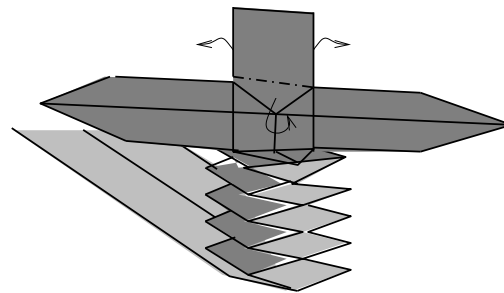

13.

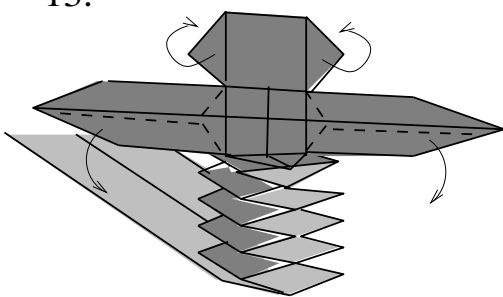

14.

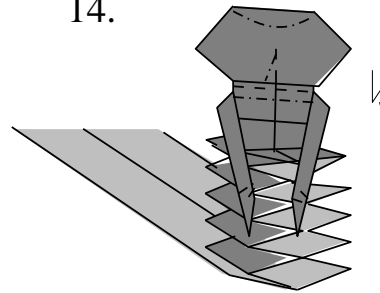

## VI. Putting everything together.

1.

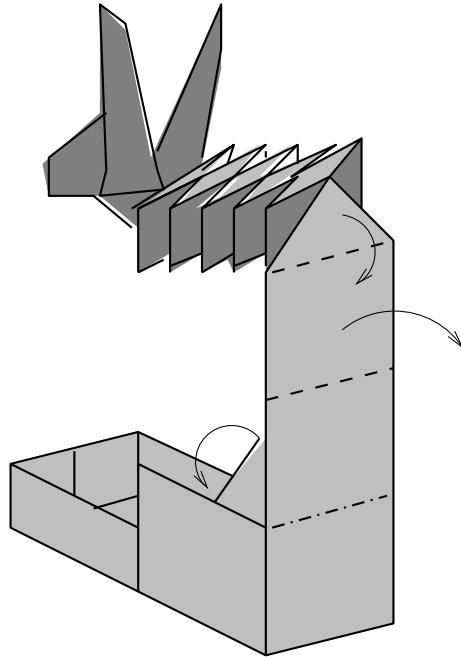

2.

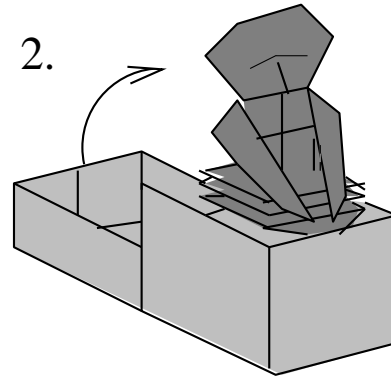

3.

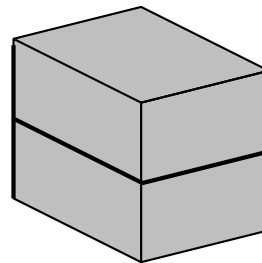



# Comments

**Start with a  $2 \times 1$  two-coloured paper. A  $12 \times 6$  inches rectangle produces a box of width 1 inch.**

## I. Precreases.

1. Valley fold slightly.
2. Valley fold at intersection between creases.
3. Valley fold along the edge.
4. Unfold back to step 1. Repeat on the other side. This divides the large side into six.
5. Precrease at indicated intersections. This divides the small side into three.
6. Divide each third into four. Add indicated diagonal creases.
7. Add vertical and horizontal creases where indicated. For the vertical creases, start dividing each segment of  $1/6$  in two.
8. Add two more diagonal creases where indicated.

## II. The Lid.

1. Valley fold on both sides to meet the center crease.
2. Valley fold along existing crease which divide the small side in three.
3. Raise simultaneously the right and the bottom flap at 90 degrees, adding a mountain fold. The vertical valley fold corresponds to  $1/4$  of the large side. Rotate the model.
4. Reverse fold.
5. Raise the left side at 90 degrees, adding a diagonal mountain fold. This is the mirror image of step 3.
6. Reverse fold.
7. The model should be symmetrical. Rotate.
8. Valley fold down.
9. Raise the left flap at 90 degrees simultaneously with the bottom part. A mountain fold is needed. You have to push on the side to unfold a mountain fold.
10. Like so. Repeat on the right.
11. Fold each side of the lid in half. Be careful with the corners.

12. Raise the bottom part of the model. The valley fold corresponds to one half of the lid.
13. Like so. Close sink on each side. Be careful not to tear up the paper.
14. Mountain fold to close the lid.
15. The lid is completed. Note how the indicated valley fold works.

### III. The box.

1. Rotate the model.
2. Raise the lower part along existing crease, adding mountain and valley folds. The side of the box has the same size as the lid.
3. Close sink.
4. Close sink. Repeat on the other side.
5. The box is completed.

### IV. The spring.

1. Rotate the model.
2. Rabbit ear where indicated.
3. Mountain fold. Rotate the model.
4. Raise on layer up, pulling out some paper.
5. Valley fold up two flaps.
6. Valley fold down the flaps. Some folds have been rearranged in the operation.
7. Close sink two flaps.
8. Valley fold to the left.
9. Repeat step 5 to 7 in mirror image.
10. There is one remaining flap at the bottom. Open sink.
11. The colour reversal for the spring is completed.
12. Raise the coloured flaps at 90 degrees. Rotate the model.
13. Open the layers, at the middle. There must be three layers on each side.

14. Add mountain and valley folds where indicated, using existing creases. The distance between two valley folds is one half of the width. Check the number of creases otherwise there will not be enough paper for Jack.
15. Close the layers back to step 13. Do not unfold the mountain and valley folds. The small squares in the middle will form naturally on the front layer.
16. The spring is completed.

## V. Jack!

1. Valley fold up on each side.
2. Fold in half three flaps of the upper section. Hidden diagonal folds are needed for each flap.
3. Unfold back to step 2.
4. Close sink three flaps.
5. Repeat step 2 to 4 on the other side.
6. Open the layers at the middle, while pulling down the upper section. There must be six flaps on each side. Two hidden mountain folds are needed.
7. Valley fold up at 90 degrees. Rotate the model.
8. This is a difficult step inspired from Mark Kirchenbaum's Skeleton. Fold down the front layer on each side as far as you can, using the indicated valley fold. You will need to rearrange the hidden layers, unfolding vertical mountain and valley folds, adding horizontal ones. See the result on next drawing.
9. This is another difficult step. You need to open the arms and squash fold them to the sides. Two squash are needed behind to do so.
10. Pull out some paper where indicated, and flatten.
11. Valley fold down where indicated.
12. Pull out two layers of paper on each side, adding a mountain fold at the bottom of the head.
13. Like so. Wrap around the paper on each side, to lock the head. You need to slightly unfold the head to do so. Rabbit ear the arms.
14. Shape the head. Add a crimp to reduce the neck. Jack is completed.

## VI. Putting everything together.

1. This is how the model should look like at this stage. Valley fold Jack and the spring along the vertical section. Put everything in the box, using a valley fold and a mountain fold.
2. The model is completed. You can put Jack in his box (be careful not to break his arms!) and close the lid.
3. Like so.

# Jonathon Jump Ant

By Perry Bailey © 1999

This model is for my son Jonathon who I have not heard from in many years, but who remains in my heart and in my thoughts.

①

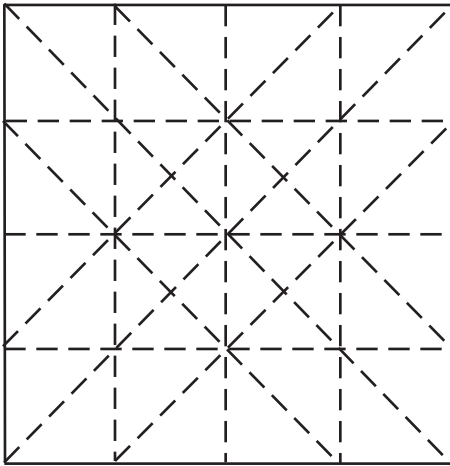

To begin precrease the paper as shown in the diagram. White side up if using Origami Paper. Please note that you don't have to do any precreasing, it just makes it easier the first time around.

②

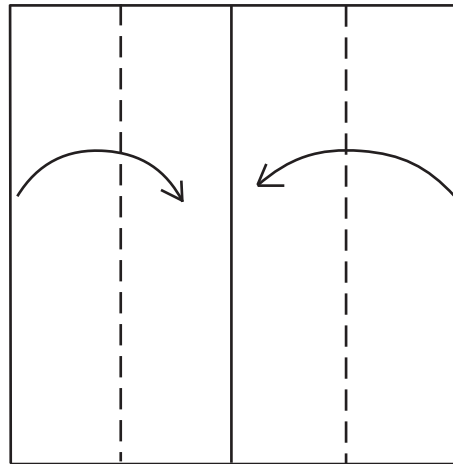

Cupboard fold the sides to the center of the model.

③

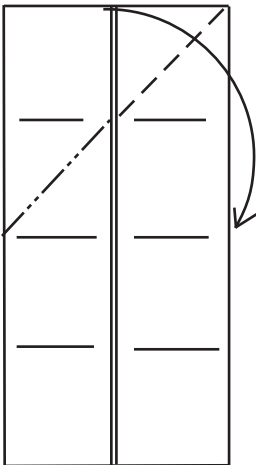

Mountain fold the top layer of the left side of the model, from the half way point, up to the center of the model one quarter of the length from the top. In doing this you will bring the upper right inside corner of the paper down to the left of the model one quarter of the way up from the bottom. Go ahead and for convenience fold the top quarter of the right side in a valley fold just so you can see that flat it matches the next diagram.

④

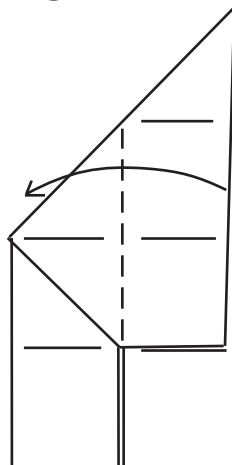

Now while bringing the left side of the model back over to the left repeat step 3 on the right side of the model.

⑤

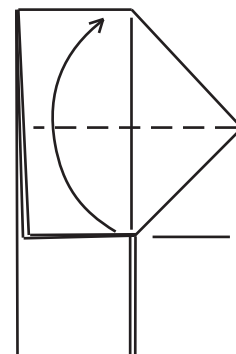

Valley fold up the top (left) flap bring the raw edge to the top of the model.

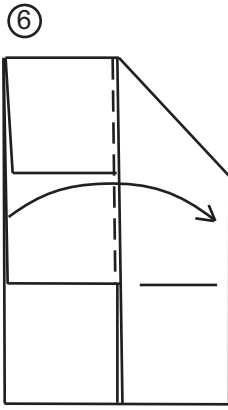

6 Valley fold all the upper layers to the right.

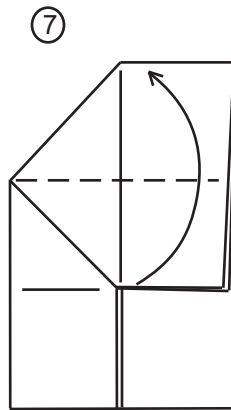

7 Valley fold the flap up to the top of the model.

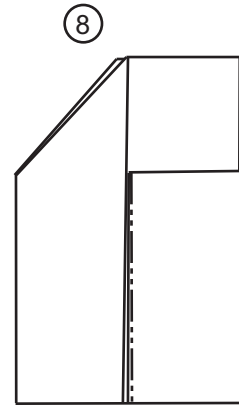

8 Mountain fold the bottom 2 Layers of the model under to the left.

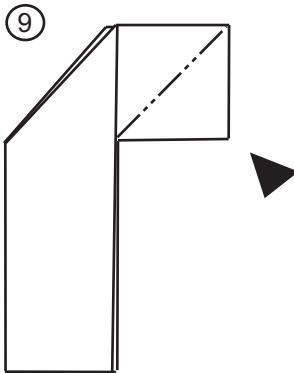

9 Perform an Inside reverse fold on both sides (flaps). This will give you three points, and a good start on half of the legs.

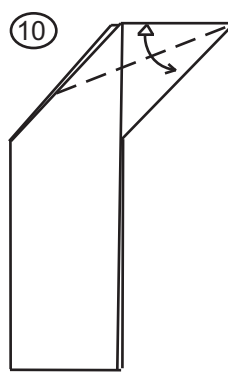

10 Valley fold top layer down so the raw edge is even with the bottom edge of the flap, then unfold.

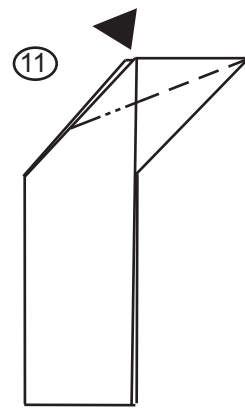

11 Inside reverse fold the flap along the lines of the crease made in the previous step.

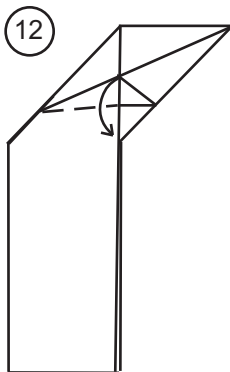

12 Valley fold down the flap created by the reverse fold.

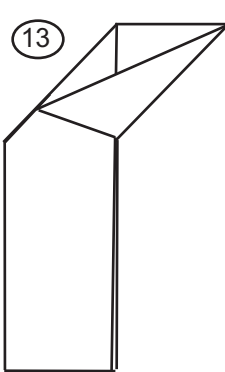

13 Repeat step 10 through 12 on the other side of the model.

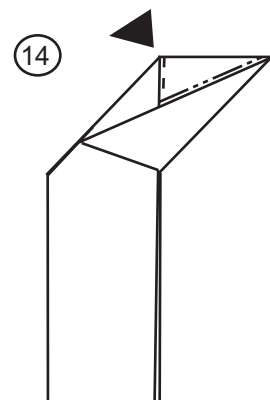

14 Reverse fold the flap sticking up on each side into the model.

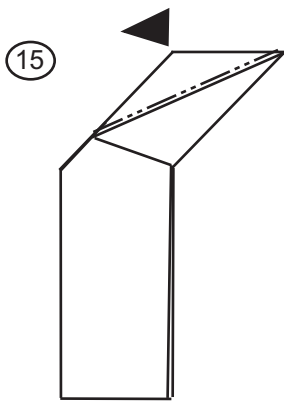

15  
 Perform an open sink on the center flap making it even with the side flaps, you will need to open up the top of the model to do this. (Unless you are a masochist and then feel free to make it as hard to do as you like, things like, not precreasing the sink, and so on.)

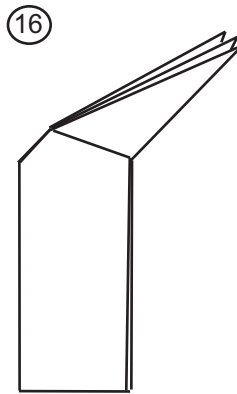

16  
 At this point half of the legs are made, you may pat yourself on the back.



16a  
 At this point the view looking down at the model from above should slightly resemble This, in a vague sort of way.

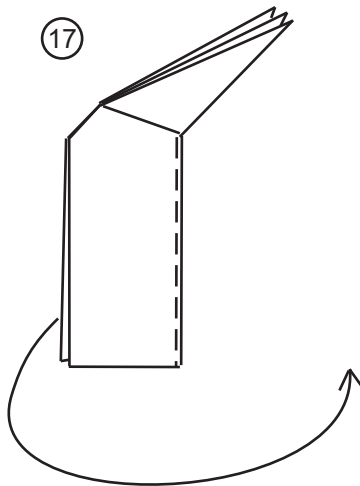

17  
 Bring the back 2 layers from behind.

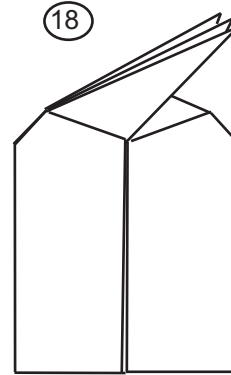

18  
 Now repeat step 3 through 17 on the bottom of the model.

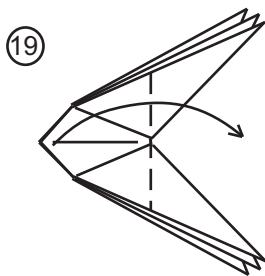

19  
 Valley fold the top flap to the right of the model. There are many layers at this point and it becomes a little more difficult to work with.

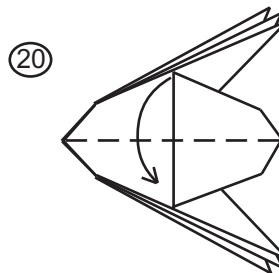

20  
 Valley fold the top half of the model down, this will make it easier to work with.

21

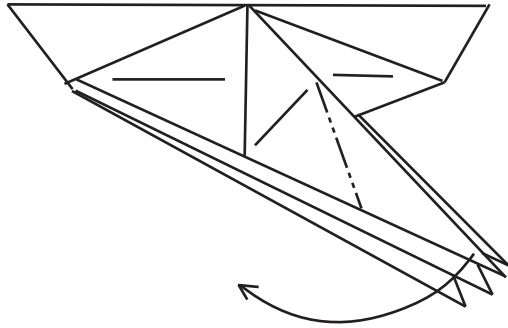

First of all, I have enlarged the diagram to make it easier to read and easier for me to draw. Take the top leg or flap of the 3 on the side facing up and do an inside reverse fold.

22

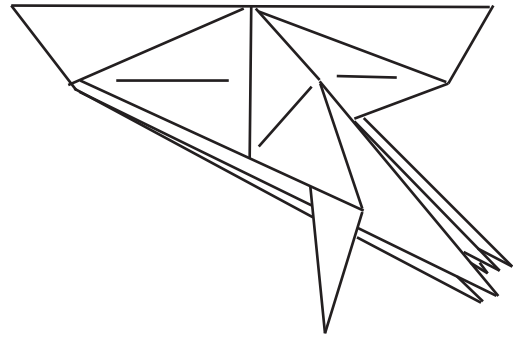

Now to show this next step I am going to separate the top leg from the rest of the model to make it less confusing visually.

23

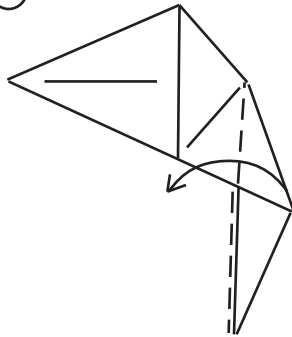

Fold over the top layer of the leg to the left, this opens up the leg so we can lock it into place.

24

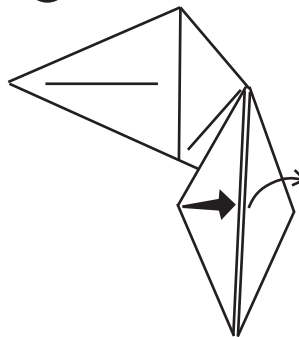

Now to lock the leg in place lift up the flap or top layer of the leg and tuck the right half of the leg into the left half. On the center leg of each side there will be more than one layer to lift.

25

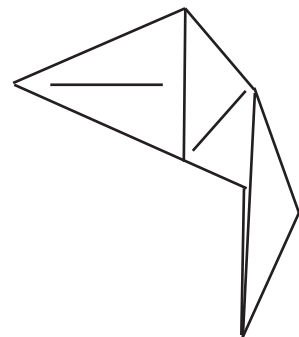

This is how the individual legs should look.

26

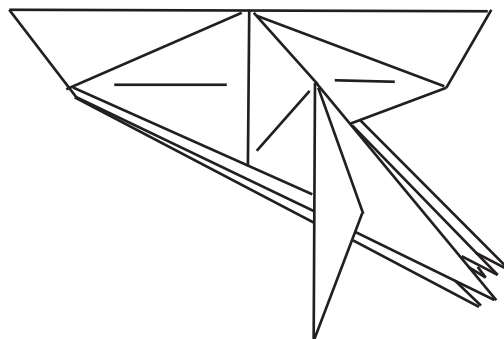

Repeat steps 23 - 25 on all of the legs.



27

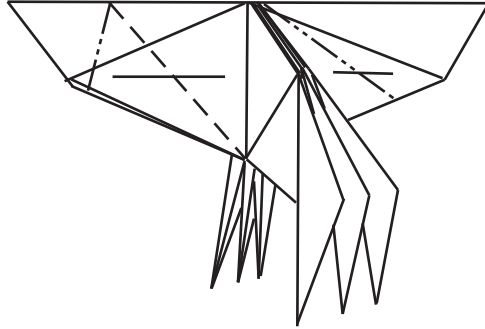

Now to finish the model, you make an accordion fold on the front of the Jump Ant to form the head. Then just a mountain fold on each side of the back of the model to form it's body. I suggest that you spread the legs by holding the **center Leg** and then spread the legs on the sides out

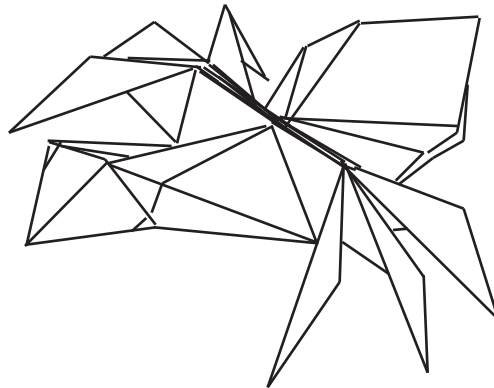

Now to make Jonathon Jump Ant jump, just tap him where the lines converge and watch him jump!!

# “Касатка (кит-убийца)”

Автор: Роберт Ланг (США)

Эта модель складывается в технике “inside-out”, то есть, для более реалистичного изображения касатки используется окраска обеих сторон квадрата. Более-менее опытный оригамист справится с ней без особых проблем. На мой взгляд, эта достаточно изящная модель - хороший пример, как можно достичь желаемого результата без чрезмерных издевательств над бумагой. Иногда оригамисты на это способны!

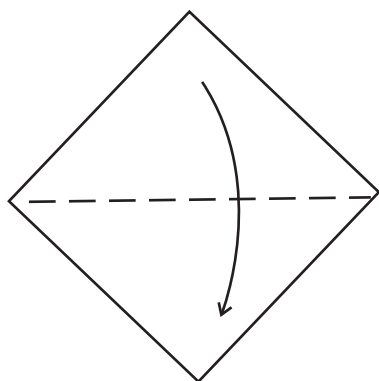

1. Согните квадрат пополам по диагонали.

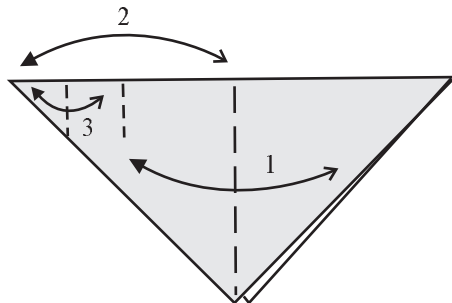

2. Перегните складку трижды.

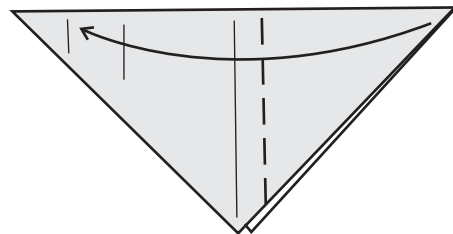

3. Согните правый угол к линии, намеченной в последний раз.

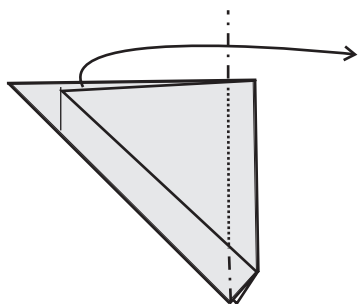

4. Отогните левый угол по намеченной линии.

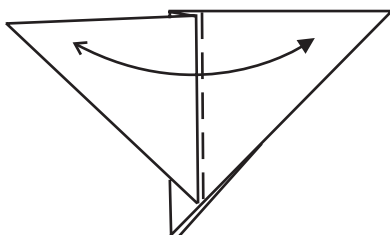

5. Перегните.

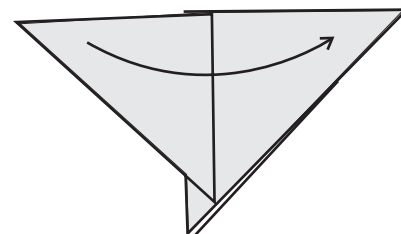

6. Отогните левый угол вправо.

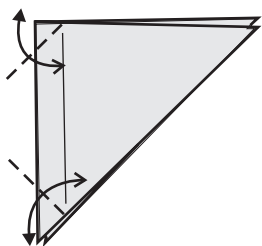

7. Глубинные сгибы.

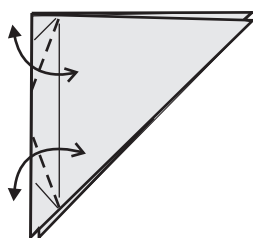

8. Ещё пара глубинок.

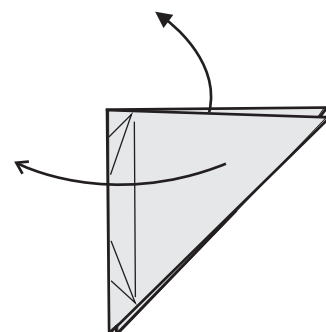

9. Полностью разверните.

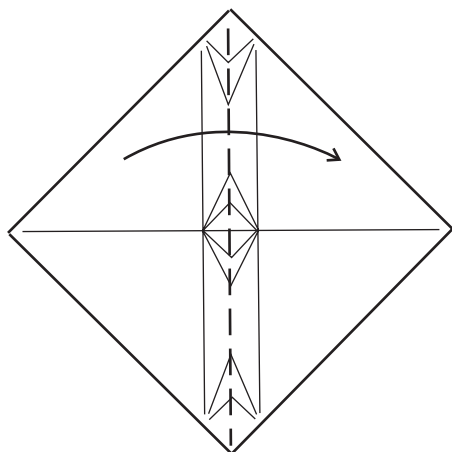

10. Согните квадрат по вертикальной диагонали.

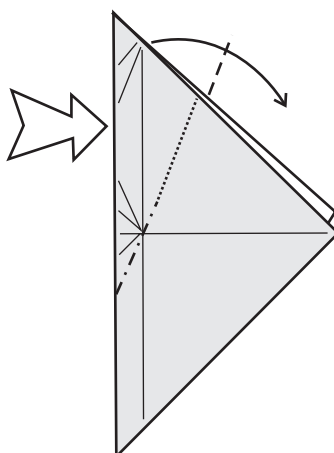

11. Сделайте внутреннюю складку, используя существующие сгибы. Не проглаживайте!

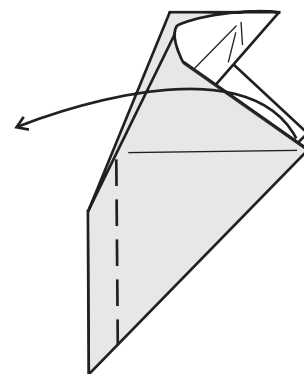

12. Отогните верхний слой влево по намеченной линии.

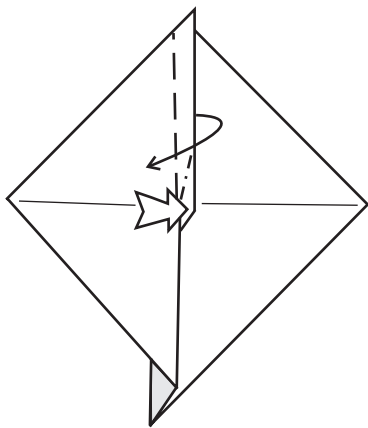

13. Согните складку влево по намеченным линиям заглагом.

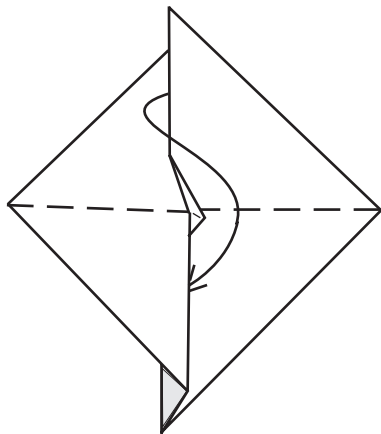

14. Согните пополам, при этом вставьте верхнюю складку в "карман".

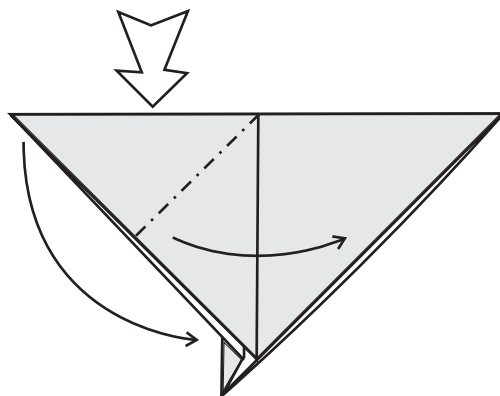

15. Раскройте карман.

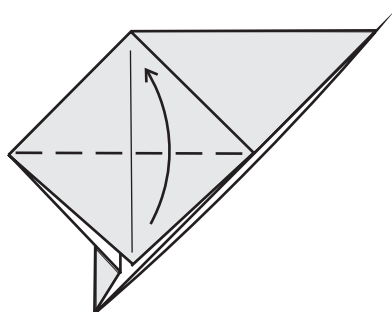

16. Отогните угол вверх.

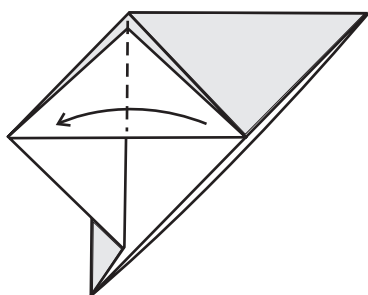

17. Закройте складку.

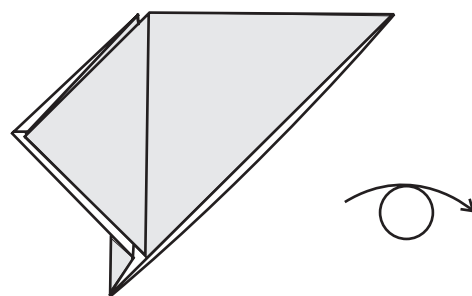

18. Проверьте результат и переверните фигуру.

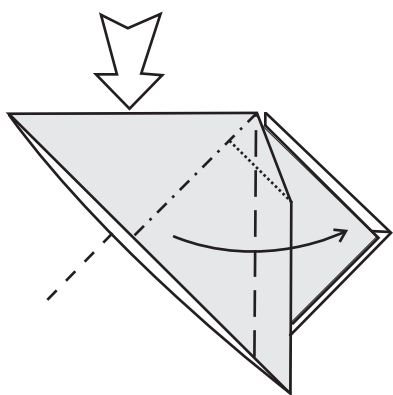

19. Раскройте карман.

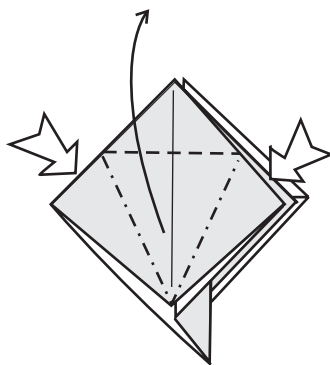

20. Лепесточный сгиб.

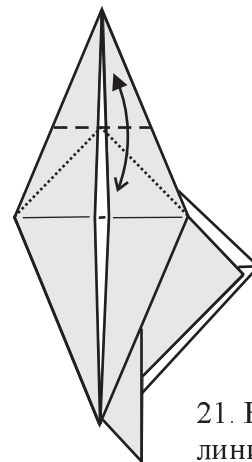

21. Наметьте линию.

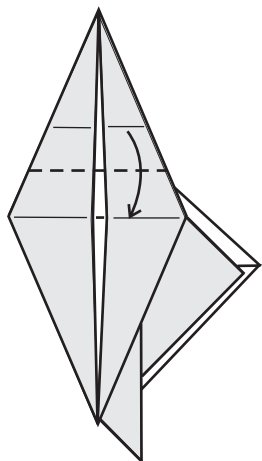

22. Согните угол вниз, совмещая намеченные ранее линии.

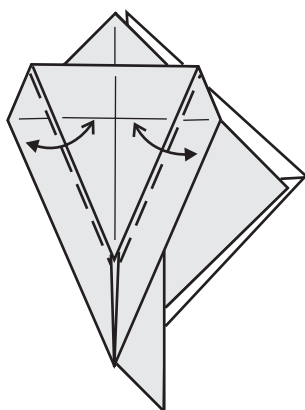

23. Две глубинные складки.

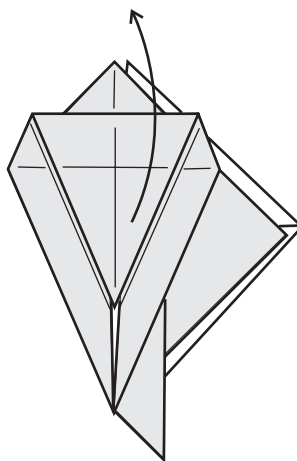

24. Отогните угол вверх.

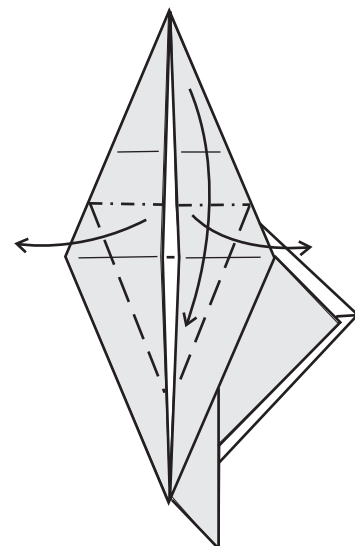

25. Раскройте створки складки, одновременно сгибая угол вниз.

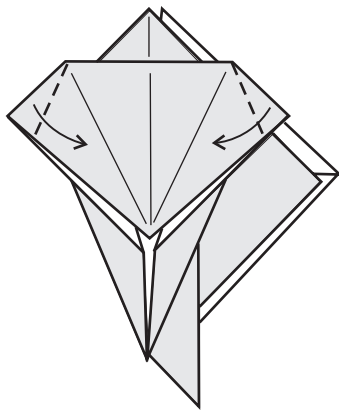

26. Согните два угла.

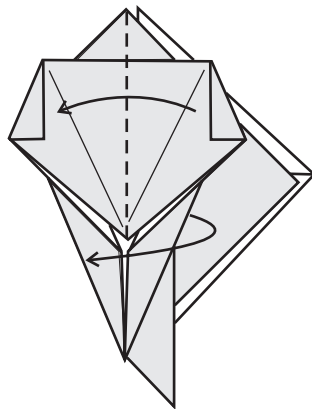

27. Закройте фигуру и поверните её на 90 градусов.

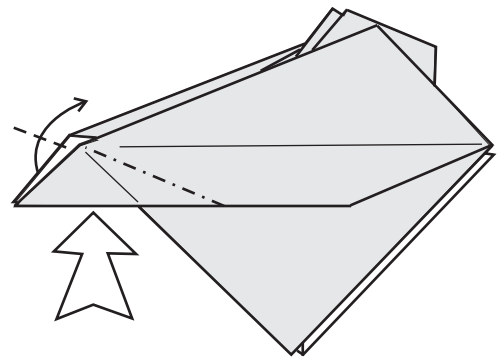

28. Сделайте внутренние горные сгибы на двух углах.

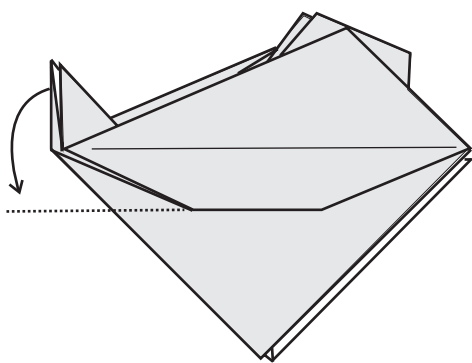

29. Вытащите внутренний слой.

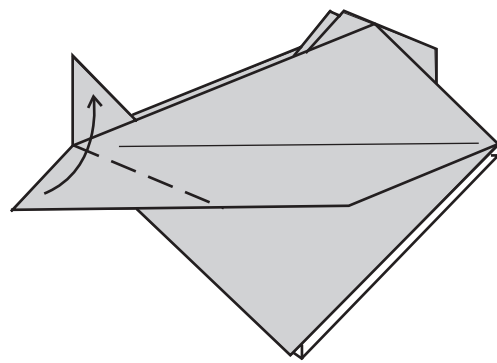

30. Согните угол вверх так, чтобы он совпал с другим углом.

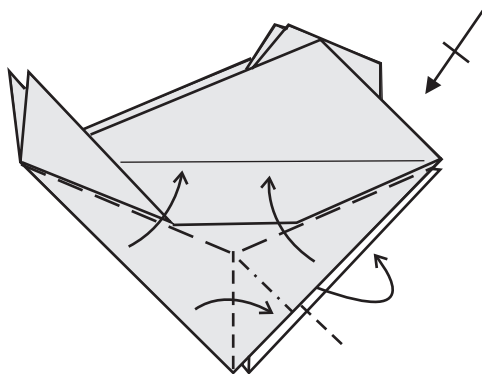

31. Складка "ухо кролика".  
Повторите с другой стороны.

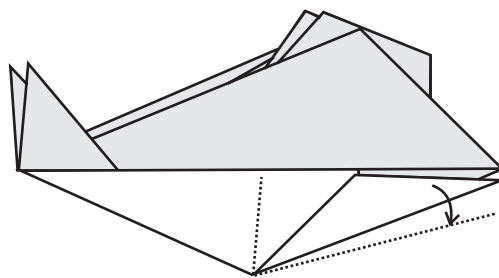

32. Осторожно потяните угол вниз.

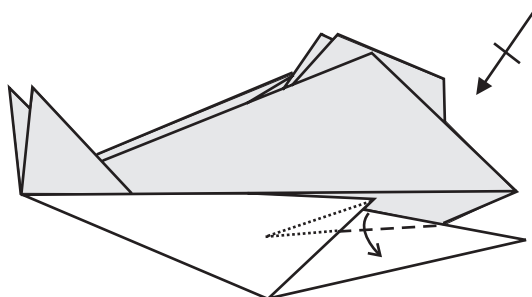

33. Глубинная складка.

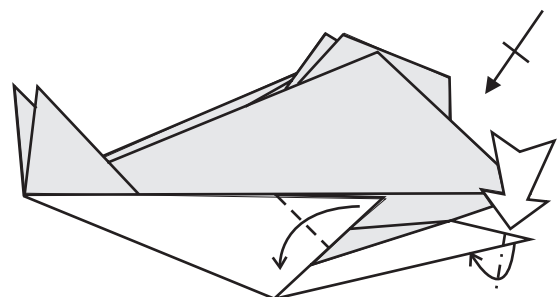

34. Отогните плавники. Внутренняя складка справа.

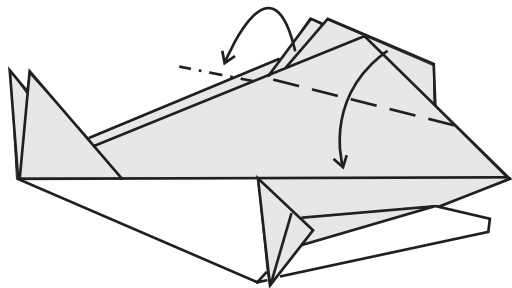

35. Сделайте пару глубинных сгибов.

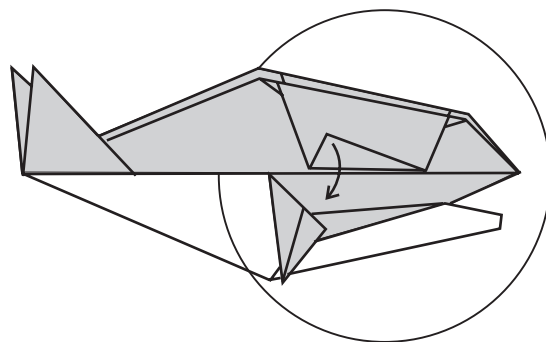

36. Отогните уголок вниз.

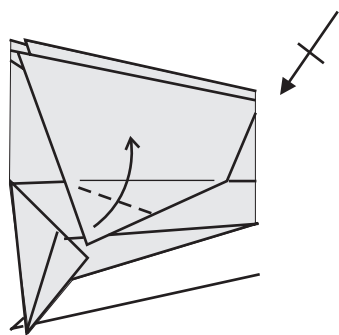

37. Согните угол вниз по биссектрисе.

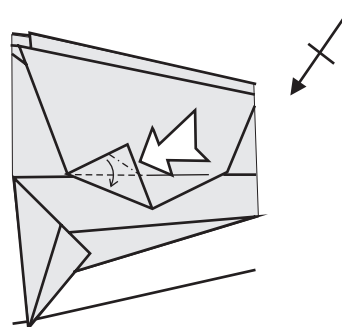

38. Раскройте карман.

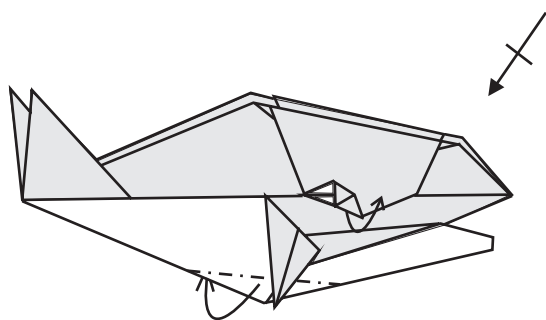

39. Два горных сгиба.  
Накройте часть складки  
в районе глаза слоем бумаги,  
который находится ниже.

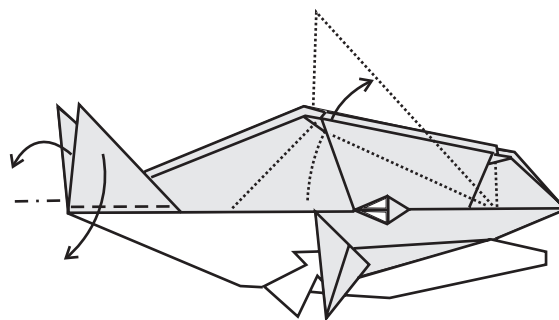

40. Сделайте хвост и поднимите  
спинной плавник кита.

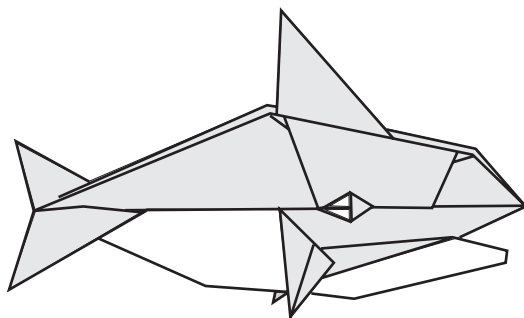

41. Касатка, прозванная моряками  
“морским волком”, готова!

# Кусудама

Автор: Нина Острун (г. Москва)



Начните с "базы блина"

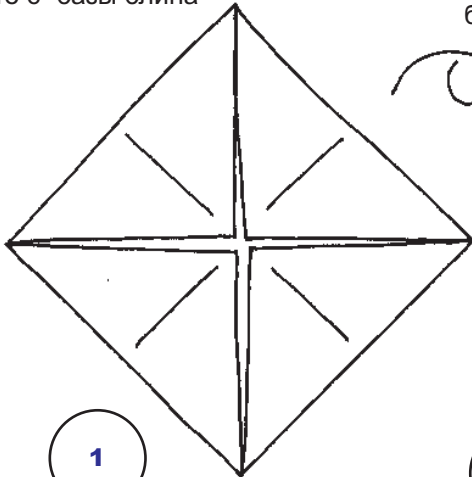

1

Затем сложите базу "квадрат"

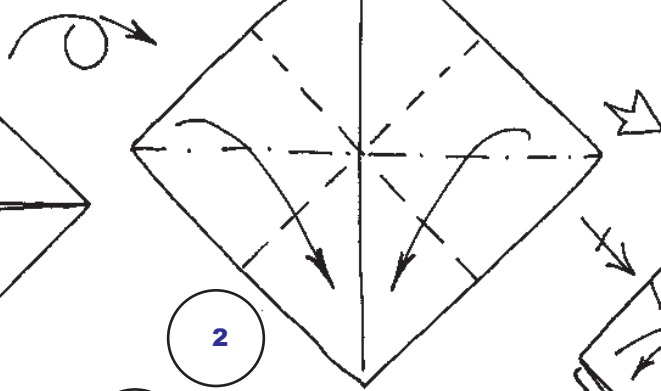

2

4

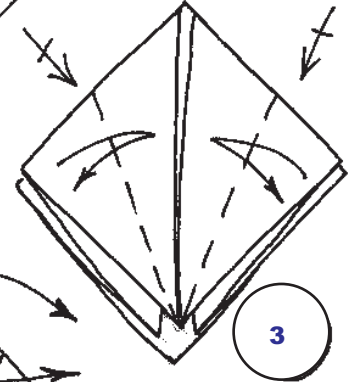

3

Повторите операцию с другой стороны

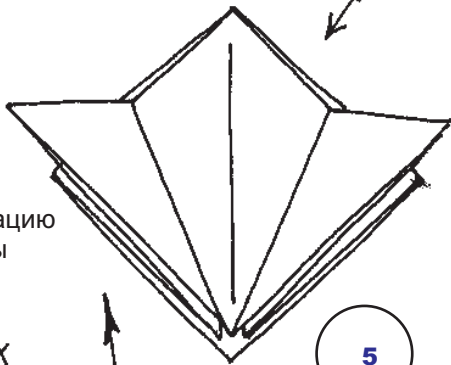

5

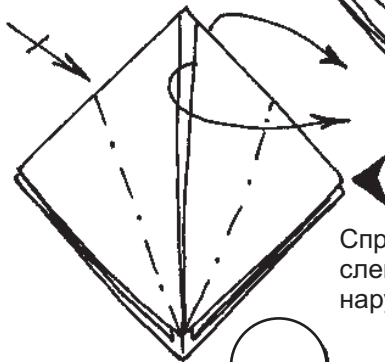

4

Справа вогните все слои внутрь, слева - верхний слой выгните наружу

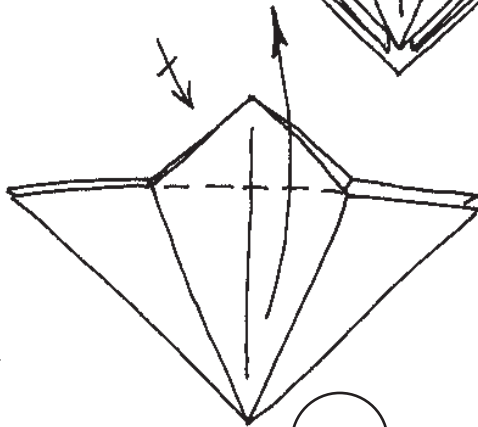

6

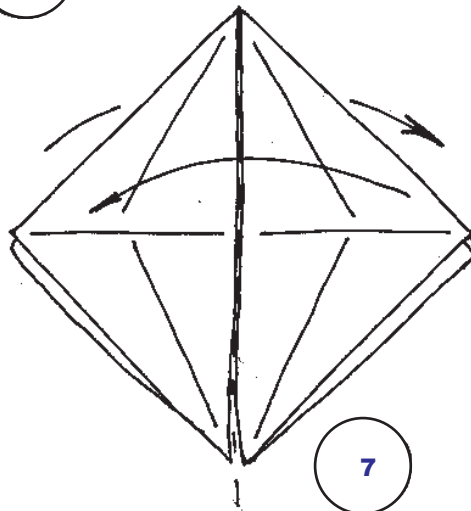

7

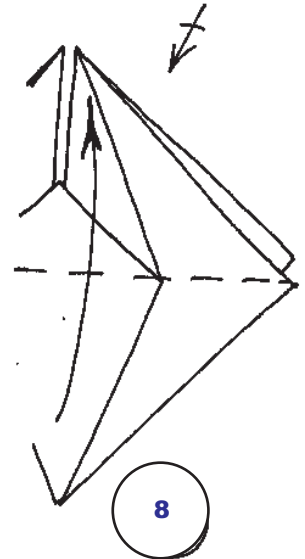

8

Все углы "звезды" должны "встретиться" внизу!

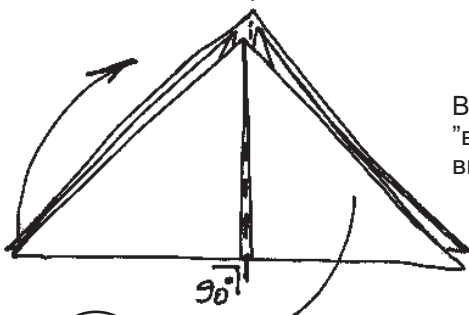

9

Отверните передний и задний треугольники так, чтобы получился крест

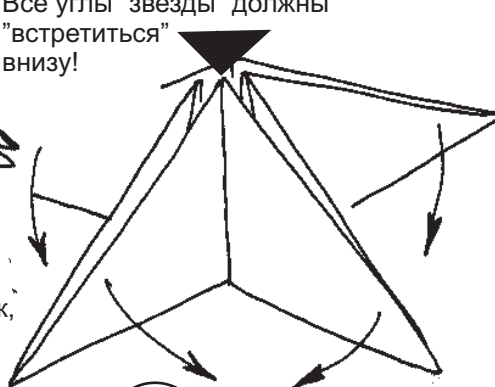

10

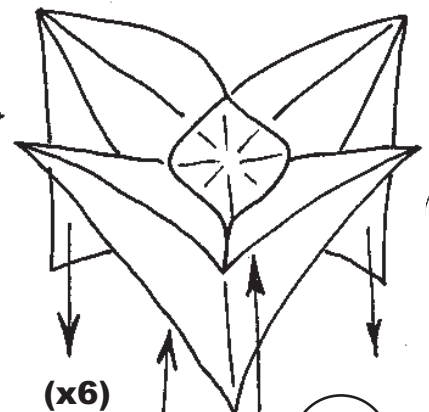

(x6)

11

Первый элемент готов! Сложите ещё 5 и соберите кусудаму! Модули отлично держатся без клея!

Low Intermediate  
A 6" square makes a 3" model

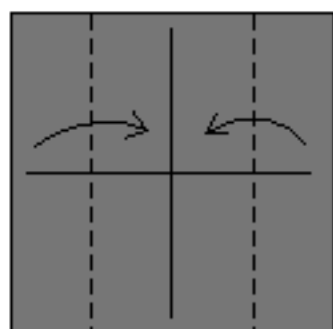

1. Valley sides to center.



2. Reverse fold the four corners.

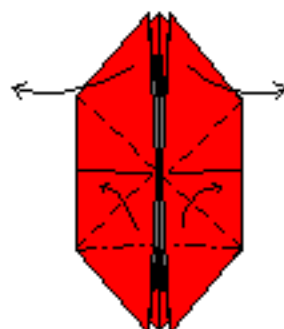

3. Spread out the top. Swivel up the flaps at the bottom.

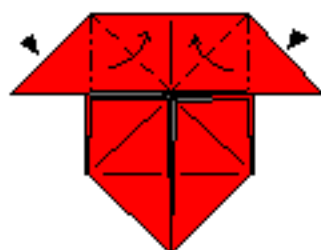

4. Squash fold the top flaps.



5. Valley the single layers outwards.

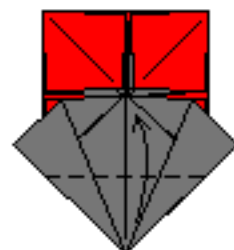

6. Valley up.



7. Valley down.

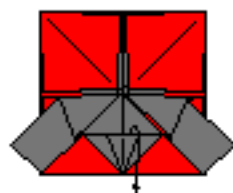

8. Swing down.



9. Fold back up while folding in the sides.

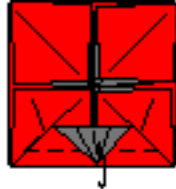

10. Pull down as far as possible.



11. Valley and precrease where indicated.



12. Make valley folds.



13. Squash fold.

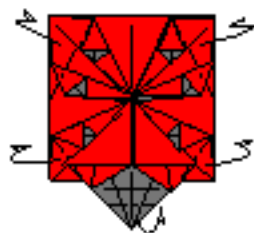

14. Round model with Mountain folds.



15. Completed Simple Ladybug  
© 1996 Marc Kirschenbaum



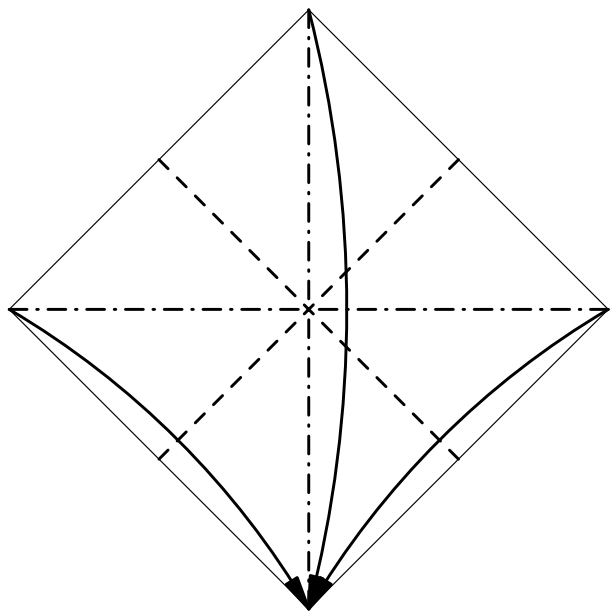

1

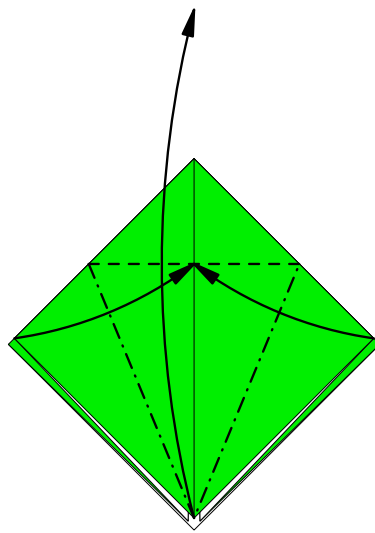

2

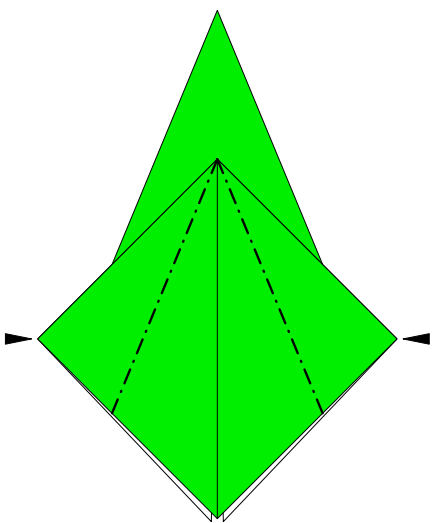

3

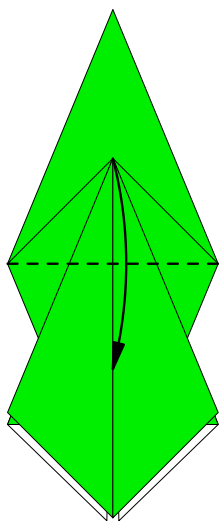

5

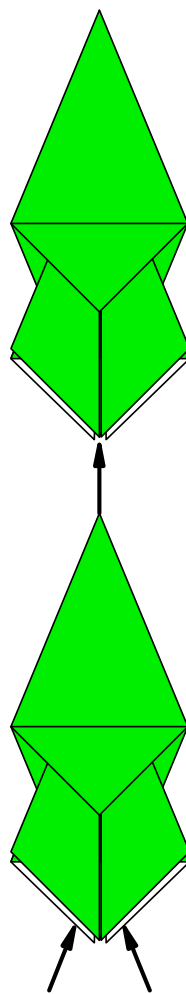

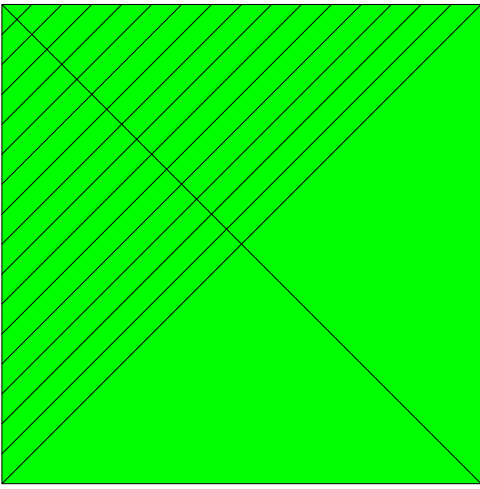

1 Make diagonal creases so dividing one half in 16.

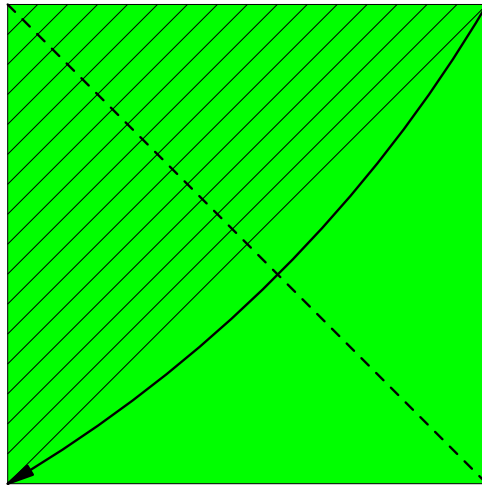

2

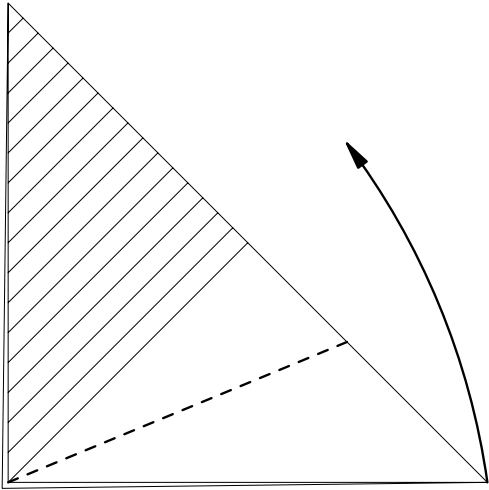

3

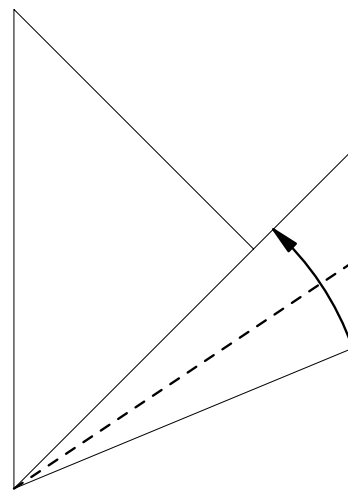

4

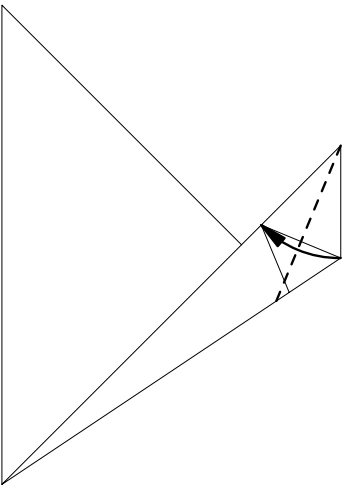

5

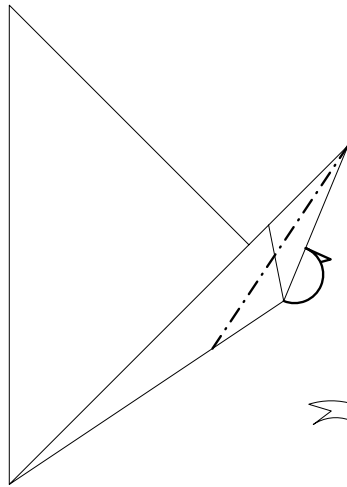

6



1

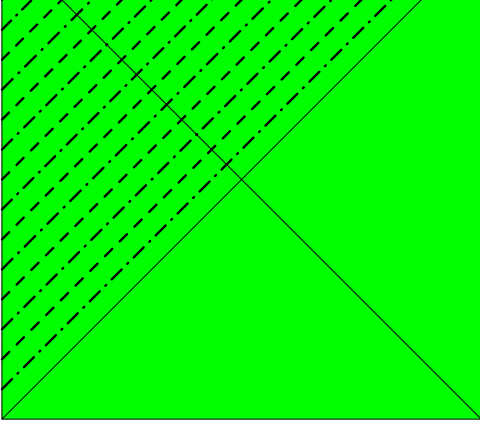

7 Zigzag left upper half.

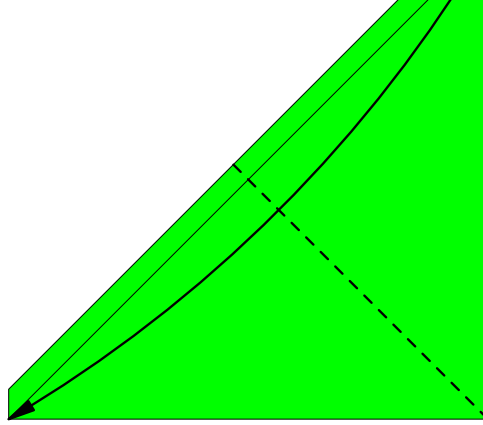

8

3D  
→

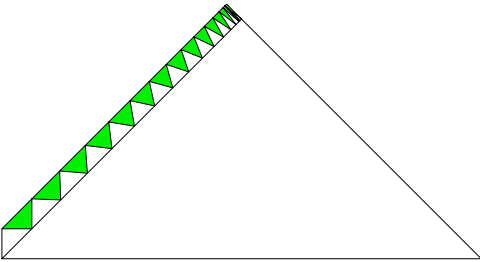

9 Repeat folds of 3 up to 6.

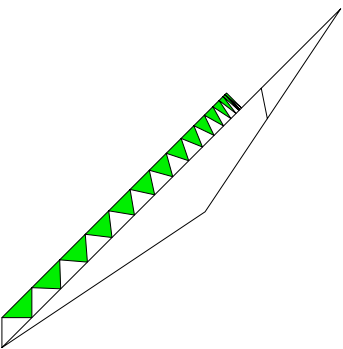

10 Curl the stalk.

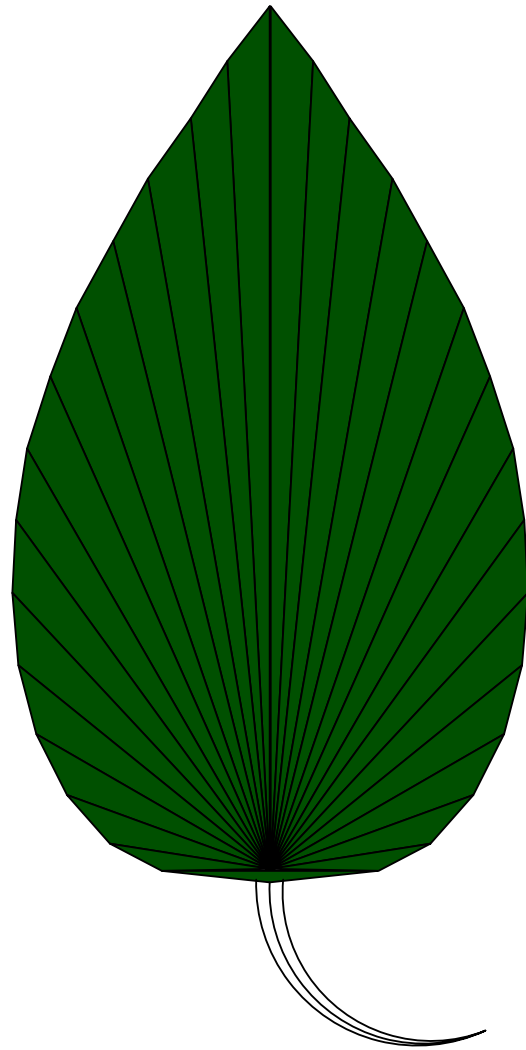

# Waterlilly

Maarten van Gelder

© 1991 Apr

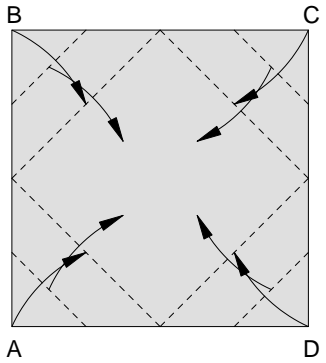

1

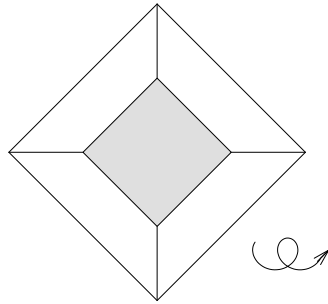

2

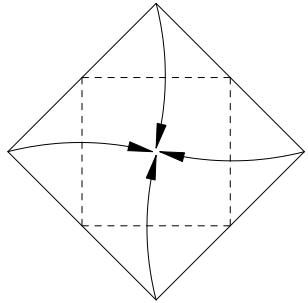

3

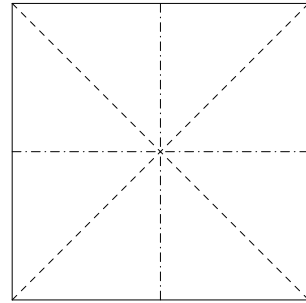

4

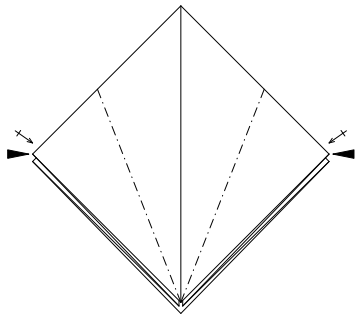

5

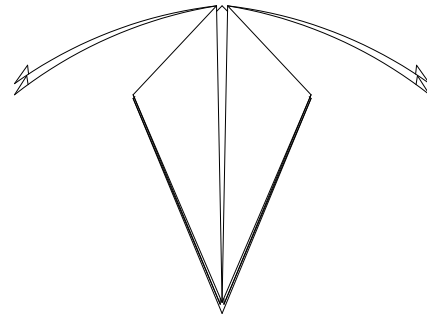

6

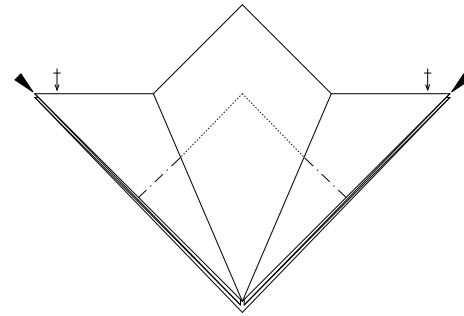

7

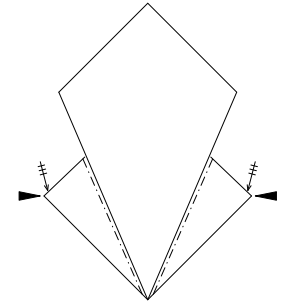

8

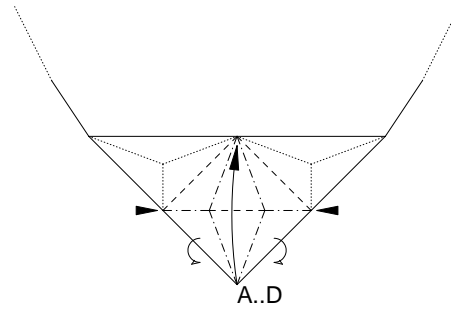

9 Unfold points A..D completely and reorder the folds as shown. Fold the lilly again with points A..D inside but visible now. Folds are shown on the white side.

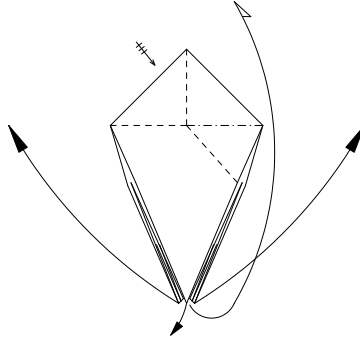

10

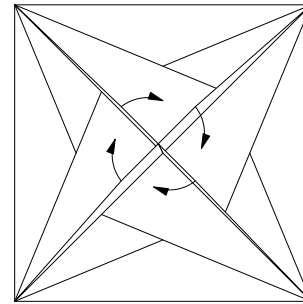

11 Push raised centre flat in a spiral movement.

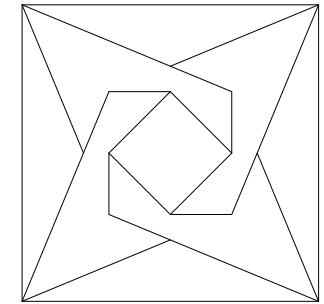

12

Instead of pushing the raised centre flat it is also possible to fold the centre inside the model to give the flower a colored heart. Very difficult!

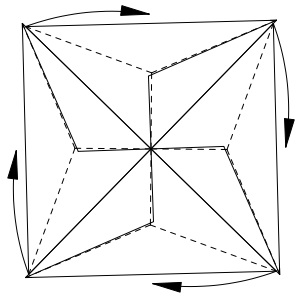

13



3D

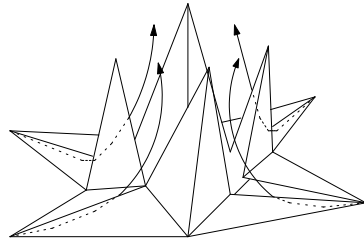

14 Get points A..D (diagram 1) out.

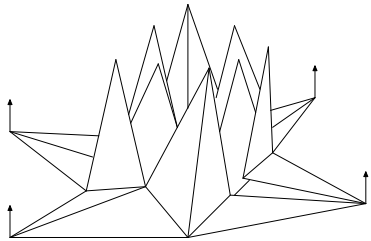

15 Curl points.

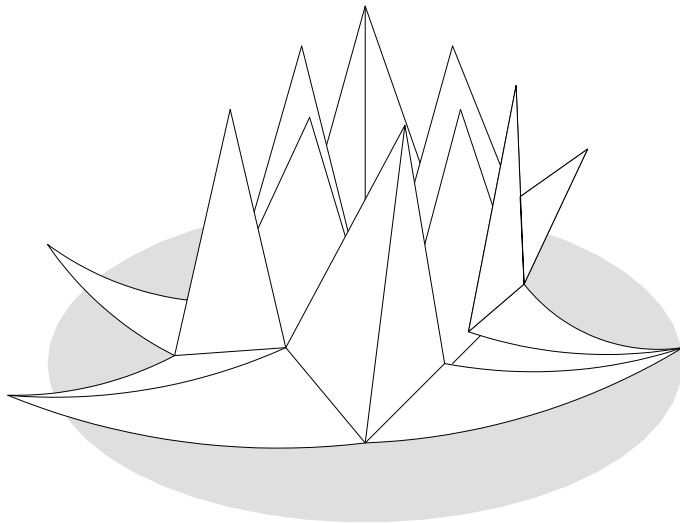

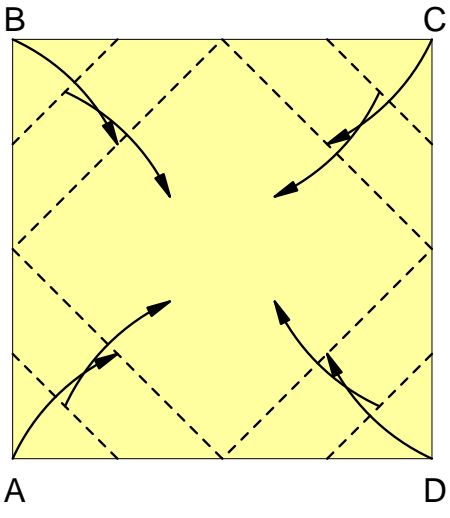

1

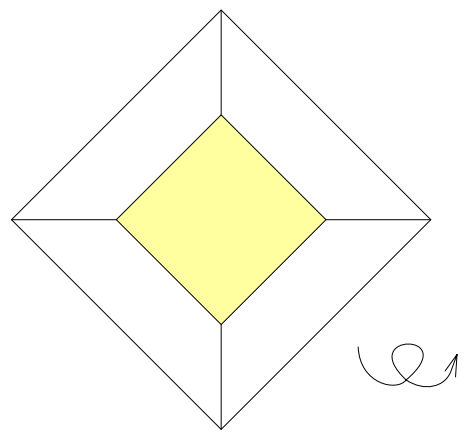

2

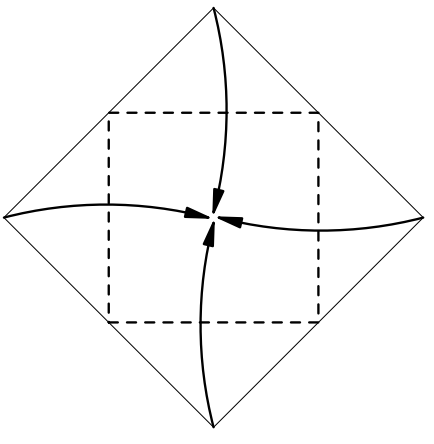

3

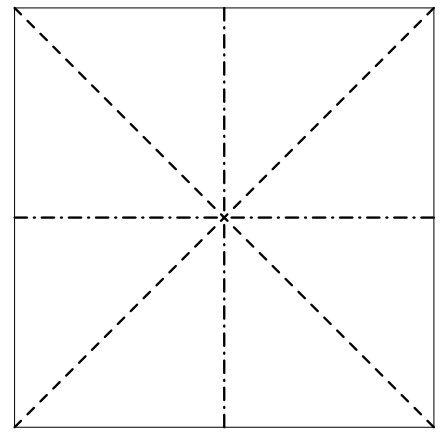
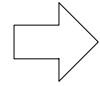

4

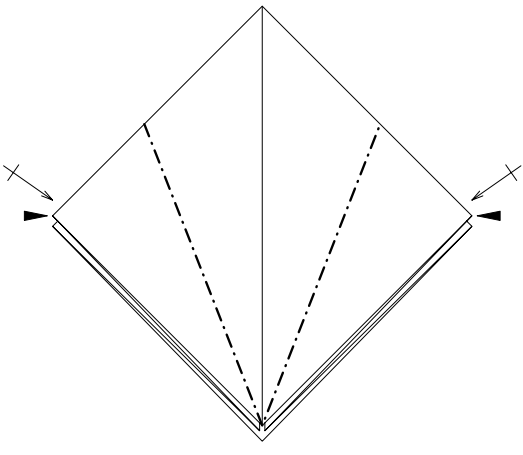

5

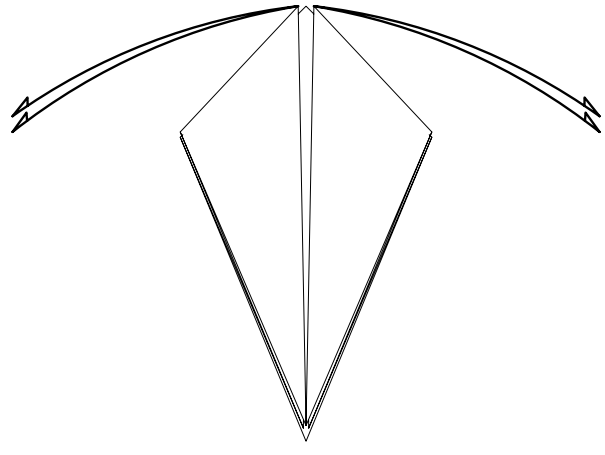

6

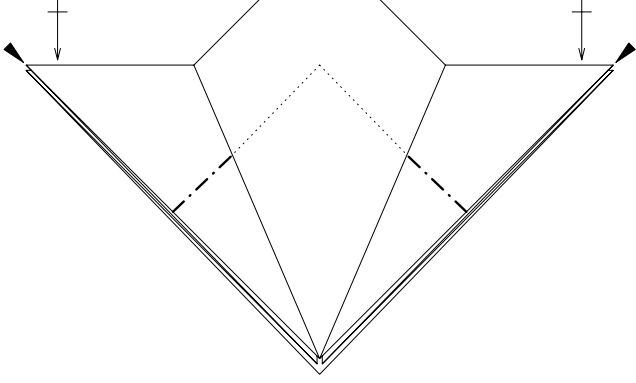

7

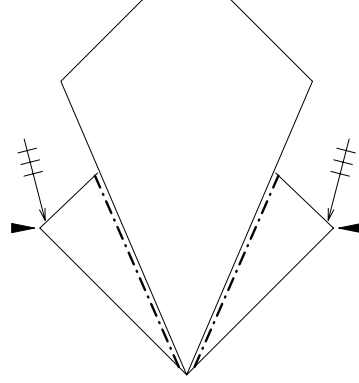
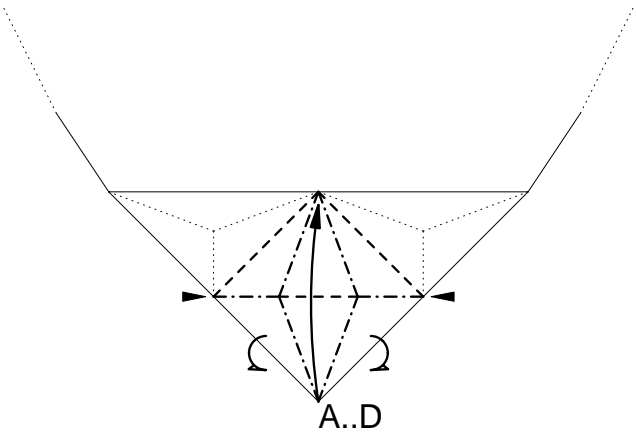

8

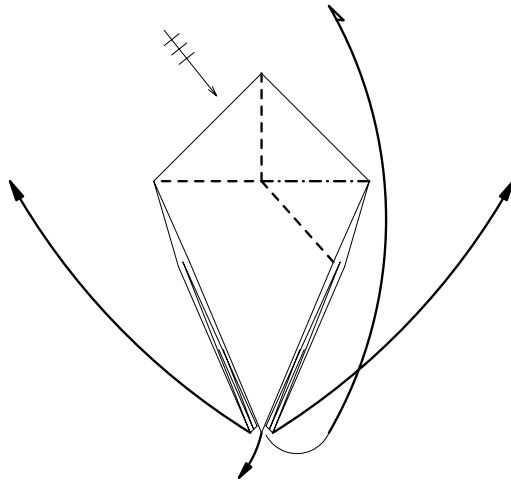

9 Unfold points A..D completely and reorder the folds as shown. Fold the lilly again with points A..D inside but visible now. Folds are shown on the white side.

10

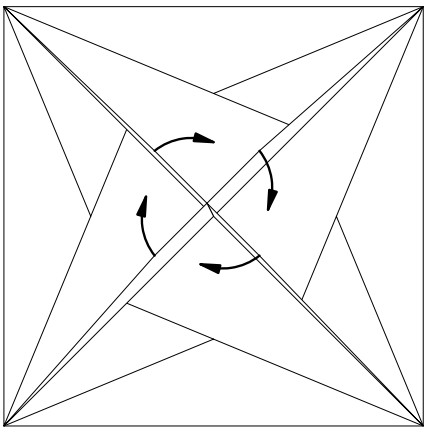

11 Push raised centre flat in a spiral movement.

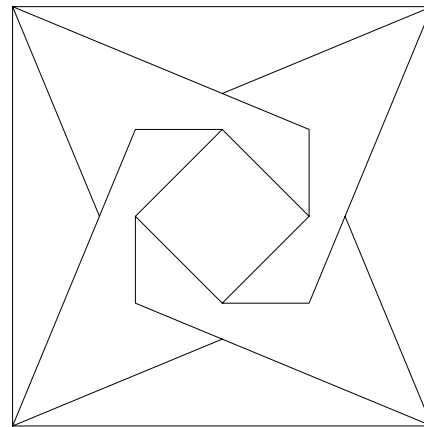

12

Instead of pushing the raised centre flat it is also possible to fold the centre inside the model to give the flower a colored heart. Very difficult!



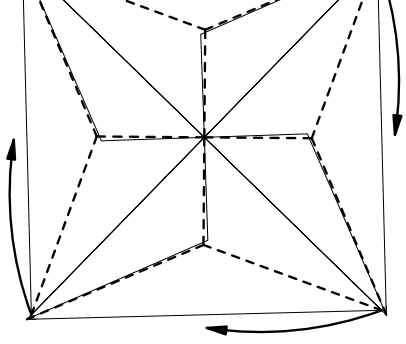

3D

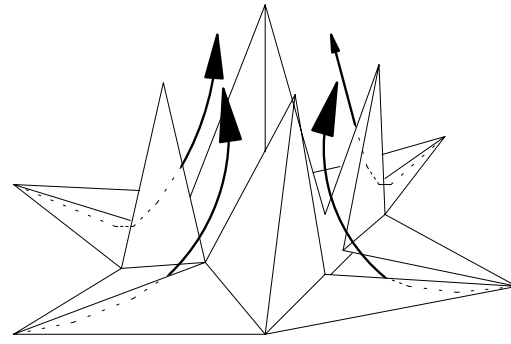

13

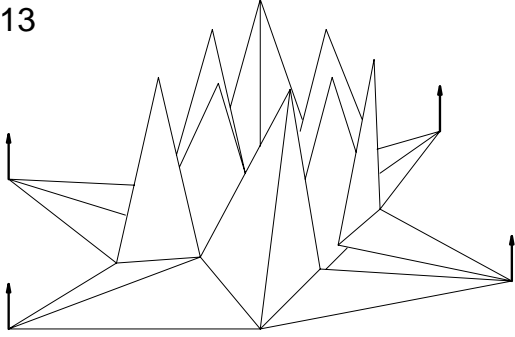

14 Get points A..D (diagram 1) out.

15 Curl points.

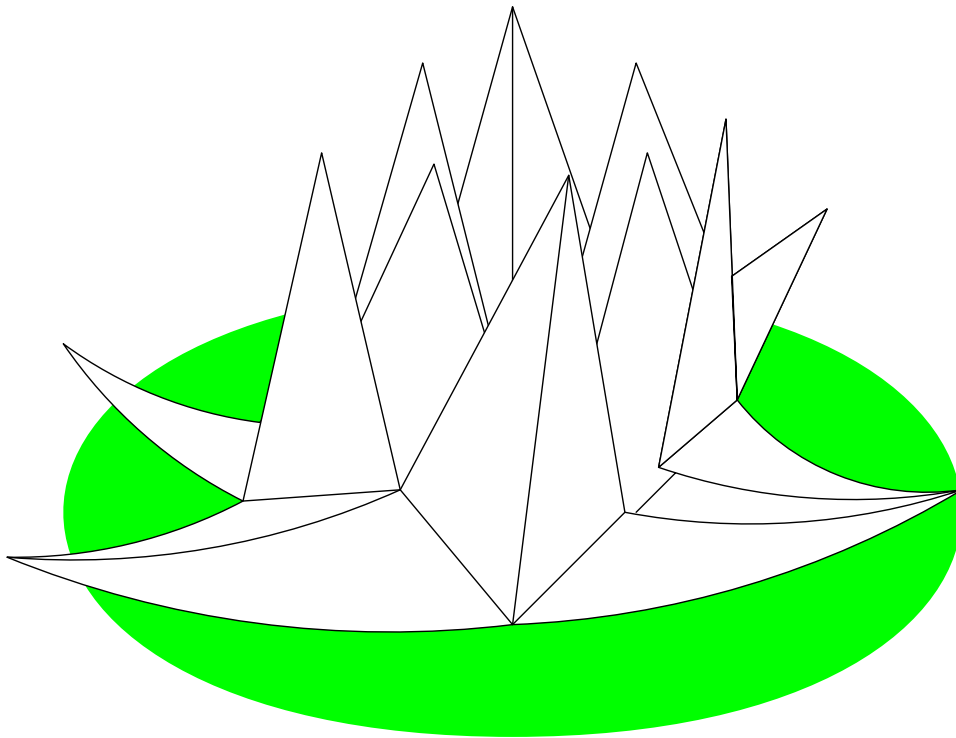



Start with white side up  
 Mark points A, B, C and E as given by the marks around the square  
 The small angles at A and B are about 7.5 degrees (and the same size)

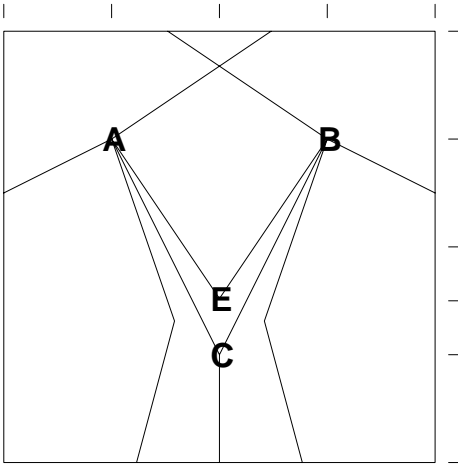

1

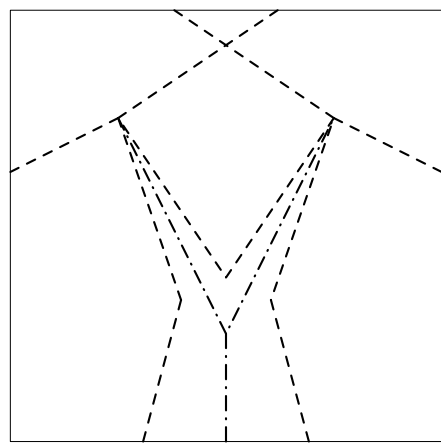

2

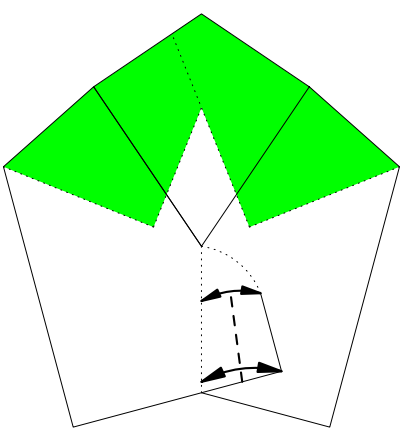

3

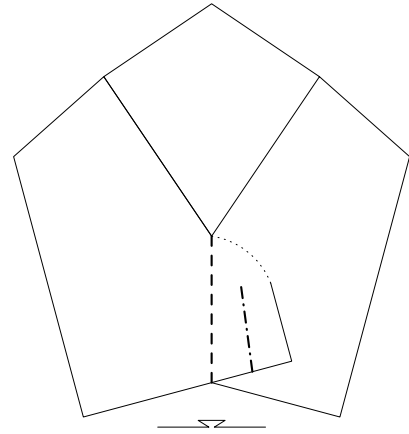

4 The large flaps at the top are not drawn  
 Squash fold flap

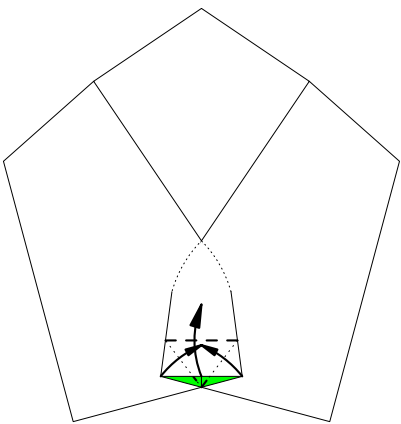

5 Flatten top folds/flaps

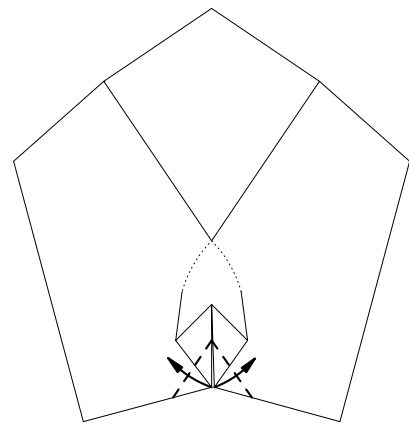

6

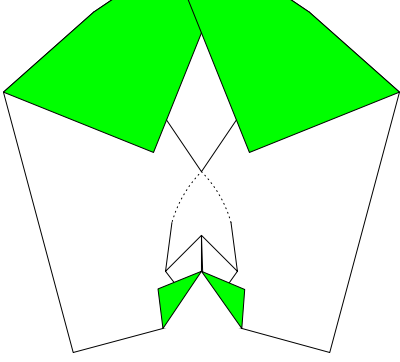

7

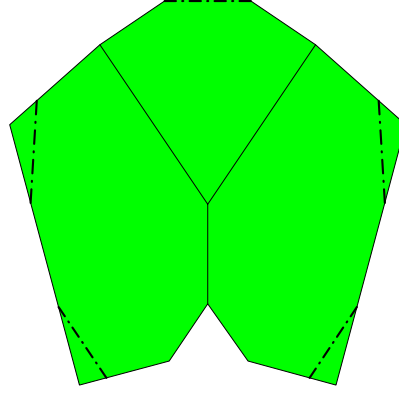

8 Round off the corners

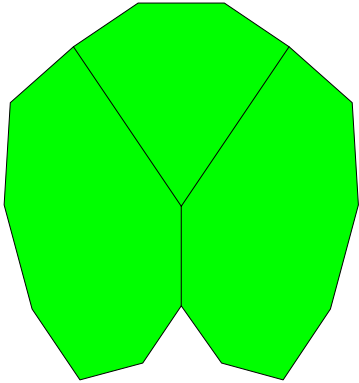

9 Again: soften the corners

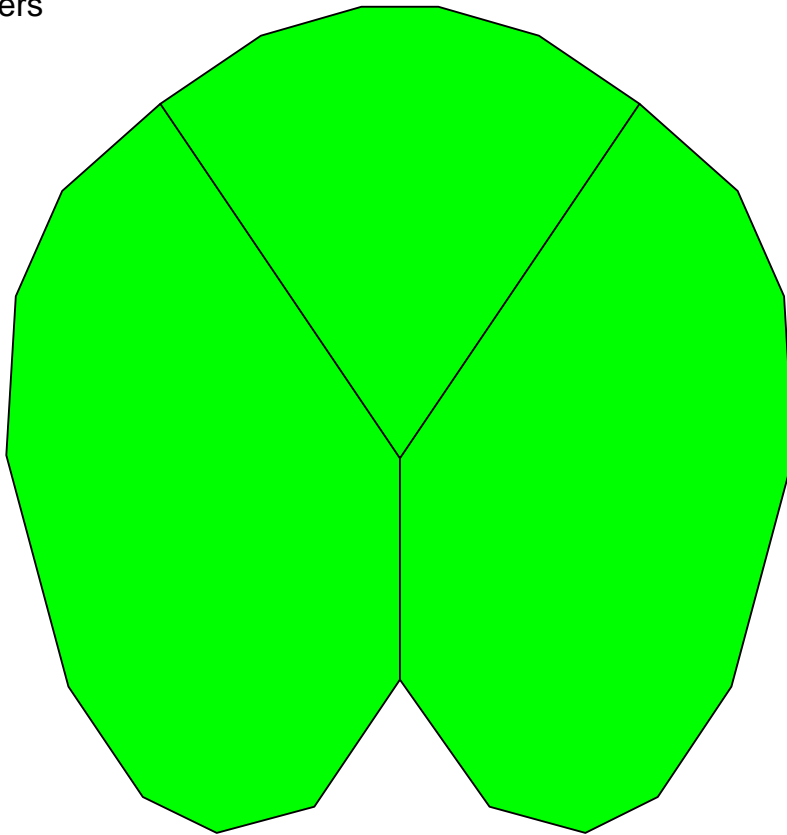

# Lily-Fly

by Kalei Anne Lundberg  
copyright 2000

This model appeared while I was playing with the lily base and because I wanted to send a butterfly to Sweden. The diagrams are offered for personal use any other use please contact me for permission at [lilyfly@kalei.com](mailto:lilyfly@kalei.com).

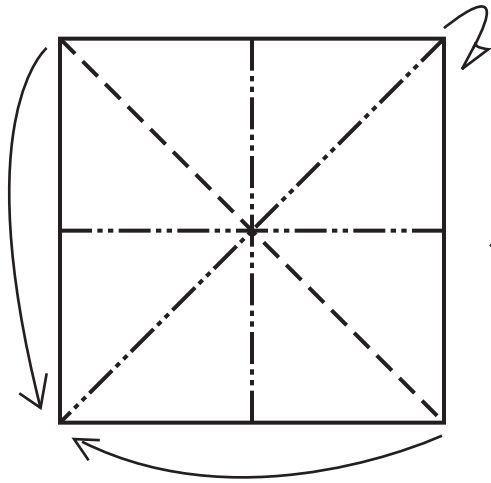

1. Do the star precrease, color side up, and collapse the model into a colored preliminary fold.

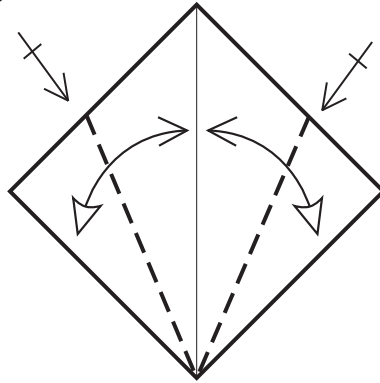

2. Fold and unfold to the center line. Repeat on the other side.

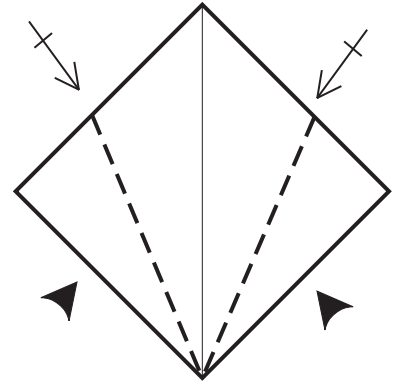

3. Inside reverse fold along the preceased lines. Repeat on the other side.

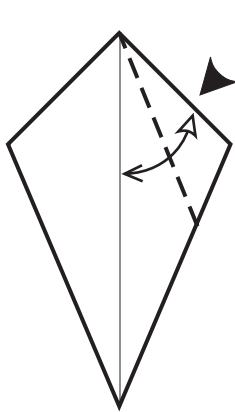

4. Fold and unfold to the center line. Spread squash fold along the precrease.

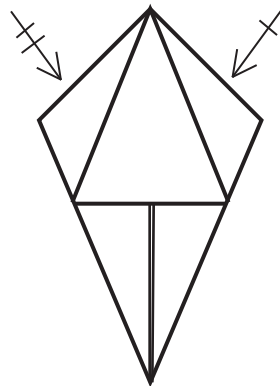

5. Model after the spread squash is complete. Repeat on the other 3 sides. Note this is the lily base with the small points tucked to the inside.

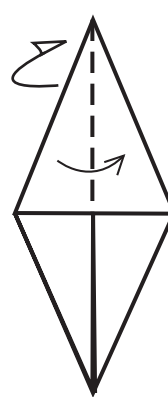

6. Fold a single layer on the front and back left side to the right. Note: that the right side of the model will now enclose two full points

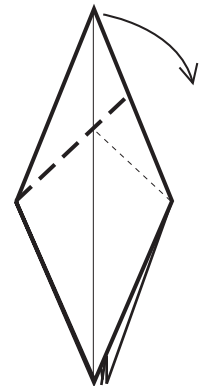

7. Valley fold the top point down. This fold will fall along the interior thickness.

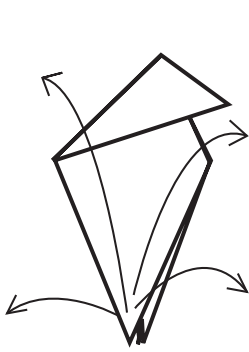

8. Open up the four points. The model will lay flat. Note: The reverse side of the model should be oriented as in step 13.

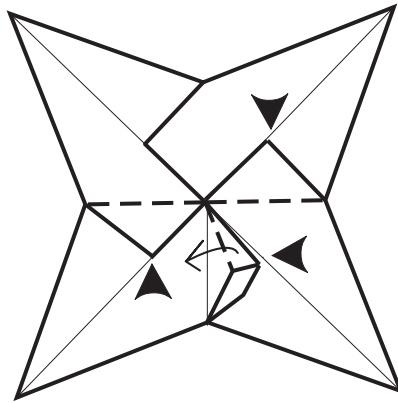

9. Inside reverse the two triangular folds between the top and bottom set of wings. Squash fold the bottom triangular fold.

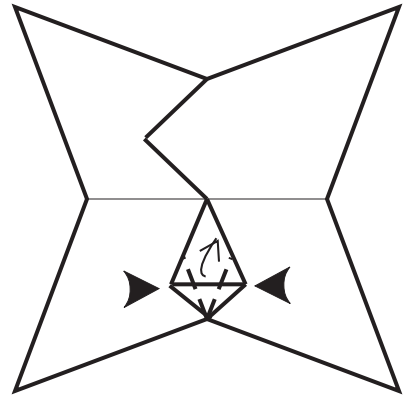

10. Petal fold.

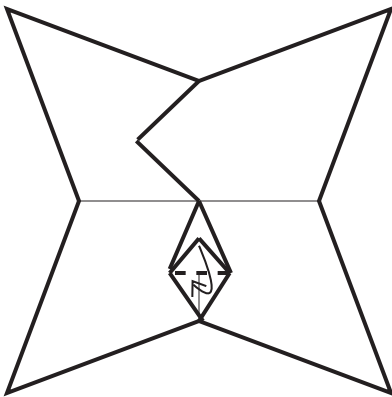

11. Tuck the small point to the inside.

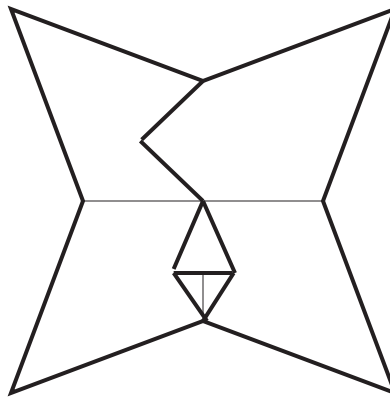

12. Turn model over.

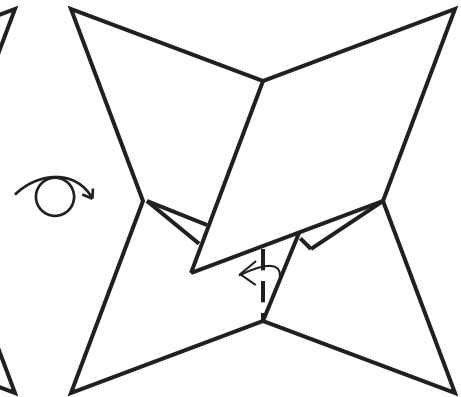

13. Valley fold the top layer to the left to complete the separation between the two bottom wings.

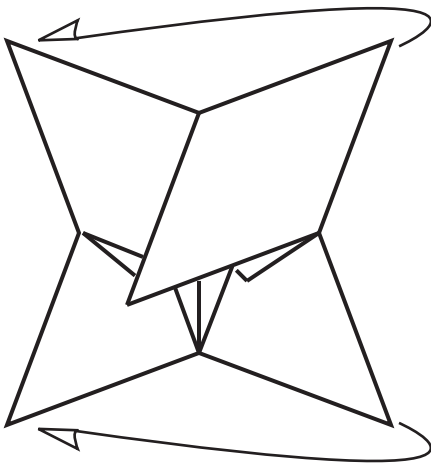

14. Fold model in half.

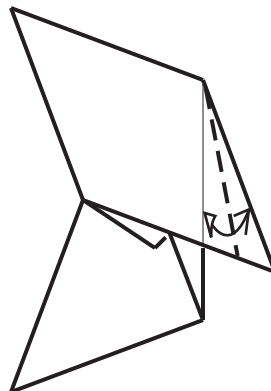

15. Fold and unfold to align along the edge of the wings.

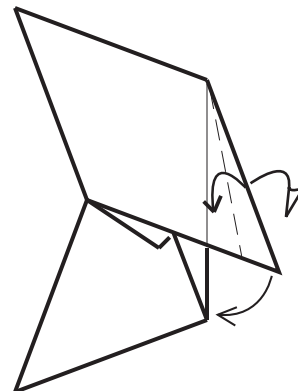

16. Outside reverse along the precrease line while sliding the point downward. This will cause a small crimp fold on either side of the model.

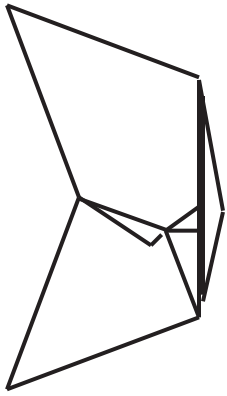

17. Note that the crimp curls up over the top wing and tucks into the body.

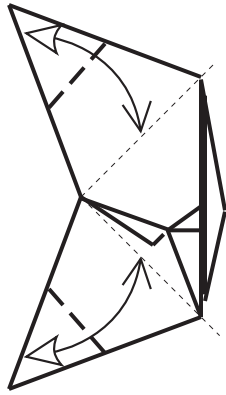

18. Fold and unfold. Light lines show the landmark. Repeat on back.

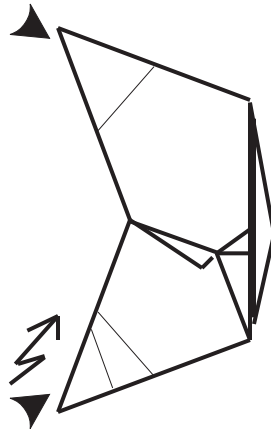

19. Reverse fold the tips to the inside. The bottom wings have an extra reverse fold for the tip. Repeat on back.

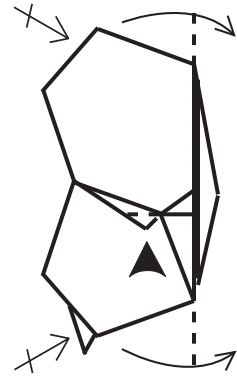

20. Reverse fold the small tip between the wings along line. Repeat on the back. Fold wings to the right repeat on the back.

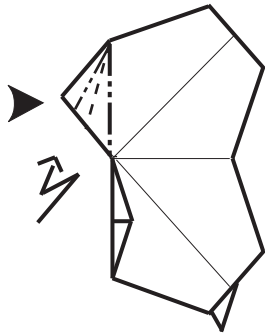

21. Step reverse fold the tip three times. Note the second reverse will be even with the body side of the model. Open.

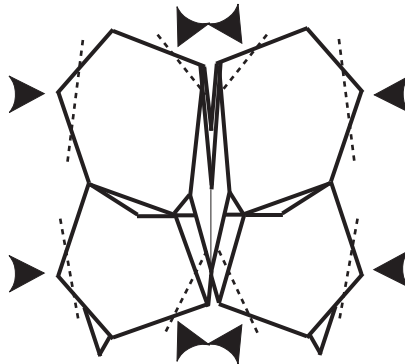

22. Shape the wings by sinking the tips through all layers. Some of these can be a bit tricky.

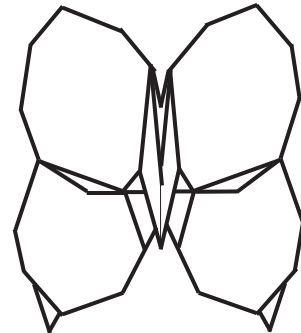

23. Ta Dah!!!!

Start with a rectangular sheet

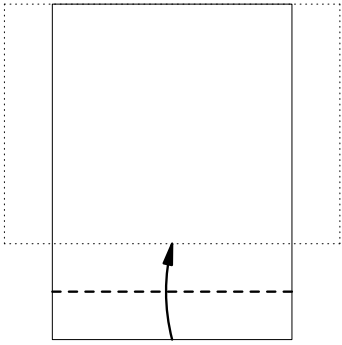

1 Use one sheet as a measure for the other

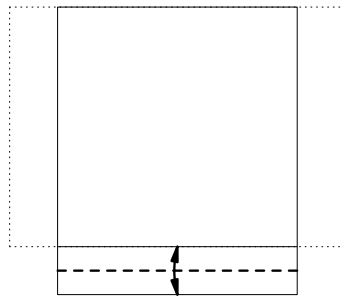

2 Unfold and repeat at other end

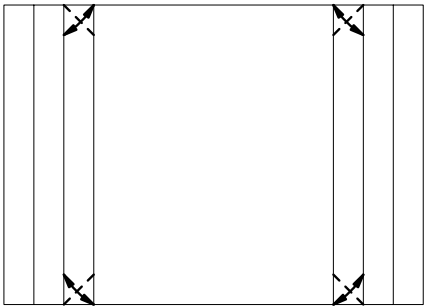
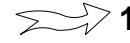

3

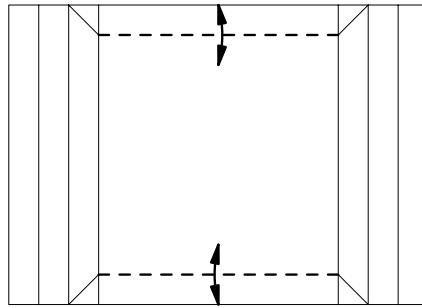

4

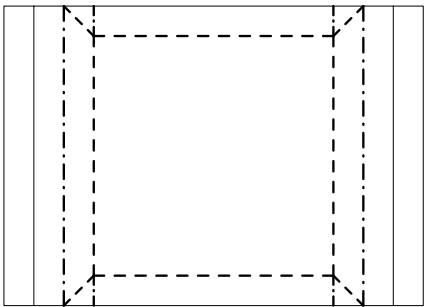

5 Make a 'tray' (3D)

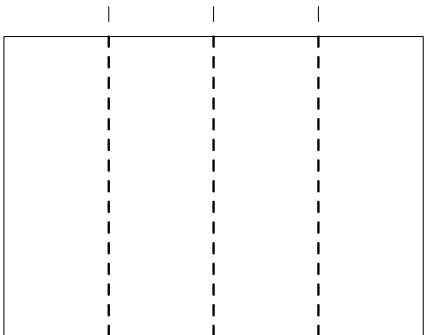
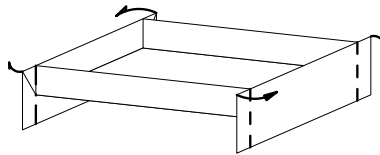

7 Divide in four and make a 'tube'

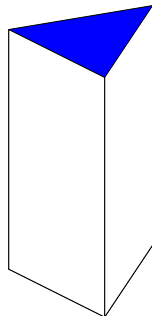

Make five 'tubes' per level  
Make two trays per level  
Place tray on floor or table  
(fold bottom strip up)  
Put five tubes on the tray  
Place tray upside-down on tubes  
Place next tray normally on top  
Put five tubes on the tray  
Etcetera ...

# Happy Good Luck Bat by Michael LaFosse

Intermediate

This model, designed for the New York Asia Society in 1984, is the Japanese symbol for good luck. The bat is "happy" because the tapering of the ears in the final step causes it to appear to be smiling. The model is intended to be wet-folded from a half a square of paper, colored identically on both sides, but it may also be folded from a single square folded in half diagonally. A 10" square produces a 5" model. Michael LaFosse has been producing professional quality origami products for over twenty years. For information on purchasing instructional video tapes of this and many other models write him at 170 Margin Street, Haverhill, MA 01832 or Fax him at (508) 373-5503

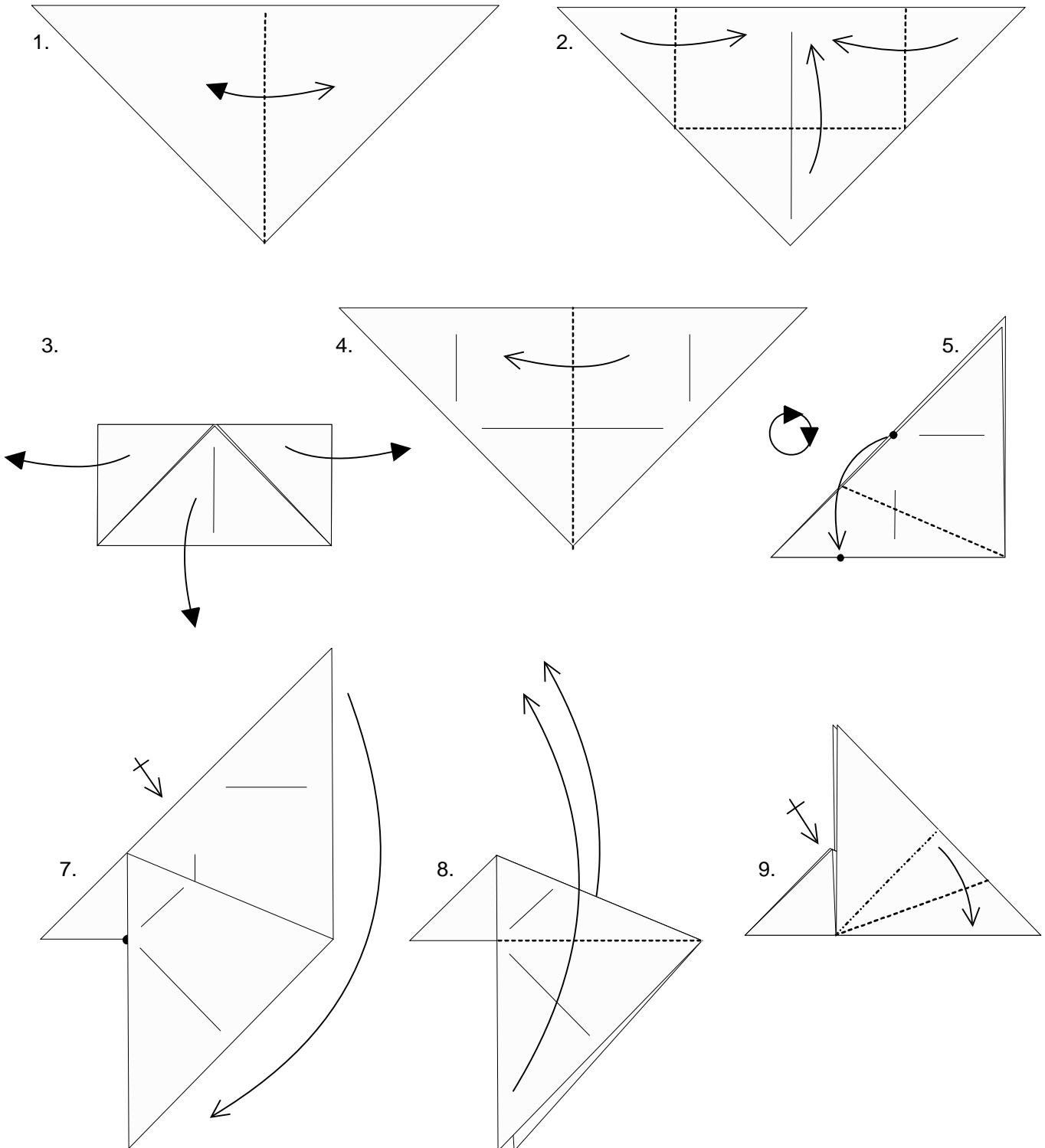

Diagrammed by J.C. Nolan - Sept.'94

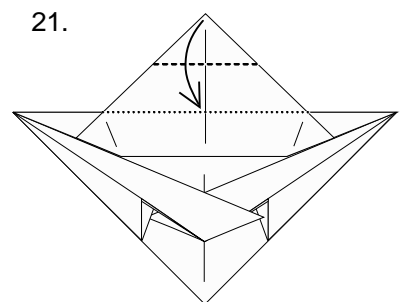
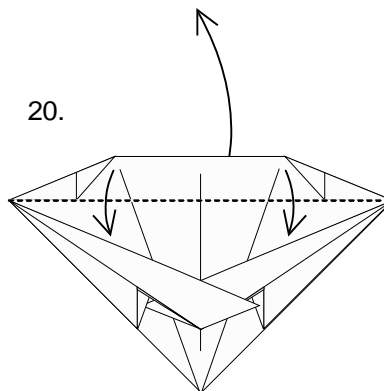
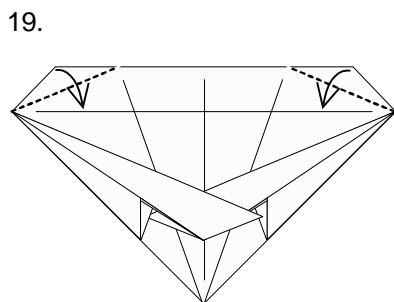
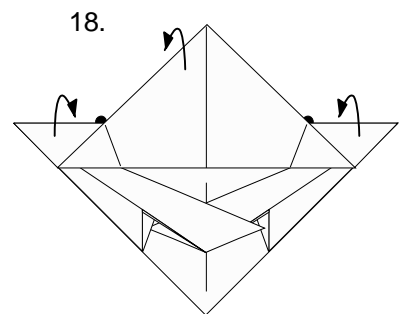
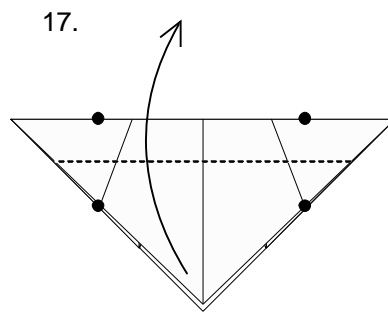
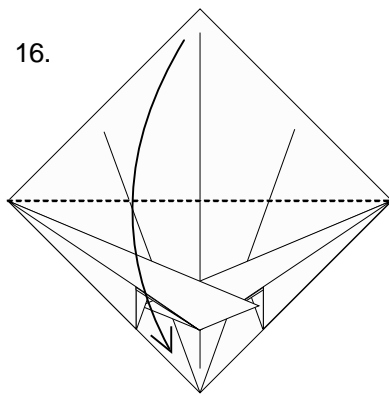
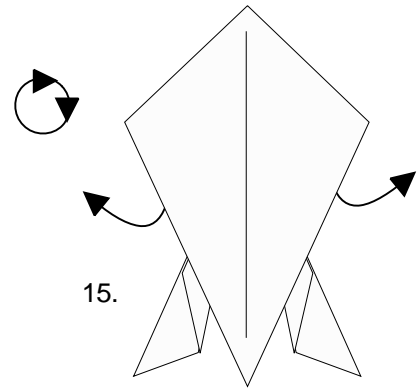
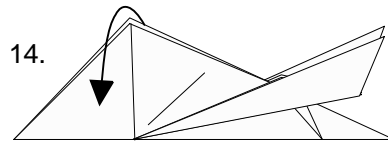
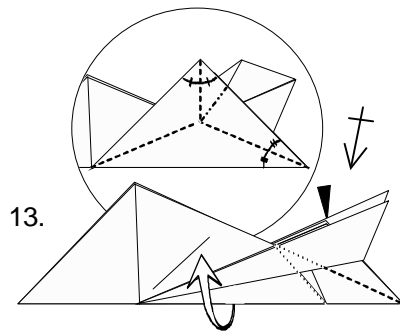
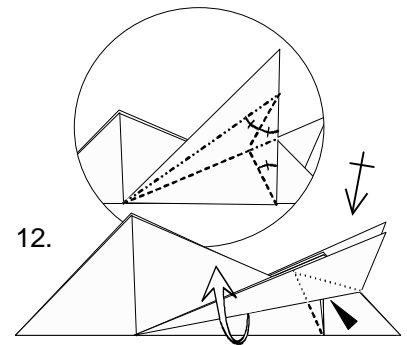
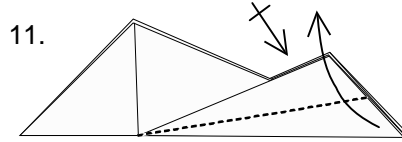
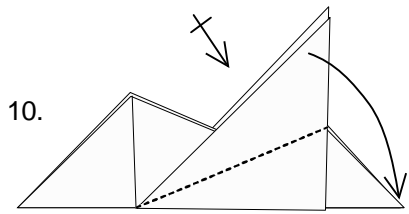



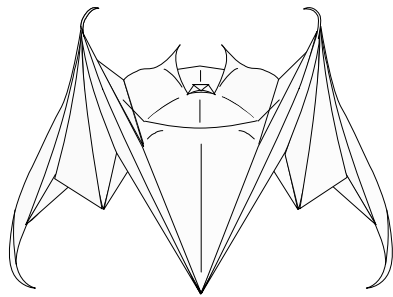
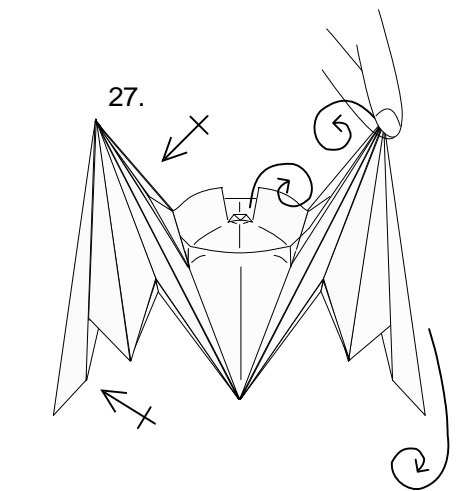
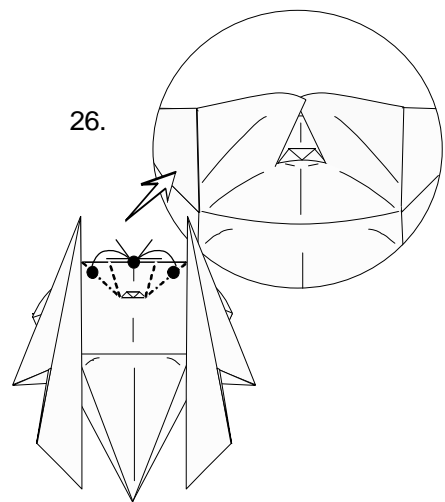
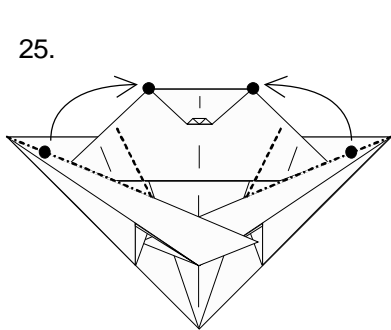
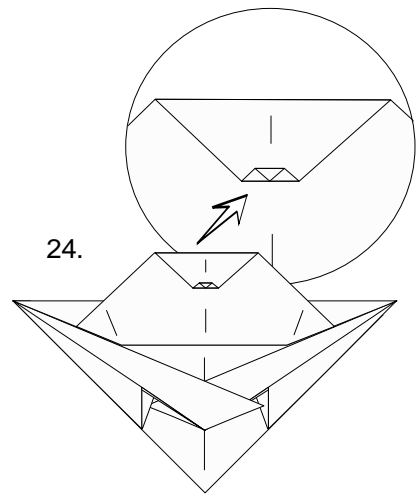
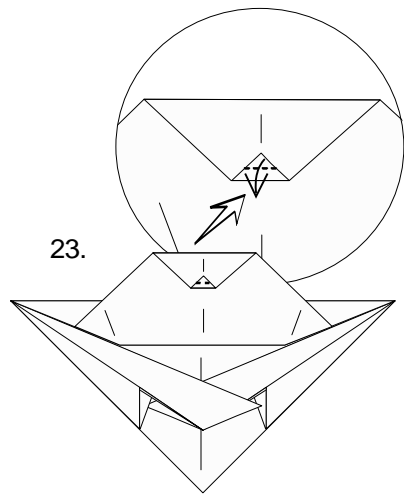
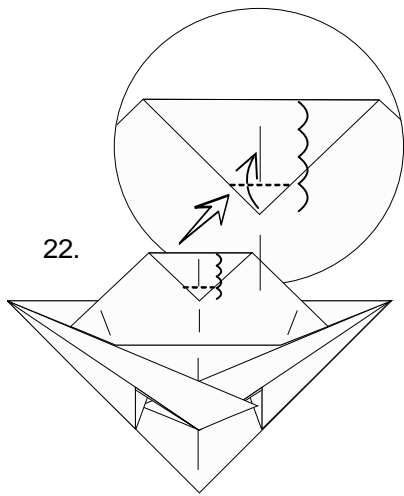

**Grumpy Bat**  
*(Taper Ears Inward)*

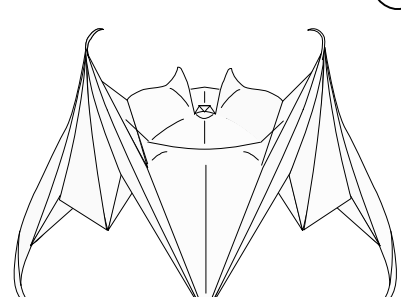

**Vocal Bat**  
*(Open Mouth)*

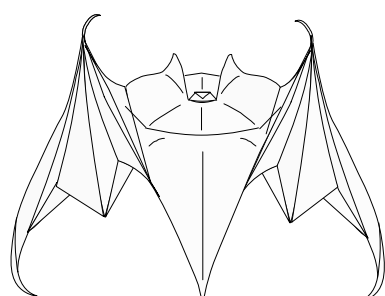

**Tapered Bat**  
*(Taper Bottom Inward)*

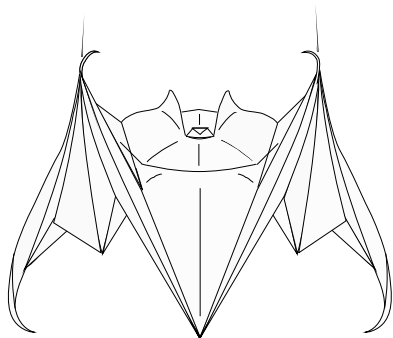

**Happy Bat**  
*(Original Version)*

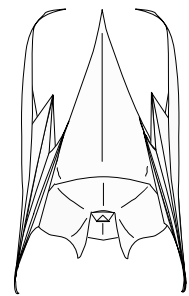

**Sleeping Bat**  
*(Taper Bottom, Invert & Compress)*

# Manatee by Gabriel Willow

Intermediate A 10" square produces a 9" model.

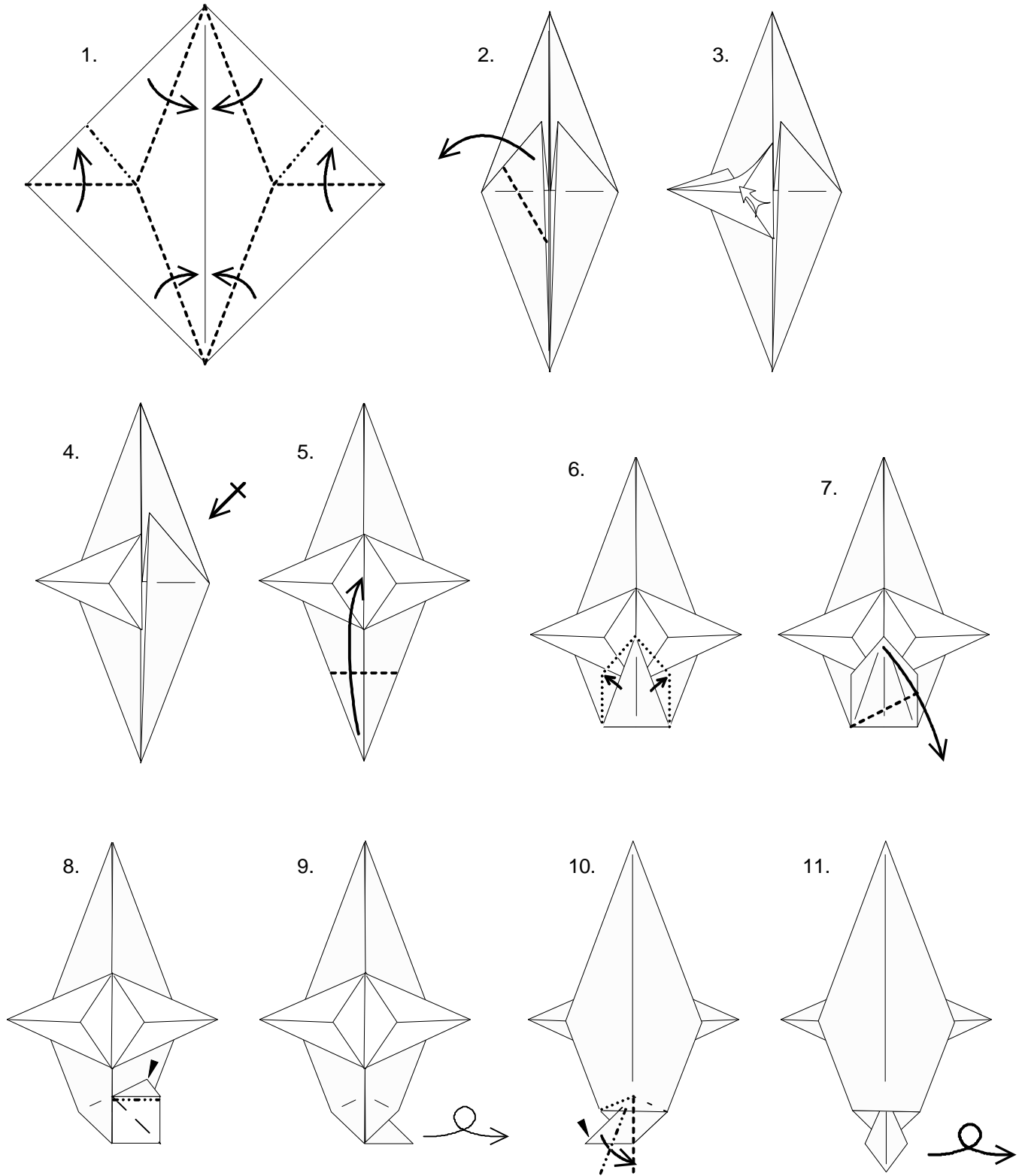

12.

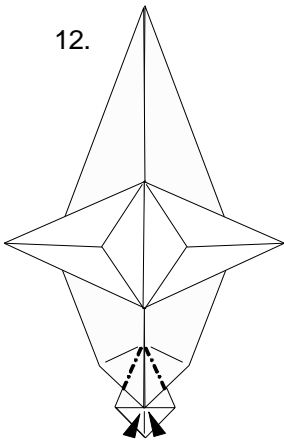

13.

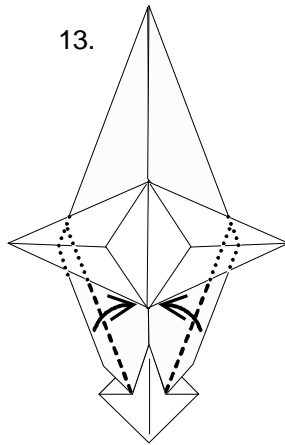

14.

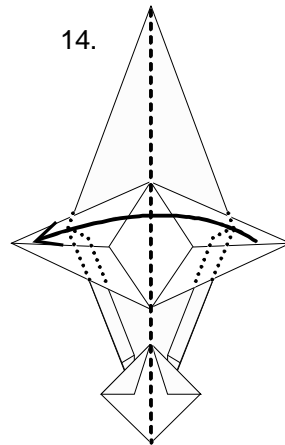

15.

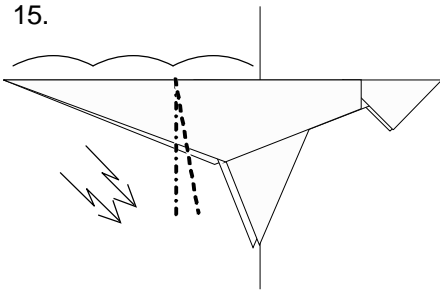

16.

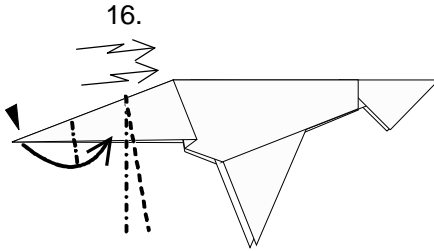

17.

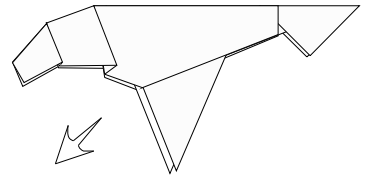

18.

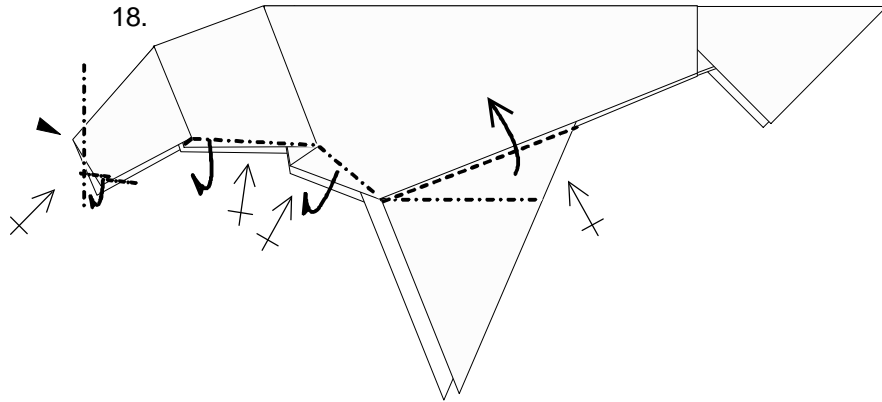

19.

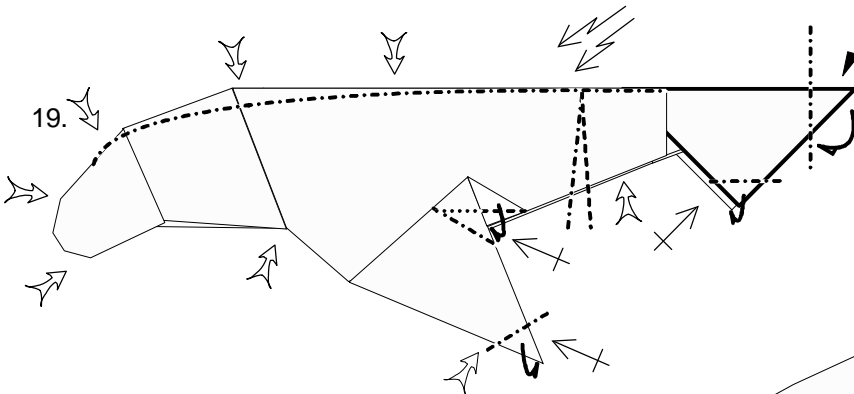

20.

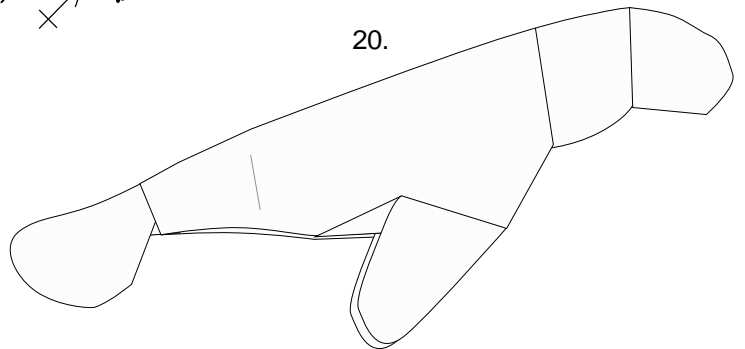

# Praying Mantis

by Robert J. Lang

Copyright ©1990. All rights reserved.

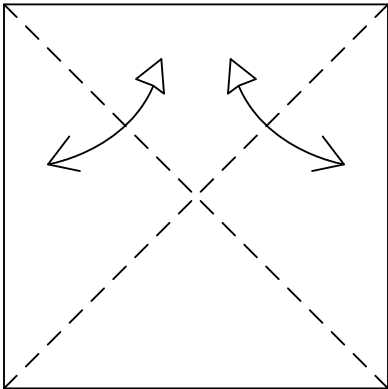

1. Crease the diagonals.

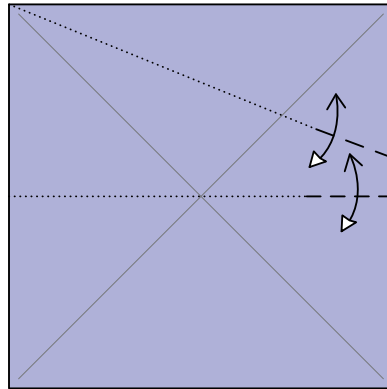

2. Fold and unfold.

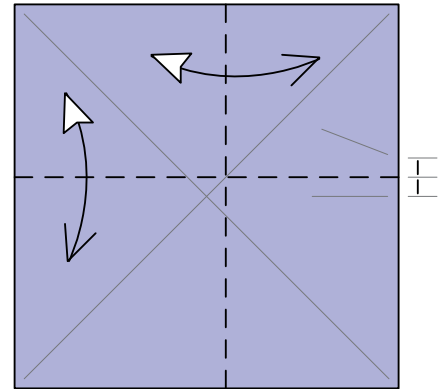

3. First make the horizontal crease halfway between the two pinch marks. Then make the vertical crease through the intersection of the horizontal crease and the diagonal of the square.

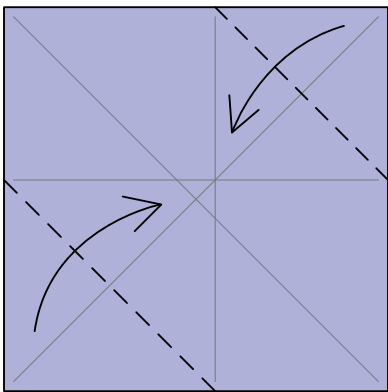

4. Fold the corners in and turn the paper over.

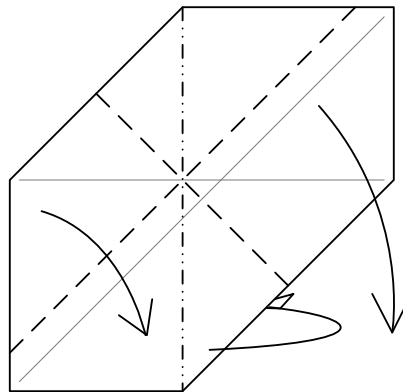

5. Fold a Waterbomb Base based on the new creases.

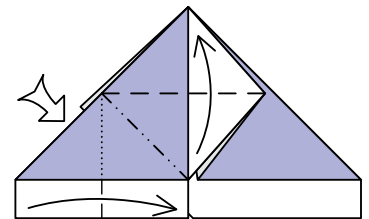

6. Swivel-fold.

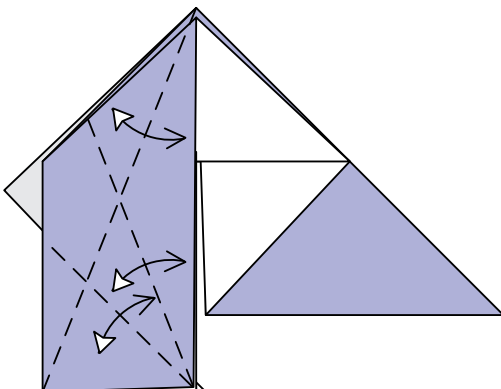

7. Fold and unfold.

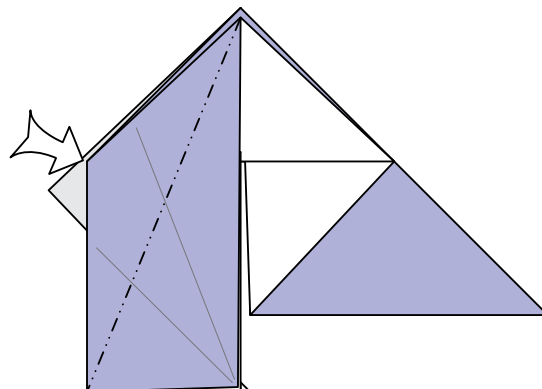

8. Open-sink the corner..

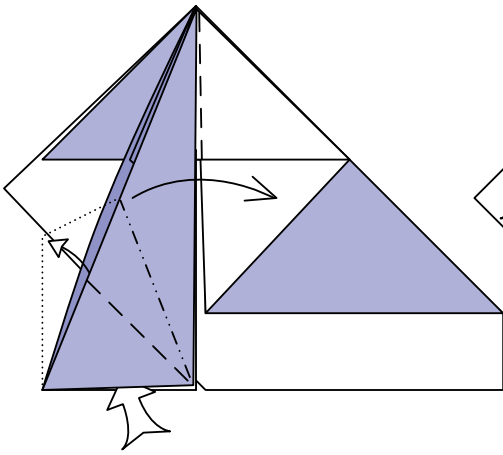

**9.** Open out the sink and push some paper up from the inside; pinch the excess paper in half and swing it over to the left.

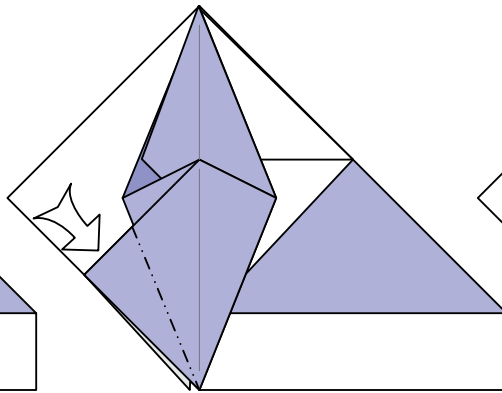

**10.** Reverse-fold the corner.

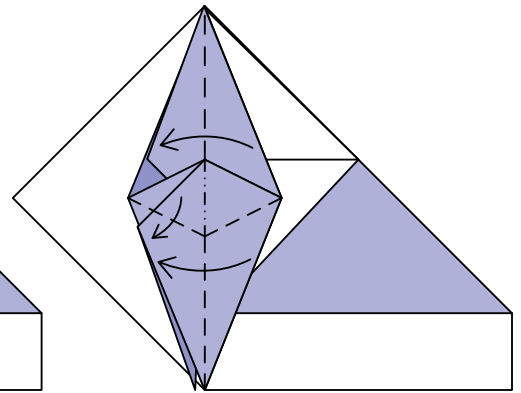

**11.** Pull down the edge of the pocket and fold the right layer back to the left.

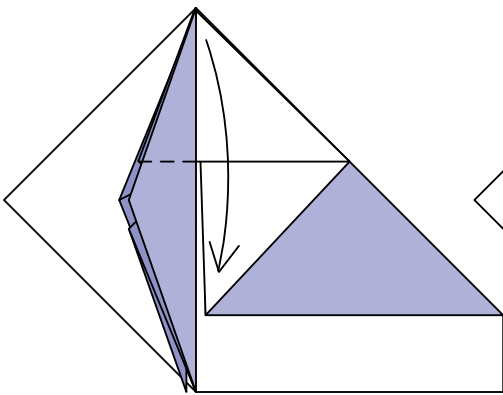

**12.** Fold one flap down.

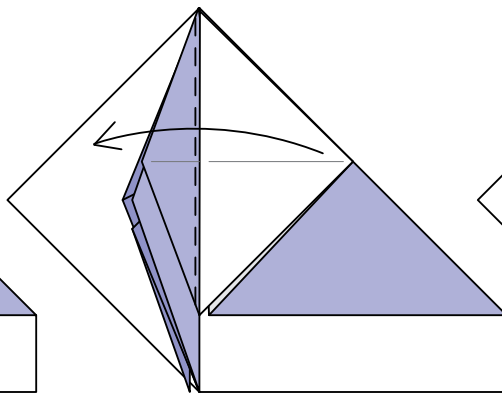

**13.** Swing one layer from right to left.

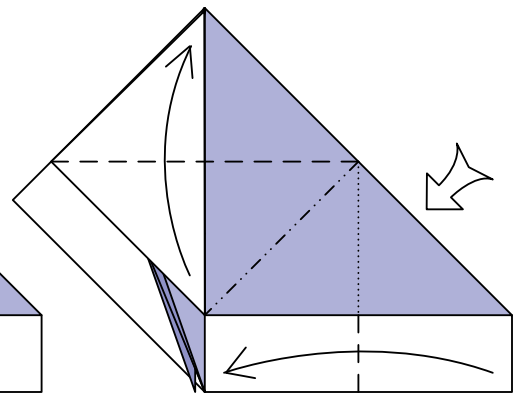

**14.** Repeat steps 6–13 on the right.

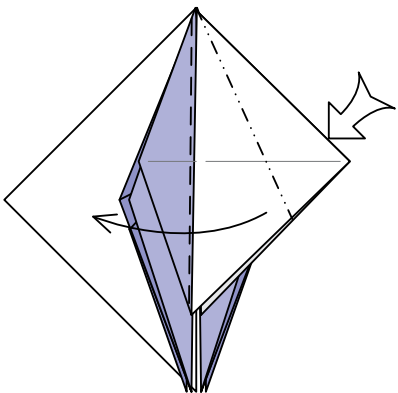

**15.** Squash-fold.

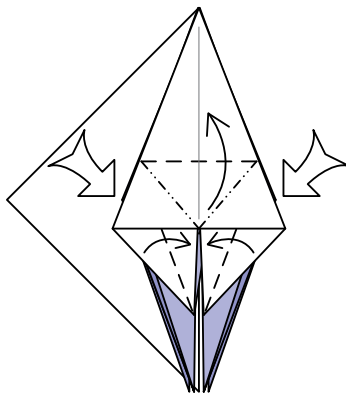

**16.** Petal-fold.

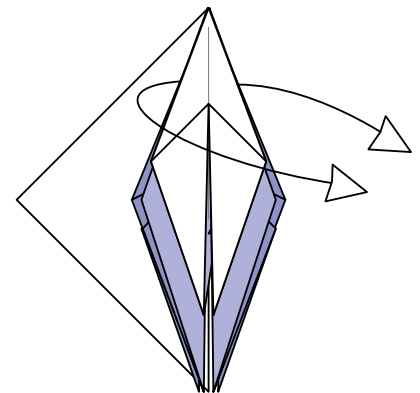

**17.** Unwrap a single layer.

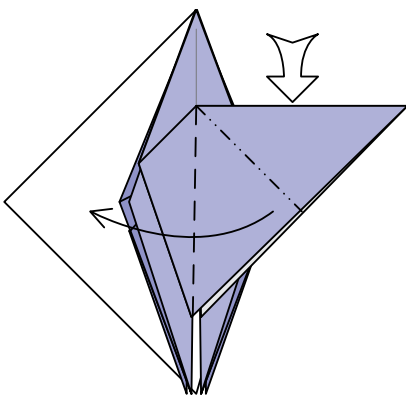

**18.** Squash-fold.

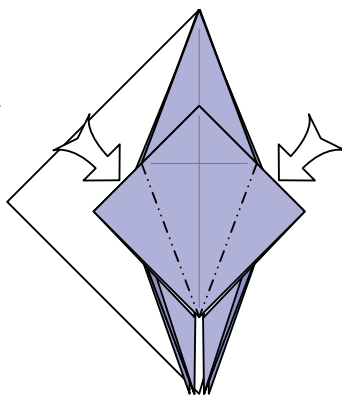

**19.** Reverse-fold the edges.

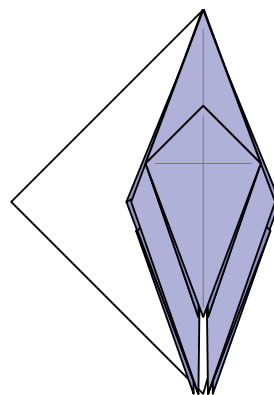

**20.** Turn the model over.

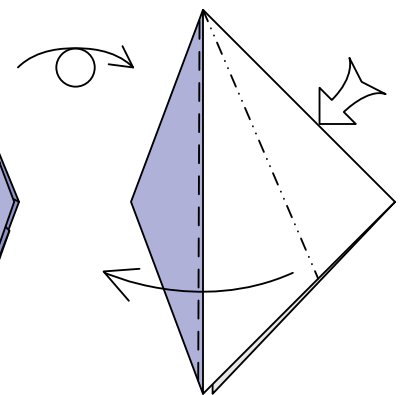

**21.** Repeat steps 15–17.

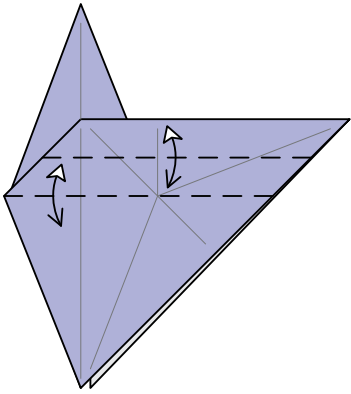

**22.** Fold and unfold.

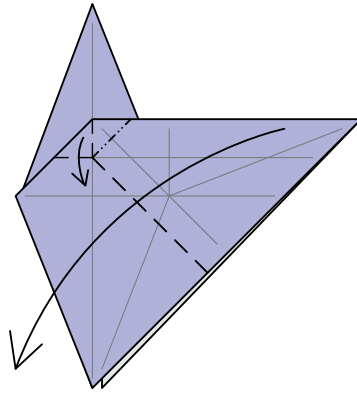

**23.** Fold the flap down, using the newly-made creases as a guide.

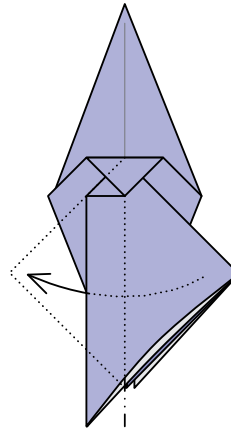

**24.** Reverse-fold a single layer out from the inside.

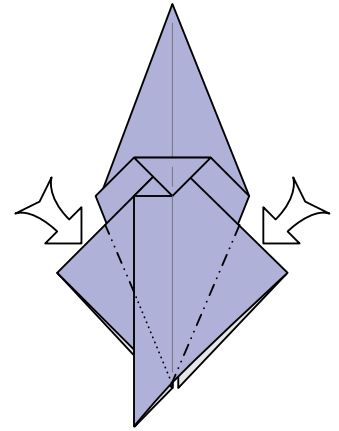

**25.** Reverse-fold the edges.

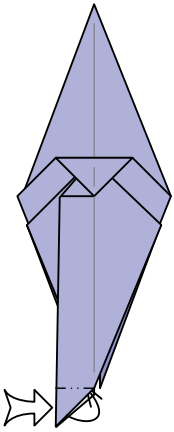

**26.** Reverse-fold the bottom corner.

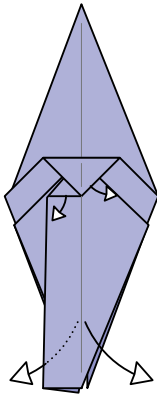

**27.** Pull out the layers trapped under the triangular hood. The model will not lie flat.

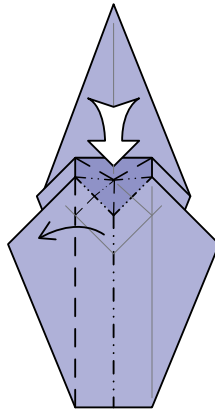

**28.** Open-sink the shaded region and refold.

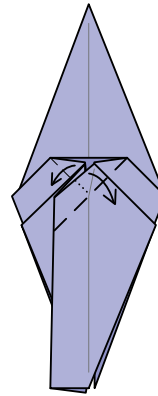

**29.** Flatten the sunk region.

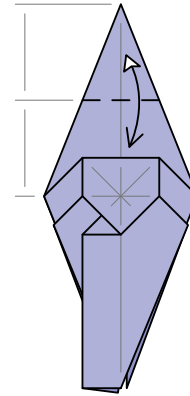

**30.** Fold and unfold.

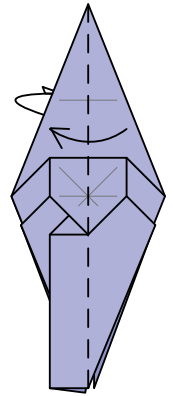

**31.** Fold one layer to the left in front and one to the right behind.

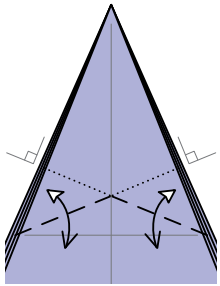

**32.** Top of the model. Fold and unfold.

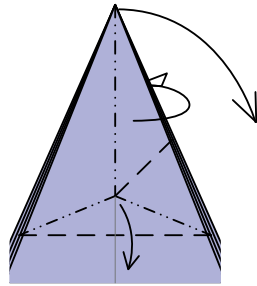

**33.** Pleat and fold a rabbit ear from the thick point using the existing creases.

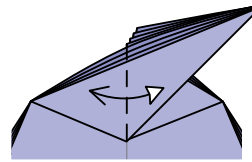

**34.** Fold and unfold through all layers.

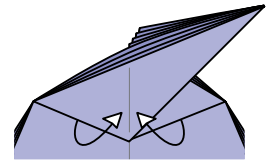

**35.** Wrap one layer of paper to the front.

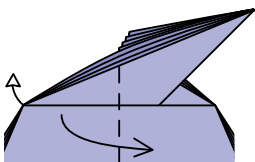

**36.** Fold one layer to the right, releasing the trapped paper at the left that links it to the next layer.

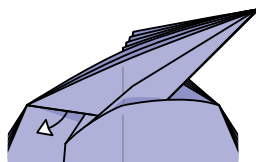

**37.** In progress. Pull paper out from here.

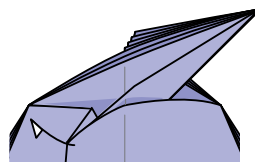

**38.** Close the model back up.

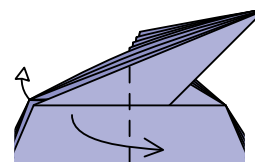

**39.** Repeat steps 36–38 on the next two layers.

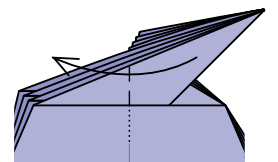

**40.** Swing the point over to the left.

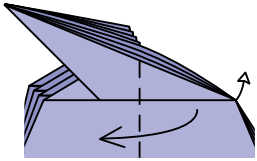

**41.** Repeat steps 36–39 on the right.

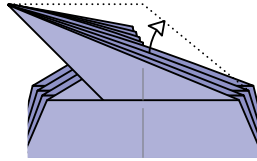

**42.** There are four edges on the top right; pull out as much of the loose paper between the third and fourth edges as possible. A hidden pleat disappears in the process.

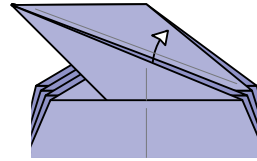

**43.** Pull out the loose paper between the first and second layer.

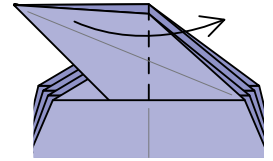

**44.** Swing the point back to the right.

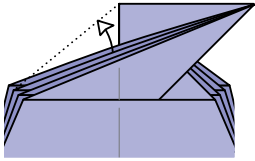

**45.** Repeat steps 42–43 on the left.

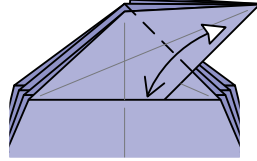

**46.** Fold and unfold.

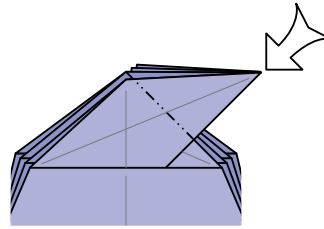

**47.** Open-sink the point. You will have to open out the top of the model somewhat to accomplish this.

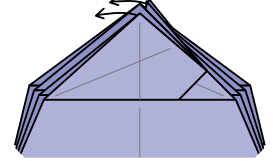

**48.** Rearrange the layers at the top so that the central square forms a Preliminary Fold.

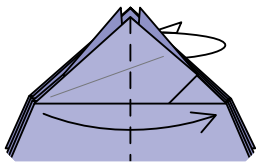

**49.** Fold one layer to the right in front, and one to the left behind. The model should be symmetric as in step 31.

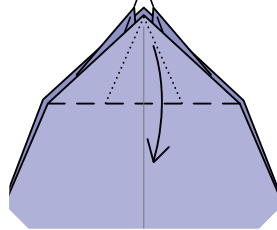

**50.** Petal-fold.

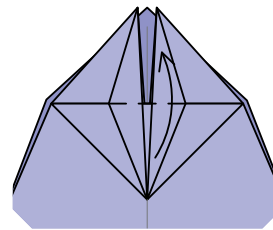

**51.** Fold the flap back upward.

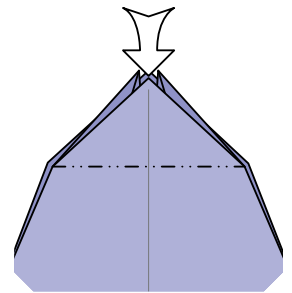

**52.** Closed-sink the point. (Be careful! It is very easy to rip the paper.)

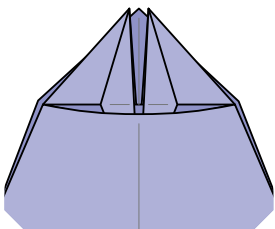

**53.** Repeat steps 50–52 behind.

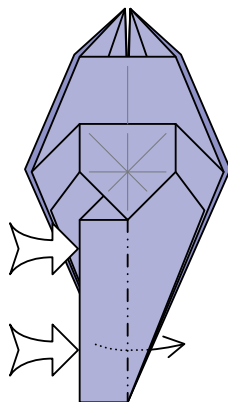

**54.** Reverse-fold the long edge all the way through the model (closed-sink the corner at the top).

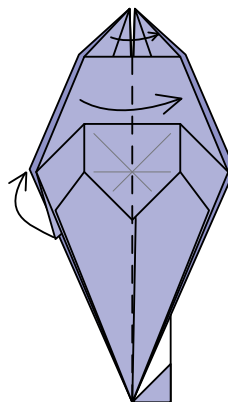

**55.** Fold two layers to the right (in the process, you undo the reverse fold you made back in step 11).

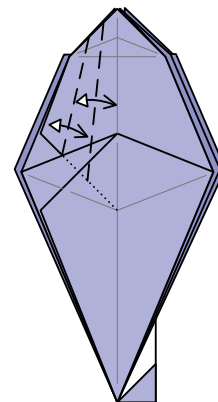

**56.** Crease into thirds.

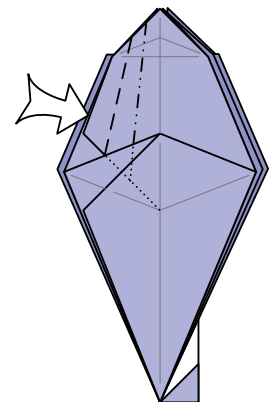

**57.** Sink (open at the bottom, closed at the top) the edge in and out on the existing creases.

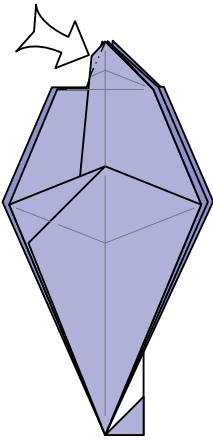

**58.** Sink the corner at the top.

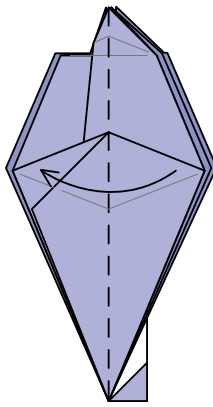

**59.** Fold one layer back to the left.

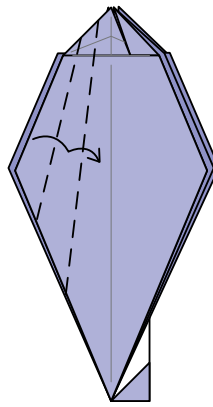

**60.** Fold one layer in thirds.

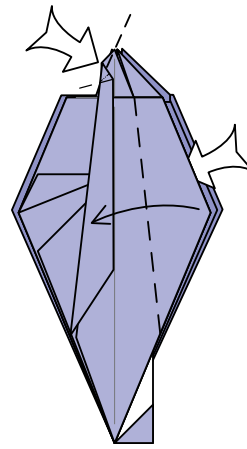

**61.** Crimp the top left corner. Fold one layer from the right to overlap the left layer, flattening the point behind.

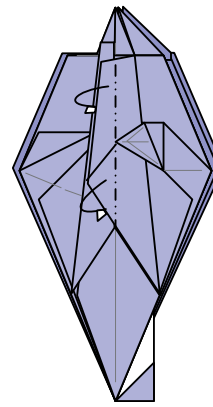

**62.** Mountain-fold the edge underneath.

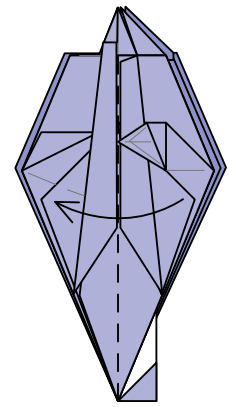

**63.** Fold one layer from right to left.

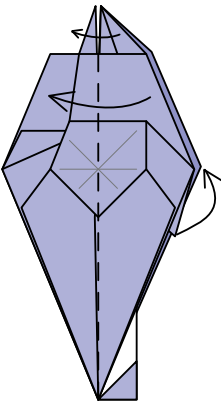

**64.** Repeat steps 55–62 on the right.

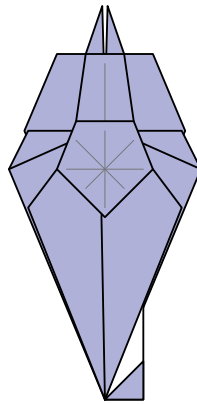

**65.** Turn the model over.

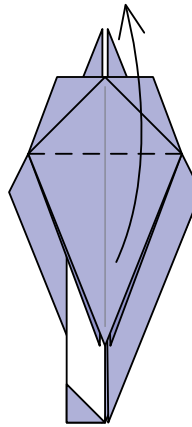

**66.** Fold one flap up.

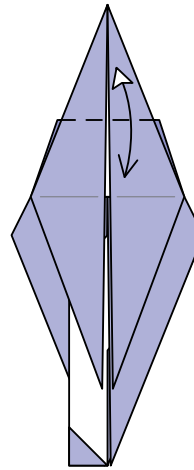

**67.** Fold and unfold; the crease lies on top of the horizontal edge of the layers behind.

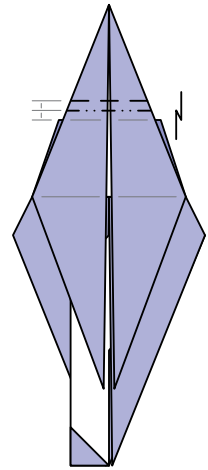

**68.** Pleat above the crease you just made.

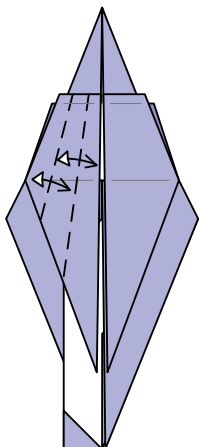

**69.** Crease into thirds.

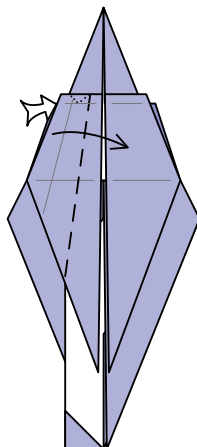

**70.** Fold the flap over on one of the creases you just made, and make a linked pair of swivel folds at the top.

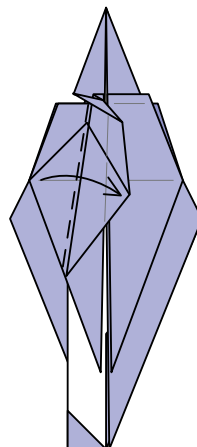

**71.** Fold the next layer over the top of the one you just folded.

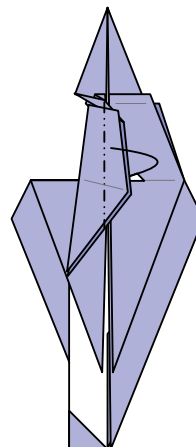

**72.** Mountain-fold both layers together.

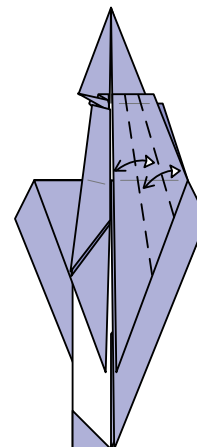

**73.** Repeat steps 69–72 on the right.

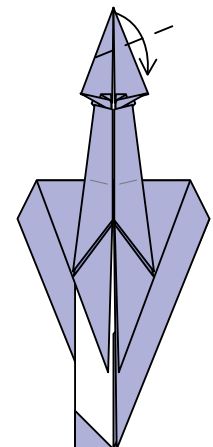

**74.** Fold the top point down to the right.



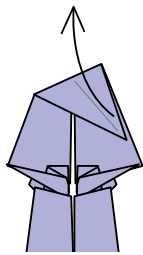

75. Unfold.

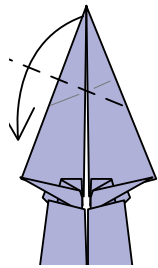

76. Fold the top down to the left.

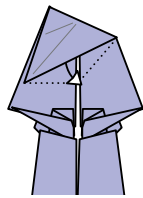

77. Pull out some loose paper.

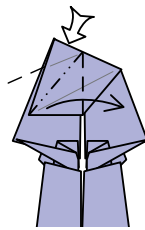

78. Squash-fold the flap over to the right.

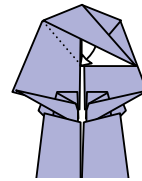

79. Pull out some loose paper.

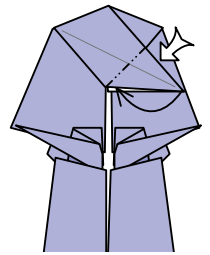

80. Reverse-fold the point.

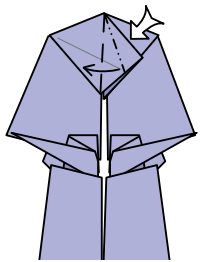

81. Squash-fold.

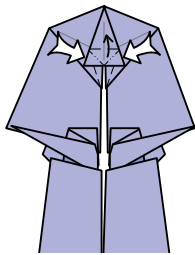

82. Petal-fold.

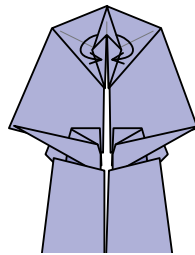

83. Bring one layer to the front on each side.

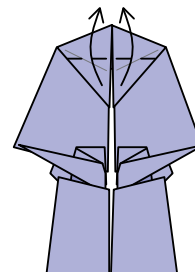

84. Fold the two points upward (the exact amount isn't critical).

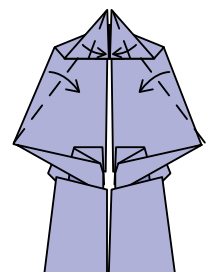

85. Narrow the two points and the sides of the main flap.

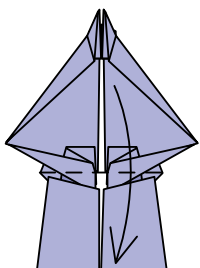

86. Fold the head down.

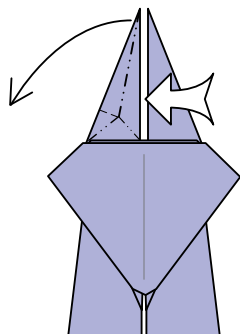

87. Double-rabbit-ear the left point.

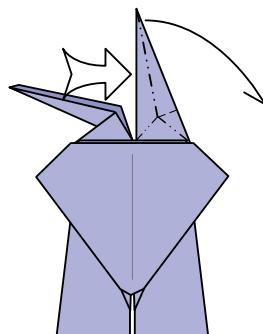

88. Repeat on the right.

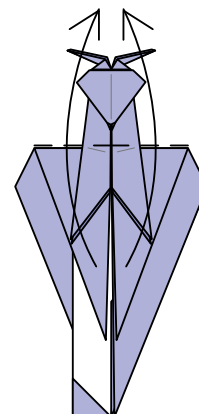

89. Fold up one point as far as possible on each side.

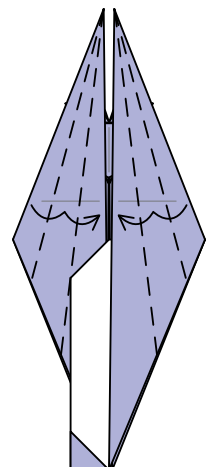

90. Fold each side in thirds.

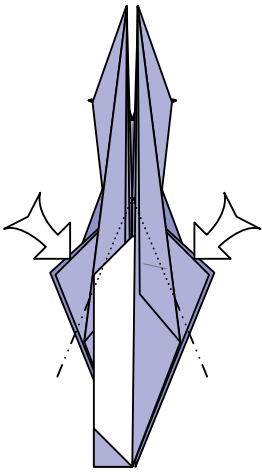

**91.** Open-sink the side corners (top layer only).

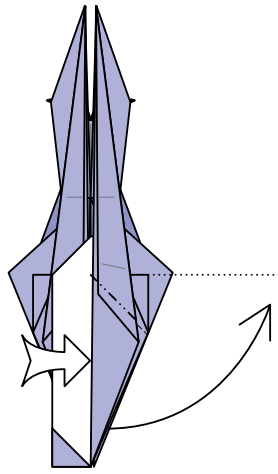

**92.** Reverse-fold the point out to the side.

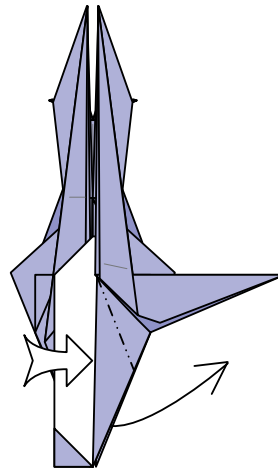

**93.** Reverse-fold the next point out to the side.

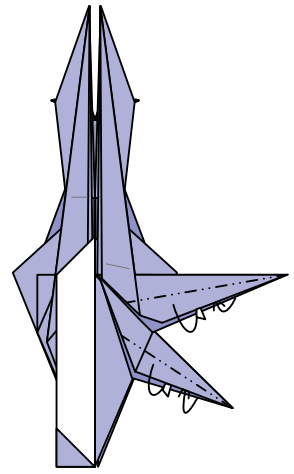

**94.** Narrow the legs with mountain and valley folds.

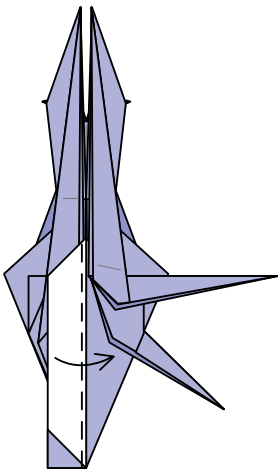

**95.** Swing the white layer over to the right.

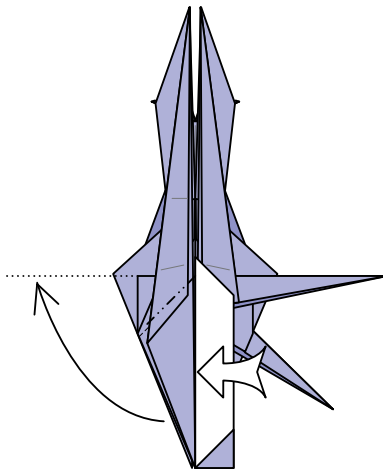

**96.** Repeat steps 92–95 on the left.

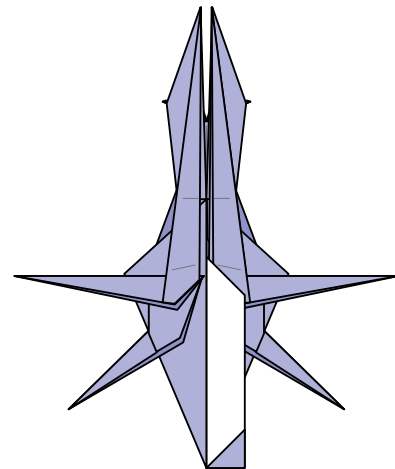

**97.** Turn the model over.

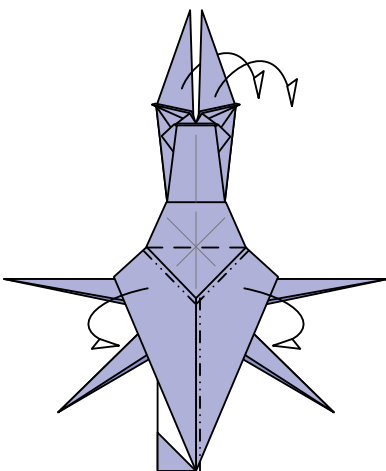

**98.** Fold the lower portion of the model in half, but keep the upper portion flat. Fold the forelegs down away from the body.

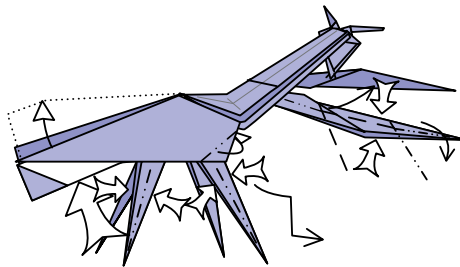

**99.** Shape the legs by pinching them in half. Pinch and reverse-fold the forelegs to shape them. Mountain-fold the edges of the body. Reverse-fold the white edge at the abdomen upward.

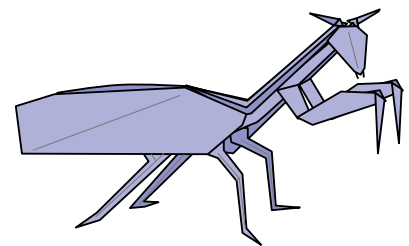

**100.** Praying Mantis

# Martini Glass (or Birdbath)

Copyright 1998-99 Stephen Hecht. All Rights Reserved

Begin with a rectangle of proportions 7 x 3. A rectangle 248mm x 106mm yields a model 65mm tall, with a 43mm base diameter and a 68mm top diameter. Although I designed the model for a dollar bill, I don't recommend using one, as the process is unpleasant, and the product is small and ugly.

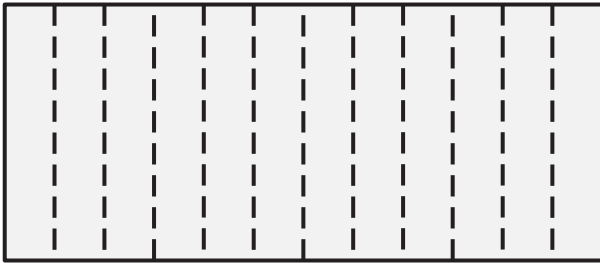

1. Begin with white side up. Divide into 1/12ths with valley-creases. (After the 1/3 lines, it's pretty easy.)

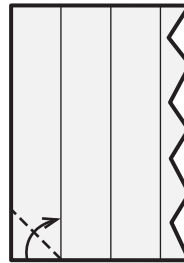

2. Soft valley-fold. Repeat at right end.

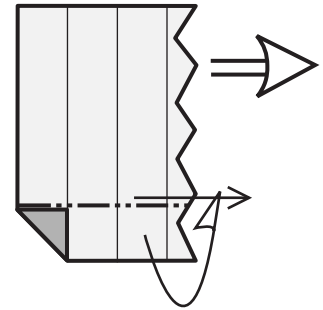

3. Mountain-fold all the way across the bottom. Unfold completely.

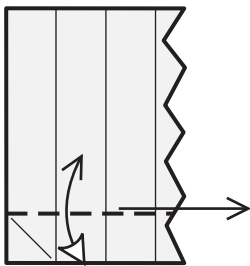

4. Valley-fold on same crease. Unfold.

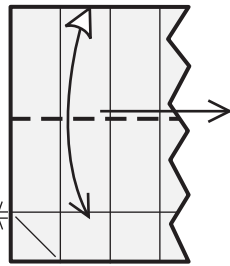

5. Valley top edge to a little bit below the crease. Unfold.

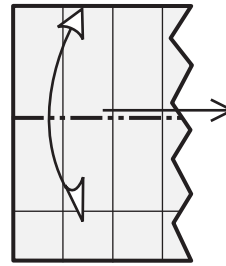

6. Mountain on same crease. Unfold.

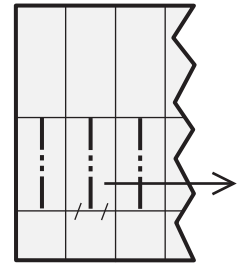

7. Add mountain-creases, bisecting the little rectangles.

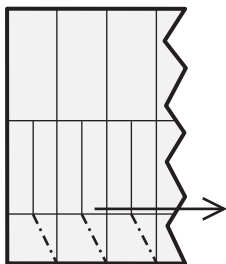

8. Add mountain-creases (see next step for technique).

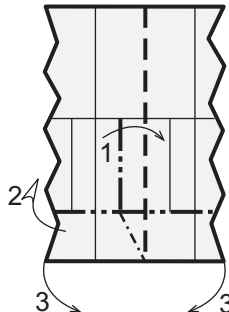

8a. Technique: grab a pleat, swing bottom under until perpendicular, then spread bottom of pleat, pinching the mountain-fold.

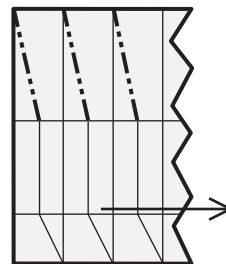

9. Add more mountain-creases (see next step for technique).

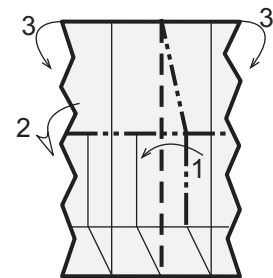

9a. Technique: similar to 8a.

# Martini Glass (continued)

Copyright 1998-99 Stephen Hecht. All Rights Reserved

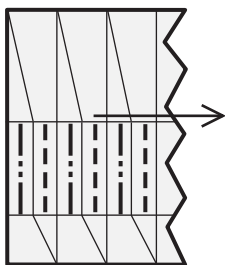

10. Add mountain and valley creases (see next 2 steps for technique).

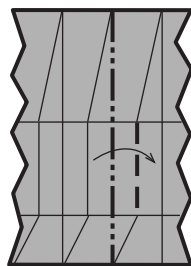

10a. (other side!) Technique: grab a pleat...

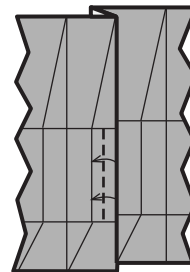

10b. ...and valley through both layers of the pleat, and unfold.

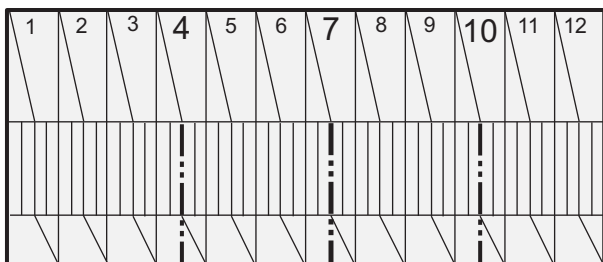

11. Back to white side. Extend middle mountain crease to bottom edge in sectors 4, 7, and 10.

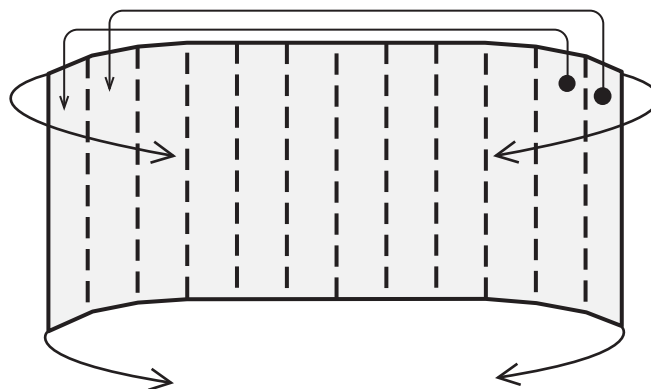

12. Roll into a tube on the 1/12 valley creases. Two segments will overlap (doesn't matter which are on top).

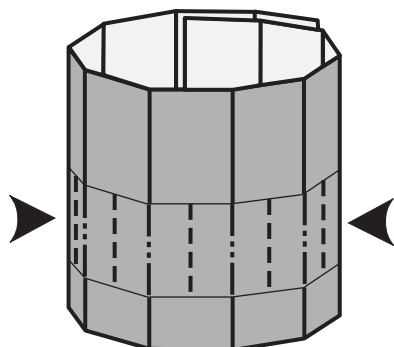

13. Pinch the middle region, using the 1/12 creases and their bisectors. Keep the two overlapped sectors together as a single layer.

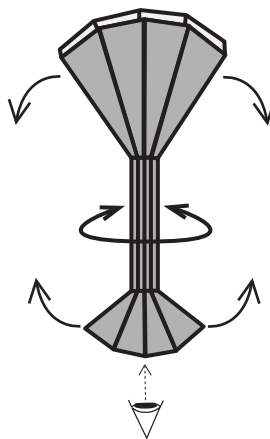

14. Distribute the middle ridges cylindrically, then spread and flatten the base, while rounding the top into a 10-sided cone. No new creases!

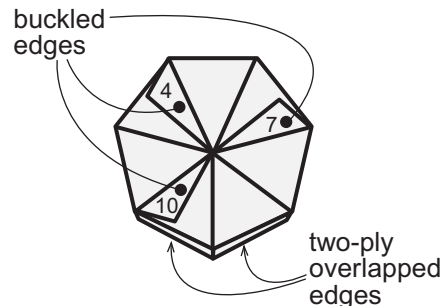

15. View from below. Form a septagon, using the extended mountain-creases in sectors 4, 7, and 10 to buckle three of the triangles.

# Martini Glass (continued)

Copyright 1998-99 Stephen Hecht. All Rights Reserved

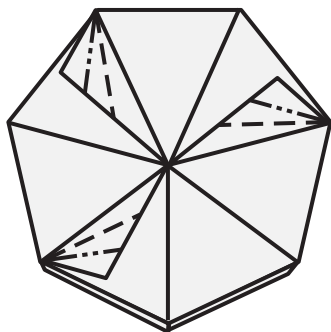

16. (Enlarged) Pleat each loose flap in thirds.

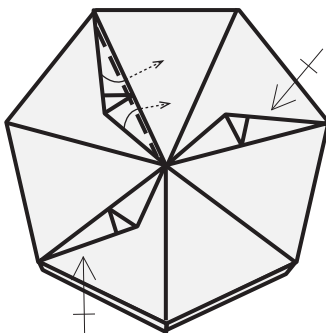

17. Tuck pleated flap into the pocket. Repeat with other two flaps. Some shifting needed.

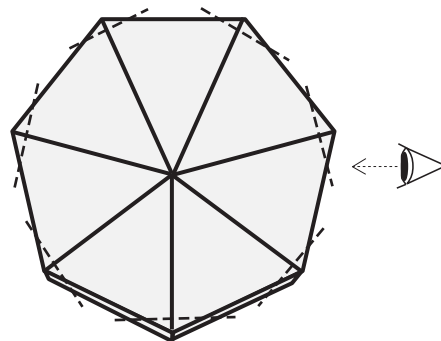

18. Trim corners.

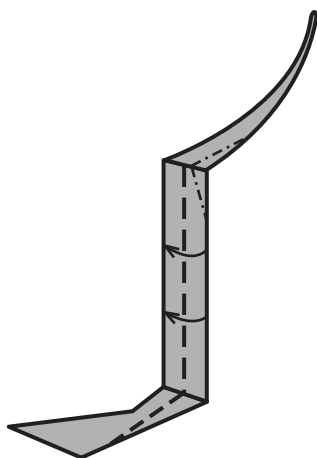

19. This is a single vertical ridge of the "stem", with attached section of base and bowl.

Using existing creases (from step 10), fold in half, but only until perpendicular. Note valley fold at base. Also note mountain folds at the top, which don't flatten.

Repeat all the way around the stem, keeping overlap together, and treating some edges two-at-a-time. Gradually tighten up the structure, bit-by-bit. Patience!

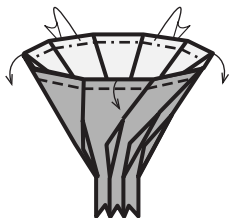

20. Top of the "bowl". Flip over tiny rim.

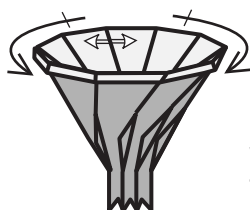

21. Stretch pleats all the way around, adjust, flatten, sharpen.



22. Finished.

# FANTASY MASK MATT SLAYTON

DIAGRAMS ALEX BARBER

1994

1

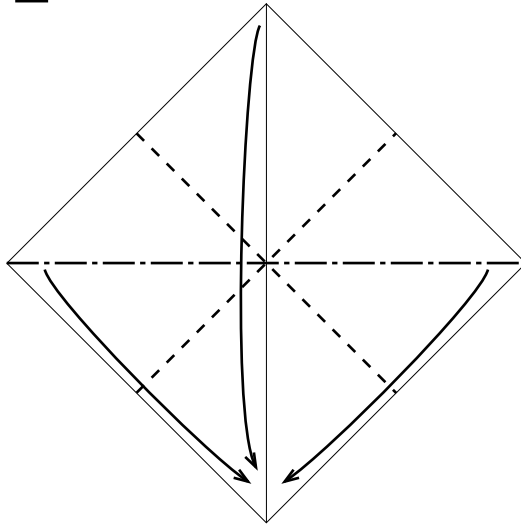

start white side up  
preliminary base

2

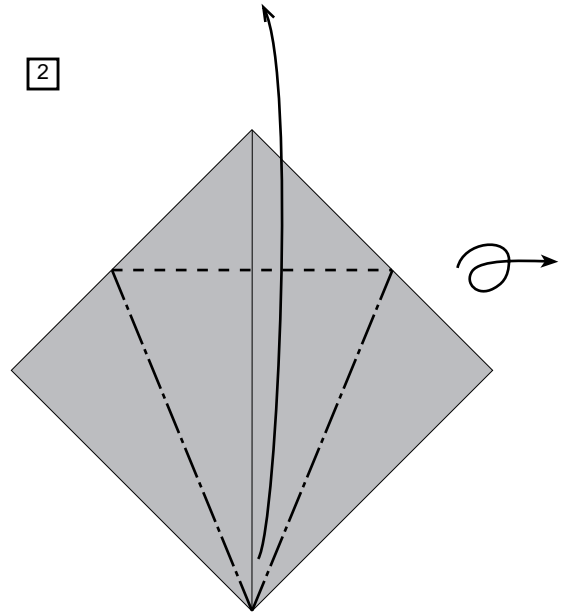

petal fold top flap  
turn model over

3

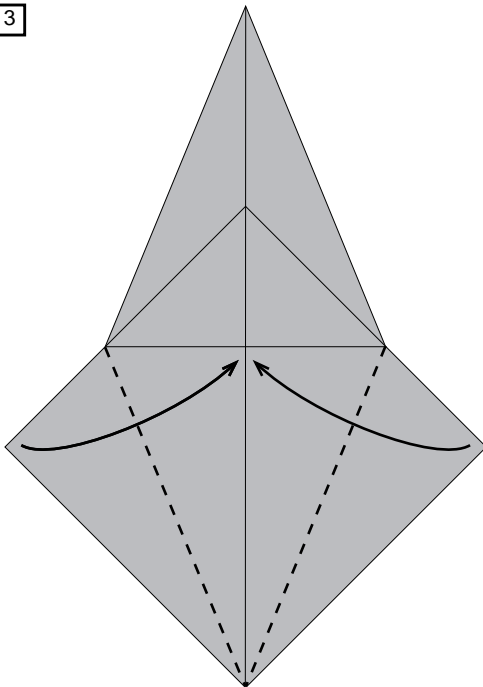

fold flaps to center

4

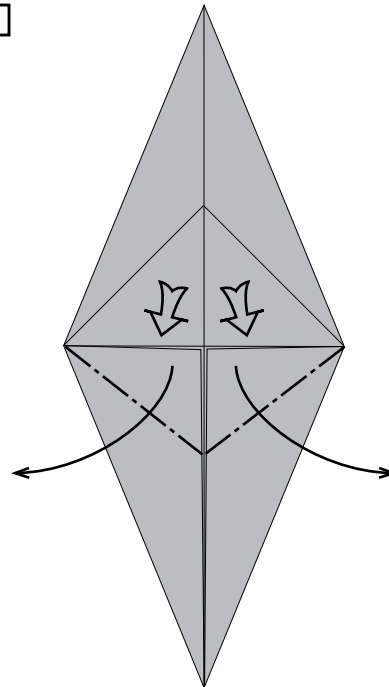

squash flaps open

5

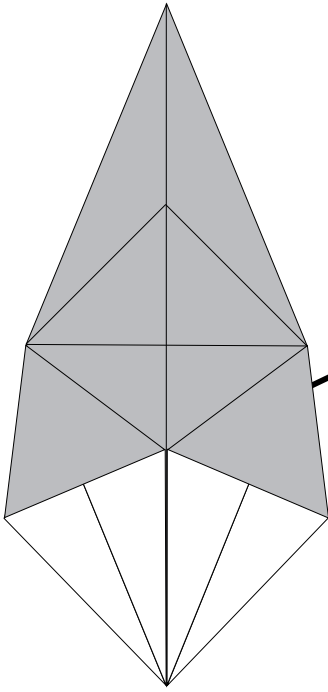

turn model over

6

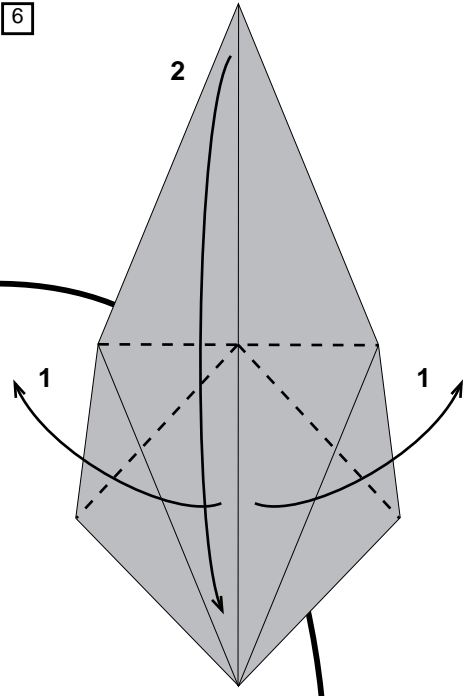

fold the flaps in the order shown

7

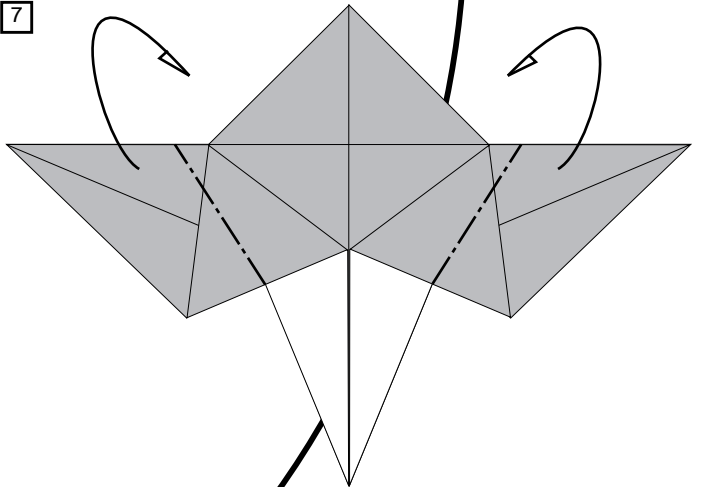

fold flaps behind to make horns

9

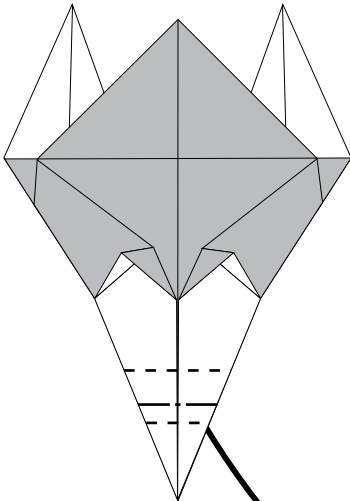

pleat top layer to form nose

8

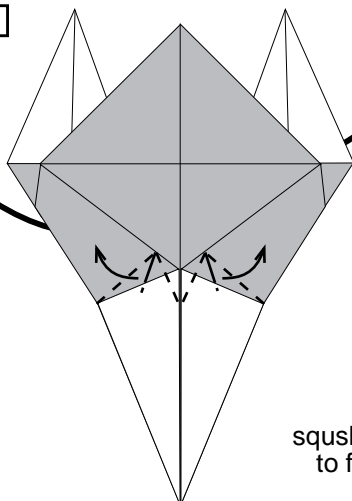

squash the points to form eyes

10

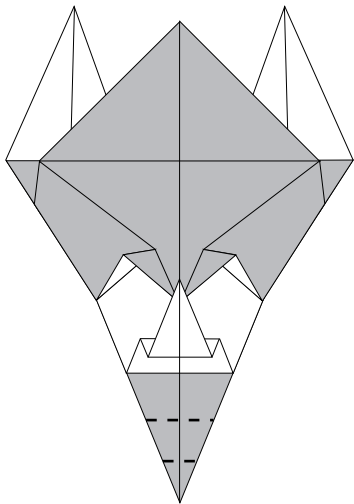

fold over the bottom flap for the chin

11

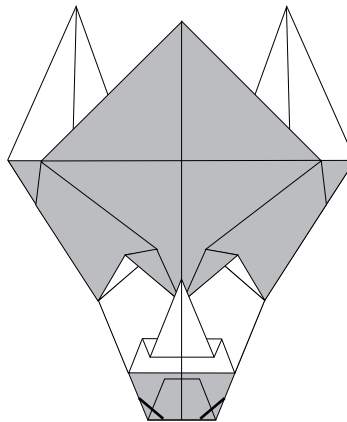

round the chin

12

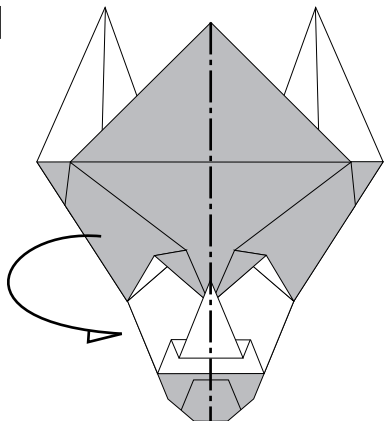

fold the model in half

13

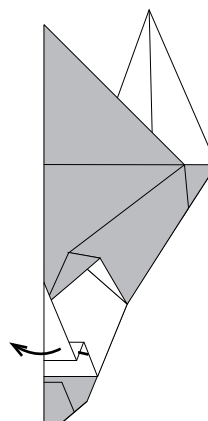

swivel the nose out

14

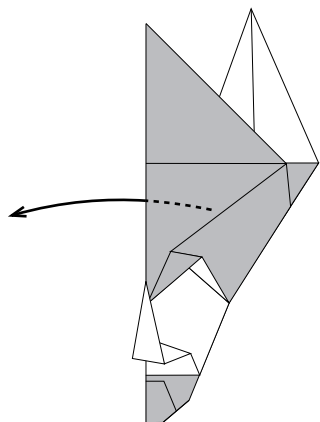

open the model out and keep the nose pointing up

15

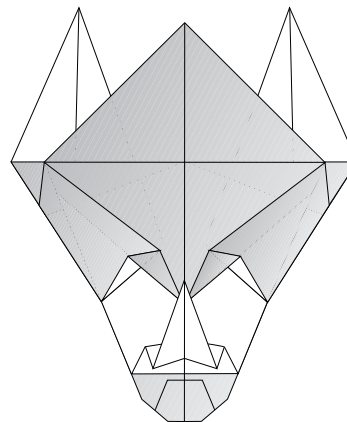



# Magic Cube Unit

by Eugeny Fridrikh, Russia

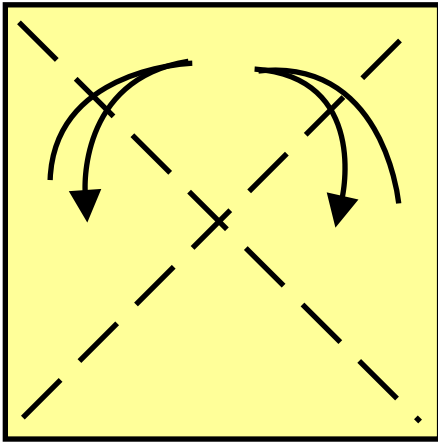

1. Take for the Magic Cube 6 squares of paper both sides colored differently. The optimal side length is 12-15 cm.

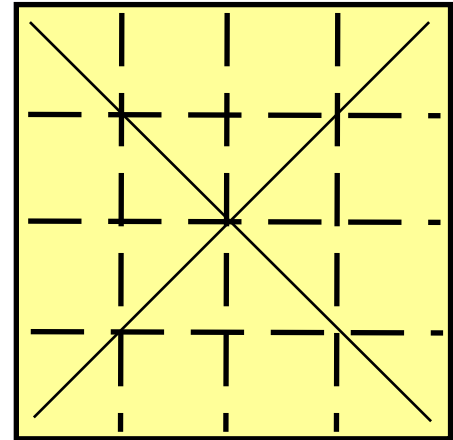

2. Divide the square on 16 parts by valley folds and otherwise the paper.

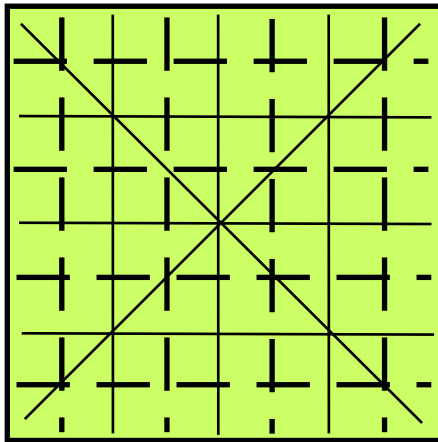
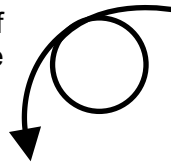

3. Now make more valleys to divide the square on 64 parts, like a chess board.

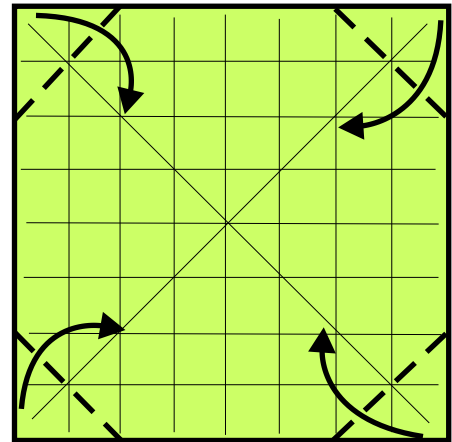

4. Fold four angles to the diagonals.

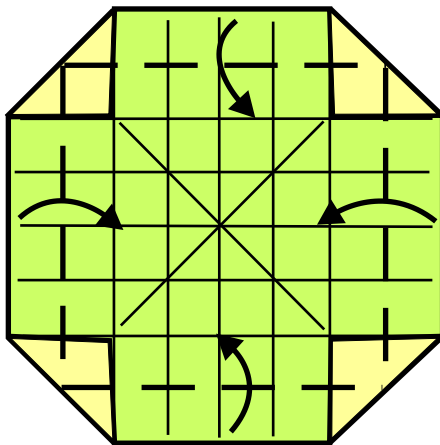

5. Valley folds again.

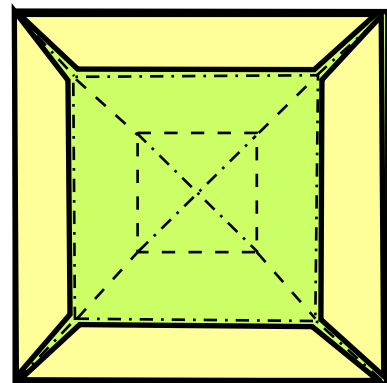

6. Close the paper, using the existing folds.

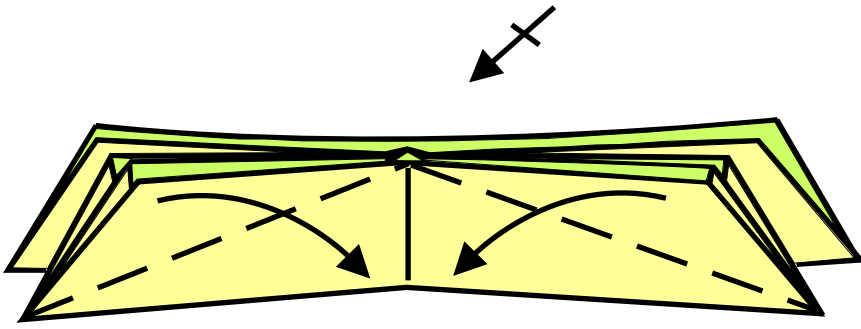

7. Two valley folds on the first layer.

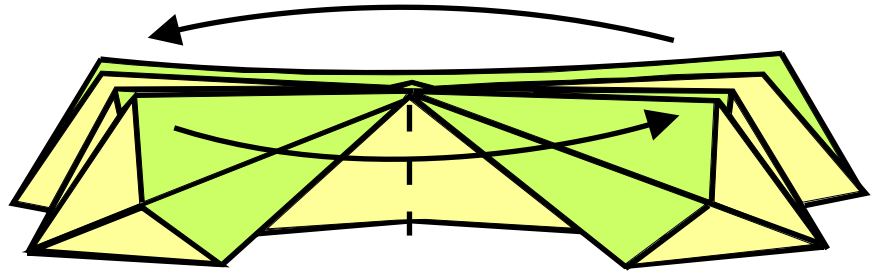

8. Flip through the left part to the right on the front and right part to the left on the back.

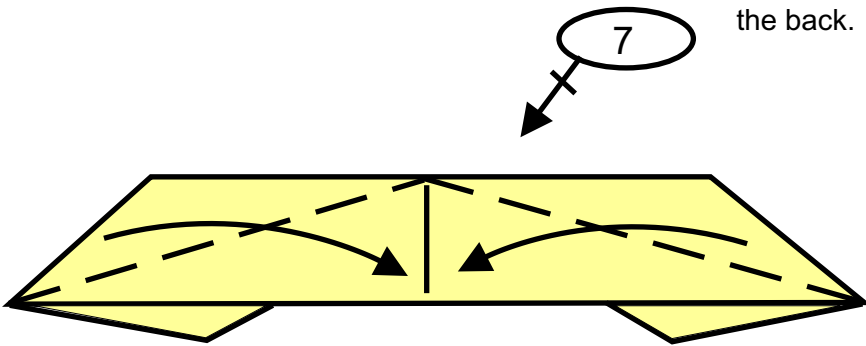

9. Repeat step 7 on both sides.

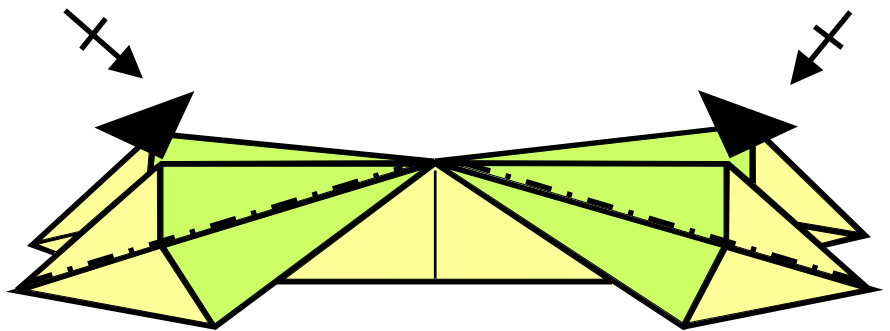

10. Open-sink.

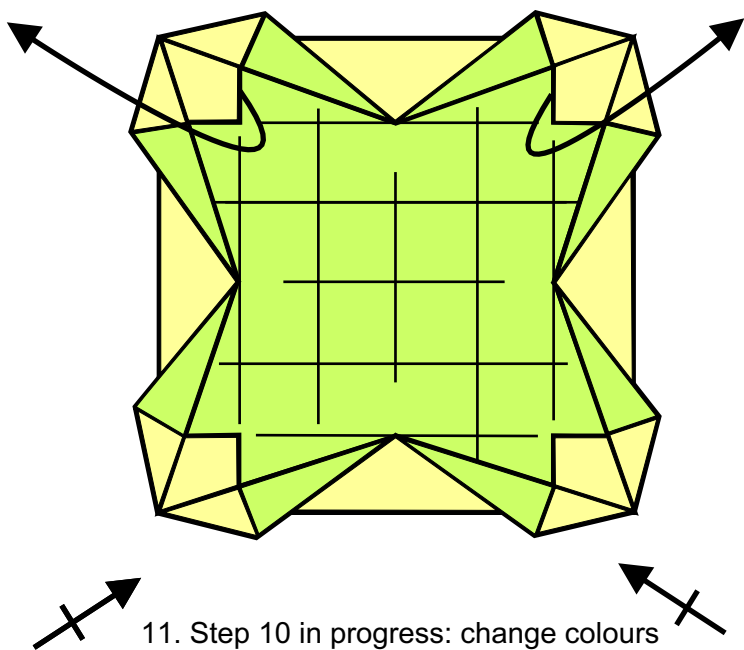

11. Step 10 in progress: change colours on the angles firstly.

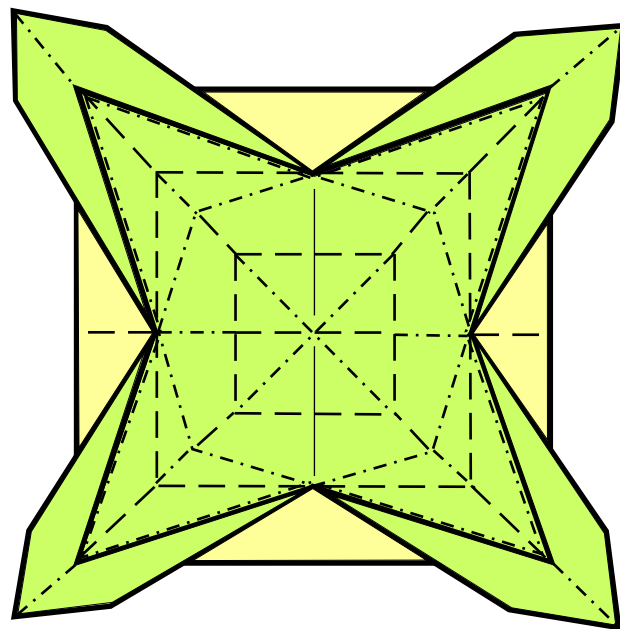

12. Now fold the model by all "valleys" and "mountains" shown on this diagram to close.

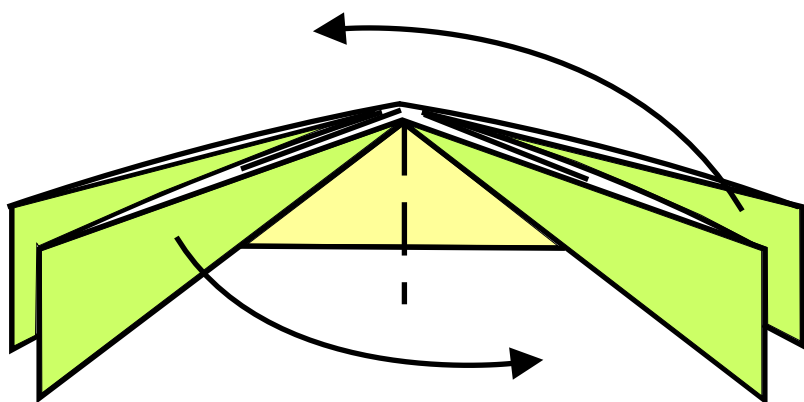

13. Make the cross form.

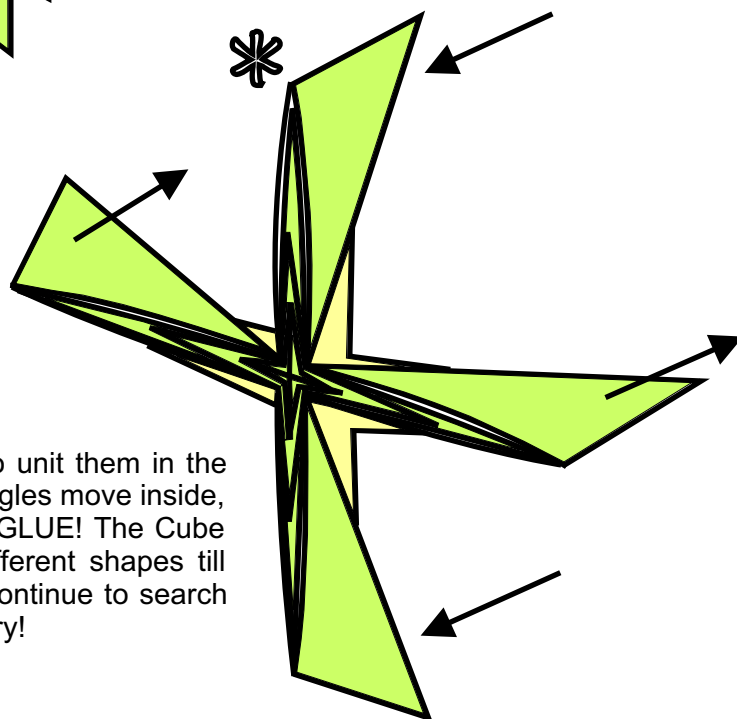

14. The module is ready. Fold 5 such figures and start to unit them in the Cube shape. The main principle of uniting: two opposite angles move inside, two other opposite angles - outside. Angle to angle. Use GLUE! The Cube you'll receive is very flexible. You can transform it in different shapes till the flower and egg. You can even fold it inside out and continue to search new forms! Try to play with this model to explore it's mystery!

# Miss Piggy

1

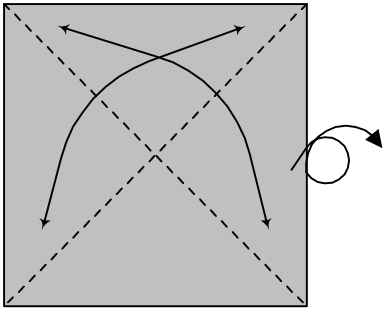

2

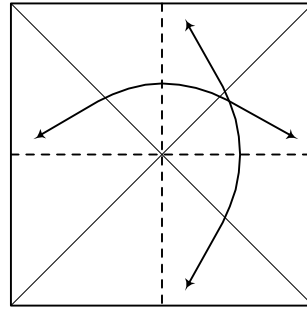

3

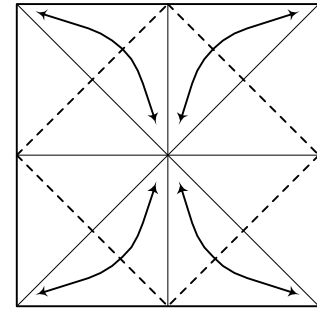

Crease the 4 corners.

4

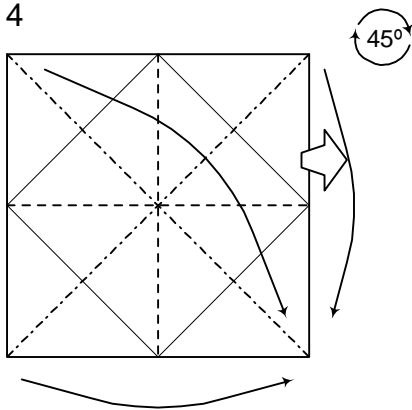

Preliminary fold.

5

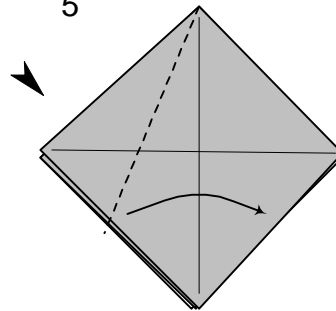

Squash fold.

6

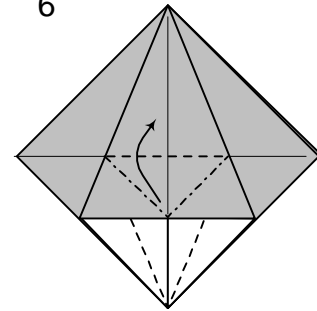

Petal fold.

7

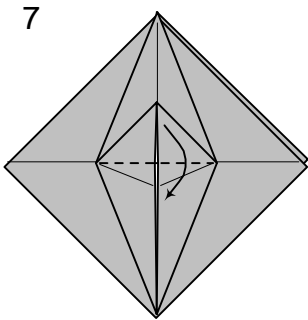

8

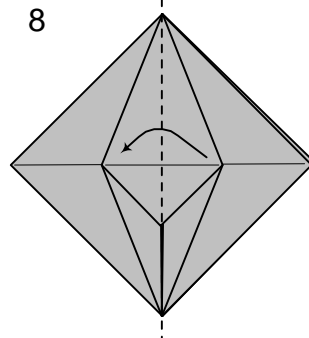

9

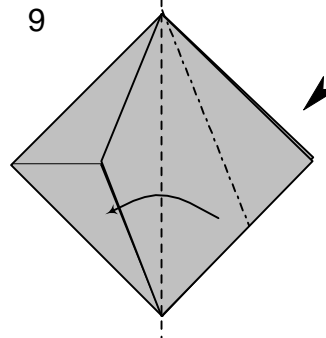

10

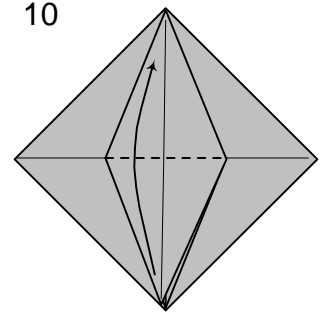

Repeat steps 5-8 on the right side

11

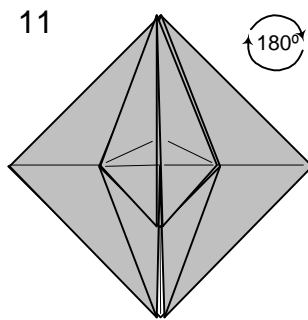

↑ 180°

12

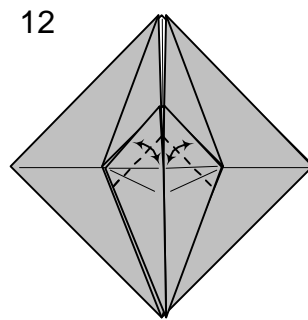

Crease one layer only, so the edge touches the centre.

13

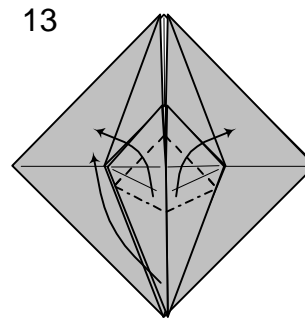

Squash fold using the crease made in step 12.

14

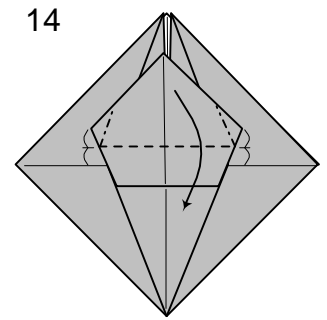

Squash again - see step 15 for where to flatten the sides.

# Miss Piggy

15

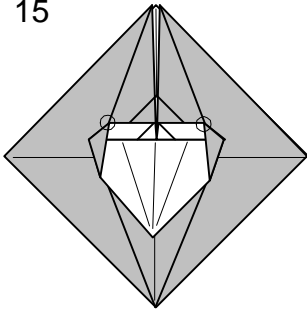

The tip of the squash fold should lie along the layer behind, as circled.

16

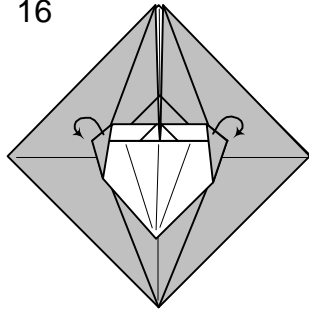

Wrap a single layer behind (colour change). To do this you need to partially unfold the model.

17

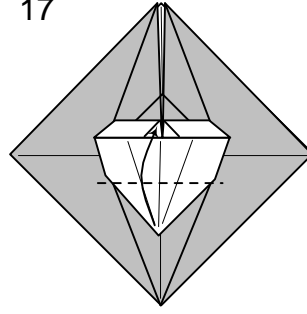

18

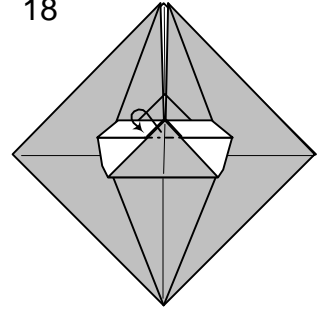

Tuck behind.

19

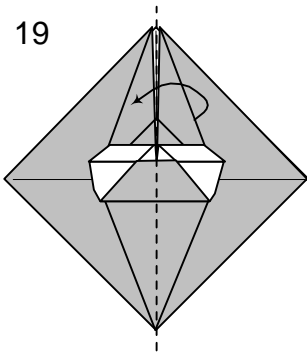

20

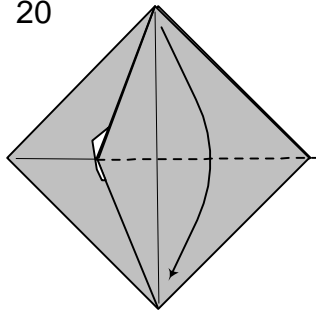

21

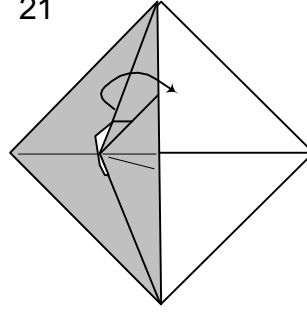

22

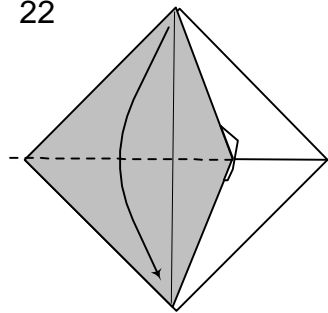

23

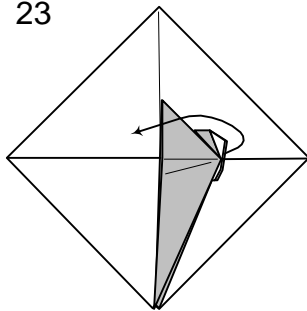

Swing back to make the model symmetrical

24

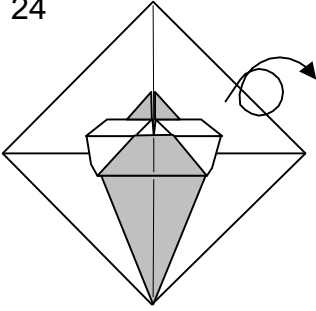

25

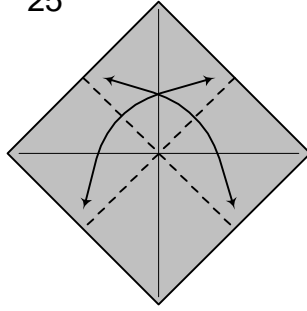

Crease the square but not the model behind

26

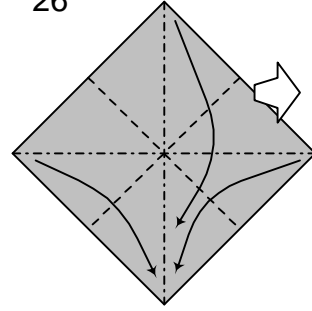

Preliminary fold

27

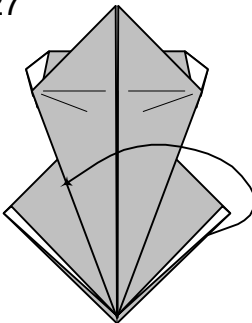

28

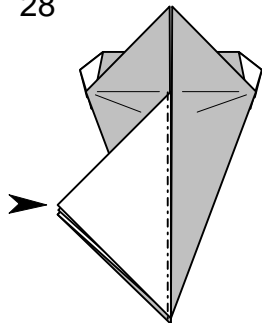

Inside reverse fold the top layer, a hidden double layer will also move.

29

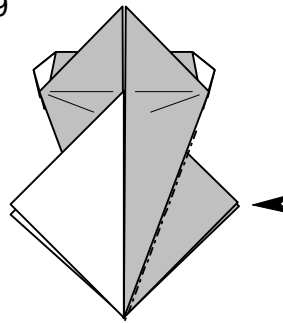

Inside reverse fold the top layer.

30

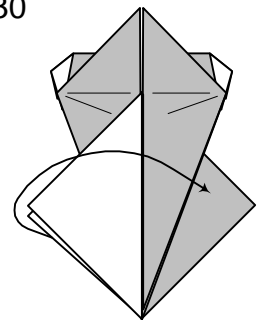

Repeat steps 27-29 on the left side.

# Miss Piggy

31

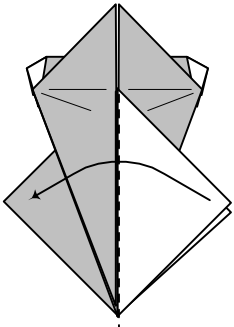

Fold flap to left so the model is symmetrical.

32

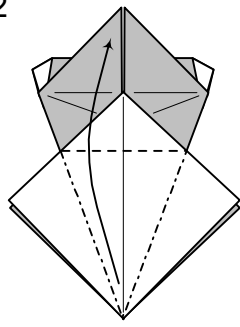

Petal fold.

33

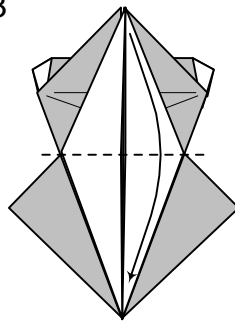

34

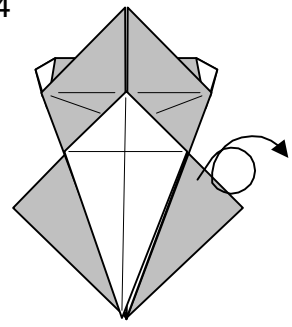

35

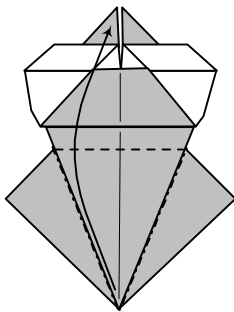

36

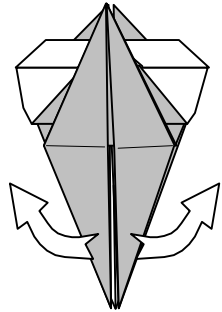

Pull the 2 points to unfold the 'bird base'.

37

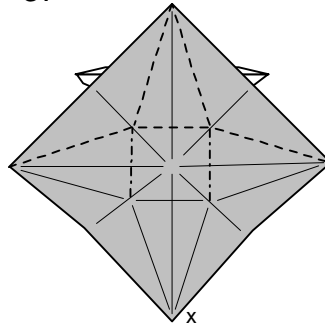

Valley fold the existing creases, bringing point 'X' towards you.

38

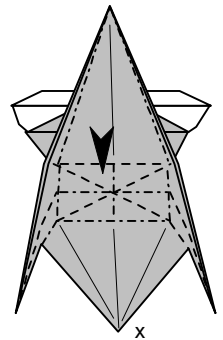

Sink the middle and bring the sides in to flatten.

39

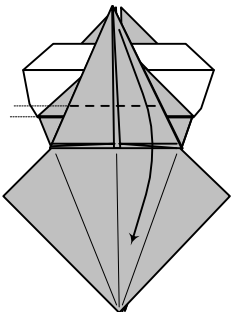

Fold the point down, creasing a little above the layer behind.

40

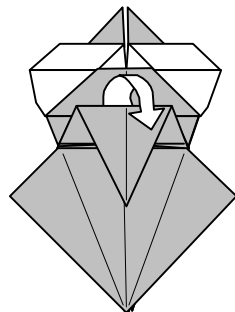

Bring the layer behind to the front.

41

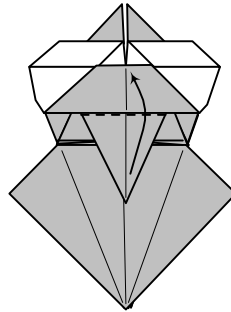

42

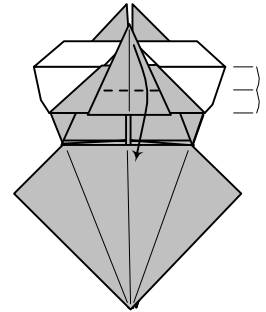

43

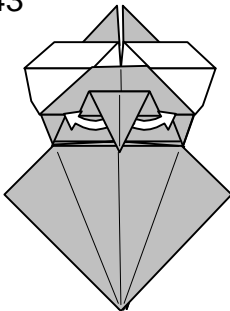

Pull out some paper.

44

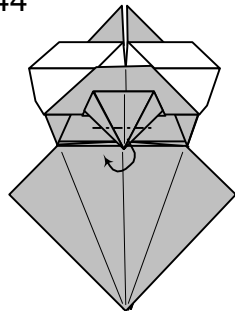

45

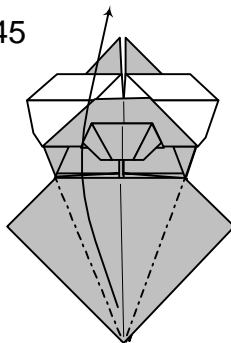

46

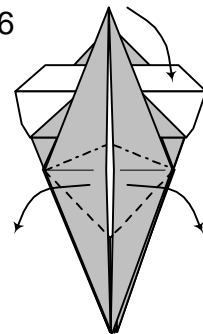

Squash fold. The valley creases line up with the edges of the hidden sunk point.

# Miss Piggy

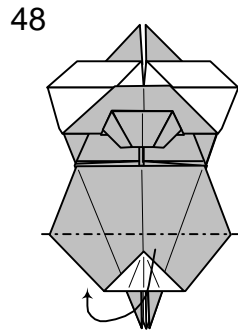
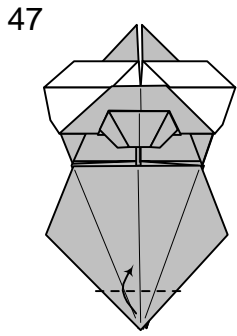

Tuck inside.

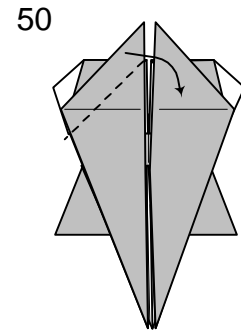
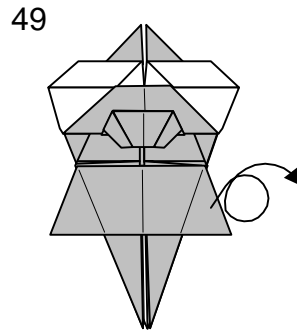

Valley fold as far as possible.

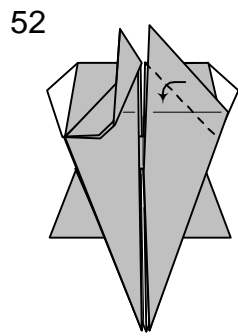
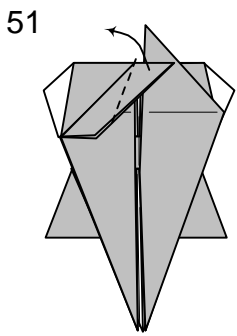

Repeat steps 50-51 on the other side.

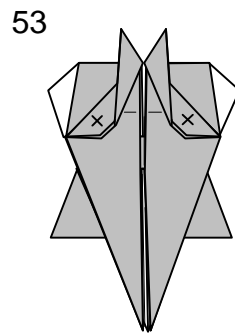

Separate the double layers and allow 'X' to move behind.

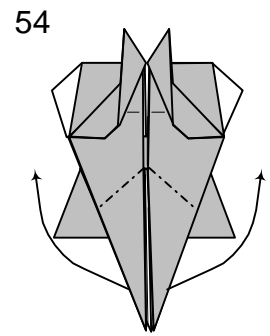

Inside reverse folds.

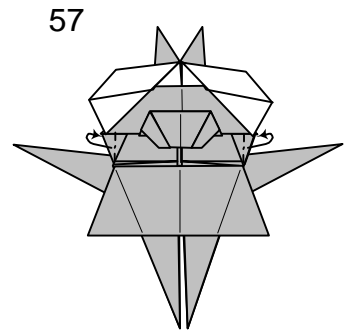
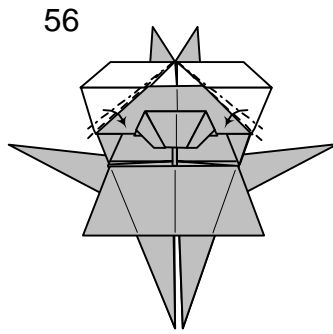
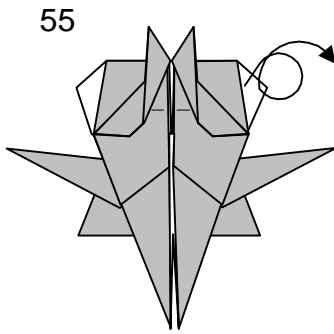

Mountain fold to narrow the neck (repeat behind).

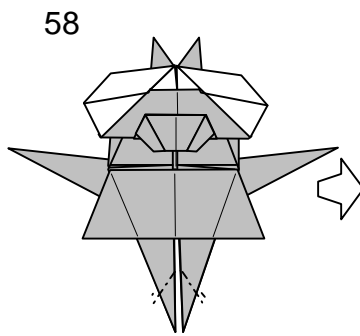

Squash fold the feet.

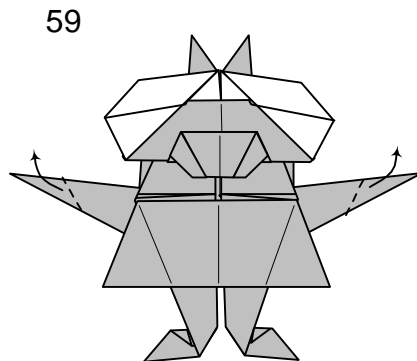

Make soft squash folds for the hands.

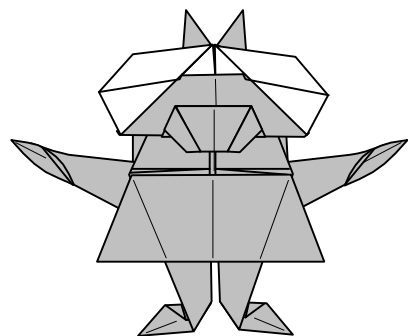

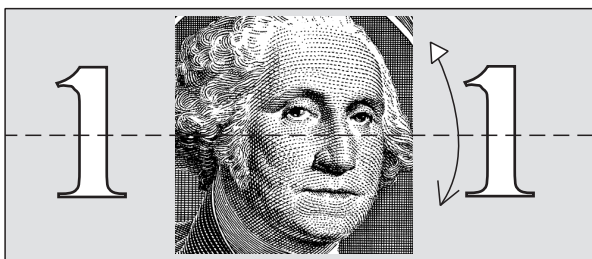

1. Precrease in half.

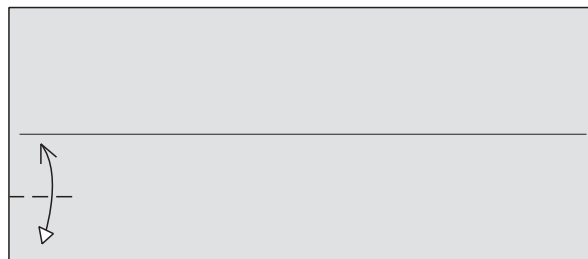

2. Precrease at the left edge.

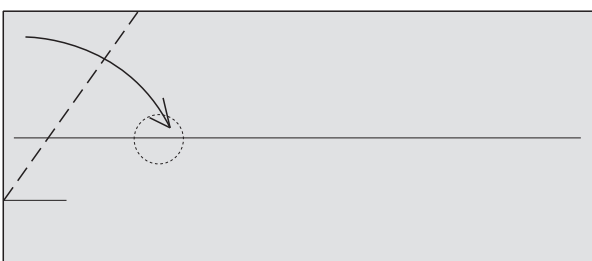

3. Valley to the center crease. It should also hit the end of the circle marking.

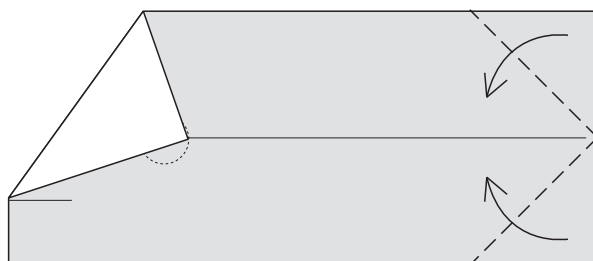

4. Valley the corners to the center.

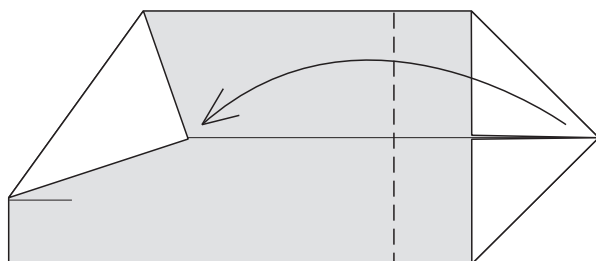

5. Valley the corner over to the tip of the flap.

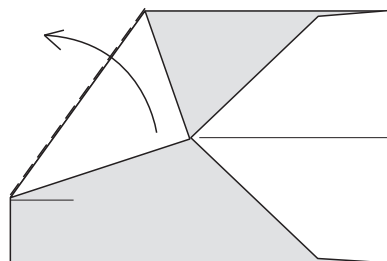

6. Unfold the flap.

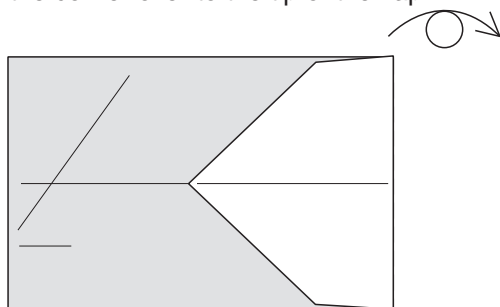

7. Turn over.

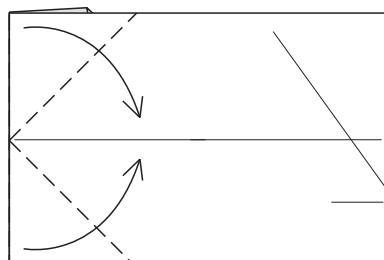

8. Valley the corners to the center.



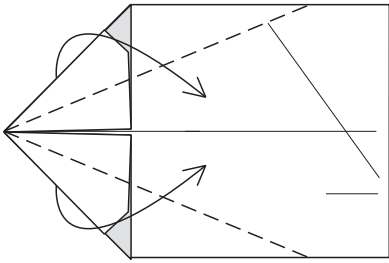

9. Valley to the center.

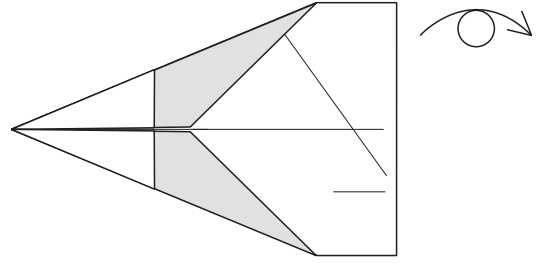

10. Turn over.

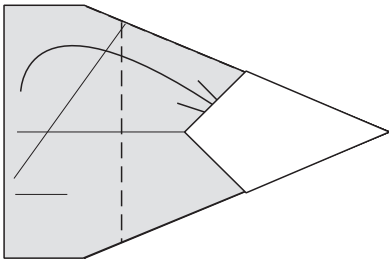

11. Valley the edge under the pocket.

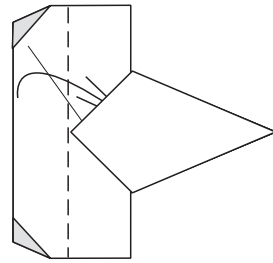

12. Valley again under the pocket.

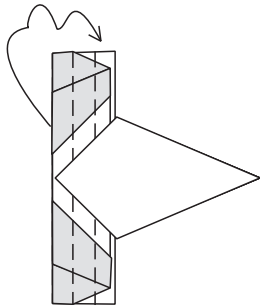

13. Fold the remaining section into thirds.

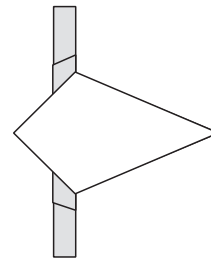

14. Completed unit. Make four more units.

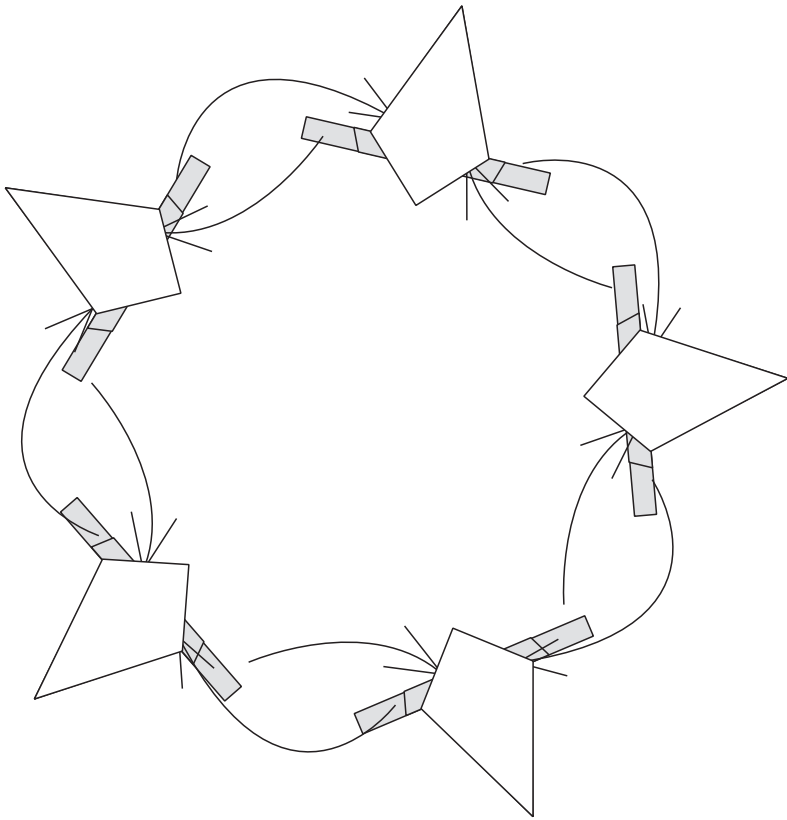

15. Tuck the tabs into the pockets in front and behind.

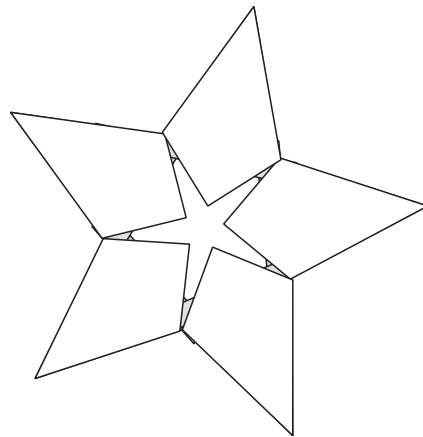

16. Completed Five-Dollar Star.

# Monkey

1

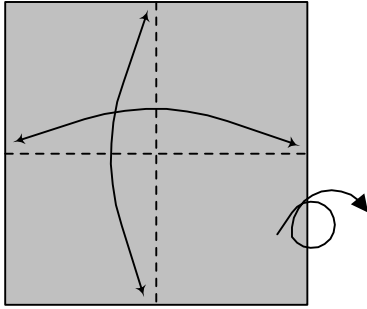

2

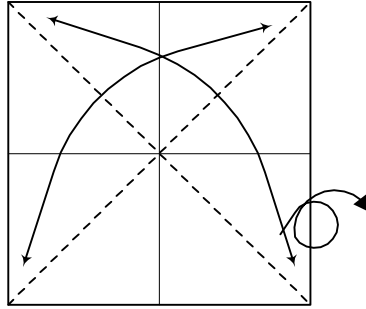

3

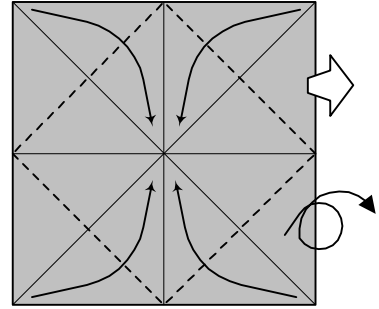

4

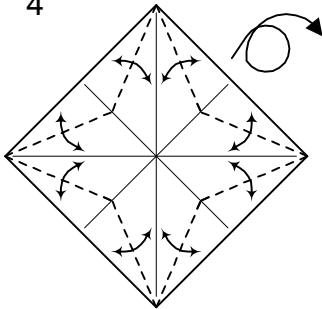

Crease the top layer only.

5

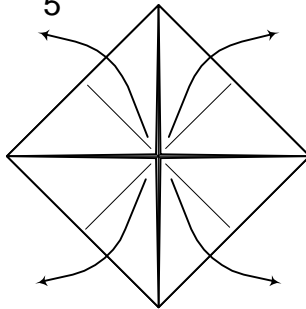

Unfold.

6

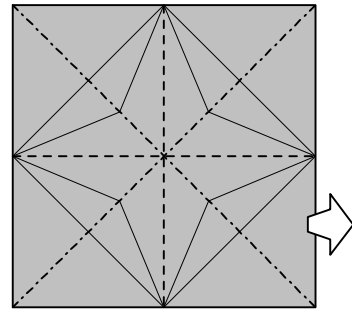

Form a waterbomb base.

7

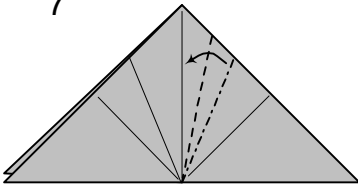

Bisect the angle.

8

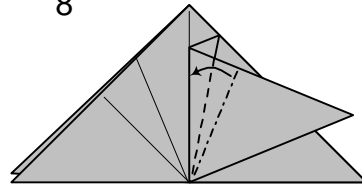

Pleat again.

9

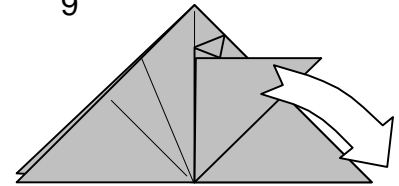

Unfold to step 7.

10

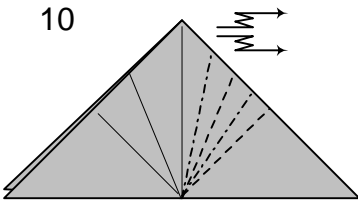

Make 4 inside reverse folds on existing creases.

11

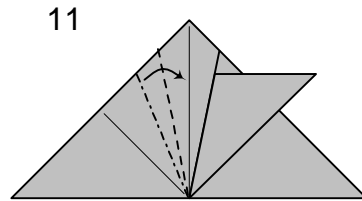

Repeat steps 7-10 on the left side.

12

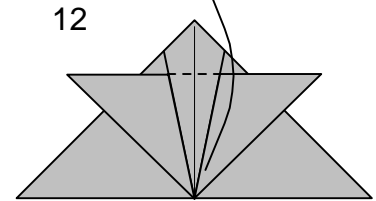

13

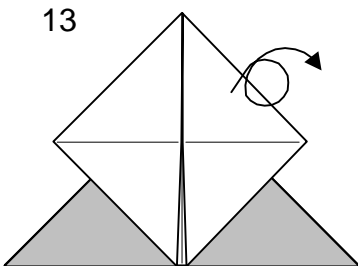

14

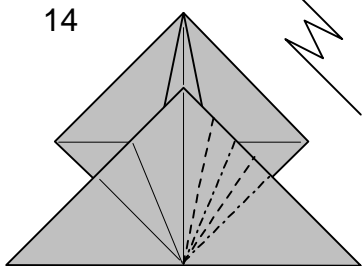

Double pleat (like steps 7-8).

15

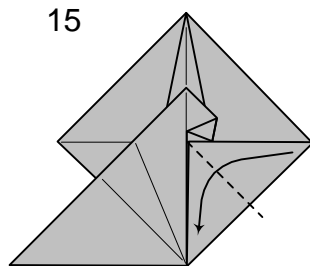

# Monkey

16

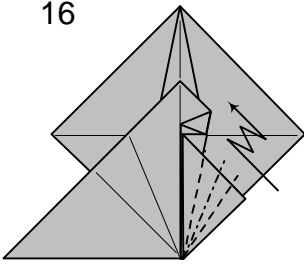

Double pleat the 4 layers.

17

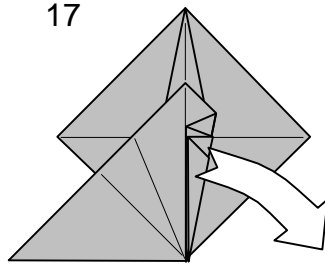

Unfold to step 14.

18

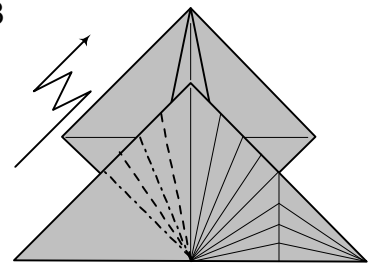

Repeat steps 14 to 17 on the left side.

19

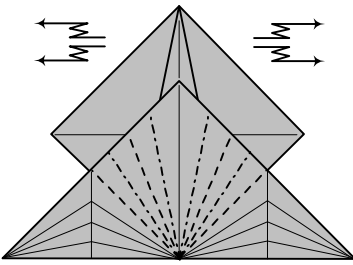

Make 2 sets of inside reverse folds, as in step 10.

20

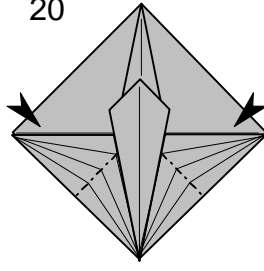

Reverse fold the 2 points.

21

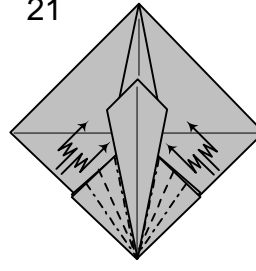

Finally, 4 more sets of reverse folds.

22

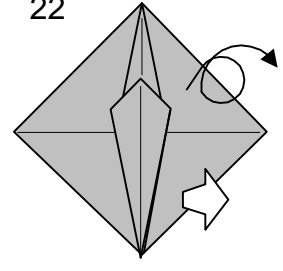

23

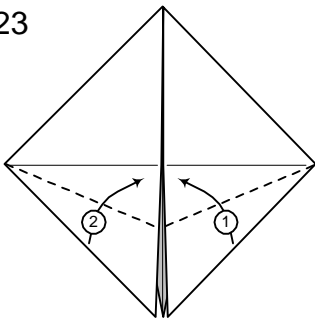

Fold the flap on the right first.

24

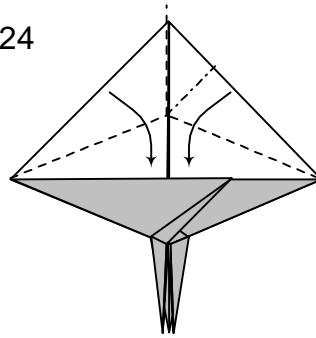

Rabbit ear.

25

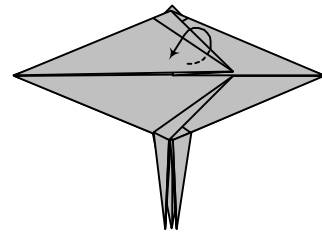

Wrap 1 layer over the point.

26

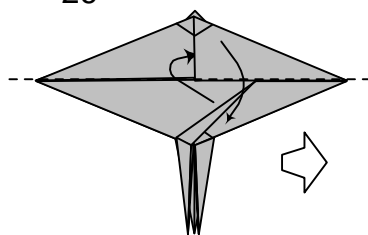

Valley fold the top down while tucking the point behind to lock.

27

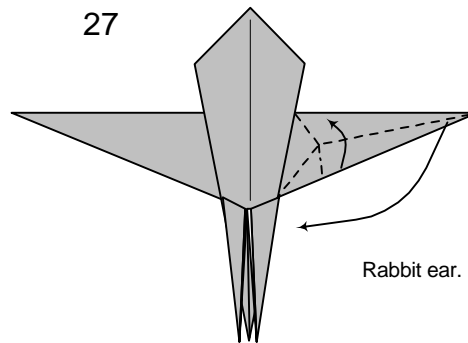

Rabbit ear.

28

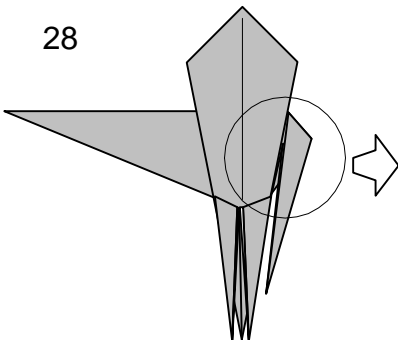

29

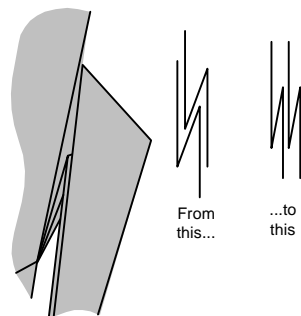

From this...

...to this

Separate the 2 inner layers, no new creases are required.

30

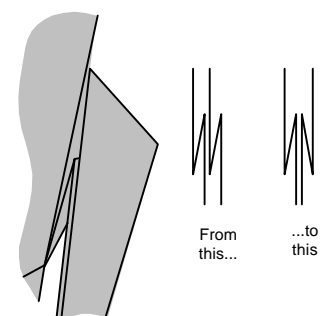

From this...

...to this

Reverse the existing creases so the flap is inside the model.

# Monkey

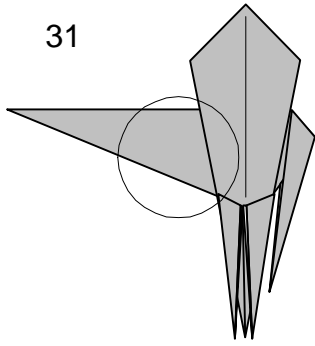

31

Repeat steps 27-30 on the left side.

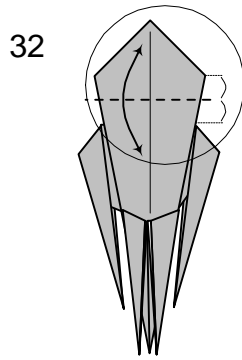

32

Make a sharp crease.

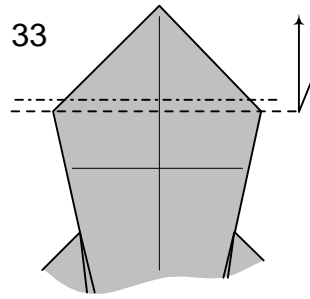

33

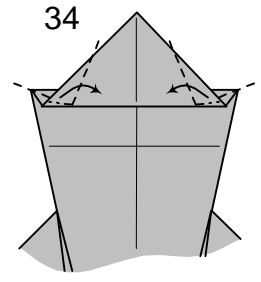

34

Narrow the sides.

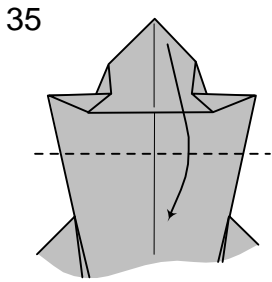

35

Fold the head down.

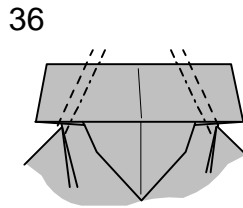

36

Valley and mountain fold each side to make the ears.

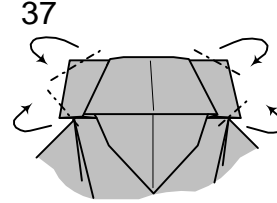

37

Round off the ears.

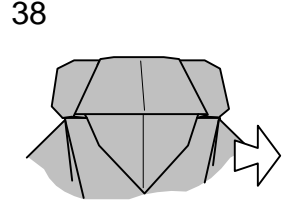

38

The nose can be shaped by slightly 'inflating' the point.

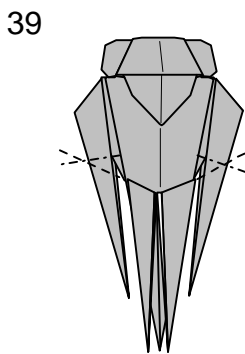

39

Use simple valley and mountain folds to shape the arms.

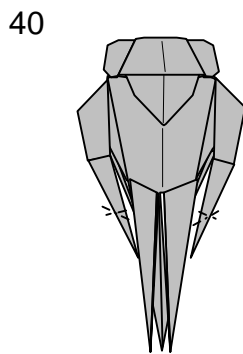

40

Gently squash fold the hands.

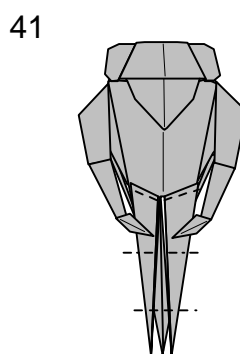

41

Bend the legs into shape.

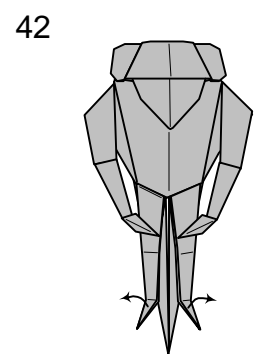

42

Twist the feet and spread the paper a little to make the feet wider.

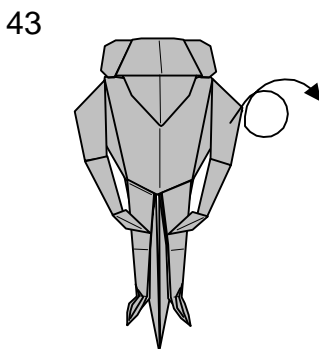

43

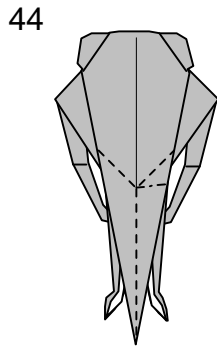

44

Rabbit ear.

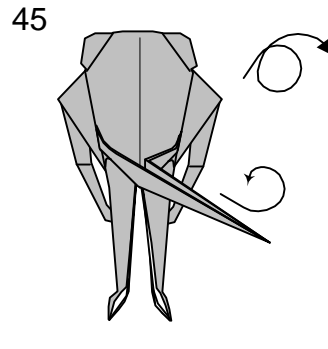

45

Give the tail a nice curve.

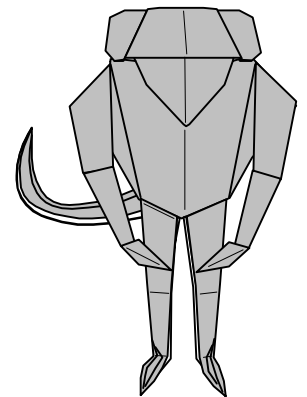

Шлем с  
Шлем by  
EUGENY FRIDRIKH, RUSSIA

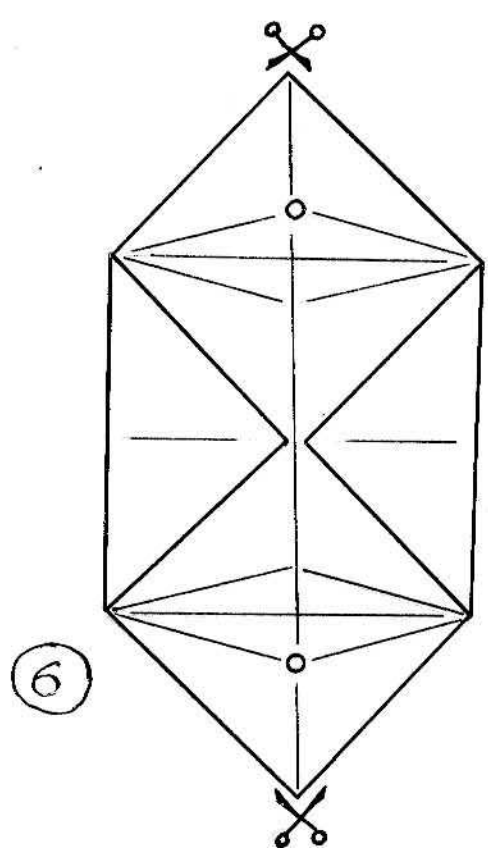
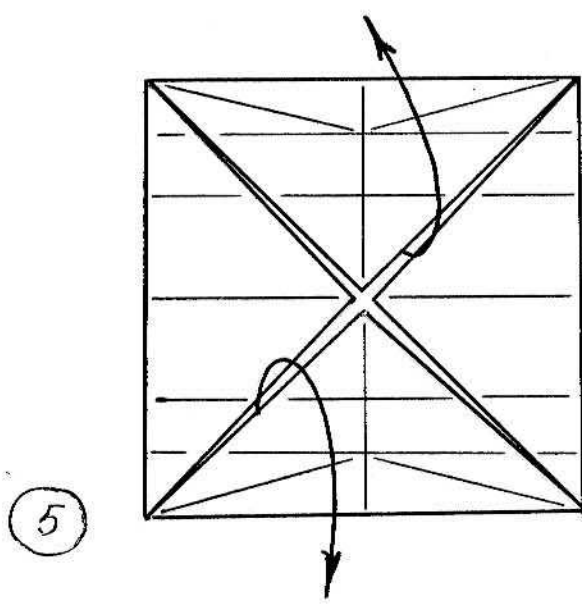
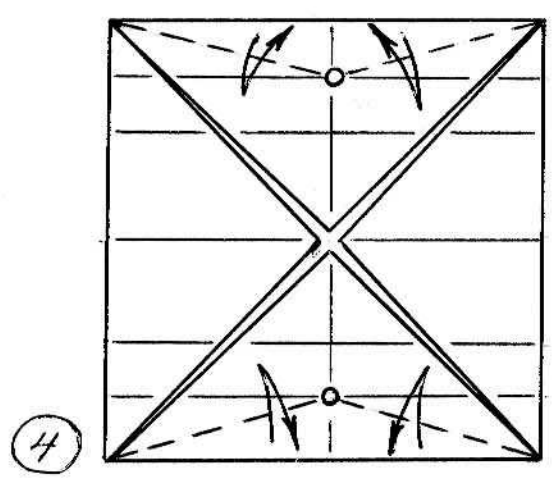
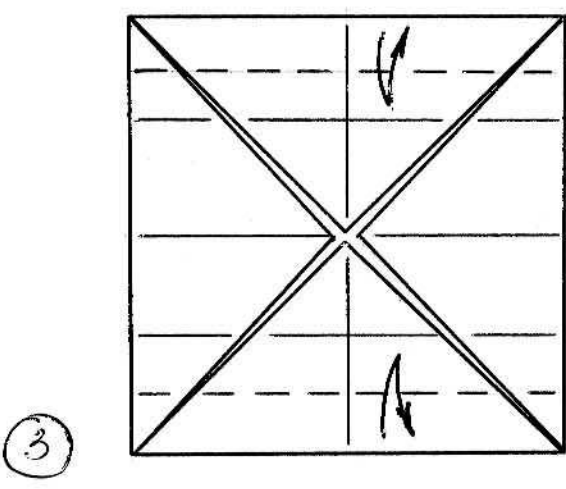
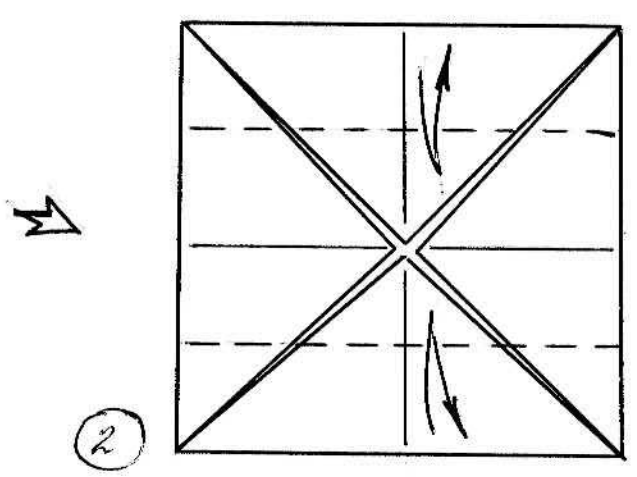
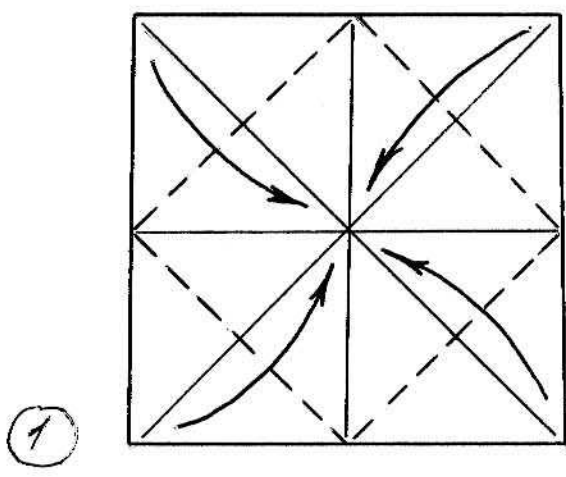

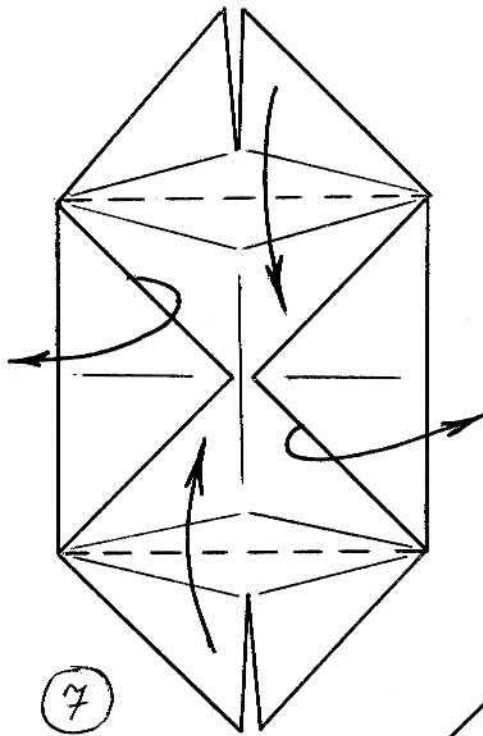

7

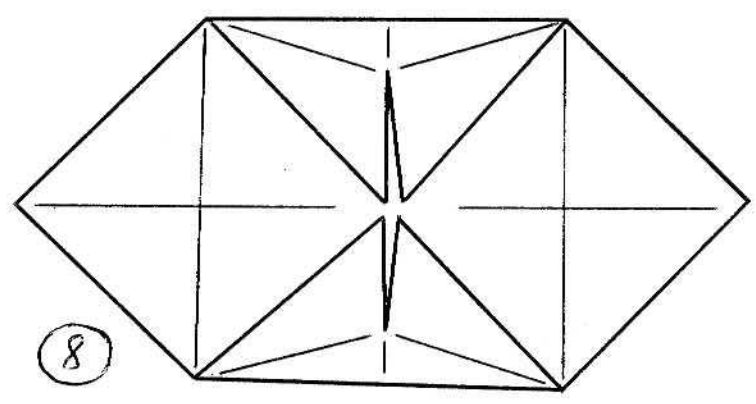

8

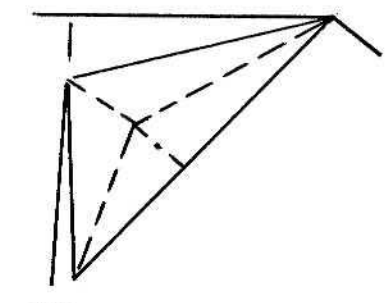

9

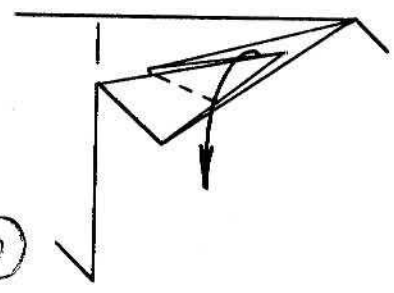

10

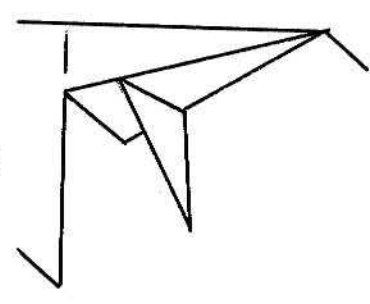

11

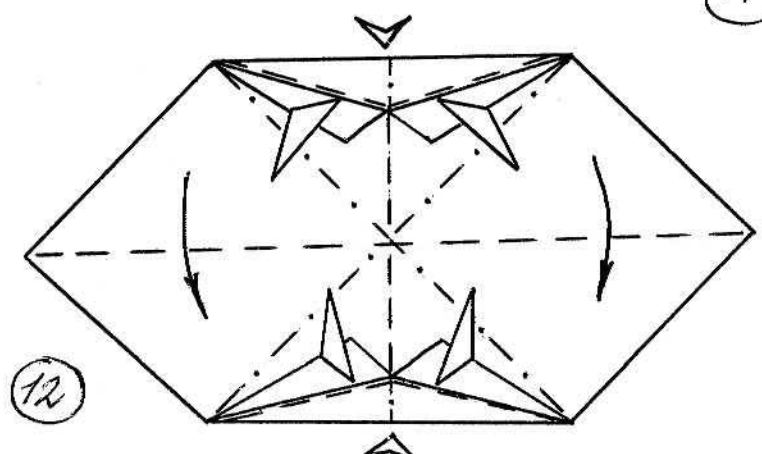

12

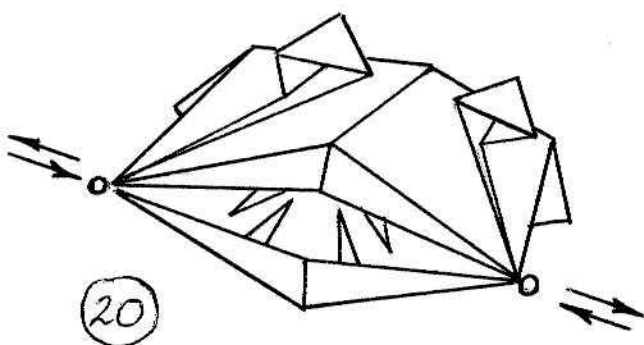
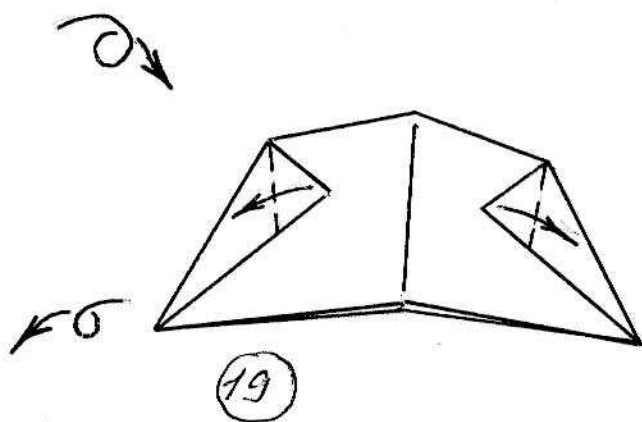
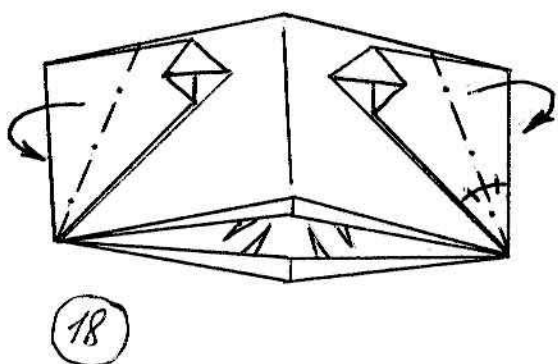
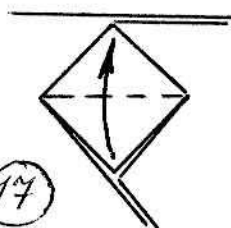
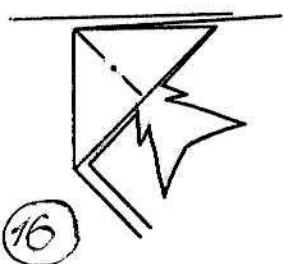
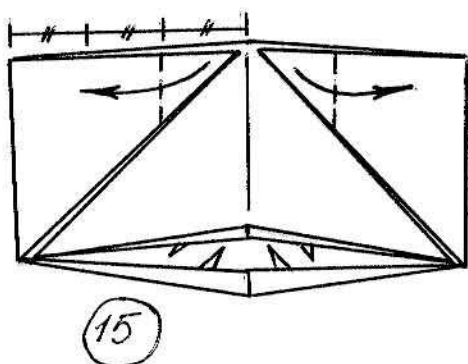
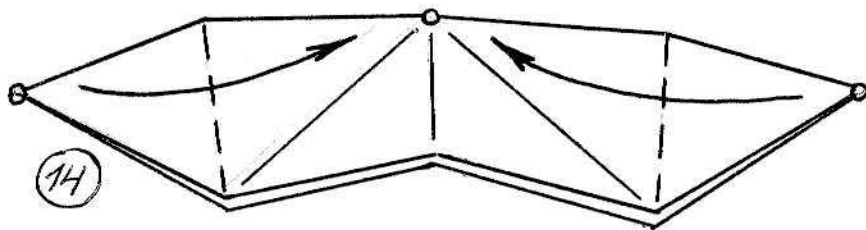
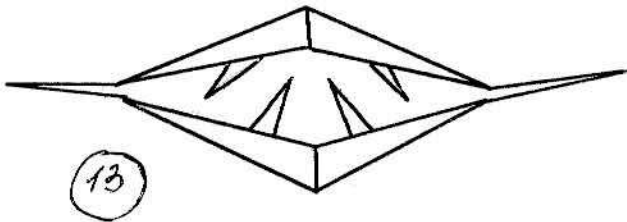



# “Растущая и убывающая луна”

Автор: Джереми Шефер (США)

Эта модель - для поклонников сложного оригами.  
Для её складывания вам понадобится большой лист  
бумаги, но лучше - фольги.

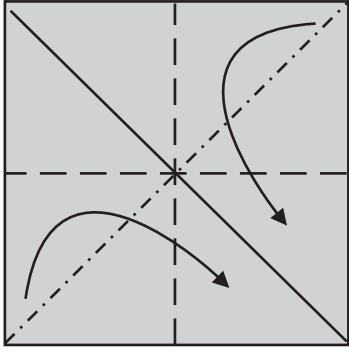

**1** Сложите базовую форму “квадрат”

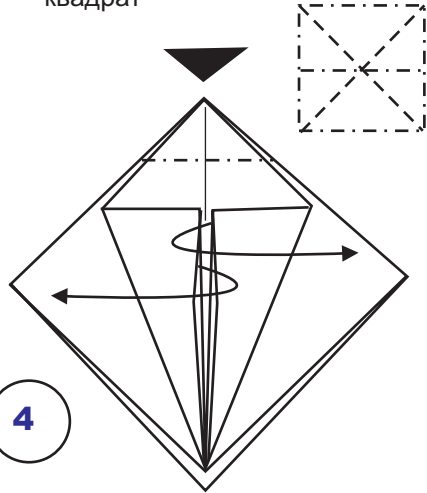

**4**

Вогните угол внутрь

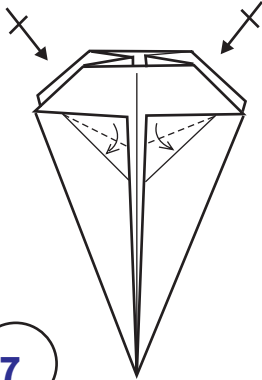

**7**

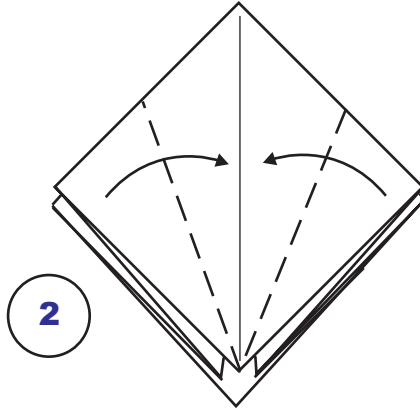

**2**

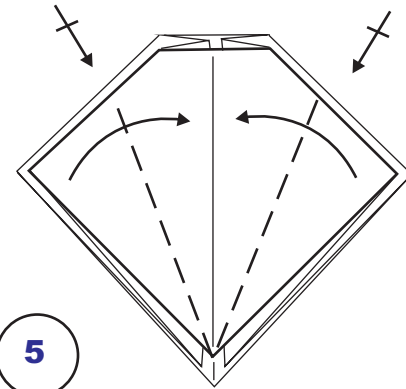

**5**

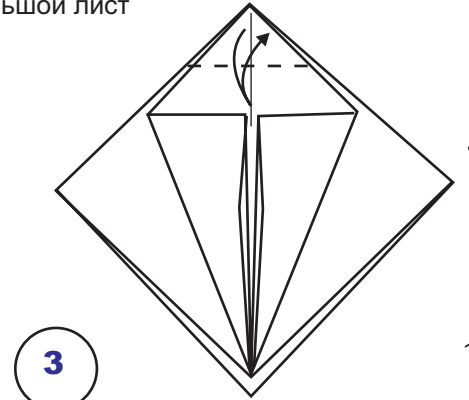

**3**

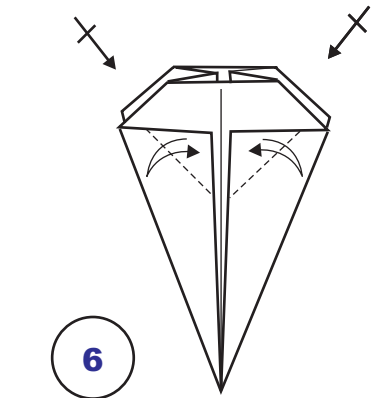

**6**

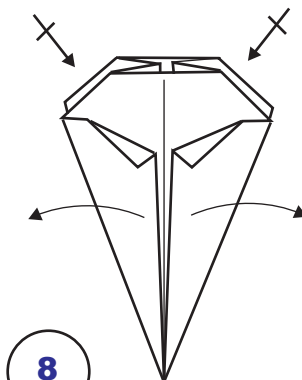

**8**

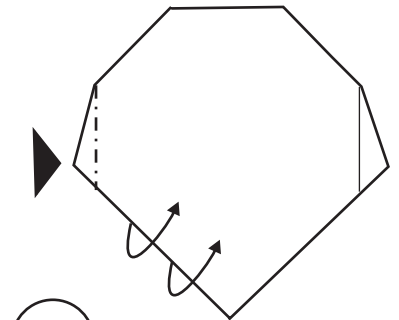

**9**

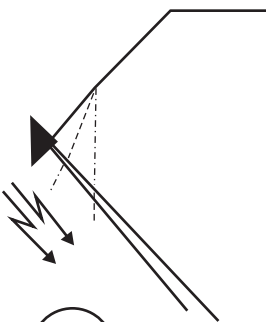

**10**

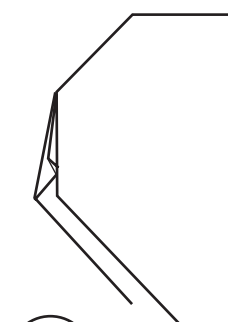

**11**

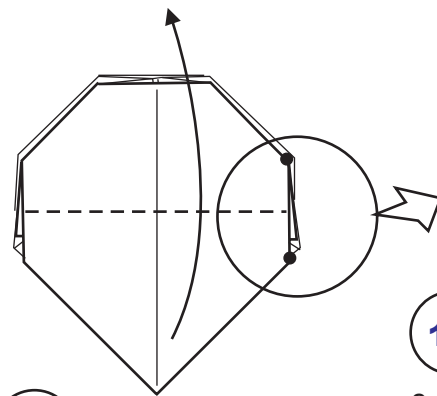

**12**

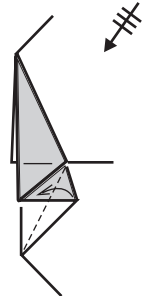

**13**

Здесь показано, что происходит внутри складки при выполнении шага 12

Шаг 9 в прогрессе: держите уголок двумя пальцами и просто вогните его внутрь

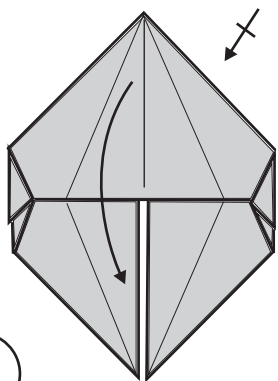

14

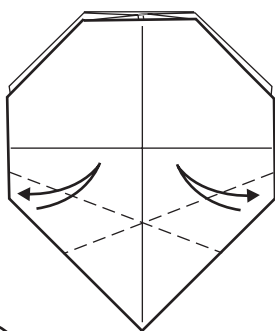

15

Сделайте две глубинные складки. На другой стороне не сгибайте!

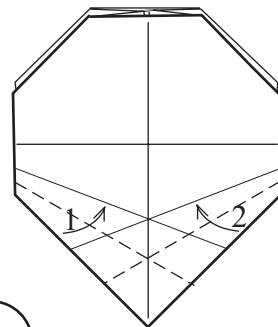

16

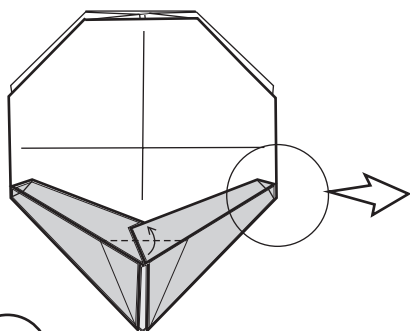

17

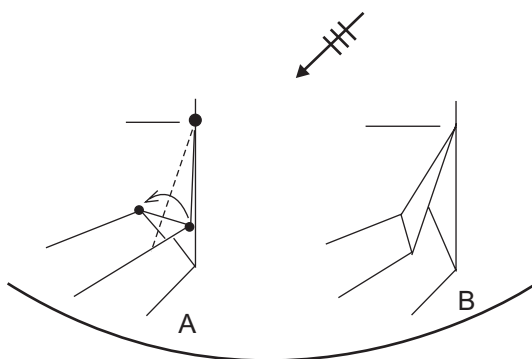

18

Согните таким образом каждый из четырёх уголков

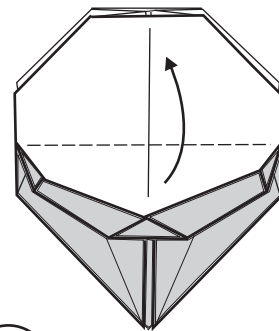

19

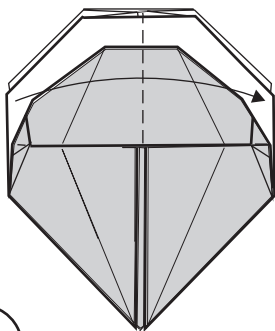

20

Отогните один слой вправо

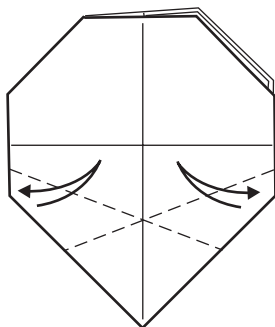

21

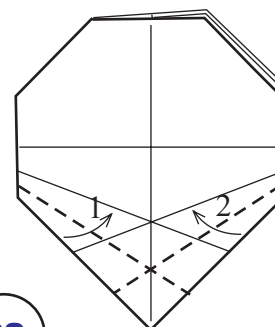

22

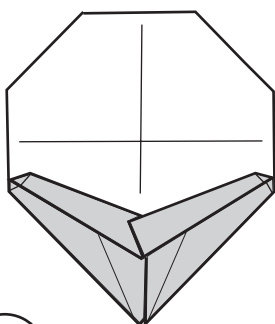

23

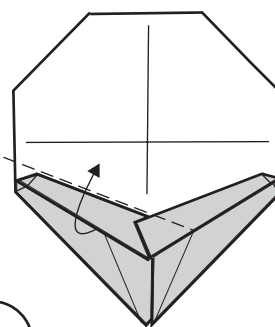

24

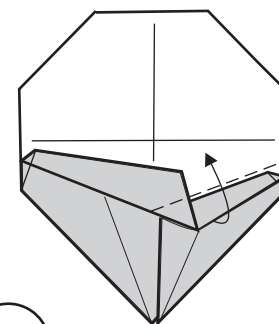

25

26

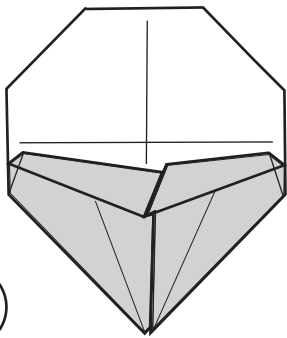

27

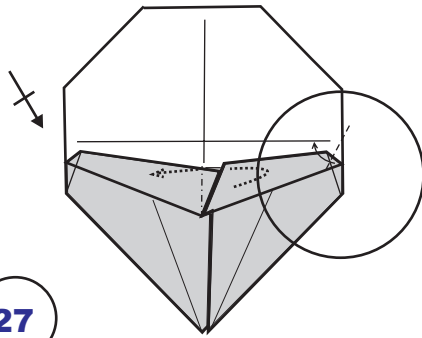

28

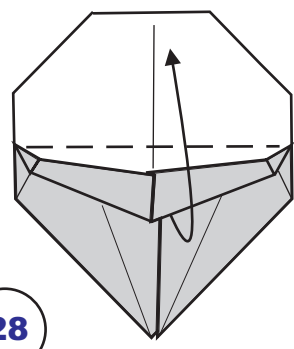

29

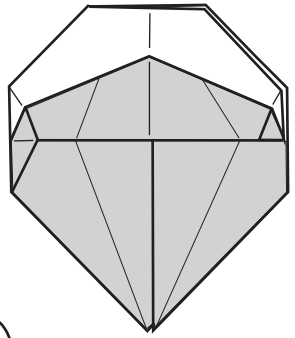

Проверьте результат  
и переверните на другую  
сторону

30

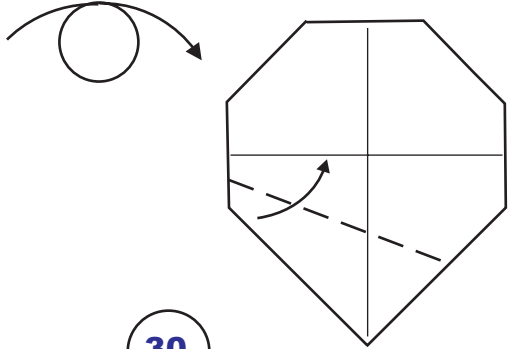

31

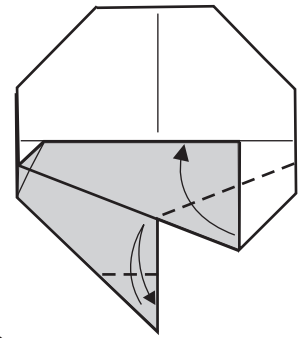

32

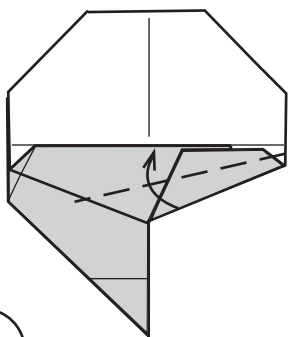

33

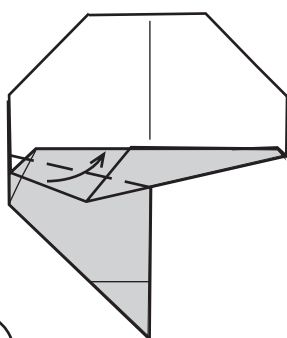

34

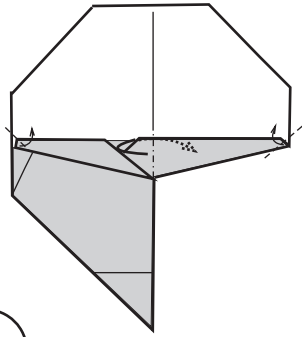

35

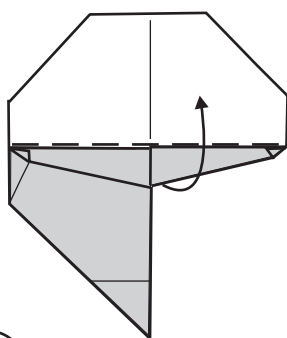

36

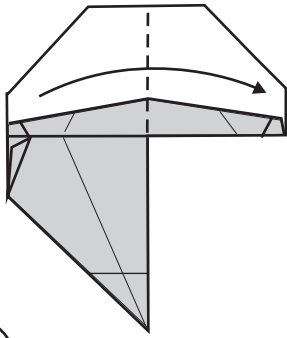

37

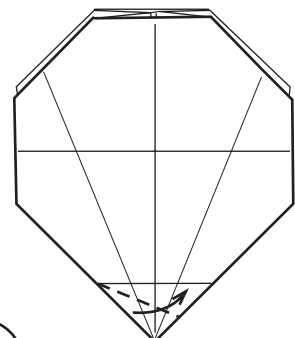

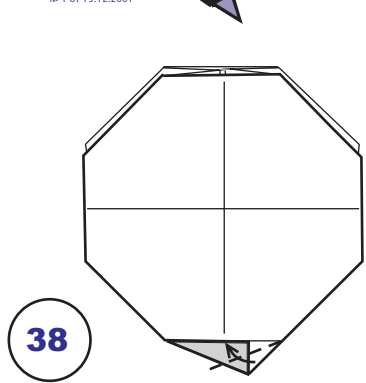

38

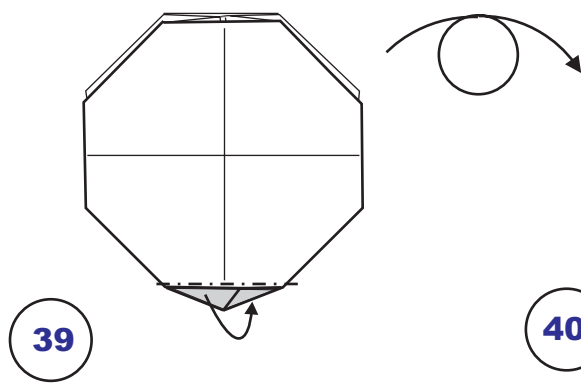

39

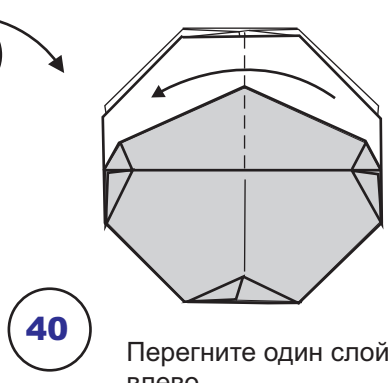

40

Перегните один слой влево

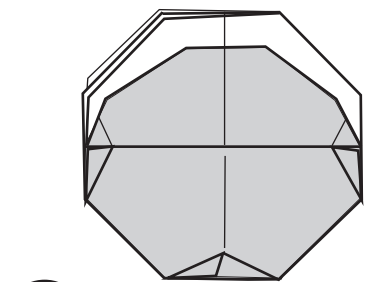

41

Проверьте результат и поверните фигуру на 90 градусов по часовой стрелке

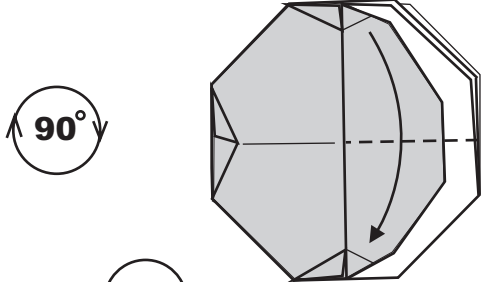

42

Начинаем трансформации! Сначала вы видите остроносый месяц

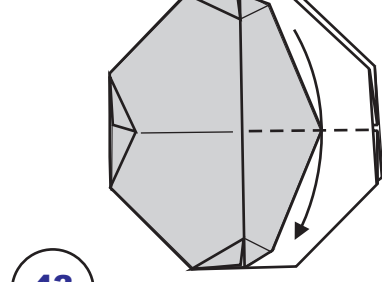

43

...луна набирает силу...

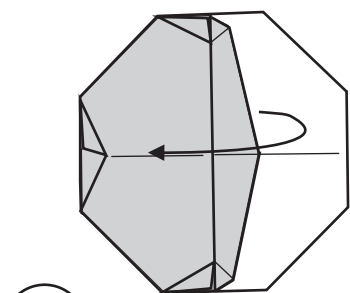

44

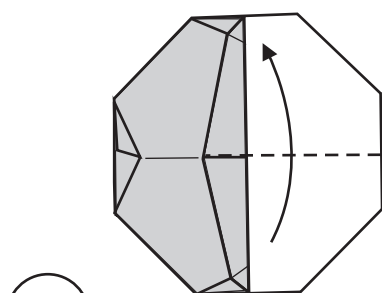

45

...мы уже видим половину луны!

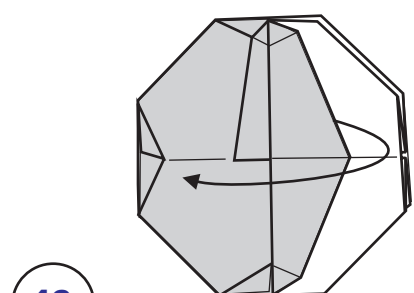

46

(Промежуточный этап: отогните один слой влево)

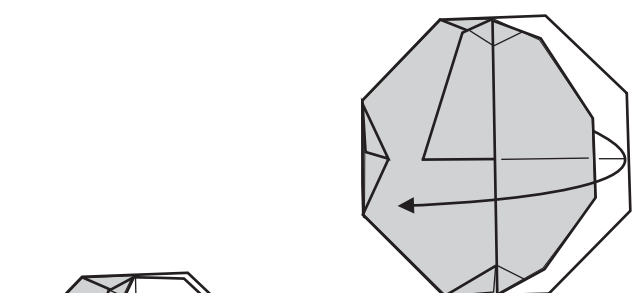

47

Луна продолжает наливаться...

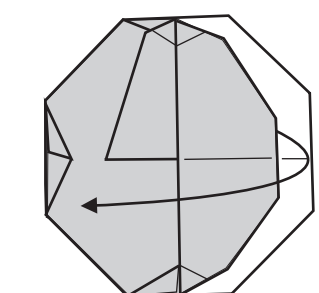

48

(Промежуточный этап)

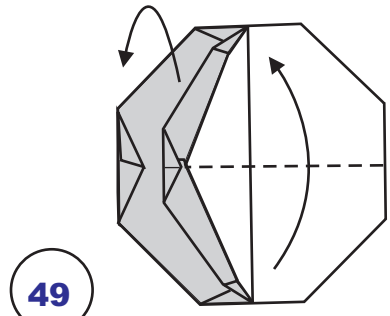

49

...до полнолуния осталось совсем немного!

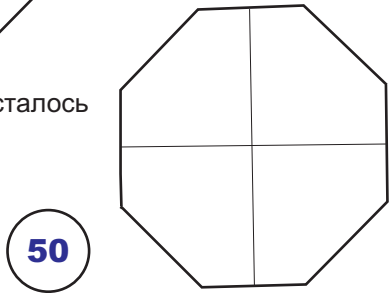

50

Наконец, возшла полная луна! Попробуйте теперь заставить её снова "похудеть"!

# MUSHROOM MATT SLAYTON

DIAGRAMS ALEX BARBER

1994

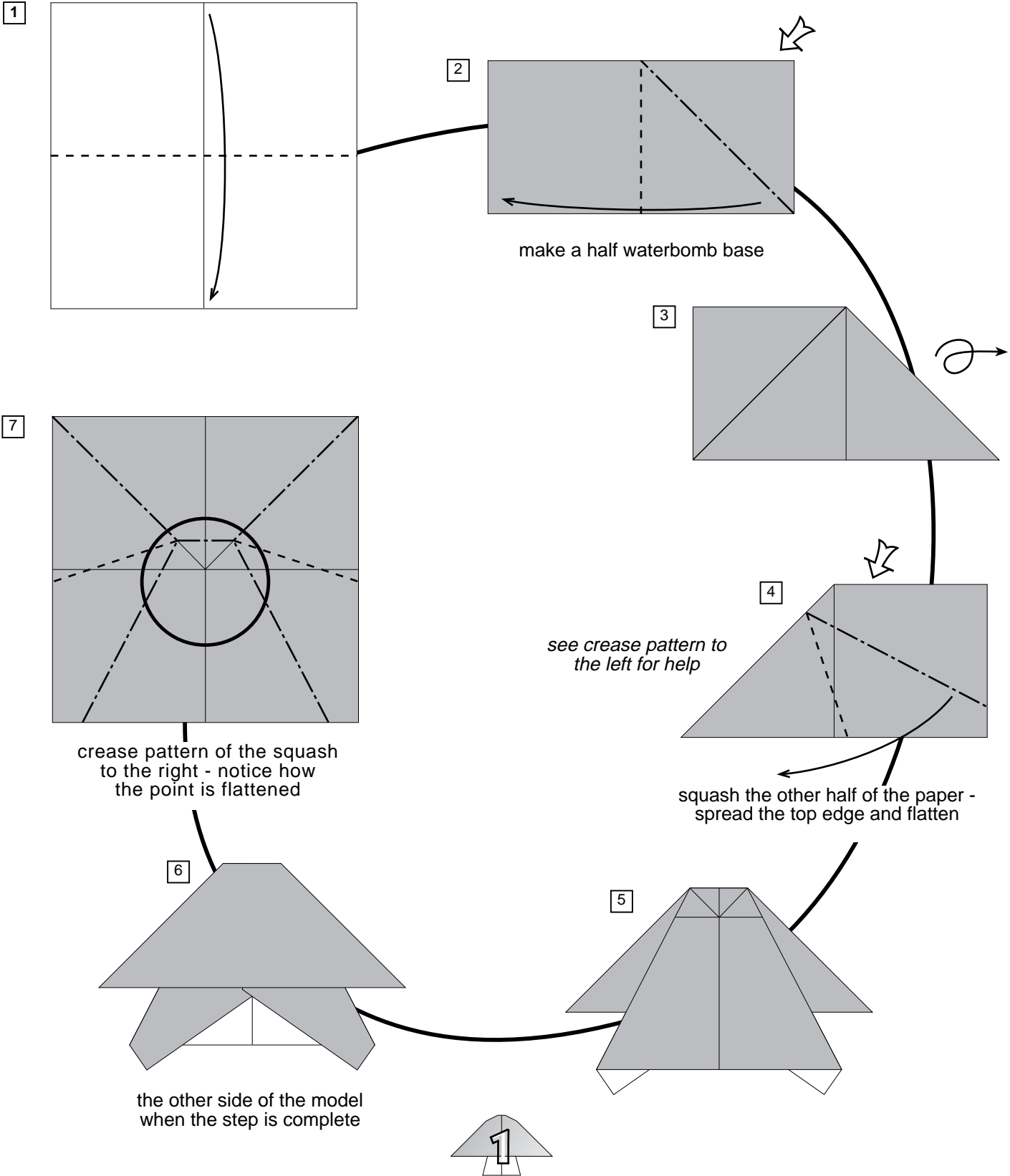

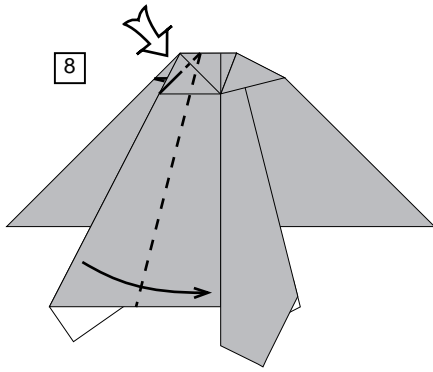

8  
fold in sides while squashing  
the top point

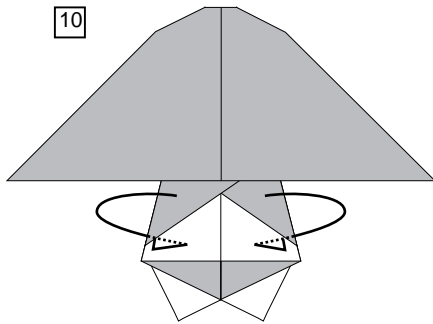
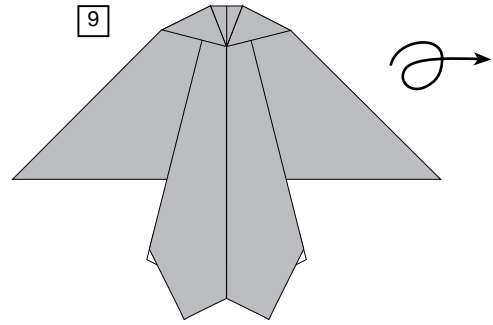

10  
pull out top layers and  
tuck behind in pockets

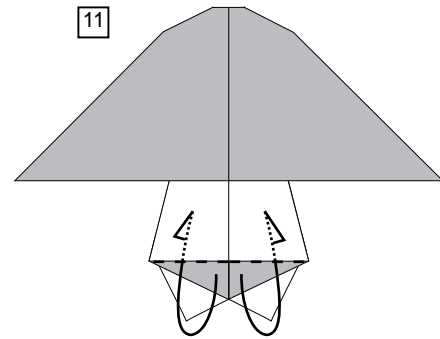

11  
tuck flaps inside

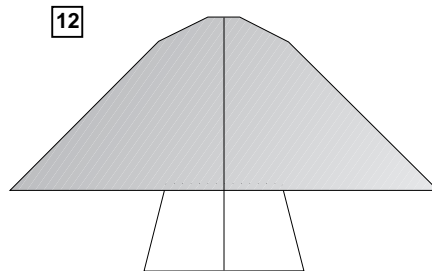

12



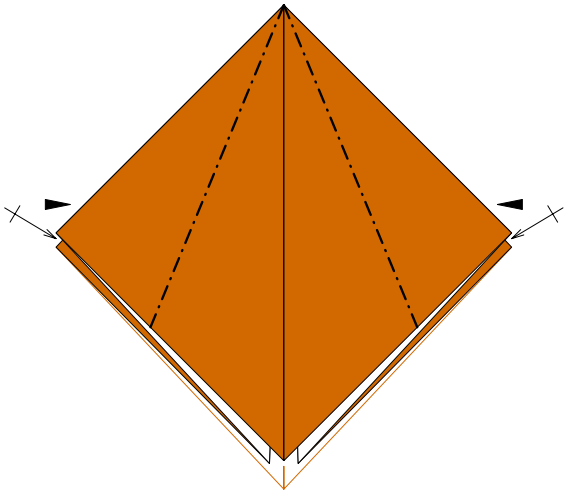

1 Start with preliminary fold  
colour outside

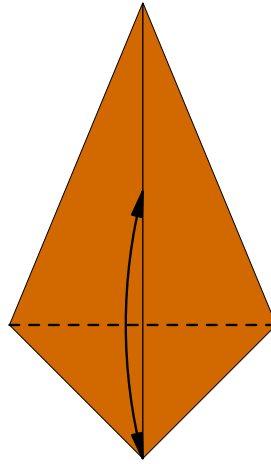

2

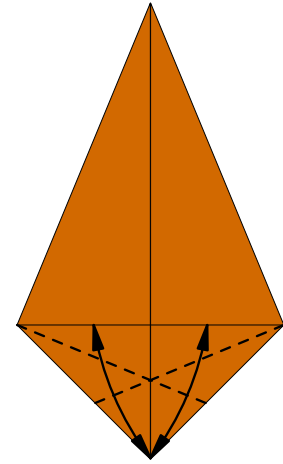

3 Repeat step 2 and 3  
on other corners

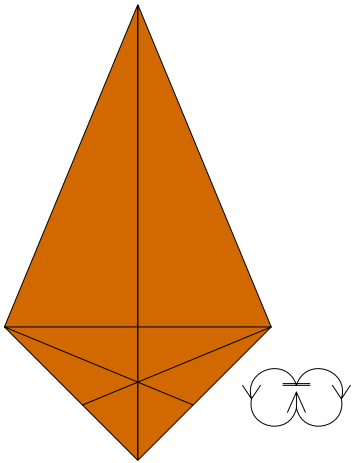

4 Turn inside out

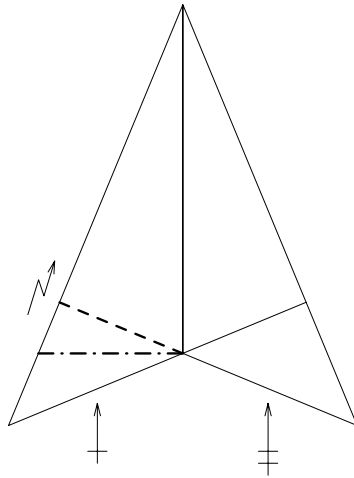

5

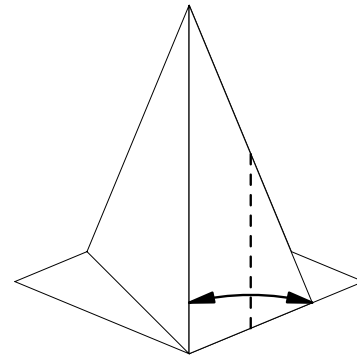

6

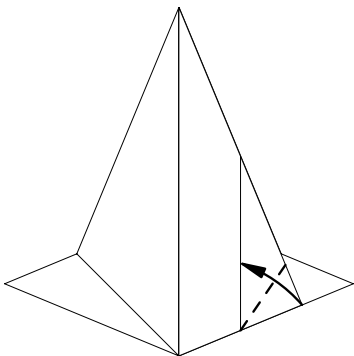

7

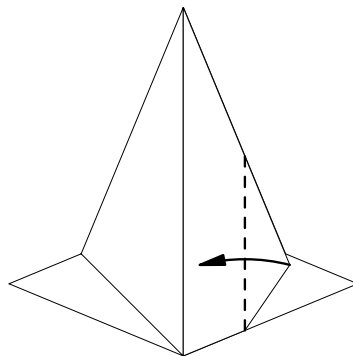

8

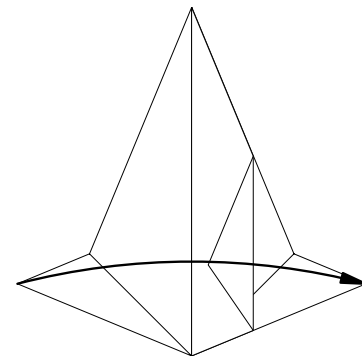

9 One layer

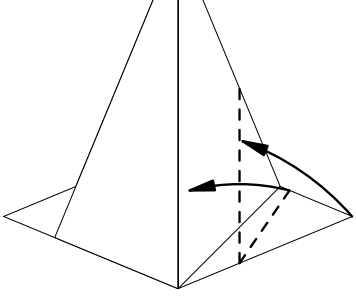

10 Repeat step 6 to 8  
on this flap  
Repeat these steps  
on all other flaps

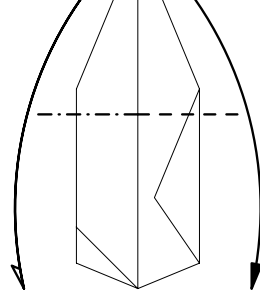

11

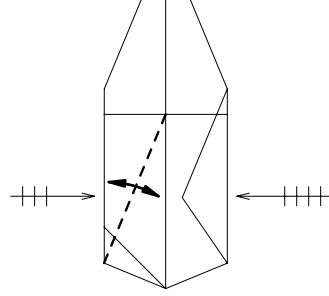

12

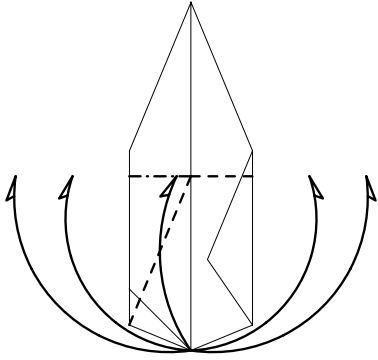

13 Open model using  
existing creases

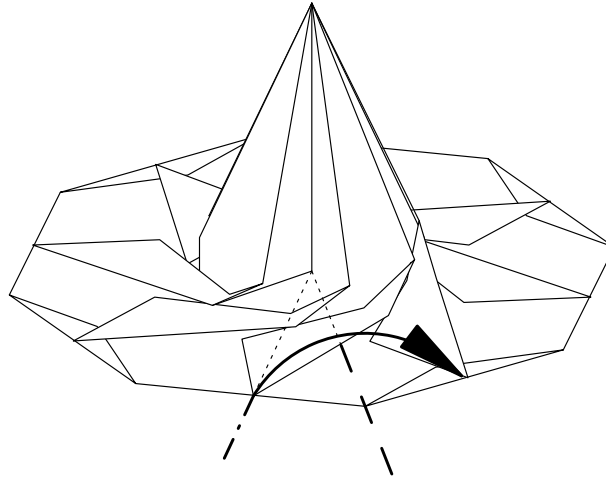

14 'Crimp'

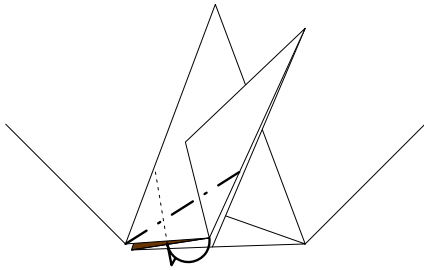

15 Block the crimpfold

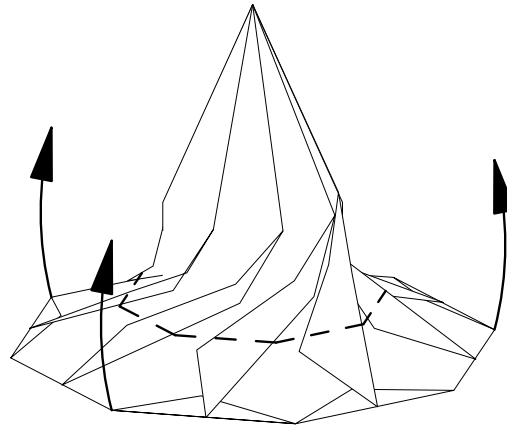

16

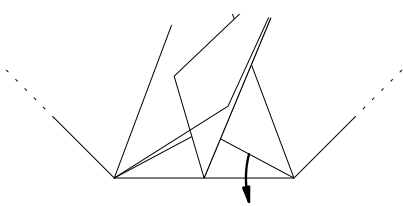

17 Open

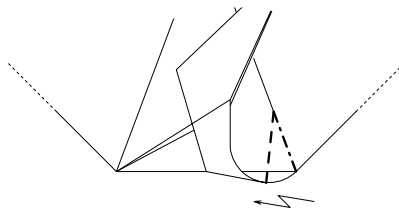

18 Crimp



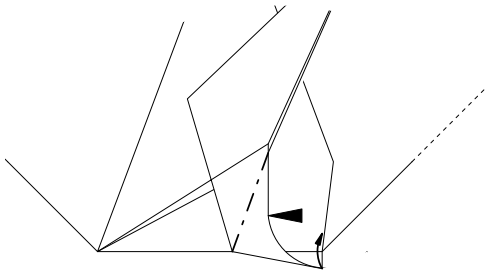

19 Close again to lock

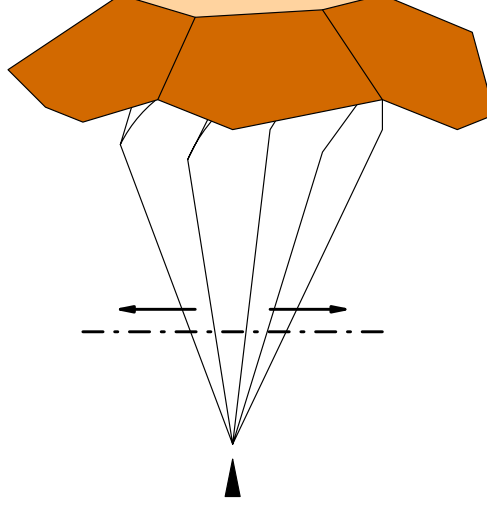

20 Widen stem

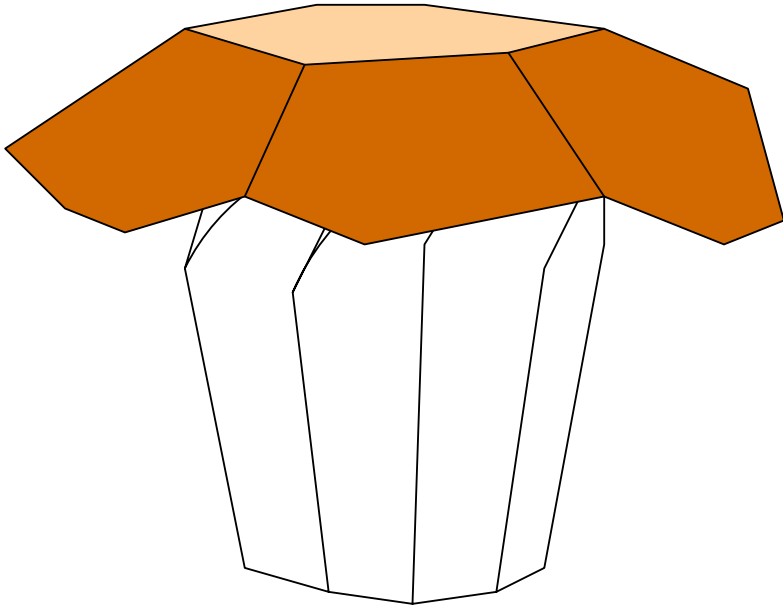

# Nuclear Crane created & diagrammed

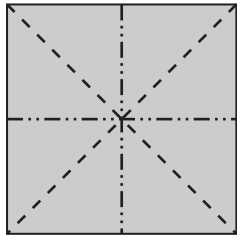

1] "Octasect" paper with valley and mountain folds.

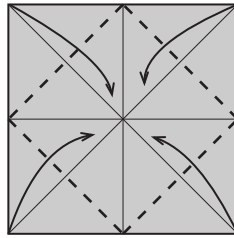

2] Blintz corners.

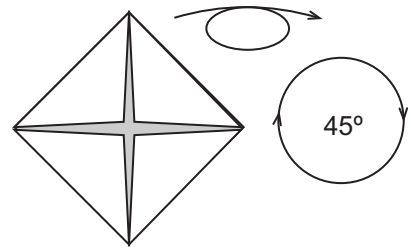

3] Turn over and rotate.

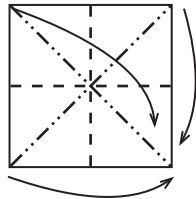

4] Collapse to a preliminary fold.



5] Rotate.

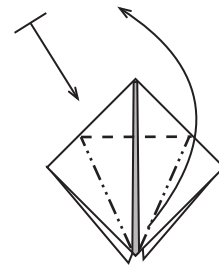

6] Petal fold.  
Repeat behind.

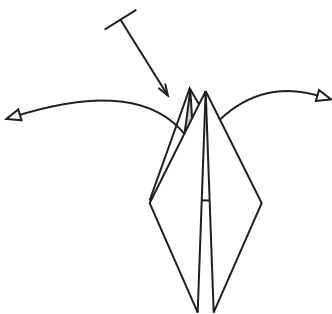

7] Pull out the trapped paper on each side. Repeat behind.

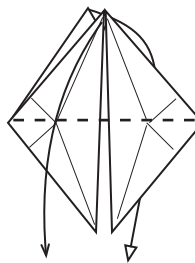

8] Fold one layer down in front and one down behind.

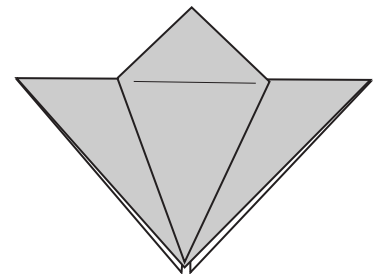

9] The completed Blintzed Bird Base.

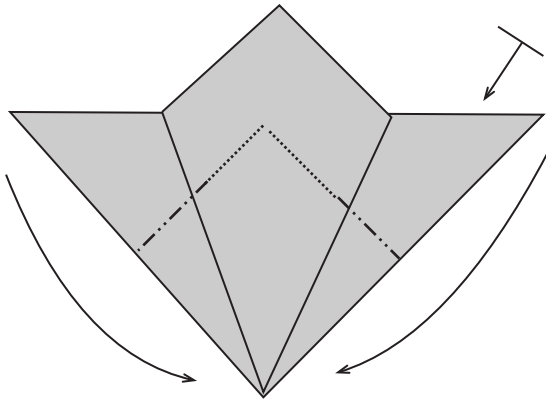

10] Begin with a colored blintzed bird base. Reverse fold the flaps down. Repeat behind.

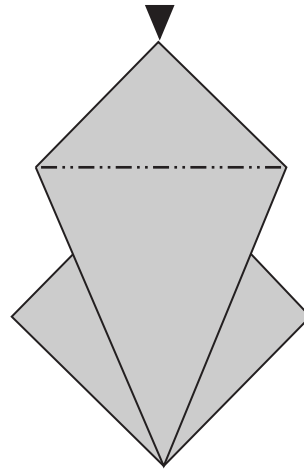

11] Sink the top triangle.

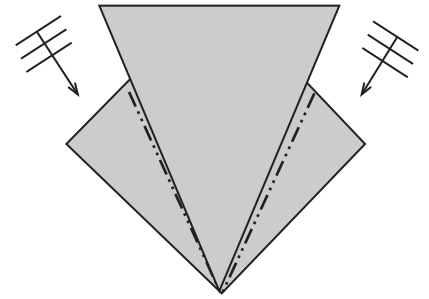

12] Eight reverse folds.

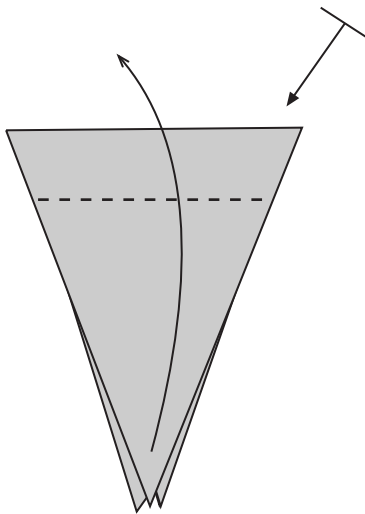

13] Fold one flap up as far as it will go. Repeat behind.

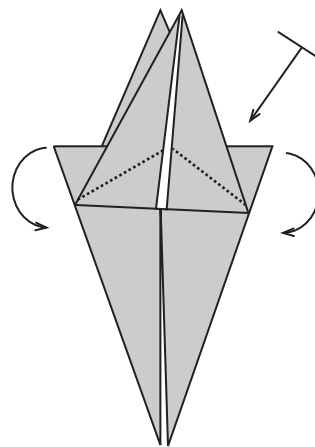

14] Reverse fold corners to the inside of the top pocket. Repeat behind.

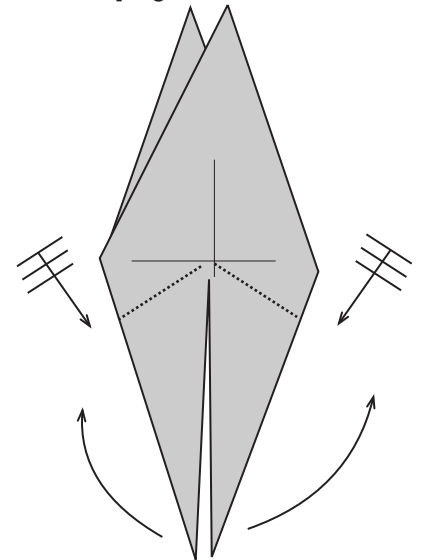

15] The result is a bird base with an extra middle point on each side. Reverse fold six points up.

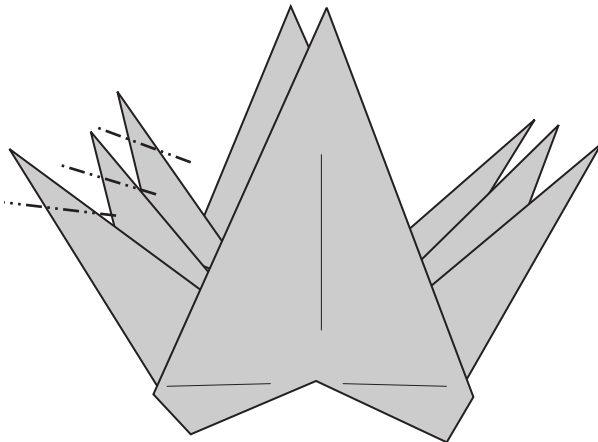

16] Reverse fold heads. Hold base of neck and tug middle tail -- wings will flap. Hopefully, Bird will fly far away from the nuclear site that gave him 3 heads!

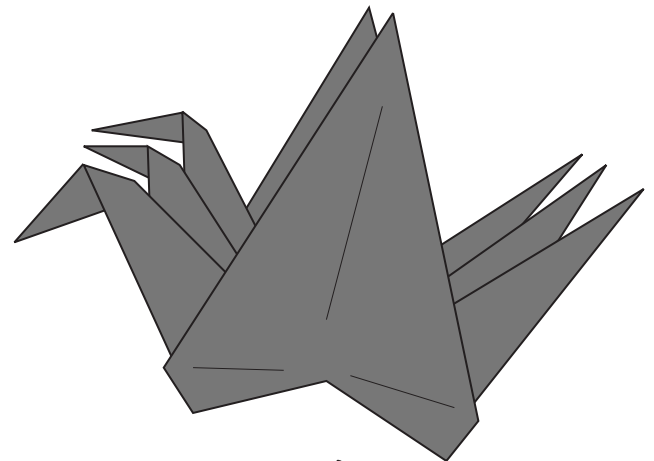

JacAI Art ©1996

# OBJECTS

by Eugeny Fridrikh

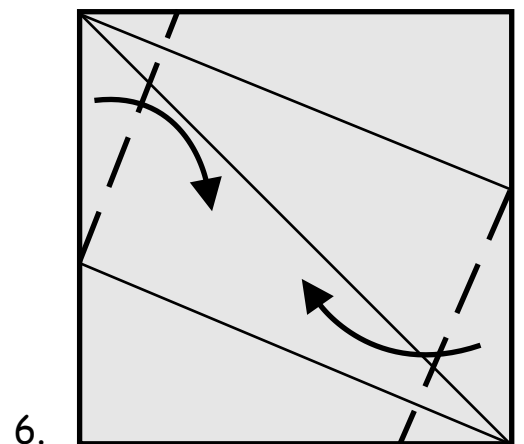
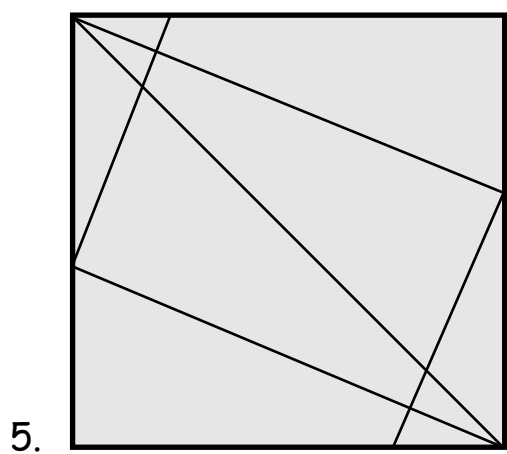
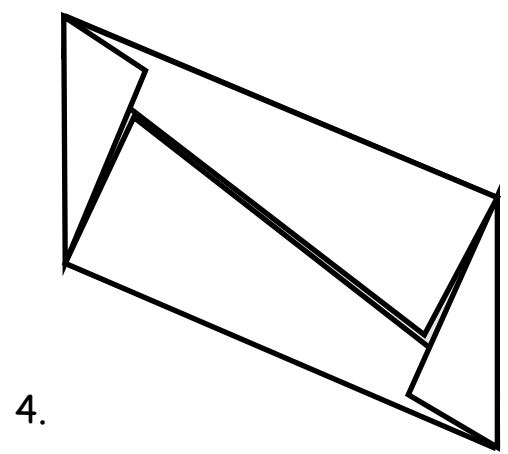
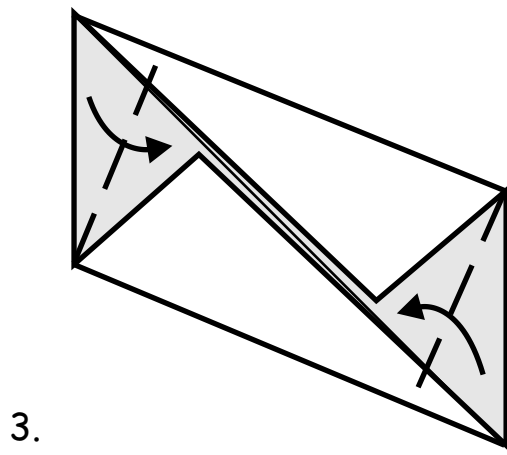
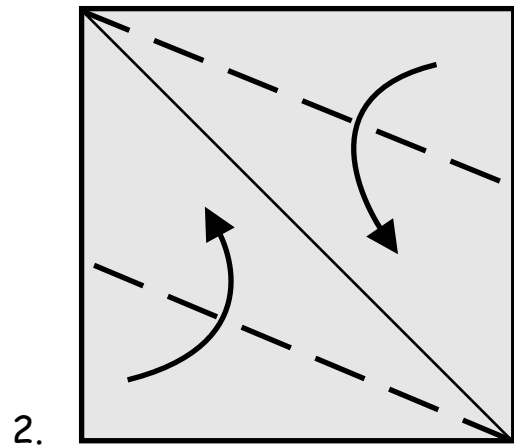
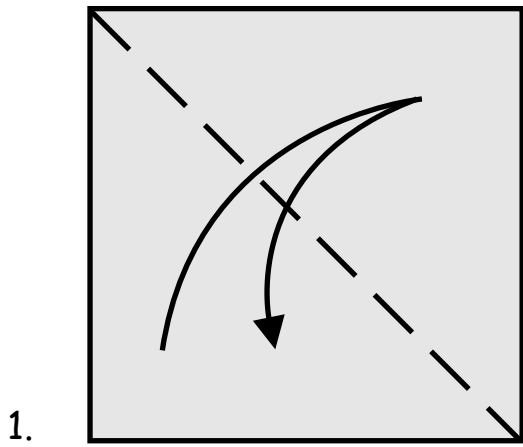

7.

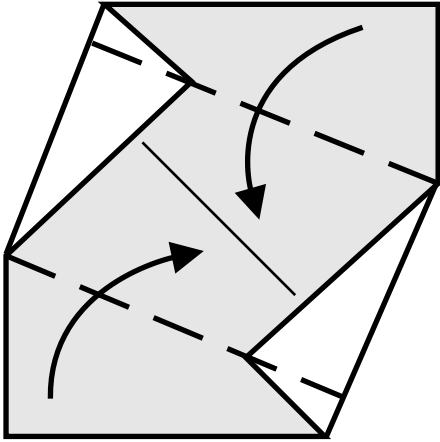

8.

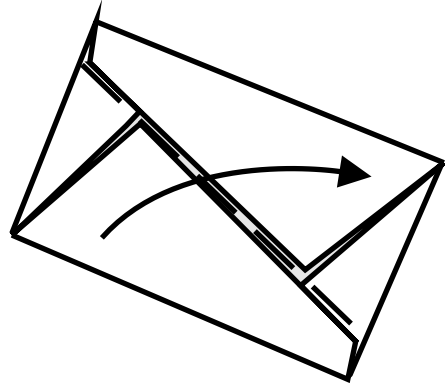

9.

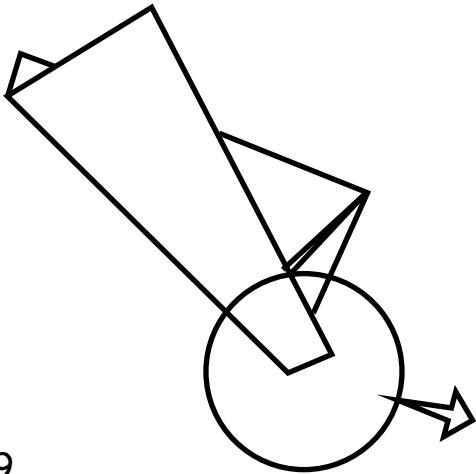

10.

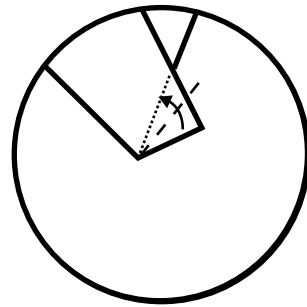

11.

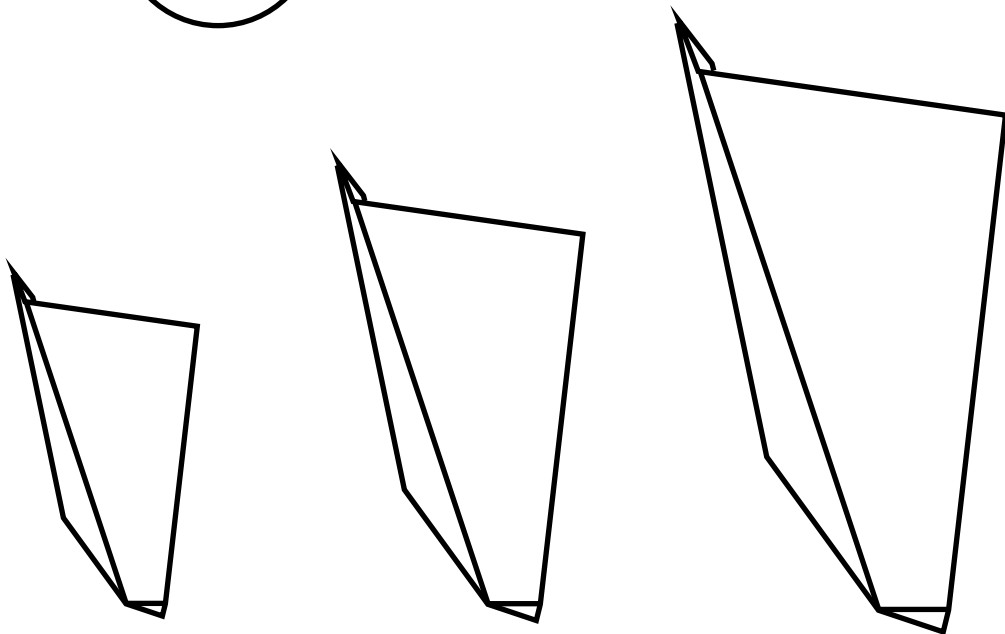

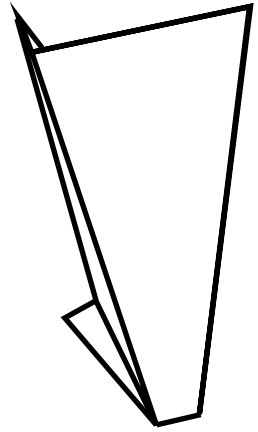
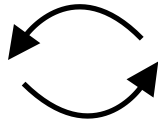
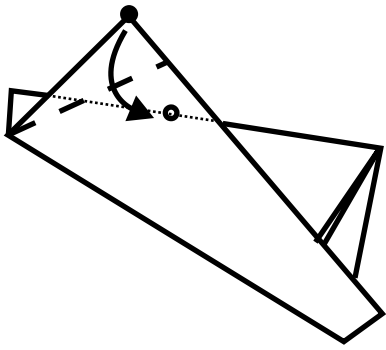

9".

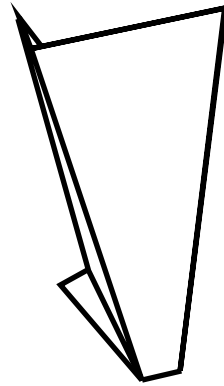
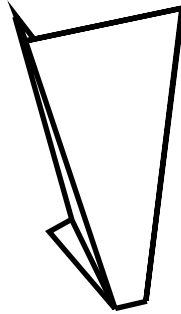

10".

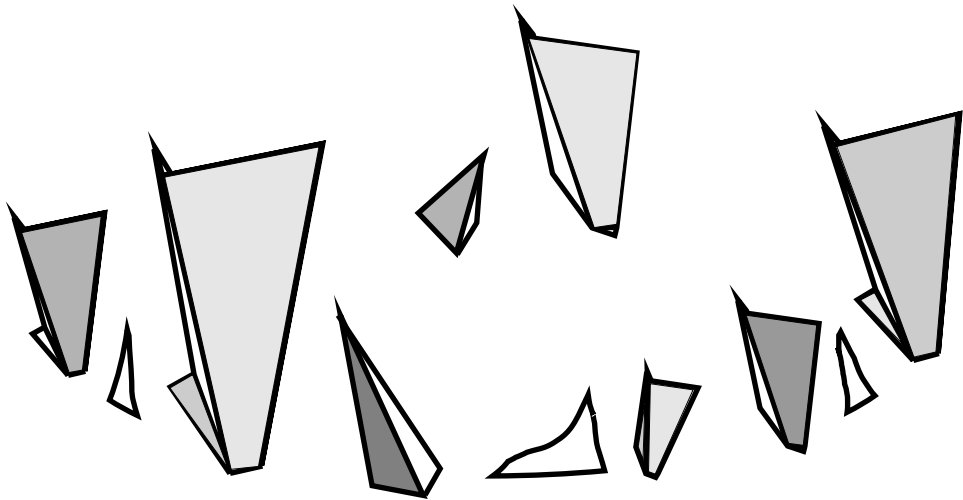

# An Odd Duck

By Perry Bailey Copyright 1974, 2000

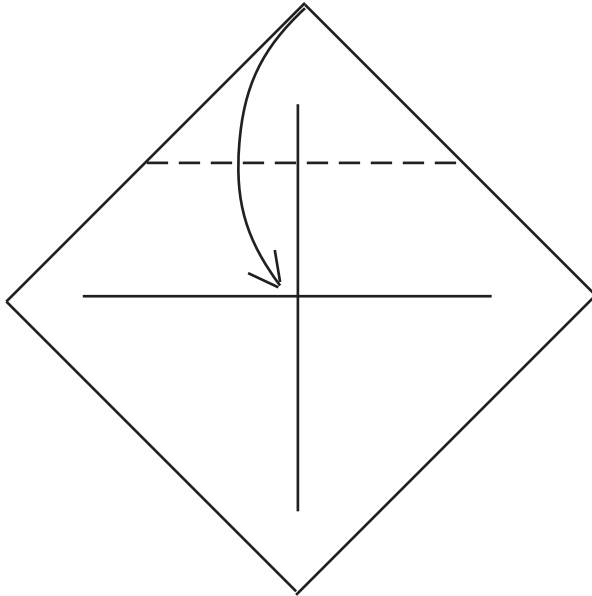

1. Fold in half on the diagonal in both directions then fold the top point down to the middle.

2. Mountain fold the sides to the center of the model then Valley fold it in half on the diagonal.

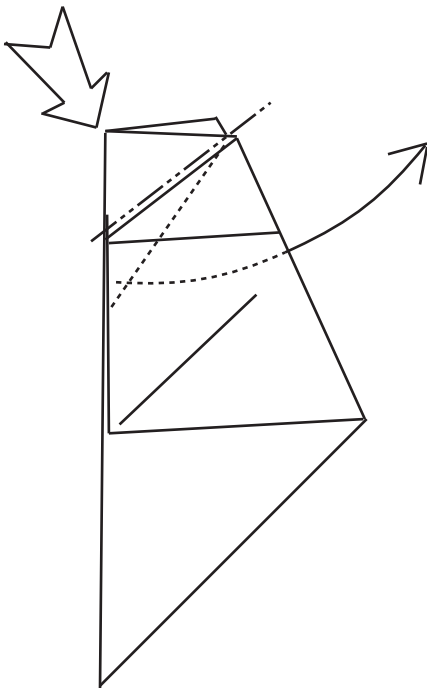
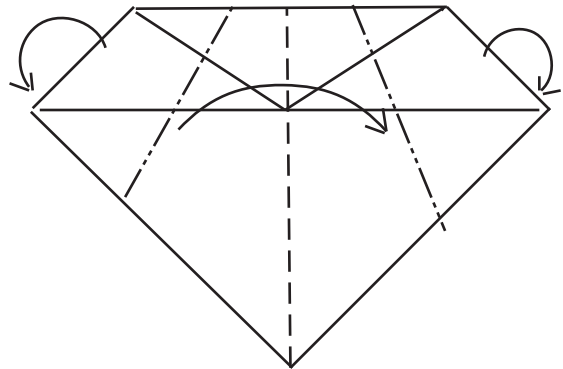

3. Grab the inner flap and bring it up as far as you can while sinking the upper corner.

4. Fold a rabbits ear on each side of the body as if making the fish base.

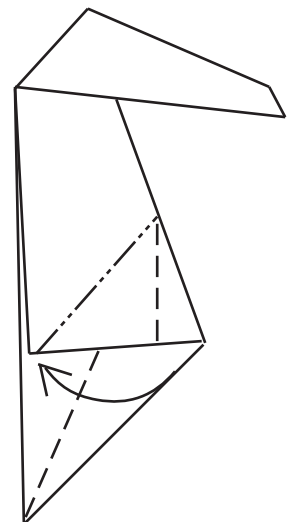

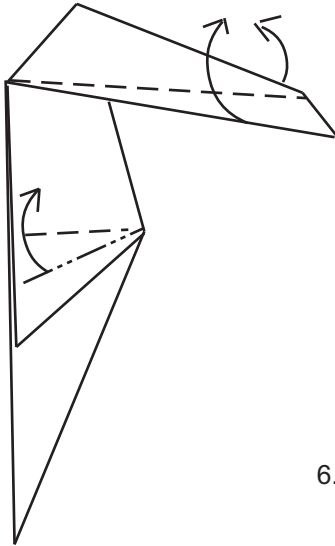

5. Reverse fold the upper flap up, then squash fold the rabbit ears on both sides.

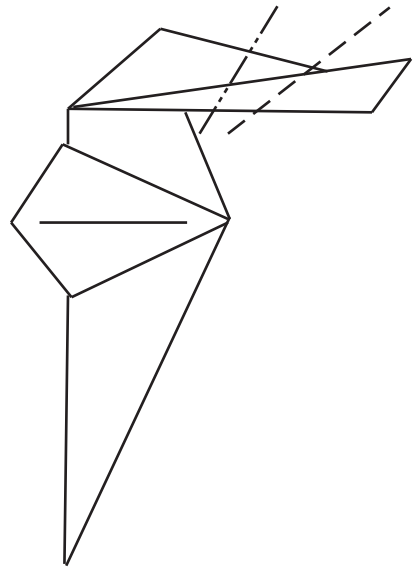

6. Pleat the flap inward so that it comes out like the next diagram.

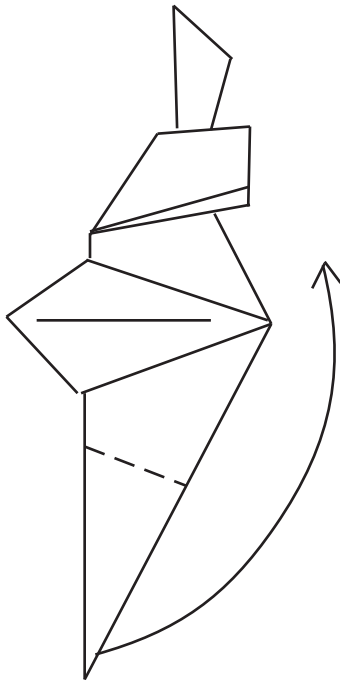

7. Reverse fold the lower flap up with in body so that a part of it will stick out the front to form the feet.

8. Fold the bottom of the model up into the interior then fold the top edge in the front down so form the head a little better.

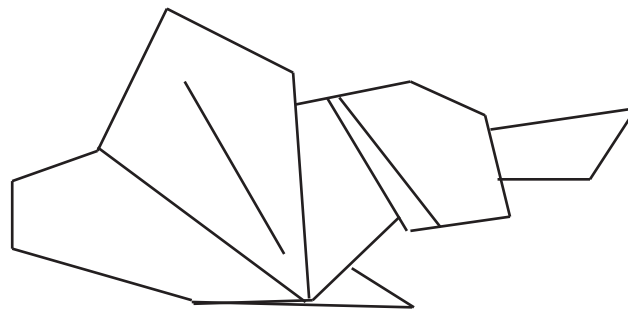
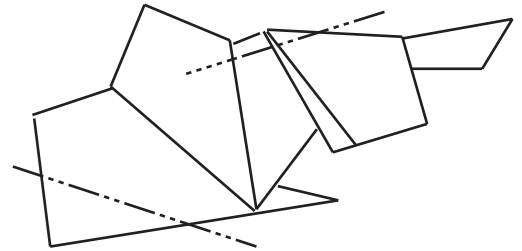

All of which makes for a truly Odd Duck!



# Open House II

Designed in 7/97 and diagrammed in 8/98;  
Another simple windmill based example

© 1998 Sy Chen

1. Start from windmill base with color side out;  
Fold top flap right; squash lower right flap and  
lower left flap

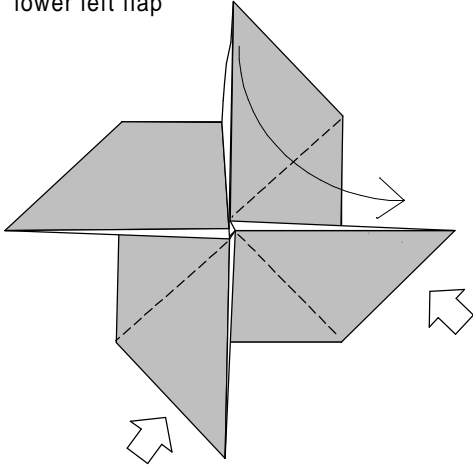

2. Open doors

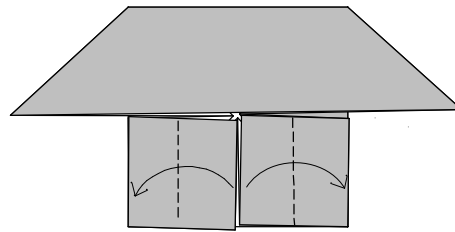

3. In progress; Fold center flap down to the  
bottom edge

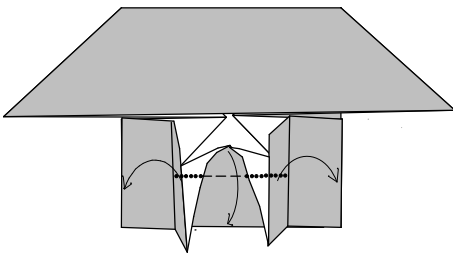

4. In progress; Flatten the doors by pressing the fold

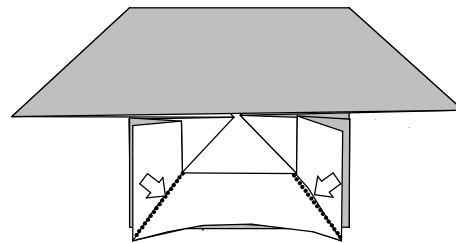

5. Finished model with doors fully opened;  
Close doors

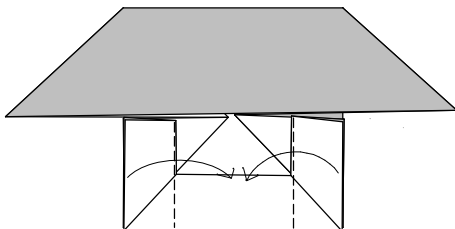

6. Finished model with doors fully closed;  
Ready for door open/close

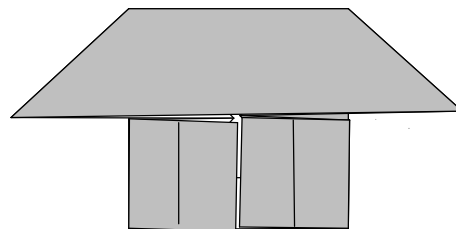

# Old Sparky

created/diagrammed by Alec Fehl 7/24/00

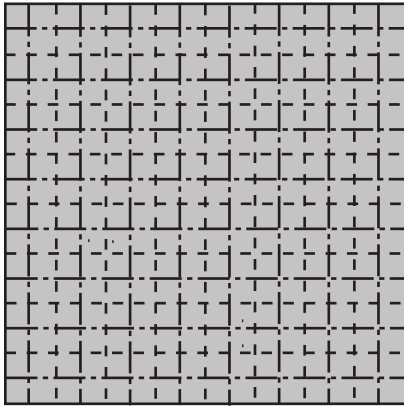

1] Precrease 16ths. Note center is valley.

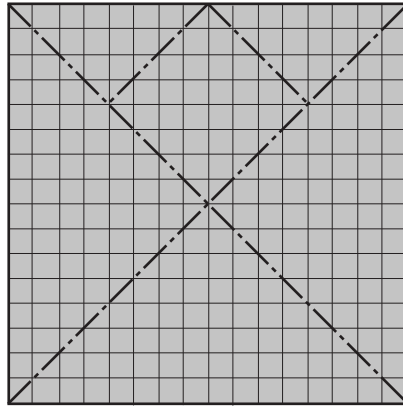

2] Mountain diagonals and mini-diagonals.

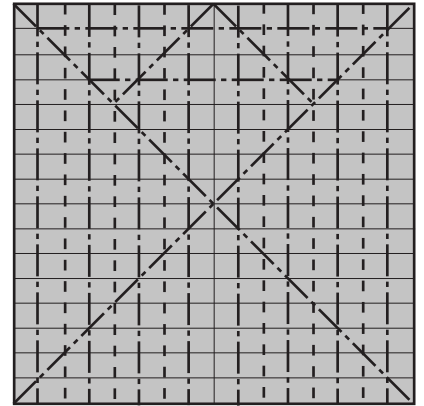

3a] Collapse left side. See next step for detail...

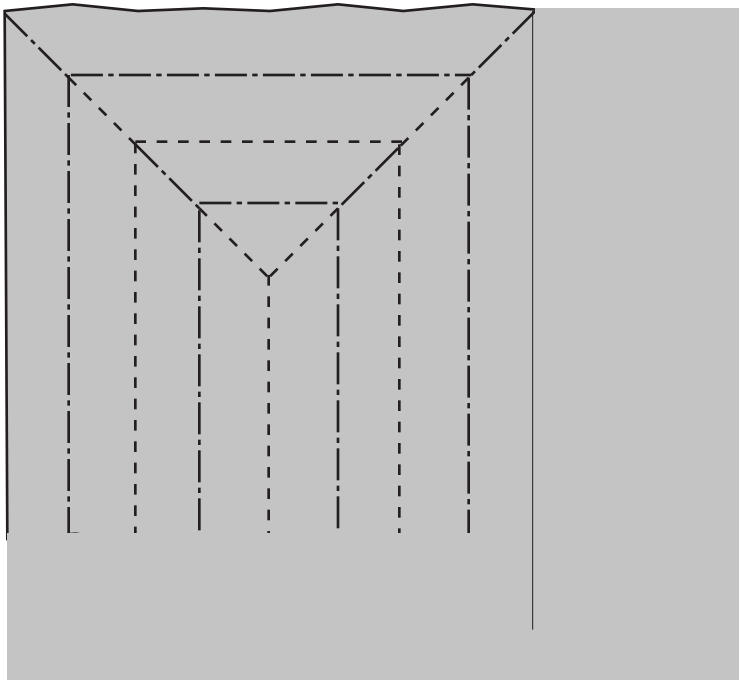

3b] Close up of collapse.

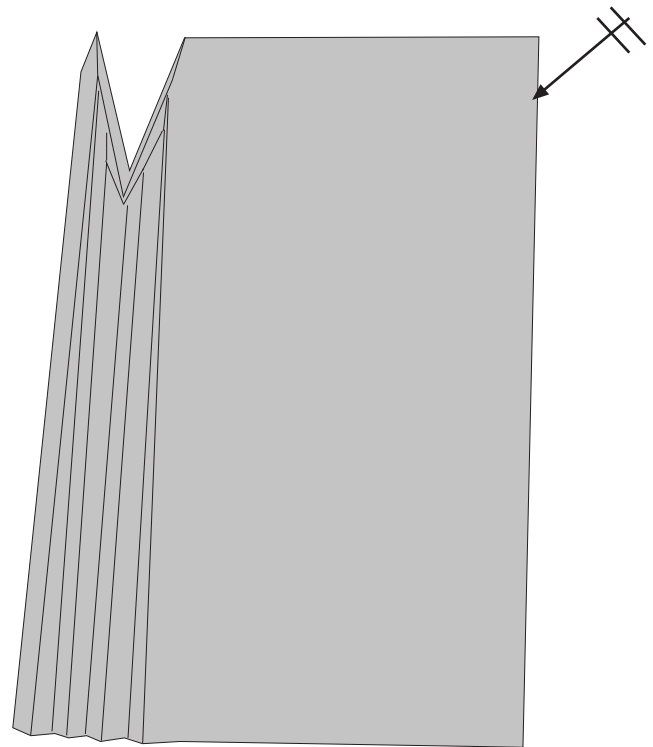

4] Looks something like this. Repeat on right.

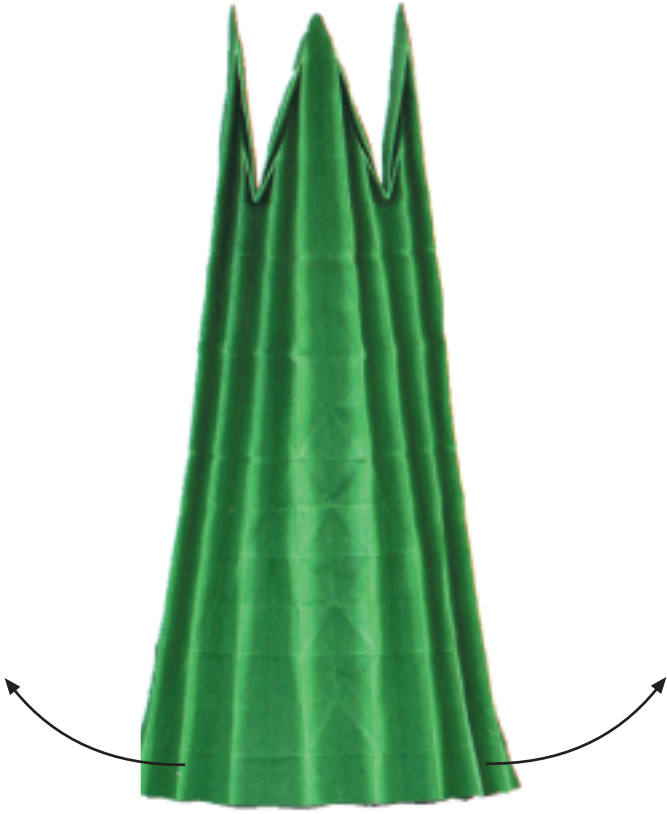

5] Looks like this. Spread apart bottom.

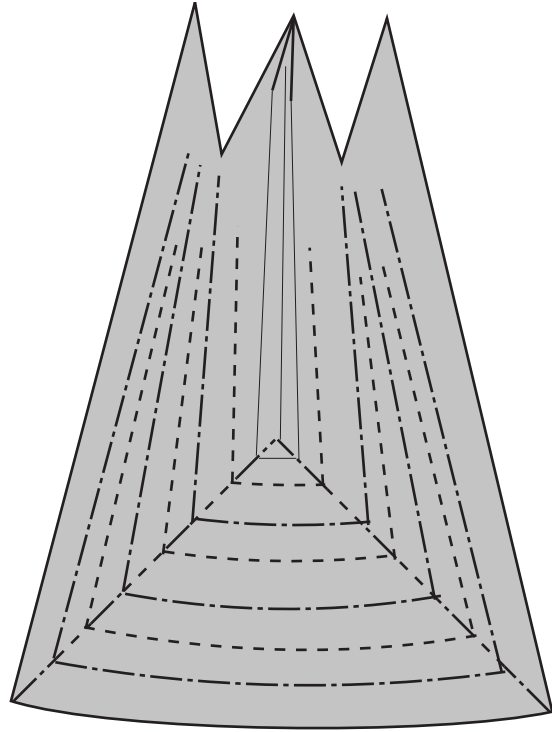

6] Collapse on creases.

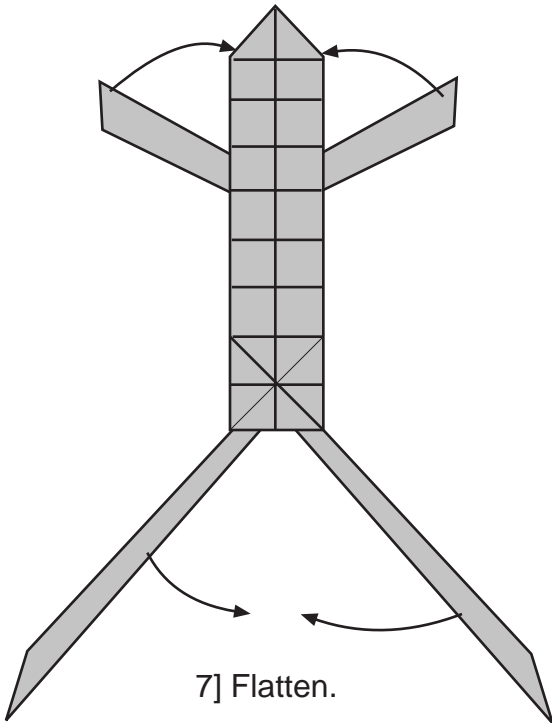

7] Flatten.

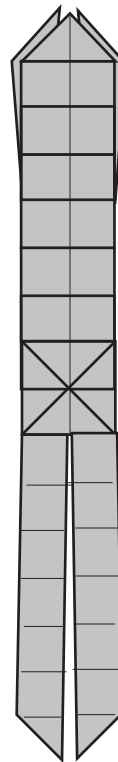

8] Turn over.

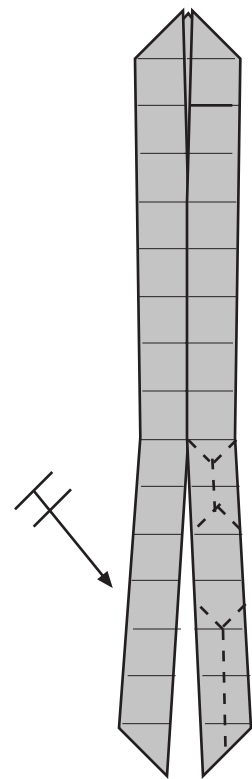

9] Rabbit ear 3 times. Repeat on left.

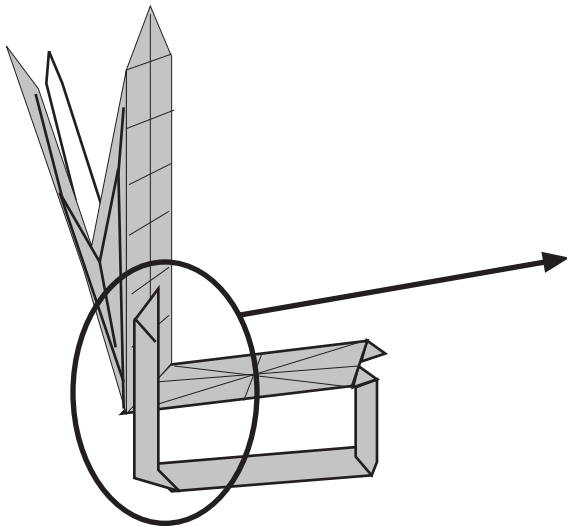

10] Focus on the back leg.

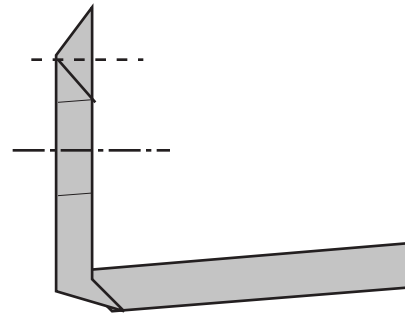

11] Valley tip. Mountain between existing creases.

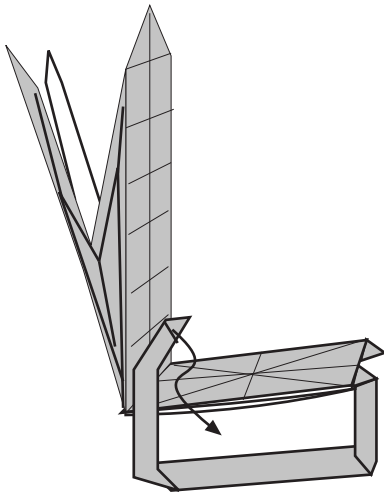

12] Tuck inside middle layer or seat. Repeat on other leg.

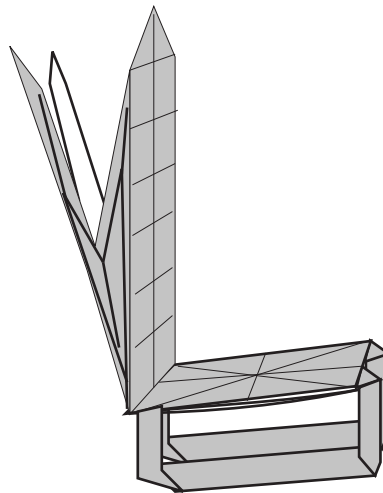

13] Flip chair over.

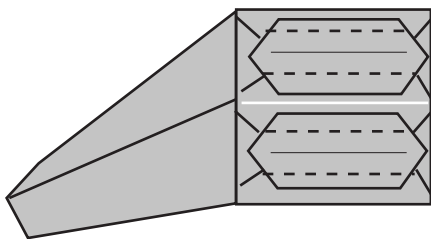

14] Thin bottom of legs, then...

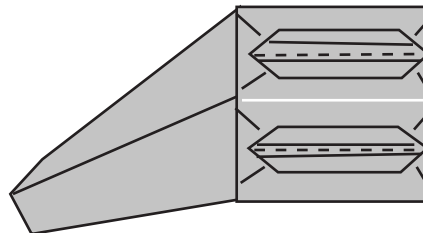

15] Fold in half.

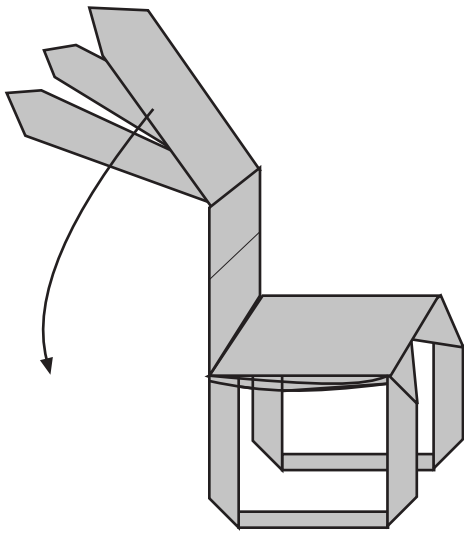

16] Fold down.

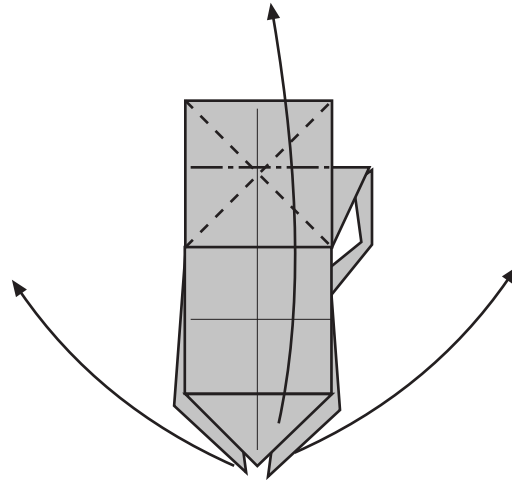

17] Water-bomb top layer and allow 2 flaps to slide out.

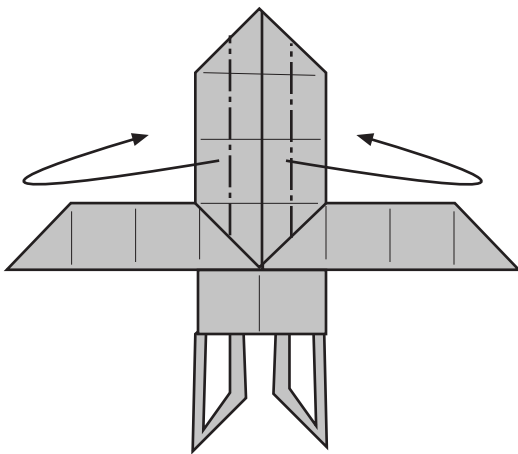

18] Mountain flap to thin.

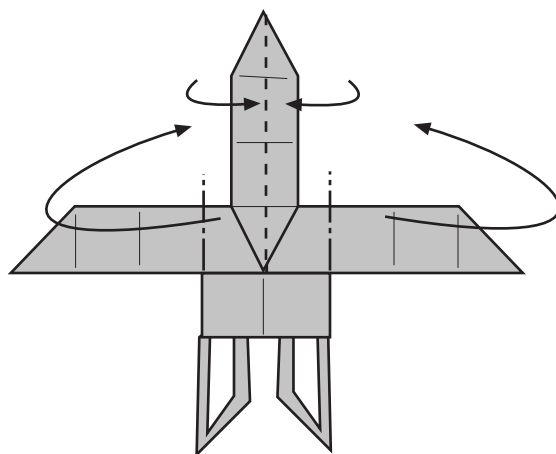

19] Mountain arms over. Valley (pinch) top flap.

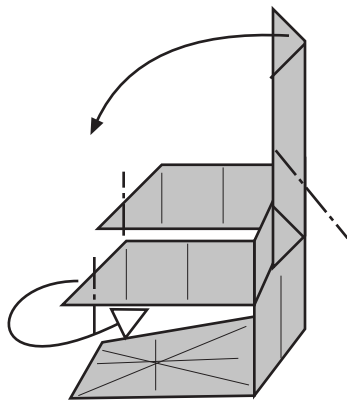

20] (Legs not shown.) Outside reverse top. Inside reverse fold tips or arms 1/2 way.

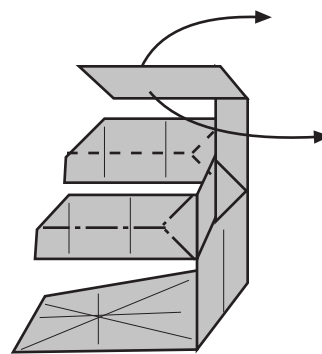

21] Rabbit ear arms. Pinch them very tight so they overlap back of chair. This will help to lock them in place. Pull flaps out of top and mold 'helmet'.

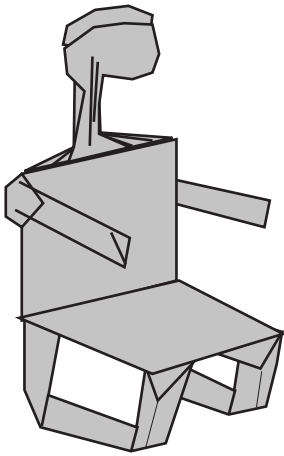

# On the Water, Under Water

by Herman van Goubergen

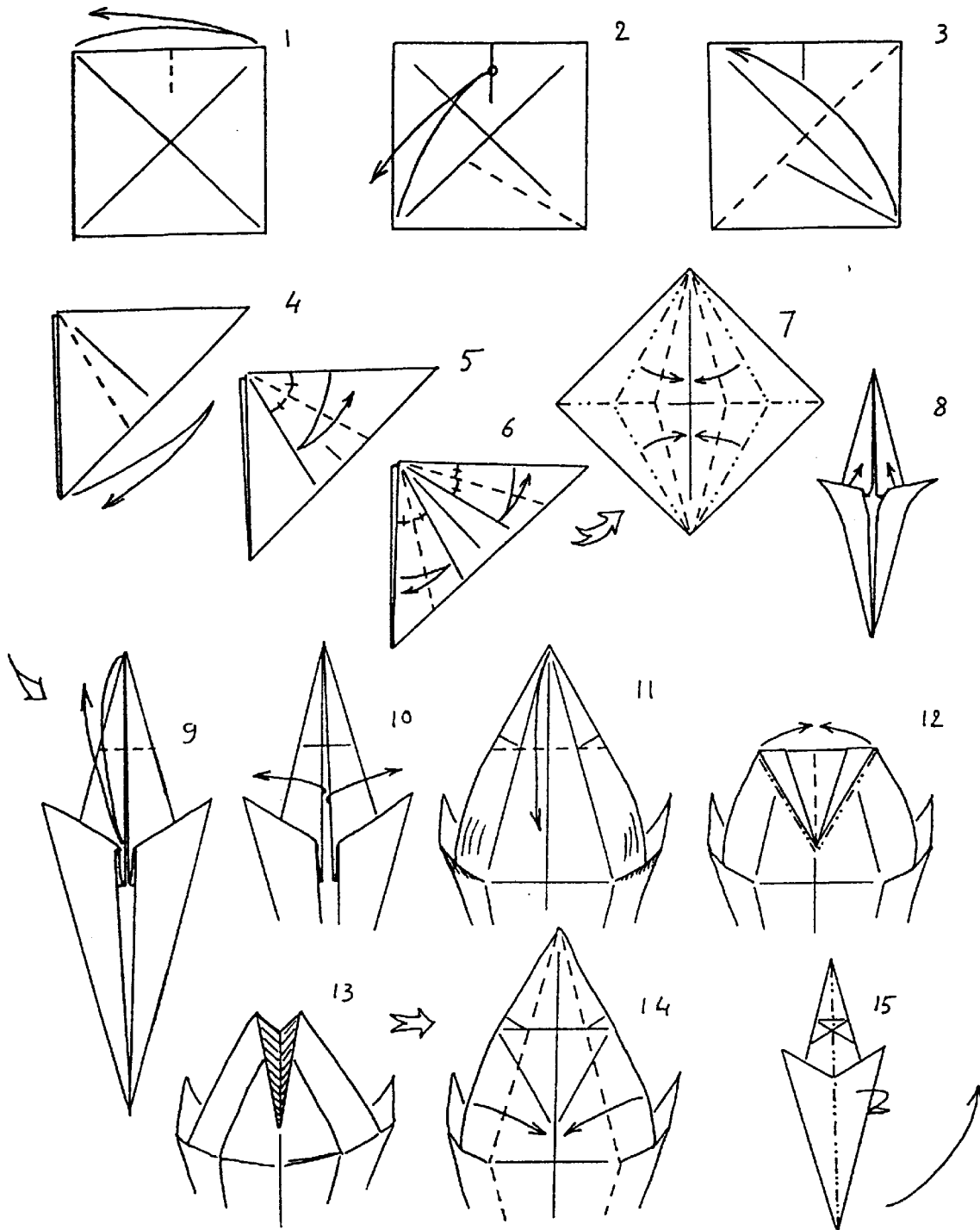

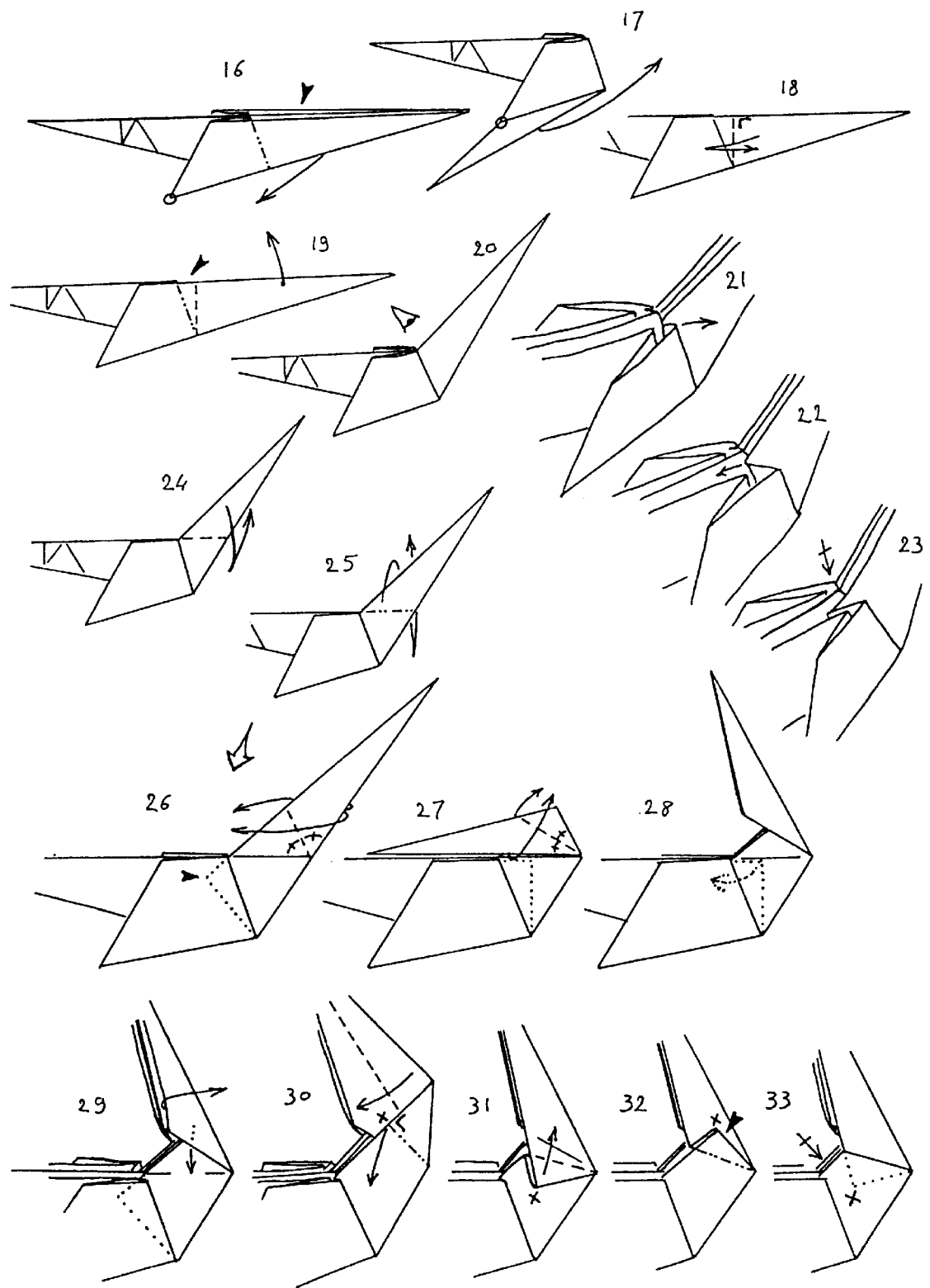



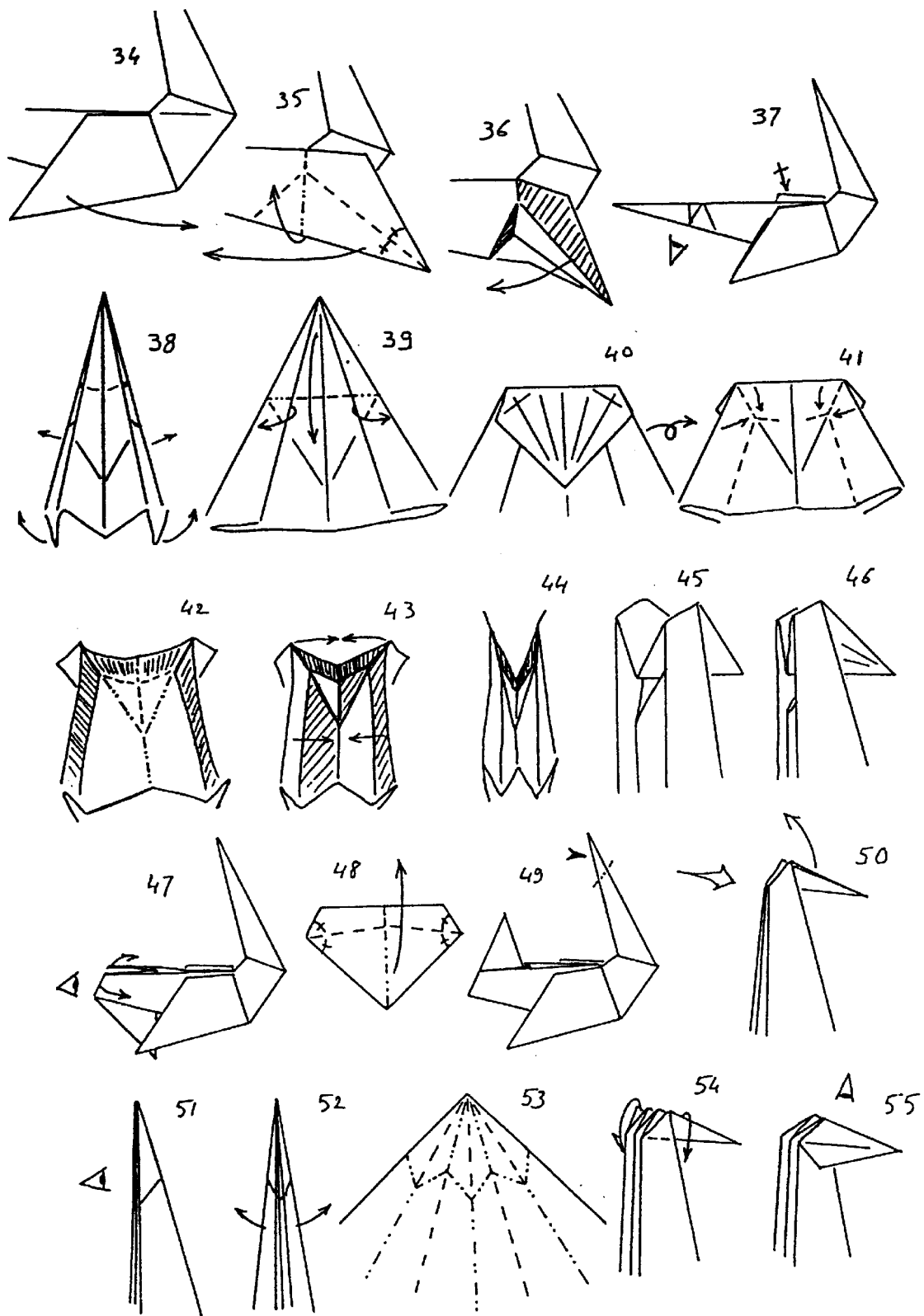

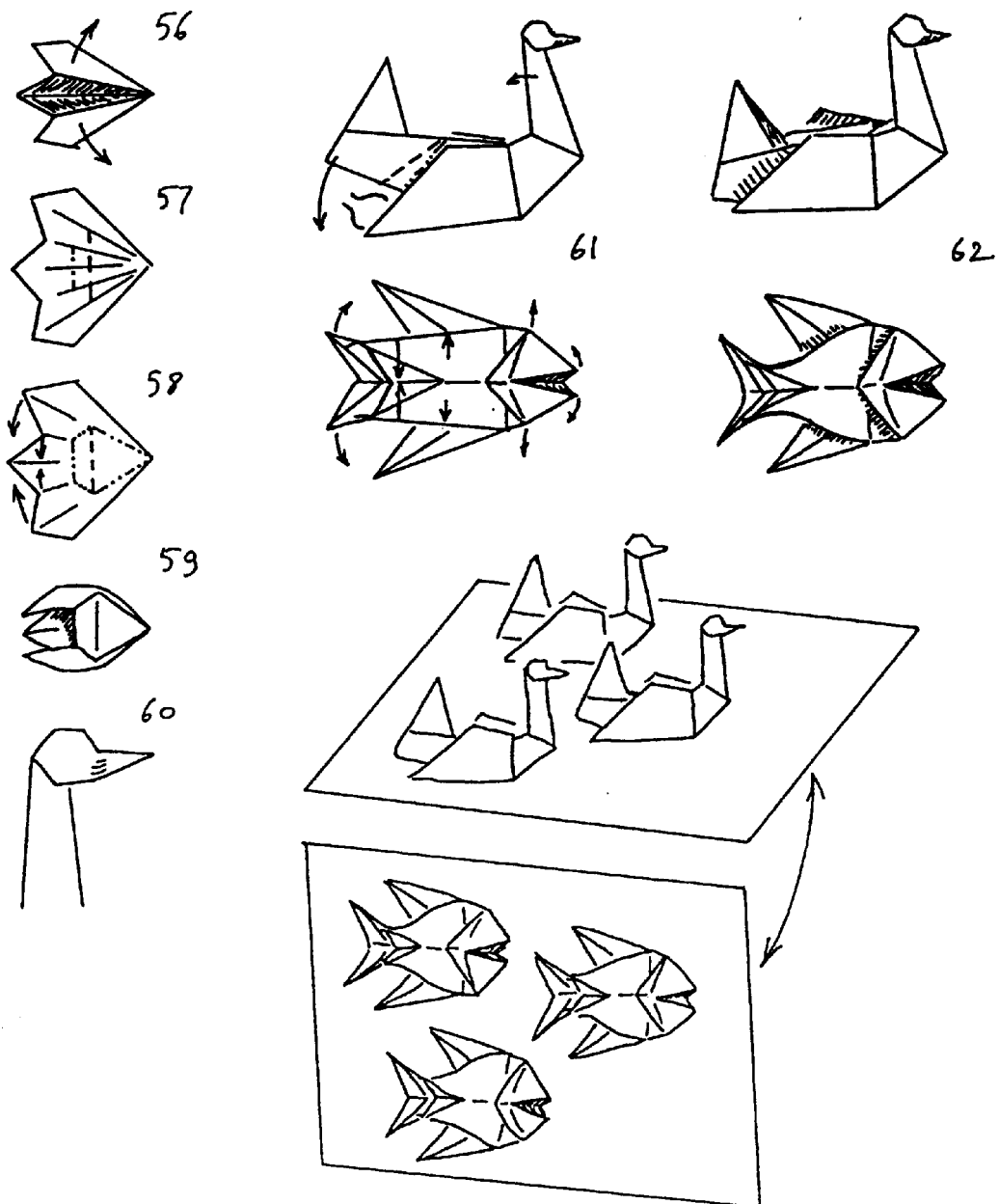

© HERMAN VAN GOUBERGEN 95-96

Use a square of blue foil. The paper is white side up in step 7. The final moulding will be difficult if you don't use foil. Fix a flock/shoal on a sheet of transparent plastic (acetate, glass, ...) with small pieces of sticky tape. Small sizes work sell: I cut up one 15×15 cm square to make 4 birds/fish.

Copyright © 1995–1996 Herman van Goubergen, all rights reserved.  
 PDF version 1999 by Sebastian Marius Kirsch <skirsch@t-online.de>.  
 Distribution for noncommercial purposes is free. Please contact the author  
 if you want to use this model for commercial purposes.

# OSTRICH

Design: 18.08.94

by Hans Birkeland (Norway) ©1994

Diagrams: 28.08.94

Begin with the dark side up.

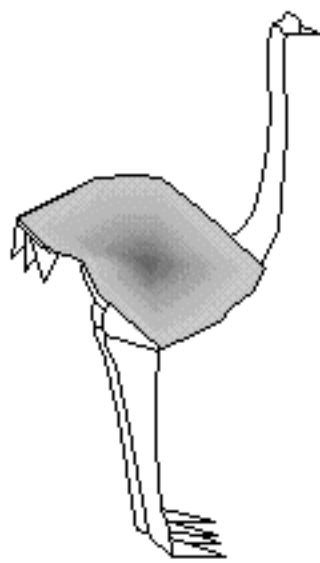

Folding pattern :

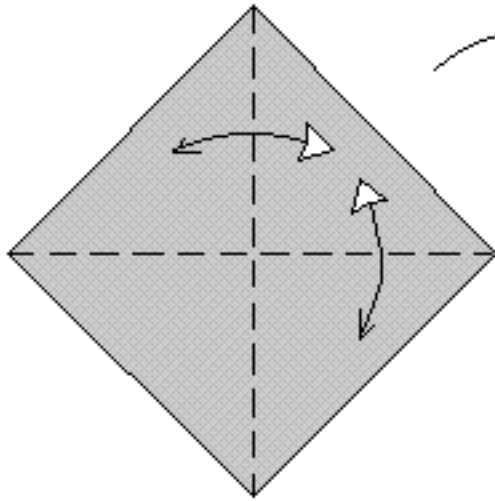
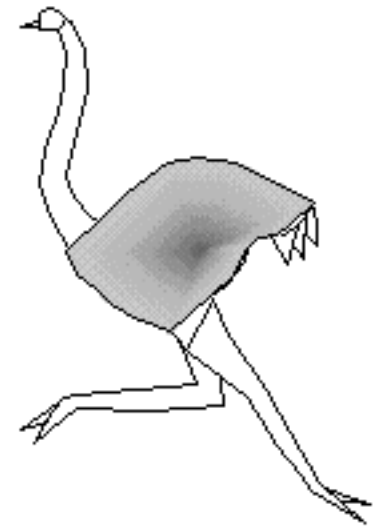
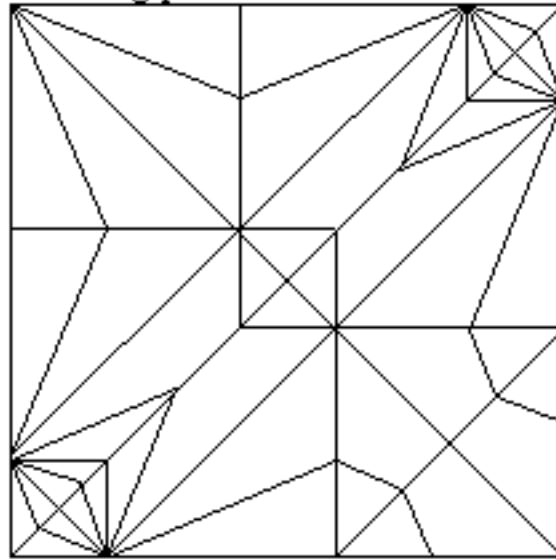

**1** Fold and unfold.  
Turn the paper over.

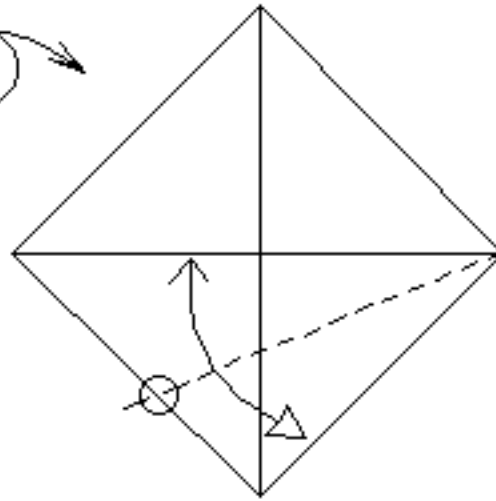

**2** Make a mark where the  
crease meets the edge.

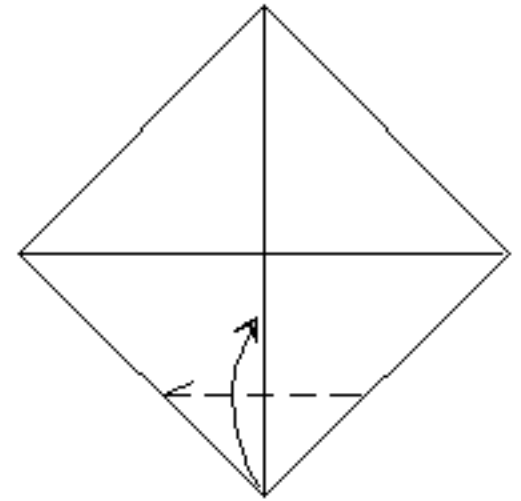

**3** Valley-fold.

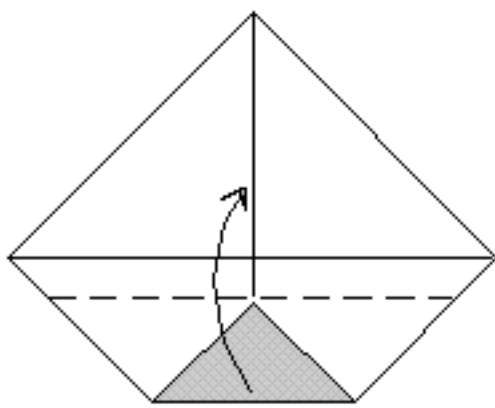

**4** Valley-fold.

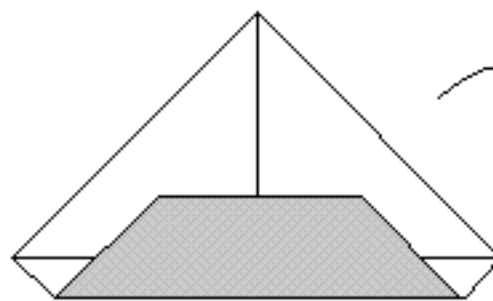

**5** Turn the paper over.

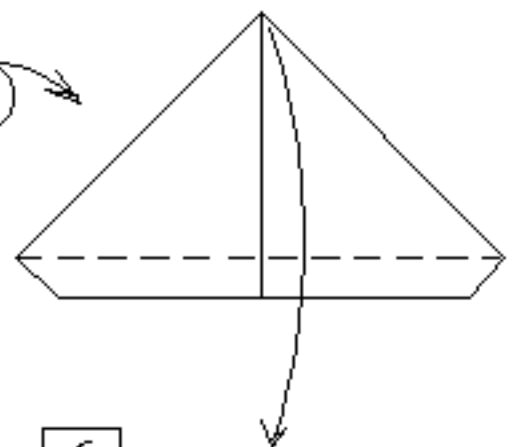

**6** Valley-fold one layer.

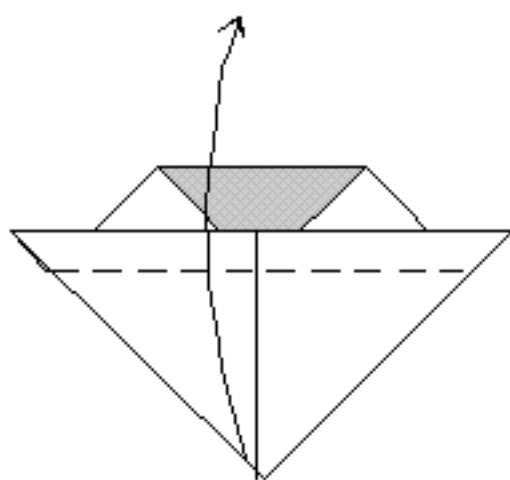

**7** Valley-fold, using the hidden horizontal edge as a guide.

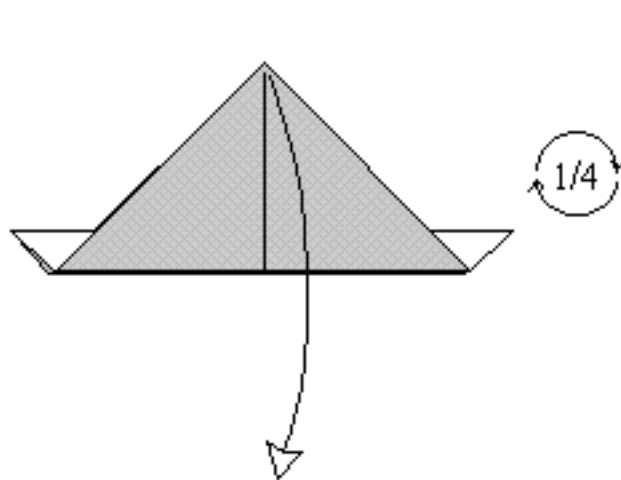

**8** Unfold and rotate 1/4 clockwise.

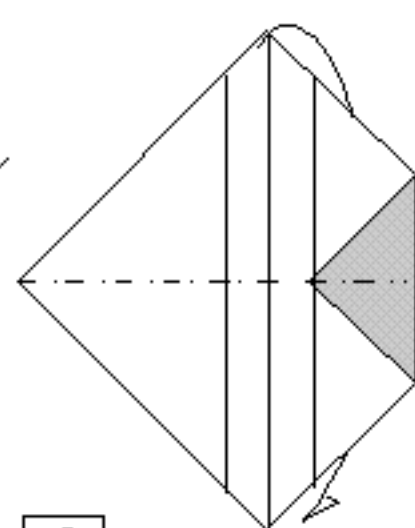

**9** Mountain-fold in half.

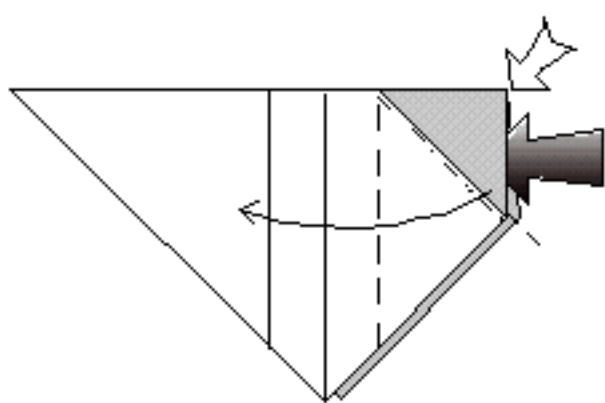

**10** Squash-fold.

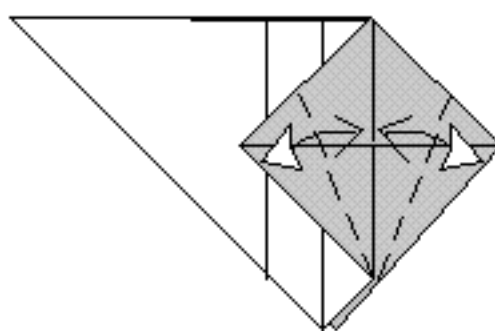

**11** Fold and unfold.

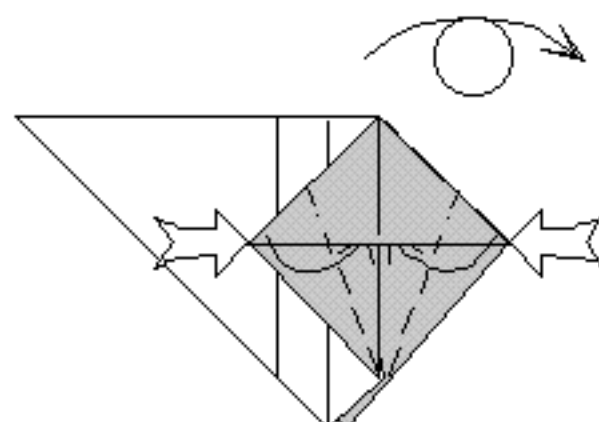

**12** Reverse-fold on the existing creases. Turn the model over.

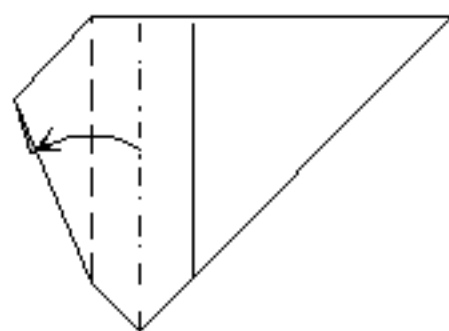

**13** Pleat the upper layers.

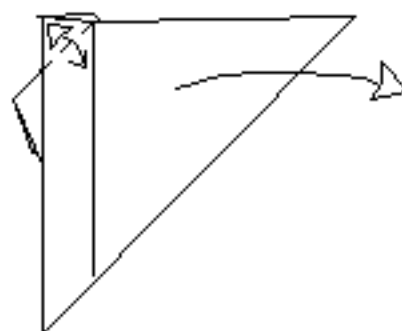

**14** Fold and unfold. Then unfold the pleat.

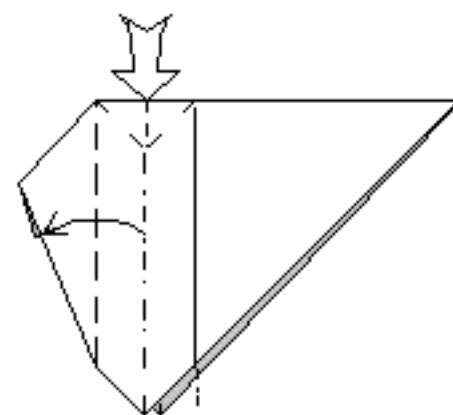

**15** Collapse on existing creases.

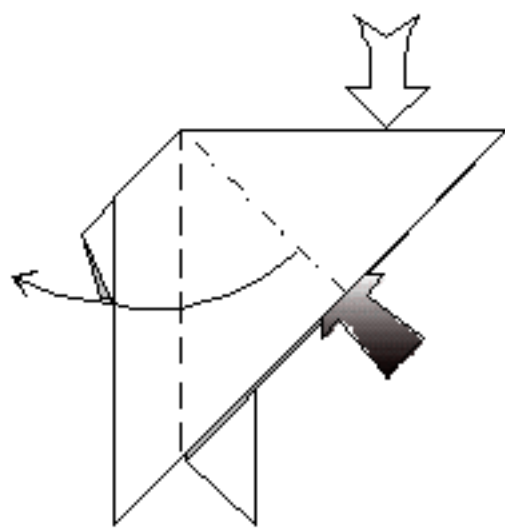

**16** Squash-fold the large flap.

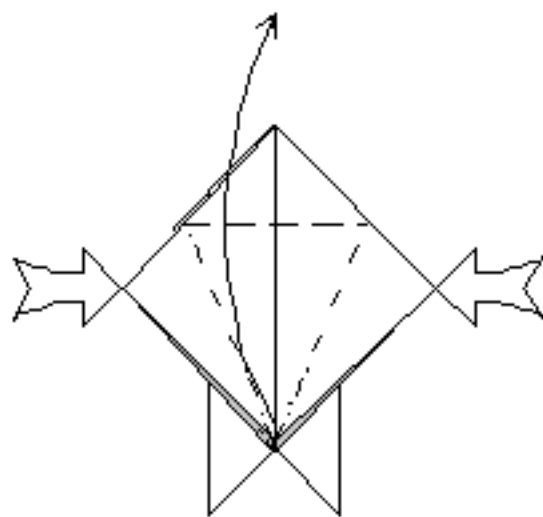

**17** Petal-fold.

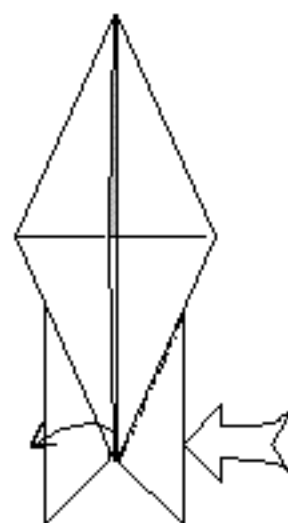

**18** Reverse-fold along the edge.

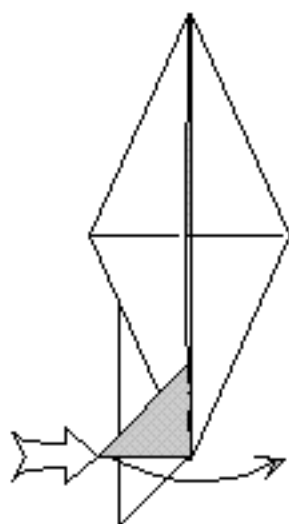

**19** Reverse-fold.

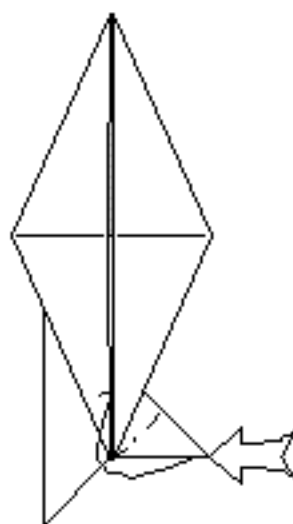

**20** Reverse-fold.

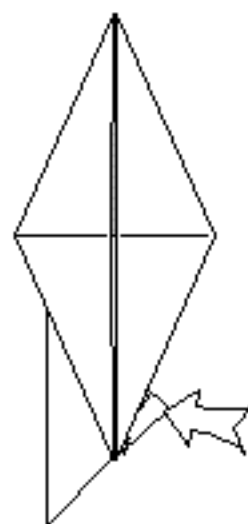

**21** Reverse-fold.

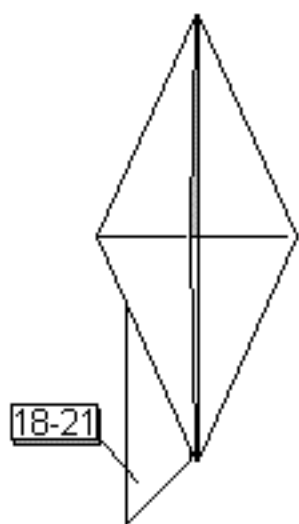

**22** Repeat steps 18-21 on the left.

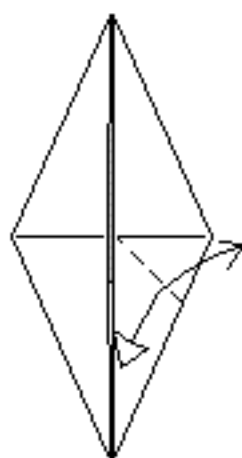

**23** Fold along the angle bisector and unfold.

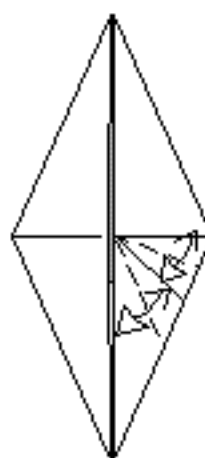

**24** Make more angle bisectors.

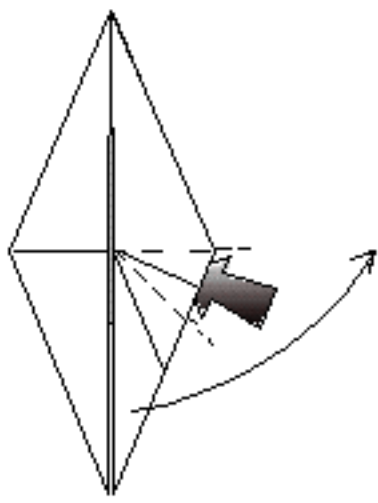

**25** Open up between the second and third layer and crimp symmetrically.

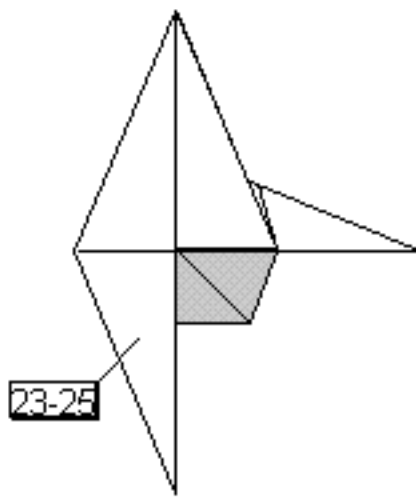

**26** Repeat steps 23-25 on the left.

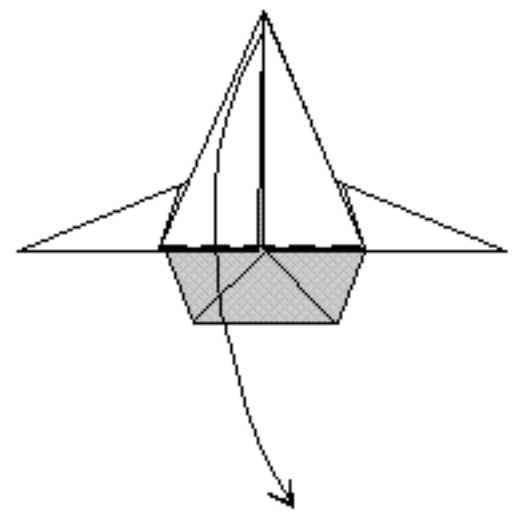

**27** Valley-fold the flap down.

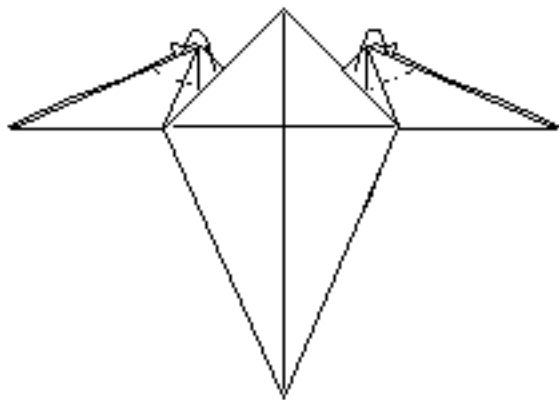

**28** Mountain-fold the two edges inside on existing creases. Repeat behind.

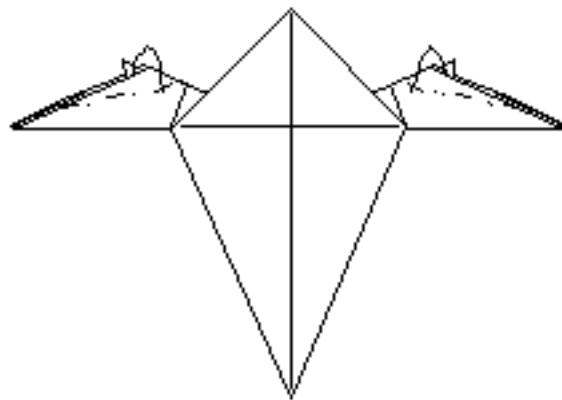

**29** Thin the legs by folding the edges inside. Repeat behind. The nearest edges are quite thick between the toes.

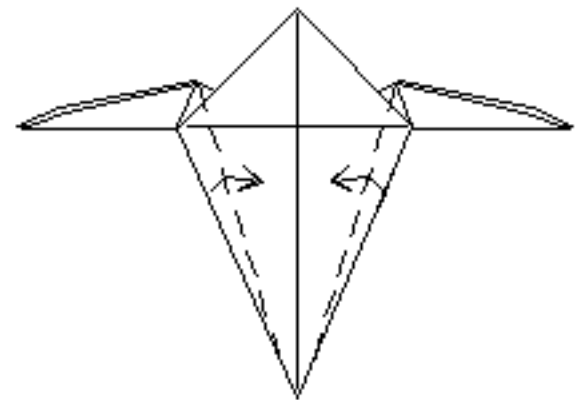

**30** Valley-fold the edges. Note that the creases end a little above the bottom point.

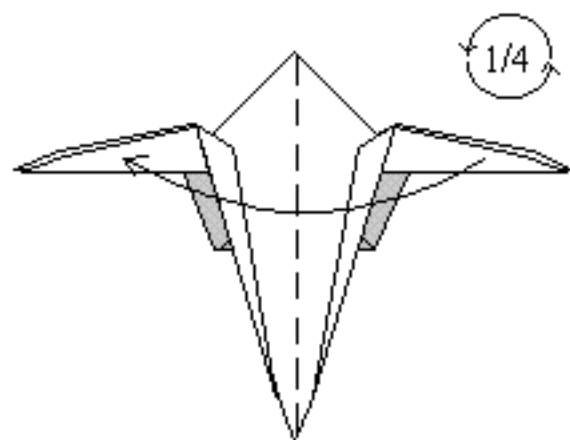

**31** Valley-fold the model in half and rotate 1/4 turn counterclockwise.

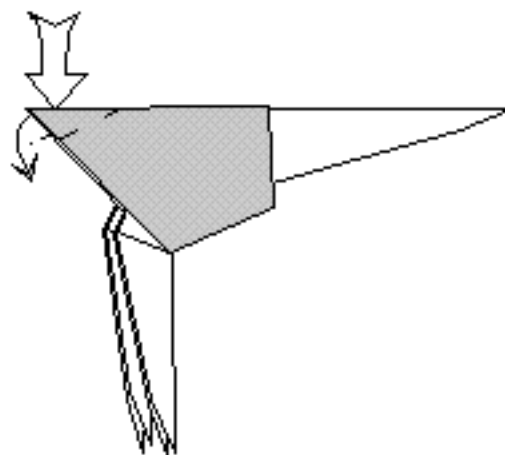

**32** Reverse-fold the tail and spread the three points to make feathers.

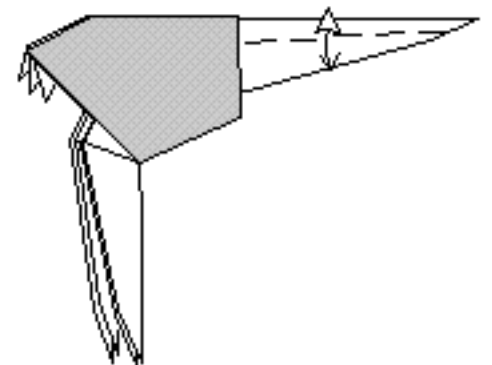

**33** Fold down the upper edge of the neck and unfold.

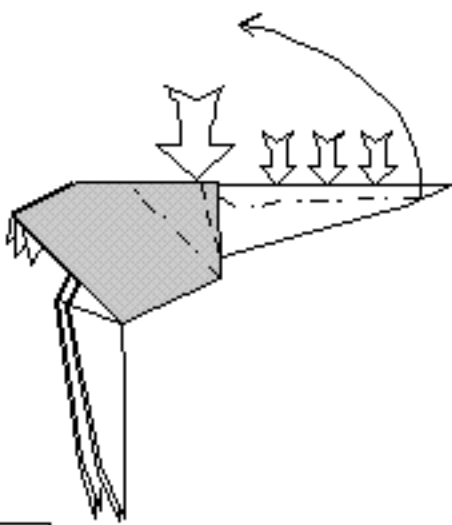

- 34** Crimp the root of the neck with two reverse-folds, incorporating the sink on creases made in step 33.

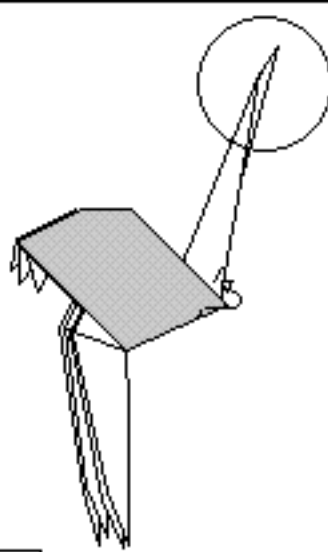

- 35** Mountain-fold the edge inside. Repeat behind. Next view is of the head.

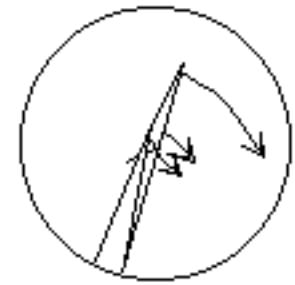

- 36** Outside-reverse-fold the head.

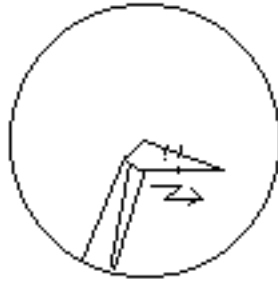

- 37** Reverse-fold the beak.

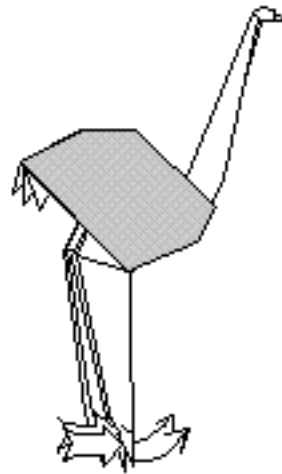

- 38** Reverse-fold the two toes to the front, choosing a layer that keeps the colour white. Repeat on the other leg.

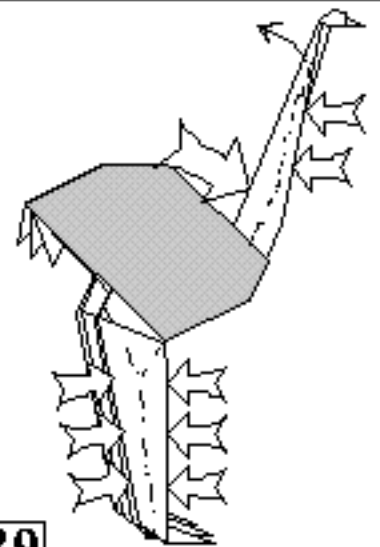

- 39** Pinch the legs to make them thinner. The neck should also be softly pinched and given a nice rounding.

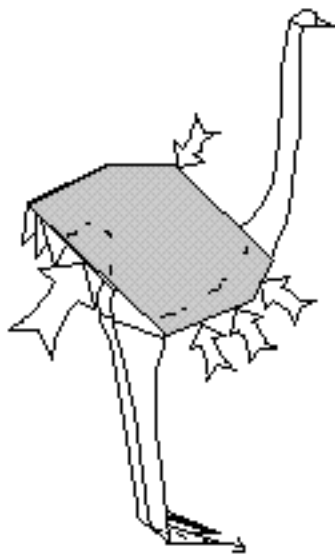

- 40** Pinch the toes and curve them slightly. Make the body 3-D and push in the area between the legs and the tail-feathers.

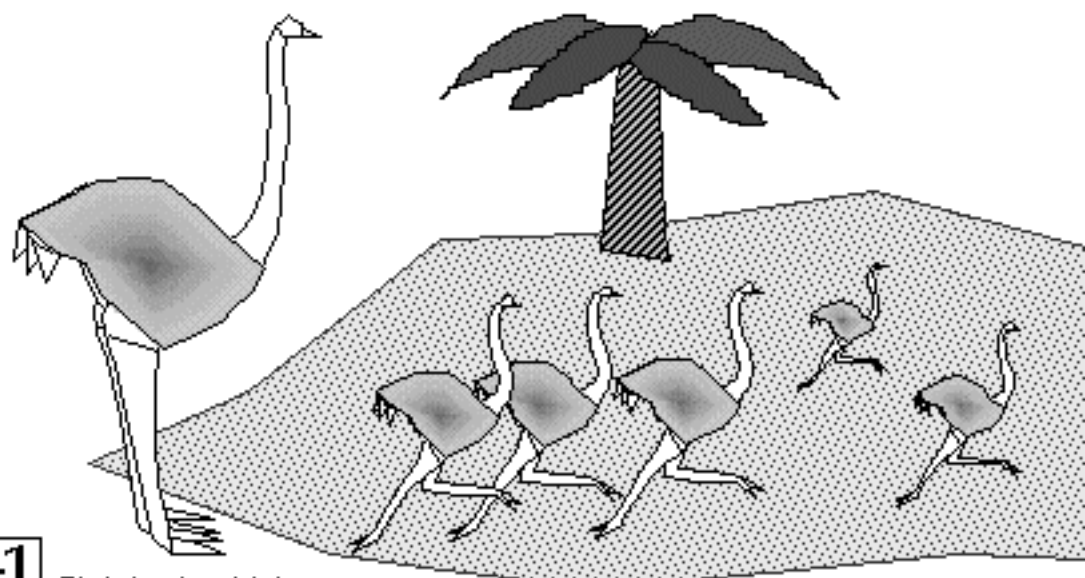

- 41** Finished ostrich. Make several ostriches in different postures; running, hiding their heads in the sand, looking in different directions etc.

# Pajarita boxes

by Eugeny Fridrikh

## Lid unit A

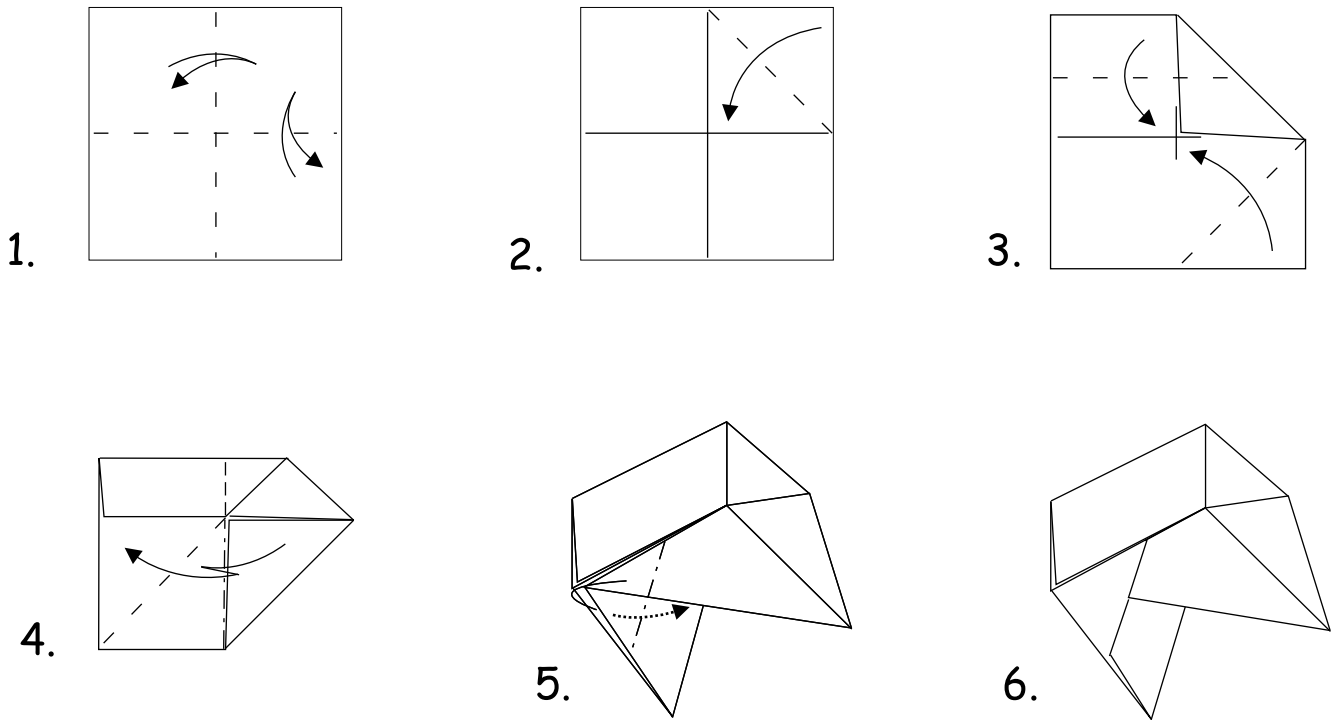

## Lid unit B

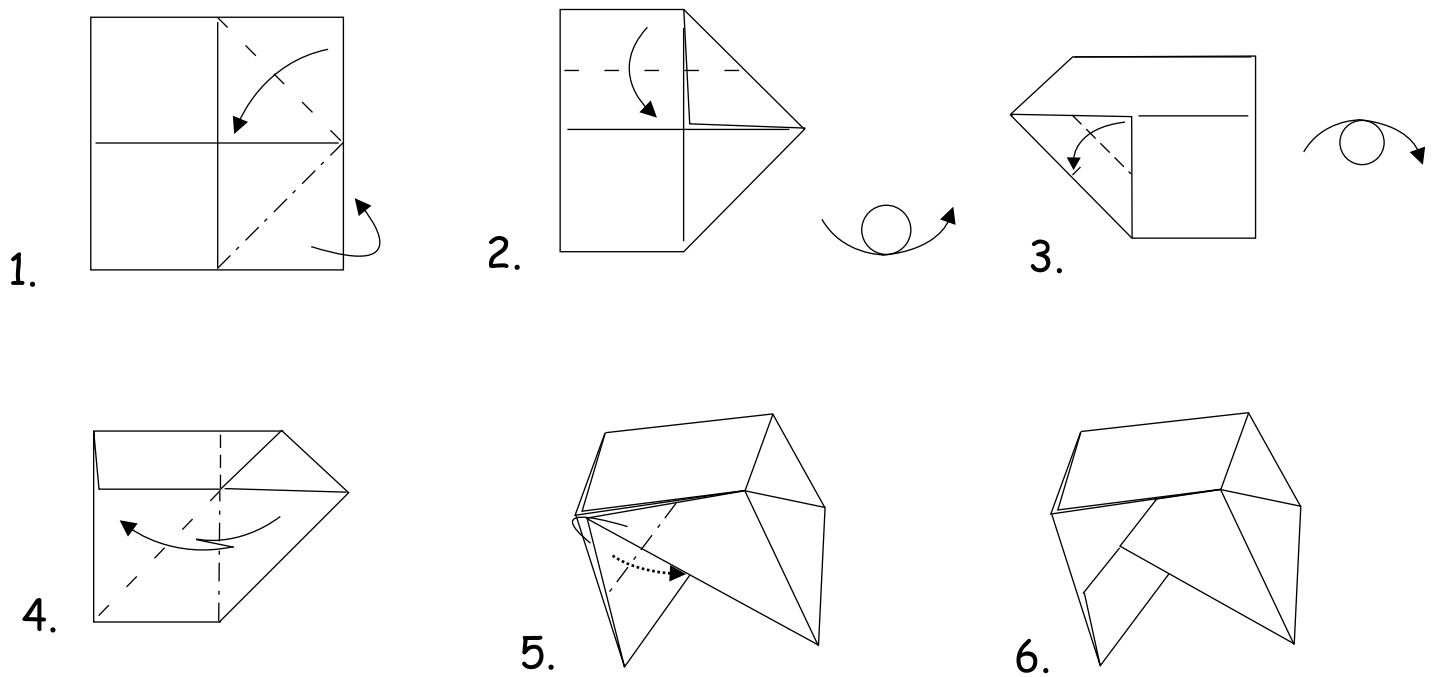



# Lid unit C

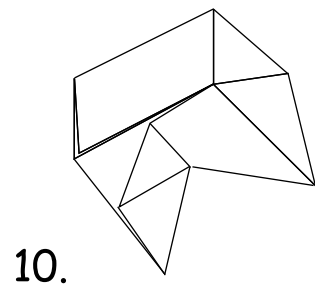
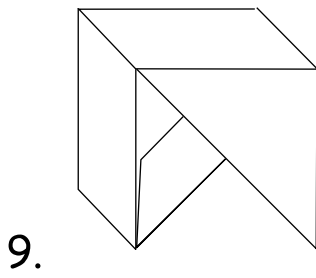
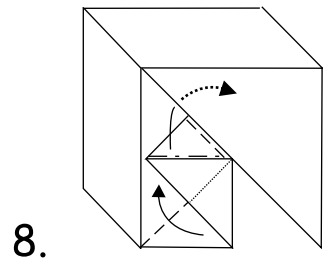
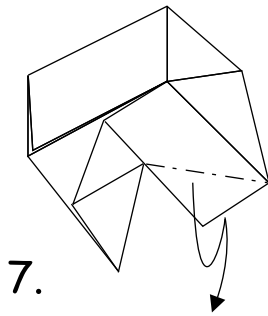
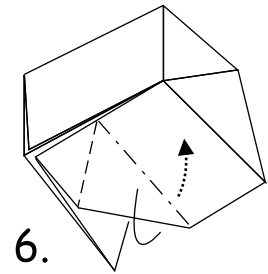
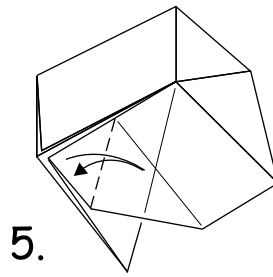
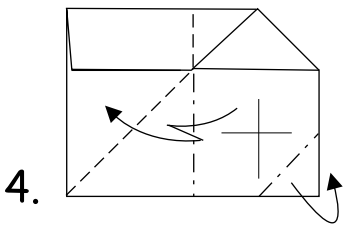
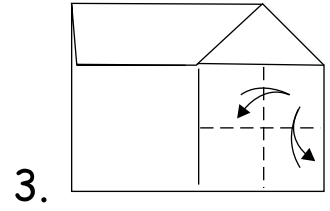
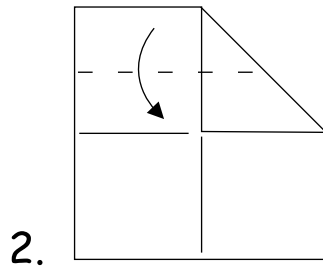
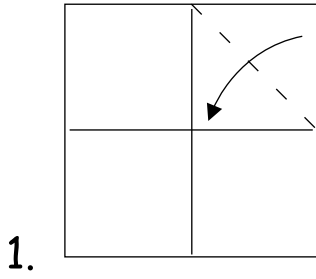

### Lid unit D

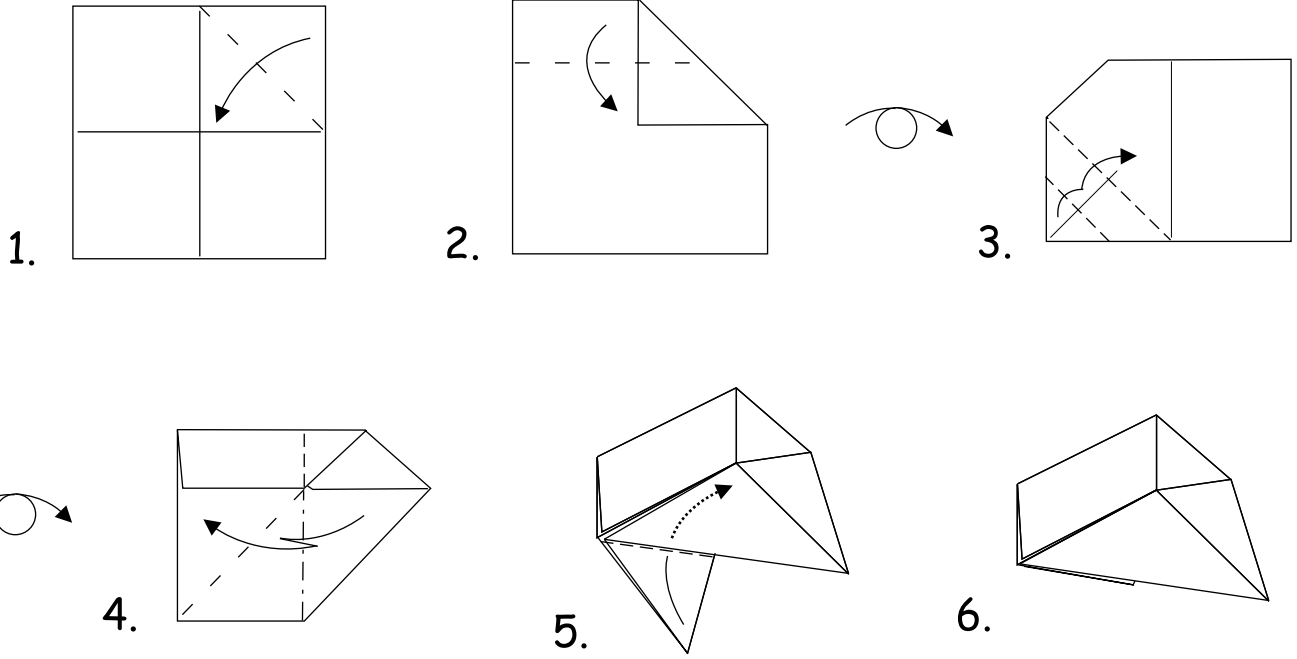

### Assembling:

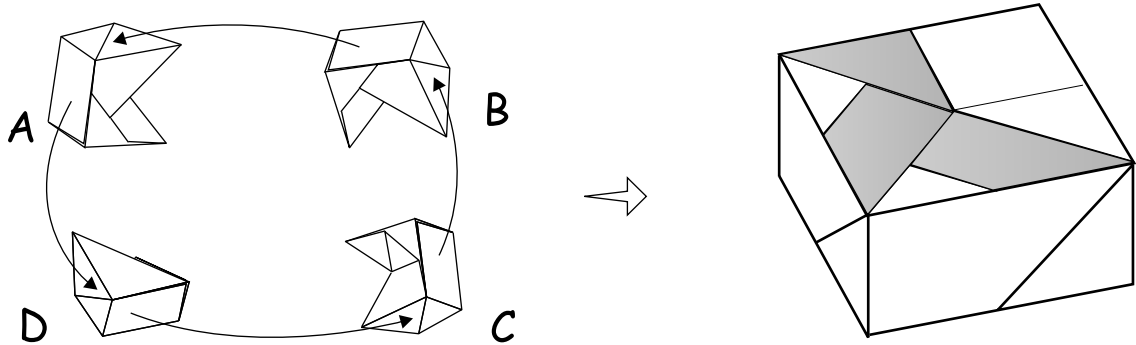

### Bottom unit A

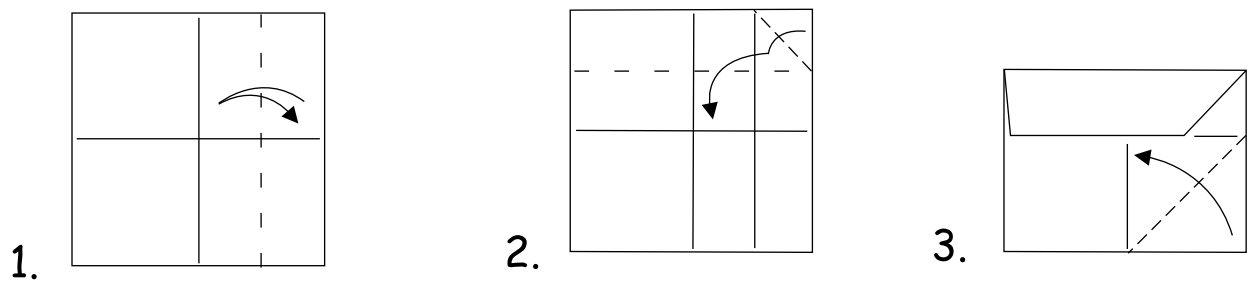

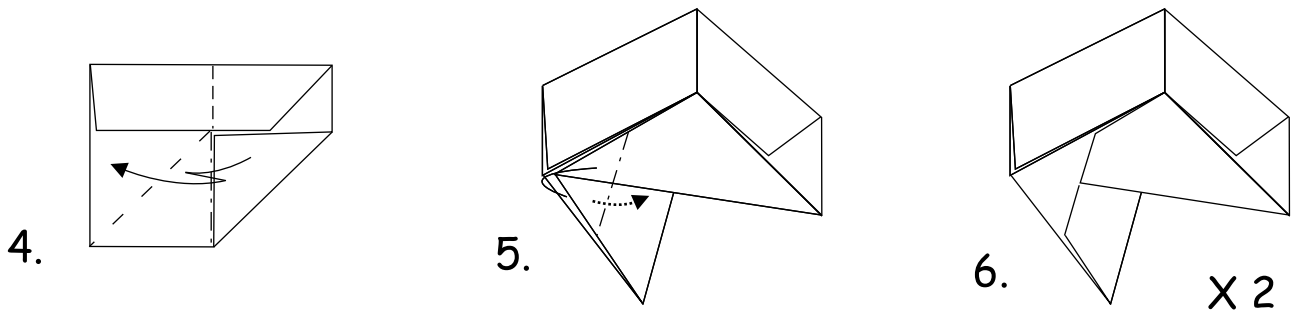

**Bottom unit B**

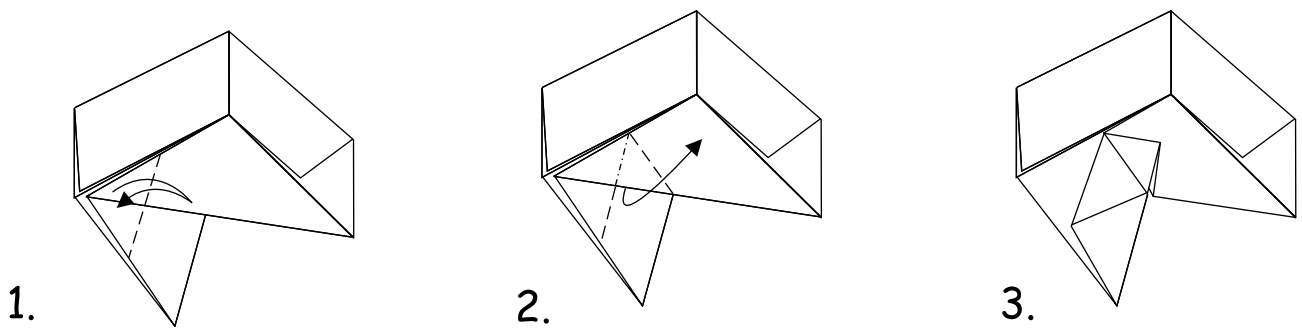

Repeat 1-4 steps  
of unit A

**Bottom unit C**

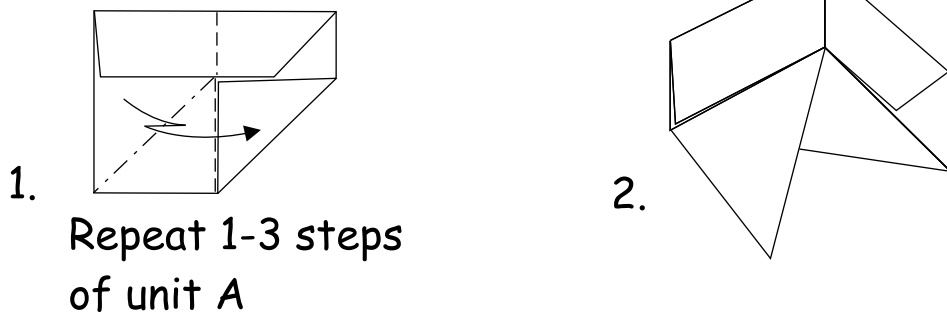

**Assembling**

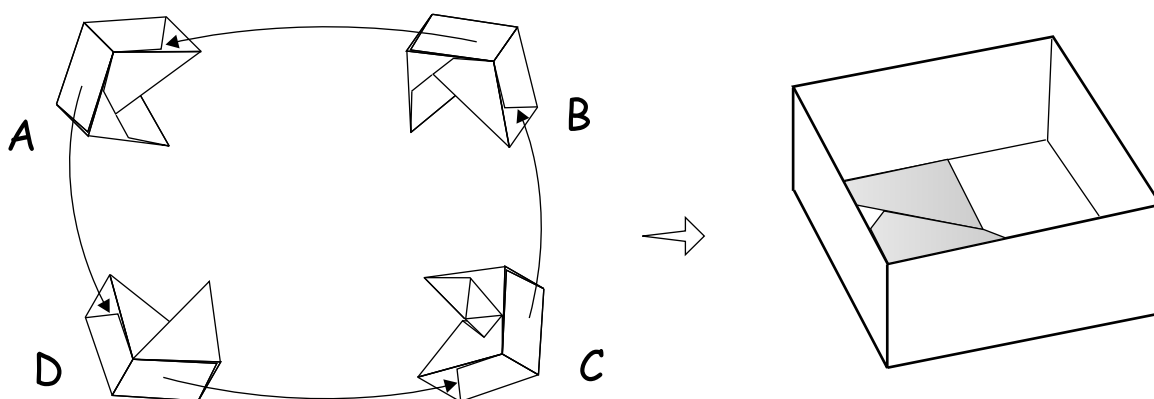

# Windmill variation

## Lid units A & B

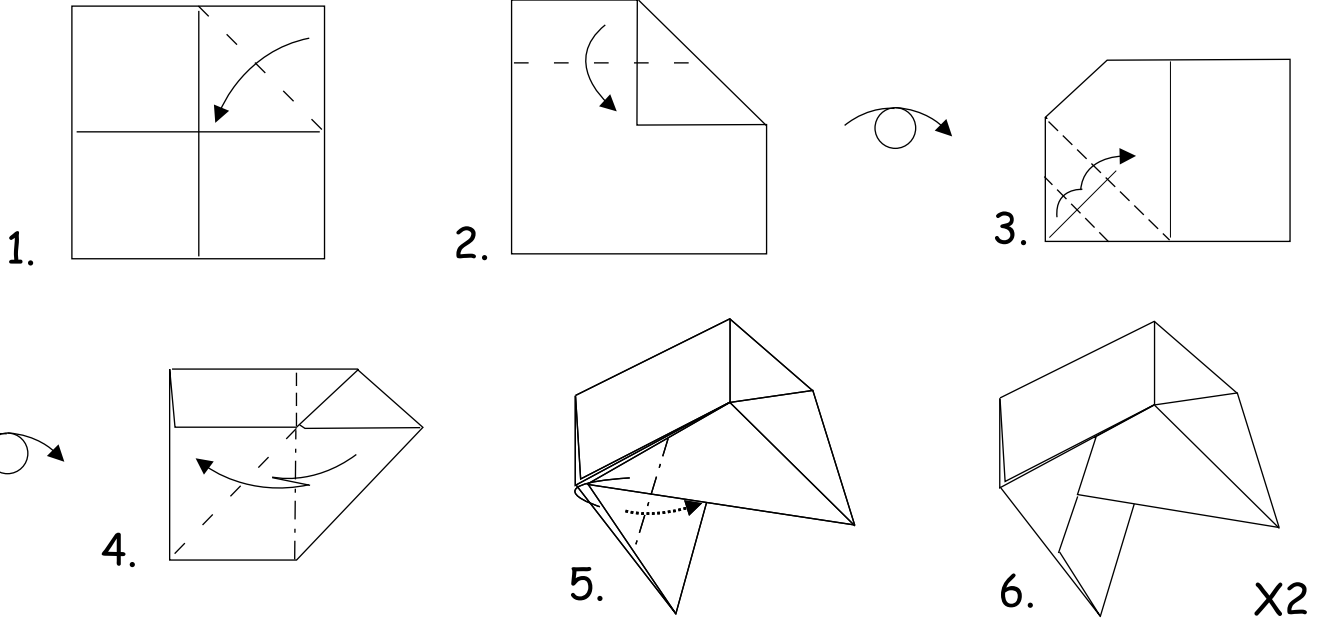

## Unit C (see p. )

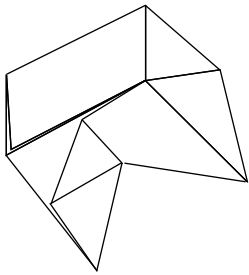

## Unit D (see p. )

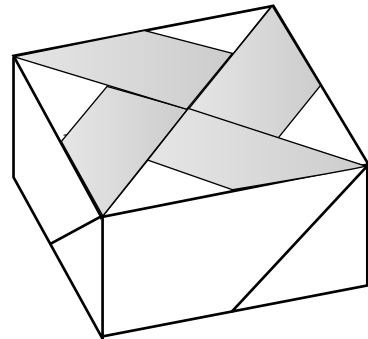
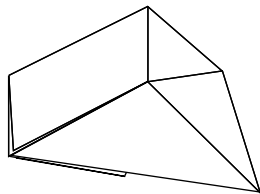

Make the bottom from  
4 units A of the first box

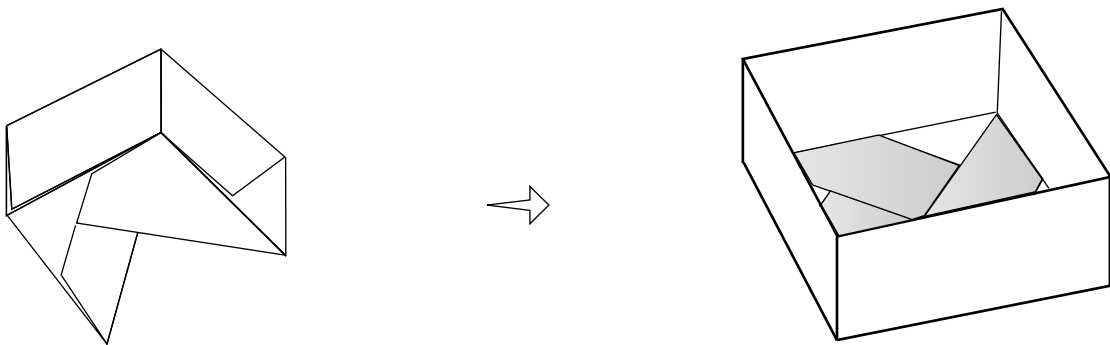

# Sailboat variation

## Lid unit A

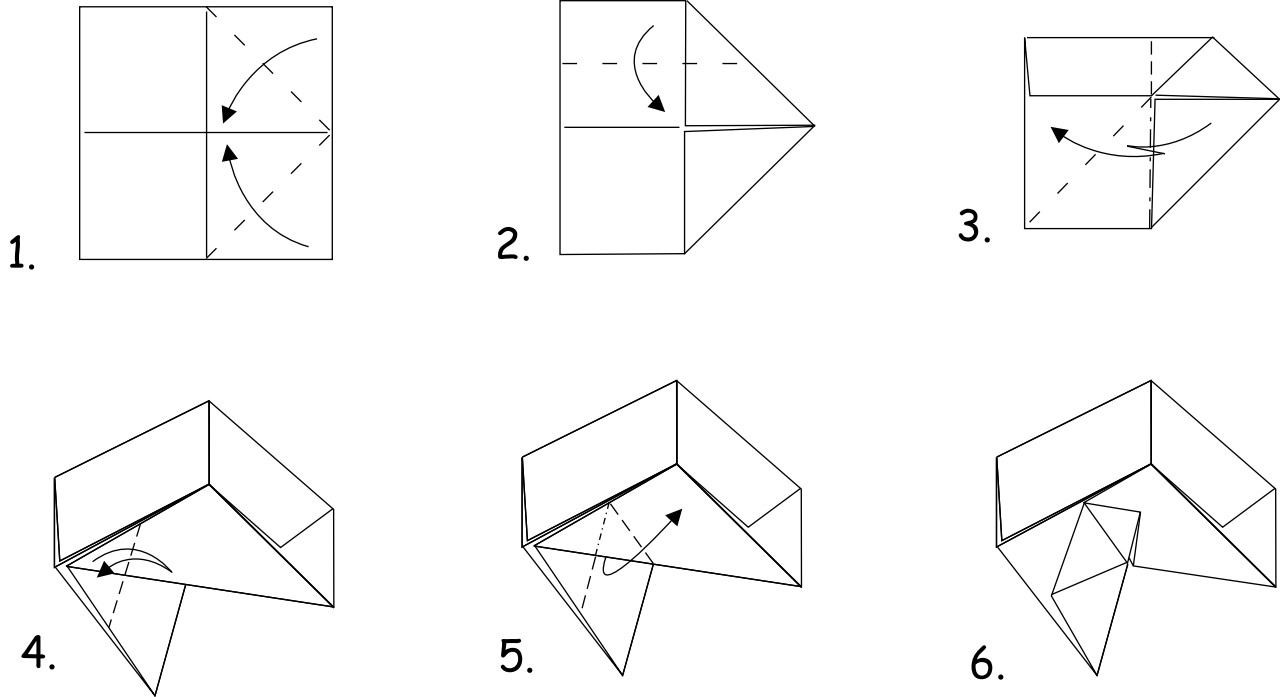

## Lid unit B & C

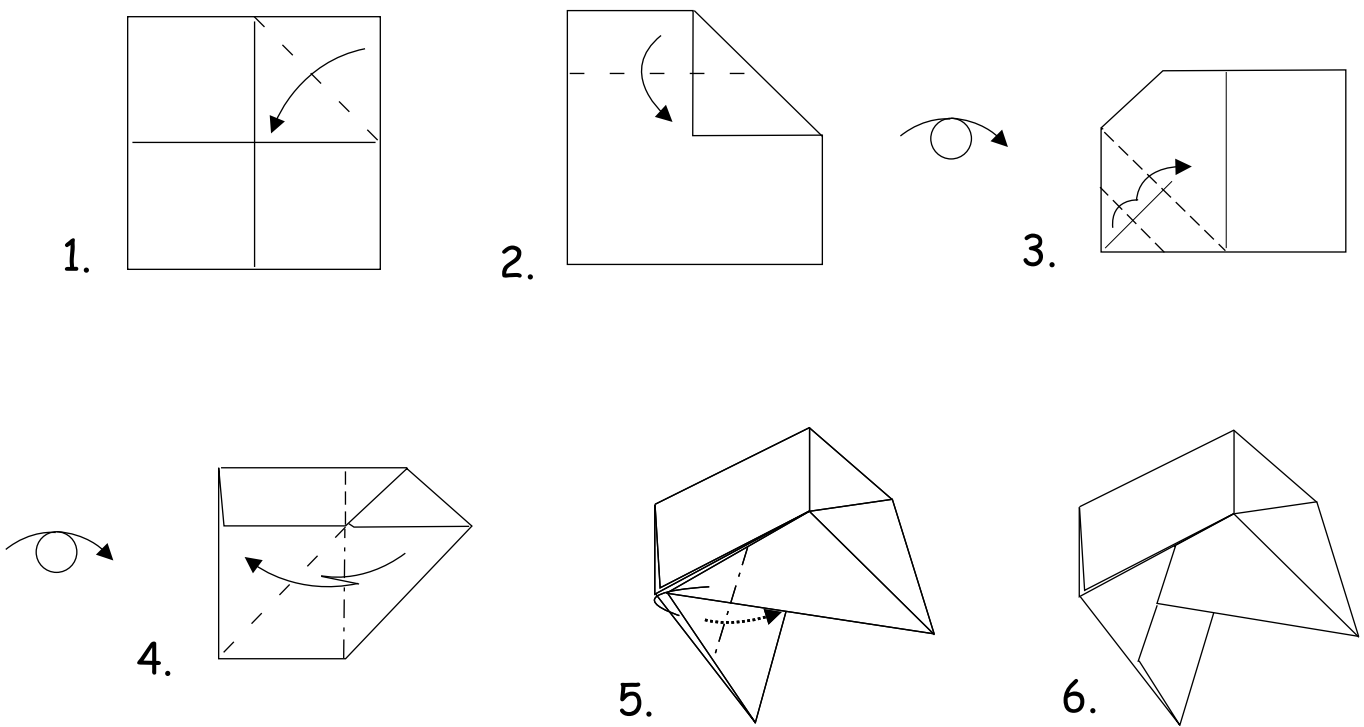

**Lid unit D**

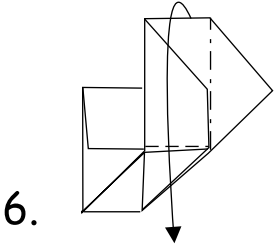
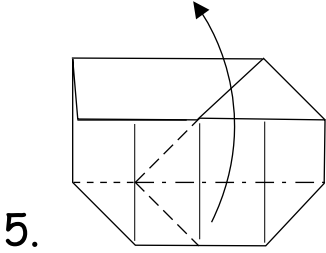
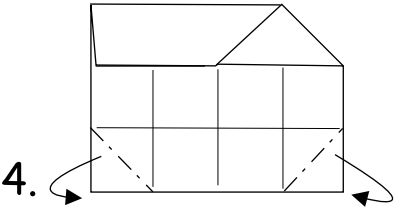
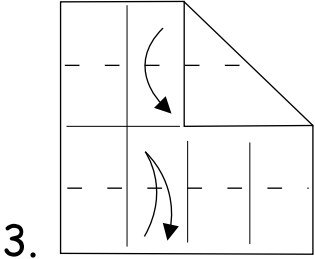
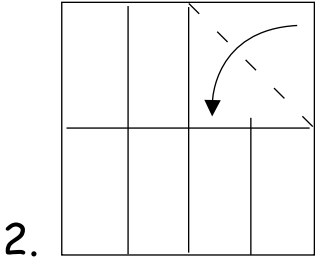
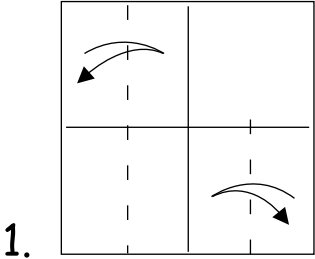

**Assembling C + D**

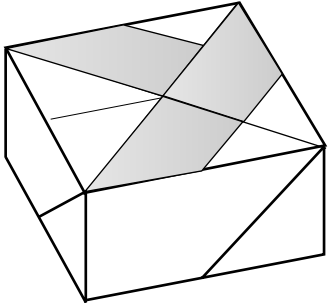
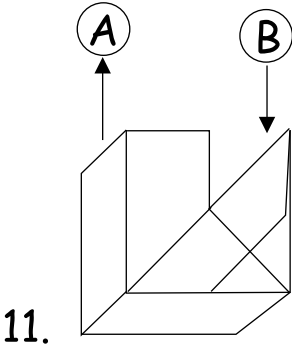
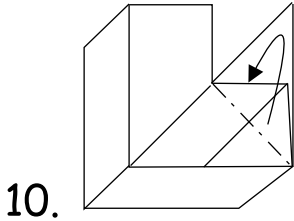
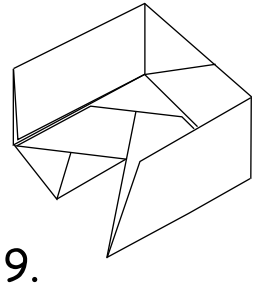
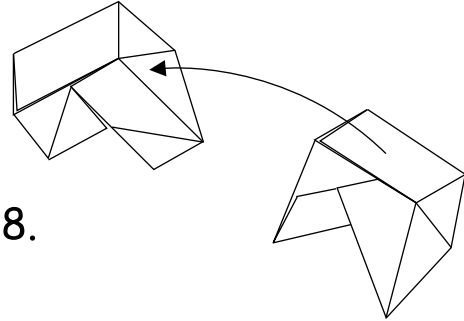
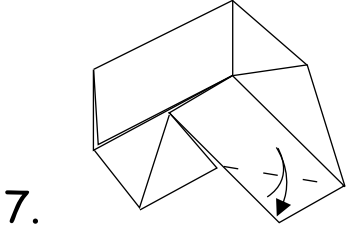

### Bottom unit A&B

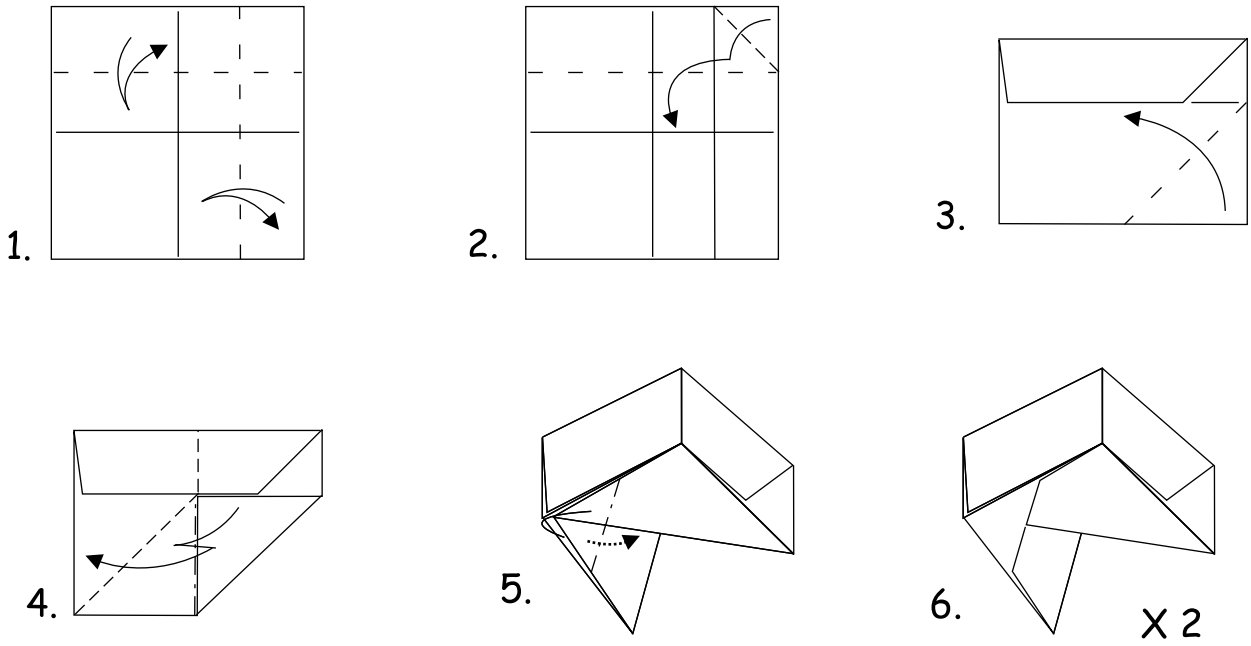

### Bottom unit C

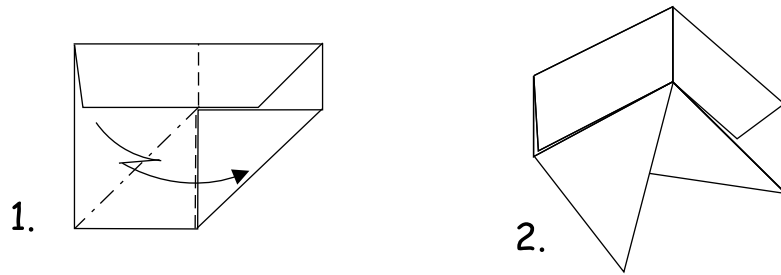

### Bottom unit D

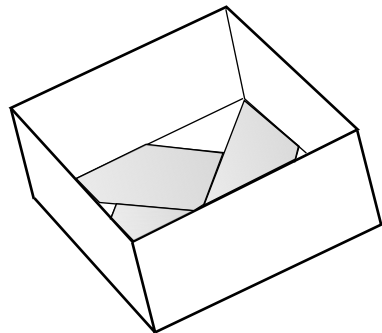
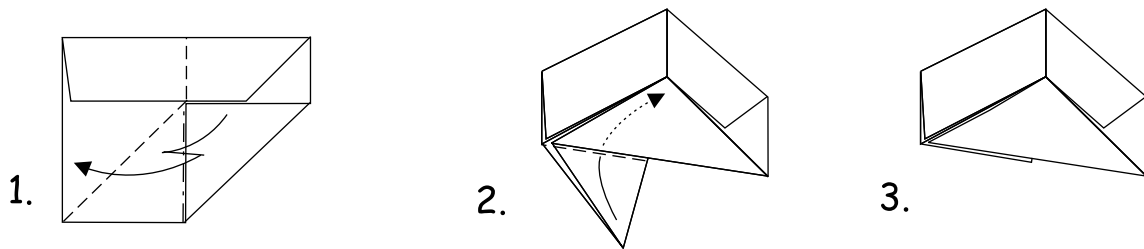

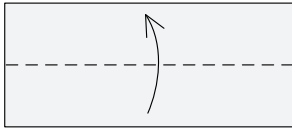

1. Begin with a dollar, green side up. Fold the it in half lengthwise, with the green side inside.

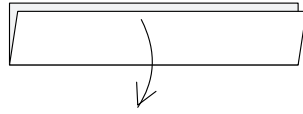

2. Unfold.

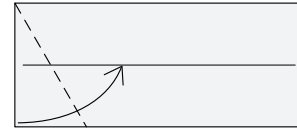

3. Fold the bottom left corner upward to lie on the horizontal center line. The crease should run through the upper left corner.

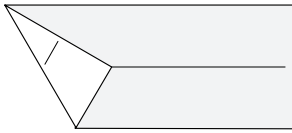

4. Like this. Turn the paper over from top to bottom.

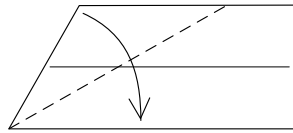

5. Fold the left edge down to lie along the bottom edge.

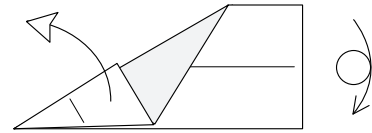

6. Like this. Unfold completely, and turn the paper back over so that the green side faces up.

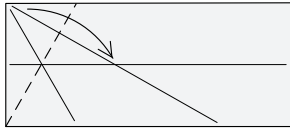

7. Repeat steps 3–6, but begin with the upper left corner rather than the lower left. When you have completed step 6 (unfolding the paper), don't turn it over again, but leave it white side up, with the creases to the left.

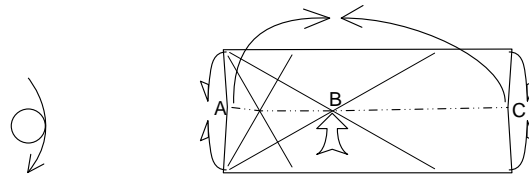

8. Push down point B (where the two diagonal creases cross) and bring points A and C toward each other. As you do this, bring the two left corners of the dollar toward each other and the two right corners toward each other, folding along the crease made in step 1, so that the white side is on the outside at each end.

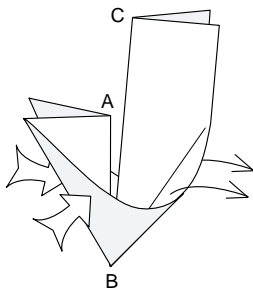

9. Pinch the left side of the model flat using the existing creases. Then, while holding edges AB and BC together, flatten out the rest of the model, forming new creases as necessary.

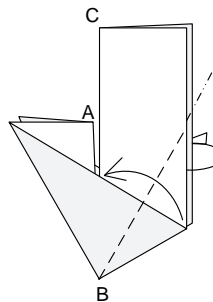

10. Fold the front lower right edge up to touch the two vertical edges; repeat behind.

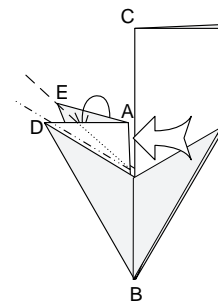

11. Push corner A down so that it goes between corners D and E, using existing creases.



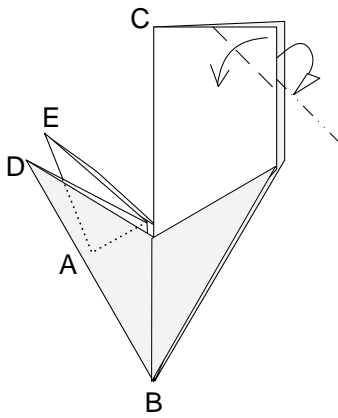

12. The dotted line shows where corner A winds up. Now fold one of the upper right corners down along a diagonal—the exact amount isn't critical. Fold an equal amount down on the other flap (on the other side).

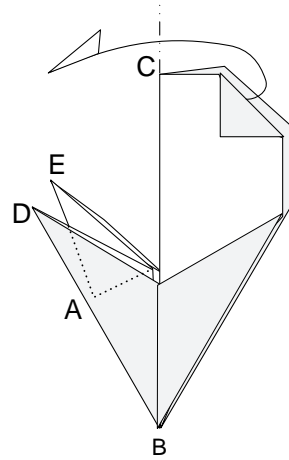

13. Hold flaps D and E together, and fold the back flap from the right side to the left, as if you were turning a page of a book facing away from you.

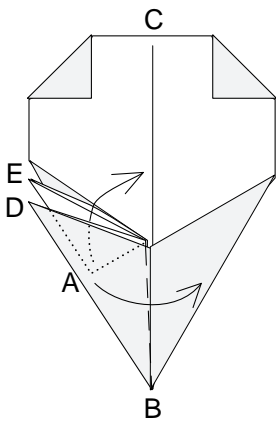

14. Fold flap D over to the right; in the process, corner A comes up, undoing step 11.

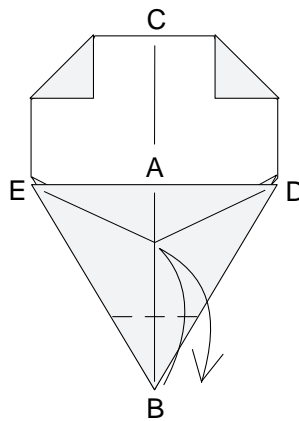

15. Fold the thick point at the bottom (point B) up to touch the junction of three creases in the middle of the green triangle; make a small crease, unfold, and turn the model over, keeping the point at the bottom.

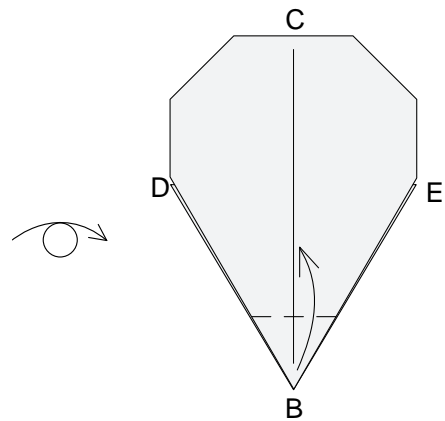

16. Fold point B upward on the crease you just made (reversing its direction).

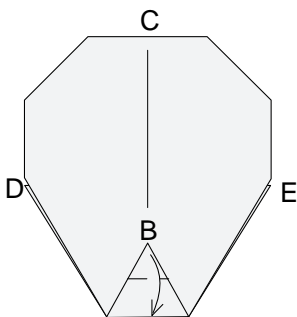

Fold point B back down to touch the bottom edge.

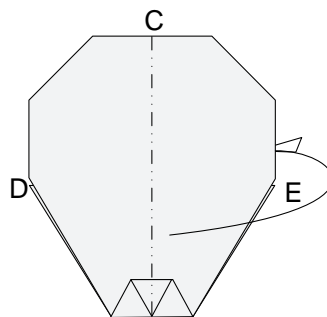

18. Carefully (because of the thickness) fold the model in half vertically.

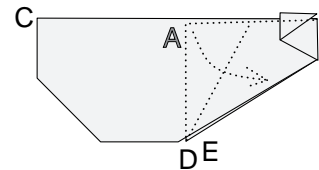

19. Fold corner A (which is hidden inside the model) back down between corners D and E (as you did in step 11).

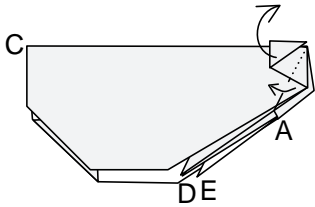

20. The zig-zag corner at the right is the neck and head. Pinch the head between two fingers and pull it upward so that its left edge becomes vertical (look ahead to step 21 to see the result). Note that the creases that form touch corner A.

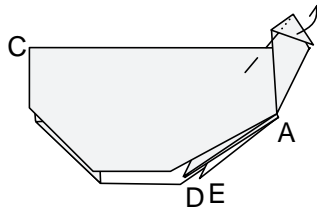

21. Now, pinch the head near its beak and pull it upward, so that the bottom edge is nearly horizontal.

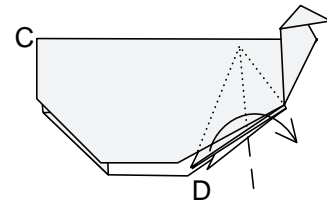

22. Take the nearest hidden point (point D) and fold it over to the right and downward as far as possible; the action is a combination of twisting and pulling. Repeat on the other side (point E).

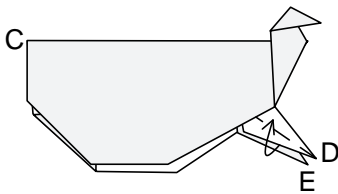

23. Fold both of the legs (points D and E) in half to narrow them. This is difficult with small paper, and if you don't mind a fat-legged peacock, you can skip this step.

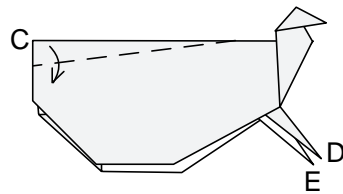

24. Fold a narrow strip of the back edge (the exact amount isn't critical) downward, tapering to a point where the paper gets thick.

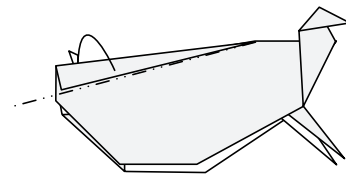

25. Fold the same width of paper behind, folding over the first pleat you made.

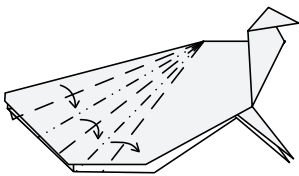

26. Continue pleating the tail back and forth, making a fan. The exact amount isn't critical, but look at the next step for an idea of how far to go.

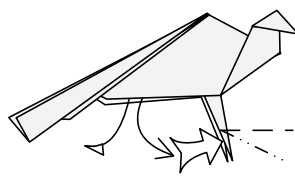

27. The tail consists of a double layer of pleats; separate the edges of the bottom of the tail and the layers of the pleats from each other. Working from the center, spread the tail out like a fan. Fold the tips of the legs forward to form feet.

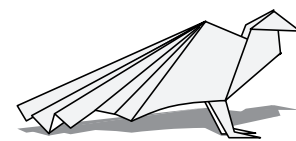

28. The finished peacock.

start white side up

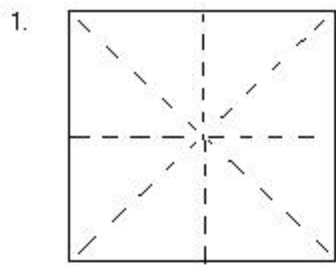

1. Precrease the paper in half in all 4 directions

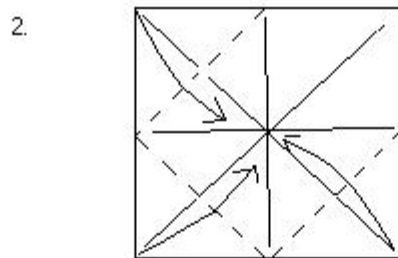

2. Fold three of the corners into the middle

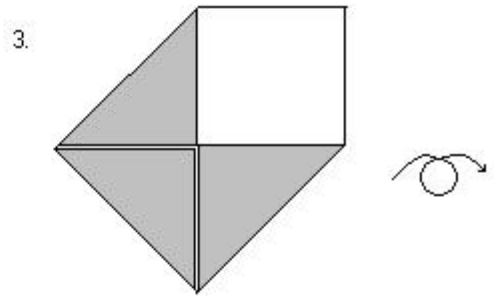

3. Turn over and rotate

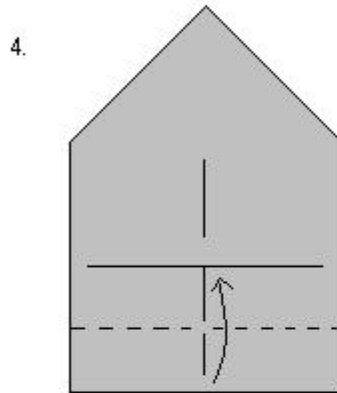

4. Fold to the center

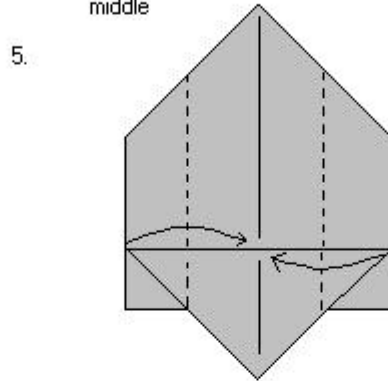

5. Fold to the center

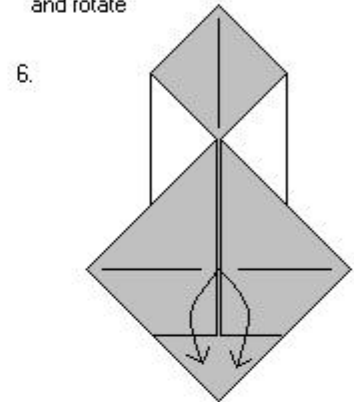

6. Pull out the 2 points

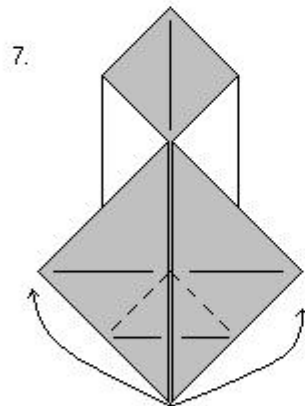

7. 2 valley folds

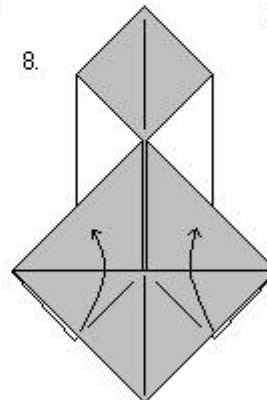

8. Reverse fold the 2 triangles out from inside

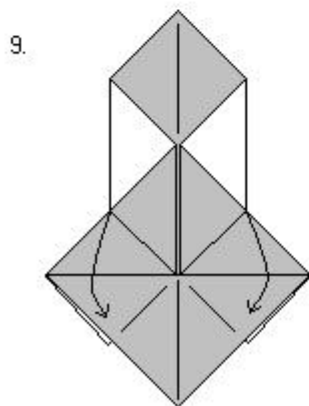

9. Fold the flaps down

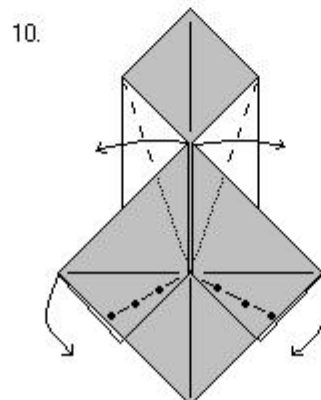

10. Squash folds

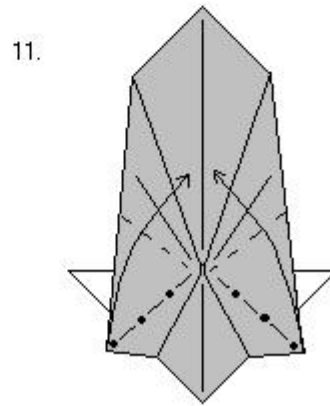

11. Swivel the points up

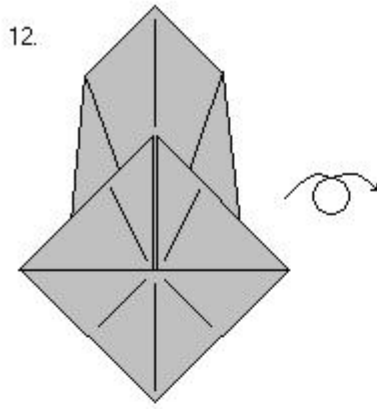

Turn over

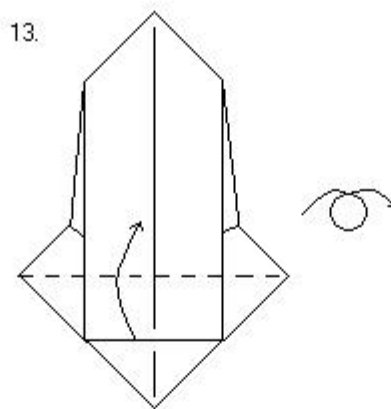

Valley fold the thick flap up  
Turn over

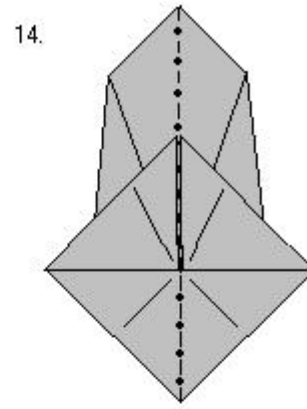

Fold in half and rotate

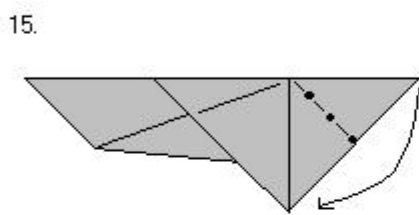

Reverse fold

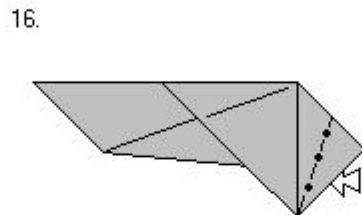

Reverse fold  
Repeat behind

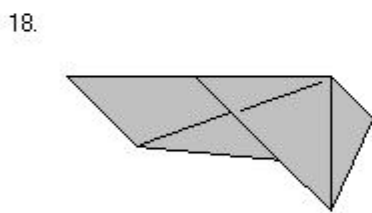
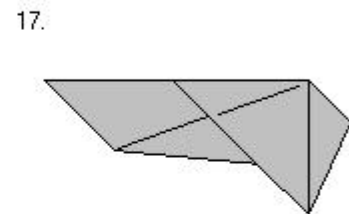

Unfold the reverse folds

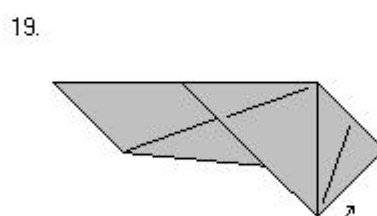

Pull the center point  
out a little bit

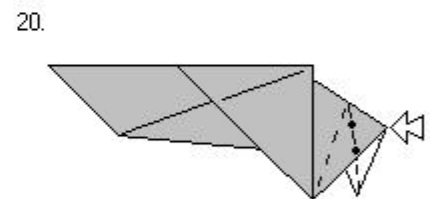

Squash fold  
Repeat behind

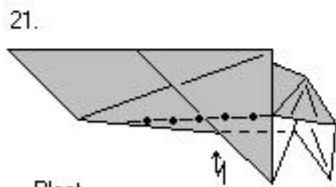

Pleat  
Repeat behind

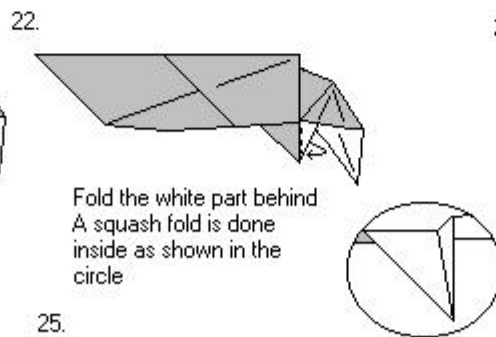

Fold the white part behind  
A squash fold is done  
inside as shown in the  
circle

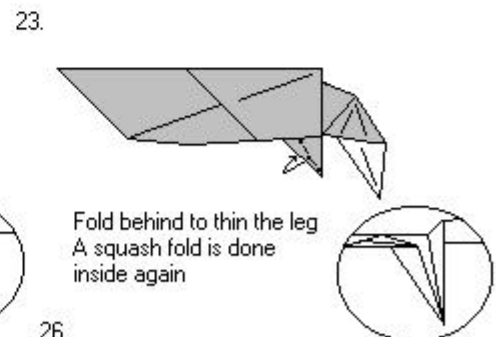

Fold behind to thin the leg  
A squash fold is done  
inside again

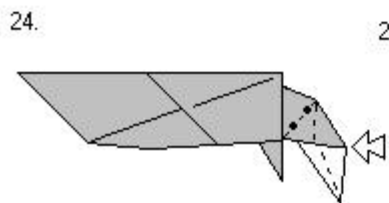

Swivel to thin the neck

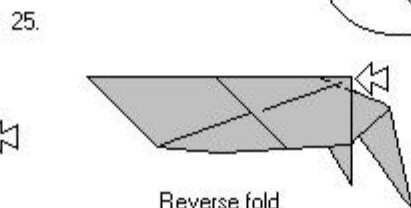

Reverse fold

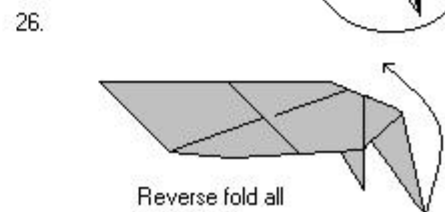

Reverse fold all  
the way up

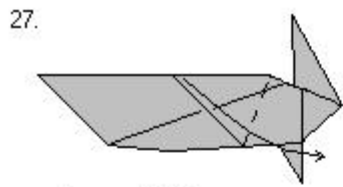

Repeat behind

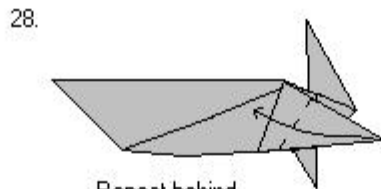

Repeat behind

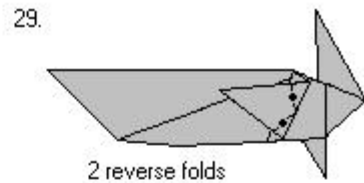

2 reverse folds  
Repeat behind

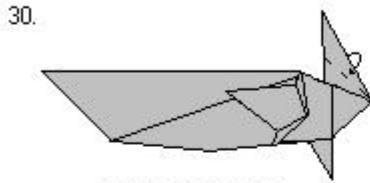

Outside reverse fold

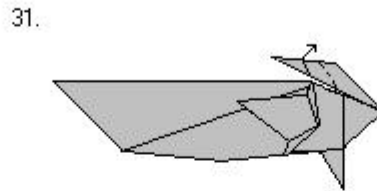

Outside reverse fold

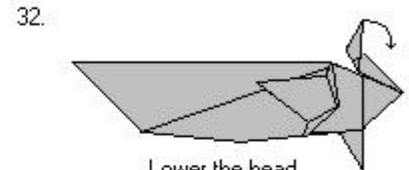

Lower the head  
with a crimp

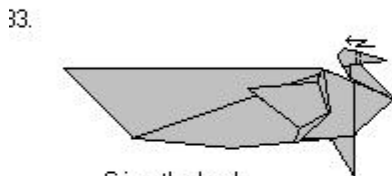

Crimp the beak

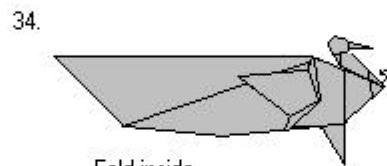

Fold inside  
Repeat behind

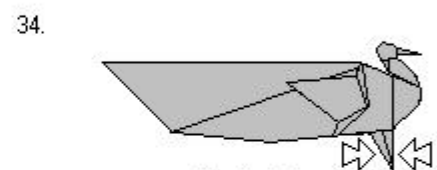

Pinch the leg  
Repeat behind

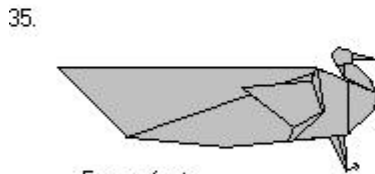

Form a foot  
Repeat behind

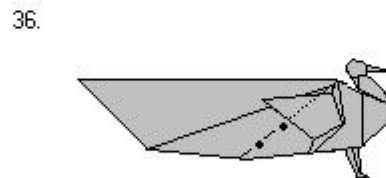

Form a foot

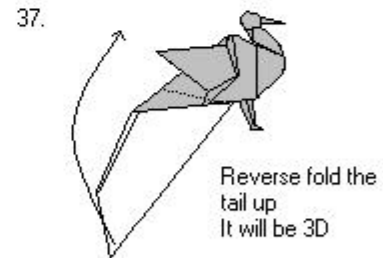

Reverse fold the  
tail up  
It will be 3D

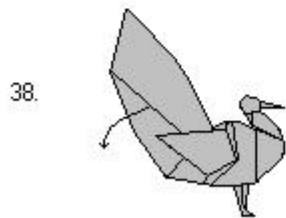

Pull out the paper

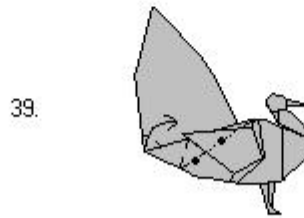

Fold the paper inside

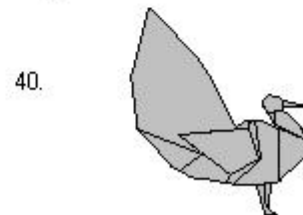

Peacock

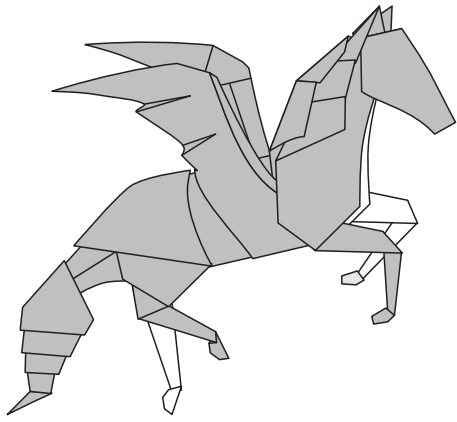

# Pegaso

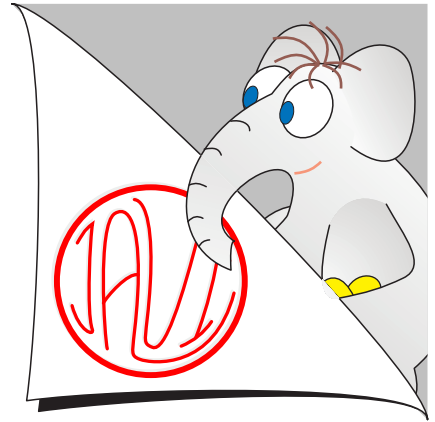

Autor: J. Aníbal Voyer

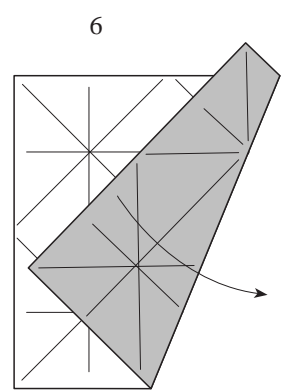
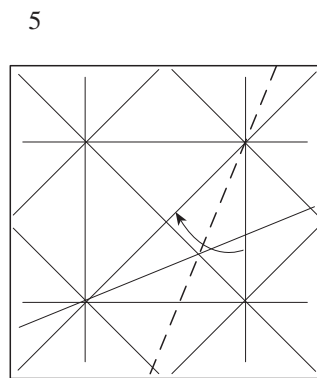
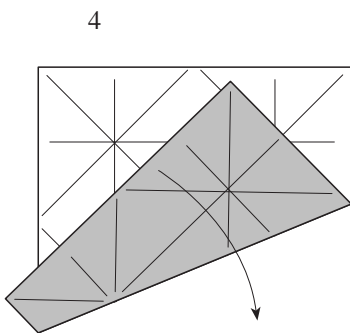
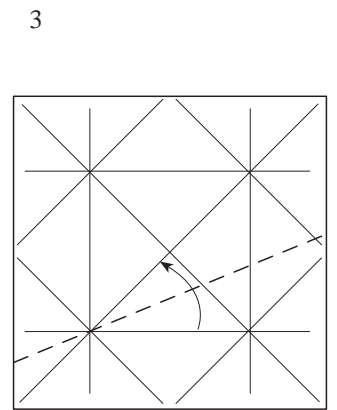
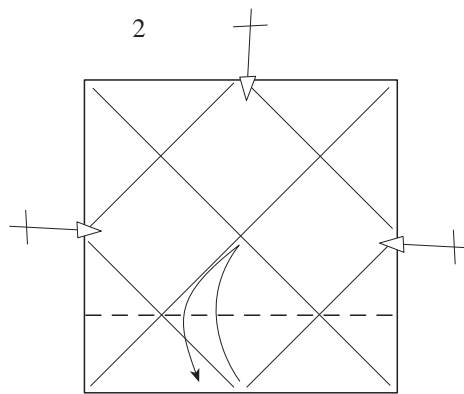
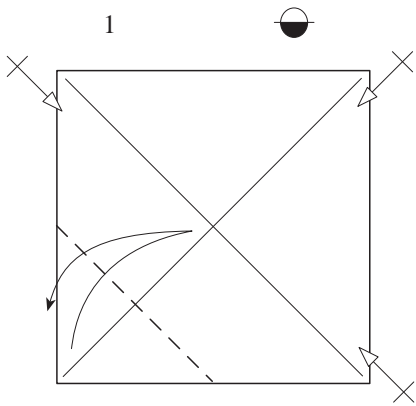

7 Repetir de 3 a 6  
a la izquierda

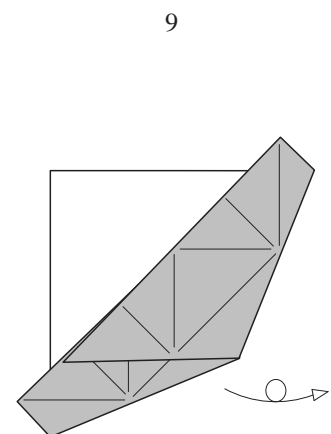
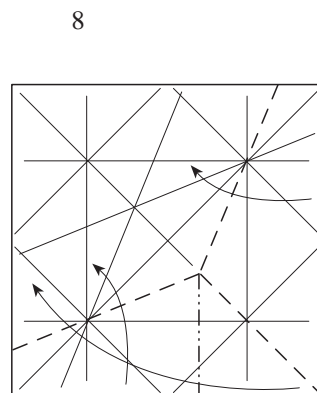
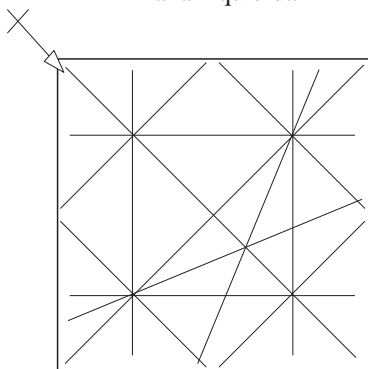

10

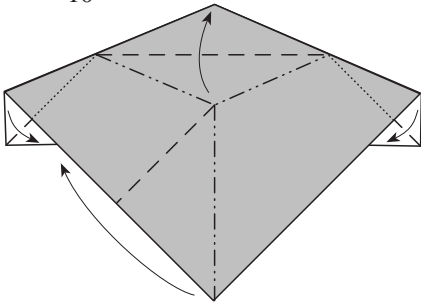

11 Plegar la línea AB sobre BC y desplegar

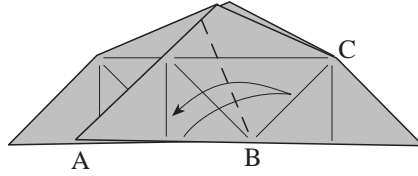

12

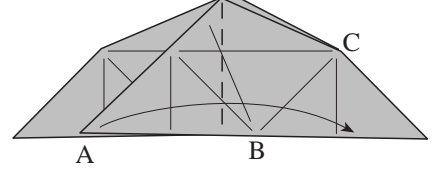

13 Plegar la línea AB sobre BC y desplegar

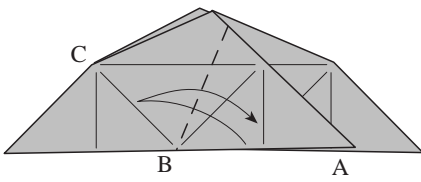

14

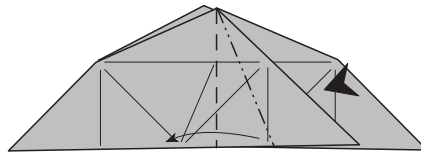

15

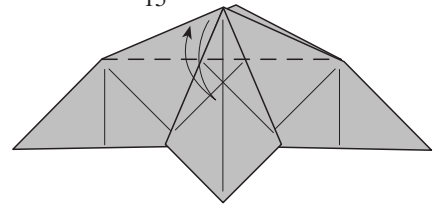

16

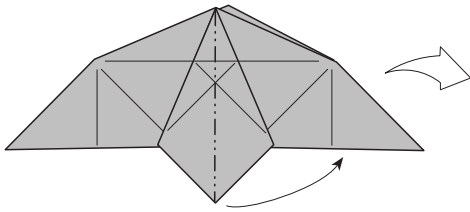

17 Plegar y desplegar

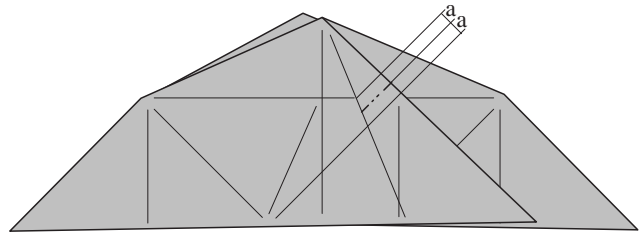

18 Plegar y desplegar

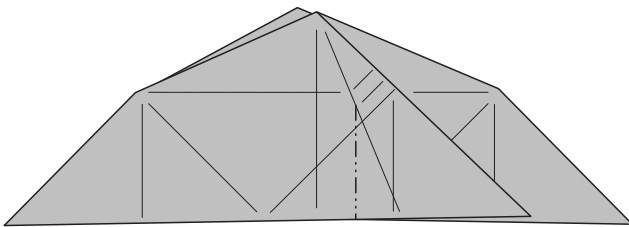

19

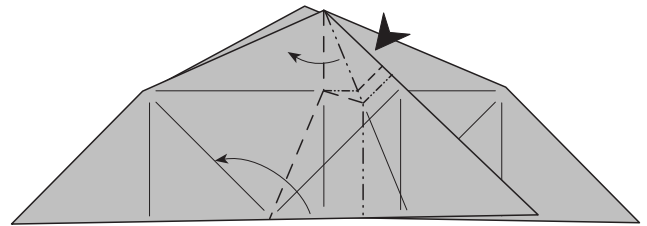

20 Repetir detrás del paso 11 al 19

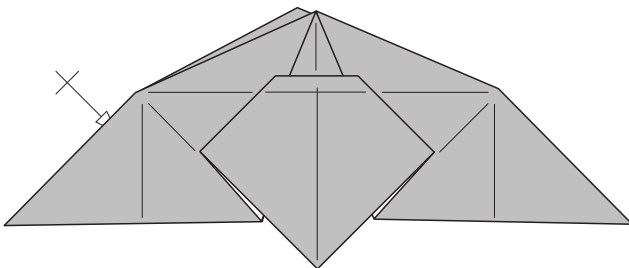

21 Repetir detrás

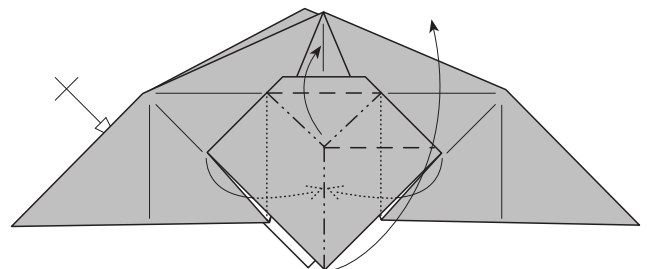

22

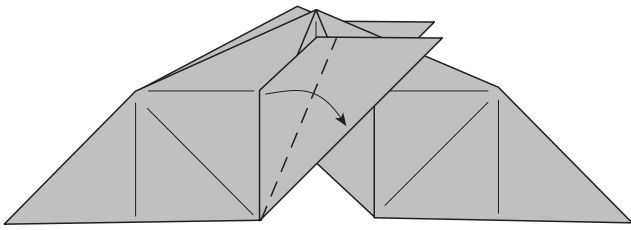

23

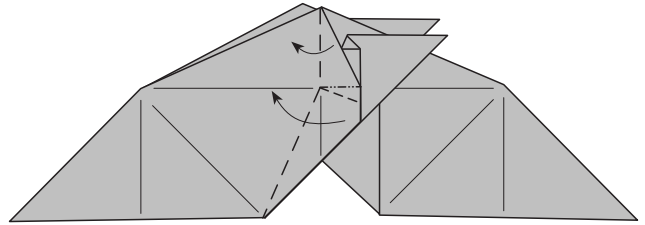

24

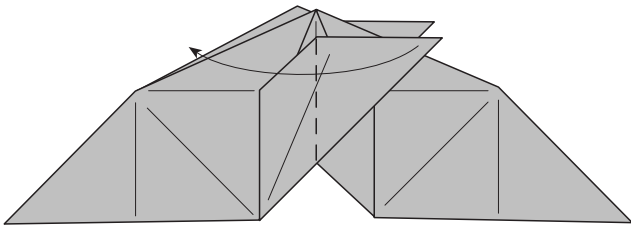

25 Repetir a la derecha los pasos 22 y 23

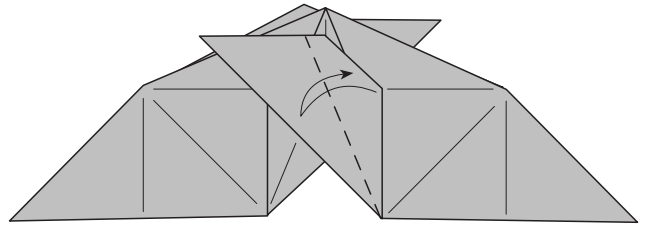

26

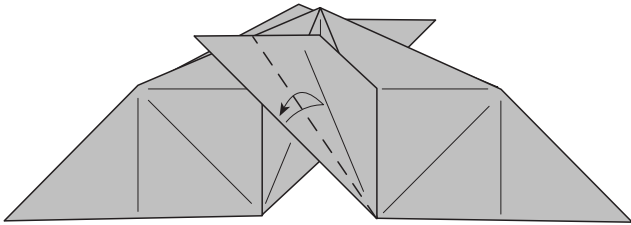

27

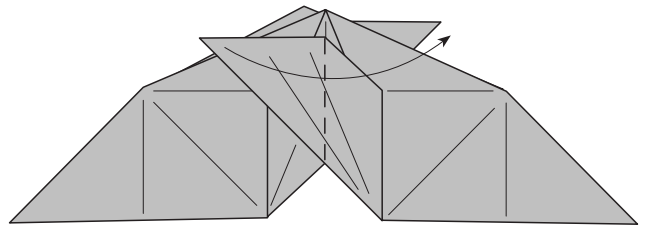

28

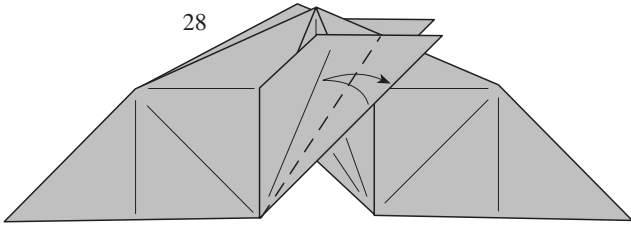

29 En este paso el modelo no se puede dejar plano

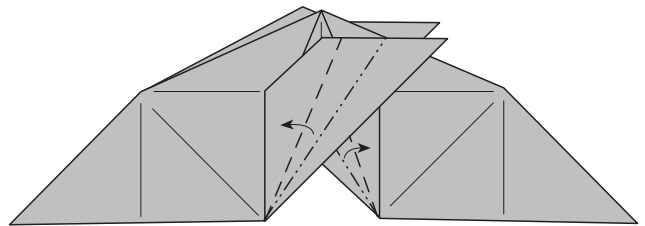

30

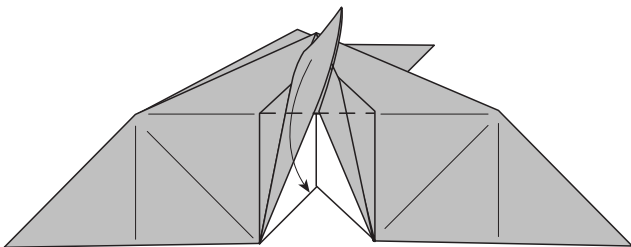

31 Aplastar la esquina

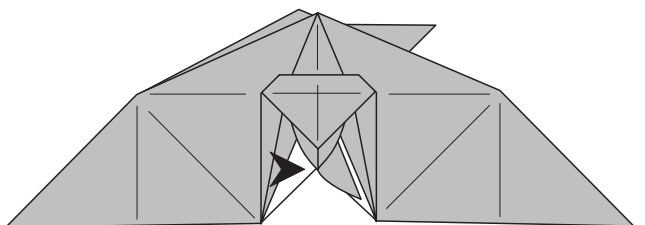



32 Tirar del ala

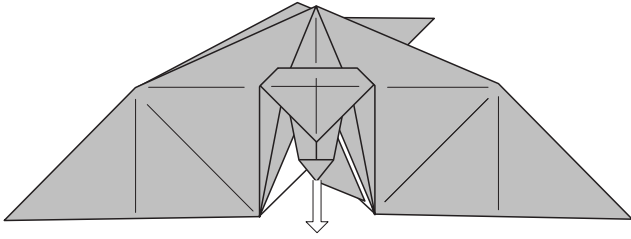

33 Repetir detrás del paso 22 al 32

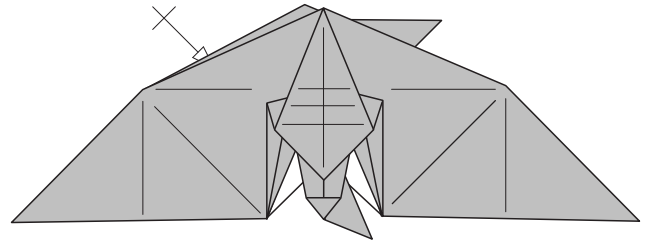

34

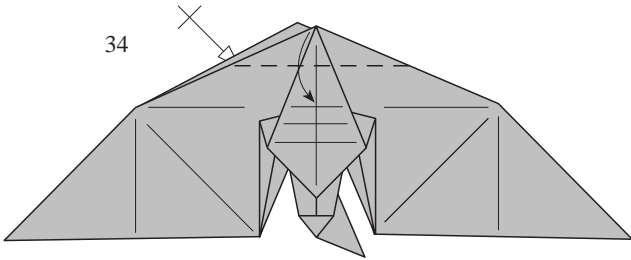

35

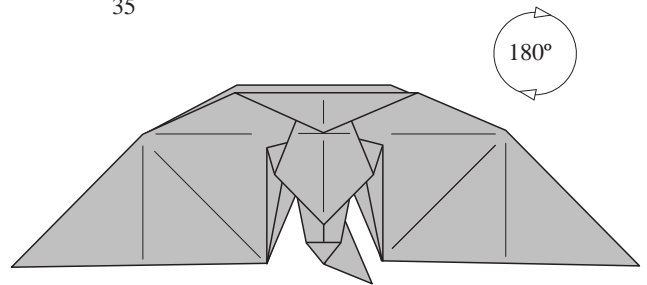

36

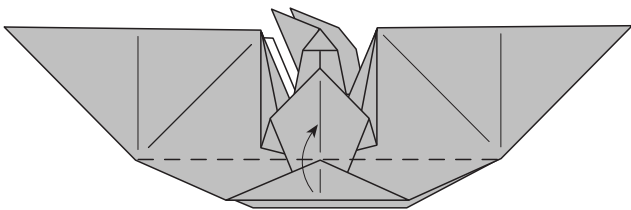

37

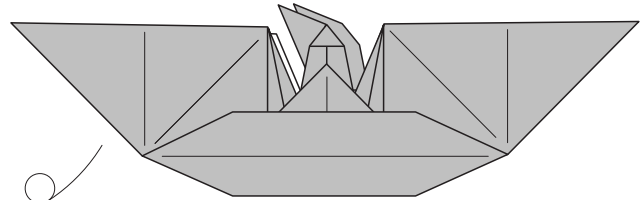

38

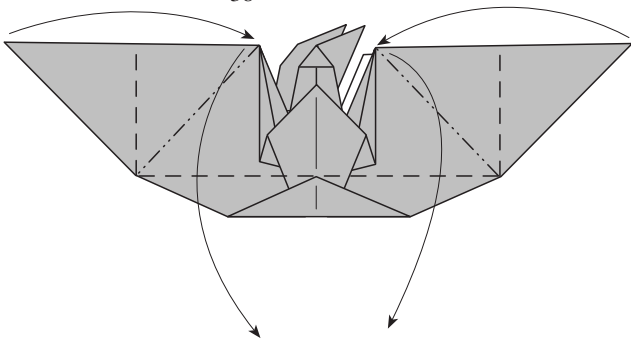

39

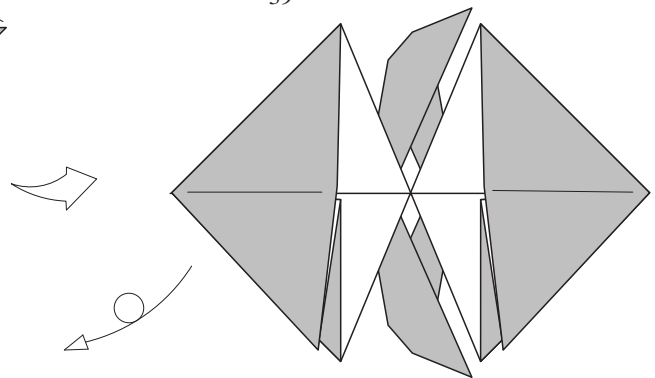

40

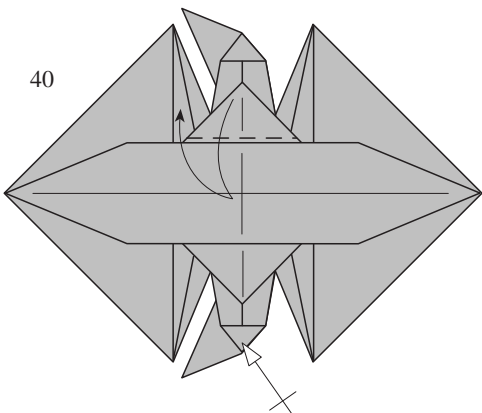

41

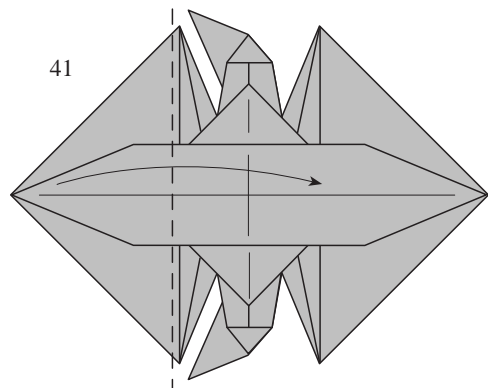

42

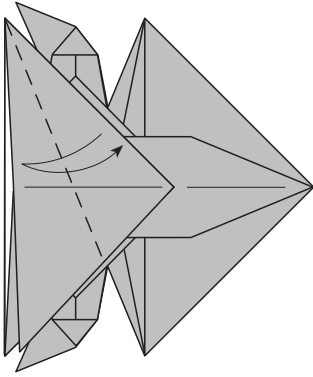

43

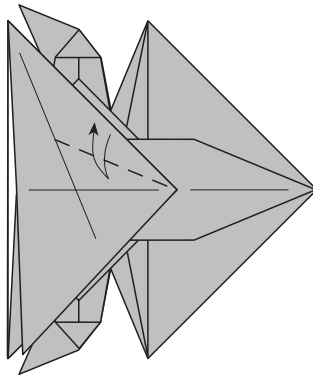

44

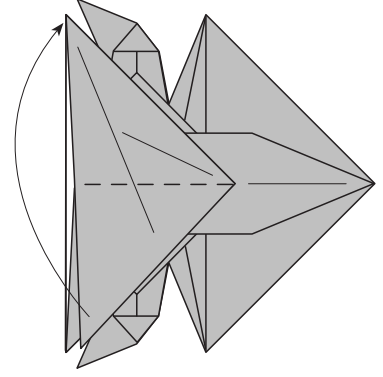

45

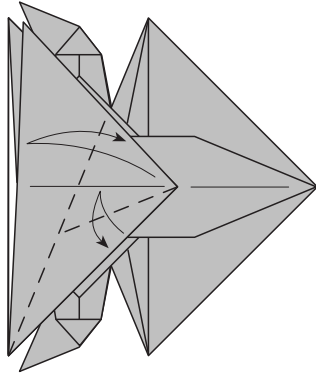

46

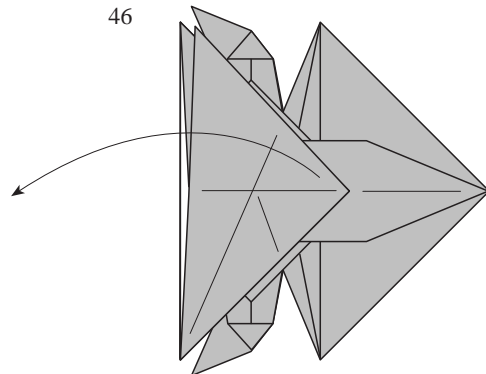

47 Vista en perspectiva

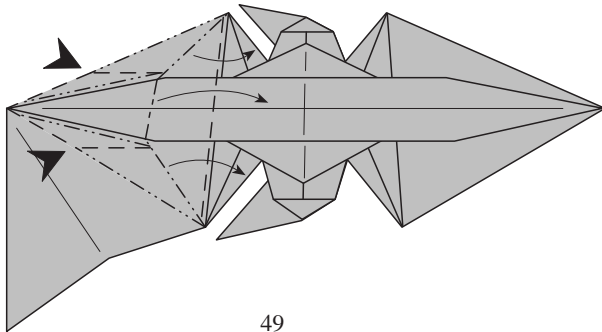

48

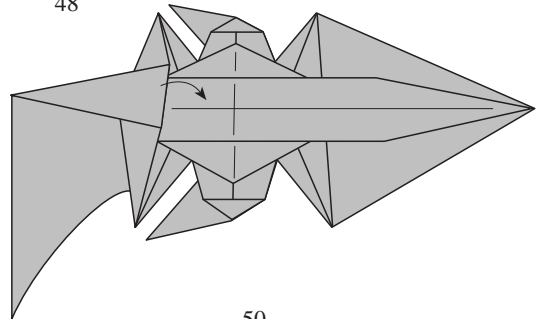

49

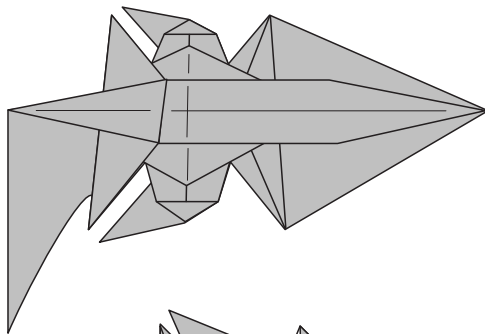

50

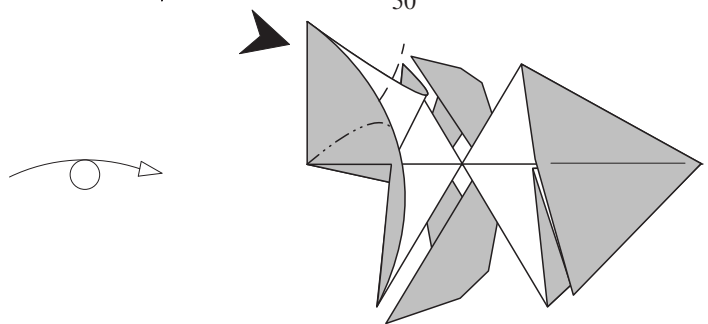

51

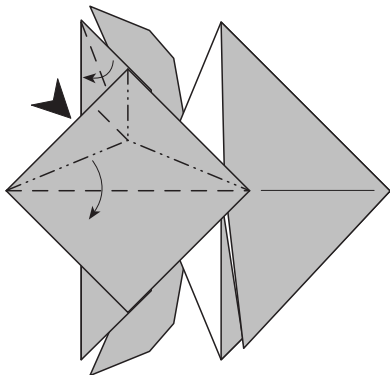

52 Desplegar

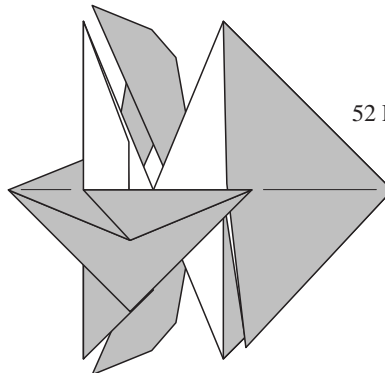

53

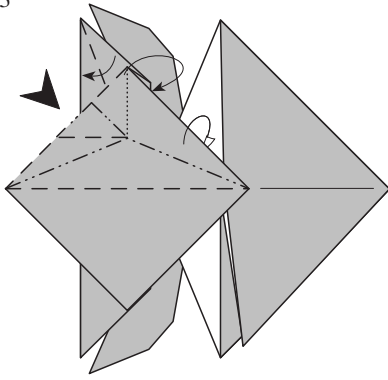

54 Repetir del 51 al 53

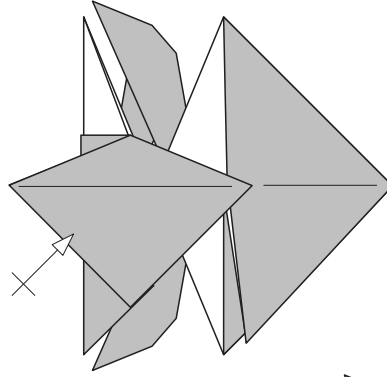

55

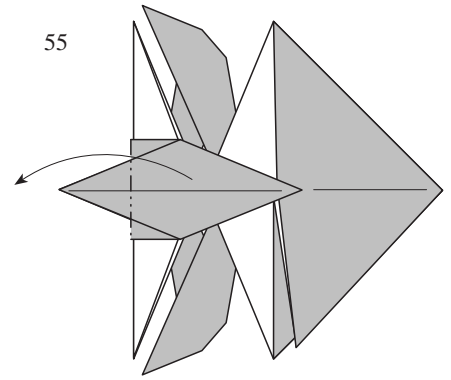

56

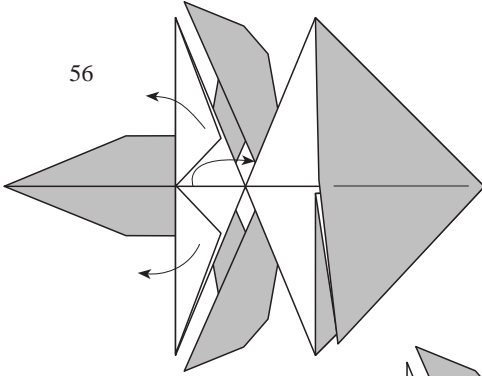

57

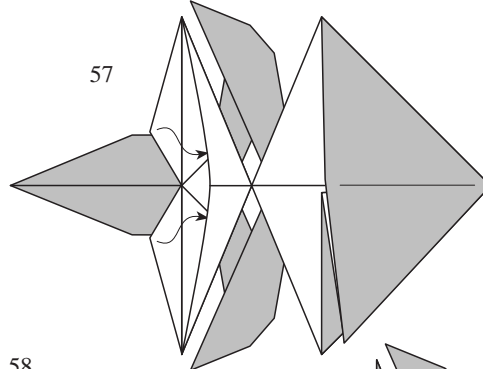

58

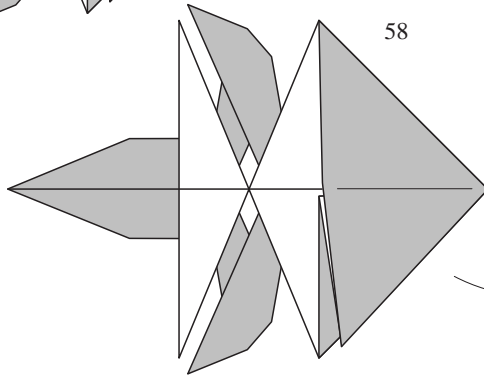

59

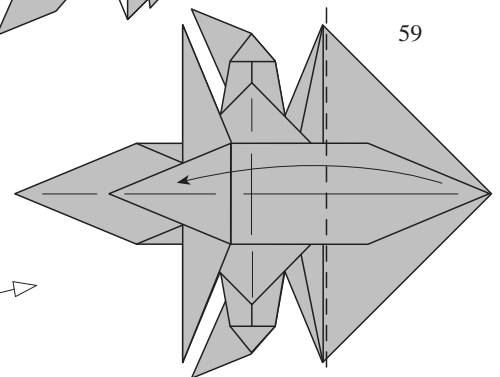

60

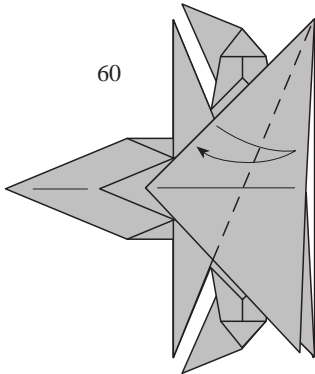

61

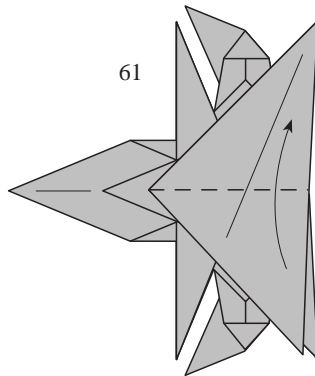

62

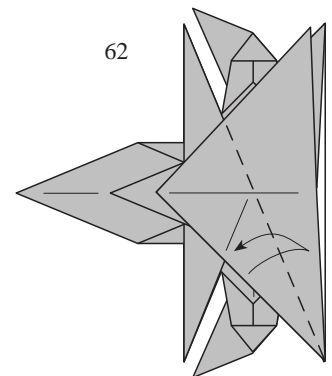

63

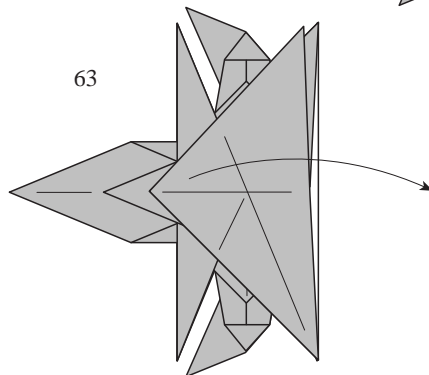

64

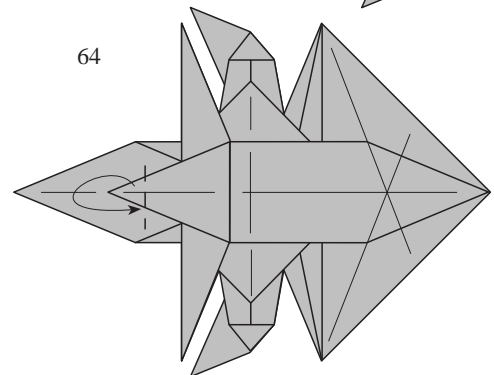

65

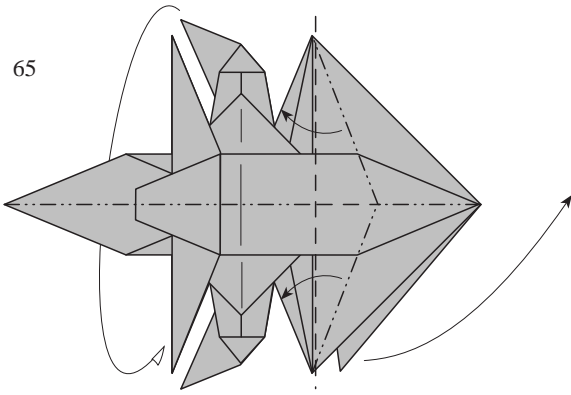

66 Girar

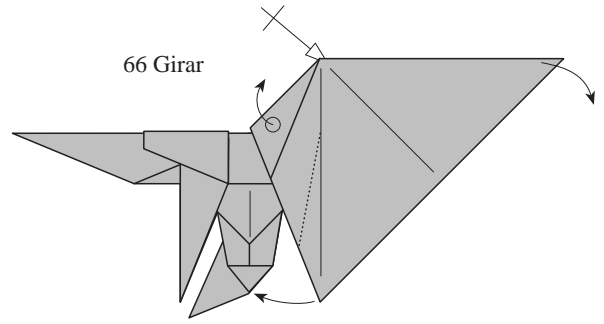

67 Levantar las alas

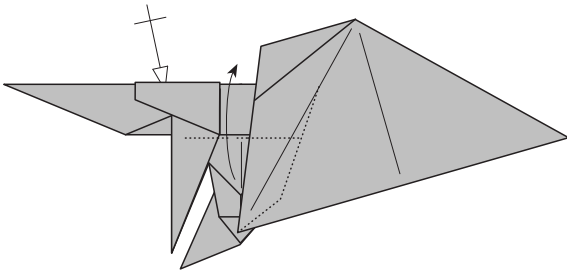

68 Abrir el modelo para que se vea el interior, pero no marcarlo

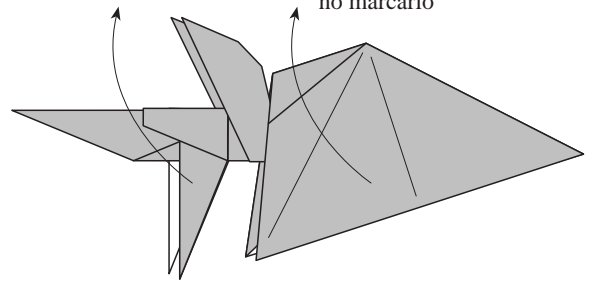

69

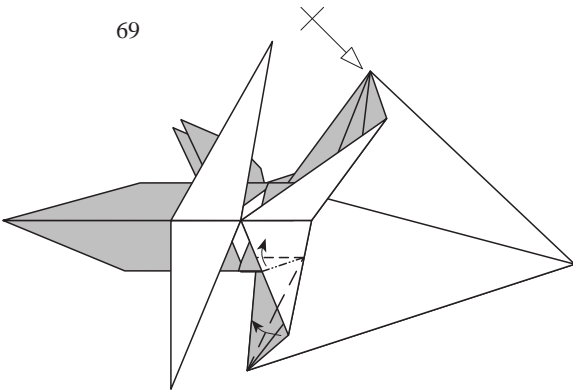

70 Cerrar

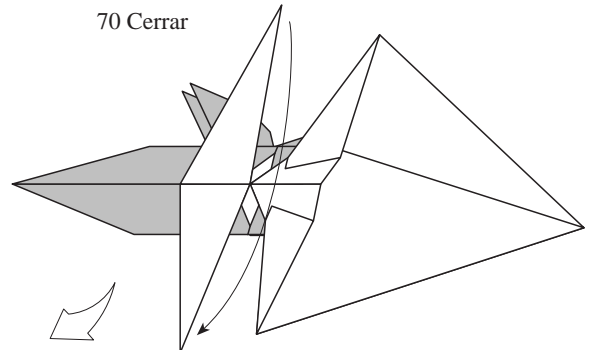

71

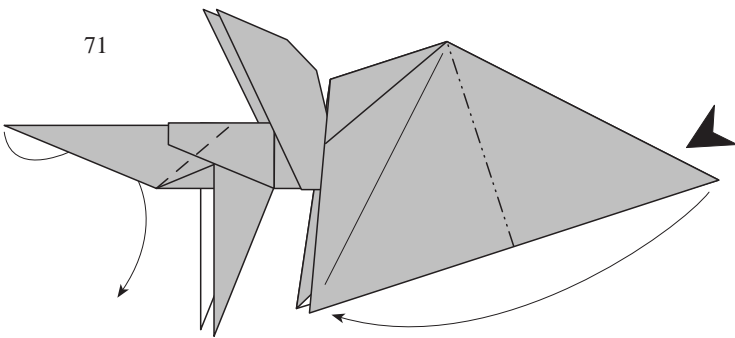

72

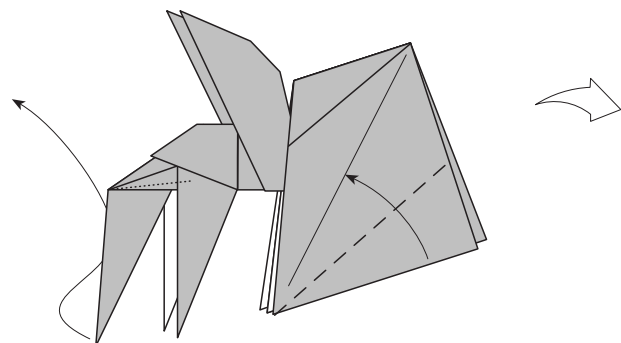

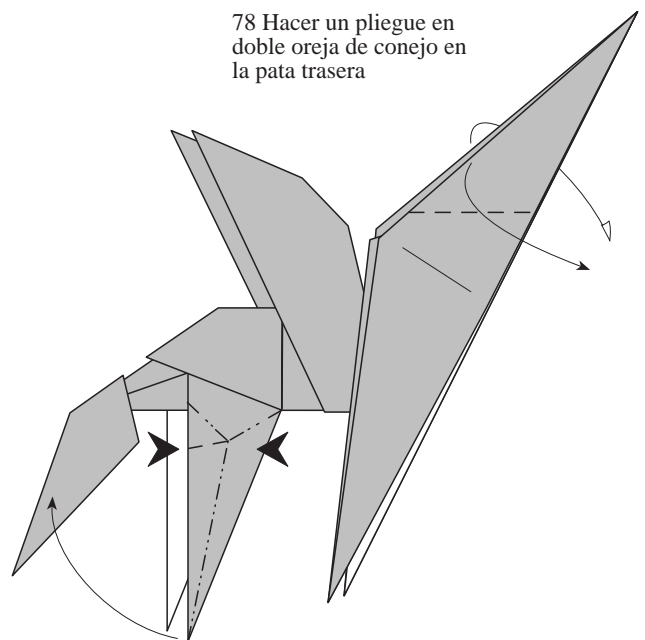
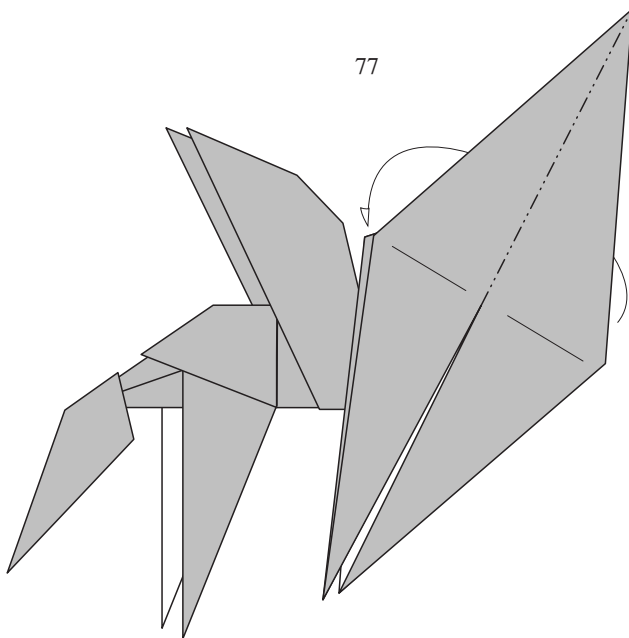
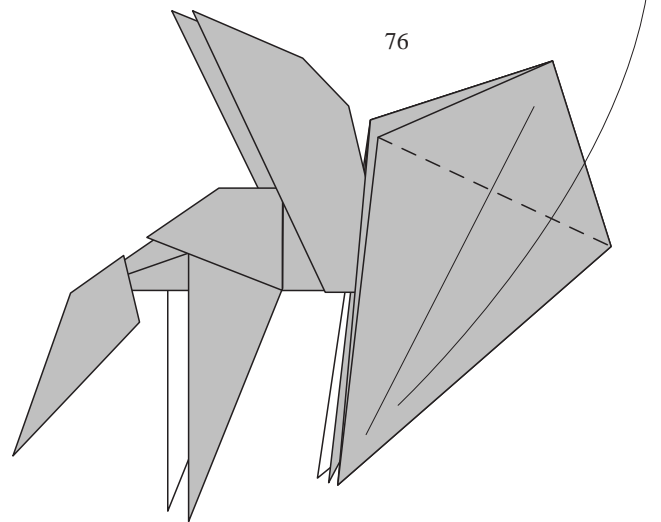
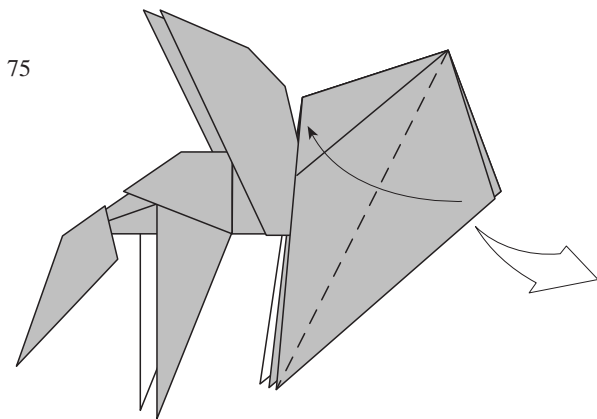
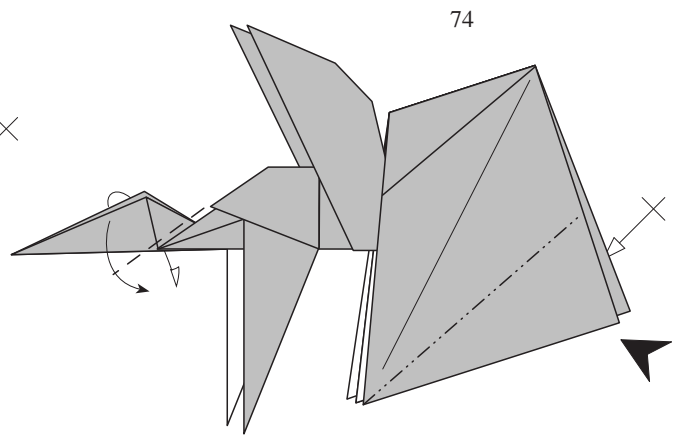
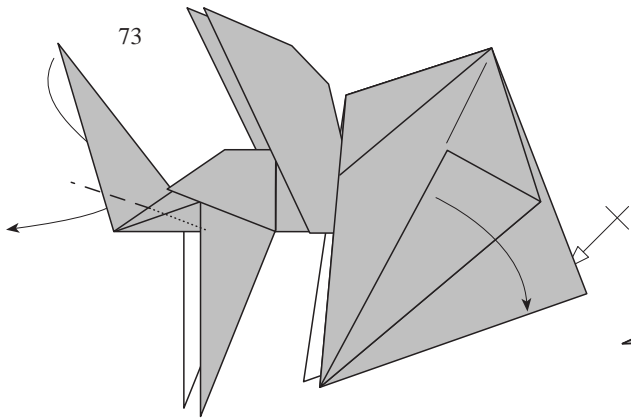

79

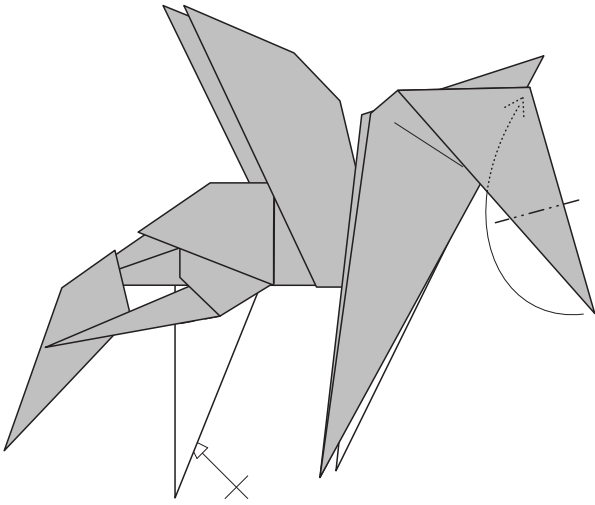

80

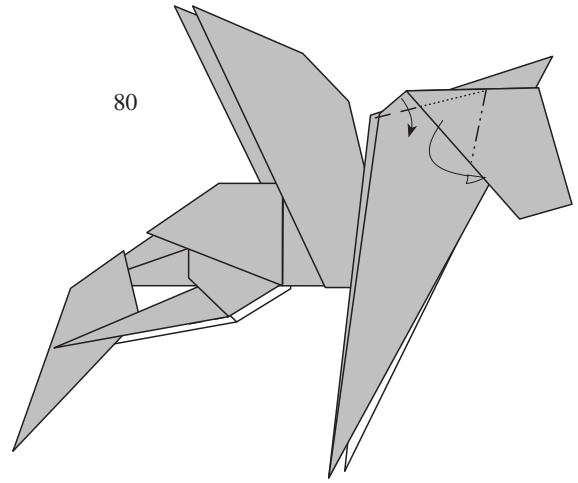

81

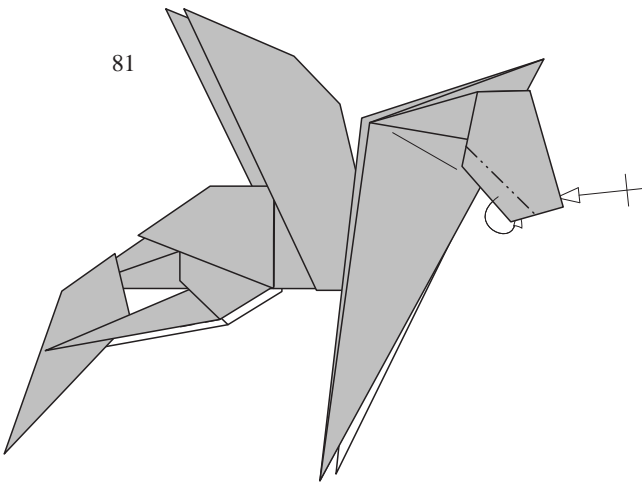

82

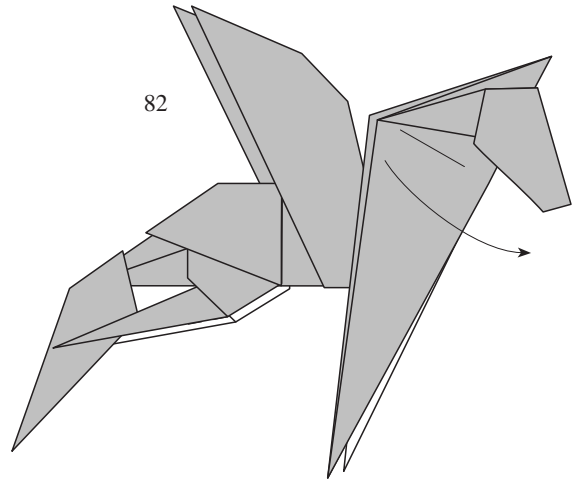

83

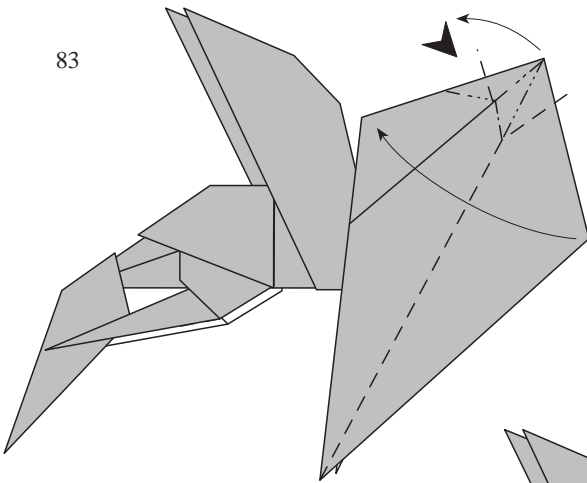

84

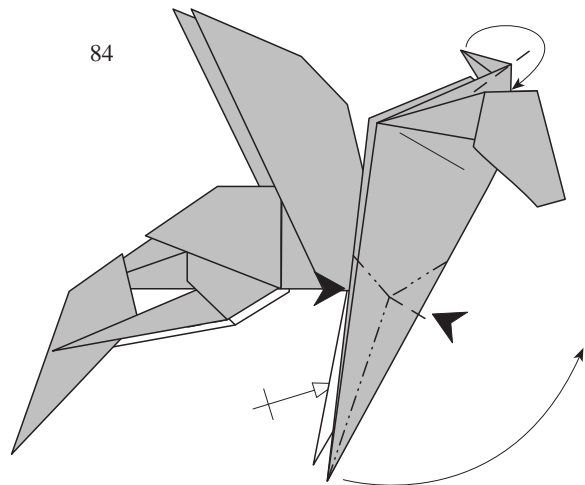

85

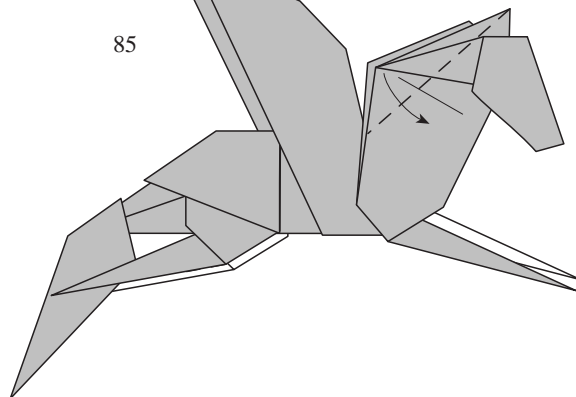

86

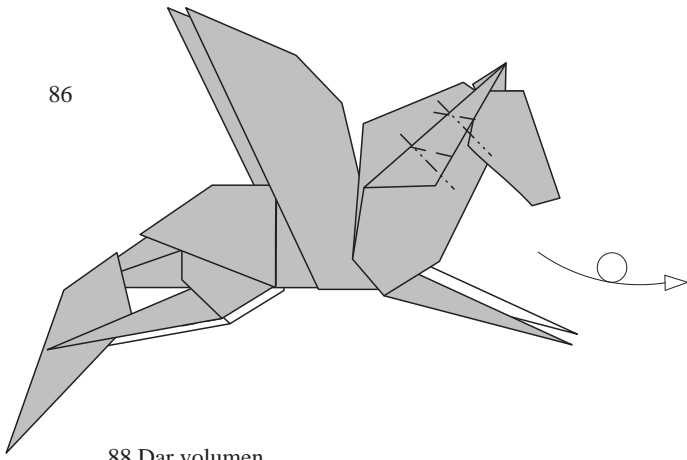

87 Repetir 85 y 86

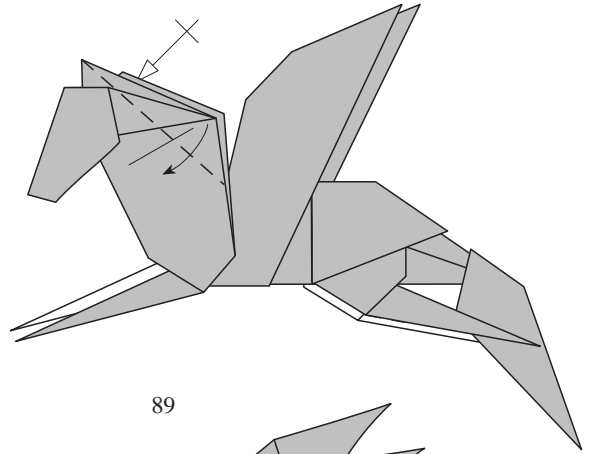

88 Dar volumen

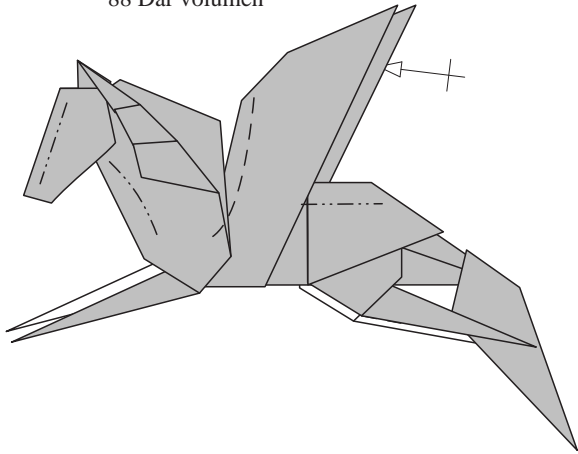

89

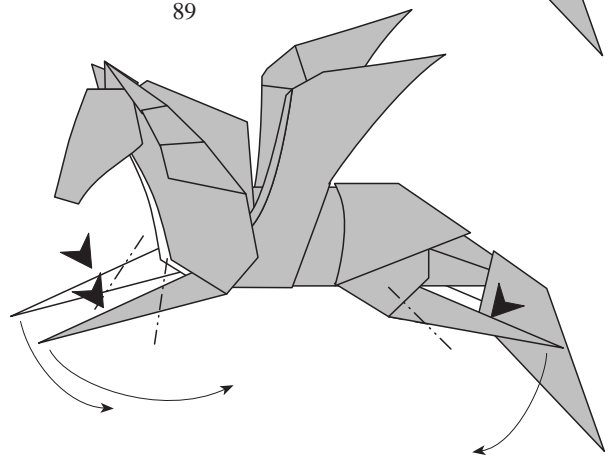

90

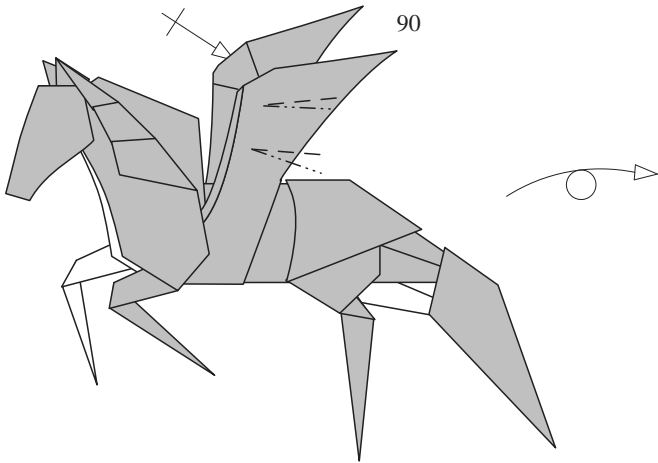

91

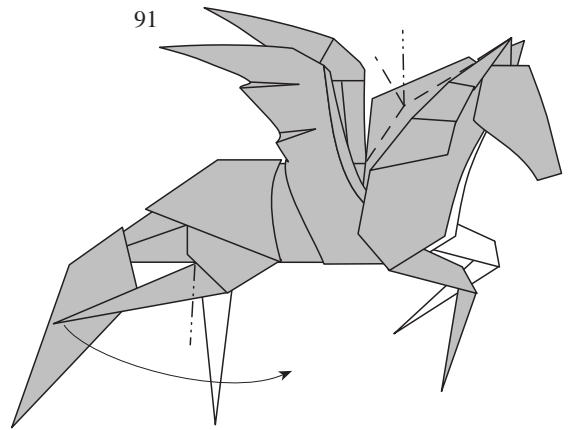

92

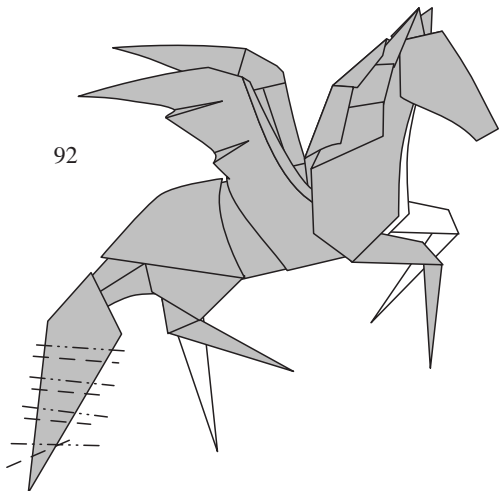

93

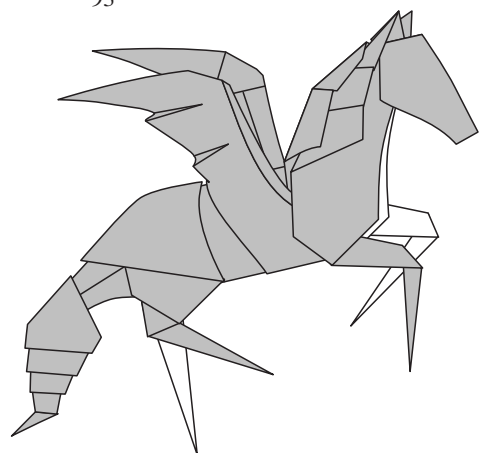

PLEGADO DE LOS CASCOS

94

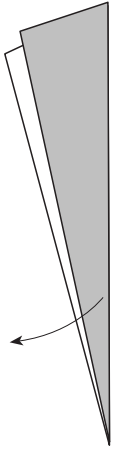

95

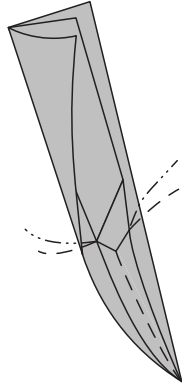

96

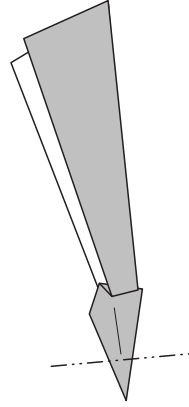

97

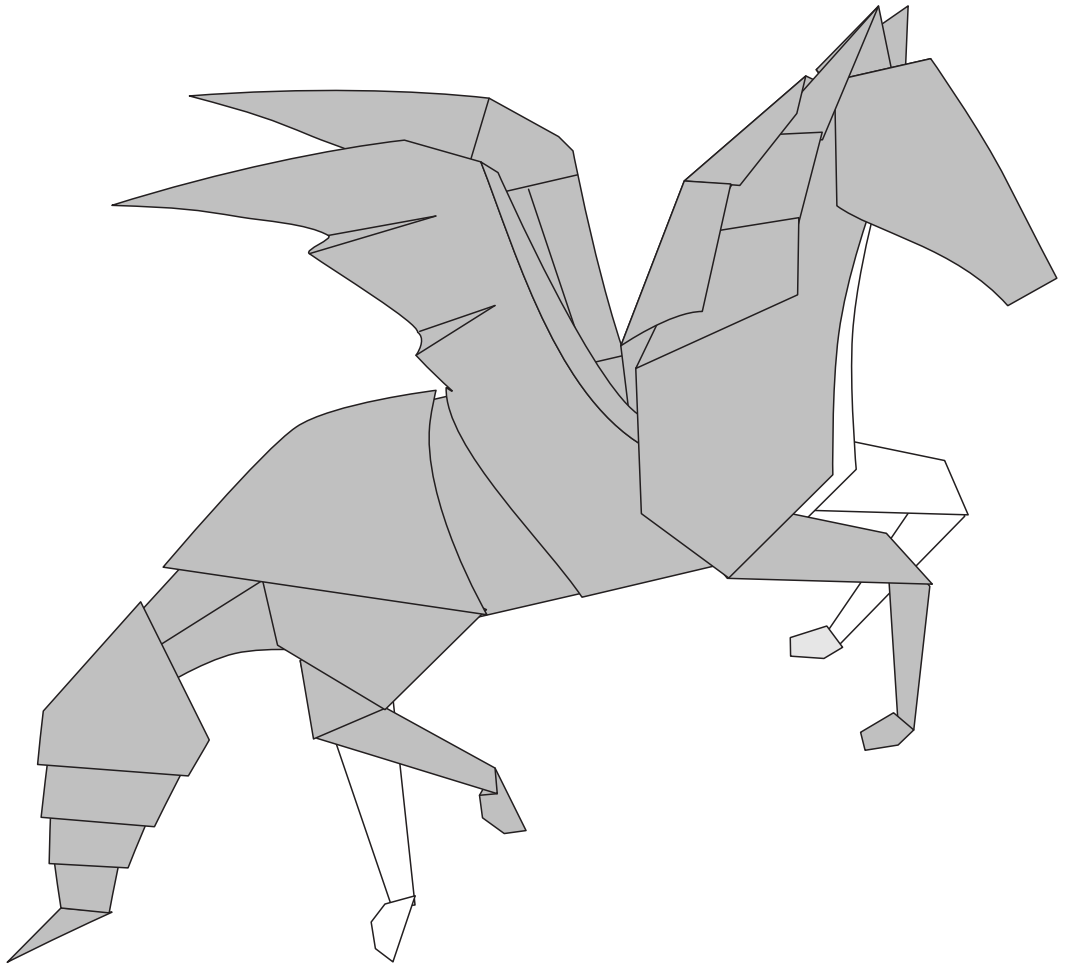
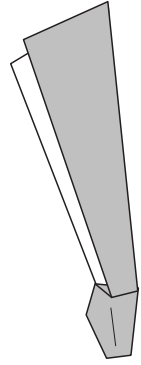



start white side up

1.

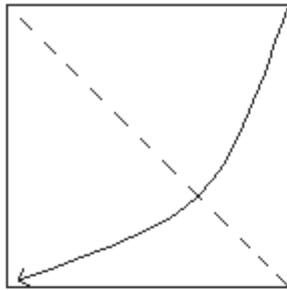

Fold in half and rotate

2.

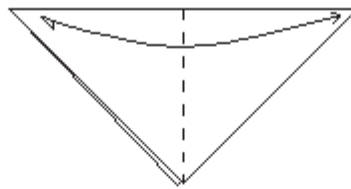

Fold in half and unfold

3.

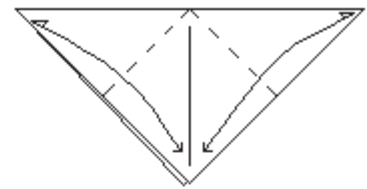

Valley fold and unfold

4.

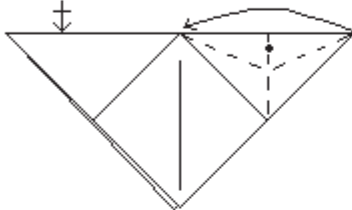

Rabbit ear on both top corners

5.

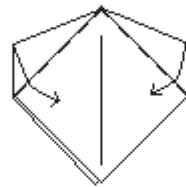

Valley fold both points down

6.

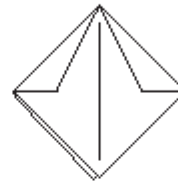

Turn over

7.

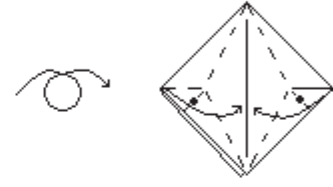

Rabbit ears

8.

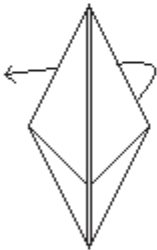

Fold in half  
Rotate

9.

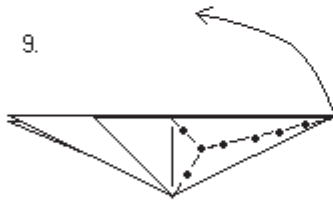

Double rabbit ear  
the neck up

10.

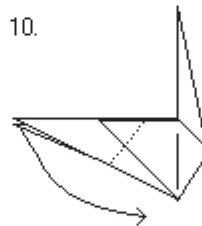

Valley fold the  
leg down  
Repeat behind

11.

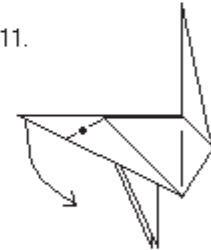

Reverse fold

12.

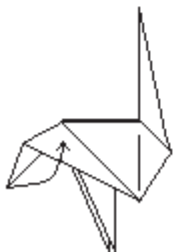

Valley fold the thick  
point into the model

13.

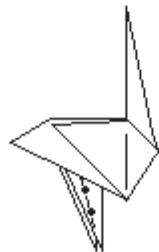

Mountain fold to  
thin the leg

14.

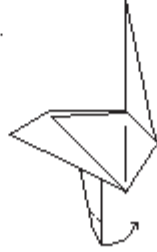

Reverse fold to  
form the foot  
Repeat behind

15.



16.

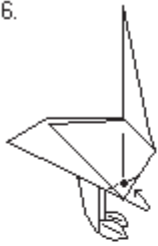

Mountain fold  
Repeat behind

17.

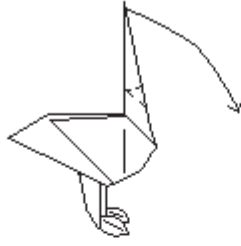

Crimp the  
head down

18.

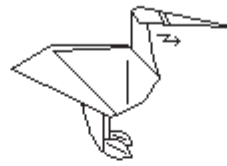

Crimp to form  
the bill

19.

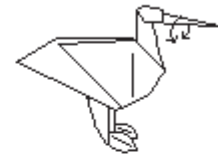

Separate the top  
and bottom bill

20.

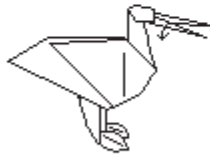

Spread the  
lower bill

21.

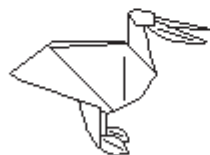

Pelican

# Pencil pot

Created by Marc Vigo Anglada  
May 1994

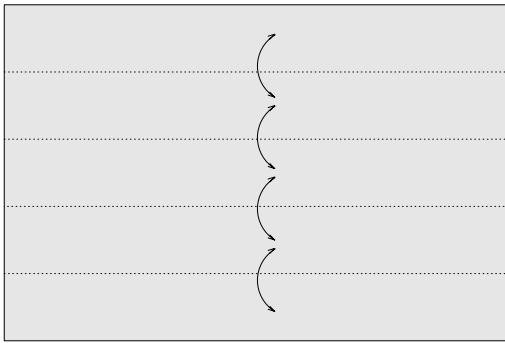

1. Start with a rectangle. Fold and unfold five horizontal stripes

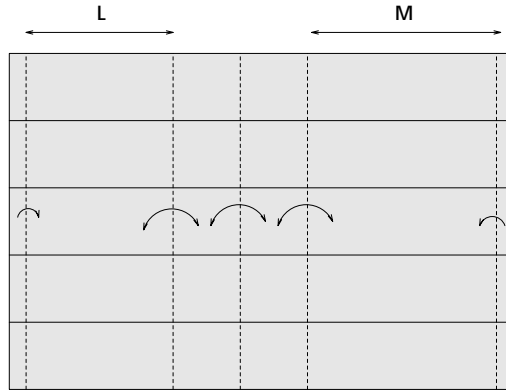

2. The lengths L and M determine the heights of resulting pots

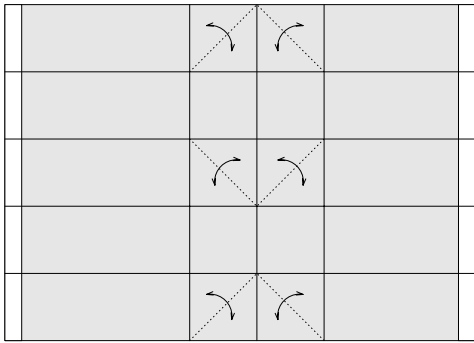

3.

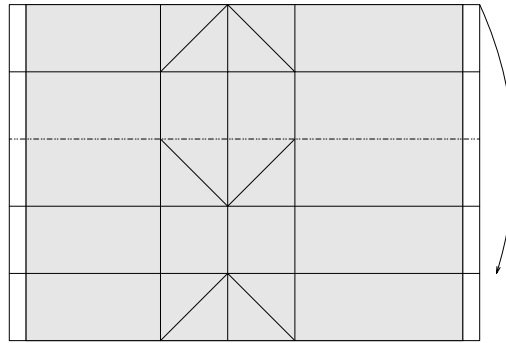

4.

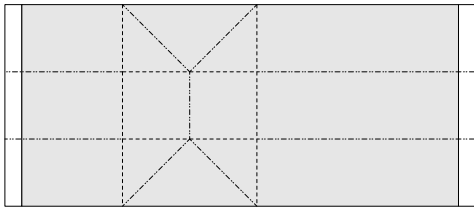

5. Horizontal folds are at 90 degrees

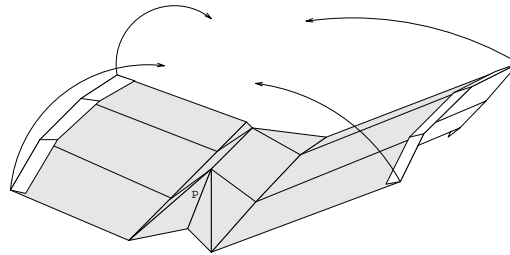

6. Fold in process

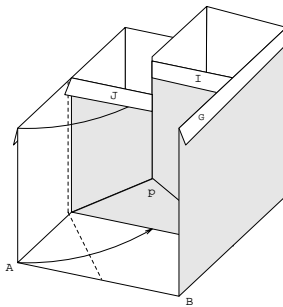

6.

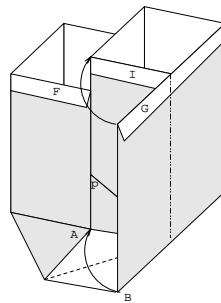

7.

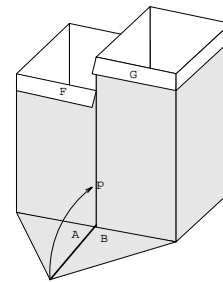

8. Raise point while tucking A and B inside pockets behind P

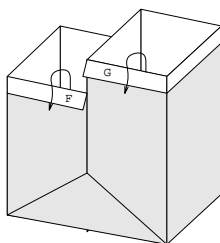

9. Tuck G under I and F under J to lock the model

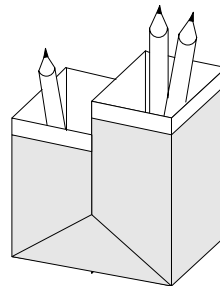

# PENGUIN (page1)

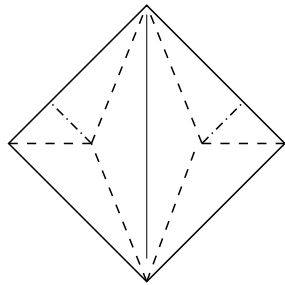

1. Colored face is behind.  
Rabbit ear on both sides.

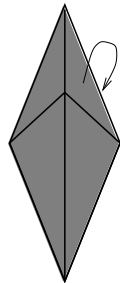

2. Swing upper flap down behind.

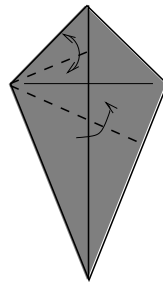

3. Valley fold lower flap at right angle. Precrease upper left flap at angle bisector.

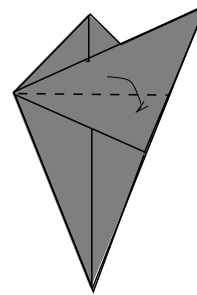

4. Valley fold down at right angle.

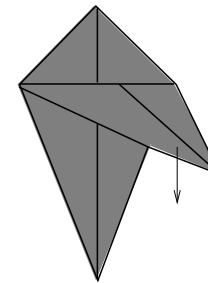

5. Unfold back to step 4.

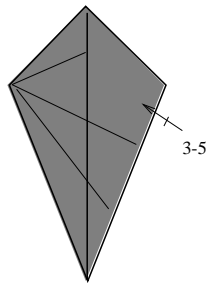

6. Repeat steps 3 to 5 in mirror image.

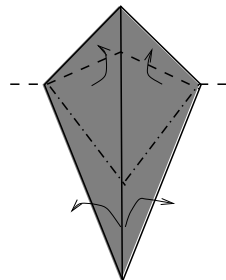

7. Open lower flap while raising it up, using existing creases.

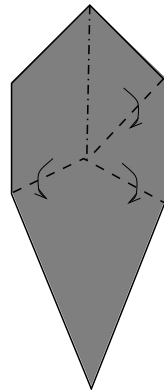

8. Inverse rabbit ear top flap.

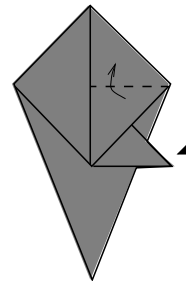

9. Squash fold up.

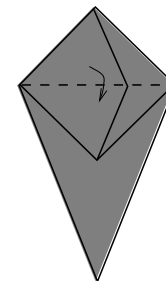

10. Valley fold down.

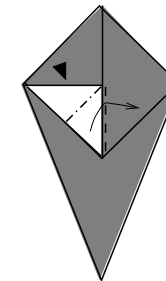

11. Squash fold the white flap.

# PENGUIN (page2)

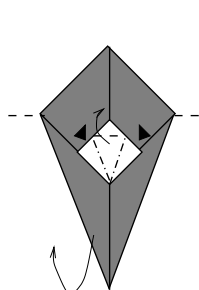

12. Petal fold the white flap. Then flip the back flap up.

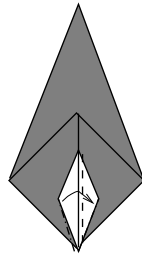

13. Valley fold white flap to the left.

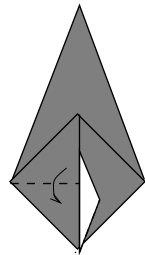

14. Valley fold one flap down (some paper has to be pulled out.)

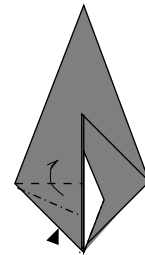

15. Squash fold front flap.

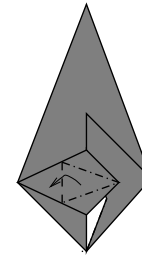

16. Petal fold.

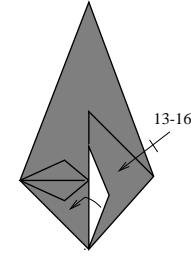

17. Flip white flap to the left. Repeat steps 13 to 16 in mirror image.

24. Squash fold on both sides.

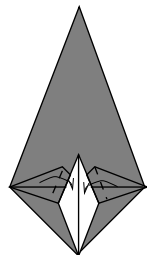

18. Valley fold both flaps at right angle to form the arms.

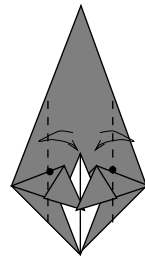

19. Precrease so that both corners meet in the center. Note the black dots, used as reference on step 21.

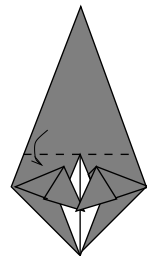

20. Valley fold down

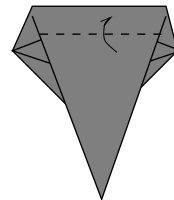

21. Valley fold up so that the crease meets the black dots marked on step 19.

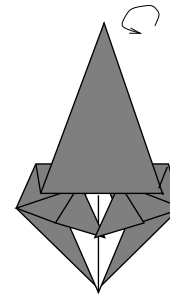

22. Turn Over

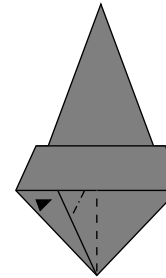

23. Squash fold the small triangular flap. (part of it is hidden behind the horizontal flap)

PENGUIN (page3)

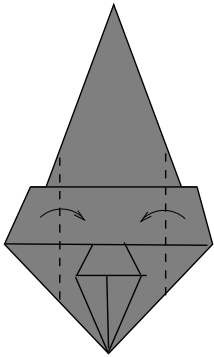

23(bis). Valley fold on both sides using existing creases.

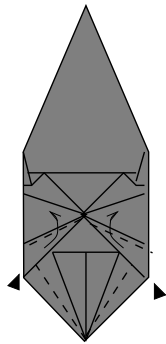

24. Squash fold on both sides.

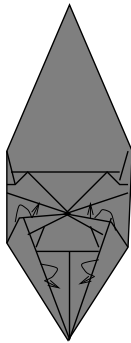

25. Hide both upper flaps inside pocket, raise two triangular flaps to front. (These steps are facultative).

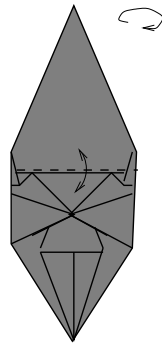

26. Precrease, then turn over.

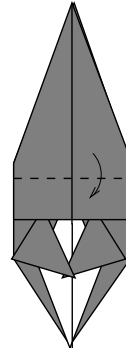

27. Valley fold down using crease made on step 26.

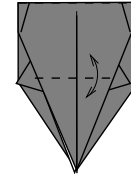

28. Precrease in half.

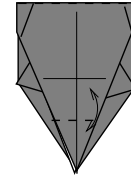

29. Precrease in half, then unfold to step 27.

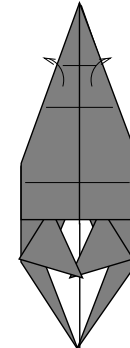

30. Open both flaps. Model wont lie flat.

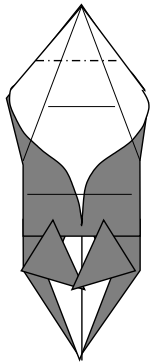

31. Mountain fold behind using existing crease.

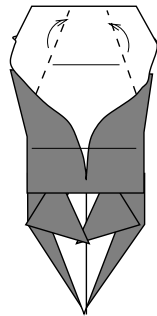

32. Close flaps back.

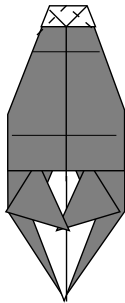

33. Valley fold at angle bissector.

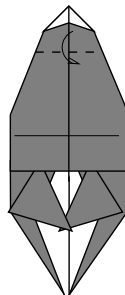

34. Valley fold down.

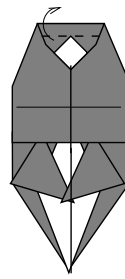

35. valley fold up.

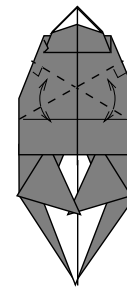

36. Precrease at right angle.

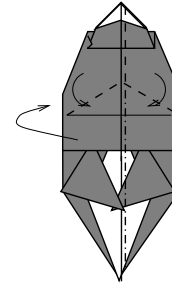

37. Mountain fold the model in half while making a rabbit ear at the top to form the head.

PENGUIN (page4)

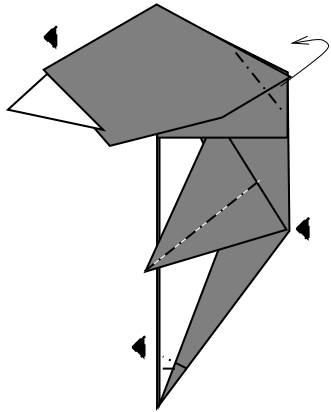

38. Inside reverse fold where indicated, to form the arms. Shape the head using mountain fold and pushing it slightly down (it will make it 3D). Crimp the legs to form the feet.

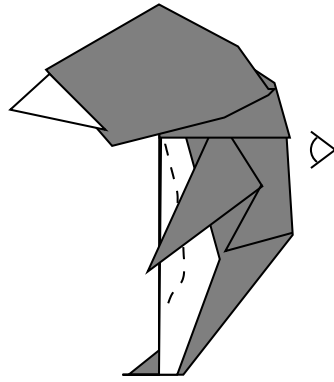

29. Round the body by inserting a finger between the two main flaps.

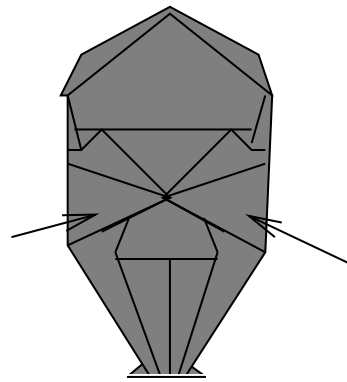

40. The two pointed flaps can be raised a little and tucked inside one another to somewhat close the model in a rounded shape.

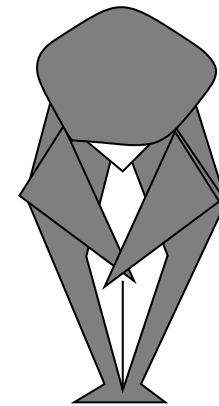

41. finished.

# Penguin

Diagrammed by: František Grebeníček (2000)  
www.origami.cz

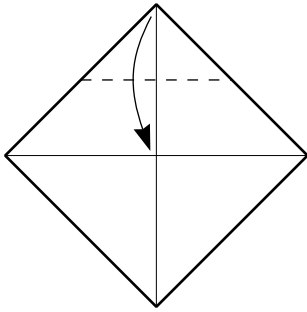

1) Fold to the center.

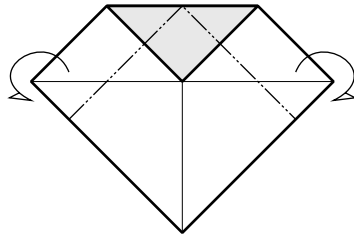

2) Fold backwards.

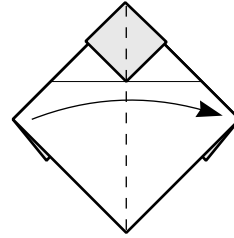

3) Fold in half.

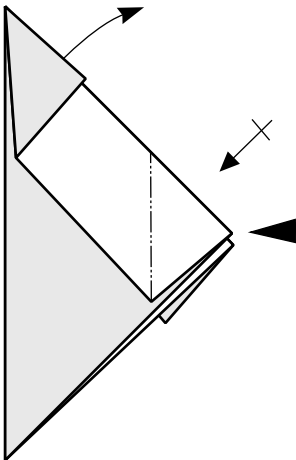

4) Pull out head.  
Reverse-fold flap on  
the right side and  
repeat behind.

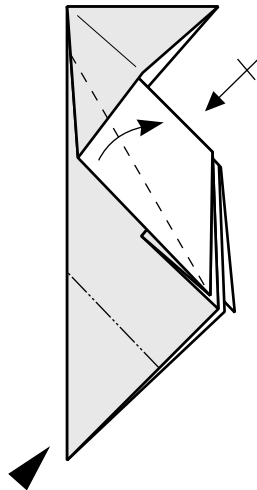

5) Complete wings.  
Reverse-fold lower  
flap.

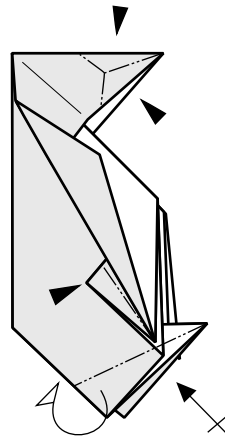

6) Squash beak.  
Reverse-fold tips of  
wings. Fold inwards to  
complete feet.

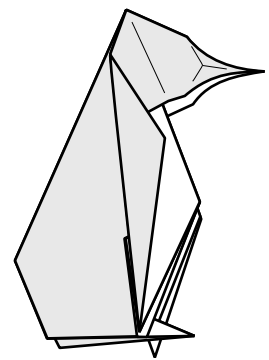

7) Finished penguin.



# Pureland Fish by Marc Kirschenbaum

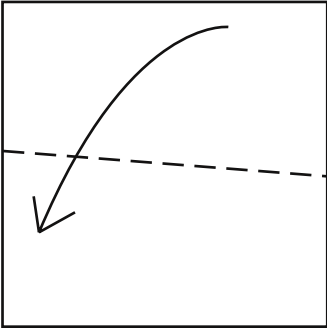

1. Make a slightly offset valley fold.

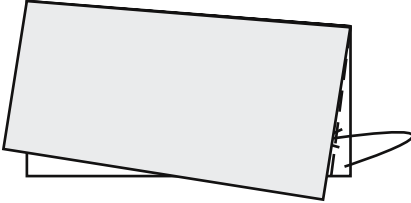

2. Valley the protruding white area into the model.

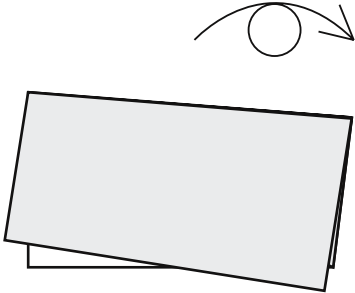

3. Turn over.

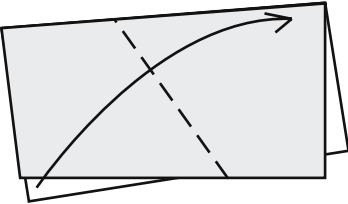

4. Valley the lower left corner to the upper right corner.

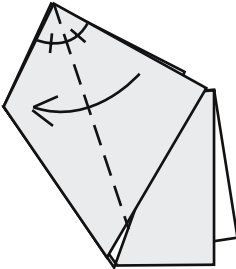

5. Valley along the angle bisector.

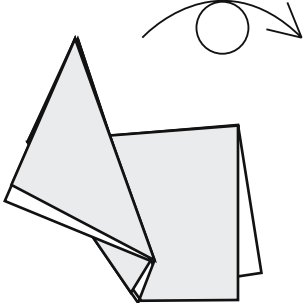

6. Turn over.

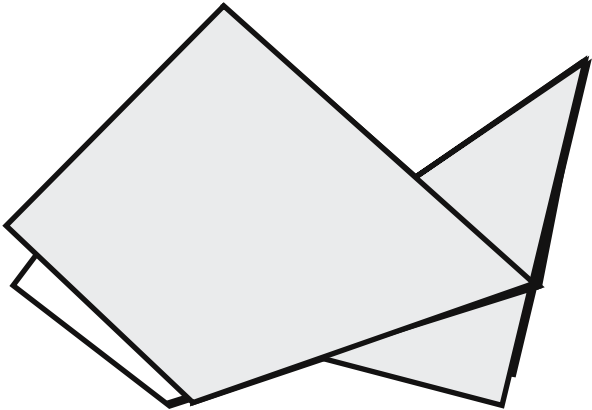

7. Completed Pureland Fish. This model was inspired by a challenge posed by Paul Jackson.

# 3 spotted pig 3

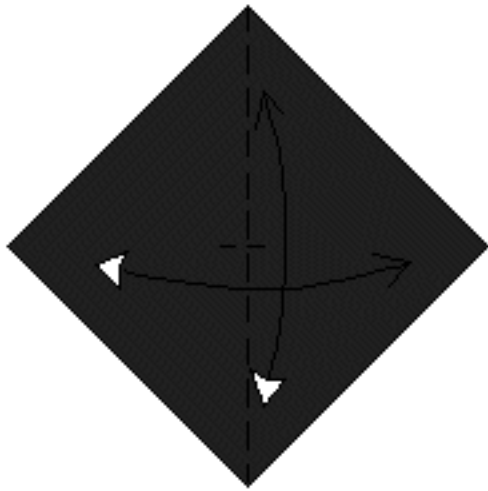

**1** Begin with the dark side up. Fold and unfold.

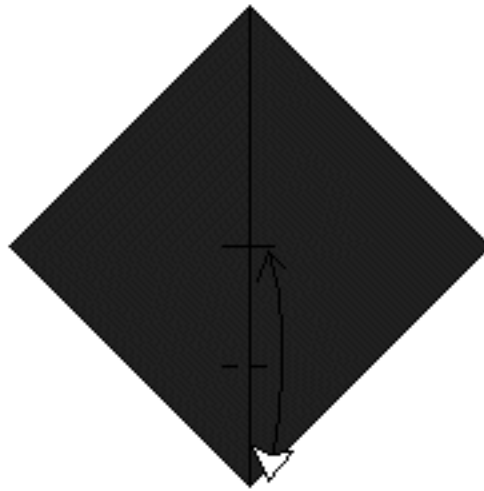

**2** Fold and unfold.

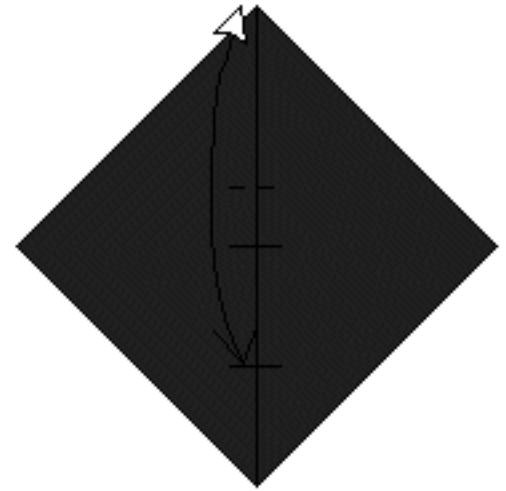

**3** Fold and unfold.

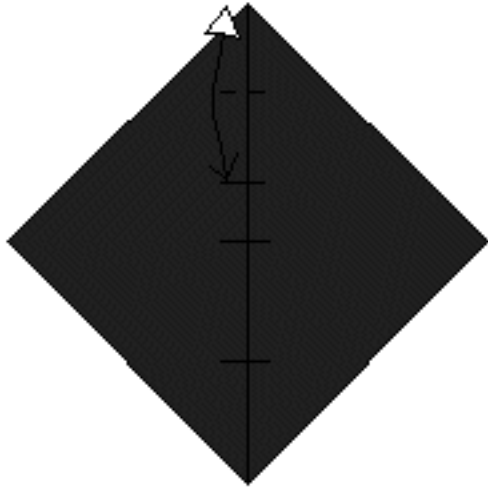

**4** Fold and unfold.

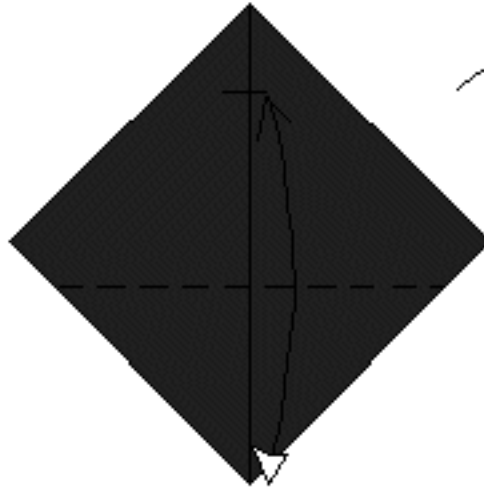

**5** Fold and unfold. Turn the paper over.

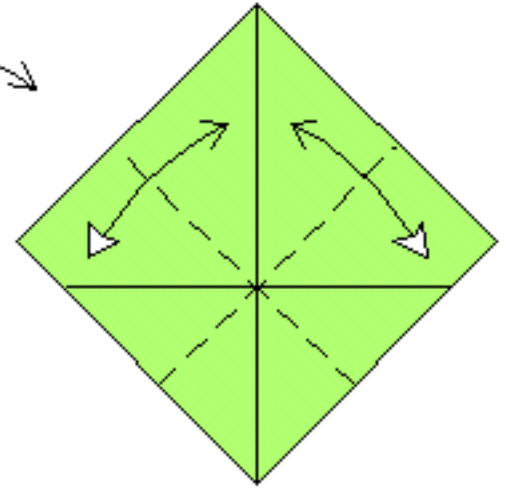

**6** Fold and unfold.

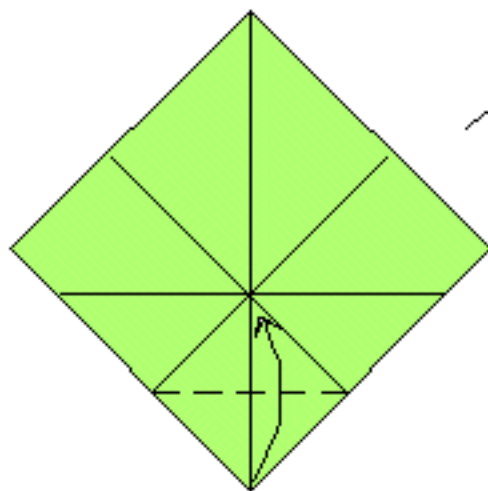

**7** Valley-fold. Turn the paper over and rotate.

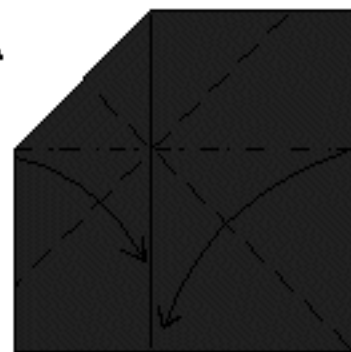

**8** Make an asymmetric waterbomb base on existing creases.

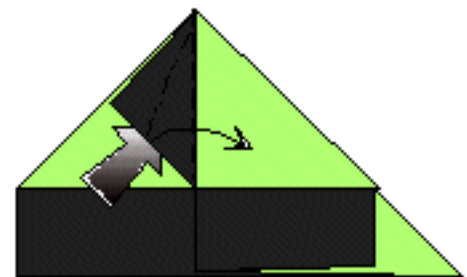

**9** Squash-fold.

# 3 spotted pig 3

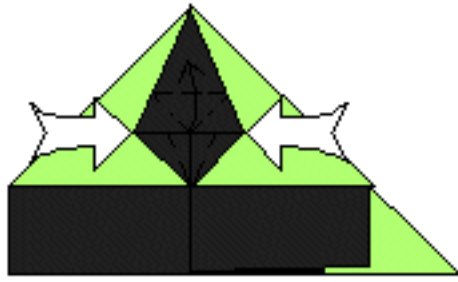

**10** Petal-fold.

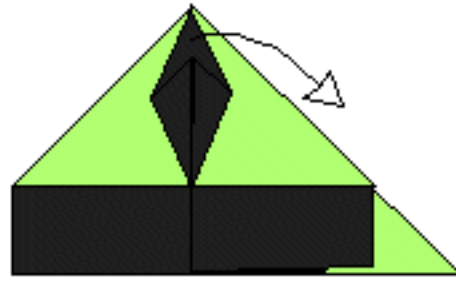

**11** Unfold.

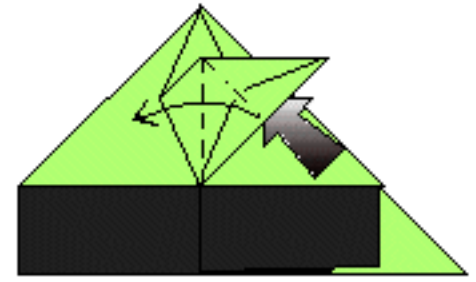

**12** Squash-fold.

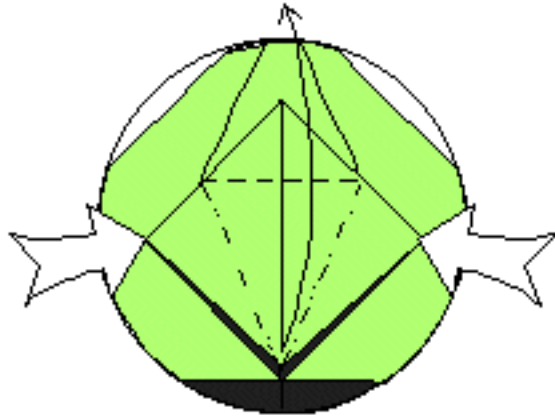

**13** Enlarged view.  
Petal-fold.

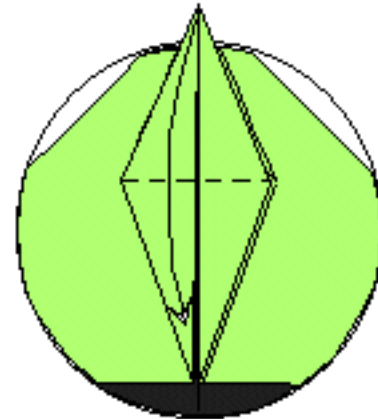

**14** Fold the flap down.

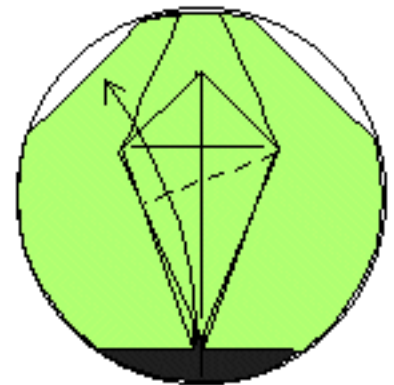

**15** Fold the flap up so that  
the left edges are parallel.

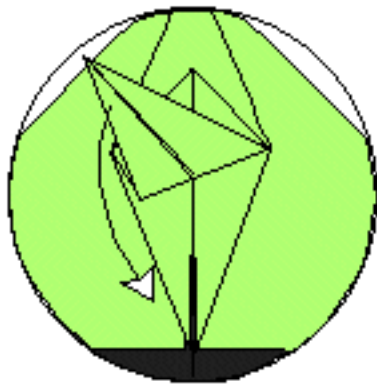

**16** Unfold.

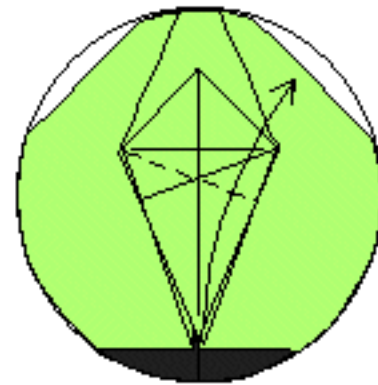

**17** Repeat step 15  
on the right.

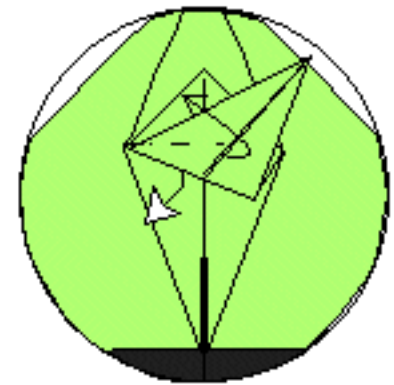

**18** Pull out the trapped  
layers of paper.

# 3 spotted pig 3



**19** Squash-fold.



**20** Pull out the loose paper.

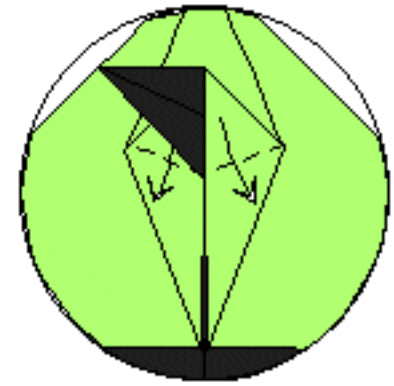

**21** Open out and down.

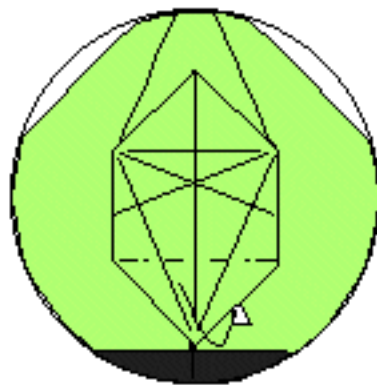

**22** Mountain-fold behind.

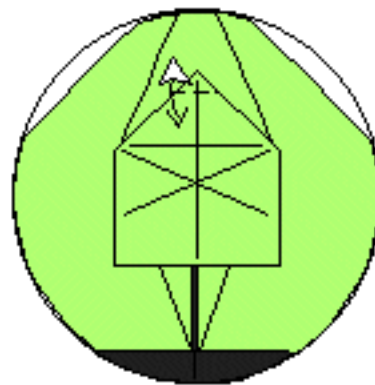

**23** Fold and unfold the tip of the corner.

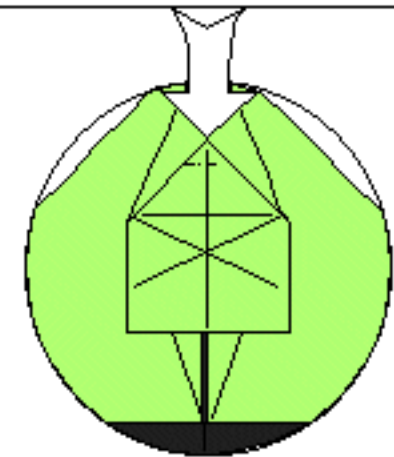

**24** Open-sink.

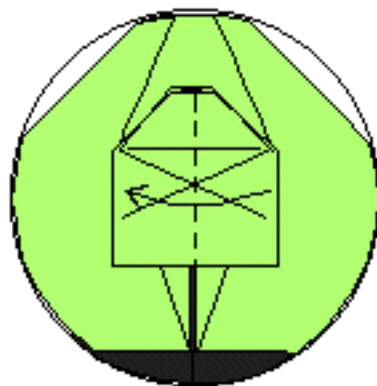

**25** Book-fold one layer to the left.

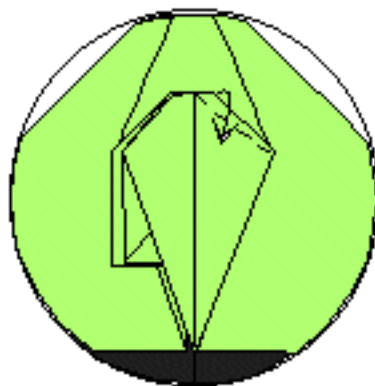

**26** Valley-fold the edge downward.

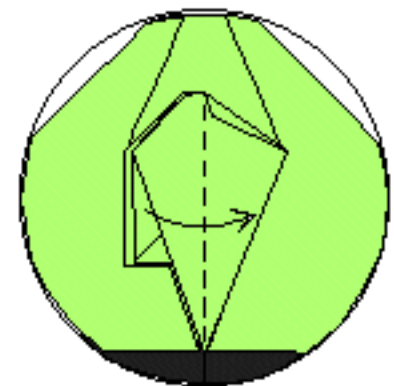

**27** Book-fold one layer back to the right.

# 3 spotted pig 3

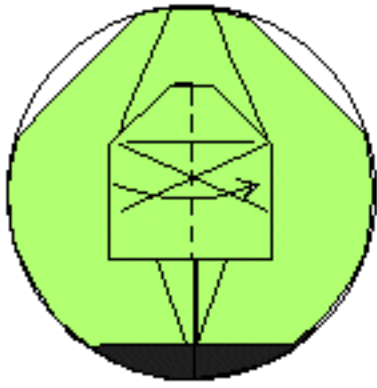

**28** Repeat steps 25-27 on the left.

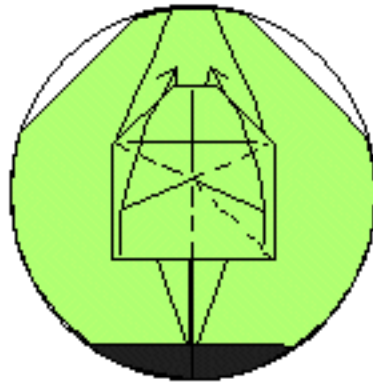

**29** Refold on existing creases.

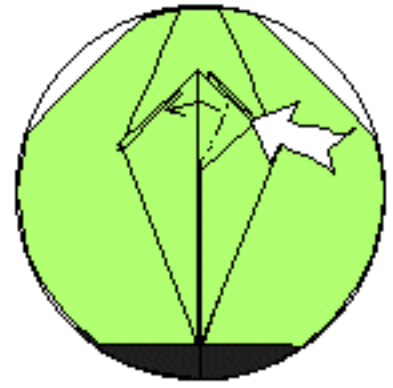

**30** Squash-fold.



**31** Inside petal fold.

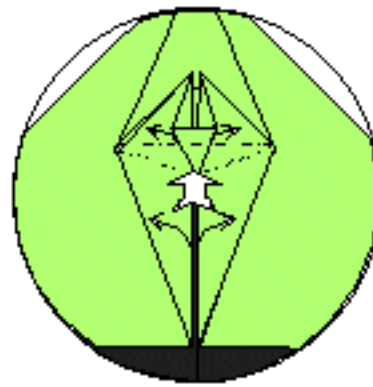

**32** Open out the trapped edges and mountain-fold the hidden triangle upward. Then close the edges.

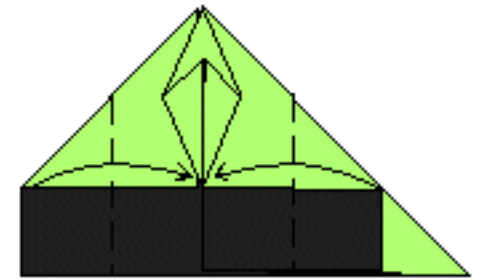

**33** Valley-fold the edges to the mid-line.

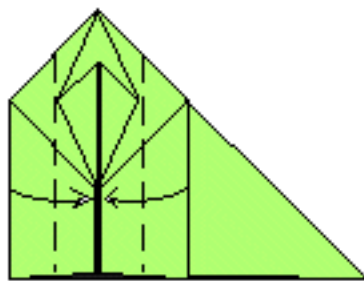

**34** Valley-fold once more.

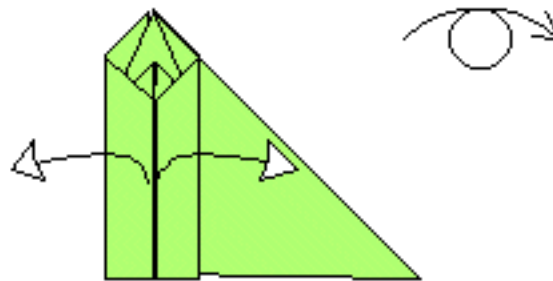

**35** Unfold to step 33 and turn the model over.

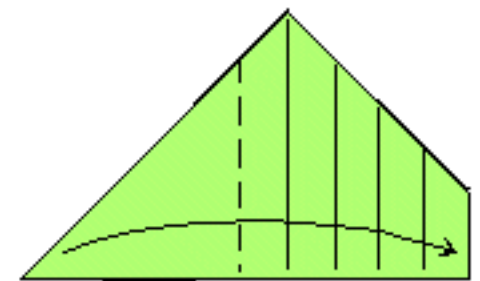

**36** Valley-fold the large flap to the right, so that the fold falls on top of an existing crease.

# 3 spotted pig 3

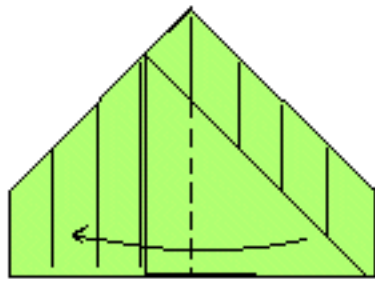

**37** Valley-fold the flap to the left.

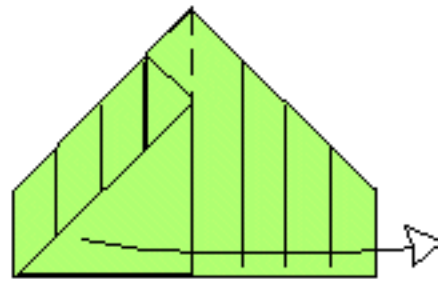

**38** Unfold the flap to the right.

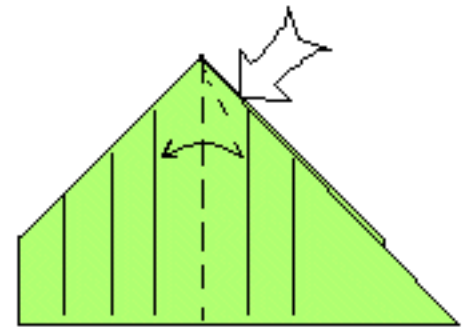

**39** Squash-fold, only pressing flat on the top of the model.

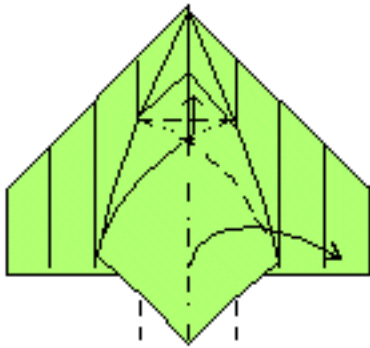

**40** Collapse, mostly on existing creases.

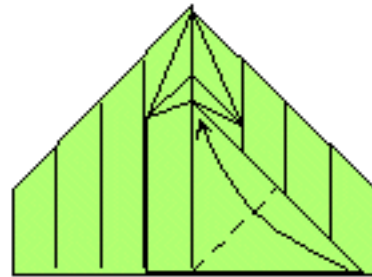

**41** Valley-fold.

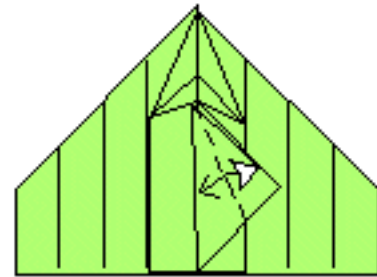

**42** Fold and unfold. Unfold to step 41.

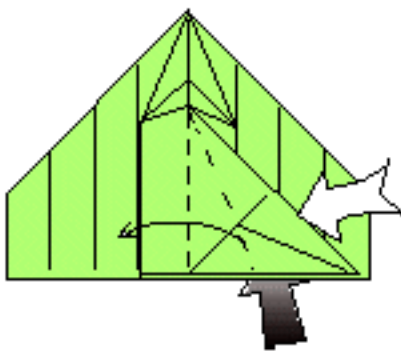

**43** Squash-fold.

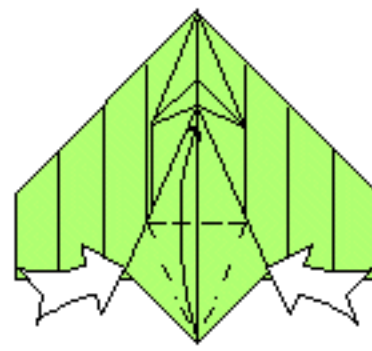

**44** Petal-fold on existing creases.

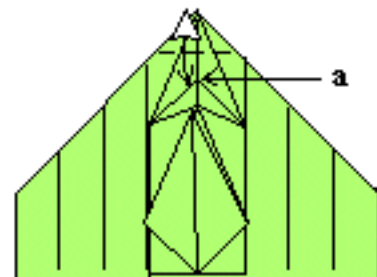

**45** Fold the top corner a little below point **a** and unfold.

# 3 spotted pig 3

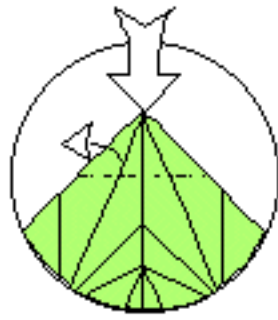

**46** Enlarged view. Closed sink, except for the pocket on the left side, which should be open.

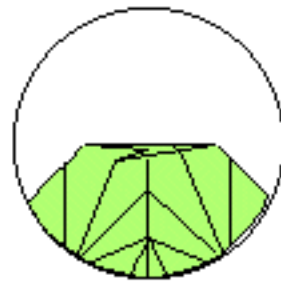

**47** Like this. Turn the model over.

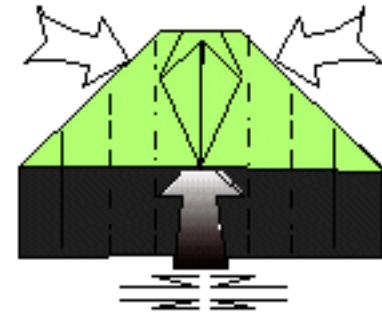

**48** Crimp symmetrically.

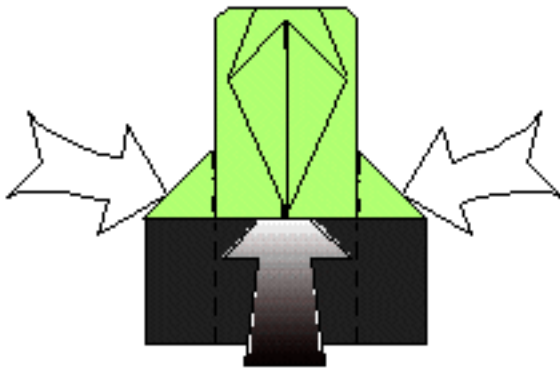

**49** Crimp once more.



**50** Fold and unfold. The crease goes through the two small edges at the top and through all layers at the bottom.

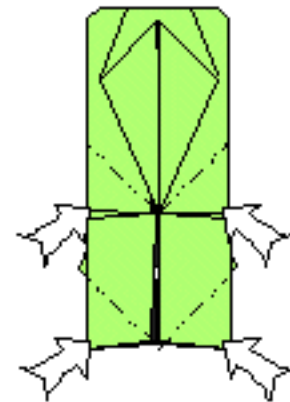

**51** Reverse-fold all corners on existing creases.



**52** Pull the nearest points outward, thereby stretching the points underneath.

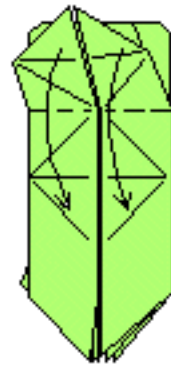

**53** Fold the flaps down.



**54** Repeat steps 52-53 at the bottom, stretching the points between the first and third pair. Turn the model over.



# 3 spotted pig 3

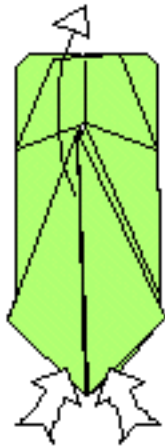

**55** Hold the second pair of points and stretch the large flap upward.

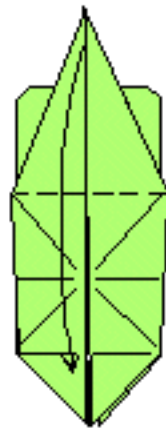

**56** Like this. Valley-fold part of the flap down.



**57** Fold the whole model in half, incorporating a reverse-fold as shown.

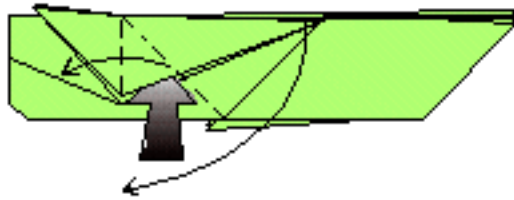

**58** Open up between the first and second layer and swivel-fold the leg. Repeat behind.

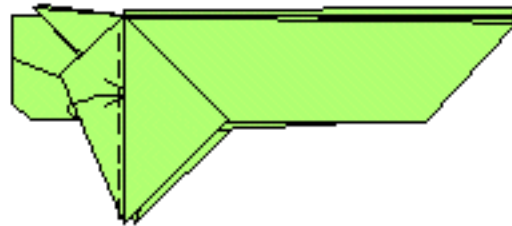

**59** Put the edge into the pocket. Repeat behind.

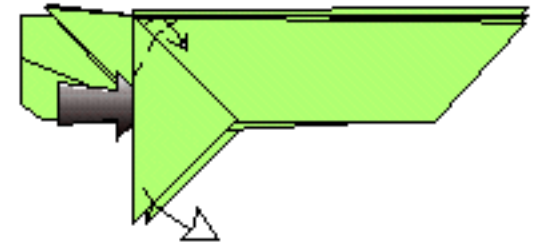

**60** Open up between the first and second layer, lift the leg outward and reverse-fold the upper corner.

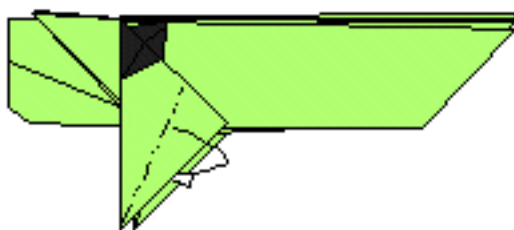

**61** Mountain-fold. Repeat behind.

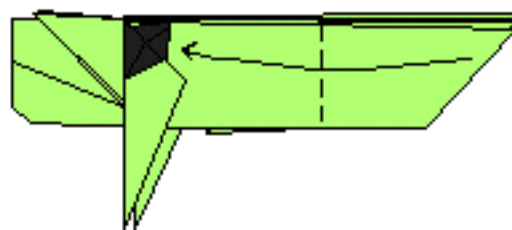

**62** Valley-fold one flap to the left. Repeat behind.

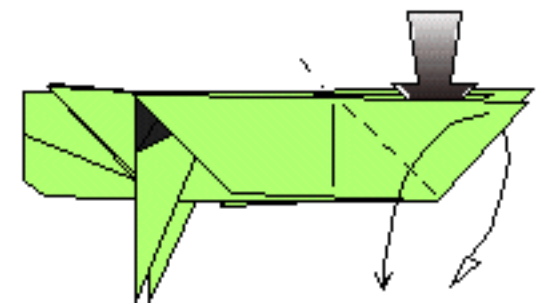

**63** Outside reverse-fold the leg on existing creases. On the back side, just valley-fold the leg down.



# 3 spotted pig 3

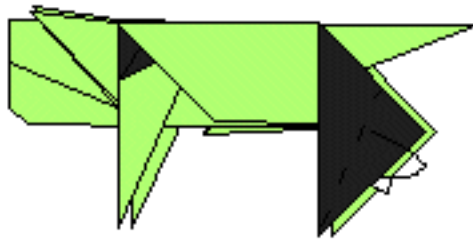

**64** Mountain-fold.  
Repeat behind.

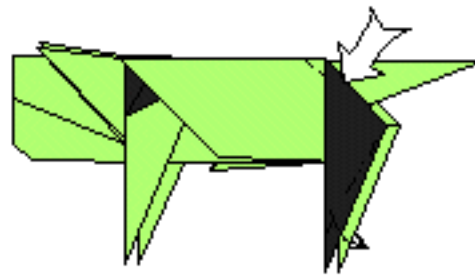

**65** Swivel-fold.

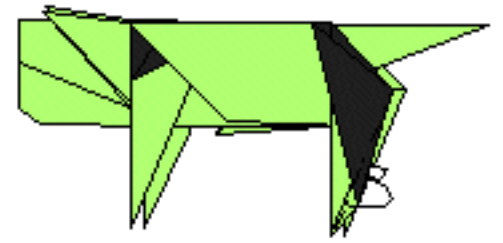

**66** Mountain-fold the  
edge behind.

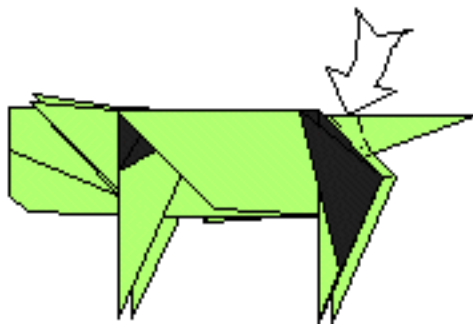

**67** Crimp the tail with  
two reverse folds.

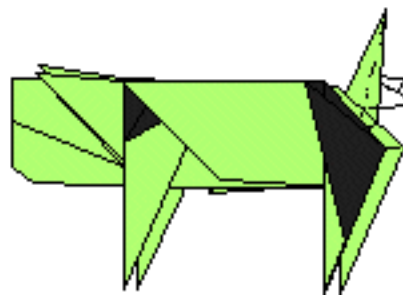

**68** Mountain-fold the edge  
inside. Repeat behind.

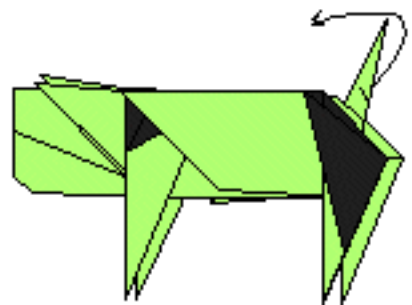

**69** Outside reverse-fold.

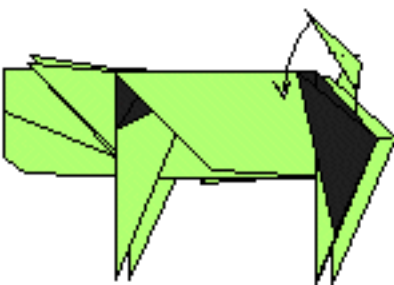

**70** Reverse-fold.  
Then outside reverse-fold  
and reverse-fold to curl  
the tail.

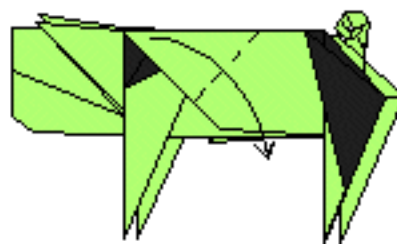

**71** Valley-fold.



**72** Squash-fold.

# 3 spotted pig 3

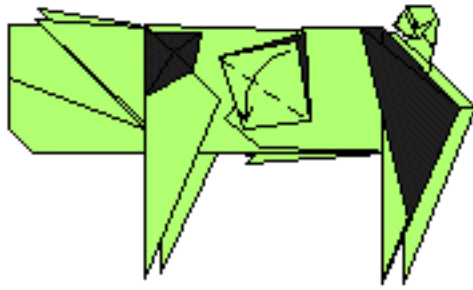

**73** Valley-fold.



**74** Mountain-fold the corners behind. Turn the model over.

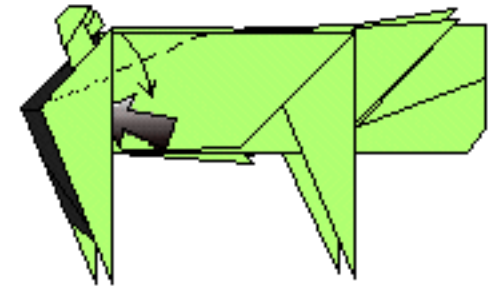

**75** Valley-fold one layer down.

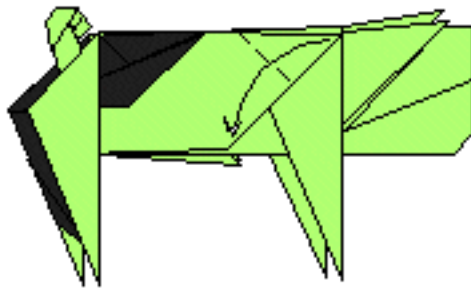

**76** Valley-fold.

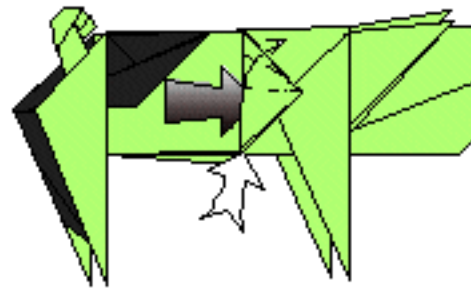

**77** Squash-fold a little asymmetrically.

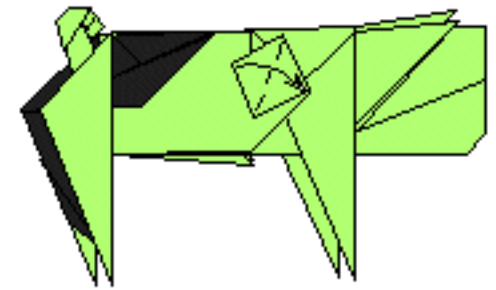

**78** Valley-fold.

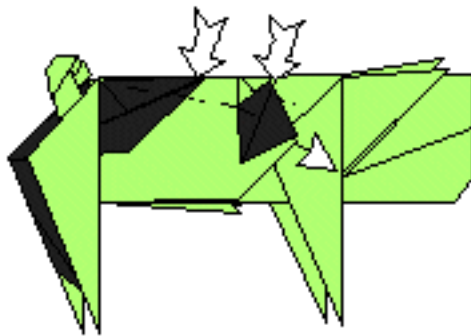

**79** Mountain-fold the corners behind and put the flap underneath the front leg.

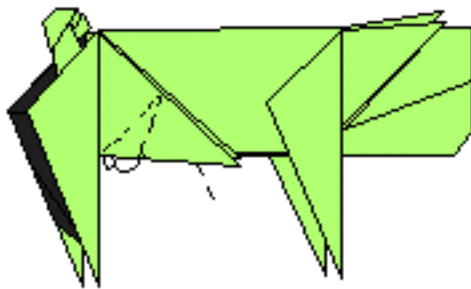

**80** X-ray view of the belly. Swivel-fold the nearest flap.

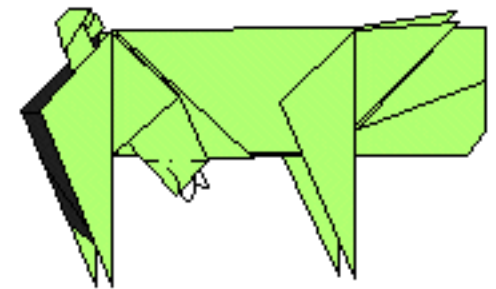

**81** Mountain-fold the corner behind.

# 3 spotted pig 3

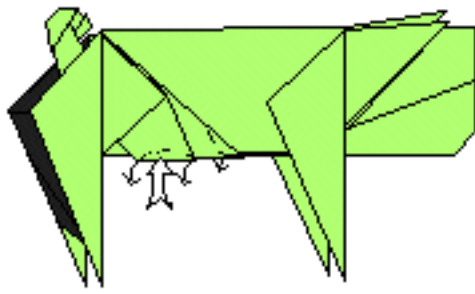

**82** Pinch to make three tiny points.

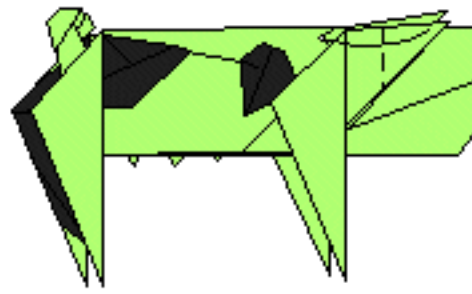

**83** Valley-fold the ear to the left as far as it will go. Repeat behind.

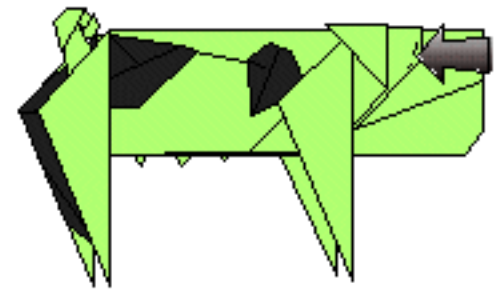

**84** Spread-squash the corner to make an eye. Repeat behind.

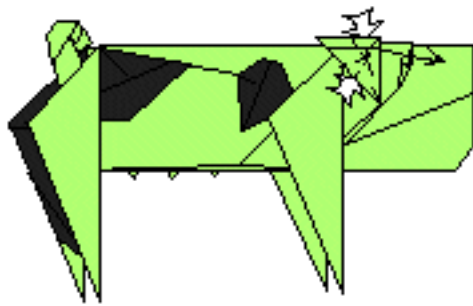

**85** Fold the flap to the right, making the ear 3-dimensional. Repeat behind.

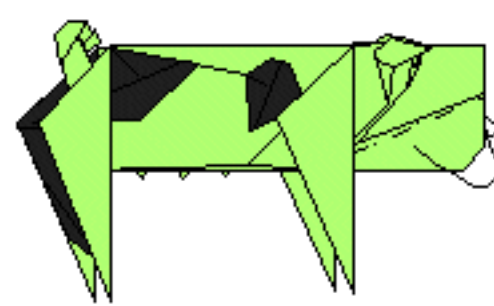

**86** Mountain-fold the corner into the closed pocket two layers behind it.

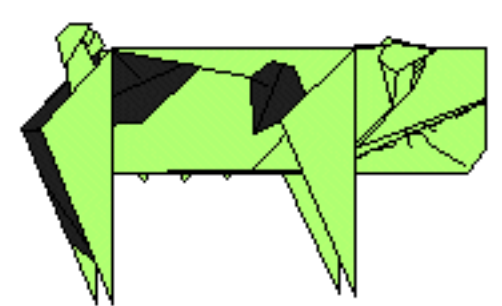

**87** Valley-fold the other corner into the front pocket.

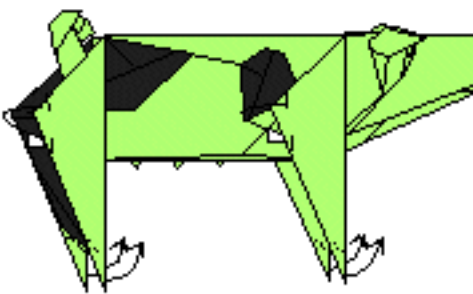

**88** Mountain-fold the corners of the legs. Repeat behind. Reverse-fold the feet.

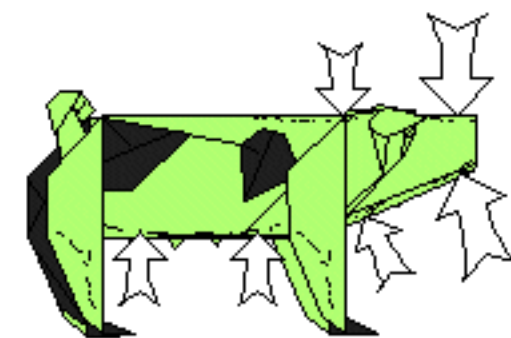

**89** Make the body 3-dimensional.



**90** The pig is finished.

# Piggy

Diagrammed by: František Grebeníček (1998)  
www.origami.cz

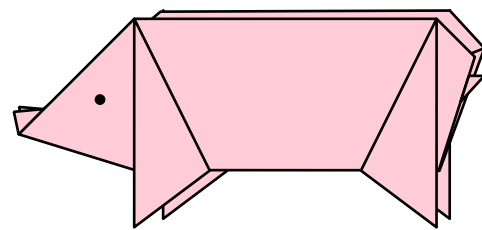
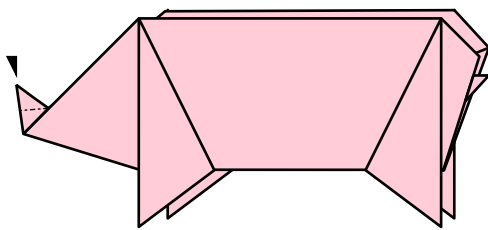
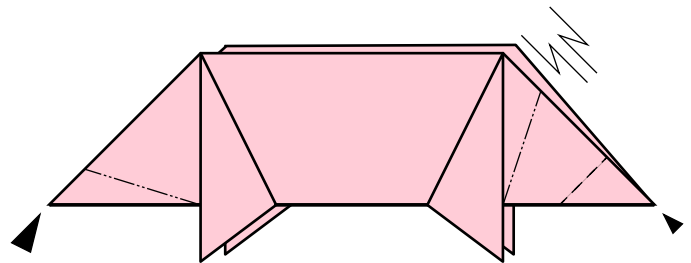
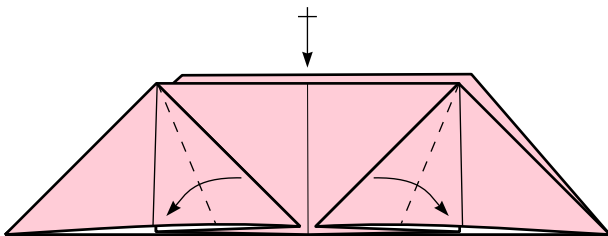
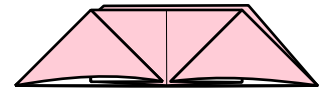
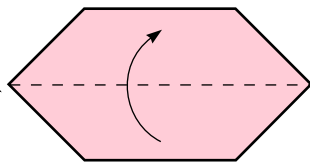
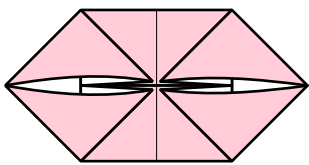
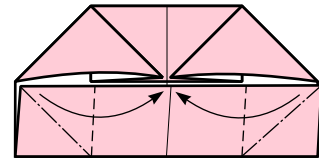
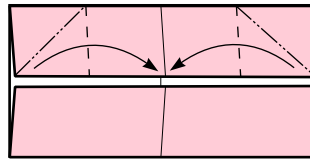
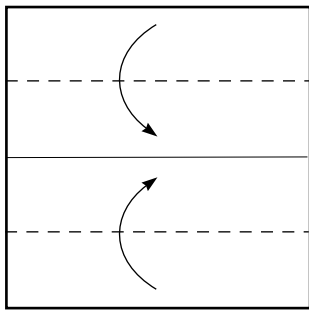

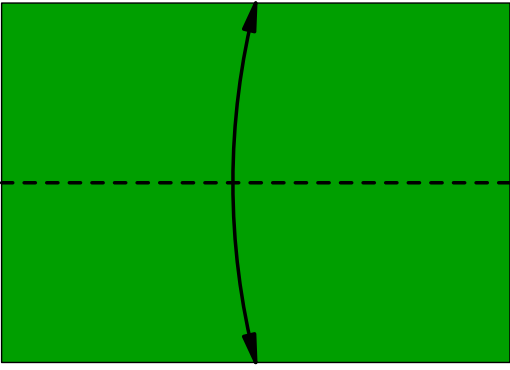

1

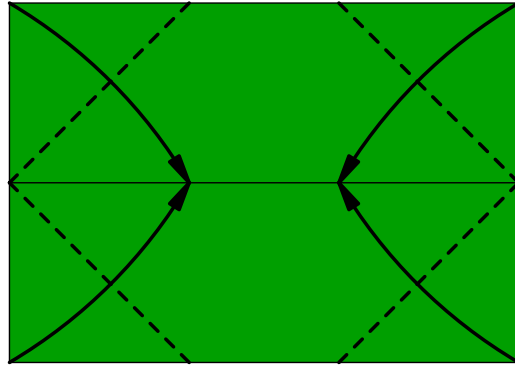

2

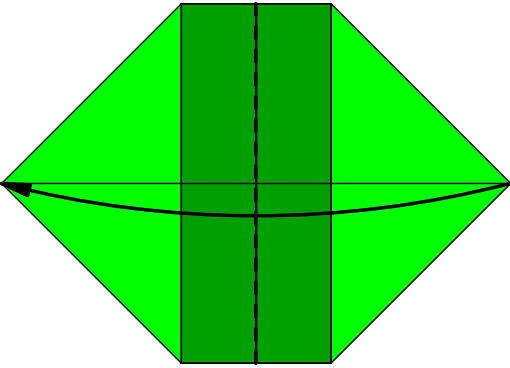

3

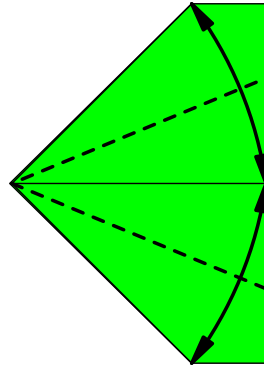

4

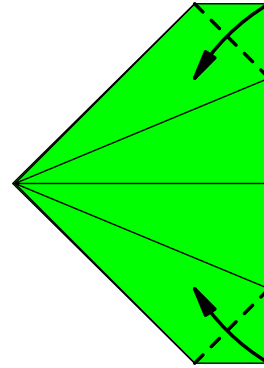

5

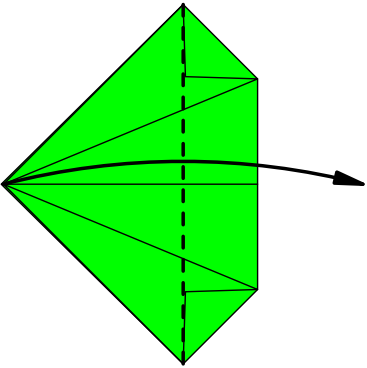

6

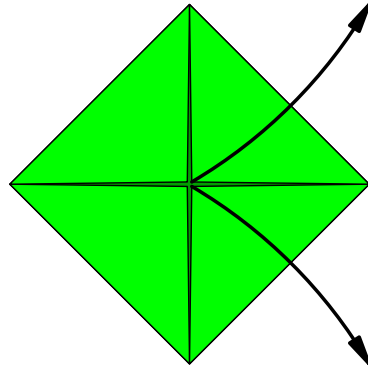

7

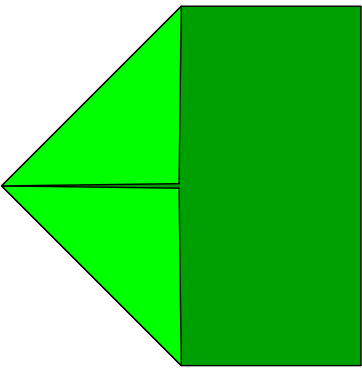

8

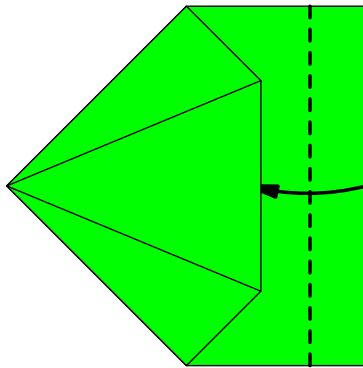

9

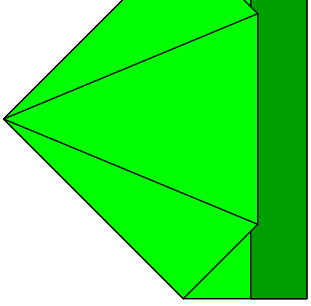

10

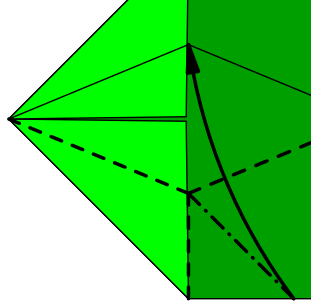

11

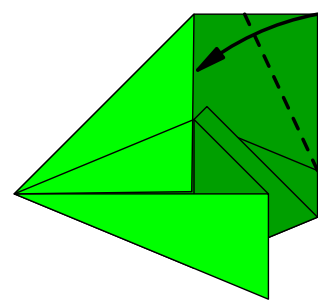

12

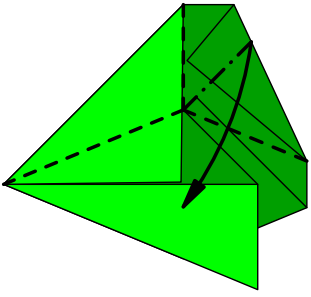

13

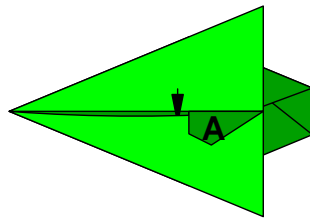

14

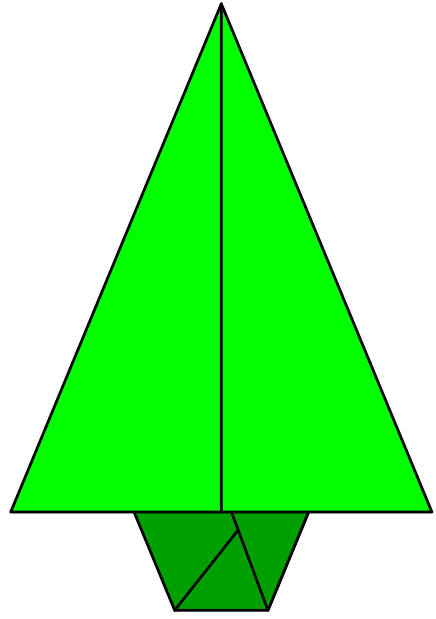

1)

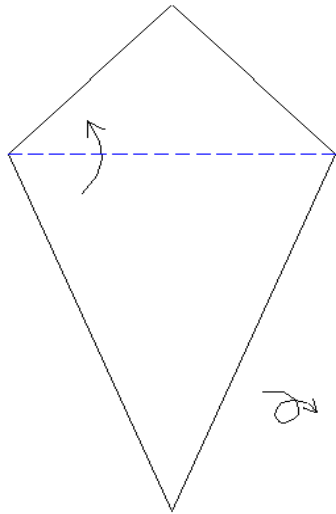

Begin with a bird base, colored side out, and fold the front flap all the way up. Turn the model over. Note that no shading is shown because there are no color changes, and it makes some of the folds easier to see.

2)

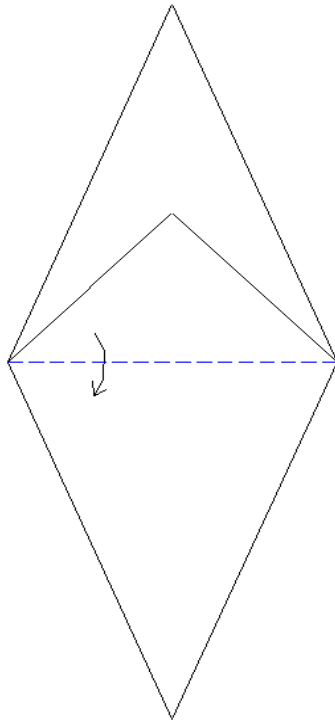

Fold the triangular peak all the way down.

3)

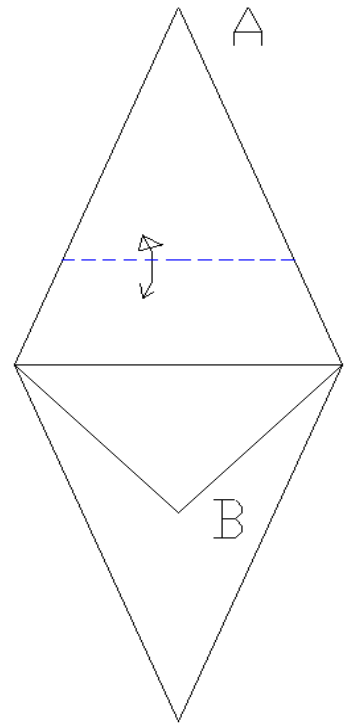

Fold tip 'A' to tip 'B'. Unfold.

4)

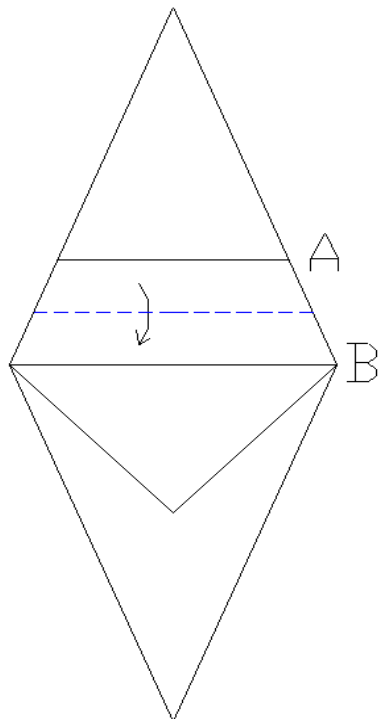

Fold crease 'A' to crease 'B'.

5)

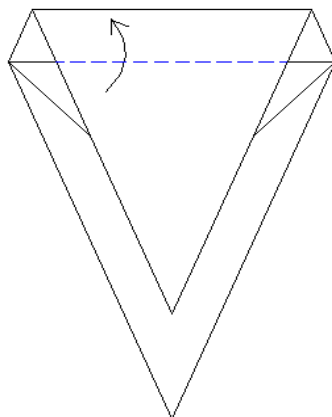

Fold the top flap up along the existing crease. This will become the cockpit.

6)

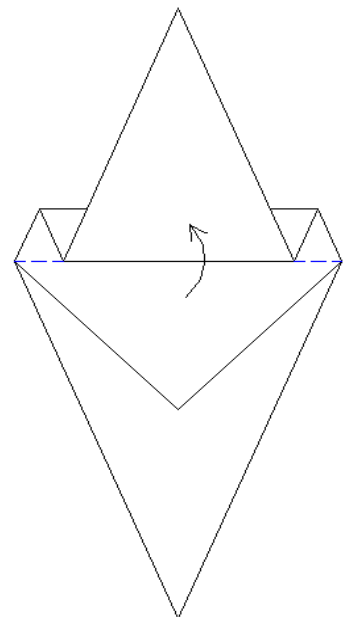

Fold the triangular peak all the way up.

7)

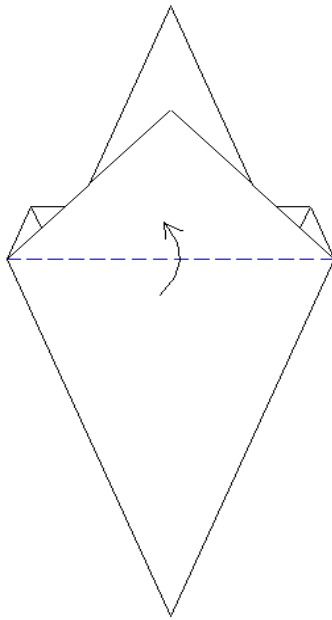

Fold the bottom flap all the way up. This will become the main wing

8)

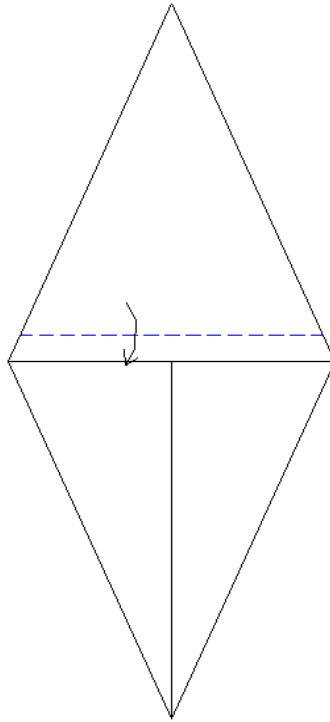

Fold the wing flap down, about half way between the crease you just made and the edge formed from creasing the top flap. The exact amount is not important.

9)

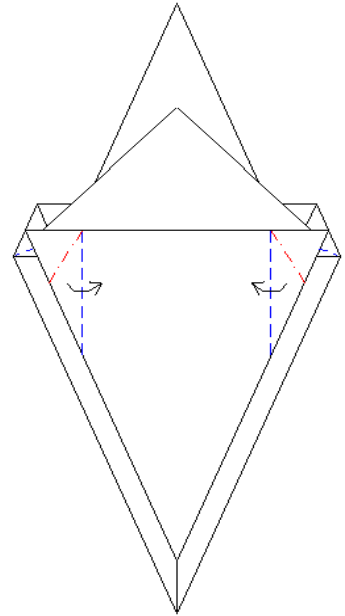

Squash the sides of the wing flap so that the edges are vertical. Again, the exact amount is not important, but try to line up the intersection of the top of the horizontal creases and the cockpit flap with the vertical crease. The intersection is hidden in the diagram.

10)

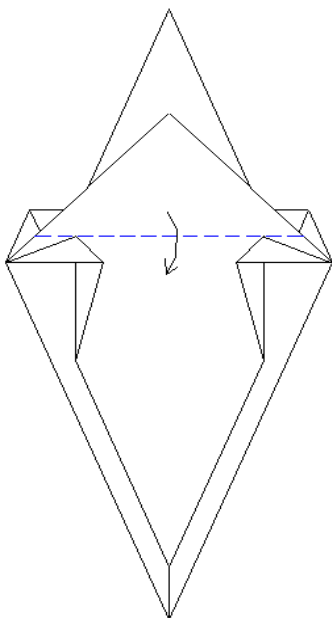

Fold the triangular peak down at the crease you made in step 8.

11)

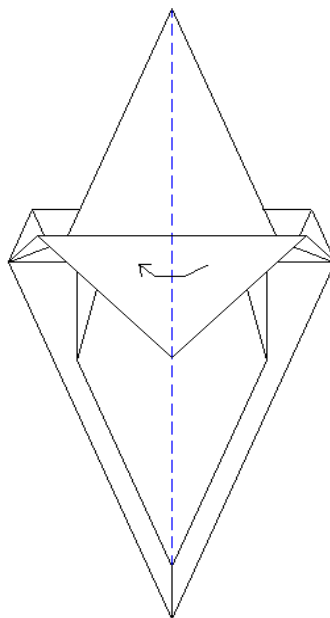

Fold the model in half along the vertical axis from right to left.

12)

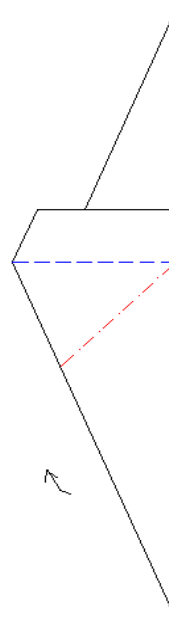

Squash-fold the top flap up and to the left. Repeat on the flap on the back. These will



13)

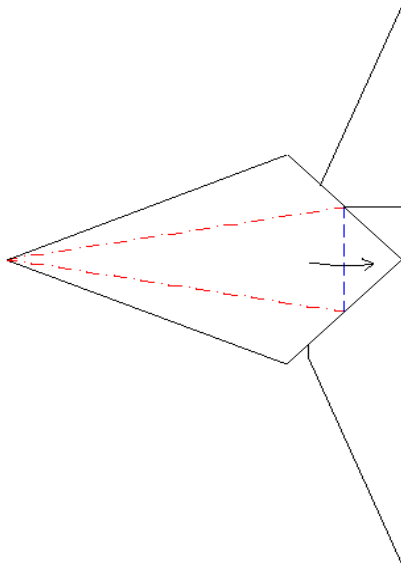

Petal fold the s-foil right. Repeat behind.

14)

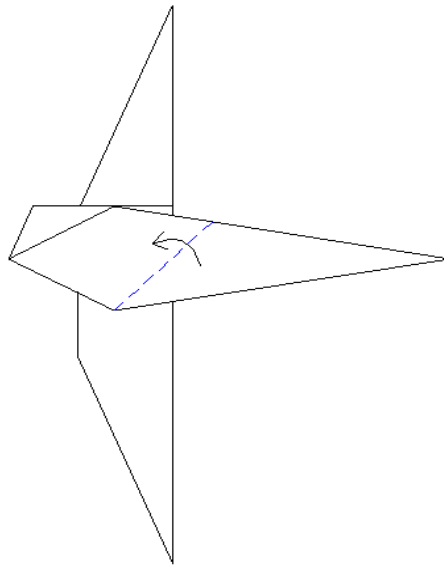

Fold the flap up and to the left along a 45° line. Repeat behind.

15)

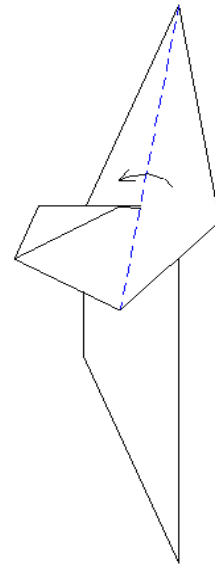

Unfold the fold on the left side that was made when you made the petal-fold in step 13. Repeat behind.

16)

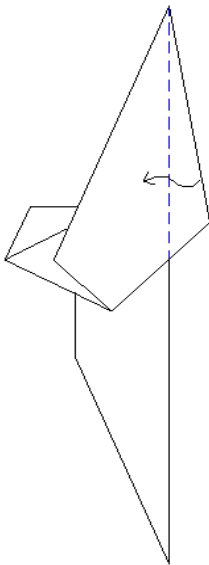

Fold the front half of the s-foil back along the centerline, and tuck it under the top sheet of paper. Repeat behind.

17)

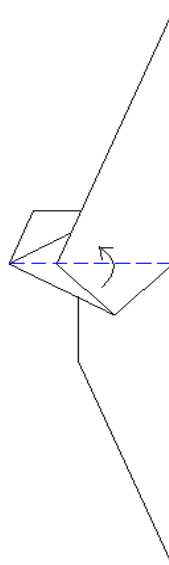

Fold the flap up along the horizontal. Repeat behind.

18)

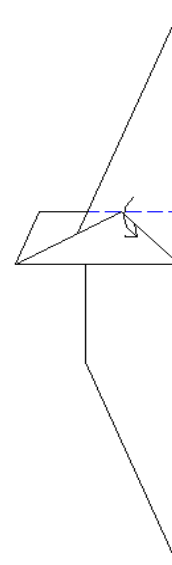

Fold the s-foil down as far as you can. This crease will be horizontal, and will fall along the edge of the engine pod. Repeat behind.

19)

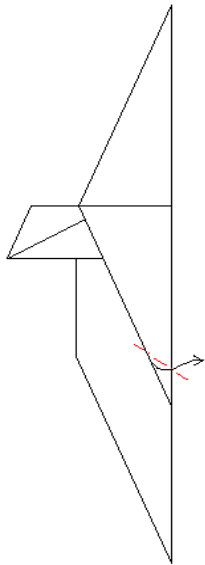

Inside-reverse fold the tip of the s-foil to make the wingtip cannon. If you treat the flap you folded inside in step 17 as one side, and do the reverse between that flap and the single sheet, you will end up with the bottom of the cannon white. Repeat behind.

20)

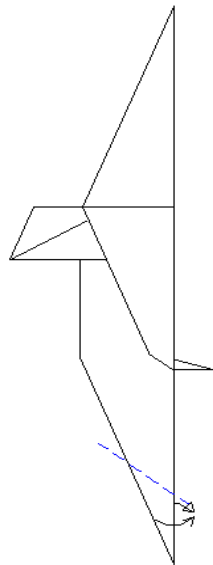

Outside-reverse fold the end of the main wing to make the main wing cannon.

21)

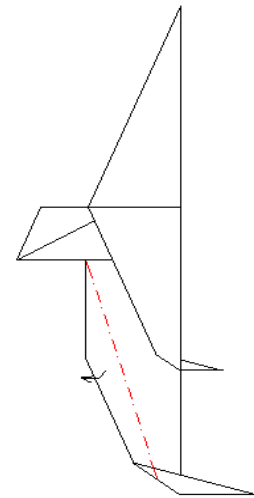

Finish forming the main wing by folding this flap inside the body. The midpoint of the 45° line made by the outside-reverse fold makes the bottom endpoint of the crease. The exact position, however, is not important, as long as it looks good. Repeat behind.

22)

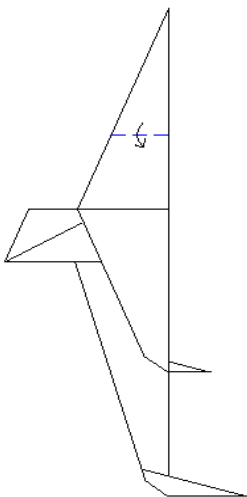

Fold the tip of the cockpit flap down to the bottom horizontal crease.

23)

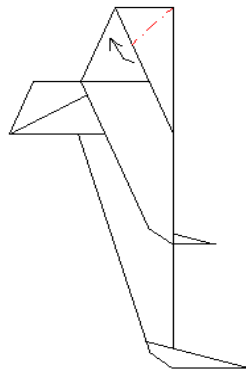

Squash the flap up and to the left.

24)

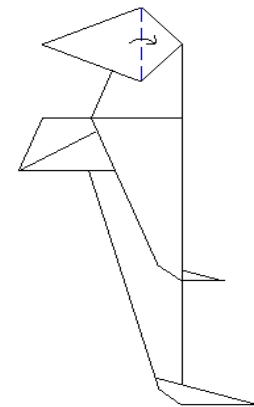

Fold the flap over as far as you can to the right.

25)

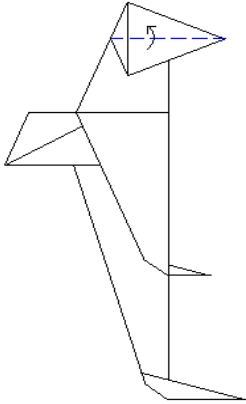

Fold the lower half of the flap up.

26)

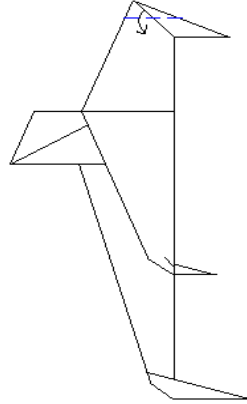

Fold the tip down to the crease that formed in the last step. Repeat behind.

27)

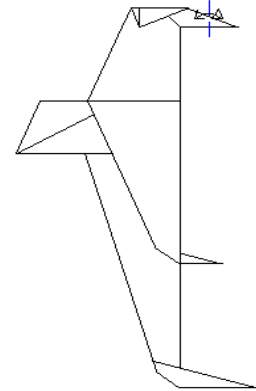

Fold the tip to the vertical edge and unfold.

28)

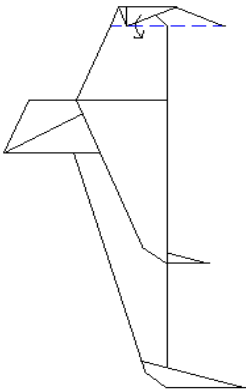

Fold the flap down along the crease made in step 26. Repeat behind.

29)

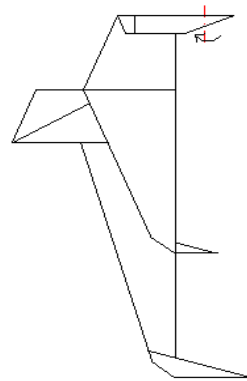

Fold the tip of the nose in along the crease made in step 28.

30)

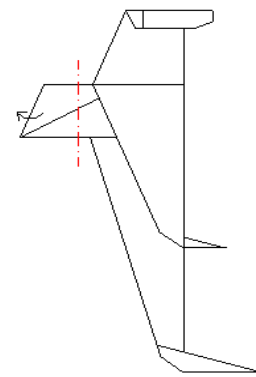

Fold the back of the engine pod into the body. Repeat behind.

31)

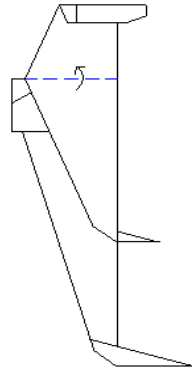

Fold the s-foils up to a horizontal position,  
and your B-Wing is ready to fly.

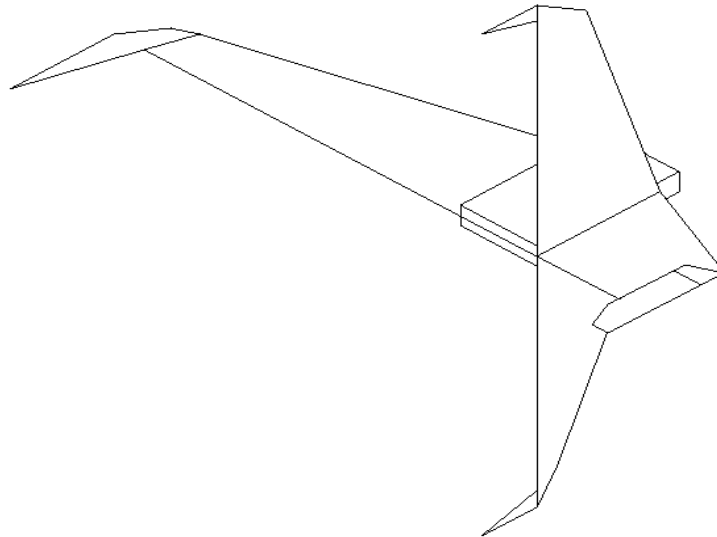

The completed B-Wing. This is a pretty crude isometric view, but hey, I don't do this for a living. There are two things I am unhappy with; the S-Foils should be below the engine pod, and the model is so thick that it needs a locking mechanism. Maybe those items will get fixed in a future revision (i.e., when I have more time).

# F-102 by Michael LaFosse

Michael LaFosse has been producing professional quality origami products for over twenty years. For information on purchasing instructional video tapes of this and many other models write him at 170 Margin Street, Haverhill, MA 01832 or Fax him at (508) 373-5503

Hi-Intermediate Start with a square of paper, colored side down. A 10" piece of paper produces a 4" model.

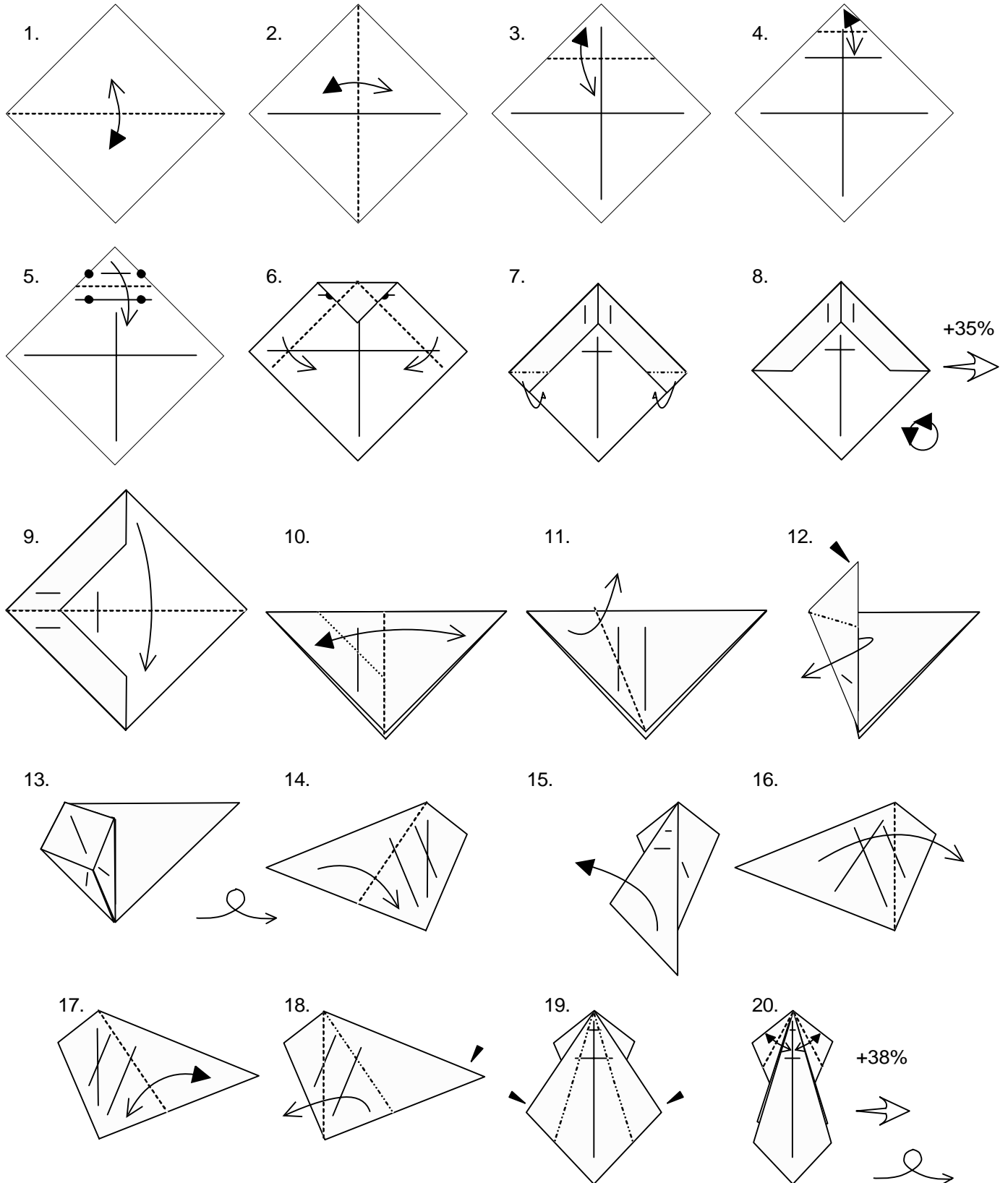

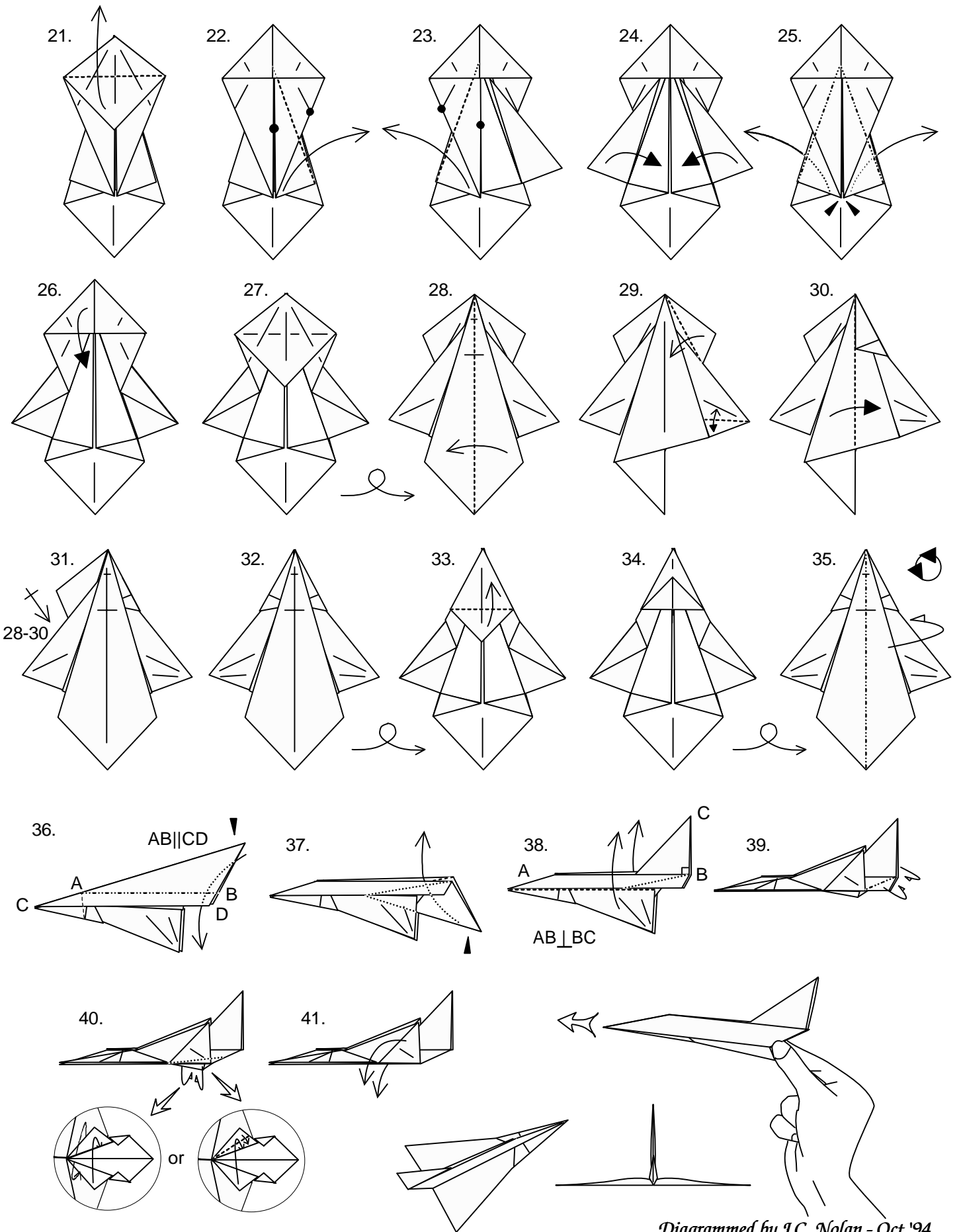

You may couple this units in two directions. So they can make a plane of squares.  
 You may create two different mosaics on both sides of the plane.  
 See 'Vest' as an example.

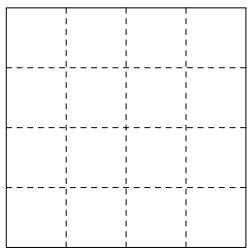

1 Precrease.

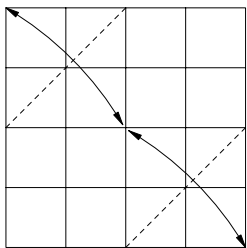

2

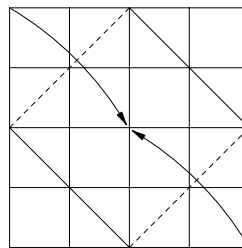

3

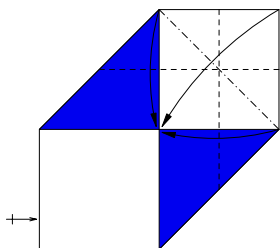

4

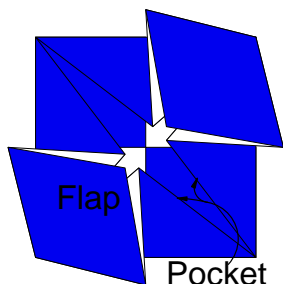

5 Put flap in pocket to couple two units.

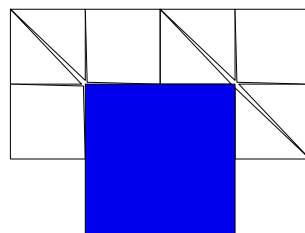

6 Fill the plane by coupling more units.

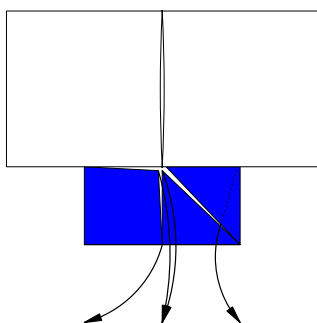

7 Locking the edge of the assembly. Get paper out.

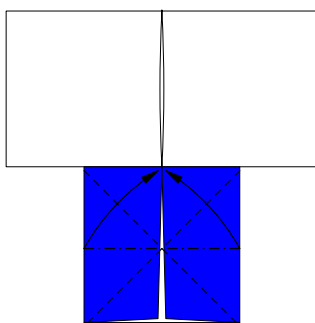

8

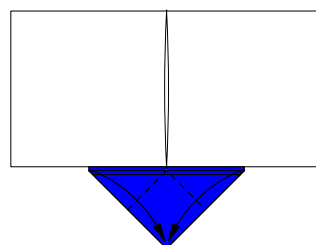

9

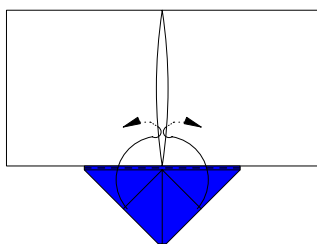

10 Fold flap up and lock it with the two small triangles.

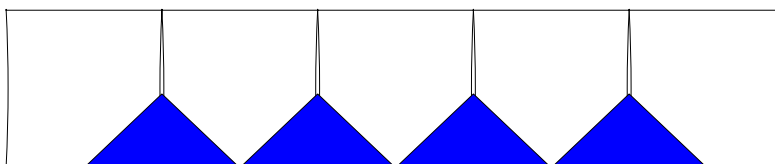

11 The edge will look like this.

# PRACTICE PENGUIN BOOKMARK (TEACHING MODEL)

by VALERIE VANN - NOVEMBER 1996

Drawing & Text 20 Nov. 1996

Copyright 1996 Valerie Vann

Internet: 75070.304 @compuserve.com

The PRACTICE PENGUIN BOOKMARK is a TEACHING MODEL. The model is 2-dimensional and can be used as a bookmark or to decorate a greeting card. It will stand upright though, and can be used as a party place card. (Use a jelly bean or candy egg for a penguin egg!) The front and back of the model are similar, not identical. The primary purpose of the model, however, is a "teaching" or "practice" model, as it incorporates the following folding techniques: Squash & Petal Folds, Grimps, a Double Rabbit Ear, a Closed Wrap, and 1 to 3 Closed Sinks (2 sinks are optional). As the model is otherwise simple, a spoiled closed sink will result in minor loss of effort, while success yields more than a simple folded sheet. Use 6 or 7 inch square origami paper (kami) to start, then try smaller sizes.

- Mountain Fold
- - - Valley Fold
- Existing Crease
- ..... Hidden/Guide Line

① Start with a WHITE PRELIMINARY BASE  
SQUASH FOLD top right layer.

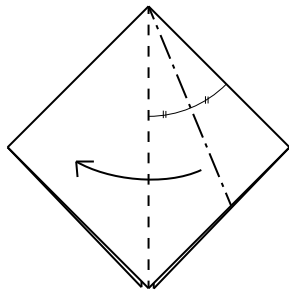

② PETAL FOLD

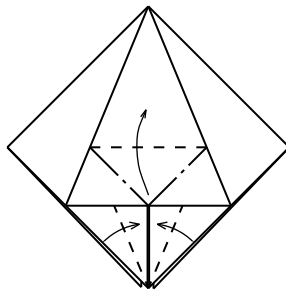

③ CLOSE WRAP the right half of the Petal Fold. (Similar to Inside Reverse fold so it is underneath.)

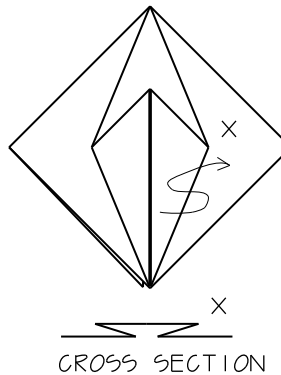

④ Pull out left extra middlelayer. ("Pull out some paper...")

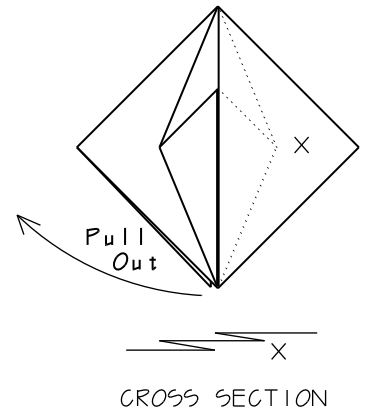

⑤ Bring back lower point of model to front. (Turn model inside out, color up.)

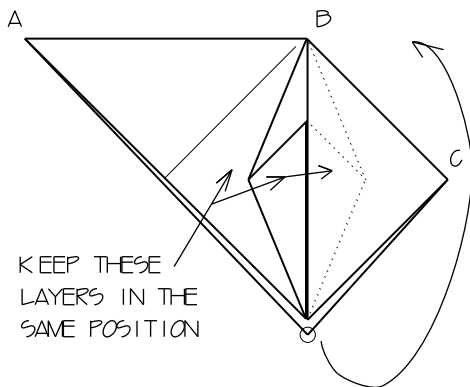

⑥ Turn Model over, Left to Right.

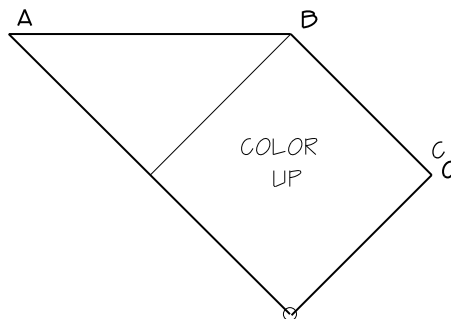

MODEL HAS COLORED SIDE OUT NOW.

⑦ SQUASH FOLD Point A

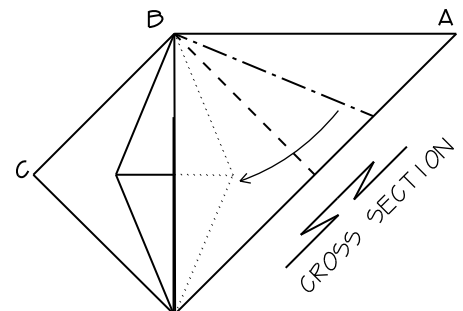

RATING - SIMPLE to FAIRLY DIFFICULT SINK - A TEACHING MODEL



Drawing & Text 20 Nov. 1996

Copyright 1996 Valerie Vann

Internet: 75070.304 @compuserve.com

8 DOUBLE RABBIT EAR  
 Point A.  
 Start with PETAL FOLD, A to B.

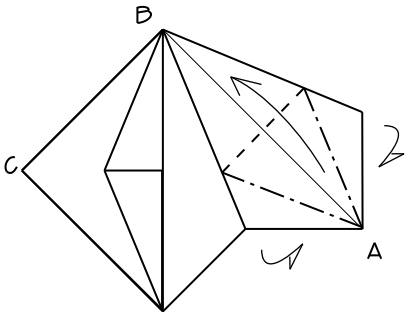

9 Fold Point A  
 Down again

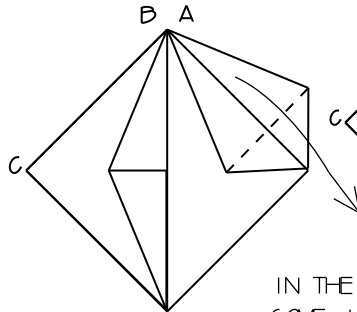

10 Complete  
 DOUBLE  
 RABBIT EAR

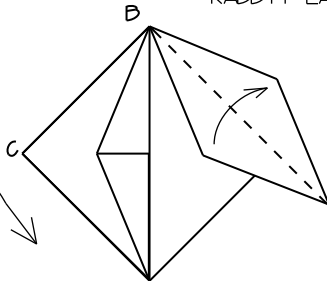

11 Untold to  
 Step 10

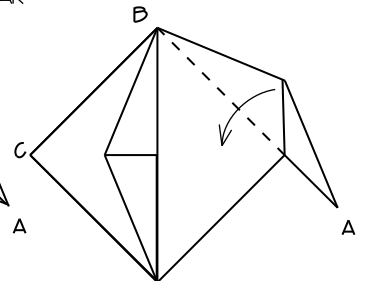

IN THE REMAINDER OF THE PENGUIN, YOU GET TO PRACTICE  
 SOME JUDGEMENT FOLDS WHILE SHAPING THE HEAD & BACK...

12 CRIMP  
 Top Layer

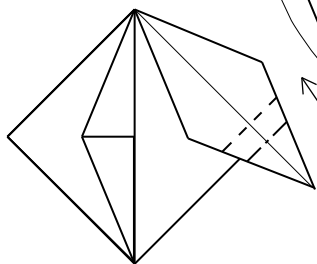

13 Refold  
 Steps 10-11



14 CLOSE SINK BACK

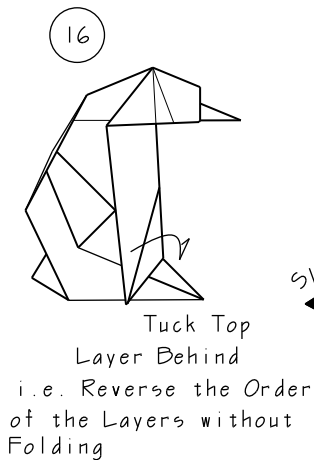
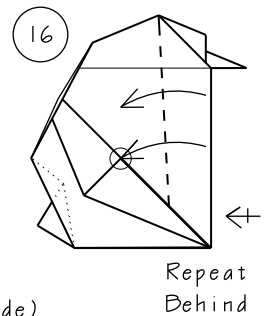
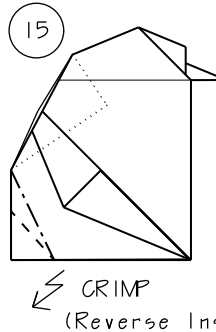
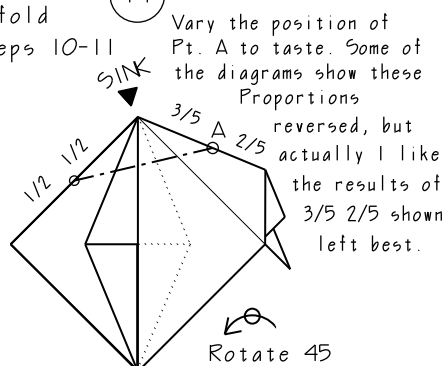

17 Tuck Lower Right  
 Points Inside.  
 CRIMP Head as Shown  
 CLOSE SINK Back  
 Above Tail

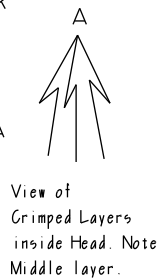
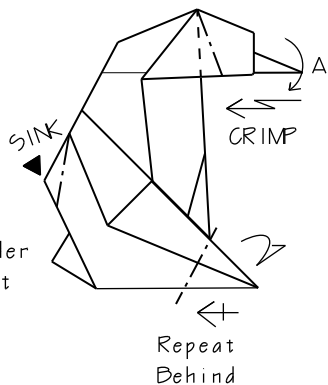

18 CLOSE SINK  
 Top of Head.  
 This is the  
 hardest sink.  
 Tuck in corners of head.

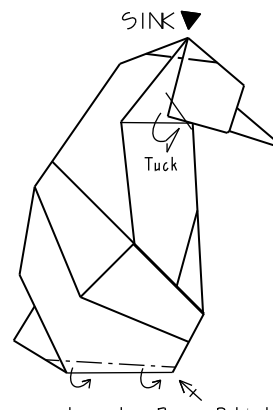

Tuck bottom edge under. Repeat Behind.  
 Note: Fold slopes up slightly toward tail.

THE PRACTICE  
 PENGUIN BOOKMARK

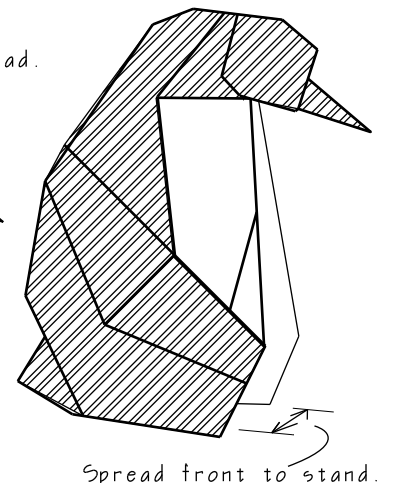

RATING - SIMPLE to FAIRLY DIFFICULT SINK - A TEACHING MODEL

Drawing & Text 20 Nov. 1996

Copyright 1996 Valerie Vann

Internet: 75070.304 @compuserve.com

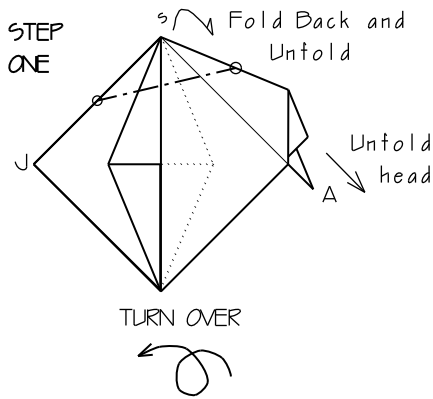

ANOTHER LESSON ABOUT SINKS that can be illustrated using the PRACTICE PENGUIN MODEL: Many "Closed Sinks" do not have to be executed using the basic directions for a closed sink; that is, inverting the sink area by pushing the highest point down inside the model. Many Closed Sinks can be partially or entirely performed as an open sink, and the model pleated around the area of the sink to get exactly the same "closed sink" configuration.

This usually results in a neater sink. For example, there is a lovely little Elephant by Paul Jackson with a closed sink indicated across the back that doesn't have to be done as a closed sink at all. In the Practice Penguin, the large closed sink on the back of the Penguin in Step 14 can be done as a series of pleats inside.

Learn to examine models with closed sinks and see if there is a tactic to avoid a full inversion of the sink. Partially unfolding the model will help.

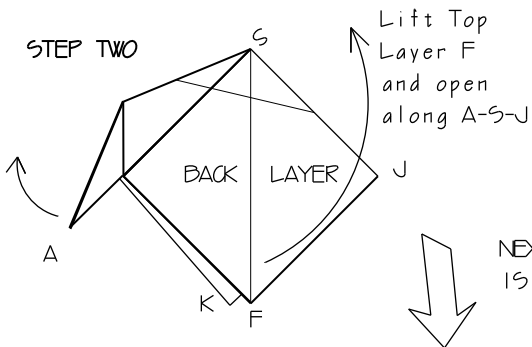

NEXT STEP IS 3-D

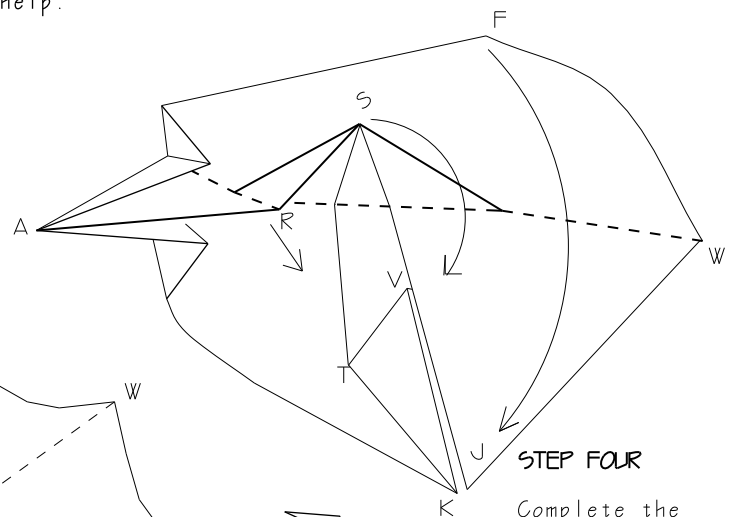

Complete the CLOSED SINK by positioning all the pleats along their existing creases, and closing the back layer F down to meet Pts. J and K as it was before the sink.

NEXT STEP IS STILL 3-D

STEP THREE

Carefully turn pleat A-R-S-J in along existing creases and the line made for the sink in Step 14 (shown above at First Step here).

Re-Form all the pleats along existing lines in the direction of the arrows, while flattening

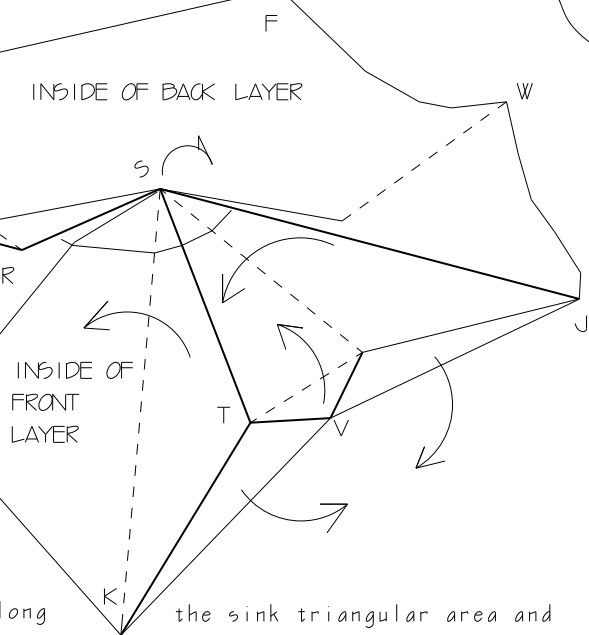

the sink triangular area and tilting Pt. S toward the inside of the back layer.

RATING - SIMPLE to FAIRLY DIFFICULT SINK - A TEACHING MODEL

# Origami Instruction Sheet: Crane

- Mountain fold e.g. fold B under to C
- - - - - Valley fold e.g. fold A onto C
- ===== Border of model
- ===== Existing crease

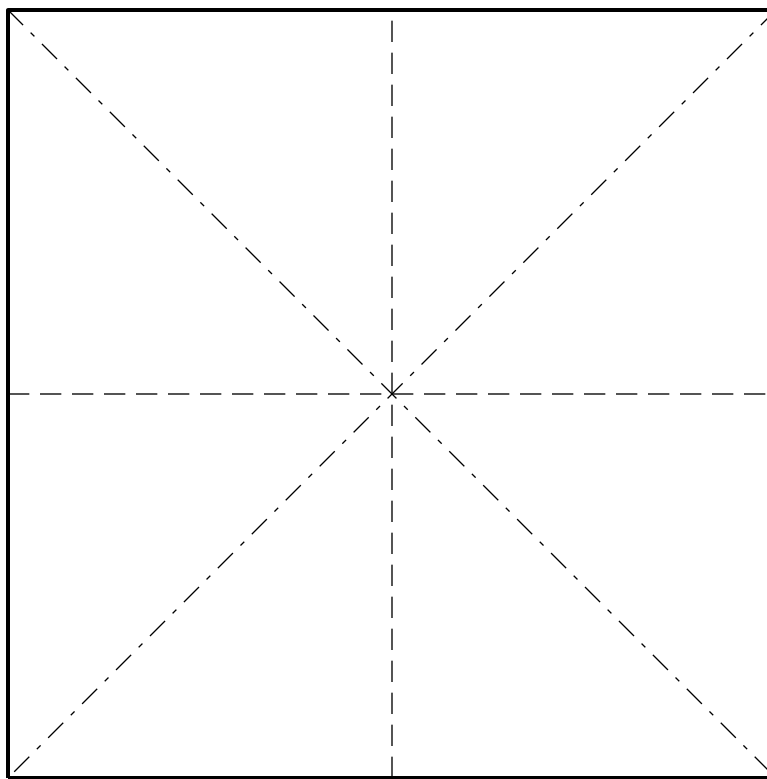
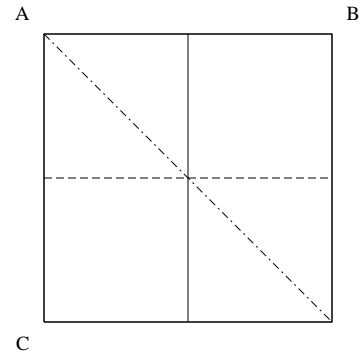

Crease each fold and unfold. Then fold along all existing creases simultaneously. You will get a diamond shape. This is called the Preliminary Fold. Orient it with the closed end up, and the open part down. You should have 2 flaps on the left, 2 on the right, 4 at the bottom, and 1 at the top.

# Pteranodon goes human

By Hans Birkeland (Norway) ©1993

Model : 93.08.04  
Diagrams : 93.08.14

A 15 cm square will produce a finished model about 9.5 cm high.  
Begin with the white side up.

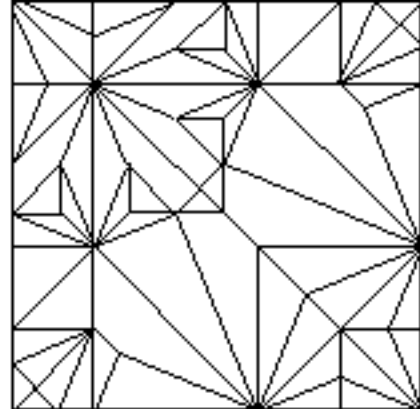

1

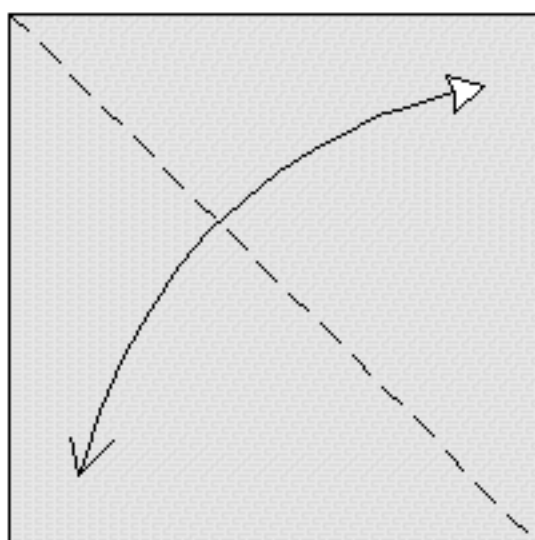

Fold and unfold.

2

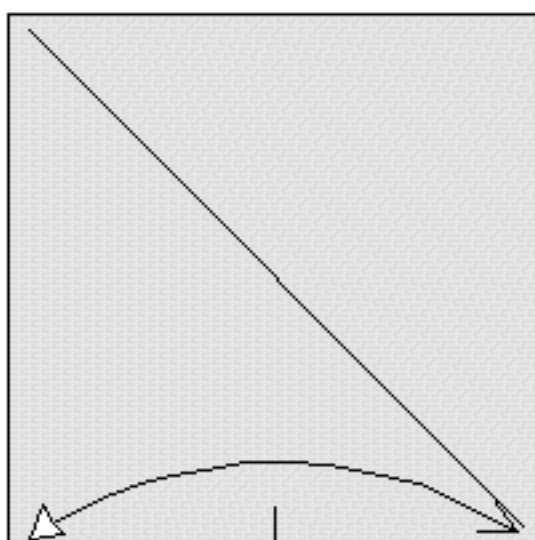

Fold and unfold. Just make a mark.

3

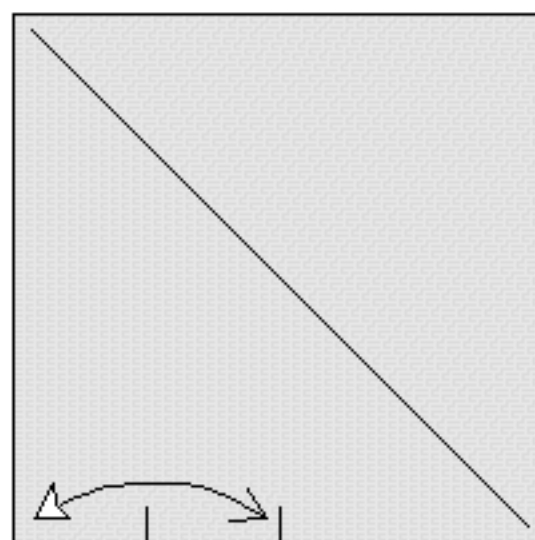

Fold and unfold. Just make a mark.

4

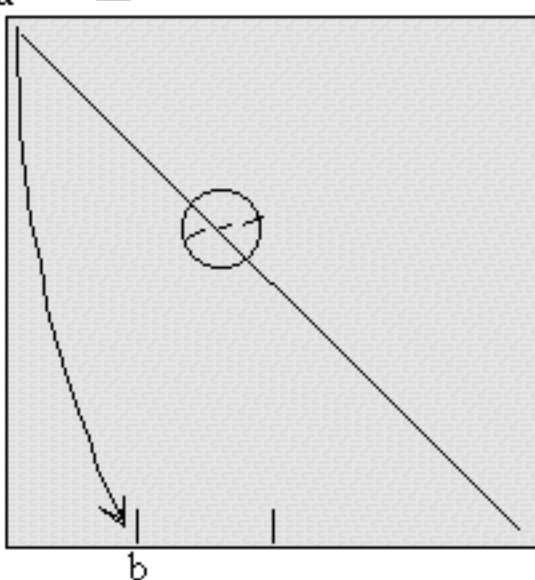

Fold corner a to mark b, pressing flat only where the fold hits the diagonal.

5

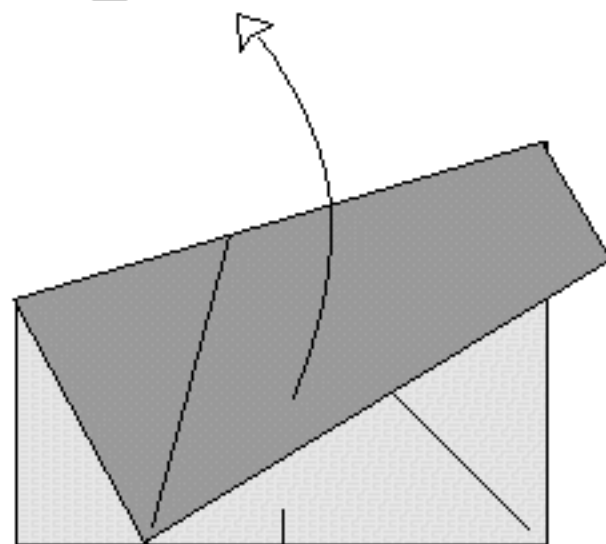

Unfold.

6

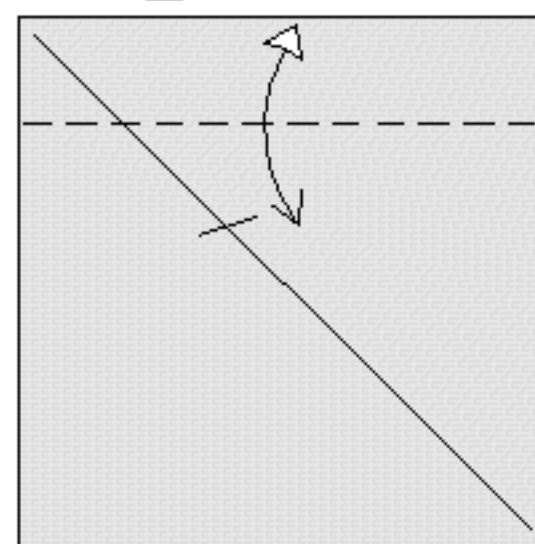

Fold and unfold, using the mark from step 4 as a guide.

7

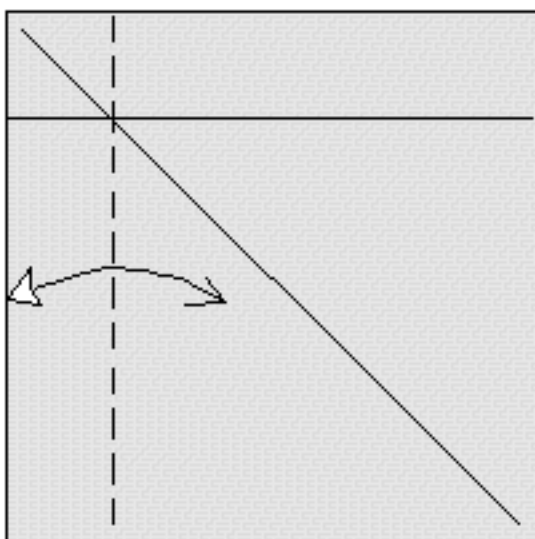

Fold and unfold.

8

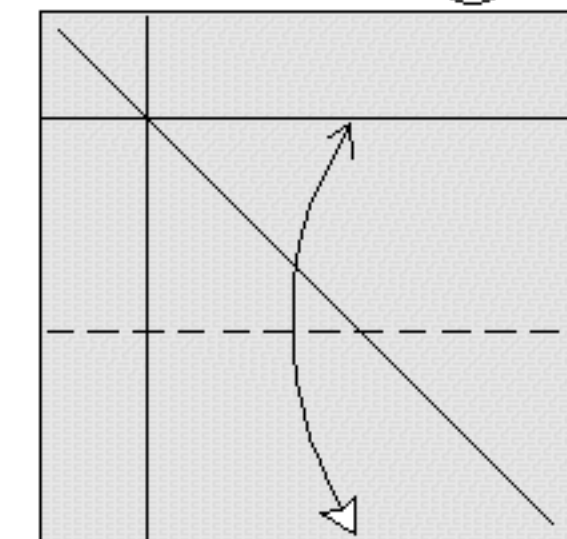

Fold and unfold.

9

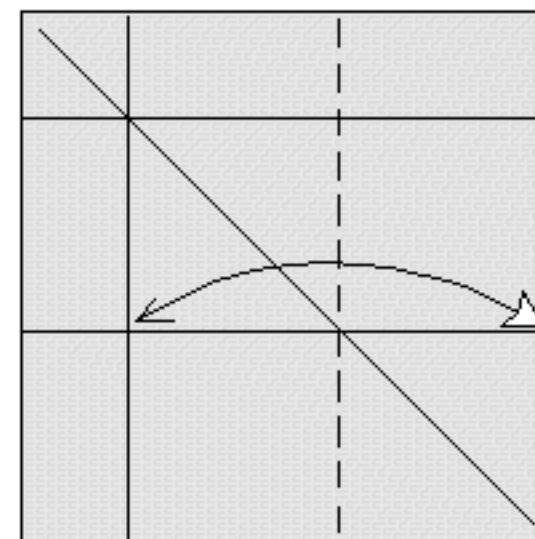

Fold and unfold.  
Turn the paper over.

10

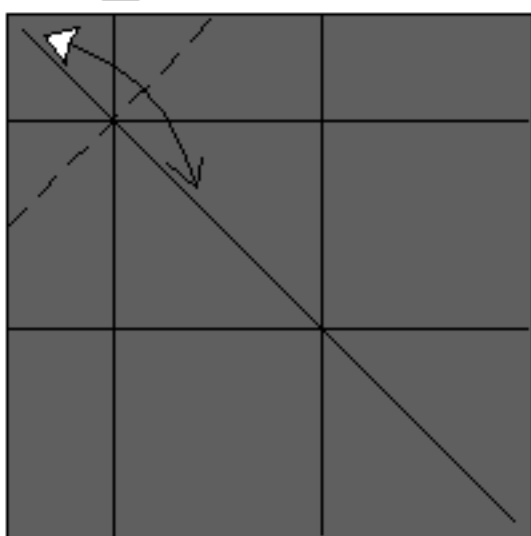

Fold and unfold. Turn the paper over.

11

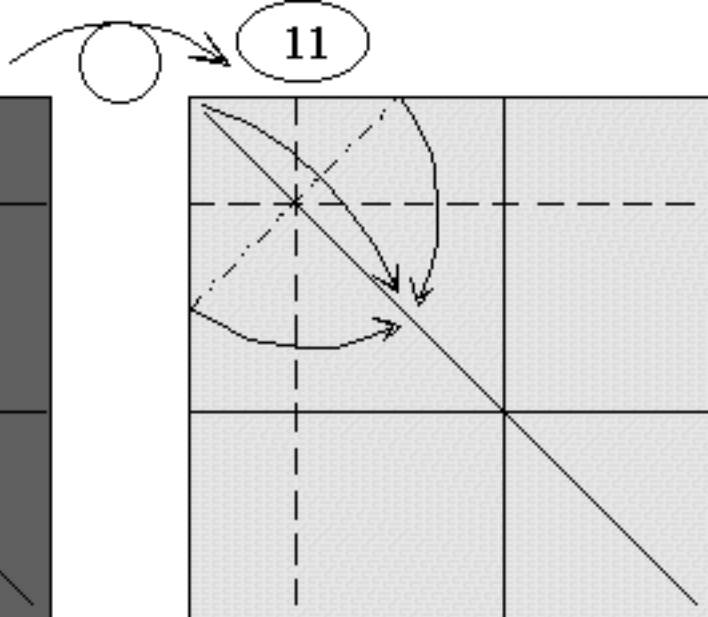

Collapse on existing creases.

12

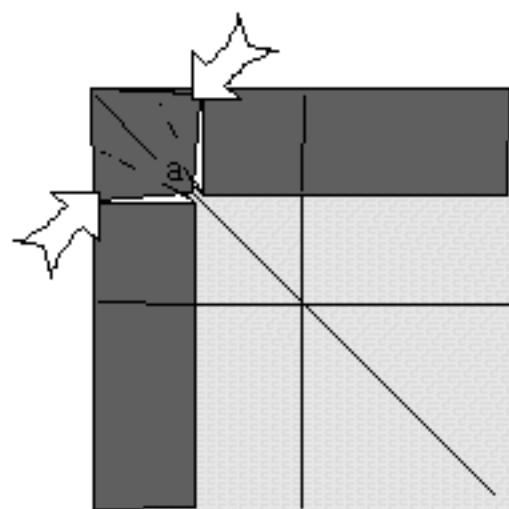

Reverse-fold the edges, but don't let the mountain-folds reach corner a.

13



Enlarged view. Fold the small corners along the center-line.

14

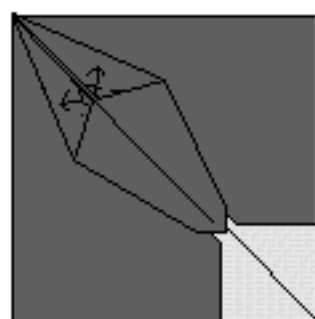

Valley-fold the small corners to make eyes.

15

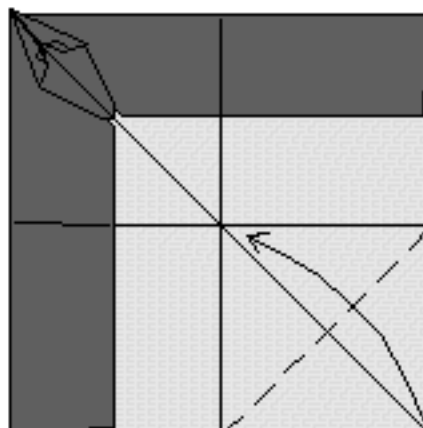

Valley-fold the corner.

16

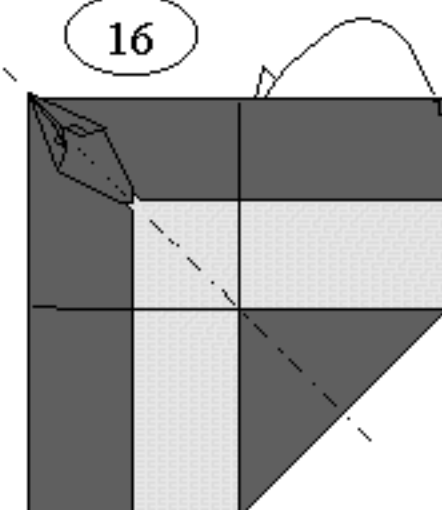

Mountain-fold in half.

17

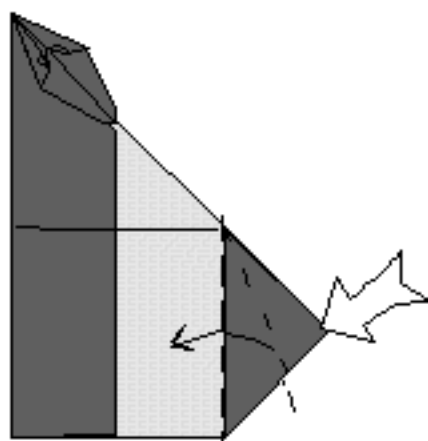

Squash-fold.

18

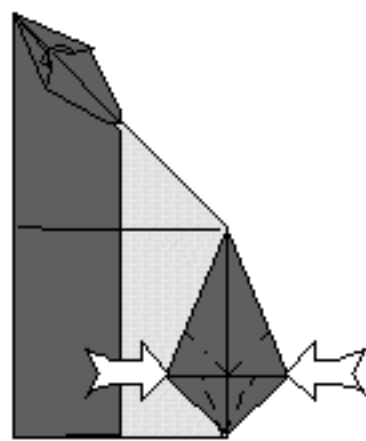

Reverse-fold.

19

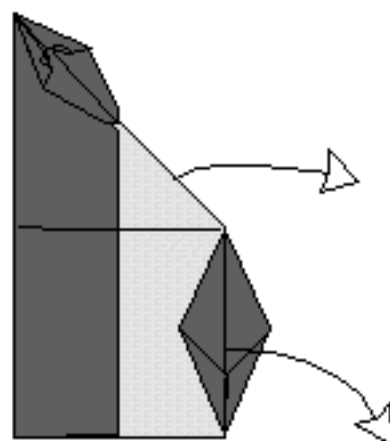

Unfold to step 15.

20

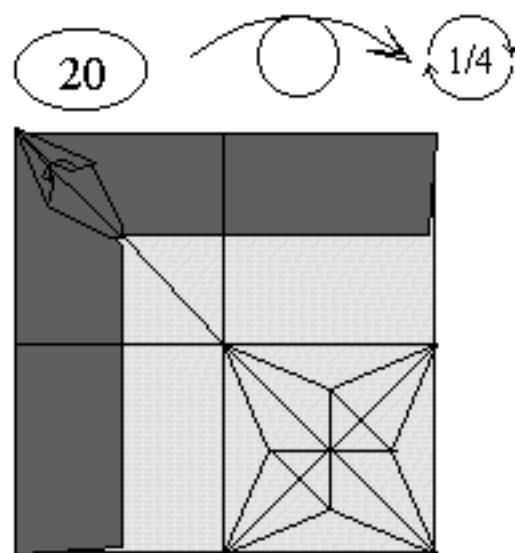

Turn the model over and rotate 1/4 clock-wise.

21

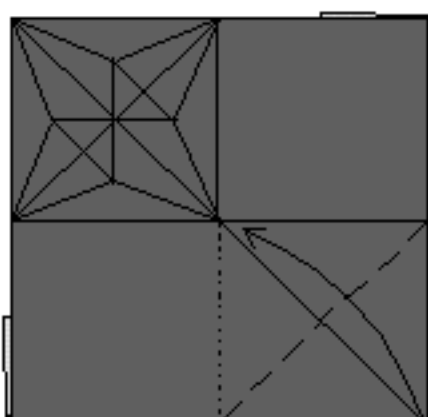

Repeat steps 15-19 on this side.

22

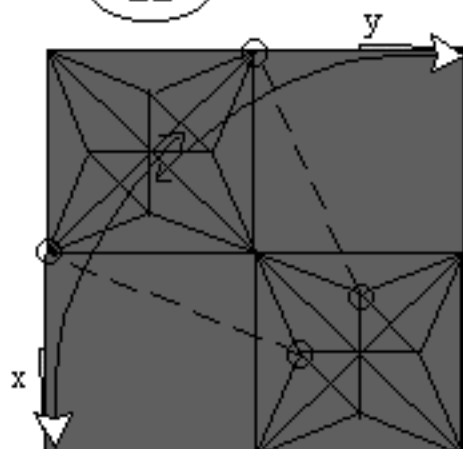

Crease where indicated. The edges x and y will lay along the old 45° crease.

23

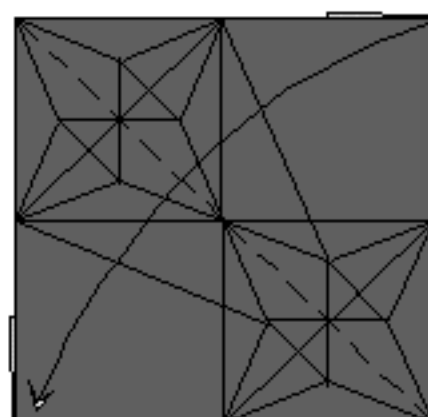

Valley-fold in half.

24

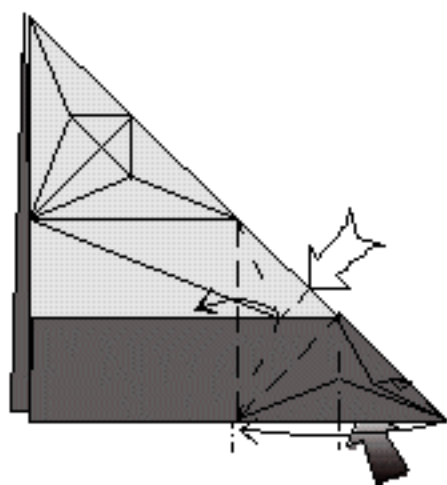

Collapse symmetrically on old creases.

25

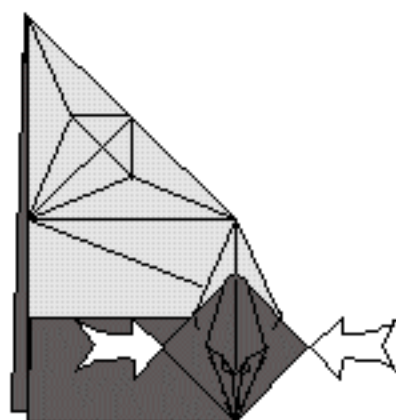

Reverse-fold.

26

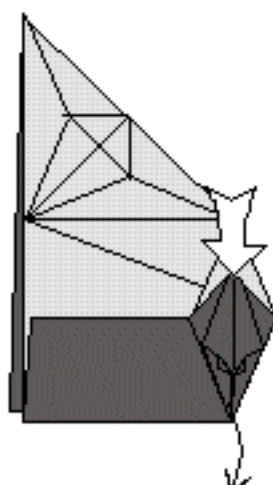

Pull the loose flap down as far as it will go, making a Stretched Bird Base.

27

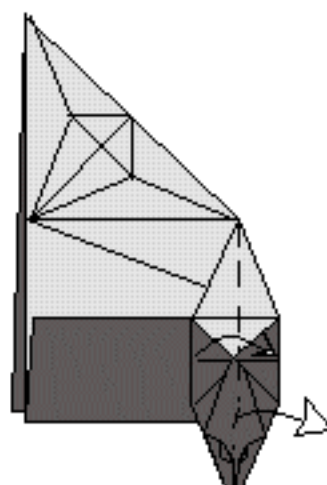

Book-fold the edge to the right, simultaneously pulling out the head-flap.

28

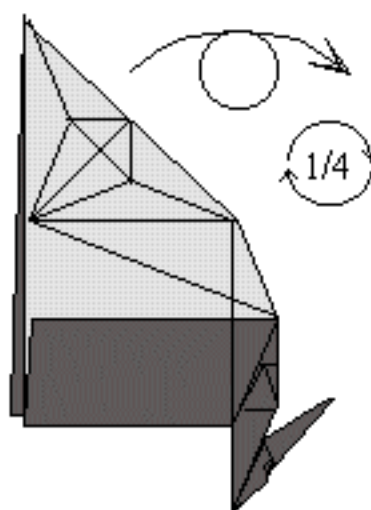

Turn the model over and rotate 1/4 clock-wise.

29

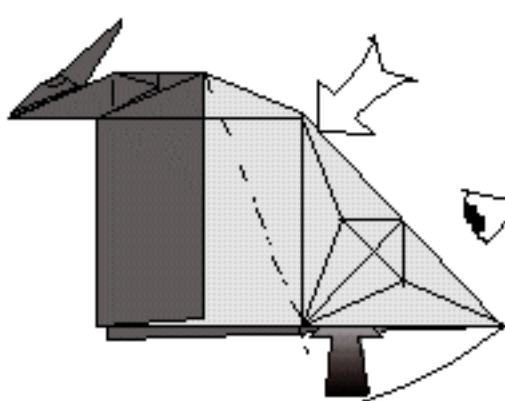

Sink. Next view from the right side.

30

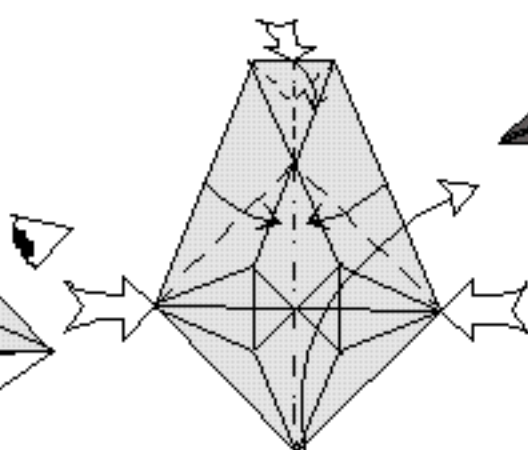

In the process, reverse-fold the bottom corner up on old creases.

31

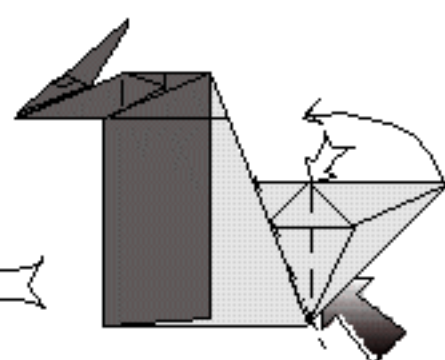

Crimp symmetrically.

32

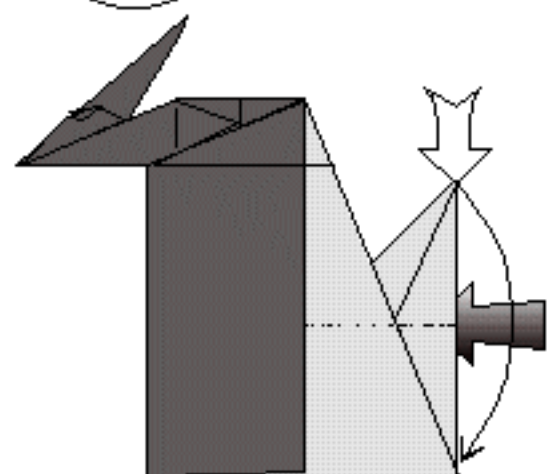

Reverse-fold.

33

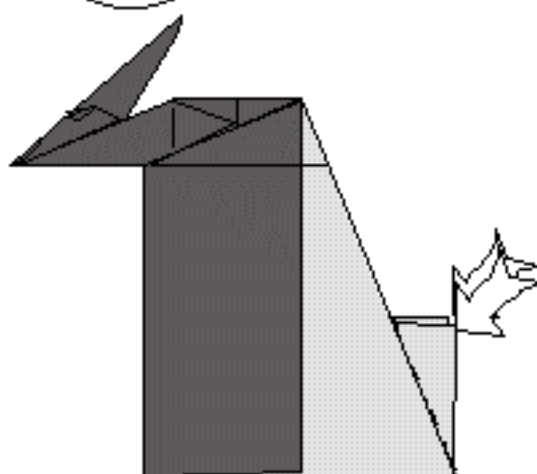

Reverse-fold the two edges.

34

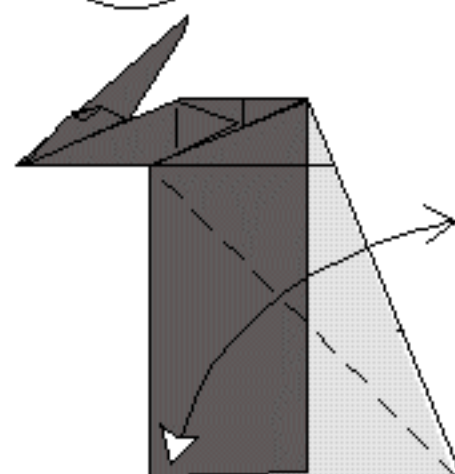

Fold and unfold.

35

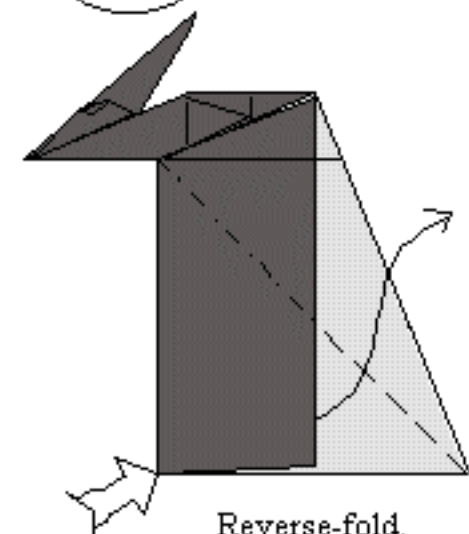

Reverse-fold.

36

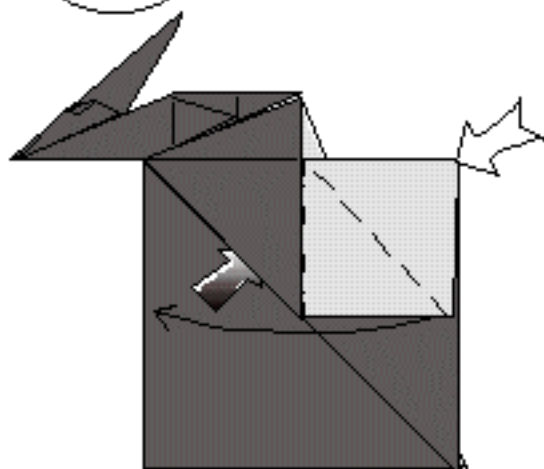

Swivel-fold. Don't press flat at the right edge.

37

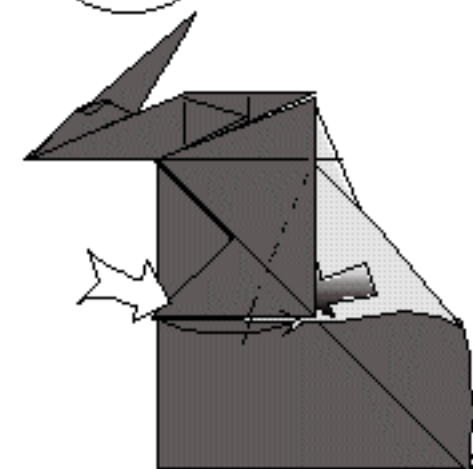

Reverse-fold.

38

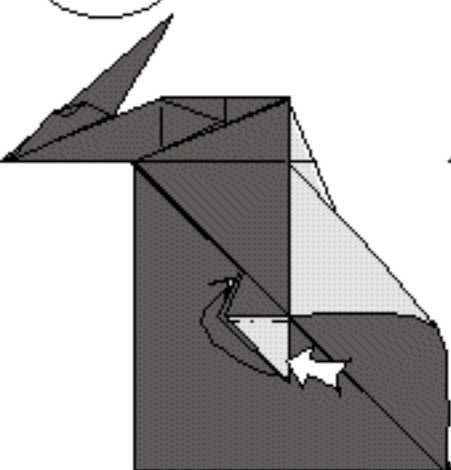

Reverse-fold the corner inside.

39

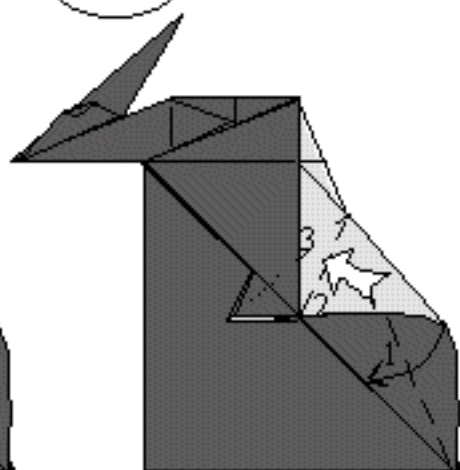

Make the creases in the indicated order and swivel-fold.

40

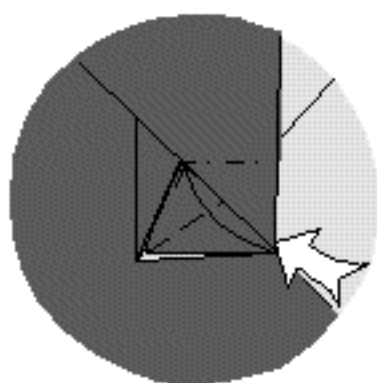
Enlarged view.  
Reverse-fold.

41

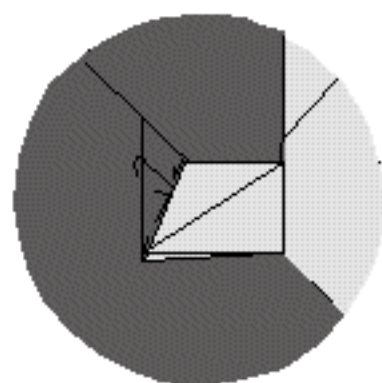

Valley-fold the edge inside.

42

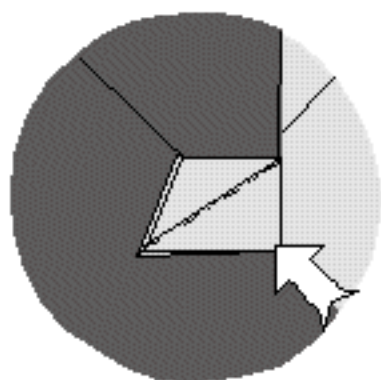

Reverse-fold.

43

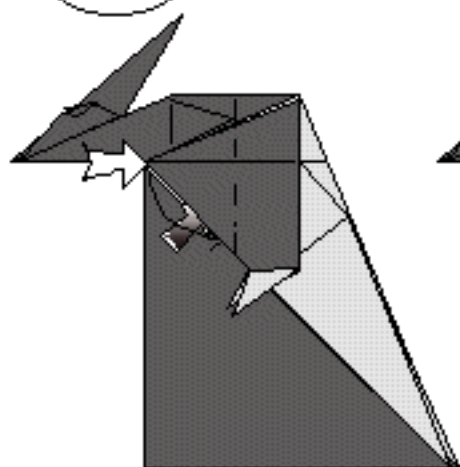

Reverse-fold.

44

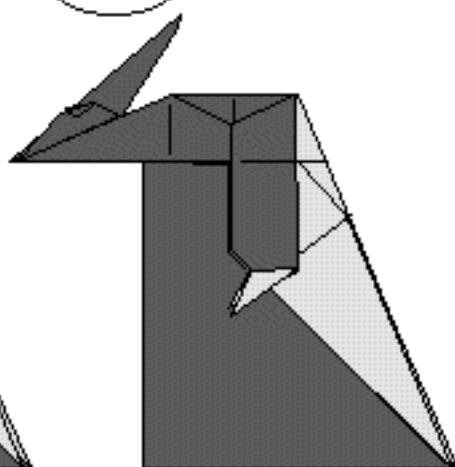

Repeat steps 34-43 behind.

45

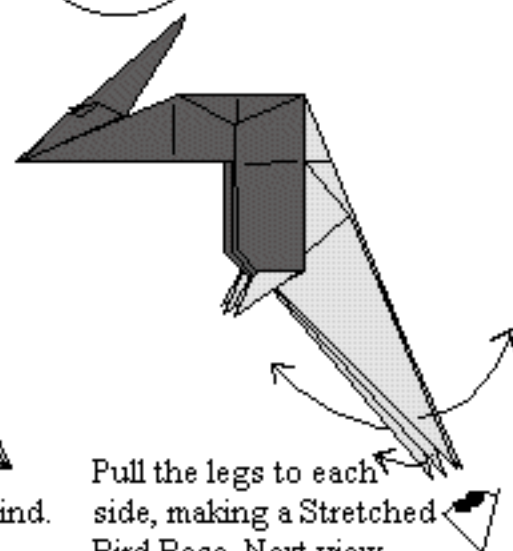

Pull the legs to each side, making a Stretched Bird Base. Next view from the underside.

46

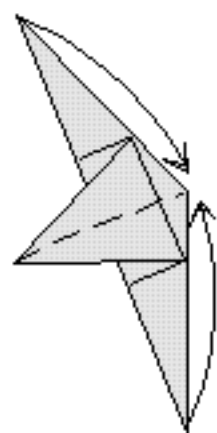

Like this. Return the legs to the position in step 45.

47

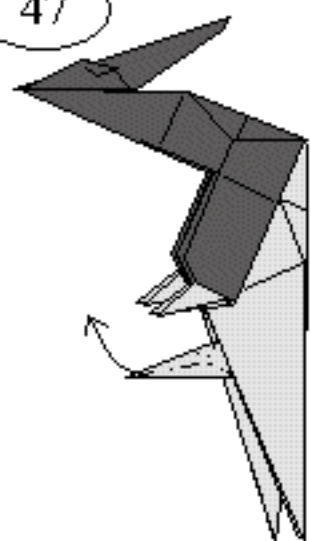

Fold a double rabbit ear.

48

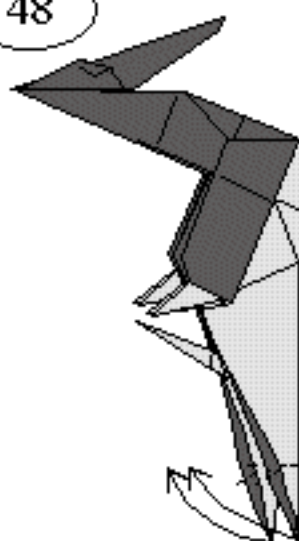

Open up between the middle layers of each leg and squash-fold to make feet.

49

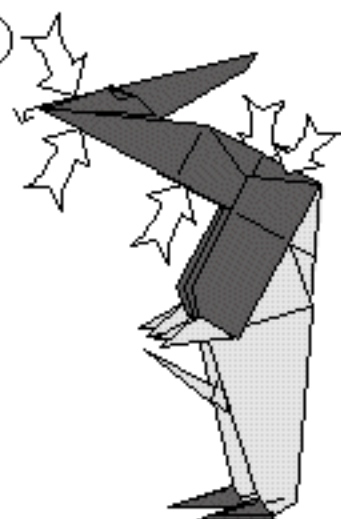

Squeeze the beak and round the neck.

50

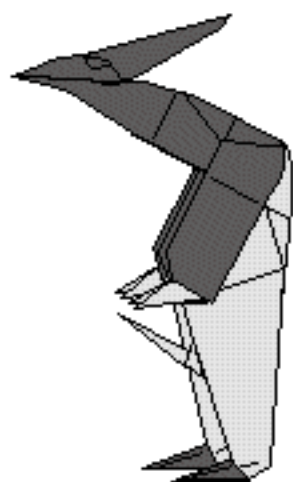

Finished "Pteranodon goes human".

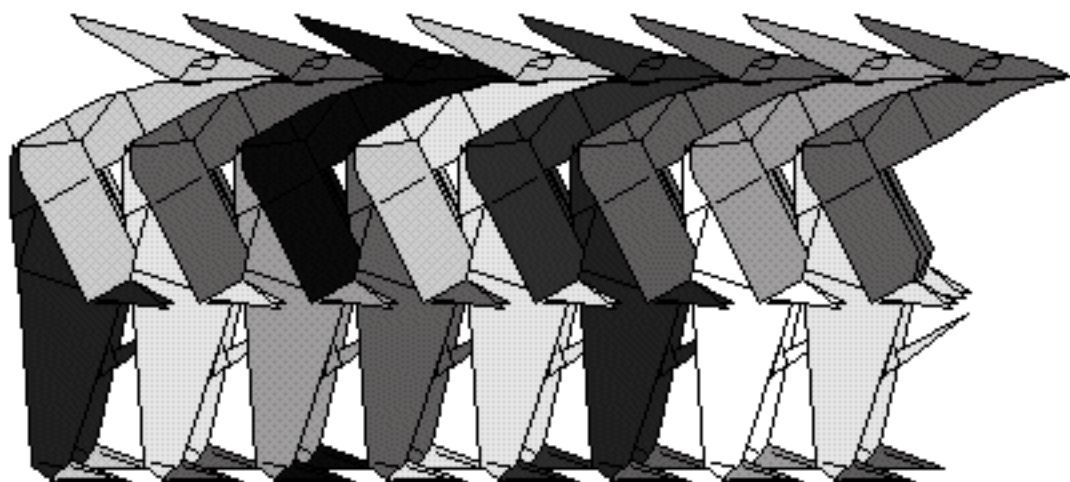

The modular (impure) version.

---

# Bebé Pteranodon

---

Fernando Gilgado Gomez

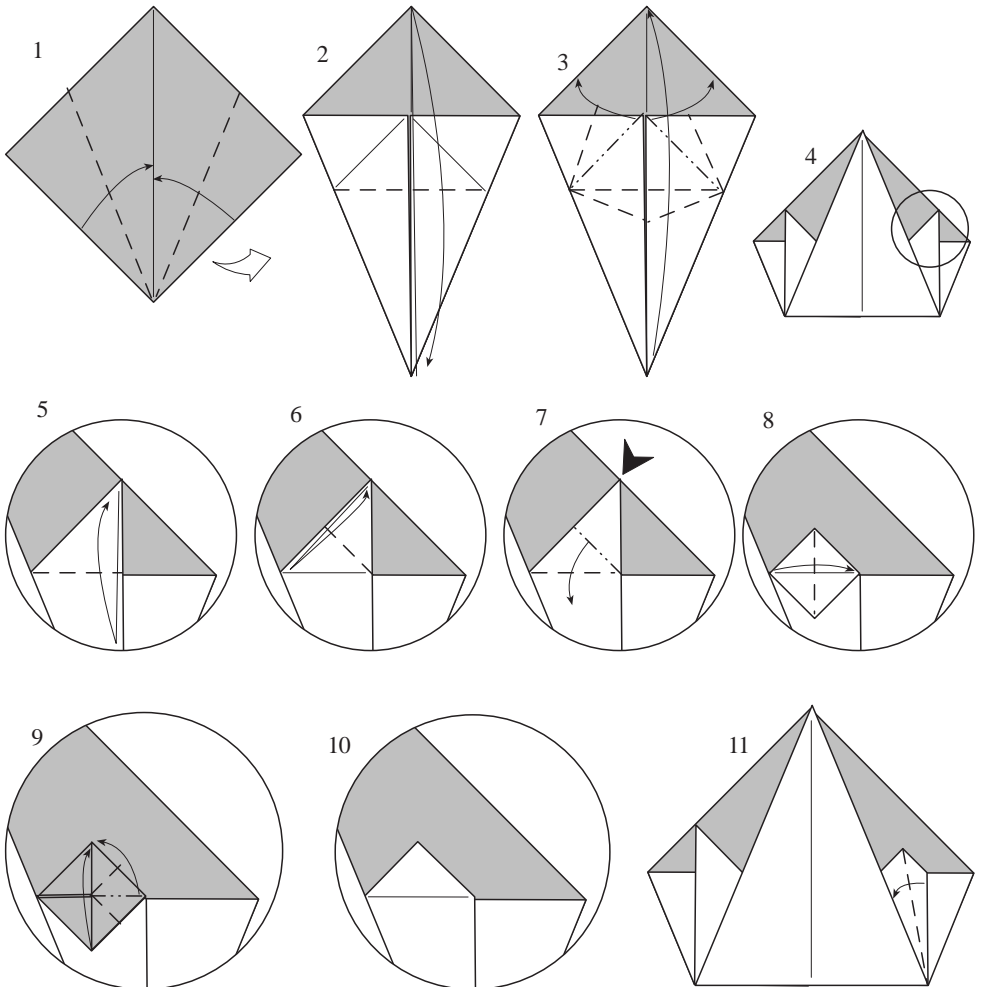
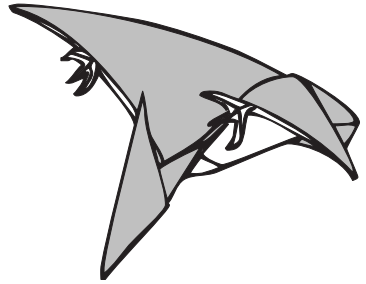



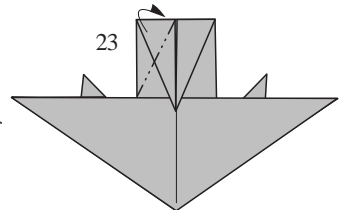
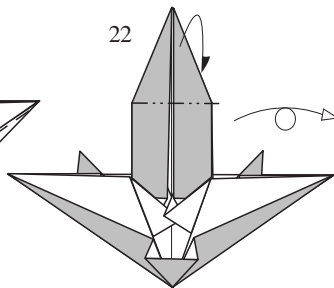
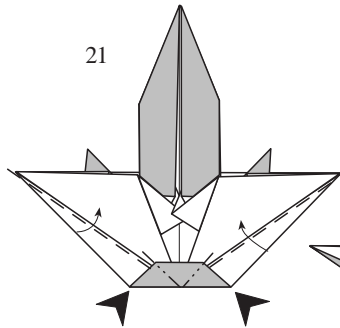
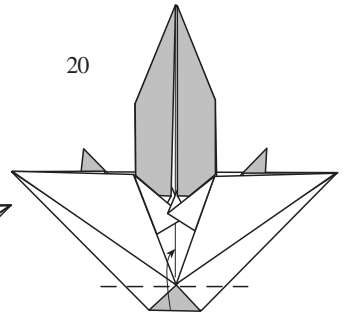
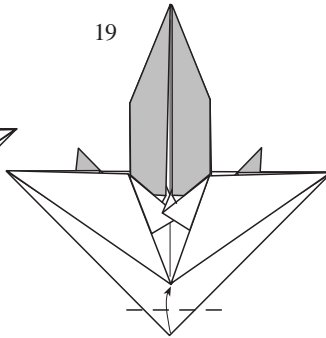
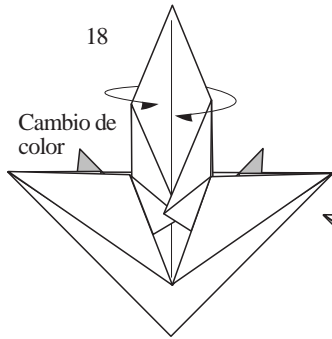
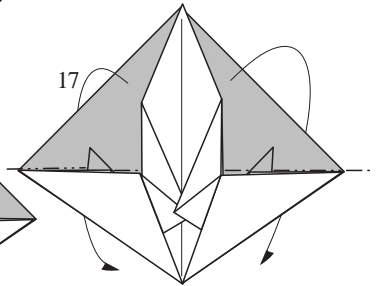
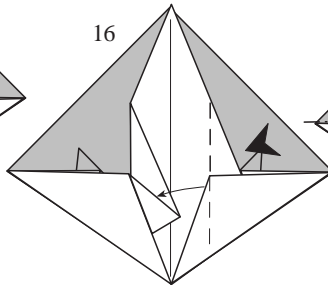
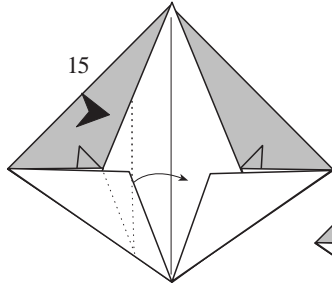
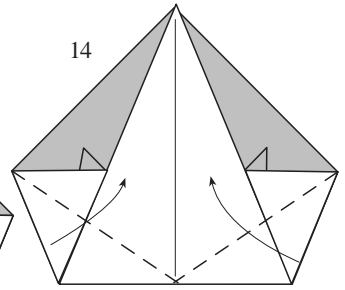
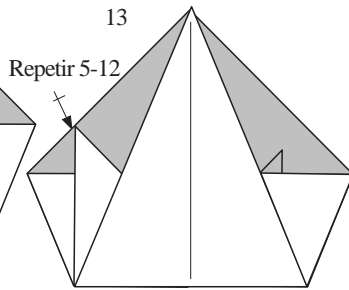
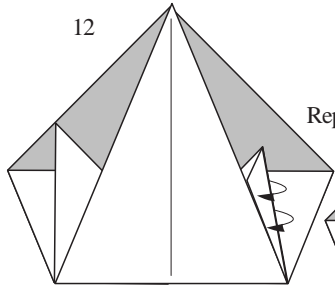

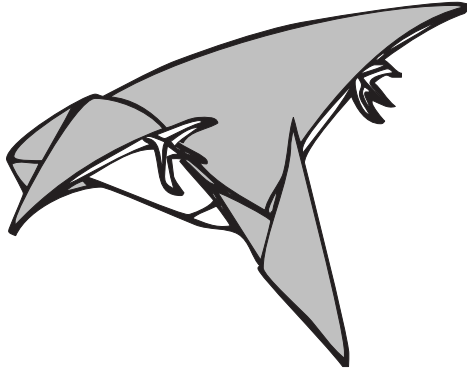
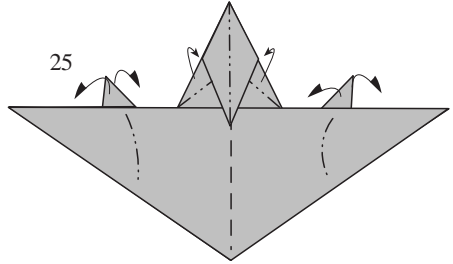
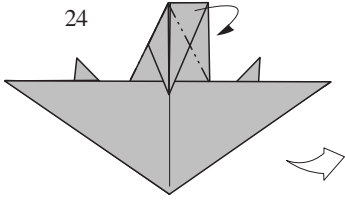

# Flying Pterodactyl

(c) Marc Vigo Anglada  
Diagrammed on April 23, 1994

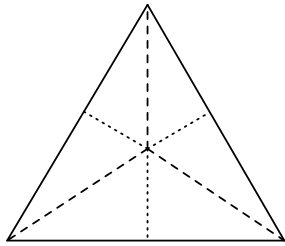

1 Begin with an equilateral triangle. Make a preliminary fold

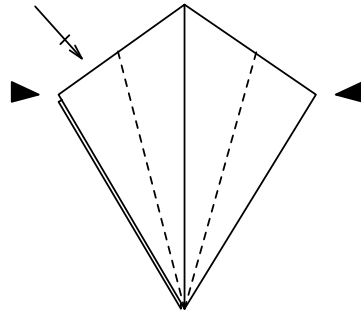

2 Reverse fold the three corners

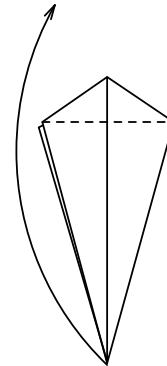

3

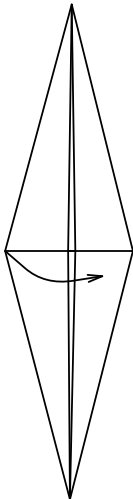

4 Fold one layer to the right

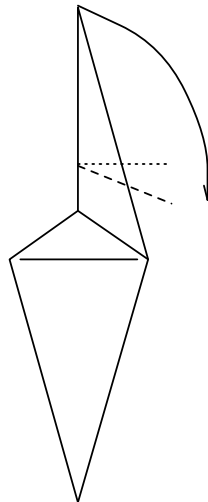

5 Crimp fold

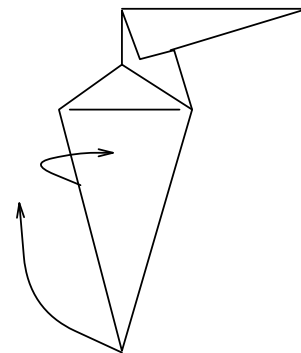

6 Unfold inner layer while raising wings

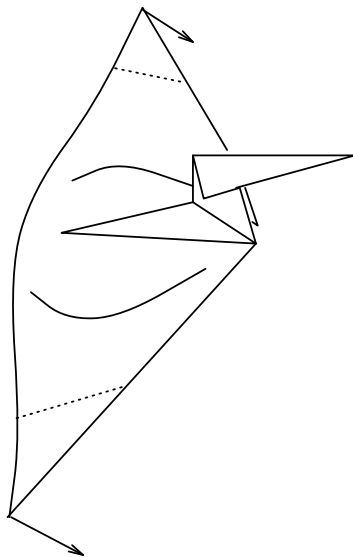

7 Fold wings slightly down

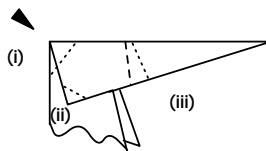

8 Head detail  
(i) Sink tip of head  
(ii) Mountain fold  
(iii) Crimp fold

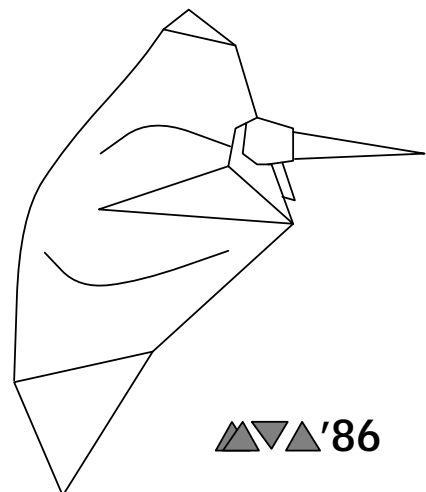

# Pumpkin Face © 1996 Sy Chen

(1) Use orange/non-orange duo-color square. Start with orange side down. Mark center using diagonal folds

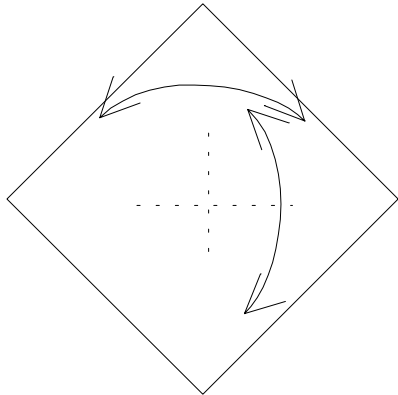

(2) Fold side corners to cover center mark; They will overlap as shown in the next step. (JF)

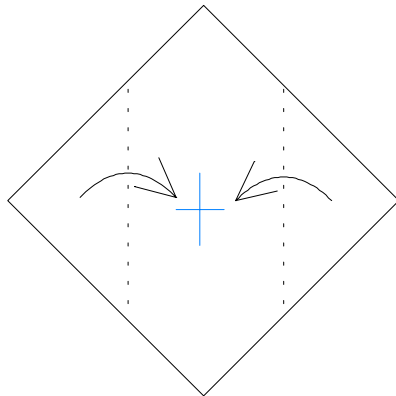

(3) Top corner A to B; mountain fold bottom corner

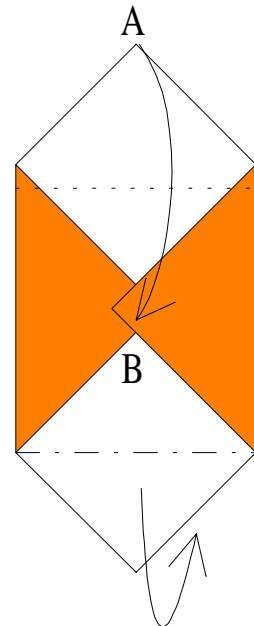

(6) Push bottom corners and Swivel E and F between layers to round the pumpkin (JF). Make sure leave some non-orange color out.

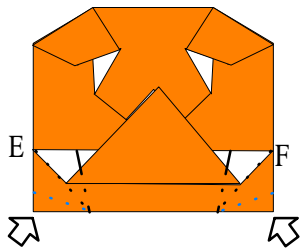

(5) Valley fold

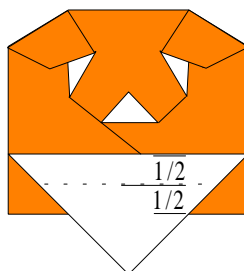

(4) Push top corners and Swivel C and D to form the eyes and round the corners (JF); Fold center tip up to form nose (JF); Valley fold bottom edge to meet Point B and bring triangular flap behind to front.

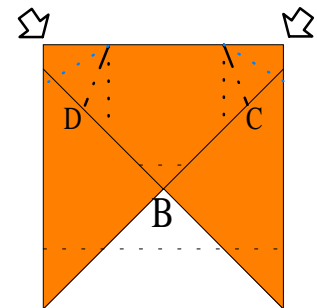

(7) Valley and mountain judgment fold

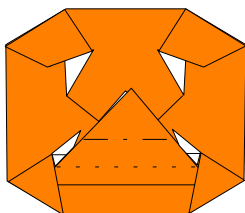

(8) Tuck all 3 teeth into mouth and shape the center tooth by swivel folds

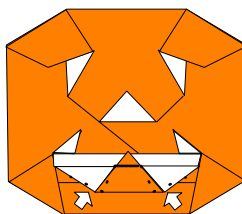

(9) The finished Pumpkin Face

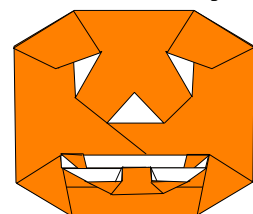

\* JF - Judgment Fold

© 1996 Sy Chen

# Puppy Pounce

By Perry Bailey ©1997

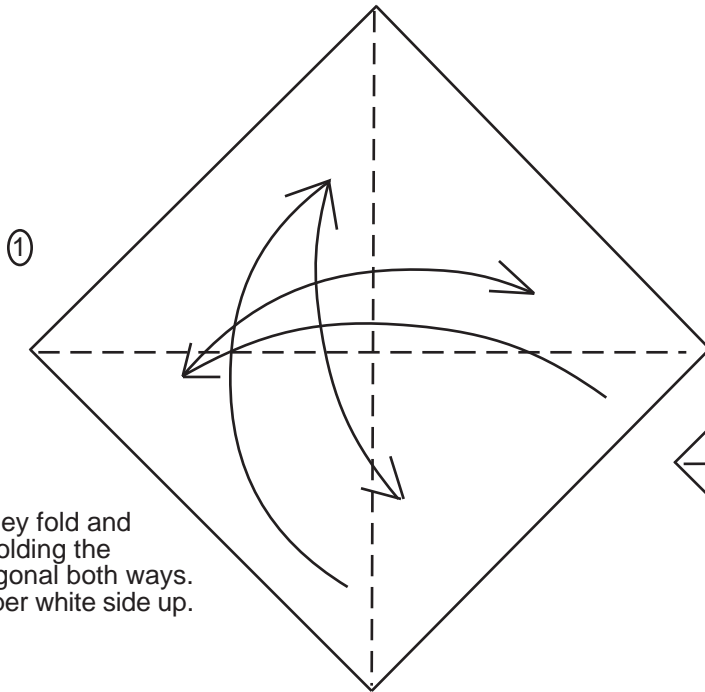

Valley fold and unfolding the diagonal both ways. Paper white side up.

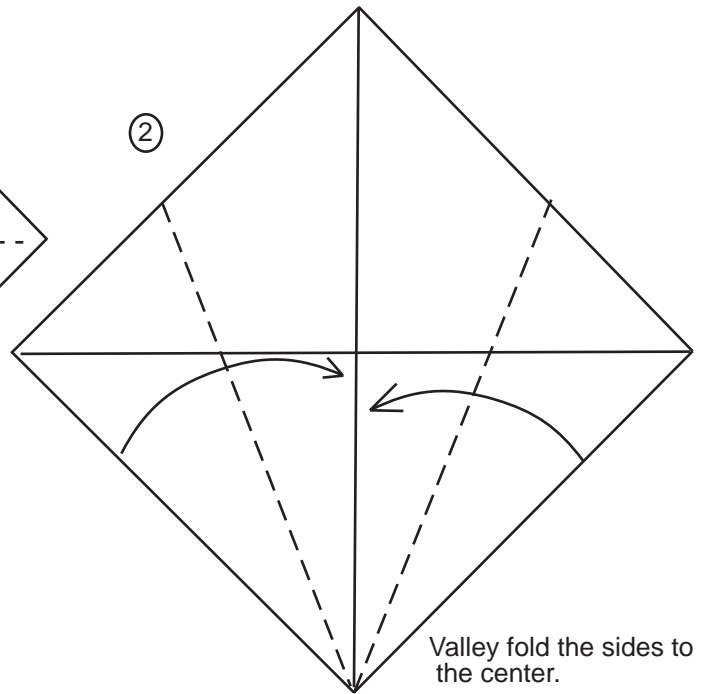

Valley fold the sides to the center.

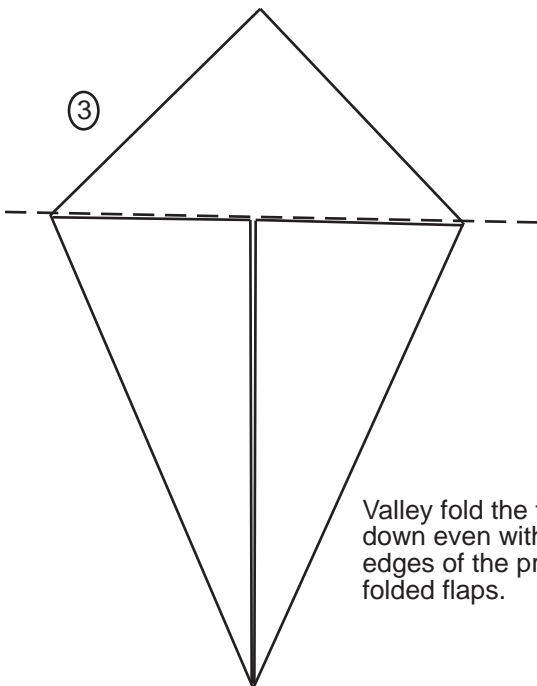

Valley fold the top flap down even with the raw edges of the previously folded flaps.

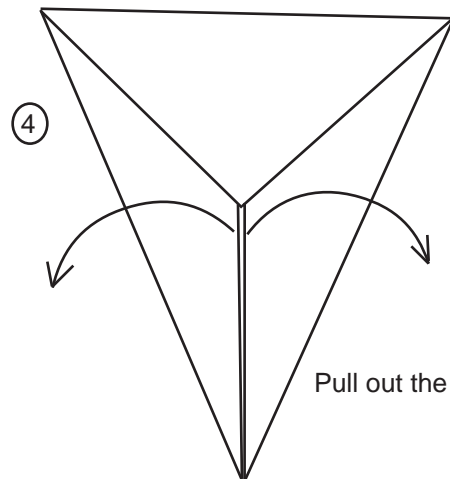

Pull out the two side flaps.

5

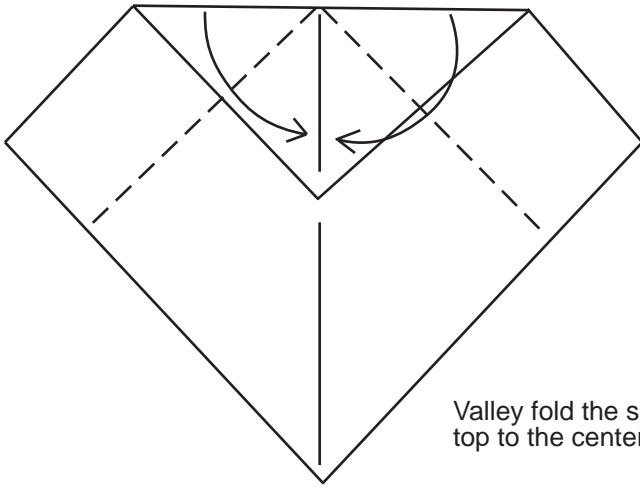

Valley fold the sides from the top to the center of the model.

6

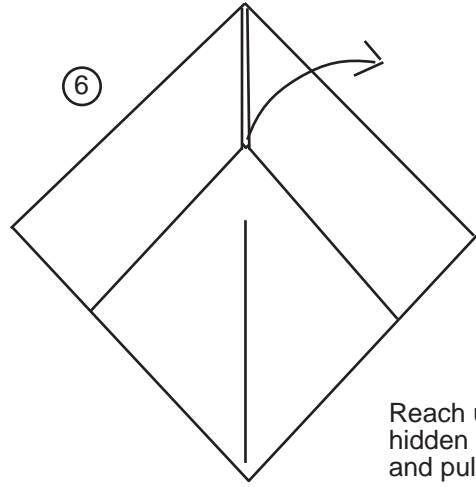

Reach under to the hidden center flap and pull it out.

7

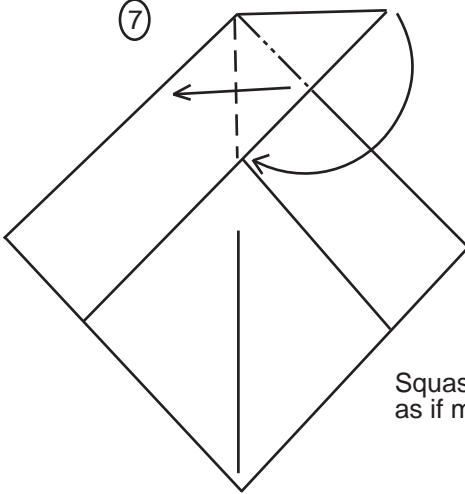

Squash fold the flap down as if making a preliminary base.

8

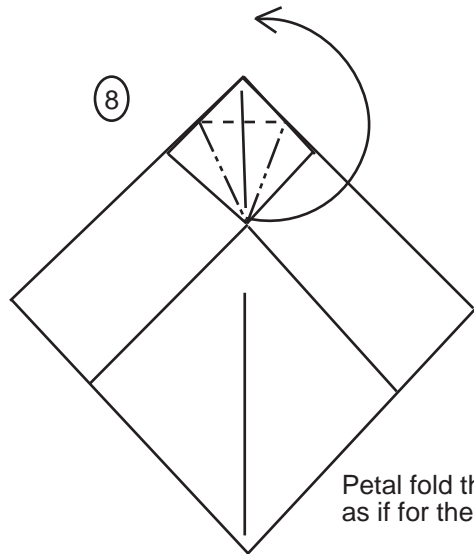

Petal fold the top flap up as if for the bird base.

9

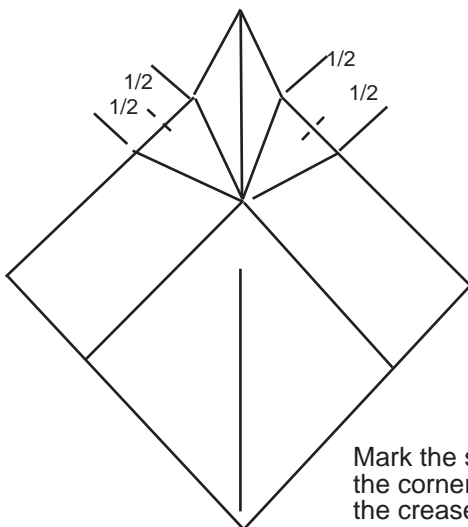

Mark the spot half way between the corner of the bird base and the crease formed in step 2.

10

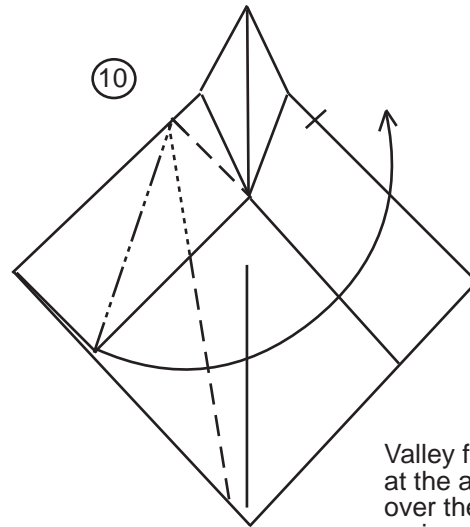

Valley fold the top layer only at the angle bisector, then fold over the flap as shown to form an irregular rabbits ear. Note, the long line on the bottom layer does not go to the tip. It is formed by flattening the paper after the two folds on the top layer.

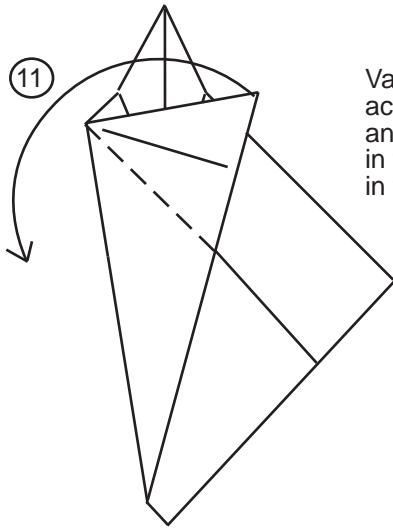

Valley fold the flap back across it's self, so that the angle bisector you folded in the last step is unfolded in this step.

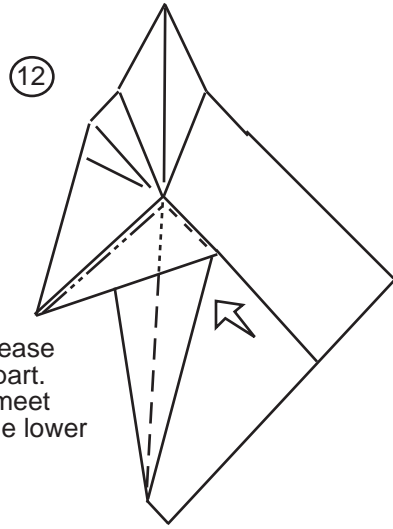

Swivel fold the flap under itself so the raw edge and the crease meet, on the upper part. The crease will not meet the edge all along the lower part.

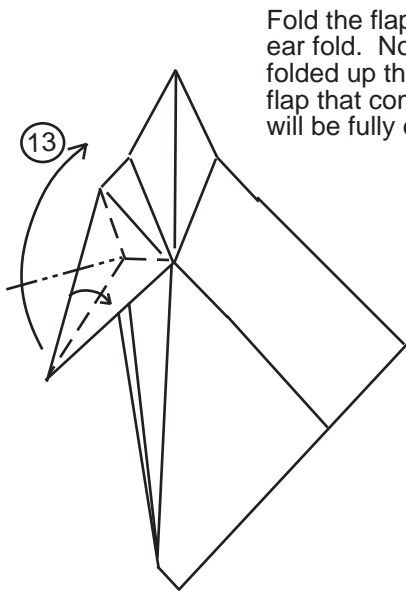

Fold the flap up in a rabbits ear fold. Note that when folded up the paper under the flap that comes to the surface will be fully extended.

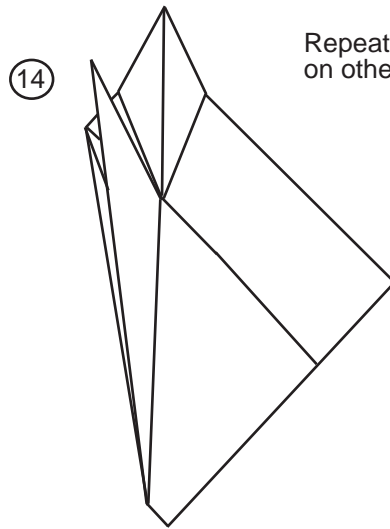

Repeat steps 10 - 13 on other side.

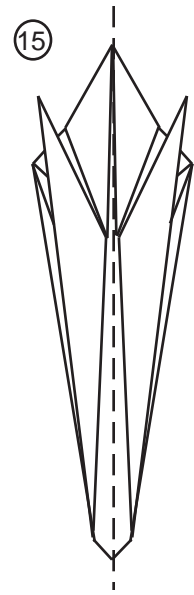

Valley fold in half and turn 90 degrees to the left.

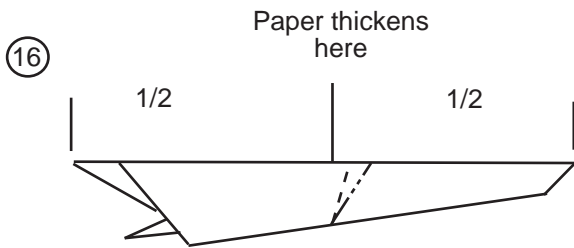

Paper thickens here

1/2

1/2

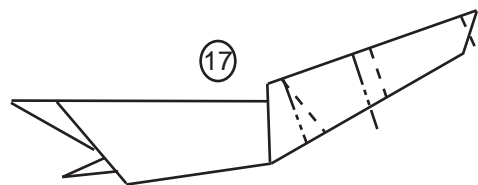

Crimp fold the front of the model back so that the bottom of the crimp is even with where the paper thickens at the top, and so that it will stick up above the surface at the top

Now we form the head, all it takes in order left to right, a crimp, a pleat an outside reverse fold.

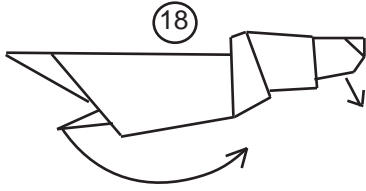

Valley fold the legs forward, as seen in 19  
Pull the snout down a little to taste.

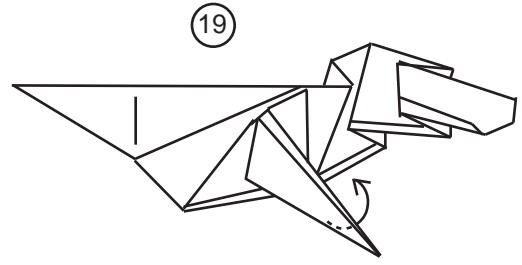

This is a cut away view of the inside of the model, as if the entire front half were missing. At this point work a colour change on the front legs by taking the bottom layer of the front leg and pull it out.

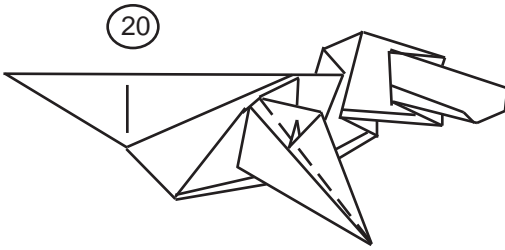

Then tuck the layer you pulled out in the previous step and tuck it into the leg, this will make the leg the same colour as the body.

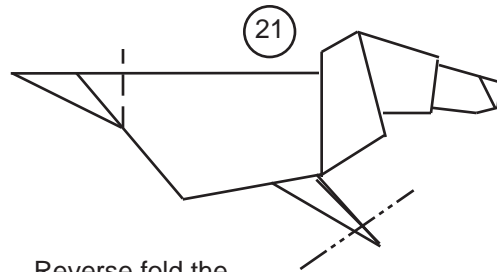

Reverse fold the tips of the front legs in to themselves. Then reverse fold the top two layers of the rear end over towards the front.

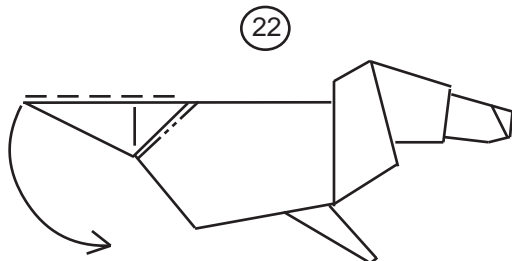

Reverse fold the hind end down.

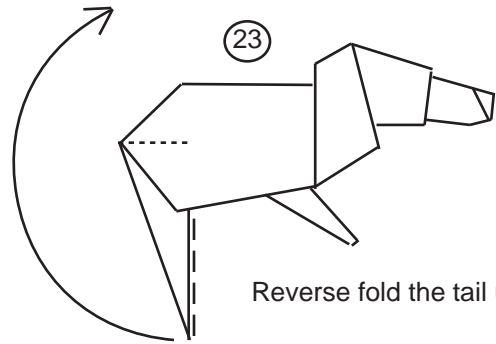

Reverse fold the tail up.

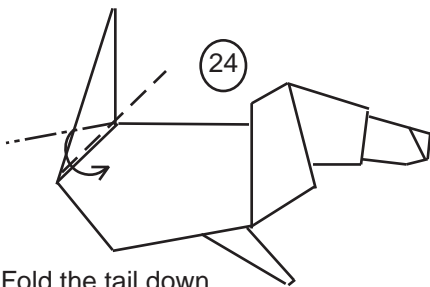

Fold the tail down with a crimp fold, then tuck the outside flaps in to the model.

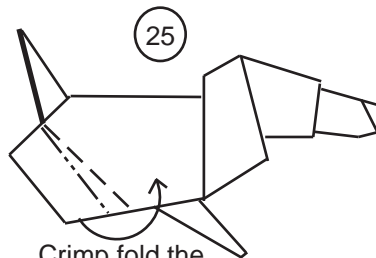

Crimp fold the body to form the rear end of the dog. (Here is a hint, do it one side at a time.)



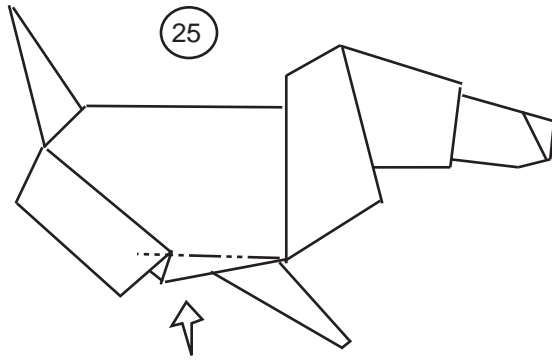

Mountain fold the excess paper up inside of the model and your done!

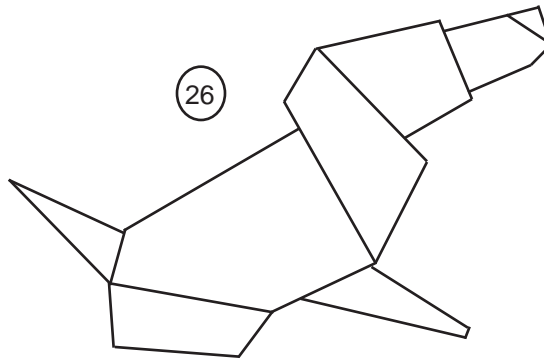

To See the puppy pounce, just tap his tail!

# Pureland Puppy by J.C. Nolan (Jan '95)

©'95

Beginner (Pureland)

Fold from a small square of paper with the colored side down. A 4" piece of paper produces a model 2" high.

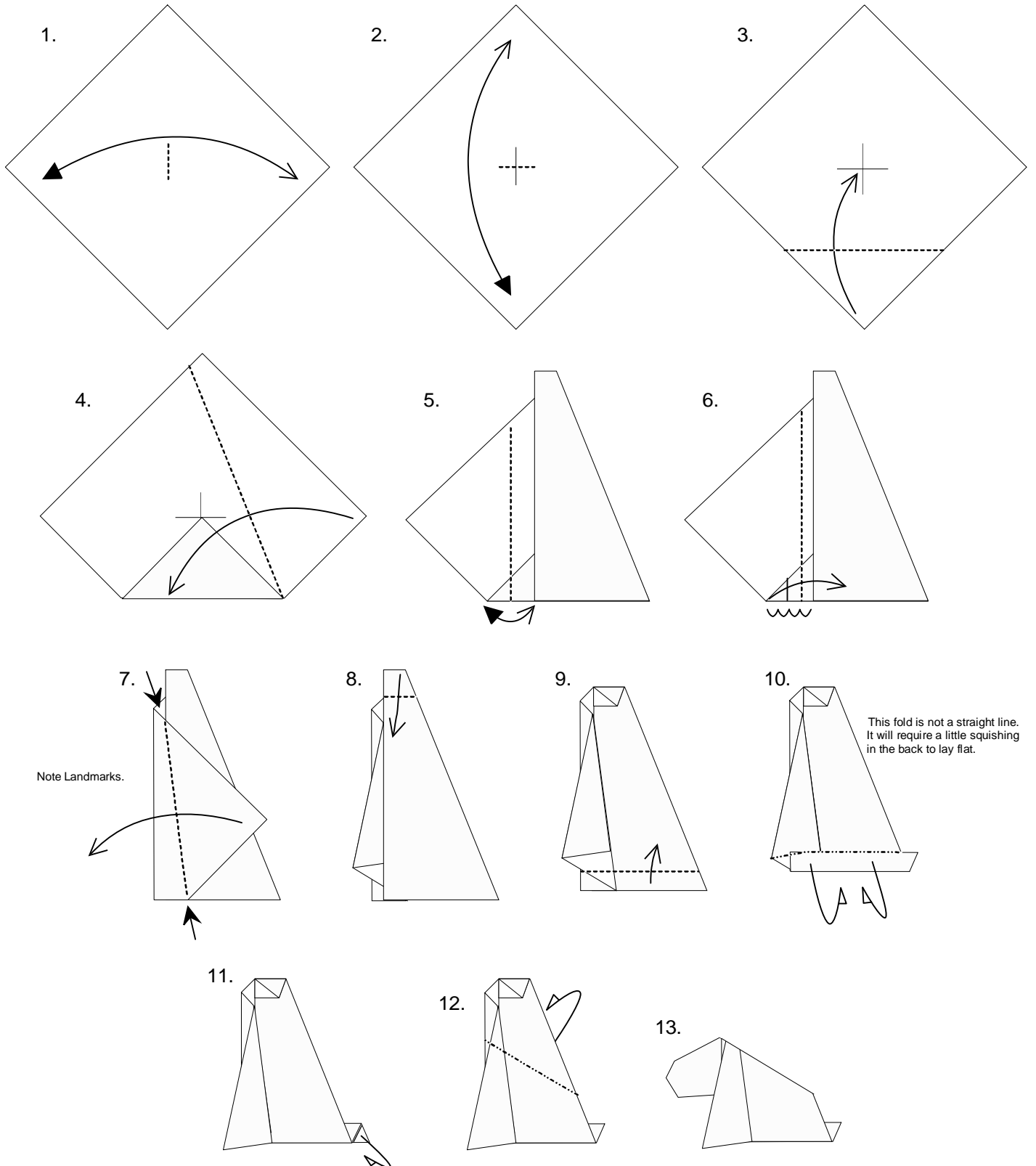

# Pyramid Container

Designed in 8/23/98 and diagrammed in 8/98;  
Inspired by traditional cup

© 1998 Sy Chen

1. Start from waterbomb base with container inside color up

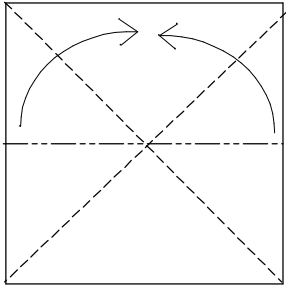

2. Enlarged

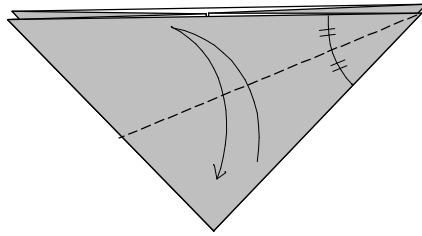

3. Upper right corner meets the end of the crease

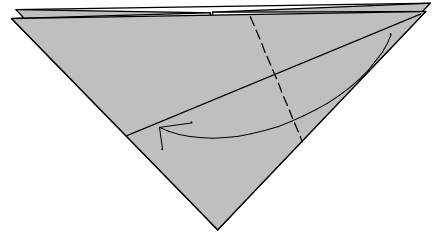

4. Fold and unfold

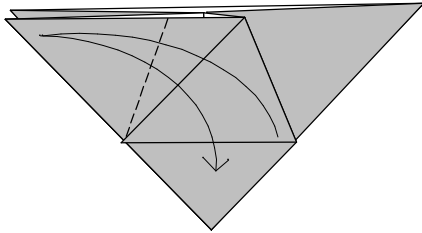

5. Tuck into pocket

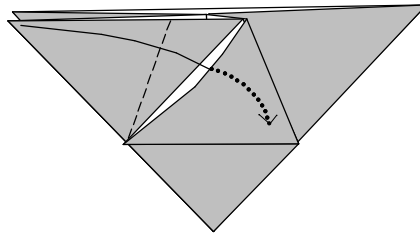

6. Repeat behind as in steps 2-5

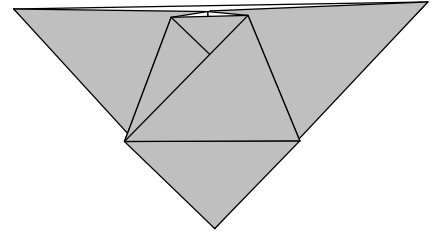

7. Enlarged; Push bottom and open the container

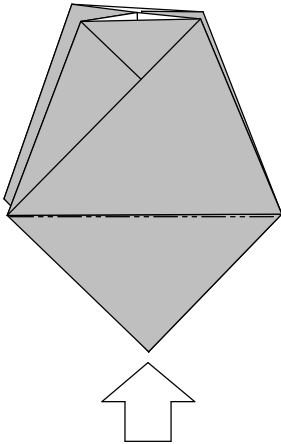

8. Finished; What can you put inside?

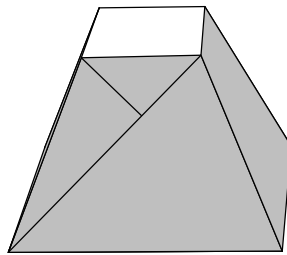

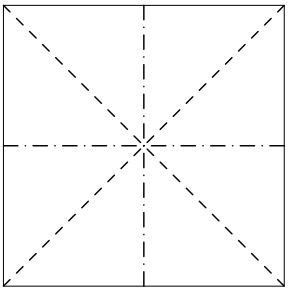

1

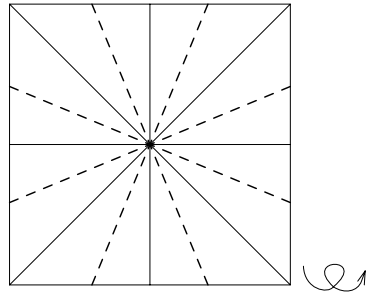

2

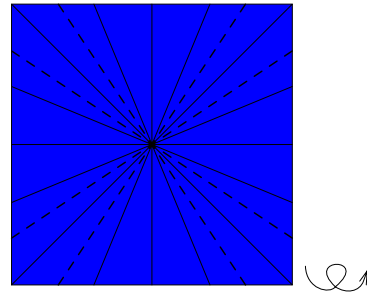

3

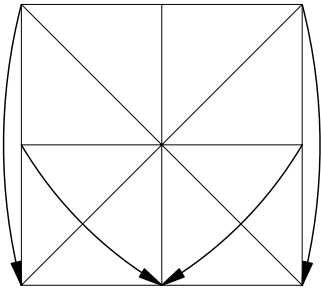

4

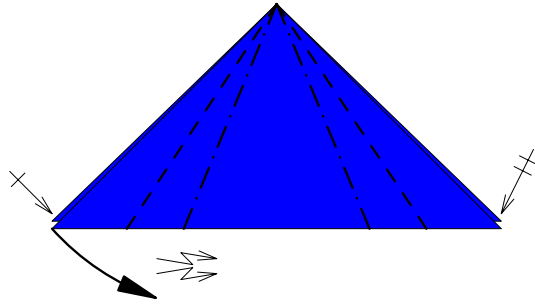

5

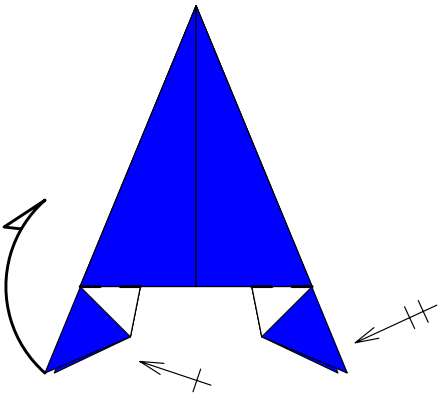

6 Outside reverse fold the tips

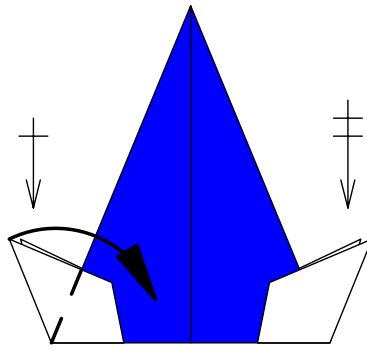

7

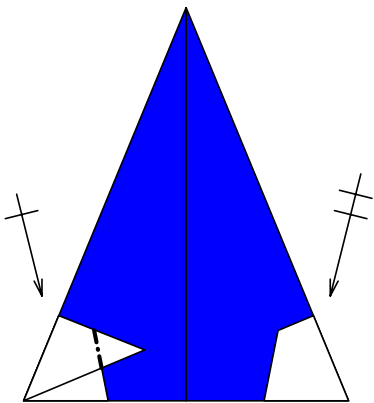

8 Fold tip behind  
Make 3D

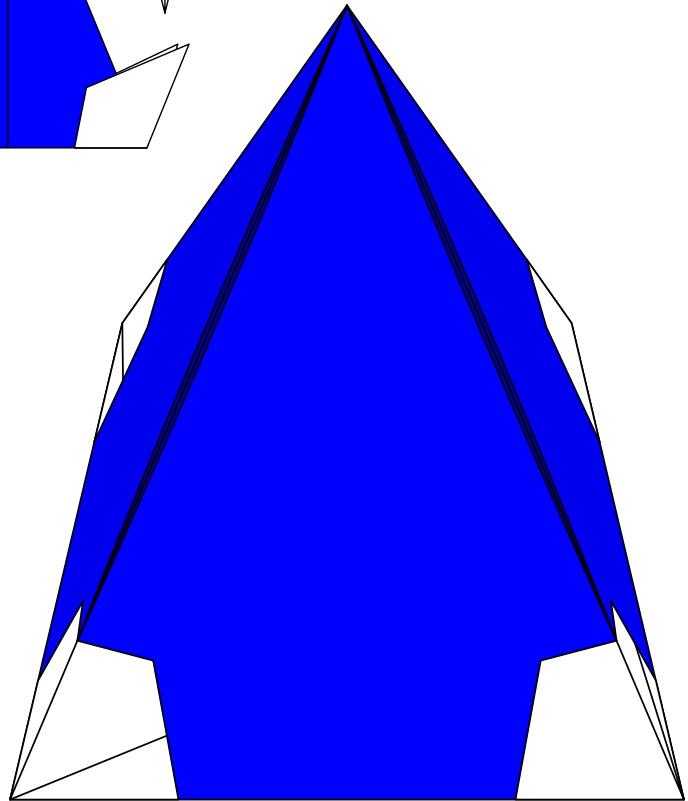

# Starship (Racer)

by Perry Bailey © 1973–1999  
inspired by Kunihiko Kasahara

Yet another model that  
should only be made from  
foil paper!

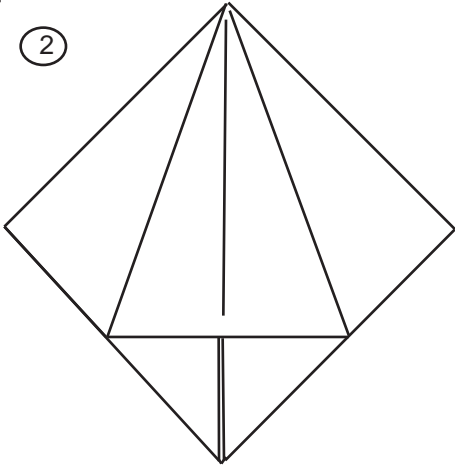
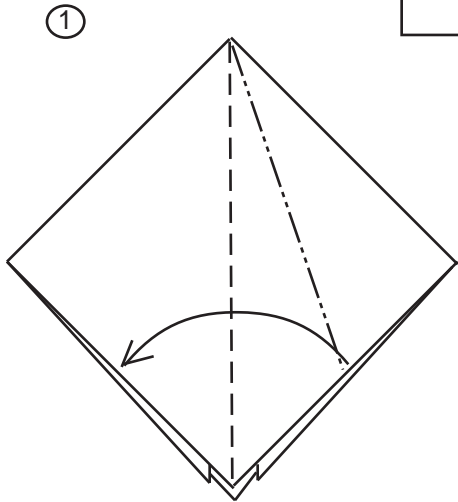

Start with the preliminary base and squash fold the right flap as shown in diagram 2,

Then repeat the squash fold on the other three flaps, as if making the frog base.

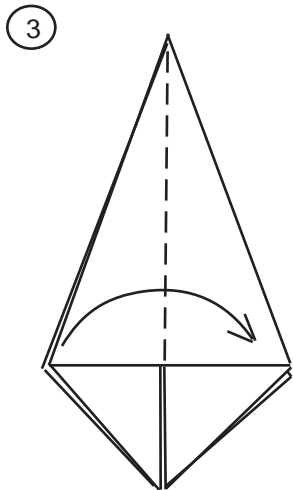

Now fold over one flap on both sides.

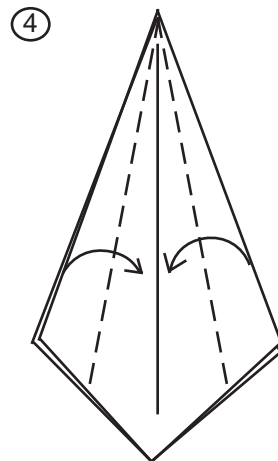

Valley fold the sides to the middle to thin the model down. Repeat on all sides, that is three more times..

5

Fold one flap over on both sides.

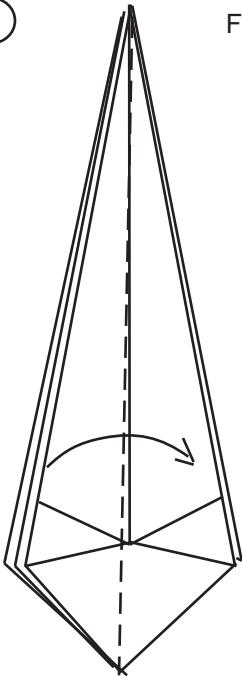

6

Now fold inwards the outside edges, note that they do not go all the way over. Repeat on the other three sides.

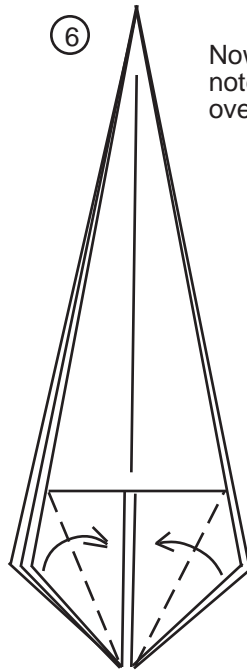

7

Reverse fold up all four points all the way to the center of the model.

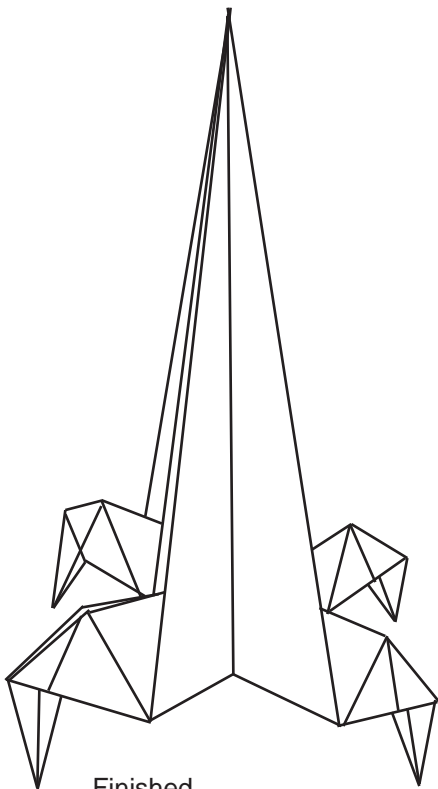
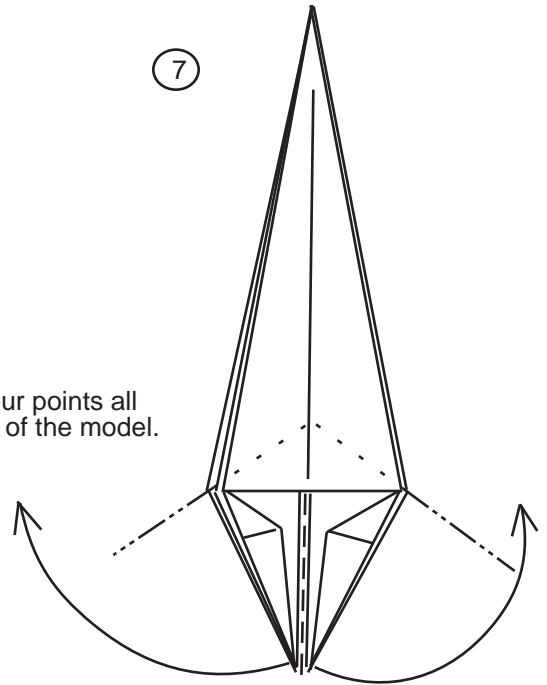

Finished

8

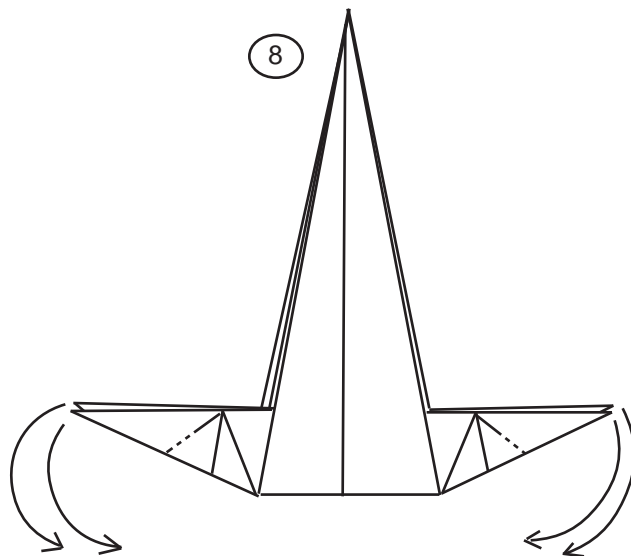

Reverse fold the four legs down evenly so it will stand correctly. Then either even out the flaps so they are equidistant or use a tool to bring the four sides out if you prefer.

# Reading the Paper

by Herman van Goubergen

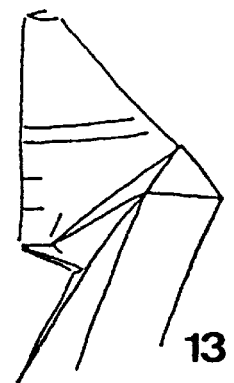
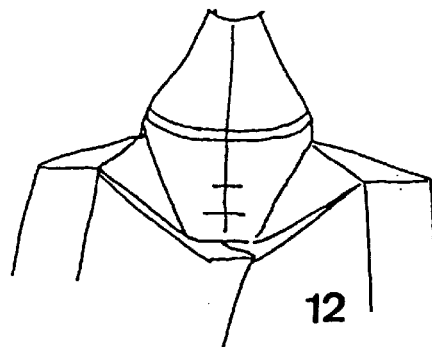
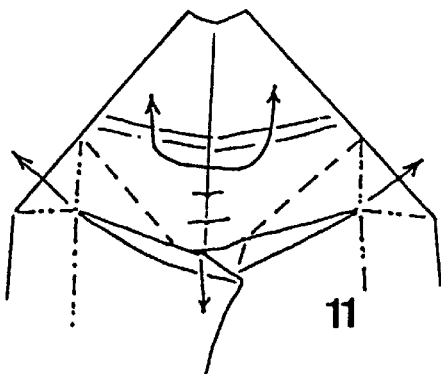
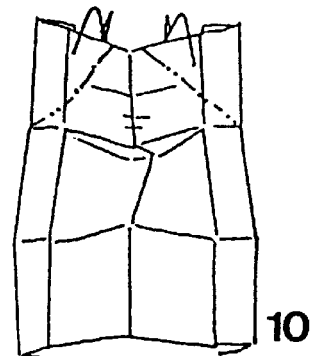
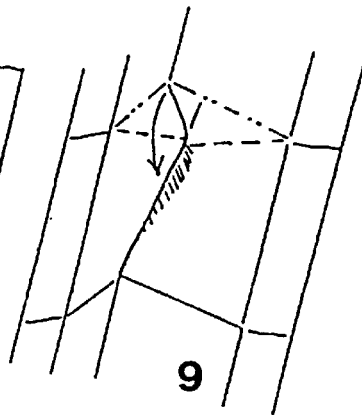
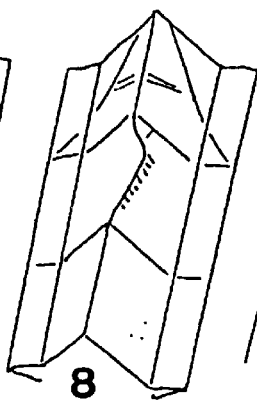
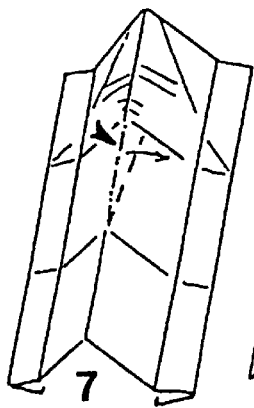
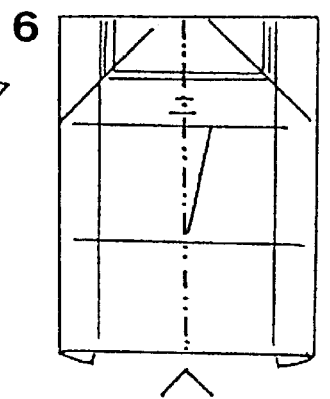
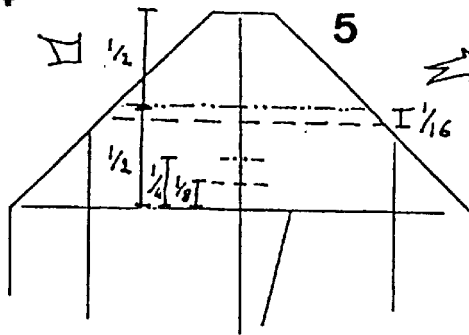
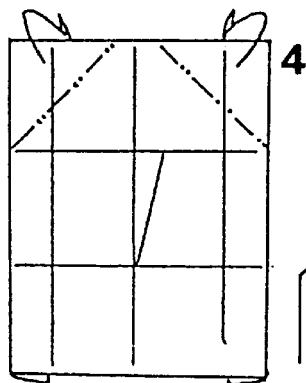
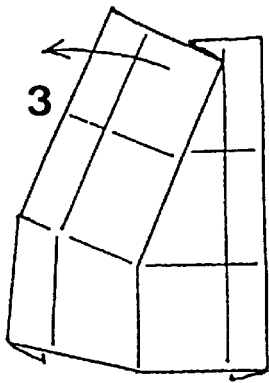
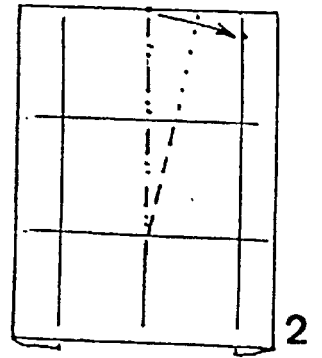
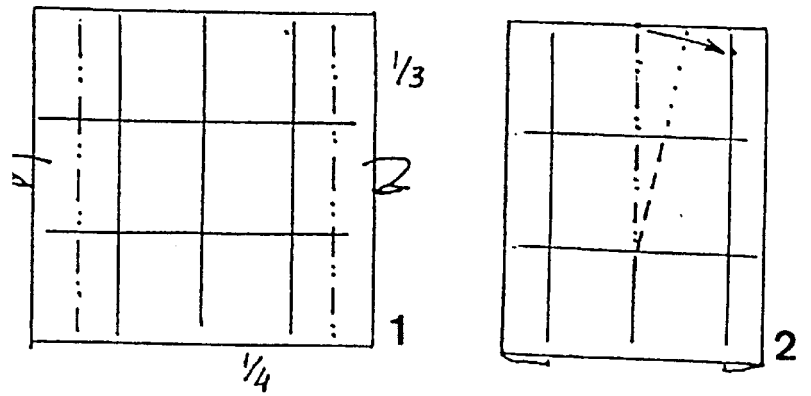

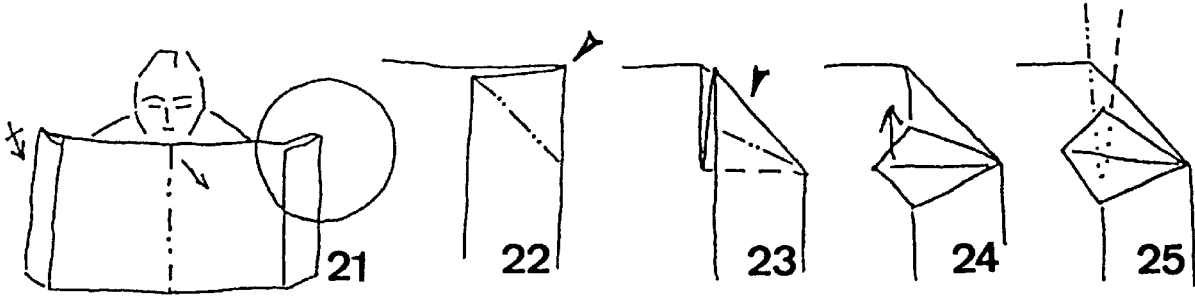
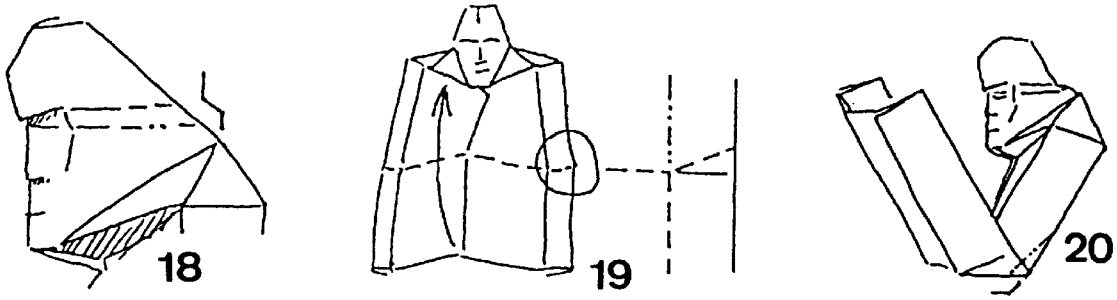
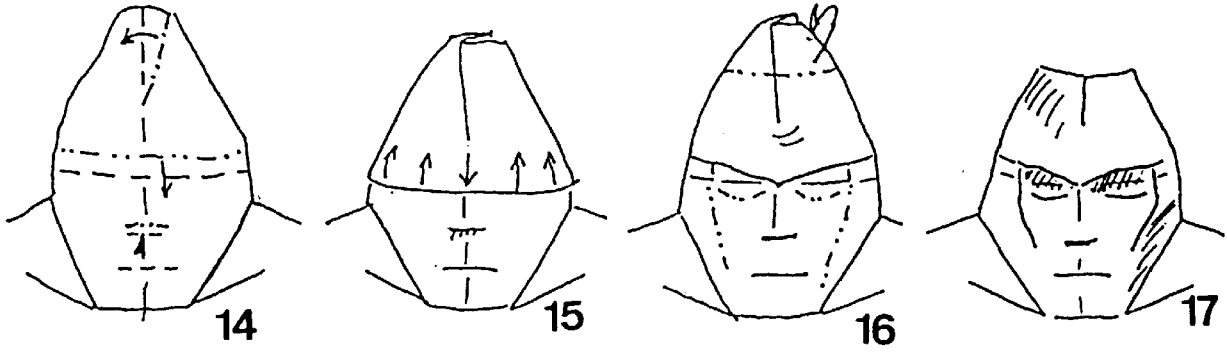

Copyright © 1992 Herman van Goubergen, all rights reserved.  
 PDF version 1999 by Sebastian Marius Kirsch <skirsch@t-online.de>.  
 Distribution for noncommercial purposes is free. Please contact the author  
 if you want to use this model for commercial purposes.



Chinese Modular Unit  
Diagrammed by  
Robert Hudson  
4/11/96

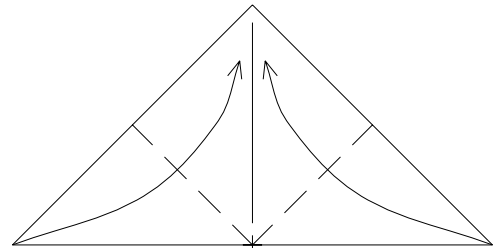
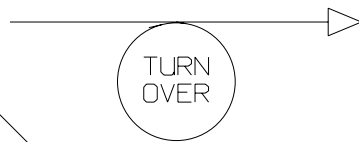
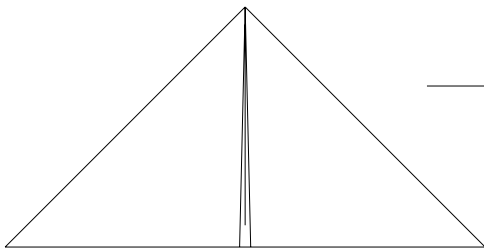
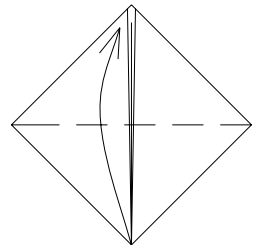
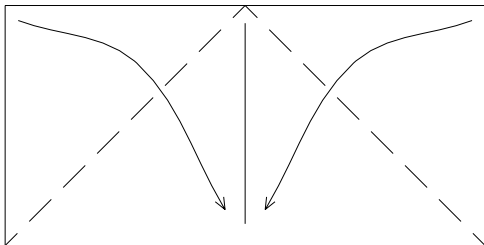
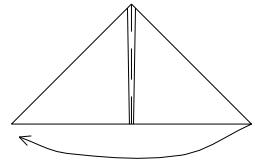
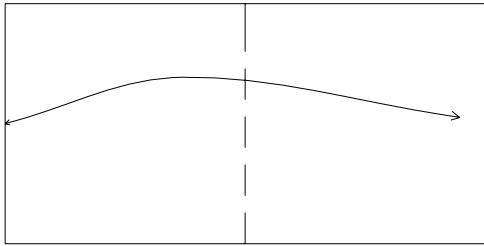
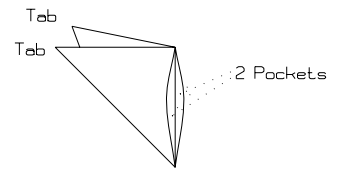

# MASCOTA DESCANSANDO

José Tomas Buitrago Molina  
Colombia (c) 1997

Media hoja tamaño carta: 4 ¼" x 11" (11x28 cm).  
Tamaño final: 3" (7.6 cm)  
Color abajo

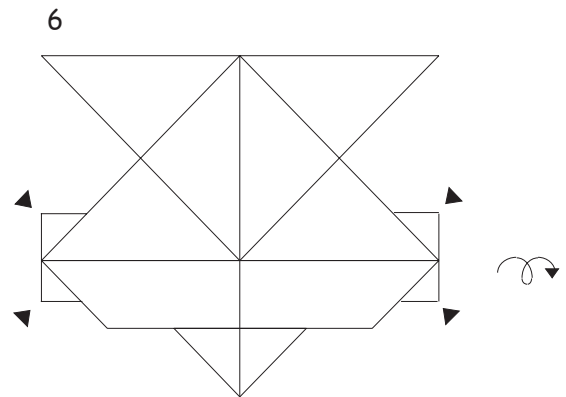
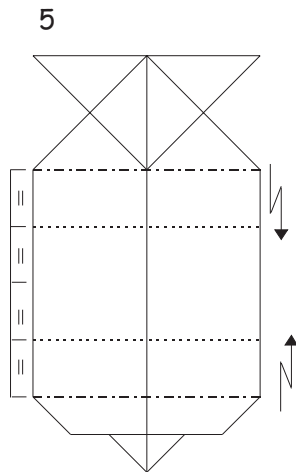
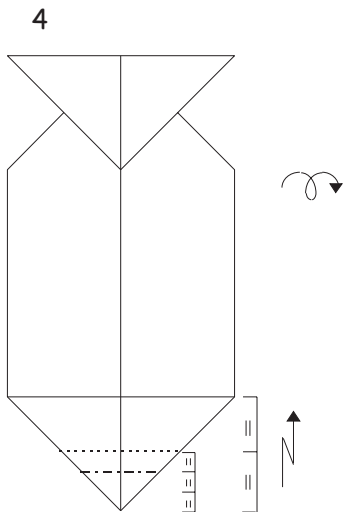
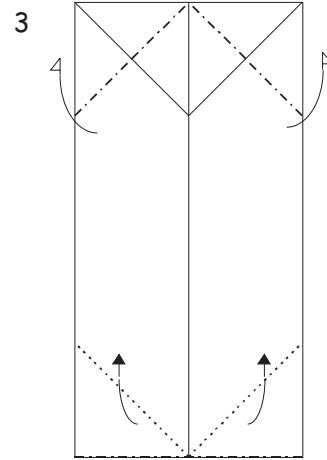
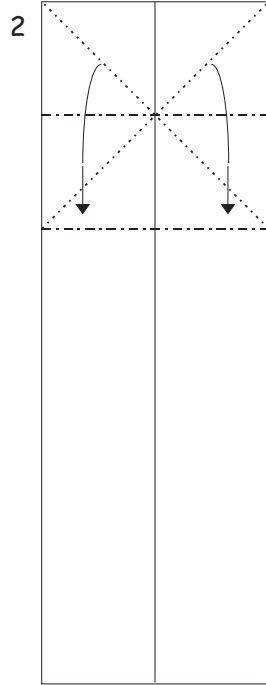
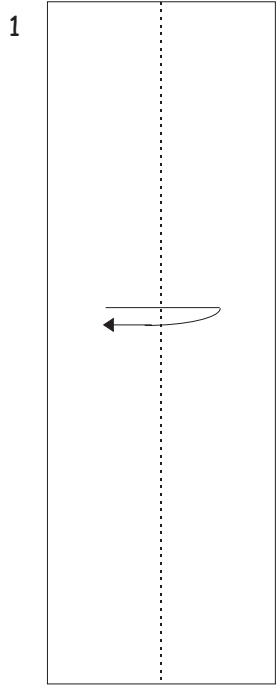

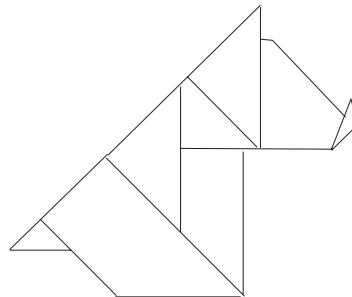
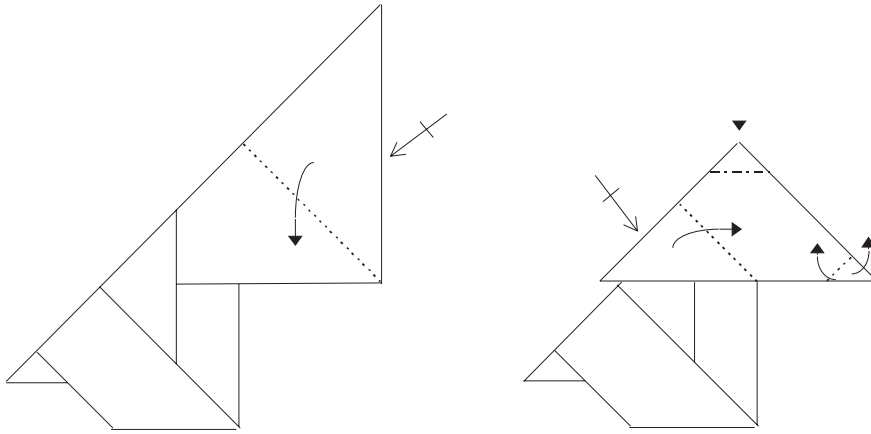
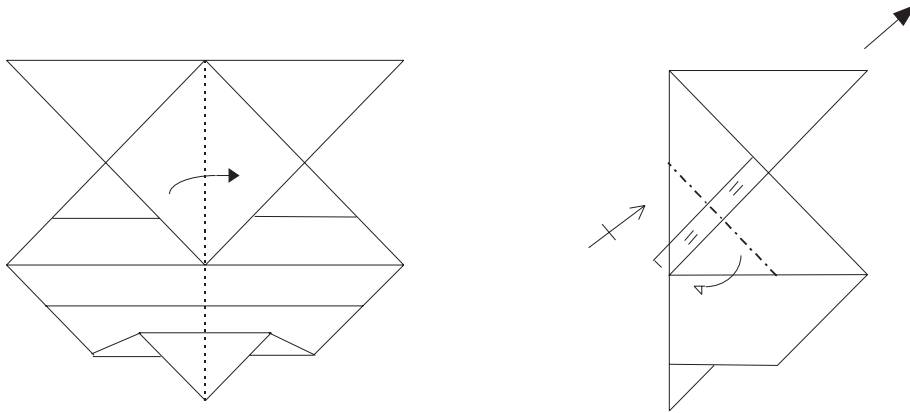

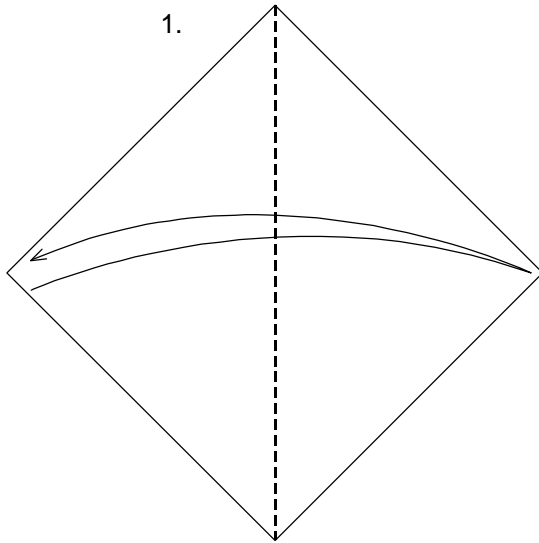

A sheet of paper of at least 20 cm square would be preferred for this model. Fold and unfold diagonally in half, creasing well.

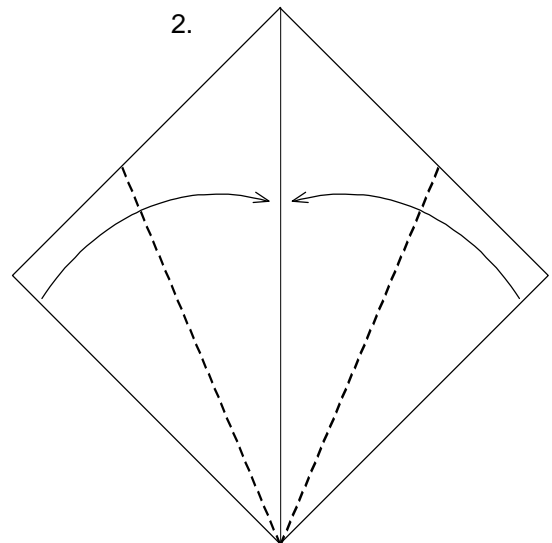

Now fold the lower diagonal edges to meet along the vertical crease line in the centre.

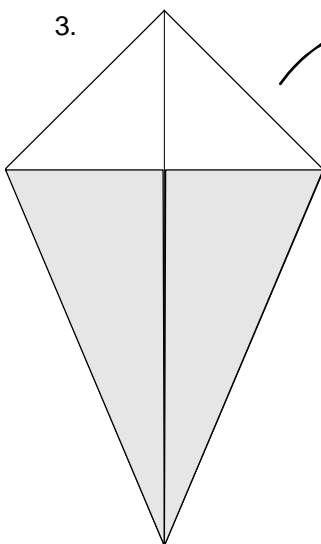

Turn paper over ...

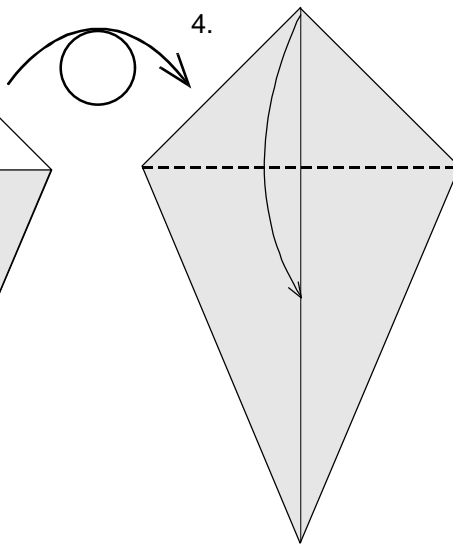

... and fold down the triangular portion at the top as illustrated.

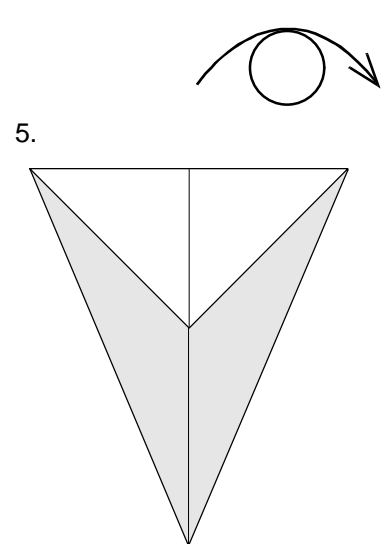

Turn the paper over again ...

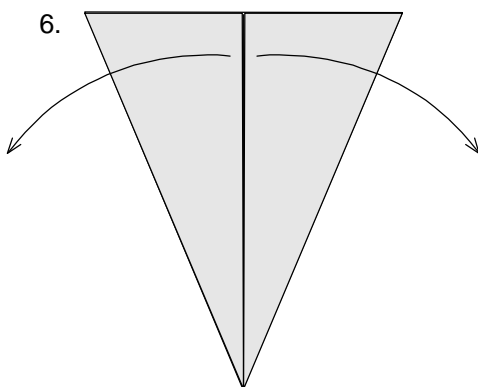

... and unfold the overlapping layer to each side ...

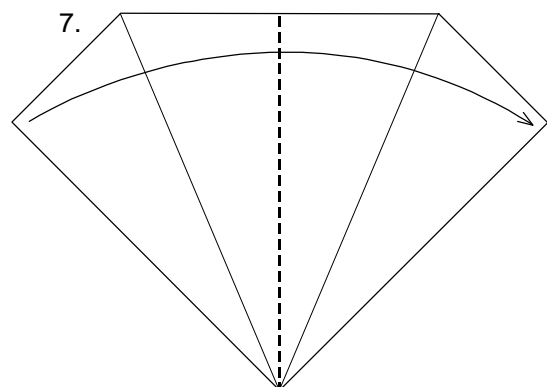

... like this. Now fold vertically in half, from left to right ...

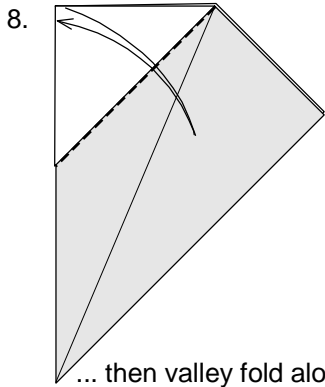

8.

... then valley fold along the edge of the white triangular portion, crease firmly, and unfold.

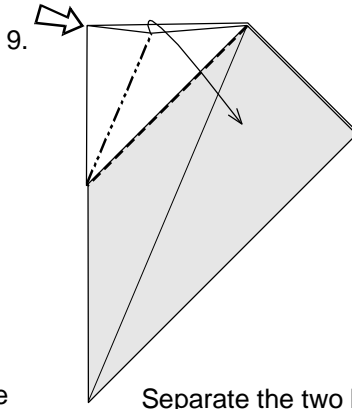

9.

Separate the two layers along the horizontal edge and squash fold.

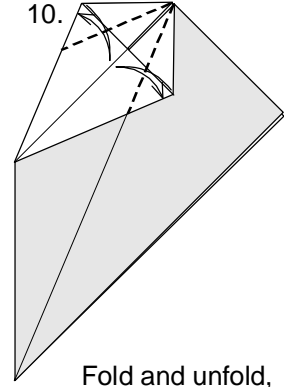

10.

Fold and unfold, Creasing firmly ...

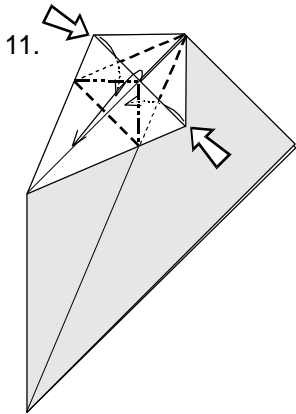

11.

Do a petal fold by pulling the diagonal edge of the uppermost layer 45 degrees down and to the left, while drawing in the horizontal and vertical edges at the top together ...

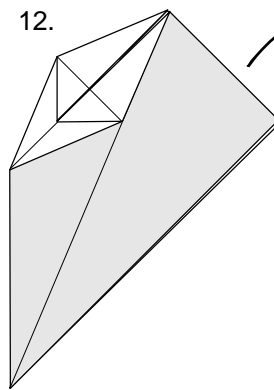

12.

... like this. Turn the paper over, ...

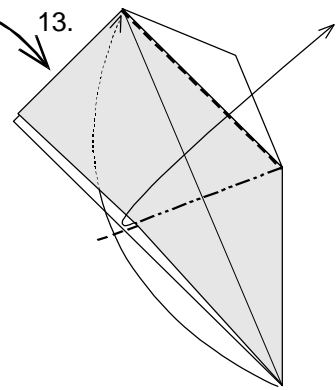

13.

... separate the two layers along the diagonal edges on the left and squash fold.

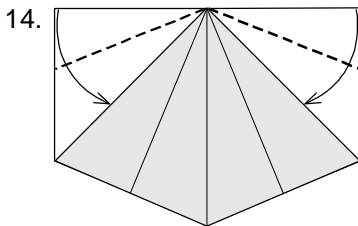

14.

Valley fold the horizontal edge of the white layer to meet the diagonal edge of the coloured layer on each side, ...

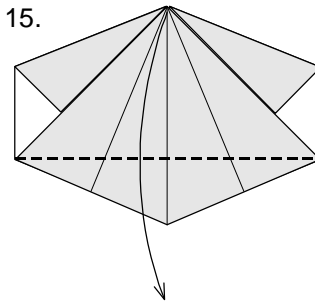

15.

... then fold down the coloured triangular portion in the middle as illustrated.

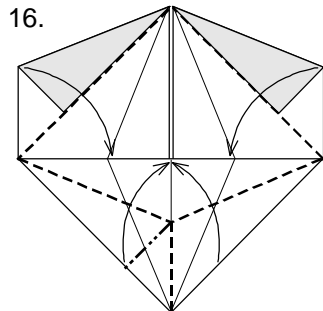

16.

Fold down both corners at the top, and do a rabbit's ear fold at the bottom ...

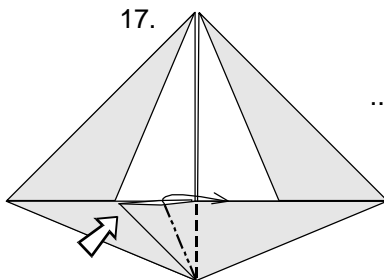

17.

... like this. Separate the two layers of the triangular tab and squash fold, ...

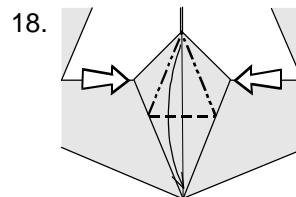

18.

... then mountain fold along the existing diagonal crease lines to narrow the upper section before bringing the point at the top to meet the point at the bottom ...

19.

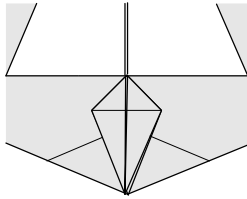

... like this.

20.

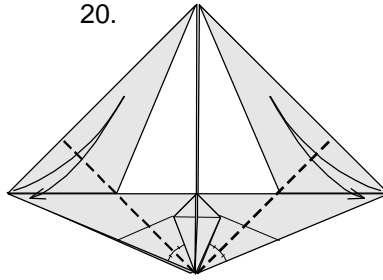

Fold the lower diagonal edges to meet the adjacent diagonal edge of the kite-shaped flap in the centre, crease firmly, and unfold.

21.

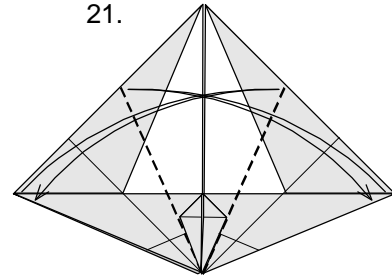

Fold and unfold again as illustrated, creasing firmly again.

22.

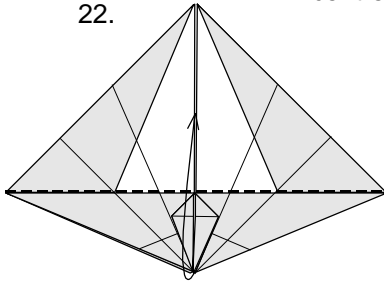

Fold the first layer up,...

23.

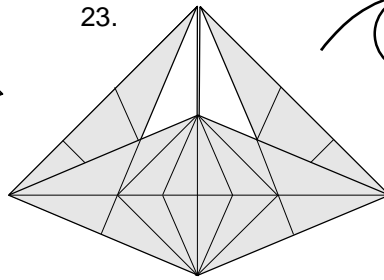

... then turn the model over.

24.

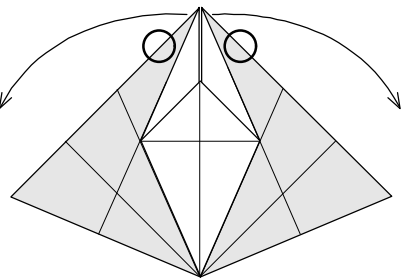

Grasp each side at the circled areas, holding the coloured portions only, then pull apart to open out ...

25.

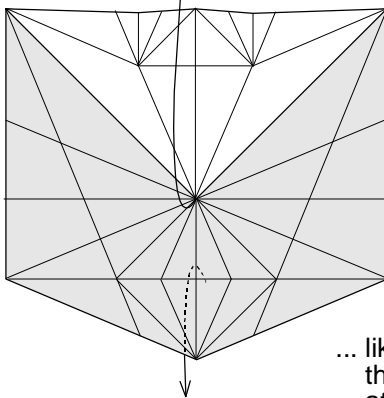

... like this. Now lift up the the white triangular layer at the top and the second layer at the bottom ...

27.

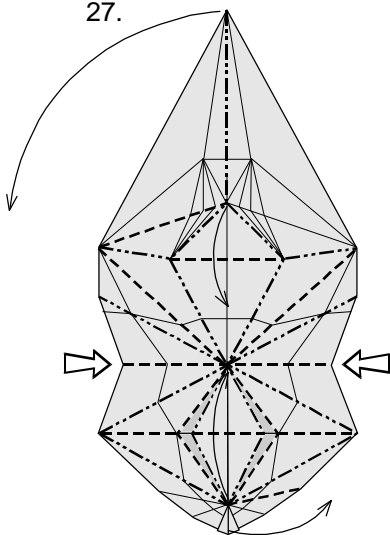

... like this ...

26.

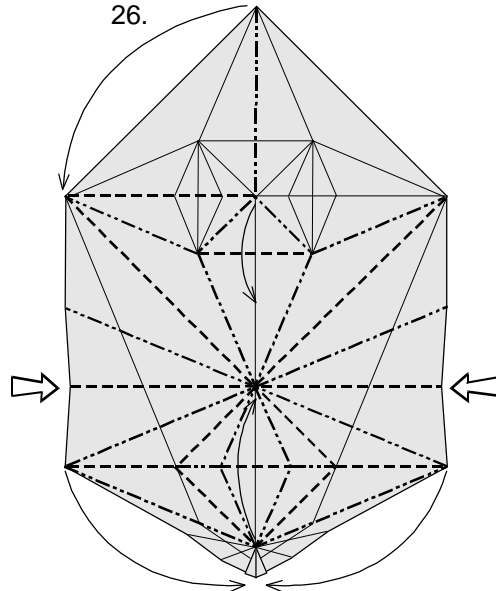

... then collapse along the existing crease lines with mountain and valley folds as illustrated ...

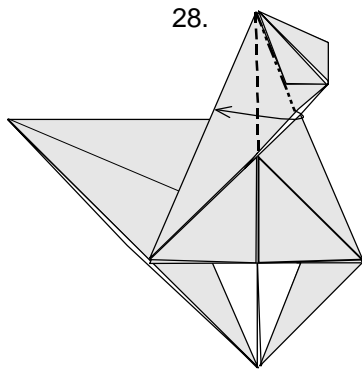

Draw one layer to the left and squash fold ...

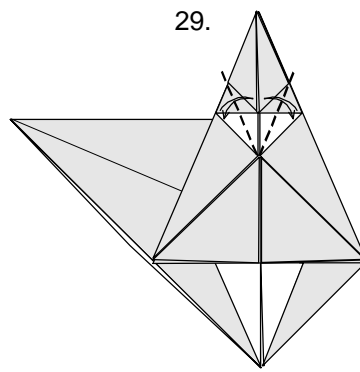

... as illustrated, then fold and unfold, creasing firmly.

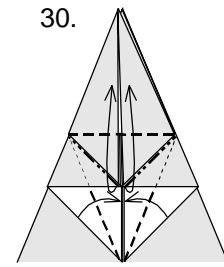

Valley fold the triangular tabs in the middle upwards, at the same time valley folding the lower diagonal edges to meet in the centre ...

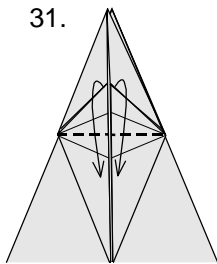

... like this. Fold down the triangular tabs in the middle again.

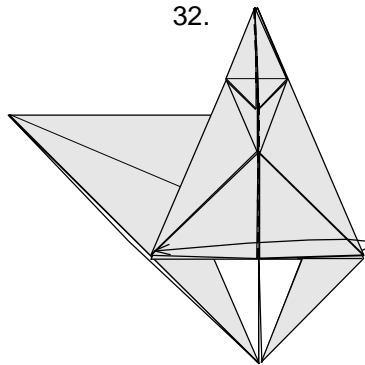

Swivel one layer on the right to the left.

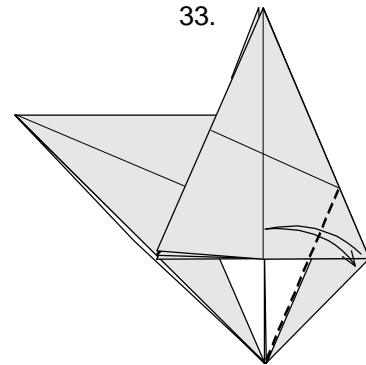

Fold and unfold, creasing firmly, ...

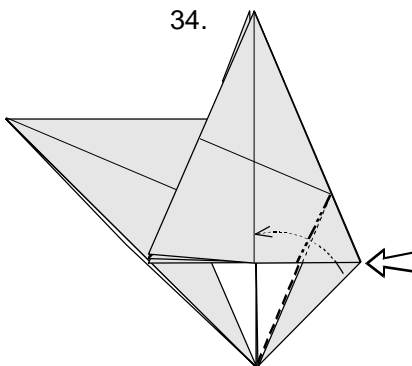

... then reverse fold along the crease lines made in Step 33

...

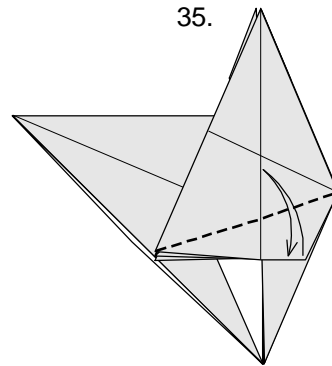

... like so. Fold and unfold, creasing firmly again, ...

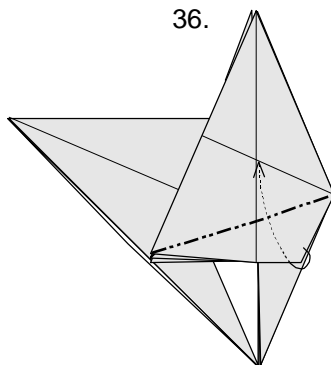

... then mountain fold the excess paper under along the crease line made in Step 35.

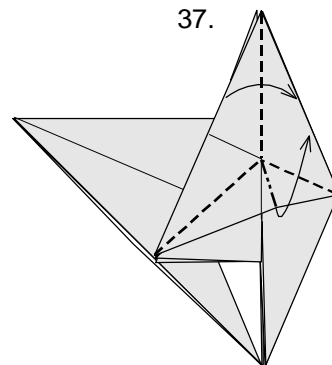

Rabbit's ear fold as shown, swivelling one layer on the left to the right.

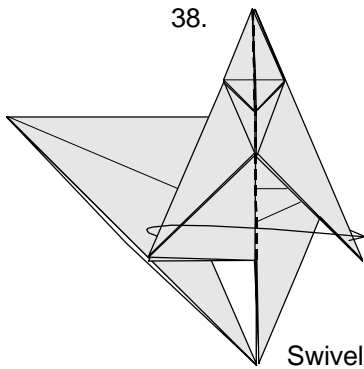

38.

Swivel one layer on the left to the right, and repeat from Step 33 on this side.

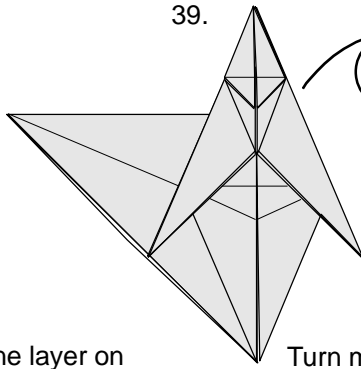

39.

Turn model over.

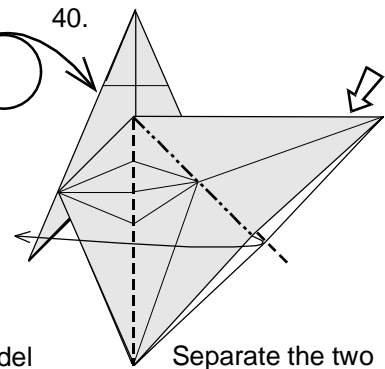

40.

Separate the two layers along the diagonal edges and squash fold, ...

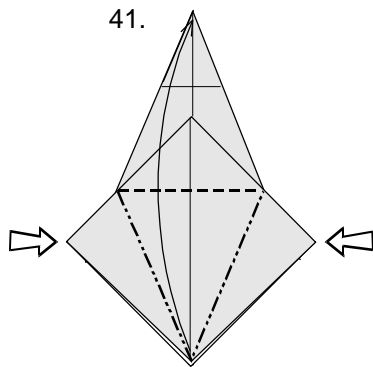

41.

... like this. Reverse fold the corners along the existing crease lines and bring the resulting point at the bottom all the way to the top.

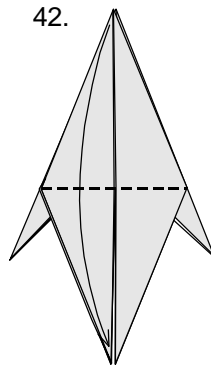

42.

Fold the flap down again ...

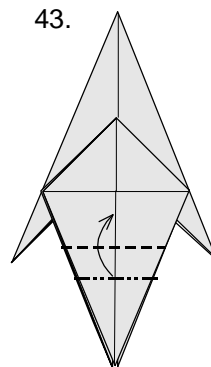

43.

... and crimp with a mountain and valley fold, ...

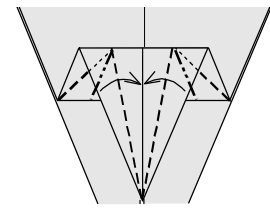

44.

... then narrow as illustrated ...

45.

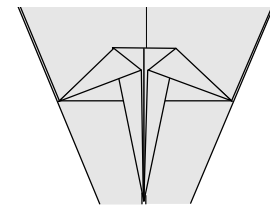

... like this.

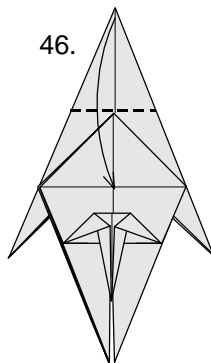

46.

Fold down one layer from the top ...

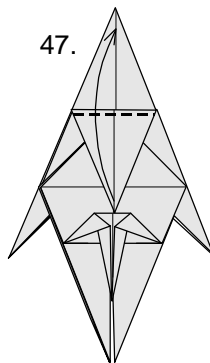

47.

... then fold up again, making a little crimp.

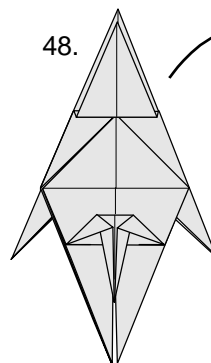

48.

Turn the model over.

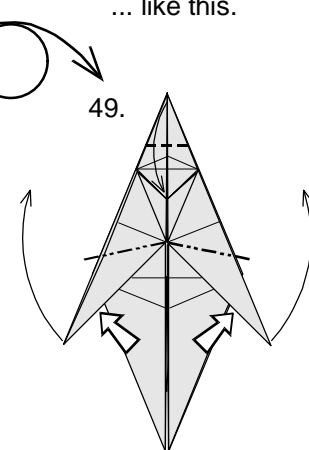

49.

Fold down the first layer at the apex of the model and crease well, then reverse fold the points on each side.

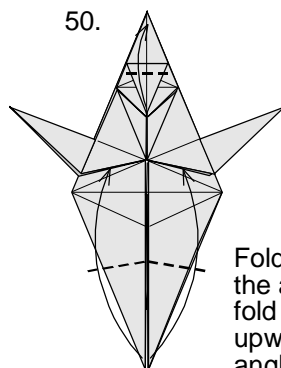

50.

Fold up the the first layer at the apex again, and valley fold the lower points upwards at the illustrated angles and proportions.

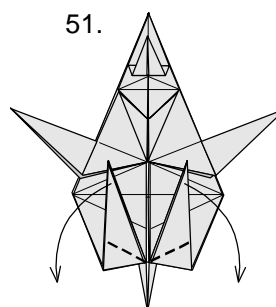

51.

Valley fold the lower points down again.



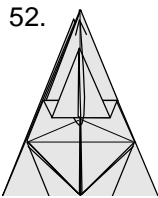

52. Unfold the Steps at 49 and 50 on the apex of the model ...

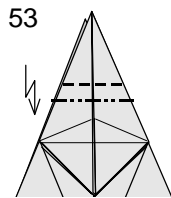

53. ... and refold along the crease lines as illustrated, ...

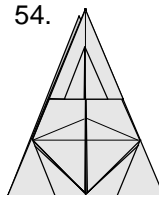

54. ... like this.

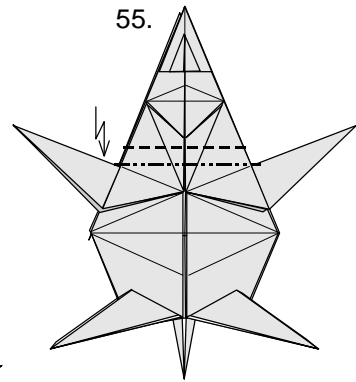

55. Make a crimp as illustrated with a mountain and valley fold, ...

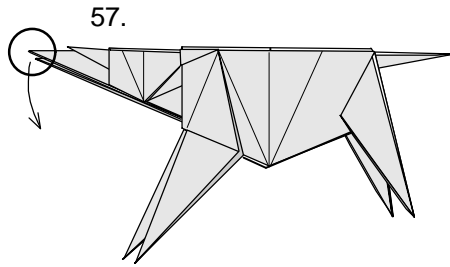

57. Grasp the head firmly and pull down gently ...

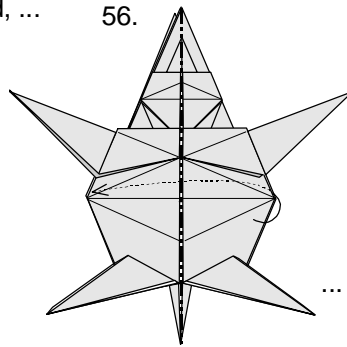

56. ... then mountain fold the model vertically in half.

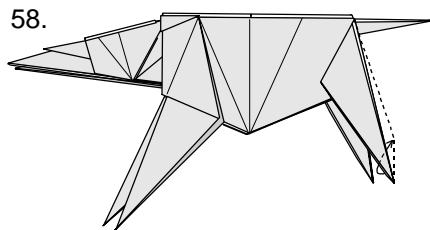

58. Broaden each hind leg by drawing out the second layer to the back as indicated by the dotted lines.

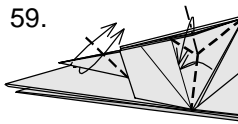

59. Rabbit's ear fold the triangular tabs on each side to form the ears, then flatten the head temporarily and outside reverse fold the short point in the middle to form one horn.

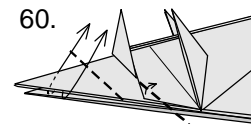

60. Outside reverse fold the next point to form the second horn, and valley fold the little corner on each side to form the eyes.

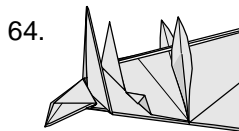

64. ... like this.

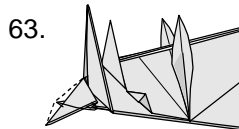

63. ... then lift up the first layer on each side ...

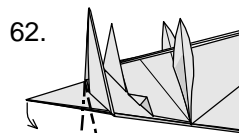

62. Crimp fold the front of the remaining point under ...

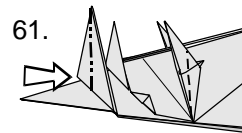

61. Sink the front section of the horn. A pair of tweezers will help. Open out both ears as shown.

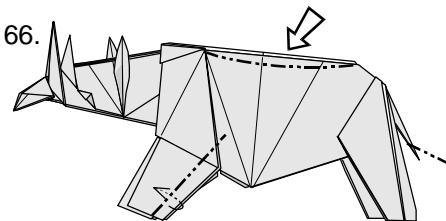

66. Narrow both sides of the forelegs by fold the excess paper within. Do another reverser fold at the tip of the tail, then complete the model by rounding off the back.

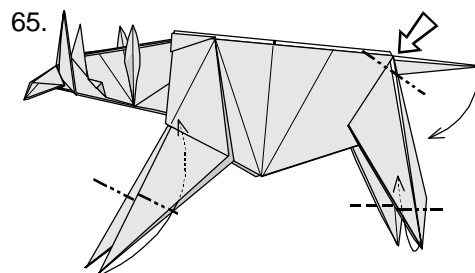

65. Inside reverse fold all the legs and the base of the tail as illustrated.

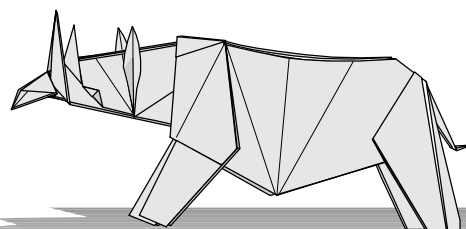

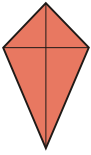

Start with a bird base.

Valley fold both sides of the upper layer to the middle and open again. The creases shouldn't pass the horizontal line.

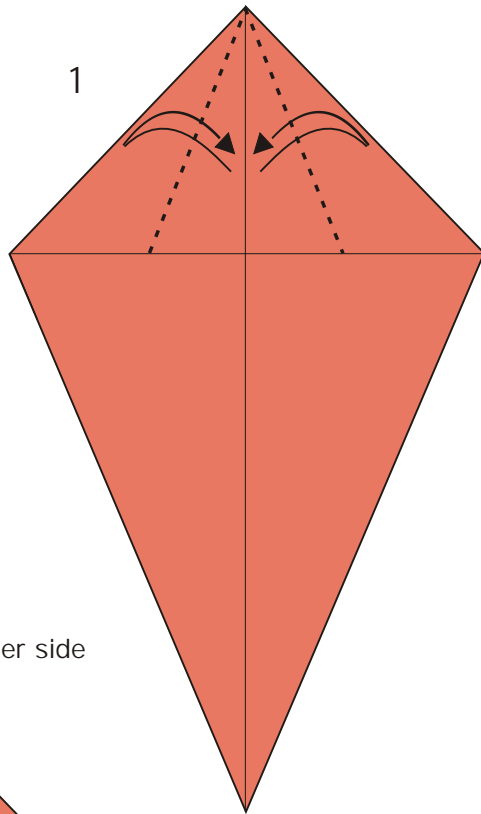

Precrease the following valley folds, which are changed into mountain folds later on. The vertical line has to meet the circled corner. Make sure to crease only the short distance between the two dots on the horizontal and vertical line. While making this crease, the flap doesn't lie flat.

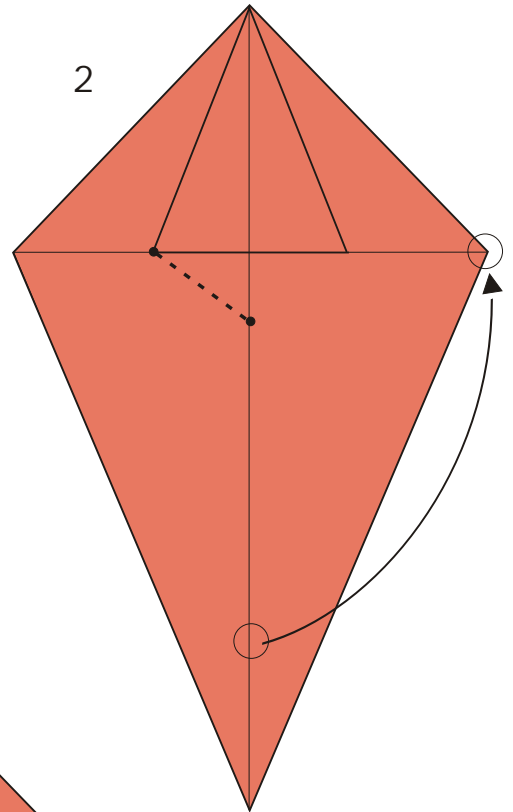

Repeat step 2 on the other side and unfold again.

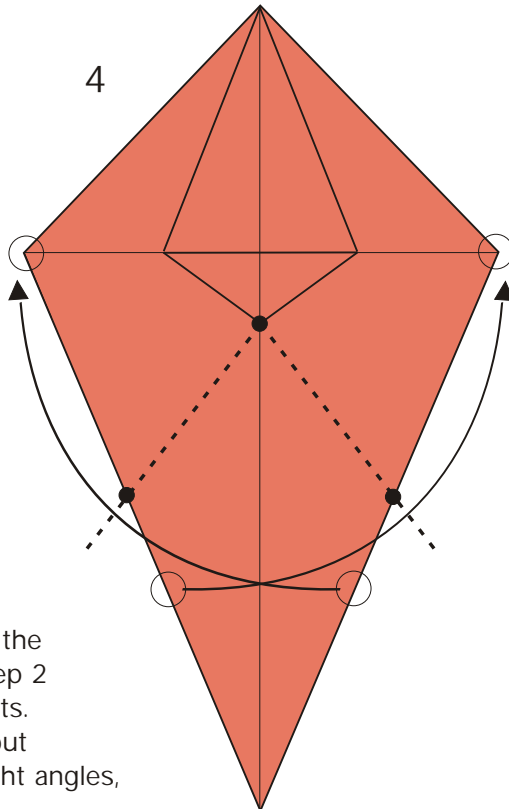
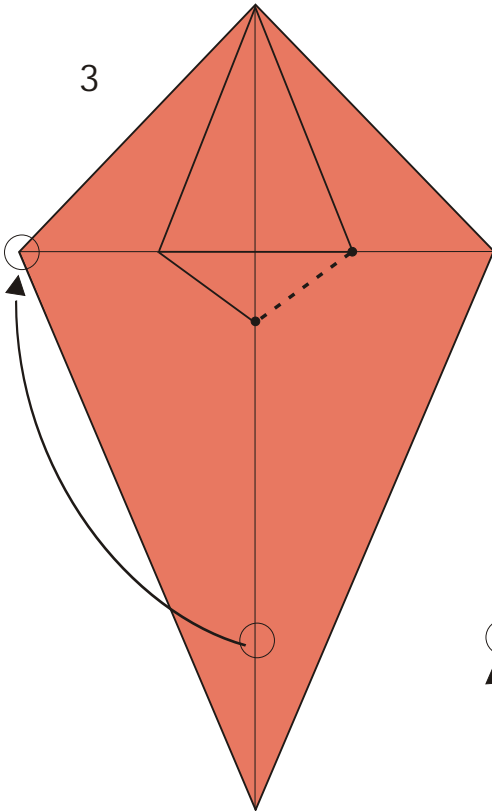

Now make the circled edges meet the upper corners across, similar to step 2 and 3. Crease only between the dots. I had best results with this angle, but you could also experiment with right angles, shown in step (B).

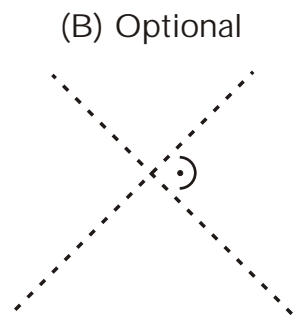

Collapse the upper layer by folding up the dot, so it touches the vertical line. Note, that the precreased valley folds, which you made in step 2, 3 and 4 will have to change into mountain folds. The four additional valley folds A) and B) will come naturally.

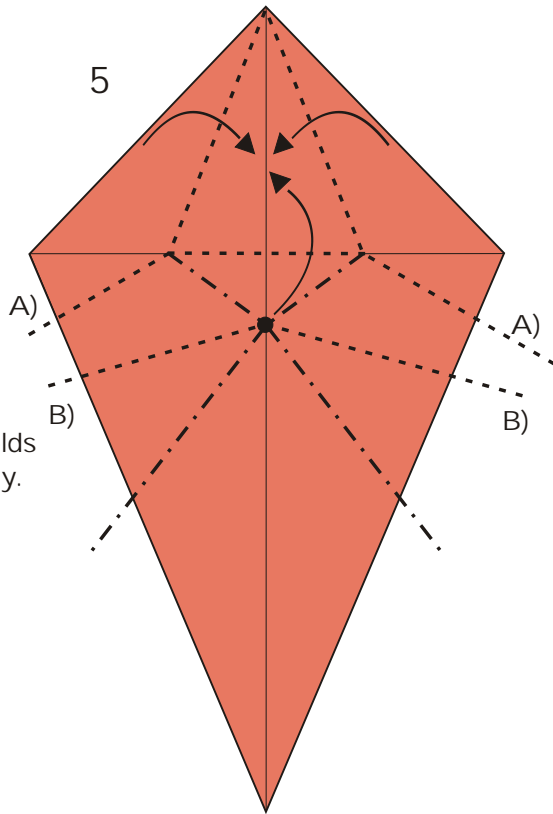

This is what your model should look like now. Swing up layer from underneath to the top.

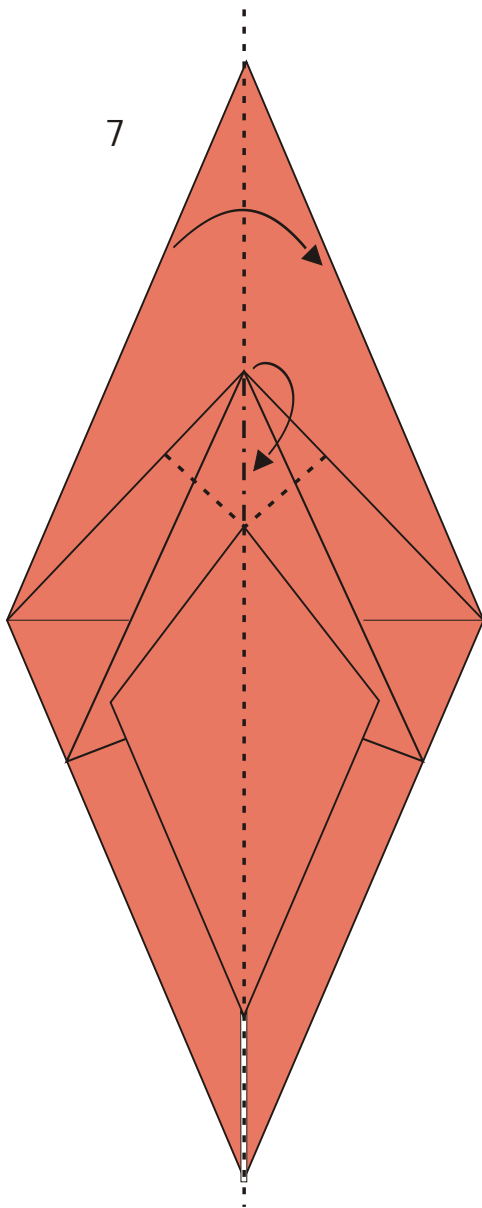
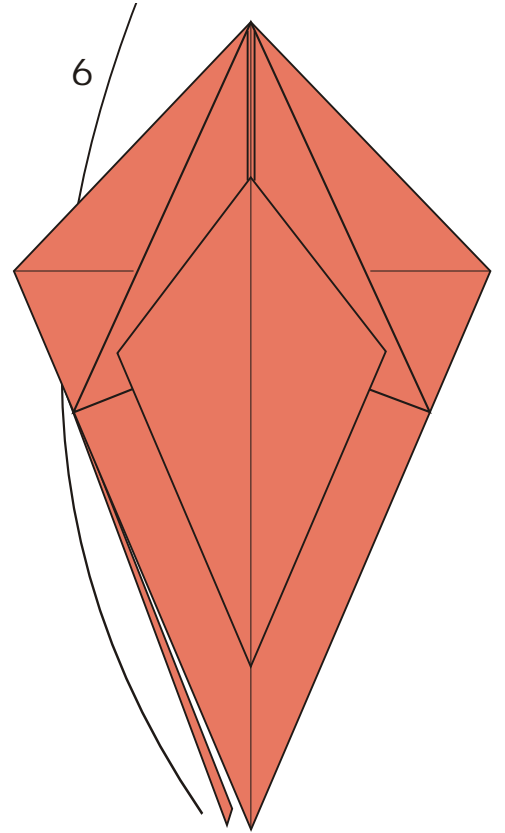

Fold model in half, while bringing down the lower tip of the bird base on the indicated valley and mountain folds.

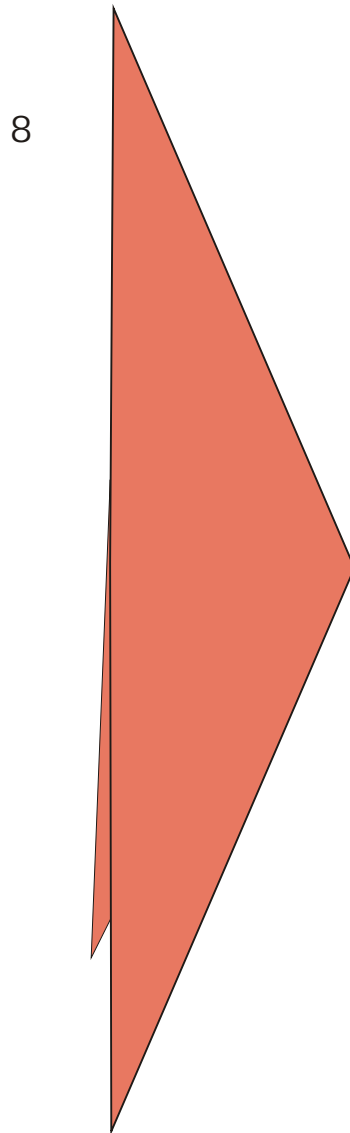

Let's have a look under the first layer. Push up marked corner to make the tail.

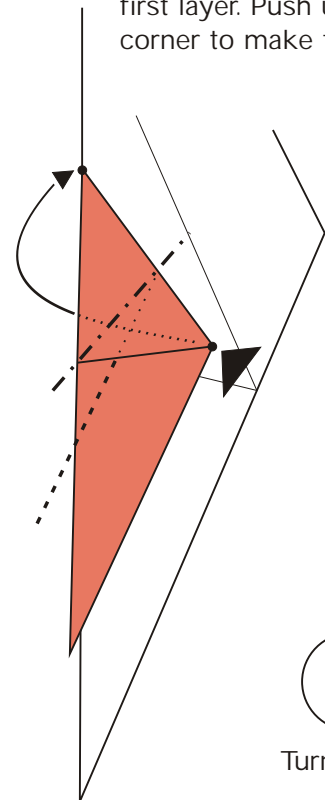

90°  
Turn model

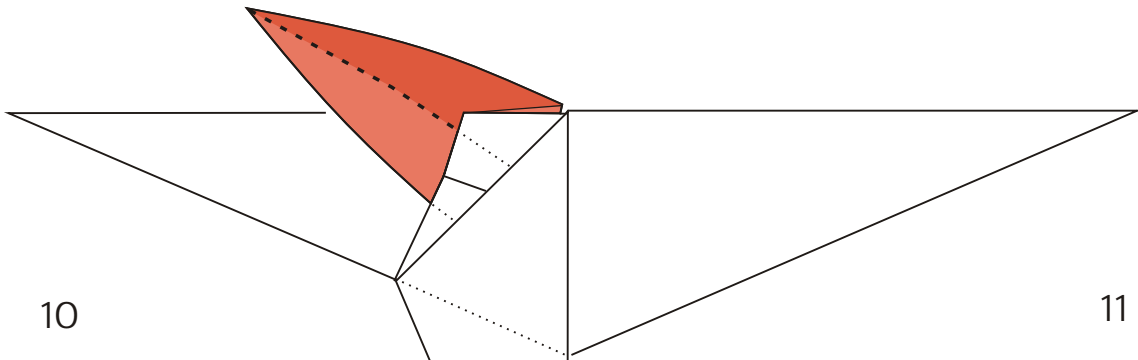

10  
 (In this 3D diagram the first layer is folded down, to allow a better view on to the tail underneath. Don't crease.)  
 In the next diagram you will notice, that part of the tail's paper swung to the left side.

Turn model over:



11  
 This is, what the model looks like from behind. Repeat step 9 on this side. While you push up the hidden marked corner, the tail will slip up into the vertical position, shown in the following diagram.

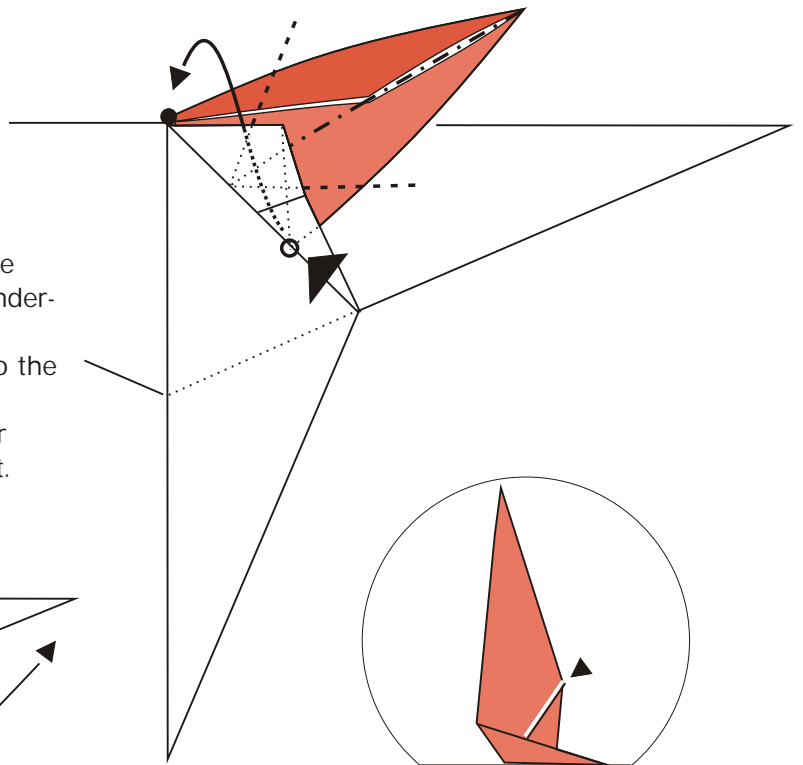

12

In the next diagrams I'll use white slivers to indicate underneath layers. Bring back the top layer to the former position. Widen tail inside with your thumb, so it doesn't lie flat.

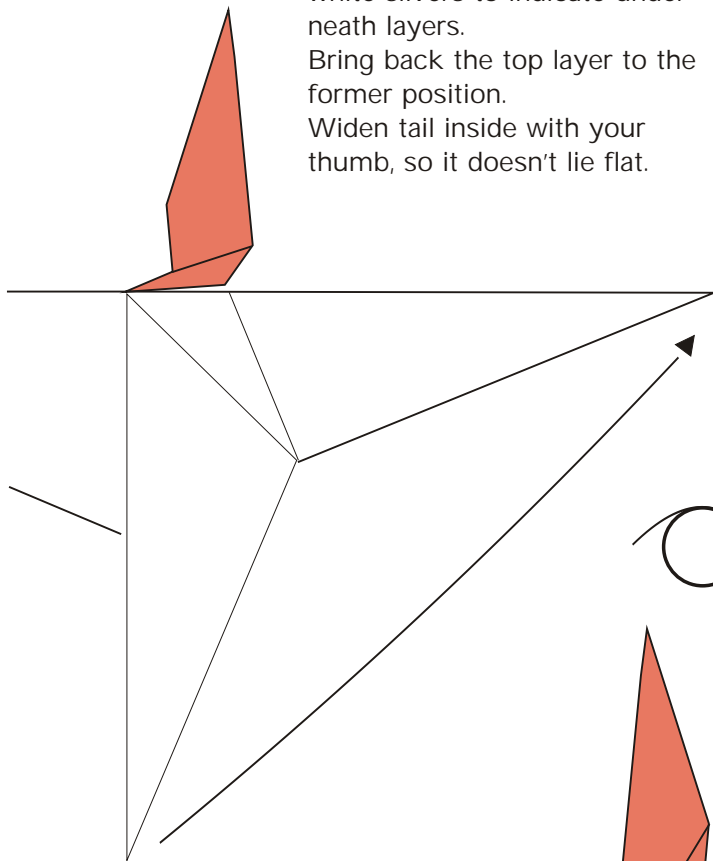

This extra layer is the little difference, you will notice when turning the model over.

13 Inside reverse fold the neck.

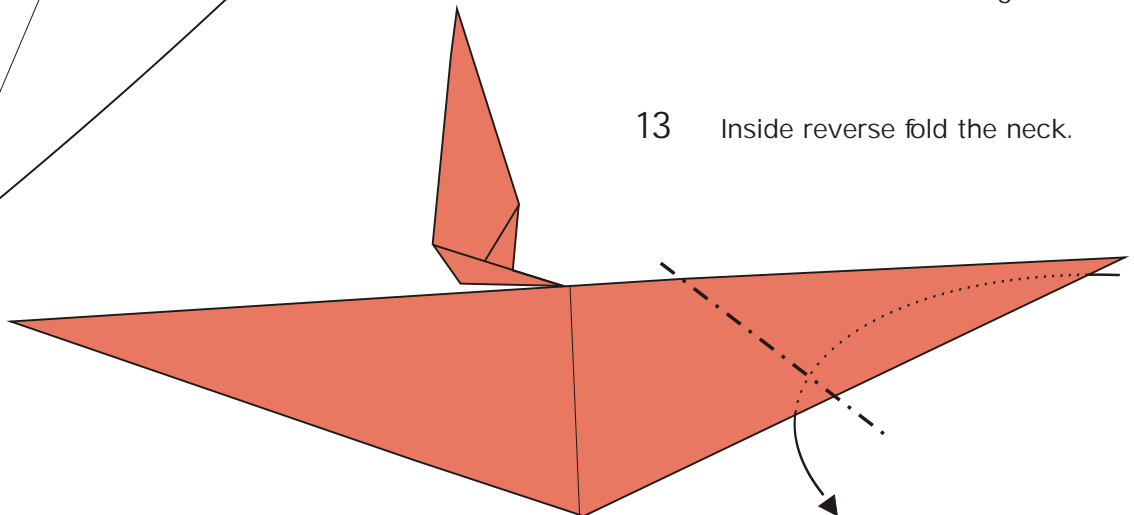

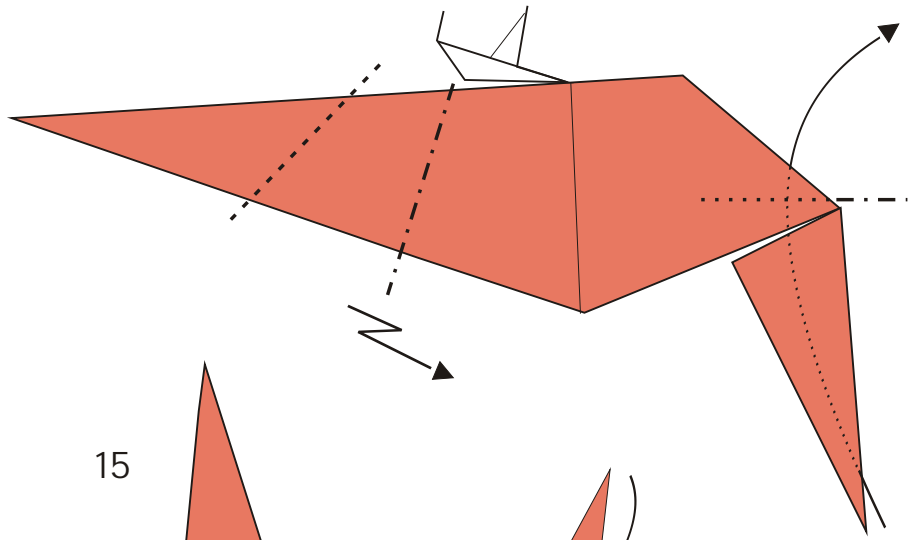

14

Inside reverse fold the front of the model to prepare the head. In the diagram you can see the hidden mountain fold. Then mountain fold the leg and valley fold again. Turn model over and repeat behind.

15

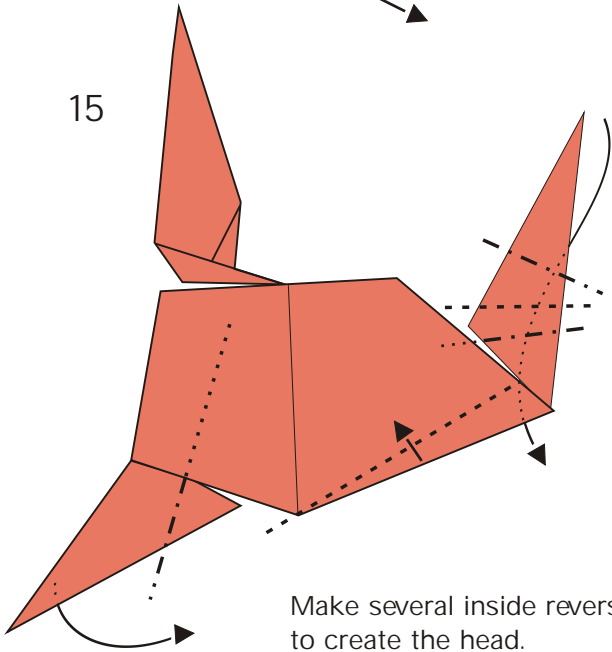

Make several inside reverse folds, to create the head. Valley fold the chest to obtain a nicely curved eye (paper shouldn't lie flat) and inside reverse fold the leg as shown. Repeat behind.

16

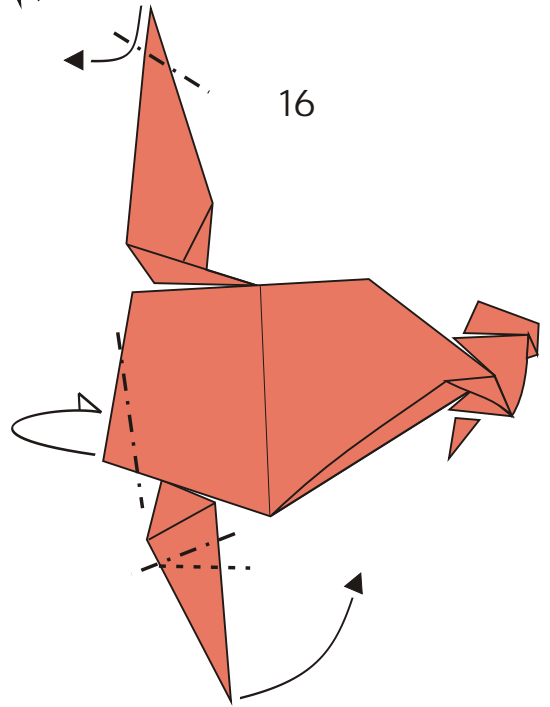

17

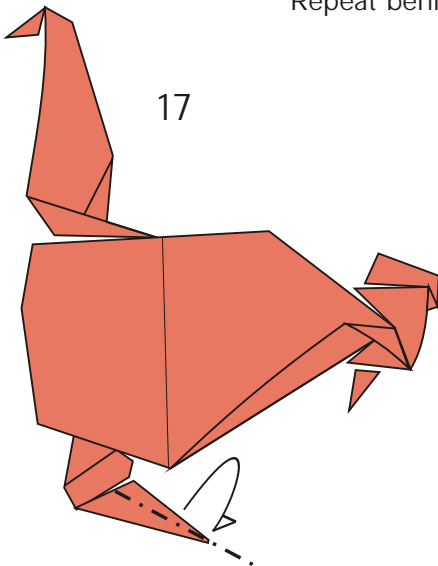

18

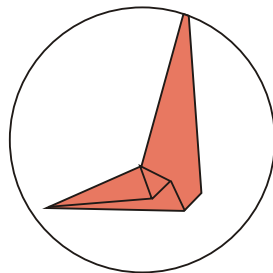

View of the other side of the leg.

Inside reverse fold the tip of the tail. First mountain fold, then valley fold the leg as indicated. Optionally you could make a crimp fold instead, to create a wider foot. Mountain fold part of the hind inside the body. Repeat behind.

Mountain fold leg in half, to make it thinner. Repeat on the other leg. In case you tried a crimp fold in step 12, you can skip this step.

Complete rooster.

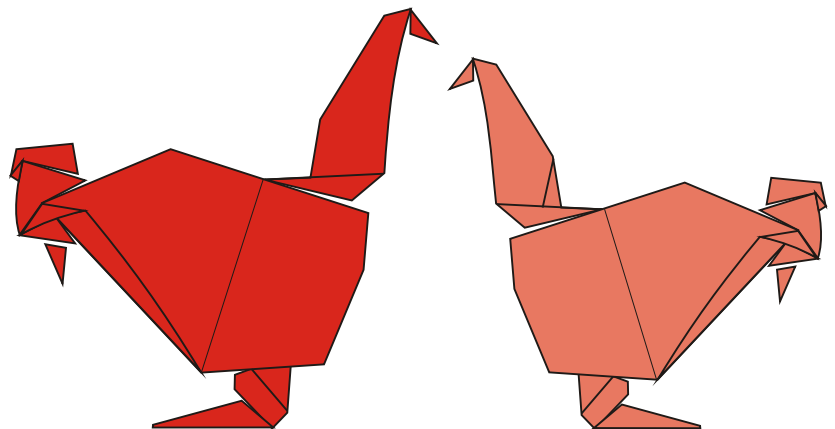

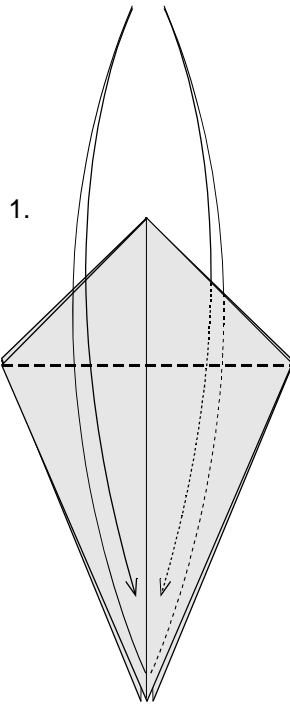

1. Begin by folding a Bird Base from a 20 to 25cm square, preferably coloured on both sides.

Fold the flap facing you all the way up, crease well, and unfold. Repeat at the back.

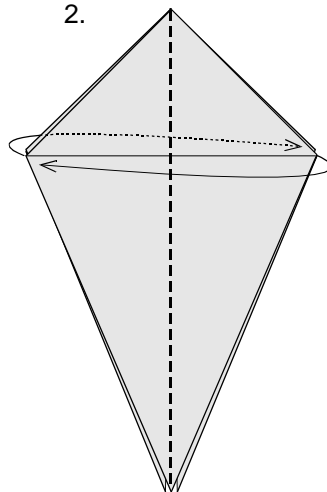

2. Swivel the uppermost flap on the right to the left, and the left flap at the bottom to the right.

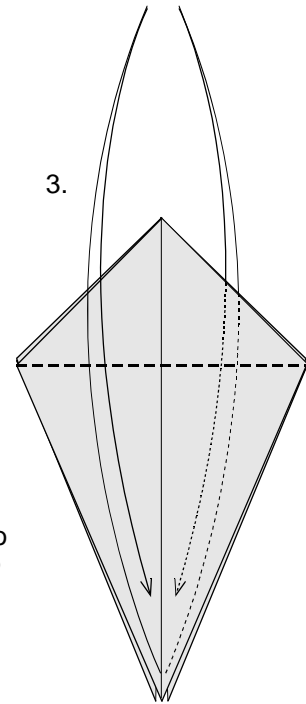

3. Fold the flap facing you all the way up again, crease well, and unfold. Repeat once more at the back.

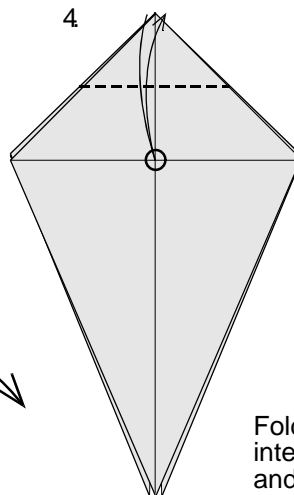

4. Fold the apex to meet the intersection of the the verticle and horizontal crease lines below. Crease firmly and unfold.

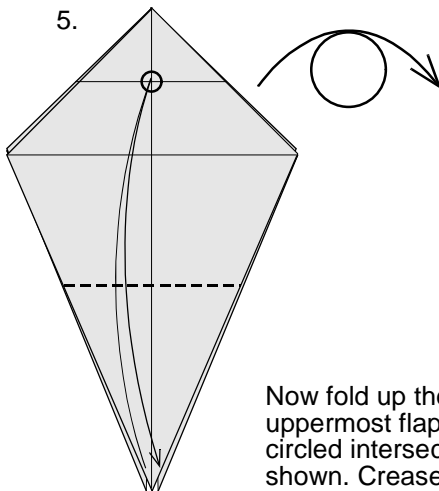

5. Now fold up the tip of the uppermost flap to meet the circled intersection as shown. Crease firmly and unfold, then turn the model over and repeat this step at the back.

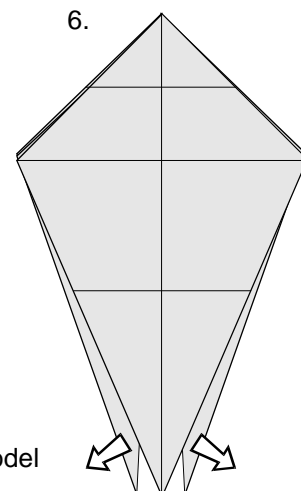

6. Open out the model slightly ...

7.

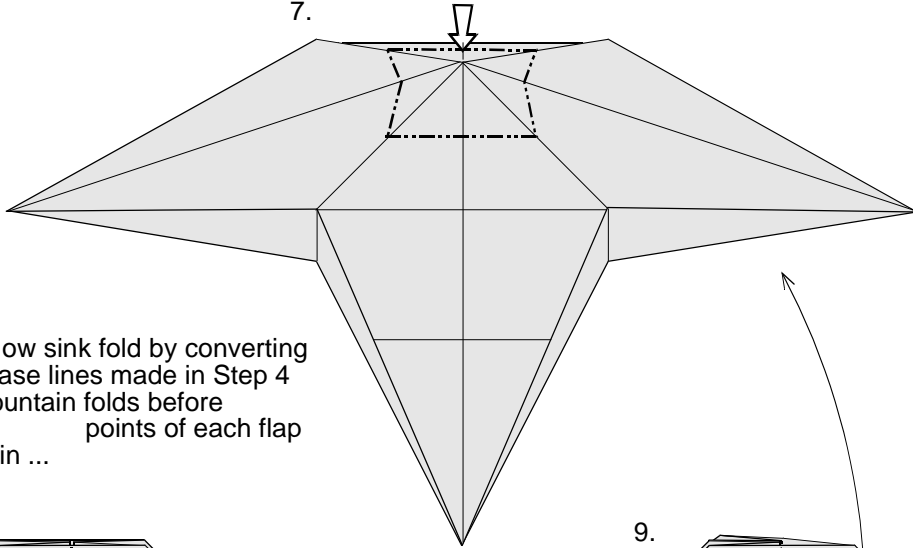

... like this. Now sink fold by converting the crease lines made in Step 4 into mountain folds before bringing the points of each flap together again ...

8.

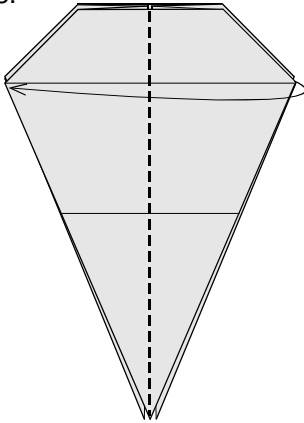

9.

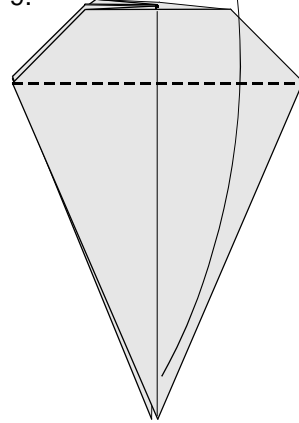

... like this. Swivel one flap on the right to the left ...

10.

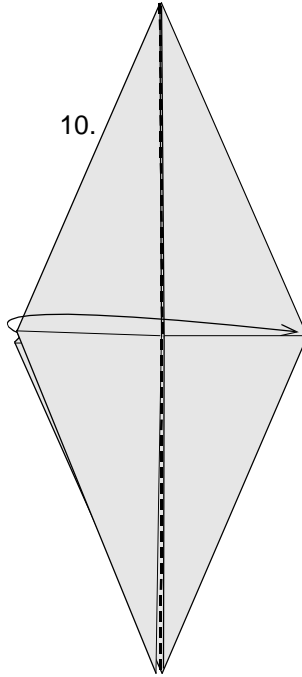

Fold up ...

11.

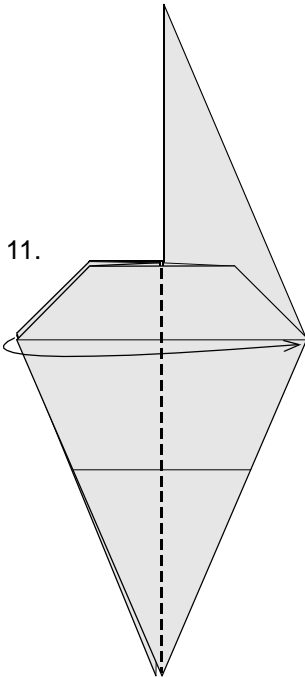

... then fold the first flap on the left to the right ..

12.

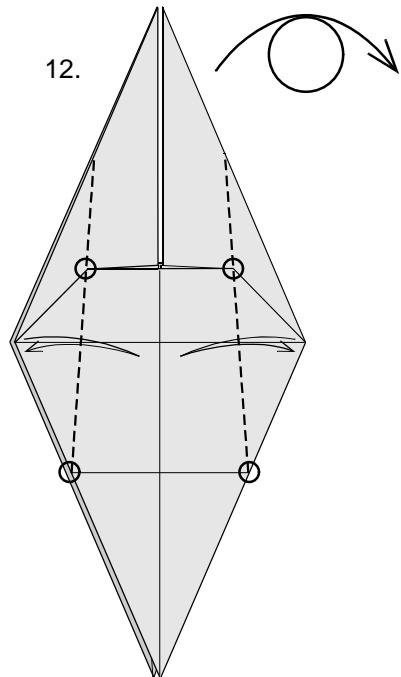

... and repeat Steps 8 to 10 on the left.

Fold and unfold carefully as illustrated, through the circled intersecting lines and corners. Crease firmly. Turn model over and repeat on the other side.

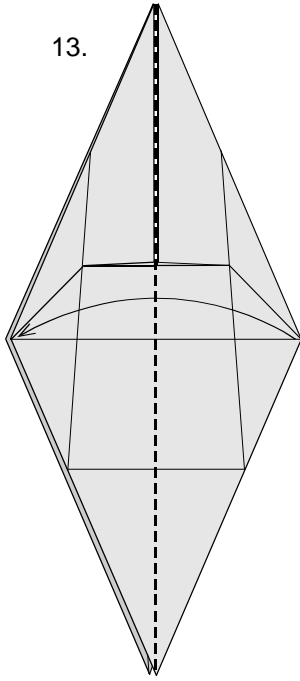

Swivel the flap on the right to the left ...

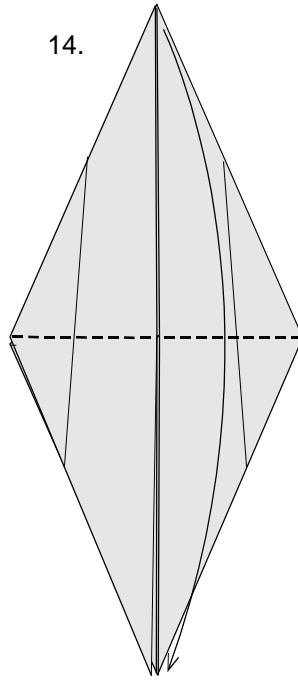

... then fold down the triangular piece at the top.

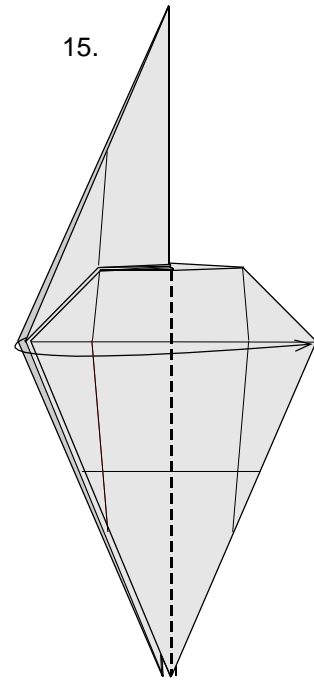

Swivel two layers on the left to the right, then repeat Steps 13 and 14 on the left. That done, swivel one layer on the right to the left ...

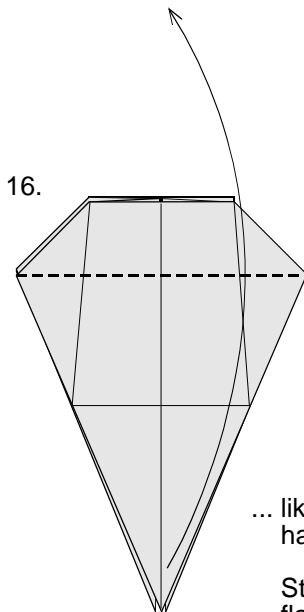

... like this, returning the lower half of the model to its original position before the start of Step 13. Fold the triangular flap up again ...

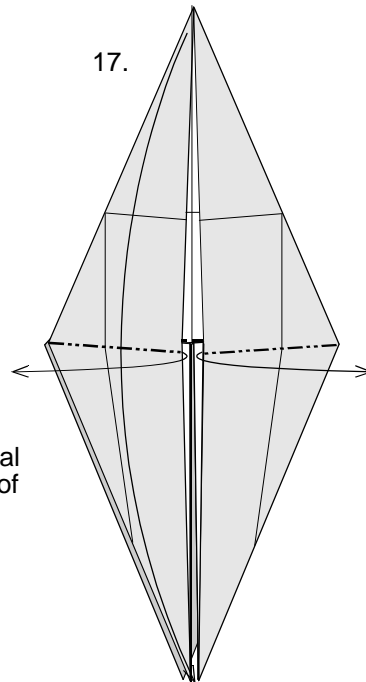

Lift one layer from each side and open out to the left and right, bringing the point at the top all the way down at the same time ...

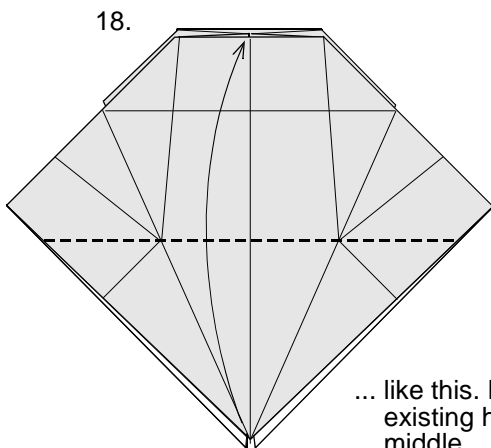

... like this. Fold the first layer up along the existing horizontal crease line in the middle.



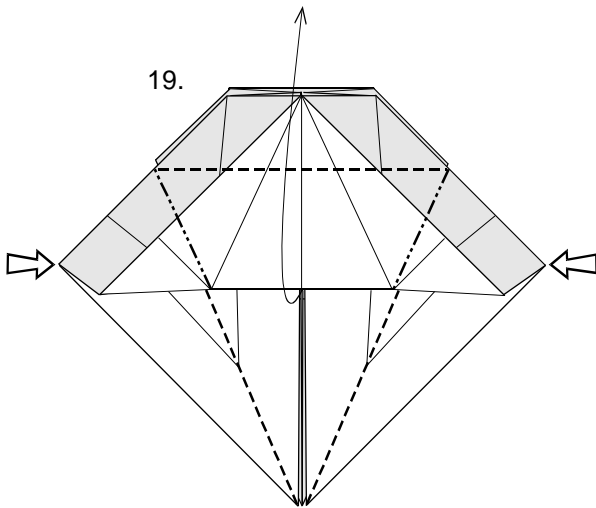

19. Lift up the horizontal edge in the middle and reverse fold on the left and right along existing crease lines ...

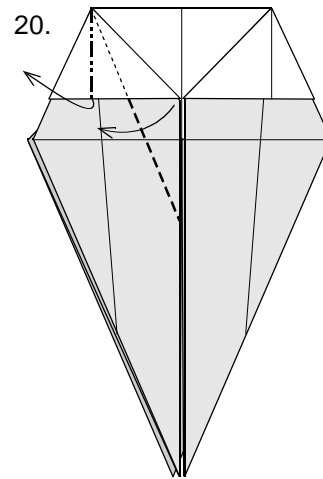

20. Make a mountain fold along the existing vertical crease line while lifting and swivelling the pocket to the left ...

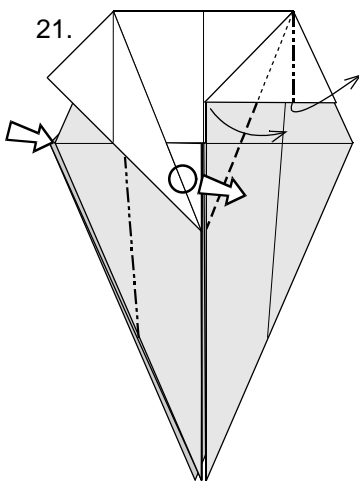

21. ... like this. Repeat Step 20 on the right. Next, open out the left half of the model by grasping the circled area and pulling to the right.

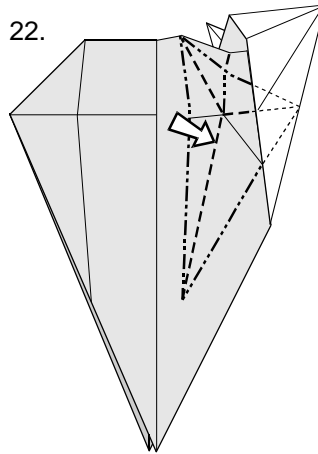

22. Now sink fold along the existing crease lines as illustrated ...

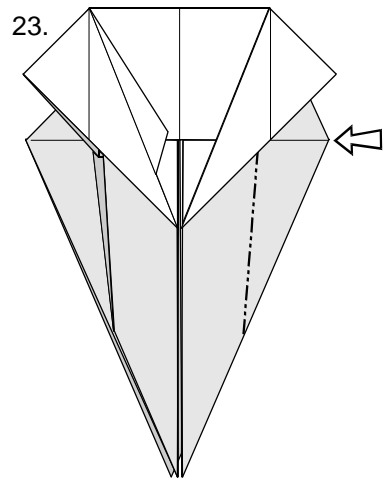

23. ... like this. Repeat Step 22 on the right ...

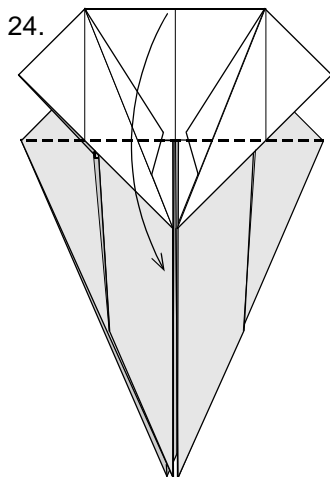

24. ... then fold down the flap at the top.

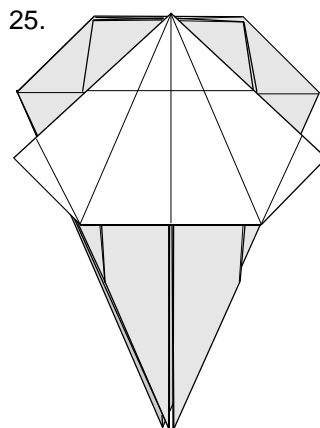

25. Turn model over and repeat Steps 16 to 24 on the other side

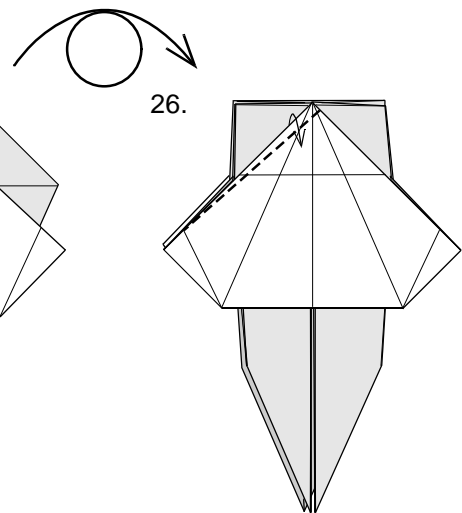

26. Valley fold a little of the left edge down precisely as illustrated ...

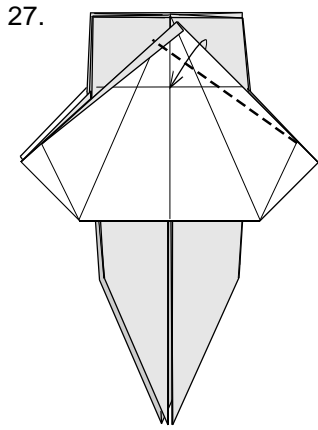

... then the right, bringing the edge to the intersecting vertical and horizontal lines.

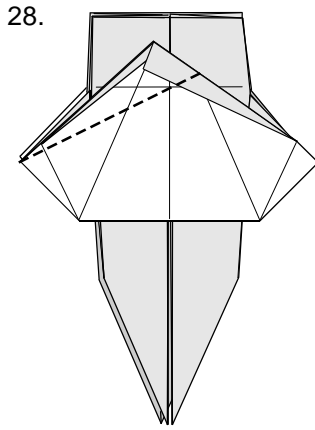

Valley fold on the left again, like this ..

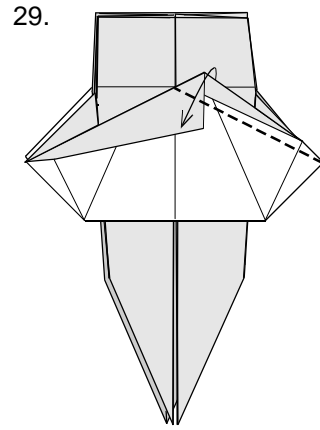

... then on the right once more, in the precise proportions illustrated.

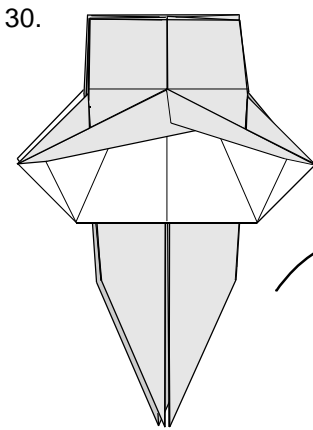

Turn the model over ...

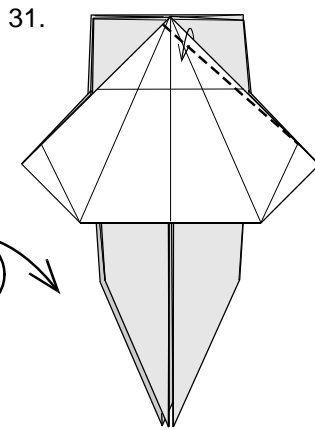

... and repeat Steps 26 to 29, but in the opposite direction, beginning from the right edge.

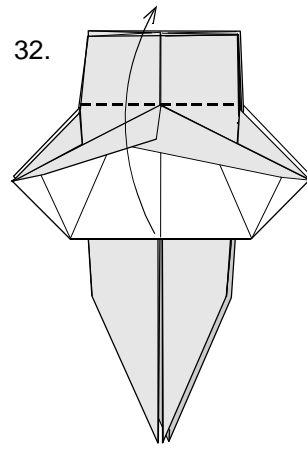

Your model should now look like this, a mirror image of Diagram 30. Fold the flap up again.

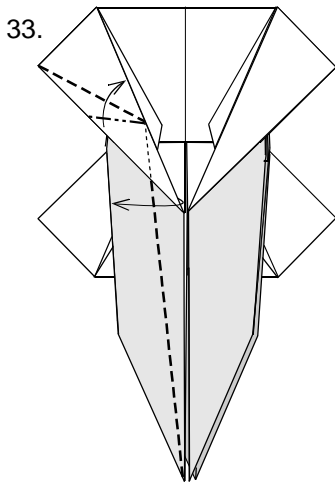

This is a somewhat difficult. Valley fold at the top, aligning with the diagonal edge of the layer underneath, while making another valley fold along the length of the lower piece ...

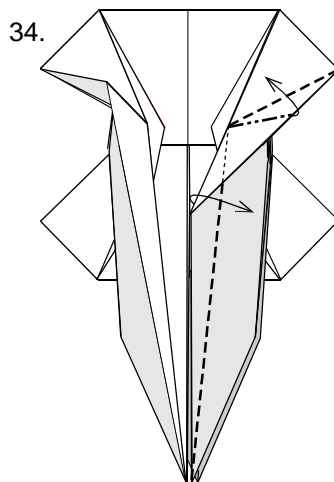

... until your model looks like this. Repeat Step 33 on the right.

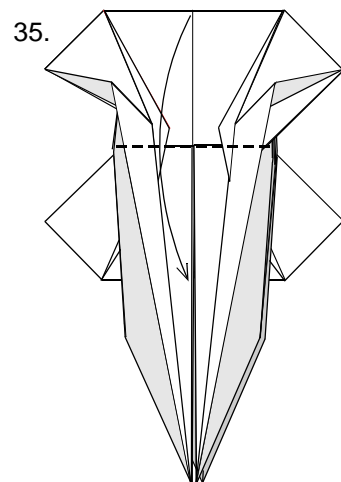

Fold down the flap at the top again, ...

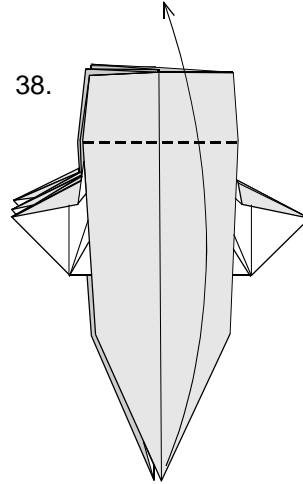
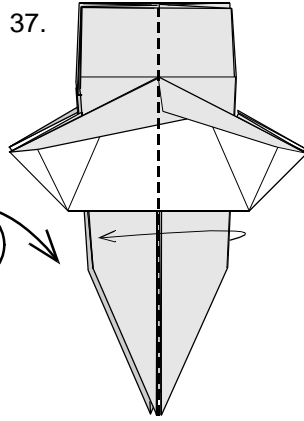
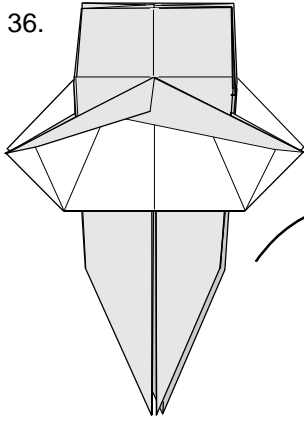

... turn the model over, and repeat from Step 32 on the other side.

Note that the narrower coloured layer in the middle of the model is now to the right. Swivel one flap on the right to the left ...

... then fold this piece at the lower half of the model all the way up.

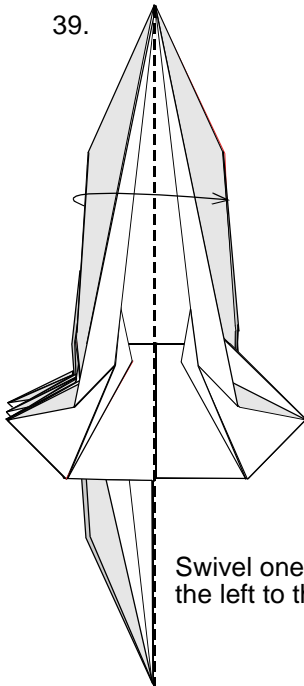

Swivel one leaf on the left to the right ...

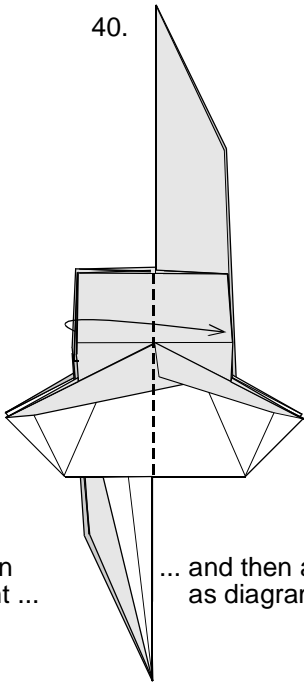

... and then another, as diagrammed.

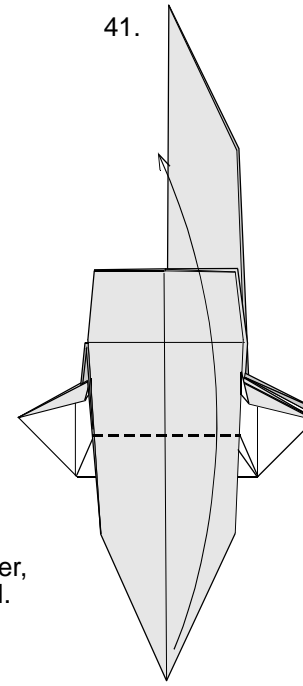

Valley fold up, approximately in line with the corners of the underlying piece ...

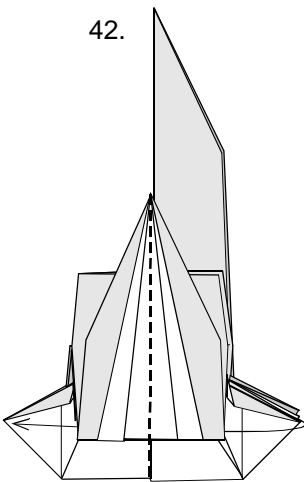

... then fold one leaf on the right to the left ...

...

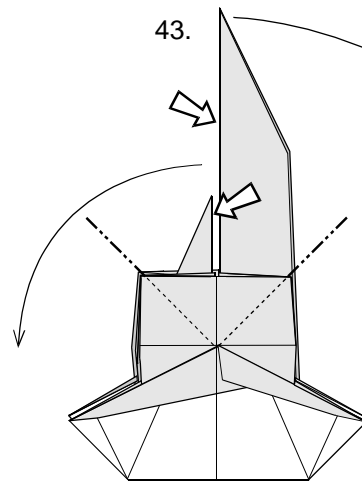

Reverse fold at the base of each of the two pieces at the top ...

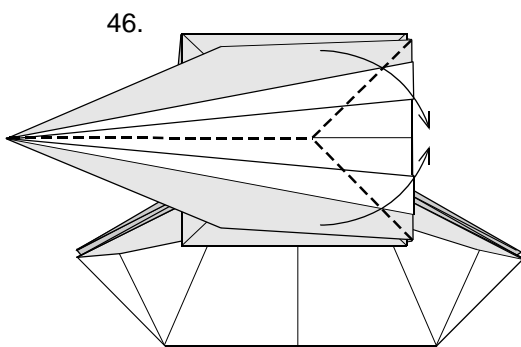
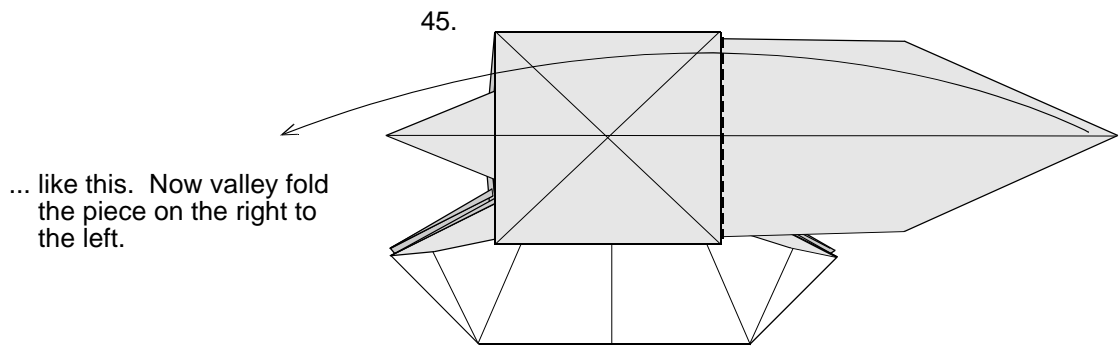
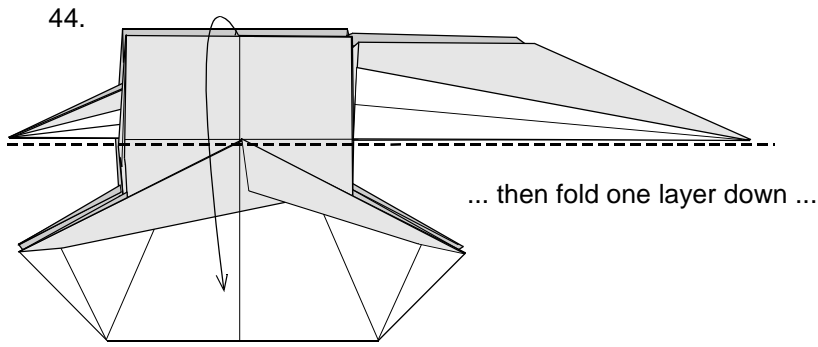

Do a rabbit's ear fold as illustrated. Follow the angles of the diagonal fold lines closely.

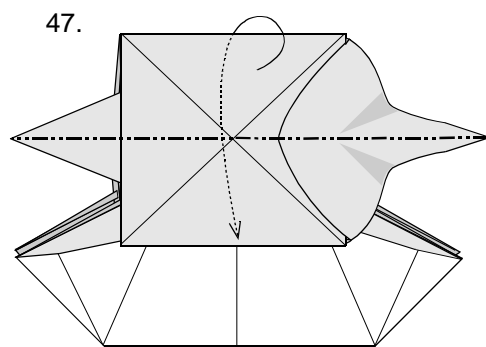

Now mountain fold behind as shown.

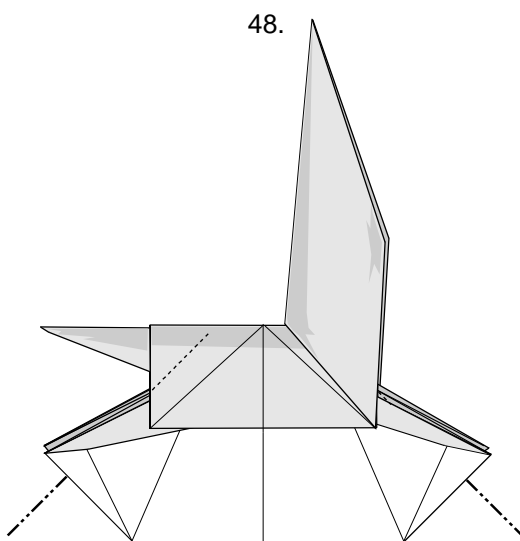

The next step is not clearly shown as it involves folds within the body. There should be four right-angled tabs just above the legs. Mountain fold each of these over the base of the legs to lock the legs in place.

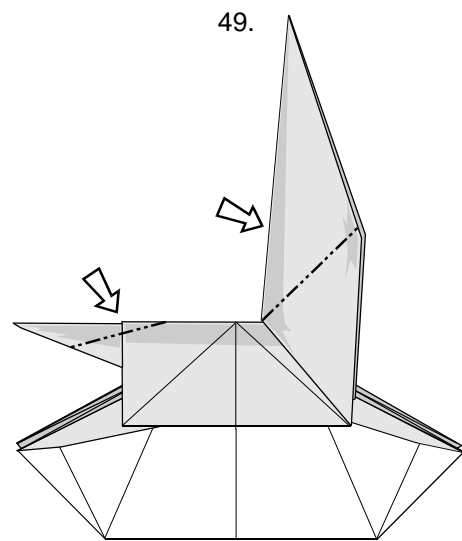

Reverse fold the head and tail pieces at the precise angles illustrated.

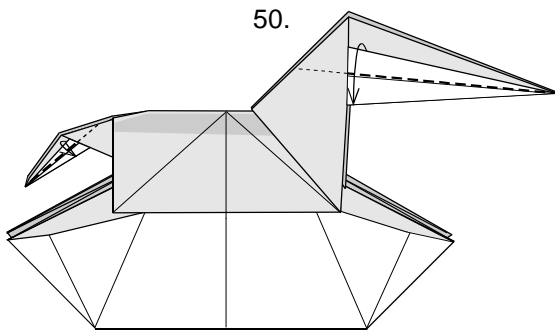

Fold down the white overlapping layer on both sides of the head and tail pieces ...

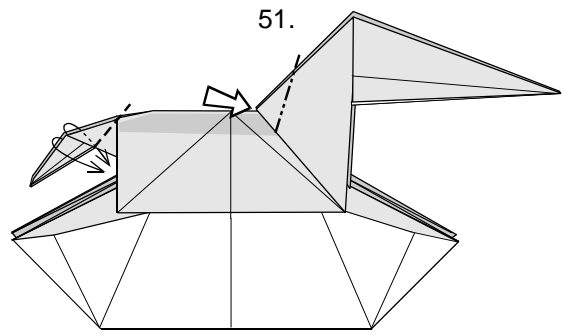

... then separate the two halves at the bottom temporarily before doing an outside reverse fold at the tail, and sinking the corner at the base of the neck.

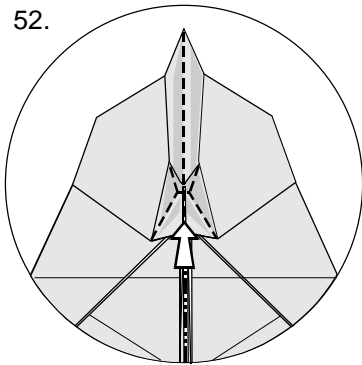

Seen from the back, sink the base of the neck like this, then bring the two halves of the model at the bottom together again.

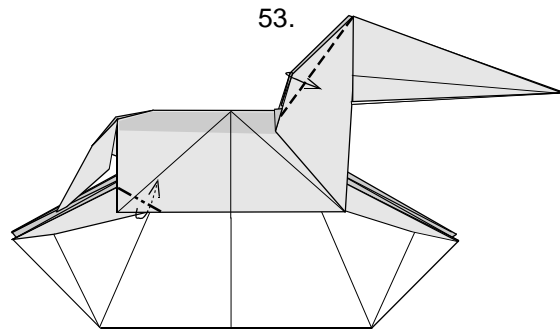

Mountain fold the corner at the base of the hind leg and valley fold the first layer at the back of the neck. Repeat on the other side.

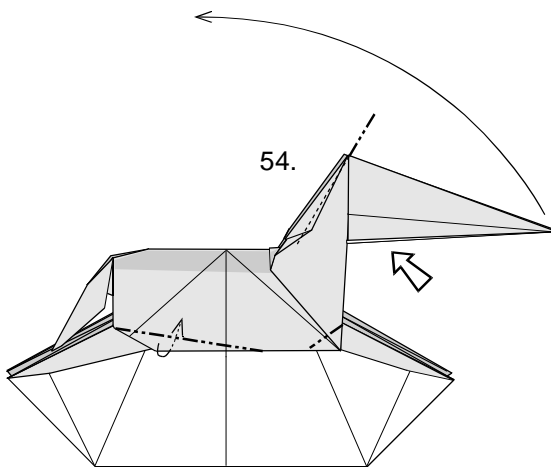

Reverse fold the head piece on the right. Mountain fold the lower edge and corner of the body as illustrated, then repeat behind.

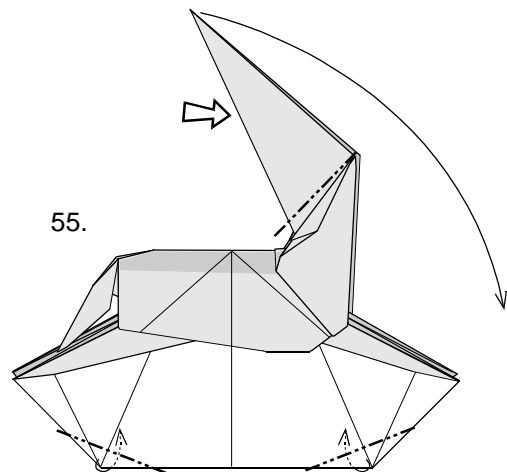

Reverse fold the head piece again, precisely as shown. Mountain fold the corners at the bottom next, repeating behind.

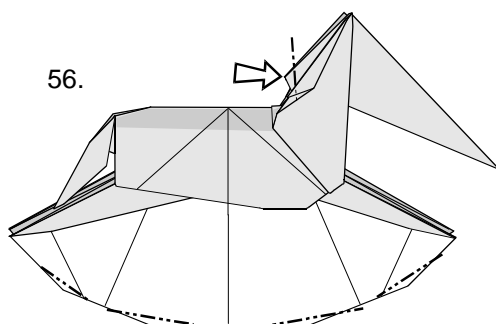

Separate the layers on the right of the head piece temporarily, as in Step 51, and sink the corner at the back of the neck just a little. Reverse fold more of the corners at the bottom as diagrammed, to round off the rocker. Repeat behind again.

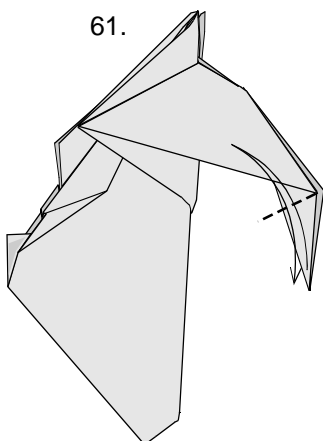
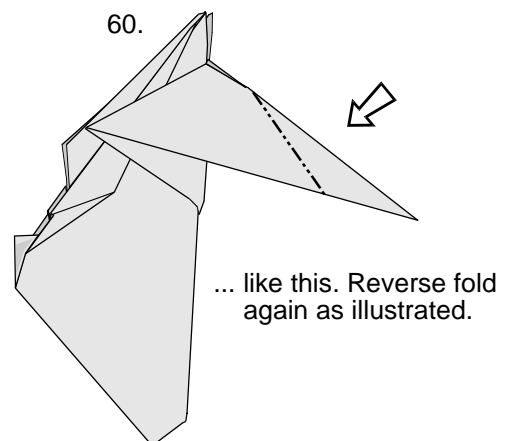
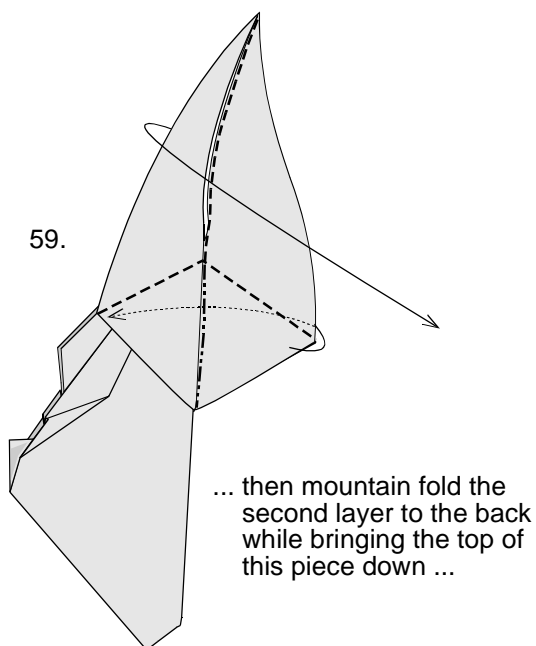
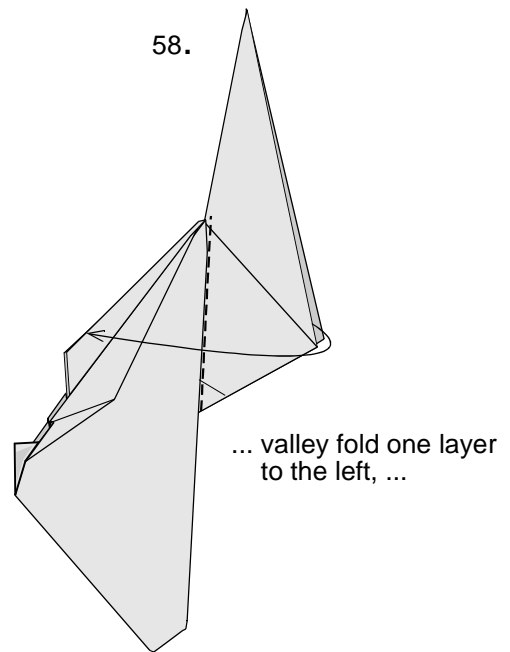
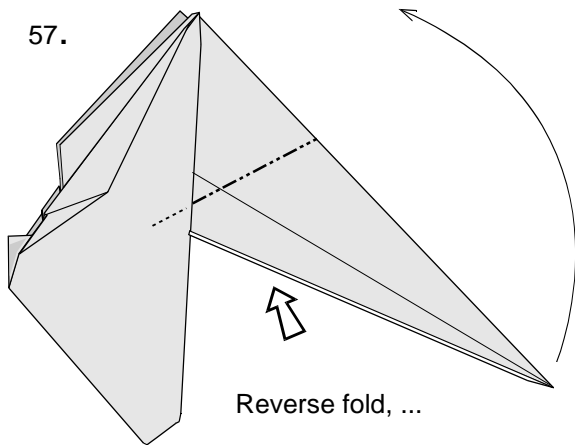

Valley fold precisely as illustrated, crease firmly, and unfold.

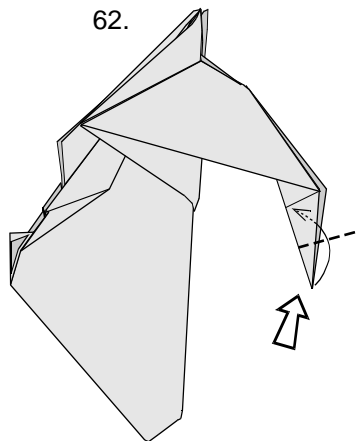

Reverse fold the tip neatly in between the two layers immediately above, slightly less than midway from the crease made in Step 61...

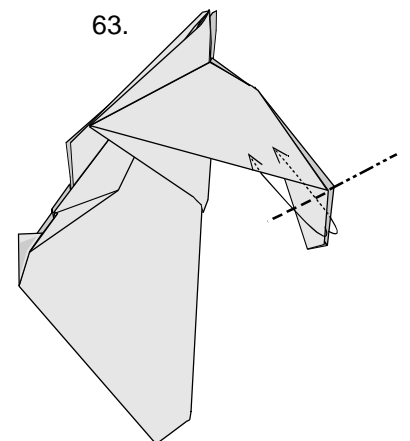

... then do an outside reverse fold along the crease lines made in Step 61 ...

64.

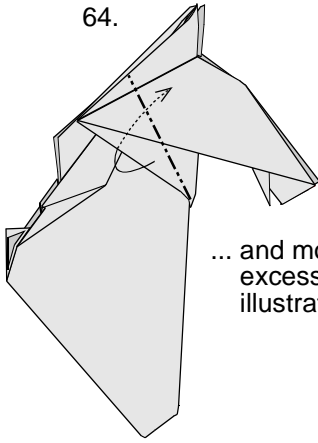

... and mountain fold the excess paper under as illustrated.

65.

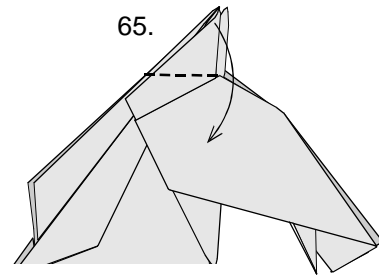

Valley fold the ear on this side down, and repeat on the other side.

67.

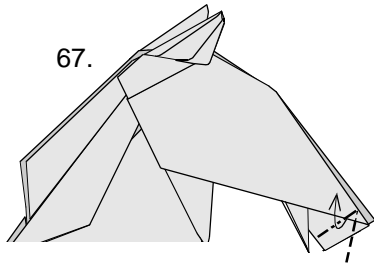

Now do a little crimp fold on each side of the nose as illustrated ...

66.

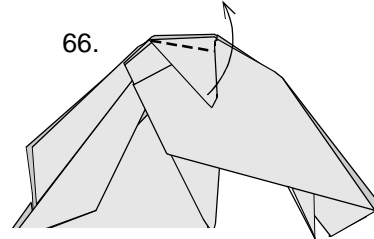

Complete the ears by valley folding each of them into position.

68.

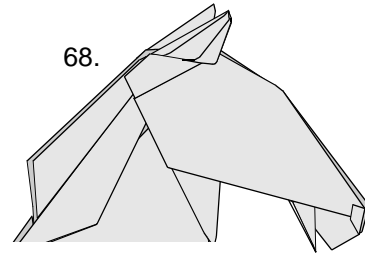

... to complete the head.

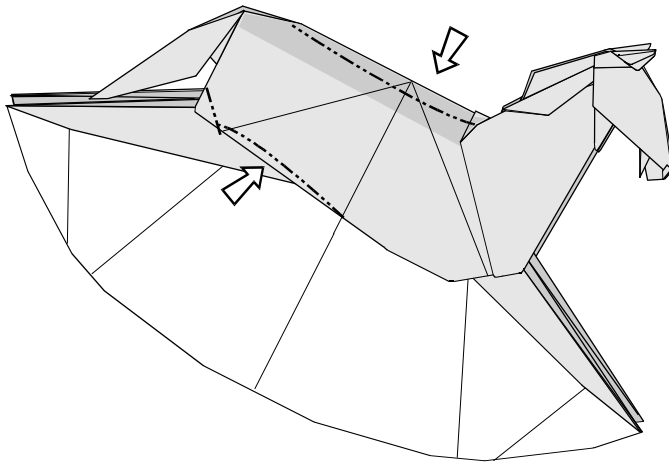

Mountain fold the corners at the base of both hind legs, then round out the body by pushing the back gently down, and the adomen area slightly upwards.

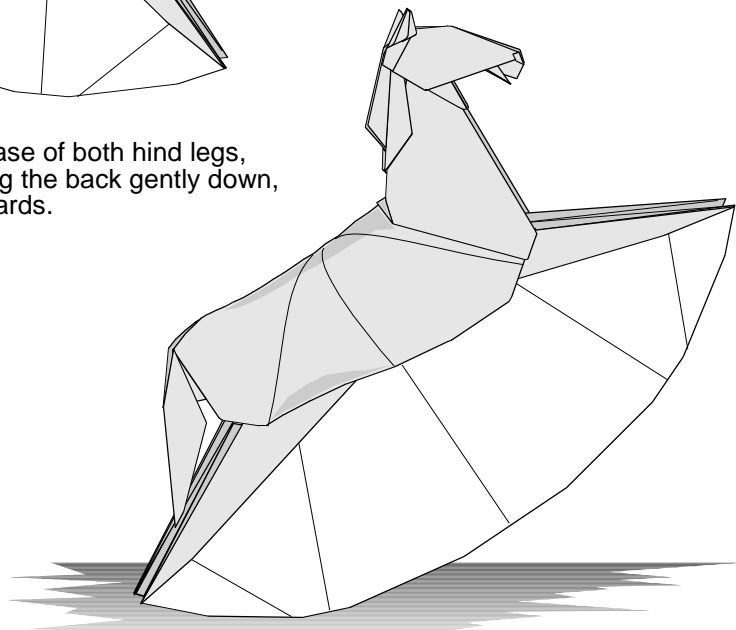

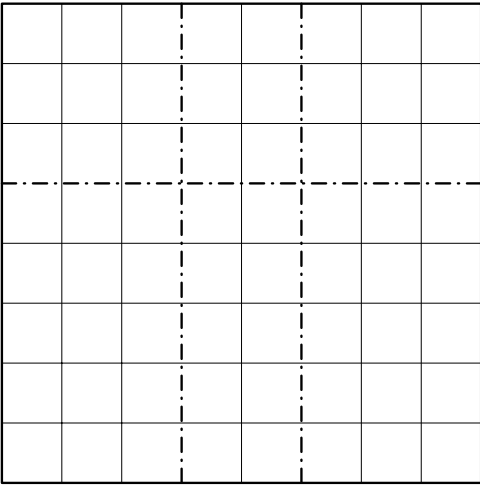

1

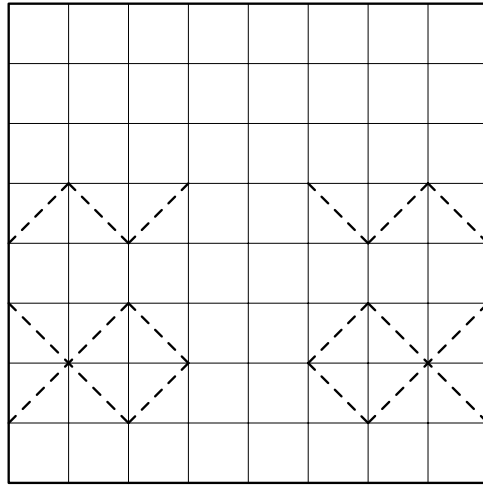

2

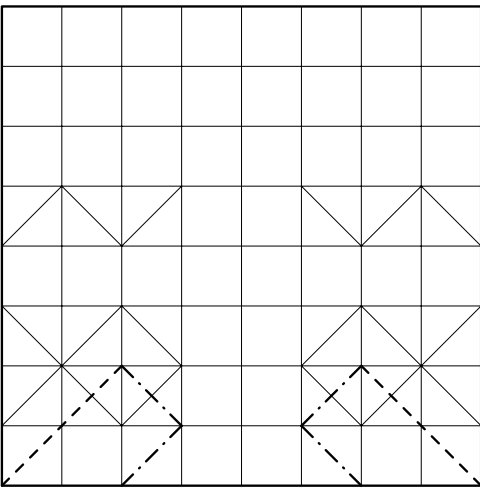

3

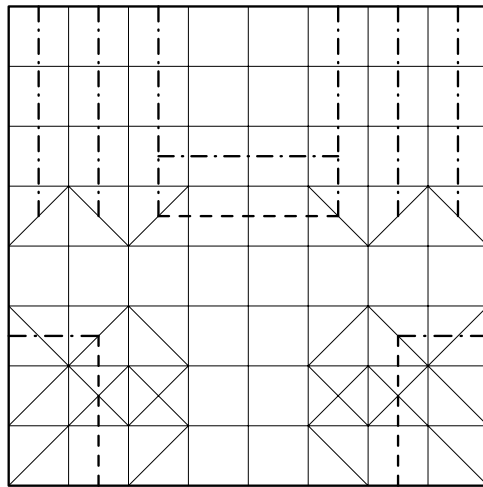

4

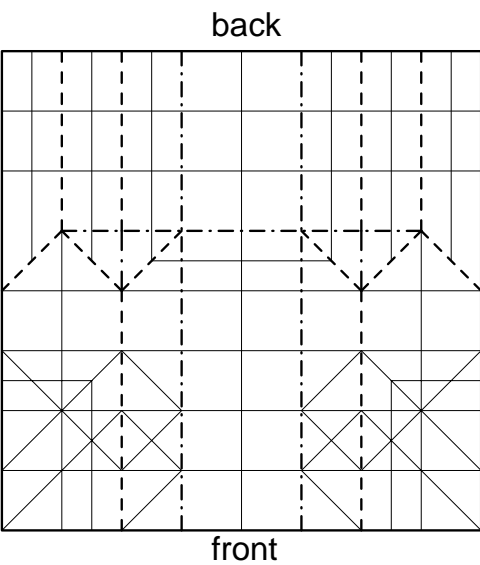

5

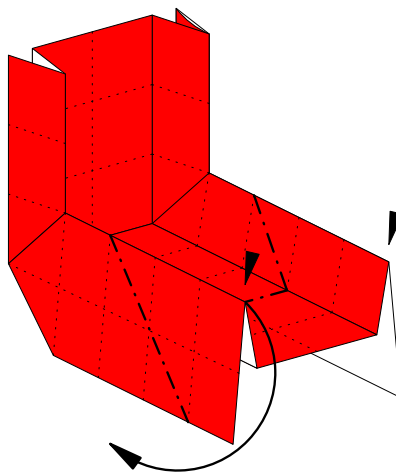

6



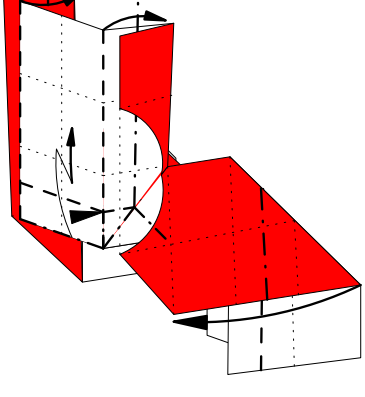

7

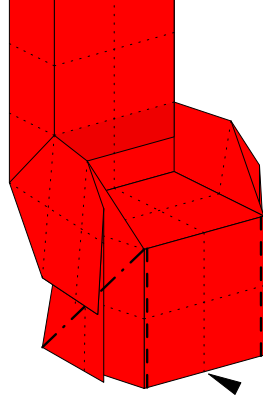

8 Dark area is double

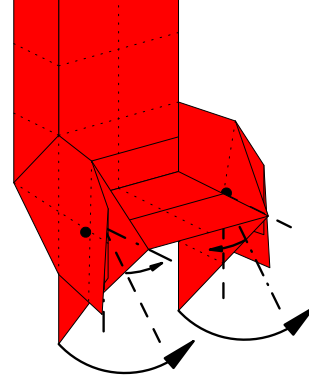

9 Swivel bottom front around line in seat (through dots)

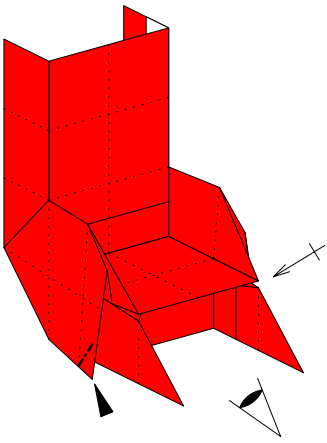

10

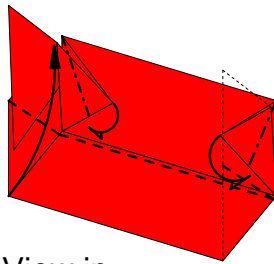

View in front bottom part

11 Fold triangles and lock with next fold

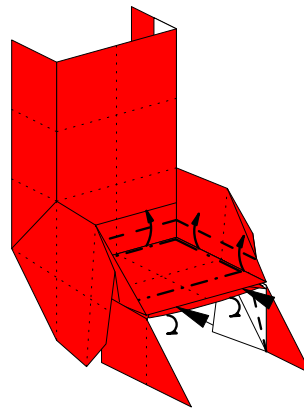

12 Form seat and fold bottom layer back

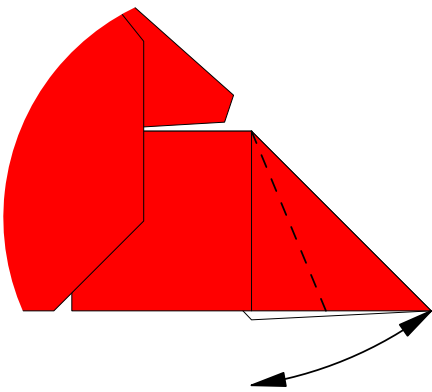

13 Front wheels

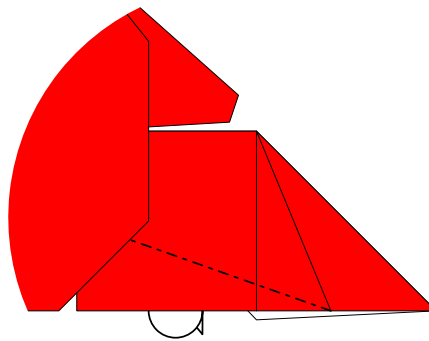

14

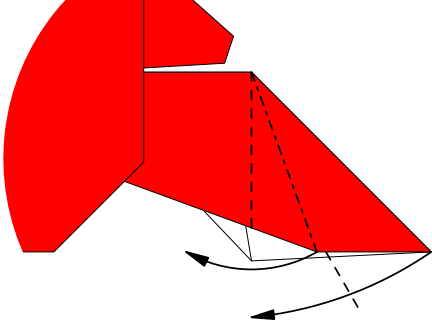

15

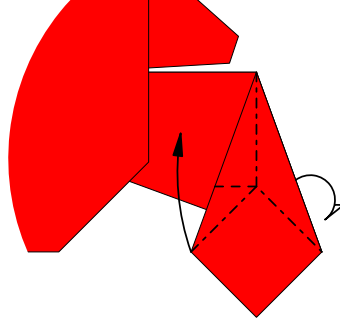

16

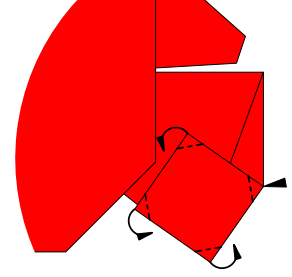

17

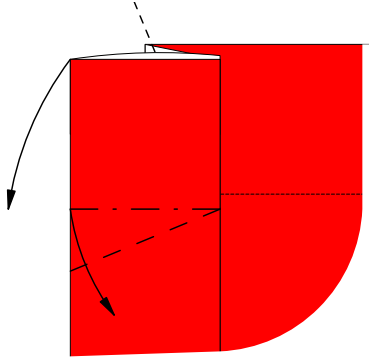

18 Handles on top of back

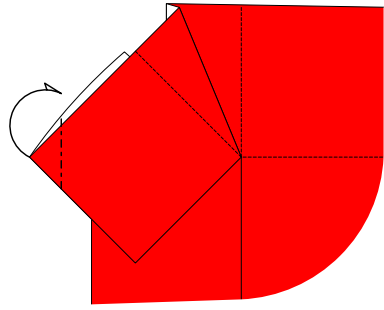

19

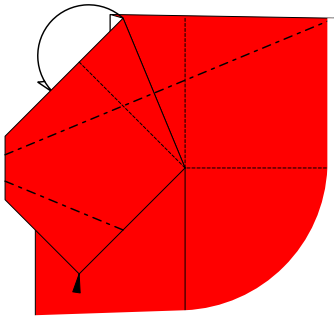

20

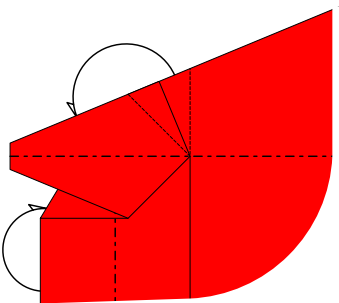

21

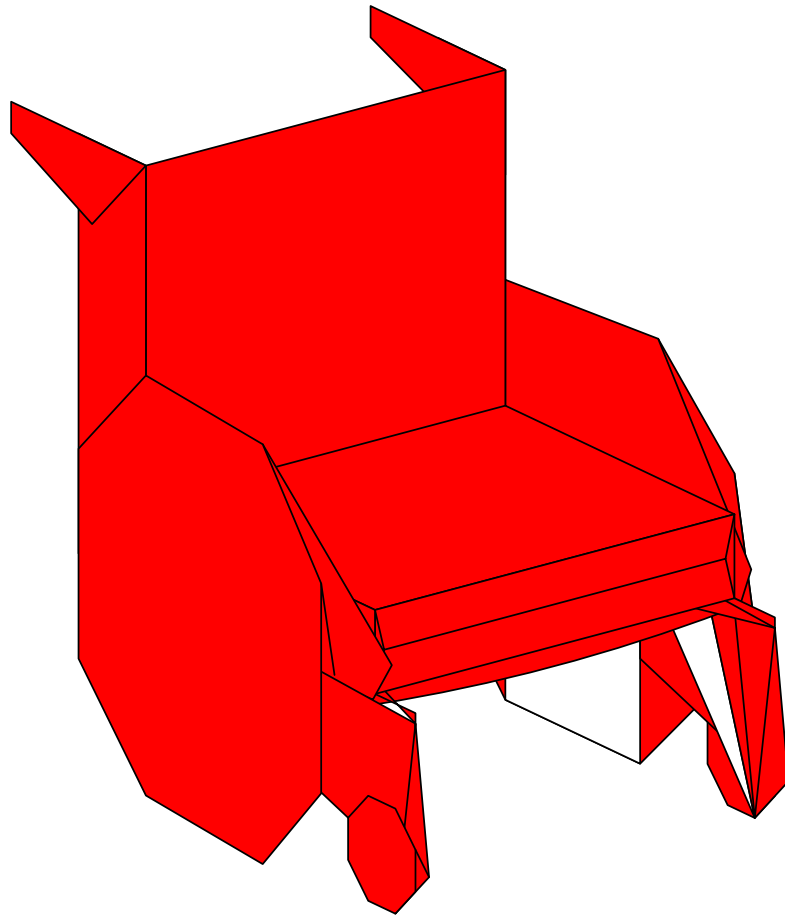

# “Ромео + Джульетта”

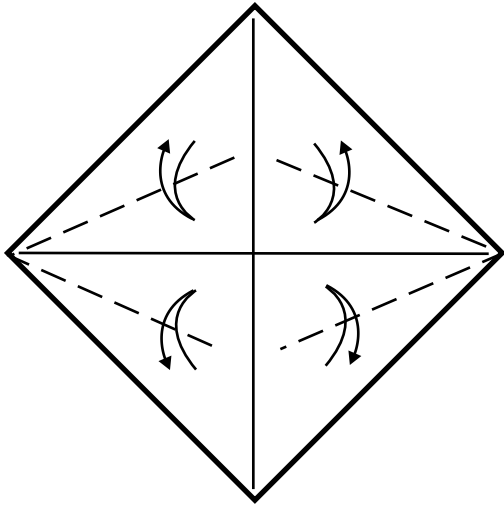

1. Перегните квадрат по диагоналям.  
Сделайте глубинные складки на биссектрисах противоположных углов.

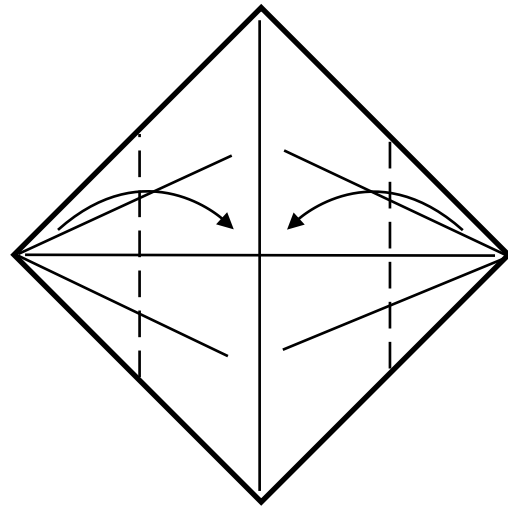

2. Согните два угла квадрата к центру...

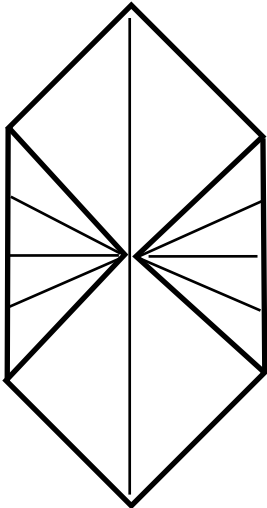

3. ...и переверните фигуру!

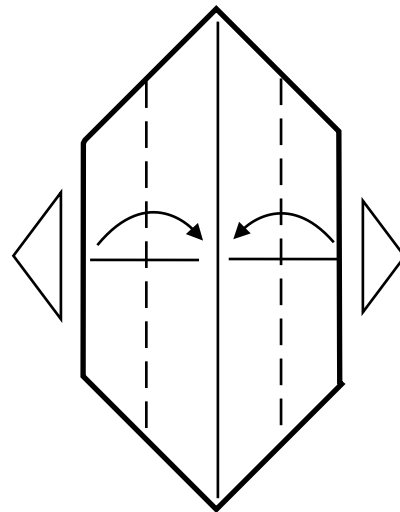
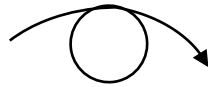

4. Согните стороны к середине,  
при этом два треугольника  
окажутся снаружи.

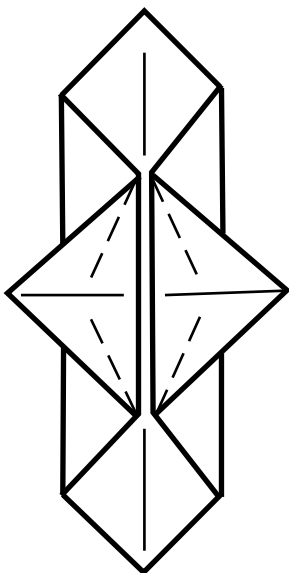

5. Перегните противоположные углы  
треугольников по биссектрисам.

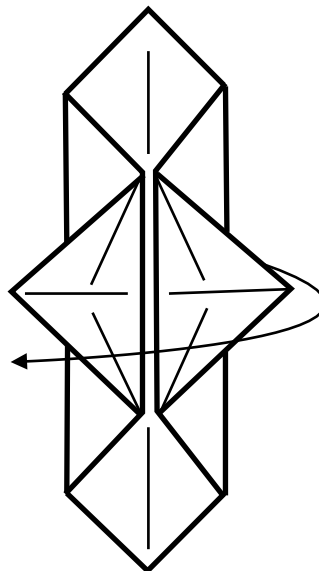

6. Отогните правый треугольник  
влево.

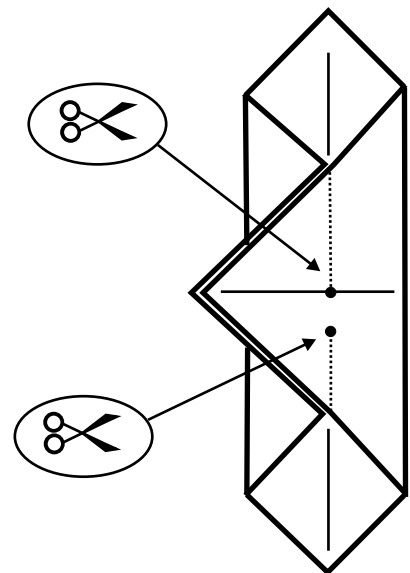

7. Сделайте два надреза: один - к  
диагонали, второй - немного не  
доходя до неё.

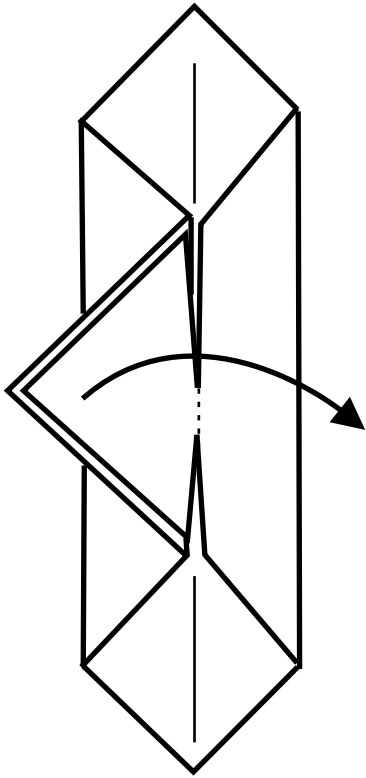

8. Отогните треугольник назад. Повторите операцию со вторым треугольником.

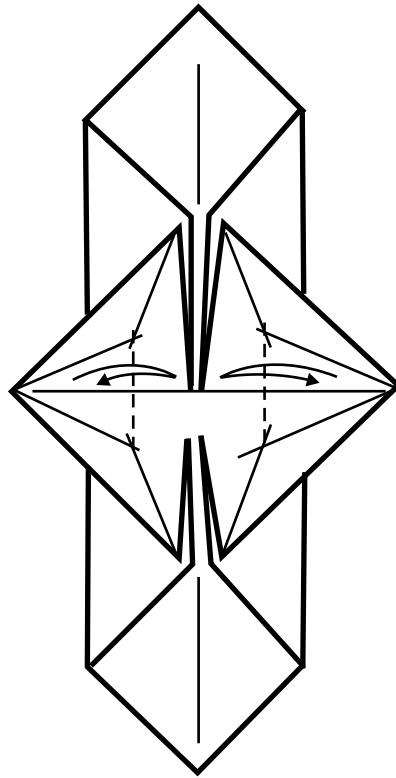

9. Проведите две "глубинки" через точки пересечения ранее намеченных линий.

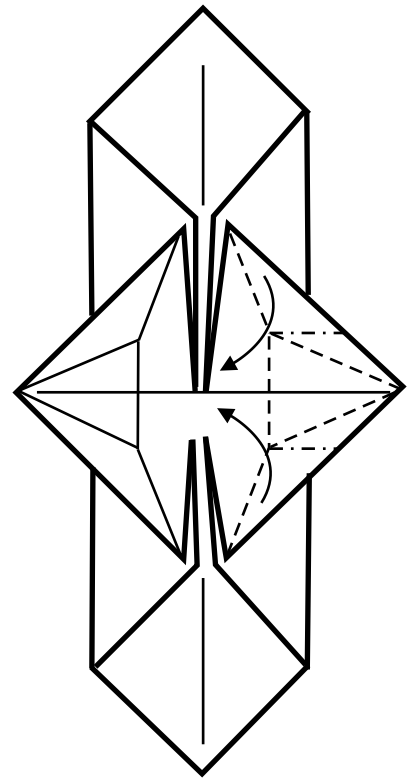

10. Складываем одновременно по всем линиям.

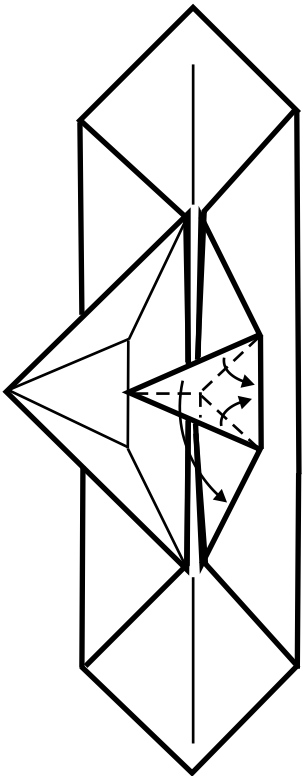

11. Складка "ухо кролика".

10 - 11

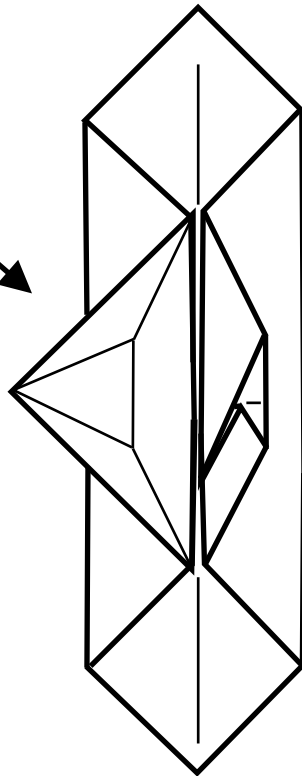

12. Повторите операции 10 - 11 с другой стороны.

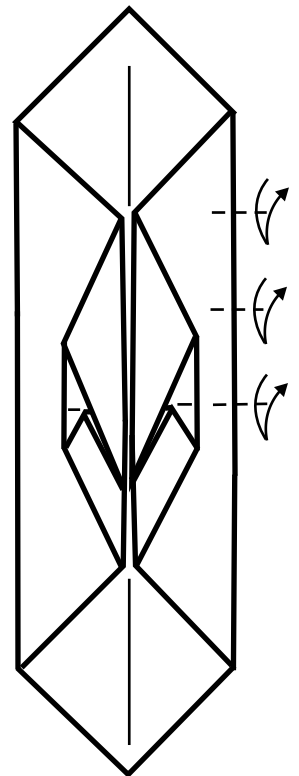

13. Сделайте "засечки" на складке. Величина "шага" -  $1/8$  длины диагонали.

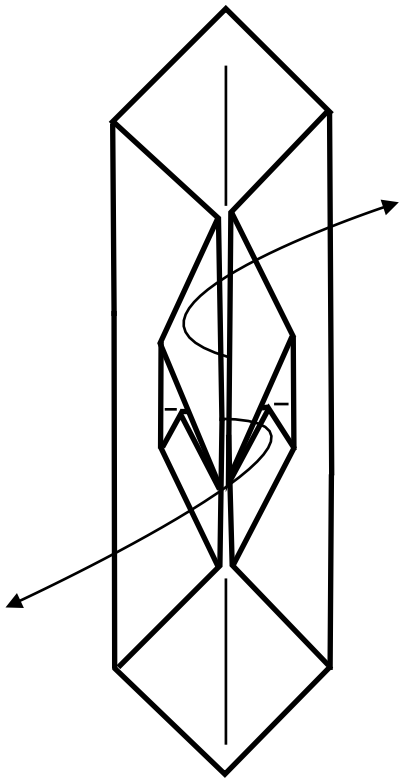

14. Раскройте складку

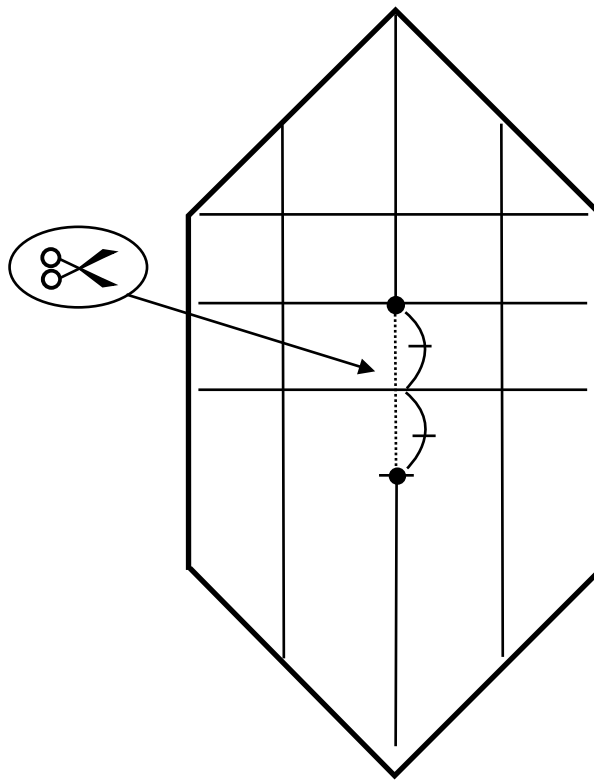

15. Сделайте разрез посередине.

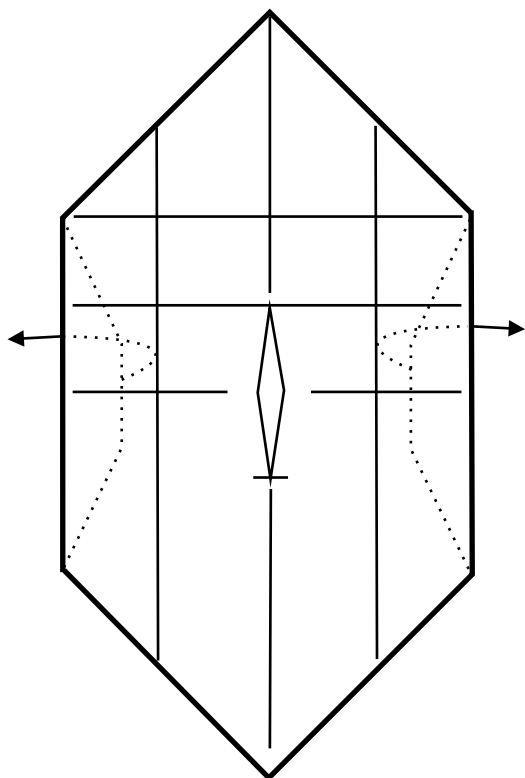

16. Отогните наружу скрытые части складки.

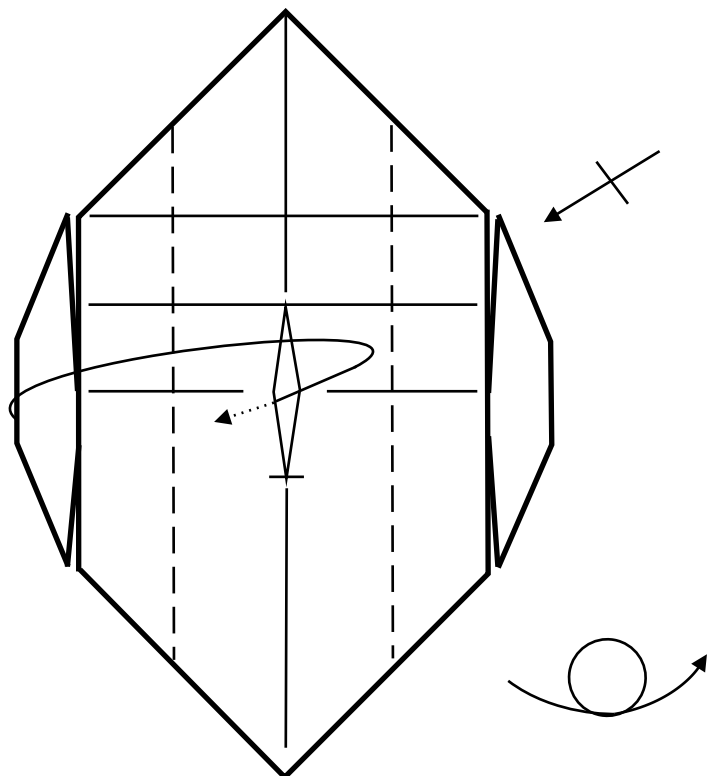

17. Наиболее сложный момент: нужно продеть боковые части фигуры сквозь отверстие. Для этого необходимо аккуратно согнуть углы складок так, чтобы их ширина соответствовала ширине отверстия.

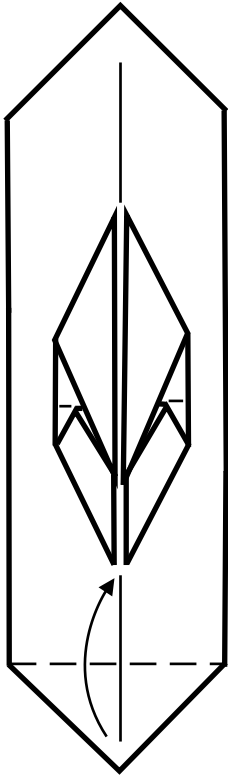

18. Согните нижний угол вверх.

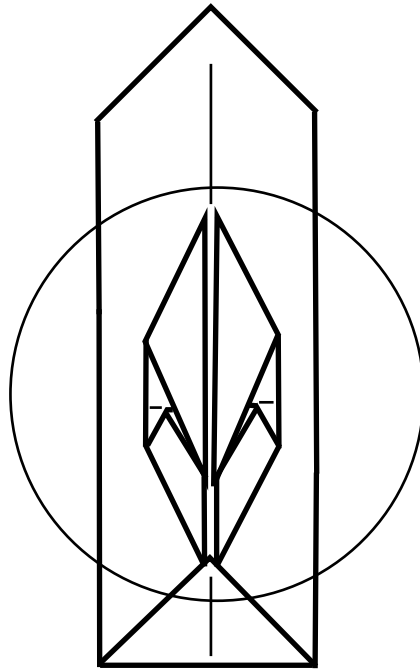

19. Следующие операции будут производиться только складках, составляющих верхний слой фигуры.

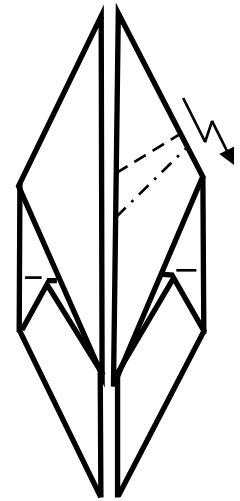

20. Согните назад "складку-молнию".

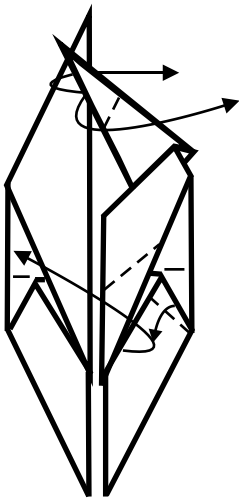

21. Продолжаем работать над женской фигурой.

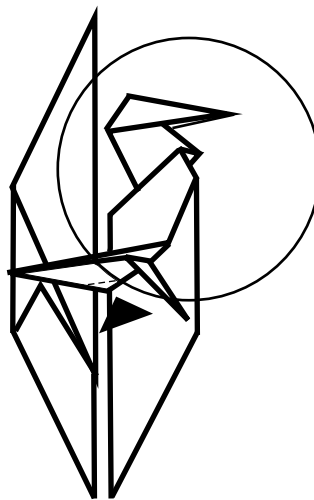

22. Вогните уголок внутрь.

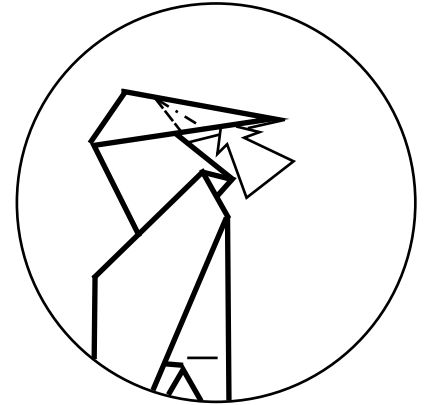

23. Голова крупно. Раскройте "карман". Складка не симметрична!

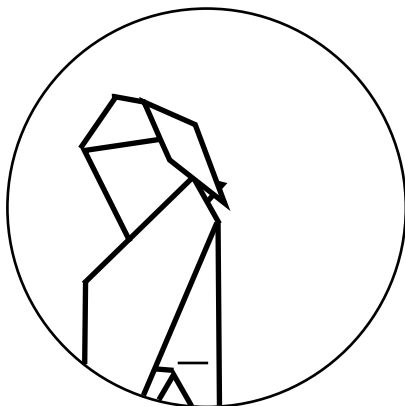

24. Сравните результат с рисунком.

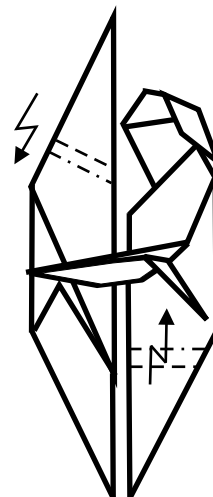

25. Складки-"молнии"верху слева и внизу справа.

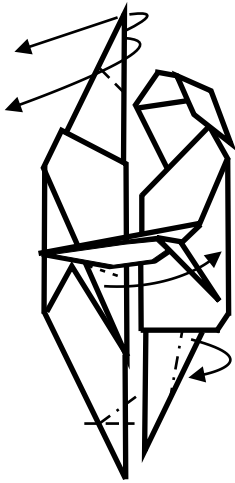

26. Выверните верхний угол наизнанку. Формируем ноги. Позвольте "кавалеру" обнять "даму"!

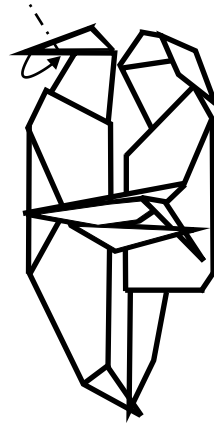

27. Последний штрих...

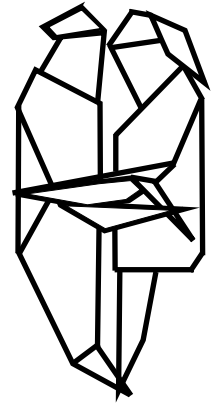

28. ...и влюблённая пара готова!

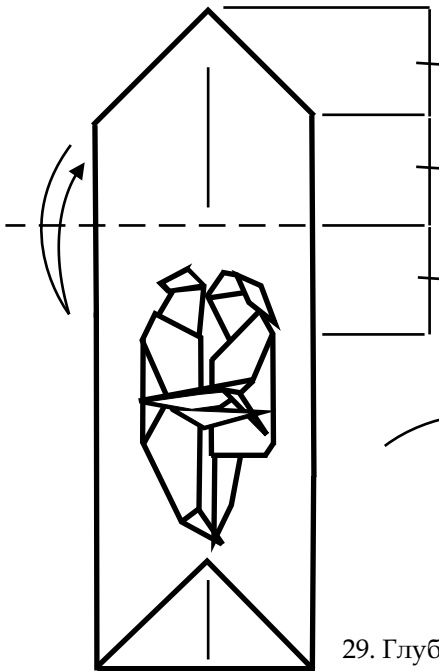

29. Глубинная складка на лицевой стороне фигуры. Переверните на другую сторону.

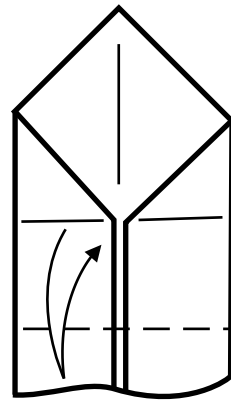

30. Глубинная складка.

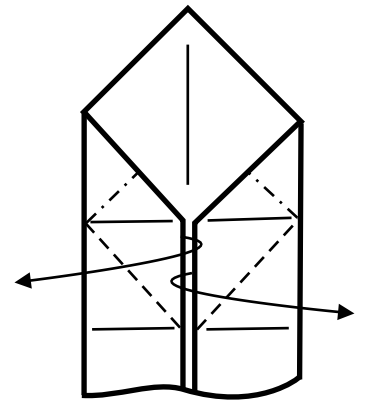

31. Раскройте верхнюю часть фигуры, используя намеченные сгибы.

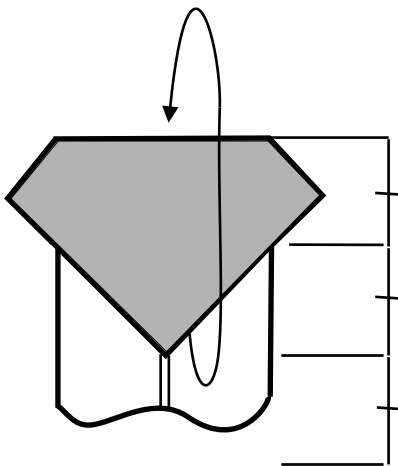

32. Осторожно выверните заштрихованную часть фигуры наизнанку.

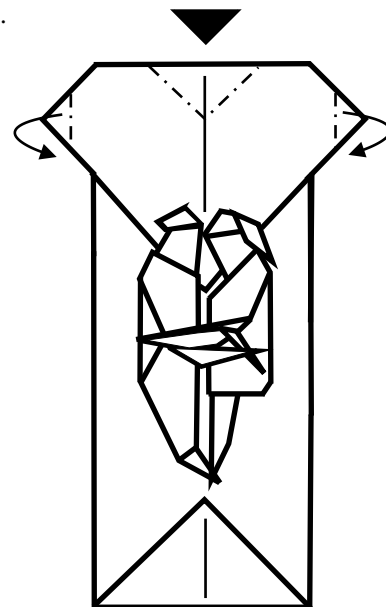

33. "Горными" сгибами придайте верхней части фигуры форму сердца.

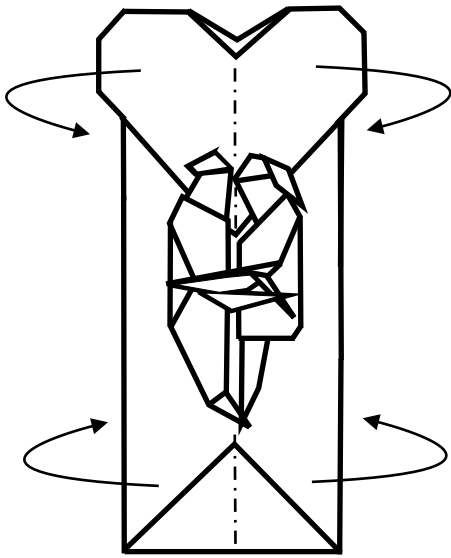

34. Согните фигуру так, чтобы её боковые стороны образовали прямой угол, а фигуры влюблённых остались на одной плоскости.

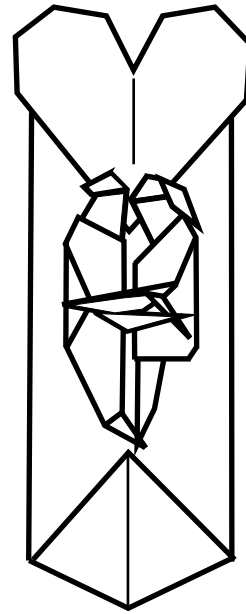

35. Фигура готова!  
Если хотите, это памятник Вечной Любви, воплощённый в бумаге.



# Kawasaki Rose

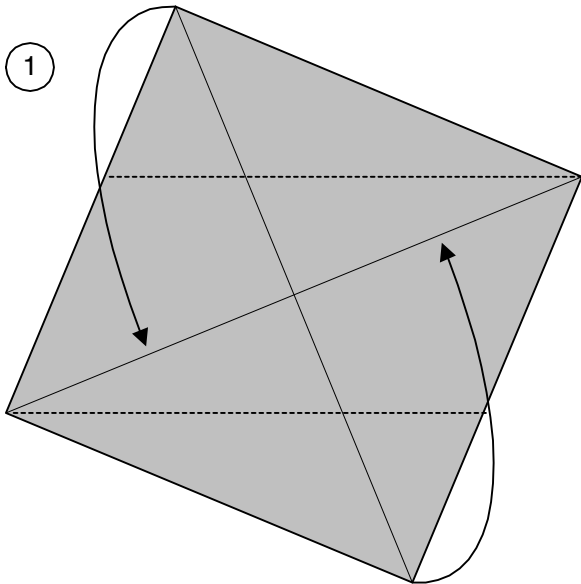

Folding the rose begins with creating a grid on the paper at a 22.5 degree angle,  $45 \text{ degree}/2$ . Crease diagonals, and with the coloured side up, valley fold left side to the diagonal. Repeat above. It is important to fold the correct side to the diagonal, as shown in the diagram.

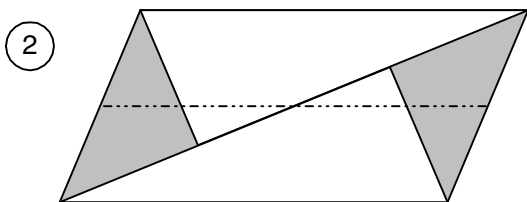

Mountain fold only the bottom layer

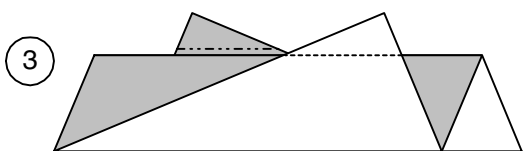

Valley fold the tip of the front layer so that it is flush with the layer behind. Repeat behind.

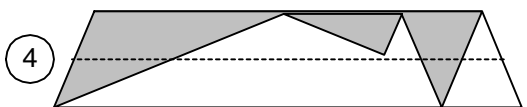

Valley fold/unfold first two layers of paper. Repeat behind

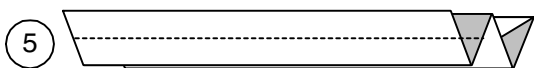

Valley fold/unfold first four layers of paper. I recommend that the folder fold at most two layers of paper at a time to avoid paper drift. The type of fold (valley or mountain) is unimportant at this point in folding

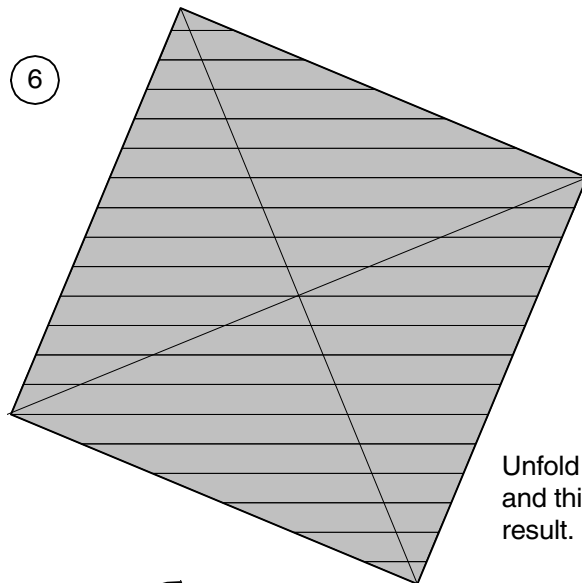

Unfold steps 1 to 4 and this is the result.

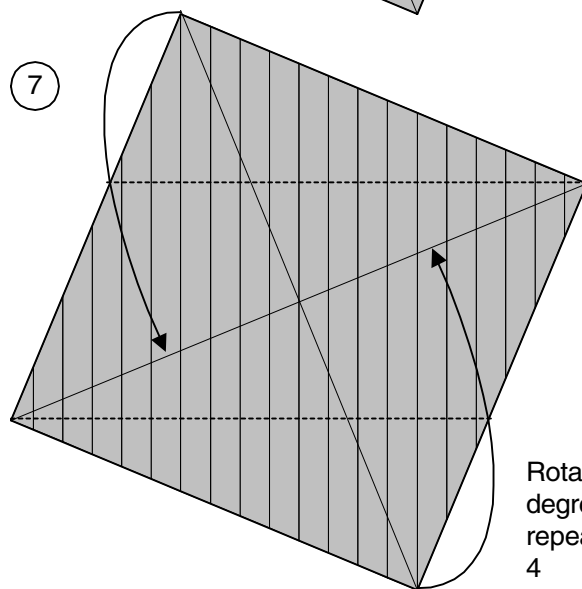

Rotate 90 degrees and repeat steps 1 to 4

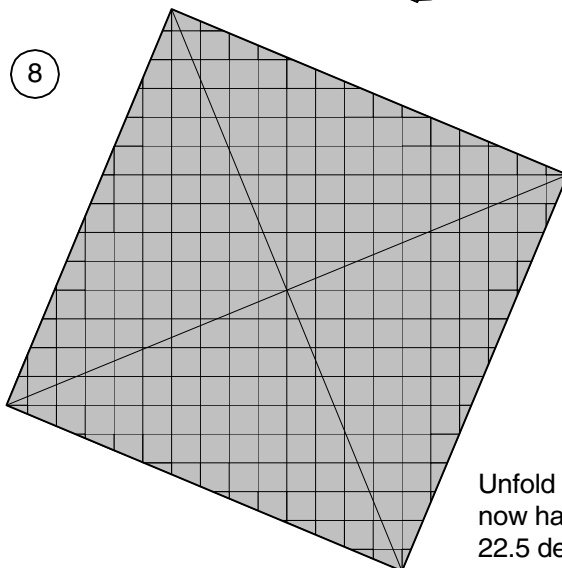

Unfold and you should now have a grid on a 22.5 degree angle.

Kawasaki Rose	1/5
Designer: Toshikazu Kawasaki	
Diagrammed By: Winson Chan	
Revision: 2.1	Date: 4/29/96

9

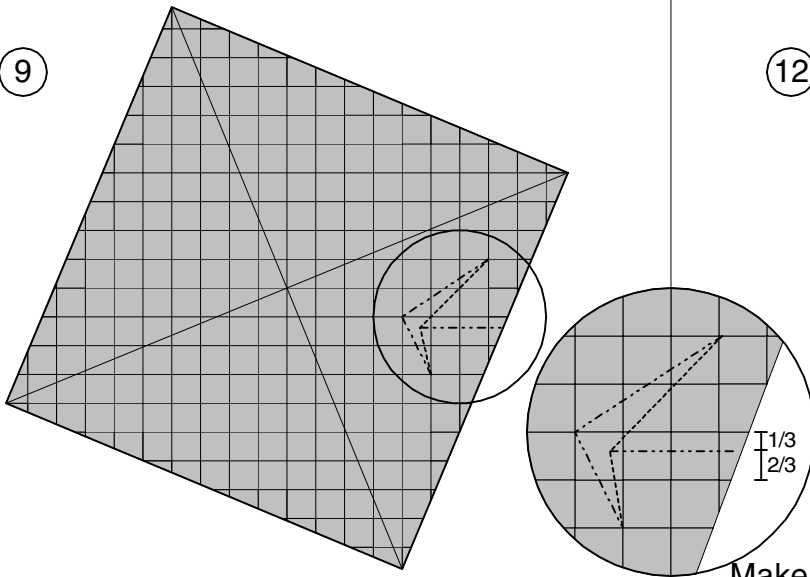

Make the following mountain and valley folds. See enlargement. Notice the position of the horizontal crease. Repeat on all four sides

10

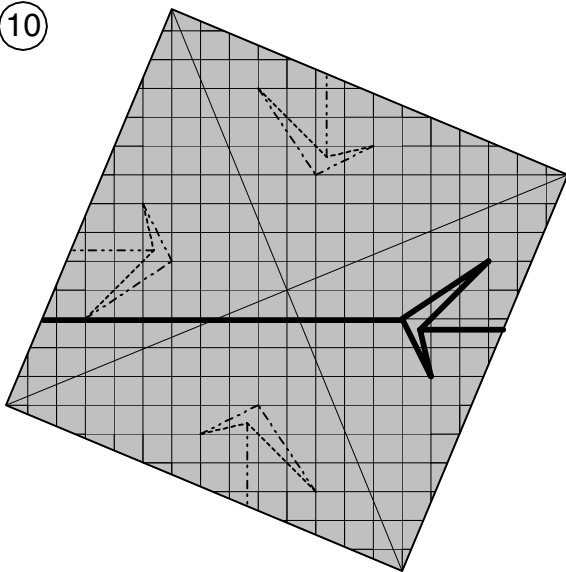

The paper should look like this after completing each set. Reinforce each set of folds by crimping along the darkened line.

11

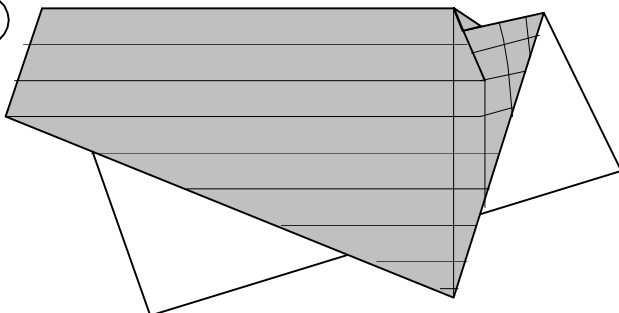

This is what one of the crimps looks like. Repeat on all four sets.

12

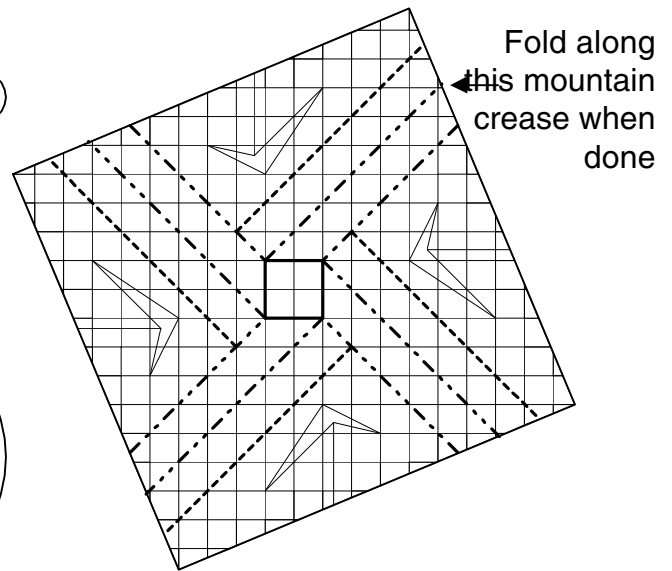

Make the following mountain and valley folds. They are at 45 degrees relative to the grid. The square in the centre can be used as a guide. When these creases are complete, mountain fold along the crease indicated, the entire length of the paper

13

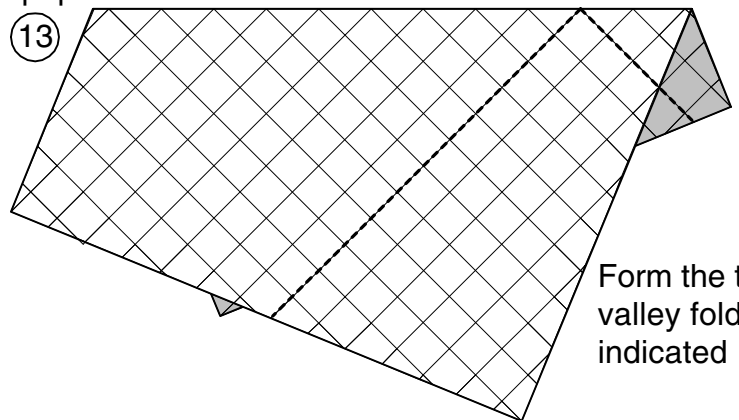

Form the two valley folds indicated

14

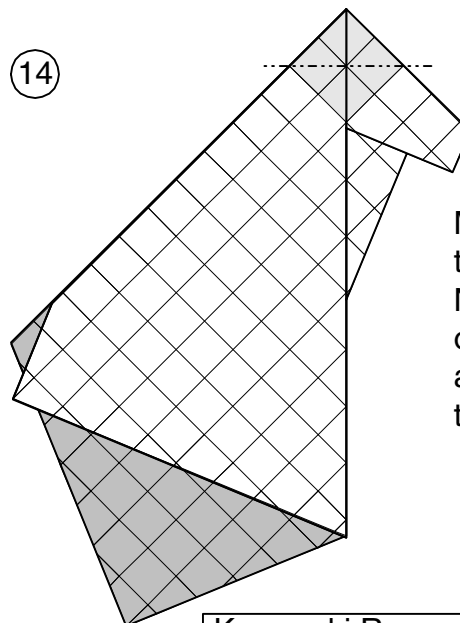

Mountain fold the top point behind. Notice the location of the light gray area over the next three steps.

15

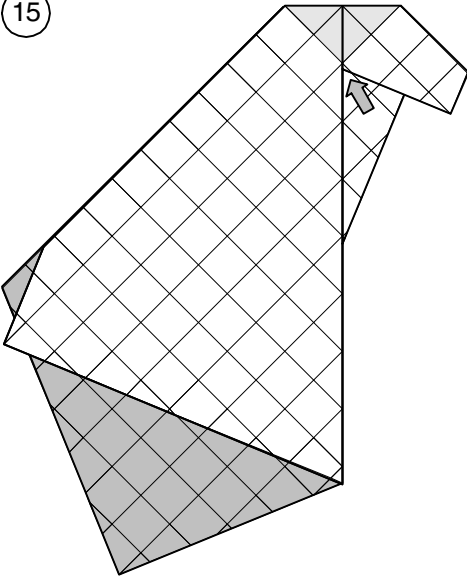

Open up the model by inserting a finger into the section indicated. Model will not remain flat. Notice the movement of the light gray section

16

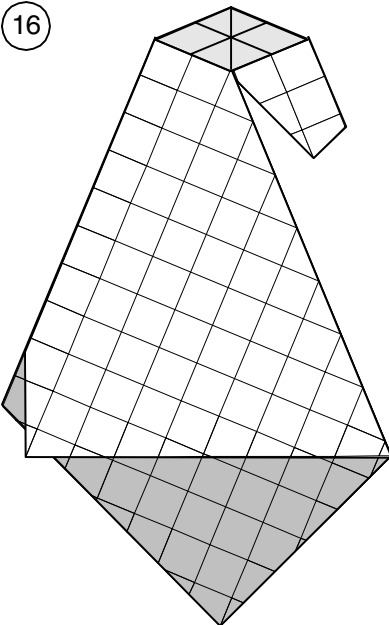

Unfold model to step 12.

17

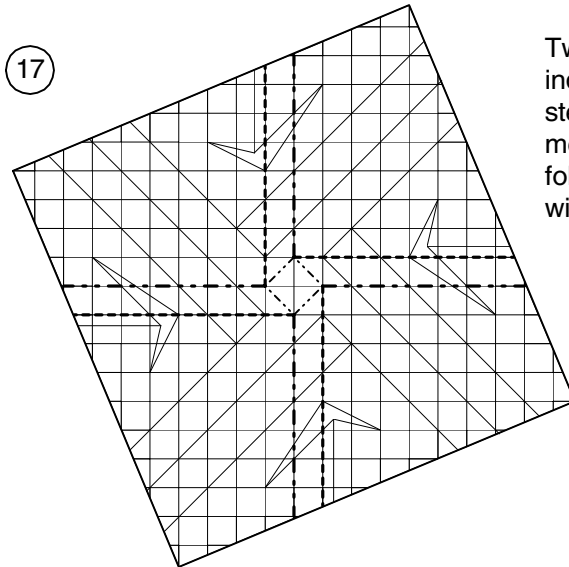

Twist fold along the lines indicated. The next 2 steps provide a simple method of doing a twist fold if you are not familiar with it.

18

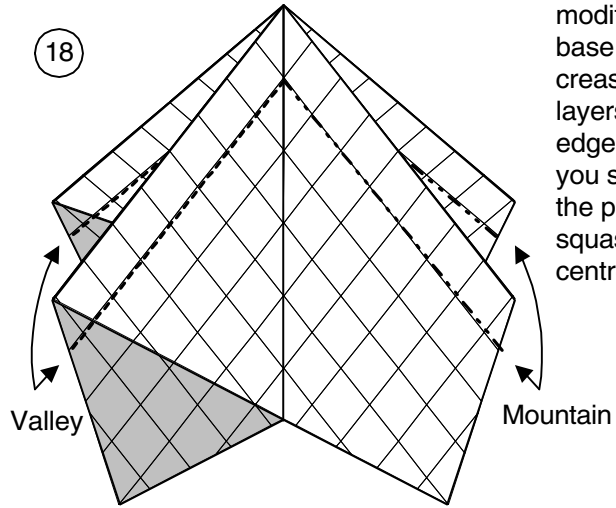

Form a (slightly modified) waterbomb base along existing creases. Fold both layers of paper on each edge as indicated, while you spread out/ flatten the paper. Carefully squash the paper in the centre into a square.

19

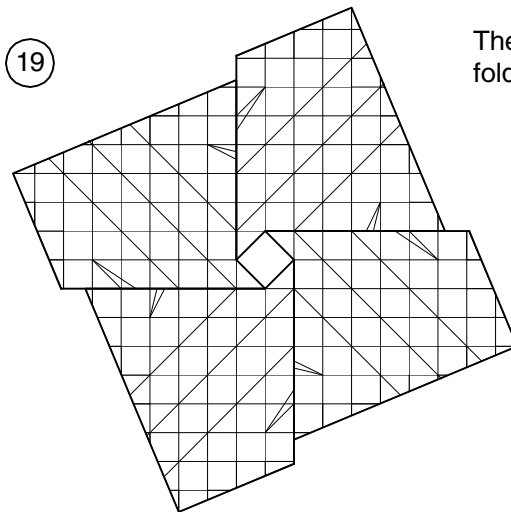

The model after the twist fold. Flip paper over.

20

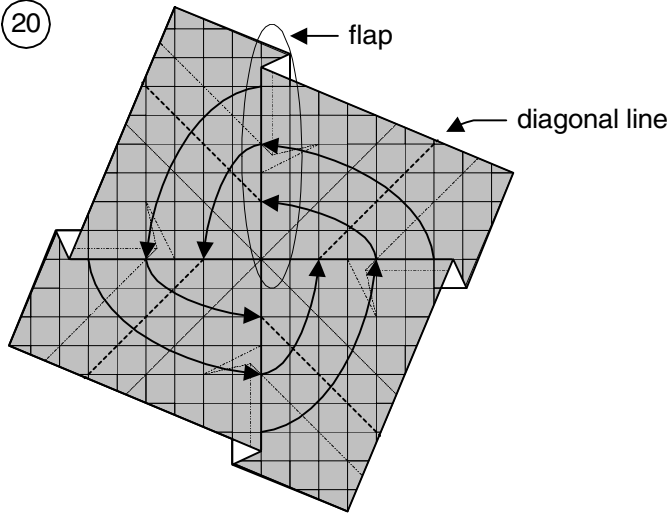

Bring together the flaps formed by the twist fold. Valley fold along the diagonal line to help with this. Model will not remain flat, and should resemble a cylinder. Make sure that the centre points up, not down.

21

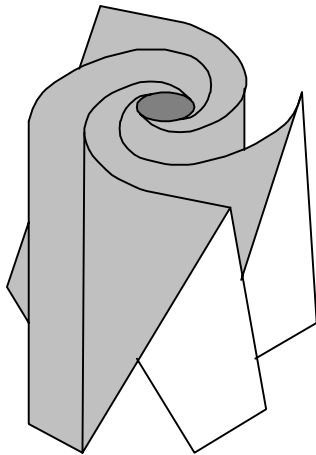

To create the cylinder like appearance of the model, place one hand around the model, insert one finger (of the other hand) and rotate finger clockwise. Be careful not to make break the paper. The model will wrap tightly around your finger. This step will improve the look of the model and is not essential.

22

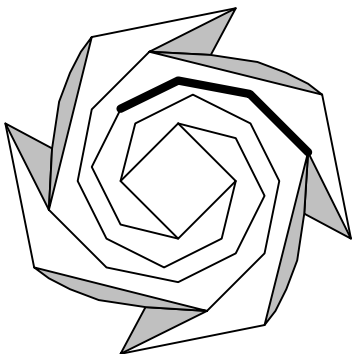

View from the bottom of the rose before the reverse folds. Notice the movement of the darkened line. See step 25.

23

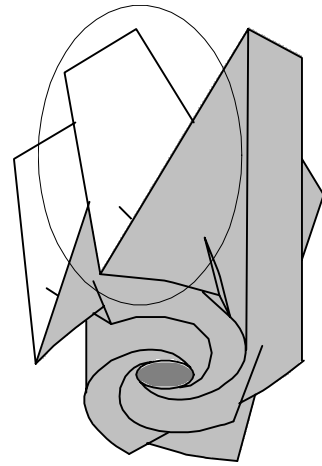

Re-form the crimps in step 11. Turn the model upside down. Notice the enlargement of the indicated area in the next step. The next few steps will consist of re-forming the folds in steps 13 to 16. This will lock the base of the rose.

24

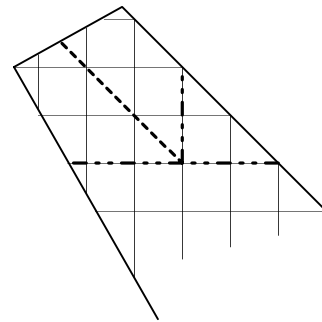

Enlargement of the indicated area in the previous step. No new creases are needed. All creases were folded in correct direction (mountain or valley) in steps 13 to 16. Make sure to fold both layers of paper. The folder should realize this fold is essentially a reverse fold. A review of a reverse fold is found on page 5.

25

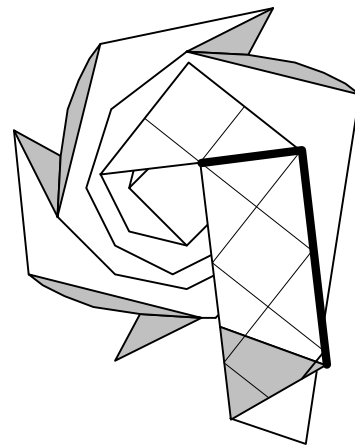

This is what the model looks like. Notice the darkened line, and compare it with the diagram in step 22. Repeat this with all 4 flaps.

Kawasaki Rose	4/5
Designer: Toshikazu Kawasaki	
Diagrammed By: Winson Chan	
Revision: 2.1	Date: 4/29/96

26

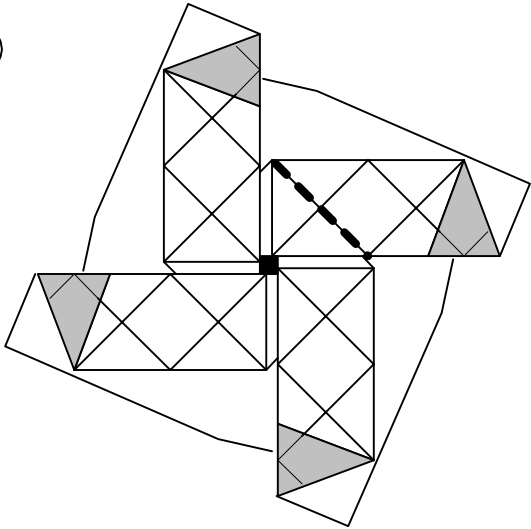

This is what the model looks like after the inside reverse fold on each flap. It is essential that the hole in the centre is as small as possible. Try pulling on the flaps to reduce the size of the hole. Next, do an outside reverse fold (on the two layers) so that it wraps back around the model.

27

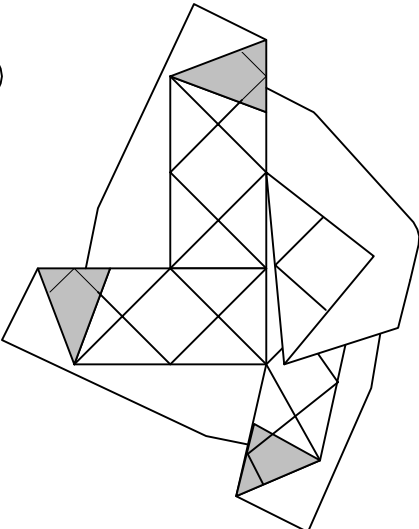

This is what the model looks like after one outside reverse fold. Notice how we have now refolded steps 13 to 16. Now do the same on the remaining 3 flaps so that the four flaps overlap each other. The last fold is the most difficult.

28

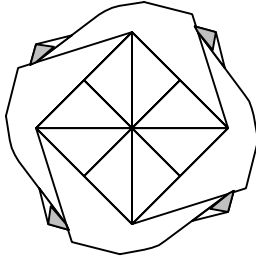

The underside of the completed rose. The rose is now essentially done. Flip the rose over, reform the centre by inserting a finger and rotating it clockwise as in step XX. Form petals into desired shape. The rose is now complete

29

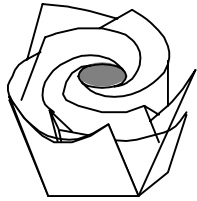

A very poor drawing of the top of the rose. I'll fix it in my next revision!

Have Fun!

The Kawasaki Rose was taught to me ( the diagrammer) by Joseph Wu, who was taught by Toshikazu Kawasaki at the Convention in New York in 1994.

You can make copies of these diagrams for personal use and for friends, but do not make large number of copies for wide distribution (i.e. at a Convention).© 1996

Inside Reverse Fold

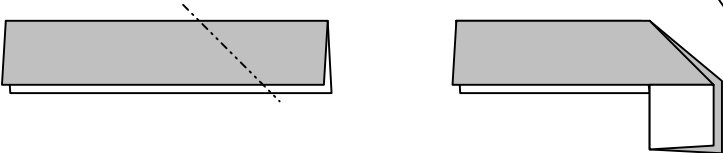

Outside Reverse Fold

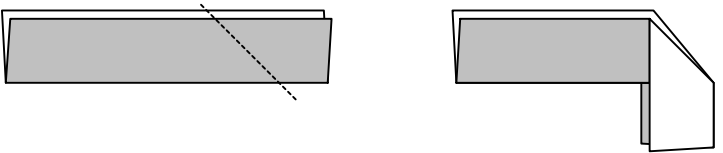

Kawasaki Rose	5/5
Designer: Toshikazu Kawasaki	
Diagrammed By: Winson Chan	
Revision: 2.1	Date: 4/29/96

# Base for Kawasaki's rose ©1993 by Joseph Wu

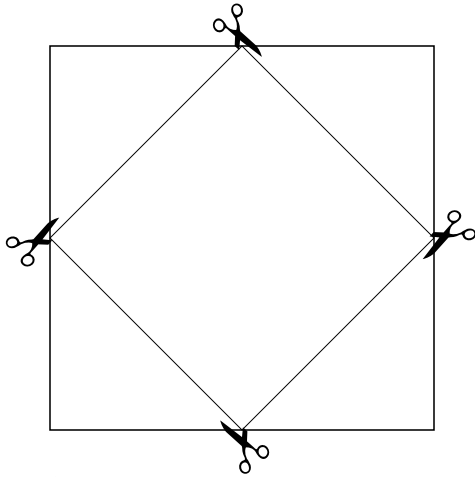

1. A square the same size as was used for the rose.

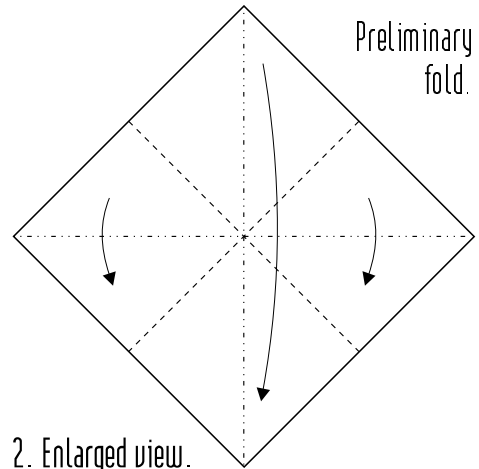

Preliminary fold.

2. Enlarged view.

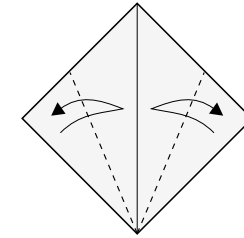

Repeat behind.

3.

Tuck inside, following the creases.  
Repeat behind.

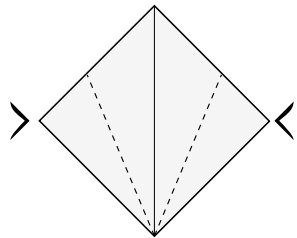

4.

Repeat behind.

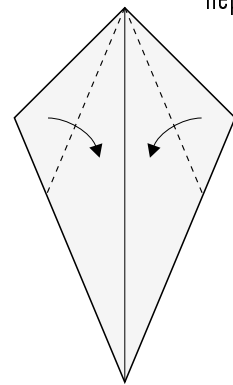

5. Bird base. Enlarged view.

Inside reverse fold the hidden layers.

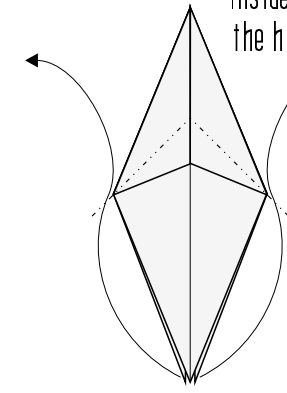

6.

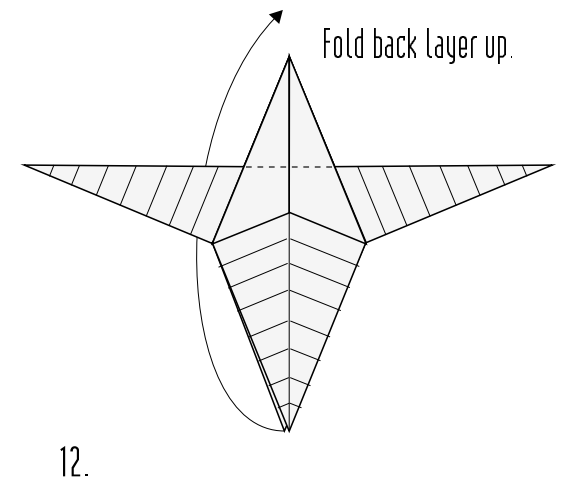
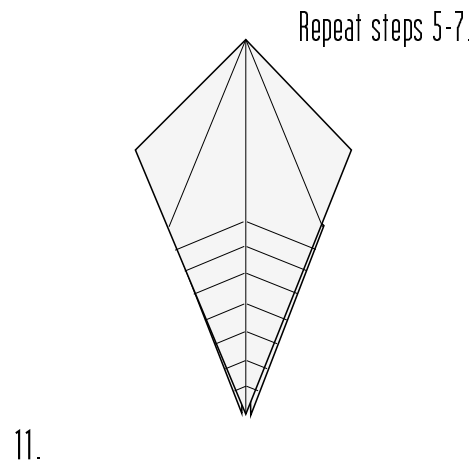
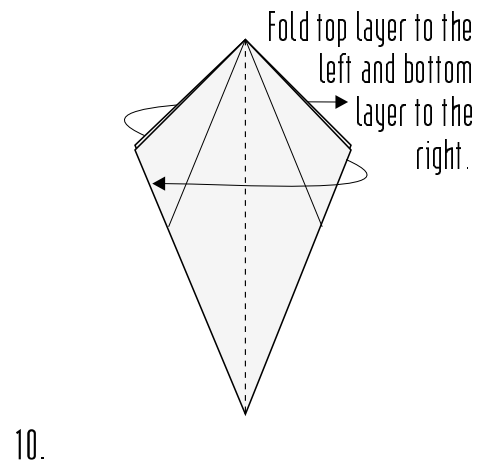
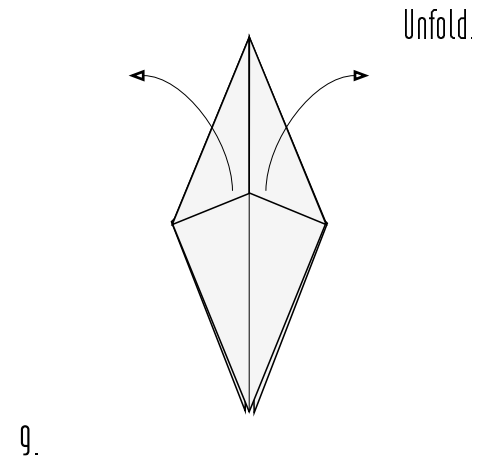
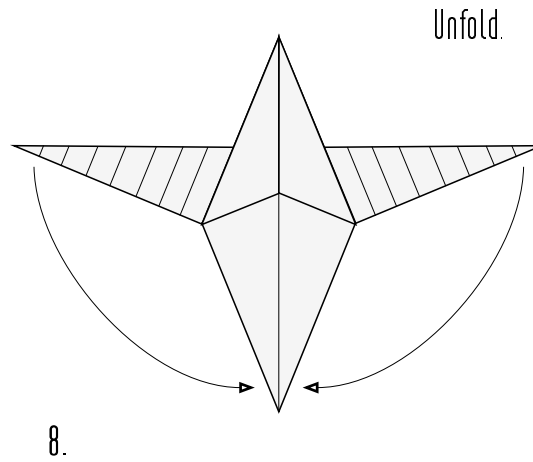
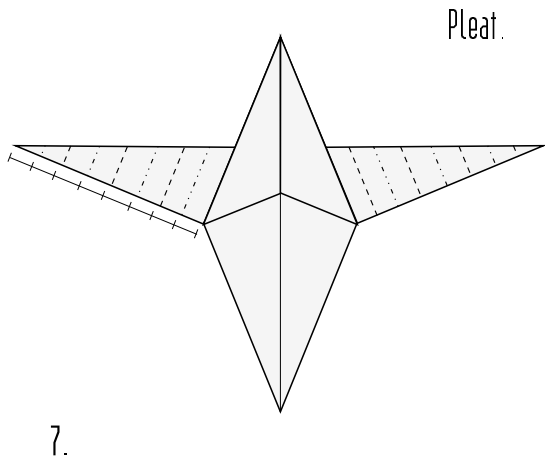

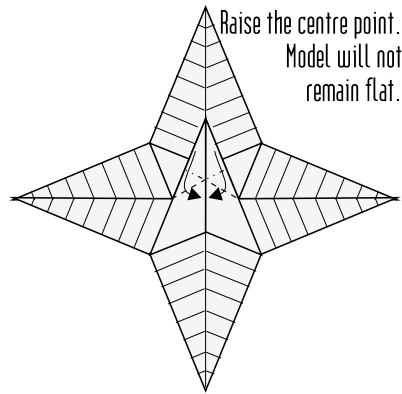

13.

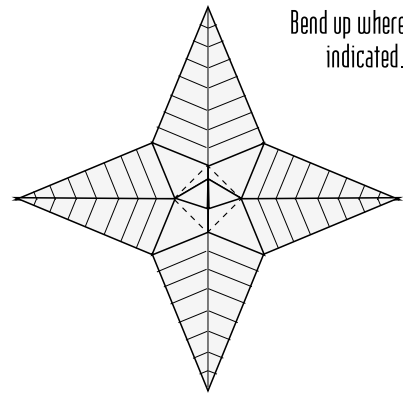

14.

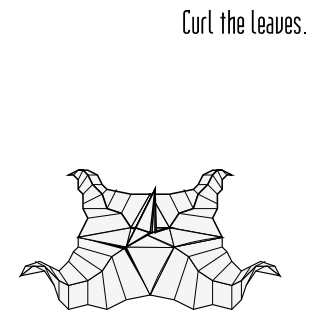

15. Insert point into bottom of rose.



# Andrea's Rose - J.C. Nolan 9/25/91

Intermediate difficulty level. A 10" piece of paper produces a 5" model.

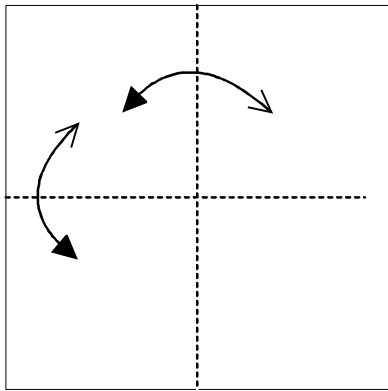

1. Fold and unfold laterally.

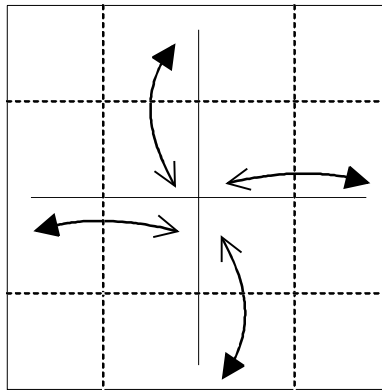

2. Fold and unfold in fourths. Turn over.

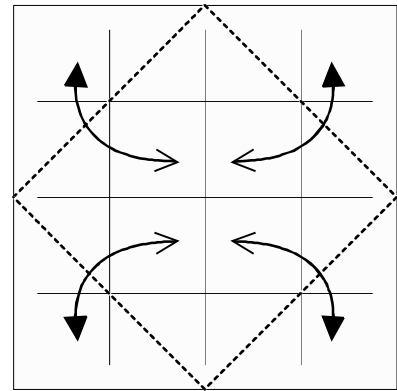

3. Fold and unfold. Turn over.

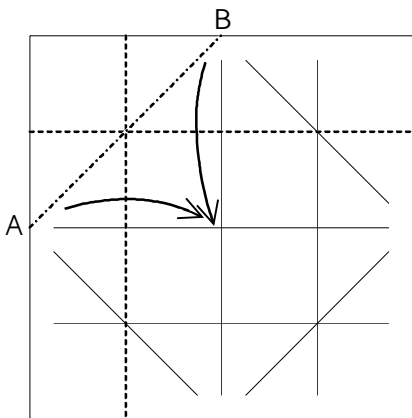
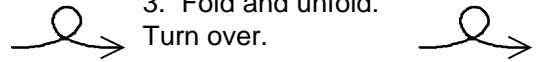

4. Following the existing creases start to fold a windmill base, bringing points A and B to the center.,

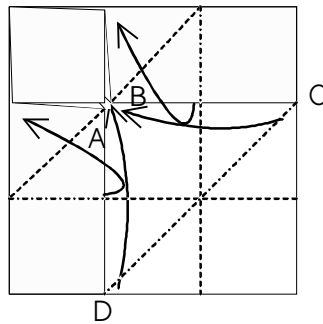

5. To complete the base, do the same with C & D.

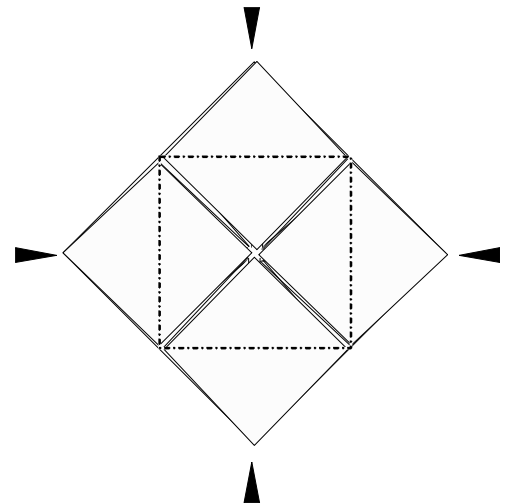

6. This is a completed windmill base. Sink all four corners.

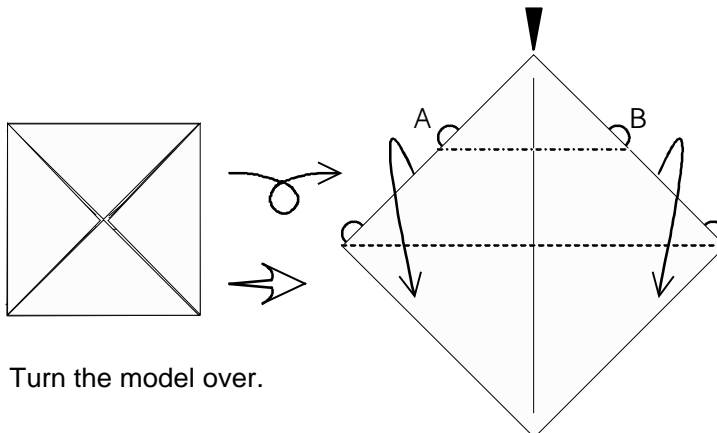

7. Turn the model over.

8. Now you will execute the next level of sinks using the spread-squash method. Note the location of the four anchor points. Place your two index fingers on the upper points, under two layers of paper, and your thumbs on the lower points, under just one layer of paper, and pull the upper layer of paper downward, across the center of the model, pushing on the upper point with your third thumb, causing it to spread-squash into a square located directly over the center of the model.

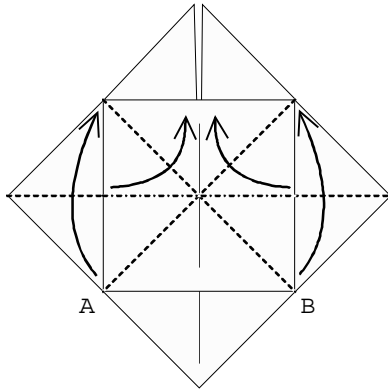

9. Fold the spread-squash back up on the existing creases, pulling one layer from each side inward and upward.

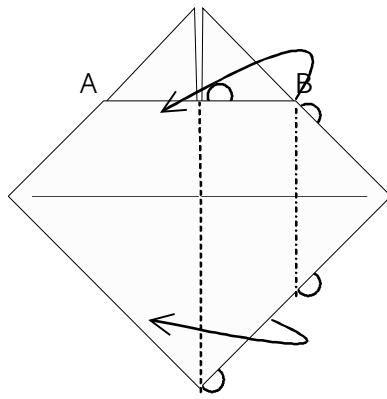

10. Now, repeat steps 8-9 on the next corner. Note the placement of fingers. Be careful when folding the sink back up, it is as easy to grab two layers as one.

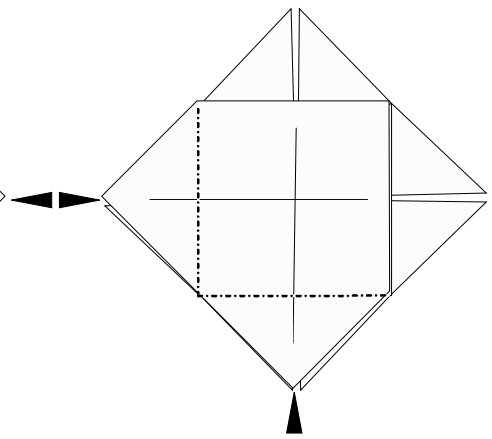

11. Repeat the sink on the last two corners.

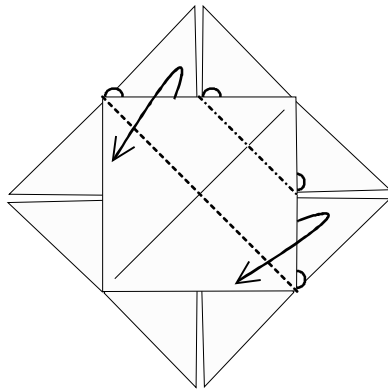

12. The second level of sinks is complete. The model should be symmetric in four directions, if it is not, then a mistake was made in folding up the sinks. Continue sinking on the next level.

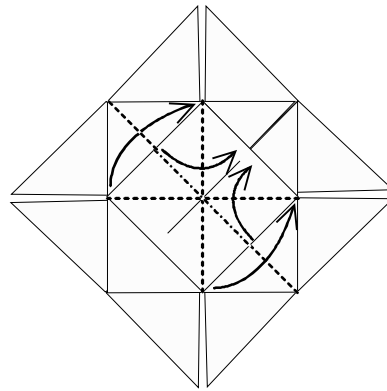

13. Note that the squashed square is always in the center of the model. Fold up as before.

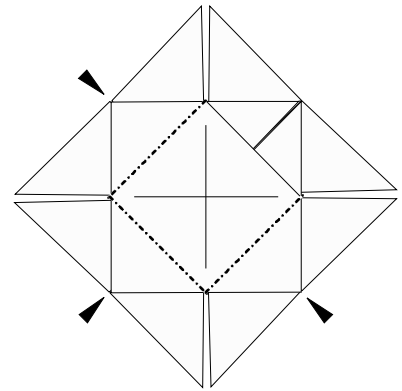

14. Complete the level by sinking the other 3 corners.

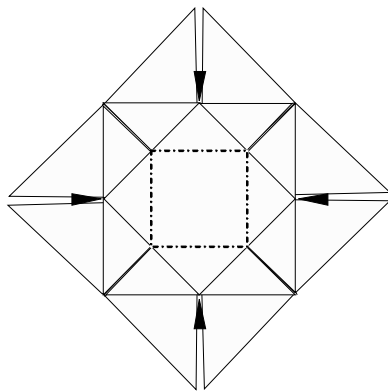

15. Keep adding levels until your paper shreds irrecoverably, your eyes explode, or you feel satiated by the process. As a challenge, I recommend eight levels on an 10" piece of paper.

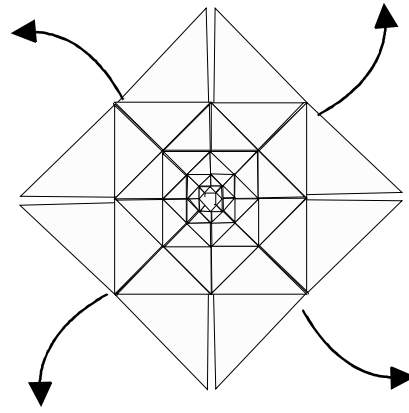

16. To complete the model, valley fold the last set of flaps towards the center, and pull the flaps out from behind.

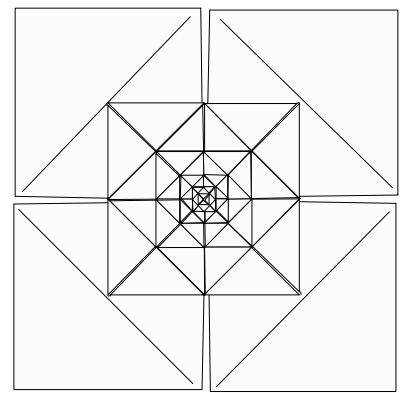

17. Completed model.

**From a picture in Paul Jackson's Encyclopaedia of Papercraft and Origami Techniques**

- Valley fold
- ..... Mountain fold

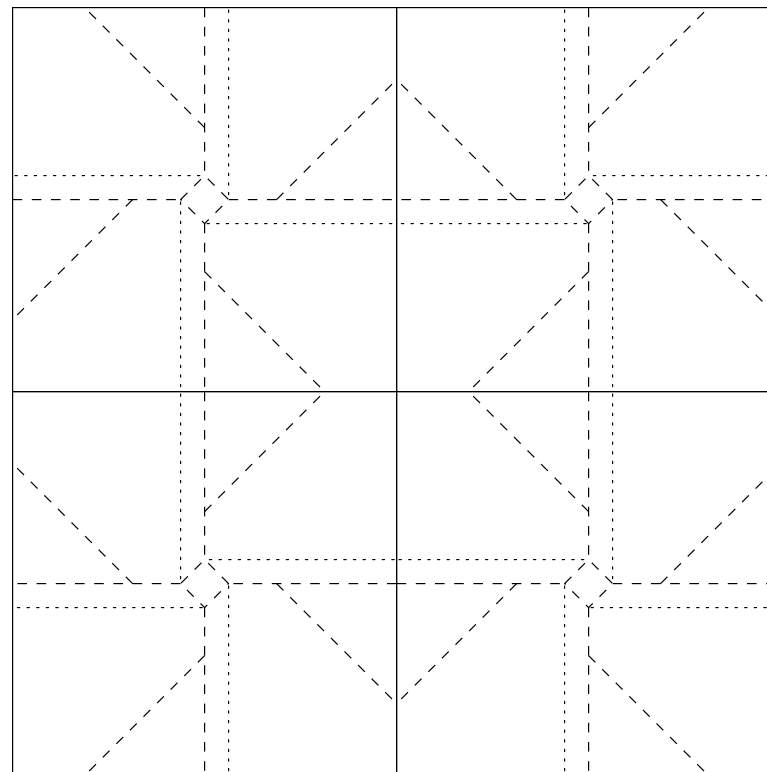
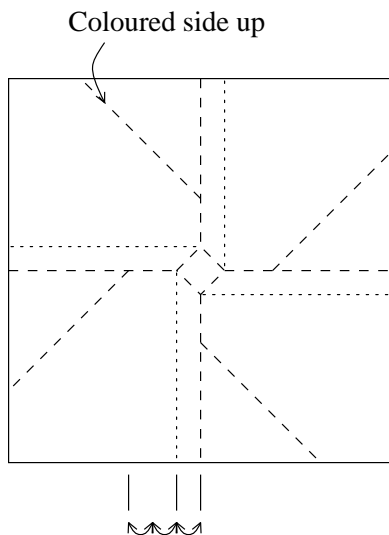

Above is a single rose. It's the same idea as Kawasaki's rose published in *Origami for the Connoisseur* but rotated by 45 degrees. I haven't worked out a way of locking the repeated design; there are several ways of locking a single rose. It's much easier to continue the mountain folds across the entire width of the paper. The picture on the right shows (if it's not already obvious) how to fit roses together.

I've not seen instructions for the Crystallized roses anywhere; Kawasaki may well have a better way of making it. All criticisms of this diagram should be addressed at me, not him!

bruce@liverpool.ac.uk Bruce Stephens

# Rose Brooch a tribute to Toshie Takahama

©1997 Sy Chen

Modified from Toshie Takahama's Rose Brooch in 8/97  
and diagrammed in 12/97-1/98

1. Start from duo-color square with  
leaf color side up and rose color down

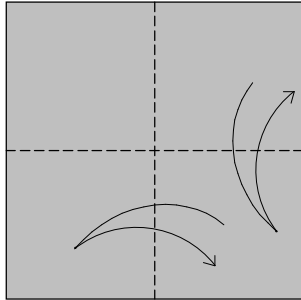

2. Fold edges to the center and unfold

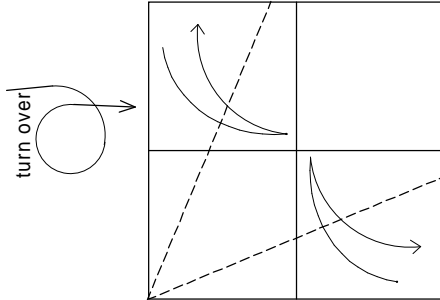

3. Repeat for other 3 corners

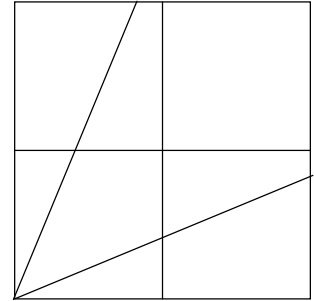

4. Four more creases

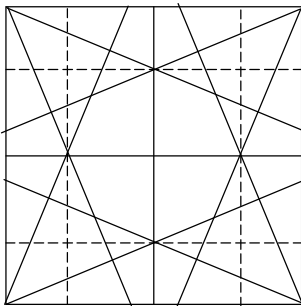

5. Valley fold A to B and unfold

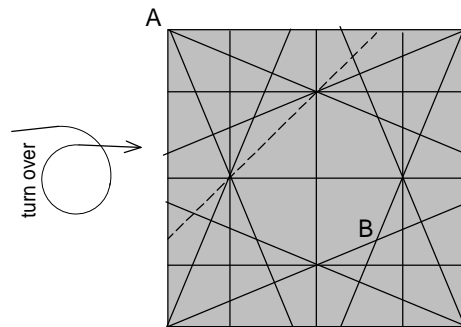

6. Repeat 5 for other 3 corners

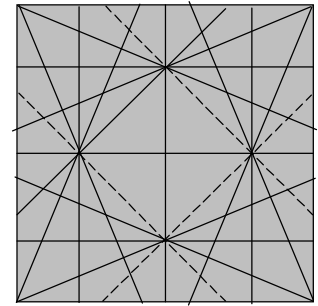

7. Bring 4 corners upward using pre-crease

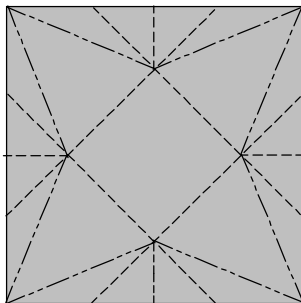

8. In progress - 3D view

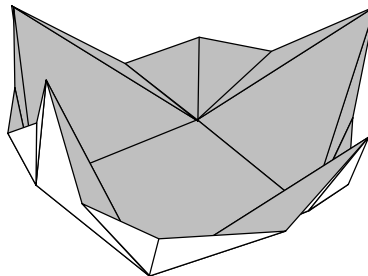

9. 3D view; Twisting collapse; Model  
turns into flat again

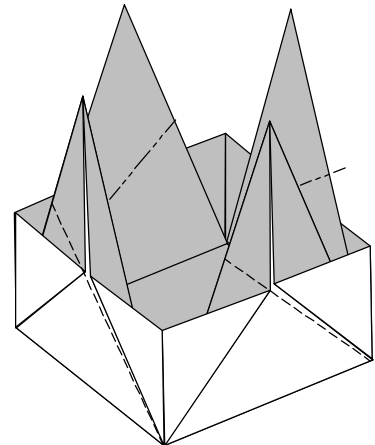

10. Turn over

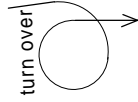
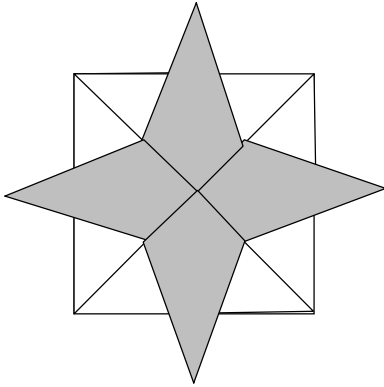

11.

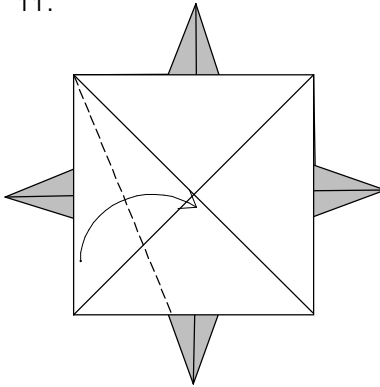

12.

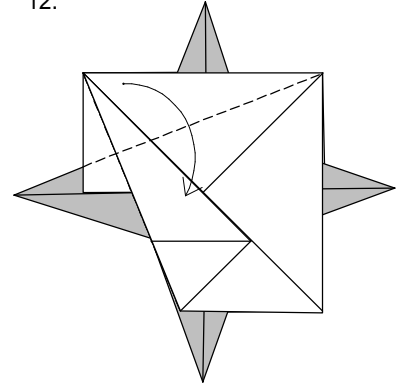

14. Fold lower right corner so the left part is inside reverse fold. Make sure the fold makes all corners the same. See next step.

13.

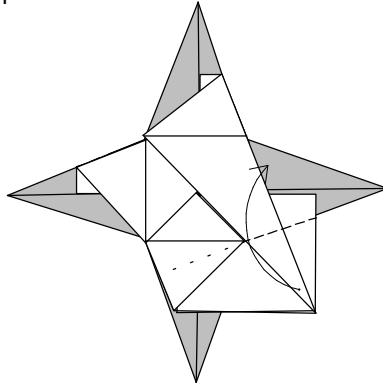
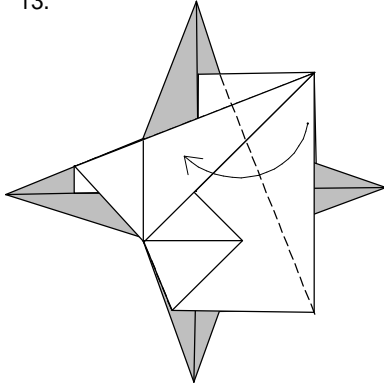

15.

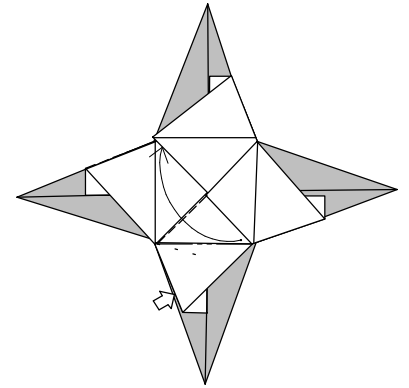

16.

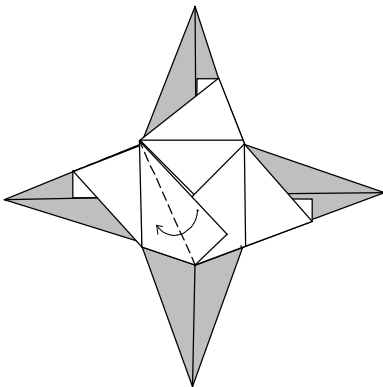

17. Hide flap C under layer D; Lift layer D and bend flap C may help

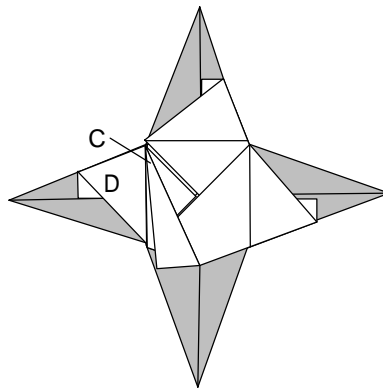

18. Repeat steps 15-17 for other 3 flaps

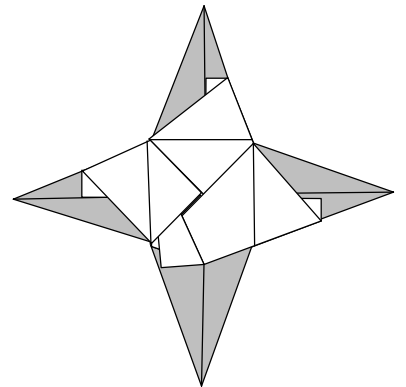

19. Turn over

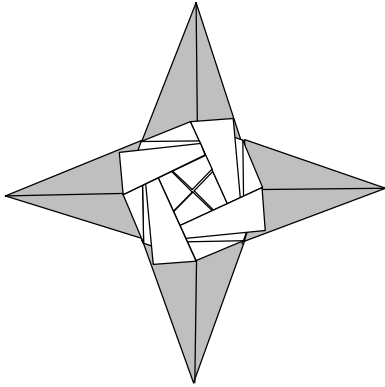

20.

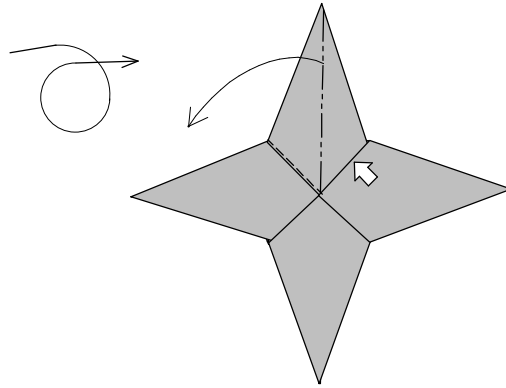

21. Alternative mountain and valley fold; Use your own judgement to decide # of folds and interval; It need not to be precise.

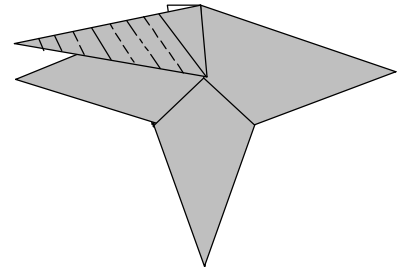

22. Unfold the pleating to step 20 but don't make it totally flat

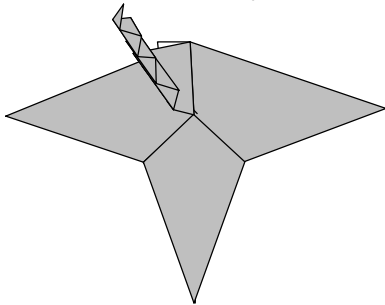

23. Repeat steps 20-22 for other three leaves

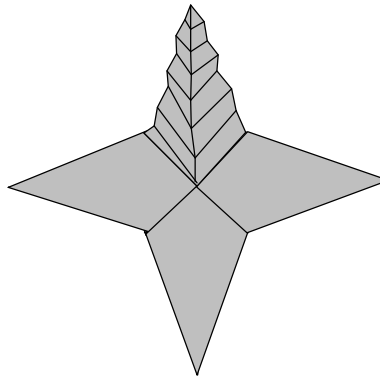

24. Turn over

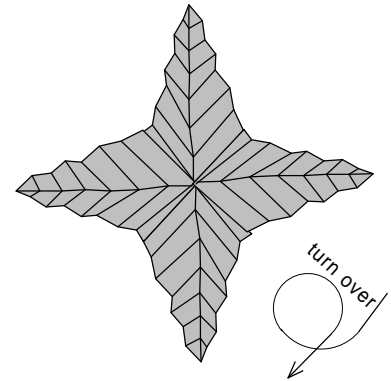

25. Open out and round the center flap

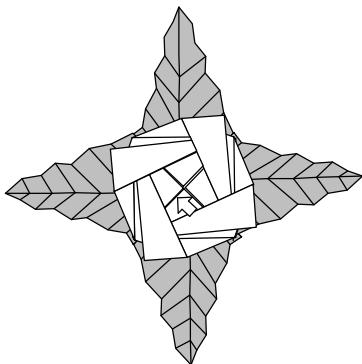

26. Repeat for other flaps

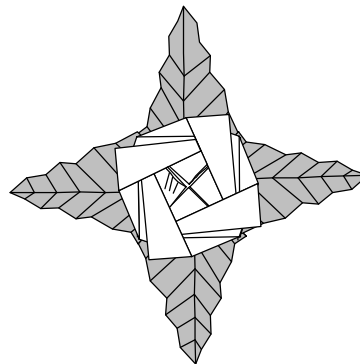

27. Finished

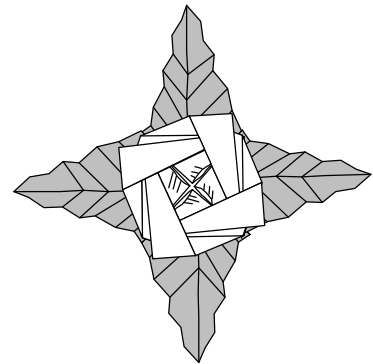

# MAP OF KAWASAKI'S "ROSE CRYSTALLIZATION" (Tessellation) Shown in Jackson's Encyclopedia

—— Mountain Fold  
- - - - Main Valley Fold  
- · - · Initial Valley Fold

Drawing & Text 11 July 1995  
Copyright 1995 Valerie Vann  
Internet: 75070.304@compuserve.com

## TOP VIEW

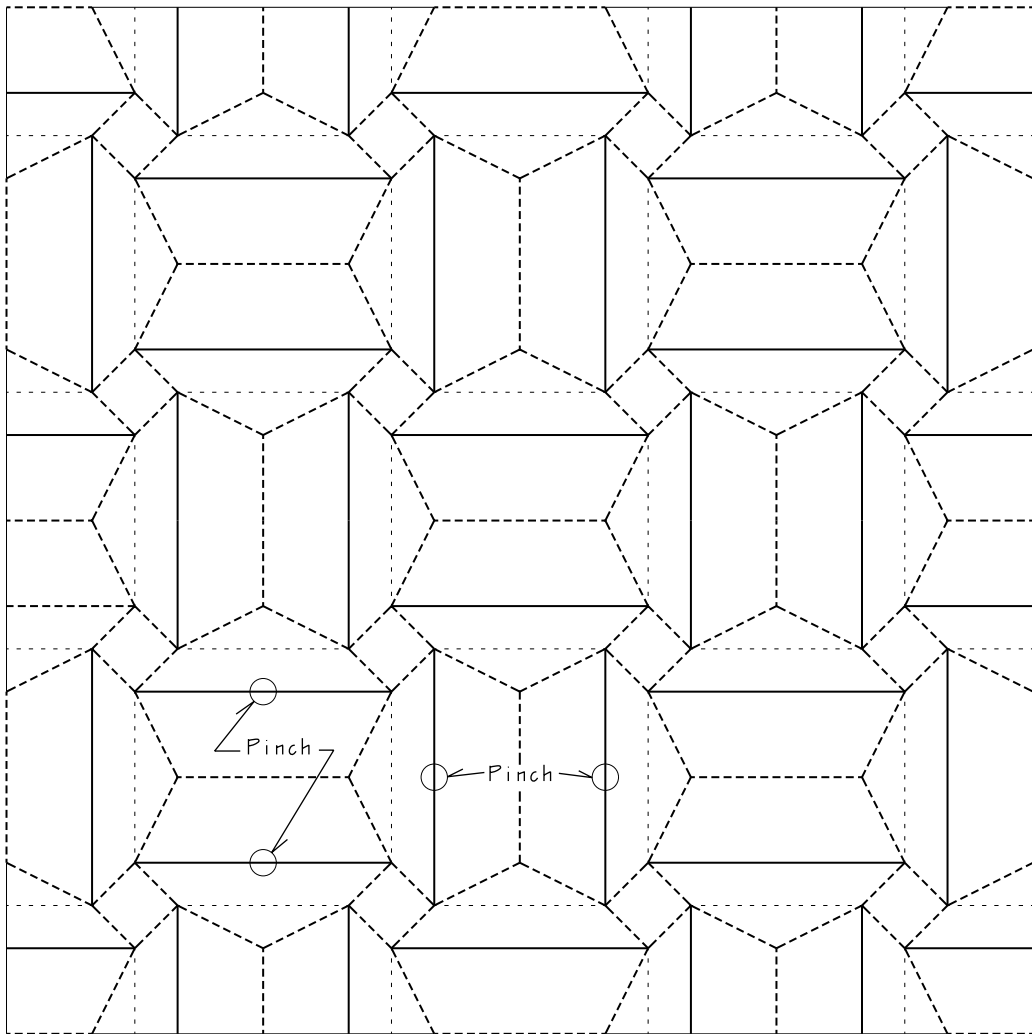

1. With Color Side Up, Valley Fold on  $1/8$ ths (eighths)
2. Mountain Fold on  $1/12$ ths (twelfths), except those that already have Valley Folds.
3. Pre-Crease the SINKs at the Small Squares and the Diagonal Valley Folds as shown on the Map.
4. Collapse the Sinks using only the Initial Valley Folds and the Mountain Folds.
5. With Top up, Pinch adjacent Mountain Folds together and twist the Sinks so the Main Valley Folds take over.
6. Turn over and sharpen creases, twist sinks further as necessary until the whole model is reduced to about the size (area) of the sixteen sink squares.

NOTE: This Diagram is a "Best Solution So Far" case of Reverse Engineering.  
It is not guaranteed to be how Kawasaki does it!

# Santa by Steven Casey

Begin with a square white side up.

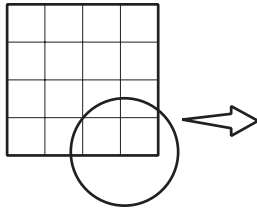

1. Precrease into 4 x 4 using Valley folds. Scale change.

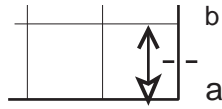

2. Fold a to b. Pinch. Unfold.

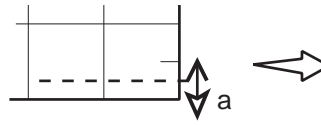

3. Fold a to b to pinch mark. Unfold. Scale change.

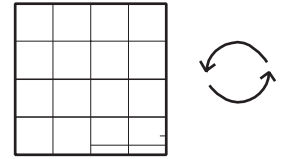

4. Rotate 90 degrees to the left.

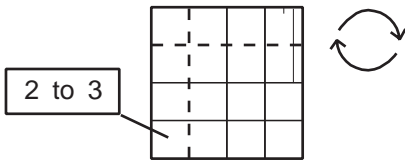

5. Repeat steps on the left side. Rotate to position in step 4.

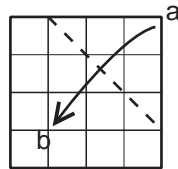

6. Fold a to b. Creases made in steps 2 to 5 not shown until step 30.

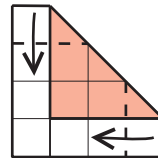

7. Valley top and right edges.

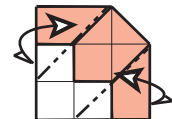

8. Mountain fold behind. Unfold.

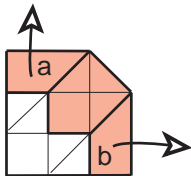

9. Open out flaps a and b.

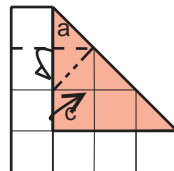

10. Lift c slightly, and allow a to slip under.

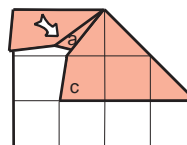

11. This shows the fold in progress.

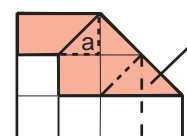

12. Repeat step 10 where shown.

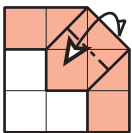

13. Mountain fold. Unfold.

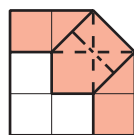

14. Collapse into a waterbomb base.

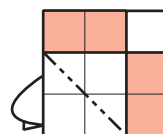

15 Mountain fold.

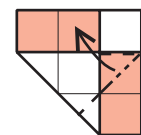

16 Swival fold.



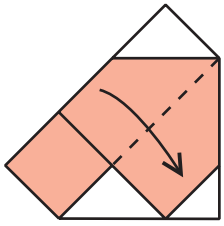

17. Valley.

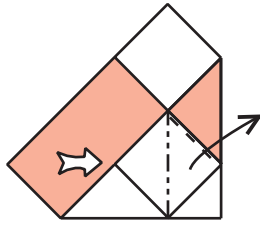

18. Sink then valley.

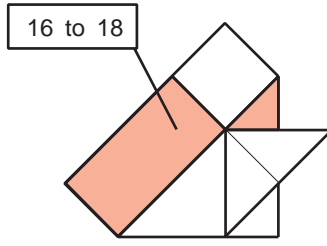

19. Repeat steps other side.

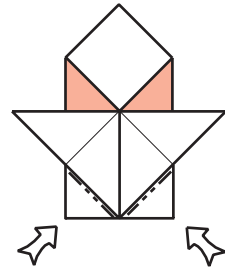

20. Sink bottom corners

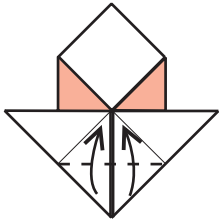

21. Valley both points up.

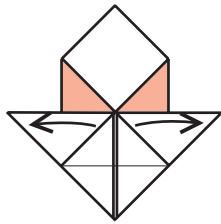

22. Pull points outward.

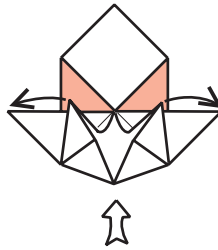

23. Shows the fold in progress.

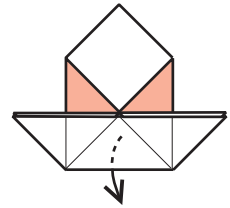

24. Unfold flap from behind.

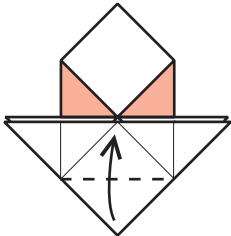

25. Valley top layer.

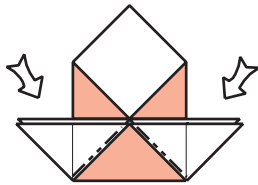

26. Reverse fold two top points.

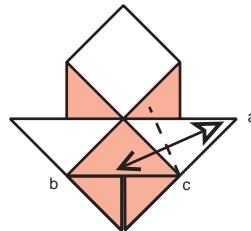

27. Fold double raw edge a - c along closed edge b - c. Unfold.

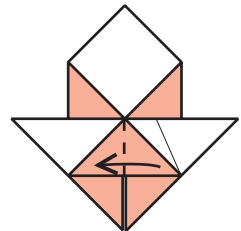

28. Valley top flap to the left.

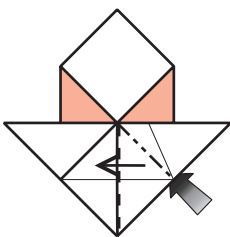

29. Squash fold.

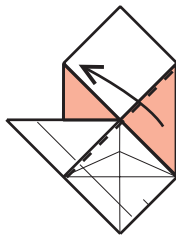

30. Valley top flap up. Creases made in step 2 to 4 now shown.

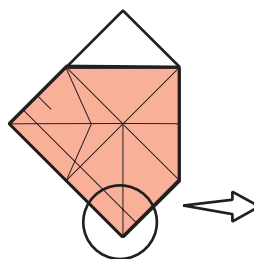

31. See detail. Scale change

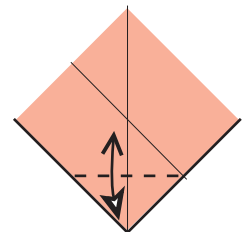

32. Fold corner up to intersection of diagonal and centre crease. Unfold.

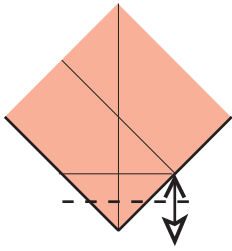

33. Valley corner up to Horizontal crease. Unfold.

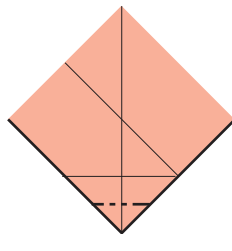

34. Sink.

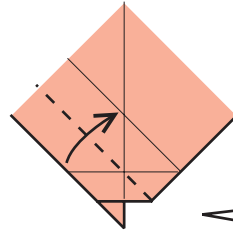

35. Valley entire edge to diagonal crease. Scale change.

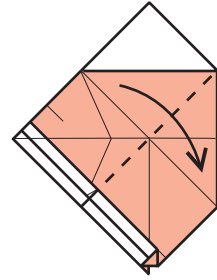

36. Valley diagonal.

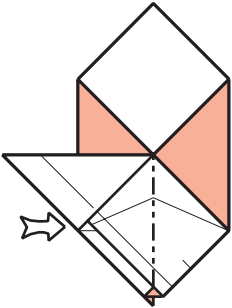

37. Sink.

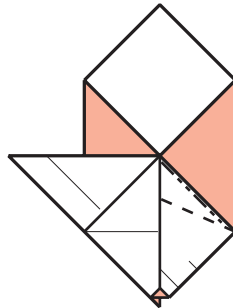

38. Double reverse fold.

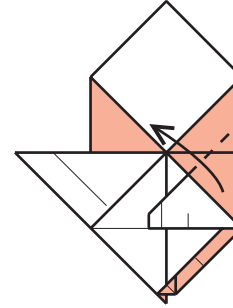

39. Valley fold.

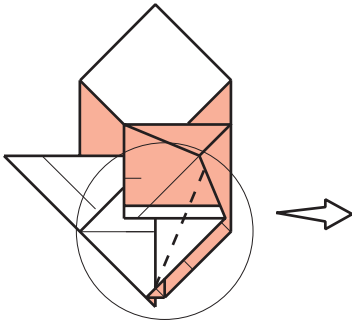

40. See detail next step.

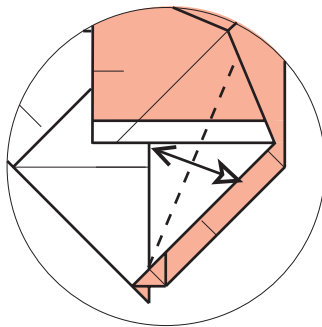

41. Valley fold. Unfold.

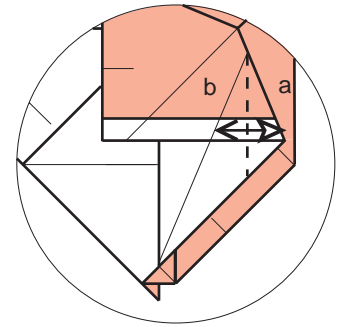

42. Fold edge "a" across to diagonal crease "b". Unfold.

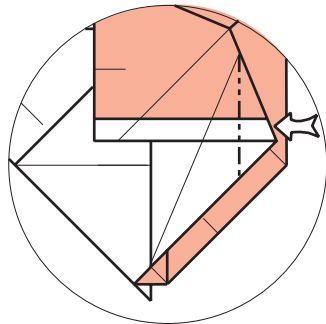

43. Sink.

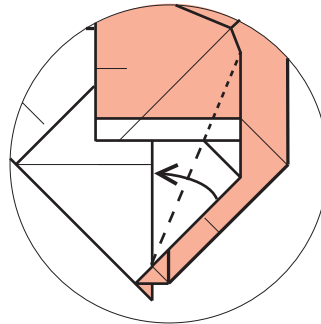

44. Combination valley/sink.

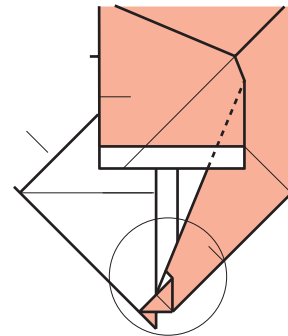

45. See detail next step.

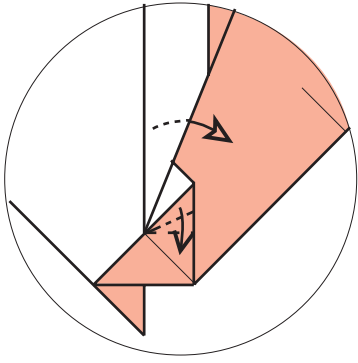

46. Pull out trapped layer.  
Swival fold.

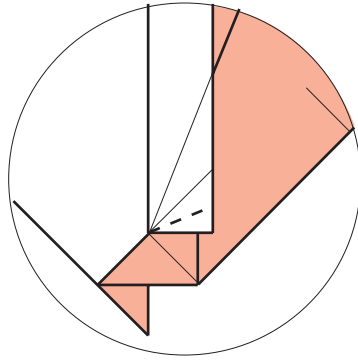

47. Valley fold.

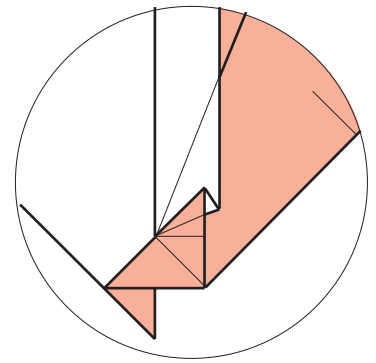

48. The result.

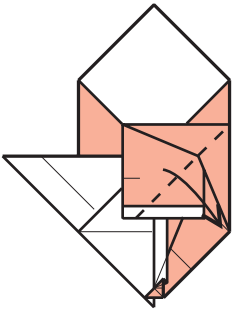

49. Valley fold.

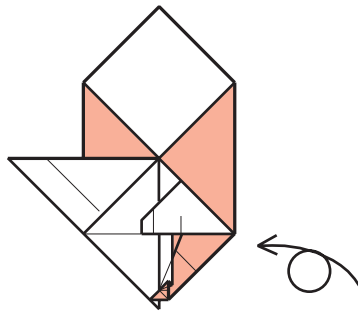

50. Turn over right  
to left.

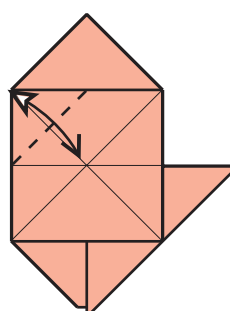

51. Valley. Unfold.

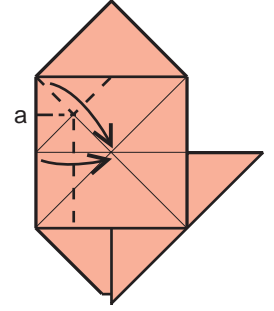

52. Collapse.

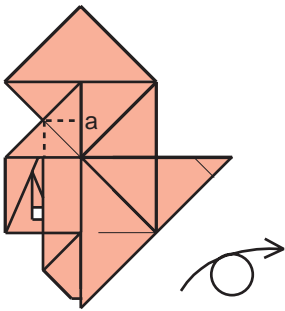

53. This is the result.  
Turn over.

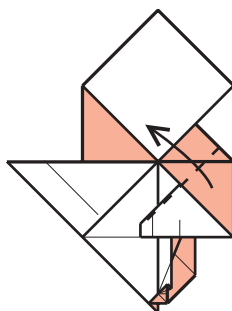

54. Valley flap up.

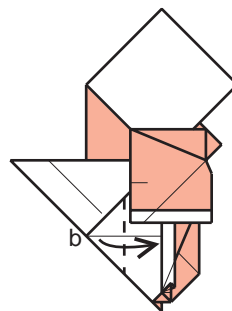

55. Valley corner "b".

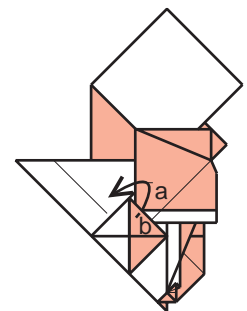

56. Place flap "a" over  
"b".

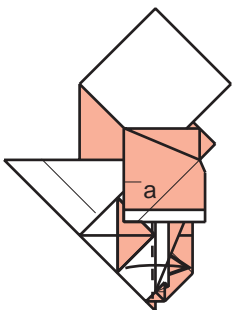

57. Valley fold , partly  
under flap "a".

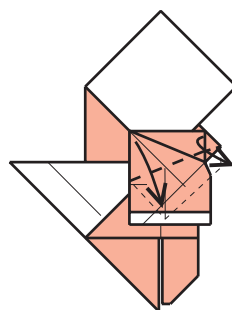

58. Valley fold flap down  
and pull out corner  
pocket.

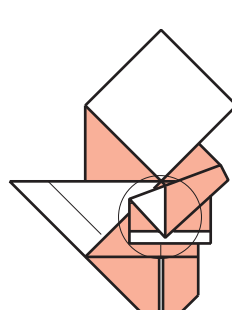

59. See detail.

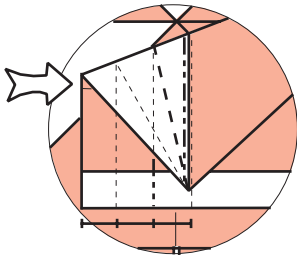

60. Double reverse fold.  
Look ahead to next  
step.

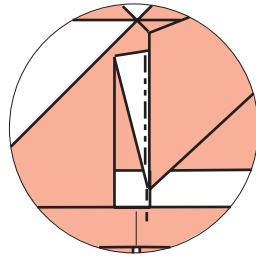

61. Reverse fold.

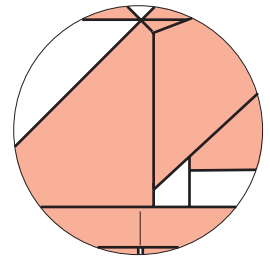

62. Next step shows  
a full view.

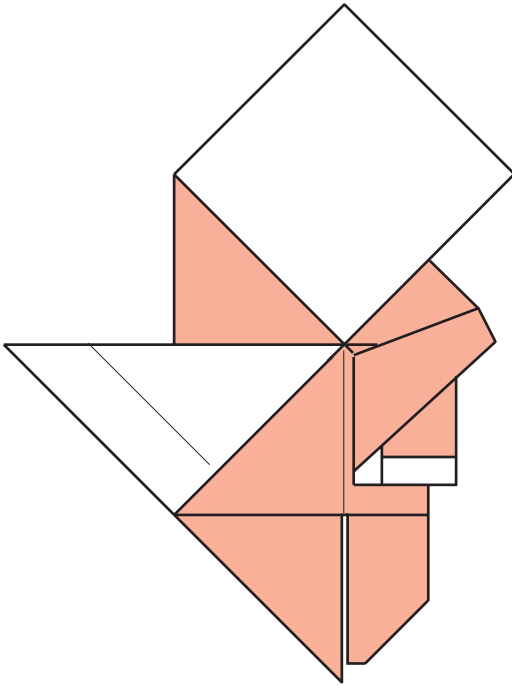

63. Repeat steps 27 to 62  
other side.

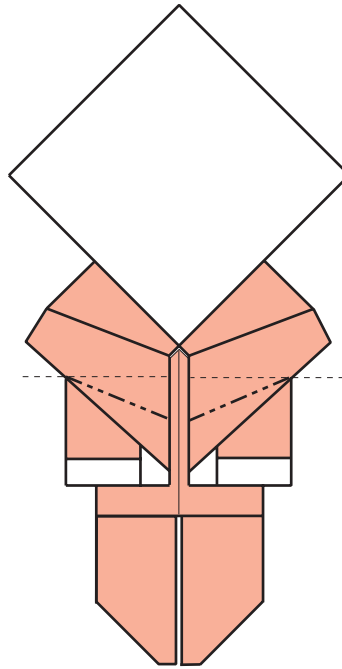

64. Reverse fold to  
form hands.

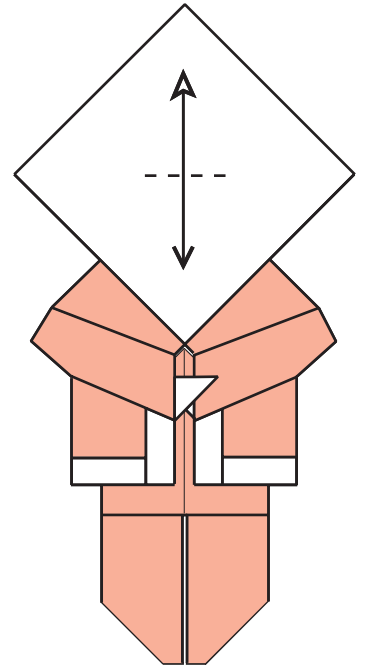

65. Valley fold then unfold.  
Next steps show only  
the upper section.

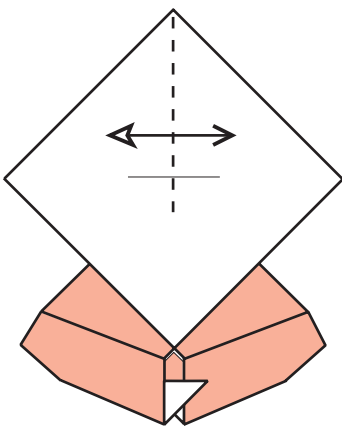

66. Valley fold in half.  
Crease only where  
shown. Unfold.

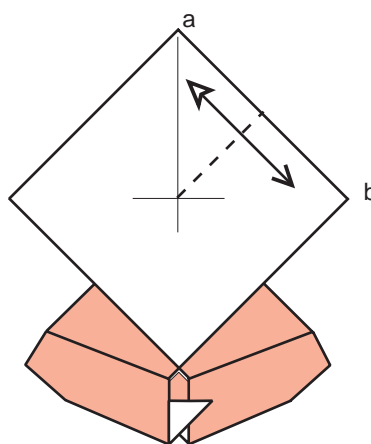

67. Fold "a" to "b" crease  
only where shown.  
Unfold.

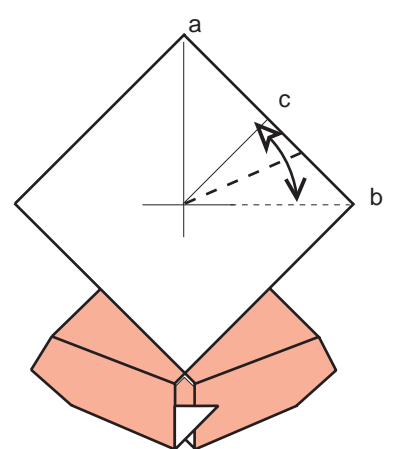

68. Valley fold "c"  
down in line  
with "b". Unfold.

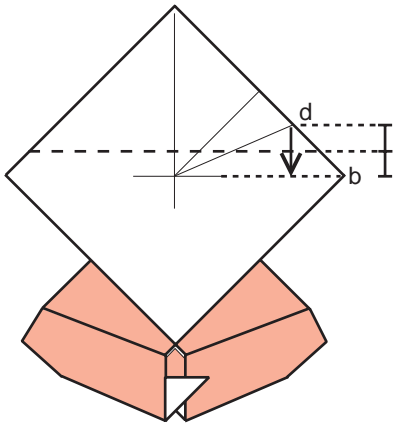

69. Valley fold "d" down in line with "b".

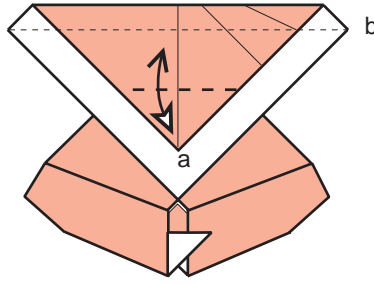

70. Valley corner "a" so that it lines up with corner "b"

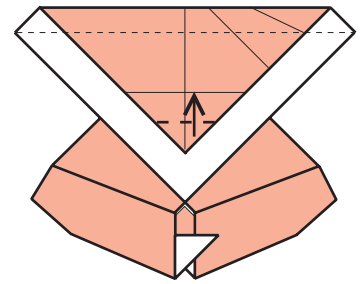

71. Fold the corner up to the horizontal crease.

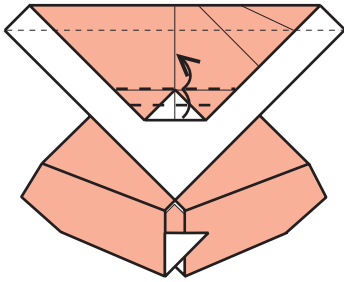

72. Fold over and over.

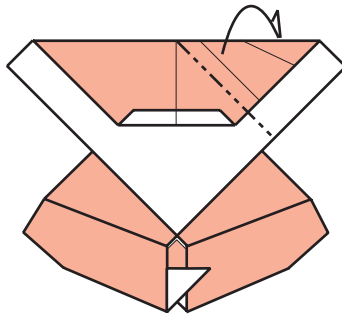

73. Mountain fold.

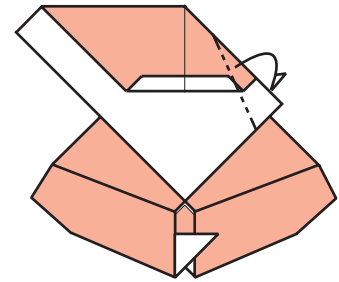

74. Mountain fold.

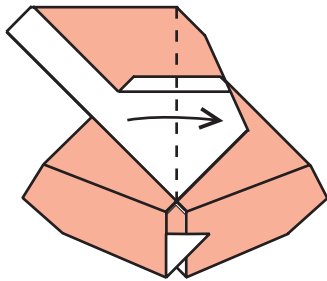

75. Valley in half.

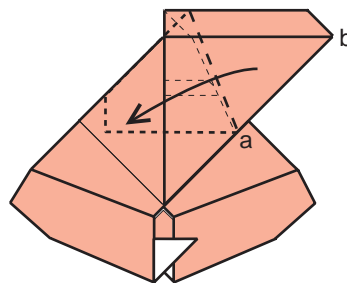

76. Starting at point "a" valley the flap down so that edge a - b lies horizontal.

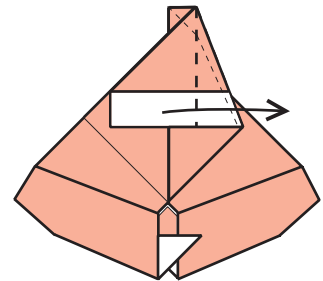

77. Valley over to the right.

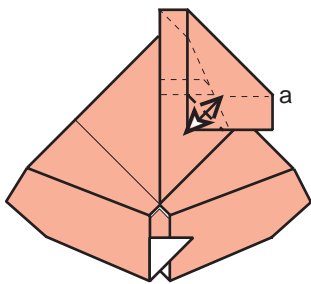

78. Fold corner up in line with point "a". Unfold.

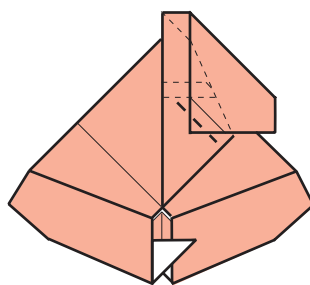

79. Fold corner up to Diagonal crease.

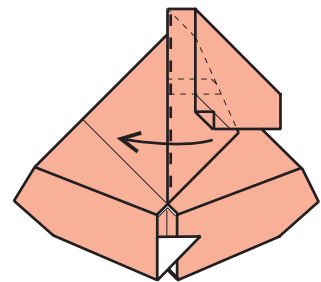

80. Valley top flap over to the left.

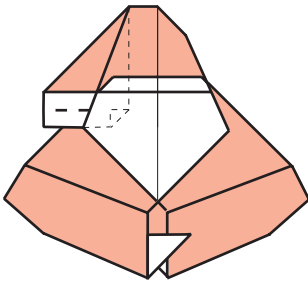

81. Valley edge up to the coloured edge.

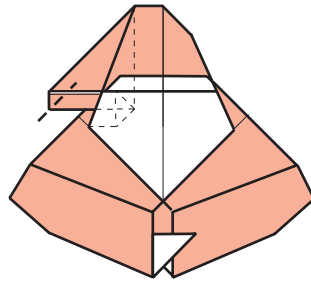

82. Note there will be some paper creep, resulting in a small strip of white edge. Valley the corner down to form a tassel.

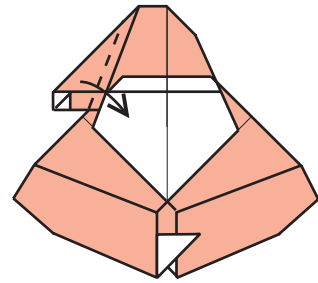

83. Valley onto left side of face.

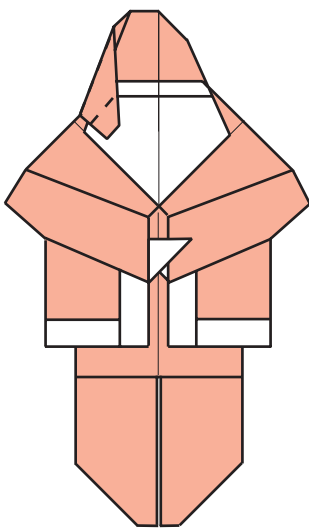

84. Valley lower part of hat to reveal the tassel.

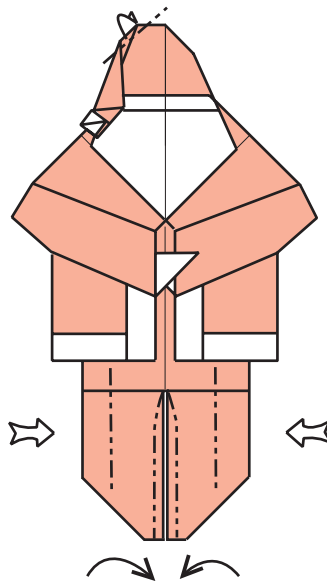

85. Mountain fold to finish off the hat. Press legs into a half square tube shape using mountain folds.

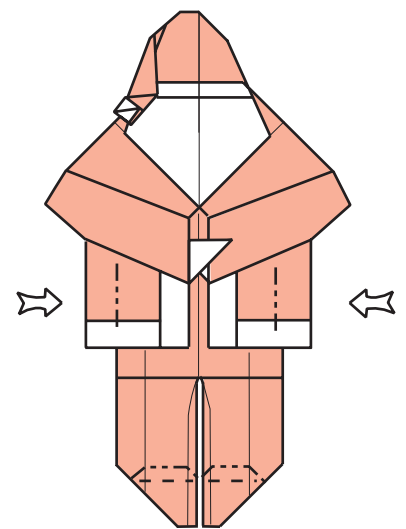

86. Double reverse fold "tubular" legs to form feet. With a little adjustment the model will stand.

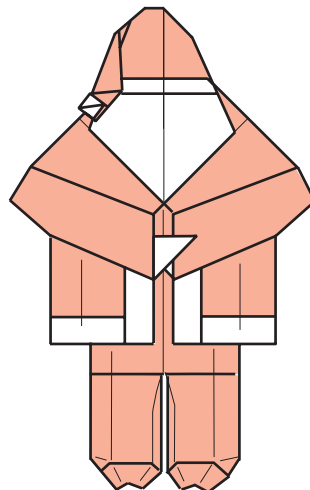

# sea-lions

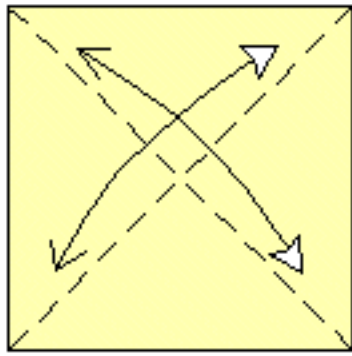

**1** Begin with the white side up.  
Fold and unfold the diagonals.

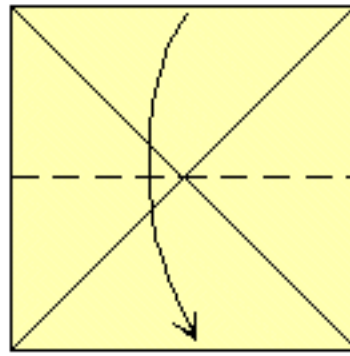

**2** Valley-fold.

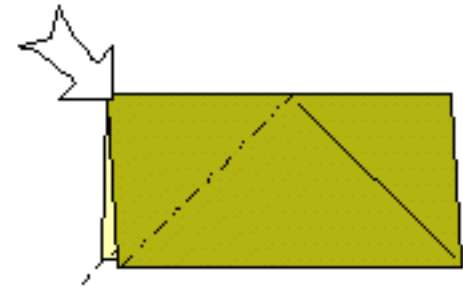

**3** Reverse-fold.

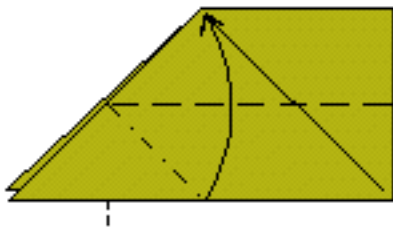

**4** Swivel-fold.  
Repeat behind.

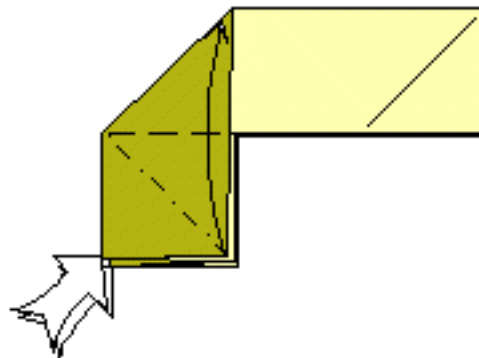

**5** Squash-fold.  
Repeat behind.

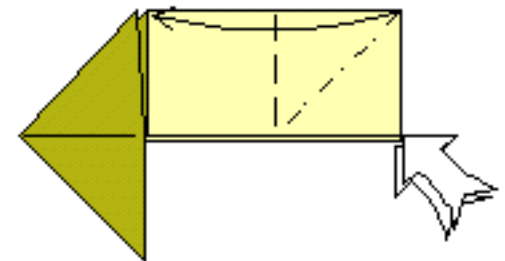

**6** Squash-fold.  
Repeat behind.

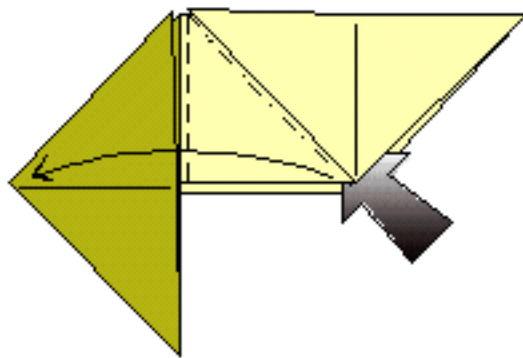

**7** Squash-fold.

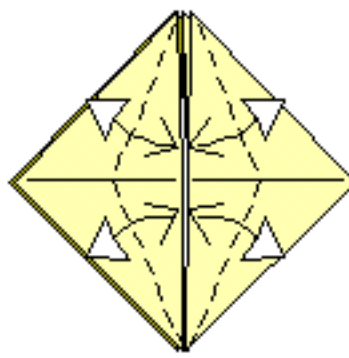

**8** Fold and unfold the  
angle bisectors through  
the white layers.

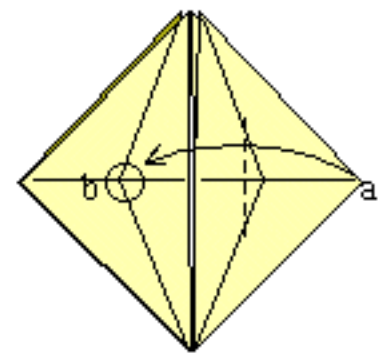

**9** Fold corner a to the crossing  
at b, pressing flat only where  
indicated.

# sea-lions

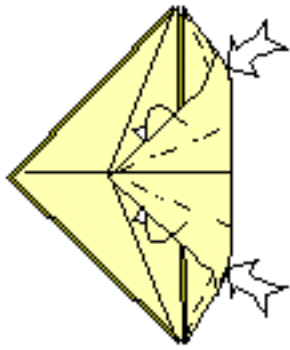

**10** Swivel-fold.

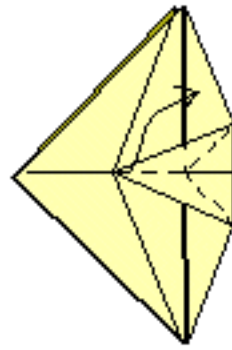

**11** Make a rabbit-ear.

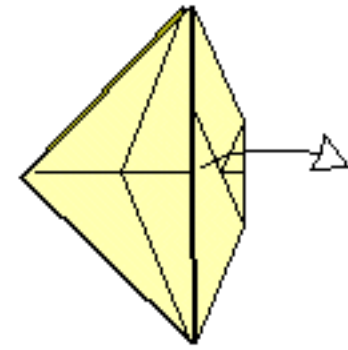

**12** Unfold the flap.

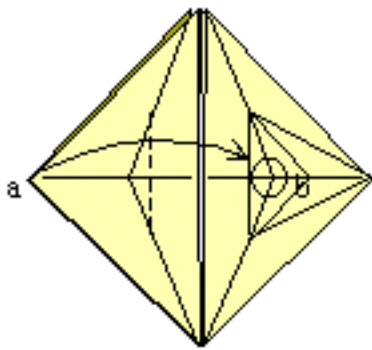

**13** Repeat steps 9-11 on the left.

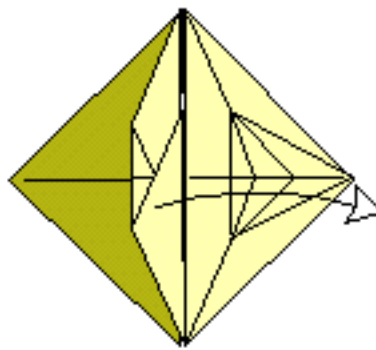

**14** Unfold the flap to the right.

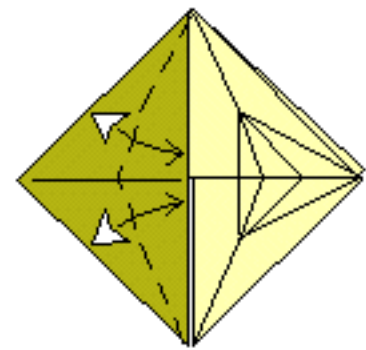

**15** Repeat steps 8-11 on the left. Repeat behind.

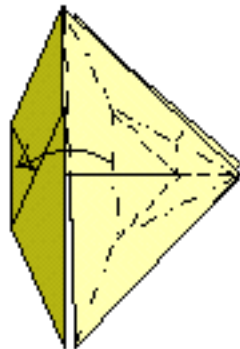

**16** Refold the right flap to the position in step 14. Repeat behind.

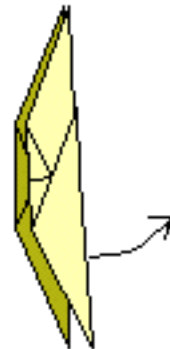

**17** Slide the outer layers to the right.

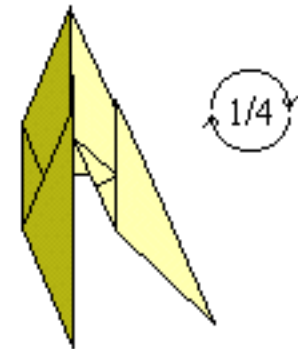

**18** Like this. Rotate the model.



# sea-lions

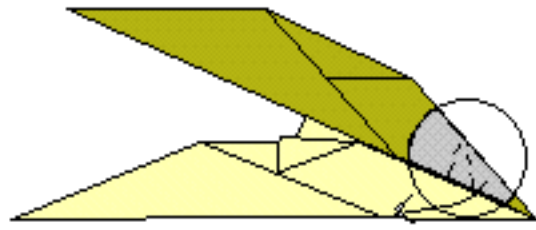

**19** Crimp the hidden flap.

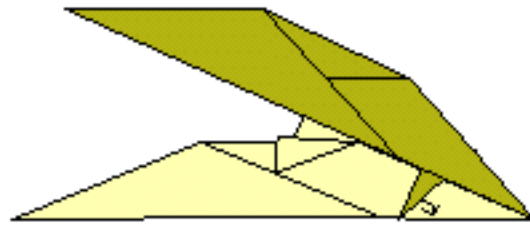

**20** Slide out some paper.

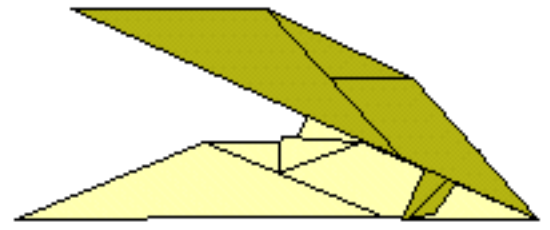

**21** Repeat steps 19-20 behind. Repeat on the lower sea-lion.

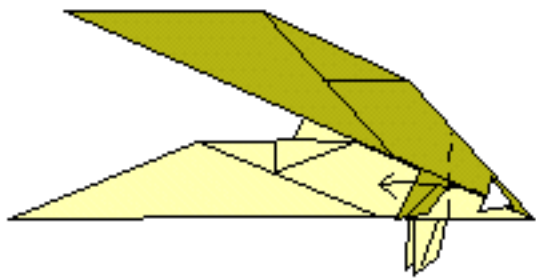

**22** Fold and unfold through all layers.

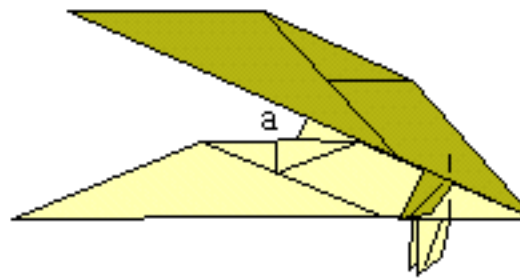

**23** Sink the corner inside, opening up between the layers at **a**. Turn the model over.

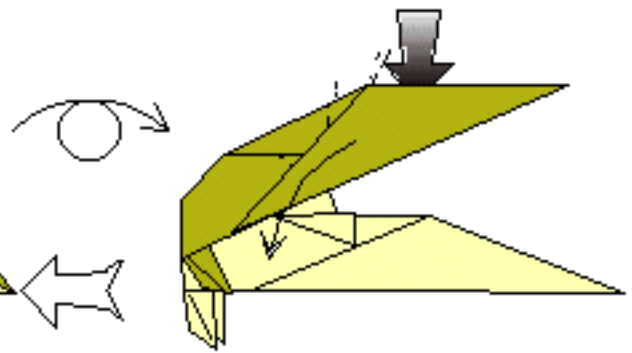

**24** Crimp the upper body symmetrically, letting the front legs slide downward.

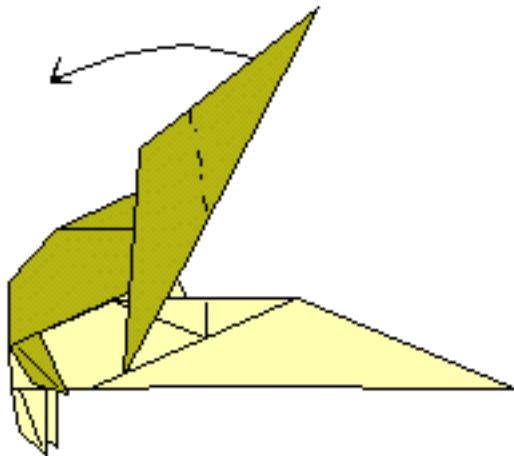

**25** Reverse-fold.

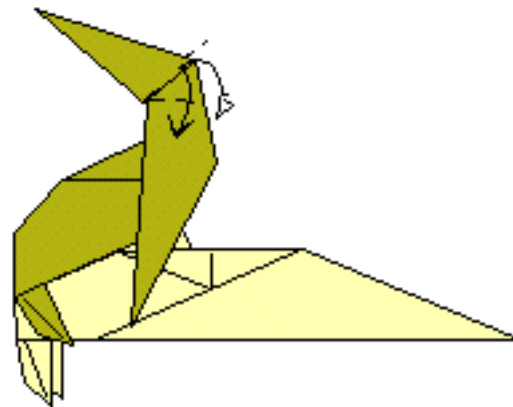

**26** Crimp.

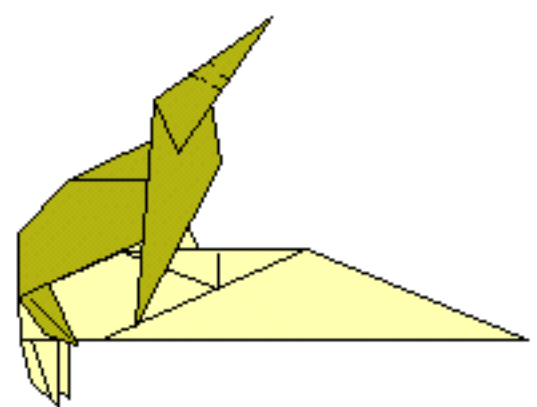

**27** Reverse-fold in and out.

# sea-lions

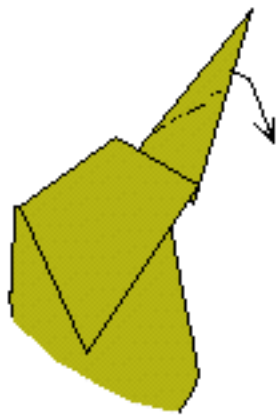

**28** Detail of head.  
Reverse-fold.

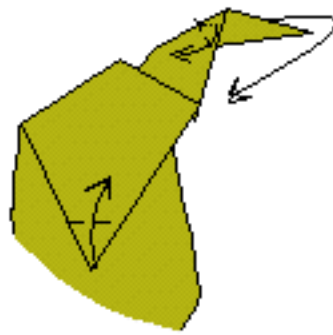

**29** Outside-reverse-fold.  
Valley-fold the ear-  
flaps.



**30** Outside-reverse-fold the  
mouth. Squash-fold the  
nostrils. Open up the  
ears.

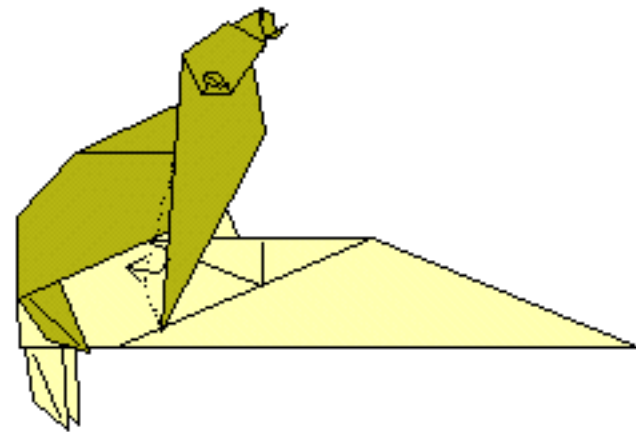

**31** Slide out some paper.  
Repeat behind.

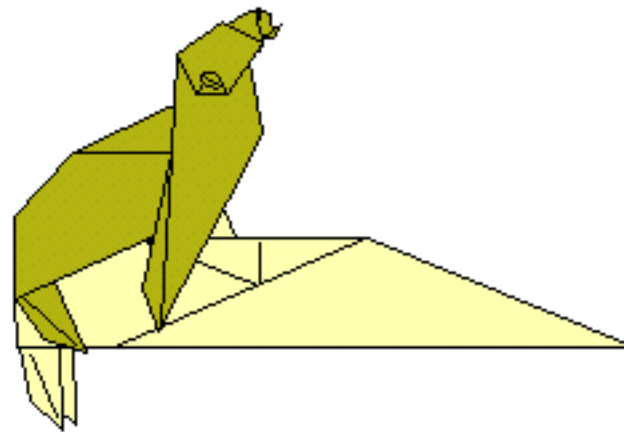

**32** Repeat steps 24-31  
on the lower sea-lion.

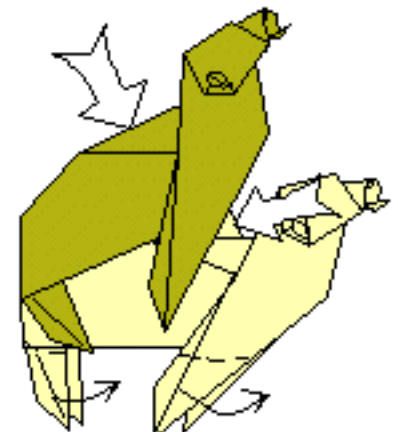

**33** Push in the area between  
the two animals, as the upper  
sea-lion is pushed down.  
Spread the lower flippers.

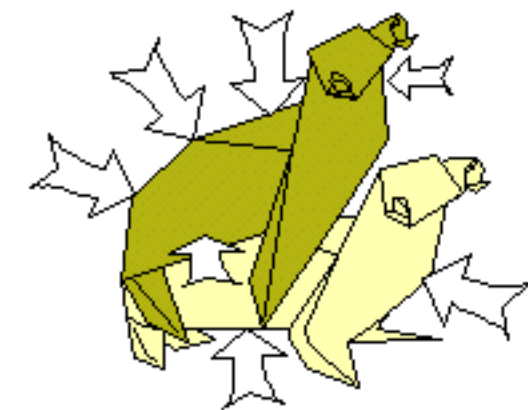

**34** Make the bodies  
3-dimensional.

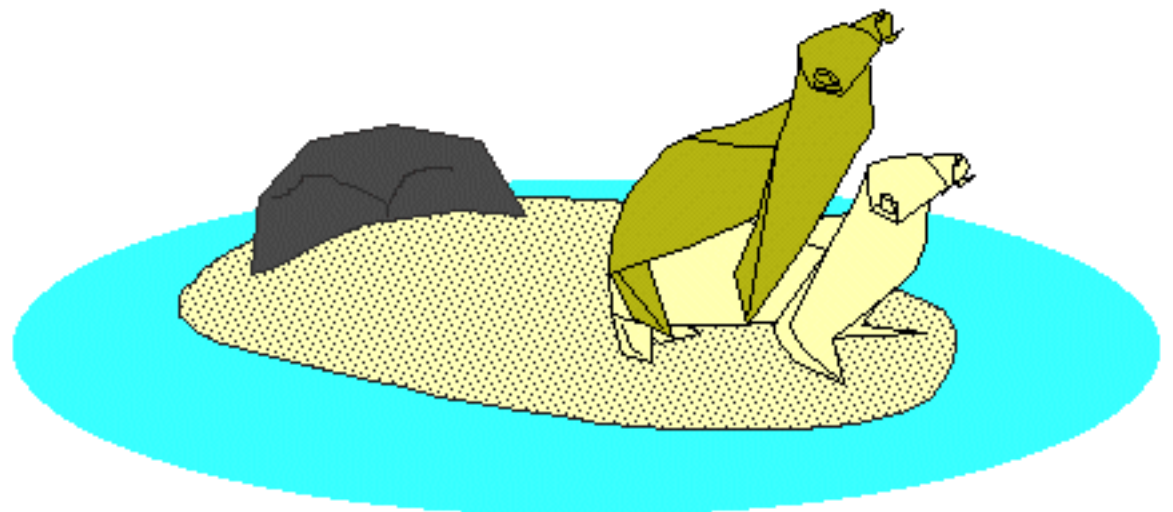

**35** Finished sea-lions.

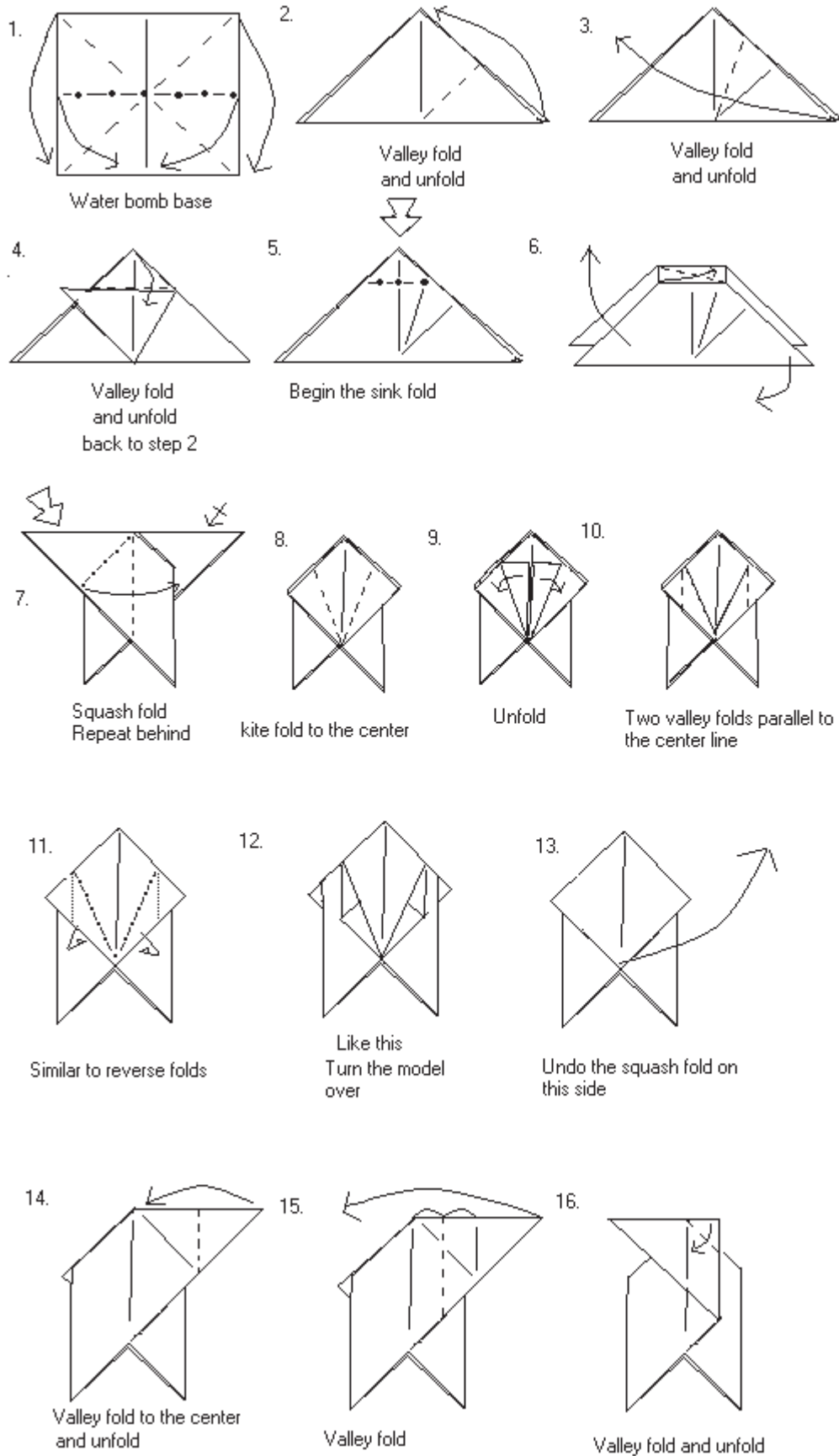

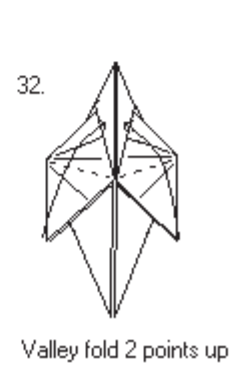
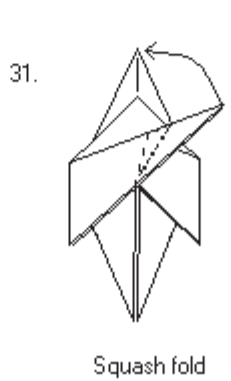
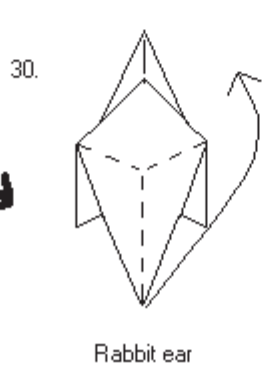
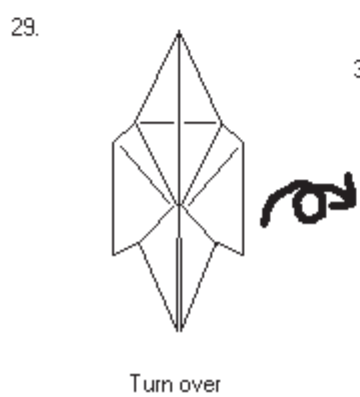
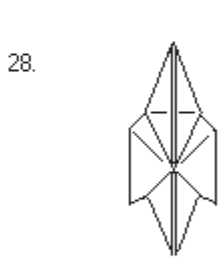
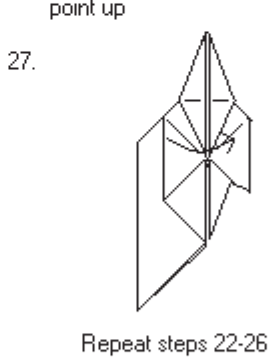
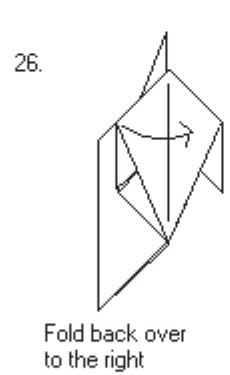
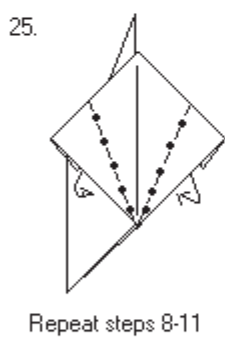
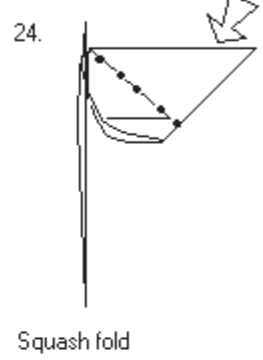
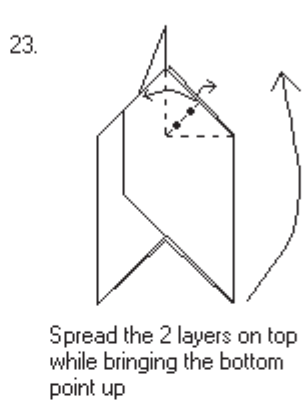
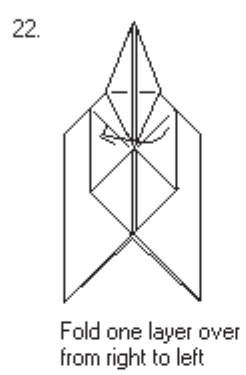
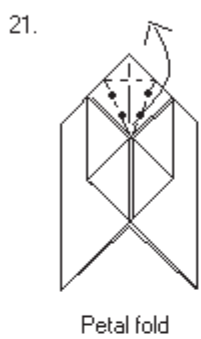
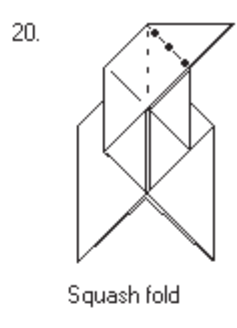
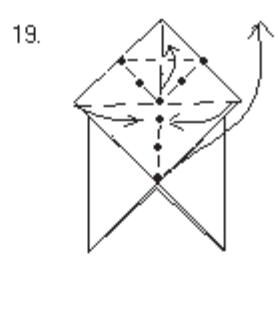
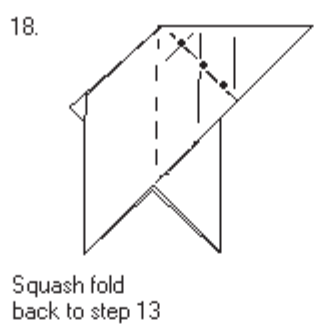
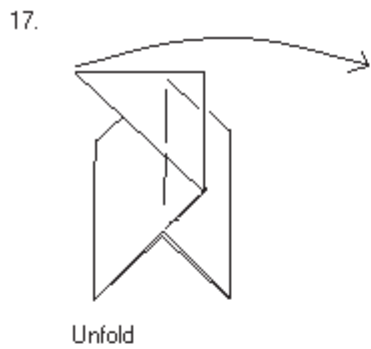

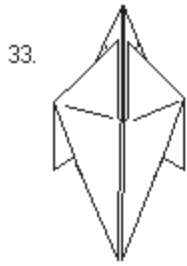

Turn over

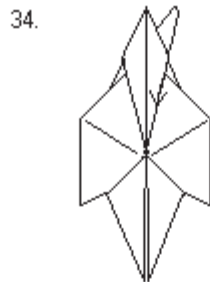

Pull the first 3 layers down to completely stretch out the square in the center

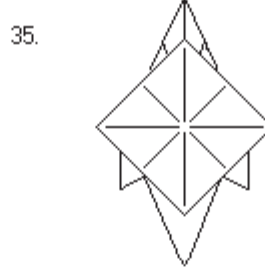

Turn over

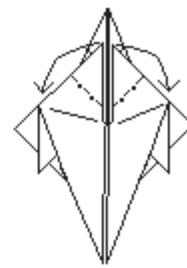

Make 2 mountain folds

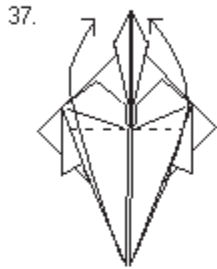

Valley folds

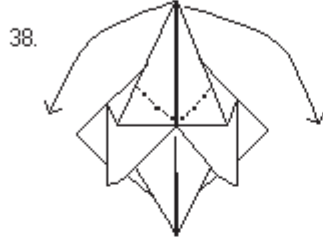

2 reverse folds

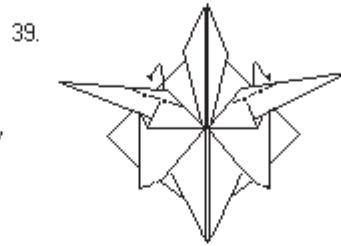

2 mountain folds

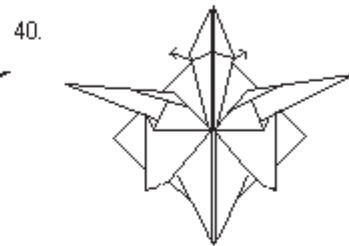

Spread out the head by pulling the

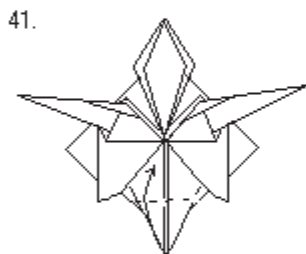

Valley fold

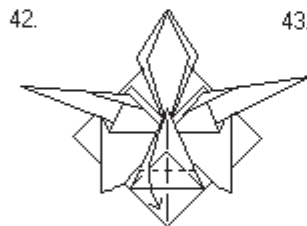

Valley fold

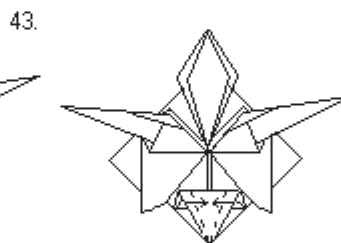

Make a squash fold on each side while thinning the tail

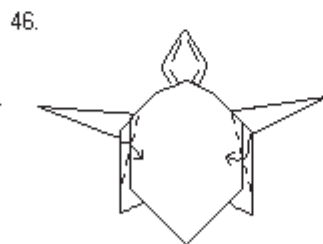
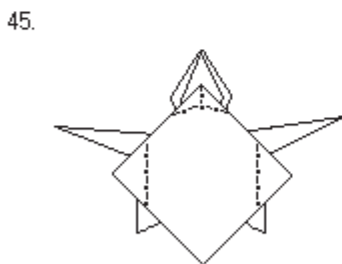
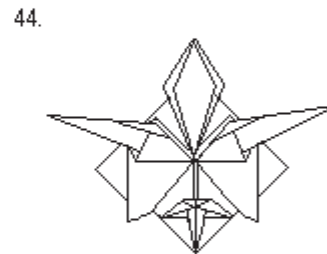

Make 2 valley folds through all layers hiding the thick paper inside

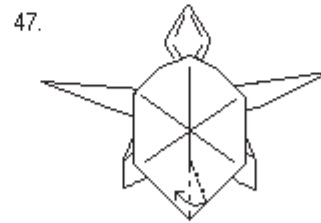

Make a pleat to make the shell 3D

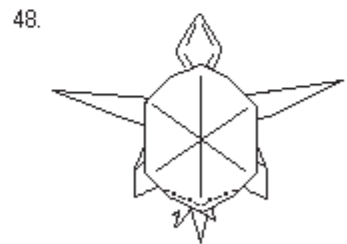

Mountain fold to lock the shell

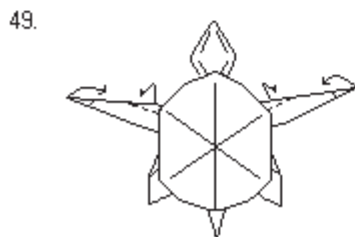

2 reverse folds and 2 mountain folds

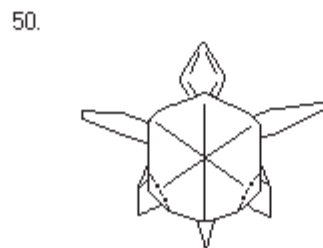

Round off the shell with 2 mountain folds

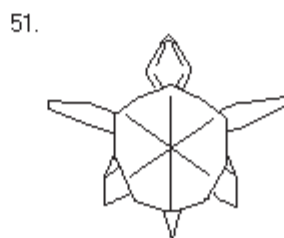

Round off the tip of the head

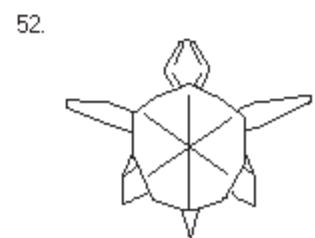

This model was commissioned by the New York Times, and appeared in the business section of the Sunday, April 11, 1999, edition. It was designed on April 7-8, 1999. The tail construction borrows heavily from John Montrroll's *blue shark* that appears in *Origami Sea Life*. The body is based on my *orca* model.

Permission is granted for duplication of these diagrams for personal use and for teaching purposes. The model may not be used commercially (sold, displayed, photographed, or taught) without the express consent of the designer. Requests for permission may be made by email at <josephwu@ultranet.ca> or by telephone at +1-604-730-0306 ext. 105.

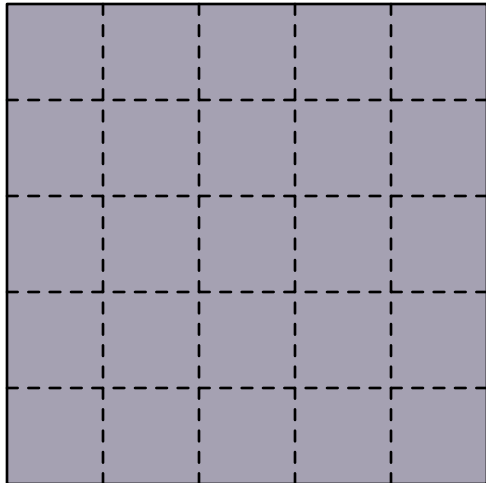

1. Precrease into fifths.

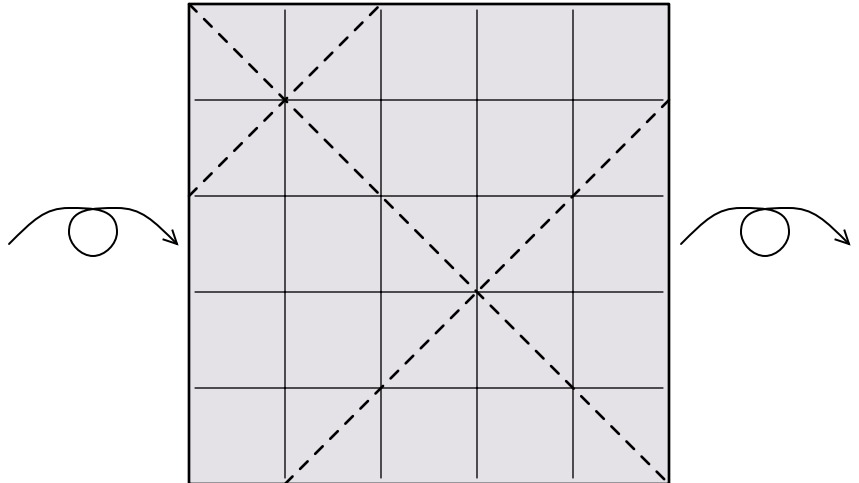

2. Precrease.

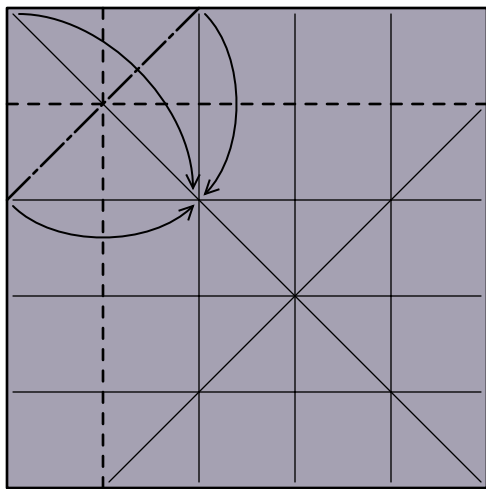

3. Collapse.

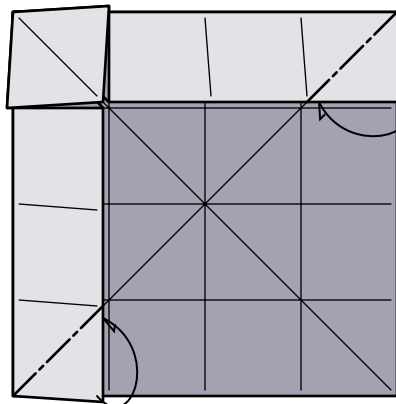

4. Mountain fold two corners under.

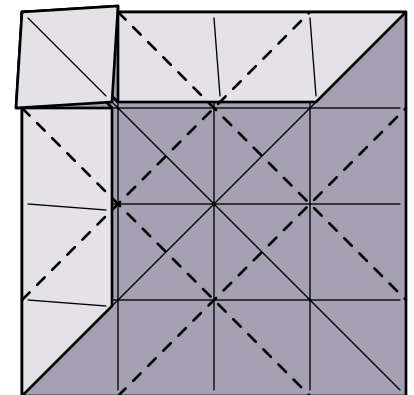

5. Precrease.

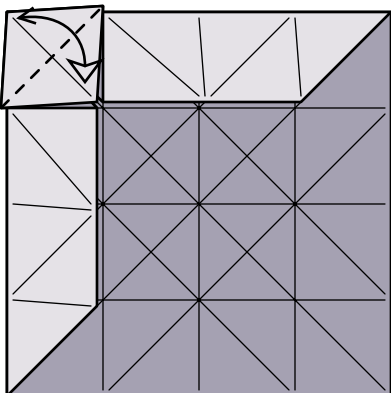

6. Precrease top layer only.

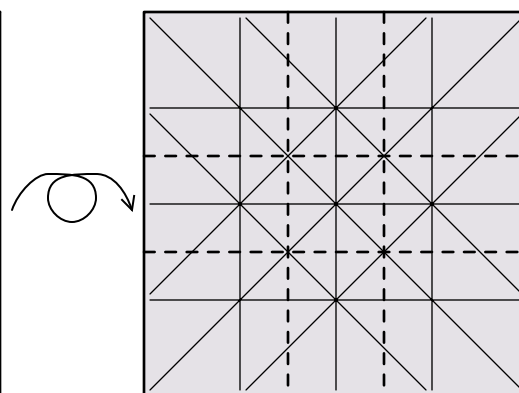

7. Precrease.

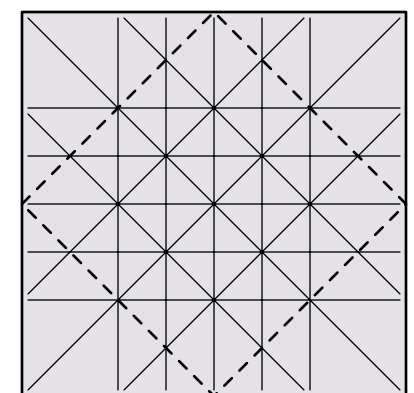

8. Precrease. (This step can be omitted.)

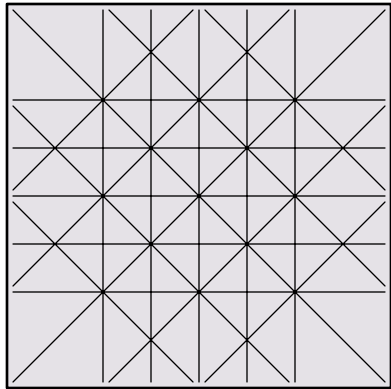

9. Grid precreasing complete.

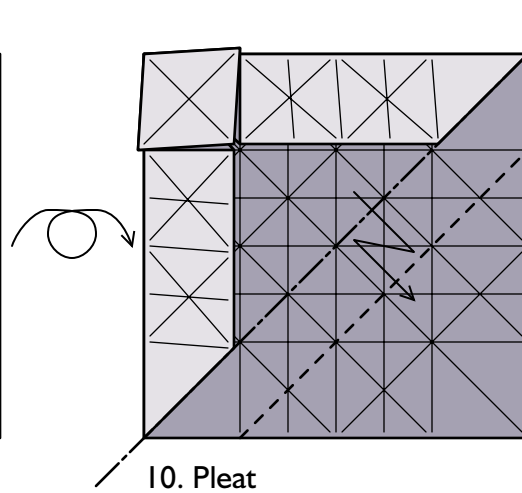

10. Pleat

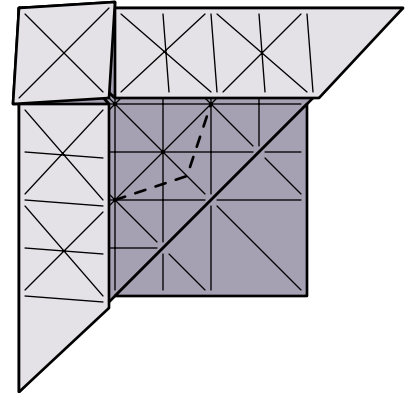

11. Precrease through all three layers.

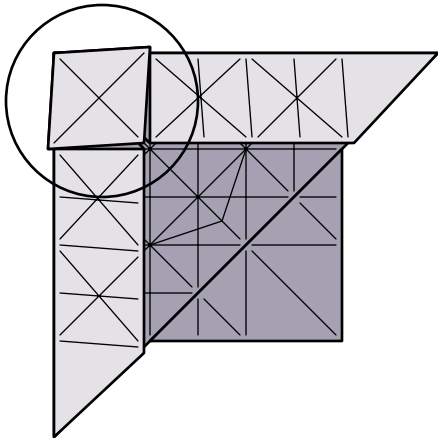

12. Zoom in.

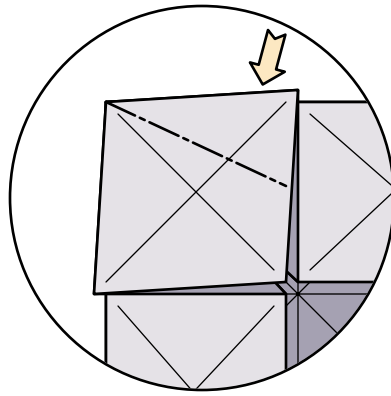

13. Squash one side.

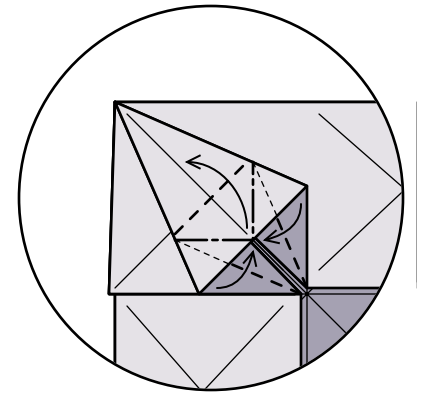

14. Petal fold.

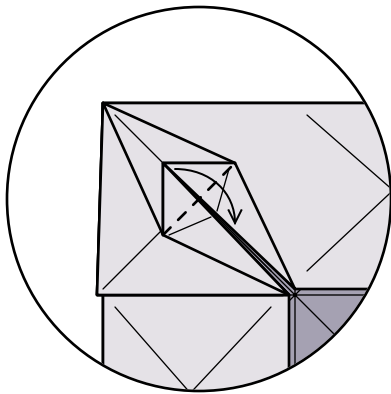

15. Valley fold flap down.

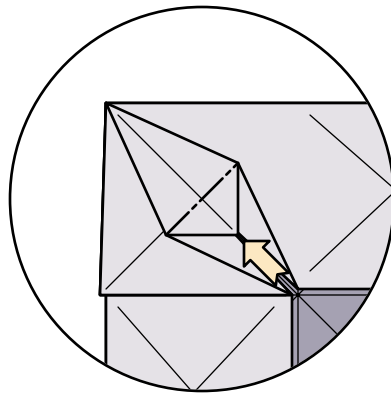

16. Tuck the flap inside.

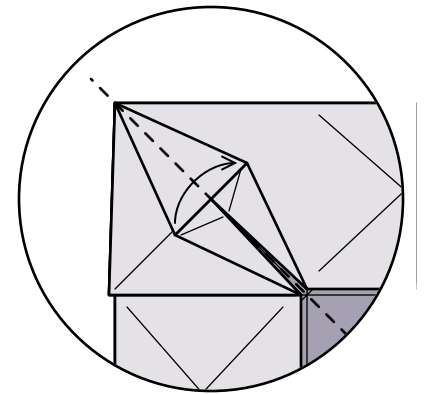

17. Fold flap back.

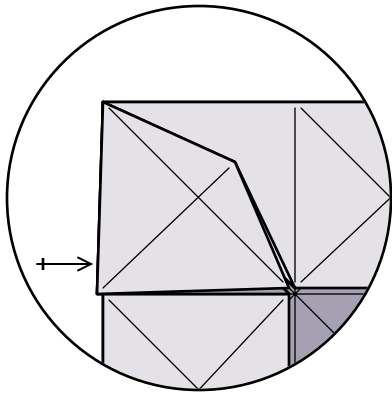

18. Repeat steps 13-17 on the other side.

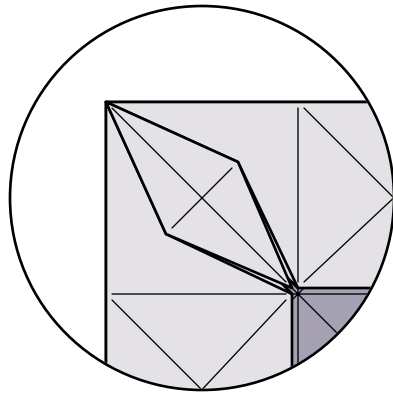

19. Zoom out.

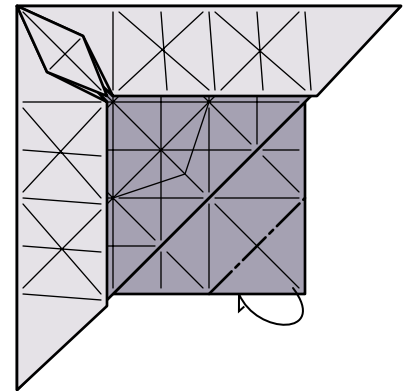

20. Mountain fold the tip behind.

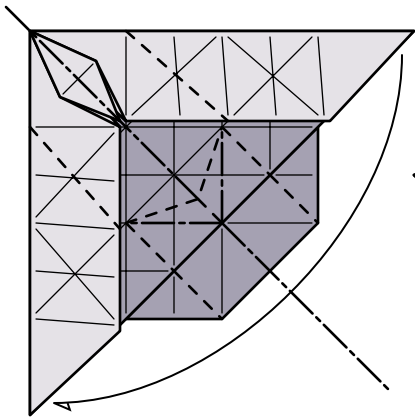

21. Fold in half, forming the dorsal fin at the same time. The sides will not lay flat.

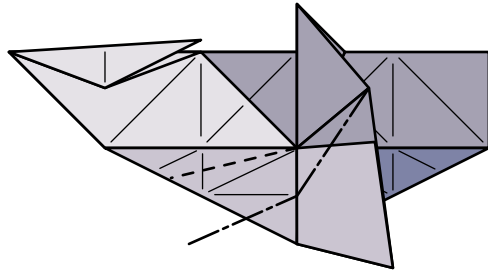

22. [Enlarged view.] Collapse the near and far sides against the body.

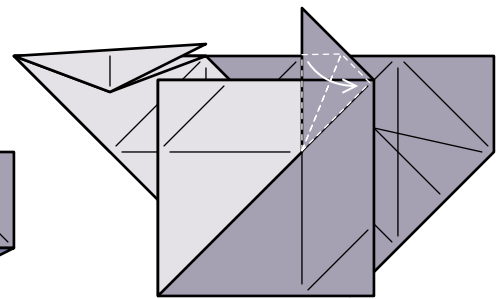

23. Inside reverse fold the innermost layer.

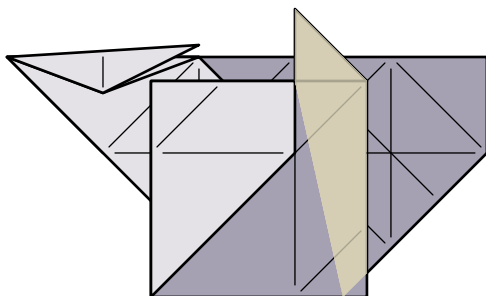

24. Wrap a layer around to the front. Repeat behind.

25. Fold the near side up. Repeat behind.

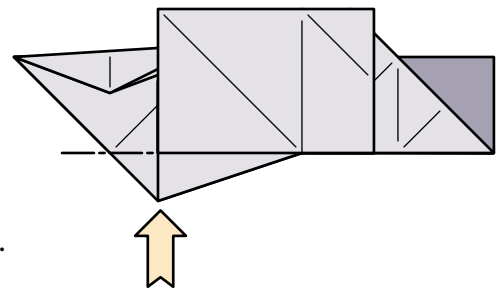
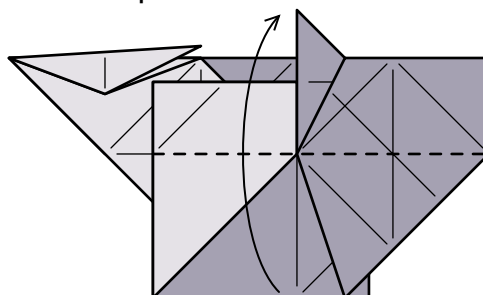

26. Inside reverse fold. Repeat behind.



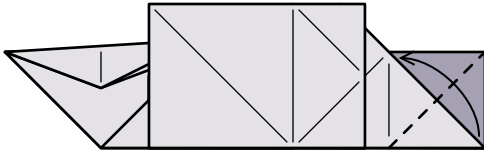

27. Fold corner up. Repeat behind.

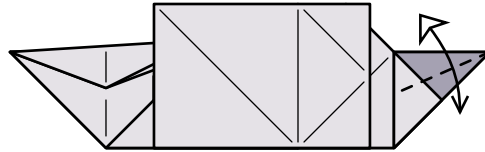

28. Precrease the new flap. Repeat behind.

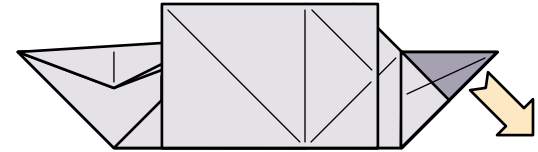

29. Pull out a single layer.

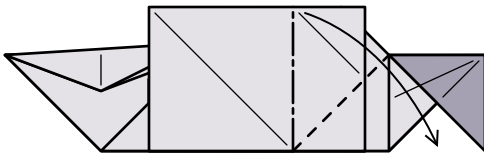

30. Fold the top layer down towards the head. The rest of the side will not lie flat.

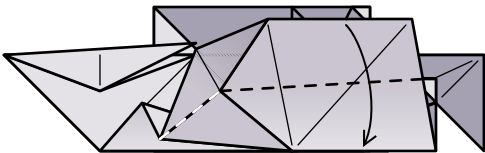

31. Fold the long flap down in half, flattening the side.

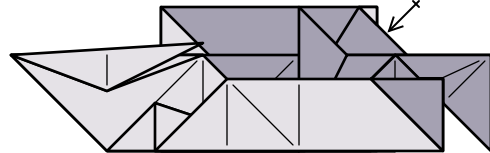

32. Repeat steps 30-31 behind.

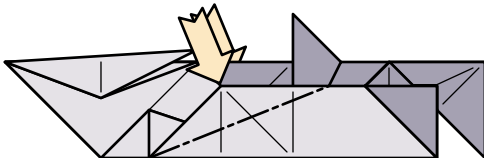

33. Open sink. Be careful since it is not possible to precrease this step. Repeat behind.

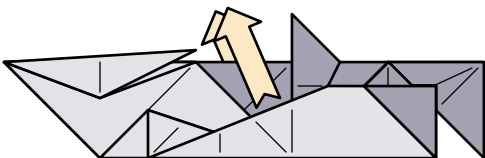

34. Pull one layer back out. Repeat behind.

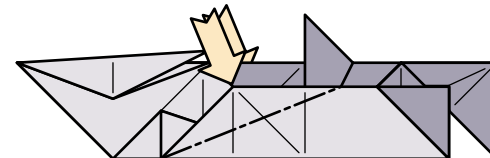

35. Closed sink. The sink must take place along the outermost layer. Repeat behind. **Steps 34-35 are optional!**

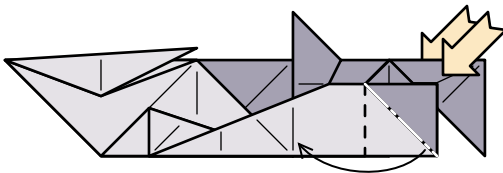

36. Squash fold. Repeat behind.

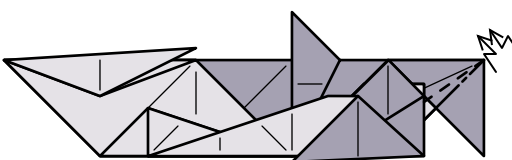

37. Crimp the nose (one layer only).

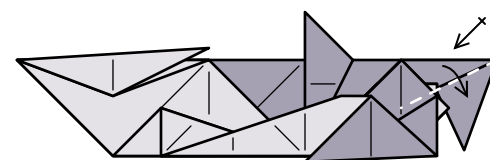

38. Fold the two sides of the head down to cover the crimp.

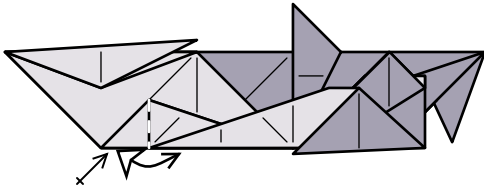

39. Precrease through both layers on one side. Repeat behind.

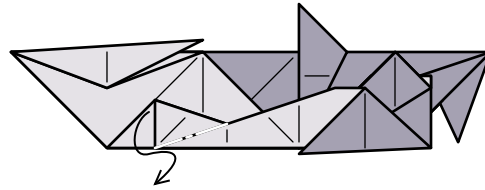

40. Inside reverse fold. Model will not lie flat.

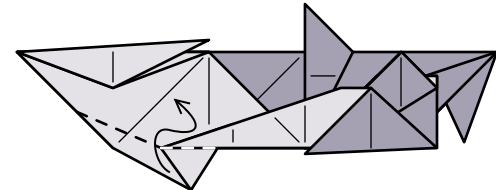

41. Inside reverse fold. Model will now lie flat.

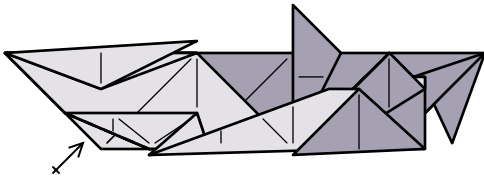

42. Repeat steps 40-41 behind.

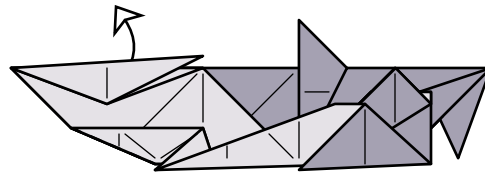

43. Bring up two layers from behind.

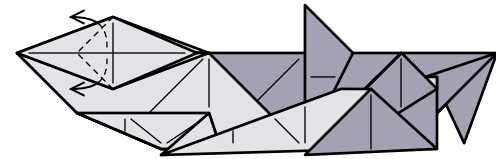

44. Inside reverse fold the two hidden corners.

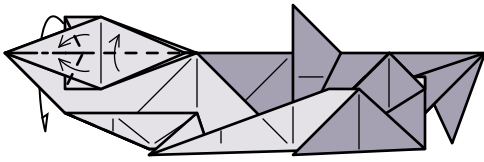

45. Fold the top layers back down, incorporating the outside reverse fold in the top layer.

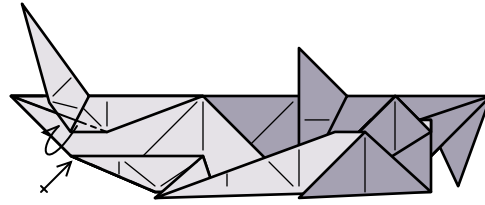

46. Fold the small corner under. Repeat behind.

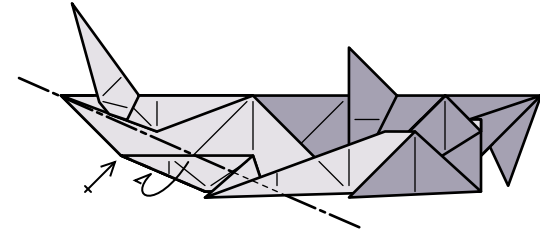

47. Fold the thick layer inside. There will be a small squash under the back fin. Repeat behind.

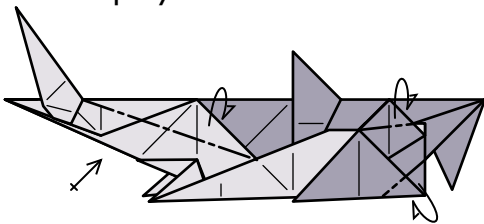

48. Make three mountain folds to lock the loose flaps. Repeat behind.

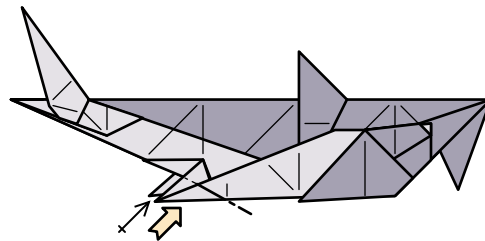

49. Inside reverse fold the back fin. Separate the layers as evenly as possible. Repeat behind.

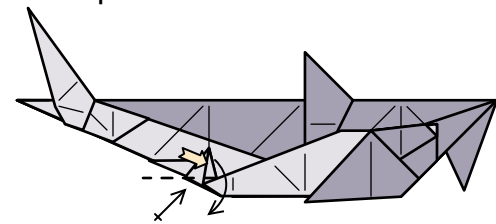

50. Fold the back fin down, spreading the small pocket shown. Repeat behind.

51. Valley fold the 'shoulder' down, incorporating the inside reverse fold to form the front fin. Repeat behind.

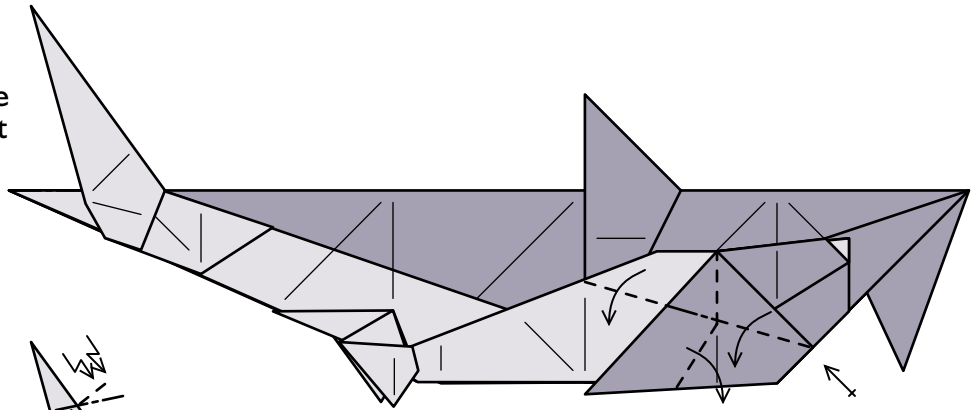

52. Crimp the top of the tail, and inside reverse fold the bottom of the tail.

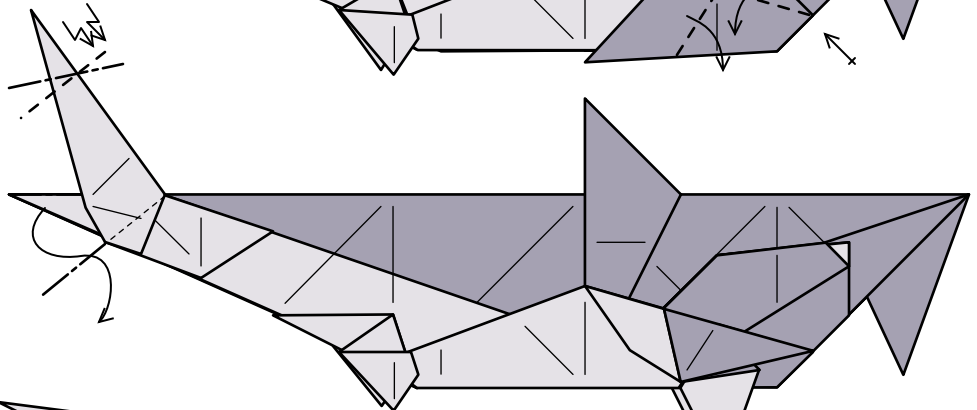

53. Pull out a layer from both sides of the tail. Flatten the front of the head (the model will become 3D).

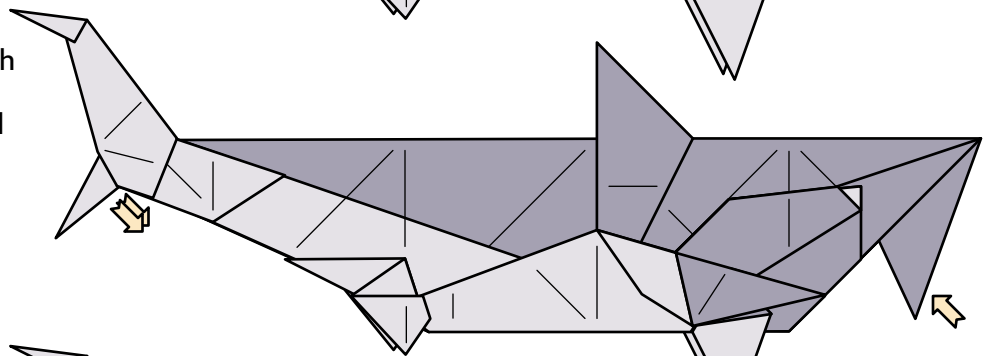

54. Mountain fold the loose corner under the head inside. Fold the front fins out sideways from the body. Round the body.

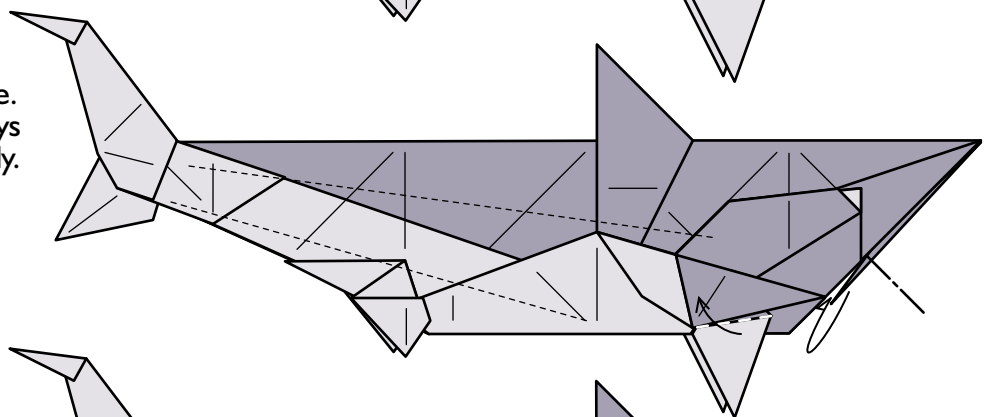

55. The completed great white shark.

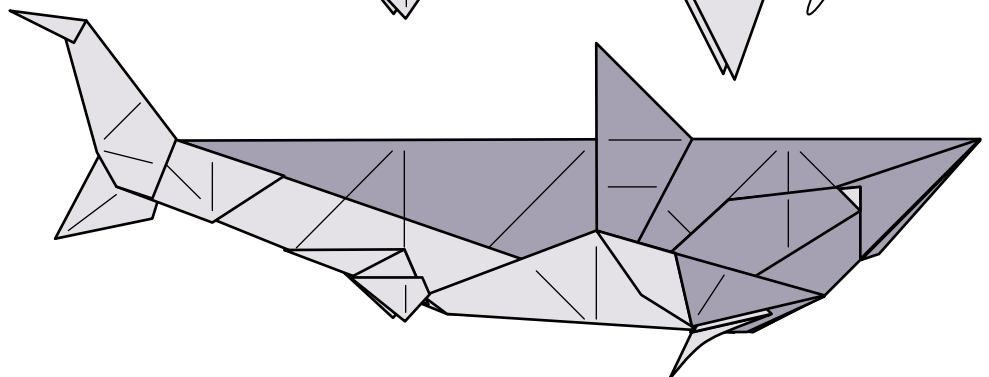

# Sheep

Designed and diagrammed by Andy Carpenter (1998).

Use a sheet of strong white paper (white on both sides) with dimensions of 1: 1.8.

A sheet 30cm by 54cm will produce a model approximately 14cm by 9cm.

Wet fold the paper for best results.

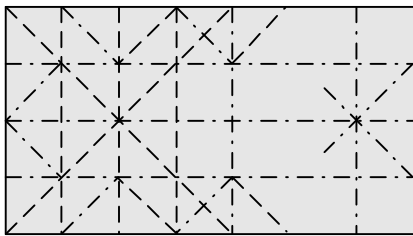

1. Precrease before wet folding.

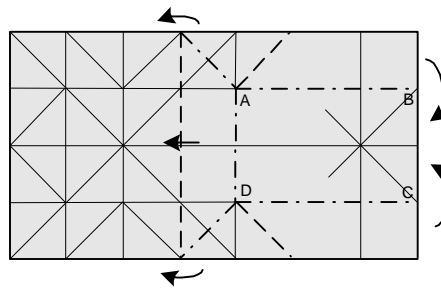

2.

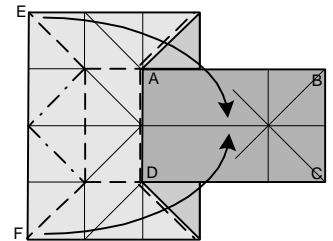

3.

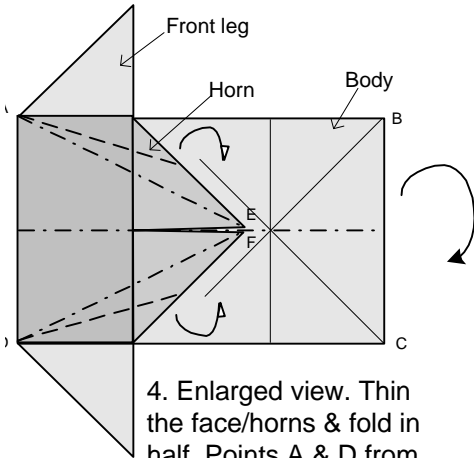

4. Enlarged view. Thin the face/horns & fold in half. Points A & D from step 3 are hidden by another layer of paper.

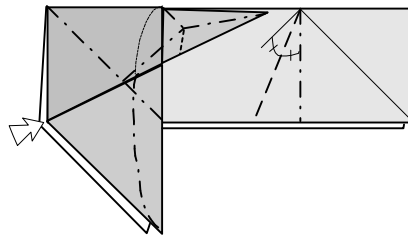

5. Rabbit ear the horn, thin the vertical raw edge from head to front legs, then sink fold the front legs with two layers of paper on each side. Crimp fold to form the back leg. Repeat behind.

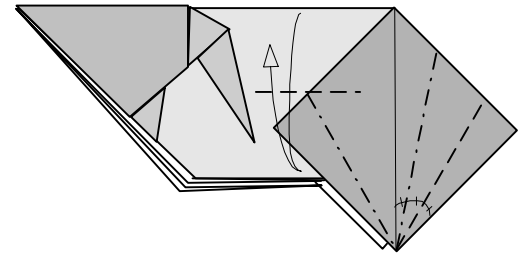

6. Enlarged view. Reverse fold both sides of the back leg. The fold on the right trisects the angle. Repeat behind.

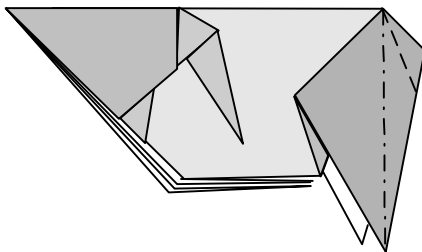

7. Repeat behind.

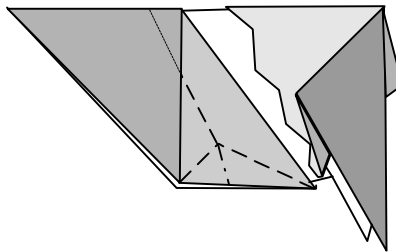

8. Front left side of model cut away. Rabbit ear fold both front legs. The one shown is the far side front leg.

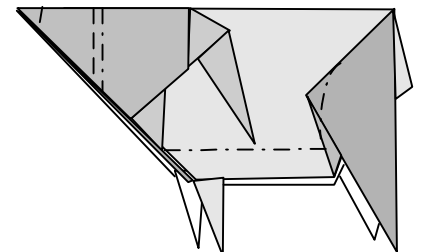

9. Repeat behind.

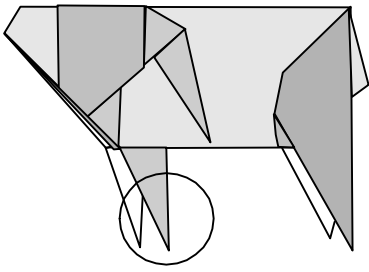

10.

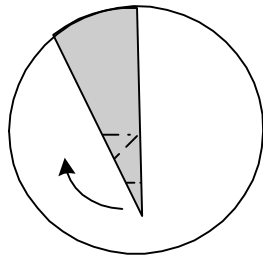

11. Repeat for all 4 feet.

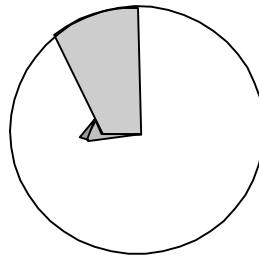

12. Like this...

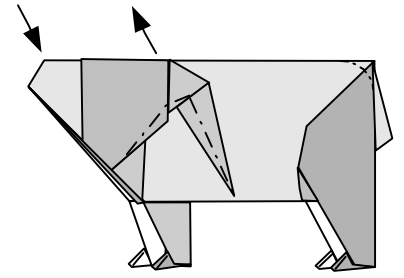

13. Push the face down and pull the back of the head up. Fold to shape head and horns. Repeat behind.

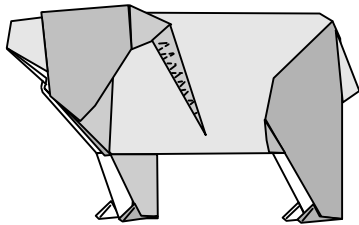

14. Repeatedly crimp fold to curve the horn. Repeat behind.

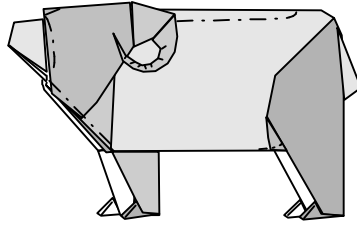

15. Fold to shape the body. Repeat behind.

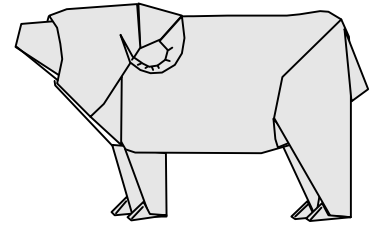

16. The final sheep.

# Space Shuttle

## An example of a Lifting Body

By Perry Bailey © 1998

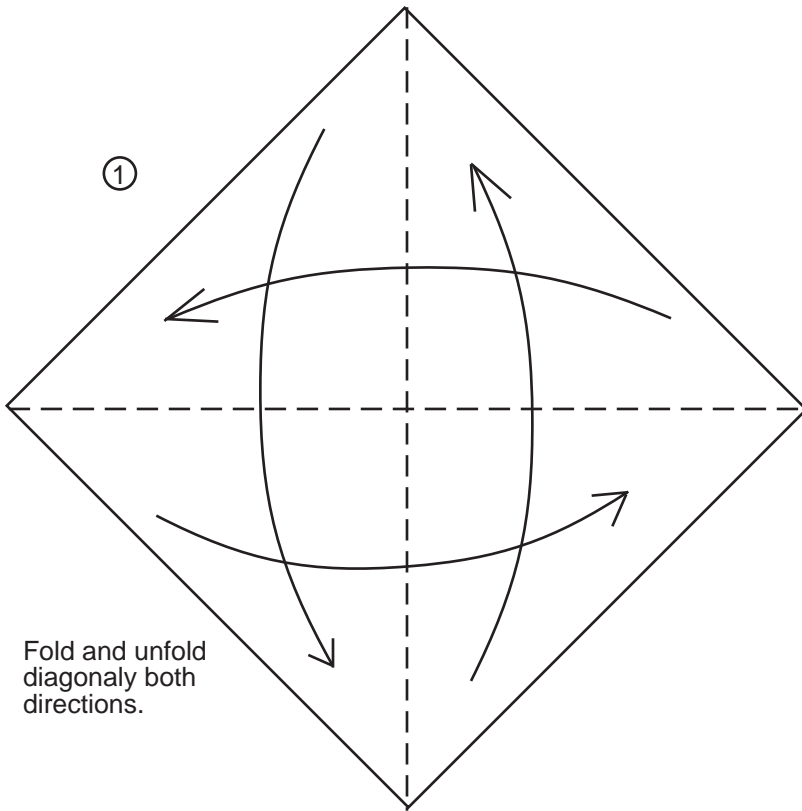

①  
Fold and unfold diagonally both directions.

A smidgen of science to go with this model. In a traditional airplane all of the lift, is supplied by the wings, but as speed increases this puts more and more stress on the wings, the answer as was determined years ago is to use a "lifting body". That is a plane or as in this case a space shuttle that maximizes the strength of structure by using the body of the shuttle itself as the wings. It has not been used heavily in the aviation world, due to politics, but it was the only chance for a ship that needed to re-enter an atmosphere from orbit. Unfortunately a true lifting body would by its nature be very stable as it comes down but not very manoeuvrable at high speed. NASA solved this problem but using a large rudder fin atop the vehicle this stabilized the side to side motion, making it as stable as the forwards and up and down motions. The only other problem was to find a long enough strip to land the shuttle because of the forward speed required to keep it aloft. The space Shuttle was the end of a long line of experiments in this type of flight. For those who have seen the old TV series the "Six Million Dollar Man" the scene in the beginning was a real crash of one of the early lifting bodies designed by NASA, they were flown up by airplane and then dropped, our current space shuttle design was the winner.

PVB

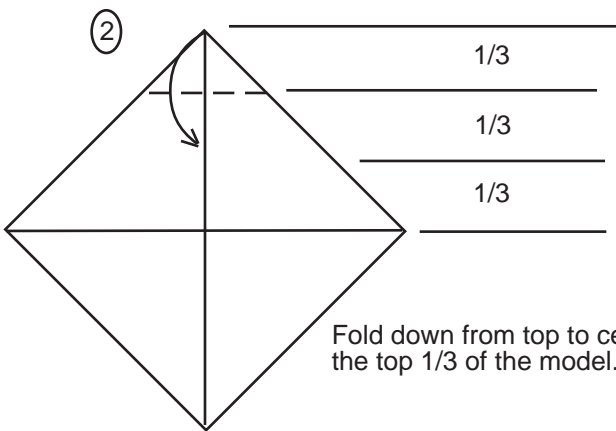

②  
Fold down from top to center the top 1/3 of the model.

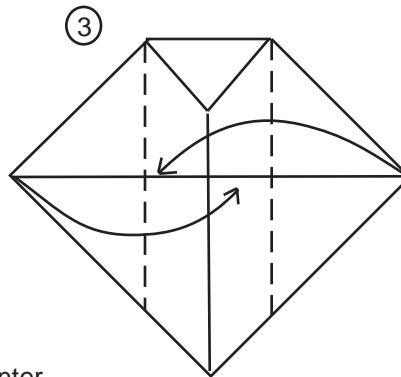

③  
Now valley fold and unfold each side, then unfold the top.

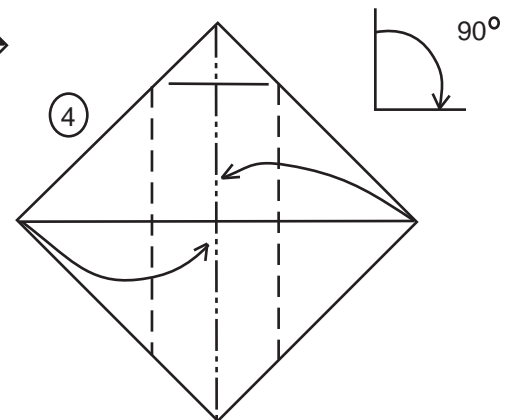

④  
Mountain fold the middle and valley fold the 2 sides. then turn 90 degrees to the right.

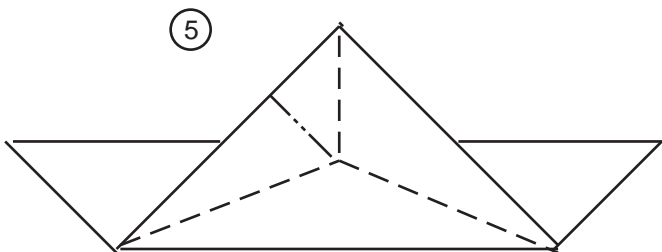

⑤  
Fold the flap on each side into a rabbit's ear that points to the back of the model. The first crease in step 1 is the front.

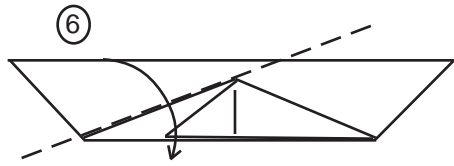

Valley fold the left side down along the line of the rabbits ear created in step 5.

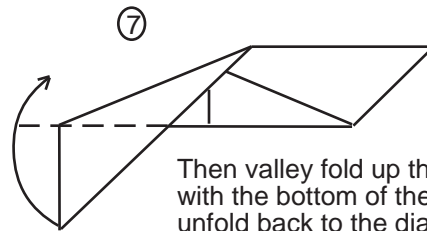

Then valley fold up the flap even with the bottom of the model then unfold back to the diagram at step 6.

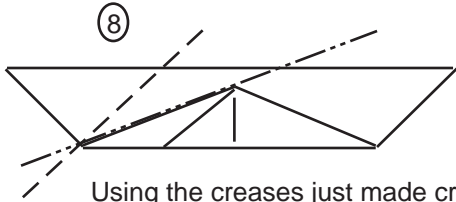

Using the creases just made crimp fold the tail section into place.

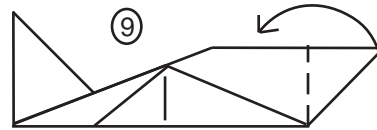

Valley fold the right flap to the left along the crease made in step 2.

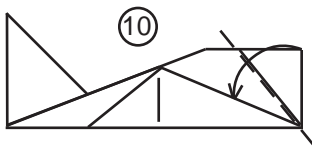

Valley fold the front over using the raw edge of the previous fold then unfold the front, then reverse fold the entire front end of the model down along the crease you just made.

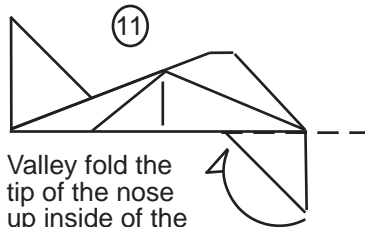

Valley fold the tip of the nose up inside of the model. This will lock the front end of the shuttle in place.



Fold the flap over to the right. the next view is enlarged.

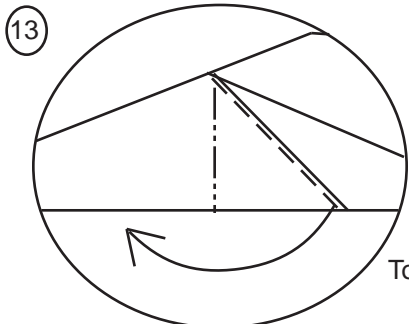

Reverse fold the flap under the top layer of paper.

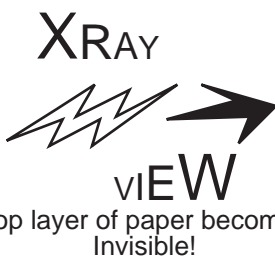

Valley fold the flap up inside of the wing to lock it into place.

Repeat on other side making sure that it also points to the back and locks the same way.

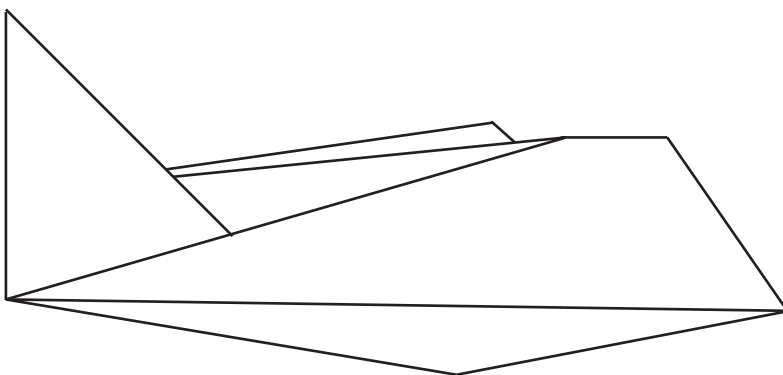

Finished model.

Now that you have finished the model you get to test it. Hold it out at arms length and drop it. If you held it level or with the nose slightly downwards it will glide gently down to the floor in the same position as you dropped it (nearly). The design is very stable, if you could get 20 or 30 feet off the ground in a closed environment you could drop it upside down or backwards and it would right itself. Hold the model out at arms length again, tilt the model this time at a steep angle and you will see why it is so important to the space shuttle, that it enter the atmosphere at just the right angle. Too far either way and it would crash, instead of land. This model is just a toy. But the real life space shuttle, doesn't have the luxury of making mistakes. The people who work for NASA, the pilots, and crews, do a near impossible job, and do it so well it looks easy!  
PVB

# Silver & Golden Rectangles

(Diagrams © 1999 by Joseph Wu)

## Silver Rectangle - ratio of 1:root 2

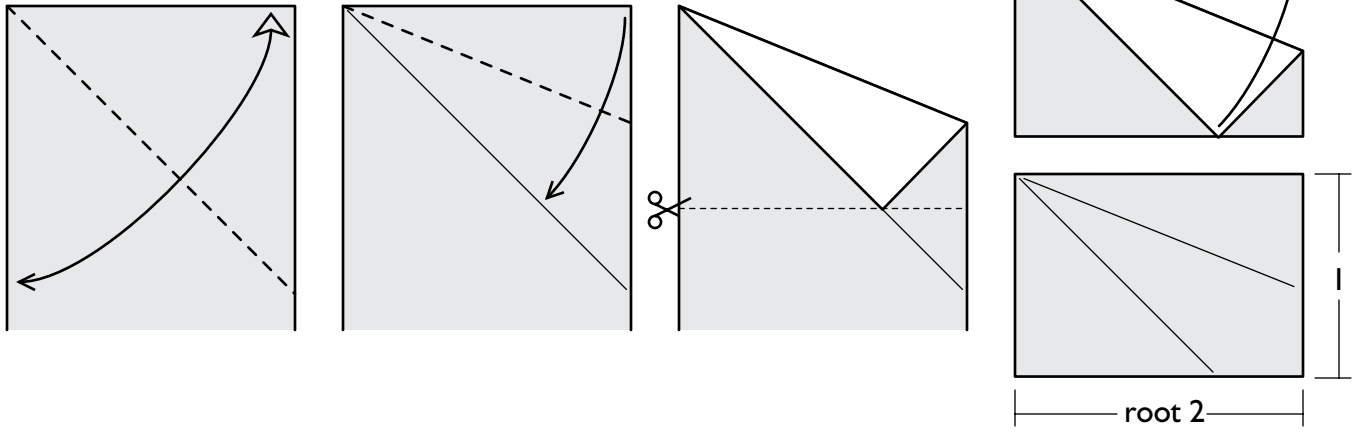

## Golden Rectangle - $1/a = (1+a)/1$

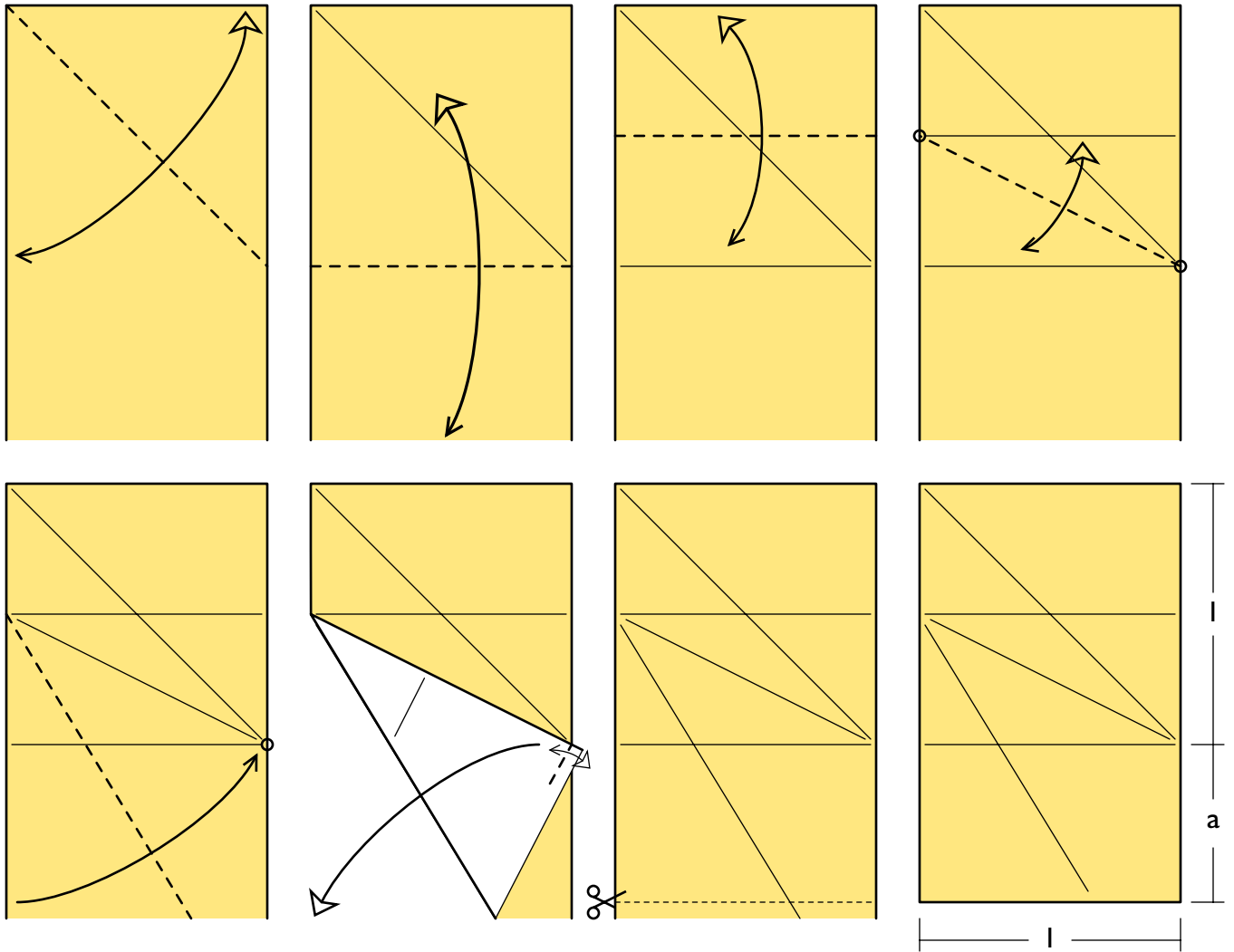



Шаг 1  
© Skull & bones by Eugeny Fridrikh, Russia

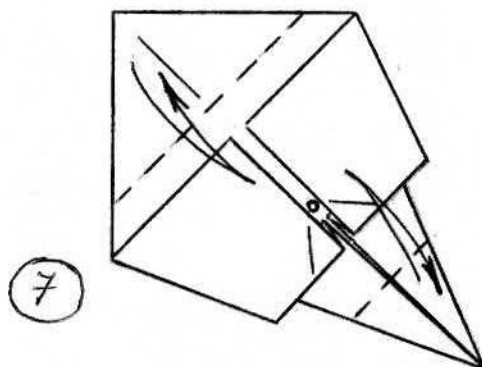
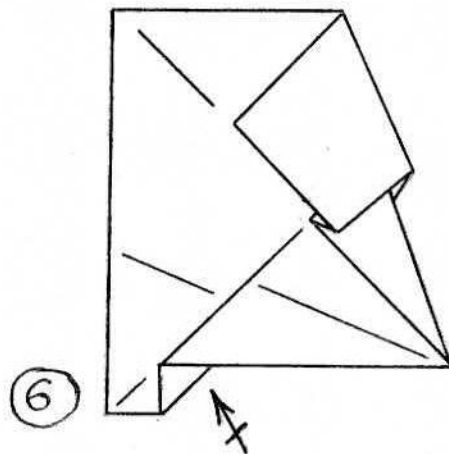
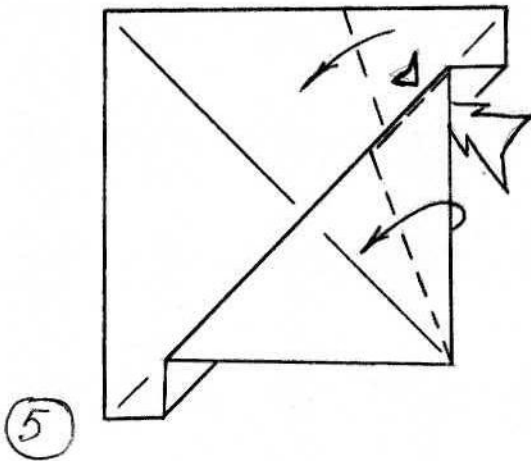
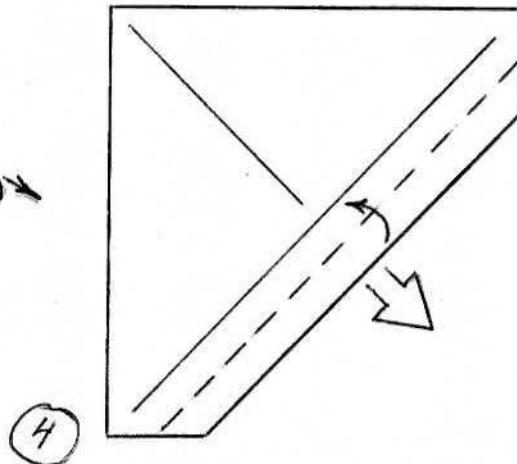
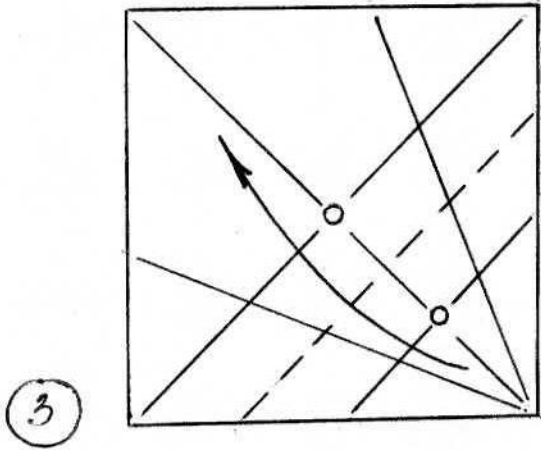
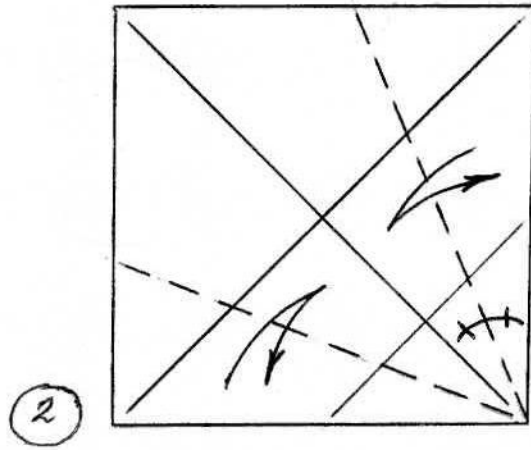
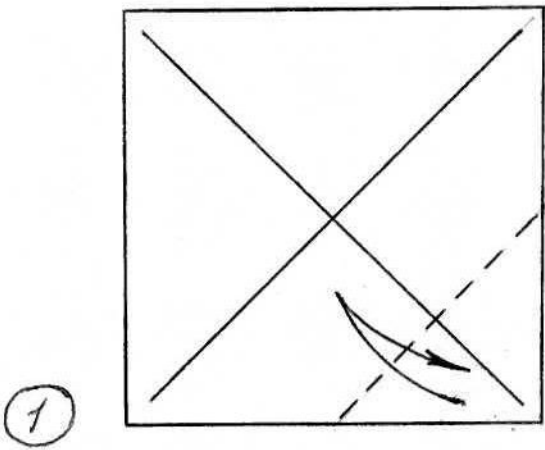

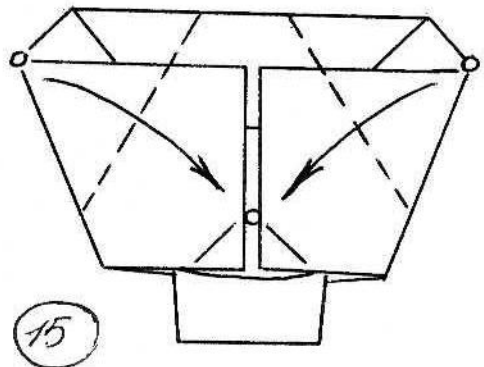
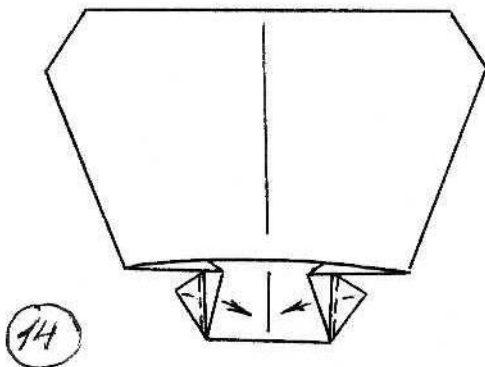
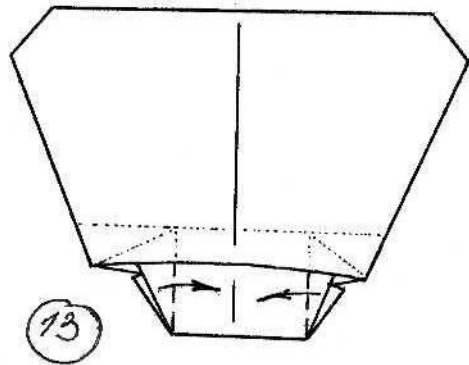
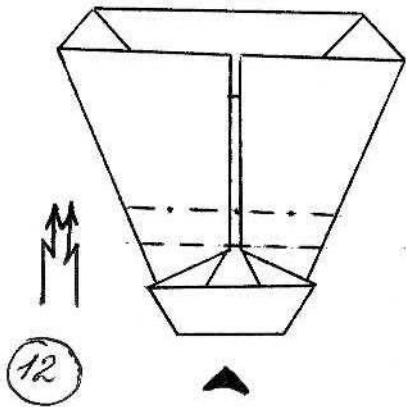
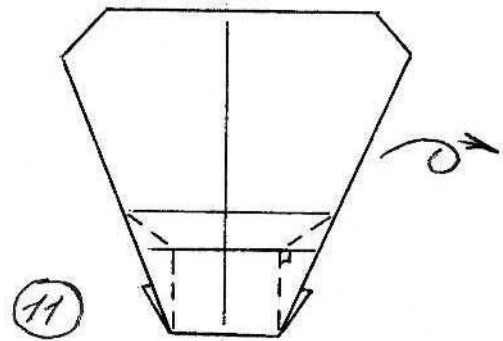
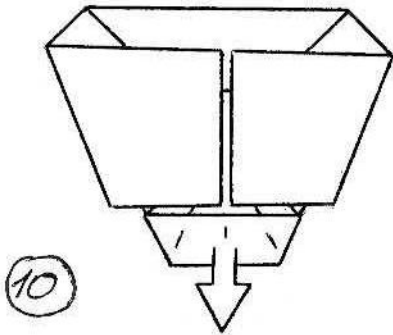
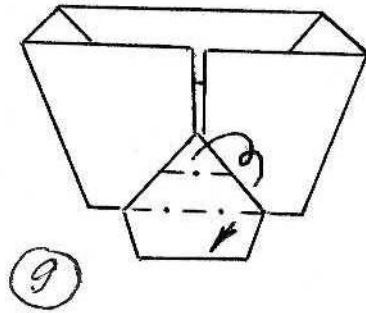
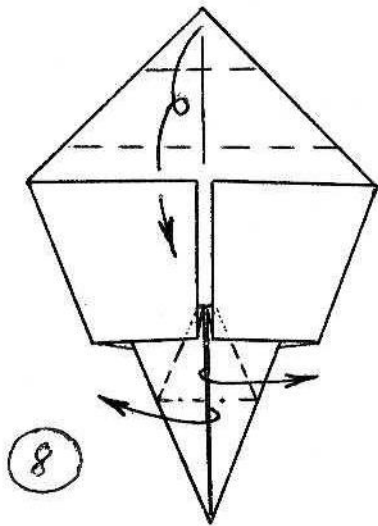

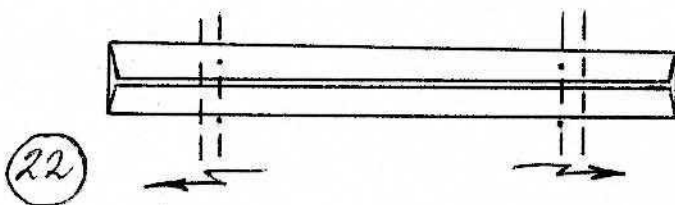
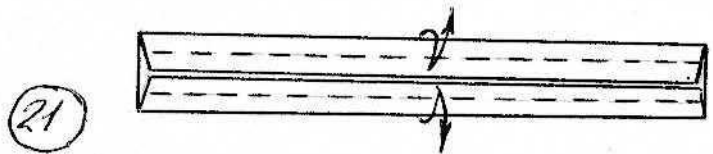
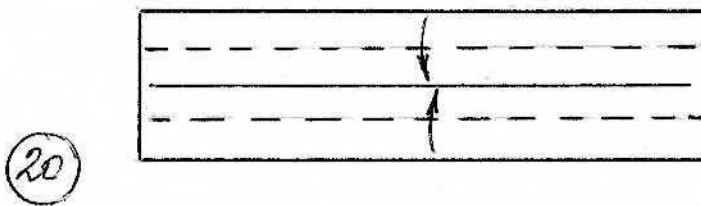
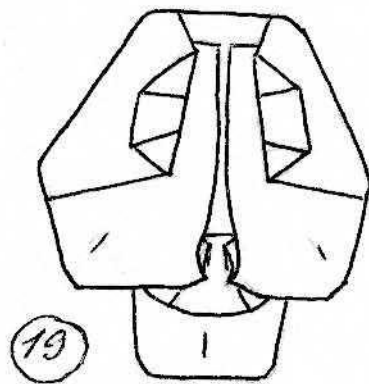
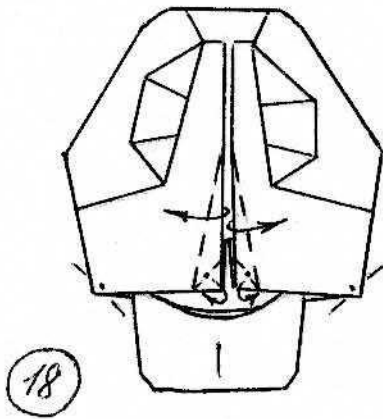
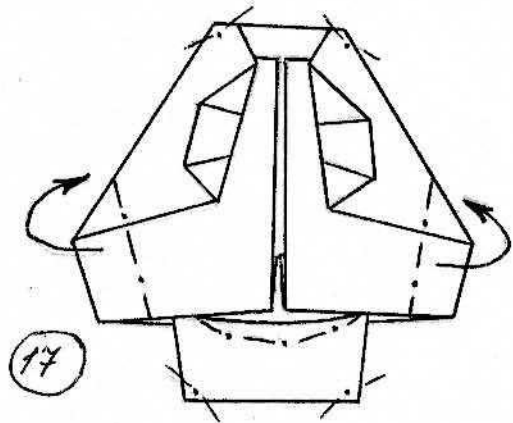
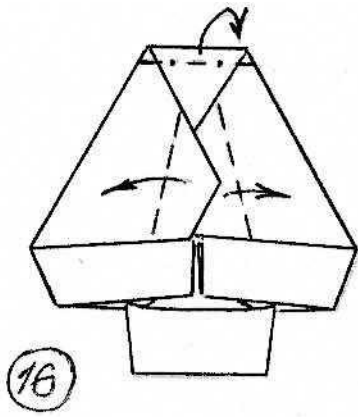

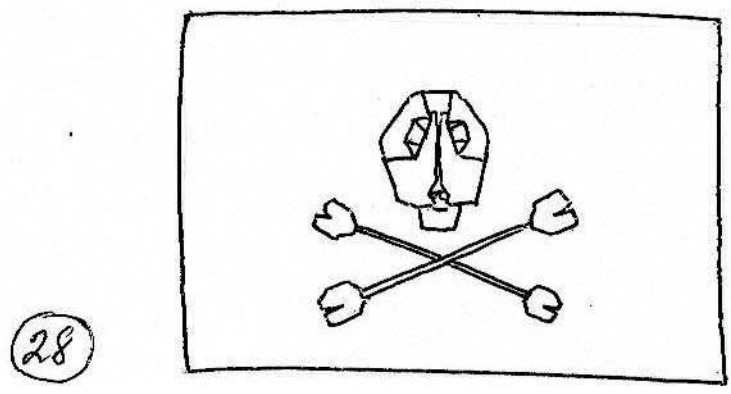
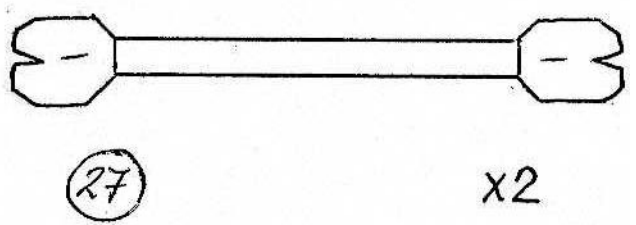
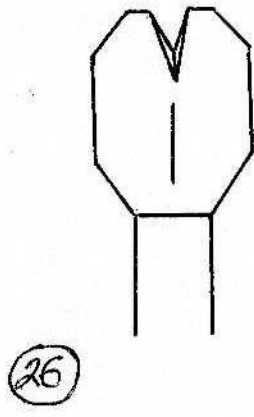
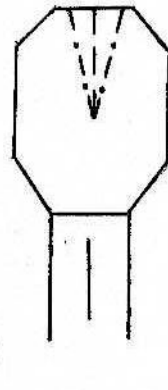
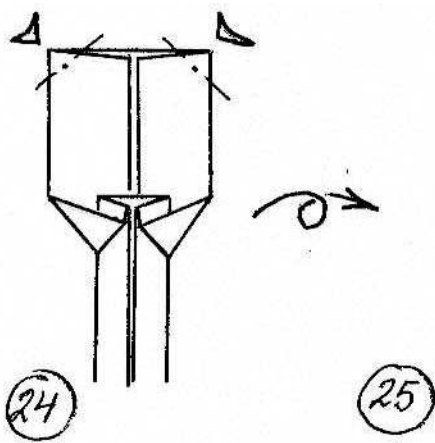
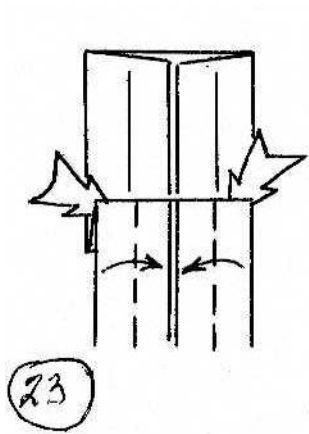

Start with a white hexagon. For best effect, use a sheet of translucent paper, such as tracing paper.

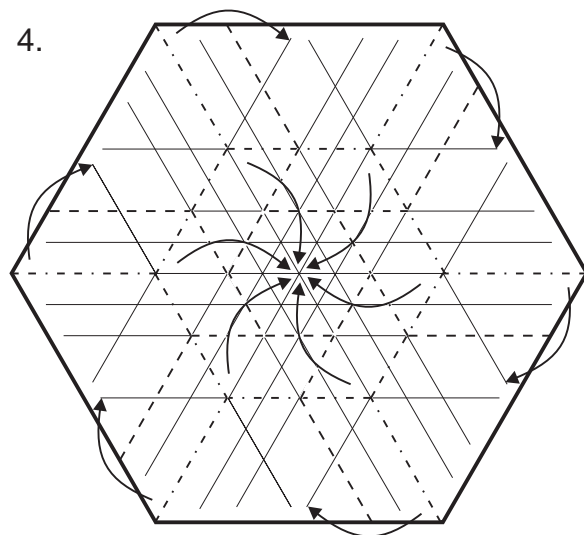
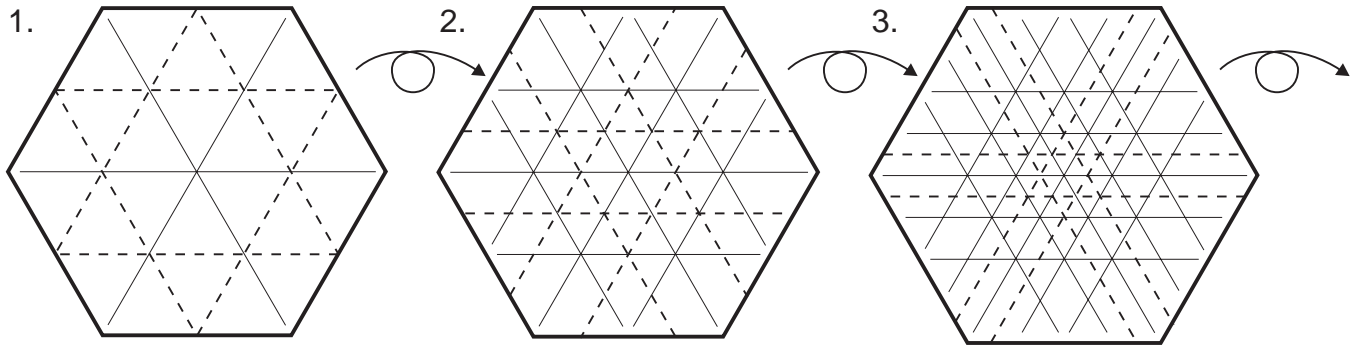

This collapse is similar to the collapse that forms the centre of the sand dollar in *Origami Sea Life*, but cannot be done in the manner shown there because it generates extra creases (which detract from the transparent effect of the snowflake).

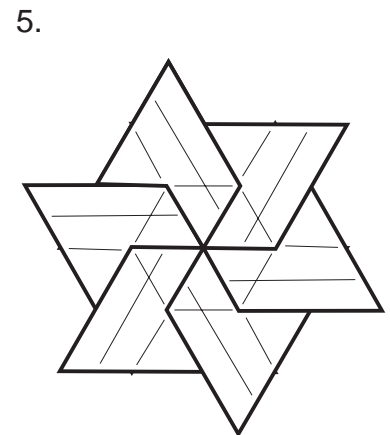

6. Focus on one of the flaps, standing it up.

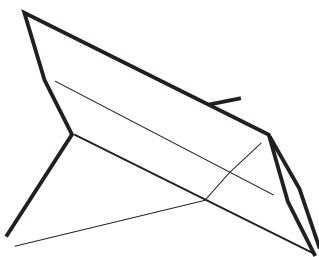

7. Flatten the flap, squashing the shaded area. Note that the squash is **not** symmetrical!

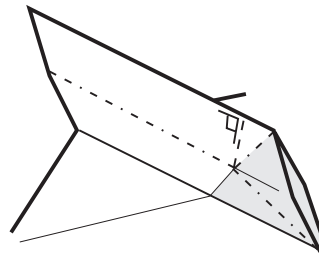

8. Result of previous step. Repeat on other five flaps, **alternating the thick part of the squash folds.**

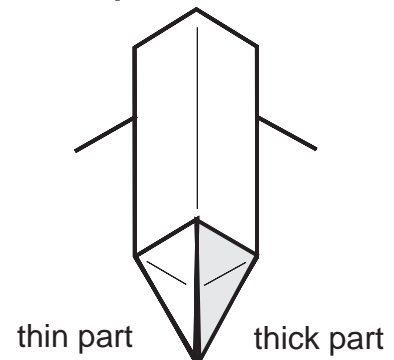

9. Swivel. (Shaded areas are thicker.)

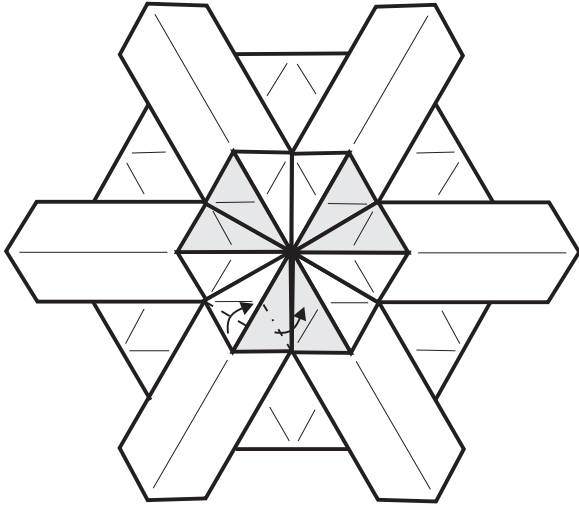

10. Mountain fold excess under flap.

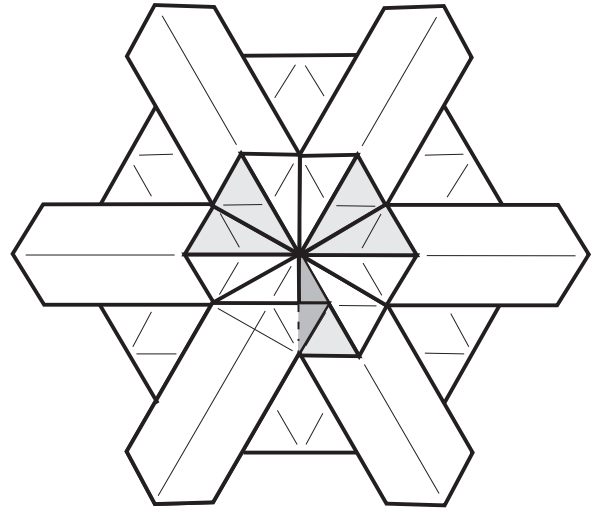

11. Repeat steps 9 & 10 five times.

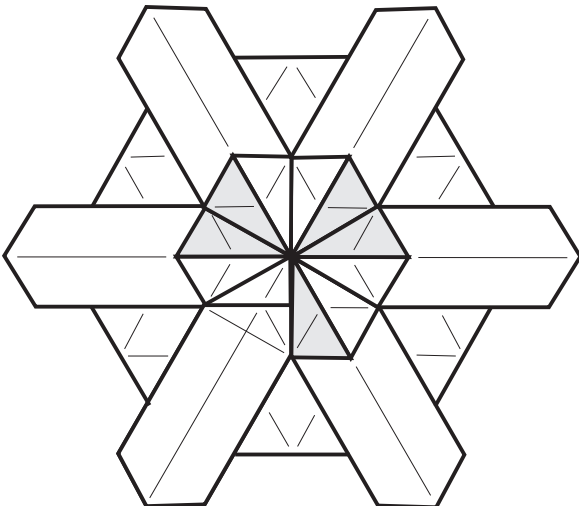

12. Valley fold three central points outward.

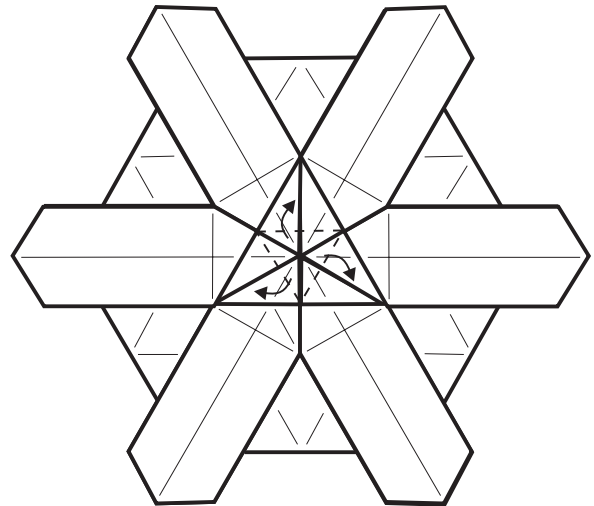

13. The centre completed. Turn over.

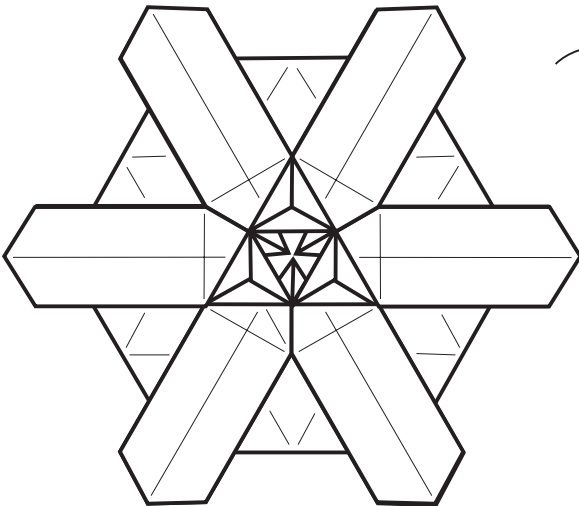

14. Swivel.

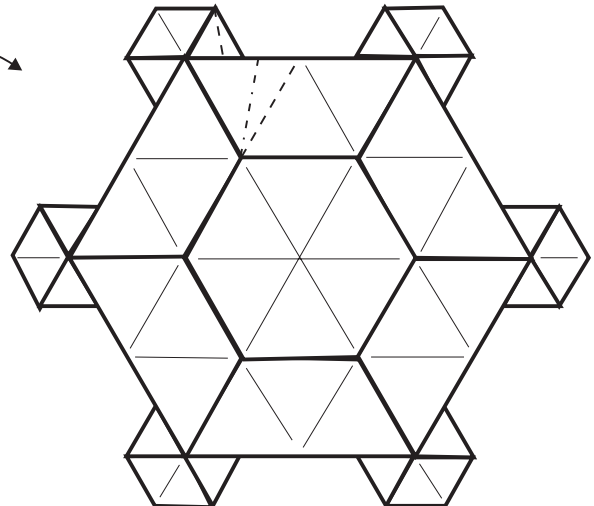

15. Repeat 11 times.

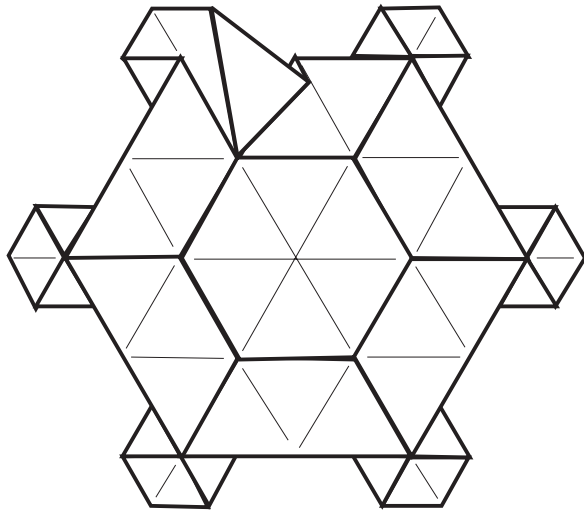

16. The back completed. Turn over.

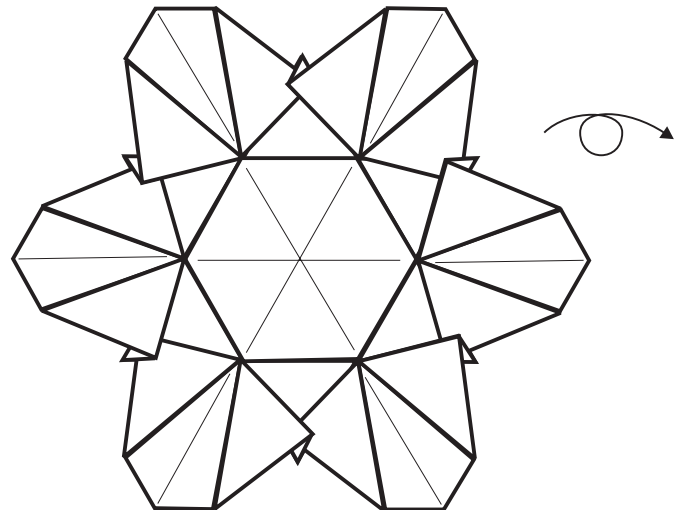

17. The completed snowflake.  
Make sure to look through it at a light source.

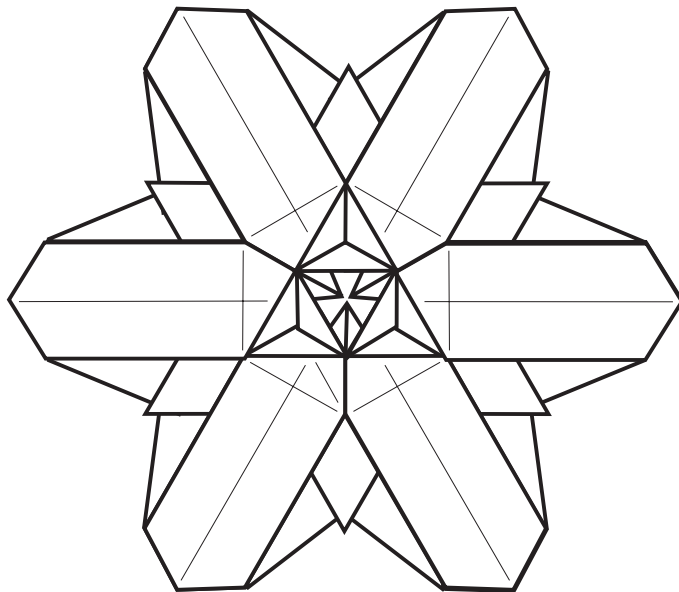

Notes: It is quite possible that someone has already done this snowflake. Anyone who has ever explored the symmetries of hexagonal paper is likely to have done some snowflake designs, and these are, necessarily, similar. I know that Yoshizawa has done similar work, and I've seen similar ideas by Dr. Suzuki at the *Origami Tanteidan* convention in the summer of 1996. There are probably others. Still, this was an original effort, the result of a challenge by Doug Philips to design a snowflake for the cover of *Imagiro*. It is one of over 30 different designs, the result of an effort to simplify some of the more complex ideas (because Doug would have to fold 25 of them, and also to ease my diagramming). I hope you enjoy it, and that you will use it as a stepping stone to designing your own snowflakes.

# The Simple Sorcerer

Inspired by John Montrols Grass

By Perry Bailey

Placed in the  
Public Domain  
1996 by Author

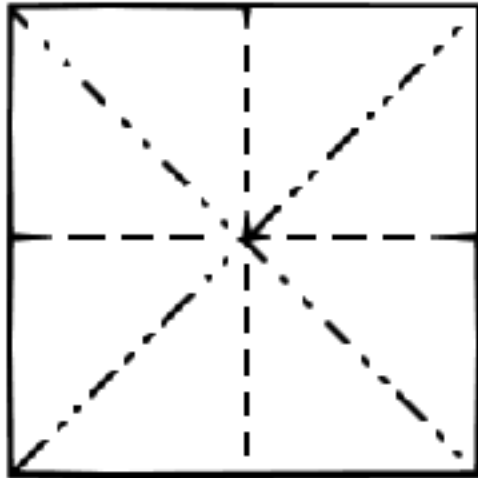

1. Start out by making the Triangle or water bomb base.

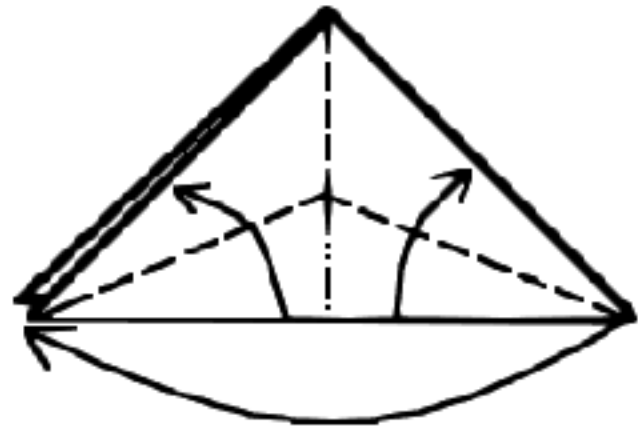

2. Fold the raw edges up to outer part of the model while folding 1 layer of paper to the left.

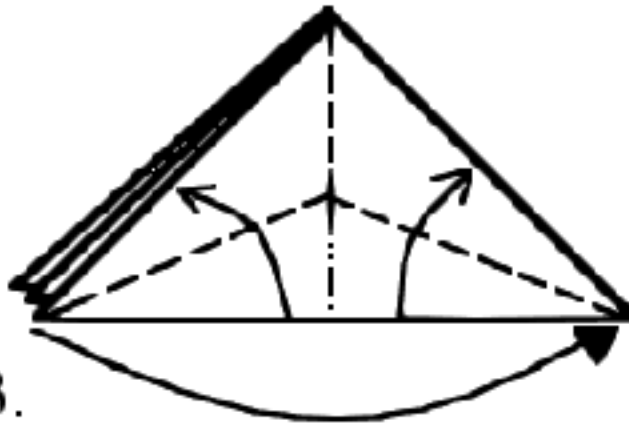

3. Fold the raw edges up as in #2 but this time fold over 2 layers of paper to the right.

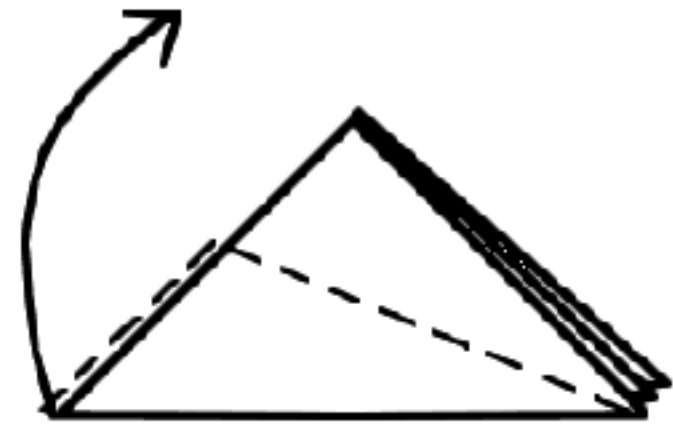

4. Now reverse fold the flap up along the lines shown.



5. Model should look like this. flip over as in #6.

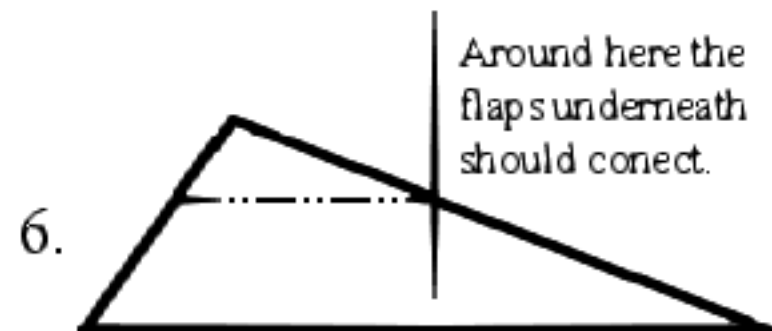

6. Perform a closed sink on the model.



7. Now raise the top flap so you can see what is beneath it.



Placed in the  
Public Domain  
1996 by Author

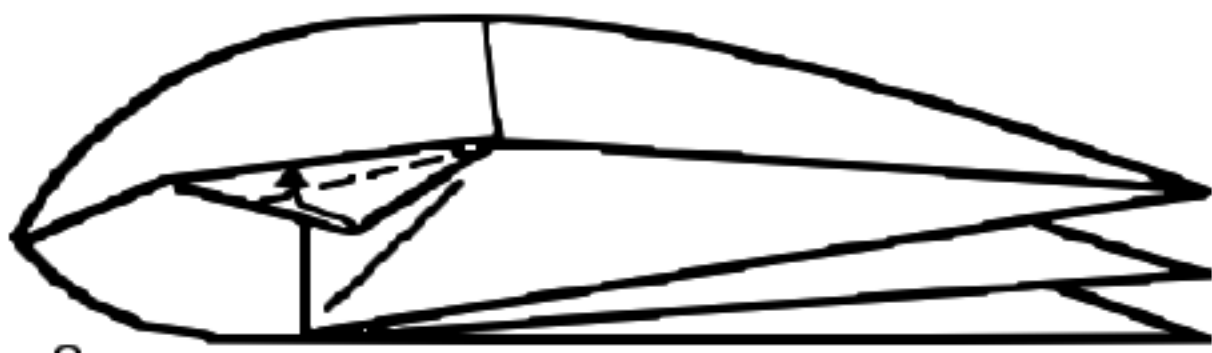

8. Fold over the flap inside of the model that was created by the sink done earlier. then flip model over horizontally.

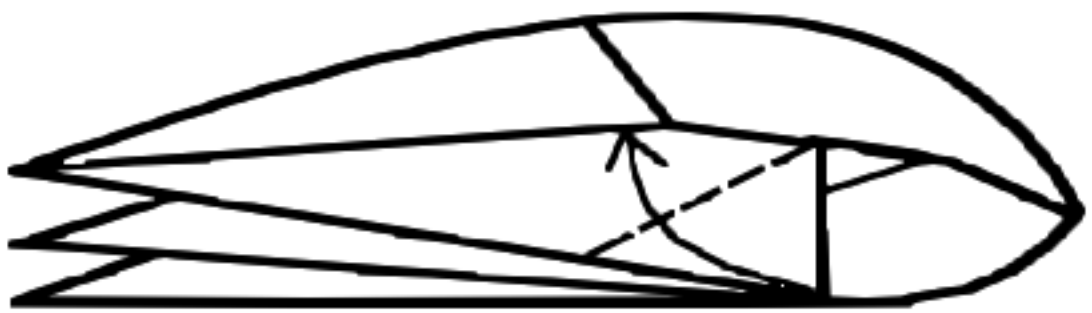

9. Now fold up the big interior flap, these two folds serve to lock the model together. Then flatten back down and flip over as in #10.

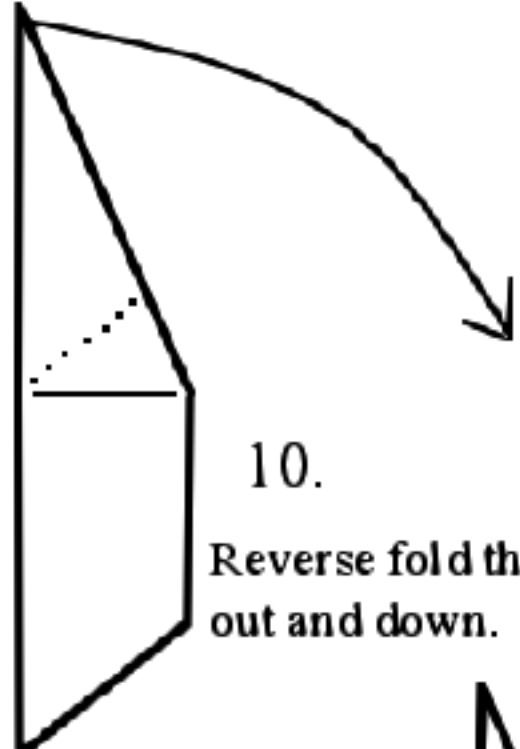

10. Reverse fold the center flap out and down.

11. Model should look like this. Now turn the model so the point sticking out is facing you and separate the back a little as in the next illustration.

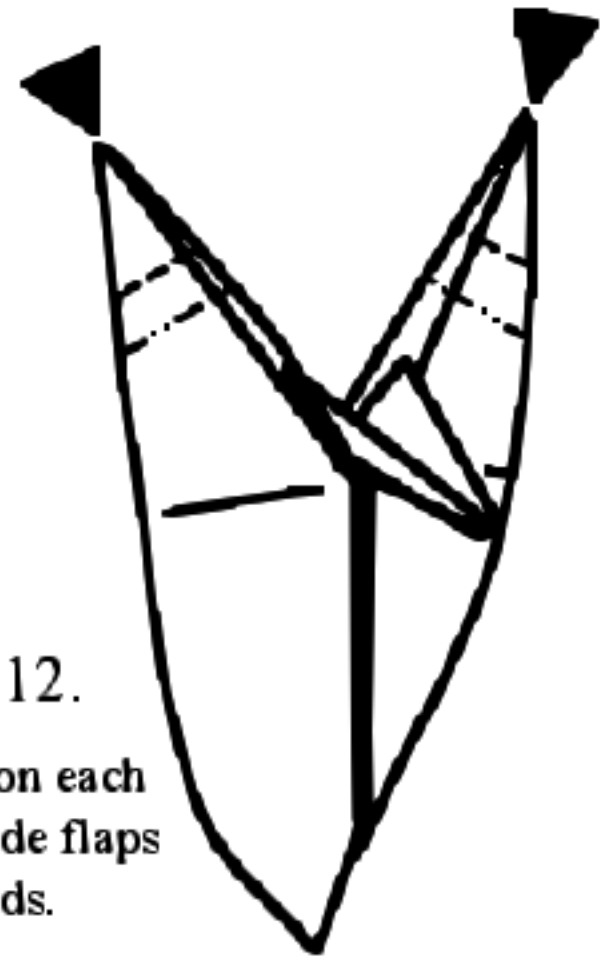
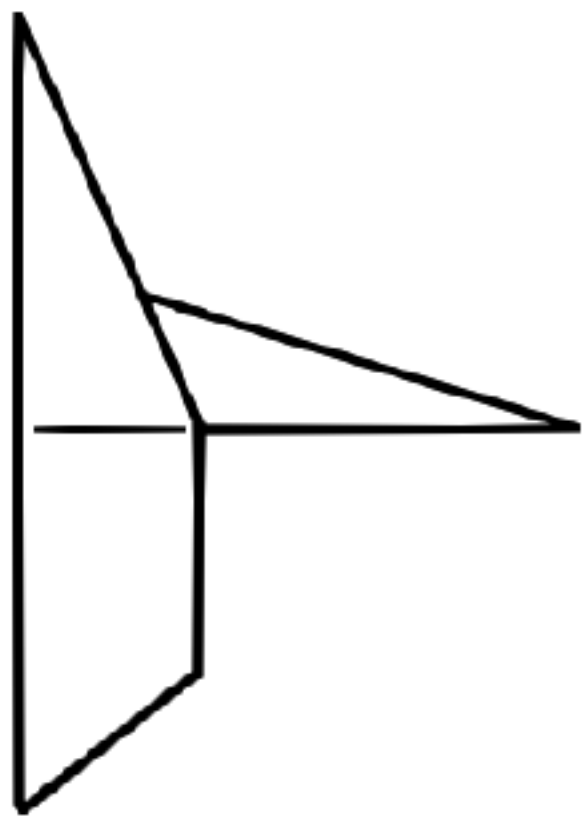

12. Holding 1 layer out slightly on each side fold the tips of the outside flaps in as shown to make the hands.



13.

Open up the center flap as shown.



14.

Reverse fold the center flap part of the way back, to make the cowl of the sorcerers robe.



15.

Now using the existing crease for the bottom, fold down the arms of the model. Then fold up on both sides the models base so that it can stand up.

16.

Final point, the arms will look nicer if you fold back the little flap of remaining paper as seen here.

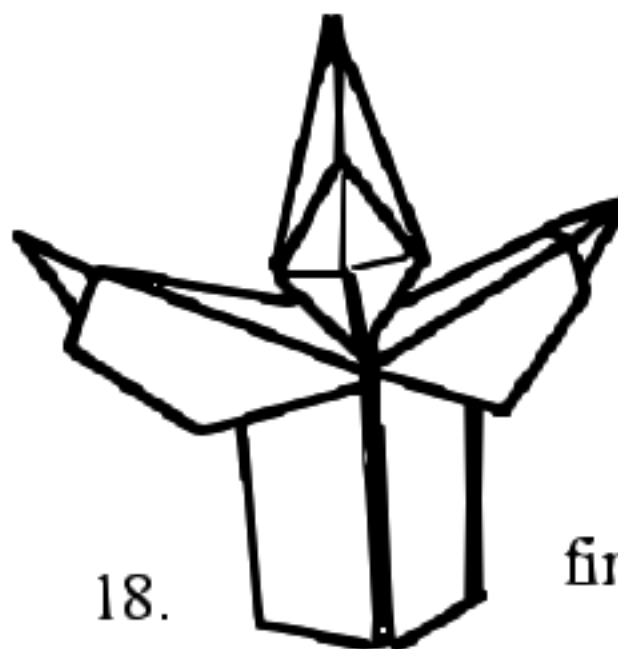

18.

finis

Sorry the picture of the final model is so bad, but an artist I ain't.

Placed in the Public Domain 1996 by Author

# HECHICERO

José Tomas Buitrago Molina  
 Colombia (c) 1998  
 Color abajo

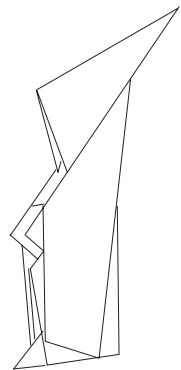
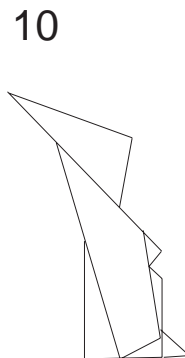
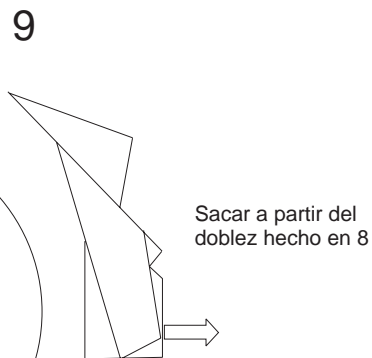
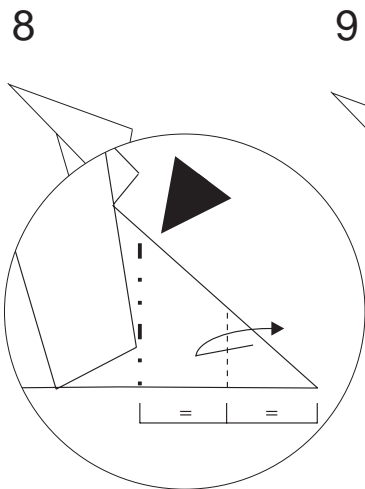
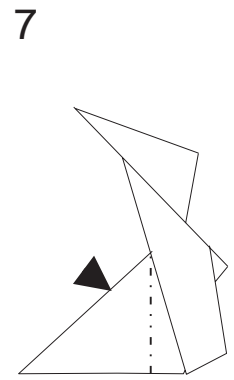
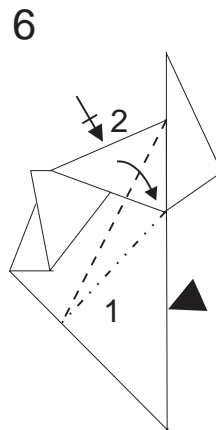
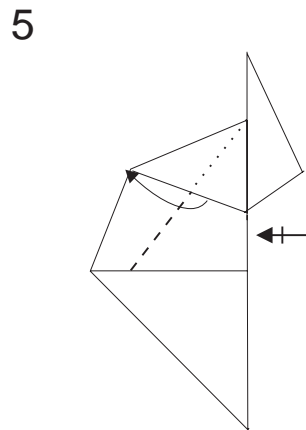
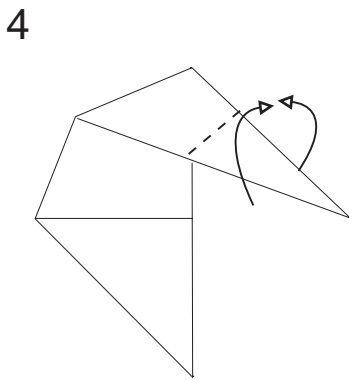
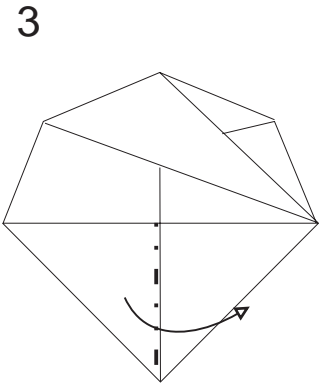
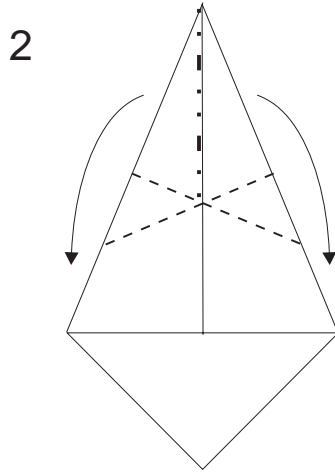
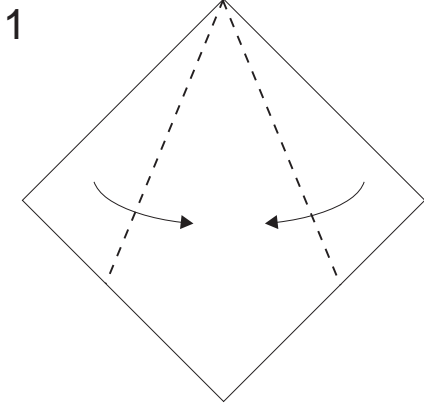

Cuadrado de 8.5 cm  
 Tamaño final 5 cm.  
 Diagramas: José Tomas Buitrago

# Sparrow

By Perry Bailey Copyright 2000

Use Mono colored paper  
or the head will be a different  
color than the body.

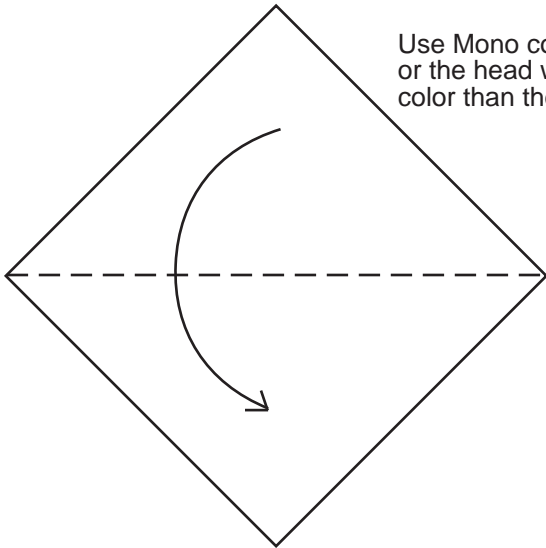

1. Fold in half on the diagonal.

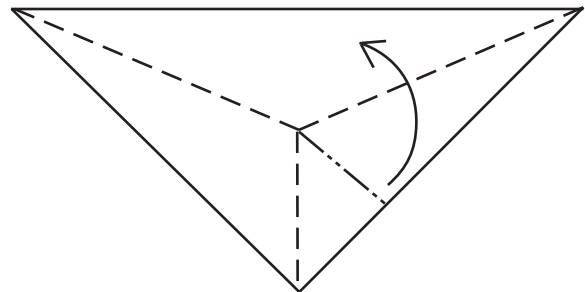

2. Fold the sides up in to a rabbits ear, or make the fish base, which ever you prefer.

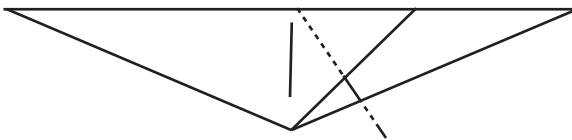

3. Reverse fold the end down from the center  
So that it is center in the middle of the model.

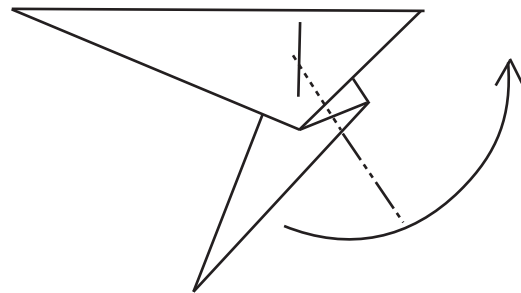

4. Reverse fold the flap part of the way back up.

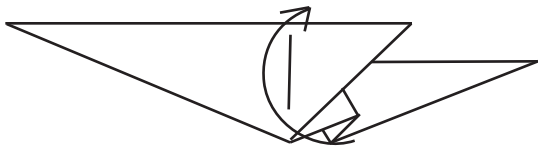

5. The model should look like this  
at this point. Now with out  
creasing the top layers open  
up the bottom of the model.

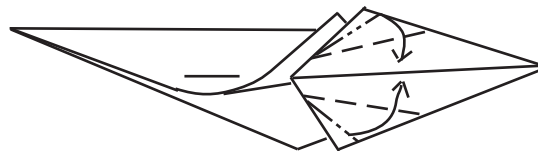

6. Swivel fold the sides into the center of the  
model to flare the tail.

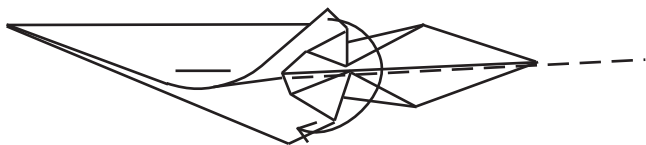

7. It should have at least a vague resemblance  
to this, if it does then fold the bottom of the  
model back down.

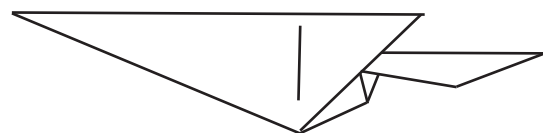

8. If all has gone well it should look like  
this, if it does then go on to the next  
step.

9. Mountain fold the trailing edge of body back into it's self to do this you probably will need to make a small swivel fold in the tail.

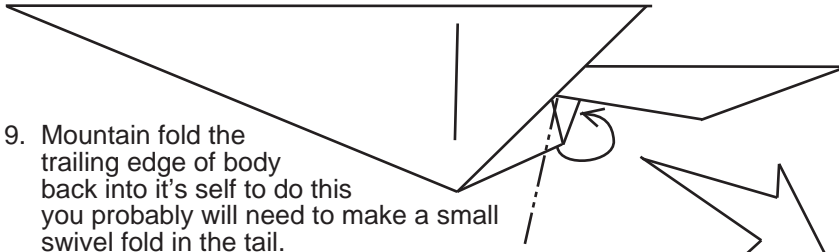

X-ray view of inside of tail if the top layers were removed.

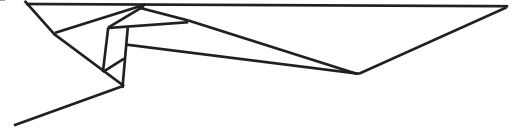

10. The swivel fold inside would look like this.

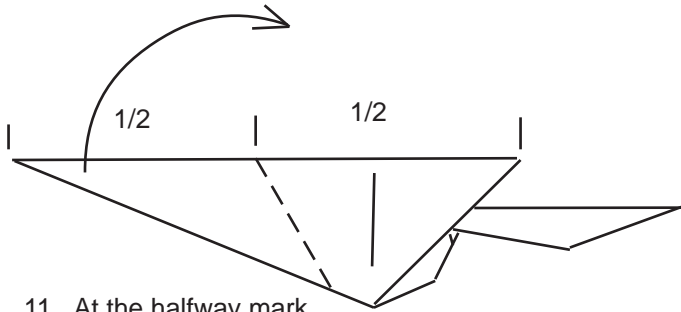

11. At the halfway mark on the top edge reverse fold the front of the model up.

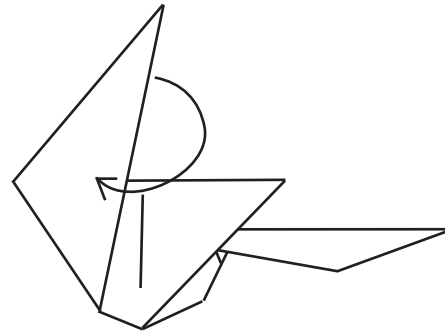

12. Now release the trapped layer of paper on each side and fold it forward. If you were to make this with regular kami (color one side white the other) you would be making a partial color change.

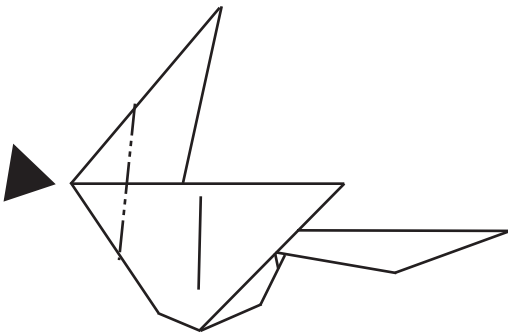

13. Sink the center layer in and then fold the outer layers into the inner sink.

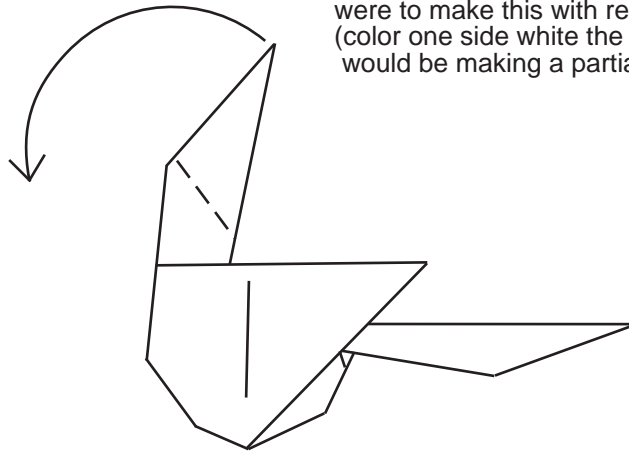

14. Reverse fold the head forward.

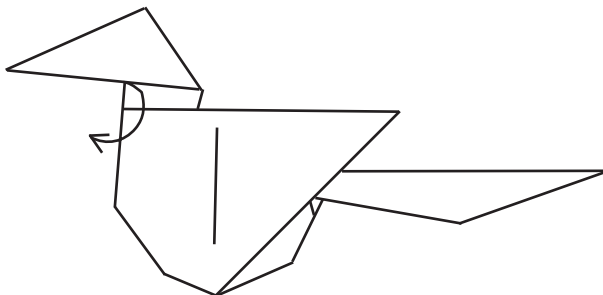

15. Now pull out the trapped layers inside of the head to make it larger.

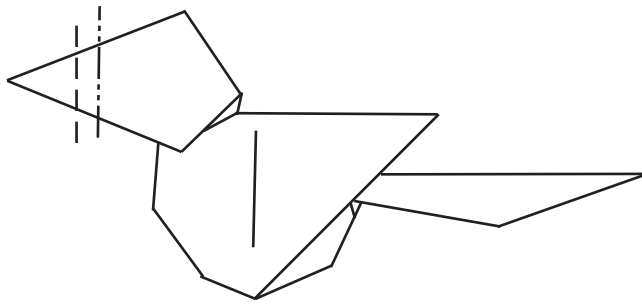

16. Pleat the beak in a bit.

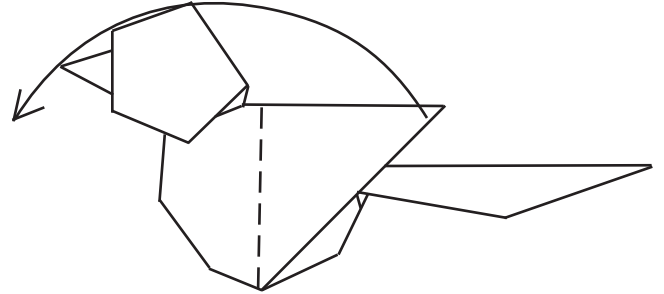

17. Fold the flaps forward, they are about to become wings!

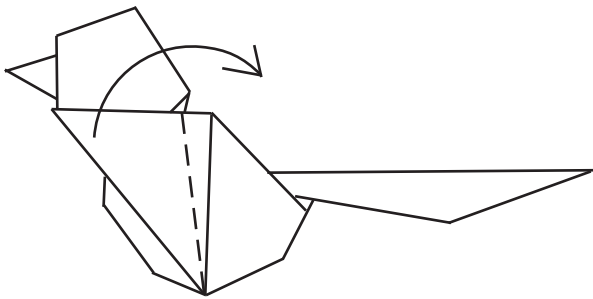

18. Fold the flaps back at a jaunty angle for the wings!

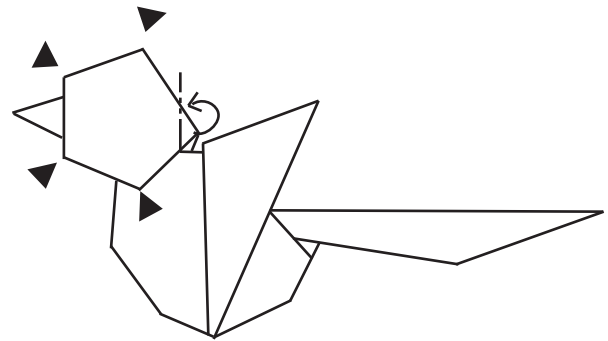

19. These are the finishing touches. Fold the back of the head in to the body, then sink the top of the head and the next spot down in the front of the head, the rest of the head can be managed just fine with mountain folds.

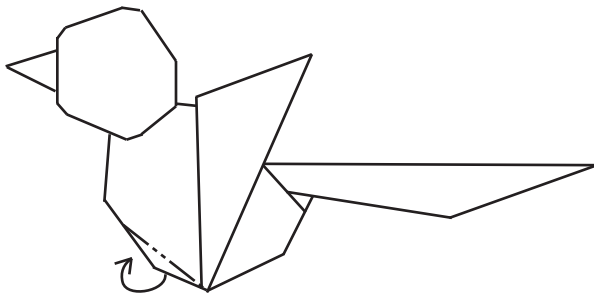

20. Tuck in a little of the breast to improve the lines.

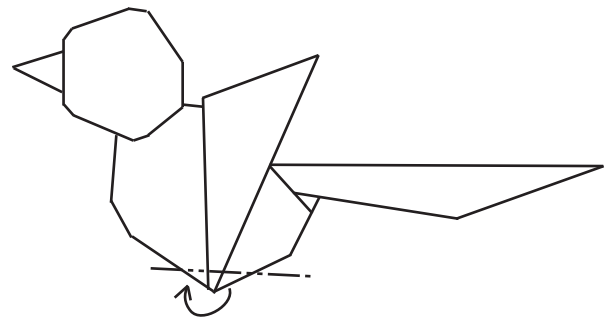

21. Mountain fold a little bit underneath so it will stand properly.

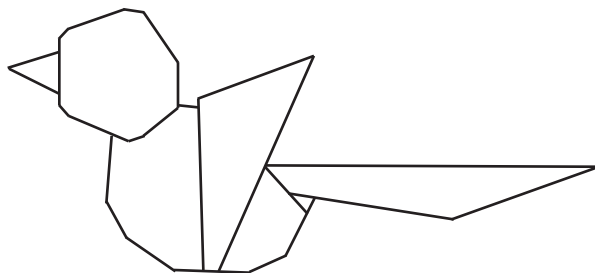

Finally, we are done!

# Spenjurmunni

Designed by Robert J. Lang

Copyright ©1999. All Rights Reserved.

Any resemblance between this origami design and a character from any irritating-sound-producing videogame, overpriced trading card, or mind-numbing, poorly-animated TV show, is purely coincidental.

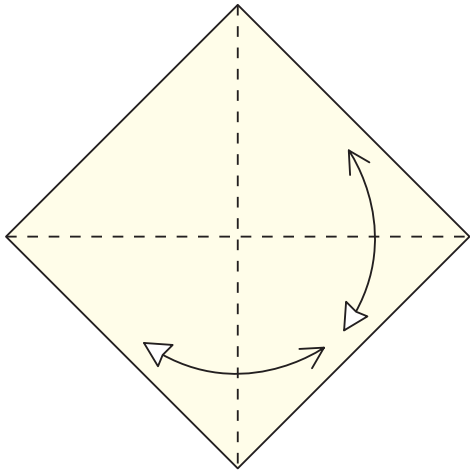

**1.** Begin with a square, white side up. Fold and unfold along both diagonals.

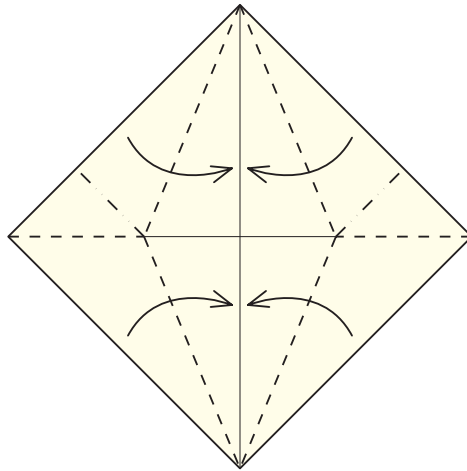

**2.** Fold a Fish Base.

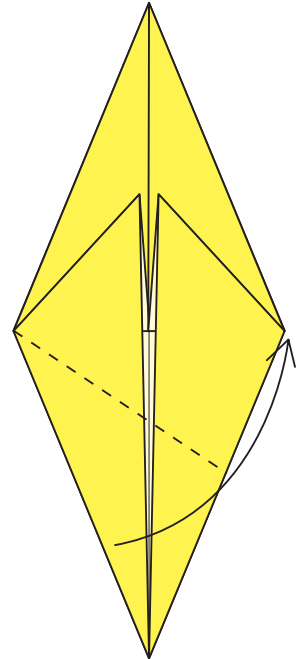

**3.** Fold the bottom point up so that its edge hits the right corner.

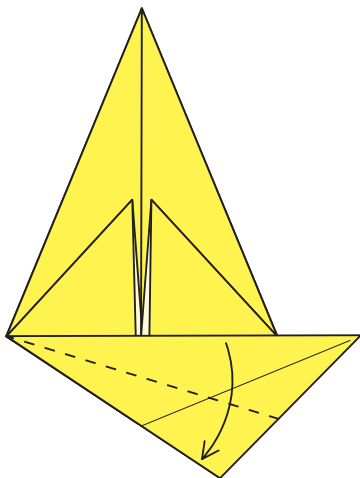

**4.** Fold the horizontal edge down so that it aligns with the folded edge.

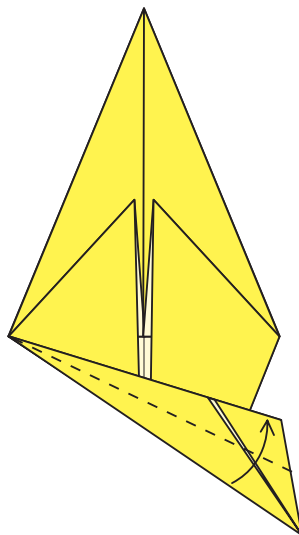

**5.** Fold the edge back up so that it aligns with a folded edge.

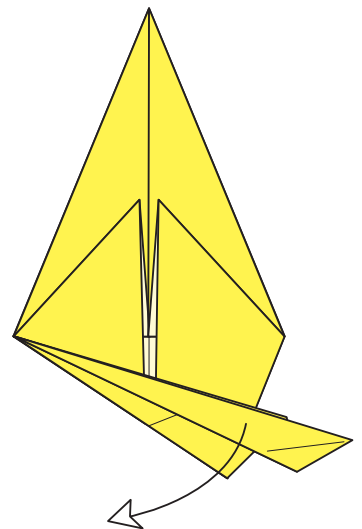

**6.** Unfold to step 3.

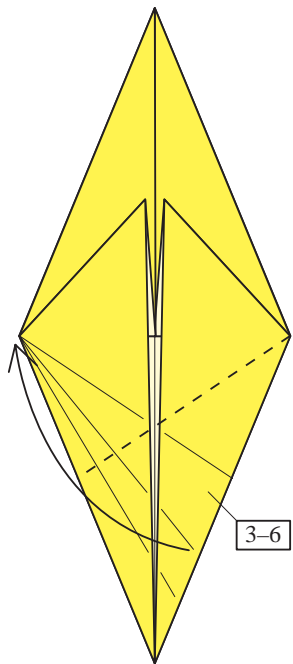

**7.** Repeat steps 3–6 on the right.

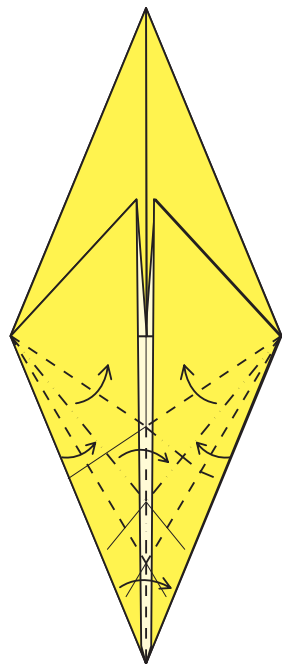

**8.** Use the creases you just made to form three nested rabbit ear folds.

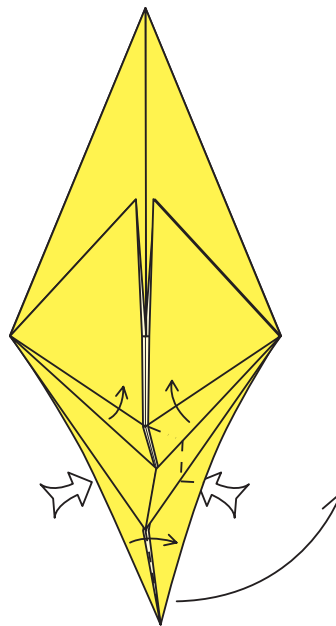

**9.** Pinch the flap in half and swing it over to the right.

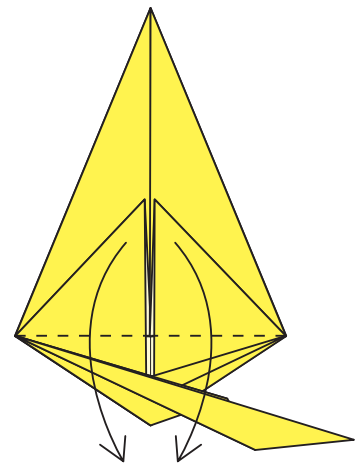

**10.** Fold the two flaps down and flatten the model firmly.

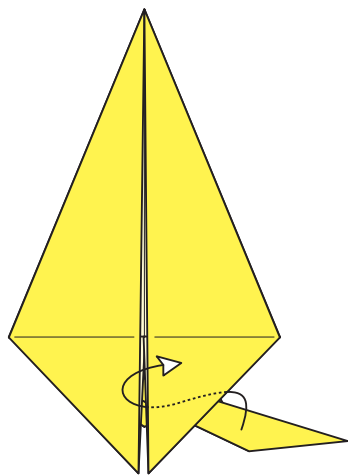

**11.** Bring the long flap to the front. This flap will be the tail.

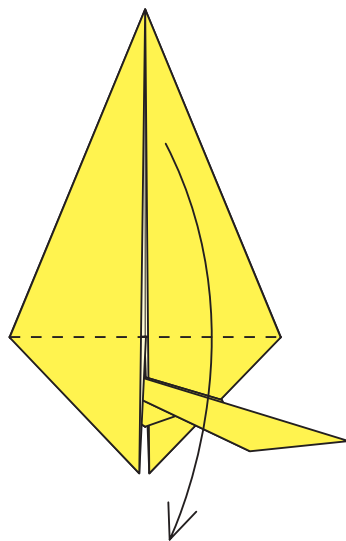

**12.** Fold the top flap down.

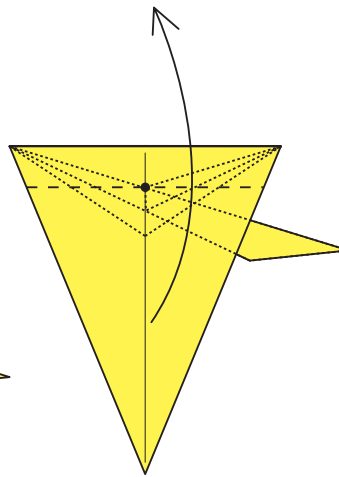

**13.** Fold the flap back up. Note that the crease hits the centerline at the same point as the tail flap.

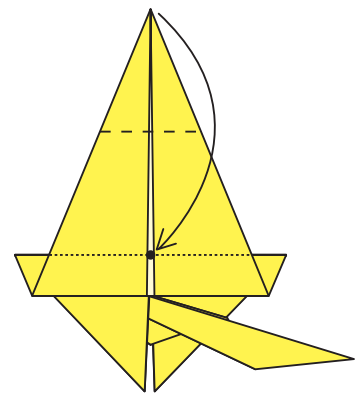

**14.** Fold the top flap down so that its tip aligns with a hidden horizontal crease.

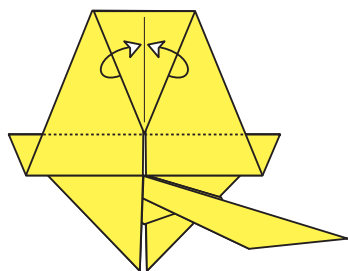

**15.** Bring the raw edges to the front on both left and right.

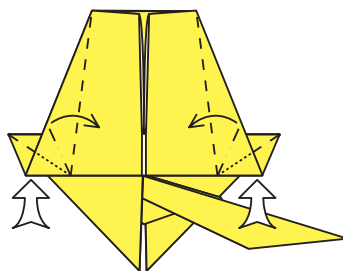

**16.** Swivel-fold the edges.

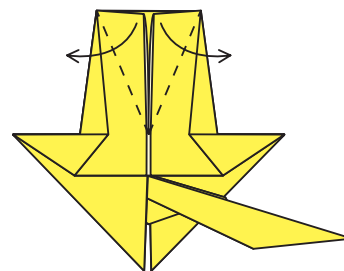

**17.** Fold the flaps out to the sides.



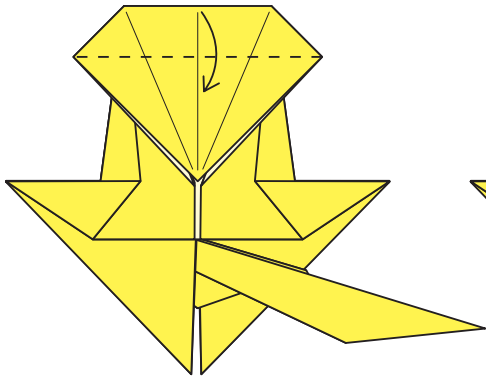

**18.** Fold the top edge down along a crease that runs from corner to corner.

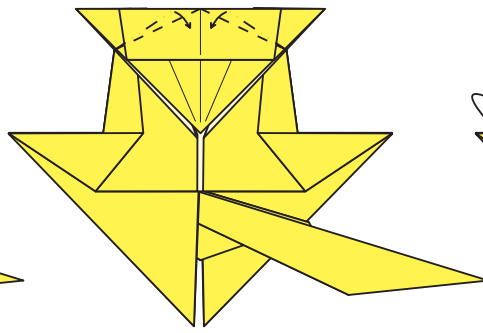

**19.** Pleat the ears at the top of the model.

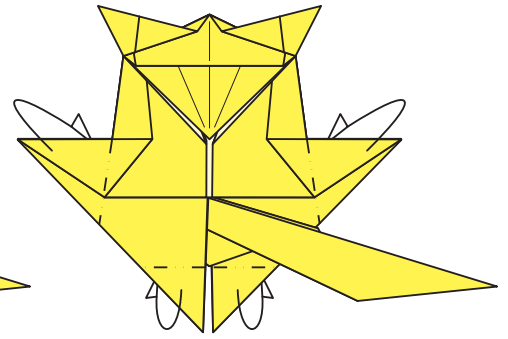

**20.** Mountain-fold four flaps to the rear.

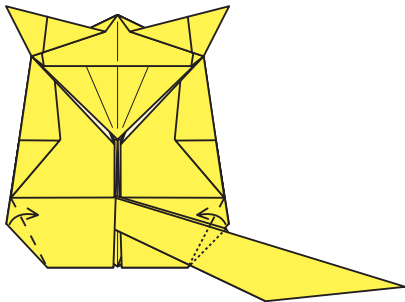

**21.** Valley-fold the corners.

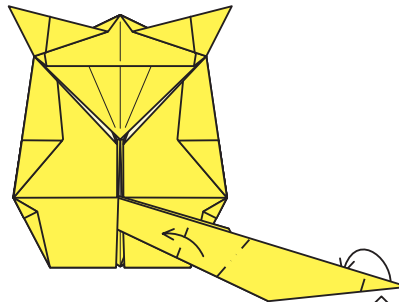

**22.** Reverse-fold the tip of the tail. Pleat the tail like a lightning bolt.

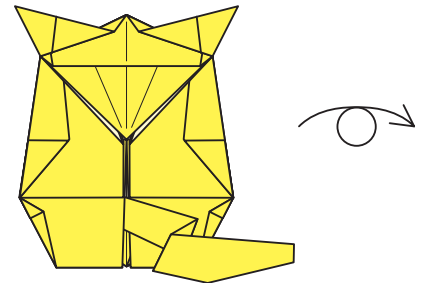

**23.** Turn the model over.

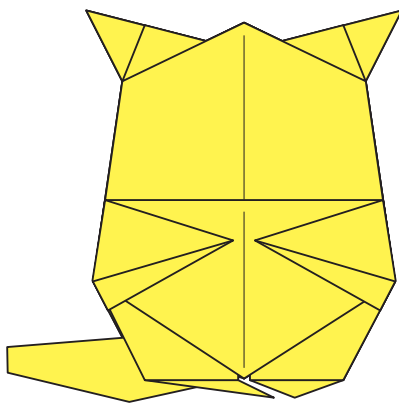

**24.** Finished model. Color on a face as shown in the next figure.

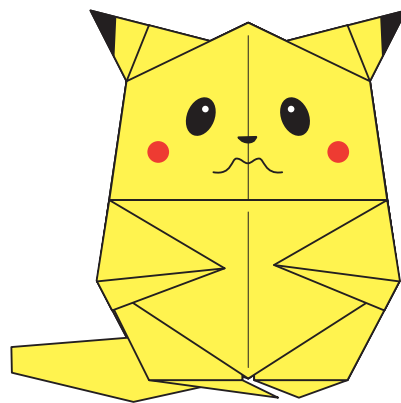

**25.** Finished Spenjurmunki, taking a peek at you.

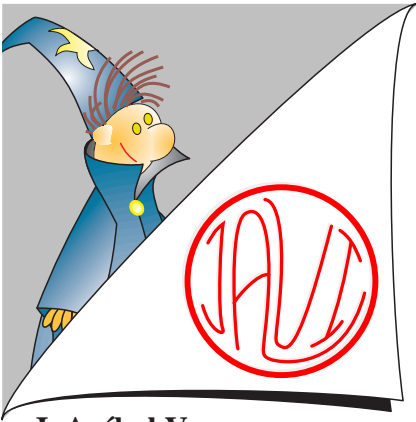

J. Aníbal Voyer

# Esfinge

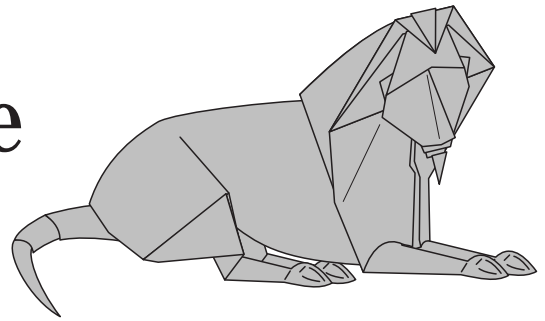

1

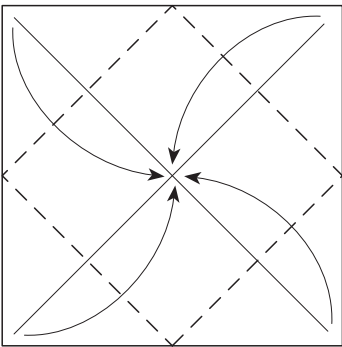

2

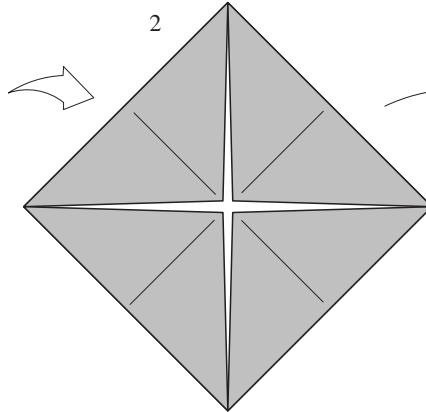

3

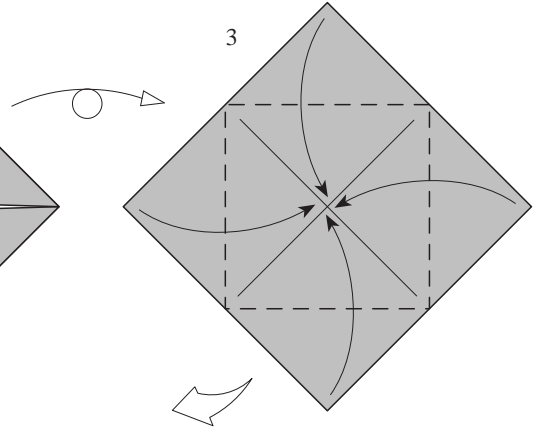

4

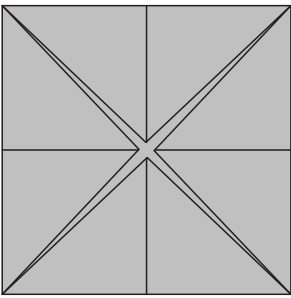

5 Desplegar hasta el paso 2

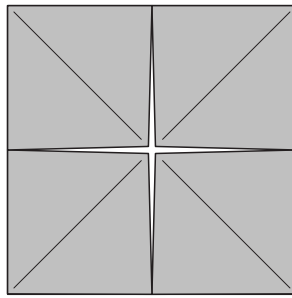

6

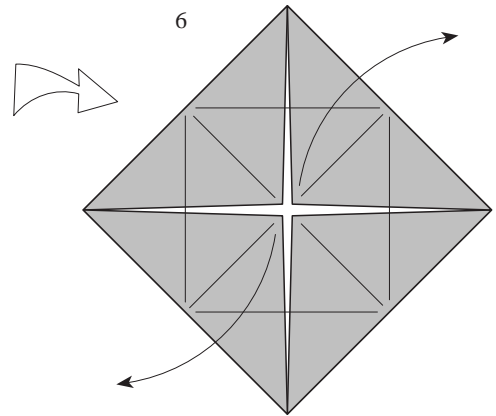

7

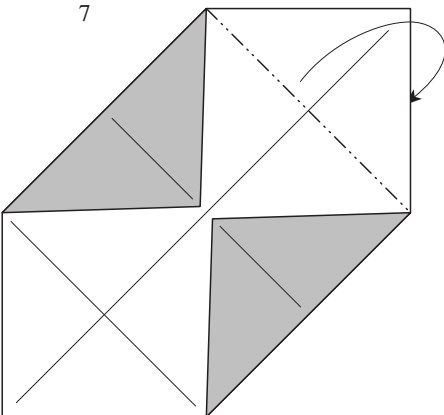

8

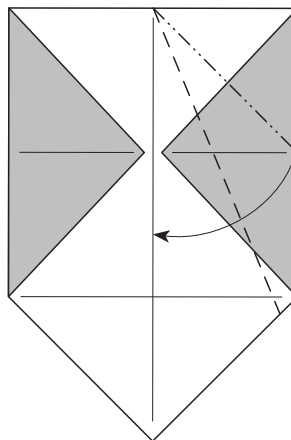

9

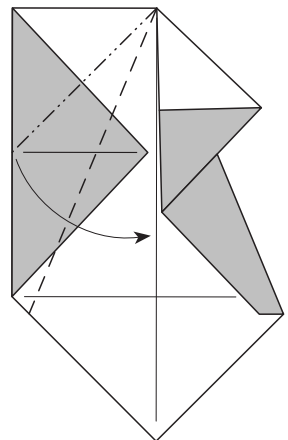

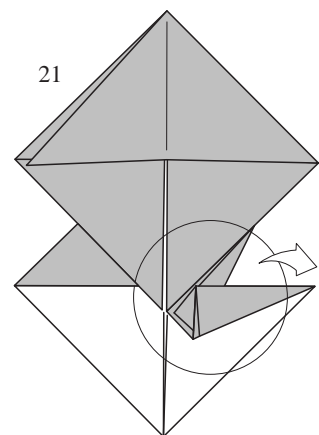
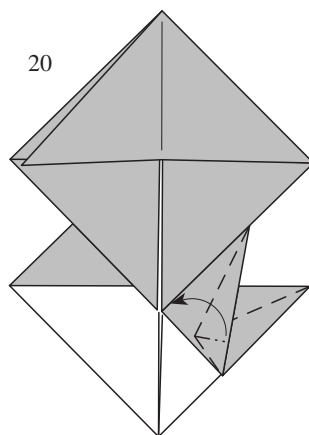
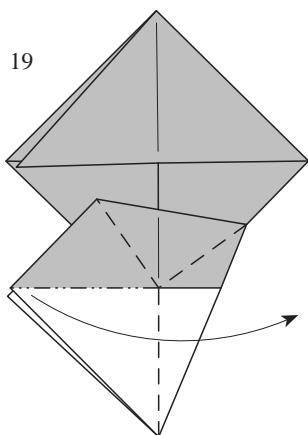
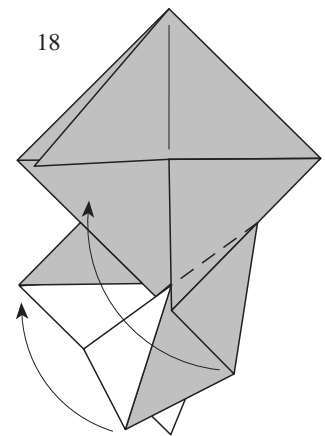
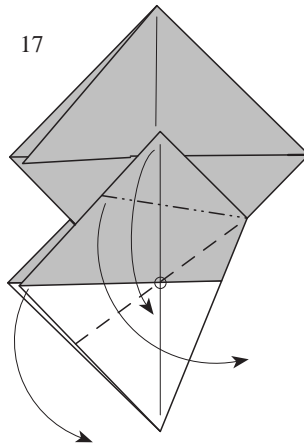
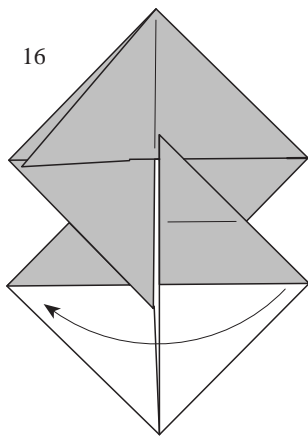
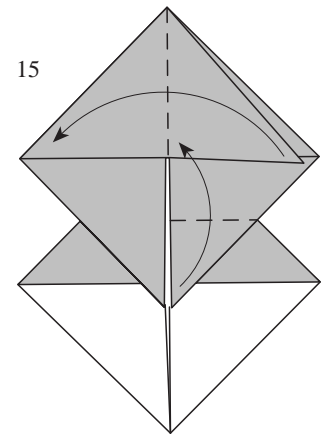
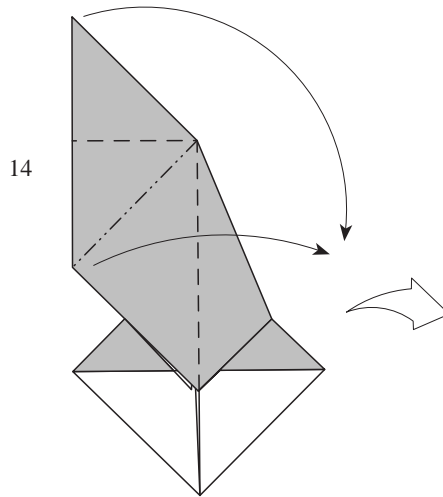
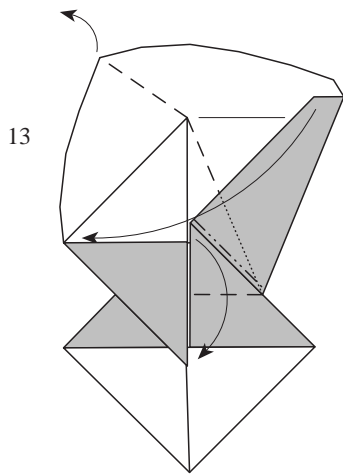
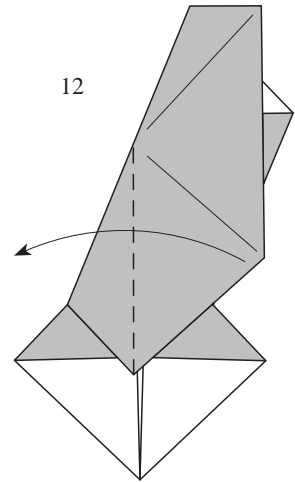
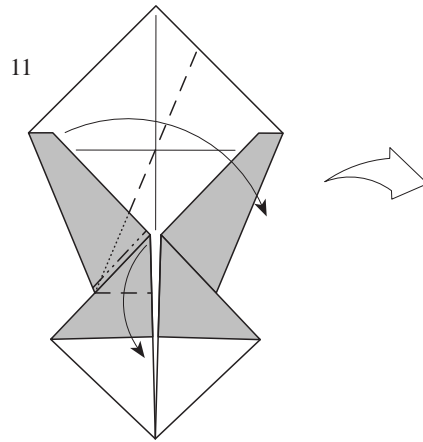
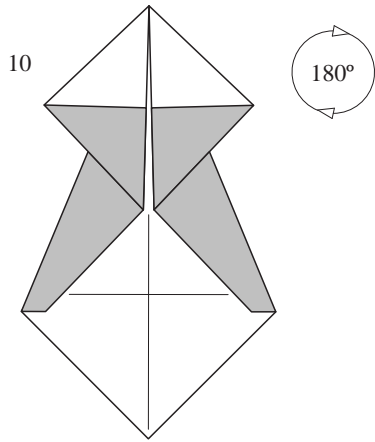

22

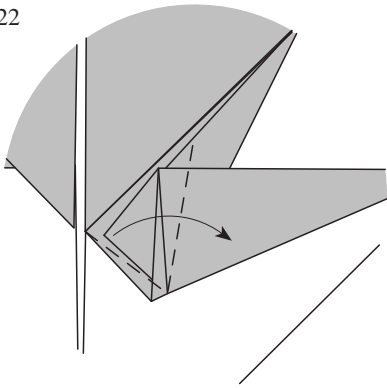

23

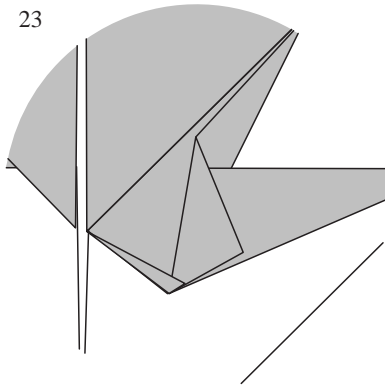

24 Repetir del 15 al 25 a la izquierda

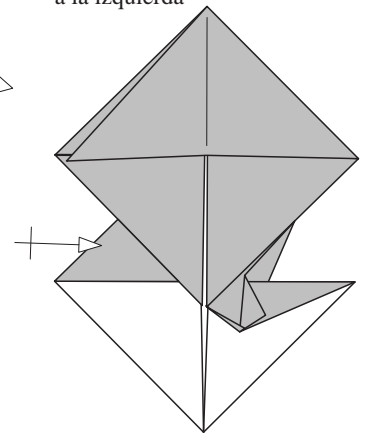

25

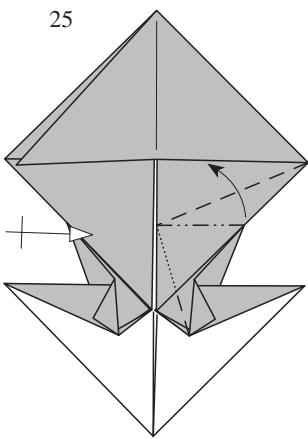

26

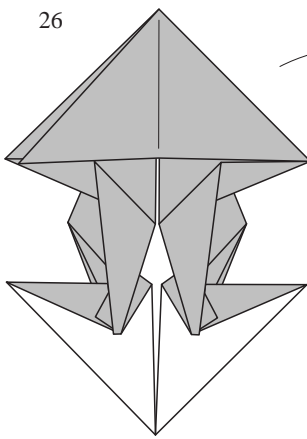

27

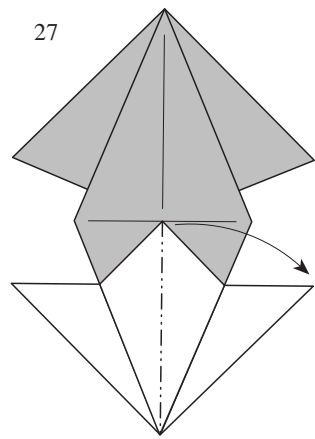

28

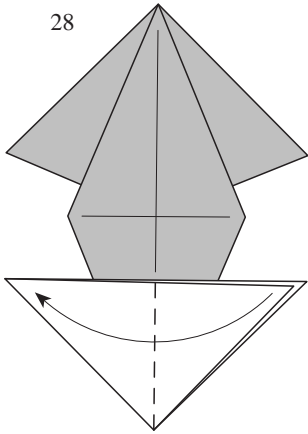

29

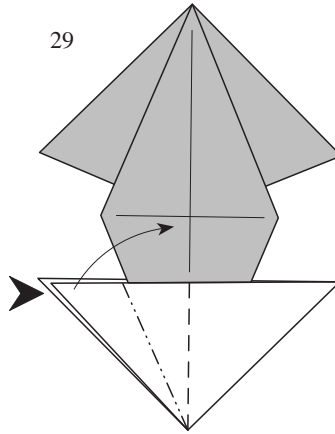

30

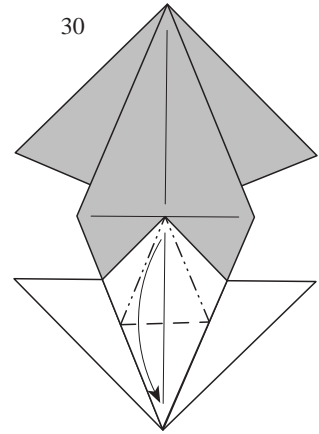

32 Desplegar hasta el paso 29

31

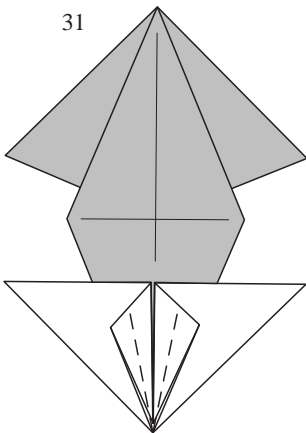

33

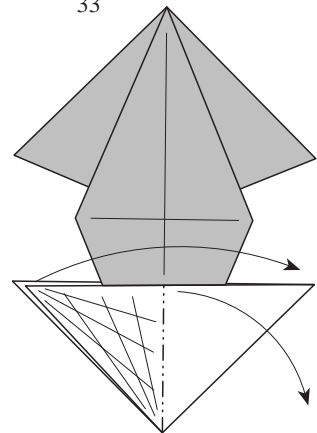

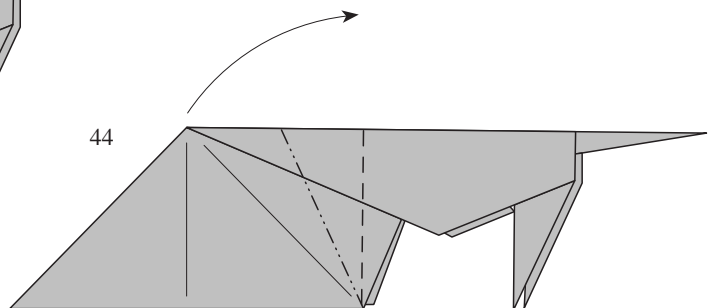
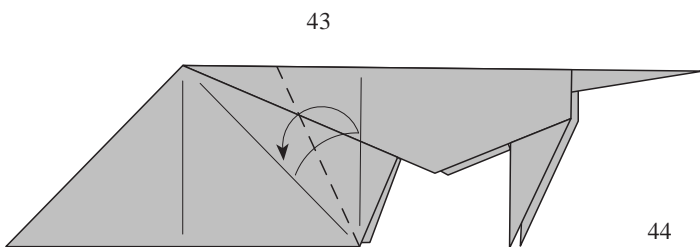
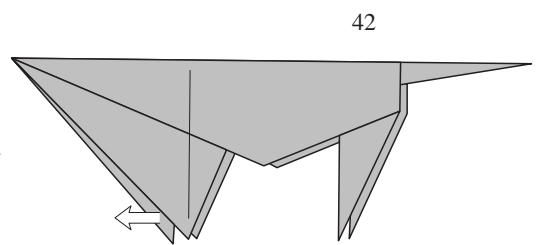
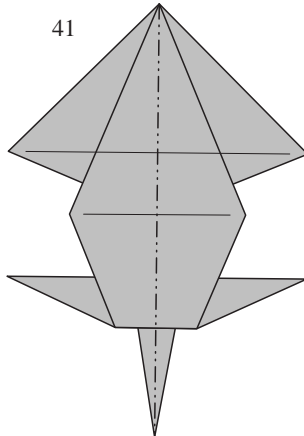
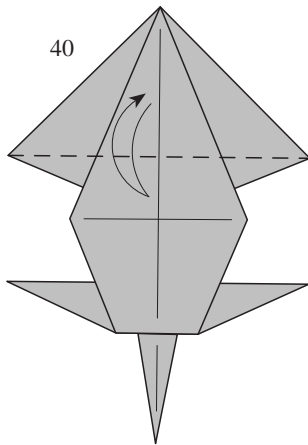
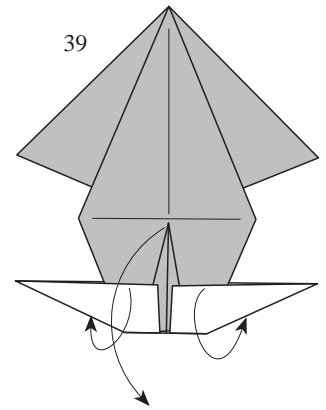
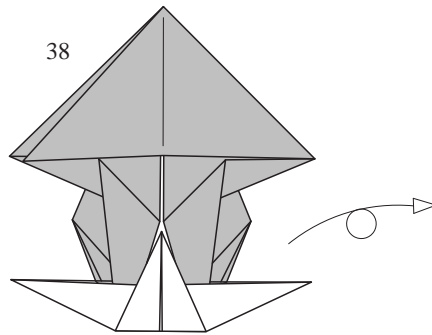
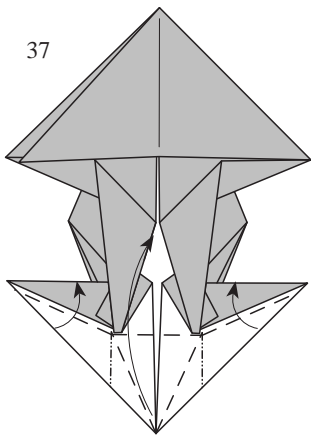
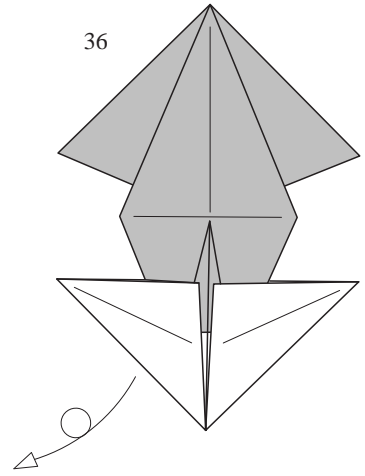
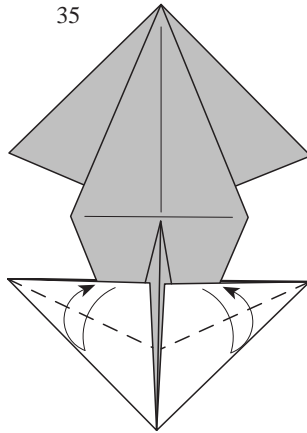
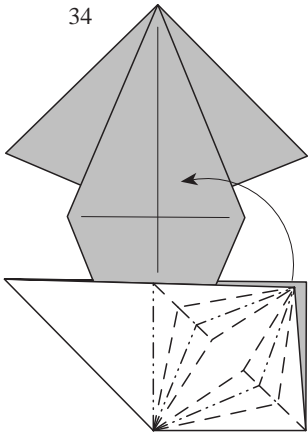

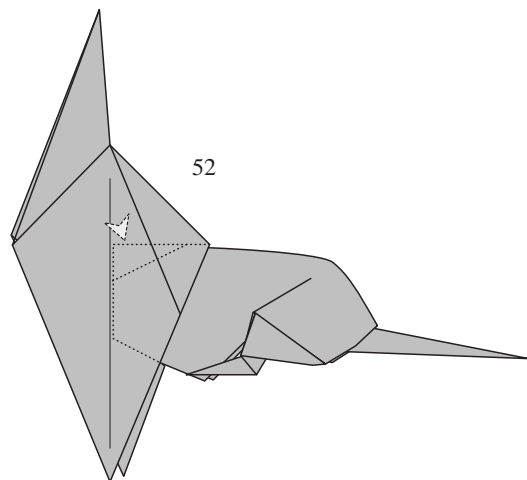
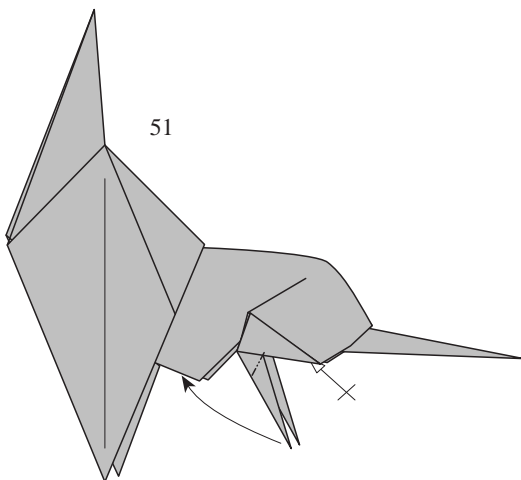
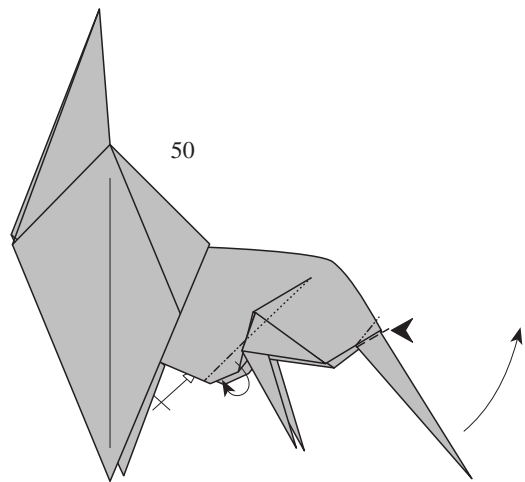
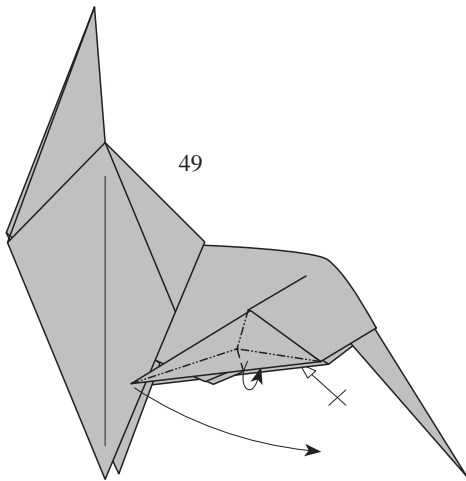
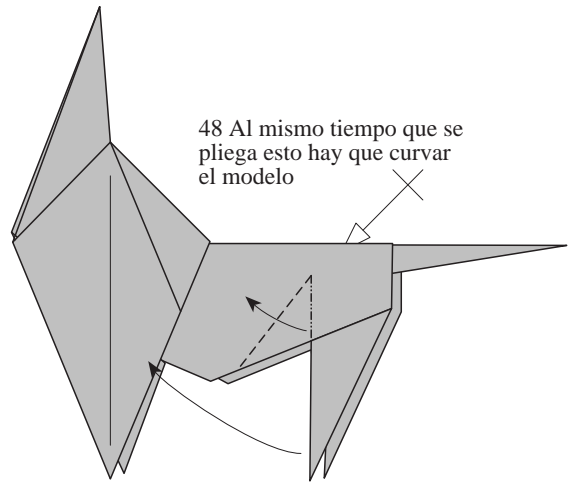
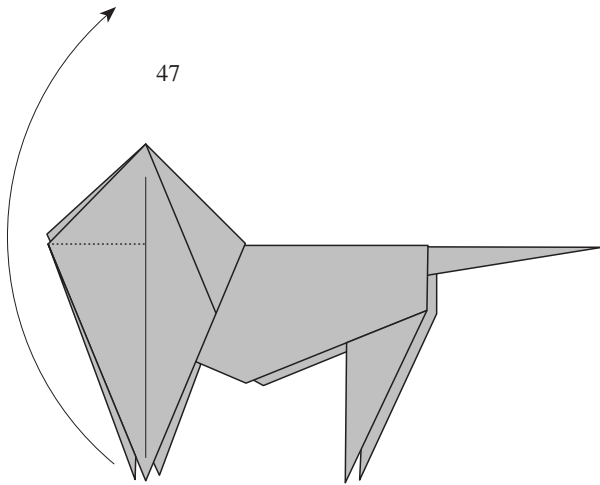
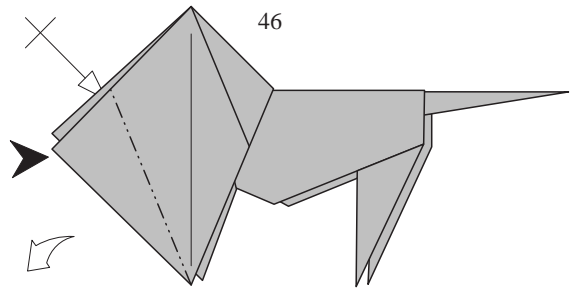
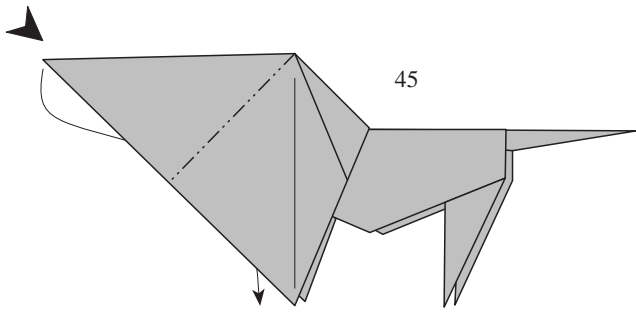

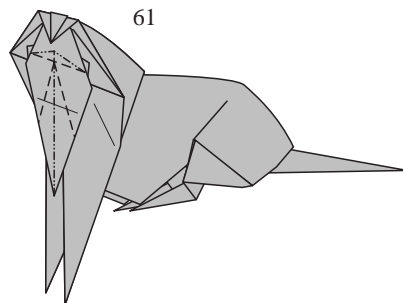
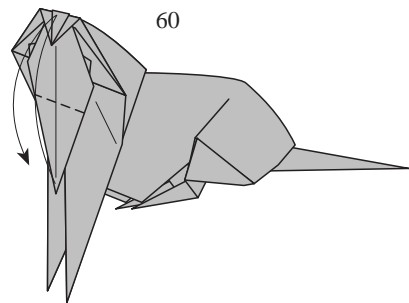
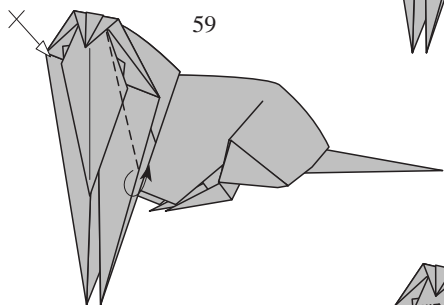
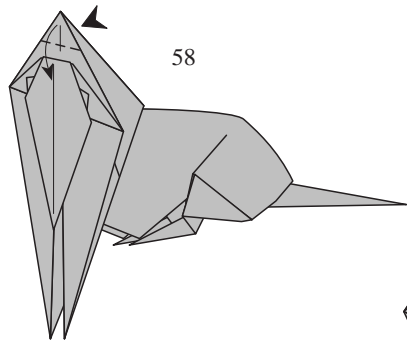
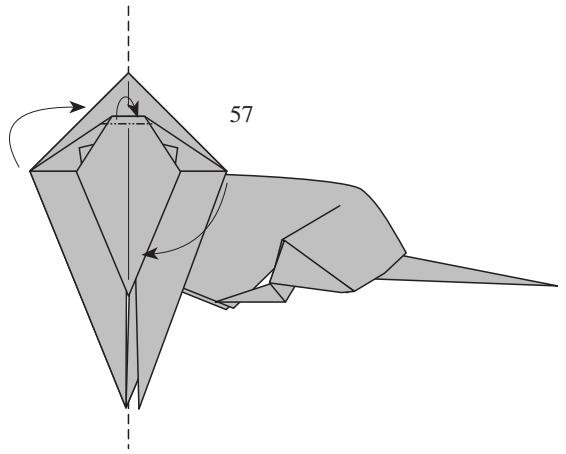
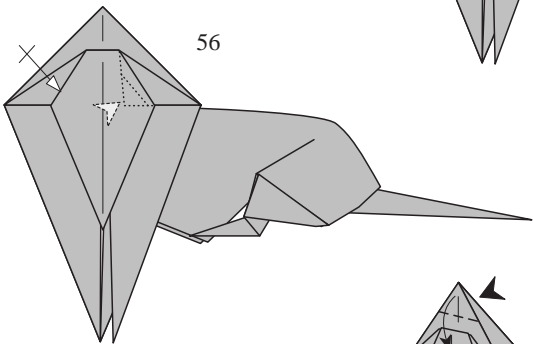
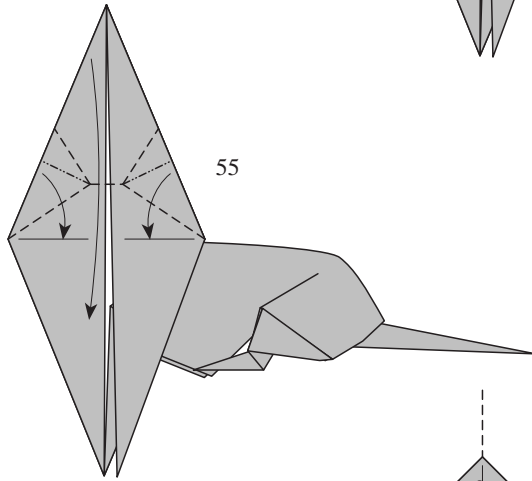
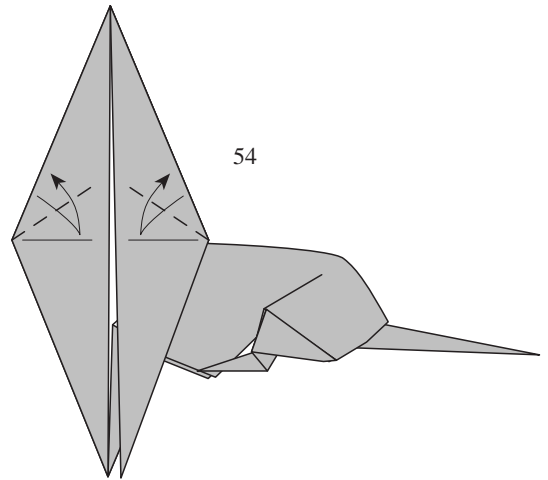
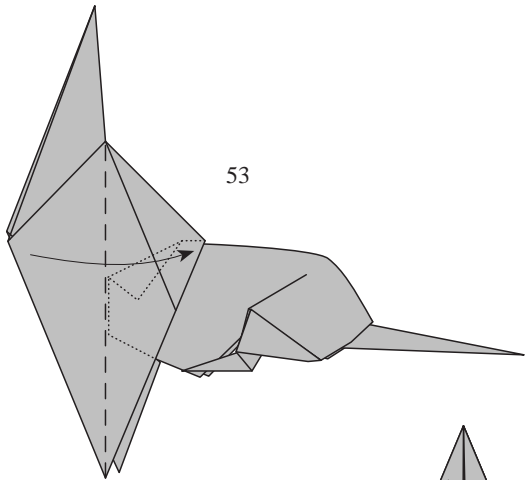

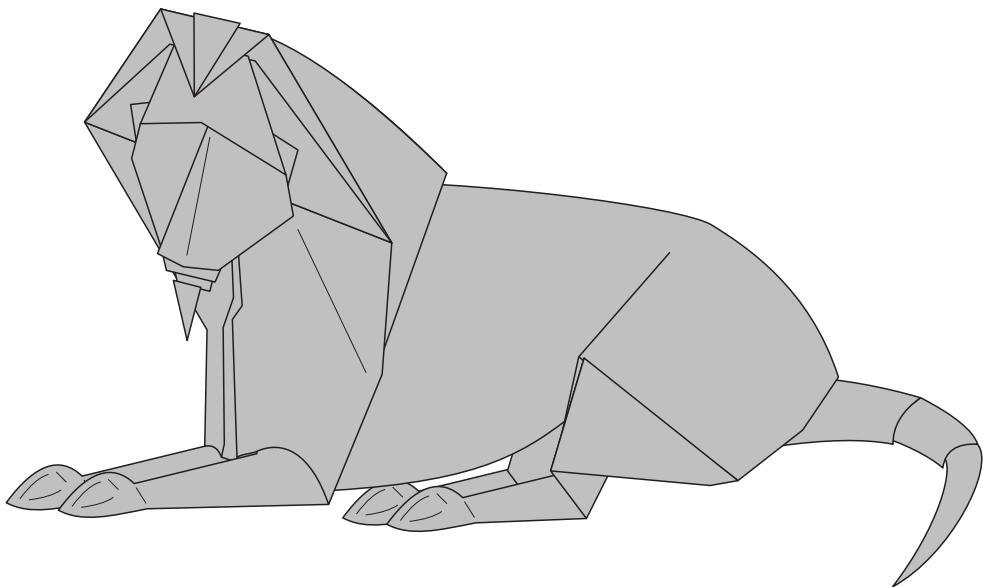
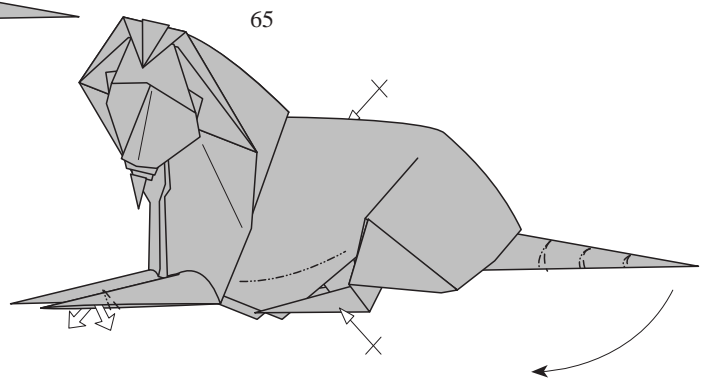
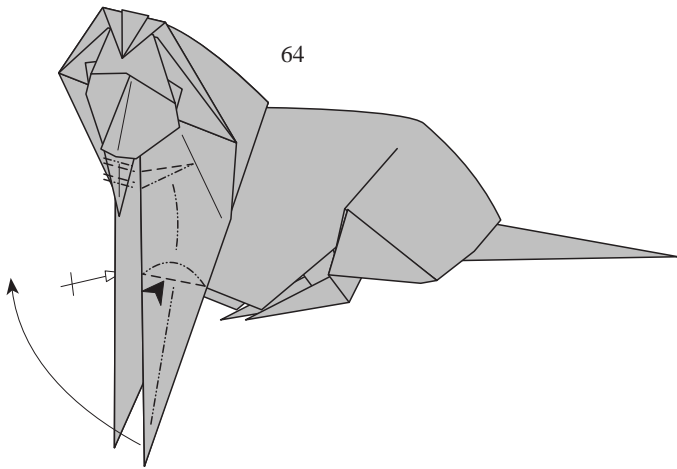
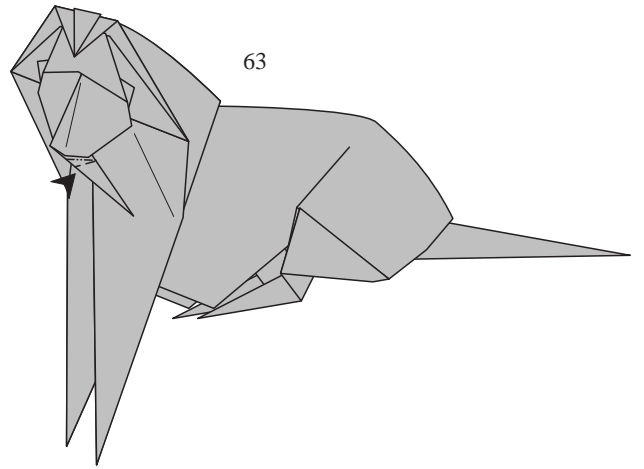
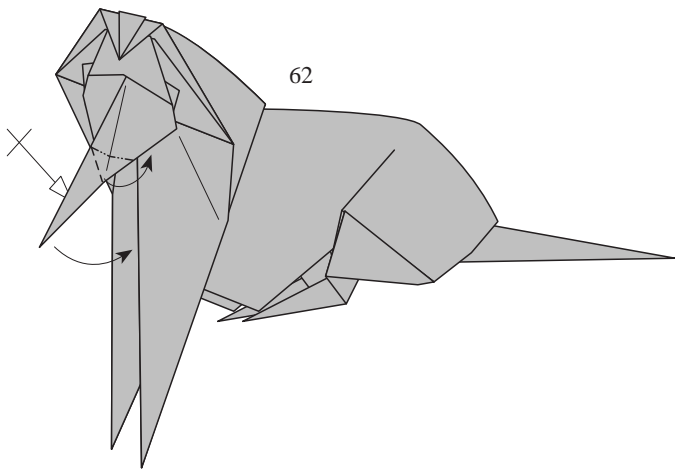



# Vouwtip moeilijk model

E.T.

Jun Meakawa  
uit: Top Origami

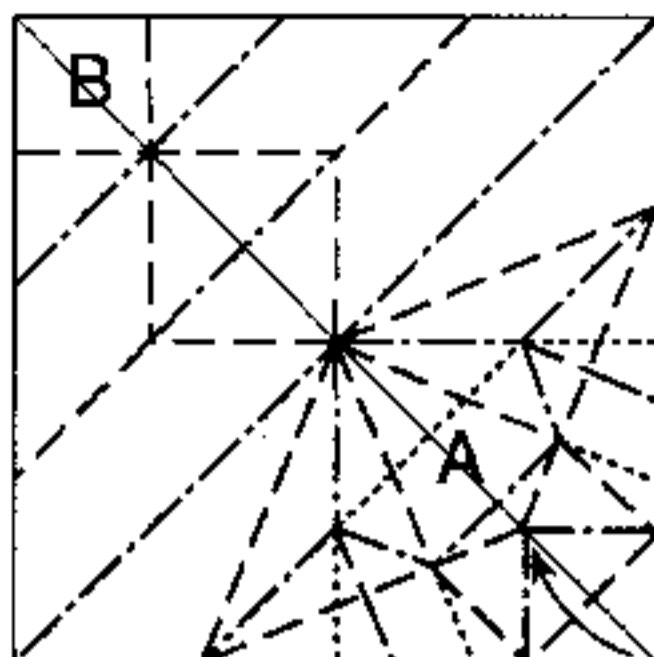

Maak de voorvouwen en vouw samen tot het volgende diagram.

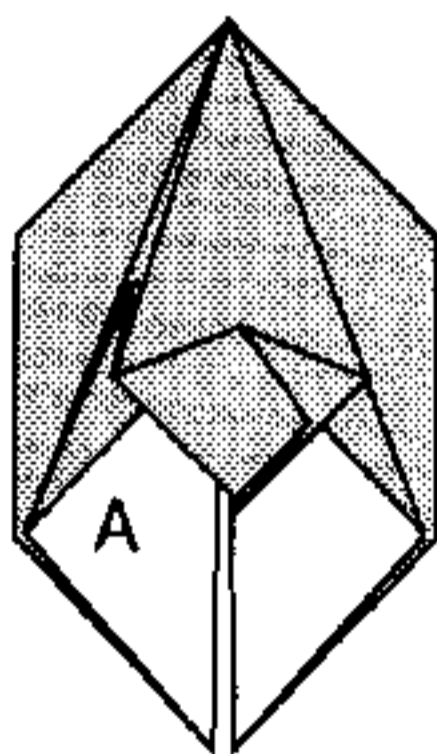

A: rechteronderkant  
van het vorige  
diagram

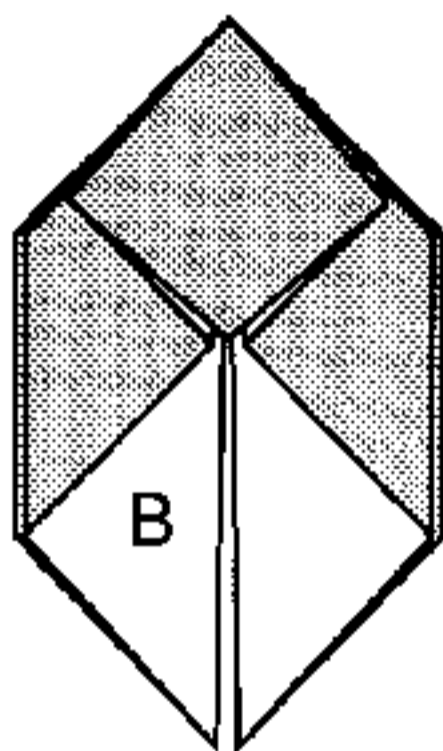

B: linkerbovenkant  
van het vorige  
diagram

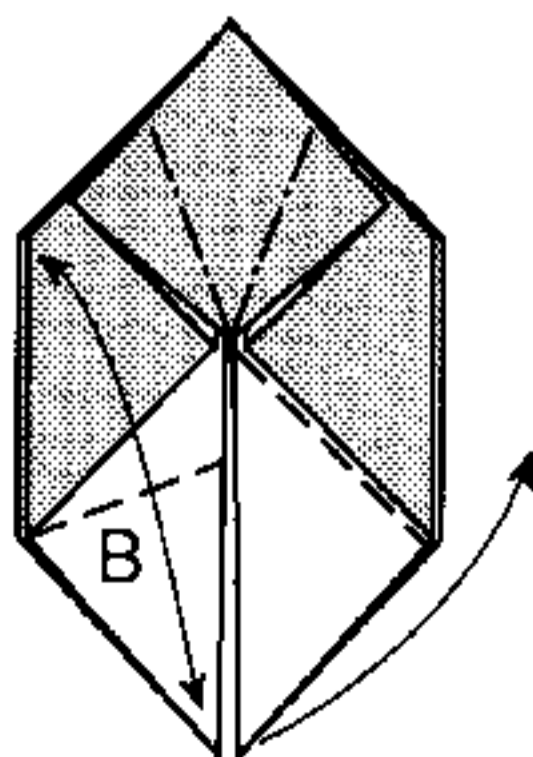
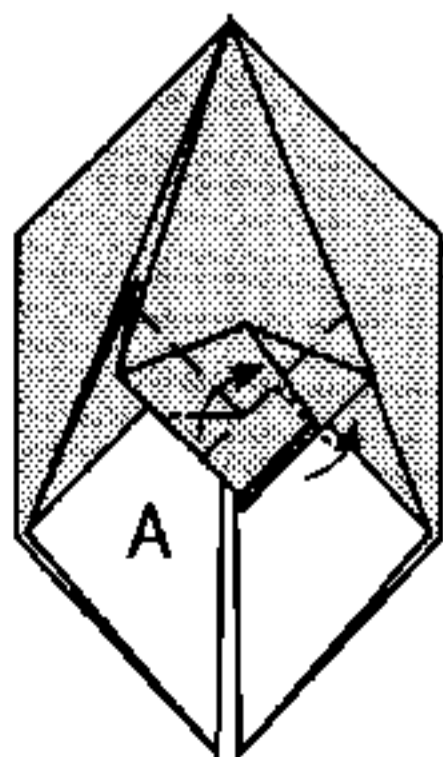

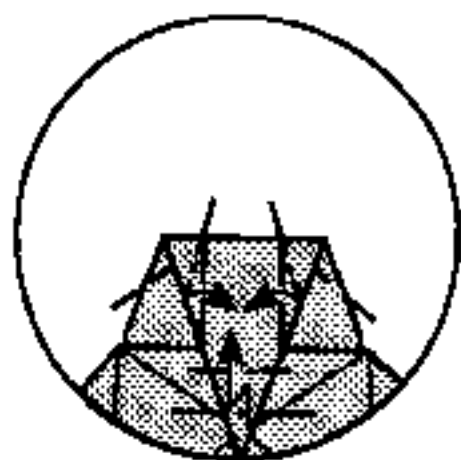
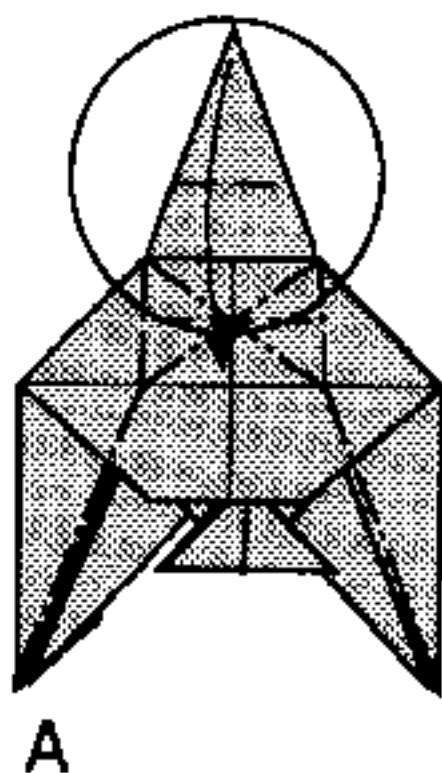
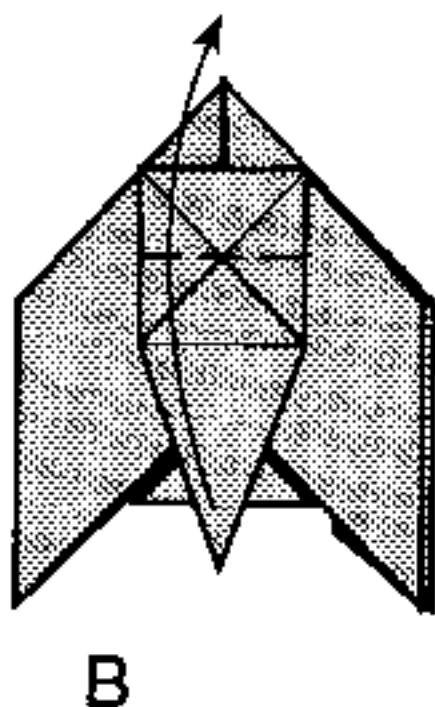
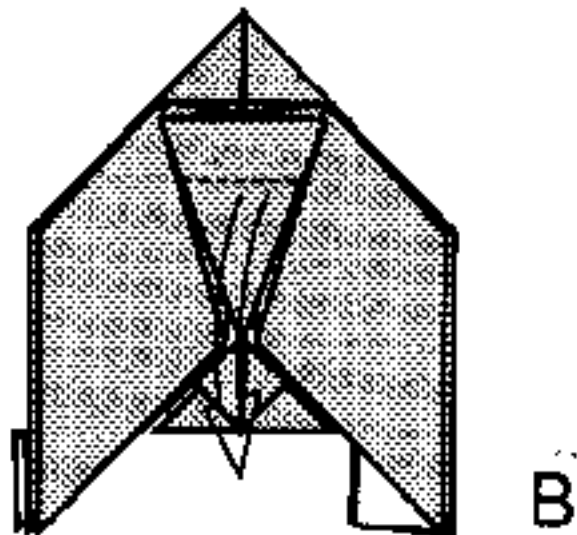
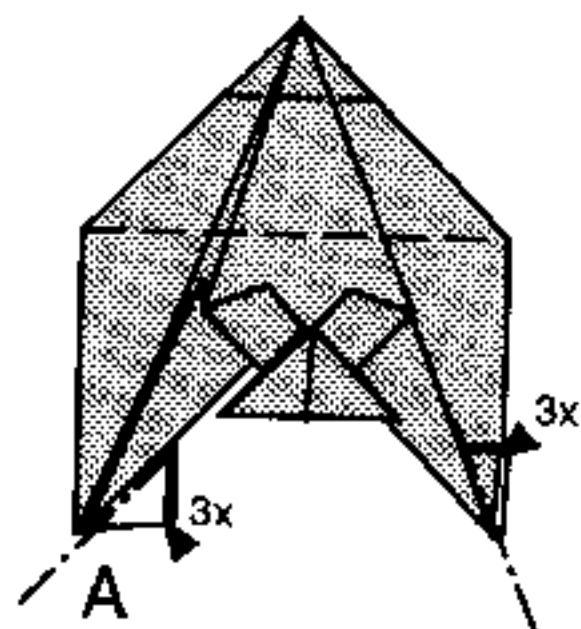
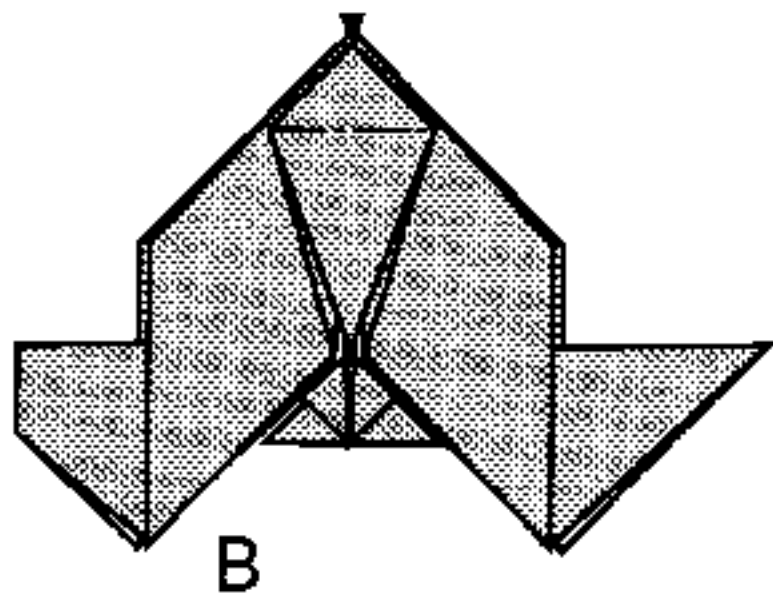
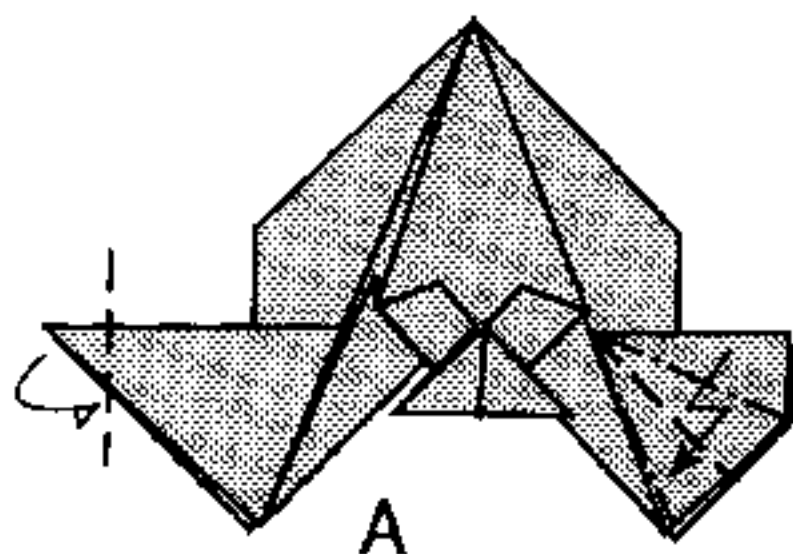

nu de handjes  
modelleren en  
ET is klaar.

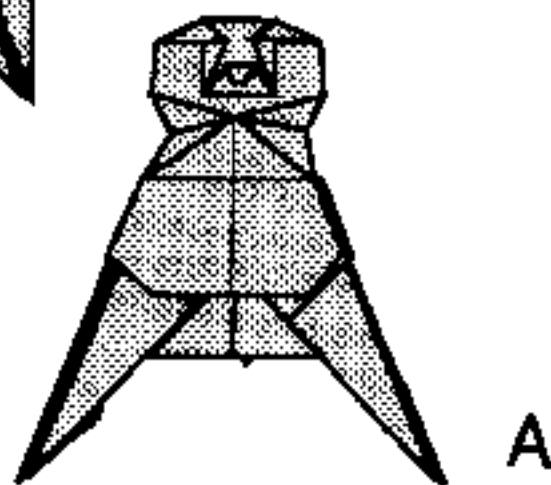

SPIDER (page1)

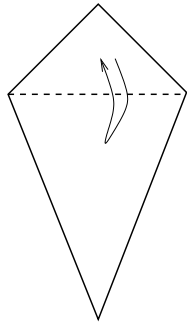

1. Start with a bird base.  
Precrease.

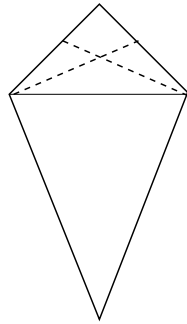

2. Precrease at angle  
bisector.

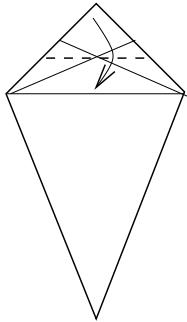

3. Valley fold at intersection  
of creases.

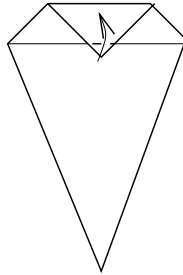

4. Valley fold up  
as indicated.

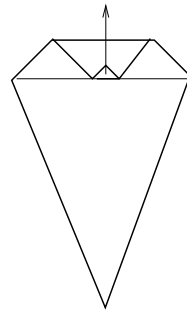

5. Open up.

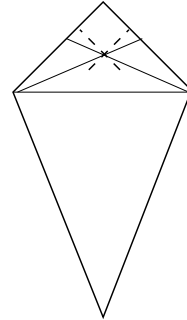

5. Precrease at right angle  
through intersection of creases

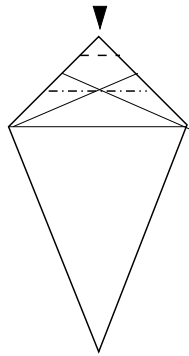

7. Double sink using  
existing creases.

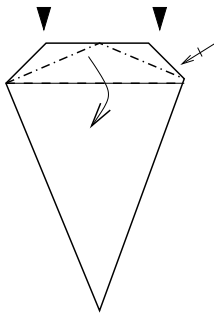

8. Spread squash using  
existing creases.  
repeat behind.

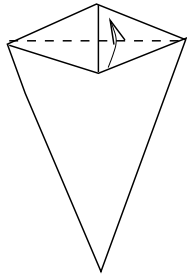

9. Close back up.  
repeat behind.

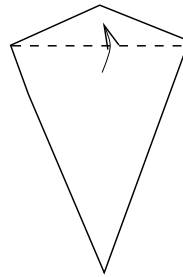

10. Valley fold one flap up.

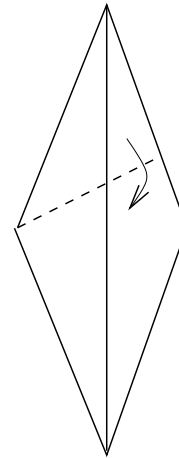

11. Valley fold at right angle.

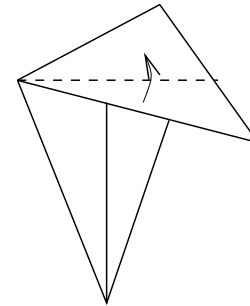

12. Valley fold up at angle  
bisector.

SPIDER (page2)

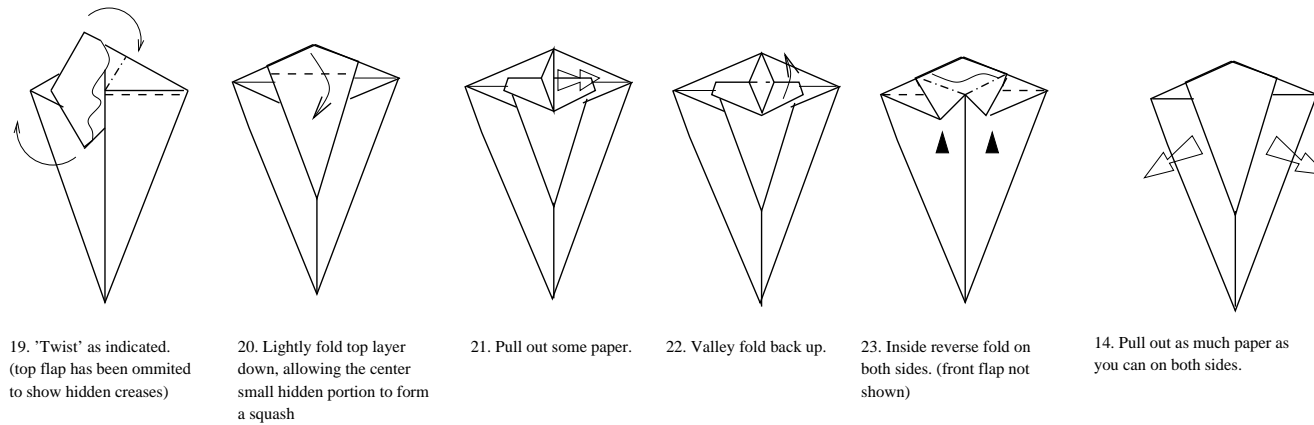
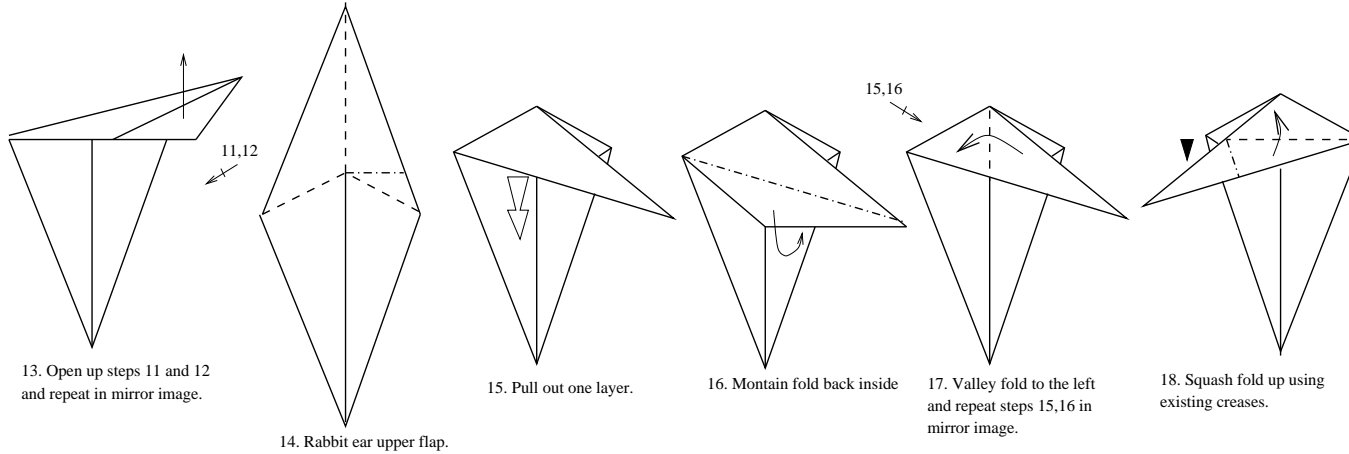

# SPIDER (page3)

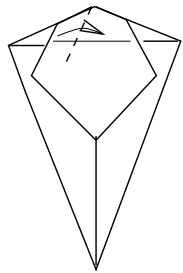

25. Slightly valley fold so that corner lies on horizontal crease, while allowing hidden flap to squash.

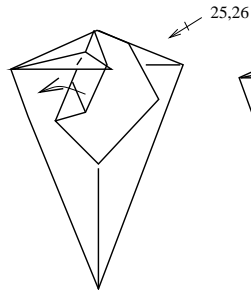

26. Valley fold back left and repeat step 25,26 in mirror image.

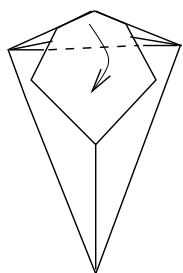

27. Slightly valley fold two flaps down.

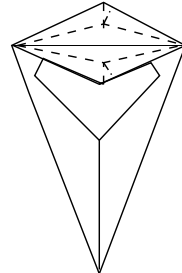

28. Rabbit ear upper and lower flap

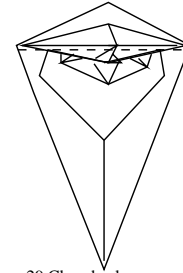

29 Close back up.

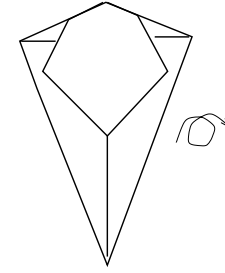

30. This will form the abdomen. Turn over.

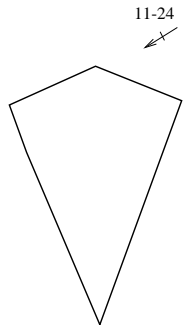

31. Repeat steps 10-23 on this side.

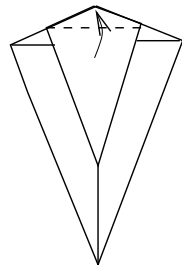

32. Valley fold front small flap up.

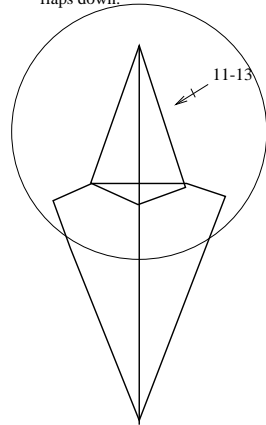

33. Repeat section 11-13 on the upper triangular section. Next drawings are a zoom of the upper section.

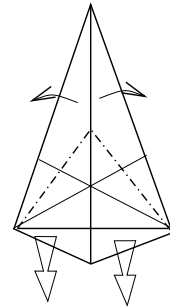

34 Pull out some paper while opening both front layers.

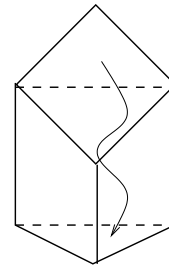

35. Valley down two times.

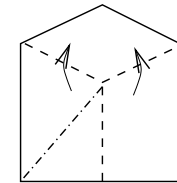

36. Rabbit ear using existing creases

SPIDER (page4)

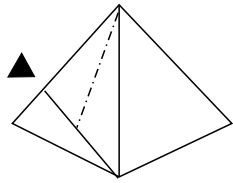

37. Inside reverse fold

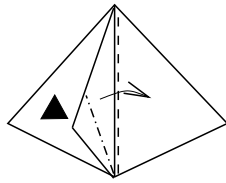

38. Squash fold.

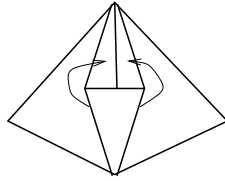

39. Bring one layer to front on both sides.

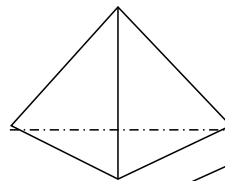

40. Close sink one flap.

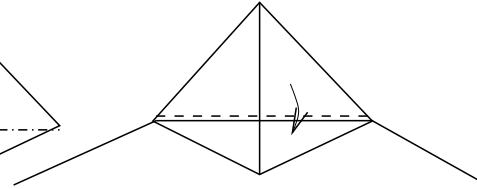

41. Valley fold down.

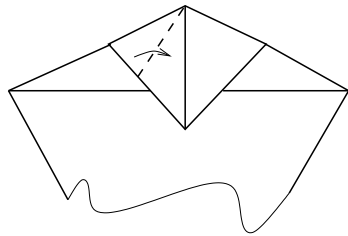

42. Valley fold so that corner lies on horizontal crease, allowing hidden flap to squash.

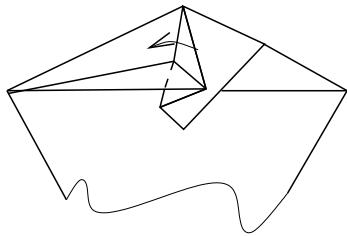

43. Valley fold to the left and repeat in mirror image.

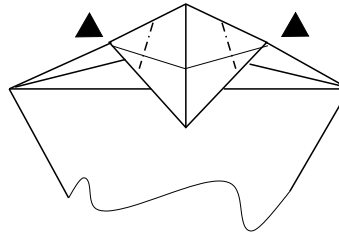

44. Inside reverse fold so that corner meets intersection of previous creases.

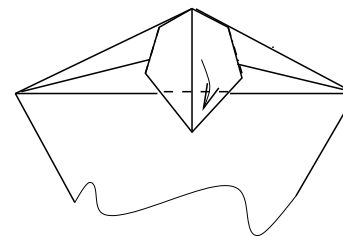

45. slightly valley fold two flaps down.

SPIDER (page5)

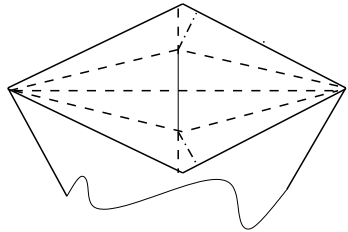

46. Rabbit ear upper and lower flap then close back to step 45. Next drawings are full view again.

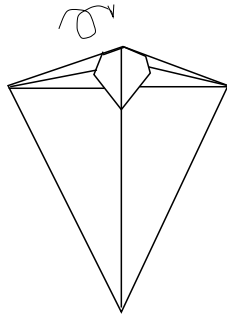

47. This will form the head.  
Turn over

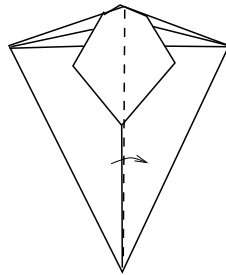

48. Fold two flaps to the right.

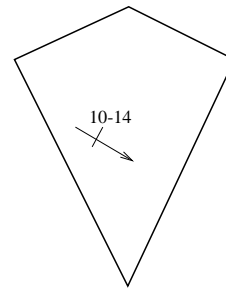

49. Repeat steps 10-14 on lower flap.

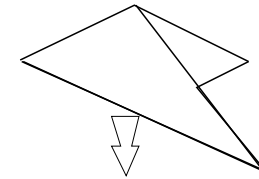

50. Only front flap is drawn  
Pull out some paper.

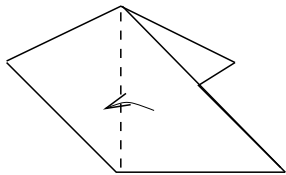

51. Valley fold to the left.

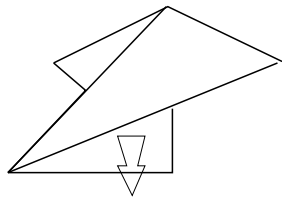

52. Pull out some paper.

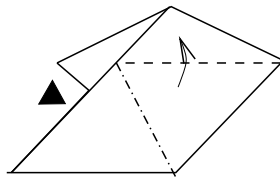

53. Squash fold up.

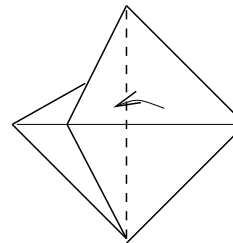

54. Valley fold left.

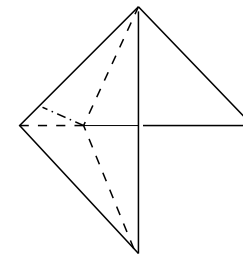

55. Rabbit ear.

SPIDER (page6)

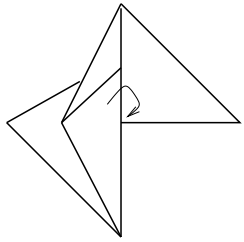

56. Reverse fold to put front flap inside the socket hidden beneath.

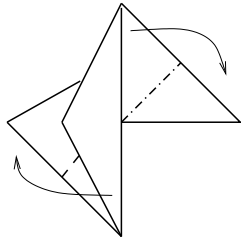

57. Twist as indicated.

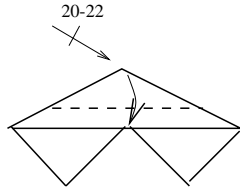

58. Repeat steps 20-22 on the upper front flap.

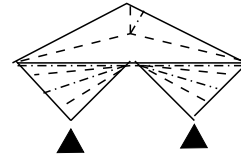

59. Inside reverse fold four times on both sides. Rabbit ear top flap.

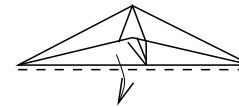

60. Valley fold two flaps down.

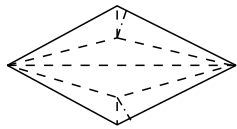

61. Rabbit ear both flaps and close back up.

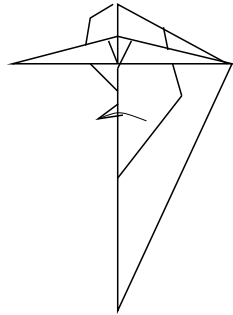

62. Full view. Valley fold left to restore the abdomen at front.

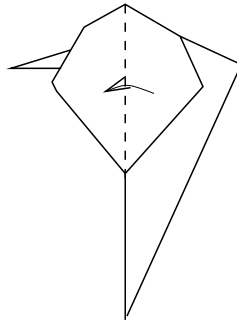

63. Valley fold two flaps to the left.

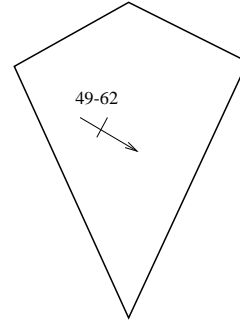

64. Repeat steps 49-62 on this side to form the four remaining legs.

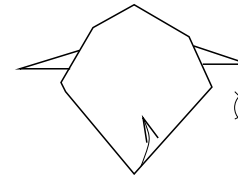

65. Raise the abdomen bottom corner at 90°. Previous creases will move and model will not lie flat any more.



# SPIDER (page7)

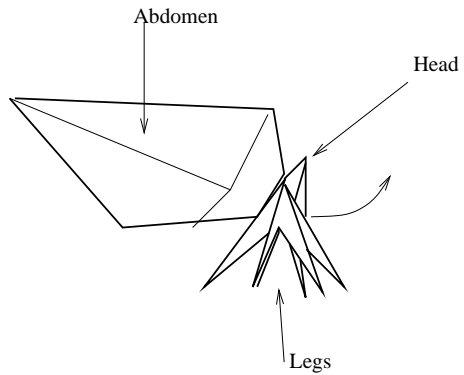

66. Schematic side view.  
Raise the head at  $90^{\circ}$  without adding any creases. Old creases will move to make it possible.

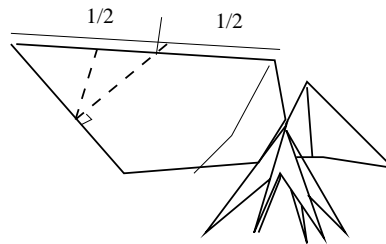

67. Precrease.

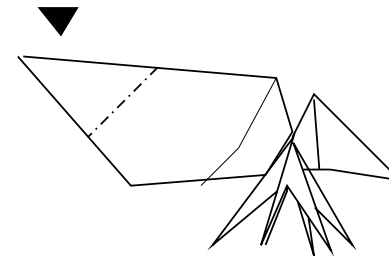

68. Inside reverse fold using precrease.

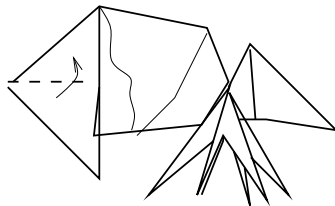

69. Valley fold up the flap hidden inside the abdomen, to lock it 3D.

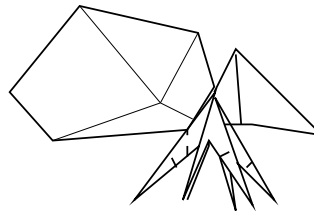

70 Shape the legs at your convenience.

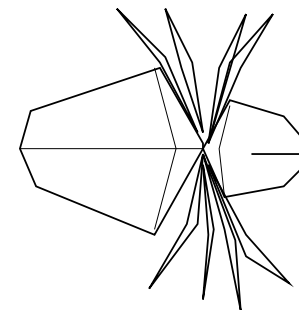

71. Schematic view of the finished spider.

# Spiral Snake

by Kalei Anne Lundberg  
copyright 2001

This model is folded from a piece of paper with a ratio of 1 to 5. A model made from a 2x10 inch paper will be approximately 4 inches long. The diagrams are offered for personal use any other use please contact me for permission at [snake@kalei.com](mailto:snake@kalei.com).

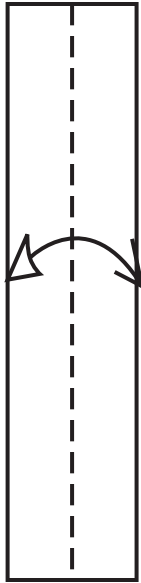

1. Starting with a 1:5 paper valley fold and unfold lengthwise.

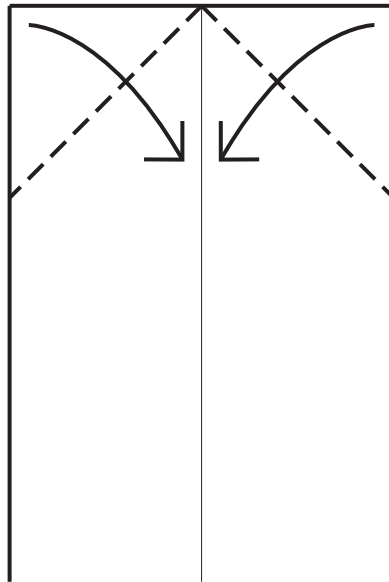

2. Tail Section: Valley fold corners to the center line.

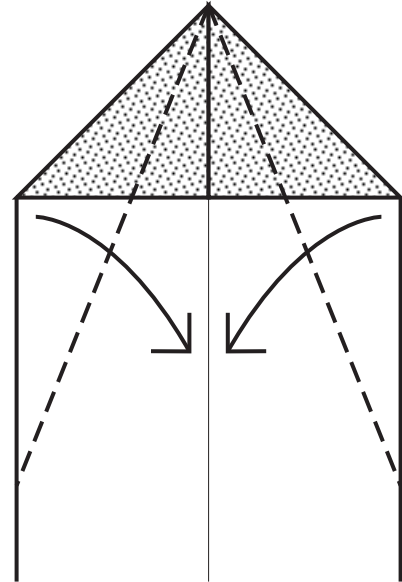

3. Valley fold to the center line.

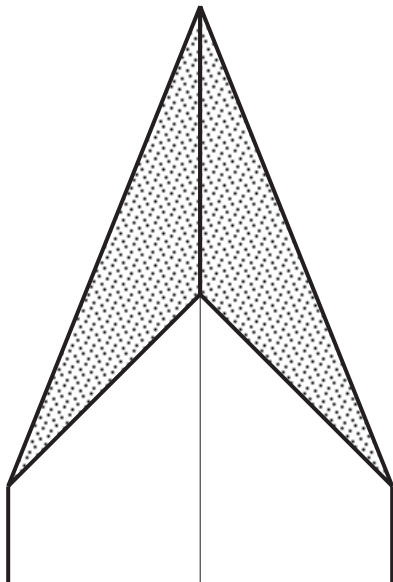

4. Completed tail section. Work the head section on the other end of the paper.

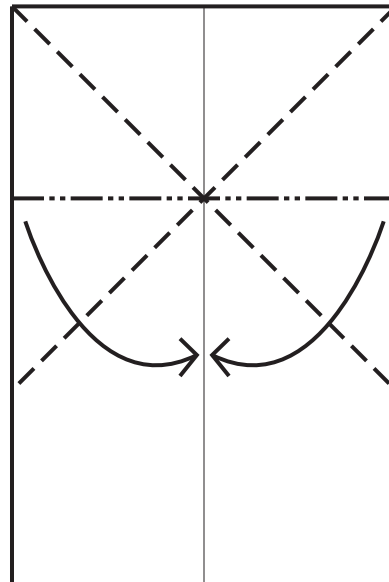

5. Precrease and collapse the model into a waterbomb form.

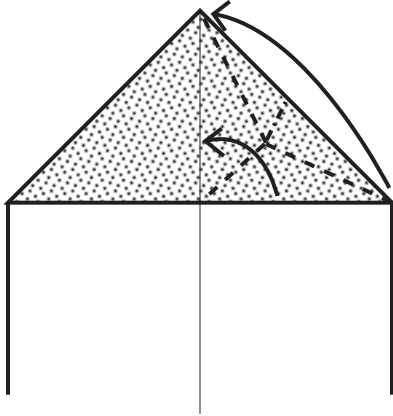

6. Rabbit ear the free point of the waterbomb upward. Repeat for the other free point.

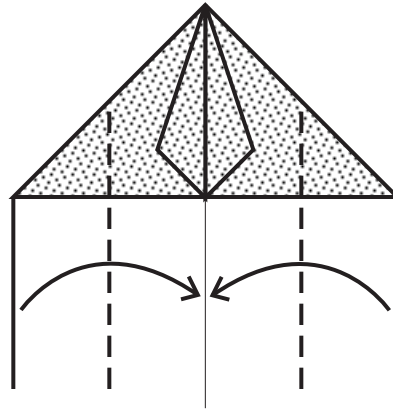

7. Valley fold to center line along the entire length of the model.

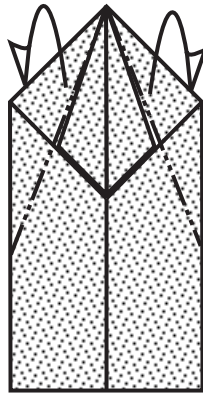

8. Mountain fold the two edges indicated.

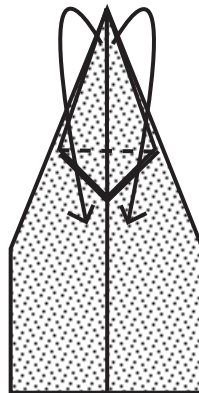

9. Valley fold the two free tips downward.

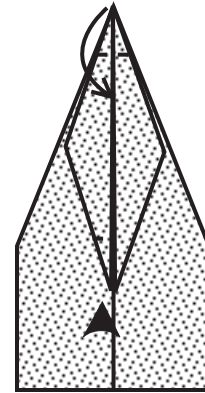

10. Valley fold the top tip downward by about 1/3. Inside reverse fold the left bottom tip by the same amount.

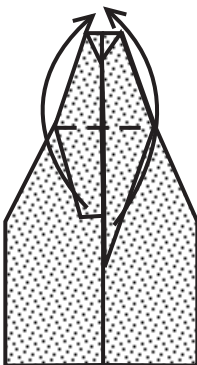

11. Fold the free tips back upward.

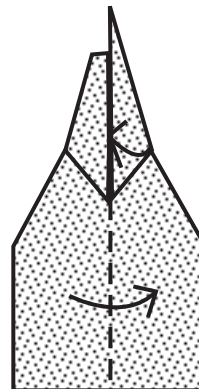

12 Valley fold the model in half while slipping the tongue portion inside the lower jaw portion to lock..

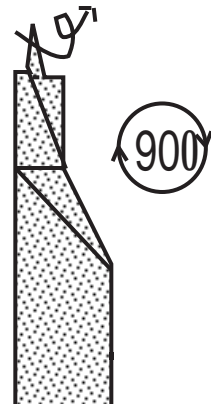

13. Give the tongue a twist to narrow.



14. Make two outside reverse folds to crimp the head section.

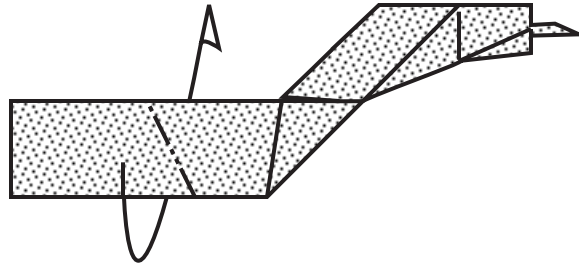

15. Mountain fold the body behind and upward. Note that the length of this angled fold should be about equal to the height of the body.

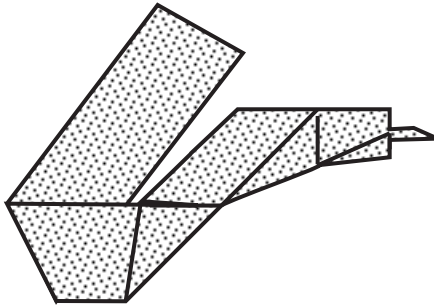

16. Turn the model a quarter turn.

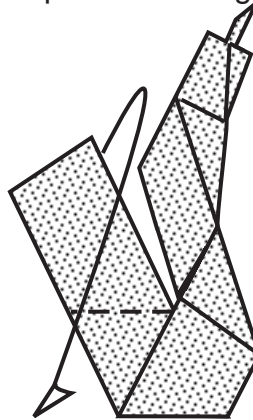

17. Valley fold. Continue to fold the body around on itself till you have the next figure.

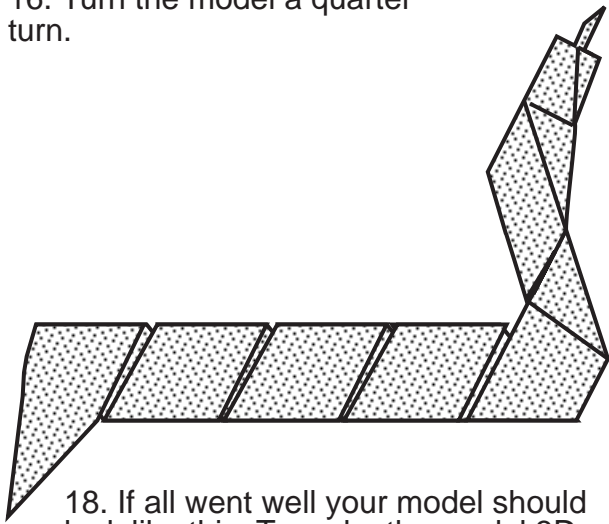

18. If all went well your model should look like this. To make the model 3D reposition the folds to look like the next figure and flatten.

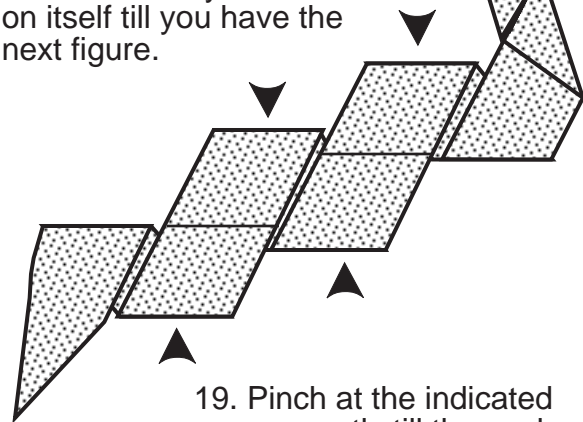

19. Pinch at the indicated arrows gently till the snake finds its equilibrium. Raise the tail at head sections at a right angle to the body and open the eye folds to make curved 3D sockets.

20. Give the tip of the tail a tiny twist...Finished! Have a happy Year of the Snake.

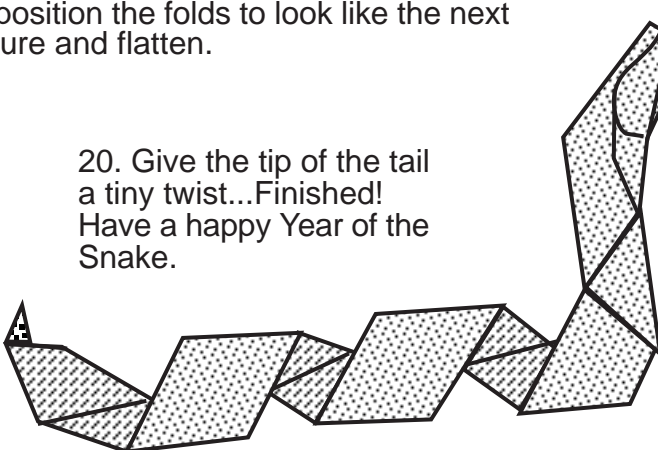

# Squirrel

By Perry Bailey ©1998

①

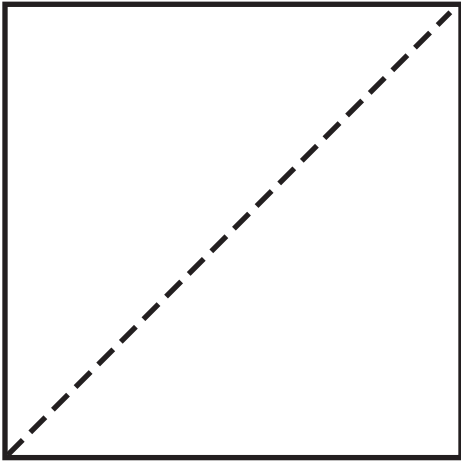

②

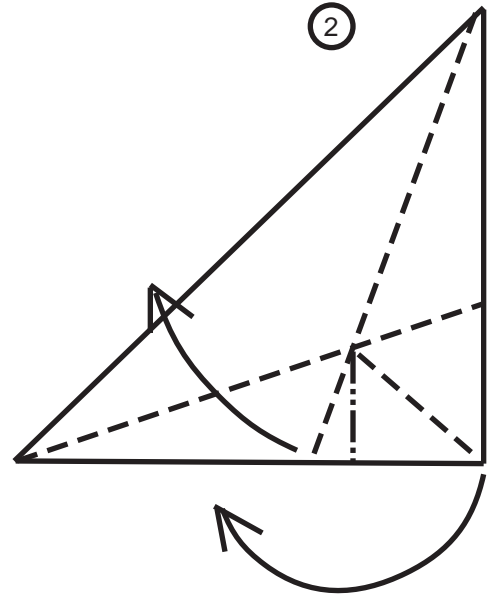

Make a fish base as shown in diagram 3.

③

Valley fold over the flap on each side in line with the crease from the previous folds.

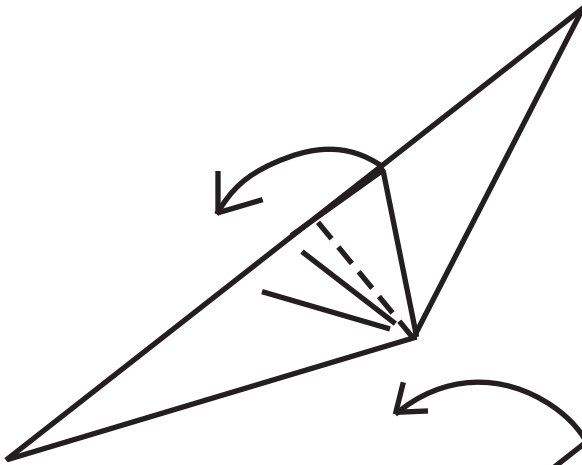

④

Open out the model, without bending the two flaps.

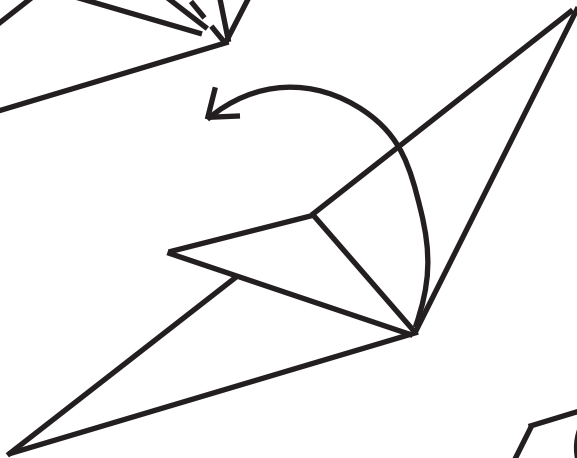

⑤

Valley fold the edges to the center, then fold the model back together.

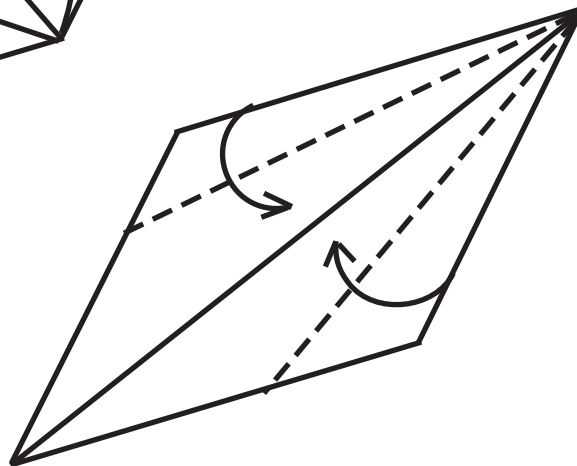

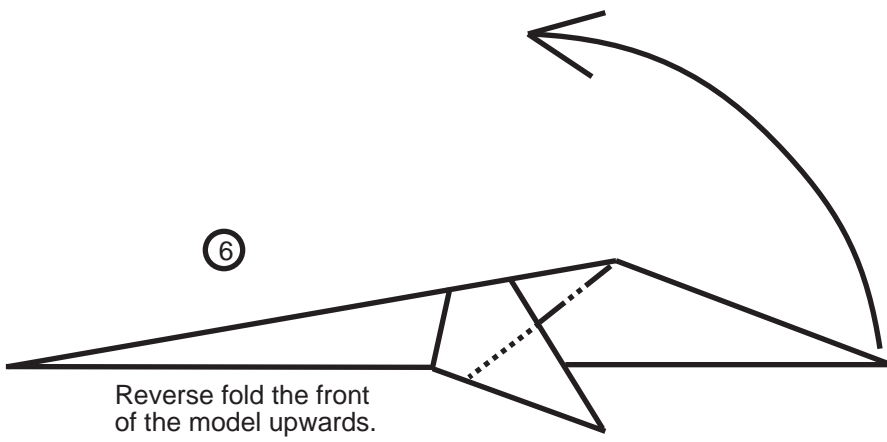

⑥

Reverse fold the front of the model upwards.

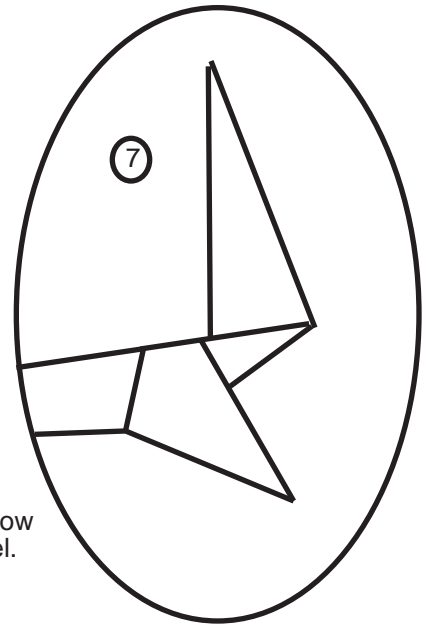

⑦

From figure 7 until we finish the front of the model we are going to show only the front of the model.

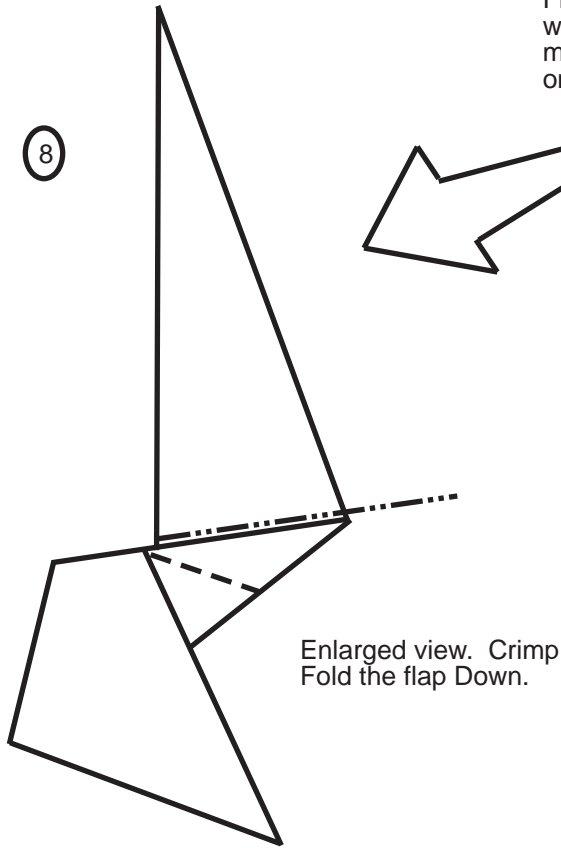

⑧

Enlarged view. Crimp  
Fold the flap Down.

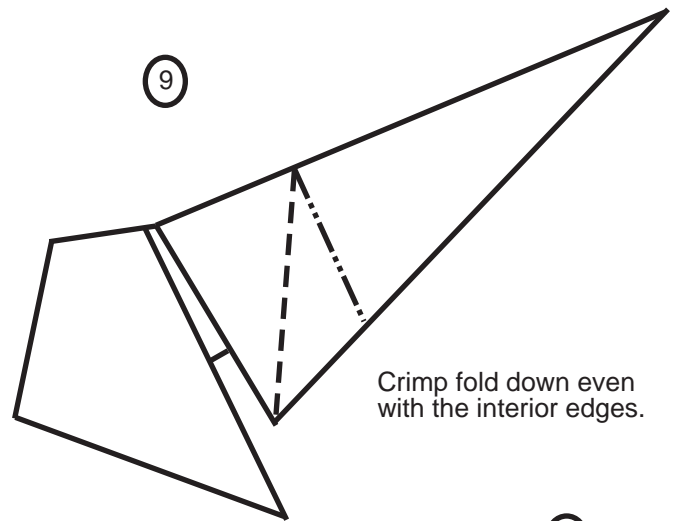

⑨

Crimp fold down even with the interior edges.

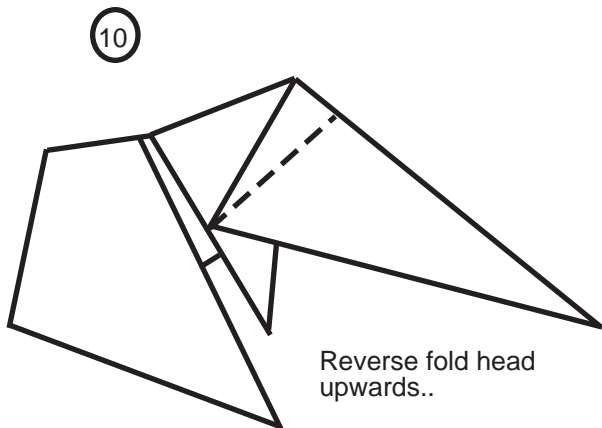

⑩

Reverse fold head upwards..

Open up the inside of the head, with the thumb or finger of your choice, push the inner layer back, while bringing the head down. Sort of a crimp, while unsinking type of fold.

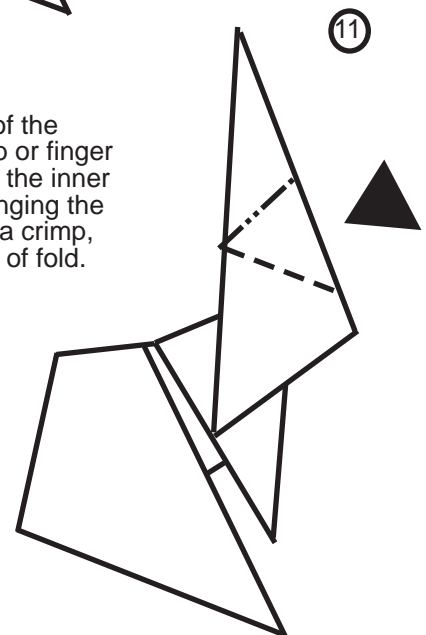

⑪

Head should resemble this, hopefully!

12

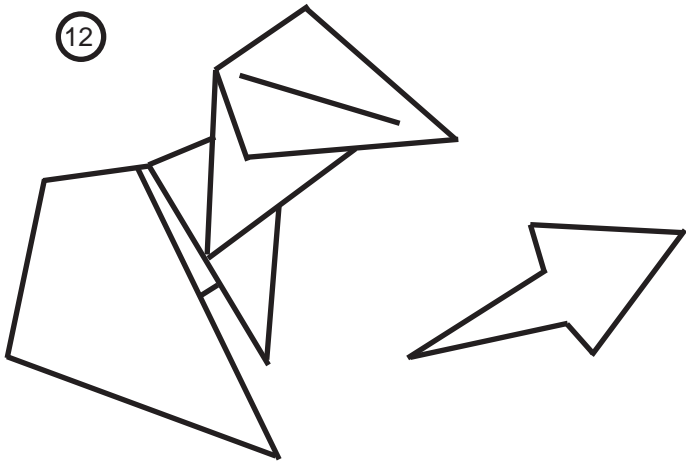

13

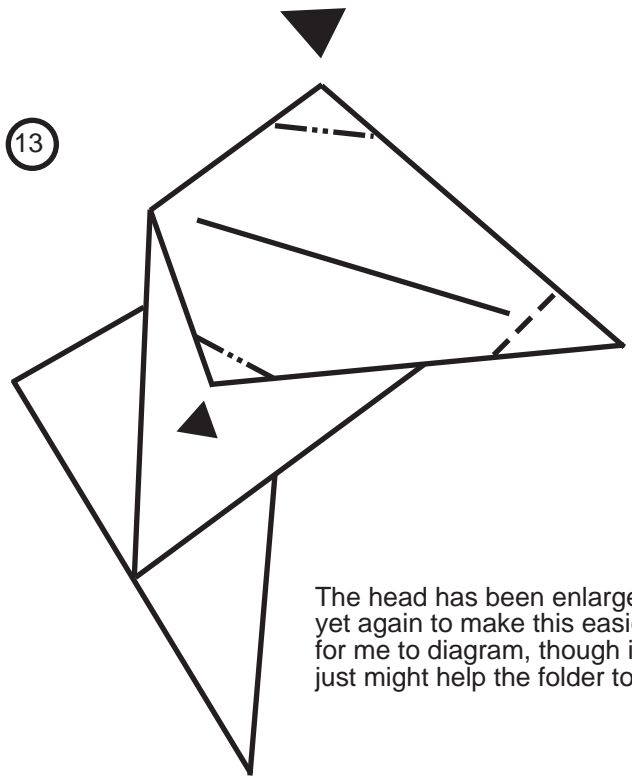

The head has been enlarged yet again to make this easier for me to diagram, though it just might help the folder too.

14

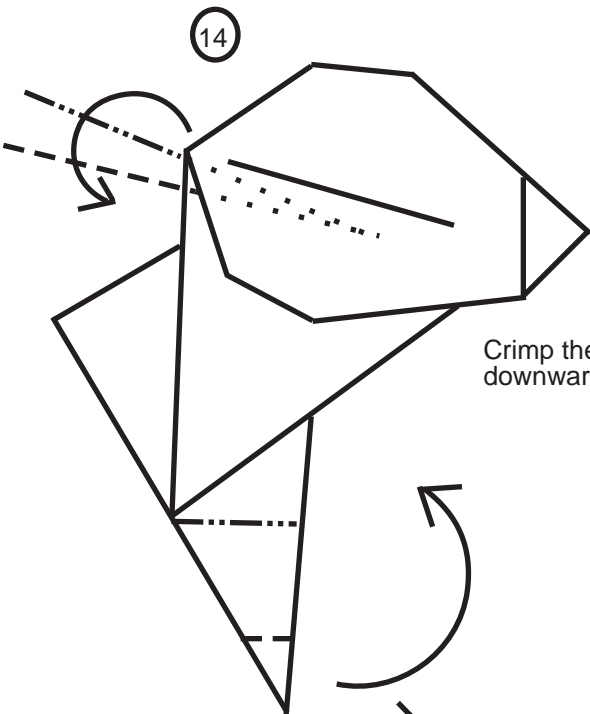

Crimp the back of the head downwards to make the ears.

15

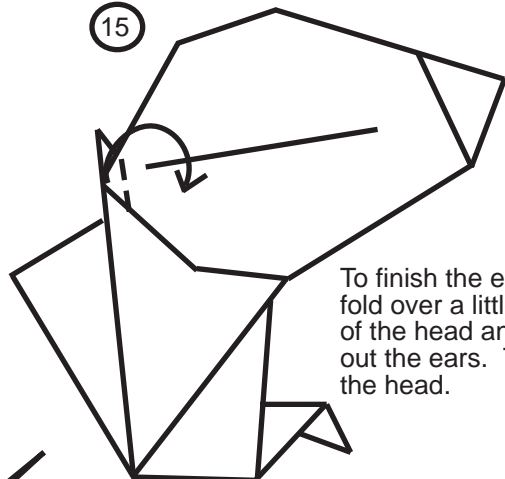

To finish the ears valley fold over a little of the back of the head and then round out the ears. This finishes the head.

16

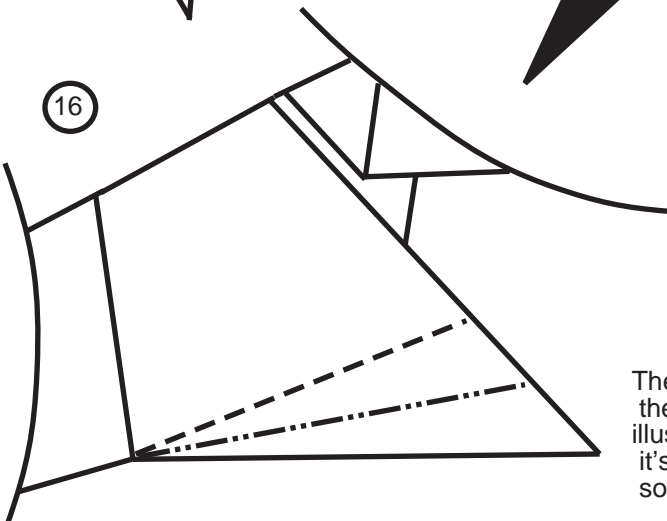

17

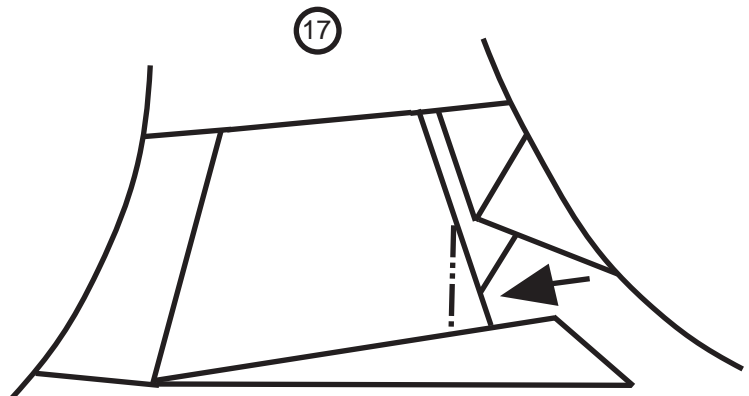

The big flaps we made earlier are the back legs. Valley fold up and then mountain fold back down to make feet. Then to create the illusion of haunches mountain fold over part of the hind leg behind it's self. The next two diagrams 18 and 19 show the back of the leg so you can see what really takes place.

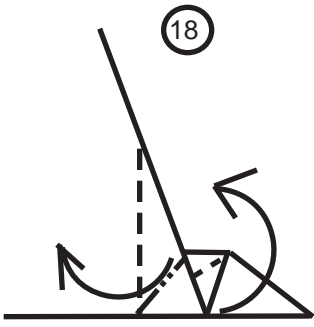

18  
This is the lock used inside the hind leg and feet.

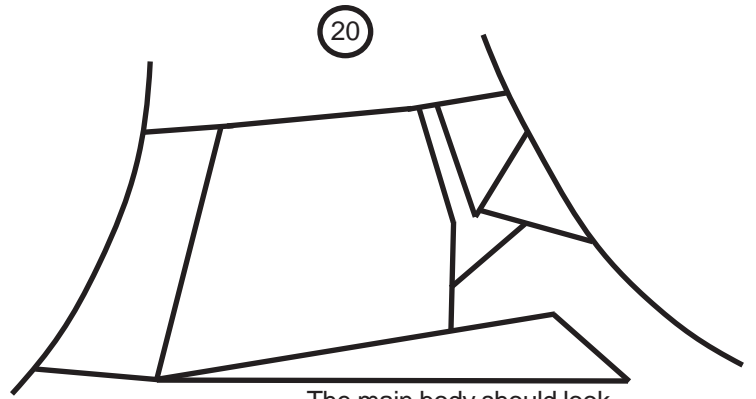
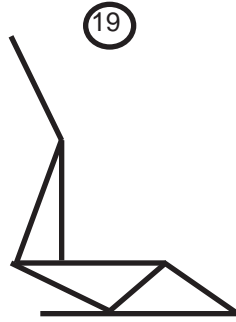

20  
The main body should look like this.

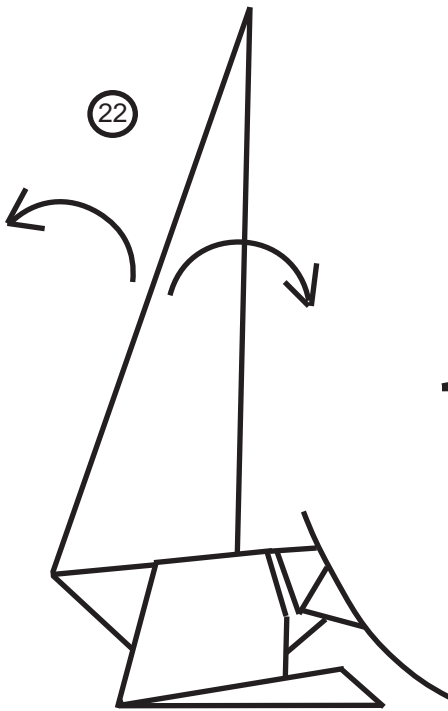

22  
Open up the tail at the back of the model.

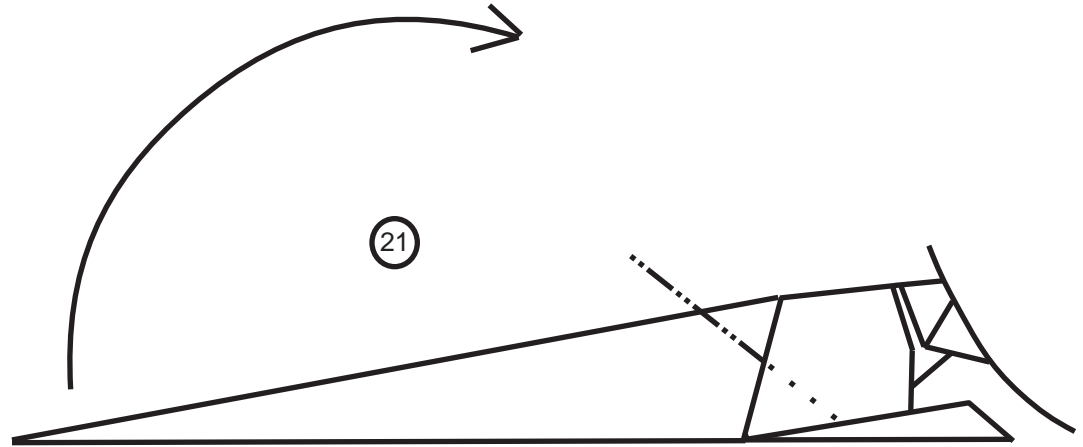

21  
Reverse fold the tail upwards.

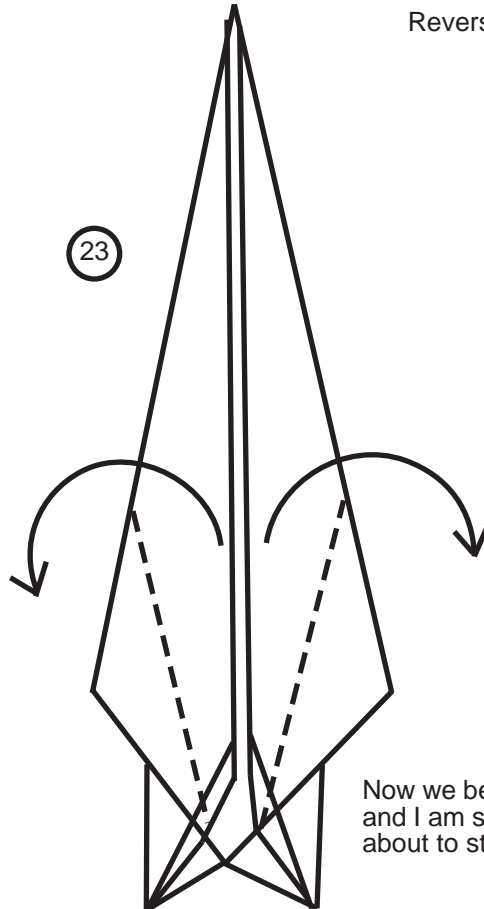

23  
Now we begin to work in 3 dimensions and I am sorry, but the diagramming is about to start suffering.



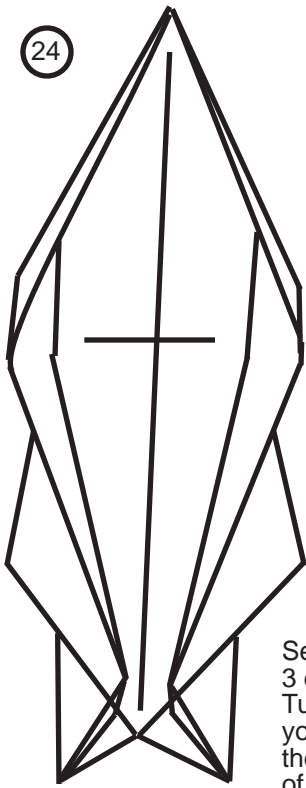

24

See, I told you I don't do 3 dimensions well!! Turn the model around so you are looking at it from the front, it would look sort of like 25 if you made the body and head disappear

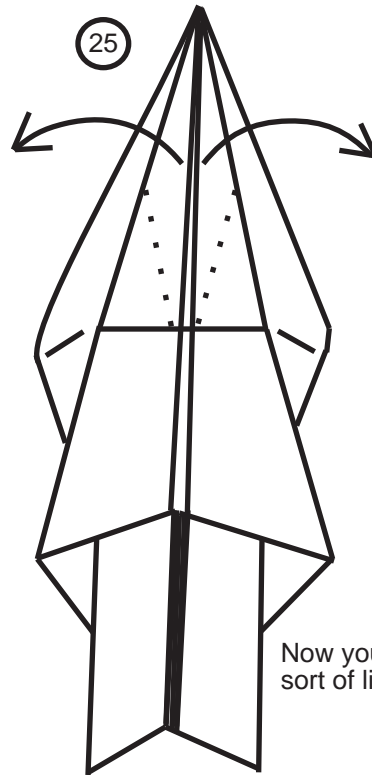

25

Now you open out the front sort of like you did the back.

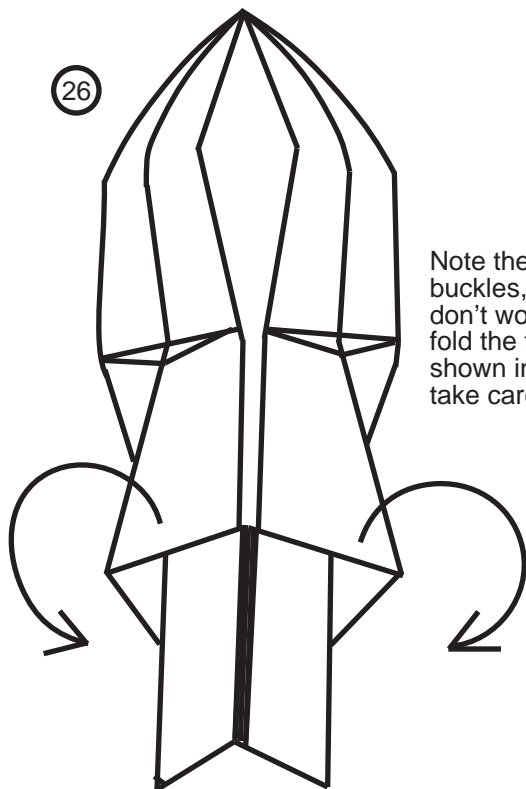

26

Note the paper sort of buckles, at one point don't worry when you fold the tail down as shown in 27 it will take care of it.

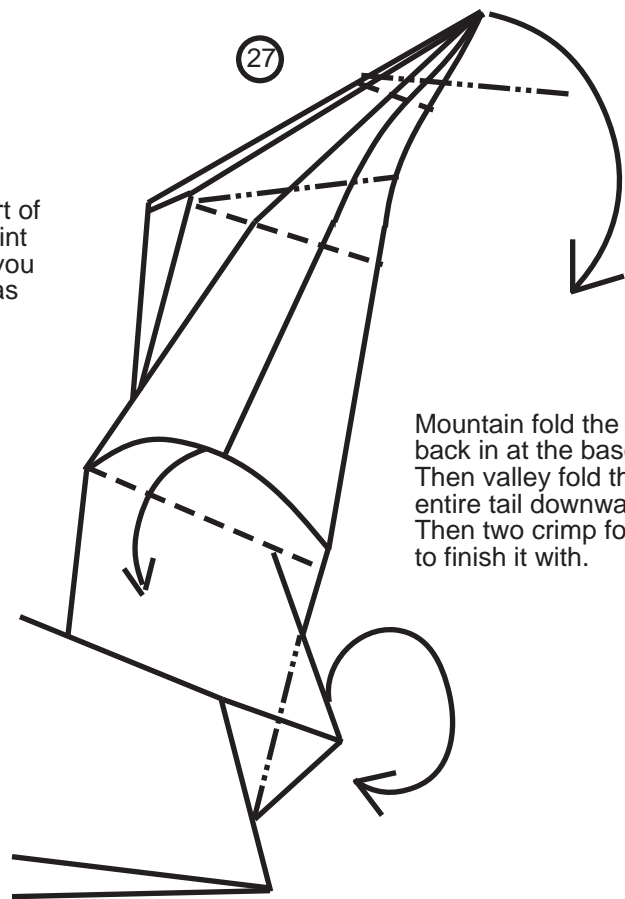

27

Mountain fold the back in at the base. Then valley fold the entire tail downwards. Then two crimp folds to finish it with.

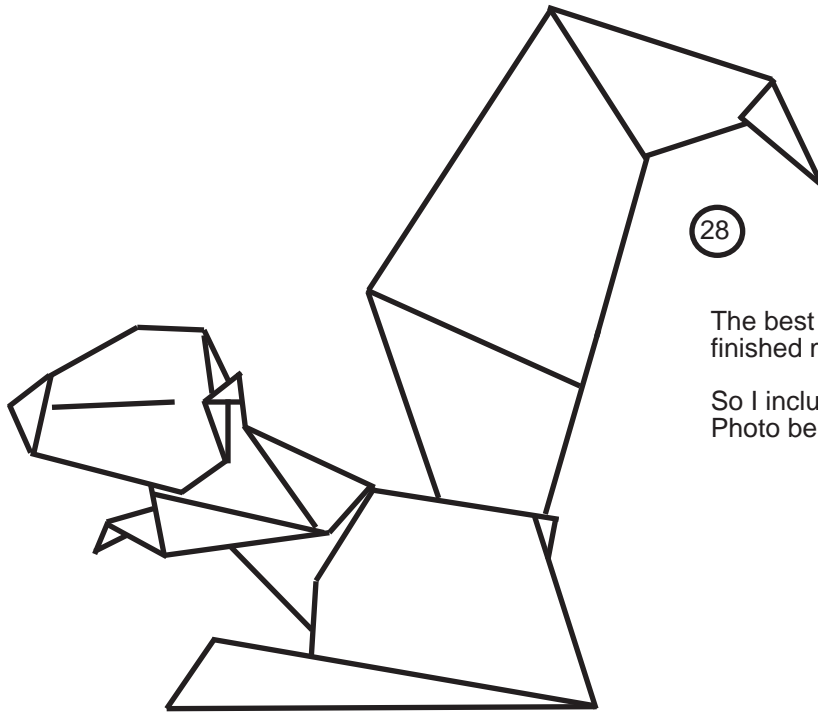

28

The best I could draw the finished model.

So I included the scanner Photo below.

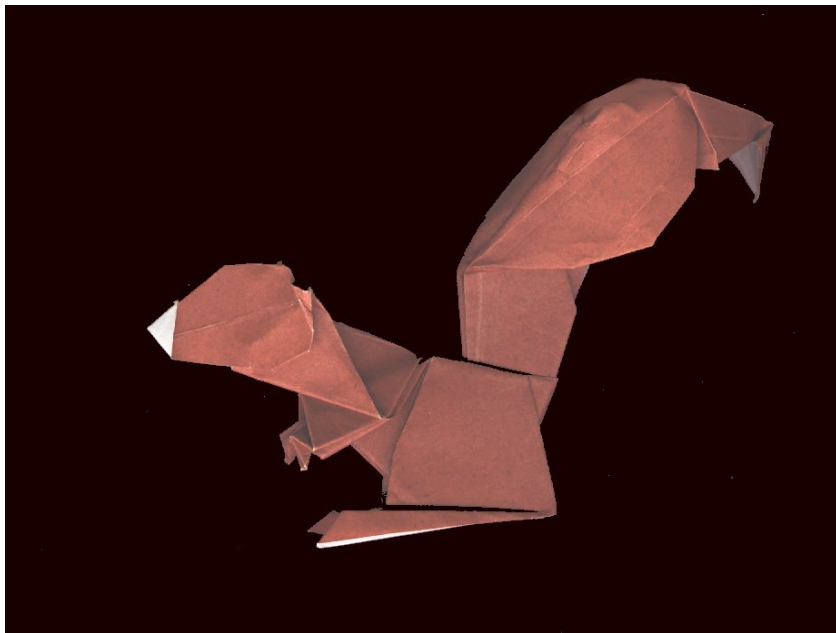

# Squirrel (1/2)

Designed by: František Grebeníček (2000)

[www.origami.cz](http://www.origami.cz)

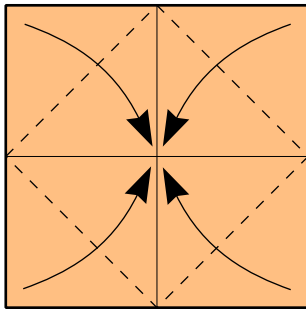

1) Blintz-fold.

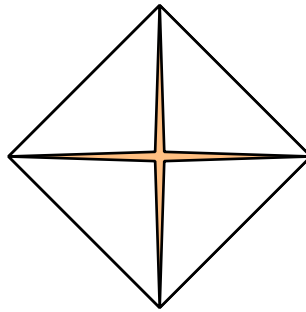

2) Turn over.

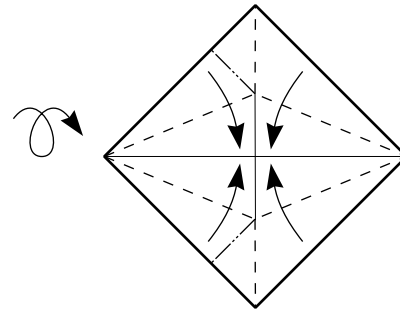

3) Rabbit ear on the upper and lower corner (basic fish fold).

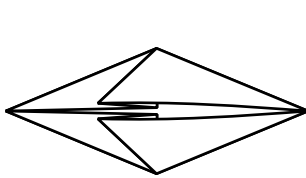

4) Turn over.

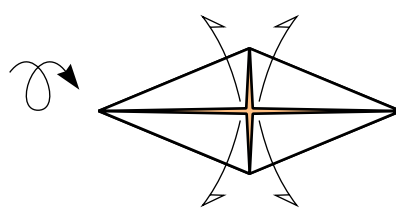

5) Open flaps.

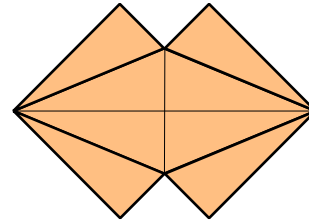

6) Turn over.

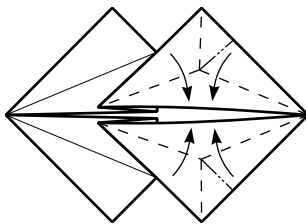

7) Turtle base. Make another rabbit ears.

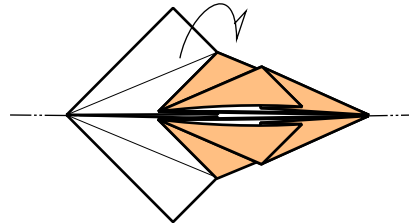

8) Fold in half.

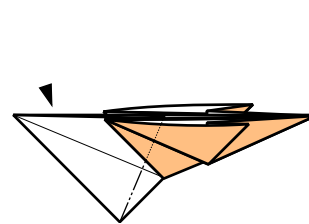

9) Reverse-fold.

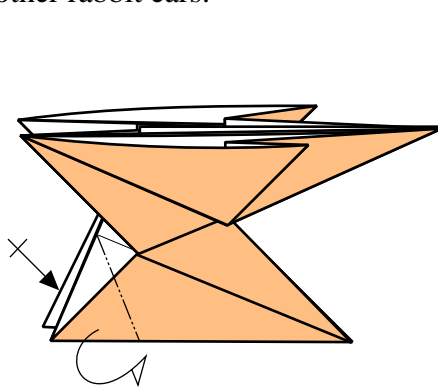

10) Fold corners inwards.

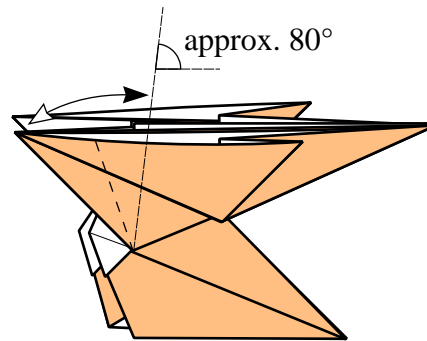

11) Fold to the indicated line. Angle should be slightly smaller than  $90^\circ$  to make the squirrel stand. Unfold.

# Squirrel (2/2)

Designed by: František Grebeníček (2000)  
www.origami.cz

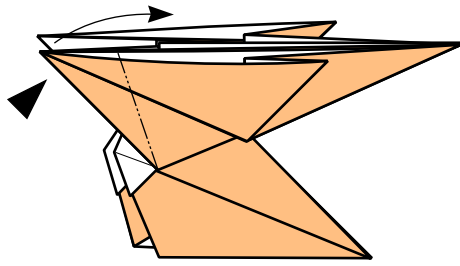

12) Reverse-fold.

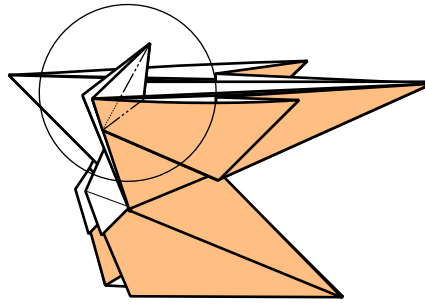

13) Detailed view.

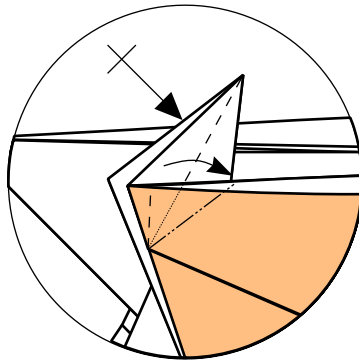

14) Complete double-rabbit ear, following indicated creases.

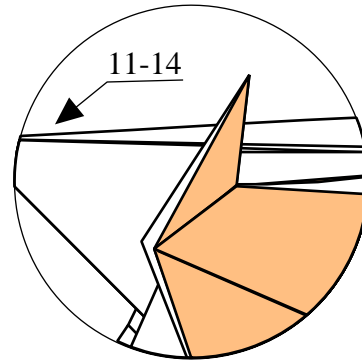

15) Repeat steps 11-14 behind.

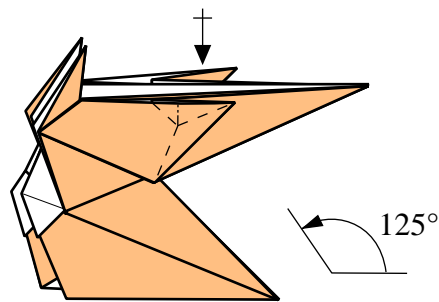

16) Rabbit ear.  
Repeat behind.

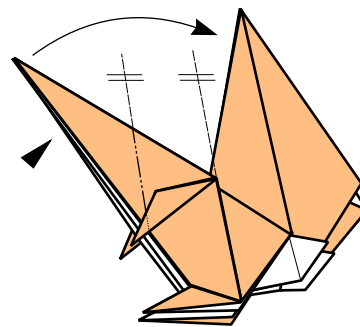

17) Reverse-fold following indicated crease.

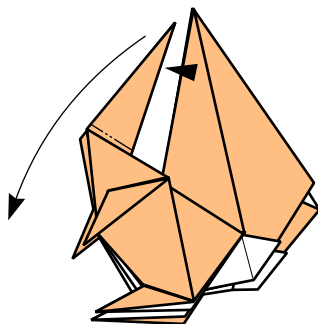

18) Reverse-fold.

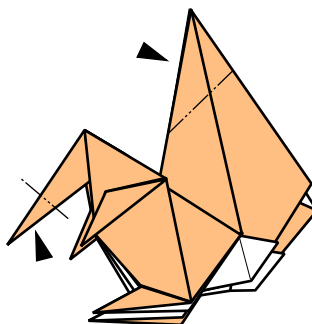

19) Reverse-folds: Finish head and tip of tail.

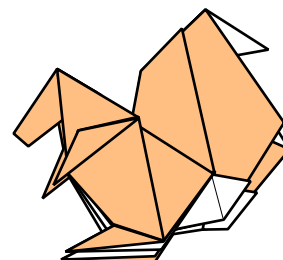

20) Squirrel.

Stand (3 dimensional) for birds and the like.  
This stand is fairly strong and stable.

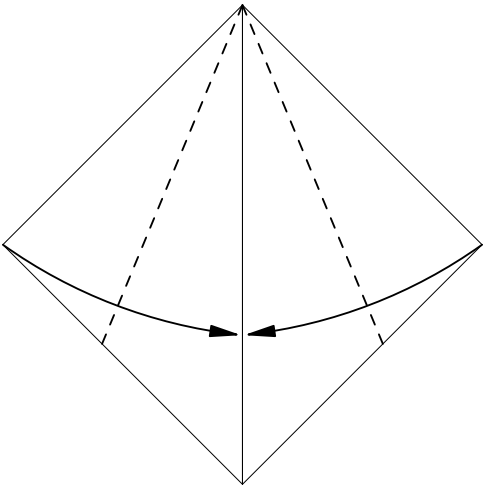

1

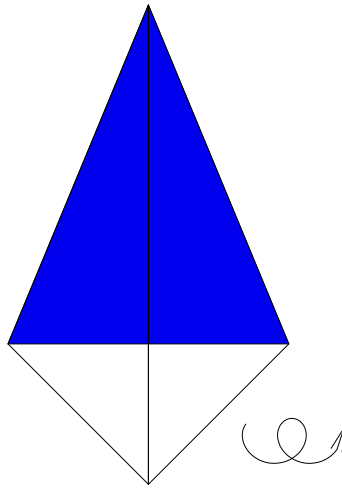

2

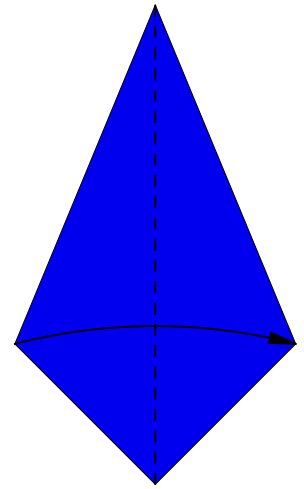

3

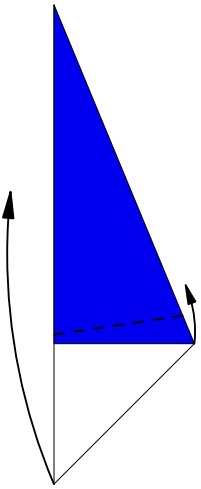

4

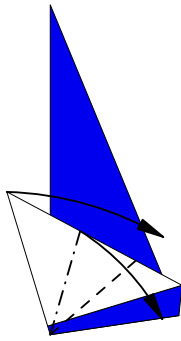

5

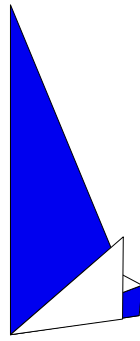

6

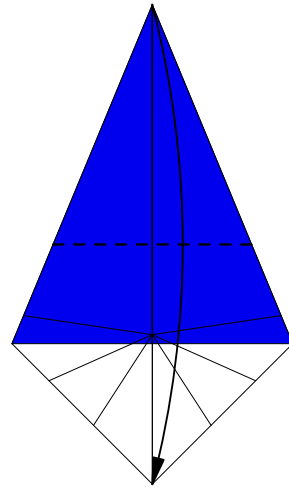

7

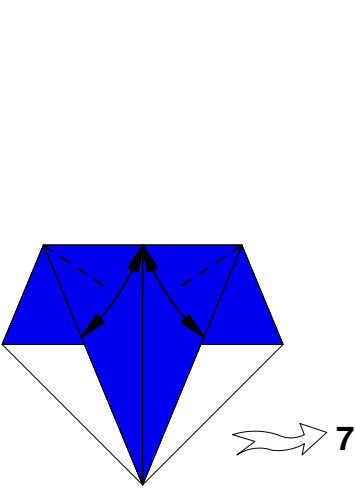

8

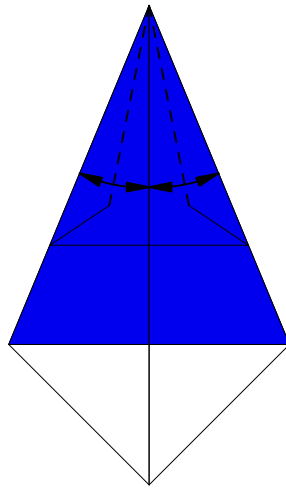

9

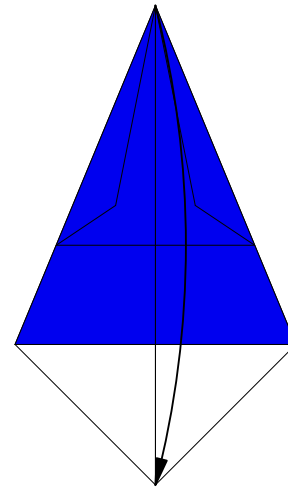

10

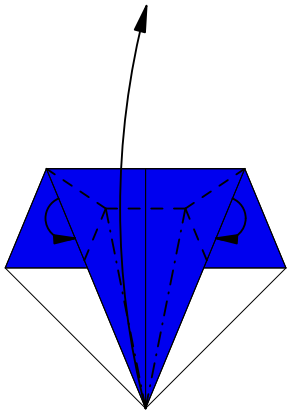

11

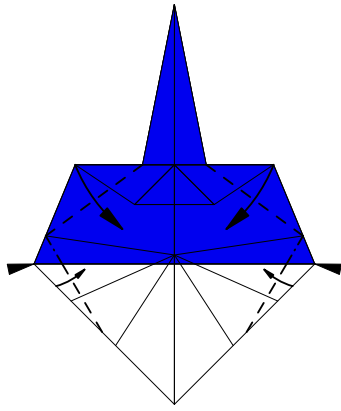

12

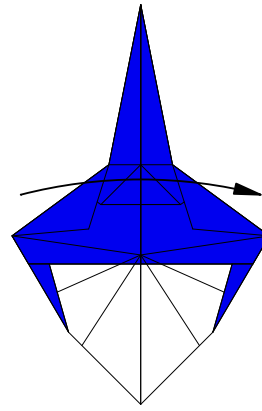

13

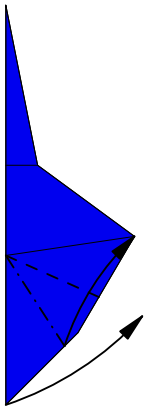

14

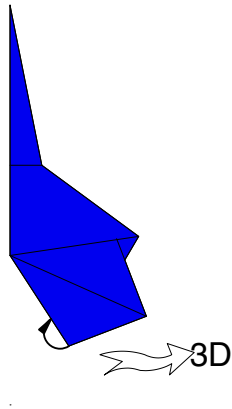

15

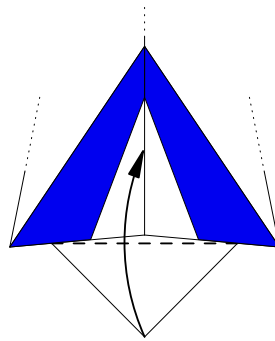

16 Inside bottom

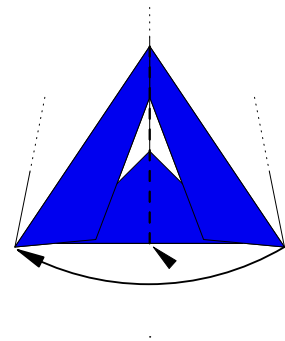

17



# 6 Pointed star box - base

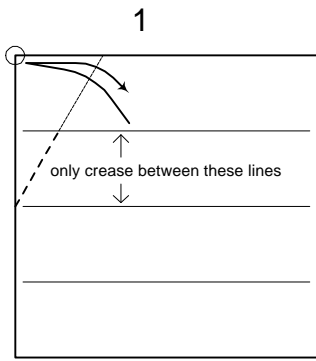

Begin with a square creased into quarters horizontally

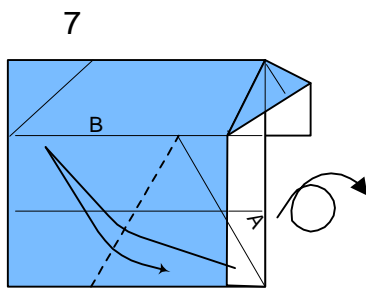
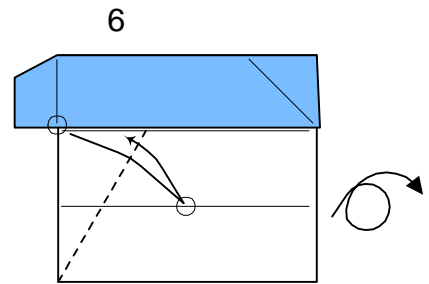
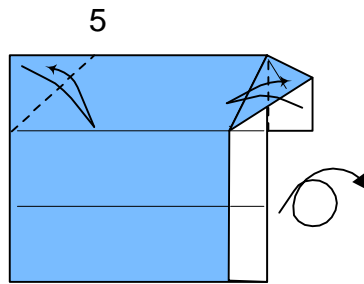
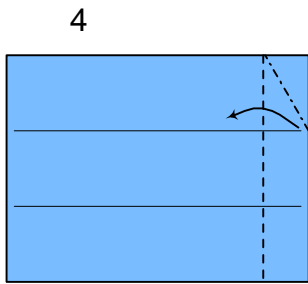
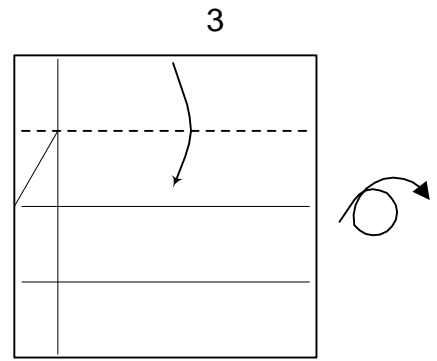
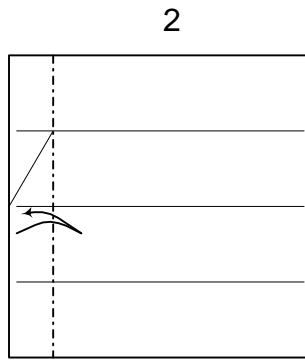

Crease so line A runs parallel to line B

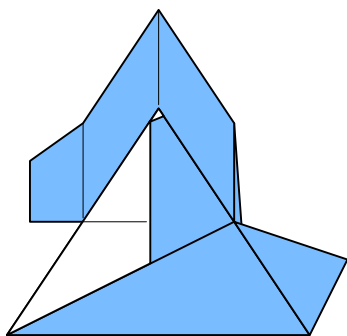
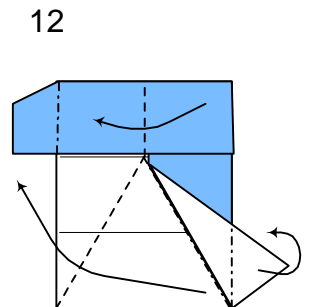
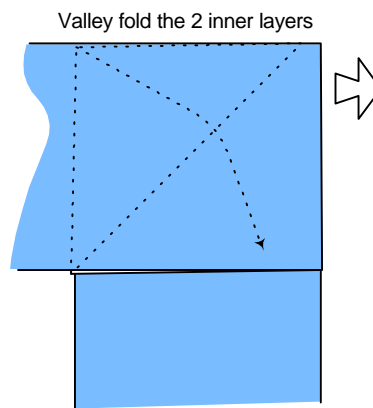
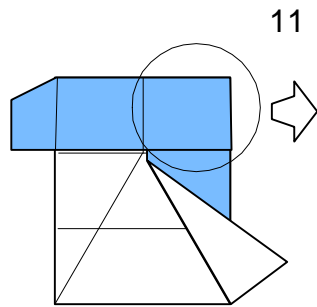
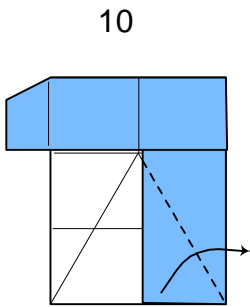
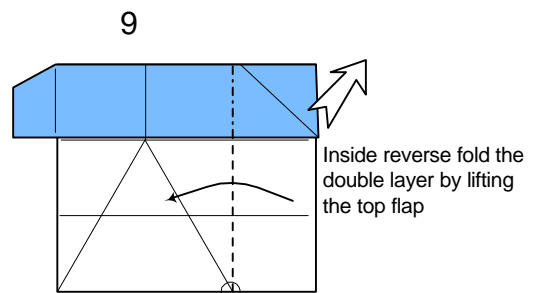
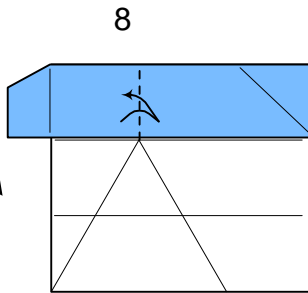

Make 5 more

# 6 Pointed star box - base

## Assembly

13

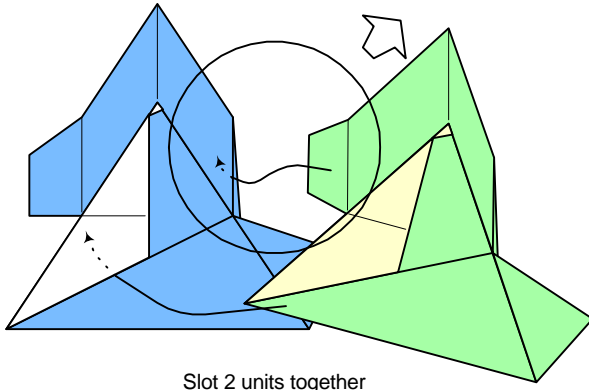

14

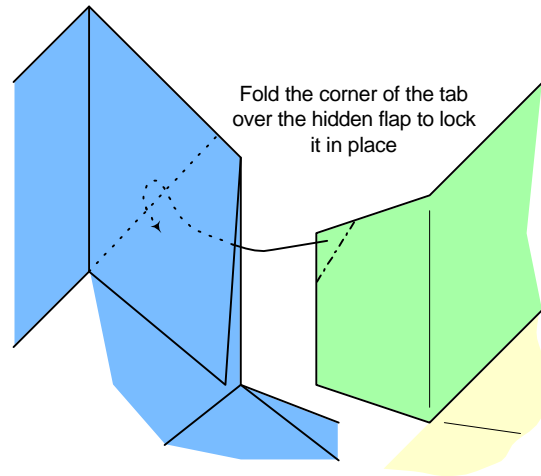

15

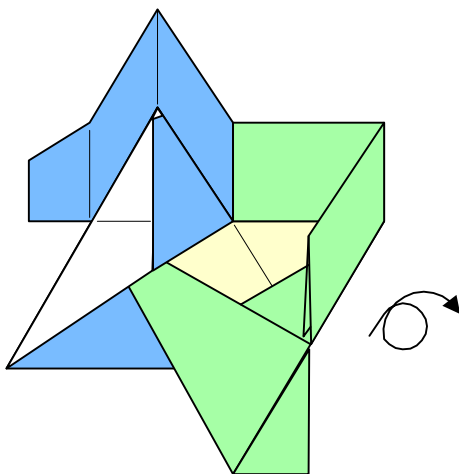

16

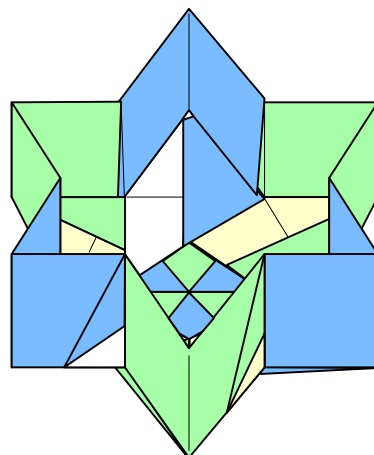
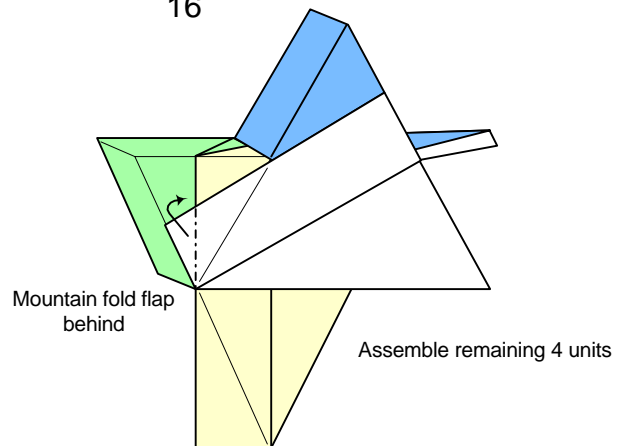



# 6 Pointed star box - lid

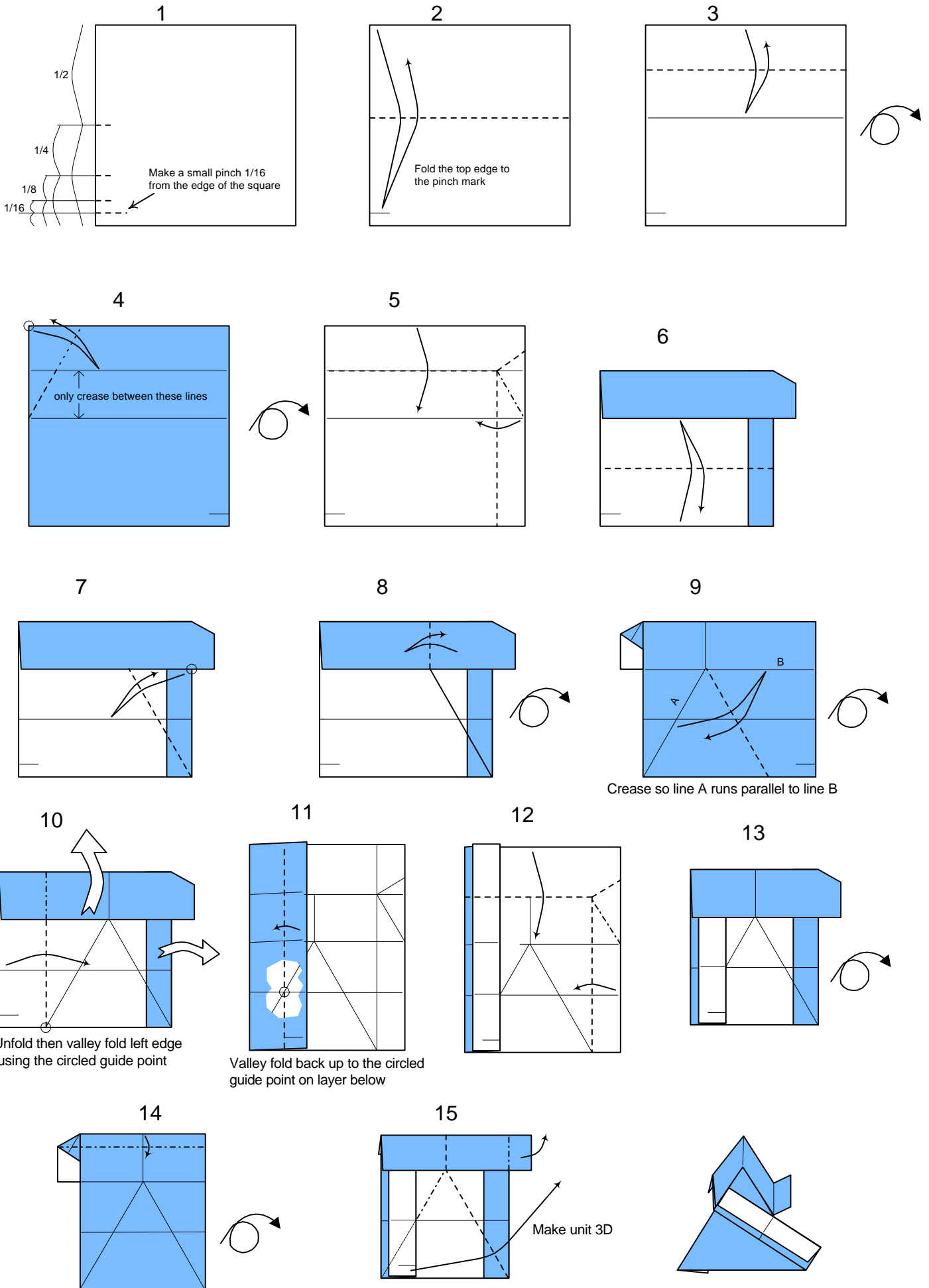

# 6 Pointed star box - lid

## Assembly

16

Insert tab into pocket  
(mate the two turned over top edges).

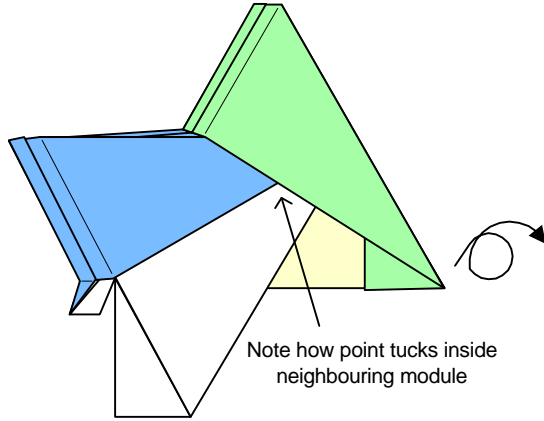
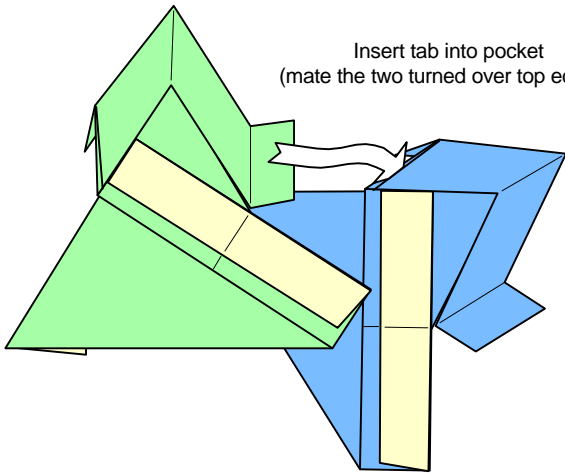

17

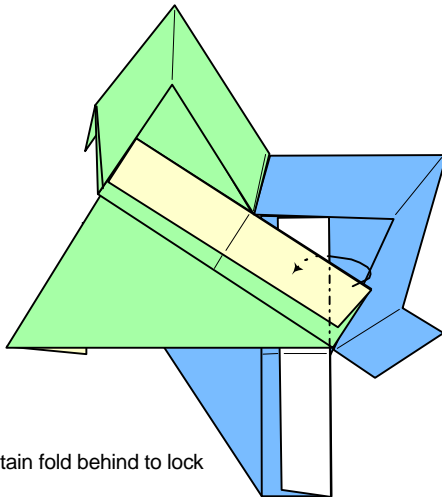

Mountain fold behind to lock

.....Assemble remaining 4 units

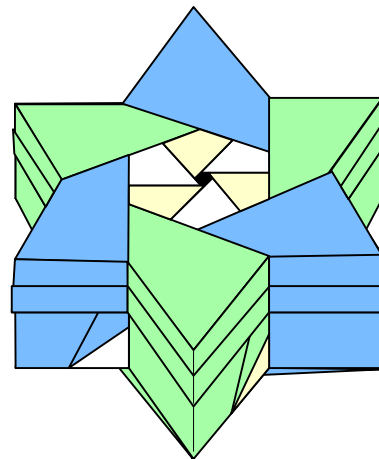
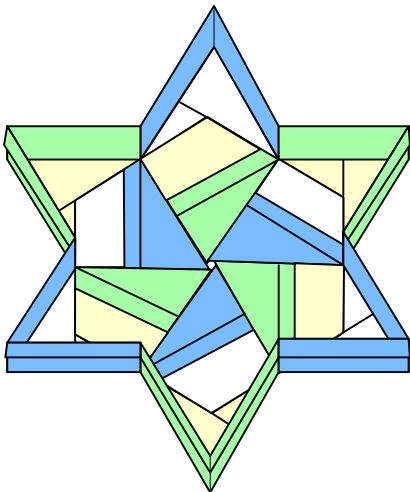

# Steamboat (traditional)

Diagrammed by: František Grebeníček (2000)  
www.origami.cz

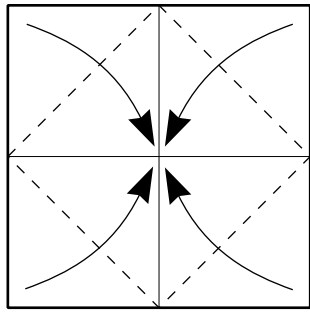

1) Blintz-fold.

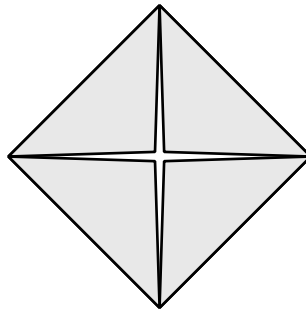

2) Turn over.

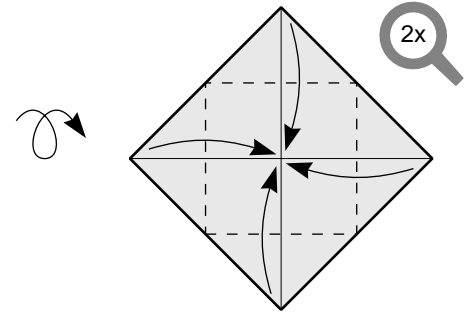

3) The second blintz-fold.

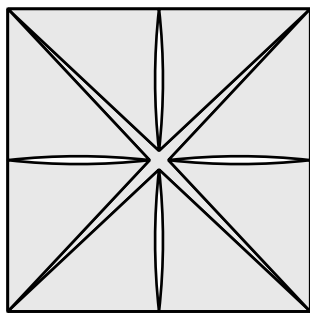

4) Turn over.

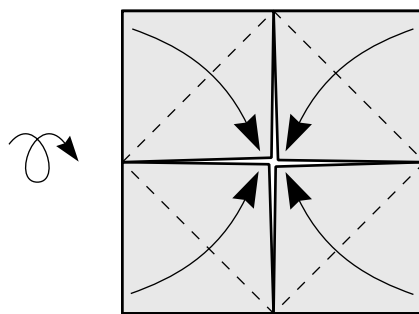

5) The third blintz-fold.

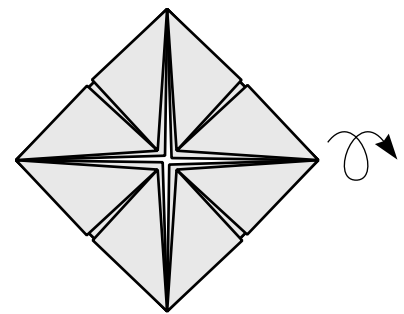

6) Turn over.

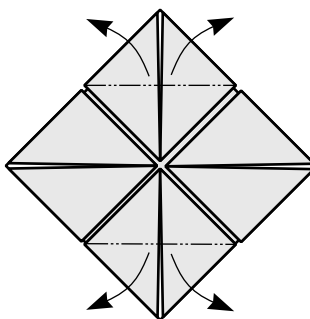

7) Open the chimneys.

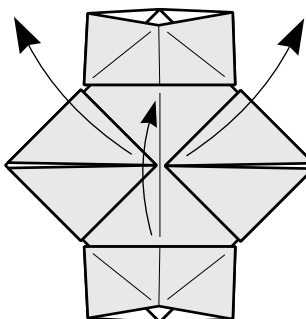

8) Fold in half pulling out the bow and the stern.

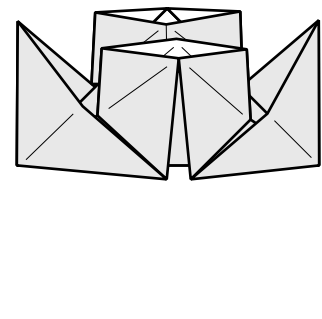

9) Finished steamboat.

Start with a square, white side up.

1.

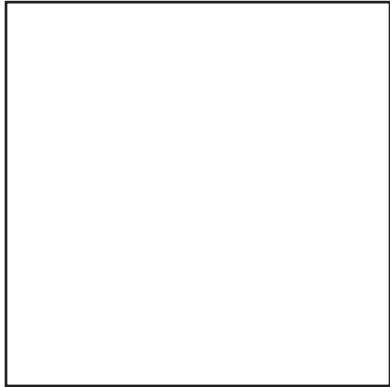

Rotate 22.5 degrees

2.

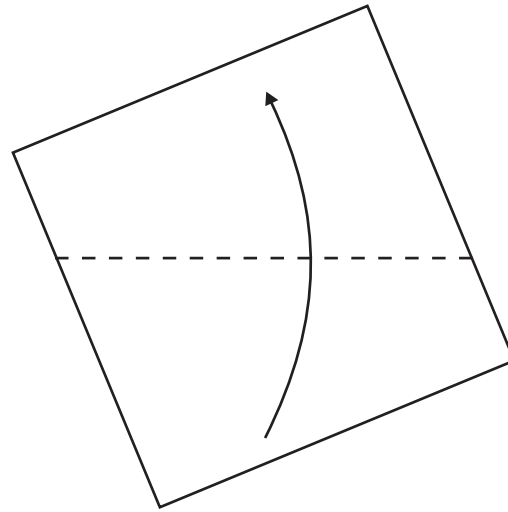

3.

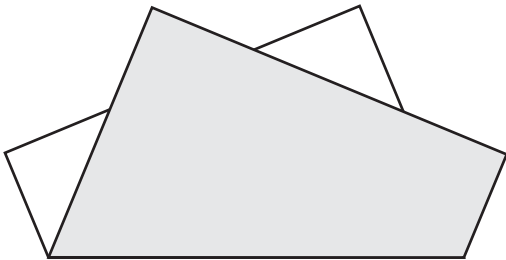

Completed one fold stegosaurus.  
Note alternating plates along the back.

This model was the result of a conversation that I had with Jonathan Baxter at the First Southeastern Origami Festival that was held in Charlotte, North Carolina, on September 20-27, 1994. Jonathan had scheduled me to teach a class of small children on Saturday (the 24th) morning, so I asked him, on Friday night, what sorts of models he wanted me to teach.

"I don't care," he said, "as long as it's simple. You can teach the two fold stegosaurus if you want."

"Well," I said, "I can do better than that. I can do a one fold stegosaurus."

And I immediately folded him one, the model that is diagrammed here. Not bad for a spur-of-the-moment inspiration, if I say so myself! Thus ends my first foray into the realm of minimalist origami.

Thanks to Cynthia Pettit for forcing me to get this diagrammed.

Start with a square, white side up.

1.

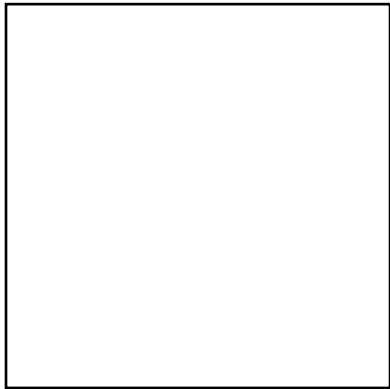

Rotate 22.5 degrees

2.

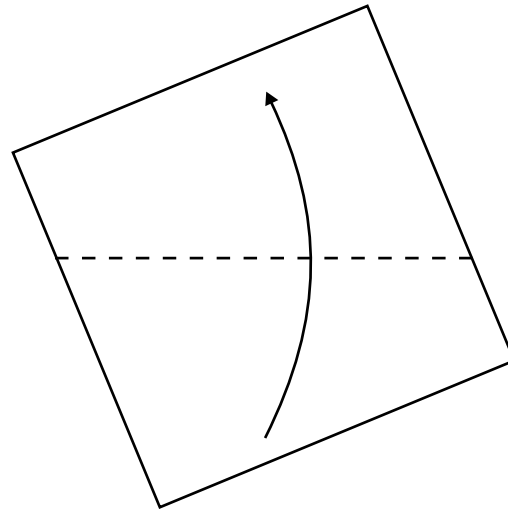

3.

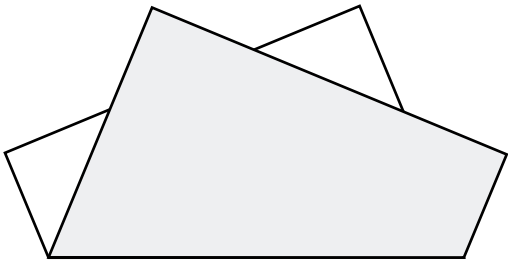

Completed one fold stegosaurus.  
Note alternating plates along the back.

This model was the result of a conversation that I had with Jonathan Baxter at the First Southeastern Origami Festival that was held in Charlotte, North Carolina, on September 20-27, 1994. Jonathan had scheduled me to teach a class of small children on Saturday (the 24th) morning, so I asked him, on Friday night, what sorts of models he wanted me to teach.

"I don't care," he said, "as long as it's simple. You can teach the two fold stegosaurus if you want."

"Well," I said, "I can do better than that. I can do a one fold stegosaurus."

And I immediately folded him one, the model that is diagrammed here. Not bad for a spur-of-the-moment inspiration, if I say so myself! Thus ends my first foray into the realm of minimalist origami.

Thanks to Cynthia Pettit for forcing me to get this diagrammed.

# Bebé Stegosaurus

Fernando Gilgado Gómez

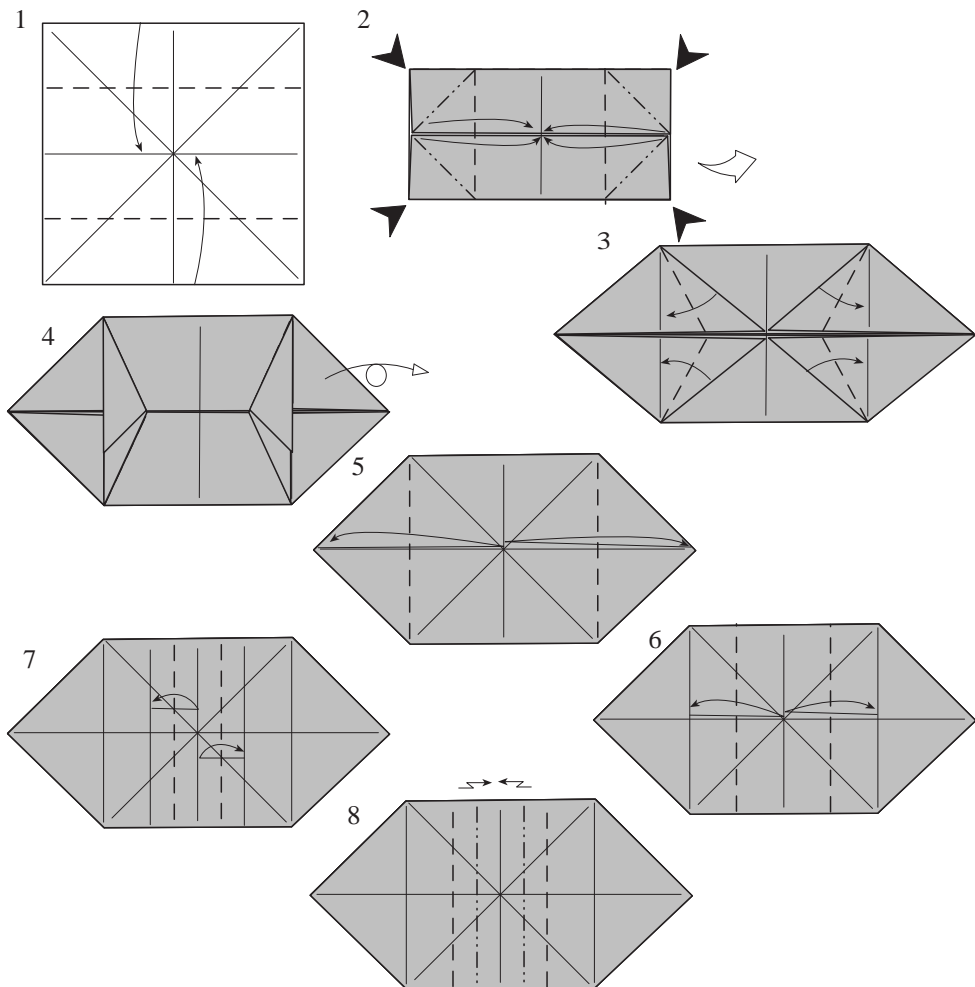
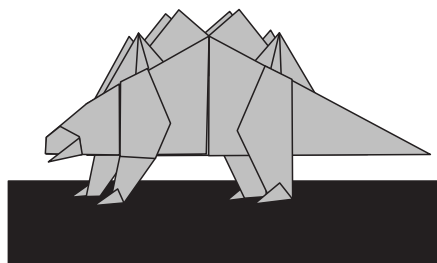

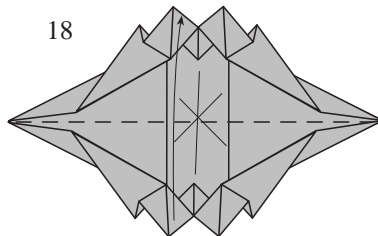
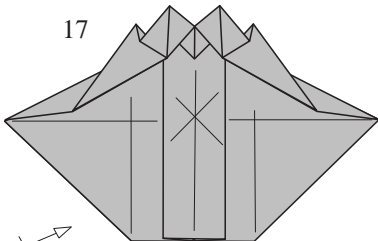
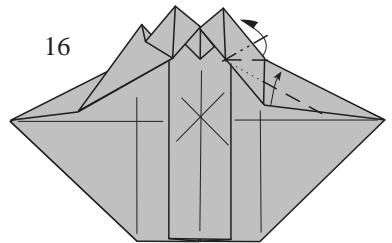
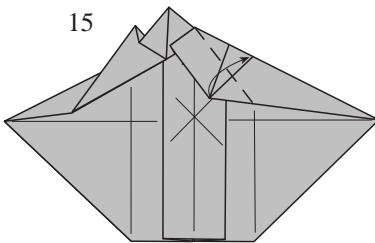
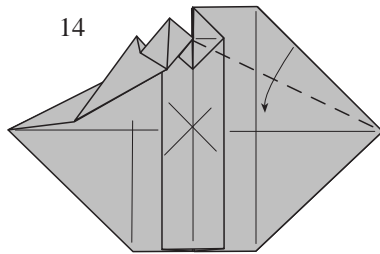
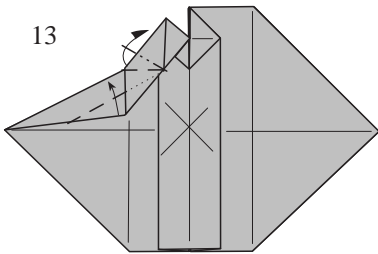
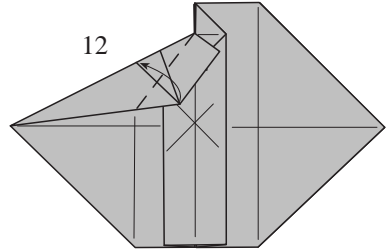
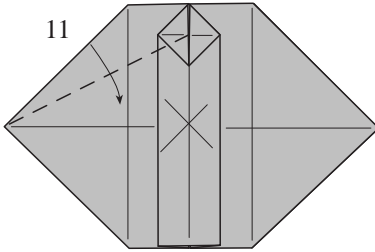
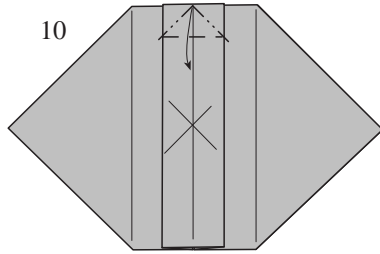
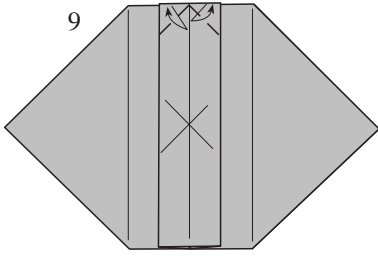

Repetir 9-16

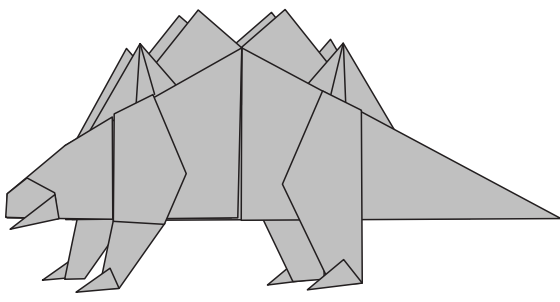
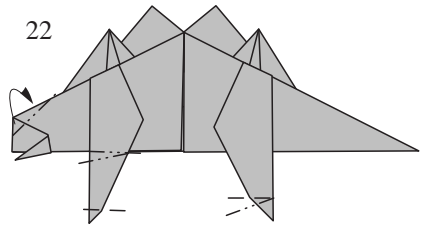
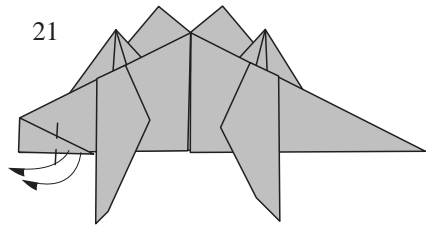
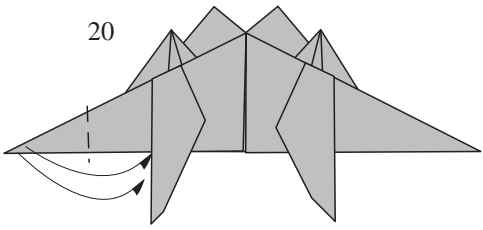
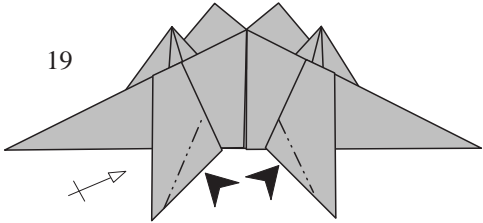



Magyar

*It may sound strange but it is true that every origami model is built up from the same set of fold types. Thus, if you learn (or already know) the following techniques of folding, you shall not have problems folding the models in this book. The folds types are related with each other, since all of them are a specific composition of "valley" and "mountain" folds (which are named differently only because of the viewer's point of view, otherwise they are the same). In the following explanatory diagrams the pictures whose number is highlighted, show how that specific fold type is denoted later in the models' diagrams.*

## Völgyhajtás / Valley fold

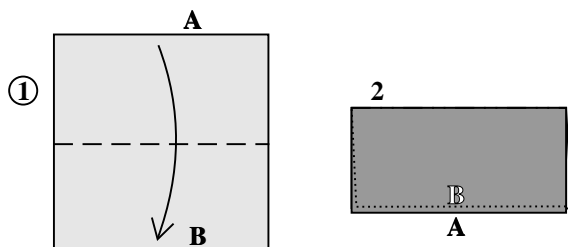

Völgyhajtásnál (1) a papírt magunk felé hajtjuk. A fenti példában az "A" élet lehajtjuk a "B"-re (2). A völgyhajtást szaggatott vonal és egyszerű vonalníl jelöli.

*A valley fold (1) means "fold the paper towards yourself". In the example above, you fold edge "A" down to "B" (2). A valley fold is denoted by a dashed line and a normal line-arrow.*

## Hegyhajtás / Mountain fold

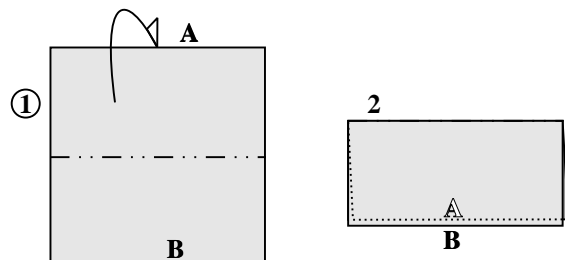

Hegyhajtásnál (1) a papírt magunktól elfelé (hátra) hajtjuk. A fenti példában az "A" élet lehajtjuk a "B" mögé (2). A hegyhajtást pont-pont-vonal és hátranyilazott fejtű nyíl jelöli.

*A mountain fold (1) means "fold the paper behind (away from yourself)". In the example above, you fold edge "A" down behind "B" (2). A mountain fold is denoted by a dot-dot-dash line and a hollow arrow.*

## Visszahajtás / Unfold

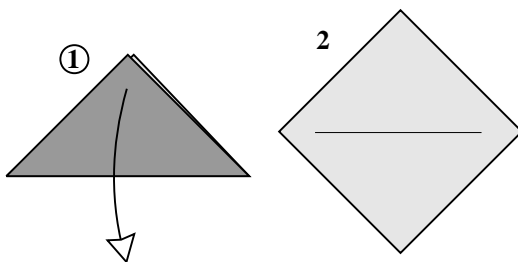

Ha valamely előző hajtást (hajtásokat) vissza kell hajtani, azt egy kétoldalt hátranyilazott nyíl jelöli. **Ugyanez a nyíl jelöli, ha valamennyi papírt ki kell húzni egy helyről.**

*Unfolding an earlier step will be indicated by a double hollow arrow. **This same arrow will also denote if you have to pull out some paper.***

## Oda-visszahajtás (élezés) Fold and unfold (creasing)

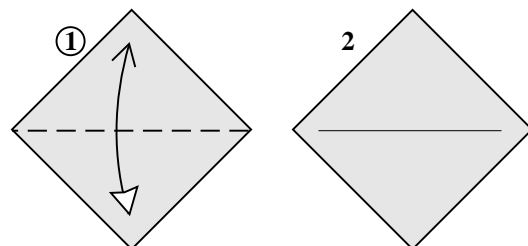

Az oda-visszahajtás vagy "élezés" (1) tulajdonképpen egy völgyhajtás és egy visszahajtás egy lépésbe való összevonása. Egyik felén (amerre hajtunk) völgyhajtás, a másikon (amerre visszahajtjuk) visszahajtás nyíl jelöli.

*Fold and unfold, or "creasing" (1), in fact, gathers a valley fold and an unfold in one step. It is indicated by a valley fold arrow on one end (in the direction you fold) and an unfold arrow on the other (in the direction you unfold).*

## Redőzés / Pleat

A redőzés egy völgy- és egy hegyhajtásból áll (ha szükséges, a kép alatti cikcakk megmutatja a redőt oldalnézetben).

*A pleat consists of a valley and a mountain fold (a zigzag under the picture shows the order of the layers after pleating, if needed).*

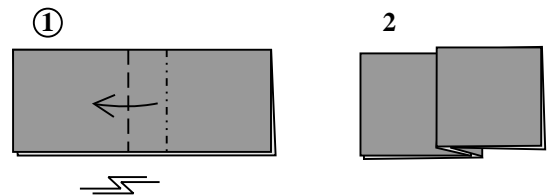

## Nyúlfülhajtás / Rabbit ear

A nyúlfülhajtás (3) három völgy- és egy hegyhajtás kombinációja. Könnyebb, ha először elhajtunk (1-2), s csak azután kezdjük el magát a nyúlfülhajtást (4-5-6). Nyúlfülhajtást forgóhajtás segítségével is lehet készíteni (lásd alább).

*The rabbit ear (3) is a combination of three valley and one mountain fold. It is easier to precrease first (1-2) and start folding the rabbit ear only after that (4-5-6). A rabbit ear can also be made by means of a swivel fold (see below).*

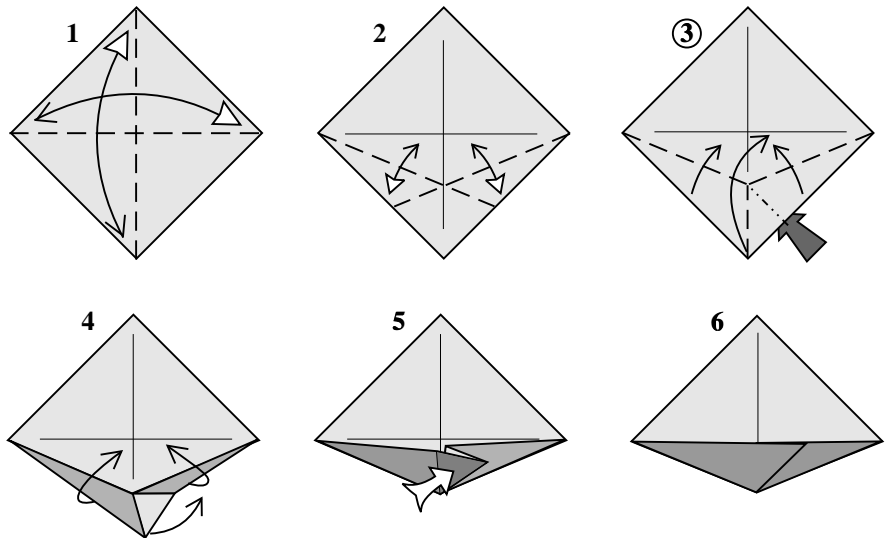

## Forgóhajtás / Swivel-fold

Forgóhajtásnál (4) úgy hajtunk át egy csücsöt, hogy a papír egy másik része is hajtásra kényszerül (azaz elfordul). A hajtás közben az itt "A"-val jelölt papírrész elforgatását eredményezi (5-6).

*The swivel fold (4) means folding a corner over so that some remote paper is forced to fold as well. The swivel fold makes the paper here marked with "A" rotate (5-6).*

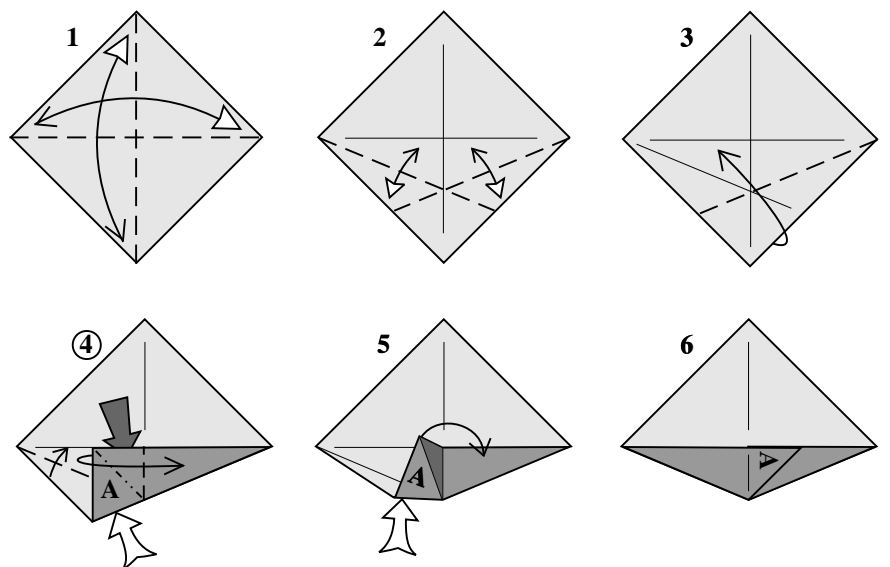

## Váltóhajtás / Reverse-fold

**Váltóhajtás befelé (2):** előhajtás (1) után a papír gerincét (itt "A") az ujjunkkal szétnyitott rétegek közé tűrjük (3-4-5).

*To make an **inside reverse fold** (2), after pre-creasing (1), open the layers and tuck the spine ("A") between them (3-4-5).*

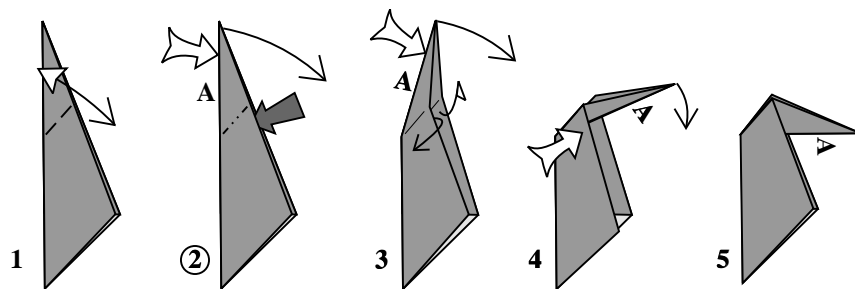

**Váltóhajtás kifelé (2):** előhajtás (1) után az ujjunkkal szétnyitott rétegeket a gerincre borítjuk, ráfordítjuk (3-4-5).

*To make an **outside reverse fold** (2), after precreasing (1), open the layers and wrap them around the spine (3-4-5).*

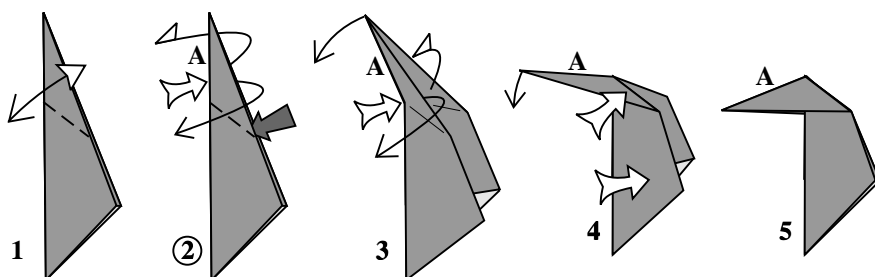

**Váltóhajtás közbeiktatása:** az áthajtással egyidőben egy váltóhajtást is elvégzünk.

*Incorporating a reverse fold: make a reverse fold while you are folding over.*

A **dupla váltóhajtás** két, egymással összeköttetésben lévő váltóhajtás egyszerre történő végrehajtása. Előfordul a 25. és a 87. oldalon.

*The **double reverse fold** is two reverse folds linked to each other and executed at the same time. This fold occurs on page 25 and page 87.*

## Törés / Crimp

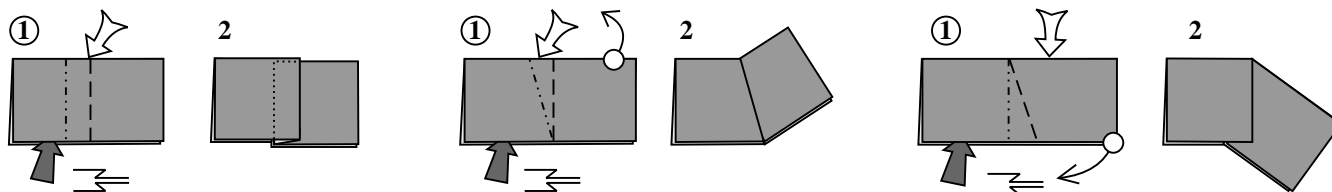

A törés (1) tulajdonképpen két egymás utáni váltóhajtás (a kép alatti cikcakk megmutatja a végeredményt oldalnézetben, azaz, hogy milyen sorrendben következnek a váltóhajtások). Fent a törés a három leggyakoribb típusa látható.

*The crimp (1) is a combination of two reverse folds (the zigzag under the picture shows the order of the layers after crimping, thus shows the order of the reverse folds). The three most common types of crimp are shown above.*

## Préshajtás / Squash-fold

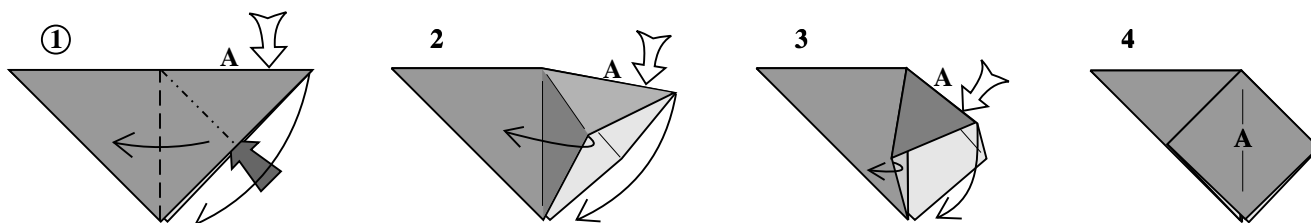

Préshajtásnál (1) a rétegeket szétnyitjuk az ujjunkkal (1-2), majd gerincét ("A") laposra préseljük (2-3-4).

*To make a squash fold (1), spread the edges apart with your finger (1-2) then squash the spine ("A") flat (2-3-4).*

## Sziromhajtás / *Petal-fold*

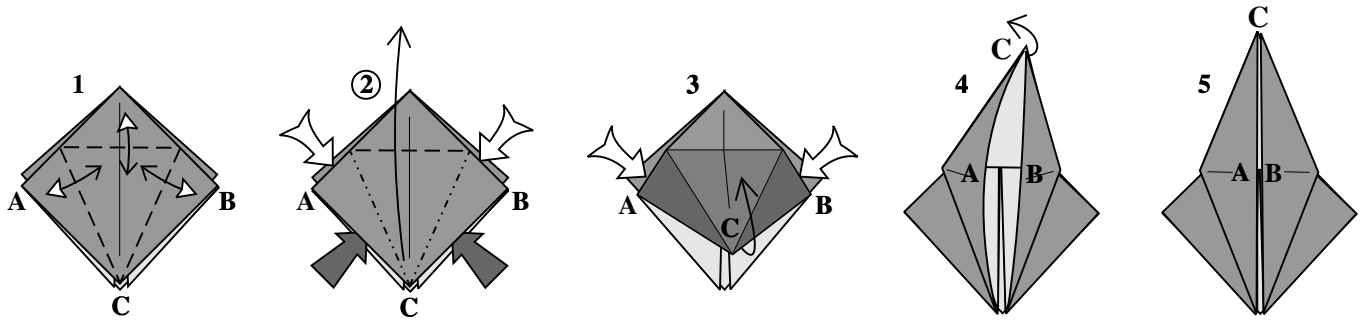

Sziromhajtással (2) vékonyítunk és hosszabbítunk egy csúcst (itt "C"). Jelölőhajtások (1) után a "C" csúcst felfelé hajtjuk (3), az "A" és "B" pontok egymás mellé kerülnek (4-5).

*A petal fold (2) narrows and lengthens a point (here "C"). After precreasing (1), Fold corner "C" up (3) so that points "A" and "B" will meet in the middle (4-5).*

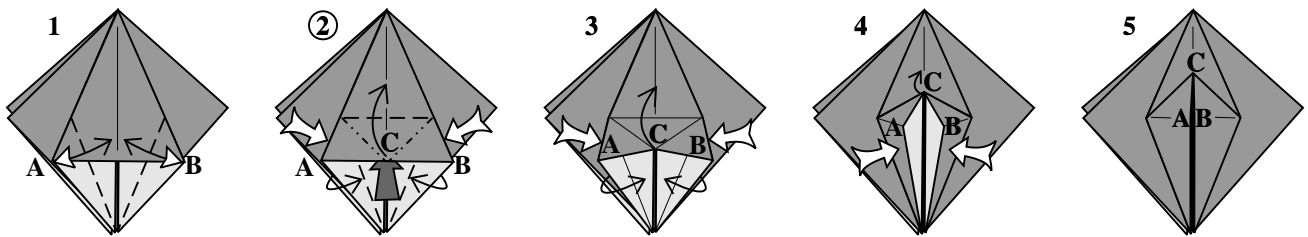

A sziromhajtás másik fajtája (2), amikor a papír széléből alakítunk ki egy csúcst (itt "C"). Jelölőhajtások (1) után kétoldalt nyomva a "C" pontot felfelé hajtjuk (2-3), majd lelapítjuk (4). Az "A" és "B" pontok egymás mellé kerülnek (5).

*Another type of the petal fold (2) creates a corner (here "C") from an edge. After precreasing (1), push both sides towards the center, fold point "C" up (2-3) and flatten it (4). Points "A" and "B" will meet in the middle (5).*

## Széthúzó préshajtás / *Spread squash fold*

A széthúzó préshajtásnál (2) -előhajtások (1) után- a papírt a kívánt mértékben szétnyitjuk (2-3), majd teljesen lelapítjuk (3-4). Figyeljük meg az "A" pont mozgását a manőver közben! Próbáljuk meg elkerülni a papír ráncolódását!

*For a spread-squash (2), first mark with valley folds (1). Then pull the paper apart until required (2-3) and flatten it completely (3-4). Watch how point "A" moves during the manoeuvre. Try to avoid the wrinkling of the paper.*

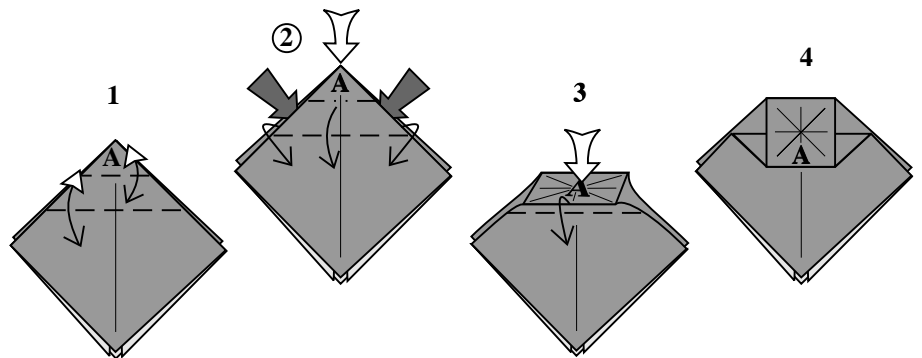

A széthúzó préshajtás egy másik gyakori típusa (1), amikor a csúcs széttelapítása után nem négyszög, hanem háromszög keletkezik.

*Another common type of spread squash (1) is when the flattened corner results in a triangle, not a square.*

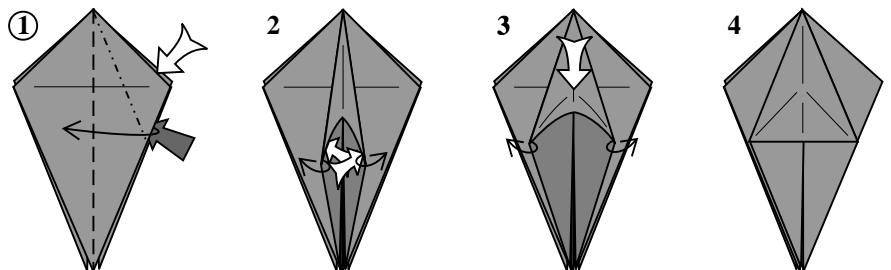

## Nyitott süllyesztés / Open sink

A süllyesztés (2) annyiban különbözik a széthúzó préshajtástól, hogy a papír szükséges mértékű széthúzása (2-3) után, azt nem lelapítjuk, hanem vissza felcsukjuk (3-4).

*The open sink (2) is closely related with the spread squash. The difference is, that after pulling the paper apart until required (2-3), instead of flattening, close it up (3-4).*

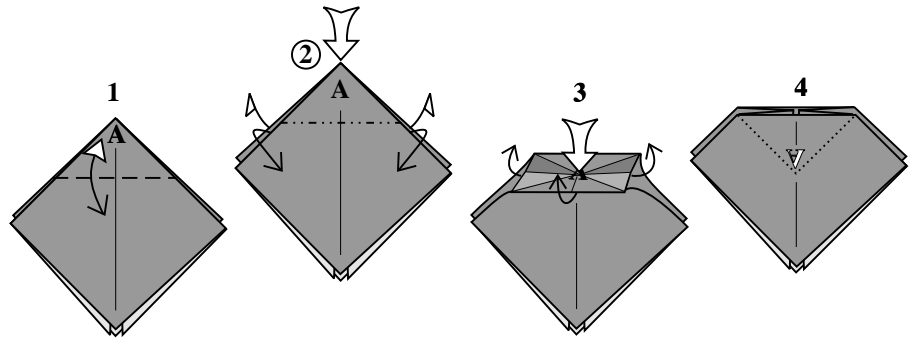

## Zárt süllyesztés / Closed sink

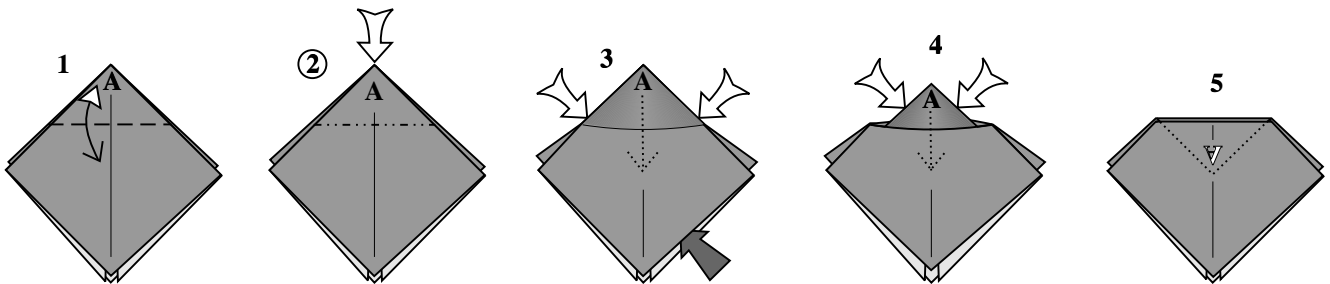

Zárt süllyesztést (2) csak előhajtás (1) után végezzünk! A süllyesztést a besüllyesztendő csúcs alapjainál kezdjük (3), majd a rétegeket együtt tartva süllyesszük be teljesen (4-5). A besüllyesztett csúcs egy zsebet fog formálni.

*Execute a closed sink (2) only after precreasing (1). Start sinking at the base of the corner to be sunk (3), then sink it completely, keeping the layers locked together (4-5). The closed sunked corner will form new pocket.*

## Borítás / Wrap

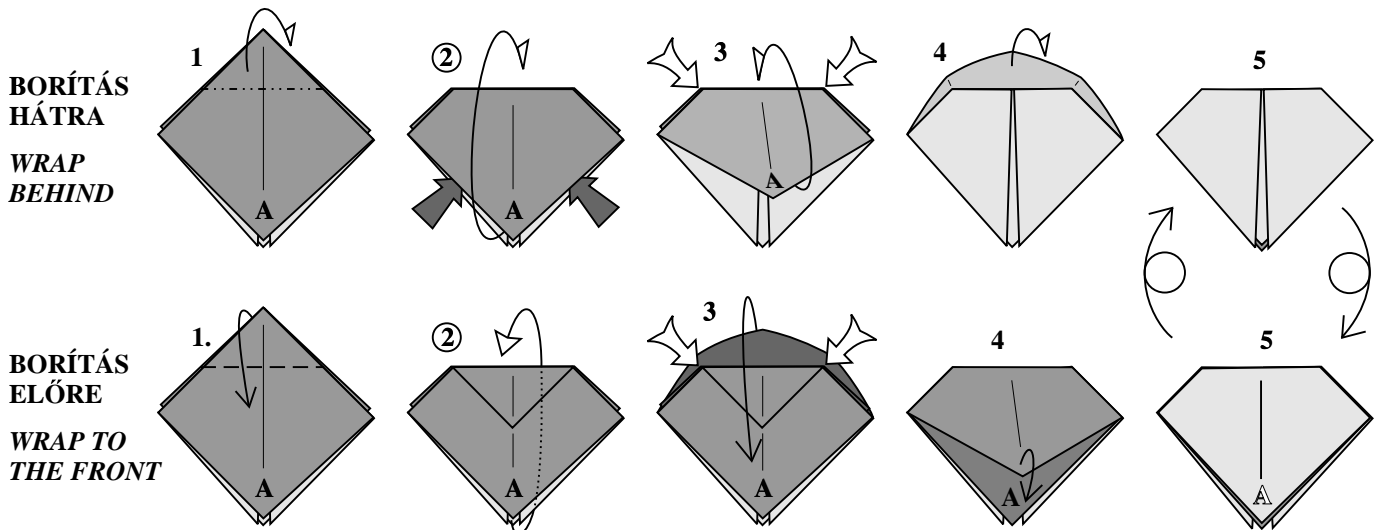

A borítás (2), ha közelebbről megvizsgáljuk, hasonlít a zárt süllyesztéshez, de amíg a zárt süllyesztésnél egy csúcsot süllyesztünk egy réteg alá, addig a borításnál egy réteget borítunk át a papír szélén. A borításnál az átborítandó réteget felnyitjuk amennyire csak lehet, aztán hirtelen kifordítjuk az egészet (3-4-5) - a modell részleges szétnyitása segít.

*The wrap (2), if observed closely, is similar to a closed sink but by wrapping, a layer is "swinged" around an edge rather than a corner being sunk underneath a layer. To make a wrap, open up the flap to be wrapped as far as possible (2-3), then suddenly invert the whole (3-4-5) - partly unfolding the model will help.*

# Talking Heads

By Perry Bailey 1999

1. Start by progressing diagonally both ways white side up or down.

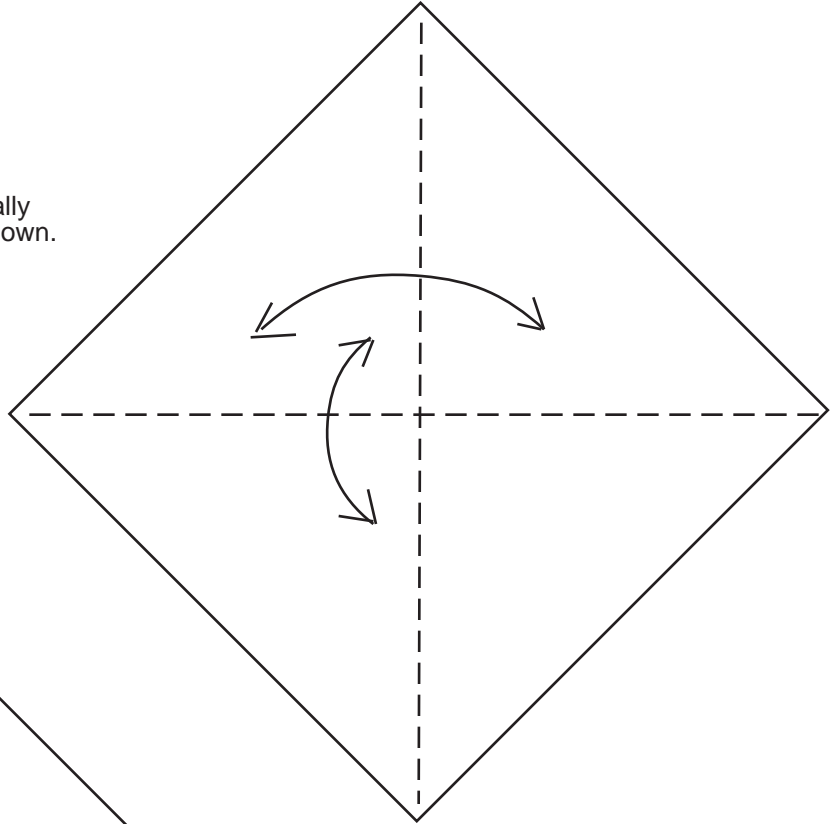

2. Pleat the bottom up, varying the amount will change the end result each time, but the top only goes to the center of the model.

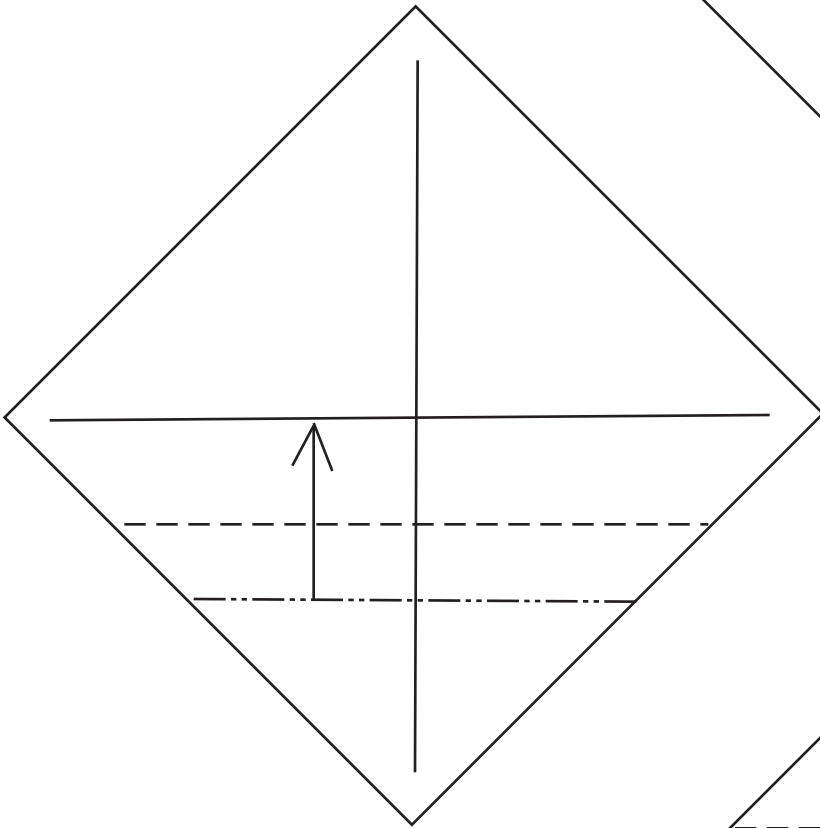

3. Pleat down and again the only important landmark is the center. Then double rabbits ear the bottom of the model, note it will not be even with the bottom in most cases, wing it.

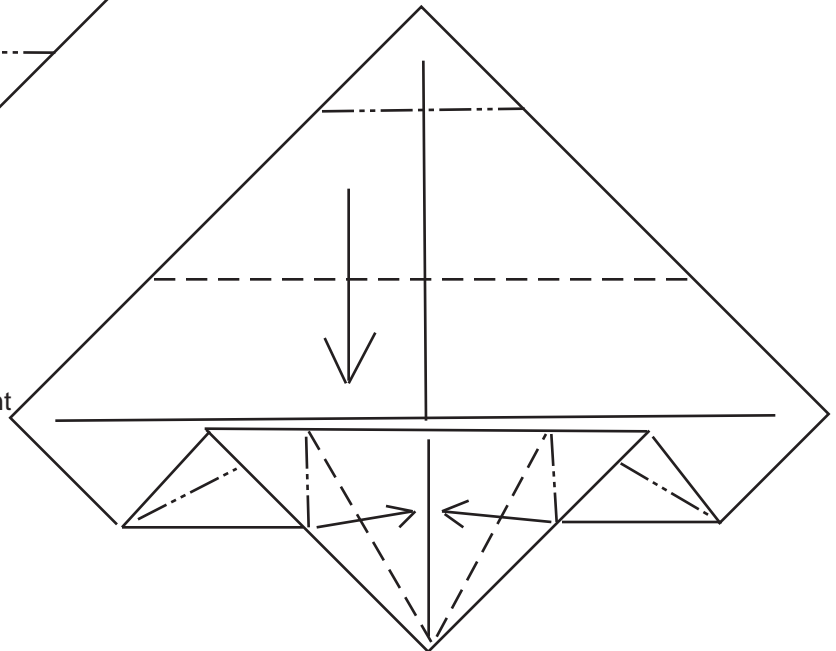

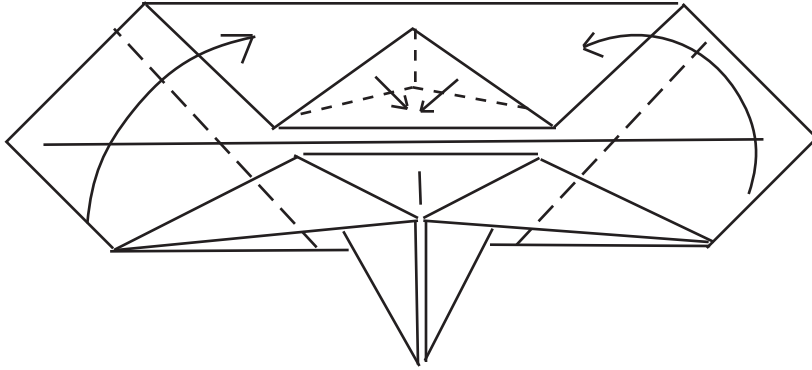

4. Rabbits ear the upper flap to form the nose and fold the flaps upwards to taste.

5. It should vaguely resemble this, the next diagram is an enlarged cutaway showing just one side.

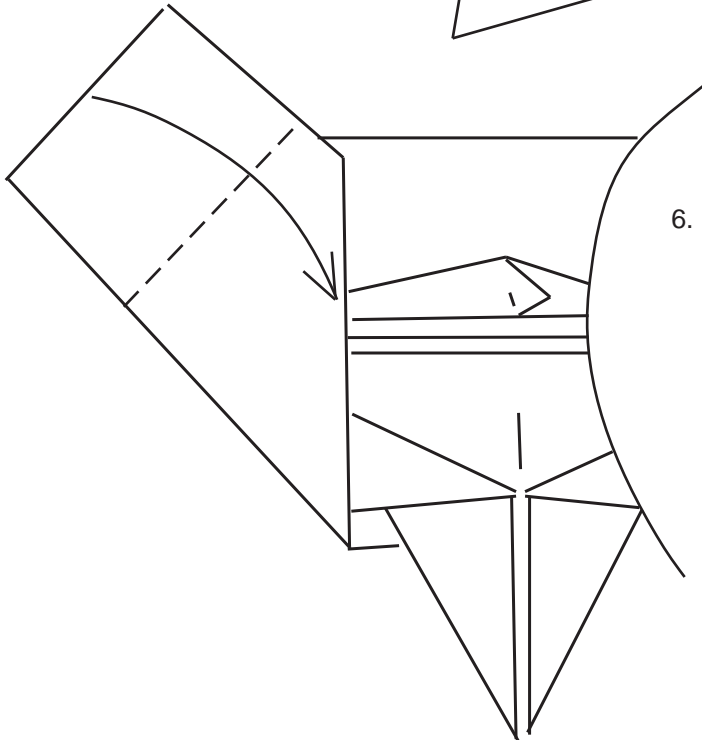
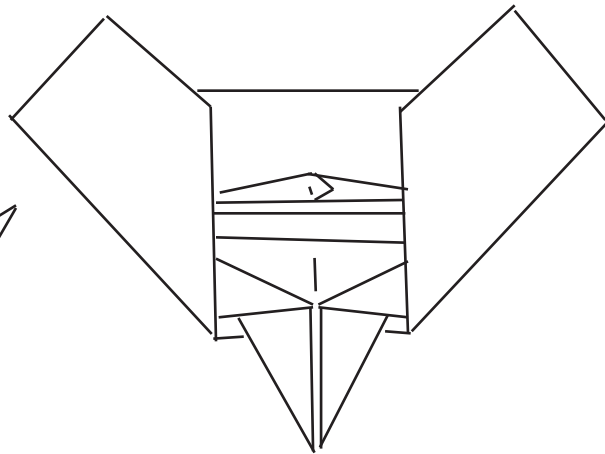

6. Fold the flap down to form the flap to make the eyes.

7. Pleat the fold over and back to give a triangle to use for the eye.

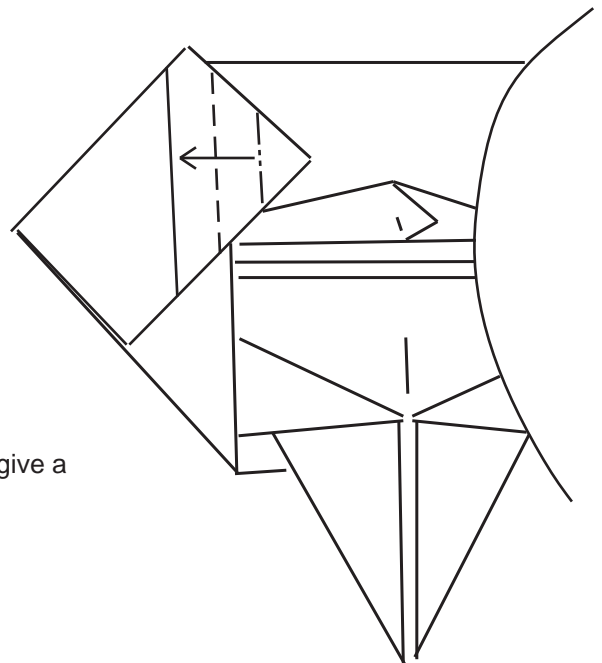

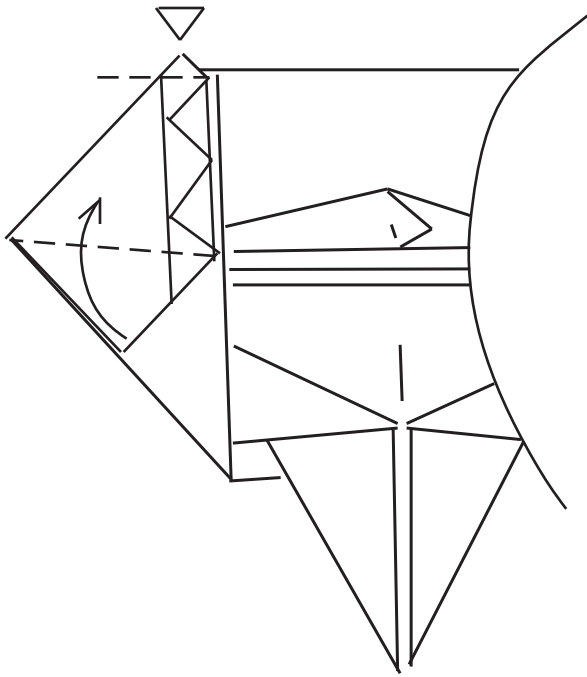

8. If there is any of the flap sticking up fold it down even with the top of the model. Valley fold the bottom of the flap up to hide the off color section below the eye.

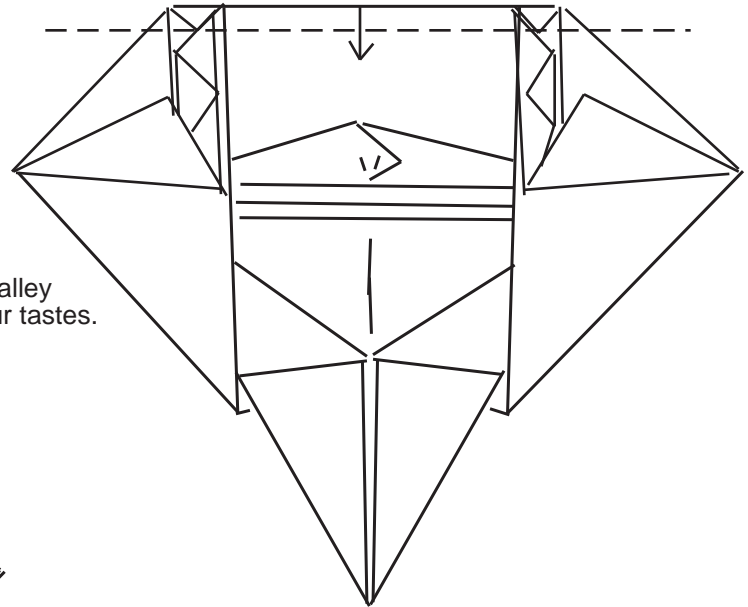

9. Now repeat to the other side and then valley fold the top of the head down to suit your tastes.

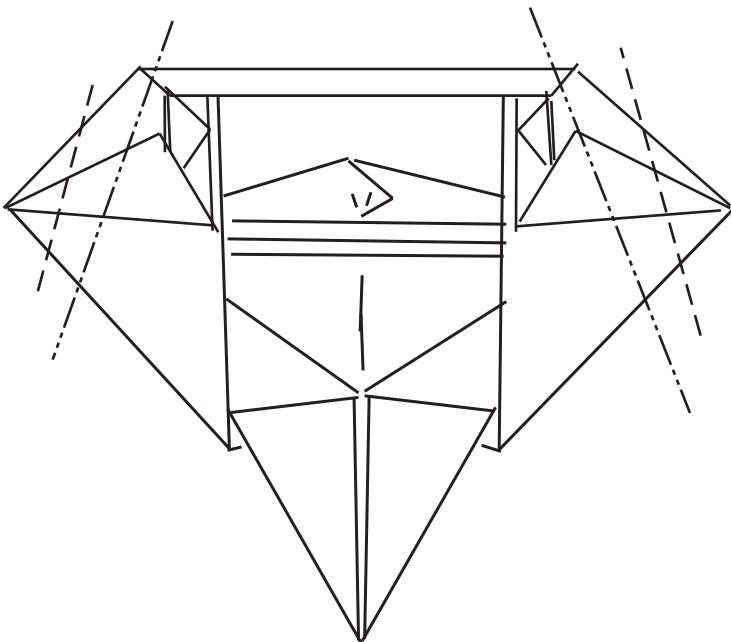

10. Now finally pleat some of the excess back and make some ears.

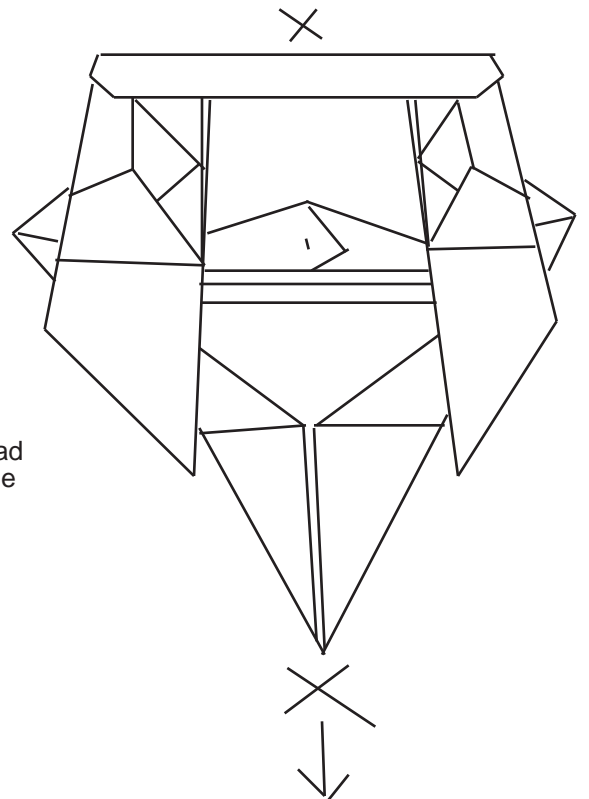

When your down grab the top of the head and the beard and pull down to make the head talk.



# The ONE DOLLAR TANK

BY: Charles Esseltine  
10/99

1.) PRECREASE A DOLLAR BILL

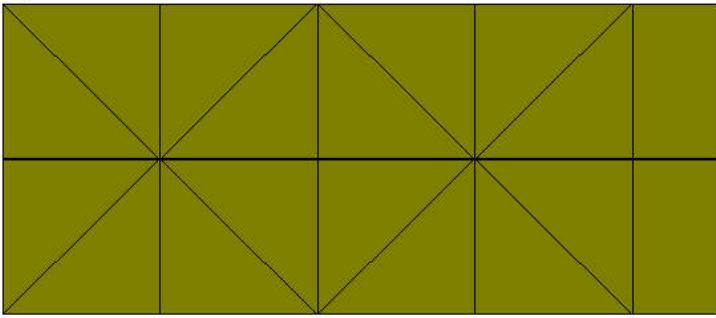

2.) MAKE A WATER BOMB BASE FROM THE MIDDLE SQUARE

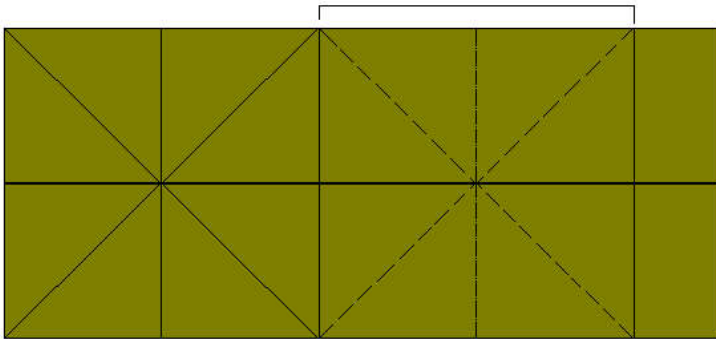

3.)

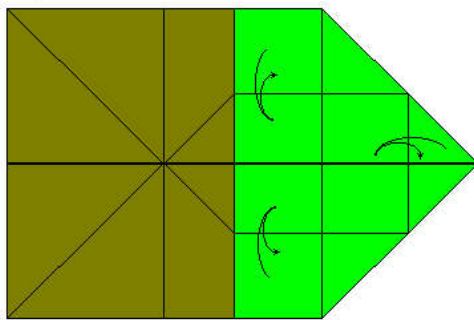

6.)

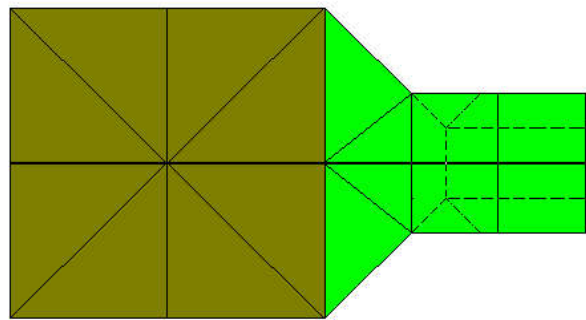

4.)

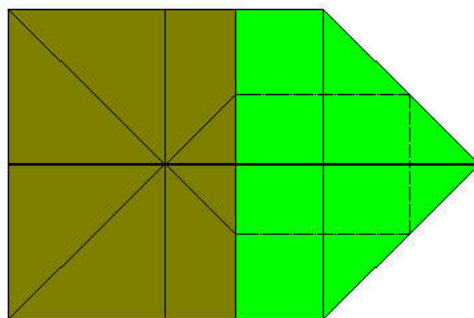

7.)

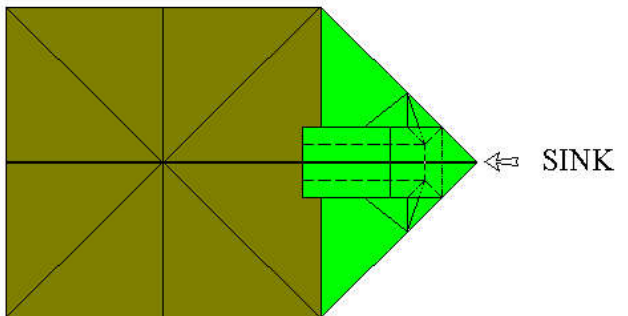

5.)

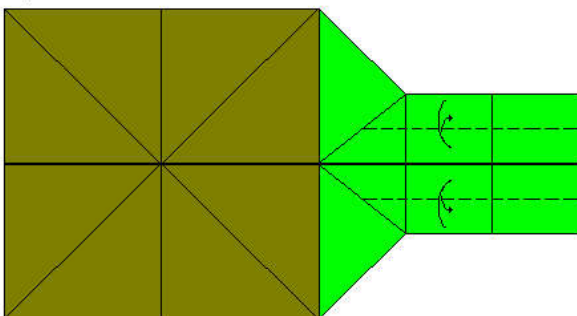

8.)

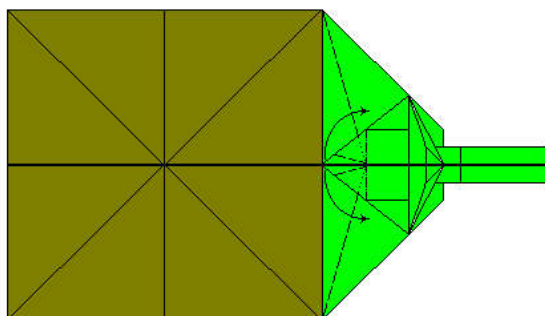

9.)

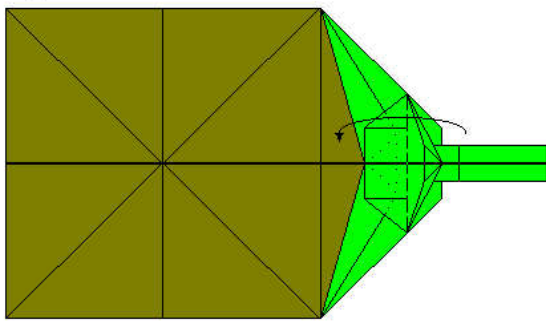

10.)

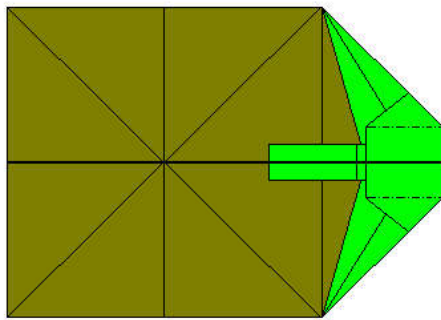

11.)

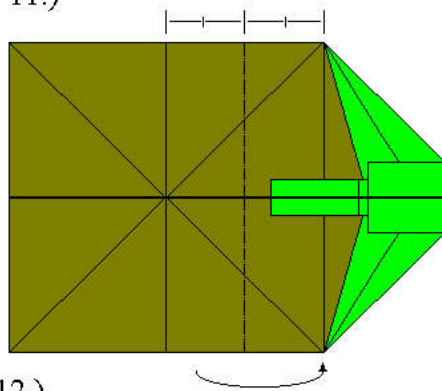

12.)

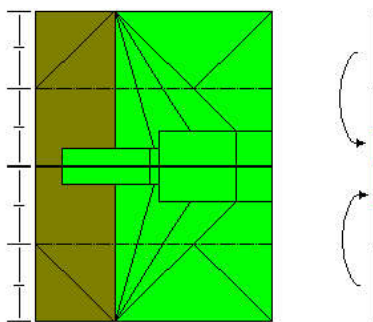

13.)

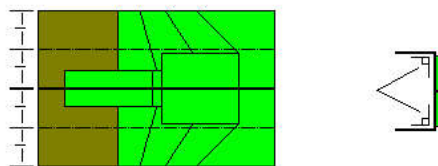

14.)

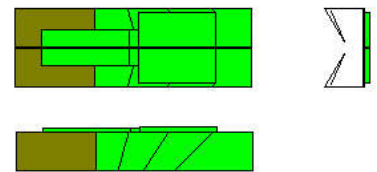

15.)

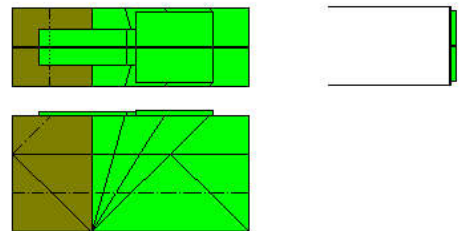

16.)

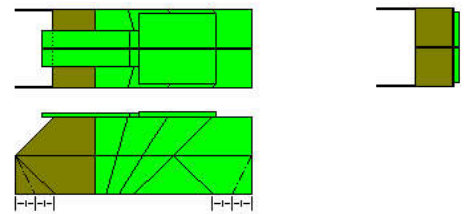

17.) Push in on the sides of the turret.

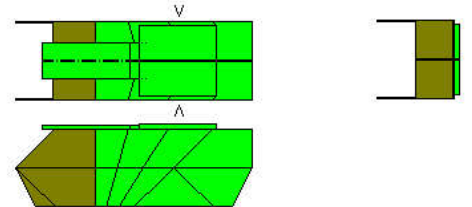

18.) Round out the barrel.

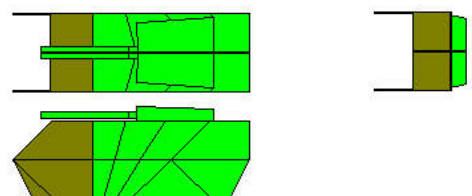

DONE !

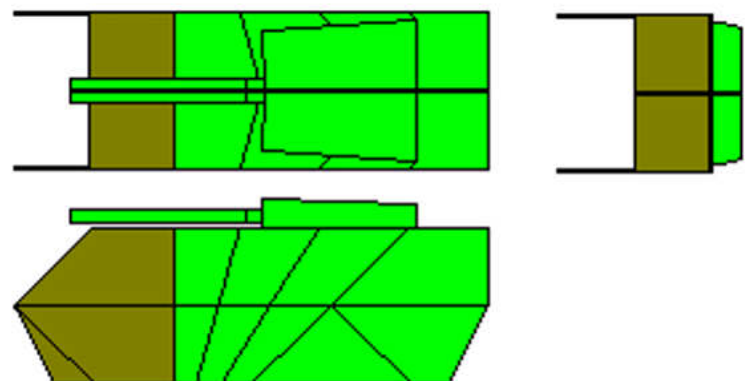

The ONE DOLLAR TANK. An just think, the army pays over a billion dollars for ONE tank. Think of how many you could fold with that kind of money!

Cut sides off  
Reinforce existing creases and then open

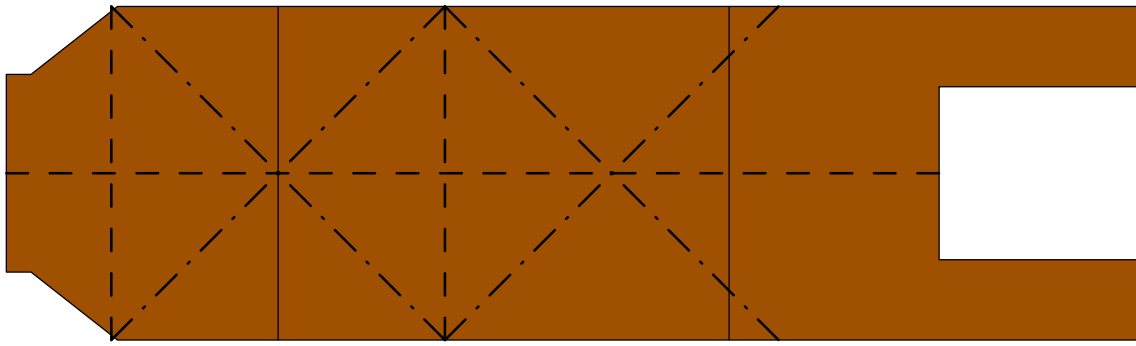

1 Only precrease

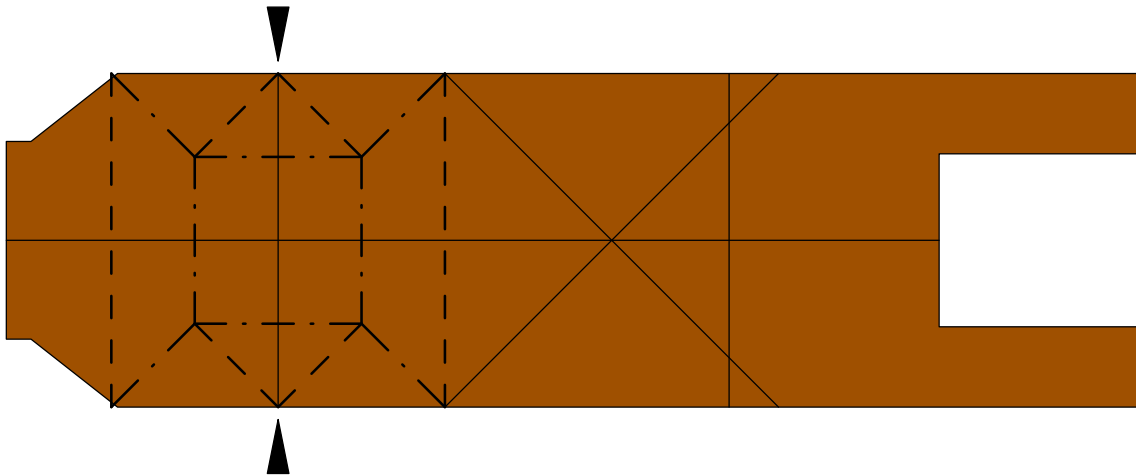

2 Make windmill base from left square

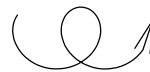
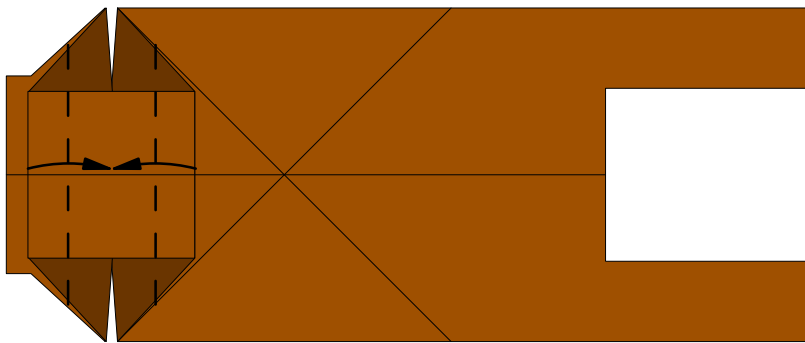

3

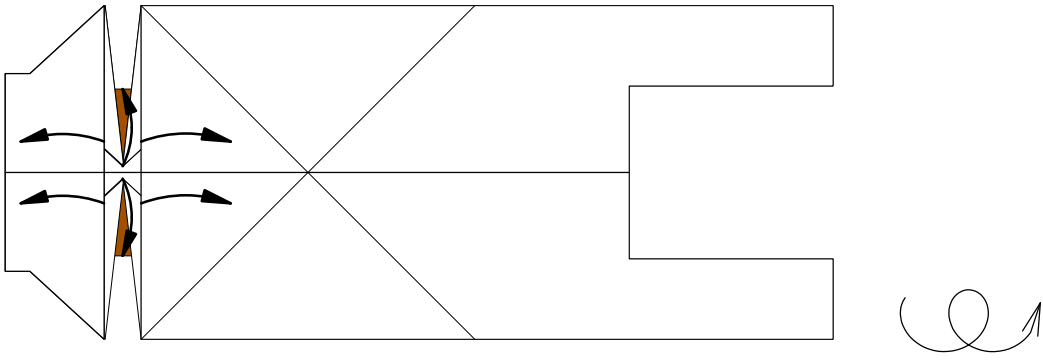

4

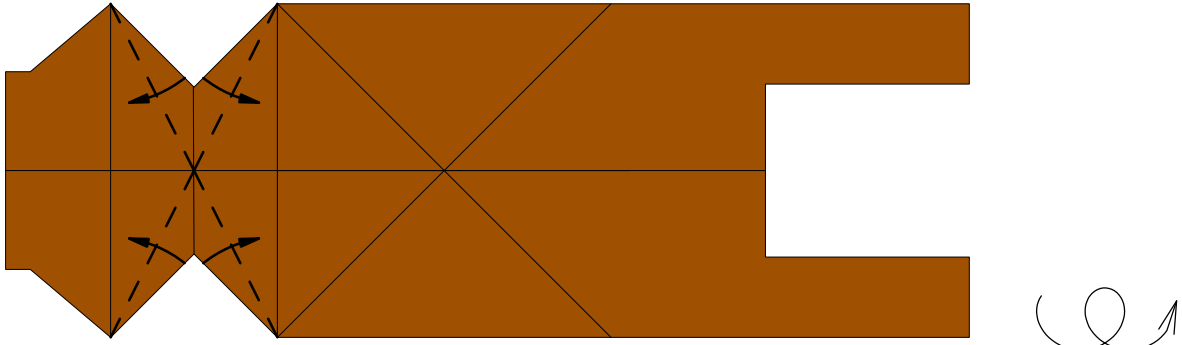

5

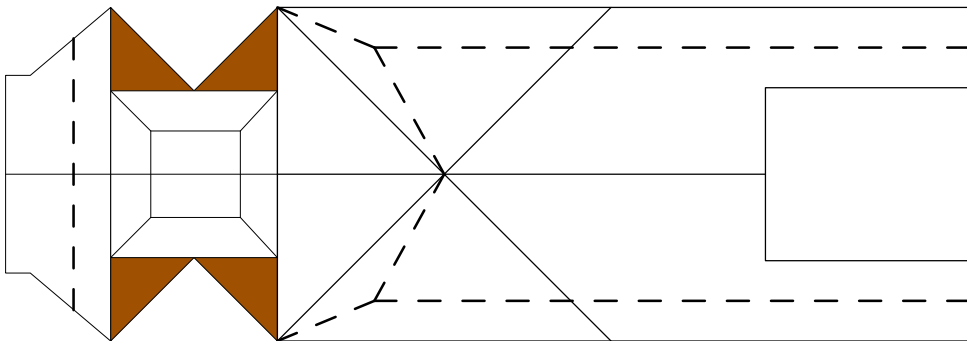

6 Precrease only

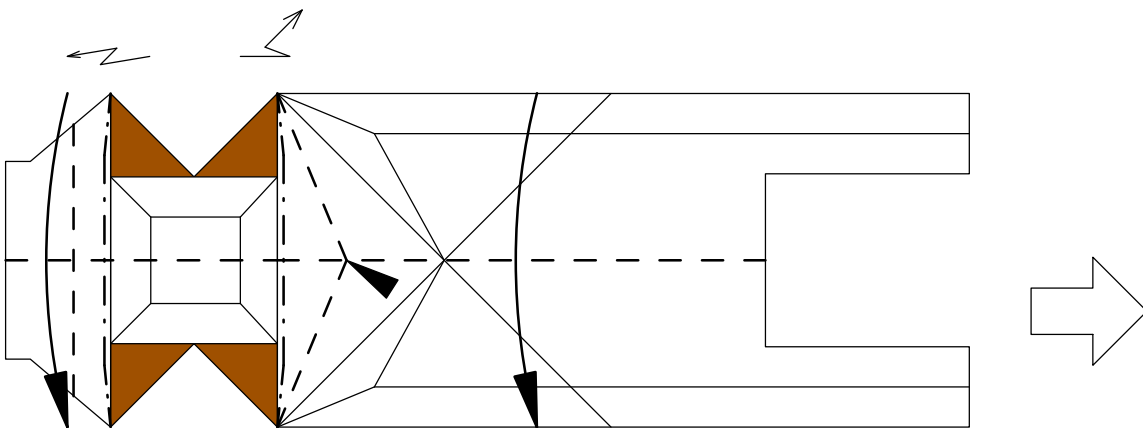

7

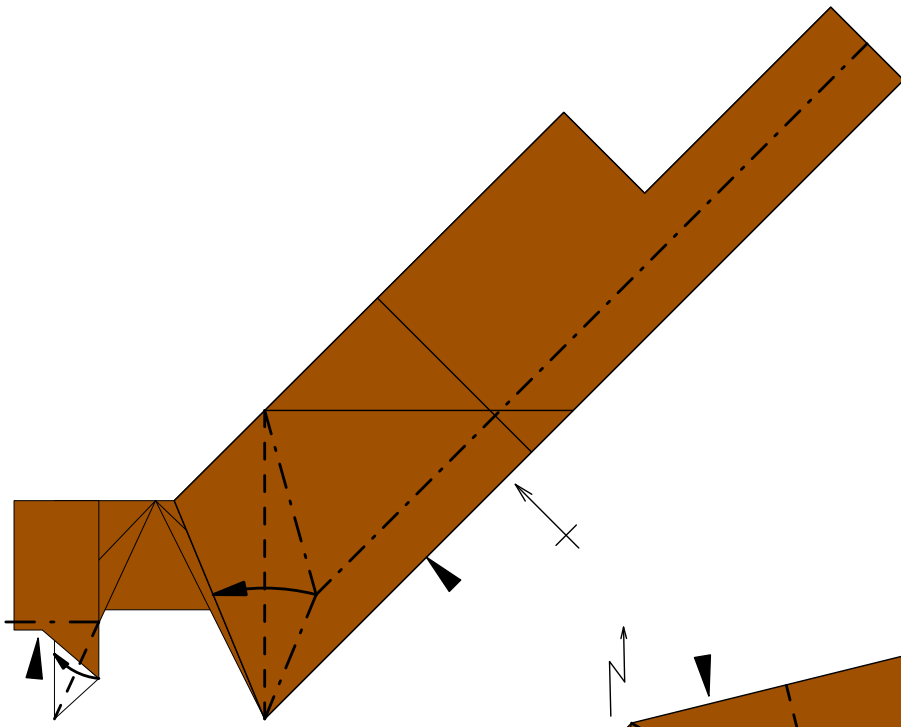

8

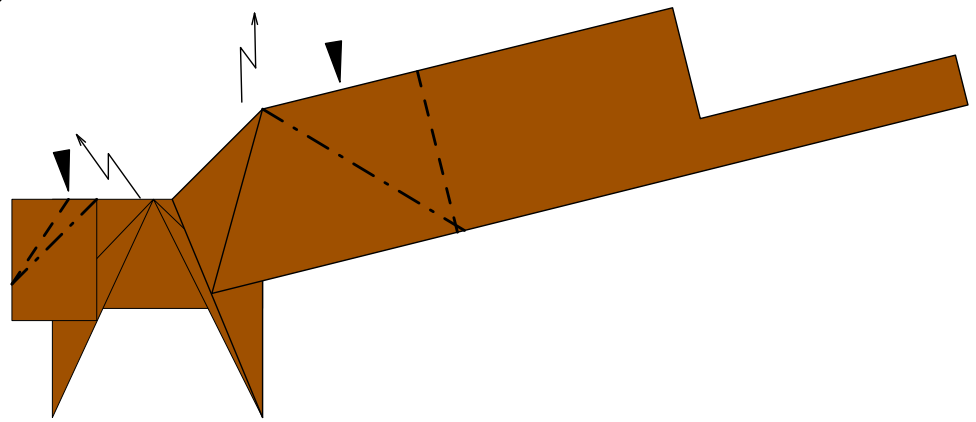

9 Sink-zigzag twice

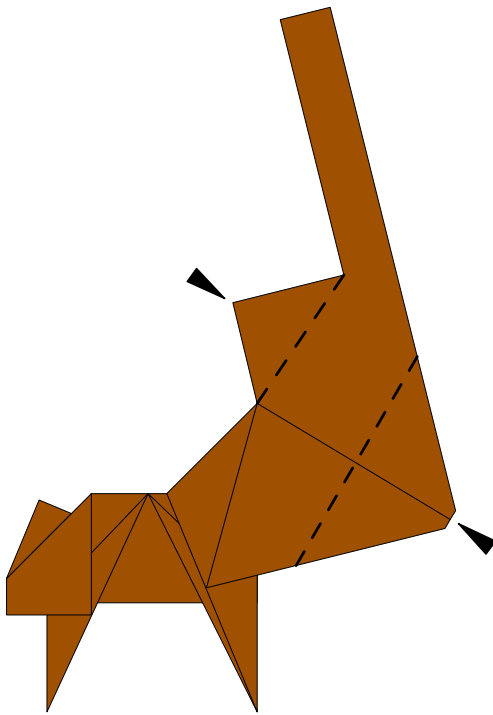

10

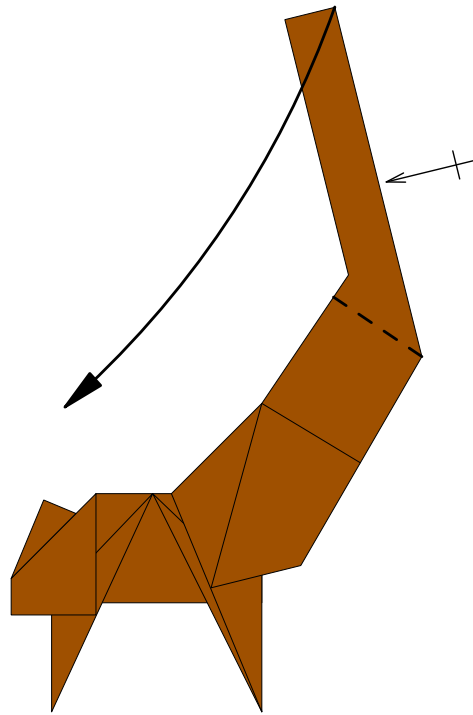

11

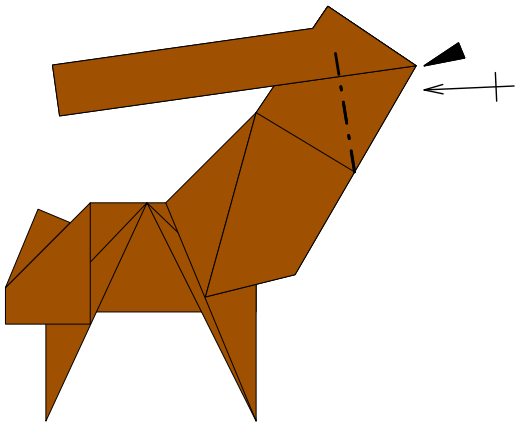

12

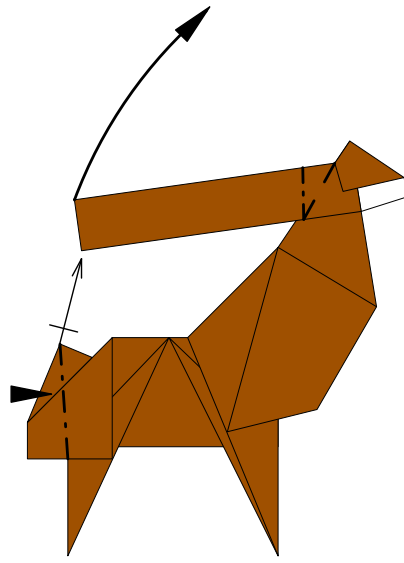

13

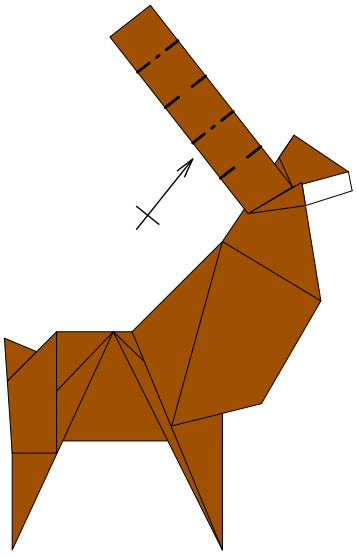

14 Zigzag antlers

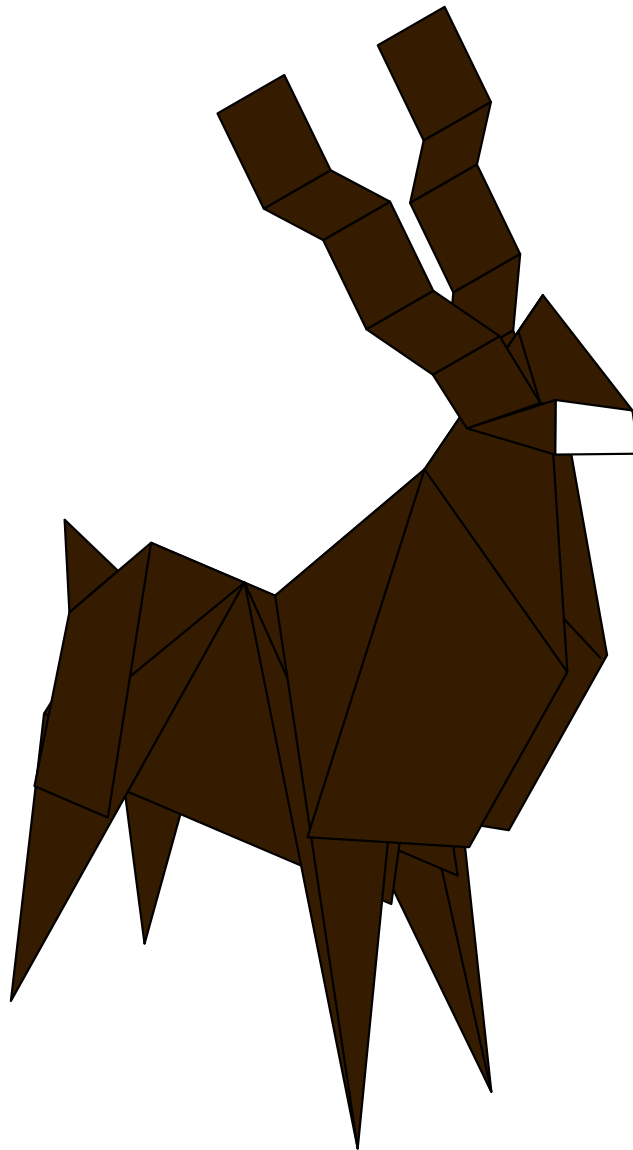

# Teddy Bear

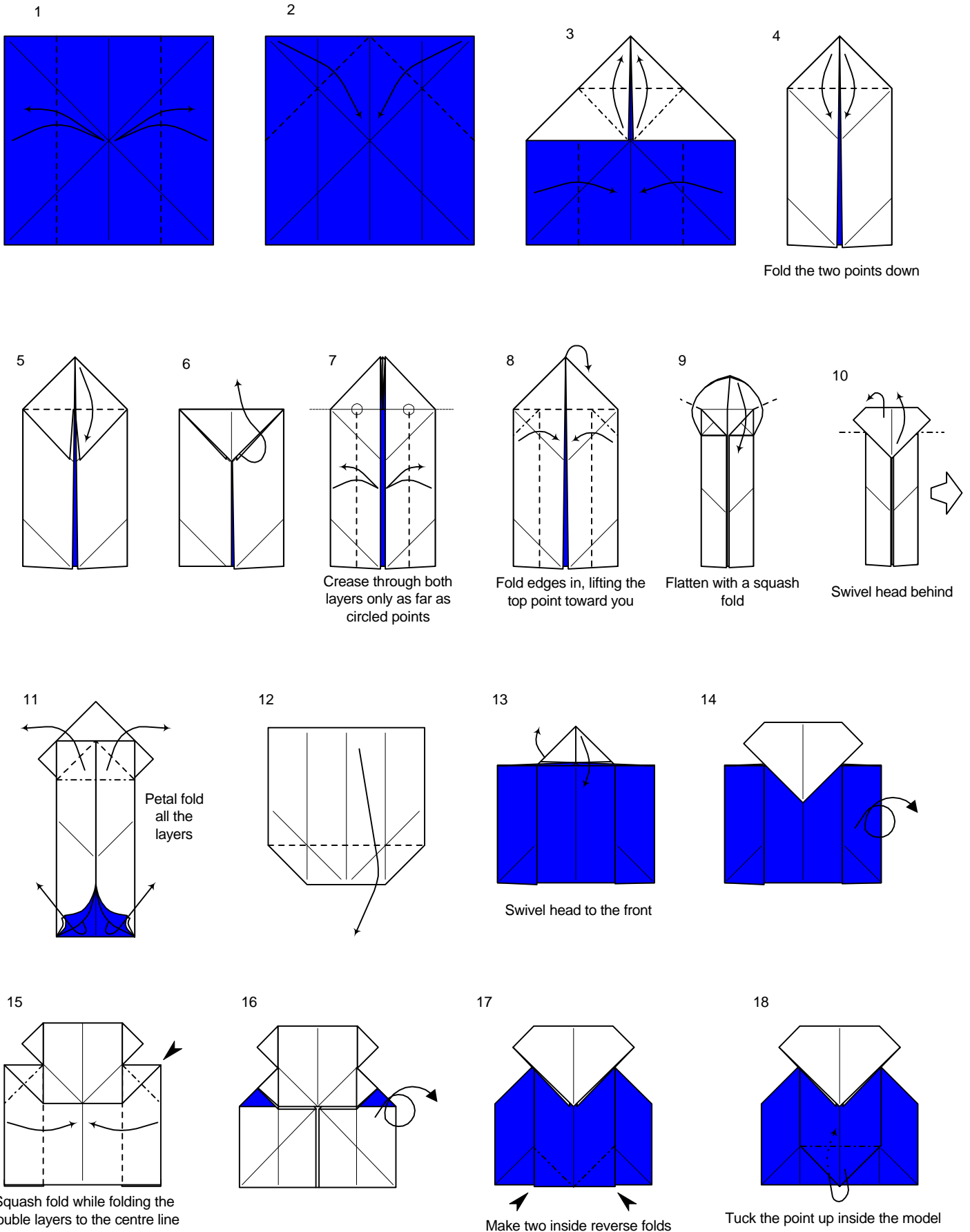

# Teddy Bear

19

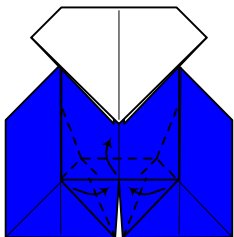

Petal fold

20

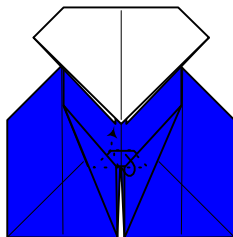

Reverse the point up inside the model

21

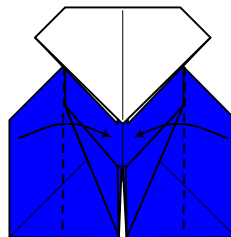

22

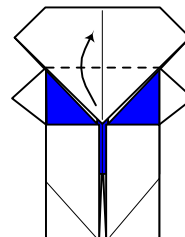

23

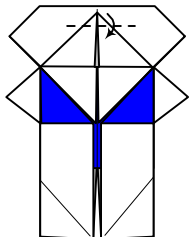

24

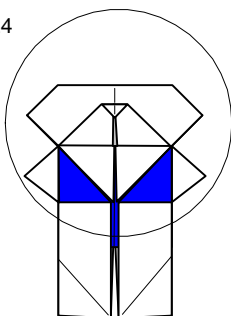

25

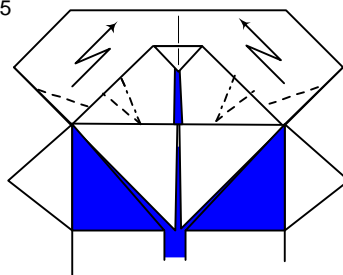

26

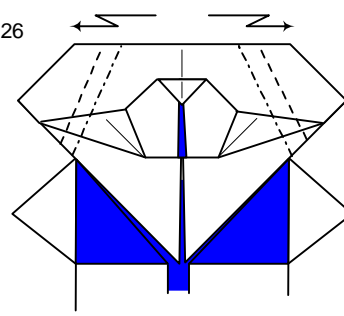

27

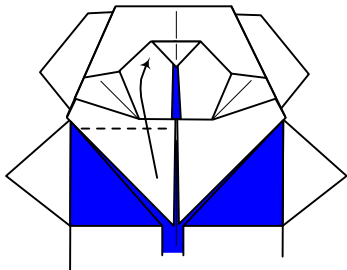

28

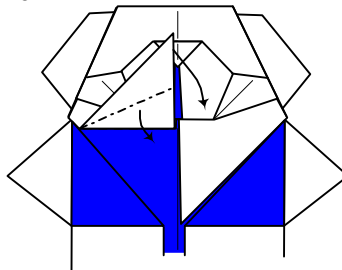

Squash fold

29

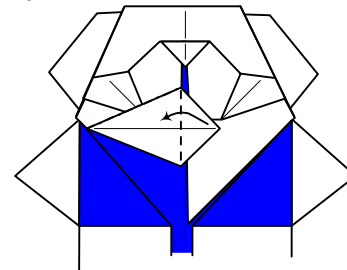

30

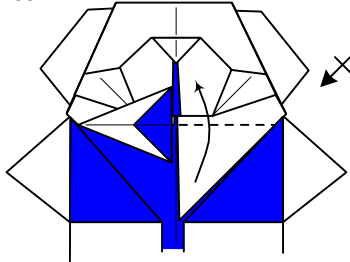

Repeat on the right side

31

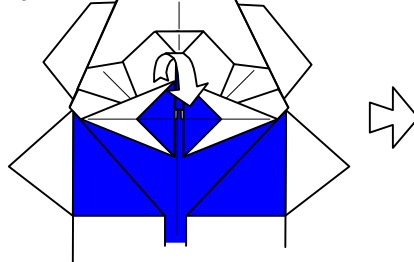

32

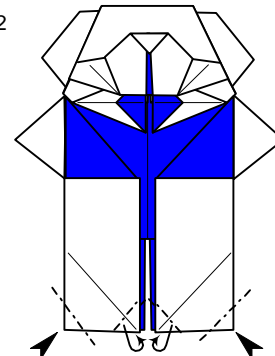

Round off the feet

33

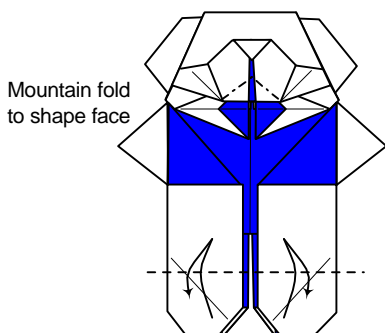

Mountain fold to shape face

34

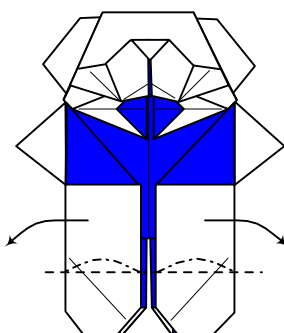

Crimp the feet while curving the body back slightly to make the legs '3D'

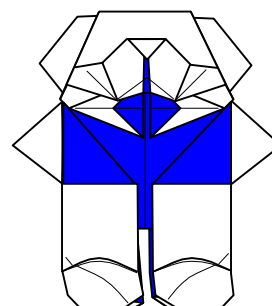



# Temate Baku

Traditional

© 2000 Jan

This model has recently been reworked by Kunihiko Kasahara from an old picture. The picture was discovered by Kunihiko in a Japanese book about architecture. It was a Japanese design for a carved wooden room decoration, showing various Origami objects.

The book dates from 1734 and thus this model is older than that.

When you have finished this modular box you may open it from any side.

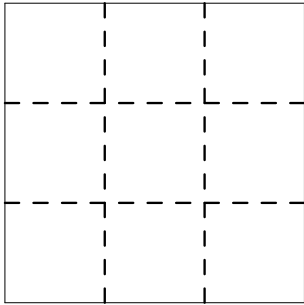

1 Divide in three in both directions

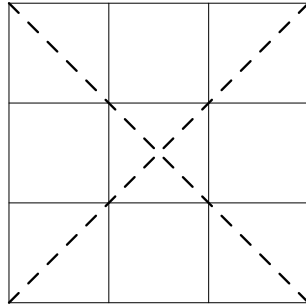

2

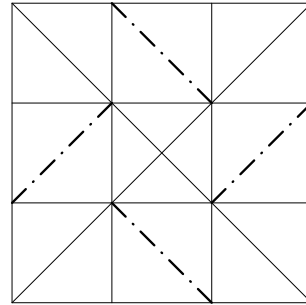

3

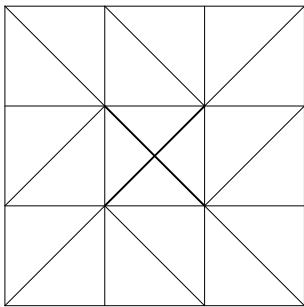

4 Cut along the bold lines (only the centre square)

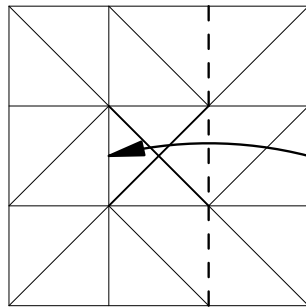

5

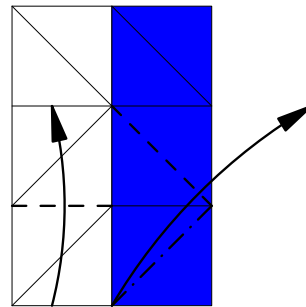

6

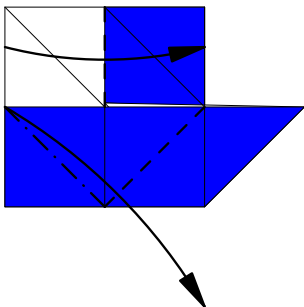

7

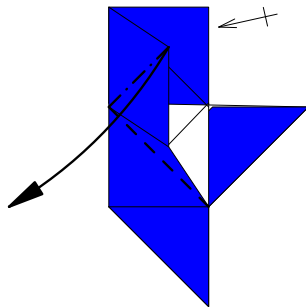

8 Repeat on third and fourth corner

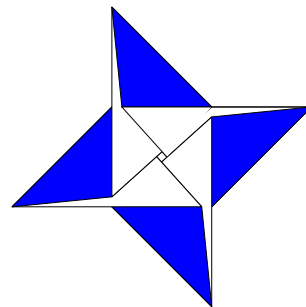

9

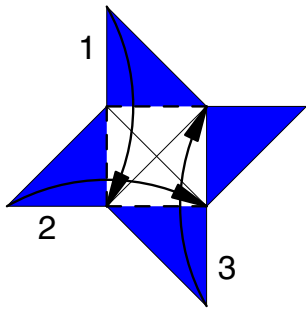

10

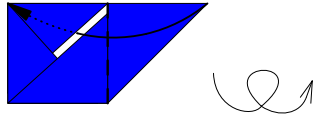

11 Put last flap under first

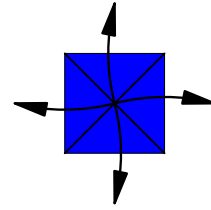

12

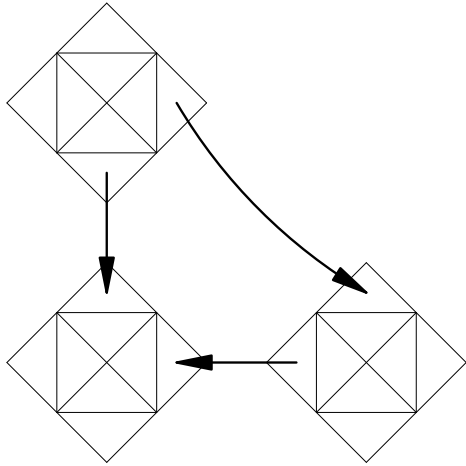

13 Make six units and make a cube by glueing the outer triangles together pairwise. Finally fold the triangles under the flaps.

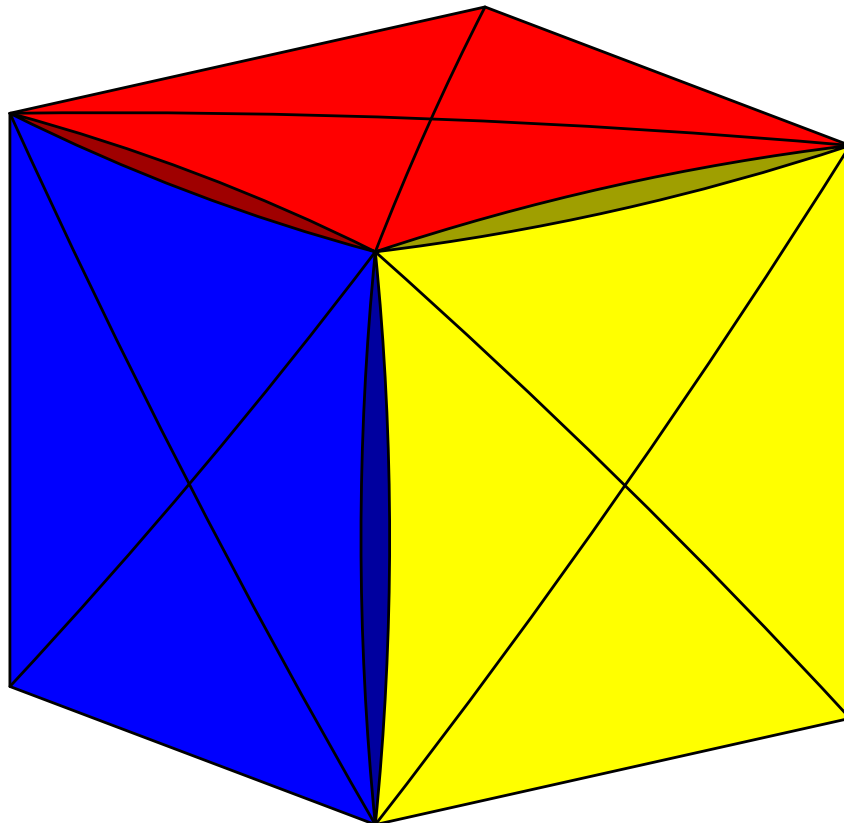

# \$ Tetrahedron

Copyright 1998 Stephen Hecht. All Rights Reserved

A dollar bill (66mm x 157mm) produces a model 38mm on a side.

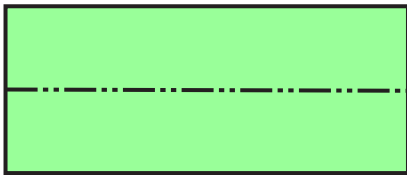

1. Either side up.  
Mountain crease bisector.

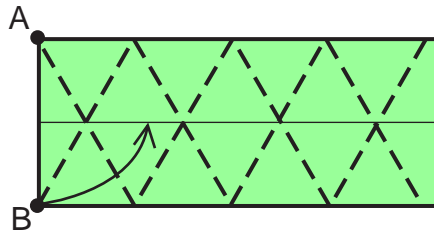

2. Pivoting on A, bring B to horizontal crease. Repeat symmetrically. Propagate 60-degree valley creases, for a total of 8 creases.

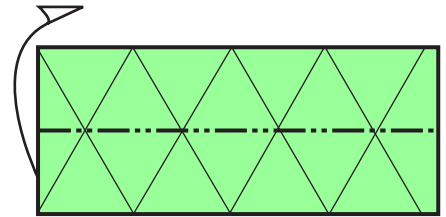

3. Swing behind.

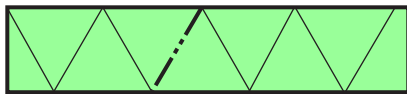

4. Reverse-fold.  
Rotate 60 degrees.

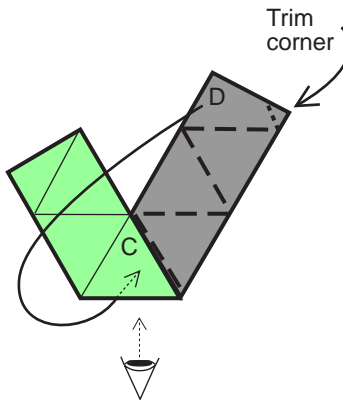

5. Triangle C will be the base of the tetrahedron. All valley folds are 120-degree planar angles. Tuck D into pocket at bottom edge of C.

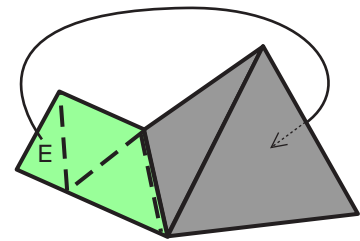

6. Model is now 3-D.  
Wrap around with 120-degree planar valley folds, and tuck E into pocket on right side of front face.

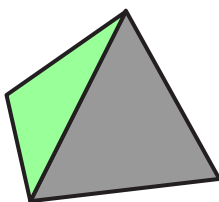

7. Done.  
There are 2 pockets you could have tucked E into. The one in the front face covers the seam, but locks loosely. The one in the right face makes a tighter lock, but leaves the seam visible.

# Throw Your Heart Away!

By Perry Bailey © 2000

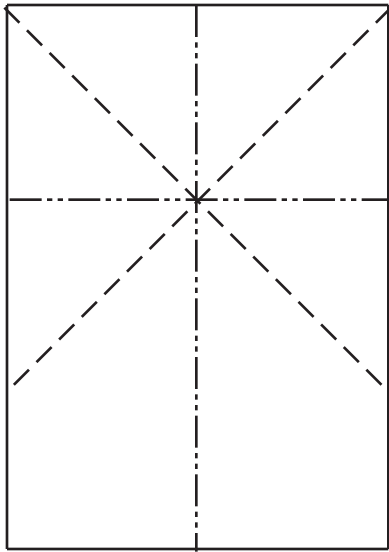

1. Precrease an A sized piece of paper with a water bomb base at the top. This seems to work best with light weight paper, turn over,

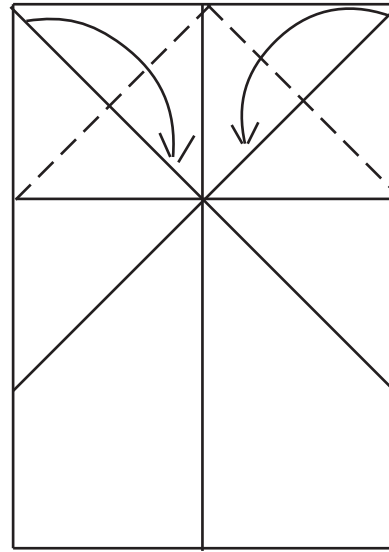
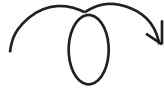

2. fold the corners to the center on the top. Then turn over the model.

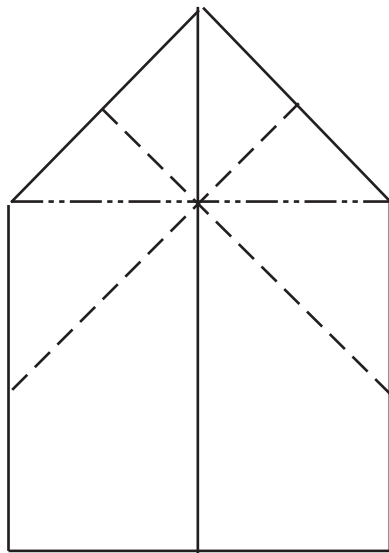
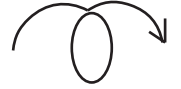

3. Fold the top of the model into a water bomb base.

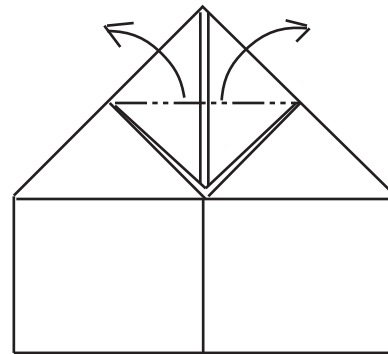

4. Swivel fold out the two sides at the top of the model.

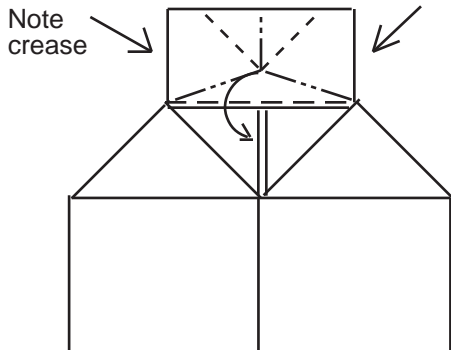

5. This looks harder than it is, really you are doing 2 swivel folds. Use the crease created in step 4 as a guide, it will come in along the center edge of the model.

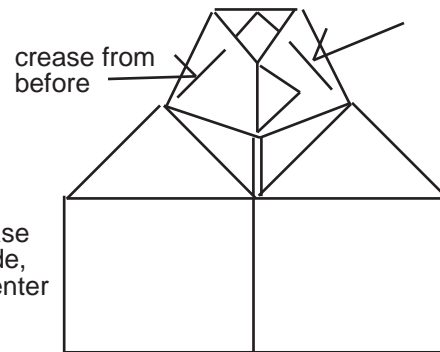

6. this is how it should appear at this time. In the next figure I will enlarge the picture.

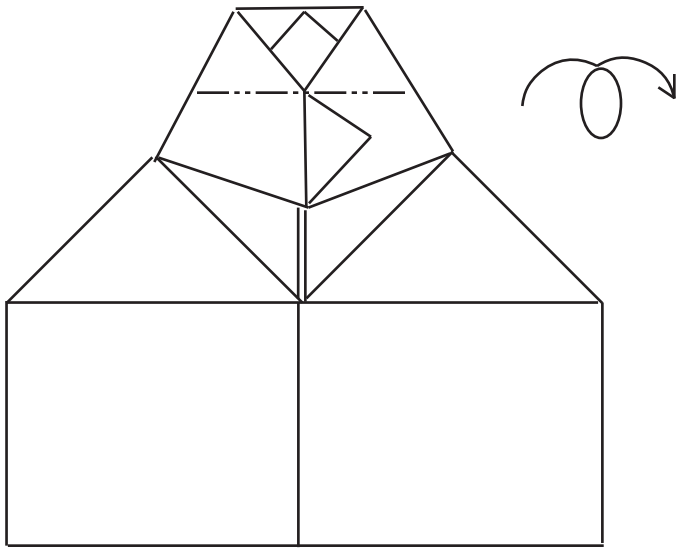

7. Mountain fold the entire top of the model back at the point of the triangle. Turn the model over.

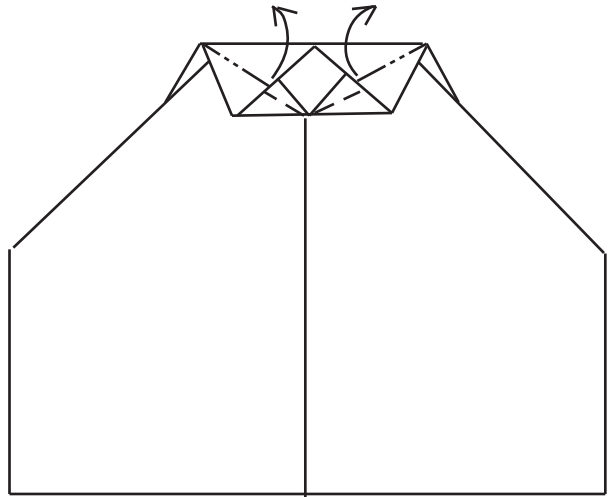

8. Swivel fold up both sides as far upwards as you can.

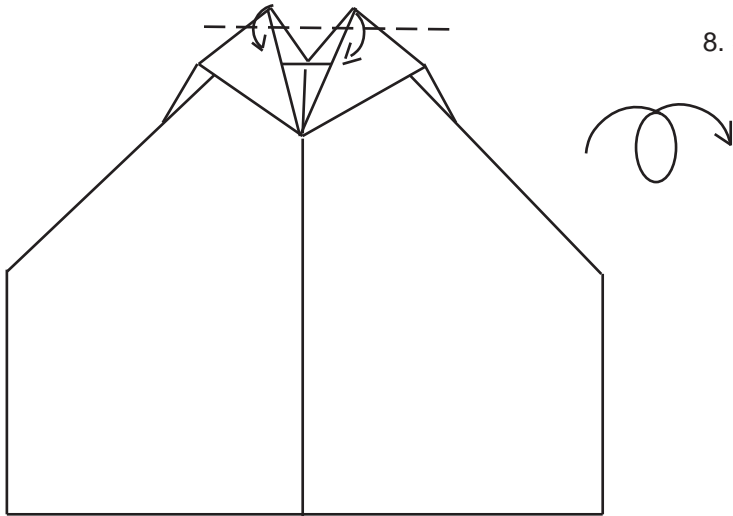

9. Fold the tip of the point down to round out the heart. turn the model back over.

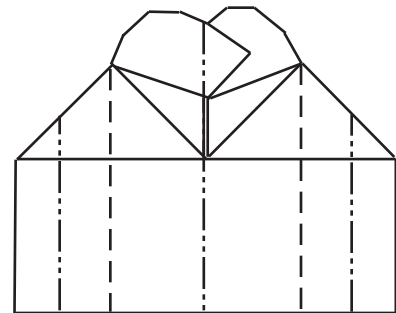

10. crese the model like shown.

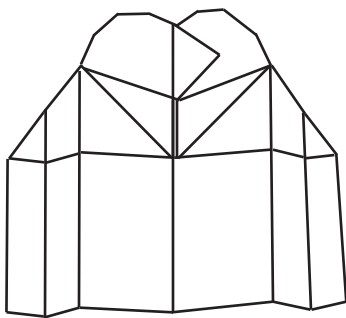

11. Note don't crese it to tightly!

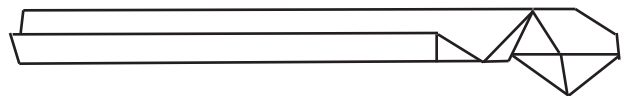

12. Note that in the folding you created a handle to hold the plane by to throw it!  
Now you can throw your heart away!  
Will it come back or will it keep on going?

# Throwing Star (traditional?)

Diagrammed by  
Robert Hudson

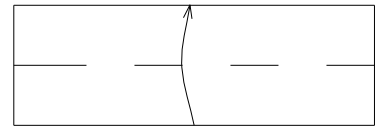
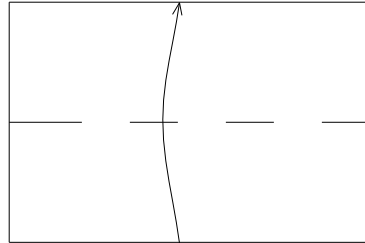
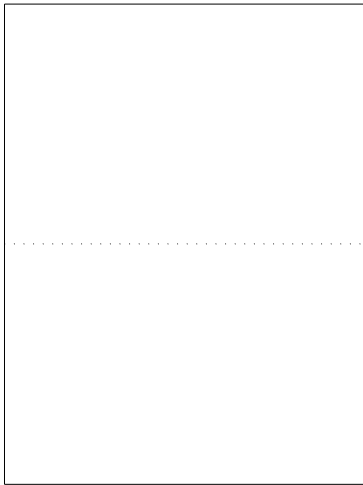

Begin by cutting an  
8.5x11" sheet of  
notebook paper in half.

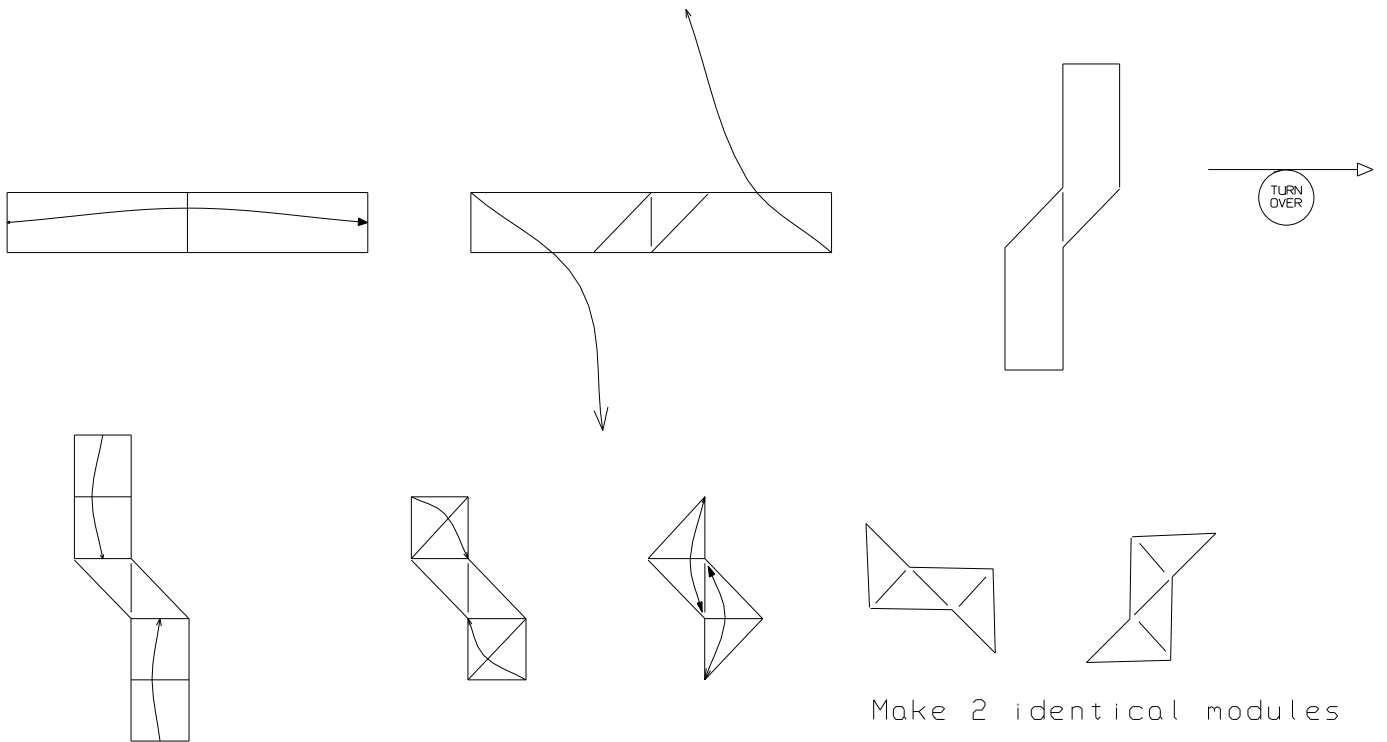

Make 2 identical modules  
Place one on top of other

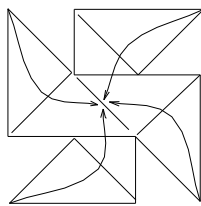

Fold 4 corners in and  
interlock at center.

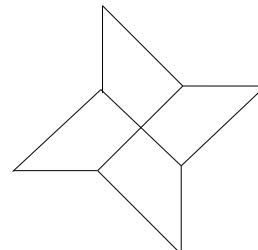

Completed Throwing Star

To draw blood, insert  
needles at 4 points and  
toss at unsuspecting sibling

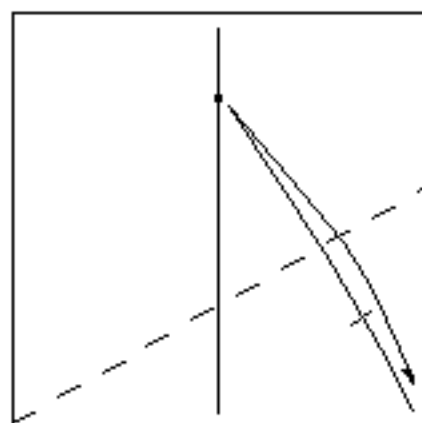

Colour down

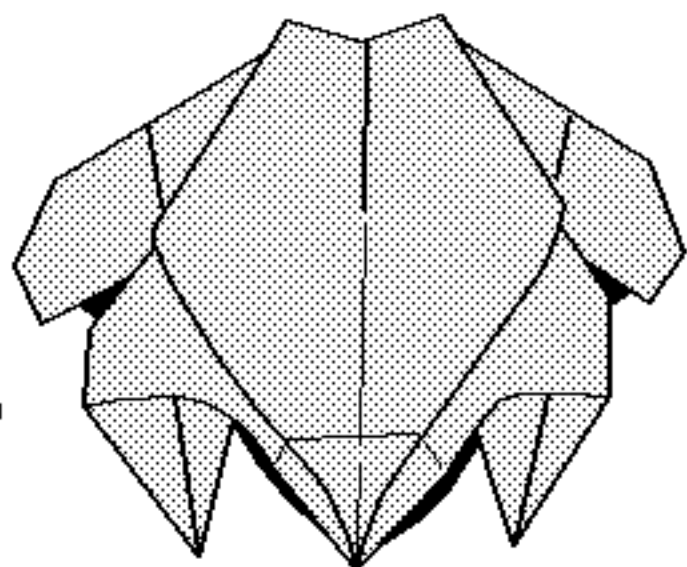
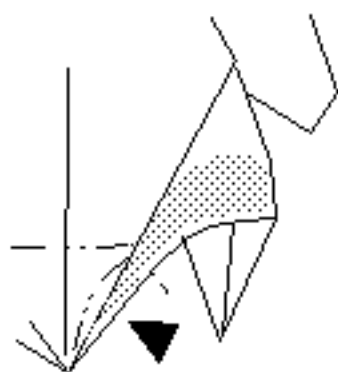
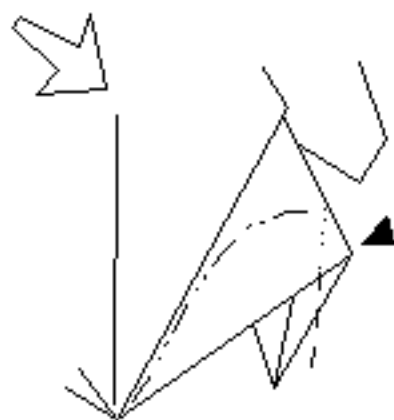
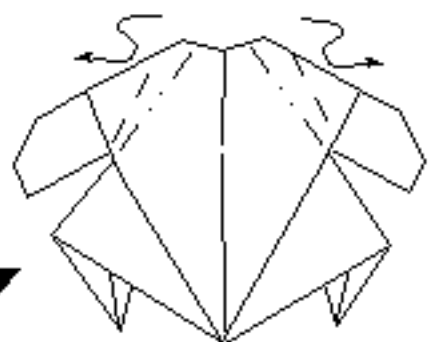
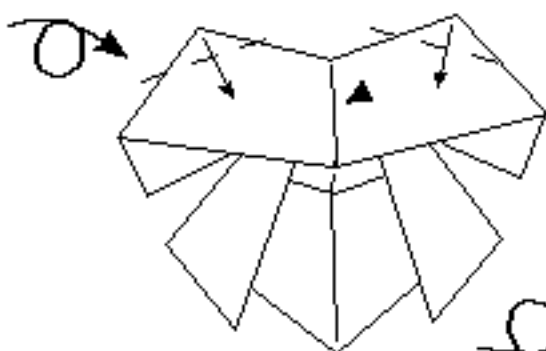
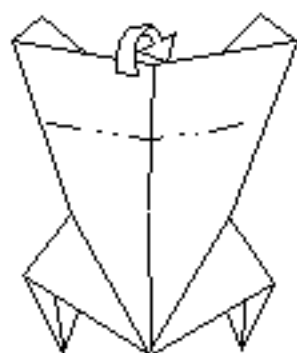
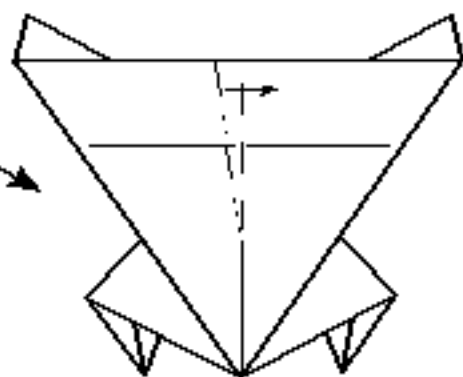
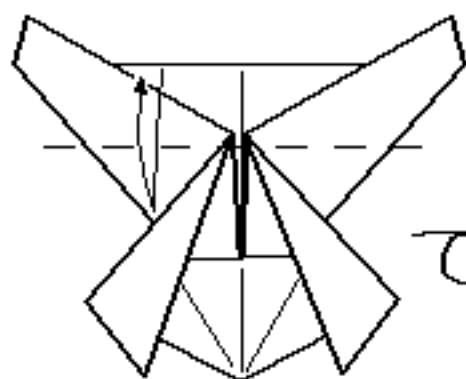
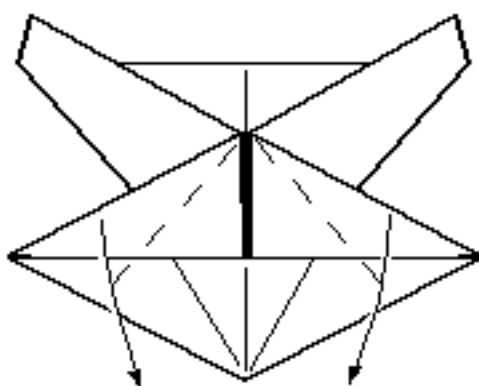
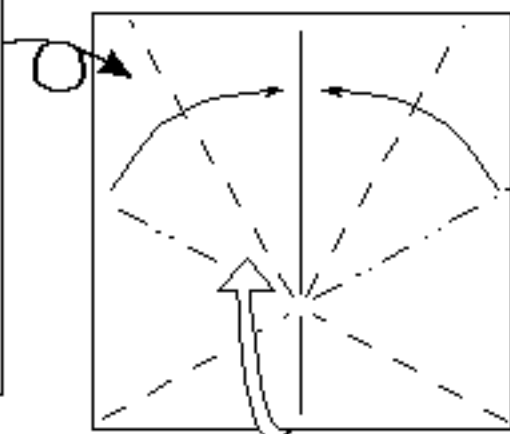
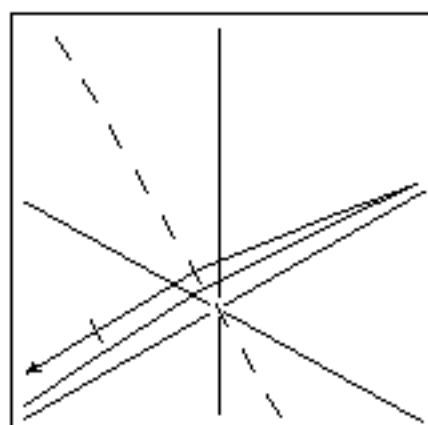

# Toad

©Nick Robinson 94

The Toad should be wet-folded, make all folds as gently as possible.

# Cartoon Dragon

By Perry Bailey © 1999

①

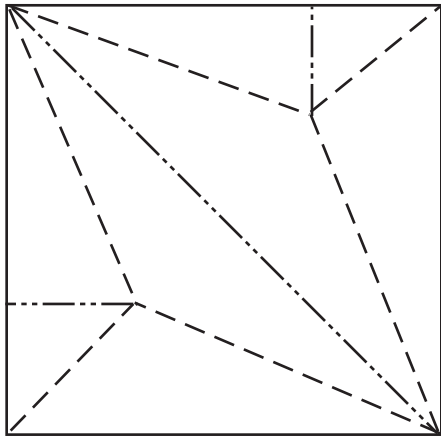

Fold into the fish base, as seen in next diagram.

②

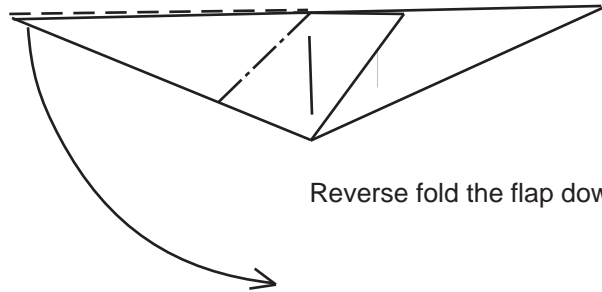

Reverse fold the flap down.

Make another inside crimp.

④

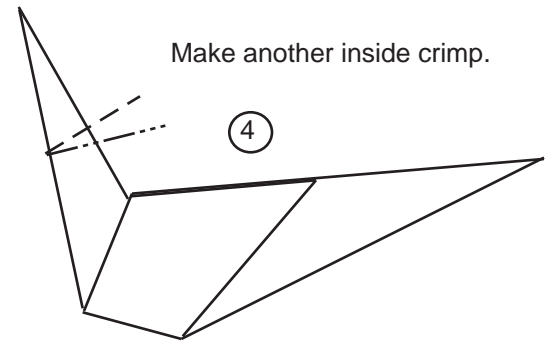

Note the first fold should have been centered to the bottom point of the model as shown. Reverse fold the flap back up.

③

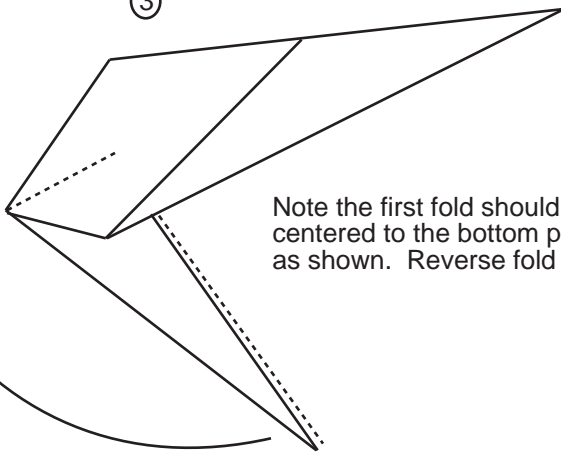

⑤

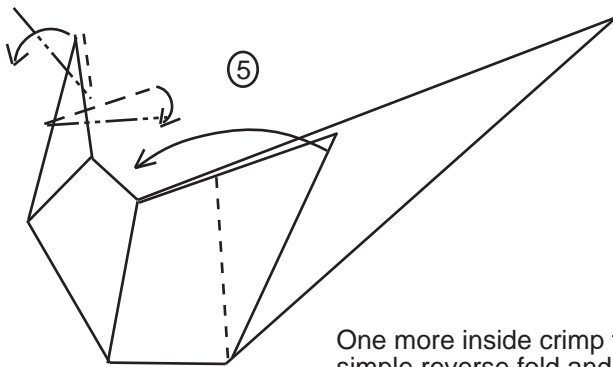

One more inside crimp fold and a simple reverse fold and the tail is complete. Valley fold the flaps back a little more than half way to make the wings for your dragon.

⑥

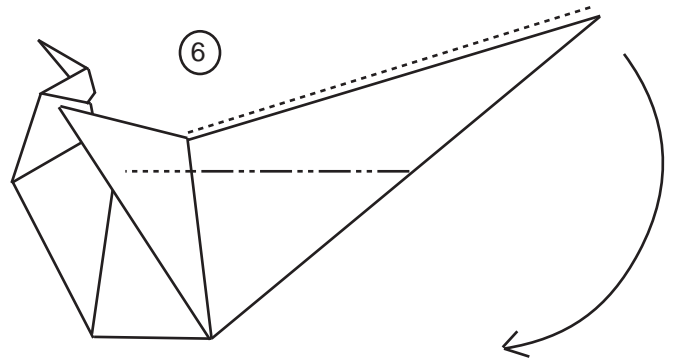

Note that on this reverse fold you are folding the down so that the top of the fold is parallel to the bottom of the model.



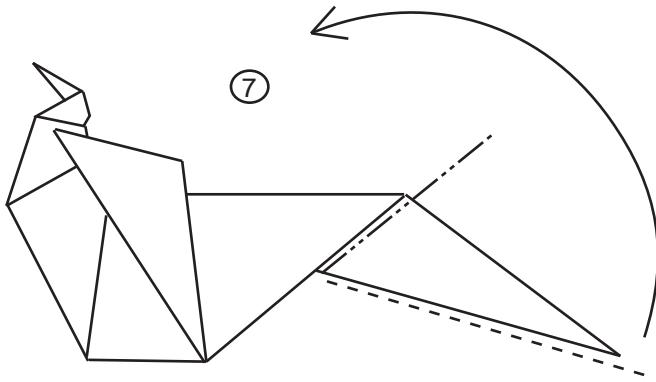

Reverse fold the flap back into the model even with the edge of the body.

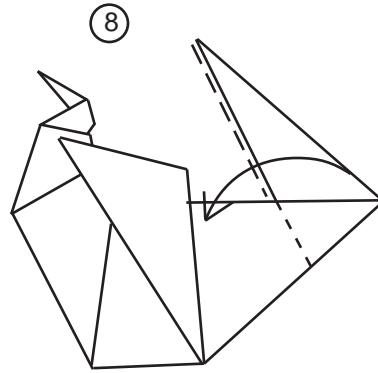

Valley fold both sides of the model back as far as it will go.

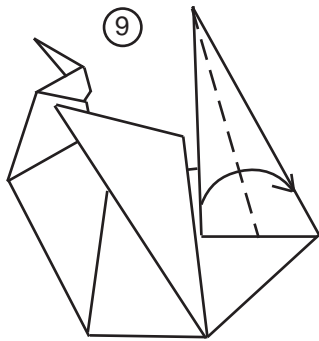

Valley fold the top layer on both sides over so it matches the front edge.

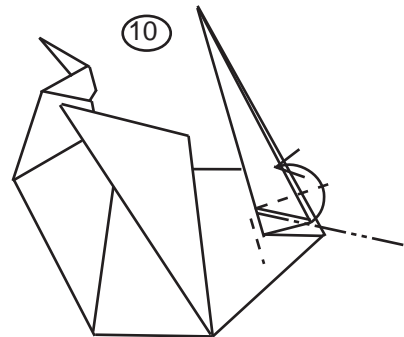

You should have a little triangle of paper where it is thicker, showing. Fold up along its edges a rabbits ear fold.

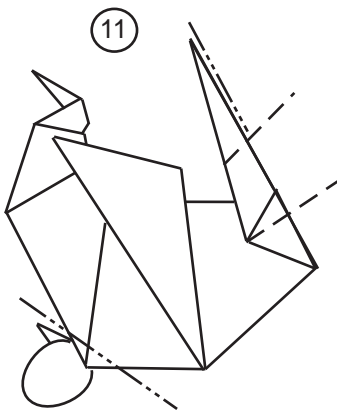

Mountain fold a little of the bottom corner of the dragons belly in to make it a little rounder. Then valley fold down the small flaps you made with the rabbits ear to make the dragons arms. Outside reverse fold the head.

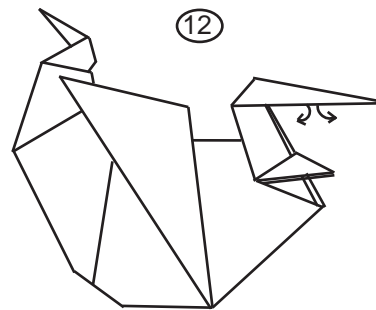

Reach up inside of the head and pull out the trapped layer to make the head larger.

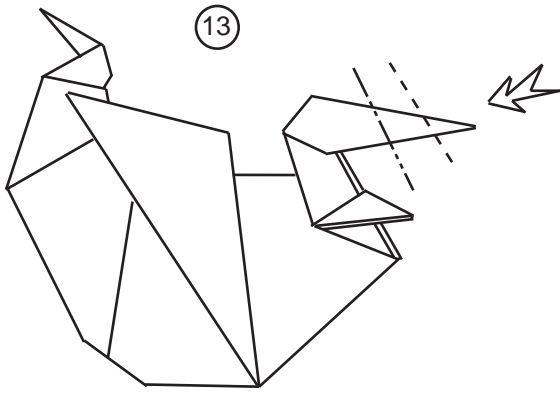

A simple set of reverse folds to form the face and lower jaw.

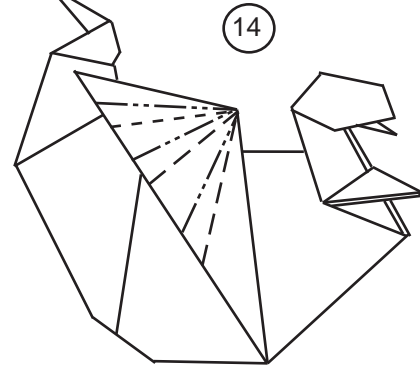

All that is left is to pleat the wings!

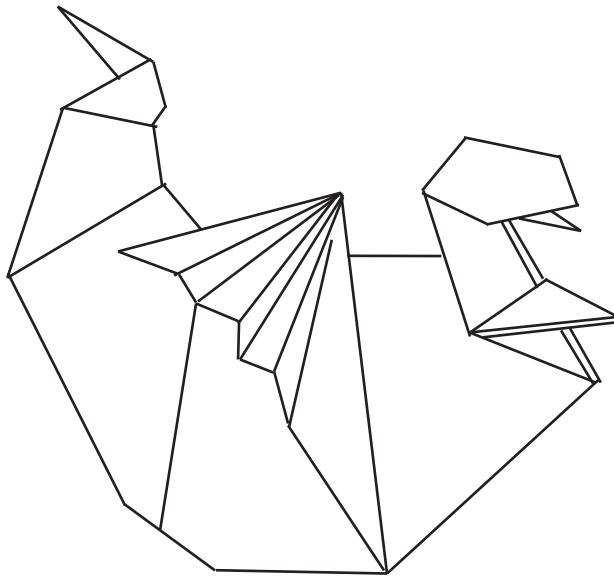

And Voila! A dragon simple enough to teach to children! And it only took me two years of fumbling for it to find it! Enjoy!!!!

# Totoro

1

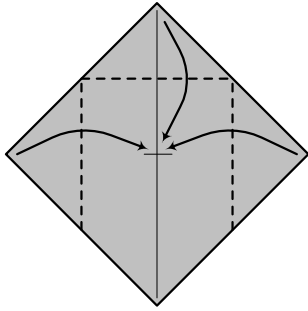

2

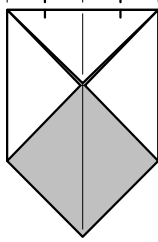

3

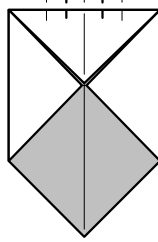

4

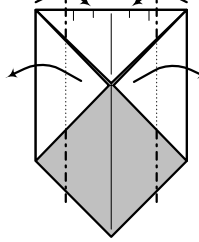

5

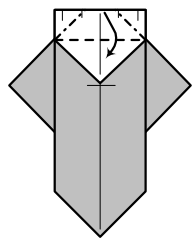

6

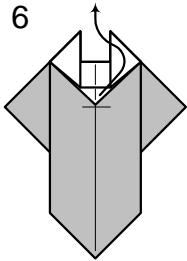

7

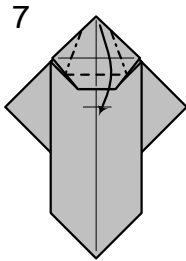

8

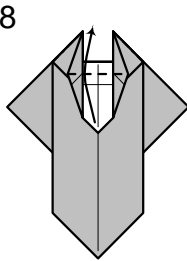

9

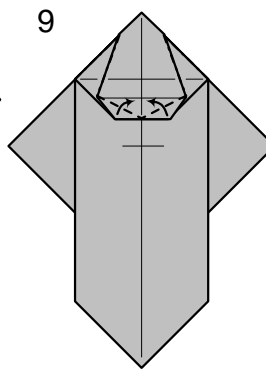

10

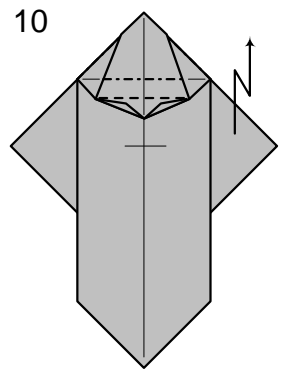

Unfold model and reform on existing creases, bringing the trapped paper to the front

Petal fold

11

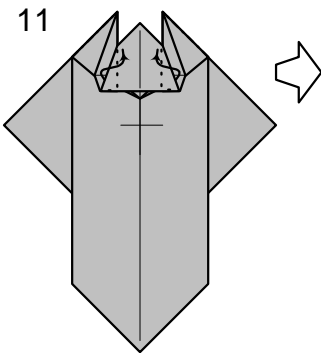

12

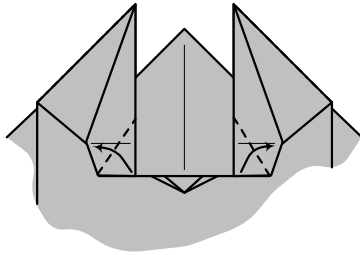

13

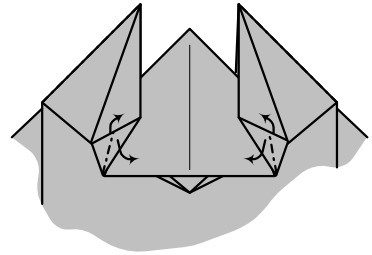

Bring raw edges to the front

14

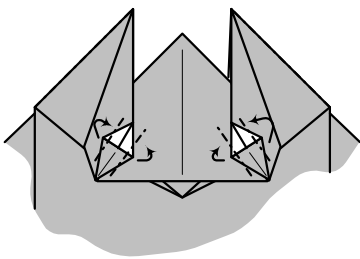

15

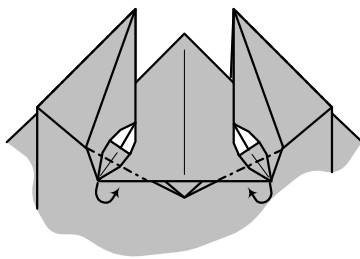

16

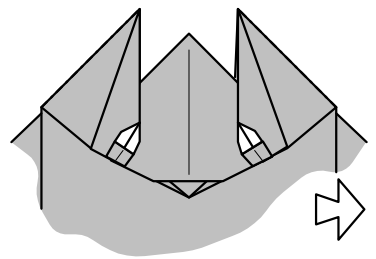

17

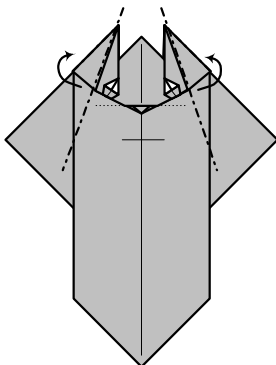

18

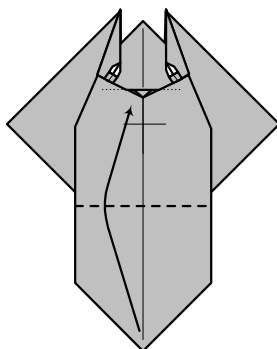

19

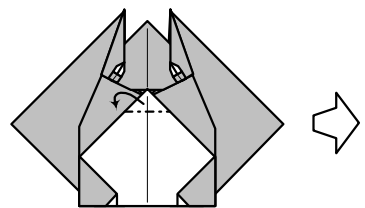

# Totoro

20

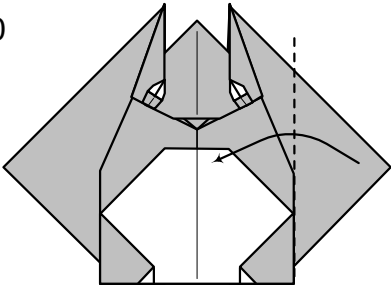

21

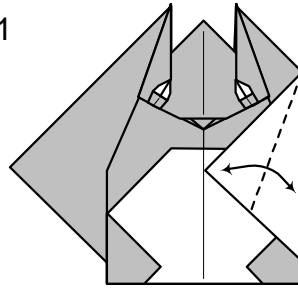

22

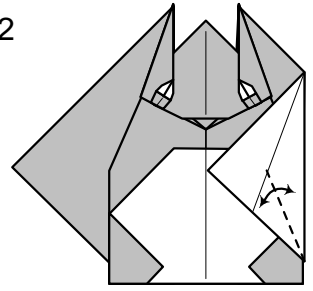

23

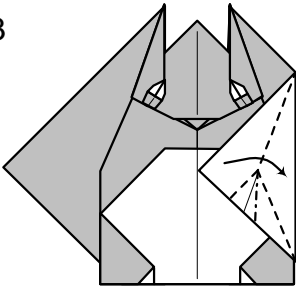

24

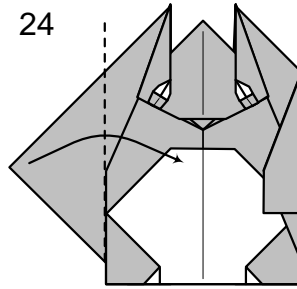

25

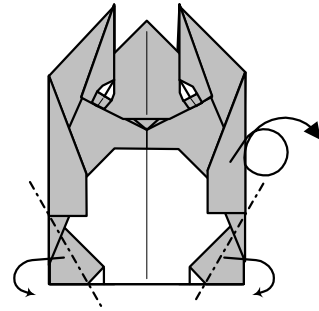

Repeat steps 20-23 on left side

26

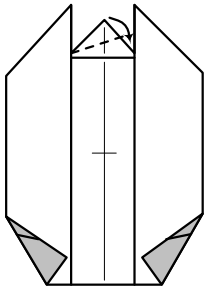

27

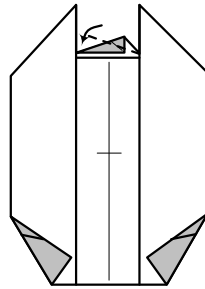

28

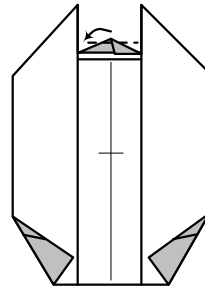

29

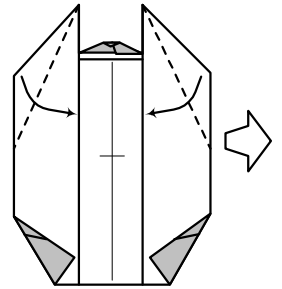

30

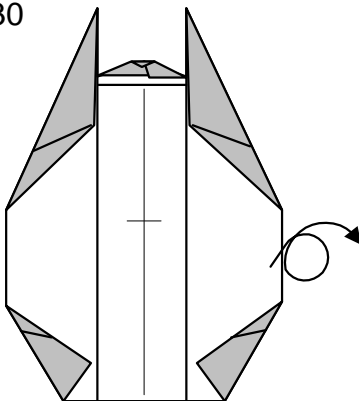

31

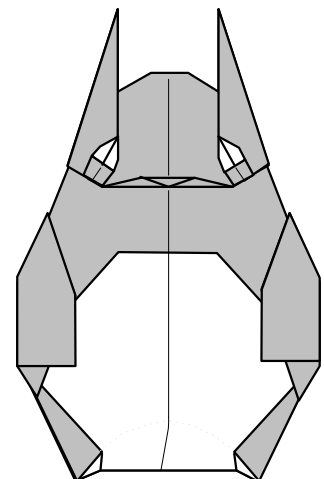
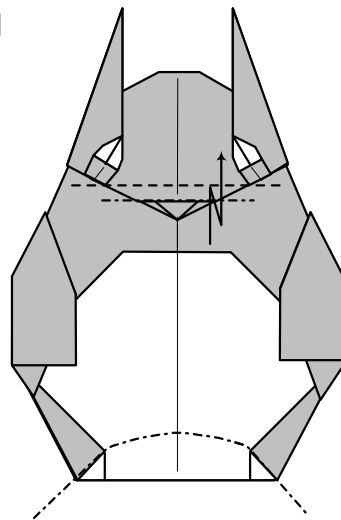

# Toucan

(Family Ramphastidae)

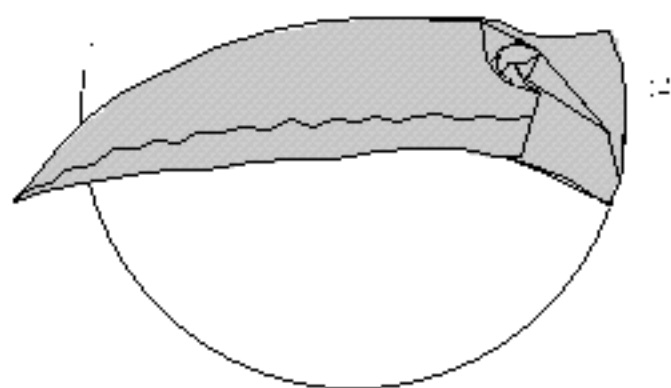
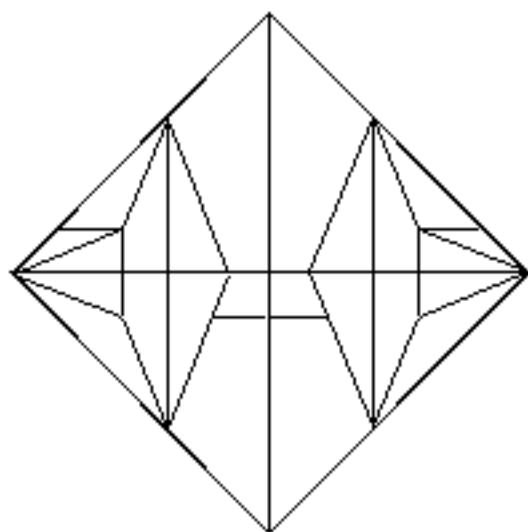

Foil-backed paper makes the final sculpturing easier. Begin with the white side up.

1

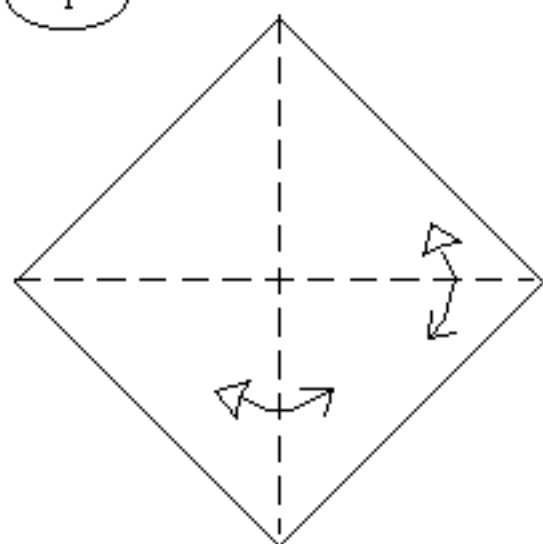

Fold and unfold.

2

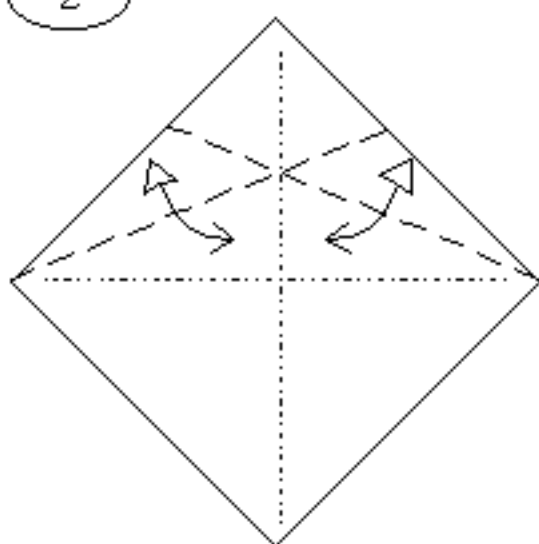

3

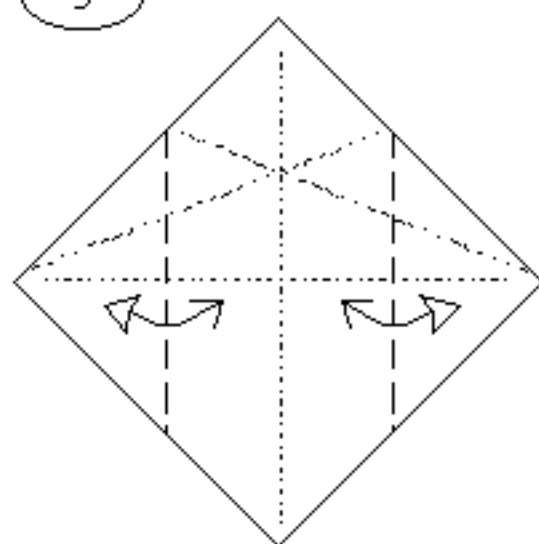

4

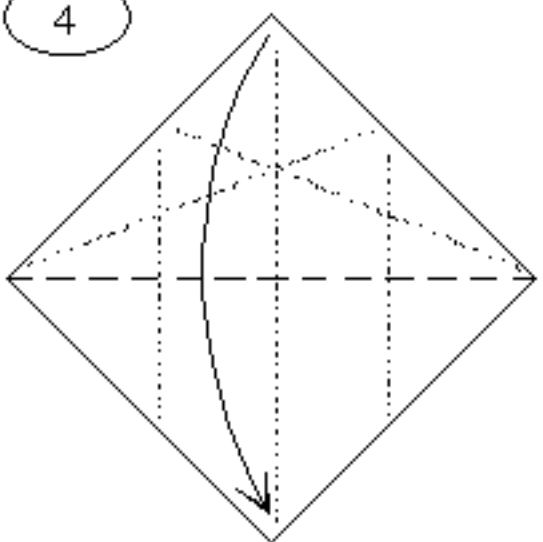

5

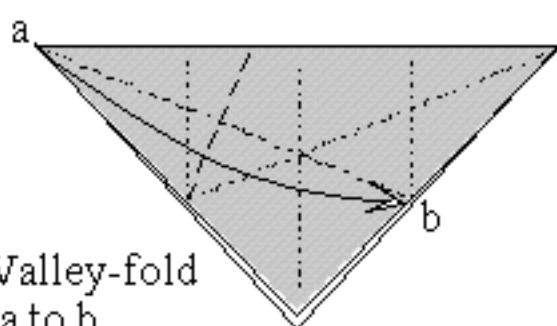

Valley-fold  
a to b.

6

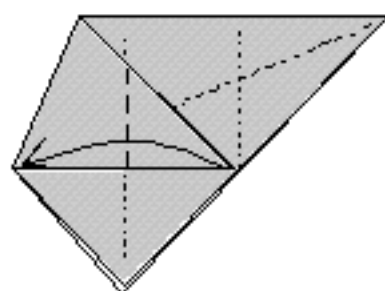

7

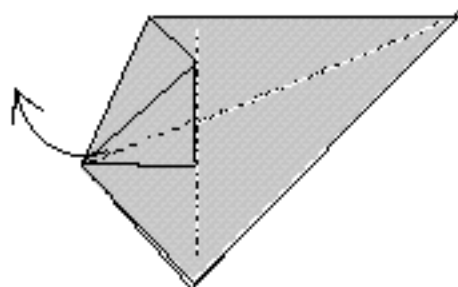

Unfold.

8

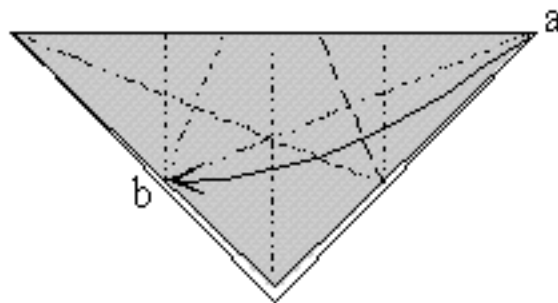

Repeat steps 5-7  
on the right.

9

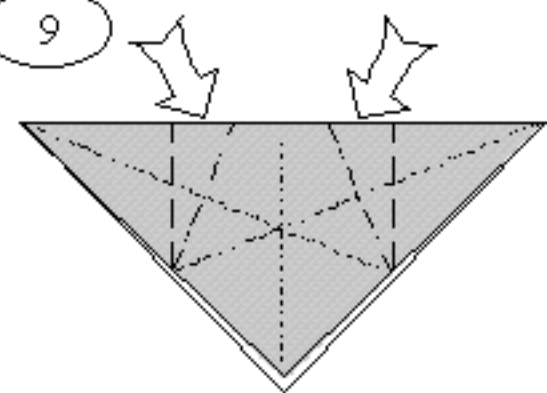

Crimp both sides.

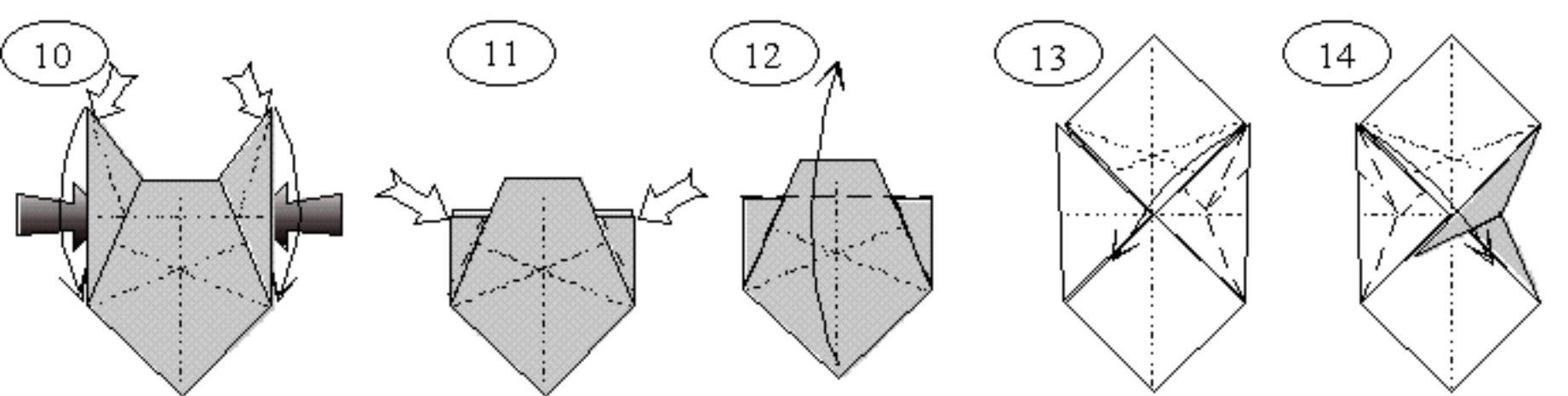

Reverse-fold down.

Reverse-fold the nearest edges inside.

Valley-fold up as far as possible.

Make a combination of rabbit-ear and swivel-fold.

Repeat on the left.

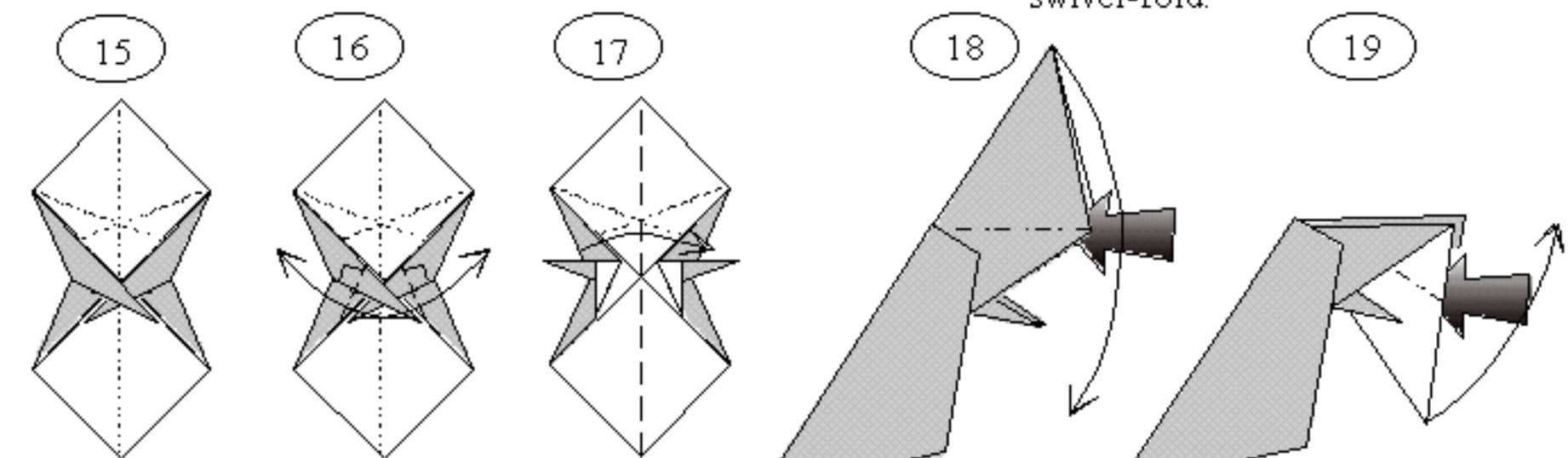

Like this.

Valley-fold the legs to each side. The lower edge becomes horizontal.

Reverse-fold. The lower left edge makes a right angle with the bottom of the wing.

Reverse-fold up, making an angle bisector.

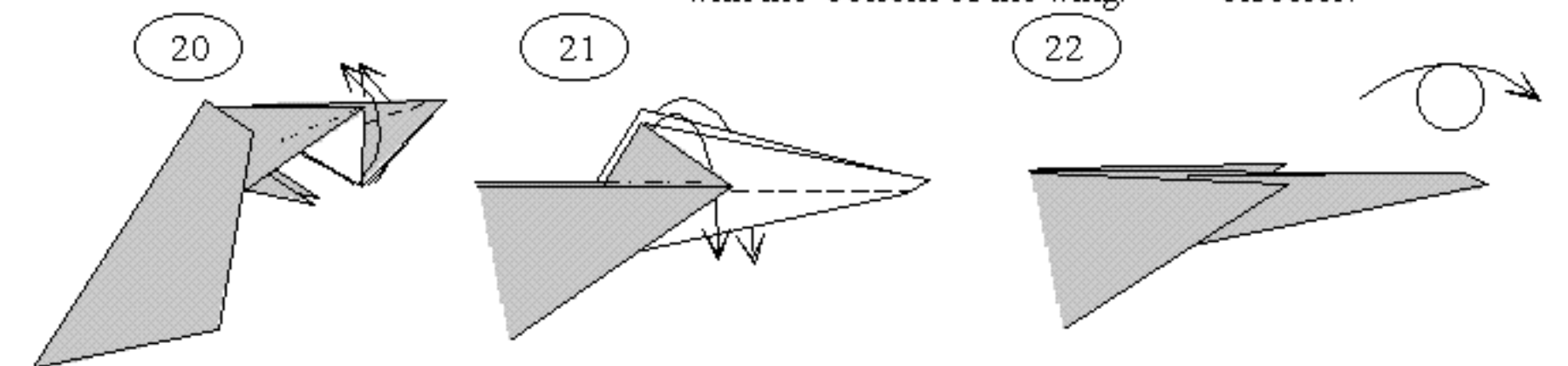

Reverse-fold up about 2/3. Note that there's a small outside-reverse-fold on the tip.

Reverse-fold down (another outside-reverse-fold on the tip of the tail).

Finished tail. Turn the paper over.

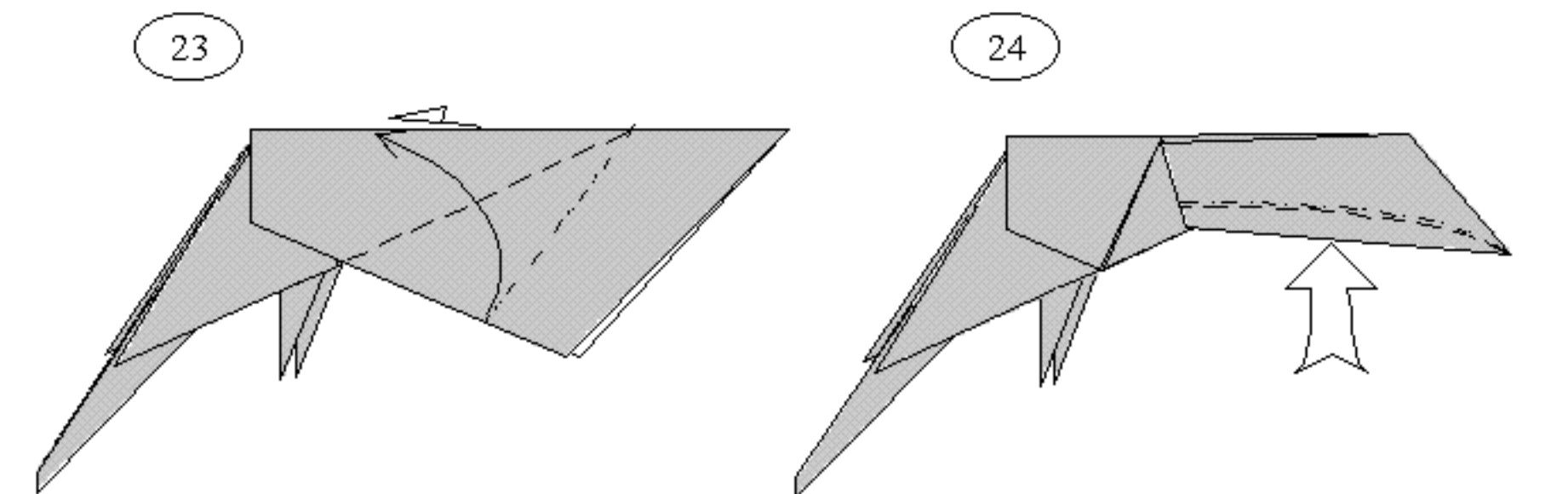

Crimp.

Make a curved pleat. Repeat behind.

25

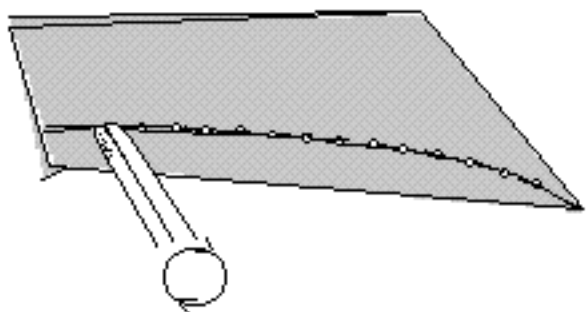

Use a pair of tweezers to make the edge of the bill jagged.

26

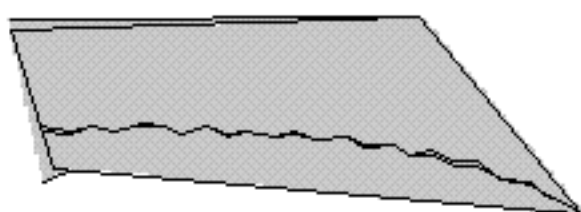

Like this. Repeat behind.

27

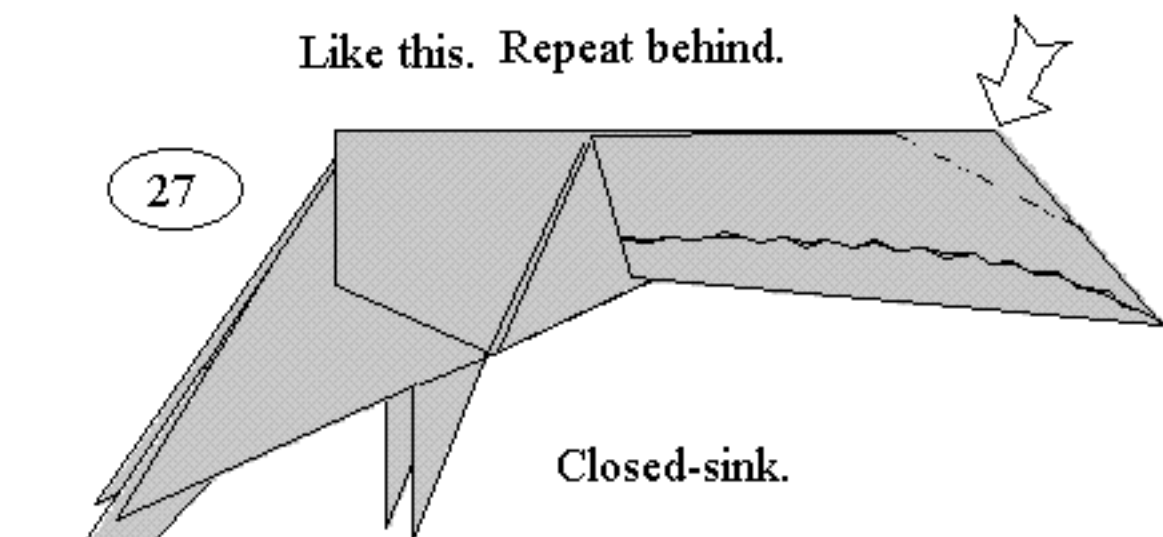

Closed-sink.

28

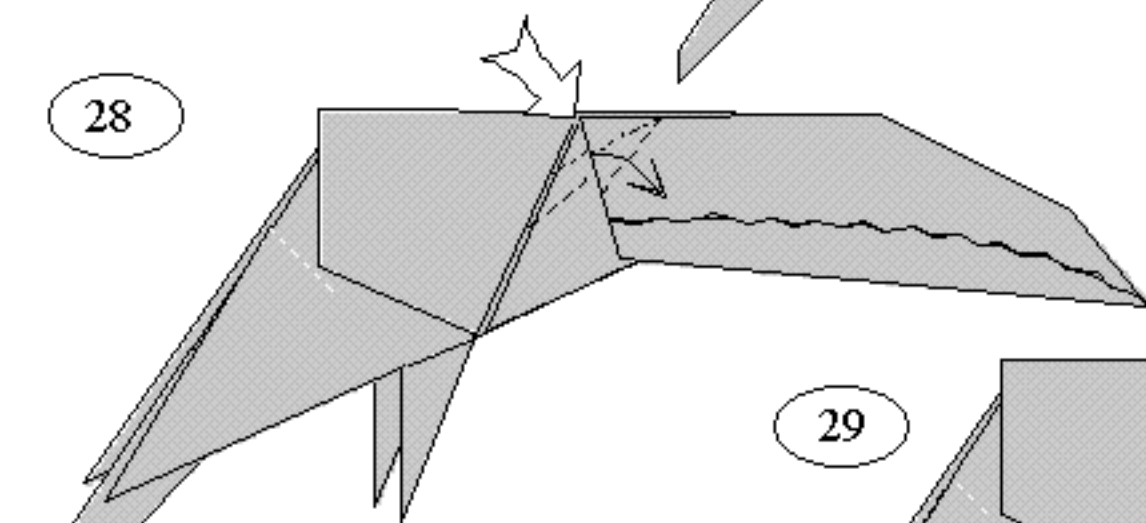

Swivel-squash the edge to make an eye.

29

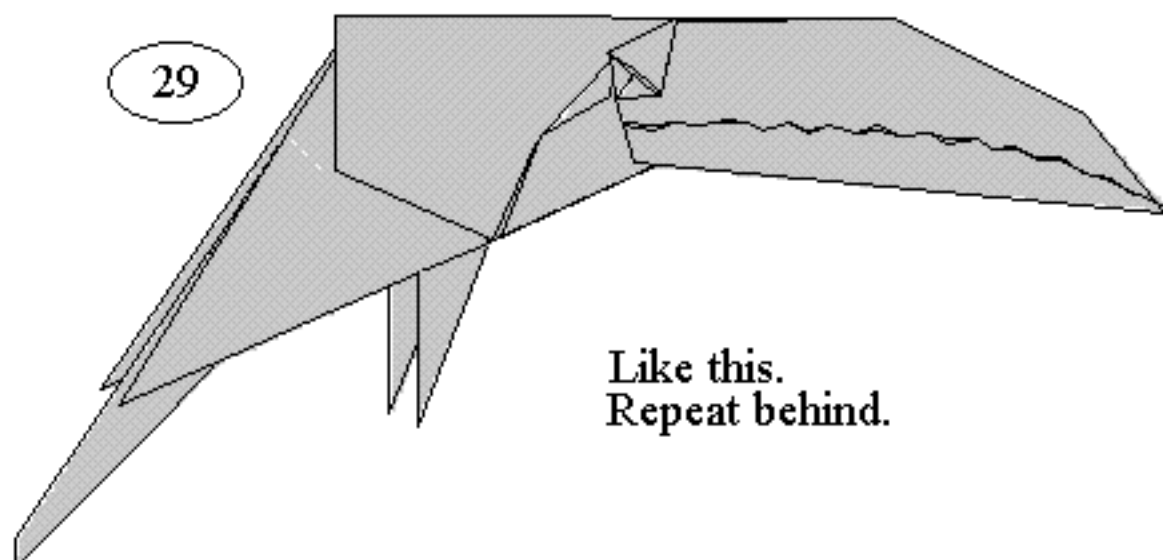

Like this.  
Repeat behind.

30

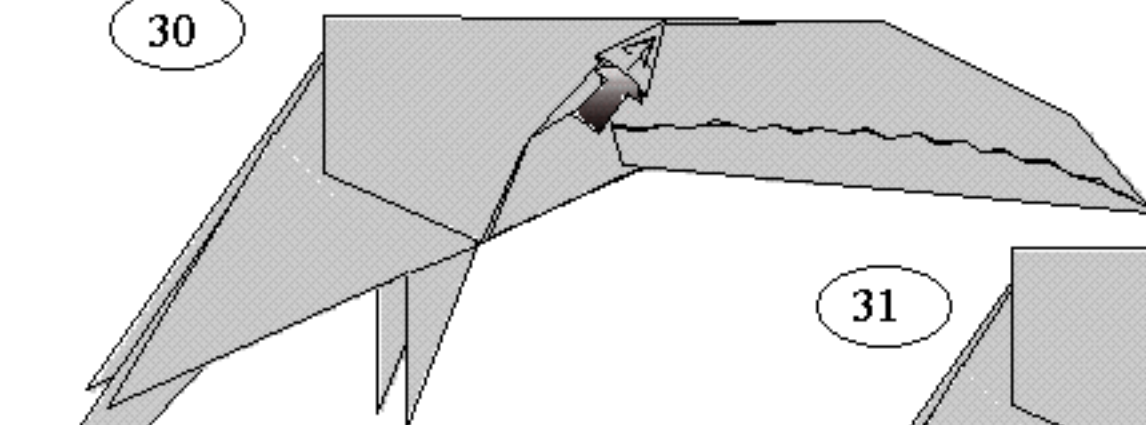

Open up between the first and second layer and petal-fold. Stop in mid-air, so that the eye is 3-dimensional.

31

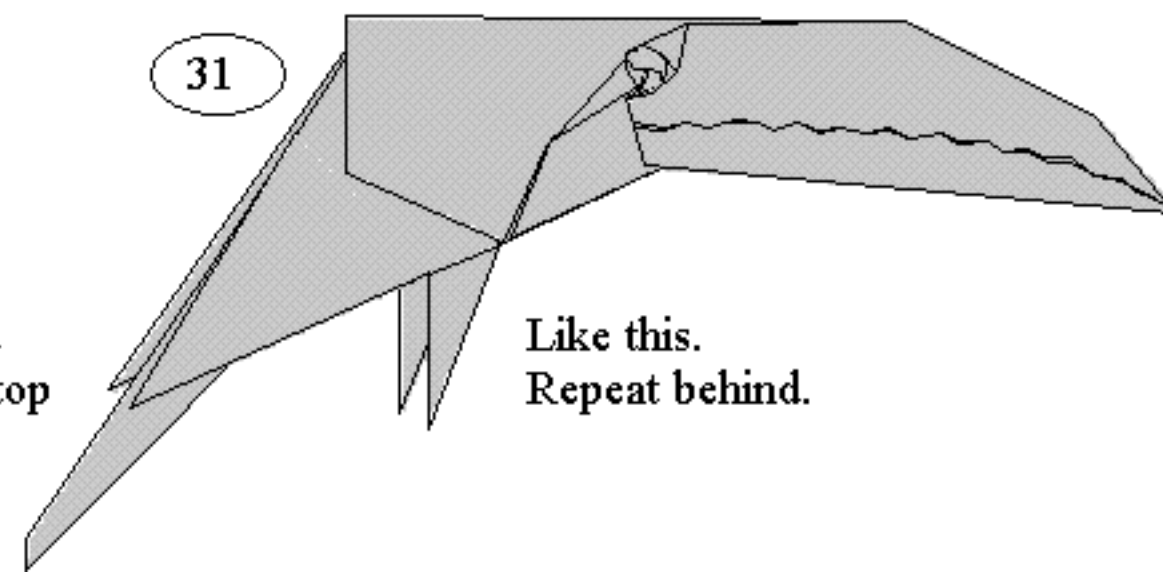

Like this.  
Repeat behind.

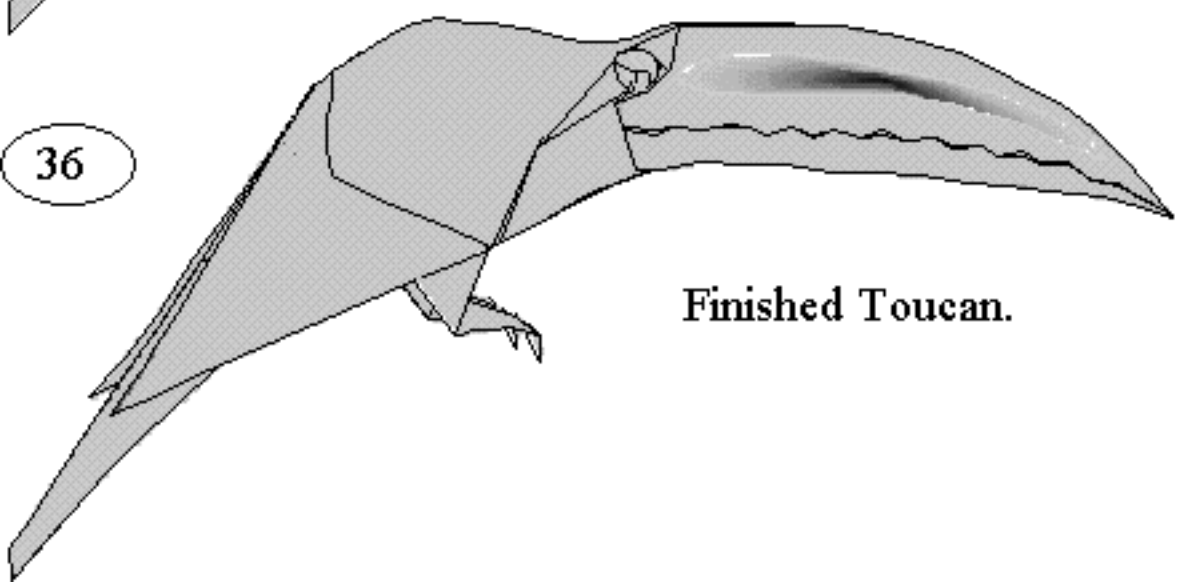
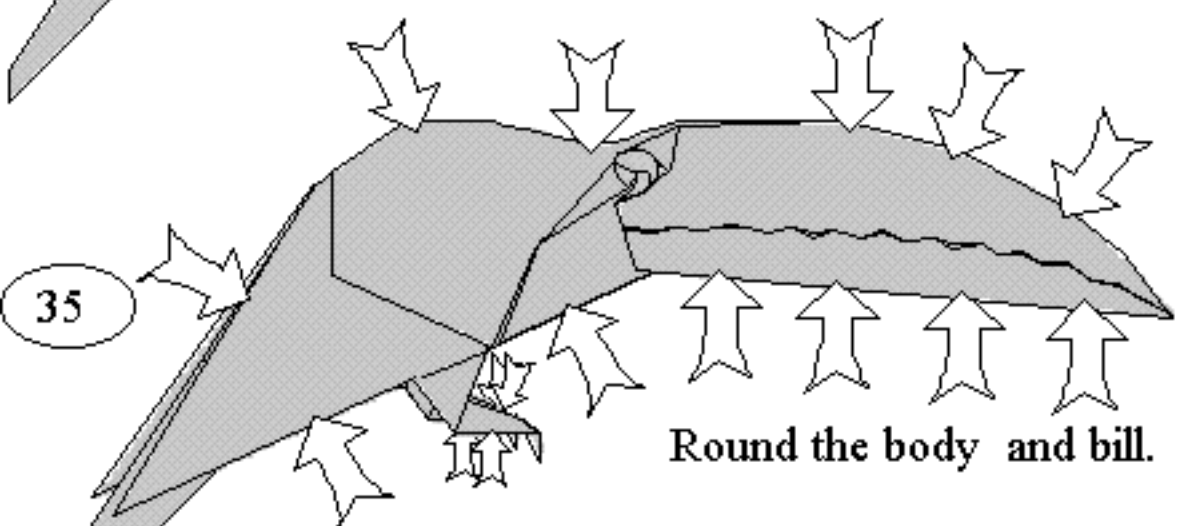
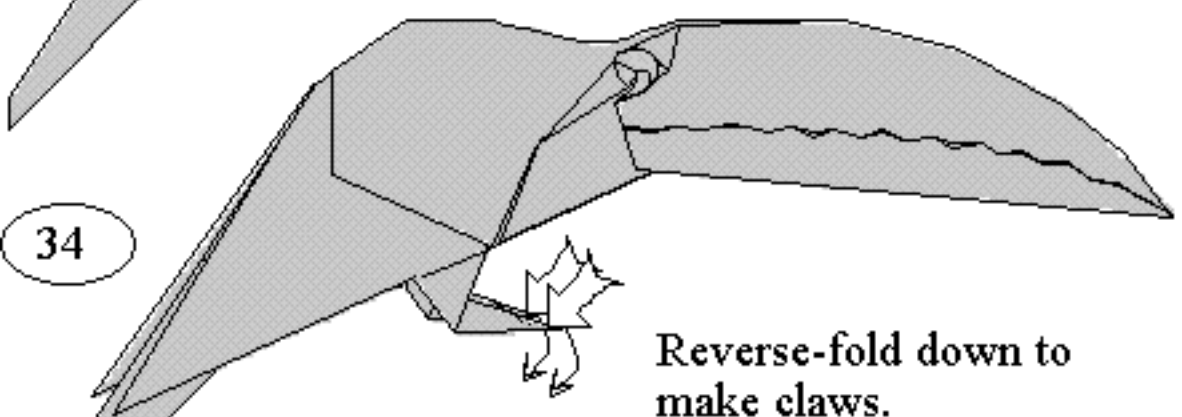
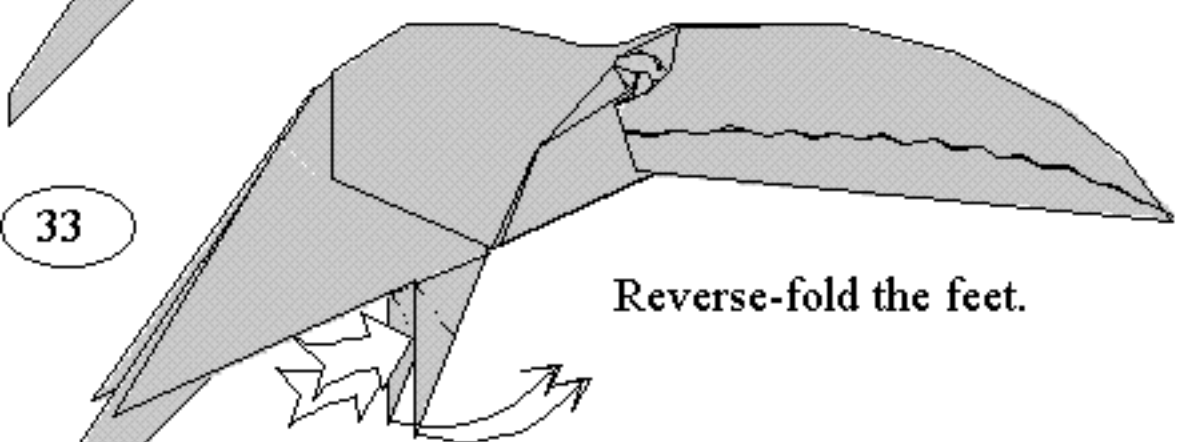
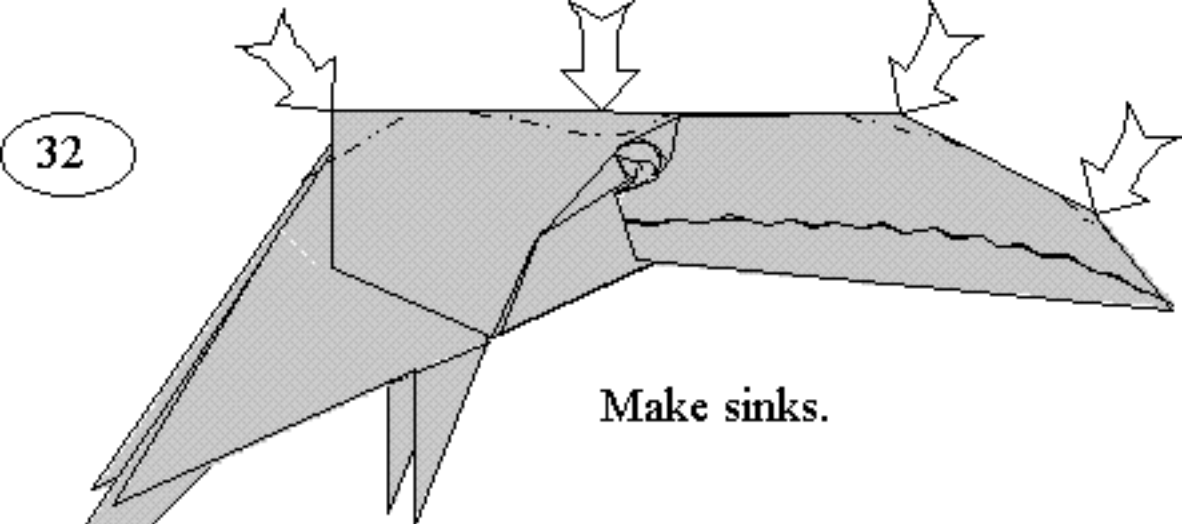



# TOWER BOX

ENJOY AND FEEL FREE TO MAKE COPIES AND  
DISTRIBUTE THESE DIAGRAMS. PLEASE EMAIL  
COMMENTS AND QUESTIONS TO  
winson\_chan@spectrumsignal.com

THERE ARE THREE SECTIONS TO THE TOWER BOX,  
TOP, MIDDLE, AND BASE. THE NUMBER OF MIDDLE  
SECTIONS DETERMINE THE HEIGHT OF THE BOX.  
DIAGRAM IS SHOWN WITH TWO MIDDLE SECTIONS

## TOP SECTION

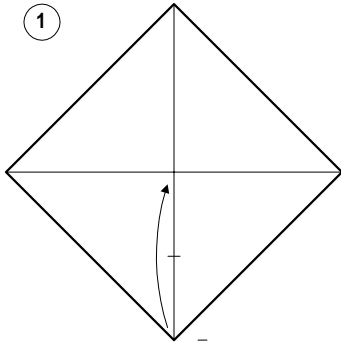

1  
CREASE DIAGONALS, FOLD  
BOTTOM CORNER TO CENTRE,  
MAKING ONLY A SMALL CREASE

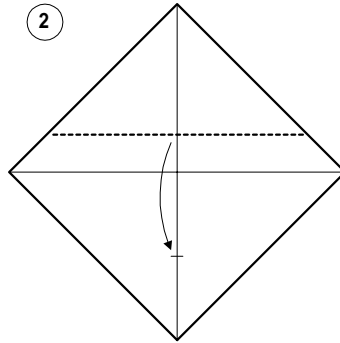

2  
FOLD TOP CORNER TO CREASE

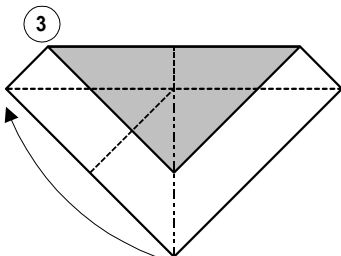

3  
FOLD ALONG LINES INDICATED TO  
COMPLETE MODULE.

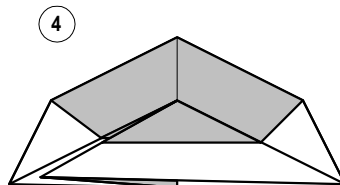

4  
COMPLETED MODULE. FOUR  
MODULES ARE REQUIRED TO  
MAKE TOP SECTION

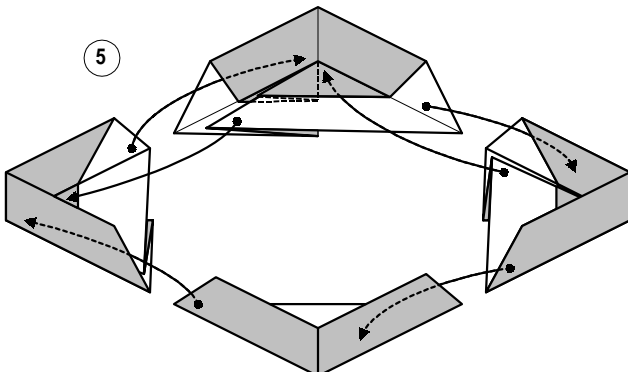

5  
ASSEMBLE FOUR UNITS AS SHOWN. BE SURE  
THAT THE TRIANGULAR FLAP REMAINS ON TOP

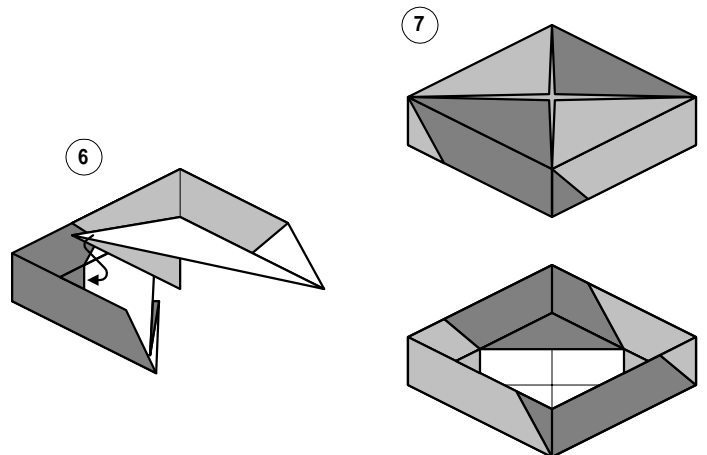
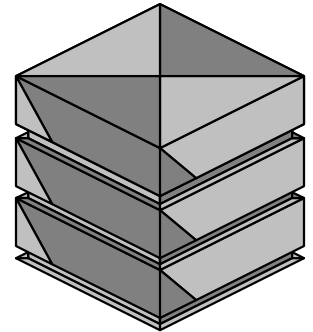
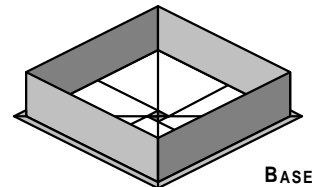
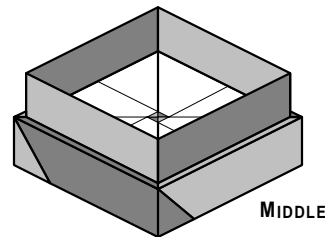
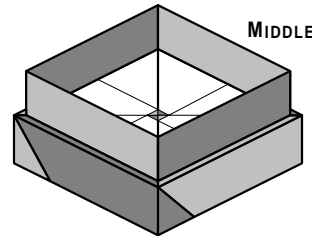
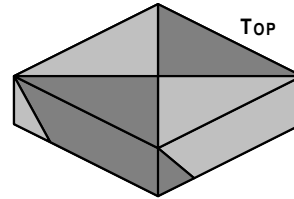

6  
TWO MODULES IN MID-ASSEMBLE. TUCK  
TRIANGULAR FLAP UNDERNEATH

7  
TWO VIEWS OF THE COMPLETED  
TOP SECTION

Model: Tower Box	Page: 1/ 3
Designer: Winson Chan	
Diagrammed By: Winson Chan, winson_chan@spectrumsignal.com	
Revision: 3.0	Date: 06/04/98

# MIDDLE SECTION (LOWER HALF)

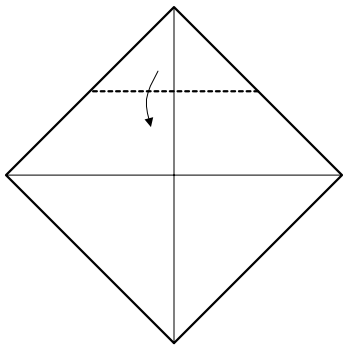

CREASE DIAGONALS, FOLD TOP CORNER TO CENTRE

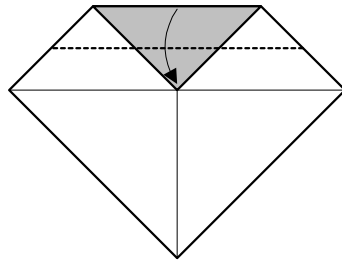

FOLD TOP EDGE TO CENTRE

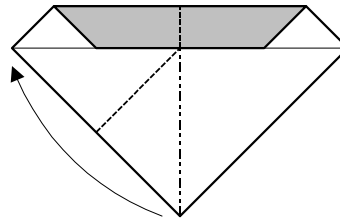

FOLD ALONG LINES INDICATED TO COMPLETE MODULE.

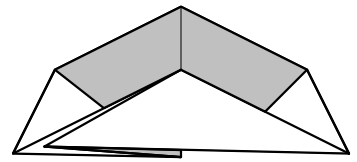

COMPLETED MODULE. FOUR MODULES ARE REQUIRED TO MAKE TOP SECTION

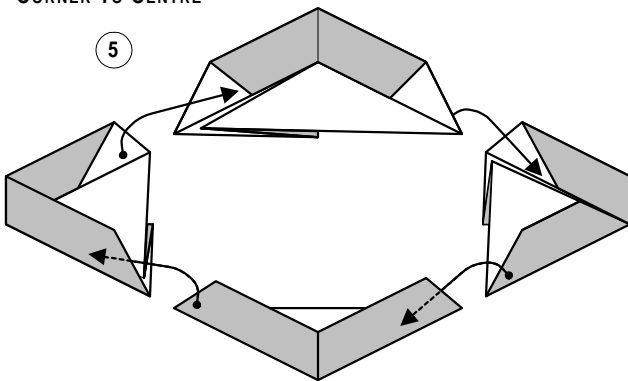

ASSEMBLE FOUR UNITS AS SHOWN. BE SURE THAT THE TRIANGULAR FLAP REMAINS ON BELOW

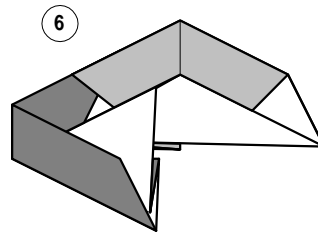

TWO MODULES IN MID-ASSEMBLE.

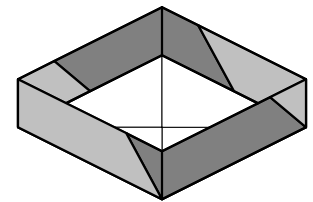
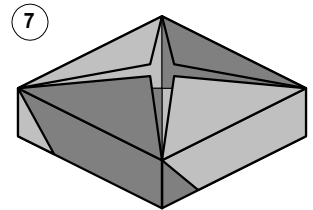

TWO VIEWS OF THE COMPLETED MIDDLE SECTION, LOWER LOWER HALF. FOUR TRIANGULAR FLAPS SHOULD EXIST ON TOP. FLAGS ARE USED TO HOLD THE LOWER MIDDLE SECTION

# MIDDLE SECTION (UPPER HALF)

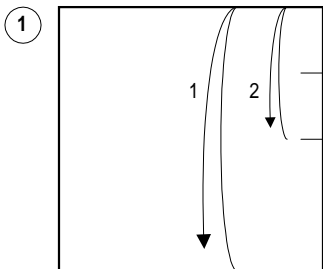

MAKE A SMALL CREASE AT THE 1/2 AND 1/4 POINT

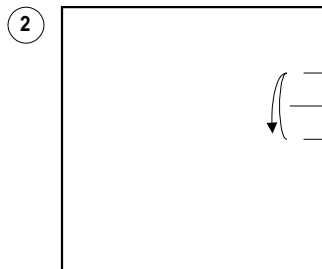

FOLD 1/2 AND 1/4 POINTS TOGETHER TO GET THE 3/8 POINT

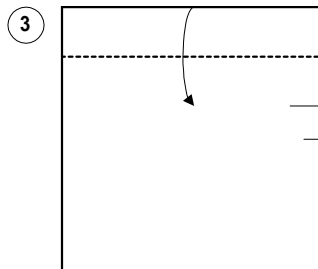

FOLD TOP EDGE TO THE 3/8 POINT

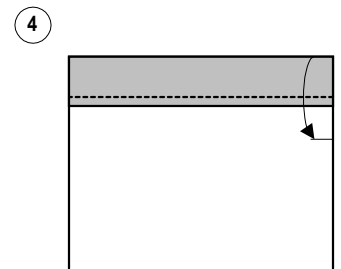

FOLD NEW EDGE TO THE 1/2 POINT

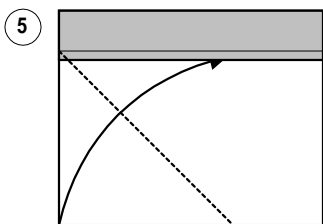

FOLD BOTTOM CORNER TO CREASE FORMED IN STEP 4

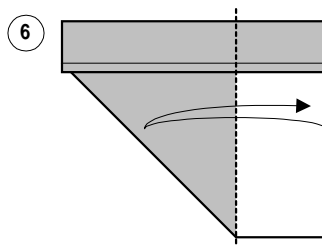

MAKE A VERTICAL CREASE USING THE EDGE OF THE TRIANGLE AS A GUIDE

Model: Tower Box	Page: 2 / 3
Designer: Winson Chan	
Diagrammed By: Winson Chan, winson_chan@spectrumsignal.com	
Revision: 3.0	Date: 06/04/98

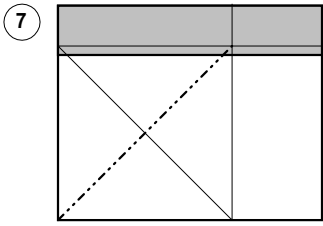

7  
UNFOLD TO STEP 4.  
BISECT BOTTOM LEFT  
CORNER

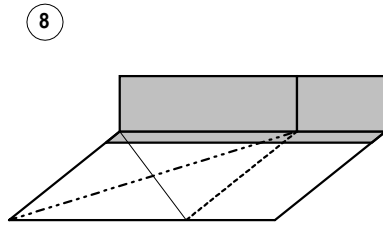

8  
VALLEY FOLD CREASE MADE IN  
STEP 4. REFOLD THE CREASES  
MADE IN STEPS 6 AND 7

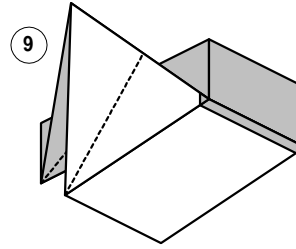

9  
MODEL SHOULD LOOK LIKE THIS.  
REFOLD CREASE MADE IN STEP 5

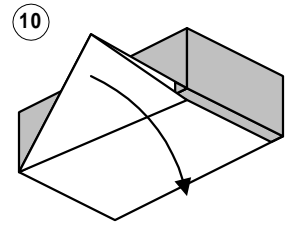

10  
FOLD TRIANGULAR  
FLAP DOWN

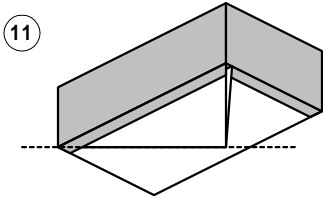

11  
VALLEY FOLD CORNER  
USING THE TRIANGLE AS A  
GUIDE

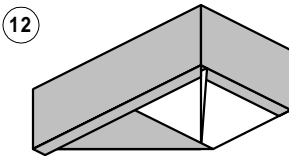

12  
COMPLETED MODULE. 4  
MODULES ARE REQUIRED  
TO MAKE THE MIDDLE  
SECTION, UPPER HALF

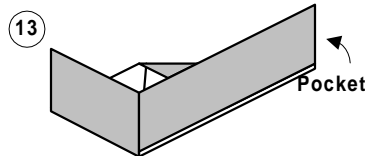

13  
REVERSE ANGLE. NOTICE  
THE POCKET

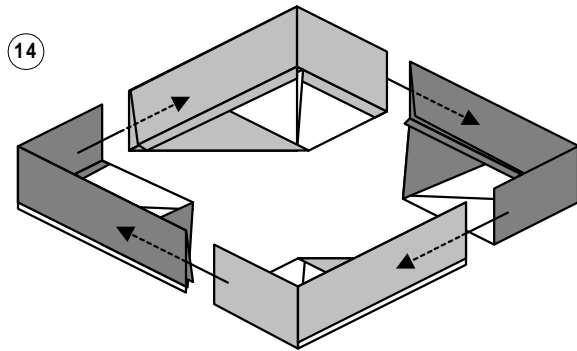

14  
ASSEMBLE THE 4 UNITS AS SHOWN

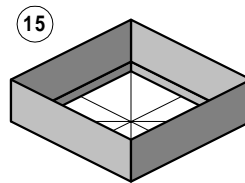

15  
COMPLETED MIDDLE  
SECTION, UPPER  
HALF

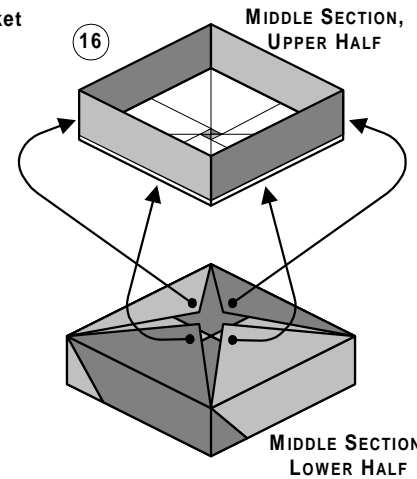

16  
MIDDLE SECTION,  
UPPER HALF

17  
MIDDLE SECTION,  
LOWER HALF

INSERT THE 4 FLAPS OF THE  
LOWER HALF INTO THE 4  
POCKETS OF THE UPPER HALF

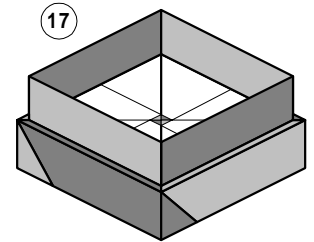

17  
COMPLETED MIDDLE SECTION

## BASE SECTION

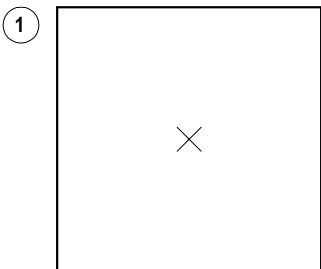

1

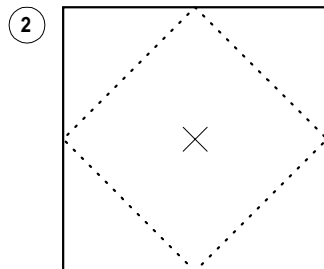

2

THE BASE IS IDENTICAL TO THE BOTTOM SECTION, BUT WITH  
THE ADDITION OF A FIFTH PIECE. FOLD THE 4 CORNERS OF THE  
FIFTH SHEET TO THE CENTER AND INSERT FLAPS INTO THE  
POCKETS OF MIDDLE SECTION LOWER HALF

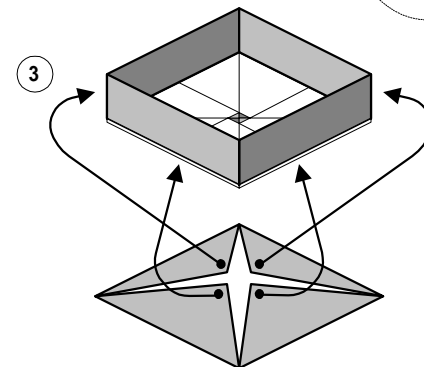

3

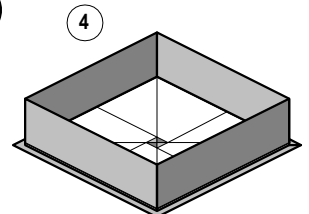

4

COMPLETED BASE

Model: Tower Box	Page: 3 / 3
Designer: Winson Chan	
Diagrammed By: Winson Chan, winson_chan@spectrumsignal.com	
Revision: 3.0	Date: 06/04/98

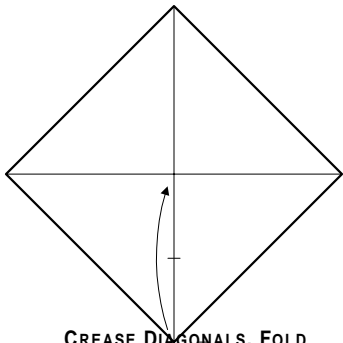

CREASE DIAGONALS, FOLD  
BOTTOM CORNER TO CENTRE,  
MAKING ONLY A SMALL  
CREASE

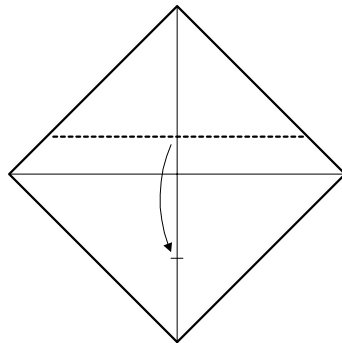

FOLD TOP CORNER TO CREASE

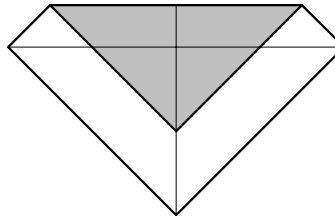

FOLD TOP LAYER IN HALF

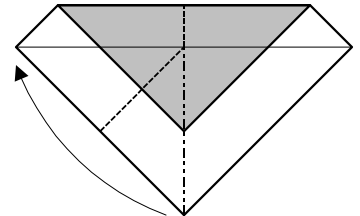

PAPER SHOULD LOOK LIKE THIS.  
UNFOLD AND ROTATE 180°

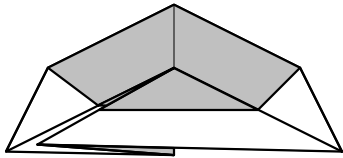

VALLEY FOLD/UNFOLD 1 AND  
2, THEN FOLD 3

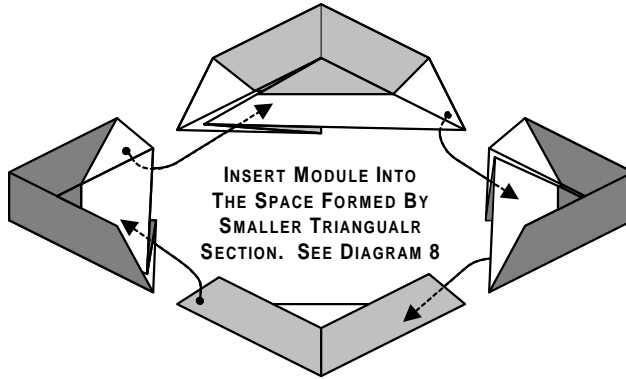

INSERT MODULE INTO  
THE SPACE FORMED BY  
SMALLER TRIANGULAR  
SECTION. SEE DIAGRAM 8

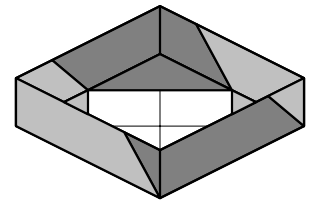
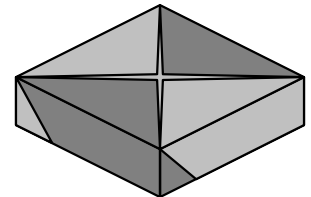
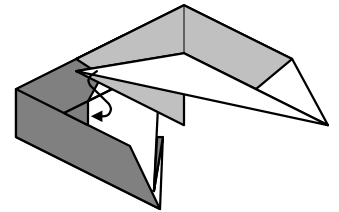

ABOVE AND BELOW VIEW OF  
COMPLETED LOWER MIDDLE  
MODULE

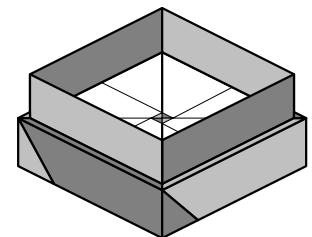

COMPLETED MIDDLE MODULE.  
MAKE AS MANY AS YOU WANT

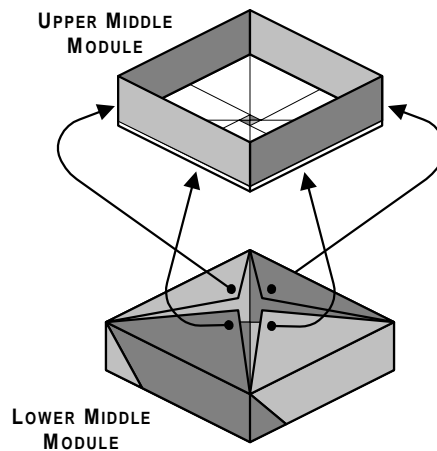

LOWER MIDDLE  
MODULE

INSERT THE 4 FLAPS OF THE  
LOWER MODULE INTO THE 4  
POCKETS OF THE UPPER MODULE

9

Tower Box - Lower Middle & Assembly 2/3	
Designer: Winson Chan	
Diagrammed By: Winson Chan	
Revision: 2.0	Date: 10/24/95

# Toy Car

by Herman van Goubergen

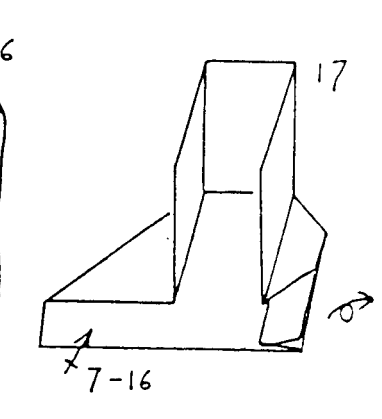
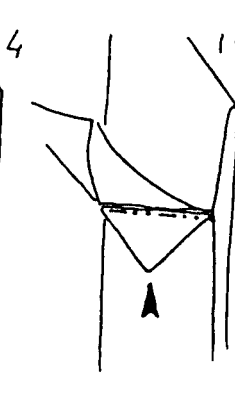
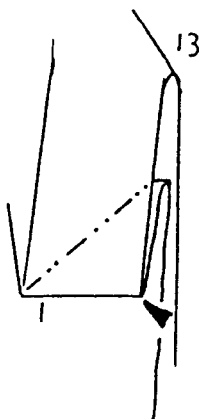
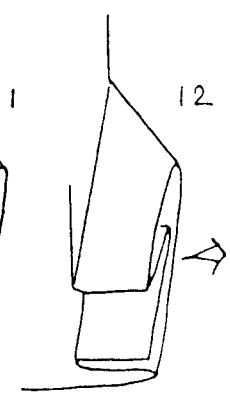
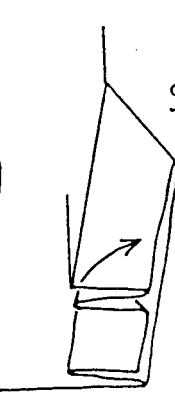
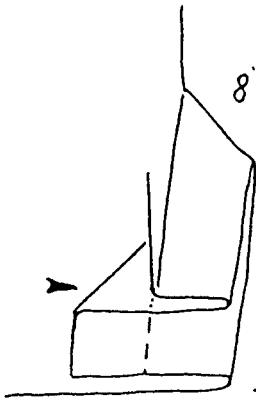
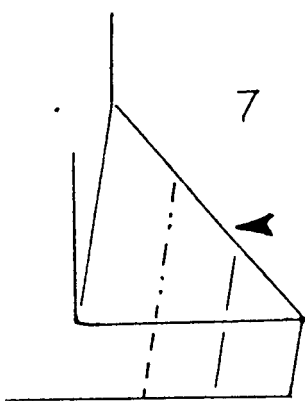
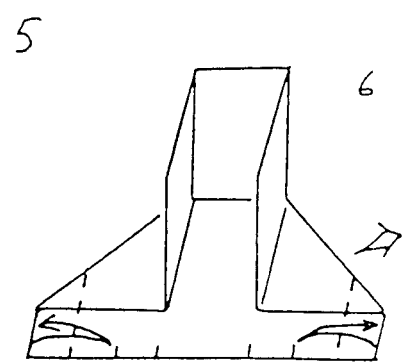
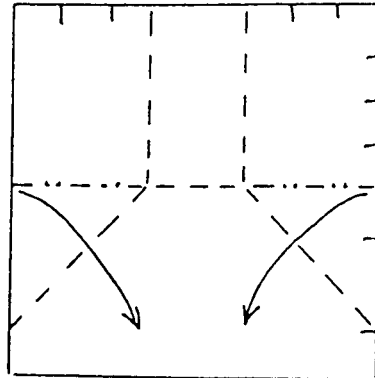
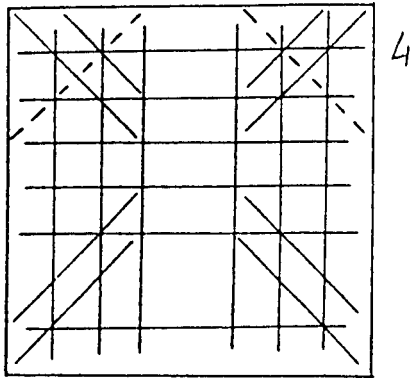
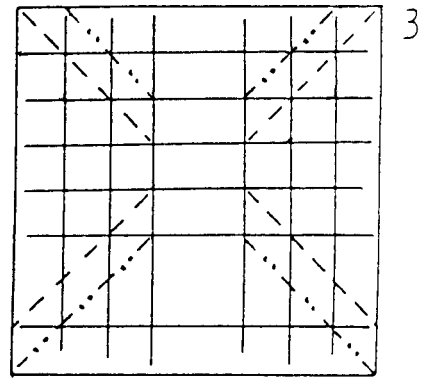
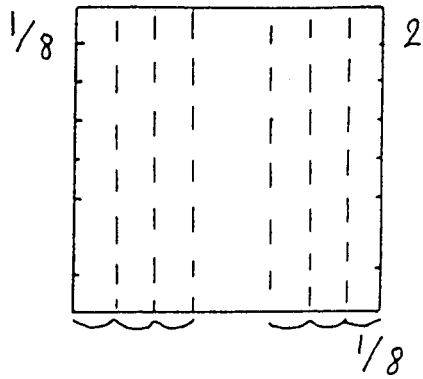
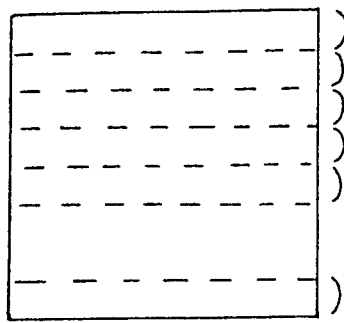

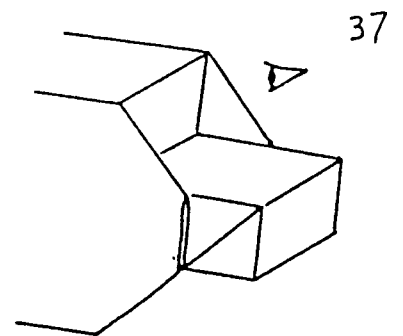
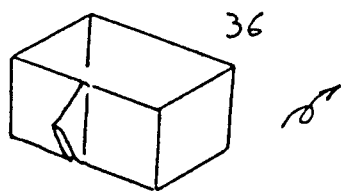
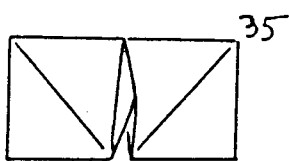
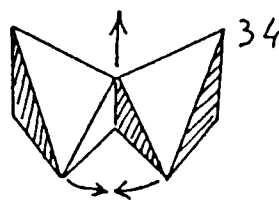
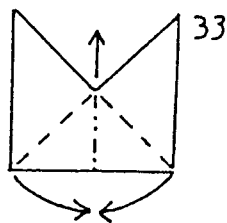
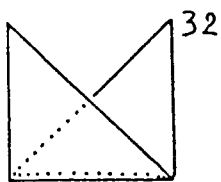
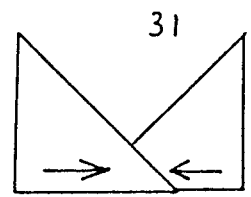
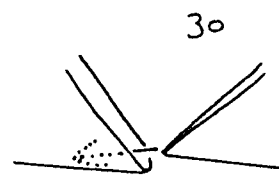
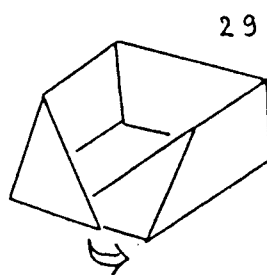
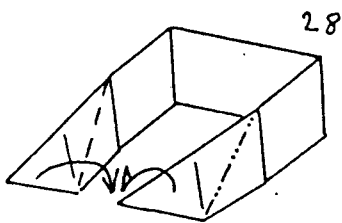
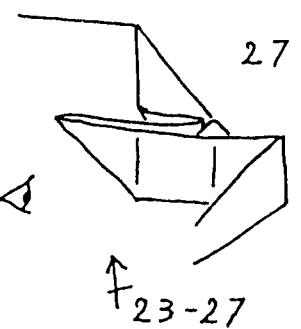
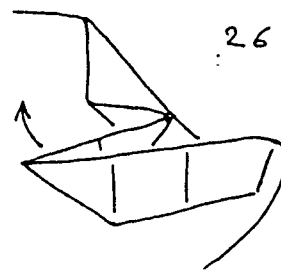
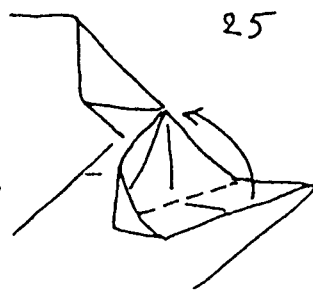
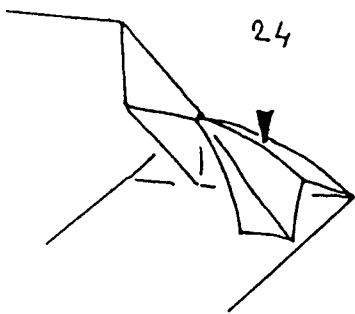
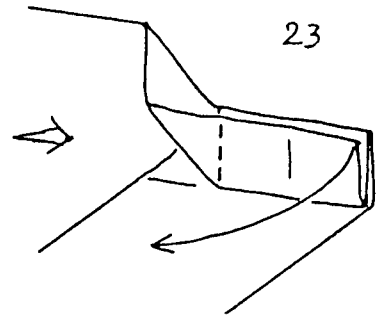
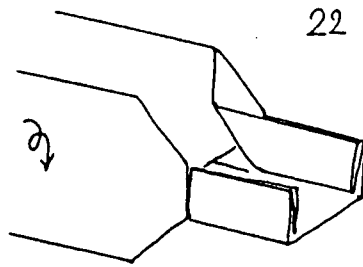
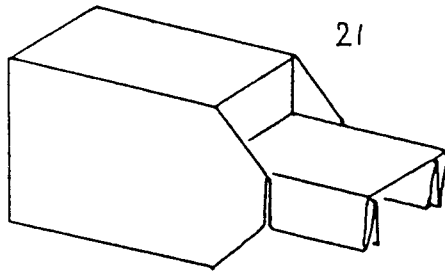
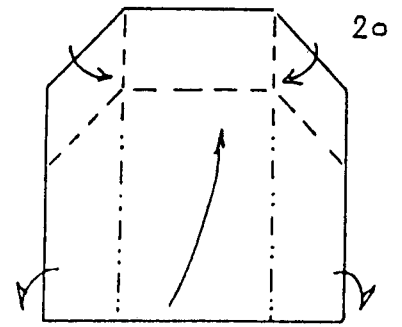
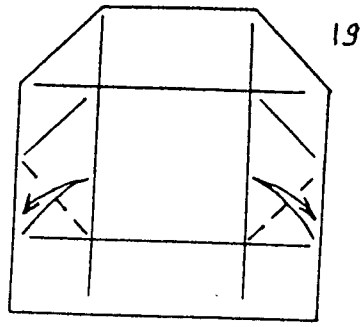
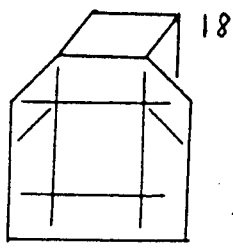

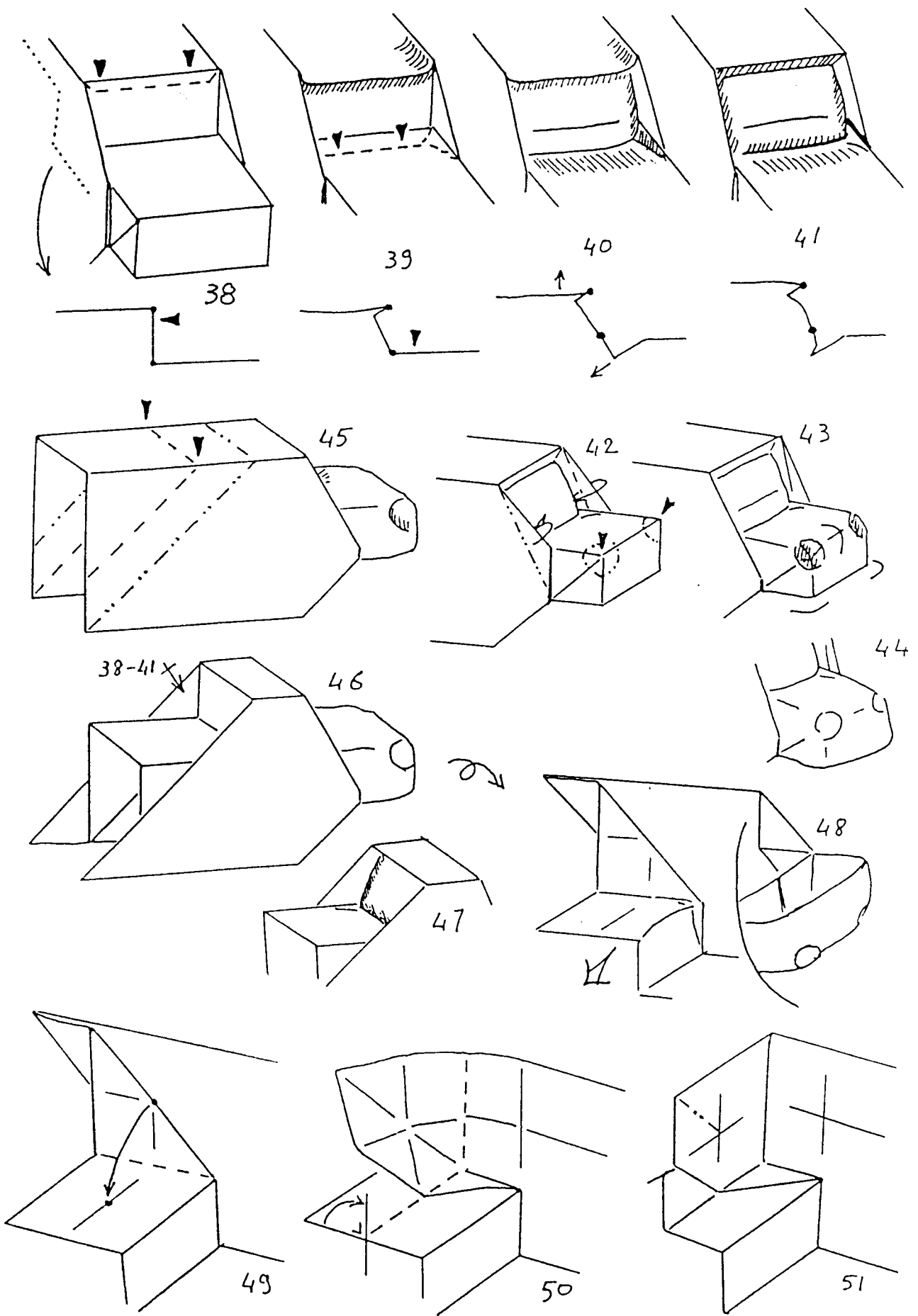

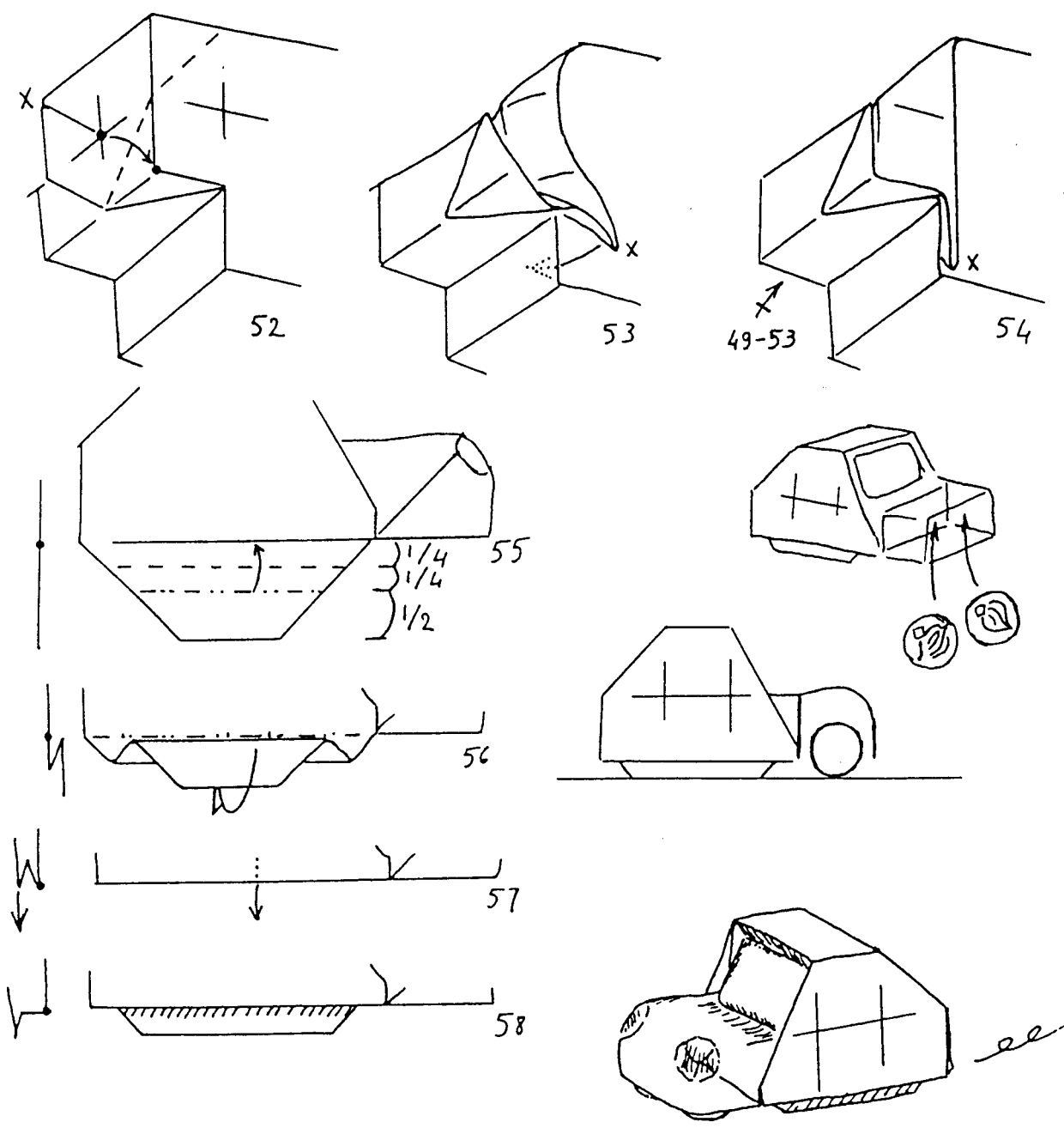

© HERMAN VAN GOUBERGEN 94-95

Use paper which is a bit heavier than kami. (I prefer paper which is coloured on one side and foil on the other side. I fold the car with the foil inside.)

Put 2 marbles in the front compartment (the engine). 15×15 cm paper will work with normal marbles. The car moves easier if the marbles are larger (heavier) but to minimize friction they should not touch the sides of the engine compartment.

Put the car on a serving tray or a box top which you tilt to 'drive' the car. With practice you can make it follow quite complicated patterns. Tilting the tray very gently creates the illusion that the car moves by itself.

At the CDO convention, the games committee got together and constructed a track for the car, complete with hairpin bends and holes in the road which you had to steer around to avoid losing your marbles!

Copyright © 1994–1995 Herman van Goubergen, all rights reserved.  
 PDF version 1999 by Sebastian Marius Kirsch <skirsch@t-online.de>.  
 Distribution for noncommercial purposes is free. Please contact the author if you want to use this model for commercial purposes.



# ORIGAMI SYMBOLS

your info here

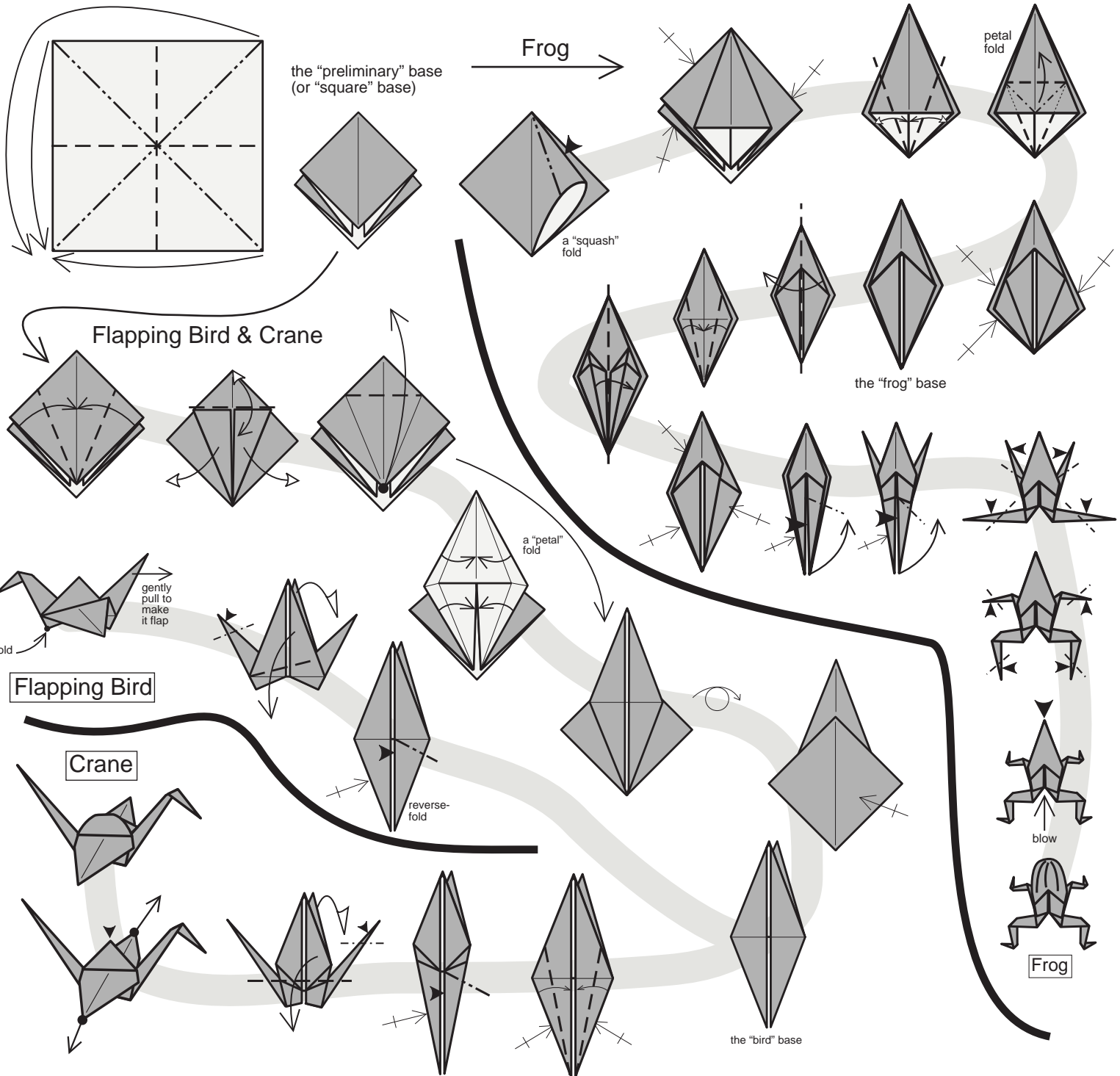
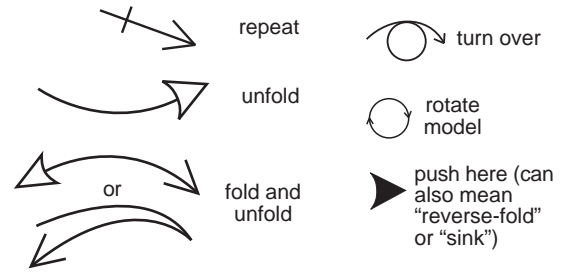
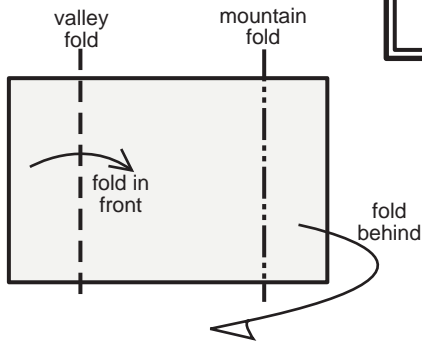
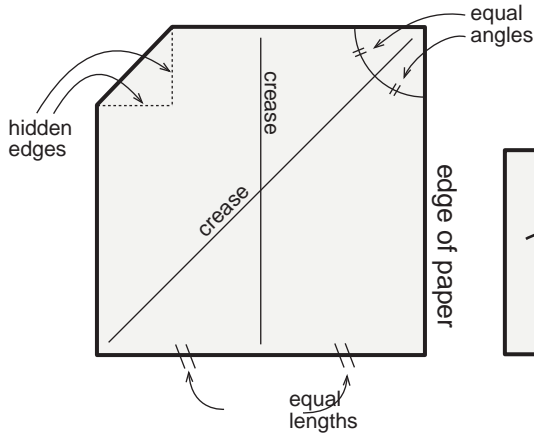

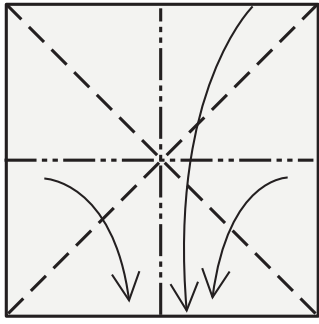

the "waterbomb" base

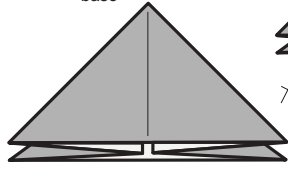

"waterbomb"

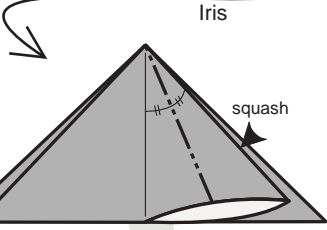
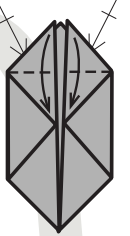
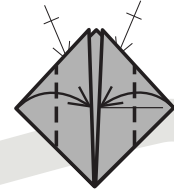
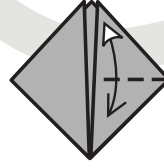
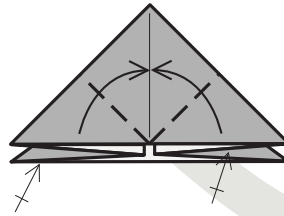

Iris

squash

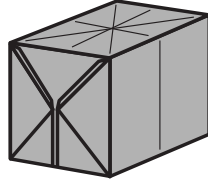

"Waterbomb"

blow

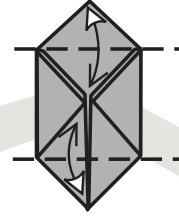

tuck in



Iris

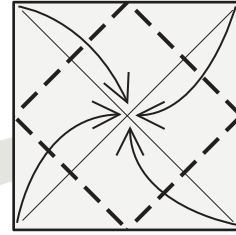
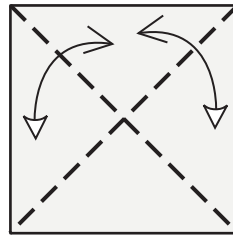
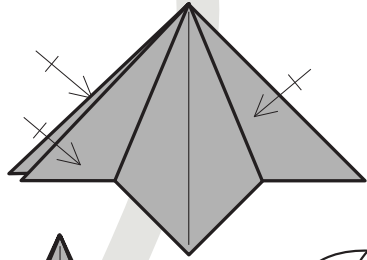

a "blintz" fold

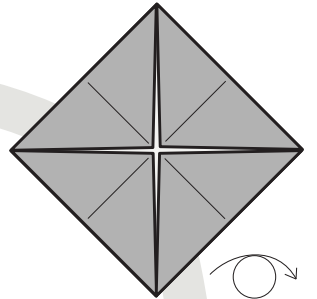

make a "preliminary" base

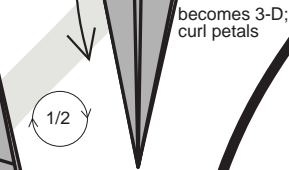
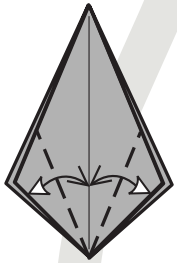

becomes 3-D; curl petals

1/2

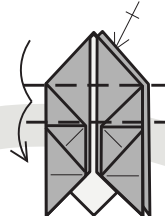
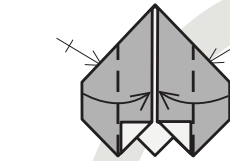

Candy Dish

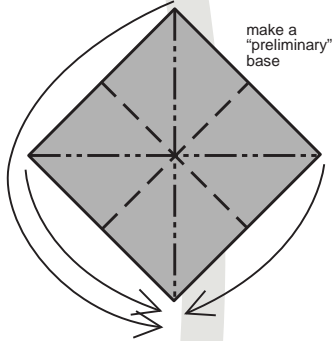

open and squash

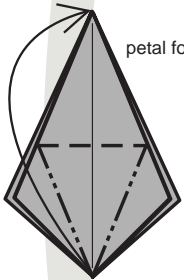

petal fold

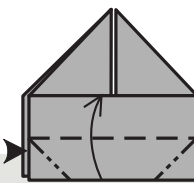
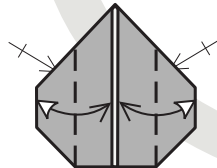
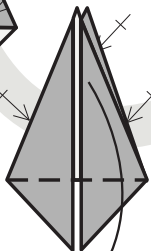
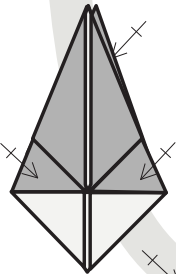
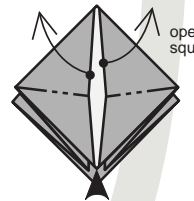
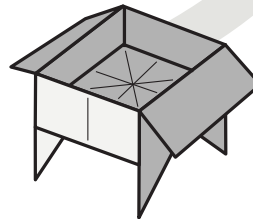
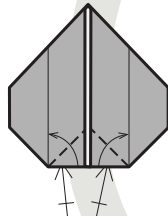
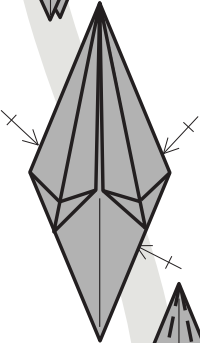

squash

1/2

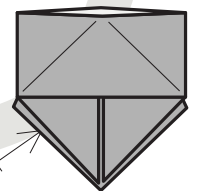

# Treasure chest

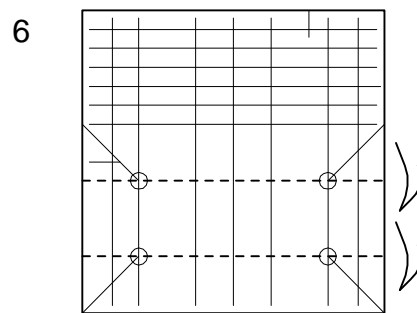
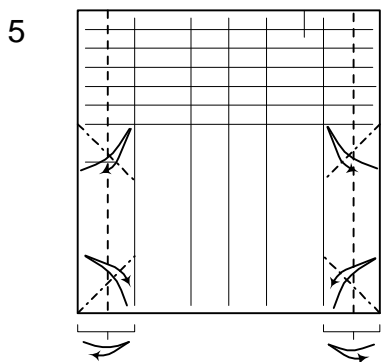
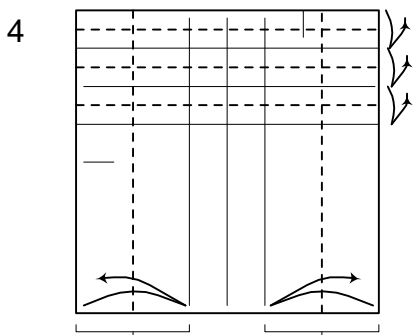
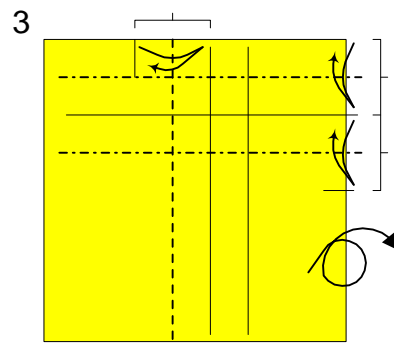
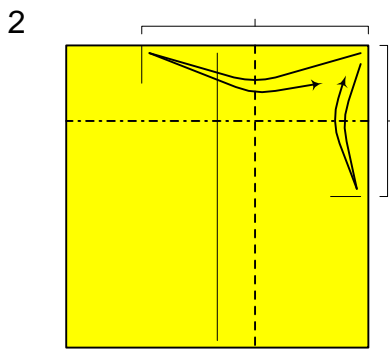
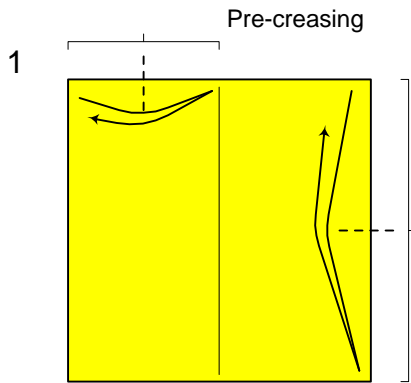

Make 2 valley folds using circled reference points

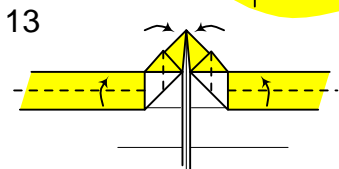
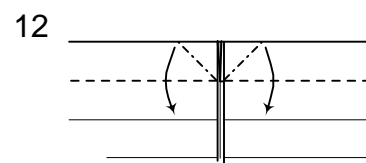
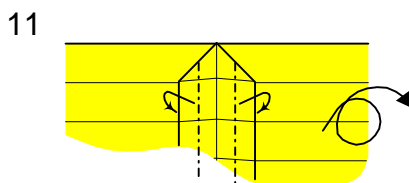
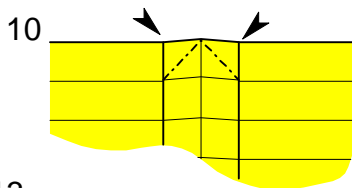
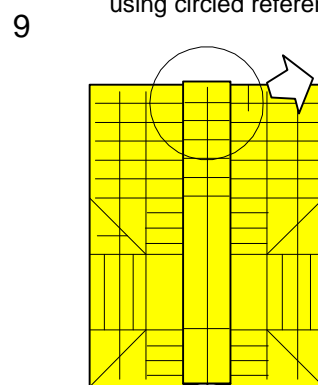
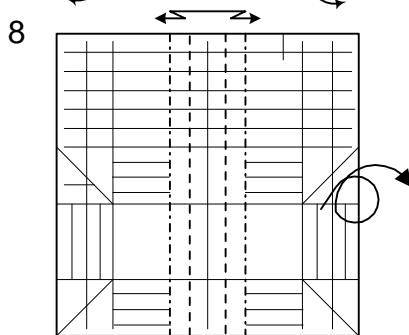
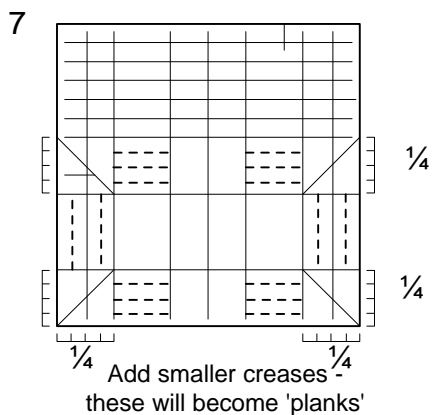

Swivel fold the edges

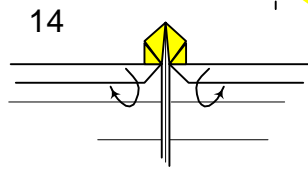

Colour change

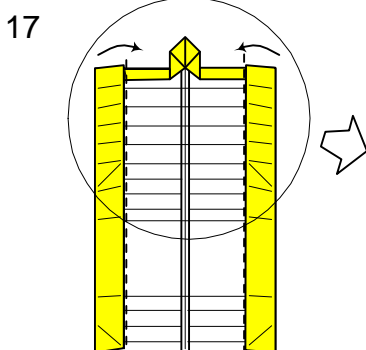
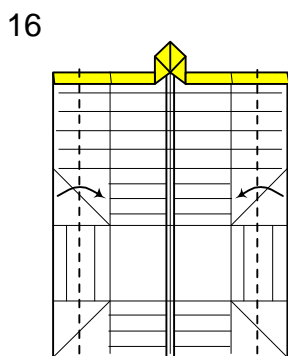
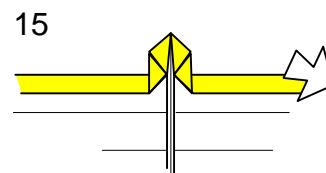

Fold creases 90° (not flat)

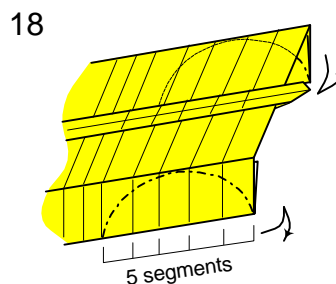

Pinch a curved mountain crease through both layers

# Treasure chest

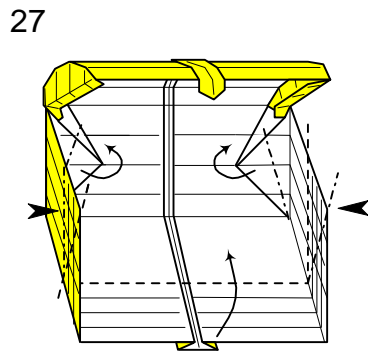
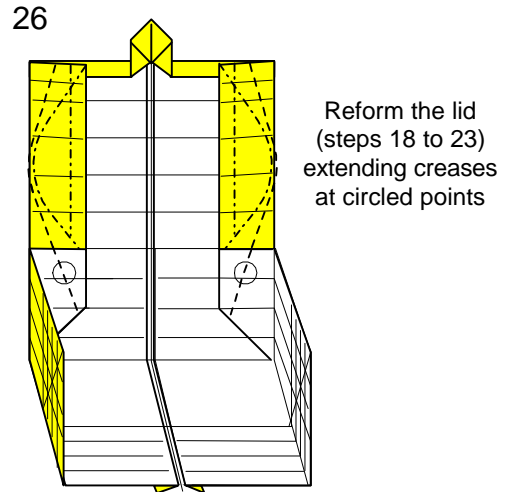
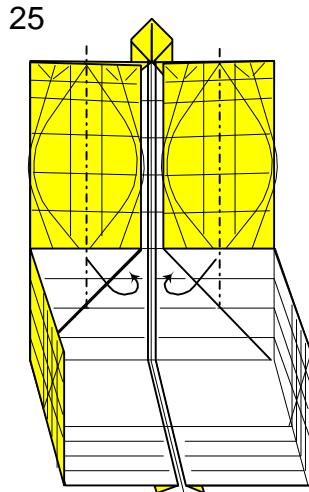
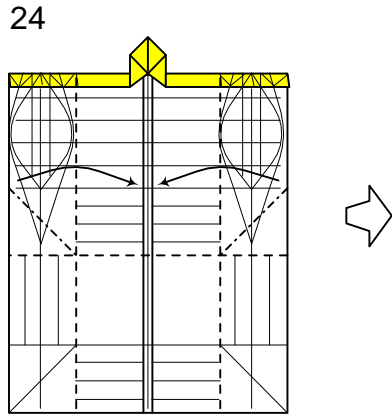
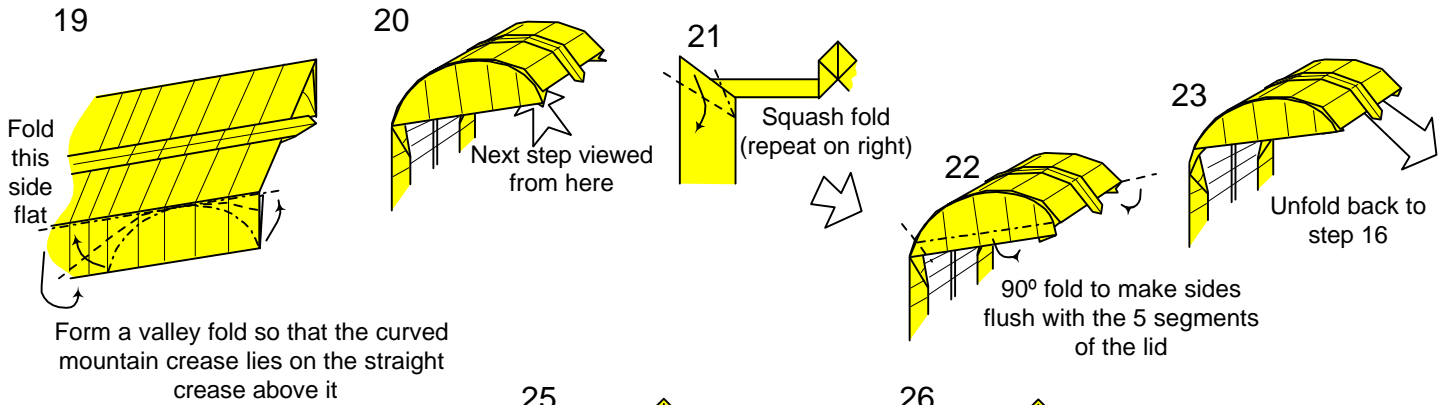

Tuck rear flaps behind to lock lid folds.  
Form the front of the chest using existing creases.

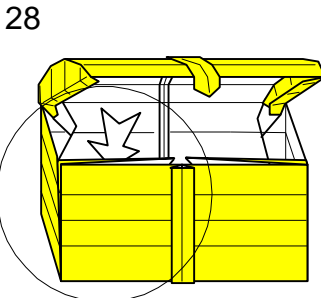

The next few steps are viewed from inside the box

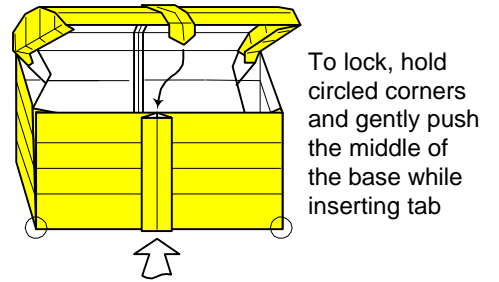
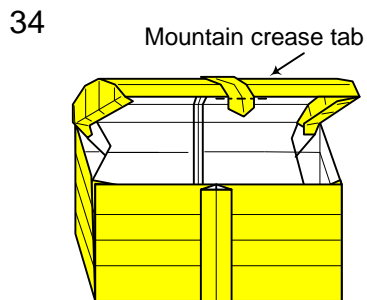
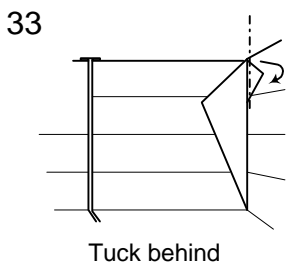
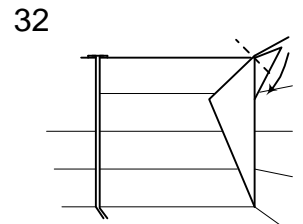
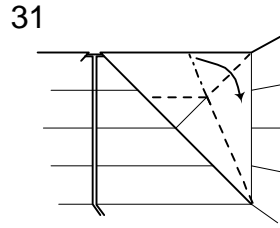
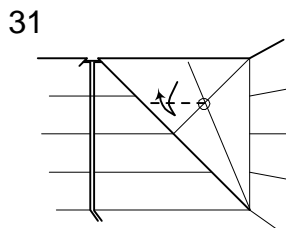
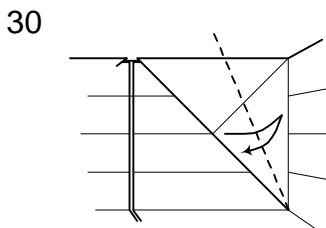
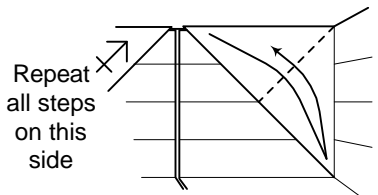

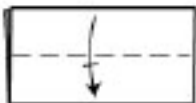
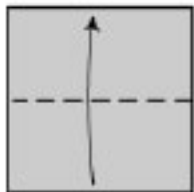

**Bear climbing a tree...**  
© Nick Robinson 2001

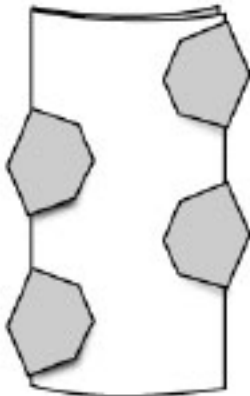
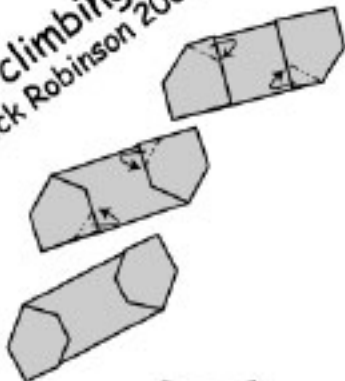

works with \$ bill, A5 etc  
dedicated to Bob Neale

# T-rex

by Marc Kirschenbaum

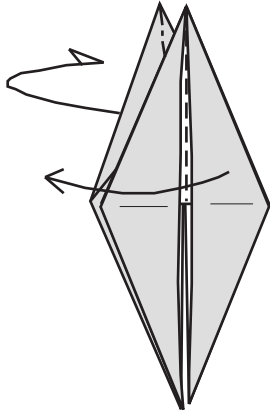

1. Begin with a colored bird base. Swing over and repeat behind.

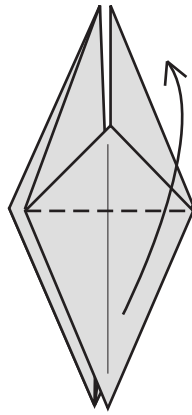

2. Valley up.

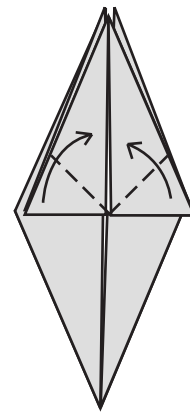

3. Valley corners to the center.

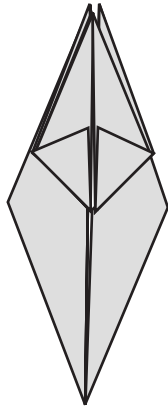

4. Turn over.

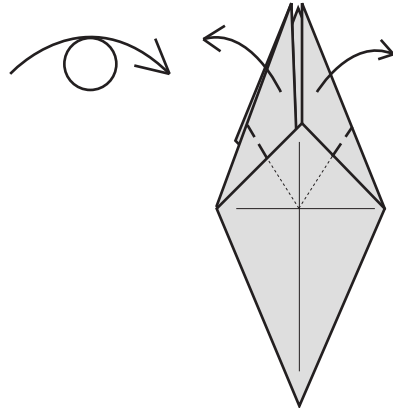

5. Valley flaps outwards. See next step for approximate positioning.

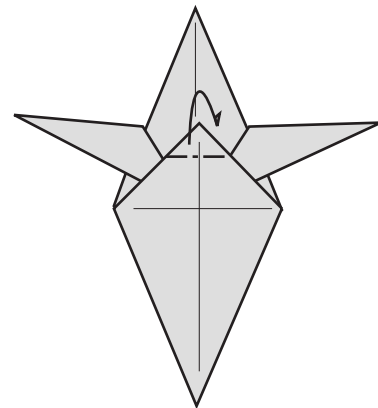

6. Note that top edges of flaps are nearly horizontal. Mountain corner into model.

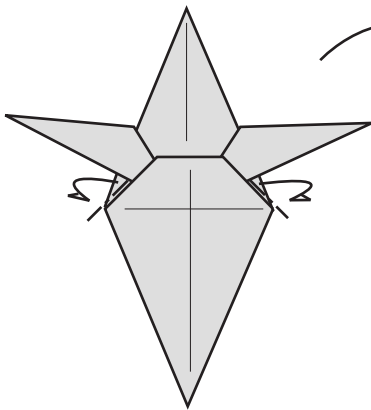

7. Mountain the excess paper back. You will have to swivel behind to accomplish this. Turn over to see the result.

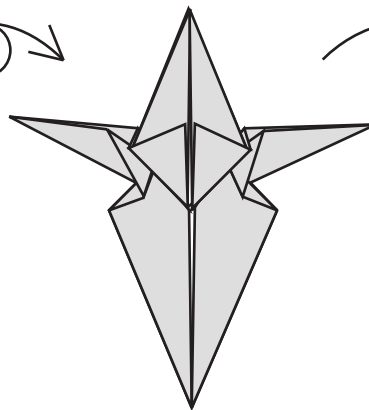

8. Turn back over.

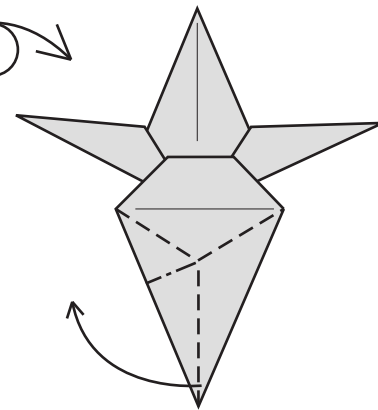

9. Rabbit ear bottom.

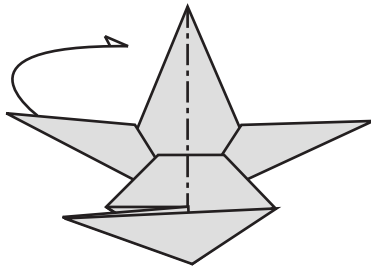

10. Fold model in half.

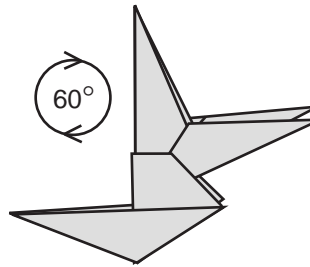

11. Rotate model approximately 60 degrees.

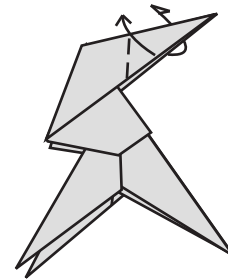

12. Outside reverse fold head.

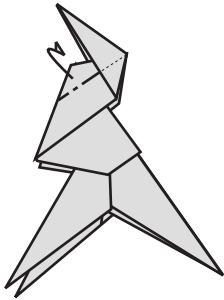

13. Mountain fold. As an option, you can sink instead.

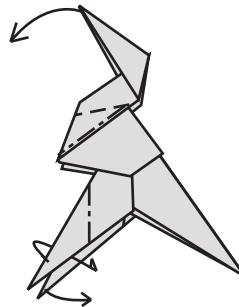

14. Crimp head forward. Mountain fold legs back.

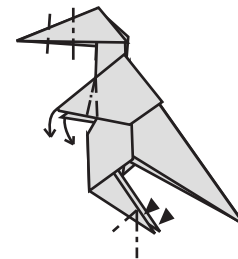

15. Crimp head to form mouth. Pleat arms. Squash to form feet. Model will stand.

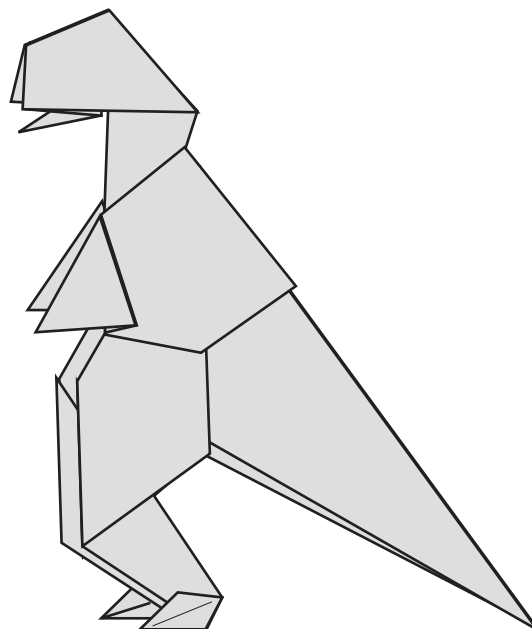

16. Completed T-rex  
©1995 Marc Kirschenbaum

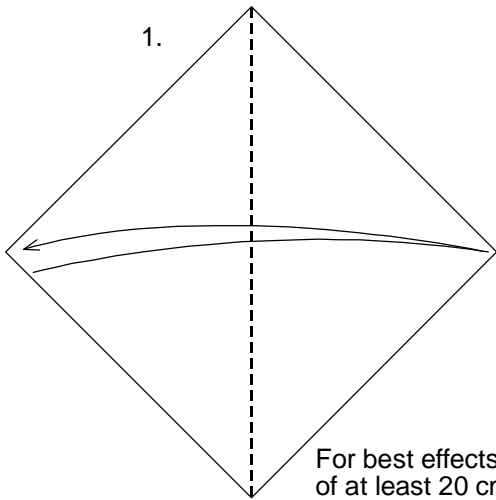

For best effects, use tissue foil of at least 20 cm square. Fold and unfold, creasing well.

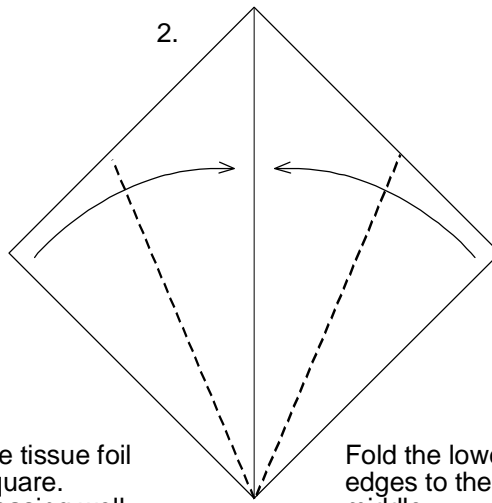

Fold the lower right and left edges to the crease line in the middle.

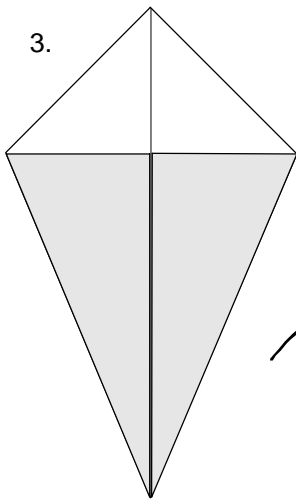

Turn paper over.

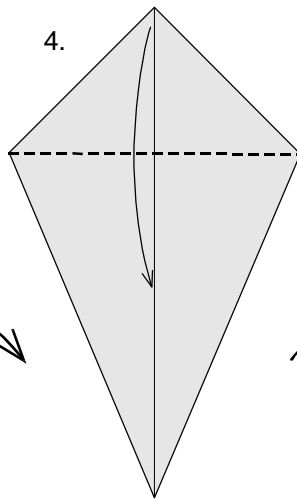

Fold down and turn over again.

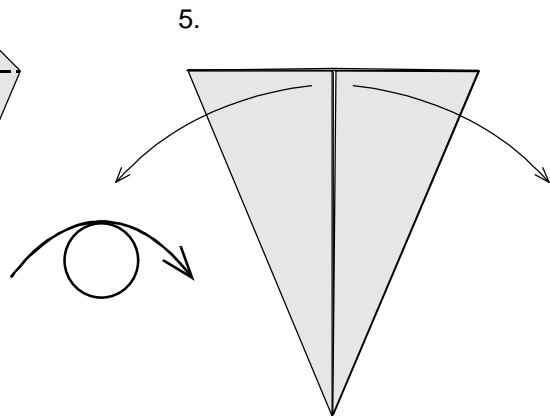

Unfold Step 2 ...

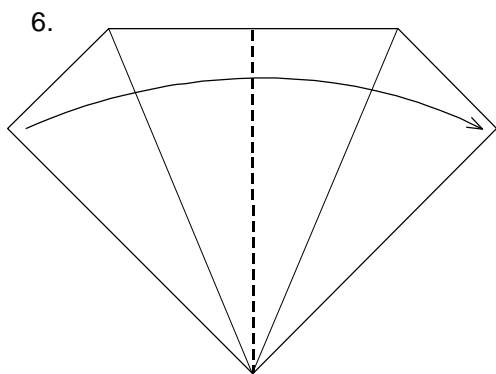

... then fold in half.

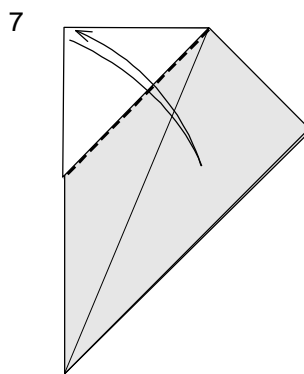

Fold and unfold, creasing firmly.

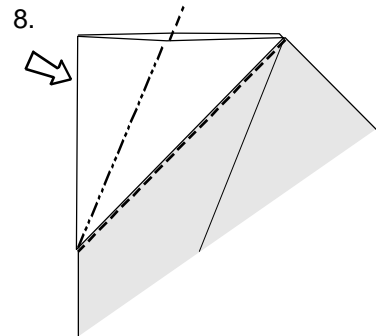

Squash fold ...



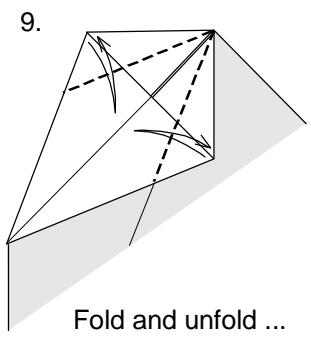

Fold and unfold ...

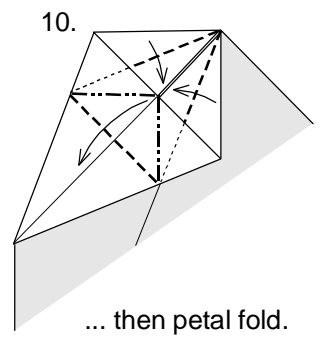

... then petal fold.

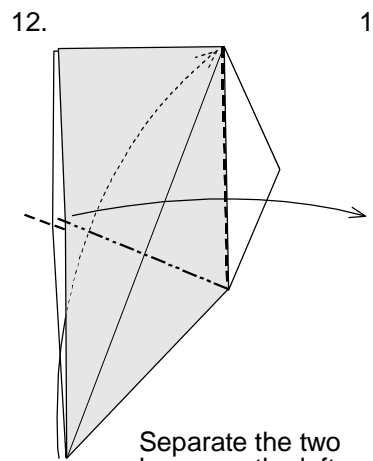
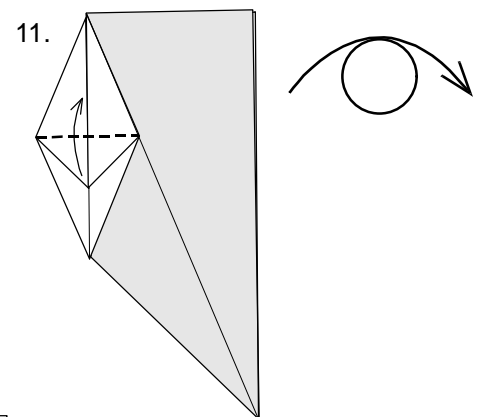

Separate the two layers on the left and squash fold.

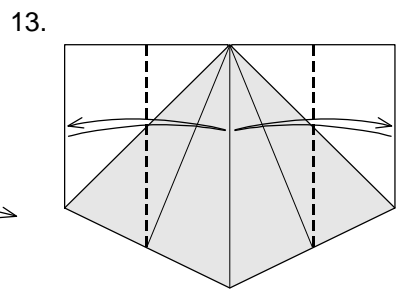

Fold and unfold again on the left and right, dividing the horizontal length into quarters.

Fold up the little triangle in the centre and turn paper over.

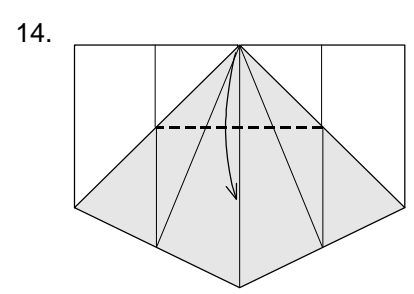

Fold down the triangle portion at the top where the creases made in Step 13 intersect the edges of the top layer.

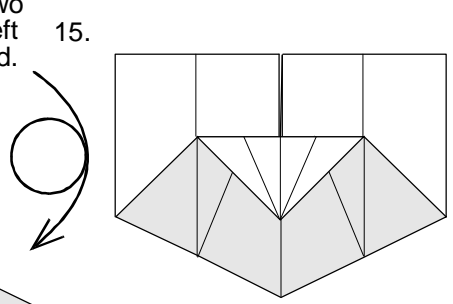

flip paper over vertically.

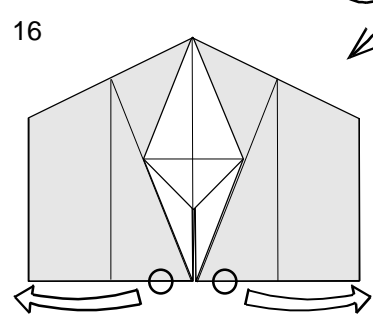

Grasp the paper firmly at the circled position and pull apart.

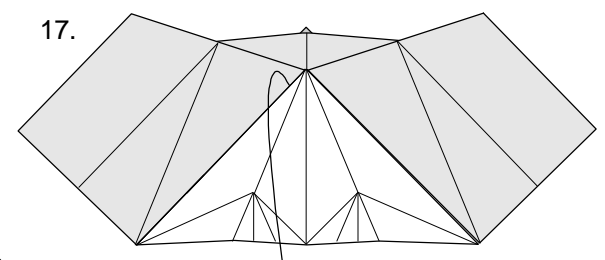

Open out the overlapping triangle ...

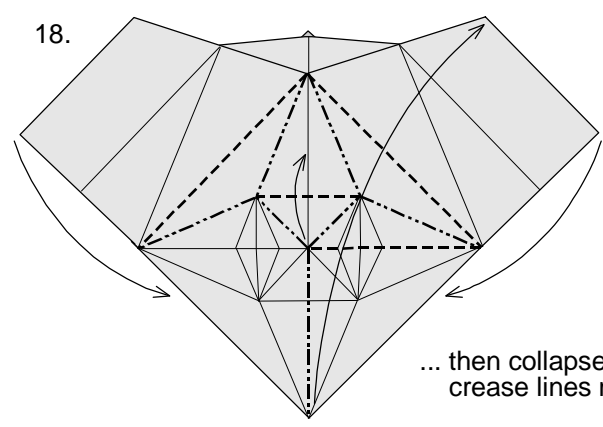

... then collapse as shown along crease lines made previously.

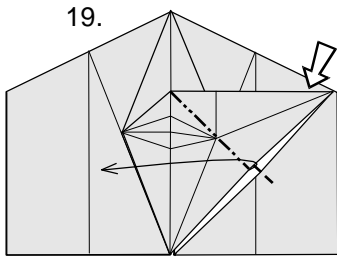

19. Separate the two layers and squash fold.

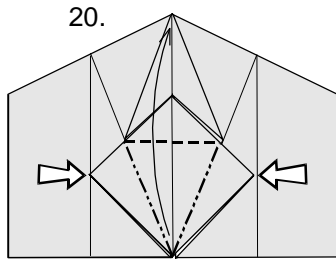

20. Reverse fold each of the two sides as you bring up the flap in the centre.

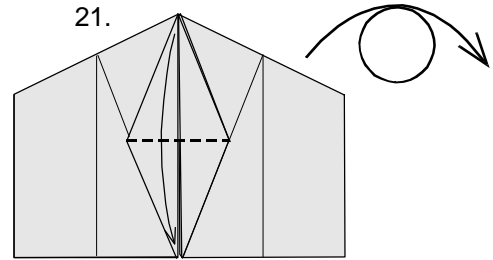

21. Now bring down the central flap and turn paper over.

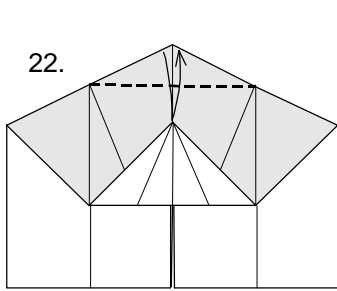

22. Fold and unfold as shown, creasing firmly.

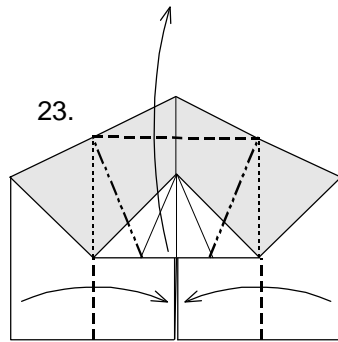

23. Bring up the top layer along creases made previously as you fold in the sides ...

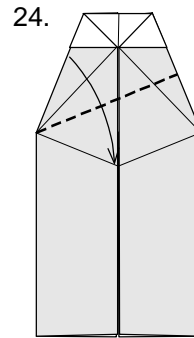

24. ... like so. Fold down, aligning with the edge of the underlying layer ...

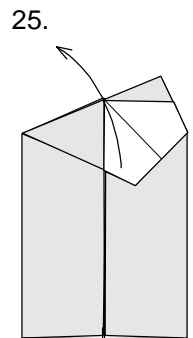

25. ... and unfold.

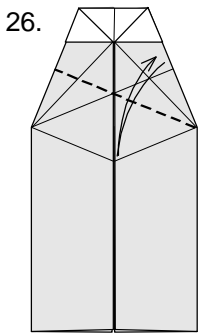

26. Repeat Steps 24 and 25 on the right ...

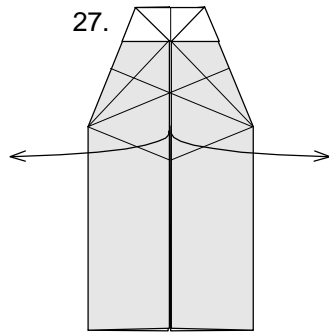

27. ... then open out as illustrated ...

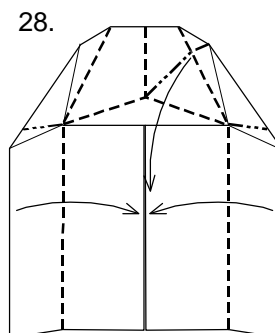

28. ... and collapse along creases made previously ...

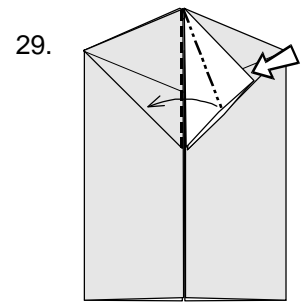

29. ... like this. Now squash fold.

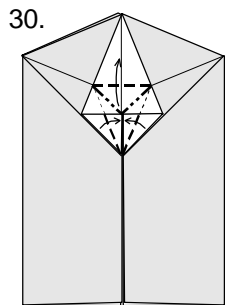

30. Petal fold, then fold through Steps 11 and 16 to 20 for this part of the assembly.

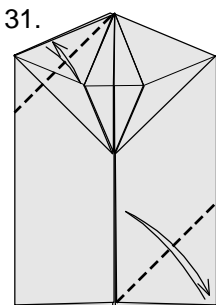

31. Fold and unfold at the top and bottom, creasing firmly ...

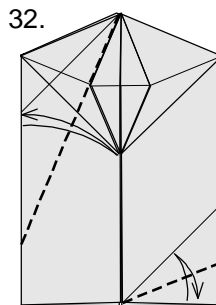

32. ... again ...

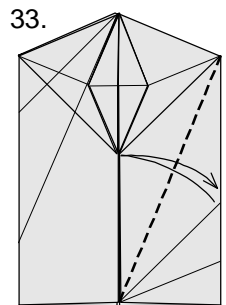

33. ... and again.

34.

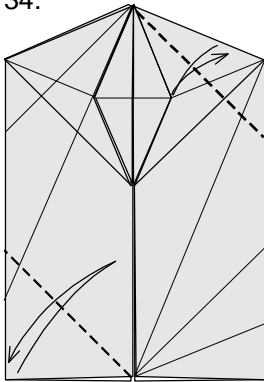

Repeat Steps 31 to 33 on the opposite sides.

35.

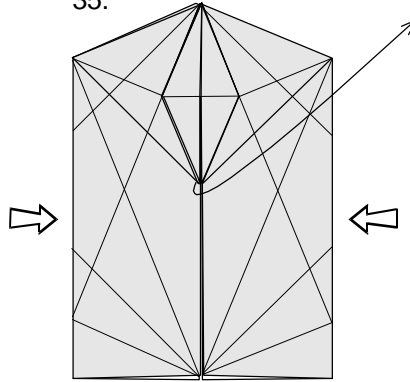

Separate the two layers at the top and bottom and open out by letting the two pieces in front, flattening the sides together.

36.

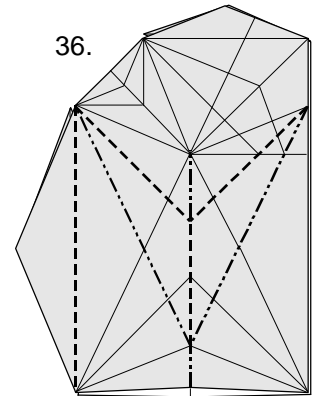

Collapse the top layer only, along crease lines made previously, like this ...

37.

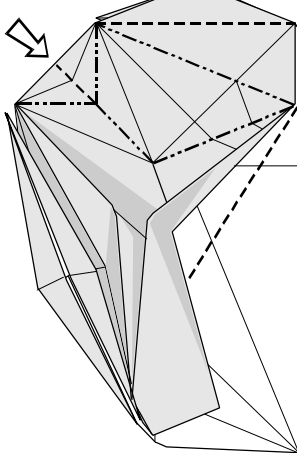

... and like this, repeating behind.

38.

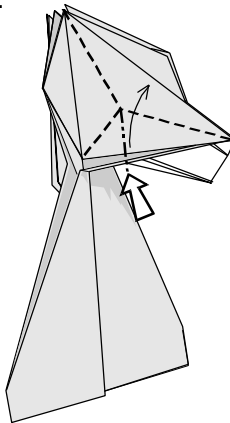

Rabbit's ear as shown, repeating behind to flatten out ...

39.

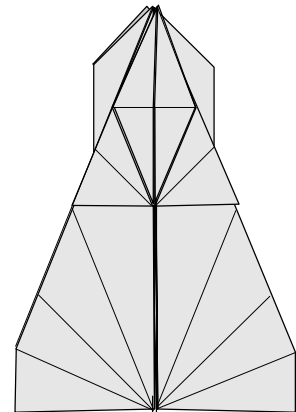

... like so.

40.

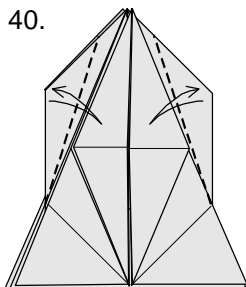

This is a close up of the upper section. Fold and unfold each of the two sides as shown, creasing firmly.

41.

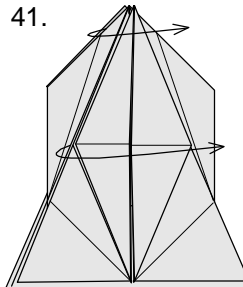

Separate the two layers at the top and side and open to the right ...

42.

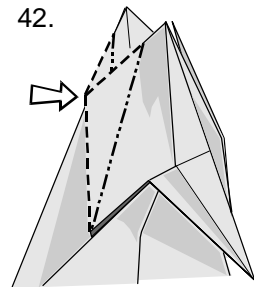

... then sink along crease lines made in Step 40 ...

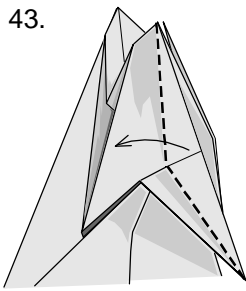

43.  
... and then close to the left.

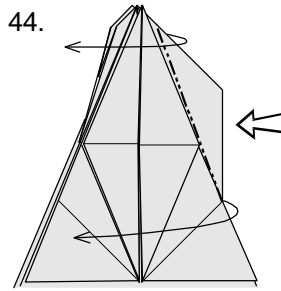

44.  
Repeat Steps 41 to 43 on the right.

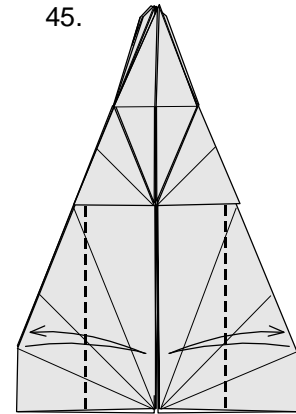

45.  
Fold and unfold, creasing well.

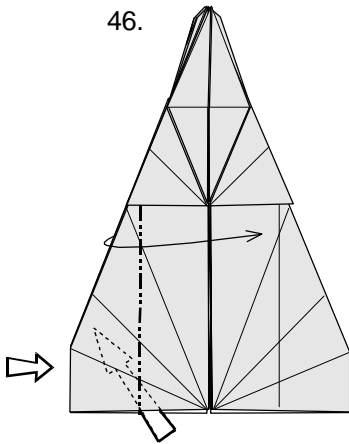

46.  
Separate the two layers on the side and push from below to flatten out ...

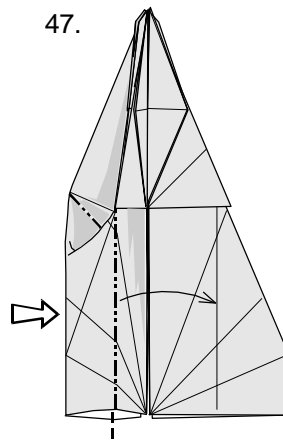

47.  
... ever so carefully ...

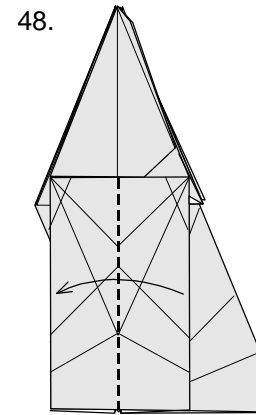

48.  
... like so. Now valley fold and close to the left.

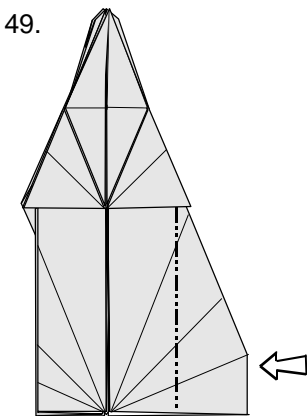

49.  
Repeat Steps 46 to 49 on the right. Fold up the flaps in the middle, bringing the corners at the bases together as in diagram 51.

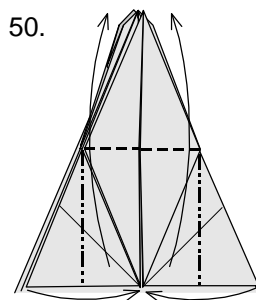

50.  
This is a close up of the top portion of the model. Fold up the frontal pieces as shown, bringing the corners at the bases together ...

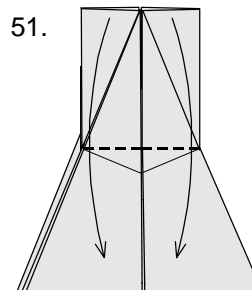

51.  
... like this, then fold down again, keeping the corners together.

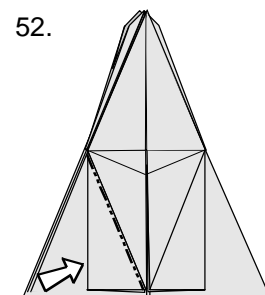

52.  
Reverse fold on the left.

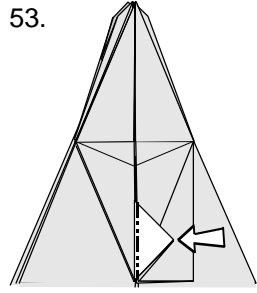

Reverse fold again ...

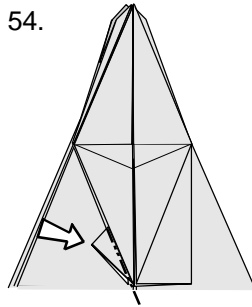

... and again.

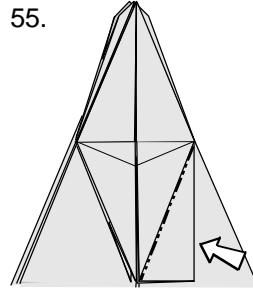

Repeat Steps 52 to 54 on the right to complete the top for now.

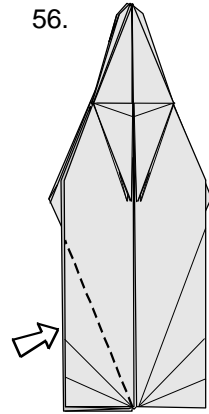

Reverse fold the top layer on the left.

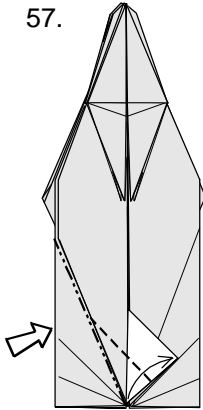

Valley fold the upper layer as shown, then reverse fold the second layer on the left.

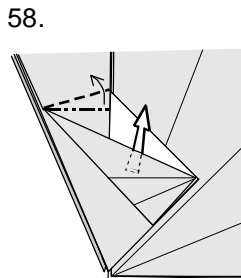

Crimp fold the top layer while opening out the hidden pleats ...

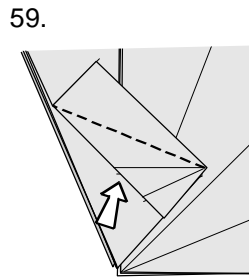

... like this. Reverse fold.

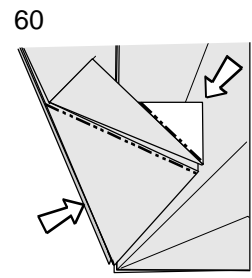

Reverse fold the next layer on the left, and reverse fold on the right again

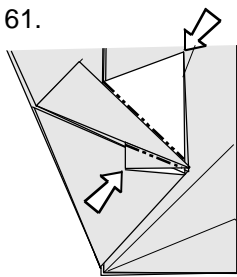

Two more reverse folds ...

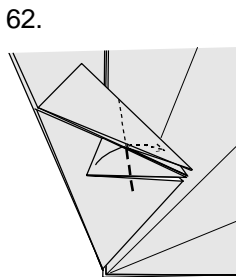

... then valley fold ...

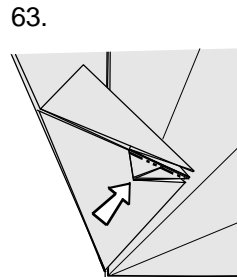

... before finishing off with yet another reverse fold.

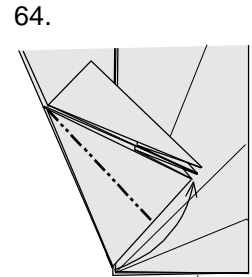

Repeat Steps 57 to 61 for the remain layer on the left.

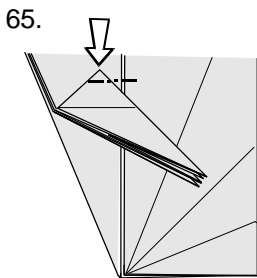

Sink fold and repeat behind, then repeat from Step 56 on the right half of the model.

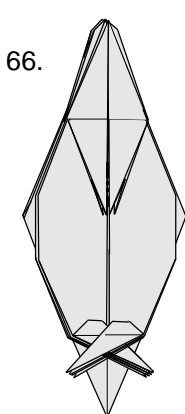

The model should now look like this.

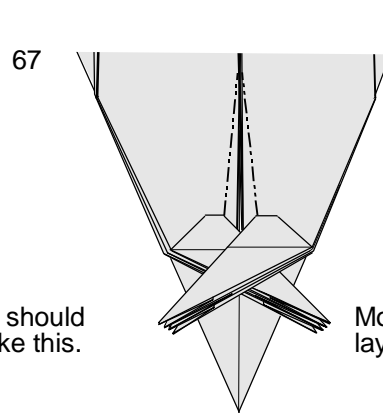

Mountain fold, the top layer only, as shown.

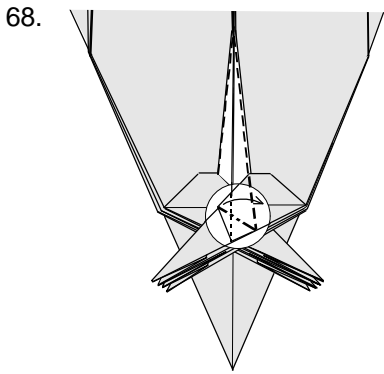

Valley fold the next layer under, forming a gusset with the hidden layers at the bottom...

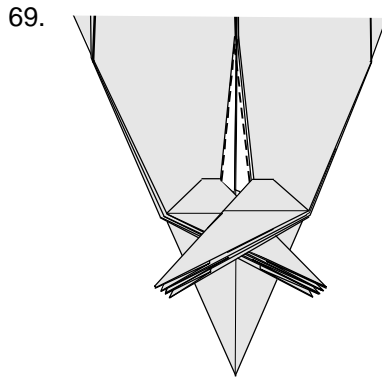

.. then valley fold the third and fourth layers together.

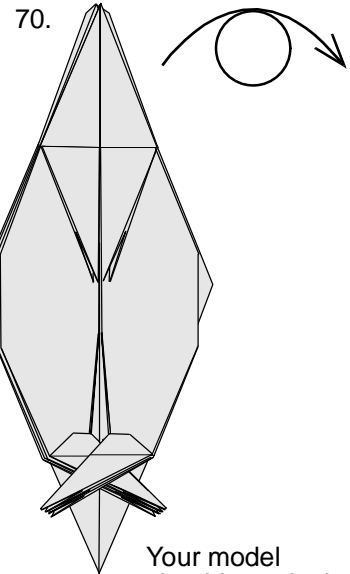

Your model should now look like this. Turn model over.

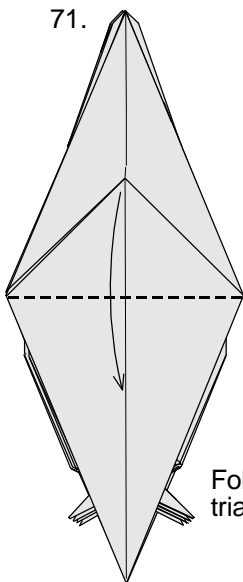

Fold down this triangle piece ...

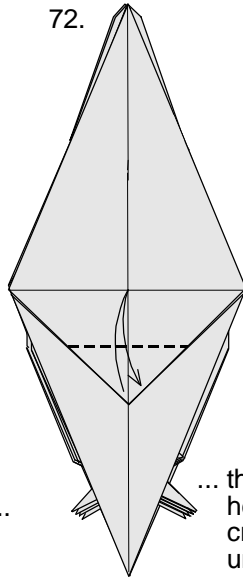

... then fold half its height upwards, crease well, and unfold.

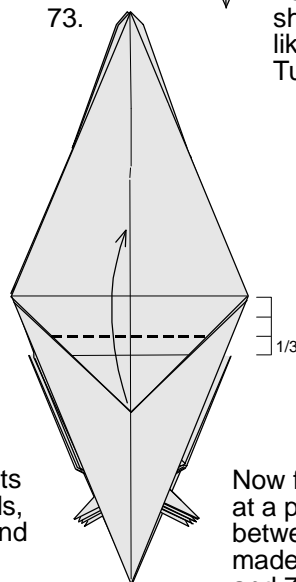

Now fold up again, at a point one-third between the lines made in Steps 71 and 72 as shown.

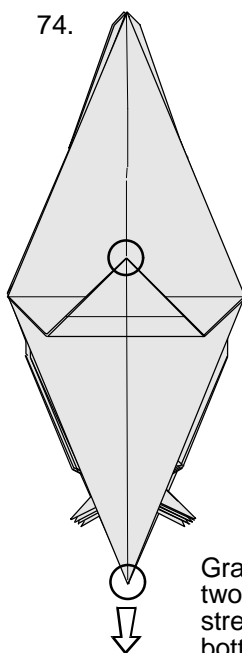

Grasp the model at the two circled locations and stretch by pulling the bottom point downwards.

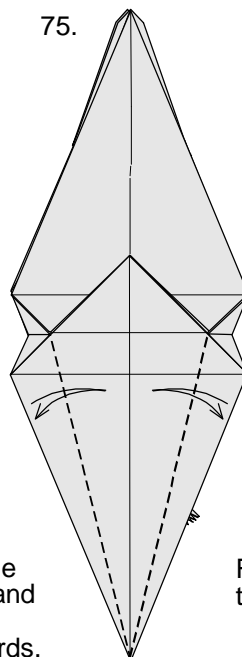

Fold and unfold each of the two sides, creasing firmly.

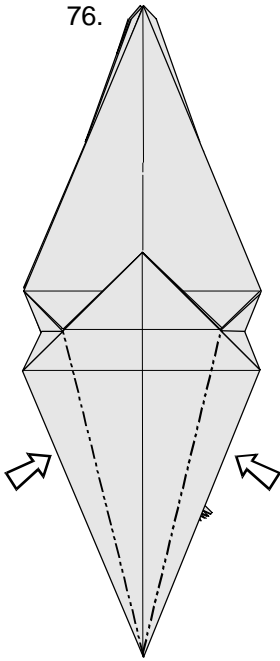

76. Sink along crease lines made in Step 75, as in Step 42.

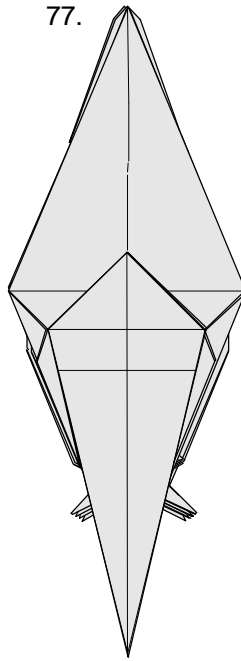

77. Turn model over.

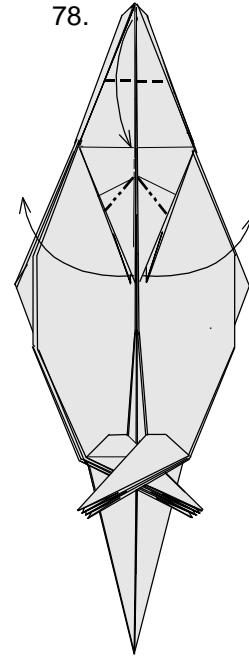
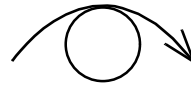

78. Reverse fold the points in the middle at differing angles, separating the two upper layers from the four layers below. Fold down the uppermost layer at the top as illustrated.

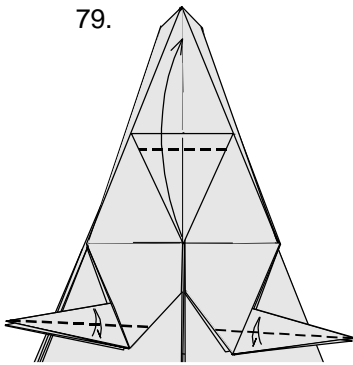

79. Fold up at the top again, then fold and unfold the lower points as illustrated.

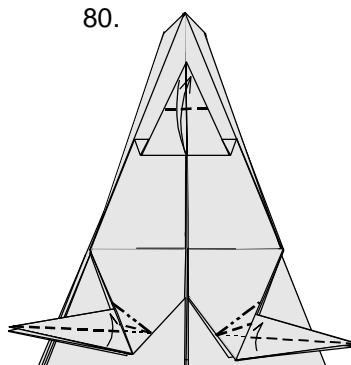

80. Fold down at the top. Next, narrow the points at the bottom while tucking the overlapping layers under as shown.

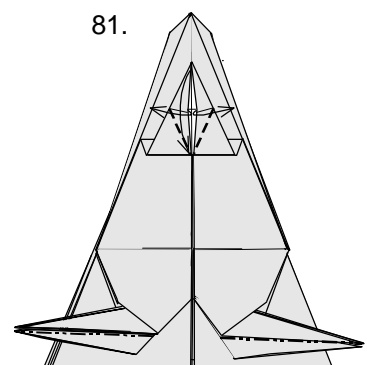

81. Open out to separate the left and right sides while bringing the tip down again. Narrow the inner halves of the lower points as in Steps 79 and 80.

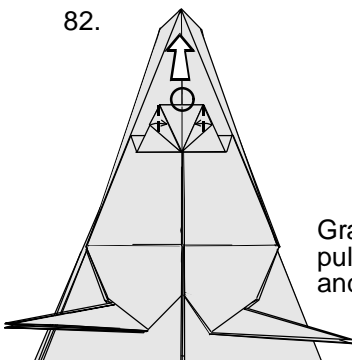

82. Grasp the circled area and pull up to unfold Steps 78 and 79 ...

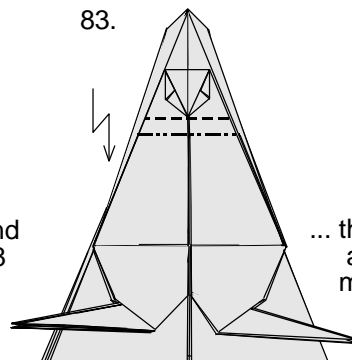

83. ... then crimp fold to reverse along the crease lines made previously ...

84.

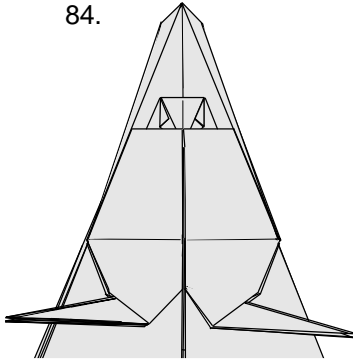

This is how your model should look after Step 83.

85.

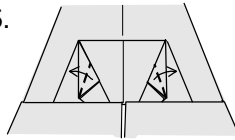

Fold the lower corners over ...

86.

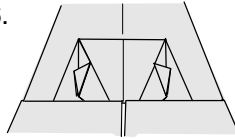

.. like this. These will be the eyes.

87.

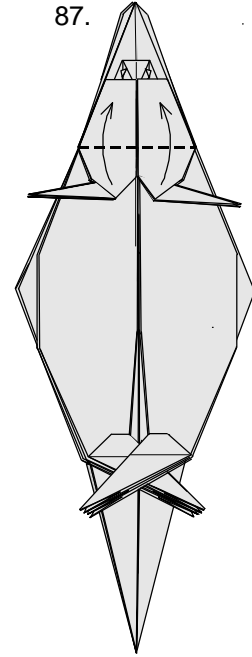

Fold up the central pieces. These will be the forelegs.

88.

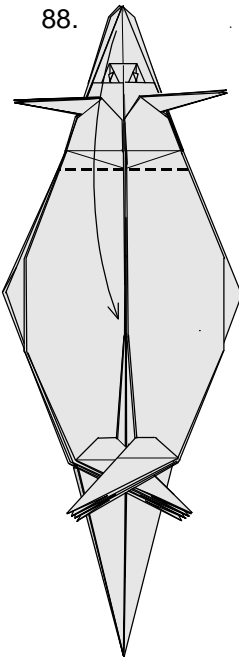

Fold down the top portion at the point shown in the illustration.

89.

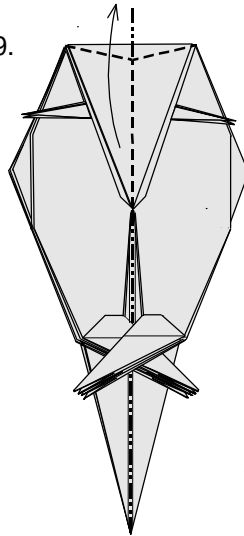

Crimp fold at the top while folding the model in half ...

90.

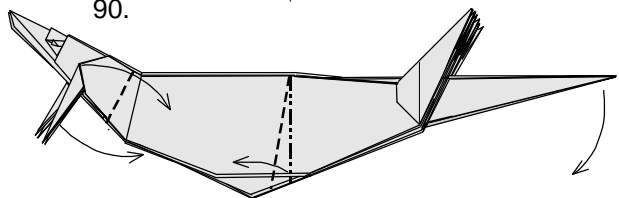

... like this.  
Crimp fold both sides of the body.  
Fold down the forelegs again.

91.

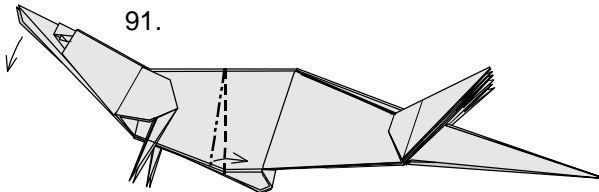

Crimp fold both sides of the body again ...

92.

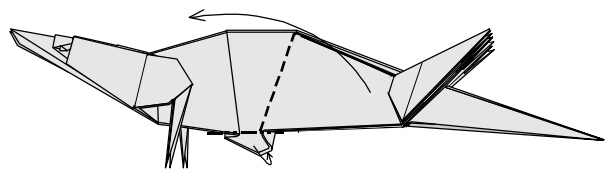

... then bring up the hind leg.  
Hide the excess paper at the belly with a mountain fold into the body.



93.

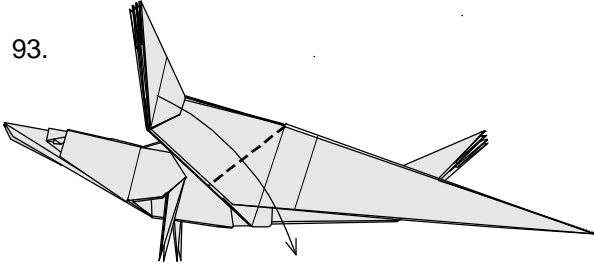

Valley fold down again.

94.

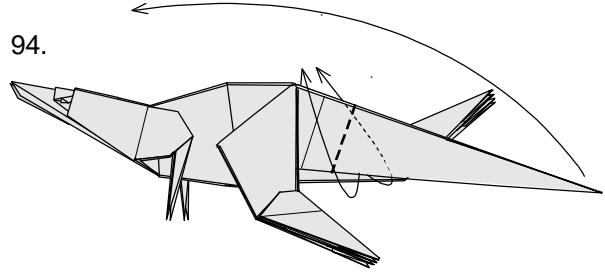

Repeat Steps 92 and 93 on the other hind leg, at a slightly different angle for greater realism. Outside reverse fold the tail as illustrated.

95.

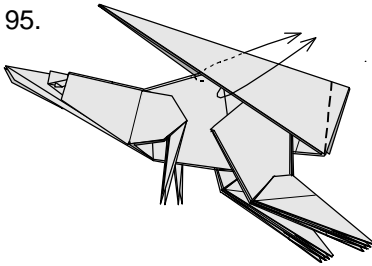

Outside reverse fold again, crimping the tail.

96.

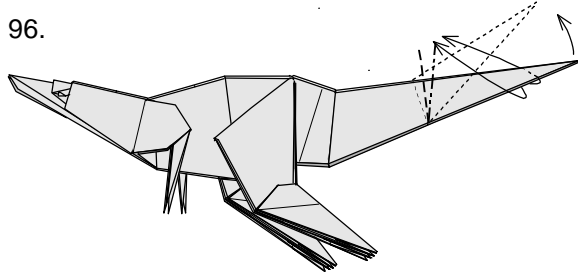

Repeat Steps 94 and 95 along the indicated position on the tail.

97.

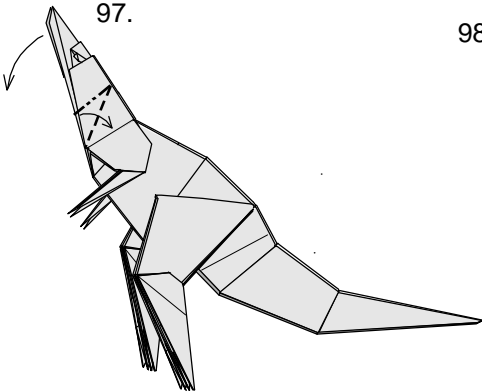

Crimp fold separately on each side of the model as illustrated.

98.

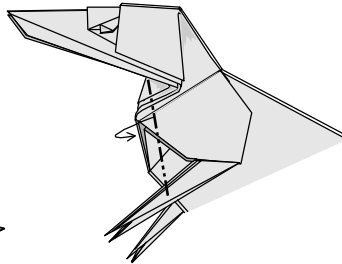

Mountain fold the excess paper into the body. Repeat on the other side.

99.

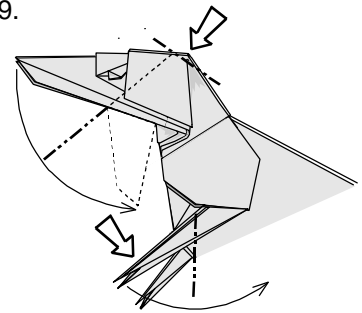

Reverse fold the foreleg and lower half of the mouth piece. Sink fold the corner at the back of the head.

100.

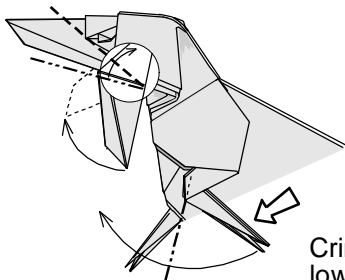

Crimp fold both sides of the lower jaw within the head as illustrated. Reverse fold the foreleg again.

101.

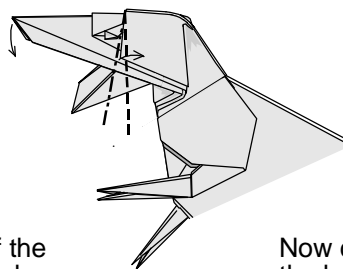

Now crimp fold both sides of the head to bring the upper jaw downwards.

102.

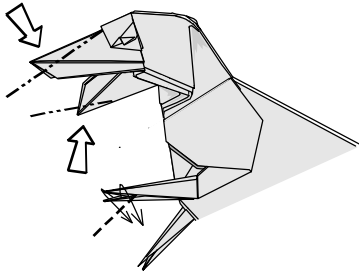

Outside reverse fold the lower point on the foreleg. Reverse fold the upper and lower jaws at the illustrated angles.

103.

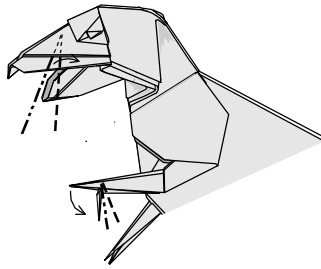

Crimp fold both sides of the upper point on the foreleg. Next, crimp fold both sides of the lowest layer of the upper jaw, drawing out the overlapping layers at the nose as you do so.

104.

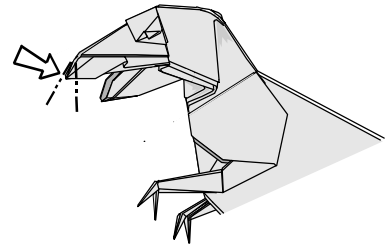

Repeat Steps 102 and 103 on the other foreleg, differing the angles slightly. Reverse fold again at the nose.

104.

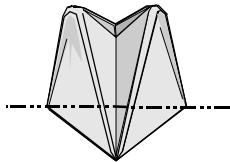

This is a close up of the front of the upper jaw. Mountain fold the triangle under ...

105.

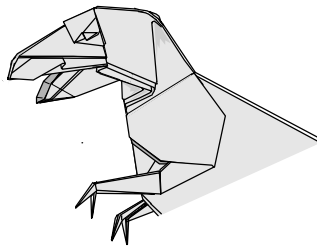

... and the head is finished.

106.

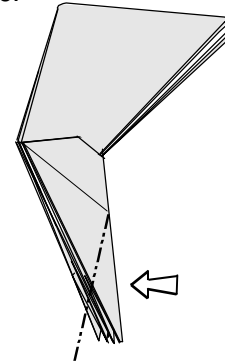

And now for the left hind leg. Reverse fold the uppermost layer as shown, making a gusset at the top.

106.

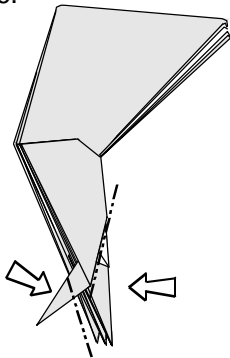

Repeat Step 105 on the next two points on the right, then reverse fold the point on the left again as shown.

107.

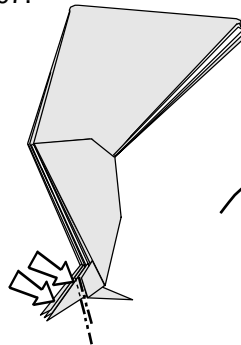

Repeat Step 106 on the first two point on the left. Turn model over.

108.

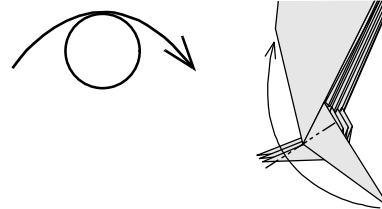

Reverse fold the last point all the way into itself ...

109.

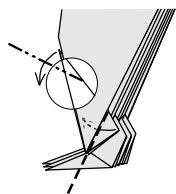

Reverse fold the hidden tip on the left, then tuck in the excess paper on the right ...

110.

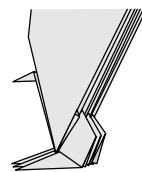

... like this. Turn model over again.

111.

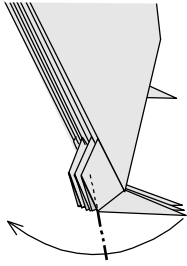

You will need to fold each of the three similar points one at a time from Step 111 through 114. Reverse fold ...

112.

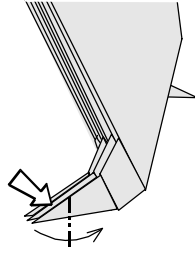

... again ...

113.

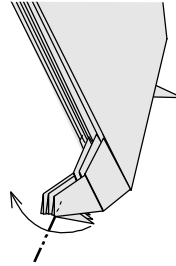

... and again ...

114.

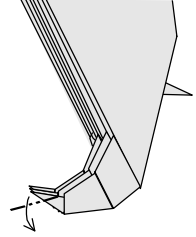

... and yet again.

115.

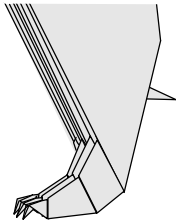

The foot should now look like this. Complete the other foot.

116.

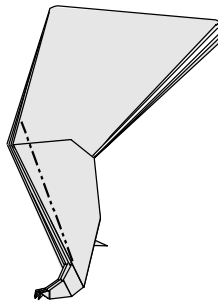

Divide the layers on the left side equally in two, then mountain fold each side to narrow the lower leg.

117.

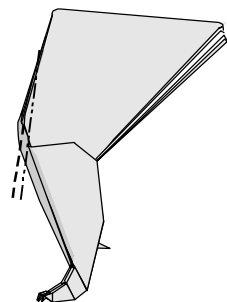

Do the same for the thigh.

118.

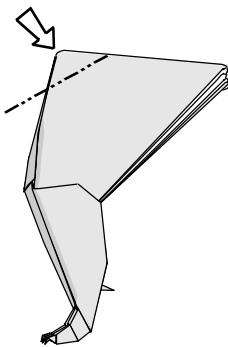

Reverse fold the corner of the upper thigh. Complete the other leg and you're all done!

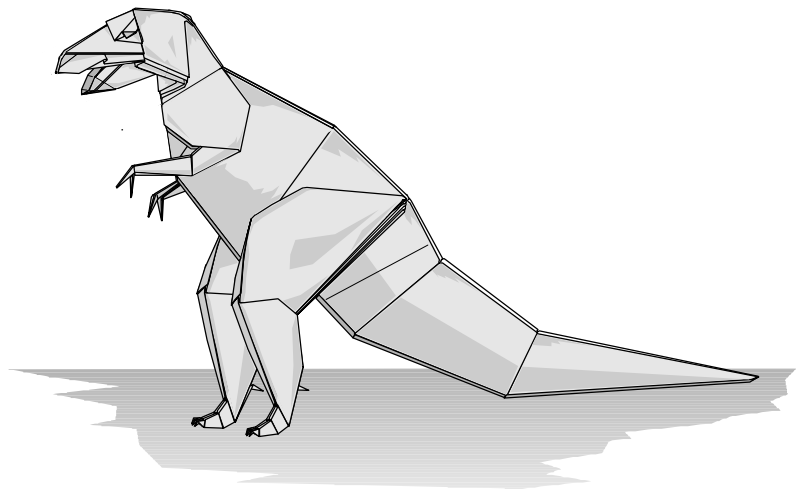

# Bebé Triceratops

Fernando Gilgado Gómez

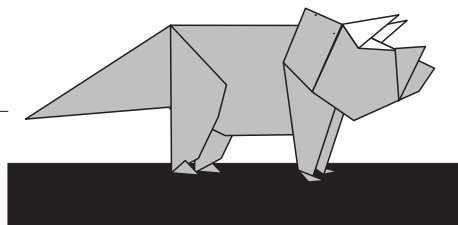

1

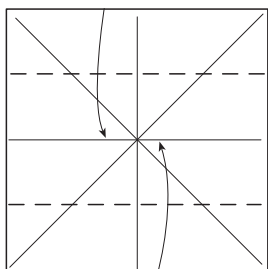

2

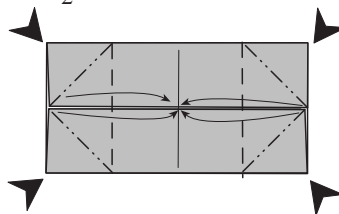

3

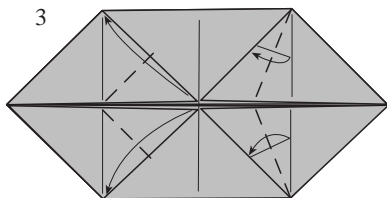

4

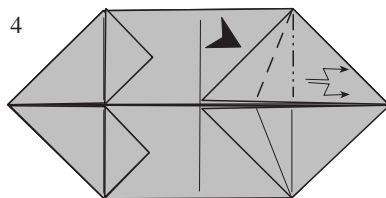

6

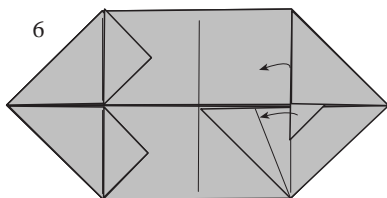

7

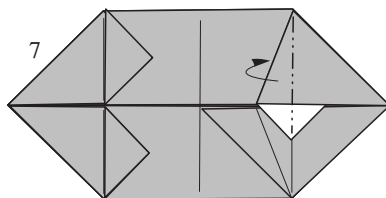

8

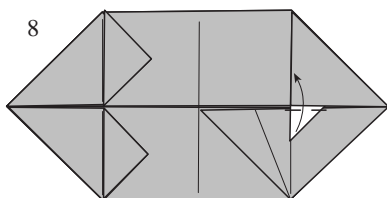

9

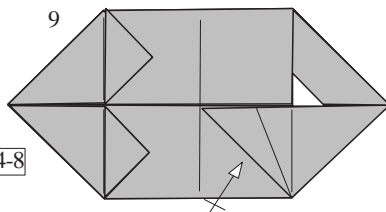

Repetir 4-8

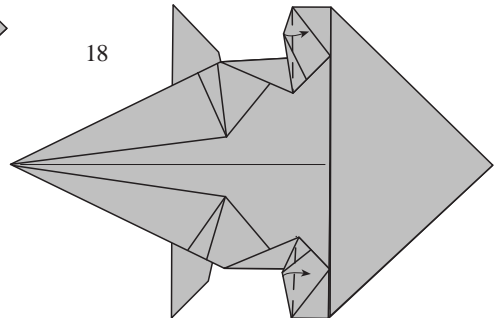
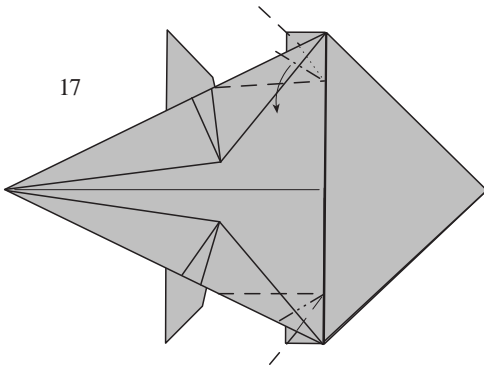
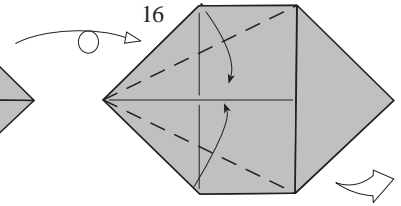
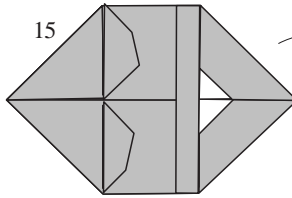
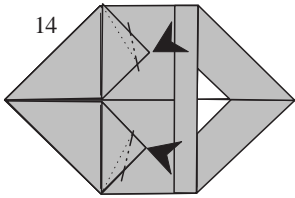
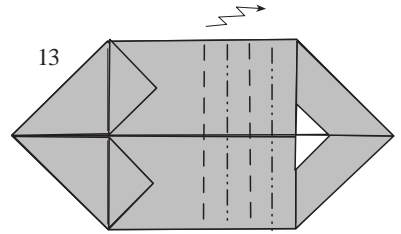
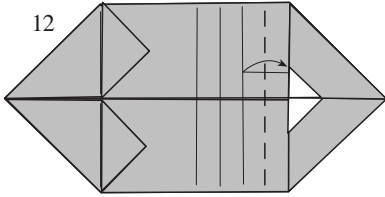
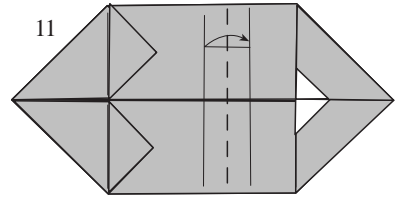
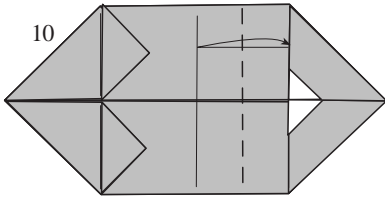

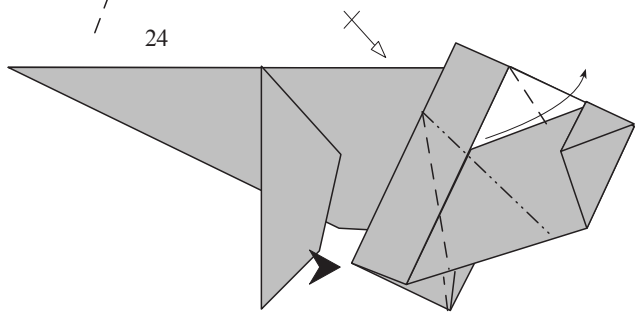
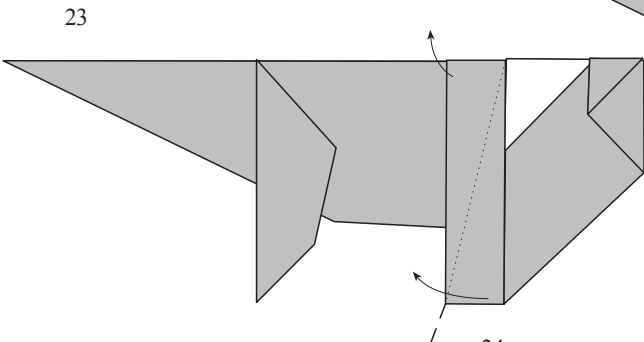
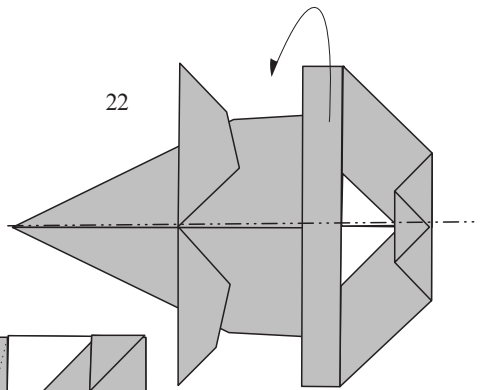
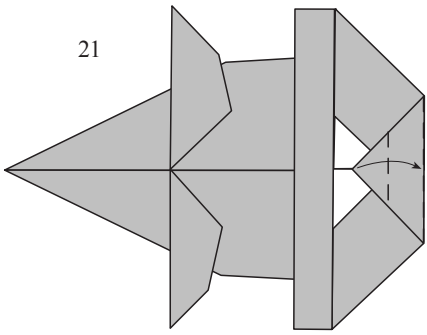
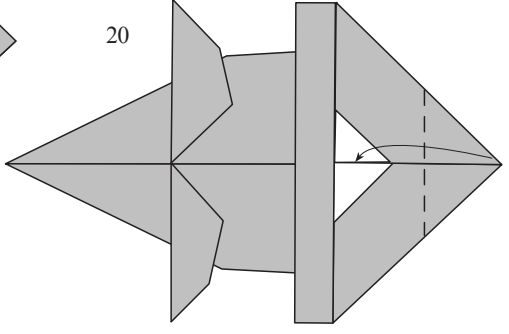
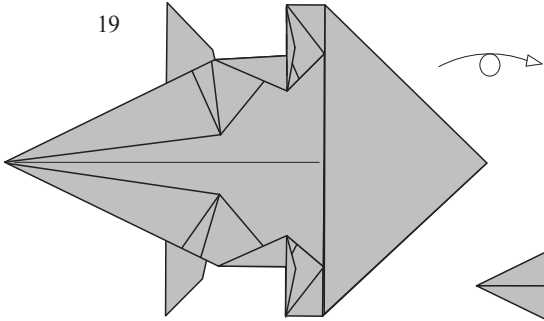

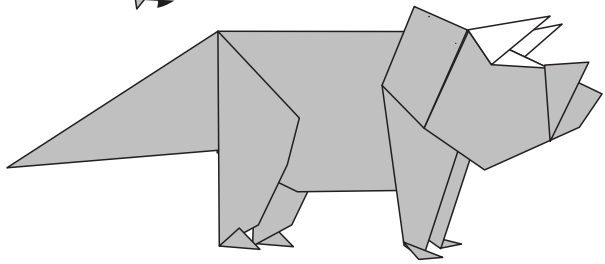
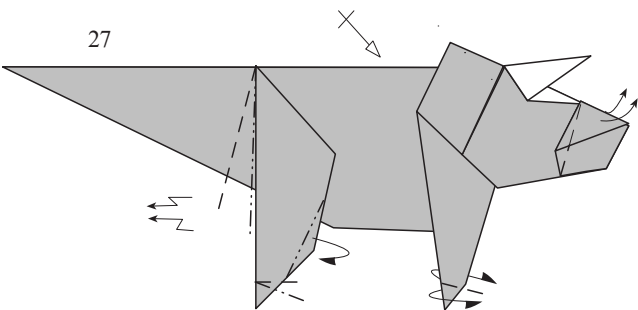
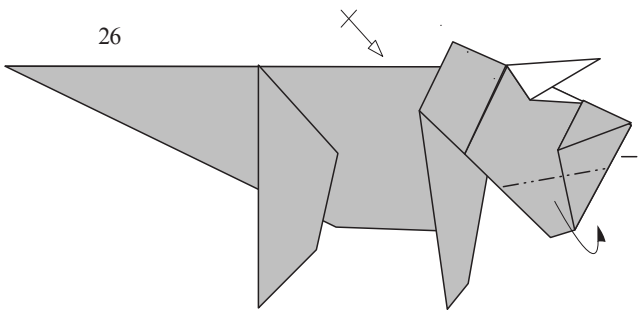
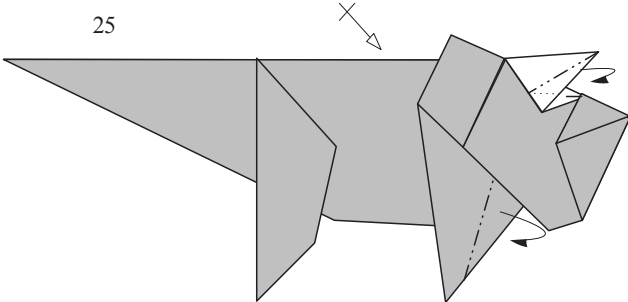

# Triceratops

by Jerry Harris

Begin with a square, white side up, with the vertical diagonal precreased. A square of 10" results in a model of approximately 5.8" long and 1.67" tall at the hip.

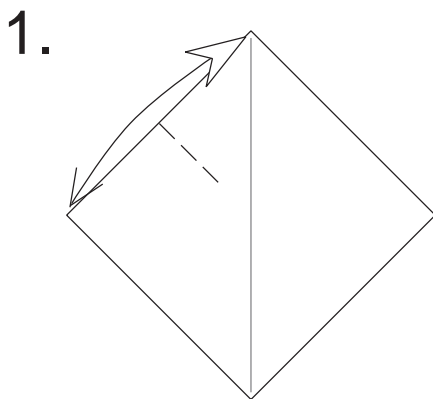

Valley fold the left edge in half, creasing only at the very edge, and unfold.

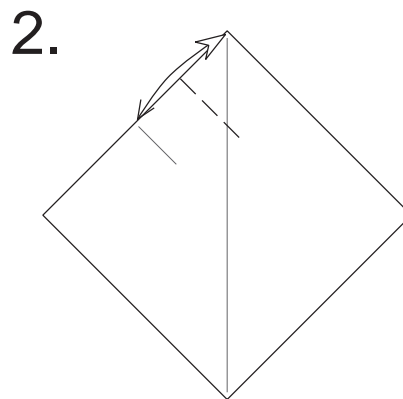

Valley fold 1/4 at the left side, again creasing only at the edge, and unfold.

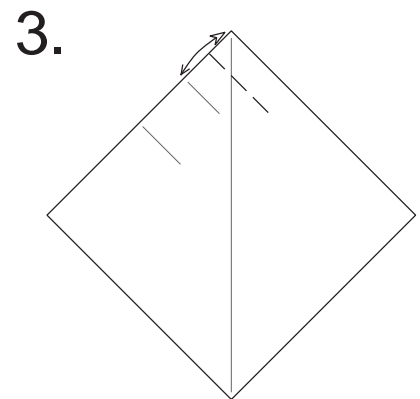

Valley fold 1/8 at the left side, again creasing only at the edge, and unfold. This is the mark that is referred to in Step 7.

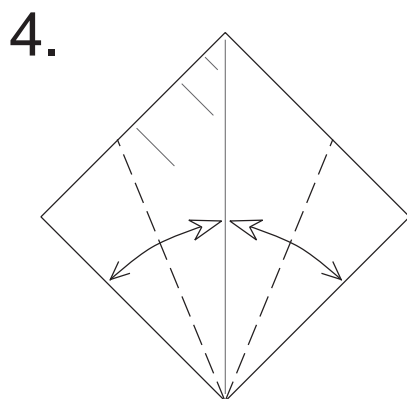

Valley fold lower angle bisectors to the center and unfold.

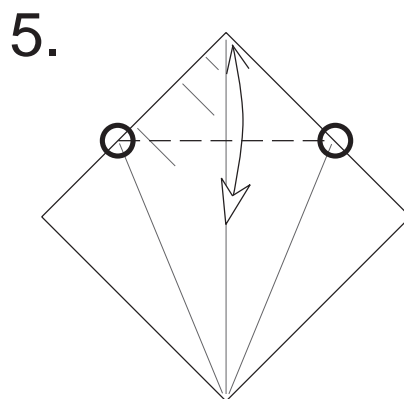

Valley fold, connecting the tops of the angle bisectors, and unfold.

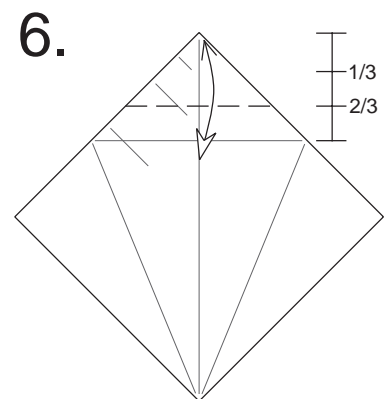

Valley fold through a point 2/3 the way between the top point and the crease connecting the angle bisectors (made in Step 5) and unfold.

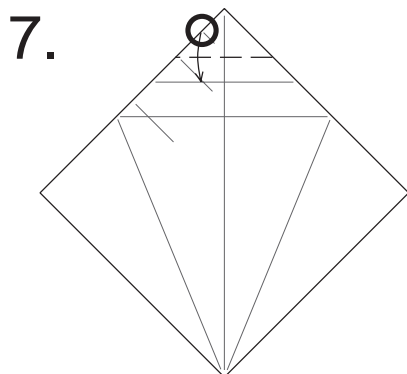

Valley fold the top point down so the 1/8 mark from Step 3 touches the 2/3 line from Step 6.

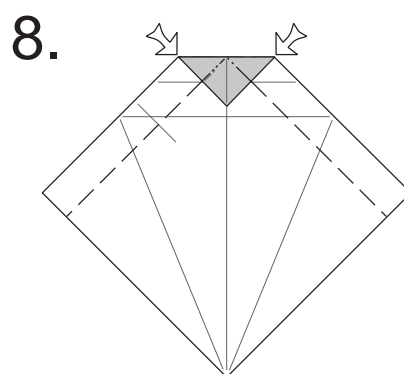

Reverse fold the top corners in to the center, creating a small preliminary base at the top.

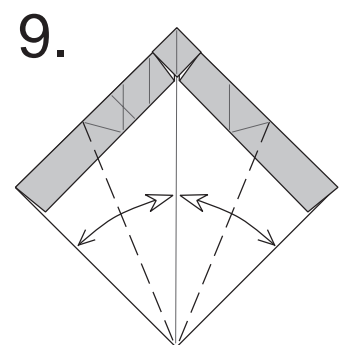

Remake the angle bisectors through the new flaps at the top and unfold.



10.

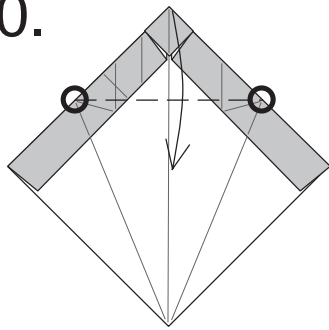

Valley fold the top point down, connecting the tops of the angle bisectors.

11.

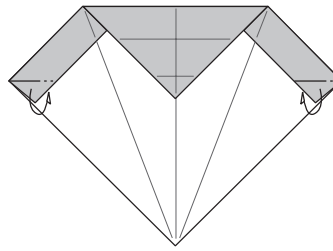

Mountain fold the loose corners at the sides under.

12.

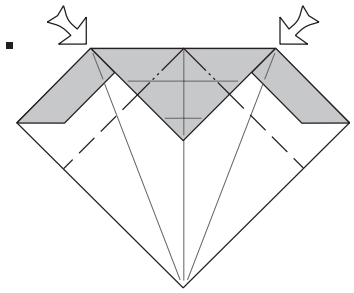

Reverse fold the top corners in to the center, creating another preliminary base at the top.

13.

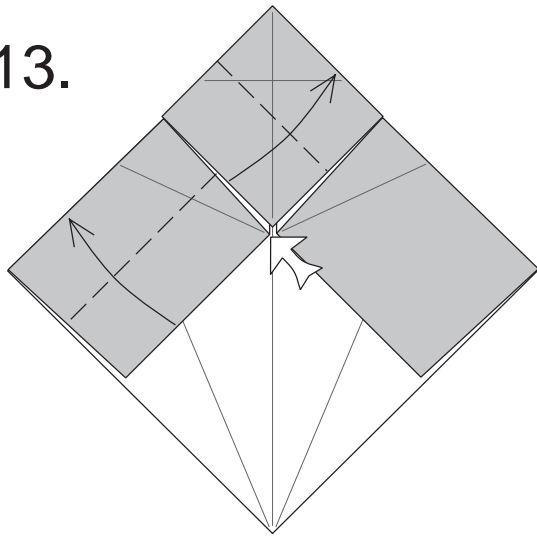

Valley fold the lower left side of the preliminary base at the top in half. As you do this, you will have to squash the flap underneath, folding the inner edge of the colored flap to the outer edge.

14.

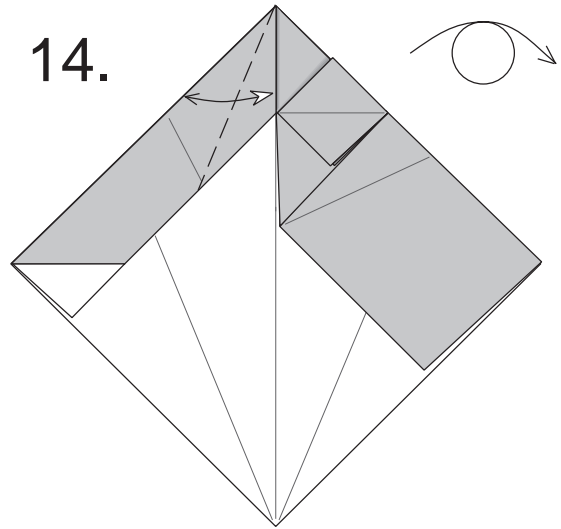

The result. The first small preliminary base should lay perfectly between the edges and the center, forming 1/4 of the larger one (made in Step 12). Valley fold the angle bisector at the top, using only the top flap and unfold (the model will not lay flat as you do this). Turn over from side-to-side.

15.

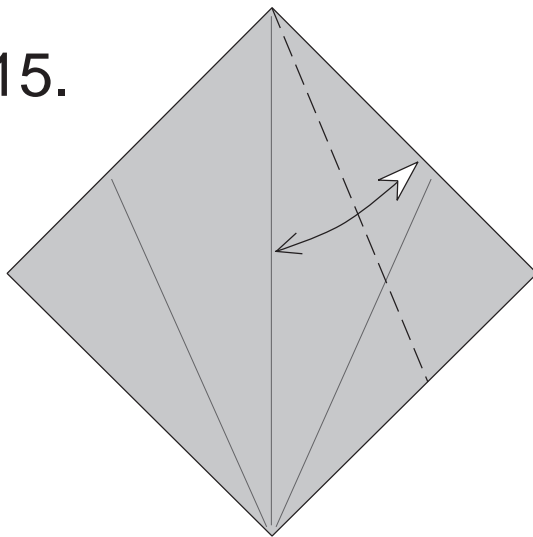

Valley fold the corresponding angle bisector on the back. The paper will not lay flat as you do this, and you'll have to crease the top part and bottom part separately. Unfold.

16.

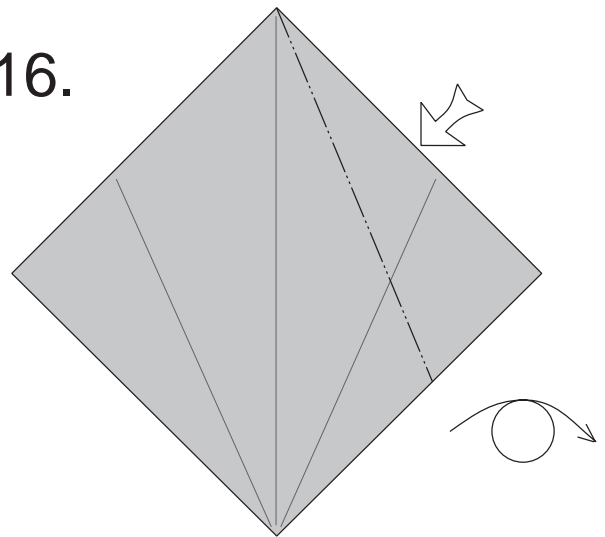

Reverse fold the right side on the fold you just made. Again, the paper will not lay flat. Turn back over from side-to-side.

17.

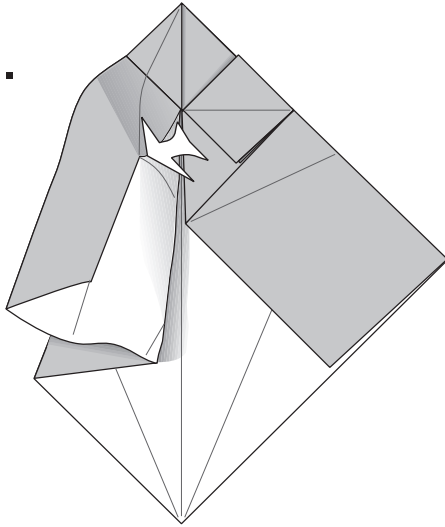

Invert the broad, raised point. The model will still not lay flat, but will be concave instead of convex.

18.

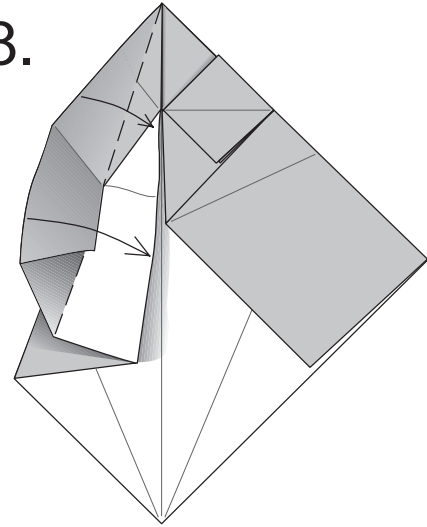

Valley fold the now concave flap down along the crease made in Step 14, and flatten the model.

19.

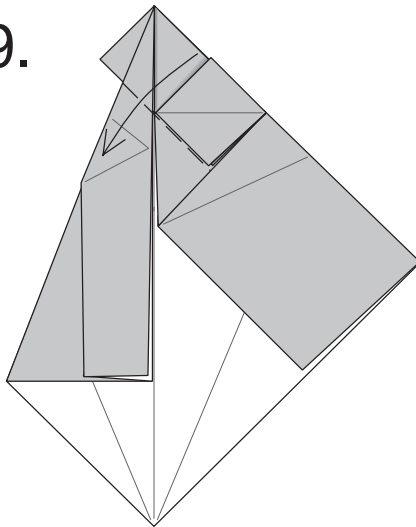

The result. Fold the flap containing the small preliminary base back down to the left.

20.

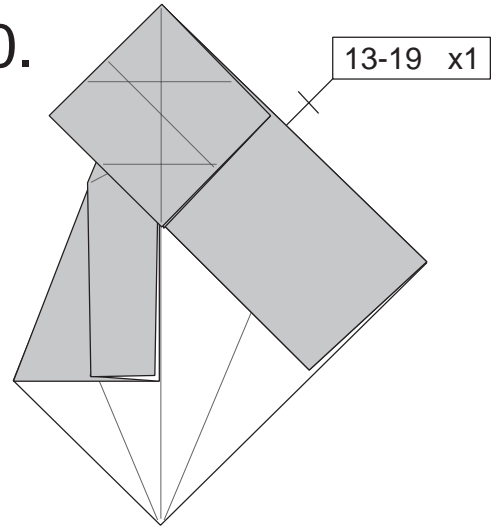

Repeat Steps 13-19 in mirror image on the right side.

21.

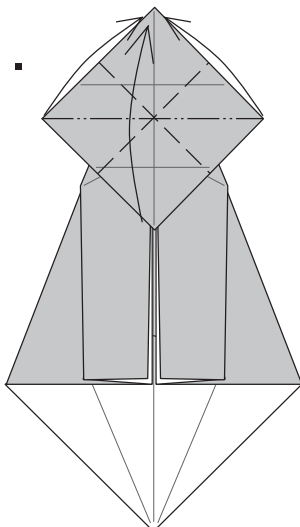

Collapse the square at the top as a preliminary base.

22.

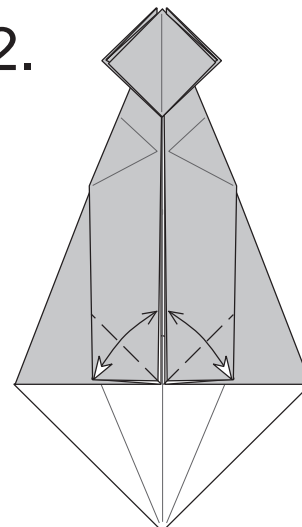

Valley fold the bottoms of the long, rectangular strips to the center line and unfold.

23.

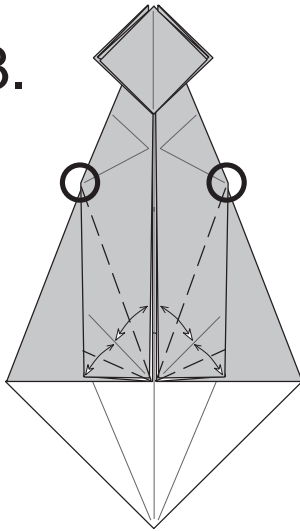

Quadrisection the angle of the lower end of the rectangular flaps. Note that the long, innermost folds connect to the angle on the outside edge of the long flap.

24.

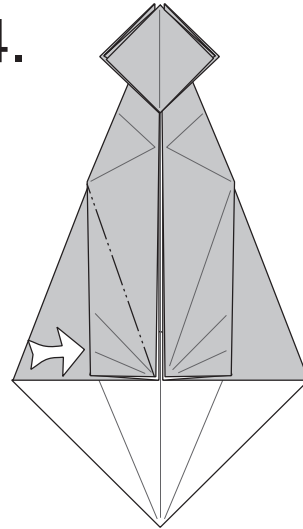

Reverse fold the left flap on the long, innermost quadrisection line.

25.

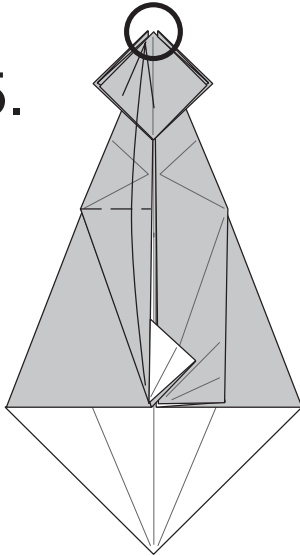

With only the uppermost flap of the reverse fold, begin to fold it up to match the top point of the model. The next few steps show more folds being made while this is being done.

26.

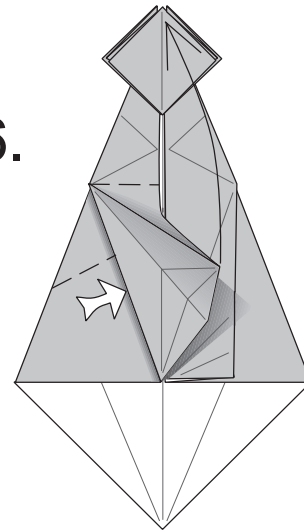

As you continue to fold the point up to the top, you must push in the layer beneath it. The valley fold beneath that is on an existing crease.

27.

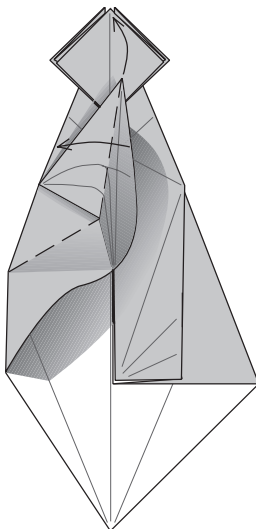

Now the point is closer to the top. Using existing creases, fold the flap down to the left. It still won't lay flat.

28.

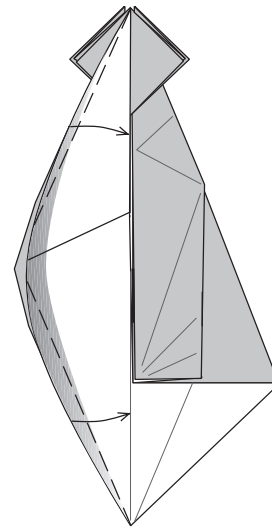

Flatten the model by valley folding the raised flap down to the center line. The bottom half of this fold occurs on an existing crease line.

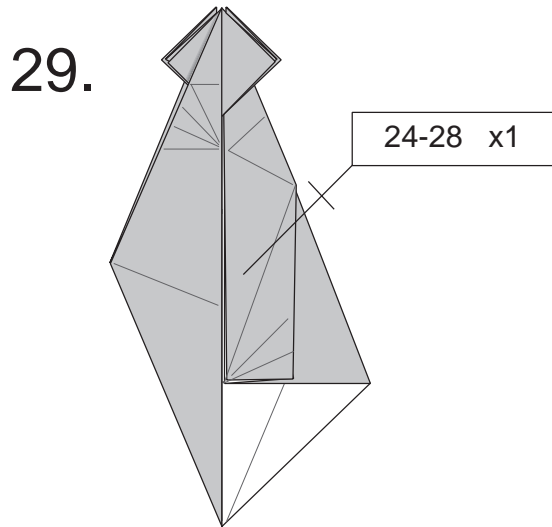

The result. Repeat Steps 24-28 on the right side.

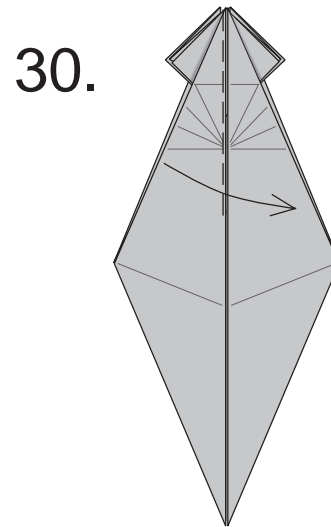

Pull the uppermost, double-thickness top layer to the right to expose the hidden layer beneath. The paper will not lie flat.

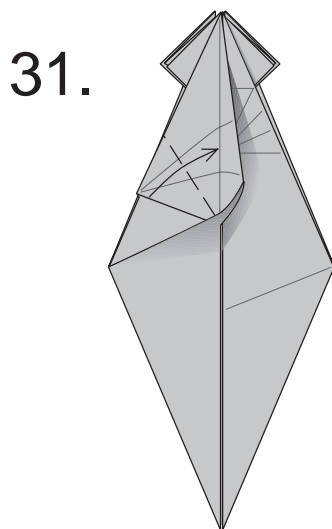

Bisect the thick, hidden flap by valley folding its lower edge to the center line.

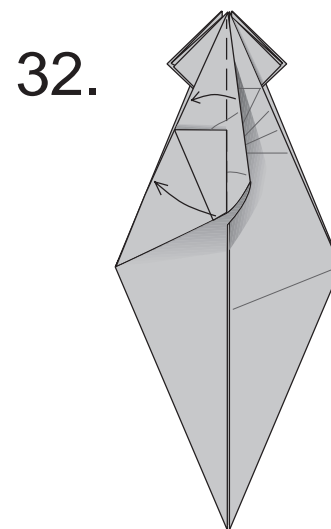

Close the model over the hidden flap again.

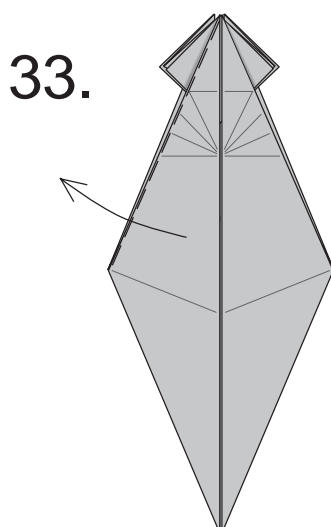

Pull the uppermost, single-layer top flap to the left, exposing another hidden flap (this is the same view as Step 28).

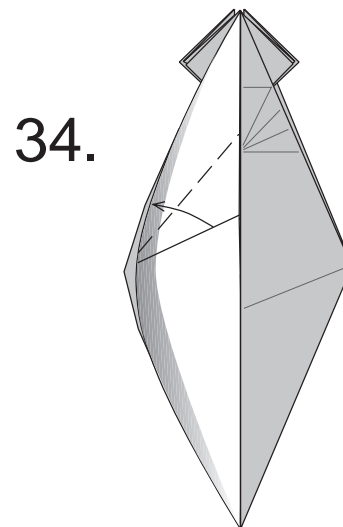

Bisect the hidden flap. This will lock the fold of the hidden flap folded in Step 31.

35.

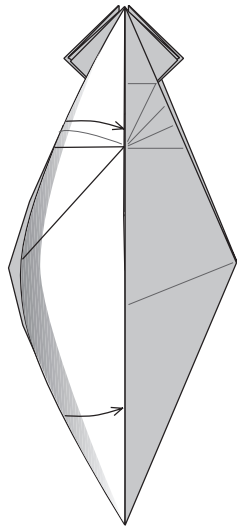

Close the flap again.

36.

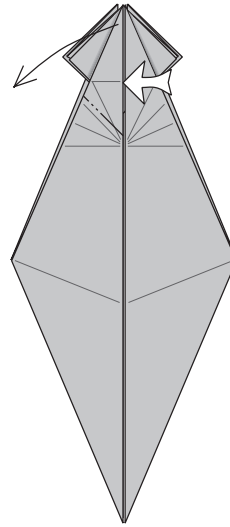

Reverse fold the top left point out to the left. The lower end of the reverse fold line is located at the point at which the layers are locked together.

37.

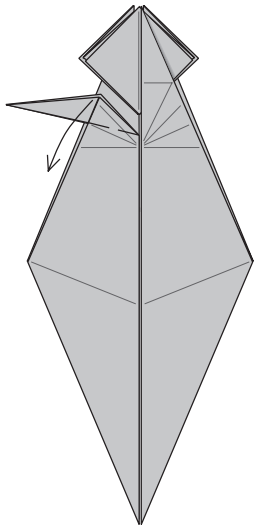

This point will be one of the front legs. Valley fold the top layer of the point down.

38.

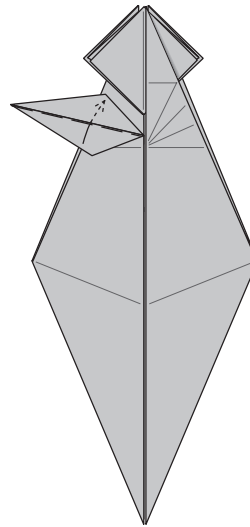

Tuck the lower flap under the layers of the upper flap.

39.

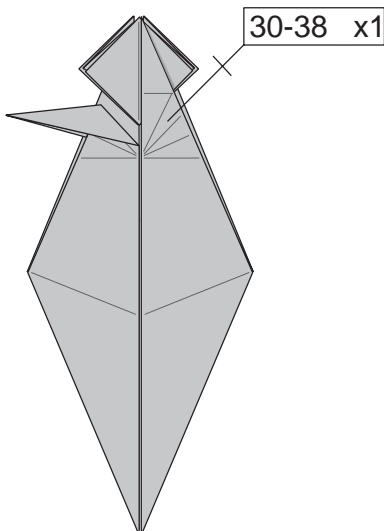

Repeat Steps 30-38 in mirror image on the right side.

40.

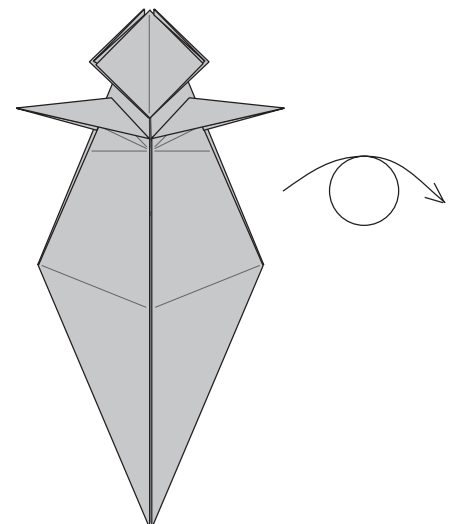

Turn over from side-to-side.

41.

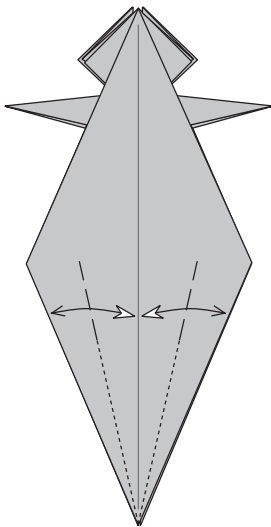

Valley fold the lower edges to the center line, bisecting its lower angle, but only crease near the center of the model.

42.

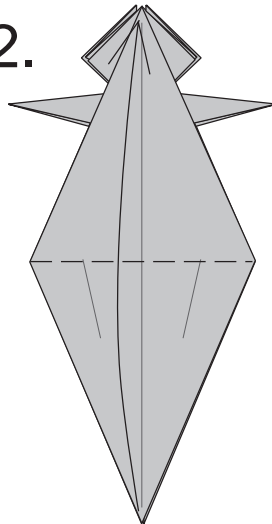

Valley fold the lower point to the top.

43.

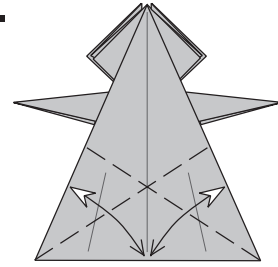

Valley fold the left and right edges of the uppermost point to the horizontal bottom edge and unfold, bisecting the lower corners.

44.

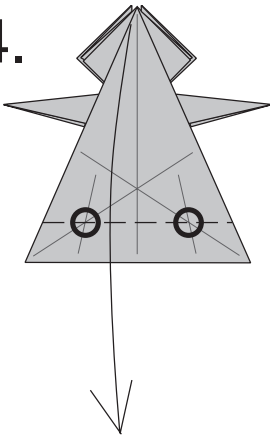

Valley fold the uppermost point down through the intersections of the angle bisectors from Steps 41 and 43.

45.

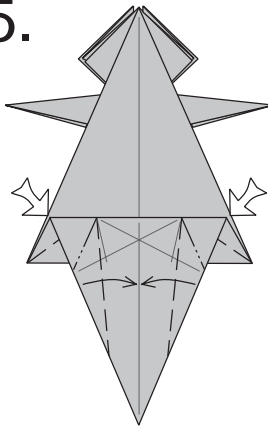

Narrow the tail by folding the sides in towards the center line. Note that the folds do not go all the way to the tip of the point. As you do this, squash fold the gussets at the sides; they should line up with the horizontal edge underneath.

46.

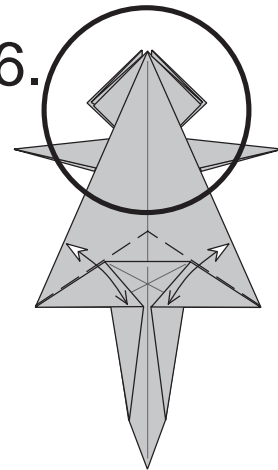

Valley fold the whole thickness of the body along the edge of the flap at the base of the tail and unfold. The next few steps focus in on the head (the top assembly).

47.

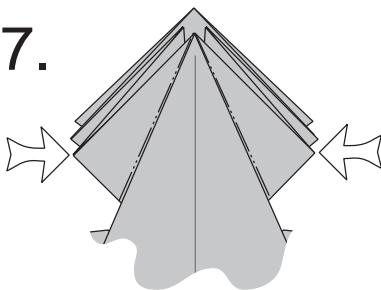

Reverse fold the first pair of flaps inwards (as in a bird base).

48.

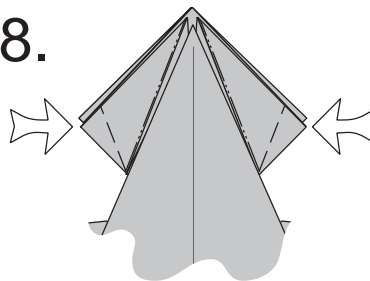

Reverse fold the next pair of flaps. The layer you can see in this figure goes in all the way, but the layer beneath it does not, and the resultant edge is vertical.

49.

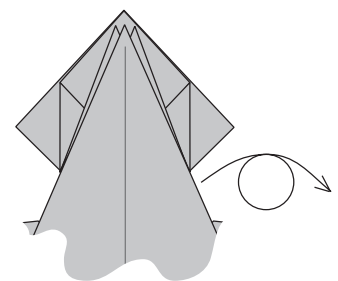

The result. Turn the model over from side-to-side; the next diagram is still a close-up of the head.

50a.

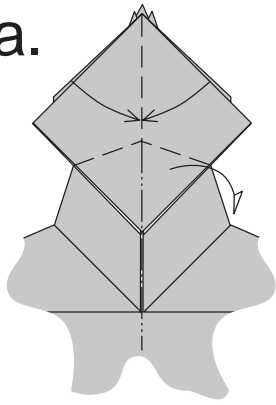

50b.

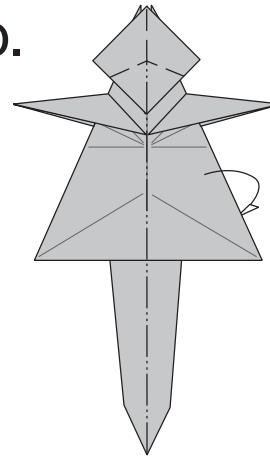

Mountain fold the whole body in half (right side under the left), incorporating the rabbit ear on the head end (close-up). Rotate counterclockwise 90°.

51.

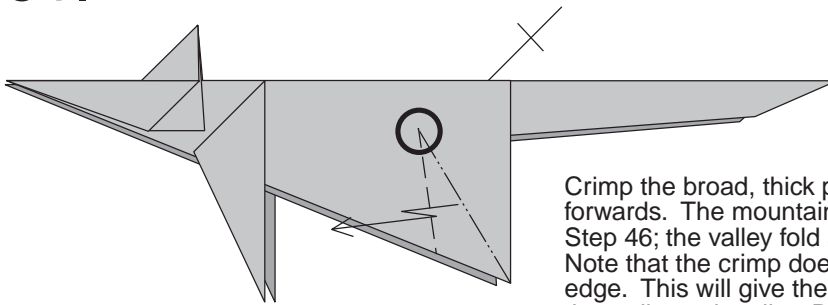

Crimp the broad, thick points towards the tail (the hind legs) forwards. The mountain fold is on the crease you made in Step 46; the valley fold are new, and are not quite vertical. Note that the crimp does not progress all the way to the top edge. This will give the model a degree of three-dimensionality. Repeat the crimp behind.

52.

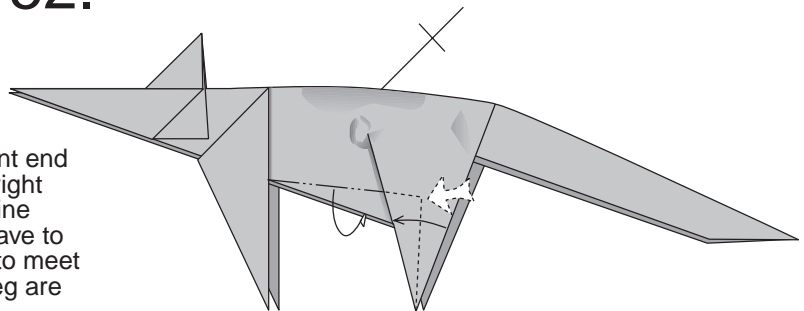

Narrow the belly with a mountain fold. The front end of the fold should meet or go slightly past the right edge of the front leg; the back end of the fold line continues under the hind leg, where you will have to squash a gusset by folding the edge of paper to meet the front edge of the leg (the folds inside the leg are indicated by the x-ray lines). Repeat behind.

53.

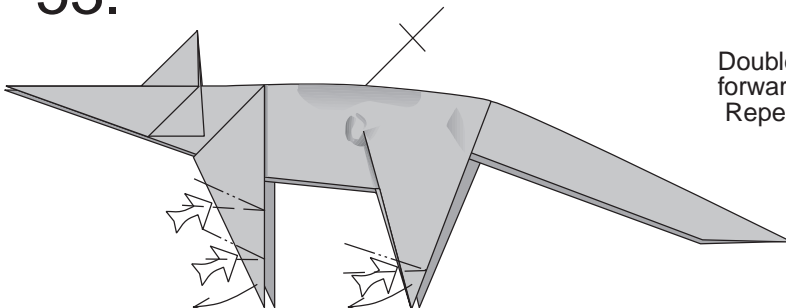

Double reverse fold the front leg twice, curling them forwards. Double reverse fold a foot on the hind leg. Repeat behind.

54.

Double reverse fold the tail, bringing it back up close to horizontal. Reverse fold the tip of the front foot in to shorten it. Repeat the front foot fold behind.

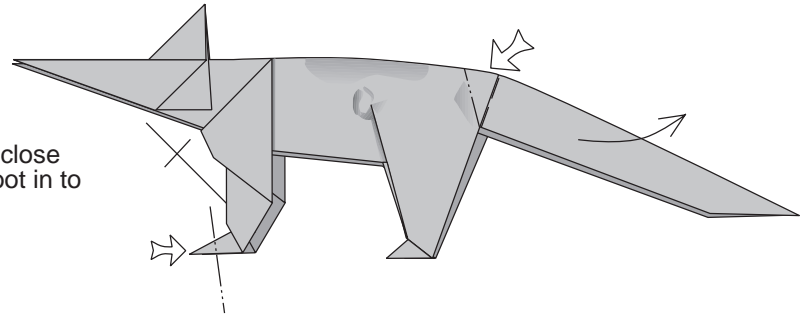

55.

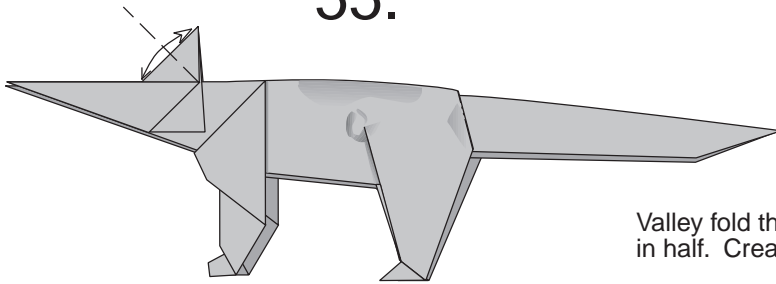

Valley fold the small triangle above the head (the frill) in half. Crease heavily, and unfold.

56.

Unfold the rabbit ear which forms the frill point (folded in Step 50a), allowing the flap on the far side of the model to swing upwards. The first small preliminary base (from Step 9) will reappear.

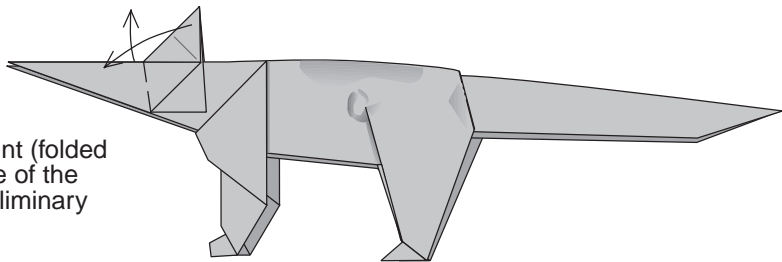

57.

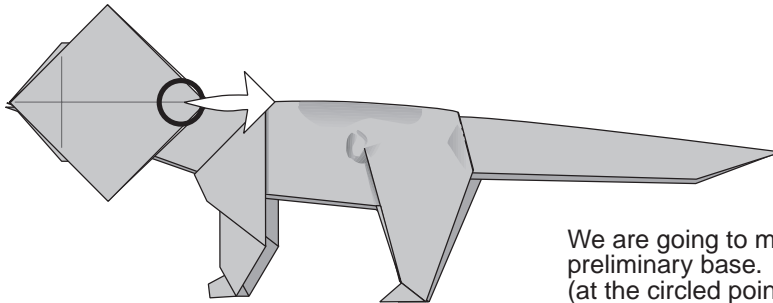

We are going to make the frill larger by unfolding the preliminary base. Grabbing only the uppermost layer (at the circled point), pull it to the right. The thicker point (the one you folded in Step 55) will swing outwards so that, in the diagram, it will be pointing out of the page towards you. The next diagram shows this view.

58.

Squash down the raised center point, using the mountain folds formed by the valley fold in Step 55. Some paper will be pulled out from the sides of the frill as you do this. The resultant flap won't lay flat.

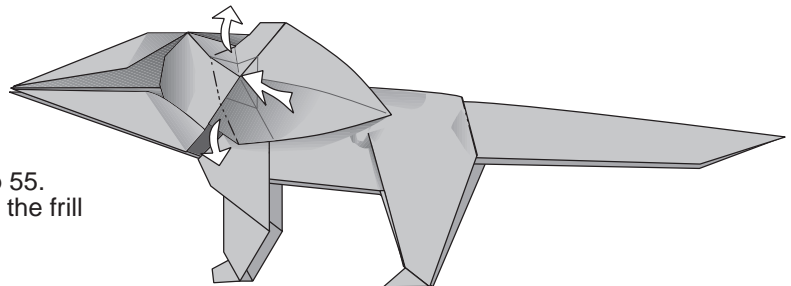



59.

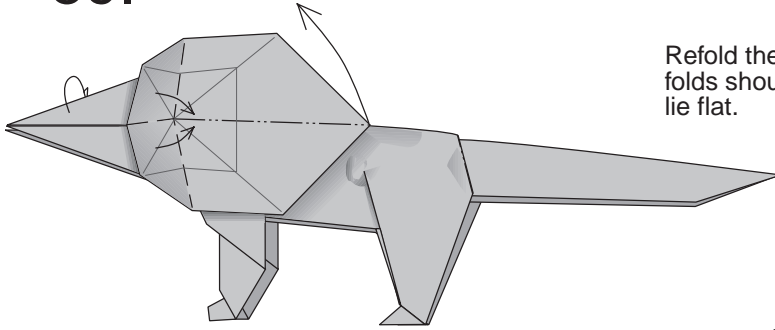

Refold the rabbit ear you unfolded in Step 56 — the folds should reform rather easily. The paper will now lie flat.

60.

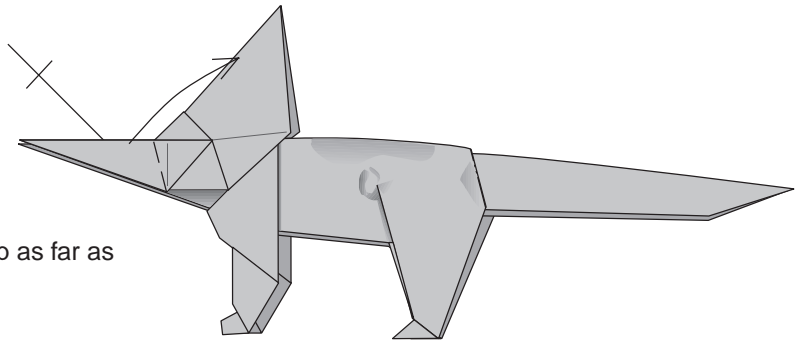

Valley fold the horns up as far as possible.

61.

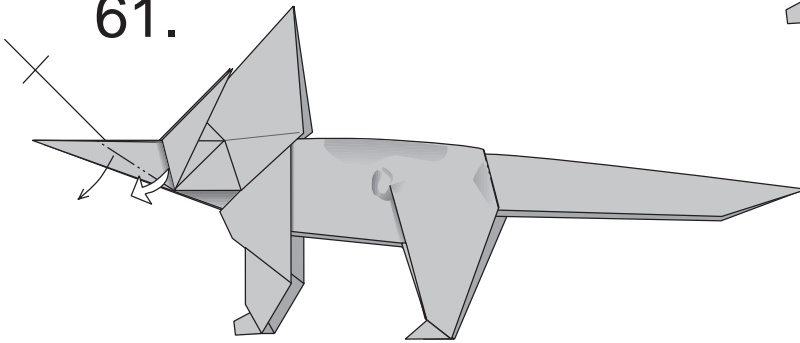

Pull a single layer down from the side of the snout; some paper will be pulled out from under the horn. Repeat behind.

62.

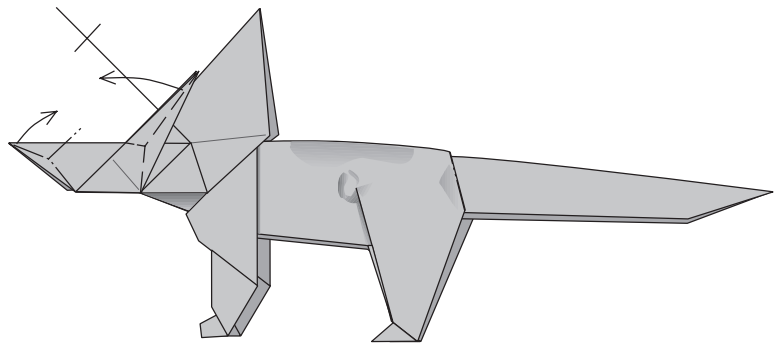

Rabbit ear the horn so it arches forward over the snout; repeat behind. Double rabbit ear the tip of the snout to form a nose horn.

63.

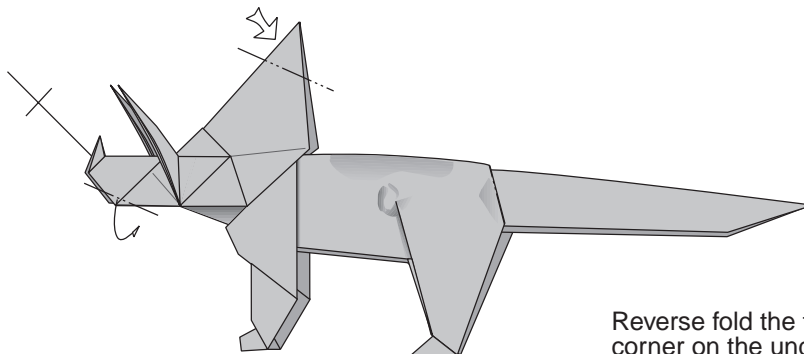

Reverse fold the tip of the frill inside. Mountain the corner on the underside of the snout inside; repeat behind.

64.

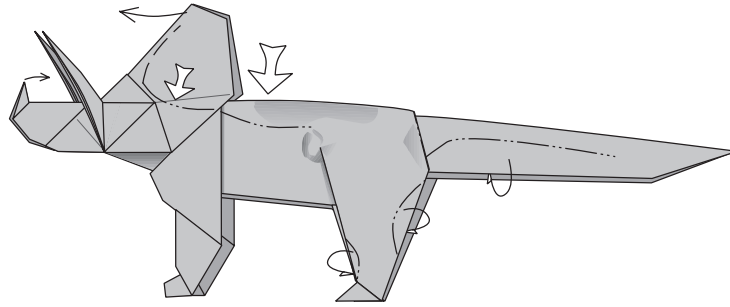

Finish rounding out the body by pushing in the back to match the three-dimensionality produced with the crimps in Step 51. Round the tail and hind leg, as well; repeat behind. Make the frill more three-dimensional by creating a large dimple on the left side — this will produce a slight crimping motion to bring the frill forward, but the central mountain fold stays in place. Repeat behind. Curl the nose horn backwards.

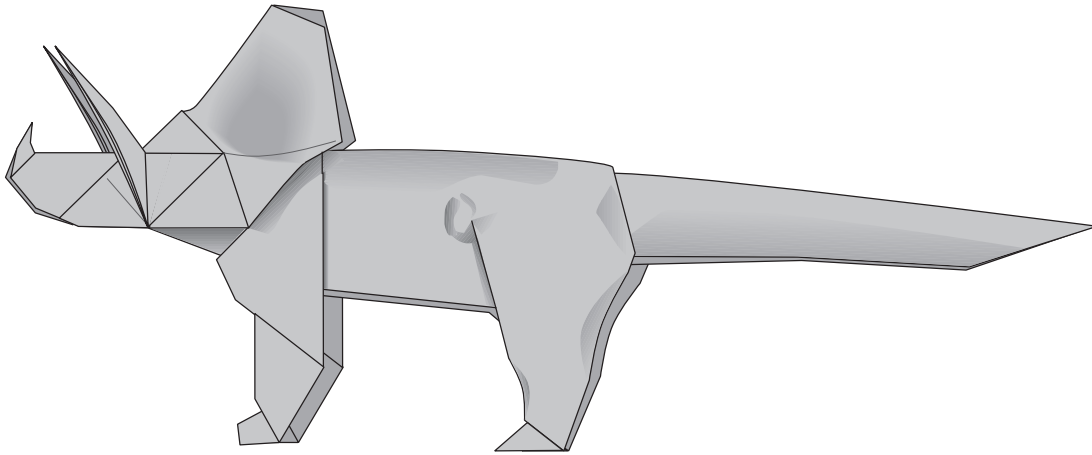

Finished *Triceratops*.

Start with rectangle 1x8

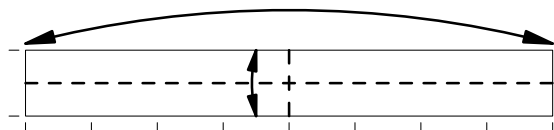

1

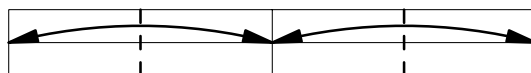

2

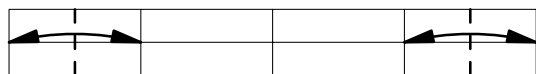

3



4



5

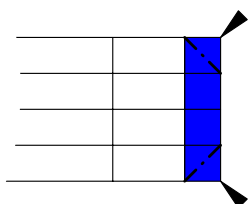

6

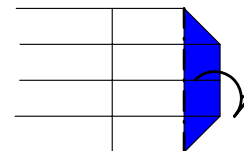

7

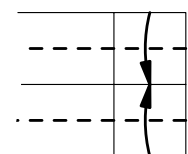

8

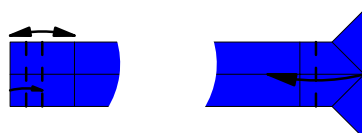

9

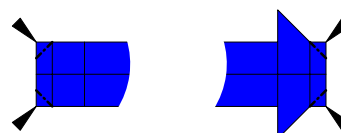

10

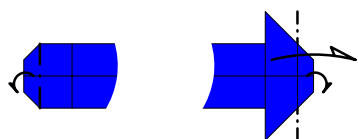

11

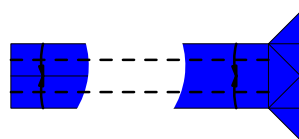

12

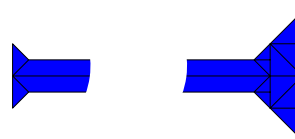

13

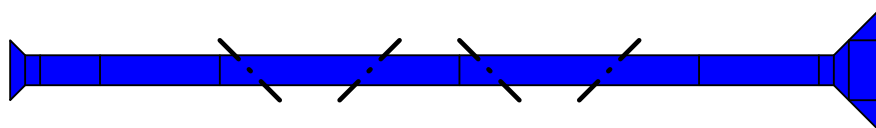

14



# Tut 'n Cleo' by J.C. Nolan (Jan '95)

©'95

Beginner (Pureland) Fold from a square of paper with the colored side down. A 6" piece of paper produces a 6" model.

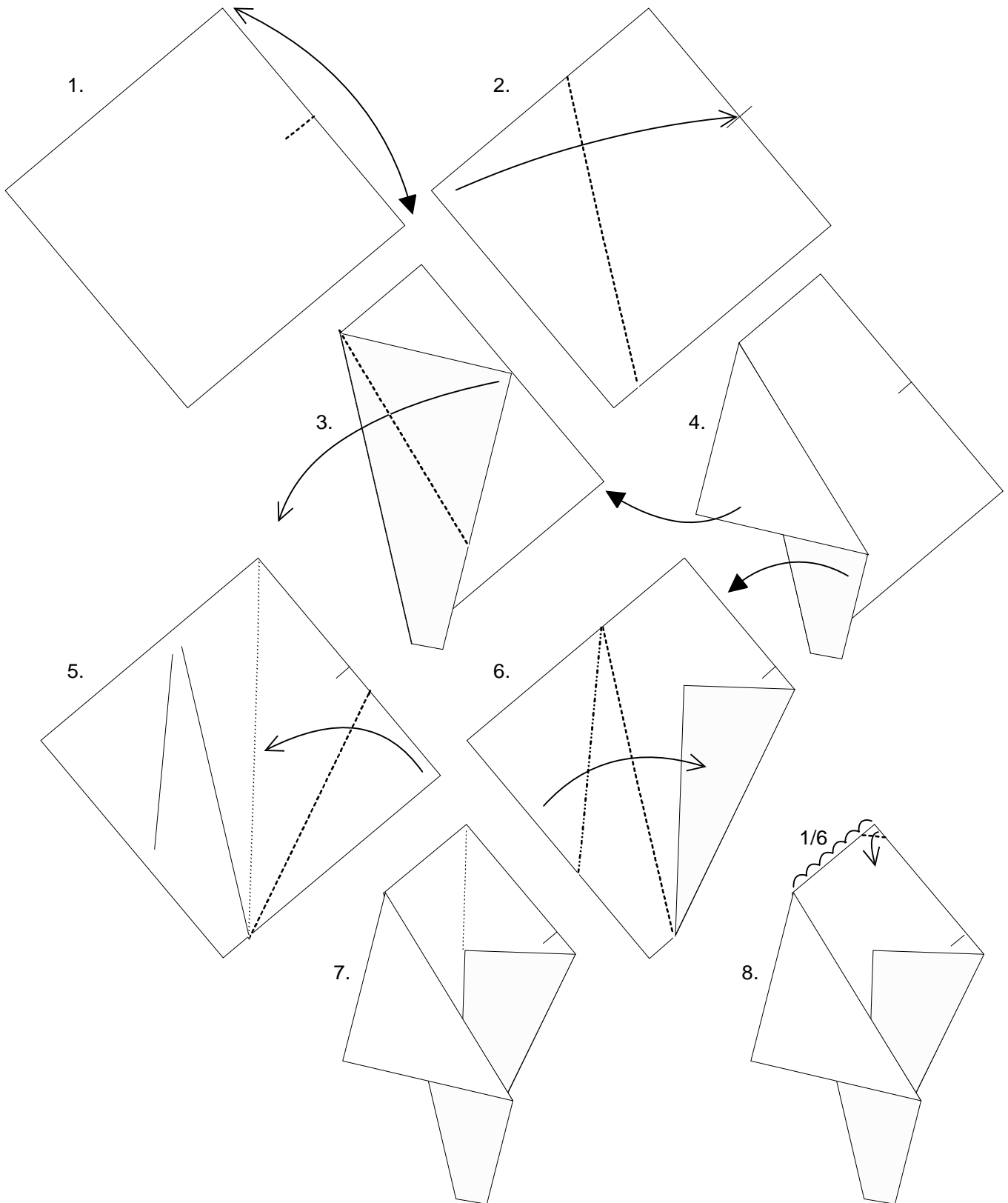

Diagrammed by J.C. Nolan - Feb. '95

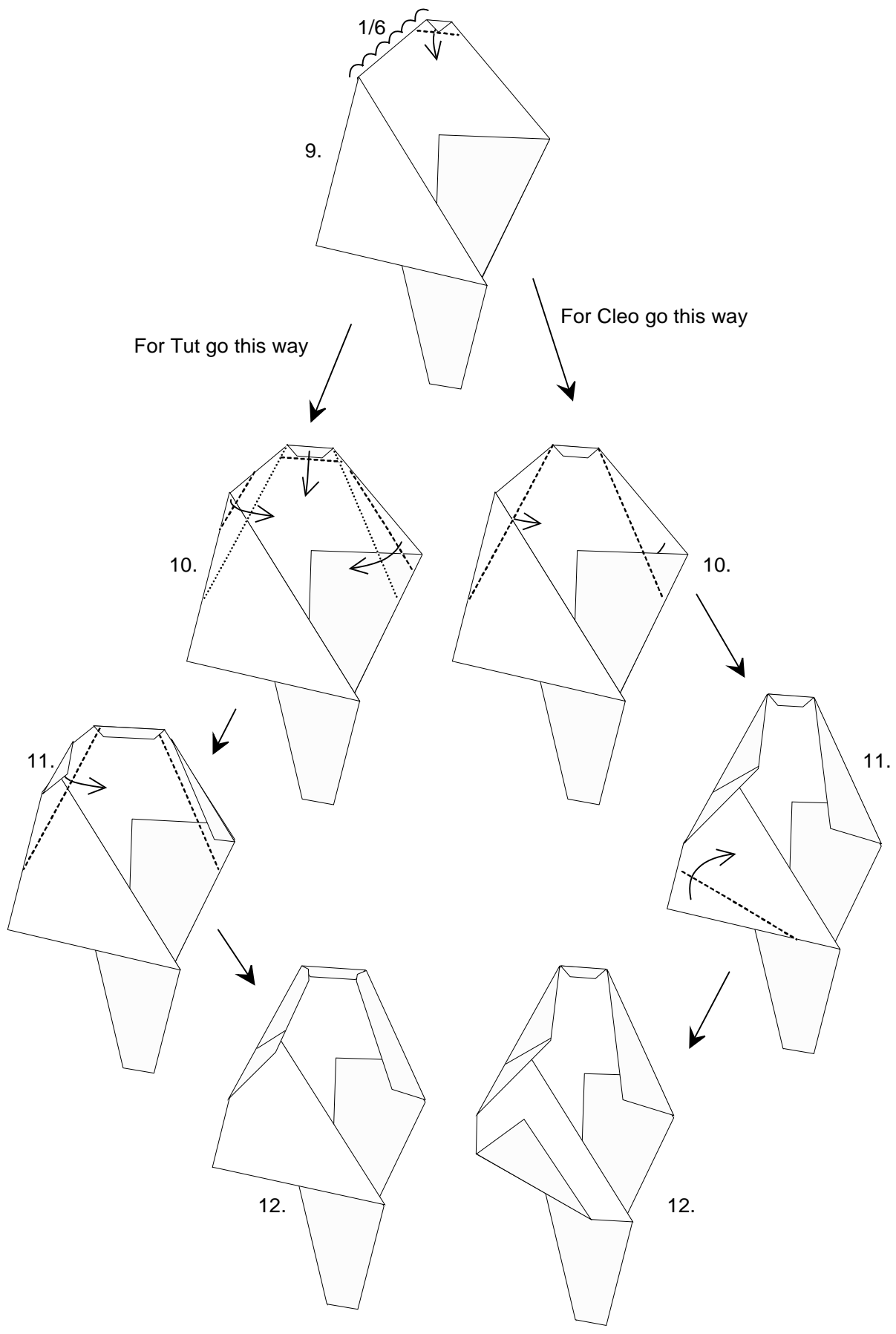

King Tutankhamen

Cleopatra

# Twisted Dancer

By Perry Bailey ©1998

The dimension of the paper will fit a 1x1.76 ratio or you could take a piece of 8.5x11 inch typing paper cut a 8.5x8.5 inch square, take the piece left over fold it in half lengthwise then cut it in half at the crease. Giving an approx. piece of 10.9cmx6.2cm or there about.

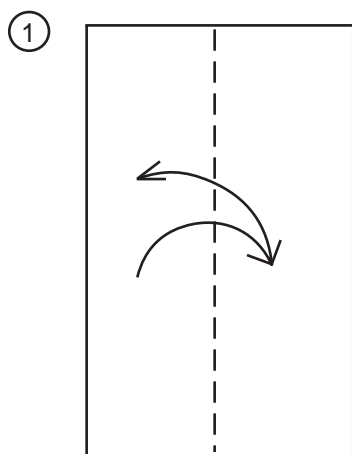

Fold in half, unfold.

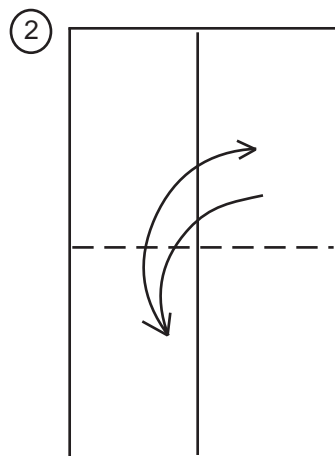

Fold in half, unfold.

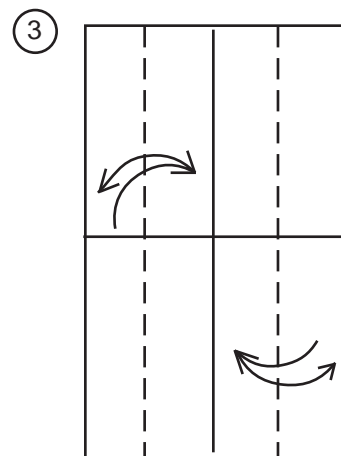

Fold both sides in to the center, unfold.

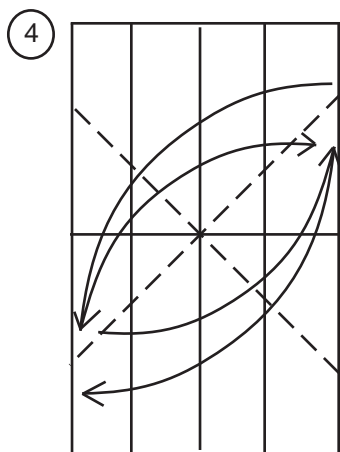

Fold over diagonally at the center, then unfold. Repeat in other direction as if for a waterbomb base.

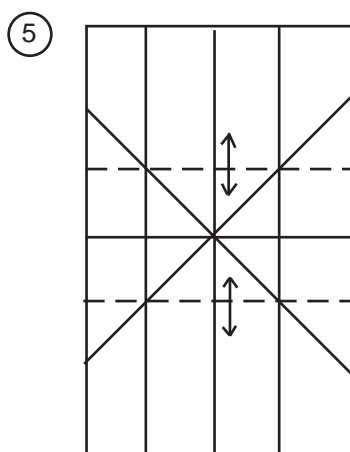

Valley fold at the place where the diagonal fold meets the outside horizontal folds, first the upper then the lower. This should give you a square in the center.

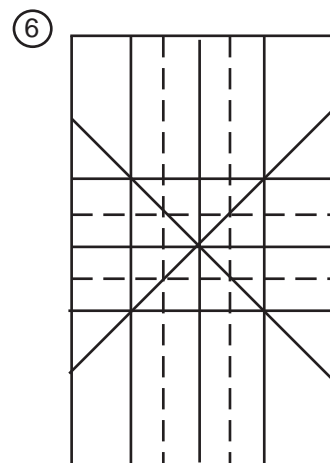

Add the additional creases shown here, this will give you an even smaller square in the center.

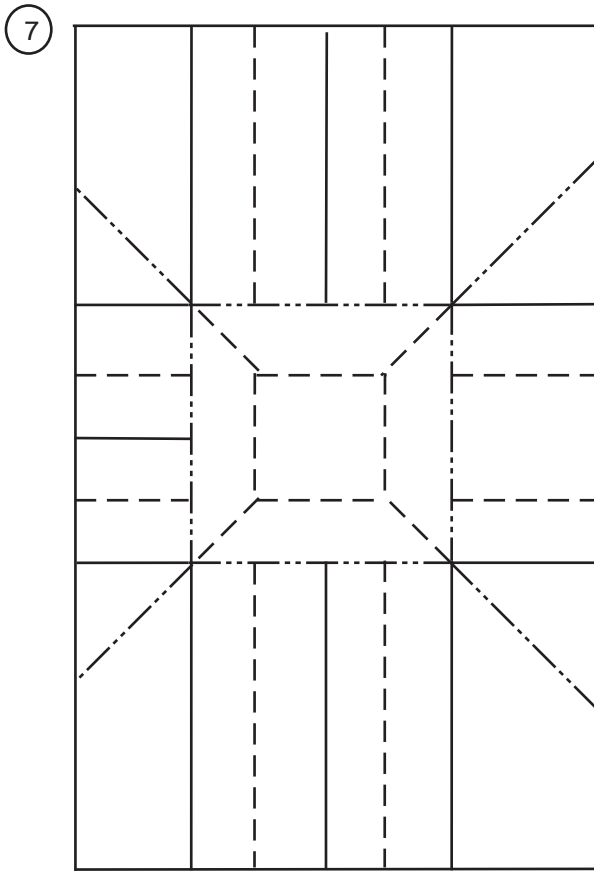

Pinch the paper in at the four corners of the big square so that the little square drops down inside of the model. It is easiest to preform this move if you precrease the model as shown in the diagram marked 7. This should give you something vaguely reminiscent of diagram 8, I hope. If so the push in the sides of th model to the center while bringing up the top and bottom from below. If you are familiar with twist folds feel free to look at 10 or 11 and ignore all of this and do it your way. It is the result that counts, not how you got there.

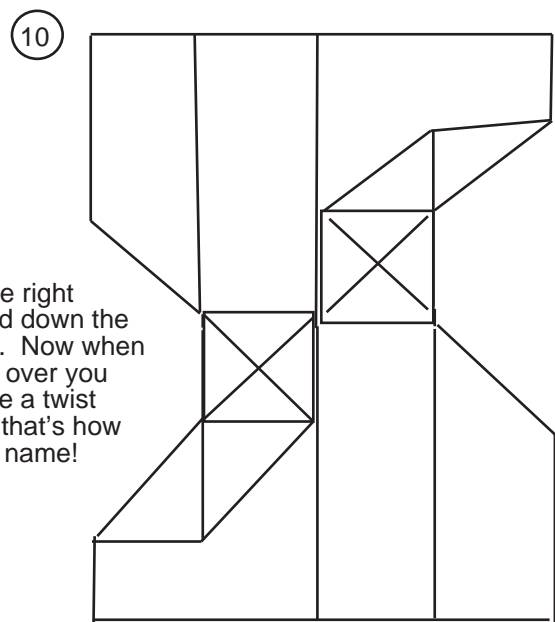
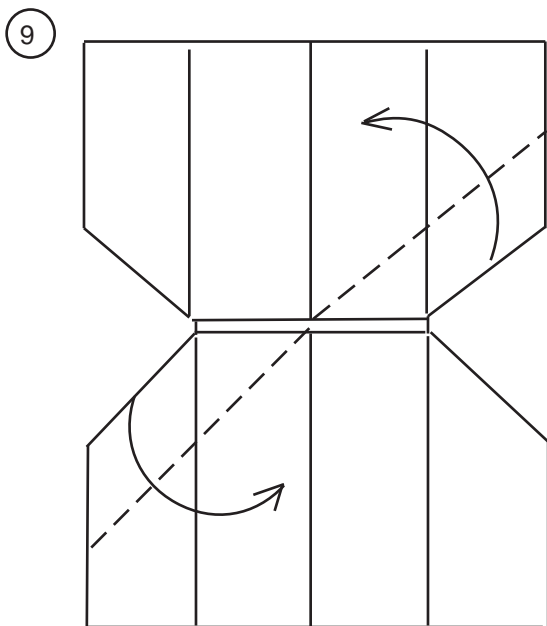
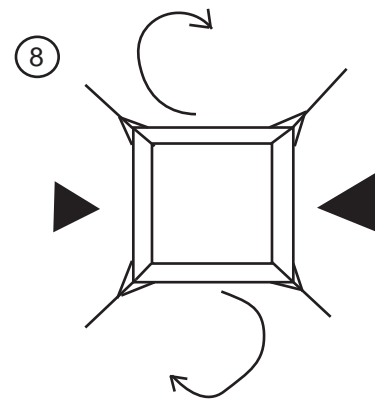

Fold up the right corner, fold down the left corner. Now when you turn it over you have made a twist fold! And that's how he got his name!

11

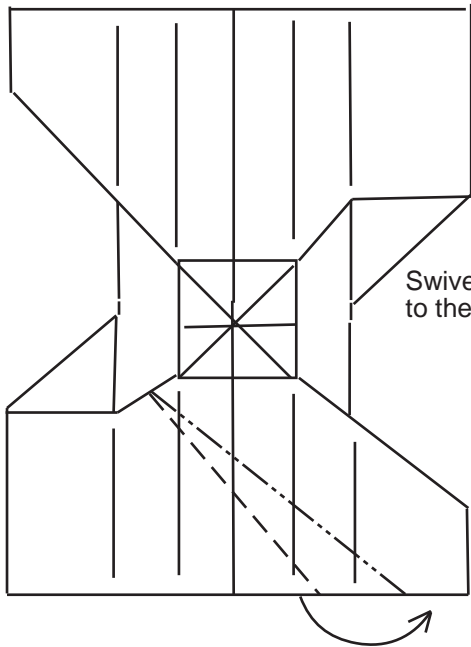

Swivel fold the leg under to the right.

12

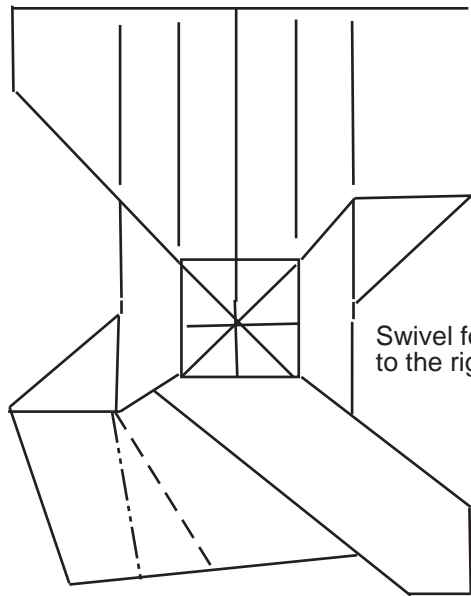

Swivel fold a leg over to the right.

13

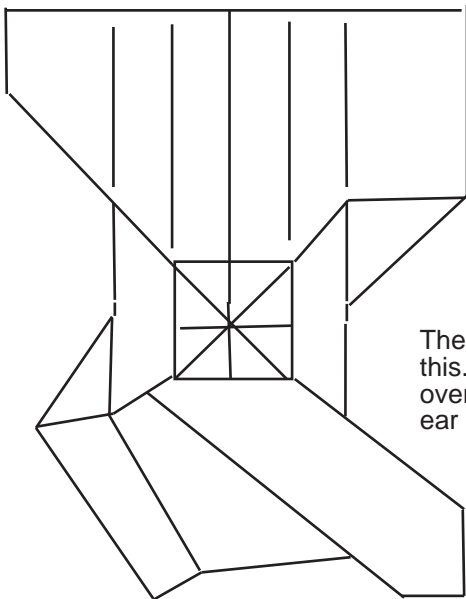

The legs should look like this. Then turn the model over and do a double rabbits ear upwards.

14

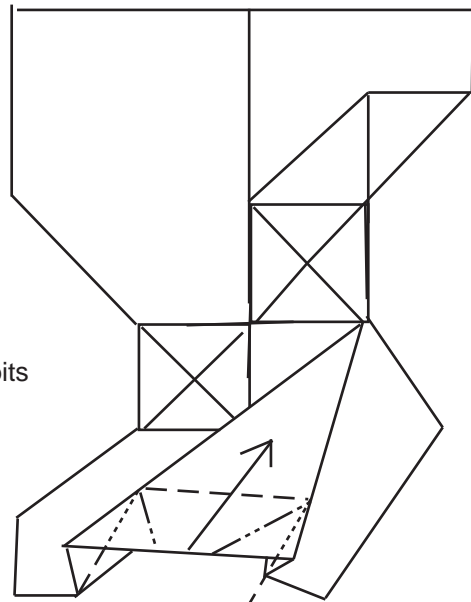



15

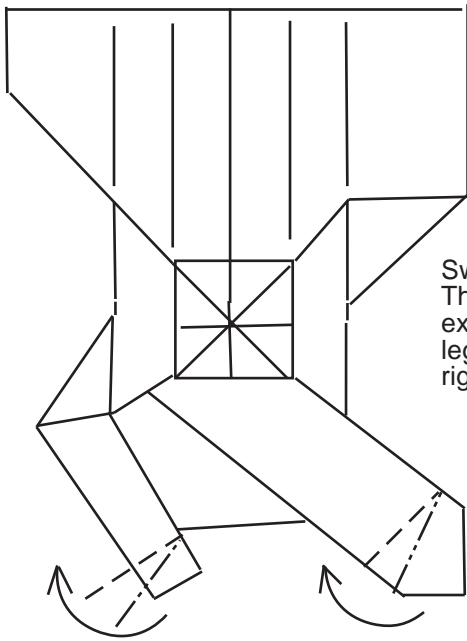

Swivel fold up the feet.  
Then fold back behind the  
extra paper to thin the left  
leg. Reverse fold the  
right foot inwards.

16

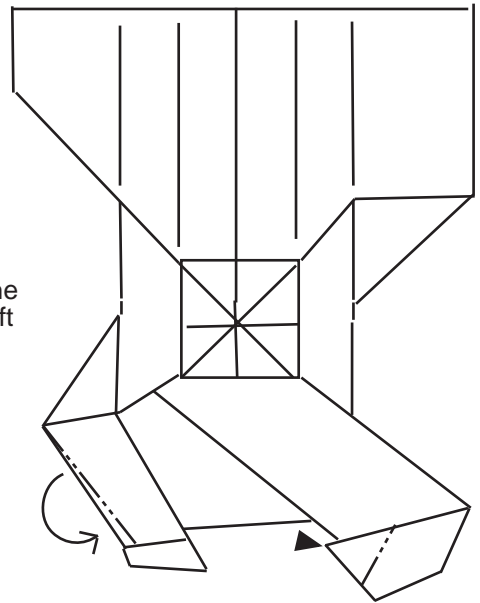

17

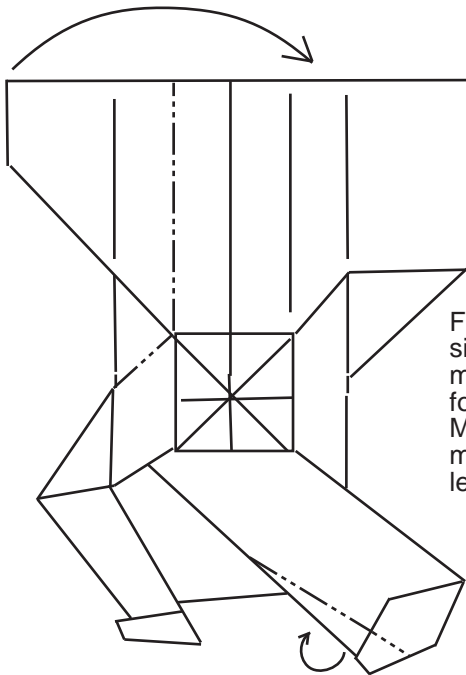

Fold the entire left  
side as shown behind the  
model, this will cause a swivel  
fold behind the model.  
Mountain fold the excess  
material of the right  
leg behind as far up  
as you can, it makes  
the appearance of a  
knee. Turn the model  
over, valley fold the  
arm back out.

18

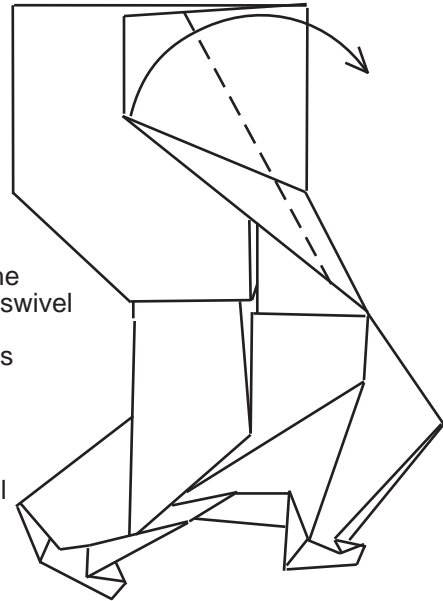

19

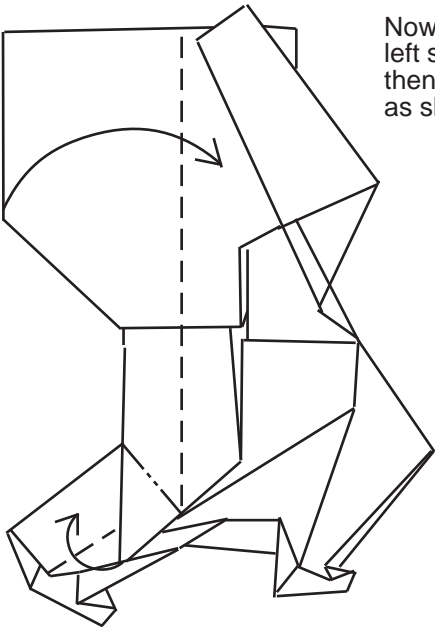

Now valley fold the entire left side over as seen from the back, then reverse fold the arm back out, as shown in the enlarged diagram.

20

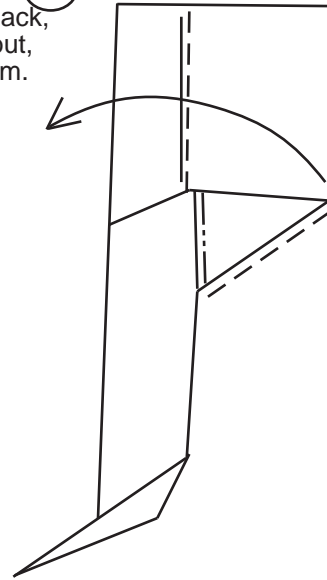

21

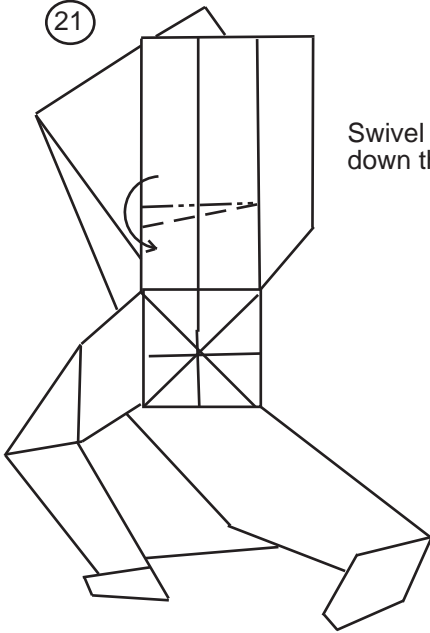

Swivel fold down the head.

22

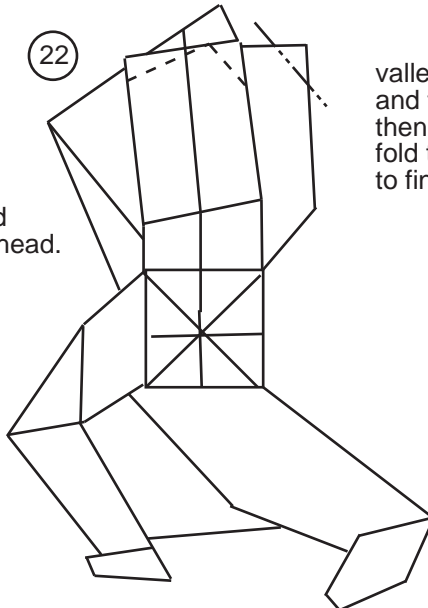

valley fold down the hair and the tip of the right arm. then as seen in 23 mountain fold the excess paper back to finish the model.

23

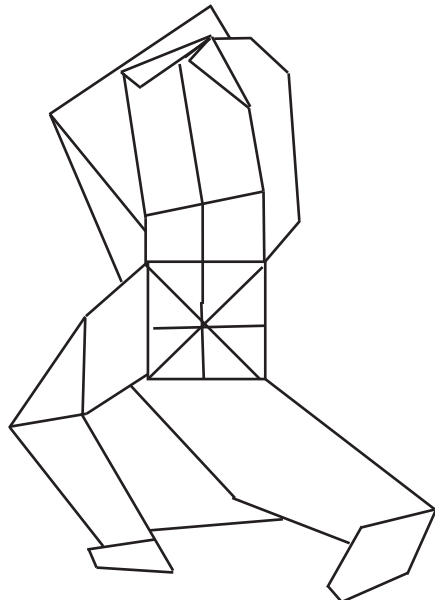
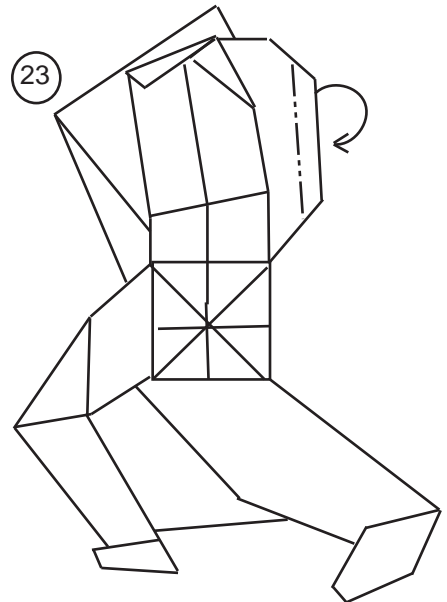

Finished!

Is he dacing for joy?  
 Is he dancing in rage?  
 Is it a dance of panic?  
 Or a dance of pain?  
 Maybe the pee pee dance?  
 Who can say?  
 But he dances it!  
 Again and again!

# #5 Twin Crane

(c) 3/98 by Julius Kusserow

page 1/1

This "Twin Crane" is based on a "Twin Crane" model I saw 9 month ago. Possible it is a recreation of a design from a person unknown to me or it is a different design. It was the first advanced origami model I have ever seen and the base for my new passion: Origami. Thanks to Martin Hunger who taught me my first model. Thanks to Nayumi Kitamura who show the model of the "Twin Crane" to me.

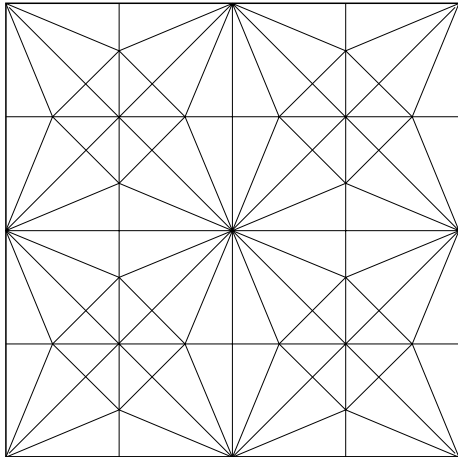

<-(0) The unfolded model without the creases from narrowing tails and necks and making the heads (step 22).

Square shape paper of length X gives  
ca. 0.5 X width  
ca. 0.3 X depth and  
ca. 0.3 X height model.

(1)-> Fold and unfold both diagonals as valleys. White side up.

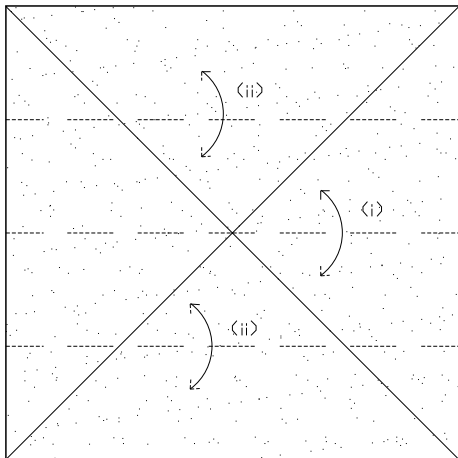
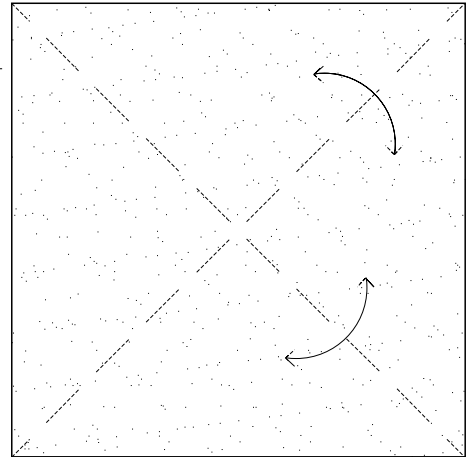

<-(2) (I) Fold and unfold centre crease. (II) Fold to centre crease.

(3)-> as in (2) turn around.

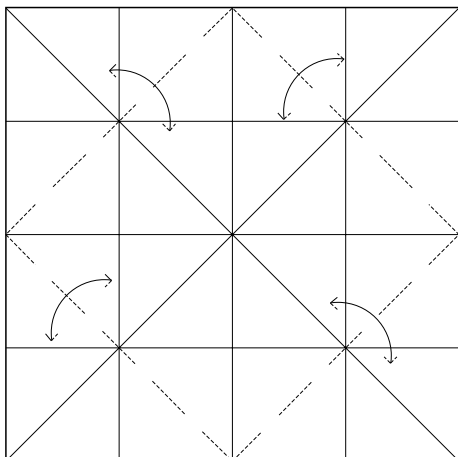
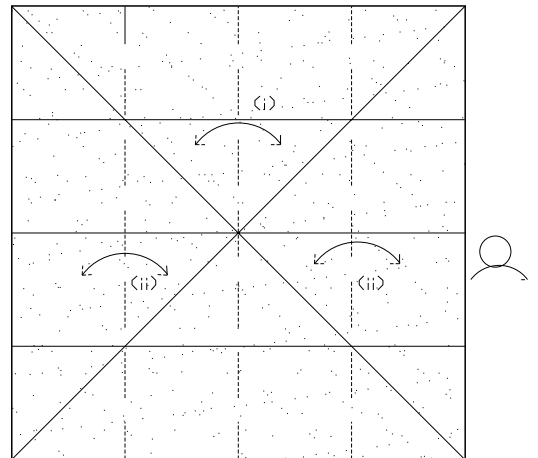

<-(4) Blitz and unfold. Turn around.

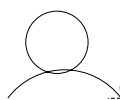

(5)-> Fold a "Preliminary Base".

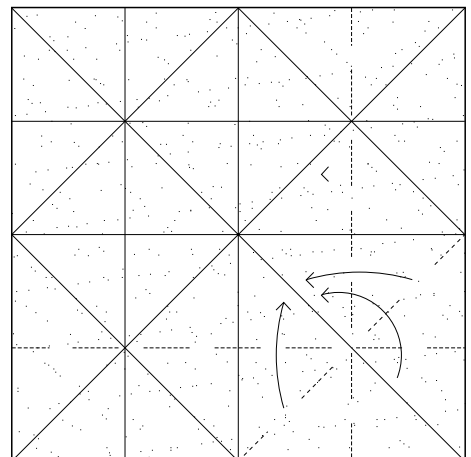

# Twin Crane

(c) 3/98 by Julius Kusserow

page 2/3

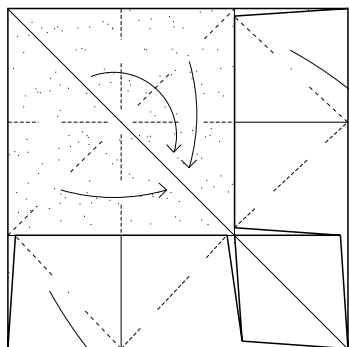

<-(6) Fold another "Preliminary Base". Fold two rabbit ears. Circle 45 degree right.

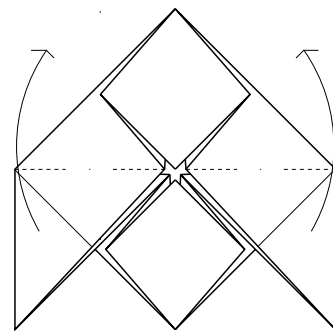

<(7)-> Fold as mountain. Let swing rabbit ears to top.

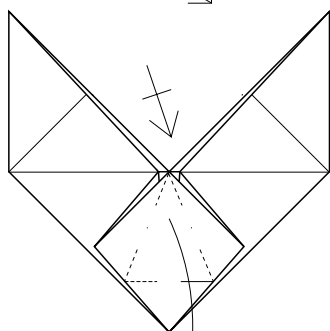

<-(8) Petalfold. Repeat behind.

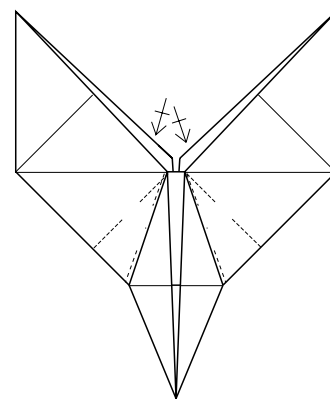

<(9)-> inside reverse and outside reverse fold to create the rest of the bird base. Fold all 4 reverse folds simultaneous.

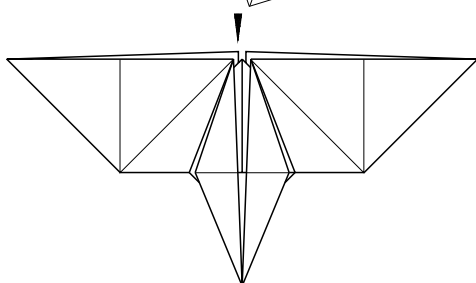

<-(10) Unsink middle. You can also do (9) and (10) in on step. Try to create the other half of the bird base. Sometimes this is the easier way.

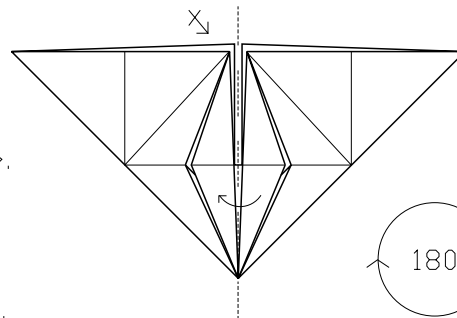

<(11)-> Fold first and second flap to the left. Repeat on other side. Circle 180 degree.

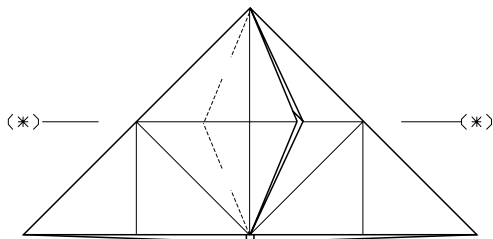
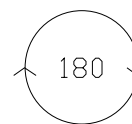

<-(12) Precrase up to (\*) crease.

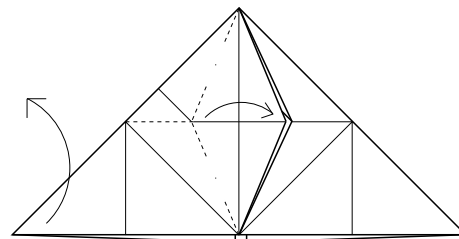

<(13)-> Squash. Fold flap to the left.

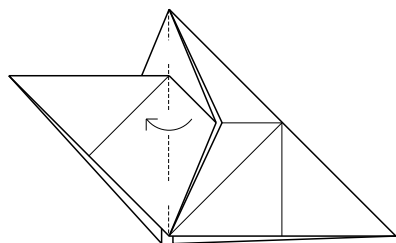

<-(14) Fold first flap to the left.

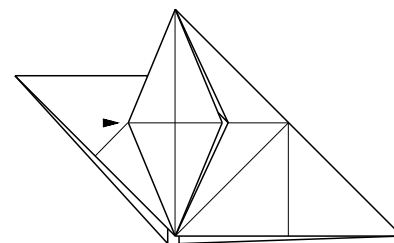

<(15)-> Close sink flap from step 14.

# Twin Crane

(c) 3/98 by Julius Kusserow

page 3/3

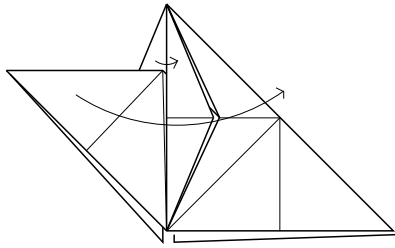

<- (16) Fold large flap and first small flap to the right.

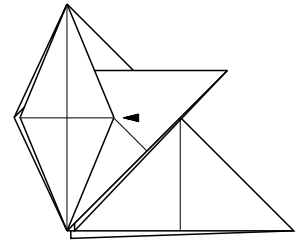

(17)-> Close sink.

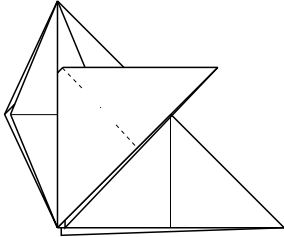

(18) Squashfold.

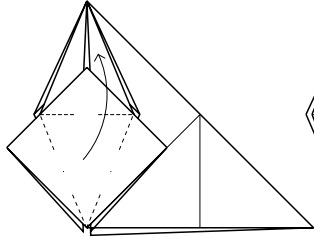

(19)-> Petalfold.

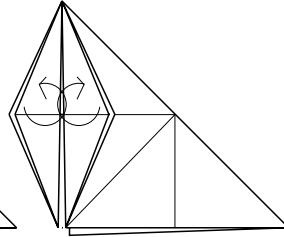

<- (20) Left and right: put flap in the pocket from close sinks in steps 15/17.

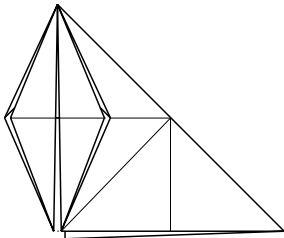

(21) Repeat steps 11-20 (22) Fold two flaps on other side.

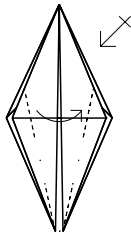

(22) Fold two flaps to the right. Repeat behind.

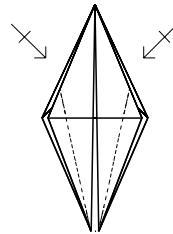

<- (23) Narrow neck and to with valleys (first step). Repeat behind.

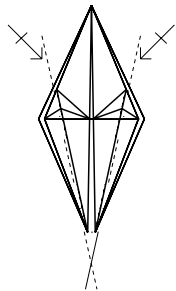

<- (24) Narrowing neck and tail, step two with mountains. Repeat behind.

(25)-> Inside reverse necks and tails. Inside reverse heads. Pull on wings to give the body volumuna.

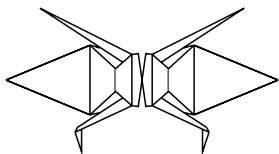
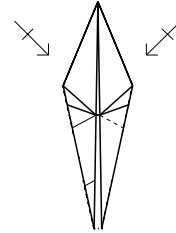

Finished "Twin Crane"

<- Top View

-> Bottom View

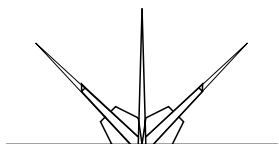
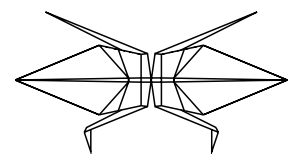

<- Front View

-> Side View

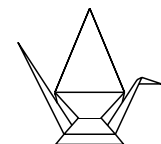

# Tyrannosaurus

Begin with a square, white side up, with both diagonals precreased.

1

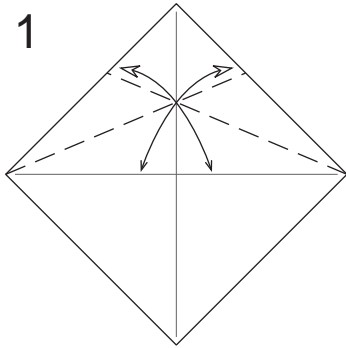

Valley fold the top edges to the center line, creating the angle bisectors.

2

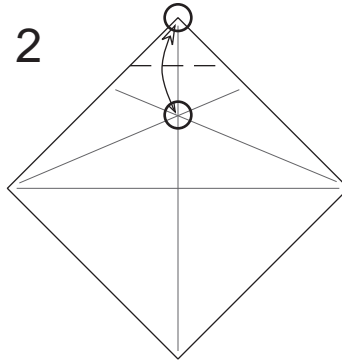

Valley fold the top point to the intersection of the angle bisectors created in Step 1.

3

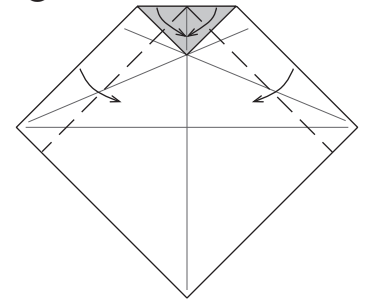

Valley fold both sides of the new top edge and the attached paper below it to the center line.

4

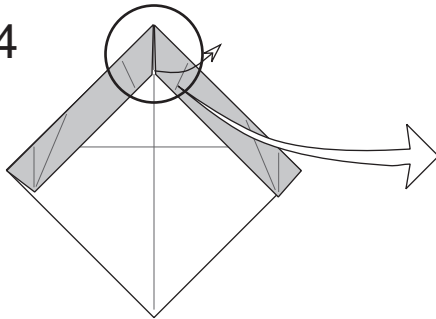

Pull out the point (the one folded down in Step 2) hidden by the flaps folded down in Step 3. The next few diagrams are close-ups of the top of the model.

5

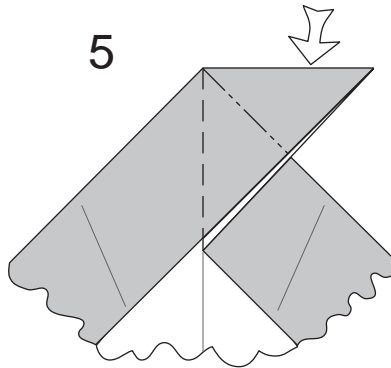

Squash fold the point at the top to create a small preliminary fold.

6

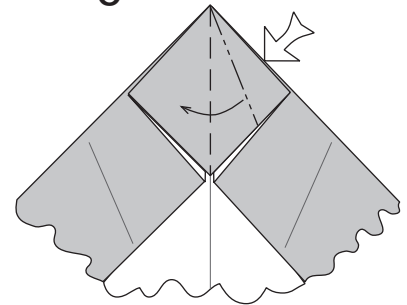

Squash fold the right side of the preliminary fold.

7

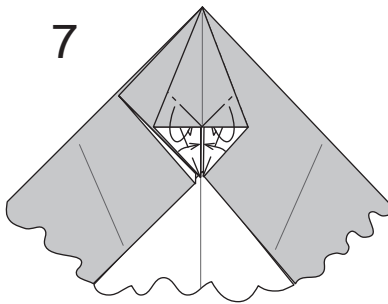

Petal fold the flap, leaving the petal pointing down.

8

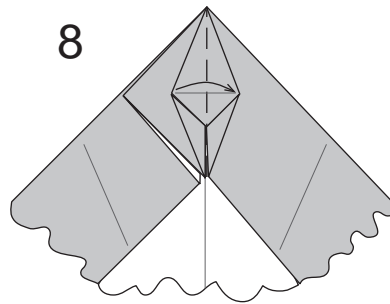

Fold the left flap of the petal back over to the right.

9

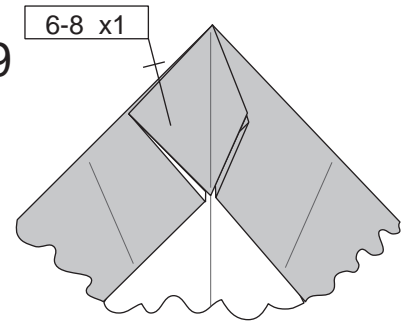

Repeat Steps 6-8 in mirror image on the left side of the model.

10

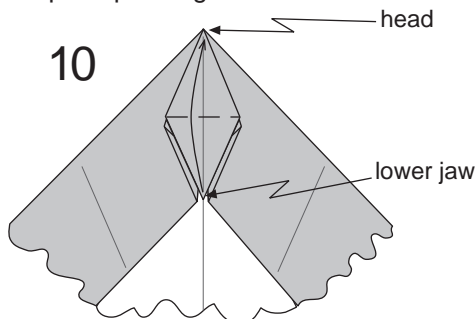

Valley fold the point created by the petal folds up to meet the top of the model. This point will be the lower jaw. The next step returns to a full view of the model.

11

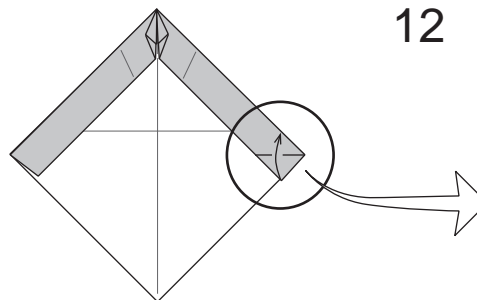

Valley fold the lower right corner of the long, rectangular flap (from Step 3) up along the angle bisector. The next few steps are close-ups of this region.

12

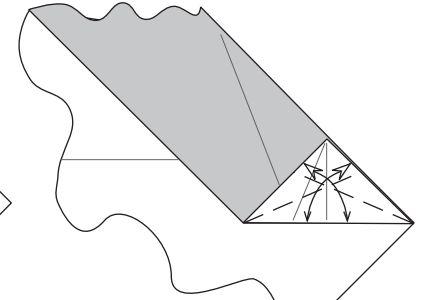

Valley fold the sides of the small white triangle to its lower edge and unfold.

13

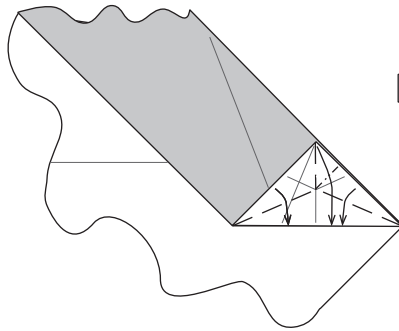

Rabbit ear the white triangle. The point created by the rabbit ear will become the first toe (see Step 65). The next step returns to a full view of the model.

14

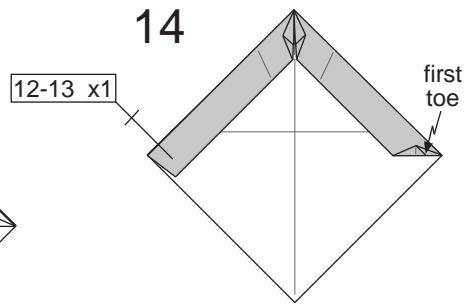

Repeat Steps 12-13 on the left side of the model.

15

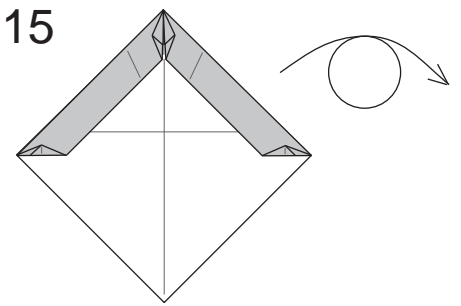

Turn the model over from side-to-side. The next diagrams are enlarged.

16

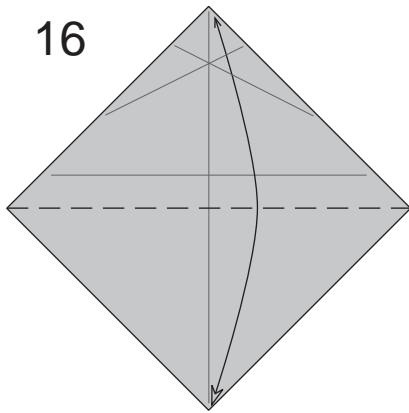

Create a new horizontal diagonal crease by valley folding the lower point to the upper, then unfold.

17

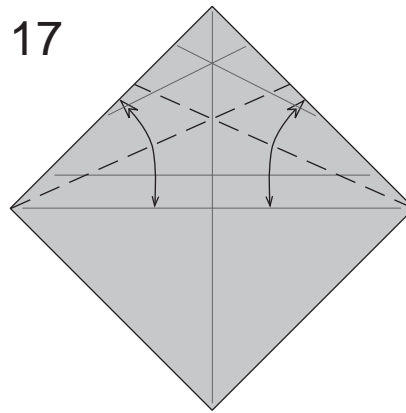

Valley fold the top edges to the new horizontal diagonal line and unfold, creating new angle bisectors.

18

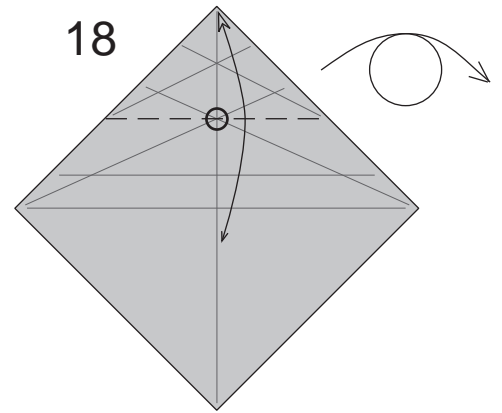

Valley fold the top point down such that the crease goes through the intersection of the angle bisectors (from Step 17) and unfold. Turn the model over from side-to-side.

19

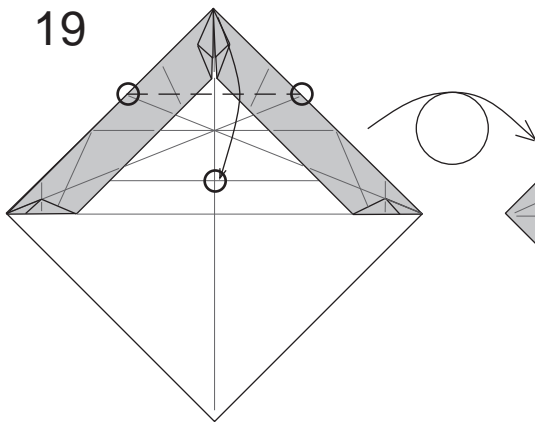

Valley fold the top point down so that the crease connects the points where the angle bisectors (from Step 16) intersect the top edges. (The point falls on the intersection of the vertical diagonal and the original horizontal diagonal.) Turn the model over from side-to-side.

20

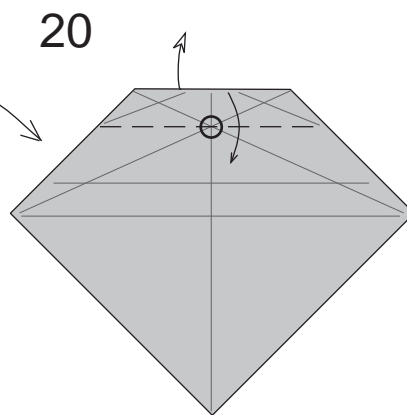

Valley fold the top edge down on the crease from Step 18, allowing the point with the lower jaw to swing up from behind.

21

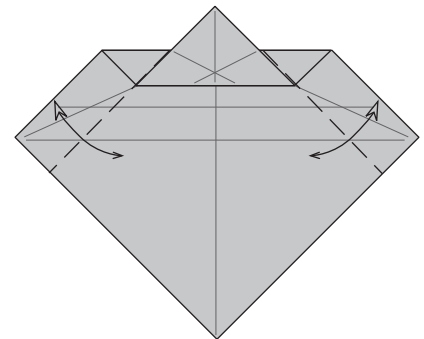

Valley fold the top sides inward along the edge of the uppermost, triangular point and unfold. (These creases also happen to fall along the edges of the rectangular flaps on the other side of the model.)

22

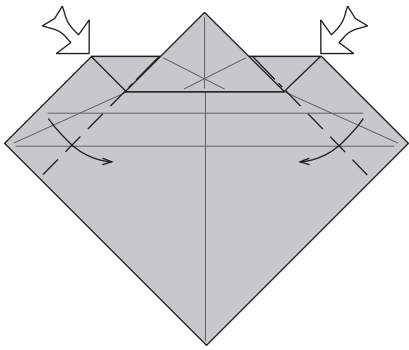

Reverse fold the top sides inward along the creases from Step 21. The next diagrams are enlarged.

23

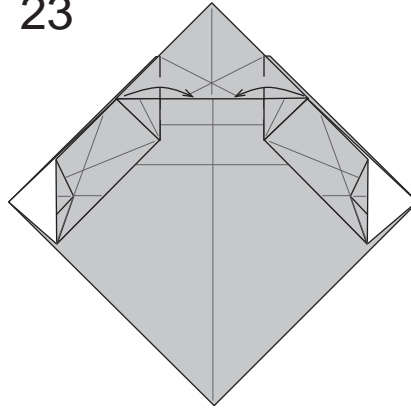

Valley fold the two small, triangular points at the sides of the pleated top point inwards.

24

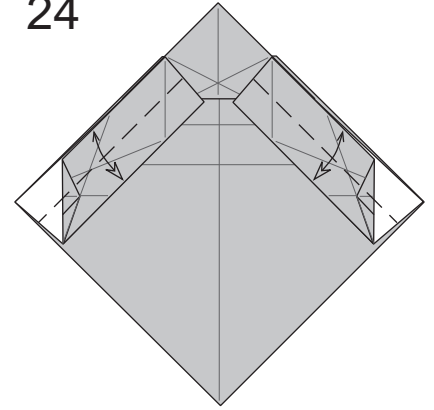

Valley fold the two rectangular flaps in half lengthwise and unfold.

25

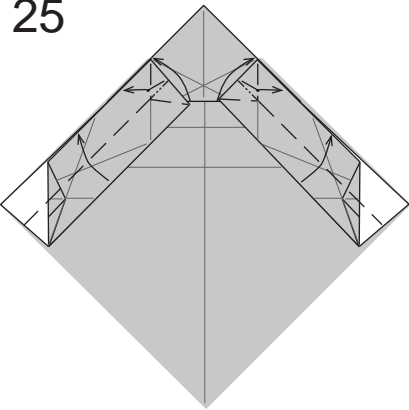

Collapse the rectangular flaps with a rabbit ear at the top end, leaving the ears pointing up. These points will be the arms.

26a

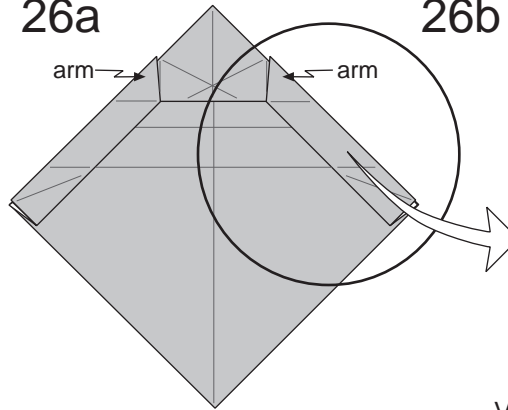

The result. The next few diagrams are close-ups of the right side of the model.

26b

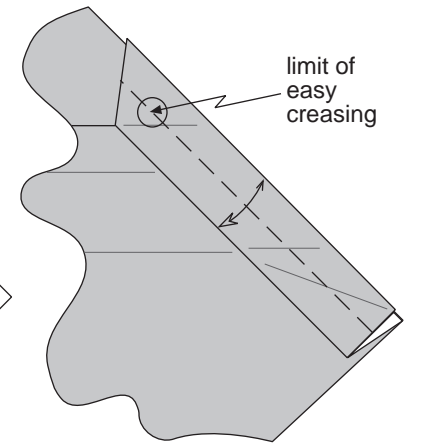

Valley-fold the rectangular flap in half again. Towards the arm point, the fold becomes increasingly difficult to do, and you won't be able to crease easily on the point itself.

27a

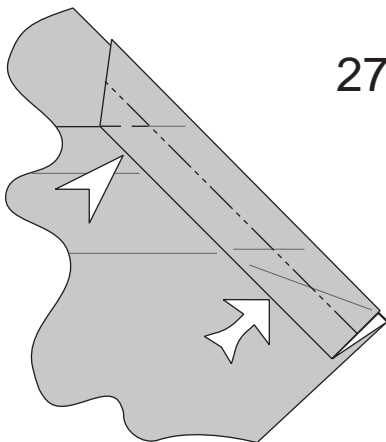

Open sink the upper end and reverse fold the lower end of the inner edge of the rectangular flap using the creases from Step 26b. The next diagram shows the resultant crease pattern on the inside of the flap (which you would see if you opened the flap back up to Step 25).

27b

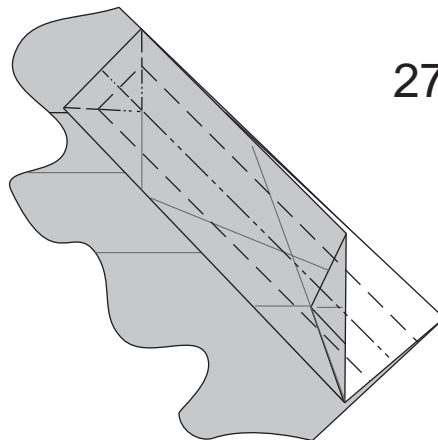

This is the crease pattern which will allow the sink to be performed. Note how the folds change around the upper end. The next diagram shows the rectangular flap in the process of being collapsed.

27c

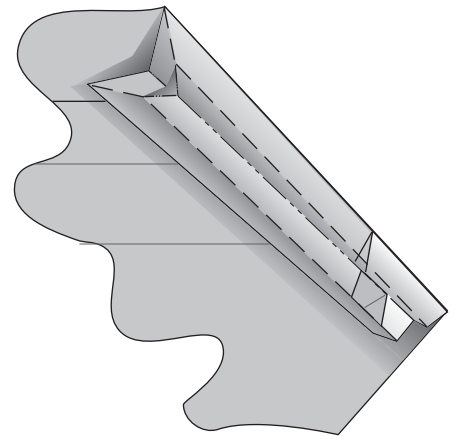

The sink in progress...



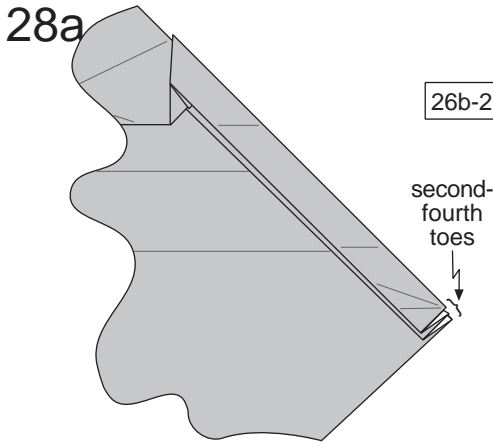

The result. The series of pleats created at the end of the rectangular flap will become the second, third, and fourth toes. The next diagram returns to a full view of the model.

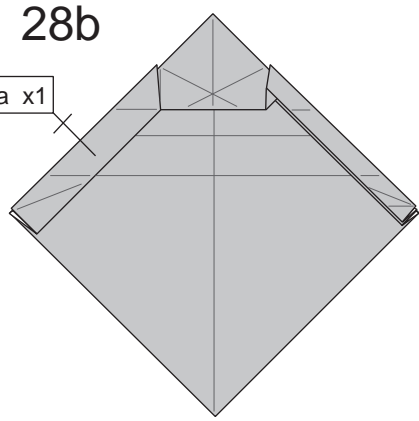

Repeat Steps 26b-28a in mirror image on the left side of the model.

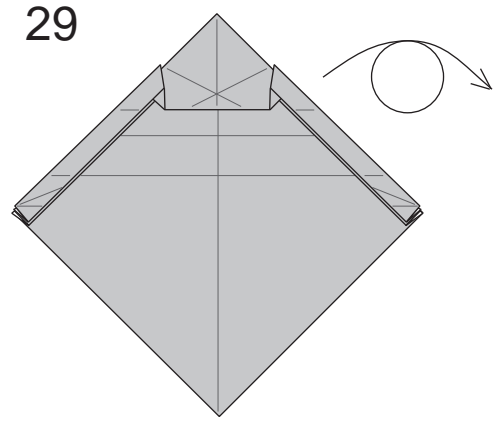

Turn the model over from side-to-side.

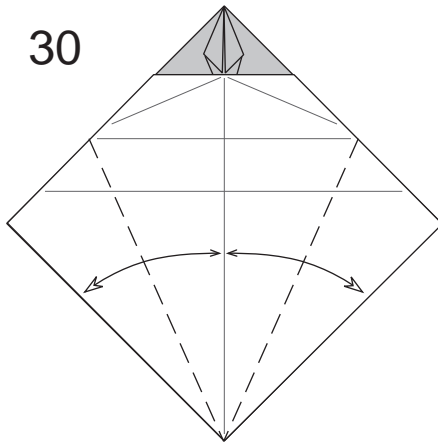

Valley fold the lower edge to the vertical, center diagonal, bisecting the angles of the bottom point, and unfold.

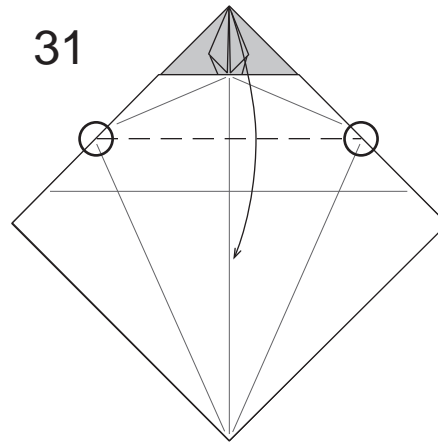

Valley fold the top point down so that the endpoints of the crease connect the upper endpoints of the angle bisectors from Step 30.

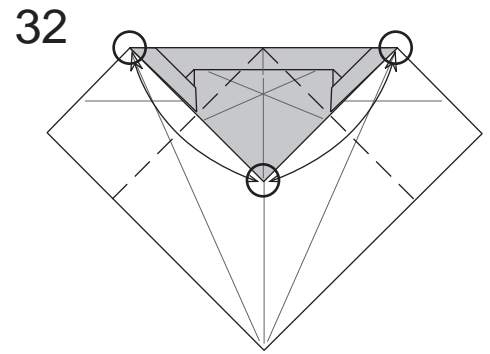

Valley fold the top sides in to the vertical, center diagonal; this brings the two corners at the top in to meet the tip of the colored point. Unfold.

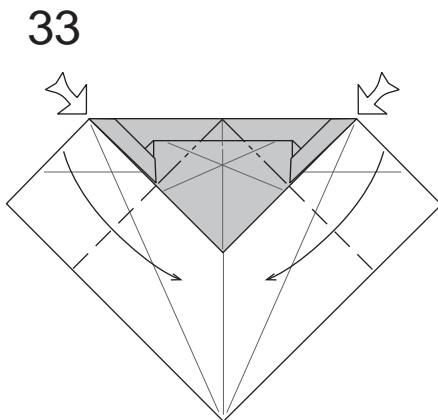

Reverse fold the top sides in along the creases made in Step 32. The next diagrams are enlarged.

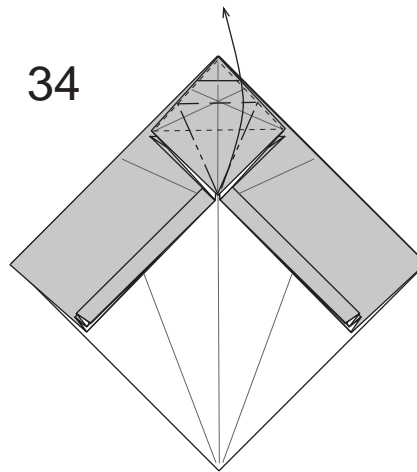

Petal fold the preliminary form at the top of the model. Note that there is a hidden white flap under the top-most colored layer (indicated by the x-ray lines); this flap is not included with the top-most flap in the petal.

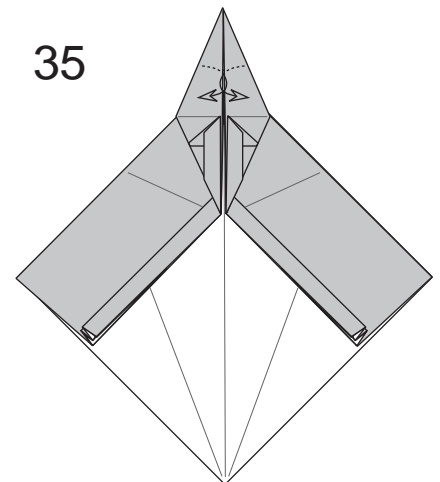

Reach inside the top of the petal and pull out the hidden lower jaw assembly (from Step 10), placing it on top of the layers currently covering it.

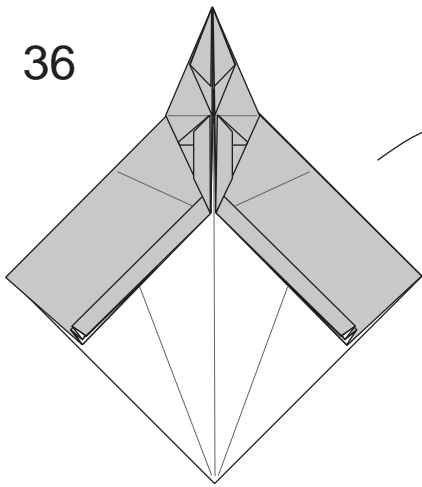

36

Turn the model over from side-to-side.

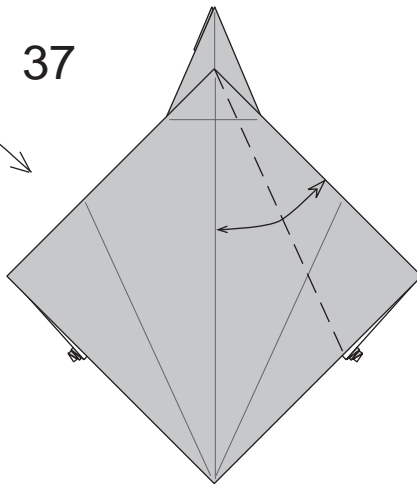

37

Valley fold the right side in to the center line and unfold.

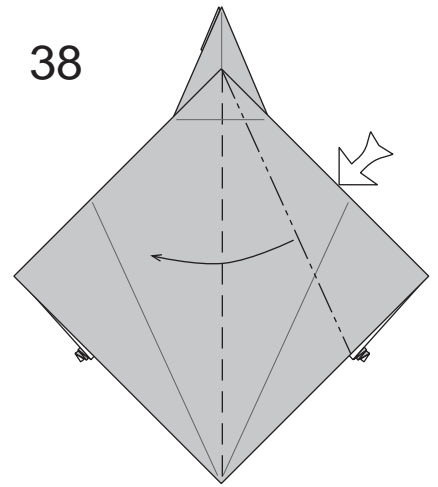

38

Squash fold the right side on the crease from Step 37.

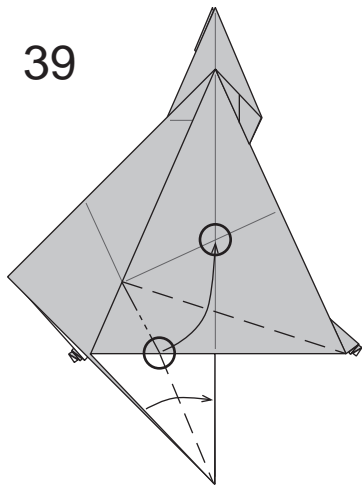

39

Squash fold the lower horizontal edge upwards, valley folding along the angle bisector of the white triangle.

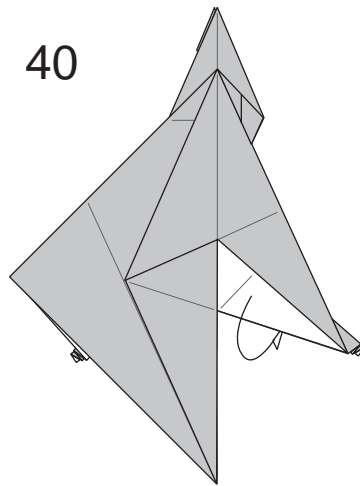

40

Fold the portion of the model with the white flap underneath and inside the model.

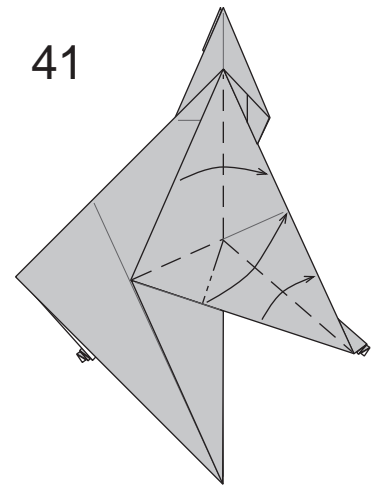

41

Fold the flap back over to the right, incorporating a rabbit ear in the large triangle.

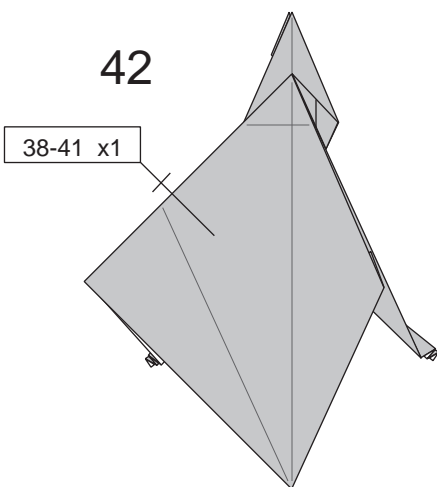

42

Repeat Steps 38-41 in mirror image on the left side of the model. The point created at the bottom will be the tail.

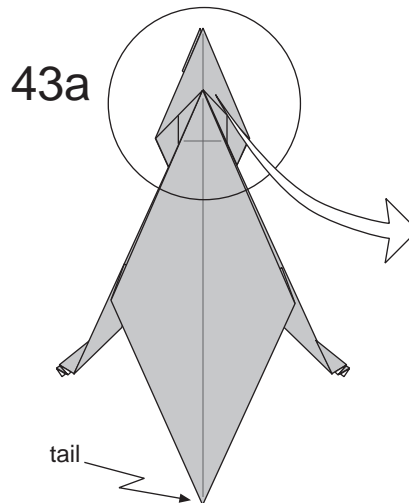

43a

The next few diagrams detail the top of the model (where the head and lower jaw points are located).

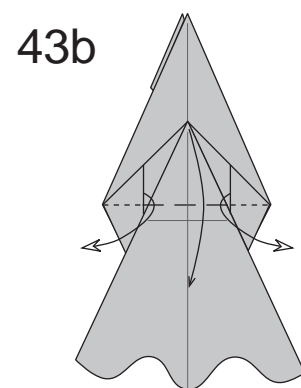

43b

Valley fold the short, broad, triangular point down as far as possible; simultaneously, pull out the loose flaps at the sides of the point.

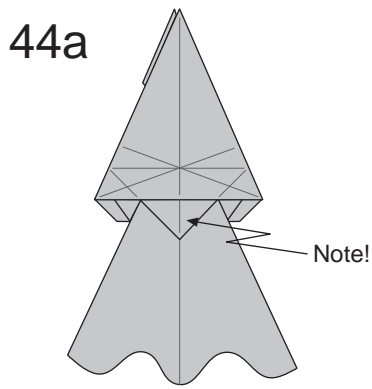

The result. Note the small, short, broad, downward-pointing, triangular point protruding from beneath the head assembly. This is the point referred to in Step 46. The next diagram returns to a view of the whole model.

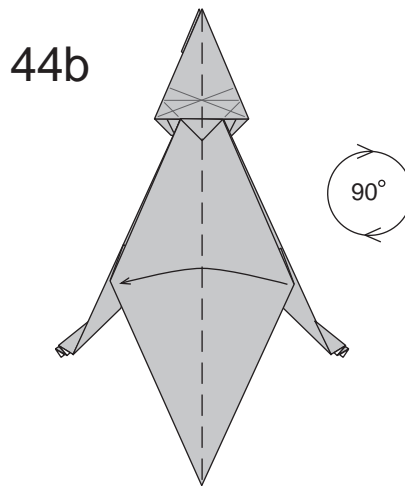

Valley fold the entire model in half along the vertical line (right over left), and rotate the model 90° clockwise. The next diagrams are enlarged.

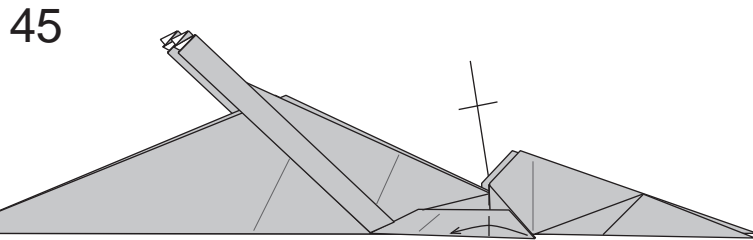

Valley fold the arm point toward the legs and tail; repeat behind.

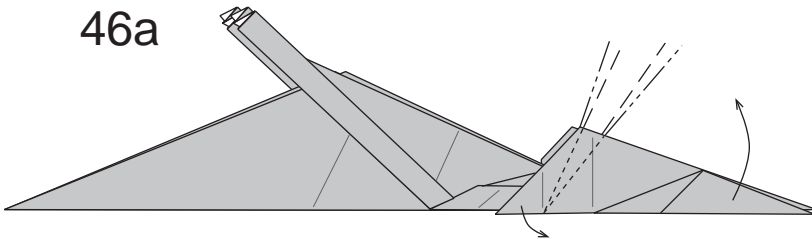

Outside crimp the head assembly upwards while swinging the arm points down. The mountain fold lines run alongside the edges of the short, triangular point noted in Step 44a. The next diagram shows where these folds are if the model is opened up to Step 44a. (Remember that, since the next diagram shows the *inside* of this step, what you see in this step as mountain folds will appear as valley folds inside!)

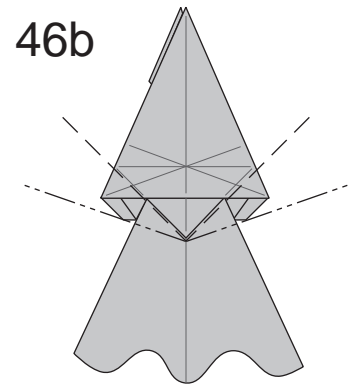

The layout of the folds for the crimp in Step 44a. The next diagram returns to a view of the whole model.

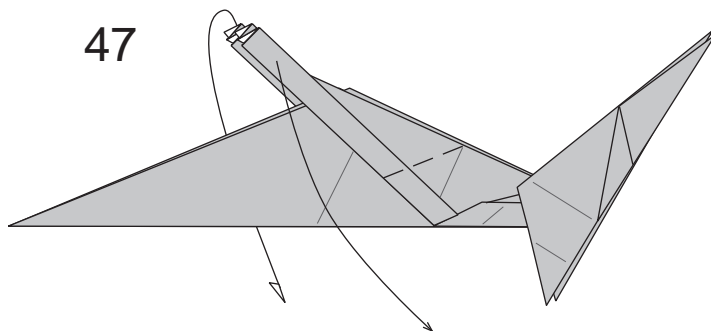

Valley fold the hind leg down, squashing a tiny gusset where the leg meets the back; repeat behind. To make a walking stance, fold the leg behind down so that it is angled behind the other.

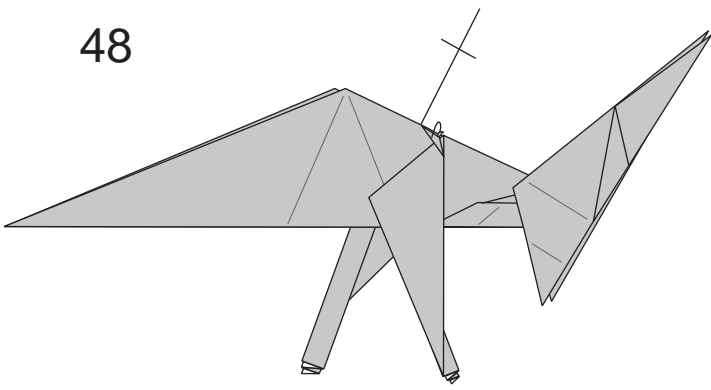

48 Outside reverse fold the flap forming the gusset so that the gusset is on the inside of the leg flap; repeat behind.

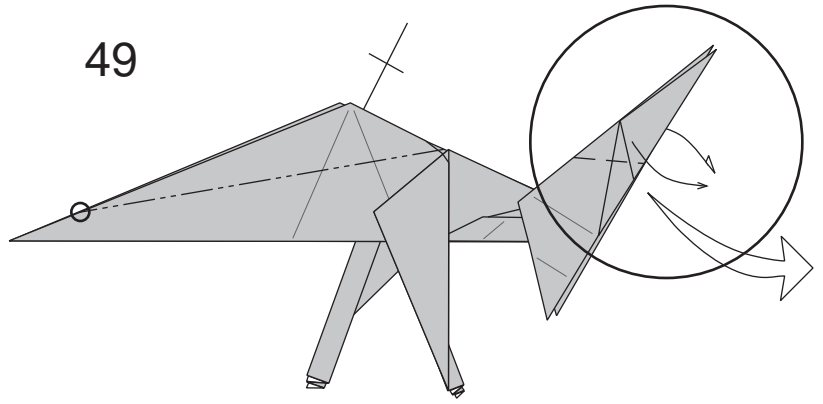

49 Mountain fold the top tail flaps inside to narrow the tail; note that the fold line goes from the top of the leg to a point close to, but not at, the tip of the tail. Repeat behind. Outside reverse fold the head. The next few diagrams are a close-up of the head region.

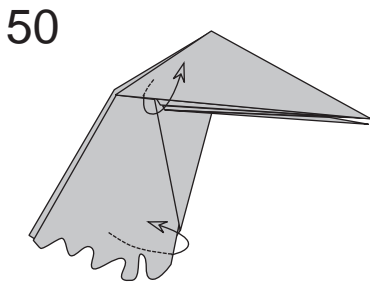

50 Pull out a single layer of paper from inside the head; this layer is attached to the outermost layer on the neck, which is also pulled out to cover the visible portion of the lower jaw complex (from Step 10). The layer is somewhat trapped so you may have to unfold part of the model to free it.

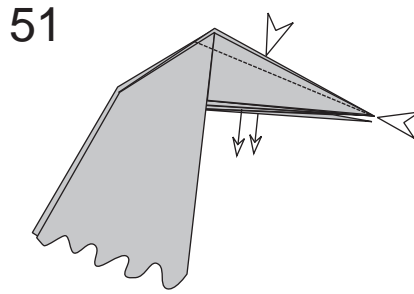

51 This is a difficult step. Grab the lower jaw point and the next 2 layers out from it (the three innermost layers) on both sides and pull them *gently* downward (it is easy to tear the paper if the paper is pulled too hard). As you do this, some paper will slide out from inside the head, and the central point on the top should collapse inwards a bit (lowering it between the points pulled out in Step 50; the fold is indicated by the x-ray line) and a bit of the tip of the snout will sink inwards to round out the snout. This move will create a fuller head for the model.

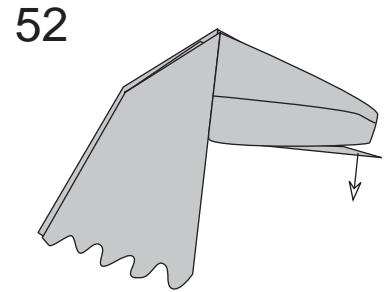

52 Pull the lower jaw down to open the mouth.

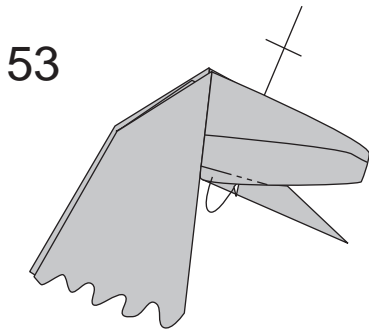

53 Mountain fold two layers inside at the back of the head (where it meets the lower jaw) inside. The innermost of these two layers is connected with the lower jaw, so a bit of paper from the lower jaw point may swivel inwards with the rest of the fold. Repeat behind.

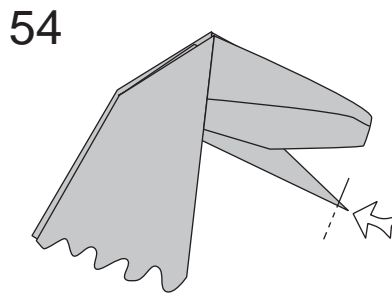

54 Reverse fold the tip of the lower jaw inside.

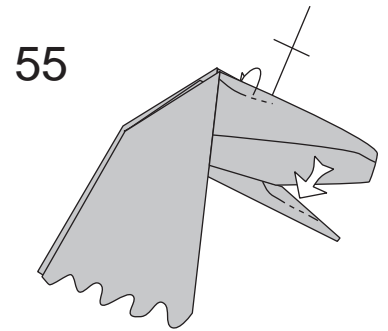

55 Mountain fold (more of a bend, really) inwards to create brow "horn"; repeat behind. Dent in some paper in the lower jaw and curl it slightly. The head is now finished; the next steps return to a full view of the model.

56

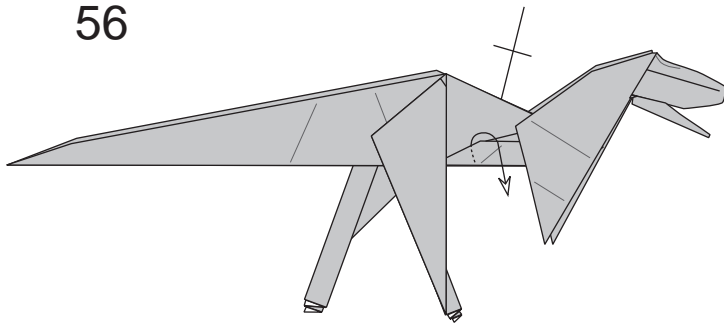

Between the arm and leg, along the lower edge of the belly, there is a thickness of paper which is connected to the toe assembly. Pull out the crimped layers underneath the surface layers to create a larger, rounder belly. Repeat behind.

57

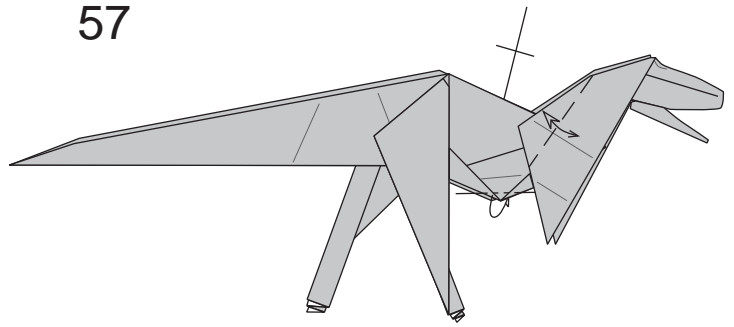

Fold the tips of the belly underneath. Valley fold and unfold the back of the neck between the head and the arm point as far as it will easily go. Repeat both moves behind.

58

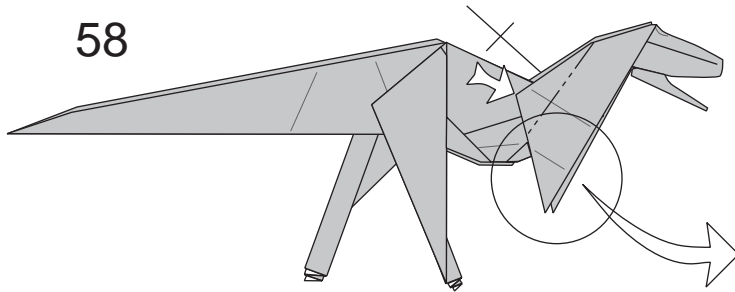

Reverse fold the back of the neck inside along the crease made in Step 57; this will narrow the neck. Repeat behind. The next steps are close-ups of the arm points.

59

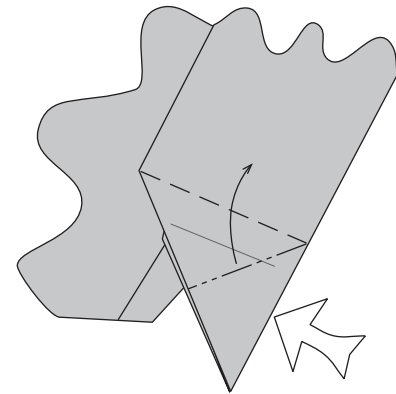

Squash fold the arm point as a preliminary base.

60

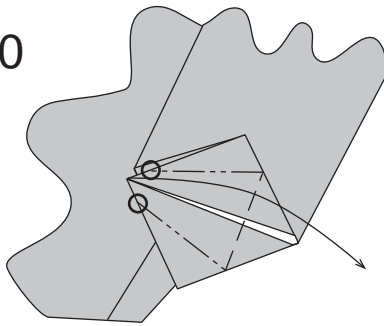

Petal fold the arm outward; note that the ends of the petal fold do not meet the tip of the point.

61

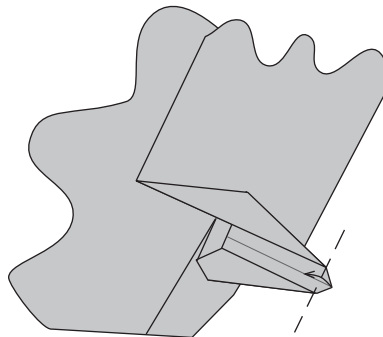

Valley fold the tip of the arm point in, connecting the ends of the asymmetrical petal from Step 60.

62

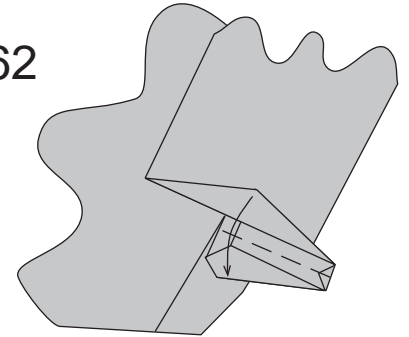

Valley fold the top half of the arm point down, closing the petal fold.

63

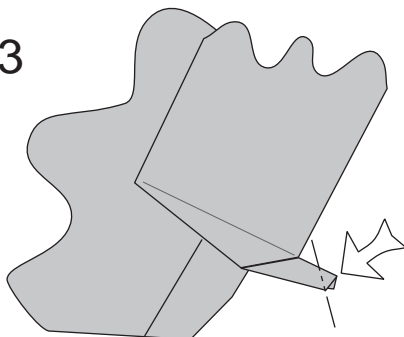

Reverse fold the tip of the arm inwards to create a two-fingered hand. The next steps return to a full view of the model.

64

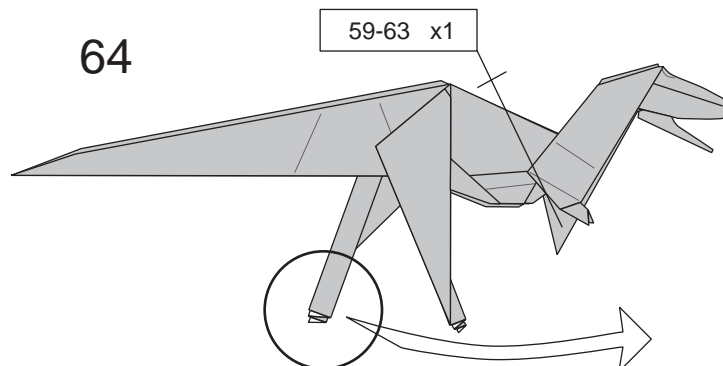

Repeat Steps 59-63 on the remaining arm and hand. The next steps focus in on the left foot.

65

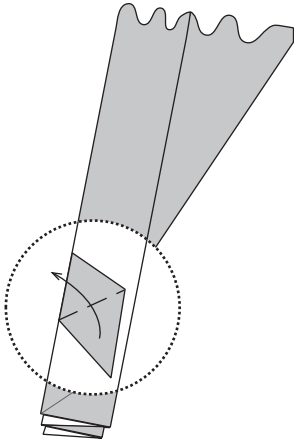

Beneath the first layer is the first toe (the tiny rabbit ear from Step 13). Valley fold the point out as far as possible.

66

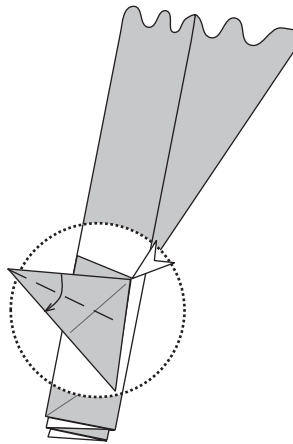

Valley fold the first toe in half (or as close as possible); this will result in an asymmetrical spread-squash of the base of the toe point. Make sure as you spread the point that none of the paper will stick out from inside the leg.

67

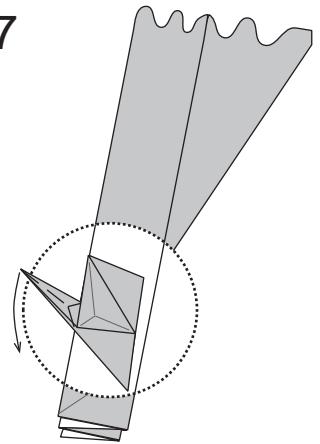

The result. Rabbit ear the toe downward.

68

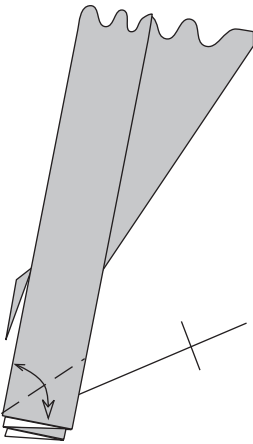

Valley fold the top layer in half along an angle bisector and unfold. Repeat on the flap behind.

69

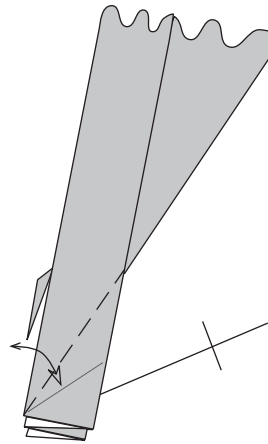

Valley fold the top layer so that the crease from Step 68 lies on the back edge (this is another angle bisector). Repeat on the flap behind.

70

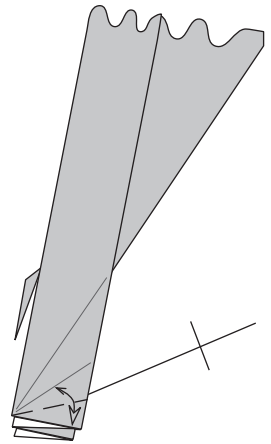

Valley fold on an angle bisector so that the lower edge meets the crease from Step 68. Repeat on the flap behind.

71

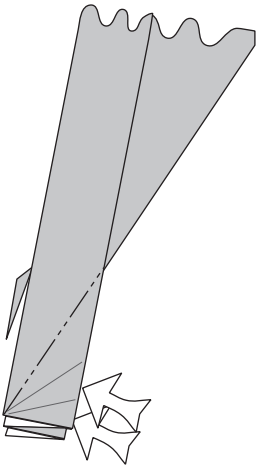

Reverse fold on the longest angle bisector (from Step 69); repeat on the remaining flap.

72

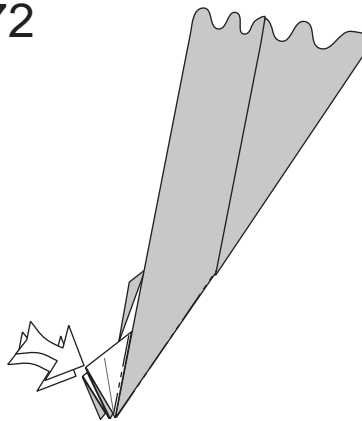

Reverse fold on the next angle bisector (from Step 68); repeat on the remaining flap.

73

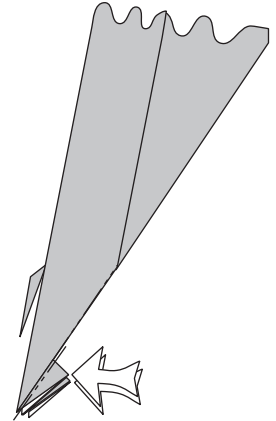

Reverse fold on the remaining angle bisector (from Step 70); repeat on the remaining flap. This forms the second - fourth toes. The next step returns to a full view of the model.

74

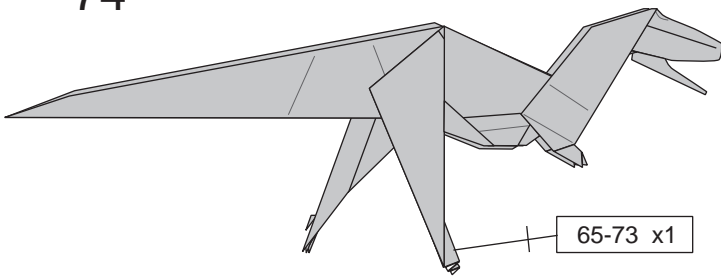

Repeat Steps 65-73 on the right foot.

75a

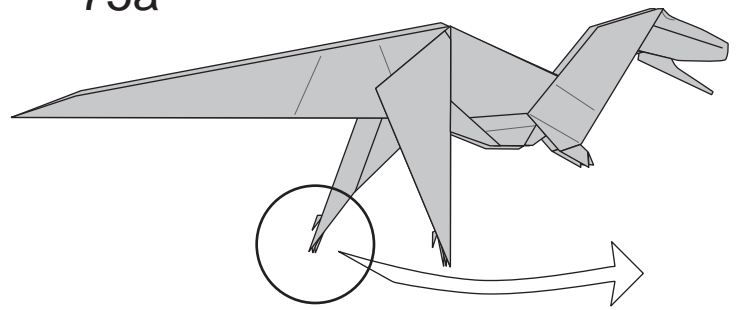

The next steps again focus on the left foot.

75b

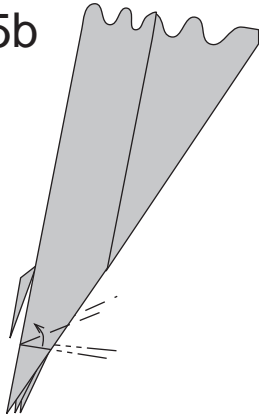

Outside crimp the second-fourth toes as a single unit, distributing the layers evenly (three on each side, dividing the middle toe) on each side of the crimp.

76

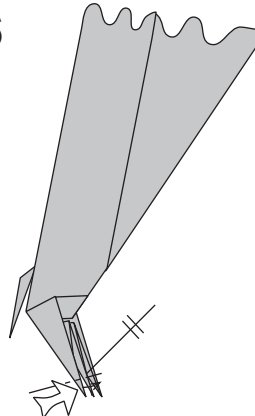

Reverse fold the tip of the innermost (second) digit to make a toe tip; repeat on the other third and fourth toes. This foot is on the tips of the toes because the left foot is in the process of stepping off the ground. The next diagram returns to a full view of the model.

77a

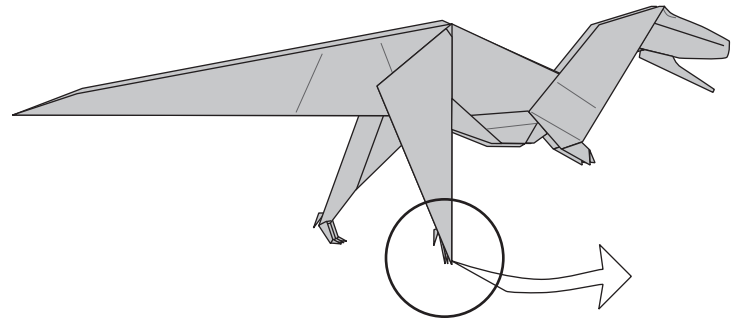

The left foot is complete. The next few diagrams are close-ups of the right foot.

77b

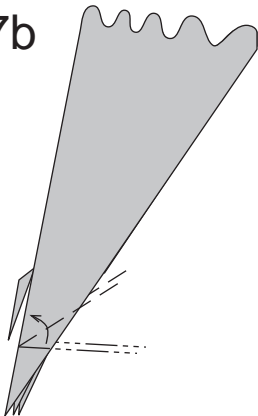

As in Step 75b, outside crimp the second-fourth toes as a single unit, distributing the layers evenly, but this time make a much steeper crimp, so that the bottom of the foot is just below horizontal.

78

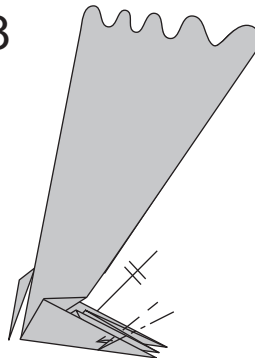

Make a shallow inside crimp to form the tip of the fourth toe; repeat on the second and third toes. The next diagram returns to a full view of the model.

79

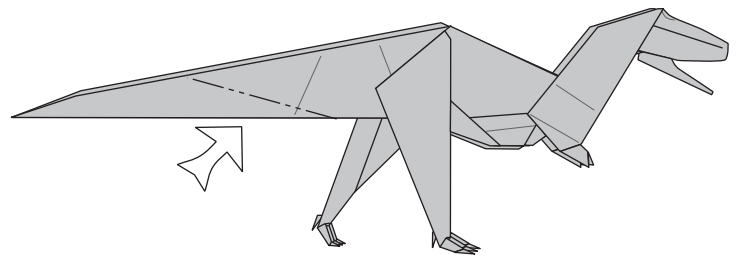

Shallowly reverse fold the tail; note that the upper end of the reverse fold is a little more than halfway down the tail point.

80

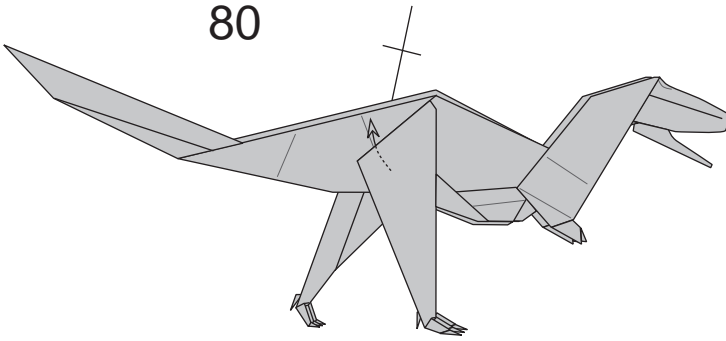

Pull out a single layer of paper from behind the back of the thigh; repeat behind.

81

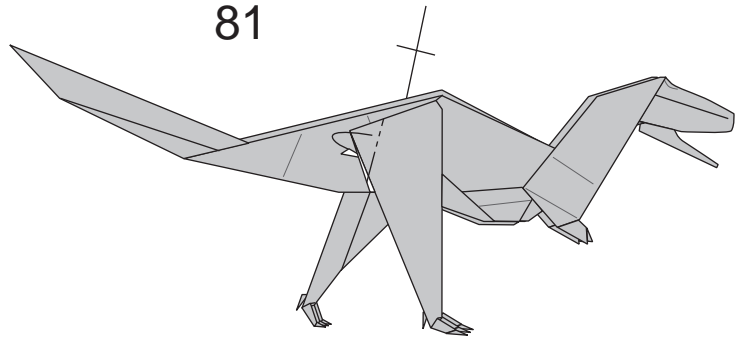

Fold the corner of the paper pulled out from Step 80 to round out the thigh; repeat behind. The next diagram is enlarged.

82

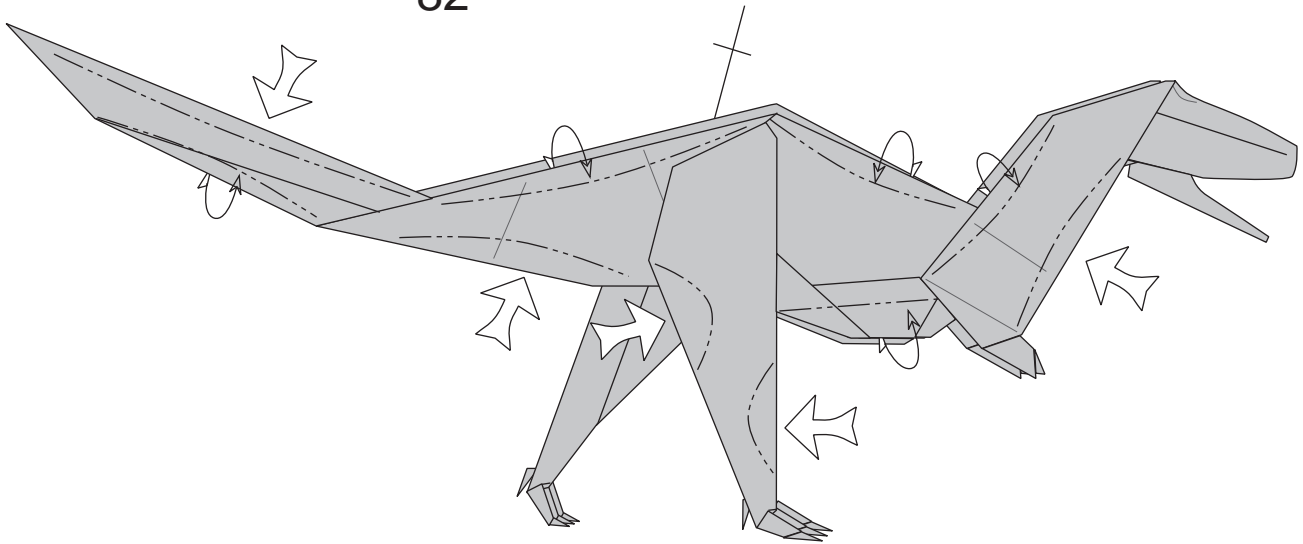

Shape the legs by denting in some paper at the rear of the thigh and the front of the shin. Round the neck, belly, back, and tail.

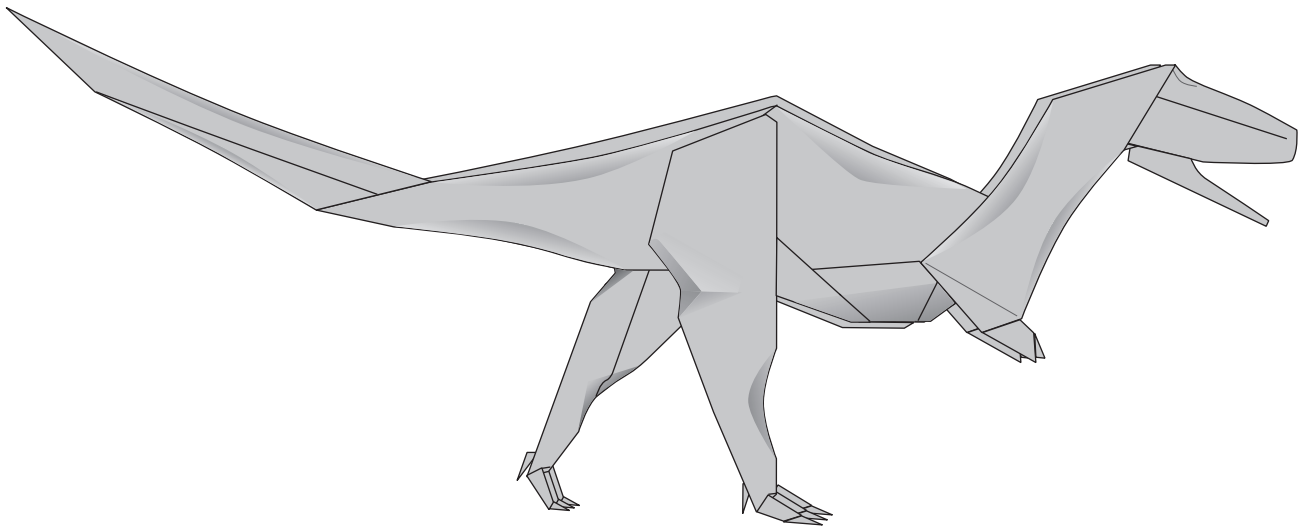

**FINISHED TYRANNOSAURUS**



---

# Bebé Tiranosaurus

---

Fernando Gilgado Gómez

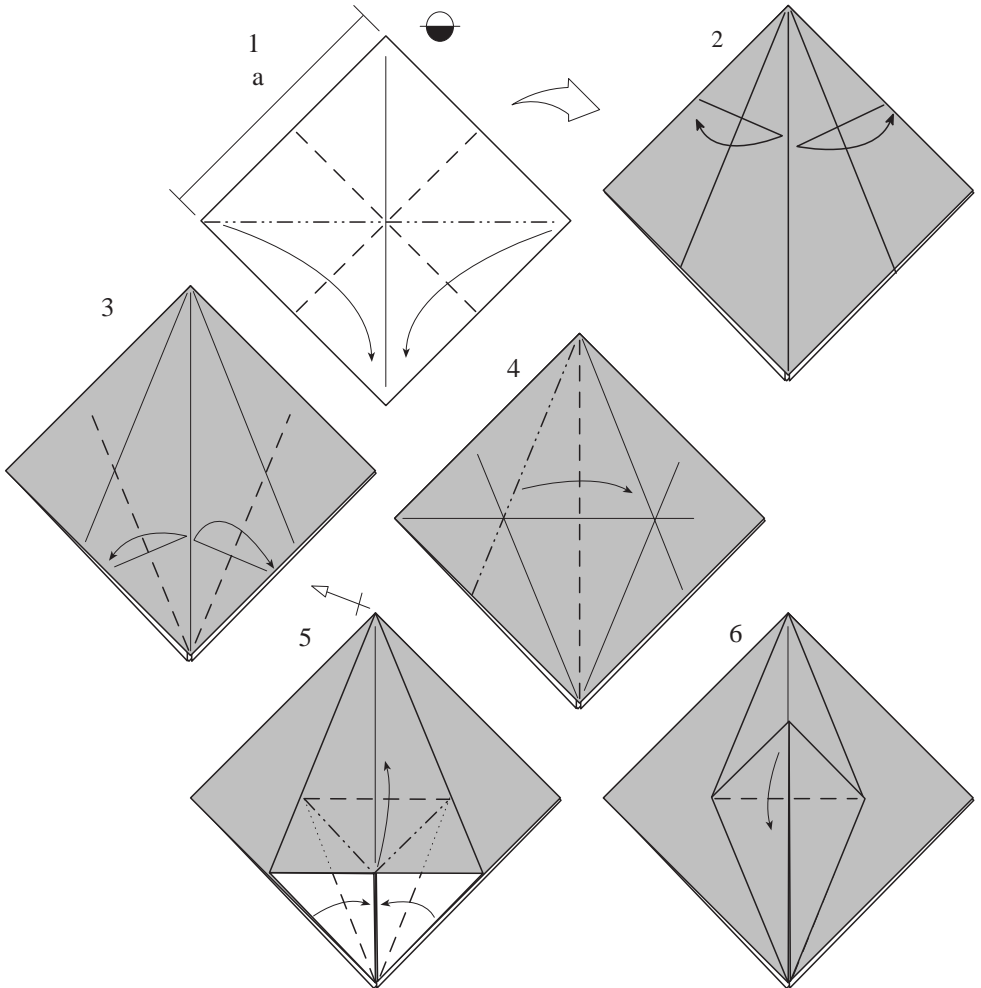
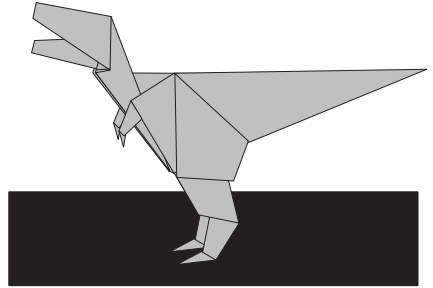

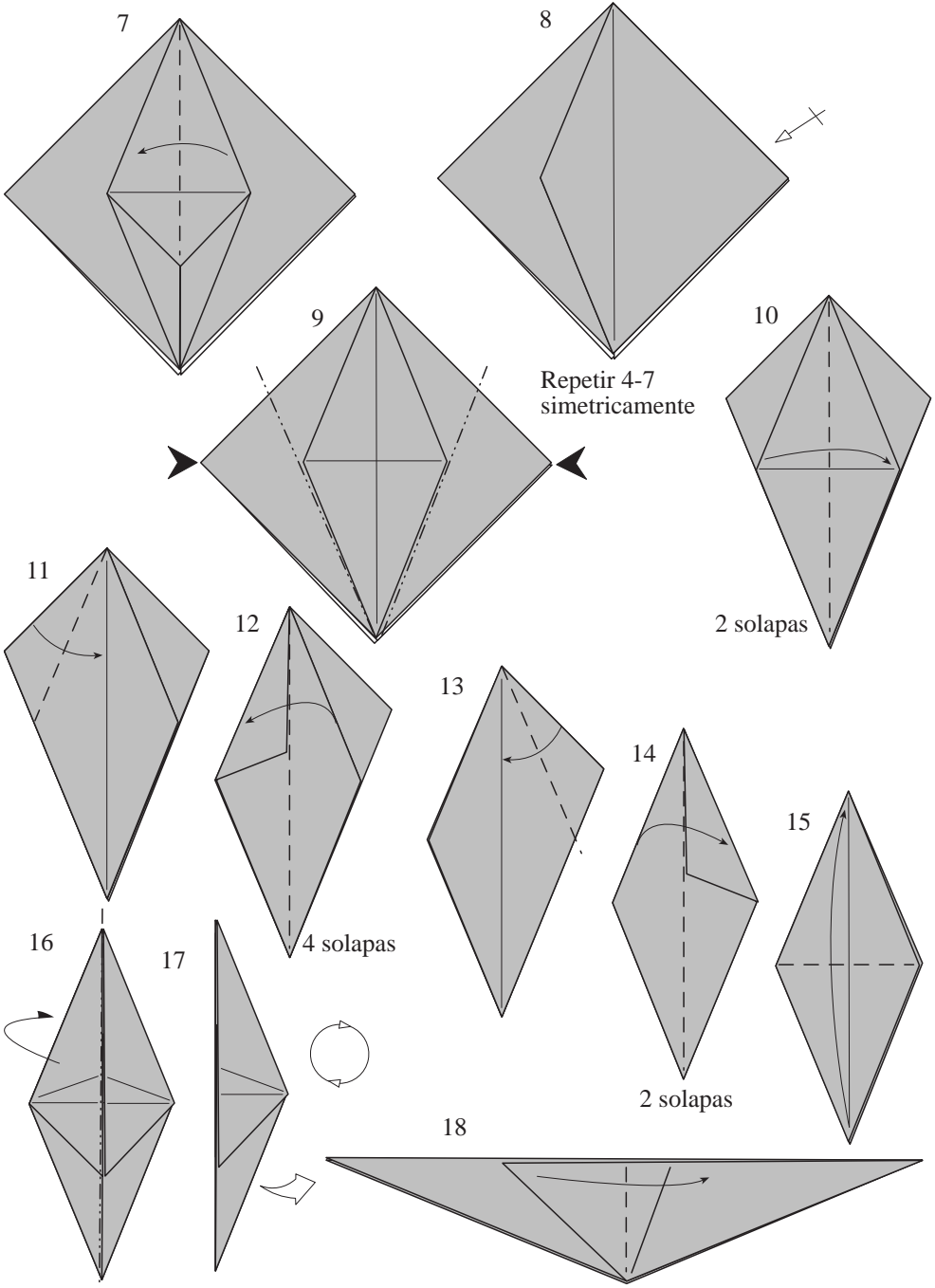

7

8

9

10

11

12

13

14

15

16

17

18

Repetir 4-7  
simetricamente

2 solapas

4 solapas

2 solapas

---

19

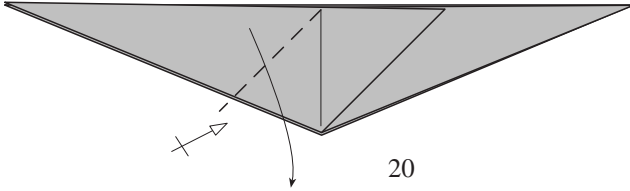

20

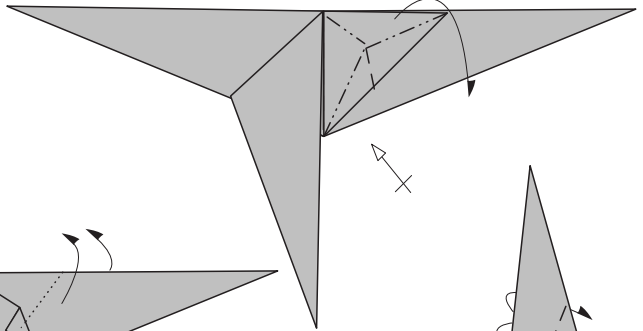

21

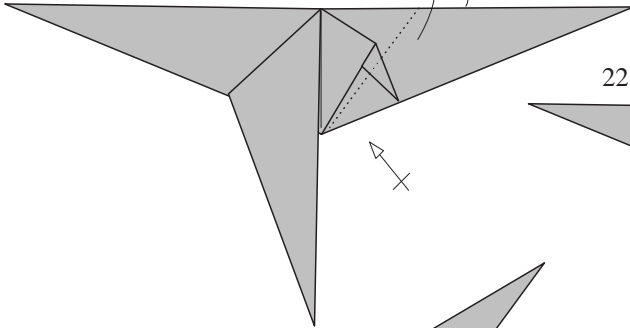

22

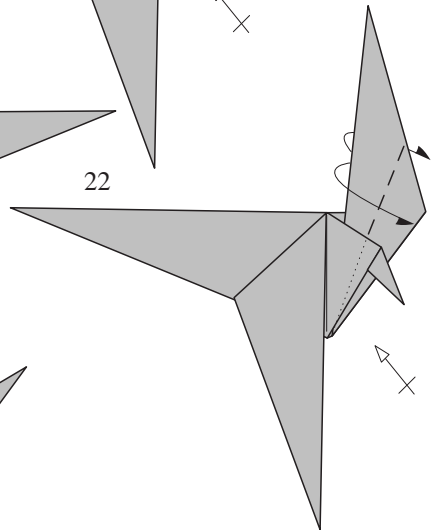

23

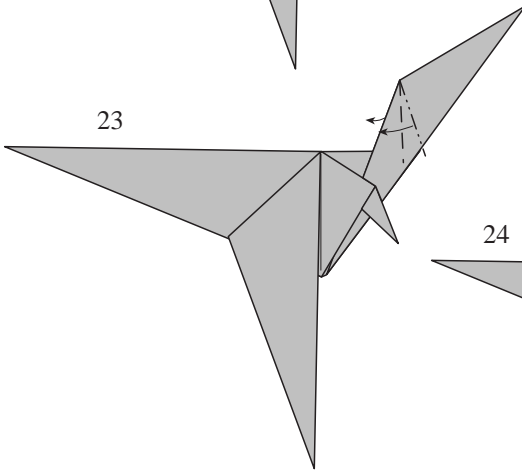

24

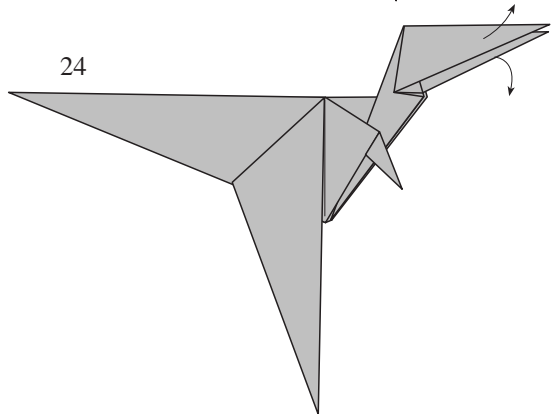

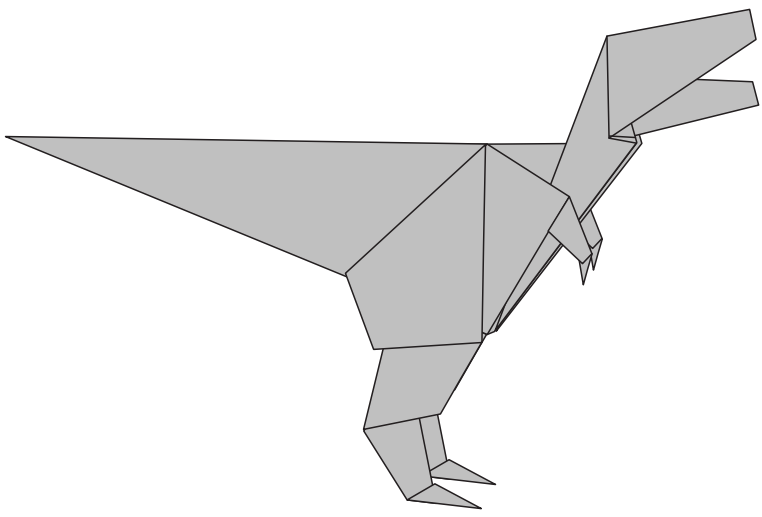
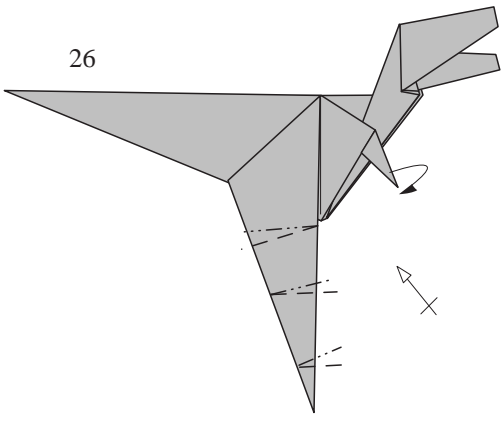
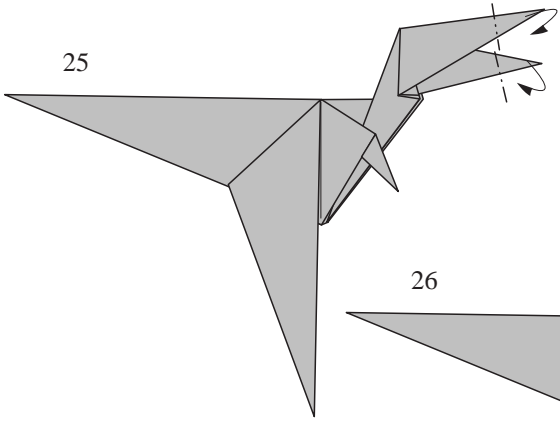

# A Simple Unicorn

by Perry Bailey

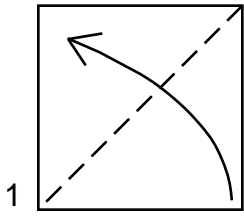

1

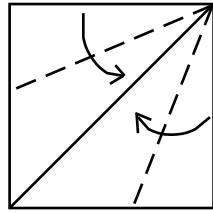

2

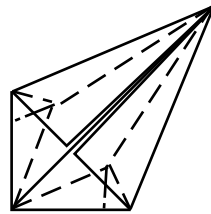

3 rabbit ear fold

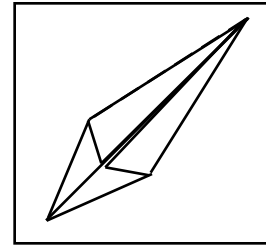

4 enlarge next frame

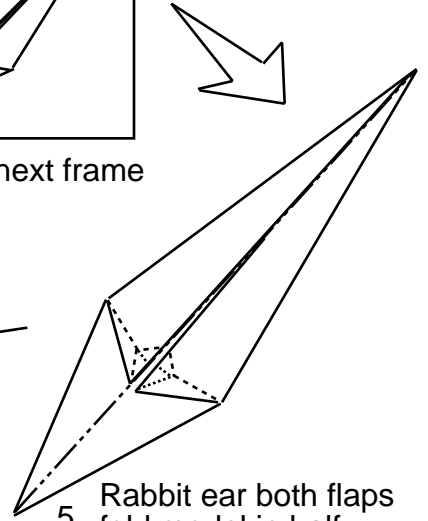

5 Rabbit ear both flaps fold model in half.



6 Reverse fold

Turn over

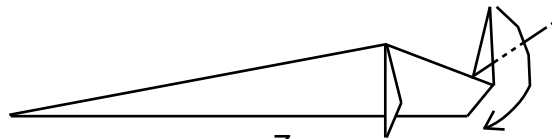

7 Reverse fold

With many thanks to George Rhodes, For giving me the idea for this model, from his bull, printed in "The Art of Origami" By Samuel Randlett. I made this Model for my daughter Erralee Who had trouble with more complex Unicorns.

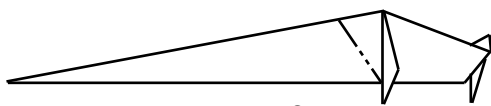

8 Reverse fold

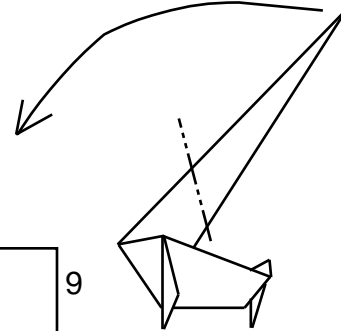

9 Reverse fold

This model is placed in the public domain. and may be used, copied, folded, spindled, and mutilated, At your discretion.  
My only request is if you print or publish it, please credit me for the design, and if possible send me a copy of the publication.  
P. Bailey 6-26-1997

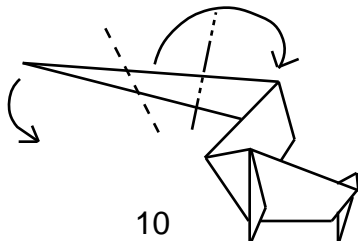

10

2 Reverse folds to make head and horn

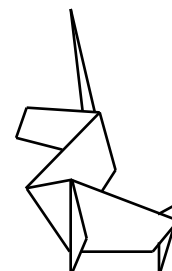

11. Finished

# Unicorn Bust

Eileen Tan  
eileen@tristan.tn.cornell.edu  
16 February 2001

## Head

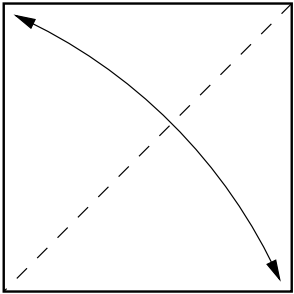

1. Crease diagonally and unfold.

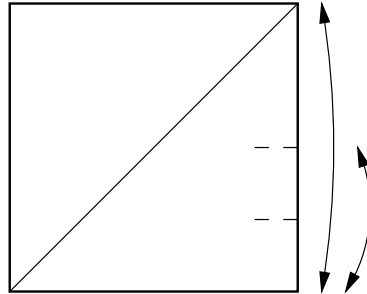

2. Pinch twice to make a quarter mark.

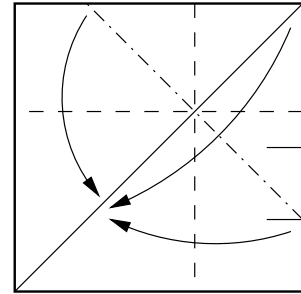

3. Fold a preliminary base.

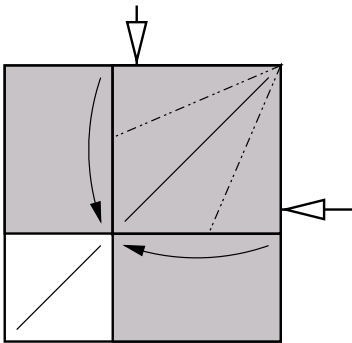

4. Reverse fold the sides.

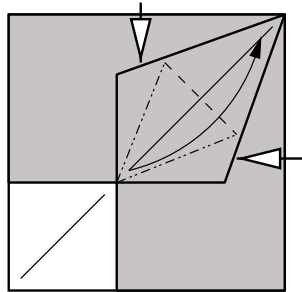

5. Petal fold.

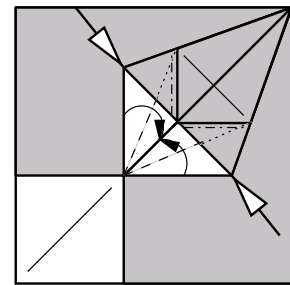

6. Reverse fold the sides.

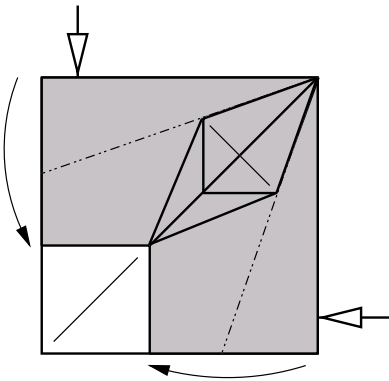

7. Reverse fold the sides.

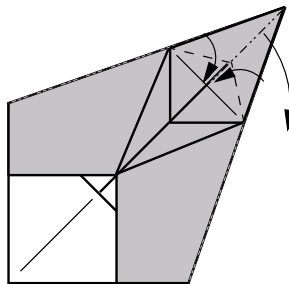

8. Rabbit ear the topmost point.

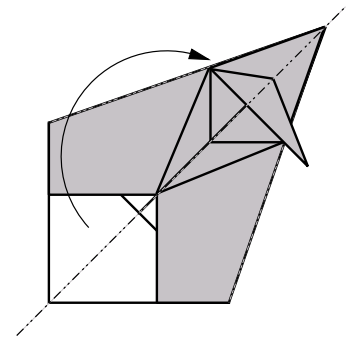

9. Mountain fold the model in half.

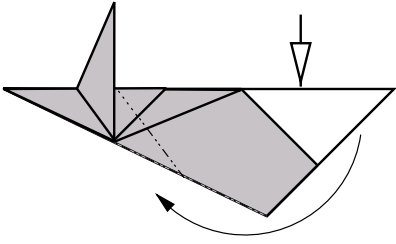

10. Reverse fold.

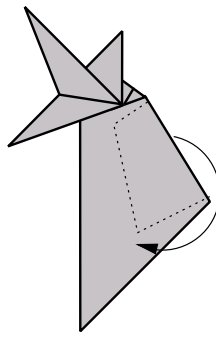

11. Wrap the hidden layer around to the front; repeat behind.

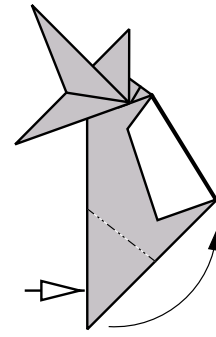

12. Reverse fold.

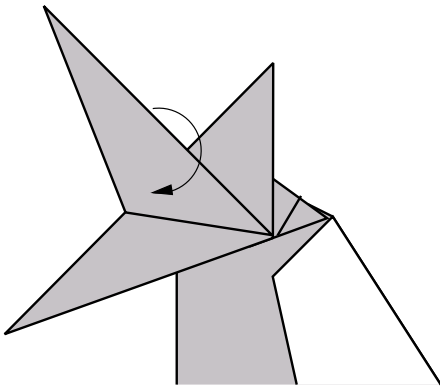

13. Closeup of the head. Wrap one layer to the front of the horn, repeat behind. (This colour change is optional).

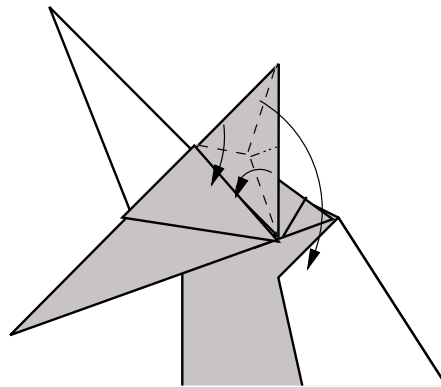

14. Rabbit fold the ear; repeat behind.

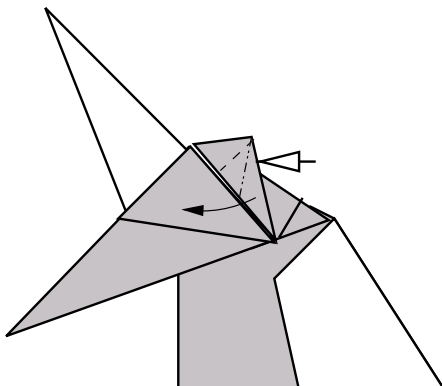

15. Squash fold; repeat behind.

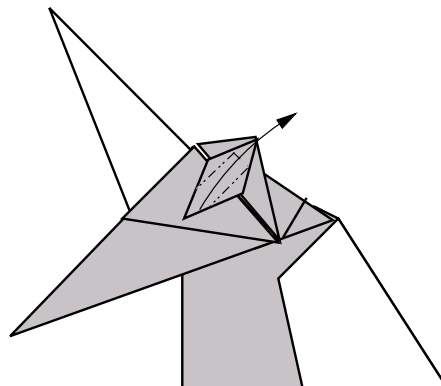

16. Petal fold, repeat behind.

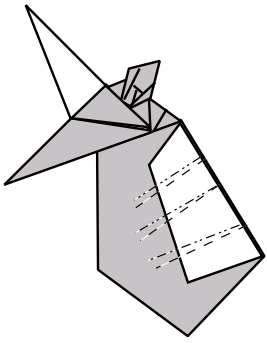

17. Crimp the mane; repeat behind.

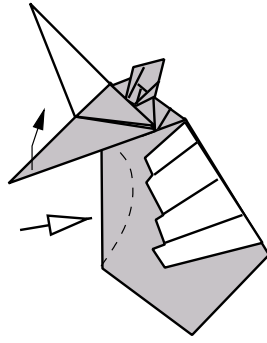

18. Curve the neck; slide the paper at the muzzle upwards.

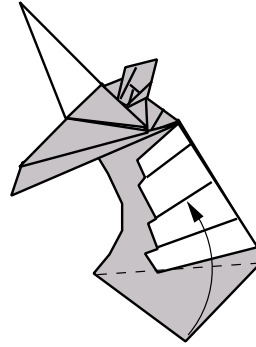

19. Fold the bottom flaps upwards so that they are perpendicular to the head.

viewed from front

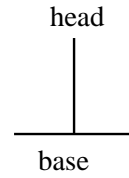

## Stand

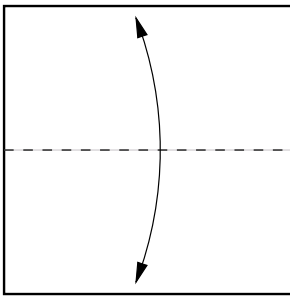

1. Fold and unfold.

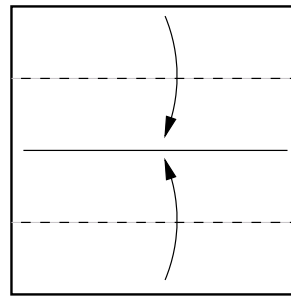

2. Fold almost to the centre, leaving a gap for the head (see next figure).

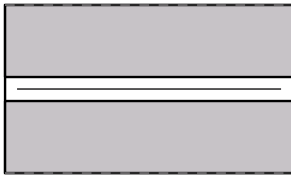

3. Check that the head slides snugly into the gap (See figure 12)

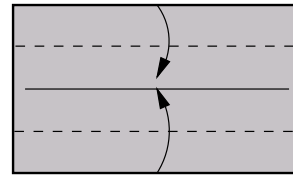
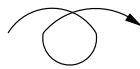

4. Valley fold to the centre.

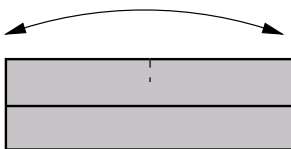

5. Make a pinch mark.

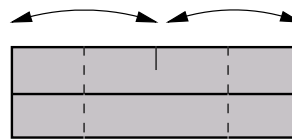

6. Fold and unfold.



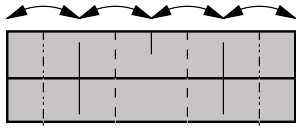

7. Fold and unfold.

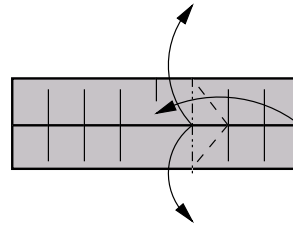

8. Unfold the top and bottom sides and fold the right side up simultaneously (see the next figure).

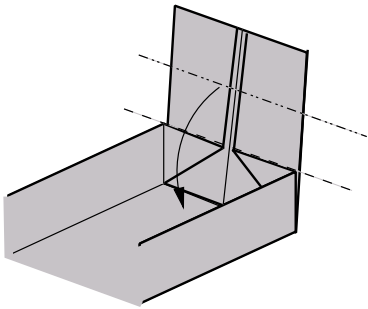

9. Fold the paper into the box in an 'L' shape.

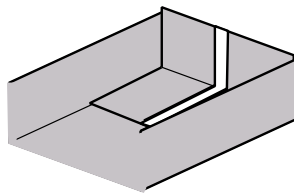

10. Like this. Repeat steps 8-9 on the left side.

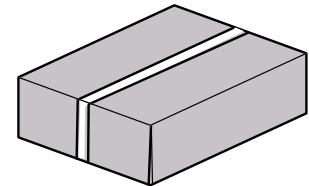
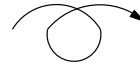

11. Completed stand.

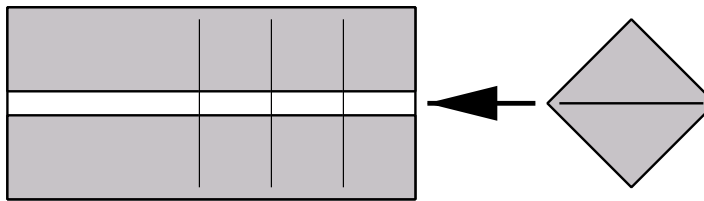

12. Unfold one of the sides, slip the unicorn head in, and refold.

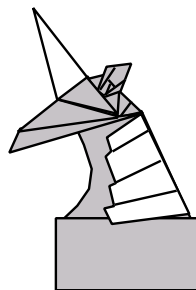

12. Finished Unicorn Bust.

# 145 point sea urchin

by Toshiyuki Meguro (Japan) © 1990

Diagrams and folding method by Hans Birkeland  
© 1994

Use thin paper that doesn't tear easily.  
The size should be at least 40 x 40 cm.  
Begin with the dark side up.

Folding pattern :

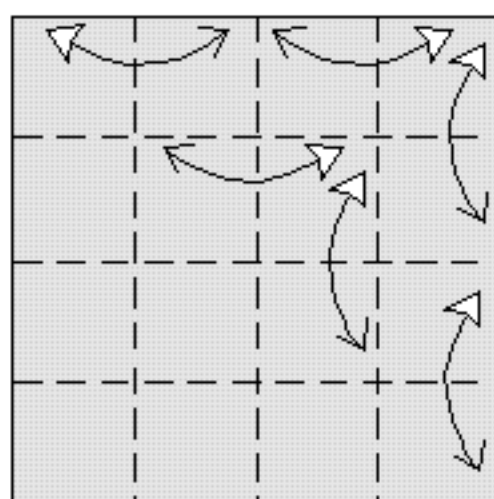
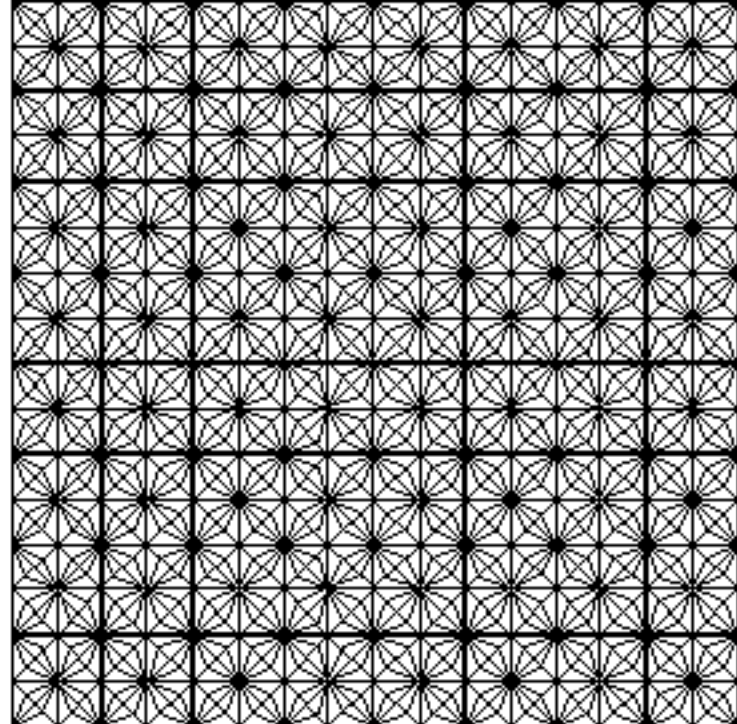

1. Crease the paper into fourths vertically and horizontally.

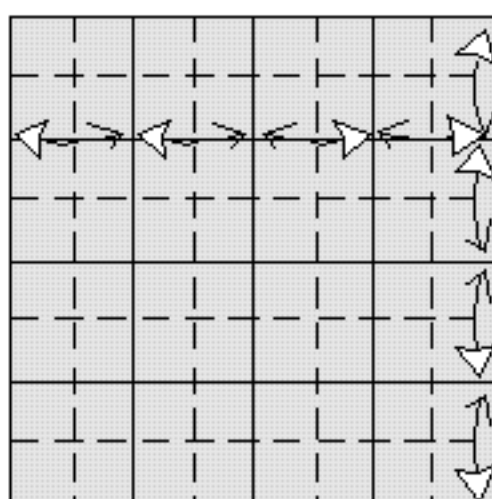

2. Crease the paper into eights vertically and horizontally.

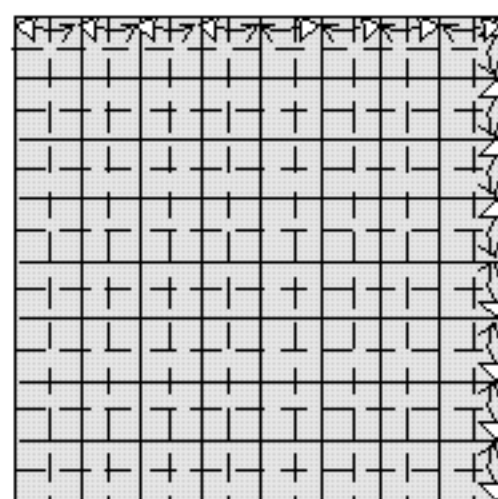

3. Crease the paper into sixteenths vertically and horizontally. Turn the paper over.

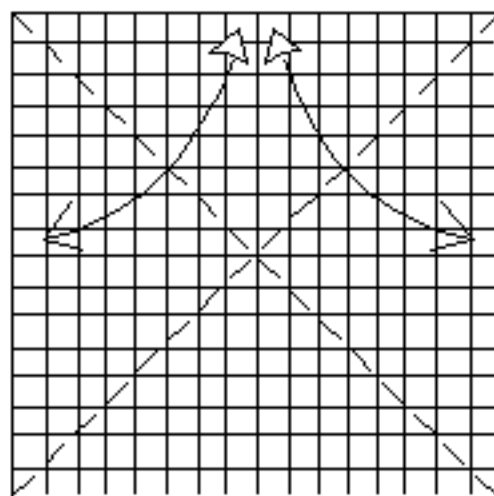

4. Crease the diagonals.

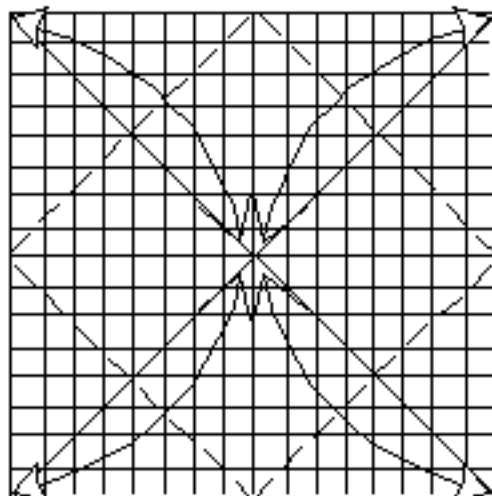

5. Bring the corners to the center, crease, and unfold.

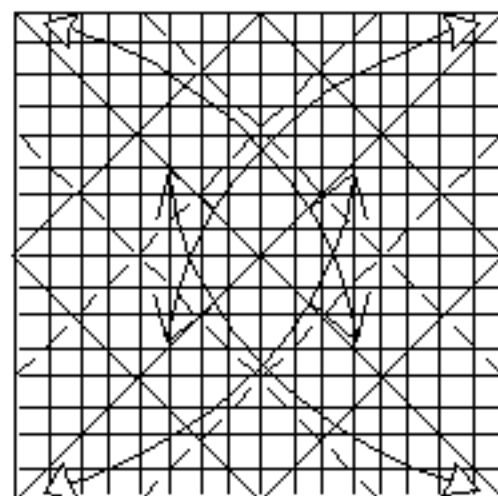

6. Add more diagonal creases.

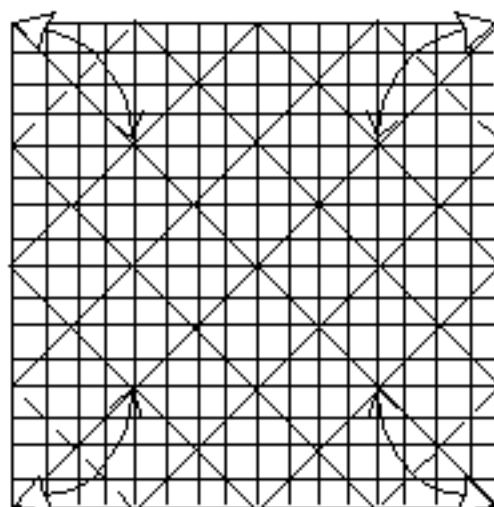

7. And more.

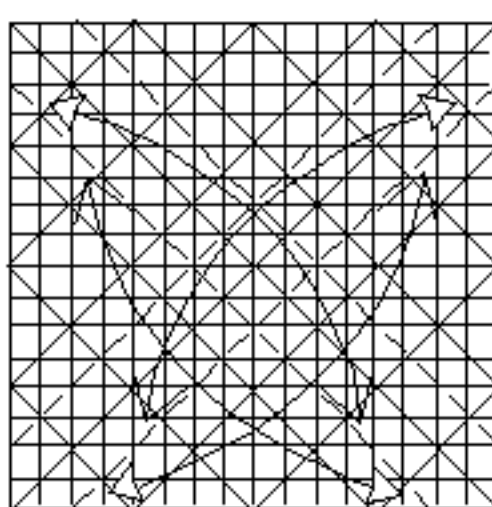

8. And more.

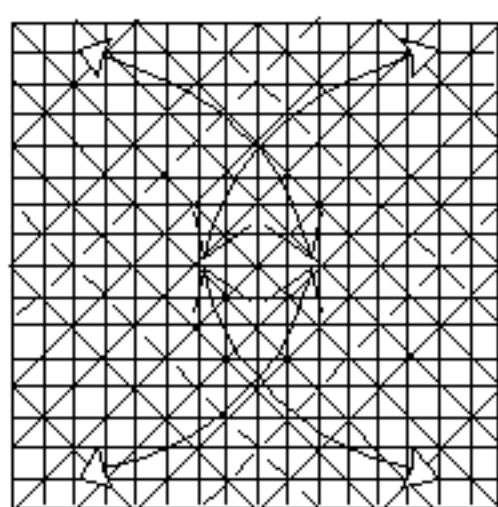

9. And more.

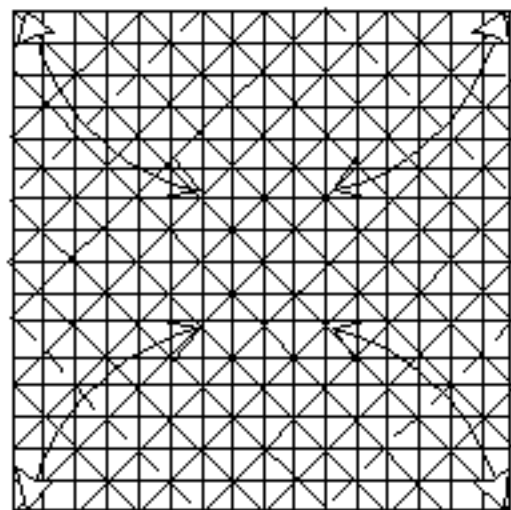

10. And more.

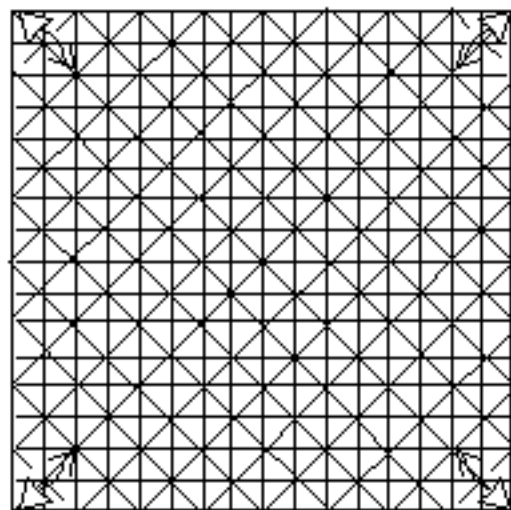

11. And more.  
Turn the paper over.

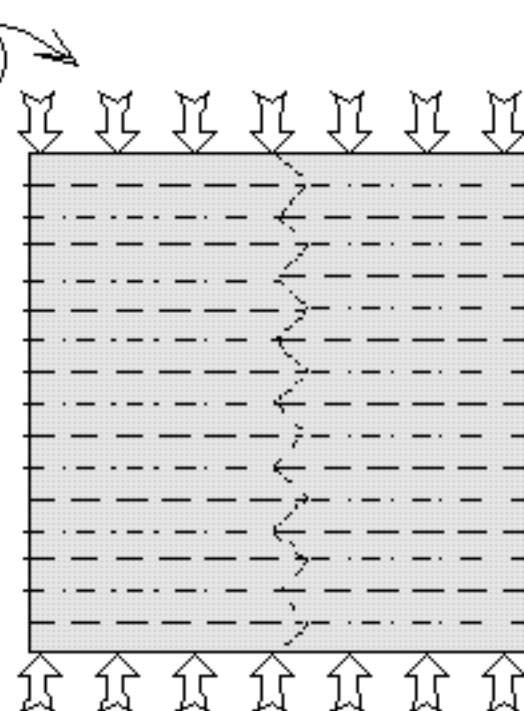

12. Collapse on existing creases.

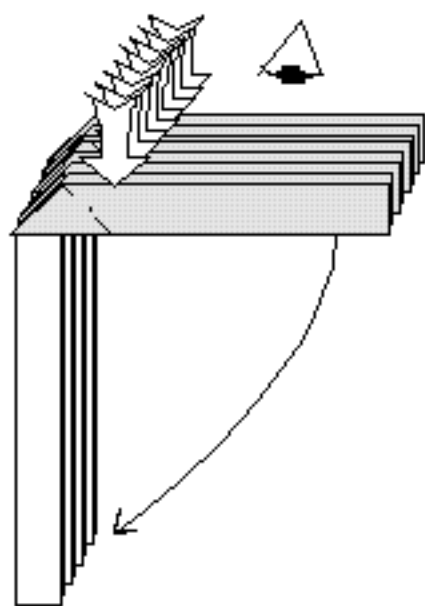

13. Reverse-fold all eight edges on existing creases. The easiest way to do this is to spread out the paper and reverse the creases that make up the fan (see step 14) before collapsing.

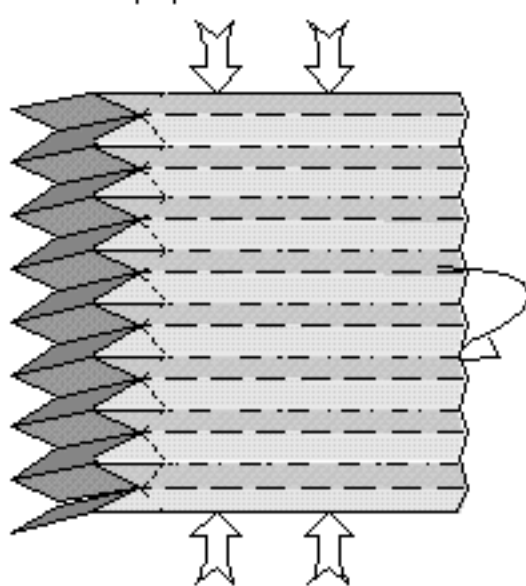

14. Step 13 seen from above.

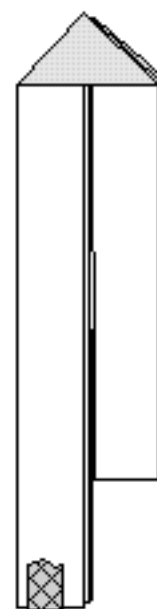

15. To make the following steps easier to perform, put a piece of tape at the bottom of the long assembly to keep the layers together.

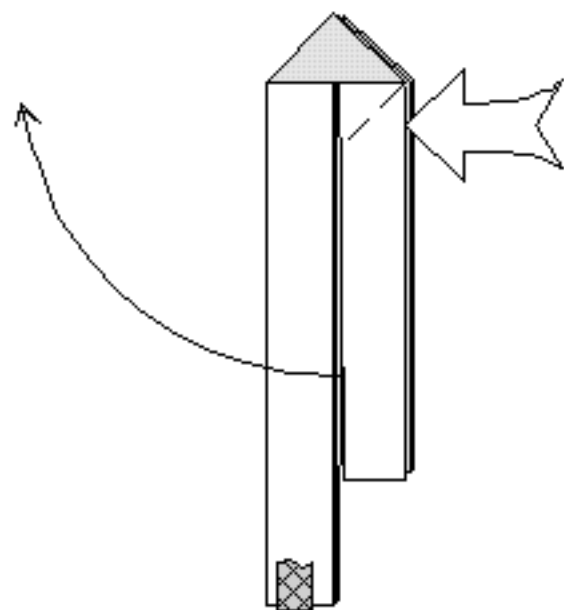

16. Continue reverse-folding on existing creases. This time it's a bit more difficult, because the model can't be opened out as in step 13/14. The process is described in more detail in steps 17-20.



17. Bookfold one layer to the left.

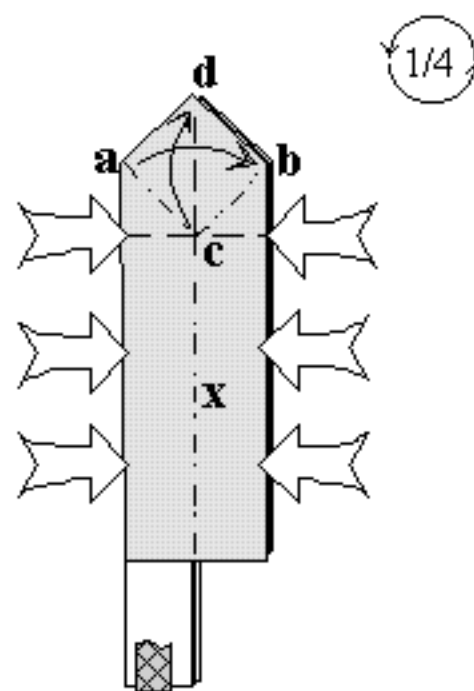

18. Make the edge (x) stand out by pushing in the sides of the nearest layer. Then swing corner (a) to the right to meet corner (b), and let corner (c) meet corner (d). The model is now 3-D. Rotate the model 1/4 turn counter-clockwise.

1/4

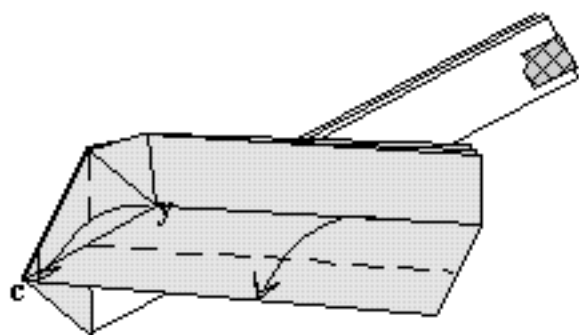

**19.** Closed-sink corner (y) outward so that it meets corner (c). Repeat with the next 6 similar corners.

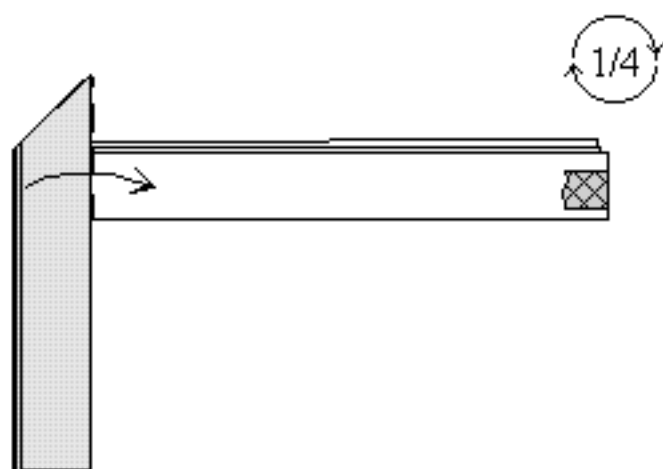

**20.** Book-fold the assembly to the right. Rotate the model  $1/4$  turn clockwise.

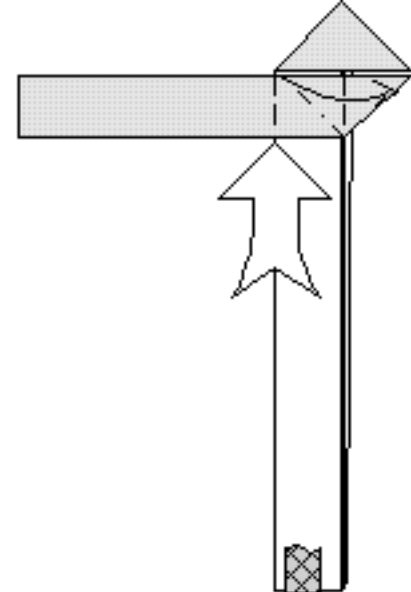

**21.** Repeat steps 18-20, pretending that you already have book-folded a layer to the left. Be careful and do not rush: this process is quite difficult! It is important that you only use existing creases. Notice that the model starts resembling a spiral. Continue reverse-folding, repeating steps 17-20 /18-20 every second turn until there is no paper left.

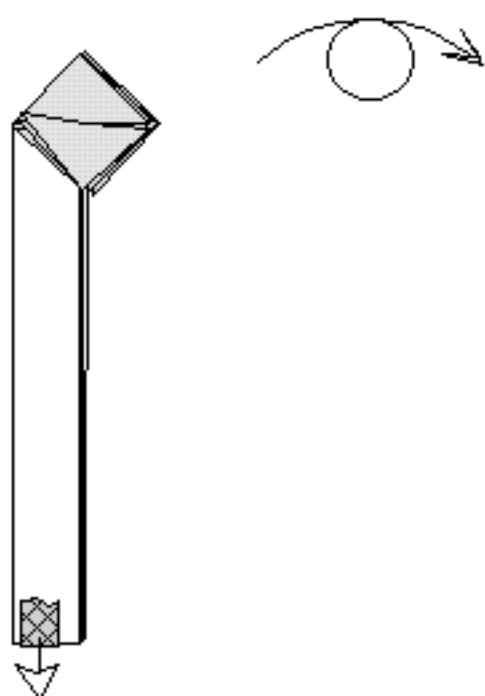

**22.** Like this. Now take off the tape and turn the model over.

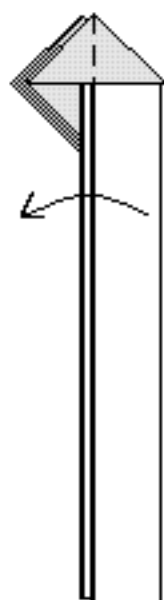

**23.** Repeat the process from steps 17-21 on the other long assembly.

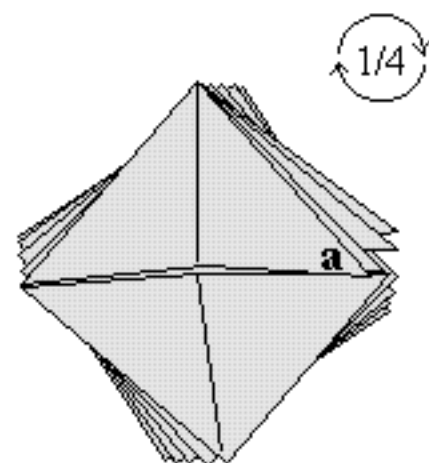

**24.** Like this. Rotate the model  $1/4$  turn clockwise so that the end of the spiral (a) points downward.

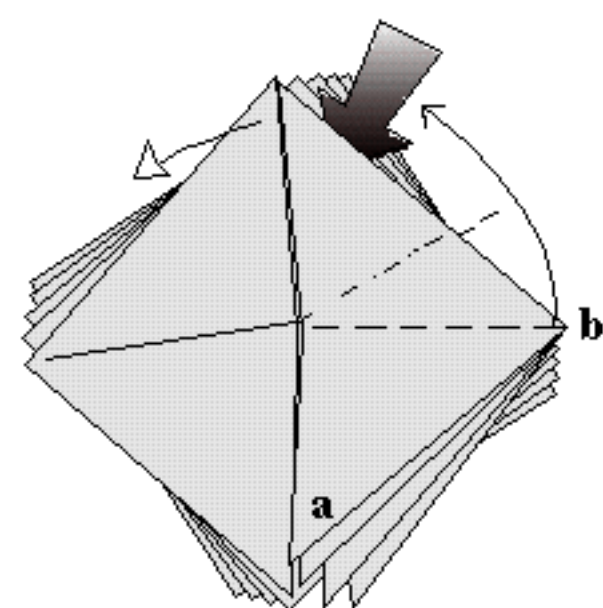

**25.** Open out one layer at the top, press together the two edges below corner (b) and swivel upward. Then press flat.

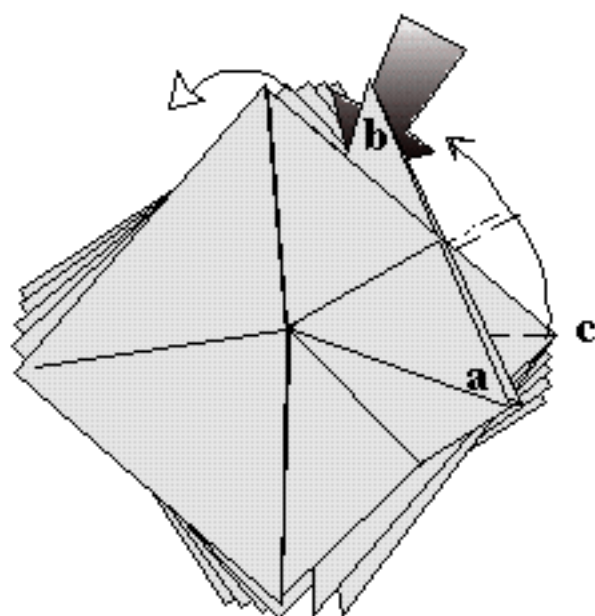

**26.** Open out two layers at the top, press together the two edges below corner (c) and repeat the process from step 24. Then continue swivel-folding the next six corners. In the next drawing, only four of the eight corners are shown.

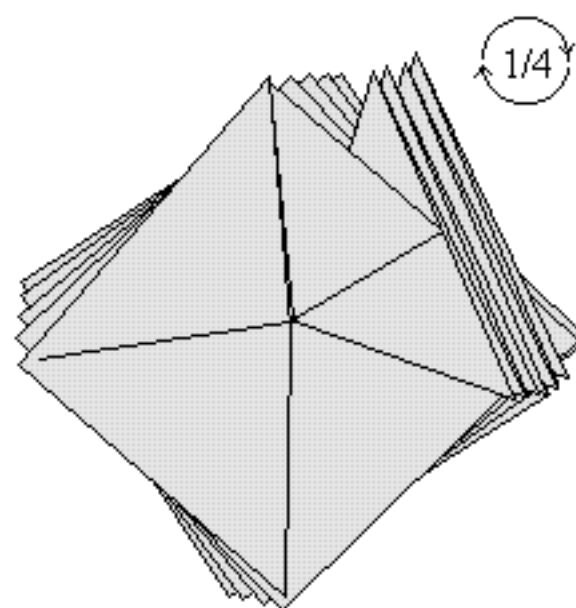

**27.** Rotate the model  $1/4$  turn clockwise.

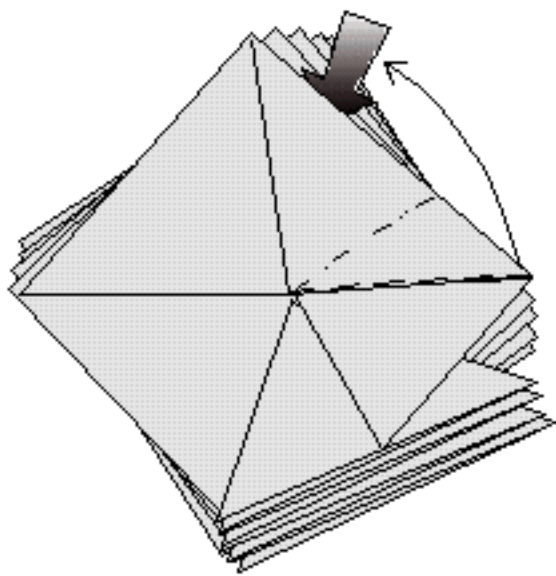

**28.** Swivel-fold the nearest layer.

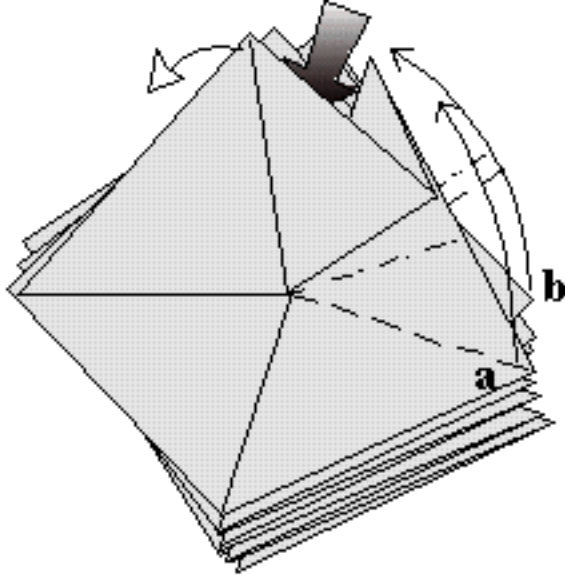

**29.** Open out one layer at the top and swivel-fold corner (a) and (b) together.

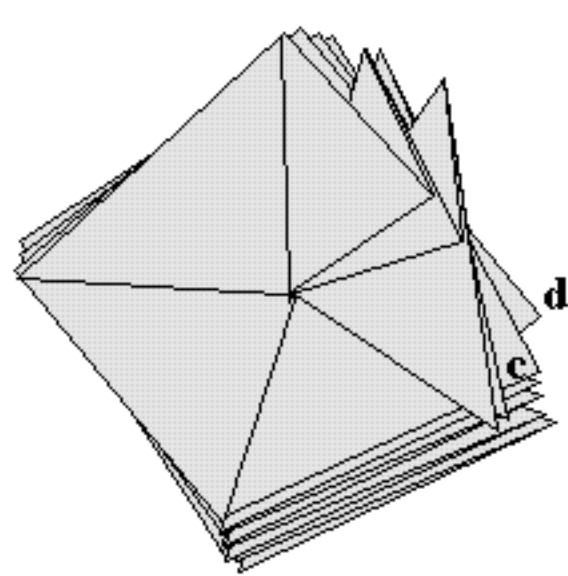

**30.** Repeat the process with corner (c) and (d) and then continue until there are eight points on the lower row and nine on the upper (the last corner on the upper row will be folded as in step 28).

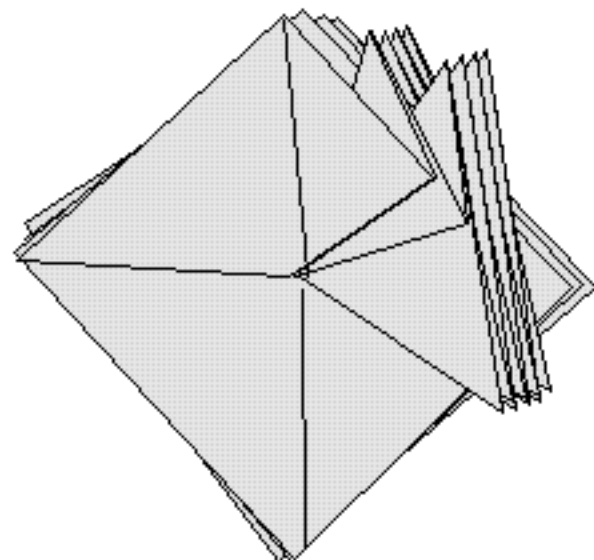

**31.** Repeat steps 27-30, with the only difference that now the old points will follow the new ones in the swivel-process. Then repeat steps 27-30 on the three next groups of corners.

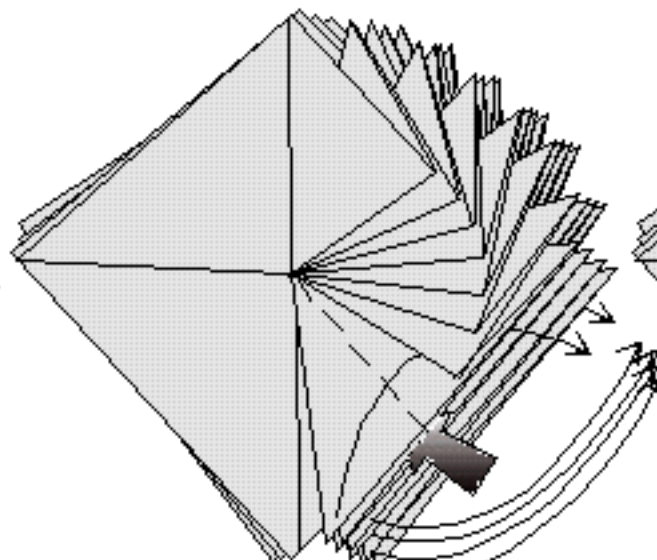

**32.** Valley-fold the nearest edge upward and put it underneath the next edge. Repeat behind. Reverse-fold the seven corners in between.

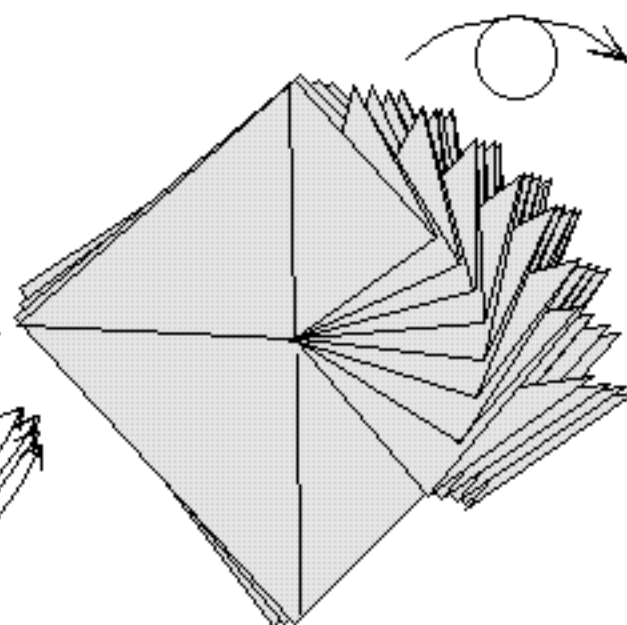

**33.** Turn the model over and repeat steps 25-32. In the next step, a part of the model is seen from the side.



**34.** The layers between the points might get out of order. This is how they should be arranged.

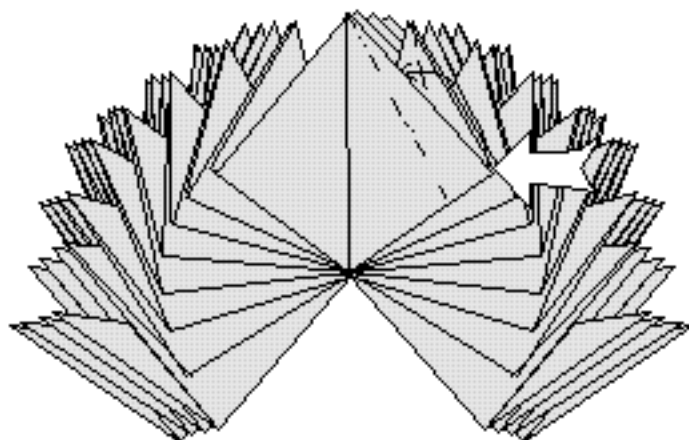

**35.** Narrow all the points with reverse-folds, starting on the top, and taking a row at the time. Each reverse-fold narrows an edge that connects two points. It might be helpful to use tweezers. When you're finished, spread out the points to make the model 3-dimensional.

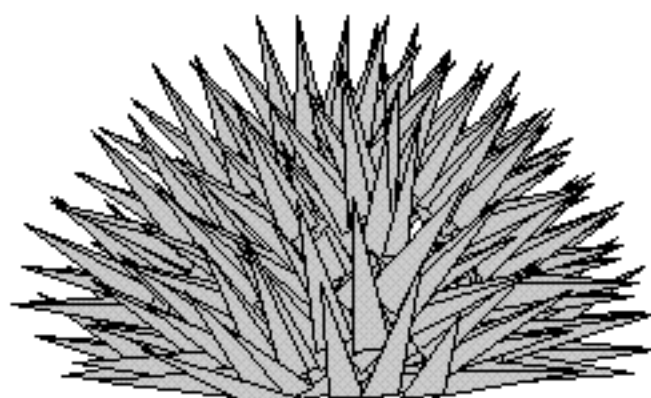

**36.** The finished 145-point sea urchin.

# Pacific Giant Red Sea Urchin

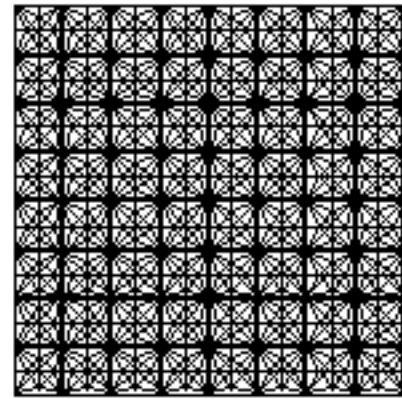
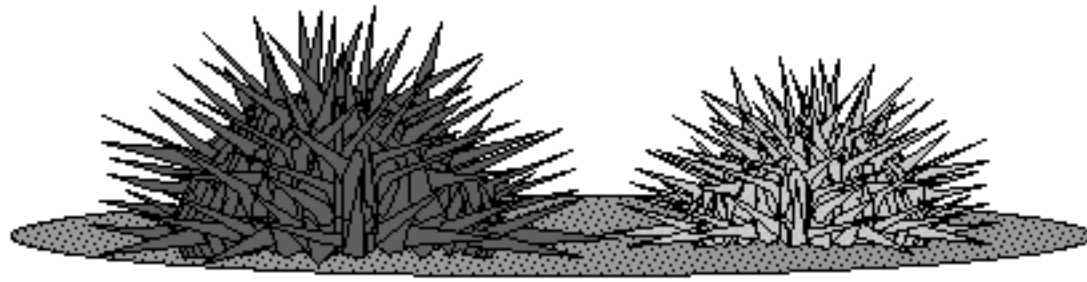

Based on Robert J. Lang's "Atlantic Purple Sea Urchin".  
Use paper that doesn't tear easily, or use foil-backed paper.  
Use a square measuring at least 30 inches (75 cm) to a side.  
Begin with the white side up.

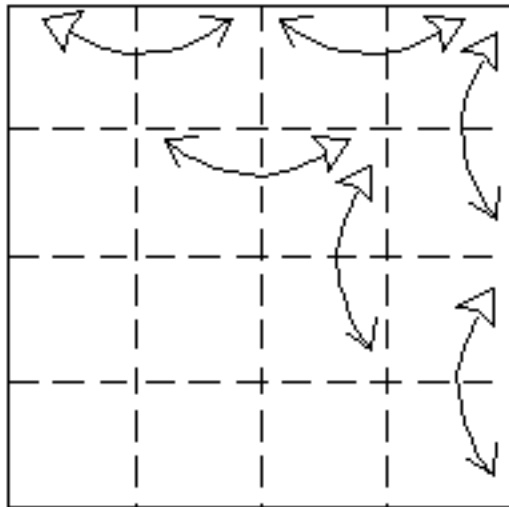

**1.** Crease the paper into fourths vertically and horizontally.

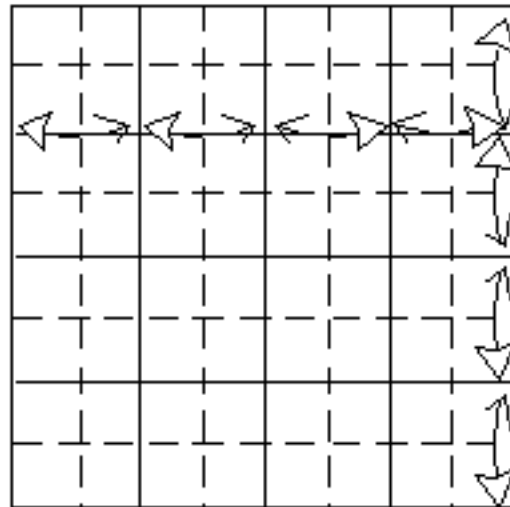

**2.** Crease the paper into eights vertically and horizontally.

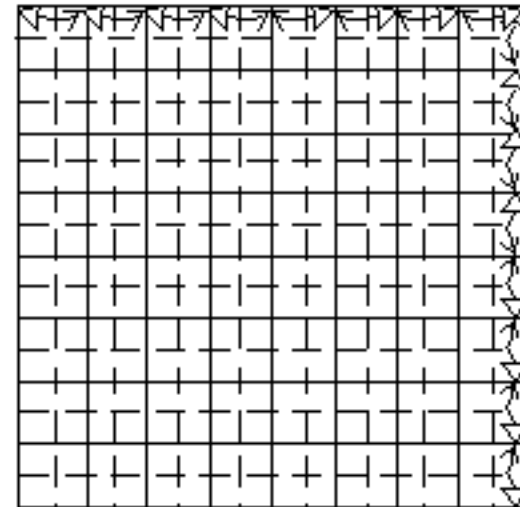

**3.** Crease the paper into sixteenths vertically and horizontally.

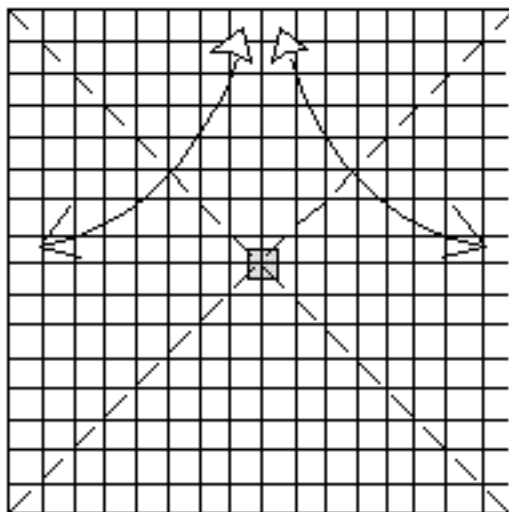

**4.** Crease the diagonals. For extra safety, put a piece of tape at the center of the paper.

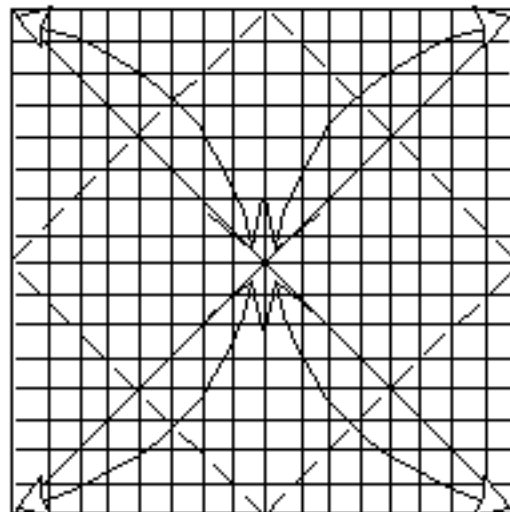

**5.** Bring the corners to the center, crease, and unfold.

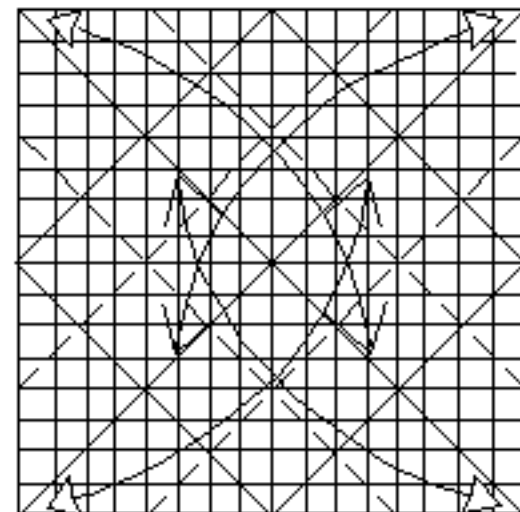

**6.** Add more diagonal creases.

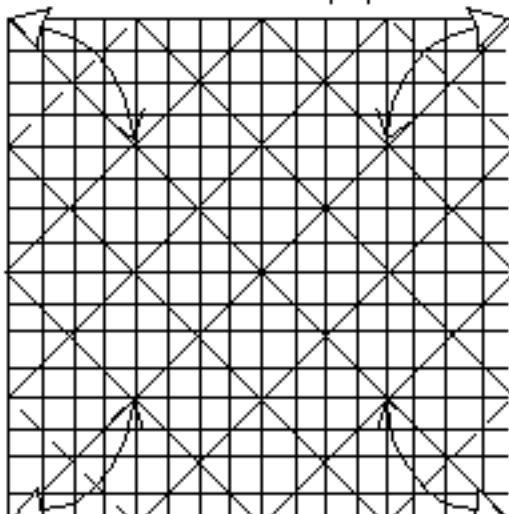

**7.** And more.

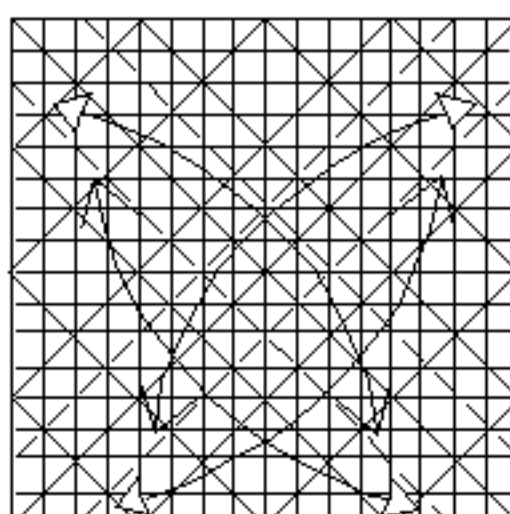

**8.** And more.

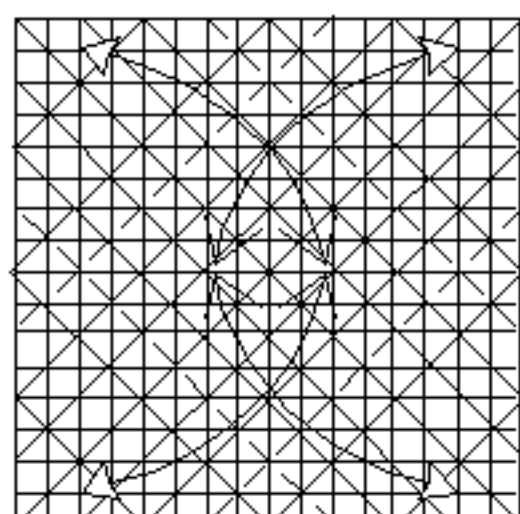

**9.** And more.

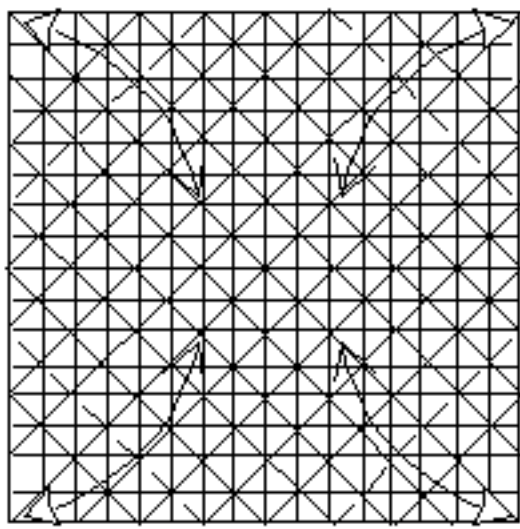

10. And more.

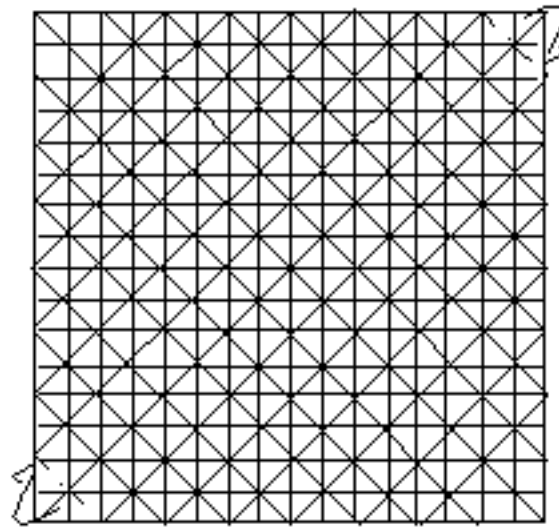

11. Mountain-fold two opposing corners behind.

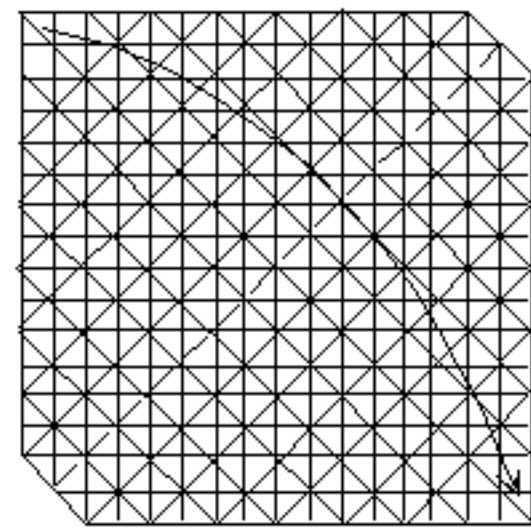

12. Valley-fold in half.

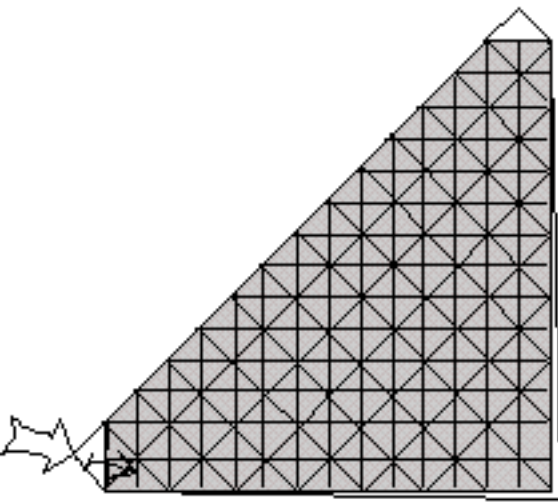

13. Squash-fold.

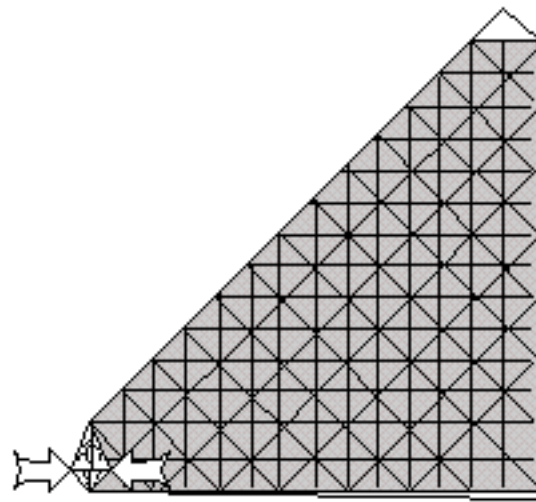

14. Petal-fold.

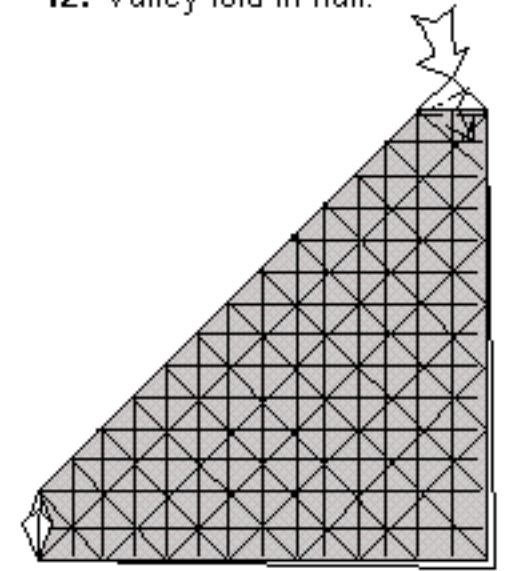

15. Repeat steps 13 - 14 on the top corner and unfold to step 11.

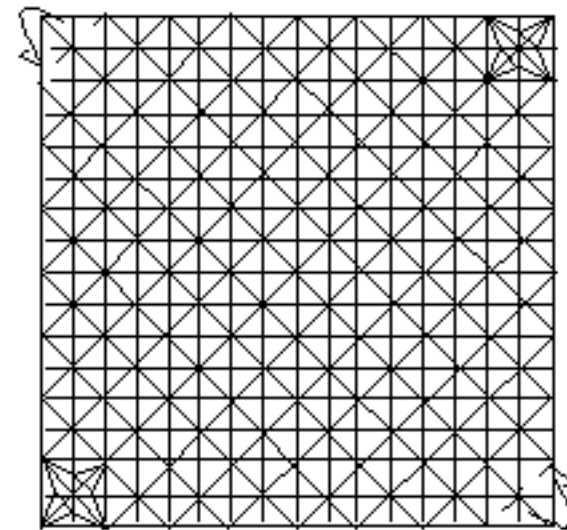

16. Repeat steps 11 - 15.

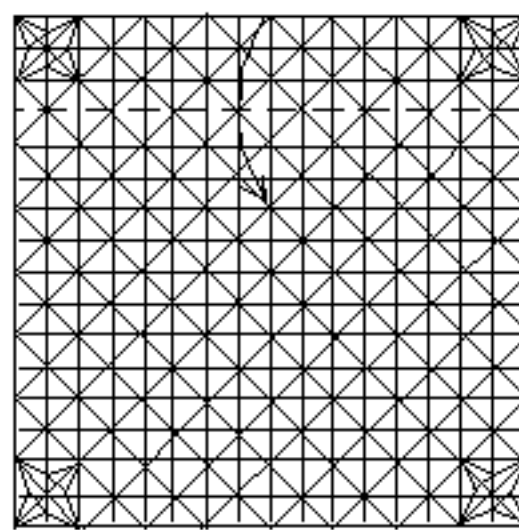

17. Valley-fold.

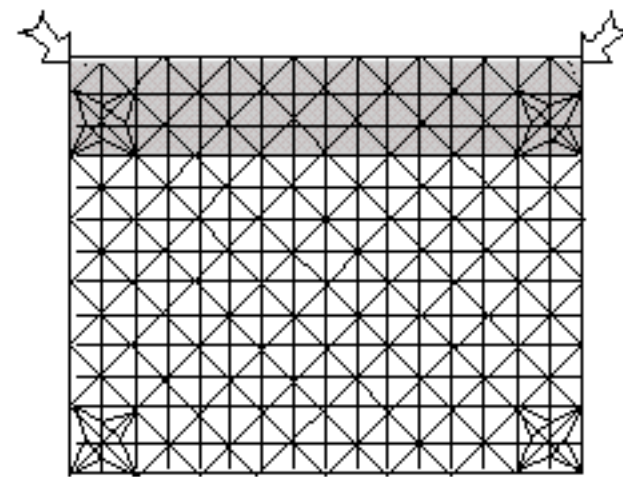

18. Reverse-fold along angle bisectors and unfold completely. Repeat on all similar places along the edges of the square.

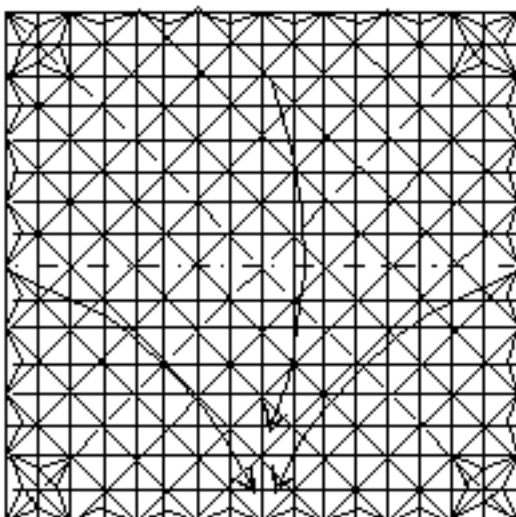

19. Precreasing complete. Fold a Waterbomb Base.

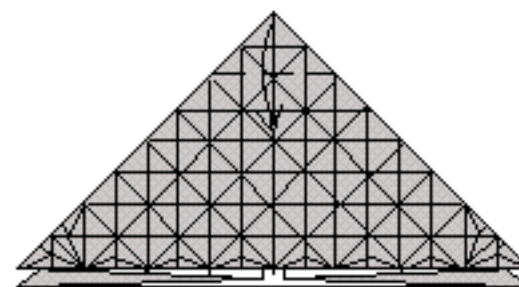

20. Valley-fold.

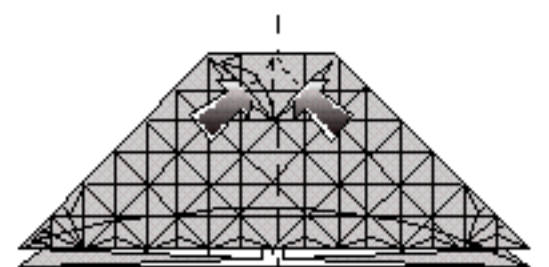

21. Open up on both sides of the top corner and fold the right side of the model over to the left.

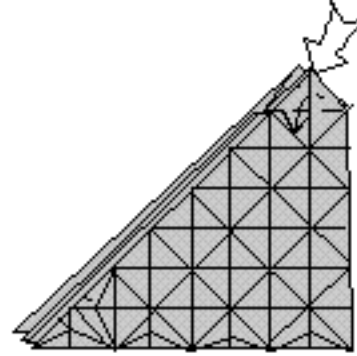

**22.** Squash-fold.

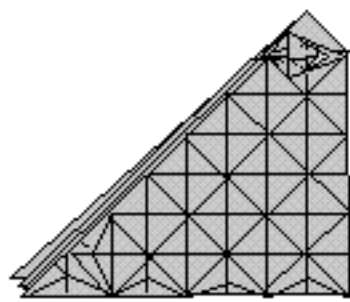

**23.** Petal-fold.

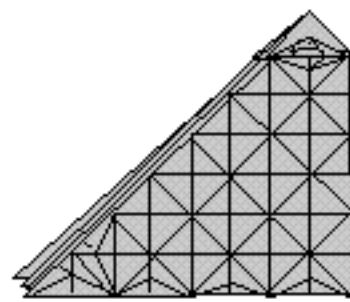

**24.** Valley-fold the flap to the left.

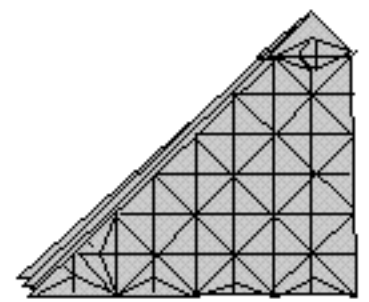

**25.** Repeat steps 22 - 24 behind and unfold to step 20. Turn the model over.

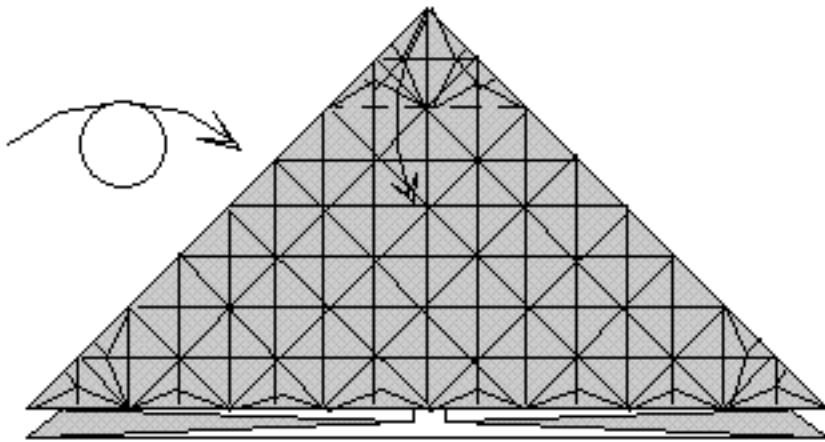

**26.** Repeat steps 20 - 25.

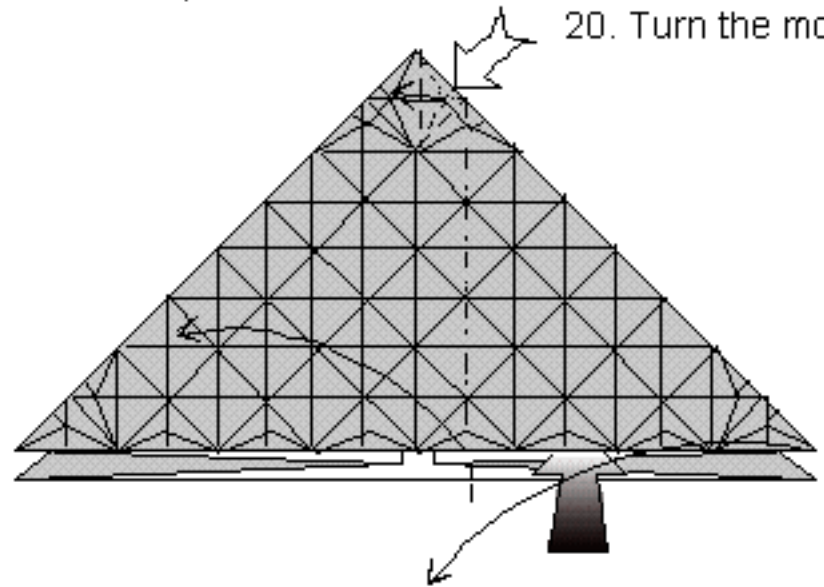

**27.** Lift one flap at the left side and collapse on existing creases. The paper will not lie flat.

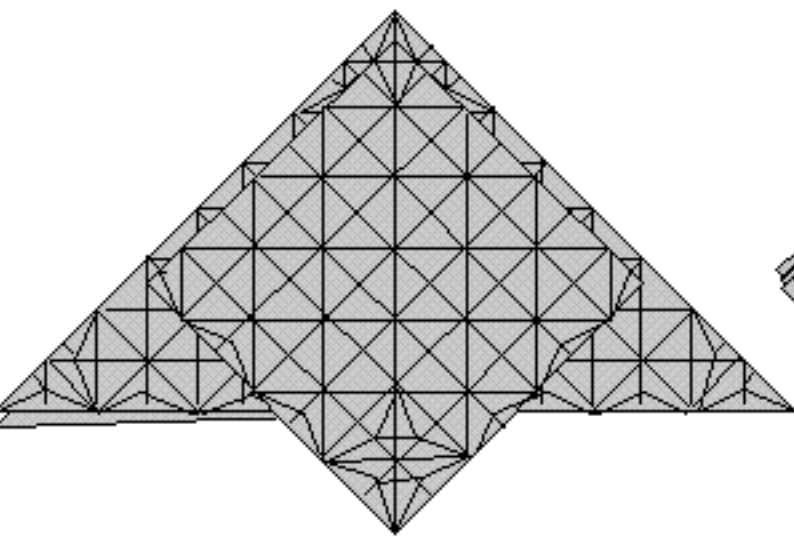

**28.** Repeat step 27 on the three other flaps.

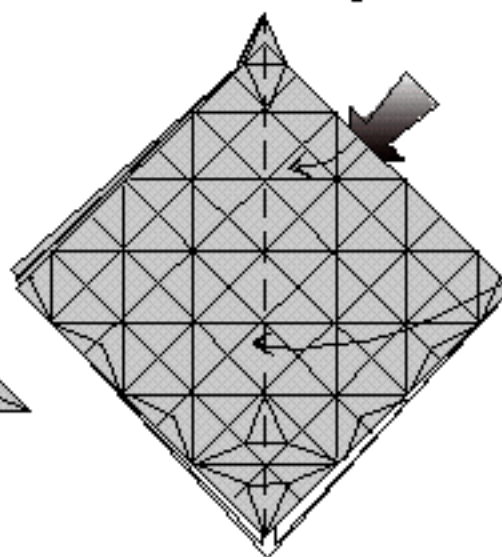

**29.** Swing one edge to the left. Inside, book-fold one of the small edges to the left.

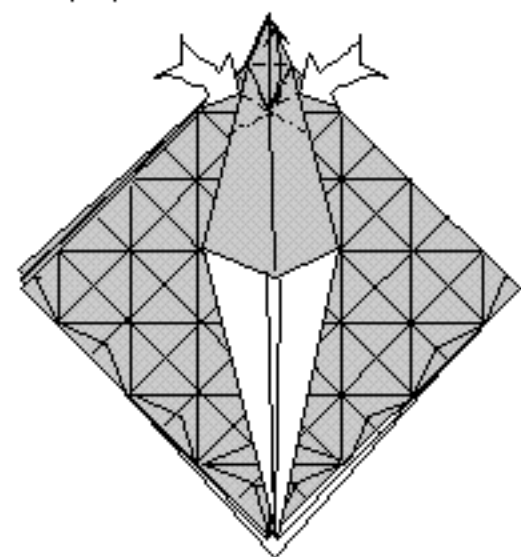

**30.** Closed-sink the corner to the top and collapse on existing creases. The model will not lie completely flat.

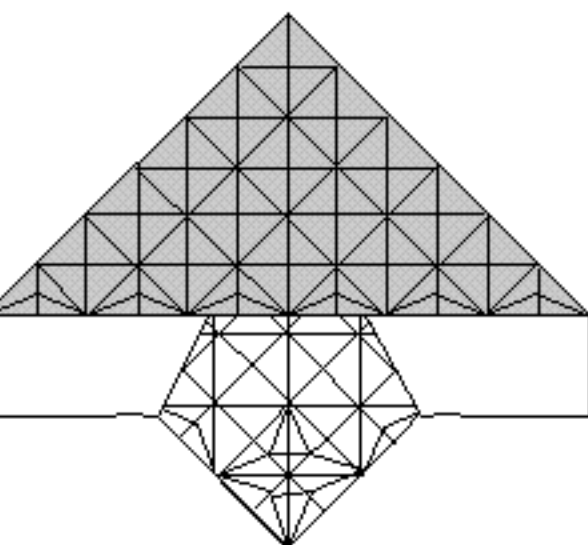

**31.** Repeat steps 29 - 30 on the three similar flaps.

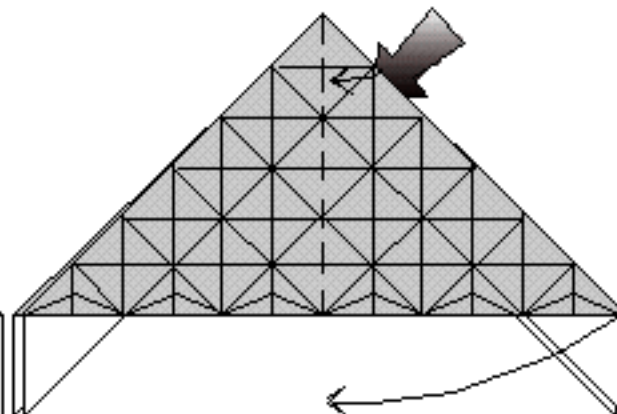

**32.** Repeat step 29.

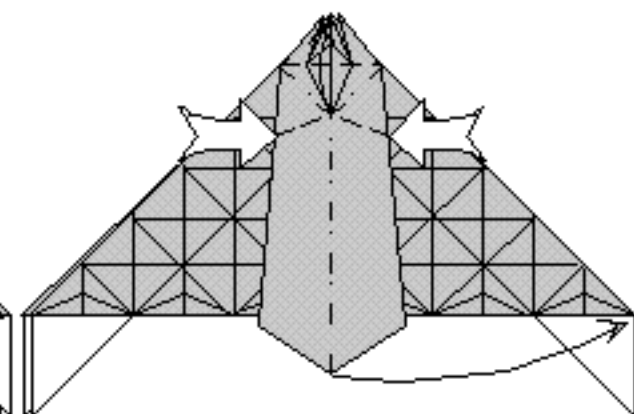

**33.** Closed-sink the corner up as in step 30, and collapse on existing creases.



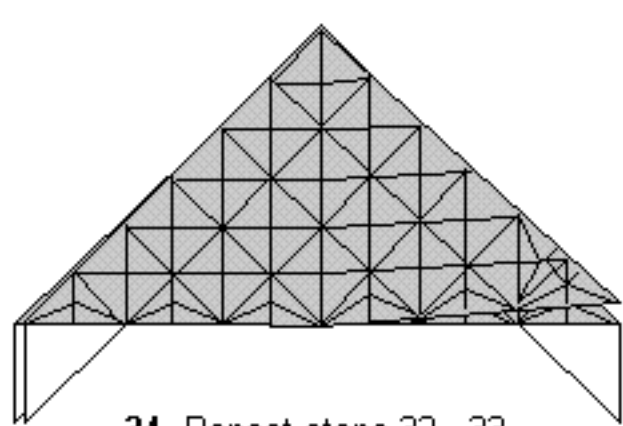

**34.** Repeat steps 32 - 33 on the three similar flaps.

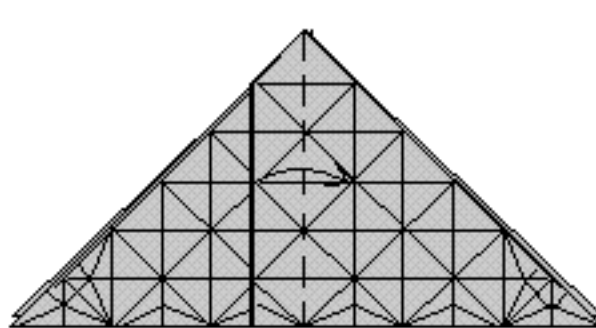

**35.** Book-fold one edge to the right.

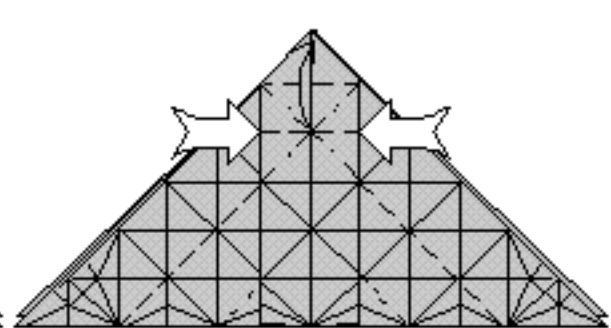

**36.** Push in the sides and collapse on existing creases.

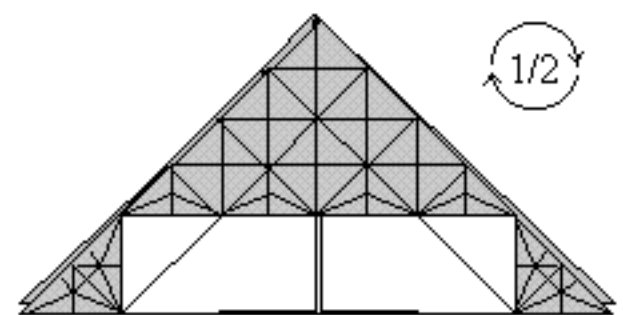

**37.** Repeat steps 35 - 36 on the three similar places. Then rotate the model 1/2 turn clock-wise.

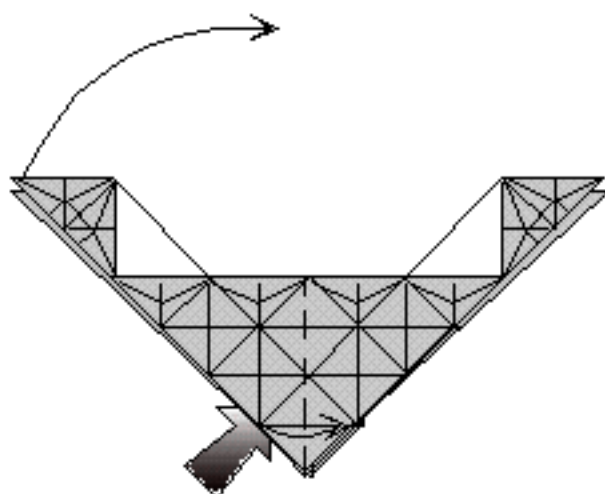

**38.** Lift one large flap and fold the bottom of the right edge to the right.

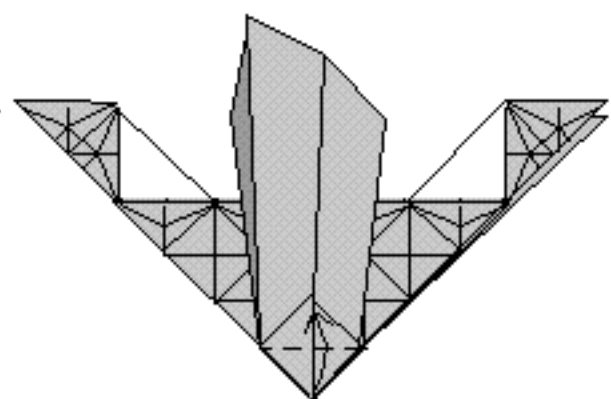

**39.** Valley-fold one triangular flap upward.

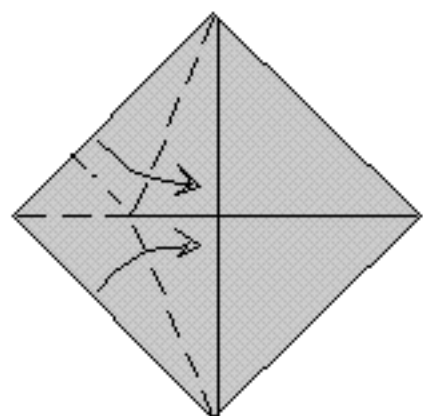

**40.** Enlarged view of the bottom corner. Fold a rabbit ear.

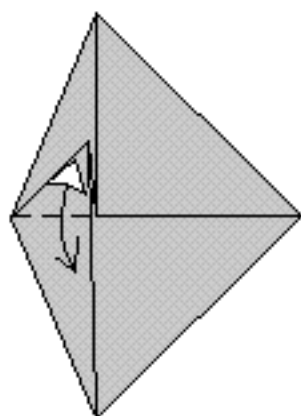

**41.** Fold and unfold several times.

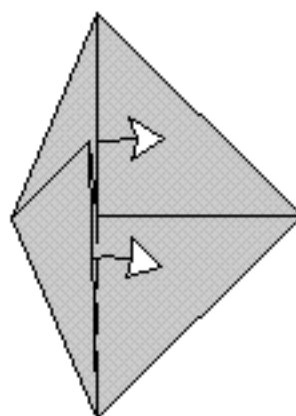

**42.** Pull a single layer of paper out from inside the rabbit ear.

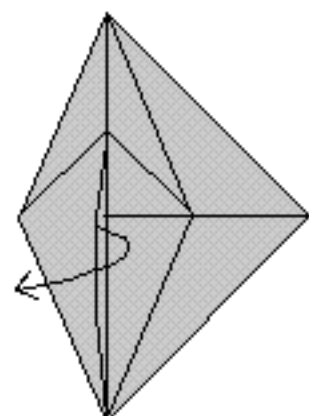

**43.** Open out the pocket slightly.

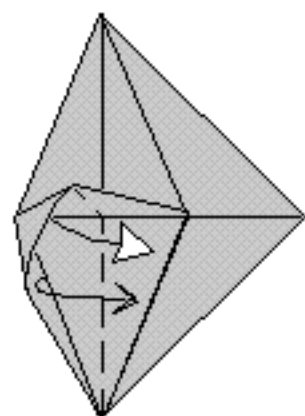

**44.** Pull all the edges out from inside the pocket, turning a layer inside-out as you go.

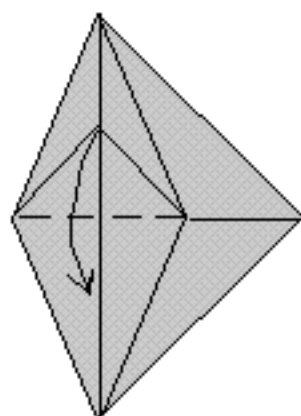

**45.** Fold the point down.

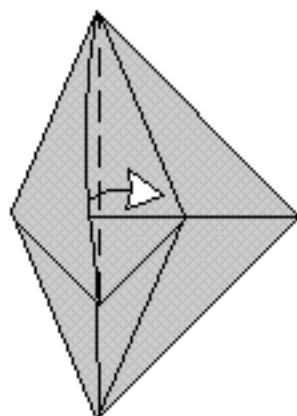

**46.** Repeat steps 43- 44 on the top.

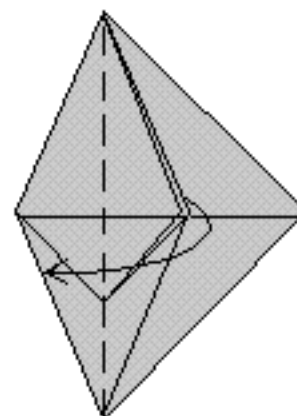

**47.** Fold all of the layers to the left.

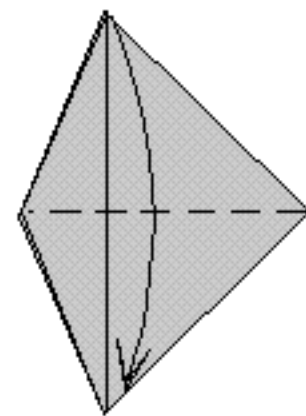

**48.** Fold the loose point down.

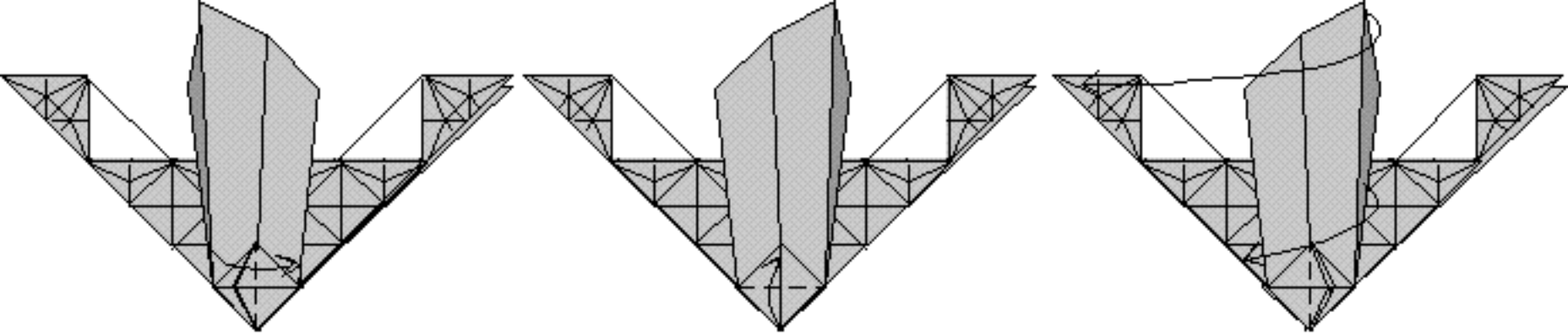

**49.** Fold one long edge and then one triangular flap to the right.

**50.** Repeat steps 39 - 48.

**51.** Swing the large flap back to the left and flatten.

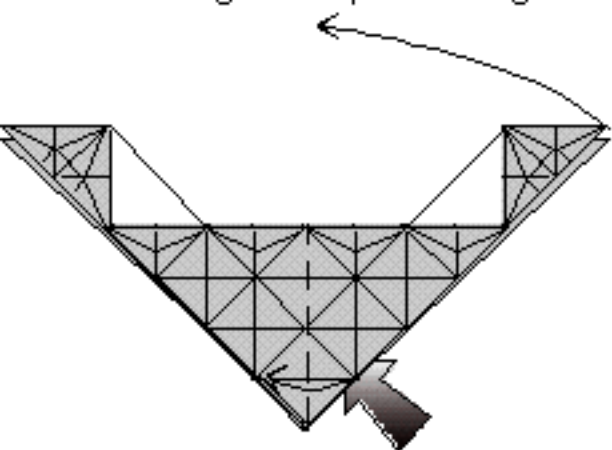

**52.** Repeat steps 38 - 51 on two large flaps and 38 - 50 on the third.

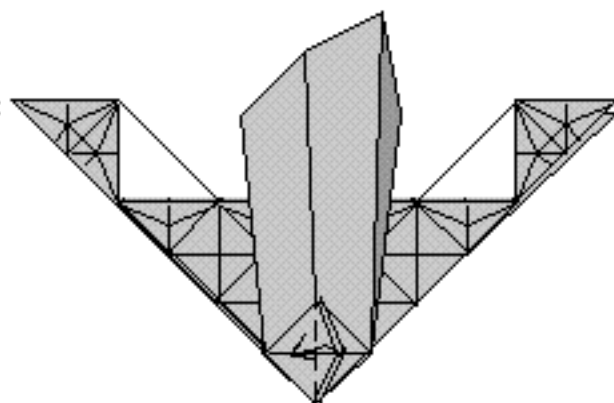

**53.** Fold one small flap to the left. Then rotate the model 1/2 turn.

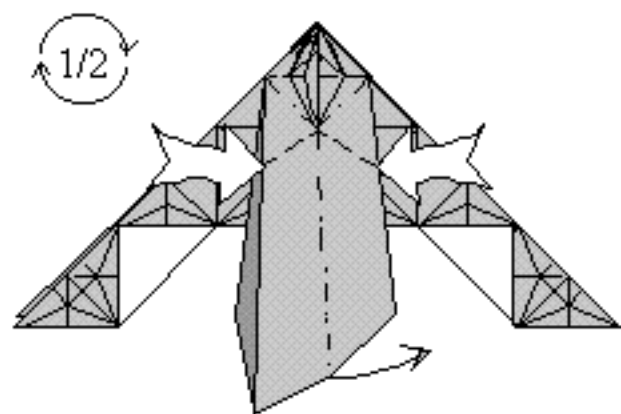

**54.** Closed-sink the corner to the top and collapse on existing creases. The model will not lie flat.

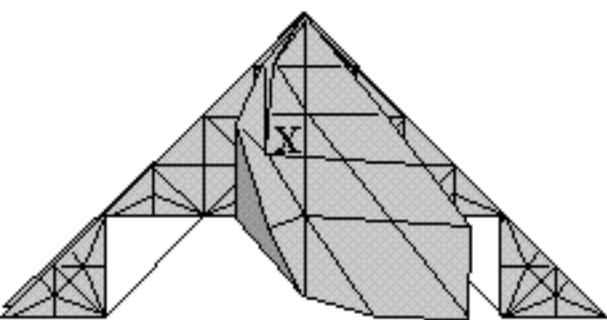

**55.** Open out from the inside the paper marked X. Simultaneously, closed-sink the corner underneath it upward, as in step 54. The two small flaps should be on each side of the sink, as in step 54. Collapse on existing creases.

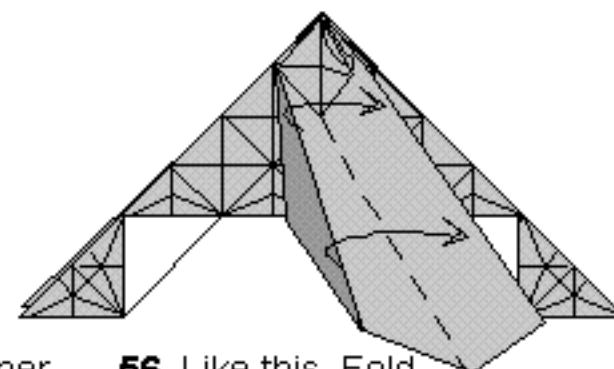

**56.** Like this. Fold the flap to the right.

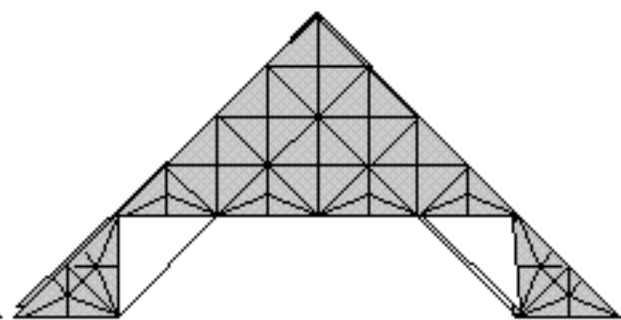

**57.** Repeat steps 53 - 56 on the three other flaps.

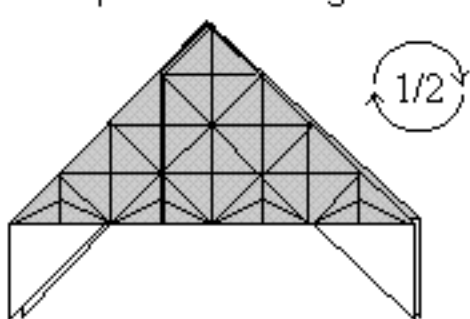

**58.** Rotate the model 1/2 turn.

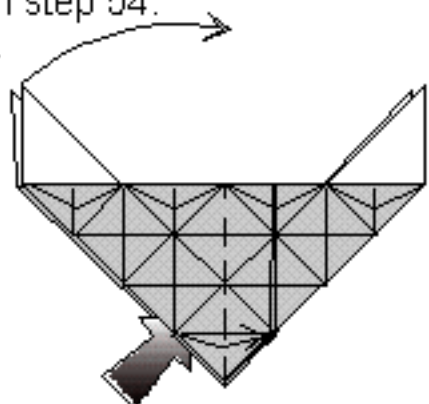

**59.** Repeat steps 38 - 48 + 51 on all four flaps.

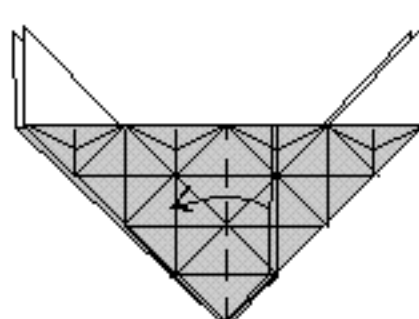

**60.** Book-fold one edge to the left. Then rotate the model 1/2 turn.

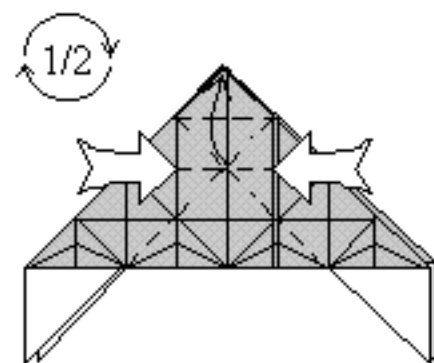

**61.** Push in the sides and collapse on existing creases.

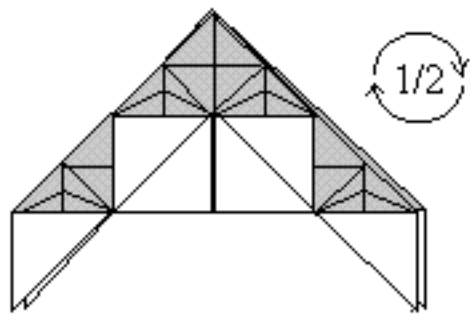

**62.** Rotate the model 1/2 turn.

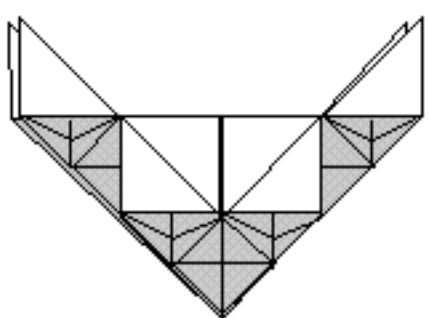

**63.** Repeat steps 60 - 62 on the three other sides.

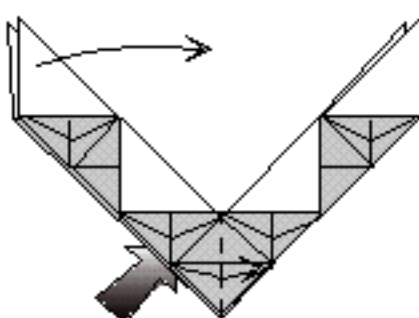

**64.** Repeat steps 38 - 51 on all four flaps.

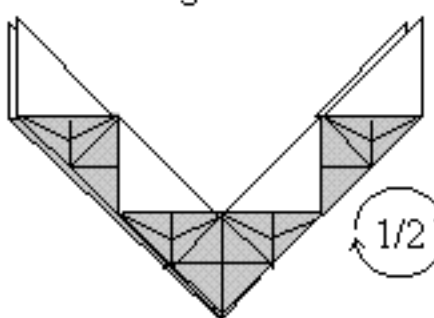

**65.** Rotate the model 1/2 turn.

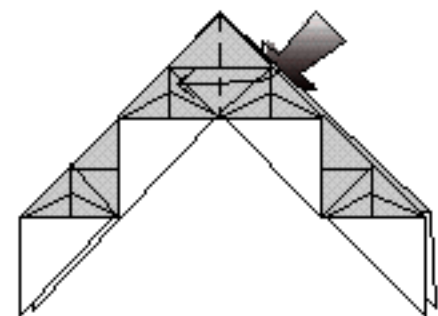

**66.** Valley-fold two 45° edges + one of the two small flaps inside to the left. Then repeat steps 54 - 56. Step 55 has to be done twice, one time on each side of the large flap.

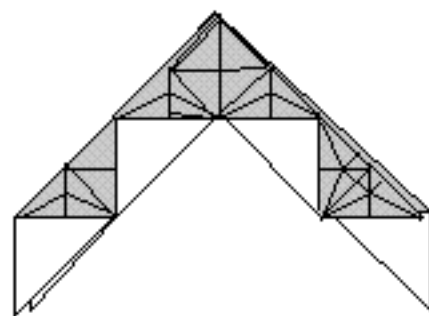

**67.** Repeat step 66 on the three other large flaps.

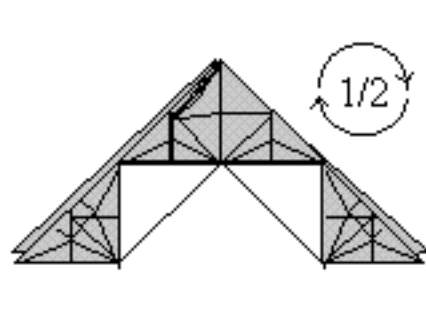

**68.** Rotate the model 1/2 turn.

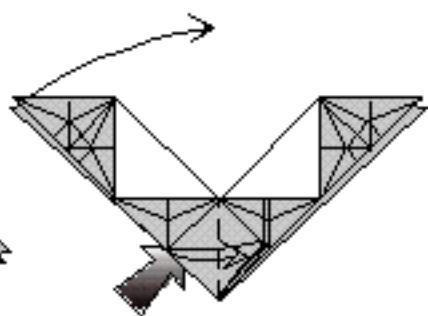

**69.** Repeat steps 38 - 57! The model is now getting very thick. Be careful!!

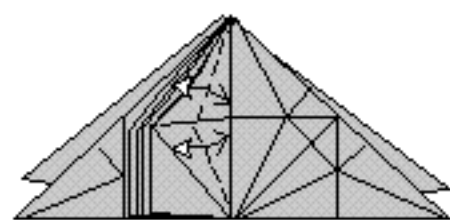

**70.** Crease the angle bisectors on the first of the four edges.

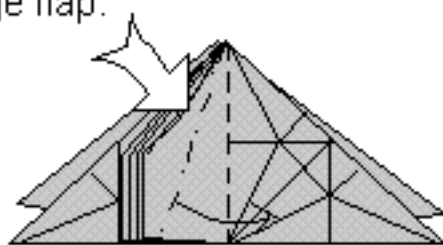

**71.** Squash-fold the edge, but flatten only its upper half.



**72.** Pinch the sides of the lower part of the squash and swing the resulting flap to the left.

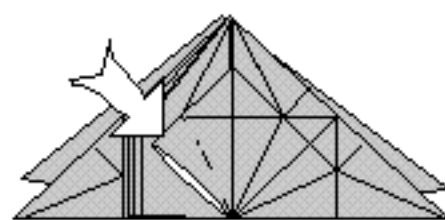

**73.** Reverse-fold the edge on existing creases.

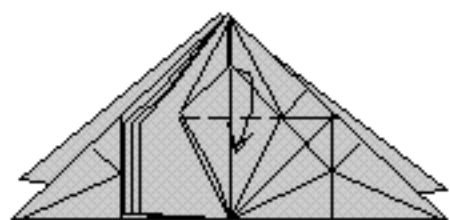

**74.** Fold the point down.



**75.** Pull all the folded edges out of the pocket as in step 46.

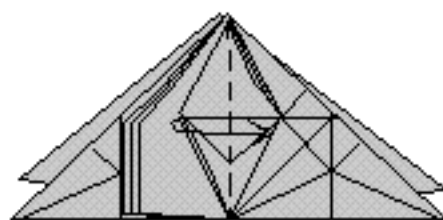

**76.** Fold all layers to the right.

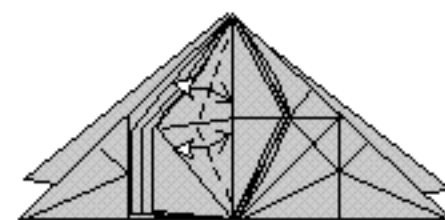

**77.** Repeat steps 70 - 76 on the 15 similar edges.

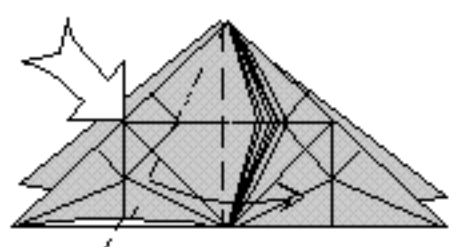

**78.** Squash-fold on existing creases, but flatten only the upper half.

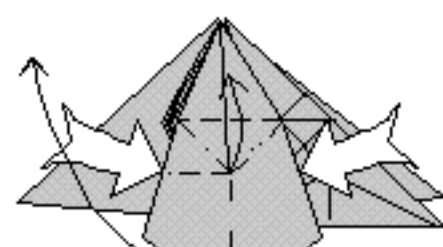

**79.** Pinch the lower edges of the squash-fold together and collapse on existing creases.

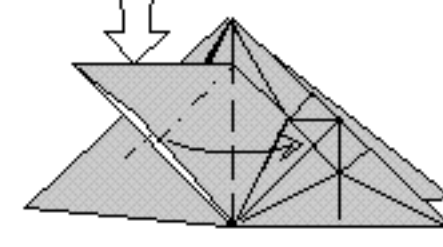

**80.** Squash-fold.

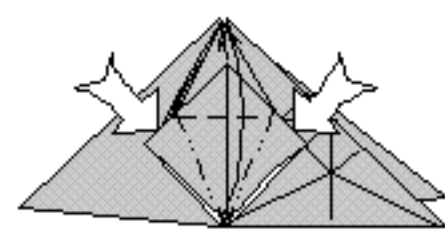

**81.** Petal-fold.

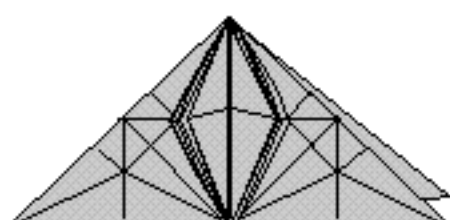

**82.** Repeat steps 78 - 81 on the three other flaps.

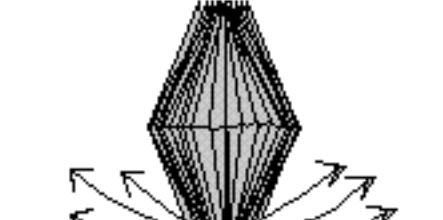

**83.** Reverse-fold the 28 points at the bottom outward and rabbit-ear each of them.

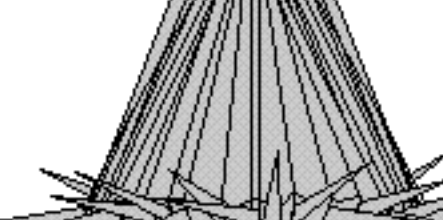

**84.** Rabbit-ear each of the 53 points at the top outward and adjust all 81 points to point in all directions. Then pinch all points to make them thinner.



**85.** Detail of a single point. Fold a rabbit ear.

**86.** Like this.



**87.** Pacific Giant Red Sea Urchin

# \$ Valentine

Designed & diagrammed by Sy Chen on 2/97

©1997 Sy Chen

(1) Start from 3x7 paper or \$; Fold & unfold

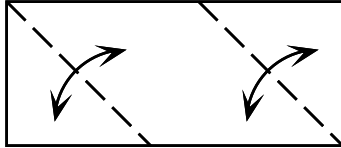

(2)

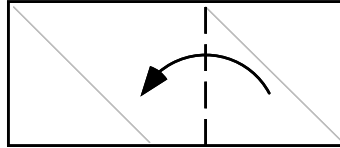

(3) Inside reverse corner into center of the square

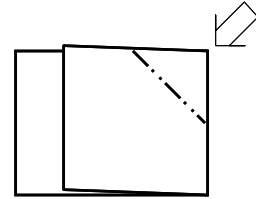

(6) Judgement valley fold

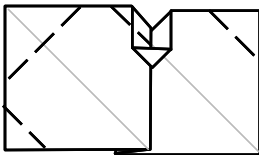

(5) In-Progress: squash

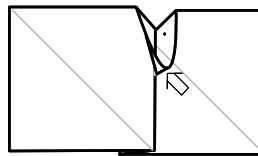

(4) Use the left end of the crease as the guide

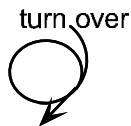
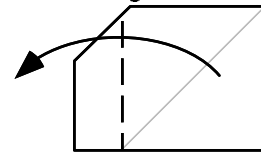

(7) Enlarged view; Mountain fold lower right corner of the 1st heart; Push heart top & pinch heart center to form 3D

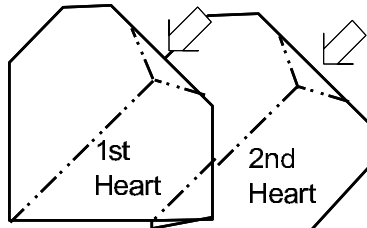

(8) Finished

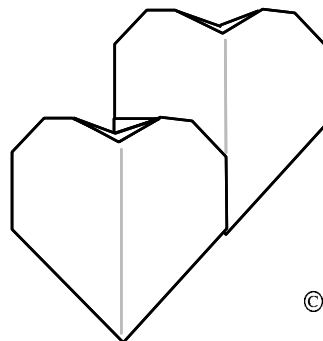
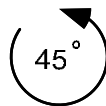

©1997 Sy Chen

# Vampire

model Matt Slayton  
diagrams Alex Barber  
copyright nineteen ninety four

1

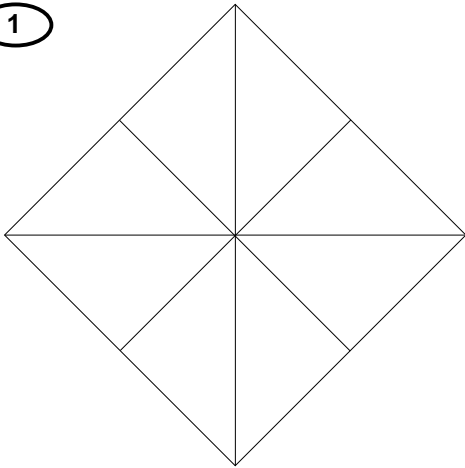

start with white side up

2

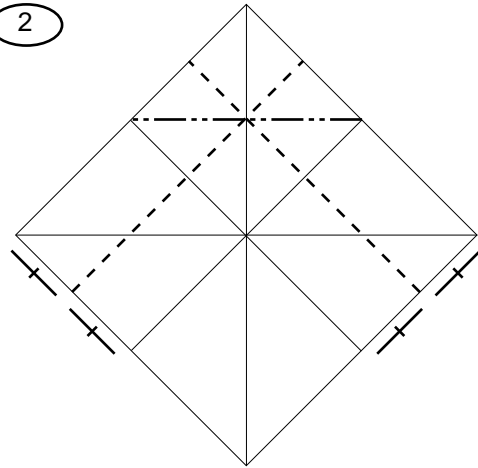

make a preliminary base...

3

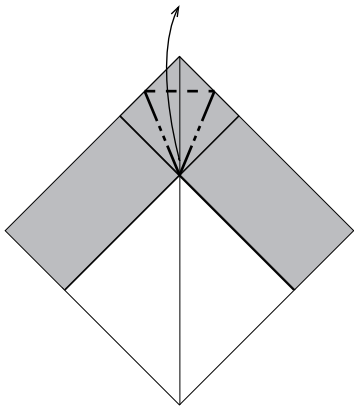

...then a bird base

4

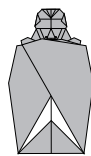
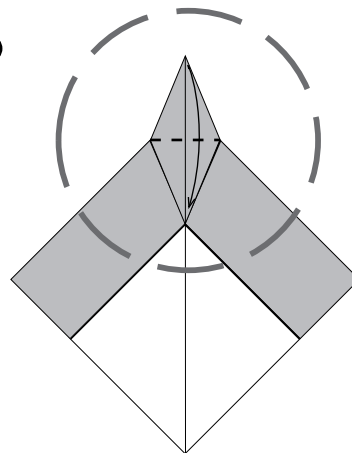

ONE

5

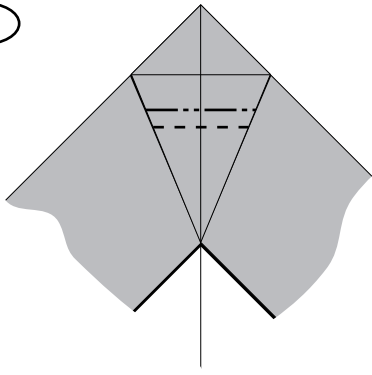

6

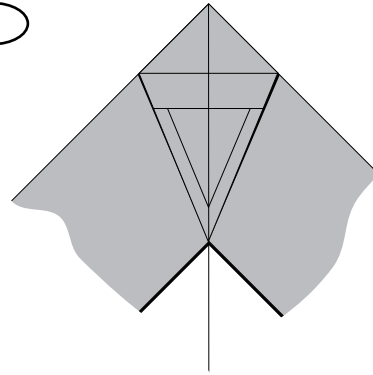

pleat the brow...

7

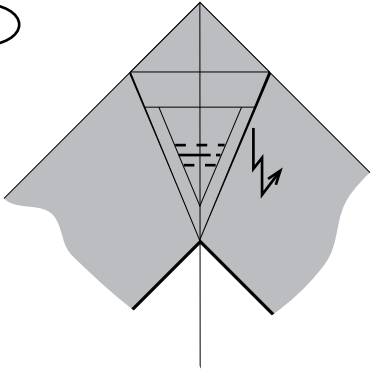

8

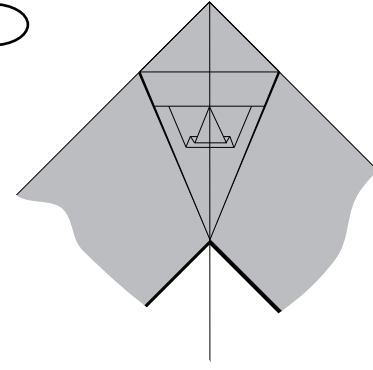

...and the nose

9

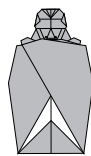
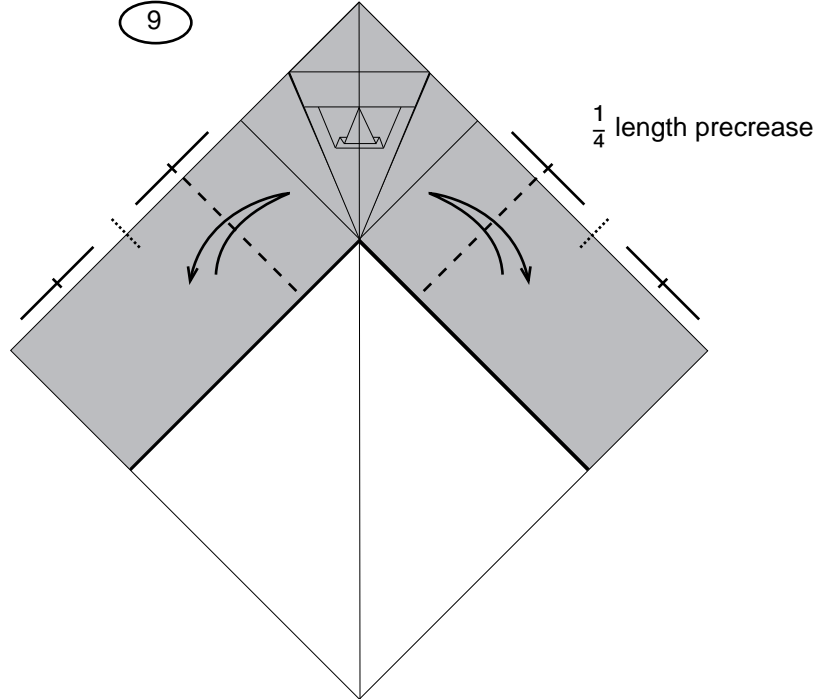

two

10

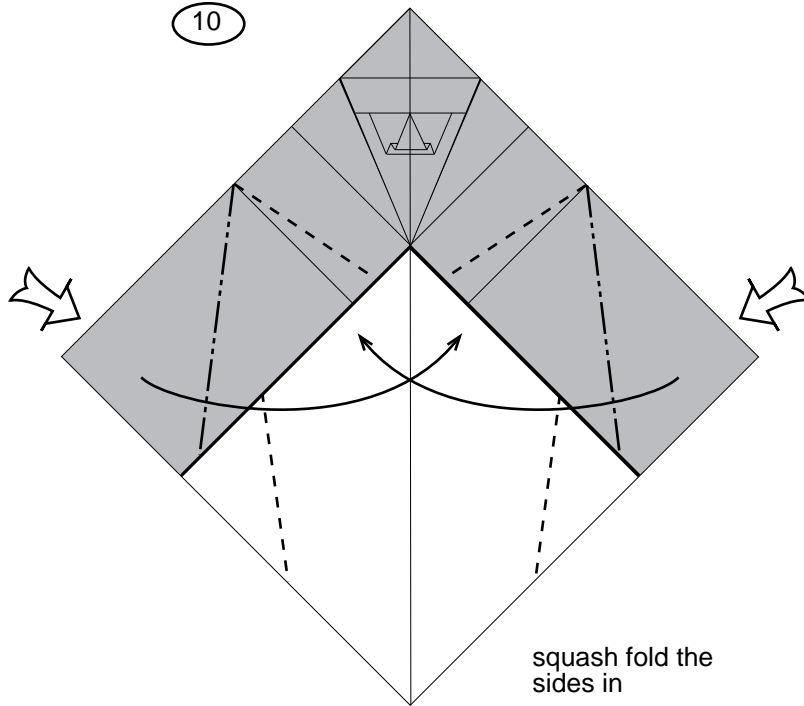

squash fold the sides in

11

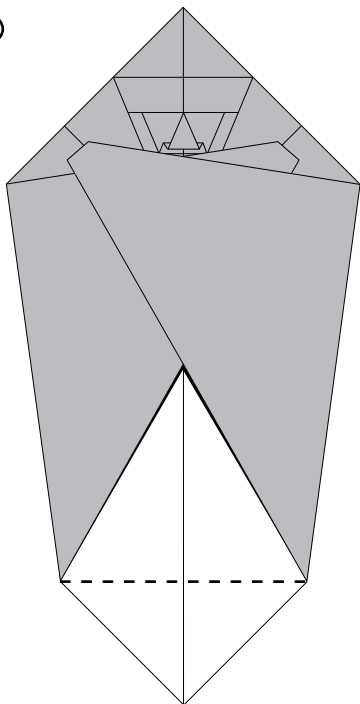

12

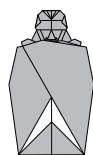
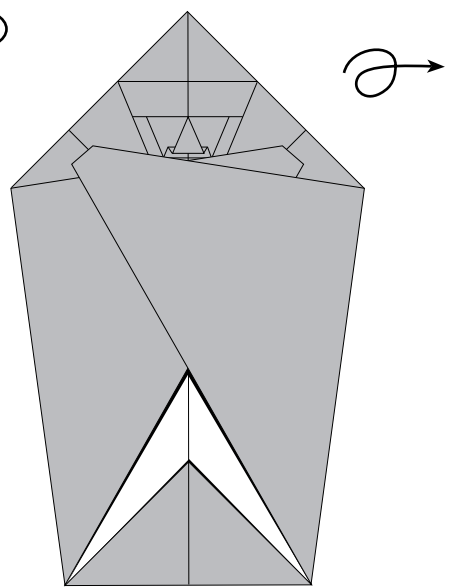

three

13

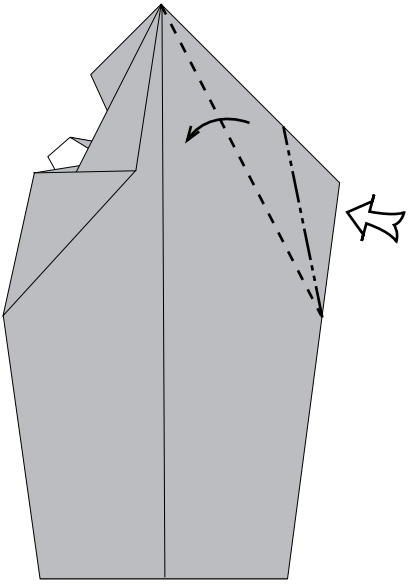

squash fold the sides,  
but not to the center

14

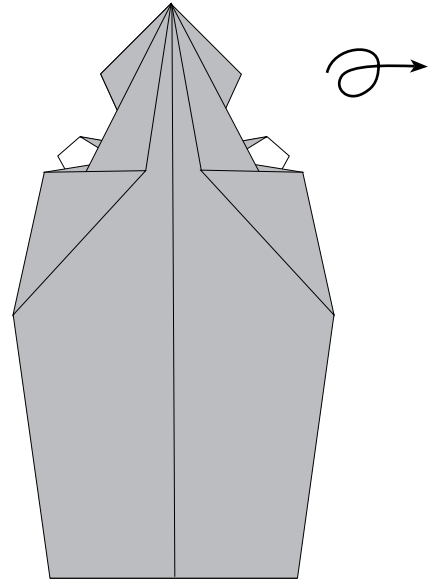

15

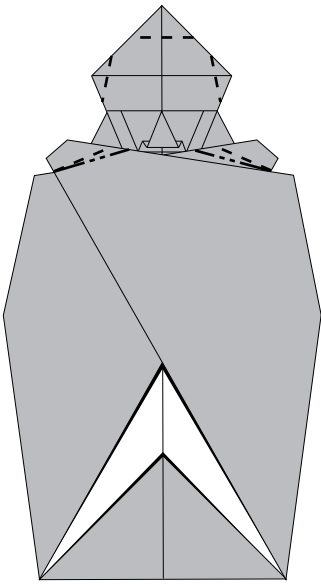

crimp the hands and  
finish shaping the head

16

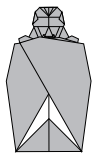
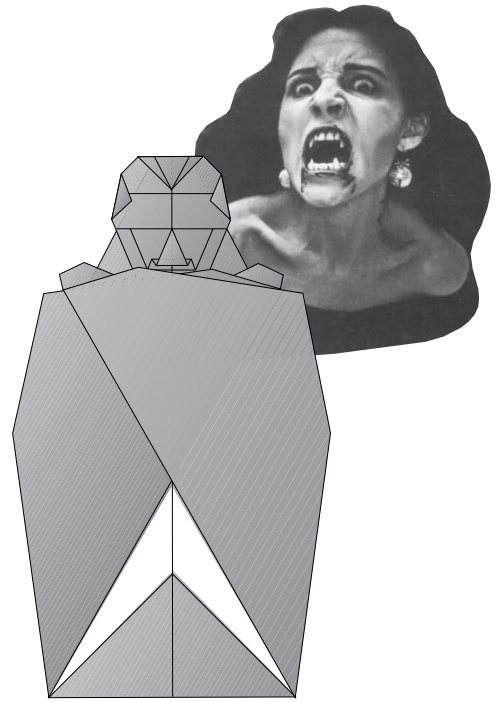

FOUR



# 3 design-vase 3

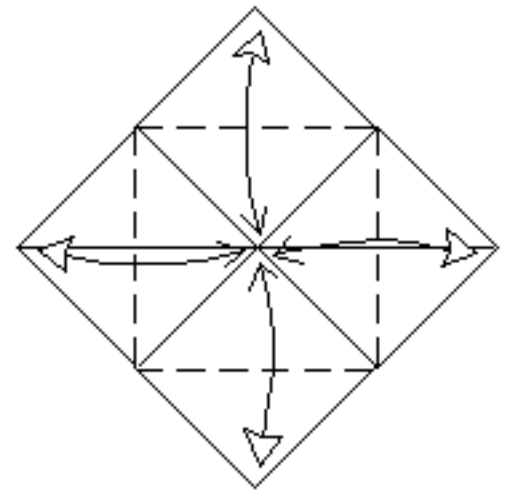
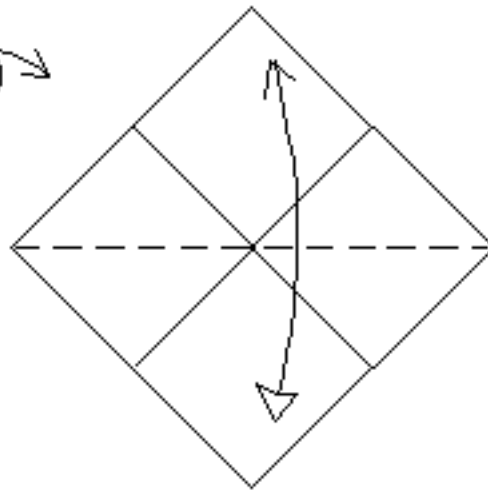
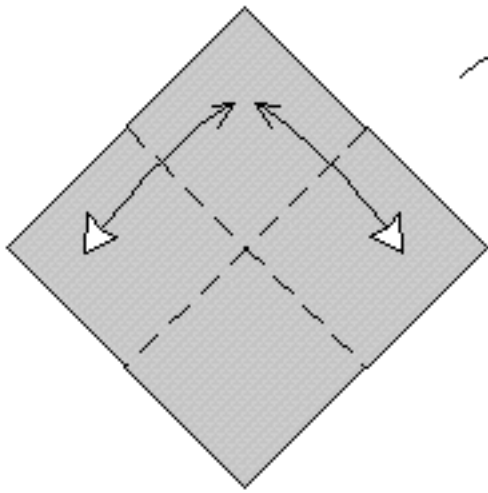

**1** Start with the (silver) colored side up. Fold and unfold. Turn the paper over.

**2** Fold and unfold.

**3** Fold and unfold.

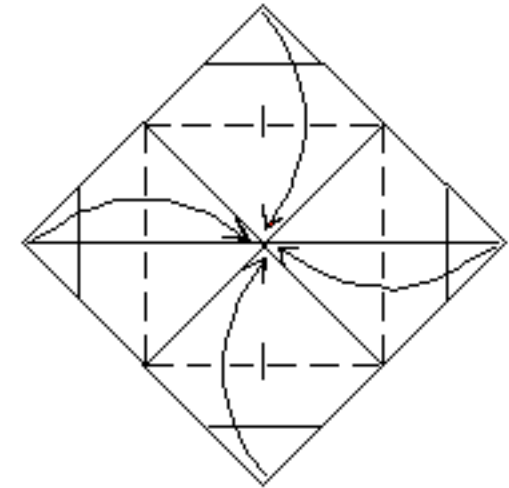
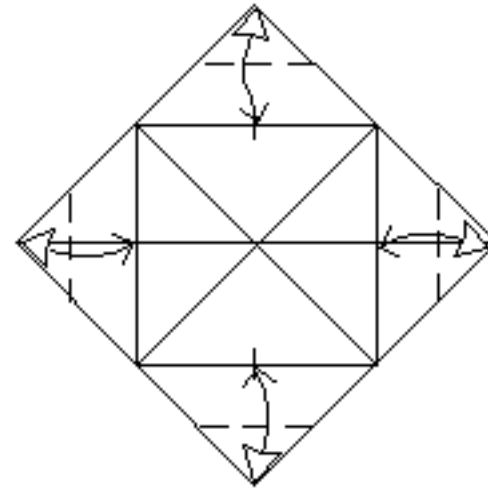
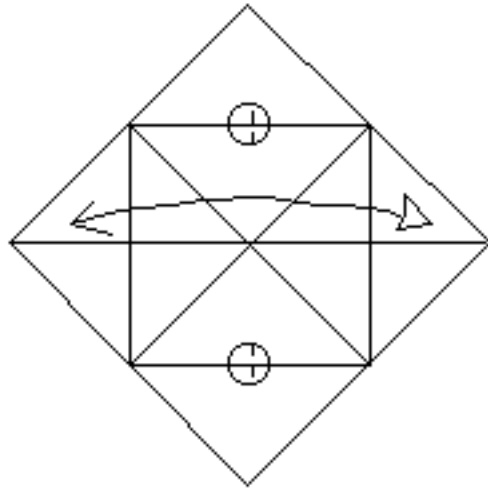

**4** Make small marks where indicated.

**5** Fold and unfold.

**6** Valley-fold on existing creases.

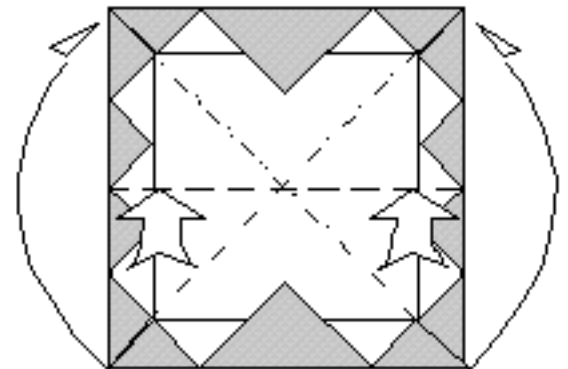
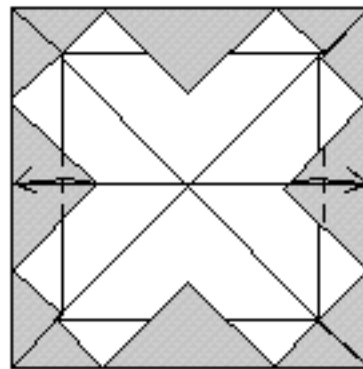
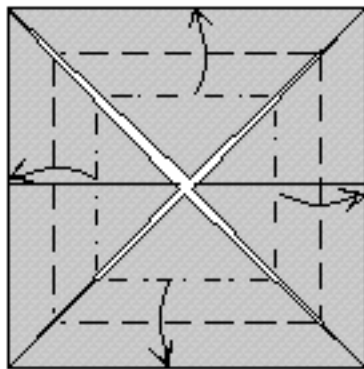

**7** Fold the existing mountain edges so that they align with the outer edges.

**8** Valley-fold.

**9** Make a waterbomb-like collapse.

# <sup>3</sup> design-vase <sup>3</sup>

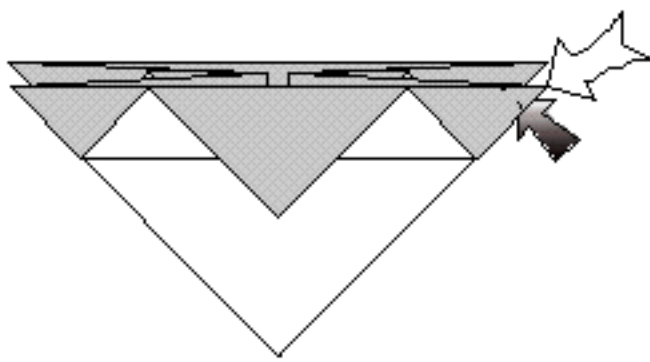

**10** Reverse-fold the corner.  
Repeat 3 times.

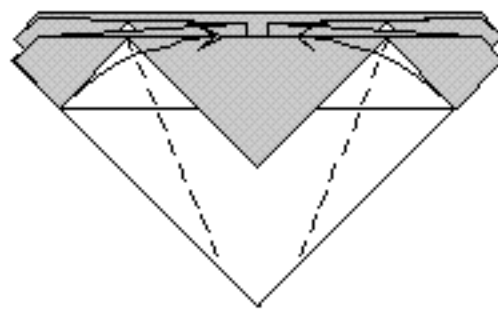

**11** Valley-fold so that the inner  
edges are parallel.  
Repeat behind.

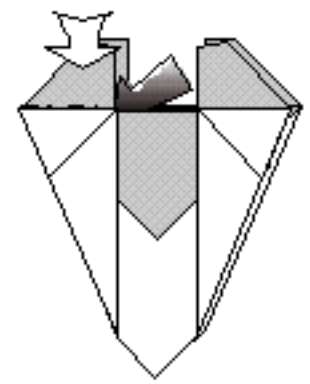

**12** Open the pocket and  
mountain-fold the flap  
inside down into it.  
Repeat 3 times.

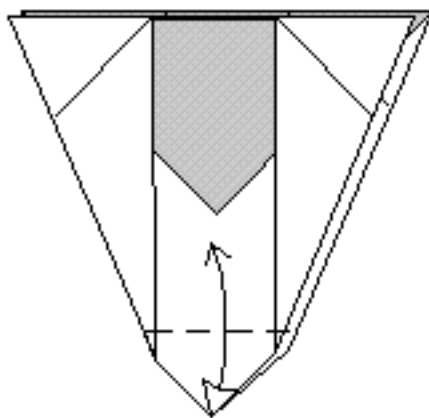

**13** Fold and unfold.

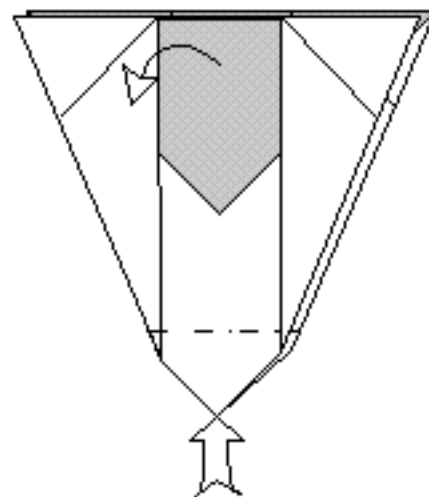

**14** Open up the vase and sink  
the bottom corner on existing  
creases.

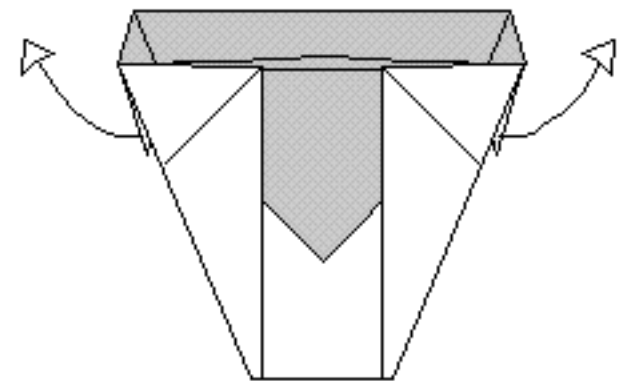

**15** Open out the side flaps..

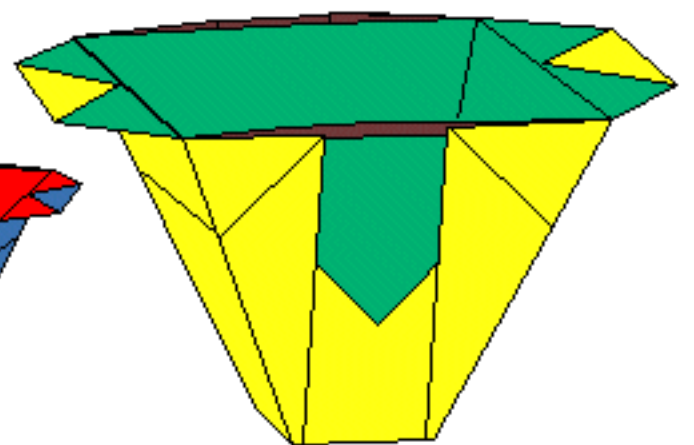
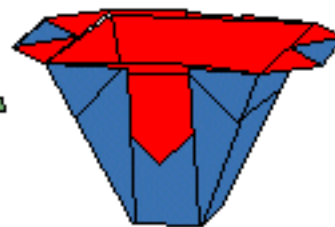
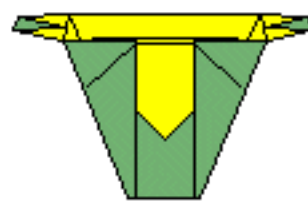
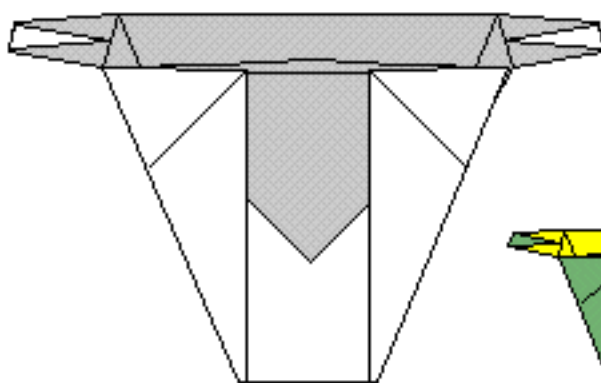

**16** Finished vase.

# BOCA (a.k.a ELDERLY VENUS FLYTRAP)

José Tomas Buitrago Molina  
Colombia (c) 1997  
Color arriba

1

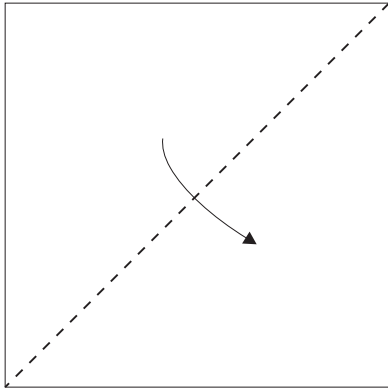

2

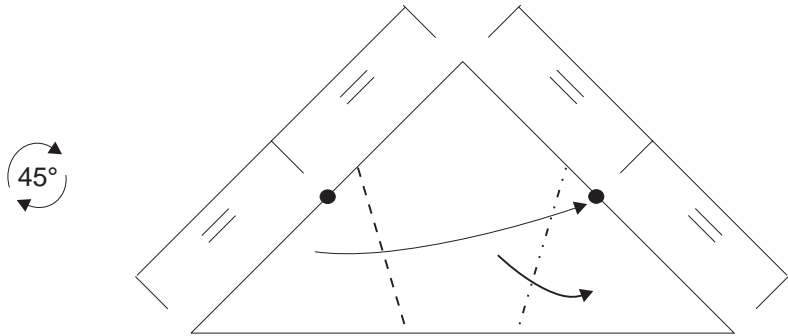

3

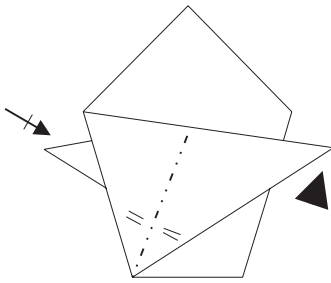

4

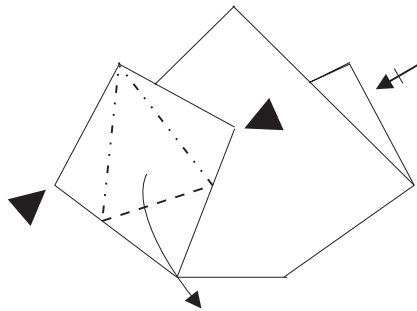

5

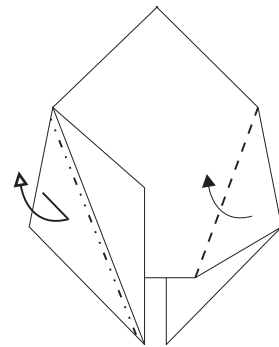

6

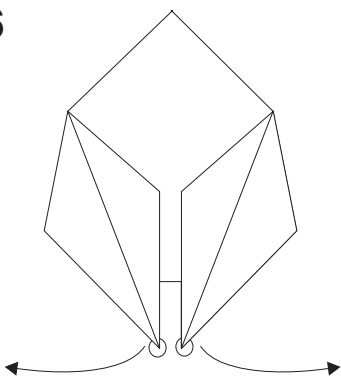

7

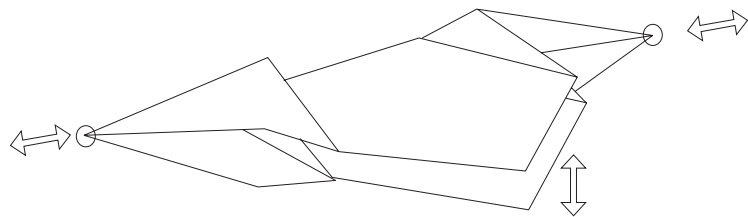

Cuadrado de 8 cm  
Tamaño final 5.5 cm.

Diagramas: José Tomas Buitrago

# Verdi's Vase

Traditional

Collected by Philip Shen, diagrammed by Mark Kennedy  
This traditional Chinese Vase was popularized in the United States  
by Verdi Adams, who taught it to a generation of paperfolders at  
The Origami Center of America.

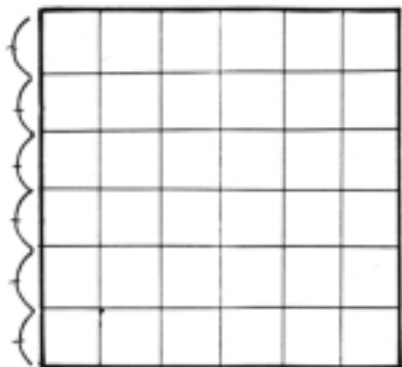

1. White side up. Crease into sixths in both directions.

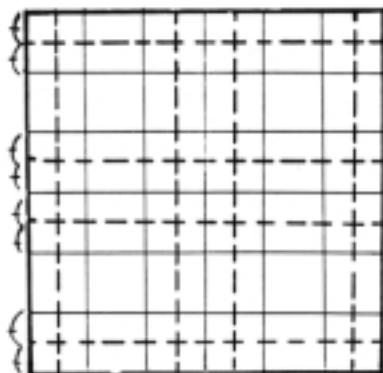

2. Crease in half the first, third, fourth and sixth 6ths in both directions.

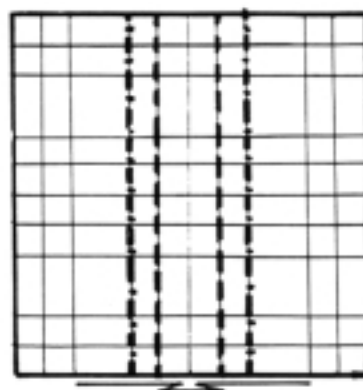

3. On existing creases, pleat to the center line.

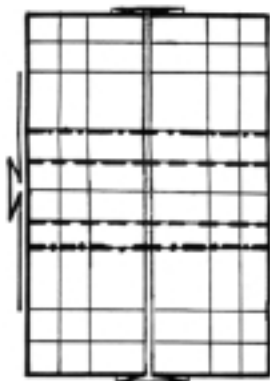

4. On existing creases, pleat to the center line.

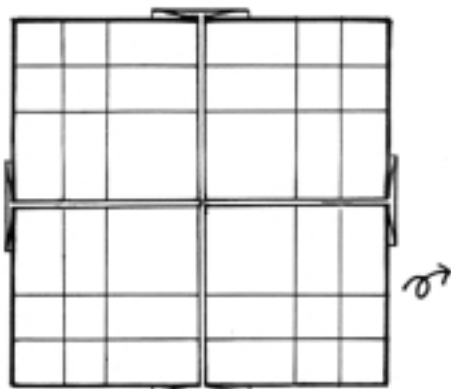

5. Pleats on both directions complete. Turn over.

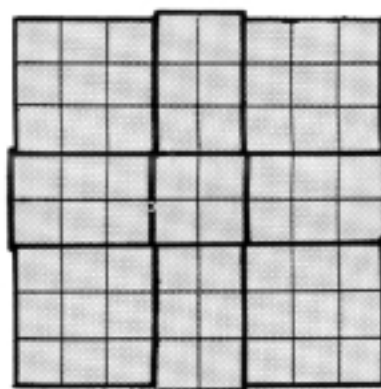

6. Perform the moves detailed in 6a and 6b on all four center pleats.

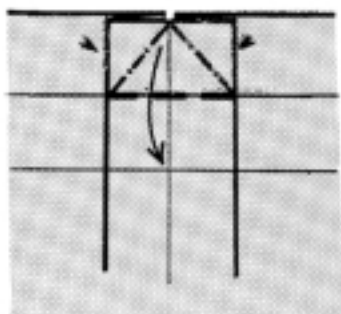

6a. Pull down top layer while squashing in the sides.

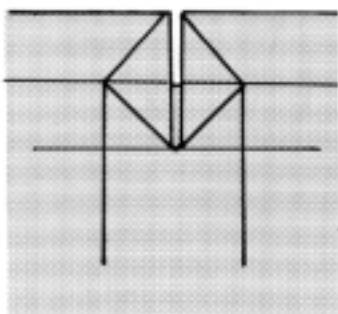

6b. Squashes complete.

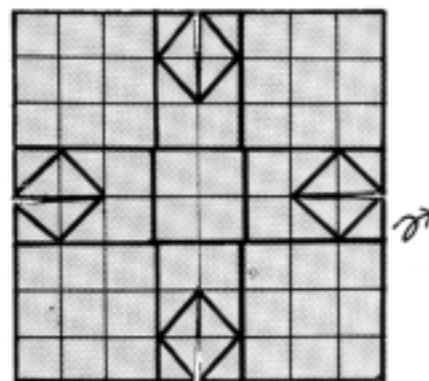

7. Moves completed on all four sides. Turn over.

# Verdi's Vase

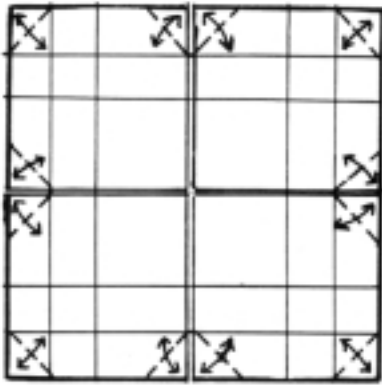

8. Precrease corners as shown to make step 11 easier.

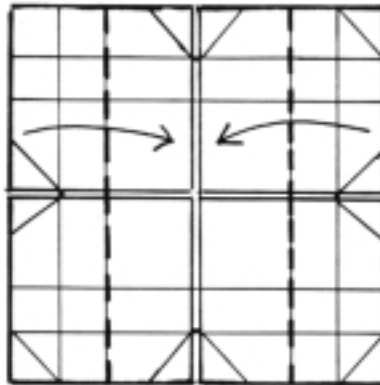

9. Cupboard door fold sides to the center.

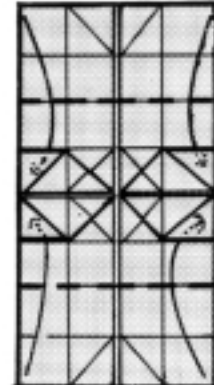

10. Cupboard door fold top and bottom to center and tuck the corners into the pockets.

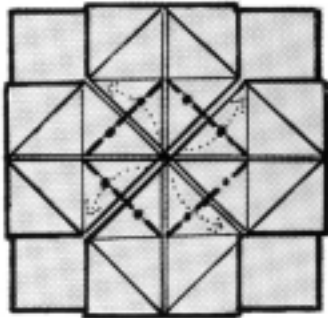

11. Along the precreases done in step 8, mountain fold the triangles inside the model.

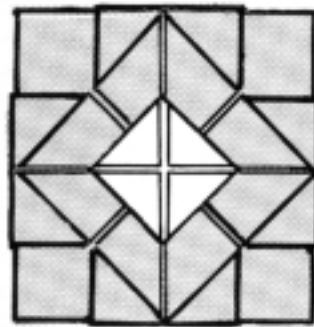

12. All folding is done. Turn over.

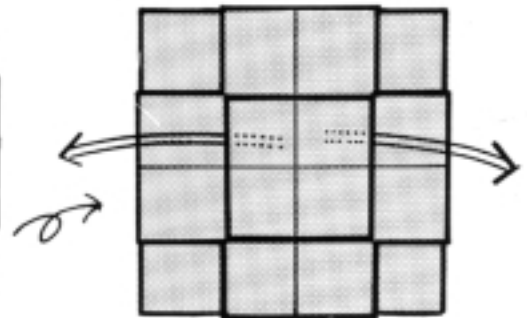

13. Start to open out vase by pulling out the extra layers along the sides. Be careful and work slowly.

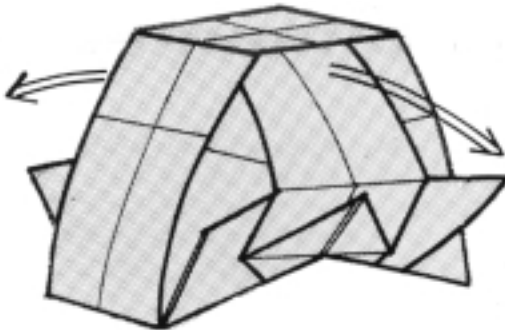

13b. One pair of sides already pulled out. Pull out the other side.

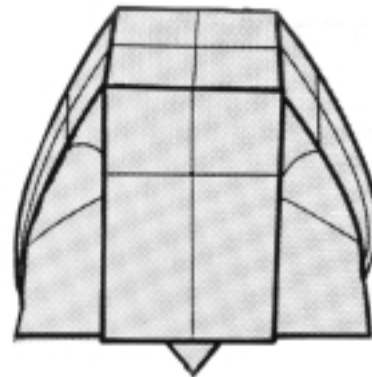

14. All sides are pulled out. Turn over.

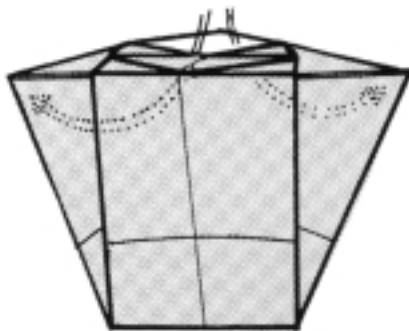

15. Reach inside the top of the vase, poke out and round the corners.

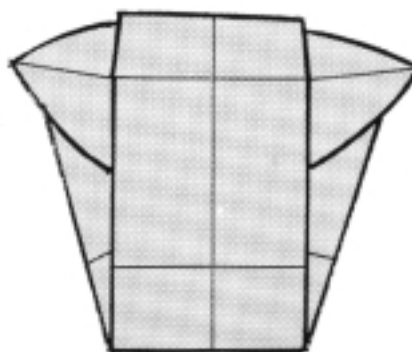

16. Vase complete – side view.

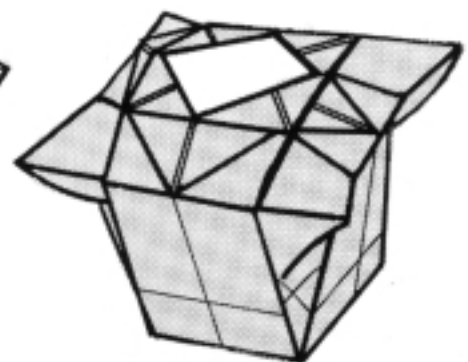

17. Vase complete – top view.

Diagrams by Mark Kennedy © 1989

# Vest

Maarten van Gelder

© 1994 Apr

Assembly of Plane units. The triangles of the locking edge units are not shown. The eight 'inside' corners (marked with a dot) should be glued to prevent them from ripping. The bold printed edge could be glued too for security.

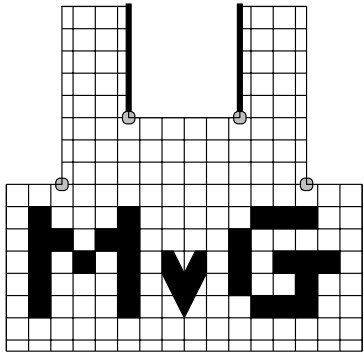

1 Outside back  
MvG: Maarten van Gelder  
The 'v' is put on from extra paper

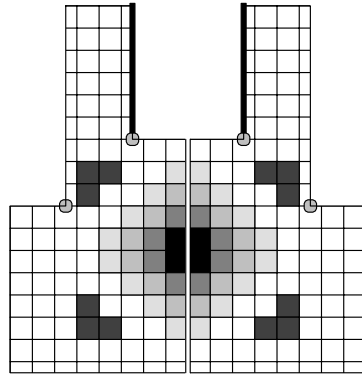

2 Outside front

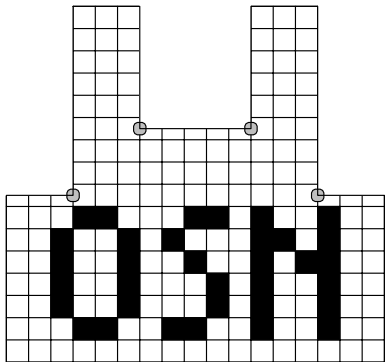

3 Inside back  
OSN: Origami Societeit Nederland

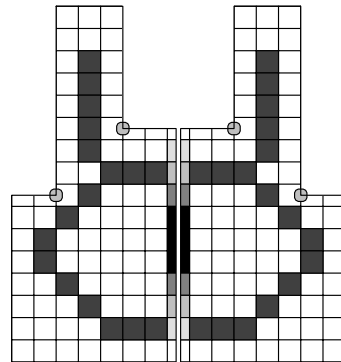

4 Inside front

65 ■ blue  
46 ■ lightgreen  
16 ■ orange  
12 ■ red  
10 ■ violet  
645 □ white  
20 □ yellow

+  
814 sheets total needed for this vest (use 7.5x7.5 cm squares)

start white side up, precrease in all four directions

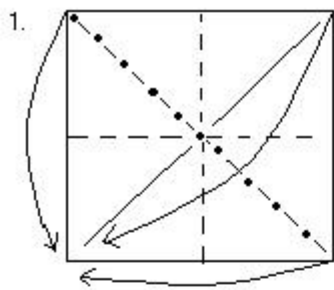

1. Collapse into preliminary base  
Rotate

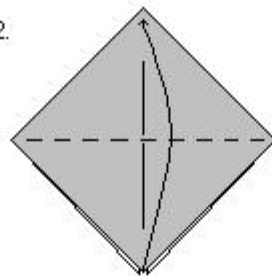

2. Valley fold the corner up  
Repeat behind

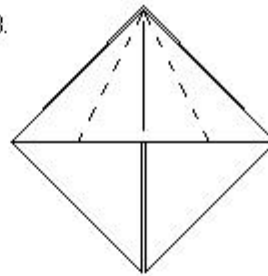

3. Precrease  
Repeat behind

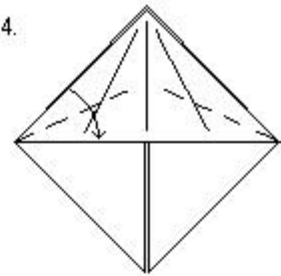

4. Precrease  
Repeat behind

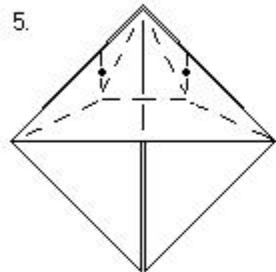

5. Thin the point  
and bring it down  
Repeat behind

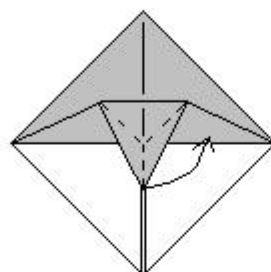

6. Rabbit ear  
Repeat behind

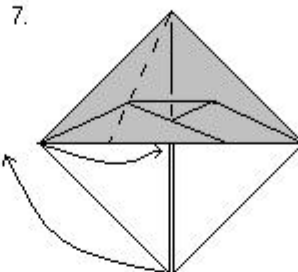

7. Pull the triangular flap up and  
to the left while folding the  
corner to the center line

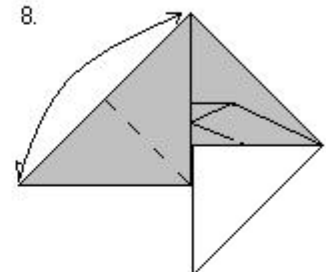

8. Fold and unfold

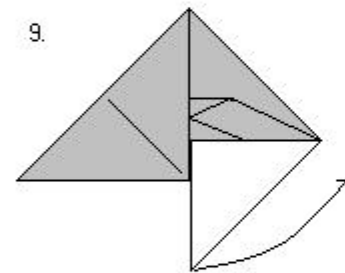

9. Unfold this reverse fold

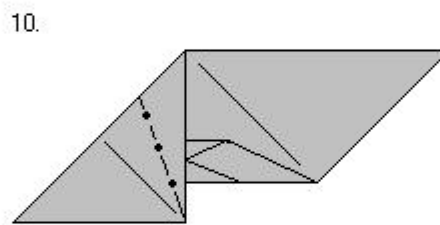

10. Reverse fold

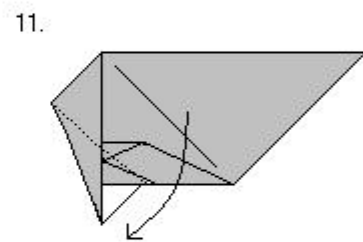

11. Reverse fold the point  
inside the model

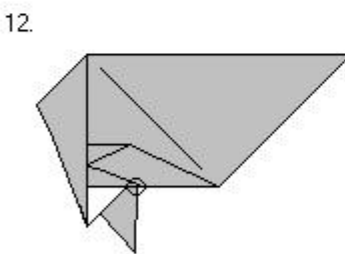

12. Circle shows landmark  
for step 11

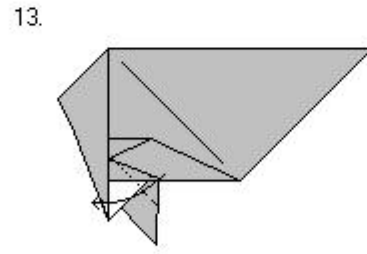

13. Reverse fold  
Repeat behind

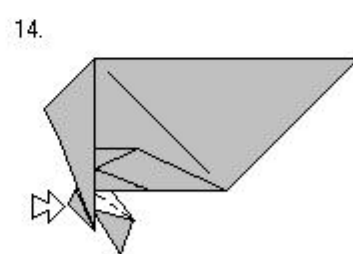

14. Reverse fold  
Repeat behind

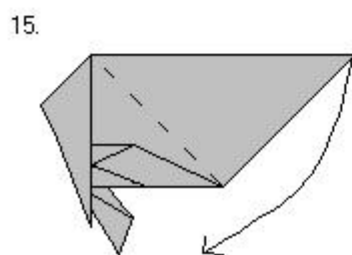

15. Reverse fold

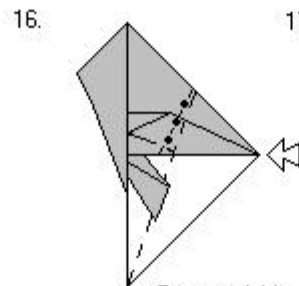

16. Reverse fold  
Repeat Behind

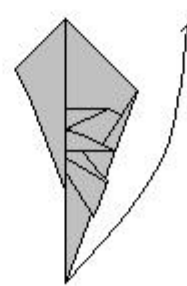

17. Reverse fold up

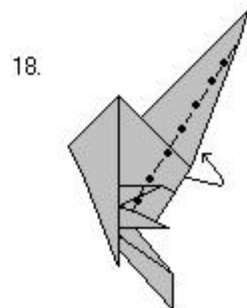

18. Mountain fold  
Repeat behind

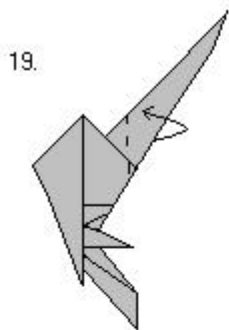

Outside Reverse fold

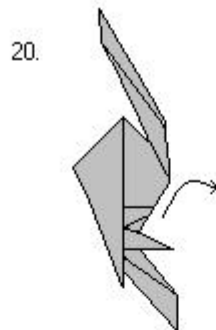

Rotate 45 degrees

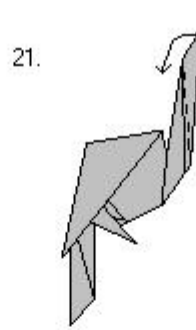

Reverse fold

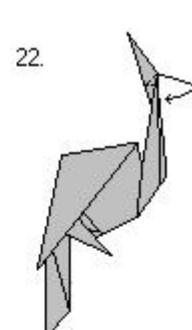

Crimp the head down

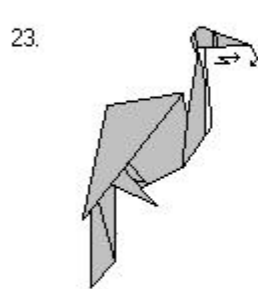

Crimp the bill down slightly

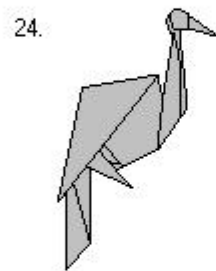

Fold the tip of the bill down a tiny bit

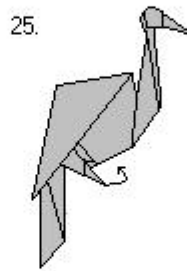

Crimp the leg up  
Repeat behind

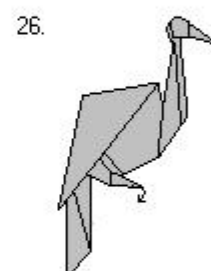

Reverse fold to form a foot  
Repeat behind

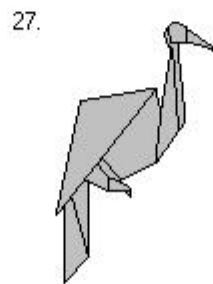



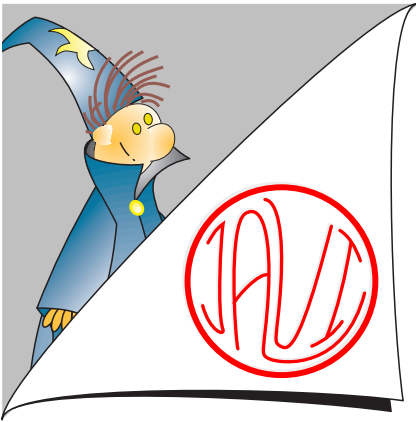

Autor: J. Aníbal Voyer

# Avispa

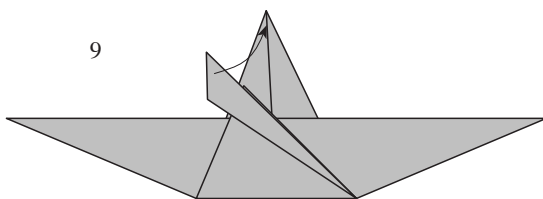
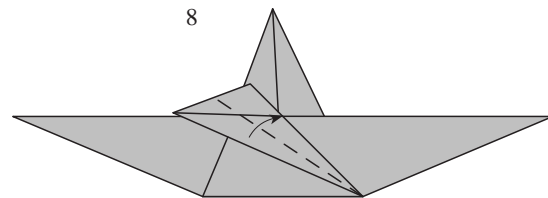
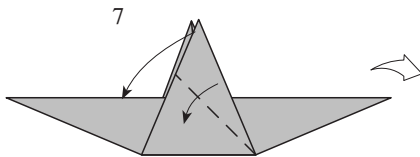
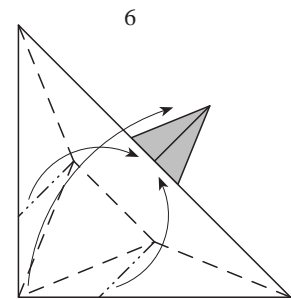
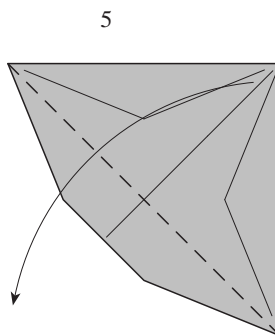
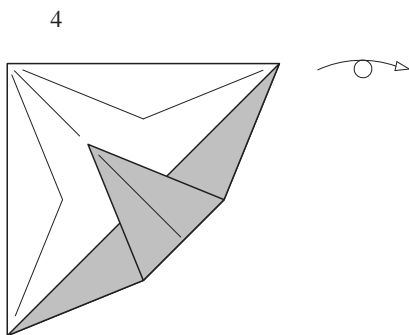
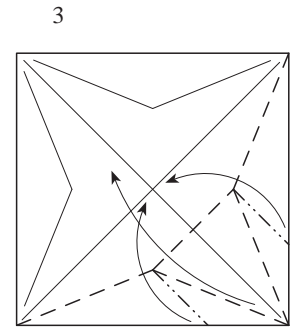
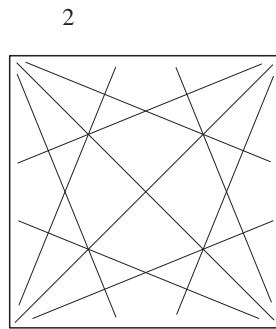
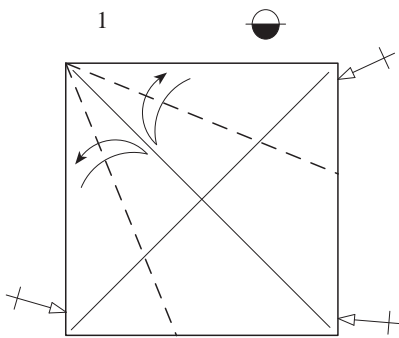
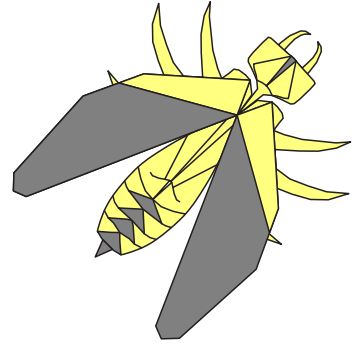

10 Repetir 7-9 a la izquierda

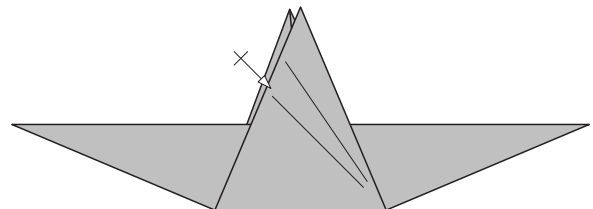

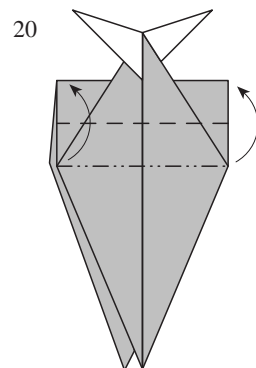
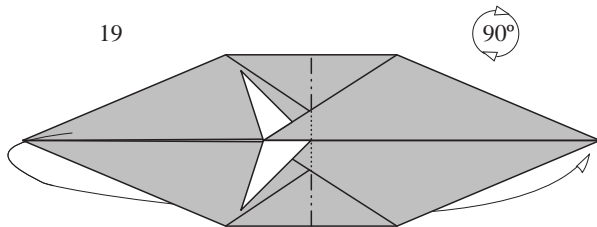
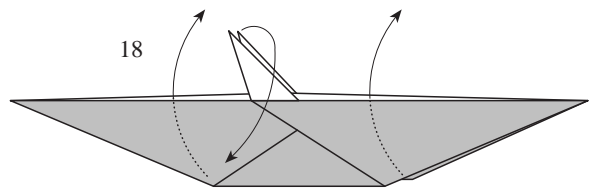
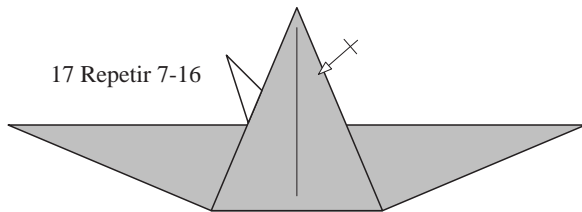
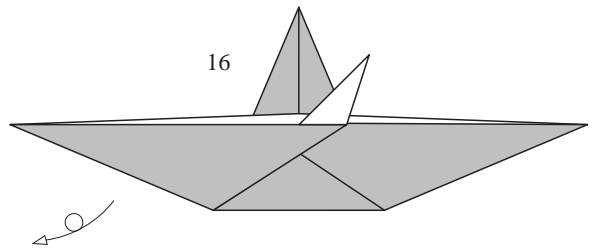
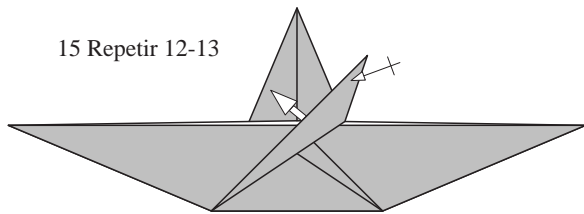
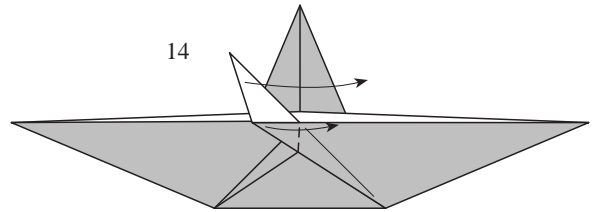
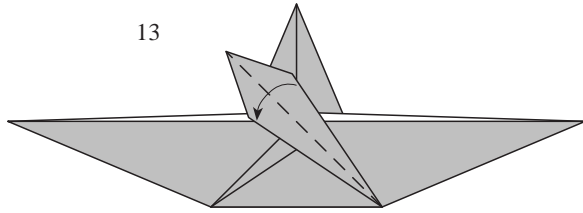
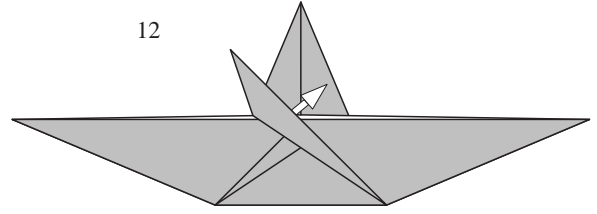
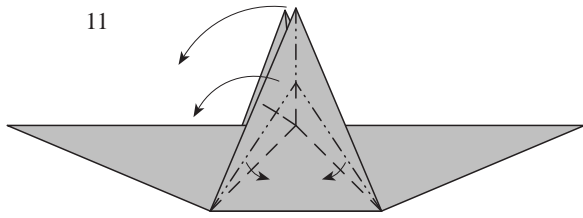

21

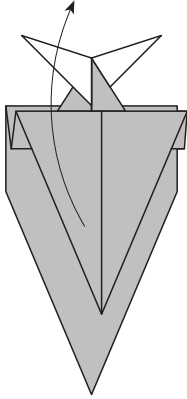

22

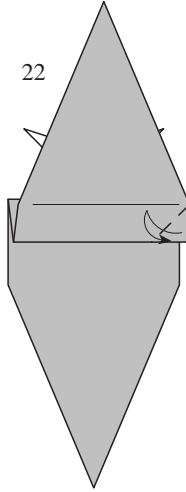

23

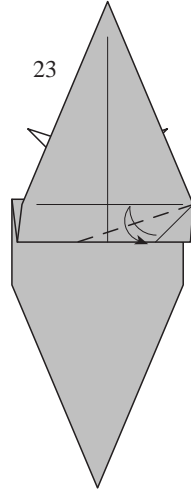

24

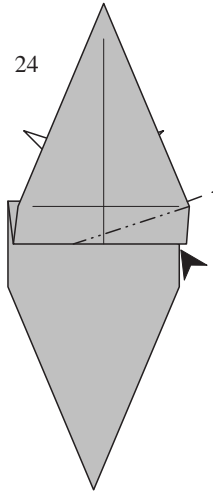

25

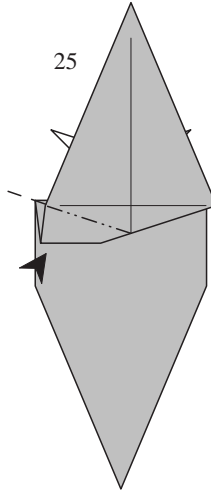

26

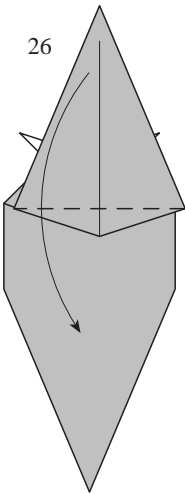

27

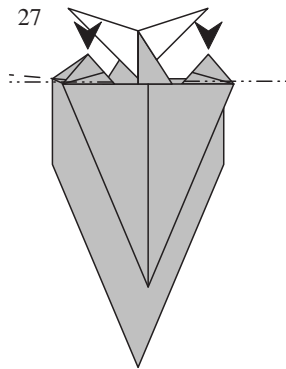

28

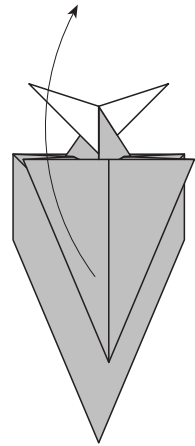

29

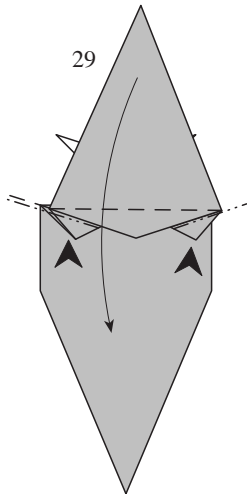

30

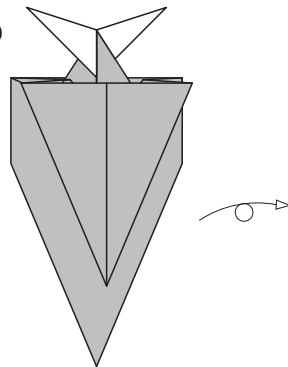

31 Repetir 20-29

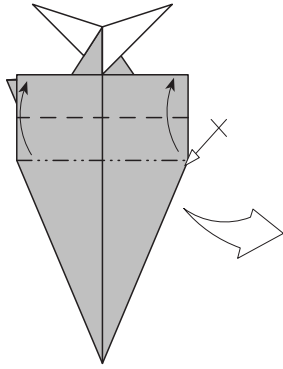

32

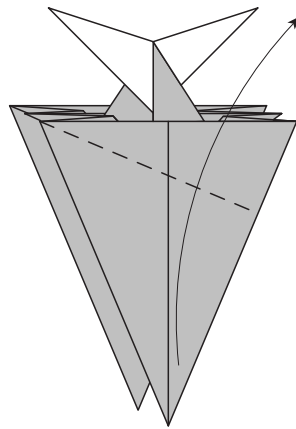

33

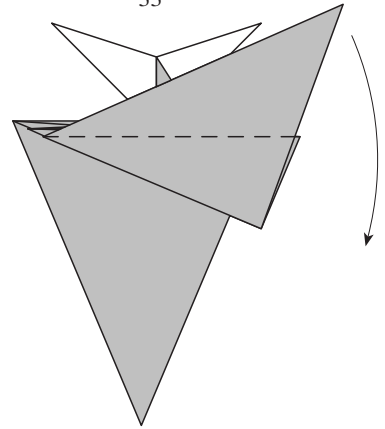

34

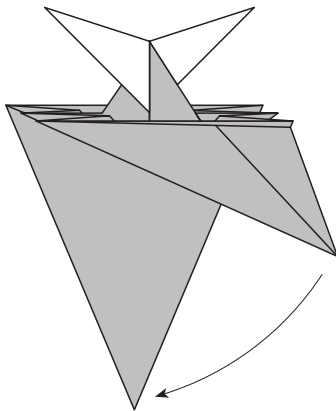

35 Repetir 32-34

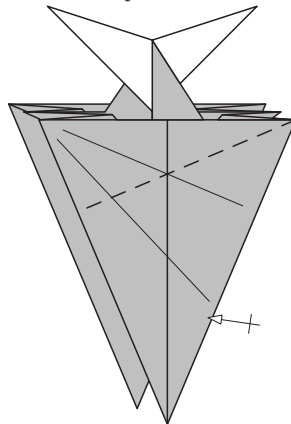

36 Repetir detrás 32-35

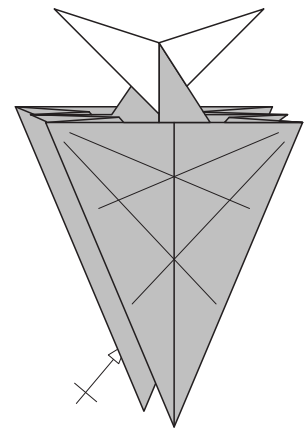

37

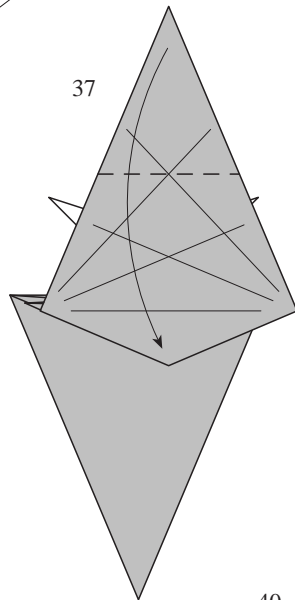

38

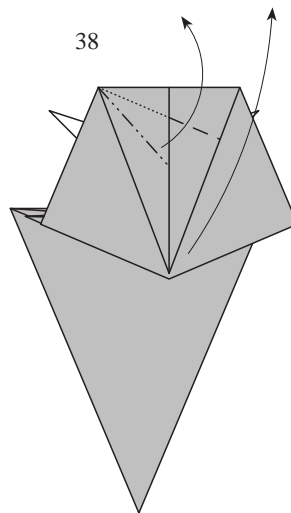

39

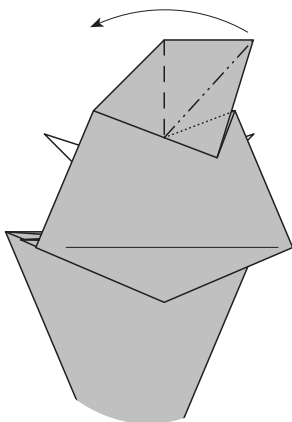

40

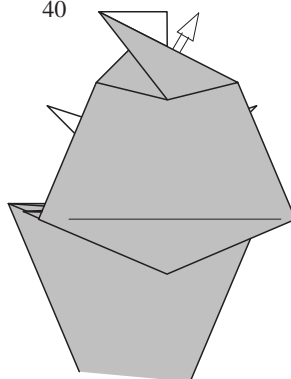

41

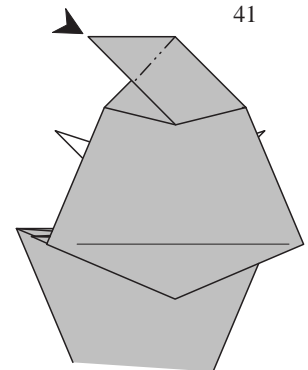

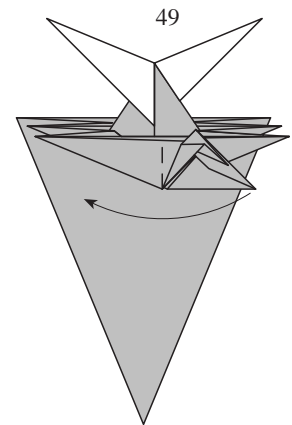
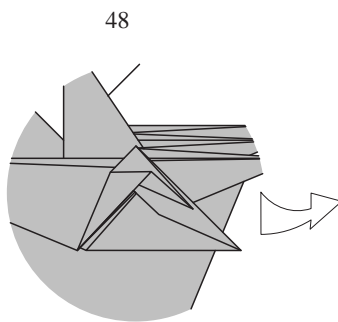
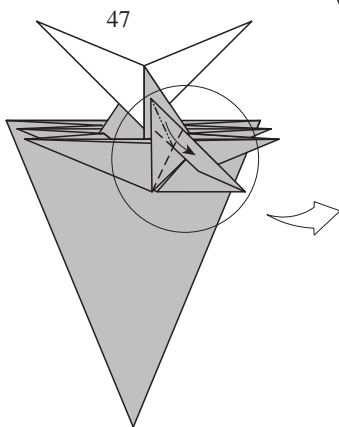
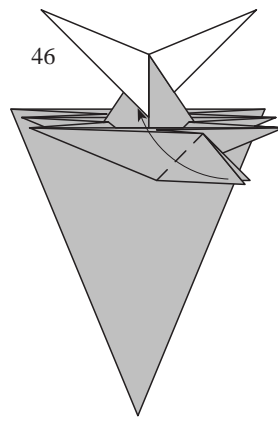
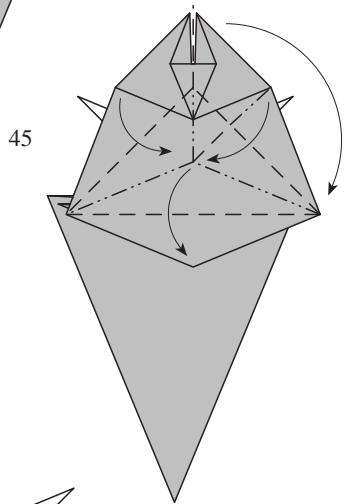
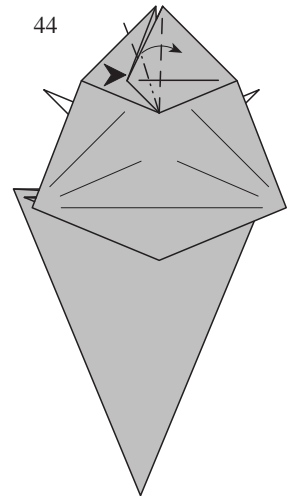
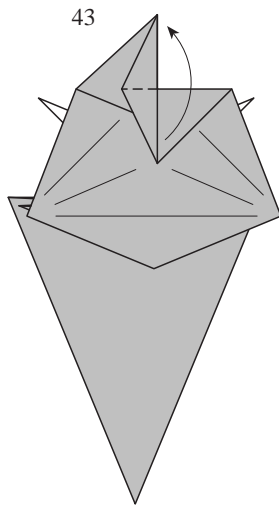
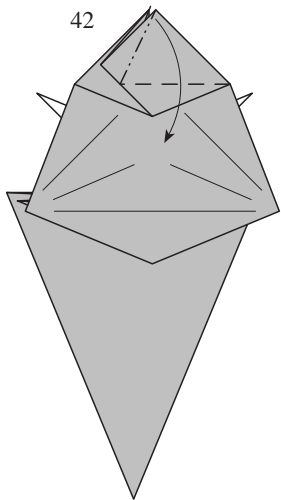

50 Repetir 46-49

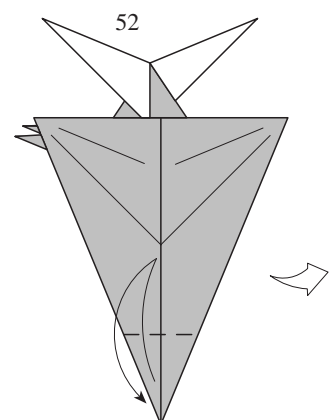
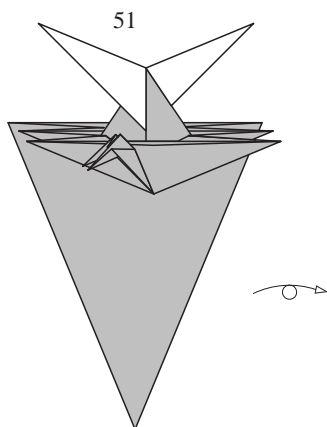
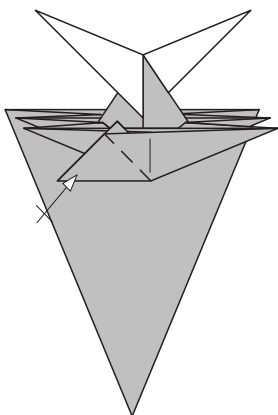

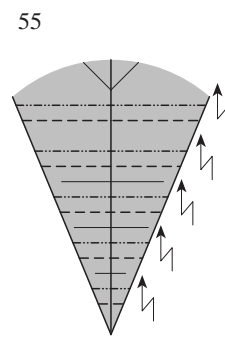
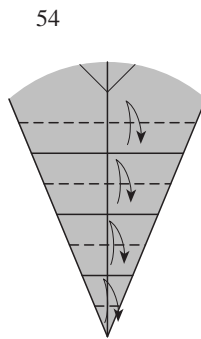
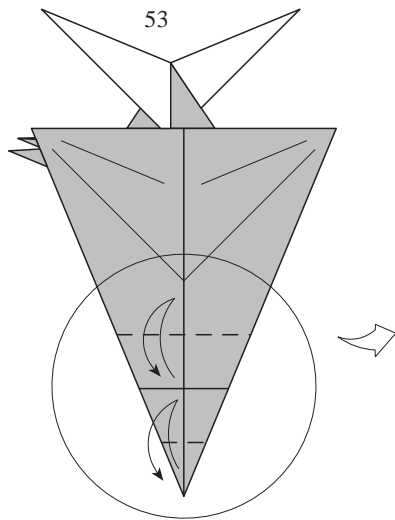

56 Repetir en los demás

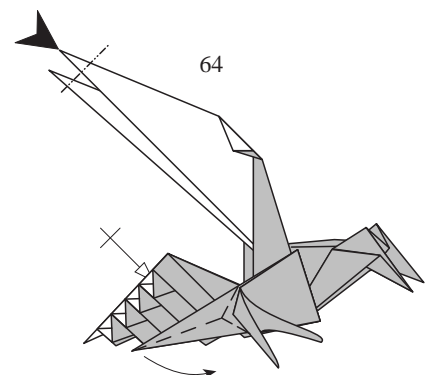
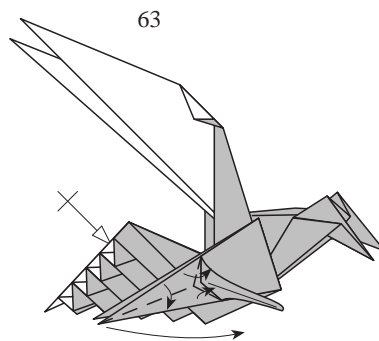
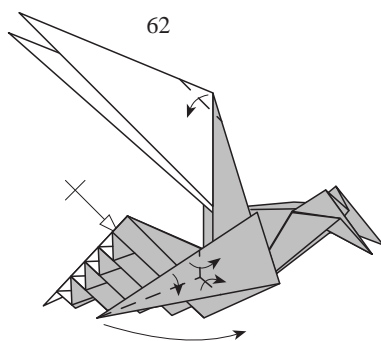
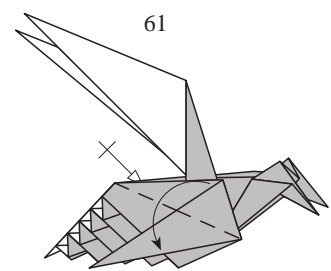
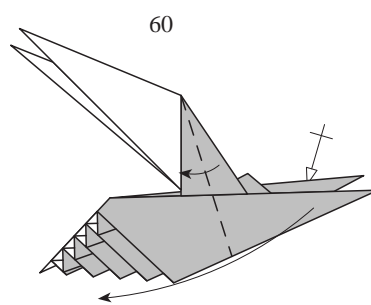
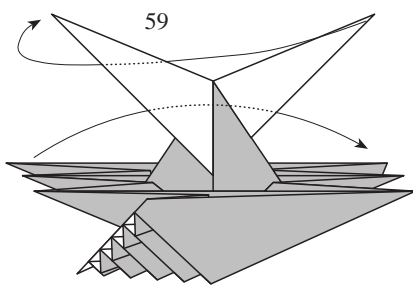
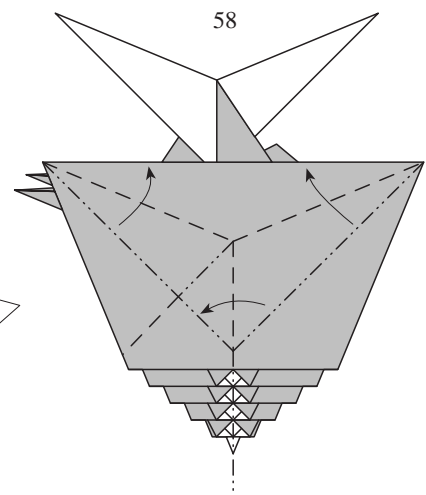
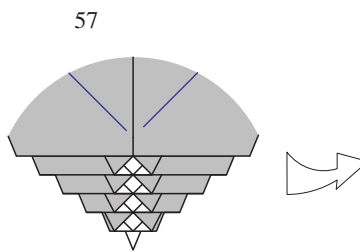
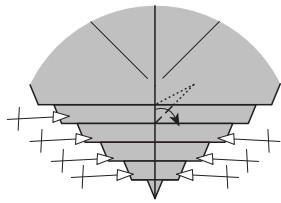

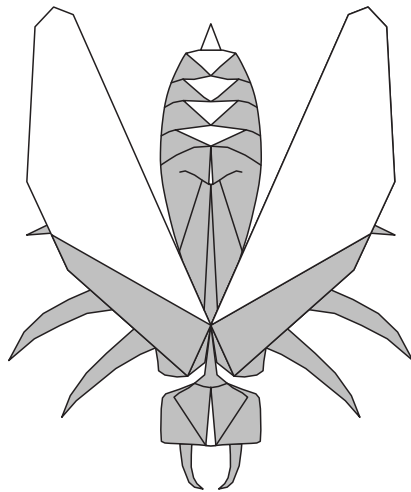
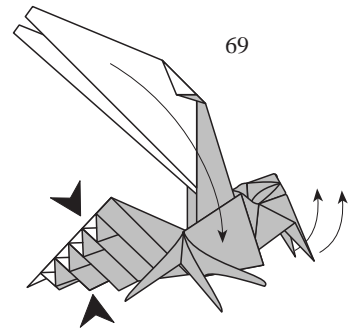
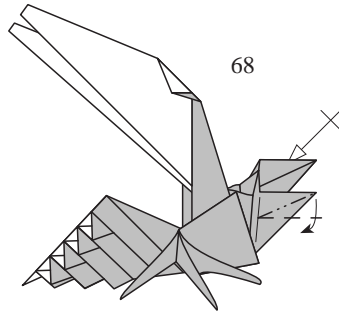
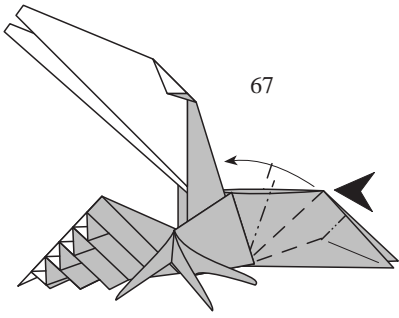
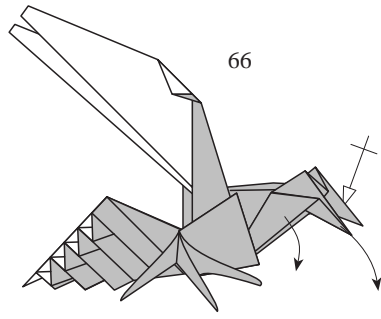
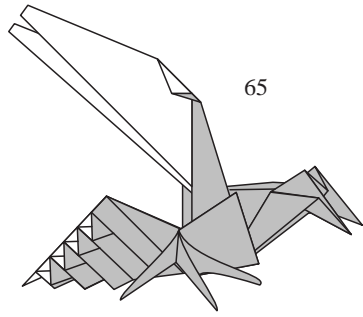

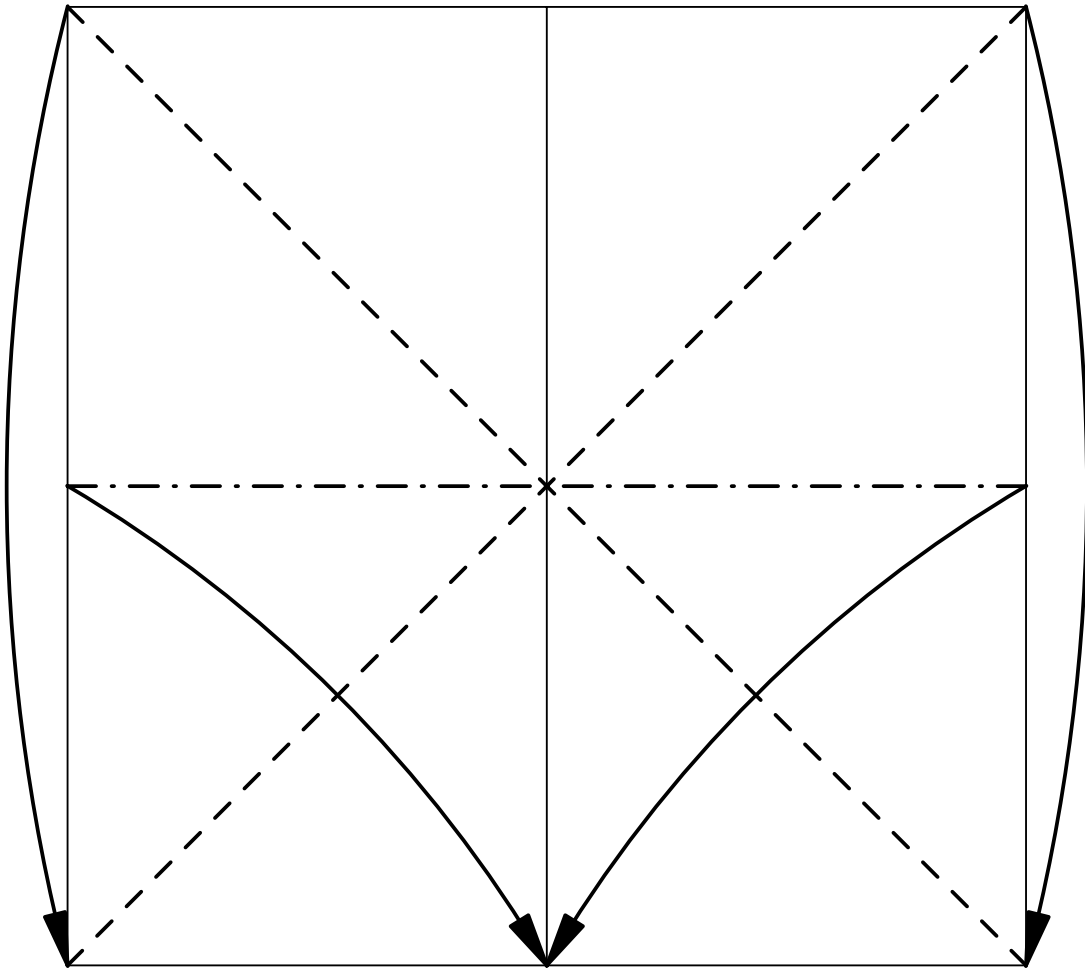

1 Make mountain and valley creases and then collapse as indicated

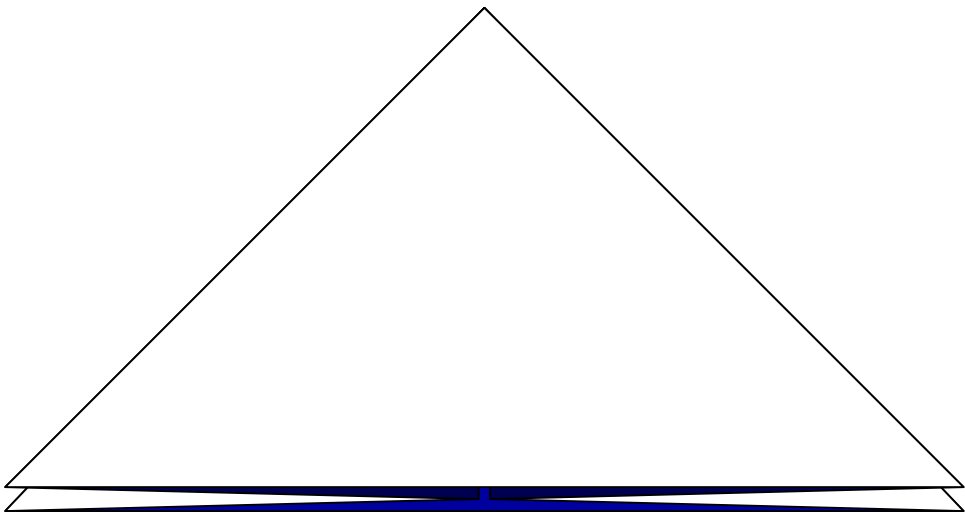

2 Waterbomb base finished



# Weasel by Gabriel Willow (ME)

Intermediate Fold from a colored square of paper with the colored side down.  
A 10" piece of paper produces a model 7" in length.

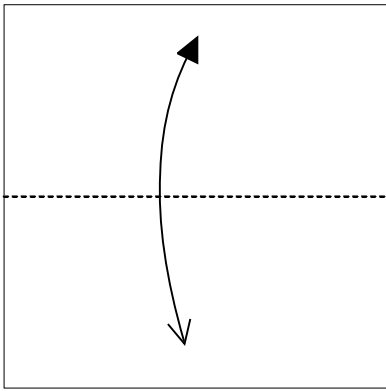

1. Fold and unfold in half.

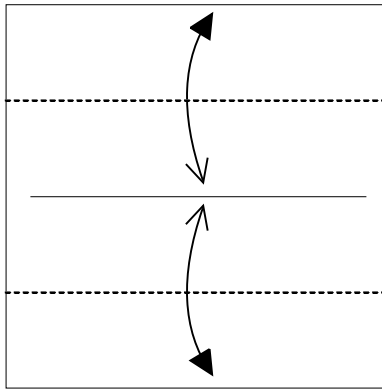

2. Fold and unfold in fourths.

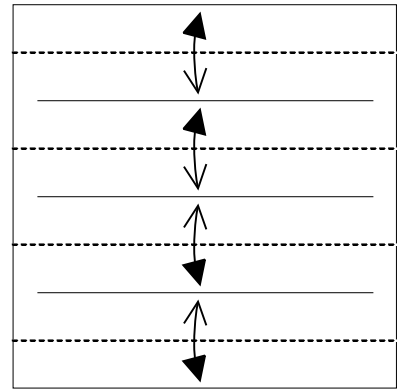

3. Fold and unfold in eighths.

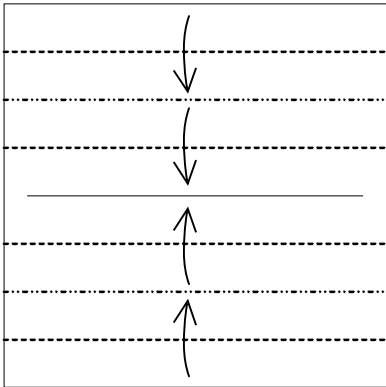

4. Pleat as shown.

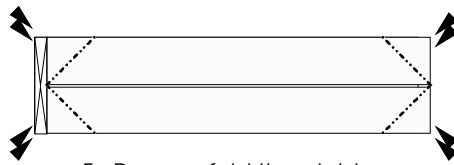

5. Reverse fold the eight corners.

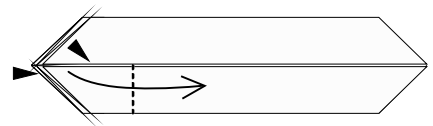

6. Stretch the point.

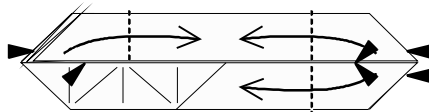

7. Stretch the remaining three points.

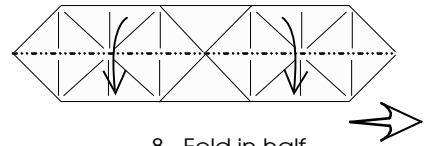

8. Fold in half.

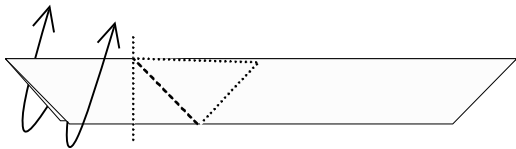

9. Outside reverse-fold.

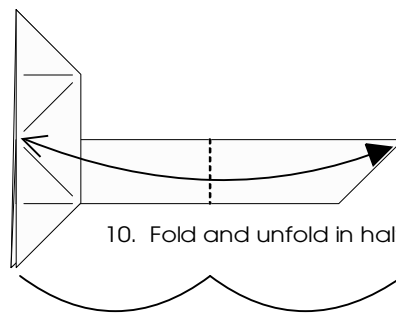

10. Fold and unfold in half.

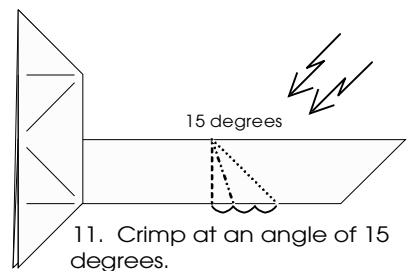

11. Crimp at an angle of 15 degrees.

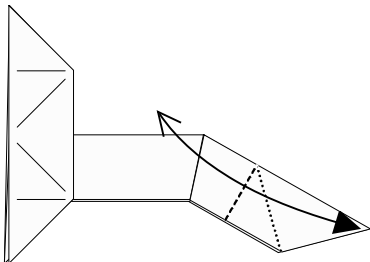

12. Fold and unfold using the internal structures as a guideline.

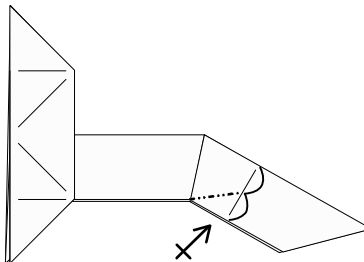

13. Carefully pinch the mountain fold into place in front and behind.

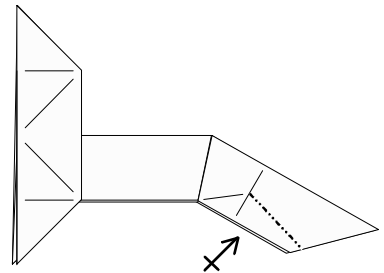

14. Carefully pinch the next mountain fold into place in front and behind.

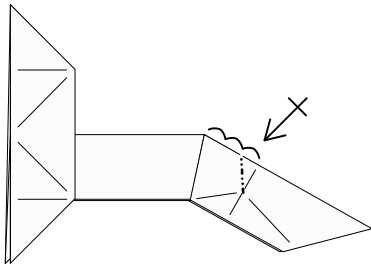

15. Pinch the final mountain fold into place in front and behind.

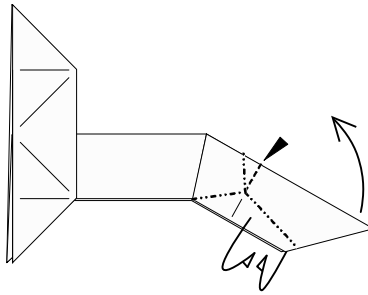

16. Put the construction in place by pushing in where shown while swinging the point upward and the lower flaps inward. Be careful not to split the paper.

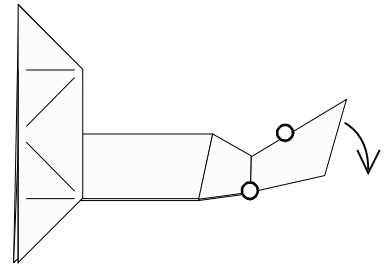

17. Pinch the model where shown and rotate the tail downward.

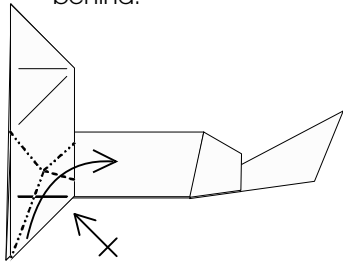

18. Rabbit-ear the point in front and behind.

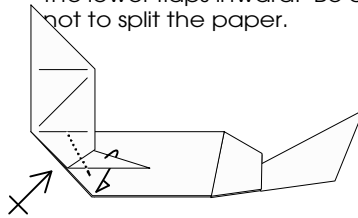

19. Pull the leg down, in front and behind.

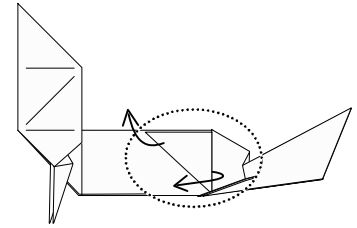

20. Cut away view. Pull out the trapped layers.

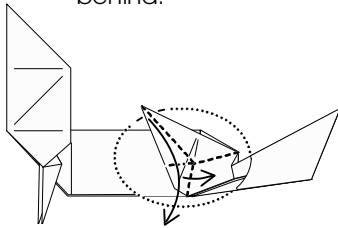

21. Rabbit ear downward.

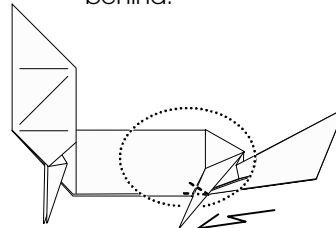

22. Crimp to bring the leg up into place. See the following illustration for proper positioning.

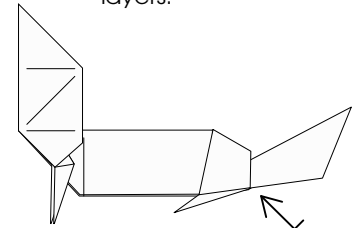

23. Repeat the last three steps on the other leg.

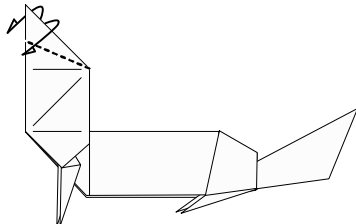

24. Outside reverse fold.

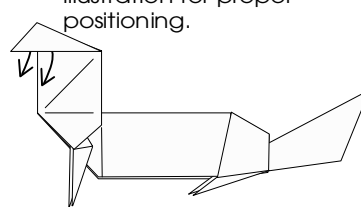

25. Pull down the hidden layers from both sides.

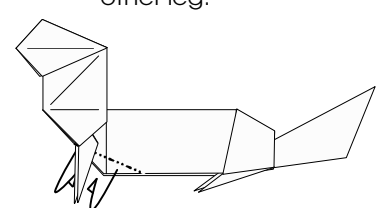

26. Fold the flaps inside.

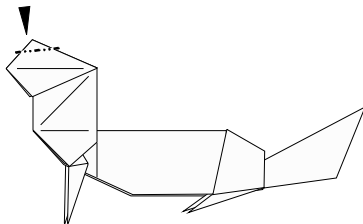

27. Sink the tip.

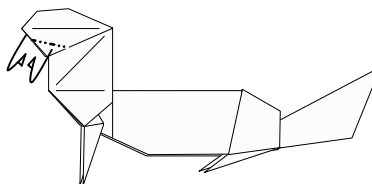

28. Fold the flaps inside.

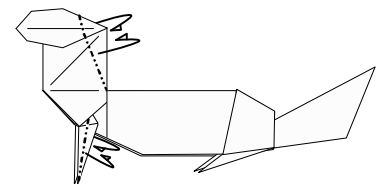

29. Fold the flaps inside. Note, the upper fold is not a straight line.

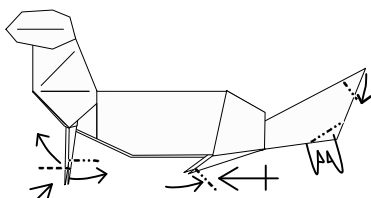

30. Complete the feet. Shape the model as shown.

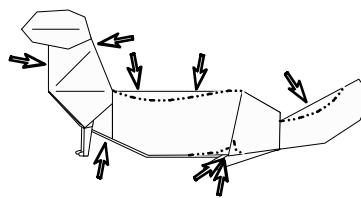

31. Continue shaping.

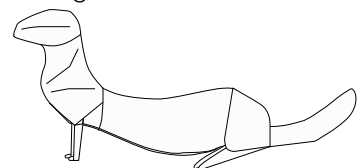

32. Completed model.

The wheelchair and me  
a deep sigh ...  
Burning eyes,  
a silent sob ...  
Confused thoughts,  
impotence and shame.  
Cut off from the world,  
lonely and alone.  
Fly ... but where  
Damn ... walking is over.



Be courageous and strong,  
make a new start.  
Learn to go sitting,  
enter that wheelchair.  
Discover soon  
you'll run fast,  
without making a step.

People look down on you ...  
rather talk with a "stander",  
about you and how.  
You feel rage and pain ...  
words get stuck.

To be a child and small ...  
is to show your will power.  
My "IQ" is equal ... to yours.  
You need neither shun me,  
nor push me about.  
Because ... me and my wheelchair ...  
attain our end together!

Y.L.van Muilekom

This human figure consists of two sheets  
The top part of the body should start white side down to get a white 'shirt'  
The bottom part should be color down to get colored trousers  
Designed because I needed two white/black dressed people to my wheelchair

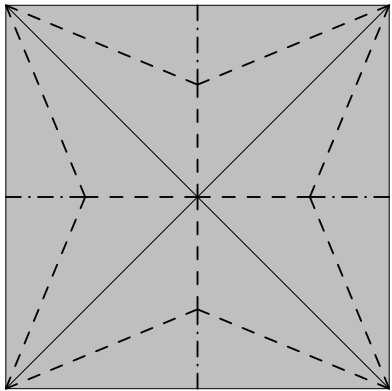

1 Top part of body

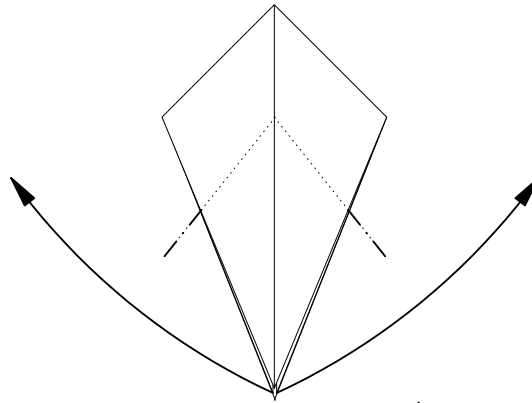

2

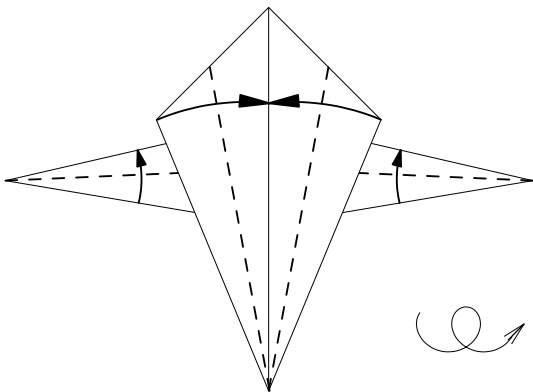

3

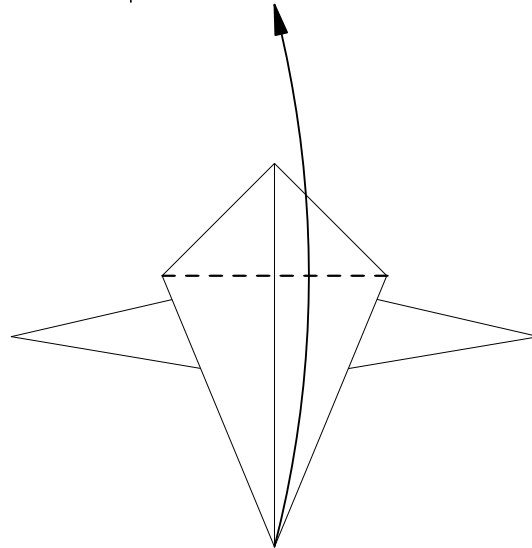

4

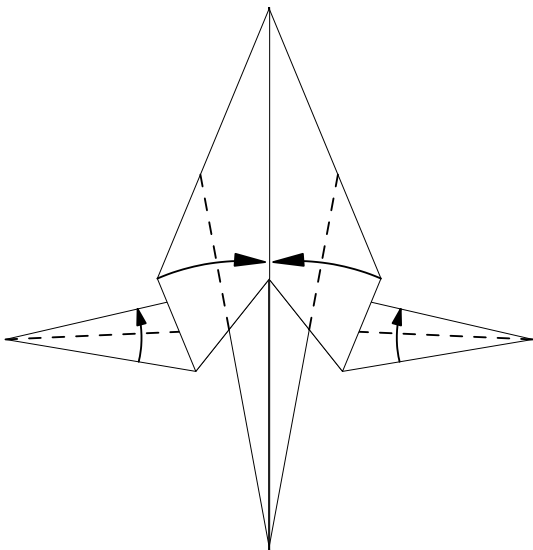

5

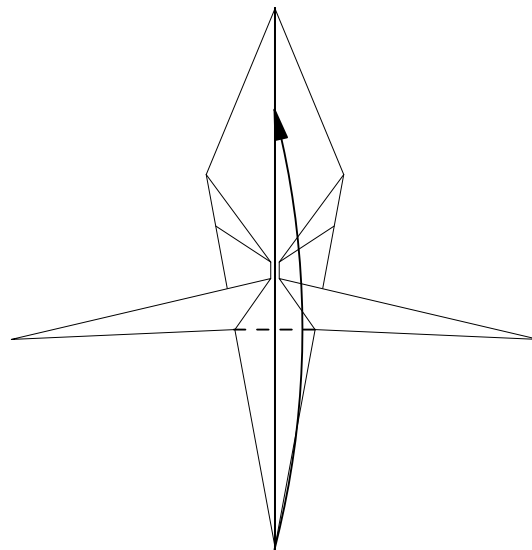

6

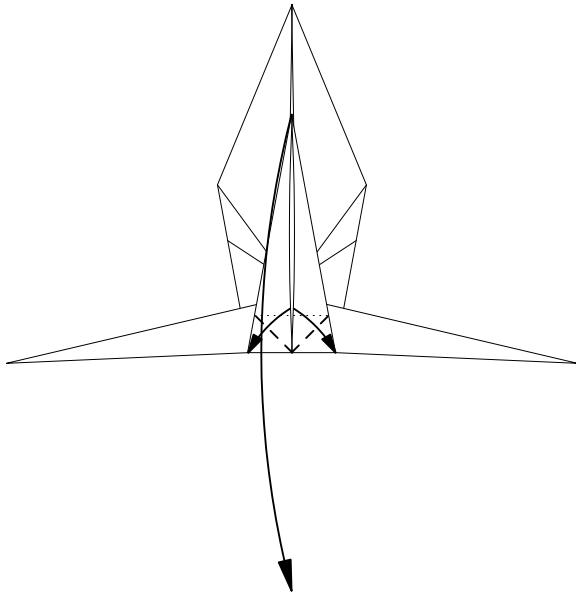

7

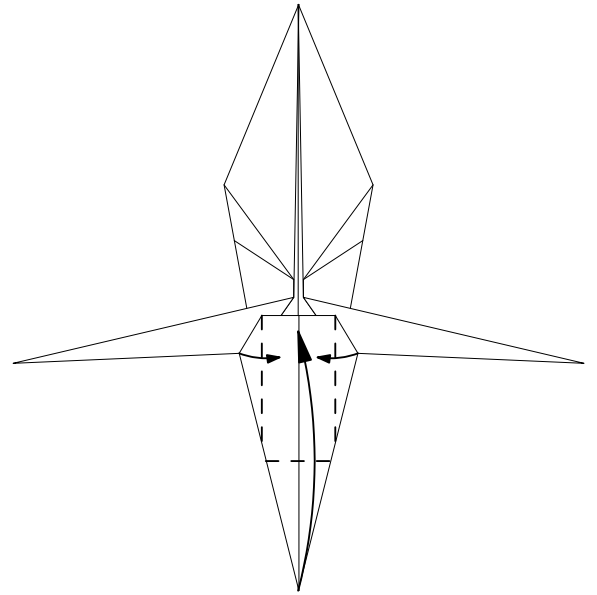

8

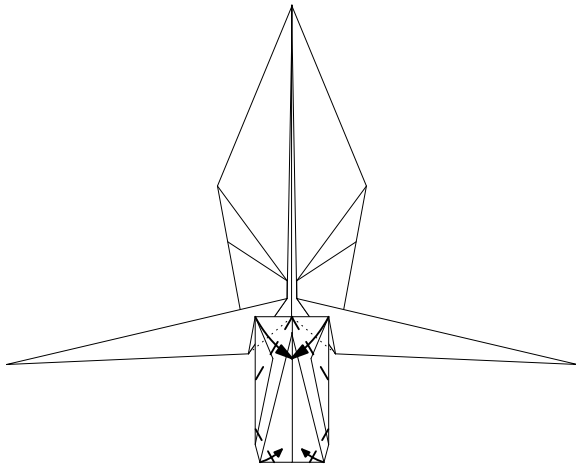

9

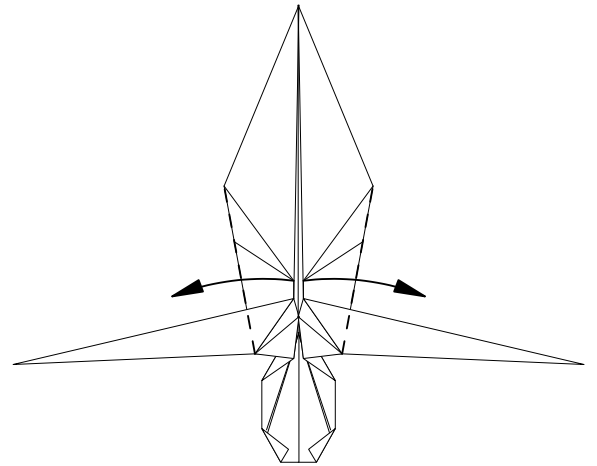

10

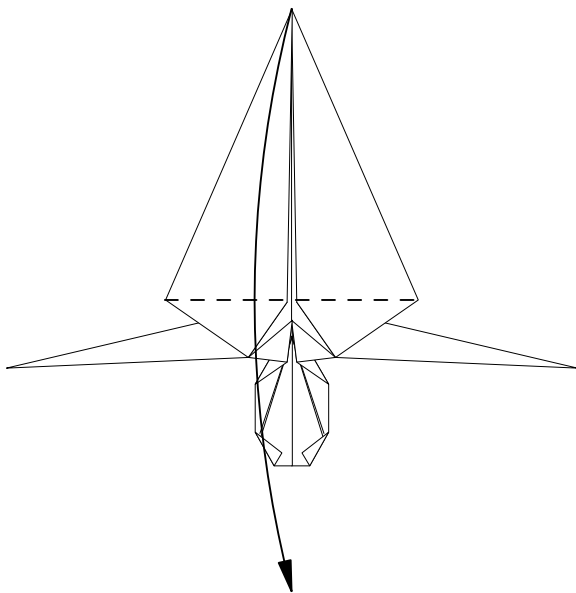

11

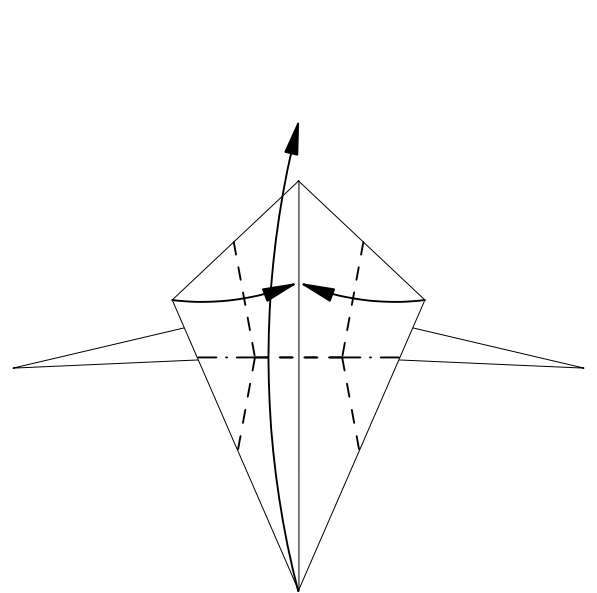

12

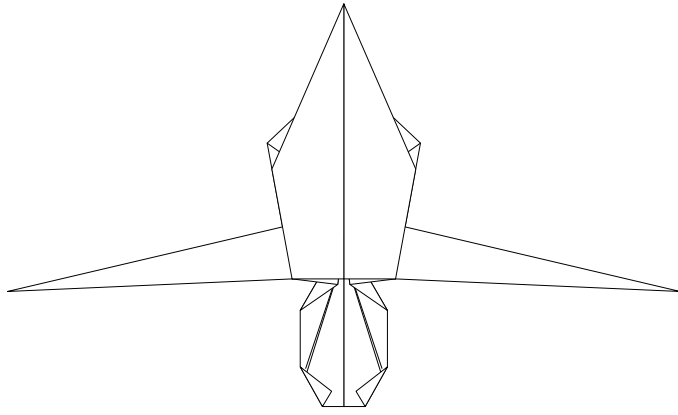

13 Top part of body finished

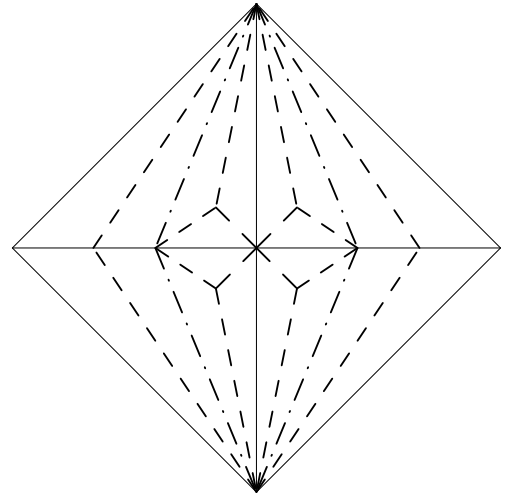

14 Bottom part of body; precrease

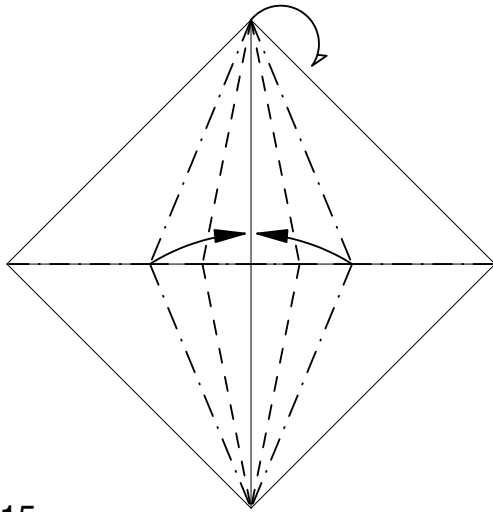

15

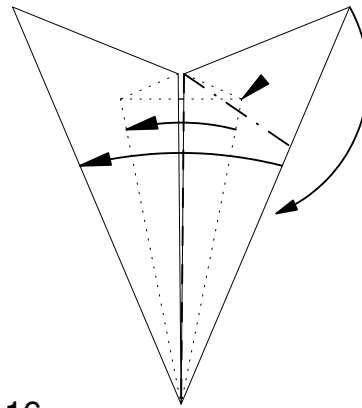

16

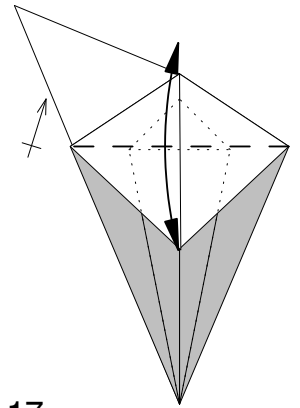

17

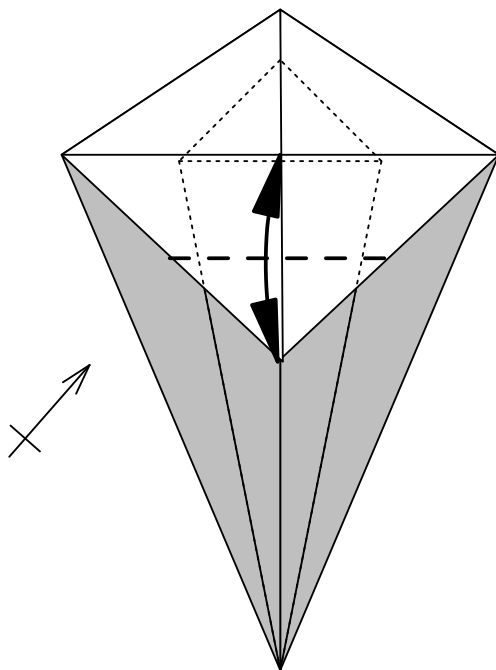

18 Bottom part of body finished

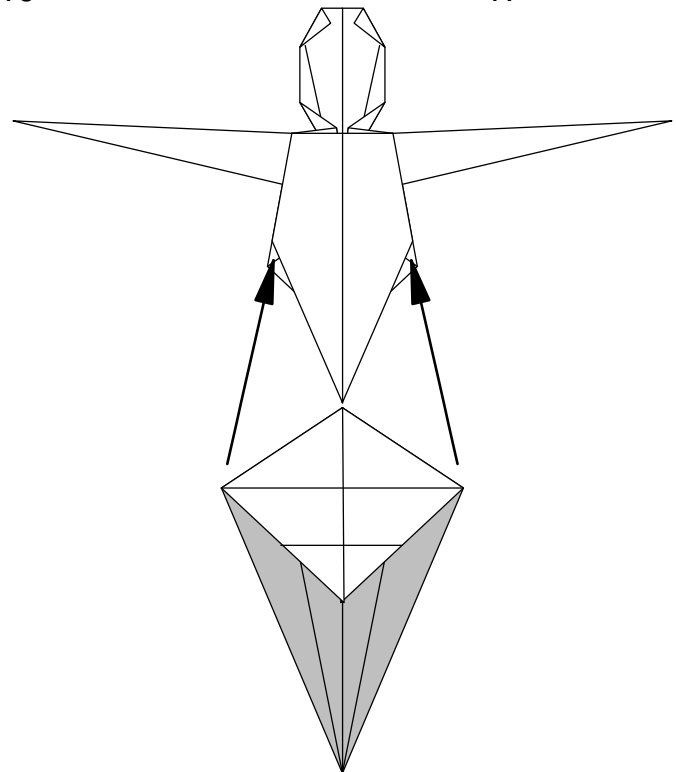

19 Insert bottom part in top part

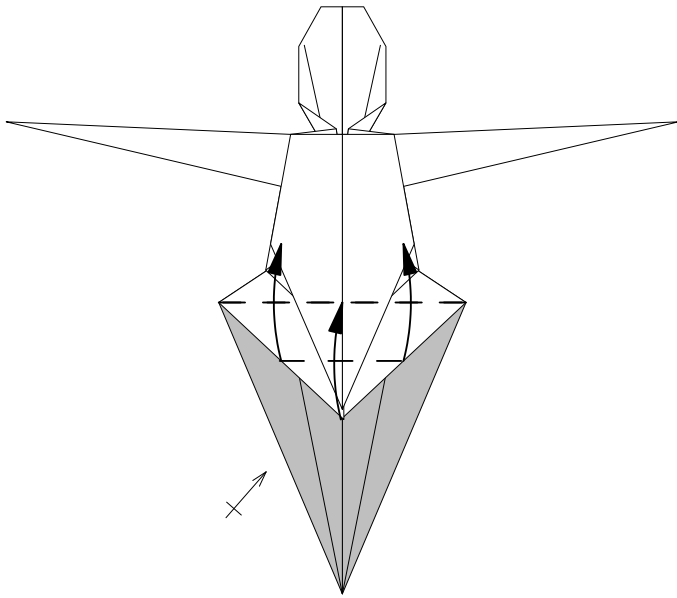

20

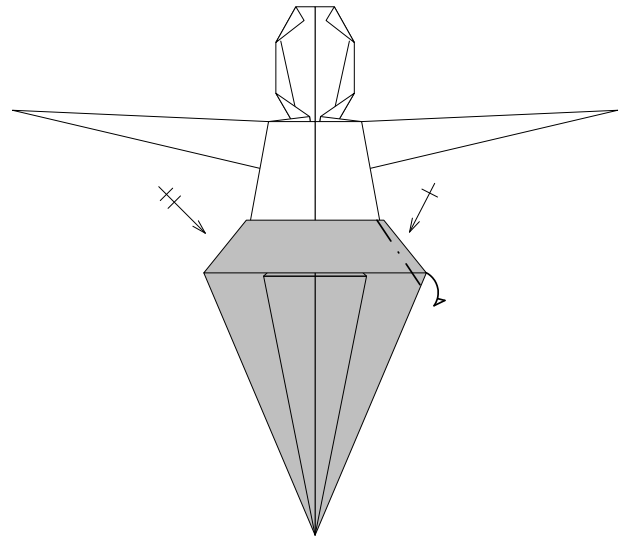

21

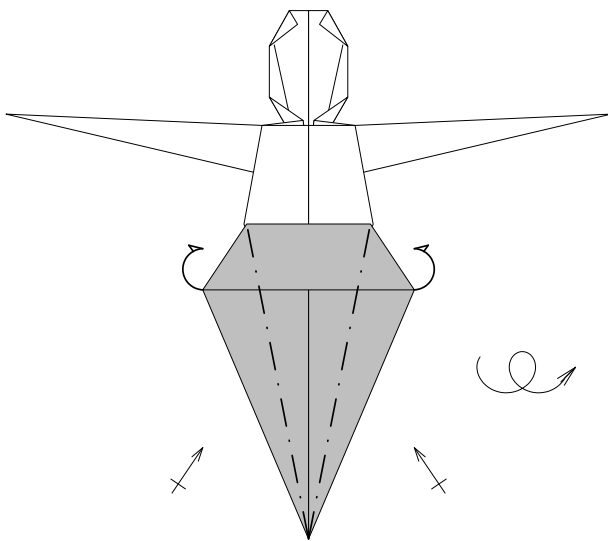

22 Fold inside

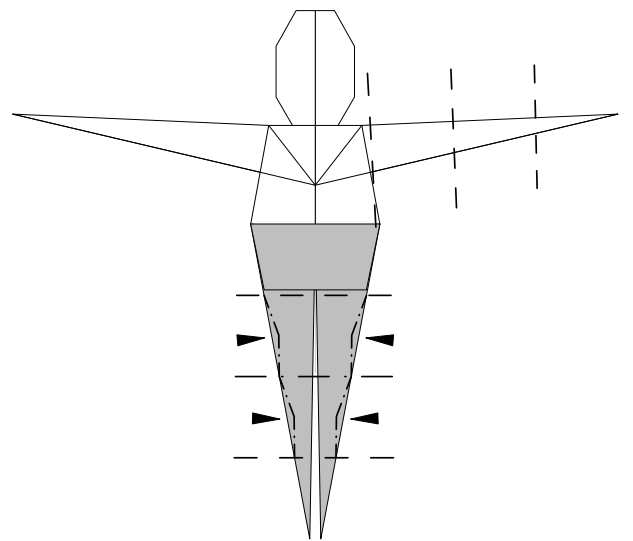

23 Form arms and legs

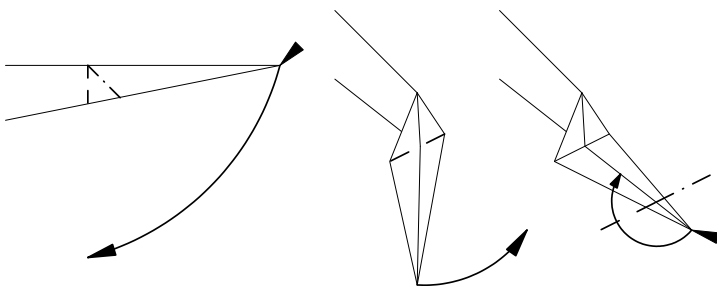

24 Form hands

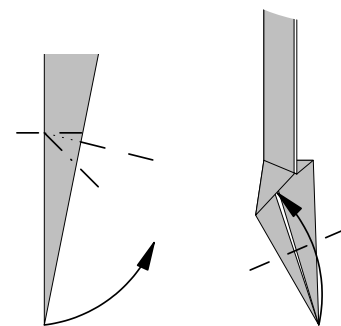

25 Form feet

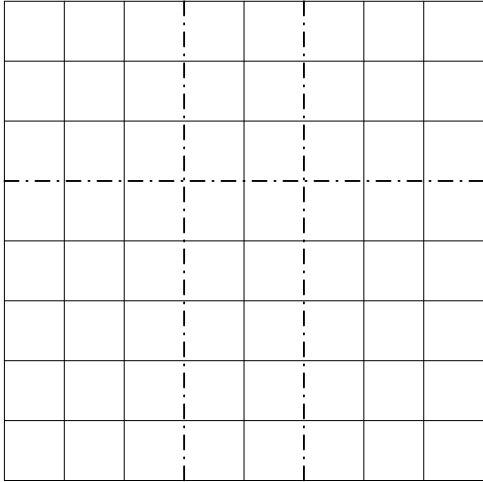

1

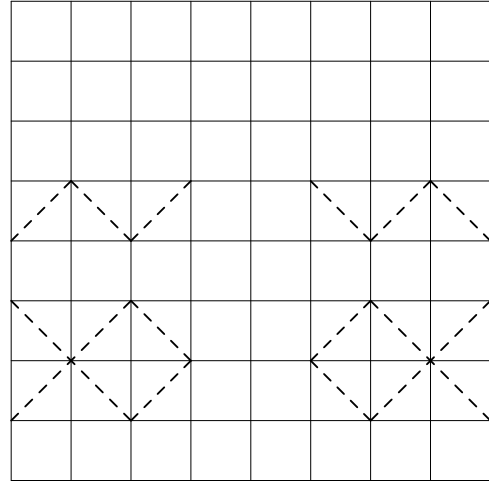

2

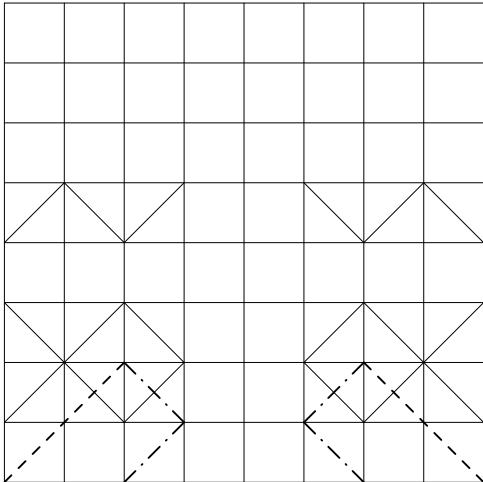

3

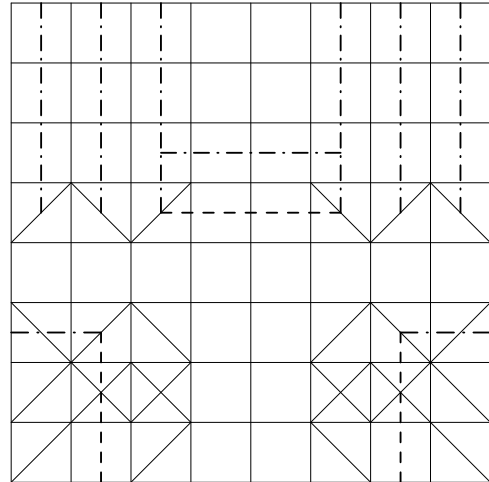

4

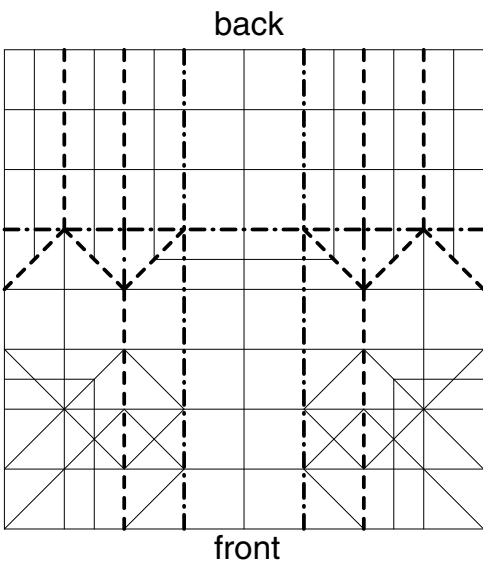

5

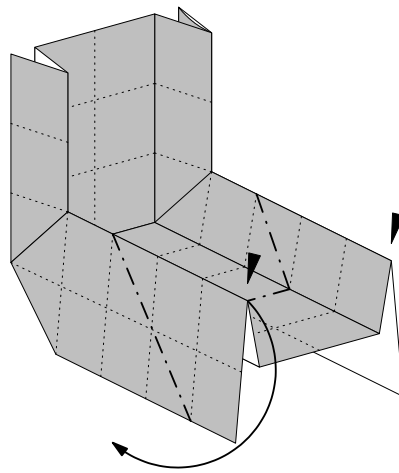

6



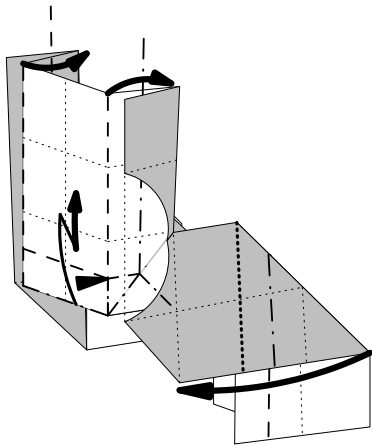

7

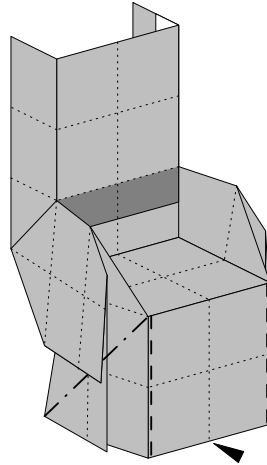

8 Dark area is double

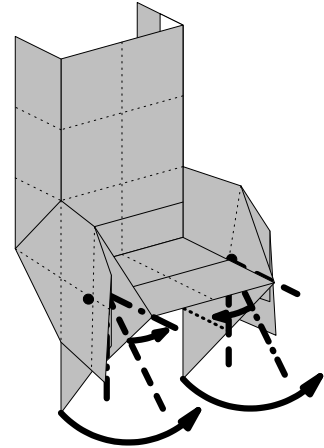

9 Swivel bottom front around line in seat (through dots)

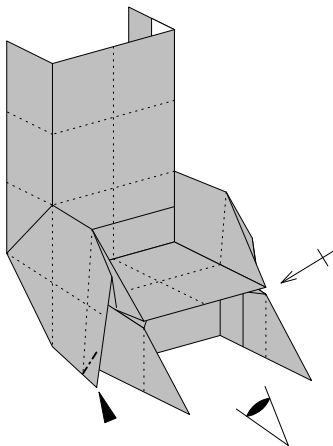

10

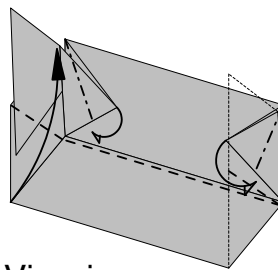

View in front bottom part

11 Fold triangles and lock with next fold

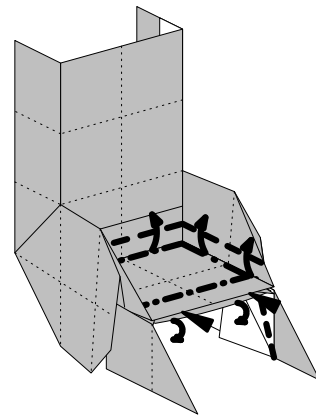

12 Form seat and fold bottom layer back

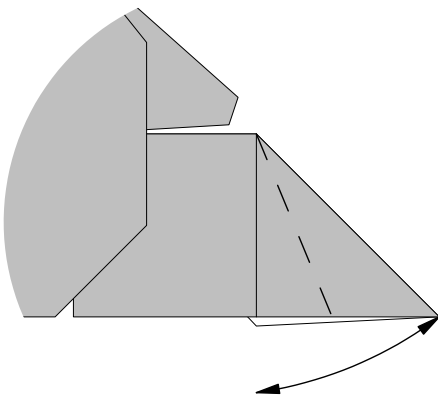

13 Front wheels

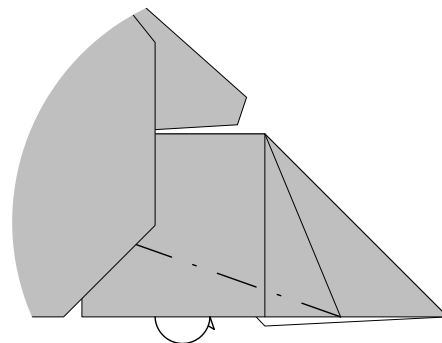

14

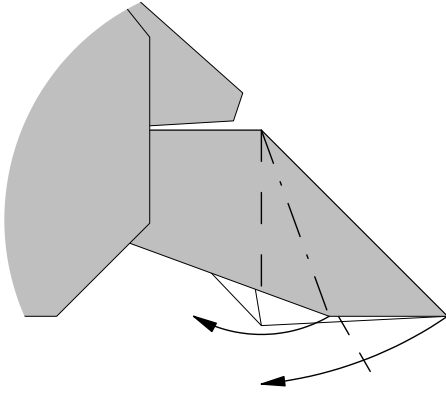

15

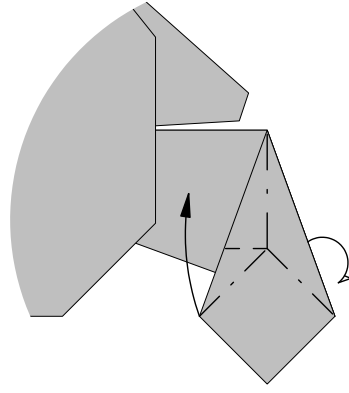

16

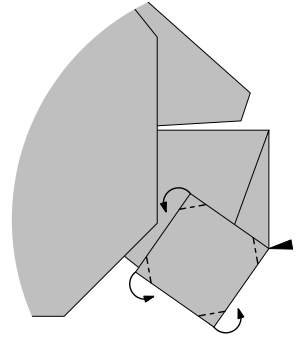

17

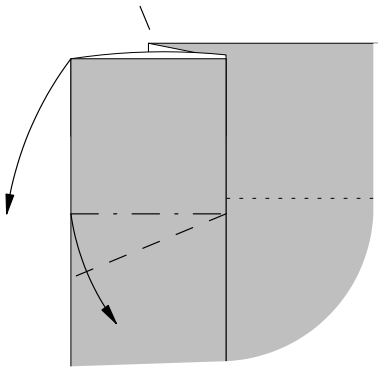

18 Handles on top of back

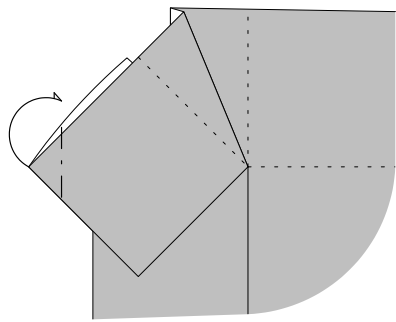

19

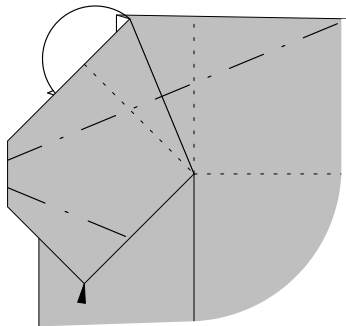

20

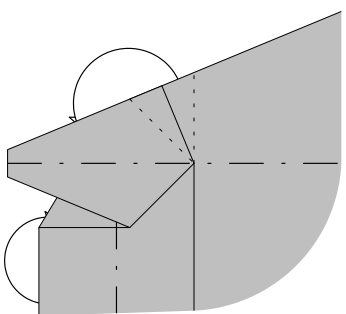

21

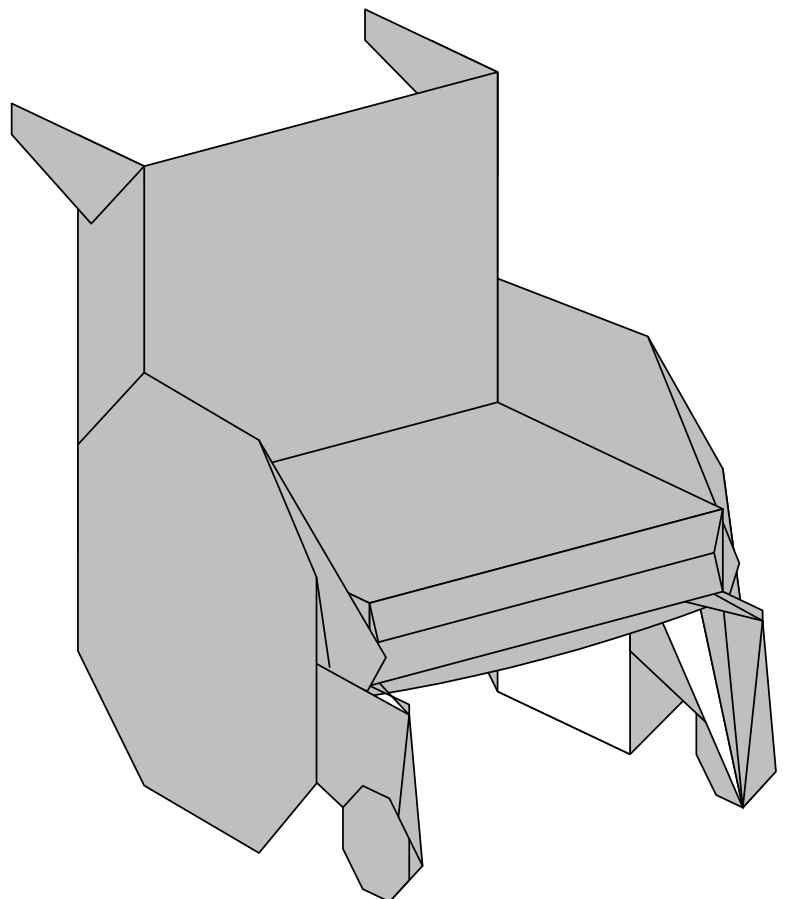

# Windmill

Maarten van Gelder

© 1990 Sep

This windmill has white sails and a coloured house and may stand alone. If you want to put the windmill to stand, fold the back flap under 90 degrees. Because the windmill tends to tumble forward you may fold a small wedge shaped strip at the bottom (in the back flap most and in front nothing). Use foil: in diagram 7 you double 26 layers together!

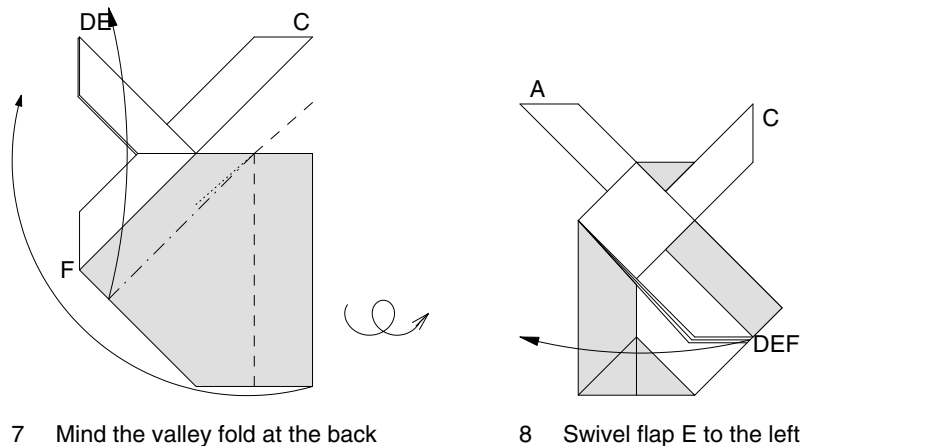
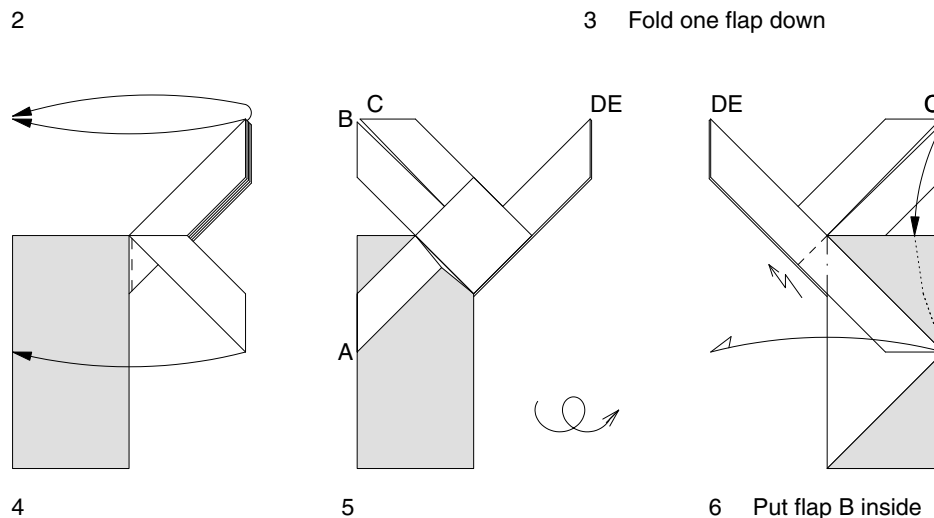
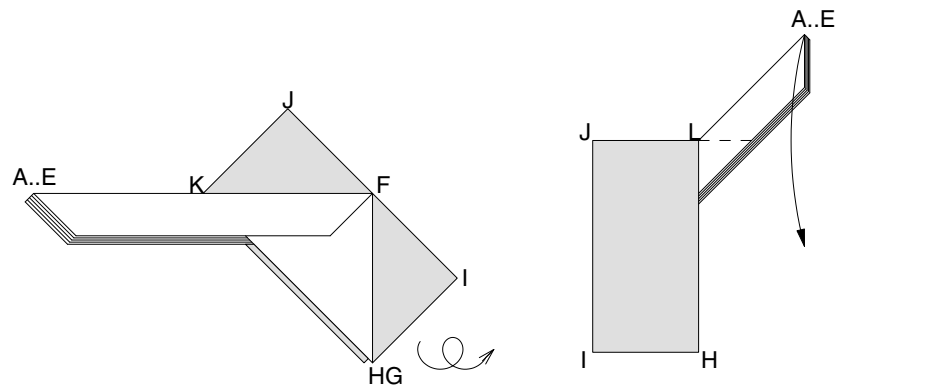
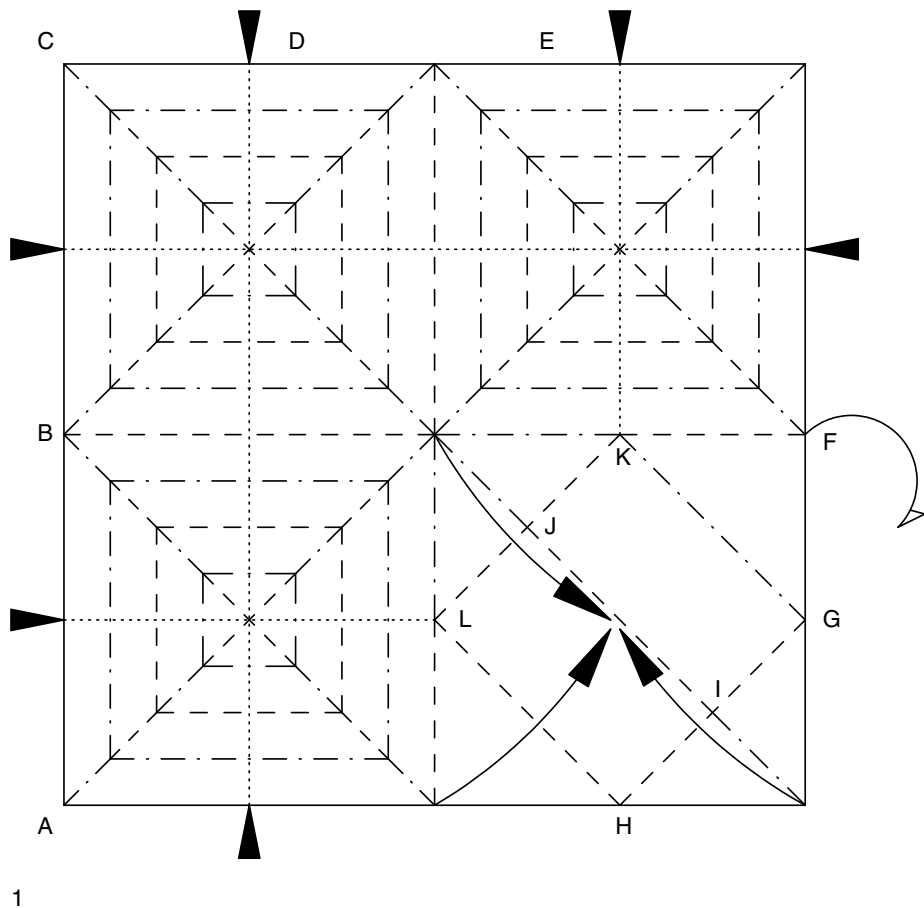

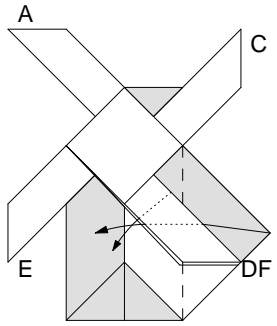

9 Open flap F and hide tip F

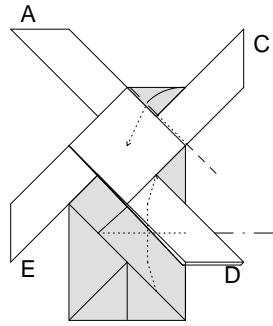

10 Lower flap is inside the model.

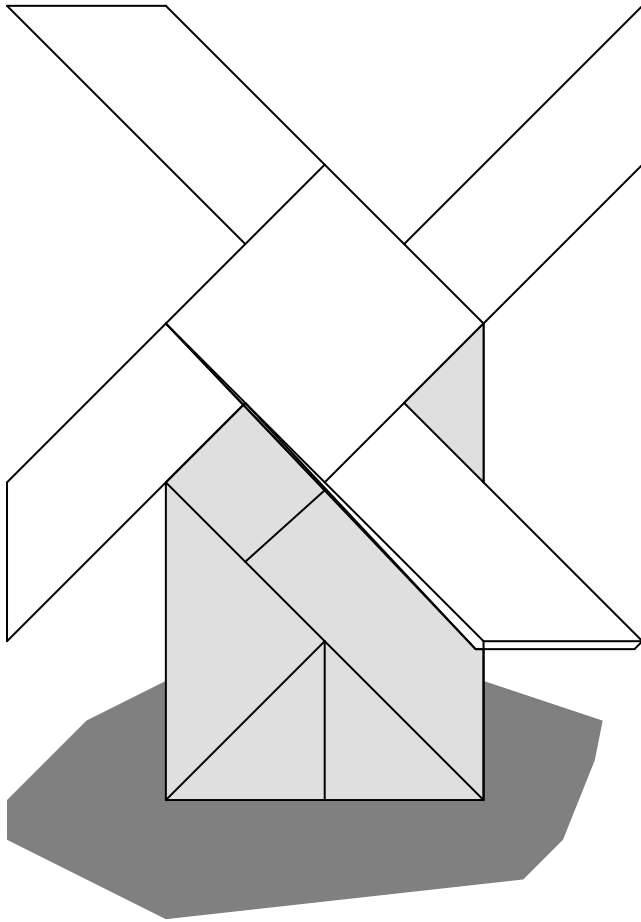

This windmill has white sails and a coloured house and may stand alone.  
If you want to put the windmill to stand, fold the back flap under 90 degrees.  
Because the windmill tends to tumble forward you may fold a small wedge  
shaped strip at the bottom (in the back flap most and in front nothing).  
Use foil: in diagram 7 you double 26 layers together!

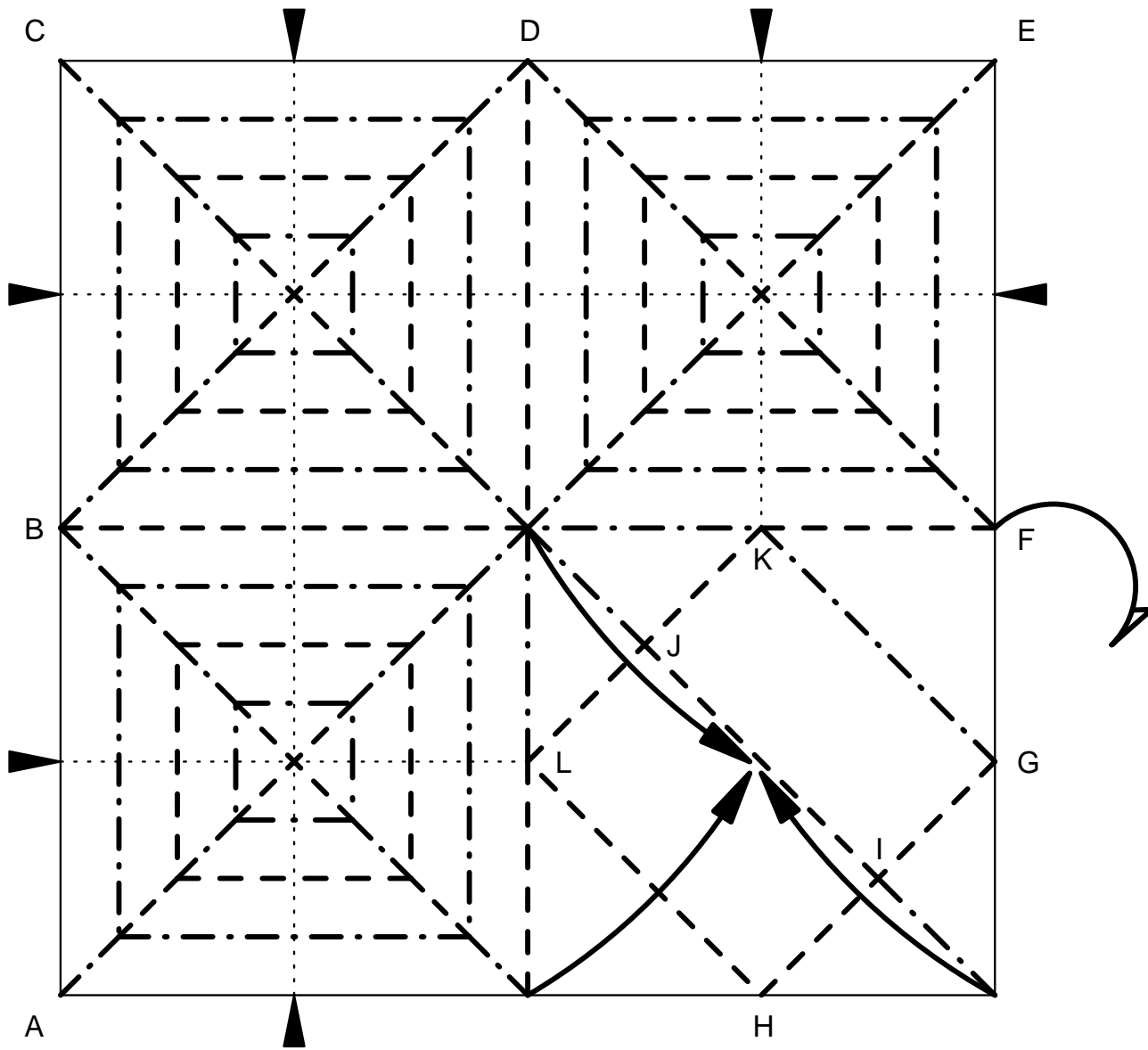

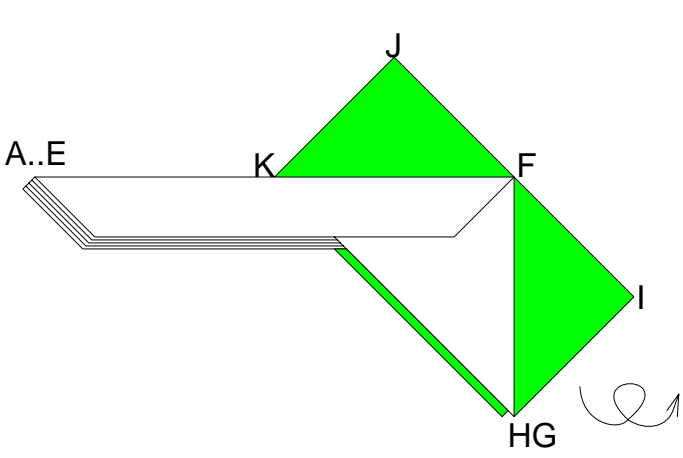

2

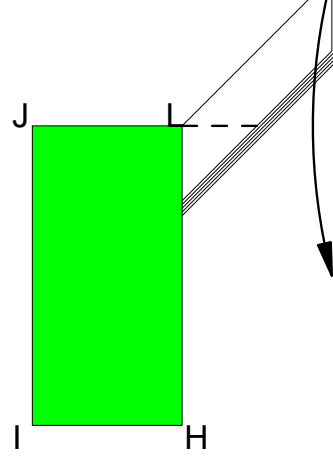

3 Fold one flap down

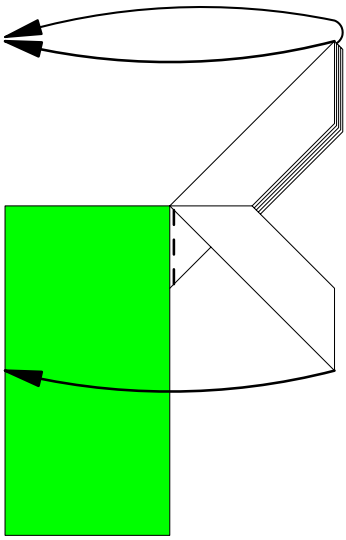

4

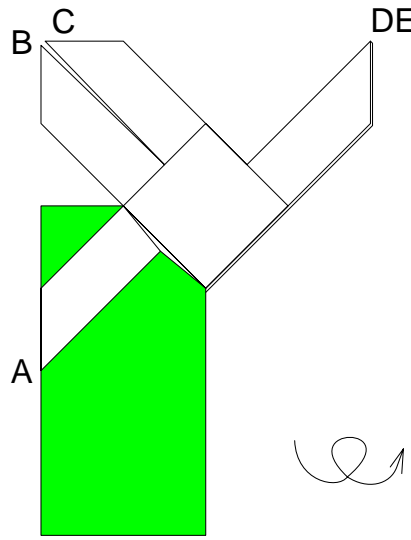

5

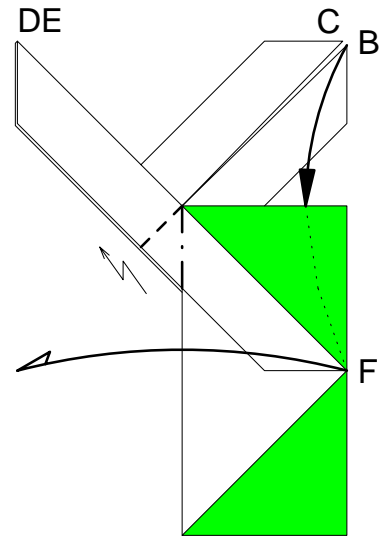

6 Put flap B inside model

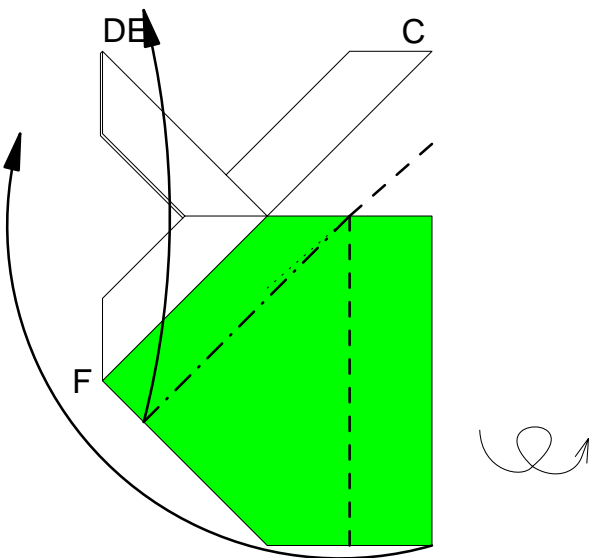

7 Mind the valley fold at the back

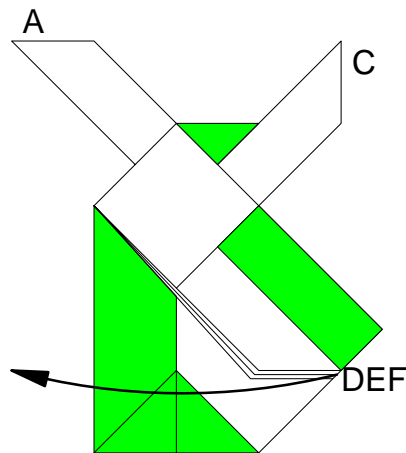

8 Swivel flap E to the left

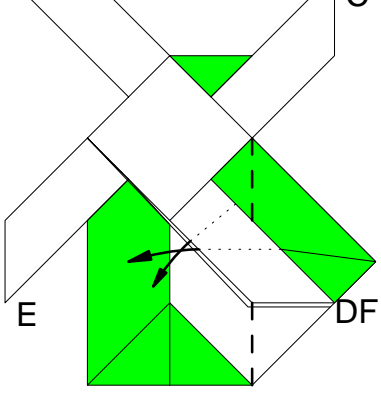

9 Open flap F and hide tip F

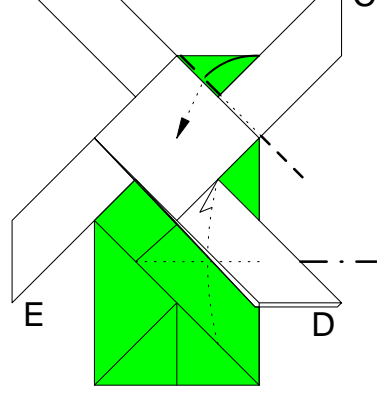

10 Lower flap is inside the model.

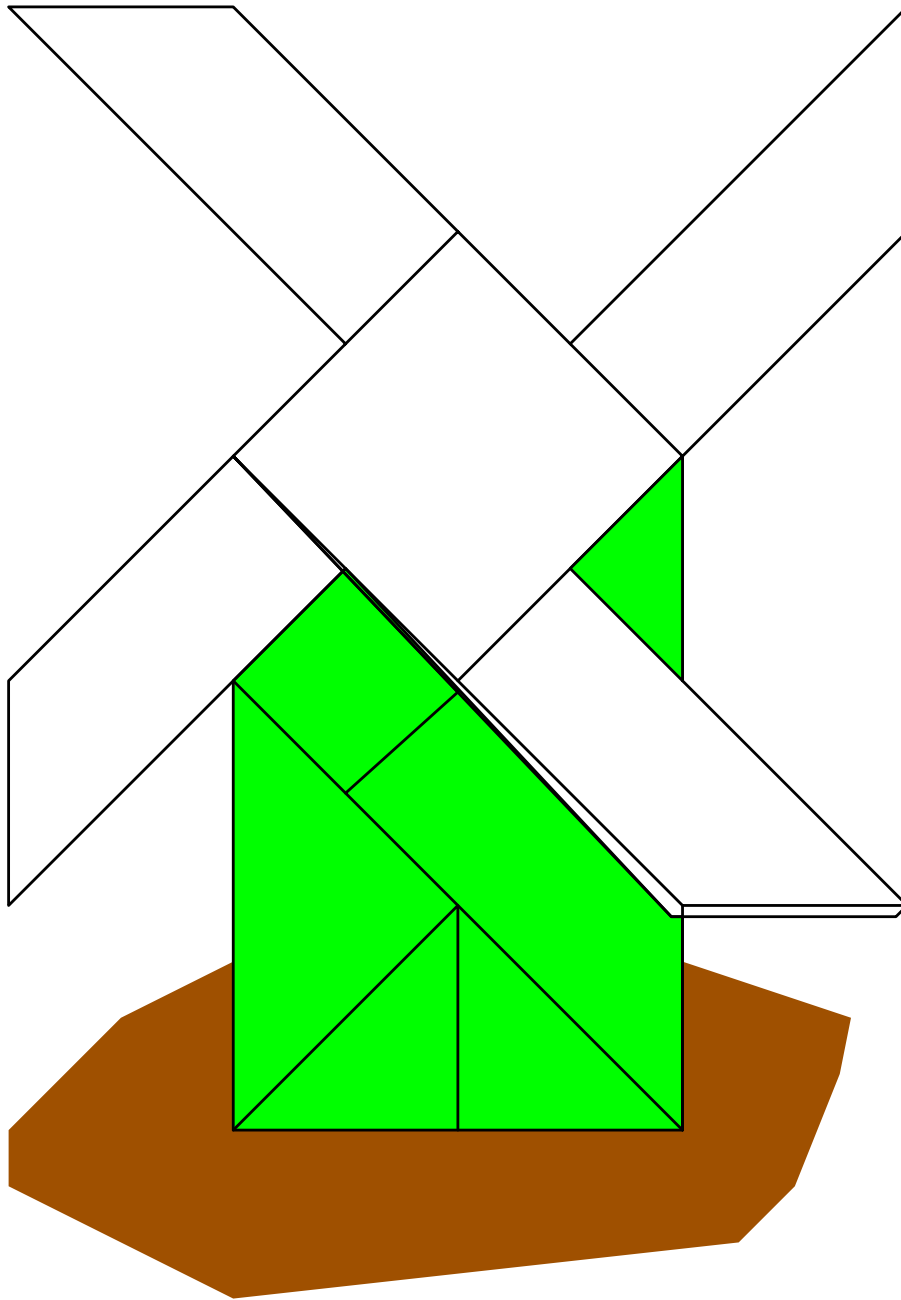

start white side up

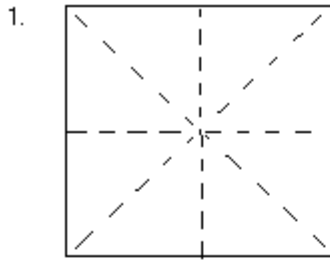

1.

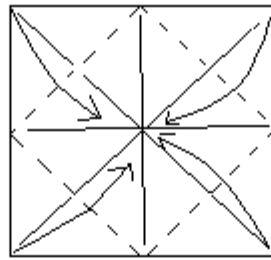

2.

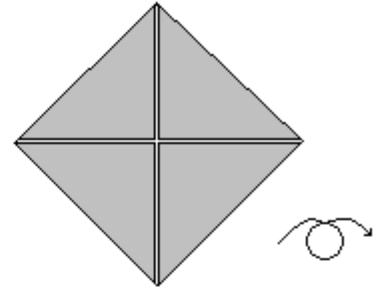

3.

Precrease the paper in half in all 4 directions

Fold all 4 corners to the middle

Turn over

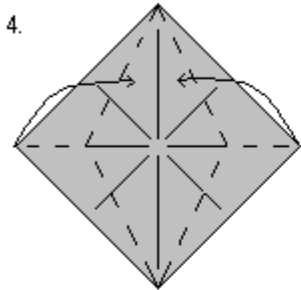

4.

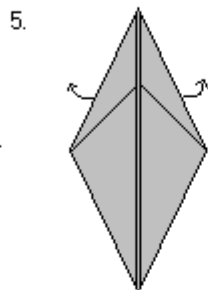

5.

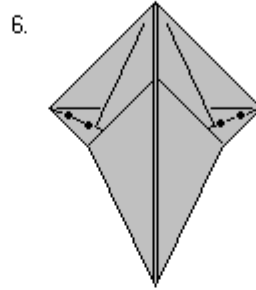

6.

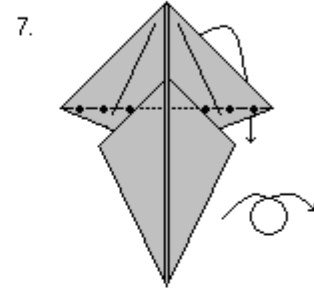

7.

2 rabbit ears

Pull out the 2 flaps

2 mountain folds

Fold back  
Turn over

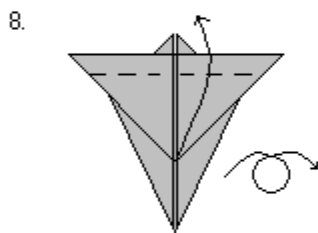

8.

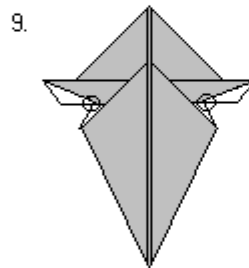

9.

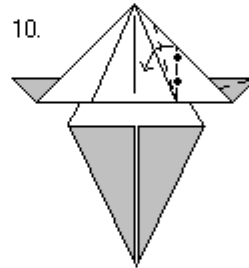

10.

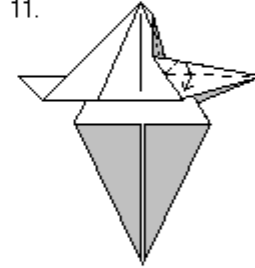

11.

Valley fold. See step 9 for reference points  
Turn over

Turn back over

Swivel

Swivel again

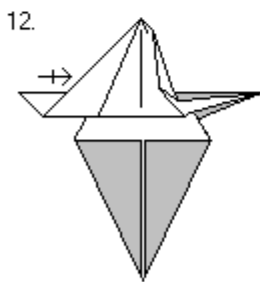

12.

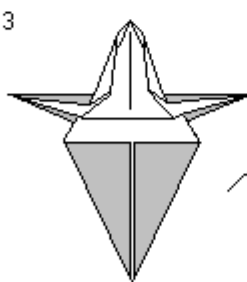

13.

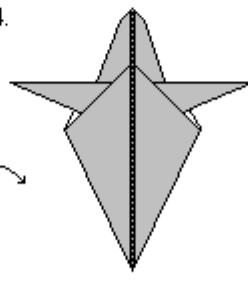

14.

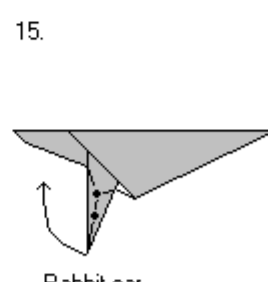

15.

Repeat 10 and 11 on the left side

Turn over

Mountain fold in half and rotate

Rabbit ear  
Repeat behind

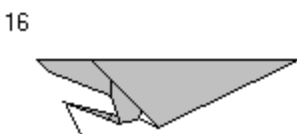

16.

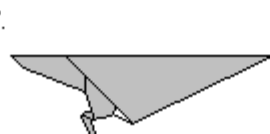

17.

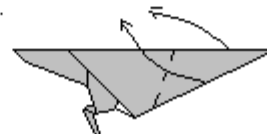

18.

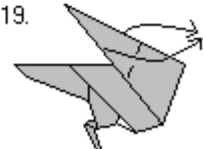

19.

Mountain fold  
Repeat behind

Form the foot  
Repeat behind

Outside reverse fold

Outside reverse fold



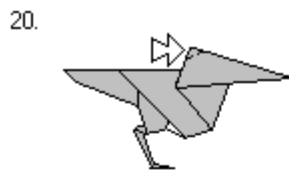

Reverse fold the top of the head



Crimp to form the beak

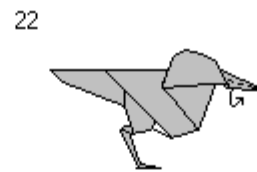

Thin the beak with a mountain fold  
Repeat behind

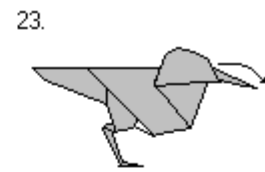

Curve the beak slightly

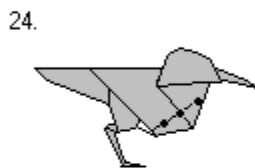

Mountain fold  
Repeat behind

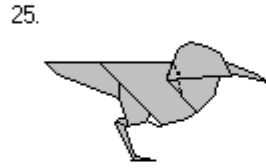

Reverse fold  
Repeat behind

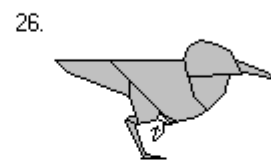

Mountain fold the white part behind  
Repeat behind

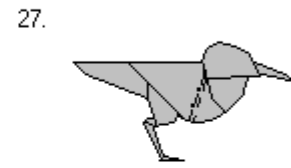

A small pleat to form a wing  
Repeat behind

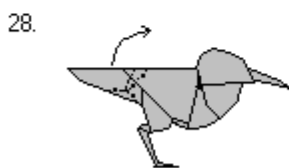

Crimp the tail up

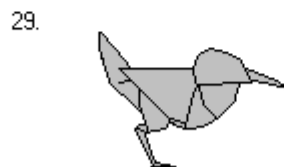

Wren

# \$ Christmas Tree

Copyright 1999 Stephen Hecht. All Rights Reserved

A dollar bill makes a model 65mm wide and 82mm tall.



1. Start black side up. At the left end, mark halfway. At the right end, crease into quarters.

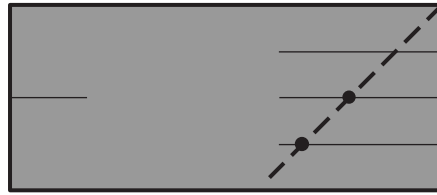

2. Crease angle bisector, sharp only at the intersections noted.

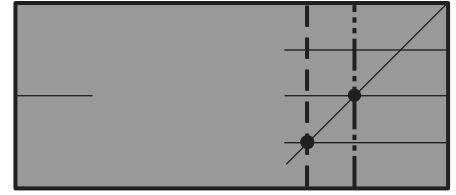

3. Pleat through marked intersections.

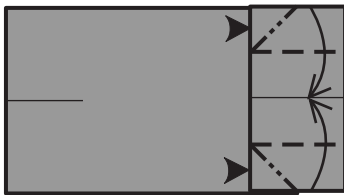

4. Squash-fold. Rotate model a quarter turn.

1/4

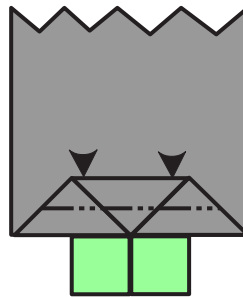

5. Closed-sink halfway.

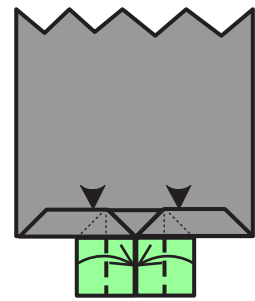

6. Fold to middle. Hidden squashes are necessary.

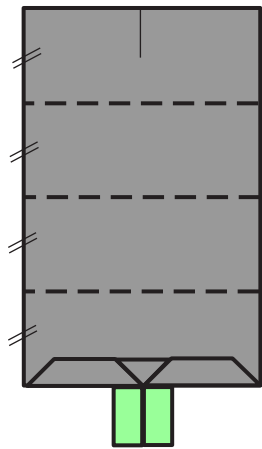

7. Crease at quarters. Turn over.

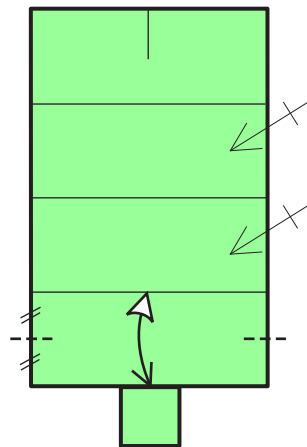
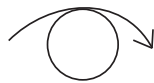

8. Mark halfway. Repeat on next two quarters, but not on the top quarter.

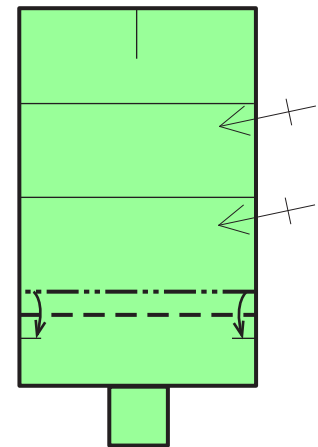

9. Bring existing mountain-creases to the marks, creating a pleat. Repeat on next two quarters, but not the top.

# \$ Christmas Tree (continued)

Copyright 1999 Stephen Hecht. All Rights Reserved

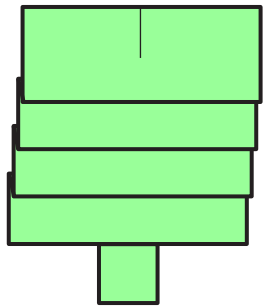

10. Unfold the pleats.  
Turn over.

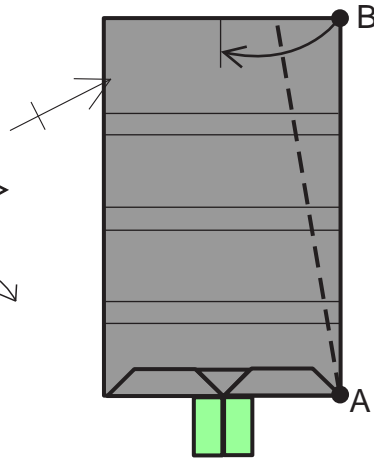

11. Pivot at "A", and bring corner "B" to the center mark. Repeat on the left.

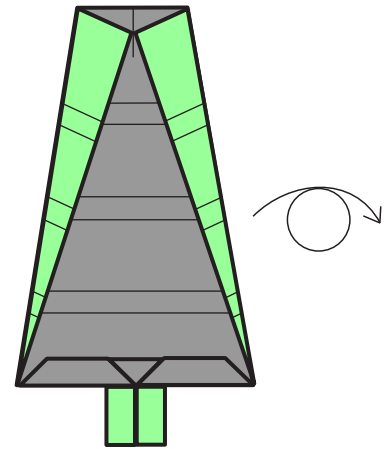

12. Turn over.

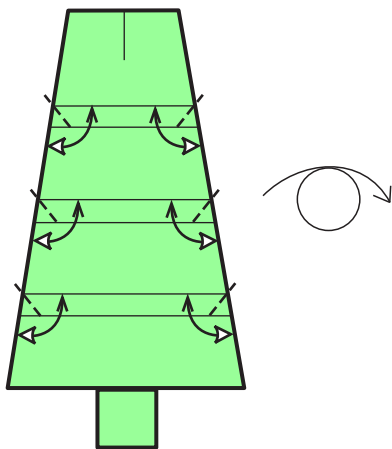

13. Crease angle-bisectors, only between the pleats.  
Turn back over.

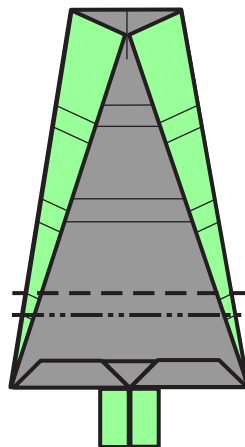

14. Reform lowest pleat through both layers.

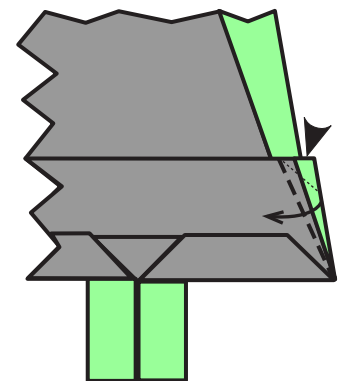

15. Detail of lower-right of model. Squash. The x-ray line is the precrease from step 13.

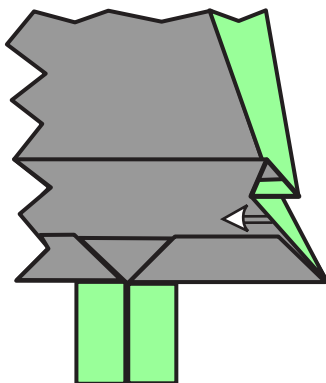

16. Open pleat, unfold upper layer, re-pleat, and re-squash lower layer.

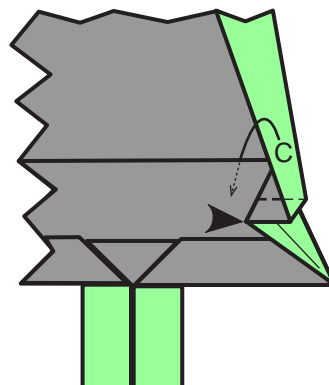

17. Valley-fold where shown, tuck "C" back behind as far as possible, then squash.

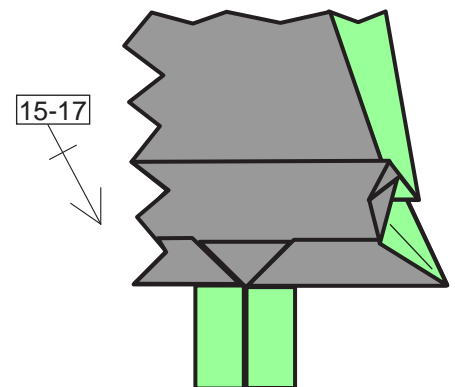

18. Like this. Repeat steps 15-17 at left edge of model.

# \$ Christmas Tree (continued)

Copyright 1999 Stephen Hecht. All Rights Reserved

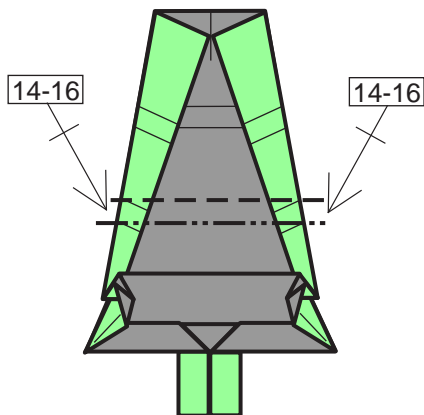

19. Repeat steps 14-16 on the middle pleat, at left and right edge.

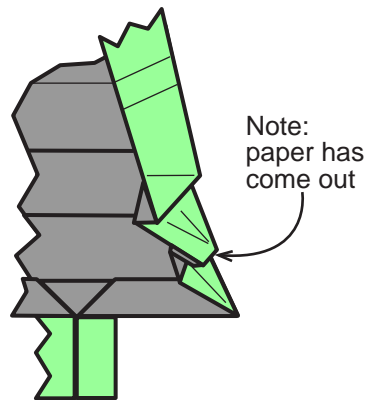

20. This is what the lower-right of the model should look like.

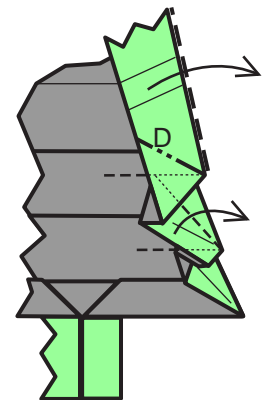

21. Make two interlocked swivel-folds. Mountain-fold "D" is the only new crease.

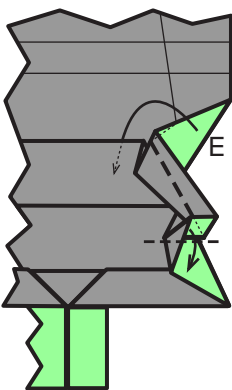

22. Swivel again, tucking "E" behind (as in step 17). Diagonal valley crease is extended to edge.

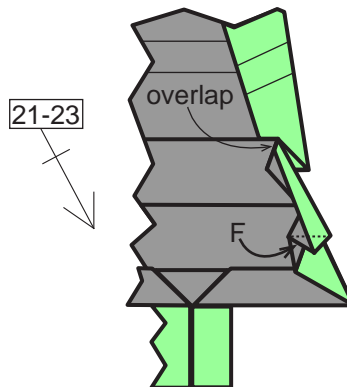

23. Reverse-folding at "F", tucking inside (use tweezers). Repeat steps 21-23 at left edge of model.

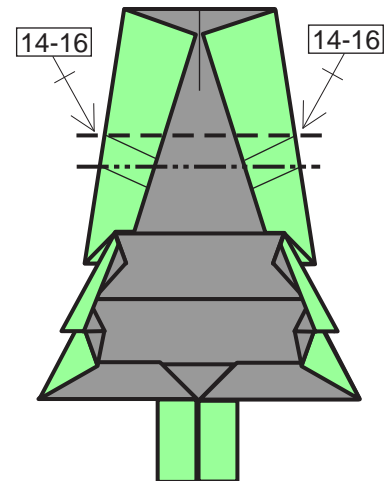

24. Repeat 14-16 on the highest pleat.

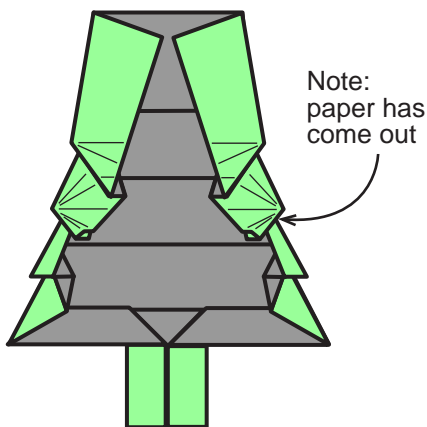

25. This is what the model should look like.

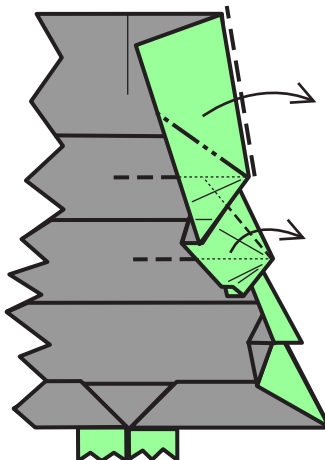

26. Make two interlocked swivel-folds. Similar to step 21.

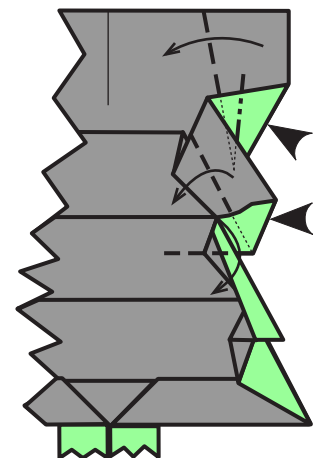

27. Similar to step 22, but don't tuck behind at the top.

# \$ Christmas Tree (continued)

Copyright 1999 Stephen Hecht. All Rights Reserved

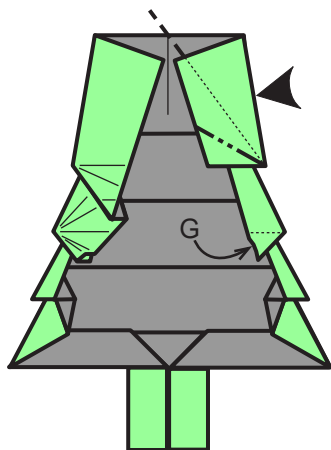

28. Reverse-folding at "G", tucking inside (use tweezers, and it's a tight fit). At the top, squash, shifting paper in top layer.

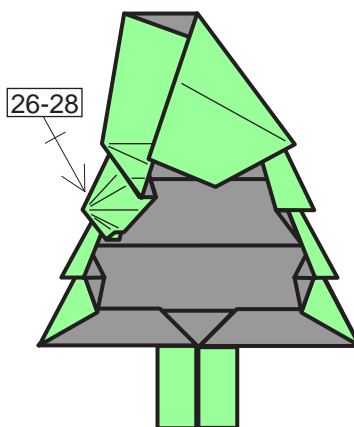

29. Repeat steps 26-28 at left edge of model.

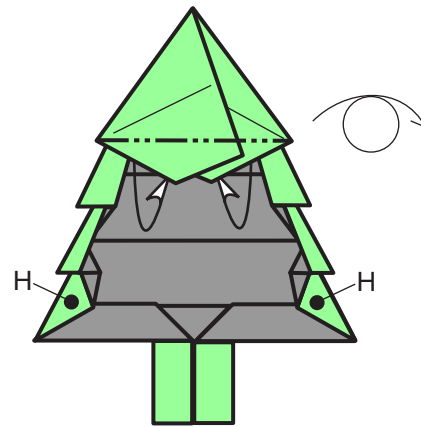

30. Interlock and mountain-fold two layers together, tucking inside. Bring the "H" flaps to front, if they've slipped behind. Turn over.

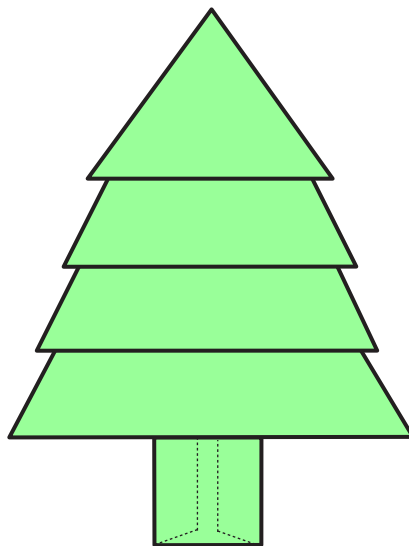

31. Finished. It will stand if you spread the "trunk" flaps a bit.

# Wayne Ko's Chi-Wing Fighter

10" square or larger is recommended

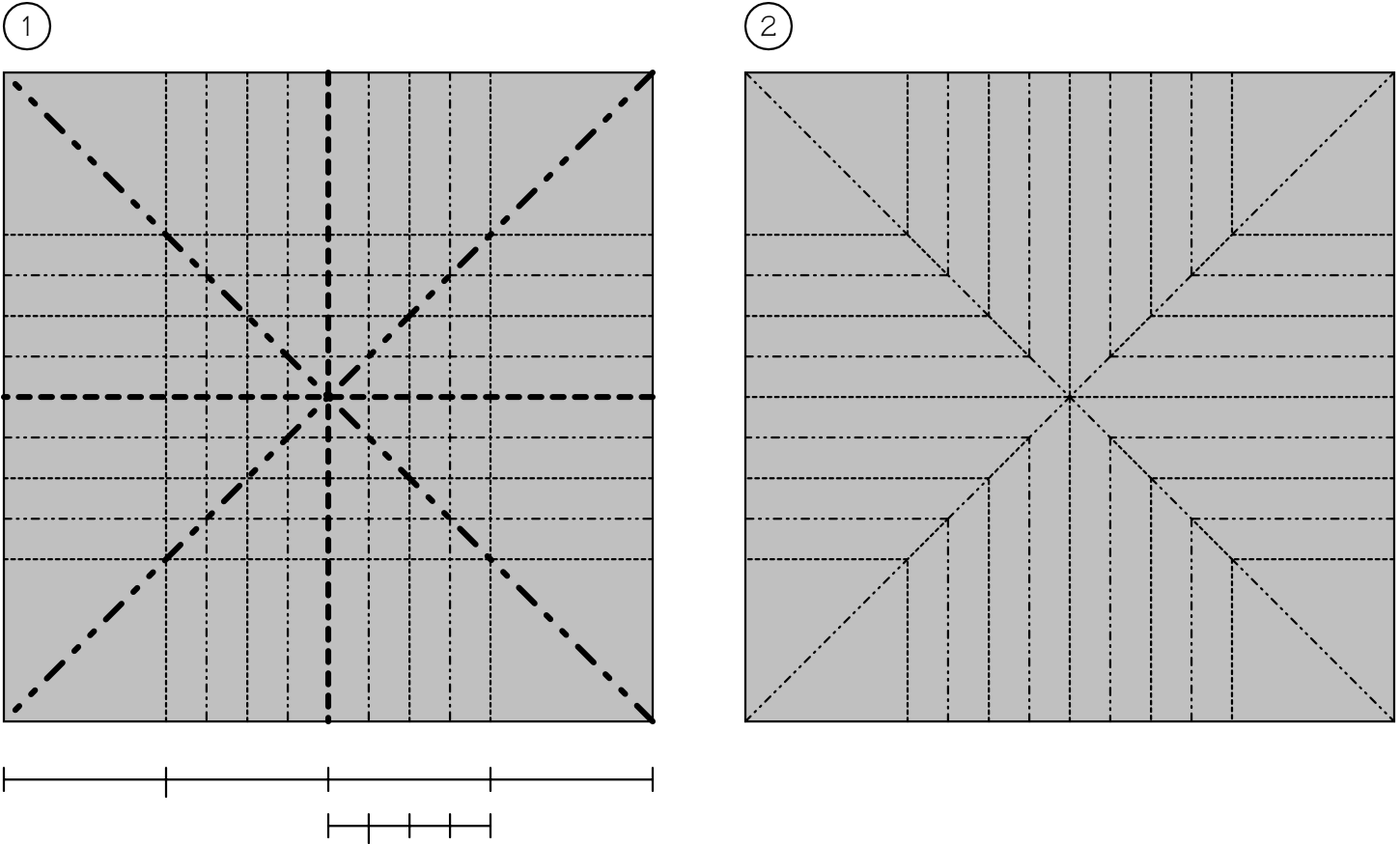

Colour side up. Start with a waterbomb base as indicated by. Fold into quarters, and fold middle sections into 16ths. Notice alternation valley and mountain folds.

No new folds in this diagram. Unnecessary folds have been removed. Reform waterbomb base and do a series of inside and outside reverse folds.

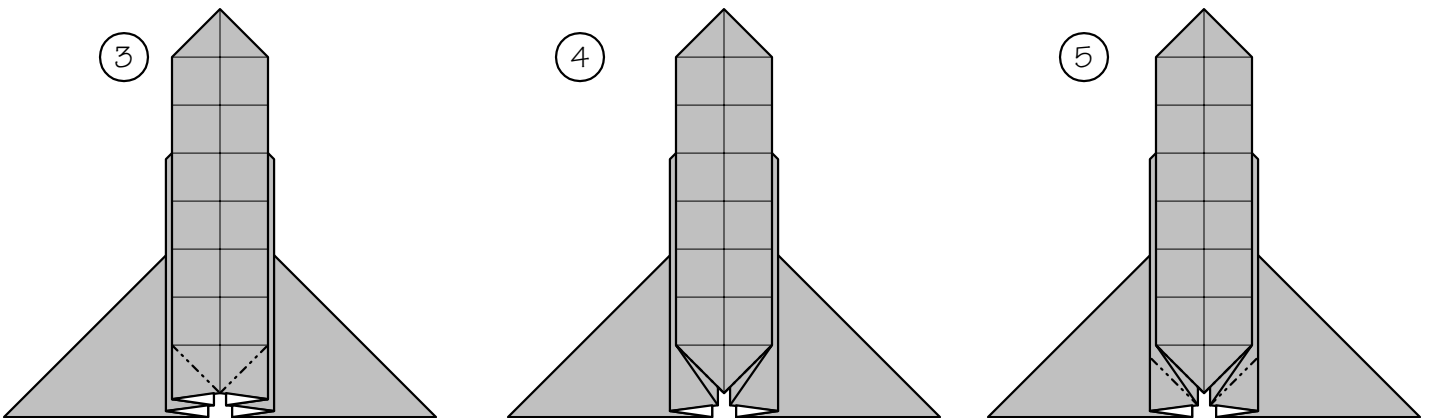

Model should lie flat, features in above diagram have been exaggerated to see features underneath. Fold corners and reverse

Model should now look like this.

With the second layer, fold corners and then reverse

Model: Chi-Wing Fighter	Page 1 of 5
Designer: Wayne Ko	
Diagrammed By: Winson Chan	
email : winson_chan@spectrumsignal.com	
Revision: 1.0	Date: 06/23/98 <sup>®</sup>

6

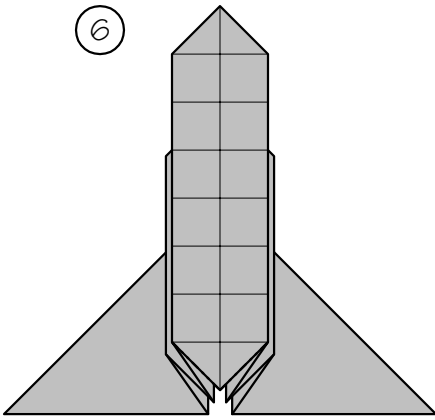

Model should now look like this

7

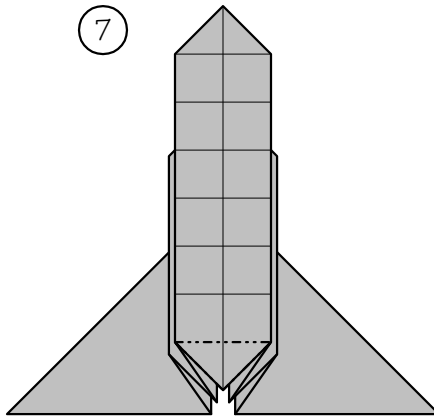

Reverse fold the tip on top layer

8

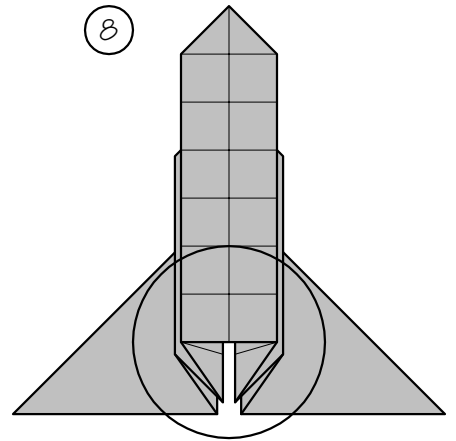

Model should now look like this. Next two steps will be an enlargement of circled area

9

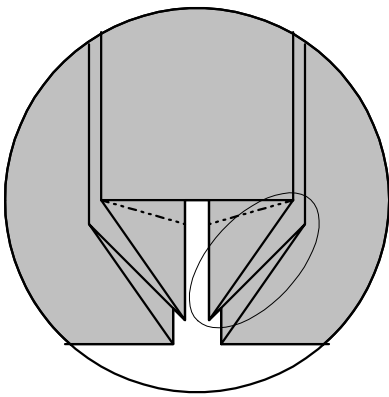

Reverse fold the tip on either side. Notice the valley fold, this edge should remain where it is, do not fold inside

10

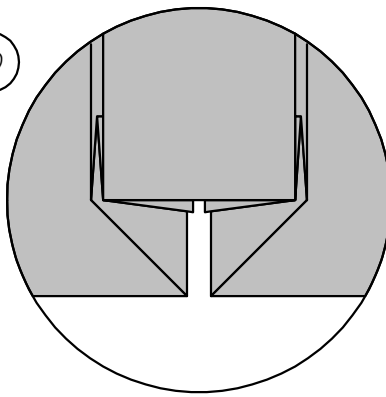

Model should now look like this, notice where the layers end up. Repeat on backside

11

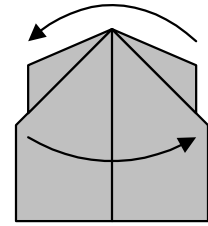

View of the top of the model. Rotate flaps to reveal the sides

12

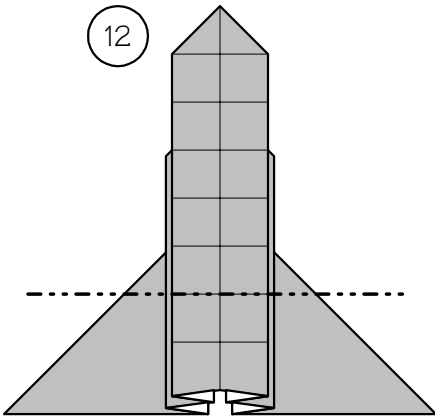

Valley fold half the layers, do this only on one side

13

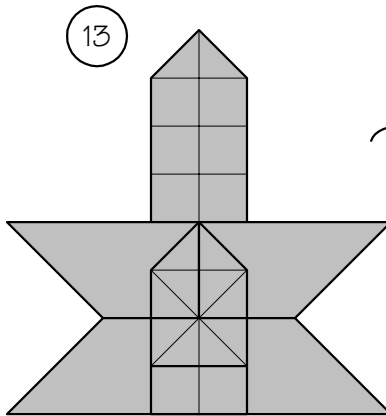

Model should now look like this. Flip model over

14

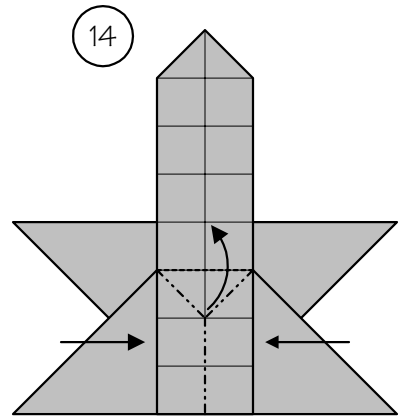

Make mountain and valley creases as shown. Push the sides in so that the top layer of paper as back end of the model rises. Model does not remain flat

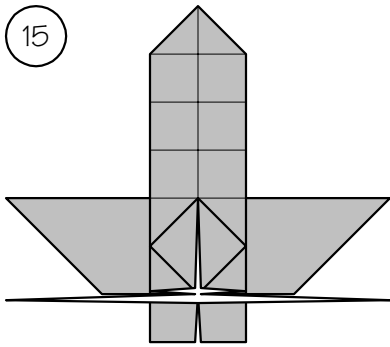

3-D →

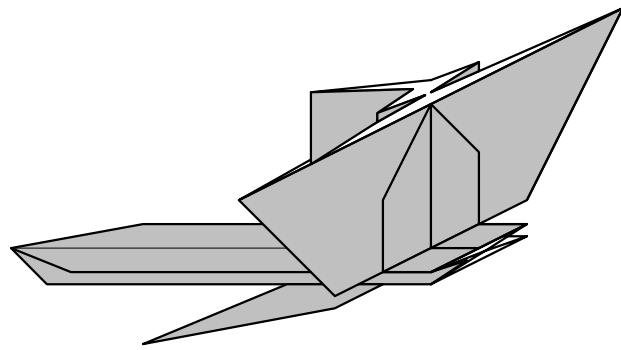

Model should now look like this. A 3-D view is shown on the right, and a side view in step 16

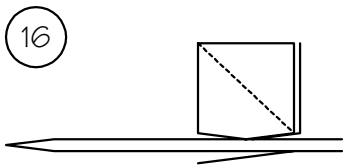

Side view. Flatten wing by folding along crease indicated

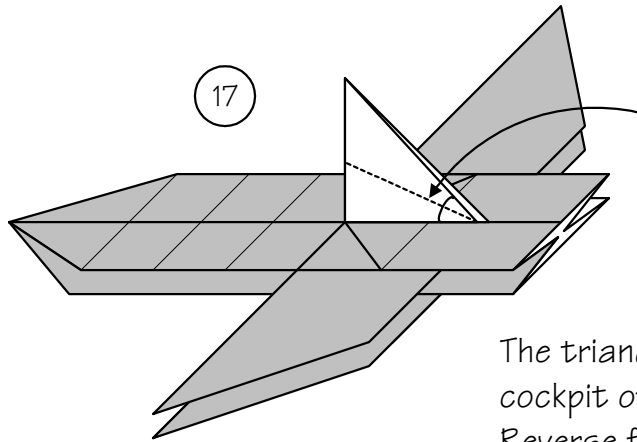

bisect 45 degree angle

The triangle forms the cockpit of the X-wing. Reverse fold along line indicated

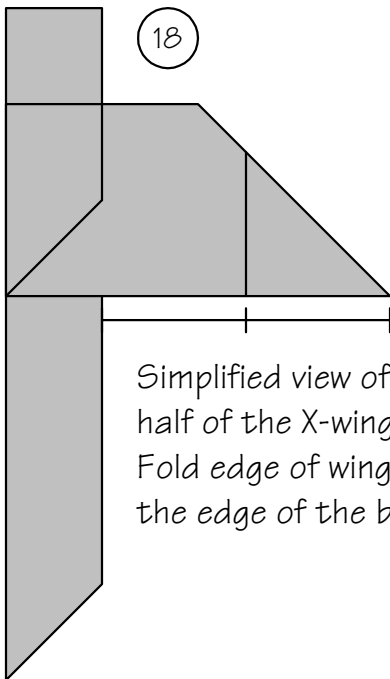

Simplified view of half of the X-wing. Fold edge of wing to the edge of the body

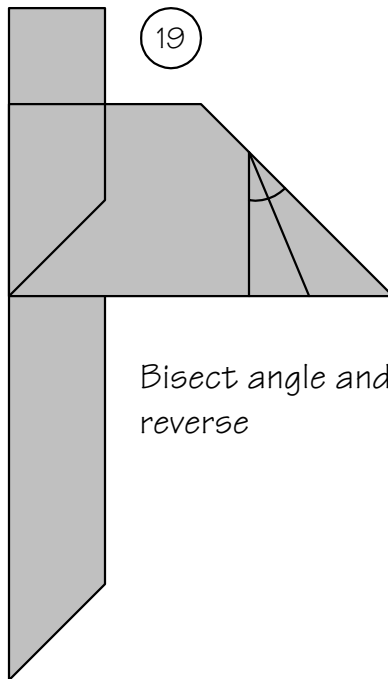

Bisect angle and reverse

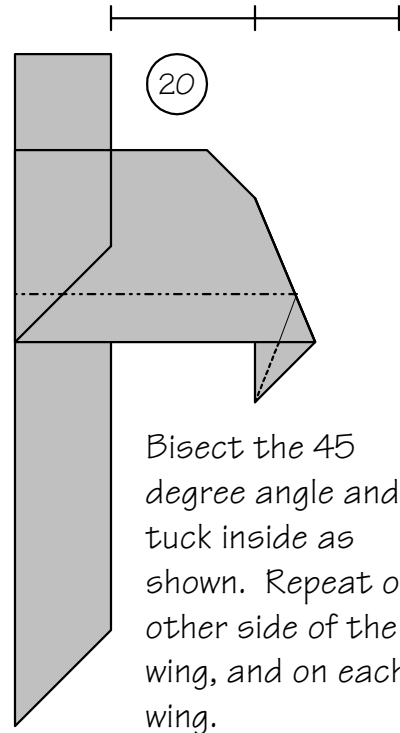

Bisect the 45 degree angle and tuck inside as shown. Repeat on other side of the wing, and on each wing.



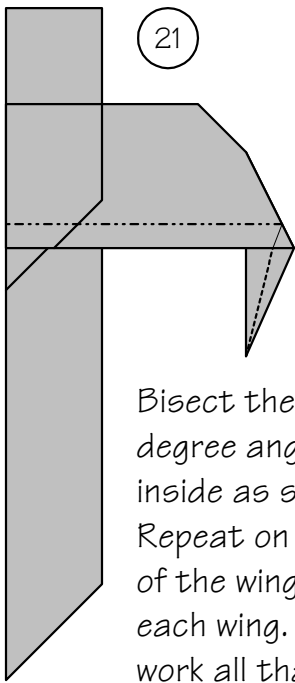

21  
 Bisect the 22.5 degree angle and tuck inside as shown. Repeat on other side of the wing and on each wing. I'm doesn't work all that well, scrunching the paper a bit might be needed

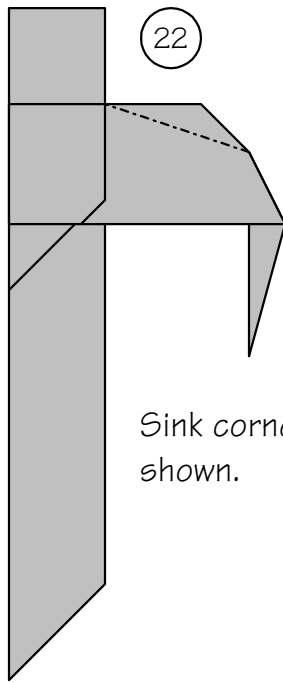

22  
 Sink corner as shown.

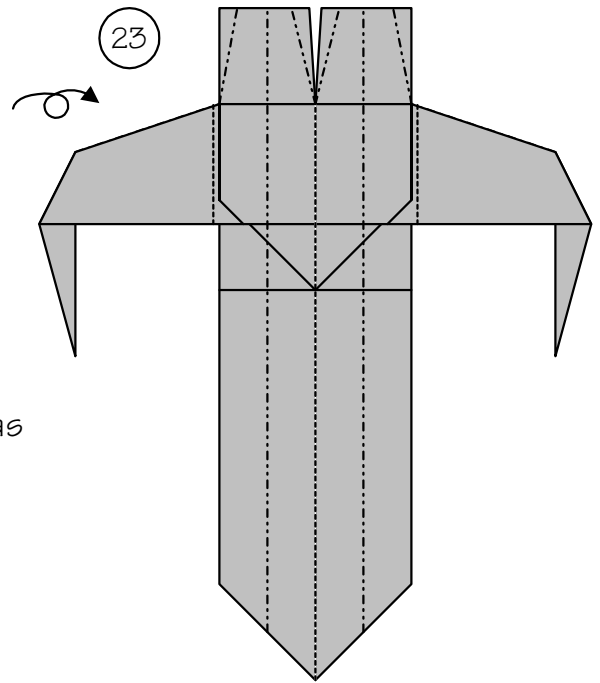

23  
 Flip model over, you are now looking at the bottom of the x-wing. Fold each side of the body in half. The section near the tip is a reverse fold, while the section near the top forms a right angle. Valley fold the wings to form right angle. Shape engines as shown. See next step for side view

24

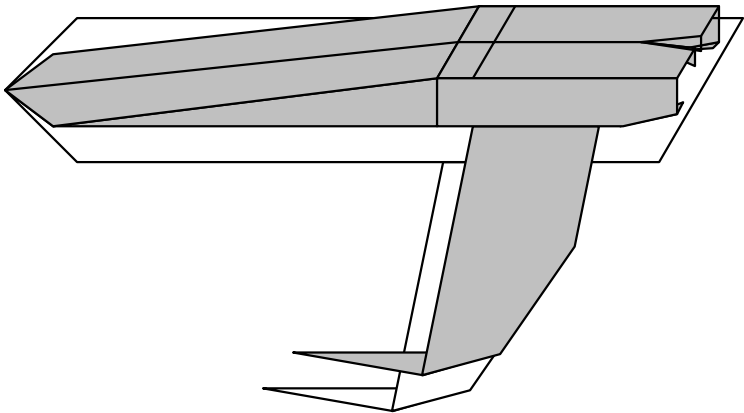

The diagram is not to scale and the perspective is wrong, but I think you get the idea. The entire model should be the coloured side, but the diagram shows only the bottom as grey.

Model: Chi-Wing Fighter	Page 4 of 5
Designer: Wayne Ko	
Diagrammed By: Winson Chan	
email : winson_chan@spectrumsignal.com	
Revision: 1.0	Date: 06/23/98®

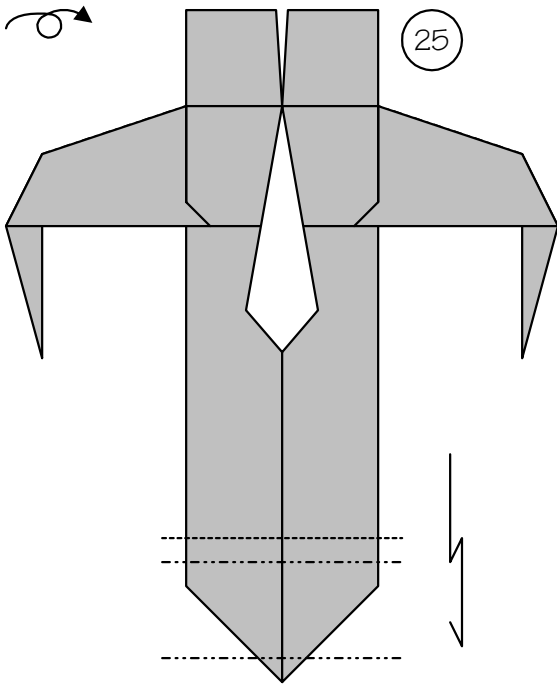

Unfold the top layer and flatten the tip. Make the crimp as indicated

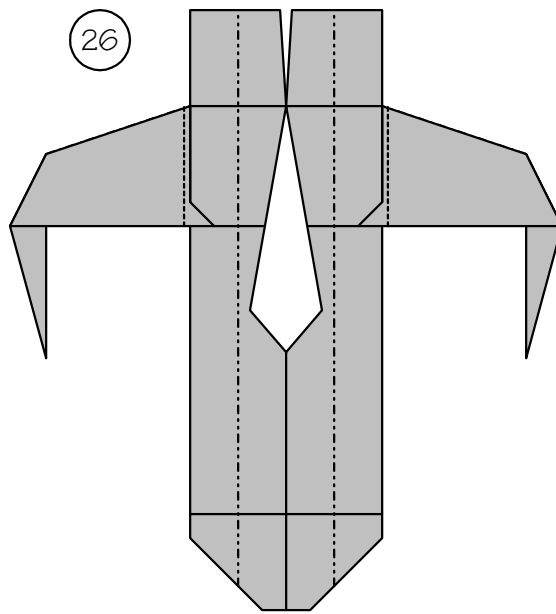

Fold each side of the body in half, shape the engines by folding each corner down. Valley fold the base of each wing. Model does not remain flat.

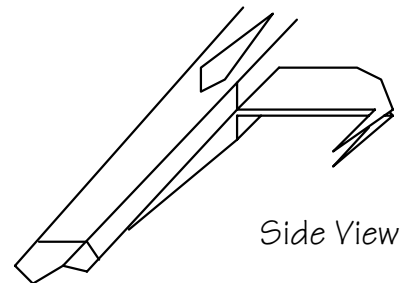
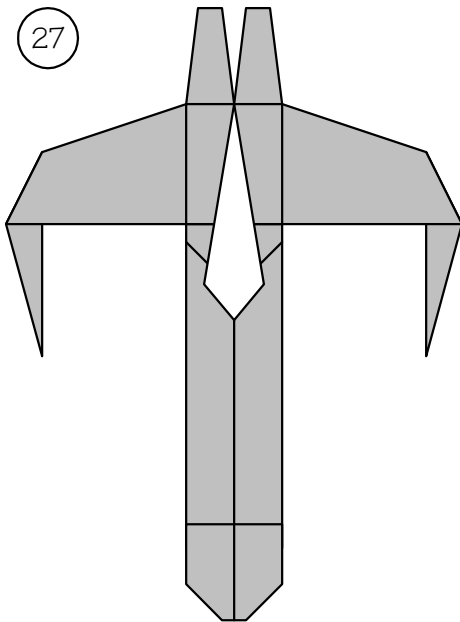
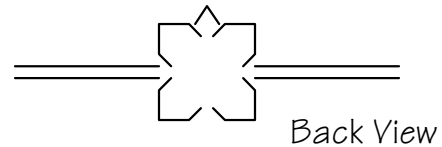

If you have any questions or comments about the diagrams email me. Remember, this is rev 1.0 of the diagrams so don't be surprised if there are some mistakes. Feel free to make copies of these diagrams and share with everyone. Don't forget, origami should be shared and given away, so make something nice and give it to someone you know or someone you don't, it may make their day. Happy Folding!

Model is now complete. Notice side and back views

Model: Chi-Wing Fighter	Page 5 of 5
Designer: Wayne Ko	
Diagrammed By: Winson Chan	
email : winson_chan@spectrumsignal.com	
Revision: 1.0	Date: 06/23/98®

# Tai-Chi Symbol

Designed in 7/95 and diagrammed in 11/98 ~ 12/98  
10 cm square produces 5 cm wide model

© 1998 Sy Chen

1. Start from duo-color square with either side up

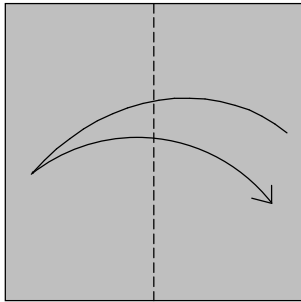

2.

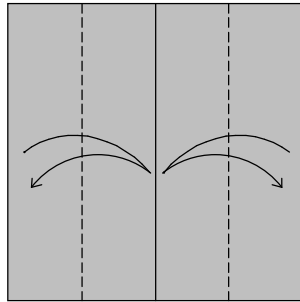

3.

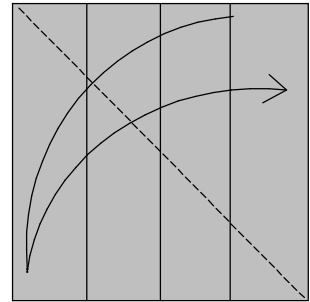

4. Pleat corners; Use diagonal crease as guide to align

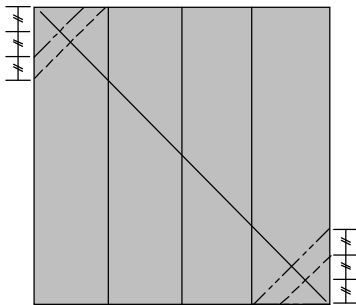

5.

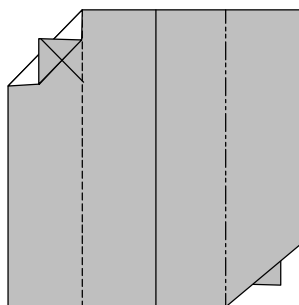

6.

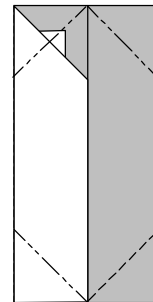

7.

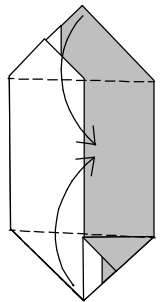

8. Enlarged; Pull out upper hidden corner; Pull out lower outside corner

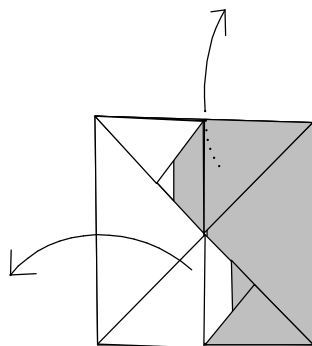

9.

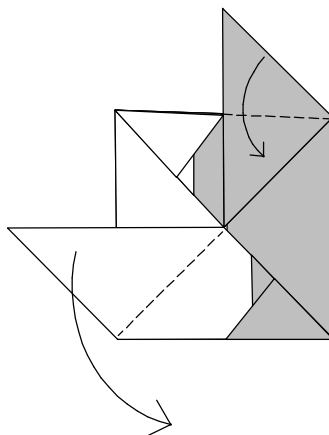

10.

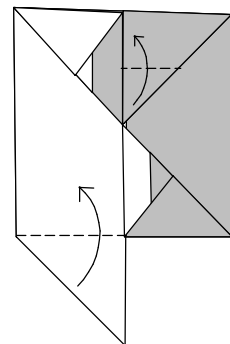

11. Fold 4 corners to form octagon shape

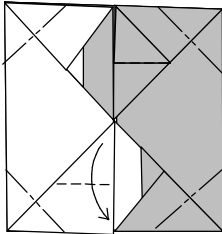

12. Squash

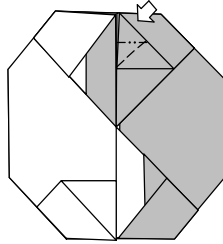

13.

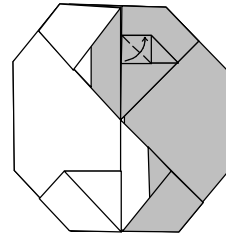

14.

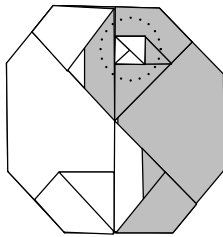

15. Focus view; Mountain fold 4 corners to form octagon shape

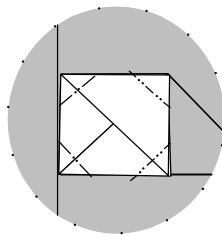

16. Finished small octagon

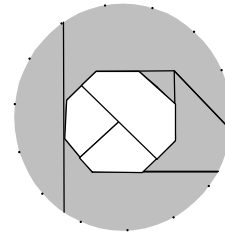

17. Repeat 12-16 for lower triangular flap

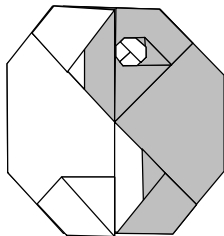

18. Finished

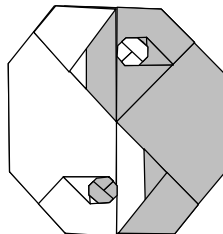

A *yuan bao* is a small metal ingot that was used in ancient China as money. Most of them were of silver, but gold ones did exist. Start with a 5 by 4 rectangle of gold foil. A 15 by 12 cm (6 by 4.8 inches) rectangle results in a model that is roughly life sized.

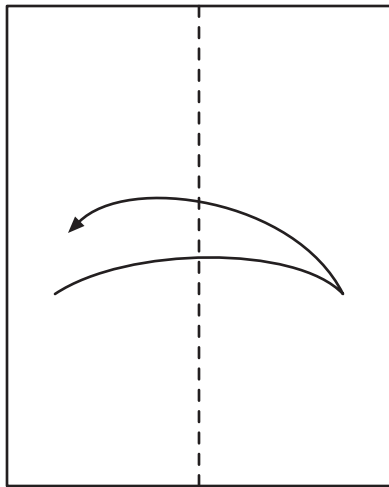

1. Fold and unfold.

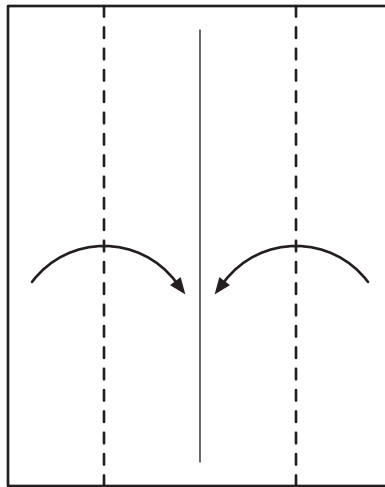

2. Fold two edges to the middle.

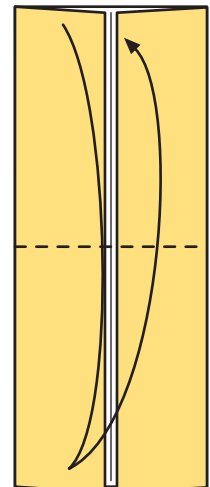

3. Fold and unfold.

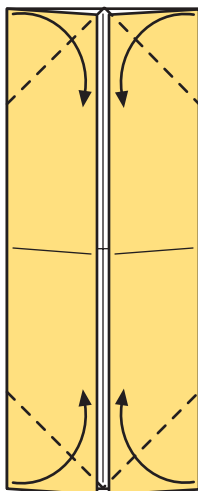

4. Fold the corners.

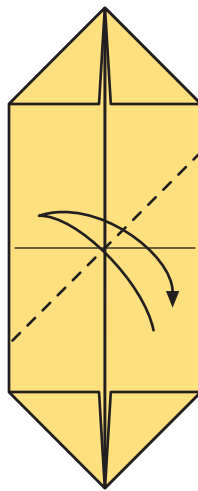

5. Fold and unfold.

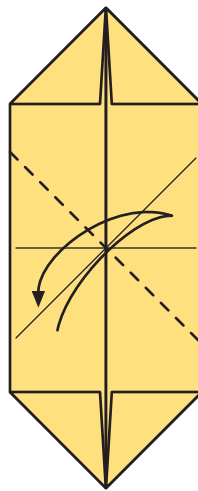

6. Fold and unfold.

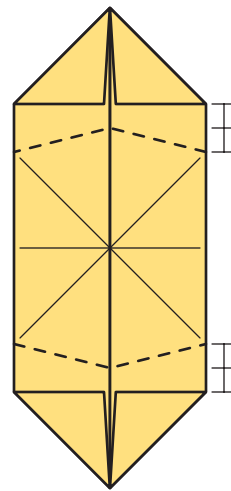

7. Fold and unfold these four creases.

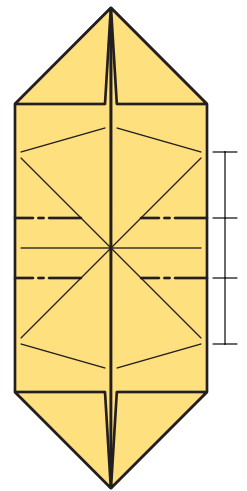

8. Fold and unfold into thirds in the marked areas only.

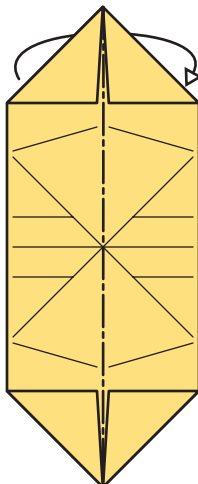

9. Fold half of the model behind.

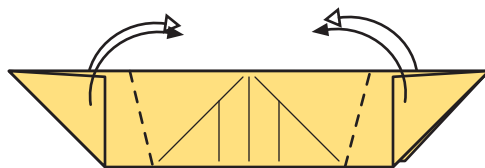

10. Outside reverse fold the ends along the creases made in step 7.

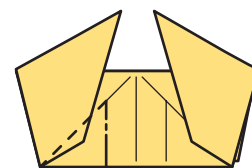

11. Crimp the middle layers along the existing creases, tucking under the outside layers. The model will not lie flat, and the centre will begin to form a rounded dome shape.

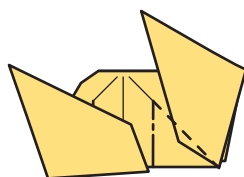

12. Repeat on the other side.



**13. Yuan bao complete.**

1.

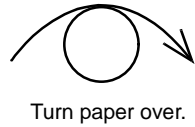
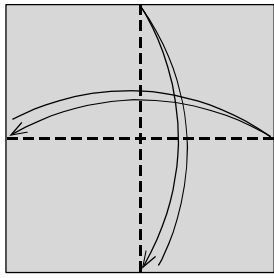

2.

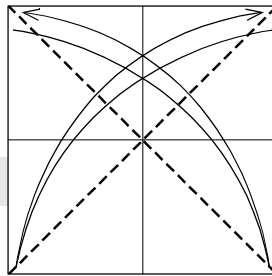

3.

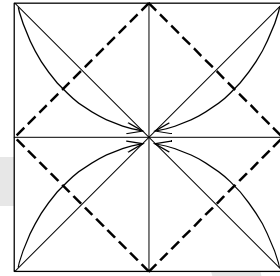

6.

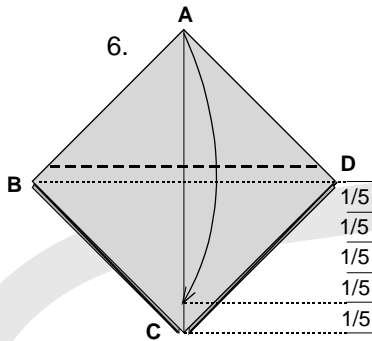

Hold all layers firmly in position and fold corner A down as shown, about 1/5th of the distance between line BD and corner C.

5.

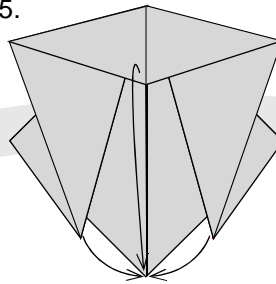

4.

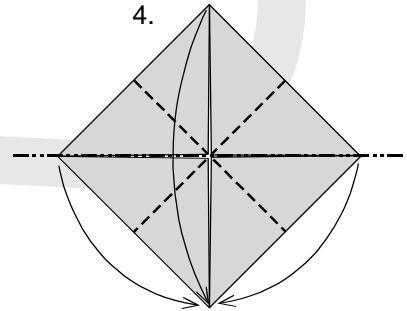

7.

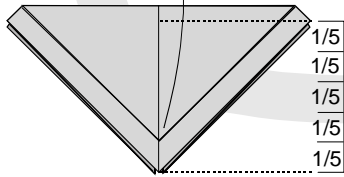

Crease firmly through all layers and unfold.

8.

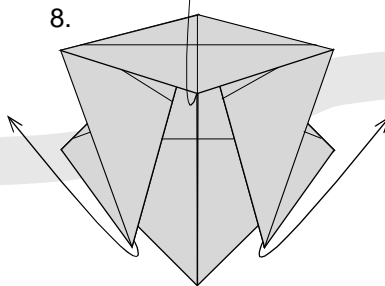

Unfold to position at start of Step 4, ...

9.

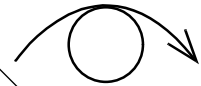
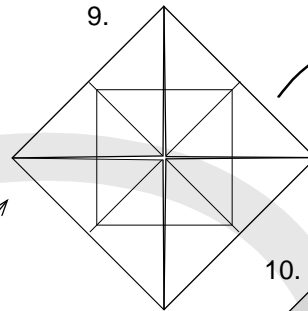

... then turn paper over

10.

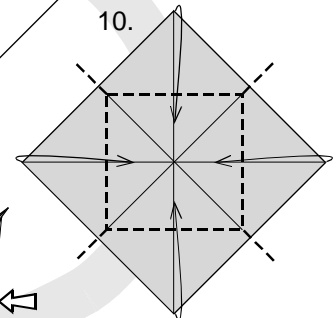

Bring each of the four corners to a verticle position, along the crease lines made in Steps 6 & 7.

13.

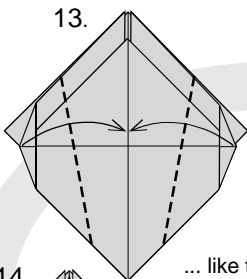

... like this.

12.

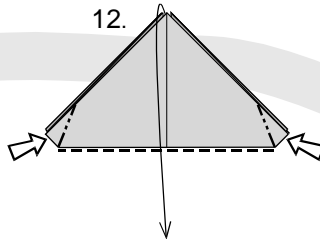

Fold one layer all the way down, drawing the corners in at the same time to form a neat triangle on each side, ...

11.

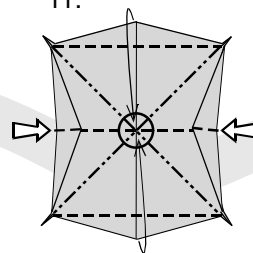

Now push the each side to the middle to bring the circled point in the centre towards you.

14.

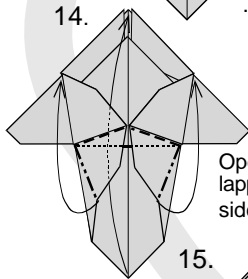

Open out the overlapping layer on each side as you fold up.

15.

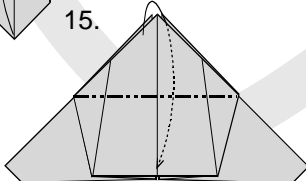

Fold the triangular piece into the pocket immediately behind, then repeat from Step 12 at the back.

16.

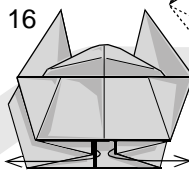

Open out to form a hollowed square at the bottom.

17.

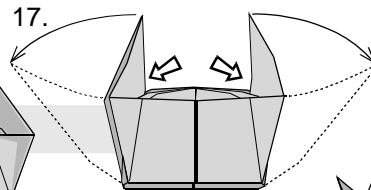

Push the upright flaps outwards.

Finally, adjust the shape of the yuanbao until it looks like this.

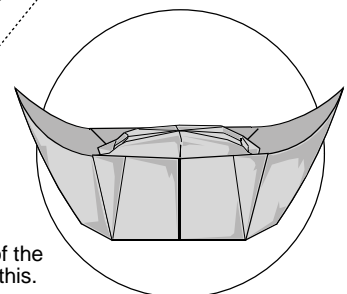

# Unicorn from Zog

By Hans Birkeland (Norway) © 1993

Model : 92.11.29

Diagrams : 93.04.22

Try paperbacked foil with the colours black & gold or green & gold.  
A 15 cm square will produce a finished model about 7.5 cm long.  
Begin with the golden side up.

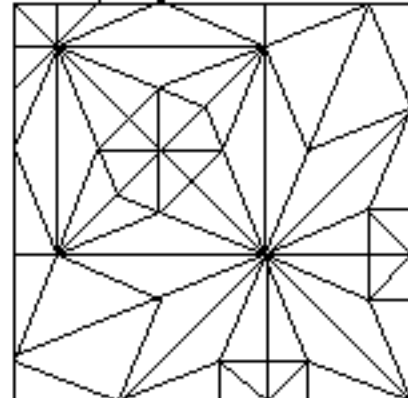

1

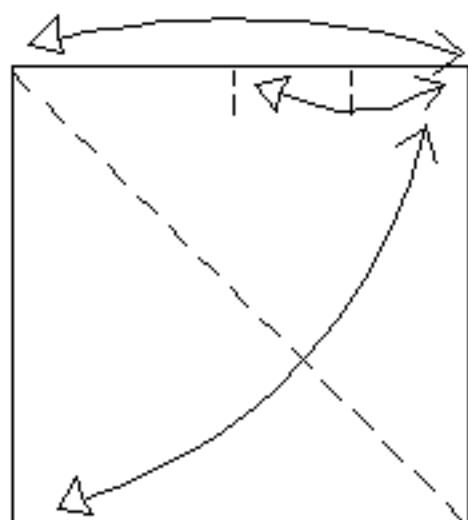

Fold and unfold.

2

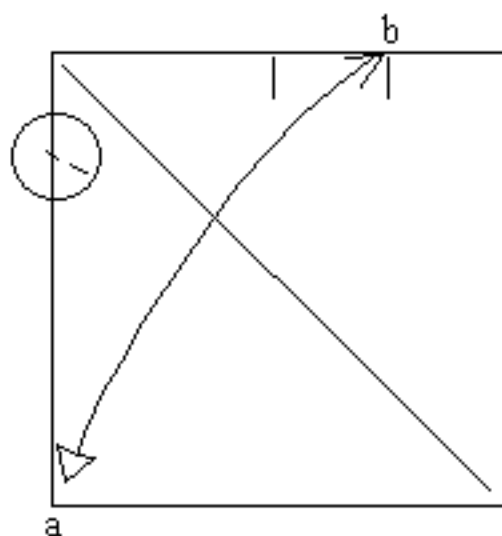

Fold corner a to mark b and unfold, making a mark at the left edge.

3

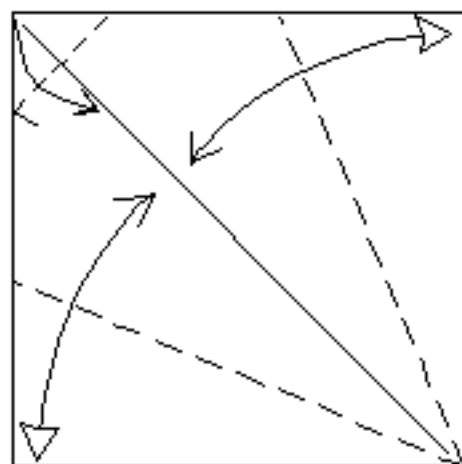

4

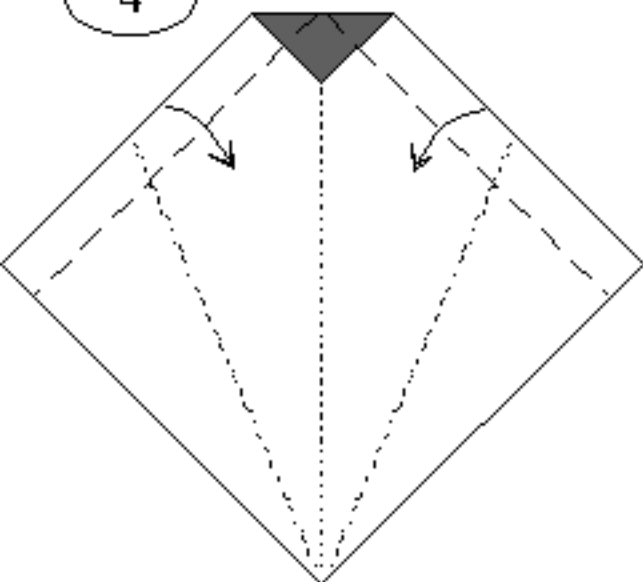

5

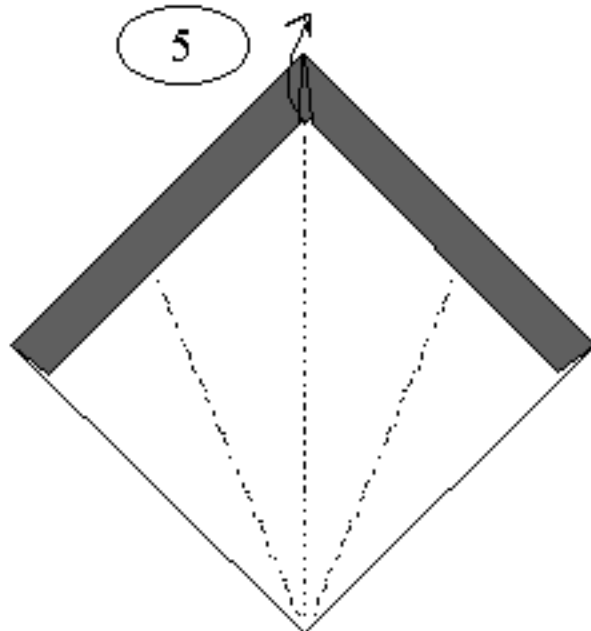

Pull out the hidden paper and reassemble it.

6

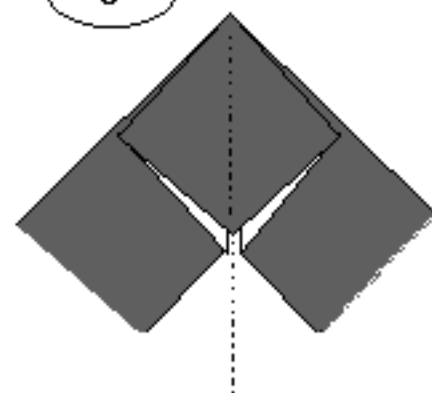

Enlarged view.

7

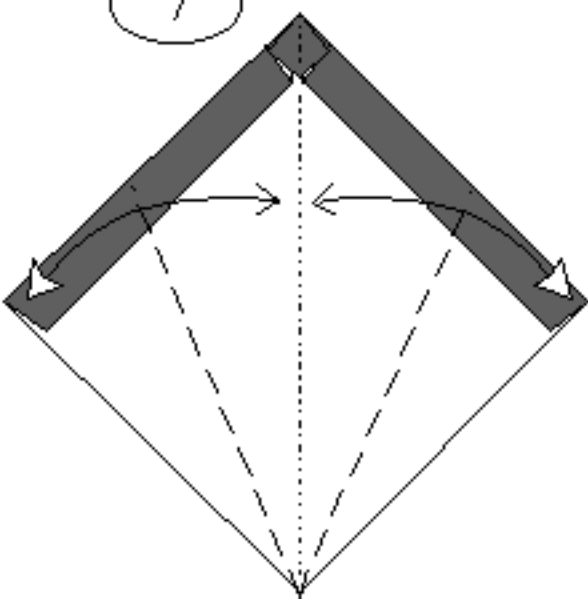

8

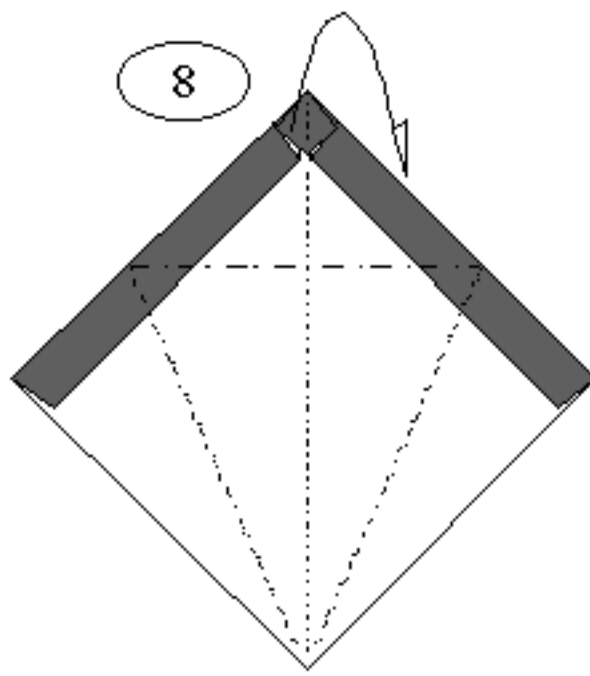

9

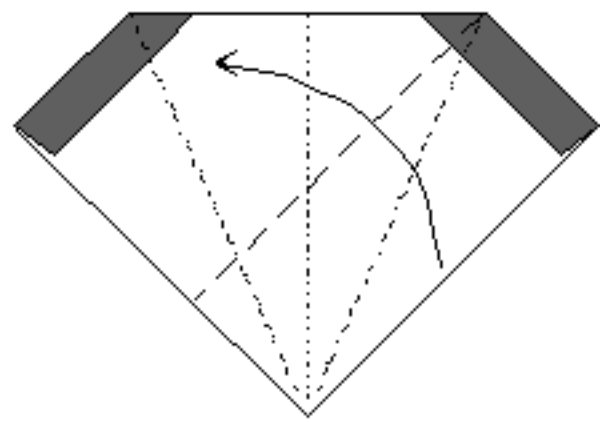

10

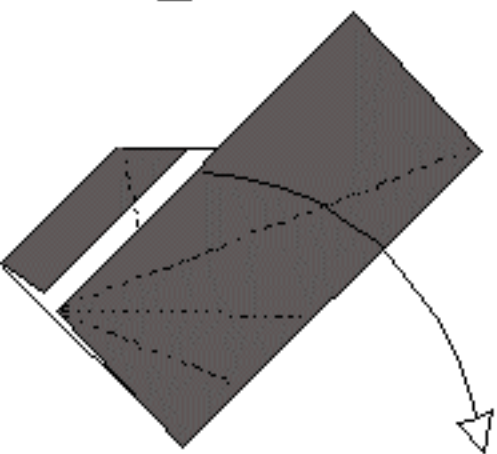

11

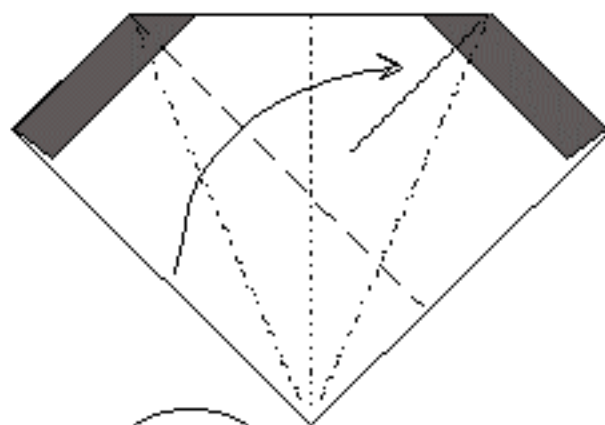

12

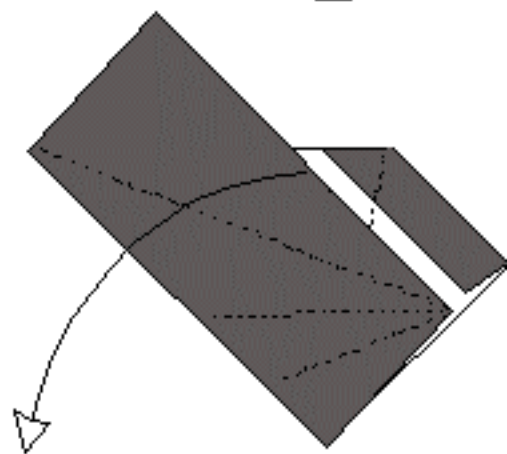

13

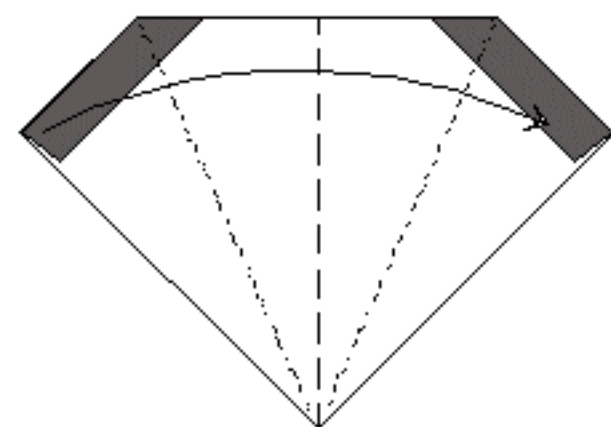

14

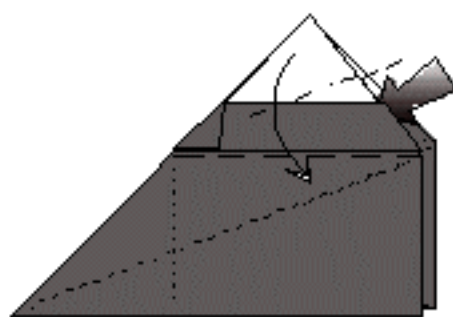

15

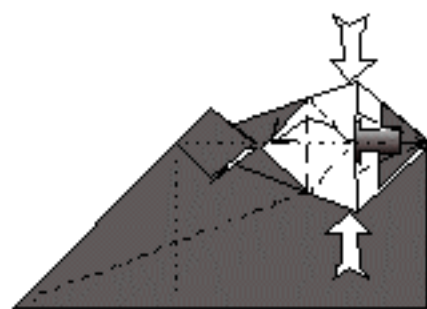

Squash-fold.

Petal-fold.

16

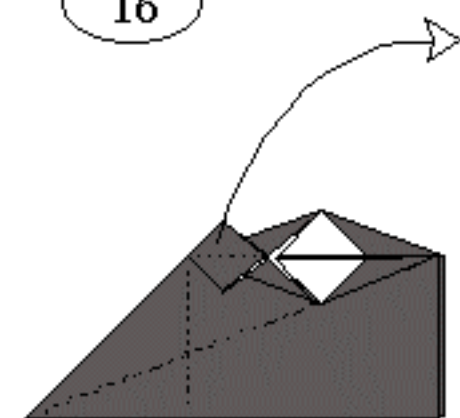

17

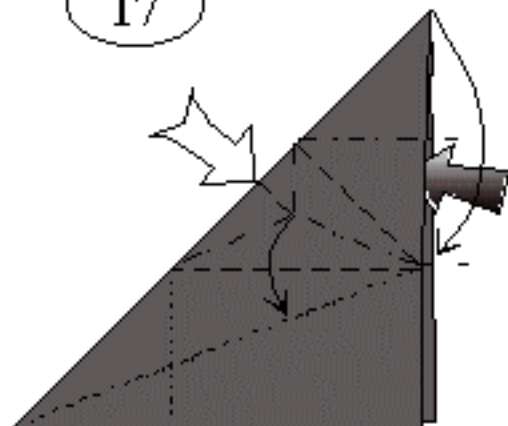

18

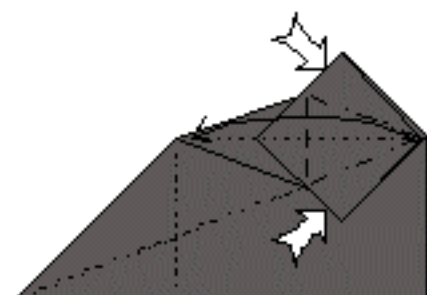

Unfold.

Collapse symmetrically  
on old creases.

Petal fold.

19

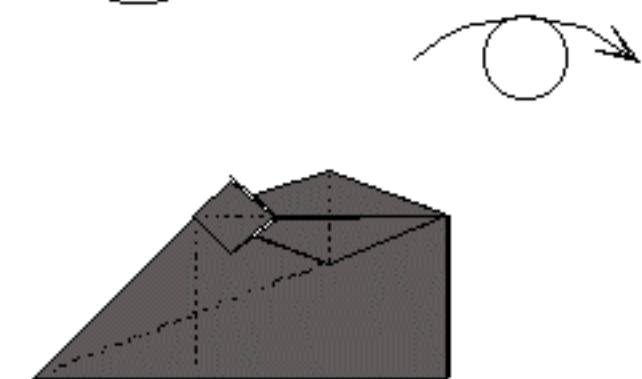

20

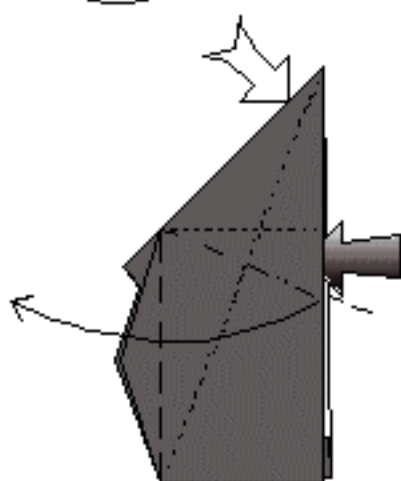

21

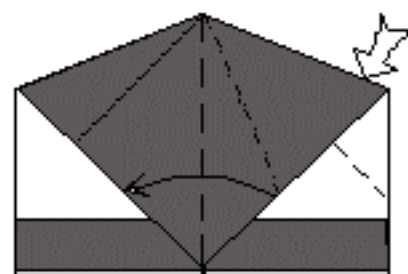

Swivel-fold.



22

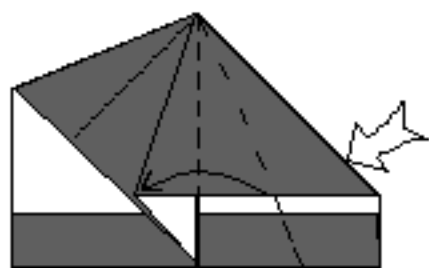

Swivel-fold.

23

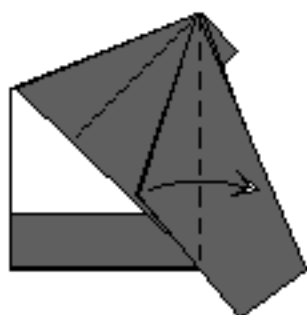

Book-fold one layer.

24

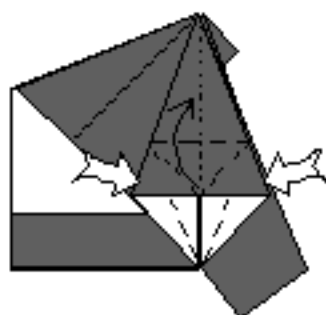

Petal-fold and fold the little triangle down.

25

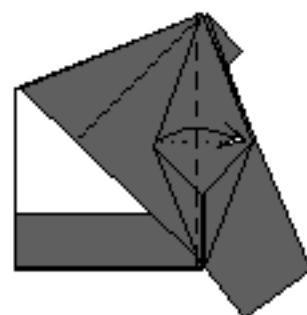

Book-fold one layer.

26

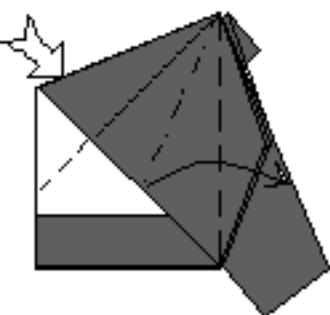

Repeat steps 21-25 on this side.

27

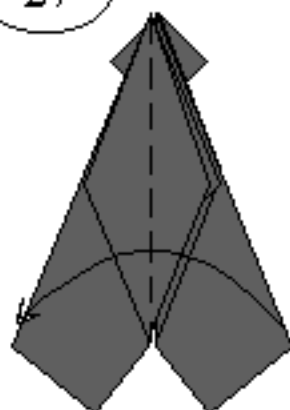

Valley-fold in half.

28

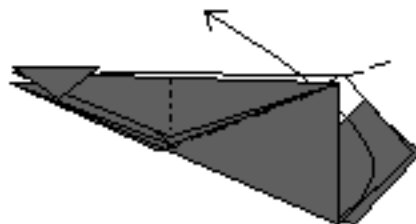

Reverse-fold the nearest flap.

29

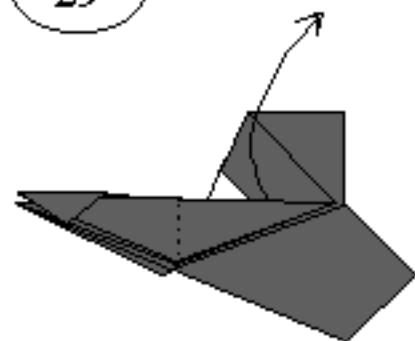

Pull out some trapped paper and rearrange the reverse-fold. This may be a bit difficult.

30

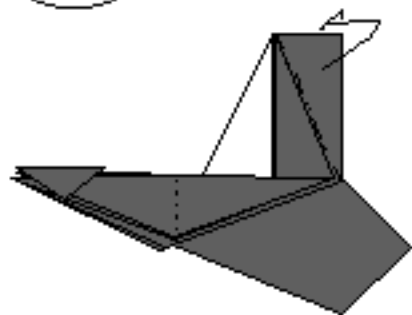

31

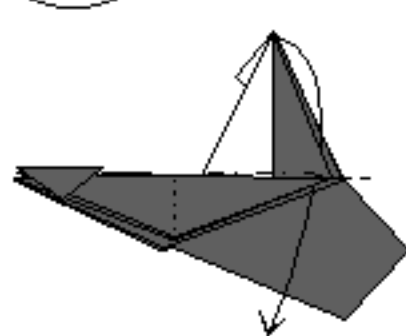

Reverse-fold.

32

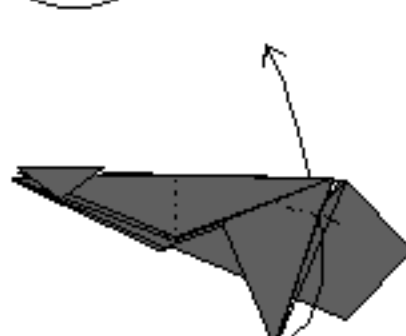

Reverse-fold.

33

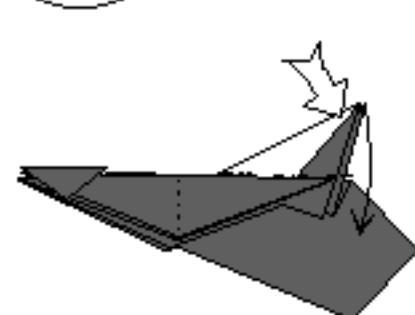

Reverse-fold.

34

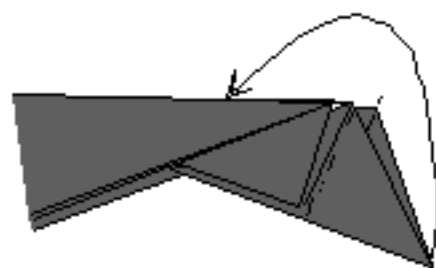

Reverse-fold.

35

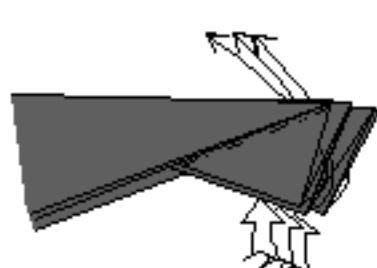

Reverse-fold three times.

36

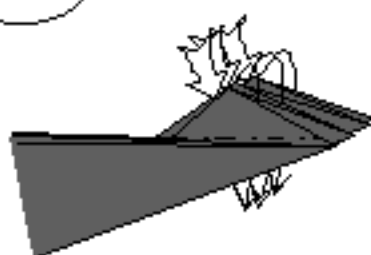

Reverse-fold three times.

37

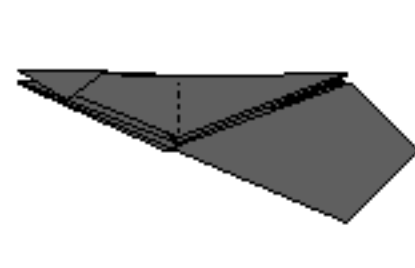

Repeat steps 28-36 on the other leg.

38

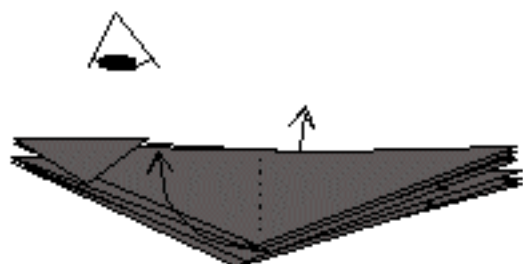

Open flat.

39

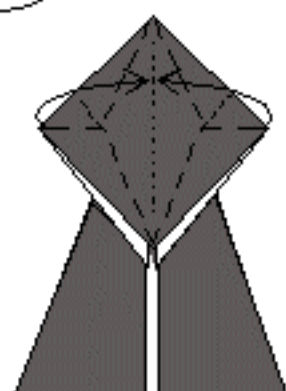

Fold a fish base.

40

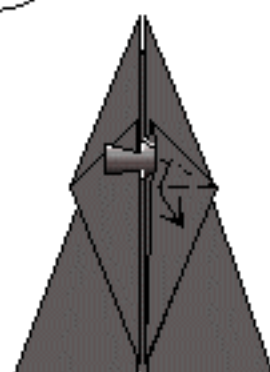

Squash. (open between the nearest layers to get colour-changed eyes)

41

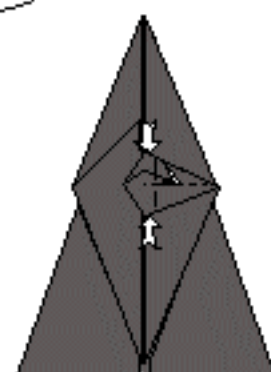

Petal-fold the eye, but let it be 3-dimensional.

42

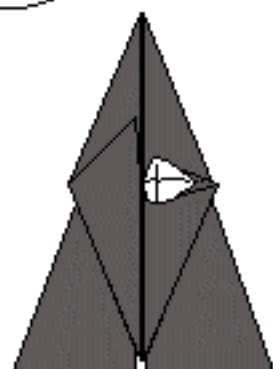

Repeat steps 40-41 on the left eye.

43

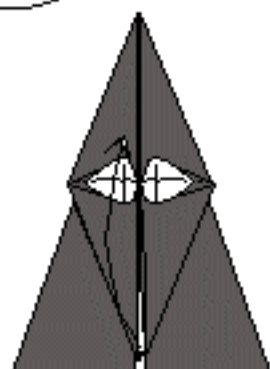

Pull out the horn from between the layers.

44

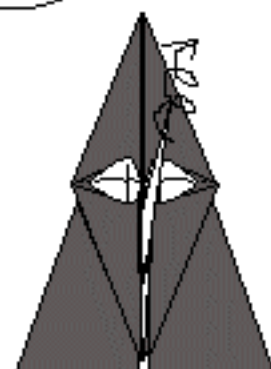

Twist the horn round and round.

45

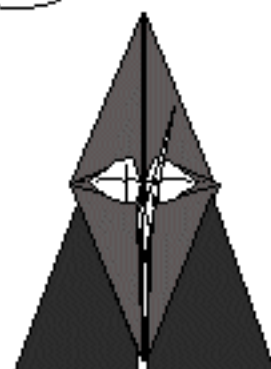

Place the dark edges on top of the nearest edges, but let the eyes be free.

46

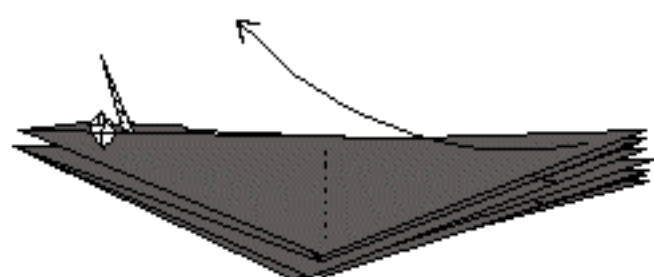

Lift the nearest leg.

47

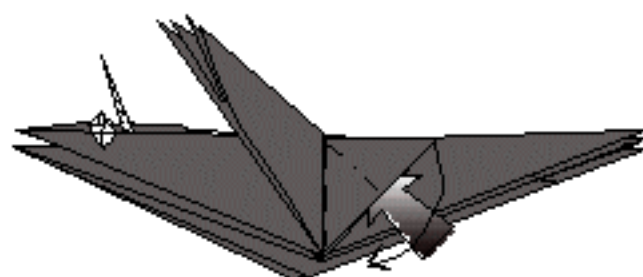

Squash.

48

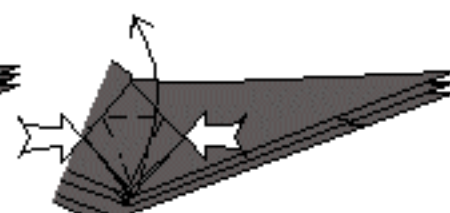

Petal-fold and fold the left side of the petal-fold to the right.

49

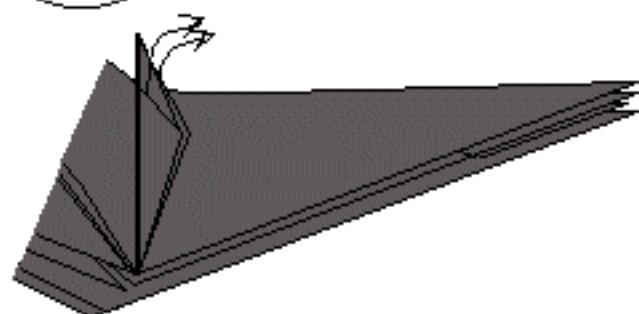

Pull out the trapped paper on each side.

50

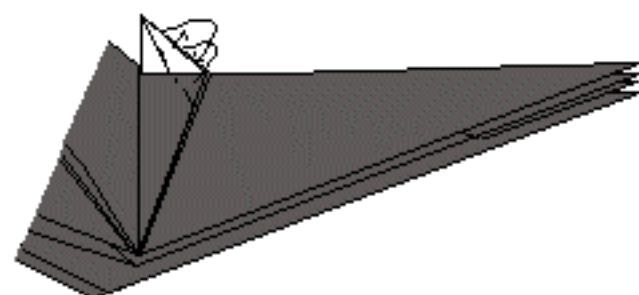

Fold the edges inside the little spine. Release the leg and repeat steps 46-50 behind.

51

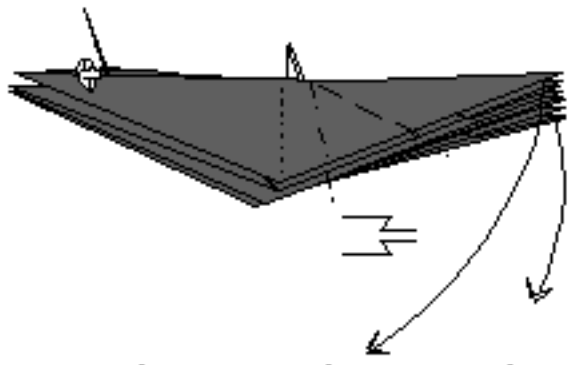

Open between the second and third layer and crimp the nearest leg symmetrically. Repeat behind.

52

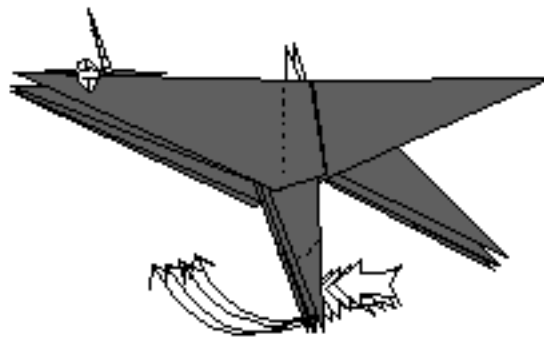

Reverse-fold the 4 toes on each foot to the left. Repeat on the other leg.

53

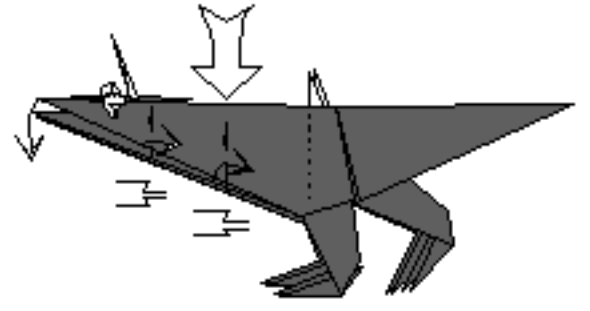

Crimp symmetrically. The neck is rounded.

54

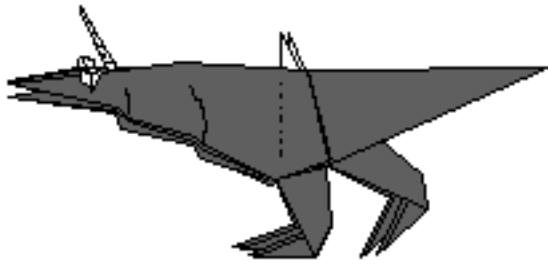

Like this. If you want, you can round the neck a bit more.

55

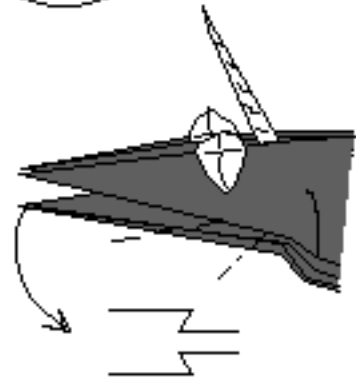

Crimp symmetrically.

56

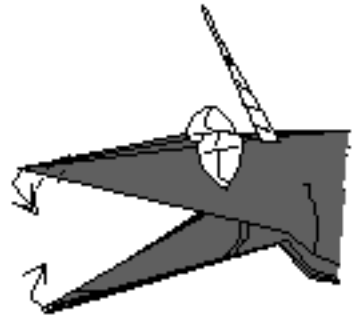

Crimp the upper jaw and outside-reverse-fold the lower.

57

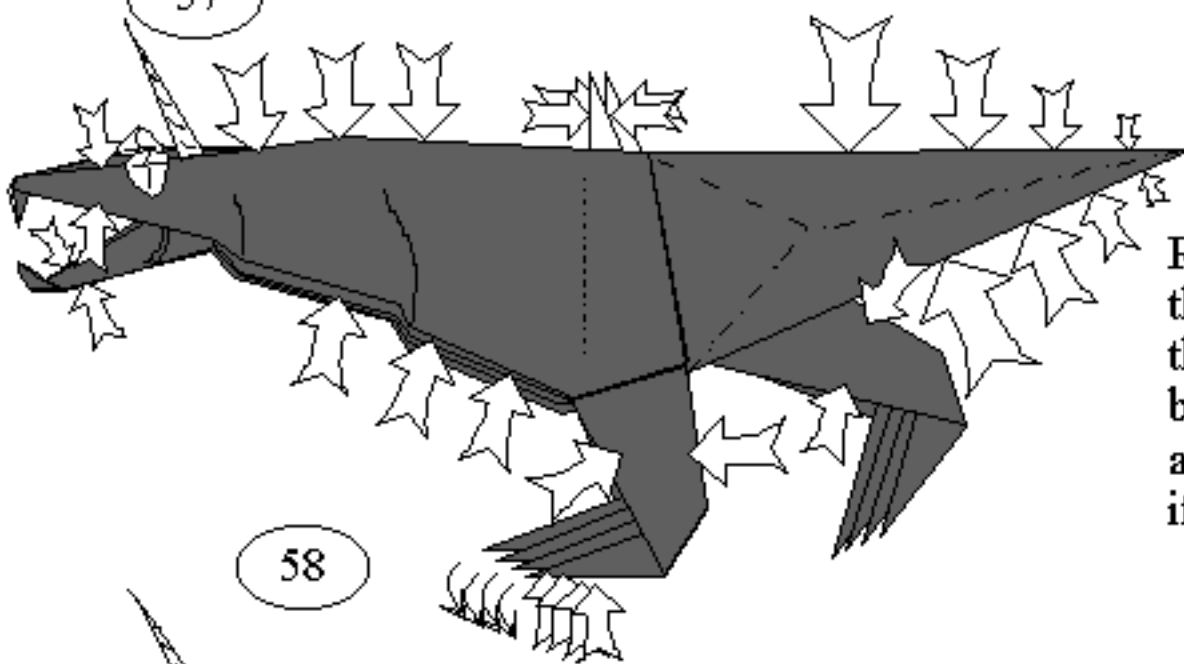

Round the body and make the tail 3-dimensional. Curl the toes and spread them a bit apart. The beast should be able to stand on one foot, as if running.

58

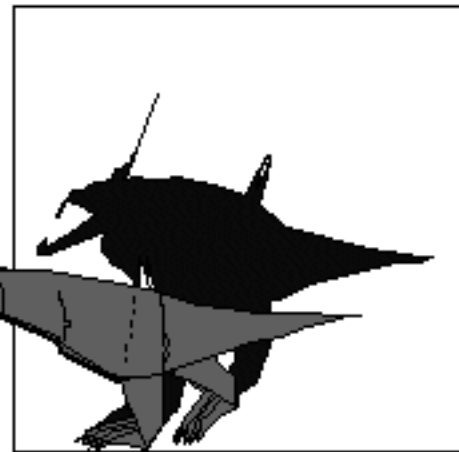
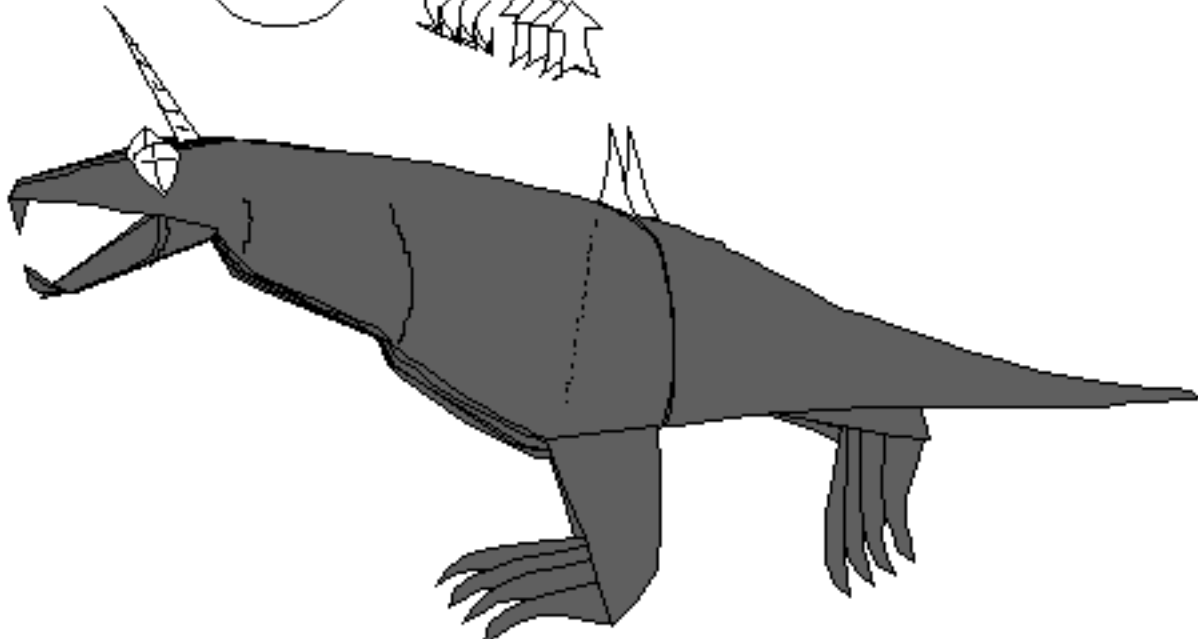

# Unicorn from Zog

# The Great Swanny

Maarten van Gelder

© 1997 Aug

The name of this model comes from the hotel (Dutch: Het Grote Zwaantje) in de Lutte, Netherlands where I had holidays in August 1997.  
Fold the swan from white paper. The drawings show what happens when you fold it from normal (two color) Origami paper.

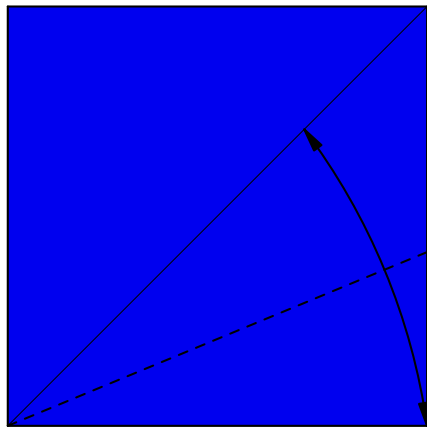

1

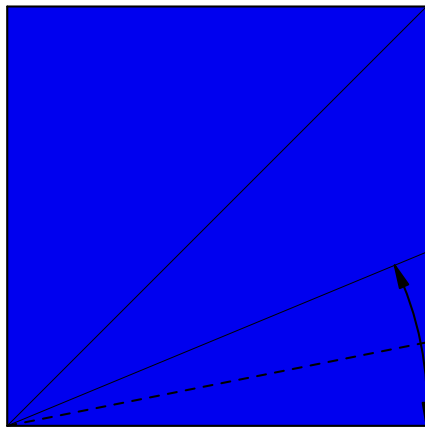

2

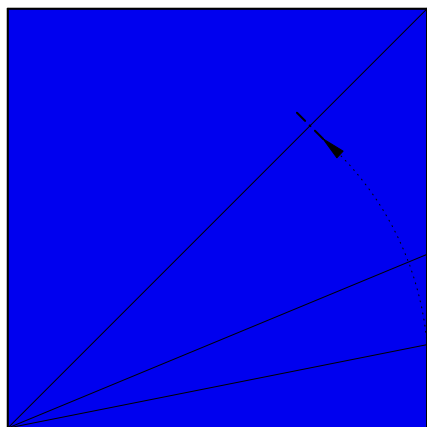

3 Mark only

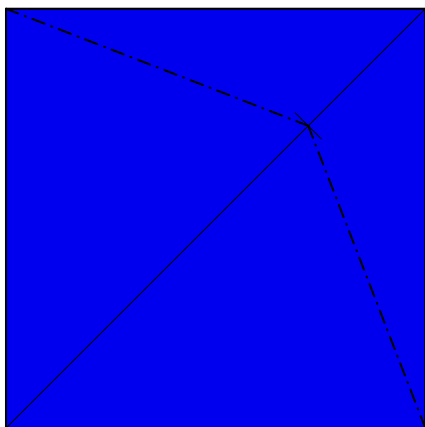

4

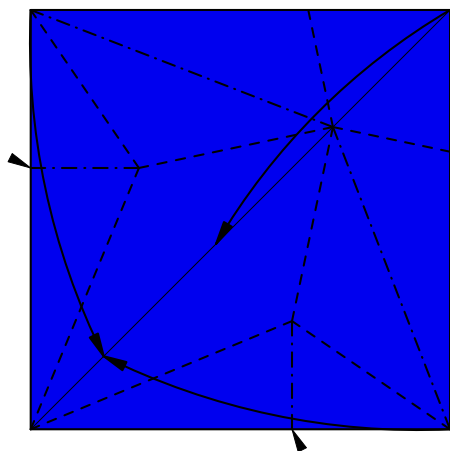

5 Collapse

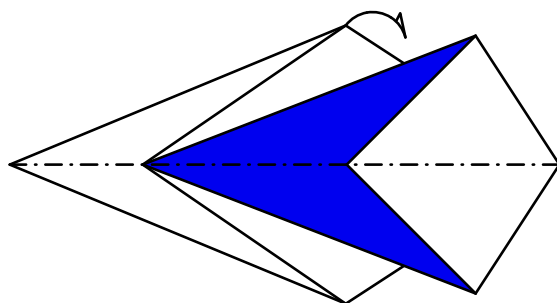

6

# The Great Swanny

Maarten van Gelder

© 1997 Aug

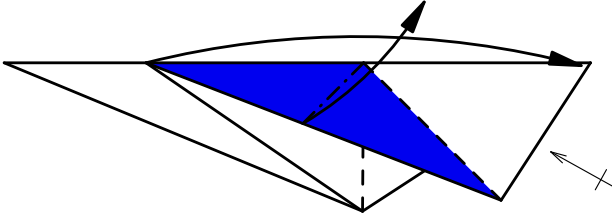

7

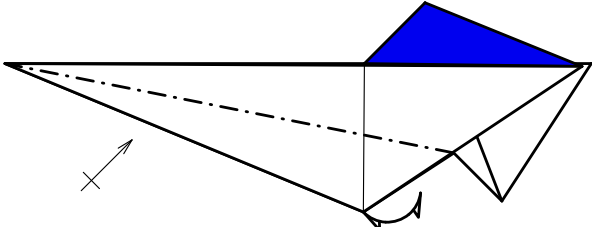

8

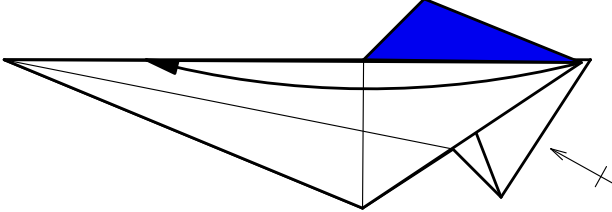

9

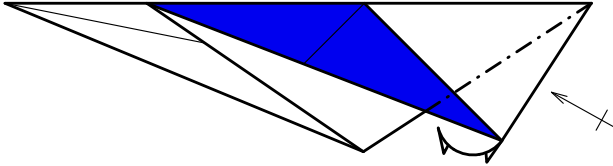

10

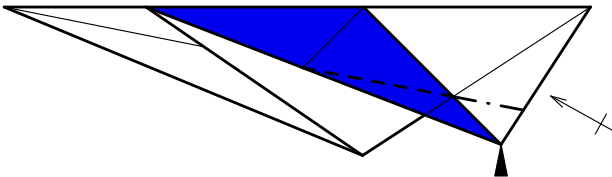

11

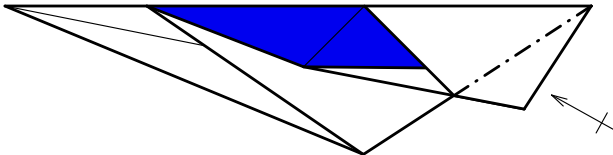

12

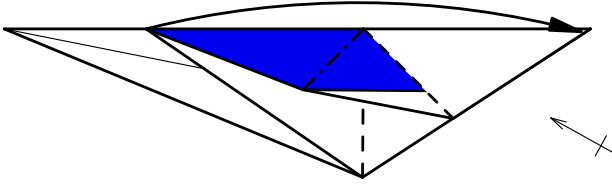

13

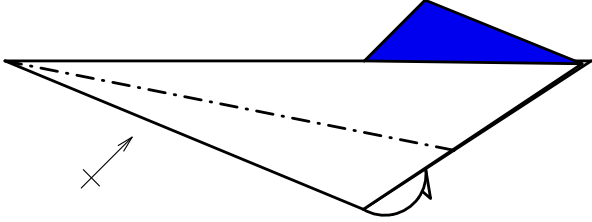

14

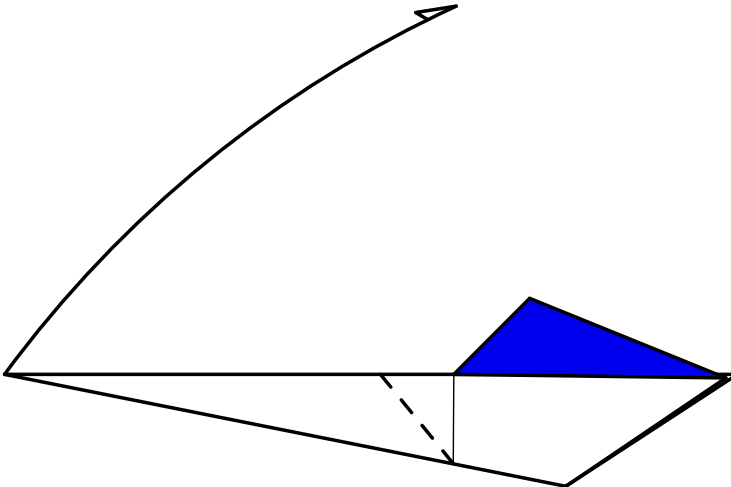

15

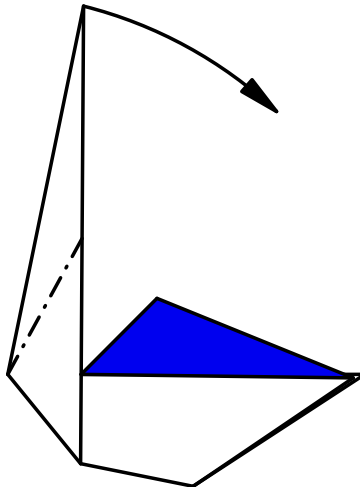

16

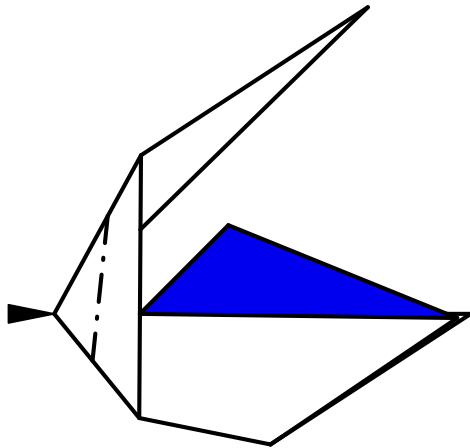

17

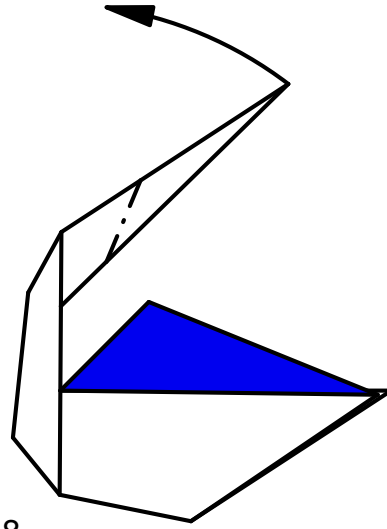

18

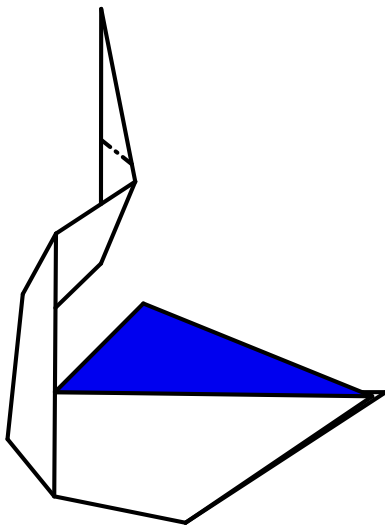

19

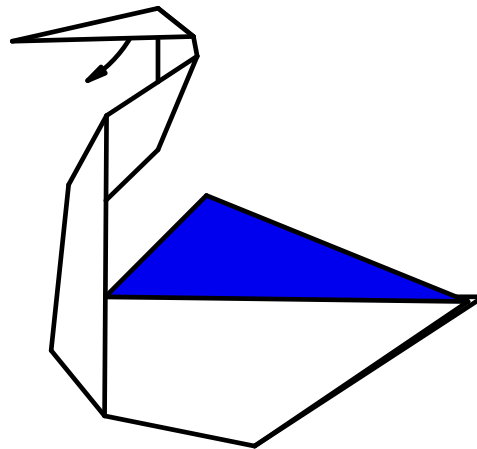

20

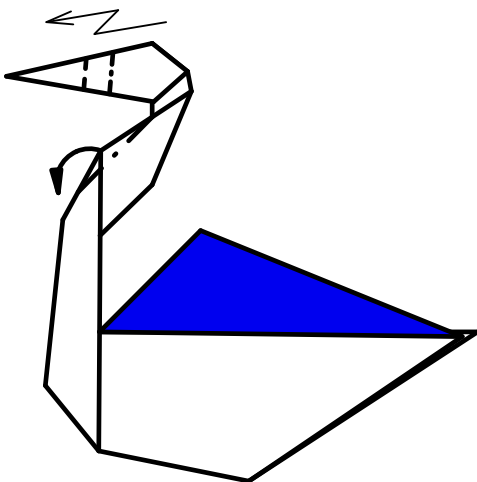

21 Make body 3D

