

The Upholstery and Chairmaking Trades of Eighteenth-Century Newport, 1730–1790

Jennifer N. Johnson

May 14, 2012

Submitted in partial fulfillment of the
requirements for the degree

Master of Arts in the History of the Decorative Arts and Design

MA Program in the History of the Decorative Arts and Design
Cooper-Hewitt, National Design Museum, Smithsonian Institution;
and Parsons The New School for Design

2012

©2012

Jennifer Nikole Johnson

All Rights Reserved

Acknowledgements

This study was made possible by my thesis advisor, Patricia Kane, a truly great teacher and an inspiring scholar, whose encouragement, expertise, and enthusiasm have been invaluable. Her research for Yale University Art Gallery's Rhode Island Furniture Archive forms the foundation of this thesis. The many hours she devoted to poring over primary source documents – with help from principal researchers Dennis Carr, now Assistant Curator, Decorative Arts and Sculpture, at the Museum of Fine Arts, Boston, and Ben Coleman, a former Marcia Brady Tucker Curatorial Fellow at Yale University Art Gallery – have brought to light the names of the previously unknown Rhode Island craftsmen featured in this thesis.

I am also indebted to the following individuals for sharing their time, knowledge, and collections: Mark Anderson and Wendy Cooper of Winterthur Museum; Elizabeth Beach of the Colonel Daniel Putnam Association; Kristen Costa Francoeur, Bruce MacLeish, and Pieter Roos of the Newport Restoration Foundation; Caitlin Emery and Jessica Urick of the Preservation Society of Newport County; Erik Gronning of Sotheby's; John Hays and Andrew Holter of Christie's; Morrison Heckscher and Nicholas Vincent of the Metropolitan Museum of Art; Stuart Holzer (collector); Elizabeth Lahikainen of Elizabeth Lahikainen and Associates; Ellen Madison of the Babcock-Smith House Museum; Alan Miller (independent furniture historian); Jennifer Robinson and Ruth Taylor of the Newport Historical Society; George Schoedinger (collector); and Adams Taylor (independent collections consultant).

Special thanks are due to Gregory P. Feit, without whose patience, support, and editorial skills this thesis might never have been completed.

Table of Contents

Acknowledgements.....	i
Table of Contents	iii
List of Illustrations	v
Introduction.....	1
Chapter One: The Upholstery Trade in the Eighteenth Century.....	6
Origins and Development of the Trade.....	6
The Eighteenth-Century Upholsterer	8
The Fabrication of Seating Furniture: Materials, Tools, and Techniques	13
Chapter Two: The Upholsterers of Eighteenth-Century Newport	24
Chapter Three: The Chairmakers of Eighteenth-Century Newport.....	38
Chapter Four: Catalogue of Upholstered Chairs.....	54
1. Side Chair, 1725 –1745, Probably Newport	54
2. Side Chair, 1730 –1760, Probably Newport	60
3. Side Chair, 1750–1775, Newport.....	67
4. Armchairs (pair), 1755-1775, Probably Newport	74
5. Easy Chair, 1758, Newport, Caleb Gardner Jr. (upholsterer).....	81
6. Easy Chair, 1725–1755, Probably Newport	88
7. Easy Chair, 1775–1790, Newport.....	98
8. Easy Chair, 1780–1800, Newport.....	105
Conclusion	111
Bibliography	118
Appendix 1: Upholsterer Biographies	129
Caleb Gardner Jr. (1729–1801).....	129

Peter Hall (w. 1736).....	137
John Harvey (w. 1744).....	139
John Moore (d. 1762).....	140
Kendall Nichols (b. c. 1722–1774).....	147
William Stanton (w. 1754).....	152
Robert Stevens (1713–1780).....	154
Appendix 2: Chairmaker Biographies	163
Benjamin Baker (1734/5–1822).....	163
Giles Barney (1725–1783).....	170
Daniel Dolorson (w. 1758–1759)	173
Daniel Dunham (b. between 1685 and 1687, d.1758)	177
Daniel Dunham III (1738–1815)	181
Joseph Dunham (1723/4–1802).....	183
Benjamin Gould (1735–1821)	187
John Lamb Jr. (w. 1747–1758).....	191
John McClure (w. 1747–1749).....	193
John Ormsby (w. 1733–1739).....	196
Samuel Phillips (w. 1782, d. 1788).....	199
John Pitman (c. 1726–1768).....	200
Joseph Pitman (c. 1695–1731).....	205
John Proud Jr. (1714–1794).....	208
Joseph Proud (1711–1769)	213
William Robson (w. 1733; d. by 1737).....	219
Timothy Waterhouse (c.1715–1792)	223
Illustrations	230

List of Illustrations

- Figure 1: Trade Card of Christopher Gibson, London, 1730–1742.
- Figure 2: “Menuiserie en Meubles, Sieges,” from *Encyclopédie, ou dictionnaire raisonné des sciences, des arts et des métiers, etc.*, eds. Denis Diderot and Jean le Rond D'Alembert.
- Figure 3: Bedstead, 1760-1800, Connecticut.
- Figure 4: Original show fabric of an easy chair, probably made in Newport, 1725–1755.
- Figure 5: John Hamilton Mortimer, Sergeant-at-Arms Bonfoy, His Son, and John Clementson, Sr., England, ca. 1770.
- Figure 6: Sample Book of Benjamin and John Bower, April 1, 1771.
- Figure 7: Upholsterer's tools, from *Encyclopédie, ou dictionnaire raisonné des sciences, des arts et des métiers, etc.*, eds. Denis Diderot and Jean le Rond D'Alembert.
- Figure 8: Slip seat with early webbing and sack cloth, Newport, 1760–1785.
- Figure 9a: Slat-back chair, Rhode Island, 1725–1750.
- Figure 9b: Banister-back chair, Newport, 1720–1740.
- Figure 10a: Roundabout chair, Newport, 1755–1780.
- Figure 10b: Detail of chair in figure 10a.
- Figure 11: Side chair, New England, 1730–1750.
- Figure 12: Side chair, attributed to John Gaines III (1704–1743), Portsmouth, NH, 1735–1743.
- Figure 13: Side chair, Rhode Island, 1740–1750.
- Figure 14: Side chair, attributed to John Townsend, 1750-1775.
- Figures 15–16: Detail of chair in Figure 14.
- Figure 17: Arm chairs, probably made by John Townsend, 1785–1800.
- Figure 18: Detail of chair in Figure 17.

Figure 19: Side chair, probably made in Newport, 1725-1745.

Figures 20–24: Details of chair in Figure 19.

Figure 25: Side chair, 1730–1760.

Figure 26: Side view of chair in Figure 25.

Figure 27: Side chair, 1730–1760, probably made in Newport.

Figure 28: Side chair, 1725–1740, probably made in Boston.

Figure 29: Side chair, attributed to John Goddard, c. 1762, Newport.

Figure 30a: Rear stretcher of the chair in Figure 26.

Figure 30b: Rear stretcher of chair in Figure 50.

Figure 31a: Proper left front foot of chair in Figure 26.

Figure 31b: Proper left front foot of chair in Figure 50.

Figure 32: Slip seat of chair in Figure 26.

Figure 33: Side chair, Newport, 1755–1775.

Figure 34: Detail of chair pictured in Figure 33.

Figure 35: Back of chair in Figure 33.

Figure 36: Detail of chair in Figure 33.

Figure 37: Slip seat of chair in Figure 33.

Figure 38: Side chair, Newport, 1755–1775.

Figure 39: Side chair, Newport, 1755–1775.

Figure 40: Side chair, Newport, 1755–1775.

Figure 41: Side chair, Newport, 1755–1775.

Figure 42: Side chair, Newport, 1760–1785.

Figure 43: Armchair, probably Newport, 1740–1760.

Figure 44: Armchair, probably Newport, 1740–1760.

Figure 45: Abraham Redwood II, attributed to Samuel King, Newport, 1773–1780.

- Figure 46: Armchairs, 1740–1760, New York.
- Figure 47: Detail of chair pictured in Figure 44.
- Figure 48: Detail of chair pictured in Figure 43.
- Figure 49: Detail of chair in Figure 43.
- Figure 50: Easy Chair, upholstered by Caleb Gardner Jr., 1758, Newport.
- Figures 51–52: Details of chair in Figure 50.
- Figure 53: Easy Chair, Newport, 1740–1760
- Figure 54: Easy Chair, Newport, 1740–1760.
- Figures 55–59: Details of upholstery of chair in Figure 50.
- Figure 60: Easy Chair, possibly Newport, 1725–1755.
- Figure 61: Easy chair, Boston, 1700–1710.
- Figure 62: Easy chair, Newport, 1780–1800.
- Figures 63–71: Details of chair in Figure 60.
- Figure 72a: Easy chair, Newport, 1775–1790.
- Figure 72b: Photo of the chair in Figure 72a before re-upholstering.
- Figure 73: Easy chair, Philadelphia.
- Figure 74: Easy chair, probably made in Philadelphia, 1760–1780.
- Figure 75–78: Details of chair in Figures 72a and 72b.
- Figure 79: Detail of original upholstery tacks with cut shanks and wrought heads.
- Figure 80: Easy chair, Newport, 1760–1790.
- Figure 81: Easy chair, Newport, 1760–1790.
- Figure 82: Easy chair, Newport, 1780–1800.
- Figure 83: Diagram showing the typical arm construction of a vertical scroll easy chair.
- Figure 84: Detail of chair in figure 82.
- Figure 85: Detail of chair in figure 82.

Figure 86: Detail of chair in figure 82.

Figure 87: Easy chair fitted with chamber pot, 1795–1810, probably made in Rhode Island.

Figure 88: Detail of chair in figure 83.

Figure 89: Mrs. Robert Stevens (née Anstris Elizabeth Wignall, 1723–1802), attributed to John Singleton Copley, c. 1740–1750.

Figure 90: Robert Stevens' former house, Newport.

Introduction

Although much has been written about the furniture of eighteenth-century Newport, Rhode Island, scholarship has focused primarily on pieces made by or attributed to the highly celebrated cabinetmakers of the Townsend and Goddard families.¹ While such furniture is undoubtedly deserving of high praise and close attention, this approach undervalues significant contributions made by the city's lesser-known craftsmen. Of the various branches of eighteenth-century Newport cabinetmaking, chairmaking and the closely related trade of upholstery are areas that could especially benefit from further study. Chairs made in the late baroque and rococo styles (henceforth referred to as "Queen Anne" and "Chippendale," respectively) have been attributed to the city, but almost nothing is known about the craftsmen who made and upholstered them.

Eighteenth-century chairs were virtually never signed or labeled by their makers. As a result, many high-style chairs thought to be from Newport have at one time or another been given Townsend or Goddard attributions.² Much of the small amount of literature on Newport seating furniture has focused on chairs thought to be the work of these famous makers. Notable exceptions include a series of articles by Joseph K. Ott detailing new discoveries related to Newport craftsmen, including chairmakers and upholsterers, and Dennis Carr's 2004 article on Benjamin Baker (ca. 1735–1822), a relatively unknown Newport cabinetmaker who specialized in chairs.³ In addition to the

¹ For a comprehensive summary of the history of scholarship on Rhode Island furniture, see Morrison H. Heckscher, "Newport Furniture: A View over Times," in *John Townsend: Newport Cabinetmaker*, exh. cat. (New York: The Metropolitan Museum of Art, 2005), 3–11.

² The only labeled seating furniture by a member of the Townsend or Goddard families is a set of four 1800 Federal-style chairs made by John Townsend.

³ Articles by Joseph K. Ott include "Recent Discoveries Among Rhode Island Cabinetmakers and Their Work," *Rhode Island History* 28, no. 1 (Winter 1969): 3–25; "More Notes on Rhode Island Cabinetmakers and Their Work" *Rhode Island History* 28, no. 2 (May 1969): 49–52; "Still More Notes on Rhode Island

dearth of attributable examples, the assignment of chairs to Newport makers is further complicated by a study published in 1996 in *American Furniture* by Leigh Keno, Joan Barzilay Freund, and Alan Miller.⁴ The article contends that Newport did not have an extensive chairmaking industry in the first half of the century, and that the majority of pre-1750 chairs attributed to the city were actually imported from Boston. Moreover, the authors state that there were no upholsterers and only one chairmaker working in Newport between 1730 and 1750, an assertion belied by recent evidence analyzed in this thesis.⁵ Although Boston's position as the center of early chairmaking in the American colonies does not preclude the production of upholstered seating furniture in Newport prior to 1750, the article led to widespread re-attribution of chairs previously thought to have been made in Newport.

That Newport makers were producing chairs during the third quarter of the eighteenth century – when the city was experiencing an unprecedented growth in both population and affluence – is undisputed. During this time, Newport chair exports surpassed those of Boston, which, by 1760, had become the only colonial seaport with a stagnant economy.⁶ Newport's dominance in the chairmaking trade was established by the research of Jeanne Vibert Sloane, whose analysis of shipping records from Annapolis, Maryland, revealed that Newport exported three times as many chairs as Boston between

Cabinetmakers" *Rhode Island History* 28, no. 4 (November 1969): 111–121. For Dennis A. Carr's article, see Carr, "The Account Book of Benjamin Baker," *American Furniture* (2004): 59–89.

⁴ Leigh Keno, Joan Barzilay Freund, and Alan Miller, "The Very Pink of the Mode: Boston Georgian Chairs, Their Export, and Their Influence," *American Furniture* (1996), 292. This study was followed up by a second related article, Joan Barzilay Freund and Leigh Keno, "The Making and Marketing of Boston Seating Furniture in the Late Baroque Style," *American Furniture* (1998): 1–40.

⁵ The number of chairmakers was cited as zero in Keno, Freund, and Millers' 1996 article, but was updated to one in the 1998 follow-up.

⁶ Keno, Freund, and Miller, "The Very Pink of the Mode," 298.

the years of 1756 and 1774.⁷ Newport's flourishing furniture trade ended with the Revolution, when the British occupation devastated the city's economy and forced many of its residents to flee.

Of critical importance to this study are records compiled by Yale University Art Gallery for its Rhode Island Furniture Archive, the culmination of years of research on the state's furniture and furniture makers from the seventeenth through the early nineteenth centuries. A wealth of new information on Newport's upholsterers and chairmakers exists in these primary source materials, which include judicial, land, probate, town-meeting, and town-council records. Such eighteenth-century documents are invaluable, because they typically identify not only an individual's name and town of residence, but also his occupation. Patricia Kane, Yale University Art Gallery's Friends of American Arts Curator of American Decorative Arts, has generously allowed me access to Yale's archival documents, which I have closely analyzed and supplemented with additional research. The hope is that my own findings – which include information gleaned from genealogical records, census data, and historical newspapers – will build upon the information in the Rhode Island Furniture Archive, thereby contributing to a more complete and detailed portrait of the lives of Newport's chairmakers and upholsterers.

Data gathered for the Rhode Island Furniture Archive indicates that, between 1730 and 1790, there were at least sixteen chairmakers and nine upholsterers active in Newport. Central to this thesis are individual biographies of these makers (see Appendix

⁷ Jeanne Vibert Sloane, "John Cahoon and the Newport Furniture Industry," *Old-Time New England: New England Furniture, Essays in Memory of Benno M. Forman* (Boston: Society for the Preservation of New England Antiquities, 1987), 90.

1 and Appendix 2). Through the interpretation of documentary evidence, an attempt has been made to illuminate the lives of these craftsmen. Several makers referred to as chairmakers in documentary evidence have, however, been excluded from this survey. These include Joseph Vickary (w. 1756–d. 1818) and Jonathan Cahoon (w. 1739–1786), whose primary output is believed to have been Windsor chairs, a form of seating furniture outside the scope of this study. Also excluded were the handful of makers alternately referred to in Newport records as chairmakers and chaisemakers. In addition to making chaises and carriages, such craftsmen produced riding chairs, a mode of transportation popular in both eighteenth-century England and America. The resemblance of riding chairs – which were mounted on two wheels and conveyed by a horse – to ordinary chairs, explains why their makers were sometimes identified as chairmakers.⁸

Chapters one and two of this thesis relate to the upholstery trade. In addition to supervising the fabrication of seating furniture and beds, eighteenth-century upholsterers were also considered arbiters of taste, creating fashionable interiors integrated through textiles. Their responsibilities often comprised those of both merchants and craftsmen. The first chapter provides a brief history of the trade and a discussion of its practice in eighteenth-century London and America. The second chapter, drawing from information contained in the upholsterer biographies, focuses specifically on the lives, work, and ambitions of the upholsterers of eighteenth-century Newport.

The third chapter is an analysis of Newport's chairmaking trade. Based on information from the chairmaker biographies, it includes an examination of the lives and work of individual makers, the ties of family and marriage that united these craftsmen,

⁸ Thomas A. Kinney, *The Carriage Trade: Making Horse-Drawn Vehicles in America* (Baltimore, MD: Johns Hopkins University Press, 2004), 13.

and evidence of their participation in the export trade. Where possible, attempts have been made to determine the types of chairs produced by given makers.

While extremely rare, there are examples of Newport seating furniture that retain all or parts of their original upholstery, which generally consisted of webbing, sackcloth, stuffing, canvas, and finish fabric. The fourth chapter of this paper is a catalogue of eight chairs – three side chairs, an armchair, and four easy chairs – each of which retains at least some element of its original upholstery. There is a strong probability that the chosen examples were made in Newport, although a few cannot be attributed to the city with absolute certainty. The entries contain an in-depth analysis of any remaining upholstery and, where possible, of the techniques used in its fabrication.⁹ Of equal importance is a discussion of the form and construction of each chair's frame, and the stylistic traits thought to be indicative of its Newport's origins.

Through biographies of craftsmen, analyses of Newport's chairmaking and upholstery trades, and a careful examination of chairs with surviving original upholstery, it is hoped that this study will enhance existing knowledge of the chairmakers and upholsterers of eighteenth-century Newport.

⁹ For my understanding of eighteenth-century upholstery practice, I am greatly indebted to the works of previous scholars, including Mark Anderson, Leroy Graves, Morrison H. Heckscher, F. Carey Howlett, Brock Jobe, Elizabeth Lahikainen, Andrew Passeri, and Robert F. Trent.

Chapter One: The Upholstery Trade in the Eighteenth Century

Origins and Development of the Trade

Although the origins of the upholstery trade can be traced back to the late thirteenth century, it was not until the 1600s that the craft truly flourished.¹⁰ The first upholsterers were coffer-makers, early craftsmen who constructed leather-covered boxes for traveling.¹¹ The role had increased in importance by the Middle Ages, when textiles were an essential component of portable wealth. Medieval courts frequently moved from residence to residence, and items such as tapestries, carpets, cushions, and bed hangings could be easily packed, transported, and adapted to new spaces. These textiles were cared for by the *fourrier*, who would use them to transform bare interiors into suitable backdrops for displays of courtly magnificence.¹² Aristocratic life gradually became more fixed, and, by the sixteenth century, responsibility for the arrangement of interiors had fallen to the Gentleman Usher (or *huissier*). Caring for the furnishings was overseen by the Yeoman of the Wardrobe, with the actual work was carried out by seamstresses, laundry maids, and joiners.¹³

In the early seventeenth century, aristocratic French women took the lead in the creation of unified and comfortable interiors, and upholstery was increasingly relied upon

¹⁰ Geoffrey Beard, *Upholsterers and Interior Furnishing in England, 1530–1840* (New Haven and London: Yale University Press for The Bard Graduate Center for Studies in the Decorative Arts, 1997), 1; Peter Thornton, “Upholstered Seat Furniture in Europe, 17th and 18th Centuries,” in *Upholstery in America & Europe from the Seventeenth Century to World War I* (New York and London: W. W. Norton & Co., 1987), 29.

¹¹ Beard, *Upholsterers and Interior Furnishing in England*, 1; R. W. Symonds, “The Upholstered Furniture at Knole,” *The Burlington Magazine for Connoisseurs* 86, no. 506 (May, 1945), 110.

¹² Thornton, *Seventeenth-Century Interior Decoration in England, France, and Holland* (New Haven and London: Yale University Press, Published for the Paul Mellon Centre for Studies in British Art, 1978), 97.

¹³ *Ibid.*, 97–98.

to achieve such effects. Harmonious spaces were created through the coordination of walls hangings, bed and window curtains, and upholstered seating furniture.¹⁴

Continental craftsmen made great advances in the comfort of such furniture, which had previously been padded only through the strategic placement of cushions. Textiles that had formerly been displayed on walls or draped over furniture now began to be fixed to seating furniture over a layer of stuffing. Since seat and back padding was apt to distort, new methods such as quilting were devised to secure it.¹⁵ Upholstery practices continued to evolve and improve, and the majority of techniques used in the eighteenth century and beyond were already in place by 1700.¹⁶

The French taste for *en suite* interiors had also become fashionable in seventeenth-century England, where early upholsterers were called “upholders.” The term had been used in the thirteenth century to refer to dealers in small wares and secondhand clothing, but the trade had gradually increased in status.¹⁷ By the beginning of the seventeenth century, upholders had embraced a new role, assuming responsibility for the provision and refurbishing of household furnishings, especially those that involved textiles. In 1626, the upholsterer’s Company of the City of London, which had been in existence since 1459, was granted a new royal charter. This document was lost in the Great Fire in London, but it probably acknowledged the evolution of the trade.¹⁸ The term “upholsterer” was in use by at least 1616, but even in the eighteenth century,

¹⁴ Ibid., 7–10.

¹⁵ Peter Thornton, “Upholstered Seat Furniture in Europe,” 29; Audrey H. Michie, “Upholstery in All Its Branches: Charleston, 1725–1820,” *Journal of Early Southern Decorative Arts* (1985): 22–23.

¹⁶ Thornton, “Upholstered Seat Furniture in Europe,” 29.

¹⁷ Beard, *Upholsterers and Interior Furnishing*, 1; Thornton, *Seventeenth-Century Interior Decoration*, 99.

¹⁸ Thornton, *Seventeenth-Century Interior Decoration*, 99.

English craftsmen continued to identify themselves as both “upholsterer” and “upholder” when advertising their services.¹⁹

The Eighteenth-Century Upholsterer

The upholstery trade in eighteenth-century London was both profitable and prestigious. The anonymous author of *A General Description of All Trades*, a 1747 publication intended to assist parents in choosing their children’s professions, described the work as “not hard, but clean and genteel . . . therefore fit for smart Youths, who have no Strength to spare.” If these tradesmen were not genteel, the author asked, “what would the nice Ladies do with them?”²⁰ This rhetorical question hints at the degree of interaction that had developed between upholsterers and their affluent customers, a privilege that elevated the profession above most other trades. Visiting clients’ homes for consultations or to oversee work in progress gave upholsterers a unique insight into the demands and aspirations of the wealthy – a knowledge that could be used to spread current fashions or invent new ones.²¹ In *The London Tradesman*, another 1747 publication meant to assist youths in their choice business, Robert Campbell depicts the role of the upholsterer as similar to that of today’s interior designer. Adopting the persona of a client wishing to outfit his newly built home, Campbell writes, “I have just finished my House, and must now think of furnishing it with fashionable Furniture. The Upholder is chief Agent in this Case. He is the Man upon whose Judgment I rely in the Choice of Goods; and I suppose he has not only Judgment in the Materials, but Taste in the

¹⁹ Michie, “Upholstery in All Its Branches,” 22–23.

²⁰ *A General Description of All Trades* (London: Printed for T. Waller, 1747), 215.

²¹ Thornton, *Seventeenth-Century Interior Decoration*, 99–100.

Fashions, and Skill in the Workmanship.”²² Such expertise was equally desirable to both sophisticated aristocrats seeking to set the latest trends and to affluent merchants desiring to emulate their social betters.

As arbiters of taste, upholsterers needed an appropriately impressive setting in which to receive their clientele of “nice Ladies” and gentlemen. The more practical aspects of their trade also required adequate space, and large London firms had entire rooms dedicated to upholstery work. Thomas Chippendale, who identified himself as an upholsterer in his will, had a chair room, a looking glass room, a room for carving and gilding, and two feather rooms.²³ The image of a commodious and elegant London upholstery shop survives on the trade card of Christopher Gibson, a London upholsterer who worked from 1730 to at least 1745 (fig. 1). In the forefront of the shop is a fashionably dressed man, possibly Gibson himself, showing a high-style chair to two female customers. Around these figures are a variety of ready-made caned and upholstered chairs, some of which are grouped in a whimsical display suspended from the wall. In the middle section of the shop are two upholsterers, one working on a chair and the other on a bed. Behind them, in the rear of the shop, is an area stocked from floor to ceiling with rolls of textiles. A looking glass, a luxury item frequently sold by upholsterers, hangs on the wall. Presenting a striking contrast to Gibson’s upholstery shop is an illustration of a furniture makers’ workshop from Denis Diderot’s *Encyclopédie* (fig. 2). The image depicts the *menuisiers en meubles*, who made chairs as well as unveneered case furniture, as shabbily dressed craftsmen hunched over their

²² Robert Campbell, *The London Tradesman* (London: T. Gardner, 1747), 169–170.

²³ Beard, *Upholsterers and Interior Furnishing*, 11; Michie, “Upholstery in All Its Branches,” 32.

work. Unlike the grand interior of Gibson's shop, their workspace is small, crowded, and disorderly.

Although generally a lucrative trade, establishing an upholstery business was an expensive proposition. Such a venture required "considerable Stock to set up with," including expensive imported textiles. In London, this initial investment was estimated to run between £100 and £1000.²⁴ The same appears to have been the case in New England, where Boston upholsterer Samuel Grant invested £600 to stock his shop in 1728.²⁵ Before they could hope to open their own establishment, however, would-be upholsterers first had to complete an apprenticeship. Then, for those without the means to open their own shop, it was necessary to seek employment with another upholsterer as a journeyman. In London, a mid-eighteenth-century journeyman upholsterer worked from 6 am to 8 pm, and could expect to make £0.2.6 to £0.3.0 per day or, if paid by the year, £15 to £30 plus board.²⁶

As in England and Europe, American upholsterers tended to be located in cities. Not only did an urban environment provide a larger and more affluent client base, but it allowed ready access to the imported materials and specialized craftsmen that were both crucial to the trade.²⁷ In a large London shop, the ancillary craftsmen employed by an upholsterer included: "Journeymen in his own proper Calling, Cabinet-Makers, Glass-Grinders, Looking-Glass Frame-Carvers, Carvers for Chairs, Testers, and Posts of Bed, the Woolen-Draper, the Mercer, the Linen-Draper, several Species of Smiths, and a vast

²⁴ Campbell, *The London Tradesman*, 170, 340.

²⁵ Brock Jobe, "Boston Upholstery Trade, 1700–1775," *Upholstery in America & Europe*, 67.

²⁶ Campbell, *The London Tradesman*, 340; *A General Description of All Trades*, 215.

²⁷ Jobe, "Boston Upholstery Trade," 65.

many Tradesmen of the other mechanic Branches.”²⁸ While Newport upholsterers may not have had such a bevy of craftsmen at their beck and call, they certainly relied on other trades – specifically chairmakers, joiners, and cabinetmakers – to supply the wooden structures necessary for their craft. Newport upholsterer Robert Stevens (1713–1780), for example, employed the cabinetmaker John Goddard (1789–1843) to make some of the furniture he upholstered.²⁹

Advising customers on their interior décor and fabricating beds, curtains, and seating furniture were not the only services provided by eighteenth-century upholsterers. *A General Description of All Trades* lists several other roles that fell within their purview, noting that “many of them are great Shop-keepers, who have abundance of ready-made Goods for sale always by them,” and that “most of them are also Appraisers.”³⁰ This appears to have been the case not only in London, but also in Newport, where several upholsterers, including Caleb Gardner Jr. (1729–1801) and Robert Stevens, worked as shopkeepers.³¹ Stevens was also involved in appraisals, recording the inventories of several estates, including those of James Searing, in 1755, and Gottlieb Eckstein, in 1770.³² Some upholsterers even served as undertakers, arranging funerals, supplying coffins, and draping churches in black.³³ Black cloth

²⁸ Campbell, *The London Tradesman*, 170.

²⁹ See chapter two of this thesis, “The Upholsterers of Eighteenth-Century Newport.”

³⁰ *A General Description of All Trades* (London: Printed for T. Waller at the Crown and Mitre, 17XX), 215.

³¹ See chapter two of this thesis.

³² Inventory of James Searing, February 3, 1755, Newport Town Council and Probate (hereafter cited as NTCP), Family History Library [hereafter cited as FHL] film 0944999, vol. 11, p. 253; Inventory of Gottlieb Eckstein, May 1, 1770, NTCP, FHL film 0945000, vol. 16, p. 135.

³³ Jobe, “Boston Upholstery Trade,” 65; Karin-Marina Walton, *The Golden Age of English Furniture Upholstery, 1660-1840; Temple Newsam House, Leeds, Exhibition Catalogue, 15 August-15 September 1973* (Leeds: Temple Newsam House, 1973), xxi.

hangings could be tacked up with black-varnished nails, which may have been the intended use of the “1 m [thousand] black d^o [tacks] 5/6” supplied to Newport upholsterer John Moore (d. 1762) by the brazier Stephen Ayrault in 1733.³⁴ Eighteenth-century coffins were also generally covered with black cloth, the edges of which were embellished with brass nails.³⁵ Robert Stevens may have applied such upholstery to the “Birch Coffin for Widow Chambers,” supplied to him by John Goddard in June 1774 at a cost of £1.1.0.³⁶

The “proper Craft” of an upholsterer, as defined by *The London Tradesman*, was fitting up “Beds, Window-Curtains, [and] Hangings” and covering “Chairs that have stuffed Bottoms”³⁷ As the most costly and important of all household furnishings, eighteenth-century beds could be elaborate confections (fig. 3). An essential step in the fabrication of a bed was employing a suitable craftsmen to make a bedstead, which often included a carved headboard and tester. From at least 1764 to 1767, Robert Stevens commissioned John Goddard to make both whole and partial bedsteads.³⁸ In addition to obtaining the bedstead, an upholsterer’s tasks included fitting the bedstead with a canvas or “sacking bottom,” making mattresses, bolsters, and pillows, and bed hangings. Many yards of textiles were required for a full set of hangings, which included a tester cloth,

³⁴ Beard, *Upholsterers and Interior Furnishing*, 19, 22; Account, June 26, 1733–December 20, 1733, in case file, Stephen Ayrault, Newport, brazier v. John Moore, Newport, upholsterer, case 113, May 1735 term, Newport County Court of Common Pleas, Record Book (Rhode Island Judicial Record Center, Pawtucket, Rhode Island, hereafter cited as NCCCP, RB), vol. A, p. 312.

³⁵ Walton, *The Golden Age*, xxi.

³⁶ Account, Estate of Robert Stevens To the Estate of John Goddard, March 1764–November 1781, case 23, November 1791 term, NCCCP RB, vol. J, p. 672.

³⁷ Campbell, *The London Tradesman*, 170.

³⁸ See chapter two of this thesis.

inside and outside valances, head cloth, curtains, counterpanes, and bases or skirts.³⁹ Like bed hangings, window curtains were made and installed by upholsterers. In the eighteenth century, the three types of treatments available for window curtains were straight hanging, festooned, or Venetian, the latter of which could be raised by pulling on a cord.⁴⁰ In an account dated September 14, 1774, Newport upholsterer Caleb Gardner billed Abraham Redwood for matching bed and window curtains.⁴¹

The Fabrication of Seating Furniture: Materials, Tools, and Techniques

Upholsterers used a variety of materials in the fabrication of seating furniture, including finish fabric, upholstery foundation, stuffing, hardware, and trim. An excellent means for exploring each of these elements exists in a 1764 account for chairs supplied by Philadelphia upholsterer Plunkett Fleeson to the Providence mercantile firm of Nicholas Brown and Company.⁴² An equally valuable source of information is the initial order for the chairs, which also survives in a letter to Philadelphia merchant John Relfe, who acted as an intermediary. In their letter, Nicholas Brown and Company requested “One Easy Chair Mahogany fraim covered with Greene Furniture made in the best Manner the Last you sent us was Very Slightly Made & Six Mahogany fraim Chairs with Leather Bottoms & Co[vere]d with Greene Herreteene Bottoms made and polished in the

³⁹ Florence M. Montgomery, “18th-Century American Bed and Window Hangings,” in *Upholstery in America & Europe*, 167; Jobe, “Boston Upholstery Trade,” 75–76.

⁴⁰ Montgomery, “18th-Century American Bed and Window Hangings,” 163–164.

⁴¹ See chapter two of this thesis.

⁴² John Brown was member of Nicholas Brown and Company until he established his own firm in 1771. Both John and Nicholas had previously ordered easy chairs from Pluckett Fleeson, and it is not clear for whom the chairs ordered in 1764 were intended. See Wendy A. Cooper, “The Purchase of Furniture and Furnishings by John Brown, Providence Merchant, Part I: 1760–1788,” *The Magazine Antiques* 103, no. 2 (February 1973): 329, 332.

best Manner of about 50/ or 55/ Value.”⁴³ Fleeson itemized his bill for the chairs as follows:

		£	s	d
To a Mahogany Easy Chair Frame		2	5	0
To Bottoming 6 Chairs [?]	@ 5/	1	10	0
To 11 Yds Harateen	@ 4/	2	4	0
To 13 Yds Canvas for the Chair	@ 1/6	0	19	6
To 8 [pounds] Curled Hair	@ 1/10	0	14	8
To girth & tax		0	7	0
To 3 1/2 of Feathers	@ 3/	0	10	6
To 1 1/2 Yds Ticken	@ 3/6	0	5	3
To 18 Yds Silk Lace	@ 8 ^d	0	12	0
To thread Silk & Cord		0	3	0
To a sett Castors		0	8	0
To making the Easy Chair		1	18	0
		£ 11	13	11 ⁴⁴

The first item listed in the account is a mahogany easy chair frame, for which the Brown firm requested a cover of “Greene Furniture,” a term that was probably a generic way of describing textiles used to upholster furniture.⁴⁵ It took between six and seven yards of fabric to upholster an easy chair, depending on whether the textile had a pattern that required centering.⁴⁶ Samuel Grant used “6 1/2 yd chainy” to upholster an easy chair in 1729.⁴⁷ Fleeson bill’s includes a charge for “11 Yds Harateen,” so the remaining material would have been used for the side chairs. Harateen belongs to a group of related

⁴³ Cooper, “The Purchase of Furniture and Furnishings by John Brown,” 331. Unfortunately no similarly detailed accounts exist from Newport, however, John Brown is known to have ordered seating furniture from John Goddard, and is also thought to have obtained an armchair with Philadelphia characteristics from either Newport or Providence (see catalogue entry 7).

⁴⁴ Cooper, “The Purchase of Furniture and Furnishings by John Brown,” 329.

⁴⁵ The term “Greene Furniture” could also be interpreted as referring to a slipcover patterned with green furniture checks, but no such fabric appears on the bill.

⁴⁶ Andrew Passeri and Robert F. Trent, “Two New England Queen Anne Easy Chairs with Original Upholstery,” *Maine Antique Digest* (April, 1983): 26-A.

⁴⁷ Jobe and Kaye, *New England Furniture*, 365.

worsted fabrics that also includes damasks, camlet, cheney, and moreen. These textiles, imported to New England via London, were widely used as upholstery material in the eighteenth-century.⁴⁸ Worsted damasks, which featured reversible patterns created by contrasting areas of gloss and matte, were the most expensive of the group.⁴⁹ Even costlier versions, made of silk or a combination of silk and wool, were available to the wealthiest of clients.⁵⁰ Worsted camlets were plain weave fabrics to which different finishes could be applied with water and heat to create cheney, harateen, and moreen.⁵¹ Watering – a process during which the cloth is folded in irregular triangles, put onto a roller, and rolled under heavy blocks of stone – resulted in waved and intersecting lines that imitated the look of more expensive silk moiré. Additional embellishment could be embossed onto the fabric using engraved metal cylinders. Popular patterns included meandering lines, flowers and butterflies, or an occasional combination of the two.⁵² These fabrics and patterns were available in bright shades of red, indigo, dark green, and gold.⁵³ The intensity of color is apparent in the fabric of a Newport easy chair thought to have belonged to Godfrey Malbone, and now in the collection of the Daniel Putnam Association in Brooklyn, Connecticut (see catalogue entry six). Although the chair's watered and embossed fabric is much faded, the vibrancy of its original raspberry color is still visible in some of its creases (fig. 4). Such worsted fabrics would have been

⁴⁸ Florence M. Montgomery, *Textiles in America, 1650–1870* (New York and London: W. W. Norton & Company, 1988), 103.

⁴⁹ Jobe, “Boston Upholstery Trade,” 67; Montgomery, *Textiles in America*, 213.

⁵⁰ Jobe, “Boston Upholstery Trade,” 67.

⁵¹ Montgomery, *Textiles in America*, 188.

⁵² Jobe, “Boston Upholstery Trade,” 69.

⁵³ Montgomery, *Textiles in America*, 103.

available in Newport, and several appear in a 1770 inventory of Caleb Gardner's shop goods, including "2 Small Remnants Hariteene," "15 $\frac{3}{4}$ y^{ds} Camblets," and "2 $\frac{2}{3}$ y^{ds} white wor^d Damask."⁵⁴

In addition to the easy chairs, Brown firm's order included "Six Mahogany fraim Chairs with Leather Bottoms & Co[vere]d with Greene Herreteene Bottoms." These would most likely have been side chairs with fixed leather upholstery and green harateen slipcovers. Although Fleeson's bill makes no mention of leather, it was presumably included in his charge of "Bottoming of 6 Chairs." Less expensive than textiles, leather was the most common chair covering of the eighteenth century.⁵⁵ During the first quarter of the century, the most fashionable leather was imported from northern Russia via London.⁵⁶ Made from reindeer hides, Russian leather underwent a complex treatment process that included tanning the skins with willow bark and currying them with birch oil.⁵⁷ The hides were then hammered in two directions, which imparted a highly desirable diamond pattern. This crosshatched grain was imitated by European tanners, who tried to achieve the same effect through scoring, rolling, or scorching.⁵⁸ After the first quarter of the century, Russian leather became difficult to obtain, and upholsterers were forced to use lesser-quality hides from local tanners. In 1727, Thomas Finch told a Boston customer seeking Russian leather chairs that "New England red Leather" was available,

⁵⁴ Inventory of Caleb Gardner, June 14, 1770, *Granted Petitions of the General Assembly (1756-1828)*, vol. XIV, 32.

⁵⁵ Jobe, "Boston Upholstery Trade," 69; Jobe and Kaye, *New England Furniture*, 341.

⁵⁶ Jobe, "Boston Upholstery Trade," 69; Robert F. Trent, "17th-Century Upholstery in Massachusetts," in *Upholstery in America & Europe*, 46.

⁵⁷ R. W. Stevenson, "A 200-Year-Old Gift From Under the Sea," *The New York Times* (April 22, 2002), accessed online, <http://www.nytimes.com/2002/04/28/nyregion/a-200-year-old-gift-from-under-the-sea.html?pagewanted=all&src=pm>.

⁵⁸ Trent, "17th-Century Upholstery," 46.

“but there’s no Rushia in Town.”⁵⁹ Such local leather was generally made from goat-, seal-, or calfskins. The natural color of the hides varied, with seal being off-white, goat slightly darker, and calf a deep brown; they could also be dyed black or red.⁶⁰ From July 1733 to August 1734, Newport upholsterer John Moore purchased thirty-seven hides from Nathan Townsend, a local tanner.⁶¹

Although not found in Fleeson’s bill, hair cloth – woven from a weft of hair from the manes and tails of horses and a warp of linen, cotton, or wool – was also used to cover seating furniture from at least the mid-eighteenth century. This durable textile was most often a plain black, but was also available in other colors, including green and red. It had a satin-like finish and could be patterned with stripes or diaperwork.⁶² “Horse hair seating” was available in Boston from at least 1765, when it was advertised in the *Boston Evening Post* and included in a list of “Upholsterers Goods” on the trade card of Ziphion Thayer.⁶³

The reference to “Greene Herreteene Bottoms” included in the Brown firms’ order of chairs indicates that fixed upholstery was not the only option available to the eighteenth-century consumer. Seating furniture was often fitted with removable slipcovers, which, like fixed upholstery, could be coordinated with the rest of the room. In this case, Fleeson made the side chairs’ harateen covers *en suite* with the easy chair’s upholstery. Slipcovers were often used to protect more expensive fixed upholstery. The

⁵⁹ Brock Jobe, “The Boston Furniture Industry 1720 –1740,” *Boston Furniture of the Eighteenth Century* (Boston: Colonial Society of Massachusetts, 1974), 39.

⁶⁰ Jobe, “Boston Upholstery Trade,” 71.

⁶¹ See chapter two of this thesis.

⁶² Montgomery, *Textiles in America*, 100, 254; Jobe, “Boston Upholstery Trade,” 69; Michie, “Upholstery in All Its Branches: Charleston,” 37.

⁶³ Jobe, “Boston Upholstery Trade,” 69.

converse was sometimes true, however, as with the chairs provided by Fleeson. Their leather upholstery would most likely have been for everyday use, and the green harateen for more formal occasions. In the second half of the century, slipcovers of light, washable linen or cotton fabrics became popular.⁶⁴ These were often favored in the summer months, but could also be used year-round to protect more expensive upholstery from everyday wear.⁶⁵ Furniture checks, a plain-weave cloth with colored warp and weft stripes intersecting to form squares, were the most popular of these lighter fabrics.⁶⁶ Different patterns were often chosen for public and private rooms, with checks and stripes being more prevalent in libraries and parlors, and printed cottons preferred for bed chambers, where they were often en suite with the bed hangings (fig. 5).⁶⁷ A sample book in the collection of the Metropolitan Museum of Art includes a selection of linen checks that probably would have been used for furniture (fig. 6). Dated April 1, 1771, it was prepared by Manchester merchants Benjamin and John Bower for Capt. Nicholson of the Brigantine Havannah.⁶⁸ The size of the checks varied, as did the colors, which included red, plum, green, blue, and yellow. Robert Stevens provided checked fabric to his Newport customers as early as 1738, when he sold “17 ¹/₄ y^{ds} of Check” for £6.16.0 to

⁶⁴ Linda Baumgarten, “Protective Covers for Furniture and Its Contents,” *American Furniture* (1993), 4.

⁶⁵ Montgomery, *Textiles in America*, 127.

⁶⁶ *Ibid.*, 197.

⁶⁷ Baumgarten, “Protective Covers,” 4.

⁶⁸ Sample Book of Benjamin and John Bower, April 1, 1771, Metropolitan Museum of Art, New York, NY; Montgomery, *Textiles in America*, 399.

Edward Barton, a chaisemaker. He also listed them in his 1767 advertisement, in which he described a selection of “3-4, 7-8, and yard-wide Checks.”⁶⁹

In addition to materials for the chairs’ finish fabric, Fleeson’s bill included the items essential for building upholstery foundation. The first of these components was “girth,” or girt webbing, used to support the seats and backs of upholstered furniture.⁷⁰ The name of these thin, coarsely woven strips comes from their origins as girths, which used to hold horses’ saddles in place.⁷¹ Made of flax and hemp, girt webbing was woven on narrow looms in widths ranging from about $1\frac{5}{8}$ to $2\frac{1}{16}$ inches. It was available in both plain and twill weaves, with plain being the more popular until the beginning of the nineteenth century. Plain-weave webbing was generally striped, and the colors found in eighteenth-century examples are white, shades of brown and black, or a combination.⁷² American upholsterers followed the English practice of interlacing widely spaced strips of webbing. Using a tool called a pincer (fig. 7, see tool labeled “Fig. 2.”), they stretched the webbing across the chair frame and secured it with tacks. The seat of a side chair could be supported with as few as three strips, two running from front to back, and one from side to side (see fig. 8). This differed from the French practice of using tightly interwoven strips of webbing that obviated the need for sack cloth.⁷³ In August 1733,

⁶⁹ Account, February 1738, in case file, Robert Stevens, Newport, upholsterer v. Edward Barton, Newport, chaisemaker, case 92, November 1739 Term, NICCP Record Book, vol. B, p. 7; *The Newport Mercury*, June 15–22, 1767, <http://infoweb.newsbank.com/>.

⁷⁰ For a comprehensive study of girth webbing, see E. C. Milnes, *History of the Development of Furniture Webbing* (Leeds: E. C. Milnes, 1983).

⁷¹ *Ibid.*, 2–3.

⁷² *Ibid.*, 6, 8–9, 15.

⁷³ Jeffrey Munger, “French Upholstery Practices of the Eighteenth Century,” in *Upholstery in America & Europe*, 122–123.

John Moore purchased “Girth Webb” from the Newport brazier Stephen Ayrault. Each piece was priced at approximately £0.6.9, but no clue is given as to their length.

Two other components essential to upholstery foundation included in Fleeson’s bill were padding for the chairs, consisting of “8 [pounds] Curled Hair,” and “13 Yds Canvas,” which included the two layers of linen that enclosed the padding. After tacking the girth webbing to the seat frame, upholsterers covered it with a coarse layer of linen called “sack cloth.” Because the strips of webbing were spaced so far apart, sack cloth served to provide additional support, as well to create a base for the stuffing to rest upon. In New England, eighteenth-century seating furniture was stuffed with marsh grass, curled hair – usually from the manes and tails of horses, passed over a sharp edge to give it curl and spring – or a combination thereof.⁷⁴ Over the stuffing was another layer of linen, generally of a finer weave than the sack cloth. Linen was also used to enclose the bunches of marsh grass that formed the edge rolls of easy chairs.⁷⁵ Although Fleeson’s bill uses the general term “Canvas,” a similarly detailed 1729 bill from the account book of Samuel Grant lists “crocus & Ozn^a [osnaburg],” two varieties of coarse linen fabric.⁷⁶ Chairs were sometimes finished in plain linen and protected with removable slipcovers. Another of Fleeson’s clients, John Cadwalader, purchased thirty-two chairs, three sofas, and an easy chair between October 1770 and January 1771. All were “finish’d in Canvis,” and were fitted with blue and white checked cases trimmed with blue and white fringe.⁷⁷ An easy chair in the collection of Colonial Williamsburg, made between 1785

⁷⁴ Passeri and Trent, “Two New England Queen Anne Easy Chairs,” 27A.

⁷⁵ Morrison H. Heckscher, “18th-Century American Upholstery Techniques: Easy Chairs, Sofas, and Settes,” in *Upholstery in America & Europe*, 98.

⁷⁶ Jobe and Kaye, *New England Furniture*, 365.

⁷⁷ Baumgarten, “Protective Covers for Furniture,” 5.

and 1795 and thought to be from Rhode Island, was finished in plain canvas (fig. 88). The absence of nail holes in the chair's original linen shell, which survives virtually intact, indicates that it was never upholstered with a finish fabric. The chair is equipped with a chamber pot concealed beneath a slip seat, and was probably originally fitted with a loose, informal slipcover for ease of use.⁷⁸

Fleeson's bill also reflects the materials used in making an easy chair cushion. The "1 1/2 Yds Ticken [ticking]" refers to a linen twill fabric used for cushion cases, which would have enclosed the "3 1/2 [pounds] of Feathers."⁷⁹ Ticking was generally striped with colors that depended on its country of manufacture. In France it was often brown and white, while the English favored black and white.⁸⁰ In 1737, Robert Stevens provided "ticken" to Newport mariner John Trobridge, and, in 1770, "Bedtick" was among the items for sale in Caleb Gardner's shop.⁸¹ As the term implies, "Bedtick" was also used to make mattresses.

Two types of hardware, "a sett Castors" and "tax" [tacks], were also billed to the Brown firm. The mention of casters – brass or leather wheels affixed to the feet or base of eighteenth-century furniture to increase its mobility – is significant in that it is evidence of their early use on an easy chair owned in Newport. Iron tacks were essential to upholsterers, who used them to attach every layer of upholstery (fig. 7, see tack labeled

⁷⁸ *Ibid.*, 5.

⁷⁹ Montgomery, *Textiles in America*, 363.

⁸⁰ Thornton, *Seventeenth-Century Interior Decoration*, 117.

⁸¹ Account, in case file, Robert Stevens, Newport, upholsterer v. John Trobridge, Newport, mariner, case 15, November 1737 term, NICCP RB, vol. A, p. 486 (cited in Notes on Robert Stevens, RIFA, YUAG); Inventory of Caleb Gardner, June 14, 1770, Granted Petitions of the General Assembly (1756-1828), vol. XIV, 32.

“Fig. 10”).⁸² The tacks used during most of the eighteenth century had hand-forged shafts and hammered heads. In 1780, tacks with cut shanks became available, but heads continued to be hammered by hand until the advent of machine-stamped heads in the early nineteenth century. Tacks were available in several sizes, and upholsterers stocked them in large quantities.⁸³ In 1733, John Moore purchased thousands of “large tax” and “middle tax” from the brazier Stephen Ayrault, buying 5,500 in the month of August alone. Moore also purchased “6^d [penny] nails” and “20^d [penny] nails” on several occasions.⁸⁴

Not included on Fleeson’s bill were brass nails, which were often used to embellish eighteenth-century seating furniture (fig. 7, see nail labeled “Fig. 8”). These nails had domed heads and square tapered shafts, and came in a variety of sizes. In order to avoid damaging the brass, upholsterers first made a hole for the nail using a punch, and then pushed the nail in with a driving-bolt (fig. 7, see tools labeled “Fig. 9” and “Fig. 7”).⁸⁵

While decorative nails were apparently not used on the Brown firms’ easy chair, Fleeson did use both “Cord” and “18 Yds Silk Lace,” two varieties of trimming commonly employed in the eighteenth-century to cover seams and ornament edges.⁸⁶ Lace was the contemporary term for a woven tape that was sewn or glued over upholstery

⁸² Jobe, “Boston Upholstery Trade,” 73.

⁸³ Jobe, “Boston Upholstery Trade,” 72.

⁸⁴ Account, June 26, 1733–December 20, 1733, in case file, Stephen Ayrault, Newport, brazier v. John Moore, Newport, upholsterer, case 113, May 1735 term, NCCCCP RB, vol. A, p. 312.

⁸⁵ Jobe, “Boston Upholstery Trade,” 72–73.

⁸⁶ Linda Wesselman Jackson, “Beyond the Fringe: Ornamental Upholstery Trimmings in the 17th, 18th and Early 19th Centuries,” in *Upholstery in America & Europe*, 131.

seams to create a flat trim.⁸⁷ Remnants of original tape are visible on two Newport easy chairs. The first, with upholstery attributed in Caleb Gardner, is in the collection of Metropolitan Museum of Art. The second, thought to have been made for Godfrey Malbone, is owned by the Daniel Putnam Association. In addition to woven tape, cord was also used to trim the Gardner chair. In contrast to the flatness of tape, cord was used to create a raised border. Rather plain in itself, cord was often covered with tape, which would be sewn. Unfortunately none of the tape covering remains on the cord of the Gardner chair, but this treatment can be seen on a New England easy chair in the collection of the Brooklyn Museum.⁸⁸

⁸⁷ Jackson, "Beyond the Fringe," 131; Heckscher, "18th-Century American Upholstery Techniques," 100–103.

⁸⁸ Heckscher, "18th-Century American Upholstery Techniques," 102–103

Chapter Two: The Upholsterers of Eighteenth-Century Newport

From 1730 to 1790, nine upholsterers are known to have practiced their trade in Newport.⁸⁹ Five of these men – Peter Hall (w. 1736), John Harvey (w. 1744), Kendall Nichols (c. 1722–1774), John Moore (w. 1732–d. 1762), William Stanton (w. 1754) – have only very recently been identified through Newport court, probate, and land records compiled by Yale University Art Gallery and closely analyzed for this thesis. Others, such as Caleb Gardner Jr. (1729–1801) and Robert Stevens (1713–1780), were already known, but further discoveries now provide a more complete picture of their lives and work.⁹⁰ In comparison to the few known Newport upholsterers, there were at least thirty-six individuals involved in some aspect of the trade in Charleston, South Carolina, during the same time frame. Even this relatively large number of craftsmen appears to have been surpassed by Boston, where forty-four upholsterers are thought to have been working between 1700 and 1775.⁹¹ Considering this large discrepancy in numbers – not to mention the economic prosperity enjoyed by Newport from the 1760s until the Revolution – it seems very likely that the city was home to other, yet-to-be-identified upholsterers. Unfortunately, given that many of Newport’s records were lost or badly damaged during the Revolution, these craftsmen may forever remain unknown.

⁸⁹ For complete biographies of these upholsterers, see Appendix 1.

⁹⁰ Robert Stevens was first identified by Joseph K. Ott. See, Ott, “Recent Discoveries Among Rhode Island Cabinetmakers,” 7. Ott also found evidence of two additional Newport upholsterers, Robert Stevens Jr. (1713–1780) and John Williams (w. 1786), who both did work for Isaac Senter. Senter paid Williams £2.2.0 for “stuffing an easy chair” in May 1786. He paid Stevens £6 for “covering 8 chair bottoms” and £5 for “stuffing a sofa” in 1789, and £1.4.0 for “cover 2 chairs” in 1796. Biographies for Williams and Stevens Jr. are not included since no other evidence of their work as upholsterers has been discovered. Stevens Jr. is named in several court cases, but he is referred to as a merchant rather than an upholsterer.

⁹¹ Jobe, “The Boston Upholstery Trade,” 65.

It is interesting to note that Newport upholsterers apparently did not advertise their services in newspapers. The only known exceptions were Caleb Gardner, who did advertise in Rhode Island, but only after he was living in Providence, and Robert Stevens, whose only known advertisements announced goods for sale in his shop rather than any details regarding his trade. In contrast, Charleston upholsterers, who were the subject of a detailed study by Audrey Michie published in the *Journal of Early Southern Decorative Arts*, frequently made use of newspapers to attract customers. Their advertisements – including those of women such as Elizabeth Brampfield, who placed a notice in the *The South Carolina Gazette* in 1751 announcing that she made easy chair covers – provide a rich source of information about the city’s upholstery trade.⁹² A search through the database *America’s Historical Newspapers* reveals that Philadelphia and New York upholsterers also advertised with some regularity, although the practice seems to have been less common in Boston.

Through an exhaustive search of Charleston newspaper advertisement, Michie determined that the city’s upholsterers preferred the more modern term “upholster” to the older term “upholder.” In Newport, similar information can be garnered from the above mentioned public records, which reveal that terminology describing the trade varied until the middle of the eighteenth century. As in England, the earlier term “upholder” persisted, but was evidently used interchangeably with “upholsterer.” At times the labels were employed simultaneously, as was the case with John Moore, who was identified in a 1735 court document as an “Upholder alias Upholsterer.”⁹³ This essentially redundant

⁹² Michie, “Charleston Upholstery in All Its Branches,” 27. Elizabeth Brampfield’s advertisement appeared in Charleston’s *South Carolina Gazette* on June 5, 1751.

⁹³ Writ, May 2, 1735, in case file, Stephen Ayrault, Newport, brazier v. John Moore, Newport, upholsterer, May 1735 term, case 113, NCCCCP RB, vol. A, p. 312.

reference to Moore's trade probably indicates a transition from the earlier "upholder" to the more modern "upholsterer." Several years later, in two 1741 court cases, Moore's profession was listed as "Upholder," but the record keeper subsequently modified the entry to read "Upholsterer."⁹⁴ The last known use of the term "upholder" in Newport is found in a 1750 lawsuit brought against Robert Stevens.⁹⁵

Although Newport's court, probate, and land records provide an excellent means of identifying an individual's trade and establishing his presence in the city, they sometimes provide few additional details. Such is the case with upholsterers Peter Hall, John Harvey, and William Stanton. Nothing has yet been discovered about their births or their families, and, moreover, the presence of each in Newport can only be documented for a single year. It is thus possible that their residence in the city was brief. Interestingly, there was an upholsterer by the name of Peter Hall working in Philadelphia in April 1745, when he placed an advertisement in *The Pennsylvania Gazette* announcing that he made "all Sorts of Beds, Chairs, or any other Furniture fit for any House."⁹⁶ Although an intriguing possibility, no link can be established at present between the Philadelphia upholsterer and the Peter Hall who was in Newport in 1736. As for William Stanton, small details about his upholstery trade exist in an account submitted as evidence when Stanton was sued by Newport cordwainer Samuel Phillips. In the 1754 account, Phillips

⁹⁴ John Moore, Newport, upholsterer v. Joseph Chaplin, Jr, Newport, joiner, November 1741 term, NCCCP RB, vol. B, p. 250; John Moore, Newport, upholsterer v. James Sweet, Newport, mariner, November 1741 term, case 68, NCCCP RB, vol. B, p. 328.

⁹⁵ Thomas Ward, Newport, gentleman v. Robert Stevens, Newport, upholder, November 1750 term, case 347, NCCCP RB, vol. C, p. 595. In an earlier 1745 case, Stevens was identified as an "Upholder alias Upholsterer;" see Robert Stevens, Newport, upholder alias upholsterer v. Benjamin Pitman, mariner, Samuel Pitman, bricklayer, and Moses Pitman, May 1745 term, case 253, NCCCP RB, vol. B, p. 704.

⁹⁶ Alfred Coxe Prime, *The Arts & Crafts in Philadelphia, Maryland, and South Carolina: Gleanings from Newspapers* (Topsfield, MA: Walpole Society, 1929), vol. 2, p. 203.

bills Stanton on several occasions for either a “Reacking” or a “Reaching,” probably an eighteenth-century term for stretching leather.⁹⁷ Since both men’s trades involved working with leather, it is conceivable that Phillips may have provided such a service for Stanton.

John Moore is the earliest upholsterer to have left a substantial trace of his Newport trade. His origins remain a mystery, but Moore is known to have worked as a Newport upholsterer from at least 1732 until his death in 1761.⁹⁸ The most valuable records documenting Moore’s trade are two surviving accounts. Both provide compelling evidence of the fabrication of at least some upholstered seating furniture in Newport in the 1730s. The first account is from Nathan Townsend, a Newport currier, who sued Moore for over an unpaid bill.⁹⁹ From July 1733 to August 1734, Townsend supplied Moore with thirty-seven hides. The only leather identified by type on the invoice were three horse hides for £0.11.4 each and a calf skin for £0.10.6. Significantly less was the charge for dressing “2 larg Skins red,” which cost only £0.4.0 apiece. The remaining thirty-one hides were £0.12.0 each. Although the invoice does not indicate the animal source for these remaining hides, they are closest in cost to the horse hides. Also noteworthy is that, with the exception of the calf skin, all of the leather was dyed. The color was specified as red for all but the horse hides, which were described only as having been dressed and colored. Moore’s purchase of the hides suggests that he was

⁹⁷ Samuel Phillips, Newport, cordwainer v. William Stanton, Newport, upholsterer, November 1754 term, case 398, NCCCP, vol. D, p. 703; Account, January 3, 1754 to August 3, 1754, in case file, Phillips v. Stanton.

⁹⁸ Judith Cranston, Newport, widow v. John Moore, Newport, upholsterer, November 1732 term, case 142, NCCCP RB, vol. A, p. 167.

⁹⁹ Nathan Townsend, Newport, currier v. John Moore, Newport, upholsterer, case 126, May 1735 term, NCCCP RB, vol. A, p. 308; Account, July 1733–August 1774, in case file, Townsend v. Moore.

partnering with early Newport chairmakers in the fabrication of leather covered seating furniture like the chair featured in catalogue entry one. The pair of armchairs described in catalogue entry four, which were probably made in Newport, demonstrates a later use of leather upholstery.

The second surviving account related to Moore's trade was from Newport brazier Stephen Ayrault, who also sued Moore over an unpaid bill.¹⁰⁰ From June 26 to December 19 of 1733, Ayrault debited Moore for five "pieces Girth Webb," three orders of "glew," and thousands of nails and tacks, including "middle tax," "large tax," "black d^o [tax]," "brads," and six- and twenty-penny nails. Moore also purchased upholstery tools, including "1 hammer" and "3 awle hafts," the latter of which were pointed tools used for making holes in wood or leather. The account also records a "Verbel Order" from Moore for £0.8.5 worth of "Sundrys" on behalf of John Ormsby, a chairmaker who worked in Newport from at least 1733 to 1739.¹⁰¹ Moore's order of supplies for Ormsby indicates that they probably had a business relationship. If this was indeed the case, it represents the earliest known collaboration between a Newport upholsterer and chairmaker.

Robert Stevens had the longest career of any known Newport upholsterer. He was born in Boston, and may have completed his apprenticeship there. It is, however, equally possible that he apprenticed in Newport, where he was practicing his trade in 1736, at the

¹⁰⁰ Stephen Ayrault, Newport, brazier v. John Moore, Newport, upholsterer, case 113, May 1735 term, NCCCP RB, vol. A, p. 312. Account, June 26, 1733–December 20, 1733, in case file, Ayrault v. Moore.

¹⁰¹ The account from Ayrault to Moore is the earliest indication of Ormsby's presence in Newport. The last known reference to Ormsby in Newport is contained in a 1739 court case. See Henry Vug, Portsmouth, a free negro man, v. John Ormsby, Newport, chairmaker, May 1739 term, case 269, NCCCP RB, vol. A, p. 639.

age of twenty-three.¹⁰² Stevens also worked as a shopkeeper and a merchant, activities in which he was partnering with his son Robert by 1767. The elder Stevens appears to have practiced his upholstery trade until his death in 1780. He is referred to as an upholster in a court document relating to his estate, and, according to his inventory, he had two pounds worth of curled hair in his kitchen at the time of his death.¹⁰³

Stevens utilized advertisements on at least two occasions, though, as previously stated, they did not directly mention his upholstery trade. The first time was in 1764, when he announced the availability of “A Variety of Paper Hangings.”¹⁰⁴ Wallpaper, which probably developed as an inexpensive substitute for leather or textile-covered walls, was an important element of eighteenth-century household decoration. As such, it often fell within the purview of the upholsterer, although it was also sold by merchants, paperhangers, bookbinders, and painters.¹⁰⁵ In 1767, a second advertisement, this time for Robert Stevens & Son, announced the arrival of a long list of ready-made goods “Just imported from BRISTOL . . . and from LONDON.”¹⁰⁶ These included textiles, sewing equipment ceramics, nails, birdshot, snuff, cider, and beer.

¹⁰² A 1736 court case is the earliest known record of Stevens’ being in Newport. See Robert Stevens, Newport, upholsterer v. Daniel Underwood, Newport, hatter, November 1736 Term, case 12, NCCCP, RB, vol. A, p. 415.

¹⁰³ Stevens was referred to as an upholsterer when his son petitioned to have his estate declared insolvent. See Petition of Robert Stevens Jr., March 4, 1784, Newport County Superior Court, vol. F, p. 231. For the complete inventory of Robert Stevens, see Nicki Hise, “Gentility and Gender Roles Within the 18th-Century Merchant Class of Newport, Rhode Island” (master’s thesis, paper 22, University of Massachusetts Boston, 2010), 106–108, http://scholarworks.umb.edu/masters_theses/22.

¹⁰⁴ *The Newport Mercury*, October 10, 1763, <http://infoweb.newsbank.com/>.

¹⁰⁵ Many Charleston upholsterers entered into the paperhanging trade. See Michie, “Charleston Upholstery in All Its Branches,” 64–66.

¹⁰⁶ *The Newport Mercury*, June 15–22, 1767, <http://infoweb.newsbank.com/>.

Stevens' upholstery trade is documented in three accounts. In October 1739, he provided chairs to the South Kingstown, Rhode Island, courthouse.¹⁰⁷ Unfortunately, the account provides no clues as to the type of chairs or whether they were upholstered. The £46.10.0 paid to Stevens is equally inconclusive, as the number of chairs is not specified. Evidence of Stevens' trade in upholstered furniture is, however, set forth in the two reciprocal accounts between the estates of Stevens and John Goddard. The bill from Stevens to Goddard includes a charge of £14.0.0 for covering a chair in 1776. An earlier 1768 charge for £61.6.0 appears to have been for chairs commissioned and paid for by Stevens, but never executed by Goddard. Stevens also supplied the cabinetmaker with leather, fabric, and pins.¹⁰⁸ The other invoice details items supplied by Goddard to Stevens from 1764 to 1781, including four sets of "bed cornishes," "a Cornished Bed," "6 Mahogany Chair Frames," "8 Black Walnut Chairs," "6 Mahogany Chair Frames," "2 Easy Chairs," and three coffins, one of which was for his daughter and another of which was for himself.¹⁰⁹ Among the seating furniture listed in the account are two easy chairs, which were provided in March 1764 and which cost £3.2.6 (£1.11.3 each). Goddard's bill also included "8 Black Walnut Chairs @ 5 Dollars" at £12 (£1.10.0 each), supplied in July 1766, and "6 Mahogany Chair Frames @ 4 ½ Doll" at £8.2.0 (£1.7.0 each), supplied in October 1773.¹¹⁰ These fourteen chairs were probably side chairs given that they were

¹⁰⁷ "Account for Sundry Necessaries at the Court House in South Kingstown," February Session 1739/40, Accounts Allowed 1716-1740, Rhode Island State Archives, Providence, RI.

¹⁰⁸ Ott, "More Notes on Rhode Island Cabinetmakers and Their Work," 49. The original invoice is in the Channing-Ellery Papers at the Rhode Island Historical Society, Providence, Rhode Island.

¹⁰⁹ Account, Estate of Robert Stevens To the Estate of John Goddard, March 1764–November 1781, case 23, November 1791 term, NCCCP RB, vol. J, p. 672.

¹¹⁰ It is difficult to infer anything from the prices of the chairs, since the account was drawn up by Goddard's sons, Stephen and Thomas, and it is not clear whether the charges reflect contemporary prices or

purchased in sets. Other varieties of seating furniture – including roundabouts and easy chairs – were typically specified by type in eighteenth-century accounts. The invoice also reveals that Stevens dealt in beds, another important aspect of the eighteenth-century upholstery trade. These beds were often elaborate, with cornishes that were carved from wood and then upholstered.

Less is known about Kendall Nichols Jr., who was born in or around 1722, probably in Newport. Although most likely practicing his trade as early as 1743 or 1744 – at which time he would have turned twenty-one and presumably would have completed his apprenticeship – the first known reference to Nichols as a Newport upholsterer does not appear until a 1761 court case.¹¹¹ He was subsequently referred to as an upholsterer in 1773 and 1774 lawsuits, the latter of which was brought against his widow after his death. Unfortunately, none of the known documents relating to Nichols provide any information about his work as an upholsterer. He is, however, mentioned in the account book of Job Townsend Jr. (1726-1778) in January 1767, when Townsend charged the upholsterer £6.15.0 for Samuel Simson's order. While the order is not specified, it is highly plausible that the craftsmen were collaborating on a piece of upholstered furniture.¹¹²

prices for the years in which the chairs were made. Furthermore, for the side chairs, the individual chair prices are in dollars and the total amounts are in pounds.

¹¹¹ See Thomas Norrington, Plymouth, Massachusetts, baker v. Kendal Nichols, Jr., Newport, upholsterer, November 1761 term, NCCCP RB, vol. F, p. 545; Kendall Nichols, Newport, upholsterer v. Patrick Brady, Newport, mariner, May 1773 term, case 43, NCCCP RB, vol I, p. 322; Nichols v. George, vol I, p. 361; and Joseph Hamand Jr, Newport, merchant v. Sarah Nichols, Newport, widow, May 1774 Term, case 30, NCCCP RB, vol. I, 514.

¹¹² Martha H. Willoughby, "The Accounts of Job Townsend, Jr.," *American Furniture* (1999), Appendix, accessed online, <http://www.chipstone.org/>.

Caleb Gardner Jr. is unique in that he is the only eighteenth-century Newport upholsterer to whom an object can be attributed. Based on its inscription, a 1758 easy chair in the collection of the Metropolitan Museum of Art is believed to be an example of his work (see catalogue entry 5). Gardner was born in Brookline, Massachusetts, in 1729, but his family had relocated to Newport by at least 1740.¹¹³ He was probably working as an upholsterer in or around 1750, at which time he would have been twenty-one. Gardner also worked as a shopkeeper until at least 1770, when he petitioned for protection under the 1756 Insolvent Debtors Relief Act. As a result of his bankruptcy, his shop goods, along with the contents of his house, were inventoried and sold to pay off his debts.

Gardner continued to practice the upholstery in Newport until at least 1774. On two occasions, he purchased side chairs from Benjamin Baker (1734/5–1822), a Newport cabinetmaker who specialized in chairs. In his account book, Baker debited Gardner for “4 mehogni Chair frams @ £56 p” in September 1772 and “2 mehogni Chair frams @ £56 p” in April 1774.¹¹⁴ Two additional accounts testify to Gardner’s continued presence in Newport throughout 1774. In September, he billed Abraham Redwood \$25 for “making suit of Crimson Silk Bed & Window Curtains,” and another \$5 “To my Attendance.” The latter charge indicates that Gardner went to Redwood’s home to install the curtains, highlighting the unique access enjoyed by upholsterers to the houses of their

¹¹³ *Vital Records of Brookline, Massachusetts, to the End of the Year 1849* (Salem, MA: The Essex Institute, 1929), 28. His father is probably the Newport shopkeeper Caleb Gardner (c. 1683–1761), who was involved in multiple court cases from 1740 to 1754. See Caleb Gardner, Newport, shopkeeper v. Job Casewell, Newport, house carpenter, May 1740, NCCCP, RB, vol. B, p. 54.

¹¹⁴ Benjamin Baker’s Account Book, transcribed in Carr, “The Account Book of Benjamin Baker,” 59–89.

wealthy clients.¹¹⁵ The final record of Gardner's Newport career is a December 1774 account in which he bills Mrs. Rachel Wright £40 for "making a Easy Chair."¹¹⁶

By 1783, Gardner was working in Providence, where he advertised that he carried "on his Business, in all its Branches," and that his work was "in the best Manner, and after the newest fashion." The only other known record of Gardner's Providence upholstery trade is a 1790 invoice, in which he billed Enos Hitchcock of Providence £1.16 "To making a Easy Chair and Case."¹¹⁷ Although this amount is substantially lower than the £40 charged to Rachel Wright, such prices cannot be relied upon as an accurate basis for comparison given the fluctuations of pre- and post-Revolution Rhode Island currency. Nevertheless, it is possible that the chair made for Hitchcock was lower in price because it was finished only in linen, and that the "case," or slipcover, was of an inexpensive material such as checked cotton. A second interpretation of "case" – a term that often appears in furniture bills in the context of a packing case – suggests that Hitchcock intended to ship the chair.

No apprenticeship records survive for Newport upholsterers, so these and other work relationships can only be surmised through the pairing of names in court documents. Such circumstantial evidence, found in the records of the Newport County Court of Common Pleas, links the names of both Kendall Nichols Jr. and Caleb Gardner

¹¹⁵ Morrison H. Heckscher, *American Furniture in the Metropolitan Museum of Art: Late Colonial Period, The Queen Anne and Chippendale Styles* (New York: Random House, 1985), 122; for actual invoice, see "Abraham Redwood Esq. To Caleb Gardner D^r," September 14, 1774, mss., Newport Historical Society, Newport, Rhode Island. At this early date, the dollar amounts listed in the account were undoubtedly Spanish milled dollars.

¹¹⁶ Heckscher, *American Furniture*, 122; for actual invoice see "M^{rs}. Rachel Wright To Caleb Gardner D^r," December 31, 1774, Haight mss., Newport Historical Society.

¹¹⁷ Joseph K. Ott, "Still More Notes on Rhode Island Cabinetmakers and Allied Craftsmen," *Rhode Island History* 28, no. 4 (Nov. 1969), 117; also quoted in Heckscher, *American Furniture*, 122; for actual invoice, see "Mr. Hitchcock order to Mr. Gardner 1.16.0," January 29, 1790, Enos Hitchcock Papers, Rhode Island Historical Society, Providence, Rhode Island.

Jr. to that of Robert Stevens. In a 1743 case, Nichols acted as a bondsman for Stevens and Newport joiner Nathaniel Baker.¹¹⁸ Given that Nichols was twenty-one at the time, it is possible that he was apprenticing with or working for Stevens. A second court case, in which Roberts was sued in 1750 by Newport gentleman Thomas Ward, provides a link to the upholsterer Caleb Gardner Jr. When the sheriff attempted to find and arrest Stevens, the upholsterer was not to be found, so the sheriff instead confiscated “a small Knife & fork in a Sheath Delivered to me by Caleb Garnder jun as the Estate of ye Def^t.”¹¹⁹ The fact that Gardner delivered the knife and fork suggests that he may have been at Stevens’ home or shop when the sheriff arrived, an indication that the twenty-one-year-old Gardner apprenticed with or worked for Stevens. Stevens himself was born in Boston, and it is possible that he completed his apprenticeship there. If this was the case, he left soon after his training ended, as he working in Newport as early as 1736, at the age of twenty-three.¹²⁰

While continuing to practice their trades, many upholsterers sought greater financial and social status by engaging in mercantile pursuits or – at the very least – by keeping shops of readymade goods. Although referred to as an upholsterer in probate records related to his estate, John Moore also kept a shop at the time of his death.¹²¹

¹¹⁸ Benjamin Pitman, mariner, Samuel Pitman, bricklayer, and Moses Pitman, fellmonger, all of Newport v. Robert Stevens, Newport, upholder alias upholsterer, May 1745 term, case 253, NCCCP, RB, vol. B, p. 704; Note, December 1, 1743, in case file, Pitman3 v. Stevens.

¹¹⁹ Writ, October 24, 1750, in case file, Thomas Ward, Newport, gentleman v. Robert Stevens, late of the same Newport, upholder, November Term, case 347, NCCCP RB, vol. c, p. 595.

¹²⁰ Stevens’ birth is recorded in Eugene R. Stevens and William Plumb Bacon, *Erasmus Stevens, Boston, Mass., 1674-1690, and His Descendants* (New York: Tobias A. Wright, 1914), 70. For the first known record of Stevens’ presence in Newport, see Robert Stevens, Newport, upholsterer v. Daniel Underwood, Newport, hatter, November 1736 Term, case 12, NCCCP Record Book, vol. A, p. 415.

¹²¹ He is identified as a shopkeeper by his son-in-law in a posthumous lawsuit to collect money due to his estate. See Samuel Yeats, Newport, painter and administrator of the goods, debts, etc., of John Moore, shopkeeper v. John Sovenall, Newport, mariner, November 1762 term, NCCCP, RB, vol. f, p. 700.

There is no evidence that Kendall Nichols Jr. worked as a shopkeeper, although his father probably did. The elder Nichols was referred to as an “influential merchant” by one early historian, and owned “several Houses, Shops, Stores,” all of which were sold after his death to pay his creditors.¹²² Whether or not the younger Nichols owned a shop, he did have ambitions beyond his trade. In May and November 1733 court cases, he identified himself as a gentleman and as a “yeoman alias upholsterer,” respectively.¹²³ As mentioned above, Caleb Gardner Jr. also kept a shop. His inventory of goods contained primarily textiles, including “Harriteene,” “white wor[ste]^d Damask,” and “furniture Checks,” all of which were frequently used in upholstering furniture. Gardner blamed his financial troubles on the “Alteration made in the Price of Goods by divers Persons opening Cash Shops by Reason whereof he was obliged to sell his Goods much cheaper than he could possibly afford, or suffer them to lye on Hand.”¹²⁴ Evidently, it was his efforts to undersell the competition that led Gardner to bankruptcy. It is not known whether he opened another shop in Providence, or whether he supported himself solely by his upholstery trade. The most ambitious of all the Newport upholsters was probably Robert Stevens. In addition to having a shop in Newport’s Brenton’s Row, he was actively engaged in mercantile pursuits. In 1747 he insured the voyage of a ship from Stonington, Connecticut, to Kingston, Jamaica, and in 1767 was involved in financing the passage of another to the Cape Verde Islands. By 1760, Stevens owned a ship with fellow

¹²² See Edward Peterson, *History of Rhode Island* (New York: John S. Taylor, 1853), 318; and “To Be Sold,” dated April 16, 1768, *The Newport Mercury*, May 9–16, 1768, May 30–June 6, 1768, June 20–27, 1768, July 11–18, 1768, August 29–September 5, 1768, <http://infoweb.newsbank.com/>.

¹²³ See Kendall Nichols, Newport, gentleman v. Patrick Brady, Newport, mariner, May 1773 term, case 43, NCCCP RB, vol I, p. 322; and Joseph Hamand Jr, Newport, merchant v. Kendall Nichols, Newport, yeoman, alias upholsterer, November 1773 term, case 284, NCCCP, RB, vol. I, p. 455.

¹²⁴ Petition of Caleb Gardner, filed June 15, 1770, *Granted Petitions of the General Assembly (1756-1828)*, vol. XIV, 32, Rhode Island State Archives, Providence, Rhode Island.

merchants William Vernon and Robert Crooke. He also participated in the slave trade on at least one occasion, in 1756, when he and two fellow merchants commissioned a ship to bring six slaves from Africa to Newport.¹²⁵ Perhaps the greatest testament of Stevens' ambition is a portrait of his wife, attributed to John Singleton Copley, which is now in the collection of the Newport Historical Society (fig. 89). In the life-size painting, Anstris Elizabeth Stevens is depicted with a book in her hand, having just been interrupted in the genteel pastime of reading. The background is indistinct, but she appears to be sitting in a high-style Queen Anne chair with a carved crest. Behind her is a window, through which a stately classical column is visible. Through the commissioning of such a portrait, Stevens was asserting his family's social status, and their membership in the elite merchant class.

With the limited evidence available, it is difficult to draw any definitive conclusions about the economic success of the Newport upholsterers. Caleb Gardner certainly did not find the profession lucrative, although his financial problems were evidently due to his lack of success as a shopkeeper rather than an upholsterer. Robert Stevens appears to have been more successful. Despite an industrious career, however, his estate was worth only £199.9.3 at the time of his death and was eventually declared insolvent.¹²⁶ In all probability, this was due to the economic devastation suffered by Newport as a result of the Revolution. Faring better than Gardner and Stevens was John

¹²⁵ See Certificate of Insurance, October 2, 1747, in case file, John Dennison, Stonington, CT, merchant v. Robert Stevens, Newport, upholsterer, June 1750 term, case 51 Providence County Court of Common Pleas, vol. 3, p. 65; Samuel Pease, Glastonbury, CT, mariner v. William Vernon, Robert Crooke, and Robert Stevens, Newport, merchants, December 1760 term, case 106, PCCCP, vol. 4, p. 391; Robert Stevens & Son, Newport, merchants v. Eleazer Trevett, Newport, mariner, November 1767 term, NCCCP RB, vol. H, p. 19; and Robert Stevens, Samuel Vernon and William Vernon, all of Newport, merchants v. Caleb Godfrey, Newport, merchant, November 1758 term, case 138, NCCCP RB, vol. F, p. 7.

¹²⁶ For a reference to Stevens' inventory, see note 16.

Moore, who – despite being sued on multiple occasions for failing to pay his debts – died with an estate valued at over £500.¹²⁷ His financial status, like that of his fellow upholsterers, was probably dependent on the economic conditions in Newport. The unprecedented period of wealth and prosperity enjoyed by the city in the 1760s would have ensured Moore the affluent clients so necessary to the success of his business.

¹²⁷ Inventory of John Moore, June 7, 1762, NTCP, FHL film 0945000, vol. 13, p. 153–54; published in printed in Edward Wallace Phillips, *The Descendants of Seth Yeats (or Yates) of Newport, Rhode Island, and the Descendants of John Yeats (or Yates) of Providence, Rhode Island* (Bloomington, IN: iUniverse, 2008), 8.

Chapter Three: The Chairmakers of Eighteenth-Century Newport

Evidence recently compiled by Yale University Art Gallery indicates that at least sixteen chairmakers worked in Newport at various times between 1730 and 1790.¹²⁸ This number does not, moreover, include the handful of cabinetmakers known to have made seating furniture. Of the sixteen identified Newport chairmakers, twelve were active between 1730 and 1750, during which time much of the seating furniture purchased by Newport clients is generally thought to have been supplied by Boston.¹²⁹ Although Boston's prominent role in the chairmaking of this period cannot be disputed, it now seems likely that Newport's contribution has been unfairly underestimated. Indeed, in two influential articles on the Boston chairmaking industry, the authors noted that at least twenty-two chairmakers were working in Boston between 1730 and 1750, but cited the number of their Newport counterparts as zero.¹³⁰

While new evidence suggest a much livelier and more robust eighteenth-century Newport chair trade than previously imagined – especially in regard to the number of makers active prior to 1750 – it is difficult to determine precisely which of the Newport makers were producing chairs that would have been upholstered. Some, such as Daniel

¹²⁸ Daniel Dunham (b. 1686–1758), Joseph Pitman (c. 1695–1731), Joseph Proud (1711–1769), William Robson (w. 1733–d. by 1737), John Ormsby (w. 1733–1739), John Proud Jr. (1714–1794), Timothy Waterhouse (c.1715–1792), Joseph Dunham (1723/4–1802), Giles Barney (1725–1783), John McClure (w. 1747–1749), John Lamb, Jr. (w. 1747–1758), John Pitman (c. 1726–1768), Benjamin Gould (1735–1821), Daniel Dolorson (w. 1758-1759), Daniel Dunham III (1738–1815), and Samuel Phillips (w. 1782–d. 1788). For complete biographies of these craftsmen, see Appendix 2. The list does not include Windsor chairmakers Joseph Vickary (w. 1756–d. 1818) and Jonathan Cahoone (w. 1739–1786).

¹²⁹ The first twelve chairmakers listed in note 1 were active between 1730 and 1750.

¹³⁰ Keno, Freund, and Miller, “The Very Pink of the Mode,” 266–306; Freund and Keno, “The Making and Marketing of Boston Seating,” 1–40.

Dunham, who was born in or around 1686 and was probably active from around 1707 until his death in 1758, were most likely making rush-bottomed slat- or banister-back chairs (fig. 9 a, b). In April of 1735, Dunham billed Newport cooper John West “for halfe a Dusson of fore Back Chears” priced at £0.7.8 apiece. The “fore” in “fore Back Chears” probably referred to the number of horizontal or vertical supports on each chair back.¹³¹ Other early makers, such as Joseph Proud, were almost definitely making high-style chairs. Proud was born in England in 1711, but by 1714 his family had immigrated to Newport, where he was probably working as a chairmaker from at least 1732. His earliest output may have included maple chairs like the example described in catalogue entry one. The most compelling evidence of Proud’s having made framed chairs is a 1765 account in which Proud billed Dr. Christopher Champlin for six chairs at £42 each, significantly more than the £36 charged by Benjamin Baker in 1761 for mahogany side chairs.¹³² Further evidence is found in the 1769 inventory of Proud’s estate, which, in addition to “8 maple chairs almost finished,” included fifty feet of black walnut and an easy chair frame. Given that Proud had a stock of walnut, an expensive hardwood, it is likely that he was making high-style seating furniture in addition to less expensive maple chairs.¹³³

As is the case with Newport’s upholsterers, chairmaking apprenticeships can sometimes be inferred through the pairing of names in legal documents. For example, an analysis of court records suggests that chairmaker Benjamin Gould (1735–1821) may

¹³¹ Account, April 1, 1735, Daniel Dunham, Newport, house carpenter v. John West, Newport, cooper, November 1735 term, case 147, NCCCP, RB, vol. A, p. 362.

¹³² N. David Scotti and Joseph K. Ott, “Notes on Rhode Island Cabinetmakers,” *The Magazine Antiques* 87, no. 5 (May 1965): 572. Benjamin Baker’s Account Book, 1760–1792, Newport Historical Society, Rhode Island. The account book is transcribed in Carr, “The Account Book of Benjamin Baker,” 46–89.

¹³³ Inventory of Joseph Proud, September 7, 1769, NTCP, FHL film 0945000, vol. 16, p. 90–91. Also cited in Scotti and Ott, “Notes on Rhode Island Cabinetmakers,” 572.

have trained with Joseph Proud. In 1755, a Benjamin Gould witnessed a bond in which Joseph Bull, a Newport merchant, promised to pay Proud £391.¹³⁴ Given that Gould would have been only nineteen at the time, it is possible that he was chosen as a witness because of his business relationship with Proud. While a link between Gould and Proud can only be tentatively established, court documents explicitly name the apprentice of another chairmaker, John McClure (w. 1747–1749), whose presence in Newport can be documented for the years 1747 to 1749. McClure was referred to as a “chairmaker” in a three-year legal dispute with Newport house carpenter Isaac Cowdry, whom he sued for “will fully enticing away an Apprentice Boy (called Isaac Cowdry Jun[io]r) belonging to the plaint[iff].” McClure won the initial case, but ultimately lost on appeal.¹³⁵

McClure himself was very likely Boston-trained. Given the dates of his known presence in Newport, he is almost certainly the John McClure of Boston who came to Newport to seek his fortune. McClure’s time in Newport is described in the diary of his son Daniel, who wrote: “While Newport in Rhode Island was in a flourishing state, My Father concluded to move there, with the expectation of bettering his worldly circumstances. He continued there a few years disappointed in his expectation & displeased with the loose and irreligious state of the place, although they found many pious Christians there . . . he returned to Boston with his family when I was a child.” The disappointing outcome of his court case with Isaac Cowdry would likely have added to McClure’s disillusionment with the city. McClure’s son further reported that, once back

¹³⁴ Bond, March 28, 1755, in case file, Joseph Proud, Newport, chairmaker v. Joseph Bull, Newport, merchant, May 1756 term, case 147, NCCCP, RB, vol. E, p. 242.

¹³⁵ John McClure, Newport, chairmaker v. Isaac Cowdry, Newport, house carpenter, November 1747 Term, NCCCP, Record, RB, vol. C, p.131; Isaac Cowdry, house carpenter, Newport, appellant v. John McClure, chairmaker, Newport, appellee, March 1748, NCSC, RB, vol. D, p. 86; Cowdry v. McClure, November 1748, NCSC, Record Book D, p. 103.

in Boston, his father “carried on a small trade” – possibly in chairmaking – and “kept a retailing shop of groceries.”¹³⁶

Another previously unknown chairmaker who may have apprenticed in Boston was Daniel Dolorson, who worked in Newport from at least 1757 to 1759.¹³⁷ Nothing is known about his birth or his family, but he was probably the Daniel Dolorson who married Temperance Norton in Boston in 1755.¹³⁸ The only known records of Dolorson’s presence in Newport are two court cases, one in 1758 and another in 1759, both between Dolorson and Alanson Gibbs, a Newport joiner and shopkeeper.¹³⁹ At the center of the related disputes were reciprocal accounts, two of which document Dolorson’s work as a chairmaker. A 1759 account lists twenty-five chairs supplied to Gibbs by Dolorson, most of which are identified either by style or material. The only two entries identified by both are two black walnut roundabouts priced at £12 apiece, and four mahogany roundabouts priced at £14 apiece. The charge for a single roundabout chair to be used as a close-stool was also £14. On two occasions, Dolorson supplied Gibbs with “4 Chairs with Compass seats.” The first set was priced at £7 per chair, and the second set at £6 per chair.¹⁴⁰ It is almost certain that these eight chairs were made in the Queen Anne or Chippendale style,

¹³⁶ David McClure and Franklin B. Dexter, *Diary of David McClure, Doctor of Divinity, 1748–1820* (New York: The Knickerbocker Press, 1899), 3.

¹³⁷ The spelling of Dolorson’s name differs in the documents cited in the following footnotes. Variations include Dollorson, Dollinson, Dollison, Dollenson, and Dolenson. Within the text, I have consistently referred to the chairmaker as Dolorson,

¹³⁸ *The Manifesto church: Records of the church in Brattle square, Boston, with Lists of Communicants, Baptisms, Marriages, and Funerals, 1699–1872* (Boston: The Benevolent Fraternity of Churches, 1902), 248.

¹³⁹ Alanson Gibbs, Newport, joiner v. Daniel Dollison, Newport, chairmaker, November 1758 term, case 113, NCCCP, RB, vol. f, p. 54; Daniel Dollenson, Newport, joiner v. Alanson Gibbs, Newport, joiner, May 1759 term, case 17, NCCCP RB, vol. f, p. 108.

¹⁴⁰ Account, March 23, 1759, in case file, Gibbs v. Dollison. In addition to roundabout and compass seat chairs, an earlier bill from Dolorson also includes “flag bottom chairs,” mahogany tea tables, and turned elements of roundabout chairs. Account, July 19, 1758, in case file, Dollenson v. Gibbs.

given that they had compass seats and that Dolorson was working in mahogany and walnut.¹⁴¹

A second account submitted as evidence in the cases is a four-page bill from Gibbs to Dolorson, dated December 1757 to April 1759, which includes charges for a wide variety of goods and services, such as food, board, and personal necessities.¹⁴² Gibbs was also supplying Dolorson with the raw materials of his trade, including £4's worth of "Black Wornut for a Cheare By Agreement" and £4's worth of "Mohogany for ditto." Other charges related to Dolorson's trade were £38 for the "Carvers Bill," £6.8.0 for the "Turners Bill," and £7.10.0 for "My Acco^t for Turning." Given that Dolorson was paying for such services, it can be assumed that he was not a turner or a carver himself, and that he contracted out such work to other craftsmen. The reference to carving is significant in that it is proof of a collaboration between a Newport chairmaker and a Newport carver. Gibbs also billed Dolorson for several pieces of furniture, including two bedsteads, a table, and two roundabout chairs. It is curious that Gibbs was supplying Dolorson with roundabouts, given that Dolorson was also making them for Gibbs.

The chairs made by Gibbs were significantly more expensive than those made by Dolorson. One of Gibbs' roundabouts, made of unspecified wood, was £20, and the other, made of mahogany, was £40. An intriguing candidate for one of the roundabouts made by Gibbs is a chair stamped "Gibbs" on the top surface of its front leg (fig. 10a, b). The chair has previously been associated with joiner John Gibbs, who worked in Newport from at least 1730 to 1754. There is, however, no evidence that John Gibbs made roundabouts or

¹⁴¹ Compass seats, which were used on some chairs of both the Queen Anne and Chippendale periods, have rounded fronts and curved sides (see fig. 8).

¹⁴² Account, December 1757–April 1759, in case file, Dollenson v. Gibbs.

any other variety of chair. If Alanson Gibbs did make the stamped chair, which is by no means certain, the ball-and-claw foot may have been the work of the same carver for whose services he billed Dolorson.

Like the Townsend and Goddard families of cabinetmakers, Newport chairmakers were closely connected through ties of kinship and marriage. There were at least three chairmakers in the Dunham family, including Daniel (b. 1686–1758), his son Joseph (1723/4–1802), who probably apprenticed with his father, and his grandson Daniel Dunham (1738–1815). Another such family was the Pitmans. Joseph (c. 1695–1731) and his nephew John (c. 1726–1768) were chairmakers, and at least five other Pitman family members practiced various woodworking trades.

Perhaps the best example of Newport chairmakers united by both blood and marriage were the Quaker families of Proud and Waterhouse. By 1714, John Proud (d. 1757), a watch- and clockmaker, moved his family from England to Newport, where his sons Joseph (1711–1769) and John (1714–1794) both worked as chairmakers. It is possible, but by no means definite, that another Proud brother, William, also practiced the trade. There was a William Proud (c. 1723–1779) who worked as a Providence chairmaker with his sons Samuel (1762–1833) and Daniel (1762–1833).¹⁴³ In 1738, Hannah Proud, the sister of John and Joseph, married Newport chairmaker Timothy Waterhouse (c.1715–1792). It is not known whether the three men worked together, but it

¹⁴³ Although it is tempting to assume that Joseph and John Proud's brother William was the Providence chairmaker, the birth date of the William Proud born in Newport is recorded in Arnold's Vital Records as October 9, 1720, and the birth date of the Providence chairmaker is c. 1723, based on his death date and his recorded age when he died. See James N. Arnold, *Vital Records of Rhode Island, 1636–1850. First series Births, marriages and deaths. A Family Register for the People. Volume 7: Friends and Ministers* (Providence: Narragansett Historical Publishing Company, 1895), 70, and The Rhode Island Historical Cemeteries Transcription Project, <http://www.rootsweb.com/~rigenweb/cemetery/index.html> (hereafter cited as RIHCTP).

is possible that Waterhouse met his wife through a business connection with one or both of her brothers. Waterhouse, who was born in Portsmouth, New Hampshire, also had another brother-in-law who worked as a chairmaker. When he was 12 or 13, his older sister married the chairmaker John Gaines III (1704–1743), who had moved to Portsmouth from Ipswich to practice his trade. It is very likely that Waterhouse apprenticed with Gaines, although there is no corroborating evidence.

This highly interesting discovery suggests the possibility that Waterhouse may have made chairs that demonstrated both Newport and Portsmouth characteristics. A pair of chairs reflecting attributes found on the seating furniture of both cities was published in *American Antiques from Israel Sack Collection* in 1974 (fig. 11). The chairs were attributed to the “school of John Gaines” because of their block-and-turned front legs, ample Spanish feet, shaped front seat rail, and double-ball-and-ring turned front stretcher, all of which are characteristics found on four side chairs from a set made by Gaines III that descended in the Gaines/Brewster family (fig. 12).¹⁴⁴ The chairs are different from other Portsmouth examples, however, in their distinctive eared crest rails, which are strikingly similar to those seen on contemporary Newport chairs (fig 13).¹⁴⁵

No study of Newport’s chairmaking trade would be complete without a discussion of the city’s cabinetmakers and joiners. It is likely that a substantial number of Newport’s high-style Queen Anne and Chippendale chairs were made by craftsmen who did not identify themselves as chairmakers, including the famed Townsend and Goddard

¹⁴⁴ John Gaines’ daughter, Mary, married Plymouth joiner David Brewster (1739–1818). See Brock W. Jobe and Diane C. Ehrenpreis, *Portsmouth Furniture: Masterworks from the New Hampshire Seacoast* [exhibition catalog] (Hanover, NH: University Press of New England, 1993), 48.

¹⁴⁵ Israel Sack, Inc., *American Antiques from Israel Sack Collection*, vol. 4 (Alexandria, VA: Highland House Publishers, 1974), 937, fig. P5052. Thanks to Patricia E. Kane for bringing this chair to my attention.

families. A set of six side chairs with hooped crests and flat stretchers were long believed to have been made by Job Townsend Sr., but this attribution has now been called into question (see catalogue entry 2). While it is probable that Job Sr. made framed chairs, there is no documentary evidence to support the supposition. Proof of his son Job Townsend Jr.'s chair production does exist, however, and can be found in the younger Townsend's surviving ledger and day book. According to these accounts, which cover the years 1750 to 1778, the forms of seating furniture produced by Job Jr. included a "round about Chiar" for £45 in 1765, an "Easy Chair Frame" for £40 in 1770, a "Child Chair" for £7 in 1774, and four close-stools, priced from £10 (for one of unspecified wood made in 1753) to £45 (for a "Black Walnut Closl Stool Chair" made in 1765). On two occasions Job Jr. made sets of "6 Chairs made of Black Walnut," – first in 1766 for an unspecified price and then in 1768 for £30 each – which were probably side chairs. Job Jr. also made three chairs of unspecified form, two in 1767 for £30 each and another in 1770 for £45.¹⁴⁶ Unfortunately, not enough is known of Townsend's work to enable any attributions to him. Given his prices, materials, and the forms documented in his accounts, however, it is very likely that most of the chairs he produced were framed chairs that would have been upholstered.

The most famous member of the Townsend clan, cabinetmaker John Townsend (1732–1809), is also known to have made chairs. A set of four Federal-style side chairs bear his label and a date of 1800. No other labeled Townsend chairs are known to survive, but documentary references to seating furniture made by the cabinetmaker include eight mahogany chairs in 1764 and twelve mahogany chairs in 1769, both for

¹⁴⁶ For a transcription of Job Townsend Jr.'s ledger and account book, see Willoughby, "The Accounts of Job Townsend, Jr.," Appendix.

merchant Aaron Lopez, as well as close-stools in 1781, 1791, 1794, and 1797.¹⁴⁷ Probate documents related to Townsend's estate offer further evidence of his chair output. His 1809 inventory reveals that, at the time of his death, the seating furniture in his shop included "8 Black Walnut framed Chairs \$24," "8 Mahogany Chairs not put together \$16," "2 Easy Chair frames \$8," and "8 Blk Walnut frames Chairs \$24." In his will, Townsend bequeathed "eight mahogany chairs with Claw feet, six Black walnut Chairs with Hair bottoms, [and] my Easy Chair" to his daughter Mary.¹⁴⁸

Attributions of chairs to Townsend are typically based either on a history of descent in his family or on stylistic attributes. Two side chairs owned by the Newport Restoration Foundation (NRF), both of which descended in the Townsend family, are considered touchstones for Townsend chairs (fig. 14). Their ball-and-claw feet can be authenticated as Townsend-made based on their resemblance to those of his signed case furniture and tables (fig. 15). Their distinguishing features include slender talons with three articulated knuckles (the central one closest to the upper one) and smooth rear talons that continue up into the legs.¹⁴⁹ The splats of the NRF chairs are very similar to those of other chairs attributed to Townsend (fig. 16). Although the general design of these splats was popular in Rhode Island, Townsend's splats are distinctive in that the central arches of his crests have a recessed field embellished with a diaper pattern.

Another chair attributed to Townsend, with the same splat design but with pad feet, is in

¹⁴⁷ Morrison H. Heckscher, *John Townsend: Newport Cabinetmaker*, exh. cat. (New York: The Metropolitan Museum of Art, 2005), 56, 181–183.

¹⁴⁸ Will of John Townsend, June 1, 1805, and Inventory of John Townsend, May 13, 1809, Newport Probate (Newport City Clerk's Office, Newport, Rhode Island, hereafter cited as Newport Probate), vol. 4, p. 600–601, 635. Quoted in Heckscher, *John Townsend*, 203, 207.

¹⁴⁹ Michael Moses, *Master Craftsmen of Newport: The Townsends and Goddards* (Tenafly, N.J.: MMI Americana Press, 1984), 147.

the collection of the Metropolitan Museum of Art. Townsend also made easy chairs, and an example in the collection of the Rhode Island Historical Society has been attributed to him based on the style of its ball-and-claw feet.¹⁵⁰ Other chairs believed to have descended in Townsend's family include two armchairs with straight legs ornamented with stop-fluting, a style Townsend employed from at least the mid-1780s (fig. 17).¹⁵¹ The two arm chairs are remarkably similar, with the exception of their arms, one having open arm panels with scrolled armrests, and the other having upholstered arm panels with straight armrests. A distinctive element also found on other Newport armchairs is the arched front surface of the arm supports where they meet the tops of the front legs (fig. 18).¹⁵² For an example of a stop-fluted easy chair by another, unknown Newport maker, see catalogue entry eight.

It has also been well established that John Goddard (1724–1785) made chairs, including a “Two Armed Chiar . . . The Feet in Imitation of Eagles Claws” in 1766 for a West Indian client of the mercantile firm of Nicholas Brown and Company,¹⁵³ “common Chairs” and “Leather chairs” for Moses Brown in 1763,¹⁵⁴ and “10 Mahogany Chaire Frames” for Christopher Champlin in 1775.¹⁵⁵ Goddard is known to have collaborated

¹⁵⁰ Heckscher, *John Townsend*, 102.

¹⁵¹ *Ibid.*, 140.

¹⁵² Conversation with Patricia E. Kane, the Friends of American Arts Curator of American Decorative Arts, Yale University Art Gallery.

¹⁵³ Draft letter from Nicholas Brown and Co. to Mr. Bogman, dated June 20, 1766, box 357, folder 7, Brown Family Business Papers, John Carter Brown Library at Brown University. Quoted in Heckscher, *John Townsend*, 47.

¹⁵⁴ The “common Chairs,” are referenced in a June 30, 1763, letter from Goddard to Moses Brown; the “Leather Chairs,” are mentioned in the draft of an October 10, 1763, letter from Brown to Goddard. Both letters are quoted in Moses, *Master Craftsmen of Newport*, 196–197.

¹⁵⁵ Walter A. Dyer, “John Goddard and His Block-Fronts,” *Antiques* 1, no. 5 (May 1922): 207. Also cited in Scotti and Ott, “Notes on Rhode Island Cabinetmakers,” 572.

with the upholsterer Robert Stevens on the fabrication of seating furniture, having supplied him with two easy chairs in March 1764, “8 Black Walnut Chairs” in July 1766, and “6 Mahogany Chair Frames” in October 1773.¹⁵⁶ Several chairs can be attributed to Goddard based on the design of their ball-and-claw feet, which have clear parallels in his case furniture and tables. Goddard’s feet are realistically depicted, with long, attenuated talons that have well-delineated knuckles and long claws, as well as a bulge where the rear digits meet the feet.¹⁵⁷ Chairs with Goddard-style feet include corner chairs, side chairs, easy chairs, and arm chairs (for examples of a side chair and easy chair, see catalogue entries 3 and 7).

In addition to the celebrated craftsmen discussed above, there were other, lesser-known Newport cabinetmakers and joiners who also made framed chairs. Although a cabinetmaker by trade, Benjamin Baker produced a greater number of chairs than any other furniture form. His work is well documented in his surviving account book, which details his business from 1760 to 1792.¹⁵⁸ From 1760 to 1782, when he made his last recorded chair, Baker’s output comprised one close-stool of unidentified wood priced at £35, two mahogany roundabouts priced at £32 each, three mahogany close-stools priced from £32 to £36 each, twenty black walnut side chairs priced from £20 to £28 each, forty maple side chairs priced at £12.10.0 to £18 each, and sixty-two mahogany side chairs priced at £32 to £56 each. In another of the few documented cases of a possible

¹⁵⁶ Account, Estate of Robert Stevens To the Estate of John Goddard, March 1764–November 1781, case 23, November 1791 term, NCCCP RB, vol. J, p. 67.

¹⁵⁷ Moses, *Master Craftsmen of Newport*, 210.

¹⁵⁸ Benjamin Baker’s Account Book, 1760–1792, Newport Historical Society, Rhode Island. For an in-depth analysis of Baker’s career and account book, see Carr, “The Account Book of Benjamin Baker,” 46–89. See also, “Benjamin Baker, 1734 or 1735–1822,” Rhode Island Furniture Archive, Yale University Art Gallery, New Haven, CT, <http://rifa.art.yale.edu/> (hereafter cited as RIFA, YUAG).

collaboration between a Newport cabinetmaker and a Newport upholsterer, Baker provided Caleb Gardner with “4 mehogni Chair frams @ £56 p” in 1772 and “2 mehogni Chair frams @ £56 p” in 1774. Baker also supplied chairs to cabinetmaker John Townsend, whom he billed in 1782 for two sets of eight and a set of six “Mohigni chair frams” ranging in price from £4.16.0 to £6 per chair. Baker’s account book also reveals that he had a business relationship with chairmaker Daniel Dunham (1738–1815). In 1762, there were numerous transactions between the two men, including credits to Dunham for “118 foot bord” and “5 Days work.”¹⁵⁹

Other craftsmen known to have made chairs include joiner William Robson (d. by 1737), cabinetmaker Walter Nichols (1748–1823), and joiner and shopkeeper Alanson Gibbs, the last of whom, as mentioned above, made roundabout chairs. Although Robson’s one known commission was for a mahogany desk and bookcase, he was referred to as a chairmaker in a 1737 posthumous lawsuit, indicating that he made at least some seating furniture. Nichols’ production of chairs is well documented in the personal accounts of Dr. Isaac Senter of Newport. He provided Senter with “8 mahogany chairs 13-4-0” in 1782, “10 mahogany oval top chairs @ 40/ and 2 same with arms @ 50/” in 1795, and “8 chairs 16-0-0” in 1796.¹⁶⁰ The “oval top” chairs were undoubtedly in the Federal style, but given that Nichols had probably been working since 1769, when he would have been twenty-one, it is likely that he made Chippendale chairs as well.

In addition to fulfilling commissions for local clientele, Newport craftsmen took advantage of the city’s status as a flourishing port and engaged in sea trade. The reliance of the eighteenth-century Newport furniture industry on export trade is confirmed by an

¹⁵⁹ Benjamin Baker’s Account Book, transcribed in Carr, “The Account Book of Benjamin Baker,” 59–89.

¹⁶⁰ Joseph K. Ott in “Recent Discoveries Among Rhode Island Cabinetmakers,” 8–9.

early historian, Thomas Hornsby, who notes that “All the cabinetmakers on Bridge and Washington Streets, employed a large number of hands, manufacturing furniture, for which a ready market was found in New York and the West Indies.” One of the craftsmen mentioned by Hornsby as being “extensively engaged in manufacturing furniture” for these markets was Benjamin Baker, whose primary output was chairs.¹⁶¹ Documentary evidence of Newport’s export furniture trade is found in the inward shipping records of the Southern ports of Annapolis, Maryland, and Charleston, South Carolina. Between April 6, 1756, and December 24, 1775, sixty-seven ships brought 380 chairs, twenty-five case pieces, and twenty tables from Newport to Annapolis. While almost twice as many Boston ships brought cargo to Annapolis during the same period, in general they carried only three pieces of furniture for every nine brought by Newport vessels.¹⁶² According to shipping records from 1764 and 1767, Charleston was also the recipient of substantial amounts of Newport furniture, including 133 chairs, seventy case pieces, and thirty-three tables.¹⁶³ This preponderance of chairs is confirmed by the imports and exports ledger maintained by the British colonial government. These records indicate that, from 1769 to 1772, Rhode Island exported an average of 512 chairs per year to markets in the American colonies and the West Indies. The number of case furniture and tables was considerably lower, at 217 and 110, respectively.¹⁶⁴ Such totals suggest

¹⁶¹ Thomas Hornsby, “Newport, Past and Present,” *Newport Daily Advertiser*, December 8, 1849. Quoted in Sloane, “John Cahoone and the Newport Furniture Industry,” 92.

¹⁶² Port of Annapolis Entries, 1756–1775, Maryland, vol. 1 ms. 21, Maryland Historical Society; analyzed in Keno, Freund, and Miller, “The Very Pink of the Mode,” 299, and Jeanne A. Vibert, “Market Economy and the Furniture Trade of Newport, Rhode Island, The Career of John Cahoone, Cabinetmaker: 1745–1765” (master’s thesis, University of Delaware, 1981), 19–21.

¹⁶³ Margaretta M. Lovell, “‘Such Furniture as Will Be Most Profitable’: The Business of Cabinetmaking in Eighteenth-Century Newport,” *Winterthur Portfolio* 26, no. 1 (spring, 1991): 60.

that Newport chairmakers played a pivotal role in supplying seating furniture for export markets.

While the participation of Newport cabinetmakers in the export trade has been the subject of studies by Jeanne Vibert Sloane and Margaretta M. Lovell, less is known of these cabinetmakers' counterparts in the chairmaking industry, who were undoubtedly eager to capitalize on the export trade as well. Chairmaker Timothy Waterhouse appears to have exported chairs in partnership with his son Timothy Jr., who was engaged in mercantile pursuits by at least 1765.¹⁶⁵ In November of that year, the elder Waterhouse supplied his son with several pieces of seating furniture, including six chairs for £40, one great chair for £14, and twelve chairs for £60.¹⁶⁶ Although it is uncertain whether these particular chairs were intended for export, it seems likely that the two would have collaborated on such ventures. Timothy Jr. is known to have shipped desks and chairs to North Carolina on at least one occasion, in 1764, when he charged George Cornell £10 for "2 Desks," £2.15.0 for "1 Doz Chairs," and £1 for another "1/2 Doz D^o[chairs]."¹⁶⁷ Cornell, identified as a Newport gentleman, shipped the furniture to North Carolina and

¹⁶⁴ Carr, "The Account Book of Benjamin Baker," 49. Carr cites Anne Rogers Haley ("Whither Bound? Exports of Rhode Island Furniture on the Eve of the American War of Independence, 1768–1772" [manuscript], p. 6), who calculated the Rhode Island furniture exports based on figures recorded in the "Imports and Exports (America) Ledger, 1768–1774" (Public Records Office, Kew, England).

¹⁶⁵ For the first reference to Waterhouse Jr. as merchant, see Timothy Waterhouse Jr., Newport, merchant v. Sarah Downer, Newport, widow, November 1765 term, NCCCCP RB, vol. G, p. 492.

¹⁶⁶ Account, May 28, 1766, in case file, James Rodman, Newport, mariner v. Timothy Waterhouse Jr., Newport, shopkeeper, May 1766 Term, case 149, NCCCCP RB, vol. G, p. 608.

¹⁶⁷ The charges on this account and the account referenced in the following footnote are specified as being in North Carolina currency. Account from Waterhouse Jr. to Cornell, 1765, in case file, Timothy Waterhouse Jr., Newport, merchant v. George Cornell, Newport, gentleman, May 1766 term, case 213, NCCCCP RB, vol. G, p. 582.

sold it on Timothy Jr.'s behalf, charging him a total of £3.3.2 for freight, storage, and commission.¹⁶⁸

The elder Timothy Waterhouse's brother-in-law, John Proud Jr., who was both a chairmaker and a shopkeeper, also engaged in export trade. In 1747, Proud was involved in a lawsuit concerning a ship he co-owned with two other men, James Lyon, a cooper, and Oliver Paddock, a cordwainer, both of Newport. In what was almost certainly part of a mercantile venture, the men had engaged the mariner John Morriss of Maryland in "the conversion and disposition of a certain Sloop called the Humingbird of the Burthen of forty five Tonns with her Mast, Bowsprit, Yards, Sails, Rigging, Cable, Anchors, & Boat."¹⁶⁹ Other evidence that Proud was trading by sea is found in an account from Samuel Hall, a printer from Salem, Massachusetts. From June 1763 to April 1765, Hall supplied Proud with an "Almanack for 1764," "Money Tables," "Portage Bills," "Bonds," "Bills Laden," "Powers [of] attorney," and "Bills [of] Sale."¹⁷⁰ Portage bills are shipping documents used to keep track of crew members' wages, and "Bills Laden," or bills of lading, are documents acknowledging the receipt of shipped goods. Unfortunately, there is no record of the contents of the cargo that Proud was involved in shipping, but he was identified as a Newport chairmaker when Hall sued him over the unpaid invoice.

Waterhouse and Proud are just two of the many makers who doubtless participated in the export trade. Given the substantial number of chairs shipped from

¹⁶⁸ Account from Cornell to Waterhouse Jr., November 20, 1764, in case file, Waterhouse Jr. v. Cornell.

¹⁶⁹ James Lyon, cooper, John Proud, chair maker, and Oliver Paddock, cordwainer, all of Newport v. John Morriss of Cympuxon in the County of Worchester in the Province of Maryland Mariner. [Need to find citation at Yale].

¹⁷⁰ Account, June 22, 1763 to April 13, 1765, in case file, Samuel Hall, Salem, Essex County, MA, printer v. John Proud, Newport, chairmaker, May 1770 term, case 163, NCCCP RB, vol. H, p. 521.

Newport during the second half of the eighteenth century, there were certainly others whose entrepreneurial spirits would have led them to seek distant, as well as local, markets for their seating furniture.

Chapter Four: Catalogue of Upholstered Chairs

1. *Side Chair, 1725 –1745, Probably Newport*¹⁷¹

The earliest form of seating furniture included in this study is a turned and joined leather chair in the collection of the Newport Historical Society (NHS) (fig. 19).¹⁷² The chair is thought to have belonged to William Ellery (1727–1820), and was probably made in Newport between 1725 and 1745.¹⁷³ Chairs of this type had American antecedents in leather-covered interpretations of the fashionable cane chairs produced in London from about 1664 into the early eighteenth century. They were made in Boston, the first center of chairmaking in colonial America, and exported throughout the colonies in large numbers.¹⁷⁴ Earlier examples generally have tall, straight backs, with stiles that are angled backwards above the seat rails, and flat back panels flanked by turned stiles.¹⁷⁵ The NHS chair represents a partial transition from these William and Mary forms to the more modern Queen Anne style, and reflects characteristics of both: its Spanish feet, turned front legs, and ball-and-ring turned front stretcher are typical of the earlier chairs; while its yoked crest rail, molded stiles, and serpentine or “crooked” stiles and back panel

¹⁷¹ This chair has been published in Jobe and Kaye, *New England Furniture*, 341, fig. 91c. See also, “RIF954,” RIFA, YUAG.

¹⁷² For a closely related examples, see Oswaldo Rodriguez Roque, *American Furniture at Chipstone* (Madison: University of Wisconsin Press, 1984), 112–113, no. 47, and Skinner, Inc., Boston, *American Furniture and Decorative Arts*, sale cat. (June 8, 2008), 28, lot 41.

¹⁷³ “RIF954,” RIFA, YUAG. Given the date of the chair, it is probable that Ellery’s parents, William Ellery Sr. (1701–1764) and Elizabeth Almy (1703–1783), were the original owner. It is likely that Ellery Sr., a wealthy merchant, would have owned such stylish seating furniture.

¹⁷⁴ Patricia E. Kane, *300 Years of American Seating Furniture: Chairs and Beds from the Mabel Brady Garvan and Other Collections at Yale University* (Boston: New York Graphic Society, 1976), 56; Jobe and Kaye, *New England Furniture*, 339.

¹⁷⁵ Kane, *300 Years of American Seating Furniture*, 61.

were new innovations.¹⁷⁶ Chairs with crooked backs, designed to echo the curve of the sitter's back, were available in Boston as early as February 1722/23, when the upholsterer Thomas Fitch sold "1 doz. crook'd back chairs" for £16:4:0.¹⁷⁷ Like their predecessors, these chairs were popular export items, and were no doubt shipped to Newport, where they would have influenced local craftsmen.¹⁷⁸ It is possible, for example, that early Newport chairmakers like Joseph Proud and Timothy Waterhouse were partnering with early upholsterers like John Moore in the fabrication of such seating furniture.

Both the chair's original leather and foundation upholstery survive in remarkable condition, providing an excellent example of what may have been an early collaboration between a Newport chairmaker and upholsterer (fig. 20). The trapezoidal seat is supported by three strips of webbing – two running from front to back, and one from side to side – that are tacked to the top surface of the seat rails and interwoven in a lattice pattern. The webbing is a plain weave, and its pattern is much faded, but a central white stripe, flanked by what appear to be brown stripes, is still discernible. On top of the webbing is a layer of coarsely woven, linen sackcloth, which is presumably also tacked to the top of the seat rails. The sackcloth would have absorbed much of the stress placed upon the seat since the strips of webbing were spaced so far apart.¹⁷⁹ The chair's stuffing, visible through a tear in the sack cloth, appears to be marsh grass, a commonly used padding in early New England chairs (fig. 21). It was typically arranged in bunches

¹⁷⁶ Ibid., 61–62.

¹⁷⁷ Quoted in Benno M. Forman, *American Seating Furniture, 1630–1730: An Interpretive Catalogue* (New York and London: W.W. Norton & Company, 1988), 335.

¹⁷⁸ Brock Jobe, "The Boston Furniture Industry, 1720–1740," in *Boston Furniture of the Eighteenth Century* (Boston: Colonial Society of Massachusetts, 1974), 40.

¹⁷⁹ Trent, "17th-Century Upholstery in Massachusetts," 43.

running parallel to the front seat rail, resulting in the slightly domed, round-shouldered upholstery profile seen on the NHS chair.¹⁸⁰ The marsh grass is also visible through a small hole in the leather upholstery, indicating that the leather was placed directly over the stuffing rather than over a layer of linen. In seventeenth- and early eighteenth-century Massachusetts chairs, this extra layer was typically considered unnecessary as the leather was strong enough to prevent the grass from poking through.¹⁸¹ It is likely that a similar conservation of materials was also practiced by Newport upholsterers.

With the foundation upholstery in place, the upholsterer would have laid the leather down over the marsh grass. Because leather was apt to distort when stretched, it was generally not cut exactly to size before being placed over the stuffing. The leather had to be manipulated to accommodate the front legs and stiles, and was generally folded at the front corners and cut at the rear corners, with the outer strips of leather folded around the outsides of the rear posts and the middle flap pulled over the rear seat rail. The leather was then tacked about half way down the outside surface of the seat rails. Next, the seat was finished with a thin strip of leather, or trim strip, which was affixed to the outside edges of the seat rails (fig. 22).¹⁸² On the NHS chair, the tacks holding the leather seat in place can be felt beneath the trim strip, which is made up of four pieces. On the back rail is a small piece of leather (a), to which are nailed two longer pieces that wrap around the stiles and continue to the side rails (b, c). A fourth piece of leather covers the front rail (d), wraps around the tops of the front legs and a portion of the side rails, and is there nailed in place over elements b and c. The use of multiple leather strips was no

¹⁸⁰ Ibid., 43.

¹⁸¹ Ibid., 44.

¹⁸² Ibid., 47.

doubt part of an effort to conserve materials by utilizing what was available. When attaching the trim strip to the seat rails of the NHS chair, the upholsterer employed a sort of decorative hierarchy based on the visibility of each rail.¹⁸³ On the rear seat rail, which was ranked last in visual importance, the trim strips were simply secured with two rows of rosehead nails. On the side rails, which were slightly more conspicuous, the upholsterer used a row of decorative brass nails over a row of rosehead nails. The most ornate treatment was reserved for the front seat rail, which was embellished with two rows of brass nails.

Once all the layers of upholstery were in place, it was necessary to secure them in order to prevent the grass stuffing from shifting. This was accomplished through of a series of stitches at the center of the seat, a practice referred to today as “double-stuff stitching.” The double-stuff stitches on Massachusetts chairs are usually in the shape of a rectangle.¹⁸⁴ The upholsterer of the NHS chair chose a trapezoid – echoing the shape of the seat itself – and his stitches pass through every upholstery layer, from the webbing to the leather. In executing the double-stuff stitching, upholsterers did not always include the leather in their stitches. They often did, however, thereby unintentionally weakening the leather and contributing to an eventual collapse of the seat.¹⁸⁵ Fortunately this has not occurred on the NHS chair, and the surface of its intact leather seat retains three of the four buttons used to secure the thread (fig. 23). The buttons, which have a greenish tint, appear to be made of an organic material, probably wool.¹⁸⁶ They are placed at the

¹⁸³ Conversation with Adams Taylor, independent consultant on the collections of the Newport Historical Society, October 18, 2011.

¹⁸⁴ Trent, “17th-Century Upholstery in Massachusetts,” 44–45.

¹⁸⁵ *Ibid.*, 44–45.

¹⁸⁶ Conversation with Mark Anderson, Head Furniture Conservator, Winterthur Museum, January 25, 2012.

corners of the square, and each has a groove at its center through which the stitches are held in place.

The back panel of the NHS chair was also padded and upholstered. Although badly deteriorated, enough remains of the leather upholstery to establish its original treatment (fig. 24). No webbing was used, so the foundation consisted only of a layer of linen sackcloth nailed to the inside surface of the back panel. Remnants of the sackcloth are visible from the outside surface of the back panel, which – in keeping with the visual hierarchy of the seat rails – was left unupholstered. The stuffing, which does not survive but would almost certainly have been marsh grass, was covered with a rectangular piece of leather. Like the front seat rail, the highly visible back panel is elaborately embellished. The leather is held in place with two rows of decorative brass nails that run around its perimeter.

Construction Notes

The rectangular side stretchers are joined to the front and rear legs with double-sided tenons, offset toward the inside and pinned in front and back. The back stretcher is joined to stiles with double-shouldered tenons, offset toward the inside. The ball-and-ring turned front stretcher is joined to the front legs with round tenons with a slight shoulder. The seat frame is joined with double-sided tenons. The block and turned legs terminate in Spanish feet that sit on platforms. Each foot has two laminates, one at the front and another at the outside. The left foot has lost both laminates, and the right foot has lost its side laminate, half its front laminate, and the platform at its base. The molded stiles are tenoned into the molded, yoked crest rail and through pinned. The stay rail, or lower back

rail, is joined to the stiles with double-shouldered tenons. The vertical back panels are joined to the crest and lower back rail with single-shouldered tenons. The block of wood under the crest rail, to which the upholstery of the back panel is tacked, is nailed to vertical rails of the back panel. The rear legs are raked backwards, and the back feet are unchamfered.

Woods

Maple

Measurements

Height: 41 $\frac{3}{4}$ "; seat height: 17 $\frac{3}{8}$ "; width (at front feet): 19 $\frac{1}{2}$ "; depth (foot to foot): 18

$\frac{3}{4}$ "

2. *Side Chair, 1730 –1760, Probably Newport*

This chair from the collection of the Newport Historical Society is part of a group of at least eighteen related examples traditionally associated with Newport cabinetmaker Job Townsend (1699–1765) (fig. 25).¹⁸⁷ Its bold design reflects the late baroque love of curves, which is embodied in the yoked crest with hooped shoulders, the vase-shaped splat, the cabriole legs with scrolled knees, the compass seat, and the flat, shaped stretchers. Further enhancing the effect are the crooked stiles and splat, which impart a gentle serpentine curve to the chair’s profile (fig. 26). The majority of chairs of this type, including this example, have side and front seat rails carved into a flat-arch. Additional decorative treatment was given to at least five examples, each of which has a more elaborately carved front seat rails with central astragals (fig. 27).¹⁸⁸

The form of the NHS chair is based on English prototypes. Chairs with hooped crests are rare in American furniture. They were first introduced in combination with straight-sided, crooked splats – inspired by English interpretations of Chinese forms and referred to as “India backs” during the period – which were typically embellished with veneers.¹⁸⁹ Examples with straight-sided splats include both armchairs and side chairs, and have either flat or turned stretchers (fig. 28). The compass seats and vase-shaped splats of chairs such as the NHS example are later stylistic developments, reflecting a progression towards the more curvilinear Queen Anne style.¹⁹⁰

¹⁸⁷ See “RIF4189 (set of 3),” “RIF214 (set of 6),” “RIF1227,” “RIF1231 (set of 2),” “RIF2736,” “RIF334,” “RIF3410,” “RIF3753,” “RIF4936,” and “RIF78,” RIFA, YUAG.

¹⁸⁸ See “RIF334,” “RIF3410,” “RIF3753,” “RIF4936,” and “RIF78,” RIFA, YUAG.

¹⁸⁹ Freund and Keno, “The Making and Marketing of Boston Seating Furniture,” 15.

¹⁹⁰ Nancy E. Richards and Nancy Goyne Evans, *New England Furniture at Winterthur: Queen Anne and Chippendale Periods* (Winterthur, DE: Winterthur Publications, 1997), 26.

The Townsend attribution originated in 1930, when a set of six related chairs were included in the Anderson Galleries estate sale of dealer Philip Flayderman. The chairs were catalogued as having been made by Townsend around 1730, but no evidence was given to support the claim.¹⁹¹ They were purchased by dealer Israel Sack and sold at the same venue two years later, where they were catalogued as being “part of a group of pieces made by Job Townsend for the Eddy family of Rhode Island in 1743.” In support of the attribution, Sack stated that another piece in the group of Eddy furniture was labeled by Townsend.¹⁹² Despite the inherent weakness of Sack’s argument – namely, that a label on one piece of furniture is not sufficient to prove origin of another – the attribution persisted until the 1990s, when many chairs believed to have been made in Newport were reassigned to Boston based on research conducted by Leigh Keno, Jean Barzilay Freund, and Alan Miller.¹⁹³ In a 1998 article, Freund and Keno reattributed the Eddy chairs to Boston based on several stylistic elements, including their hooped crests, flat stretchers, and carved C-scrolls. They also cited chairs’ relationship to the earlier “India back” chairs, which they also attributed to Boston.¹⁹⁴

Subsequently, the chairs have been given a more general attribution, based on an in-depth analysis of the eighteen related examples conducted by scholar and curator Milo

¹⁹¹ Milo M. Naeve, “A New England Chair Design of 1730–1760 and Attributions to the Job Townsends of Newport, Rhode Island,” *Newport History: Bulletin of the Newport Historical Society* 72 (Spring 2003):1,4. For the original Townsend attributions, see Anderson Galleries, Inc. and American Art Association, New York, *Colonial Furniture, Silver, and Decorations: The Collection of the Late Philip Flayderman*, sale cat. (January 2–4, 1930), 250–251, lot 492.

¹⁹² American Art Association and Anderson Galleries, Inc., New York, *One Hundred Important American Antiques*, sale cat. (January 9, 1932), 110–11, lot 80, quoted in Naeve, “A New England Chair Design,” 1, 4.

¹⁹³ Keno, Freund, and Miller, “The Very Pink of the Mode,” 266–306.

¹⁹⁴ Freund and Keno, “The Making and Marketing of Boston Seating Furniture,” 33–34. A related chair owned by Winterthur has also attributed reattributed to Boston, see Richards and Evans, *New England Furniture at Winterthur*, 26–27.

M. Naeve. After studying their measurements, construction, and design, he concluded that the chairs were from ten different sets made in eight different shops in coastal New England.¹⁹⁵ Naeve further hypothesized that if one of the variations was made by Job Townsend Sr. – or his son, whose ledger and daybook prove that he made chairs – a likely candidate would be a chair in the collection of the Art Institute of Chicago (see fig. 27). That chair’s unnecessarily sturdy construction, Naeve argues, may be indicative of the hand of a cabinetmaker, given that a chairmaker would likely have been more economic in his technique and use of material. Naeve points to the thickness of the front seat rail, the extra pins used to secure the joints, and the use of corner blocks to reinforce the seat as evidence of the maker’s refusal to skimp on materials.¹⁹⁶

Given the lack of any definitive evidence supporting a Townsend or Boston attribution, Naeve’s theory that the chairs originated in various shops throughout coastal New England is all that can be said with any certainty. It is entirely possible, however, that any or all of the related chairs were made in Newport, and, indeed, several stylistic elements found on the NHS example do support a tentative Newport attribution. Though chairs with flat stretchers are known to have been made in Boston – Samuel Grant Samuel used them as early as February 1741/42, when he billed Benjamin Dolbear for “2 Chairs false Seats Flat Strechers”¹⁹⁷ – such evidence does not preclude the possibility that craftsmen in other parts of New England also adopted the style. Examples of flat-stretchered chairs made in Newport include two side chairs originally owned by Nicholas

¹⁹⁵ Naeve, “A New England Chair Design,” 1–17.

¹⁹⁶ *Ibid.*, 9.

¹⁹⁷ Samuel Grant Account Book, February 3, 1741/42, Massachusetts Historical Society, quoted in Freund and Keno, “The Making and Marketing of Boston Seating Furniture,” 19.

Brown of Providence and attributed to John Goddard (fig. 29).¹⁹⁸ Thought to have been made in or around 1762, the chairs have stretchers of a similar shape to those of the NHS chair, but have rounded top edges. If Job Townsend Sr. did make the NHS chair, or one of the related examples, it is conceivable that Goddard, who probably apprenticed with Townsend, drew inspiration from his master's earlier work.

Naeve did not include rear stretchers in his analysis of the chairs, reasoning that the configuration of stretcher turnings could differ within the same shop or be duplicated by multiple shops. Nevertheless, the rear stretcher of the NHS chair is closely related to that of several Newport easy chairs, including the example from the collection of the Metropolitan Museum of Art believed to have been upholstered by Caleb Gardner Jr. Both chairs' stretchers have "arrow-shaped" ends capped with two ring turnings, one small and the other more prominent, and swelled centers (fig. 30 a, b).¹⁹⁹ The front feet of the two chairs are also similar, with ample pads that have sharply delineated disks (fig. 31 a, b). Other characteristics pointing to a possible Newport attribution for the NHS chair are its substantial weight and the treatment of its back legs, which are unchamfered below the rear seat rail. All of these features are typical of chairs made in Rhode Island.²⁰⁰ Judging from photographic evidence, all of the related chairs have unchamfered rear feet. In contrast, the earlier "India back" chairs tended to have chamfered rear legs (see fig. 28).

¹⁹⁸ Christie's, New York, *Important American Furniture and Folk Art*, January 20, 2012, lots 114 and 115, <http://m.christies.com/sale/list/featured/1/?KSID=f3f4a82dfb05670c04f31745034758b9>.

¹⁹⁹ Other Newport easy chairs with similar rear stretchers include one in a private collection (fig. 53), and another previously owned by Godfrey Malbone Jr. and now in the collection of the Preservation Society of Newport (fig. 53).

²⁰⁰ See notes for "RIF214," RIFA, YUAG

Although the leather on the slip seat of the NHS chair has been replaced, the foundation upholstery – including sack cloth, webbing, and stuffing – appears to be original (fig. 32). The seat is supported with three strips of webbing, two running front to back and one running side to side, which are tacked to the top surface of the frame. The webbing is plain weave, and each strip is 1 ¾ inches wide. Although quite faded, the pattern appears to have been a central white stripe bordered in light brown, and two darker brown stripes on either side. This same pattern is also seen on the chairs in catalogue entries number 6 and 7. Over the webbing is a coarse layer of sack cloth, also nailed to the top surface of the seat frame, which is woven from linen threads varying substantially in width. The seat is stuffed with grass, probably marsh grass, which can be seen through the open weave of the sack cloth.

Construction Notes

The flat side stretchers are joined to the front legs and stiles with double-shouldered tenons and pinned in front and behind. The flat medial stretcher is tenoned into side stretchers. The rear stretcher is joined to the rear legs with round tenons. The front and side seat rails are tenoned into the tops of the front legs and secured with square pins. The side rails are joined to stiles with double-shouldered tenons and secured with a single square pin towards bottom of the rail. The underside of the proper right seat rail is roughly finished. The rear rail is joined to stiles with double-sided tenons, slightly offset to the outside and secured with square pins. The crest is tenoned into stiles and through pinned. The tenons of the crest are visible from its underside. The rear surfaces of the crest rail and stiles have chamfered edges. Chamfering of the stiles ceases just above the

seat rail and then continues from just below the seat rail to just above the rear stretcher. The rear feet are angled backwards, but are not chamfered. The splat is slotted into the crest and into a molded shoe, which is affixed to the back seat rail with a single nail on either side. The outer surface of the splat is flush with the shoe and recessed where it meets the crest. The cabriole legs terminate in disk-shaped pad feet that sit upon smaller disks. The carved scrolls of the knees continue into the knee returns, which are secured with nails.

Incisions/Marks

“VIII” inscribed on underside of front seat; “VI” inscribed on top surface of front seat rail.

Woods

Primary: walnut; Secondary: maple (seat)

Measurements

Height: 41 ½"; seat height: 17 ¾"

Width (at back feet and back rail): 15"

Depth (foot to foot): 21 ½"

Provenance

Thomas George Hazard, Jr. (born 1862), Narragansett Pier, Rhode Island; by descent to Mrs. Thomas George Hazard Jr., Narragansett Pier; by descent to Peyton Randolph

Hazard (died 1961), Newport, Rhode Island; bequeathed in 1962 to the Newport Historical Society.²⁰¹

²⁰¹ "RIF4189," RIFA, YUAG.

3. *Side Chair, 1750–1775, Newport*

A side chair in the collection of the Metropolitan Museum of Art (2011.221) is one of the earliest types definitively assigned to Newport (fig. 33).²⁰² It has the distinctive ball-and-claw feet and powerful stance traditionally associated with the work of John Goddard.²⁰³ The chair's form is transitional, combining attributes of the Queen Anne and Chippendale styles. Its compass seat, crooked stiles, and rounded crest with carved shell demonstrate the late Baroque enthusiasm for the curves embodied in Queen Anne forms. Elements indicative of an evolution toward the Chippendale style are the pierced splat and the ball-and-claw feet, the latter of which – though seen in earlier chairs – became much more prevalent with the Rococo interest in carved embellishment.

The chair's proportions are broad and low to the ground, and its appearance of solidity is consistent with its substantial weight. At the center of the crest rail is a six-lobed shell with a thin bottom border terminating in scrolled volutes (fig. 34). The undulating surface of its lobes contrasts with the flat, unadorned face of the crest rail and stiles. The shell is positioned slightly higher upon the crest than in other similarly designed chairs, leaving a narrow void below it.²⁰⁴ The crest rail is unusual in the exaggerated curves of its arches, which are reminiscent of the hooped crests of a group of flat-stretched Queen Anne side chairs formerly attributed to Job Townsend (fig. 25). The combination of these

²⁰² Morrison Heckscher, Amelia Peck, and Carrie Reborá Barratt, "Anatomy of an Acquisition: Treasures from the Ann and Philip Hozer Collection," *The Magazine Antiques* 160, no. 2 (August 2001): 191, 195. See also, "RIF390," RIFA, YUAG. In "The Very Pink of the Mode: Boston Georgian Chairs, Their Export, and Their Influence," Leigh Keno, Joan Barzilay Freund, and Alan Miller describe a similar chair in the collection of the Rhode Island Historical Society as adopting design elements of earlier Boston chairs but stating them with "a strong Newport accent" (p. 296).

²⁰³ Exhibition Placard (2011.221), American Wing, Metropolitan Museum of Art, New York; Heckscher, "Anatomy of an Acquisition," 195.

²⁰⁴ Conversation with Nicholas Vincent, Research Associate, American Wing, Metropolitan Museum of Art, New York, October 13, 2011.

double arches with the inward sweep of the stiles gives the chair's back a heart-like shape. The chair's width at its back feet is two inches narrower than at its rear seat rail, creating a dramatic cinched effect when viewed from behind (fig. 35). The vase-shaped splat has a sharply incut neck, and is pierced with one diamond void flanked by two elongated voids. This design seems to have remained popular in Newport and is sometimes combined with strap work on later examples. The face of the chair's front seat rail is flat, and the shape of the compass seat was achieved through serpentine side rails joined to the rounded corners of the upper legs. The gently curved cabriole legs have uncarved, rounded knees, and ball-and-claw feet of the type generally associated with John Goddard (fig. 36).²⁰⁵ Devoid of webbing, their long, attenuated talons have well-delineated knuckles and long claws, and there is a pronounced bulge where the rear digits meet the feet. Tendons initiating from the talons extend upward into the ankles to form pronounced ridges. Other attributes typical of Newport chairs of the period include the unchamfered back feet and the ring turnings abutting the bulbs of the front stretcher. Uncharacteristic elements are the thinness of the block-and-turned stretchers and the lack of prominence of the ring turnings toward the rear of the side stretchers.²⁰⁶

The upholstery foundation of the chair's slip seat appears to be original (fig. 37). The seat is supported by three strips of webbing – two running from front to back, through which one strip running from side to side is interwoven – that are tacked to the top surface of the seat frame. The plain-weave webbing strips are two inches wide. The pattern has faded significantly, but it appears to have been a central blue strip bordered in

²⁰⁵ Moses, *Master Craftsmen of Newport*, 210.

²⁰⁶ Conversation with Patricia Kane, Friends of American Arts Curator of American Decorative Arts, Yale University Art Gallery.

white, flanked by thinner white strips bordered in blue. Over the webbing the upholsterer has tacked two layers of linen sackcloth. The fabric is very coarsely woven, with a thread count of approximately fourteen threads per inch, and with threads that are very irregular in thickness. The loose weave of the linen may have necessitated an additional layer to keep the horsehair stuffing from poking through. Some of the strands of black horsehair have worked their way around the front edge of the slip seat and are visible on its underside. On top of the stuffing is a layer of linen that may also be original. It is of a finer weave than the sack cloth, as was common in eighteenth-century upholstery. The linen has been drawn around the edges of the slip seat and tacked to its underside. The nails securing it appear to be old and are spaced approximately an inch apart. The outer layer of linen is covered in a faded green-blue velvet that is not original. It has been pulled over the edges of the slip seat and tacked to its underside. The original fabric – probably either leather, horsehair, or a worsted textile – would have been affixed in the same way, and these earlier tack holes are visible on the underside of the seat.

No other chairs from the same set as the Metropolitan's are known, but there are three groups of related chairs that are virtually identical. Chairs in the first group appear to differ only in the treatment of their rear legs, which are not chamfered between the seat rail and stretcher like those of the Metropolitan example. One chair from this group is in the collection of the Museum of Fine Arts, Boston (39.172, fig. 38),²⁰⁷ another is owned by the Chipstone Foundation, Fox Point, Wisconsin (1962.12),²⁰⁸ and a third, formerly in

²⁰⁷ Museum of Fine Arts, Boston, <http://www.mfa.org/collections/object/side-chair-38712>; Edwin J Hipkiss, *Eighteenth-Century American Arts: The M. and M. Karolik Collection* (Cambridge, Mass.: Harvard University Press, 1950), 142–143, no. 80. See also “RIF749,” RIFA, YUAG.

²⁰⁸ Roque, *American Furniture at Chipstone*, 122–123, no. 52. See also “RIF949,” RIFA, YUAG.

the collection of The Henry Ford, Dearborn, Michigan, was sold by Sotheby's in 2001.²⁰⁹ The second group consists of a set of six chairs sold at Christie's in 1992 that are thought to have originally belonged to Stephen Hopkins (1707–1785) of Providence, Rhode Island (fig. 39).²¹⁰ As in the previous group, their back legs are unchamfered between the rear seat rails and stretchers. Their splats differ from those of the aforementioned chairs in that the undersides of the scrolls are partially carved, so that their edges are delineated where they intersect the two innermost vertical elements of the splat. The third group comprises two chairs sold at Christie's in 1995 (fig. 40).²¹¹ Their splats are similar to those of the Stephen Hopkins chairs, but their scrolls are even further defined, with carved undersides where they intersect all four vertical elements of the splats. Their back legs are chamfered between the rear seat rails and stretchers.

Chairs of this design were also made with solid splats, as demonstrated in an example from the collection of the Rhode Island Historical Society (RIHS) (fig. 41).²¹² The RIHS chair has the same carved shell, ball-and-claw feet, exaggeratedly arched crest, and narrow width at the rear feet. Like most of the abovementioned chairs, its back legs are unchamfered. The only significant difference in the RIHS example is its solid, vase-shaped splat, a stylistic element associated with earlier Queen Anne forms. Given the

²⁰⁹ Sotheby's, New York, *Important Americana including Silver, Prints, Folk Art, Furniture, and Property formerly in the Estate of Ulysses S. Grant*, sale cat. (January 18–19, 2001), 246, lot 698. See also, "RIF3487," RIFA, YUAG.

²¹⁰ Christie's, New York, *Important American Furniture, Silver, Prints, Folk Art, and Decorative Arts*, sale cat. (January 17–18, 1992), 214–15, lot 426. See also, "RIF322," RIFA, YUAG.

²¹¹ Christie's, New York, *The Collection of Mr. and Mrs. Eddy Nicholson*, sale cat. (January 27–28, 1995), 286–87, lot 1089. See also "RIF293," RIFA, YUAG.

²¹² Joseph K. Ott, *The John Brown House Loan Exhibition of Rhode Island Furniture* (Providence: Rhode Island Historical Society, Providence, 1965), 8-9, no. 7. See also "RIF1204," RIFA, YUAG.

overall similarity of the solid- and pierced-splat examples, however, it is likely that they were made around the same time.

Another closely related set of slightly later chairs, one of which is in the collection of the Metropolitan (55.134), have carved knees and trapezoidal seats that display a more fully developed Chippendale aesthetic (fig. 42).²¹³ All of the known examples have unchamfered rear legs, splats with partially carved volutes, carved shells with central C-scrolls, and angular knees with relief-carved anthemions. The curves of the crest rails are less pronounced than those of the chairs from the other sets. Despite these differences, they are closely related to the plain knee examples through the presence of the same thin, unremarkable stretchers and ball-and-claw feet, suggesting the possibility that they originated from the same shop.²¹⁴

Construction Notes

The side stretchers are joined to the front legs with round tenons and through pinned; they are joined to the rear legs with double-shouldered tenons, offset toward the outside, and through pinned. The medial stretcher is joined to the blocks of the side stretchers with round tenons. The rear stretcher is joined to rear legs with round tenons. The underside of the rear stretcher is flat at its thickest points, indicating that the width of the original block of wood was insufficient to complete the turnings. The bottom edges of the

²¹³ Morrison H. Heckscher, *American Furniture*, 44–45, 336, no. 9. See also “RIF769,” RIFA, YUAG. Other known chairs from this set include a pair sold at Christie’s in 2000 [Christie’s, New York, *Important American Furniture, Folk Art, and Decorative Arts*, sale cat. (October 5, 2000), 76–81, lots 95; see also “RIF1,” RIFA, YUAG]; a chair advertised in 2008 by Bernard and S. Dean Levy, Inc., New York [find Antiques ad; see also “RIF567,” RIFA, YUAG]; and a pair and a single chair sold at Sotheby’s in 2011 [Sotheby’s, New York, *Property from the Hascoe Family Collection: Important American and English Furniture, Fine & Decorative Art*, sale cat. (January 23, 2011), 30–31, lot 34 and lot 65; see also “RIF722” and “RIF4279,” RIFA, YUAG].

²¹⁴ Heckscher, *American Furniture*, 44.

front and side seat rails are carved into flat arches, and their upper edges are rounded. The front rail is tenoned into the tops of the front legs and pinned. The side rails are tenoned into the tops of the front legs and pinned. They are joined to the stiles with double-shouldered tenons, offset to the outside, and pinned twice. The rear rail is tenoned into the stiles and through pinned. There are rasp marks on the undersides of the seat rails. The front corners of the seat frame are reinforced with two-part vertical corner blocks. The inside blocks are secured with single pins, and the outside blocks are glued. The uncarved knees are flanked by ogee-shaped knee brackets. All are glued in place, with the exception of the proper left front bracket, which is nailed.²¹⁵ The one-piece, molded shoe is affixed to the rear seat rail with a single nail on either side. The vase-shaped, pierced splat is slotted into the crest rail and shoe. The front of the splat is flat, and its back edges are slightly beveled. Its back surface is flush with the shoe and recessed where it joins the crest. A center line, used by the maker to lay out the splat, is visible on its front surface above the diamond piercing. The splat's upper edges and proper left volute have broken off and been reattached.²¹⁶ A single piece of wood was used for the crooked stiles and rear legs. Above the seat rail, the stiles are flat in front and rounded at the back; they are tenoned into the crest rail and pinned. The top of the proper right stile has been repaired with a patch, and is pinned twice beneath the point where it joins the crest rail. The corners of the rear legs are chamfered between the rear seat rail and stretcher. The rear legs rake backwards, and the rear feet are unchamfered. The slip seat is tenoned and pinned. The chair has an old, desiccated finish.

²¹⁵ Object file (2011.221), American Wing, Metropolitan Museum of Art, New York.

²¹⁶ Ibid.

Incisions/Marks

“V” incised on underside of the slip seat; “II” incised on top surface of front seat rail; “I” incised on back of crest rail to right of center and on back center of seat rail.

Woods

Primary: mahogany; Secondary: chestnut and pine (corner blocks); maple (slip seat)

Measurements

Height: 37 $\frac{3}{4}$ "; height (seat): 17"

Width (front feet): 20 $\frac{1}{2}$ "; width (rear seat rail): 15 $\frac{5}{8}$ "; width (rear feet): 12 $\frac{5}{8}$ "

Depth (foot to foot): 20 $\frac{3}{4}$ "

Provenance

Israel Sack, Inc., New York, 1981; sold to Ann and Philip Holzer, Great Neck, New York, by 2001; given by him to The Metropolitan Museum of Art, New York, 2001.²¹⁷

²¹⁷ “RIF1309,” RIFA, YUAG.

4. *Armchairs (pair), 1755-1775, Probably Newport*

The origin of this pair of armchairs forms an ongoing debate among scholars (fig. 43 and 44).²¹⁸ The upholstered example is in the collection of Winterthur Museum, and its mate, formerly in the collection of Joseph K. Ott, was sold at Christie's on January 20, 2012. The chairs are believed to have descended in the family of Abraham Redwood II (1709–1788) – who resided in Newport and Portsmouth, Rhode Island, and Antigua – and one of the pair may be the hooped-arm chair depicted in an oft-published portrait of the wealthy Quaker (fig. 45).²¹⁹ The pioneering 1981 article on the Redwood chairs was penned by Ott, who assigned them to Newport.²²⁰ Then, in 1997, the Winterthur example was catalogued as a Boston chair by Nancy E. Richards and Nancy Goyne Evans, who associated the bone-shaped medial stretcher and cylinder-and-block legs, as well as the hooped arms and lobed crest – features seen on English antecedents – with earlier Boston examples.²²¹ Most recently, the chair was tentatively re-attributed to Newport by Christie's in their catalogue for the January 2012 sale of the collection of Mr. and Mrs. Joseph K. Ott.²²²

²¹⁸ See “RIF1342” and “RIF 2694,” RIFA, YUAG.

²¹⁹ It has been argued that what at first glance appears to be a structural support below Redwood's elbow, giving the impression of a roundabout chair, is either a sheath of papers or a book protruding from his coat. The chair in the portrait can never be identified with any certainty, however, since painters undoubtedly took liberties when depicting their subjects' surroundings. See Joseph K. Ott, “Abraham Redwood's Chairs?,” *Antiques* 119, no. 3 (March 1981): 671; and Richards and Evans, *New England Furniture at Winterthur*, 172.

²²⁰ Ott, “Abraham Redwood's Chairs?,” 671–672. Ott's Newport attribution was based primarily on stylistic elements believed to be indicative of Newport origin, including the chair's dynamic stance, bold knees, front feet, cylinder-and-block rear legs, and block of the medial stretcher.

²²¹ Richards and Evans compare the hooped arms of these chairs to the hooped crests of another group of chairs traditionally attributed to Newport cabinetmaker Job Townsend (see catalogue entry 2). The chairs were also assigned to Boston in Freund and Keno, “The Making and Marketing of Boston Seating Furniture,” 13–14.

²²² Christie's, New York, *The Collection of Mr. and Mrs. Joseph K. Ott*, sale cat. (January 20, 2012), 20–23, lot 138.

The resemblance of the two chairs to English prototypes has led both Ott and Richards and Evans to suggest that their maker may have been a foreign-born craftsman.²²³ Richards and Evans identified early Georgian antecedents for the tripartite, lobed crest and also for the combination of narrow-waisted back, broad compass seat, and crooked arm posts and hoop arms. They also compared Redwood's chairs to later French-style chairs illustrated by Chippendale in his 1762 edition of *The Gentleman and Cabinet Maker's Director*, and to later variations published by Ince and Mayhew and Manwaring.²²⁴ As noted in Christie's catalogue of the Ott sale, Redwood's chairs were not the only examples of their kind that were made in the American colonies. A group of at least seven New York armchairs, all of which are thought to have been made in the same shop, are closely related in both design and construction (fig. 46).²²⁵ Similarities in construction include rear legs that are continuous with the stiles, which have outer edges shaped by the addition of blocks.²²⁶ The New York chairs are not, however, identical to these examples. In addition to lacking stretchers, they differ in that they have rounded rear legs and arched crests. Furthermore, although the arm design of the New York chairs

²²³ Ott hypothesized that the maker may have been English-born chairmaker Joseph Proud (1711–1769), at the time was believed to have apprenticed in his native country. Recent research reveals, however, that Prouds' family had immigrated to Newport by 1714 (see Proud's biography in this master's thesis). Proud remains a possible candidate, however – if the chair was indeed made in Newport – since he was working there at the time. Ott, "Abraham Redwood's Chairs?," 672.

²²⁴ Richards and Evens, *New England Furniture at Winterthur*, 171–172.

²²⁵ Christie's New York, *Property from the Collection of Mrs. J. Insley Blair*, sale cat. (January 21, 2006), lot 522. In its catalogue entry for lot 522, Christie's lists five examples, including one at Winterthur, a pair in the collection of the Metropolitan Museum of Art, two in private collections (one illustrated in Israel Sack, Inc., *American Antiques from Israel Sack*, vol. V, 1190, and another in an Israel Sack, Inc., advertisement, *The Magazine Antiques* [July 1975], inside front cover), and an unpublished chair sold by Leigh Keno, Inc. in 1991. A seventh chair from the same group was sold at Sotheby's in 2008. See Sotheby's, New York, *Property of Rear Admiral Edward P. Moore and Barbara Bingham Moore*, sale cat. (September 26, 2008), lot 36.

²²⁶ See Christie's, *The Collection of Mr. and Mrs. Joseph K. Ott*, 20–23, lot 138; and Christie's, *Property from the Collection of Mrs. J. Insley Blair*, lot 522.

includes crooked supports, their arms terminate in outward scrolls rather than in hoops.

Although the Ott chair has lost its original upholstery, it provides important evidence about the way the two chairs were framed. That they were made by a consummate craftsman is apparent in both the exceptional quality of the chairs' construction and in their exquisite finishing details. Using multiple scribe lines that demonstrate a precise attention to detail, the maker meticulously laid out the junctures where the arms meet the stiles and where the dovetailed tops of the front legs are joined to the seat rail (fig. 47). Many elements of the chair were impeccably finished despite the fact that they were intended to be concealed with upholstery. Most striking are the stiles, the inner edges of which are shaped into graceful curves (fig. 44). In addition, the stiles are made of mahogany rather than a less expensive secondary wood, indicating a disinclination to conserve materials and reduce costs. Similar refinements include the bottom of the crest, which is carved into a tripartite arch, and the lightly chamfered interior edges of the seat rails. Such careful craftsmanship is more typical of Newport than of Boston, where chairs intended for the export market were often inexpensively made. Other characteristics suggesting a Newport origin are the use of cherry, a wood found more frequently in the furniture of Rhode Island than that of Massachusetts, and the presence of sapwood in the mahogany, which is visible on the proper-left rear stile and the proper-left medial stretcher block.²²⁷ Rhode Island makers seem to have valued the decorative quality of sapwood's contrasting lightness, and it is used even more

²²⁷ The more frequent use of cherry in Rhode Island furniture is noted Christie's, *The Collection of Mr. and Mrs. Joseph K. Ott*, 20–23, lot 138. The characteristic use of sapwood in Rhode Island furniture has been observed by Patricia E. Kane, Friends of American Arts Curator of American Decorative Arts, Yale University Art Gallery.

conspicuously on at least two chairs attributed to John Goddard (see, for example, fig. 42).

While much of the construction of the Ott chair's Winterthur mate is hidden from view, the chair is an invaluable document of eighteenth-century upholstery practices. The seat is supported by five strips of webbing – three running from front to back, and two from side to side – each of which is tacked to the top surface of the seat rails and interwoven in a typical lattice pattern (fig. 48). The strips are approximately 2" at their widest point and $1\frac{7}{8}$ " at their narrowest point. The webbing is a plain weave, and its pattern is amazingly well-preserved, with a central black stripe bordered in light brown stripes, and two black stripes on either side. The dye used for the faded brown stripes was apparently much more fugitive than that used for the black, which are still vibrant. Over the webbing is a layer of coarsely woven sackcloth, on which the stuffing was placed. Because the leather is still *in situ*, it is not known whether an extra layer of linen was used between it and the stuffing. Eighteenth-century upholsterers did not always deem the extra layer necessary when using leather, which was typically sufficient to prevent the grass and/or hair padding from poking through. Although the outside of the chair's back panel does not retain its original leather, its foundation upholstery is concealed by a replacement cover. The back panel may have had webbing, or its stuffing might simply have been supported with sack cloth.

The surface of the chair's leather cover is corroded, but its original color appears to have been a rich brown. The piece of leather covering the seat was probably first tacked to the outside surface of the rear seat rail, and then pulled over the seat and secured with brass nails. The decorative nails are approximately one half inch in diameter

and are placed so closely together as to be almost touching. The nails run along the bottom edge of the front and side rails, and also border the bottom arm supports, reaching a little more than halfway up their sides (fig. 49). The leather covering the inside surface of the back panel appears to be pulled under the stay rail and tacked to the back surface of the seat rail rather than to the stay rail itself. Its sides and tops were probably tacked to the rear surface of the stiles and crest in order to secure it while the leather covering the outside back panel was applied. Although that leather panel does not survive, remnants found under the brass nails indicate that it was pulled over the edge of the inside back panel leather. The survival of these fragments proves that the outside back panel was always covered, despite the ornamental shaping of the stiles. The decorative nails that run along the outside surfaces of the stiles and crest secure the leather of both the inside and outside back panels. Three nails were also used on the front surface of each stile just above the seat. Above the seat rail, the outside surface of the stiles was covered with the leather from the inside back panel. Where the stiles intersect with the side seat rails, however, the leather from the outside back panel was wrapped around their outer edges to meet the leather of the seat. A row of brass nails along the juncture of the stile and side rail was used to secure the edges of both pieces of leather in place (fig. 49).

Construction Notes²²⁸

The front face of the crest has a chamfered top edge that continues into the stiles. A knot in the proper-right underside of the crest prevented the maker from fully carving out the

²²⁸ These construction notes apply to the Ott chair. Any differences observed in the Winterthur chair will be noted parenthetically; however, many construction details of that chair are concealed by the original leather upholstery.

arch. The stiles are joined to the crest with double-sided rectangular tenons. The outer edges of the stiles are pieced out from the crest to just below where they join the arms. The pieced members are secured with screws. The inner members of the stiles are continuous with the rear legs, which are raked backwards and rounded from several inches below the rear seat rail to the rear stretchers. The rear feet are chamfered, and their forward-facing edges have canted corners. The arms are rabbeted to slots cut into the outer edges of the pieced-out stile members, and are affixed with screws concealed by wooden plugs. The tops of the arm supports are tenoned into the arms. The bottoms of the arm supports are rabbeted to the side seat rails, and are probably secured with screws concealed with wooden plugs (there are three round plugs on each arm support, but probably only two were original since there are two on each arm support of the Winterthur chair). The stay rail is tenoned into the stiles with double-sided tenons, offset to the outside and pinned. The side and front seat rails are laid horizontally. The top, inside edges of the seat rails have a slightly beveled edge. Saw marks are visible on the top of the front rail. The side rails are joined to the front rail with double-shouldered horizontal tenons and secured with two pins, and are tenoned into the stiles and secured with a single pin. The side rails have rear returns that would have been covered with upholstery (on the Winterthur chair, these are tenoned and glued to the back posts).²²⁹ The back rail is tenoned into stiles with double-sided tenons, which are offset toward the outside and pinned. The front legs are joined to the front rail with open dovetails. The cabriole legs terminate in pad feet with shallow disks visible at back of the feet. Each knee block is secured with four rose head nails (each is secured with four on the

²²⁹ Richards and Evans, *New England Furniture at Winterthur*, 173.

Winterthur chair). The side stretchers are joined to front legs with vertical rectangular tenons, and to back legs with double-sided vertical tenons, offset slightly to the outside. Only the rear joint is pinned (on the Winterthur chair, both joints are pinned and through-pins are used in front). The medial stretcher is joined to the side stretchers with double-shouldered horizontal tenons. The rear stretcher is joined to the stiles with round tenons.

Woods²³⁰

Primary: mahogany; Secondary: cherry

Measurements

Height: 34 ½"; seat height: 13 5/8"

Width (front feet): 21 ½"; Width (back rail): 14 3/16"; Width (back feet): 14 1/8"

Depth (seat): 21 ½"

²³⁰ Christie's, New York, *The Collection of Mr. and Mrs. Joseph K. Ott*, lot 138.

5. *Easy Chair, 1758, Newport, Caleb Gardner Jr. (upholsterer)*

An easy chair (50.228.3) in the collection of the Metropolitan Museum of Art is remarkable in two respects (fig. 50).²³¹ First, it is one of the few New England easy chairs to retain its original upholstery, an Irish-stitch needlework with an embroidered pictorial back panel. Second, on the outside face of its crest is a pencil inscription, “Gardner Jun^r Newport May 1758,” that reveals not only the name of its probable upholsterer, but also its Newport origins and the date of its fabrication (fig. 51). Though furniture is sometimes inscribed with the name of its owner, the inclusion of the place and date make it more likely that the signer of this piece was someone involved in its fabrication. The Gardner Jr. named on the chair was almost certainly Caleb Gardner Jr. (1729–1801), an upholsterer who practiced his trade first in Newport and then in Providence.²³² Surviving accounts indicate that Gardner upholstered at least two other easy chairs. On December 31, 1774, he charged Mrs. Rachel Wright of Newport £40 for “making a Easy Chair.”²³³ In another account, dated January 29, 1790, he billed Enos Hitchcock (1745–1803) of Providence £1.16 for “making a Easy Chair and Case.”²³⁴ A precedent for an upholsterer signing his work may exist in the form of an easy chair in the collection of the Carnegie Museum of Art (83.37).²³⁵ The chair is signed in chalk by William Roby and dated June

²³¹ For the Metropolitan’s catalogue entry on this chair, see Heckscher, *American Furniture*, 122–124, 366, no. 72. See also, “RIF768,” RIFA, YUAG.

²³² See biography of Caleb Gardner Jr. in this master’s thesis.

²³³ Heckscher, *American Furniture*, 122; for actual invoice see “Mrs. Rachel Wright To Caleb Gardner,” Haight mss., Newport Historical Society, Rhode Island.

²³⁴ Ott, “Still More Notes on Rhode Island Cabinetmakers,” 117; also cited in Heckscher, *American Furniture*, 122; for actual invoice, see “Mr. Hitchcock order to Mr. Gardner 1.16.0,” Enos Hitchcock Papers, Rhode Island Historical Society, Providence, Rhode Island.

²³⁵ William Roby, Easy Chair, 1742, 88.37, Collections Database, Carnegie Museum of Art, Pittsburgh, PA, <http://www.cmoa.org/searchcollections/details.aspx?item=1023681>. See also, Andrew Passeri and Robert F. Trent, “More on Easy Chairs,” *Maine Antique Digest* (December 1987), 2-B.

1742 on the inside of its right rear stile in chalk. He is probably the “William Roby, Jun., of Boston, upholsterer” who is named in an Essex County, Massachusetts, deed.²³⁶ As Gardner did on the Metropolitan chair, Roby placed his signature in an area intended to be concealed by upholstery.

The arms of the Gardner chair, like those of the majority New England Queen Anne easy chairs, terminate in vertical scrolls. The construction of the frame is also typical of such chairs, with rear legs that are continuous with the stiles, and side and front seat rails tenoned into the tops of the front legs.²³⁷ Given the chair’s documented Newport origin, its more distinctive characteristics may be helpful in assigning other Queen Anne easy chairs to Newport. In his catalogue entry for the Gardner chair, Morrison H. Heckscher identified these as the high arch of the crest, the largeness of the front feet, and the unchamfered rear legs. Other potential Newport characteristics are the prominent ring on the side stretchers and the downward-sloping profile of the wings (fig. 52).²³⁸ A strikingly similar chair in a private collection has a strong Rhode Island provenance (fig. 53). Although the chair has lost its front feet, it has the same arched chest, unchamfered rear legs, downward-sloping wing profile, and prominent side stretcher turning. The two chairs also have the same medial and rear stretchers, with swelled centers and “arrow-shaped” ends capped with two ring turnings (one small and the other more prominent). Also sharing all of the above characteristics is a second easy

²³⁶ Essex Registry of Deeds, book 83, leaf 123. Cited in Frank A. Gardner, “The Burrill, Burrell Family of Essex County, Mass.,” *Essex Institute Historical Collections* 52 (1916), 56.

²³⁷ For a second type of seat construction found on New England easy chairs, see the catalogue entry 6 of this master’s thesis.

²³⁸ I am indebted to Patricia Kane, Friends of American Arts Curator of American Decorative Arts, Yale University Art Gallery, for sharing her thoughts on Rhode Island stretchers, and to Erik Gronning, Vice President, Senior Specialist American Furniture & Decorative Arts, Sotheby’s, for sharing his ideas on the wing profile of Newport easy chairs.

chair thought to have originally been owned by Godfrey Malbone Jr. (1724–1785), and now in the collection of the Preservation Society of Newport (PSNC.1716a-b) (fig. 54). Another similarity between this example and the Gardner chair are their pad feet, the backs of which have sharply delineated disks.

With the exception of its back panel, the Gardner chair is covered in an “Irish-stitch” pattern, embroidered on linen with a worsted crewel yarn. The woman who executed the once vibrantly colored needlework probably stitched the individual panels on an embroidery frame and then had Gardner mount them on the chair.²³⁹ The visible areas of the chair’s cushion were covered in the same flame-stitch, whereas on the inconspicuous side and bottom panels, an embossed worsted fabric was substituted. The embroidered back panel of the chair depicts a whimsical landscape featuring rolling hills, swimming ducks, flying birds, leaping deer, and a shepherd tending his sheep (fig. 55).²⁴⁰ It is worked in crewel on a linen ground using what today is called a Roumanian couching stitch. Both the stitch and the composition of the needlework are related to a group of 1750s embroidered pictures from Boston, where seventeenth- and eighteenth-century girls were often sent to complete their educations.²⁴¹ A Massachusetts easy chair in the Bayou Bend Collection retains a flame-stitch cover very similar to that of the

²³⁹ Boston upholsterer Samuel Grant stuffed “7 Seats cov^d wth needle work” for the Scollary family in 1756. See Brock Jobe, “The Boston Upholstery Trade,” 72.

²⁴⁰ The two inches that are missing from the bottom of the embroidered back panel may be the result of the needlework having frayed.

²⁴¹ Object file (50.228.3), American Wing, Metropolitan Museum of Art, New York, NY.

Gardner chair, but its back panel is covered with a red worsted fabric rather than with embroidery.²⁴²

The only area of foundation upholstery visible on the Gardner chair is that of its seat frame, which is supported by eight strips of webbing tacked to the tops of the seat rails (fig. 56). In addition to the three strips running from front to back and the three strips running from side to side, interwoven in the typical lattice pattern, diagonal strips were used to provide additional support. The webbing is twill-weave with a brown herringbone pattern. This is unusual in that, prior to 1800, plain-weave webbing was by far more common than twill. Also atypical is the three-chevron pattern of the Gardner chair's twill, since earlier twills were generally simple twills or single-chevron twills (fig. 57).²⁴³ The chair's coarsely woven linen sackcloth is also visible, and is tacked to the top surface of the seat rails over the webbing. As with the Malbone chair, this was covered with a layer of marsh grass, which is visible through the loose weave of the sackcloth.

Evidence of the Gardner chair's original ornamental trimming is also well preserved. Unlike the Malbone chair, which was finished with only a flat woven tape, the Gardner chair was trimmed with both tape and cord.²⁴⁴ The upholsterer sewed tape over the cord to create a raised border that encircles the tops of the arm cones, runs up the top edges the arm and wing panels, and forms a false crest (fig. 58). The Malbone chair has a similar false crest, but on that example the upholsterer created the same effect using flat-

²⁴² David Warren, *Bayou Bend: American Furniture, Paintings and Silver from the Bayou Bend Collection* (Houston: Museum of Fine Arts, 1793), 50–51. See also, Morrison H. Heckscher, "18th-Century American Upholstery Techniques," 103.

²⁴³ Milnes, *Development of Furniture Webbing*, 8–11. In the course his study of webbing, Milnes found only one example of a three-chevron twill dating from the second half of the eighteenth century.

²⁴⁴ Another easy chair trimmed with both tape and cord is a Massachusetts example in the Brooklyn Museum of Art. See "Wing Chair," accession number 32.38, Collections Database, Brooklyn Museum, Brooklyn, NY, <http://www.brooklynmuseum.org/>.

sewn tape (see catalogue entry 6, fig. 60). Another similarity between the Gardner and Malbone chairs is the use of flat tape behind the arm cones and along the bottom of the side and front seat rails. Tape was also used along the front edge of the Gardner chair's arm cones, disappearing beneath the seat cushion. On the front seat rail, the tape continues only as far as the inner knee brackets.²⁴⁵ The tape on the side rails is unusual in that it was applied in two layers. The first layer is a green silk with a yellow weft thread, on which is centered a narrow strip of black tape, probably originally silver in color (fig. 59). The upholsterers of both the Gardner and Malbone chairs used polished iron nails to affix the tape on the seat rails and arm cones. These have cast heads and shanks like those of brass nails, and would have had a similar sheen.²⁴⁶ Tape was also used to conceal the seams of the Gardner chair's cushion, which were raised to produce the same effect as cord.²⁴⁷

One of the most invaluable aspects of the Gardner chair is that it has retained its original shape, providing an accurate record of typical eighteenth-century upholstery profiles. While its exterior surfaces are relatively streamlined, with the fabric of the back panel and the exterior wing and arm panels pulled tightly over the frame, its inside surfaces provided a comfortably padded environment for the sitter. This makes perfect sense, considering that these chairs were thought to be used primarily by the elderly and the infirm. The generous amount of stuffing used, still held firmly in place, is especially

²⁴⁵ Heckscher, "18th-Century American Upholstery Techniques," 103.

²⁴⁶ Passeri and Trent, "Two New England Queen Anne Easy Chairs," 28A.

²⁴⁷ Heckscher, "18th-Century American Upholstery Techniques," 103.

evident in the rounded profile of the interior wings. The cushion, too, retains its original form, with a height of over four inches.²⁴⁸

Construction Notes

Side stretchers are joined to the front leg with a square tenon and pinned once; tenoned into rear leg and pegged once. The medial stretcher is joined to the side stretchers with round tenons. The rear stretcher is joined to the rear legs with round tenons. There is a visible shoulder on the proper left rear stretcher where it joins the leg.

Incisions/Marks

Signed in pencil on the back of crest rail: "Gardner Jun^r Newport May / 1758 / W"

Woods

Primary: walnut (front legs, stretchers); Secondary: maple (rear stiles, crest rail, seat rail)²⁴⁹

Measurements

Height: 46 $\frac{3}{8}$ "; height (seat): 12"

Width (front feet): 32"; width (seat back): 24"; width (seat front): 30"; width (arms): 32 $\frac{3}{8}$ "

Depth (seat): 22 $\frac{3}{4}$ "; Depth (feet): 25 $\frac{7}{8}$ "²⁵⁰

²⁴⁸ Ibid., 98, 100.

²⁴⁹ Heckscher, *American Furniture*, 72.

²⁵⁰ Measurements are taken from Heckscher, *American Furniture*, 72.

Provenance

Keech or Keach family, Newport, Rhode Island, c. 1850, and later Burlington, Vermont; sold to an unknown individual, Connecticut, 1926; Ginsburg and Levy, Inc., New York, 1926; sold to Mrs. J. Insley Blair (née Natalie Knowlton, 1884–1951), Tuxedo Park, New York; given to The Metropolitan Museum of Art, New York, 1950.²⁵¹

²⁵¹ “RIF768,” RIFA, YUAG.p

6. *Easy Chair, 1725–1755, Probably Newport*

This amazing survival is one of only a handful of known examples of New England easy chairs retaining original upholstery (fig. 60).²⁵² Now in the collection of the Colonel Daniel Putnam Association in Brooklyn, Connecticut, the chair's original owner is believed to have been Godfrey Malbone Jr. (1724–1785), who moved from Newport to Brooklyn in 1766. Given the date range of the chair (1725–1765), it is also possible that it was bequeathed to him by his father, Newport merchant Godfrey Malbone Sr. (1695–1768). Although a June 1766 fire that destroyed the elder Malbone's Newport mansion would seem to preclude the latter scenario, it is rendered plausible by the postscript to the following notice published in *The Newport Mercury*: “Last Saturday the following most unfortunate Accident happened . . . a Chimney in the very costly and beautiful House of Col. Godfrey Malbone took Fire . . . and in a short Time the whole Building (except the Walls) was reduced to Ashes. We hear the greatest Part of the Furniture was saved.”²⁵³ Godfrey Malbone Jr. died in 1785, and in 1791, his Brooklyn farm was purchased by Colonel Daniel Putnam (1759–1831), in whose family the chair is thought to have descended.²⁵⁴

The form of the Malbone chair is typical of New England easy chairs with cabriole legs made during Queen Anne and Chippendale periods. As demonstrated by

²⁵² Other known examples of New England easy chairs with original upholstery are owned by the Metropolitan Museum of Art, the Brooklyn Museum, Bayou Bend, and the Wadsworth Atheneum. Until recently, the Malbone chair was on loan to the Connecticut Historical Society, where it underwent an in-depth examination by upholstery experts Andrew Passeri and Robert F. Trent. For their analysis of the chair, see Passeri and Trent, “Two New England Queen Anne Easy Chairs,” 26A–28A. This chair is also included in the Rhode Island Furniture Archive, see “RIF1749,” RIFA, YUAG.

²⁵³ *The Newport Mercury*, June 9, 1766, <http://infoweb.newsbank.com/>.

²⁵⁴ Ann Putnam Browne, *Putnam Elms: The Homestead of Daniel Putnam, 1882–1953* [Pamphlet], June 1, 1953.

Morrison Heckscher in his 1971 *Antiques* article “Form and Frame: New Thoughts on the American Easy Chair,” the upholstered elements of such chairs changed very little prior to the Federal period.²⁵⁵ American easy chairs made prior to the Revolution had arms that terminated either in C-scrolls or vertical cones. Chairs of the C-scroll variety have arms in which the horizontal and vertical elements are connected by a downward sweeping C (fig. 61). In New England, this arm design was first seen on William and Mary easy chairs, and was later adopted by Newport makers and used in conjunction with Marlborough legs (fig. 62). Easy chairs that combined cabriole legs with C-scrolls, however, were made almost exclusively in Philadelphia.²⁵⁶ The Malbone chair belongs to a second variety of easy chairs with arms terminating in outward scrolling vertical cones. Except in Philadelphia, this was by far the more common form of American cabriole easy chair.²⁵⁷

The Malbone chair exhibits other characteristic traits of New England cabriole easy chairs in the construction of its front legs and seat rails. The shape of the seat is trapezoidal but for its rounded front corners, which echo the curves of the knees. Its rails are laid horizontally, and the side rails appear to be tenoned into the front rail (fig. 63).²⁵⁸ This method of framing the seat was one of two employed by New England chairmakers, the other being seat rails tenoned into the square tops of the legs.²⁵⁹ The joints connecting

²⁵⁵ Morrison H. Heckscher, “Form and Frame: New Thoughts on the American Easy Chair,” *Antiques* 100, no. 6 (December 1971): 887-889.

²⁵⁶ There are two arm chairs assigned to Newport, one of which was originally owned by John Brown, with C-scrolled arms and no stretchers. See “RIF844” and “RIF1651,” RIFA, YUAG.

²⁵⁷ Heckscher, “Form and Frame,” 892.

²⁵⁸ In contrast, Philadelphia easy chairs typically have rounded front seat rails that are connected to the side rails with a lap joint. See Heckscher, “Form and Frame,” 890-892.

²⁵⁹ *Ibid.*, 890.

the Malbone chair's front legs to the underside of the front seat rail are not visible, but New England makers generally used dovetails.²⁶⁰ Also typical of New England examples is the construction of the chair's rear legs and stiles, which are made from single pieces of wood, a trait that continued in Newport until the introduction of the saddle-cheek easy chairs of the Federal period.²⁶¹ On the Malbone chair, the maple rear legs have been dyed a dark brown to match the walnut of the front legs and stretchers.

While the front legs of New England easy chairs are not often helpful in determining their age – simple pad feet continued to be made during the Chippendale era alongside those of the more expensive ball-and-claw variety – the C-scrolls on the knees of the Malbone chair are distinctive. Chairs with scrolled knees are thought to have been made as early as 1725, and are typically assigned to Boston.²⁶² There is no evidence, however, that this leg design was exclusive to Boston, and, indeed, it is entirely possible that such chairs were also made in Newport. A potential link to Newport can be established through the decorative finishing techniques used by the chair's upholsterer, which are remarkably similar to those employed on a 1758 chair signed by Newport upholsterer Caleb Gardner Jr. in the collection of the Metropolitan Museum of Art (see catalogue entry 5). Both chairs have false crests that evoke the scrolled crests on certain William and Mary easy chairs (fig. 61). This illusion was created with cord on the Metropolitan chair, and with woven tape on the Malbone example (fig. 64). A second interesting correlation is the use of polished iron nails to secure the tape running along the bottom edge of the front and side seat rails and up the outside edge of the arm cones.

²⁶⁰ Ibid., 892.

²⁶¹ Heckscher, "Form and Frame," 892.

²⁶² Freund and Keno, "The Making and Marketing of Boston Seating Furniture," 16–21.

The nails have cast heads and shanks as do their brass counterparts, and were probably similarly bright when new.²⁶³

The Malbone chair is an invaluable document of eighteenth-century upholstery work. As is evident from existing itemized bills (see account from Plunkett Fleeson to the firm of Nicholas Brown and Company, p. 13–14), wooden frames constituted a relatively small percentage of an easy chair's cost. Worsted show fabrics, though typically more expensive than the frames, also were not the most expensive component. Rather, it was the materials used in the fabrication of the foundation upholstery that were the costliest element of an easy chair.²⁶⁴ The worsted show textile of the Malbone chair has suffered some deterioration, and much can be gleaned about the construction of the foundation upholstery from the areas of fabric loss. Because of the rarity of this example, it is useful to analyze the techniques employed by its upholsterer.

It is likely that the upholsterer began with the seat, which is supported by six interwoven strips of 1 3/4-inch webbing (three running front to back and three from side to side) tacked to the tops of the seat rails (fig. 65). The webbing is a plain-weave, and is patterned with a central white stripe bordered in brown, with two darker brown stripes on either side. Over this framework is a layer of linen sackcloth that is also tacked to the tops of the seat rails. The sack cloth is coarsely woven, with a thread count of approximately fourteen threads per inch. Running along the top of the front seat rail is a two-inch edge

²⁶³ Passeri and Trent, "Two New England Queen Anne Easy Chairs," 28A.

²⁶⁴ The high cost of the materials used in the upholstery foundation is also substantiated by a 1731 account from Boston upholsterer Samuel Grant. See Jobe and Kaye, *New England Furniture*, 365.

roll (fig. 66).²⁶⁵ Made of straw encased in linen, the edge roll has a dual purpose: to keep the chair's cushion from sliding off the seat deck, and to contain the thin layer of marsh grass with which the upholsterer covered the sackcloth.²⁶⁶ The stuffing is covered with a piece of linen nailed to the outside faces of the seat rails. As is typically the case in eighteenth-century upholstery, the weave of the linen used to cover the stuffing and the edge roll is finer than that of the sack cloth.

The foundation upholstery of the back panel is fabricated much like that of the seat. It was not, however, required to support as much weight, and therefore only four strips of webbing were necessary. The webbing is the same width and pattern as that of the seat. It consists of two horizontal strips tacked to the inside surface of rear stiles, interwoven with two vertical strips tacked to the inside surfaces of the crest rail and the medium (the horizontal rail above the rear seat rail) (see fig. 67). The sack cloth covering the webbing is tacked to the front surfaces of the crest and rear posts, and pulled under the medium rail and tacked to the outside edge of the seat rail. The chair's back was stuffed with marsh grass, some of which is visible above the rear seat rail. Based on surviving examples and itemized accounts, such as those of Grant and Fleeson, it was more typical of New England upholsterers to pad the backs of easy chairs with horsehair that was well secured with twine.²⁶⁷ The stuffing of the Malbone chair is secured with only a single triangle of twine stitches, located in the upper middle section of the back panel (fig. 67). Not surprisingly, this proved inadequate, and the marsh grass sank to the

²⁶⁵ According to Passeri and Trent, the straw used in both the chair's edge rolls and stuffing is marsh grass, which was commonly used alone or in combination with horse hair in eighteenth-century upholstered New England furniture. Passeri and Trent, "Two New England Queen Anne Easy Chairs," 27A.

²⁶⁶ *Ibid.*, 27A.

²⁶⁷ *Ibid.*, 28A.

bottom and had to be repositioned during restoration.²⁶⁸ As with the seat, the stuffing is covered with a fine linen that is drawn over the crest and tacked on its outer edge.

The upholsterer used two different types of linen to line the sides of the chair: a coarse sackcloth on the arm panels (the areas between the arm stiles and cones), and a finer linen on the wing panels (the areas between the rear stiles and arm stiles). A straw edge roll wrapped in linen is tacked along the inside top edge of the wing and arm, and runs from the top of the wing to the front of the arm cone (fig. 68). The edge roll helps to contain the horsehair that pads the interior wing and arm panels, and continues around to the front surface of the arm cones. A layer of fine linen covers the stuffing, and is tacked to the top edge of the arms and wings, the inside surfaces of the back posts, and the side seat rails. At the front of the chair, it is drawn around the arm cones and tacked to their outside surfaces. A skimmer of horsehair running along the tops of the arm rests provides additional cushioning for the sitter (fig. 68).

The Malbone chair is covered in a vibrant raspberry-colored worsted textile – either cheney, harateen, or moreen – with a watered finish and embossed pattern of meandering lines.²⁶⁹ Andrew Passeri and Robert Trent determined that the Malbone chair could be upholstered with six yards of fabric, but that an additional yard would be necessary to compensate for the centering of the pattern.²⁷⁰ It is worth noting that the upholster covered the entire chair in the same worsted fabric rather than using a less expensive substitute in inconspicuous places such as the seat deck and back panel, as was

²⁶⁸ Ibid.

²⁶⁹ Today it is difficult to differentiate between eighteenth-century worsted textiles. No documented samples of cheney are known, and those of harateen and moreen are virtually identical. See Montgomery, *Textiles in America*, 199; and Broke Jobe, “Boston Upholstery Trade,” 69.

²⁷⁰ Passeri and Trent, “Two New England Queen Anne Easy Chairs,” 28A.

sometimes the case.²⁷¹ This practice is documented in an itemized bill for an easy chair fabricated by Boston upholsterer Samuel Grant that includes “1 Y^d 1/8 Print,” most likely a printed cotton, in addition to “6 1/2 Y^d chainy.”²⁷² The upholsterer of the Malbone chair did attempt to conserve the expensive worsted textile, however, by piecing out the seat, cushion boxing, and even the arm panels, an area highly visible when the chair is viewed from the side.²⁷³

An examination of the multiple layers of fabric affixed to the outside surface of the rear seat rail reveals that the sack cloth and linen of the back panel are tacked over the show fabric of the seat (fig. 69). This means that the upholsterer covered the seat with the worsted show textile before beginning to build the upholstery foundation of the back panel.²⁷⁴ The material covering the interior back panel is drawn over the crest and tacked to its outer surface. The exterior back panel fabric does not survive, but an examination of the wooden frame suggests it was tacked to the bottom surface of the rear rail, the outside faces of the back post, and about halfway up the outside surface of the crest rail. It was then joined to the fabric on the inside back panel and outside wing panels with large white stitches of linen line that ran along the outer edges of the stiles and crest rail.²⁷⁵ The show fabric of the interior and exterior arm and wing panels is joined with

²⁷¹ Heckscher, “18th-Century American Upholstery Techniques,” 98; Passeri and Trent, “Two New England Queen Anne Easy Chairs,” 27A.

²⁷² Samuel Grant, Account Book, December 3, 1729, p. 32, Massachusetts Historical Society; printed in Jobe and Kaye, *New England Furniture*, 365. See also, Passeri and Trent, “Two New England Queen Anne Easy Chairs,” 27A.

²⁷³ Passeri and Trent, “Two New England Queen Anne Easy Chairs,” 28A.

²⁷⁴ Conversation with Patricia Kane, Friends of American Arts Curator of American Decorative Arts, Yale University Art Gallery, August 24, 2011.

²⁷⁵ The term “line” was used in contemporary accounts. Passeri and Trent, “Two New England Queen Anne Easy Chairs,” 28A.

two rows of the same large stitches, which run along their top edge of the panels from the tops of the stiles to the arm cones.

The upholsterer concealed the abovementioned seams with decorative tape woven in a chevron pattern. The color of the tape matches that of the show textile, with the addition of a yellow weft thread (fig. 70).²⁷⁶ Although some of the tape has disintegrated, its original placement can be discerned from the dark shadows that remain on the show textile. As previously noted, the tape ran along the bottom edge of the side and front seat rails, across the bottom of the arm cones, and up the cones' outer edge, and was secured with irregularly spaced polished iron nails with quarter-inch heads.²⁷⁷ The tape also ran along the outer edges of the arms, wings, and crest, where it was flat sewn with small stitches rather than nailed in place. It is badly frayed in these locations, but the yellow weft thread is still visible. The tape running up the inside edge of the arm and wing panels formed the false crest (fig. 64), while the tape along the outside edges continued across the back of the crest. The textile covering the arm cones is badly deteriorated, but the tape would have almost certainly encircled the tops of the cones.

The final upholstered element of the chair is its cushion (fig. 71), which was stuffed with a mixture of down and quill, and encased in "tick," a linen twill commonly used for eighteenth-century cushions and mattresses.²⁷⁸ The show fabric used to cover the cushion consists of two panels and a strip of boxing 4 ½ inches wide. The seams are

²⁷⁶ Conversation with Patricia Kane, August 24, 2011.

²⁷⁷ Passeri and Trent, "Two New England Queen Anne Easy Chairs," 28A.

²⁷⁸ The cushion's stuffing is not visible but was recorded by Passeri and Trent during restoration. See Passeri and Trent, "Two New England Queen Anne Easy Chairs," 28A.

trimmed with tape and finished with raised edges, which give them a rounded contour and create the illusion that the tape was applied over cord.²⁷⁹

Construction/Condition Notes

The side stretchers are joined to the back legs with double-shouldered tenons, offset to the outside. The rear stretcher is slotted into the rear legs with round tenons. The medial stretcher is a replacement. The stretchers are not pinned. The seat rails are crudely shaped, and hatchet marks are visible on their inside surfaces (fig. 65). The side rails become narrower as they progress towards the back legs. The arched scribe line is visible on the bottom surface of the front seat rail, but was not adhered to when the rail was shaped. The back legs are chamfered between the back stretcher and rail, and the back feet are very slightly chamfered. The crest rail and medium are joined to the stiles with double-shouldered tenons. The wing and arm posts are tenoned into the side seat rails. The knee blocks and the toe of the right foot are missing.

Woods

Walnut (front legs and stretchers), maple (arm rest, seat frame, crest rail, stiles, back legs, wing and arm panels), and oak (arm cones).

Measurements

Height: 47"; Height (seat): 13"; Width: 33 ¼"; Depth: 21 ½"

²⁷⁹ Ibid. This technique is also described in Heckscher, "18th-Century American Upholstery Techniques", 102–103.

Provenance

Godfrey Malbone (1724–1785), Newport, Rhode Island, and Brooklyn, Connecticut; by descent to Mary Putnam Fogg (1843–1928), Brooklyn; bequeathed by her to Mary Putnam Clewly, Brooklyn; given by her to the Colonel Daniel Putnam Association, Brooklyn, 1928.

7. *Easy Chair, 1775–1790, Newport*

This exceedingly rare chair represents an attempt by a Newport maker to replicate a Philadelphia easy chair (fig. 72). The C-scroll arms, balloon seat, and lack of stretchers are all characteristics seldom seen on New England seating furniture, and the combination of these attributes on a single Newport easy chair is perhaps unique in the history of American furniture. Despite its lack of resemblance to other Newport models, the chair's distinctive front feet are irrefutable evidence of its Newport origins. Ball-and-claw feet of this type are typically associated with the work of John Goddard.²⁸⁰

It is possible that the chair that served as the inspiration for this example was one of the Philadelphia easy chairs owned by Providence merchants John and Nicholas Brown.²⁸¹ In the 1760s, the firm of Nicholas Brown and Company purchased at least three easy chairs through its Philadelphia agent John Relfe, who commissioned the chairs from British-trained Philadelphia upholsterer Plunkett Fleeson. Easy chairs were shipped to the Browns by Relfe in 1762, 1763, and 1764. The first was for John, the second for Nicholas, and the third may have been for either. Wendy Cooper has suggested that the chair shipped to John Brown in 1762 may be one pictured in figure 73, which descended in his family and is now in a private collection.²⁸² It is unlikely that the chair served as the model for this example, however, since its armrests are horizontal scrolls rather than

²⁸⁰ Moses, *Master Craftsmen of Newport*, 210. The chair was attributed to Goddard when it was included in a Christie's sale in 2008. See Christie's, *New York Property from the Collection of George and Lesley Schoedinger*, sale cat. (January 18, 2008), 48–49, lot 508.

²⁸¹ The idea of John Brown's easy chair being the source of inspiration to the Newport maker of this chair was first proposed by Alan Brown. The theory is also discussed in David H. Conradsen, *Useful Beauty: Early American Decorative Arts From St. Louis Collections*, exh. cat. (St. Louis, MO: Saint Louis Art Museum, 1999), 43, and Christie's, *New York Property from the Collection of George and Lesley Schoedinger*, 52–53. Christie's further posits that John Goddard, who is known to have made furniture for John Brown during the 1760s, may have had the opportunity to examine one of John Brown's easy chairs. The chair is also included in the Rhode Island Furniture Archive (see "RIF1651").

²⁸² Cooper, "Furniture and Furnishings by John Brown," 329, 332.

the C-scrolls seen on the Newport chair. A more probable candidate is another chair also thought to have descended in the John Brown family (fig. 74). Although the second Brown chair has previously been attributed to Newport, most likely based on its provenance, both its form and construction are similar to those of Philadelphia models. It is possible that Fleeson made both chairs, each of which has related shell-carved knees and scrolled knee returns.

Despite its stylistic similarity to its Philadelphia counterparts, the construction of the Newport chair's frame does not conform to techniques employed by Philadelphia craftsmen. Furniture consultant and historian Alan Miller has suggested that the chair's maker had access to a Philadelphia easy chair only in its upholstered state, and that ignorance of the frame resulted in certain anomalies in construction. The first departure from standard Philadelphia construction is in the C-scrolled arms, which typically have flat, front-facing arm stiles with rounded tops forming the ends of the scrolls of the horizontal arm rests (see fig. 83).²⁸³ In this example, however, the arm stiles are side-facing and are simply tenoned into the horizontal boards of the arm supports, forming no part of the scrolled arm rests. Another unusual aspect of the arm construction is the transition between the horizontal and vertical scrolled elements. These elements are usually connected with sloping ramps, which are virtually nonexistent on this example. The maker, or perhaps the upholsterer, achieved the necessary downward-sweeping curves by in-filling these junctures with triangular pieces of leather nailed in place (fig. 75).

²⁸³ Heckscher, "Form and Frame," 892–893.

The Newport chair's balloon-shaped seat, with its dramatically rounded front seat rail, is another characteristic typically found on Philadelphia cabriole easy chairs. The seats of New England chairs were trapezoidal, with straight front seat rails that sometimes had rounded corners.²⁸⁴ On this chair, the maker achieved a Philadelphia form with New England construction methods. The side and front rails are joined with tenons rather than with lap joints and pins in the Philadelphia manner.²⁸⁵ The method used to join the front legs to the seat rail on the Newport chair is unconventional by both Philadelphia and New England standards. The front legs of chairs from both regions generally terminate in dovetails that are either slotted up through the seat rails or inserted into dovetail shaped-openings at the outer edge of the seat rails.²⁸⁶ In contrast, the maker of the Newport chair inserted the legs into the front seat rail using thin rectangular tenons.²⁸⁷

The construction of the rear legs and stiles, which are made of separate pieces of wood spliced together above the rear seat rail, is also atypical (fig. 76). Though more often seen in Philadelphia chairs, this configuration was also used in New England. In both regions, however, the stiles are normally joined to the rear seat rails, and the inside tops of the rear legs are cut in a wedge and affixed to the outside of the stiles with glue and nails or screws.²⁸⁸ In contrast, the maker of this chair used an unusual variation in

²⁸⁴ An example of a New England chair with a trapezoidal seat and rounded front corners is in the collection of the Colonel Daniel Putnam Association (see catalogue entry 6). Heckscher, "Form and Frame," 890–892.

²⁸⁵ *Ibid.*, 890.

²⁸⁶ *Ibid.*, 892.

²⁸⁷ Conversation with Alan Miller, December 15, 2011.

²⁸⁸ In New England, the legs simply abut the stiles. Philadelphia makers often modified the joint by rabbeting the top of the rear legs into the stiles. Heckscher, "Form and Frame," 892.

which the ends of the legs and stiles are both cut at a wedge-shaped angle, with the inside surfaces of the stiles joined to the outside surfaces of the legs.²⁸⁹

Notwithstanding the imitation of certain Philadelphia characteristics, the maker of this chair succeeded in creating an original Newport design.²⁹⁰ The chair is notably compact, and its Philadelphia-like form is combined with a decidedly upright New England stance. In contrast, Philadelphia chairs were larger and were designed with outward flaring arms, a feature achieved by tilting the vertical members of the arm and wing panels toward the outside of the frame. The outward angle of each element – from the rear stiles, to the wing stiles, to the arm stiles – was slightly greater than that of the last, resulting in a gradual splay.²⁹¹

This chair is also a highly important document of eighteenth-century Newport upholstery practice. Although the show fabric does not survive, its current worsted cover is a close approximation of a small remnant of original material that was found under an upholstery tack.²⁹² The chair does retain some of its original foundation upholstery, which is documented in photographs taken before the re-upholstering. The surviving elements include two vertical strips of webbing on the back panel and much of foundation upholstery on the wings and arms. The plain-weave webbing is the same pattern as that used on the Malbone chair (fig. 77), with a central white stripe bordered in light brown, and two darker brown stripes on either side. The upholsterer covered the

²⁸⁹ Such construction, which lacks the physical support of the traditional method, has been observed on a number of chairs assigned to New York and Connecticut. Heckscher, “Form and Frame,” 892.

²⁹⁰ Conversation with Alan Miller, December 15, 2011.

²⁹¹ Mark Anderson and Robert F. Trent, “A Catalogue of American Easy Chairs,” *American Furniture* (1993): 217. The authors credit Alan Miller as the source of this information.

²⁹² Conversation with Alan Miller, December 15, 2011.

ends of the webbing with strips of leather for added reinforcement before nailing them to the inside surfaces of the crest and stay rails. The horizontal strips of webbing on the back panel do not survive, and it is unclear from available photographs how many were interwoven with the vertical strips. The foundation upholstery of the wing and arm panels only partially survives, but photographic evidence provides sufficient detail to reconstruct its fabrication (fig. 78). A foundation for the padding was created by covering the open spaces between the arm and wing stiles and between the wing stiles and rear stiles with linen sackcloth. The two pieces of fabric were nailed to the inside surfaces of the wing and arm elements, and to the top surfaces of the side seat rails. To contain the stuffing, the upholsterer used an edge roll encased in fine linen. The roll runs along the top inside edges of the wing and arm panels – from the front of the arm rest to the juncture of wing and crest – and is nailed to their top and inside surfaces, as well as to the front face of the arm rest. The cavity created by the edge roll was filled with a layer of grass topped with a layer of curled hair. This was then covered with a layer of fine linen nailed to the top edge of the wing and arm panels and the inside of the stiles. The bottom edge of the linen was probably nailed to the inside surfaces of the arm and wing stiles and the top of the seat rails; and, at the front of the chair, it appears to have been wrapped around the vertical scrolled elements in front of the arm rests, and then nailed to the chair's outer surface.

Yet another remarkable aspect of this chair is its original upholstery tacks, which have cut shanks and wrought heads (fig 79). Cut tacks were first advertised in 1775 by Jeremiah Wilkinson (1741–1842) of Cumberland, Rhode Island.²⁹³ Wilkinson's tacks

²⁹³ Conversation with Alan Miller, December 15, 2011. See also, Christie's, New York *Property from the Collection of George and Lesley Schoedinger*, 53.

were cut from iron plates and headed by hand, resulting in fairly uniform shanks but irregular heads.²⁹⁴ The one drawback to these early cut-shank tacks was that they were all one size. Upholsterers typically used tacks of varied lengths since certain elements, such as webbing, needed the additional reinforcement of longer shanks.²⁹⁵ The presence of these tacks is also useful in dating the chair, since it could not have been upholstered before their introduction in 1775. Thus if Goddard was the maker, the chair must date between 1775 and 1785, the year of his death.

The chair is unique in that it is the only known Newport cabriole easy chair with C-scroll arms. The chair's lack of stretchers is another feature seldom seen in chairs from Newport. A chair with similar feet and no stretchers, but with vertical arm cones, was sold at Christie's in 2001 (fig. 80).²⁹⁶ Other cabriole chairs with distinctive Newport ball-and-claw feet are in the collections of the Newport and Rhode Island Historical Societies. Both have stretchers, vertical scrolls, and straight front seat rails typical of New England easy chairs. The feet of the Newport Historical Society chair are similar to those of this example (fig. 81).²⁹⁷ The Rhode Island Historical Society chair has been attributed to

²⁹⁴ William Hampton Adams, "Machine Cut Nails and Wire Nails: American Production and Use for Dating 19th-Century and Early-20th-Century Sites," *Historical Archaeology* 36, no. 4 (2002): 66–88.

²⁹⁵ Conversation with Alan Miller, December 15, 2011.

²⁹⁶ Christie's, New York, Important American Furniture, Silver, Prints, Folk Art, and Decorative Arts, sale cat. (January 18–19, 2001), 50–51, lot 59. See also, "RIF3228," RIFA, YUAG. For two other possible examples of Newport cabriole easy chairs, see Albert Sack, *Fine Points of Furniture: Early American* (New York: Crown Publishers, 1950), 65, and Henry W. Cooke Co. Auctioneers, Providence, R.I., Executor's Sale, *Public Auction: The Wonderful Collection of Antique Furniture Belonging to the Late Nathan Cushing*, sale cat. (June 15, 1934), lot 229. These two chairs are also documented in The Rhode Island Furniture Archive, see "RIF4267" and "RIF2316."

²⁹⁷ Ruth S. Taylor, "Connected to the Past: Objects from the Collections of the Newport Historical Society," *Antiques and Fine Art* 8, issue 6 (Summer/Autumn 2008): 183. See also, "RIF4066," RIFA, YUAG.

John Townsend based on the similarity of its feet to those on a signed Townsend card table.²⁹⁸

Condition Notes

Right knee returns and part of the left, inside knee return are replaced; the left front toe is replaced; small losses to the tops of the shells have been in-filled. The chair has been covered with a non-intrusive upholstery that protects the original foundation upholstery.²⁹⁹

Woods³⁰⁰

Primary: mahogany; Secondary: cherry, yellow pine, yellow poplar

Measurements³⁰¹

Height: 46 ½"; Width: 34"; Depth: 24 ½"

²⁹⁸ Heckscher, *John Townsend*, 102, no. 14. See also, "RIF846," RIFA, YUAG.

²⁹⁹ The frame was restored by Alan Miller, the repairs were colored and finished by Keith Lackman, and the chair was upholstered by Leroy Graves. Details of the repairs and re-upholstery are taken from Alan Millers notes on the chair.

³⁰⁰ "RIF1651," RIFA, YUAG.

³⁰¹ Christie's, *New York Property from the Collection of George and Lesley Schoedinger*, 48.

8. *Easy Chair, 1780–1800, Newport*

Stop-fluted legs like those seen on this easy chair (fig. 82) represent a Newport interpretation of the straight-legged furniture popularized in England by Thomas Chippendale.³⁰² Straight, or “Marlborough,” legs had been fashionable in England since the mid-eighteenth century, featuring prominently in the 1754 and 1755 editions of Chippendale’s *The Gentleman and Cabinet-Maker’s Director*. The style was available in Philadelphia by at least 1772, when it was included as an option in *Prices of Cabinet and Chair Work*.³⁰³ This booklet – a listing of amounts charged for various forms of furniture that was published by the city’s craftsmen – gives the cost of an easy chair frame with “Marlborough feet, bases and brackets” as £2.10.0, the same amount charged for pad feet and uncarved knees.³⁰⁴ Given that Marlborough legs were an accepted alternative to cabriole legs for both seating furniture and tables at the time of the booklet’s publication, it is likely that they had already been in use for several years.

Although produced elsewhere in America, straight legs embellished with stop-fluting appear to have been most popular with Newport makers.³⁰⁵ The first known reference to fluted legs in Newport is in May 1769, when John Goddard sold Newport merchant Aaron Lopez “2 Mahogany Square Tables . . . fluting legs.”³⁰⁶ John Townsend

³⁰² Keno Auctions, New York, *Important Americana, Paintings, Furniture and Decorative Arts* (January 17, 2012), lot 84, <http://kenoauctions.com/>.

³⁰³ Heckscher, *John Townsend*, 140.

³⁰⁴ *Prices of Cabinet and Chair Work* (Philadelphia, PA: Printed by James Humphreys, Jr., 1772; reprinted in 2005 by the Philadelphia Museum of Art), 9.

³⁰⁵ Barry A. Greenlaw, *New England Furniture at Williamsburg* (Williamsburg, VA: The Colonial Williamsburg Foundation, Virginia, 1974), 71.

³⁰⁶ Quoted in Heckscher, *John Townsend*, 140. For the original account, see Series 2, box 12, Aaron Lopez Papers, American Jewish Historical Society, New York, NY.

had also adopted the style by at least the mid-1780s, and four stop-fluted tables bear his label. The presence of stop-fluted legs alone cannot be used to attribute furniture to either cabinetmaker, however, given the high probability that the form was produced in a number of shops.³⁰⁷

Three distinct styles of easy chair were paired with stop-fluted legs by eighteenth-century Newport makers. The form demonstrated here, with vertical-scrolled armrests, was by far the most common for both straight-legged and cabriole easy chairs. Other examples with vertically scrolled arms and stop-fluted legs may be found in the collections of The Colonial Williamsburg Foundation and the Museum of Fine Arts, Houston.³⁰⁸ Although exceedingly rare, Newport makers occasionally combined stop-fluted legs with C-scroll arms. The C-scroll form predominantly is seen on Philadelphia Queen Anne- and Chippendale-style chairs. While the design was sometimes employed by New England makers during the William and Mary period, it is seen on only a handful of the region's cabriole or straight-legged chairs. One example with C-scrolled arms and stop-fluted legs was sold at Christie's in January 2012.³⁰⁹ Stop-fluted legs are also occasionally seen on a third, later style of easy chair called a "saddle cheek," a form

³⁰⁷ Heckscher, *John Townsend*, 140. Heckscher cites documentary evidence of fluted furniture being made by Townsend Goddard in 1787 and listed in the 1811 inventory of Edmund Townsend.

³⁰⁸ Greenlaw, *New England Furniture at Williamsburg*, 78–79, no. 69; and David B. Warren *et al.*, *American Decorative Arts and Paintings in the Bayou Bend Collection, The Museum of Fine Arts, Houston* (Houston: Museum of Fine Arts, Houston, 1998), 58, no. F98. See also, RIFA, YUAG, RIF162 and RIF236.

³⁰⁹ Christie's, New York, *The Collection of Mr. and Mrs. Joseph K. Ott*, sale cat. (January 20, 2012), 34–35, lot 141. See also, RIFA, YUAG, RIF1673. For other related examples, see RIF4700 and RIF2839 (the latter has horizontal conical scrolls, but lacks vertical scrolls).

inspired by an engraving in English furniture designer George Hepplewhite's 1788 *Cabinet-Maker and Upholsterer's Guide*.³¹⁰

The leg and the arm construction of this easy chair are typical of chairs with straight legs and vertically scrolled arms. The side and front seat rails are tenoned into the tops of the front legs, a method used for all straight-legged, and the majority of cabriole-legged, New England easy chairs.³¹¹ Although a portion of the arm stile is concealed by upholstery, it appears to be made up of a flat inner board and a rounded outer board, which together form the outward scroll of the arm cone. The two boards are capped by the arm rest, a flat board terminating in an outward scroll that conforms to the shape of the arm cone (fig. 84).³¹² The construction of the rear legs and stiles is more unusual. They are formed with two pieces of wood joined just above the stay rail. The angled ends of both boards are rabbeted together with the stile over the leg, and secured with screws (fig. 84). This is a variation of a much more stable construction – seen in both Philadelphia and New England – in which the stiles are joined to the rear seat rail, and the angled ends of the rear legs are laid flush against the stiles and secured with screws or nails.³¹³ The rather anomalous construction seen on this chair was also employed on a Newport easy chair with C-scrolled arms and ball-and-claw feet (fig. 76). On that example, however, only the leg is rabbeted into the stile, whereas on this chair, the stile is also rabbeted into the leg.

³¹⁰ Heckscher, "Form and Frame," 890. For examples of saddle cheek easy chairs with stop-fluted legs, see RIFA, YUAG, RIF368 and RIF1417.

³¹¹ Heckscher, "Form and Frame," 890.

³¹² *Ibid.*, 892.

³¹³ *Ibid.*

At only forty-four inches high, the chair is several inches shorter than typical examples. It is possible that its feet have lost some height, or that they originally sat on castors. Also worth noting is that its legs only have three stop flutes on each of their front and side surfaces, as opposed to the more common number of four or five. This was probably a less expensive option, and arguably gives the chair's legs a less elegant, more ponderous appearance.

Although the seat has been replaced, much of the foundation upholstery on the chair's back, wings, and arms survives.³¹⁴ The original upholstery of the back panel includes five strips of webbing, two vertical and three horizontal, interwoven in a lattice pattern (fig. 85). The webbing is single weave, and each strip is approximately two inches wide. Much of the pattern is surprisingly vivid, and includes a central dark brown stripe bordered in white, with a white stripe bordered in dark brown on either side. The central stripe appears to have originally been flanked with light brown stripes, but these have significantly faded. The webbing was nailed to the front surfaces of the crest, stay rail, and stiles, and was covered with a layer of coarse sackcloth. The original grass stuffing is visible through a small tear in the fabric. The stuffing is held in place with several twine stitches, but it is unclear whether they are all original. Some stitches pass through both the webbing and the sackcloth, and others pass through only the sackcloth.

The wing and arm panels were also lined with sackcloth. The hair stuffing is visible in several places through tears in the fabric of the inside wings and arms. It is unclear whether an edge roll was used along the top inside edges of the wings and arms to contain the chair's padding. Fabric tears in this location reveal stuffing, but not the

³¹⁴ According to the auction catalogue, "Various 19th century repairs to muslin, seat and cushion [were] made by Walt Mullen Upholstery, Valley Forge, PA."

extra layer of linen that would have been used to encase an edge roll (fig. 86). The top of the arm rest was padded with hair, which protrudes from under the outside edge of the linen. The stuffing was also continued around to the front face of the arm cone, where hair can also be seen through a large tear in the fabric. The layer of linen was placed over the stuffing on the inside surfaces of the chair back and the wing and arm panels, and then tacked to the frame. It originally encircled the arm cones and was tacked to their outer, rear edge.

Along the top inside edges of the crest, wings, and arms is a line of stitches where the linen covering the front of the chair is joined to another fragment of fabric (fig. 87). On the crest, the stitches are looser and the fabric they join appears to be different than that of the inside back panel, indicating that it is probably a patch. The fragments joined to the inside of the wings and arms – which are of a similar fabric and are tightly stitched – appear, however, to have been part of the original foundation upholstery. Upholsterers generally joined the inside and outside panels of linen in this manner when encasing an entire easy chair frame in linen (fig. 87).³¹⁵ Chairs upholstered in this way were fitted with slipcovers rather than with a fixed show fabric. This is puzzling, however, given that three pieces of what are thought to be this chair's original red finish fabric are preserved under rose head nails (fig. 88). Given these conflicting pieces of evidence, it is difficult to come to a definitive conclusion about how the chair was originally upholstered.

³¹⁵ Heckscher, "18th-Century American Upholstery Techniques," 105.

Notes on Construction

The side stretchers are tenoned into the front and rear legs and pinned. The rear stretcher is tenoned into the rear legs and pinned. The medial stretcher is tenoned into the side stretchers. The front and side seat rails are tenoned into the tops of the front legs and pinned. The side seat rails are tenoned into the stiles and pinned twice. The rear seat rail is tenoned into the stiles and pinned twice. The stay rail is tenoned into the stiles and pinned. The ends of the stiles and rear legs are cut at angles, rabbeted together with the stile on top, and secured with screws. The crest is tenoned into the tops of the stiles and pinned twice. The tops of the wing are tenoned into the tops of the stiles and pinned. The wing stiles are tenoned into the top of the wings and the side seat rails. The arm supports are tenoned into the wing stiles. The flat boards of the arm stiles are tenoned into the arm supports and the side seat rails.

Woods

Primary: mahogany; Secondary: maple

Measurements

Height: 44"

Conclusion

The chairmakers and upholsterers of eighteenth-century Newport have heretofore received little attention. In the past, many high-style chairs believed to have been made in Newport were attributed to members of the Townsend and Goddard families, a phenomenon not limited to seating furniture. More recently, a focus on Boston's dominance in the trades of chairmaking and upholstery during the first half of the eighteenth century has overshadowed the role played by Newport. Lack of evidence, however – rather than any oversight on the part of scholars of Newport furniture – has been the primary reason that many of the city's craftsmen have remained obscure. Indeed, a significant number of Newport's chairmakers and upholsterers were completely unknown until identified through primary source documents compiled by Yale University Art Gallery for its Rhode Island Furniture Archive.

An analysis of available evidence, including the above-mentioned primary source materials, indicates that a greater number of craftsmen than previously supposed were engaged in Newport's upholstery and chairmaking trades. Proof that upholstered seating furniture was being produced in Newport at an early date is found in accounts detailing the purchases of the upholsterer John Moore, who obtained upholstery materials and tools from the local brazier in 1733, and hides from the local currier in 1733 and 1734. At least two other upholsterers, Robert Stevens and Peter Hall, were also working in Newport in the 1730s.

Some of Newport's earliest upholsterers may have learned their trade in larger cities, including Boston. John Moore's origins are unknown, and it is possible that he

apprenticed somewhere other than in Newport. Robert Stevens was born in Boston, and it is likely that he completed his training there before relocating to Newport. If he did apprentice in Boston, he would have passed on the techniques he acquired there to the next generation of Newport upholsterers. His son, Robert Stevens Jr., would almost certainly have apprenticed with his father, and evidence suggests that the elder Stevens may have also trained Kendall Nichols Jr. and Caleb Gardner Jr.

It is likely that several Newport chairmakers also learned their trade in Boston, including Daniel Dolorson and John McClure. Other outside influences came from Portsmouth, New Hampshire, where Timothy Waterhouse probably trained with his brother-in-law John Gaines III before moving to Newport, where he may have worked with his other brothers-in-law John and Joseph Proud. These chairmakers undoubtedly imparted characteristics of the seating furniture from their native cities to the chairs they produced in Newport. Other chairmakers – those who were born in Newport, or had lived there from an early age – probably trained in their native city. Some, including craftsmen from the Pitman, Proud, and Dunham families, had relatives in the woodworking trades with whom they probably apprenticed.

In many cases, there is insufficient evidence to determine which Newport chairmakers were producing seating furniture that would have been upholstered. Production of higher-end chairs can be established with certainty only in the cases of Job Townsend Jr., John Townsend, John Goddard, Alanson Gibbs, Benjamin Baker, Joseph Proud, and Daniel Dolorson. Of those craftsmen, only Proud and Dolorson are identified as “chairmakers” in primary source documents. With the exception of Gibbs, who was a joiner, all of the others were cabinetmakers (although Baker did make more chairs than

any other furniture form). Some chairmakers were producing turned, slat-back chairs with flag-bottoms, including Daniel Dunham, Joseph Dunham, Giles Barney, and Joseph Pitman, who each had flags in their shops at the times of their deaths. The fact that they made inexpensive chairs does not, however, preclude their having made Queen Anne- or Chippendale-style seating furniture as well. John Goddard, who is known to have made arm chairs, easy chairs, corner chairs, and side chairs in walnut and mahogany, also made “common chairs,” probably slat-backs, for Moses Brown.

There are a few documented examples of potential collaborations between Newport upholsterers and the craftsmen who made seating furniture, including both chairmakers and cabinetmakers. John Moore may have had a business relationship with Newport chairmaker John Ormsby, for whom he placed an order for “Sundrys” from Newport brazier Stephen Ayrault in 1733. Robert Stevens purchased chair frames from John Goddard in 1764, 1766, and 1773, and covered a chair for Goddard in 1776. Kendall Nichols’ name is mentioned in the account book of Job Townsend Jr., with whom he may have collaborated on an unknown order for Samuel Simson in 1767. Cabinetmaker Benjamin Baker, probably one of Newport’s most prolific chairmakers, supplied Caleb Gardner with sets of side chair frames in 1772 and 1774.

Shipping records document the existence of a lively furniture export trade in Newport during the third-quarter of the eighteenth century. Newport’s craftsmen produced more chairs than any other furniture form for clientele in both the American colonies and the West Indies. Although such evidence suggests that a substantial number of chairmakers participated in Newport’s export trade, definitive proof of their identity is still lacking. One probable candidate is chairmaker Timothy Waterhouse, who appears to

have exported chairs in partnership with his merchant son, Timothy Jr. Another chairmaker, John Proud, was extensively engaged in the export trade, although the contents of the cargo he shipped are as yet unknown.

Mercantile pursuits were fundamental to the success of many eighteenth-century upholsterers, including those of Newport. Robert Stevens not only actively practiced his trade – collaborating with John Goddard on the fabrication of seating furniture and beds – but also co-owned a ship, participated in the slave trade, and kept a shop, where he and his son sold a variety of goods imported from England. John Moore and Caleb Gardner Jr. also supplemented their upholsterer’s incomes by working as shopkeepers, and an inventory of Gardner’s shop reveals that it was primarily stocked with textiles.

While the Revolution dealt a devastating blow to all Newport’s craftsmen, the merchant-upholsterers may have suffered most acutely because of their dual role. The British occupation of the city, which lasted from 1776 to 1779, crippled Newport’s trade. A significant percentage of residents fled, many never to return. The lives of two Newport upholsterers, Robert Stevens and Caleb Gardner Jr., reflect the choice available to Newport’s merchants during and after the Revolution: remain in the city to eke out a living on a sharply diminished trade, or leave and attempt to begin again in a new city.³¹⁶ Stevens – whose long and ambitious career, it is safe to assume, had brought him some degree of affluence prior to the Revolution – chose to stay. Unable to earn enough to pay his debts, his estate was declared insolvent after his death in 1780. Gardner had experienced a financial crisis several years prior to the war, and was jailed for debt in 1770. Forced to sell his personal possessions and the stock of his store, Gardner

³¹⁶ Lynne Withey, *Urban Growth in Colonial Rhode Island: Newport and Providence in the Eighteenth Century* (Albany: State University of New York Press, 1984), 77.

attempted to reestablish himself in Newport, apparently with little success. Sometime during the Revolution, he relocated to Providence, a city left relatively unscathed by the Revolution, where he was practicing his trade by at least 1783.

While primary source materials are invaluable in illuminating the lives of Newport's chairmakers and upholsterers, details about their work are best gathered through an examination of Newport seating furniture. Examples of extant colonial upholstery are scarce, and examples of Newport seating furniture with original upholstery are exceedingly rare. Morrison Heckscher has shown that the techniques used in eighteenth-century New England upholstery work were fairly consistent, a fact that makes it difficult to identify any practices particular to Newport craftsmen.³¹⁷ As demonstrated by two Newport easy chairs examined in this study, it is possible that certain finishing techniques were especially popular in Newport. The upholsterers of the Gardner and the Malbone easy chairs both used decorative tape to create false crest rails, a detail evoking the scrolled crests of earlier William and Mary chairs (see catalogue entries 5 and 6). A second similarity was both upholsterers' use of polished iron tacks, rather than brass tacks, to secure the tape along the chairs' seat rails. The presence of these techniques on two Newport easy chairs may be indicative of a link between their upholsterers. Given the dearth of New England examples in general, however, these may have been techniques practiced throughout the region on chairs for which original upholstery evidence does not survive.

The identification of characteristic features of Newport chair frames is complicated by their similarity to Boston examples, some of which were previously

³¹⁷ Heckscher, "18th-Century American Upholstery Techniques," 103.

attributed to Newport. This affinity is hardly surprising given the movement of craftsmen and furniture between the two cities. The majority of chairs catalogued for this thesis, however, do possess attributes that are indicative of their Newport origins. The most obvious of these are the carved ball-and-claw feet of the chairs in catalogue entries 3 and 7, the style of which suggests a possible association with John Goddard. Other features observed on multiple Newport chairs are unchamfered rear feet and thick stretchers, two elements that no doubt contribute to the substantial weight of many examples. This heft is consistent with the careful workmanship observed in Newport furniture in general, indicating of a reluctance on the part of the craftsmen to skimp either on materials or technique. Stretcher turnings can also provide clues to a chair's place of origin. Patterns frequently observed on the front and rear stretchers of Newport examples include bulb- or arrow-shaped ends abutted with an extra ring turning.³¹⁸ The presence of chestnut – a tree indigenous to Rhode Island as a secondary wood – and the visible use of sapwood are also strong indicators of Newport origin.³¹⁹

An analysis of primary source materials related to Newport craftsmen, as well as an examination of their surviving work, provides fascinating insights into the chairmaking and upholstery trades of eighteenth-century Newport. The tantalizing details gleaned from historical records, many of which were compiled for Yale University Art Gallery's Rhode Island Furniture Archive, have been invaluable in the identification of previously unknown craftsmen, and the illumination of the lives and careers of others known by name only. There are undoubtedly many more yet-to-be-made discoveries that

³¹⁸ See chairs in catalogue entries 2, 3, and 5.

³¹⁹ For chairs with visible sapwood, see catalogue entry 4 and figure 42. For chairs that use chestnut as a secondary wood, see catalogue entry 3 and figures 14 and 41.

will further expand our knowledge of – and appreciation for – the lives and work of Newport’s lesser-known craftsmen.

Bibliography

- Adams, William Hampton. "Machine Cut Nails and Wire Nails: American Production and Use for Dating 19th-Century and Early-20th-Century Sites." *Historical Archaeology* 36, no. 4 (2002): 66–88.
- Allen, Devere, *Some Prudence Island Allens* (Wilton, CT: 1942).
- American Art Association and Anderson Galleries, Inc., New York. *One Hundred Important American Antiques*, sale cat. (January 9, 1932).
- The American Journal and General Advertiser*, Providence, Rhode Island, <http://infoweb.newsbank.com/>.
- Anderson Galleries, Inc. and American Art Association, New York. *Colonial Furniture, Silver, and Decorations: The Collection of the Late Philip Flayderman*, sale cat. (January 2–4, 1930).
- Anderson, Robert Charles. *The Great Migration Begins: Immigrants to New England 1620–1633*. Boston: New England Historic Genealogical Society, 1995, vol. I.
- Arnold, James N. *Vital Record of Rehoboth, 1642-1896*. Providence, RI: Narragansett Historical Publishing Company, 1897).
- Arnold, James N. *Vital Records of Rhode Island, 1636–1850. First series Births, marriages and deaths. A Family Register for the People. Vol. 7, Friends and Ministers*. Providence: Narragansett Historical Publishing Company, 1895.
- Arnold, James N. *Vital records of Rhode Island, 1636-1850. First series Births, marriages and deaths. A Family Register for the People. Volume VIII: Episcopal and Congregational*. Providence: Narragansett Historical Publishing Company 1896.
- Arnold, James N. *Vital records of Rhode Island, 1636-1850. First series Births, marriages and deaths. A Family Register for the People. Volume 10: Town and Church*. Providence: Narragansett Historical Publishing Company 1896.
- Austin, John Osborne. *The Genealogical Dictionary of Rhode Island*. Albany, NY, 1887; reprinted Baltimore, MD: Genealogical Publishing Company, 2008.
- Baldwin, Thomas W. *Vital Records of Reading, Massachusetts, to the Year 1850*. Boston: [Wright & Potter Printing Company], 1712.
- Banks, Charles Edward. "The Joseph Norton Family." In *The History of Martha's Vineyard, Dukes County, Massachusetts, vol. 3, Family Genealogies*. Boston: George H. Dean, 1911, accessed online, <http://history.vineyard.net/nortonj.htm>.

- Barclay, Mrs. John E. "Notes on the Dunham Family of Plymouth, Mass." *The American Genealogist*, whole number 119, vol. 30, no. 3 (July 1953): 143–55.
- Bartlett, John Russell, ed. *Records of the Colony of Rhode Island and Providence Plantations in New England*, vol. 5, 1741 to 1756. Providence: Knowles, Anthony & Co., 1860.
- Bates, Samuel A. (ed.), *Vital Records of Braintree, Massachusetts, 1640-1793*. Randolph, MA: Daniel H. Huxford, Printer, 1886.
- Baumgarten, Linda. "Protective Covers for Furniture and Its Contents." *American Furniture* (1993): 3–14.
- Beaman, Alden G. *Rhode Island Vital Records, New Series*, vol 11, *Births, 1590-1930, from Newport Common Burial Ground Inscriptions*. East Princeton, MA: Rhode Island Families Association, 1985.
- Beard, Geoffrey W. *Upholsterers and Interior Furnishing in England, 1530-1840*. New Haven, CT: Published for the Bard Graduate Center for Studies in the Decorative Arts by Yale University Press, 1997.
- Bjerkoe, Ethel Hall. *The Cabinetmakers of America*. Garden City, NY: Doubleday and Co., 1957.
- Boston Births, Baptisms, Marriages, and Deaths, 1630–1699*, Ninth Report of the Boston Record Commissioners (Boston, 1883; rpt. Baltimore, 1978 *The American Genealogist*), 28.
- Bowen, Edward Augustus. *Lineage of the Bowens of Woodstock, Connecticut*. Cambridge, MA: Riverside Press, 1897.
- Brewster, Charles Warren. *Rambles about Portsmouth: Sketches of Persons, Localities, and Incidents of Two Centuries*. Portsmouth, NH: Lewis W. Brewster, 1869, vol. 2.
- Browne, Ann Putnam. *Putnam Elms: The Homestead of Daniel Putnam, 1882–1953* [Pamphlet], June 1, 1953.
- Campbell, Robert. *The London Tradesman*. London: T. Gardner, 1747.
- Carpenter Jr., Ralph E. *The Arts and Crafts of Newport Rhode Island: 1640–1820*. Newport, Rhode Island: The Preservation Society of Newport County, 1954.
- Carr, Dennis A. "The Account Book of Benjamin Baker." *American Furniture* (2004): 59–89.

Carr, Edson Irving. *The Carr Family Records*. Rockton, Illinois: Herald Printing House, 1894.

Christie's, New York. The Collection of Mr. and Mrs. Eddy Nicholson, sale cat. (January 27–28, 1995).

Christie's, New York. *The Collection of Mr. and Mrs. Joseph K. Ott*, sale cat. (January 20, 2012).

Christie's, New York. *Important American Furniture, Folk Art, and Decorative Arts*, sale cat. (October 5, 2000).

Christie's, New York. *Important American Furniture and Folk Art*. January 20, 2012.

Christie's, New York. *Important American Furniture, Silver, Prints, Folk Art, and Decorative Arts*, sale cat. (January 17–18, 1992).

Christie's, New York. *Important American Furniture, Silver, Prints, Folk Art, and Decorative Arts*, sale cat. (January 18–19, 2001).

Christie's, New York. *Property from the Collection of George and Lesley Schoedinger*, sale cat. (January 18, 2008).

Christie's New York. *Property from the Collection of Mrs. J. Insley Blair*, sale cat. (January 21, 2006).

Coleman, Peter J. "The Insolvent Debtor in Rhode Island 1745-1828." *The William and Mary Quarterly*, Third Series, vol. 22, no. 3 (July 1965), 413-434.

Conradson, David H. *Useful Beauty: Early American Decorative Arts From St. Louis Collections*, exh. cat. St.Louis, MO: Saint Louis Art Museum, 1999.

Cooke, Edward S., ed. *Upholstery in America & Europe: From the Seventeenth Century to World War I*. New York: Norton, 1987.

Cooper, Wendy. "The Purchase of Furniture and Furnishings by John Brown, Providence Merchant, Part 1, 1760-1788." *Antiques* 103, no. 2 (February 1973): 328–337.

Cutter, William Richard. *Historic Homes and Places and Genealogical and Personal Memoirs, Relating to the Families of Middlesex County, Massachusetts*. New York: Lewis Historical Publishing Company, 1908, vol. 3.

Davis, Walter Goodwin, *The Ancestry of Joseph Waterhouse, 1754-1837, of Standish, Maine*. Portland, Me: Anthoensen press, 1949.

Dexter, Franklin Bowditch. *Biographical Sketches of the Graduates of Yale College, Annals of the College History, vol. 3*. New York: Henry Holt and Company, 1903.

Downing, Antoinette Forrester, and Vincent Scully, *The Architectural Heritage of Newport, Rhode Island, 1640-1915*. New York: C.N. Potter, 1967.

Dumont, A. Henry. *The Articles of Faith, and Church Covenant, of the United Congregational Church, of Newport, R.I.* Newport: James Atkinson, 1834.

Dunham, Isaac Watson. *The Dunham Genealogy: English and American Branches of the Dunham Family*. Norwich Conn: Bulletin Print, 1907.

Dyer, Walter A. "John Goddard and His Block-Fronts." *Antiques* 1, no. 5 (May 1922): 203–208.

Evans, Nancy Goynes. "Identifying and Understanding Repairs and Structural Problems in Windsor Furniture." *American Furniture* (1994). Accessed online, <http://www.chipstone.org/>.

Fairbanks, Lorenzo Sayles. *Genealogy of the Fairbanks Family in America, 1633–1897*. Boston: American Printing and Engraving Company, 1897.

Forman, Benno M. *American Seating Furniture, 1630–1730: An Interpretive Catalogue*. New York and London: W.W. Norton & Company, 1988.

Freund, Joan Barzilay and Leigh Keno. "The Making and Marketing of Boston Seating Furniture in the Late Baroque Style." *American Furniture* (1998): 1–40.

Gardner, Frank A. "The Burrill, Burrell Family of Essex County, Mass." *Essex Institute Historical Collections* 52 (1916), 54–75.

A General Description of All Trades. London: Printed for T. Waller, 1747.

Greenlaw, Barry A. *New England Furniture at Williamsburg*. Williamsburg, VA: The Colonial Williamsburg Foundation, Virginia, 1974.

Heckscher, Morrison H. *American Furniture in the Metropolitan Museum of Art: Late Colonial Period, The Queen Anne and Chippendale Styles*. New York: Random House, 1985.

Heckscher, Morrison H. "Form and Frame: New Thoughts on the American Easy Chair." *Antiques* 100, no. 6 (December 1971): 886-93.

Heckscher, Morrison H. *John Townsend: Newport Cabinetmaker*, exh. cat. New York: The Metropolitan Museum of Art, 2005.

- Heckscher, Morrison, Amelia Peck, and Carrie Rebora Barratt. "Anatomy of an Acquisition: Treasures from the Ann and Philip Holzer Collection." *The Magazine Antiques* 160, no. 2 (August 2001): 190–197.
- Henry W. Cooke Co. Auctioneers, Providence, R.I. Executor's Sale. *Public Auction: The Wonderful Collection of Antique Furniture Belonging to the Late Nathan Cushing*, sale cat. (June 15, 1934).
- Hipkiss, Edwin J. *Eighteenth-Century American Arts: The M. and M. Karolik Collection*. Cambridge, Mass.: Harvard University Press, 1950.
- Hise, Nicki. "Gentility and Gender Roles Within the 18th-Century Merchant Class of Newport, Rhode Island" (master's thesis, paper 22, University of Massachusetts Boston, 2010).
- Hornsby, Thomas. "Newport Past and Present." *Newport Daily Advertiser*, December 8, 1849.
- Israel Sack, Inc., *American Antiques from Israel Sack Collection*. Alexandria, VA: Highland House Publishers, 1974, vol. 4.
- Jobe, Brock. "The Boston Furniture Industry 1720–1740." In *Boston Furniture of the Eighteenth Century*, edited by Walter Muir Whitehill, Brock Jobe, and Jonathan L. Fairbanks, 3–48. Boston: Colonial Society of Massachusetts, 1974.
- Jobe, Brock W., and Diane C. Ehrenpreis. *Portsmouth Furniture: Masterworks from the New Hampshire Seacoast* [exhibition catalog]. Hanover, NH: University Press of New England, 1993.
- Jobe, Brock, and Myrna Kaye, *New England Furniture: The Colonial Era: Selections from the Society for the Preservation of New England Antiquities*. Boston: Houghton, Mifflin, 1984.
- Kamil, Neil D. "Hidden in Plain Sight: Disappearance and Material Life in Colonial New York." *American Furniture* (1995). Accessed online, <http://www.chipstone.org>.
- Kane, Patricia E. *300 Years of American Seating Furniture: Chairs and Beds from the Mabel Brady Garvan and Other Collections at Yale University*. Boston: New York Graphic Society, 1976.
- Kane, Patricia E. "A Newly Discovered Rhode Island Cabinetmaker Thomas Spencer of East Greenwich." *Antiques* 177, no.3 (April/May 2010): 114–119.
- Keno Auctions, New York. *Important Americana, Paintings, Furniture and Decorative Arts* (January 17, 2012).

Keno, Leigh, Joan Barzilay Freund, and Alan Miller. "The Very Pink of the Mode: Boston Georgian Chairs, Their Export, and Their Influence." *American Furniture* (1996): 266–306.

The London Magazine, or, Gentleman's Monthly Intelligencer 37 (1768): 711.

Lovell, Margaretta M. "'Such Furniture as Will Be Most Profitable': The Business of Cabinetmaking in Eighteenth-Century Newport." *Winterthur Portfolio* 26, no. 1 (spring, 1991): 27–62).

The Manifesto church: Records of the church in Brattle square, Boston, with Lists of Communicants, Baptisms, Marriages, and Funerals, 1699–1872. Boston: The Benevolent Fraternity of Churches, 1902.

May, John Joseph. *Danforth Genealogy*. Boston: Charles H. Pope, 1902.

McClure, David, and Franklin B. Dexter. *Diary of David McClure, Doctor of Divinity, 1748–1820*. New York: The Knickerbocker Press, 1899.

McClure, James Alexander. *The McClure Family*. Petersburg, VA: Frank A. Owen, 1914.

McCracken, George E. "Terms of Relationship in Colonial Times." In *American Genealogist* 55 (1979): 52–54.

[McLentok]. *A Report of the Record Commissioners of the City of Boston Containing the Boston Marriages from 1700 to 1751*. Boston: Municipal Printing Office, 1898.

Michie, Audrey H. "Upholstery in All Its Branches: Charleston, 1725–1820." *Journal of Early Southern Decorative Arts* (1985): 20–84.

Miller, William Davis. "Dr. Joseph Torrey and His Record Book of Marriage." *Rhode Island Historical Society Collections* 18, no. 4 (October, 1925), 102–111, 142–153.

Milnes, E. C. *History of the Development of Furniture Webbing*. Leeds: E. C. Milnes, 1983.

Montgomery, Florence M. *Textiles in America, 1650-1870*. New York: Norton, 1984.

Moses, Michael. *Master Craftsmen of Newport: The Townsends and Goddards*. Tenafly, N.J.: MMI Americana Press, 1984.

Naeve, Milo M. "A New England Chair Design of 1730–1760 and Attributions to the Job Townsends of Newport, Rhode Island." *Newport History: Bulletin of the Newport Historical Society* 72 (Spring 2003): 1–17.

National Society of the Colonial Dames of America. *Third Record Book of the National Society of Colonial Dames in the State of Rhode Island and Providence Plantations*. Providence: Snow & Farnham Co., 1908.

New England Families, Genealogical and Memorial. Boston: The American Historical Society, 1916, vol. 5.

The *Newport Herald*, Newport, Rhode Island, <http://infoweb.newsbank.com/>.

The Newport Mercury, Newport, Rhode Island, <http://infoweb.newsbank.com/>.

“Newport Town Records.” *Newport Historical Magazine* 2, no. 3 (January, 1882), 158–169.

Notes and Queries: A Medium of Intercommunication for Literary Men, General Readers, Etc. 6th series, vol. 7 (May 26, 1883): 415.

Ott, Joseph K. “Abraham Redwood's Chairs?” *Antiques* 119, no. 3 (March 1981): 669–673.

Ott, Joseph K. *The John Brown House Loan Exhibition of Rhode Island Furniture*. Providence: Rhode Island Historical Society, Providence, 1965).

Ott, Joseph K. “Recent Discoveries Among Rhode Island Cabinetmakers and Their Work.” *Rhode Island History* 28, no. 1 (Winter 1969): 3–25.

Ott, Joseph K. “Still More Notes on Rhode Island Cabinetmakers and Allied Craftsmen.” *Rhode Island History* 28, no. 4 (Nov. 1969), 111–121.

Passeri Andrew, and Robert F. Trent. “More on Easy Chairs.” *Maine Antique Digest* (December 1987), 1B–5B.

Passeri, Andrew, and Robert F. Trent. “Two New England Queen Anne Easy Chairs with Original Upholstery.” *Maine Antique Digest* (April, 1983): 26A–28A.

Peterson, Edward. *History of Rhode Island*. New York: John S. Taylor, 1853.

Pierce, R. Andrew. “Joseph Daggett of Martha’s Vineyard, His Native American Wife, and Their Descendants.” *The New England Historical and Genealogical Register* 161 (January 2007): 5–21.

Phillips, Edward Wallace, *The Descendants of Seth Yeats (or Yates) of Newport, Rhode Island, and the Descendants of John Yeats (or Yates) of Providence, Rhode Island*. Bloomington, IN: iUniverse, 2008.

Prices of Cabinet and Chair Work. Philadelphia, PA: Printed by James Humphreys, Jr., 1772; reprinted in 2005 by the Philadelphia Museum of Art.

Prime, Alfred Coxe. *The Arts & Crafts in Philadelphia, Maryland, and South Carolina: Gleanings from Newspapers*. Topsfield, MA: Walpole Society, 1929), vol. 2.

Providence Patriot, Providence, Rhode Island, <http://infoweb.newsbank.com/>.

A Report of the Record Commissioners Containing Boston Births, Baptisms, Marriages, and Deaths, 1630-1699. Boston: Rockwell and Churchill, 1833.

A Report of the Record Commissioners of the City of Boston Containing the Boston Marriages from 1700 to 1751. Boston: Municipal Printing Office, 1898.

Richards, Nancy E., and Nancy Goyne Evans. *New England Furniture at Winterthur: Queen Anne and Chippendale Periods*. Winterthur, DE: Winterthur Publications, 1997.

The Rhode-Island Republican, Providence, Rhode Island, <http://infoweb.newsbank.com/>.

Rodriguez Roque, Oswaldo. *American Furniture at Chipstone*. Madison: University of Wisconsin Press, 1984).

Sack, Albert. *Fine Points of Furniture: Early American*. New York: Crown Publishers, 1950.

Scotti, N. David, and Joseph K. Ott. "Notes on Rhode Island Cabinetmakers." *The Magazine Antiques* 87, no. 5 (May 1965): 572.

Skinner, Inc., Boston. *American Furniture and Decorative Arts*, sale cat. (June 8, 2008).

Sloane, Jeanne Vibert. "John Cahoon and the Newport Furniture Industry." In *New England Furniture: Essays in Memory of Benno M. Forman*. Boston: Society for the Preservation of New England Antiquities, 1987, 88–122.

Sotheby's, New York. *Important Americana*, sale cat. (January 28–30, 1988).

Sotheby's, New York. *Important Americana including Silver, Prints, Folk Art, Furniture, and Property formerly in the Estate of Ulysses S. Grant*, sale cat. (January 18–19, 2001).

Sotheby's, New York. *Property from the Hascoe Family Collection: Important American and English Furniture, Fine & Decorative Art*, sale cat. (January 23, 2011).

Sotheby's, New York. *Property of Rear Admiral Edward P. Moore and Barbara Bingham Moore*, sale cat. (September 26, 2008).

Stevens, Eugene R. and William Plumb Bacon. *Erasmus Stevens, Boston, Mass., 1674-1690, and His Descendants*. New York: Tobias A. Wright, 1914.

Stevenson, R. W. "A 200-Year-Old Gift From Under the Sea," *The New York Times* (April 22, 2002). Accessed online, <http://www.nytimes.com/2002/04/28/nyregion/a-200-year-old-gift-from-under-the-sea.html?pagewanted=all&src=pm>.

Symonds, R. W. "The Upholstered Furniture at Knole." *The Burlington Magazine for Connoisseurs* 86, no. 506 (May 1945), 110–115.

Taylor, Ruth S. "Connected to the Past: Objects from the Collections of the Newport Historical Society." *Antiques and Fine Art* 8, issue 6 (Summer/Autumn 2008): 180–185.

Thornton, Peter. *Seventeenth-Century Interior Decoration in England, France, and Holland*. New Haven and London: Yale University Press, Published for the Paul Mellon Centre for Studies in British Art, 1978.

Thurston, Charles Myrick. *Descendants of John Pitman: The First of the Name in the Colony of Rhode Island*. New York: The Trow & Smith Book Manufacturing Co., 1868.

Updike, Wilkins, James MacSparran, and Daniel Goodwin. *A History of the Episcopal Church in Narragansett, Rhode Island*. Boston: The Merrymount Press, 1907, vol. 2.

The United States Chronicle, Providence, Rhode Island, <http://infoweb.newsbank.com/>.

Vibert, Jeanne A. "Market Economy and the Furniture Trade of Newport, Rhode Island, The Career of John Cahoon, Cabinetmaker: 1745–1765" (master's thesis, University of Delaware, 1981).

Vital Records of Brookline, Massachusetts, to the End of the Year 1849. Salem, MA: The Essex Institute, 1929).

Vital Records of Edgartown, Massachusetts, to the Year of 1850. Boston: New England Genealogical Society, 1906.

Vital Records of Roxbury, Massachusetts, to the End of the Year 1849. Salem, MA: The Essex Institute, 1925, accessed online, "Births - Abbot to Bryant," (http://dunhamwilcox.net/ma/roxbury_b1.htm).

Vital Records of Salem, Massachusetts, to the End of the Year 1849, Volume I.—Births. Salem: Essex Institute, 1916).

Walton, Karin-Marina. *The Golden Age of English Furniture Upholstery, 1660-1840; Temple Newsam House, Leeds, Exhibition Catalogue, 15 August-15 September 1973*. Leeds: Temple Newsam House, 1973.

Ward, Robert Leigh. "The English Origin and First Marriage of Deacon John Dunham of Plymouth, Massachusetts." *The American Genealogist* 71 (July 1996): 130–133.

Warren David B., et al., *American Decorative Arts and Paintings in the Bayou Bend Collection, The Museum of Fine Arts, Houston*. Houston: Museum of Fine Arts, Houston, 1998.

Warren, David. *Bayou Bend: American Furniture, Paintings and Silver from the Bayou Bend Collection*. Houston: Museum of Fine Arts, 1993.

Wiblow, Benjamin Franklin (ed.). *Little Compton Families*. Baltimore, MD: Reprinted for Clearfield by Genealogical Publishing Co., Inc., 2003, vol. 1.

Willoughby, Martha H. "The Accounts of Job Townsend, Jr." *American Furniture* (1999), 109–161.

Withey, Lynne. *Urban Growth in Colonial Rhode Island: Newport and Providence in the Eighteenth Century*. Albany: State University of New York Press, 1984.

Archival Sources

Note: The majority of primary source documents used for the thesis were accessed through Yale University's Rhode Island Furniture Archives. Below is a list of their physical locations.

Newport City Hall, Newport, Rhode Island
Newport Land Evidence

Newport Historical Society, Newport, Rhode Island
Newport Probate Administration Bonds
Newport Town Council and Probate
Society of Friends, East Greenwich, Monthly Meeting Records
Society of Friends, Newport, Monthly Meeting Records

Rhode Island Furniture Archive, Yale University Art Gallery, New Haven, Connecticut

Rhode Island State Archives, Providence, Rhode Island
General Treasury Accounts Allowed
Granted Petitions of the General Assembly (1756-1828), vol. XIV, 32
List of Persons Permitted to Reside in the State, Council of War, Letters and Accounts
Treasurer's Receipts 1740s

Rhode Island Supreme Court, Judicial Records Center, Pawtucket, Rhode Island
King's County Court of Common Pleas Record Books
Newport County Court of Common Pleas Record Books
Newport County Court of General Sessions of the Peace Record Books
Newport County Superior Court Record Books

Appendix 1: Upholsterer Biographies

Caleb Gardner Jr. (1729–1801)

Caleb Gardner Jr. is the only eighteenth-century Rhode Island upholsterer to whom an object has been attributed. He is thought to have upholstered an easy chair in the collection of the Metropolitan Museum of Art (accession number 50.228.3), based on a graphite inscription on its crest rail that reads, “Gardner Junr / Newport May / 1758.”³²⁰

Caleb Gardner Jr. was most likely born in Brookline, Massachusetts, on January 18, 1729.³²¹ He was the son of Caleb Gardner (c. 1683–1761), and his first wife, Abial Phipps. His paternal grandparents were Thomas Gardner (1645-c.1724)³²² and Mary Bowles (born 1655)³²³ of Brookline, Massachusetts, and his maternal grandparents were Solomon Phipps Jr. (born c. 1649-1701) and Mary Danforth (1650-1729) of Charlestown, Massachusetts.³²⁴ The elder Caleb Gardner moved his family to Newport shortly after his second marriage to Elizabeth Phipps (died after 1761), the niece of his first wife. There he engaged in West Indies trade, sold English goods, and owned a lumber wharf.³²⁵ He is probably the Caleb Gardner referred to as a Newport shopkeeper in multiple court cases

³²⁰ “Caleb Gardner, 1729–1801,” RIFA, YUAG.

³²¹ “Caleb Gardner, 1729–1801,” RIFA, YUAG. For a record of his birth, see *Vital Records of Brookline, Massachusetts, to the End of the Year 1849* (Salem, MA: The Essex Institute, 1929), 28. In addition to the upholsterer, several individuals named Caleb Gardner appear in eighteenth century court, probate, and land records, including a South Kingston yeoman (c. 1710–1796), a Newport merchant (1738–1806), and the upholsterer’s father, a Newport shopkeeper (1683–1761); for life dates, see RIHCTP.

³²² For life dates of Thomas Gardner, see Edward Augustus Bowen, *Lineage of the Bowens of Woodstock, Connecticut* (Cambridge, MA: Riverside Press, 1897), 221.

³²³ *Vital Records of Roxbury, Massachusetts, to the End of the Year 1849* (Salem, MA: The Essex Institute, 1925), accessed online, “Births - Abbot to Bryant,” (http://dunhamwilcox.net/ma/roxbury_b1.htm).

³²⁴ John Joseph May, *Danforth Genealogy* (Boston: Charles H. Pope, 1902), 20-21.

³²⁵ Bowen, *Lineage of the Bowens*, 221.

from 1740 to 1754, including a 1741 case in which he sued the joiner Israel Chapman for money due by book.³²⁶ It is conceivable that he was also an upholsterer and that his son carried on the family business.

Caleb Gardner Jr. was working as an upholsterer in Newport from at least 1758, the date inscribed on the Metropolitan's easy chair. He married Eleanor Phillips (died 1803) at Newport's Trinity Church in August 1752.³²⁷ They had seven children who were baptized at the Second Congregational Church of Newport: John (baptized 1753); Elizabeth (baptized 1755), John 2d (baptized 1756), Eleanor (baptized 1759), Caleb Phipps (baptized 1763), and Solomon and Sarah (twins, baptized 1765).³²⁸

The elder Caleb Gardner died on September 29, 1761.³²⁹ His will has suffered water damage and is largely illegible, but among the items left to his son Caleb were his Newport dwelling house (with rooms allocated to his wife, Elizabeth), land that bordered on Thames Street, and warehouse buildings. His will also contained the request that for "a term of three years" his wife and son "Improve my Whole Estate" by "carrying on Shop Keeping" in order to "enable my est[ate] to Pay and Discharge my Debts."³³⁰ In 1764, at the end of the three years, the family may have needed to raise additional money to settle claims against the estate. Caleb Gardner Jr., his mother, and Samuel Lyndon,

³²⁶ Caleb Gardner, Newport, shopkeeper v. Israel Chapman, Newport, joiner, case 209, November 1741 term, NCCCP, RB, vol. B, 236.

³²⁷ James N. Arnold, *Vital records of Rhode Island, 1636-1850. First series Births, marriages and deaths. A Family Register for the People. Volume 10: Town and Church* (Providence: Narragansett Historical Publishing Company 1896), 449.

³²⁸ James N. Arnold, *Vital records of Rhode Island, 1636-1850. First series Births, marriages and deaths. A Family Register for the People. Volume VIII: Episcopal and Congregational* (Providence: Narragansett Historical Publishing Company 1896), 445.

³²⁹ Caleb Gardiner's obituary, "Newport, October 6," *New-Hampshire Gazette*, October 23, 1761, <http://infoweb.newsbank.com/>. See also, RIHCTP.

³³⁰ Will of Caleb Gardner, April 3, 17[year illegible], NTCP, FHL film 0945000, vol. 13, 126, 129-131.

probably his brother-in-law,³³¹ advertised the sale of “A certain WHARF, with several Warehouses thereon [...] in the town of Newport, lately possessed by Capt. Caleb Gardner, deceased.”³³²

By 1770, Gardner had been jailed for debt. He appeared before Newport’s General Assembly in June to petition for protection under the 1756 Insolvent Debtors Relief Act, giving the following explanation for his financial troubles:

The petition of Caleb Gardner of Newport Shopkeeper humbly sheweth that in the Year 1759 his Father died possessed of a fair Estate Part of which he gave to the Petitioner but under great Disadvantages and the Remainder among his other Children: That in Order to keep the Estate entire and to better his Circumstances in the World he by the Advice of his Friends purchased the Remainder of his father's Real Estate for which he gave a large Price and became indebted upon Interest: That since that Time having a considerable Quantity of Shop-Goods purchased at a high Rate upon Credit then was a very sudden Alteration made in the Price of Goods by divers Persons opening Cash Shops by Reason whereof he was obliged to sell his Goods much cheaper than he could possibly afford, or suffer them to lye on Hand; by which he lost very considerably.³³³

³³¹ Samuel Lyndon Jr. married Elizabeth Gardner on December 22, 1734, see “Newport Town Records,” *Newport Historical Magazine* 2, no. 3 (January, 1882), 167. He was probably the Samuel Lyndon Jr. who worked as a joiner from at least 1733 to 1754. See “Samuel Lyndon, Jr.,” RIFA, YUAG.

³³² Advertisement, *The Newport Mercury*, September 24, 1764, issue 319, 1, <http://infoweb.newsbank.com>.

³³³ Petition of Caleb Gardner, filed June 15, 1770, *Granted Petitions of the General Assembly (1756-1828)*, vol. XIV, 32, Rhode Island State Archives, Providence, Rhode Island. Gardner’s petition incorrectly names the year of his father’s death as 1759. The elder Gardner actually died in 1761, a date documented by his obituary and tombstone (see note 10), and the fact that his will was proved in November of that year (see Will of Caleb Gardner, proved November 2, 1761, NTCP, FHL film 0945000, vol. 13, p. 139).

Gardner also assured the General Assembly that

he is not reduced to his present distressed Situation (confined in a Gaol & having a Wife & six helpless Children depending upon his Labour for Subsistence) by any Idleness or Extravagance he having always endeavoured by Industry and Frugality to maintain his Family and honestly pay all his Creditors; which he makes no Doubt will be allowed by all his acquaintance.³³⁴

Protection under the Act required that the debtor turn over his entire estate to three court-appointed commissioners, who would then distribute the proceeds among his creditors.³³⁵ Gardner believed that this would allow him to “satisfy all his Creditors and have something left to begin the World again and endeavour to support his Family.”³³⁶

As part of his petition, he submitted inventories of his “Real and Personal Estate,” which consisted of “My House Stores Wharf & Stables under Mortgage to Sundry Persons,” and an inventory of his shop goods. Gardner’s shop was stocked primarily with textiles, including “Green Baize, “Bedtick,” “Calliminco,” “Camblet,” “Mohair & Cruel,” “Harriteene,” “Plush,” “Stuff,” “white wor^d Damask,” “gauze,” “Silk,” “Velvet,” “Taby,”

³³⁴ Petition of Caleb Gardner, filed June 15, 1770, *Granted Petitions of the General Assembly (1756-1828)*, vol. XIV, 32.

³³⁵ Peter J. Coleman, “The Insolvent Debtor in Rhode Island 1745-1828,” *The William and Mary Quarterly*, Third Series, vol. 22, no. 3 (July 1965), 415.

³³⁶ Petition of Caleb Gardner, *Granted Petitions of the General Assembly (1756-1828)*, vol. XIV, 32.

“Callico,” “figure’d Mode,” “furniture Checks,” and “Oznabrigs.”³³⁷ Gardner’s upholsterer’s tools were not listed in either inventory. Debtors were allowed to keep necessary items such as bedding and wearing apparel, so it is possible that Gardner was also allowed to keep the tools of his trade since they would have enabled him to support himself and his family.³³⁸ Several of Gardner’s creditors, one of whom was the upholsterer Robert Stevens, signed a document recommending the acceptance of his petition.³³⁹ The petition was granted, and, on October 25, 1770, Gardner appeared before the justices of the superior court and took an oath to assign “his estate for the use of his creditors.”³⁴⁰

Gardner benefited from his protection under the Act in 1772, when he was twice sued by Newport husbandman John Anthony for money due by book.³⁴¹ Anthony first sued Gardner, identified as a Newport upholsterer, for £10 and was awarded £5.17 lawful money, but Gardner appealed the decision. In the second case, Anthony sought £150 owed to him by Gardner for the keeping of his horses.³⁴² The court ruled that Gardner was only liable for £24.06.10, the amount accrued after he had been granted protection under the Act. He was not obligated “to pay for the Time before he receiv’d the Benefit

³³⁷ Inventory of Caleb Gardner, June 14, 1770, *Granted Petitions of the General Assembly (1756-1828)*, vol. XIV, 32.

³³⁸ Coleman, “The Insolvent Debtor,” 415.

³³⁹ *Ibid.*

³⁴⁰ A document witnessing the oath is included in the case file, *John Anthony, Newport, husbandman v. Caleb Gardner, Newport, upholsterer*, case 83, November 1772 term, NCCCP RB, vol. 1.

³⁴¹ *John Anthony, Newport, husbandman v. Caleb Gardner, Newport, upholsterer*, case 83, May 1772 term, NCCCP RB, vol. 1, 173.

³⁴² Account, “Caleb Gardemar to John Anthony,” November 21, 1770, in case file, *Anthony v. Gardner; Plea, May 1772*, in case file, *Anthony v. Gardner*.

of the Insolvent Act,³⁴³ since anything before that date should have been paid by the commissioners of his estate. Anthony appealed, but the jury upheld its initial verdict.

Gardner's financial troubles continued, and in 1774 he was sued by Newport merchant Gideon Sisson for failure to pay rent.³⁴⁴ Gardner had leased a dwelling house from Sisson from January 16, 1772 to April 16, 1774, for a quarterly fee of £2.16.3.³⁴⁵ Sisson won the case, and Gardner was evicted. He was ordered to pay £25.6.2, the amount of his back rent. Gardner is referred to as a Newport upholsterer throughout the case. His continued practice of the trade is also documented by two invoices from the same year. In an account dated September 14, 1774, he billed Abraham Redwood "To making suit of Crimson Silk Bed & Window Curtains," charging his him \$25 for the curtains and another \$5 "To my Attendance."³⁴⁶ Another account, dated December 31, 1774, he debits Mrs. Rachel Wright £40 of Newport "To making a Easy Chair."³⁴⁷

Gardner apparently spent the next several years in the army. His military career is recounted by his great-great-grandson, Lincoln Greene, in his 1917 application for membership to the Massachusetts Society of the Sons of the American Revolution. Greene writes that Gardner "was appointed Captain in Col. William Richmond's R.I. reg[imen]t., Oct. 31, 1775; was promoted to Major of the 1st reg[imen]t, R.I. brigade, in

³⁴³ Anthony v. Gardner, case 83, November 1772 term, NCCCP RB, vol. 1, 189; Anthony v. Gardner, Newport County Superior Court, vol. F, 73 [find rest of citation].

³⁴⁴ Gideon Sisson, Newport, merchant v. Caleb Gardner, Newport, upholsterer, case 148, May 1774 term, NCCCP RB, vol. I, 526.

³⁴⁵ Account for rent, "Caleb Gardner to Gid[eon] Sisson," undated, in case file, Sisson v. Gardner.

³⁴⁶ Heckscher, *American Furniture*, 122; for actual invoice, see "Abraham Redwood Esq. To Caleb Gardner D[ebite]^d," mss., Newport Historical Society, Newport, Rhode Island. At this early date, the dollar amounts listed in the account were undoubtedly Spanish milled dollars.

³⁴⁷ Heckscher, *American Furniture*, 122; for actual invoice see "M^{rs}. Rachel Wright To Caleb Gardner D[ebite]^d," Haight mss., Newport Historical Society.

Feb. 1776; promoted to Lieut[enant]-Colonel, same reg[imen]t, R.I. Continental Line, Aug. 1776, served till 1781.”³⁴⁸

By 1783, Gardner was working as an upholsterer in Providence. He ran an advertisement in *The Providence Gazette and Country Journal* announcing that

Caleb Gardner, Upholsterer, Begs Leave to inform the Public that he carries on his Business, in all its Branches, at the House of Paul Tew, Esq; opposite Mr. Samuel Young’s. The Favours of the Public will be gratefully acknowledged, and those who may please to employ him may depend on having their Orders executed in the best Manner, and after the newest fashion.³⁴⁹

Gardner’s work as a Providence upholsterer is also documented in an invoice, dated January 29, 1790, in which he bills Enos Hitchcock £1.16 “To making a Easy Chair and Case.”³⁵⁰

When Caleb Gardner died in Providence in 1801, *The United States Chronicle* reported that

Friday Morning last, Col. Caleb Gardner [died], in the 73d Year of his Age. Through a long Life, he supported the Character of an honest and upright Man, and met the Approached of Death with the Calmness and Fortitude which peculiarly characterise the Christian- he died regretted, as he lived respected by

³⁴⁸ Lincoln Greene, Membership application for the Massachusetts Society of the Sons of the American Revolution, dated June 23, 1917, approved August 3, 1917, <http://www.ancestry.com/>.

³⁴⁹ “Caleb Gardner, Upholsterer,” *The Providence Gazette and Country Journal*, May 24, 1783, <http://infoweb.newsbank.com>; also quoted in “Caleb Gardner, 1729–1801,” RIFA, YUAG.

³⁵⁰ Joseph K. Ott, “Still More Notes on Rhode Island Cabinetmakers,” 117; also quoted in Heckscher, *American Furniture*, 122; for actual invoice, see “Mr. Hitchcock order to Mr. Gardner 1.16.0,” Enos Hitchcock Papers, Rhode Island Historical Society, Providence, Rhode Island.

all his Friends and Acquaintance, and has left a Widow and Children to lament a Loss to them irreparable.³⁵¹

Two years later the same paper announced the death of his wife, “Mrs. Eleanor Gardner, relict of the late Col. Caleb Gardner, formerly of Newport.”³⁵² They are both buried in Swan Point Cemetery in Providence.³⁵³

³⁵¹ “Died,” *United States Chronicle*, October 29, 1801, <http://infoweb.newsbank.com>; also quoted in “Caleb Gardner, 1729–1801,” RIFA, YUAG.

³⁵² *United States Chronicle*, “Deaths,” November 24, 1803, <http://infoweb.newsbank.com>.

³⁵³ *New England Families, Genealogical and Memorial* (Boston: The American Historical Society, 1916), vol. 5, 112.

Peter Hall (w. 1736)

Little is known about the life of upholsterer Peter Hall. He was identified as a Newport upholsterer in 1736, when he was sued by Benjamin Boylston, a yeoman from Mendon, Massachusetts, for money due by bond. The Newport County Court of Common Pleas decided in Boylston's favor, ordering Hall to pay £38.14.5 plus the cost of the suit.³⁵⁴ No other evidence of Hall's presence in Newport has yet been discovered. There was, however, an upholsterer by the same name working in Philadelphia in April 1745, when the following advertisement appeared in *The Pennsylvania Gazette*: "Peter Hall, Upholsterer, in Chestnut-Street, Makes all Sorts of Beds, Chairs, or any other Furniture fit for any House: Also will teach any Person to draw Draughts in a short Time for Flourishing or Embroidering, at the most reasonable rates."³⁵⁵ Clouding the situation even further is the fact that there are references to other Peter Halls in Rhode Island. One man by the name of Peter John Hall was born in 1717 in Portsmouth, but his date of birth is slightly too late for him to have been the Newport upholsterer.³⁵⁶ According to census data, there was another Peter Hall living in Charlestown in 1774.³⁵⁷ The name Peter Hall is also mentioned in conjunction with that of a John Harvey of Charlestown. Interestingly, there was a John Harvey identified as a Newport "upholder" in a 1744 lawsuit.³⁵⁸ When the Charlestown Harvey died in 1747, Hall acted as one of the

³⁵⁴ Benjamin Boylston, Mendon, Worcester County, Massachusetts v. Peter Hall, Newport, upholsterer, Newport, November 1736 term, NCCCP RB, vol. A, p. 420.

³⁵⁵ Prime, *The Arts & Crafts in Philadelphia, Maryland, and South Carolina*, vol. 2, p. 203.

³⁵⁶ Peter John Hall had moved to Lower Dutchess County, New York, by 1747, where he built a house that still stands. See "The History of Christy House," <http://www.hallchristyhouse.com/the-history-of-the-christy-house.html>.

³⁵⁷ 1774 Rhode Island Census, Ancestry, <http://www.ancestry.com/>.

³⁵⁸ Elisha Johnson, Newport, mariner v. John Harvey, Newport, upholder, May 1744 term, NCCCP RB, vol. B, p. 556.

bondsmen for William Harvey, the administrator of his father's estate.³⁵⁹ Another possibility is that Peter Hall was born in Massachusetts, since the aforementioned 1736 case establishes that he had at least one business relationship in Mendon.

³⁵⁹ Inventory of John Harvey, April 6, 1747, Charlestown Town Council and Probate, 1738–1759, vol. 1, p. 136. The inventory is cited on Rootsweb, "Harvey Family of Charleston," <http://news.rootsweb.com/th/read/RIWASHIN/2006-05/1146583481>. The fact that Peter Hall acted as a bondsman for William Harvey is mentioned on Genealogy.com, "Harvey Family of Washington County RI," <http://genforum.genealogy.com/ri/washington/messages/266.html>.

John Harvey (w. 1744)

All that is currently known about John Harvey is that he was working as a Newport upholsterer in 1744. He is referred to as an “upholder” in a suit brought against him by Elisha Johnson, a Newport mariner, for money due by note. Johnson was awarded £11 plus court costs.³⁶⁰ No other evidence of Harvey’s presence in Newport has yet been discovered. According to census data, there was a John Harvey living in Charlestown, Rhode Island, in 1774.³⁶¹ There was also a John Harvey from Charlestown who died in 1747.³⁶² When Harvey’s son William was named the administrator of his father’s estate, one of his bondsmen was Peter Hall. It is interesting to note that Peter Hall was the name of an upholsterer known to have been working in Newport in 1736.³⁶³ There is no evidence, however, that either of the men mentioned in the 1747 probate document were the same John Harvey and Peter Hall who worked as Newport upholsterers.

³⁶⁰ Elisha Johnson, Newport, mariner v. John Harvey, Newport, upholder, May 1744 term, NCCCP, RB, vol. B, p. 556, Rhode Island Judicial Record Center, Pawtucket, Rhode Island.

³⁶¹ 1774 Rhode Island Census, Ancestry, <http://www.ancestry.com/>.

³⁶² Inventory of John Harvey, April 6, 1747, Charlestown Town Council and Probate, 1738–1759, vol. 1, p. 136. The inventory is cited on Rootsweb, “Harvey Family of Charleston,” <http://news.rootsweb.com/th/read/RIWASHIN/2006-05/1146583481>. The fact that Peter Hall acted as a bondsman for William Harvey is mentioned on Genealogy.com, “Harvey Family of Washington County RI,” <http://genforum.genealogy.com/ri/washington/messages/266.html>.

³⁶³ Benjamin Boylston, Mendon, Worcester County, Massachusetts v. Peter Hall, Newport, upholsterer, Newport, November 1736 term, NCCCP RB, vol. A, p. 420.

John Moore (d. 1762)

John Moore worked as an upholsterer in Newport from at least 1731 until 1762, during which time he was involved in numerous lawsuits. The first known reference to Moore as a Newport upholsterer is contained in court records relating to a 1732 suit brought against him by Newport widow Judith Cranston for money due “for goods sold and delivered.” Moore lost the case, and was ordered to pay £16.17.6 plus court costs.³⁶⁴ Over the next few years, Moore was sued several times for failure to pay his debts. One case involving money owed to Newport vintner Robert Little for “Sundry Liquors Sold and Delivered at sundry times . . . in the Years of Our Lord 1731, 1732, &1733”³⁶⁵ establishes his presence in Newport by at least 1731.

Moore may have had some sort of business relationship with the cordwainer Samuel Phillips, whose mark appears on almost all of the known documents signed by Moore. Moore would later marry Lydia Yeats, the sister of Phillips’ wife, Rachel. Both Moore and Phillips were named on a 1733 bond, in which Moore was identified as an “upholder,” promising to pay Newport merchant George Dunbar £24.2.9, half of which was due in one year. It was only Moore, however, who was named in the 1734, 1735, and 1736 lawsuits in which Dunbar tried to recover his money. Dunbar was awarded £12.5.10 in each case.³⁶⁶

³⁶⁴ Judith Cranston, Newport, widow v. John Moore, Newport, upholsterer, November 1732 term, case 142, NCCCP, RB, vol. A, p. 167; Complaint, November 9, 1732, in case file, Cranston v. Moore.

³⁶⁵ Robert Little, Newport, vintner v. John Moore, Newport, upholsterer, case 67, NCCCP RB, vol. A, p. 192; Complaint, May 17, 1733, in case file, Little v. Moore.

³⁶⁶ George Dunbar, Newport, merchant v. John Moore, Newport upholsterer, November 1734 term, case 90, NCCCP RB, vol. A, p. 282; November 1735 term, case 200, NCCCP RB, vol. A, p. 358; November 1736 term, case 136, vol. A, p.424; Complaint, July 29, 1733, in aforementioned case files, Dunbar v. Moore.

Two 1735 court cases relate to Moore's upholstery trade. In the first, he was sued by the Newport currier Nathan Townsend over an unpaid account. The court awarded Townsend £21.4.6, the amount due, minus £7 that had previously been paid. The following account, detailing hides supplied to Moore from July 1733 to August 1734, was submitted to the court:

1733	John Moore D[ebite] ^d			
			£	
July	To Dressing and Collouring	3 Horse Hides	1	14
Aug ^t	To Ditto and Collouring	4 Hides red	2	8
Oct	To Ditto & D[itt] ^o	8 Ditto red	4	16
	To D[itt] ^o	6 Ditto red	3	12
Jan	To Ditto	4 D[itt] ^o	2	8
	To a Calf Skin Dressed		10	6
1734	To Dressing 3 Hides red		1	16
Ap ^l 19	To D[itt] ^o 5 D[itt] ^o		3	
Aug ^t	To D[itt] ^o 2 larg Skins red			8
	To D[itt] ^o 1 Hide red			
			£ 21 4 6 ³⁶⁷	

The only hides identified by type in Townsend's bill were "3 Horse Hides" and "a Calf Skin Dressed." With the exception of the calf skin, all of the leather was dyed red.³⁶⁸

The second 1735 lawsuit, Moore was sued by Newport brazier Stephen Ayrault for failure to pay his account.³⁶⁹ From June 26 to December 19 of 1733, Ayrault supplied Moore with tools, upholstery webbing, and thousands of upholstery tacks in various sizes:

³⁶⁷ Nathan Townsend, Newport, currier v. John Moore, Newport, upholsterer, May 1735 term, case 126, NCCCP RB, vol. A, p. 308; Account, July 1733–August 1774, in case file, Townsend v. Moore.

³⁶⁸ Nathan Townsend, Newport, currier v. John Moore, Newport, upholsterer, May 1735 term, case 126, NCCCP RB, vol. A, p. 308; Account, July 1733–August 1774, in case file, Townsend v. Moore.

³⁶⁹ Stephen Ayrault, Newport, brazier v. John Moore, Newport, upholsterer, May 1735 term, case 113, NCCCP RB, vol. A, p. 312.

1733 John More D[ebited]

June 26	To 5 [?] large tax 3/	5[?] midle d ^o [ditto] 2/5	5:5
30	To 5[?] large d ^o 3/	5[?] midle d ^o 2/5	5:5
July 3	To 1 m [thousand] Large tax 6/	1 m black d ^o 5/6	11:6
	To Sundrys D[ebited] John Ormsby [by] Verbel order		8:5
7	To 1 m midle tax 4/9	Aug 4 th 1 m lar. d ^o 5/6	10:3
Aug 4	To 1/2 m midle do 2/5	16 th 1 hammer 2/	4:5
17	To 1 m Large tax 5/6	22 ^d 1 m midle d ^o 4/9	10:3
	To 1 m Large do 5/6	2 pieces Girth Webb 13/5	18:11
28	To 1 m tax 5/6	29 th 3 pieces Girth Webb 20/3	1:5:9
	To 1 m tax 5/6	3 awle hafts 1/3	6:9
30	To 3 [?] brads 2/6	Sept ^r 1 - 1 m midle tax 4/9	7:3
Sept ^r 29	To 1 m Large tax 5/6	Oct ^r 3 ^d 1 m d ^o 5/6	11:0
Oct ^r 3 ^d	To 1 m midle do 4/9	11 th 1 m lar d ^o 5/6	10:3
12	To 1/2 m midle do 2/5	15 th 1 m lar d ^o 6/	8:5
16	To 1 m d ^o 6/	19 th 3[pounds?]20d Nails 9/	15:0
20	To 1 m large tax 6/	24 th 1m d ^o 6/	12:0
30	To 3 [pounds?] 6 ^d Nail		5:6
Nov ^r 7	To 2 [pounds?] glew 5	13 th 1m midle do 4/10 ^d	9:10
21	To 1/4 [pounds?] 20 ^d Nails 1/0		1:0
24	To 1 m large tax 5/9 ^d	28 th 1 m d ^o 5/9 ^d	11:6
Dec ^r 5	To 1[pounds?] 6 ^d Nails 22 ^d	1 [pounds?] glew 2/6 1 m tax 5/9 ^d	10:1
11	To 1 m tax 5/9 ^d	12 th 1 m d ^o 5/9 ^d	11:6
19	To 1 m do 5/9 ^d	20 th 2 [pounds?] Nails 6/	11:9
	Errors Excepted		<u>11:12:2</u> ³⁷⁰

The account also includes “Sundrys” for John Ormsby per “Verbel Order” at a cost of £0.8.5. John Ormsby (1704–1766) was a chairmaker who was active in Newport from at least 1733 to 1739. Moore’s order on Ormsby’s behalf suggests the two probably had a business relationship.

Several of Moore’s lawsuits involved joiners. In 1736, he sued Newport joiner William Robson for failure to pay rent.³⁷¹ Moore’s attorney submitted a complaint stating

³⁷⁰ Account, June 26, 1733–December 20, 1733, in case file, Ayrault v. Moore.

that Moore had let Robson “a Certain Shop in said Newport bounded west upon Thames Street South upon Land now in Possession of Robert Sherman Easterly and Northerly on Land in Possession of Peter Coggeshall” from May 20, 1733 to February 20, 1736, at a cost of £3 per quarter.³⁷² The court awarded Moore £33 in back rent for the eleven quarters that Robson had occupied the shop. Then, in 1741, Moore sued Newport joiner Joseph Chaplin Jr. for failure to pay an account. He was awarded £81.0.3 and 3 farthings, minus £51.8.0 “Credit of y^e Acc^t given into court” by Chaplin.³⁷³ In the record book of the Newport County Court of Common Pleas, Moore’s profession was first written in as “upholder,” but was then changed to “upholsterer.” The same correction was made when Moore’s 1741 suit against Newport mariner James Sweet for money due by note was recorded.³⁷⁴ The mark of Moore’s future wife Lydia appears on the note, in which Sweet promises to pay Moore £31.³⁷⁵ It is not certain whether this is the same James Sweet who identified himself as a Newport joiner when sued in 1739 by John Davis, a Newport tailor, for money due by note. Both Sweet and Moore signed the note, in which Sweet promises to pay Davis £12.³⁷⁶

³⁷¹ John Moore, Newport, upholsterer v, William Robson, Newport, joiner, May 1736 term, case 185, NCCCP RB, vol. A, p. 396.

³⁷² Complaint, filed May 13, 1736, in case file, Moore v. Robson.

³⁷³ John Moore, Newport, upholsterer v. Joseph Chaplin, Jr, Newport, joiner, November 1741 term, NCCCP RB, vol. B, p. 250.

³⁷⁴ John Moore, Newport, upholsterer v. James Sweet, Newport, mariner, November 1741 term, case 68, NCCCP RB, vol. B, pg. 328.

³⁷⁵ Note, May 14, 1740, in case file, Moore v. Sweet.

³⁷⁶ Note, September 25, 1738, in case file, John Davis Jr, Newport, tailor v. James Sweet, Newport, joiner, May 1739 Term, case 27, NCCCP, RB, vol. A, p. 629.

The 1741 case with Sweet is the last known reference to Moore until his death on February 2, 1762.³⁷⁷ Moore's will, dated January 7, 1762, named his wife Lydia as executrix.³⁷⁸ Although she did outlive him, she had died by the time the will was submitted to the town council on June of the same year. The council appointed Lydia's son from her previous marriage, Samuel Yeats, to act as administrator in her place. In addition to his wife, Moore's will named his son, John Moore, and his daughter, Elizabeth Hughes.³⁷⁹ Also submitted to the council was his household inventory, valued at over £500.³⁸⁰ Possibly related to his upholstery trade were "1 case of instruments" valued at £10. A posthumous court case reveals that, in addition to his work as an upholsterer, Moore also kept a shop. He is referred to as a shopkeeper in November 1762, when Samuel Yeats sued Newport mariner John Sovenall on behalf of Moore's estate for £160 due by book.³⁸¹

Nothing is known of Moore's birth, family, or early life. He married Lydia Yeats (or Yates, c. 1702–1741) on February 17, 1741 at the Second Congregational Church in Newport.³⁸² Lydia was born in Stonington, Connecticut, and was the daughter of Richard Carder and Mary Richardson. She had previously married Newport cordwainer Seth

³⁷⁷ Date of death recorded on a list of members, "Second Baptist Church Records," manuscript at the Newport Historical Society; cited in Phillips, *The Descendants of Seth Yeats*, 2, note 10.

³⁷⁸ Will of John Moore, Newport, upholsterer, January 1, 1762, NTCP, FHL film 0945000, vol. 13, p. 153–54; printed Phillips, *The Descendants of Seth Yeats*, 6–7.

³⁷⁹ Will of John Moore, NTCP, FHL film 0945000, vol. 13, p. 153–154; Phillips, *The Descendants of Seth Yeats*, 6–7.

³⁸⁰ Inventory of John Moore, June 7, 1762, NTCP, FHL film 0945000, vol. 13, p. 153–54; published in Phillips, *The Descendants of Seth Yeats*, 8.

³⁸¹ Samuel Yeats, Newport, painter and administrator of the goods, debts, etc., of John Moore, shopkeeper v. John Sovenall, Newport, mariner, November 1762 term, NCCCCP RB, vol. f, p. 700.

³⁸² Phillips, *The Descendants of Seth Yeats*, 1–2; Arnold, *Vital records of Rhode Island*, vol. 8, 470.

Yeats (1699–1740/41) on November 28, 1723, at Trinity Church.³⁸³ In addition to her son Samuel (1724–1786), she may have had the following daughters with her first husband: Mary (c. 1726–1762), Elizabeth (c. 1727–1820), and Lydia (1733).³⁸⁴ It is not known whether the children named in Moore’s will, John Moore and Elizabeth Hughes, were a result of his marriage to Lydia or of a previous marriage. A shop kept by Lydia after the death of her first husband is mentioned in the court proceedings of the estate of Peleg Carr, whose legacy included the “rent of Lydia Yeats shop.”³⁸⁵

Additional details of Moore’s life are documented in the records of Newport’s Second Baptist Church, which he joined on December 19, 1734. Moore had apparently developed a less than virtuous reputation by 1741, prompting the following entry in the church records: “At our church Meeting December ye 3 day 1741 we considered the Surcumstances of John Moore and discoursed Concerning the Evil and publick Reports that was about him. But he being absent at this Meeting We could do nothing with him at this Meeting but thought it proper to put him by from our Communion at this time until some other opportunity to talk more concerning him.” Two subsequent sets of minutes relating to meetings on December 31, 1741 and March 4, 1741/2 also indicate his absence. Moore finally appeared on the “5th day of the following week,” when he “denied what he had evidently formerly admitted,” which was having “a bad character of keeping bad company.” Moore was advised by the church “to Remove his abode to some Civil house for where he has made his abode was an uncivil house being a publick house

³⁸³ Phillips, *The Descendants of Seth Yeats*, 1.

³⁸⁴ *Ibid.*, 9. Phillips asserts that although there is no direct evidence that these were Lydia’s daughters, they were the only Yates living in Newport at the time and had legal ties to each other.

³⁸⁵ Phillips, *The Descendants of Seth Yeats*, 5–6.

and a very Disorderly one.”³⁸⁶ These discussions occurred around the same time as both Moore’s marriage to Lydia Yeats and the last known mention of his name in court records. It is possible that their marriage led him to reform his life and brought him more financial security, enabling him to pay his debts.

³⁸⁶ Second Baptist Church Records, Mss at Newport Historical Society [n.p.]; quoted in Phillips, *The Descendants of Seth Yeats*, 8.

Kendall Nichols (b. c. 1722–1774)

Kendall Nichols Jr. was the son of Kendall (1686–1767) and Mary Nichols (1695–1768).³⁸⁷ His paternal grandparents were John Nichols (1651–1721) and Abigail Kendall (1655–1721) of Reading, Massachusetts.³⁸⁸ The elder Kendall Nichols was born in Reading but by 1720 had moved to Newport, where he was one of the founding members of the city’s Congregational Church.³⁸⁹ A disagreement with the church arose in 1724, when pastor Nathaniel Clap refused to baptize Nichols’ child (possibly Kendall Nichols Jr.).³⁹⁰ In a letter to Nichols and his wife, Clap implies moral failings on the part of the couple, writing, “Glad would I be, to hope that you are converted from sin to God in Jesus Christ.”³⁹¹ The true reason behind the slight, however, may have been a misunderstanding about Clap’s ownership of the parsonage, which was apparently built for him at Nichols’ expense.³⁹²

³⁸⁷ For the life dates of Kendall and Mary Nichols, see RIHCTP. Mary Nichols’ maiden name and the date of her marriage are unknown. It is therefore possible that she was not the first wife of Kendall Nichols or the mother of Kendall Nichols Jr.

³⁸⁸ Thomas W. Baldwin, *Vital Records of Reading, Massachusetts, to the Year 1850* (Boston: [Wright & Potter Printing Company], 1712), 136,544; William Richard Cutter, *Historic Homes and Places and Genealogical and Personal Memoirs, Relating to the Families of Middlesex County, Massachusetts* (New York: Lewis Historical Publishing Company, 1908), vol. 3, 919.

³⁸⁹ A. Henry Dumont, *The Articles of Faith, and Church Covenant, of the United Congregational Church, of Newport, R.I.* (Newport: James Atkinson, 1834), 4; Arnold, *Vital records of Rhode Island*, vol. 8, 430.

³⁹⁰ Around the same time, Clap ceased to administer the sacrament of the Lord’s Supper to the entire congregation because its members were “not of sufficiently holy conversation.” See Dumont, *The Articles of Faith*, 4–5, and Peterson, *History of Rhode Island*, 318–320.

³⁹¹ Dumont, *The Articles of Faith*, 4–5.

³⁹² Peterson, *History of Rhode Island*, 318–320.

Although one early source identifies the elder Kendall Nichols as an “influential merchant,”³⁹³ he also worked as a stone mason. In 1726, he was paid by John Stevens, a builder and stone mason, for “valueing and measuring the mason’s work of the almshouse.”³⁹⁴ The Newport Town Council also compensated Nichols for work done on at least three occasions, including in 1746 for “Work he did at the Watch House £4.19,” in 1748 “for mason work done for both watch houses £9.14,” and in 1753 “for work done at the pest house.”³⁹⁵

Kendall Nichols Jr. was born in or around 1722, probably in Newport.³⁹⁶ It is possible, but by no means certain, that he apprenticed with Newport upholsterer Robert Stevens. In 1743, at the age of about twenty-one, he acted as a bondsman for Stevens and Newport joiner Nathaniel Baker, suggesting that they may have had some sort of business relationship. Nichols signed a bond in which Stevens and Baker promised to pay £645 to Benjamin, Samuel, and Moses Pitman. The Pitmans sued Stevens for default in May 1745.³⁹⁷ Nichols was admitted as a freeman to the colony at a meeting of the General Assembly on May 1, 1744.³⁹⁸ He married Sarah Paine of Jamestown on March 13, 1745, at the Second Congregational Church of Newport. She was probably the daughter of John

³⁹³ Ibid, 318.

³⁹⁴ “Account book of John Stevens,” The Joseph Downs Collection of Manuscripts and Printed Ephemera, Henry Francis du Pont Winterthur Museum, Winterthur, Delaware, 34, http://findingaid.winterthur.org/html/HTML_Finding_Aids/doc1243.htm.

³⁹⁵ NTCP, FHL film 0944999, vol. 9, p. 187; NTCP, FHL film 0944999, vol. 11, p. 119; NTCP, FHL film 0945000, vol. 12, p. 109.

³⁹⁶ RIHCTP.

³⁹⁷ Benjamin Pitman, mariner, Samuel Pitman, bricklayer, and Moses Pitman, fellmonger, all of Newport v. Robert Stevens, Newport, upholder alias upholsterer, May 1745 term, case 253, NCCCCP, RB, vol. B, p. 704; Note, December 1, 1743, in case file, Pitman v. Stevens.

³⁹⁸ John Russell Bartlett, ed., *Records of the Colony of Rhode Island and Providence Plantations in New England*, vol. 5, 1741 to 1756 (Providence: Knowles, Anthony & Co., 1860), 81.

Paine (c. 1697–1773) of Jamestown.³⁹⁹ The couple had at least one child, a daughter named Abigail.⁴⁰⁰ Nichols is first referred to as a Newport upholsterer in 1761, when he was sued by Thomas Norrington, a baker from Plymouth, Massachusetts, for £264 in damages for money due by book.⁴⁰¹ Nichols may have collaborated with cabinetmaker Job Townsend Jr. on at least one occasion. Townsend’s account book records a charge of £6.15.0 to the upholsterer in January 1767 for Samuel Simson’s order.⁴⁰²

The elder Kendall Nichols died September 18, 1767.⁴⁰³ He bequeathed his real and personal estate to his wife, Mary, to be divided between his children, Kendall and Abigail, at the time of his widow’s death.⁴⁰⁴ An inventory taken by Edmund Townsend and Nathan Luther values the estate at £1199:11.⁴⁰⁵ On February 1, 1768, Mary Nichols appeared before of the town council to declare the estate insolvent, with known claims by creditors totaling £7850:03.⁴⁰⁶ The council recommended the sale of enough of her late husband’s real estate to cover the debts. From May to November, Mary Nichols and her

³⁹⁹ A house on Third Street in Newport belonged to “Abigail Nichols Oatley, daughter of Kendall Nichols, inherited from her grandfather John Pain”; see Antoinette Forrester Downing and Vincent Scully, *The Architectural Heritage of Newport, Rhode Island, 1640-1915* (New York: C.N. Potter, 1967), 492. John Payne was owed £3,000 by the elder Kendall Nichols estate (see NTCP, FHL film 0945000, vol. 15, 177).

⁴⁰⁰ Abigail Nichols married Capt. Samuel Oatley on November 21, 1771; see William Davis Miller, “Dr. Joseph Torrey and His Record Book of Marriage,” *Rhode Island Historical Society Collections* XVIII, no. 4 (October, 1925), 149. Kendall Nichols’ great-grandson, the son of his daughter Abigail’s son Ray Sands Oatley, was Nichols Kendall Oatley (1809–1894), a furniture maker and merchant who was working in Providence in at least 1832. See “Nichols K. Oatley,” RIFA, YUAG.

⁴⁰¹ Thomas Norrington, Plymouth, Massachusetts, baker v. Kendal Nichols, Jr., Newport, upholsterer, November 1761 term, NCCCP RB, vol. F, p. 545; Norrington v. Nichols, May 1762 term, NCCP RB, vol. F, p. 640.

⁴⁰² Martha H. Willoughby, “The Accounts of Job Townsend, Jr.,” *American Furniture* (1999), Appendix, accessed online, <http://www.chipstone.org/>.

⁴⁰³ RIHCTP.

⁴⁰⁴ Will, Kendall Nichols, Esq., proved October 5, 1767, NTCP, FHL film 0945000, vol. 15, p. 148.

⁴⁰⁵ Inventory, Kendall Nichols, Esq., October 3, 1767, NTCP, FHL film 0945000, vol. 15, p. 149.

⁴⁰⁶ Town Council minutes, February 1, 1768, NTCP, FHL film 0945000, vol. 15, p. 174.

co-executors, Benjamin King and Joseph Belcher, placed a series advertisements in *The Newport Mercury* of announcing the sale of “The real Estate of Kendall Nichols, Esq; late of Newport, deceased, consisting of several Houses, Shops, Stores, &c. which will be sold together, or separate, as shall best suit the Purchaser.”⁴⁰⁷ Mary died on June 18, 1768, and any remaining assets or debt presumably passed to her children.

Three court cases reveal that Kendall Nichols Jr. was still working as an upholsterer in 1773, although apparently aspiring to a higher status. The first two cases involved the nonpayment of rent for “one Great room, one Bed Room, Wash room and Closet, being part of a Dwelling House,” which Kendall leased to Newport mariner Patrick Brady in May 1772 for the sum of £4.10 per year. A third man, Captain Thomas George, agreed to pay on Brady’s behalf.⁴⁰⁸ Nichols, however, never received his rent, and in May 1773 he sued Brady for “trespass and ejectment” and George for failure to perform a promise.⁴⁰⁹ Nichols was referred to in the two suits as a gentleman and as an upholsterer, respectively. In a November 1773 case, he was identified as a “yeoman alias upholsterer,” having been sued by Newport merchant Joseph Hammand Jr. for money due by note. The court awarded Hammand “Thirty six Dollars & five shillings & four pence half penny Lawful Money,” the full amount due. Nichols died on January 2, 1774, before discharging his debt.⁴¹⁰ In May 1774, Hammand attempted to recover his money by suing Nichols’ widow for £30 in damages. The court ruled that Hammand should

⁴⁰⁷ “To Be Sold,” dated April 16, 1768, *The Newport Mercury*, May 9–16, 1768, May 30–June 6, 1768, June 20–27, 1768, July 11–18, 1768, August 29–September 5, 1768, <http://infoweb.newsbank.com/>.

⁴⁰⁸ “Memorandum of an agreement,” May 2, 1772, in case file, Kendall Nichols, Newport, upholsterer v. Thomas George, Newport, gentleman, May 1773 term, case 360, NCCCCP RB, vol I, p. 361.

⁴⁰⁹ Kendall Nichols, Newport, gentleman v. Patrick Brady, Newport, mariner, May 1773 term, case 43, NCCCCP RB, vol I, p. 322; Nichols v. George, vol I, p. 361.

⁴¹⁰ Nichols is buried in the Newport’s Common Burial Ground, see “Nickols Kendall, Jr,” RIHCTP.

“recover & have of the Goods and Chattels of the said Kendall dec(ease)^d in the hands of the said Sarah the Sum of twelve pounds one shilling and four pence three farthings lawful money.”⁴¹¹

⁴¹¹ See Joseph Hamand Jr, Newport, merchant v. Kendall Nichols, Newport, yeoman, alias upholsterer, November 1773 term, case 284, NCCCCP, RB, vol. I, p. 455; and Joseph Hamand Jr, Newport, merchant v. Sarah Nichols, Newport, widow, May 1774 Term, case 30, NCCCCP RB, vol. I, 514.

William Stanton (w. 1754)

Very little is known about the life of Newport upholsterer William Stanton. Nothing has yet been found about his birth or family, and the few facts related to his trade come from four court cases brought against him in the Newport County Court of Common Pleas. It is very likely that Stanton was only in Newport for a short period of time.

The first two cases involving William Stanton were both tried in May 1754. In one, he was sued by Newport inholder James Sisson over an unpaid account. The case file contains an invoice for £133.0.1, dating from February 1753 to January 1754, in which Sisson bills Stanton for a variety of items, including cash, paper, and blankets.⁴¹² Stanton lost the case and was ordered to pay the amount of the invoice minus a credit of £68.16.11. In the second case, Stanton was sued by Newport barber Benoni Peckham for failing to pay for a wig. In the corresponding unpaid account, Peckham charges Stanton twenty-two pounds for “one Light Gray Wigg” and one pound for “Curling a Wigg.”⁴¹³ A note on the writ served to Stanton on April 23, 1754, reads “If you dont know the Def[t.] pray inquire of the Pl[t.],” suggesting that Stanton had not been in Newport long.⁴¹⁴ The court decided in favor of Peckham, and Stanton was ordered to pay the twenty-three pounds.

In November 1754, Stanton was sued a third time. On this occasion, it was over an unpaid account from cordwainer Samuel Phillips, possibly relating to Stanton’s

⁴¹² James Sisson, Newport, inholder v. William Stanton, Newport, upholsterer, May 1754 term, case 35, NCCCP RB, vol. D, p. 542, 587, 703; Account, February 1753 to January 1754, in case file, Sisson v. Stanton (account cited in notes on William Stanton, RIFA, YUAG).

⁴¹³ Peckham, Newport, barber v. William Stanton, Newport, upholsterer, May 1754 term, case 501, NCCCP, vol. D, p. 587. Account, February 1753, in case file, Peckham v. Stanton.

⁴¹⁴ Writ, dated April 1, 1754, in case file, Peckham v. Stanton.

upholstery trade.⁴¹⁵ The invoice submitted to the court by Phillips includes charges to Stanton on seven different occasions for either a “Reacking” or a “Reaching,” probably an eighteenth-century term for stretching leather.⁴¹⁶ It is likely that, as a cordwainer, Phillips would have provided such a service. The amounts billed to Stanton ranged from twelve shillings to £9.18.0, indicating that the charges were probably based on the quantity – and possibly also the type – of leather being stretched. The sheriff could not find Stanton when attempting to serve him the writ, and instead “attached his personal estate in the hands of Job Little.”⁴¹⁷ Stanton lost the case and was required to pay the £26.3.1 account.

It is uncertain whether the Stanton ever paid Phillips, but the Sisson and Peckham judgments remained unsatisfied. Sisson tried to sue Stanton again in May 1755, but the deputy sheriff reported that “neither [his] body nor estate [was] to be found.”⁴¹⁸ It is likely that Stanton had left Newport for good by that time, and no further evidence of his presence in the city has been discovered.

⁴¹⁵ Samuel Phillips, Newport, cordwainer v. William Stanton, Newport, upholsterer, November 1754 term, case 398, NCCCP, vol. D, p. 703; Account, January 3, 1754 to August 3, 1754, in case file, Phillips v. Stanton.

⁴¹⁶ The Oxford English Dictionary lists an obsolete definition of “reaching” as “capable of being stretched;” see “reaching, adj.,” Oxford English Dictionary, <http://www.oed.com/>. “Reaching leather” was a term sometimes used “to indicate the quality of yielding or suppleness;” see *Notes and Queries: A Medium of Intercommunication for Literary Men, General Readers, Etc.*, 6th series, vol. 7 (May 26, 1883): 415.

⁴¹⁷ Writ, October 2, 1754, in case file, Phillips v. Stanton (writ cited in notes on William Stanton, RIFA, YUAG).

⁴¹⁸ James Sisson, Newport, inholder v. William Stanton, Newport, upholsterer, May 1755 term, NCCCP, RB, vol. E, p. 132.

Robert Stevens (1713–1780)

The Newport upholsterer Robert Stevens was born in Boston on February 21, 1713.⁴¹⁹ He was the son of John Stevens (1671–1721) and Grace Gammon, who were married by Reverend Cotton Mather on June 6, 1694.⁴²⁰ His paternal grandparents were Erasmus and Elizabeth Stevens of Boston.⁴²¹ Robert married Anstis Elizabeth Wignall (1723–1802), the daughter of John Wignall and Mary Rogers of Newport, at Newport’s Second Congregational Church on September 21, 1738.⁴²² A portrait of Mrs. Stevens, attributed to John Singleton Copley, is now in the collection of the Newport Historical Society (fig. 90). Robert and Anstis had at least fifteen children: Mary (bp. 1739), Anstis Elizabeth (c. 1740–1740), John (bp. 1740), Robert (1742–1743), Robert (1743–1831), Mary (bp. 1744–1745), Anstis Elizabeth (1745–1745), Elnathan (bp. 1748), Elnathan, (bp. 1749), Joseph (bp. 1751), Abigail (bp. 1753), Elnathan Hammond (bp. 1758), William Wignall (bp. 1759), Mary (1761–1780), and Anstis Elizabeth (1763–1823).⁴²³

It is not known whether Robert Stevens completed his apprenticeship in Newport or Boston, but by the age of twenty-three he was working as a Newport upholsterer. He was identified as such in November 1736, when he successfully sued Newport hatter

⁴¹⁹ Stevens and Bacon, *Erasmus*, 70.

⁴²⁰ Stevens and Bacon, *Erasmus Stevens*, 65. A record of the marriage of John Stevens and Grace Gammon can be found in *A Report of the Record Commissioners Containing Boston Births, Baptisms, Marriages, and Deaths, 1630-1699* (Boston: Rockwell and Churchill, 1833), 218.

⁴²¹ Stevens and Bacon, *Erasmus Stevens*, 23. According to family tradition, Erasmus came to Massachusetts from Pemaquid, Maine, and his ancestors were from Cornwall, England.

⁴²² Stevens and Bacon, *Erasmus Stevens*, 70; Arnold, *Vital records of Rhode Island*, vol. 8, 479. Stevens’ wife’s name is spelled “Anstress” in the church records, but “Anstis” on her tombstone and in Stevens and Bacon’s *Erasmus Stevens*. See, RIHCTP.

⁴²³ Baptism dates are from Arnold, *Vital Records*, vol. 8, 453; life dates are from Stevens and Bacon, *Erasmus Stevens*, 70–71, and RIHCTP.

Daniel Underwood for £4.2.0 due by book.⁴²⁴ Throughout the next several decades, Stevens appears regularly in court records, usually as the plaintiff but occasionally as the defendant. The trades assigned to him in these records document the upward progression of his career from upholsterer, to shopkeeper, to merchant. Stevens was identified almost exclusively as an upholsterer or upholder until the early 1750s, when he was referred to in a case that began in 1750 and was concluded in 1752 as an “upholsterer, alias merchant.”⁴²⁵ Thereafter, Stevens was consistently identified as a merchant, with the exception of three cases – in 1740, 1741, and 1758 – in which he was called a shopkeeper.⁴²⁶ In the 1741 case, Stevens and two other shopkeepers, Jacob Richardson and Elnathan Hammond, were sued by Edmund Townsend for damages in the amount of £3700 for money due by bond. Townsend, identified as “Cabinet-maker and Town Treasurer,” won the case but was awarded only £393.8.7.

Extant accounts reveal some of the items that Stevens was selling early in his career, such as “ten yards of Garlix and One Worsted Cap” sold for £4.2.0 in 1735;⁴²⁷ loaf sugar and “ticken” sold for £8.12.6;⁴²⁸ “17 1/4 yd of Check [@] 8/” sold for £6.16.0 in

⁴²⁴ Robert Stevens, Newport, upholsterer v. Daniel Underwood, Newport, hatter, November 1736 Term, case 12, NCCCP Record Book, vol. A, p. 415.

⁴²⁵ John Culverson, Newport, mariner v. Robert Stevens, Newport, upholsterer, alias merchant, May 1750 term, NCCCP RB, vol. C, p. 559.

⁴²⁶ Robert Stevens, Newport, shopkeeper v. Banister Cane, Newport, mariner, November 1740 term, NCCCP RB, vol. B, p. 208; Robert Stevens, Newport, shopkeeper v. Daniel Gains, Newport, painter, case 153, May 1741 term, NCCCP RB, vol. B, p. 196; Edmund Townsend, Newport, Cabinet-maker and Town Treasurer v. Jacob Richardson Elnathan Hammond and Robert Stevens, Newport, shopkeepers, May 1758 term, NCCCP RB, vol. E, np.

⁴²⁷ Complaint, filed November 4, 1736, in case file, Stevens v. Underwood.

⁴²⁸ Account, in case file, Robert Stevens, Newport, upholsterer v. John Trobridge, Newport, mariner, November 1737 term, case 15, NCCCP RB, vol. A, p. 486 (account cited notes on Robert Stevens, RIFA, YUAG).

1738;⁴²⁹ “2211 galls of Pumpings [molasses] @ 2.8 gall” sold for £294.16.0 in 1739;⁴³⁰ coats, fabrics, and thread in 1739;⁴³¹ and seven barrels of flour from 1739 to 1740.⁴³² In another account dating from 1741 to 1743, Stevens billed Daniel Russell, a Newport shopkeeper, for £359.7.5 worth of goods, including a variety of fabrics, lace, buttons, thread, cord, binding, ribbon, garters, gloves, handkerchiefs, fans, combs, lute string, and a trunk.⁴³³

Stevens was also a supplier of furniture. In October 1739, he was paid £46.10 for supplying chairs to the South Kingstown court house. Two payments of £0.1.0 for the chairs’ “Freight” and “Carting” were made to Jonathon Nichols and Jes Niles, respectively.⁴³⁴ Unfortunately, the account does not provide any clues as to the type of chairs Stevens provided or whether they were upholstered. Another account from the estate of John Goddard does, however, confirm Stevens’ trade in upholstered furniture. The invoice details items supplied by Goddard to Stevens from 1764 to 1781, including chairs, beds, and coffins:

⁴²⁹ Account, February 1738, in case file, Robert Stevens, Newport, upholsterer v. Edward Barton, Newport, chaisemaker, November 1739 term, case 92, NCCCP Record Book, vol. B, p. 7.

⁴³⁰ Account, May 17, 1739, in case file, Robert Stevens, Newport, upholder v. Walter Chapman, shipwright alias tallow chandler alias distiller, May 1740 term, case 217, NCCCP RB, vol. B, p. 75.

⁴³¹ Account, August 1739, in case file, Stevens v. Cane (account cited notes on Robert Stevens, RIFA, YUAG).

⁴³² Account, 1739–1740 [more exact date on actual account?], Robert Stephens, Newport, upholder v. Moses Howard, Newport, baker alias laborer, case 31, November 1741 term, NCCCP RB, vol. B, p. 215.

⁴³³ Account, February 1741–November 1743, in case file, Robert Stevens, Newport, upholder v. Daniel Russell, Newport shopkeeper alias gentleman, May 1744 term, case 26, NCCCP RB, vol. B, p. 523.

⁴³⁴ “Account for Sundry Necessary’s at the Court House in South Kingstown,” February Session 1739/40, Accounts Allowed 1716-1740, Rhode Island State Archives, Providence, RI.

Estate of Robert Stevens To the Estate of John Goddard D^r

1764	3 M ^o	To 2 Easy Chairs	3	2	6
	4 M ^o	To 1 Set of Bed Cornishes	1	10	
	5 M ^o	To 1 Ditto	1	10	
1765	1 M ^o	To 1 folding Leaf for Table and mending a Screen		12	10 ½
	8 M ^o	To a Set of Cornishes for Bed	1	10	
1766	7 M ^o	To 8 Black Walnut Chairs @ 5 Dollars	12		
1767	11 M ^o	To a cornished Bed	5	12	6
		To a Set of Cornishes	1	6	3
1773	10 M ^o	To 6 Mahogany Chair Frames @ 4 ½ Doll	8	2	
1774	6 M ^o	To a Birch Coffin for Widow Chambers	1	1	
1781	11 M ^o	To a Coffin for his Daughter	3	6	
		To Ditto for himself	3	12	
Lawful money			£	43	5
					1 ½

Errors Excepted Stephen & Thomas Goddard Administrators⁴³⁵

With the exception of the “folding Leaf for a Table,” all of the items listed on the invoice would have been finished by an upholsterer, presumably Stevens or someone in his employ. The final charge is for Steven’s own coffin.

No apprentices or journeymen working for Stevens have been identified, but two possible candidates are Newport upholsterers Kendall Nichols Jr. and Caleb Gardner Jr., both of whom are linked to Stevens in the records of the Newport County Court of Common Pleas. In a 1743 case, Nichols acted as a bondsman for Stevens and Newport joiner Nathaniel Baker.⁴³⁶ In the bond, signed by Stevens, Baker, Nichols, and John Tanner, Stevens and Baker promised to pay £322.10 to Benjamin, Samuel, and Moses

⁴³⁵ Account, Estate of Robert Stevens To the Estate of John Goddard, March 1764–November 1781, case 23, November 1791 term, NCCCP RB, vol. J, p. 67.

⁴³⁶ The Pitmans sued Stevens for default in May 1745 and were awarded £240.19.2 plus court costs. See Benjamin Pitman, mariner, Samuel Pitman, bricklayer, and Moses Pitman, fellmonger, all of Newport v. Robert Stevens, Newport, upholster alias upholsterer, May 1745 term, case 253, NCCCP, RB, vol. B, p. 704; Note, December 1, 1743, in case file, Pitman v. Stevens.

Pitman. Given the fact that Nichols was twenty-one at the time, it is possible that he was apprenticing with or working for Stevens. A second court case, in which Stevens was sued in 1750 by Newport gentlemen Thomas Ward, provides a link to the upholsterer Caleb Gardner Jr. Ward had previously sued the vintner Samuel Webb for money due by note, and Stevens had acted as his bail. Ward won the case and subsequently brought suit against Stevens for failing to “cause the said Samuel either to perform the said final judgment so obtain’d or surrender his Body to our Goal in Newport.”⁴³⁷ The sheriff attempted to find and arrest Stevens, but “For want of ye Body of ye within Def^t,” he instead attached “a small Knife & fork in a Sheath Delivered to me by Caleb Garnder jun as the Estate of ye Def^t.”⁴³⁸ This implies that Gardner may have been at Stevens’ home or shop when the sheriff came to arrest him, suggesting that the twenty-one-year-old Gardner apprenticed with or worked for Stevens.

Stevens’ mercantile activities are documented in other eighteenth-century court records. His signature appears on a 1747 certificate of insurance for the voyage of the brigantine *Elizabeth* from Stonington, Connecticut, to Kingston, Jamaica.⁴³⁹ Stevens promised £200 of the total £2000 pledged in insurance money. The ship and cargo were lost in a hurricane while anchoring at Saint Christopher, and in 1750, Stevens was sued by the captain, Robert Dennison, in an attempt to collect the money.⁴⁴⁰ Dennison won

⁴³⁷ Writ, October 24, 1750, in case file, Thomas Ward, Newport, gentleman v. Robert Stevens, late of the same Newport, upholder, November Term, case 347, NCCCP RB, vol. c, p. 595.

⁴³⁸ Writ, October 30, 1750, in case file Ward v. Stevens.

⁴³⁹ Certificate of Insurance, October 2, 1747, in case file, John Dennison, Stonington, CT, merchant v. Robert Stevens, Newport, upholsterer, June 1750 term, case 51, Providence County Court of Common Pleas, vol. 3, p. 65.

⁴⁴⁰ Notes on Robert Stevens, RIFA, YUAG.

and was awarded £200, but Stevens appealed and the verdict was overturned.⁴⁴¹ By at least 1760, Stevens jointly owned a ship with fellow merchants William Vernon and Robert Crooke. The men were sued by their ship's captain, Samuel Pease, after he was held for ransom by French privateers.⁴⁴² By 1767, Stevens had gone into business with his son, Robert, and the two were involved in financing the passage of the sloop *Industry* to the Cape Verde Islands. In November, father and son successfully sued the ship's captain, Eleazer Trevett Jr., for failure to pay the £737 balance due on the settlement of the voyage.⁴⁴³

As was the case with many mid-eighteenth-century Newport merchants, Stevens was involved in the slave trade. In 1756, the sloop *Hare*, under the command of Caleb Godfrey, brought six slaves from Africa to Newport on behalf of Robert Stevens and Samuel and William Vernon, also merchants. An account detailing the subsequent sale of the slaves reveals that Stevens sold a boy for £410 and two girls for £700, the Vernons sold a boy for £420, and William Vernon purchased one of the girls for £350. The sixth slave, a girl, did not survive the passage, and charges for her nursing, medicine, and coffin are included in the account.⁴⁴⁴

⁴⁴¹ Robert Stevens, Newport, merchant, appellant v. John Dennison, Stonington, CT, merchant, appellee, September 1750 term, Providence County Superior Court Record Book, vol. 1, p. 67.

⁴⁴² Samuel Pease, Glassenbury, CT, mariner v. William Vernon, Robert Crooke, and Robert Stevens, Newport, merchants, December 1760 term, case 106, PCCCP, vol. 4, p. 391 (case cited in notes on Robert Stevens, RIFA, YUAG).

⁴⁴³ Robert Stevens & Son, Newport, merchants v. Eleazer Trevett, Newport, mariner, November 1767 term, NCCCP RB, vol. H, p. 19. Trevett appealed the case in September 1768 and lost, and the following month Robert Stevens & Son successfully renewed their suit. See Eleazer Trevett, Newport, merchant v. Robert Stevens & Son, Newport, merchants, September 1768, Newport County Superior Court, vol. E, p. 395; and Robert Stevens & Son, Newport, merchants v. Eleazer Trevett, Newport, November 1768 term, case 50, NCCCP RB, vol H, p. 186.

⁴⁴⁴ Account, October 3, 1758, in case file, Robert Stevens, Samuel Vernon and William Vernon, all of Newport, merchants v. Caleb Godfrey, Newport, merchant, November 1758 term, case 138, NCCCP RB, vol. F, p. 7.

Like most merchants, Stevens imported goods from England. Evidence of the types of merchandise he was importing in the 1760s is found in two newspaper advertisements. In 1764, it was announced in *The Newport Mercury* that “A Variety of Paper Hangings” were “Lately Imported, and to be Sold,—By Robert Stevens.”⁴⁴⁵ Then, in 1767, Robert Stevens & Son advertised their latest imported wares:

Just imported from BRISTOL, in the Ship America, Capt. Peters, and from LONDON, via Boston, and to be sold, By Robert Stevens & Son, as cheap as can be bought in any of the neighbouring Governments, An Assortment of English Goods, 3-4, 7-8 and yard-wide Checks, 3-4, 7-8 and yard-wide Irish Linens, Dowlas, Ruffia Linens, Sheetings, Silk Crapes, Cableteens, Calamancoes, Shalloons and Tammies, Threads, Calicoes, sewing Twine, an Assortment of Stone, Delf and Nottingham Ware by the Hogshead or Crate, Pins and Needles, narrow and wide Qualities, Ruffia and Ravens Duck, Ticklenburg, Oznabrigs, 6 by 8 Window Glass, 4d. 6d. 8d. 10d. and 20d. Nails, goose, duck and pidgeon Shot, &c. &c. &c, Tilloch’s Snuff by the Cask or Dozen, Bristol Beer and English Cyder by the Cask or Dozen.⁴⁴⁶

One of the English firms that Robert Stevens & Son did business with was the Liverpool firm of George Campbell Jr. and Stephen Hayes, whom they sued in 1769 for £220 in damages for money due by book.⁴⁴⁷ Stevens would have sold his imported goods in his Brenton’s Row shop, which he occupied from at least 1764 to 1774.⁴⁴⁸

⁴⁴⁵ *The Newport Mercury*, October 10, 1763, <http://infoweb.newsbank.com/>.

⁴⁴⁶ *The Newport Mercury*, June 15–22, 1767, <http://infoweb.newsbank.com/>.

⁴⁴⁷ Robert Stevens and Robert Stevens, Jr., Newport, merchants v. George Campbell Jr, and Stephen Hayes, Liverpool, Great Britain, merchants, case 82, May 1769 term, NCCCCP RB, vol H, p. 342. Campbell and Hayes appeared on a list of bankrupts in 1768, see *The London Magazine, or, Gentleman's Monthly Intelligencer* 37 (1768): 711.

⁴⁴⁸ A 1764 newspaper advertisement for the shop of the merchant Thomas Brenton describes its location as “adjoining to Mr. Robert Stevens, in Brenton’s Row,” see *Newport Mercury*, January 12, 1762, issue 281, <http://infoweb.newsbank.com/>. Another 1774 advertisement for Newport hatter James Anthony reports that his business is “in Brenton’s-row, between the shops occupied by Mr. Robert Stevens and Major Jonathan Otis,” see *Newport Mercury*, April 4, 1774, issue 813, <http://infoweb.newsbank.com/>.

Stevens supplemented his income by appraising estates, an activity traditionally associated with the upholsterers' trade.⁴⁴⁹ He was also appointed commissioner of several estates, including that of Newport chairmaker John Pitman (c. 1726–1768).⁴⁵⁰ Stevens held at least one public office in Newport, evinced by the fact that he was referred to as one of the “late Overseers of the Poor” in a May 1751 court case.⁴⁵¹ His other civic responsibilities included being appointed as referee in at least three court cases, including one involving Newport joiner Jonathan Bryer.⁴⁵²

Robert Stevens died on November 18, 1780, and his will and inventory were proved on December 3, 1781.⁴⁵³ The inventory listed the contents of Stevens' house, which were valued at £199.9.3. The only item related to his upholstery trade was some curled hair valued at two pounds, which was stored in his kitchen. Upholstered seating furniture owned by Stevens included “3 ditto [maple] chairs, leather bottomed,” “one easy chair with slip, very old,” and “1 couch and squab” located in the parlor; “4 mahogany chairs, leather bottomed” and “2 maple ditto [chairs] Green Harrateen” in the

⁴⁴⁹ See, for example, Inventory of Gottlieb Eckstein, taken by Charles Bardin and Robert Stevens, May 1, 1770, NTCP, FHL film 0945000, vol. 16, p. 135; and Inventory of James Searing, taken by Robert Stevens and William Ellery, February 3, 1755, NTCP, FHL film 0944999, vol. 11, p. 253.

⁴⁵⁰ Town Council meeting, September 4, 1769, NTCP, FHL film 0945000, vol. 16, p. 80.

⁴⁵¹ William Read, Newport, merchant, *et al.* v. Samuel Maryott, Newport, tailor, May 1751 term, NCCCCP RB, vol. C, p. 664.

⁴⁵² Whitehorn v Whitehorn, November 1758 term, NCCCCP RB, vol. F, p. 68; Mumford v. Taggart, November 1758 term, NCCCCP RB, vol. F, p. 70; and Jonathan Bryer, N, joiner, P, v, Sarah Rumreil, N, shopkeeper, November 1759 term, case 56, NCCCCP RB, vol. F, p. 205. In the case of Mumford v. Taggart, Stevens was replaced as referee due to illness.

⁴⁵³ An obituary, stating “Deaths . . . At Newport, Mr. Robert Stevens, Merchant,” was published in *The American Journal and General Advertiser*, December 9, 1780, <http://infoweb.newsbank.com/>. His exact date of death is on his tombstone, see RIHCTP. Stevens' will and inventory were proved at the Newport Town Council Meeting, December 3, 1781, Newport Probate, vol. 1, p. 61.

great chamber; and “6 maple chairs, three harrateen bottomed” in the chamber over the parlor.⁴⁵⁴

On March 3, 1783, Robert Stevens Jr. appeared before the Town Council to declare his father’s estate insolvent.⁴⁵⁵ Commissioners were appointed to receive the claims of his creditors, which amounted to £1066.16.9 1/2. Robert Stevens Jr. successfully petitioned the Newport County Superior Court on March 4, 1784, for permission to sell his late father’s real estate in order to pay claims against the estate. In the court record, the elder Stevens is referred to as an upholsterer, indicating that he continued to practice his trade despite having been engaged in mercantile pursuits for many years.⁴⁵⁶

In April 1784, the sale of Stevens’ real estate was announced in the following advertisement in *The Newport Mercury*: “A Lot of Land of 60 Feet Front and 90 feet deep, with a Dwelling House and Stable thereon. Also a Lot of 40 Feet Front and 90 Feet deep adjoining the same, with an old Building on it, in Clarke Street Newport, belonging to the Estate of Robert Stevens, deceased.”⁴⁵⁷ The dwelling house was probably one that Stevens purchased in 1742 from Comfort Hatch, the widow of Nathaniel Hatch.⁴⁵⁸ It still stands today at 31 Clarke Street (fig. 90).

⁴⁵⁴ For the complete inventory of Robert Stevens, see Nicki Hise, “Gentility and Gender Roles Within the 18th-Century Merchant Class of Newport, Rhode Island” (master’s thesis, paper 22, University of Massachusetts Boston, 2010), 106–108, http://scholarworks.umb.edu/masters_theses/22.

⁴⁵⁵ Newport Town Council Meeting, March 3, 1783, Newport Probate, vol. 1, p. 91.

⁴⁵⁶ Petition of Robert Stevens Jr., March 4, 1784, Newport County Superior Court, vol. F, p. 231.

⁴⁵⁷ *Newport Mercury*, April 9, 1784, <http://infoweb.newsbank.com/>.

⁴⁵⁸ Newport Land Evidence (City Hall, Newport, Rhode Island, hereafter cited as NLE), vol. 17, p.117. Downing and Scully, *The Architectural Heritage of Newport*, 468.

Appendix 2: Chairmaker Biographies

Benjamin Baker (1734/5–1822)

Although a cabinetmaker by trade, Benjamin Baker produced a greater number of chairs than any other furniture form. His work is well documented in his surviving account book, which details his business activities from 1760 to 1792.⁴⁵⁹ In addition to chairs, Baker made case furniture, tables, stands, teaboard, clock cases, bedsteads, and coffins. He fulfilled orders both for the homes of Newport patrons, and for merchants participating in venture cargo expeditions. Although one early historian noted that Baker was “extensively engaged in manufacturing furniture” for export to New York and the West Indies, his account book indicates that he made shipping “casing” for only fourteen items, comprising case furniture, tables, and stands.⁴⁶⁰ Other activities recorded in the account book include repairing furniture, assembling clocks and bedsteads in clients’ homes, and supplying other cabinetmakers with piecework, such as turned legs and pillars, parts for clock cases, and table hinges. Baker supplemented his cabinetmaker’s income through house and ship carpentry, day labor, and odd jobs. Such work became increasingly important with the Revolution and Newport’s subsequent economic decline. After the mid-1770s, Baker’s furniture output slackened, and the pieces he did produce after the Revolution were made almost exclusively for other cabinetmakers.⁴⁶¹

⁴⁵⁹ Benjamin Baker’s Account Book, 1760–1792, Newport Historical Society, Rhode Island. For an in-depth analysis of Baker’s career and account book, see Carr, “The Account Book of Benjamin Baker,” 46–89. See also, “Benjamin Baker, 1734 or 1735–1822,” RIFA, YUAG.

⁴⁶⁰ Carr, “The Account Book of Benjamin Baker,” 54–55. The quote is from Thomas Hornsby, “Newport Past and Present,” *Newport Daily Advertiser*, December 8, 1849. Quoted in Sloane, “John Cahoon,” 92, and Carr, “The Account Book of Benjamin Baker,” 54.

⁴⁶¹ Carr, “The Account Book of Benjamin Baker,” 47–48, 55–56.

There are three pieces of case furniture signed by Baker, two of which may be recorded in his account book. The first is a dressing table, signed “-enjamin Baker / he mad it” on the back of the skirt, which was possibly the “Low Draws” made in 1764 for Newport goldsmith Jonathan Otis for £75. The second is a clock case, with a label reading “Made and Sold By Benjamin Baker in Newport 1772,” which is probably the “mehogheni Clock case” for £140 debited to clockmaker Tomas Claggett on August 3, 1772. A high chest, signed “Benjamin Baker” on its backboard, may also have been made by Baker, but this attribution is less certain since elements of the chest are closely related to those of one signed by John Townsend. The two men are known to have had a business relationship. Baker’s Easton’s Point shop was located near Townsend’s, and his account book debits Townsend for chair frames and coffins, and for “making counter & shelf in your shop.”⁴⁶²

Out of the 203 pieces of furniture made by Baker that are recorded his account book, 128 are chairs. No seating furniture has been attributed to him, but one of a set of six chairs that were possibly made by Baker is said to have descended in the family of his daughter Susan Howland. Unfortunately, its whereabouts are unknown.⁴⁶³ The chairs listed in Baker’s account book include close-stools, roundabouts, and side chairs (referred to as “chair fraims” and always made in multiples), the latter of which he produced in both maple and in expensive imported woods. Also listed in the account book are charges for mending chairs, making rockers for a chair, and “Civring [covering] Chairs Bottoms,”

⁴⁶² Carr, “The Account Book of Benjamin Baker,” 49–54. See also, “RIF981,” “RIF1208,” and “RIF1210,” RIFA, YUAG. Dennis Carr offers several possible explanations for the presence of Baker’s signature on the high chest, including that the chest was made by Baker with components purchased from Townsend, made by Townsend and repaired by Baker, or that Townsend commissioned the chest’s carcass from Baker and finished it himself.

⁴⁶³ Carr, “The Account Book of Benjamin Baker,”

as well as a credit to an unknown person for “6 mapil Chairs frams @ £20.” All of

Baker’s entries relating to chairs, in chronological order, are as follows:

			£		
1760	Ebeinezer Rumill	Dr			
Aug. 21	To 2 Roundeboute Chairs of mehogni @ £32 p		064	00	00
Nov. 2	To 8 Chair frames of mehogni @ £32 p		256	00	00
July 7	To 8 Chair frames of mehogni @ £32 p		256	00	00
Mar. 14	To 1 Cloststol Chair frames of mehogni @ £32 p		032	00	00
1761	John Codginton [Coddington]	Dr			
Mar. 2	To 1 dozen of mehogni Chair fraims @ £53 p		£636	00	00
May 18	To 1 Clost Stol Chair frim of mehogni		36	00	00
Sept. 19	To 1 Clost Stol Chair fraim of mehogni		36	00	00
1761	William Gardnar [Gardner]	Dr	£216		
Oct. 2	To 6 mehogni Chair fraims @ £36 p				
1762	Samuil Brinton [Samuel Brenton]	Dr			
June 12	To 16 Chire frames of mapil @ £12-10 p			00	00
Feb 5	To 4 mapil Chair fraims @ £14 p		056	00	00
1764	Jonathan Otis	Dr			
July 3	To 8 mapils Chairs fraims @ £16 p		128	0	0
1764	Mr. Joseph & William Wonton	Dr			
Apr. 27	To 8 Black wornut Chairs fraims @ £28 p		224	0	0
	To on Dozen of Black wornut Chairs fraims @ £28 p		336	0	0
1766					
Feb. 20	To one Clost Stool Chair		35	0	0
Mar. 3	To mending 6 Chairs and Crain 10		22	0	0
1770	Mr. Samuel Moses	Dr			
Sept. 11	To 6 mapil Chairs fraims		90	00	00
1772	Mr. Caleb Gardner	Dr			
Sept. 29	To 4 mehogni Chair frams @ £56 p		£224	0	0
1773	Super	Cr			
May 5	By 6 mapil Chairs frams @ £20 p £120		60	0	0
1774	[Mr. Caleb Gardner]				
Apr. 13	To 2 mehogni Chair frams @ £56 p		112	0	0

1774	Mr. Thomas Claggett	Dr			
Nov. 30	To 6 mapil chair frames [@ £18 p]		108	0	0
1782	Mr. John Towsend [Townsend]	Dr			
May 3	To mending mohigni chair chanin		0	6	0
July 15	To making 8 Mohigni chair frams		4	16	
Aug. 2	To making 8 Mohigni chair frams		6	0	
Dec. 19	To making 6 mehogni chair frams		5	8	0
1783	Mr. Jacob Rodis Rivera	Dr			
Jun 6	To Repairing 12 Chair		0	10	0
1786	Mr. Jacob Rods Revra [Rivera]	Dr			
Jan. 9	to Civring Chairs Bottoms		0	9	0
Feb. 3	to mending Chair		0	1	0
1786	Mr. Joseph Lopez	Dr			
June 12	To mending Chair & Desk		0	6	0
1787	Mr. Frank and Son	Dr			
	to making Rockers to Chair		0	1	6 ⁴⁶⁴

From 1760 to 1782, when he made his last recorded chair, Baker's output comprised one close-stool of unidentified wood priced at £35, two mahogany roundabouts priced at £32 each, three mahogany close-stools priced from £32 to £36 each, twenty black walnut side chairs priced from £20 to £28 each, forty maple side chairs priced at £12.10.0 to £18 each, and sixty-two mahogany side chairs priced at £32 to £56 each. In one of the few documented cases of a possible collaboration between a Newport cabinetmaker and a Newport upholsterer, Baker provided Caleb Gardner with "4 mehogni Chair frams @ £56 p" in 1772, and with "2 mehogni Chair frams @ £56 p" in 1774. The only cabinetmaker Baker supplied with chairs was apparently John Townsend, whom he billed in 1782 for "8 Mohigni chair frams" at £4.16.0, "8 Mohigni chair frams" at £6, and "6 mehogni chair

⁴⁶⁴ Benjamin Baker's Account Book, transcribed in Carr, "The Account Book of Benjamin Baker," 59–89.

frams” for £5.8.0. The account book also reveals that Baker had a business relationship with chairmaker Daniel Dunham (1738–1815). In 1762, there were numerous transactions between the two men. Baker provided Dunham with cash, rum, and molasses. In addition to many food-related items, Dunham was credited for “118 foot bord” and “5 Days work.”⁴⁶⁵

In contrast to the well-documented nature of his work, little is known about Baker’s family history and early life. It is possible that he was the son of Patience Allen, daughter of Ebenezer Allen (b. c. 1695) of Prudence Island, and Benjamin Baker, son of Benjamin and Mary Baker of North Kingston.⁴⁶⁶ His might also have been the son of the Benjamin Baker and Bathsheba Wright who married in Newport on September 3, 1732.⁴⁶⁷ Regardless of his parentage, Baker’s year of birth can be approximated from the information given in his obituary.⁴⁶⁸ He was born in 1734 or 1735, and probably would have completed his apprenticeship around 1755 or 1756. On January 28, 1759, he married Martha Simpson (1734/5–1815) at the Second Congregational Church of Newport.⁴⁶⁹ They had at least four children, three of whose names – Susan, John, and William – are recorded in Baker’s account book. Also mentioned in the account book are

⁴⁶⁵ Benjamin Baker’s Account Book, transcribed in Carr, “The Account Book of Benjamin Baker,” 59–89.

⁴⁶⁶ Devere Allen, *Some Prudence Island Allens* (Wilton, CT: 1942), 46. In 1777, Ebenezer Allen of Warwick bequeathed “a set of Jacket and Britches silver buttons” to his sister Patience’s son Benjamin Baker (Will of Ebenezer Allen, Warwick, yeoman, September 12, 1776, proved November 25, 1777, Warwick Probate, vol. 3, p. 391-394).

⁴⁶⁷ *Rhode Island Vital Records 1636–1850* (Online database: AmericanAncestors.org, New England Genealogical Society, 2002), originally published by James N. Arnold as *Vital Records of Rhode Island, 1636–1850. First series Births, marriages and deaths. A Family Register for the People* (Providence: Narragansett Historical Publishing Company).

⁴⁶⁸ According to his obituary, Baker was eight-seven when he died in 1822, see *The Rhode-Island Republican*, January 9, 1822, <http://infoweb.newsbank.com>.

⁴⁶⁹ Arnold, *Vital records of Rhode Island*, vol. 8, 475. According to her obituary, Martha Baker Simpson was eighty when she died on December 26, 1815, see *The Rhode-Island Republican* on January 17, 1816, <http://infoweb.newsbank.com>

sons-in-law Henry Howland, who married Susan, and Henry Goddard, a shipwright married to another daughter, Ellenor, who is named in Baker's will.⁴⁷⁰

Baker's name rarely appears in Newport court records. In May 1764, he was sued for ten pounds in damages by James Easton, Nicholas Easton, Peter Barker, Giles Slocum, and Jacob Mott Jr. over twenty-five shillings in rent that he owed for a house and land on Easton's Point. In his plea, Baker explained that the plaintiffs had refused to accept the bills of credit he had offered as payment, and that he was willing instead to pay them in lawful money. The case was continued to the November 1764 term, where the court ruled that Baker's offer was sufficient and ordered the plaintiffs to pay court costs. They appealed to the Newport County Superior Court, where the lower court's decision was upheld and their request for permission to appeal to "the King in Council in Great Britain" was denied.⁴⁷¹ Baker purchased the same lot of land on June 10, 1800.⁴⁷² The only other known legal dispute involving Baker arose in 1767, when he was sued by Newport shopkeeper Sarah Rumreil for money due by note.⁴⁷³ The court awarded Rumreil £259.0.4 plus court costs. In the related court records, Baker is identified as a shop joiner rather than as a cabinetmaker as he had been in the 1764 litigation.

⁴⁷⁰ Carr, "The Account Book of Benjamin Baker," 54. Will of Benjamin Baker, December 5, 1821, Newport Probate, vol. 11, p. 117.

⁴⁷¹ James Easton, ship carpenter, Nicholas Easton, Esq., both of Newport, Peter Barker, Middletown, yeoman, and Giles Slocum and Jacob Mott Jr., both of Portsmouth, yeoman v. Benjamin Baker, Newport, cabinetmaker, May 1764 term, case 214, NCCCCP RB, vol. G, 271, 305; James Easton *et al.* v. Benjamin Baker, NCSC, vol. E, p. 276. Also cited in Carr, "The Account Book of Benjamin Baker," 54, 58; and "Benjamin Baker, 1734 or 1735–1822," RIFA, YUAG.

⁴⁷² Richard Mitchell, Middletown, blacksmith, Benjamin Mott, Portsmouth, yeoman, Samuel Thurston, yeoman Benjamin Hadwen, Merchant and Clarke Rodman, schoolmaster Newport to Benjamin Baker, Newport, cabinetmaker, May 10, 1800, NLE, vol. 12, p. 102.

⁴⁷³ Sarah Rumreil, Newport, shopkeeper v. Benjamin Baker, Newport, shop joyner, May 1768 term, NCCCCP RB, vol. G, p. 787.

Baker is named in two documents in the Rhode Island State Archives that are dated during the period of the Revolution. The first is a January 1776 bill from John Mowry for food and drink delivered to Benjamin Baker “by the order of John Northup and B Gardner.”⁴⁷⁴ The account does not specify why Baker was in need to food and drink. The second is a December 1779 communication to “His Excellency The Commander in Chief at Newport.” Baker was apparently absent from Newport when the city was evacuated in October 1779, and his name was included on a list of subscribers who, “being Absent from our Family’s at the Time of the Evacuation of Newport would wish to Return to our Familys.”⁴⁷⁵

When Benjamin Baker died in January 1822, a notice in *The Rhode-Island Republican* announced the “Funeral from his late dwelling; at the house of the widow Helme, near the North Battery, this afternoon, at 2 o’clock. Relations and friends are invited to attend without further notice.”⁴⁷⁶ His wife had died in 1815, and his son-in-law Henry Goddard was named administrator of the estate. Baker bequeathed his Easton’s Point land and house to his daughter Ellenor Goddard.⁴⁷⁷

⁴⁷⁴ Account, January 23, 1776, December session 1776, C#0292, General Treasurer: Accounts Allowed, Rhode Island State Archives. Cited in Car, “The Account Book of Benjamin Baker,” 58, note 13.

⁴⁷⁵ Rhode Island State Archives, List of Persons Permitted to Reside in the State, December 2, 1779, Council of War, Letters and Accounts, vol. 1, p. 128. Also cited in Car, “The Account Book of Benjamin Baker,” 58, note 13.

⁴⁷⁶ *Rhode-Island Republican*, “Died,” January 9, 1822. <http://infoweb.newsbank.com>. Also cited in “Benjamin Baker, 1734 or 1735–1822,” RIFA, YUAG, and Car, “The Account Book of Benjamin Baker,” 58, note 13.

⁴⁷⁷ Will of Benjamin Baker, December 5, 1821, Newport Probate, vol. 11, p. 117.

Giles Barney (1725–1783)

Giles Barney was born in Newport in 1725.⁴⁷⁸ He was the son of Israel Barney (1701–1769), originally of Rehoboth, Massachusetts,⁴⁷⁹ and Mercy Dring (b. 1701), originally of Little Compton, Rhode Island.⁴⁸⁰ His paternal grandparents were Israel Barney (b. 1675), born in Salem, Massachusetts,⁴⁸¹ and Elizabeth Brackett (1678–1743), born in Braintree, Massachusetts.⁴⁸² His maternal grandparents were Thomas Dring (b. 1666) and Mary Butler (b. 1770), of Little Compton.⁴⁸³ Giles Barney married his first cousin Tabitha Dring (b. 1725–after 1782), the daughter of his uncle Thomas Dring (1704–1787) and Sarah Searle (1700–1783), of Little Compton, on November 15, 1750.⁴⁸⁴ They had at least four children: Daniel (born c. 1751), Sarah (born c. 1753), Hannah (born c. 1755), and Mary (born c. 1757).⁴⁸⁵

Giles Barney was probably working as a chairmaker in Newport from around 1746. The first known reference to Barney as a Newport chairmaker is not until May

⁴⁷⁸ According to Family Search (www.familysearch.org), Barney was born in Newport, but the location of his birth cannot yet be confirmed elsewhere.

⁴⁷⁹ James N. Arnold, *Vital Record of Rehoboth, 1642-1896* (Providence, RI: Narragansett Historical Publishing Company, 1897), 529.

⁴⁸⁰ Benjamin Franklin Wiblour (ed.), *Little Compton Families, Volume 1* (Baltimore, MD: Reprinted for Clearfield by Genealogical Publishing Co., Inc., 2003), 244–45.

⁴⁸¹ *Vital Records of Salem, Massachusetts, to the End of the Year 1849, Volume I.—Births* (Salem: Essex Institute, 1916), 67.

⁴⁸² Samuel A. Bates (ed.), *Vital Records of Braintree, Massachusetts, 1640-1793* (Randolph, MA: Daniel H. Huxford, Printer, 1886), 654. For a record of the marriage of Israel Barney and Elizabeth Brackett, see Arnold, *Vital Record of Rehoboth*, 20.

⁴⁸³ Wiblour, *Little Compton Families*, 244–45.

⁴⁸⁴ *Ibid.*, 245.

⁴⁸⁵ Children named in Giles Barney's will, dated December 3, 1782, proved March 3, 1783, Newport Probate, vol. 1, p. 90. The birthdates of his children were compiled using Family Search (www.familysearch.org), but cannot yet be confirmed elsewhere.

1763, however, when he was sued by Newport clothier Caleb Earl.⁴⁸⁶ Earl had leased Barney a dwelling house from January 1762 to April 1763 for a quarterly fee of £21.⁴⁸⁷ When Barney failed to pay, Earl took him to court in an attempt to collect five quarters of unpaid rent. The suit was successful, and Barney was ordered to pay Earl £105 old tenor plus court costs. Barney was again referred to as a chairmaker in 1768, when he served as one of the administrators of the estate of a Newport mariner.⁴⁸⁸

Giles Barney died in Newport in 1783. His will, dated December 3, 1782, was proved on March 3, 1783.⁴⁸⁹ Barney bequeathed his personal estate to his wife, Tabitha, including “the profits and Improvements of my House and Shop adjoining thereto and Land unto the same Belonging.” He specified that the property would pass to his son, Daniel, upon his wife’s death or remarriage. He also named each of his daughters, Sarah Munro, Hannah Barney, and Mary Cleveland, to whom he left “four Spanish mill’d dollars” apiece. An inventory of Barney’s personal estate, valued at £18.11.3, was submitted at the time his will was proved.⁴⁹⁰ Related to his trade were “Sundry Chairmaker Tools £0.12.0 . . . two Benches and a lathe £0.9.0, a Quantity of flags £2.8.0, [and] Parcel Stuff for Chairs £0.6.0.”

The fact that Barney’s shop contained two benches suggests that he had an apprentice or a journeyman working for him. The presence of a lathe indicates that the turned elements of Barney’s chairs were made in his shop, either by him or by a turner.

⁴⁸⁶ Caleb Earl, Newport, clothier v. Giles Barney, Newport, chair maker, case 201, May 1763 term, NCCCP, RB, vol. g, p. 245.

⁴⁸⁷ Complaint, May 1764, in case file, Earl v. Giles.

⁴⁸⁸ The name of the deceased is illegible. See Newport Probate Administration Bonds (Newport Historical Society, Newport, Rhode Island), vol. 2, 1762–1769, FHL film 0942000.

⁴⁸⁹ Will of Giles Barney, dated December 3, 1782, proved March 3, 1783, NP, vol. 1, p. 90.

⁴⁹⁰ Inventory of Giles Barney, March 3, 1783, NP, vol. 1, p. 90.

Flags were a type of vegetable fiber, and would have been used to make chair seats, probably for slat- or banister-back chairs. Barney's inventory also includes "his sexton tools £0.12.0." Sextons were minor church officers whose responsibilities included performing maintenance and digging graves. Barney may have performed such tasks to supplement the money he earned as a chairmaker.

Daniel Dolorson (w. 1758–1759)

Although very little is known about the life of Newport chairmaker Daniel Dolorson,⁴⁹¹ he was probably the Daniel Dolorson who married Temperance Norton in Boston on May 8, 1755, at the Church in Brattle Square.⁴⁹² His wife was most likely the Temperance Norton who was born in 1726 in Edgartown, Massachusetts, the daughter Enoch Norton (1700-1768) and Hephzibath Daggett (b. 1706).⁴⁹³ If the Newport chairmaker was indeed the same Daniel Dolorson who married in Boston, he may also have completed his apprenticeship there.

The only evidence regarding Dolorson's work as a chairmaker comes from court records detailing two law suits with Newport joiner Alanson Gibbs.⁴⁹⁴ Dolorson was identified as a chairmaker in November 1758, when he was sued by Gibbs for £1200 due by book.⁴⁹⁵ The case file includes a writ served to Dolorson and signed by another chairmaker, Joseph Vickary (d. 1818), who "became his bail."⁴⁹⁶ The presence of Vickary's signature suggests a potential business relationship between the two. The suit was subsequently dropped by Gibbs, who was required to pay court cost amounting to

⁴⁹¹ The spelling of Dolorson's name differs in the documents cited in the following footnotes. Variations include Dollorson, Dollinson, Dollison, Dollenson, and Dolenson. Within the text, I have consistently referred to the chairmaker as Dolorson, except in certain quotations.

⁴⁹² *The Manifesto church*, 248.

⁴⁹³ Charles Edward Banks, "The Joseph Norton Family," in *The History of Martha's Vineyard, Dukes County, Massachusetts, vol. 3, Family Genealogies* (Boston: George H. Dean, 1911), accessed online, <http://history.vineyard.net/nortonj.htm>; R. Andrew Pierce, "Joseph Daggett of Martha's Vineyard, His Native American Wife, and Their Descendants," *The New England Historical and Genealogical Register* 161 (January 2007), 13; *Vital Records of Edgartown, Massachusetts, to the Year of 1850* (Boston: New England Genealogical Society, 1906), 56.

⁴⁹⁴ Although identified as a joiner in his suits with Dolorson, Gibbs is referred to in other Newport court cases as a trader, shopkeeper, or merchant.

⁴⁹⁵ Alanson Gibbs, Newport, joyner v. Daniel Dollison, Newport, chairmaker, November 1758 term, case 113, NCCCP, RB, vol. f, p. 54.

⁴⁹⁶ Writ, dated July 10, 1758, in case file, Gibbs v. Dollison.

£6.18.0. The dispute was not over, however, and in May 1759 Dolorson brought suit against Gibbs for £500 due by book.⁴⁹⁷ The court ruled against Dolorson, this time identified as a joiner rather than a chairmaker, and ordered him to pay £8.14.8 in court costs.

Reciprocal accounts between Dolorson and Gibbs were submitted as evidence in the aforementioned trials. Dolorson's work as a chairmaker is documented in a 1759 account, in which he charges Gibbs for both making and mending chairs:

1759 M^f. Alanson Gibbs To Daniel Dolenson D^f:

To Making 2 Round about Chairs	23=4=0
To Making 1 Ditto for Clostool	14=0=0
To Ditto 4 Chairs with Compas Seats	28=0=0
To Ditto 4 Chairs with Ditto	24=0=0
To Making 2 Black Walnut R ^d abouts	24=0=0
To Ditto 4 Mahogany Round abouts	56=0=0
To Making 8 Mahogany Chairs	96=0=0
To Mending 4 old Chairs	4=10=0
To 1 [pound?] Glew	1=4=0
To 2 Hundreds Brads	0=16=0
Newport March 23 ^d 1759	£271=14=0 ⁴⁹⁸

Most of the chairs listed on the account are identified either by style or material. The only two entries including both style and material were for “2 Black Walnut R[oun]^d abouts” at £24, or £12 apiece, and “4 Mahogany Round abouts” at £56, or £14 pounds apiece. Another entry for roundabout chairs specified “2 Round about Chairs” for £23.4.0, or £11.12.0 per chair. These may have been black walnut as well, but were slightly less

⁴⁹⁷ Daniel Dollenson, Newport, joiner vs. Alanson Gibbs, Newport, joiner, May 1759 term, case 17, NCCCP RB, vol. f, p. 108.

⁴⁹⁸ Account, Gibbs to Dolenson, March 23, 1759, in case file, Dollenson v. Gibbs. In addition to roundabout and compass seat chairs, an earlier bill from Dolorson to Gibbs includes “flag bottom chairs,” mahogany tea tables, and turned work for roundabout chairs. Account, Gibbs to Dolorson, July 19, 1758, in case file, Dollenson v. Gibbs.

expensive than the other walnut pair. A single roundabout chair to be used as a close-stool was priced at £14, the same amount Dolorson charged for his mahogany roundabouts. The chair could also have been walnut, however, with its higher price reflecting the additional expense of equipping the chair for use as a close-stool. The other variety of chairs included on the account are compass seat chairs, which were most likely in either the Queen Anne or Chippendale styles. Dolorson charged £28, or £7 per chair, for one set of four, and £24, or £6 per chair, for a second set. The differences in price could have been due to a variety of factors, including materials and carving. In addition to supplying and mending chairs for Gibbs, Dolorson also supplied him with materials related to his trade, including glue and brads.

The account from Gibbs, who apparently was a shopkeeper as well as a joiner, charges Dolorson £897.7.0 for a wide variety of goods and services provided from December 1757 to April 1759.⁴⁹⁹ Dolorson apparently boarded with Gibbs, who charged him for a total of 27 “Weakes Board,” first at a rate of £7 per week and then at £8. A related charge was for “13 Weeks To Hire of Household Staf Bed & Beding @60/39.0.0.” The majority of items listed in the account were food and drink. Other charges were for household necessities like wood and candles, personal accessories such as a hat, stockings, and multiple pairs of shoes, and a variety of textiles, including “Garlix,” “Shalloon,” “Rattein,” “Mohaire,” “Broad Cloth,” “Linnen,” “Buckram,” “Checks,” “Chints,” and “Holland.” Gibbs also billed Dolorson for several pieces of furniture, including a “Bead sted for Your self 22.0.0,” a “1 Table 12.0.0,” a “Round a Bout Cheare 20.0.0,” a “Bead Stead without Scrues Capt[ain] Howe 23.0.0,” and a “D^o [mahogany]

⁴⁹⁹ Account, Dollorson to Gibbs, December 1757–April 1759, in case file, Dollenson v. Gibbs. All items subsequently listed above are from this account.

Round about Chear 40—.” Charges relating to Dolorson’s work as a chairmaker include “Black Wornut for a Cheare By Agreement 4.0.0,” “Mohogony for ditto 4.0.0,” a “Carvers Bill 38.0.0,” a “Turners Bill 6.8.0,” and a charge for “My Acco^t for Turning 7.10.0.”

*Daniel Dunham (b. between 1685 and 1687, d.1758)*⁵⁰⁰

Daniel Dunham worked in Newport as both a house carpenter and a chairmaker.⁵⁰¹ He was born in Plymouth, Massachusetts, between 1685 and 1687.⁵⁰² Daniel was the son of Joseph Dunham (1635/6–1702/3) and his second wife, Esther Wormall (1642–died after 1715), of Plymouth. His paternal grandparents were Deacon John Dunham, Sr. (1589–1668/9), born in Scrooby, Nottinghamshire, England, and Abigail Ballou, who were married in Leyden, Holland in 1622, and immigrated to Plymouth in 1632.⁵⁰³ His maternal grandparents were Joseph and Miriam Wormall.⁵⁰⁴ By at least 1709, Daniel had moved to Newport, where he married Sarah (possibly Wiles) (d. 1772).⁵⁰⁵ They had at least nine children: Daniel (1712-1796), John (b. 1715), Robert (b.

⁵⁰⁰ The draft document “Daniel Dunham Biography,” by Dennis Carr, was helpful in compiling this biography (RIFA, YUAG).

⁵⁰¹ Dunham identifies himself as a house carpenter in various legal documents, including his will. See Will of Daniel Dunham, Newport, house carpenter, dated March 12, 1750, recorded March 6, 1758, NTCP, FHL film 0944999, vol. 11, p. 145.

⁵⁰² Daniel Dunham was baptized in 1687. In his father’s will, dated March 9, 1702/3, Daniel was identified as a minor, which means he could not have been born before 1685. Mrs. John E. Barclay, “Notes on the Dunham Family of Plymouth, Mass.,” *The American Genealogist*, whole number 119, vol. 30, no. 3 (July 1953): 143–55. Cited in Carr, “Daniel Dunham Biography,” 1.

⁵⁰³ Carr, “Daniel Dunham Biography,” 1; Barclay, “Notes on the Dunham Family of Plymouth, Mass.,” 143–55; Robert Leigh Ward, “The English Origin and First Marriage of Deacon John Dunham of Plymouth, Massachusetts,” *The American Genealogist* 71 (July 1996): 130–133; and Robert Charles Anderson, *The Great Migration Begins: Immigrants to New England 1620–1633* (Boston: New England Historic Genealogical Society, 1995), vol. I, 599–603.

⁵⁰⁴ *Boston Births, Baptisms, Marriages, and Deaths, 1630–1699*, Ninth Report of the Boston Record Commissioners (Boston, 1883; rpt. Baltimore, 1978 *The American Genealogist*), 28.

⁵⁰⁵ A land deed in Plymouth dated 5 April 1709 names “Daniel Donham of Newport,” who sold to William Canaday one half of 40 acres bequeathed to him and his brother “Benajah” by their “honored father Joseph Dunham . . . and half the house and barn and orchards being a neck of land lying northward by the road.” See, Mrs. John E. Barclay, “Notes on the Dunham Family,” 155; and Isaac Watson Dunham, *The Dunham Genealogy: English and American Branches of the Dunham Family* (Norwich Conn: Bulletin Print, 1907), 206.

1716), Sarah (b. 1718), Joseph (1723/4–1802), Benjamin (b. 1720), Mercy (b. 1727), Abigail (b. 1728), and Esther (b. 1730).⁵⁰⁶

The earliest known reference to Dunham as a Newport chairmaker in Newport occurs in a 1720 deed, documenting the sale of land to Thomas Brown, a Newport felmonger.⁵⁰⁷ Two surviving accounts document Dunham's work as a chairmaker. In the first account, dating from June 1726/7 to February 1730/1, Dunham charges Newport vintner William Swan for bottoming, mending, and making chairs:

1726/7	To bottuming a Littel Char	0	01	2
June 1727	To mending a whealbaro	0	02	6
Detto	To mending & Bottuming of a Char	0	03	0
Octob 1728	To 1 Days work for me and my sun	0	16	0
Detto ye 9	To 3 Days work for me and my sun	1	16	0
ye 14	To 2 Days work for my self	1	00	0
ye 19	To 1 Days work for me and my sun	0	16	0
ye 21	To 13 Days work for me my sun	2	08	0
Febr ye 11	To 1½ Days work for my self	0	15	0
1731/2	To making of 4 Chars	1	09	4
Febr ye 15	To mending and bottoming of Chars	0	12	8
		£	09	19 08 ⁵⁰⁸

Also included on the bill are day labor charges for Dunham and for his son. These charges were probably were unrelated to the chairs listed in the account, and may have been for house carpentry.⁵⁰⁹

In the second account, dated April 1, 1735, Dunham charged Newport cooper John West £2.6.0 (or £0.7.8 per chair) “for halfe a Dusson of fore Back Chears” and

⁵⁰⁶ Dunham, *The Dunham Genealogy*, 206.

⁵⁰⁷ Deed, Daniel Dunham, Newport, chairmaker, to Thomas Brown, Newport, felmonger, May 24, 1720, recorded July 1, 1720, NLE, vol. 6, p. 163, 178.

⁵⁰⁸ Account, 1726/7 to 1730/1, in case file, William Lascells, Newport, perukemaker, admin. of William Swan (deceased), late of Newport, vintner v. Daniel Dunham, Newport, chairmaker, November 1737 term, case 190, NCCCP, RB, vol. A, p. 481. Quoted in Carr, “Daniel Dunham,” 2.

⁵⁰⁹ Carr, “Daniel Dunham,” 2–3.

£0.13.6 (or £0.10.11 per chair) for Tow Low Chears 0=13=6.”⁵¹⁰ The “fore” in “fore Back” probably refers to the number of horizontal or vertical supports on each chair back, indicating that Dunham was most likely making rush-bottomed, slat- or banister-back chairs.⁵¹¹ The “Low” in “Low Chears” may have referred to either the height of the chairs’ back, or of the chairs themselves.

Dunham was sued on at least three occasions in 1738 and 1739. In each case, he was absent when the sheriff arrived to serve him the writ, so tools from his shop were seized to serve as his estate. These included “one pair of compasses” and “One old Gimblet” in 1738, and “One Narrow Chissell” and “One Grindstone” in 1739.⁵¹² A gimlet is a drill-like tool used for boring holes in wood.

In 1739, Dunham contracted small pox. During his illness, he was cared for by Newport cordwainer John Benson, who billed him £12 for “our extraordinary troble and attendance of Daniel Dunham in the small pox Night and Day for five weeks with Rich Cordials Victuals and also Victuals for his Wife.” In November of 1740, Benson sued Dunham over the unpaid account.⁵¹³ Dunham died on February 2, 1758. He bequeathed his personal estate to his wife, Sarah, stating that his children “already had portions and

⁵¹⁰ Account, April 1, 1735, Daniel Dunham, Newport, house carpenter, v. John West, Newport, cooper, November 1735 term, case 147, NCCCP, RB, vol. A, p. 362.

⁵¹¹ Carr, “Daniel Dunham,” 3.

⁵¹² Writ, April 4, 1738, served May 10, 1738, in case file, Jonas Minturn, Newport, butcher v. Daniel Dunham, Newport, chairmaker, May 1738 term, case 156, NCCCP, RB, vol. A, p. 543; Writ, May 6, 1738, served May 8, 1738, in case file, Joseph Coggeshall, Newport, cordwainer v. Daniel Dunham, Newport, chairmaker, May 1738 term, case 258, NCCCP, RB, vol. A, p. 556. Writ, May 7, 1739, served May 9, 1739, in case file, Mordecai Dunbar, Newport, tailor v. Daniel Dunham, Newport, chairmaker, May 1739 term, case 210, NCCCP, RB, vol. A, p. 617.

⁵¹³ Account, 1739, in case file, John Benson, Newport, cordwainer v. Daniel Dunham, Newport, house carpenter, November 1740 term, case 225, NCCCP, RB, vol. B, p. 119.

their mother has greater occasion.”⁵¹⁴ The inscription on his gravestone reads: “Daniel Dunham, son of Joseph Dunham and Esther Wormall, born at Plymouth, New England. Went to Martha’s Vineyard, thence to Newport and died Feb. 2, 1758.”⁵¹⁵ There were at least two other chairmakers in the Dunham family, including Daniel’s son Joseph – who probably apprenticed with his father – and his grandson Daniel (1738–1815), the child of his son by the same name.

⁵¹⁴ Will of Daniel Dunham, Newport, house carpenter, 12 March 1750, proved 6 March 1758, NTCP, FHL film 0944999, vol. 11, p. 145.

⁵¹⁵ Dunham, *The Dunham Genealogy*, 206.

Daniel Dunham III (1738–1815)

Daniel Dunham III was the son of Daniel Dunham Jr. (1712–1796), a house carpenter, and Abigail Hart of Newport. His paternal grandparents were Daniel Dunham (1689–1758), a Newport chairmaker and house carpenter, and Sarah (possibly Wiles) (d. 1772).⁵¹⁶ He married Elizabeth Donham (Dunham) on December 18, 1759, in Edgartown, Massachusetts.⁵¹⁷ After Elizabeth's death, Daniel probably married Alice Gladding (baptized 1755), the daughter of Joseph, a Newport cordwainer, and Priscilla.⁵¹⁸

Dunham is referred to as a Newport chairmaker in 1792, 1794, and 1797 land deeds, and again in 1803, when he was appointed to administer the estate of Newport hatter Gideon Cornell, Jr.⁵¹⁹ The chairmaker is identified in the 1792 and 1794 documents as Daniel Dunham III, and in the 1797 and 1803 documents as Daniel Dunham Jr. It is unclear whether this is the same Daniel Dunham, or whether Daniel Dunham III had a son who was also a chairmaker. If the latter is the case, the father and son may have identified themselves as Jr. and Sr. after the death of Daniel III's father in 1796.

⁵¹⁶ Dunham, *The Dunham Genealogy*, 206.

⁵¹⁷ Daniel Dunham is referred to in the marriage record as "Daniel Jr. of Newport." See *Vital Records of Edgartown*, 118. This was probably the Elizabeth Dunham whose life dates are listed on her gravestone as 1732–1789 (see RIHCTP).

⁵¹⁸ Alice's baptism is recorded in Arnold, *Vital records of Rhode Island*, vol. 8, 405. Daniel and Alice were married by at least 1792, when their names appear together on a deed documenting the sale of land belonging to Alice's late father, Joseph Gladding. See Henry Gladding, Newport, cordwainer, *et al.*, to Charles Burdick, Newport, tailor, July 6, 1792, NLE, vol. 5, p. 104–105.

⁵¹⁹ Simon Newton, Newport, distiller, to Daniel Dunham, the third, Newport, chairmaker, January 5, 1794, NLE, vol. 4, p. 292; William Marchant, South Kingston, Esq., to Daniel Dunham, Jr., Newport, chairmaker, June 12, 1797, NLE, vol. 6, p. 453; Daniel Dunham, Jr., Newport, chairmaker, appointed the administrator of the estate of Gideon Cornell, Jr. late Hatter, February 7, 1803, Newport Probate, vol. 4, p. 27. See note 3 for 1792 land deed.

A Daniel Dunham is known to have provided chairs to Dr. Isaac Senter of Newport.⁵²⁰ From 1782 to 1789, Dunham performed a variety of services for Senter, including making, mending bottoming, coloring, varnishing, and adding rockers to chairs. Chairs made by Dunham for Senter include a writing or knitting chair for £0.18.0 in December 1782, six chairs for £3.12.0 in April 1783, three chairs for £0.18.0 in November 1783, three “three back chears” for £0.12.0 in October 1785, and one writing stool for £0.6.0 in December 1787. It is unclear what type of chairs Dunham was making, since the materials and forms are not specified.⁵²¹ The one exception is the charge for the “three back chairs,” which were probably slat- or banister-back chairs, with three horizontal or vertical elements, respectively. Given that Dunham was also coloring and bottoming chairs, it is probable that he was both making and maintaining painted, rush-bottomed chairs. Another surviving account documents Dunham’s sale of two chairs to Joseph Lopez in September 1787.⁵²²

⁵²⁰ Senter’s purchases of furniture were documented by Ott in “Recent Discoveries Among Rhode Island Cabinetmakers,” 3–25.

⁵²¹ Prices cannot be relied upon as an accurate basis for analysis given the fluctuations of post-Revolution Rhode Island currency.

⁵²² Aaron Lopez Papers P-11 Box 6, folder 59, item 011, American Jewish Historical Society, New York, New York.

Joseph Dunham (1723/4–1802)

Joseph Dunham was the son of Newport chairmaker and house carpenter Daniel Dunham (1689–1758) and Sarah (died 1772).⁵²³ His paternal grandparents were Joseph Dunham (1635/6–1702/3) and his second wife, Esther Wormell (1642–died after 1715), of Plymouth, Massachusetts. Daniel Dunham was born in Plymouth but had moved to Newport by at least April 1709.⁵²⁴ Joseph was born on February 24, 1723/4, probably in Newport.⁵²⁵ He married Elizabeth Orne at Newport’s First Congregational Church on October 24, 1744,⁵²⁶ and the couple had at least five children. Three daughters, Sarah, Mary, and Hannah, were still living at the time of Dunham’s death and are named in his will.⁵²⁷

It is possible that Joseph apprenticed with his father. At least one of Daniel Dunham’s sons most likely did so. In an account dated June 1726/7 to February 1730/1, Dunham charged Newport vintner William Swan for a total of 18 “Days work for me and my sun,” as well as an additional 3 1/2 “Days work for my self.” Also included on the account were charges for bottoming, mending, and making chairs.⁵²⁸ The labor charges may have been for house carpentry since the chairs were listed as separate items. Joseph

⁵²³ Dunham, *The Dunham Genealogy*, 206.

⁵²⁴ A land deed in Plymouth dated April 5, 1709 names “Daniel Donham of Newport,” who sold to William Canaday one half of 40 acres bequeathed to him and his brother “Benajah” by their “honored father Joseph Dunham . . . and half the house and barn and orchards being a neck of land lying northward by the road.” See, Barclay, “Notes on the Dunham Family,” 155.

⁵²⁵ Dunham, *The Dunham Genealogy*, 206.

⁵²⁶ Arnold, *Vital records of Rhode Island*, vol. 8, 468.

⁵²⁷ Will of Joseph Dunham, April 28, 1802, NTCP, FHL film 0944997, vol. 3, p. 364–66. The will also lists several of Dunham’s grandchildren, two of whose last names indicate that he had had another daughter and a son.

⁵²⁸ Account, 1726/7 to 1730/1, in case file, William Lascells, Newport, perukemaker, admin. of William Swan (deceased), late of Newport, vintner, v. Daniel Dunham, Newport, chairmaker, November 1737 term, case 190, NCCCP, RB, vol. A, p. 481.

was too young to have been working with his father at this time, so the son referenced in the account was either Daniel (1712-1796), John (b.1715-), or Robert (b. 1716).⁵²⁹

The first known reference to Joseph Dunham as a Newport chairmaker is in 1748, when he purchased land from Newport house carpenter Daniel Dunham, who was probably his father or possibly his brother.⁵³⁰ In 1755, the chairmaker sued East Greenwich mariner Nathaniel Dyer for failure to pay him £47.6 old tenor.⁵³¹ In a note dated January 1, 1755, Dyer requested that Jos. Hammond give the bearer £47.6 to be paid in flour.⁵³² Hammond, who was probably the merchant named in a 1768 court case that involved chairmaker Timothy Waterhouse, refused.⁵³³ Dyer was ordered to pay Dunham the amount owed plus the cost of the suit. Other references to Dunham as a chairmaker are found in 1758 and 1780 court cases, a 1762 probate administration bond, and in two 1799 land deeds.⁵³⁴ The deeds describe a piece of Newport land purchased by Dunham in May 1799 for \$87, which he sold just three months later for only \$47.50. The purchaser, Portsmouth yeoman Henry Wiles, may have been a relative of Dunham through his mother, Sarah.

⁵²⁹ Dunham, *The Dunham Genealogy*, 206.

⁵³⁰ Deed, Daniel Dunham, Newport, house carpenter, to Joseph Dunham, Newport, chairmaker, August 13, 1748, recorded March 17, 1748, NLE, vol. 3, p. 134.

⁵³¹ Joseph Dunham, Newport, chairmaker v. Nathaniel Dyer, East Greenwich, mariner, May 1755 term, case 479, NCCCP, RB, vol. E, p. 86.

⁵³² Note, January 1, 1755, in case file, Dunham v. Dyer.

⁵³³ Complaint, May 27, 1755, in case file, Dunham v. Dyer. A Joseph Hammond was named in the case: Walter Chaloner, N, Esq, high sheriff of said county v. Joseph Hammond, Jr, merchant, Jonathan Nichols, innholder, and Timothy Waterhouse, chair-maker, all of Newport, May 1768 court term, NCCCP RB, vol. H, p. 149.

⁵³⁴ Thomas Cranston, Newport, Esq. v. Joseph Dunham, Newport, chairmaker, May 1758 term, NCCCP, RB, vol. E, p. 782; Joseph Dunham, Newport, chairmaker v. George Browning, Little Compton, yeoman, 1780, NCCCP, RB, vol. I ½, p. 182; Administration bond for estate of Jacob Thayer, Newport, mariner, December 6, 1762, NPAB, vol. 2, p. 11; Deed, Robert Shearman, Newport, butcher, to Joseph Dunham, Newport, chairmaker, May 30, 1799, NLE, vol. 7, p. 58; Deed, Joseph Dunham, Newport, chairmaker, to Henry Wiles, Portsmouth, yeoman, August 30, 1799, NLE, vol. 7, p. 59.

Joseph Dunham died in May of 1802. His obituary in the *Providence Phoenix* read: “Died...At Newport, Mr. Joseph Dunham, in the 81st year of his age.—It may be said, without exaggeration, that he has ever sustained, from his youth, an unexceptionable character for honesty, integrity, and uprightness.”⁵³⁵ Dunham’s will, dated April 28, 1802, named his daughters Sarah Ginnedo, Mary Read, and Hannah Corey, and his grandsons John Read, Joseph Dunham Corey, Philip Dunham, and Nathan Vaughn. The latter two grandchildren were probably the sons of a deceased son and daughter, respectively, since their parents are not named in the will. Dunham’s wife Elizabeth had also predeceased him, and he made his daughter Hannah and her husband, Abraham Corey, his executors.⁵³⁶

Joseph Dunham’s inventory contains several items related to his trade, including “Rounds and Backs for Chairs got out 2 Dolls” and “50 bunches flags 4 boxes 3 Dolls.” These items reveal that at least some of the chairs made by Dunham had flag-bottoms and rounds, or turned stretchers.⁵³⁷ The presence of the stretchers indicates that Dunham was probably a turner, or that he employed one in his shop. Also listed in the inventory were “15 Old Chairs 2 Dolls 50 Cts” and “30 New Chairs 15 Dolls.”⁵³⁸ The inventory does not specify whether these chairs were the work of Dunham, although it is likely, given their

⁵³⁵ *Providence Phoenix*, May x, 1802, <http://infoweb.newsbank.com/>.

⁵³⁶ Will of Joseph Dunham, Aril 28, 1802, NTCP, FHL film 0944997, vol. 3, p. 364-66.

⁵³⁷ Nancy Goyme Evans notes that the terms “stretcher” and “chair round” are both found in eighteenth- and nineteenth-century accounts, and were used interchangeably; see Evans, “Identifying and Understanding Repairs and Structural Problems in Windsor Furniture,” *American Furniture* (1994), accessed online, <http://www.chipstone.org/>.

⁵³⁸ Inventory of Joseph Dunham, June 11, 1802, NTCP, FHL film 0944997, vol. 3, p. 369.

number, that he did make the new chairs. Valued only at only 50¢ a piece, they were probably slat-back chairs, a type of chair that his father had also made.⁵³⁹

Dunham's entire estate, valued at only \$173.86, was declared insolvent in an advertisement that ran the *Newport Mercury* on June 1802.⁵⁴⁰ The commissioners requested that all claims be submitted to them and any outstanding debts be paid to Abraham and Hannah Corey. Listed in the commissioner's report among the items charged against Dunham's estate was his coffin, made by cabinetmaker William Nichols for \$10.⁵⁴¹

⁵³⁹ In a 1735 account, Daniel Dunham debited John West "for halfe a Dusson of fore Back Chears 2=6=," which were probably chairs with four horizontal slats; see Account, 1 April 1735, in case file, Daniel Dunham, Newport, house carpenter, v. John West, Newport, cooper, case 147, November 1735 term, NCCCP, RB vol. A, p. 362.

⁵⁴⁰ *The Newport Mercury*, dated June 7, 1802, <http://infoweb.newsbank.com/>.

⁵⁴¹ Estate of Joseph Dunham, administrative account, January 5, 1803, NTCP, FHL film 0944998, vol. 4, p. 14.

Benjamin Gould (1735–1821)

Newport chairmaker Benjamin Gould, son of James Gould (c. 1711–1748) and Martha Stanton (1712–1776), was born on August 12, 1735.⁵⁴² His paternal grandparents were Thomas Gould (1654/5–1734) and Elizabeth Mott (1672–1751) of Newport.⁵⁴³ His maternal grandparents were Benjamin Stanton (1684–1760) and Martha Tibbetts (d. 1752) of Newport.⁵⁴⁴ The Goulds were a Quaker family, and in June 1761 the chairmaker Timothy Waterhouse was appointed by the Society of Friends to inquire into Benjamin Gould’s intention to marry Lydia Spencer (c. 1737–1777), the daughter of Thomas Spencer (1717–1753) and Margaret Goddard (1718–1765) of East Greenwich.⁵⁴⁵

Lydia Spencer came from a family of woodworkers, both on her father’s and mother’s sides. Her father was a shipwright, yeoman, and cordwainer, and her paternal grandfather, John Spencer (1693–1774), was a carpenter. Her maternal grandfather, Daniel Goddard (1697–1764), was a housewright and shipwright, and her uncle was famed Newport cabinetmaker John Goddard (1723/24–1785). Her brothers were Thomas Spencer (1752–1840), an East Greenwich shop joiner, and Daniel Spencer (1741–1801),

⁵⁴² Arnold, *Vital Records of Rhode Island*, vol. 7, 61, 105, 122. RIHCTP.

⁵⁴³ For Thomas Gould’s birth and death, see Arnold, *Vital records of Rhode Island*, vol. 7, 59, 104; for Elizabeth Mott Gould’s birth and death, see vol. 7, 68, 114; for their marriage, see vol. 7, 25.

⁵⁴⁴ John Osborne Austin, *The Genealogical Dictionary of Rhode Island* (Albany, NY, 1887; reprinted Baltimore, MD: Genealogical Publishing Company, 2008), 202; Arnold, *Vital Records of Rhode Island*, vol. 7, 61, 122; and RIHCTP.

⁵⁴⁵ Meeting minutes, Portsmouth, June 30, 1761, Society of Friends, Newport, Monthly Meetings 1739–1773, FHL film 0022417, p. 224. For Lydia Spencer’s life dates see RIHCTP. Her parents are identified in Arnold, *Vital Records of Rhode Island*, vol. 7, p. 34. For information on the Spencer family of woodworkers, see Patricia E. Kane, “A Newly Discovered Rhode Island Cabinetmaker Thomas Spencer of East Greenwich,” *Antiques* 177, no.3 (April/May 2010): 114–119; and “Thomas Spencer, 1752–1840” and “Daniel Spencer, 1741–1801,” RIFA, YUAG.

who worked as a shop joiner and cabinetmaker in Newport, Providence, and Dartmouth, Massachusetts. Signed examples of the work of both brothers survive.⁵⁴⁶

Benjamin Gould and Lydia Spencer were married on July 30, 1761.⁵⁴⁷ They had at least eight children: James (1762–1783), Margaret (b. 1764), Job (b. 1767), Anne (1768–1784), Thomas (1770–1820), Hannah (1772–1839), Henry (1774–1775), and Henry (b. 1775).⁵⁴⁸ While residing in Newport, Gould was elected to at least four town offices, including Field-Driver in 1764 and 1765, Pound Keeper in 1765, and Surveyor of Highways in 1788.⁵⁴⁹

Gould would have most likely completed his training around 1756, and it is possible that he apprenticed with Newport chairmaker Joseph Proud. In 1755, a Benjamin Gould witnessed a bond in which Joseph Bull, a Newport merchant, promised to pay Proud £391. John Wilkinson, possibly the joiner (w. 1750–1753), served as the second witness.⁵⁵⁰ Gould would have been nineteen at the time. The first known reference to Gould as a Newport chairmaker is found in a 1767 lawsuit. Gould sued Portsmouth yeoman and trader John Shrieve Jr. for defaulting on a note in which he promised to pay Gould “Twenty Spanish Silver Mild Dollars, in good Merchantable New England Rum.”⁵⁵¹ The court ruled in favor of Gould, ordering Shrieve to repay his debt and the

⁵⁴⁶ For a desk and bookcase by Thomas Spencer, see “RIF1447,” and for an example by Daniel Spencer, see “RIF2912,” RIFA, YUAG.

⁵⁴⁷ Arnold, *Vital Records of Rhode Island*, vol. 7, p. 34.

⁵⁴⁸ *Ibid.*, vol. 7, 60, 104, 106.

⁵⁴⁹ *Newport Mercury*, June 11, 1764, Issue 301, pg. 3; *Newport Mercury*, June 10, 1765, issue 353, pg. 3, *Newport Herald*, June 5, 1788, vol. 2, issue 67, p. 3, <http://infoweb.newsbank.com/>.

⁵⁵⁰ Joseph Proud, Newport, chairmaker v. Joseph Bull, Newport, merchant, Bond, May 1756 term, case 147, NCCCCP, RB, vol. E, p. 242; Bond, March 28, 1755, in case file, Proud v. Bull.

⁵⁵¹ Benjamin Gould, Newport, chairmaker v. John Shrieve Jr., Portsmouth, yeoman, alias trader, May 1767 term, case 171, NCCCCP, RB, vol. G, p. 794; Note, December 20, 1766, in case file, Gould v. Shrieve.

costs of the suit. Gould was again referred to as a Newport chairmaker in 1770, when he was appointed as an administrator of the estate of his aunt Sarah Stanton of Newport.⁵⁵²

Gould temporarily relocated his family during several years of the Revolution. In April 1776, the East Greenwich Society of Friends accepted a certificate from the Newport meeting on behalf of Gould, his wife, and children.⁵⁵³ The same year, he billed Preserved Pearce of East Greenwich £0.10.0 for mending a chair and £9.12.0 for bottoming six chairs.⁵⁵⁴ Gould was listed as residing in East Greenwich in the 1777 Rhode Island military census, but probably returned to Newport at some point during the year.⁵⁵⁵ His wife, Lydia, died on May 16, 1777, and is buried in Newport.⁵⁵⁶ After her death, Gould appears to have removed to Cranston, but was living in Newport again by September 1780, when his return was reported at the Cranston Society of Friends meeting.⁵⁵⁷ In 1782, Gould married Lydia Thurston, daughter of Jonathan and Lydia Thurston of Newport.⁵⁵⁸ She died just a few years later on December 10, 1785.⁵⁵⁹ The last known reference to Benjamin Gould as a chairmaker is in a 1790 land deed documenting his sale of Newport land to wheelwright William Stall. By 1808, when he sold land to his son Henry, a Newport potter, he had presumably retired and was identifying himself as a

⁵⁵² Estate administration of Sarah Stanton, Newport, spinster, January 1, 1770, NTCP, FHL film 0945000, vol. 16, p. 112, Newport City Hall, Newport, Rhode Island. An inventory of the estate was taken by John Goddard and Thomas George.

⁵⁵³ Meeting minutes, East Greenwich, April 8, 1776, East Greenwich Society of Friends, FHL film 1332, vol. 2, p. 63.

⁵⁵⁴ Ott, "Recent Discoveries Among Rhode Island Cabinetmakers," 20.

⁵⁵⁵ RI 1777 Military Census Index, www.ancestry.com.

⁵⁵⁶ RIHCTP.

⁵⁵⁷ Meeting Minutes, Cranston, September 4, 1780, East Greenwich Society of Friends, FHL film 1332, vol. 2, p. 93.

⁵⁵⁸ Arnold, *Vital Records of Rhode Island*, vol. 7, p. 36.

⁵⁵⁹ RIHCTP.

yeoman.⁵⁶⁰ Gould spent the rest of his life in Newport, where he died on August 20, 1821, at the age of 86.⁵⁶¹

⁵⁶⁰ Deed, Benjamin Gould, Newport, chairmaker alias yeoman to William Stall, Newport, wheelwright, June 19, 1790, NLE, vol. 4, p. 325; Benjamin Gould, Newport, yeoman to Henry Gould, Newport, potter, April 22, 1808, NLE, vol. 12, p. 25.

⁵⁶¹ Gould is recorded as living in Newport on the 1790, 1800, 1810, and 1820 United States Federal Censuses, see Ancestry, www.ancestry.com. For his date of death, see "Deaths," *Providence Patriot*, August 29, 1821, vol. 3, issue 69, p. 3, <http://infoweb.newsbank.com/>; and RIHCTP.

John Lamb Jr. (w. 1747–1758)

Nothing has yet been discovered about the birth and family of John Lamb Jr., who worked as a Newport chairmaker from at least 1747 until at least 1758. He was probably the John Lamb who married Mary Fairbanks (b. c. 1725), the daughter of David Fairbanks of Bristol and Newport and Susannah Stacey of Newport, at the Second Congregational Church in Newport on August 5, 1744.⁵⁶²

The first known reference to Lamb as a Newport chairmaker is in May 1747, when he was sued by Newport mariner Richard Gould for failure to pay rent. A complaint filed by Gould claims that, beginning in November 1745, Lamb occupied “one chamber or upper room” in Gould’s house. A year later, Lamb refused to pay the agreed upon annual rent of £11.⁵⁶³ A writ served on December 15, 1746, is signed by Daniel Goddard, who acted as Lamb’s bail.⁵⁶⁴ This was probably the Daniel Goddard (1697-1764) who worked as a shipwright and housewright in Newport.⁵⁶⁵ The court ruled in favor of Gould, and ordered Lamb to pay the £11 plus court costs. By 1748, Lamb had changed residences. His new abode is mentioned in a document regarding partition of the lands of Nathaniel Newdigate of Warwick, which describes a “piece of land situate lying and being in

⁵⁶² Arnold, *Vital records of Rhode Island*, vol. 8, 469; Lorenzo Sayles Fairbanks, *Genealogy of the Fairbanks Family in America, 1633–1897* (Boston: American Printing and Engraving Company, 1897), 75.

⁵⁶³ Richard Gould, Newport, Mariner v. John Lamb Jr., Newport, chairmaker, May 1747 term, NCCCCP, RB, vol. C, p. 94.

⁵⁶⁴ Writ, dated November 21, 1746 and served December 15, 1746, in case file, Richard Gould v. John Lamb, Jr.

⁵⁶⁵ RIFA, YUAG.

Newport with y^e dwelling house & shop thereon standing the s[ai]^d shop being now used as a small tenement or dwelling house and in y^e tenure and occupation of John Lamb.”⁵⁶⁶

Ten years later, Lamb again had trouble paying his rent. In 1758, he was sued by Newport shipwright Isaac Chapman in an action of trespass and ejectment for “unjustly with-holding from the pl[ain]t[iff] the possession of a certain lower room being formerly a coopers shop in Newport, aforesaid and is part of the warehouse on the pl[ain]t[iff]’s wharff.”⁵⁶⁷ The court ordered Lamb to vacate the premises and to pay Chapman £74.10 in back rent minus a £26 credit. The lawsuit with Chapman is the last known record of Lamb’s presence in Newport.

⁵⁶⁶ Partition of the Lands of Nathaniel Newdigate of Warwick, July 4, 1748. Warwick Deeds, vol. 7, p. 386–389.

⁵⁶⁷ Isaac Chapman, Newport, shipwright v, John Lamb, Newport, chairmaker, May 1758 term, NCCCCP, RB, vol. E, p. 746.

John McClure (w. 1747–1749)

John McClure worked as a chairmaker in Newport from at least 1747 to 1749. In November 1747, he was referred to as a “chairmaker” when he sued Newport house carpenter Isaac Cowdry for “will fully enticing away an Apprentice Boy (called Isaac Cowdry Jun[io]r) belonging to the plaint[iff].”⁵⁶⁸ The Newport County Court of Common Pleas ruled in McClure’s favor but awarded him only £200 of the £500 in damages he sought. In March 1748, Isaac Cowdry appealed the decision in the Newport Country Superior Court. The case was not decided until November 1748, when the court reversed the previous verdict and ordered John McClure to pay court costs.⁵⁶⁹ McClure attempted to have the Superior Court’s decision reversed in March 1749, but the jury decided in favor of Cowdry, and McClure was again ordered to pay court costs.⁵⁷⁰ There are no other known references indentifying McClure as a chairmaker.

John McClure (c. 1720–1769) may have been the individual born near Londonderry in Northern Ireland.⁵⁷¹ His ancestors were Scottish Highlanders who settled in Northern Ireland in the early seventeenth century. In 1729, his father, Samuel McClure (c. 1689–1769), emigrated with his family to Boston, in search of civil and religious

⁵⁶⁸ John McClure, Newport, chairmaker v. Isaac Cowdry, Newport, house carpenter, November 1747 Term, NCCCP, RB, vol. C, p.131. Among those summoned to give evidence in the case were Hezekiah Carpenter (probably the house carpenter who worked in Newport from at least 1731 to 1732) and Thomas Melville (probably the housewright, house carpenter, and joiner who worked in Newport from at least 1752 to 1767); see RIFA, YUAG.

⁵⁶⁹ Isaac Cowdry, house carpenter, Newport, appellant v. John McClure, chairmaker, Newport, appellee, March 1748, NCSC, RB, vol. D, p. 86; Cowdry v. McClure, November 1748, NCSC, RB, vol. D, p. 103.

⁵⁷⁰ John McClure, chair-maker, Newport v. Isaac Cowdry, Newport, house carpenter, March 1749, NCSC, RB, vol. D, p. 135.

⁵⁷¹ McClure and Dexter, *Diary of David McClure*, 1. His approximate birth date was found on FamilySearch (<https://www.familysearch.org/>), but cannot yet be confirmed elsewhere; for his death date, see James Alexander McClure, *The McClure Family* (Petersburg, VA: Frank A. Owen, 1914), 160.

freedom.⁵⁷² There he became the first deacon of a Scotch-Irish émigré church, which was modeled on the Presbyterian Church of Scotland. John McClure later succeeded his father to this office.⁵⁷³ John McClure married Rachel McClintock (c.1719–1765) in Boston on August 5, 1740.⁵⁷⁴ She was the daughter of William McClintock (c. 1679–c. 1769), who had emigrated from Ireland with the McClures and purchased a farm in Medford, Massachusetts.⁵⁷⁵ The couple had thirteen children: William (1741–1783), Samuel (1743–1815), John (1745–1785), Rachel (1746–1813), David (1748–1820), James (1750–1791), Daniel (1753–1775), Thomas (1754–d. after 1802), Jane (1757–1805), Nancy (1759–1813), Joseph (1761–1829, twin), Benjamin (1761–1787, twin), and Ruth (1763–1765).⁵⁷⁶

Although John McClure’s life in America was spent primarily in Boston, he did briefly move his family to Newport, and the dates of his residence there correspond with the aforementioned court case. It is likely that McClure completed his apprenticeship in Boston and worked there as a chairmaker before relocating to Newport. Two of the McClure’s children, Rachel and David, were baptized at the First Congregational Church in Newport in February 1746/7 and December 1748, respectively.⁵⁷⁷ David McClure’s diary records his family’s time there:

⁵⁷² McClure and Dexter, 1.

⁵⁷³ Ibid.

⁵⁷⁴ [McLentok] *A Report of the Record Commissioners of the City of Boston Containing the Boston Marriages from 1700 to 1751* (Boston: Municipal Printing Office, 1898), 233. Rachel McClure’s approximate date of birth was found on FamilySearch (<https://www.familysearch.org/>), but cannot yet be confirmed elsewhere.

⁵⁷⁵ McClure and Dexter, 2.

⁵⁷⁶ McClure, *The McClure Family*, 160–161. Some life dates were found on FamilySearch (<https://www.familysearch.org/>), but cannot yet be confirmed elsewhere.

⁵⁷⁷ Arnold, *Vital records of Rhode Island*, vol. 8, 407.

While Newport in Rhode Island was in a flourishing state, My Father concluded to move there, with the expectation of bettering his worldly circumstances. He continued there a few years disappointed in his expectation & displeased with the loose and irreligious state of the place, although they found many pious Christians there, he returned to Boston with his family when I was a child.

McClure's son further reported that, once back in Boston, his father "carried on a small trade" – possibly his chairmaking trade – and "kept a retailing shop of groceries."⁵⁷⁸

Although his identity is by no means certain, if the above John McClure was the chairmaker who worked in Newport from 1747 to 1749, the disappointing outcome of his court case with Isaac Cowdry would likely have added to his disillusionment with the city.

⁵⁷⁸ McClure and Dexter, 3. David McClure graduated from Yale College in 1769, and served as a Trustee of Dartmouth College from 1777 to 1800, receiving from them the honorary degree of Doctorate of Divinity in 1803. See Franklin Bowditch Dexter, *Biographical Sketches of the Graduates of Yale College, Annals of the College History, vol. 3* (New York: Henry Holt and Company, 1903), 344–346.

*John Ormsby (w. 1733–1739)*⁵⁷⁹

Nothing has yet been discovered about the birth and family of John Ormsby, but he worked as a Newport chairmaker from at least 1733 to 1739. The earliest known evidence of Ormsby's presence in Newport is a 1733 bill from Newport brazier Stephen Ayrault to Newport upholsterer John Moore. On July 3, Ayrault charged Moore £0.8.5 for "Sundrys" for John Ormsby per "Verbel Order." Other charges on the account are for materials and tools used in upholstering seating furniture, including 5 pieces of "Girth Webb," thousands of tacks, nails, and brads in various sizes, a hammer, and "3 awle hasts."⁵⁸⁰ Moore's order on Ormsby's behalf indicates the two probably had a business relationship. If this is indeed the case, it may represent the earliest known collaboration between a Newport chairmaker and a Newport upholsterer.

Ormsby's work as a chairmaker is documented in a 1738 court case in which he was sued by Henry Jordan, a Newport tailor, over an unpaid account.⁵⁸¹ Interestingly, Ormsby is referred to in the court records as a "vintner alias chairmaker," indicating that he also worked as a wine merchant. In the 1737 account, Jordan bills Ormsby for "turning a coat" – a way of refreshing a worn out garment by turning it inside out – and related supplies, including buttons and new material for lining the coat. The account also records the following items supplied by Ormsby to Jordan, which are listed as credits:

⁵⁷⁹ A draft document on John Ormsby by Dennis Carr, in the files of Yale University Art Gallery, was helpful in compiling this biography.

⁵⁸⁰ Account, June 26 to December 19, 1733, in case file, Stephen Ayrault, Newport, brazier v. John Moore, Newport, upholsterer alias upholsterer, May 1735 term, case 113, NCCCP, RB, vol. A, p. 312.

⁵⁸¹ Henry Jordan, Newport, tailor v. John Ormsby, Newport, vintner alias chairmaker, , May 1738 term, case 146, NCCCP, RB, vol. A, p. 542. Jordan won the case and was awarded £3.15.6 plus court costs.

By 4 Cheres [Chairs] att 7s p. ^f Chere	£	1	8	0
By Sundreys in the Shop		0	4	2
By a joyant Stool		0	12	0
By a pound of Butter		0	3	0
B[y] Sundreys		0	1	6
	£	2	8	8 ⁵⁸²

The price of £0.7.0 per chair was slightly less than the £0.7.8 per chair charged by fellow chairmaker Daniel Dunham, when he made six “fore Back Chears” for Newport cooper John West in 1735.⁵⁸³ Dunham was almost certainly making slat- or banister-back chairs, and the “fore” in “fore Back probably indicated the number of horizontal or vertical support elements on each chair back.⁵⁸⁴ Given the similarity in price, it is probable that the chairs supplied by Ormsby to Jordan were of the same variety.

Ormsby was also referred to as a Newport chairmaker in three subsequent court cases. In 1738, he was sued by Peter Buliod, a Newport ropemaker, over unpaid rent.⁵⁸⁵ In the complaint, Buliod’s lawyer states that on December 12, 1737, his client “let to the Defend[an]t his Bake House in Newport and Half his Garden to hold from said time for One quarter of a Year thence next ensuing paying therefor the Cost of four pounds & ten shill[ing]s.”⁵⁸⁶ When the sheriff attempted to serve the writ on Ormsby, he failed to find him, and instead “attach’d one Small Pigen, one old Mop, one Water Barril & One old

⁵⁸² Account, 1737, in case file, Jordan v. Ormsby.

⁵⁸³ Account, 1 April 1735, in case file, Daniel Dunham, Newport, house carpenter v. John West, Newport, cooper, November 1735 term, case 147, NCCCP, RB, vol. A, p. 362.

⁵⁸⁴ Dennis Carr, draft biography of Daniel Dunham, Yale University Art Gallery.

⁵⁸⁵ Peter Buliod, Newport, ropemaker v. John Ormsby, Newport, chairmaker, May 1738 term, case 245, NCCCP, RB, vol. A, p. 553.

⁵⁸⁶ Complaint, filed May 18, 1738 by Daniel Updike, attorney, in case file, Buliod v. Ormsby. Buliod won the case and was awarded £4.10 plus court costs.

Broom as the proper Estate of the Def[endan]ts.”⁵⁸⁷ The last known record of Ormsby’s presence in Newport is found in two May 1739 lawsuits. In one case, the chairmaker was sued by Henry Vug of Portsmouth, Rhode Island, “a Free Negro Man,” for failing to repay a note in the amount of £5.12.8.⁵⁸⁸ The court ordered Ormsby to repay Vug and cover the cost of the suit. In a second case, Ormsby was the plaintiff. He sued Jonathan Strickland, a cordwainer, over an unpaid June 1736 account “for meat Drink and Lod[g]ing & Cash.” Ormsby’s suit was successful, and he was awarded the £2.13.5 due to him.⁵⁸⁹

⁵⁸⁷ Writ, May 9, 1738, in case file, Buliod v. Ormsby.

⁵⁸⁸ Note, April 5, 1738, in case file, Henry Vug, Portsmouth, a free negro man v. John Ormsby, Newport, chairmaker, May 1739 term, case 269, NCCCP, RB, vol. A, p. 639.

⁵⁸⁹ Account, June 1736, in case file, John Ormsby, Newport, chairmaker v. Jonathan Strickland, now resident of Newport, cordwainer, May 1739 term, case 155, NCCCP, RB, vol. A, p. 623.

Samuel Phillips (w. 1782, d. 1788)

Little is known about the life of Newport chairmaker Samuel Phillips.⁵⁹⁰ He is probably the Samuel Phillips who married Sarah Lambert on March 7, 1775, at Reverend Gardiner Thurston's Second Baptist Church in Newport.⁵⁹¹ The first known reference to Samuel Philips as a Newport chairmaker is found in a court case tried during the August 1782 term of the King's County Court of Common Pleas. Phillips was sued by Exeter shop joiner Joseph Sanford on behalf of William Harrison for money due by note. Philips was ordered to pay Harrison fifteen silver dollars plus court costs.⁵⁹² He was again referred to as a chairmaker after his death, when his widow, Sarah Philips, presented an inventory of his estate to the Newport Town Council on December 1, 1788. The council granted her request to be made administrator of the estate of her late husband, who had died without making a will. The only item in his inventory possibly related to his trade is a "parcel of Old Tools" valued at £0.4.6. It is possible that he made the "1 doz 'Com[mon]' Slitt Back Chairs" listed among his furniture and valued at £0.18.0. His entire personal estate, valued at only £10.14.0, was declared insolvent in 1794.⁵⁹³ Among the claims made against Philips' estate was a £1.10.0 charge from Newport cabinetmaker Samuel Sanford (w. 1789) for making a coffin.⁵⁹⁴

⁵⁹⁰ A biography of Samuel Phillips is included in Yale University Art Gallery's Rhode Island Furniture Archive, see "Samuel Phillips, born ca. 1750, died 1788," RIFA, YUAG.

⁵⁹¹ Arnold, *Vital Records of Rhode Island*, vol. 7, p. 359.

⁵⁹² Joseph Sanford, Exeter, shop joiner, assignee of William Harrison v. Samuel Phillips, Newport, chair maker, August 1782 Term, King's County Court of Common Pleas, vol. I, case 202, p. 623.

⁵⁹³ Inventory of Samuel Phillips, December 1, 1788, Newport Probate, vol. 2, pp. 94-95.

⁵⁹⁴ 1794 admin acct of Samuel Phillips insolvent, May 2, 1794, Newport Probate, vol. 2, p. 358; "Samuel Sanford, Jr., worked 1789," RIFA, YUAG.

John Pitman (c. 1726–1768)

John Pitman, son of Benjamin Pitman (1697–1762) and Mary (c. 1697–1746), was born in Newport, Rhode Island in or around 1726.⁵⁹⁵ His paternal great grandfather, Henry Pitman (c. 1640–c. 1684), was one of the first settlers of Nassau on the island of New Providence in the Bahamas. His paternal grandfather, John Pitman (1663–1711), who married Mary Saunders (c. 1766–1711), remained on his father’s land, where he erected a shipyard and built several vessels. The land was officially granted to him by the island’s Lords Proprietors in January of 1699. Benjamin Pitman (father of chairmaker John Pitman) was born in New Providence, but his family soon relocated when their house was burned during a 1703 raid by Spanish and French forces. In 1710, they settled in Newport, Rhode Island, after living for a time on Current Island and Thesa Island in the Bahamas.⁵⁹⁶

John Pitman worked as a chairmaker in Newport from at least 1764 until his death in 1768.⁵⁹⁷ On May 6, 1750, he married Abigail Nichols (c. 1727–1780), the daughter of Andrew Nichols and Abigail Plaisted.⁵⁹⁸ The couple had six children: Elizabeth (1753–1771), John (1757–1809), Mary (1758–1841), Andrew (1762–before 1771), Thomas Gilbert (1764–1842), and Benjamin (1766–1811).⁵⁹⁹

⁵⁹⁵ Charles Myrick Thurston, *Descendants of John Pitman: The First of the Name in the Colony of Rhode Island* (New York: The Trow & Smith Book Manufacturing Co., 1868), 11.

⁵⁹⁶ Thurston, 7–8. After the death of John Pitman (grandfather to the chairmaker) in 1711, the Nassau estate was leased within the family. The lease had apparently expired by 1762, when the family began to collect evidence to support their claim to the property. Disputes arose, however, and they failed to act in time. The Revolution began and the estate was lost under the British statute of limitations. See Thurston, 9.

⁵⁹⁷ Thurston, 11; RIHCTP.

⁵⁹⁸ Thurston, 11. Abigail Pitman may have been from Boston, where her parents were married on March 10, 1725. See *A Report of the Record Commissioners of the City of Boston Containing the Boston Marriages from 1700 to 1751* (Boston: Municipal Printing Office, 1898), 128.

⁵⁹⁹ Thurston, 12, 29, 20.

Several members of the Pitman family were involved in the woodworking trades. John Pitman's uncle Joseph Pitman (1695–1731) was also a chairmaker.⁶⁰⁰ His brother James Pitman (1700–1769) was a Newport joiner,⁶⁰¹ whose sons James (1740–c.1784) and William (1746–c.1784) were both Newport shop joiners.⁶⁰² John Pitman's sons were also craftsmen: John Pitman, Jr., apprenticed as a joiner and is later referred to in land deeds and court records alternately as a carpenter and a housewright,⁶⁰³ and Benjamin Pitman was a housewright.⁶⁰⁴ There was also a Benjamin Pitman working in Newport as a joiner in 1745, who may have been John Pitman's father, although there is no evidence to support this.⁶⁰⁵

The earliest known reference to John Pitman as a Newport chairmaker is October 11, 1764, when he was appointed as one of the administrators of the estate of Newport mariner Edward Harris.⁶⁰⁶ Then, on March 2, 1767, he was again identified as a chairmaker when made an administrator of the estate of Newport widow Ann Morgan.⁶⁰⁷ A November 1767 court case reveals that Pitman also worked as a shopkeeper. In the

⁶⁰⁰ Thurston, 10. Joseph Pitman Inventory, June 7, 1731, Newport Probate Miscellaneous Inventories 1721–1748, FHL film 0942000, p. 90.

⁶⁰¹ Thurston, p. 11; Will of James Pitman, Newport, shop joiner, will dated September 4, 1762, proved December 4, 1769, NTCP, FHL film 0945000, vol. 16, p. 103.

⁶⁰² Thurston, 24. Will of James Pitman, Newport, shop joiner, will dated 5 October 1774, proved February 2, 1784, NTCP, FHL film 0944997, vol. 1, p. 162. Will of William Pitman, Newport, shop joiner, will dated April 28, 1772, proved October 14, 1784, NTCP, FHL film 0944997, vol. 1, p. 205.

⁶⁰³ William Crossing, Newport, gentleman v. John Pitman, Newport, joyner, case 362, case 362, November 1769 term, NCCCP, RB, vol. H, p. 435. Deed, Thomas Cranston, Esq., Newport, gentleman to John Pitman, Jr., Newport, carpenter, September 9, 1783, NLE, vol. 2, pp. 13–12. Will of John Pitman, Newport, housewright, November 29, 1808, NTCP, FHL film 0944998, vol. 4, pp. 608–10.

⁶⁰⁴ Benjamin Pitman, Jr., Inventory, Newport, housewright, July 27, 1811, NTCP, FHL film 0944998, vol. 5, p. 31.

⁶⁰⁵ Temperance Grant, widow, and Patrick Grant, Newport, merchant v. Benjamin Pitman, Newport, joiner, May 1745 term, NCCCP RB, vol. B, p. 693.

⁶⁰⁶ NPAB, vol. 2, p. 93.

⁶⁰⁷ NPAB, vol. 2, p. 221.

suit, brought against him in the Newport Court of Common Pleas by North Kingston yeoman Nathaniel Tibbetts for money due by note, he is referred to as a “shopkeeper alias chairmaker.”⁶⁰⁸ In a May 19, 1768 note signed by Pitman, he promised to pay Tibbetts £437.6.0. He made one payment of £107.16.8 on July 7, 1768, and another of £8.0.0 on October 8, 1768.⁶⁰⁹ When Pitman defaulted on a payment of £30, he was sued by Tibbetts, and ordered by the court to pay the balance of the debt plus court costs.⁶¹⁰

John Pitman died on December 27, 1768.⁶¹¹ His will, dated December 26, 1768, mentions his wife, Abigail, to whom he bequeathed his house, land, and personal estate “for the bringing up of my children.” He also named each of his children, leaving his daughters, Elizabeth and Mary, “one large Silver Spoon a Piece,” his oldest son, John, “my Silver Shoe Buckles,” and to his “Three Youngest Sons Thomas, Benjamin, and Andrew four Shillings a Piece.”⁶¹² One of the executors of John Pitman’s will was John Pitman, Esq., who was probably the son of his uncle, the chairmaker Joseph Pitman.⁶¹³ Among the witnesses were Caleb Arnold and Joseph Clarke.⁶¹⁴ The will was proved on

⁶⁰⁸ Nathaniel Tibbetts, North Kingston, yeoman v. John Pitman, Newport, shopkeeper, alias chairmaker, November 1768 term, case 147, NCCCP, RB, vol. H, p. 211.

⁶⁰⁹ Note, May 19, 1768, in case file, Tibbetts v. Pitman.

⁶¹⁰ Tibbetts v. Pitman.

⁶¹¹ Thurston, 11; The Rhode Island Historical Cemeteries Transcription Project.

⁶¹² Will of John Pitman, Newport, chairmaker, December 26, 1768, NTCP, FHL film 945000, vol. 15, pp. 15–16.

⁶¹³ John Pitman (1719–1800) was the son of Joseph Pitman and Mary Whitman, and married Mary Simmons (c. 1717–1789). See Thurston, p. 10. He is most likely the same John Pitman who was referred to in Newport court and land records prior to 1768 as “John Pitman, blacksmith,” and in subsequent years as “John Pitman, Esq.” No known references to John Pitman, Esq. occur after his death on March 2, 1800.

⁶¹⁴ There were several craftsmen with these names working in Rhode Island during the eighteenth century: Joseph Clark, house joiner and house carpenter, Warwick and Newport (w. 1721–1736); Joseph Clarke, house carpenter, Newport (w. 1742); Joseph Clark, house carpenter, Warwick (w. 1738/9–1773); Caleb Arnold, house carpenter and housewright, Newport (w. 1739–1743); Caleb Arnold, housewright, Newport (w. 1775). See RIFA, YUAG.

February 6, 1769, and an inventory of John Pitman's personal estate, valued at £487.10.0, was recorded.⁶¹⁵

Despite the not insubstantial value of John Pitman's assets, there was not enough money to pay his creditors. In July 1769, Abigail Pitman appeared at a town council meeting to declare her late husband's estate insolvent.⁶¹⁶ The council appointed shopkeeper Paul Mumford and cordwainer Jacob Stockman to receive claims for any outstanding debts, but replaced them in September with Jonathan Otis and Robert Stevens, probably the upholsterer.⁶¹⁷ Otis and Stevens advertised for claims against the estate in the *Newport Mercury* on September 18, 1769.⁶¹⁸

In November 1769, John Pitman's son John, referred to as "joyner Son and Heir at Law of John Pitman late of said Newport Chairmaker," was sued for defaulting on a debt incurred by his father.⁶¹⁹ A note signed by John Pitman, Sr., on September 20, 1768, promises to pay £188.1.4 to Newport gentleman William Crossing.⁶²⁰ John Pitman, Jr., was ordered to pay the debt, and a writ served on September 13, states: "for want of the def[endan]ts Body or Personal Estate by me to be found I attached his Real Estate in the

⁶¹⁵ Although the son of Benjamin Pitman, John Pitman is referred to in his inventory as "John Pitman jun[io]r." In the eighteenth century, "junior" and "senior" were used to distinguish between two men with the same name, either in the same family or town, and did not necessarily indicate a father-son relationship. See George E. McCracken, "Terms of Relationship in Colonial Times" in *American Genealogist* 55 (1979): 53.

⁶¹⁶ NTCP, FHL film 945000, vol. 16, pp. 65, 80. On November 10, 1771, Abigail Pitman joined the Second Congregational Church of Newport, where her four surviving children, John, Mary, Thomas, and Benjamin, were baptized. She moved to South Kingston in 1775, and died there on June 17, 1780 at the age of 54. See Thurston, 11; Arnold, *Vital Records of Rhode Island*, vol. 8, p. 450; RIHCTP.

⁶¹⁷ NTCP, FHL film 945000, vol. 16, pp. 65, 80.

⁶¹⁸ Pitman is referred to as "John Pitman, jun." in the advertisement. *Newport Mercury*, September 18, 1769, p. 4, <http://infoweb.newsbank.com>.

⁶¹⁹ William Crossing, Newport, gentleman v. John Pitman, Newport, joyner, November 1769 term, NCCCP, RB, , case 362, vol. h, p. 435.

⁶²⁰ Note, September 20, 1768, in case file, Crossing v. Pitman.

Possesion of James Rogers merchant & Joseph Weeden.”⁶²¹ John Pitman, Jr., who would have been twelve at the time, was already apprenticing as a joiner. He may have apprenticed with one of his cousins, Newport shop joiners James and William Pitman.

⁶²¹ Writ, September 13, 1769, in case file, Crossing v. Pitman.

Joseph Pitman (c. 1695–1731)

Joseph Pitman, son of John Pitman (1663–1711) and Mary Saunders (c. 1766–1711), was born on Harbor Island in the Bahamas.⁶²² John Pitman moved the family to Nassau on the Bahamian island of New Providence. He settled on land previously occupied by his father, Henry Pitman (c.1640–c.1684), one of the first settlers of Nassau, and erected a shipyard where he built several vessels. The land was officially granted to John Pitman by the island’s Lords Proprietors in January 1699. After his house was burned during a 1703 raid by Spanish and French forces, he relocated his family, first living on Current Island and Thesa Island in the Bahamas, and finally settling in Newport in 1710.⁶²³

Joseph Pitman married Mary Whitman on December 19, 1717. She may have been the daughter of Samuel Whitman, who was appointed guardian to Joseph and two of his brothers, Benjamin (1697–1762) and James (1700–1769), on January 7, 1712, shortly after the deaths of their parents. Their children were John (1719–1800), Mary (b.1721), Samuel (b.1723), Martha (b.1725), Joseph (b.1729), and Sarah (b.1731).⁶²⁴

Joseph Pitman died on March 21, 1731.⁶²⁵ Little is known about his life, but his inventory, presented at a June 1731 town council meeting, reveals details about his work as a chairmaker. His shop, valued at £35, included “Working tools £5.5,” “Chaires made

⁶²² Thurston, *Descendants of John Pitman*, 7–9. Their life dates are also recorded in Alden G. Beaman, *Rhode Island Vital Records, New Series*, vol 11, *Births, 1590-1930, from Newport Common Burial Ground Inscriptions* (East Princeton, MA: Rhode Island Families Association, 1985), 320.

⁶²³ Thurston, *Descendants of John Pitman*, 7–8. After the death of John Pitman (grandfather to the chairmaker) in 1711, the Nassau estate was leased within the family. The lease had apparently expired by 1762, when the family began to collect evidence to support their claim to the property. Disputes arose, however, and they failed to act in time. The Revolution began and the estate was lost under the British statute of limitations (see Thurston, *Descendants of John Pitman*, 9).

⁶²⁴ Thurston, *Descendants of John Pitman*, 10–11, 24.

⁶²⁵ Alden, *Common Burial Ground Inscriptions*, 320.

£6.18,” “flaggs £2,” “Stuff partly Worked 20/,” “3 Barrells Lam[p]black £4.5,” a “grind stone & winch 10/,” and “Timber 35/.”⁶²⁶ Flags were a type of vegetable fiber, and would have been used to make chair seats, probably for slat- or banister-back chairs. Lampblack was a black pigment made from soot, which could be used for finishing furniture.⁶²⁷ The reference to “Stuff partly Worked” probably referred to partially made parts for chairs.

Several members of the Pitman family were involved in the woodworking trades. Joseph Pitman’s nephew John Pitman (c. 1726–1768) was a chairmaker,⁶²⁸ and had sons who were also craftsmen: John Jr. (1757–1809) apprenticed as a joiner and is later referred to in land deeds and court records alternately as a carpenter and a housewright,⁶²⁹ and Benjamin (1766–1811) was a housewright.⁶³⁰ Another of Joseph Pitman’s nephews, James Pitman (1700–1769), was a Newport joiner,⁶³¹ and his sons, James (1740–c. 1784) and William (1746–c. 1784), were both Newport shop joiners.⁶³² Another Benjamin

⁶²⁶ Joseph Pitman Inventory, June 7, 1731, Newport Probate Miscellaneous Inventories 1721–1748, FHL film 0942000, p. 90.

⁶²⁷ A “1/2 barrel of Lamp black” was listed in the 1715 inventory of New York chairmaker and joiner Jean Suire, see Neil D. Kamil, “Hidden in Plain Sight: Disappearance and Material Life in Colonial New York,” *American Furniture* (1995), accessed online, <http://www.chipstone.org>.

⁶²⁸ Nathaniel Tibbets, North Kingston, yeoman v. John Pitman, Newport, shopkeeper, alias chairmaker, November 1768 term, NCCCP 1783, Newport RB, case 147, vol. H, p. 211.

⁶²⁹ William Crossing, Newport, gentleman, v. John Pitman, Newport, joyner, case 362, November 1769 term, NCCCP, RB, vol. h, p. 435. Deed, Thomas Cranston, Esq., Newport, gentleman to John Pitman, Jr., Newport, carpenter, September 9, NLE, vol. 2, p. 13–12. Will of John Pitman, Newport, housewright, November 29, 1808, NTCP, FHL film 944998, vol. 4, p. 608–10.

⁶³⁰ Benjamin Pitman Jr., Inventory, Newport, housewright, July 27, 1811, NTCP, FHL film 944998, vol. 5, p. 31.

⁶³¹ Thurston, *Descendants of John Pitman*, 11; Will of James Pitman, Newport, shop joiner, will dated September 4, 1762, proved December 4, 1769, NTCP, FHL film 0945000, vol. 16, p. 103.

⁶³² Thurston, *Descendants of John Pitman*, 24. Will of James Pitman, Newport, shop joiner, will dated October 5, 1774, proved February 2, 1784, NTCP, FHL film 0944997, vol. 1, p. 162. Will of William Pitman, Newport, shop joiner, will dated April 28, 1772, proved October 14, 1784, NTCP, FHL film 0944997, vol. 1, p. 205.

Pitman, who worked in Newport as a joiner in 1745, may have been Joseph Pitman's brother, although there is no evidence to support this.⁶³³

⁶³³ Temperance Grant, widow, and Patrick Grant, Newport, merchant, v. Benjamin Pitman, Newport, joyner, May 1745 term, NCCCP RB, vol. B, p. 693.

John Proud Jr. (1714–1794)

John Proud Jr. was born in Newport on July 22, 1714.⁶³⁴ His parents, John Proud (d. 1757) and Rebecca Fothergill (d. 1732), were from Yorkshire, England, and lived near the town of Gisburn.⁶³⁵ The family immigrated to Newport in 1713 or 1714, where the elder John Proud worked as a watch- and clockmaker.⁶³⁶ John Jr. probably apprenticed in Newport, and most likely completed his training in or around 1735. On September 22, 1738, he married Ann Greene (b. 1718), the daughter of Deborah Carr (1692–1729) and John Greene (1691–1757) of Potowomut, Rhode Island.⁶³⁷ John and Anne had at least two children, John (b. 1738) and Deborah (1745–1803).⁶³⁸ The Prouds were Quakers, and John Jr. would no doubt have been well acquainted with other Friends in the woodworking trades. Beginning in 1754, his name appears frequently in the monthly meeting minutes of the Religious Society of Friends.⁶³⁹

⁶³⁴ Arnold, *Vital Records of Rhode Island*, vol. 7, 70.

⁶³⁵ Will of John Proud, dated [August?] 22, 1757, proved November 7, 1757, NTCP, FHL film 0945000, vol. 12, p. 127-129. For Rebecca Fothergill Proud's death date, see Arnold, *Vital Records of Rhode Island*, 116, and RIHCTP.

⁶³⁶ According to Arnold's *Vital Records of Rhode Island* (p. 70), John and Rebecca Proud's daughter Hannah was born in England on November 30, 1712. In his will, John Proud left his watch- and clockmakers' tools to his grandson Timothy Waterhouse.

⁶³⁷ Their marriage is recorded in Arnold, *Vital Records of Rhode Island*, 138. For the life dates of Ann Green and her parents, see Edson Irving Carr, *The Carr Family Records* (Rockton, Illinois: Herald Printing House, 1894), 40; Wilkins Updike, James MacSparran, and Daniel Goodwin, *A History of the Episcopal Church in Narragansett, Rhode Island* (Boston: The Merrymount Press, 1907), vol. 2, 404; and National Society of the Colonial Dames of America, *Third Record Book of the National Society of Colonial Dames in the State of Rhode Island and Providence Plantations* (Providence: Snow & Farnham Co., 1908), 15.

⁶³⁸ Deborah married James Davis (1744–1825); see Colonial Dames of America, *Third Record Book*, 15. For a record of the birth of John Proud III, see *Rhode Island Vital Records 1636–1850* (Online database: AmericanAncestors.org, New England Genealogical Society, 2002), originally published by James N. Arnold as *Vital Records of Rhode Island, 1636–1850. First series Births, marriages and deaths. A Family Register for the People* (Providence: Narragansett Historical Publishing Company).

⁶³⁹ See, for example, Society of Friends, Newport, RI, Monthly Meetings 1739–1773, FHL film 0022417, p. 127, 132, 148, 152.

John Proud Jr.'s brother Joseph Proud (1711–1769) and his brother-in-law Timothy Waterhouse (c.1715–1792) were also Newport chairmakers, but it is not known whether the three men ever worked together. It is possible that Waterhouse met his wife, Hannah Proud (1712–1802), through a business connection with one or both of her brothers. There was also a family of Providence chairmakers by the name of Proud – William Proud (c. 1723–1779) and his sons Samuel (1762–1833) and Daniel (1762–1833) – but it is unclear whether they were related to the Newport Prouds.⁶⁴⁰ John and Joseph Proud did have a brother named William, but his birthday is recorded in Arnold's *Vital Records* as 1720 rather than 1723.⁶⁴¹

The elder John Proud died in 1757, and his will names four sons, Joseph, John, William, Isaac, and Robert, and four daughters, Hannah, Rebecca, Mary, and Ann. To his son John, he bequeathed his “wearing apparel of every kind,” along with a “Chime clock and . . . Still Standing in the garden,” to be divided with his sisters Mary and Ann. The money resulting from the sale of “four Lots of Land Situate Lying at the Point” was to be shared by John, Joseph, Hannah, Rebecca, Mary, and Ann.⁶⁴² In 1759, John Jr. ran an advertisement announcing that this land would be sold at auction on April 27. In the same advertisement, he requested that all demands against the estate of his father be brought to him, “as there are a Number of small ones unsettled.”⁶⁴³

It is evident from Newport court cases that John Proud Jr. was both a chairmaker and a shopkeeper, and that he also engaged in mercantile pursuits. The first known

⁶⁴⁰ RIFA, YUAG; RIHCTP.

⁶⁴¹ Arnold, *Vital Records of Rhode Island*, 70.

⁶⁴² Will of John Proud, August 22, 1757, NTCP, FHL film 0945000, vol. 12, p. 127.

⁶⁴³ The Newport Mercury, April 24, 1759, <http://infoweb.newsbank.com/>.

reference to Proud as a Newport chairmaker is a 1747 lawsuit against mariner John Morriss of Maryland.⁶⁴⁴ The case concerned a ship co-owned by Proud, Newport cooper James Lyon, and Newport cordwainer Oliver Paddock. In what was almost certainly part of a mercantile venture, the men had engaged Morriss in “the conversion and disposition of a certain Sloop called the Humingbird of the Burthen of forty five Tonns with her Mast, Bowsprit, Yards, Sails, Rigging, Cable, Anchors, & Boat.” Morriss did not deliver, and was ordered by the court to either return the ship or pay £960. Several years later, in 1753, Proud was identified as a shopkeeper when he sued John Burr Jr., a Newport pail maker.⁶⁴⁵ It may have been in his capacity as shopkeeper that Proud ran a 1762 advertisement announcing “Cash given for old Pewter” in *The Newport Mercury*.⁶⁴⁶ Despite his other ventures, Proud continued to work as a chairmaker. He was once more referred to as such in 1767, when sued for money due by note by Newport tinsplate worker Joseph Burrill, and again in 1770, when sued over an unpaid account by Samuel Hall, a printer from Salem, Massachusetts.⁶⁴⁷ The account from Hall, which dates from June 1763 to April 1765, provides further evidence that Proud was involved in some sort of mercantile activity. It includes an “Almanack for 1764,” “Money Tables,” “Portage Bills,” “Bonds,” “Bills Laden,” “Powers [of] attorney,” and “Bills [of] Sale.”⁶⁴⁸ Portage

⁶⁴⁴ James Lyon, cooper, John Proud, chair maker, and Oliver Paddock, cordwainer, all of Newport v. John Morriss of Cympuxon in the County of Worchester in the Province of Maryland Mariner (cited in Notes on John Proud Jr., RIFA, YUAG).

⁶⁴⁵ John Proud Jr., Newport, shopkeeper v. John Burr, Junr. Newport, pailmaker, May 1753 term, NCCCP, RB, vol. D, p. 279.

⁶⁴⁶ The Newport Mercury, March 30, 1762, <http://infoweb.newsbank.com/>.

⁶⁴⁷ Proud lost the case and was ordered to pay £23.12 legal money plus court costs. See Joseph Burrill, Newport, tinsplate worker v. John Proud, Newport, chairmaker, May 1767 term, case 234, NCCCP, RB, vol. G, p. 800; Samuel Hall, Salem, Essex County, MA, printer v. John Proud, Newport, chairmaker, case 163, May 1770 term, NCCCP RB, vol. H, p. 521.

⁶⁴⁸ Account, June 22, 1763 to April 13, 1765, in case file, Hall v. Proud.

bills are shipping document used to keep track of crew members' wages, and "Bills Laden," or bills of lading, are documents acknowledging the receipt of shipped goods. Unfortunately there is no record of the contents of the cargo that Proud was apparently involved in shipping. The account also contains a charge of £24 for "the Mercury from July 16, 1763 to July 16, 1766." This probably refers to *The Newport Mercury*, suggesting that Proud may have spent at least part of this time in Salem, where he would have wanted to stay abreast of events in his home town.

In 1770, Proud evidently began having problems with alcohol. In the Friends' May meeting minutes, it recorded that he was "frequently overtaken with strong drink." Proud was apparently made ill by his over-indulgence and began to miss meetings. In July, he was prevented from coming by "some indisposition of body," in August he was "not of ability of body to attend," and in September he "gave encouragement" that he would attend, but did not. In October, Proud still had not appeared, but expressed his contrition by sending a written statement to the meeting "condemning his misconduct in making use of too much spirituous liquor." The statement was read publicly by William Lake at the November meeting, which Proud did attend.⁶⁴⁹

Proud had moved to Greenwich by 1786, when it was mentioned at the February Friends' meeting that he had "some time past removed within the verge of Greenwich monthly meeting without a certificate."⁶⁵⁰ Proud died in January 1794 at the age of

⁶⁴⁹ Friends, Newport, RI, Monthly Meetings 1739–1773, FHL film 0022417, p. 330, 331, 332, 334, 336, 339, 341, 342; Friends, Newport, RI, Monthly Meetings 1773–1799, FHL film 0022417, p. 41.

⁶⁵⁰ The certificate was granted in May 1787, after discussion at several subsequent meetings. See Friends, Newport, RI, Monthly Meetings 1773–1799, FHL film 0022417, p. 315, 318, 321, 360, 636.

seventy-nine. In his obituary, which appeared in *The United States Chronicle*, he was praised as “A Man who feared God and eschewed Evil.”⁶⁵¹

⁶⁵¹ *The United States Chronicle*, January 9, 1794, <http://infoweb.newsbank.com/>.

Joseph Proud (1711–1769)

Joseph Proud was born on April 2, 1711, near Gisburn in Yorkshire, England.⁶⁵² He was the son of John Proud (d. 1757) and Rebecca Fothergill (d. 1732).⁶⁵³ By 1714, the family had immigrated to Newport, where John Proud worked as a watch- and clockmaker.⁶⁵⁴ Joseph probably apprenticed in Newport, and would most likely have completed his training around 1732. He married Mary Wood (b. 1712–1771), the daughter of William Wood (c. 1675–1753) and Amy Clark (c. 1682–1726) of Newport, in or around 1735.⁶⁵⁵ Both families were Quakers and, on March 27, 1735, Joseph and Mary attended the Society of Friends women’s meeting in Portsmouth to announce their intention to wed. They attended a second meeting in April, where it was decided that there was nothing to hinder their marriage.⁶⁵⁶ The couple had at least three children: Amy (1736–1773), Rebecca (b. 1738), and Mary (1743–1777).⁶⁵⁷

Joseph Proud was an active member of the Religious Society of Friends, and his name appears frequently in monthly meeting minutes. On numerous occasions he was

⁶⁵² Arnold, *Vital Records of Rhode Island*, vol. 7, 70.

⁶⁵³ Will of John Proud, dated [August?] 22, 1757, proved November 7, 1757, NTCP, FHL film 0945000, vol. 12, p. 127-129. For Rebecca Fothergill Proud’s death date, see Arnold, *Vital Records of Rhode Island*, vol. 7, 116, and RIHCTP.

⁶⁵⁴ The Prouds probably moved to Newport in 1713 or 1714. According to Arnold’s *Vital Records of Rhode Island* (p. 70), John and Rebecca Proud’s daughter Hannah was born in England on November 30, 1712, and their son John was born in Newport on July 22, 1714. John Proud’s will mentions his watch- and clockmakers’ tools.

⁶⁵⁵ Arnold, *Vital Records of Rhode Island*, 83, 129. The date of their marriage is incorrectly recorded as March 17, 1730 (p. 27, 39). For Mary Wood Proud’s death date, see *Rhode Island Vital Records 1636–1850* (Online database: AmericanAncestors.org, New England Genealogical Society, 2002), originally published by James N. Arnold as *Vital Records of Rhode Island, 1636–1850. First series Births, marriages and deaths. A Family Register for the People* (Providence: Narragansett Historical Publishing Company).

⁶⁵⁶ Arnold’s *Vital Records of Rhode Island* (vol. 7, p. 27) incorrectly lists the date of their marriage as March 17, 1730. Society of Friends, RI Monthly Meetings, 1690–1759, March 27, 1735, FHL film 0022415, p. 75, and April 24, 1735.

⁶⁵⁷ Arnold, *Vital Records of Rhode Island*, vol. 7, 70; RIHCTP.

appointed to serve as a Newport representative for monthly and quarterly meetings.⁶⁵⁸ He assisted the Society with vetting potential new members, investigating the transgressions of existing Friends, obtaining certificates for visiting and traveling members, and enquiring into prospective marriages.⁶⁵⁹ Proud witnessed marriages as well, including that of cabinetmaker John Goddard (1723/4–1785) and Hannah Townsend (1728–1804) in 1746, in order to ensure that they were “orderly performed” or “decently consummated.”⁶⁶⁰ He was also entrusted with overseeing the maintenance of the Friends’ meeting house, and in 1744 submitted an account for £30 to cover expenses related to its care during the years 1742 and 1743.⁶⁶¹ Proud would no doubt have been well acquainted with fellow Quakers in the woodworking trades, and the minutes mention his name in conjunction with those of the cabinetmakers John Goddard and Christopher Townsend, the carpenter Isaac Lawton, and the chairmaker Timothy Waterhouse, who was his brother-in-law.⁶⁶² Proud also worked with Goddard and Waterhouse, as well as with the cabinetmaker Job Townsend, on estate appraisals, which he conducted regularly.⁶⁶³ Proud does not appear to have been particularly active in Newport public affairs, although he

⁶⁵⁸ For example, he represented Newport at the monthly meeting of September 25, 1740, and was appointed in September 1754 to attend the next quarterly meeting (Society of Friends, Newport, RI, Monthly Meetings 1739–1773, FHL film 0022417, p. 11, 128).

⁶⁵⁹ For examples of Proud performing these activities, see Society of Friends, Newport, RI, Monthly Meetings 1739–1773, FHL film 0022417, p. 54, 146, 175, 283.

⁶⁶⁰ Society of Friends, Newport, RI, Monthly Meetings 1739–1773, FHL film 0022417, p. 51–52.

⁶⁶¹ Society of Friends, Newport, RI, Monthly Meetings 1739–1773, FHL film 0022417, p. 35.

⁶⁶² Society of Friends, Newport, RI, Monthly Meetings 1739–1773, FHL film 0022417, p. 52–55, 149, 210, 275–276.

⁶⁶³ An inventory of the estate of Mary Goodspeed taken by Joseph Proud and Job Townsend was proved on September 6, 1756 (NTCP, FHL film 0945000, vol. 12, p. 57.); in 1762, Joseph Proud and John Goddard appraised the estate of Newport merchant David Lake (NTCP, FHL film 0945000, vol. 13, p. 179); and on November 30, 1745, Joseph Proud and Timothy Waterhouse took the inventory of Newport cordwainer Joshua Easton (NTCP, FHL film 0944999, vol. 9, p. 144).

did serve as one of the overseers of the poor in 1748, along with shopkeeper Caleb Gardner and upholsterer Robert Stevens.⁶⁶⁴

Joseph Proud was probably working as a Newport chairmaker from at least 1732, when he would have been twenty-one, and presumably would have finished his apprenticeship. In 1737, when his name appears in the ledger of Henry Ayrault, who supplied Proud with hardware in exchange for chairs.⁶⁶⁵ He is first identified as a Newport chairmaker in 1742, when he sued the physician John Brett for money due by book.⁶⁶⁶ Proud was involved in another legal dispute in 1750, when he sued Newport merchant Gideon Cornell for money due by note.⁶⁶⁷ Throughout the next two decades, Proud was involved in at least twelve court cases. The majority were related to attempts to collect money owed to two estates – those of Newport cordwainer Matthew Pate and Newport mariner James Hayden – for which he was an executor. At least three, however, involved debts owed to Proud himself. In May 1755, he successfully prosecuted Newport boat builder Jonathan Bowers to recover an unpaid balance of £228.13.7 on a note for £414.8.0.⁶⁶⁸ He was also victorious in a second case, in which he sued Newport joiner Jonathan Phillips Jr. for failing to pay £108.4 due by note. Phillips was unable to pay, and, in May 1758, Proud won a related lawsuit in which he sued Newport butcher

⁶⁶⁴ Newport County Court of General Sessions of the Peace, Record Book, November 15, 1748, p. 19.

⁶⁶⁵ Scotti and Ott, “Notes on Rhode Island Cabinetmakers,” 572.

⁶⁶⁶ Proud was awarded £7.19.0 plus court costs. See Joseph Proud, Newport, chairmaker v. John Brett, Newport, physician, May 1742 term, NCCCP Record Book, vol. B, p. 319.

⁶⁶⁷ Cornell was ordered to pay Proud £453.0.6 plus court costs. Cornell appealed the decision, but, in August 1750, Proud complained to the Newport County Superior Court that the merchant had not prosecuted his appeal. The court upheld its previous verdict and ordered Cornell to pay court costs. See Joseph Proud, Newport, chairmaker v. Gideon Cornell, Newport, merchant, May 1750 term, case 106, NCCCP RB, vol. C, p. 519; Proud v. Cornell, August 29, 1750, NCSC RB, vol. D, p. 216.

⁶⁶⁸ Joseph Proud, Newport, chairmaker v. Jonathan Bowers, Newport, boatbuilder, May 1757 term, case 291, NCCCP RB, vol. E, p. 481.

Thomas Cornell, who had acted as Phillips' bail and was therefore responsible for the debt.⁶⁶⁹ The fact that Proud was the plaintiff in all of the aforementioned court cases indicates that he was financially secure enough both to pay his own creditors and to lend substantial sums to others.

Joseph Proud's father, John, died in 1757, and his will names five sons, Joseph, John, William, Isaac, and Robert, and four daughters, Hannah, Rebecca, Mary, and Ann. Among the property bequeathed to his children was money arising from the sale of "four Lots of Land Situate Lying at the [Easton's] Point."⁶⁷⁰ The sale of the Easton's Point land is recorded in a deed that includes the names of Joseph and Mary Proud, John and Ann Proud, Timothy and Hannah [Proud] Waterhouse, and several other Proud children.⁶⁷¹ John Proud's will also specified that his watch- and clockmakers' tools be given to his grandson Timothy Waterhouse, who later became a merchant.⁶⁷²

There are two surviving accounts documenting Proud's work as a chairmaker. The first is a September 1743 account in which he bills the Colony for chair frames supplied in 1742 and 1743.⁶⁷³ A second invoice, dated June 1765, records the sale of six chairs to Dr. Christopher Champlin for £42 apiece.⁶⁷⁴ As noted by N. David Scotti in the

⁶⁶⁹ Joseph Proud, Newport, chairmaker v. Jonathan Phillips Jr., Newport, joiner, May 1757 term, NCCCP RB, vol. E, p. 439; Joseph Proud, Newport, chairmaker v. Thomas Cornell, Newport, butcher, May 1758 term, NCCCP RB, vol. E, p. 718; Proud v. Cornell, November 1758 term, NCCCP, RB, vol. F, p. 77.

⁶⁷⁰ Will of John Proud, dated [August?] 22, 1757, proved November 7, 1757, NTCP, FHL film 0945000, vol. 12, p. 127–129.

⁶⁷¹ Joseph Proud, *et al.*, to John Dockray, Newport, merchant, four lots being Lots 34, 41, 5-, --, 2nd Div, Easton's Point, B. ---- on Streets N. on the fifty fourth forty second and thirty ---- ---ty fourth and twenty third lots (cited in Notes on Joseph Proud, RIFA, YUAG).

⁶⁷² Timothy Waterhouse Jr., Newport, merchant v. Sarah Downer, Newport, widow, November 1765 term, NCCCP RB, vol. G, p. 492.

⁶⁷³ Rhode Island State Archives Treasurer's Receipts 1740s.

⁶⁷⁴ Scotti and Ott, "Notes on Rhode Island Cabinetmakers," 572.

May 1965 issue of *Antiques*, Chaplin's purchase of ten mahogany chair frames from John Goddard ten years later for £44 each suggests that Proud was making chairs of a similar quality.⁶⁷⁵

Joseph Proud died on August 28, 1769.⁶⁷⁶ His will, which is almost entirely illegible, names his wife, Mary, to whom he bequeathed "the Dwelling house where I now Live," and his daughters Ann Barney and Mary Clarke.⁶⁷⁷ It also includes a reference to "my shop standing in Friends Land adjoining to the shop of Samuel Easton."⁶⁷⁸ Proud's inventory, recorded by Philip Wanton and John Goddard, sheds further light on his trade. In addition to a variety of woodworking tools, his shop contained two lathes, a turning wheel, four benches, as well as "one Easie Chairs fraimes [£]30," "56 Chair Legs £15," "8 Maple Chairs almost finished £96," and "50 foot Black Walnut." The inventory also listed the contents of Proud's house, which included the following chairs: "50 Maple Chairs @ £12 £600," "1 Round About Do [maple] £12," "8 Black Walnut Do [roundabouts] @ £20 £160," "6 D^o [roundabouts @ £20] £120," and "6 D^o [roundabouts @ £20] £120." While the total value of Proud's estate is illegible, the aggregate amount of the legible valuations exceeds £2000.⁶⁷⁹

Joseph Proud was survived by at least two family members who continued to practice the chairmaking trade in Newport. His brother John Proud (1714–1794) and his brother-in-law Timothy Waterhouse (c.1715–1792) were both chairmakers, but it is not

⁶⁷⁵ Ibid.

⁶⁷⁶ RIHCTP.

⁶⁷⁷ Amy Proud had married Nathaniel Barney, a tanner, in 1756, and Mary Proud had married Nathaniel Clarke in 1762. See Arnold, *Vital Records of Rhode Island*, vol. 7, 27.

⁶⁷⁸ Will of Joseph Proud, proved October 2, 1769, NTCP, FHL film 0945000, vol. 16, p. 89.

⁶⁷⁹ Inventory of Joseph Proud, September 7, 1769, NTCP, FHL film 0945000, vol. 16, p. 90–91. Also cited in Scotti and Ott, "Notes on Rhode Island Cabinetmakers," 572.

known whether the three men worked together. It is possible that Waterhouse met his wife, Hannah Proud (1712–1802), through a business connection with one or both of her brothers. It is also unclear whether a family of Providence chairmakers by the name of Proud – William Proud (c. 1723–1779) and his sons Samuel (1762–1833) and Daniel (1762–1833) – were related to the Newport Prouds.⁶⁸⁰ Although it is tempting to assume that Joseph and John Proud’s brother William was the Providence chairmaker, his birth date is recorded in Arnold’s *Vital Records* as October 9, 1720.⁶⁸¹

⁶⁸⁰ RIFA, YUAG; RIHCTP.

⁶⁸¹ Arnold, *Vital Records of Rhode Island*, vol. 7, 70.

*William Robson (w. 1733; d. by 1737)*⁶⁸²

William Robson worked in Newport from at least 1733 until at least 1736.

Though nothing is yet known of his birth or family, evidence of his presence in Newport is found in the records of the Newport County Court of Common Pleas. During his lifetime, Robson was referred to in various court cases as a joiner. In two posthumous lawsuits, the first in 1737 and the second in 1738, he was, however, identified as a chairmaker and a cabinetmaker, respectively.

The first known court cases involving Robson were in 1735, when he was sued by two different Newport butchers, James Allen Jr. and Thomas Huxum, over unpaid accounts.⁶⁸³ A lengthy account from Allen details copious amounts of meat – including beef, lamb, mutton, and veal – provided to Robson from June 1733 to April 1735. The same bill also includes charges to Robson for meat sent to Newport joiner Moses Chaplin on four different occasions.⁶⁸⁴ Huxum charges Robson for the same types of meat, supplied from April to July 1734.⁶⁸⁵ The amount of meat ordered by Robson indicates that he was supporting a considerable number of people, which, in addition to his own family, may have included other woodworkers.⁶⁸⁶ Robson was absent when constable

⁶⁸² Robson's surname is written alternatively as "Robson," "Robinson," and "Robertson" in various historical documents.

⁶⁸³ James Allen Jr., Newport, butcher v. William Robinson, joiner, Newport, May 1735 term, case 134, NCCCP, RB, vol. A. p. 309; Thomas Huxum (Huxham), Newport, butcher, v. William Robson, Newport, joiner, May term 1735, case 151, NCCCP, RB, vol. A, p. 313.

⁶⁸⁴ The total amount of Allen's bill to Robson was £60.12.4. Account, June 1733 to April 1735, in case file, Allen v. Robinson.

⁶⁸⁵ At £6.12.9, the amount of Huxon's bill to Robson was significantly smaller than Allen's. Account, April 1734–August 1734, in case file, Huxum v. Robson.

⁶⁸⁶ Dennis Carr, Draft Biography of William Robson, RIFA, YUAG, 1–2.

Martin Howard tried to serve him the writ for the Huxum case, so Howard attached “one Small Key which was Del[ivere]^d to me by his . . . wife to be the proper Estate of her Husbands.”⁶⁸⁷

Several lawsuits were brought against Robson over the next few years, including a May 1736 case in which he was sued by the upholsterer John Moore over unpaid rent. Moore had leased “a Certain Shop in said Newport bounded west upon Thames” to Robson from May 1733 to February 1736, at a rate of £3 per quarter. The court ruled in favor of Moore, ordering Robson to pay £33 plus court costs.⁶⁸⁸ Robson was still alive in November 1736, when he was sued by tailor Samuel Pike over an unpaid note, but he had died by May 1737, when two lawsuits were brought against the executor of his estate, shopkeeper Samuel Rhodes.⁶⁸⁹

The first case, which documents Robson’s work as a joiner, involved a mahogany desk and bookcase commissioned by merchant Sueton Grant but never finished by Robson.⁶⁹⁰ The complaint filed by Grant’s lawyer stated that in July 1734 his client “did deliver and put into the Possession of the aforesaid William a parcell of mohogoney bords and Plank and other materials in order to be made up into a Book Case & Desk” but that “before the said Book Case & Desk was finished he the said William Died.”⁶⁹¹

The sale of the wood to Robson is recorded in Grant’s account book as a charge of £25

⁶⁸⁷ Writ, served May 7, 1735, in case file, Huxum v. Robson. Quoted in Carr, William Robson, 2.

⁶⁸⁸ John Moore, Newport, upholsterer v. William Robson, Newport, joiner, May 1736 term, case 185, NCCCP, RB, vol. A, p. 396; complaint, May 13, 1736, in case file, Moore v. Robson.

⁶⁸⁹ Samuel Pike, Newport, tailor v. William Robson, Newport, joiner, November 1736 term, case 177, NCCCP, RB, vol. A, p. 428.

⁶⁹⁰ Sueton Grant, Newport, merchant v. Samuel Rhodes, Newport, shopkeeper, executor of William Robson (deceased), Newport, joiner, May 1737 term, case 23, NCCCP, RB, vol. A, p. 435.

⁶⁹¹ Complaint, filed May 19, 1737, in case file, Grant v. Rhodes. Quoted in Carr, William Robson, 3.

“To Robinson ye Joyner for all the Board & Plank sold him in part of a Moho: Book Case & Desk he’s to finish in three Months.”⁶⁹² Grant’s use of the phrase “in part” suggests that only a portion of the mahogany provided to Robson was intended to be used in the fabrication of the desk and bookcase, indicating that Robson was making other mahogany furniture.⁶⁹³ The jury ruled that Rhodes, who had refused to give up possession the unfinished piece, had to pay Grant £20 plus court costs. Interestingly, the case file includes the testimony of Job Townsend Sr., who was called as a witness in the trial, and who recounted the following disagreement between himself and Robson over the desk and bookcase:

Job Townsend of Newport testifieth that some time in the year 1737 he had some discord with Sueton Grant about a Desk & Bookcase that he had a making at William Robinson of Newport (Deceased), & said Sueton Grant said that said Robinson had used him very ill & that he could not get him to Finish it & I told him ye said Grant that I would Taulk to said Robinson about it & persuade said Robinson to finish it & if he would not finish it he would Sew him & get me to make one for him & after some time said Grant told me he was so Poor that he would get nothing if he did Sew him – would have me take it to finish – accordingly I went to said Robinson told him what Mr Grant & I was Taulking about Finishing said Desk & he made answer & said “Damn it what business have you with it – I know how to finish my own work myself.”⁶⁹⁴

Townsend’s testimony sheds light on Robson’s dire financial situation, and also provides a fascinating insight into the relationship between two rival cabinetmakers.

In the second May 1737 lawsuit, Robson was referred to as a chairmaker. His executor, Rhodes, sued Robert Currie, identified as a glazier, late of Newport, for unpaid rent. Beginning on April 1, 1736, Robson had rented Currie “a small shop standing on

⁶⁹² Account from book of Sueton Grant, n.d., in case file, Grant v. Rhodes. Quoted in Carr, William Robson, 3.

⁶⁹³ Carr, William Robson, 3–4.

⁶⁹⁴ Original record in case file, Grant v. Rhodes. Quoted in Mabel M. Swan, “The Goddard and Townsend Joiners, Part I,” *Antiques* 49, no. 4 (April 1946): 230; and in Heckscher, *John Townsend*, 57, note 17.

Peleg Woods Wharf in Newport and to the Westward of Thomas Jones's House" for four and a half months, at a rate of £0.20.0 per month. The court ruled that Rhodes should recover £4.10.0 plus court costs from Currie.⁶⁹⁵ In the last known case involving Robson's estate, tried in May 1738, he was referred to as a cabinetmaker. Rhodes was sued by John Bazin, a Newport paver, over an unpaid account. The court ruled that Robson's estate pay Bazin £2.18.0 plus court costs.⁶⁹⁶

The identification of Robson as a chairmaker suggests that his output of furniture included a substantial number of chairs. And, given that he was a joiner and was working in mahogany, it is conceivable that Robson made framed chairs that would have been upholstered. This possibility is all the more intriguing considering that he rented his shop from the upholsterer John Moore, with whom he may have collaborated on upholstered seating furniture.

⁶⁹⁵ Samuel Rhodes, Newport, shopkeeper, executor of William Robson (deceased), late of Newport, chairmaker v. Robert Currie, late of Newport, glazier, May 1737 term, case 220, NCCCP, RB, vol. A., p. 463. Complaint, filed May 19, 1737, in case file, Rhodes v. Currie. Quoted in Car, William Robson, 4.

⁶⁹⁶ John Bazin, Newport, paver v. Samuel Rhodes, Newport, shopkeeper, executor of William Robson (deceased), late of Newport, cabinetmaker, May 1738 term, NCCCP, RB, vol. A, p. 528.

Timothy Waterhouse (c.1715–1792)

Timothy Waterhouse was born in Portsmouth, New Hampshire, in or around 1715.⁶⁹⁷ He was the son of Timothy Waterhouse (c. 1675–1748), a tanner and cordwainer, and Ruth Moses (1679–1769). Timothy's paternal grandparents were Richard Waterhouse (d. 1718), who was also a tanner, and Sarah Fernald (d. c. 1701).⁶⁹⁸ His maternal grandparents were probably Lieutenant Aaron Moses (c. 1650–1713) and Ruth Sherburne (1660–d. before 1686) of Portsmouth.⁶⁹⁹ In January 1727/8, Timothy's older sister Ruth (baptized 1710) married the charimaker John Gaines III (1704–1743).⁷⁰⁰ Gaines was the son of the Ipswich turner and chairmaker John Gaines II, and had moved to Portsmouth in 1724 to practice his trade.⁷⁰¹ Timothy Waterhouse would have been twelve or thirteen when his sister married, and it is highly probable that he apprenticed with his brother-in-law, although there is no evidence of this.

It is not known when Waterhouse moved to Newport, but the first record of his presence there is on January 28, 1738, when he and Hannah Proud (1712–1802) attended the Society of Friends women's meeting to announce their intention to wed. They were given permission to proceed with their union at a second meeting in February, and were

⁶⁹⁷ Timothy Waterhouse was baptized on August 14, 1715. Walter Goodwin Davis, *The Ancestry of Joseph Waterhouse, 1754-1837, of Standish, Maine* (Portland, Me: Anthoensen press, 1949), 9–12.

⁶⁹⁸ Davis, *The Ancestry of Joseph Waterhouse*, 4–6, 9.

⁶⁹⁹ Davis, *The Ancestry of Joseph Waterhouse*, 76–78. See also Charles Warren Brewster, *Rambles about Portsmouth: Sketches of Persons, Localities, and Incidents of Two Centuries* (Portsmouth, NH: Lewis W. Brewster, 1869), vol. 2, 45–46.

⁷⁰⁰ Davis, *The Ancestry of Joseph Waterhouse*, 11.

⁷⁰¹ Ethel Hall Bjercoe, *The Cabinetmakers of America* (Garden City, NY: Doubleday and Co., 1957), 99–100.

married in Newport on May 11, 1738.⁷⁰² Hannah Proud was the daughter of John Proud (d. 1757) and Rebecca Fothergill (d. 1732).⁷⁰³ She was born in or Gisburn in Yorkshire, England, but her Quaker family had immigrated to Newport by 1714.⁷⁰⁴ Her father was a Newport watch- and clockmaker, and her brothers, Joseph Proud (1711–1769) and John Proud Jr. (born 1712), were chairmakers.⁷⁰⁵ It is conceivable that Timothy Waterhouse worked for or with Joseph or John Proud when he came to Newport, and was thereby introduced to their sister. Timothy and Hannah had at least seven children: Sarah (b. 1739–d. before 1775), Samuel (1740–d. before 1775), Timothy (1742–d. before 1775), John (1744–1763), Ruth (b. 1746), Benjamin (1748–d. in infancy), Benjamin (1754–1846), and Rebecca (c. 1757–1822).⁷⁰⁶

Waterhouse adopted his wife's family's Quaker faith and became a prominent member of the Religious Society of Friends. He was regularly appointed to committees and often served as one of the Newport representatives for their monthly and quarterly

⁷⁰² Society of Friends, RI Monthly Meetings, 1690-1759, FHL film 0022415, p. 84. Davis, *The Ancestry of Joseph Waterhouse*, 11. James N. Arnold incorrectly lists the date of their marriage as March 17, 1730, in *Vital Records of Rhode Island*, vol. 7, 27, 38. Timothy Waterhouse was admitted as a freeman of Newport in 1740. See Davis, *The Ancestry of Joseph Waterhouse*, 23.

⁷⁰³ For Hannah Proud Waterhouse's life dates, see Arnold, *Vital Records of Rhode Island*, vol. 7, 70, and *The Newport Mercury*, May 25, 1802, <http://infoweb.newsbank.com/>. For the year of John Proud's death, see Will of John Proud, dated [August?] 22, 1757, proved November 7, 1757, NTCP, FHL film 0945000, vol. 12, p. 127–129. For Rebecca Fothergill Proud's death date, see Arnold, *Vital Records of Rhode Island*, 116, and RIHCTP.

⁷⁰⁴ Davis, *The Ancestry of Joseph Waterhouse*, 23. The Prouds probably moved to Newport in 1713 or 1714. Hannah was born in England on November 30, 1712, and her brother John was born in Newport on July 22, 1714.

See Arnold, *Vital Records of Rhode Island*, vol. 7, 70.

⁷⁰⁵ In his will, John Proud mentions his watch- and clockmakers' tools.

⁷⁰⁶ Arnold, *Vital Records of Rhode Island*, 38, 80–81, 128; Davis, *The Ancestry of Joseph Waterhouse*, 24–25. Their son Benjamin (1754–1846) became a prominent physician, and, in 1799, he introduced the small-pox vaccination in the United States after first testing it on himself and his family. There is a 1775 portrait by Gilbert Stuart (1755–1828) of Waterhouse as a young man in the collection of the Redwood Library and Athenaeum in Newport.

meetings.⁷⁰⁷ He also was frequently selected to inquire into marriage intentions and observe weddings, including that of Andrew Cozzens and Mary Townsend, Christopher Townsend's daughter, which he and John Goddard were appointed to observe.⁷⁰⁸ In addition to the Prouds, Waterhouse would no doubt have been well acquainted with other Friends in the woodworking trades, including the Goddard and Townsend families.⁷⁰⁹

When his father died in 1748, Timothy Waterhouse inherited a house and land in Portsmouth, which he sold in 1751.⁷¹⁰ Hannah Waterhouse also inherited land when her father, John Proud, died in 1757. Proud left his children "four Lots of Land Situate Lying at the [Easton's] Point," which were to be sold and the profits divided.⁷¹¹ The sale of the Easton's Point land is recorded in a deed that includes the names of Timothy and Hannah Waterhouse, John and Joseph Proud, and several other Proud children. John Proud bequeathed his watch and clockmakers' tools to his grandson Timothy Waterhouse.⁷¹²

The first reference to Timothy Waterhouse as a Newport chairmaker was in March 1746, when he was named an auditor in a court case between Eleazer Arnold, a

⁷⁰⁷ For example, Timothy Waterhouse and Christopher Townsend represented Newport at the March 1744 monthly meeting, and, on October 26, 1749, were appointed to attend the quarterly meeting. See Society of Friends, Newport, RI, Monthly Meetings 1739–1773, FHL film 0022417, p. 34, 79. For instances of Waterhouse serving on committees, see Society of Friends, Newport, RI, Monthly Meetings 1739–1773, FHL film 0022417, p. 104, 134, 135, 143, 216, 252–253, 272, 288, 290, 296–297, 302, 306, 320.

⁷⁰⁸ Society of Friends, Newport, RI, Monthly Meetings 1739–1773, FHL film 0022417, p. 255, 256, 257.

⁷⁰⁹ The Society of Friends meeting minutes mention his name in conjunction with those of John Goddard and Christopher Townsend. See Society of Friends, Newport, RI, Monthly Meetings 1739–1773, FHL film 0022417, p. 34, 35, 75, 79, 111, 147, 255, 256, 257; Society of Friends, Newport, RI, Monthly Meetings 1773–1790, FHL film 0022418, p. 112.

⁷¹⁰ Davis, *The Ancestry of Joseph Waterhouse*, 10–11, 24.

⁷¹¹ Will of John Proud, August 22, 1757, NTCP, FHL film 0945000, vol. 12, p. 127.

⁷¹² Will of John Proud, dated [August?] 22, 1757, proved November 7, 1757, NTCP, FHL film 0945000, vol. 12, p. 127–129.

blacksmith, and Robert Taylor, a merchant.⁷¹³ In addition to working as a chairmaker, he conducted estate appraisals, including that of Samuel Ellis, identified as a Newport carver, whose inventory included ten carving tools valued at £0.15.0.⁷¹⁴ Waterhouse was evidently highly regarded in Newport, and served on the Town Council in at least 1754, when he attended a meeting in the role of councilman.⁷¹⁵ In 1781 he was elected to serve as a deputy of the Rhode Island General Assembly, and from 1781 to 1791 he was a justice of the Newport County Court of Common Pleas.⁷¹⁶

There are several surviving accounts documenting Waterhouse's work as a chairmaker. In 1755, he sued Newport cooper George Whitehorn over an unpaid account for chairs. The bill shows that Waterhouse provided Whitehorn with six chairs in October 1754 for fourteen pounds and six more in November of the same year for ten pounds.⁷¹⁷ Waterhouse also supplied chairs to his son, Timothy Jr., who, despite inheriting his grandfather's tools, was working as a shopkeeper by 1763 and was engaged in mercantile pursuits as early as 1765.⁷¹⁸ A surviving account from Timothy Sr. to Timothy Jr.

⁷¹³ NCSC, RB, vol. C, p. 396.

⁷¹⁴ Inventory of Samuel Ellis, Newport, carver, June 3, 1745, NTCP, FHL film 0944999, vol. 10.

⁷¹⁵ NTCP, FHL film 0944999, vol. 11, p. 232. By July 1756, Waterhouse was no longer listed among the councilmen (NTCP, FHL film 0944999, vol. 11, p. 44).

⁷¹⁶ Davis, *The Ancestry of Joseph Waterhouse*, 24.

⁷¹⁷ Timothy Waterhouse, Newport, chairmaker v. George Whitehorn, Newport, cooper, May 1755 term, case 540, NCCCP RB, vol. E, p. 92.

⁷¹⁸ Timothy Waterhouse Jr. had begun a business with his younger brother John, who died in 1763. He is referred to in a May 1766 court case as the "only survivor of the partnership of Timothy Waterhouse Jr. and John Waterhouse." See Jacob Barney Jr., Newport, hatter v. Timothy Waterhouse Jr., Newport, merchant, May 1766 term, case 13, NCCCP RB, vol. G, p. 594. For the first references to Waterhouse Jr. as a shopkeeper and merchant, see George Lawton and Timothy Waterhouse Jr., Newport, shopkeepers v. Robert Barker, Bristol, innholder, May 1763 term, NCCCP RB, vol. F, p. 35; and Timothy Waterhouse Jr., Newport, merchant v. Sarah Downer, Newport, widow, November 1765 term, NCCCP RB, vol. G, p. 492.

includes chairs provided by the former to the latter in November 1765.⁷¹⁹ Listed on the bill are six chairs for £40, one great chair for £14, and twelve chairs for £60.⁷²⁰ Timothy Jr. was almost certainly exporting some of the chairs made by his father. A 1766 lawsuit with George Cornell, indentified as a Newport gentleman, reveals that Timothy Jr. provided desks and chairs for shipment to North Carolina.⁷²¹ The case file contains a 1764 bill from Cornell to Waterhouse Jr. for £3.3.2 (North Carolina currency), which includes freight costs for transporting the desks and chairs to North Carolina, storage of the furniture, and commission on its sale.⁷²² An account from Waterhouse itemizing the furniture sold by Cornell on his behalf includes charges, also in North Carolina currency, of £10 for “2 Desks,” £2.15.0 for “1 Doz Chairs,” and £1 for “¹/₂ Doz D^o.”⁷²³ Timothy Waterhouse Jr.’s suit was successful, and Cornell was ordered to pay £12.15.0 minus the £3.3.2 charge for freight, storage, and commission.⁷²⁴

In 1774, Timothy Waterhouse supplied chairs to the Newport Colony House. An account for chairs ordered by the General Assembly includes “1 Dozⁿ Slit Back Chairs

⁷¹⁹ The account is related to a May 1766 lawsuit in which Timothy Jr. was sued by James Rodman over an unpaid note for £863. When the sheriff could not locate Timothy Jr., he noted on a writ that he had “attached his personal Estate in ye hands of Timothy Waterhouse Senior.” In the case file is a three-page inventory of Timothy Jr.’s shop goods, recorded by Timothy Sr., which includes an assortment of fabrics and trimmings, sewing supplies, gloves, stockings, handkerchiefs, snuff boxes, whips, rugs, a “Chery Tree Desk,” and many other sundry items. See James Rodman, Newport, mariner v. Timothy Waterhouse Jr., Newport, shopkeeper, May 1766 Term, case 149, NCCCP RB, vol. G, p. 608.

⁷²⁰ Account, May 28, 1766, in case file, Rodman v. Waterhouse Jr.

⁷²¹ Timothy Waterhouse Jr., Newport, merchant v. George Cornell, Newport, gentleman, May 1766 term, case 213, NCCCP RB, vol. G, p. 582.

⁷²² Account from Cornell to Waterhouse Jr., November 20, 1764, in case file, Waterhouse Jr. v. Cornell.

⁷²³ Account from Waterhouse Jr. to Cornell, 1765, in case file, Waterhouse Jr. v. Cornell. The invoice total of £12.15.0 (North Carolina currency) was incorrectly tallied, and is a pound short

⁷²⁴ Timothy Waterhouse Jr. was also awarded £3.9.6 ¹/₄ (lawful money) for another unpaid bill to Cornell for sundry items that included snuff, paper, hose, shoes, thread, ribbon, gimp, ferret [tape], muslin, and tammy

for the Colony house,” which Waterhouse supplied for £3.⁷²⁵ A second invoice, dated June 1776, documents another £0.18.7 ¼ paid to Waterhouse for “mending Varnishing and Bottoming eight chairs for the Colony House in Newport.”⁷²⁶ The chairs requiring repairs were very likely those he had supplied in 1774, which would have had flag (or rush) bottoms. The last known record of chairs supplied by Waterhouse is a 1786 account to Clarke Rodman for “1 doz. chairs at different times [£]4-16-0” and “a small chair [£]0-5-0.” Also included on the bill was a charge of £0.5.0 for “mending 2 chairs.”⁷²⁷

Timothy Waterhouse died in Newport on March 20, 1792.⁷²⁸ His obituary, published in *The Herald of the United States*, reads: “Died – At Newport, the Hon. Timothy Waterhouse, Esq; aged 78; a gentleman, long esteemed and respected as a citizen, and as a Magistrate.”⁷²⁹ *The United States Chronicle* also recorded his death, referring to him as a “Gentleman universally respected and beloved by all who knew him.”⁷³⁰ In 1796, his widow, Hannah, son Benjamin, and daughter Rebecca advertised the sale of “The House and Lot of Land, which belonged to the late Timothy Waterhouse,” described as “pleasantly situated near the Centre of Town . . . bounded Two Sides on a Street, and fronts a pleasant Square.”⁷³¹ The house was purchased in

⁷²⁵ Timothy Waterhouse Bill to Colony House, December 1774, Rhode Island State Archives Treasurer’s Receipts 1740s.

⁷²⁶ Timothy Waterhouse Bill to Colony House, June 1776, Rhode Island State Archives Treasurer’s Receipts 1740s.

⁷²⁷ Joseph K. Ott, “Still More Notes on Rhode Island Cabinetmakers and Allied Craftsmen,” *Rhode Island History* 28, no. 4 (November 1969), 119.

⁷²⁸ Davis, *The Ancestry of Joseph Waterhouse*, 24.

⁷²⁹ *Herald of the United States*, April 7, 1792, <http://infoweb.newsbank.com/>.

⁷³⁰ *United States Chronicle*, April 12, 1792, <http://infoweb.newsbank.com/>.

⁷³¹ *Newport Mercury*, June 28, 1796, <http://infoweb.newsbank.com/>.

August 1797 by Matthew Barker for 500 Spanish milled dollars.⁷³² Hannah died in 1802 in Cambridge, Massachusetts, where she was probably living with her son Dr. Benjamin Waterhouse, who taught at Harvard from 1783 to 1812.⁷³³ Her obituary, published in *The Newport Mercury*, read: “Died – At Cambridge (Mas.) very suddenly, Mrs. Hannah Waterhouse, widow of the late Timothy Waterhouse, Esq. of this town, in the 90th year of her age. She was a native of Yorkshire in England; and distinguished through life for a placid temper; and enlarged understanding.”⁷³⁴

⁷³² NLE, vol. 6, p. 598. Cited in Davis, *The Ancestry of Joseph Waterhouse*, 24.

⁷³³ Davis, *The Ancestry of Joseph Waterhouse*, 24.

⁷³⁴ *The Newport Mercury*, May 25, 1802, <http://infoweb.newsbank.com/>.

Illustrations



Figure 1: Trade Card of Christopher Gibson, London, 1730–1742, Victoria and Albert Museum, London.



Figure 2: “Menuiserie en Meubles, Sieges,” from *Encyclopédie, ou dictionnaire raisonné des sciences, des arts et des métiers, etc.*, eds. Denis Diderot and Jean le Rond D’Alembert. University of Chicago: ARTFL Encyclopédie Project (Spring 2011 Edition), Robert Morrissey (ed), <http://encyclopedie.uchicago.edu/>.



Figure 3: Bedstead, 1760-1800, Connecticut. Metropolitan Museum of Art, New York (49.91). The carved cornice is upholstered in blue and white cotton. Originally, there would probably have been a long curtain at the foot of the bed. See Florence M. Montgomery, *Textiles in America, 1650–1870* (New York and London: W. W. Norton & Company, 1988), 34, fig. 24.



Figure 4: Original show fabric of an easy chair, probably made in Newport, 1725–1755, Daniel Putnam Association, Brooklyn, CT.



Figure 5: John Hamilton Mortimer, Sergeant-at-Arms Bonfoy, His Son, and John Clementson, Sr., England, ca. 1770, Paul Mellon Collection, Yale Center for British Art, New Haven, CT

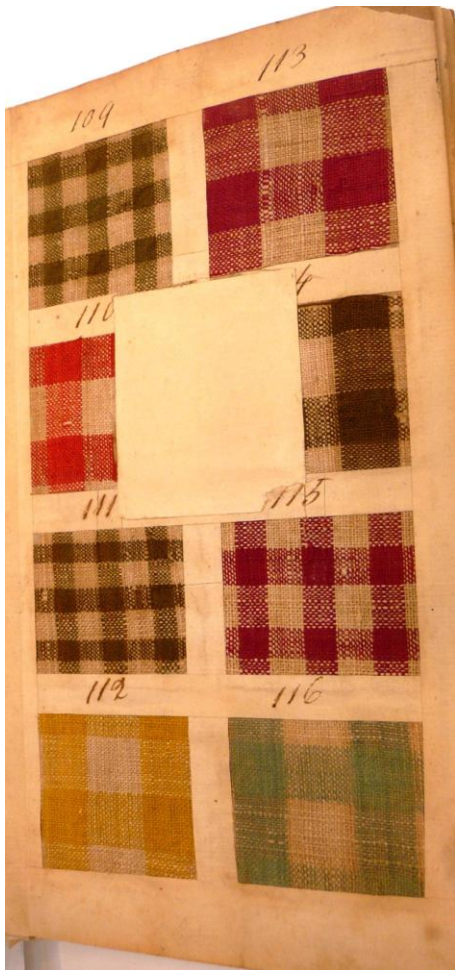

Figure 6: Sample Book of Benjamin and John Bower, April 1, 1771, Metropolitan Museum of Art, New York.

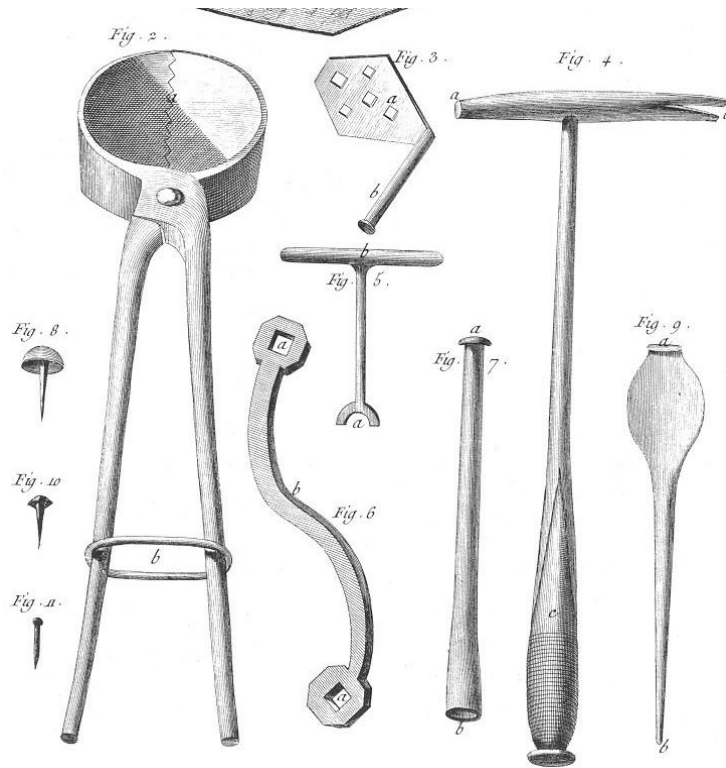

Figure 7: Upholsterer's tools, from *Encyclopédie, ou dictionnaire raisonné des sciences, des arts et des métiers, etc.*, eds. Denis Diderot and Jean le Rond D'Alembert. University of Chicago: ARTFL Encyclopédie Project (Spring 2011 Edition), Robert Morrissey (ed), <http://encyclopedie.uchicago.edu/>.



Figure 8: Slip seat with early webbing and sack cloth, Newport, 1760–1785, Metropolitan Museum of Art (accession number : 2011.221), New York.



Figure 9a: Slat-back chair (RIF4151), Rhode Island, 1725–1750. Reprinted from Luke Vincent Lockwood, *Colonial Furniture in America*, vol. 2 (New York: Charles Scribner's Sons, 1926), 18, fig. 427.

Figure 9b: Banister-back chair (RIF445), Newport, 1720–1740. Private Collection. Photo: Rhode Island Furniture Archive, Yale University Art Gallery.

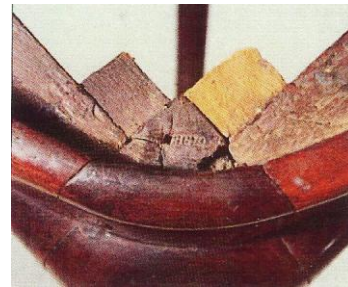

Figure 10a (left): Roundabout chair (RIF1097), Newport, 1755–1780, mahogany. Private Collection. Reprinted from *American Antiques from Israel Sack Collection*, vol. 10, p. 84, plate IX.

Figure 10b (above): Chair in figure 10a, showing top surface of front leg with Gibbs stamp. Reprinted from Harold Sack and Deanne Levison, "American Roundabout Chairs," *Antiques* 139, no. 5 (May 1991): 942, plate IXa.

Figure 11: Side chair, formerly attributed to “School of John Gaines, Portsmouth, NH,” 1730–1750. Reprinted from Israel Sack, Inc., *American Antiques from Israel Sack Collection*, vol. 4 (Alexandria, VA: Highland House Publishers, 1974), 937, fig. P5052.



Figure 12: Side chair, attributed to John Gaines III (1704–1743), Portsmouth, NH, 1735–1743. Maple. Private Collection. The chair descended in the Brewster family. John Gaines’ daughter, Mary, married Plymouth joiner David Brewster (1739–1818). Reprinted from Brock W. Jobe and Diane C. Ehrenpreis, *Portsmouth Furniture: Masterworks from the New Hampshire Seacoast* [exhibition catalog] (Hanover, NH: University Press of New England, 1993), 48, fig. 30.

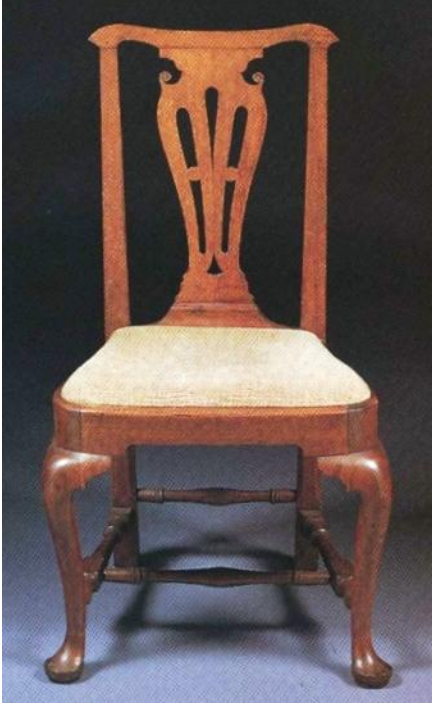

Figure 13: Side chair (RIF1864), Rhode Island, 1740-1750. Walnut. Christie's, New York, January 22, 1994, lot 273.



Figure 14: Side chair (RIF380), attributed to John Townsend, 1750-1775. Maple, white pine, chestnut. Newport Restoration Foundation, Newport, Rhode Island, 1999.537.2.



Figure 15: Detail of chair in Figure 14, showing Townsend-style ball-and-claw foot.



Figure 16: Detail of chair in Figure 14, showing crest with central carved embellished with diaper pattern.



Figure 17: Arm chairs (RIF4433 and RIF1675), probably made by John Townsend, 1785–1800. Mahogany, maple, pine. Christie's, New York, January 20, 2012, lots 148 and 149.



Figure 18: Detail of chair (Figure 17) with upholstered arm panels, showing arched front surface of the arm support.



Figure 19: Side chair, probably made in Newport, 1725-1745. Maple with original leather upholstery. Newport Historical Society, Rhode Island (1885.2).

Photo: Newport Historical Society



Figure 20: Detail of figure 19. The original, sackcloth, webbing, and double-stuff stitching are visible on the underside of the chair's seat.



Figure 21: Detail of figure 19. The marsh grass stuffing is visible through a tear in the sackcloth on the underside of the seat.



Figure 22: Detail of figure 19. Trim strips on side seat rail secured with a row of brass nails above a row of rose head nails.



Figure 23: Detail of figure 19. Original leather seat with double-stuff stitching secured with leather buttons.



Figure 24: Detail of figure 19. Original sackcloth on outer surface of back panel.

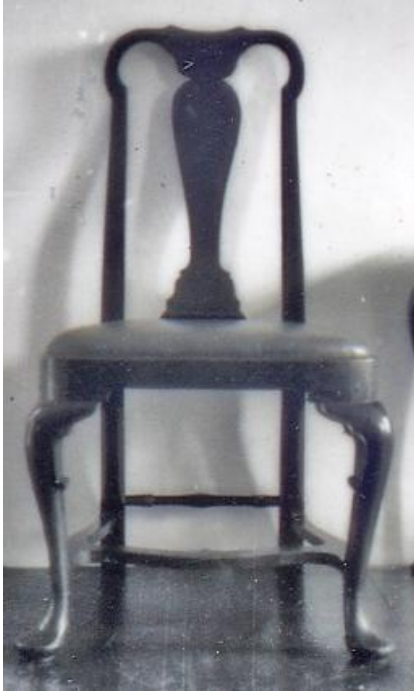

Figure 25: Side chair, 1730–1760, probably made in Newport. Walnut and maple. Newport Historical Society, Newport, Rhode Island (1960.1.1). Photo: Newport Historical Society.

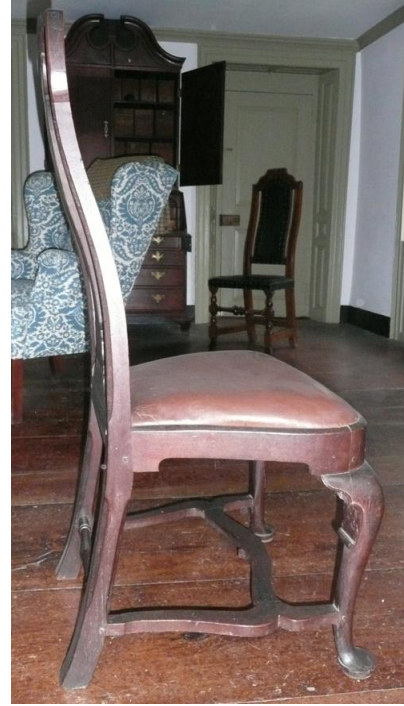

Figure 26: Side view of Newport Historical Society side chair.



Figure 27: Side chair, 1730–1760, probably made in Newport. Walnut and pine or maple. The Art Institute of Chicago, Chicago, IL (1979.54).



Figure 28: Side chair, 1725–1740, probably made in Boston. Walnut. Preservation Society of Newport County, Newport, Rhode Island (PSNC.1787a-b). Courtesy of The Preservation Society of Newport County.



Figure 29: Side chair, attributed to John Goddard, c. 1762, Newport. Mahogany. Christie's, New York, *Important American Furniture and Folk Art*, January 20, 2012, lot 114.



Figure 30a: Rear stretcher of the Newport Historical Society chair.

Figure 30b: Rear stretcher of the Metropolitan Museum of Art's Caleb Gardner easy chair (see fig. 50).



Figure 31a: Proper left front foot of the Newport Historical Society side chair.



Figure 31b: Proper left front foot of the Metropolitan Museum of Art's Caleb Gardner easy chair (see fig. 50).



Figure 32: Slip seat of the Newport Historical Society side chair showing what appears to be the original foundation upholstery.



Figure 33: Side chair, Newport, 1755–1775. Mahogany, maple, and chestnut. Metropolitan Museum of Art (2011.221), New York. Photo: Metropolitan Museum of Art.



Figure 34: Detail of chair pictured in Figure 33. Lower edges of volutes on the splat are not delineated.



Figure 35: Back of chair in Figure 33.



Figure 36: Detail of Figure 33.



Figure 37: Slip seat of chair in Figure 33. Webbing, sack cloth, stuffing, and linen are probably original.



Figure 38: Side chair, Newport, 1755–1775. Mahogany and cherry. Museum of Fine Arts, Boston (39.172). The rear legs are unchamfered.

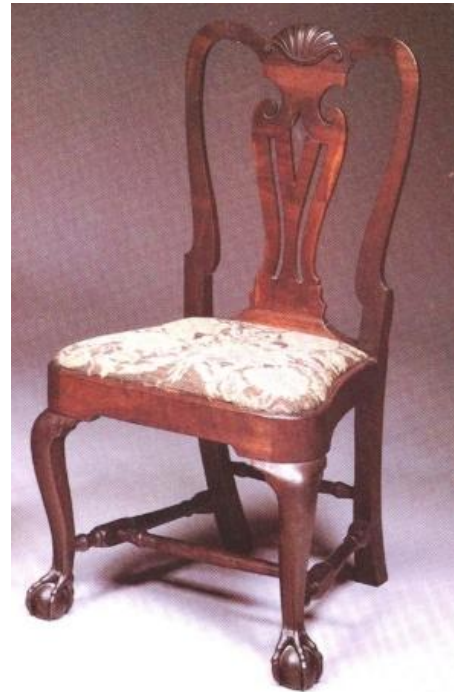

Figure 39: Side chair, Newport, 1755–1775. Mahogany. Christie's, New York, January 17, 1992, lot 426. The rear legs are unchamfered and the scrolls of splat are partially delineated.

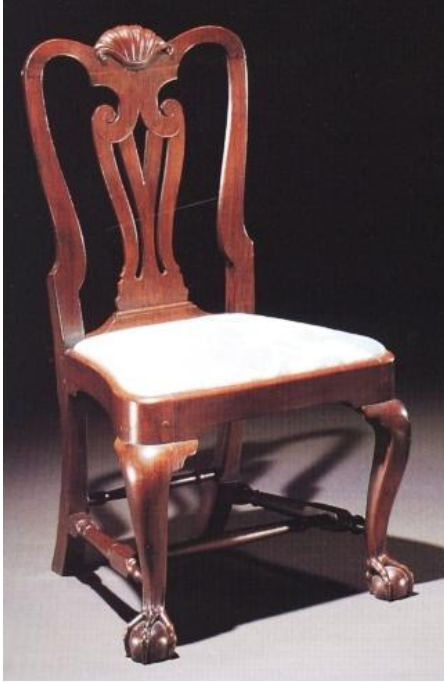

Figure 40: Side chair, Newport, 1755–1775. Mahogany. Christie's, New York, January 27–28, 1995, lot 1089. The rear legs are chamfered between rear rail and stretcher and the scrolls of the splat are fully delineated.



Figure 41: Side chair, Newport, 1755–1775. Mahogany, chestnut, and maple. Rhode Island Historical Society (1953.1.25), Providence.



Figure 42: Side chair, Newport, 1760–1785. Mahogany and maple. Metropolitan Museum of Art (55.134), New York.



Figure 43: Armchair, probably Newport, 1740–1760. Mahogany, maple. Winterthur Museum and Country Estate, Winterthur, Delaware.



Figure 44: Armchair, probably Newport, 1740–1760. Mahogany, cherry. Christie's, New York, January 20, 2012, lot 138.

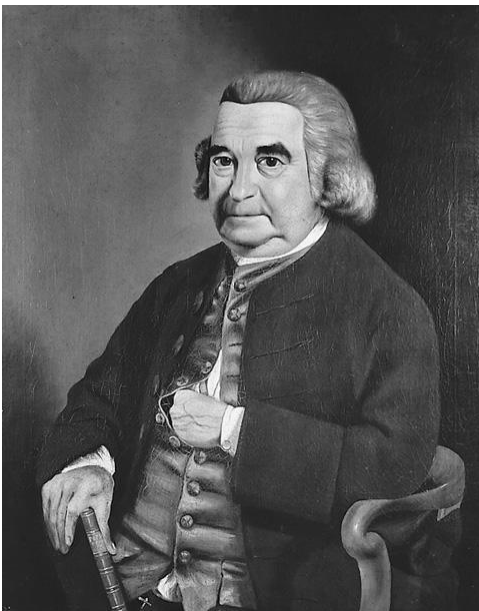

Figure 45: Abraham Redwood II, attributed to Samuel King, Newport, 1773–1780. Oil on canvas. 42 1/2" x 33 1/2". Collection of the Redwood Library and Atheneum, Newport (www.redwoodlibrary.org).



Figure 46: Armchairs, 1740–1760, New York. Walnut, ash, white pine. Metropolitan Museum of Art (11.60.148, .149).



Figure 47: Detail of chair pictured in Figure 44, showing laying out lines at juncture of dovetailed front leg and seat rail.



Figure 48: Detail of chair pictured in Figure 43, showing original webbing and sack cloth.



Figure 49: Detail of chair pictured in Figure 43, showing decorative nail treatment of stile and arm support. The column of nails at the juncture of the seat and stile secures both seat leather and the leather that wraps around the stile from the outside back panel.



Figure 50: Easy Chair, upholstered by Caleb Gardner Jr., 1758, Newport. Walnut and maple. Metropolitan Museum of Art, New York (50.228.3).

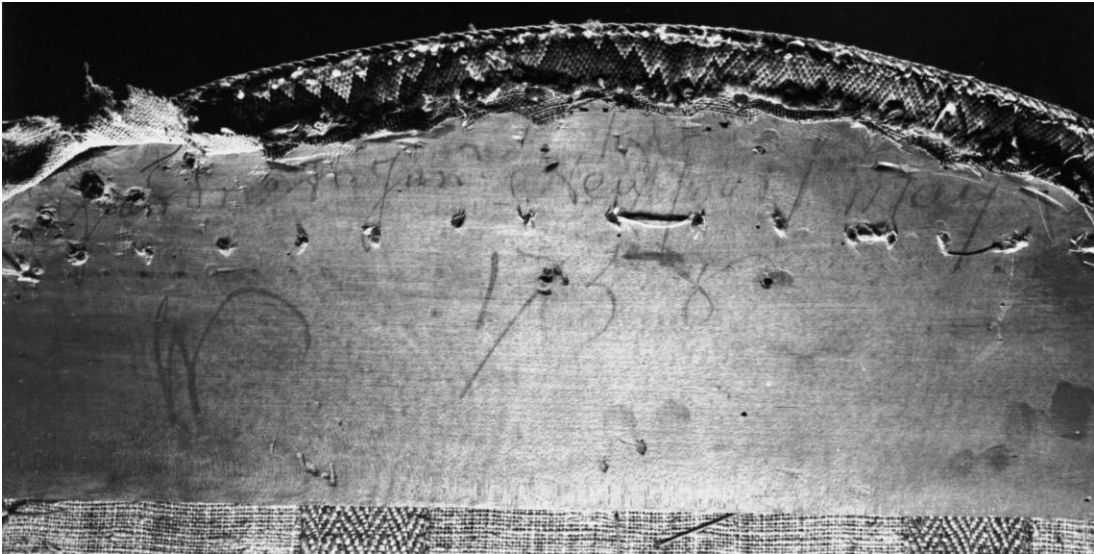

Figure 51: Detail of Gardner easy chair showing the graphite inscription on the rear face of the crest.



Figure 52: View of Gardner easy chair showing wing profile and prominent ring of side stretcher.



Figure 53: Easy Chair, Newport, 1740–1760. Walnut and maple. Private collection. Photo: Rhode Island Furniture Archive, Yale University Art Gallery.



Figure 54: Easy Chair, Newport, 1740–1760. Mahogany. Preservation Society of Newport (PSNC.1716a-b). Courtesy of The Preservation Society of Newport County.



Figure 55: Detail of Gardner chair showing embroidered back panel. Photo: Metropolitan Museum of Art, New York.



Figure 56: Detail of Gardner chair showing the underside of the seat frame.



Figure 57: Detail of Gardner chair showing three-chevron pattern of twill webbing.



Figure 58: Detail of Gardner chair showing remnants of cord and false crest. None of the tape that originally encased the cord has survived.



Figure 59: Detail of Gardner chair showing remnants of green tape on the arm cone, and of green and black tape on the right proper side seat rail. In both locations, the tape is held in place with polished iron nails.



Figure 60: Easy Chair, possibly Newport, 1725–1755. Walnut, maple, oak. Colonel Daniel Putnam Association, Brooklyn, CT.



Figure 61: Easy chair, Boston, 1700–1710. Maple and oak. Winterthur Museum and Country Estate, Delaware.



Figure 62: Easy chair, Newport, 1780–1800. Mahogany and cherry. Private collection.



Figure 63: Detail of Malbone chair showing the joint of the front and side seat rails and the front leg.



Figure 64: Detail of crest of Malbone chair. The tape on the crest does not survive, but the dark shadow shows its original location.



Figure 65: Detail of Malbone chair showing underside of seat with original webbing and sack cloth. While the strips of webbing running from side to side are woven in the typical lattice pattern, the three strips running front to back are woven over two, under one; under two, over one; and over two, under one.



Figure 66: Detail of Malbone chair showing the cushion, front seat rail, and straw edge roll.



Figure 67: Detail of Malbone chair showing the back panel with original webbing, sack cloth. Also visible within the upper middle square formed by the webbing is the triangle of twine stitches.



Figure 68: Detail of Malbone chair showing the top of arm cone with straw edge roll, horsehair stuffing, and skimmer of horsehair on top of arm panel.



Figure 69: Detail of the Malbone chair showing multiple layers of fabric on the rear seat rail. Also visible are the marsh grass stuffing of the back panel, the maple of the stile, and the dyed rear leg.



Figure 70: Detail of proper left rear seat rail of Malbone chair showing decorative tape with chevron pattern and polished iron tacks.



Figure 71: Detail of cushion showing the striped "tick" encasing the feather stuffing and the raised decorative seams.



Figure 72a: Easy chair, Newport, 1775–1790. Mahogany, yellow pine, yellow poplar.



Figure 72b: Photo of the chair before re-upholstering.



Figure 73: Easy chair, Philadelphia. Reprinted from *The Magazine Antiques* (February 1973), p. 329, fig. 3. This chair descended in the John Brown family and may be one of the easy chairs procured by John Relfe from Plunkett Fleeson in 1761/2 or 1764.



Figure 74: Easy chair, probably made in Philadelphia, 1760–1780. Mahogany, birch, maple, pine. Reprinted from *Philip and Ann Holzer, Philip and Ann Holzer Collection* (1990), 63.



Figure 75: Detail of chair in Figures 72a and 72b showing leather used to create ramp connecting the horizontal and vertical elements of the C-scroll arms. Photo: Gavin Ashworth.



Figure 76: Detail of chair in Figures 72a and 72b showing joint of the rear leg and stile. Photo: Gavin Ashworth.



Figure 77: Detail of chair in Figures 72a and 72b showing webbing on stay rail reinforced with leather strip. Photo: Gavin Ashworth.



Figure 78: Detail of chair in Figures 72a and 72b showing surviving foundation upholstery of arm and wing panel. Photo: Gavin Ashworth.

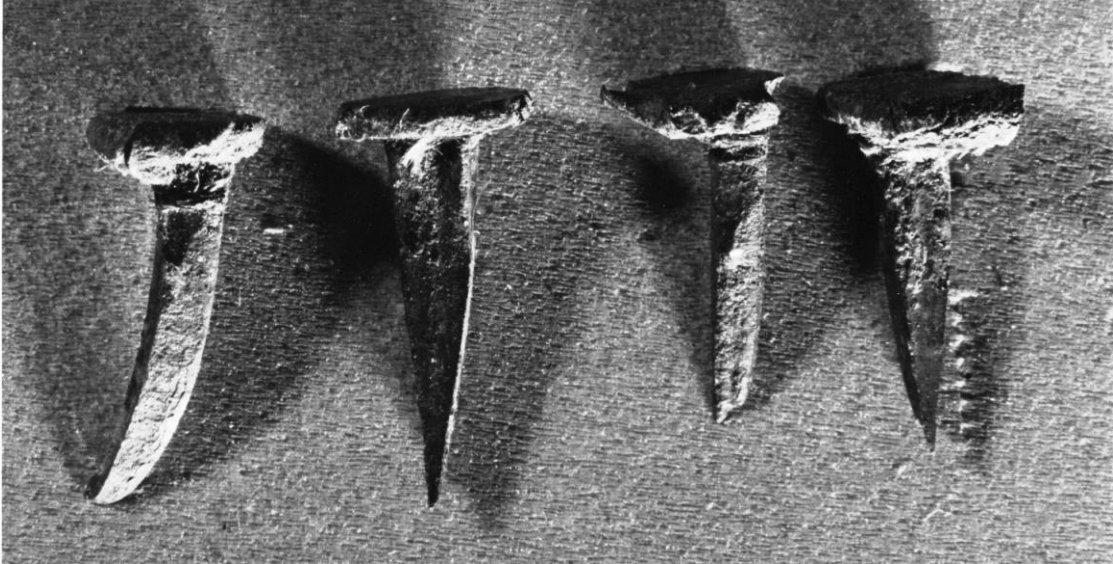

Figure 79: Detail of original upholstery tacks with cut shanks and wrought heads. Possibly made by Jeremiah Wilkinson of Cumberland, Rhode Island. Photo: Gavin Ashworth.



Figure 80: Easy chair, Newport, 1760–1790. Mahogany. Private collection. Christie's, New York, January 18–19, 2001, lot 59.



Figure 81: Easy chair, Newport, 1760–1790. Mahogany. Newport Historical Society, Rhode Island.



Figure 82: Easy chair, Newport, 1780–1800. Mahogany and maple.

Photo: Keno Auctions, New York, *Important Americana, Paintings, Furniture and Decorative Arts* (January 17, 2012), lot 84, <http://kenoauctions.com/>.

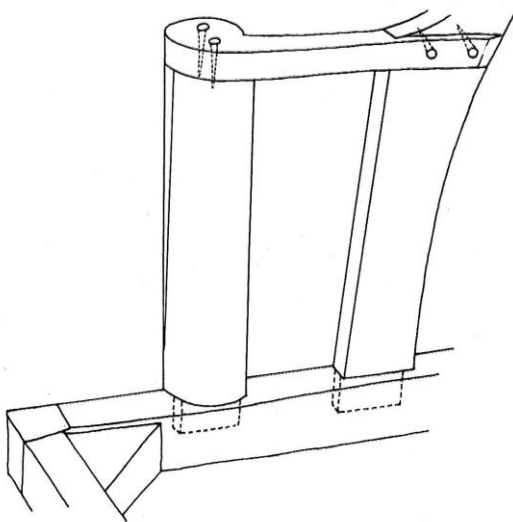

Figure 83: Diagram showing the typical arm construction of easy chairs of the vertical scroll variety.

Reprinted from Morrison H. Heckscher, "Form and Frame: New Thoughts on the American Easy Chair," *Antiques* 100, no. 6 (December 1971): 893.



Figure 84: Detail of chair in figure 82, showing joint of rear leg and stile.



Figure 85: Detail of chair in figure 82, showing original webbing and sackcloth of back panel.



Figure 86: Detail of chair in figure 82, showing inside of wing panel. The tears reveal hair stuffing, but no edge roll. Also visible are the stitches that join the linen of the front panel to another strip of linen.



Figure 87: Easy chair fitted with chamber pot, 1795–1810, probably made in Rhode Island. Birch, white pine, maple. Colonial Williamsburg, Williamsburg, VA, (1977-215).

This easy chair was upholstered in plain linen, and would have been fitted with a case. There is no evidence of a show fabric having been attached to the frame. The front and back panels of linen are sewn together.

Photo: Colonial Williamsburg.



Figure 88: Detail of chair in figure 82, showing what appears to be the original show fabric beneath a rose head nail.



Figure 89: Mrs. Robert Stevens (née Anstris Elizabeth Wignall, 1723–1802), attributed to John Singleton Copley, c. 1740–1750, Newport Historical Society (1886.1).



Figure 90: Robert Stevens' former house stands at 31 Clarke Street, Newport. Stevens purchased the house from Comfort Hatch in 1742.