

4. HVAC AND REFRIGERATION SYSTEM

Syllabus

HVAC and Refrigeration System: Vapor compression refrigeration cycle, Refrigerants, Coefficient of performance, Capacity, Factors affecting Refrigeration and Air conditioning system performance and savings opportunities.

Vapor absorption refrigeration system: Working principle, Types and comparison with vapor compression system, Saving potential

4.1 Introduction

The Heating, Ventilation and Air Conditioning (HVAC) and refrigeration system transfers the heat energy from or to the products, or building environment. Energy in form of electricity or heat is used to power mechanical equipment designed to transfer heat from a colder, low-energy level to a warmer, high-energy level.

Refrigeration deals with the transfer of heat from a low temperature level at the heat source to a high temperature level at the heat sink by using a low boiling refrigerant.

There are several heat transfer loops in refrigeration system as described below:

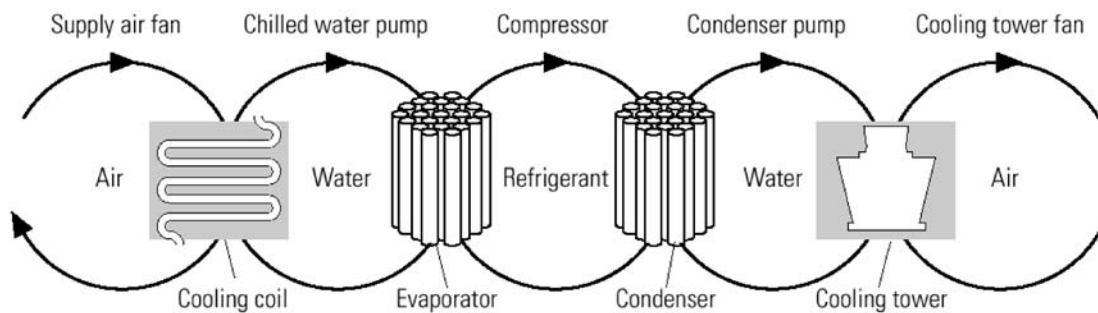

Figure 4.1 Heat Transfer Loops In Refrigeration System

In the Figure 4.1, thermal energy moves from left to right as it is extracted from the space and expelled into the outdoors through five loops of heat transfer:

- **Indoor air loop.** In the leftmost loop, indoor air is driven by the supply air fan through a cooling coil, where it transfers its heat to chilled water. The cool air then cools the building space.
- **Chilled water loop.** Driven by the chilled water pump, water returns from the cooling coil to the chiller's evaporator to be re-cooled.
- **Refrigerant loop.** Using a phase-change refrigerant, the chiller's compressor pumps heat from the chilled water to the condenser water.
- **Condenser water loop.** Water absorbs heat from the chiller's condenser, and the condenser water pump sends it to the cooling tower.
- **Cooling tower loop.** The cooling tower's fan drives air across an open flow of the hot condenser water, transferring the heat to the outdoors.

Air-Conditioning Systems

Depending on applications, there are several options / combinations, which are available for use as given below:

- Air Conditioning (for comfort / machine)
- Split air conditioners
- Fan coil units in a larger system
- Air handling units in a larger system

Refrigeration Systems (for processes)

- Small capacity modular units of direct expansion type similar to domestic refrigerators, small capacity refrigeration units.
- Centralized chilled water plants with chilled water as a secondary coolant for temperature range over 5°C typically. They can also be used for ice bank formation.
- Brine plants, which use brines as lower temperature, secondary coolant, for typically sub zero temperature applications, which come as modular unit capacities as well as large centralized plant capacities.
- The plant capacities upto 50 TR are usually considered as small capacity, 50 – 250 TR as medium capacity and over 250 TR as large capacity units.

A large industry may have a bank of such units, often with common chilled water pumps, condenser water pumps, cooling towers, as an off site utility.

The same industry may also have two or three levels of refrigeration & air conditioning such as:

- Comfort air conditioning (20° – 25° C)
- Chilled water system (8° – 10° C)
- Brine system (sub-zero applications)

Two principle types of refrigeration plants found in industrial use are: Vapour Compression Refrigeration (VCR) and Vapour Absorption Refrigeration (VAR). VCR uses mechanical energy as the driving force for refrigeration, while VAR uses thermal energy as the driving force for refrigeration.

4.2 Types of Refrigeration System

Vapour Compression Refrigeration

Heat flows naturally from a hot to a colder body. In refrigeration system the opposite must occur i.e. heat flows from a cold to a hotter body. This is achieved by using a substance called a refrigerant, which absorbs heat and hence boils or evaporates at a low pressure to form a gas. This gas is then compressed to a higher pressure, such that it transfers the heat it has gained to ambient air or water and turns back (condenses) into a liquid. In this way heat is absorbed, or removed, from a low temperature source and transferred to a higher temperature source.

The refrigeration cycle can be broken down into the following stages (see Figure 4.2):

1 – 2 Low pressure liquid refrigerant in the evaporator absorbs heat from its surroundings, usually air, water or some other process liquid. During this process it changes its state from a liquid to a gas, and at the evaporator exit is slightly superheated.

2 – 3 The superheated vapour enters the compressor where its pressure is raised. There will also be a big increase in temperature, because a proportion of the energy input into the compression process is transferred to the refrigerant.

3 – 4 The high pressure superheated gas passes from the compressor into the condenser. The initial part of the cooling process (3 - 3a) desuperheats the gas before it is then turned back into liquid (3a - 3b). The cooling for this process is usually achieved by using air or water. A further reduction in temperature happens in the pipe work and liquid receiver (3b - 4), so that the refrigerant liquid is sub-cooled as it enters the expansion device.

4 – 1 The high-pressure sub-cooled liquid passes through the expansion device, which both reduces its pressure and controls the flow into the evaporator.

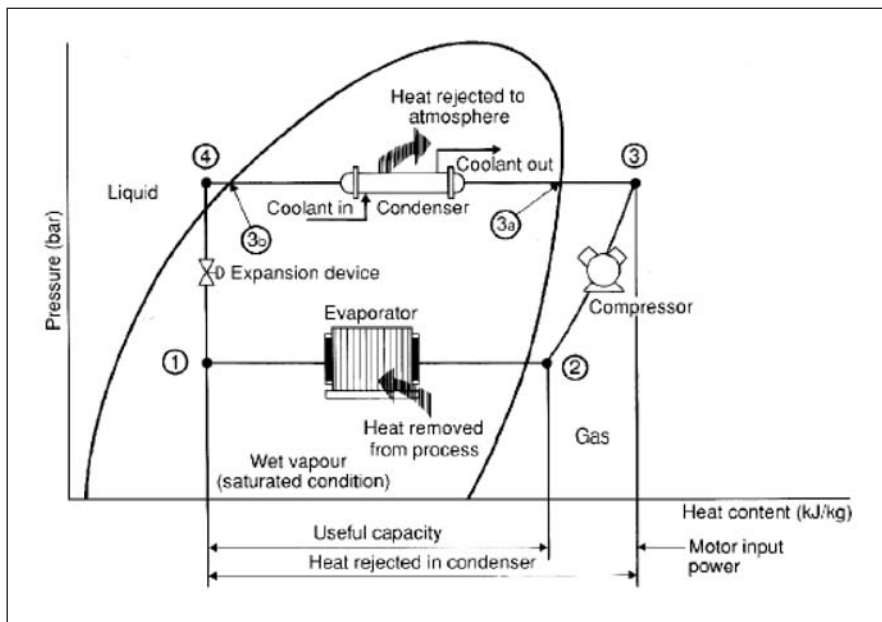

Figure 4.2: Schematic of a Basic Vapor Compression Refrigeration System

It can be seen that the condenser has to be capable of rejecting the combined heat inputs of the evaporator and the compressor; i.e. $(1 - 2) + (2 - 3)$ has to be the same as $(3 - 4)$. There is no heat loss or gain through the expansion device.

Alternative Refrigerants for Vapour Compression Systems

The use of CFCs is now beginning to be phased out due to their damaging impact on the protective tropospheric ozone layer around the earth. The Montreal Protocol of 1987 and the subsequent Copenhagen agreement of 1992 mandate a reduction in the production of ozone depleting Chlorinated Fluorocarbon (CFC) refrigerants in a phased manner, with an eventual stop to all production by the year 1996. In response, the refrigeration industry has developed two alternative refrigerants; one based on Hydrochloro Fluorocarbon (HCFC), and another based on Hydro Fluorocarbon (HFC). The HCFCs have a 2 to 10% ozone depleting potential as compared to CFCs and also, they have an atmospheric lifetime between 2 to 25 years as compared to 100 or more years for CFCs (Brandt, 1992). However, even HCFCs

are mandated to be phased out by 2005, and only the chlorine free (zero ozone depletion) HFCs would be acceptable.

Until now, only one HFC based refrigerant, HFC 134a, has been developed. HCFCs are comparatively simpler to produce and the three refrigerants 22, 123, and 124 have been developed. The use of HFCs and HCFCs results in slightly lower efficiencies as compared to CFCs, but this may change with increasing efforts being made to replace CFCs.

Absorption Refrigeration

The absorption chiller is a machine, which produces chilled water by using heat such as steam, hot water, gas, oil etc. Chilled water is produced by the principle that liquid (refrigerant), which evaporates at low temperature, absorbs heat from surrounding when it evaporates. Pure water is used as refrigerant and lithium bromide solution is used as absorbent

Heat for the vapour absorption refrigeration system can be provided by waste heat extracted from process, diesel generator sets etc. Absorption systems require electricity to run pumps only. Depending on the temperature required and the power cost, it may even be economical to generate heat / steam to operate the absorption system.

Description of the absorption refrigeration concept is given below:

The refrigerant (water) evaporates at around 4°C under the high vacuum condition of 754mmHg in the evaporator. When the refrigerant (water) evaporates, the latent heat of vaporization takes the heat from incoming chilled water.

This latent heat of vaporization can cool the chilled water which runs into the heat exchanger tubes in the evaporator by transfer of heat to the refrigerant (water).

EVAPORATOR

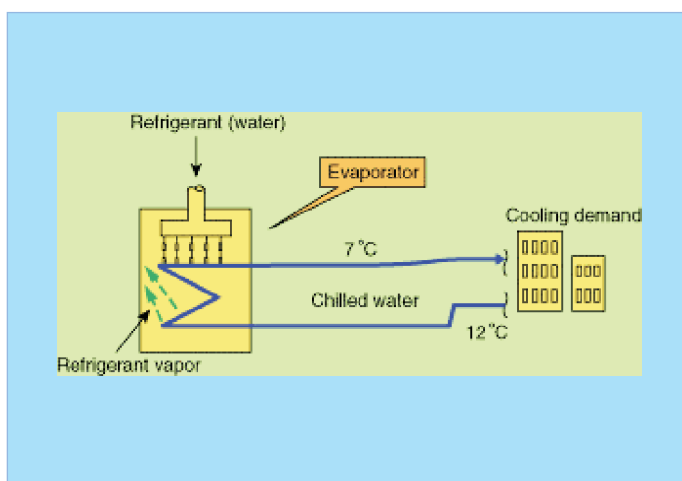

In order to keep evaporating, the refrigerant vapor must be discharged from the evaporator and refrigerant (water) must be supplied. The refrigerant vapor is absorbed into lithium bromide solution which is convenient to absorb the refrigerant vapor in the absorber. The heat generated in the absorption process is led out of system by cooling water continually. The absorption also maintains the vacuum inside the evaporator.

ABSORBER

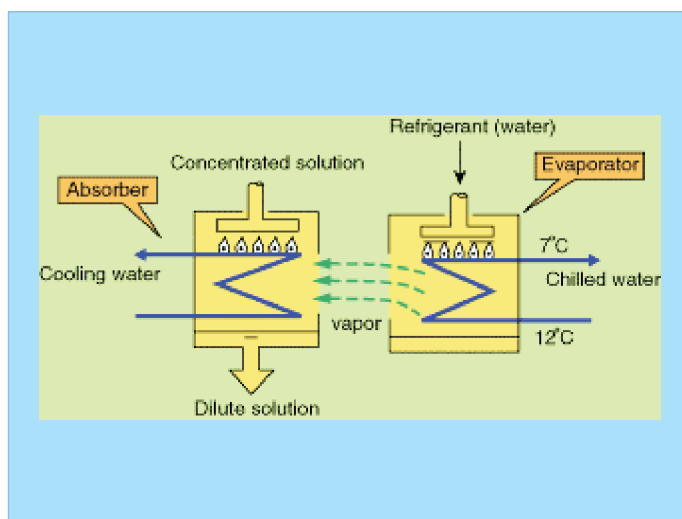

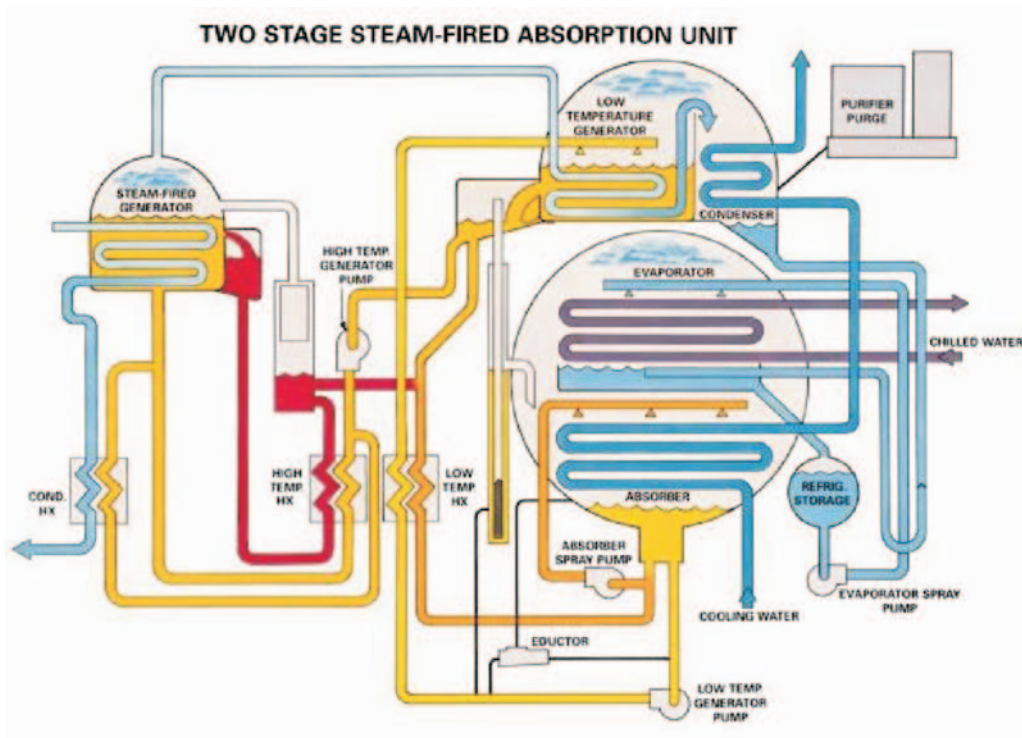

Figure 4.3 Schematic of Absorption Refrigeration System

Evaporative Cooling

There are occasions where air conditioning, which stipulates control of humidity up to 50 % for human comfort or for process, can be replaced by a much cheaper and less energy intensive evaporative cooling.

The concept is very simple and is the same as that used in a cooling tower. Air is brought in close contact with water to cool it to a temperature close to the wet bulb temperature. The cool air can be used for comfort or process cooling. The disadvantage is that the air is rich in moisture. Nevertheless, it is an extremely efficient means of cooling at very low cost. Large commercial systems employ cellulose filled pads over which water is sprayed. The temperature can be controlled by controlling the airflow and the water circulation rate. The possibility of evaporative cooling is especially attractive for comfort cooling in dry regions. This principle is practiced in textile industries for certain processes.

4.3 Common Refrigerants and Properties

A variety of refrigerants are used in vapor compression systems. The choice of fluid is determined largely by the cooling temperature required. Commonly used refrigerants are in the family of chlorinated fluorocarbons (CFCs, also called Freons): R-11, R-12, R-21, R-22 and R-502. The properties of these refrigerants are summarized in Table 4.1 and the performance of these refrigerants is given in Table 4.2.

TABLE 4.1 PROPERTIES OF COMMONLY USED REFRIGERANTS						
Refrigerant	Boiling Point ** (°C)	Freezing Point (°C)	Vapor Pressure * (kPa)	Vapor Volume * (m ³ / kg)	Enthalpy *	
					Liquid (kJ / kg)	Vapor (kJ / kg)
R - 11	-23.82	-111.0	25.73	0.61170	191.40	385.43
R - 12	-29.79	-158.0	219.28	0.07702	190.72	347.96
R - 22	-40.76	-160.0	354.74	0.06513	188.55	400.83
R - 502	-45.40	---	414.30	0.04234	188.87	342.31
R - 7 (Ammonia)	-33.30	-77.7	289.93	0.41949	808.71	487.76

* At -10°C

** At Standard Atmospheric Pressure (101.325 kPa)

TABLE 4.2 PERFORMANCE OF COMMONLY USED REFRIGERANTS*					
Refrigerant	Evaporating Press (kPa)	Condensing Press (kPa)	Pressure Ratio	Vapor Enthalpy (kJ / kg)	COP** _{carnot}
R - 11	20.4	125.5	6.15	155.4	5.03
R - 12	182.7	744.6	4.08	116.3	4.70
R - 22	295.8	1192.1	4.03	162.8	4.66
R - 502	349.6	1308.6	3.74	106.2	4.37
R - 717	236.5	1166.5	4.93	103.4	4.78

* At -15°C Evaporator Temperature, and 30°C Condenser Temperature

** $COP_{carnot} = \text{Coefficient of Performance} = \text{Temp}_{Evap.} / (\text{Temp}_{Cond.} - \text{Temp}_{Evap.})$

The choice of refrigerant and the required cooling temperature and load determine the choice of compressor, as well as the design of the condenser, evaporator, and other auxiliaries. Additional factors such as ease of maintenance, physical space requirements and availability of utilities for auxiliaries (water, power, etc.) also influence component selection.

4.4 Compressor Types and Application

For industrial use, open type systems (compressor and motor as separate units) are normally used, though hermetic systems (motor and compressor in a sealed unit) also find service in some low capacity applications. Hermetic systems are used in refrigerators, air conditioners, and other low capacity applications. Industrial applications largely employ reciprocating, centrifugal and, more recently, screw compressors, and scroll compressors. Water-cooled systems are more efficient than air-cooled alternatives because the temperatures produced by refrigerant condensation are lower with water than with air.

Centrifugal Compressors

Centrifugal compressors are the most efficient type (see Figure 4.4) when they are operating near full load. Their efficiency advantage is greatest in large sizes, and they offer considerable economy of scale, so they dominate the market for large chillers. They are able to use a wide range of refrigerants efficiently, so they will probably continue to be the dominant type in large sizes.

Centrifugal compressors have a single major moving part - an impeller that compresses the refrigerant gas by centrifugal force. The gas is given kinetic energy as it flows through the impeller. This kinetic energy is not useful in itself, so it must be converted to pressure energy. This is done by allowing the gas to slow down smoothly in a stationary diffuser surrounding the impeller.

To minimize efficiency loss at reduced loads, centrifugal compressors typically throttle output with inlet guide vanes located at the inlet to the impeller(s). This method is efficient down to about 50% load, but the efficiency of this method decreases rapidly below 50% load.

Older centrifugal machines are not able to reduce load much below 50%. This is because of “surge” in the impeller. As the flow through the impeller is choked off, the gas does not acquire enough energy to overcome the discharge pressure. Flow drops abruptly at this point, and an oscillation begins as the gas *flutters* back and forth in the impeller. Efficiency drops abruptly, and the resulting vibration can damage the machine. Many older centrifugal machines deal with low loads by creating a false load on the system, such as by using hot gas bypass. This wastes the portion of the cooling output that is not required.

Another approach is to use variable-speed drives in combination with inlet guide vanes. This may allow the compressor to throttle down to about 20% of full load, or less, without false loading. Changing the impeller speed causes a departure from optimum performance, so efficiency still declines badly at low loads. A compressor that uses a variable-speed drive reduces its output in the range between full load and approximately half load by slowing the impeller speed. At lower loads, the impeller cannot be slowed further, because the discharge pressure would become too low to condense the refrigerant. Below the minimum load provided by the variable-speed drive, inlet guide vanes are used to provide further capacity reduction.



Figure 4.4 Centrifugal Compressor

Reciprocating Compressors

The maximum efficiency of reciprocating compressors (see Figure 4.5) is lower than that of centrifugal and screw compressors. Efficiency is reduced by clearance volume (the compressed gas volume that is left at the top of the piston stroke), throttling losses at the intake and discharge valves, abrupt changes in gas flow, and friction. Lower efficiency also results from the smaller sizes of reciprocating units, because motor losses and friction account for a larger fraction of energy input in smaller systems.

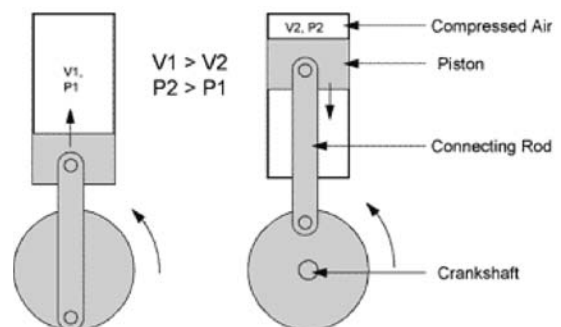

Figure 4.5 Reciprocating Compressor

Reciprocating compressors suffer less efficiency loss at partial loads than other types, and they may actually have a higher absolute efficiency at low loads than the other types. Smaller reciprocating compressors control output by turning on and off. This eliminates all part-load losses, except for a short period of inefficient operation when the machine starts.

Larger multi-cylinder reciprocating compressors commonly reduce output by disabling (“unloading”) individual cylinders. When the load falls to the point that even one cylinder provides too much capacity, the machine turns off. Several methods of cylinder unloading are used, and they differ in efficiency. The most common is holding open the intake valves of the unloaded cylinders. This eliminates most of the work of compression, but a small amount of power is still wasted in pumping refrigerant gas to-and-fro through the unloaded cylinders. Another method is blocking gas flow to the unloaded cylinders, which is called “suction cutoff.”

Variable-speed drives can be used with reciprocating compressors, eliminating the complications of cylinder unloading. This method is gaining popularity with the drastic reduction in costs of variable speed drives.

Screw Compressors

Screw compressors, sometimes called “helical rotary” compressors, compress refrigerant by trapping it in the “threads” of a rotating screw-shaped rotor (see Figure 4.6). Screw compressors have increasingly taken over from reciprocating compressors of medium sizes and large sizes, and they have even entered the size domain of centrifugal machines. Screw compressors are applicable to refrigerants that have higher condensing pressures, such as HCFC-22 and ammonia. They are especially compact. A variety of methods are used to control the output of screw compressors. There are major efficiency differences among the different methods. The most common is a slide valve that forms a portion of the housing that surrounds the screws.

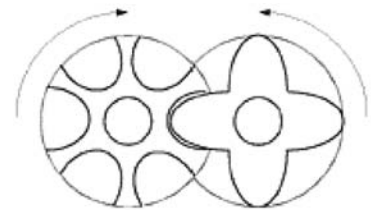

Figure 4.6 Screw Compressor

Using a variable-speed drive is another method of capacity control. It is limited to oil-injected compressors, because slowing the speed of a dry compressor would allow excessive internal leakage. There are other methods of reducing capacity, such as suction throttling that are inherently less efficient than the previous two.

Scroll Compressors

The scroll compressor is an old invention that has finally come to the market. The gas is compressed between two scroll-shaped vanes. One of the vanes is fixed, and the other moves within it. The moving vane does not rotate, but its center revolves with respect to the center of the fixed vane, as shown in Figure 4.7. This motion squeezes the refrigerant gas along a spiral path, from the outside of the vanes toward the center, where the discharge port is located. The compressor has only two moving parts, the moving vane and a shaft with an off-center crank to drive the moving vane. Scroll compressors have only recently become practical, because close machining tolerances are needed to prevent leakage between the vanes, and between the vanes and the casing.

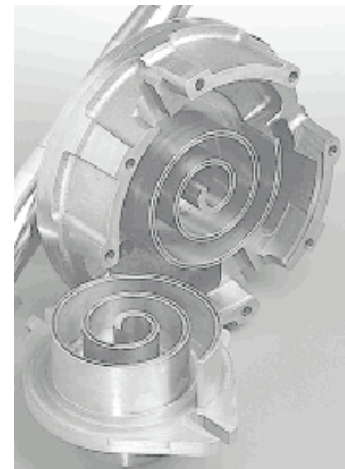

Figure 4.7 Scroll Compressor

The features of various refrigeration compressors and application criteria are given in the Table 4.3.

TABLE 4.3 COMPARISON OF DIFFERENT TYPES OF REFRIGERATION PLANTS*(Source : Ashrae & Vendor Information)*

S. No	Parameters	Vapour Compression Chillers			Vapour Absorption Chiller					
		Reciprocating	Centrifugal	Screw	LiBr	Single Effect	Double Effect	Half Effect	Triple Effect	Ammonia
1	Refrigeration Temp. Range (Brine / Water)	+7 to -30°C	+7 to -0°C	+7 to -25°C	Above 6°C					Upto -33°C
2	Energy Input	Electricity	Electricity	Electricity	Heat (Steam / Hot Water / Hot Oil/Direct Fired)	Heat (Steam / Hot Water / Hot Oil/ Direct Fired)	Heat (Hot Water)	Heat (Steam /Hot Oil /Direct Fired)	Heat (Steam /Hot Water / Hot Oil)	
3	Heat Input Temp. Range -Maximum - Minimum	-	-	-	Minimum 85°C	Minimum 130°C	Minimum 55°C	Minimum 190°C	Minimum 85°C	
	Typical Energy to TR Ratio									
4	Air Conditioning Temp. Range	0.7-0.9 kW/TR	0.63kW/TR	0.65 kW/TR	5000 kcal/TR	2575 kcal/TR	7500 kcal/TR	2000 kcal/TR	4615 kcal/TR	
	Subzero Temp. Range	1.25 to 2.5 kW/TR	-----	1.25 to 2.5 kW/TR	-----	-----	-----	-----	6666 kcal/hr	
5	Refrigerant	R11,R123,R134a Ammonia	R22, R12	R22, R134a Ammonia	Pure Water	Pure Water	Pure Water	Pure Water	Pure Ammonia	
6	Absorbent	-----	-----	-----	Water-LiBr solution	Water-LiBr solution	Water-LiBr solution	Water-LiBr solution	Ammonia-LiBr solution	
	Typical single unit capacity range									
7	Air Condition temp. range	1-150 TR	300 TR & above	50-200 TR	30 TR & above	30 TR & above	30 TR & above	50 TR & above	30 TR & above	
	Subzero temp. range	10-50 TR	-----	50-200 TR	-----	-----	-----	-----	30 TR & above	
8	Typical COP at Part Load upto 50%	Reduces at part load	Reduces at part load	Improves by 15-20%	Marginal Improvement at Part Load					No variation
9	Typical Internal Pressure Levels -Low -High	0.15-0.40 bar a	2.5-3.5 bar a	2-5.5 bar	5-6 mm Hg (abs)	5-6 mm Hg (abs)	5-6 mm Hg (abs)	5-6 mm Hg (abs)	1.2kg/cm ² (a)	
	Typical Internal Temp. Levels	1.20-1.50 bar a -25 to 50°C	11-12 bar -5 to 50°C	18-20 bar -25 to 50°C	60-70 mm Hg (abs) +4 to 75°C	370-390 mm Hg (abs) +4 to +130°C	60-70 mm Hg (abs) +4 to 130°C	2 kg/cm ² (a) +4 to 160°C	-25 to +150°C	

S. No	Parameters	Vapour Compression Chillers				Vapour Absorption Chiller				
		Reciprocating	Centrifugal	Screw	LiBr					Ammonia
					Single Effect	Double Effect	Half Effect	Triple Effect	Single Stage	
10	Typical Cooling tower capacity range per 100 TR of chillers -Air conditioning Temperature Range - Subzero temp. range	130 190	120 -----	120 160	260 ---	200 ---	370 ---	170 ---	290 290	
11	Typical Make-up water quantity range in Ltrs/Hr. -Air Conditioning temperature range -Subzero temp. range	672 983	620 ---	620 830	1345 ---	1035 ---	1914 ---	880 ---	1500 1500	
12	Material of construction -Generator -Absorber -Evaporator -Condenser -Solution Heat Exchange -Solution Pump -Refrigerant pump	---	---	---	Cu-Ni or Stainless Steel Cu-Ni Cu-Ni Cu-Ni Carbon Steel Cast Iron Hermetically Sealed (Canned motor type) Cast Iron Hermetically Sealed (Canned motor type)	---	---	---	Carbon Steel Carbon Steel Carbon Steel Carbon Steel Carbon Steel Cast Iron with Meh.Seal Not needed	
13	Expected Life	25-30 years			15-20 years				50 years	
14	Normally Expected Repairs / Maintenance	Periodic Compressor Overhaul Tube Replacement after 1-12 years			Tube Replacement due to Corrosion				Practically no repairs	
15	Factory Assembled packaged Or Site Assembled	Factory Assembled							Factory Assembled upto 230 TR in A/C & subzero range	
16	Beneficial Energy Sources	Low cost Electricity	Low cost Electricity	Low cost Electricity	a) Waste Heat b) Low cost steam / Low cost fuels					

S. No	Parameters	Vapour Compression Chillers			Vapour Absorption Chiller				
		Reciprocating	Centrifugal	Screw	LiBr				
					Single Effect	Double Effect	Half Effect	Triple Effect	Ammonia Single Stage
17	Critical Parameters	-Electricity supply	-Lubrication System -Compressor Operation & Maintenance -Electrical Power Panel Maintenance	----		a) Vacuum in Chiller b) Purge System for Vacuum c) Corrosion Inhibitors in Absorbent d) Surfactants in Absorbent e) Cooling Water Treatment f) Cooling Water Temperature g) Heat Source Temperature			Sudden Power failure for 45-60 min. or more can disturb the distillation column for continuous operation. Needs D.G.set if there is frequent power failure for periods longer than 30 min.

4.5 Selection of a Suitable Refrigeration System

A clear understanding of the cooling load to be met is the first and most important part of designing / selecting the components of a refrigeration system. Important factors to be considered in quantifying the load are the actual cooling need, heat (cool) leaks, and internal heat sources (from all heat generating equipment). Consideration should also be given to process changes and / or changes in ambient conditions that might affect the load in the future. Reducing the load, e.g. through better insulation, maintaining as high a cooling temperature as practical, etc. is the first step toward minimizing electrical power required to meet refrigeration needs. With a quantitative understanding of the required temperatures and the maximum, minimum, and average expected cooling demands, selection of appropriate refrigeration system (single-stage / multi-stage, economized compression, compound / cascade operation, direct cooling / secondary coolants) and equipment (type of refrigerant, compressor, evaporator, condenser, etc.) can be undertaken.

4.6 Performance Assessment of Refrigeration Plants

- The cooling effect produced is quantified as tons of refrigeration.(TR).

1 TR of refrigeration = 3024 kCal/hr heat rejected.

- The refrigeration TR is assessed as $TR = Q \times C_p \times (T_i - T_o) / 3024$

Where Q is mass flow rate of coolant in kg/hr

C_p is coolant specific heat in kCal /kg deg C

T_i is inlet, temperature of coolant to evaporator (chiller) in °C

T_o is outlet temperature of coolant from evaporator (chiller) in °C.

The above TR is also called as chiller tonnage.

- The specific power consumption kW/TR is a useful indicator of the performance of refrigeration system. By measuring refrigeration duty performed in TR and the kiloWatt inputs, kW/TR is used as a reference energy performance indicator.
- In a centralized chilled water system, apart from the compressor unit, power is also consumed by the chilled water (secondary) coolant pump as well condenser water (for heat rejection to cooling tower) pump and cooling tower fan in the cooling tower. Effectively, the overall energy consumption would be towards:
 - Compressor kW
 - Chilled water pump kW
 - Condenser water pump kW
 - Cooling tower fan kW, for induced / forced draft towers
- The specific power consumption for certain TR output would therefore have to include:
 - Compressor kW/TR
 - Chilled water pump kW/TR
 - Condenser water pump kW/TR
 - Cooling tower fan kW/TR

The overall kW/TR is the sum of the above.

The theoretical Coefficient of Performance (Carnot), COP_{Carnot} - a standard measure of refrigeration efficiency of an ideal refrigeration system- depends on two key system temperatures, namely, evaporator temperature T_e and condenser temperature T_c with COP being given as:

$$COP_{Carnot} = T_e / (T_c - T_e)$$

This expression also indicates that higher COP_{Carnot} is achieved with higher evaporator temperature and lower condenser temperature.

But COP_{Carnot} is only a ratio of temperatures, and hence does not take into account the type of compressor. Hence the COP normally used in the industry is given by

$$COP = \frac{\text{Cooling effect (kW)}}{\text{Power input to compressor (kW)}}$$

where the cooling effect is the difference in enthalpy across the evaporator and expressed as kW. The effect of evaporating and condensing temperatures are given in the Figure 4.8 and Figure 4.9 below:

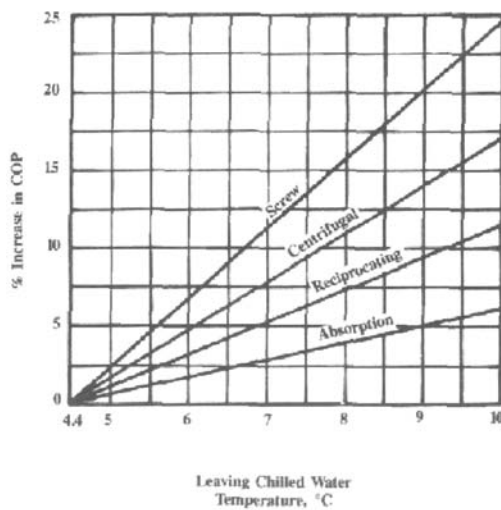

Figure 4.8 Effect Of Evaporator Temperature On Chiller COP

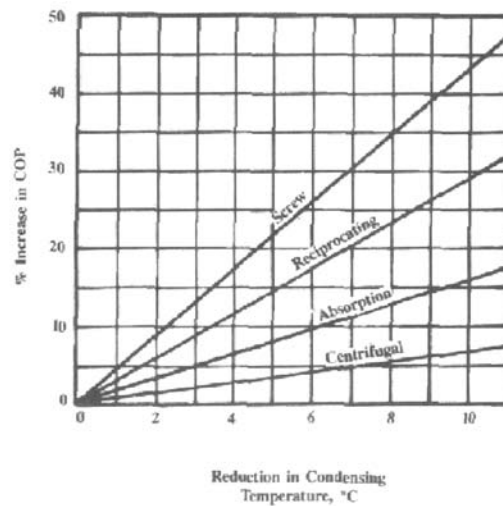

Figure 4.9 Effect of Condensing Temperature On Chiller COP

In the field performance assessment, accurate instruments for inlet and outlet chilled water temperature and condenser water temperature measurement are required, preferably with a least count of 0.1°C. Flow measurements of chilled water can be made by an ultrasonic flow meter directly or inferred from pump duty parameters. Adequacy check of chilled water is needed often and most units are designed for a typical 0.68 m³/hr per TR (3 gpm/TR) chilled water flow. Condenser water flow measurement can also be made by a non-contact flow meter directly or inferred from pump duty parameters. Adequacy check of condenser water is also needed often, and most units are designed for a typical 0.91 m³/hr per TR (4 gpm / TR) condenser water flow.

In case of air conditioning units, the airflow at the Fan Coil Units (FCU) or the Air Handling Units (AHU) can be measured with an anemometer. Dry bulb and wet bulb temperatures are

measured at the inlet and outlet of AHU or the FCU and the refrigeration load in TR is assessed as ;

$$\text{TR} = \frac{Q \times \rho \times (h_{\text{in}} - h_{\text{out}})}{3024}$$

Where, Q is the air flow in m^3/h

ρ is density of air kg/m^3

h_{in} is enthalpy of inlet air kCal/kg

h_{out} is enthalpy of outlet air kCal/kg

Use of psychometric charts can help to calculate h_{in} and h_{out} from dry bulb, wet bulb temperature values which are, in-turn measured, during trials, by a whirling psychrometer.

Power measurements at, compressor, pumps, AHU fans, cooling tower fans can be accomplished by a portable load analyzer.

Estimation of air conditioning load is also possible by calculating various heat loads, sensible and latent based on inlet and outlet air parameters, air ingress factors, air flow, no. of people and type of materials stored.

An indicative TR load profile for air conditioning is presented as follows:

- Small office cabins = 0.1 TR / m^2
- Medium size office i.e., = 0.06 TR/ m^2
10 – 30 people occupancy
with central A/C
- Large multistoried office = 0.04 TR/ m^2
complexes with central A/C

Integrated Part Load Value (IPLV)

Although the kW/TR can serve as an initial reference, it should not be taken as an absolute since this value is derived from 100% of the equipment's capacity level and is based on design conditions that are considered the most critical. These conditions occur may be, for example, during only 1% of the total time the equipment is in operation throughout the year. Consequently, it is essential to have data that reflects how the equipment operates with partial loads or in conditions that demand less than 100% of its capacity. To overcome this, an average of kW/TR with partial loads ie Integrated Part Load Value (IPLV) have to be formulated.

The IPLV is the most appropriate reference, although not considered the best, because it only captures four points within the operational cycle: 100%, 75%, 50% and 25%. Furthermore, it assigns the same weight to each value, and most equipment usually operates at between 50 % and 75% of its capacity. This is why it is so important to prepare specific analysis for each case that addresses the four points already mentioned, as well as developing a profile of the heat exchanger's operations during the year.

4.7 Factors Affecting Performance & Energy Efficiency of Refrigeration Plants

Design of Process Heat Exchangers

There is a tendency of the process group to operate with high safety margins which influences the compressor suction pressure / evaporator set point. For instance, a process cooling requirement of 15°C would need chilled water at a lower temperature, but the range can vary from 6°C to say 10°C. At 10°C chilled water temperature, the refrigerant side temperature has to be lower, say -5°C to +5°C. The refrigerant temperature, again sets the corresponding suction pressure of refrigerant which decides the inlet duty conditions for work of compression of the refrigerant compressor. Having the optimum / minimum driving force (temperature difference) can, thus, help to achieve highest possible suction pressure at the compressor, thereby leading to less energy requirement. This requires proper sizing of heat transfer areas of process heat exchangers and evaporators as well as rationalizing the temperature requirement to highest possible value. A 1°C raise in evaporator temperature can help to save almost 3 % on power consumption. The TR capacity of the same machine will also increase with the evaporator temperature, as given in Table 4.4.

TABLE 4.4 EFFECT OF VARIATION IN EVAPORATOR TEMPERATURE ON COMPRESSOR POWER CONSUMPTION			
Evaporator Temperature (°C)	Refrigeration Capacity* (tons)	Specific Power Consumption	Increase in kW/ton (%)
5.0	67.58	0.81	-
0.0	56.07	0.94	16.0
-5.0	45.98	1.08	33.0
-10.0	37.20	1.25	54.0
-20.0	23.12	1.67	106.0

* Condenser temperature 40°C

Towards rationalizing the heat transfer areas, the heat transfer coefficient on refrigerant side can be considered to range from 1400 – 2800 watts /m²K.

The refrigerant side heat transfer areas provided are of the order of 0.5 Sqm./TR and above in evaporators.

Condensers in a refrigeration plant are critical equipment that influence the TR capacity and power consumption demands. Given a refrigerant, the condensing temperature and corresponding condenser pressure, depend upon the heat transfer area provided, effectiveness of heat exchange and the type of cooling chosen. A lower condensing temperature, pressure, in best of combinations would mean that the compressor has to work between a lower pressure differential as the discharge pressure is fixed by design and performance of the condenser. The choices of condensers in practice range from air cooled, air cooled with water

spray, and heat exchanger cooled. Generously sized shell and tube heat exchangers as condensers, with good cooling tower operations help to operate with low discharge pressure values and the TR capacity of the refrigeration plant also improves. With same refrigerant, R22, a discharge pressure of 15 kg/cm² with water cooled shell and tube condenser and 20 kg/cm² with air cooled condenser indicate the kind of additional work of compression duty and almost 30 % additional energy consumption required by the plant. One of the best option at design stage would be to select generously sized (0.65 m²/TR and above) shell and tube condensers with water-cooling as against cheaper alternatives like air cooled condensers or water spray atmospheric condenser units.

The effect of condenser temperature on refrigeration plant energy requirements is given in Table 4.5.

TABLE 4.5 EFFECT OF VARIATION IN CONDENSER TEMPERATURE ON COMPRESSOR POWER CONSUMPTION			
Condensing Temperature (°C)	Refrigeration Capacity (tons)	Specific Power Consumption	Increase in (kW / TR) kW/TR (%)
26.7	31.5	1.17	-
35.0	21.4	1.27	8.5
40.0	20.0	1.41	20.5

* Reciprocating compressor using R-22 refrigerant.
Evaporator temperature.-10°C

Maintenance of Heat Exchanger Surfaces

After ensuring procurement, effective maintenance holds the key to optimizing power consumption.

Heat transfer can also be improved by ensuring proper separation of the lubricating oil and the refrigerant, timely defrosting of coils, and increasing the velocity of the secondary coolant (air, water, etc.). However, increased velocity results in larger pressure drops in the distribution system and higher power consumption in pumps / fans. Therefore, careful analysis is required to determine the most effective and efficient option.

Fouled condenser tubes force the compressor to work harder to attain the desired capacity. For example, a 0.8 mm scale build-up on condenser tubes can increase energy consumption by as much as 35 %. Similarly, fouled evaporators (due to residual lubricating oil or infiltration of air) result in increased power consumption. Equally important is proper selection, sizing, and maintenance of cooling towers. A reduction of 0.55°C temperature in water returning from the cooling tower reduces compressor power consumption by 3.0 % (see Table 4.6).

TABLE 4.6 EFFECT OF POOR MAINTENANCE ON COMPRESSOR POWER CONSUMPTION

Condition	Evap. Temp (°C)	Cond. Temp (°C)	Refrigeration Capacity* (tons)	Specific Power Consumption kW/Ton	Increase in (kW/ton) (%)
Normal	7.2	40.5	17.0	0.69	-
Dirty condenser	7.2	46.1	15.6	0.84	20.4
Dirty evaporator	1.7	40.5	13.8	0.82	18.3
Dirty condenser and evaporator	1.7	46.1	12.7	0.96	38.7

* 15 ton reciprocating compressor based system. The power consumption is lower than that for systems typically available in India. However, the percentage change in power consumption is indicative of the effect of poor maintenance.

Multi-Staging For Efficiency

Efficient compressor operation requires that the compression ratio be kept low, to reduce discharge pressure and temperature. For low temperature applications involving high compression ratios, and for wide temperature requirements, it is preferable (due to equipment design limitations) and often economical to employ multi-stage reciprocating machines or centrifugal / screw compressors.

Multi-staging systems are of two-types: compound and cascade – and are applicable to all types of compressors. With reciprocating or rotary compressors, two-stage compressors are preferable for load temperatures from -20 to -58°C , and with centrifugal machines for temperatures around -43°C .

In multi-stage operation, a first-stage compressor, sized to meet the cooling load, feeds into the suction of a second-stage compressor after inter-cooling of the gas. A part of the high-pressure liquid from the condenser is flashed and used for liquid sub-cooling. The second compressor, therefore, has to meet the load of the evaporator and the flash gas. A single refrigerant is used in the system, and the work of compression is shared equally by the two compressors. Therefore, two compressors with low compression ratios can in combination provide a high compression ratio.

For temperatures in the range of -46°C to -101°C , cascaded systems are preferable. In this system, two separate systems using different refrigerants are connected such that one provides the means of heat rejection to the other. The chief advantage of this system is that a low temperature refrigerant which has a high suction temperature and low specific volume can be selected for the low-stage to meet very low temperature requirements.

Matching Capacity to System Load

During part-load operation, the evaporator temperature rises and the condenser temperature falls, effectively increasing the COP. But at the same time, deviation from the design operation point and the fact that mechanical losses form a greater proportion of the total power negate the effect of improved COP, resulting in lower part-load efficiency.

Therefore, consideration of part-load operation is important, because most refrigeration applications have varying loads. The load may vary due to variations in temperature and process

cooling needs. Matching refrigeration capacity to the load is a difficult exercise, requiring knowledge of compressor performance, and variations in ambient conditions, and detailed knowledge of the cooling load.

Capacity Control and Energy Efficiency

The capacity of compressors is controlled in a number of ways. Capacity control of reciprocating compressors through cylinder unloading results in incremental (step-by-step) modulation as against continuous capacity modulation of centrifugal through vane control and screw compressors through sliding valves. Therefore, temperature control requires careful system design. Usually, when using reciprocating compressors in applications with widely varying loads, it is desirable to control the compressor by monitoring the return water (or other secondary coolant) temperature rather than the temperature of the water leaving the chiller. This prevents excessive on-off cycling or unnecessary loading / unloading of the compressor. However, if load fluctuations are not high, the temperature of the water leaving the chiller should be monitored. This has the advantage of preventing operation at very low water temperatures, especially when flow reduces at low loads. The leaving water temperature should be monitored for centrifugal and screw chillers.

Capacity regulation through speed control is the most efficient option. However, when employing speed control for reciprocating compressors, it should be ensured that the lubrication system is not affected. In the case of centrifugal compressors, it is usually desirable to restrict speed control to about 50 % of the capacity to prevent surging. Below 50 %, vane control or hot gas bypass can be used for capacity modulation.

The efficiency of screw compressors operating at part load is generally higher than either centrifugal compressors or reciprocating compressors, which may make them attractive in situations where part-load operation is common. Screw compressor performance can be optimized by changing the volume ratio. In some cases, this may result in higher full-load efficiencies as compared to reciprocating and centrifugal compressors. Also, the ability of screw compressors to tolerate oil and liquid refrigerant slugs makes them preferred in some situations.

Multi-level Refrigeration for Plant Needs

The selection of refrigeration systems also depends on the range of temperatures required in the plant. For diverse applications requiring a wide range of temperatures, it is generally more economical to provide several packaged units (several units distributed throughout the plant) instead of one large central plant. Another advantage would be the flexibility and reliability accorded. The selection of packaged units could also be made depending on the distance at which cooling loads need to be met. Packaged units at load centers reduce distribution losses in the system. Despite the advantages of packaged units, central plants generally have lower power consumption since at reduced loads power consumption can reduce significantly due to the large condenser and evaporator surfaces.

Many industries use a bank of compressors at a central location to meet the load. Usually the chillers feed into a common header from which branch lines are taken to different locations in the plant. In such situations, operation at part-load requires extreme care. For efficient operation, the cooling load, and the load on each chiller must be monitored closely. It is more efficient to operate a single chiller at full load than to operate two chillers at part-load. The distribution system should be designed such that individual chillers can feed all branch lines. Isolation valves must be provided to ensure that chilled water (or other coolant) does not flow

through chillers not in operation. Valves should also be provided on branch lines to isolate sections where cooling is not required. This reduces pressure drops in the system and reduces power consumption in the pumping system. Individual compressors should be loaded to their full capacity before operating the second compressor. In some cases it is economical to provide a separate smaller capacity chiller, which can be operated on an on-off control to meet peak demands, with larger chillers meeting the base load.

Flow control is also commonly used to meet varying demands. In such cases the savings in pumping at reduced flow should be weighed against the reduced heat transfer in coils due to reduced velocity. In some cases, operation at normal flow rates, with subsequent longer periods of no-load (or shut-off) operation of the compressor, may result in larger savings.

Chilled Water Storage

Depending on the nature of the load, it is economical to provide a chilled water storage facility with very good cold insulation. Also, the storage facility can be fully filled to meet the process requirements so that chillers need not be operated continuously. This system is usually economical if small variations in temperature are acceptable. This system has the added advantage of allowing the chillers to be operated at periods of low electricity demand to reduce peak demand charges - Low tariffs offered by some electric utilities for operation at night time can also be taken advantage of by using a storage facility. An added benefit is that lower ambient temperature at night lowers condenser temperature and thereby increases the COP.

If temperature variations cannot be tolerated, it may not be economical to provide a storage facility since the secondary coolant would have to be stored at a temperature much lower than required to provide for heat gain. The additional cost of cooling to a lower temperature may offset the benefits. The solutions are case specific. For example, in some cases it may be possible to employ large heat exchangers, at a lower cost burden than low temperature chiller operation, to take advantage of the storage facility even when temperature variations are not acceptable. Ice bank system which store ice rather than water are often economical.

System Design Features

In overall plant design, adoption of good practices improves the energy efficiency significantly. Some areas for consideration are:

- Design of cooling towers with FRP impellers and film fills, PVC drift eliminators, etc.
- Use of softened water for condensers in place of raw water.
- Use of economic insulation thickness on cold lines, heat exchangers, considering cost of heat gains and adopting practices like infrared thermography for monitoring - applicable especially in large chemical / fertilizer / process industry.
- Adoption of roof coatings / cooling systems, false ceilings / as applicable, to minimize refrigeration load.
- Adoption of energy efficient heat recovery devices like air to air heat exchangers to pre-cool the fresh air by indirect heat exchange; control of relative humidity through indirect heat exchange rather than use of duct heaters after chilling.
- Adopting of variable air volume systems; adopting of sun film application for heat reflection; optimizing lighting loads in the air conditioned areas; optimizing number of air changes in the air conditioned areas are few other examples.

4.8 Energy Saving Opportunities

a) Cold Insulation

Insulate all cold lines / vessels using economic insulation thickness to minimize heat gains; and choose appropriate (correct) insulation.

b) Building Envelope

Optimise air conditioning volumes by measures such as use of false ceiling and segregation of critical areas for air conditioning by air curtains.

c) Building Heat Loads Minimisation

Minimise the air conditioning loads by measures such as roof cooling, roof painting, efficient lighting, pre-cooling of fresh air by air- to-air heat exchangers, variable volume air system, optimal thermo-static setting of temperature of air conditioned spaces, sun film applications, etc.

e) Process Heat Loads Minimisation

Minimize process heat loads in terms of TR capacity as well as refrigeration level, i.e., temperature required, by way of:

- i) Flow optimization
- ii) Heat transfer area increase to accept higher temperature coolant
- iii) Avoiding wastages like heat gains, loss of chilled water, idle flows.
- iv) Frequent cleaning / de-scaling of all heat exchangers

f) At the Refrigeration A/C Plant Area

- i) Ensure regular maintenance of all A/C plant components as per manufacturer guidelines.
- ii) Ensure adequate quantity of chilled water and cooling water flows, avoid bypass flows by closing valves of idle equipment.
- iii) Minimize part load operations by matching loads and plant capacity on line; adopt variable speed drives for varying process load.
- iv) Make efforts to continuously optimize condenser and evaporator parameters for minimizing specific energy consumption and maximizing capacity.
- v) Adopt VAR system where economics permit as a non-CFC solution.

QUESTIONS

1.	List a few types of air conditioning systems in use.
2.	1 TR of refrigeration is a) 50 kCal/hour b) 3024 kCal/hour c) 1000 kCal/hour d) 100 kCal/hour
3.	Explain with a sketch the working principle of a vapour compression refrigeration plant
4.	Explain the working principle of vapour absorption refrigeration system.
5.	Of the following, which has zero ozone depletion potential? a) R11 b) R22 c) HFC 134a d) HCFC22
6.	List a few energy efficiency improvement options in a refrigeration plant.
7.	Name different types of compressors used in refrigeration system.
8.	Throttling as a means of capacity control applies to Reciprocating compressor b) Screw compressor c) Scroll Compressor d) Centrifugal compressor
9.	Explain the phenomenon of surge in a centrifugal compressor.
10.	What is the refrigeration load in TR when 15 m ³ /hr of water is cooled from 21°C to 15°C? If the compressor motor draws 29 kW, chilled water pump draws 4.6 kW, condenser water pump draws 6.1 kW and Cooling Tower fan draws 2.7 kW, what is overall kW/TR?
11.	Explain the term Integrated Part Load Value (IPLV).
12.	Explain the impact of condensing and evaporation temperatures on compressor power consumption.
13.	Briefly list various energy conservation opportunities in a refrigeration plant.

REFERENCES

1. Technology Menu on Energy Efficiency (NPC)
2. ASHRAE Hand Book
3. NPC Case Studies
4. Vendor Information