

History of Trigonometry

With Classroom Applications

Mohandas Raj, Mohandas.Raj@gpc.edu

Martha Nega, Martha.Nega@gpc.edu

Presented at AMATYC 37, Austin, Texas

11 November 2011

Introduction

- My interest in trigonometry
- What is trigonometry?
- Development of prerequisite ideas
- Ancient applications
- Development of modern ideas
- Modern applications

What Is Trigonometry?

*Systematic calculation of lengths of sides and measures of angles for **any** triangle, from sufficient given information.*

- Prerequisite ideas:
 - Association of numbers with sides of a triangle, corresponding to the length of that side
 - Concept of angle as the difference in inclination between two adjacent sides
 - Numerical measure for angles

What Is Trigonometry?

- So, trigonometry already requires a number of sophisticated mathematical concepts:
 - Association of numbers with sides of a triangle, representing lengths
 - Association of numbers with angles of a triangle, representing the measure of the angle
 - Idea of a function of an angle
 - Symbolic notation

What Is Trigonometry?

- Some of the fundamental ideas go back even to ancient Egypt and Mesopotamia, but their “trigonometry” would not pass our definition.
- Even after it was developed, it wasn't considered math, but merely a calculational tool, like log tables.
- Trigonometry recognisable to us did not arise until the 18th century.

Egypt, (Middle Kingdom, c. -2000)

- Herodotus said that much Greek mathematics originated in Egypt, and that Egyptian mathematics arose from land measurement and pyramid construction.
- Made use of the 3-4-5 triangle to create right angles.
- No evidence that they used or knew of anything like the Pythagorean theorem.



Egypt, (Middle Kingdom, c. -2000)

- Had the correct formula for the volume of a frustum of a pyramid: $\frac{1}{3}(a^2 + ab + b^2)$.
- Back then, formulae were given as examples and expressed in words, like this:

“Square the numbers 2 and 4 and add to the sum of these squares the product of 2 and 4, the result being 28. This result is then multiplied by a third of 6. See, it is 56; you have found it correctly.”
- Although this involves measurement of triangles, it is not trigonometry according to our definition.

Egypt (Middle Kingdom, c. -2000)

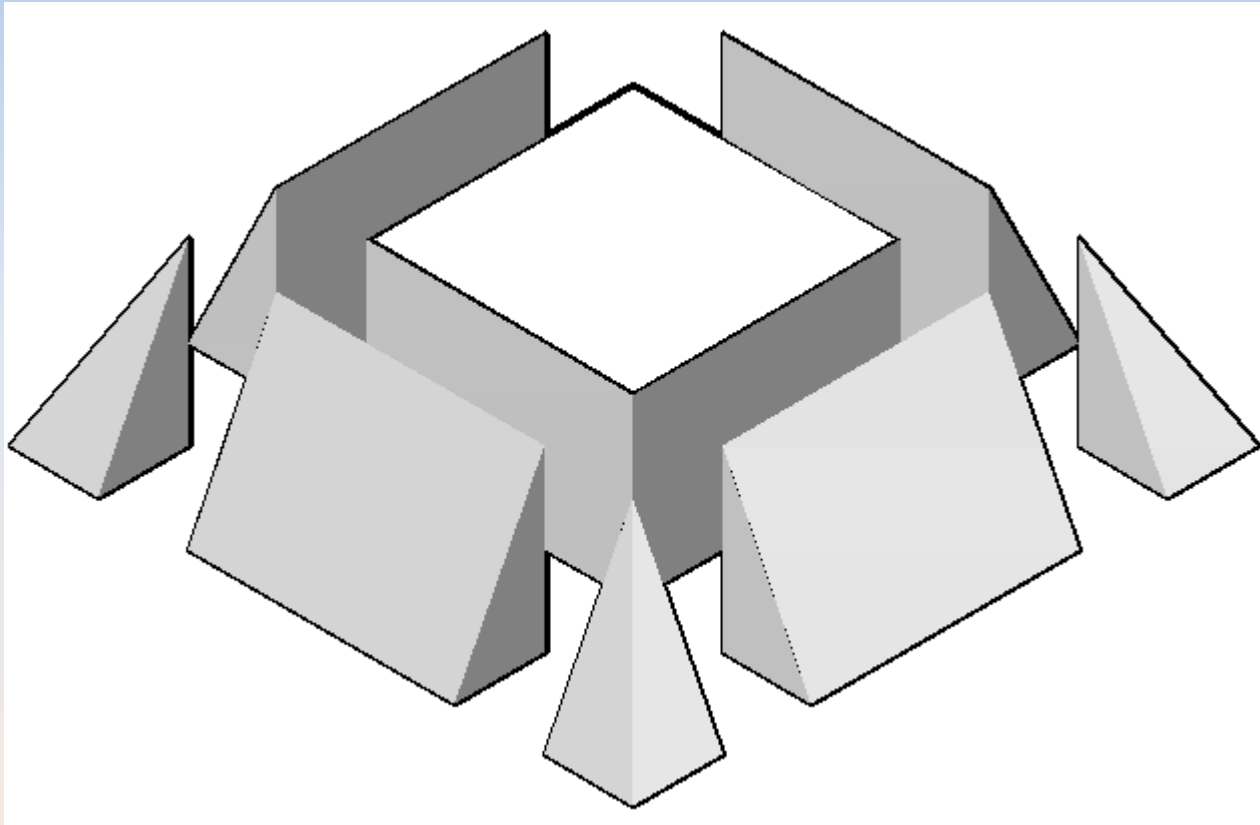

Mesopotamia, c. -3500 to -500

- The term “Mesopotamian” includes many cultures and peoples over a span of more than 3000 years.
- Mesopotamian written record goes back more than 5000 years.
- Motivated primarily by recording and analysis of astronomical data.

Mesopotamia, c. -3500 to -500

- Summary of achievements
 - Solution of quadratic and some cubic equations
 - Development of a spherical coordinate system for astronomical observation
 - Positional number system made it equally easy to work with whole numbers or fractions
 - Approximated square roots using a method similar to Newton's method.
 - Kept meticulous records of star positions, solar and lunar eclipses for centuries

Pythagorean Triples

- We have a tablet containing a list of triads of numbers dating from approx. -1700.
- Sexagesimal Pythagorean triples.
- Probably derived from the observation that
$$(p^2 - q^2)^2 + (2pq)^2 = (p^2 + q^2)^2$$
- The list has all 38 triples for $2 \leq p < 60$.
- We don't know if they had applications for it.

The Pythagoreans (-580 to c. -400)

- Most famous for the Pythagorean theorem
- Their work on the pentagram, dodecahedron, extreme and mean ratios, and incommensurability surely led them to encounter infinitesimals, limits of sequences, and the infinite, but their rigid philosophy prevented them from pursuing any of these concepts.
- The proof of the theorem, as presented by Euclid, involves areas, not lengths of lines.



Euclid's Proof of the Pythagorean Theorem

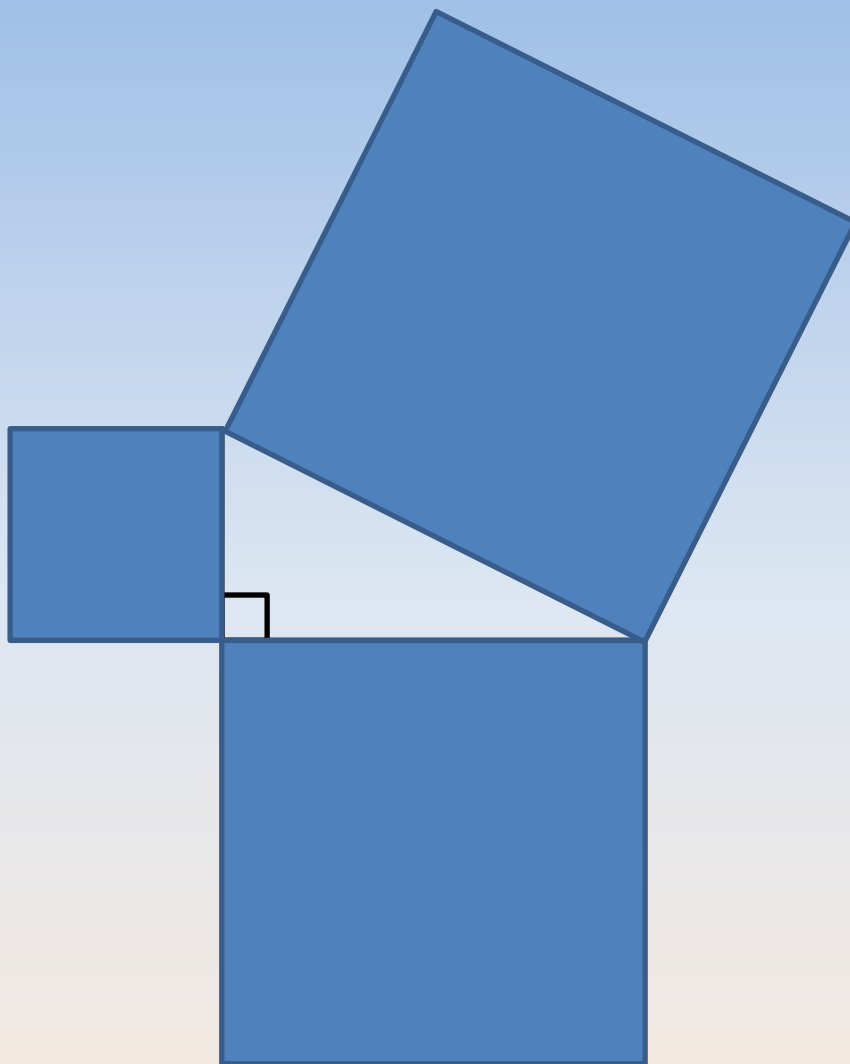

Hippocrates (fl. c. -430)

- Studied the properties of circles, which are fundamental in trigonometric development.
- Book III of Euclid's *Elements* summarises this work.

The Circle Theorems

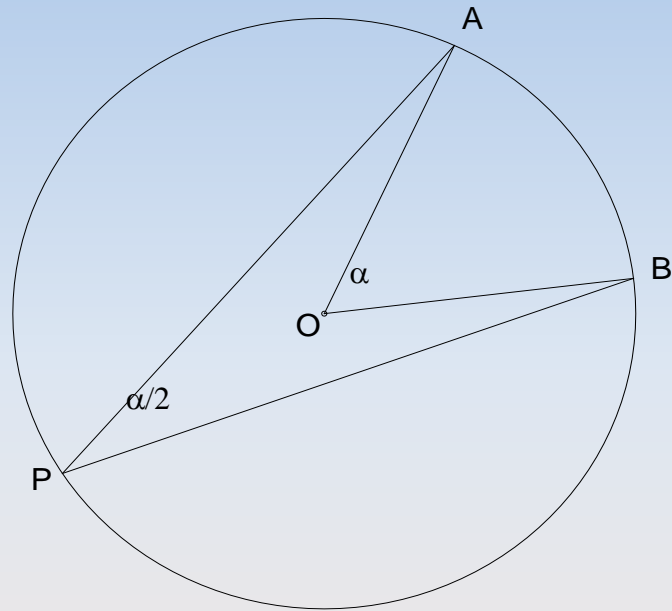

Elem. III.20
 $\angle O = 2 \angle P$

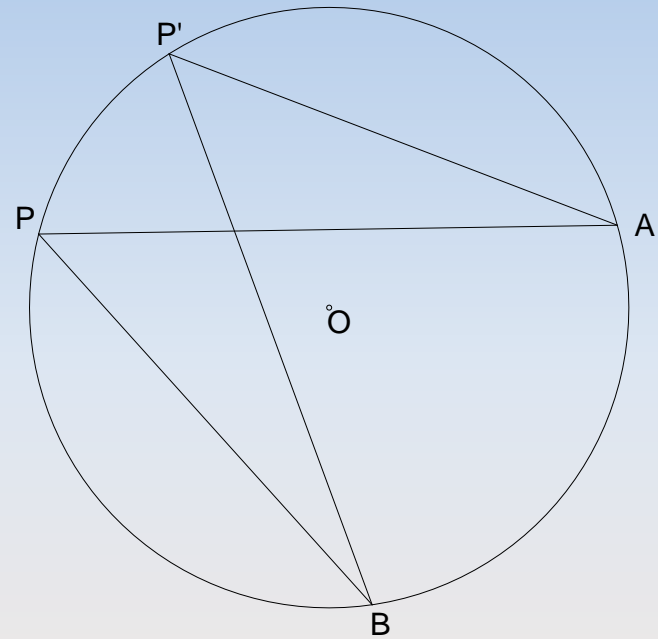

Elem. III.21
 $\angle P = \angle P'$

The Circle Theorems

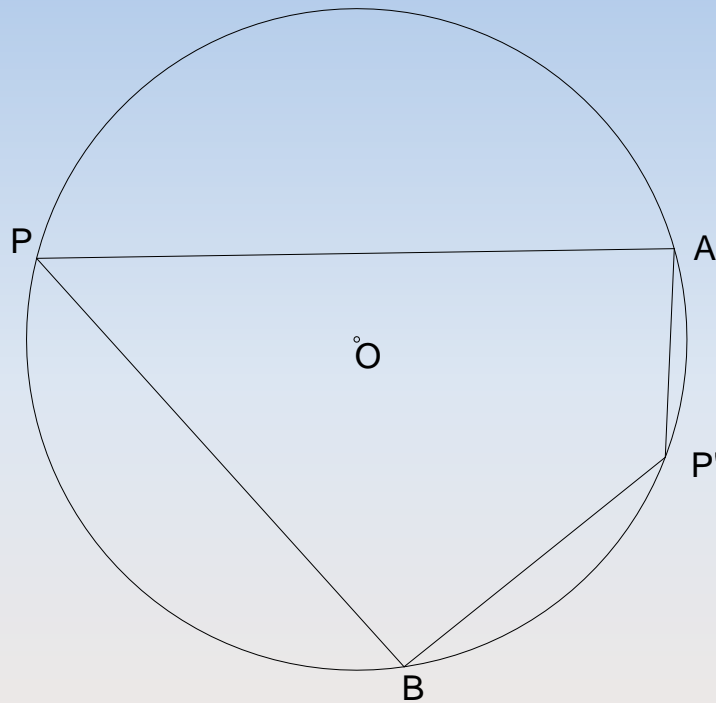

$$\angle P + \angle P' = 180^\circ$$

Elem. III.22

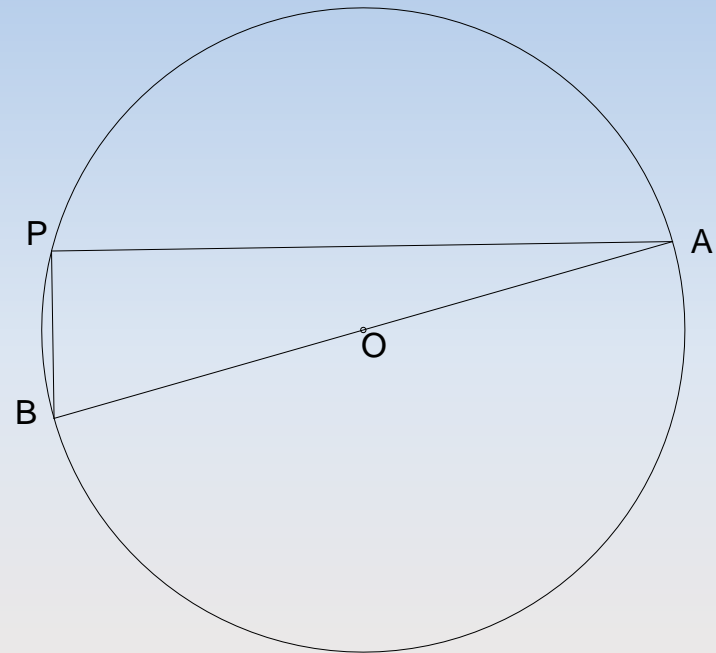

$$\angle P = 90^\circ$$

Elem. III.31

Applications

- The generations of mathematicians following Euclid were more applications-oriented.
- Among them we mention only a few:
 - Aristarchus (distances to the Moon and the Sun)
 - Archimedes (“broken chord” theorem)
 - Eratosthenes (circumference of the Earth)
 - Hipparchus (the first trigonometer?)
 - Menelaus (spherical trigonometry, law of sines)

Aristarchus (c. -310 to -230)

- Proposed a heliocentric model for the solar system.
- Conceived of celestial bodies as objects in space whose sizes and distances could be measured.
- Gave upper and lower bounds for the sizes and distances of the Sun and Moon.
- Discovered and explained parallax.

Aristarchus (c. -310 to -230)

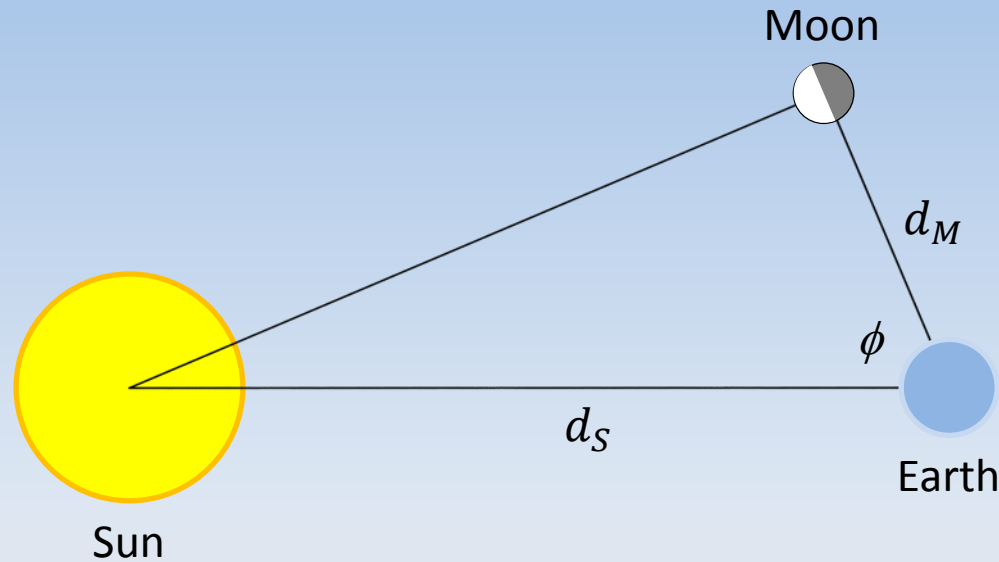

- Estimated 87° for ϕ .
- Used a well-known inequality to obtain bounds on d_S/d_M .



Aristarchus (c. -310 to -230)

- If $0 < \beta < \alpha < \pi/2$, then

$$\frac{\sin \alpha}{\sin \beta} < \frac{\alpha}{\beta} < \frac{\tan \alpha}{\tan \beta}.$$

- Aristarchus, Hipparchus and Archimedes after him, used this inequality without comment.
- Apparently it was well-known at the time.
- Unclear how it may have first been discovered.
- The first proof we have is that of Ptolemy.



Aristarchus (c. -310 to -230)

- Using the inequality, Aristarchus was able to show that

$$18 < \frac{d_s}{d_m} < 20$$

- Of course, the real value is closer to 400.
- The problem is that in fact, $\phi \approx 89^\circ 50'$.
- But the method is unimpeachable.

Aristarchus (c. -310 to -230)

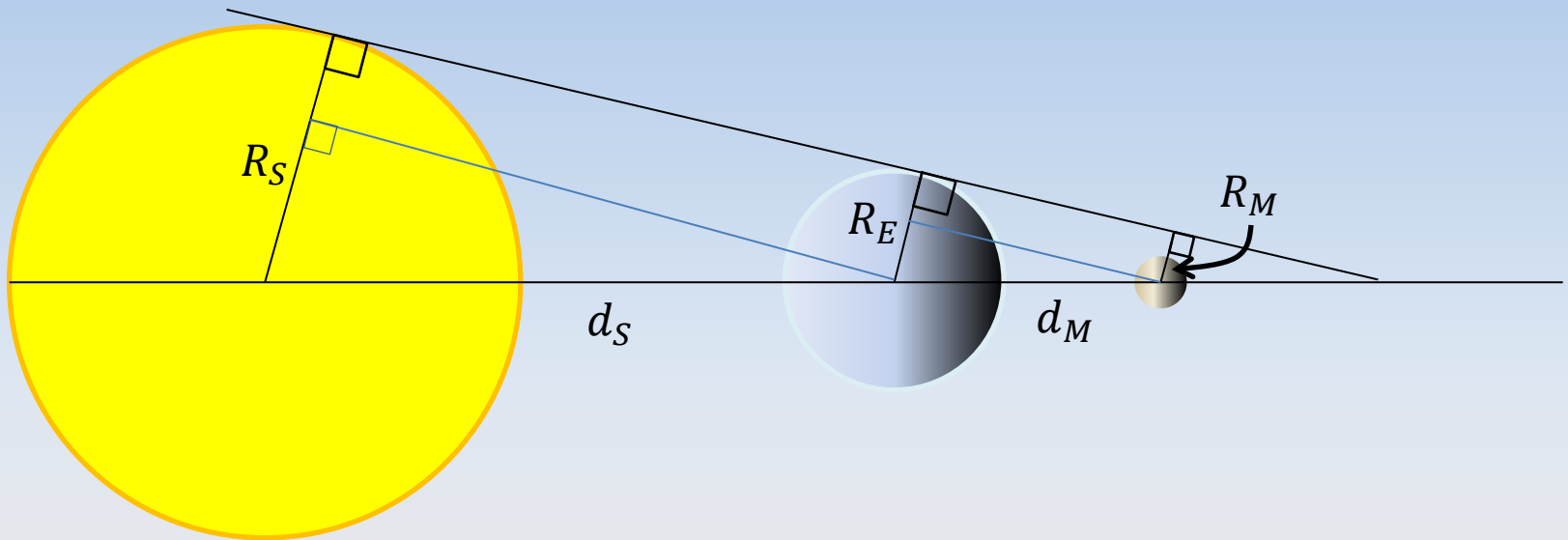

- Use similarity of triangles to determine d_S/d_M .
- Inserting his estimate of 19 for this ratio, he thereby also obtained estimates for R_S/R_E and R_M/R_E .

Aristarchus (c. -310 to -230)

- Ratio of sizes of the Sun to the Moon, by analysis of lunar eclipses.
- Can get the same result much more easily by using the previous result plus the fact that the Sun and Moon have almost the same apparent diameter as seen from Earth.
- Did this not occur to Aristarchus? Did he object to it for some reason? We may never know.

Aristarchus (c. -310 to -230)

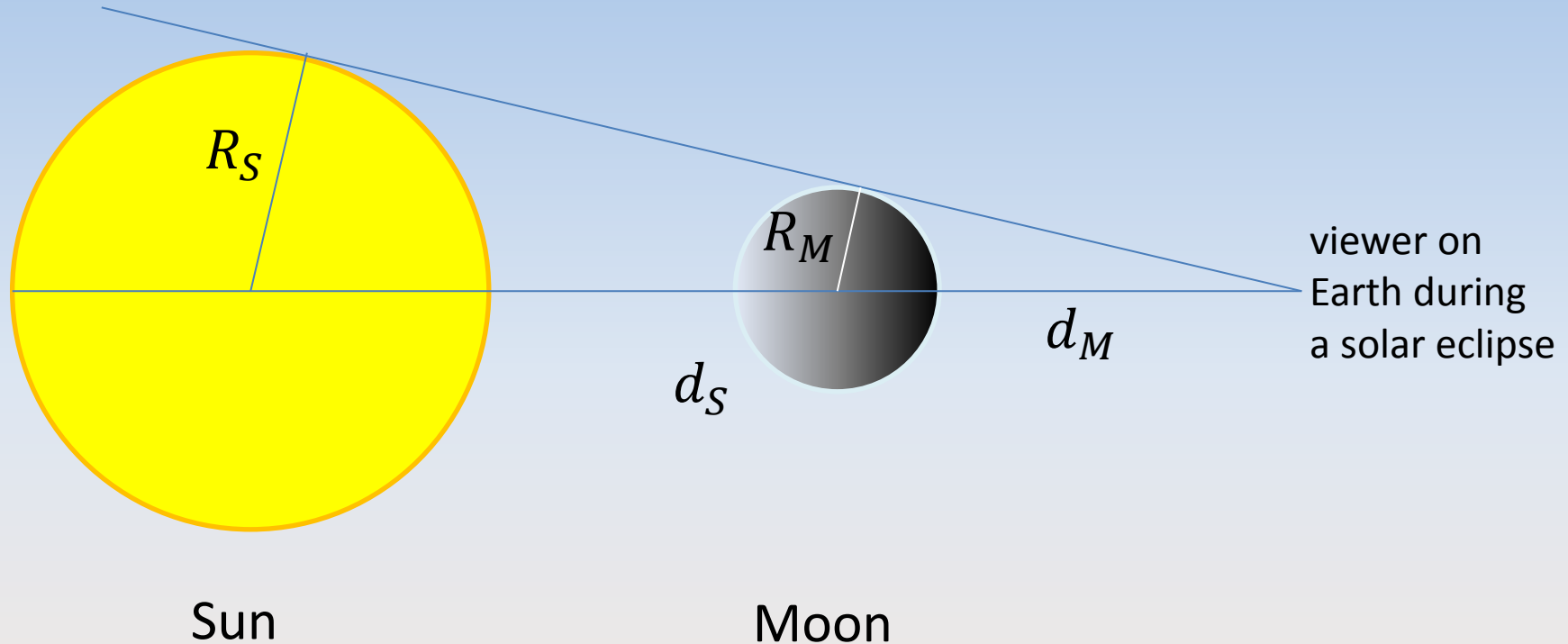

$$\frac{R_S}{R_M} = \frac{D_S}{D_M}$$

Why not??

Archimedes (-287 to -212)

- Generally considered the preeminent scientist and mathematician of ancient times.
- We focus on his contributions to trigonometry.

Archimedes (-287 to -212)

- “Broken chord” theorem

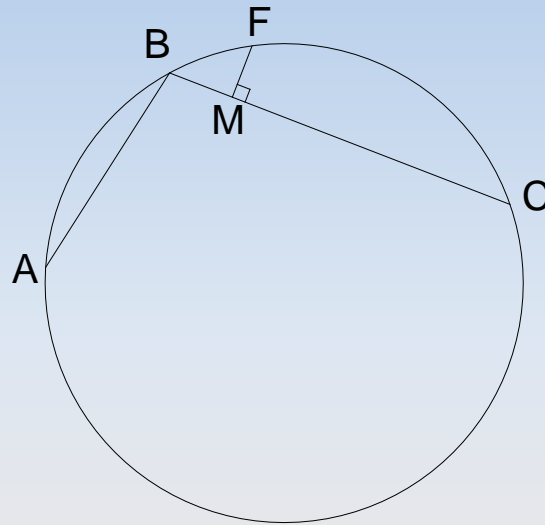

The “broken chord” is ABC . If F is the midpoint of the arc ABC , and if a perpendicular is dropped onto the broken chord, meeting it at M , then M is the midpoint of the broken chord ABC .

Archimedes (-287 to -212)

- We do not know whether Archimedes had trigonometrical applications for the broken chord theorem, but the difference of angles formulas are derivable from it.
- It is clear that he used this theorem in situations where we would use the sine law.

Archimedes (-287 to -212)

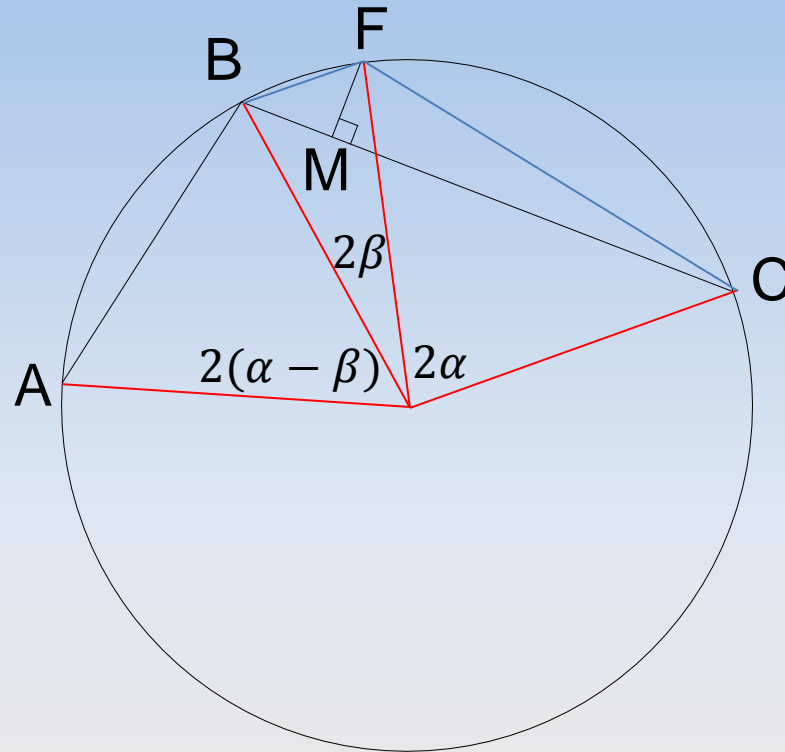

$$FC = \text{ch } \alpha = 2 \sin \alpha$$

$$BF = \text{ch } \beta = 2 \sin \beta$$

$$AB = \text{ch } (\alpha - \beta) = 2 \sin(\alpha - \beta)$$

and

$$MC = FC \cos \beta = 2 \sin \alpha \cos \beta$$

$$MB = BF \cos \alpha = 2 \sin \beta \cos \alpha$$

Eratosthenes (-275 to -194)

- Of the famed Alexandrian school
- Most famous for his surprisingly accurate estimate of the circumference of the Earth.
- Used the fact that at the summer solstice, the sun in Syene is directly overhead, while in Alexandria it is 7° from overhead.
- Knowing the distance between the two cities allows the circumference to be estimated.

Hipparchus (c. -180 to -125)

- Renowned astronomer.
- Apparently studied in Babylonia, bringing back with him centuries' worth of astronomical records and the idea of subdividing a circle into 360 parts.
- Used the Babylonian data to predict a solar eclipse and discover the precession of the equinox.

Hipparchus (c. -180 to -125)

- Considered by many to be the first true trigonometer.
- Devised a table of chords to simplify astronomical calculations.
- Wrote a treatise in twelve books on the subject, which has been lost.

Hipparchus's chord function

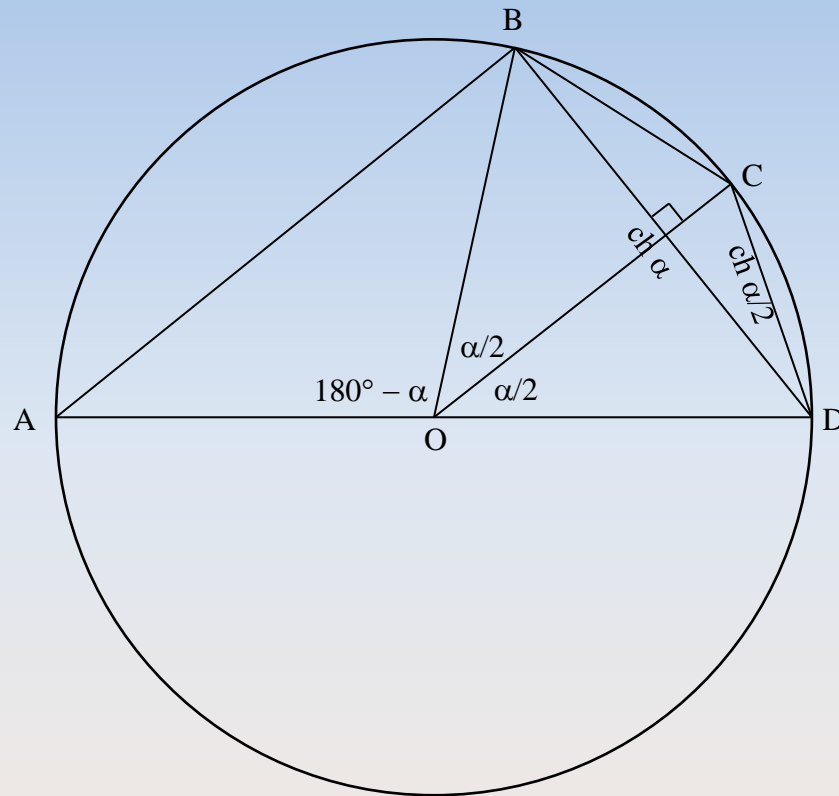

Hipparchus's chord function

Relationships between the chord function and modern functions

$$\text{ch } \alpha = 2R \sin \frac{\alpha}{2}$$

$$\text{ch } (180^\circ - \alpha) = 2R \cos \frac{\alpha}{2}$$

Pythagorean theorem

$$\text{ch}^2 \alpha + \text{ch}^2 (180^\circ - \alpha) = 4R^2$$

Half-angle formula

$$\text{ch}^2(\alpha/2) = R^2 - R \text{ch}(180^\circ - \alpha)$$

$$\text{ch } 90^\circ = R\sqrt{2} \qquad \text{ch } 60^\circ = R$$

Many other relations are also possible.

Hipparchus's chord function

- Starting from a known chord value such as $\text{ch } 60^\circ$ and making use of the supplementary angle and half-angle formulas, Hipparchus built a table of chords up to 180° in increments of $3\frac{3}{4}^\circ$.
- Hipparchus took $R = 3438$ miles, which yields a circumference of 21 602 miles, exactly Eratosthenes's estimate for the circumference of the Earth.

Menelaus (fl. c. -100, Alexandria)

- Extended several plane geometry theorems to the sphere, making them more naturally suited for astronomical calculations.
- Discovered the spherical law of sines.
- Was the first to recognise a great circle as the spherical analogue of a straight line.

Menelaus (fl. c. -100, Alexandria)

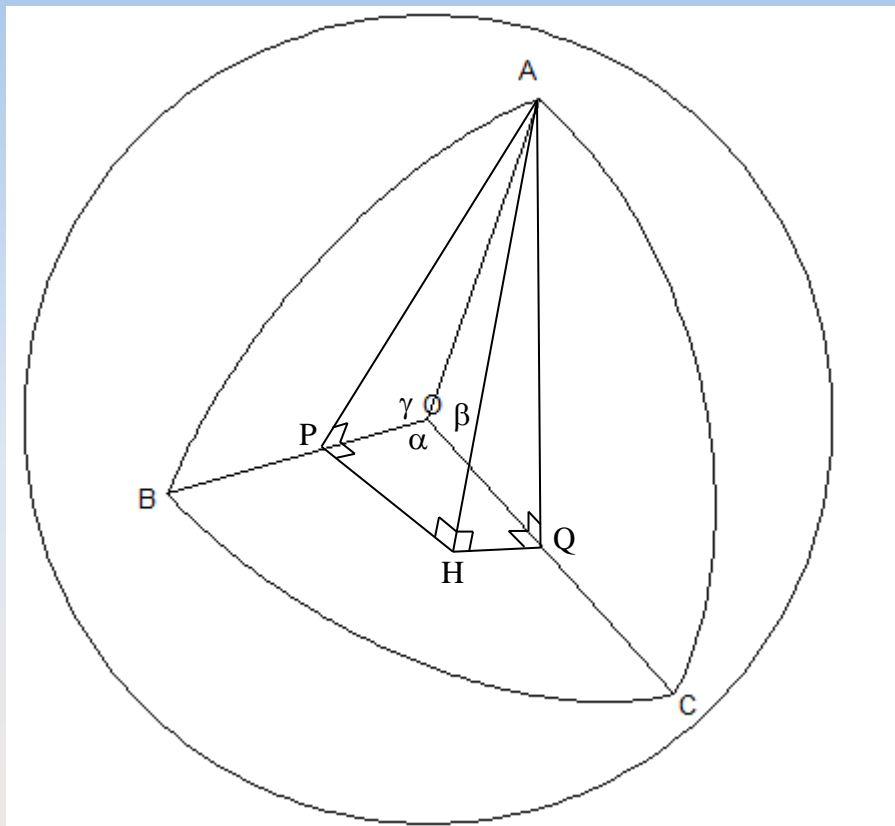

Spherical Law of Sines

$$\frac{\sin \alpha}{\sin A} = \frac{\sin \beta}{\sin B} = \frac{\sin \gamma}{\sin C}$$

Heron (10 to 70, Alexandria)

- We mention only a famous formula for the area of a triangle which was actually known to Archimedes.
- His proof was purely geometric, and so very laborious!
- A modern proof would make essential use of the laws of sines and cosines.

Heron (10 to 70, Alexandria)

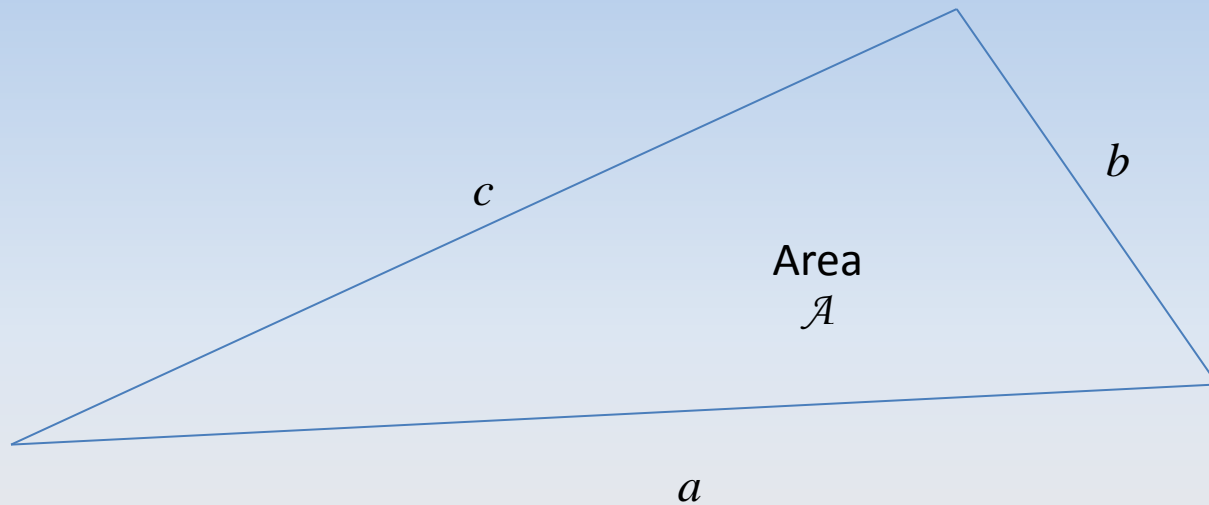

$$\mathcal{A}^2 = s(s - a)(s - b)(s - c)$$

$$s = \frac{1}{2}(a + b + c)$$

Ptolemy (fl. 127 to 151, Alexandria)

- His *Mathēmatikē Syntaxis* (better known by its Arabic name *Almagest*), was one of the most influential scientific works of all time
- Comprehensive treatise of planetary motions
- Geocentric solar system, explaining planetary motions in terms of cycles and epicycles
- Used and greatly extended Hipparchus's trigonometry
- Made good use of a theorem named after him

Ptolemy's Theorem

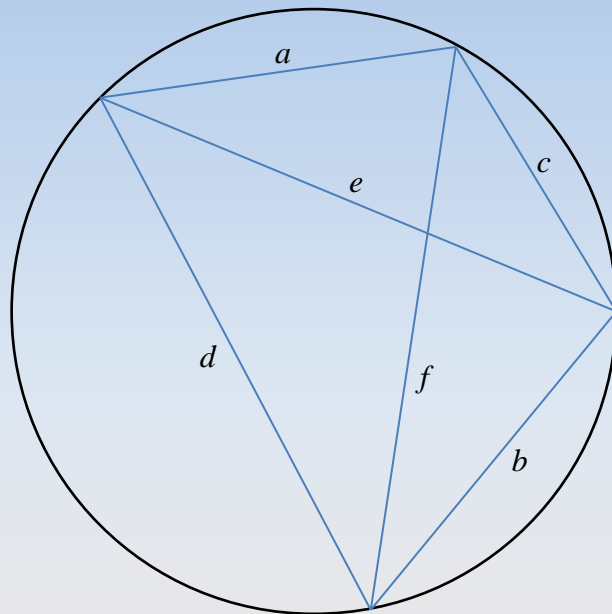

For any convex cyclic quadrangle,

$$ab + cd = ef$$

Consequences of Ptolemy's Theorem

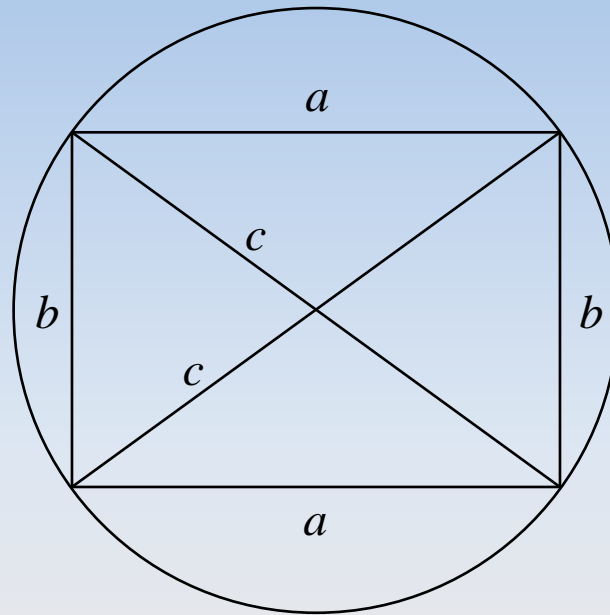

If the quadrangle is a rectangle, then

$$a^2 + b^2 = c^2$$

Consequences of Ptolemy's Theorem

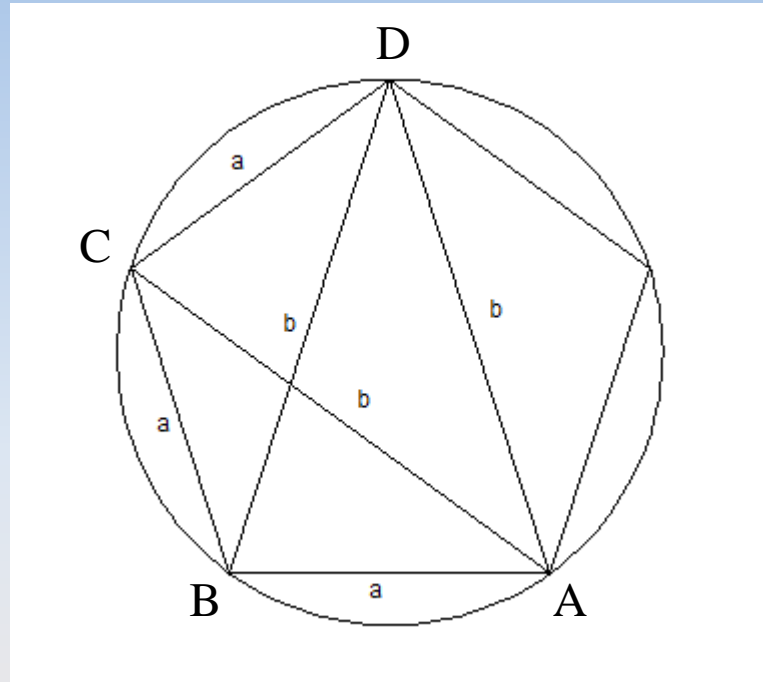

If the quadrangle is ABCD, in an inscribed pentagon, then

$$\frac{b}{a} = \frac{1 + \sqrt{5}}{2}$$

Consequences of Ptolemy's Theorem

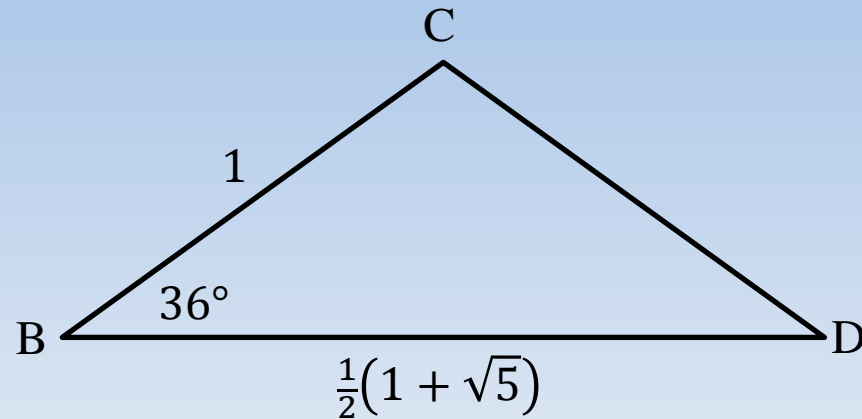

$$\cos 36^\circ = \frac{1}{4}(1 + \sqrt{5})$$

$$\sin 36^\circ = \frac{1}{4}\sqrt{10 - 2\sqrt{5}}$$

Ptolemy's chord table

- Gave chords for a circle with $R = 60$ in sexagesimal digits, accurate to the second sexagesimal place (that is, to $\frac{1}{3600}$).
- The fractional digits were called by mediaeval scholars *partes minutiae primae* and *partes minutiae secundae*, which became our *minutes* and *seconds*.
- Included a column called *hexikostōn* (sixtieths):

$$\frac{\text{ch} \left(\theta + \frac{1}{2} \right) - \text{ch} \theta}{1/2}$$

Ptolemy's chord table

Arc	Chord			Sixtieths		
109	97	41	38	0	36	23
109 ½	97	59	49	0	36	9
110	98	17	54	0	35	56
110 ½	98	35	52	0	35	42
111	98	53	43	0	35	29
111 ½	99	11	27	0	35	15
112	99	29	5	0	35	1

$$\begin{aligned}
 \text{ch } 109\frac{3}{4} &= \text{ch } 109\frac{1}{2} + \text{hex } (109\frac{1}{2}) \left(\frac{1^p}{4}\right) \\
 &= 97^p 59'49'' + (36'09'')(15')
 \end{aligned}$$

$$\longrightarrow f(x) = f(x_0) + f'(x_0)(x - x_0) \longleftarrow$$

The Siddhāntas (Doctrines)

- Instead of the chord function, the half-chord (that is, the sine) function is used as the basic trigonometric function.
- The Sanskrit word for “half-chord” is *ardha-jyā*
- Often shortened to *jīva* in writings.
- When Hindu works were translated into Arabic, *jīva* was transliterated as *jiba*.
- As Arabic is generally written without vowels, it was written simply *jb*.

Story of the word “sine”

- As *jiba* has no other meaning in Arabic, over time *jb* came to be pronounced *jayb* (meaning, “inlet” or “bosom of a dress”).
- When Fibonacci translated Arabic works into Latin in the 13th century, he translated *jayb* as *sinus*, meaning “bay” or “inlet”.
- So that is where the name of the sine function came from!
- The other Hindu trig function, *koti-jyā*, naturally became *co-sinus* or cosine function.

Relation between chord and jīva

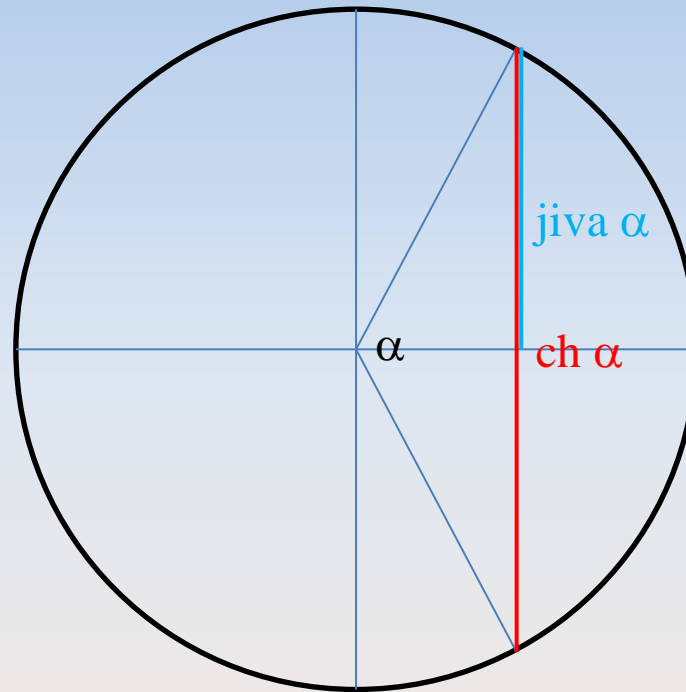

Brahmagupta (fl. ~628)

- Proved Heron's formula trigonometrically, and then extended the formula to cover cyclic quadrangles:

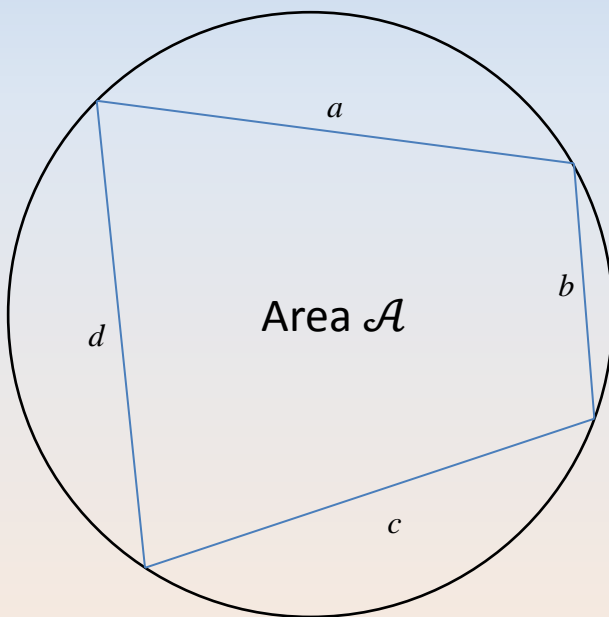

$$\mathcal{A}^2 = \frac{1}{16} (s - a)(s - b)(s - c)(s - d)$$

$$s = \frac{a + b + c + d}{2}$$

Brahmagupta (fl. ~628)

- Brahmagupta made use of the infinite series representations for cosine, sine, and arctangent.
- We do not know whether he discovered them himself, or how they were obtained.
- Predated Newton and Leibniz by more than 1000 years!

Bhāskara (1100s)

- The most succinct proof of the Pythagorean theorem EVER!

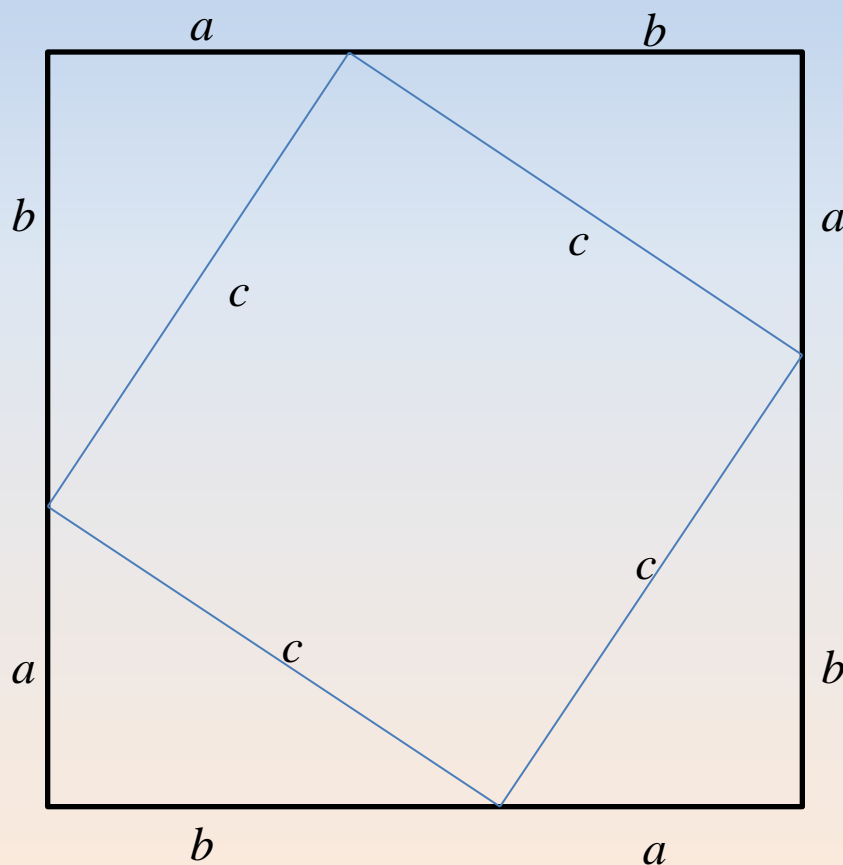

$$4 \cdot \frac{1}{2}ab + c^2 = (a + b)^2$$

$$a^2 + b^2 = c^2$$

Islamic mathematics, c. 800 - 1200

- Centre of Islamic scholarship was in Baghdad.
- After the Arab conquests of the 7th and 8th centuries, much Hellenic writing was translated into Arabic and disseminated.
- Here it was reconciled with Indian mathematics and number system, and took on a modern form we would recognise today.
- Eastern “algebra” was unified with Western “geometry”.
- The six modern trig functions sin, cos, tan, cot, sec, and csc originated at this time (with different names, of course).

Abū al-Wafā (Persia, 940 – 988)

- Renowned astronomer.
- Like many before him, used trigonometry mainly as a calculational convenience.
- Gave a direct proof of the sum- and difference-of-angles formulas in a form that would be recognised today.
- Published a table of trigonometric values in increments down to $\frac{1^\circ}{4}$.

Al-Wafā's proof of $\sin(\alpha + \beta)$ formula

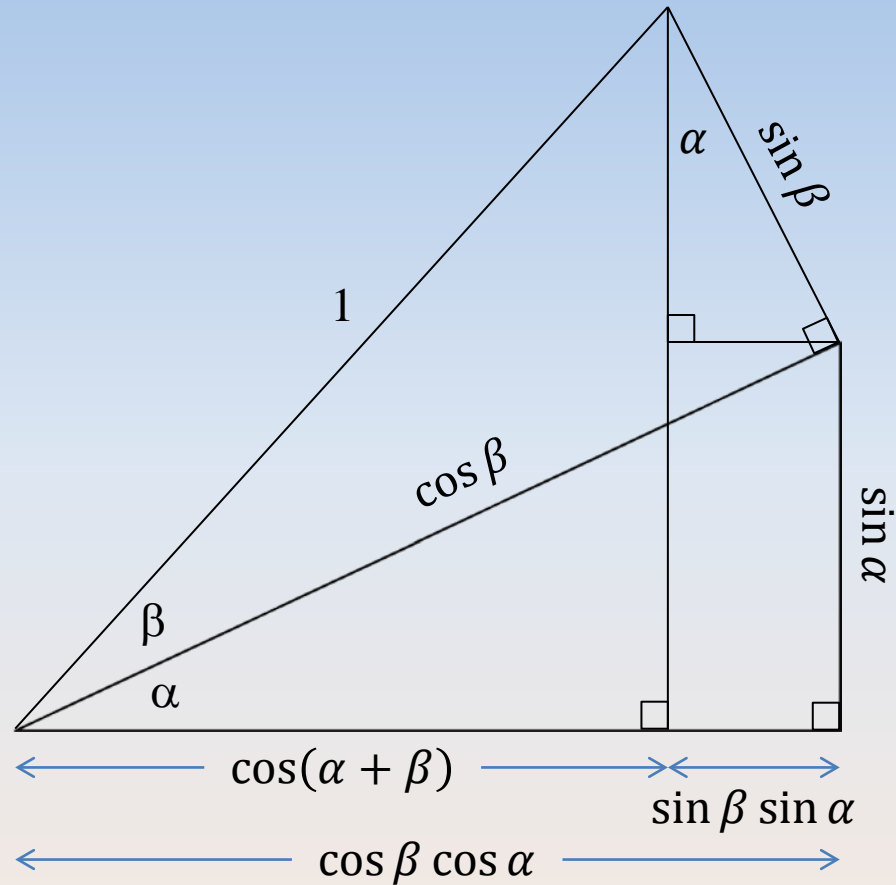

Al-Bīrūnī (Persia, 973-1048)

- One of the most renowned scholars of his day.
- Developed a simple method for estimating the radius of the Earth.
- Much less cumbersome than Eratosthenes's method.

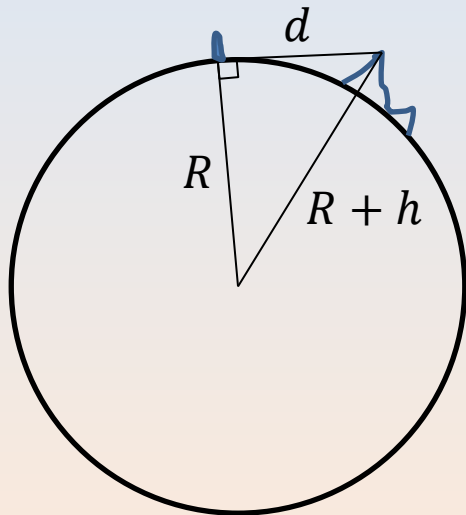

$$R = \frac{d^2 - h^2}{2h}$$

The Mediaeval Philosophers

- We mention only Fibonacci and Levi ben Gershon.

The Mediaeval Philosophers

- Fibonacci translated many works from the Arabic into Latin.
- Credited with introducing the decimal number system, 0 as a fully-fledged number, as well as sines and cosines, into Europe.



The Mediaeval Philosophers

- Levi ben Gershon, a Jewish philosopher, produced the first trigonometric table using sines and cosines, decimal numbers (with sexagesimal fractions), and square roots.
- Made full use of the sum- and difference-of-angles, double-angle and half-angle formulas.
- His table was in increments of 3° , and linearly interpolated in between, down to $\frac{1}{2}^\circ$.

Birth of Trigonometric Functions

- In the 1660s Newton and Leibniz were independently developing calculus, and at the same time the concept of a *function*.
- Leibniz seems to have been the first to think of $\sin x$ as a function of the variable x .
- Both Newton and Leibniz made use of infinite series representations, which made for estimates as accurate as desired.

François Viète (1540 - 1603, France)

- Can be regarded as the father of modern algebra, and as well the father of modern trigonometry.
- Multiple-angle formulas and trigonometric polynomials, using complex numbers.
- Trigonometry in complex arithmetic
- Trigonometric solution of the cubic equation.
- We see in Viète's work a more abstract notion of trigonometry: functions of real numbers.

François Viète (1540 - 1603, France)

- Solution of the reduced cubic equation

$$y^3 = py + q$$

- Based on Viète's identity

$$\cos^3 \theta = \frac{1}{4} \cos 3\theta + \frac{3}{4} \cos \theta$$

set $y = u \cos \theta$ and determine the required value of u .

- Solve for $\cos 3\theta$, then for $\cos \theta$, then for y .



François Viète (1540 - 1603, France)

- Viète was the first to derive and use the tangent law

- ...and the product-to-sum laws

$$\sin x \sin y = \frac{1}{2} [\cos(x - y) - \cos(x + y)]$$

- ...and the sum-to-product laws

$$\sin x + \sin y = 2 \sin \frac{x + y}{2} \cos \frac{x - y}{2}$$

François Viète (1540 - 1603, France)

- ...and the multiple angle formulas

$$\cos nx = \sum_{k=0}^n (-1)^k \binom{n}{2k} \cos^{n-2k} x \sin^{2k} x$$

and

$$\begin{aligned} \sin nx &= \sum_{k=0}^n (-1)^k \binom{n}{2k+1} \cos^{n-2k-1} x \sin^{2k+1} x \end{aligned}$$

Abraham de Moivre (1667 – 1754, France/London)

- $(\cos \theta + \iota \sin \theta)^n = \cos n\theta + \iota \sin n\theta.$
- To discover this formula it is necessary to regard complex numbers as points on a plane.
- Then observe that complex multiplication is a dilative rotation in the plane.
- de Moivre's formula is a formalisation of this phenomenon.

Abraham de Moivre (1667 – 1754, France/London

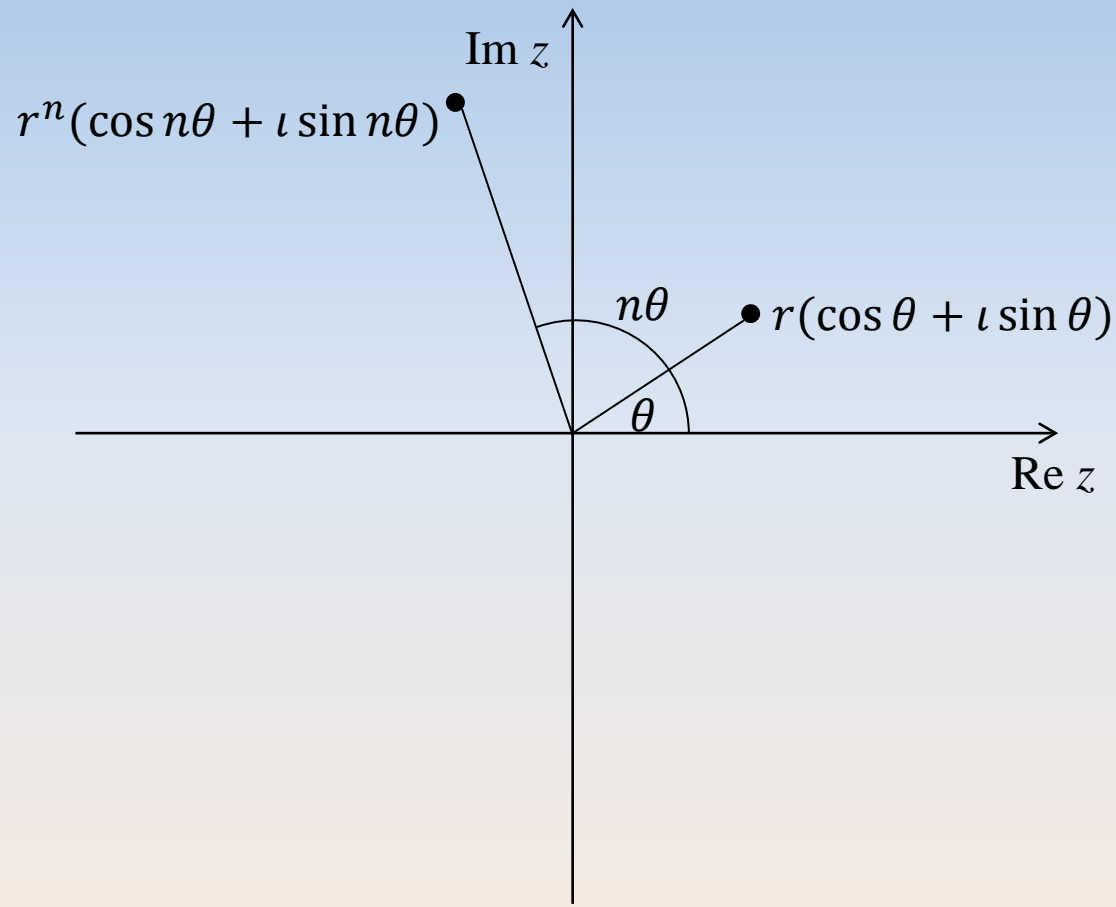

Leonhard Euler (1707 - 1783, Basel)

- $e^{i\theta} = \cos \theta + i \sin \theta$.
- Philosophers and mathematicians have pondered the significance of this identity.
- Roger Cotes, a contemporary of Newton, had discovered a closely related result using integrals:

$$\log(\cos \theta + i \sin \theta) = i\theta$$

- Euler discovered it using infinite series.

Joseph Fourier (1768 – 1830, France)

- In his work on the theory of heat, which remains influential to this day, he proved that any periodic function can be expressed as a (possibly) infinite series of sines and cosines.
- If the period is T , then

$$f(x) = a_0 + \sum_{n=1}^{\infty} a_n \cos \frac{2\pi n x}{T} + b_n \sin \frac{2\pi n x}{T}$$

- The coefficients are found based on the fact that $\sin \frac{2\pi m x}{T}$ and $\cos \frac{2\pi n x}{T}$ are orthogonal:

Joseph Fourier (1768 – 1830, France)

$$\int_{-\pi}^{\pi} \cos mx \sin nx \, dx = 0$$

$$\int_{-\pi}^{\pi} \cos mx \cos nx \, dx = \begin{cases} \pi, & m = n \\ 0, & m \neq n \end{cases}$$

$$\int_{-\pi}^{\pi} \sin mx \sin nx \, dx = \begin{cases} \pi, & m = n \\ 0, & m \neq n \end{cases}$$

The End!

References

1. Brown, James W and Ruel V Churchill. Complex Variables and Applications. Sixth Edition. McGraw-Hill, Inc. (1996).
2. Coxeter, H S M and S L Greitzer. Geometry Revisited. The Mathematical Association of America (1967).
3. Gelfand, I M and M Saul. Trigonometry. Birkhäuser (2001).
4. Heath, Thomas L. A History of Greek Mathematics. Volume II: From Aristarchus to Diophantus. Dover Publications, Inc. (1981).
5. http://en.wikipedia.org/wiki/Ptolemy's_table_of_chords .
6. Merzbach, Uta C and Carl B Boyer. A History of Mathematics. Third Edition. John Wiley & Sons, Inc. (2011).
7. Smart, W M. Textbook on Spherical Astronomy. Sixth Edition. Cambridge University Press (1977).
8. Van Brummelen, Glen. The Mathematics of the Heavens and the Earth. Princeton University Press (2009).