

Origami 101



Step by step
instruction booklet

Table of Contents

- Tips and Tricks (p. 2)
- Extra Resources (p. 2)
- Basic Folds (p. 3-12)
 - Mountain Fold (p. 3)
 - Valley Fold (p. 3)
 - Inside Reverse Fold (p. 4-5)
 - Outside Reverse Fold (p. 6-7)
 - Square Base (p. 8)
 - Petal Fold (p. 9)
 - Petal Fold Variation (p. 11)
 - Squash Fold (p. 12)
- Fox (easy) (p. 13)
- Pigeon (easy) (p. 14)
- Crane (medium) (p. 15-19)
- Iris (hard) (p. 20-21)

All tutorials are from Origami.me
We wish we could make instructions this lovely!

Tips and Tricks

- SLOW DOWN! You want to make sure all of your edges line up and that your folds are creased well, and that takes some time and focus.
- KEEP THE SAME ORIENTATION! The tutorials are very specific, so it is extremely helpful to keep your paper in the same position that the tutorial is showing and follow along from there.
- CONSULT YOUR GUIDE! Is a particular fold not making sense? Flip back to the "Basic Folds" pages and check to make sure you're doing it right. If you still have issues, check out some of the resources below to find some YouTube videos and other step-by-step instructions online.
- VIDEOS ARE YOUR FRIEND! It can help to see the way the paper is supposed to move and fold, rather than relying on the 2D diagrams. There are so many resources out there to help out!
- DON'T GET FRUSTRATED! It's just paper. You can always try again. If you need more materials, a square of any size from most types of paper will serve you just fine!

Extra Resources!

- Find these tutorials and many more at <https://origami.me/diagrams/>.
- Learn by watching! A list of videos can be found at <https://origami.me/video-tutorials/>
- Check out these titles in our collection:
 - LaFosse & Alexander's essential book of origami : the complete guide for everyone by Michael LaFosse (Adult Nonfiction, 736.982 LAF)
 - Origami, plain and simple by Robert Neale (Adult Nonfiction 736.982 NEA)
 - Origami : 30 fold-by-fold projects by Paulo Mulatinho (Adult Nonfiction 736.982 MUL)
 - Origami palooza : dragons, turtles, birds, and more! by Christopher Harbo (Juvenile Nonfiction J 736.982 HAR)
 - Origami paper animals by Didier Boursin (Juvenile Nonfiction J 736.982 BOU)

Basic Folds

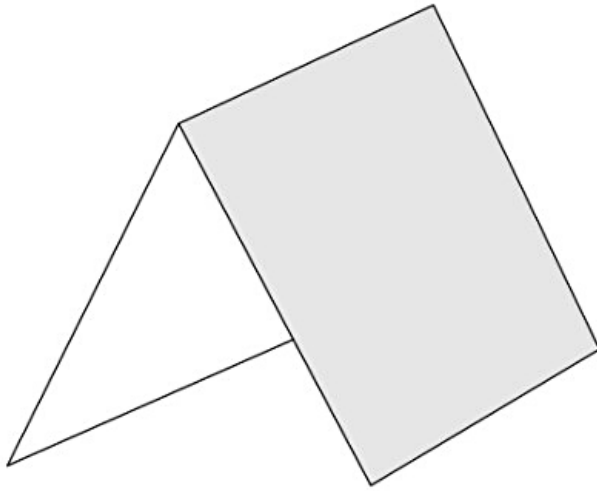

MOUNTAIN FOLD

With a **Mountain Fold** the crease bends the paper down and the crease resembles a mountain.

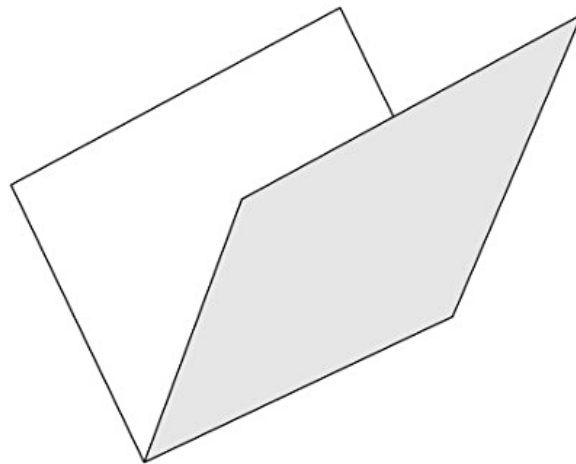

VALLEY FOLD

With a **Valley Fold** the crease bends the paper up and the crease resembles a valley.

INSIDE REVERSE FOLD

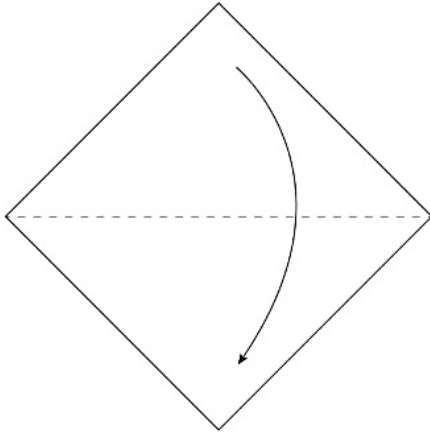

Step 1) Start with a square of paper, white side up and fold it in half diagonally. This isn't actually part of the Inside Reverse Fold but it'll give you a shape that you can use to make the Inside Reverse Fold on.

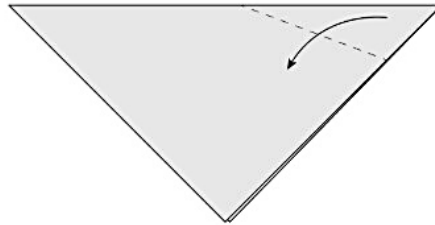

Step 2) Fold along the dotted line. This is where you're going to make the inside reverse fold. Your fold doesn't have to match the exact position of the line so don't worry if it doesn't measure up exactly.

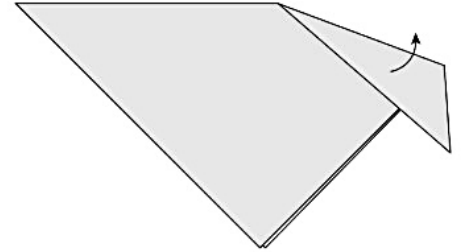

Step 3) Crease this fold well and then unfold it.

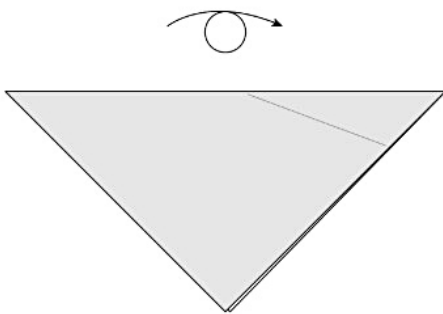

Step 4) Turn the paper over.

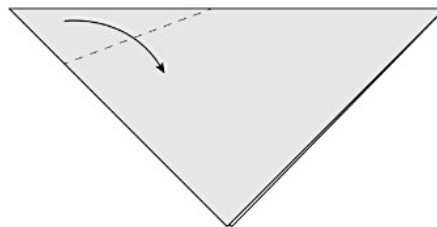

Step 5) Make a fold along the dotted line. This will be the opposite side of the fold you made earlier. Now you're folding this the other way.

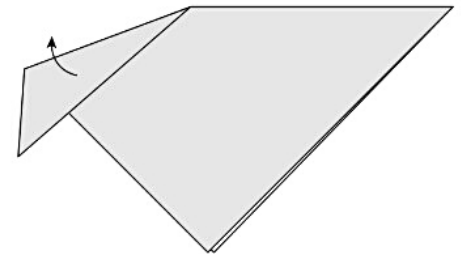

Step 6) Crease this fold well and then unfold it.

INSIDE REVERSE FOLD (continued)

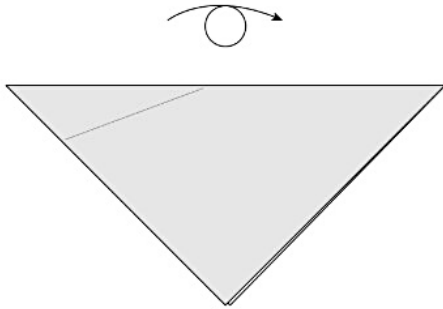

Step 7) Turn the paper over again so it's back the way it was before.

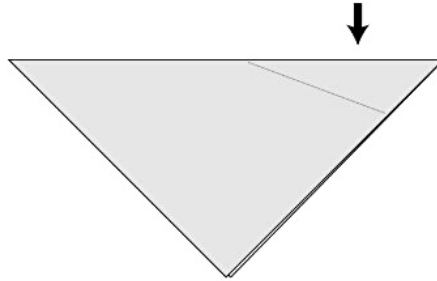

Step 8) Push the paper inside the model following the two folds you made before.

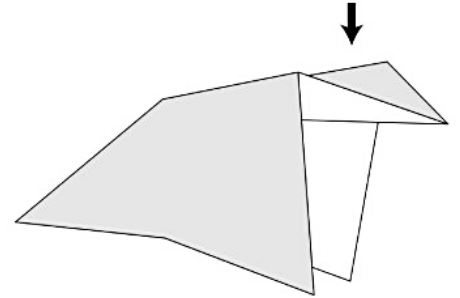

Step 9) Push the paper all the way inside the model and flatten along the creases you already made.

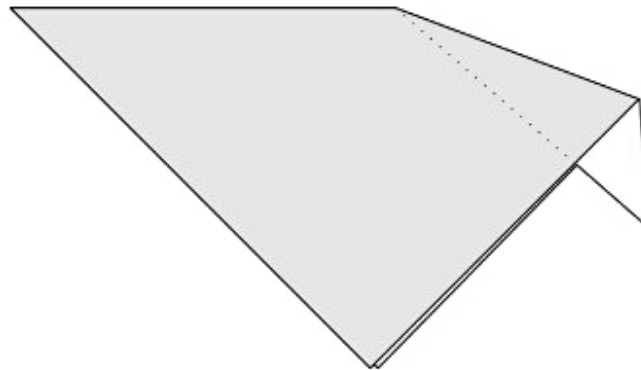

The completed Inside Reverse Fold. The dotted line shows the path of the paper inside the model.

OUTSIDE REVERSE FOLD

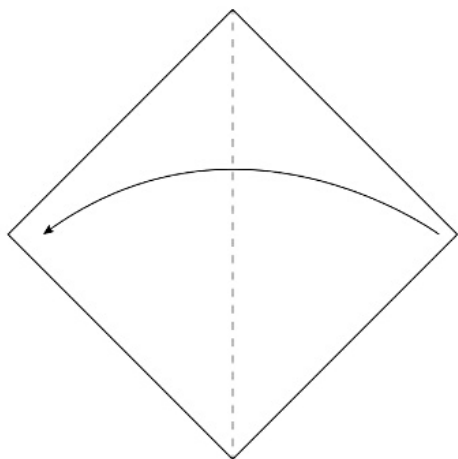

Step 1) Start with a square of paper, white side up and fold it in half diagonally. This isn't part of the Outside Reverse Fold but it will give us a shape we can use to demonstrate the fold.

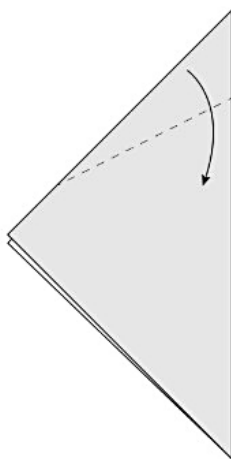

Step 2) Fold the paper along the dotted line. This will be where you will make the Outside Reverse Fold. Your fold doesn't have to line up exactly where the line is so don't worry about making it completely perfect.

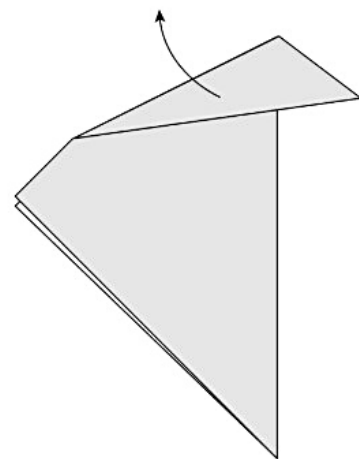

Step 3) Crease this fold well and then unfold it.

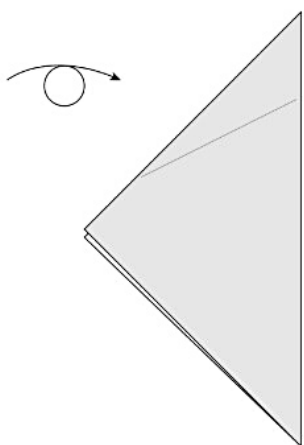

Step 4) Turn the paper over.

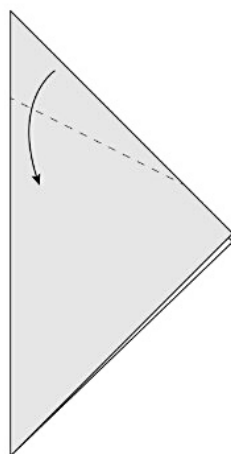

Step 5) Fold the paper along the dotted line. This will be the opposite side of the crease you made earlier.

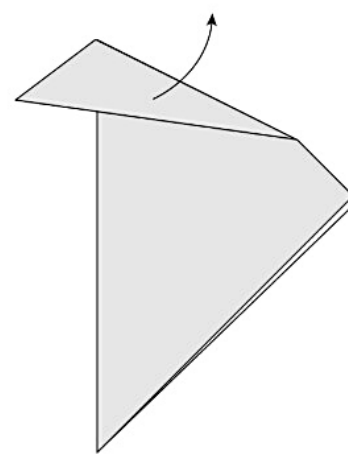

Step 6) Crease this well and then unfold it.

OUTSIDE REVERSE FOLD (continued)

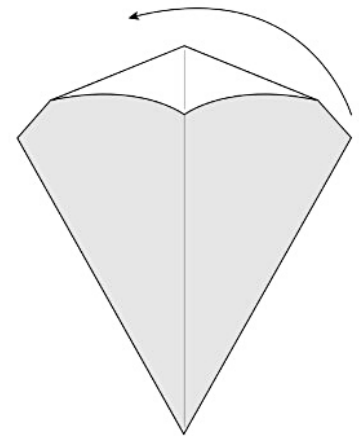
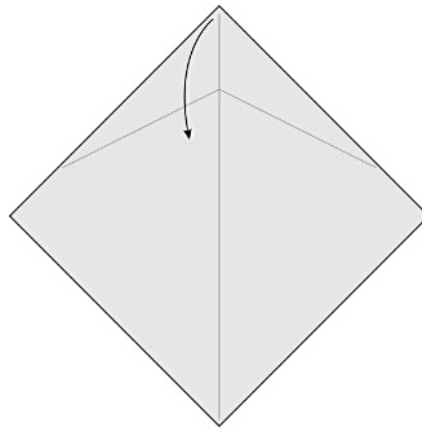
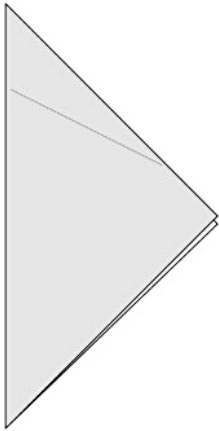

Step 7) Fold the paper outside the model along the creases you already made. To make it a bit easier you can open the model up.

Step 8) Fold the paper down along the creases you already made.

Step 9) As you fold the paper down close the model up again along the crease you made in step 1. The paper you folded down should flatten nicely on the outside of the model.

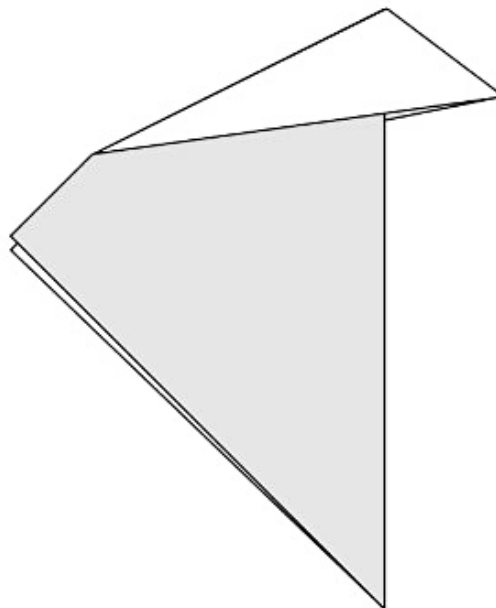

The completed Outside Reverse Fold. It's the opposite of the Inside Reverse Fold. The shape of the fold is essentially the same it's just folded the other way and outside the model.

SQUARE BASE

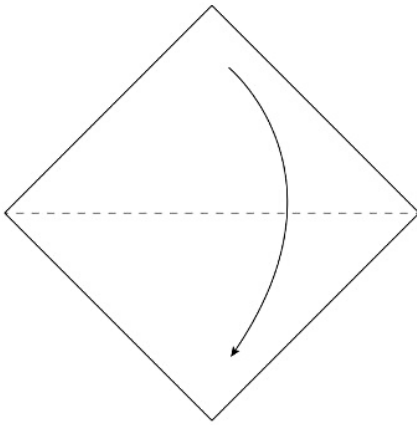

Step 1) Start with a square sheet of paper with the white side up. Fold it in half along the dotted line.

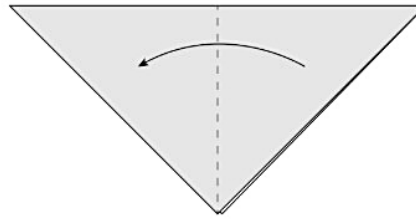

Step 2) Fold the paper in half again along the dotted line.

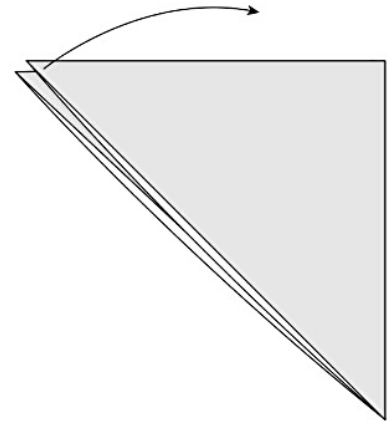

Step 3) Bring the top flap of paper up.

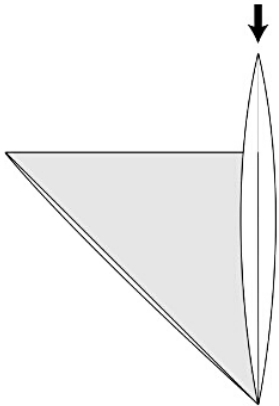

Step 4) Squash fold this flap of paper down. Make sure you keep both sides symmetrical. You should end up with a diamond shape.

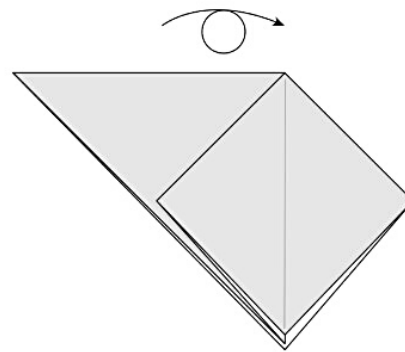

Step 5) Turn the model over.

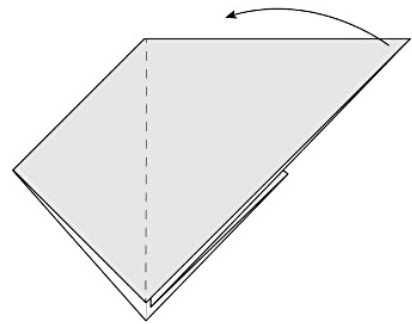

Step 6) Lift up the top left flap of paper to the middle.

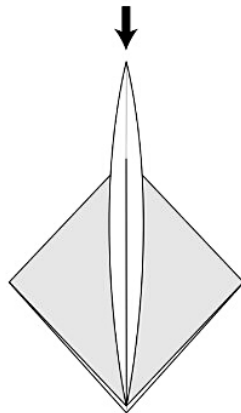

Step 7) Squash fold this flap of paper down. Make sure you keep both sides symmetrical. You should end up with a diamond shape matching the one on the other side.

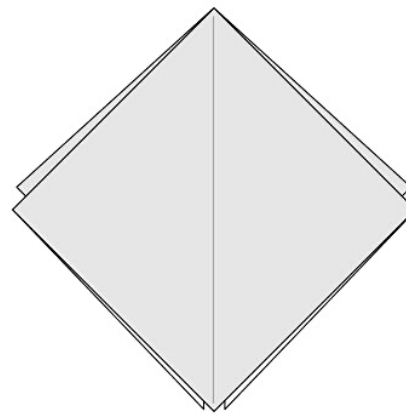

The completed Square or Preliminary Base.

PETAL FOLD

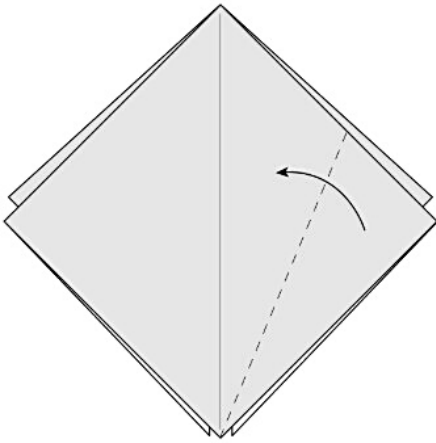

Step 1) For this example start off with a Square Base. The instructions for this base are later in this guide. This is the most common way to make a Petal Fold. Fold the top right flap of paper to the centre along the dotted line.

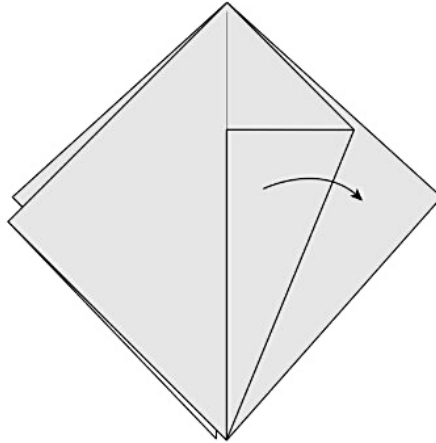

Step 2) Crease this fold well and then unfold it.

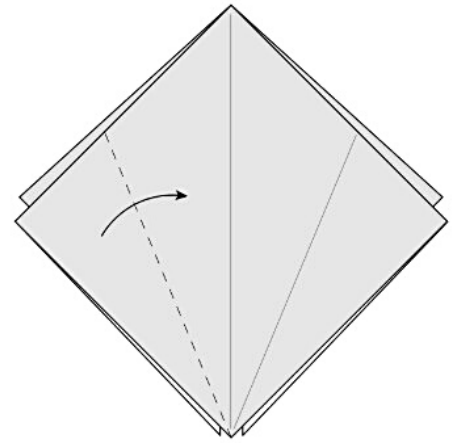

Step 3) Fold the top left flap of paper to the centre along the dotted line.

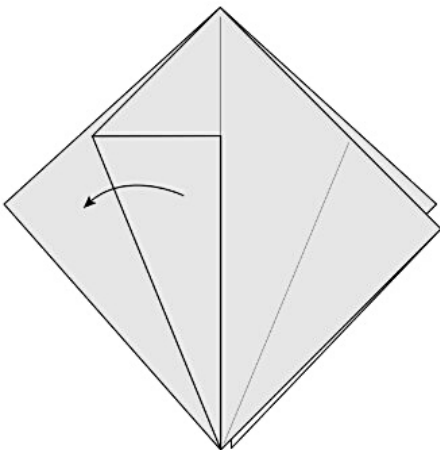

Step 4) Crease this fold well and then unfold it.

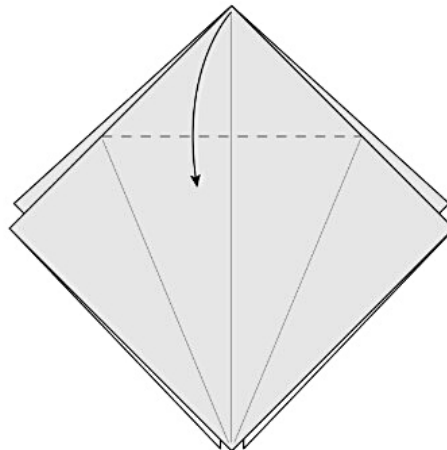

Step 5) Fold the top part of the model down along the dotted line. The end points of this line should line up with the tops of the lines from the two creases you just made.

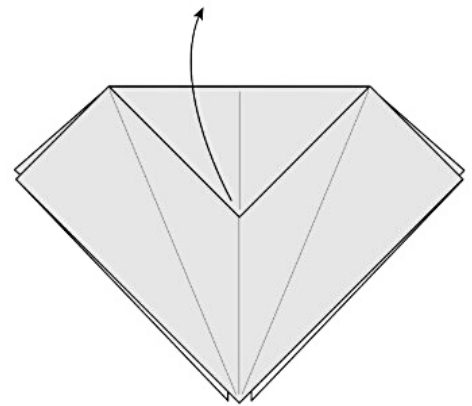

Step 6) Crease this fold well and then unfold it.

PETAL FOLD (continued)

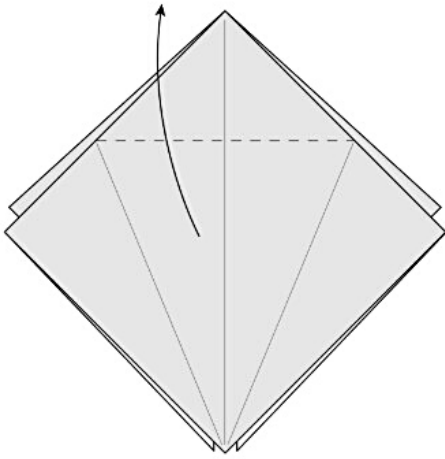

Step 7) Open up the top flap of paper folding it upwards along the horizontal crease you just made.

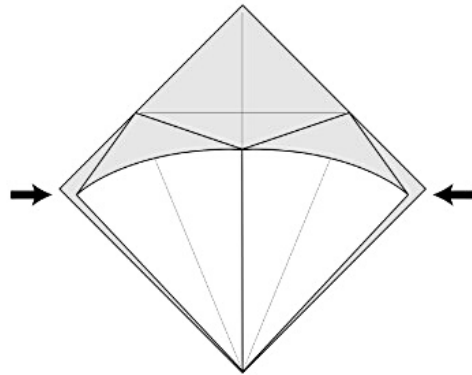

Step 8) As you lift the paper up also fold in the sides along the two creases you made on each side.

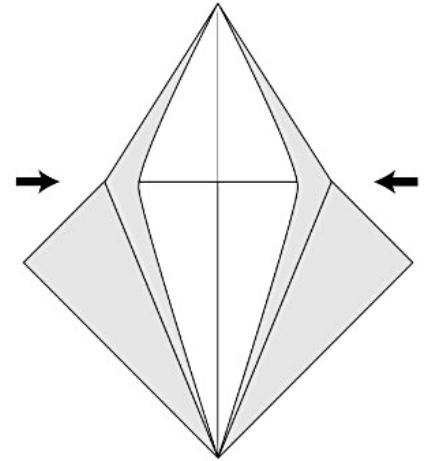

Step 9) Lift the paper all the way up and flatten everything along the 3 creases you already made. If you made the creases well everything should fall into place easily.

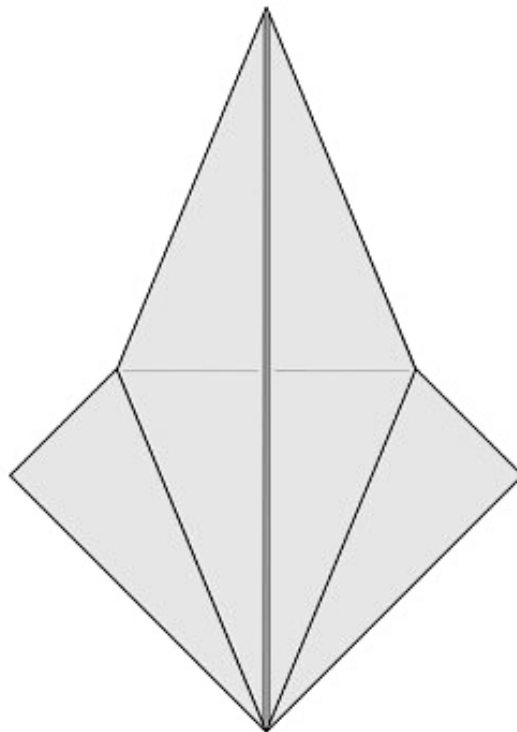

The completed Petal Fold.

PETAL FOLD VARIATION

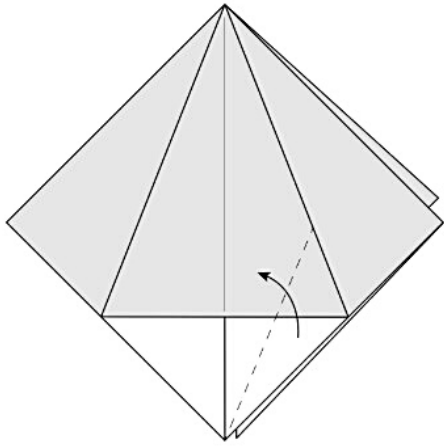

Step 1) Start off with a Square Base that has one of the four flaps Squash Folded. This is the exact shape that you'll usually see this Petal Fold Variation made on. Fold the top right flap to the centre along the dotted line.

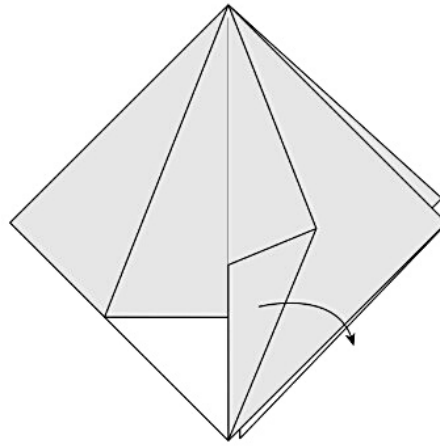

Step 2) Crease this fold well and then unfold it.

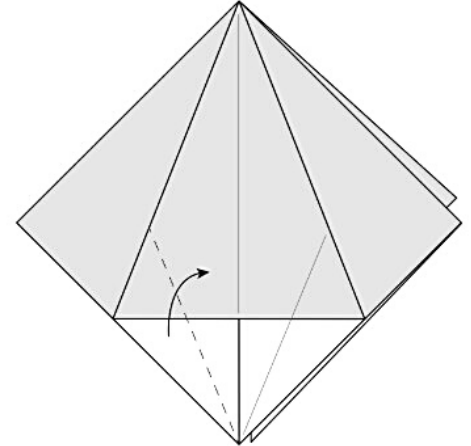

Step 3) Fold the top left flap to the centre along the dotted line.

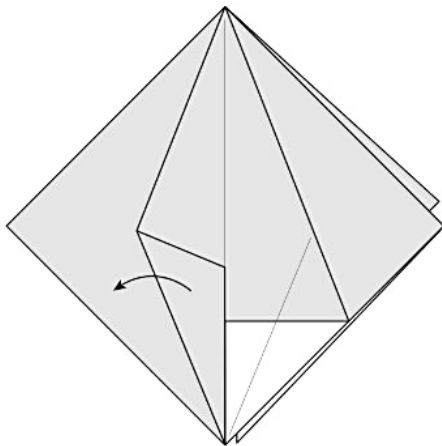

Step 4) Crease this well and then unfold it.

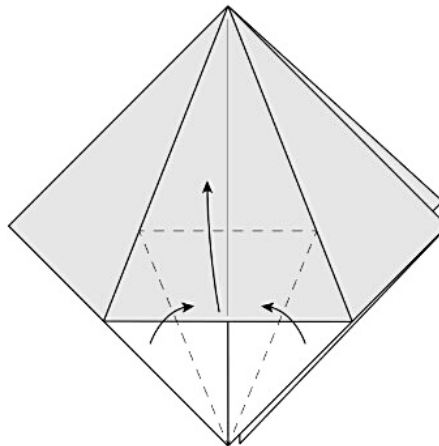

Step 5) Lift the top flap of paper up along the dotted horizontal line opening it up. There is no pre-existing crease along this line so you'll have to make it yourself as you fold the flap up.

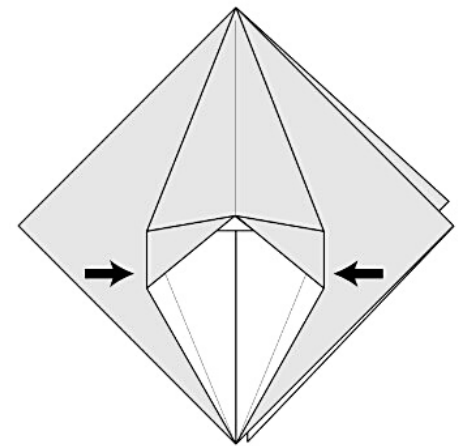

Step 6) As you fold up the flap of paper also fold in the sides along the creases you already made on each side and push everything flat.

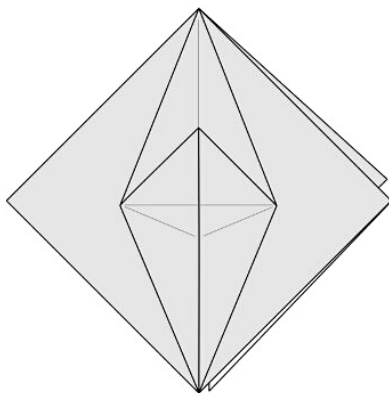

The completed Petal Fold Variation.

SQUASH FOLD

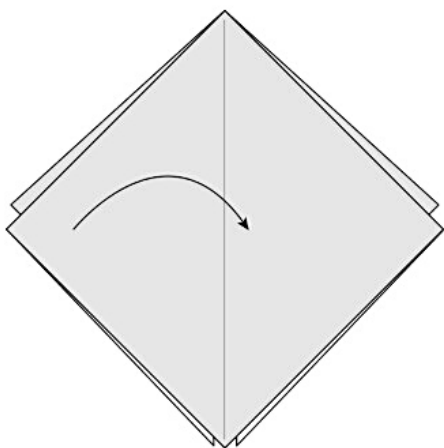

Step 1) This example starts with a Preliminary Base. The instructions for this base are further in this guide. Squash folds can be performed on a variety of different shapes, not just this base.

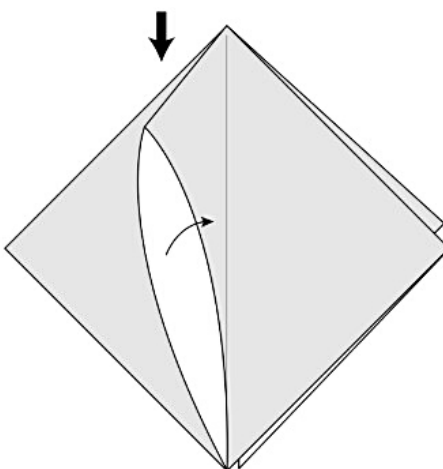

Step 2) There are four flaps of paper on this base, lift one of them up. You will make a squish fold on this flap.

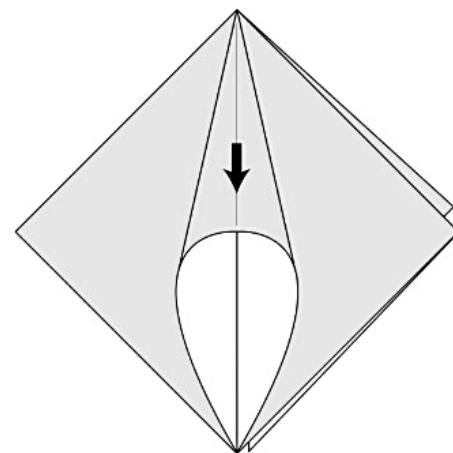

Step 3) Push down on the crease so you completely flatten the flap. Make sure both sides are symmetrical.

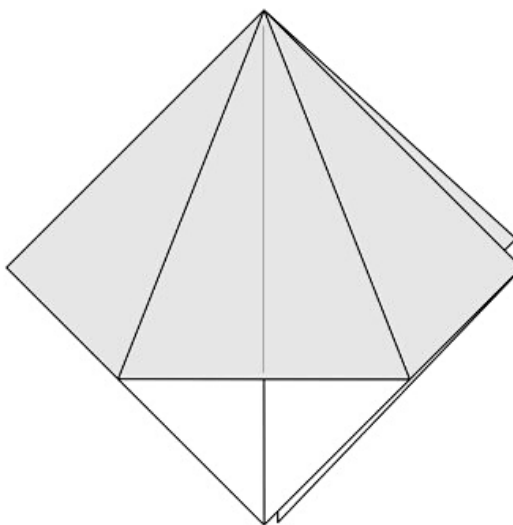

The completed Squash Fold.

Fox (easy)

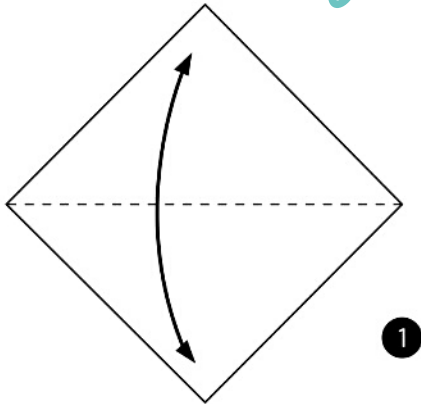

Step 1) Fold the paper in half and then unfold it.

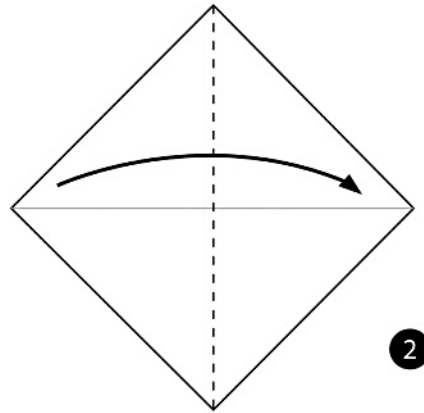

Step 2) Fold the paper in half the other way.

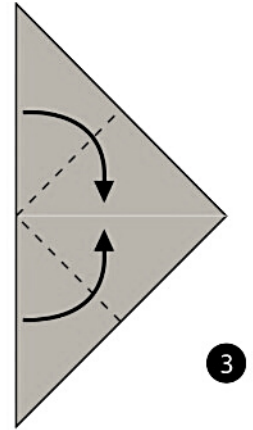

Step 3) Fold the top and bottom in along the dotted lines.

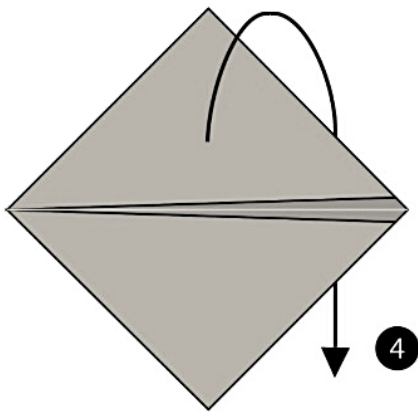

Step 4) Fold the paper in half over behind.

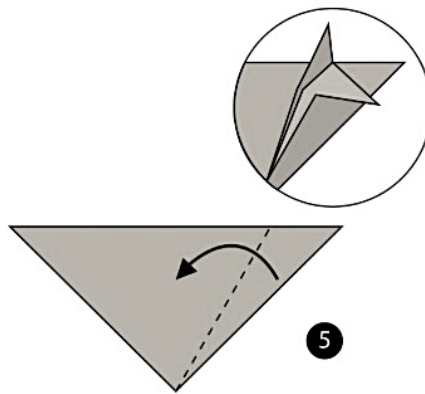

Step 5) Open the paper over to the left. Push the paper in the middle down to make the head.

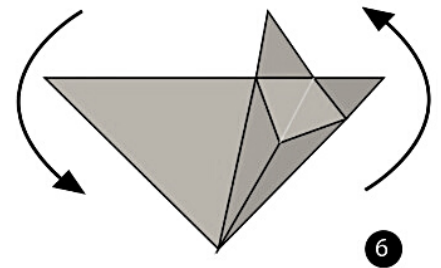

Step 6) Turn the model so it's sitting upright.

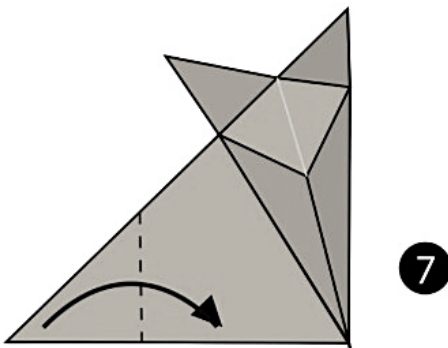

Step 7) Fold the side along the dotted line to make the tail.

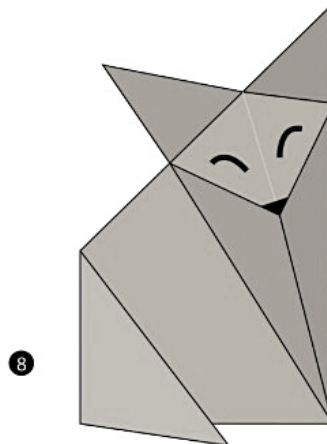

The completed fox

Pigeon (easy)

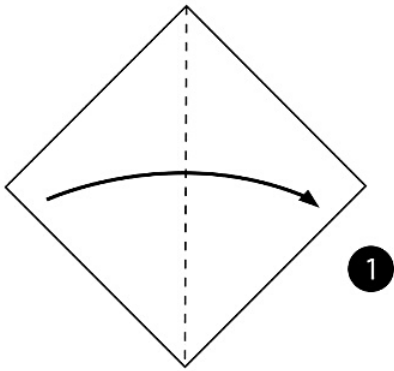

Step 1) Fold the paper in half.

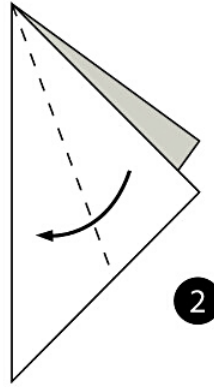

Step 2) Fold the top layer of paper over along the dotted line.

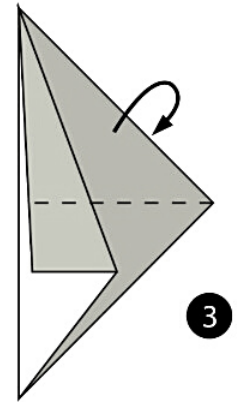

Step 3) Fold the top half of the paper in behind the model.

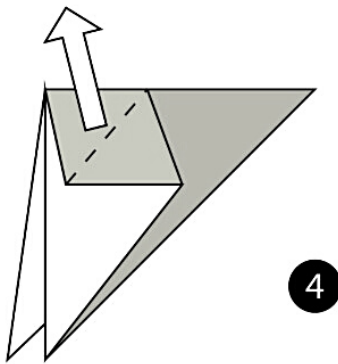

Step 4) Open up the top flap of paper and Squash Fold it flat. Take a look at the next diagram to see the final position of the paper.

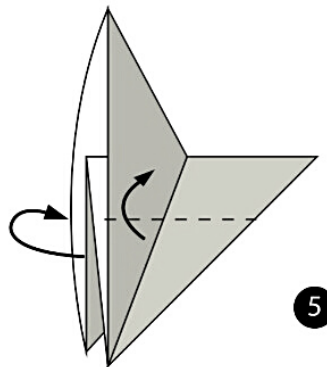

Step 5) Fold the paper up along the dotted line and repeat on the other side.

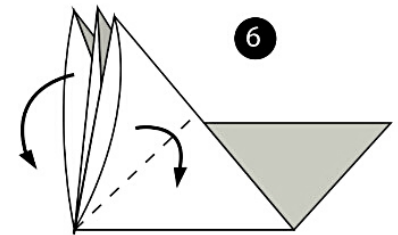

Step 6) Fold the paper down along the dotted line and repeat on the other side.

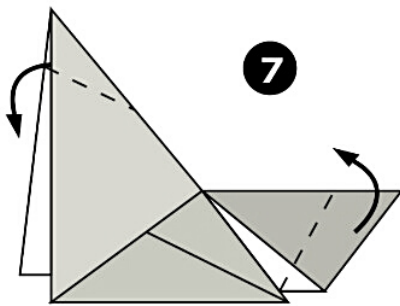

Step 7) Make an Inside Reverse Fold to form the head and make an Outside Reverse Fold to make the tail.

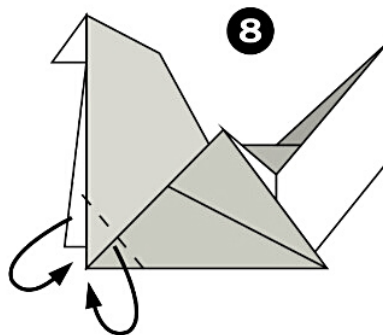

Step 8) Fold the paper inside along the dotted line and repeat on the other side.

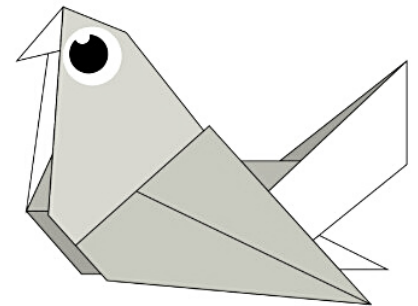

The complete pigeon

Crane (medium)

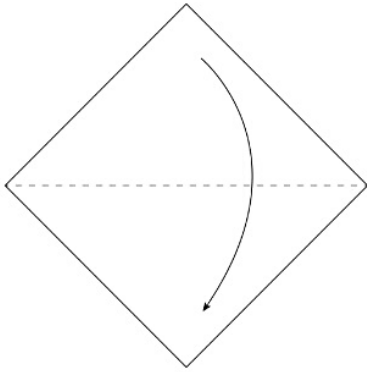

Step 1) Start with the white side of the paper facing up and fold in half diagonally.

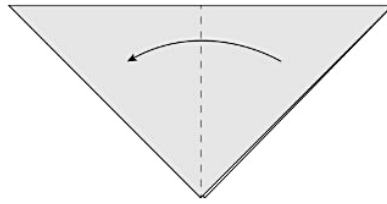

Step 2) Fold in half again along the dotted line.

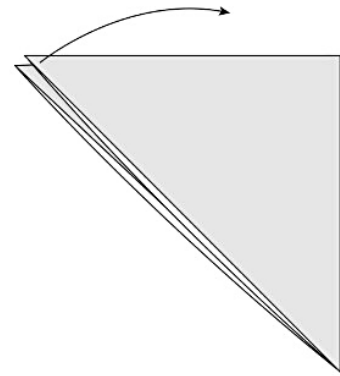

Step 3) Fold that flap back and...

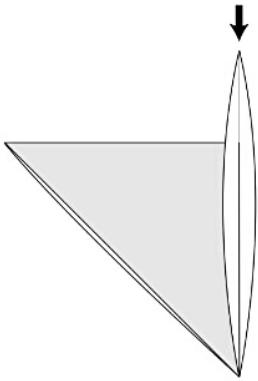

Step 4) Squash fold this flap down.

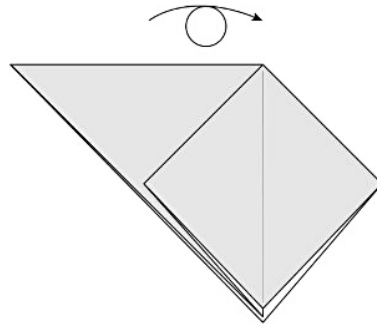

Step 5) Turn the model over, we're going to repeat the last few steps on the other side.

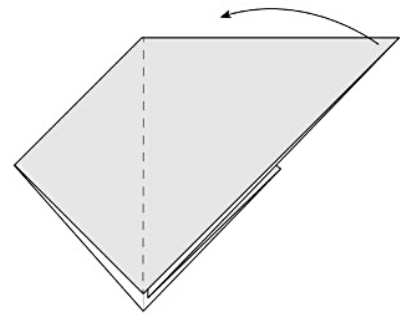

Step 6) Fold the flap over to the left along the dotted line.

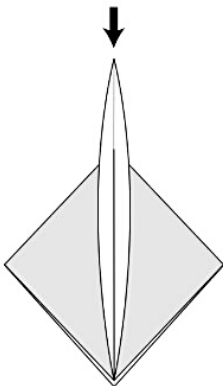

Step 7) Squash fold this flap down.

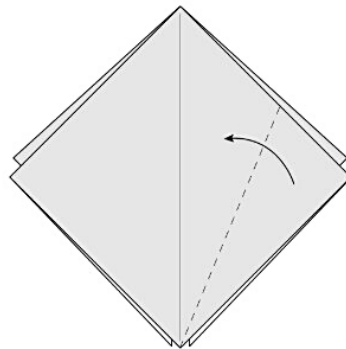

Step 8) You now have a completed square or preliminary base. With a few more folds we'll turn it into a bird base. Fold the side flap to the centre along the dotted line.

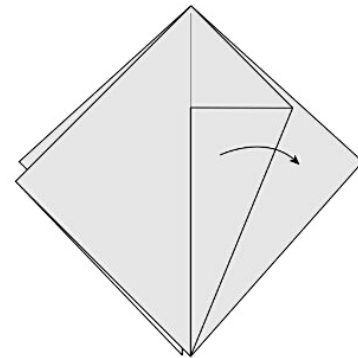

Step 9) Crease this fold well and then unfold it.

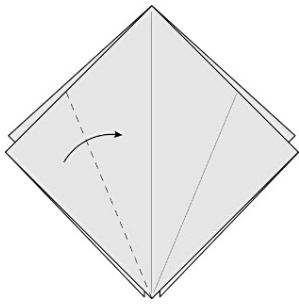

Step 10) Fold the flap on the other side to the centre along the dotted line.

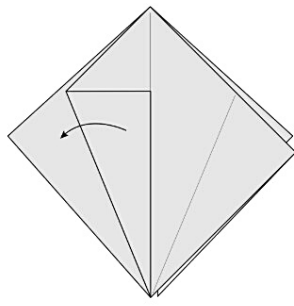

Step 11) Crease this well and unfold.

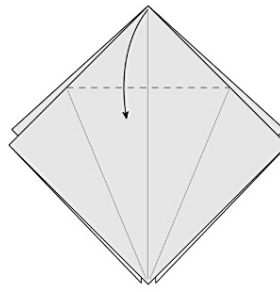

Step 12) Fold the top down along the dotted line.

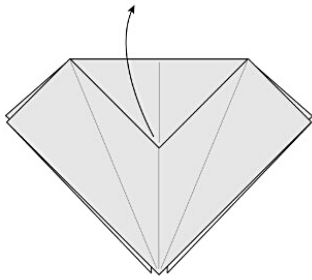

Step 13) Crease this well and unfold.

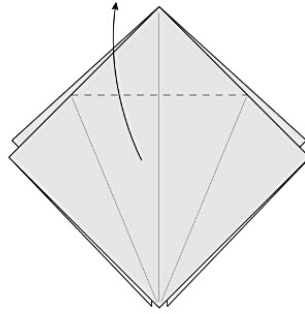

Step 14) Lift the top flap of paper up along the crease you just made. We're going to make a petal fold.

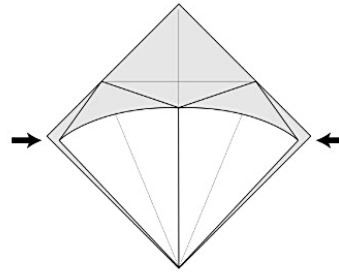

Step 15) Continue lifting up and push in the sides along the creases you made in the previous couple of steps.

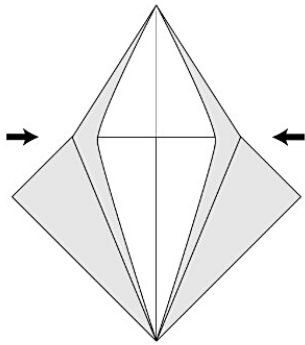

Step 16) Flatten everything along the creases you already made.

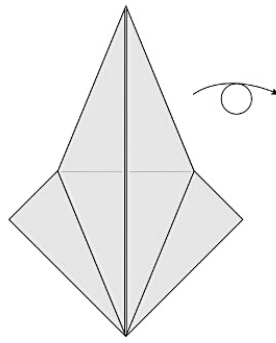

Step 17) The completed petal fold. Turn the model over, we're going to make a petal fold on the other side too.

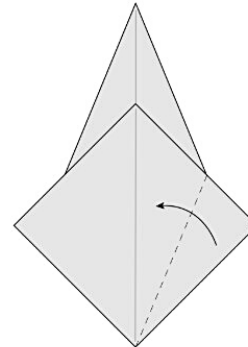

Step 18) Fold the side to the centre along the dotted line.

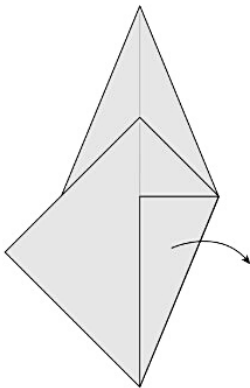

Step 19) Crease this well and then unfold.

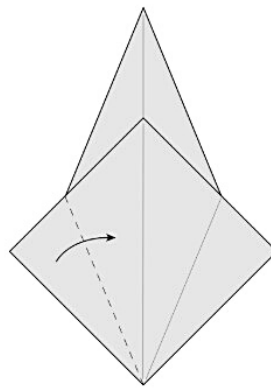

Step 20) Fold the other side to the centre along the dotted line.

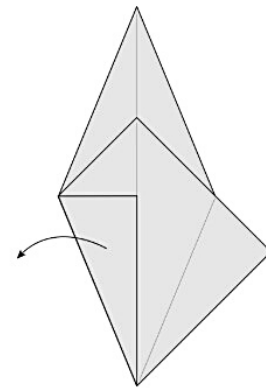

Step 21) Crease this well and unfold.

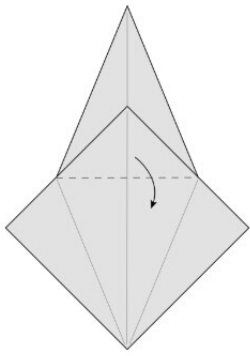

Step 22) Fold the top down along the dotted line.

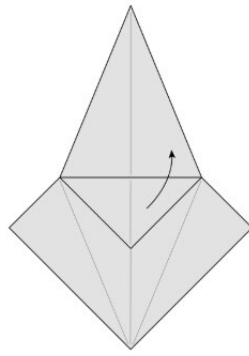

Step 23) Crease this well and unfold.

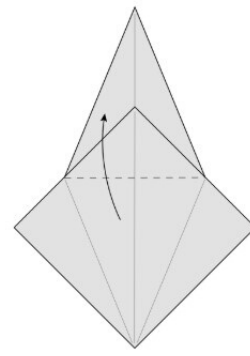

Step 24) Lift the top flap of paper up along the crease you just made. We're going to make another petal fold.

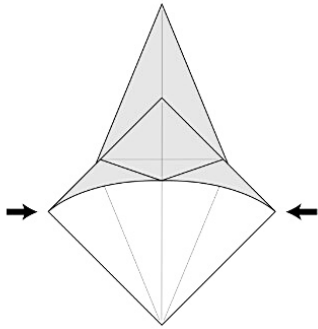

Step 25) Continue lifting up and push in the sides along the creases you made in the previous couple of steps.

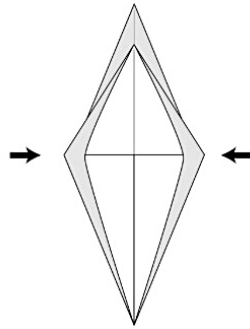

Step 26) Flatten everything along the creases you already made.

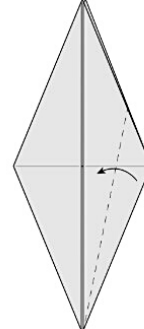

Step 27) The completed petal fold. At this point you also have a completed bird base. Next we're going to fold the neck and the tail. Fold the top flap on the right to the centre along the dotted line.

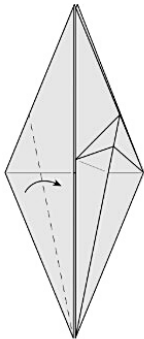

Step 28) Fold the top flap on the left to the centre along the dotted line as well.

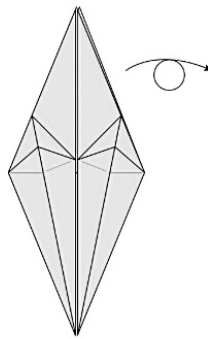

Step 29) Turn the model over, we're going to repeat the last to steps on the other side.

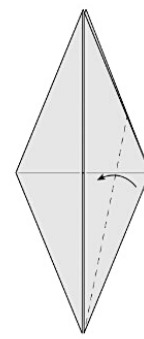

Step 30) Fold the top flap on the right to the centre along the dotted line.

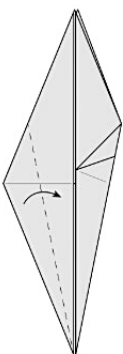

Step 31) Fold the top flap on the right to the centre along the dotted line as well.

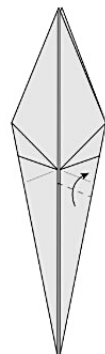

Step 32) Fold the long thin section of paper on the right up along the dotted line.

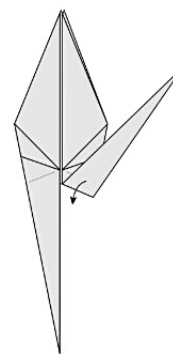

Step 33) Crease this well and unfold.



Step 34) Fold the long thin section of paper on the left up just like you did on the other side.

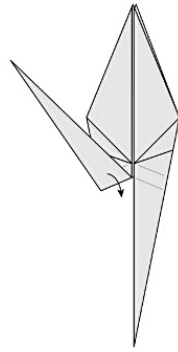

Step 35) Crease this well and unfold.

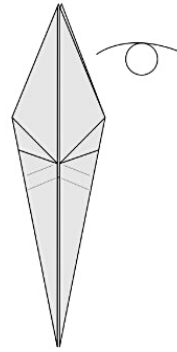

Step 36) Turn the model over, we're going to repeat the last couple of steps on the other side.

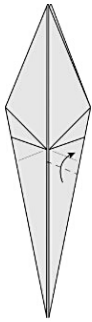

Step 37) Fold the long thin section of paper on the right up along the dotted line. There's already a crease here but now you're going to fold it the other way.

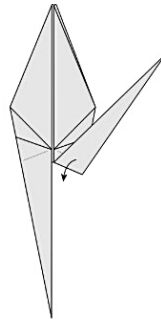

Step 38) Crease this well and unfold.

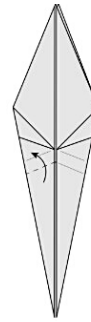

Step 39) Fold the long thin section of paper on the left up just like you did on the other side. There's also a crease here already and you're also going to fold it the other way.

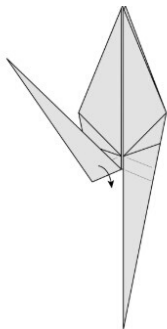

Step 40) Crease this well and unfold.

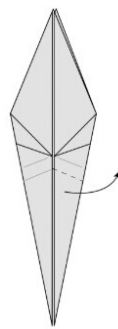

Step 41) Now we're going to make an inside reverse fold along the creases you just made on the right side of the model.

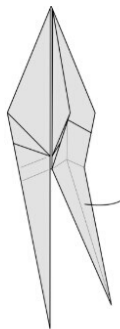

Step 42) Lift the paper up inside the model along the creases you already made and flatten everything.

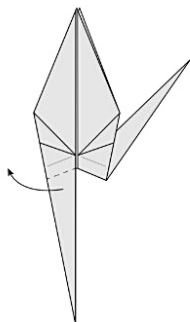

Step 43) Make another inside reverse fold along the creases you already made along the left side of the model.

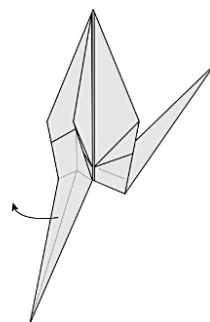

Step 44) Lift the paper up inside the model along the creases you already made and flatten everything.

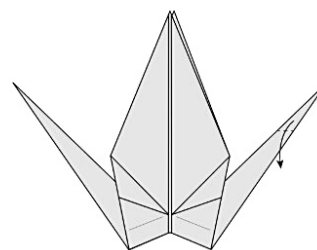

Step 45) Now we're going to fold the head. Fold the long thin section of paper on the left down along the dotted line.

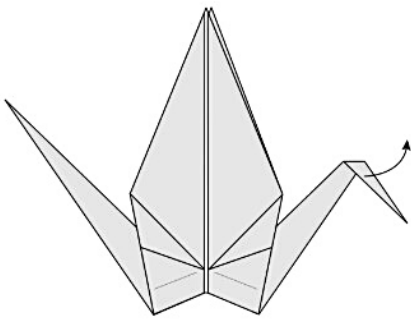

Step 46) Crease this well and unfold.

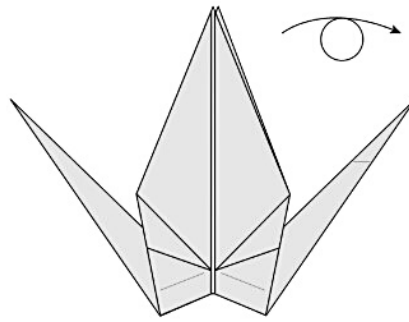

Step 47) Turn the model over so we can repeat this on the other side.

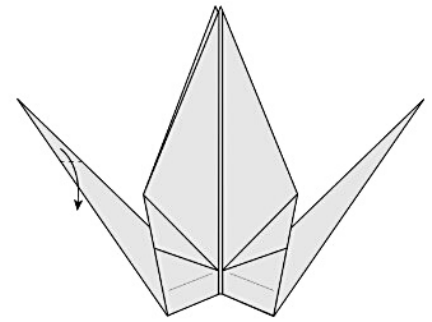

Step 48) Fold the long thin section of paper on the left side now down along the dotted line. This is folded the opposite way along the crease you already folded on the other side.

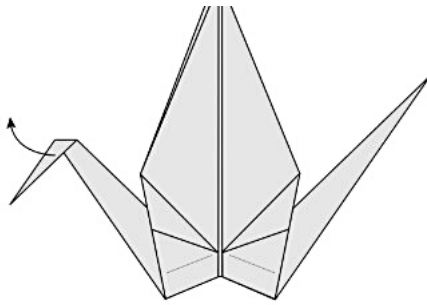

Step 49) Crease this well and unfold.

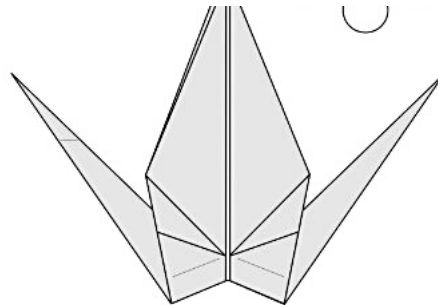

Step 50) Turn the model over again so it's facing the way it was before.

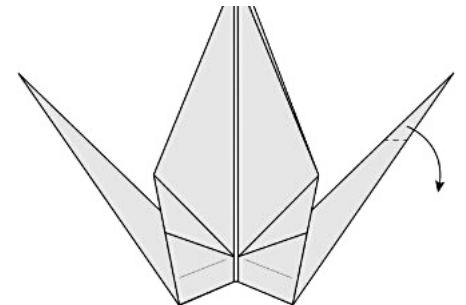

Step 51) Fold the head by making an inside reverse fold along the creases you made in the previous couple of steps. The head is then folded inside the neck.

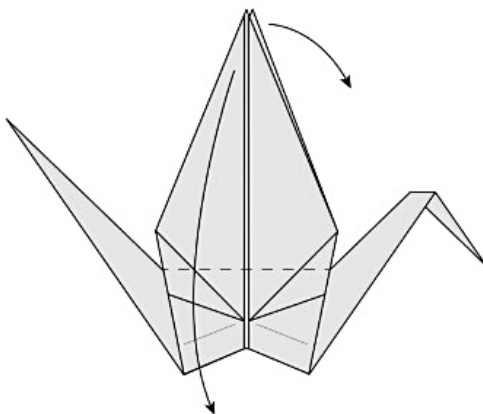

Step 52) Fold down the wings on both sides along the dotted line.

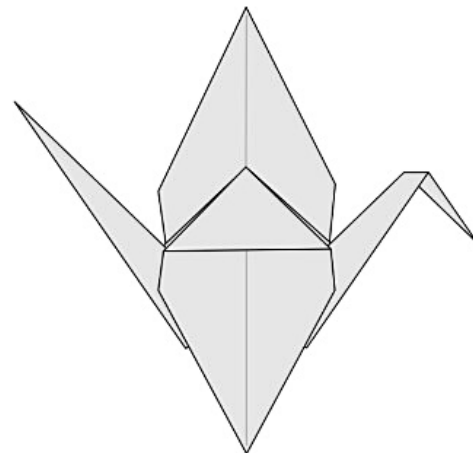

The completed origami crane, good job!

Iris (hard...ish)

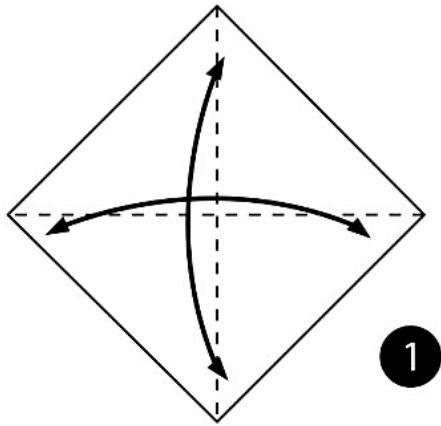

Step 1) Fold and unfold the paper in half both ways.

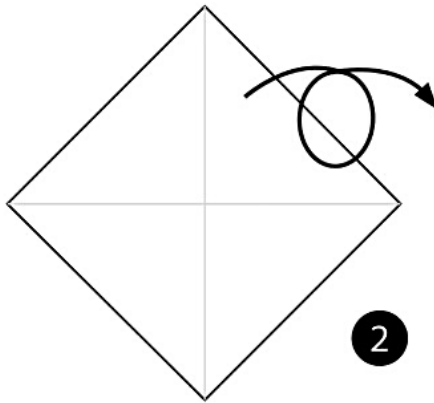

Step 2) Turn the paper over.

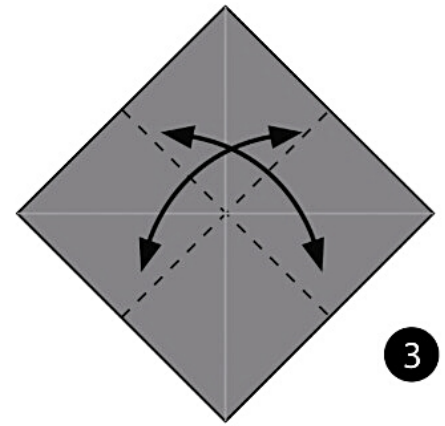

Step 3) Fold and unfold the paper in half both ways.

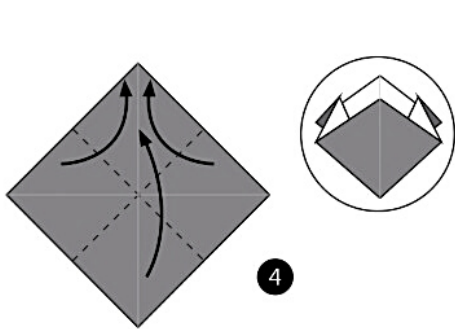

Step 4) Close the paper up into a Square Base using the existing creases.

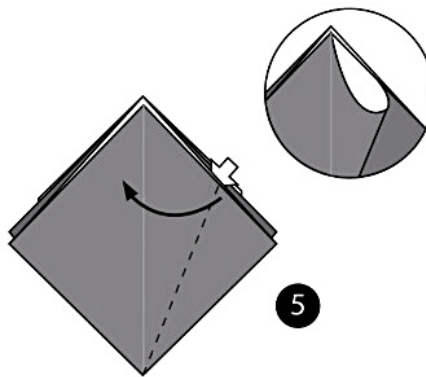

Step 5) Open up one of the flaps on the top and Squash Fold it flat.

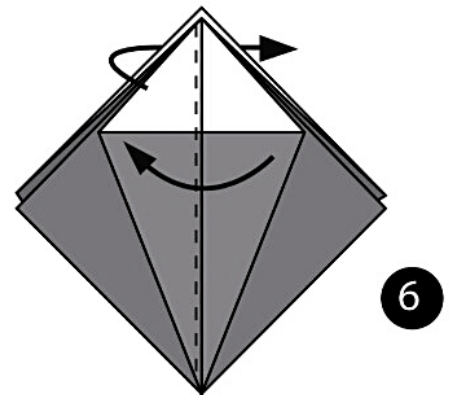

Step 6) Fold the flaps over to get access to the other 3 flaps and Squash Fold each of them like you did in step 5.

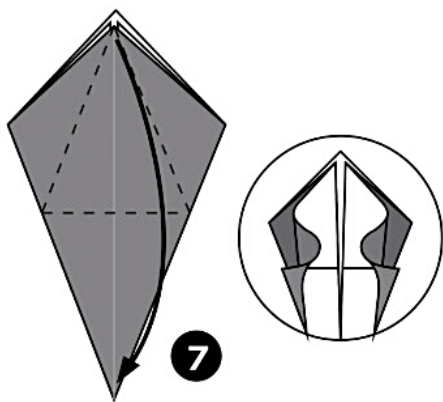

Step 7) Make a Petal Fold along the dotted lines.

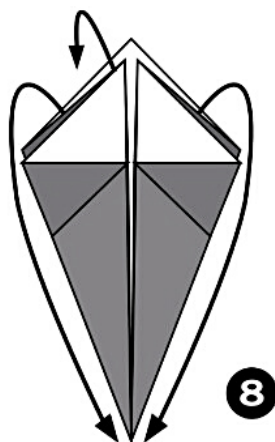

Step 8) Make another Petal Fold just like in step 7 on the other 3 sections of the model.

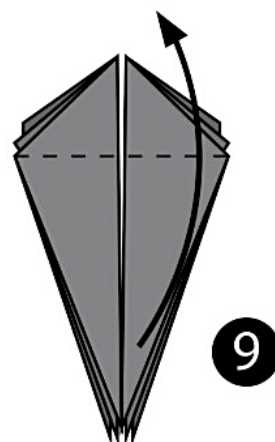

Step 9) Fold the top flap of paper up along the dotted line, then repeat on the other 3 sections.

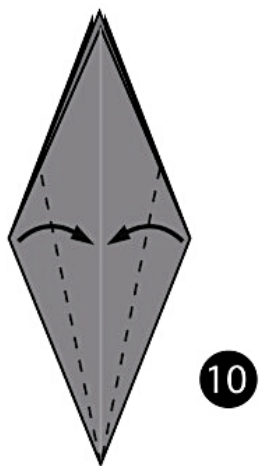

Step 10) Fold both sides in to the centre along the dotted lines, then repeat on the other 3 sections.

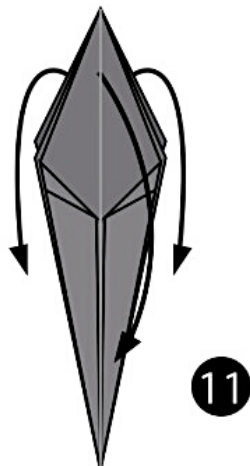

Step 11) Fold the four flaps of paper at the top down to form the iris petals while opening up the model to a 3D shape.

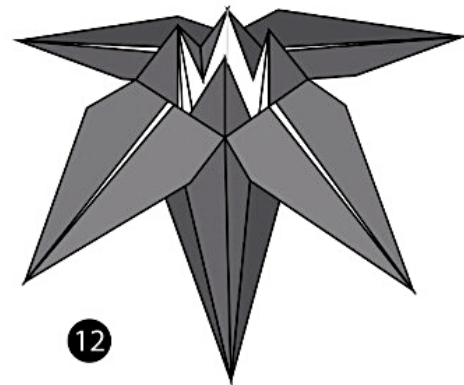

The complete iris