

Rock Mechanics - an introduction for the practical engineer

Parts I, II and III

First published in

Mining Magazine April, June and July 1966

Evert Hoek

This paper is the text of three lectures delivered by the author at the Imperial College of Science and Technology, London in November 1965 as part of the University of London series of Special University Lectures in Mining and Metallurgy.

Rock Mechanics - an introduction for the practical engineer

E. Hoek, Ph.D., M.Sc. (Eng.), B.Sc. (Eng.).
Senior Chief Research Officer, Rock Mechanics Division,
National Mechanical Engineering Research Institute,
South African Council for Scientific and Industrial Research,
Pretoria, Republic of South Africa

Part 1. Theoretical Considerations

In this, the first of three articles containing extracts from a series of six lectures delivered at the Royal School of Mines, Imperial College of Science and Technology in November 1965, the author covers theoretical considerations. The other two will deal with laboratory techniques and then with rock mechanics in the field.

The purpose of this series of articles is to present some of the principles of rock mechanics to the reader who is interested in knowing something about the subject without having to become too involved in technical details. The content of the articles is based, almost entirely, upon the author's own experience and, hence, does not represent a complete review of the whole subject of rock mechanics. Consequently, the formulation of an overall rock mechanics philosophy has been assiduously avoided and the reader is left to draw his own conclusions from the facts as they are presented.

Definition and Scope

In 1963 the Rock Mechanics Committee of the American National Academy of Science adopted the following definition¹:

Rock mechanics is the theoretical and applied science of the mechanical behaviour of rock. It is that branch of mechanics concerned with the response of rock to the force fields of its physical environment.

It is convenient to subdivide rock mechanics into the following branches:

- a) *Structural rock mechanics*, which is concerned with the stability of engineering structures in which the material is predominantly rock.
- b) *Comminution*, which is concerned with the reduction of rock to small fragments by the application of external forces as in drilling, blasting, cutting and grinding.

Both these branches of rock mechanics involve the control of rock deformation and fracture processes. In the first case, excessive rock failure (in this context, failure is taken to mean either excessive deformation or fracture) must be avoided in order to preserve the stability of the structure and, in the second case, rock fracture must be induced with the minimum input of external energy. Major disasters, such as the Malpasset and

Vajoint dam failures, and the Coalbrook mine disaster, serve to illustrate the importance of rock fracture in practical engineering terms.

Rock Fracture - Griffith Theory

Rock mechanics research in South Africa was initiated some 15 years ago in an effort to provide an understanding of the rockburst hazard which occurs in many deep-level gold mines.

The effects of a typical rockburst are illustrated in Figure 1. It has been defined² as damage to underground workings caused by the uncontrolled disruption of rock associated with a violent release of energy additional to that derived from falling rock fragments. The main causes of rockbursts are associated with the energy changes induced by mining in the rocks surrounding large excavations and these causes have been reviewed elsewhere².

From the rock mechanics point of view, the main characteristic of a rockburst is the fact that it occurs in hard, brittle, highly competent rocks. Consequently, in studying the fracture behaviour of these rocks, it was considered justifiable to study the behaviour of the rock material itself, treating it as a homogeneous, isotropic solid and ignoring the effect of major geological discontinuities. The deficiency of this approach, when applied to the fractured and geologically discontinuous rocks which occur on or near the earth's surface will be immediately obvious to the reader. Nevertheless, it is believed that an understanding of the basic mechanism of the fracture of rock material can be of assistance in formulating a rational behaviour pattern for rock masses.

Griffith's theory of brittle fracture³, modified by McClintock and Walsh⁴ to allow for the predominantly compressive stresses in rock mechanics, has been found to provide a reliable theoretical basis for the prediction of rock fracture phenomena⁵. This theory is based upon the assumption that fracture initiates at inherent cracks and discontinuities within the material and that propagation of these cracks occurs as a result of the tensile stress which is induced at the crack tip under load. Brace⁶ has shown that fracture in hard rock usually initiates in grain boundaries which can be regarded as the inherent discontinuities required by the Griffith theory.

Griffith's original theory was concerned with brittle fracture under conditions of applied tensile stress and he based his calculations upon the assumption that the inherent crack, from which fracture initiates, could be treated as an elliptical opening. When applied to rock mechanics, in which the applied stresses are predominantly compressive, this simplifying assumption is no longer valid and the theory has to be modified to account for the frictional forces which occur when the crack faces are forced into contact. This modification was carried out by McClintock and Walsh⁴ who made further simplifying assumptions concerning the mechanism of crack closure. These simplifying assumptions have recently been theoretically validated by Berg⁷.

The extent to which the modified Griffith theory defines the fracture behaviour of rock is

illustrated in Figure 2. Published triaxial strength test data for the fifty rock and concrete types listed in Table 1 are included in this graph. In order to render the test results comparable and to minimise differences caused by different testing techniques, specimen sizes and environmental conditions, the values are plotted on dimensionless scales which are obtained by dividing each test result by the uniaxial compressive strength of that particular material.

A further illustration of the usefulness of the Griffith theory in defining the fracture behaviour of hard rock is given in Figure 3. In this figure a theoretical Mohr envelope is fitted to Mohr fracture circles obtained from triaxial tests on specimens of a typical South African quartzite.

In spite of the encouraging agreement between theoretical and experimental results, illustrated in Figures 2 and 3, it would be incorrect to suggest that the Griffith's theory provides a complete description of the mechanism of rock fracture. It must be emphasised that its derivation is such that it is only strictly correct when applied to fracture initiation under static stress conditions⁵. It is largely fortuitous that it can be so successfully applied to the prediction of the fracture of rock specimens since, once fracture has initiated, propagation of this fracture and ultimate disintegration of the specimen is a relatively complex process^{8, 9, 10}. Fortunately, it appears that the forces involved in fracture propagation are closely analogous to the friction forces assumed in the modified Griffith theory and hence the general form of the equations which define fracture propagation is very similar to that of the equations which define fracture initiation.



Figure 1. Effects of a rockburst in a deep-level South African gold mine.

The original and modified Griffith theories, when expressed in terms of the stresses at fracture⁵, contribute little to the understanding of rock fracture under dynamic stress conditions, the energy changes associated with fracture or the deformation process of rock. However, since the theoretical concept of fracture initiation from inherent cracks has proved so useful in describing the observed fracture behaviour of rock, this concept is being extended to the theoretical study of energy changes and deformation processes in rock^{11,12}.

The author is particularly fascinated by the belief that the processes which govern the failure of large, fissured and discontinuous rock masses are very similar to those which operate during the failure of a small rock specimen¹⁰. It is hoped that a rational theoretical description of the movement of interlocking blocks of rock in a large rock mass will eventually be built up.

Additional Factors Governing Fracture

The Griffith theory was derived on the assumption that the material contains a random distribution of uniform cracks and that the inherent physical properties of the material remain constant. It is interesting to consider to what extent the theoretical concepts of the Griffith theory can be modified to cover cases in which the above assumptions do not apply.

Fracture of anisotropic rock

An extreme example of a rock in which inherent cracks are not randomly distributed is slate. If it is assumed that slate contains two crack systems, one preferentially oriented system of large bedding plane cracks and one randomly oriented set of small grain boundary cracks, it becomes possible to calculate the stress levels at which fracture would initiate under various conditions^{13 14}.

Figure 4 illustrates the remarkable agreement between the predicted and observed fracture behaviour of slate specimens subjected to uniaxial compression. It will be noted that the highest strength of slate can be as much as four times its lowest strength, depending upon the orientation of the bedding planes to the direction of applied load.

An important practical conclusion which can be drawn from Figure 4 is that a comparison of the results obtained from compression tests on core drilled normal to and parallel to the bedding planes does not necessarily determine whether the material is anisotropic - a procedure sometimes advocated by those concerned with "practical" tests. In the case of slate, the compressive strength of specimens drilled normal to and parallel to the bedding planes is almost the same, and if the strength of the specimen in which the bedding planes are oriented at 30 degrees to the direction of applied load is not taken into account, one may be tempted to conclude that slate is isotropic. This extreme example is included to demonstrate the dangers involved in drawing conclusions from inadequate test data.

Rock Mechanics

Table 1. Summary of Triaxial Test Results on Rock and Concrete

Graph Point	Material	Uniaxial Compressive Strength in lb./sq. in	Tested by
1	Marble	13 700	Ros and Eichinger
2	Marble	18 000	Ros and Eichinger
3	Marble	20 000	Von Karman
4	Carthage Marble	10 000	Bredthauer
5	Carthage Marble	7500	Bredthauer
6	Wombeyan Marble	10 000	Jaeger
7	Concrete	2 380	McHenry and Kami
8	Concrete	3 200	Akroyd
9	Concrete	6 000	Jaeger
10	Concrete	5700	Fumagalli
11	Concrete (28 day)	3510	Balmer
12	Concrete (90 day)	4 000	Balmer
13	Granite Gneiss	25 500	Jaeger
14	Barre Granite	24200	Robertson
15	Granite (slightly alt)	10 000	Wreuker
16	Westerly Granite	33 800	Brace
17	Iwaki Sandstone	1 780	Horibe and Kobayashi
18	Rush Springs andstone	26 000	Bredthauer
19	Pennant Sandstone	22 500	Price
20	Darley Dale Sandstone	5780	Price
21	Sandstone	9 000	Jaeger
22	Oil Creek Sandstone	**	Handin
23	Dolomite	24000	Bredthauer
24	White Dolomite	12 000	Bredthauer
25	Clear Fork Dolomite	**	Handin
26	Blair Dolomite	**	Handin
27	Blair Dolomite	75 000	Brace
28	Webtuck Dolomite	22 000	Brace
29	Chico Limestone	10 000	Bredthauer
30	Virginia Limestone	48 000	Bredthauer
3i	Limestone	20 000	Jaeger
32	Anhydrite	6 000	Bredthauer
33	Knippa Basalt	38 000	Bredthauer
34	Sandy shale	8 000	Bredthauer
35	Shale	15 000	Bredthauer
36	Porphy	40 000	Jaeger
37	Siouxyr Quartzite	**	Handin
38	Frederick Diabase	71 000	Brace
39	Cheshire Quartzite	68 000	Brace
40	Chert dyke material	83 000	Hoek
4i	Quartzitic shale (Dry)	30 900	Colback and Wiid
42	Quartzitic shale (Wet)	17 100	Colback and Wiid
43	Quartzitic sandstone (dry)	9070	Colback and Wiid
44	Quartzitic sandstone (wet)	4970	Colback and Wiid
45	Slate (primary cracks)	4300	Hoek
46	Slate (secondary cracks)	15 900	Hoek
47	Dolerite	37 000	CSIR
48	Quartzite (ERPM Footwall)	31 000	CSIR
49	Quartzite (ERPM Hanging wall)	43 200	CSIR
50	Glass	91 000	CSIR

** Presented in dimensionless form by McClintock and Walsh.

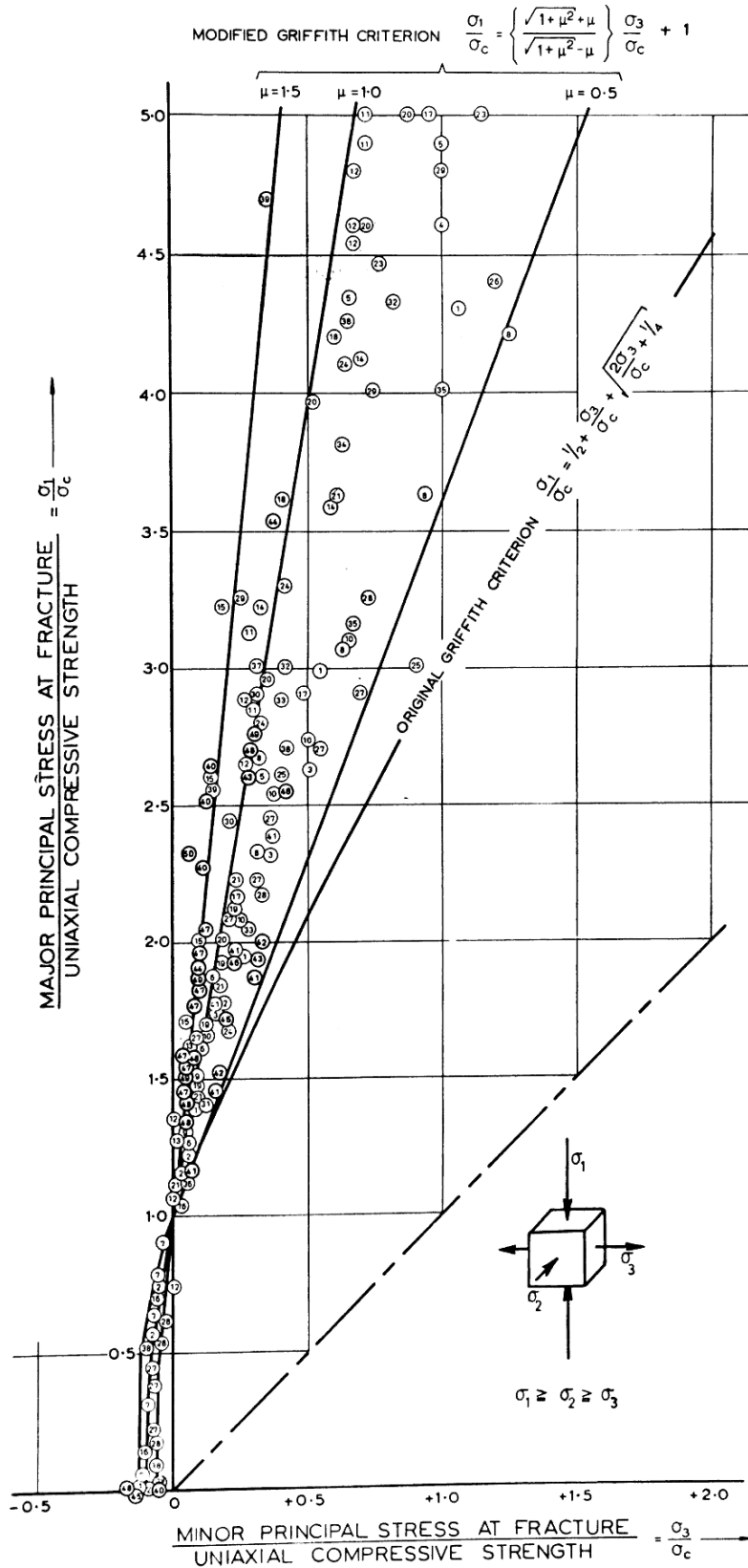

Figure 2. Triaxial fracture data for 50 rock and concrete materials listed in Table 1.

Slate is a relatively simple example of an anisotropic material, having only one set of dominant planes of weakness. The same theoretical process as was applied in the case of slate could be extended to describe the behaviour of a material such as coal which may have two or more cleat systems in addition to its bedding planes.

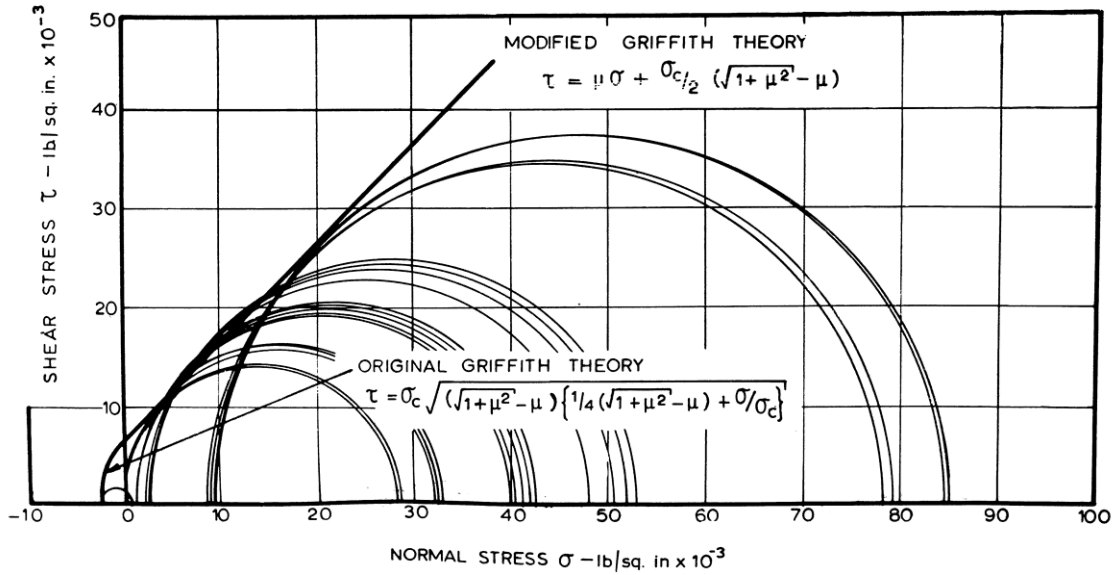

Figure 3. Mohr fracture diagram for typical Witwaterstrand quartzite with a uniaxial compressive strength $\sigma_c = 30,000$ p.s.i. and a coefficient of internal friction $\mu = 1.00$

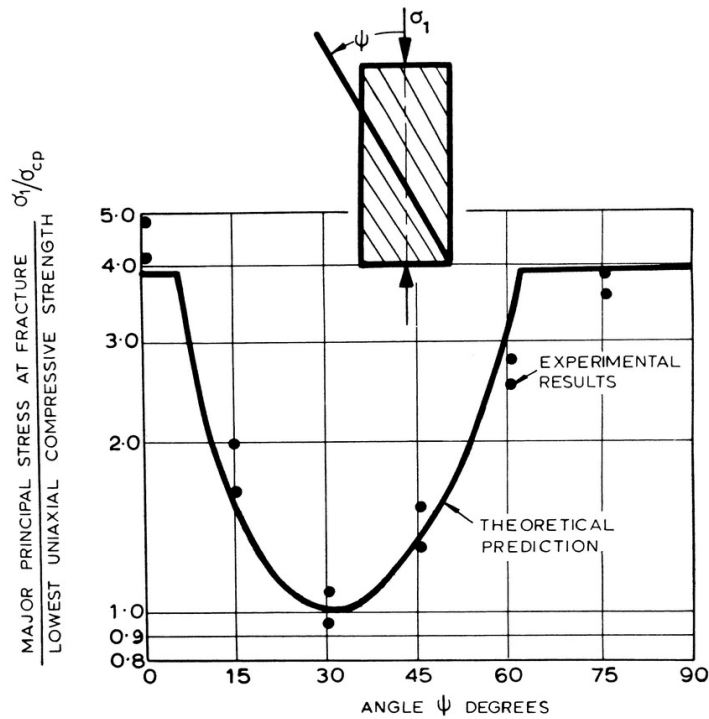

Figure 4. Relationship between bedding plane orientation and strength of slate

Influence of environment upon rock strength

It is frequently assumed that the strength of rock is not significantly influenced by the temperature or humidity of its surroundings. It has, however, been demonstrated that this assumption, particularly on the influence of humidity, can be seriously in error¹⁵.

The influence of temperature upon the strength of rock is probably not significant within the normal range of temperatures encountered by the civil or mining engineer. However, at great depths where the temperatures approach the melting point of some of the rock constituents, the reduction in strength may be significant and could be of importance to those concerned with the overall behaviour of the earth's crust and with the origin of deep-level earthquakes.

The influence of moisture upon the strength of rock is so important that the author advocates that tests on coal and soft rocks should be carried out on site. In order to minimise changes in the moisture content of the specimen, the tests should be carried out as soon as the specimens have been removed from the parent rock. The practical details of this type of test will be discussed later.

The influence of moisture content upon the strength of quartzitic shale is illustrated in Figures 5 and 6 which are reproduced from a paper by Colback and Wiid¹⁵. It will be seen that a saturated specimen of this quartzitic shale is only half as strong as a dry specimen. Colback and Wiid have postulated that this reduction in strength is due to a reduction in the molecular cohesive strength of the rock material when moisture is present.

The practical importance of the influence of moisture upon the strength of rock in structural rock mechanics is the danger of a normally stable structure becoming unstable in wet conditions. In comminution, the strength reduction obtained under wet conditions results in more efficient cutting or drilling.

Influence of fluid pressure

In addition to the strength reduction associated with a high moisture content, a further threat to the stability of a rock structure occurs when water is present under pressure. This fluid pressure reduces the compressive stress acting across a fissure or fracture plane and hence the frictional resistance which causes interlocking of blocks of rocks can be reduced. In an extreme case, one block can be literally floated off another by the buoyance effect of water pressure. The role of fluid pressure in determining the strength of a rock mass is fairly well understood¹⁶ and its influence can be allowed for in strength calculations.

The practical importance of the influence of moisture upon the strength of rock in structural rock mechanics is the danger of a normally stable structure becoming unstable in wet conditions. In comminution, the strength reduction obtained under wet conditions results in more efficient cutting or drilling.

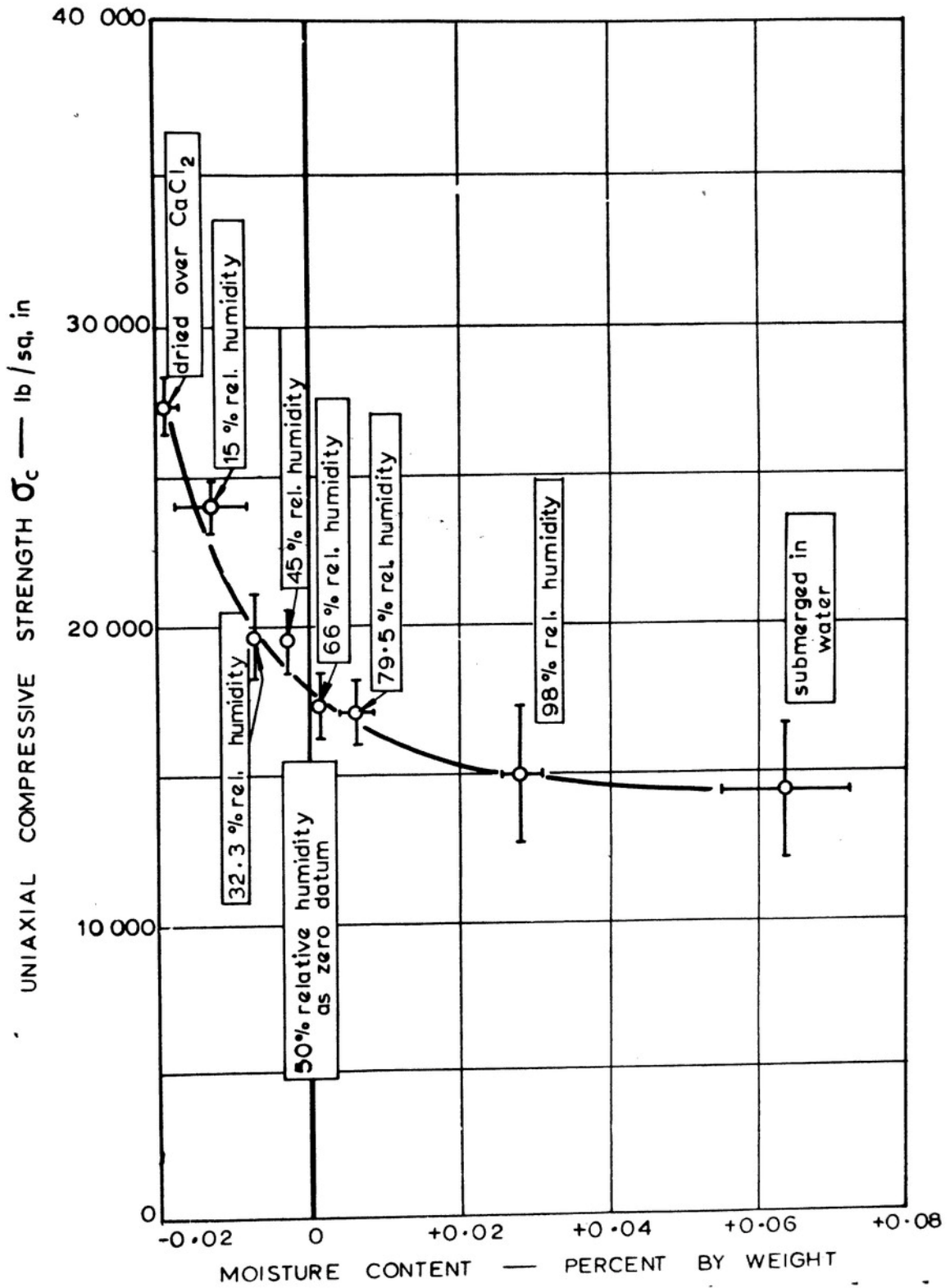

Figure 5. Relationship between uniaxial compressive strength and moisture content for quartzitic shale specimens (Colback & Wiid).

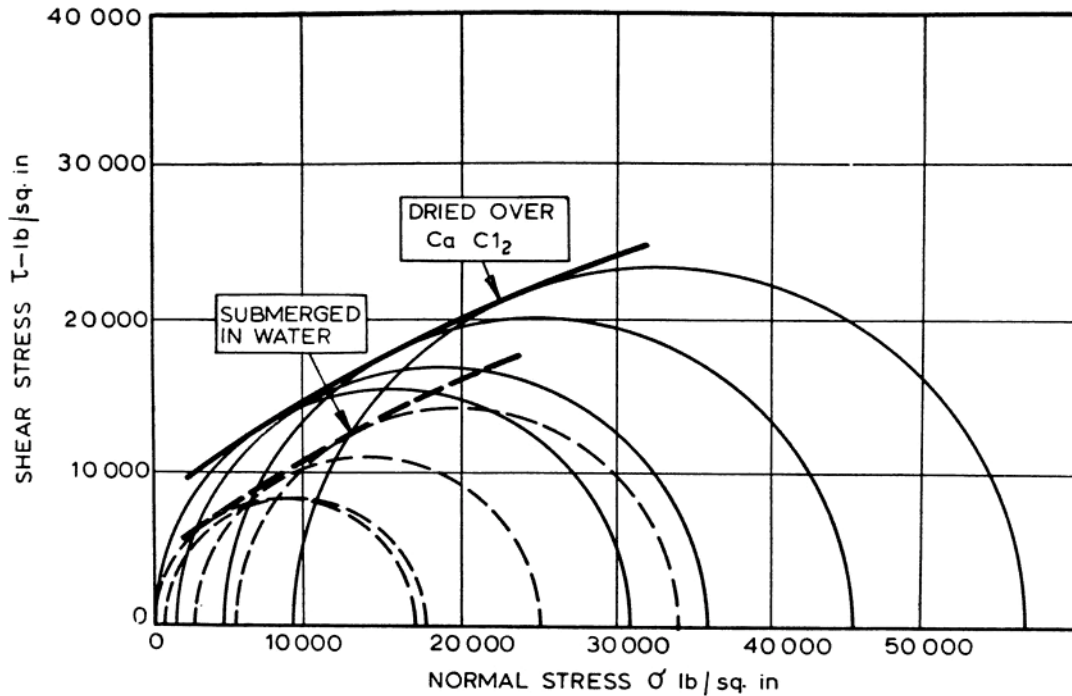

Figure 6. Mohr fracture envelopes showing the effect of moisture on the compressive strength of quartzitic shale (from Colback & Wiid)

Influence of fluid pressure

In addition to the strength reduction associated with a high moisture content, a further threat to the stability of a rock structure occurs when water is present under pressure. This fluid pressure reduces the compressive stress acting across a fissure or fracture plane and hence the frictional resistance which causes interlocking of blocks of rocks can be reduced. In an extreme case, one block can be literally floated off another by the buoyance effect of water pressure. The role of fluid pressure in determining the strength of a rock mass is fairly well understood¹⁶ and its influence can be allowed for in strength calculations.

Time-dependent failure of rock

One of the least understood aspects of the mechanical behaviour of rock is the influence of time upon its deformation and fracture. It is convenient to consider this subject under two headings:

- a. *Weathering* which is the gradual deterioration of an exposed rock surface. This deterioration may take place in the absence of applied stress and is due mainly to physical and chemical processes which are governed by the environment to which the rock is exposed;

- b. *time-dependent mechanical behaviour* which involves the deformation or fracture of rock under conditions of constant applied stress (frequently referred to as “creep”, a term which the author avoids because of the possible confusion with the process of creep in metals which need not be the same as in rock).

In most practical cases, both of these phenomena play a part and it is usually impossible to establish which of the two is the main cause of failure.

Experience in South Africa shows that coal pillars usually fail a number of years after they have been mined. Examination of the pillars and measurements of time-dependent deformation suggests that both weathering and time-dependent failure are important.

Consequently, one must conclude that a full understanding of the time-dependent behaviour of rock must involve a knowledge of both weathering and time-dependent failure. To the best of the author's knowledge, no complete and systematic study of the process of rock weathering has ever been undertaken and this deficiency presents an interesting challenge to rock mechanics research workers.

Time-dependent mechanical behaviour of rock has been fairly intensively investigated, both theoretically¹⁷ and experimentally¹⁸, but a great deal more remains to be done before this knowledge can be effectively applied to practical problems. For the engineer faced with the problem of designing a rock structure in which weathering or time-dependent failure may be important, the most realistic approach appears to be to use the results of short time laboratory tests with a liberal allowance for the possible strength reduction with time.

The extent to which the strength will reduce with time depends upon so many unknown factors that no definite rules could be suggested but the author believes that under severe conditions, a reduction of 50 per cent over a ten year period is possible.

Influence of Specimen Size

It is accepted that the strength of a brittle material is dependent upon the size of the test specimen and yet very little reliable quantitative data on this effect is available. In the author's opinion, the most rational approach to this problem is that adopted by Protodiakonov¹⁹ and his most important conclusions are presented in Figure 7.

The parameter 'm', as defined in Figure 7, depends upon the nature of the material and also upon the state of stress to which the specimen is subjected. From the few experimental data which are available the author has made the following estimates of the value of 'm':

Coal and soft rocks subjected to compression	$5 < m < 10$
Coal and soft rocks subjected to tension	$10 < m < 50$
Hard rock subjected to compression	$2 < m < 5$
Hard rock subjected to tension	$5 < m < 10$

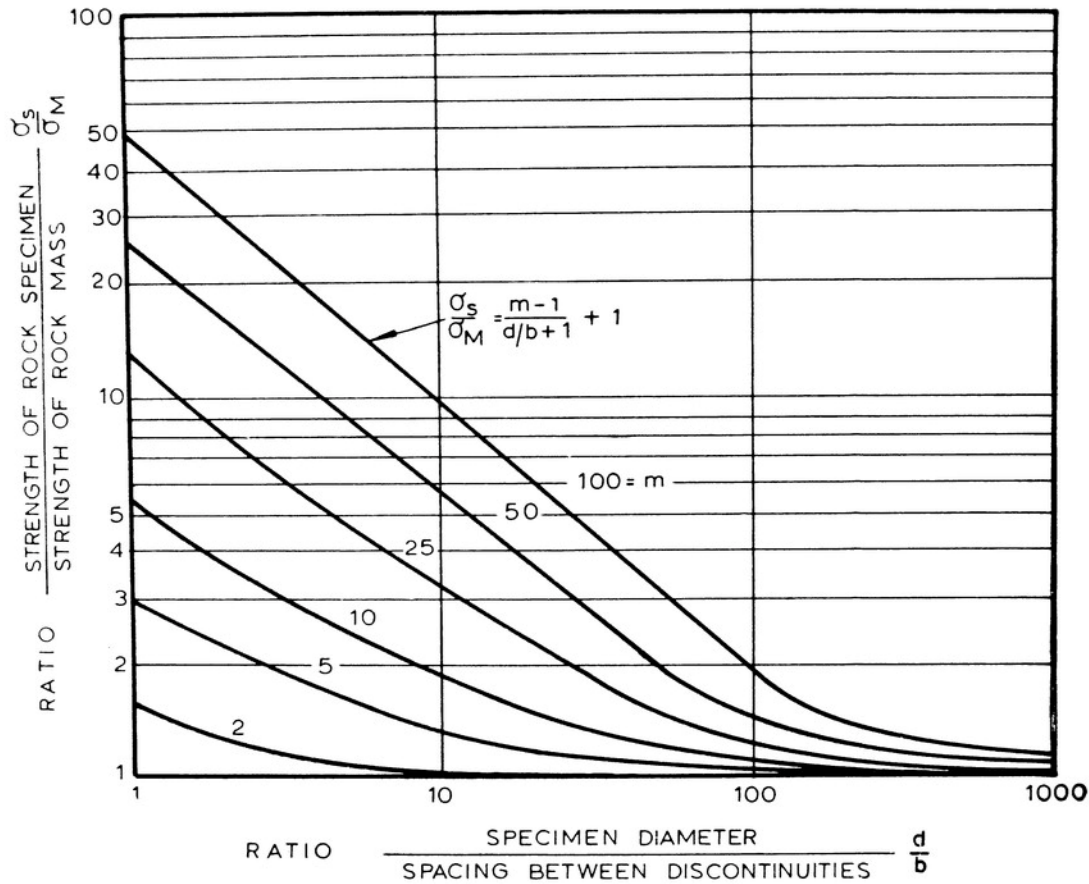

Figure 7. Relationship between specimen size and strength according to Protodiakonov

While these estimates must be treated with extreme caution, they do enable one to arrive at an order of magnitude for the acceptable specimen size.

Hence for a material such as coal subjected to compression, the specimen size should be approximately 50 to 100 times the spacing between discontinuities if the strength of the specimen is to be within 10 per cent of the rock mass. Since the spacing between discontinuities in may, as a first approximation, be equated to the cleat spacing which can be in the order of 2 inches, the specimen diameter required is estimated at between 100 and 200 inches.

This size of specimen would daunt even the most courageous exponent of large-scale testing and yet, if Protodiakonov's deductions and the author's estimates are reasonably accurate, it may have to be accepted at most tests on coal carried out on specimens which are far too small to give meaningful results.

In a series of large-scale tests planned by the Coal Mining Research Controlling Council of South Africa in conjunction with the Council for Scientific and Industrial Research. It is proposed to test coal specimens to 8 feet cube (the technique to be used will be

discussed later). The results of these tests should contribute towards a more reliable evaluation of the problem of the size effect in strength testing.

In the case of hard rocks such as the Witwatersrand quartzites, the value of 'm' for compression is believed to lie between 2 and 5 and the spacing between discontinuities, in this case assumed to be the grain boundaries, may be of the order of 1/10 of an inch. Hence, from Figure 7, the diameter of specimen required to give a strength value within 10% of that for the massive rock (excluding the effect of major discontinuities) is between one and 2 inches.

Stability of Rock Structures

In designing a rock structures such as the dam foundation or underground excavation, the most important consideration is the stability of the entire structure. Local rock failure at the points of high stress or in zones of exceptionally low strength may only be significant if this failure forms part of a sequence of events, which leads to collapse of the structure.

The obvious question which the practical engineer, will ask is – what are the main factors which govern the stability of a rock structure and what information of these factors and their interaction does the science of rock mechanics provide?

Two main problem types

In discussing this question it is necessary to distinguish between two main types of structural rock mechanics problems:

- a. Underground excavations in solid homogeneous rock, such as the massive quartzites which occur in the deep-level gold mines in South Africa, in which the stability of the rock surrounding the excavation is primarily dependent upon progressive failure of the *rock material*.
- b. Rock structures such as dam foundations and surface excavations in which the material is so faulted and fissured that the stability of the structure depends upon the movement of interlocking blocks within the *rock mass* rather than upon failure of the rock material.

Progressive failure of the rock surrounding an excavation

When a rock specimen is loaded in a hydraulically actuated testing machine, the behaviour of the specimen at the point of fracture is obscured by the behaviour of the testing machine. The release of the energy stored in the hydraulic system usually results in violent disintegration of the rock specimen with the consequent loss of all post-fracture data. On the other hand, an elevator of rock which forms part of a rock mass and which is subjected to an identical state of stress to that applied by the testing machine will behave in an entirely different manner, what is the point of failure has been reached. In

this case, disintegration of the rock element may be arrested by the transfer of load onto an adjacent development, which previously carried a lower load. In this way, local fracture induces a redistribution of stress, which may or may not result in further fracture.

In an attempt to understand this process of progressive failure, the author has studied the initiation and propagation of fracture in rock under non-uniform stress conditions such as those which occur around underground excavations²⁰.

An example of this type of analysis is presented in Figure 8 in which the theoretical fracture contours in the rock surrounding square and elliptical tunnels are compared. In deriving these contours it was assumed that fracture initiation in the material, assumed to be a homogeneous quartzite, is defined by the Mohr envelope illustrated in Figure 3. This fracture criterion is combined with the stress distribution in the material surrounding the excavations²¹ to give the fracture contours and the critical crack trajectories²⁰.

The fracture contours are plotted in terms of the vertical pressure P which would have to be applied to the material surrounding the excavation in order to cause initiation of fracture at any point. Hence, if the fracture contours has a value $P = 10,000$ p.s.i., all the material enclosed by this contour, i.e. the material in which the fracture contours have lower values, would be prone to failure if the vertical applied pressure P was 10,000 p.s.i..

The vertical applied pressure P is due primarily to the weight of the overburden, increasing at a rate of approximately one p.s.i. per foot of depth. The local pressure P , which acts upon a particular time or former may, however, be intensified by mining activities in the vicinity of this tunnel. Hence, at a time situated in the pillar may be subjected to a vertical applied pressure P or 15,000 p.s.i., while the pillar itself may be only a subjected to a nominal pressure, due to its depth below the surface, of 7000 p.s.i..

The critical crack trajectories define the most dangerous crack orientation at any point in the material surrounding the tunnel. An inherent flaw or discontinuity oriented in this direction would fail at a lower stress level than that required to initiate failure from any other floor, of similar size, but at a different orientation, in the vicinity.

The significance of the fracture contours and critical crack to trajectories, illustrated in Figure 8, is interpreted in more practical terms in Figure 9. In both cases, the lowest fracture contour occurs in the roof (and floor) of the excavation; hence failure can be expected to initiate at these points. Since the critical crack trajectories in this region lie parallel to the vertical access of the excavation, a vertical crack will occur as shown in Figure 9a.

Experimental studies of the formation of vertical roof and floor cracks²² have shown that, apart from a redistribution of the stress and the proximity of the crack from the stability of excavation is not endangered by the formation of these cracks. It must also be pointed out that the tendency for these cracks to form is markedly reduced by the presence of natural applied stress due to the restraint of the surrounding rock²³.

The initiation of sidewall fracture, illustrated in Figure 9b is dependent upon the geometrical shape of the excavation. In the case of the square tunnel, the high stress concentration in the sharp corner results in fracture initiation at a vertical applied pressure $P > 7500$ p.s.i.. The critical trajectories suggest that this fracture would propagate in such a way that "slabbing" of the site wall would occur.

The occurrence of this sidewall slabbing is illustrated in Figure 10, which shows a haulage in quartzite at a depth of 9500 feet below surface in a South African gold mine. Figure 10a shows the haulage in an area removed from mining activity and Figure 10b shows the sidewall fracture associated with an increase in stress level due to extraction of the reef immediately above the haulage.

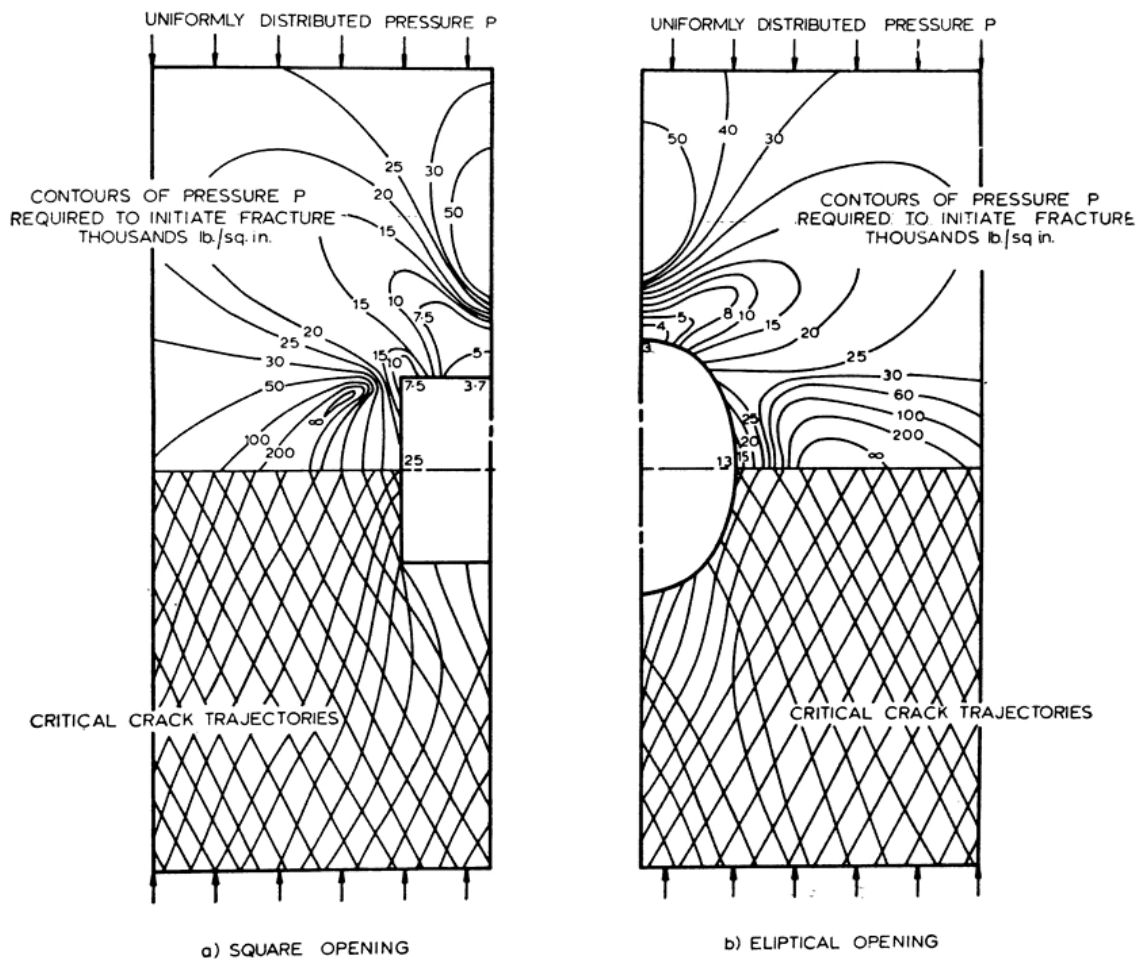

Figure 8. Fracture contours and critical crack trajectories in quartzite surrounding square and elliptical tunnels

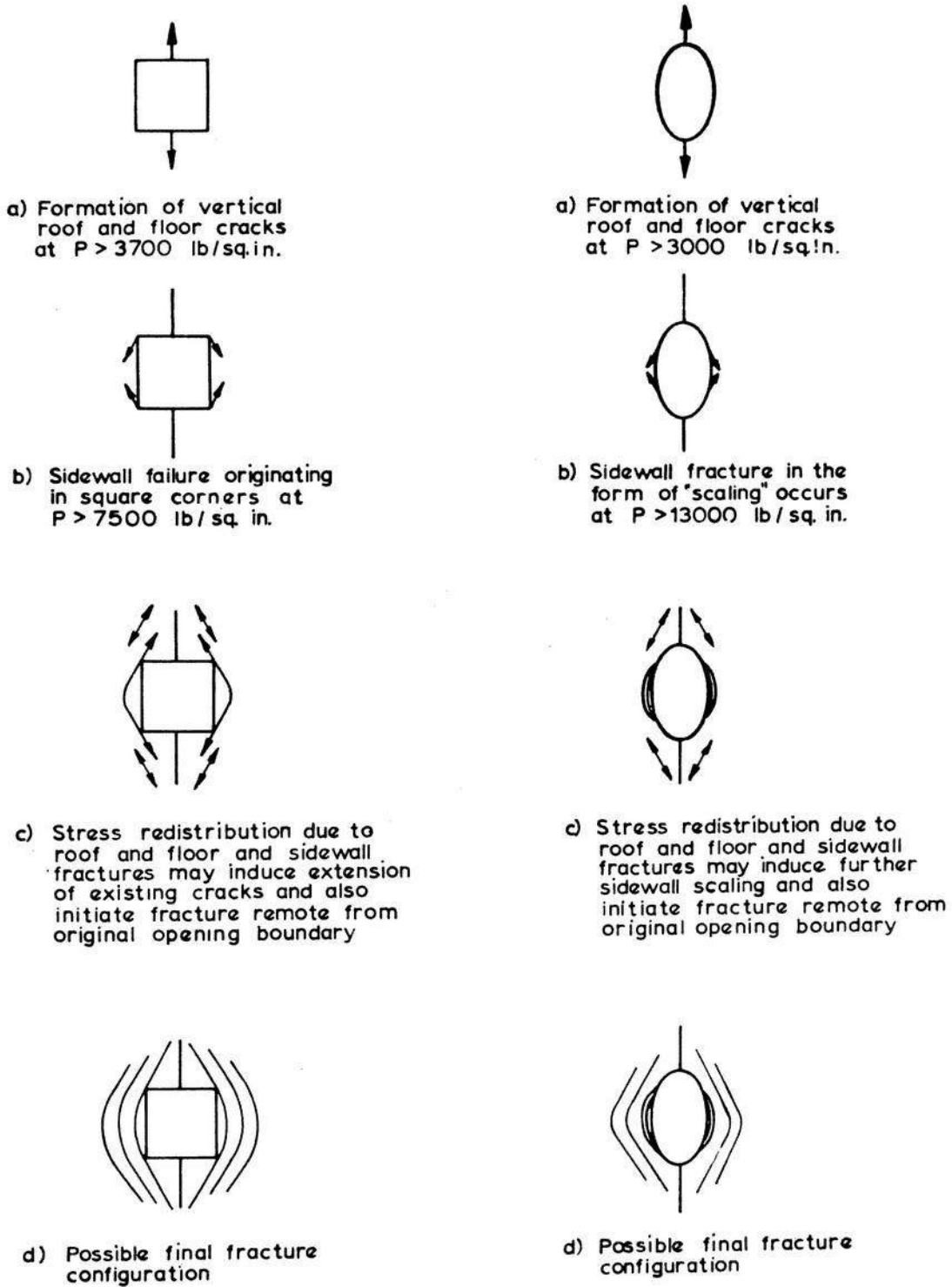

Figure 9. Possible fracture sequence for square and elliptical tunnels in hard quartzite subjected to vertical pressure P only



Figure 10a. Square tunnel in quartzite remote from mining activities. Depth of 9,500 ft. below surface in a South African gold mine

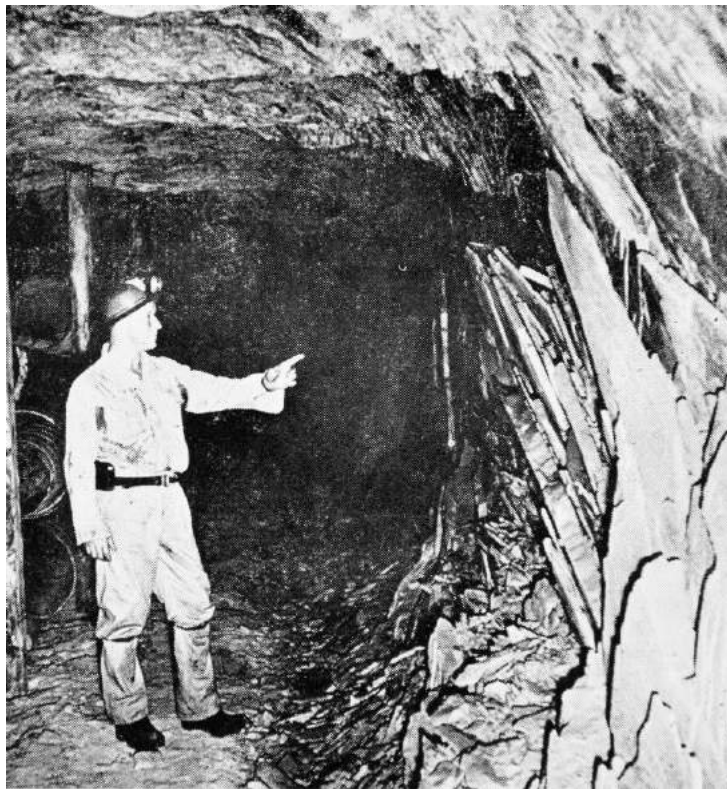

Figure 10b. Sidewall slabbing in a square tunnel in quartzite which had been subjected to a pressure increase due to over-mining. Depth below surface 9,500 ft.

In the case of the elliptical tunnel, sidewall failure can be anticipated at $P > 13,000$ p.s.i. And this it would probably take the form of a sidewall "scaling" as shown in Figure 9b. The fact that this scaling occurs at such high stress levels is important. Practical experience in deep level mines which use both square and elliptical tunnels confirms that the elliptical tunnel, at the same depth, has a lower tendency to sidewall failure and requires less maintenance and support in the form of rockbolting. Evidence from model studies²² suggest that the next stage in failure might be associated with the stress redistribution in the roof and the floor and may follow the pattern illustrated in Figure 9., resulting in the final fracture configurations illustrated in figure 9d.

It must be emphasised that this analysis has been carried out on the assumption that the excavations are situated in solid, homogeneous quartzite, which is subject to vertical pressure only. The presence of a fault, Fissure or marked anisotropic strength behaviour would have a significant influence upon the analysis and would invalidate the conclusions reached.

A further difficulty, which has emerged from fracture studies on models²⁰, is that the stress distribution in the rock around an excavation is drastically altered by failure of rock. In order to overcome this difficulty, it is necessary to re-analyse the stress distributions at each new boundary condition created by propagation of the fracture. While this form of analysis has been done²⁰, it is, at present, far too complex and tedious to the practical value. This example has been quoted to illustrate an approach which the author believes may lead to a better understanding of the problems of stability of rock structures.

Another approach, still in its early stages, has been adopted by Deist²⁴ and Cook²⁷. This approach is based upon the assumption that, beyond a certain level of stress (failure), the load carrying capacity of an element of rock decreases linearly with increasing strain. This assumption has been experimentally verified by Cook using a specifically designed to "stiff" testing machine²⁶. Diest has carried out theoretical studies into the stability of the fracture-solid rock boundary around excavations and, while, as yet only simple cases have been analysed, promising results have been obtained.

A recent paper by Fairhurst and Cook²⁷ suggests that a factor which may play an important part in determining the stability of the rock around a mining excavation is the buckling of sidewall slabs such as that those illustrated in Figure 10 b.

It will have become obvious to the reader that, as yet, the engineer who is faced with the problem of designing a stable structure is very little practical information at his disposal. At the same time, it will be appreciated at a start has been made in determining the most important factors governing the stability of rock structures and that the problem, having been defined, will be subjected to concentrated study until an unacceptable practical solution has been achieved.

Stability of a rock mass

To the best of the author's knowledge there are, as yet, no general rules analysing the stability of a rock mass. In any case, rock structures in which the rock is fissured and faulted can take such a wide variety of forms that the only logical approaches to treat each individual case on its merits.

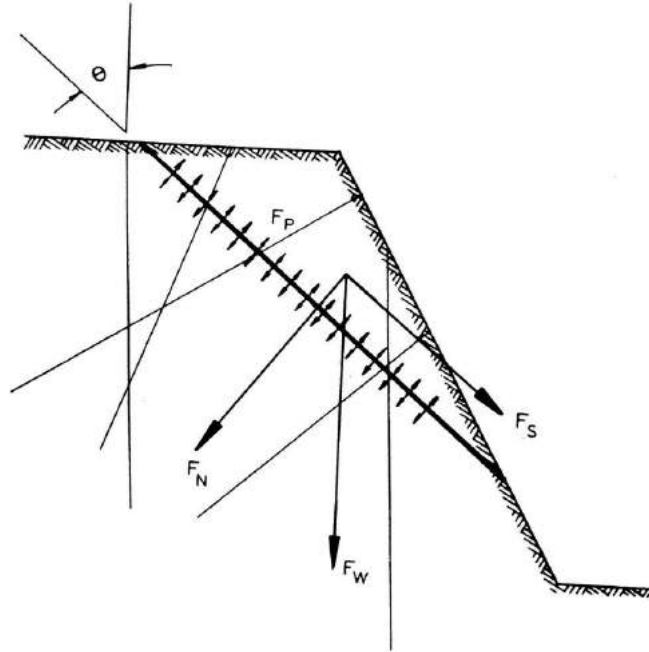

Figure 11. Forces acting on a rock slope containing a geological discontinuity

A practical example of such treatment, derived from actual experience, is presented in Figure 11, which illustrates a rock slope in which several geological discontinuities are known to exist. A cursory examination of this figure shows that only one of these discontinuities (marked as a heavy line) represents a threat to the stability of the system. The forces acting on this potential failure plane are as follows:

- F_W – the total weight of the rock wedge
- F_N – the normal force acting across the plane
- F_S – the shear force acting along the plane
- F_P – the total force due to fluid [pressure (if present) within the rock mass.

The condition for unstable equilibrium is

$$F_S = \mu (F_N - F_P)$$

where μ is the coefficient of friction which is effective along the potential failure plane.

The requirement for stability of the slope can be expressed as follows:

$$\mu > \frac{\cos\theta}{\sin\theta - F_P/F_W}$$

From the limited amount of experimental data available, it is believed that the coefficient of friction, μ between two dry rock surfaces is in the region of 0.7. This value could be considered lower if the potential failure plane contains soft filling material or if the rock services had deteriorated.

Control of Fracture in a Rock Structure

Rock has several physical characteristics which distinguishes it from other materials, and, of these, the most important structural characteristics are:

- (a) The large difference between the tensile and compressive strengths.
- (b) The rapid increase in strength with increasing natural or confining pressure.
- (c) The tendency for the structural properties of some rocks to deteriorate with time due to weathering.

Bearing these characteristics in mind, the engineer has the following techniques to add his disposal for making optimum use of its materials:

- (i) The design of the structure to avoid, if possible concentrations of tensile stress.
- (ii) The use of support means methods which increase the strength of the structure by increasing lateral pressure or restraint in zones of high compressive stress.
- (iii) The protection of surfaces which are liable to weather.

Design of rock structures for optimal stress distribution.

In mining, the geometry of the orebody being mined dictates the layout of the major excavations within the mine. The only practical control which the engineer can exercise in this case is in support methods and in the sequence of mining². However, in the case of secondary excavations such service haulages, airways, pumping chambers, etc, a mine designer usually has a reasonable amount of freedom, which he can use to position these excavations were the most favourable stress distribution.

The calculation of the stress distribution around excavations is a complex process²¹ which would certainly not benefit the average engineer to attempt to learn. Fortunately, there are several relatively simple model techniques which can be used, either by the engineer himself or by a university or research organisation, which could undertake this work on a contract basis, to give solutions which are sufficiently accurate and practical design purposes. These techniques are discussed in Part 2.

In the case of civil engineering structures such as dam foundations for open-cast excavations, the engineering is usually in a position to design the structure of optimum stress conditions (in relation to the structural material at his disposal).

In this case, the low tensile strength of rock, particularly if it contains unfavourably oriented flaws and fissures, must be kept in mind and the structure designed to minimise tensile stress is as far as possible. Since this subject falls outside the scope of the author's experience, the interested reader is referred to the work of Muller²⁸ and Serafim²⁹ for further details on the application of rock mechanics to do to the design of civil engineering structures.

Use of support in rock structures

In this context, support denotes the use of materials other than rock to improve the local properties of the rock and thereby improve the stability of the structure as a whole. Hence, for example lining a shaft with concrete is frequently used to inhibit local deterioration and failure of the rock surface.

Generally structural support its used a) to support broken rock and to prevent it from breaking and b) to improve the strength of rock mass by increasing lateral stress in selected areas.

In the first case, the use of timber, steel or concrete structures or of rock bolts is familiar to any engineer who has been concerned with mining or tunnelling. The main purpose of this support is to minimise the danger of falling rock and to prevent a loose pieces of rock from choking a passage-way. The use of this type of support depends so much upon local conditions that it would be meaningless to attempt to formulate general rules. On the other hand, the use of support to increase the strength of rock is a less well-known concept and deserves close examination.

One of the principal features which distinguishes rock from other structural materials, is the stress required to cause failure. In the case of quartzite, the stress fracture increases by six units per every unit increased in confining pressure. Hence, for quartzite with an unconfined compressive strength of 30,000 p.s.i., the stress required to fracture of specimen, subjected to a confining pressure of 1000 p.s.i., would be 36,000 p.s.i..

If therefore, it is required to increase the strength of rock in a particular area, this can best be achieved by artificially increasing the triaxial compressive stresses acting on this area. This increase can be achieved by the use of such devices as rock bolts or steel arches.

High tensile steel rockbolts have been used successfully in South Africa to inhibit sidewall fracture of excavations. Rockbolting can be particularly effective when joints are present in the rock since bolts placed normal to the joint plane increase the resistance of the joint to shear movement by increasing the friction forces and also by the pinning action of the bolts themselves. The use of steel arches in tunnels provides effective support for the broken roof rock and also increases the strength of the sidewall. The

volume increase associated with early sidewall fracture results in a packing up of broken between the steel arch and the solid rock surface. The restraint provided by these rock fragments is usually adequate to prevent further sidewall failure.

Protection of rock surfaces from weathering

Many rock types deteriorate rapidly when exposed to the atmosphere - a phenomenon commonly known as weathering. Hence a rock which appears to have desirable structural properties when freshly exposed may be unacceptable after having been allowed to wear there for a few months. In some extreme cases in the author's experience, soft rock specimens left exposed to the atmosphere between preparation and testing have disintegrated into heaps of rubble within a few days.

In most cases, very simple remedial measures will prevent or at least effectively inhibit weathering. Frequently painting or spraying the exposed surface with a thin mixture of cement and water will provide sufficient protection. Rocks which are particularly prone to weathering may require a fairly thick covering of cement or concrete or some similar sealant. A commercially available unit which sprays foam plastic onto exposed rock surfaces has been found effective in some South African coal mines.

Summary and Practical Conclusions

The following characteristics distinguish rock from other commonly used structural materials, apart from concrete, which behaves in a similar manner.

- a) Rock failure is generally of a brittle type, ie, it occurs with little prior warning and is not accompanied by a large non-elastic (plastic) deformations.
- b) The tensile strength of rock is usually of the order of 1/10 of its unconfined compressive strength.
- c) The strength of rock increases rapidly with increasing confining pressure.
- d) Some rocks exhibit marked anisotropic strength behaviour due to the existence of preferentially oriented weakness planes such as the bedding planes in a sedimentary rock.
- e) Most rocks exhibit some degree of time-dependent deformation or fracture behaviour.
- f) Some rocks suffer from a serious strength reduction when wet.
- h) Fresh rock surfaces exposed to the atmosphere are liable to deteriorate in time (weather).

The most effective use of the structural characteristics of rock can be achieved if these physical properties are kept in mind and if necessary precautions are taken in designing a rock structure. Some of these precautions are:

- 1) The structure should be designed to avoid or, at least, minimise zones of high tensile stress.
- 2) Support techniques such as the use of rockbolts can be used to improve the stability of rock structure by increasing the confining pressure and hence to compressive strength of the material.
- 3) When a rock structure contains geological weaknesses in the form of bedding planes, fissures, faults, joints or dykes, due allowance must be made for the directional strength variation associated with these features.
- 4) In calculating the strength of rock structure, allowance should be made for the possible reduction in strength with time.
- 5) Exposed surfaces of rocks which are particularly liable to weathering should be protected, as far as possible, from exposure to the atmosphere.

Current activity in rock mechanics, throughout the world, is such that significant advances in knowledge can be anticipated during the next decade. The interested reader is therefore advised to keep in contact with rock mechanics literature, and with the proceedings of the conferences which take place from time to time.

List of References

- 1) Judd, W. R. (1963). Rock stress, rock mechanics and research. *Proc. Intl. Conf. on the State of Stress in the Earth's Crust*. Santa Monica, ed. W. R. Judd. Elsevier Publishing Co., New York, 1964, PP- 5-53.
- 2) Cook, N.G.W. et al. (1966). Rock mechanics applied to rockbursts— a synthesis of the results of rockburst research in South Africa up to 1965. *Journal South African Institution of Mining and Metallurgy*, Vol. 66, No. 10, pp. 435-528.
- 3) Griffith, A. A. (1925). Theory of rupture. *First Intl. Cong. Appl. Mech.* Delft, 1924. Technische Boekhandel en Drukkerij, ed. J. Waltman Jr., pp. 55-63.
- 4) McClintock, F. A. and Walsh, J. B. (1962). Friction on Griffith cracks in rock under pressure. *Intl. Cong. Appl. Mech.* Berkeley, American Soc. Mech. Engrs., New York, 1963, pp. 1015-1021.
- 5) Hoek, E. (1965). *Rock fracture under static stress conditions*. Ph.D. Thesis, University of Cape Town, 1965, also South African Council for Scientific and

Industrial Research Report MEG 383.

- 6) Brace, W. F. (1961). Dependence of fracture strength of rocks on grain size. *Penn. State Univ. Mineral Expt. Sta. Bull.*, No. 176, 1961, pp. 99-103.
- 7) Berg, C. A. (1965). Deformation of fine cracks under high pressure and shear. *J. Geophysical Res.*, Vol. 70, No. 14, pp. 3447-3452.
- 8) Brace, W. F. and Bombolakis, E. G. (1963). A note on brittle crack growth in compression. *J. Geophysical Res.*, Vol. 68, No. 12, pp. 3709-3713.
- 9) Hoek, E. and Bieniawski, Z. T. (1965). Brittle fracture propagation in rock under compression. *Intnl. J. Fracture Mechanics*, Vol. 1, No. 3, pp. 137-155.
- 10) Hoek, E. and Bieniawski, Z. T. (1966). Fracture propagation mechanism in hard rock. *Proc. First Intnl. Congress on Rock Mechanics*, Lisbon.
- 11) Walsh, J. B. (1965). The effect of cracks on the uniaxial compression of rocks. *J. Geophysical Res.*, Vol. 70, No. 2, pp. 399-411.
- 12) Walsh, J. B. (1965). The effects of cracks on the compressibility of rocks. *J. Geophysical Res.*, Vol. 70, No. 2, 1965, pp. 381-389.
- 13) Hoek, E. (1964). Fracture of anisotropic rock. *J. S. Afr. Inst. Min. Metall.*, Vol. 64, No. 10, pp. 510-518.
- 14) Walsh, J. B. and Brace, W. F. (1964). A fracture criterion for anisotropic rock. *J. Geophysical Res.*, Vol. 69, No. 16, 1964, pp. 3449-3456.
- 15) Colback, P. S. B. and Wiid, B. L. (1965). The influence of moisture content on the compressive strength of rock. *Proc. Third Canadian Symposium on Rock Mechanics*, Toronto.
- 16) Nicolayasen, O. (1965). The role of fluid pressure in the failure of rock and other porous media. Unpublished report *Bernard Price Institute of Geophysical Research*, July.
- 17) Robertson, E. C. (1964). Viscoelasticity of rocks. *Proc. Intnl. Conf. State of Stress in Earth's Crust*. Santa Monica, 1963, ed. W. R. Judd. Elsevier Publishing Co., New York, pp. 181-224.
- 18) Hardy, H. R. (Jnr.). (1965). Study of the inelastic behaviour of geologic materials. *Ph.D. Thesis*. Virginia Polytechnic Institute, June.
- 19) Protodiakonov, M. M. (1964). Methods of evaluation of cracks and strength of rock systems at depth. *Proc. 4th Intnl. Conf. Strata Control and Rock Mechanics*. New

York, (Presented in Russian). South African Council for Scientific and Industrial Research Translation No. 449.

- 20) Hoek, E. (1966). Rock fracture around mining excavations. *Proc. 4th Intl. Conf. on Strata Control and Rock Mechanics.*, New York.
- 21) Savin, G. N. (1961). *Stress concentration around holes*. Translated from Russian in Intl. Series of monographs in aeronautics and astronautics, Pergamon Press, New York.
- 22) Hoek, E. (1963). Experimental study of rock stress problems in deep level mining. *Experimental Mechanics*, ed. Rossi, Pergamon Press, London, pp. 177-193.
- 23) Denkhaus, H. G. (1948). The application of the mathematical theory of elasticity to problems of stress in hard rock at great depth. *Ass. Mine Mngrs. S. Africa*, Vol. 1958/59, pp. 271-310.
- 24) Deist, F. H. (1965). A non-linear continuum approach to the problem of fracture zones and rockbursts. *5. Afr. Inst. Min. Metall.*, Vol. 65, No. 10, May, 1965.
- 25) Cook, N. G. W. (1965). A note on rockbursts considered as a problem of stability. *5. Afr. Inst. Min. Metall.*, Vol. 65, No. 10, May, 1965.
- 26) Cook, N. G. W. (1965). Failure of rock, *Intl. J. Rock Mech. and Min. Sci.*, Vol. 2, No. 4..
- 27) Fairhurst, C. and Cook, N. G. W. (1966). The phenomenon of rock splitting parallel to a surface under a compressive stress. *Proc. 1st Intl. Congress on Rock Mechanics*, Lisbon.
- 28) Muller, L. (1963). Application of rock mechanics in the design of rock slopes. *Proc. Intl. Conf. on State of Stress in the Earth's crust*, Santa Monica.. Ed. W. R. Judd, Elsevier publishers, New York, pp. 575-598.
- 29) Serafim, J. L. (1963). Rock mechanics considerations in the design of concrete dams. *Proc. Intl. Conf. State of Stress in the Earth's crust*. Santa Monica. Ed. W. R. Judd, Elsevier publishers, New York, pp. 611-645.

Part II. Laboratory Techniques in Rock Mechanics

The construction of any large structures such as a dam wall, an open pit, or a deep level mine excavation results in changes in the stress distribution, which existed prior to the creation of the structure. This disturbance of the existing stress state can lead to deformation and failure of the rock and to changes in the stress distribution. The structure will reach a state of stable equilibrium when the stress has been redistributed in such a way that the strength of the rock is not exceeded at any point in the structure.

Article techniques understanding of the stress, and the strength of a rock mass, discussed in Part III of this paper, are both difficult and expensive. Consequently, for most rock mechanic problems, it becomes necessary to make a number of simplifying assumptions and to study the problem in the laboratory by means of theoretical or physical models.

Theoretical Stress Analysis

In studying the distribution of stress in a rock structure, the mathematical theory of elasticity has proved a most useful of existing material behaviour theories. Not only is it the simplest of these theories, but it has been found to give a remarkably accurate prediction of the observed behaviour of massive rocks structures¹.

A major advance in the calculation of the stress in the rock surrounding excavations in thin seam or reef deposit has been made by Salamon⁴. His mathematical techniques have proved particularly useful in the study of the stress displacements in deep level South African gold mines. When it is required to study the stress distribution in the rock around excavations which are very close together, or around shallow tunnels or tunnels in dam walls, the mathematical difficulties increased to a level at which even a competent mathematician would seek an alternative method of solution. Fortunately, this alternative is available in the form of photoelastic models.

Photoelastic Stress Analysis

The photoelastic stress analysis technique depends upon the fact that certain optical properties of most transparent material change when these materials are subject to stress. Hence if a stressed plastic or glass model is viewed in polarised light, coloured interference fringe patterns are observed and these patterns can be interpreted in terms of the direction of the principal stresses and the magnitude of the maximum shear stress at any point in the model⁵.

On a very important advantage of photo elasticity is that three-dimensional stress problems can be studied by means of the "stress freezing" technique. In this technique, a three-dimensional scale more goal of the structure under consideration is machine from a suitable material, usually an epoxy resin⁶, and this model is then subjected to a thermal cycle while under load.

As soon as the more goal has been slowly heated to a critical temperature, usually in the

region of 160°C, and then allowed to cool to room temperature, the load is removed and a photoelastic pattern will have been "frozen" into the model. Careful cutting of this model of our slices to be examined in polarised light, and that three-dimensional stress distribution in the model to be determined.

In many stress problems which are of interest in rock mechanics, a high degree of accuracy can be achieved in two or three dimensional photoelastic stress analysis. There is, however, a certain class of problem in which Poisson's ratio effects can introduce very large errors. This class includes models in which body forces due to gravitational stress are important and also composite models in which different strata are represented by different photoelastic materials. Consequently, in considering the application of photoelasticity to the analysis of the stress distribution in rock structures, great care must be taken to ensure that the errors introduced by the fact that all the similitude requirements⁸ cannot be satisfied within the acceptable limits which appertain to the analysis.

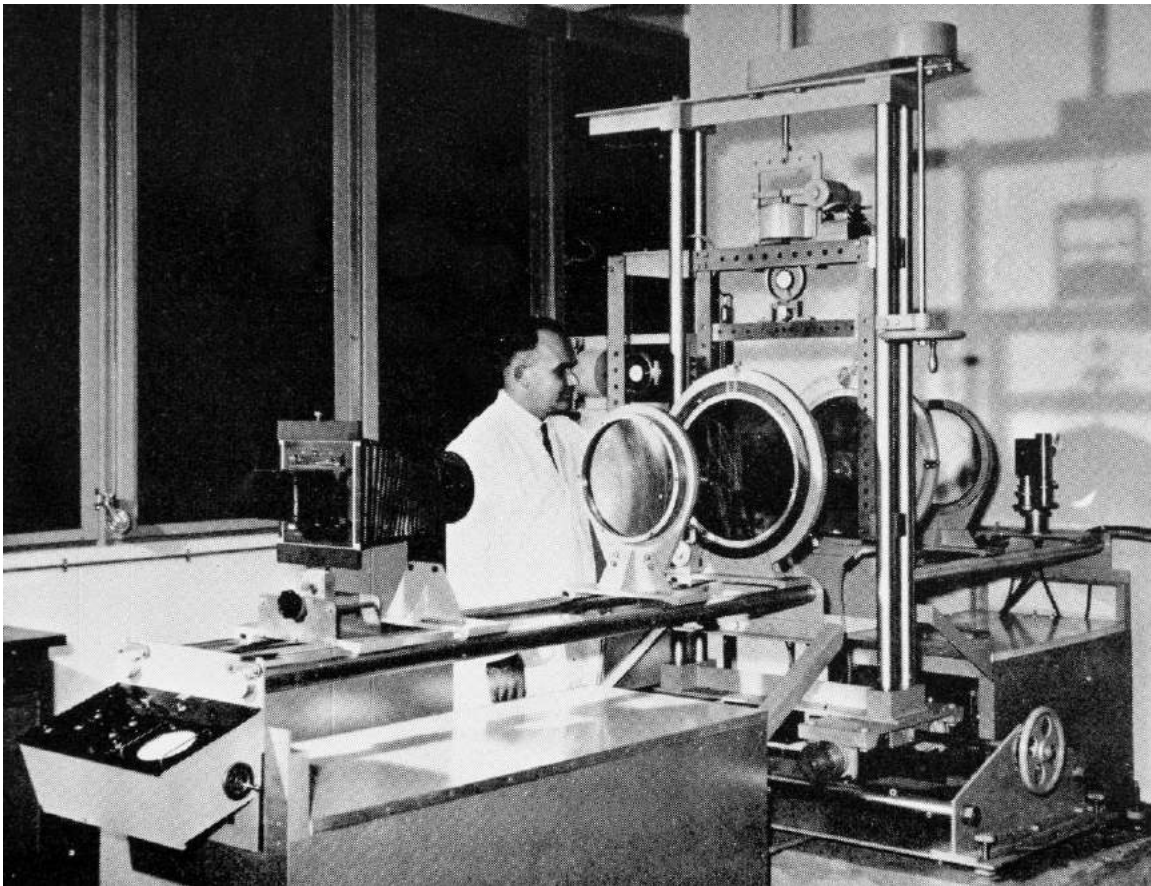

Figure 1. The C.S.I.R. polariscope for producing a 12 in.diameter beam of polarised light for photoelastic model analysis.

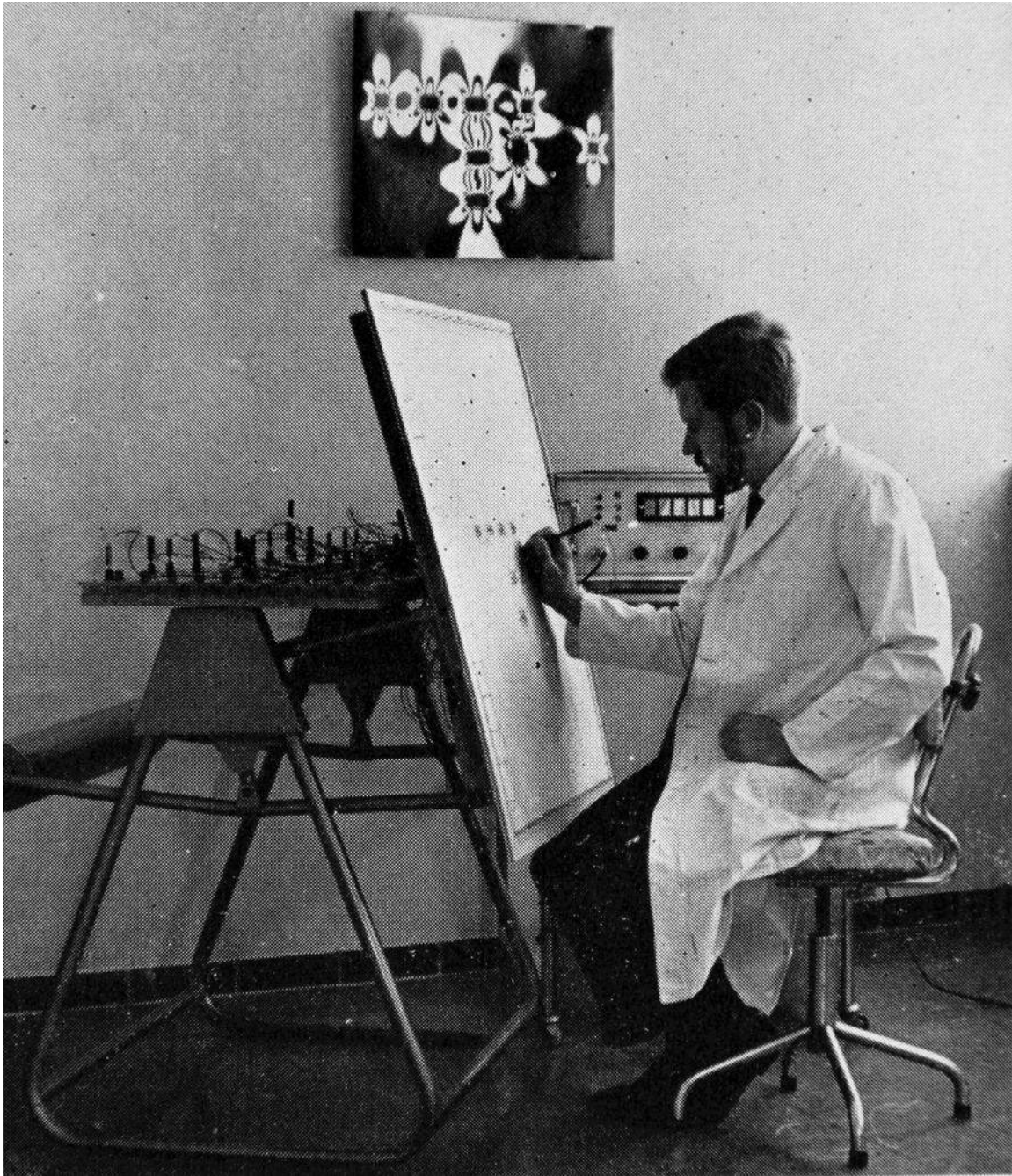

Figure 2. Conducting paper analogue for the solution of the La Place equation.

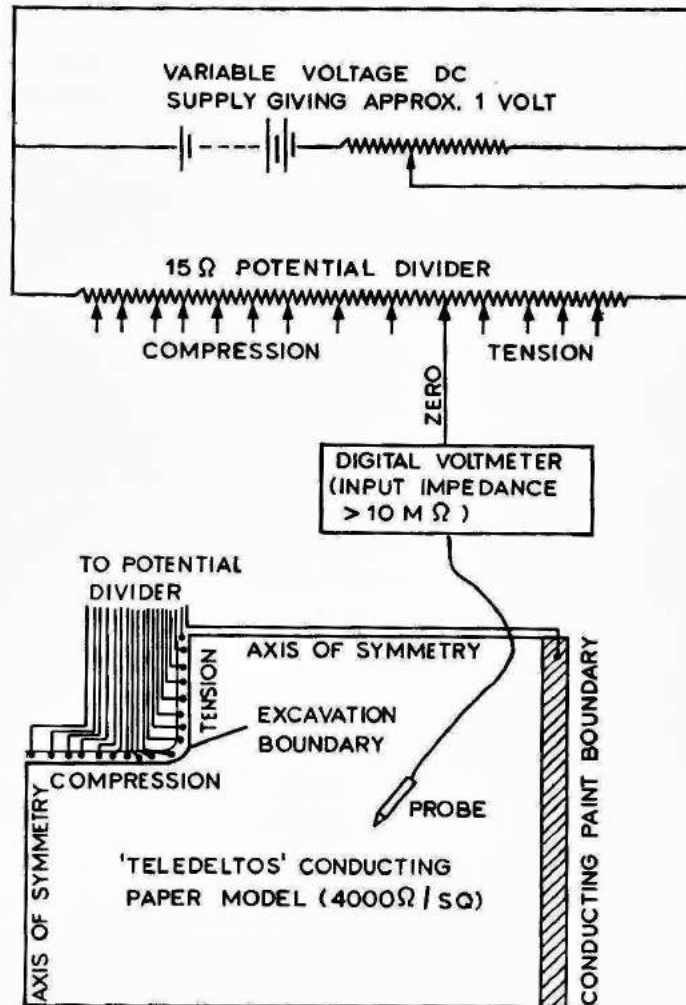

Figure 3. Circuit for conducting paper analogue.

A major difficulty associated with photoelastic stress analysis is the manufacture and loading of the model. A three-dimensional model of a relatively complex structure may take several weeks of careful casting, curing, annealing, machining, stress-freezing, and finally slicing and analysis. The necessity for producing models of high quality cannot be over emphasised since results obtained from a poor quality model may be several hundred percent in the error and could lead to serious consequences if incorporated into a major structural design.

From these remarks, it will be obvious to the reader that photoelasticity, while a very useful stress analysis tool, is only suitable for use in an adequately equipped laboratory in which staff with the necessary training are available to carry out the analysis. One of the factors which has inhibited the full exploitation of the photoelastic technique, particularly in mining engineering, is the scarcity of research workers with a sound training in photoelasticity. Since the demand for such personnel far exceeds the supply, this problem is liable to remain for many years to come.

Stress Separation Techniques

The failure of rock depends primarily upon the maximum and minimum principal stresses at the point under consideration. Since the photoelastic model gives information on the maximum shear stress, which is proportional to the difference between the principal stresses in the plane under consideration, it is necessary to make use of some of the techniques in order to obtain sufficient information for the separation of the principal stresses.

In the case of two-dimensional problems, e.g. the stress distribution around a long horizontal tunnel, the most convenient technique is the conducting paper analogy for the solution of the La Place equation. The second order differential equation covers the distribution of the some of the principal stresses in a stressed elastic body and the analogy is in the possible by the fact that the voltage flow in a uniformly conducting sheet is governed by the same equation 9.

The equipment used by the author for this analogue is illustrated in Figure 2 and the circuit, which has been found most convenient, is shown in Figure 3.

In the case of three-dimensional problems, particularly in those which no clearly defined planes of symmetry exist, the principal stress separation is a difficult and time-consuming operation¹⁰. Fortunately, in many rock mechanics problems, simplification of a three dimensional stress distribution to a number of two-dimensional distributions is often possible and consequently a great deal of time can be saved if one is prepared to accept a solution containing relatively small inaccuracies.

Some examples of photoelastic stress analysis

The author has made extensive use of two-dimensional photoelasticity in the study of the fracture of Rock around mining excavations^{11, 12}. Much of this work is being carried out on glass, one the best photoelastic materials for the study of compressive stress problems, and a sample of a typical photoelastic stress pattern in the model is illustrated in Figure 4. The details of the loading device used in these fracture studies will be discussed in a later section of this paper.

Three-dimensional photoelastic studies of the stress distribution in coal pillars and of the interaction of multiple excavations in shaft pillars have been carried out at the request of particular mining companies. Since the cost of such a photoelastic analysis is a fraction of the cost of developing and shaft system, it would be logical to use this technique as a design tool rather than as a means of explaining failure is after difficulties have been experienced.

In studying the interaction of a number of major excavations, extending over an appreciable range of depth, the usual assumption that the influence of gravitational loading can be ignored was not acceptable and the model was loaded in the centrifuge illustrated in Figure 5¹³. In this case the model is placed in an oven mounted at the end of the centrifuge rotor and the stress-freezing cycle is carried out while the model is being subjected to a centrifugal acceleration of approximately 100 times the acceleration due to

gravity. This model of loading reduces the stress gradient in which the model which is equivalent to the increase in stress with depth in a large rock structure.

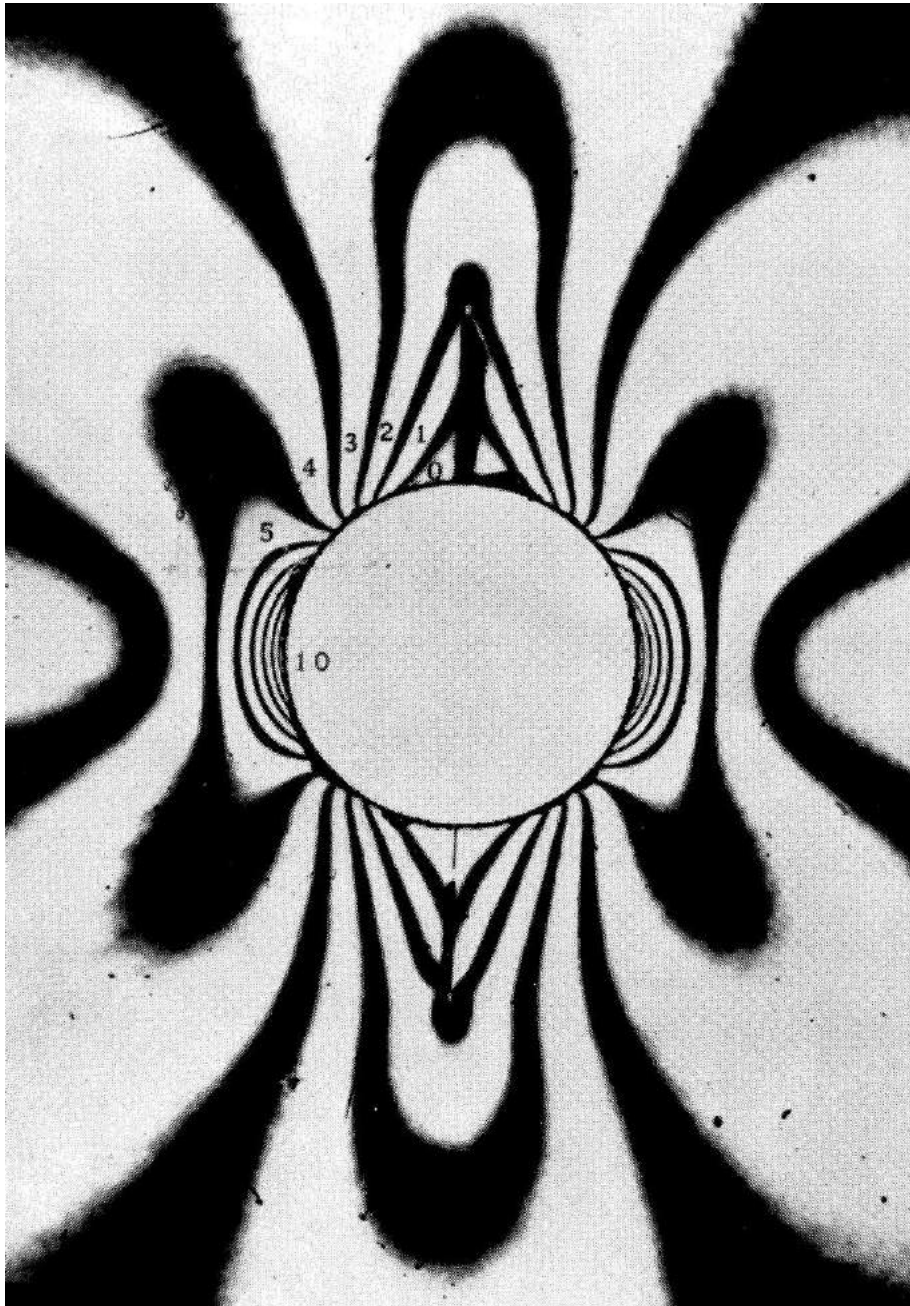

Figure 4. Photoelastic pattern in a glass plate model containing a central circular hole from which vertical tensile cracks have propagated.

An example of the type of analysis which has been carried out with the aid of the centrifuge is illustrated in Figure 6. This photoelastic pattern shows the test stress distribution in the material surrounding a number of mine excavations into reef horizons. In this particular model, the sizes of the excavations were calculated so that the vertical displacements and centrifugal acceleration of 100 times the acceleration due to gravity would be proportional to the elastic displacements in the rock and surrounding the underground excavations. Consequently in the large excavations, closure, i.e. contact between the roof and floor of the excavation, occurred and its influence upon the stress distribution could be studied.

The author considers that this type photoelastic analysis would be particularly suitable for the analysis of the stress distribution into walls, rock slopes or shallow tunnels, all of which are important in civil engineering.

The Mechanical Properties of Rock

The deformation and failure characteristics of rock are obviously important in the design of rock structures. Techniques that the determination of these properties in situ (discussed in Part III of this paper) are difficult and expensive. Consequently, most rock mechanics research workers have resorted to the determination of the mechanical properties of rock on small-scale specimens tested in the laboratory.

As discussed in part one of this paper, it is believed that these small-scale tests, when properly carried out, give reliable values for highly competent fine grained rocks such as quartzite. There can be no doubt that small-scale tests on materials such as coal can only give a very approximate indication of what the in situ properties are likely to be (see Figure 7 and of Part I), can be established experimentally, thereby permitting the reliable extrapolation of small scale results in the in situ conditions.

A common misconception in rock properties testing is that elaborate specimen preparation and testing techniques are not justified because the inherent scatter in the results will override any attempt to obtain accurate measurements. The author's experience suggests that remarkably consistent and meaningful results can be obtained if sufficient care is taken in the preparation and testing of rock specimens.

Specimen preparation

Since most properties testing is carried out on core specimens, the first requirement of a rock mechanics laboratory, in which the mechanical properties of rock are to be studied, is a suitable diamond drilling machine. The most important requirement for such a machine is rigidity and smoothness of operation. Any vibration generated in the machine and transmitted to the diamond core-barrel results in poor quality core which necessitates circumferential grinding.

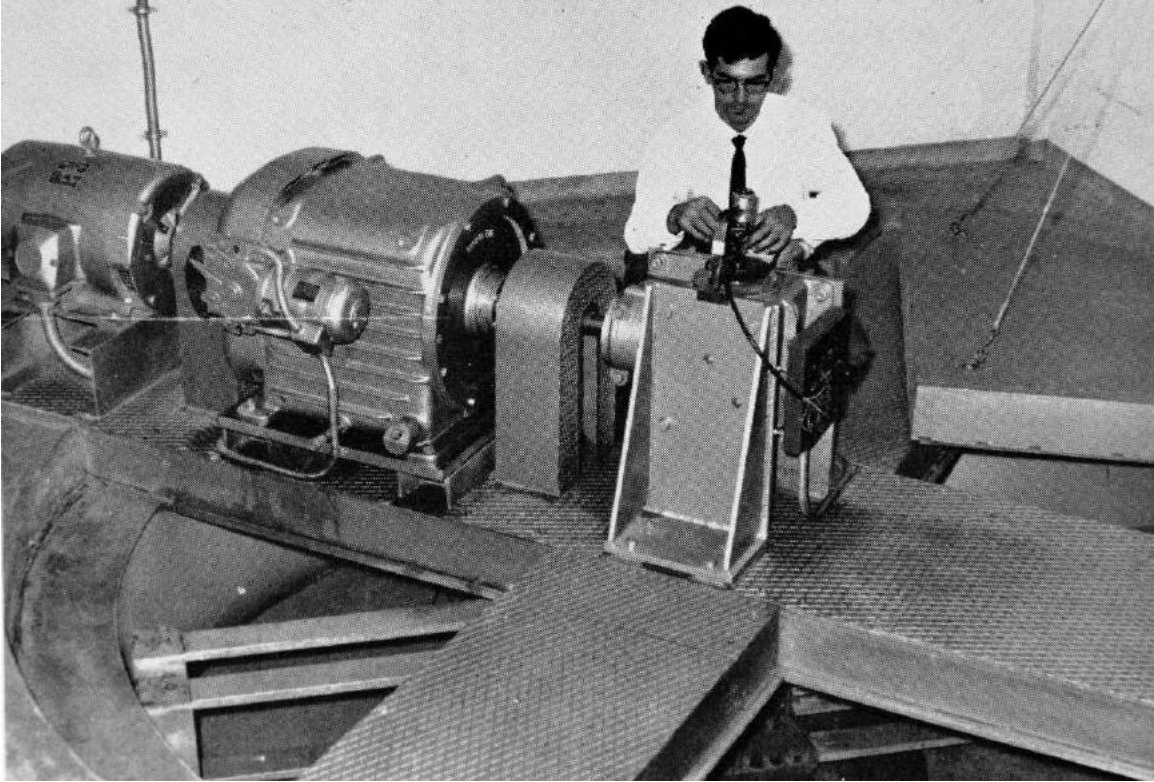

Figure 5. The C.I.S.R.'s 9 ft. diameter centrifuge for subjecting models to acceleration of up to 1,000 times the acceleration due to gravity.



Figure 6. Photoelastic pattern in a min model which was stress-frozen at a centrifugal acceleration of 100 times the acceleration due to gravity.

The machine used by South African C.S.I.R., illustrated in Figure 7, is an electrically driven machine in which the drill thrust and feed are controlled hydraulically. As discussed in Part III of this paper, this machine is also used the field drilling. When drilling the particular rock sample, the optimal drilling speed, drill thrust and rate of feed are established by initial trials and these factors are then maintained constant for the drilling programmes. The resulting corner is straight and parallel and requires no further attention to its cylindrical surface.

Preparation and the ends of the specimen is carried out by cutting the specimen to length by means of a diamond saw and then grinding the ends flat and parallel. This end grinding can be carried out in a number of ways but one of the most convenient methods is illustrated in Figure 8. In this machine, the core is held in an accurately aligned Vee block which is moved slowly across the face of a diamond impregnated cupwheel.

Specimens for tensile tests are ground to a profile with a reduced test section in the lathe illustrated in Figure 9. A diamond impregnated wheel is mounted on a tool-post grinder which is moved in a predetermined path by means of a template guide.

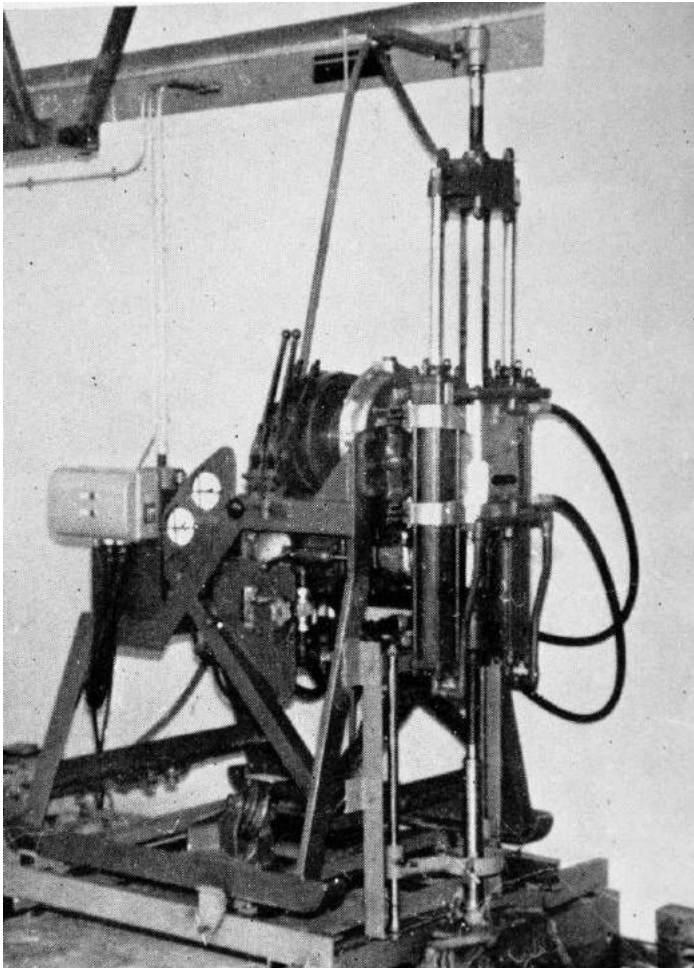

Figure 7: Drilling machine used to obtain specimens in the laboratories of the South African C.S.I.R.

Figure 8: Machine used by the C.S.I.R. for grinding the ends of cylindrical specimens.

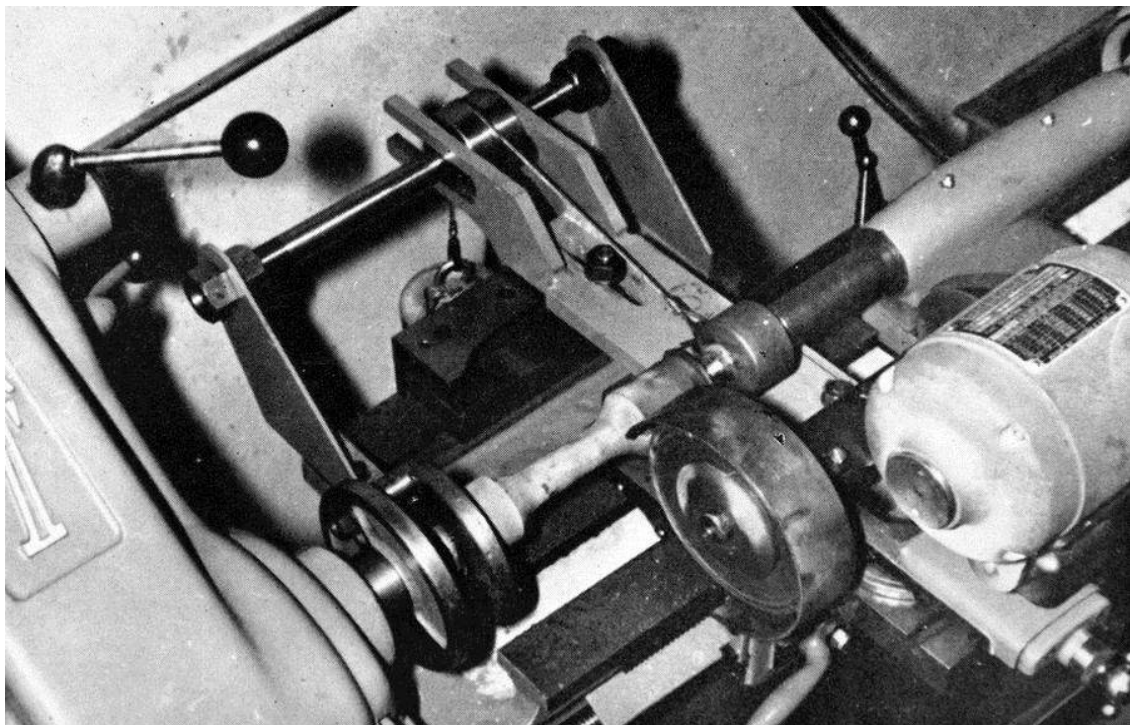
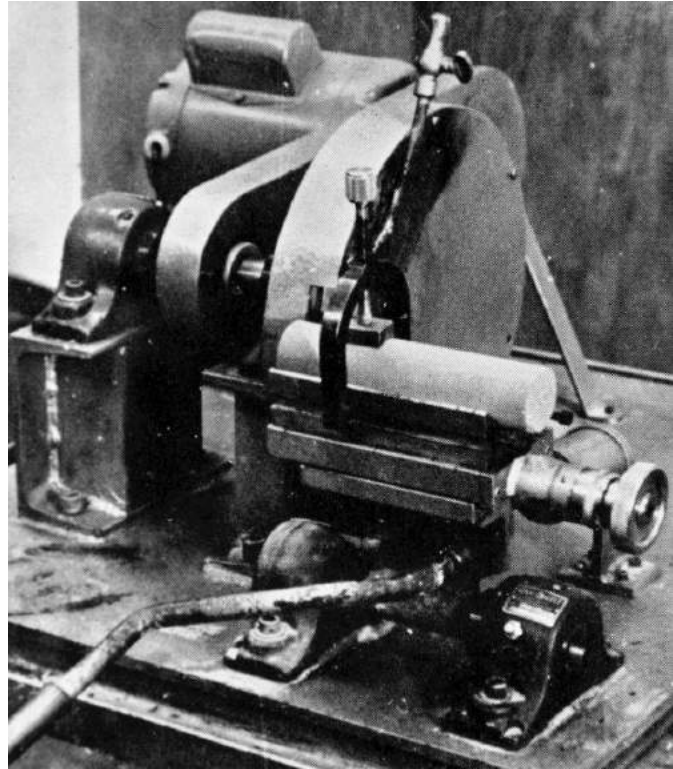

Figure 9. Apparatus for the preparation of tensile specimens in the laboratories of the South African C.S.I.R.

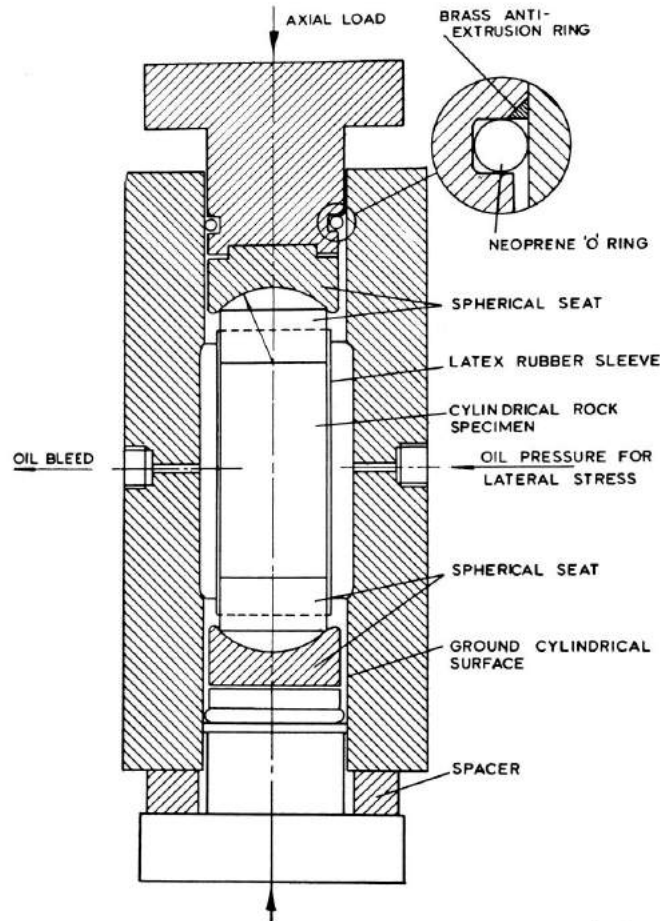

Figure 10. Apparatus for subjecting cylindrical rock specimens to triaxial compressive stress conditions.

Testing Techniques

In the design of rock structures such as dam foundations or vertical mineshafts, the deformation of the rock is of prime importance since excessive deformation may result in failure of the dam wall in severe misalignment of the shaft steelwork. On the other hand, the stability of rock structures such as tunnels, open pits or underground excavations is dependent upon the strength and failure characteristics of the rock.

The deformation characteristics of rock most conveniently studied on cylindrical specimens subject it to uniaxial compression. Strain gauges, bonded to the rock surface are the most reliable measuring devices and the convenience of using gauges would normally outweigh the relatively high cost of the gauges.

An important consideration in rock deformation measurement, particularly for civil engineering applications, is the accurate measurement of deformation at lower stress levels. It is frequently assumed that nonlinear stress-strain behaviour at low stress levels

is due to “bedding in” of the specimen and load fixtures. This important part of the curve is usually ignored and an average elastic modulus, calculated from the linear portion of the stress-strain curve at higher stress levels, is quoted. Considering that many civil engineering structures and shallow mines are subjected to stress levels of less than 100 p.s.i., The application of an elastic modulus determined at the stress level of several thousands of p.s.i. is meaningless.

Consequently, when that deformation characteristics of rocks which occur in structures subjected to low levels of stress are being studied, great care must be taken to ensure that the load and strain and measured with sufficient accuracy. In these tests, the accuracy of the testing machines scale cannot be relied upon and it is advisable to use dead weight loading or to load the specimen in series with a sufficiently accurate load-cell.

Probably the most common test carried out rock specimens in the laboratory is to subject them to uniaxial compressive stress until disintegration of the specimen occurs. Since the uniaxial compression test is only a special case of triaxial testing, it is included in the following discussion on triaxial testing.

The most convenient techniques are testing a cylindrical rock specimen under triaxial stress conditions is to apply a uniform hydraulic pressure to the cylindrical surface in an apparatus such as illustrated in Figure 10. The features embodied in the design illustrated in Figure 10 have been thoroughly evaluated in the course of thousands of tests carried out on similar, although slightly more elaborate, equipment used by the C.S.I.R.. One of the most important features of this design is the anti-extrusion ring which acts in conjunction with the neoprene “O” ring. This combination results in a very low friction seal (friction approximately 1% of the hydraulic pressure) which has been found effective pressures of up to 50,000 p.s.i.. Other important features other spherical seeks to eliminate ending in the specimen and the latex rubber sleeve which prevents penetration of the hydraulic fluid into the pores of the specimen. Although not included in Figure 10, it is a relatively simple matter to bring strain gauge leads out from the pressure chamber if it is required to study the deformation characteristics and triaxial stress conditions.

It will be noted that the specimen length, shown in Figure 10, is twice the specimen diameter and that the steel plattens are the same diameter as the specimen. These dimensions have been carefully chosen to give as uniform as possible of stress distribution in the specimen.

A discussion on triaxial test systems must include the pump system is to apply and to control the hydraulic pressure. Such a hydraulic system, in the author's opinion, the most ideal, is illustrated in Figure 11. Experience using systems such as these has revealed that the hydraulic pressure is almost free of spurious pressure pulses and an extremely delicate control of the rate of loading and pressure can be achieved by operating only one control-the needle bypass valve.

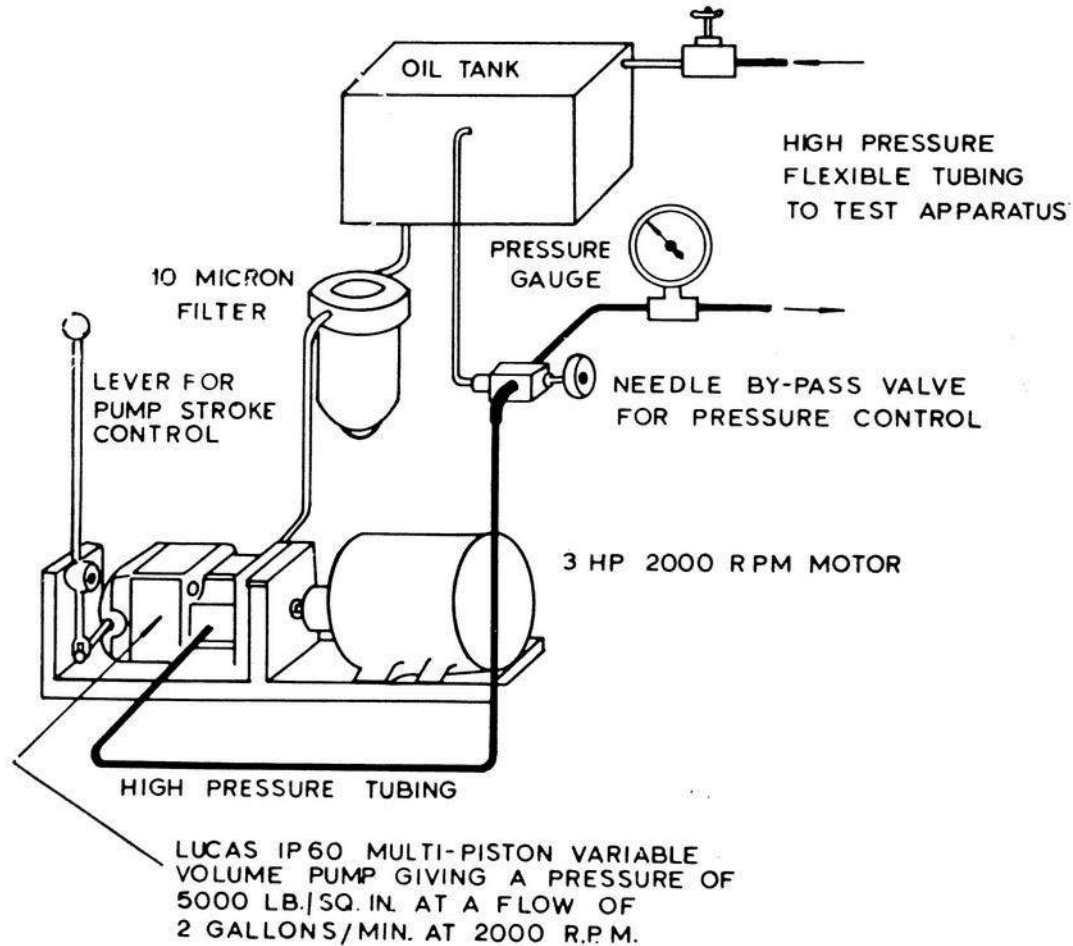

Figure 11. Circuit used for producing accurately controlled hydraulic pressures.

This particular system is only suitable for hydraulic pressures of up to 5000 p.s.i.. Higher pressures require more elaborate systems as well as the use of rigid steel high-pressure tubing. In the author's opinion, most practical triaxial testing, except on very hard rocks such as quartzite, can be carried out at the confining pressure of less than 5000 p.s.i..

A complete description of the fracture behaviour of rock material requires that its tensile strength be determined. This apparently simple requirement represents one of the most difficult experimental problems in rock properties testing. The principal difficulties associated with tensile tests on rock are the prevention of failure within the grips and the elimination of bending in the specimen. These difficulties have been largely overcome in the design illustrated in Figure 12. In this device, the sleeved specimen is loaded hydraulically. The difference in area between the enlarged ends of the specimen and the test section results in the development of an axial tensile stress. In the specimen the combination of the axial tensile stress and radial hydraulic pressure is such that tensile failure is induced in the specimen.

A three-dimensional photoelastic analysis of the stress distribution in the specimen has established that the fillets joining the test section to the enlarged ends do not influence the

stress distribution. Practical experience confirms the uniformity of the stress distribution, since fracture invariably occurs within the test section of the specimen.

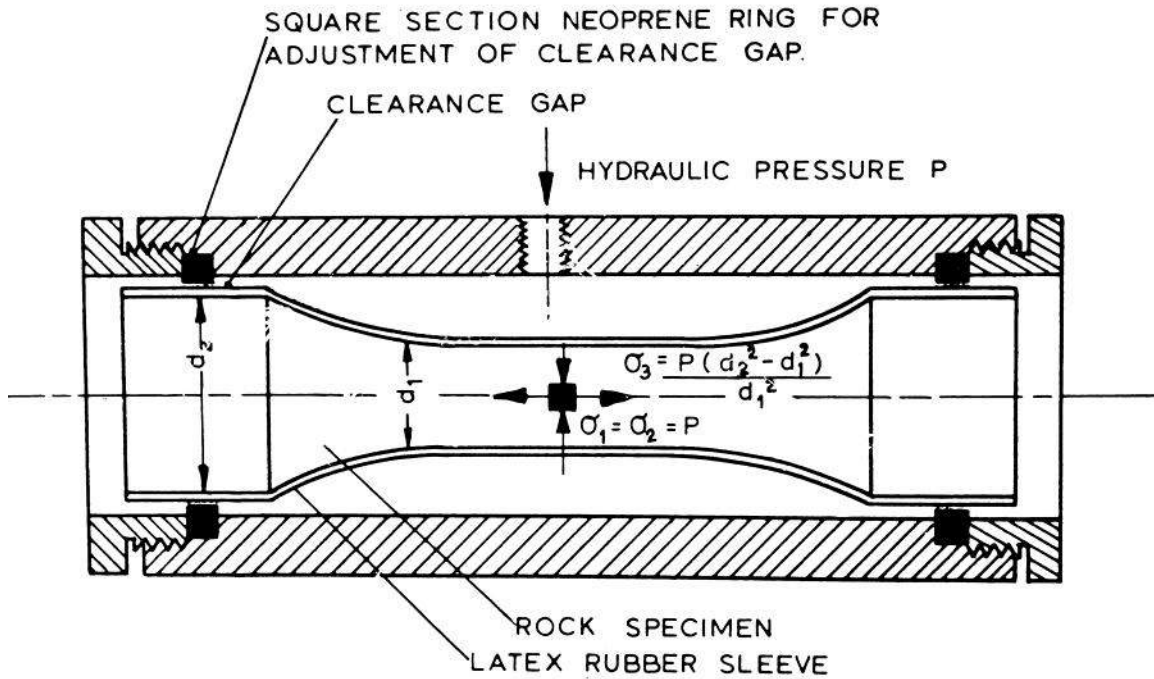

Figure 12. Apparatus for determining the tensile strength of rock specimens.

The Influence of the Method of Loading

Most rock properties tests are carried out in machines in which the load is controlled hydraulically. In these machines, the energy stored in hydraulic system is sufficient to cause rapid disintegration of the specimen as soon as its load carrying capacity is diminished by internal fracturing.

On the other hand, if the specimen is loaded in a “stiff” machine in which the load is removed from the specimen as soon as its load carrying capacity diminishes, the violent disintegration of the specimen is prevented.

In comparing these two loading systems, it is necessary to consider the behaviour of an element within a rock structure.

When the strength of the rock is exceeded at a particular point in structure, due either to a local weakness or to excessively high stress at that point, fracturing at the rock commences. This fracturing is accompanied by an increased load carrying capacity and hence the load is redistributed over the surrounding intact and fractured rock. If the

surrounding rock can carry this additional load without fracturing, a state of stable equilibrium will have been established in which the original rock element may be extensively damaged but will not have disintegrated and may still retain some portion of its original load carrying capacity.

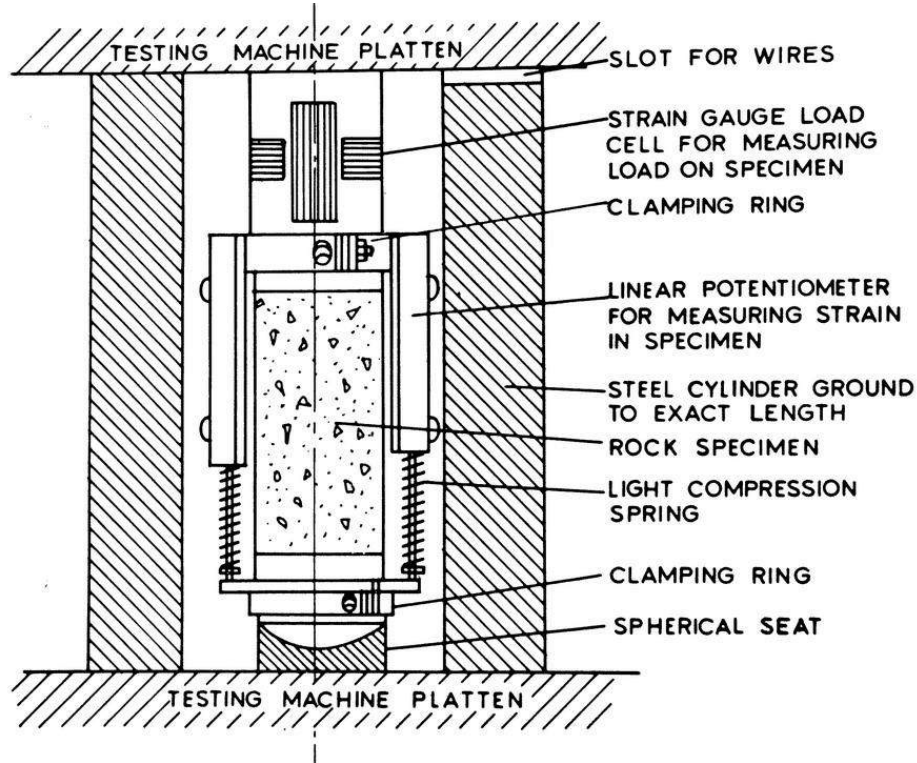

Figure 13. Apparatus for tests to simulate load transfer from a specimen at point of failure.

This fracture sequence can be stimulated by means of the apparatus illustrated diagrammatically in Figure 13. The specimen is loaded in parallel with the steel cylinder which has a large enough cross-sectional area, in relation to the area of the specimen corner to ensure that a high proportion of the load is carried by the cylinder. The steel cylinder and the rock specimen undergo the same axial deformation and when the rock specimen fails, the load which it carries is transferred on to the steel cylinder (corresponding to the surrounding rock in the structure) and, provided that this additional load does not result in additional deformation in the cylinder, the failure of the rock specimen will have been effectively arrested.

Though the increase in the load results in control deformation of the cylinder and hence the specimen and, consequently, the post-fracture behaviour of the specimen can be studied in detail. Such studies have been carried out by Cook¹⁵ and Paulding¹⁶ and cement are eschewing theoretical conclusions, based on their post from Frank sure behaviour of hard rock, have been put forward by Diest¹⁷.

It must be emphasised that the behaviour of the rock up to the point of fracture is

theoretically independent of whether the load is applied hydraulically or in the “stiff” machine. Since current design procedure is (perhaps incorrectly) neglect the post-fracture behaviour of the material, the conventional testing technique remains acceptable. However, the above discussion on the possible fracture sequence in the rock structure does emphasise the point that rock properties testing techniques must always be tailored to suit the practical requirements and should never be an end in themselves.

Indirect Properties Testing Techniques

A discussion on techniques for the determination of rock properties would not be complete without some mention of indirect test methods. These methods aim of providing a simple and convenient test which can be used, in the field if necessary, to give an estimate of some rock property which may be difficult to obtain accurately without elaborate laboratory facilities.

One of the best known of such methods is the Brazilian test in which tensile failure is induced in a disc by compressing it across a diameter^{19, 20}. Providing that a certain amount of care is taken in interpreting the results of this test, reasonably accurate estimates of the uniaxial tensile strength of a rock can be obtained. This test is particularly useful for comparative studies on one rock type, e.g. a study of the influence of moisture content upon the uniaxial tensile strength. In such a study, a large number of disc specimens can easily be prepared and tested while profiled tensile specimens of the type discussed in the previous section could only be tested in sport quantities.

A simple test which can be used to determine whether anisotropy exists in a rock involves pressing the ball into the centre of the flat surface of a disc specimen²¹. The disc will split across the diameter and anisotropy can be detected if a preferred failure direction is observed in a number of such tests.

The difficulty associated with the interpretation of any indirect test on rock is the fact that the actual stress distribution in the specimen may not be accurately known. In the case of the Brazilian test, the stress distribution and hence the point of fracture initiation can be altered by changing the area over which the load is applied to the edges of the disc specimen¹⁹. If such changes can be induced intentionally under controlled conditions in the laboratory, it is more than likely that they would occur accidentally under field conditions and thereby invalidate the test.

If directional tests can only be made to yield reliable results under carefully controlled laboratory conditions, is it not preferable to devote his time to carrying out direct tests in which the stress on the specimen depends only upon the cross-sectional area of the specimen and upon the applied load?

Model Studies of the Interaction of Stress and Fracture

In the previous sections of this paper, the techniques used with a study of the stress distribution in rock structure and the methods used for determining the mechanical properties of rock have been discussed independently. The question now arises as to the interaction of the stress in the structure and the fracture of rock. To what extent is the stress distribution altered by fracture of a rock and how do these two phenomena influence one another in the establishment of a state of stable equilibrium in the structure?

As a first approach to this problem, the technique of model studies has been adopted by the Rock Mechanics Division of the South African C.S.I.R.. The models, which are designed to fail under control stress conditions, are instrumented to permit the study of the sequence of events leading to the final collapse of the model.

Biaxial loading of the plate models

The photograph reproduced in Figure 14 illustrates the machine used to apply biaxial compressive loads to plate models. Four diametrically opposed hydraulic pistons applied loads of up to 100 tons, in both vertical and horizontal directions, through an articulated low distributing device, onto the edge of the 6 inch square model of up to 1/2" thickness. Lateral restraint is provided to prevent buckling of the model and to induce conditions approaching plane strain in the plate.

The machine used in the study of the fracture of material surrounding excavations in the uniformed stress field (simulating mine excavations at depth). The models may be cut from rock may be manufactured from some artificial brittle material such as plaster of Paris. Glass models have been used for certain types of fracture studies^{22 23} (see Figure 4). In the case of rock or glass models, excavations of the desired shape are ultrasonically machined into the model²⁴.

Since it is desirable to study the stress distribution over the entire model surface during failure of the model, the most useful stress analysis techniques are of the bi-refringent layer method^{25 26} and the Moire fringe technique²⁷.

The bi-refringent layer method involves bonding a layer of photoelastic plastic onto the surface of the model with a reflective adhesive. The photoelastic pattern induced in this layer by the deformation of the model is observed in reflected polarised light.

The Moire French technique depends upon the interference between a deformed grid of fine lines (several hundred lines per inch) which has been photographically deposited onto the model surface and an undeformed master pattern through which the grid on the model is viewed.

Unfortunately, the analysis of the patterns produced by either of the above techniques is a complex and time-consuming process and, consequently, their use is restricted.

The series of photographs reproduced in Figure 15 illustrates the application of the bi-refringent layer technique to the study of the failure of rock around a circular excavation²⁸.

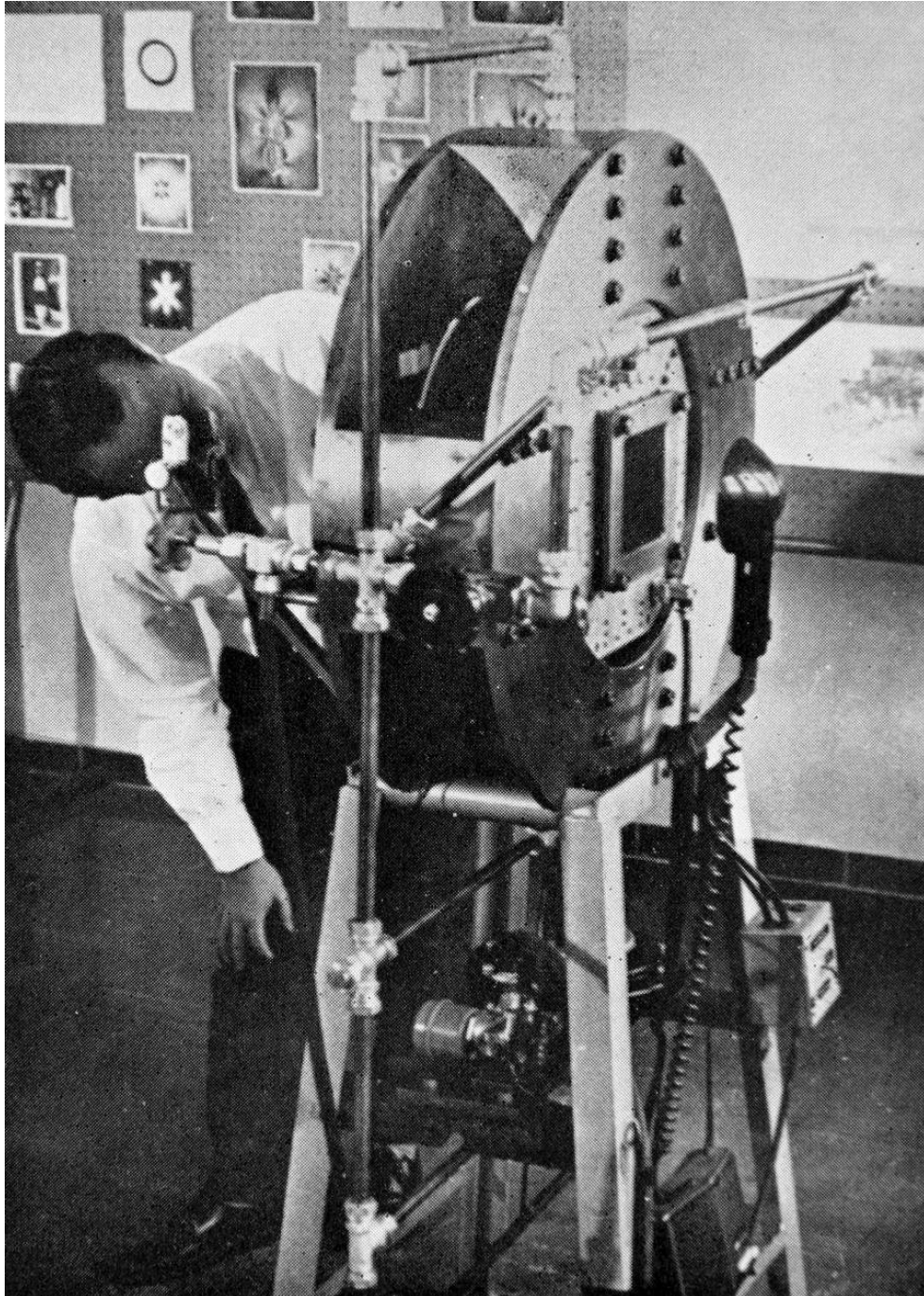

Figure14. Apparatus used by the C.S.I.R. for subjecting plate models to biaxial compressive loading.

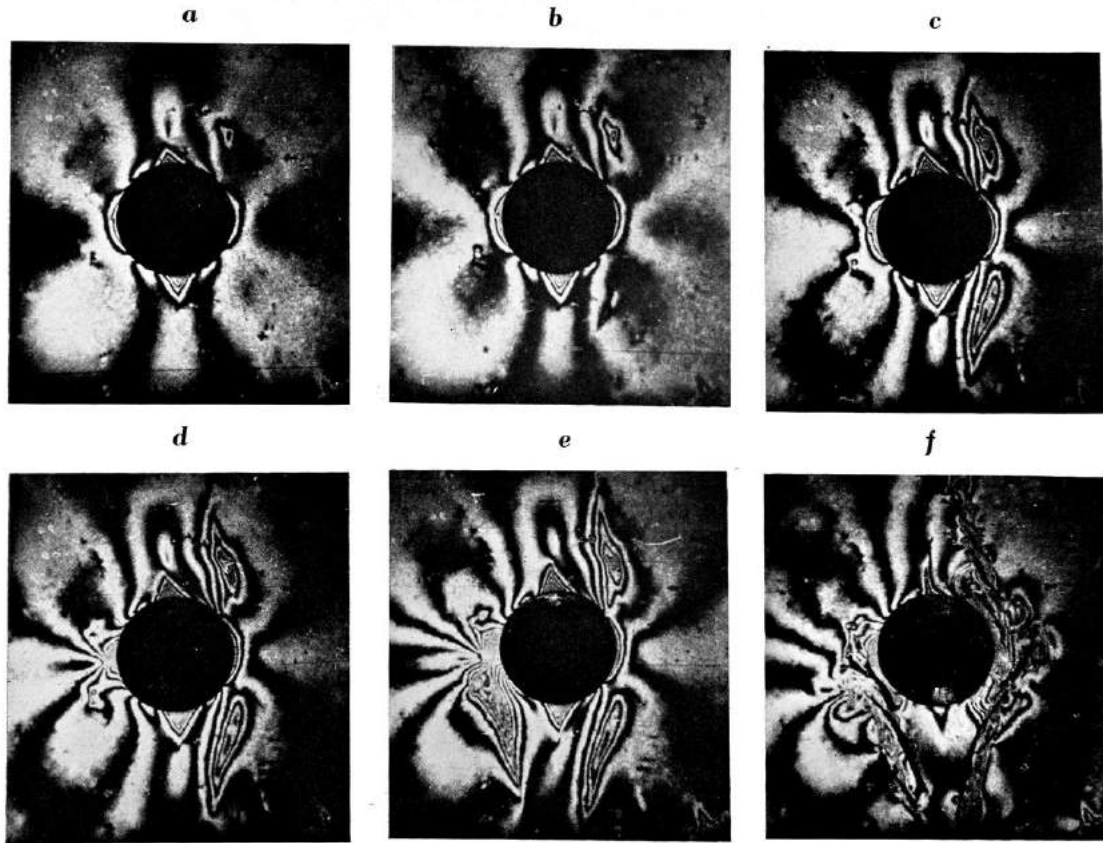

Figure 15. Reflected light photographs of the photoelastic patterns induced in a birefringent lay by fracturing of the rock surrounding a circular excavation in a plate model.

Fracture Studies in a Centrifuge

When considering the stability of a massive rock structure in which body forces are of prime importance, e.g a steep slope, the only practical technique which can be used to stimulate the loading conditions on the model is to load this model in a centrifuge.

The loss of similitude which govern the relationship between the behaviour of the model and of the rock structure, up to the point of failure, show that an exact scale model of the structure, manufactured from the rock itself will behave in an identical manner to the structure if it is subjected to a uniform acceleration which is universally proportional to the scale factor¹³. Hence, if the model is built to a scale of 1:1000 and subjected to an acceleration of 1000 times the acceleration due to gravity, its behaviour will simulate that of the structure.

In order to satisfy the requirements of accuracy of loading, safety of operation and overall cost¹³, a practical limit for centrifuge design is considered to be a machine which will subject a 1 foot cube model to an acceleration of 1000 times acceleration due to gravity. Such a machine has been constructed by the South African C.S.I.R. and is illustrated in

Figure 5.

When it is required to model a structure of the scale less than 1:1000, the capacity of the centrifuge becomes a limiting factor and it is then necessary to use model materials which satisfy the same behaviour laws of rock but which have a lower modulus of deformation and ultimate strength. Hence, a material which has 1/10 the modulus of defamation and ultimate strength of rock can be used to model a structure to a scale of 1 to 10,000 if the model is subjected to an acceleration of 1000 times that due to gravity¹³. Obviously, finding material which satisfies these requirements is not an easy task¹¹ and the full exploitation of the C.S.I.R. Centrifuge has been inhibited by difficulties in manufacturing models which adequately satisfy the the similitude to the requirements.

An example of the importance of this technique in studying the role of body forces in the stability of rock structure is illustrated in Figure 16. In the study, identical plaster of Paris models of a mine layout (compare Figure 6) were manufactured and some were subjected to uniformly distributed edge loading in a compression testing machine while others were loaded in the centrifuge. Examination of the fracture pattern as illustrated in Figure 16 reveals that fracture initiated at similar points in both models but the direction of propagation is markedly influenced by the presence or absence of body forces.

While the author feels that the role of the centrifuge and more interesting is important, it is essential to realise that techniques for the manufacture of true physical models and even the understanding of the basic laws which govern similitude beyond the point of fracture, are, as yet, imperfect. Until progress has been made in the solution of these problems, there is little justification for the building of high-capacity, and therefore expensive, and centrifuges.

Geological Services in the Laboratory

While mechanical engineers are required to give detailed specifications of the material so that any reader with the necessary knowledge can make use of their information, rock mechanics research workers, the author included, are notorious for a tendency to refer to the materials as “one-sided” or “sandstone” without further qualification.

If rock mechanics is to grow into mature science, it is essential that systematic method of classifying materials be adopted. Such classifications already exist for most easily be compiled within the framework of geology. Consequently it is felt that no rock mechanics of laboratory is complete without the service of a geologist.

Ideally, a complete petrographic description, containing as much quantitative information as possible, should accompany each report or publication dealing with tests on rock. In this way, available information will gradually become more generally applicable and a deeper understanding of the common problems and rock mechanics will be achieved.

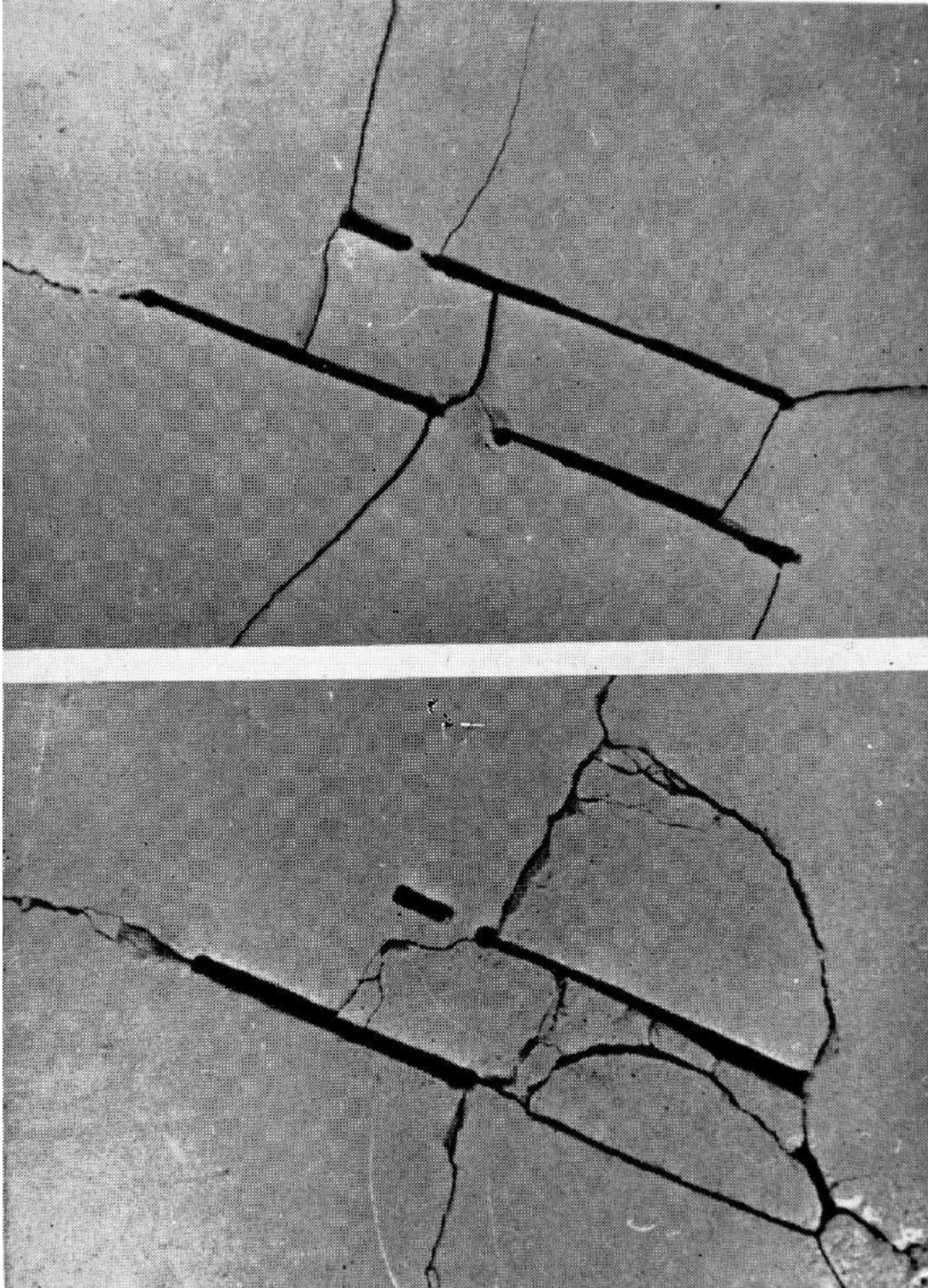

Figure 16. Comparison between the propagation of fracture in plaster of paris models subjected to uniformly distributed edge loading (upper photograph) and centrifugal acceleration (lower photograph).

Summary and Conclusions

Because of the practical difficulties associated with carrying out a complete rock mechanics investigation in the field, laboratory studies and simplified physical theoretical models play an important part in the solution of such problems. Provided that sufficient care is taken in planning, executing and interpreting laboratory investigations and provided that the practical requirements are kept in mind at all times, the results of these investigations can be very useful in designing rock structures.

Numerous techniques for the determination of the stress distribution in rock structures exist. When the problem is too complex to be solved mathematically, the photoelastic technique can be used to get results, the quality of which is directly proportional to the effort expended on manufacturing and loading the model and analysing resulting fringe patterns. Instead in the mechanical properties of rock in the laboratory, attention to detail in specimen preparation and testing techniques is important if meaningful results are to be obtained.

One of the most important problems in rock mechanics is the stability of structures in which some fracturing of the rock has taken place. Hence, an underground excavation may be stable in spite of the fact that the periphery of the excavation is extensively fractured. The interaction of the solid and fractured rock and the changes in stress distribution which are associated with fracture propagation most conveniently studied by means of laboratory models.

In carrying out the small studies, it is essential that the laws of similitude be adequately understood and rigidly adhered to. Failure to comply with these requirements reduces a physical model to the status of a demonstration model and the results of the study are only of qualitative significance

List of References

- 1) Cook, N.G.W. et al. (1966) Rock Mechanics applied to Rockbursts – a synthesis of the results of rockburst research in South Africa up to 1965. *J. S. African Inst. Min. Metall.* Vol. 66, No. 10, 435-528.
- 2) Denkhaus, H.G. (1958) The application of the mathematical theory of elasticity to problems of stress in hard rock at great depth. *Ass. Min. Mngrs. S. Africa.* Vol. 1958/9, 271-310.
- 3) Savin, G.N. (1961) Stress concentration around holes. . Translated from Russian in *International Series of monographs in aeronautics and astronautics*. Pergamon Press, New York.
- 4) Salamon, M.D.G. (1964) Elastic analysis of displacements and stresses induced by mining of seam or reef deposits. *J. S. African Inst. Min. Metall.* Vol. 64, Nos. 4, 6 and

- 10.
- 5) Frocht, M.M. (1961) *Photoelasticity*. Vols. I and II. John Wiley and Sons Inc. New York.
- 6) Leven, M.M. (1963) Epoxy resin for photoelastic use. *Photoelasticity*. Edited by M.M. Frocht, Pergamon Press, New York, 145-165.
- 7) Sanford, R.J. (1966) The validity of three-dimensional photoelastic frozen stress work. *Brit J. Appli. Phys.* Vol. 13, 99-108.
- 8) Dixon, J.R. (1962) Problems of materials for composite models in photoelastic frozen stress work. *Brit. J. Appl. Phys.* Volume 13, 64-67.
- 9) Karplus, W.J. (1958) *Analog Simulation , solution of field problems*. McGraw-Hill Book Co. Inc., New York.
- 10) Allison, I.M. (1965) Stress separation by block integration. *Brit. J. Appl. Phys.* Vol. 16, 1573-1582.
- 11) Hoek, E. (1966) Experimental study of rock stress problems in deep level mining. *Experimental Mechanics* ed. Rossi, Pergamon Pres, London, 177-193.
- 12) Hoek, E. (1965) The design of a centrifuge for the simulation of gravitational force fields in mine models. *J. S. African Inst. Min and Metall.* Vol. 65. No. 9, 455-487.
- 13) Protodiakonov, M.N. (1964) Methods of evaluation of cracks and strength of rock systems at depth. *Proc. 4th Intl. Conf. Strata Control and Rock Mech.* New York. May 1964 (In Russian). S.A.C.S.I.R. Translation No. 449. January 1965, 36 pages.
- 14) Cook, N.G.W. (1965) A note on rockbursts considered as a problem of stability. *S.A. Inst. Min. and Metall.* Vol. 65, No. 8.
- 15) Paulding, B.W. (1965) Techniques used in studying the fracture mechanics of rock. *Fifth Pacific Area National Meeting ASTM, Washington.*
- 16) Deist, F.H. (1965) A non-linear continuum approach to the problem of fracture zones and rockbursts. *S.A. Inst. Min. and Metall.* Vol. 65, No. 10.
- 17) Colback, P.S.B. (1966) An analysis of brittle fracture initiation and propagation in the Brzilian test. *Proc. First Intl. Cong. On Rock Mech. Min.* Lisbon, September 1966.
- 18) Hobbs, D.W. (1964) The tensile strength of rocks. *Intl. J. Rock Mec. Min. Scie.* Vol. 1, 385-396.

- 19) Paulmann, H.G. (1966) Messung der Festigkeits-Anisotropie tektonischen Ursprungs en Gesteinproben. *Proc. First Intl. Cong. On Rock Mech.*, Lisbon.
- 20) Hoek, E. and Bieniawski, Z.T. (1965) Brittle fracture propagation in rock under compression. *Intl. J. Fracture Mech.*, Vol 1, 135-145.
- 21) Rosenberg, L.D., Kazantsev, V.F., Makarov, L.O. and Yakhimovich, D.F. (1964) *Ultrasonic Cutting*. Translated from Russian by J.E.S. Bradley and published by Consultants Bureau Enterprises Inc., New York, 142 pages.
- 22) Zandman, F. (1956) Analyse des Constraints pr Vernis Photoelastiques. *Groupement pour L'Avancement des Methodes d'Analyse des Constraints*. Vol 2. No. 6, 3-14.
- 23) Hoek, E. and Bieniawski, Z.T. (1963) A large field reflection polariscope. *S. African Mech. Eng.* Vol. 12, No. 8, 222-226.
- 24) Thiocaris, P.S. (1962) Moire Fringes, a powerful measuring device. *Appl. Mech. Rev.* Vol. 15, No. 5. 333-339.
- 25) Hoek, E. (1964) Rock fracture around mining excavations. *Proc. 4th. Intl. Conf. on Strata Control and Rock Mech.*, New York. Columbia University Press, 334-348.

Part III – Rock mechanics in the field

The successful solution of a rock mechanics problem usually depends upon contributions made by the research worker and the practical engineer. In order that the research work should obtain results of practical value, and, having obtained such results, be able to communicate them to the ingenuity and intelligible terms, it is essential that he should remain in constant contact with the field problem. On the other hand, effective co-operation can only be achieved if the practical engineering is familiar with the principal features, the potential and the limitations of the techniques which are available to the rock mechanics research worker.

This part of the paper describes some of the techniques which are available free investigation of rock mechanics problems in the field.

Analysis of Field Records

An obvious, though frequently neglected corner means of investigating rock mechanics problems is the analysis of field records. Analysis of the site records will often reveal the presence of common factors which warrant further investigation.

The statistical analysis of records in depth below surface, a type of excavation, proximity to geological discontinuities, etc, collected from the site of rock posts in South African gold mines, has greatly assisted research workers in achieving an understanding of the rockburst phenomenon¹.

Similarly, the analysis of mine records has revealed factors which may be important in controlling the collapse of coal pillars in bord and pillar workings.

Obviously, the value of any such analysis depends on the quality of records kept and also upon the purpose for which the analysis is intended. In general, a field record should not be overlooked as a potential source of information.

Geological observations

In the problem involving the behaviour of a large rock mass, the strength and deformation characteristics of the rock material may be of secondary importance compared to the presence of geological discontinuities such as faults or dykes. Hence, a rock slope, in which the material may have excellent mechanical properties, maybe unstable due to the presence of a single or critically oriented fault. Consequently come any rock mechanics investigation in the field should include a geological examination of the site.

Rock Mechanics



- a) BOREHOLE DRILLED TO REQUIRED DEPTH AND
END FLATTENED AND POLISHED WITH DIAMOND TOOLS



- b) STRAIN CELL BONDED ON TO END OF BOREHOLE
AND STRAIN READINGS RECORDED



- c) BOREHOLE EXTENDED WITH DIAMOND CORE
BARREL THEREBY STRESS-RELIEVING CORE



- d) CORE WITH STRAIN CELL ATTACHED REMOVED.

Figure 1. Sequence of operations in Leeman's method for measuring rock stress.

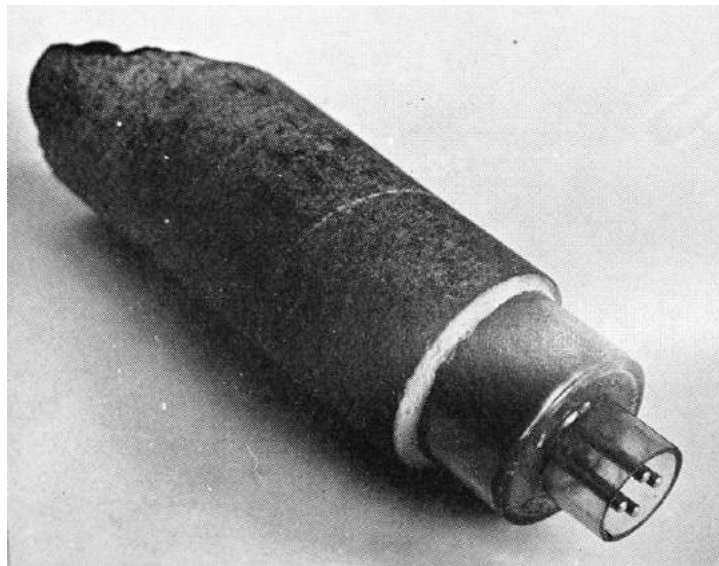

Figure 2. A C.S.I.R. Strain cell bonded on to a rock core recovered from a borehole.

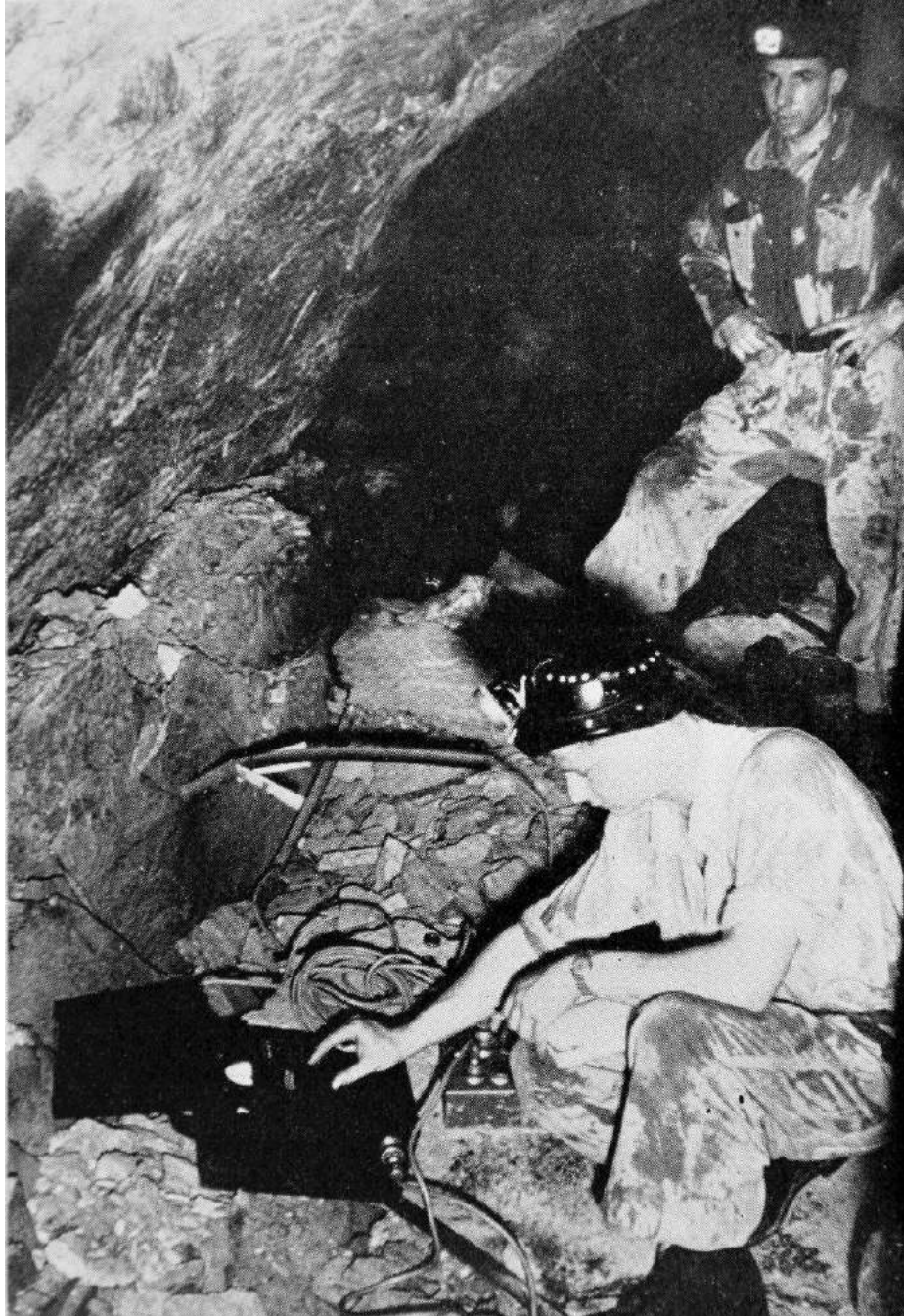

Figure 3. The measurement of stress in a deep level South African gold mine.

The type of observations required charges depend upon the nature of the problem being studied in the include the classification of rock types, measurements of frequency in orientation of faults, fissures, cleats or bedding planes and the determination of the extent of weathering.

In order that these geological and observation should be of practical value to the engineer, they should be quantitative rather than qualitative and, where possible, a sufficiently large

number measurement should be made to permit statistical evaluation of the results.

Stress, Strain and Deformation Measurements

The application of any theory to the prediction of rock behaviour can only be justified if the observations are in agreement with the theoretical predictions. Since stresses, strains and displacements play an important role in practically all rock behaviour theories, the measurement of these quantities is an important task in field rock mechanics.

Precise levelling

One of the most successful techniques to be used in South Africa for the study of rock deformation is the precise levelling of survey benchmarks, installed either on surface or in underground excavations. Using high quality level in instruments, the careful observer can detect displacements over a few hundredths of an inch². Since displacements of several millimetres frequently occur in large rock structures, the resolution of these precise levelling techniques is adequate for most practical purposes.

An important practical consideration in installing benchmarks to a precise levelling is that they should be anchored sufficiently deep in the rock to avoid the influence of local surface conditions. Where long-term measurements are required, care should be taken that the benchmarks are manufactured from corrosion resistant material and that any exposed portion of the benchmark is protected from accidental damage due to the passage of equipment and even heavily booted personnel.

In addition to the measurement of vertical displacement by levelling, extensometer measurements can be used to measure horizontal movements between adjacent benchmarks.

An important advantage of precise levelling and extensometer measurements is that the movement of the benchmark is influenced by a comparatively large volume of rock surrounding the point at which the benchmark is anchored. Consequently, local small-scale discontinuities in the rock do not have a significant influence upon the behaviour of the benchmark.

The disadvantage associated with the use of benchmarks is that they can only be installed in tunnels and room service where there is sufficient room for a man to gain access.

Extensometer measurements in boreholes

When access to the installation of benchmarks can be provided, displacement measurements of comparable accuracy can be obtained from wires clamped in boreholes. Spring-loaded clamps which apply upright clamping force against the walls of the borehole can be used to form the end of a tensioned measuring wire in a predetermined position and any displacement of the clamp will result in a measurable movement at the wire. If provision is made for the wire to pass through the body of the clamp, the borehole can be

used to measure differential movements in the rock mass.

This type of installation has been extensively used in South Africa the measurement of subsidence in coal mines³. Clamps have been successfully installed in vertical boreholes at depths in excess of 600 feet below surface measuring stations.

Strain gauge measurements

The electrical resistance strain gauge is used extensively for the measurement of local strains in engineering components and it is not surprising that numerous attempts have been made to apply to the measurement of strains in rock structures.

One of the most successful techniques for this type of measurement has been devised by E.R. Leeman the South African Council for Scientific and Industrial Research^{4, 5}. This technique involves bonding a strain gauge rosette onto the flat end of a borehole. The gauge is protected by a rubber filled plastic moulding which also secures the electrical connections which link the strain cell with the installing tool. The sequence of operations involved in obtaining a set of strain measurements from a point in a rock body is illustrated diagrammatically in Figure 1.

The advantages of this technique its simplicity and the relatively low cost of the instrumentation and strain cells. The cells have been successfully installed at depths in excess of 160 feet in rock bodies. The large amount of practical experience gained in South African gold and coal mines has contributed to the perfection of the instrumentation application of the technique.

A disadvantage associated with this technique is that the gauge measures the strain in a small volume of rock and the results can be significantly influenced by local small scale discontinuities in the rock. Since calculation of the stress state in the rock from the three measured strains involves the knowledge of the elastic properties of the material, local variations in these properties can give rise to serious errors in the calculated stresses.

In order to overcome this problem, work is currently being carried out on an apparatus which is designed to load the core onto which the strain cell is bonded in such a way that the stresses, which existed before the cell was overcored, are restored. In this way, the strain cell is used only as an indicator of the stresses in the rock and, since the stresses are measured directly on hydraulic pressure gauges, the elastic properties of the rock do not enter into the calculation of the results. If this technique proves successful, it is intended that it will be used to this on site to load the cores soon as they are removed from the boreholes and thereby provide the user with an immediate measure of the stress in the rock.

A further disadvantage of the above technique is that the three strain measurements are all in the plane of the flat for borehole end. These three strain measurements are not adequate for the determination of the complete three-dimensional state or stress in a rock body unless the borehole is drilled parallel to one of the principal stresses. In many

practical problems, the principal stress directions can be assumed with sufficient accuracy to permit use of the technique but, where such assumptions cannot be made, it is necessary to use three boreholes to determine a complete state of stress. These three boreholes must be drilled from different directions towards the point at which the stress is to be determined and the drilling of such a configuration of boreholes presents many practical problems.

A recent development by Leeman⁶ is an instrument which is designed to measure the complete state of three dimensional stress in a rock body from a single borehole. This technique involves bonding three rosettes strain gauges onto the inside of a borehole. The rock to which this cell is bonded is then overcored with a larger diameter core barrel, resulting in a stress-relieved cylinder.

Miscellaneous measuring techniques

In addition to the measuring techniques already discussed, there are several less refined field techniques which warrant brief consideration.

It has frequently been observed, when drilling and highly stressed rock, that the core breaks into discs such as those illustrated in Figure 4. Some investigations into the reason for this discing has been carried out^{7,8} and it has been suggested that the thickness of the discs could be used as an indirect indication of the stresses and the rock mass. To the best of the author's knowledge, no serious attempt has been made to apply this technique on the field but it does represent an interesting possibility.

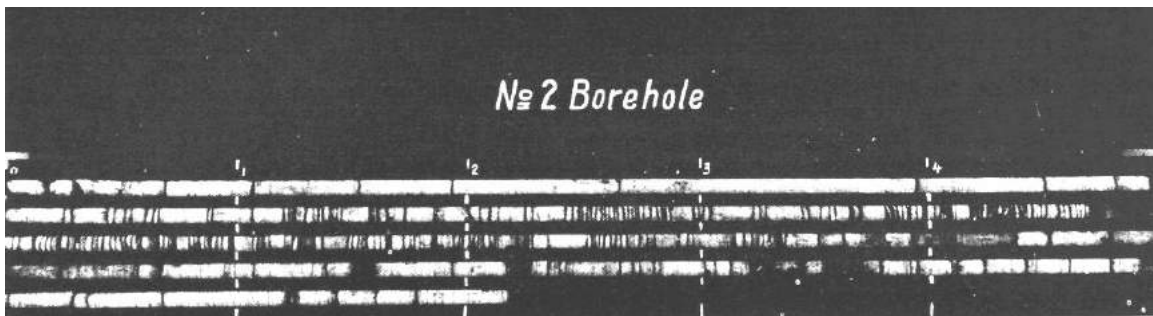

Figure 4. Disking of core recovered from a borehole drilled into highly stressed rock.

Flat pancake jacks, consisting of two thin steel sheets welded together along the edges, have been used in various field applications ranging from the measurement of stress^{9, 10} to the measurement of load in the timber packs used as supporting mine excavations. Apart from the difficulties associated with successfully welding the periphery of the plates together, these jacks are simple and effective in operation.

Numerous dynamometers for measuring the load in rock bolts are available. One of the most effective, in the author's opinion, is a dynamometer which makes use of a photoelastic disc transducer which has been developed by Sheffield University. The principal requirements of rock bolt dynamometer that it should be inexpensive and simple

to install and operate. Such an instrument can be used in large numbers to obtain the low distribution in the pattern of bolts-an important consideration in mining operations were a large number of bolts are used to support purposes.

The closure and ride, the vertical and horizontal components of the displacement of the roof and floor of a mining excavation, play an important part in the calculation of the overall behaviour of the rock surrounding the excavation¹. An instrument from measuring closure and ride is illustrated in Figure 5. This particular instrument is no longer in use, having been succeeded by devices which have made the promote measurement and reporting of the required quantities. It has, however, been included in this discussion because it represents the simple and yet effective type of instrument which is considered ideal from any field applications. In general, such instrumentation should be rugged, are simple to install and operate and should be make use of the simplest possible mechanical components which will do the job required.

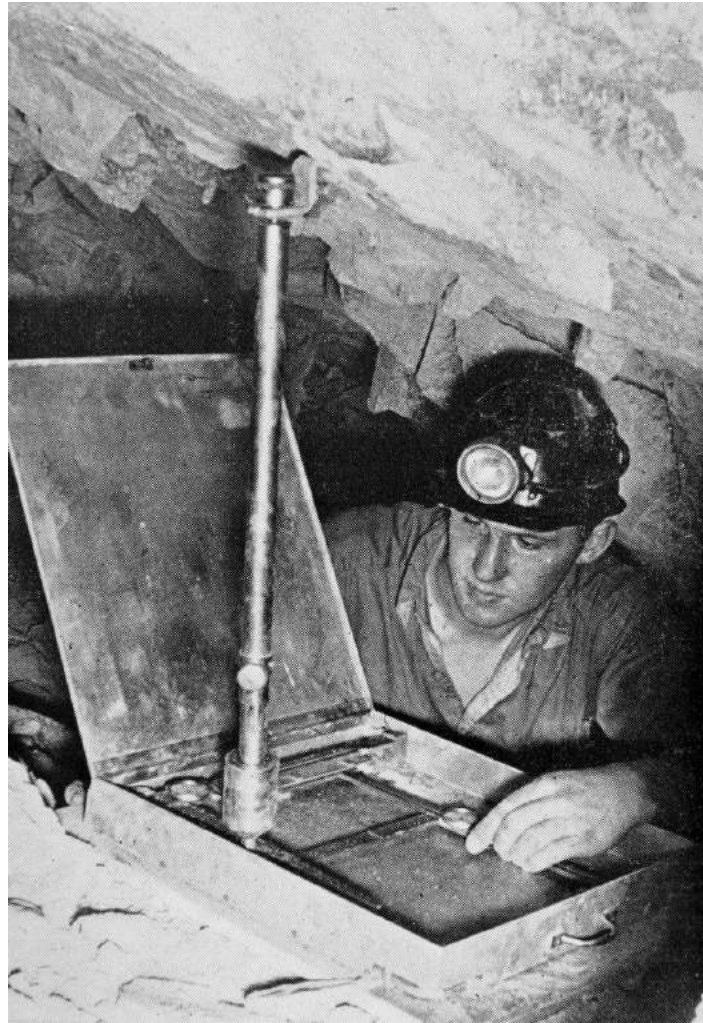

Figure 5. An instrument used by the South African C.S.I.R. for the measurement of closure and ride in a slope in a deep-level gold mine.

As stated in the introduction to part one of this paper, the discussion is limited to the author's own experience and are not intended to be a complete review of the entire subject of rock mechanics. The interested reader will find a wealth of publications on similar instrumentation and is advised to choose instrumentation which is best suited to his particular needs.

The Detection of Discontinuities in Rock

As already mentioned in this paper, the presence of the geological discontinuities such as a fault or a dyke can have a significant influence upon the behaviour of a rock mass. Similarly, fracture planes induced by stress changes in the structure can play an important part in determining the stability of the structure. The detection of these discontinuities, whether inherent or induced to the rock, is the task of major importance in field rock mechanics.

An obvious approach is the systematic mapping of the visible traces of these discontinuities on the exposed surface of an excavation. While this method can give useful information, it suffers from severe limitations in that major discontinuities can exist in the close proximity of the excavation and, because of their orientation, cannot be detected by visual examination.

An improvement on the visual examination of exposed surfaces can be achieved by examining the inside services of borehole drilled into the rock. For this purpose, several types of borehole camera, utilising both photographic and television principles, have been placed on the market. One of the most effective instruments of which the author is aware is a simple inclined mirror surrounded by a cluster of lights. This device is pushed into the borehole to the required depth in the image of the borehole services are observed in the mirror by means of a telescope.

Any visual examination, whether of the surface of the excavation or of the interior of a borehole, suffers from the disadvantage that, insufficient measurements are to be made to be a practical value, the method becomes excessively tedious and time-consuming.

Sonic and seismic techniques

In an effort to overcome the limitations of the visual inspection techniques discussed above, several devices which detect the passage of elastic waves through the rock have been involved.

One of these devices, designed by the Canadian Department of Mines and Technical surveys¹¹, measures the time taken for a pressure wave to travel from its source to a detector. The time taken for such an elastic wave to travel a given distance depends upon the nature of the material and, the more discontinuities which are present in the rock, the longer will be this travel time.

The instrument consists of two almost identical probes which are placed in boreholes in

the rock. Hydraulically actuated pistons gripped the probe in the borehole and force the transducer into intimate contact with the rock surface. The elastic waves generated by knocking the rods holding one of the probes in the borehole with a hammer. A timing signal is generated when this pulse leaves the probe and enters the rock and is terminated when it leaves the rock and enters the detector probe.

In operation, these boats are placed at various distances in several boreholes drilled outwards from the excavation. Travel times with various propositions are recorded in a network travel times is hereby established. Variation in travel times in various portions of the rock mass indicate the presence of discontinuities.

An instrument developed by the South African Council for Scientific and Industrial Research utilises reflected rather than transmitted pulse¹². In this instrument, a single probe is placed in the borehole this probe contains both transmitter and detector units. Ultrasonic pulses generated by the transmitter are reflected back from discontinuities in the rock and their presence can be established by observing the signal is received by the detector unit on oscilloscope screen.

In research into the problem of rock bursts which occur in deep level South African gold mines extensive use has been made of seismic techniques similar to those used in the detection of earthquakes^{13, 14}. A network of seismometers installed in boreholes in various locations in a mine is continuously monitored by a multichannel tape recorder. Any seismic event such as a rock burst radiates elastic waves and, by recording the arrival times of these waves at the various seismometers, the focus of the event can be determined. Use of this seismic technique in South Africa has contributed greatly to the understanding of the rock burst of phenomenon¹.

Similar techniques, in which the passage of elastic waves generated by explosions are recorded, had been used for prospecting and for the study of the elastic properties of rock masses¹⁵. Since the author has no personal experience of these techniques, they are merely mentioned for the information of the reader.

Determination of the In Situ Properties of Rock

A knowledge of the deformation and strength properties of rock is fundamental to any design of rock structures. As already discussed in previous parts of this paper, small-scale test in the laboratory do not always give results which are representative of the properties of the rock mass. Consequently, the determination of the properties of the rock material on a rock mass in situ is an important aspect of field rock mechanics.

Field tests on small-scale specimens

Although most test on small-scale specimens can be carried out in the laboratory, there are cases in which it is preferable to carry out these tests on site. An example of such a case involves tests on rocks which curator rapidly when removed from the parent rock

body that specimens cannot be successfully transported to the laboratory.

In research carried out by the South African CSIR under half of the Coal Mining Research Controlling Council, this problem arose in carrying out properties tests on small-scale coal specimens. At one stage, 5 tons of coal were transported to a distance of about 70 miles to the CSIR laboratories. No core specimens were recovered from this material in spite of very elaborate precautions taken by the laboratory technicians responsible for the drilling.

As a result of this experience, it was decided that all future tests on materials such as coal, a mudstone, shale and similar rock materials would be carried out on site, as soon as possible after removal of the core from the borehole.

The mobile drilling rig, illustrated in Figure 6, is used by the South African CSIR for both stress management drilling and the recovery and preparation of small scale test specimens. This drill consists of an identical unit to that illustrated in Figure 7 of Part II of this paper. The drilling machine is mounted on a trailer for highway towing and is fitted with a specimen preparation unit-visible above the motor at the front end of the machine in Figure 6. This machine, almost identical to the specimen end grinding machine illustrated in Figure 8 of Part II of this paper, is driven by a Vee belt from the main motor of the drilling machine. It can be fitted with either a diamond saw for cutting the core into suitable lengths or a diamond cup-wheel for grinding the specimen ends.

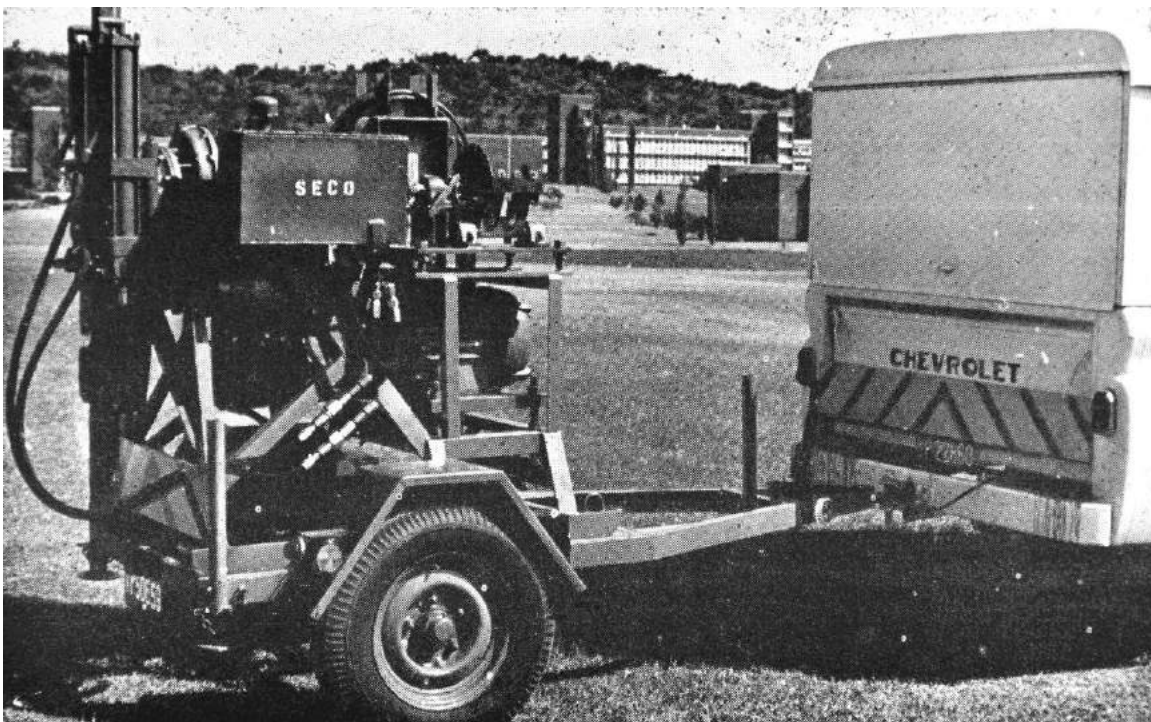

Figure 6. Mobile equipment used by the South African C.S.I.R. for drilling and specimen preparation in coal mines.

Specimens can be prepared with this equipment within a very short time of the removal of the core from the hole and, once prepared the specimens can be tested immediately in equipment such as that illustrated in Figure 10 of Part II of this paper.

In addition to the addition to the use of this equipment in special circumstances such as those discussed above, the author believes that there is considerable justification for carrying out all properties tests on site. The reason for this belief is that the liaison between the site and the laboratory is usually imperfect. This frequently results in the field and laboratory personnel being at cross-purposes and in the practical engineer being presented with a mass of tables and graphs which are of little value to him in the solution of his problems.

A more realistic approach, admittedly not always possible, is that the person responsible for the solution of a particular problem should himself carry out the necessary properties tests with equipment such as that described above. In this way, he can evaluate the results as he goes along and he need only carry out those tests which are directly relevant to his problem. In cases where it is not justified to provide such services on the mine or on the civil engineering site, the services of a research organisation, university or a consulting concern can be used.

Large scale rock properties tests

When a rock mass contains a large number of fissures, faults, cleats or bedding planes, it is usually difficult to obtain a reliable estimate of the strength and deformation characteristics of this rock mass from test on small scale specimens of the rock material. Under these conditions, serious consideration must be given to conducting large scale tests in situ.

Unfortunately, large scale tests are almost always extremely expensive and fraught with practical difficulties. This explains why so few tests of this type have been carried out and why it is necessary to reserve such tests for special circumstances.

In a series of large scale tests currently being conducted by the South African C.S.I.R on behalf of the Coal Mining Research Controlling Council of South Africa, it is planned to test coal specimens of up to eight feet cube in situ.

The specimens for these tests are cut from the corner of a coal pillar by means of a universal coal cutting machine as illustrated in Figure 8. A typical specimen is illustrated in Figure 9 and it will be noted that the specimen remains attached to the floor, having been cut free on five sides. Hydraulically actuated jacks are inserted between the top and bottom faces of the horizontal cut at the top of the specimen and the specimen is loaded against the roof and floor.

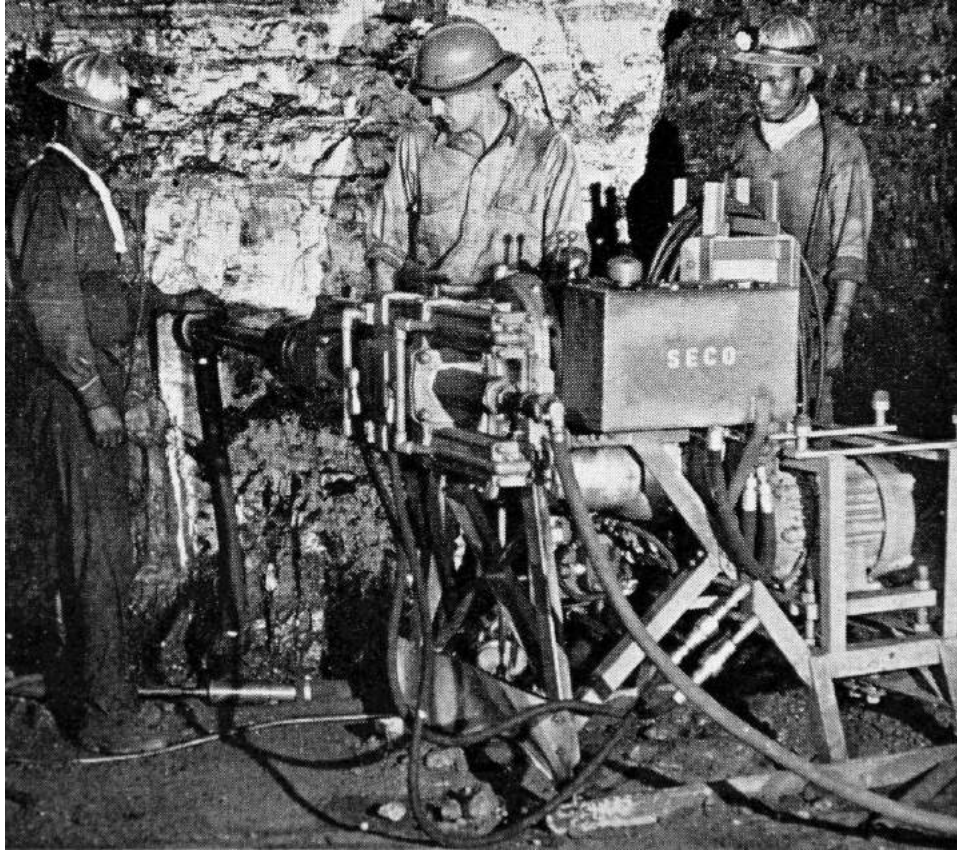

Figure 7. Drilling coal specimens for properties testing



Figure 8. A universal coal cutter being used to prepare large scale coal specimens.

By preparing the vertical faces of the specimen first and then installing strain measuring instrumentation before the horizontal cut is taken, a measure of the elastic recovery of the stress-relieved specimen can be obtained. This provides an estimate of the load carried by the specimen before commencement of the test. The jacks are then inserted and the specimen loaded to fracture, axial and lateral strain measurements being taken at intervals during the loading.

The test illustrated in Figure 9 was part of a preliminary series designed to establish the feasibility of this testing technique and to study the major problems associated with the preparation and testing of coal specimens in situ. As a result of the experience gained during these tests, it is planned to construct further jacks which will eventually be used to load specimens with a loaded surface measuring eight feet by eight feet.

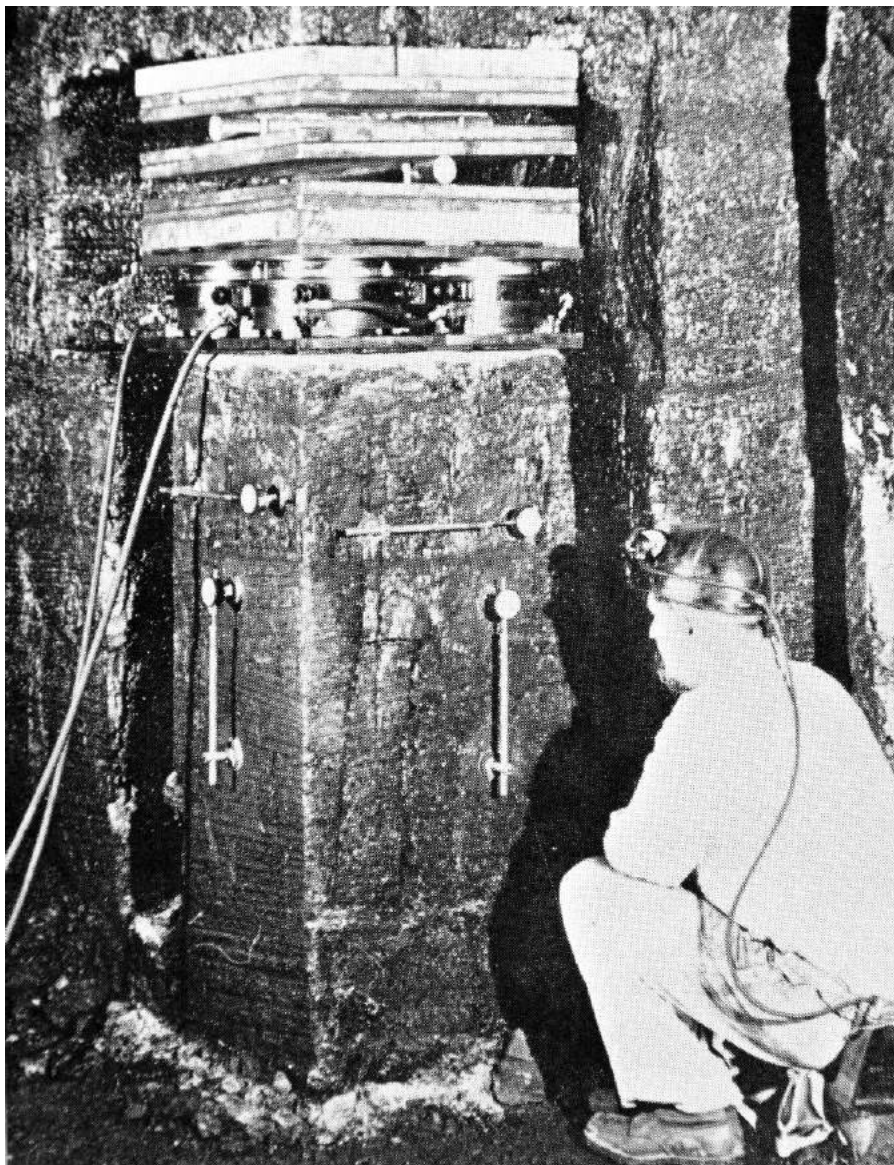

Figure 9. A large scale coal specimen under test.

Similar tests, carried out with a different aim, have recently been reported by Lama¹⁶, and it appears that, for coal, this technique is highly effective.

The problem of conducting large scale tests in surface excavations such as open pits and quarries is further complicated by the fact that the specimens can only be loaded horizontally if the rock itself is to be used to support the reactions of the loading jacks. The magnitude of the loads involved in large scale testing is such that the design of the “testing machine” in the surrounding rock presents more of a problem than the preparation of the specimen itself.

From the brief discussion presented above, the reader will appreciate that large-scale tests can only be carried out on a very limited scale. Consequently, an important objective in rock mechanics is to establish a reliable relationship between large-scale and small-scale specimens in order that the results of small-scale tests may be extrapolated to predict large-scale behaviour. Such a relationship has been suggested by Protodiakonov (see Figure 7 of Part I of this paper) but the experimental determination of such a relationship is a task which will require the efforts of a dedicated team of research workers with a very large budget to work with.

Indirect properties testing in the field

The practical engineer does not always require an accurate value for the strength or deformation characteristics of the rocks in which he is working. In many cases, a large number of approximate values obtained at various points on the site is preferable.

One of the most convenient and effective instruments for determining in approximate value for the uniaxial compressive strength of a rock is the Schmidt hammer—originally designed for use on concrete. The relationship between the Schmidt Type N Impact Hammer reading and the uniaxial compressive strength of rock and coal according to Skutta¹⁷, is presented in Figure 10. It is estimated that, over the operational procedure is in accordance with the German Standard Specification DIN 4240¹⁸, the uniaxial compressive strength can be estimated to an accuracy of $\pm 2,000$ lb/sq.in. (± 150 Kp./sq.cm).

Since the drillability of rock is reasonably closely related to its uniaxial compressive strength¹⁹, it is also possible to use the Schmidt hammer to give an estimate of the rate at which a particular rock could be drilled²⁰.

This part of the paper has been concerned with instrumentation and techniques for determining stresses in rock structures, the extent of fracture in rock, and the determination of deformation and strength characteristics of rock in situ. This paper is not intended to be a complete catalogue of all available instruments and techniques and the examples which are given are intended to illustrate the underlying principles of rock mechanics testing in the field.

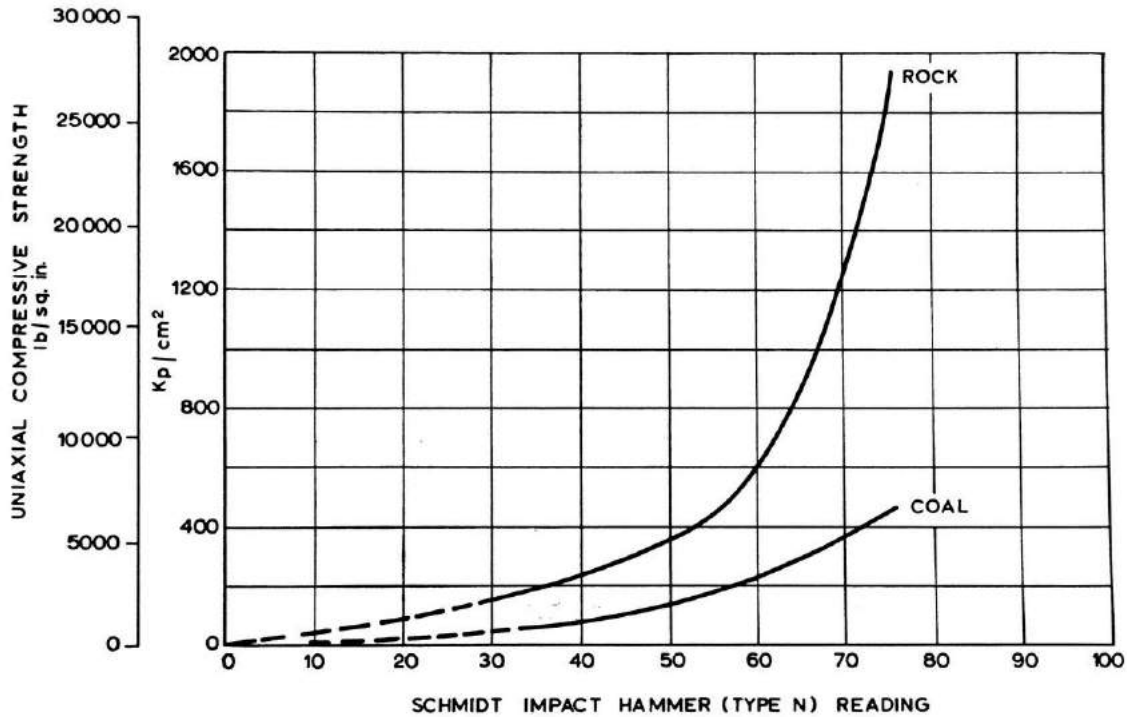

Figure 10. Relationship between the uniaxial compressive strength of rock and the Schmidt impact hammer reading (according to Skutta).

It will be appreciated that field measurements alone will seldom suffice for the solution of a practical rock mechanics problem and that, ideally, the results of such measurements should always be correlated with theoretical and laboratory results. If this is done, a rational pattern of rock behaviour can gradually be built up and the experience gained in solving each problem can contribute to future solutions.

List of References

- 1) Cook, N.G.W. et al. (1966) Rock Mechanics applied to Rockbursts – a synthesis of the results of rockburst research in South Africa up to 1965. *J. S. African Inst. Min. Metall.* Vol. 66, No. 10, 435-528.
- 2) Ortlepp, W.D. and Cook, N.G.W. (1965) The measurement and analysis of the deformation around deep, hard-rock excavations. *Proc. 4th Intl. Conf. on Rock Mech. And Strata Control.* New York, 140-152.
- 3) Salamon, M.D.g. and Orowecz, K.I. (1966) Mathematical analysis of the stress and displacement distributions around bord and pillar workings. *Proc. 1st Intl. Cong. on Rock Mechanics.* Lisbon.
- 4) Leeman, E.R. (1964) Remote measurement of rock stress under development in

South Africa. *Eng. And Mining J.* Vol 165, No. 9, 103-107.

- 5) Leeman, E.R. (1964) The measurement of stress in rock. Parts I to III. *J. S. African Inst. Min. and Metall.* Vol 65, No. 2, 48-114 and Vol 65, No. 4, 254-284.
- 6) Leeman, E.R. and Hayes, D.J. (1966) A technique for determining the complete state of stress in rock using a single borehole. *Proc. 1st Intl. Cong. on Rock Mechanics.* Lisbon.
- 7) Jaeger, J.C. and Cook, N.G.W. (1963) Pinching-off and discing in rocks. *J. Geophysical Research*, Vol.68, No. 6, 1759-1765.
- 8) Obert, L. (1962) Effects of stress relief and other changes on physical properties of rock. U.S. Bur. Mines. R.I. 6053.
- 9) Jaeger, J.C. and Cook, N.G.W. (1963) Theory and application of curved jacks for measurement of stress. *Proc. Intl. Conf. on State of Stress in Earth's Crust, Santa Monica, 1963.* Ed. W.R. Judd, Amer. Elsevier Publishing Co. Inc., 381-395.
- 10) Merrill, R.H. (1964) In situ determination of stress by relief techniques. *Proc. Intl. Conf. State of Stress in Earth's Crust. Santa Monica, 1963.* Ed. W.R. Judd, Amer. Elsevier Publishing Co. Inc., 343-378.
- 11) Larocque, G.E. (1964) A sonic unit for the determination of in situ dynamic properties and for outlining fracture zones. *Proc. 6th. Symposium on Rock Mechanics.* Rolla, 358-380.
- 12) Lutsch, A. et al. (1962) Ultrasonic reflectometer for detecting fracture zones in gold mines. *Trans. S. African Inst. Electrical Engrs.*, March, 5 pages.
- 13) Cook, N.G.W. (1964) The application of seismic techniques to problems in rock mechanics. *Int. J. Rock Mechanics and Mining Sciences.* Vol. 1, No.2, 169-179.
- 14) Cook, N.G.W. (1962) *A study of the failure of rock surrounding underground excavations.* PhD Thesis Univ. Witwatersrand, 129 pages.
- 15) Wantland, D. (1964) Geophysical measurements of rock properties in situ. *Proc. Intl. Conf. State of Stress in Earth's Crust, Santa Monica, 1963.* Ed. W.R. Judd, Amer. Elsevier Publishing Co. Inc., 409-450.
- 16) Lama, R.D. (1966) Rockbursts – a comparison of the in situ mechanical properties of coal seams. *Colliery Guardian*, Jan. 1966, 20-25.
- 17) Skutta, E. (1962) Einfache gestienmechanische Untersuchungen als Grundlage der Ausbuplanung. *Gluukaurf*, Jh 98, Hft 25, S, 1455-1461.

Rock Mechanics

- 18) Deutsche Normen. DIN 4240 (1962). Kugelschlagprüfung von Beton mit dlichem Gefuge. April 1962, 5 pages.
- 19) White, C.G. (1965) The development of a rock drillability index. *VII Symposium on Rock Mechanics*. Penn State Univ. 1965, Vol I, 182-204. Also Ph.D. Thesis, Colorado School of Mines, 1965, 155 pages.
- 20) Furby, J. (1964) Tests on rock drillability. *Mine and Quarry Eng.*, July 1964, 292-298.