



AUDISANKARA COLLEGE OF ENGINEERING & TECHNOLOGY

(AUTONOMOUS)

Gudur, Nellore Dist, A.P (India)

DATA STRUCTURES

LECTURE NOTES

Dr.K VENKATA NAGENDRA

Mr.G.RAJESH

DATA STRUCTURES(18CS202)

OBJECTIVES:

The course should enable the students to :

1. Demonstrate familiarity with major algorithms and data structures.
2. Choose the appropriate data structure and algorithm design method for a specified application.
3. Determine which algorithm or data structure to use in different scenarios.
4. To improve the logical ability.

UNIT-I	INTRODUCTION TO ALGORITHMS AND DATA STRUCTURES	Classes:12
---------------	---	-------------------

Algorithms: Definition, Properties, Performance Analysis-Space Complexity, Time Complexity, Asymptotic Notations.**Data structures:** Introduction, Data Structures types, DS Operations.

UNIT-II	STACKS AND QUEUES	Classes:12
----------------	--------------------------	-------------------

Stacks: Introduction, Stack Operations, Applications: Infix to Postfix Conversion, Evaluation of Postfix Expression.**ueues:** Introduction, Operations on queues, Circular queues, Priority queues.

UNIT-III	LINKED LISTS AND APPLICATIONS	Classes:12
-----------------	--------------------------------------	-------------------

Linked lists: Introduction, Singly linked lists, Circular linked lists, Doubly linked lists, Multiply linked lists, Applications: Polynomial Representation.Implementation of Stack and Queue using linked list.

UNIT-IV	SORTING AND SEARCHING	Classes:12
----------------	------------------------------	-------------------

Sorting: Introduction, Selection sort, Bubble sort, Insertion sort, Merge sort, Quick sort, Heap Sort.**Searching:** Introduction, Linear search, Binary search, Fibonacci search.

UNIT-V	TREES AND BINARY TREES	Classes:12
---------------	-------------------------------	-------------------

Trees: Introduction, Definition and basic terminologies, Representation of trees.

Binary Trees: Basic Terminologies and Types, Binary Tree Traversals, Binary Search Trees.

Text Books:

1. G.A.V PAI, Data Structures and Algorithms, Concepts, Techniques and Applications, Volume1, 1stEdition, Tata McGraw-Hill, 2008.
2. Richard F. Gilberg& Behrouz A. Forouzan, Data Structures, Pseudo code Approach with C, 2ndEdition, Cengage Learning India Edition, 2007.

Reference Books:

1. Langsam,M. J. Augenstein, A. M. Tanenbaum, Datastructures using C and C++, 2nd Edition, PHI Education, 2008.
2. Sartaj Sahni, Ellis Horowitz, Fundamentals of at Structures in C, 2nd Edition, Orientblackswan, 2010.

Web References:

1. <https://www.geeksforgeeks.org/data-structures/>
2. <https://www.programiz.com/dsa>
3. <https://www.w3schools.in/data-structures-tutorial/intro/>

Outcomes:

At the end of the course students able to

1. Apply Concepts of Stacks, Queues, Linked Lists.
2. Develop Programs for Searching and Sorting, Trees.
3. Interpret concepts of trees.
4. Develop programs for Sorting and Searching.

UNIT-I

INTRODUCTION TO ALGORITHMS AND DATA STRUCTURES

Definition: - An algorithm is a **Step By Step** process to solve a problem, where each step indicates an intermediate task. Algorithm contains finite number of steps that leads to the solution of the problem.

Properties /Characteristics of an Algorithm:-

Algorithm has the following basic properties

- **Input-Output:-** Algorithm takes '0' or more input and produces the required output. This is the basic characteristic of an algorithm.
- **Finiteness:-** An algorithm must terminate in countable number of steps.
- **Definiteness:** Each step of an algorithm must be stated clearly and unambiguously.
- **Effectiveness:** Each and every step in an algorithm can be converted in to programming language statement.
- **Generality:** Algorithm is generalized one. It works on all set of inputs and provides the required output. In other words it is not restricted to a single input value.

Categories of Algorithm:

Based on the different types of steps in an Algorithm, it can be divided into three categories, namely

- Sequence
- Selection and
- Iteration

Sequence: The steps described in an algorithm are performed successively one by one without skipping any step. The sequence of steps defined in an algorithm should be simple and easy to understand. Each instruction of such an algorithm is executed, because no selection procedure or conditional branching exists in a sequence algorithm.

Example:

// adding two numbers

Step 1: start

Step 2: read a,b

Step 3: Sum=a+b

Step 4: write Sum

Step 5: stop

Selection: The sequence type of algorithms are not sufficient to solve the problems, which involves decision and conditions. In order to solve the problem which involve decision making or option selection, we go for Selection type of algorithm. The general format of Selection type of statement is as shown below:

```
if(condition)
    Statement-1;
else
    Statement-2;
```

The above syntax specifies that if the condition is true, statement-1 will be executed otherwise statement-2 will be executed. In case the operation is unsuccessful. Then sequence of algorithm should be changed/ corrected in such a way that the system will re-execute until the operation is successful.

Example1:
 // Person eligibility for vote
 Step 1 : start
 Step 2 : read age
 Step 3 : if age > = 18 then step_4 else step_5
 Step 4 : write "person is eligible for vote"
 Step 5 : write " person is not eligible for vote"
 Step 6 : stop

Example2:
 // biggest among two numbers
 Step 1 : start
 Step 2 : read a,b
 Step 3 : if a > b then
 Step 4 : write "a is greater than b"
 Step 5 : else
 Step 6 : write "b is greater than a"
 Step 7 : stop

Iteration: Iteration type algorithms are used in solving the problems which involves repetition of statement. In this type of algorithms, a particular number of statements are repeated 'n' no. of times.

Example1:

Step 1 : start
 Step 2 : read n
 Step 3 : repeat step 4 until n>0
 Step 4 : (a) $r=n \text{ mod } 10$
 (b) $s=s+r$
 (c) $n=n/10$
 Step 5 : write s
 Step 6 : stop

Performance Analysis an Algorithm:

The Efficiency of an Algorithm can be measured by the following metrics.

- i. Time Complexity and
- ii. Space Complexity.

i. Time Complexity:

The amount of time required for an algorithm to complete its execution is its time complexity. An algorithm is said to be efficient if it takes the minimum (reasonable) amount of time to complete its execution.

ii. Space Complexity:

The amount of space occupied by an algorithm is known as Space Complexity. An algorithm is said to be efficient if it occupies less space and required the minimum amount of time to complete its execution.

1. Write an algorithm for roots of a Quadratic Equation?

// Roots of a quadratic Equation
 Step 1 : start
 Step 2 : read a,b,c
 Step 3 : if (a= 0) then step 4 else step 5
 Step 4 : Write " Given equation is a linear equation "
 Step 5 : $d=(b * b) - (4 *a *c)$
 Step 6 : if (d>0) then step 7 else step8
 Step 7 : Write " Roots are real and Distinct"
 Step 8: if(d=0) then step 9 else step 10
 Step 9: Write "Roots are real and equal"
 Step 10: Write " Roots are Imaginary"
 Step 11: stop

2. Write an algorithm to find the largest among three different numbers entered by user

Step 1: Start

Step 2: Declare variables a,b and c.

Step 3: Read variables a,b and c.

Step 4: If $a > b$

 If $a > c$

 Display a is the largest number.

 Else

 Display c is the largest number.

Else

 If $b > c$

 Display b is the largest number.

 Else

 Display c is the greatest number.

Step 5: Stop

3. Write an algorithm to find the factorial of a number entered by user.

Step 1: Start

Step 2: Declare variables n, factorial and i.

Step 3: Initialize variables

 factorial \leftarrow 1

 i \leftarrow 1

Step 4: Read value of n

Step 5: Repeat the steps until $i = n$

 5.1: factorial \leftarrow factorial * i

 5.2: $i \leftarrow i + 1$

Step 6: Display factorial

Step 7: Stop

4. Write an algorithm to find the Simple Interest for given Time and Rate of Interest .

Step 1: Start

Step 2: Read P,R,S,T.

Step 3: Calculate $S = (PTR)/100$

Step 4: Print S

Step 5: Stop

ASYMPTOTIC NOTATIONS

Asymptotic analysis of an algorithm refers to defining the mathematical boundation/framing of its run-time performance. Using asymptotic analysis, we can very well conclude the best case, average case, and worst case scenario of an algorithm.

Asymptotic analysis is input bound i.e., if there's no input to the algorithm, it is concluded to work in a constant time. Other than the "input" all other factors are considered constant.

Asymptotic analysis refers to computing the running time of any operation in mathematical units of computation. For example, the running time of one operation is computed as $f(n)$ and may be for another operation it is computed as $g(n^2)$. This means the first operation running time will increase linearly with the increase in n and the running time of the second operation will increase exponentially when n increases. Similarly, the running time of both operations will be nearly the same if n is significantly small.

The time required by an algorithm falls under three types –

- **Best Case** – Minimum time required for program execution.
- **Average Case** – Average time required for program execution.
- **Worst Case** – Maximum time required for program execution.

Asymptotic Notations

Following are the commonly used asymptotic notations to calculate the running time complexity of an algorithm.

- O Notation
- Ω Notation
- θ Notation

Big Oh Notation, O

The notation $O(n)$ is the formal way to express the upper bound of an algorithm's running time. It measures the worst case time complexity or the longest amount of time an algorithm can possibly take to complete.

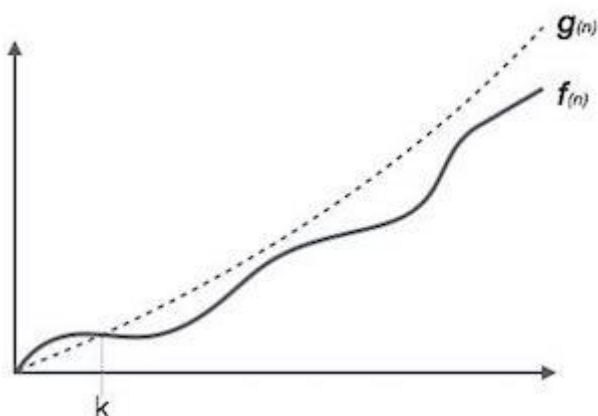

For example, for a function $f(n)$

$$O(f(n)) = \{ g(n) : \text{there exists } c > 0 \text{ and } n_0 \text{ such that } f(n) \leq c.g(n) \text{ for all } n > n_0. \}$$

Omega Notation, Ω

The notation $\Omega(n)$ is the formal way to express the lower bound of an algorithm's running time. It measures the best case time complexity or the best amount of time an algorithm can possibly take to complete.

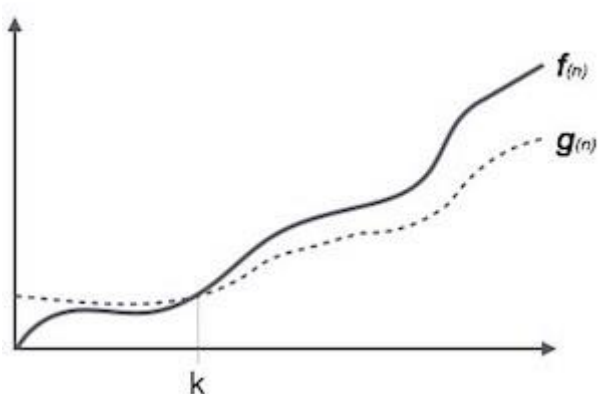

For example, for a function $f(n)$

$$\Omega(f(n)) \geq \{ g(n) : \text{there exists } c > 0 \text{ and } n_0 \text{ such that } g(n) \leq c.f(n) \text{ for all } n > n_0. \}$$

Theta Notation, θ

The notation $\theta(n)$ is the formal way to express both the lower bound and the upper bound of an algorithm's running time. It is represented as follows –

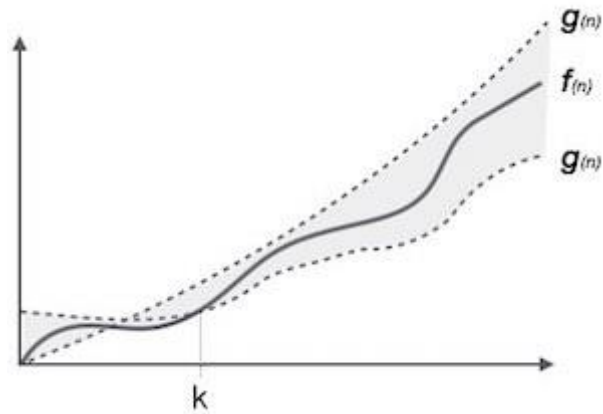

$\theta(f(n)) = \{ g(n) \text{ if and only if } g(n) = O(f(n)) \text{ and } g(n) = \Omega(f(n)) \text{ for all } n > n_0. \}$

DATA STRUCTURES

Data may be organized in many different ways logical or mathematical model of a program particularly organization of data. This organized data is called “Data Structure”.

Or

The organized collection of data is called a ‘Data Structure’.

Data Structure=Organized data +Allowed operations

Data Structure involves two complementary goals. The first goal is to identify and develop useful, mathematical entities and operations and to determine what class of problems can be solved by using these entities and operations. The second goal is to determine representation for those abstract entities to implement abstract operations on this concrete representation.

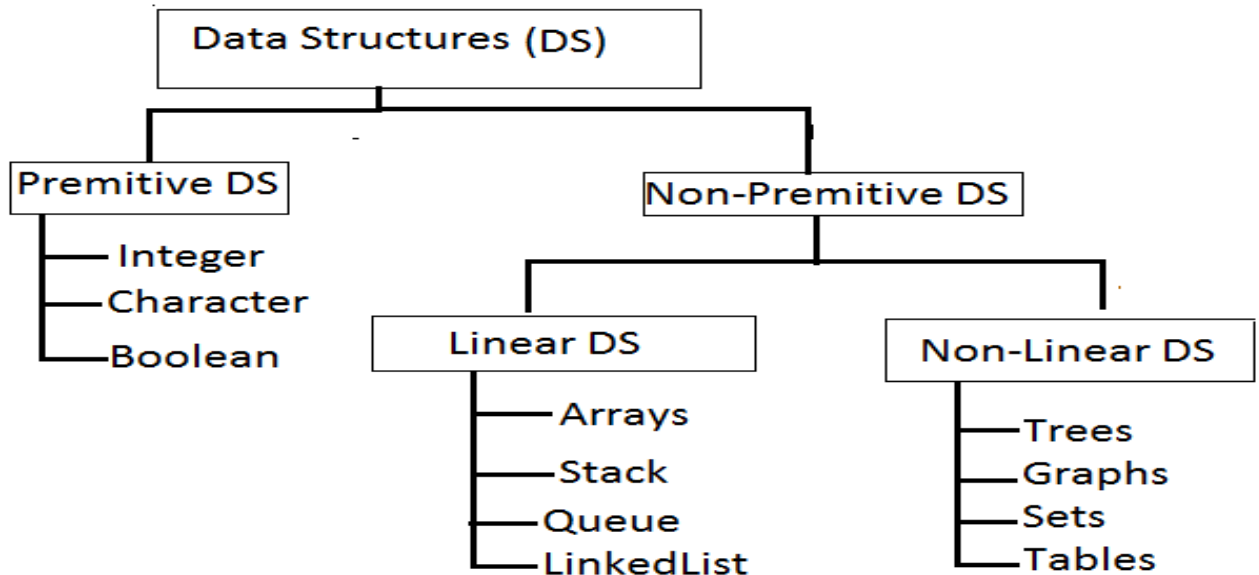

Primitive Data structures are directly supported by the language ie; any operation is directly performed in these data items.

Ex: integer, Character, Real numbers etc.

Non-primitive data types are not defined by the programming language, but are instead created by the programmer.

Linear data structures organize their data elements in a linear fashion, where data elements are attached one after the other. Linear data structures are very easy to implement, since the memory of the computer is also organized in a linear fashion. Some commonly used linear data structures are arrays, linked lists, stacks and queues.

In nonlinear data structures, data elements are not organized in a sequential fashion. Data structures like multidimensional arrays, trees, graphs, tables and sets are some examples of widely used nonlinear data structures.

Operations on the Data Structures:

Following operations can be performed on the data structures:

1. Traversing
2. Searching
3. Inserting
4. Deleting
5. Sorting
6. Merging

1. Traversing- It is used to access each data item exactly once so that it can be processed.

2. Searching- It is used to find out the location of the data item if it exists in the given collection of data items.

3. Inserting- It is used to add a new data item in the given collection of data items.

4. Deleting- It is used to delete an existing data item from the given collection of data items.

5. Sorting- It is used to arrange the data items in some order i.e. in ascending or descending order in case of numerical data and in dictionary order in case of alphanumeric data.

6. Merging- It is used to combine the data items of two sorted files into single file in the sorted form.

UNIT-II

STACKS AND QUEUES

STACKS

A Stack is linear data structure. A stack is a list of elements in which an element may be inserted or deleted only at one end, called the **top of the stack**. Stack principle is **LIFO (last in, first out)**. Which element inserted last on to the stack that element deleted first from the stack.

As the items can be added or removed only from the top i.e. the last item to be added to a stack is the first item to be removed.

Real life examples of stacks are:

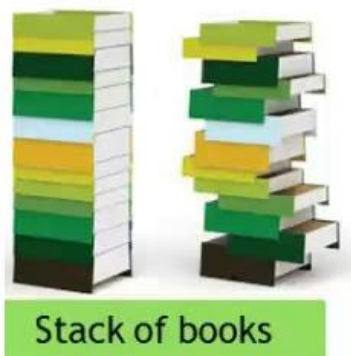

Operations on stack:

The two basic operations associated with stacks are:

1. Push
2. Pop

While performing push and pop operations the following test must be conducted on the stack.

- a) Stack is empty or not
- b) stack is full or not

1. Push: Push operation is used to add new elements in to the stack. At the time of addition first check the stack is full or not. If the stack is full it generates an error message "stack overflow".

2. Pop: Pop operation is used to delete elements from the stack. At the time of deletion first check the stack is empty or not. If the stack is empty it generates an error message "stack underflow".

All insertions and deletions take place at the same end, so the last element added to the stack will be the first element removed from the stack. When a stack is created, the stack base remains fixed while the stack top changes as elements are added and removed. The most accessible element is the top and the least accessible element is the bottom of the stack.

Representation of Stack (or) Implementation of stack:

The stack should be represented in two ways:

1. Stack using array
2. Stack using linked list

1. Stack using array:

Let us consider a stack with 6 elements capacity. This is called as the size of the stack. The number of elements to be added should not exceed the maximum size of the stack. If we attempt to add new element beyond the maximum size, we will encounter a **stack overflow** condition. Similarly, you cannot remove elements beyond the base of the stack. If such is the case, we will reach a **stack underflow** condition.

1.push():When an element is added to a stack, the operation is performed by push(). Below Figure shows the creation of a stack and addition of elements using push().

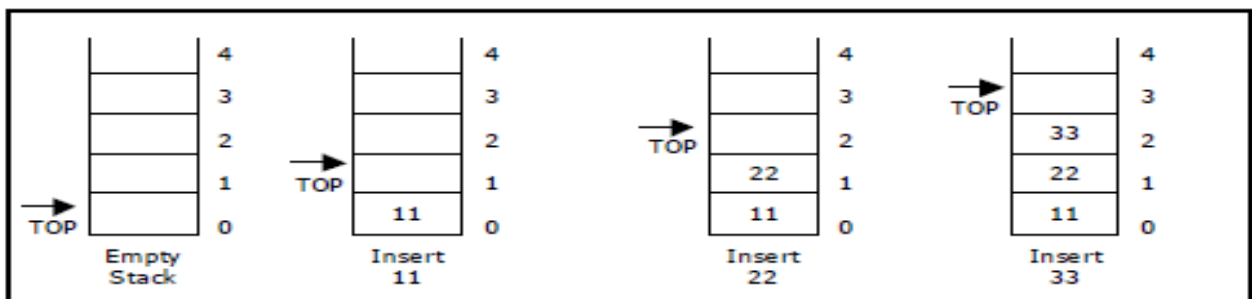

Figure . Push operations on stack

Initially **top=-1**, we can insert an element in to the stack, increment the top value i.e **top=top+1**. We can insert an element in to the stack first check the condition is stack is full or not. i.e **top>=size-1**. Otherwise add the element in to the stack.

<pre>void push() { int x; if(top >= n-1) { printf("\n\nStack Overflow.."); return; } else { printf("\n\nEnter data: "); scanf("%d", &x); stack[top] = x; top = top + 1; printf("\n\nData Pushed into the stack"); } }</pre>	<p>Algorithm: Procedure for push():</p> <p>Step 1: START</p> <p>Step 2: if top>=size-1 then Write " Stack is Overflow"</p> <p>Step 3: Otherwise 3.1: read data value 'x' 3.2: top=top+1; 3.3: stack[top]=x;</p> <p>Step 4: END</p>
--	--

2.Pop(): When an element is taken off from the stack, the operation is performed by pop(). Below figure shows a stack initially with three elements and shows the deletion of elements using pop().

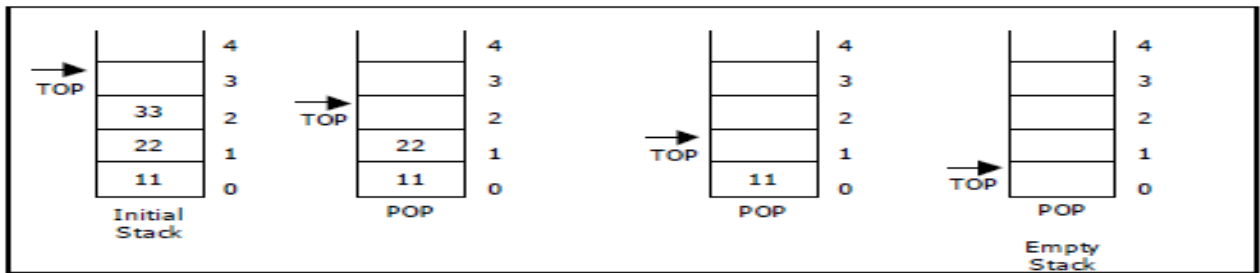
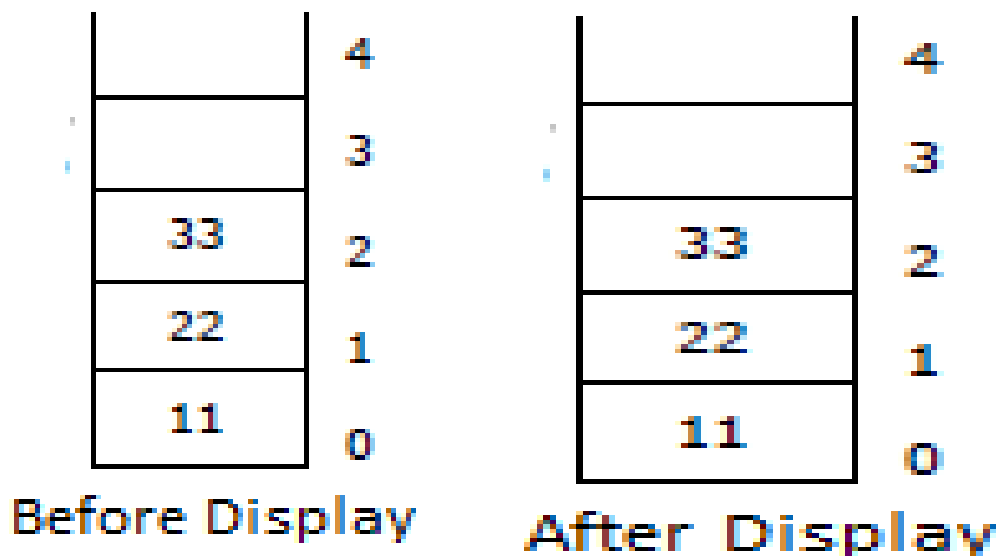

Figure Pop operations on stack

We can insert an element from the stack, decrement the top value i.e **top=top-1**. We can delete an element from the stack first check the condition is stack is empty or not. i.e **top==-1**. Otherwise remove the element from the stack.

<pre>Void pop() { If(top==-1) { Printf("Stack is Underflow"); } else { printf("Delete data %d",stack[top]); top=top-1; } }</pre>	<p>Algorithm: procedure pop():</p> <p>Step 1: START</p> <p>Step 2: if top==-1 then Write "Stack is Underflow"</p> <p>Step 3: otherwise 3.1: print "deleted element" 3.2: top=top-1;</p> <p>Step 4: END</p>
--	---

3.display(): This operation performed display the elements in the stack. We display the element in the stack check the condition is stack is empty or not i.e top=-1. Otherwise display the list of elements in the stack.



<pre> void display() { if(top== -1) { Printf("Stack is Underflow"); } else { printf("Display elements are:); for(i=top;i>=0;i--) printf("%d",stack[i]); } } </pre>	<p>Algorithm: procedure pop():</p> <p>Step 1: START</p> <p>Step 2: if top== -1 then Write "Stack is Underflow"</p> <p>Step 3: otherwise 3.1: print "Display elements are" 3.2: for top to 0 Print 'stack[i]'</p> <p>Step 4: END</p>
---	--

Source code for stack operations, using array:

```

#include<stdio.h>
#include<conio.h>
int stack[100],choice,n,top,x,i;
void push(void);
void pop(void);
void display(void);
int main()
{
    //clrscr();
    top=-1;
    printf("\n Enter the size of STACK[MAX=100]:");
    scanf("%d",&n);
    printf("\n\t STACK OPERATIONS USING ARRAY");
    printf("\n\t-----");
    printf("\n\t 1.PUSH\n\t 2.POP\n\t 3.DISPLAY\n\t 4.EXIT");
    do
    {
        printf("\n Enter the Choice:");
        scanf("%d",&choice);
        switch(choice)
        {
            case 1:
            {
                push();
                break;
            }
            case 2:
            {
                pop();
                break;
            }
            case 3:
            {

```

```

        display();
        break;
    }
    case 4:
    {
        printf("\n\t EXIT POINT ");
        break;
    }
    default:
    {
        printf ("\n\t Please Enter a Valid Choice(1/2/3/4)");
    }
}
}
while(choice!=4);
return 0;
}
void push()
{
    if(top>=n-1)
    {
        printf("\n\tSTACK is over flow");

    }
    else
    {
        printf(" Enter a value to be pushed:");
        scanf("%d",&x);
        top++;
        stack[top]=x;
    }
}
void pop()
{
    if(top<=-1)
    {
        printf("\n\t Stack is under flow");
    }
    else
    {
        printf("\n\t The popped elements is %d",stack[top]);
        top--;
    }
}
void display()
{
    if(top>=0)
    {

```

```

printf("\n The elements in STACK \n");
for(i=top; i>=0; i--)
    printf("\n%d",stack[i]);
printf("\n Press Next Choice");
}
else
{
    printf("\n The STACK is empty");
}
}

```

2. Stack using Linked List:

We can represent a stack as a linked list. In a stack push and pop operations are performed at one end called top. We can perform similar operations at one end of list using top pointer. The linked stack looks as shown in figure.

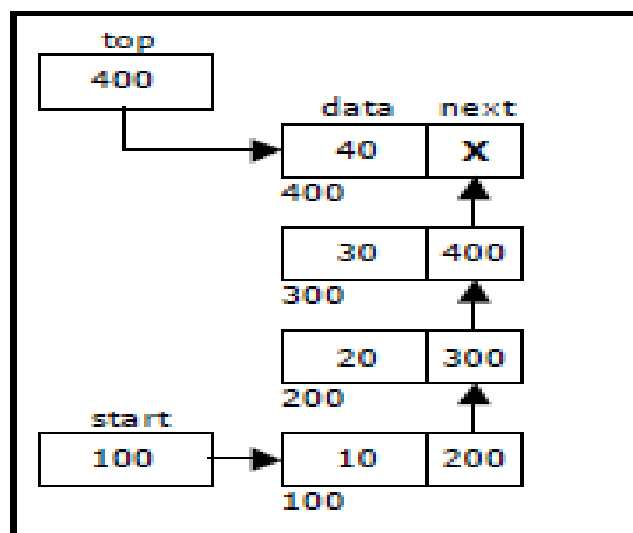

Figure Linked stack representation

Applications of stack:

1. Stack is used by compilers to check for balancing of parentheses, brackets and braces.
2. Stack is used to evaluate a postfix expression.
3. Stack is used to convert an infix expression into postfix/prefix form.
4. In recursion, all intermediate arguments and return values are stored on the processor's stack.
5. During a function call the return address and arguments are pushed onto a stack and on return they are popped off.

Converting and evaluating Algebraic expressions:

An **algebraic expression** is a legal combination of operators and operands. Operand is the quantity on which a mathematical operation is performed. Operand may be a variable like x, y, z or a constant like 5, 4, 6 etc. Operator is a symbol which signifies a mathematical or logical operation between the operands. Examples of familiar operators include +, -, *, /, ^ etc.

An algebraic expression can be represented using three different notations. They are infix, postfix and prefix notations:

Infix: It is the form of an arithmetic expression in which we fix (place) the arithmetic operator in between the two operands.

Example: A + B

Prefix: It is the form of an arithmetic notation in which we fix (place) the arithmetic operator before (pre) its two operands. The prefix notation is called as polish notation.

Example: + A B

Postfix: It is the form of an arithmetic expression in which we fix (place) the arithmetic operator after (post) its two operands. The postfix notation is called as *suffix notation* and is also referred to *reverse polish notation*.

Example: A B +

Conversion from infix to postfix:

Procedure to convert from infix expression to postfix expression is as follows:

1. Scan the infix expression from left to right.
2. a) If the scanned symbol is left parenthesis, push it onto the stack.
b) If the scanned symbol is an operand, then place directly in the postfix expression (output).
c) If the symbol scanned is a right parenthesis, then go on popping all the items from the stack and place them in the postfix expression till we get the matching left parenthesis.
d) If the scanned symbol is an operator, then go on removing all the operators from the stack and place them in the postfix expression, if and only if the precedence of the operator which is on the top of the stack is greater than (*or greater than or equal*) to the precedence of the scanned operator and push the scanned operator onto the stack otherwise, push the scanned operator onto the stack.

The three important features of postfix expression are:

1. The operands maintain the same order as in the equivalent infix expression.
2. The parentheses are not needed to designate the expression unambiguously.
3. While evaluating the postfix expression the priority of the operators is no longer relevant.

We consider five binary operations: +, -, *, / and \$ or \uparrow (exponentiation). For these binary operations, the following in the order of precedence (highest to lowest):

OPERATOR	PRECEDENCE	VALUE
Exponentiation (\$ or \uparrow or \wedge)	Highest	3
*, /	Next highest	2
+, -	Lowest	1

Example 1:

Convert $((A - (B + C)) * D) \uparrow (E + F)$ infix expression to postfix form:

SYMBOL	POSTFIX STRING	STACK	REMARKS
((
(((
A	A	((
-	A	((-	
(A	((-(
B	AB	((-(
+	AB	((-(+	
C	ABC	((-(+	
)	ABC+	((-	
)	ABC+-	(
*	ABC+-	(*	
D	ABC+-D	(*	
)	ABC+-D*		
↑	ABC+-D*	↑	
(ABC+-D*	↑(
E	ABC+-D*E	↑(
+	ABC+-D*E	↑(+	
F	ABC+-D*EF	↑(+	
)	ABC+-D*EF+	↑	
End of string	ABC+-D*EF+↑	The input is now empty. Pop the output symbols from the stack until it is empty.	

Example 2:

Convert the following infix expression $A + B * C - D / E * H$ into its equivalent postfix expression.

SYMBOL	POSTFIX STRING	STACK	REMARKS
A	A		
+	A	+	
B	AB	+	
*	AB	+*	
C	ABC	+*	
-	ABC*+	-	
D	ABC*+D	-	
/	ABC*+D	-/	
E	ABC*+DE	-/	
*	ABC*+DE/	-*	
H	ABC*+DE/H	-*	
End of string	ABC*+DE/H*-	The input is now empty. Pop the output symbols from the stack until it is empty.	

Evaluation of postfix expression:

The postfix expression is evaluated easily by the use of a stack.

1. When a number is seen, it is pushed onto the stack;
2. When an operator is seen, the operator is applied to the two numbers that are popped from the stack and the result is pushed onto the stack.
3. When an expression is given in postfix notation, there is no need to know any precedence rules; this is our obvious advantage.

Example 1:Evaluate the postfix expression: $6\ 5\ 2\ 3\ +\ 8\ * +\ 3\ +\ *$

SYMBOL	OPERAND 1	OPERAND 2	VALUE	STACK	REMARKS
6				6	
5				6, 5	
2				6, 5, 2	
3				6, 5, 2, 3	The first four symbols are placed on the stack.
+	2	3	5	6, 5, 5	Next a '+' is read, so 3 and 2 are popped from the stack and their sum 5, is pushed
8	2	3	5	6, 5, 5, 8	Next 8 is pushed
*	5	8	40	6, 5, 40	Now a '*' is seen, so 8 and 5 are popped as $8 * 5 = 40$ is pushed
+	5	40	45	6, 45	Next, a '+' is seen, so 40 and 5 are popped and $40 + 5 = 45$ is pushed
3	5	40	45	6, 45, 3	Now, 3 is pushed
+	45	3	48	6, 48	Next, '+' pops 3 and 45 and pushes $45 + 3 = 48$ is pushed
*	6	48	288	288	Finally, a '*' is seen and 48 and 6 are popped, the result $6 * 48 = 288$ is pushed

Example 2:Evaluate the following postfix expression: $6\ 2\ 3\ +\ -\ 3\ 8\ 2\ /\ +\ * \ 2\ \uparrow\ 3\ +$

SYMBOL	OPERAND 1	OPERAND 2	VALUE	STACK
6				6
2				6, 2
3				6, 2, 3
+	2	3	5	6, 5
-	6	5	1	1
3	6	5	1	1, 3
8	6	5	1	1, 3, 8
2	6	5	1	1, 3, 8, 2
/	8	2	4	1, 3, 4
+	3	4	7	1, 7
*	1	7	7	7
2	1	7	7	7, 2
↑	7	2	49	49
3	7	2	49	49, 3
+	49	3	52	52

QUEUE

A queue is linear data structure and collection of elements. A queue is another special kind of list, where items are inserted at one end called the **rear** and deleted at the other end called the **front**. The principle of queue is a **“FIFO”** or **“First-in-first-out”**.

Queue is an abstract data structure. A queue is a useful data structure in programming. **It is similar to the ticket queue outside a cinema hall**, where the first person entering the queue is the first person who gets the ticket.

A real-world example of queue can be a single-lane one-way road, where the vehicle enters first, exits first.



More real-world examples can be seen as queues at the ticket windows and bus-stops and our college library.



The operations for a queue are analogues to those for a stack; the difference is that the insertions go at the end of the list, rather than the beginning.

Operations on QUEUE:

A queue is an object or more specifically an abstract data structure (ADT) that allows the following operations:

- **Enqueue or insertion:** which inserts an element at the end of the queue.
- **Dequeue or deletion:** which deletes an element at the start of the queue.

Queue operations work as follows:

1. Two pointers called FRONT and REAR are used to keep track of the first and last elements in the queue.
2. When initializing the queue, we set the value of FRONT and REAR to 0.
3. On enqueueing an element, we increase the value of REAR index and place the new element in the position pointed to by REAR.
4. On dequeueing an element, we return the value pointed to by FRONT and increase the FRONT index.
5. Before enqueueing, we check if queue is already full.
6. Before dequeueing, we check if queue is already empty.
7. When enqueueing the first element, we set the value of FRONT to 1.
8. When dequeing the last element, we reset the values of FRONT and REAR to 0.

Representation of Queue (or) Implementation of Queue:

The queue can be represented in two ways:

1. Queue using Array
2. Queue using Linked List

1.Queue using Array:

Let us consider a queue, which can hold maximum of five elements. Initially the queue is empty.

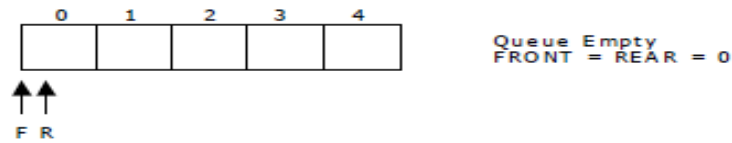

Now, insert 11 to the queue. Then queue status will be:

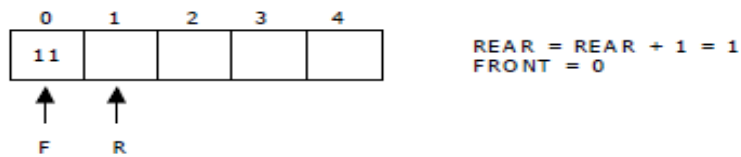

Next, insert 22 to the queue. Then the queue status is:

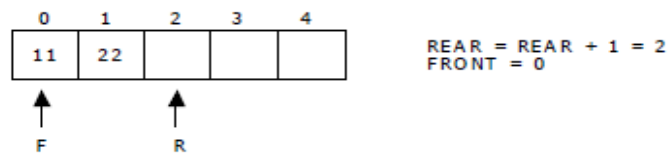

Again insert another element 33 to the queue. The status of the queue is:

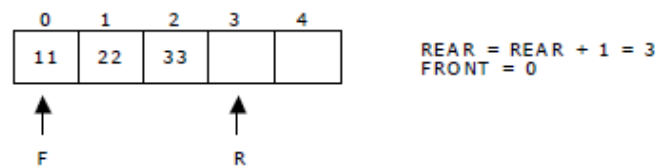

Now, delete an element. The element deleted is the element at the front of the queue. So the status of the queue is:

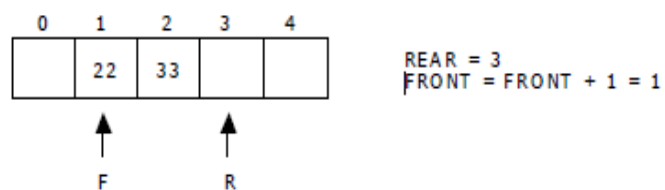

Again, delete an element. The element to be deleted is always pointed to by the FRONT pointer. So, 22 is deleted. The queue status is as follows:

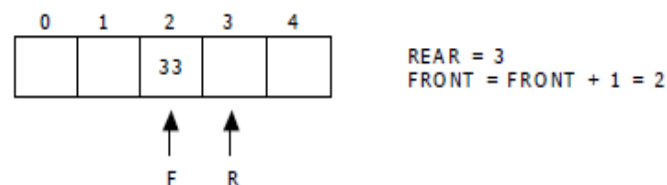

Now, insert new elements 44 and 55 into the queue. The queue status is:

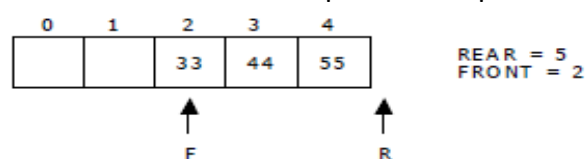

Next insert another element, say 66 to the queue. We cannot insert 66 to the queue as the rear crossed the maximum size of the queue (i.e., 5). There will be queue full signal. The queue status is as follows:

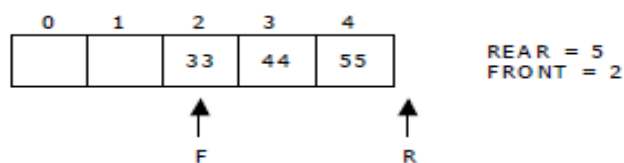

Now it is not possible to insert an element 66 even though there are two vacant positions in the linear queue. To overcome this problem the elements of the queue are to be shifted towards the beginning of the queue so that it creates vacant position at the rear end. Then the FRONT and REAR are to be adjusted properly. The element 66 can be inserted at the rear end. After this operation, the queue status is as follows:

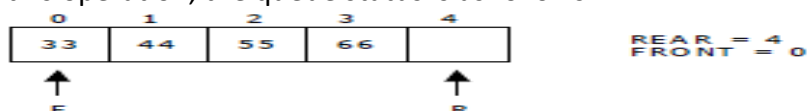

This difficulty can overcome if we treat queue position with index 0 as a position that comes after position with index 4 i.e., we treat the queue as a **circular queue**.

Queue operations using array:

a.enqueue() or insertion(): which inserts an element at the end of the queue.

<pre>void insertion() { if(rear==max) printf("\n Queue is Full"); else { printf("\n Enter no %d:",j++); scanf("%d",&queue[rear++]); } }</pre>	<p>Algorithm: Procedure for insertion():</p> <p>Step-1:START</p> <p>Step-2: if rear==max then Write 'Queue is full'</p> <p>Step-3: otherwise 3.1: read element 'queue[rear]'</p> <p>Step-4:STOP</p>
---	--

b.dequeue() or deletion(): which deletes an element at the start of the queue.

<pre>void deletion() { if(front==rear) { printf("\n Queue is empty"); } else { printf("\n Deleted Element is %d",queue[front++]); x++; } }</pre>	<p>Algorithm: procedure for deletion():</p> <p>Step-1:START</p> <p>Step-2: if front==rear then Write' Queue is empty'</p> <p>Step-3: otherwise 3.1: print deleted element</p> <p>Step-4:STOP</p>
--	---

c.dispaly(): which displays an elements in the queue.

<pre> void deletion() { if(front==rear) { printf("\n Queue is empty"); } else { for(i=front; i<rear; i++) { printf("%d",queue[i]); printf("\n"); } } } </pre>	<p>Algorithm: procedure for deletion():</p> <p>Step-1:START</p> <p>Step-2: if front==rear then Write ' Queue is empty'</p> <p>Step-3: otherwise 3.1: for i=front to rear then 3.2: print 'queue[i]'</p> <p>Step-4:STOP</p>
--	---

2. Queue using Linked list:

We can represent a queue as a linked list. In a queue data is deleted from the front end and inserted at the rear end. We can perform similar operations on the two ends of a list. We use two pointers *front* and *rear* for our linked queue implementation.

The linked queue looks as shown in figure:

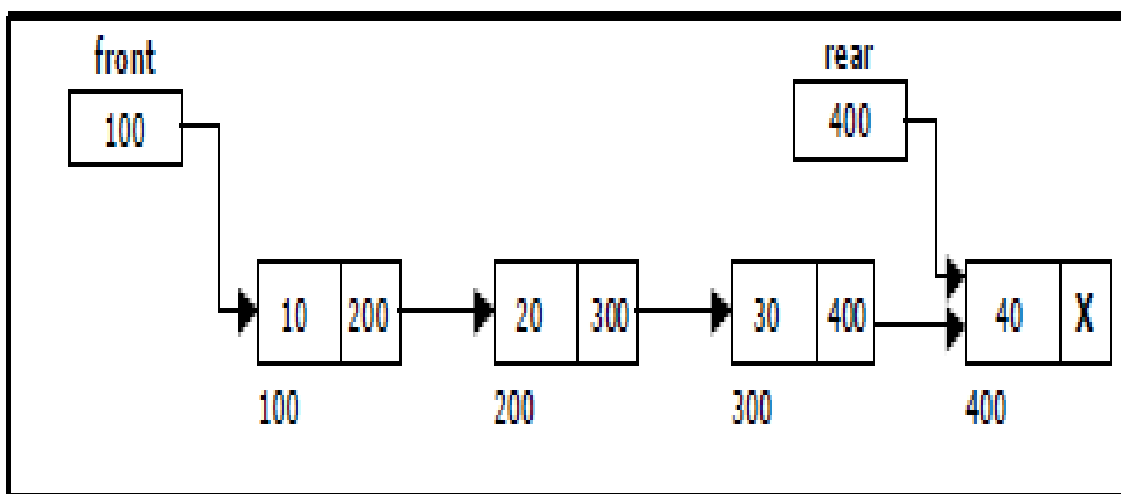

Figure : Linked Queue representation

Applications of Queue:

1. It is used to schedule the jobs to be processed by the CPU.
2. When multiple users send print jobs to a printer, each printing job is kept in the printing queue. Then the printer prints those jobs according to first in first out (FIFO) basis.
3. Breadth first search uses a queue data structure to find an element from a graph.

CIRCULAR QUEUE

A more efficient queue representation is obtained by regarding the array Q[MAX] as circular. Any number of items could be placed on the queue. This implementation of a queue is called a circular queue because it uses its storage array as if it were a circle instead of a linear list.

There are two problems associated with linear queue. They are:

- Time consuming: linear time to be spent in shifting the elements to the beginning of the queue.
- Signaling queue full: even if the queue is having vacant position.

For example, let us consider a linear queue status as follows:

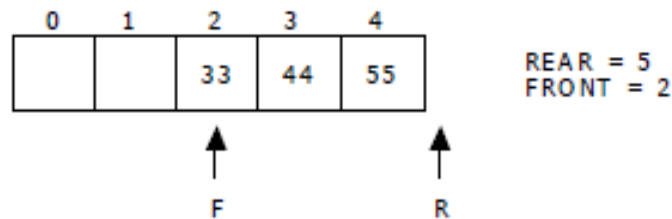

Next insert another element, say 66 to the queue. We cannot insert 66 to the queue as the rear crossed the maximum size of the queue (i.e., 5). There will be queue full signal. The queue status is as follows:

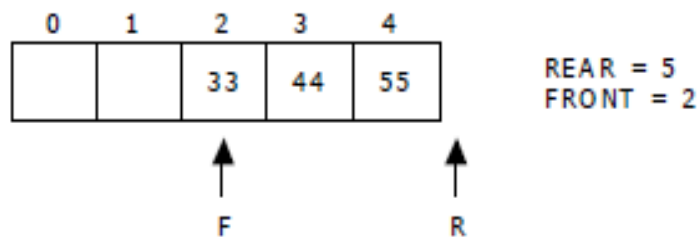

This difficulty can be overcome if we treat queue position with index zero as a position that comes after position with index four then we treat the queue as a **circular queue**.

In circular queue if we reach the end for inserting elements to it, it is possible to insert new elements if the slots at the beginning of the circular queue are empty.

Representation of Circular Queue:

Let us consider a circular queue, which can hold maximum (MAX) of six elements. Initially the queue is empty.

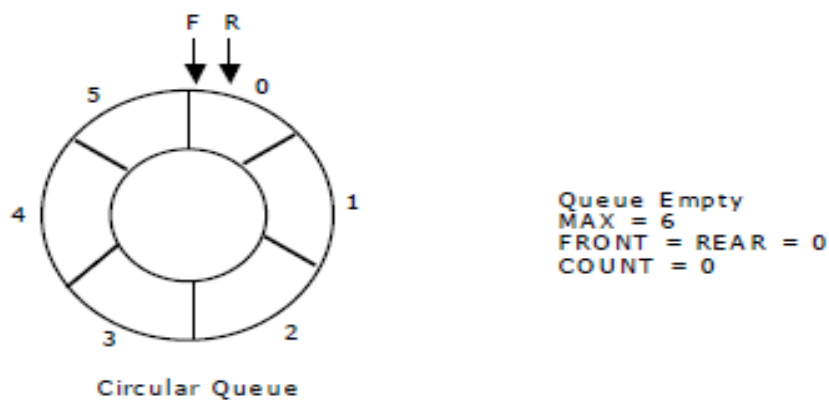

Now, insert 11 to the circular queue. Then circular queue status will be:

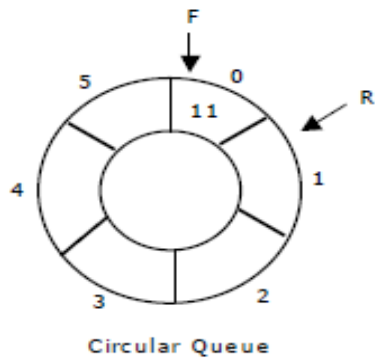

```

FRONT = 0
REAR = (REAR + 1) % 6 = 1
COUNT = 1

```

Insert new elements 22, 33, 44 and 55 into the circular queue. The circular queue status is:

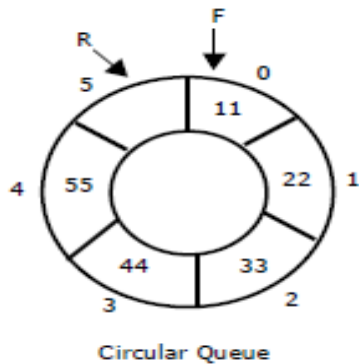

```

FRONT = 0
REAR = (REAR + 1) % 6 = 5
COUNT = 5

```

Now, delete an element. The element deleted is the element at the front of the circular queue. So, 11 is deleted. The circular queue status is as follows:

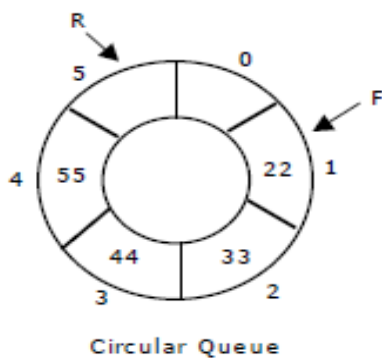

```

FRONT = (FRONT + 1) % 6 = 1
REAR = 5
COUNT = COUNT - 1 = 4

```

Again, delete an element. The element to be deleted is always pointed to by the FRONT pointer. So, 22 is deleted. The circular queue status is as follows:

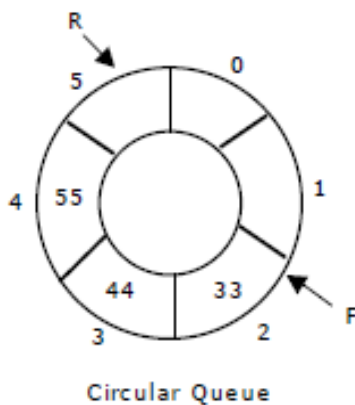

```

FRONT = (FRONT + 1) % 6 = 2
REAR = 5
COUNT = COUNT - 1 = 3

```

Again, insert another element 66 to the circular queue. The status of the circular queue is:

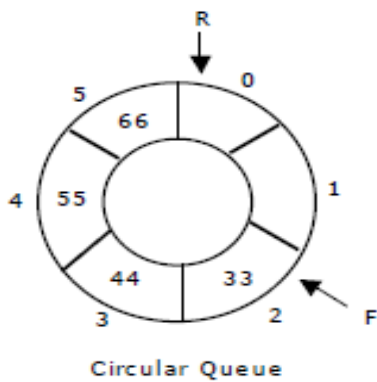

FRONT = 2
 REAR = (REAR + 1) % 6 = 0
 COUNT = COUNT + 1 = 4

Now, insert new elements 77 and 88 into the circular queue. The circular queue status is:

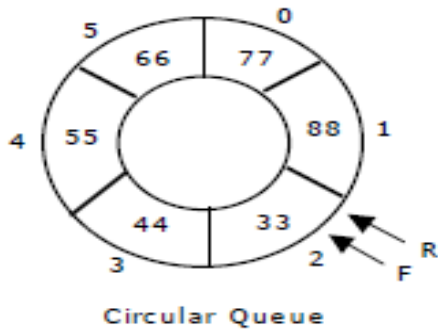

FRONT = 2, REAR = 2
 REAR = REAR % 6 = 2
 COUNT = 6

Now, if we insert an element to the circular queue, as COUNT = MAX we cannot add the element to circular queue. So, the circular queue is *full*.

Operations on Circular queue:

a.enqueue() or insertion():This function is used to insert an element into the circular queue. In a circular queue, the new element is always inserted at Rear position.

<pre>void insertCQ() { int data; if(count ==MAX) { printf("\n Circular Queue is Full"); } else { printf("\n Enter data: "); scanf("%d", &data); CQ[rear] = data; rear = (rear + 1) % MAX; count ++; } printf("\n Data Inserted in the Circular Queue "); } }</pre>	<p>Algorithm: procedure of insertCQ():</p> <p>Step-1:START</p> <p>Step-2: if count==MAX then Write "Circular queue is full"</p> <p>Step-3:otherwise</p> <p>3.1: read the data element</p> <p>3.2: CQ[rear]=data</p> <p>3.3: rear=(rear+1)%MAX</p> <p>3.4: count=count+1</p> <p>Step-4:STOP</p>
--	--

b.dequeue() or deletion():This function is used to delete an element from the circular queue. In a circular queue, the element is always deleted from front position.

<pre>void deleteCQ() { if(count ==0) { printf("\n\nCircular Queue is Empty.."); } else { printf("\n Deleted element from Circular Queue is %d ", CQ[front]); front = (front + 1) % MAX; count --; } }</pre>	<p>Algorithm: procedure of deleteCQ():</p> <p>Step-1:START</p> <p>Step-2: if count==0 then Write "Circular queue is empty"</p> <p>Step-3:otherwise</p> <p>3.1: print the deleted element</p> <p>3.2: front=(front+1)%MAX</p> <p>3.3: count=count-1</p> <p>Step-4:STOP</p>
---	--

c.display():This function is used to display the list of elements in the circular queue.

<pre>void displayCQ() { int i, j; if(count ==0) { printf("\n\n\t Circular Queue is Empty "); } else { printf("\n Elements in Circular Queue are: "); j = count; for(i = front; j != 0; j--) { printf("%d\t", CQ[i]); i = (i + 1) % MAX; } } }</pre>	<p>Algorithm: procedure of displayCQ():</p> <p>Step-1:START</p> <p>Step-2: if count==0 then Write "Circular queue is empty"</p> <p>Step-3:otherwise</p> <p>3.1: print the list of elements</p> <p>3.2: for i=front to j!=0</p> <p>3.3: print CQ[i]</p> <p>3.4: i=(i+1)%MAX</p> <p>Step-4:STOP</p>
---	--

Deque:

In the preceding section we saw that a queue in which we insert items at one end and from which we remove items at the other end. In this section we examine an extension of the queue, which provides a means to insert and remove items at both ends of the queue. This data structure is a **deque**. The word **deque** is an acronym derived from **double-ended queue**. Below figure shows the representation of a deque.

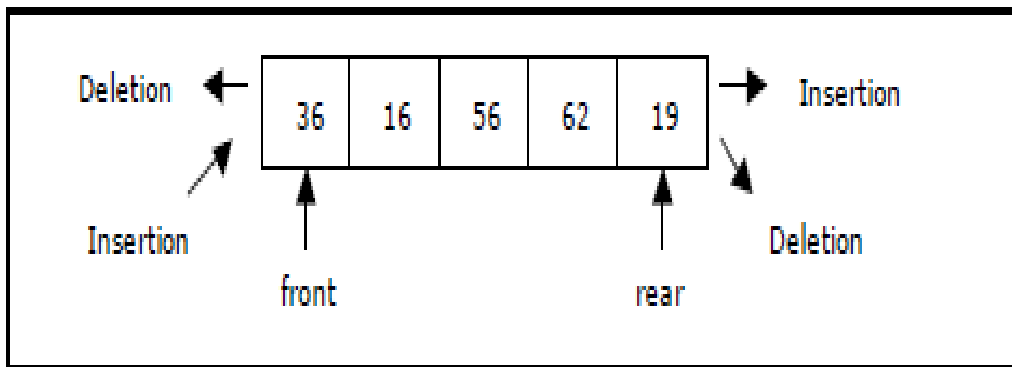

Figure Representation of a deque.

deque provides four operations. Below Figure shows the basic operations on a deque.

- enqueue_front: insert an element at front.
- dequeue_front: delete an element at front.
- enqueue_rear: insert element at rear.
- dequeue_rear: delete element at rear.

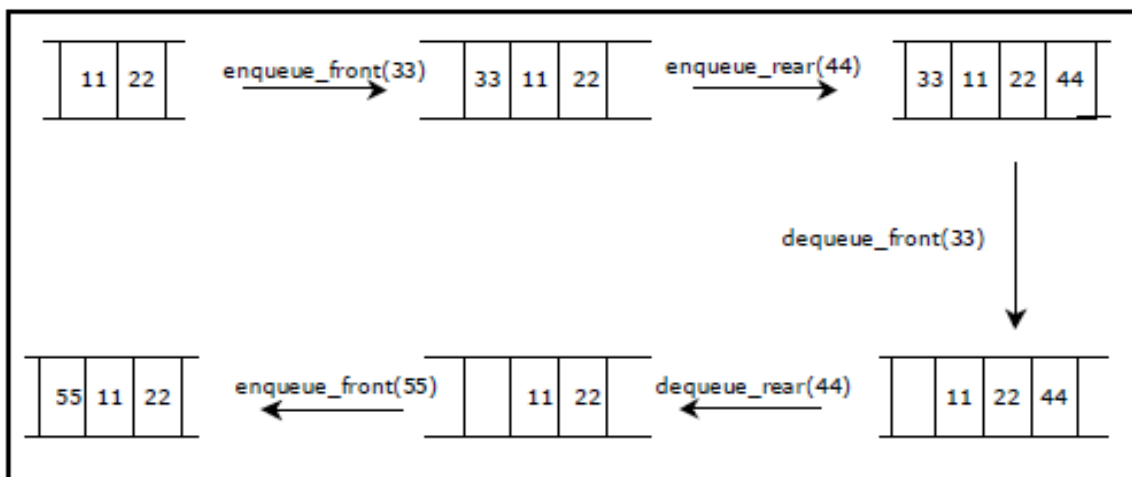

Figure Basic operations on deque

There are two variations of deque. They are:

- Input restricted deque (IRD)
- Output restricted deque (ORD)

An Input restricted deque is a deque, which allows insertions at one end but allows deletions at both ends of the list.

An output restricted deque is a deque, which allows deletions at one end but allows insertions at both ends of the list.

Priority Queue:

A **priority queue** is a collection of elements such that each element has been assigned a priority. We can insert an element in priority queue at the rare position. We can delete an element from the priority queue based on the elements priority and such that the order in which elements are deleted and processed comes from the following rules:

1. An element of higher priority is processed before any element of lower priority.
2. Two elements with same priority are processed according to the order in which they were added to the queue. It follows FIFO or FCFS(First Comes First serve) rules.

We always remove an element with the highest priority, which is given by the minimal integer priority assigned.

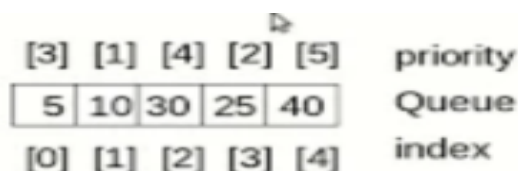

A prototype of a priority queue is time sharing system: programs of high priority are processed first, and programs with the same priority form a standard queue. An efficient implementation for the Priority Queue is to use heap, which in turn can be used for sorting purpose called heap sort

Priority queues are two types:

1. Ascending order priority queue
2. Descending order priority queue

1. Ascending order priority queue: It is Lower priority number to high priority number.

Examples: order is 1,2,3,4,5,6,7,8,9,10

2. Descending order priority queue: It is high priority number to lowest priority number.

Examples: Order is 10,9,8,7,6,5,4,3,2,1

Implementation of Priority Queue:

Implementation of priority queues are two types:

1. Through Queue(Using Array)
2. Through Sorted List(Using Linked List)

1. Through Queue (Using Array): In this case element is simply added at the rear end as usual. For deletion, the element with highest priority is searched and then deleted.

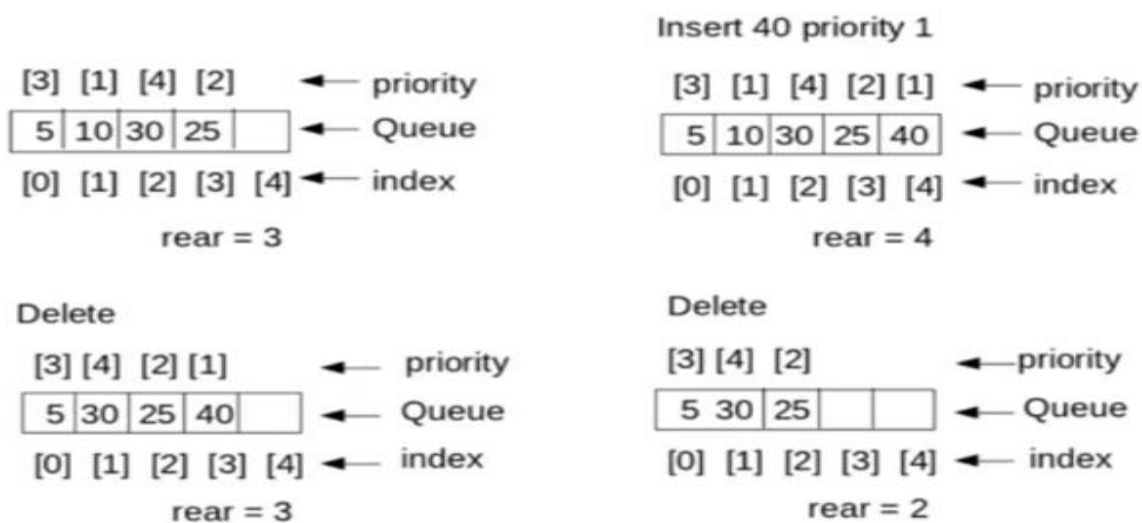

2. Through sorted List (Using Linked List): In this case insertion is costly because the element insert at the proper place in the list based on the priority. Here deletion is easy since the element with highest priority will always be in the beginning of the list.

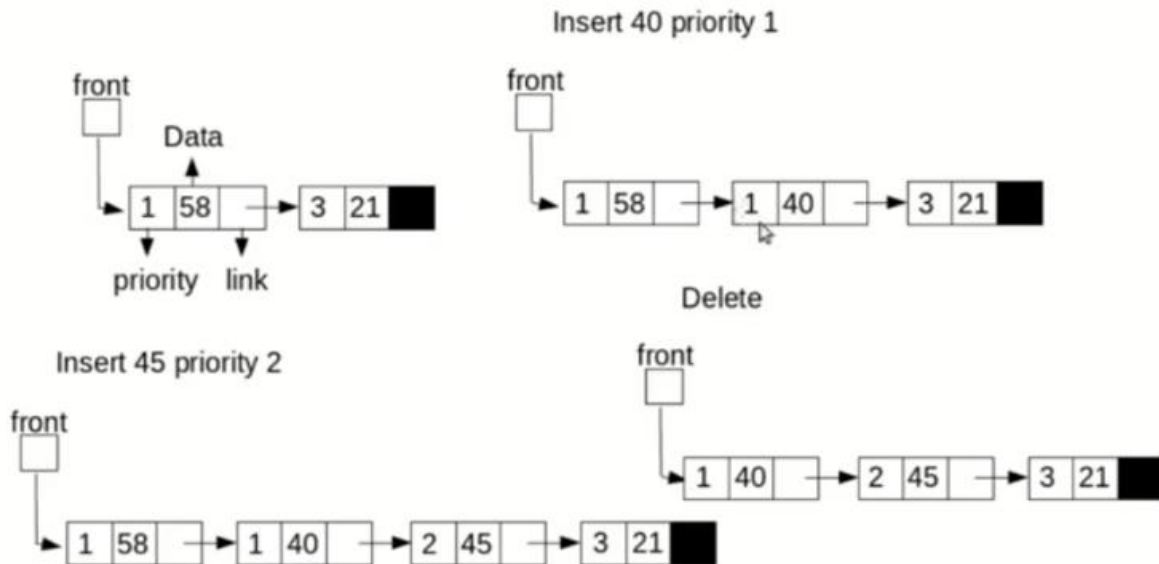

1. Difference between stacks and Queues?

stacks	Queues
1.A stack is a linear list of elements in which the element may be inserted or deleted at one end.	1.A Queue is a linear list of elements in which the elements are added at one end and deletes the elements at another end.
2. In stacks, elements which are inserted last is the first element to be deleted.	2. . In Queue the element which is inserted first is the element deleted first.
3.Stacks are called LIFO (Last In First Out)list	3. Queues are called FIFO (First In First Out)list.
4.In stack elements are removed in reverse order in which thy are inserted.	4. In Queue elements are removed in the same order in which thy are inserted.
5.suppose the elements a,b,c,d,e are inserted in the stack, the deletion of elements will be e,d,c,b,a.	5. Suppose the elements a,b,c,d,e are inserted in the Queue, the deletion of elements will be in the same order in which thy are inserted.
6.In stack there is only one pointer to insert and delete called "Top".	6. In Queue there are two pointers one for insertion called "Rear" and another for deletion called "Front".
7.Initially top=-1 indicates a stack is empty.	7. Initially Rear=Front=-1 indicates a Queue is empty.
8.Stack is full represented by the condition TOP=MAX-1(if array index starts from '0').	8.Queue is full represented by the condition Rear=Max-1.
9.To push an element into a stack, Top is incremented by one	9.To insert an element into Queue, Rear is incremented by one.
10.To POP an element from stack,top is decremented by one.	10.To delete an element from Queue, Front is

11. The conceptual view of Stack is as follows:

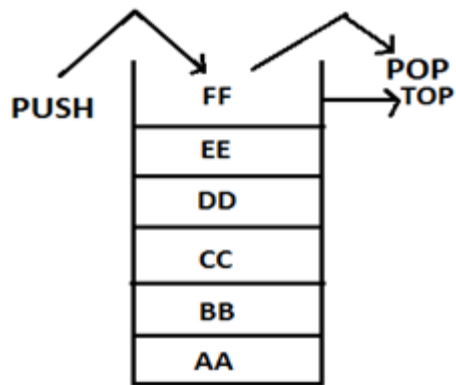

incremented by one.

11. The conceptual view of Queue is as follows:

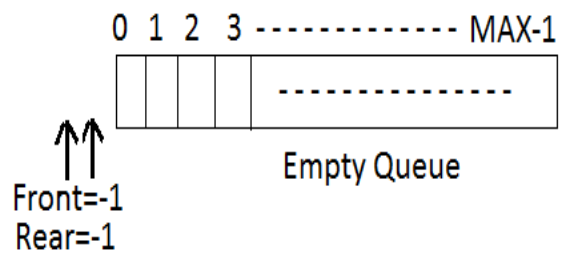

UNIT-III

LINEAR LIST

INTRODUCTION

Linear Data Structures:

Linear data structures are those data structures in which data elements are accessed (read and written) in sequential fashion (one by one). Ex: Stacks, Queues, Lists, Arrays

Non Linear Data Structures:

Non Linear Data Structures are those in which data elements are not accessed in sequential fashion.

Ex: trees, graphs

Difference between Linear and Nonlinear Data Structures

Main difference between linear and nonlinear data structures lie in the way they organize data elements. In linear data structures, data elements are organized sequentially and therefore they are easy to implement in the computer's memory. In nonlinear data structures, a data element can be attached to several other data elements to represent specific relationships that exist among them. Due to this nonlinear structure, they might be difficult to be implemented in computer's linear memory compared to implementing linear data structures. Selecting one data structure type over the other should be done carefully by considering the relationship among the data elements that needs to be stored.

LINEAR LIST

A data structure is said to be linear if its elements form a sequence. A linear list is a list that displays the relationship of adjacency between elements.

A Linear list can be defined as a data object whose instances are of the form $(e_1, e_2, e_3 \dots e_n)$ where n is a finite natural number. The e_i terms are the elements of the list and n is its length. The elements may be viewed as atomic as their individual structure is not relevant to the structure of the list. When $n=0$, the list is empty. When $n>0$, e_1 is the first element and e_n the last. I.e; e_1 comes before e_2 , e_2 comes before e_3 and so on.

Some examples of the Linear List are

- An alphabetized list of students in a class
- A list of exam scores in non decreasing order
- A list of gold medal winners in the Olympics
- An alphabetized list of members of Congress

The following are the operations that performed on the Linear List

- ✓ Create a Linear List
- ✓ Destroy a Linear List
- ✓ Determine whether the list is empty
- ✓ Determine the size of the List
- ✓ Find the element with a given index
- ✓ Find the index of a given number
- ✓ Delete, erase or remove an element given its index
- ✓ Insert a new element so that it has a given index

A Linear List may be specified as an abstract Data type (ADT) in which we provide a specification of the instance as well as of the operations that are to be performed. The below abstract data type omitted specifying operations to create and destroy instance of the data type. All ADT specifications implicitly include an operation to create an empty instance and optionally, an operation to destroy an instance.

AbstractDataType *linearList*

```
{
  instances
    ordered finite collections of zero or more elements

  operations
    empty() : return true if the list is empty, false otherwise
    size() : return the list size (i.e., number of elements in the list)
    get(index): return the indexth element of the list
    indexOf(x): return the index of the first occurrence of x in the list,
               return -1 if x is not in the list
    erase(index): remove/delete the indexth element, elements with higher in-
                  dex have their index reduced by 1
    insert(index, x): insert x as the indexth element, elements with index  $\geq$  index
                     have their index increased by 1
    output(): output the list elements from left to right
}
```

Abstract data type specification of a linear list

Array Representation: (Formula Based Representation)

A formula based representation uses an array to represent the instance of an object. Each position of the Array is called a Cell or Node and is large enough to hold one of the elements that make up an instance, while in other cases one array can represent several instances. Individual elements of an instance are located in the array using a mathematical formula.

Suppose one array is used for each list to be represented. We need to map the elements of a list to positions in the array used to represent it. In a formula based representation, a mathematical formula determines the location of each element. A simple mapping formulas is

$$\text{Location (i) = i-1}$$

This equation states that the i^{th} element of the list is in position $i-1$ of the array. The below figure shows a five element list represented in the array element using the mapping of equation.

To completely specify the list we need to know its current length or size. For this purpose we use variable length. Length is zero when list is empty. Program gives the resulting C++ class definition. Since the data type of the list element may vary from application to application, we have defined a template class in which the user specifies the element data type T . the data members length, MaxSize and element are private members are private members, while the remaining members are public. Insert and delete have been defined to return a reference to a linear list.

Insertion and Deletion of a Linear List:

Suppose we want to remove an element e_i from the list by moving to its right down by 1. For example, to remove an element $e_1=2$ from the list, we have to move the elements $e_2=4$, $e_3=8$, and $e_4=1$, which are to the right of e_1 , to positions 1, 2 and 3 of the array element. The below figure shows this result. The shaded elements are moved.

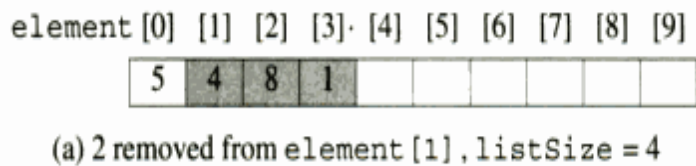
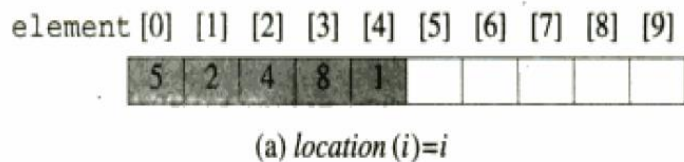

To insert an element so that it becomes element i of a list, must move the existing element e_i and all elements to its right one position right and then put the new element into position i of the array. For example to insert 7 as the second element of the list, we first move elements e_2 and e_3 to the right by 1 and then put 7 in to second position 2 of the array. The below figure shows this result. The shaded elements were moved.

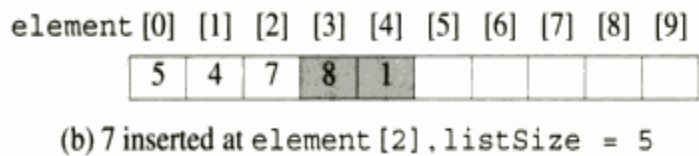

Linked Representation And Chains

In a linked list representation each element of an instance of a data object is represented in a cell or node. The nodes however need not be component of an array and no formula is used to locate individual elements. Instead of each node keeps explicit information about the location of other relevant nodes. This explicit information about the location of another node is called Link or Pointer.

Let $L=(e_1, e_2, e_3...e_n)$ be a linear List. In one possible linked representation for this list, each element e_i is represented in a separate node. Each node has exactly one link field that is used to locate the next element in the linear list. So the node for e_i links to that for e_{i+1} , $0 \leq i < n-1$. The node for e_{n-1} has no need to link to and so its link field is NULL. The pointer variables first locate the first node in the representation. The below figure shows the linked representation of a List $= (e_1, e_2, e_3...e_n)$.

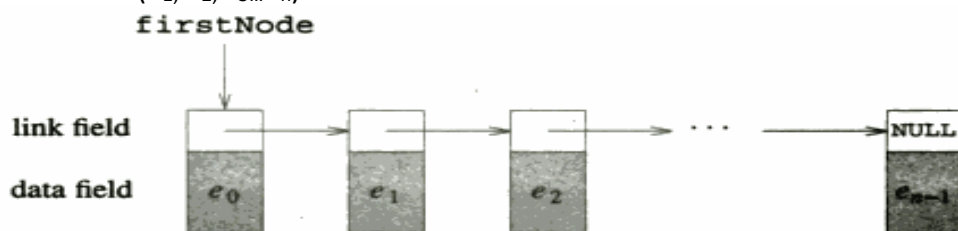

Linked representation of a linear list

Since each node in the Linked representation of the above figure has exactly one link, the structure of this figure is called a '**Single Linked List**'. the nodes are ordered from left to right with each node (other than last one) linking to the next, and the last node has a NULL link, the structure is also called a **chain**.

Insertion and Deletion of a Single Linked List:

Insertion Let the list be a Linked list with successive nodes A and B as shown in below figure. suppose a node N is to be inserted into the list between the node A and B.

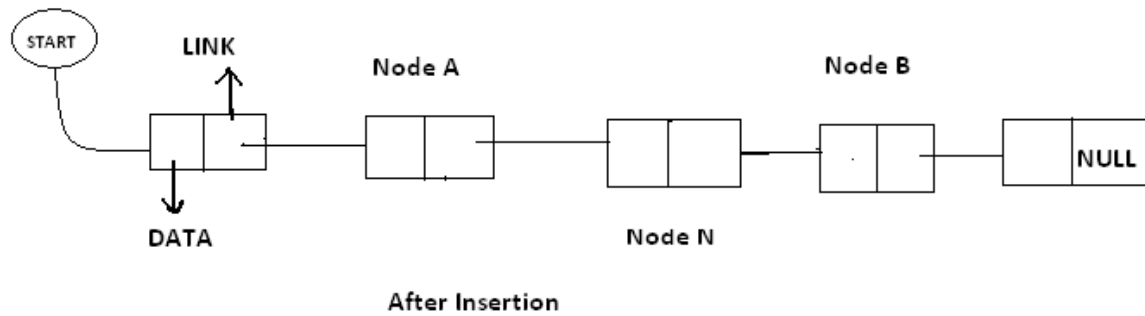
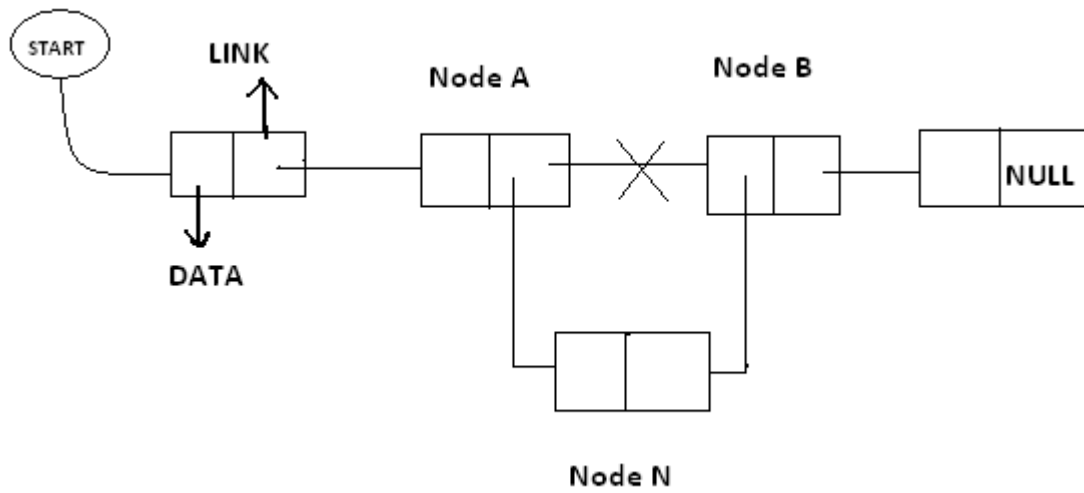

In the New list the Node A points to the new Node N and the new node N points to the node B to which Node A previously pointed.

Deletion:

Let list be a Linked list with node N between Nodes A and B is as shown in the following figure.

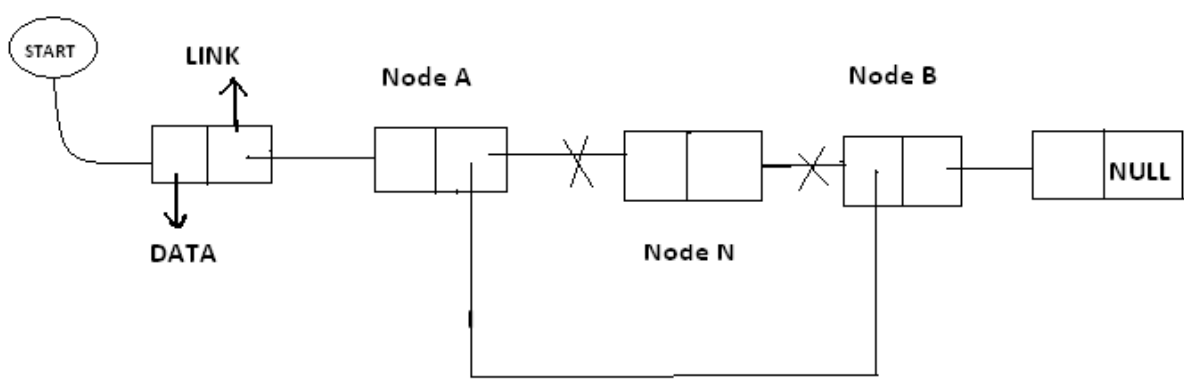

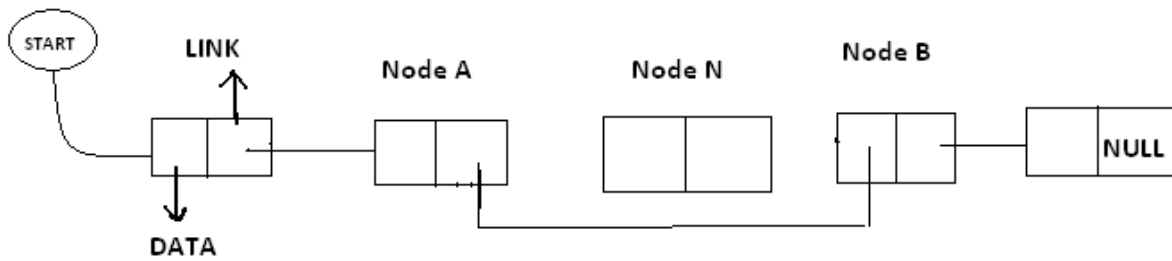

After Deletion Node N in Between Node A and Node B

In the new list the node N is to be deleted from the Linked List. The deletion occurs as the link field in the Node A is made to point node B this excluding node N from its path.

DOUBLE LINKED LIST (Or) TWO WAY LINKED LIST

In certain applications it is very desirable that list be traversed in either forward direction or Back word direction. The property of Double Linked List implies that each node must contain two link fields instead of one. The links are used to denote the preceding and succeeding of the node. The link denoting the preceding of a node is called Left Link. The link denoting succeeding of a node is called Right Link. The list contain this type of node is called a "Double Linked List" or "Two Way List". The Node structure in the Double Linked List is as follows:

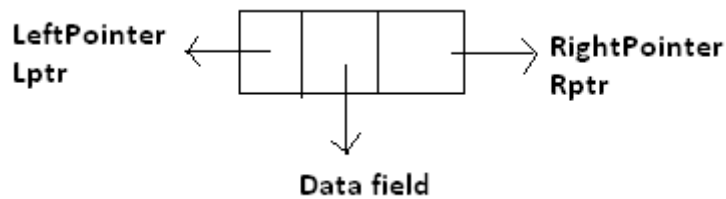

Lptr contains the address of the before node. Rptr contains the address of next node. Data Contains the Linked List is as follows.

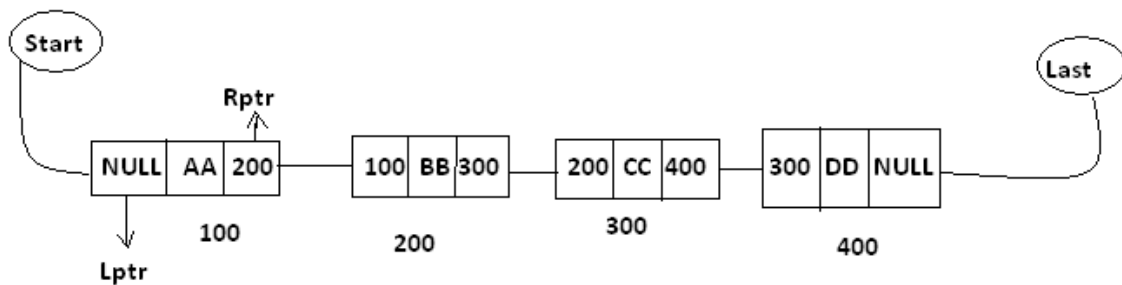

In the above diagram Last and Start are pointer variables which contains the address of last node and starting node respectively.

Insertion in to the Double Linked List: Let list be a double linked list with successive modes A and B as shown in the following diagram. Suppose a node N is to be inserted into the list between the node s A and B this is shown in the following diagram.

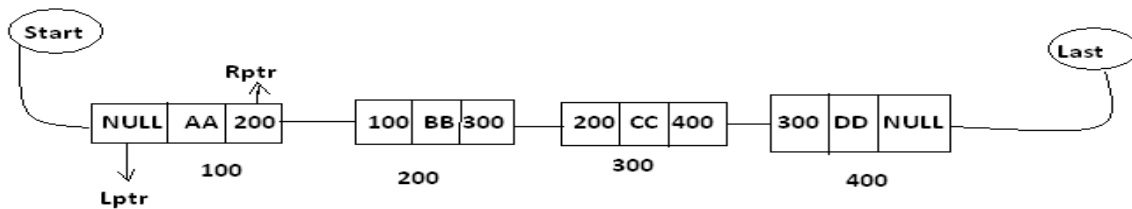

Before Insertion

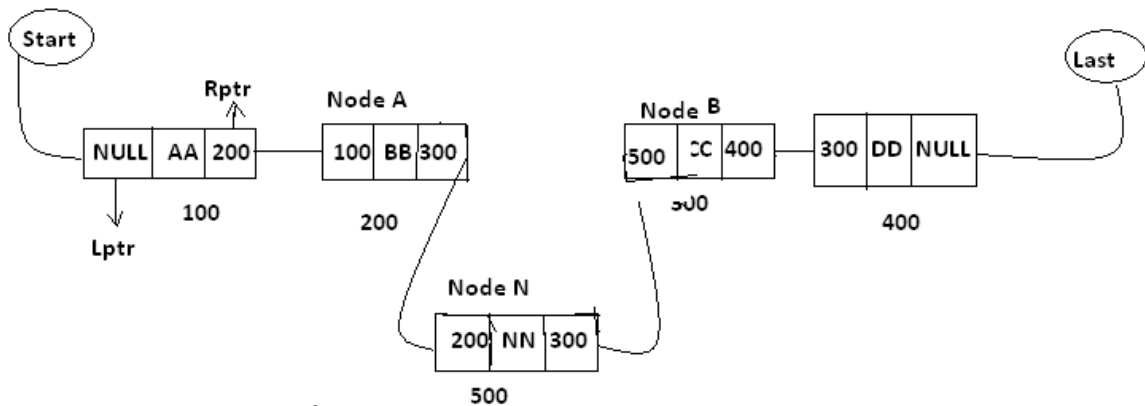

After Insertion

As in the new list the right pointer of node A points to the new node N, the Lptr of the node 'N' points to the node A and Rptr of node 'N' points to the node 'B' and Lpts of node B points the new node 'N'

Deletion Of Double Linked List :- Let list be a linked list contains node N between the nodes A and B as shown in the following diagram.

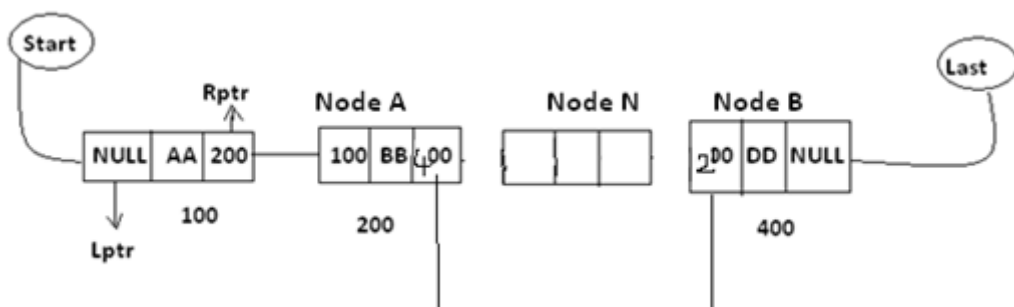

Support node N is to be deleted from the list diagram will appear as the above mention double linked list. The deletion occurs as soon as the right pointer field of node A changed, so that it points to node B and the lift point field of node B is changed. So that it pointes to node A.

Circular Linked List:- Circular Linked List is a special type of linked list in which all the nodes are linked in continuous circle. Circular list can be singly or doubly linked list. Note that, there are no Nulls in Circular Linked Lists. In these types of lists, elements can be added to the back of the list and removed from the front in constant time.

Both types of circularly-linked lists benefit from the ability to traverse the full list beginning at any given node. This avoids the necessity of storing first Node and last node, but we need a special representation for the empty list, such as a last node variable which points to some node in the list or is null if it's empty. This representation significantly simplifies adding and removing nodes with a non-empty list, but empty lists are then a special case. Circular linked lists are most useful for describing naturally circular structures, and have the advantage of being able to traverse the list starting at any point. They also allow quick access to the first and last records through a single pointer (the address of the last element)

Circular single linked list:

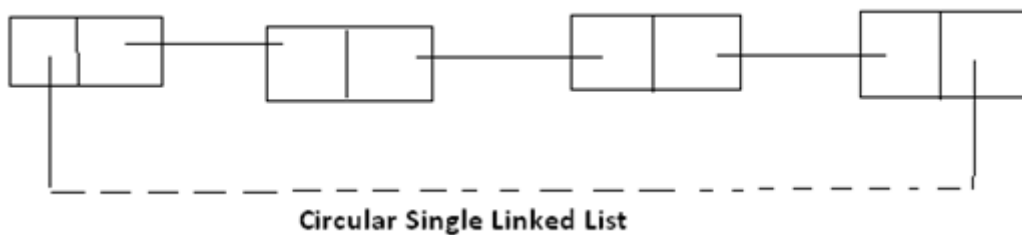

Circular linked list are one they of liner linked list. In which the link fields of last node of the list contains the address of the first node of the list instead of contains a null pointer.

Advantages:- Circular list are frequency used instead of ordinary linked list because in circular list all nodes contain a valid address. The important feature of circular list is as follows.

- (1) In a circular list every node is accessible from a given node.
- (2) Certain operations like concatenation and splitting becomes more efficient in circular list.

Disadvantages: Without some conditions in processing it is possible to get into an infinite Loop.

Circular Double Linked List :- These are one type of double linked list. In which the rpt field of the last node of the list contain the address of the first node ad the left points of the first node contains the address of the last node of the list instead of containing null pointer.

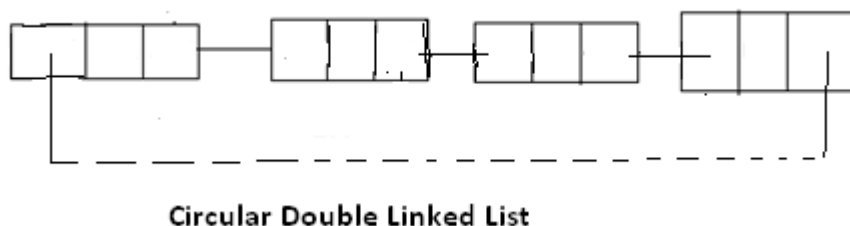

Advantages:- circular list are frequently used instead of ordinary linked list because in circular list all nodes contained a valid address. The important feature of circular list is as follows.

- (1) In a circular list every node is accessible from a given node.
- (2) Certain operations like concatenation and splitting becomes more efficient in circular list.

Disadvantage:- Without some conditions in processes it is possible to get in to an infant glad.

Difference between single linked list and double linked list?

Single linked list(SLL)	Double linked list(DLL)
1. In Single Linked List the list will be traversed in only one way ie; in forward. 2. In Single Linked List the node contains one link field only. 3. Every node contains the address of next node. 4. The node structure in Single linked list is as follows:	1. In Double Linked List the list will be traversed in two way ie; either forward and backward 2. In Double Linked List the node contains two link fields. 3. Every node contains the address of next node as well as preceding node. 4. the node structure in double linked list is as follows:

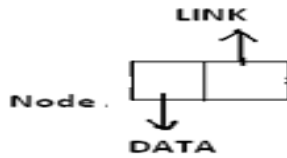

5. The conceptual view of SLL is as follows:

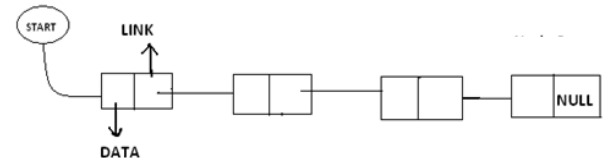

6. SLL are maintained in memory by using two arrays.

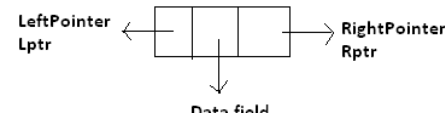

5. the conceptual view of DLL is as follows:

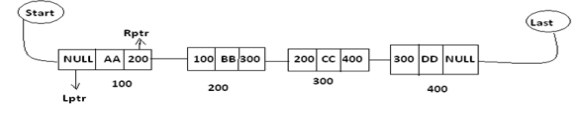

6. DLL is maintained in memory by using three arrays.

2. Difference between sequential allocation and linked allocation?

OR

Difference between Linear List and Linked List?

OR

Difference between Arrays and Linked List?

Arrays	Linked List
1. Arrays are used in the predictable storage requirement ie; exert amount of data storage required by the program can be determined.	1. Linked List are used in the unpredictable storage requirement ie; exert amount of data storage required by the program can't be determined.
2. In arrays the operations such as insertion and deletion are done in an inefficient manner.	2. In Linked List the operations such as insertion and deletion are done more efficient manner ie; only by changing the pointer.
3. The insertion and deletion are done by moving the elements either up or down.	3. The insertion and deletion are done by only changing the pointers.
4. Successive elements occupy adjacent space on memory.	4. Successive elements need not occupy adjacent space.
5. In arrays each location contain DATA only	5. In linked list each location contains data and pointer to denote whether the next element present in the memory.
6. The linear relationship between the data elements of an array is reflected by the physical relationship of data in the memory.	6. The linear relationship between the data elements of a Linked List is reflected by the Linked field of the node.
7. In array declaration a block of memory space is required.	7. In Linked list there is no need of such thing.
8. There is no need of storage of pointer or lines	

9. The Conceptual view of an Array is as follows:

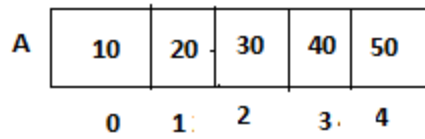

10. In array there is no need for an element to specify whether the next is stored

8. In Linked list a pointer is stored along into the element.

9. The Conceptual view of Linked list is as follows:

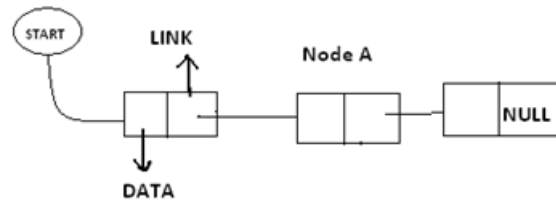

10. There is need for an element (node) to specify whether the next node is formed.

UNIT-IV SORTING AND SEARCHING

SORTING-INTRODUCTION

Sorting is a technique of organizing the data. It is a process of arranging the records, either in ascending or descending order i.e. bringing some order lines in the data. Sort methods are very important in Data structures.

Sorting can be performed on any one or combination of one or more attributes present in each record. It is very easy and efficient to perform searching, if data is stored in sorting order. The sorting is performed according to the key value of each record. Depending up on the makeup of key, records can be stored either numerically or alphanumerically. In numerical sorting, the records arranged in ascending or descending order according to the numeric value of the key.

Let A be a list of n elements $A_1, A_2, A_3, \dots, A_n$ in memory. Sorting A refers to the operation of rearranging the contents of A so that they are increasing in order, that is, so that $A_1 \leq A_2 \leq A_3 \leq \dots \leq A_n$. Since A has n elements, there are n! Ways that the contents can appear in A. these ways corresponding precisely to the n! Permutations of 1,2,3,...,n. accordingly each sorting algorithm must take care of these n! Possibilities.

Ex: suppose an array DATA contains 8elements as follows:

DATA: 70, 30,40,10,80,20,60,50.

After sorting DATA must appear in memory as follows:

DATA: 10 20 30 40 50 60 70 80

Since DATA consists of 8 elements, there are $8!=40320$ ways that the numbers 10,20,30,40,50,60,70,80 can appear in DATA.

The factors to be considered while choosing sorting techniques are:

- Programming Time
- Execution Time
- Number of Comparisons
- Memory Utilization
- Computational Complexity

Types of Sorting Techniques:

Sorting techniques are categorized into 2 types. They are Internal Sorting and External Sorting.

Internal Sorting: Internal sorting method is used when small amount of data has to be sorted. In this method , the data to be sorted is stored in the main memory (RAM).Internal sorting method can access records randomly. EX: Bubble Sort, Insertion Sort, Selection Sort, Shell sort, Quick Sort, Radix Sort, Heap Sort etc.

External Sorting: Extern al sorting method is used when large amount of data has to be sorted. In this method, the data to be sorted is stored in the main memory as well as in the secondary memory such as disk. External sorting methods an access records only in a sequential order. Ex: Merge Sort, Multi way Mage Sort.

Complexity of sorting Algorithms: The complexity of sorting algorithm measures the running time as a function of the number n of items to be stored. Each sorting algorithm S will be made up of the following operations, where $A_1, A_2, A_3, \dots, A_n$ contain the items to be sorted and B is an auxiliary location.

- Comparisons, which test whether $A_i < A_j$ or test whether $A_i < B$.
- Interchanges which switch the contents of A_i and A_j or of A_i and B .
- Assignment which set $B: A_i$ and then set $A_j := B$ or $A_j := A_i$

Normally, the complexity function measures only the number of comparisons, since the number of other operations is at most a constant factor of the number of comparisons.

SELECTION SORT

In selection sort, the smallest value among the unsorted elements of the array is selected in every pass and inserted to its appropriate position into the array. First, find the smallest element of the array and place it on the first position. Then, find the second smallest element of the array and place it on the second position. The process continues until we get the sorted array. The array with n elements is sorted by using $n-1$ pass of selection sort algorithm.

- In 1st pass, smallest element of the array is to be found along with its index pos . then, swap $A[0]$ and $A[pos]$. Thus $A[0]$ is sorted, we now have $n-1$ elements which are to be sorted.
- In 2nd pas, position pos of the smallest element present in the sub-array $A[n-1]$ is found. Then, swap, $A[1]$ and $A[pos]$. Thus $A[0]$ and $A[1]$ are sorted, we now left with $n-2$ unsorted elements.
- In $n-1$ th pass, position pos of the smaller element between $A[n-1]$ and $A[n-2]$ is to be found. Then, swap, $A[pos]$ and $A[n-1]$.

Therefore, by following the above explained process, the elements $A[0]$, $A[1]$, $A[2]$, ... , $A[n-1]$ are sorted.

Example: Consider the following array with 6 elements. Sort the elements of the array by using selection sort.

$A = \{10, 2, 3, 90, 43, 56\}$.

Pass	Pos	A[0]	A[1]	A[2]	A[3]	A[4]	A[5]
1	1	2	10	3	90	43	56
2	2	2	3	10	90	43	56
3	3	2	3	10	90	43	56
4	4	2	3	10	43	90	56
5	5	2	3	10	43	56	90

Sorted $A = \{2, 3, 10, 43, 56, 90\}$

Complexity

Complexity	Best Case	Average Case	Worst Case
Time	$\Omega(n)$	$\theta(n^2)$	$o(n^2)$
Space			$o(1)$

Algorithm

SELECTION SORT (ARR, N)

Step 1: Repeat Steps 2 and 3 for K = 1 to N-1

Step 2: CALL SMALLEST(A, K, N, POS)

Step 3: SWAP A[K] with
A[POS] [END OF LOOP]

Step 4: EXIT

BUBBLE SORT

Bubble Sort: This sorting technique is also known as exchange sort, which arranges values by iterating over the list several times and in each iteration the larger value gets bubble up to the end of the list. This algorithm uses multiple passes and in each pass the first and second data items are compared. If the first data item is bigger than the second, then the two items are swapped. Next the items in second and third position are compared and if the first one is larger than the second, then they are swapped, otherwise no change in their order. This process continues for each successive pair of data items until all items are sorted.

Bubble Sort Algorithm:

Step 1: Repeat Steps 2 and 3 for i=1 to 10

Step 2: Set j=1

Step 3: Repeat while j<=n

(A)

if a[i] < a[j] Then
interchange a[i] and a[j]
[End of if]

(B) Set j = j+1

[End of Inner Loop]

[End of Step 1 Outer Loop]

Step 4: Exit

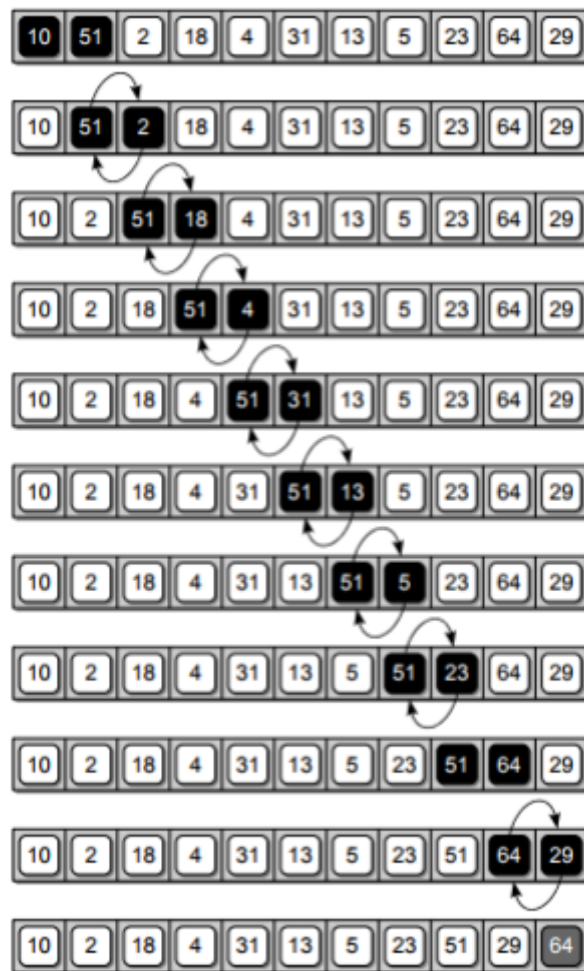

Various Passes of Bubble Sort

INSERTION SORT

Insertion sort is one of the best sorting techniques. It is twice as fast as Bubble sort. In Insertion sort the elements comparisons are as less as compared to bubble sort. In this comparison the value until all prior elements are less than the compared values is not found. This means that all the previous values are lesser than compared value. Insertion sort is good choice for small values and for nearly sorted values.

Working of Insertion sort:

The Insertion sort algorithm selects each element and inserts it at its proper position in a sub list sorted earlier. In a first pass the elements A_1 is compared with A_0 and if $A[1]$ and $A[0]$ are not sorted they are swapped.

In the second pass the element $A[2]$ is compared with $A[0]$ and $A[1]$. And it is inserted at its proper position in the sorted sub list containing the elements $A[0]$ and $A[1]$. Similarly doing i^{th} iteration the element $A[i]$ is placed at its proper position in the sorted sub list, containing the elements $A[0], A[1], A[2], \dots, A[i-1]$.

To understand the insertion sort consider the unsorted Array $A = \{7, 33, 20, 11, 6\}$.

The steps to sort the values stored in the array in ascending order using Insertion sort are given below:

7	33	20	11	6
---	----	----	----	---

Step 1: The first value i.e; 7 is trivially sorted by itself.

Step 2: the second value 33 is compared with the first value 7. Since 33 is greater than 7, so no changes are made.

Step 3: Next the third element 20 is compared with its previous element (towards left). Here 20 is less than 33. but 20 is greater than 7. So it is inserted at second position. For this 33 is shifted towards right and 20 is placed at its appropriate position.

7	33	20	11	6
---	----	----	----	---

7	20	33	11	6
---	----	----	----	---

Step 4: Then the fourth element 11 is compared with its previous elements. Since 11 is less than 33 and 20 ; and greater than 7. So it is placed in between 7 and 20. For this the elements 20 and 33 are shifted one position towards the right.

7	20	33	11	6
---	----	----	----	---

7	11	20	33	6
---	----	----	----	---

Step 5: Finally the last element 6 is compared with all the elements preceding it. Since it is smaller than all other elements, so they are shifted one position towards right and 6 is inserted at the first position in the array. After this pass, the Array is sorted.

7	11	20	33	6
---	----	----	----	---

6	7	11	20	33
---	---	----	----	----

Step 6: Finally the sorted Array is as follows:

6	7	11	20	33
---	---	----	----	----

ALGORITHM:

Insertion_sort(ARR,SIZE)

Step 1: Set i=1;

Step 2: while(i<SIZE)

 Set temp=ARR[i]

 J=i-1;

 While(Temp<=ARR[j] and j>=0)

 Set ARR[j+1]=ARR[j]

 Set j=j-1

 End While

 SET ARR(j+1)=Temp;

Print ARR after ith pass
 Set i=i+1
 End while

Step 3: print no.of passes i-1

Step 4: end

Advantages of Insertion Sort:

- It is simple sorting algorithm, in which the elements are sorted by considering one item at a time. The implementation is simple.
- It is efficient for smaller data set and for data set that has been substantially sorted before.
- It does not change the relative order of elements with equal keys
- It reduces unnecessary travels through the array
- It requires constant amount of extra memory space.

Disadvantages:-

- It is less efficient on list containing more number of elements.
- As the number of elements increases the performance of program would be slow

Complexity of Insertion Sort:

BEST CASE:-

Only one comparison is made in each pass.

The Time complexity is $O(n^2)$.

WORST CASE:- In the worst case i.e; if the list is arranged in descending order, the number of comparisons required by the insertion sort is given by:

$$1+2+3+\dots+(n-2)+(n-1) = \frac{n*(n-1)}{2};$$

$$= \frac{(n^2-n)}{2}.$$

The number of Comparisons are $O(n^2)$.

AVERAGE CASE:- In average case the number of comparisons is given by

$$\frac{1}{2} + \frac{2}{2} + \frac{3}{3} + \dots + \frac{(n-2)}{2} + \frac{(n-1)}{2} = \frac{n*(n-1)}{2*2} = \frac{(n^2-n)}{4} = O(n^2).$$

Program:

/* Program to implement insertion sort*/

```
#include<iostream.h>
#include<conio.h>
main()
{
int a[10],i,j,n,t;
clrscr();
cout<<"\n Enter number of elements to be Sort:";
cin>>n;
cout<<"\n Enter the elements to be Sorted:";
for(i=0;i<n;i++)
cin>>a[i];
for(i=0;i<n;i++)
{ t=a[i];
  J=i;
  while((j>0)&&(a[j-1]>t))
  { a[j]=a[j-1];
```

```

    J=j-1;
}
a[j]=t;
}
cout<<"Array after Insertion sort:";
for(i=0;i<n;i++)
cout<<"\n a[i]";
getch();
}

```

OUTPUT:

```

Enter number of elements to sot:5
Enter number of elements to sorted: 7    33    20    11    6
Array after Insertion sort: 6    7    11    20    33.

```

QUICK SORT

The Quick Sort algorithm follows the principal of divide and Conquer. It first picks up the partition element called 'Pivot', which divides the list into two sub lists such that all the elements in the left sub list are smaller than pivot and all the elements in the right sub list are greater than the pivot. The same process is applied on the left and right sub lists separately. This process is repeated recursively until each sub list containing more than one element.

Working of Quick Sort:

The main task in Quick Sort is to find the pivot that partitions the given list into two halves, so that the pivot is placed at its appropriate position in the array. The choice of pivot as a significant effect on the efficiency of Quick Sort algorithm. The simplest way is to choose the first element as the Pivot. However the first element is not good choice, especially if the given list is ordered or nearly ordered .For better efficiency the middle element can be chosen as Pivot.

Initially three elements Pivot, Beg and End are taken, such that both Pivot and Beg refers to 0th position and End refers to the (n-1)th position in the list. The first pass terminates when Pivot, Beg and End all refers to the same array element. This indicates that the Pivot element is placed at its final position. The elements to the left of Pivot are smaller than this element and the elements to it right are greater.

To understand the Quick Sort algorithm, consider an unsorted array as follows. The steps to sort the values stored in the array in the ascending order using Quick Sort are given below.

8	33	6	21	4
---	----	---	----	---

Step 1: Initially the index '0' in the list is chosen as Pivot and the index variable Beg and End are initiated with index '0' and (n-1) respectively.

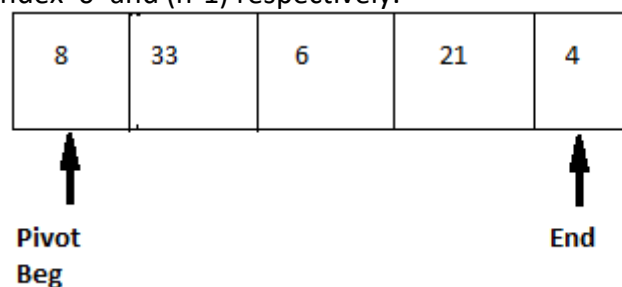

Step 7: $A[\text{Pivot}] > A[\text{End}]$ so they are swapped.

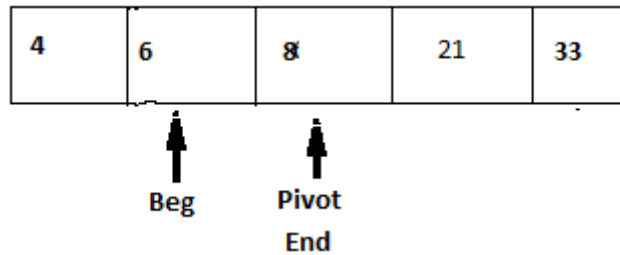

Step 8: Now the list is scanned from left to right. Since $A[\text{Pivot}] > A[\text{Beg}]$, value of Beg is increased by one and the list remains unchanged.

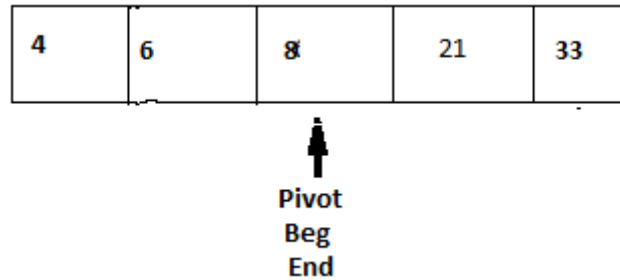

At this point the variable Pivot, Beg, End all refers to same element, the first pass is terminated and the value 8 is placed at its appropriate position. The elements to its left are smaller than 8 and the elements to its right are greater than 8. The same process is applied on left and right sub lists.

ALGORITHM

Step 1: Select first element of array as Pivot

Step 2: Initialize i and j to Beg and End elements respectively

Step 3: Increment i until $A[i] > \text{Pivot}$.

Stop

Step 4: Decrement j until $A[j] > \text{Pivot}$

Stop

Step 5: if $i < j$ interchange $A[i]$ with $A[j]$.

Step 6: Repeat steps 3,4,5 until $i > j$ i.e: i crossed j.

Step 7: Exchange the Pivot element with element placed at j, which is correct place for Pivot.

Advantages of Quick Sort:

- This is fastest sorting technique among all.
- Its efficiency is also relatively good.
- It requires small amount of memory

Disadvantages:

- It is somewhat complex method for sorting.
- It is little hard to implement than other sorting methods
- It does not perform well in the case of small group of elements.

Complexities of Quick Sort:

Average Case: The running time complexity is $O(n \log n)$.

Worst Case : Input array is not evenly divided. So the running time complexity is $O(n^2)$.

Best Case: Input array is evenly divided. So the running time complexity is $O(n \log n)$.

MERGE SORT

The Merge Sort algorithm is based on the fact that it is easier and faster to sort two smaller arrays than one large array. It follows the principle of "Divide and Conquered". In this sorting the list is first divided into two halves. The left and right sub lists obtained are recursively divided into two sub lists until each sub list contains not more than one element. The sub list containing only one element do not require any sorting. After that merge the two sorted sub lists to form a combined list and recursively applies the merging process till the sorted array is achieved.

Let us apply the Merge Sort to sort the following list:

13	42	36	20	63	23	12
----	----	----	----	----	----	----

Step 1: First divide the combined list into two sub lists as follows.

13	42	36	20	63	23	12
----	----	----	----	----	----	----

Step 2: Now Divide the left sub list into smaller sub list

13	42	36	20
----	----	----	----

Step 3: Similarly divide the sub lists till one element is left in the sub list.

13	42	36	20
----	----	----	----

Step 4: Next sort the elements in their appropriate positions and then combined the sub lists.

13	42	20	36
----	----	----	----

Step 5: Now these two sub lists are again merged to give the following sorted sub list of size 4.

13	20	36	42
----	----	----	----

Step 6: After sorting the left half of the array, containing the same process for the right sub list also. Then the sorted array of right half of the list is as follows.

12	23	63
----	----	----

Step 7: Finally the left and right halves of the array are merged to give the sorted array as follows.

12	13	20	23	36	42	63
----	----	----	----	----	----	----

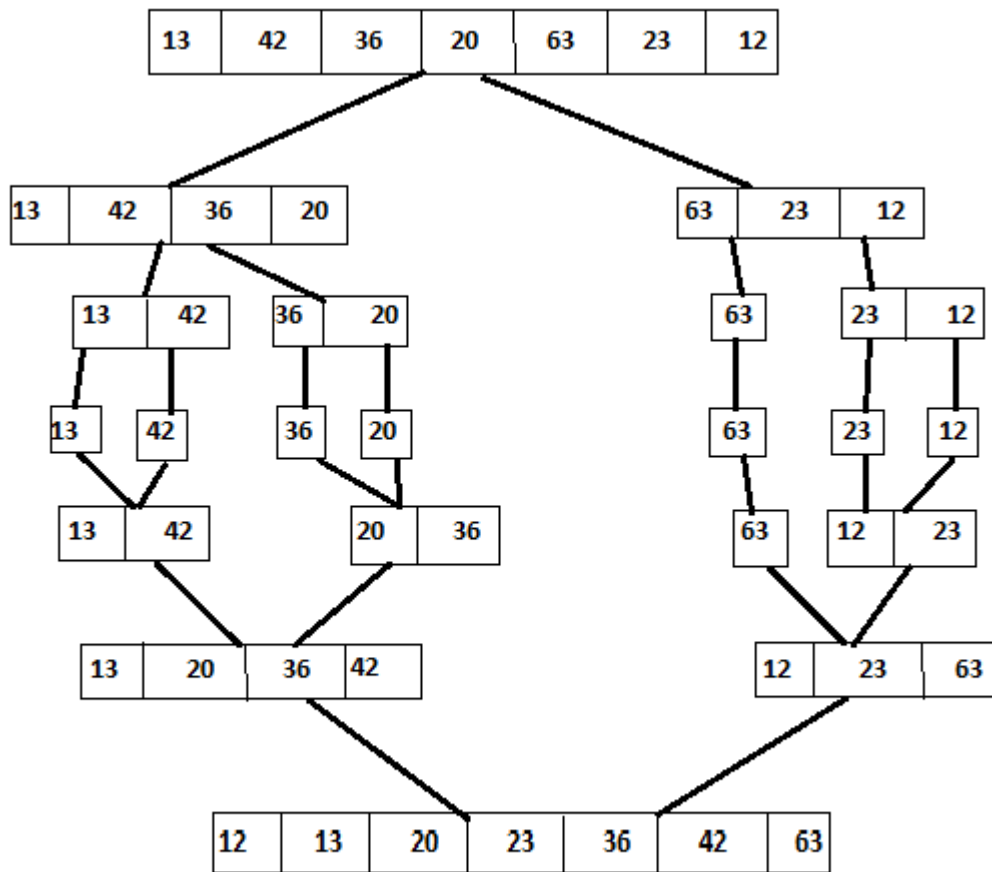

Merge Sort

Advantages:

- Merge sort is stable sort
- It is easy to understand
- It gives better performance.

Disadvantages:

- It requires extra memory space
- Copy of elements to temporary array
- It requires additional array
- It is slow process.

Complexity of Merge Sort: The merge sort algorithm passes over the entire list and requires at most $\log n$ passes and merges n elements in each pass. The total number of comparisons required by the merge sort is given by $O(n \log n)$.

External searching: When the records are stored in disk, tape, any secondary storage then that searching is known as 'External Searching'.

Internal Searching: When the records are to be searched or stored entirely within the computer memory then it is known as 'Internal Searching'.

LINEAR SEARCH

The Linear search or Sequential Search is most simple searching method. It does not expect the list to be sorted. The Key which to be searched is compared with each element of the list one by one. If a match exists, the search is terminated. If the end of the list is reached, it means that the search has failed and the Key has no matching element in the list.

Ex: consider the following Array A

23 15 18 17 42 96 103

Now let us search for 17 by Linear search. The searching starts from the first position.

Since $A[0] \neq 17$.

The search proceeds to the next position i.e; second position $A[1] \neq 17$.

The above process continuous until the search element is found such as $A[3]=17$.

Here the searching element is found in the position 4.

Algorithm: LINEAR(DATA, N, ITEM, LOC)

Here DATA is a linear Array with N elements. And ITEM is a given item of information. This algorithm finds the location LOC of an ITEM in DATA. $LOC=-1$ if the search is unsuccessful.

Step 1: Set $DATA[N+1]=ITEM$

Step 2: Set $LOC=1$

Step 3: Repeat while ($DATA [LOC] \neq ITEM$)

Set $LOC=LOC+1$

Step 4: if $LOC=N+1$ then

Set $LOC= -1$.

Step 5: Exit

Advantages:

- It is simplest known technique.
- The elements in the list can be in any order.

Disadvantages:

This method is in efficient when large numbers of elements are present in list because time taken for searching is more.

Complexity of Linear Search: The worst and average case complexity of Linear search is $O(n)$, where 'n' is the total number of elements present in the list.

BINARY SEARCH

Suppose DATA is an array which is stored in increasing order then there is an extremely efficient searching algorithm called "Binary Search". Binary Search can be used to find the location of the given ITEM of information in DATA.

Working of Binary Search Algorithm:

During each stage of algorithm search for ITEM is reduced to a segment of elements of $DATA[BEG], DATA[BEG+1], DATA[BEG+2], \dots, DATA[END]$.

Here BEG and END denotes beginning and ending locations of the segment under considerations. The algorithm compares ITEM with middle element $DATA[MID]$ of a segment, where $MID=[BEG+END]/2$. If $DATA[MID]=ITEM$ then the search is successful. and we said that $LOC=MID$. Otherwise a new segment of data is obtained as follows:

- i. If $ITEM < DATA[MID]$ then item can appear only in the left half of the segment.
 $DATA[BEG], DATA[BEG+1], DATA[BEG+2]$
So we reset $END=MID-1$. And begin the search again.

- ii. If $ITEM > DATA[MID]$ then ITEM can appear only in right half of the segment i.e. $DATA[MID+1], DATA[MID+2], \dots, DATA[END]$.

So we reset $BEG = MID + 1$. And begin the search again.

Initially we begin with the entire array DATA i.e. we begin with $BEG = 1$ and $END = n$

Or

$BEG = lb$ (Lower Bound)

$END = ub$ (Upper Bound)

If ITEM is not in DATA then eventually we obtained $END < BEG$. This condition signals that the searching is Unsuccessful.

The precondition for using Binary Search is that the list must be sorted one.

Ex: consider a list of sorted elements stored in an Array A is

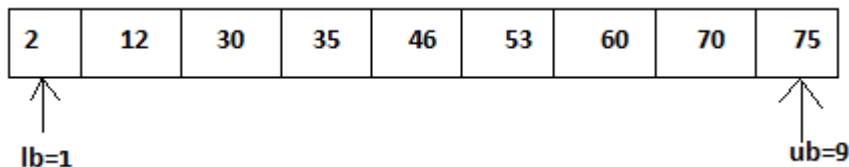

Let the key element which is to be searched is 35.

Key=35

The number of elements in the list $n=9$.

Step 1: $MID = \lfloor (lb+ub)/2 \rfloor$

$$= \lfloor (1+9)/2 \rfloor$$

$$= 5$$

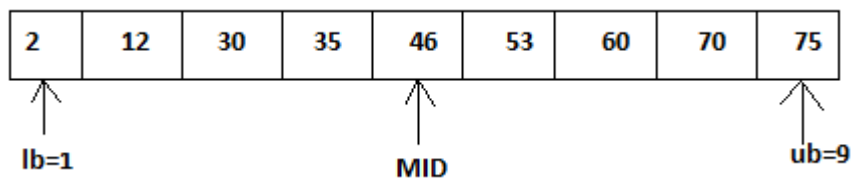

$Key < A[MID]$

i.e. $35 < 46$.

So search continues at lower half of the array.

$Ub = MID - 1$

$$= 5 - 1$$

$$= 4.$$

Step 2: $MID = \lfloor (lb+ub)/2 \rfloor$

$$= \lfloor (1+4)/2 \rfloor$$

$$= 2.$$

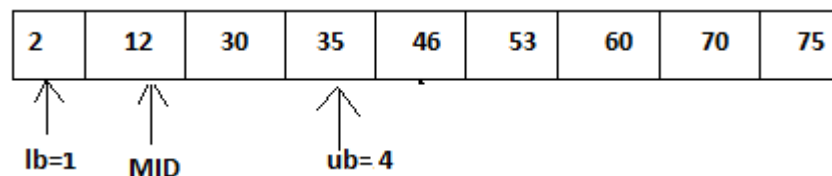

$Key > A[MID]$

i.e. $35 > 12$.

So search continues at Upper Half of the array.

$Lb = MID + 1$

$$= 2 + 1$$

$$= 3.$$

Step 3: $MID = \lfloor (lb+ub)/2 \rfloor$
 $= \lfloor (3+4)/2 \rfloor$
 $= 3.$

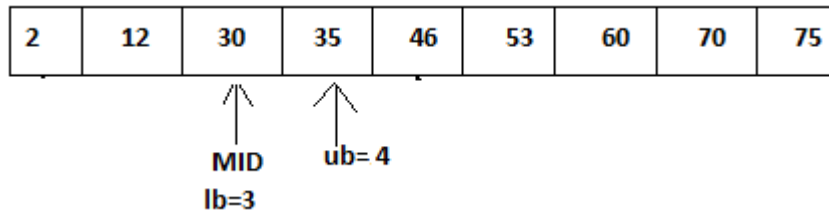

Key > A[MID]
i.e. 35 > 30.
So search continues at Upper Half of the array.
 $Lb = MID + 1$
 $= 3 + 1$
 $= 4.$

Step 4: $MID = \lfloor (lb+ub)/2 \rfloor$
 $= \lfloor (4+4)/2 \rfloor$
 $= 4.$

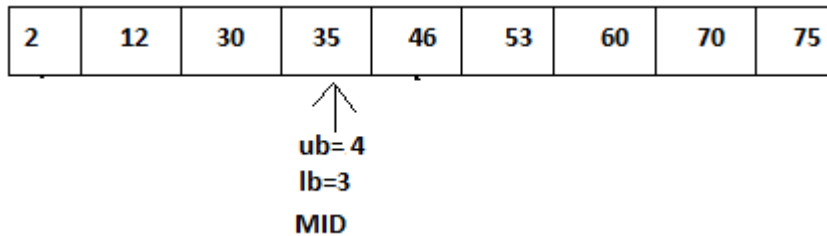

ALGORITHM:

BINARY SEARCH[A,N,KEY]

Step 1: begin

Step 2: [Initialization]

Lb=1; ub=n;

Step 3: [Search for the ITEM]

Repeat through step 4, while Lower bound is less than Upper Bound.

Step 4: [Obtain the index of middle value]

$MID = \lfloor (lb+ub)/2 \rfloor$

Step 5: [Compare to search for ITEM]

If Key < A[MID] then

Ub=MID-1

Other wise if Key > A[MID] then

Lb=MID+1

Otherwise write "Match Found"

Return Middle.

Step 6: [Unsuccessful Search]

write "Match Not Found"

Step 7: Stop.

Advantages: When the number of elements in the list is large, Binary Search executed faster than linear search. Hence this method is efficient when number of elements is large.

Disadvantages: To implement Binary Search method the elements in the list must be in sorted order, otherwise it fails.

Define sorting? What is the difference between internal and external sorting methods?

Ans:- Sorting is a technique of organizing data. It is a process of arranging the elements either may be ascending or descending order, ie; bringing some order lines with data.

Internal sorting	External sorting
1. Internal Sorting takes place in the main memory of a computer.	1. External sorting is done with additional external memory like magnetic tape or hard disk
2. The internal sorting methods are applied to small collection of data.	2. The External sorting methods are applied only when the number of data elements to be sorted is too large.
3. Internal sorting takes small input	3. External sorting can take as much as large input.
4. It means that, the entire collection of data to be sorted is small enough that the sorting can take place within main memory.	4. External sorting typically uses a sort-merge strategy, and requires auxiliary storage.
5. For sorting larger datasets, it may be necessary to hold only a chunk of data in memory at a time, since it won't all fit.	5. In the sorting phase, chunks of data small enough to fit in main memory are read, sorted, and written out to a temporary file.
6. Example of Internal Sorting algorithms are :- Bubble Sort, Internal Sort, Quick Sort, Heap Sort, Binary Sort, Radix Sort, Selection sort.	6. Example of External sorting algorithms are: - Merge Sort, Two-way merge sort.
7. Internal sorting does not make use of extra resources.	7. External sorting make use of extra resources.

Justify the fact that the efficiency of Quick sort is $O(n \log n)$ under best case?

Ans:- Best Case:-

The best case in quick sort arises when the pivot element divides the lists into two exactly equal sub lists. Accordingly

- i) Reducing the initial list places '1' element and produces two equal sub lists.
- ii) Reducing the two sub lists places '2' elements and produces four equal sub lists and so on.

Observe that the reduction step in the k^{th} level finds the location of $2^{(k-1)}$ elements, hence there will be approximately $\log n$ levels of reduction. Further, each level uses at most 'n' comparisons, So $f(n) = O(n \log n)$. Hence the efficiency of quick sort algorithm is $O(n \log n)$ under the best case.

Mathematical Proof:- Hence from the above, the recurrence relation for quick sort under best case is given by

$$T(n) = 2T(n/2) + kn$$

By using substitution method, we get

$$\begin{aligned} T(n) &= 2T(n/2) + Kn \\ &= 2\{2T(n/4) + k.n/2\} + kn \\ &= 4T(n/4) + 2kn \end{aligned}$$

·
·
·
In general

$$T(n) = 2^k T(n/2^k) + akn \text{ // after } k \text{ substitutions}$$

The above recurrence relation continues until $n=2^k$, $k=\log n$
By substituting the above values, we get

$$T(n) \text{ is } O(n \log n)$$

Quick sort, or partition-exchange sort, is a sorting algorithm that, on average, makes $O(n \log n)$ comparisons to sort n items. In the worst case, it makes $O(n^2)$ comparisons, though this behavior is rare. Quick sort is often faster in practice than other $O(n \log n)$ algorithms. Additionally, quick sort's sequential and localized memory references work well with a cache. Quick sort is a comparison sort and, in efficient implementations, is not a stable sort. Quick sort can be implemented with an in-place partitioning algorithm, so the entire sort can be done with only $O(\log n)$ additional space used by the stack during the recursion. Since each element ultimately ends up in the correct position, the algorithm correctly sorts. But how long does it take.

The best case for divide-and-conquer algorithms comes when we split the input as evenly as possible. Thus in the best case, each sub problem is of size $n/2$. The partition step on each sub problem is linear in its size. Thus the total effort in partitioning the 2^k problems of size $n/2^k$ is $O(n)$.

The recursion tree for the best case looks like this:

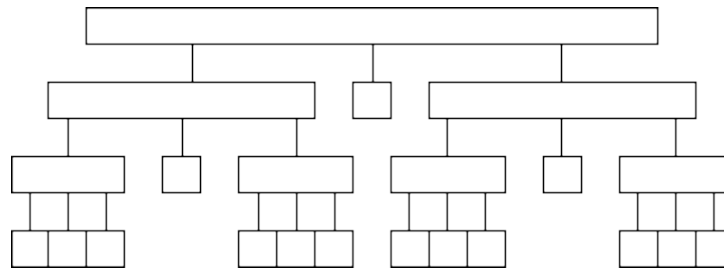

The total partitioning on each level is $O(n)$, and it takes $\log n$ levels of perfect partitions to get to single element sub problems. When we are down to single elements, the problems are sorted. Thus the total time in the best case is $O(n \log n)$.

UNIT-V TREES AND BINARY TREES

TREES

INTRODUCTION

In linear data structure data is organized in sequential order and in non-linear data structure data is organized in random order. A tree is a very popular non-linear data structure used in a wide range of applications. Tree is a non-linear data structure which organizes data in hierarchical structure and this is a recursive definition.

DEFINITION OF TREE:

Tree is collection of nodes (or) vertices and their edges (or) links. In tree data structure, every individual element is called as **Node**. Node in a tree data structure stores the actual data of that particular element and link to next element in hierarchical structure.

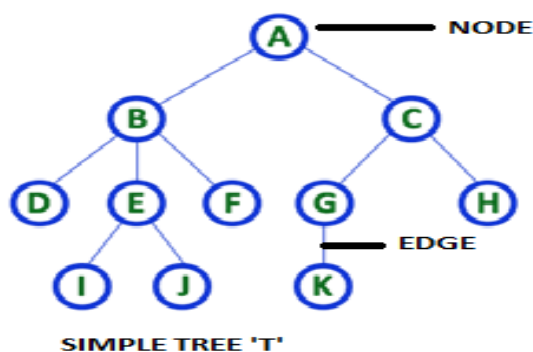

TREE with 11 nodes and 10 edges

- In any tree with '**N**' nodes there will be maximum of '**N-1**' edges
- In a tree every individual element is called as '**NODE**'

Note: 1. In a **Tree**, if we have **N** number of nodes then we can have a maximum of **N-1** number of links or edges.

2. **Tree** has no cycles.

TREE TERMINOLOGIES:

1. Root Node: In a **Tree** data structure, the first node is called as **Root Node**. Every tree must have a root node. We can say that the root node is the origin of the tree data structure. In any tree, there must be only one root node. We never have multiple root nodes in a tree.

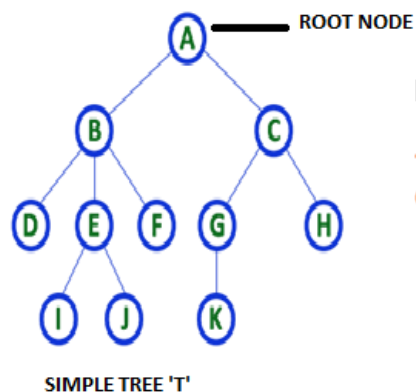

Here 'A' is the 'root' node

- In any tree the first node is called as **ROOT node**

2. Edge: In a **Tree**, the connecting link between any two nodes is called as **EDGE**. In a tree with '**N**' number of nodes there will be a maximum of '**N-1**' number of edges.

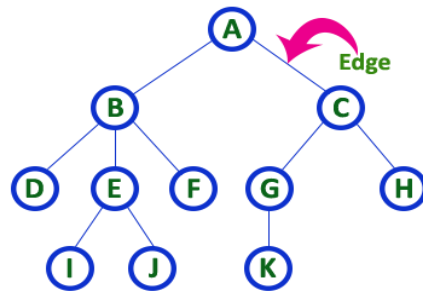

- In any tree, 'Edge' is a connecting link between two nodes.

3. Parent Node: In a **Tree**, the node which is a predecessor of any node is called as **PARENT NODE**. In simple words, the node which has a branch from it to any other node is called a parent node. Parent node can also be defined as "**The node which has child / children**".

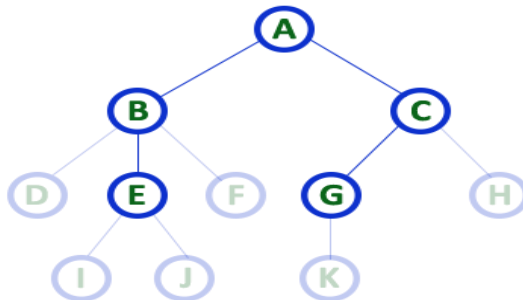

Here A, B, C, E & G are **Parent nodes**

- In any tree the node which has child / children is called '**Parent**'

- A node which is predecessor of any other node is called '**Parent**'

Here, A is parent of B&C. B is the parent of D,E&F and so on...

4. Child Node: In a **Tree** data structure, the node which is descendant of any node is called as **CHILD Node**. In simple words, the node which has a link from its parent node is called as child node. In a tree, any parent node can have any number of child nodes. In a tree, all the nodes except root are child nodes.

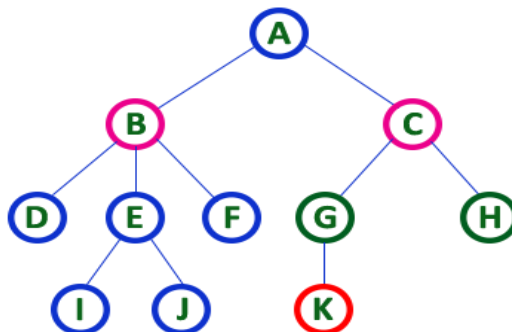

Here B & C are **Children of A**

Here G & H are **Children of C**

Here K is **Child of G**

- descendant of any node is called as **CHILD Node**

5. Siblings: In a **Tree** data structure, nodes which belong to same Parent are called as **SIBLINGS**. In simple words, the nodes with the same parent are called Sibling nodes.

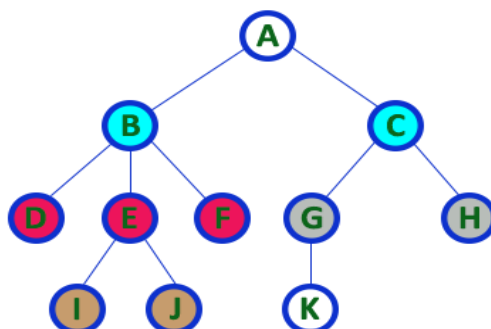

Here B & C are **Siblings**

Here D E & F are **Siblings**

Here G & H are **Siblings**

Here I & J are **Siblings**

- In any tree the nodes which has same Parent are called '**Siblings**'

- The children of a Parent are called '**Siblings**'

6. Leaf Node: In a **Tree** data structure, the node which does not have a child is called as LEAF Node. In simple words, a leaf is a node with no child. In a tree data structure, the leaf nodes are also called as External Nodes. External node is also a node with no child. In a tree, leaf node is also called as 'Terminal' node.

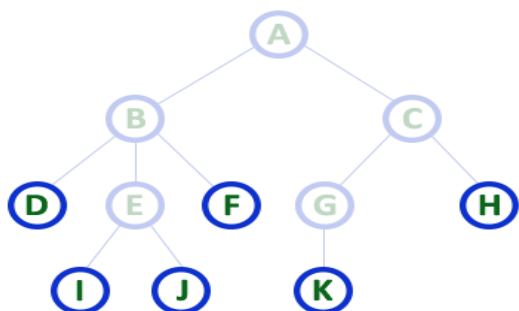

Here D, I, J, F, K & H are **Leaf nodes**

- In any tree the node which does not have children is called '**Leaf**'
- A node without successors is called a '**leaf**' node

7. Internal Nodes: In a **Tree** data structure, the node which has atleast one child is called as INTERNAL Node. In simple words, an internal node is a node with atleast one child.

In a **Tree** data structure, nodes other than leaf nodes are called as Internal Nodes. The root node is also said to be Internal Node if the tree has more than one node. Internal nodes are also called as 'Non-Terminal' nodes.

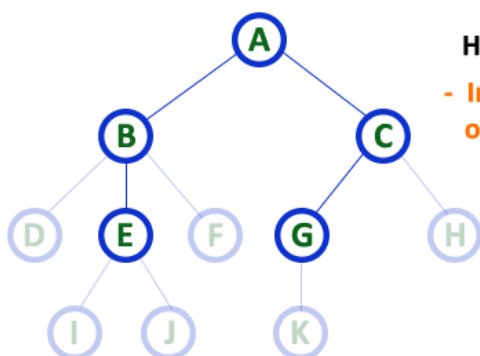

Here A, B, C, E & G are **Internal nodes**

- In any tree the node which has atleast one child is called '**Internal**' node
- Every non-leaf node is called as '**Internal**' node

8. Degree: In a **Tree** data structure, the total number of children of a node is called as **DEGREE** of that Node. In simple words, the Degree of a node is total number of children it has. The highest degree of a node among all the nodes in a tree is called as '**Degree of Tree**'

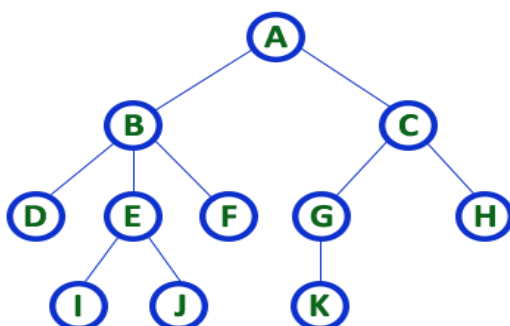

Here **Degree of B is 3**

Here **Degree of A is 2**

Here **Degree of F is 0**

- In any tree, '**Degree**' of a node is total number of children it has.

Degree of Tree is: 3

9. Level: In a **Tree** data structure, the root node is said to be at Level 0 and the children of root node are at Level 1 and the children of the nodes which are at Level 1 will be at Level 2

and so on... In simple words, in a tree each step from top to bottom is called as a Level and the Level count starts with '0' and incremented by one at each level (Step).

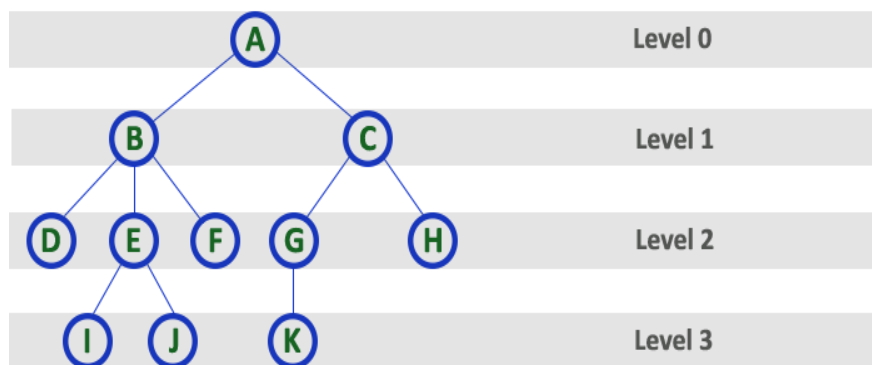

10. Height: In a **Tree** data structure, the total number of edges from leaf node to a particular node in the longest path is called as HEIGHT of that Node. In a tree, height of the root node is said to be height of the tree. In a tree, height of all leaf nodes is '0'.

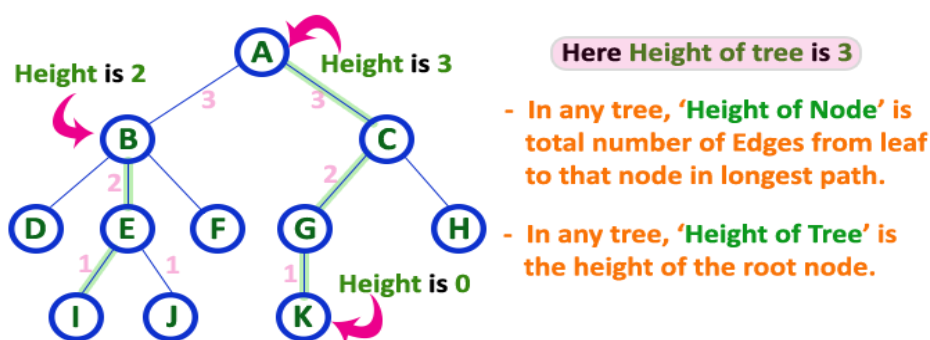

11. Depth: In a **Tree** data structure, the total number of edges from root node to a particular node is called as DEPTH of that Node. In a tree, the total number of edges from root node to a leaf node in the longest path is said to be **Depth of the tree**. In simple words, the highest depth of any leaf node in a tree is said to be depth of that tree. In a tree, **depth of the root node is '0'**.

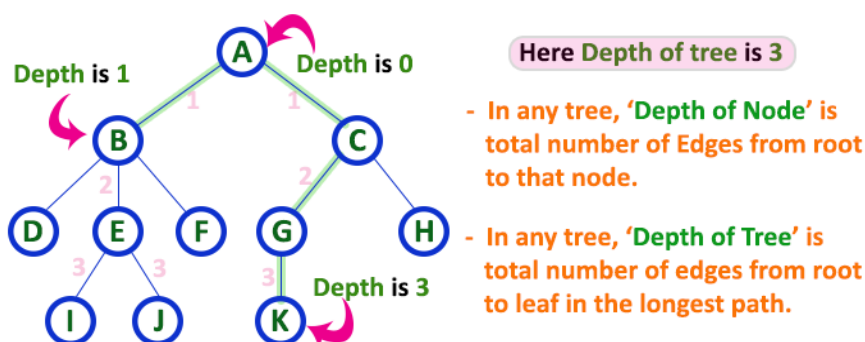

12. Path: In a **Tree** data structure, the sequence of Nodes and Edges from one node to another node is called as **PATH** between that two Nodes. **Length of a Path** is total number of nodes in that path. In below example **the path A - B - E - J has length 4**.

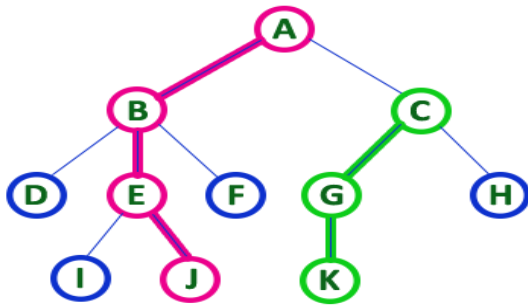

- In any tree, 'Path' is a sequence of nodes and edges between two nodes.

Here, 'Path' between A & J is

A - B - E - J

Here, 'Path' between C & K is

C - G - K

13. Sub Tree: In a Tree data structure, each child from a node forms a subtree recursively. Every child node will form a subtree on its parent node.

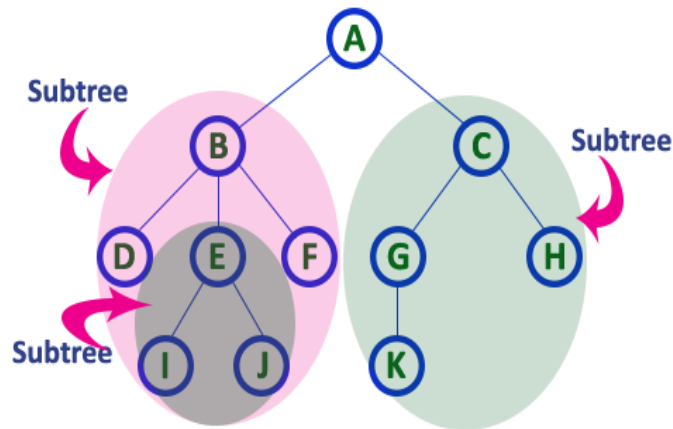

TREE REPRESENTATIONS:

A tree data structure can be represented in two methods. Those methods are as follows...

1. List Representation
2. Left Child - Right Sibling Representation

Consider the following tree...

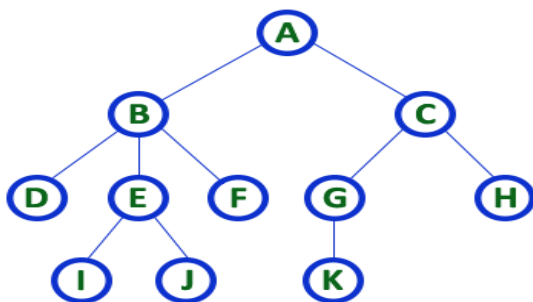

TREE with 11 nodes and 10 edges

- In any tree with 'N' nodes there will be maximum of 'N-1' edges

- In a tree every individual element is called as 'NODE'

1. List Representation

In this representation, we use two types of nodes one for representing the node with data called 'data node' and another for representing only references called 'reference node'. We start with a 'data node' from the root node in the tree. Then it is linked to an internal node

through a 'reference node' which is further linked to any other node directly. This process repeats for all the nodes in the tree.

The above example tree can be represented using List representation as follows...

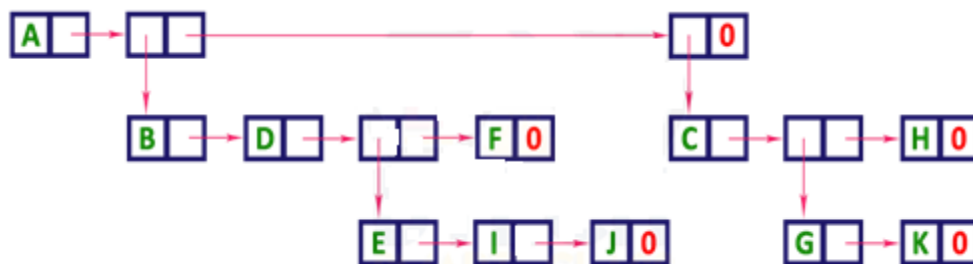

2. Left Child - Right Sibling Representation

In this representation, we use a list with one type of node which consists of three fields namely Data field, Left child reference field and Right sibling reference field. Data field stores the actual value of a node, left reference field stores the address of the left child and right reference field stores the address of the right sibling node. Graphical representation of that node is as follows...



In this representation, every node's data field stores the actual value of that node. If that node has left a child, then left reference field stores the address of that left child node otherwise stores NULL. If that node has the right sibling, then right reference field stores the address of right sibling node otherwise stores NULL.

The above example tree can be represented using Left Child - Right Sibling representation as follows...

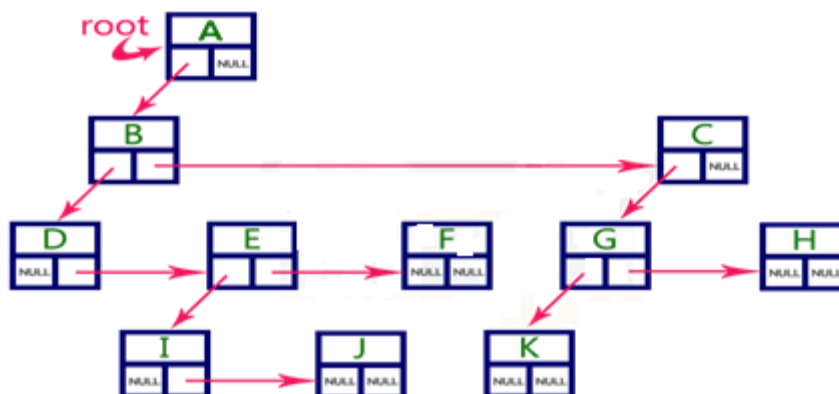

BINARY TREE:

In a normal tree, every node can have any number of children. A binary tree is a special type of tree data structure in which every node can have a **maximum of 2 children**. One is known as a left child and the other is known as right child.

A tree in which every node can have a maximum of two children is called Binary Tree.

In a binary tree, every node can have either 0 children or 1 child or 2 children but not more than 2 children.

In general, tree nodes can have any number of children. In a binary tree, each node can have at most two children. A binary tree is either empty or consists of a node called the root together with two binary trees called the left subtree and the right subtree. A tree with no nodes is called as a null tree

Example:

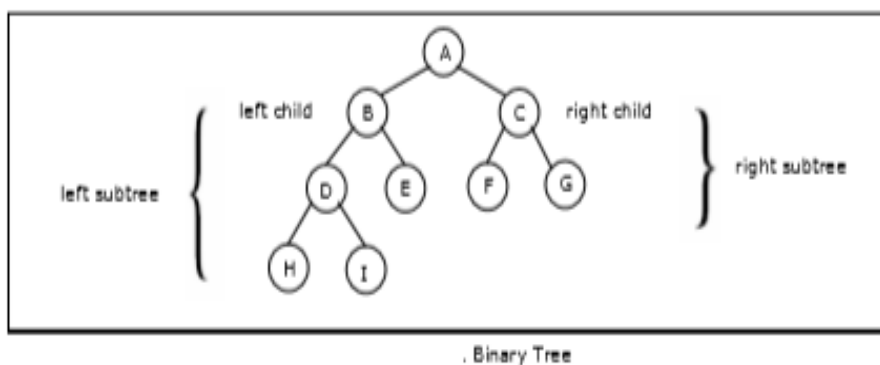

TYPES OF BINARY TREE:

1. Strictly Binary Tree:

In a binary tree, every node can have a maximum of two children. But in strictly binary tree, every node should have exactly two children or none. That means every internal node must have exactly two children. A strictly Binary Tree can be defined as follows...

A binary tree in which every node has either two or zero number of children is called Strictly Binary Tree

Strictly binary tree is also called as **Full Binary Tree** or **Proper Binary Tree** or **2-Tree**.

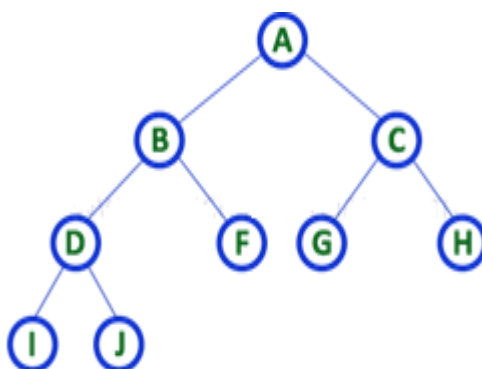

Strictly binary tree data structure is used to represent mathematical expressions.

Example

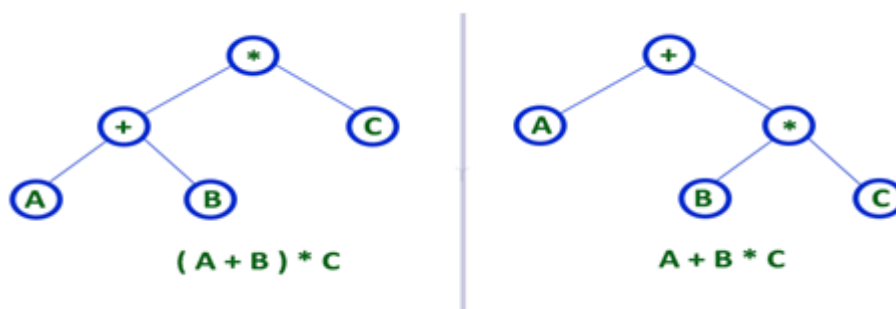

2. Complete Binary Tree:

In a binary tree, every node can have a maximum of two children. But in strictly binary tree, every node should have exactly two children or none and in complete binary tree all the nodes must have exactly two children and at every level of complete binary tree there must be 2^{level} number of nodes. For example at level 2 there must be $2^2 = 4$ nodes and at level 3 there must be $2^3 = 8$ nodes.

A binary tree in which every internal node has exactly two children and all leaf nodes are at same level is called Complete Binary Tree.

Complete binary tree is also called as **Perfect Binary Tree**.

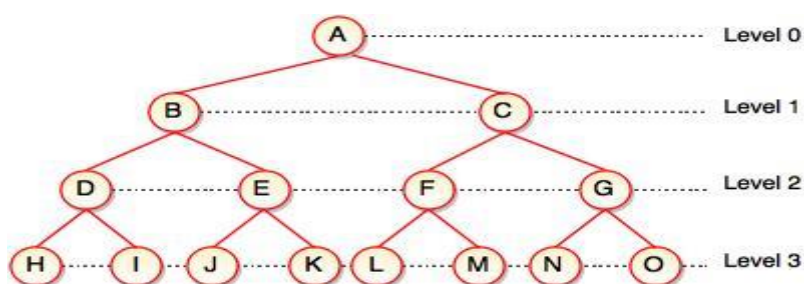
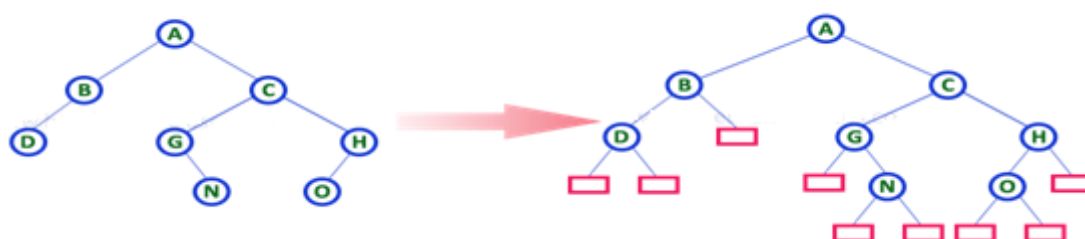

Fig. Complete Binary Tree

3. Extended Binary Tree:

A binary tree can be converted into Full Binary tree by adding dummy nodes to existing nodes wherever required.

The full binary tree obtained by adding dummy nodes to a binary tree is called as Extended Binary Tree.



In above figure, a normal binary tree is converted into full binary tree by adding dummy nodes.

4. Skewed Binary Tree:

If a tree which is dominated by left child node or right child node, is said to be a **Skewed Binary Tree**.

In a **skewed binary tree**, all nodes except one have only one child node. The remaining node has no child.

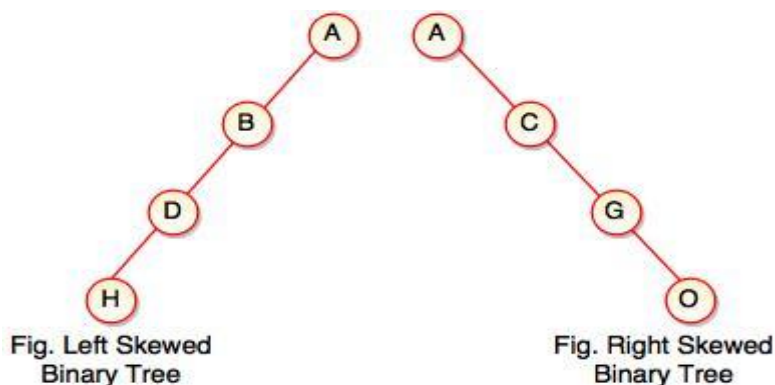

In a left skewed tree, most of the nodes have the left child without corresponding right child.

In a right skewed tree, most of the nodes have the right child without corresponding left child.

Properties of binary trees:

Some of the important properties of a binary tree are as follows:

1. If h = height of a binary tree, then
 - a. Maximum number of leaves = 2^h
 - b. Maximum number of nodes = $2^{h+1} - 1$
2. If a binary tree contains m nodes at level l , it contains at most $2m$ nodes at level $l + 1$.
3. Since a binary tree can contain at most one node at level 0 (the root), it can contain at most 2^l nodes at level l .
4. The total number of edges in a full binary tree with n nodes is $n - 1$.

BINARY TREE REPRESENTATIONS:

A binary tree data structure is represented using two methods. Those methods are as follows...

1. **Array Representation**
2. **Linked List Representation**

Consider the following binary tree...

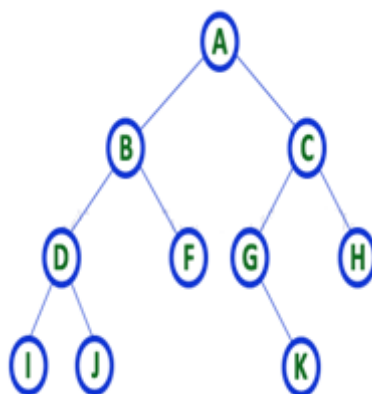

1. Array Representation of Binary Tree

In array representation of a binary tree, we use one-dimensional array (1-D Array) to represent a binary tree.

Consider the above example of a binary tree and it is represented as follows...



To represent a binary tree of depth 'n' using array representation, we need one dimensional array with a maximum size of 2^{n+1} .

2. Linked List Representation of Binary Tree

We use a double linked list to represent a binary tree. In a double linked list, every node consists of three fields. First field for storing left child address, second for storing actual data and third for the right child address.

In this linked list representation, a node has the following structure...



The above example of the binary tree represented using Linked list representation is shown as follows...

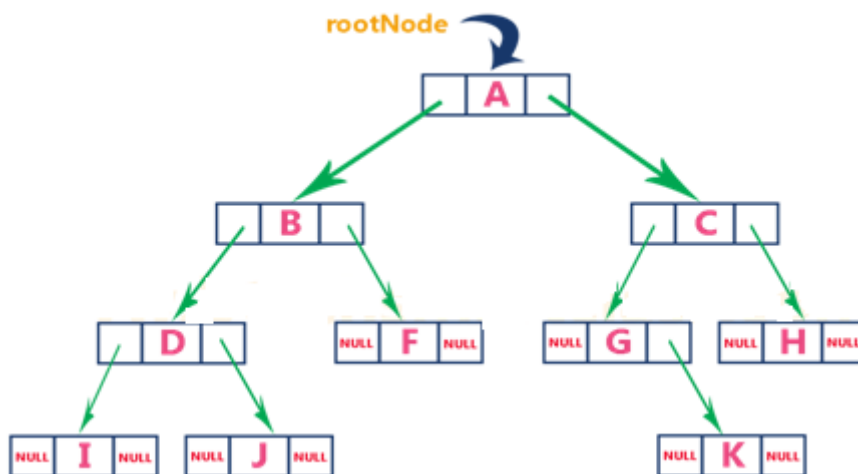

BINARY TREE TRAVERSALS:

Unlike linear data structures (Array, Linked List, Queues, Stacks, etc) which have only one logical way to traverse them, binary trees can be traversed in different ways. Following are the generally used ways for traversing binary trees.

When we wanted to display a binary tree, we need to follow some order in which all the nodes of that binary tree must be displayed. In any binary tree, displaying order of nodes depends on the traversal method.

Displaying (or) visiting order of nodes in a binary tree is called as Binary Tree Traversal.

There are three types of binary tree traversals.

1. In - Order Traversal
2. Pre - Order Traversal
3. Post - Order Traversal

1. In - Order Traversal (left Child - root - right Child):

In In-Order traversal, the root node is visited between the left child and right child. In this traversal, the left child node is visited first, then the root node is visited and later we go for visiting the right child node. This in-order traversal is applicable for every root node of all sub trees in the tree. This is performed recursively for all nodes in the tree.

Algorithm:

Step-1: Visit the left subtree, using inorder.

Step-2: Visit the root.

Step-3: Visit the right subtree, using inorder.

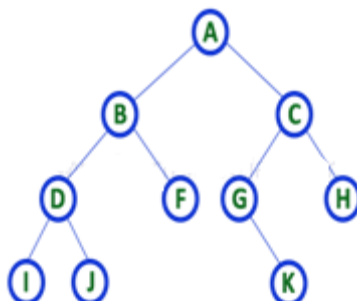

In the above example of a binary tree, first we try to visit left child of root node 'A', but A's left child 'B' is a root node for left subtree. so we try to visit its (B's) left child 'D' and again D is a root for subtree with nodes D, I and J. So we try to visit its left child 'I' and it is the leftmost child. So first we visit 'I' then go for its root node 'D' and later we visit D's right child 'J'. With this we have completed the left part of node B. Then visit 'B' and next B's right child 'F' is visited. With this we have completed left part of node A. Then visit root node 'A'. With this we have completed left and root parts of node A. Then we go for the right part of the node A. In right of A again there is a subtree with root C. So go for left child of C and again it is a subtree with root G. But G does not have left part so we visit 'G' and then visit G's right child K. With this we have completed the left part of node C. Then visit root node 'C' and next visit C's right child 'H' which is the rightmost child in the tree. So we stop the process.

That means here we have visited in the order of I - D - J - B - F - A - G - K - C - H using In-Order Traversal.

2. Pre - Order Traversal (root - leftChild - rightChild):

In Pre-Order traversal, the root node is visited before the left child and right child nodes. In this traversal, the root node is visited first, then its left child and later its right child. This pre-order traversal is applicable for every root node of all subtrees in the tree. Preorder search is also called backtracking.

Algorithm:

Step-1: Visit the root.

Step-2: Visit the left subtree, using preorder.

Step-3: Visit the right subtree, using preorder.

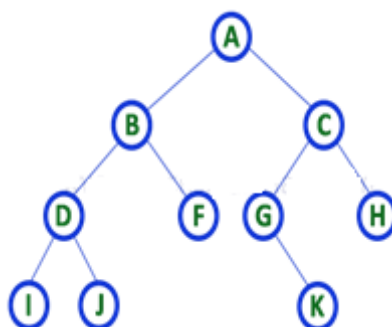

In the above example of binary tree, first we visit root node 'A' then visit its left child 'B' which is a root for D and F. So we visit B's left child 'D' and again D is a root for I and J. So we visit D's left child 'I' which is the leftmost child. So next we go for visiting D's right child 'J'. With this we have completed root, left and right parts of node D and root, left parts of node B. Next visit B's right child 'F'. With this we have completed root and left parts of node A. So we go for A's right child 'C' which is a root node for G and H. After visiting C, we go for its left child 'G' which is a root for node K. So next we visit left of G, but it does not have left child so we go for G's right child 'K'. With this, we have completed node C's root and left parts. Next visit C's right child 'H' which is the rightmost child in the tree. So we stop the process.

That means here we have visited in the order of **A-B-D-I-J-F-C-G-K-H** using Pre-Order Traversal.

3. Post - Order Traversal (leftChild - rightChild - root):

In Post-Order traversal, the root node is visited after left child and right child. In this traversal, left child node is visited first, then its right child and then its root node. This is recursively performed until the right most nodes are visited.

Algorithm:

Step-1: Visit the left subtree, using postorder.

Step-2: Visit the right subtree, using postorder

Step-3: Visit the root.

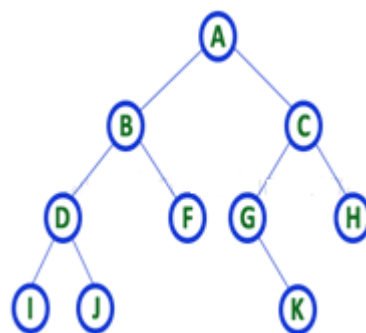

Here we have visited in the order of **I - J - D - F - B - K - G - H - C - A** using Post-Order Traversal.

Example 1:

Traverse the following binary tree in pre, post, inorder and level order.

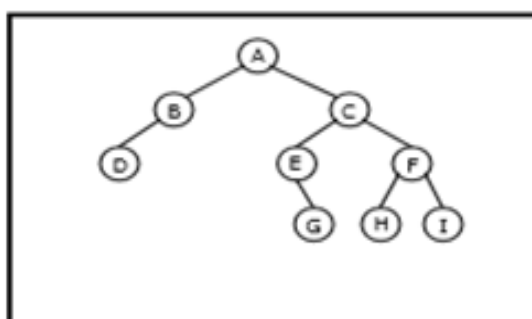

Binary Tree

- Preorder traversal yields:
A, B, D, C, E, G, F, H, I
- Postorder traversal yields:
D, B, G, E, H, I, F, C, A
- Inorder traversal yields:
D, B, A, E, G, C, H, F, I

Pre, Post, Inorder and level order Traversing

Example 2:

Traverse the following binary tree in pre, post, inorder and level order.

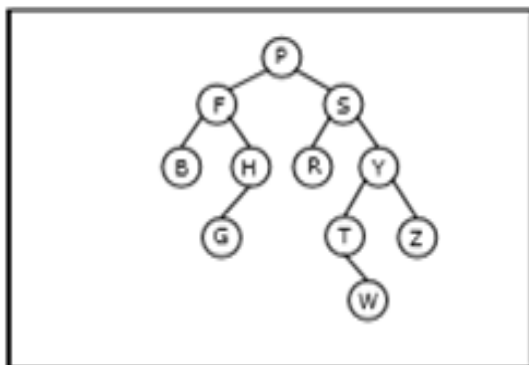

Binary Tree

- Preorder traversal yields:
P, F, B, H, G, S, R, Y, T, W, Z
- Postorder traversal yields:
B, G, H, F, R, W, T, Z, Y, S, P
- Inorder traversal yields:
B, F, G, H, P, R, S, T, W, Y, Z

Pre, Post, Inorder and level order Traversing

Example 3:

Traverse the following binary tree in pre, post, inorder and level order.

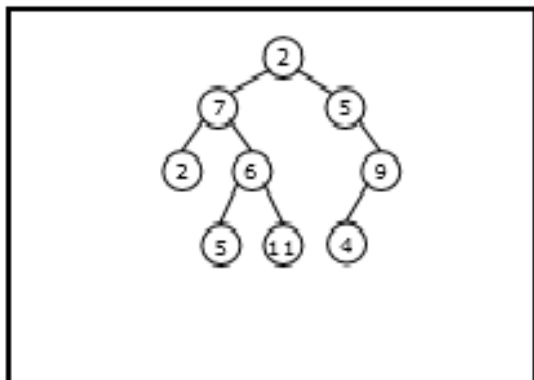

Binary Tree

- Preorder traversal yields:
2, 7, 2, 6, 5, 11, 5, 9, 4
- Postorder traversal yields:
2, 5, 11, 6, 7, 4, 9, 5, 2
- Inorder traversal yields:
2, 7, 5, 6, 11, 2, 5, 4, 9

Pre, Post, Inorder and level order Traversing

Example 4:

Traverse the following binary tree in pre, post, inorder and level order.

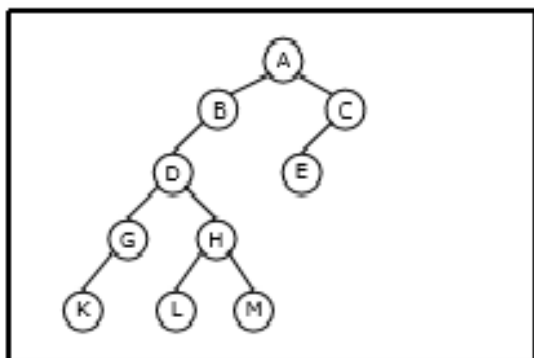

Binary Tree

- Preorder traversal yields:
A, B, D, G, K, H, L, M, C, E
- Postorder traversal yields:
K, G, L, M, H, D, B, E, C, A
- Inorder traversal yields:
K, G, D, L, H, M, B, A, E, C

Pre, Post, Inorder and level order Traversing

PROGRAMS ON DATA STRUCTURES

1. Write a C program to implement stack using arrays.
2. Write a C program to implement queue using arrays.
3. Write a C program implement the following Stack applications
 - a) infix into postfix
 - b) Evaluation of the postfix expression
4. Write a C program to implement the following types of queues
 - a) Priority queue
 - b) Circular queue
5. Write a C program to implement the Singly Linked List
6. Write a C program to implement the doubly Linked List
7. Write a C program to implement the following search algorithms.
 - i) Linear search
 - ii) Binary search
 - iii) Fibonacci search
8. Write a C program to implement the sorting algorithms.
9. Write a C program to implement binary tree using arrays and to perform binary traversals.
 - i) Inorder
 - ii) preorder
 - iii) post order
10. Write a C program to balance a given tree.

1: STACK USING ARRAYS

```
#include<stdio.h>
#include<conio.h>
#include<process.h>
int ch,max,item,top=-1,s[20]; void menu(void);
void push(int); int pop(void); void display(void); void main()
{
clrscr();
printf("ENTER STACK SIZE:"); scanf("%d",&max);
menu();
getch();
}
void menu()
{
printf("1.PUSH\n2.POP\n3.EXIT\n"); printf("ENTER YOUR CHOICE:");
fflush(stdin);
scanf("%d",&ch);
switch(ch)
{
case 1:printf("ENTER THE ELEMENT\n"); scanf("%d",&item);
push(item);
menu();
break;
case 2:item=pop(); menu();
break;
case 3:exit(0);
}
}
void push(int item)
{
if(top==max-1)
printf("STACK IS OVER FLOW\n"); else
{
top++;
s[top]=item;
}
display();
}
int pop()
{
if(top== -1)
{
printf("STACK IS UNDER FLOW\n"); return 0;
}
else
{
item=s[top]; top--;
}
display(); return item;
}
```

```

}
void display()
{
int i;
printf(" top -->");
for(i=top;i>=0;i--)
printf("%d\n\t",s[i]);
}

```

OUTPUT:

Enter stack size: 3

1. Push
2. Pop
3. Exit

Enter your choice:1

Enter the element: 3

Top: 3

1. Push
2. Pop
3. Exit

Enter your choice:1

Enter the element: 5

Top: 5

3

1. Push
2. Pop
3. Exit

Enter your choice:1

Enter the element: 9

Top: 9 5 3

1. Push
2. Pop
3. Exit

Enter your choice: 1

Enter the element: 15

Stack is overflow

Top: 9 5 3

1. Push
2. Pop
3. Exit

Enter your choice: 3

Popped element is: 9

Top: 5 3

1. Push
2. Pop
3. Exit

Enter your choice: 2

Popped element is: 5

Top: 3

1. Push

2. Pop

3. Exit

Enter your choice: 2 Stack is underflow

1. Push

2. Pop

3. Exit

Enter your choice: 3

2. QUEUE USING ARRAYS

```
#include<stdio.h>
#include<conio.h>
#include<stdlib.h> void insertion(void); void deletion(void); void display(void);
int q[10],n,i,f,r;
int f=0,r=0; void main()
{
int op;
clrscr();
printf("ENTER THE SIZE OF QUEUE:"); scanf("%d",&n);
while(1)
{
printf("\n1.INSERTION\n2.DELETION\n3.DISPLAY\n4.EXIT\n");
printf("ENTER YOUR OPTION:");
scanf("%d",&op);
switch(op)
{
case 1:insertion(); break;
case 2:deletion(); break;
case 3:display(); break; default:exit(0);
} } }
void insertion()
{
if(r>=n)
printf("QUEUE IS OVER FLOW"); else
{
r=r+1;
printf("\nENTER AN ELEMENT TO INSERT:"); scanf("%d",&q[r]);
if(f==0)
f=1;
} }
void deletion()
{
if(f==0)
printf("THE QUEUE IS EMPTY"); else
{
printf("THE DELETING ELEMENT IS:%5d",q[f]); f=f+1;
if(f>r)
f=0,r=0;
} } }
```

```

void display()
{
if(f==0)
printf("QUEUE IS EMPTY"); else
for(i=f;i<=r;i++)
printf("%5d",q[i]);
}

```

OUTPUT:

Enter the size of queue: 2

1. Insertion
2. Deletion
3. Display
4. Exit

Enter your option: 1

Enter an element to insert: q [1]:34

1. Insertion
2. Deletion
3. Display
4. Exit

Enter your option: 3 34

1. Insertion
2. Deletion
3. Display
4. Exit

Enter your option: 4

3: STACK APPLICATIONS

a) INFIX INTO POSTFIX

b) EVALUATION OF THE POSTFIX EXPRESSION

Program:(a)

```

#include<stdio.h>
#include<conio.h>
#define MAX 50
char stack[MAX];
int top=-1
void push(char); char pop();
int priority(char); void main()
{
char a[MAX],ch; int i;
clrscr();
printf("Enter an infix expression:\t"); gets(a);
printf("\the postfix expression for the given expression is:\t"); for(i=0;a[i]!='\0';i++)
{
ch=a[i];
if((ch>='a') && (ch<='z')) printf("%c",ch);
else if(ch=='(') push(ch); else if(ch=='')
{

```



```

while((ch=pop())!='(')
printf("%c",ch);
}
else
{
while(priority(stack[top])>priority(ch))
printf("%c",pop());
push(ch);
}
}
while(top>-1) printf("%c",pop());
printf("\n");
getch();
}
void push(char ch)
{
if(top==MAX-1)
{
printf("STACK OVERFLOW"); return;
}
else
{
top++;
stack[top]=ch; }
}
char pop()
{
int x; if(top== -1)
{
printf("STACK EMPTY");
}
else
{ x=stack[top]; top--; }
return x;
}
int priority(char ch)
{
switch(ch)
{
case '^': return 4; case '*':
case '/': return 3; case '+':
case '-': return 2; default : return 0;
} }

```

OUTPUT:

Enter an infix expression:

$((a + b ((b \wedge c - d))) * (e - (a / c)))$

The postfix expression for the given expression is:

$a b c \wedge d - + e a c / - *$

Program:(b)

```
#include<stdio.h>
#include<conio.h>
#include<math.h>
#include<ctype.h>
void push(char);
char pop(void);
char ex[50],s[50],op1,op2; int i,top=-1;
void main()
{
clrscr();
printf("Enter the expression:"); gets(ex); for(i=0;ex[i]!='\0';i++)
{
if(isdigit(ex[i])) push(ex[i]-48); else
{
op2=pop();
op1=pop();
switch(ex[i])
{
case '+':push(op1+op2);
break;
case '-':push(op1-op2);
break;
case '*':push(op1*op2);
break;
case '/':push(op1/op2);
break;
case '%':push(op1%op2);
break;
case '^':push(pow(op1,op2));
break;
} } }
printf("result is :%d",s[top]); getch();
}
void push(char a)
{ s[++top]=a; }
char pop()
{ return(s[top--]);
}
```

OUTPUT:

Enter the expression: 384 * 2 / +83----
Result is: 14

4: TYPES OF QUEUES

a).Priority queue

b).Circular queue

Program: (a)

```
#include<stdio.h>
#include<conio.h>
#include<malloc.h>
typedef struct node
{
    int priority;
    int info;
    struct node *link;
}n;
n *getnode()
{
    return ( (n *)malloc(sizeof(n)));
}
n *front=NULL,*temp=NULL,*ptr=NULL,*q=NULL;
void insertion();
void deletion();
void display();
void main()
{
    int ch;
    clrscr();
    printf("\tMenu\n1.Insertion\n2.Deletion\n3.Display\n4.exit");
    while(1)
    {
        printf("Enter your choice");
        scanf("%d",&ch);
        switch(ch)
        {
            case 1:insertion();
                break;
            case 2:deletion();
                break;
            case 3:display();
                break;
            case 4:exit();
            default : printf("\nInvalid choice ");
                break;
        }
    }
}
void insertion()
{ int item,item_prt;
  temp=getnode();
  printf("Enter item to insert ");
  scanf("%d",&item);
  printf("Enter item priority  ");
```

```

scanf("%d",&item_prty);
temp->priority=item_prty;
temp->info=item;
if(front==NULL || item_prty>front->priority)
{
temp->link=front;
front=temp;
}
else
{
q=front;
while (q->link!=NULL && q->link-> priority >=item_prty)
q=q->link;
temp->link=q->link;
q->link=temp;
}
}
void deletion()
{ if(front==NULL)
printf("Queue is underflow");
else
{
temp=front;
printf("Deleted item is %d\n",
temp->info);
front=front->link;
free(temp);
}
}
void display()
{
ptr=front;
if(front==NULL)
printf("Queue is underflow");
else
{
printf("Queue is :\n");
printf("priority item :\n");
while(ptr!=NULL)
{
printf("%5d %5d\n",ptr->priority,ptr->info);
ptr=ptr->link;
}
}
}
}

```

OUTPUT:

- 1 - Insert an element into queue
- 2 - Delete an element from queue
- 3 - Display queue elements
- 4 - Exit

Enter your choice: 1

Enter value to be inserted: 20

Enter your choice: 1

Enter value to be inserted: 45

Enter your choice: 1

Enter value to be inserted: 89

Enter your choice: 3

89 45 20

Enter your choice: 1

Enter value to be inserted: 56

Enter your choice: 3

89 56 45 20

Enter your choice: 2

Enter value to delete: 45

Enter your choice: 3

89 56 20

Enter your choice: 4

Program: (b)

```
#include<stdio.h>
#include<conio.h>
#define max 3
int q[max],rear=-1,front=-1;
void main()
{ int ch;
clrscr();
do
{ printf("\nqueue implementation\n");
printf("1.insert 2.delete 3.display 4.exit\n");
printf("enter your choice\n");
scanf("%d",&ch);
switch(ch)
{ case 1:insert(); break;
case 2:delete(); break;
case 3:display(); break;
case 4:exit(1);
default:printf("wrong choice\n"); break;
}
}while(ch<=4);
getch();
}
insert()
{ int item;
```

```

if(rear==max-1)
{ printf("queue overflow\n"); }
else
{ if(front==-1)
  front=0;
  printf("insert the element in queue:");
  scanf("%d",&item);
  rear++;
  q[rear]=item;
}
}
delete()
{ if(front==-1)
  { printf("queue underflow\n");
  }
  else
  { printf("element deleted from queue is:%d\n",q[front]);
    front++;
    if(front==max)
    front=rear=-1;
  }
}
display()
{ int i;
  if(front==-1)
  printf("queue is empty\n");
  else
  { printf("queue is :\n");
    for(i=front;;i++)
    { printf("%2d",q[i]);
      if(i==rear)
      return;
    } } }

```

OUTPUT:

```

1. Insert
2. Delete
3. Display
4. Exit
Enter your choice:1
Enter element to cqueue: 10
1. Insert
2. Delete
3. Display
4. Exit
Enter your choice: 1
Enter element to circular queue: 20
1. Insert
2. Delete

```

3. Display
 4. Exit
 Enter your choice: 2
 Deleted element from circular queue is: 10
 1. Insert
 2. Delete
 3. Display
 4. Exit
 Enter your choice: 3
 Elements from circular queue is: 20
 1. Insert
 2. Delete
 3. Display
 4. Exit
 Enter your choice: 4

5: SINGLY LINKED LIST

Program:

```
#include<stdio.h>
#include<conio.h>
#include<stdlib.h>
#include<alloc.h> struct node
{
int data;
struct node* link; };
typedef struct node* pnode; pnode head=NULL;
void menu(void); void insbeg(int); void delbeg(void); void insend(int); void delend(void);
void insafter(int,int); void delmid(int); void display(void); void main()
{
int ch,x,pos; clrscr(); while(1)
{
menu();
printf("enter ur choice\n"); scanf("%d",&ch);
switch(ch)
{
case 1: printf("enter element to insert\n");
scanf("%d",&x);
insbeg(x);
break;
case 2:delbeg();
break;

case 3: printf("enter element to insert\n");
scanf("%d",&x);
insend(x);
break;
case 4:delend();
break;
case 5: printf("enter element,pos to insert\n");
```

```

scanf("%d%d",&x,&pos);
insafter(x,pos);
break;
case 6:printf("enter position of element to delete\n"); scanf("%d",&pos);
delmid(pos);
break;
case 7:display();
break;
case 8:exit(0);
} } }
void menu()
{
printf("1.insbeg\n2.delbeg\n3.insend\n4.delend\n");
printf("5.insafter\n6.delmid\n7.display\n8.exit\n");
}
void insbeg(int x)
{
pnode ptr;
ptr=(pnode)malloc(sizeof(struct node));
ptr->data=x;
ptr->link=head; head=ptr;
}
void delbeg()
{
pnode tmp; int x;
if(head==NULL)
{
printf("list is empty\n"); return;
}
tmp=head;
head=tmp->link;
printf("deleted element is %d\n",tmp->data);
free(tmp);
}
void insend(int x)
{
pnode tmp,ptr;
ptr=(pnode)malloc(sizeof(struct node));
ptr->data=x;
ptr->link=NULL; if(head==NULL)
{
head=ptr;
}
else
{
tmp=head;
while(tmp->link!=NULL)
tmp=tmp->link;
tmp->link=ptr;
}
}

```



```

}
}
void delend()
{
pnodeprev=NULL,ptr=head;
int x; if(head==NULL)
{
printf("list is empty\n"); return;
}
while(ptr->link!=NULL)
{
prev=ptr; ptr=ptr->link;
}
if(prev==NULL)
head=NULL;
else
prev->link=NULL;
printf("deleted node:%d\n",ptr->data);
free(ptr);
}
void insafter(intx,intpos)
{
pnode tmp=head,ptr;
int i;
for(i=1;i<pos;i++)
{
tmp=tmp->link;
if(tmp==NULL)
{
printf("position out of range\n"); return;
}
}
ptr=(pnode)malloc(sizeof(struct node));
ptr->data=x;
ptr->link=tmp->link;
tmp->link=ptr;
}
void delmid(intpos)
{
pnodeprev=NULL,tmp=head;
int i;

if(head==NULL)
{
printf("list is empty\n"); return;
}
for(i=0;i<pos;i++)
{
prev=tmp; tmp=tmp->link;
if(tmp==NULL)
{ printf("position out of range\n"); return;

```

```

}
}

if(prev!=NULL)
    prev->link=tmp->link;
else
    head=tmp->link;
printf("deleted element: %d\n",tmp->data);
free(tmp);
}
void display()
{
    pnodeptr=head;
    while(ptr!=NULL)
    {
        printf("%d-->",ptr->data);
        ptr=ptr->link;
    }
    printf("\n");
    getch();
}

```

OUTPUT:

1. Ins beg
2. el beg
3. Ins end
4. Del end
5. Ins after
6. Del mid
7. Display
8. Exit
 - Enter your choice: 1
 - Enter element to insert: 94
1. Ins beg
2. Del beg
3. Ins end
4. Del end
5. Ins after
6. Del mid
7. Display
8. Exit
 - Enter your choice: 1
 - Enter element to insert: 90
1. Ins beg
2. Del beg
3. Ins end
4. Del ed
5. Ins after
6. Del mid
7. Display
8. Exit

Enter your choice 5
Enter element, Pos to insert

55 2

1. Ins beg
2. Del beg
3. Ins end
4. Del end
5. Ins after
6. Del mid
7. Display
8. Exit

Enter your choice 7 90->94->55->

1. Ins beg
2. Del beg
3. Ins end
4. Del end
5. Ins after
6. Del mid
7. Display
8. Exit

Enter your choice 8

6: DOUBLY LINKED LIST

Program:

```
#include<stdio.h>
#include<conio.h> struct node
{
struct node *prev; int data;
    struct node *nxt;
}
*head=NULL,*curr=NULL,*curr1=NULL,*p;

void insert(int pos)
{
int count=1,i; p=head;
while(p->nxt!=NULL)
{
count++; p=p->nxt;
}
p=head;
if(pos<=count+1)
{
curr=(struct node*)malloc(sizeof(struct node));
printf("Enter the node:");
scanf("%d",&curr->data);
curr->nxt=NULL;
curr->prev=NULL;
if(head==NULL)
```

```

{
head=curr; }
else if(pos==1)
{
head->prev=curr;
curr->nxt=head;
head=curr; }
else
{ for(i=1;i<(pos-1);i++) p=p->nxt;
curr->prev=p; curr->nxt=p->nxt;
p->nxt->prev=curr;
p->nxt=curr;
}
printf("\n%d inserted at pos:%d!\n",curr->data,pos);
}
else
printf("\nEnter a valid position!");

}
void deletenode(int data)
{
int found=0; curr=head; if(head->data == data)
{
(head->nxt)->prev=NULL; head=head->nxt;
printf("\n%d deleted!\n",curr->data);
free(curr);
}
else
{
curr=curr->nxt;
while(curr->nxt!=NULL)
{
if(curr->data==data)
{
found=1;
break;
}
else
curr=curr->nxt;
}
if(found==1 || curr->data==data)
{
curr1=curr->prev; curr1->nxt=curr->nxt; (curr->nxt)->prev=curr1; printf("\n%d
deleted!\n",curr->data); free(curr);
}
else
printf("\n%d is not present in the list!\n",data);
} }
void display()

```

```

{
curr=head;
if(head==NULL)
    printf("\nList is empty!\n"); else {
printf("\nList:\n"); while(curr->nxt!=NULL) {
printf("%d\t",curr->data); curr=curr->nxt;
}
printf("%d\n",curr->data);
}
}
void main()
{
intop,data;
clrscr();
printf("Creation of Doubly Linked List\n");
curr=(struct node*)malloc(sizeof(struct node));
curr->nxt=NULL;
curr->prev=NULL; printf("Enter the first node:"); scanf("%d",&curr->data); head=curr;
head->nxt=NULL; head->prev=NULL; do
{ printf("\nDOUBLY LINKED LIST OPERATIONS:\n1.Insert a node ");
printf("\n2.Delete a node\n3.Display\n4.Exit\n");
printf("\nSelect an operation:"); scanf("%d",&op);
switch(op)
{
case 1:
{ printf("Enter the position where you want to insert the node:"); scanf("%d",&data);
insert(data); break;
}
case 2:{
printf("Enter the node to be deleted:"); scanf("%d",&data);
deletenode(data); break; }

case 3:      {
display();
break; }
case 4:
break;
default:
printf("\nEnter a valid option!");
}
}while(op!=4);
getch();
}

```

OUTPUT:

Doubly linked list operations

1. Insert node
2. Delete node
3. Display

4. Exit
 - Select an operation: 1
 - Enter the position to insert node: 1 Enter the node: 59
 - 59 inserted at pos: 1
1. Insert node
2. Delete node
3. Display
4. Exit
 - Select an operation: 4

7: SEARCHING ALGORITHMS

- i) Linear search
- ii) Binary search
- iii) Fibonacci search

Program: (i) and (ii)

```
#include <stdio.h>
#include <conio.h>
# include <stdlib.h>
void main()
{
  Int a[10],n,flag=0,i,lb,ub,key,mid,ch;
  clrscr();
  printf("enter the size of the elements\n");
  scanf("%d",&n);
  printf("enter the elements\n");
  for(i=0;i<n;i++)
  scanf("%d",&a[i]);
  printf("enter any key element to search\n");
  scanf("%d",&key);
  printf("menu\n");
  printf("\n1.linear search\n2.binary search \n");
  printf("enter your choice:\n"); scanf("%d",&ch);
  switch(ch)
  { case 1:for(i=0;i<n;i++) if(a[i]==key)
  {
  flag=1;
  break;}
  case 2:for(lb=0,ub=n-1;lb<=ub;)
  {
  mid=(lb+ub)/2;
  if(key==a[mid])
  {
  flag=1;
  break;
  }
  else if(key<a[mid]) ub=mid-1;
  else lb=mid+1;
  }
  }
```

```

break;
default:exit(0);
}
if(flag==1)
printf("seach is successful");
else
printf("search is not successful \n");
getch();

}

```

OUTPUT:

```

Enter the size of the elements 5
Enter the elements 32 6 3 9 5
Enter any element to search 3
Menu

```

1. Linear search
2. Binary search Enter your choice: 2
Search is successful

Program:(iii)

```

#include<stdio.h>
void main()
{
int n,a[50],i,key,loc,p,q,r,m,fk;
clrscr();
printf("\nenter number elements to be entered");
scanf("%d",&n);
printf("enter elements");
for(i=1;i<=n;i++)
scanf("%d",&a[i]);
printf("enter the key element");
scanf("%d",&key);
fk=fib(n+1);
p=fib(fk);
q=fib(p);
r=fib(q);
m=(n+1)-(p+q);
if(key>a[p])
p=p+m;
loc=rfibsearch(a,n,p,q,r,key);
if(loc==0)
printf("key is not found");
else
printf("%d is found at location %d",key,loc);
getch();
}
int fib(int m)
{
int a,b,c;

```

```

a=0;
b=1;
c=a+b;
while(c<m)
{
a=b;
b=c;
c=a+b;
}
return b;
}
int rfibsearch(int a[],int n,int p,int q,int r,int key)
{
int t;
if(p<1 || p>n)
return 0;
else if(key==a[p])
return p;
else if(key<a[p])
{
if(r==0)
return 0;
else
{
p=p-r;
t=q;
q=r;
r=t-r;
return rfibsearch(a,n,p,q,r,key);
} }
else
{
if(q==1)
return 0;
else
{
p=p+r;
q=q-r;
r=r-q;
return rfibsearch(a,n,p,q,r,key);
} } }

```

OUTPUT:

Enter the number elements to be entered 8
Enter the elements 1 3 2 5 4 6 7 9
Enter the key element 9
8 is found at location 8

8: SORTING ALGORITHMS

Program: Bubble Sort

```
#include<stdio.h>
#include<conio.h>
#define TRUE 1
#define FALSE 0
void bubblesort(int x[],int n); void main()
{
intnum[10],i,n;
clrscr();
printf("Enter the no of elements\n"); scanf("%d",&n);
printf("Enter the elements\n"); for(i=0;i<n;i++) scanf("%d",&num[i]); bubblesort(num,n);
printf("sorted elements are\n"); for(i=0;i<n;i++) printf("%d\t",num[i]);
getch();}
void bubblesort(int x[],int n)
{
inthold,j,pass,K=TRUE;
for(pass=0;pass<n-1&&K==TRUE;pass++)
{
K=FALSE;
for(j=0;j<n-pass-1;j++) if(x[j]>x[j+1])
{
K=TRUE;
hold=x[j];
x[j]=x[j+1];
x[j+1]=hold;}}
```

OUTPUT:

```
Enter the no of elements 5
Enter the elements 36 23 59 68 2
Sorted elements are 2 23 36 59 68
```

Program: selection sort

```
#include<stdio.h>
#include<conio.h> void main()
{
intn,i,j,a[10],min,t;
clrscr();
printf("enter how many elements\n"); scanf("%d",&n);
printf("enter the elements\n"); for(i=0;i<n;i++) scanf("%d",&a[i]); for(i=0;i<n-1;i++)
{
min=i;
for(j=i+1;j<n;j++)
{
if(a[min]>a[j])
min=j;
}
t=a[i];
a[i]=a[min];
a[min]=t;
```

```

}
printf("the sorted elements are \n"); for(i=0;i<n;i++)
printf("%5d",a[i]);
getch();
}

```

OUTPUT:

Enter how many elements 5
Enter the elements 56 48 46 23 35
The sorted elements are 23 35 46 56 98

Program: insertion sort

```

#include<stdio.h>
#include<conio.h> void main()
{
intn,i,a[10],t,j;
clrscr();
printf("enter how many elements\n");
scanf("%d",&n);
printf("enter the elements\n");
for(i=0;i<n;i++)
scanf("%d",&a[i]);
for(i=1;i<n;i++)
{
for(j=i;j>0;j--)
{
if(a[j]<a[j-1])
{
t=a[j]; a[j]=a[j-1]; a[j-1]=t;
} } }
printf("the sorted elements are\n"); for(i=0;i<n;i++)
printf("%5d",a[i]);
getch();
}

```

OUTPUT:

Enter how many elements 5
Enter the elements 26 36 98 12 5
The sorted elements are 5 12 26 36 98

Program:Quick sort

```

#include<stdio.h>
#include<conio.h>
void quick(int a[10],intl,int n);
void main()
{
intn,i,a[10];
clrscr();
printf("enter how many elements \n"); scanf("%d",&n);
printf("enter the elements \n"); for(i=0;i<n;i++) scanf("%d",&a[i]); quick(a,0,n-1);
printf("the sorted elements are \n"); for(i=0;i<n;i++)

```

```

printf("%d \n",a[i]); getch();
}
void quick(int a[],intlb,intub)
{
inti,j,t,key;
if(lb>ub) return; i=lb;
j=ub;
key=lb;
while(i<j)
{
while(a[key]>a[i])
i++;
while(a[key]<a[j]) j--;
if(i<j)
{
t=a[i];
a[i]=a[j];
a[j]=t;
}
}
t=a[j];
a[j]=a[key];
a[key]=t;
quick(a,0,j-1);
quick(a,j+1,ub);
}

```

OUTPUT:

Enter how many elements 5
Enter the elements 65 23 89 68 71
The sorted elements are 23 65 68 71 89

program:heap sort

```

#include<conio.h>
void maxheap(int [],int,int);
void buildmaxheap(int a[],int n)
{
int i; for(i=n/2;i>=1;i--)
{
maxheap(a,i,n);
}
}
void maxheap(int a[],inti,int n)
{
intR,L,largest,t;
L=2*i;
R=2*i+1;
if((L<=n) && (a[L]>a[i])) largest=L;
else largest=i;
if((R<=n) && (a[i]>a[largest])) largest=R;

```

```

if(largest!=i)
{
t=a[i];
a[i]=a[largest];
a[largest]=t;
maxheap(a,largest,n);
}
}
void heapsort(int a[],int n)
{
inti,temp;
buildmaxheap(a,n);
for(i=n;i>=2;i--)
{
temp=a[1];
a[1]=a[i];
a[i]=temp; maxheap(a,1,i-1);
}
}
vod main()
{
int a[50],i,n; clrscr();
printf("Enter the size of array : "); scanf("%d",&n);
printf("Enter the elements of array \n"); for(i=1;i<=n;i++)
{
scanf("%d",&a[i]);
}
heapsort(a,n);
printf("sorted array is \n"); for(i=1;i<=n;i++)
{
printf("%d\t",a[i]);
}
getch();
}

```

OUTPUT:

```

Enter the size of array: 4
Enter the elements of array: 35 21 95 17
Sorted array is: 17 21 35 95

```

Program: merge sort

```

#include<stdio.h>
#include<conio.h>
void merge(int [],int ,int ,int );
void part(int [],int ,int );
int main()
{
intarr[30];
inti,size;
printf("\n\t----- Merge sorting method ----- \n\n");
printf("Enter total no. of elements : "); scanf("%d",&size);

```

```

for(i=0; i<size; i++)
{printf("Enter %d element : ",i+1);
  scanf("%d",&arr[i]);
}
part(arr,0,size-1);
printf("\n\t----- Merge sorted elements -----\\n\\n"); for(i=0; i<size; i++)

printf("%d ",arr[i]); getch();
return 0;
}
void part(intarr[],intmin,int max)
{
int mid; if(min<max)
{
mid=(min+max)/2;
part(arr,min,mid);

part(arr,mid+1,max);
merge(arr,min,mid,max);
}
}
void merge(intarr[],intmin,intmid,int max)
{
inttmp[30];
inti,j,k,m;
j=min;
m=mid+1;
for(i=min; j<=mid && m<=max ; i++)
{
if(arr[j]<=arr[m])
{
tmp[i]=arr[j];
j++;
}
else
{
tmp[i]=arr[m];
m++;
}
}
if(j>mid)
{
for(k=m; k<=max; k++)
{
tmp[i]=arr[k];
i++;
}
}
else

```

```

{
for(k=j; k<=mid; k++)
{
tmp[i]=arr[k];
i++;
}
}
for(k=min; k<=max; k++) arr[k]=tmp[k];
}

```

OUTPUT:

Merge sorting method
Enter total no of elements: 4
Enter 4 elements:
35
95
17
21
Merge sorted elements: 17 21 35 95

9.BINARY TREE TRAVERSALS

i) Preorder ii) Inorder iii) Postorder

Program:

```

#include<stdio.h>
#include<conio.h>
#include<malloc.h>
#include<stdlib.h> struct node
{
int data;
struct node *left; struct node *right; };
typedefstruct node *pnode; pnode root=NULL;
void insert(intval)
{
pnodep,q,t; t=(pnode)malloc(sizeof(struct node)); t->left=t->right=NULL;
t->data=val; if(root==NULL)
{
root=t;
return;
}
p=root;q=NULL;
while(p)
{
if(p->data==val)
{
return;
}
q=p;
if(val<p->data) p=p->left;
else if(val>p->data)
p=p->right;
}
}

```

```

}
if(val<q->data) q->left=t; if(val>q->data) q->right=t;
}
int search(int key)
{
pnode p=root;
while(p)
{
if(p->data==key) return 1;
else if(key<p->data) p=p->left;
else if(key>p->data) p=p->right;
}
return 0;
}
void inorder(pnode p)
{
if(p==NULL)
return; inorder(p->left); printf("%3d",p->data); inorder(p->right);
}
void preorder(pnode p)
{
if(p==NULL)
return;
printf("%3d",p->data);
preorder(p->left);
preorder(p->right);
}
void postorder(pnode p)
{
if(p==NULL)
return;
postorder(p->left);
postorder(p->right);
printf("%3d",p->data);
}
int main()
{
intch,x;
clrscr();
while(1)
{
printf("\n1.insertion");
printf("\n2.inorder");
printf("\n3.preorder");
printf("\n4.postorder");
printf("\n5.search");
printf("\n6.exit");
printf("\nenterur choice\n");
scanf("%d",&ch);
}
}

```

```

switch(ch)
{
case 1:printf("enter an elements\n"); scanf("%d",&x);
insert(x);
break;
case 2:inorder(root); break;
case 3:preorder(root); break;
case 4:postorder(root); break;
case 5:printf("enter key elements\n");
scanf("%d",&x);
if(search(x))
printf("found"); else
printf("not found"); break;
case 6:exit(0);
} } }

```

OUTPUT:

Tree traversal

Enter the number of terms to add 7 Enter the item 15

Enter the item 7 Enter the item 9 Enter the item 18 Enter the item 6 Enter the item 21 Enter the item 2

In order traversal 2 6 7 9 15 18 21

Pre order traversal 15 7 6 2 9 18 21

Post order traversal 2 6 9 7 21 18 15

10.BALANCE A TREE

Program:

```

#include <stdio.h>
#include <stdlib.h>
struct btnode
{
int value;
struct btnode *l;
struct btnode *r;
};

typedef struct btnode N;
N* bst(int arr[], int first, int last);
N* new(int val);
void display(N *temp);
int main()
{
int arr[] = {10, 20, 30, 40, 60, 80, 90};
N *root = (N*)malloc(sizeof(N));
int n = sizeof(arr) / sizeof(arr[0]), i;

printf("Given sorted array is\n");
for (i = 0; i < n; i++)

```



```

        printf("%d\t", arr[i]);
    root = bst(arr, 0, n - 1);
    printf("\n The preorder traversal of binary search tree is as follows\n");
    display(root);
    printf("\n");
    return 0;
}
N* new(int val)
{
    N* node = (N*)malloc(sizeof(N));

    node->value = val;
    node->l = NULL;
    node->r = NULL;
    return node;
}

N* bst(int arr[], int first, int last)
{
    int mid;
    N* temp = (N*)malloc(sizeof(N));
    if (first > last)
        return NULL;
    mid = (first + last) / 2;
    temp = new(arr[mid]);
    temp->l = bst(arr, first, mid - 1);
    temp->r = bst(arr, mid + 1, last);
    return temp;
}
void display(N *temp)
{
    printf("%d->", temp->value);
    if (temp->l != NULL)
        display(temp->l);
    if (temp->r != NULL)
        display(temp->r);
}

```

OUTPUT:

Given sorted array is

10 20 30 40 60 80 90

The preorder traversal of binary search tree is as follows

40->20->10->30->80->60->90