



**OPEN  
UNIVERSITY**

OF  
SRI LANKA

**FACULTY OF NATURAL SCIENCES**

**B.Sc. DEGREE PROGRAMME**

**LEVEL 3**

**PCU1160/PCU1161/PCU1162/  
PCU1163/PCU1164**

**ICT SKILLS**

< Experimental Copy >

**Department of Mathematics and Computer Science**

**FACULTY OF NATURAL SCIENCES**

**BACHELOR OF SCIENCE DEGREE**

**COMPUTER SCIENCE: LEVEL 03**

**PCU1160/PCU1161/PCU1162/PCU1163/PCU1164**

**ICT SKILLS**

**DEPARTMENT OF MATHEMATICS AND COMPUTER SCIENCE**

## Course Team

### Team Chair

Mr. W.P.C.D. De Silva

*B.Sc. (Colombo); M.Sc. (AIT)*

### Authors

Mrs. C.Y. Munasinghe

*B.Sc. (OUSL); M.Sc. (Colombo)*

### Content Editor

Mr. B. Hettige

*B. Sc. (USJP); M. Phil (MRT)*

### Facilitators

Mrs. A.M.K. Dewagiri

Mrs. G.D.W.M. Ariyaratna

Mrs. P. Senthilkumaran

Mr. W.M.C. Perera

The Open University of Sri Lanka

Nawala Nugegoda, Sri Lanka

Revised

First published

©[2013] Open University of Sri Lanka

All rights reserved. No part of this course book may be reproduced or transmitted in any form or by any means, electronic or mechanical, including photocopying and recording or from any information stored in a retrieval system, without permission in writing from the Open University of Sri Lanka.

## **Introduction to the course**

Welcome to the PCU1160/PCU1161/PCU1162/PCU1163/PCU1164: *ICT Skills*. This Level 3 course is one of the foundation courses offered by the Department of Mathematics & Computer Sciences. It is a 3 credits course which will require about 75 hours of study.

### **Course outline**

This course is designed for the students to improve their skills on ICT (Information and Communications Technology) enabling them to manage their tasks effectively and efficiently in their working environment. The knowledge of the office package, the Internet, e-mail, e-commerce, etc. is extensively covered in the curriculum considering the practical aspects as well. This course is similar to International Computer Driving Licence (ICDL) and prepares the students for the University Competency Test in Information Technology (UCTIT) conducted by the Ministry of Higher Education and Higher Education for Twenty-first Century (HETC) Project.

### **Structure of course**

This course consists of one book. And it contains Fundamentals of ICT, Working with Computers, Word Processing, Spreadsheet Management, Database Handling, Electronic Presentation, The Internet and Communication, Managing a Computer.

The Course material will be given with the Practical Guide and the Multimedia CD, and in order to get the best from this course be sure to use these three materials simultaneously. And also you will be supported from the Learner Management System (Moodle) in an interactive manner.

### **Teaching Strategies**

#### Day Schools

There will be six day schools during which you will be able to sort out any problems you may encounter. All the topics of this course will be covered within six day schools. In order to gain more from the day schools you are advised to work through the sessions (including all activities) before you come. The time table issued to you at the time of your registration will indicate the dates of these day schools.

### **Assessments**

You will have two closed book tests as means of continuous assessment of your progress in the course. 60% from the best mark and 40% from the next best mark will be taken to calculate the eligibility marks. Your scores will be used to determine your eligibility to sit for your final examination. Your performance on the course as a whole will be determined from your continuous assessment and final examination scores, according to the formula given in your course information sheet (more details on the course will be provided via the information sheet).

We hope that you will find the course material interesting and that you will enjoy your learning experience with the Department of Mathematics and Computer Science.

Good Luck!

# CONTENT

<b>TITLE</b>	<b>PAGE</b>
<b>SESSION 01</b>	
<b>INTRODUCTION TO ICT AND ICT SKILLS.....</b>	<b>1</b>
<b>1.1 Related terminology .....</b>	<b>1</b>
1.1.1 IT (Information Technology).....	1
1.1.2 ICT (Information and Communication Technology) .....	2
1.1.3 CS (Computer Science) .....	2
<b>1.2 Objectives of the course unit.....</b>	<b>3</b>
<b>1.3 What next in the course unit.....</b>	<b>4</b>
<b>1.4 Self Assessment Questions .....</b>	<b>4</b>
<b>SESSION 02</b>	
<b>INTRODUCTION TO COMPUTERS .....</b>	<b>5</b>
<b>2.1 What is a Computer? .....</b>	<b>5</b>
<b>2.2 Characteristics of a Computer .....</b>	<b>6</b>
2.2.1 Speed.....	6
2.2.2 Reliability.....	6
2.2.3 Accuracy .....	6
2.2.4 Diligence.....	6
2.2.5 Versatility .....	7
2.2.6 Power of remembering .....	7
2.2.7 No Feeling .....	7
2.2.8 No IQ .....	7
2.2.9 Storage .....	7
<b>2.3 Limitations of a Computer.....</b>	<b>7</b>
<b>2.4 Different Types of Computers .....</b>	<b>8</b>
<b>2.5 Different Types of Personal Computers (PCs) .....</b>	<b>9</b>
2.5.1 Desktop PCs.....	9
2.5.2 Laptop Computers.....	10
2.5.3 Netbook.....	10
2.5.4 PDAs .....	11
2.5.5 Wearable Computers .....	11
2.5.6 Tablets.....	11
<b>2.6 Main parts of a computer system .....</b>	<b>12</b>
2.6.1 Hardware.....	13
2.6.2 Software .....	13
2.6.3 Data .....	13
2.6.4 User/ Live ware .....	13
<b>2.7 Self Assessment Questions .....</b>	<b>13</b>
<b>SESSION 03</b>	
<b>COMPUTER HARDWARE.....</b>	<b>14</b>
<b>3.1 What is Computer Hardware? .....</b>	<b>14</b>

<b>3.2</b>	<b>Processing Devices .....</b>	<b>15</b>
3.2.1	The Central Processing Unit (CPU) .....	15
<b>3.3</b>	<b>Memory Devices.....</b>	<b>16</b>
3.3.1	Computer Memory.....	16
3.3.2	Random Access Memory (RAM) .....	16
3.3.3	Read Only Memory (ROM) .....	16
3.3.4	Cache.....	17
<b>3.4</b>	<b>Input Devices.....</b>	<b>17</b>
3.4.1	What is Input? .....	17
3.4.2	Data .....	18
3.4.3	Program.....	18
3.4.4	Command.....	18
3.4.5	User Response.....	18
3.4.6	Input Devices.....	18
3.4.7	Keyboard .....	19
3.4.8	Mouse .....	19
3.4.9	Scanner.....	20
3.4.10	Bar code reader .....	21
3.4.11	Optical Character Recognition .....	21
<b>3.5</b>	<b>Output Devices .....</b>	<b>22</b>
3.5.1	What is output?.....	22
3.5.2	Output Devices.....	23
3.5.3	Input & Output Devices.....	26
<b>3.6</b>	<b>Storage Devices .....</b>	<b>26</b>
3.6.1	Memory versus Storage .....	26
3.6.2	Storage .....	26
3.6.3	Storage Devices .....	27
<b>3.7</b>	<b>The System Unit.....</b>	<b>30</b>
<b>3.8</b>	<b>Motherboard.....</b>	<b>30</b>
<b>3.9</b>	<b>Power Supply Unit .....</b>	<b>32</b>
<b>3.10</b>	<b>CD-ROM Drive.....</b>	<b>33</b>
<b>3.11</b>	<b>Floppy Disk Drive .....</b>	<b>33</b>
<b>3.12</b>	<b>Card readers .....</b>	<b>33</b>
<b>3.13</b>	<b>Connecting Peripheral Devices to the Computer .....</b>	<b>34</b>
3.13.1	Ports in Your Computer .....	34
<b>3.14</b>	<b>Performance of a computer .....</b>	<b>38</b>
3.14.1	Factors affecting the Performance of computers.....	39
<b>3.15</b>	<b>Self Assessment Questions .....</b>	<b>41</b>

## **SESSION 04**

<b>COMPUTER SOFTWARE .....</b>	<b>42</b>	
<b>4.1</b>	<b>What is Software?.....</b>	<b>42</b>
<b>4.2</b>	<b>Categories of Software.....</b>	<b>42</b>
4.2.1	System Software .....	43
4.2.2	Utility Software .....	46
4.2.3	Library Programs .....	48
4.2.4	Programming Language Translators .....	48
<b>4.3</b>	<b>Application Software .....</b>	<b>49</b>
4.3.1	General Purpose Application Software .....	49

4.3.2	Special Purpose Application Software .....	50
4.3.3	Bespoke Application Software .....	50
<b>4.4</b>	<b>Self Assessment Questions .....</b>	<b>51</b>

## **SESSION 05**

<b>COMPUTER NETWORKS.....</b>	<b>52</b>
<b>5.1 What is a Computer Network? .....</b>	<b>52</b>
<b>5.2 Basic hardware and terminology in networks .....</b>	<b>53</b>
5.2.1 Node.....	53
5.2.2 Client .....	53
5.2.3 Server .....	53
5.2.4 Hub.....	54
5.2.5 IP Address.....	54
5.2.6 Network interface cards.....	54
5.2.7 Repeaters .....	54
5.2.8 Bridges.....	55
5.2.9 Switches .....	55
5.2.10 Routers .....	55
<b>5.3 Classifications of Computer Networks .....</b>	<b>55</b>
5.3.1 Classification of computer networks by scale.....	56
5.3.2 Classifications of networks based on the topology .....	58
<b>5.4 The Internet .....</b>	<b>60</b>
<b>5.5 The Intranet and Extranet.....</b>	<b>61</b>
5.5.1 The Intranet .....	61
5.5.2 The Extranet .....	62
<b>5.6 Self Assessment Questions .....</b>	<b>62</b>

## **SESSION 06**

<b>USAGE OF ICT&amp; ENVIRONMENT FOR COMPUTERS .....</b>	<b>63</b>
<b>6.1 Computers at work .....</b>	<b>63</b>
<b>6.2 Usage of ICT in different sectors .....</b>	<b>64</b>
6.2.1 Potential Sectors with ICT usage .....	64
6.2.2 ICT in Education.....	64
6.2.3 ICT in Business/Trade and Commerce.....	65
6.2.4 ICT in Banking.....	66
6.2.5 ICT in Medicine.....	67
<b>6.3 Health, Safety, and Environment for computers.....</b>	<b>68</b>
6.3.1 Work environment.....	68
6.3.2 Computer related health problems .....	69
6.3.3 Proper use of mouse, monitor, and key board .....	71
6.3.4 Reference postures .....	72
<b>6.4 Protecting environment .....</b>	<b>73</b>
6.4.1 Go paperless.....	73
6.4.2 No Screen Saver .....	73
6.4.3 Turn It Off.....	73
6.4.4 Use a Flash Drive .....	74
6.4.5 Fix Your Old Computer .....	74
<b>6.5 Self Assessment Questions .....</b>	<b>74</b>

## SESSION 07

<b>INFORMATION SECURITY AND LEGAL REGULATIONS .....</b>	<b>75</b>
<b>7.1 Introduction to Information Security .....</b>	<b>75</b>
7.1.1 Importance of Information Security.....	75
7.1.2 Possible attacks .....	76
7.1.3 Security measures .....	76
7.1.4 Forms of software threats.....	76
<b>7.2 Hardware Threats.....</b>	<b>79</b>
7.2.1 Power Faults.....	79
7.2.2 Age .....	80
7.2.3 Incompatibilities.....	80
7.2.4 Finger Faults .....	80
7.2.5 Malicious or Careless Damage .....	81
7.2.6 Data carriers .....	81
7.2.7 Magnetic Zaps .....	81
<b>7.3 Computer Related Privacy Issues.....</b>	<b>82</b>
7.3.1 Exposure in browsing Web.....	82
7.3.2 Information that reveals you .....	82
7.3.3 Limiting the information collection.....	82
7.3.4 Protecting your privacy .....	83
<b>7.4 Computer Related Legal Regulations in Sri Lanka .....</b>	<b>83</b>
7.4.1 ICT Policy formulation bodies in Sri Lanka .....	84
7.4.2 Copyright and related laws .....	85
7.4.3 Data Protection Law in Sri Lanka.....	85
<b>7.5 Self Assessment Questions .....</b>	<b>86</b>

## SESSION 8

<b>INTRODUCTION TO WINDOWS 7 .....</b>	<b>87</b>
<b>8.1 What is Windows 7? .....</b>	<b>87</b>
8.1.1 Versions of Windows 7.....	87
8.1.2 System requirements .....	88
<b>8.2 Installing Windows 7 into your PC.....</b>	<b>88</b>
<b>8.3 Basic Operations in Windows7 .....</b>	<b>89</b>
<b>8.4 Windows 7 Interface .....</b>	<b>90</b>
8.4.1 Desktop .....	90
8.4.2 Start menu .....	90
8.4.3 Task bar .....	91
8.4.4 Notification area .....	91
8.4.5 Task buttons.....	92
8.4.6 Desktop Icons .....	92
8.4.7 Shortcut Icons .....	92
8.4.8 Windows Gadgets .....	92
<b>8.5 Ending a Computing Session .....</b>	<b>93</b>
<b>8.6 Working with Windows Programs .....</b>	<b>94</b>
8.6.1 Start a Windows program .....	94
8.6.2 Using Windows Accessories .....	95
<b>8.7 Introduction to Windows 7 File System .....</b>	<b>96</b>
8.7.1 The File System in general.....	96



8.7.2	The File Hierarchy and File management .....	97
8.7.3	What is a library? .....	97
8.7.4	The System Root in Windows 7 .....	98
8.7.5	Personal Areas in Windows 7 .....	99
8.7.6	File naming conventions .....	99
<b>8.8</b>	<b>Storing and Managing Data .....</b>	<b>100</b>
8.8.1	Basic File/Folder Operations in Windows 7 .....	100
<b>8.9</b>	<b>Windows 7 User Accounts .....</b>	<b>106</b>
<b>8.10</b>	<b>The System Settings .....</b>	<b>107</b>
8.10.1	The Control Panel .....	107
8.10.2	The Control Panel in Category View .....	107
<b>8.11</b>	<b>Self Assessment Questions .....</b>	<b>108</b>

## SESSION 9

<b>WORKING WITH WINDOWS 7 .....</b>	<b>109</b>
<b>9.1 How to adjust your computer's settings .....</b>	<b>109</b>
9.1.1 System and Security .....	109
9.1.2 User Accounts and Family Safety .....	110
9.1.3 Network and Internet .....	111
9.1.4 Appearance and Personalization .....	111
9.1.5 Hardware and Sound.....	113
9.1.6 Clock, language, and Region .....	116
9.1.7 Programs .....	117
9.1.8 Ease of Access .....	118
<b>9.2 Preventive Maintenance of Your Computer .....</b>	<b>118</b>
9.2.1 What is Preventive Maintenance? .....	118
9.2.2 PM Procedures.....	119
9.2.3 Run a Virus scan .....	119
9.2.4 Recover lost clusters and Defragmentation.....	121
9.2.5 Cleanup a Disk.....	122
9.2.6 Install OS and software patches and update .....	123
<b>9.3 Self Assessment Questions .....</b>	<b>123</b>

## SESSION 10

<b>INTRODUCTION TO WORD PROCESSING AND MS OFFICE 2007 .....</b>	<b>124</b>
<b>10.1 What is Word Processing? .....</b>	<b>124</b>
10.1.1 Characteristics and features of Word processing software.....	125
<b>10.2 Existing word processing packages .....</b>	<b>125</b>
10.2.1 Open source word processors .....	125
10.2.2 Commercial software.....	128
10.2.3 Online word processors .....	128
<b>10.3 Improve your typing Skills .....</b>	<b>129</b>
10.3.1 Keyboard and its' layout .....	129
10.3.2 Working with Computer Keyboard .....	130
<b>10.4 Introduction to MS Office 2007 .....</b>	<b>131</b>
10.4.1 What is Microsoft Office? .....	131
10.4.2 History of Office Versions .....	132
10.4.3 Microsoft Office 2007 .....	132
10.4.4 System requirements for Office 2007.....	134

10.4.5	Programs Available in Office 2007 .....	134
<b>10.5</b>	<b>Self Assessment Questions .....</b>	<b>134</b>

## **SESSION 11**

<b>MICROSOFT WORD 2007 .....</b>	<b>135</b>
<b>11.1 Getting started with Microsoft Office Word 2007.....</b>	<b>135</b>
11.1.1 Start Microsoft Office Word 2007 .....	135
11.1.2 Create a new Word Document – Method 1.....	135
11.1.3 Create a new word document - Method 2 .....	136
<b>11.2 Getting familiarized with the MSWord 2007 user interface.....</b>	<b>137</b>
<b>11.3 Using MS Word Help .....</b>	<b>138</b>
<b>11.4 Some useful basic operations in MS Word .....</b>	<b>141</b>
11.4.1 Changing the typing modes .....	141
11.4.2 Show/ Hide non-printable characters.....	141
11.4.3 Save your word document.....	142
11.4.4 Close already opened word document and exit from Microsoft Word.....	142
11.4.5 Opening an existing MS Word document .....	142
11.4.6 Displaying different views of a document .....	143
11.4.7 Previewing and printing a document.....	143
11.4.8 Secure your document from others .....	145
11.4.9 Save your document in a different file format .....	146
11.4.10 Show/Hide ruler.....	146
11.4.11 Insert a page break .....	147
11.4.12 Insert date and time .....	147
<b>11.5 Self Assessment Questions.....</b>	<b>147</b>
<b>11.1 Write down two possible ways of starting MS Word. ....</b>	<b>147</b>

## **SESSION 12**

<b>EDITING , PROOFING, AND FORMATING TEXT WITH MS WORD 2007.....</b>	<b>148</b>
<b>12.1 Editing, Proofing, and Formatting text.....</b>	<b>148</b>
12.1.1 Editing your text in a document .....	148
12.1.2 Proofing your text.....	150
12.1.3 Formatting your text.....	152
<b>12.2 Format a Paragraph.....</b>	<b>156</b>
12.2.1 Align text.....	157
12.2.2 Set Line space between two line in a paragraph .....	157
12.2.3 Drop Cap .....	158
12.2.4 Create a bulleted list.....	159
12.2.5 Sorting a given list.....	159
12.2.6 Create a new numbered list.....	160
12.2.7 Column setting.....	160
<b>12.3 Page Formatting .....</b>	<b>161</b>
12.3.1 Format your documents using page setup window .....	161
12.3.2 Set Page Margins using page setup .....	162
12.3.3 Set Page Size using Page Setup .....	162
12.3.4 Set Page Layout by using Page Setup .....	163
12.3.5 Set page borders by using Page Setup.....	163
12.3.6 Insert Headers, Footers and Page Numbering.....	164
12.3.7 Insert a watermark .....	165

<b>12.4 Self Assessment Questions.....</b>	<b>166</b>
--------------------------------------------	------------

## **SESSION 13**

<b>WORKING WITH TABLES, ILLUSTRATIONS, AND MAIL MERGE .....</b>	<b>167</b>
-----------------------------------------------------------------	------------

<b>13.1 Working with tables .....</b>	<b>167</b>
---------------------------------------	------------

13.1.1 Creating a table.....	167
------------------------------	-----

13.1.2 Format your table .....	168
--------------------------------	-----

13.1.3 Setting Text Alignment inside the table.....	168
-----------------------------------------------------	-----

13.1.4 Insert a row/column to the existing table .....	169
--------------------------------------------------------	-----

13.1.5 Delete a row/column to the existing table .....	169
--------------------------------------------------------	-----

<b>13.2 Different types of Illustrations .....</b>	<b>169</b>
----------------------------------------------------	------------

<b>13.3 Working with Images .....</b>	<b>170</b>
---------------------------------------	------------

13.3.1 Insert pictures into your document .....	170
-------------------------------------------------	-----

<b>13.4 Working with ClipArt .....</b>	<b>172</b>
----------------------------------------	------------

13.4.1 Insert a ClipArt .....	172
-------------------------------	-----

13.4.2 Insert clipart on Office Online.....	173
---------------------------------------------	-----

<b>13.5 Working with Shapes .....</b>	<b>173</b>
---------------------------------------	------------

13.5.1 Insert a shape.....	173
----------------------------	-----

13.5.2 Change the size of the Shape.....	174
------------------------------------------	-----

13.5.3 Insert a new shape.....	174
--------------------------------	-----

13.5.4 Add/Edit a text in a shape.....	174
----------------------------------------	-----

13.5.5 Create a group of shapes .....	175
---------------------------------------	-----

13.5.6 Insert 3D effect into a shape.....	175
-------------------------------------------	-----

13.5.7 Insert Shadow effect into a shape .....	175
------------------------------------------------	-----

13.5.8 Change the shape style .....	176
-------------------------------------	-----

13.5.9 Change the fill colour.....	176
------------------------------------	-----

13.5.10 Change the shape .....	176
--------------------------------	-----

13.5.11 Change shape position.....	176
------------------------------------	-----

13.5.12 Change the visible order of the shapes .....	176
------------------------------------------------------	-----

<b>13.6 Working with SmartArt.....</b>	<b>177</b>
----------------------------------------	------------

13.6.1 Insert a smart Art.....	177
--------------------------------	-----

13.6.2 Working with SmartArt tools.....	178
-----------------------------------------	-----

<b>13.7 Working with Charts.....</b>	<b>179</b>
--------------------------------------	------------

13.7.1 Insert a chart into your document.....	179
-----------------------------------------------	-----

<b>13.8 Insert a WordArt .....</b>	<b>180</b>
------------------------------------	------------

<b>13.9 Working with Text boxes .....</b>	<b>181</b>
-------------------------------------------	------------

<b>13.10 Working with equations .....</b>	<b>182</b>
-------------------------------------------	------------

<b>13.11 Inserting Symbols .....</b>	<b>183</b>
--------------------------------------	------------

<b>13.12 Word Templates .....</b>	<b>185</b>
-----------------------------------	------------

13.12.1 Create a new word template .....	185
------------------------------------------	-----

13.12.2 Working with installed templates.....	185
-----------------------------------------------	-----

<b>13.13 Working with Mail Merge .....</b>	<b>186</b>
--------------------------------------------	------------

<b>13.14 Self Assessment Questions .....</b>	<b>189</b>
----------------------------------------------	------------

## **SESSION14**

<b>INTRODUCTION TO MS EXCEL 2007 .....</b>	<b>190</b>
--------------------------------------------	------------

<b>14.1 Introduction .....</b>	<b>190</b>
--------------------------------	------------

14.1.1 Start Excel 2007 .....	191
-------------------------------	-----

<b>14.2 Microsoft Excel 2007 User Interface .....</b>	<b>191</b>
-------------------------------------------------------	------------

<b>14.3</b>	<b>Working with workbooks</b> .....	<b>192</b>
14.3.1	Create a new workbook (Method 1).....	192
14.3.2	Create a new work book (Method 2).....	192
<b>14.4</b>	<b>Working with a work sheet</b> .....	<b>193</b>
14.4.1	Delete a worksheet.....	193
14.4.2	Rename an existing worksheet.....	193
14.4.3	Insert a new work sheet.....	193
<b>14.5</b>	<b>Data entry techniques</b> .....	<b>194</b>
14.5.1	AutoFill option.....	194
<b>14.6</b>	<b>Moving Data within a Workbook</b> .....	<b>196</b>
<b>14.7</b>	<b>Defining data set as a Table</b> .....	<b>197</b>
<b>14.8</b>	<b>Some useful tips</b> .....	<b>197</b>
14.8.1	Displaying Different Views of an Excel sheet.....	198
14.8.2	Window Operations.....	198
<b>14.9</b>	<b>Setting, Previewing, and Printing a document</b> .....	<b>199</b>
14.9.1	Setting/Clearing printing area.....	199
14.9.2	Previwing and Printing your work.....	200
<b>14.10</b>	<b>Self Assessment Questions</b> .....	<b>201</b>

## **SESSION 15**

<b>MANUPULATING DATA IN MS EXCEL 2007</b> .....	<b>202</b>	
<b>15.1</b>	<b>Performing Calculations on Data</b> .....	<b>202</b>
15.1.1	Define and use cell range names in formulas.....	202
<b>15.2</b>	<b>Working with Excel Formulas</b> .....	<b>203</b>
15.2.1	Copying formulas.....	205
15.2.2	Absolute Positioning.....	205
15.2.3	Paste your formula using “paste special” method.....	205
<b>15.3</b>	<b>Working with Excel functions</b> .....	<b>206</b>
15.3.1	Other functions available in Excel 2007.....	210
15.3.2	Exploring more on functions.....	210
<b>15.4</b>	<b>Sort and filter your data</b> .....	<b>210</b>
15.4.1	Sorting your data.....	210
15.4.2	Filter your data.....	212
<b>15.5</b>	<b>Errors in cells</b> .....	<b>214</b>
<b>15.6</b>	<b>Self Assessment Questions</b> .....	<b>214</b>

## **SESSION 16**

<b>SETTING DOCUMENT APPEARANCE AND WORKING WITH CHARTS</b> .....	<b>215</b>	
<b>16.1</b>	<b>Changing Document Appearance</b> .....	<b>215</b>
16.1.1	Format a cell by using cell formatting window.....	215
16.1.2	Change font effect in a cell.....	217
16.1.3	Change Border of a cell/range of cells.....	217
16.1.4	Change the fill style of a cell(s).....	218
16.1.5	Set row height.....	219
16.1.6	Set the column width.....	219
16.1.7	Merge two or more cells.....	219
16.1.8	Change the cell style.....	219
<b>16.2</b>	<b>Conditional formatting of cells</b> .....	<b>220</b>
<b>16.3</b>	<b>Applying Workbook Themes</b> .....	<b>221</b>

<b>16.4</b>	<b>Working with Charts</b> .....	<b>222</b>
16.4.1	Create a Chart using Chart tool.....	222
16.4.2	Modify chart Layout.....	223
16.4.3	Customize the appearance of a chart.....	224
16.4.4	The Chart design tool.....	224
16.4.5	The Chart Layout tool.....	225
16.4.6	The Chart Format tool.....	225
<b>16.5</b>	<b>Self Assessment Questions</b> .....	<b>226</b>

## SESSION 17

<b>INTRODUCTION TO MICROSOFT POWERPOINT 2007</b> .....		<b>227</b>
<b>17.1</b>	<b>Introduction</b> .....	<b>227</b>
<b>17.2</b>	<b>Working with MS PowerPoint 2007</b> .....	<b>228</b>
17.2.1	Starting MS PowerPoint 2007.....	228
17.2.2	Creating a new presentation (Method 1) .....	228
17.2.3	Creating a new presentation (Method 2) .....	228
<b>17.3</b>	<b>Getting Familiarized with MS Power point 2007 user Interface</b> .....	<b>229</b>
<b>17.4</b>	<b>Start your presentation</b> .....	<b>230</b>
17.4.1	Starting with the first slide.....	230
17.4.2	Inserting a new slide .....	230
17.4.3	Deleting a Slide .....	231
17.4.4	Open an existing presentation.....	231
17.4.5	Change the slide view .....	232
17.4.6	Hiding the slides.....	232
<b>17.5</b>	<b>Adding more components to the slides</b> .....	<b>233</b>
17.5.1	Adding text and images in a single slide .....	233
17.5.2	Adding hyperlinks .....	235
<b>17.6</b>	<b>Formatting Presentations</b> .....	<b>236</b>
17.6.1	Inserting a text box .....	236
17.6.2	Insert WordArt.....	237
17.6.3	Insert a Footer and Slide numbers.....	237
<b>17.7</b>	<b>Formatting backgrounds and layout</b> .....	<b>237</b>
17.7.1	Change the background style using Ribbon.....	238
17.7.1	Change the background using Format Background menu.....	239
17.7.2	Change the Slide Layout .....	239
<b>17.8</b>	<b>Applying Themes</b> .....	<b>239</b>
17.8.1	Insert Themes in to all slides.....	239
17.8.2	Insert Themes in to Selected Slides .....	240
<b>17.9</b>	<b>Using Slide Master</b> .....	<b>240</b>
17.9.1	Creating a Slide Master .....	240
17.9.2	Slide Master Tools.....	241
17.9.3	Working with slide masters .....	241
<b>17.10</b>	<b>Self Assessment Questions</b> .....	<b>243</b>

## SESSION 18

<b>ADVANCED FEATURES AND DELIVERING YOUR PRESENTATION</b> .....		<b>244</b>
<b>18.1</b>	<b>Working with Graphics, Images and Clips</b> .....	<b>244</b>
18.1.1	Insert Pictures into your slide .....	245
18.1.2	Insert a Picture from Clip Art gallery .....	245

18.1.3	Insert a Smart Art.....	246
18.1.4	Insert a Table into your presentation .....	247
<b>18.2</b>	<b>Working with Multimedia.....</b>	<b>247</b>
18.2.1	Different Types of Videos .....	247
	Animated GIFs .....	247
	Live-Action Videos .....	247
	Video File Formats.....	247
18.2.2	Insert a Movie Clip .....	248
<b>18.3</b>	<b>Inserting Sound and Narration.....</b>	<b>249</b>
<b>18.4</b>	<b>Delivering Presentations.....</b>	<b>250</b>
18.4.1	Using animations .....	250
18.4.2	Animation tools .....	250
18.4.3	Add Slide transition.....	251
<b>18.5</b>	<b>Animating Objects of your slide .....</b>	<b>252</b>
18.5.1	Types of Animations .....	252
18.5.2	Adding Animation effects for an object or an object group .....	252
18.5.3	Custom Animation in depth.....	253
18.5.4	Setting Animation Timing .....	255
<b>18.6</b>	<b>Adding Action effects .....</b>	<b>256</b>
<b>18.7</b>	<b>Getting prepared for a Live Presentation .....</b>	<b>257</b>
18.7.1	Starting and Ending a Show .....	257
18.7.2	Using the On-screen Show Controls .....	257
18.7.3	Moving from Slide to Slide.....	258
18.7.4	Jumping to Specific Slides .....	259
18.7.5	Blanking the Screen .....	259
18.7.6	Using the On-Screen Pen .....	259
<b>18.8</b>	<b>Using Custom Shows .....</b>	<b>260</b>
18.8.1	Ideas for Using Custom Shows.....	260
18.8.2	Creating Custom Shows .....	261
18.8.3	Editing Custom Shows .....	262
18.8.4	Copying Custom Shows.....	262
18.8.5	Deleting Custom Shows .....	262
18.8.6	Displaying a Custom Show .....	262
<b>18.9</b>	<b>Saving your Presentation .....</b>	<b>264</b>
<b>18.10</b>	<b>Protecting a file with a password.....</b>	<b>264</b>
18.10.1	Saving a Presentation in Other Formats .....	265
<b>18.11</b>	<b>Printing your slides.....</b>	<b>267</b>
18.11.1	Creating Handouts .....	267
18.11.2	Creating Speaker Notes .....	268
18.11.3	Printing Outline.....	269
18.11.4	Exporting Handouts or Notes Pages to Word .....	269
18.11.5	Create a Package for a CD.....	270
<b>18.12</b>	<b>Self Assessment Questions .....</b>	<b>272</b>

## SESSION 19

<b>INTRODUCTION TO DATABASES AND MICROSOFT ACCESS 2007.....</b>	<b>273</b>	
<b>19.1</b>	<b>Introduction to Databases.....</b>	<b>273</b>
19.1.1	Hierarchical model.....	273
19.1.2	Network model .....	274

19.1.3	Relational model .....	274
19.1.4	Object –Oriented model .....	274
<b>19.2</b>	<b>Database Management System .....</b>	<b>275</b>
<b>19.3</b>	<b>Basic terminology in Databases .....</b>	<b>275</b>
19.3.1	Database .....	275
19.3.2	Object .....	275
19.3.3	Table .....	275
19.3.4	Field .....	275
19.3.5	Record .....	275
19.3.6	Primary key .....	276
19.3.7	Foreign key.....	276
19.3.8	Relationships.....	276
<b>19.4</b>	<b>Different Database Management Applications.....</b>	<b>278</b>
<b>19.5</b>	<b>Introduction to Microsoft Access 2007 .....</b>	<b>278</b>
19.5.1	Start Microsoft Access .....	278
19.5.2	Create a new database .....	279
19.5.3	User interface of MS Access 2007 .....	279
19.5.4	Opening an Existing Database .....	280
19.5.5	Closing an Existing Database.....	280
19.5.6	Objects available in Access 2007 .....	280
<b>19.6</b>	<b>Exploring Tables.....</b>	<b>281</b>
19.6.1	Open a table in Datasheet view.....	281
19.6.2	Open a table in Design view .....	281
<b>19.7</b>	<b>Exploring Queries .....</b>	<b>282</b>
19.7.1	Opening a Query.....	282
19.7.2	Open a Query in design view .....	282
<b>19.8</b>	<b>Exploring Forms .....</b>	<b>282</b>
19.8.1	Opening a Form .....	283
19.8.2	Open a Form in design view.....	283
<b>19.9</b>	<b>Exploring Reports.....</b>	<b>283</b>
19.9.1	Opening a Report in the Layout view .....	284
<b>19.10</b>	<b>Save your database in other formats .....</b>	<b>284</b>
<b>19.11</b>	<b>Encrypt with a password .....</b>	<b>284</b>
<b>19.12</b>	<b>Decrypt the database .....</b>	<b>285</b>
<b>19.13</b>	<b>Self Assessment Questions .....</b>	<b>285</b>

## SESSION 20

<b>WORKING WITH TABLES AND QUERIES .....</b>	<b>286</b>	
<b>20.1</b>	<b>Creating Tables.....</b>	<b>286</b>
20.1.1	Creating table – method 1 .....	286
20.1.2	Creating table – method 2 .....	286
20.1.3	Create table in Design view .....	287
20.1.4	Delete a Table .....	290
20.1.5	Create another table.....	291
<b>20.2</b>	<b>Creating Relationships between two tables .....</b>	<b>291</b>
20.2.1	Relationship design tool .....	293
<b>20.3</b>	<b>Modifying your tables .....</b>	<b>293</b>
20.3.1	Delete Records from a table .....	293
20.3.2	Insert a new field .....	294

20.3.3	Rename a Column/field .....	294
20.3.4	Delete a column/field .....	294
<b>20.4</b>	<b>Queries .....</b>	<b>295</b>
20.4.1	Create a Query using Wizard .....	295
20.4.2	Create a Query using design view .....	296
20.4.3	More about criteria sections in the Query design tool .....	298
20.4.4	Creating advance queries by using query design tool .....	298
20.4.5	Viewing the SQL statements of created queries .....	299
<b>20.5</b>	<b>Self Assessment Questions .....</b>	<b>300</b>

## **SESSION 21**

### **WORKING WITH FORMS AND REPORTS..... 301**

<b>21.1</b>	<b>Working with Forms .....</b>	<b>301</b>
21.1.1	Create a form by using Form Wizard .....	301
21.1.2	Control Buttons in a form .....	303
21.1.3	Form views .....	304
21.1.4	Create a form by using the Design View .....	304
21.1.5	Format your form .....	310
<b>21.2</b>	<b>Working with Reports .....</b>	<b>312</b>
21.2.1	Create a report using Report wizard .....	312
21.2.2	Create a report for a created query by using wizard .....	315
21.2.3	Create a Report by using Design View .....	316
21.2.4	Report Design Tools .....	316
21.2.5	Report design window .....	317
21.2.6	Working with report controls .....	318
21.2.7	Create a report by using design view .....	318
21.2.8	Working with more report controls .....	319
<b>21.3</b>	<b>Formatting Reports .....</b>	<b>321</b>
21.3.1	Format your report by using Auto format wizard .....	321
<b>21.4</b>	<b>Self Assessment Questions .....</b>	<b>322</b>

## **SESSION 22**

### **INTRODUCTION TO THE INTERNET ..... 323**

<b>22.1</b>	<b>The Internet: an introduction .....</b>	<b>323</b>
22.1.1	What is Internet? .....	323
22.1.2	The history of the Internet .....	325
22.1.3	Differences between Internet and World Wide Web .....	326
22.1.4	Introducing the Internet buzz words .....	327
<b>22.2</b>	<b>Identifying facilities/benefits of Internet .....</b>	<b>329</b>
22.2.1	WWW .....	330
22.2.2	E-mail .....	330
22.2.3	Chat .....	330
22.2.4	Telnet .....	330
22.2.5	VoIP .....	330
<b>22.3</b>	<b>Connecting to the Internet .....</b>	<b>331</b>
22.3.1	Dial-up Connections .....	331
22.3.2	Landline .....	332
22.3.3	T-lines .....	332



22.3.4	Wi-Fi.....	332
22.3.5	Satellite.....	333
22.3.6	Cell phones.....	334
<b>22.4</b>	<b>Self Assessment Questions .....</b>	<b>335</b>

## **SESSION 23**

### **WEB BROWSERS & SEARCH ENGINES..... 336**

<b>23.1</b>	<b>Web Browsers .....</b>	<b>336</b>
23.1.1	Introducing different web browsers.....	336
<b>23.2</b>	<b>User Interfaces of Web Browsers .....</b>	<b>341</b>
23.2.1	Internet Explorer.....	342
23.2.2	Mozilla Firefox .....	343
23.2.3	Google Chrome .....	344
23.2.4	Saving the contents opened from the web browser .....	344
23.2.5	Downloading different contents from the Internet.....	344
<b>23.3</b>	<b>Search Engines.....</b>	<b>349</b>
23.3.1	Introducing different search engines.....	349
23.3.2	Finding information using search engines .....	351
23.3.3	Searching more efficiently in Google.....	352
<b>23.4</b>	<b>Browser Customization.....</b>	<b>354</b>
23.4.1	Setting up a Homepage.....	354
23.4.2	How to set up a Proxy for Firefox 3?.....	356
23.4.3	Changing the 'Content' in Options.....	357
<b>23.5</b>	<b>Self Assessment Questions .....</b>	<b>358</b>

## **SESSION 24**

### **INTRODUCTION TO THE E-MAIL ..... 359**

<b>24.1</b>	<b>E-mail .....</b>	<b>359</b>
24.1.1	Snail mail Vs. E-mail .....	359
24.1.2	How e-mail works in brief.....	360
<b>24.2</b>	<b>More about E-mailing concepts .....</b>	<b>360</b>
24.2.1	E-mail clients .....	360
24.2.2	The SMTP Server .....	361
24.2.3	The POP3 Server .....	362
24.2.4	The IMAP Server .....	362
<b>24.3</b>	<b>Different e-mailing methods.....</b>	<b>363</b>
<b>24.4</b>	<b>Need of Email etiquettes .....</b>	<b>364</b>
<b>24.5</b>	<b>Using emails.....</b>	<b>365</b>
24.5.1	Email address .....	365
24.5.2	Creating a free e-mail account .....	365
24.5.3	Receiving e-mail .....	368
24.5.4	Sending e-mail.....	369
24.5.5	Sending/receiving attachments .....	370
24.5.6	Set up an Address Book Group for List Mailing in Yahoo .....	371
<b>24.6</b>	<b>Security and risk in Internet .....</b>	<b>372</b>
24.6.1	Security settings in web browsers/e-mail client software .....	372
24.6.2	Taking precautions when using the Internet.....	373
<b>24.7</b>	<b>Self Assessment Questions .....</b>	<b>374</b>

## **SESSION 25**

<b>CURRENT AND FUTURE TRENDS IN THE INTERNET.....</b>	<b>375</b>
<b>25.1 Introduction .....</b>	<b>375</b>
<b>25.2 Introduction to E-commerce.....</b>	<b>375</b>
<b>25.3 The benefits of e-commerce .....</b>	<b>376</b>
<b>25.4 Types of Electronic Commerce.....</b>	<b>379</b>
25.4.1 B2C – Business to Consumer.....	379
25.4.2 C2B – Consumer to Business.....	381
25.4.3 B2B – Business to Business .....	382
25.4.4 C2C – Consumer to Consumer .....	383
<b>25.5 Basic Functions in the E-Commerce Site.....</b>	<b>385</b>
<b>25.6 What is e-learning? .....</b>	<b>388</b>
25.6.1 Types of e-learning .....	388
25.6.2 Advantages and Disadvantages of e-learning.....	389
25.6.3 Traditional Classroom learning Vs. E-learning .....	390
<b>25.7 Introduction to E-Government .....</b>	<b>390</b>
<b>25.8 Introduction to E-entertainment .....</b>	<b>391</b>
<b>25.9 Future of Internet .....</b>	<b>391</b>
25.9.1 Top Ten Future Trends- The Internet by 2020.....	391
<b>25.10 Self Assessment Questions .....</b>	<b>393</b>

# Session 01

## Introduction to ICT and ICT Skills

---

### Aim:

The aim of this session is to give a brief introduction to ICT Skills and introduce the terminology related to the subject.

### Objectives:

Having studied this session the student will be able to:

- Describe what IT is.
- Describe what ICT is
- Describe what CS is
- Understand the relationship between Computer Skills and ICT
- Understand the aims and objectives of learning ICT Skills



### 1.1 Related terminology

Before moving onto the topic of ICT Skills let us have a look at the different terms such as IT, ICT, and Computer Science related to this course unit and let us identify the differences among these terms.

#### 1.1.1 IT (Information Technology)

The term **Information Technology** refers to an entire field that uses computers, networking, software, and other equipment to manage information electronically in a digital form. Consider an IT department in an organization. They are equipped with computers, database Management Systems, servers, and security mechanisms for storing, processing, retrieving, and protecting information available with the organization. You might have heard about the professionals working in such department of a company like system administrators, database administrators, programmers, IT managers, network engineers. If it is a business organization, they all work together to provide services such as providing information, providing tools to improve the productivity, automating the business processes, and providing means for connect with customers. Therefore, in the modern world, IT is an essential part of all of business operations.

*UNESCO* considered Information Technology as “Scientific, technological and engineering disciplines and management techniques used in information handling and processing, their application, computers and their interaction with men and machines, and associated social, economic and cultural matters”. Accordingly, a fair knowledge in IT has become an essential qualification to work successfully in almost all organizations in the country.

### 1.1.2 ICT (Information and Communication Technology)

The term **Information and Communication Technology** can be considered as an extended version of the term IT as it involves a 'C' that represents the **communication** of data by electronic means, usually over some distance. Here, communication refers to the media broadcasting technologies, audio/video processing and transmission and telephony. Recently, the term ICT has been used to refer to the integrating telephone and audio/ visual networks with computer networks. This integration has provided large savings of costs due to the elimination of telephone networks. Simply, ICT can be seen as the integration of information technology with communication technology.

In contrast with IT according to the *Wikipedia*, Information and Communications Technology or (ICT), is often used as an extended synonym for information technology (IT). But it is a more specific term that stresses the role of unified communications and the integration of telecommunications (telephone lines and wireless signals), computers as well as necessary enterprise software, middleware, storage, and audio-visual systems, which enable users to access, store, transmit, and manipulate information.

The term ICT is more inclined and widely used in the educational sector. Some have simplified ICT as using audiovisual equipment for learning at school and the use of networks that help transmit information across schools.

IT was limited only to the textual mode of transmission of information with ease and fast. But the information not only in textual form but in audio, video or any other media is also to be transmitted to the users. Thus, the  $ICT = IT + \text{Other media}$ . It has opened new avenues, like, Online learning, e-learning, Virtual University, e-coaching, e-education, e-journal, etc. Third Generation Mobiles are also part of ICT. Mobile is being used in imparting information fast and cost effective. It provides e-mail facility also. One can access it anywhere. It will be cost effective. The ICT brings more rich material in the classrooms and libraries for the teachers and students. It has provided opportunity for the learner to use maximum senses to get the information. It has broken the monotony and provided variety in the teaching – learning situation.

As already mentioned above, by the technology of communication we process transfer digital data from one device to another. These technologies related to the communications are usually complex. Though you are not going to study about them in this material, there are some aspects of digital communication that you need to study such as the types of networks and the mechanism of getting connected with the internet. These topics are discussed within this course material in coming sessions.

### 1.1.3 CS (Computer Science)

In addition to the terms IT and ICT described above, you might have heard another terminology “Computer Science” which also sounds similar to the above two. **Computer Science** is the mother of all computational disciplines (Computer Engineering, Information Technology/Information Science, Software Engineering, ICT, etc). In simple words, Computer Science is all about computers. In contrast with IT, CS is the science of computing with in depth knowledge of working principles of computers whereas information technology is the science designed to make best use of information systems to make work easier in business environments. According to the *Wikipedia*, CS is the scientific and practical approach to computation and its applications. A computer scientist specializes in the theory

of computation and the design of computational systems. So, a computer scientist is obviously thorough in Physics, Mathematics, electrical engineering, and forms of languages. CS is a field related to research work and thus it's evolving with the innovations of the research outcomes.

Now you may have some idea that the ones who can afford to be in touch with the information and communication technology can be updated with evolving knowledge while the ones who fail or have less chances may remain in the pre-knowledge stage.

## 1.2 Objectives of the course unit

It is clear that you require some skills ranging from basic to advanced, that are needed to be able to work with computer based information systems. Simply, you will require the capability of using computers and computer software in order to deal with information and communication technologies.

Therefore, the fundamental objective of this course unit is to be able to:

- Convert
- Store
- Protect
- Process
- Transmit/communicate and
- Retrieve

information by using computers and its software. So, now you can understand that the computer skills are necessary and highly related to ICT.

Imagine that you have followed this course unit. Let us take very simple examples to brief the above six terms related to information to understand the necessary computer skills for ICT.

- You can sing a song and record your voice using a microphone and save it in your computer as a digital file which you can open and play later. Here the voice input has been *converted* into a digital media file and *stored* it in your computer for future reference. You may *save (store)* it in a CD and give it to your friend to listen.
- Imagine that you have very confidential documents saved in a folder of your computer. In order to avoid others accessing those documents you may *lock (protect)* the folder accessibility by applying a password on the folder. Simply, when someone tries to open that folder, the computer will ask for a password which is only known to you.
- If you are working in the salary division of your company you may use a simple computer program which gives the monthly salary of employees when the data such as basic salary, salary advance taken, allowances to be given, no. of overtime hours worked, and the rate of monthly salary increment are entered into the computer. Here the data given has been *processed* into the monthly salary which is important information.
- The salary particulars of all employees of Matara branch of your company may be processed at the Colombo Head office and the salary file may be sent to Matara branch through the company intranet (a network built among the branches of your company). Otherwise the salary file may be e-mailed to the branch manager at Matara. Here, using

either ways, the required salary file is *transmitted /communicated* through a computer network.

- You may be asked by your manager to give a list of employees who work in the Sales division who have exceeded a total of 250 OT hours during the last six months. It will be just a matter of calling (*retrieving*) the existing data saved in the central database to generate the report in the required format.

### 1.3 What next in the course unit

From the next session onwards, you will get familiar with computers and will acquire the necessary skills step by step. You will be able to get the skills related to some of the key applications of ICT such as text editors, spreadsheets, databases, and presentations. This *ICT Skills* course is planned to do more, than teaching basic computer literacy skills on current packages. It provides a combination of theoretical knowledge and practical skills that together comprise a mental framework that will enable the student to get familiar and learn new IT packages as they change, to solve new IT problems and use additional package features that are not explicitly taught in this course. However, the course has a strong practical focus with the intention of enabling students to use ICT's as tools for productivity and problem solving in your lives which is the aim and objective of this course unit. So it is a must to do practicals based on the content of this material to achieve the above aims and objectives.

### 1.4 Self Assessment Questions



- 1.1 Describe the following terms;
  - a. IT
  - b. ICT
  - c. CS
- 1.2 What is the difference between IT and ICT?
- 1.3 Write a note on how IT can help an organization in gaining a competitive advantage on its operations.
- 1.4 Briefly describe one way how ICT can be applied in each of the following areas.
  - a. Education
  - b. Health
  - c. Business
- 1.5 Using specific examples, describe how the information can be converted, stored, protected, processed, transmitted, and retrieved using computers and its software.
- 1.6 What are the key applications of ICT that you will learn during this course unit?

## Session 02

# Introduction to Computers

---

### Aim:

This lesson aims to provide students with an understanding the basics and the role of computation.

### Objectives:

Having studied this session the student will be able to:

- Describe what a computer is
- Identify the characteristics as well as the limitations of computers
- Identify different types of computers from the ancient ones to modern ones
- Explain what a computer system is as well as its parts



## 2.1 What is a Computer?

*A computer is a general purpose device which can be programmed to carry out a finite set of arithmetic or logical operations. Since a sequence of operations can be readily changed, the computer can solve more than one kind of problem.*

- Wikipedia

*A computer is, at its most basic, a machine which can take instructions, and perform computations based on those instructions.*

- wiseGEEK

*A computer is an electronic device which is capable of receiving the inputs (data from the user), storing it for a desired period of time, manipulating it according to the set of instructions (called program) and producing the output to the user in desired form. It performs a variety of operations in accordance to the set of instructions.*

- <http://www.trivology.com>

The above three descriptions are some standard definitions extracted from different information resources available in the World Wide Web, including *Wikipedia*, the largest free encyclopedia. Meanwhile, a computer can be defined as follows in terms of basic usage of the computer which is more readable for a layman.

*A computer is an electronic device that manipulates information, or "data". It has the ability to store, retrieve, and process data. You can use a computer to type documents, send email, and browse the internet. You can also use it to handle spreadsheets, accounting, database management, presentations, games, and more.*

When reading the above definitions you may find some common behaviors of computers such as;

- It is a man-made machine
- It accepts instructions of a human given in a sequential manner
- As per the given instructions, it performs some calculations and does changes for the information fed by human
- Releases or produces an output that is useful to the user

Since the computer is a man-made digital electronic device, it has a physical structure with several parts like the monitor, processor, mouse, and key board which are tangible. These are called **Hardware**. The sets of instructions which are also called computer programs installed in the computer are called **Software**. These softwares tell the hardware what to do and how to do to accomplish some tasks expected by the user to get done by the computer. The web browsers like Mozilla Fire Fox, Computer games, and Word processors like Microsoft Word are some examples for Software. You will learn more about these computer hardware and software in coming sessions of this course material.

## **2.2 Characteristics of a Computer**

The range of users of computers is overwhelming. Why is so popular? What can it do that we, as humans, cannot? The computer's superiority lies in its special characteristics such as speed, reliability, accuracy, diligence, versatility, storage capacity, etc. Let us discuss on each characteristic briefly.

### **2.2.1 Speed**

A computer can perform tasks very fast. For example, the amount of work that a human being can do in an entire year (if he worked day and night and did nothing else) can be accomplished by a computer within a few minutes. As you are aware now, inside the system unit, the operations occur through electronic circuits. When data, instructions, and information flow along these circuits, they travel at close to the speed of light. This allows billions of operations to be carried out in a single second.

### **2.2.2 Reliability**

Electronic components in modern computers are dependable because they have a low failure rate. The high reliability of the components enables the computer to produce consistent results.

### **2.2.3 Accuracy**

The accuracy of a computer is consistently high and the degree of accuracy of a particular computer depends upon its design. Errors can occur in a computer, but these are mainly due to human mistakes. Thus, computers can process large amounts of data and generate error-free results, provided the data is entered correctly. If inaccurate data is entered, the resulting outputs will also be incorrect. This computing principle is known as *Garbage in, garbage out (GIGO)*.

### **2.2.4 Diligence**

Unlike human beings, a computer is free from boredom, tiredness, lack of concentration, etc., hence a computer can work for hours without making any errors or complaints. Even if ten



million calculations have to be performed, a computer will perform the ten millionth calculations with exactly the same accuracy and speed as the first one.

### **2.2.5 Versatility**

The computers have the capacity to perform completely different type of work. You may use your computer to prepare payroll slips at the moment. Next moment you may use it for inventory management or to prepare electric bills. The computers are flexible enough to adapt to any type of work and outputs according to what is fed and instructed.

### **2.2.6 Power of remembering**

Every piece of information that a user 'stores' on a computer can be retained as long as it is needed and can be recalled when necessary. Even after several years, the information recalled would be identical to what was fed to the computer. A computer will never 'lose' stored information on its own; a user has to 'remove' (or delete) the information from it.

### **2.2.7 No Feeling**

Computers do not have emotions. They have no feelings and no instincts because they are machines. Although human beings have succeeded in building a memory for the computer, a computer does not possess the equivalent of a human brain. Based on our feelings, taste, knowledge and experience, we often make certain judgments in our day-to-day life, but computers cannot make such judgments on their own. Their judgment is based on the instructions given to them in the form of programs by someone.

### **2.2.8 No IQ**

Computer is a dumb machine and it cannot do any work without instruction from the user. It performs the instructions at wonderful speed and with accuracy. It is you to decide what you want to do and in what sequence. So a computer cannot take its own decision as you can.

### **2.2.9 Storage**

The computer has an in-built memory where it can store a large amount of data. This is called **Primary Storage**. This Primary Storage has a limited capacity but it is very important as the processing unit of the computer can act directly only on instructions and data on the primary storage. But, you can also store data in secondary storage devices such as floppies, which can be kept outside your computer and can be carried to other computers. These are called **Secondary Storage**. Before the computer can process the data stored in Secondary storage devices, the data must be moved from secondary storage device to primary storage. This is not a serious drawback. The computers can retrieve information from files in a secondary storage device in a few milliseconds.

## **2.3 Limitations of a Computer**

It is obvious that the computer has a variety of capabilities. Similarly, this man made machine has some its own limitations as well. Such limitations are given below:

- The computer can do only what you tell it to do-you cannot expect the computer give you something which you did not ask.
- It cannot generate information on its own-the computer will work only if you operate

it and give the instructions. It cannot give you information unless you feed it required data.

- It will give wrong information if you feed it with wrong data- the computer cannot identify what the correct data and what the wrong data are.
- It cannot correct wrong instruction- if you give the computer wrong instruction, it will not be able to do anything to rectify it. The only thing it can do is to stop functioning till you correct the mistake.

## 2.4 Different Types of Computers

When you hear the word “Computer” most of the time a **personal computer** like **desktop** or **laptop** will come to your mind as they are widely used by the people around us. However, these computers come in many sizes and shapes that perform different functions which is useful in our daily lives. You are using a type of computer even when you withdraw cash from an ATM (Automatic Teller Machine) or scan groceries at the shop, or use a calculator.

It is said that the ENIAC, which is considered as the first electronic general-purpose computer was of size of a large room (See Figure 2.1 and 2.2 below). However, with the advance of technologies the size of a today’s computer has become smaller as of a small wrist watch. These computers have different processing powers as well.

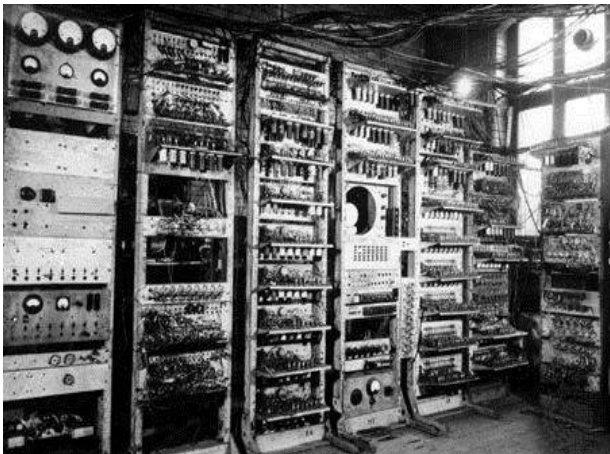

Figure 2.1: ENIAC



Figure 2.2: The ENIAC, taking up about 680 Square feet

The computers can be mainly classified into four categories as briefly described below. This classification is done based on the size and the data processing power.

1. **Microcomputers:** most common type of computers in the society. Can be used at your workplace, at school or on your study desk at home. Used by single user at a time. Small in size. Also called **Personal Computers (PCs)**.
2. **Minicomputers:** used by multi-users. In the middle when the computers are ranged from smallest to largest. Used in laboratories.
3. **Mainframes:** Largest in size. Capable of handling and processing very large amounts of data quickly.

4. **Super computers:** Used for performing complex scientific and numerical computations such as weather forecasting, fluid dynamics, nuclear simulations, theoretical astrophysics. Sometimes called as “**Workstations**”

Since the Personal Computers are the most common category of computers among the individuals let’s talk more on PCs.

## 2.5 Different Types of Personal Computers (PCs)

A Personal Computer (Mostly referred to as PC in the community) is designed as a more user-friendly device to be directly used by the end-user rather having an especially skilled separate computer operator. It is less expensive compared to other types of computers listed above. PCs come in different forms as listed below and we will have a description on each form of PC separately.

It is noticeable that only few famous forms of PCs used today are listed below and the list may be extended by adding many more in the future with the advancement of the technologies.

- Desktop
- Laptop
- Netbook
- PDAs
- Wearable Computers
- Tablets

### 2.5.1 Desktop PCs

Usually the Desktop computers are placed in a fixed location and the name has derived as it is intended to be sitting on a top of a desk. A monitor, mouse, and a key board can be seen as parts of a typical desktop computer. These computers consume low power and cost effective than the laptop computers that will be described next. The spare parts are readily available and less expensive. These computers are easy to upgrade and expand. Figure 2.3 shows a labeled standard desktop computer.

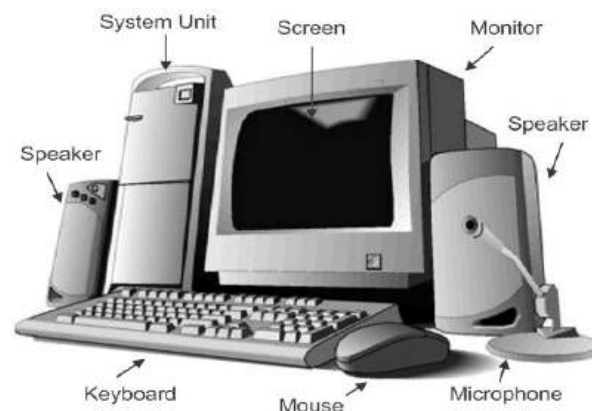

*Figure 2.3: Standard Desktop Computer*

### 2.5.2 Laptop Computers

Laptops are similar to desktop PCs in operation, but designed for mobile use. Capable of operating on the battery power and the battery can be charged with the external power adaptor. An in-built keyboard, Liquid Crystal Display unit (LCD screen), a touch pad (also known as track pad) to act as the mouse are the commonly seen components. However, a mouse can be also used instead of the touch pad. Laptops are obviously smaller in size and weight less than the desktop PCs. Therefore, it is difficult to access its internal hardware thus difficult to upgrade as much as a desktop. But adding more **RAM** or **Hard Drive** is possible (You will learn about RAM and Hard Drive in next session). Figure 2.4 below shows a typical Laptop computer. Built-in web camera is a common feature of a modern laptop computer and these laptops come in different weights, sizes, performances, speeds, and a layman may differentiate them specified by the diagonal distance of its display unit.



*Figure 2.4: Laptop Computer*

### 2.5.3 Netbook

Netbooks belong to the laptop family, but are inexpensive and relatively smaller in size. Though the set of features and the capacity of netbooks were lesser compared to regular laptops at the time of introducing them to the market, nowadays the netbooks come in advanced features and in high capacities as similar to modern laptops. Figure 2.5 shows some images of Netbooks.



*Figure 2.5: Some Netbook Computers*

### 2.5.4 PDAs

Personal Digital Assistants (PDAs) are handheld computers which are also called palmtop computers due to its size which is smaller enough to keep it on your palm. Most of the PDAs are pen-based and come with a stylus (a writing pen) to be used as the input device which is sensitive to its touch screen. Most of them can access the Internet by means of Bluetooth or Wi-Fi facilities. PDAs allow you to organize your personal or business work and to manage your tasks through its facilities. It may be used as a Cellular phone to send and receive calls, to search in the web, to download and play audio/video files, to send/receive e-mails, to type in a text editor to jot down notes or write a document, take pictures or record videos, etc. Following Figure 2.6 shows two images of PDAs.



*Figure 2.6: Personal Digital Assistants (PDAs)*

### 2.5.5 Wearable Computers

The computers that can be worn on the body are known as Wearable computers. There is a constant interaction between the computer and user. These computers are mostly used to track human actions when the hands and other sensory organs are engaged in other activities. And used with applications such as behavioral modeling systems and healthcare monitoring systems. Figure 2.7 shows some images of such wearable computers.



*Figure 2.7: Wearable Computers*

### 2.5.6 Tablets

Tablets are mobile computers larger than PDAs and smaller than Laptops described above. Usually operated by its touch screen and no formal key board are used. The people using them spent most of their time outside and would not have access to a keyboard or mouse.

Usually the input method is the stylus or the digital pen. Tablets have become famous and ideal for field technicians and health workers due to its very light nature and the portability. Some tablets are capable of recognition of natural handwritings as the mode of input. The features of tablets may vary depending on the type of job done such as graphic designing teaching purposes, gaming, or business purposes. See Figure 2.8 and 2.9 for images of some tablets.



Figure 2.8: Modern Tablet PC without the traditional keyboard



Figure 2.9: An early tablet PC with Rotating/removable keyboard

## 2.6 Main parts of a computer system

You learned in the previous section that computers come in many varieties, from tiny computers to very large super computers. But no matters how complex it is or how big it is, every computer is part of a system. A complete computer system consists of four main parts as follows (see figure 2.10 below):

- Hardware
- Software
- Data
- User (Live ware)

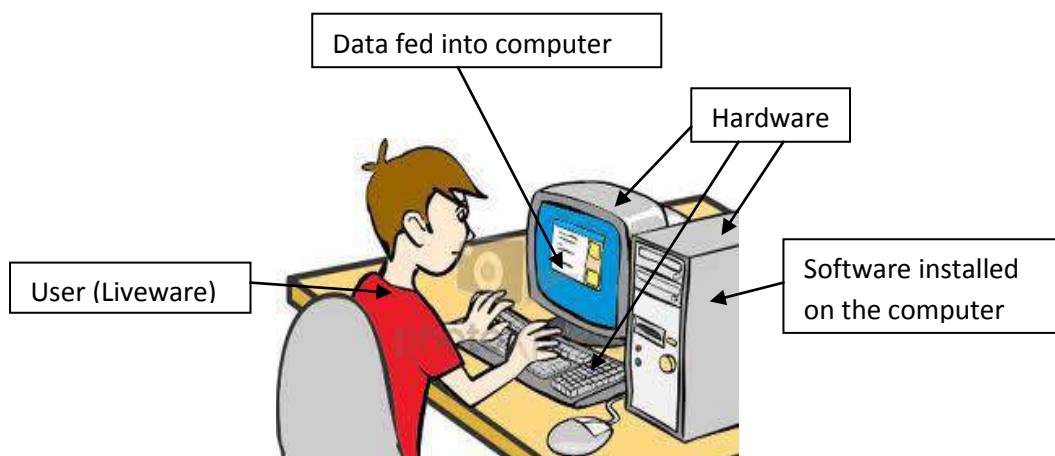

Figure 2.10: Parts of a Computer System

Let us have a look at each part of the computer system briefly.

### 2.6.1 Hardware

The tangible parts that make up the computer are called 'Hardware'. The physical parts such as monitor, key board, processor, and speakers can be identified as hardware. We can use the generic term **device** to refer any piece of hardware. You will learn deeply about computer hardware in Session 03 of this course material.

### 2.6.2 Software

Computer software is a set of instructions that tells computer hardware what to do. The computer will work according to the instructions given to it. We can use the generic term **computer program** to refer any piece of software. Some software are specially designed for the primary functions of the computer to manage its operations while some software are designed for the users to get their work done, ex. to prepare a letter. However, software can be categorized into different categories and you will learn deeply about software in Session 04 of this course material.

### 2.6.3 Data

Any individual fact or piece of information in a form suitable for use with a computer is known as 'data'. This information may be in the form of text, documents, images, audio clips or software program. The primary use of the computer is to convert these data into useful information to the user. The computer accepts data from some sources or from the user to produce useful information. Thus the raw data fed into the computer may not make much sense to the users until it is processed.

### 2.6.4 User/ Live ware

Though the computers automate most functions we cannot say that it is fully automatic, as the intervention of a human being or an operator is often needed. You may think whether a user is essential as you might have seen some performs their job without a person sitting in front of the computer. But you should not forget that the people design and build the programs running on it. The people do repairs to computer systems when needed. Therefore, 'User' is an essential part of a computer system. Further, you will learn about the applications that you can run in 'Personal computers' within this course material.

## 2.7 Self Assessment Questions



- 2.1 Define a computer.
- 2.2 Define the following terms with examples.
  - a. Hardware
  - b. Software
- 2.3 Briefly explain the relationship between Hardware, Software and users.
- 2.4 List main characteristics of the computer. Briefly describe them.
- 2.5 Write three significant limitations of the computer.
- 2.6 What are the four classifications of the computers according to their size and the data processing power?
- 2.7 List different types of personal computers. Briefly describe three.
- 2.8 Name the four main parts of a complete computer system. Briefly describe them.
- 2.9 State the difference between data and information.

## Session 03

# Computer Hardware

---

### Aim:

Aim of this session is to discuss and give a brief idea on computer hardware.

### Objectives:

Having studied this session the student will be able to:

- Describe what hardware is
- Classify computer hardware according to the usage of them
- Give examples for each category of computer hardware
- Identify the different ports of a PC
- Identify why your computer is slow
- Identify the factors affecting on performance of computers



### 3.1 What is Computer Hardware?

You are already aware that a computer system is made up of several different components. Those that can be seen and touched are referred to as the **Computer Hardware** (or simply 'hardware'). In other words, the physical equipments that are involved in the function of the computer are called its hardware. The computer hardware is typically divided into four main categories: **Processing Devices, Memory Devices, Input/, Output Devices, and Storage Devices.**

The following diagram (Figure 3.1) summarizes the classification of the computer hardware.

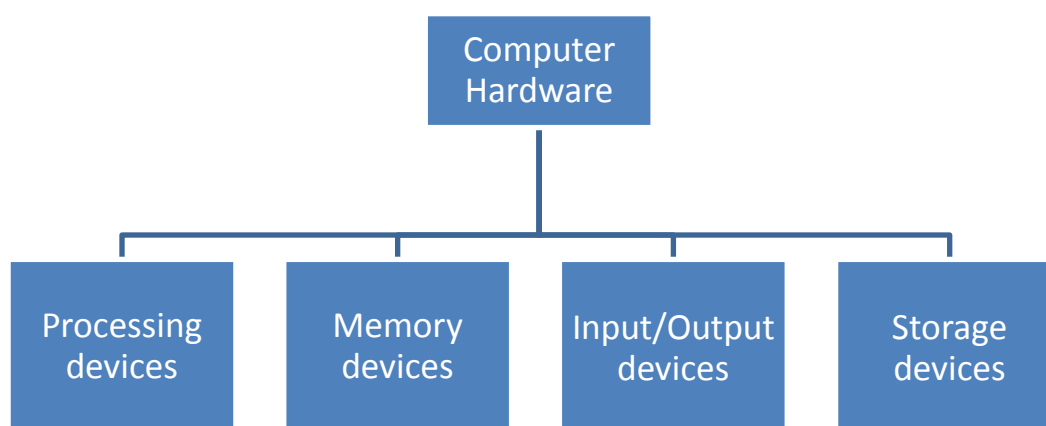

*Figure 3.1: Classification of Computer*

Following Figure 3.2 shows the basic computer architecture and the organization.



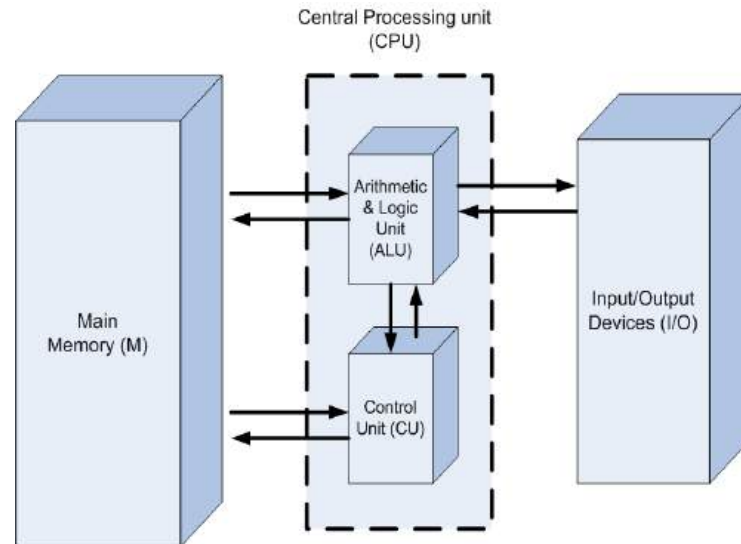

Figure 3.2: Basic computer architecture and the organization

Let us discuss on each type of hardware in the next sections with reference to the above Figure 3.1 and 3.2.

## 3.2 Processing Devices

### 3.2.1 The Central Processing Unit (CPU)

The Central Processing Unit is an electronic device which runs computer programs: a set of sequential instructions. It is also called as the **Computer Processor** or the **brain of the computer**. According to the above Figure 3.2, you can see that there are two major components namely the **Control Unit (CU)** and the **Arithmetic and Logic Unit (ALU)**. The CU is the circuitry that controls the flow of data through the processor, and coordinates the activities of the other units within it. In a way, it is the "brain within the brain", as it controls what happens inside the processor, which in turn controls the rest of the PC. The ALU is a digital circuit that performs arithmetic and logical operations. The ALU is a fundamental building block of the central processing unit of a computer, and even the simplest microprocessors contain one, for purposes such as maintaining timers. The processors found inside modern CPUs have very powerful and very complex ALUs; a single component may contain a number of ALUs.

We consider the CPU as the processing device of the computer. You are aware that the CPU contains **Control Unit (CU)** and an **Arithmetic and Logic Unit (ALU)**. These two components work together to perform the processing operations. On a PC, the CPU usually is contained on a single chip and sometimes is called **Microprocessor**. In addition to the CU and ALU, a microprocessor usually contains the **registers** and **system clock**.

Let us talk about the above sub parts briefly.

#### The Control Unit (CU)

As you know, a computer program or set of instructions must be stored in memory for a computer to process data. The CPU uses its CU to execute these instructions. Further, the CU directs and coordinates most of the operations of the computer. The speed at which the processor

carries out its operations is measured in **megahertz (MHz)**. The higher the number of MHz the faster the computer can process information. The **Intel i7, Athlon, Celron, and Duron, Ultra Spark** are some examples for the brands of processors available in the market.

### **The Arithmetic and Logic Unit (ALU)**

ALU performs the arithmetic, comparison, and logical operations. **Arithmetic operations** include addition (+), subtraction (-), multiplication (\*) and division (/). **Comparison operations** include comparing one data item to another to determine if the first item is greater than (>), equal (=), or less than (<) to the second item. **Logical operations** work with conditions such as AND, OR, NOT.

## **3.3 Memory Devices**

### **3.3.1 Computer Memory**

A character is stored in the computer as a group of 0s and 1s, called a **Byte**. The size of the memory is measured by the number of bites available. The following equalities give the measuring units of the memory.

8 Bits	= 1 Byte
1024 Bytes	= 1 Kilobyte (1KB)
1024KB	= 1 Megabyte (1MB)
1024 MB	= 1 Gigabyte (1 GB)
1024 GB	= 1 Terabyte (1 TB)

While performing a processing operation, a processor needs a place to temporarily store instructions to be executed and the data to be used with those instructions. The data and the instructions needed by the CPU are temporarily stored in the Memory. Therefore the memory acts as the internal storage of a computer. The programs that are stored in external storages are loaded into the memory before they start running. The memory of a computer may be either **volatile** or **non-volatile**. If the data will be lost as soon as the power is turned off the computer, then this type of memory is said to be Volatile. Such memory needs a continuous steady power/electricity to remain its content.

### **3.3.2 Random Access Memory (RAM)**

The **Random Access Memory (RAM)** is a volatile form of a computer memory. This small memory is capable of memorizing temporarily. It can be read and written. That is, you can both write data into RAM and read data from RAM. Together with the CPU, RAM determines the computer's speed. A computer with a large RAM and a CPU can actually run faster than a computer with a powerful CPU but with a low RAM.

### **3.3.3 Read Only Memory (ROM)**

As RAM is volatile, the computers need a non-volatile memory to read larger programs. This is known as the **Read Only Memory (ROM)**. The programs which are needed to start up your computer (Ex: to boot the computer) are stored in ROM.

Figure 3.3 and 3.4 show RAM and ROM memory chips respectively.



Figure 3.3: Random Access Memory (RAM) Chips



Figure 3.4: Read Only Memory (ROM) Chips

### 3.3.4 Cache

Most of today's computers improve their processing times by using cache (pronounced cash). Memory cache, also called a cache store or RAM cache, helps speed the processes of the computer by storing frequently used instructions and data thus reducing the access time of data. When the processor needs an instruction or data, it first searches in the cache.

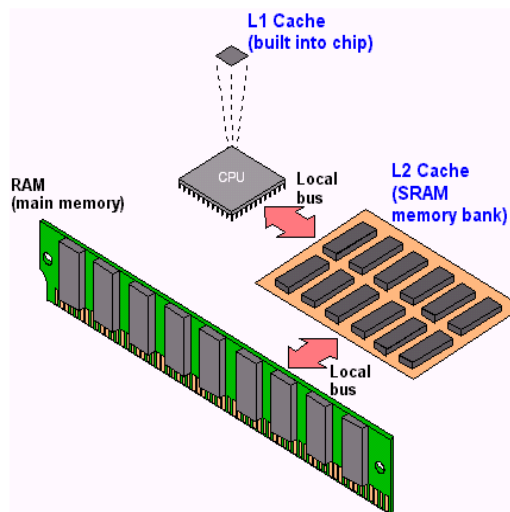

Figure 3.5: Cache

## 3.4 Input Devices

A computer executes instructions and processes data into information and stores the information for future use. Input devices are used to enter instructions and data into the computer.

### 3.4.1 What is Input?

Input is any data or instructions you enter to the memory of a computer. Once input is in memory, the CPU can access it and process the input into output. There are four types of input namely: data, programs, commands, and user responses.

### 3.4.2 Data

Data is a collection of unorganized facts that can include words, numbers, pictures, sounds, and videos. A computer manipulates and processes data into information, which is useful.

**Note:** *Although technically speaking a single item of data should be called a **datum**, the term **data** is commonly used and accepted as both the singular and plural form of the word.*

### 3.4.3 Program

A program is a series of instructions that tells a computer how to perform the tasks necessary to process data into information. Programs are kept on storage media such as a floppy disk (not used now), hard disk, CD-ROM, or DVD-ROM. Programs respond to commands issued by the user.

### 3.4.4 Command

A Command is an instruction given to a computer program. Commands can be issued by typing keywords or pressing special keys on the keyboard. A **keyword** is a specific word, phrase, or code that a program understands as an instruction. Some keyboards include keys that send a command to a program when you press them. Instead of requiring you to remember keywords or special keys, many programs allow you to issue commands by selecting menu choices or graphical objects. For examples, programs that are **menu driven** provide menus as a means of providing commands. Today, most programs have a **graphical user interface** (GUI) that uses icons, buttons, and other graphical objects to issue commands. However, GUI is the most user friendly way to issue commands.

### 3.4.5 User Response

A User Response is an instruction which is given by you to the computer by replying to a question posed by a computer program. For example, *Do you want to save the changes you made?* Based on the response given by the user, the program performs certain actions. In this example, if the answer was 'Yes', then the program saves all changes you made to the file on the storage device.

### 3.4.6 Input Devices

An **Input Device** is any hardware component that allows you to enter data, programs, commands, and user responses into a computer. Some of the commonly used input devices are listed below.

- Keyboard
- Pointing devices
  - Mouse
  - Trackball
  - Joystick
  - Touchpad
  - Light Pen
- Scanners
- Voice input systems
- Web Cam
- Bar code readers

- Optical Mark Reader (OMR)
- Scanner and Optical Character Recognition (OCR)
- Magnetic stripe reader
- Microphone
- Sensors

Let us look at some of above input devices briefly with their images.

### 3.4.7 Keyboard

The keyboard is the main input device for most computers. It is a text based input device that allows the user to input alphanumeric characters and some other special characters. The keyboard is consisting of a set of keys mounted on a board. Each key or button acts as an electronic switch corresponding to a symbol. However, to produce some symbols requires pressing and holding several keys simultaneously or in sequence; other keys do not produce any symbol, but instead affect the operation of the computer or the keyboard itself. Figure 3.6 shows a typical keyboard and its main sets of keys.

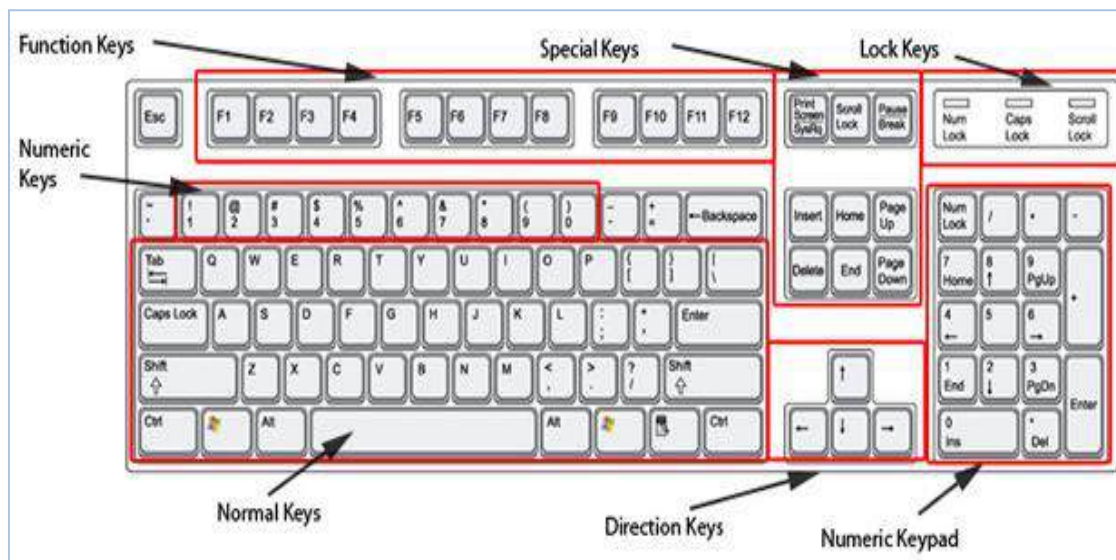

Figure 3.6: Sets of keys in a typical keyboard

### 3.4.8 Mouse

The mouse functions as a pointing device by detecting two-dimensional motion relative to its supporting surface. Physically, a mouse consists of a small case, held under one of the user's hands, with one or more buttons. It sometimes features other elements, such as "wheels", which allow the user to perform various system-dependent operations, or extra buttons or features can add more control or dimensional input. The mouse's motion typically translates into the motion of a pointer on a display, which allows for fine control of a Graphical User Interface. Furthermore, a mouse is an input device that allows the user to "point and click" or "drag and drop". Common functions are pointing (moving the cursor or arrow on the screen by sliding the mouse on the mouse pad), clicking (using the left and right buttons) and scrolling (hold down the left button while moving the mouse). Figure 3.7 shows a labeled typical mouse used as a computer input device.



*Figure 3.7: Typical mouse and the functions of its buttons and wheel*

The Figures 3.8 and 3.9 show the input devices namely the joystick and light pen



*Figure 3.8: Joystick*



*Figure 3.9: Using a Light Pen*

### 3.4.9 Scanner

A scanner is a light-sensing input device that reads printed text and graphics and then translates the pattern of light and dark colors into a digital signal that the computer can store and manipulate. The resulting image can be of different qualities depending on the resolution of the scanner. The **Flat-bed** scanner is the most popular scanner which is similar to a photo copy machine except that it creates a file (**softcopy**) of the document instead of a paper copy (**hardcopy**). The file that contains the scanned object can be stored on an external storage device, displayed on the screen, printed, faxed, sent via e-mail, or included in another document. Figure 3.10 shows a flat-bed scanner.



*Figure 3.10: Flat-bed Scanners*

### 3.4.10 Bar code reader

A bar code reader uses laser beams to read bar codes. Most items in shops, special in super markets in Sri Lanka have a bar code printed or affixed on them. The **Bar code** is a trip of vertical bars of varying widths that creates a unique reference for the particular item. Groups of bars represent individual digits and most bar codes are made up of 12-13 digits. The last number is a check digit and it is used to verify that the number has been scanned in correctly. The computer applies a set of calculations to the individual digits and the answer should equal to the last check digit. **Bar code reader** uses a visible red light to scan the bar code and it is interpreted through a decoder. The reference is matched with the stock list in the computer system to find the appropriate price. Sometimes, numbers are printed below the vertical stripes which are to be used in cases the bar code reader fails to read the code. Figure 3.11 shows a bar code reader while Figure 3.12 shows the appearance of a sample bar code.



Figure 3.11: Reading bar code using a Hand-held Bar code reader



Figure 3.12: Sample Barcode of a product

### 3.4.11 Optical Character Recognition

Optical Character Recognition (OCR) is a mechanism to identify written or printed characters on a source. When text documents are scanned, they are scanned and saved as pictures in the computer. But the OCR software converts the pictures into actual characters/text so that the text can be edited in exactly the same way as text that has been directly keyed in. Figure 3.13 shows the steps of the process of converting the text document into recognized characters.

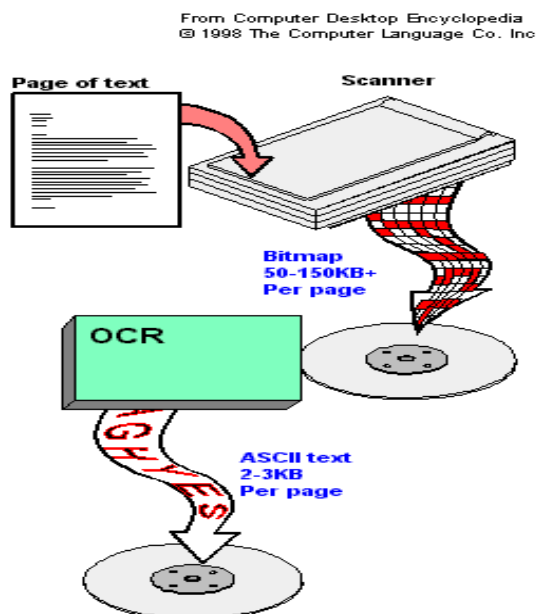

Figure 3.13: OCR processing

Following figures show some more input devices.



*Figure 3.14: Magnetic Stripe*



*Figure 3.15: Microphone for a PC*



*Figure 3.16: Web Camera*

## 3.5 Output Devices

### 3.5.1 What is output?

Output is data that has been processed into a useful form called information. A computer processes input into output. Computers generate several types of output, depending on the hardware and software being used and the requirements of the user. You may choose to display or view this output on a monitor, print it on a paper using a printer, or listen to it through speakers or a headset. Accordingly the four common types of output are text, graphics, audio, and video. A brief description on each of output type is given below.

#### **Text**

Text consists of characters that are used to create words, sentences and paragraphs. A **character** can be a letter, number, punctuation mark, or any other symbol that requires one bite of computer storage space.

#### **Graphics**

Graphics are digital representations of non-text information such as drawings, charts, pictures and photographs. Graphics also can be animated, giving them the illusion of motion. Animations are created by displaying a series of still images in rapid sequence.

Many of today's software programs support graphics. For example, you can include a photograph in a word processing document or create a chart of data in a spreadsheet program. Some software packages are specifically designed to edit graphics.

#### **Audio**

Audio is Music, speech, or any other sound. You might have learnt at school that sound waves, such as the human voice or music are **analog**. To store such sounds, a computer converts the sounds from a continuous analog signal into a digital **format**. Most output devices require that the computer converts the digital format back into analog signals.



## Video

Video consists of images that are played back at speeds that give the appearance of full motion. Video often is captured with a video input device such as video camera or VCR. Most video signals are analog; however, most of the modern video devices record the video images digitally.

A video capture card converts an analog video signal into a digital signal that a computer can understand. The digital signal then is stored on the computer's hard disk. Some output devices accept the digital signal, while others require that the computer converts the digital signals back into analog signals.

### 3.5.2 Output Devices

An output device is any computer component capable of conveying information to a user. Some commonly used output devices are listed below.

- Display devices
  - Cathode Ray Tube (CRT) monitors
  - Liquid Crystal Display (LCD) monitors / Flat-panel displays
  - LED Monitors
  - Gas plasma monitors
- Printers
  - Impact printers
    - Daisy Wheel and Dot Matrix printers
  - Non-Impact Printers
    - Ink Jet printers
    - Thermal Dye Transfer printers
    - Laser printers
- Plotters
- Audio Devices
  - Speakers
  - Headphones

You have already learnt about some of the above devices together with some images in the previous session. Therefore, let us look at some general facts about these categories of output devices.

## Monitor

The monitor displays the output to the user visually. Therefore it is also called the Visual Display Unit (VDU) or simply the screen. The monitor looks like a television, but they often have higher resolutions than a normal television. Similar to televisions, the sizes of monitors are varying and often expressed in diagonally measured distance in inches. The technology used with monitors is expanding rapidly and there are two major types of monitors that differ in the technology of visualizing the output to the user. They are **Cathode Ray Tube (CRT)** monitors, **Liquid Crystal Display (LCD)** and **Light Emitting Displays (LED)**.

The **CRT** monitor has more lines of dots per inch, higher the lines more amount of the resolution. It creates the picture by number of rows or lines of the small tiny dots. For an instance the resolution of 1024 x 768 will be sharper than 800 x 600 resolutions.

The **LCD** consists of two sheets of polarizing material with a liquid crystal solution between

them. When an electric current passed through the liquid crystal solution, crystals align so that light cannot pass through them. It is like a shutter either allows light to pass through or blocking the light.

The **LED** is the latest marketing innovation of display units. It looks similar to LCD and it is also a flat panel display. LED means Light Emitting Diode and relates to the way the display is illuminated. LED monitors still use the same Liquid Crystals as the previous LCD displays. The way the backlight works however with the LED's will lead to a number of improvements in the display.

Though CRT monitors are much cheaper than LCDs and LEDs, the CRTs consume more power than others. Figure 3.17 and Figure 3.18 show images of CRT and LCD monitors respectively.



*Figure 3.17: CRT Monitor*



*Figure 3.18: LCD Monitor*

## **Printer**

A computer printer produces a **hard copy** (permanent human-readable text and/or graphics) of documents stored in electronic form, usually on physical/tangible print media such as paper or transparencies. Many printers are primarily used as local computer peripherals, and are connected by a printer cable to a computer which serves as a document source. Some printers, commonly known as **network printers** can serve as a hardcopy device to be shared and used by any user among a group of users connected to the network. **Individual printers** are often designed to support both local and network connected users at the same time. There are several types of printers categorized based on the applied technology of printing text/graphics on the paper.

Ex:

- Impact printers (Ex. Daisy Wheel and Dot Matrix printers)
- Non-impact printers
  - Ink Jet printers
  - Thermal Dye Transfer printers
  - Laser printers

### ***Impact Printers***

Any impact printer forms characters and graphics on a piece of paper by striking a mechanism against an ink ribbon that physically contacts the paper. Because of the striking activity, impact printers generally are noisy.

Many impact printers do not provide letter-quality print. **Letter-Quality** (LQ) output is a quality of print acceptable for business letters. Many impact printers produce **near letter-quality** (NLQ)

print, which is slightly less clear than LQ. NLQ impact printers are used for jobs that require only NLQ, such as printing of mailing labels, envelopes, or invoices.

Impact printers are also ideal for printing multipart forms because they easily can print through many layers of paper. Finally, impact printers are used in many factories and retail counters as they can survive in dusty environments, vibrations, and extreme temperatures.

### ***Non-Impact Printers***

A non-impact printer forms characters and graphics on a piece of paper without actually striking the paper. Some spray ink, while others use heat and pressure to create images. Since these printers do not strike the paper, they are much quieter than the above impact printers.

See figures from 3.19 to 3.22 for images of the above different types of printers.



*Figure 3.19: Ink Jet Printer*



*Figure 3.20: Dot Matrix Printer*



*Figure 3.21: Thermal Printer*



*Figure 3.22: Some Laser Printers*

### **Plotter**

Plotters are special type of printers used to print graphical output on paper. It interprets computer commands and makes line drawings on paper using multicolored automated pens. The plotter is capable of producing graphs, drawings, charts, maps, illustrations etc. Plotters are typically used in areas such as Computer Aided Engineering (CAE) applications like CAD (Computer Aided Design) and CAM (Computer Aided Manufacturing).



*Figure 3.23: Plotter*

### 3.5.3 Input & Output Devices

Some type of hardware can act as both input and output devices. For an example, consider the touch screen which is a type of monitor that displays text or images you can touch using your figure tips. When you touch the screen, its special sensors detect the touch and the computer recognizes the point/location on the screen where you touched. Touching different locations determines different information to be displayed next or what action to be taken next. Thus this touch screen (see Figure 3.24 below) can be considered as both input and output device.



*Figure 3.24: Input data through a Touch Screen*

## 3.6 Storage Devices

Storage refers to the media on which data, instructions, and information are kept, as well as the devices that record and retrieve these items. In this section we will discuss about the storage media and storage devices.

### 3.6.1 Memory versus Storage

It is important to understand the difference between the memory what we discussed under section 3.3 and the Storage. Memory holds data and instructions temporarily while they are being processed by the CPU. Storage, also called Secondary, Auxiliary storage, or Mass storage, holds items such as data, instruction, and information for **future use**.

Think of storage as a filing cabinet used to hold file folders, and memory as the top of your desk. When you need to work with a file, you remove it from the filing cabinet (storage) and place it on your desk (memory). When you are finished with the file, you return it to the filing cabinet.

### 3.6.2 Storage

Storage is non-volatile which means that items in storage remains even when power is removed from the computer. A **storage medium** is the physical material on which the items are kept. One commonly used storage medium is a disk, which is round, flat piece of plastic or metal with a magnetic coating on which items can be written. A **storage device** is the mechanism used to record and retrieve items to and from a storage medium.

Storage devices can function as source of input and output. For example, each time a storage device transfers data, instructions, and information from a storage medium into memory (a process called **Reading**); it functions as an input source. When a storage device transfers these items from memory to a storage medium (a process called **Writing**), it functions as an output source.

The speed of a storage device is defined by its access time, which is the minimum time it takes the device to locate a single item on the disk. Compared to memory, storage devices are slow. The access time of memory devices are measured in milliseconds.

### 3.6.3 Storage Devices

Some of the commonly used storage devices are described below with their images. However, you may already have some idea about them.

#### Floppy disks

A floppy disk is a data storage medium that is composed of a disk of thin, flexible floppy magnetic storage medium encased in a rectangular plastic shell. Floppy disks are read and written by a floppy disk drive.

##### *Application*

Any use where small files such as word processing, small spread sheets and databases need to be moved from one computer to another. Useful to backup small data files.



Figure 3.25: Floppy disk

#### Fixed hard disks

A hard disk drive is the device used to store large amounts of digital information in computers and related equipment like iPods and games consoles such as the Xbox 360 and PS3. Hard disk drives are used to store operating systems, software and working data.

These are suitable for any application which requires very fast access to data for both reading and writing to. However, Hard disk drives may not be suitable for applications which need portability. Almost all computers used a fixed hard disc. Used for on-line and real time processes requiring direct access. Used in file servers for Computer networks to store large amount of data.



Figure 3.26: Fixed Hard Disk

Hard Disk drive which is often referred to as **Hard Disk** or **Hard Drive** is a device to store and retrieve data in a computer. The hard drive can store important system files like the operating system, program files and other data. Though HDDs were originally designed to be used with computers nowadays the applications for HDDs have expanded beyond computers to include digital video recorders, digital audio players, personal digital assistants, digital cameras and video game consoles. HDD is a non-volatile storage device that stores digitally encoded data. It is an electromagnetically charged surface or set of disks that record data in concentric circles known as tracks. HDDs record data by magnetizing ferromagnetic material directionally, to represent either a 0 or a 1 binary digit. They read the data back by detecting the magnetization of the material. A typical HDD design consists of a spindle which holds one or more flat circular disks called platters, onto which the data is recorded. The platters are made from a non-magnetic

material, usually aluminum alloy or glass, and are coated with a thin layer of magnetic material. Figure 3.27 and 3.28 show some images of Hard Disk Drives.

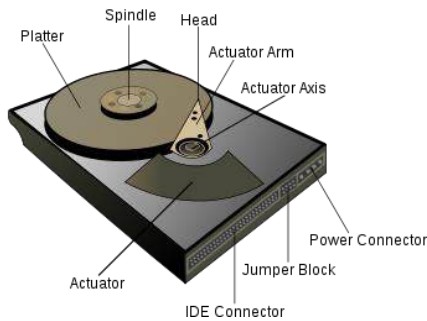

Figure 3.27: Parts of Hard Disk Drive



Figure 3.28: Outer view of a Hard Disk Drive

### Portable Hard Disks

Portable hard disk is an interesting and useful device because you can carry data about all over the place and transfer information, programs, pictures, etc. between computers. Modern portable hard disks have a massive capacity like 500GB.

*Advantages:*

- Greatly improved data cargo carrying capacity. (relative to the 1.44 Mb floppy disk)
- You don't need to worry about the other person having the same type of special cartridge drive as yourself.

*Disadvantages:*

- Hard drives have to be handled quite carefully, and when being transported should be wrapped in something soft and put in a padded bag.
- More expensive than other forms of removable media.

*Application*

Portable discs are used to store very large files which need transporting from one computer to another and price is not an issue.



Figure 3.29: Portable Hard Disk

### Magnetic tapes

**Magnetic tape** has been used for **data storage** for over 50 years. When storing large amounts of data, tape can be substantially less expensive than disk or other data storage options. Tape storage has always been used with large computer systems. Modern usage is primarily as a high capacity medium for backups and archives.

*Drawbacks*

Writing and retrieving data is slow. It uses serial access for reading and writing.



Figure 3.30: Magnetic tapes

### *Application*

Magnetic tapes are used for application which requires extremely large storage capacity where speed of access is not an issue. It is commonly used for backups of file servers for computer networks, in a variety of batch processing applications such as reading of bank cheques, payroll processing and general stock control.

### **Optical backing storage media such as CDs and DVDs**



*Figure 3.31: Image of a Compact Disk*

- CDs tend to be used for large files (but smaller than 1 GB) which are too big for a floppy disc to hold such as music and general animation.
- DVDs are used to hold very large files (several GBs) such as movie films. Both CDs and DVDs are portable i.e. they can be transported from one computer to another. Both can be used to store computer data.
- CD R/DVD R uses which require a single ‘burning’ of data, e.g. CDs - recording of music downloads from the Internet, recording of music from MP3 format, recording of data for archiving or backup purposes. DVDs – recording of film movies and television programs.
- CD RW/DVD RW uses when require the updating of information and ability to record over old data. Not suitable for music recording but is very useful for keeping generations of files. DVDs have between five and ten times the capacity of CDs.

### **Solid state backing storage**

- These are the smallest form of memory available in the market today.
- Widely used as removable storage.
- They are stronger than other forms of storage.
- Though expensive than other forms they can be easily written to and updated.

### **Memory sticks/Pen drives**

USB flash drives are typically removable and rewritable, much smaller than a floppy disk. Storage capacities typically range from 64 MB to 64 GB. USB flash drives offer potential advantages over other portable storage devices, particularly the floppy disk. They have a more compact shape, operate faster, hold much more data, have a more durable design, and operate more reliably due to their lack of moving parts. Flash drives are widely used to transport files and backup data from computer to computer.



*Figure 3.32: Pen drive*

## Flash memory cards

A **memory card** or **flash memory card** is a solid-state electronic flash memory data storage device used with digital cameras, handheld and Mobile computers, telephones, music players, video game consoles, and other electronics.

Nowadays, most new PCs have built-in slots for a variety of memory cards; Memory Stick, Compact Flash, SD, etc. Some digital gadgets support more than one memory card to ensure compatibility.



Figure 3.33: Flash memory cards

## 3.7 The System Unit

With reference to Figure 2.3 above, the System Unit of the computer is the box-like casing which contains the major electronic components that are responsible for the main functions of the computer. It should be mentioned here that many people use to refer to this as the CPU incorrectly. This erroneous reference may be due to CPU: *The brain of the commuter* being that significant. However, the electronic devices such as **CPU**, **memory**, **hard disk drive** are located inside the System Unit. In addition to the above parts, **Motherboard**, **Floppy Disk Drive**, **Power Supply unit**, and **CD-ROM Drive** are the other major components that you can find within the system unit. A brief description of each above component is given next.

**Note:** *The system unit is also called the housing, case, computer chassis, or cabinet.*

## 3.8 Motherboard

The motherboard is sometimes called the **system board**, **planner board** or **main board**. It is the **main circuit board** of a computer. The motherboard contains several **connectors** for attaching additional boards. Usually, the motherboard contains the CPU, BIOS, memory, mass storage interfaces, serial/parallel ports, expansion slots, and all the controllers required to control standard peripheral devices, such as the display screen, keyboard, and disk drive. All of the basic circuitry and components required for a computer to function are onboard the motherboard or are connected with a cable. The most important component on a motherboard is the chipset. It often consists of two components or chips known as the **Northbridge** and **Southbridge**, though they may also be integrated into a single component. These **chips** determine, to an extent, the features and capabilities of the motherboard.

See Figure 3.34 for a labelled image of a motherboard. It should be noted that the figure shows the *Asus P5N32-E SLI* motherboard. All boards will be slightly different as far as which components they have, and the locations of those components may differ, but they are fairly close.



**Note:** You are advised to explore the circuitry components attached to the mother board with the help of your lecturer or the instructor.

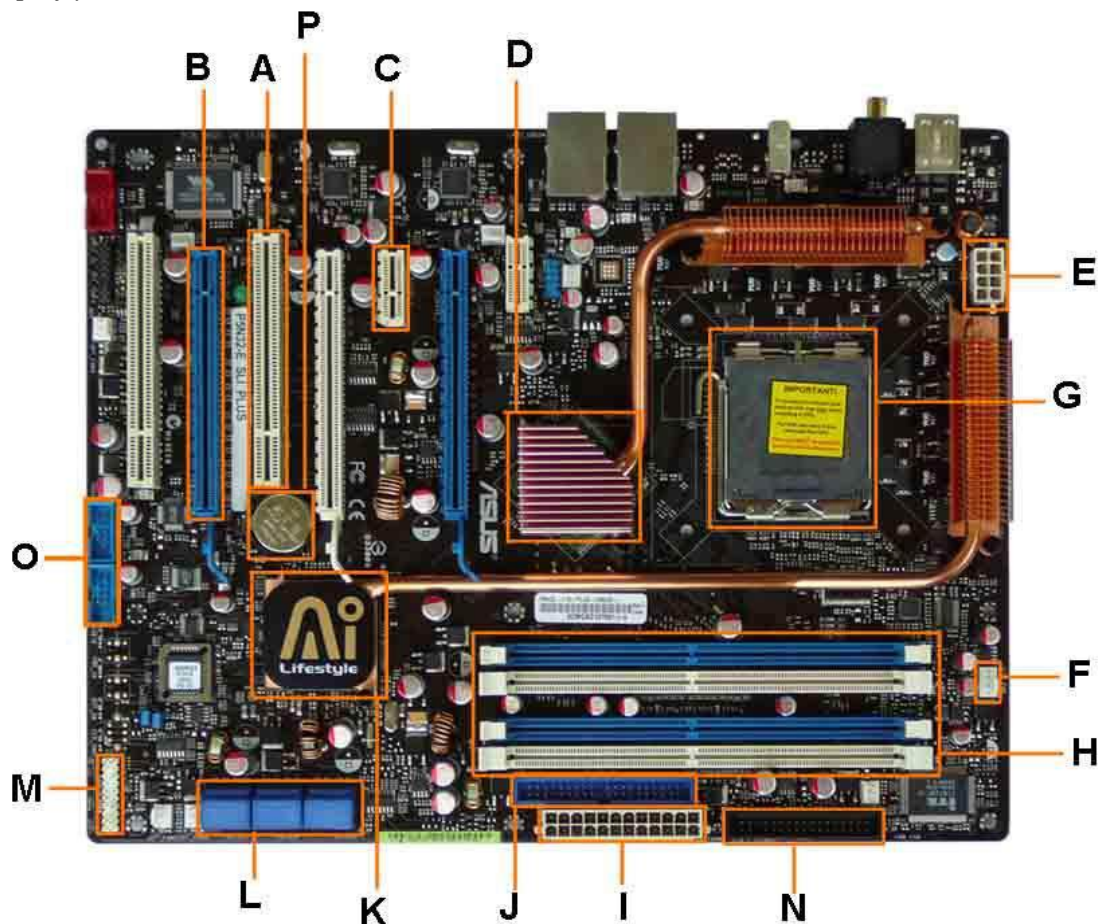

Figure 3.34: The components of a Motherboard

- A. **PCI Slot** - This board has 2 PCI slots. These can be used for components such as Ethernet cards, sound cards, and modems.
- B. **PCI-E 16x Slot** - There are 2 of them on this motherboard diagram, both are blue. These are used for your graphics card. With two of them onboard, you can run 2 graphics cards in SLI. You would only need this if you are a gamer, or working with high end video/graphics editing. These are the 16x speed versions, which are currently the fastest.
- C. **PCI-E 1x Slot** - Single slot - In the PCI-E 1x generation, each lane (1x) carries 250 MB/s compared to 133 MB/s for the PCI slots. These can be used for expansion cards such as Sound Cards, or Ethernet Cards.
- D. **Northbridge** - This is the Northbridge for this motherboard. This allows communication between the CPU and the system memory and PCI-E slots.
- E. **ATX 12V 2X and 4 Pin Power Connection** Power Connection - This is one of two power connections that supply power to the motherboard. This connection will come from your Power Supply.
- F. **CPU-Fan** Connection - This is where your CPU fan will connect. Using this connection over one from your power supply will allow the motherboard to control the speed of your fan, based on the CPU temperature.

- G. **Socket** - This is where your CPU will plug in. The orange bracket that is surrounding it is used for high end heat sink-s. It helps to support the weight of the heat sink.
- H. **Memory Slots** - These are the slots for your RAM. Most boards will have 4 slots, but some will only have 2. The color coding you see on the motherboard diagram is used to match up RAM for Dual-Channel. Using them this way will give your memory a speed boost.
- I. **ATX Power Connector** - This is the second of two power connections. This is the main power connection for the motherboard, and comes from the Power Supply.
- J. **IDE Connection** - The IDE (Integrated Drive Electronics) is the connection for your hard drive or CD / DVD drive. Most drives today come with SATA connections, so you may not use this.
- K. **Southbridge** - This is the controller for components such as the PCI slots, onboard audio, and USB connections.
- L. **SATA Connections** - These are 4 of the 6 SATA connections on the motherboard. These will be used for hard drives, and CD / DVD drives.
- M. **Front Panel Connections** - this is where you will hook in the connections from your case. These are mostly the different lights on your case, such as power on, hard drive activity etc.
- N. **FDD Connection** - The FDD is the Floppy Disk controller. If you have a floppy disk drive in your computer, this is where you will hook it up.
- O. **External USB Connections** - This is where you will plug in external USB connections for your case or USB bracket.
- P. **CMOS battery** - This is the motherboard's battery. This is used to allow the CMOS to keep its settings.

### 3.9 Power Supply Unit

Power Supply Unit (PSU) is another very important unit found in the system unit. Usually we connect the power code of the computer to the domestic mains supply. Therefore, PSU converts Alternating Current (AC) from mains supply to Direct Current (DC) with the required different voltages needed to power different components of the computer. Power supplies have a certain power output specified in Watts, a standard power supply would typically be able to deliver around 350 Watts. The more components like HDD, CD/DVD drives, and cooling fans, are connected to your computer the greater the power required from the power supply. See Figure 3.35 for an image of a typical power supply unit.



*Figure 3.35: Power Supply Unit*

### 3.10 CD-ROM Drive

Most probably, you might have seen the Compact Disks (CDs) which are commonly used as a storage media. The CD-ROM drive is a high capacity optical data storage device with a removable disk, it writes data onto or reads data from a storage medium.

A CD-ROM drive may be connected to the computer via an IDE (ATA), SCSI, S-ATA, Firewire, or USB interface or a proprietary interface. See Figure 3.36 for an image of a CD-ROM Drive.



*Figure 3.36: CD-ROM Drive*

### 3.11 Floppy Disk Drive

Floppy disks were used as a storage medium of which capacity is 1.44MB. However, nowadays the floppy disks (or diskettes) are outdated and USB Flash Disk drives and card readers have now come into play instead of floppy disks.

### 3.12 Card readers

Card reader is a data input device that can read data embedded in plastics cards which come in several forms such as bar codes, magnetic strip, computer chip. This reader may act as a memory card reader, smart card reader, magnetic card reader, or business card reader depending on the card read by the unit.

Following Figure 3.38 shows the arrangement of the components inside the system unit. However, it should be noted that there may be new components added with the advent of technology in the PCs what you can find now.



*Figure 3.37: Card reader*



Figure 3.38: Components inside the System Unit

### 3.13 Connecting Peripheral Devices to the Computer

We have already dealt about the peripheral devices in previous sections. Here we are going to see how we can connect these peripheral devices to your computer. Have you ever observed the back panel of the CPU? If you see the back panel of the CPU carefully you will come to know that there are several types of ports. They are in different colours and in different shapes. These ports can be fixed with specific ports from the peripheral devices. Hence ports can be considered as the interface in-between the computer and the peripheral devices. This mechanism is much more similar to a lock and key mechanism.

#### 3.13.1 Ports in Your Computer

Let's have a look at the available ports in a typical PC and the peripheral devices connected to the computer (Figure 3.39).

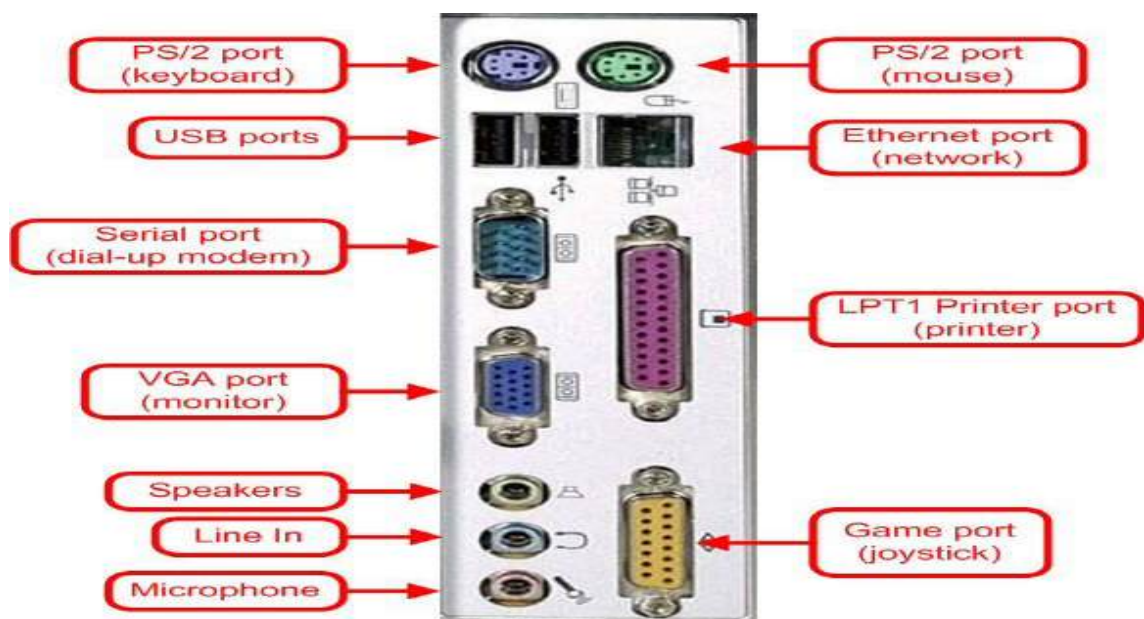
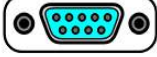



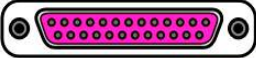
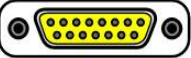

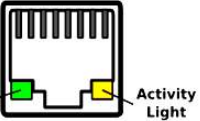





















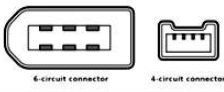

Figure 3.39: Different Ports of a Computer







# Identifying Computer Ports

<p><b>Serial Port</b> Used for PDAs and serial devices.</p> 	<p><b>PS/2 Port</b> Mouse Keyboard</p> 	<p><b>VGA Port</b> For External Monitor</p> 	<p><b>S-Video</b> For Video in/out</p> 	<p><b>HDMI</b> For High End TVs</p> 
<p><b>Parallel Port</b> Used for printers and data.</p> 	<p><b>Games Port</b> Joysticks and Midi Input</p> 	<p><b>Digital Video Interface</b></p> <p>DVI      Mini-DVI      Micro-DVI</p> 		

All Replaced by USB!

<p><b>Ethernet / RJ45</b> 10Mb/s, 100Mb/s and 1Gb/s</p>  <p>Link Light      Activity Light</p> <p>Used to connect to internet and intranet networks at high speed.</p>	<p><b>Modem / RJ14</b> 56Kb/s</p>  <p>Used to connect to internet via phone line, very slow.</p>	<p><b>Universal Serial Bus (USB)</b></p>  <p>USB 1.1 - 12Mb/s USB 2.0 - 480Mb/s USB 3.0 - 5Gb/s</p>	<p><b>USB A</b> Back of Computers</p> 	<p><b>USB B</b> Printers / Scanners</p> 
			<p><b>Mini-A</b></p> 	<p><b>Mini-B</b></p> 
			<p><b>Micro-AB</b></p> 	<p><b>Micro-B</b></p> 

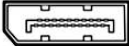
<p><b>Audio Mini-jacks Sockets</b></p> <ul style="list-style-type: none"> <li>  Microphone</li> <li>  Stereo Line-In</li> <li>  Stereo Line-Out</li> <li>  Right-to-Left</li> <li>  Center / Subwoofer</li> </ul>	<p><b>S/PDIF Digital Audio</b></p> 	<p><b>Firewire / i.Link IEEE1394</b> Video Cameras (DV) and Hard Drives</p> 	<p><b>Firewire 400Mb/s - IEEE1394a</b></p>  <p>6-circuit connector      4-circuit connector</p>
			<p><b>Firewire 800Mb/s - IEEE1394b</b></p>  <p>9-circuit connector</p>

<p><b>IEC Power Connectors</b></p> <p>C5 / C6 Cloverleaf 2.5 Amps</p> 	<p>C7 / C8 Figure of 8 2.5 Amps</p> 	<p>C13 / C14 IEC Cord 10 Amps</p> 	<p><b>eSata</b> External Hard Drive Port</p> 	<p><b>DisplayPort</b> Video and Audio Port for Home Theater Systems</p>  
			<p><b>PCMCIA / Cardbus</b> WiFi, Networking and Expansion Cards</p> 	

by Martin Owens  
Revision 05 2009-07-17



Figure 3.40: Identifying the different computer ports

You have seen the back panel of the CPU as a whole. Now let's take a look at each port individually and it is certainly going to be interesting!

### PS/2 Ports

PS/2 ports are simple and generally used as input ports to connect mice and keyboards with the computer. The green PS/2 is for the mouse while the purple ports can be connected to a keyboard. Commonly motherboards consist of these ports but this has become phased out because of the usage USB ports to connect these devices. PS/2 ports have 6-pin



*Figure 3.41: Images of PS/2 port*

### Parallel Port

This is used to connect the parallel devices to the computer. It is often called as Centronics interface after the company that designed the original standard for parallel communication between a computer and printer.

Today, the parallel port interface is scarcely used because of the rise of Universal Serial Bus (USB) and FireWire (IEEE 1394) devices.



*Figure 3.42: Images of Parallel ports*

The commonly found parallel device is the printer. Parallel ports can have 25 connections.

### Serial Port



*Figure 3.43: Images of Serial ports*

This is used to connect the serial devices to the computer. Serial port can have either 9 connections or 25 connections. Modem which is used to obtain the Internet connection is an ideal example for serial device. This was common method of data transfer throughout the history of the personal computers.

Network equipment (such as routers and switches) commonly use serial console for configuration. Serial ports are still used in these areas as they are simple, cheap and their console functions are highly standardized and widespread. A serial port requires very little supporting software from the host system.

## VGA Port

A Video Graphics Array (VGA) connector has 15 connectors in 3 rows. These 15 pins transmit video signals based on colors and video synchronizing.



Figure 3.44: VGA port

This is used to connect the monitor to the motherboard. They give an extra way to maintain an additional external monitor when using laptop. Using a VGA port is not too complicated, just plug the cable in and turn on the monitor.

## HDMI Port

HDMI (High-Definition Multimedia Interface) is a compact audio/video interface to transfer uncompressed video data and compressed/uncompressed digital audio data from a HDMI-compliant device to a computer monitor, video projector, digital television, or digital audio device which is compatible with HDMI. The existing analog video standards have been replaced with the arrival of HDMI.



Figure 3.45: HDMI port

## Universal Serial Bus (USB) Port

The most widely used hardware interface for connecting peripherals to a computer. There are typically at least two USB ports on laptops and four on desktop computers, while USB "hubs" provide more connections (there are exceptions as well).

Type	Port Image 4.5mm x 12.0mm	Connector Image
Type A		
Type B	7.3mm x 8.5mm 	
Mini-A	3.0mm x 6.8mm 	
Mini-B	3.0mm x 6.8mm 	

Figure 3.46: Different types of USB Ports



*Figure 3.47: The basic USB trident logo; indicating support for USB 2.0*

### **Fire wire Port**

FireWire is a type of cabling technology for transferring data to and from digital devices at high speed. Some professional digital cameras and memory card readers connect to the computer over FireWire. FireWire card readers are commonly faster than those that connect via USB. They are also known as IEEE 1394 or iLink. Although FireWire was invented by Apple Computer in 1995 it is now commonly used with Windows-based PCs.

FireWire is one of the fastest peripheral standards ever developed, which makes it great for use with multimedia peripherals such as digital video cameras and other high-speed devices like the latest hard disk drives and printers. It has the bandwidth of 400 megabits per second and the latest machines include FireWire ports operate at around 800 megabits per second. FireWire is a cross-platform implementation of the high-speed serial data bus which can handle up to 63 on the same bus consisting of simplified cabling and hot swapping. When this port is in use, a little monitoring light flickers.



*Figure 3.48: Fire wire logo*

### **3.14 Performance of a computer**

You may be wondering why your computer is slow at times and there are other times when it is fast in processing. This could be caused by a number of factors. They include: the speed of the CPU, the space on the hard disk, the size of the RAM, the type of the graphics card, the speed of the hard disk, if the computer is multitasking, the defragmenting files.

Note that, good computer performance may involve one or more of the following:

- Short response time for a given piece of work
- High throughput (rate of processing work)
- Low utilization of computing resource(s)
- High availability of the computing system or application
- Fast (or highly compact) data compression and decompression
- High bandwidth / short data transmission time



### 3.14.1 Factors affecting the Performance of computers

To increase the performance there are number of factors are effects including

- Performance of the Microprocessor
- Performance of the Hardware devices
- Performance of the Storage devices
- Performance of the Software

#### Performance of the Microprocessor

A microprocessor is a multipurpose, programmable device that accepts digital data as input, processes it according to instructions stored in its memory. Performance of the Microprocessor is depended on the several factors including;

- Clock speed

The speed of the CPU is also known as the clock speed of the CPU. The clock speed of the CPU is the frequency of which the processor executes instructions or the frequency by which data is processed by the CPU. It is measured in millions of cycles per second or megahertz (MHz). If the Clock speed of the CPU is fast then definitely the performance of the computer will be affected positively, in other words the computer will carry out processing functions at a faster pace.

- Bus Speed

A bus transfers data between components inside a computer. For an example, the processor is connected to the motherboard through the bus called, **Front-side bus**. The more data a bus can handle at one time, the faster it allows information to travel. The speed of the bus, measured in megahertz (MHz), refers to how much data can move across the bus simultaneously.

- Number of cores

The "core" in a processor is the microprocessor inside of the CPU. For example, if you have an i7 CPU then you have 4 microprocessors inside of the CPU; this allows you to do four things at once, as a microprocessor can only do one thing at a time.

- Available features

Some latest technologies introduced over the processor technology have increased the performance of the processor. For example, Turbo Boost Technology and the Hyper-Threading Technology

For an example, the following list gives some existing features available in the modern Intel i7 microprocessor which has increased its performance.

- Cores 4
- Threads 8
- Clock Speed 3.4 GHz
- Max Turbo Frequency 3.8 GHz
- Intel® Smart Cache 8MB



Figure 3.49: Image of Intel i7 Microprocessor

- Features
  - Intel® Turbo Boost Technology
  - Thermal Monitoring Technologies
  - Intel® Hyper-Threading Technology etc.

### Performance of the Hardware devices

Computer is a digital electronic device, consists of set of electronic circuits (Example Motherboard) therefore, performance of the hardware devices are depends on several factors including

- BUS Speed of the system
- Performance of the available ports
- Technology used to develop

The following figures show the physical architecture of the computer motherboard and the bus system.

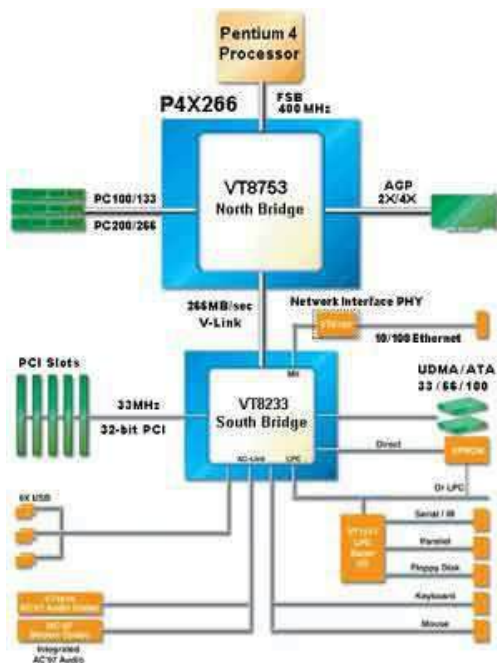

Figure 3.50: Architecture of the Motherboard

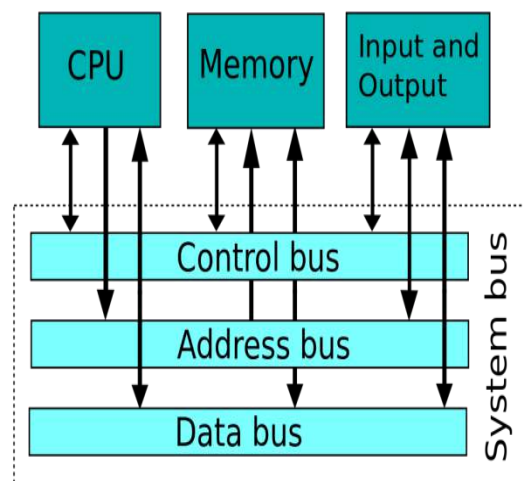

Figure 3.51: Bus system

### Performance of the Storage devices

To increase the performance of the storage devices, storage system has been divided in to the several units such as;

- Primary Memory
- Secondary Memory
- Cache memory

Accordingly, the performance of the computer goes up if the collective memory (Primary, secondary, and Cache) is high.

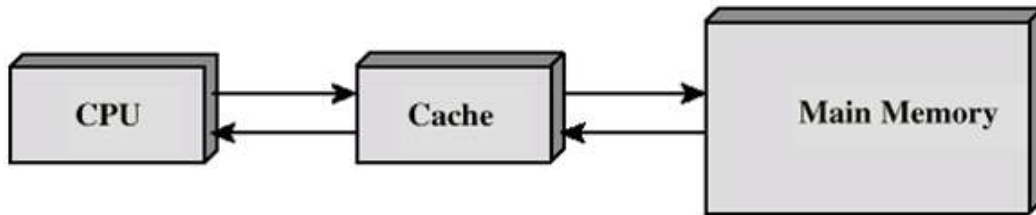

Figure 3.52: Storage system

## Performance of the Software

Here, we mainly focus on the device drivers installed into your computer. You should make sure that you have installed drivers recommended by the hardware vendor. You will learn more about the computer software in the next session and you will find what Software Drivers are in that session.



### 3.15 Self Assessment Questions

- 3.1 What is meant by the term “hardware device(s)”?
- 3.2 Briefly describe the four main categories of computer hardware.
- 3.3 What is CPU? Briefly explain the components of the CPU.
- 3.4 What is a microprocessor? Describe the factors which affect the performance of it.
- 3.5 What does the computer memory means? How is it measured?
- 3.6 Why does the computer need primary storage and secondary storage?
- 3.7 State the difference between volatile memory and non-volatile memory.
- 3.8 Explain the role of the cache memory in a computer.
- 3.9. Define the following devices.
  - a. Input devices
  - b. Output devices
- 3.10. Using suitable examples, describe the use of bar codes.
- 3.11. Briefly explain the functionality of the following display devices.
  - a. CRT Monitor
  - b. LCD Monitor
- 3.12. Suggest suitable devices for the following.
  - a. High quality printing
  - b. Quiet printing
  - c. Economical color printing
  - d. Economical printing of small quantities
  - e. High quality line drawing
- 3.13. Define the term BUS. Why are buses useful?
- 3.14. Name three ports that can be seen in a typical PC. Give an example of a device that can be connected to the computer via each port.
- 3.15. State the factors which affect the performance of computers.

## Session 04

# Computer Software

---

### Aim:

This session aims to provide the basic ideas of Software to the Students.

### Objectives:

Having studied this session the student will be able to:

- Describe what software is
- Classify computer software according to the usage of them
- Give examples for each category of computer software



## 4.1 What is Software?

Software, also called a **computer program** or simply a **program**, is a series of instructions that tells the hardware of a computer what to do. For example, some instructions direct the computer to allow you to input data from the keyboard and store it in memory. Other instructions cause data stored in memory to be used in calculations such as adding a series of numbers to obtain a total.

Before a computer can perform or execute a program, the instructions in the program must be loaded into the memory of the computer. Usually, they are loaded into memory from storage like hard disk.

When you purchase a program, you will receive one or more CD-ROMs or a single DVD-ROM on which the software is stored. To use the software, you often need to **install** the software on the computer's hard disk. Sometimes, a program can be loaded in memory directly from a CD-ROM or a DVD-ROM so that you do not have to install it on the hard disk to use it.

When you buy a computer, it usually has some software already installed in its hard disk. Thus you can use the computer as soon as you receive it. Software is the key to productive use of computers. With the correct software, a computer can become a valuable tool.

## 4.2 Categories of Software

The following diagram (Figure 4.1) shows the basic categories of software. This section will give you a description on each category of software together with some examples.

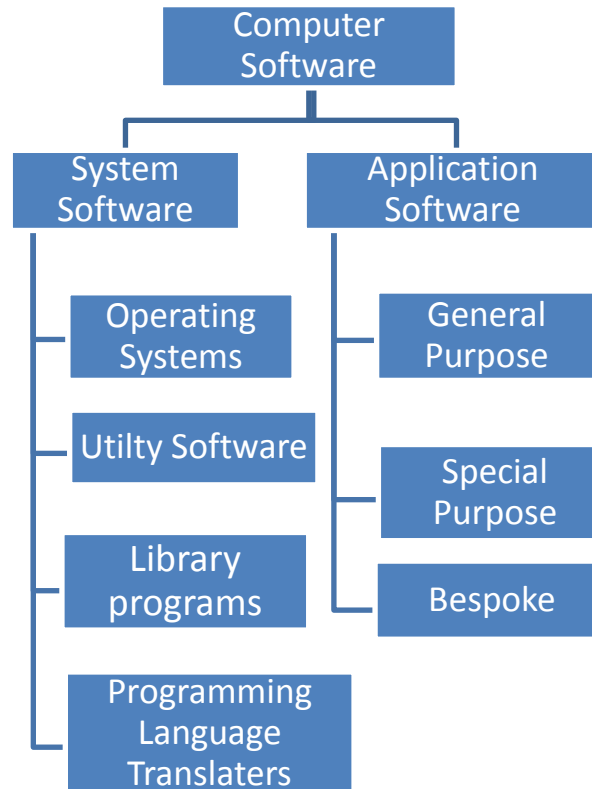

Figure 4.1: Classification of Computer Software

#### 4.2.1 System Software

System software consists of the programs that control the operations of the computer and its devices. Functions that system software performs include starting up the computer; opening, executing, running, applications; storing, retrieving, and copying files; formatting disks; reducing file sizes; and backing up the contents of a hard disk. Accordingly you can see that the System Software will handle the smooth running of all the components of the computer as well as providing general functionality for other programs to use, tools to speed up the computer, tools to develop new software and programs to keep you safe from attacks.

As shown in the above figure 4.1 there are several types of system software. Next sections will look at each type of system software together with examples.

#### Operating Systems (OS)

The Operating System contains instructions that co-ordinate all of the activities of hardware devices of your computer. It also contains instructions that allow you to run any applications software. One may define the Operating system as an interface between a user and all computer resources.

When you start a computer, the operating system is loaded or copied into memory from the computer hard disk. It remains in memory while the computer is running and allows you to communicate with the computer and other software. A computer cannot function without an operating system. It is an important component of the computer system, because it sets the standards for the application programs that run on it. All programs must “talk to” the OS.

There are two main types of Operating Systems:

**Single-user OS:** A type of OS which allows only one user at a time. There can be single-user OS either as **single-user single-task** or **single-user multi-task**. The Single-user single-task OS has to deal with only one person at a time running only one application at a time. MS DOS is an example for a single user single task OS.

Think of the OS of your Personal Computer. It is designed mainly with one user (i.e. you) in mind but that only user: you can deal with many applications running at the same time. You may word process a document with a word processing application like MS Word while listening to music played in the windows media player in parallel. Or you might be answering the school assignment while searching more facts on the internet while a suitable video is being downloaded. This type of OSs is of **single-user multi-task** OS. An example of such OS is Windows 95.

**Multi-user OS:** In some situations, we need to share the single computer among few users. So the OS should be a multi-user where more than one user is logged on to the computer and uses it at the same time. These multi users may work with remote desktop connections. Further, these different users may need to run different applications at the same time. So the OS must support multi-task facility as well. Obviously the computer should be a powerful one. Each user draws on a big power of the computer in a shared way. This type of Multi –user multi-task OSs have to manage some tasks as listed below:

- Each user logged on to the system, their workspace and so on.
- Allocate resources to the jobs they want to run.
- Keep logs of how much processing time and resources they use
- Work out the most efficient use of computer processing cycles
- Maintain security

Following are some examples of such OS:

- Windows XP, 7, 8 etc.
- Unix
- Linux (Ubuntu, Centos, Fedora etc.)

### **Desktop OS vs. Server OS**

The OS can also be categorized as Desktop OS and Server OS depending on whether the OS is to be installed in a desktop computer or a server. For example, the latest versions of the Windows OS family can be categorized as follows:

***Desktop OS:*** windows XP, windows 7, Windows 8

***Server OS:*** Windows 2000Server, Windows 2005Server, Windows 2008Server

As most of you are using Desktop Personal Computers, following web article is extracted in order to give you an overview on the different operating systems you may use.

Source: <http://www.geek.com/desktop-computer-buyers-guide/operating-system/>

## Operating Systems for your Desktop PC

Following is a note extracted from the web regarding the OS and given for the reader for additional facts about your OS

**Recommended:** Windows 7 Professional or alternative OS depending on your needs

**Minimum:** Windows 7 Home Premium

The operating system (OS) is the foundation of your computer's software. Everything that runs on the computer is based on this in one form or another and its stability and functionality will determine what you can get out of the computer.

Currently there are three main options: Windows, Linux, and Apple's OS X. They may serve the same purpose, but they are too firmly established to say that one is better than the others. Each has their own strengths and weaknesses and each will have unique appeal to different buyers.

As important as this decision is, it is largely a moot issue because the vast majority of consumer desktops sold run Windows. As of October 22, 2009 the current version is Windows 7, and it's a highly regarded update to the previous Windows Vista. Like it or not, 7 is going to be the only version of Windows that ships on most new desktops.

Apple's OS X (current version "Snow Leopard") is also an excellent OS and it's generally seen as a great choice for most home users, ranging from the casual buyers to computer professionals. While an excellent operating system it is only sold with Apple's desktops (namely the iMac and Mac Pro) so this guide might not be extremely helpful because those systems have limited options available to them.

Some types of Linux are also fantastic for home users, but it is not something people generally have experience with so it can be hard to recommend, unless if you have a close friend or family member to help you get your on your feet. It also cannot run popular applications like iTunes and Photoshop, so it can be an issue for some buyers. Linux is free and easy to run though, so any computer you build/buy will be able to run it in a trial mode (via a Live CD or on a USB key) without even having to install it. This is an ideal way to give it a try before committing to it. Not many desktops ship with Linux so this will limit a buyer's options as well.

As for Windows 7, it comes in a few different varieties. They won't all be available in all areas though. Ranging from the least to most expensive

This may look confusing but the vast majority of Windows buyers will be getting either Home Premium or Professional, so the decision won't be too hard. If you don't know why you'd want to get Professional then Home Premium will do the job nicely. Home Premium will be the right fit almost all home users

## 4.2.2 Utility Software

Utility software or utility programs are some small programs which performs specific task, usually related to managing a computer, its devices, or its programs. Most operating systems include several utility programs. Also, you can buy them as stand-alone software that offer improvements over the ones supplied with the OS. Following are some of the specific tasks done by commonly used utility programs:

- Viewing files
- Compressing files
- Diagnosing problems
- Scanning disks
- Defragmenting disks
- Uninstalling software
- Backing up files and disks
- Checking for viruses
- Displaying screen savers

Following figures show some of the user interfaces of the above utility programs.

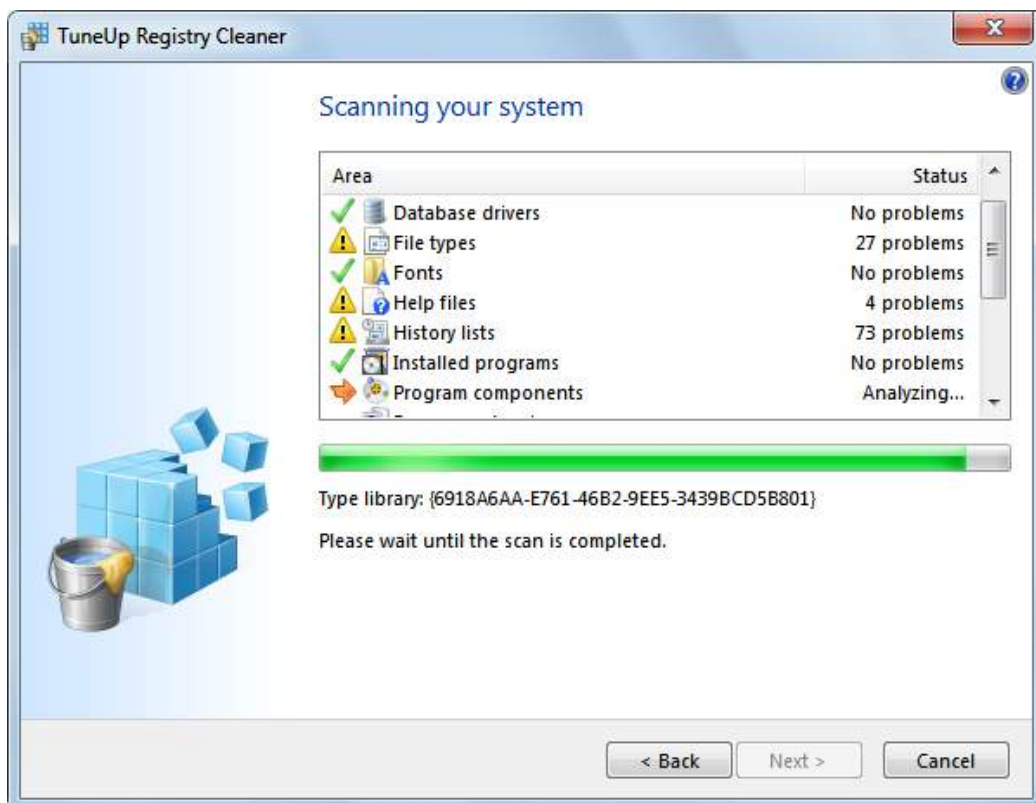

Figure 4.2: Tune up Disk Cleaner



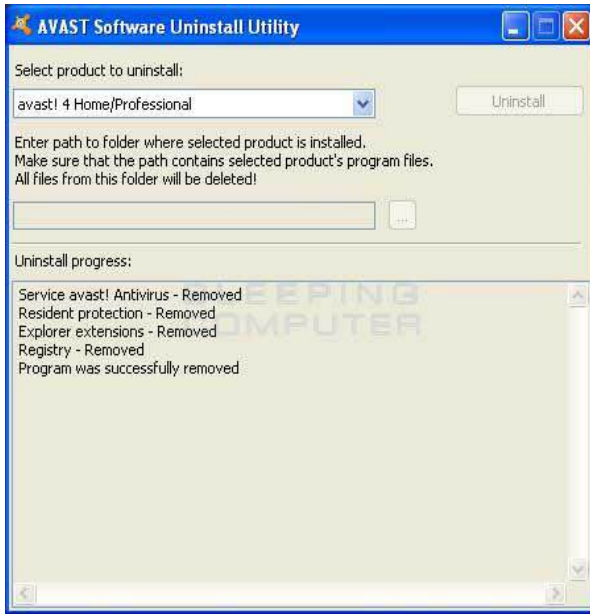

Figure 4.3: AVAST Software Uninstall Utility



Figure 4.4: WinZip file compressing utility



Figure 4.5: McAfee Antivirus Utility

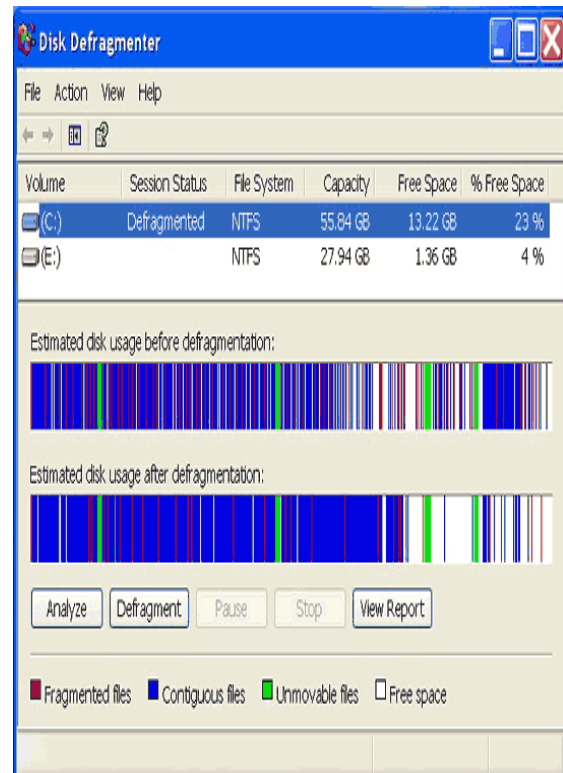

Figure 4.6: Disk Defragmenter utility

### 4.2.3 Library Programs

**Library programs** are collections of some pre-written codes or resources that are used to develop other programs. For an example, you might have noticed that all Microsoft Programs look like the same or have the same look and feel in the interfaces though the application differs. The reason for this consistent look is the using of same graphical user interface libraries when developing different applications by the Microsoft. Another classical example is, the computer game developers often buy and use pre-done graphical user interface libraries and develop new games as they need to save time and cost of entire development process. This will allow them to quickly develop a good looking game that runs on the desired hardware. In w\Windows, you can often identify library programs by their extension **.dll** (dynamic link library).

### 4.2.4 Programming Language Translators

You are already aware that a Program is a set of instructions written for performing a specific task. These instructions are just like English words. We call that these programs are written in programming **languages** that can be understood by human beings. These written programs are called that **Source codes**. However, some programs run on a **machine code** that is executed directly on computer architecture. Machine code is not easily read by humans and it is a long series of bits (i.e. ones-1 and zeros-0). Therefore, the source code is to be converted into machine code which is called an **object program**. This translation can be done by translator. Simply, the translators translate source code into machine code. There are three approaches of program translating:

- Assembler
- Interpreter
- Compiler

#### Assembler:

An assembler translates the symbolic codes of programs of an assembly language into machine language instructions (See Figure 4.7 below). The **symbolic language** is translated to the machine code in the ratio of one is to one symbolic instructions to one machine code instructions. Such types of languages are called **low-level languages**. The assembler programs translate the low-level language to the machine code. The translation job is performed either manually or with a program called **assembler**. In hand assembly, the programmer uses the set of instructions supplied by the manufacturer. In this case, the hexadecimal code for the **mnemonic** instruction is searched from the code sheet. This procedure is tedious and time-consuming. Alternate solution to this is the use of assemblers. The program called assembler provides the codes of the mnemonics. This process is fast and facilitates the user in developing the program speedily.

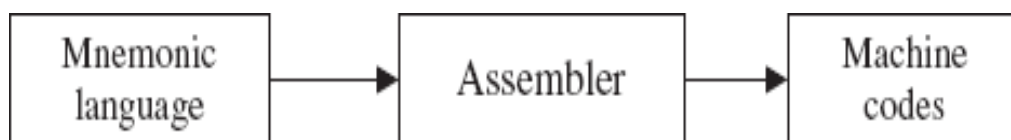

*Figure 4.7: Assembler*

#### Interpreter:

Interpreters also come in the group of translators. It helps the user to execute the source program with a few differences as compared to compilers. The source program is just like English

statements in both interpreters and compilers. The interpreter also generates object codes from the source program. Interpreter reads the program line by line, whereas in compiler the entire program is read by the compiler, which then generates the object codes. Interpreter directly executes the program from its source code. Due to this, every time the source code should be inputted to the interpreter. In other words, each line is converted into the object codes. It takes very less time for execution because no intermediate object code is generated.

### **Compiler:**

Compilers are the translators, which translate all the instructions of the program into machine codes, which can be used again and again (See Figure 4.8 below). The source program is input to the compiler. The object code is output for the secondary storage device. The entire program will be read by the compiler first and generates the object code. However, in interpreter each line is executed and object code is provided. M-BASIC is an example of an interpreter. High-level languages such as C, C++ and Java compilers are employed. The compiler displays the list of errors and warnings for the statements violating the syntax rules of the language. Compilers also have the ability of linking subroutines of the program.

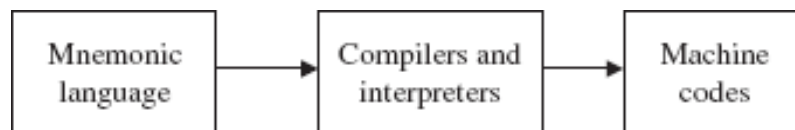

*Figure 4.8: Compilers and Interpreters*

## **4.3 Application Software**

Re-call the classification of software given in Figure 4.1. Accordingly, the second major class of Software is the Application Software. Application software consists of programs designed to perform specific tasks of users. Application Software, also called a software application or an application, can be used for the following purposes, among others:

- As a productivity/business tool
- To assist with graphics and multimedia projects
- To support household activities, for personal business, or for education
- To facilitate communications

A variety of application software is available that you can buy from software vendors in retail stores or on the Web. A specific software product, such as Microsoft Word, often is called a **Software Package**.

Based on the purposes as listed above, the application software is three-fold namely General Purpose, Special purpose, and Bespoke. Let us look at each type of applications software briefly.

### **4.3.1 General Purpose Application Software**

A general purpose application is also called ‘off-the-shelf’ applications. These are the software you use at home, university, or at work place to make you more effective and efficient while performing daily activities. These include applications such as word processors, spreadsheets, databases, desktop publishing packages, presentation packages, graphics packages, text editors, etc. Following Table 4.1 gives example uses of different general purpose applications.

General Purpose Application	Example Uses
Word Processor	Writing reports, memos, letters to customers
Spreadsheet application	Keeping simple company accounts, calculating employee payments, simple stock control systems, modeling
Database application	Keeping student data of a university, Keeping customer records, sales records, appointments system
Desktop Publishing application	Creating leaflets, posters, business cards, etc.
Presentation software	Creating presentations to be used for an audience of customers/staff.
Graphics application	Manipulating images that can be used at home, university, or a business
Web Design application	Creating personal or business web sites

*Table 4.1: Uses of General Purpose Applications*

**Note:** Within this course, you will learn deeply on one from each categories of Word Processor, Spreadsheet application, Database application, and Presentation software as tabled below.

General Purpose Application	Software covered within this course
Word Processor	Microsoft Word 2007
Spreadsheet application	Microsoft Excel 2007
Database application	Microsoft Access 2007
Presentation software	Microsoft PowerPoint 2007

*Table 4.2: Application software covered in ICT Skills Course*

### 4.3.2 Special Purpose Application Software

Special Purpose Application Software is the software created for execution of a single specific task. Some examples are Chess game, calculator, camera application in your mobile phone which allows you only to capture and share pictures, web browsers, media players, calendar programs.

### 4.3.3 Bespoke Application Software

Some organizations may feel that the general purpose software are not suitable for their task and it does not exactly what they want or it does not tallying with the current system in the organization. In this type of situation, they decide on designing and developing software specifically for them. These softwares are also called as the ‘**tailor-made software**’ or ‘**Bespoke software**’ as they are made to a specific user and customized for a specific task only. Following are the advantages and disadvantages of bespoke software:

### *Advantages:*

- The organization will get the exact system that they need
- The software will work exactly how they want it to work
- The software will only have the features that they specifically need in their job or business feeling them comfortable to use

### *Disadvantages:*

- It takes more time to develop such systems. The development duration several months or years
- Developmental cost is very high
- Sometimes it is required to employ a team of people at different stages of the development process such as analysts, programmers, testers, etc.

Following are some examples for bespoke software:

- Membership database (Insurance Industry)
- Dispatch Systems (Factory/Processing Industries)
- Sales order Systems (Newspaper Industries)
- Invoicing System (Motor Industries)
- Freelancer System (Newspaper Industries)
- Calibrating Software (Pharmaceutical Industries)  
Software that checks all medical devices to ensure that all are correctly calibrated
- Educated Marketing database (Education)
- Event Planning Database (Manages invitations, member registrations, and seminar places)
- Marketing Databases (territory management, telemarketing, direct mail campaigns, analysis)
- Sales Training Databases (Management reports of personal attainment, history, and team performance)

## **4.4 Self Assessment Questions**



- 4.1 What is Software?
- 4.2 Differentiate System software and Application software.
- 4.3 What are the responsibilities of Operating Systems?
- 4.4 Define the following with suitable examples.
  - a. Single-user OS
  - b. Multi-user OS
- 4.5 What are utility programs? Define some tasks performed by them.
- 4.6 What is meant by library programs?
- 4.7 What are program language translators? Briefly describe three translating approaches.
- 4.8 State the advantages and disadvantages of Bespoke Application Software.

## Session 05

# Computer Networks

---

### Aim:

This session aims to develop a solid grasp of network by introducing the basic concepts.

### Objectives:

Having studied this session the student will be able to:



- Describe what a computer network is
- Define the basic terminology: Nodes, Clients, Servers, and Hub with their roles in a computer network
- Classify the networks according to the scale
- Describe what LAN, MAN, and WAN are
- Classify the networks according to the topology
- Identify the basic hardware used in networking computers
- Describe what Internet, Intranet, and Extranet

## 5.1 What is a Computer Network?

Two or more independent computers connected together through a communication media form a computer network. The computers are connected in a network to exchange information and data. The computers connected in a network can also use resources of other computers such as software packages and peripherals like modems, printers, backup drives, or CD-ROM drives. Networks are built with a mix of computer hardware and computer software. Further, you do not need the same software package installed on your machine, if your network has that software installed on one of the machines on the network. In this sense, computer networks are clear means for sharing resources. This makes the use of computer technology cost effective. Following Figure 5.1 shows a typical network with four computers.

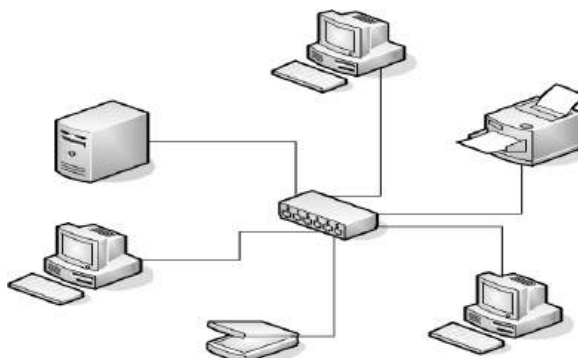

*Figure 5.1: Typical computer network*

## 5.2 Basic hardware and terminology in networks

If you explore more on computer networks, you will come across with a huge list of terminology associated with networks. Let us look at the basic terminology used in the subject of computer networks in brief. It is worth to note here that all networks are made up of basic hardware building blocks to interconnect network nodes.

### 5.2.1 Node

Any device attached to the network capable of communicating with other network devices is called a **Node**. A node can be a computer or some other device, such as a printer. Every node has a unique network address, sometimes called a Data Link Control (DLC) address or Media Access Control (MAC) address.

### 5.2.2 Client

A device or application that uses the services provided by a server is called a **Client** in the network. A client may be a PC or a workstation on a network using services provided from the network file server, or it may be that part of an application program that runs on the workstation supported by additional software running on the server. One of the most familiar clients is the Web browser.

### 5.2.3 Server

Any computer that makes access to files, printing, communications, and other services available to users of the network is called a **Server** in the network. In large networks, a dedicated server runs a special network operating system; in smaller installations, a non-dedicated server may run a personal computer operating system with peer-to-peer networking software running on top.

A server typically has a more advanced processor, more memory, a larger cache, and more disk storage than a single-user workstation. A server may also have several processors rather than just one and may be dedicated to a specific support function such as printing, e-mail, or communications. Many servers also have large power supplies, UPS (uninterruptible power supply) support, and fault-tolerant features, such as RAID technology. On the Internet, a server responds to requests from a client, usually a Web browser.

Following Figure 5.2 shows the client and server in a network.

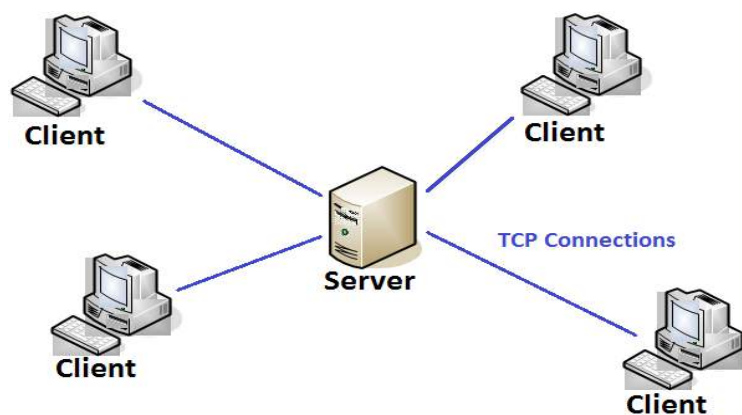
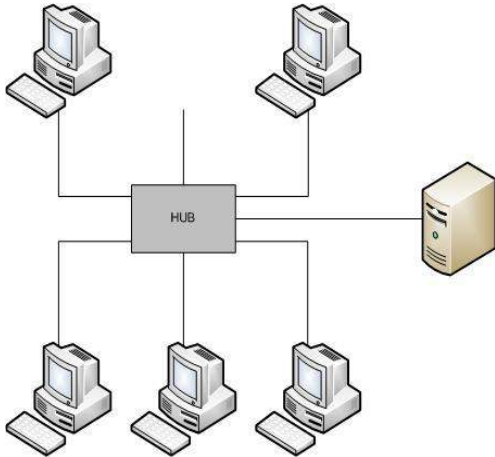

Figure 5.2: Client and Server

## 5.2.4 Hub

A device used to extend a network so that additional workstations can be attached. In some star networks, a hub is the central controlling device. Hubs typically provide from 4 to 24 connections, allowing anything from 2 to 24 devices to communicate with one another. Following Figure 5.3 shows the use of a hub in a Star network (You will learn what a star network is in the latter part of this session) while the Figure shows an enlarged view of an 8-port hub.



*Figure 5.3: Hub in a Star network*



*Figure 5.4: 8-port Hub*

## 5.2.5 IP Address

An Internet Protocol (IP) address is a numerical identification (logical address) that is assigned to devices participating in a computer network utilizing the Internet Protocol for communication between its nodes. Although IP addresses are stored as binary numbers, they are often displayed in more human-readable notations, such as 192.168.100.1 (for IPv4). The role of the IP address has been characterized as follows: "A name indicates what we seek. An address indicates where it is. A route indicates how to get there."

## 5.2.6 Network interface cards

A network card, network adapter, or NIC (network interface card) is a piece of computer hardware designed to allow computers to communicate over a computer network. It provides physical access to a networking medium and often provides a low-level addressing system through the use of MAC addresses.



*Figure 5.5: Network Interface Card*

## 5.2.7 Repeaters

A repeater is an electronic device that receives a signal and retransmits it at a higher power level, or to the other side of an obstruction, so that the signal can cover longer distances without degradation. In most twisted pair Ethernet configurations, repeaters are required for cable which runs longer than 100 meters.



### 5.2.8 Bridges

A network bridge connects multiple network segments at the data link layer (layer 2) of the OSI model. Bridges do not promiscuously copy traffic to all ports, as hubs do, but learn which MAC addresses are reachable through specific ports. Once the bridge associates a port and an address, it will send traffic for that address only to that port. Bridges do send broadcasts to all ports except the one on which the broadcast was received.

### 5.2.9 Switches

A network switch is a computer networking device that links network segments or network devices. The term commonly refers to a multi-port network bridge that processes and routes data at the data link layer (layer 2) of the OSI model. Switches that additionally process data at the network layer (layer 3) and above are often called *layer-3 switches* or multilayer switches.



Figure 5.6: Switch

### 5.2.10 Routers

A router is a networking device that forwards packets between networks using information in protocol headers and forwarding tables to determine the best next router for each packet. Routers work at the Network Layer of the OSI model and the Internet Layer of TCP/IP.



Figure 5.7: Router

## 5.3 Classifications of Computer Networks

Computer networks can be classified by considering following different aspects as the basis.

- The scale
- The connection method
- The functional relationship (Network Architectures)
- The network topology

The Table 5.1 given below classifies the computer networks according to the above different basis.

The basis	Different categories
<b>Scale</b>	Personal Area Network (PAN) Local Area Network (LAN) Metropolitan Area Network (MAN) Wide Area Network (WAN).

<b>Connection method</b>	Optical fiber Ethernet Wireless LAN Home PNA
<b>Functional Relationship (Architecture)</b>	Active Networking Client-server networking Peer-to-peer (workgroup) architectures
<b>Network topology (Arrangement of components)</b>	Bus network topology Star network topology Ring network topology Mesh network topology Tree or Hierarchical topology

*Table 5.1: Classifications of Computer Networks*

### 5.3.1 Classification of computer networks by scale

According to the Table 5.1 above, the networks can be classified into six classes abbreviated as PAN, LAN, MAN and GAN.

#### Personal Area Network (PAN)

A personal area network (PAN) is a computer network that will be useful in communicating computerized devices such as telephones and PDAs. Mostly, the PAN is communicated through wireless network technologies such as Wireless USB, Bluetooth, Z-Wave, and IrDA. You may use PANs to communicate among the personal devices or you may connect even to higher level networks or to the internet.



*Figure 5.8: Personal Area Network*

## Local Area Network (LAN)

A local area network (LAN) is a computer network covering a small geographic area, like a home, office, or group of buildings. Ex: a school (See Figure 5.10 below). The defining characteristics of LANs, in contrast to Wide Area Networks (WANs), include their much higher data transfer rates, smaller geographic range, and lack of a need for leased telecommunication lines. LANs can be small, linking as few as three computers, but often link hundreds of computers used by thousands of people. The development of standard networking protocols and media has resulted in worldwide propagation of LANs throughout business and educational organizations. The Figure 5.9 below shows a LAN consisting of six computers/work stations.



Figure 5.9: Local Area Network (LAN)

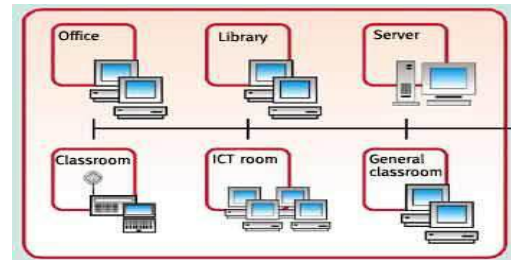

Figure 5.10: LAN in a School

## Wide Area Network (WAN)

Wide Area Network is defined as a group of computers and network devices connected across large physical areas such as states or countries. Computers connected to a Wide Area Network are often connected through the telephone system. They can also be connected through leased lines or satellites. One may define a WAN as a collection of several LANs as depicted in Figure 5.11 below.

The largest WAN in existence is the Internet. (You will learn about Internet in a coming section).

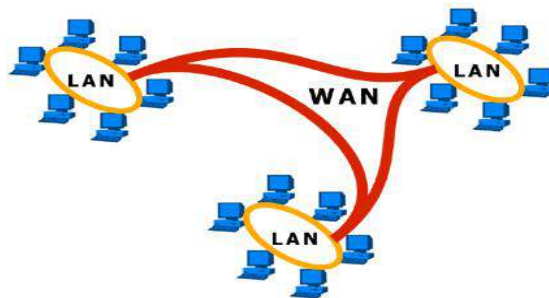

Figure 5.11: Wide Area Network

## Metropolitan Area Network (MAN)

MAN is a network that interconnect users with computer resources in a geographic area or region larger than that covered by a local area network (LAN) but smaller than the area covered by wide area network (WAN). Further a MAN is a network that connects two or more Local Area Networks or Campus Area Networks together but does not extend beyond the boundaries of the immediate town, city, or metropolitan area. See Figure 5.12 below for a typical set up of a MAN.



Figure 5.12: Metropolitan Area Network (MAN)

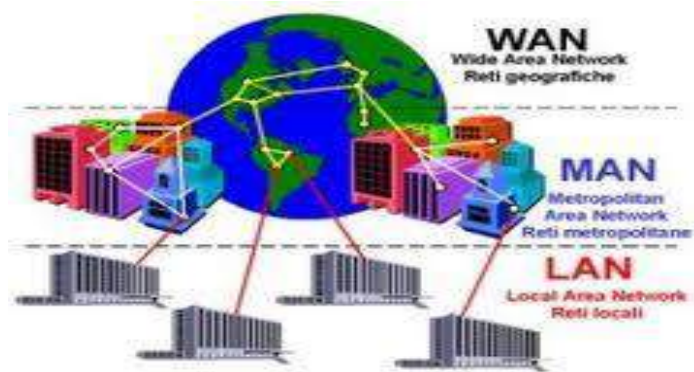

Figure 5.13: LAN, MAN, and WAN

### 5.3.2 Classifications of networks based on the topology

Network Topology is the schematic description how the arrangement of the network is including the nodes, connecting lines, and other devices. As per the above Table 5.1, the main network topologies are listed below.

- Bus
- Star
- Ring
- Mesh
- Tree/Hierarchical

Deep discussions on the topologies are beyond the level of this course unit. However, brief descriptions on each topology and images of them are given below.

#### Bus Topology

Bus networks (not to be confused with the system bus of a computer) use a common backbone to connect all devices. A single cable, the backbone, functions as a shared communication medium that devices attach or tap into with an interface connector. A device wanting to communicate with another device on the network sends a broadcast message onto the wire that all other devices see, but only the intended recipient actually accepts and processes the message.

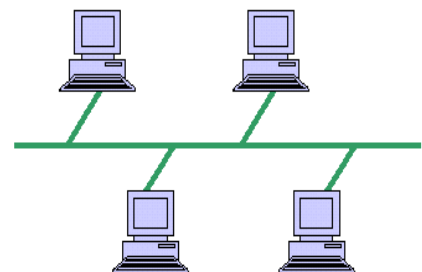

Figure 5.14: Bus topology

## Star Topology

Many home networks use the star topology. A star network features a central connection point called a "hub node" that may be a network hub, switch or router. Devices typically connect to the hub with Unshielded Twisted Pair (UTP) Ethernet.

Compared to the bus topology, a star network generally requires more cable, but a failure in any star network cable will only take down one computer's network access and not the entire LAN. (If the hub fails, however the entire network also fails.)

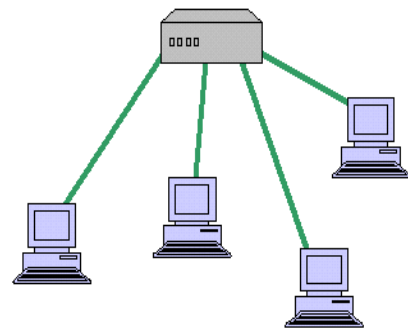

Figure 5.15: Star topology

## Ring Topology

In a ring network, every device has exactly two neighbors for communication purposes. All messages travel through a ring in the same direction (either "clockwise" or "counterclockwise"). A failure in any cable or device breaks the loop and can take down the entire network.

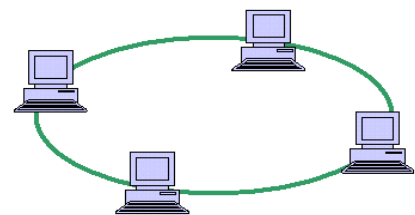

Figure 5.16: Ring topology

To implement a ring network, one typically uses FDDI, SONET, or Token Ring technology. Ring topologies are found in some office buildings or school campuses.

## Mesh Topology

Mesh topologies involve the concept of routes. Unlike each of the previous topologies, messages sent on a mesh network can take any of several possible paths from source to destination. (Recall that even in a ring, although two cable paths exist, messages can only travel in one direction.) Some WANs, most notably the Internet, employ mesh routing.

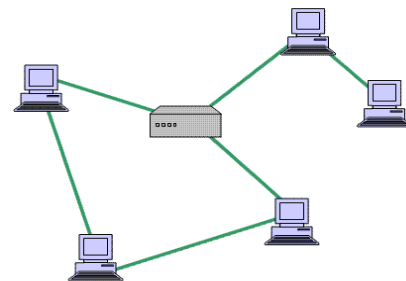

Figure 5.17: Mesh topology

A mesh network in which every device connects to every other is called a full mesh. As shown in the illustration below, partial mesh networks also exist in which some devices connect only indirectly to others.

## Tree Topology

Tree topologies integrate multiple star topologies together onto a bus. In its simplest form, only hub devices connect directly to the tree bus and each hub functions as the root of a tree of devices. This bus/star hybrid approach supports future expandability of the network much better than a bus (limited in the number of devices due to the broadcast traffic it generates) or a star (limited by the number of hub connection points) alone.

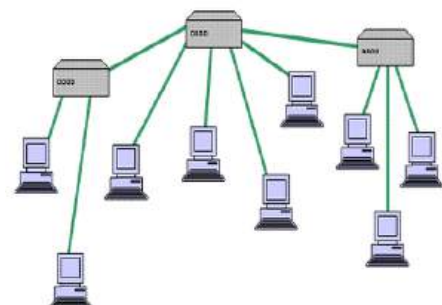

Figure 5.18: Tree topology

## 5.4 The Internet

As you are already aware, the Internet is the largest WAN in existence (See Figure 5.19 below). It is a *network of networks* that consists of millions of private, public, academic, business, and government networks, of local to global scope, that are linked by a broad array of electronic, wireless and optical networking technologies. The Internet carries an extensive range of information resources and services, such as the inter-linked hypertext documents of the World Wide Web (WWW) and the infrastructure to support email.

With the dramatic rise in demand for connectivity, the Internet has become a communications highway for millions of users. The Internet was initially restricted to military and academic institutions, but now it is a full-fledged conduit for any and all forms of information and commerce. Internet websites now provide personal, educational, political and economic resources to every corner of the planet.

**Note:** You will learn deeply on Internet under Session 22 in this course material.)

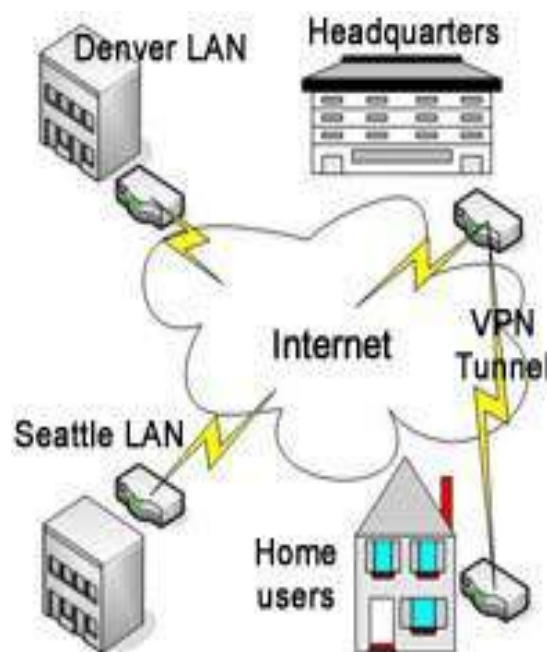

Figure 5.19: Internet: the largest WAN in existence

### Did you know?

- The foundation of the internet began in 1969, when the US Department of Defense created **ARPAnet**, a project to allow military personnel to communicate with each other in an emergency.
- By 2011, the number of internet users worldwide reached **2.2 billion**—about one third of the world's population.
- To store all of the information on the internet, you would need over **1 billion DVDs** or **200 million Blu-ray discs**.

## 5.5 The Intranet and Extranet

### 5.5.1 The Intranet

You are already aware what the Internet is. Accordingly, the internet which is a worldwide system can be accessed by any person or by any organization. Since it is a vast public communication tool, some organizations were willing to maintain their own local network which supports their employees or the members. The *Intranets* were developed as a solution to the above requirement. However, the intranet also has almost all the services provided by the Internet, but it is a private system. The access of an intranet is restricted to the authorized members or people within the organization such that the authorized members need to log on with a secure password.

More comprehensively, intranets are private networks based on Internet Technologies that are located behind an organization's firewall. A **Firewall** is a set of technologies designed to protect a private network from users on a public network. Some intranets provide access to the Internet through a special server called a **Proxy Server**, designed to cache (to store for quick re-use) frequently requested information to keep that information readily available. This type of proxy server also provides tools for tracking and controlling access to networks.

An intranet can cover a LAN where only staff in the same building or region can use it. Or it can run over a WAN where staff (authorized people) from around the world can log in.

#### **What Intranets do**

Intranets usually start by publishing web pages about the organization's events, health and safety policies, and staff newsletters. Popular applications follow, such as forms to reclaim expenses or request holidays. All these help eliminate paperwork and speed up workflows of the organization.

As more features are added, this intranet can become essential to the operation of an organization. It becomes a portal that provides access to all the things workers need.

A typical intranet may provide the services such as E-mail, File transfer, Real time chat, web pages, video and audio streaming services. Each service requires at least one server to provide the service. For example, the intranet of the Open University of Sri Lanka maintains two main servers; a web server for the *OUSL web site* and a Moodle server for the service of delivery of on-line courses.



Figure 5.20: Moodle Server

#### **Advantages of an Intranet**

- Commercial or confidential data is kept secured within the organization.
- E-mails remain private and may also be encrypted.
- High bandwidth. No connection limits unlike the Internet

- Reliable. The organization will have dedicated IT personnel to keep things running smoothly.
- Information specificity tailored to the organization or staff's needs can be published.

### 5.5.2 The Extranet

We can consider an Extranet as an extension to the Intranets what we described above. Because, the extranets are again private networks that contains information related to the company and accessible only for the members of the company BUT allowed for outside individuals as well who have obtained the authority to access. Therefore, an extranet is partially accessible to authorized outsiders.

An extranet can be configured (set up) either using a direct leased line linking all intranets or by using a secured separate link created across the participants as a VPN (Virtual Private Network). The latter method is more cost effective than the first method.

#### Advantages of Extranets

- A cost effective method to share and trade information and all other data effectively at any time to the authorized people (internal and external) such as the customers, partners, investors, suppliers who are included within the built up extranet.
- A platform for companies to conduct business-to-business deals. Can assist in strengthening relationships between two or more organizations.
- Useful when the staff of the company works outside the office, from their homes, or sales sites so that they can still be in with the company network with the access permission.

## 5.6 Self Assessment Questions



- 5.1 Why do we need to connect computers?
- 5.2 What is a computer network?
- 5.3 Briefly describe the following network components.
  - a. Client
  - b. Server
  - c. Hub
  - d. Router
- 5.4 What are the differences between a Hub and a Switch?
- 5.5 What is the use of a MODEM?
- 5.6 Briefly describe the following categories of networks.
  - a. PAN
  - b. LAN
  - c. WAN
  - d. MAN
- 5.7 Briefly explain the classifications of networks according to the topology.
- 5.8 What is meant by Internet and Intranet? Why it is important to use intranet than internet?
- 5.9 What is the most suitable connection method for the following;
  - a. Computers within a laboratory.
  - b. Connect two computer laboratories.
- 5.10 List the advantages of having an Extranet for a company.



## Session 06

### Usage of ICT & Environment for Computers

---

#### **Aim:**

This session aims to outline the uses of computers in the day to day life and comprehensively model the environmental effects as well as the physical impacts.

#### **Objectives:**

Having studied this session the student will be able to:



- Describe why the computers are used at places of work
- Identify the different sectors where the concepts of ICT are used
- Briefly describe what e-commerce, e-banking, and e-medicine are
- Describe the nature of the environment of a computer based work area
- Identify the health issues related to working with computers
- Describe how to protect our environment by bad effects from computers

#### **6.1 Computers at work**

You might have not seen a place of work without a single computer in use. The computer has become such essential equipment for almost all places of work no matter if it is a small scale or large scale company. Computer literacy in varying extents has become an essential item under the qualifications required for most of the job vacancies. However, the utilization of computers may vary from place to place depending on the nature of the business they perform.

When we consider the both private and government sector places of work in Sri Lanka, following can be considered as the typical uses of computers.

- Managing data – keep track of data about customers, products, demographics and other information important to the business, uses secured mechanisms for storages.
- Maintain financial status – Keep track of the financial status of the company on an annually, monthly or even day-to-day basis. Spreadsheet software is commonly used to track expenditures, sales, and profit and losses. Accounting software provides a business with even more assistance with financial matters, as it is used to do payroll, invoice customers, prepare taxes and execute other essential functions. Companies can use their computers to print checks for payroll and expenditures, and can form a direct link to the company's bank account.
- Communication–Uses e-mails, publishes information on web, keeps in touch with stake holders via social networks, conference meetings avoids the need of physical availability of participants of the meetings,
- Networking- shares resources, common database of files accessible for authorized members
- Research work – Investigate new products, improve the quality of the existing products through effective research

- Audio and Video business presentation
- Process simulations- The processes allows you to see effect of changes, without having to actually make those changes to your processes, can use to maximize the overall confidence with the proposed changes without implementing
- Increase productivity through Industry specific software

Though the typical usage of computers at work has been summarized as above, there will be many more answers to the question ‘What are the uses and advantages of computers in your office?’ depending on the nature of work handled within the company/office of the person. So it is not a marvelous fact that most of the organizations move towards automating the tasks with the help of modern computers.

## **6.2 Usage of ICT in different sectors**

We looked at the usage of computers in a typical office in the previous section. It was quite difficult to list of uses as it is vast. However, it can be clearly identify the sectors where ICT is now used in the Sri Lanka and in the world, in general as listed below.

### **6.2.1 Potential Sectors with ICT usage**

ICT can be potentially used in the following sectors. Note that the following list is given in general but not specific to our country. Some of the sectors may be already familiar to you in your everyday life.

- Education
- Heals care/medicine
- Agriculture
- Banking
- Business/trade and commerce
- Transport
- Manufacturing
- Travel and Tourism
- Environment
- Gender
- Culture

Following sections will give a brief to some of the above sectors with respect to usage of ICT.

### **6.2.2 ICT in Education**

The usage of concepts in ICT in the education sector also varies on its application such as,

- ICT as a subject (i.e., computer studies)
- ICT as a tool to support traditional subjects (i.e., computer-based learning, presentation, research)
- ICT as an administrative tool (i.e., education management information systems/EMIS)
- ICT as a medium of knowledge exchange

Accordingly, as a student who follows this course unit, you are dealt with the above first category; ICT as a subject. However, you will be able to get more familiar to use the computer for your studies not only this course unit but also the other courses you follow at OUSL by using your computer as a tool to support your studies. This category is often referred to as **e-learning**. We will be discussing deeply about e-learning in session 25 in this course material. However, the following description is given as it is worth to get a brief idea on what e-learning is before proceeding to the next sections.

### **E-Learning**

As per a definition given in an international journey, e-learning, sometimes termed computer-based training (CBT), internet-based training (IBT) or web-based training (WBT), includes all forms of electronically supported learning and teaching, including educational technology. The information and communication systems, whether networked learning or not, serve as specific media to implement the learning process. Accordingly you can see that the term e-Learning is really just an umbrella term which covers a wide set of electronic educational applications and processes.

Mostly, the electronic technology used here is the use of computers with the accessibility to the internet. You will be able acquire and develop your knowledge so that you will be able to demonstrate the particular topic learned which proves that it has positively influenced in your behaviors. You may consider the *OUMoodle* (<http://ousl.nodes.lk/>) which is the Learning Management System used in the Open University as a major learner support tool.

The advantages of e-learning with respect to both teaching and the learning parties can be considered as;

- Cost effective
- Saves time without sacrificing quality
- Minimizes travel cost
- Can be accessed from anywhere any time in the world
- Consistent course delivery
- Individual instruction

### **6.2.3 ICT in Business/Trade and Commerce**

Nowadays, the business IT specialist applies ICT in their organizations to achieve their commercial objectives. It makes them be quick, cheap, and more attractive to the client of their business. One of the major applications of ICT in businesses is the existence of industries where buying and selling of products or services done through internet or other computer networks. This area is called Electronic Commerce or **E-commerce**. You will learn what e-commerce is deeply in session 25 of this material. However, again for your benefit, a brief description of e-commerce is given below before moving on to the next topic.

**Online shopping** and **electronic payments** can be considered as the most famous examples of e-commerce. In online shopping, the seller creates their sales outlet in the web while the buyer brows and purchase products with mouse clicks. For an example, Amazon.com (See figure 6.1 below) is a famous online shopping destination where you will see the sale details of thousands of goods and services.



Figure 6.1: Interface of the Amazon shopping place (www.amazon.com)

Suppose that you need to buy a mobile phone online from amazon.com, there should be a mechanism to make your payment online to the supplier. This mechanism is known as electronic payments. Paying through your credit card is an example for an electronic payment. This type of e-payments very effective and you do not need worry about the safety as the reliable shopping destinations such as Amazon.com have taken sufficient safety measures.

## 6.2.4 ICT in Banking

Nowadays, for almost all operations in a bank are done with the help of the computers and the internet or any other network. Basically, the banks store all their customers account details on computers. This allows them to easily find out account information on their customers, and make changes to their account balance easily, for things such as when money is put in and withdrawn from the bank. Have you ever used an ATM card? Hopefully the answer is yes. Use of ATM cards is one of the operations used in the banking sector with the ICT. You may know that you can perform some of your banking activities without the physical movement into the bank. In another words, you do your banking online. This facility is known as **E-Banking**.

You may visit <https://www.commercialbk.com/comworks/default.asp> (See figure 6.2 and 6.3 below) to access the online banking facility of the Commercial Bank of Ceylon PLC. You may do banking with authorized access by logging to the site with your credentials.



Figure 6.2: Online banking with Commercial Bank PLC



Figure 6.3: Online Banking with Bank of Ceylon

### 6.2.5 ICT in Medicine

ICT is used in many ways related to the Medicine sector. **E-Medicine** is one of such facility. **E-Medicine** is an online clinical medical knowledge database with a collection of thousands of articles, images, videos which support you to browse and get knowledge in any matter related to the medicine field such as details of diseases, drugs, medications, health news, first-aid guides, etc. Further, you can get the answers for your own health care related question as well.

*eMedicineHealth* (<http://www.emedicinehealth.com>, see Figure 6.4 below) is an example for such online medicine database. These knowledge databases usually get updated regularly to provide an updated knowledge to the client.



Figure 6.4: Interface of an e-medicine database

## **6.3 Health, Safety, and Environment for computers**

Having read the previous sections of this session you might now have the feeling ‘what a vast range of uses we get from our computers today’. Computer, being such common equipment used by people no matter a kid or an adult; did you ever think whether you are working in a good computer based environment? Did you ever think that there are specific guide lines to use your computer with respect to its physical environment? How many hours do you spend a day in front of the computer? You might not thought of these types of questions before.

Following sections discuss about the computer based good working environment and the facts that you need to keep in mind and obey as a computer user.

### **6.3.1 Work environment**

It is essential to maintain your best possible work environment to ensure the health and the productivity of all computer users. You may think that you have arranged the furniture and the computer equipment correctly, but still it may give health issues arise if the working environment is poor. Following are the physical aspects that you need to consider with respect to a good working environment.

- Working space
- Location of workstations
- Lighting
- Decor
- Atmospheric conditions
- Noise
- Housekeeping

A briefing of each above aspect is given below.

#### **Working space**

You must have enough space to perform your tasks safely and comfortably. The amount of working space depends on the user, nature of work you do, and the devices and the furniture you need to use. Everything should not be crowded. Sometimes, you get stressed or less productive when the space is too compact. Therefore, you need to make sure that your work space gives you a good comfortable posture and that you have easy access to and from the location of your computer.

#### **Location**

It is important to think about the visual environment when locating your computer with other peripherals. Here, the arrangement of lighting, the type of light fittings used, and the location of the window are important to consider.

- The office layout should be planned around the position of light fixtures to prevent walls or partitions blocking or creating shadows over the work area.
- If the user is sitting near photocopiers and printers they may be distracted by noise and the heat generated by the other machines and also may get disturbed by the people who are coming often to operate those other machines.
- Make sure that you have an easy access to hardware and power points. Well positioned power points can prevent use of multi-plug boards and extra cable lying.

## **Lighting**

You may use artificial to provide lighting, but it is better to go for a combination of natural and artificial light. Some instances like using LCDs or if the user is an older person, then you may require high level of lighting. Your lighting should be:

- Adjustable in direction and intensity level
- Does not produce excessive contrasts in different regions of your working area
- Does not result in glare or screen reflections at nearby users. Glare may cause visual discomfort and may cause headaches as well as reduces the performance of the user.

## **Decor**

Too much of dark colors can create contrasts in brightness so that additional lighting is needed. As a general rule the ceiling should be brighter than walls and walls brighter than the floor.

## **Atmospheric conditions**

It is a known fact that people react strongly when they think the air is stuffy, stale or polluted and may express this as general dissatisfaction with the environment. So your working area should be well ventilated and have a comfortable temperature. You may use air conditioners to satisfy this condition.

## **Noise**

Noise in your working area (may be generated from equipment, ringing phones, air conditioners/fans, people work close by) can make communicating and concentrating difficult, and may be leading to stresses. Generally, the more complex a task, the lower a user's tolerance for noise is. So it is required assure that your work area is minimized with noise.

## **Housekeeping**

Good housekeeping is promoting maintenance of good health and safety in your work place. So the floors should be tidy and cleaned, environment should be dust free, and it is required to make sure that the power cables do not present tripping hazards.

### **6.3.2 Computer related health problems**

There are four potential health issues identified as associated with computer work. They are:

- Physical discomfort, pain, or injury
- Visual discomfort
- Stress
- Fatigue

These may often influence each other. Let us have a look at each issue separately.

#### **Physical discomfort, pain, or injury**

It may give several physical discomforts by working with computers. These may affect the parts of your body like muscles, connective tissues, tendons, ligaments, joints, bony structures, the blood supply, nerves and the skin.

If you are physically affected or about to affect you may get one or more symptoms as listed below.

- Pain
- Fatigue
- Muscle discomfort
- Stiffness
- Burning sensations
- Weakness
- Numbness
- Tingling

You may get these symptoms in different extents, and sometimes may get worsen gradually. However, it is important to take corrective actions as soon as symptoms present. The small changes you can make avoid bigger discomforts.

Following are two specifically identified health issues which come under the category described above.

#### Carpal Tunnel Syndrome:

The Carpal Tunnel is an area on the palm side of the wrist bordered on one side by the carpal bones and on the other by the Carpal Ligament, a fibrous band. This structure is quite rigid. If the space in between the structure gets shrink, the structures within the tunnel gets an increasing pressure. Repetitive movement at the wrist, as occurs with prolonged use of a computer keyboard can lead to inflammation in the carpal tunnel and the resultant painful syndrome. Patients usually feel pain in the forearm area as well as numbness in the affected hand in the thumb, index, long and radial half of the ring finger. This numbness often occurs at night. The treatments vary from wearing wrist splints, anti-inflammatory medications, or surgeries.

#### Neck and Back Pain:

Poor positioning of the keyboard and monitor in relation to the user can lead to discomfort of the neck and back. The monitor screen should be at a level such that the user can easily see the screen with the head held at a comfortable and neutral position. If the head has to be constantly turned or tilted in order to see the screen, this will lead to chronic aches and pains in the neck area. This along with any eye strain that occurs can lead to tension headaches. The chair or keyboard stand should be adjusted so that when sitting with the hands resting on the keyboard, the elbows should be slightly above the wrists. The chair should have firm lumbar support and it is important that the individual maintain good posture to minimize back strain.

#### **Visual discomforts**

The symptoms such as sore eyes, red eyes, watery eyes, dry eyes, blurring of vision and headaches may say that you are about to a vision problem due to computer work. So it is required to take following precautions to avoid such health issues.

- Adjustments to the work environment, such as lighting or window treatments to reduce glare and minimize variations in light levels.
- Reducing visual stress from computer work through, for example, the use of rest or alternate task breaks throughout the workday, or frequently looking into the distance to reduce focusing fatigue.



- Adjustments to the work equipment, such as the location of the screen(s), keyboard, mouse, paperwork and chair.
- Adjustments to computer software, such as ensuring that the font, font size and screen display settings meet the visual needs of the user.
- Specific lenses to meet the unique demands of computer work, such as lenses that are focused for the distance of the computer screen, lens designs that incorporate near and intermediate focusing distances, and lens tints or coatings that may help to maximize vision and comfort.
- A programme of optometric vision therapy. Some computer users may experience problems with eye focusing or eye coordination that cannot be adequately corrected with lenses but may be correctable in other ways.

## **Stress**

Stresses may cause due to problems at office or home. Some stresses are avoidable while some are unavoidable. Following are some examples avoidable stresses as it is worth to identify them as they can be avoided:

- Working for too many hours each week
- Working in a situation that is poorly set up for the work being done
- No performance feedback or only adverse feedback

A good support both from outside work and in the work place may strengthen the computer user's capacity to deal effectively with work stress. It is important to remember that for most people work is good for health and wellbeing.

## **Fatigue**

You may feel either physically, mentally, or emotionally fatigue due to bad computer use. Common approaches for preventing fatigue and discomfort when using computers include pauses, regular breaks, stretching and task variety, knowing deadlines and negotiate to get achievable deadlines, break large tasks into small parts, have plans to achieve deadlines and targets, etc.

### **6.3.3 Proper use of mouse, monitor, and key board**

In addition to the little discussions made above on what we should do to prevent the health issues, let us discuss more on prevention methods with respect to the devices you mostly use such as the mouse, monitor, and the keyboard.

#### Mouse:

- Place the mouse in an easy reach zone so that the shoulders and upper arms can be relaxed and close to the body while operating the mouse.
- Keep the wrist and hand in a neutral position, never bent.
- Keep arm and hand in line (See Figure 6.5 below)
- Use as little force as possible when clicking or dragging.
- Use alternative devices on the market such as graphic tablets and pens, touchpad, touch screens, and foots witch-operated mice.
- Use mouse wrist supports to elevate the hand and wrist if feel better when using.

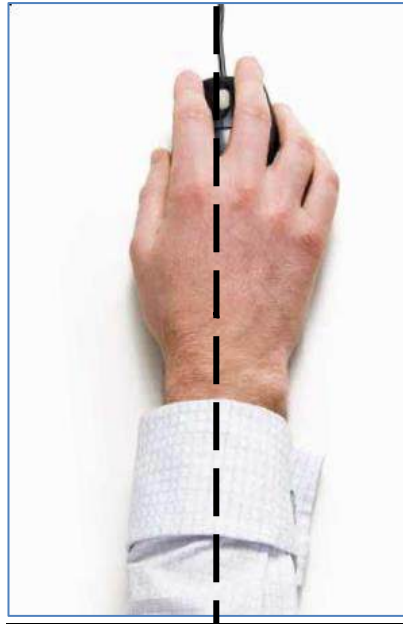

*Figure 6.5: Keep arm and hand in line*

### Monitor

- Position the monitor so that you do not have to bend the neck up or down or twist the neck sideways to view the screen.
- The top of the display screen should be at or slightly below eye level and at about 18" to 24" away from the face.
- The angle of the screen should be easily visible.
- Dark letters on a light background should be used to reduce eyestrain.
- Adjust brightness and contrast.
- Choose a monitor with good resolution for clarity of characters on the screen. The screen refresh rate should be at least 60 Hertz to eliminate screen flicker.
- The screen should be cleaned of dust frequently to ensure the image is sharp.

### Keyboard

- Place your keyboard at approximately elbow height with the surface at a comfortable angle.
- The hands and wrists should be held in a neutral position when typing: the wrists should be straight and not be bent upward, downward or sideways. This position places the least pressure on the tendons and nerves passing through the carpal tunnel.
- The shoulders should be relaxed, the upper arms should hang comfortably down along the sides of the body and the elbows should not be cocked out away from the body.
- Wrist rests can be used to cushion and support wrists in breaks between typing based on the recommendations of your doctor. However, they should not be used to support wrists or hands while typing as this usually puts a bend in the wrist.

### **6.3.4 Reference postures**

Following Figure 6.6 shows a range of acceptable postures that computer users may adopt as starting positions to move in and around, but note that there is no uniquely correct posture that would suit any user for an extended period of time.



*Figure 6.6: Reference postures*

## **6.4 Protecting environment**

Sometimes, we may not think that usage of computers may be harmful to the environment. But if you use the computer smarter, intelligently, and in moderation you can prevent those harmful effects from your computer. Some of such good practices are described below:

### **6.4.1 Go paperless**

Printing every document sent to you not only uses up paper, but also ink and energy. Instead of printing documents and filing them, try saving receipts and e-mails to your hard drive using a PDF printer. This not only helps the environment, but can often be a lot easier to keep track of than paper documents. Linux- and Mac-based systems come with this option by default; Windows users can install a free program called PDF Creator.

### **6.4.2 No Screen Saver**

Screen savers are mostly an outdated concept and few modern monitors will "burn" anymore. If your computer is set to use a screen saver, it is using electricity unnecessarily. Consider instead setting your computer monitor to turn off after a set period of time. This easily can be done in the same window where you configure your screen saver.

### **6.4.3 Turn It Off**

You don't need your computer on all the time. When you're not using it, turn it off. You might ask the question from yourself don't want to close all your programs? You may suspend the computer instead, which keeps everything open without the power usage. In Windows this is done by clicking "Start," then "Shut Down," then "Suspend." Most laptops will suspend if you close the lid.

#### 6.4.4 Use a Flash Drive

Blank CDs are a cheap and easy way to move data, but are largely disposable. If you need to move files from one computer to another without using a network, consider using a flash drive or external hard drive instead of disposable CDs. If you still prefer CDs, consider buying re-writable discs. Reusing is always a good idea if you care about the environment.

#### 6.4.5 Fix Your Old Computer

Think it is time to buy a new computer? Think again. Many computers, especially with Microsoft Windows, get slower as time goes on, but that has more to do with software than hardware. Simply reinstalling the operating system can give what seems like an old, slow computer a new lease on life. Still not fast enough? Installing more RAM is cheap, impacts the environment less and might be all you need. Try this before buying a new computer, which unnecessarily uses up resources and energy, not to mention your money.

### 6.5 Self Assessment Questions



- 6.1 Using suitable examples, describe how computerization would help an organization to perform more efficiently and effectively.
- 6.2 Briefly describe the following terms.
  - a. E-Commerce
  - b. E-Banking
  - c. E-Medicine
- 6.3 What are the advantages of e-learning with respect to both teaching and learning?
- 6.4 Briefly explain the nature of the environment that is preferable for a computer based working area.
- 6.5 What are the four potential health issues associated with computer work? Give examples.
- 6.6 Describe how to protect the environment by harmful effects of computers.

## Session 07

# Information Security and Legal Regulations

---

### Aim:

This session aims to give an idea of legal regulation that covers the information security.

### Objectives:

Having studied this session the student will be able to:

- Identify the types of computer threats that you may meet with the software and hardware of your computers
- Take safety precautions to minimize threats to your computer
- Identify and solve privacy issues
- Understand what copyright is
- Avoid using computers illegally
- Understand the other legal regulations related to computers



## 7.1 Introduction to Information Security

*Information security is the practice of defending information from unauthorized access, use, disclosure, disruption, modification, perusal, inspection, recording or destruction.*

*Wikipedia*

In the other words, Computer Security is the protection of computing systems and the data they store or access. Here, it is required to assure that your information are protected in terms of **Confidentiality, Integrity, and Availability** as illustrated in the Figure 7.1 below.



*Figure 7.1: Information Security*

### 7.1.1 Importance of Information Security

Information security plays a major role in your computing system, especially when the computer is connected to the internet or any other network. Due to being attacked, an unprotected computer can become infected or compromised within a few seconds after it is connected to the

network. In the other hand it can be a case for the other computers which are available in its network.

### **7.1.2 Possible attacks**

Following is a list of attacks that may arise with your computer if not proper security measures taken. In other words, following are the ways that your computer may behave due to being hacked.

- Record keystrokes and steal passwords.
- Send spam and phishing emails.
- Harvest and sell email addresses and passwords.
- Access restricted or personal information on your computer or other systems that you have access to.
- Illegally distribute music, movies and software.
- Distribute child pornography.
- Infect other systems.
- Hide programs that launch attacks on other computers.
- Generate large volumes of traffic, slowing down the entire system.

### **7.1.3 Security measures**

The following steps can be followed to prevent being attacked.

- Use good, cryptic passwords that can't be easily guessed. And keep your passwords secret.
- Make sure your computer's operating system and applications are protected with all necessary security "patches" and updates.
- Make sure your computer is protected with up-to-date anti-virus and anti-spyware software.
- Don't click on unknown or unsolicited links or attachments, and don't download unknown files or programs onto your computer.
- Remember that information and passwords sent via standard, unencrypted wireless are especially easy for hackers to intercept.
- Look for "https" in the URL before you enter any sensitive information or a password (The "s" stands for "secure").
- Also avoid standard, unencrypted email and unencrypted Instant Messaging (IM) if you're concerned about privacy.

### **7.1.4 Forms of software threats**

In the previous section (Section 7.1.2) you learnt what type of attacks may arise with your computer. We call that the cause of such attacks could be due to a Computer Virus, a Worm, or any other form of other harmful program. Let us discuss more about such software threats with some examples.

#### **What is a computer virus?**

We all get affected by viral infection diseases it is difficult to find a cure for a viral infections. Computer virus is a harmful computer program developed by a person that disrupts operations of a computer in various ways. It can be either malfunction of a program or set of programs, it can be a program which generates e-mails in thousands, it can be a program that damages important files such as documents beyond recovery, a program just simply destroys the files system of

computer making it completely unusable or simply a harm less program which displays a message in a taskbar or a title bar. Definitely you need to know that computer viruses do not infect any human being.

The **Creeper virus** was first detected on ARPANET, the forerunner of the Internet in the early 1970s. Creeper was an experimental self-replicating program written by Bob Thomas at BBN in 1971. Creeper copied itself to the remote system where the message, "I'm the creeper, catch me if you can!" was displayed. The Reaper program was created to delete Creeper.

A program called "**Rother J**" was the first computer virus to appear "in the wild" that is, outside the single computer or lab where it was created. Written in 1981 by Richard Skrenta, it attached itself to the Apple DOS 3.3 operating system and spread via floppy disk. This virus was created as a practical joke when Richard Skrenta was still in high school. It was injected in a game on a floppy disk. On its 50th use the Elk Cloner virus would be activated, infecting the computer and displaying a short poem beginning "Elk Cloner: The program with a personality."

### **Common virus types**

There are several types of computer viruses existing and basically they can be classified according to different categories. First two categories are resident viruses and nonresident viruses.

#### **Boot Sector Virus**

This type of virus affects the boot sector of a floppy or hard disk. This is a crucial part of a disk, in which information on the disk itself is stored together with a program that makes it possible to boot (start) the computer from the disk.

Examples of boot viruses include: Polyboot.B, AntiEXE.

#### **Worms**

Worms do not require user actions to spread, they move from system to system over networks on their own. It increases network traffic, CPU utilization of computer thereby making systems slow. Worms can do nasty actions such as creating unnecessary files inside system folders, steal information from user's computers and upload to web sites, provide unnecessary load in database servers, infect files of selected file types like script files in web servers.

Examples: Confiker, PSWBugbear.B, Lovgate.F, Trile.C, Sobig.D, Mapson

#### **Macro Viruses**

Macro viruses infect documents created by Microsoft Office programs (Word, Excel, PowerPoint and Access). Macro viruses infect to the files that are created using certain applications or programs that contain macros. These mini-programs (MACROS) make it possible to automate series of operations so that they are performed as a single action, thereby saving the user from having to carry them out one by one. A valid macro performs useful job while illegal macro might destroy important contents of a file when executed automatically.

Examples of macro viruses: Relax, Melissa.A, Bablas, O97M/Y2K.

The functionality of virus differs from one to another. Some will increase size of certain files when infected. Some other viruses especially worms create files inside Windows or other folders hiding their identity by naming them in irrelevant characters or with a name that is closer to a required system file with hidden attributes. (e.g. lsass.exe is a valid system file whereas isass.exe

is virus file). Some viruses employ polymorphic and an anti-stealth technology which prevents them from identified and erased by virus catching programs called antivirus programs.

### **Other harmful programs**

When people browse internet there are many web pages that displays a bogus question to user saying that your computer is infected with some harmful program and do you wish to clean it using their advertised program?. People are tempted to click on yes then the harmful program is installed in the computer with user's permission. Then it will always nag the user to buy the program or slows down the computer, prevent from browsing some other sites especially antivirus (virus cleaning program) vendor's sites. These programs are called **malware**.

### **Common Methods of infection**

Computer viruses can be infected using many methods. Before the popularity of computer networks most of the computer viruses are written to spread through removable media like floppies. Today most of the viruses being infected using removable media like thumb drives and through networks and the Internet.

Today most of the computer viruses are designed to exploit some kind of an error (security hole) or vulnerability of operating system or a program when it was programmed and try to sneak in to computer system using the security hole.

Resident virus always runs on computers memory and runs automatically or triggered by an action performed by user to infect or replicate itself to new locations or files. Nonresident viruses are activated when user performs specific activity such as accessing floppy/removable media, starting a specific program like Microsoft Word etc.

In a computer which is affected by a worm try to infect other computers through network. Worms run automatically and scan network shares which are not password protected or having weak passwords and try to infect the computer.

Trojan horses programs are distributed by some kind of fancy program such as screen saver which is intended to do some other task. The danger of Trojan horse is that it tries to damage the security of the computer from inside and open back door for other computer viruses to sneak in to system.

### **Suspecting a Virus/malware present in your computer**

There are several ways to find out that a computer virus or malware program is present in your computer. One of the good symptoms is that your computer suddenly slows down after installing a program downloaded from internet which gives you a good impression of that.

You can always press **Ctrl, Alt** and **Delete** and get the task manger by clicking on task manger button of your computer if it is not displayed that means you are at a problem.

If you are able to get the task manager and in performance tab CPU usage is always reaching 100% without doing any useful task then you can suspect that some kind of virus or malware is present in your computer.

If there are always nagging messages appearing and computer gets terribly slow down or does unnecessary things like moving mouse automatically when you working with Microsoft Office packages then you can suspect that a macro virus or some malware present.



If you cannot eject your thumb drive without any document or program open from that thumb drive, you are definitely infected with a virus. If you cannot see the folder options from windows explorer or you cannot show the hidden files using folder options, you can suspect that a computer virus might be present.

If you see that files are automatically created with unknown rubbish names it is a sign of virus activity. If you cannot double click and access drives in My Computer it is also can be an activity of a virus.

## 7.2 Hardware Threats

Though you manage and protect your data with proper use of software, your data may get lost or damaged due to hardware problems. Really, Hardware is a common cause of data problems. While you work, all of a sudden the power can fail, you can mistype, a repair technician can accidently damages the data, or a magnets used closer to the PC without your knowledge can damage disks. Likewise, hardware errors are of varying types and most of them are unpredictable. But, some of them have solutions; unfortunately some do not. So, it is worth to have a fair knowledge about the hardware threats to your PC and the solutions if any.

The following sections discuss the examples for possible hardware threats along with solutions, if any.

### 7.2.1 Power Faults

Your PC may be busy writing data to the disk and in a sudden power may go out. Obviously, you will be afraid if it lost your data. Your will be hurried to get know for sure if anything was damages soon after the power is back. Usually, power faults can cause data problems, particularly if they occur when data is being written to disk. Data in memory generally does not get corrupted by power problems; it just gets erased if the problems are serious enough.

Some other similar power related problems are briefed below.

**Brownout:** Lower voltages at electrical outlets. Usually they are caused by an extraordinary drain on the power system. Frequently you will see a brownout during a heat wave when more people than normal have air conditioners on full. Sometimes these power shortages will be “rolling” across the area giving everyone a temporary brownout. Maybe you’ll get yours just as that important file is being written to disk.

**Voltage Spikes:** Temporary voltage increases are fairly common. Large motors or circuit breakers in industry can put them on the electrical line. Sudden losses (ex; a driver hits a power pole) can causes spikes as the circuits balance. An appliance in your home can cause a spike, particularly with older wiring. Lightning can put large spikes on power lines. And, the list goes on. In addition to current backups and integrity information for your software and data files, including a hardware voltage spike protection device between the wall and your computer hardware (don’t forget the printer and monitor) can be very helpful.

**Frequency Shifts:** While infrequent, if the line frequency varies from the normal 60 Hertz (or 50 Hertz in some countries), the power supply on the computer can be affected and this, in turn, can reflect back into the computer causing data loss.

**Solution:** Consider using a Combined Surge Protector (CSP) and Uninterruptible Power Supply (UPS). See Figure 7.2 and 7.3 below for a CSP and UPS used for PCs respectively.



*Figure 7.2: Combined Surge Protector for a PC*



*Figure 7.3: Uninterruptible Power Supply for a PC*

### 7.2.2 Age

It is not an amazing thing that as computers age they tend to fail more often. Electronic components are stressed over time as they heat up and cool down. Mechanical components simply wear out. Some of these failures will be dramatic; something will just stop working. Some, however, can be slow and not obvious. Unfortunately, it's not a question of "if", but "when" in regard to equipment failure.

**Solution:** Keep an eye on the specials after three to five years.

### 7.2.3 Incompatibilities

You can have hardware problems on a perfectly healthy PC if you have devices installed that do not properly share interrupts. Sometimes problems are immediately obvious, other times they are subtle and depend upon certain events to happen at just the wrong time, and then suddenly strange things happen.

**Solution:** Make a really good backup before installing anything (hardware or software) so you can revert the system back to a stable state which should something crop up.

### 7.2.4 Finger Faults

Your fingers may make mistakes when using the keyboard and the mouse and they are too frequent cause of data corruption. This commonly happens when you are intending to delete or replace one file but actually get another.

If you are using a laptop computer or a notebook, another finger fault problem arises with touchpads below the space bar. It's very easy to brush the touchpad when you are typing away and suddenly find yourself entering characters in a screen location very different from where you were before you touched the pad.

**Solution:** Be careful and look up now and again to make certain your cursor is where you want it.

### 7.2.5 Malicious or Careless Damage

Someone may accidentally or purposely delete or change a file on your PC when you're not around. If you don't keep your PC locked in a safe, then this is a risk. Sometimes, you may not detect that something has happened to your data while you are not around. Most of this type of damage is done unintentionally by someone you probably know. This person didn't mean to cause trouble; they simply didn't know what they were doing when they used your PC. That may be a person who is new to use computers.

**Solution:** Never run the computer as an administrative user and have guest accounts available for others who use the computer. Keep up-to-date backups as well.

### 7.2.6 Data carriers

One possible source for computer infections is the Customer Engineer (CE), or repairman. When a CE comes for a service call, they will almost always run a diagnostic program from CD. It's very easy for these CDs to become infected and spread the infection to your computer. Sales representatives showing demonstrations via CDs are also possibly spreading viruses. Always check your system after other people have placed their data carriers such as CDs, Portable Hard disks, and USB pen drives into it. (Better yet, if you can, check their disk with up-to-date anti-virus software before anything is run.)

**Solution:** Insist on testing their CD/Pen drive/portable hard disk before use or make certain they've used an up-to-date anti-virus before coming to your location.

### 7.2.7 Magnetic Zaps

Computer data is generally stored as a series of magnetic changes on disks. While hard disks are generally safe from most magnetic threats because they are encased within the computer compartment, the older technology: floppy disks are highly vulnerable to magnets. You may be happy that Floppy disks are not now in use with your PC.

The obvious threat would be to post a floppy disk to the refrigerator with a magnet. Some of the more subtle sources of magnetism include:

**Computer Monitor:** Don't put floppy disks anywhere near the monitor; it generates a magnetic field. (Generally applies to the older CRT displays.)

**Telephone:** When ringing, telephones (particularly older phones with a bell) generate a magnetic field.

**Solution:** Stay away from magnets or sources of static of all kinds when working with a computer.

**Note:** *There are tools to assist in recovery from disk problems, but how do you know all the data is OK? These tools do not always recover good copies of the original files. Active action on your part before disaster strikes is your best defense. It's best to have a good, current backup and, for better protection, a complete up-to-date integrity-check map of everything on your disk.*

## 7.3 Computer Related Privacy Issues

### 7.3.1 Exposure in browsing Web

Sometimes, you may think that you are unidentified and unexposed to other users when you browse web sites. But there may be a possibility of leaving information about you left behind. However, you can reduce the amount of such information that reveals about you to other users by following some privacy policies. Next sections will discuss how to protect your privacy when using Web.

### 7.3.2 Information that reveals you

The following information may be automatically sent to the web sites when you visit them.

**IP address of your computer:** the Internet Protocol address assigned to each computer on the internet. It may be a static one which remains unchanged or it may be dynamic which changes time to time as you access internet.

**Domain name:** the domain (division of internet) to which your user account associated with.

**Software particulars:** There is a possibility for an organization of identifying the operating system used and the details of the web browser you use.

**Details of pages visit:** what pages and for how long you stay on a particular page, and the fact whether you used a search engine to access that page can be identified

**Other information:** some non-critical information such as the web browsing pattern and some critical information such as passwords saved in temporary memory also can be detected if the web site uses cookies.

### 7.3.3 Limiting the information collection

You can follow the actions mentioned below in order to reduce the amount of information that can be collect about you.

**Pay special attention when supply personal data:** If you don't trust any site, don't give your personal data such as your credit card details, account details, passwords, etc.

**Limiting cookies:** the cookies can provide the store data about you to the attackers who access your computer. You cannot limit it. But you can limit the use of cookies. Check and delete cookies: All popular browsers let users view and delete cookies installed on their computer. Methods vary by browser. For instance on Internet Explorer 8, go to the "Tools" menu, pull down to "Internet Options" and under the "General" tab there are options for deleting some or all cookies. There might be hundreds, so deleting all might be easiest. But the next time you visit a favorite site, you may need to retype passwords or other login data previously stored automatically by one of those cookies.

**Adjust Browser Settings:** Once you've deleted cookies, you can limit the installation of new ones. Major browsers let you accept some cookies and block others. To maintain logins and settings for sites you visit regularly, but limit tracking, block "third-party" cookies. *Safari* automatically does this; other browsers must be set manually.

**Browse safely:** If you see that the site you access is suspicious, then immediately leave the site. Keep your virus definitions updated. Scan your computer for spyware.

### 7.3.4 Protecting your privacy

To protect your identity and prevent an attacker from easily accessing additional information about you, you are required to avoid providing certain personal information such as your birth date, your phone number, and social security number online. Further, the following help protect your privacy.

**Privacy Policy:** You are advised to look for the privacy policy statement given in the sites before you submit your information such as e-mail address, name, phone number, etc. Usually, the privacy policy must state how the information they request are used and whether they are going to distribute those data to other organizations, etc.

**Encrypt the information provide:** Many sites use SSL (Secure Socket Layer) certificate to encrypt the information you provide to that site so that other attacker or an organization cannot access your information collected by the site. If the 'https:' is available in place of 'http:' in the URL of the site you visit together with the 'lock' icon as shown below, that indicates that your information will be encrypted at the time of providing them.



**Work only with trusted companies:** When you do business with some sites, you are required to assure that you trust them. You may answer yourself to the facts such as whether the company is a reputed, well established one, is it providing assurance on privacy of information provided, is there legitimate contact information provided that enables you decide that the company is a trusted one.

**Avoid using primary e-mail address:** When performing online submissions, use an additional e-mail address in place of your primary e-mail address to avoid accumulation of spam or unwanted messages.

**Avoid using Debit Cards for online purchasing:** Your Credit card usually give the protection to some extents. However, the Debit cards do not give such protection and they deduct charges immediately from your account. So, if an attacker obtains your debit card details, they will completely use your money in the account even without giving you a time to realize it.

**Use Options in providing information:** You might have found that some options are there with certain web sites to make your work easy without concerning your security. Prompting an option to remember your password is an example for such instances and such options may make your data readily available for the attackers. We can take the privacy settings given to your account in social networks such as *Face book* as another example. You can restrict the other parties accessing your data by setting the privacy options to reduce the risk of attackers.

## 7.4 Computer Related Legal Regulations in Sri Lanka

As a person who uses the computer and the internet, it is worth to get a considerable knowledge in the legal aspects related to the computer using to be aware and prevent any illegal actions. The

following sessions will brief you about the premier organizations/projects developed in Sri Lanka on this regard, the copyright law, and the data protection laws in the context of Sri Lankan law.

#### **7.4.1 ICT Policy formulation bodies in Sri Lanka**

##### **CINTEC**

Having recognized the need of development of ICT by the government of Sri Lanka, the CINTEC, “Computer and Information Technology Council of Sri Lanka” was established in 1984 to function directly under the president. Later it was renamed to “Council for Information Technology” but retained the acronym CINTEC. Over the course of its history, it has assumed more than one role in developing the IT industry, computer education, IT workforce etc. CINTEC is considered as the predecessor of ICTA which is described next. Some of the functions and duties of the council are listed below.

- To advise the Minister on ICT development related matters such as formulation of national policies, promotional strategies to use computers and applications in the country to enable them capable in meeting modern technology challenges, ICT infrastructure development, etc.
- To promote and conduct research on all aspects of computer and information technology
- To monitor development in computer and information technology and to adapt these developments for use in Sri Lanka
- To collect and disseminate information on computer and information technology and related subjects, and to provide education to the public on such subjects

##### **ICTA**

The Information and Communication Technology Agency (ICTA) of Sri Lanka is the single top body involved in ICT policy and direction for the nation. This body is wholly owned by the Government of Sri Lanka and ICTA is the implementing organization of the e-Sri Lanka Initiative. Major donors of ICTA including the World Bank will be funding a number of the Agency’s initiatives.

Some of the functions and duties of the ICTA are listed below.

- Build the necessary infrastructure to connect villages and towns to the world
- Create the enabling environment including the enactment of regulatory reform together with the acceleration of enabling laws for e-government and e-commerce and promote public - private partnerships
- Develop human resources at multiple levels to support national development
- Modernize the public sector and deliver citizen services through e-government constructs
- Promote Sri Lanka as an ICT destination renowned for producing best-of-breed in niche global markets through the use and adoption of technology and support public - private partnerships in ICT service provision
- Bridge the digital divide with applications aimed at poverty reduction and social development

## **7.4.2 Copyright and related laws**

Copyright is developed to protect the rights of the authors, performers, producers and broadcasters. Existence of such right contributes the cultural and economic development of nations. It gives a value to the author as well and they provide a widespread affordable access to their product's content to the public.

### **Need of avoiding copyright infringement**

Any act violating the rights protected is called copyright infringement. Copyright is not only a legal issue. If you use unauthorized file it may give security implications. To avoid the risk to your computer you need to make sure that you have the permission to use any copyrighted information, and only download authorized files.

### **Accessing internet and copyright infringement**

When you use or distribute information without permission from the author you will be performing actions causing copyright infringement. For an example you will be violating copyright if you download music, including an image on your website, pirating software owned by another person. So it is required to get know that you have the permission to do so.

### **Occasions where you have permission to use other's work**

When you use web sites you might find some information such as an article, an application, a chart, a video clip, etc. that you wish include into your web site or a document. Then you need to search for information about permissions to use, download, redistribute, or reproduce. Most websites have a "terms of use" page that explains how you are allowed to use information from the site (see US-CERT's terms of use for an example). You can often find a link to this page in the site's contact information or privacy policy, or at the bottom of the page that contains the information you are interested in using.

There may be restrictions based on the purpose, method, and audience. You may also have to adhere to specific conditions about how much information you are allowed to use or how their formation is presented and attributed. If you can't locate the terms of use, or if it seems unclear, contact the individual or organization that holds the copyright to ask permission.

### **Intellectual Property Act**

The intellectual Property Act no. 36 2003 is an act to provide for the law relating to intellectual property and for an efficient procedure for the registration, control and administration, set by the Parliament of the Democratic Socialist Republic of Sri Lanka. This act includes sections related to the Copyright. So it is recommended to read the related sections of the act and you may refer to act by following the link published by ICTA given below.

*[http://www.icta.lk/pdf/IntellectualPropertyActNo.36of2003\(Sectionsr.pdf\)](http://www.icta.lk/pdf/IntellectualPropertyActNo.36of2003(Sectionsr.pdf))*

## **7.4.3 Data Protection Law in Sri Lanka**

The legal protection of individuals with regard to automatic processing of personal information relating to them can be referred to as Data Protection. The Parliament of Sri Lanka has passed several legislation that cover data protection. Following are some examples. However, Sri Lanka needs more laws in the emerging new areas to attract new e-business throughout the world.

ICTA has released some guidelines to be followed by government and private sector users towards data protection.

### **Electronics Transactions Act**

The Electronic Transaction Act was passed in 2006 (Act No. 19) and it became active on 01<sup>st</sup> October 2007. This act enables to recognize and facilitate formation of contracts, the creation and exchange of data messages, electronic documents, electronic records and other communications in Electronic form in Sri Lanka. Further, this act also provides appointment of a certification authority and accreditations of certification providers.

### **Computer Crimes Act**

The Computer Crimes Act was passed into law in 2006 (Act No. 24) and it became effective on 15<sup>th</sup> July 2008. This act describes what Computer Crimes are and it provides the procedure for the investigations and prevention of such computer crimes. This act introduced the criminal implication regarding unauthorized access to a computer, computer program, data or information and unauthorized use of a computer.

### **Other Sri Lankan legislation on ICT development**

In addition to the acts described above following are some more acts passed by the Parliament of Sri Lanka which have significant impact on the ICT development.

- Information and Communication Technology Act No.27 of 2003
- Evidence (Special Provisions) Act No.14 of 1995
- Electronic Transactions Act No. 19 of 2006
- Payment and Settlement Systems Act, No. 28 of 2005
- Payment Devices Frauds Act No.30 of 2006

You may refer to more details on above acts by following the link below.

*<http://www.icta.l>*

## **7.5 Self Assessment Questions**



- 7.1 What is meant by Information Security?
- 7.2 Explain the possible attacks that may arise with your computer and how to prevent them.
- 7.3 What is a computer virus?
- 7.4 Give two types of computer viruses with two examples for each type.
- 7.5 What is meant by malware?
- 7.6 Briefly explain the ways to find out that a computer virus or malware program is present in your computer.
- 7.7 Discuss the examples for possible hardware threats to your computer along with solutions.
- 7.8 What are the functions and duties of following ICT policy formulation bodies in Sri Lanka?
  - a. CINTEC
  - b. ICTA
- 7.9 Name two acts passed by the parliament of Sri Lanka towards data protection.



# Session 8

## Introduction to Windows 7

---

### Aims:

The aim of this session is to introduce the learner to the Windows 7 operating system and get the learner familiar to operate the computer through the Operating system Windows 7.

### Objectives:

Having studied this session the student will be able to:

- Describe about the Windows 7 Operating System
- Identify and perform the basic operations in Windows 7
- Organize and work with your files



### 8.1 What is Windows 7?

Windows 7 is a latest public release version of Microsoft Windows. Windows 7 was released to manufacturing on July 2009. Windows Server 2008 R2 was released at the same time. It is redesigned with Windows Shell with a new taskbar. Windows 7 includes a number of new features, such as advances in touch and handwriting recognition, support for virtual hard disks, improved performance on multi-core processors, improved boot performance, Direct Access, and kernel improvements.

#### 8.1.1 Versions of Windows 7

1. **Starter** is the smallest version of the windows 7. Actually it is less waiting, less clicking, less hassle connecting to networks. Windows 7 Starter combines the latest in reliability and responsiveness with the familiarity and compatibility of Windows.
2. **Home Premium** makes it easy to create a home network and share all of your favorite photos, videos, and music. And you can watch shows for free when and where you want with Internet TV on Windows Media Center.
3. **Professional** is a great choice for home and for business. Using Windows 7 professional, You can run many Windows XP productivity programs in Windows XP Mode and recover data easily with automatic backups to your home or business network. You can also connect to company networks effortlessly and more securely with Domain Join. With all the exciting entertainment features of Windows Home Premium.
4. **Ultimate** is the most versatile and powerful edition of Windows 7. It combines remarkable ease-of-use with the entertainment features of Home Premium and the business capabilities of Professional, including the ability to run many Windows XP productivity programs in Windows XP Mode. For added security, you can encrypt your data with BitLocker and BitLocker-To-Go. And for extra flexibility, you can work in any of 35 languages. Get it all with Windows 7 Ultimate.

### 8.1.2 System requirements

Windows 7 requires the following computer hardware:

32 Bit	64 Bit
<ul style="list-style-type: none"><li>• A Processor of 1 GHz or faster 32-bit (x86)</li><li>• At least 1 GB of RAM memory</li><li>• A hard disk with at least 16GB space available</li><li>• DirectX® 9 graphics processor with WDDM or higher driver</li><li>• A DVD drive from which to install Windows.</li><li>• A monitor, keyboard, and mouse or other pointing device.</li></ul>	<ul style="list-style-type: none"><li>• A Processor of 1 GHz or faster 64-bit (x64)</li><li>• At least 2 GB of RAM memory</li><li>• A hard disk with at least 20GB space available.</li><li>• DirectX® 9 graphics processor with WDDM or higher driver</li><li>• A DVD drive from which to install Windows.</li><li>• A monitor, keyboard, and mouse or other pointing device.</li></ul>

*Table 8.1: Windows 7 Requirements*

## 8.2 Installing Windows 7 into your PC

The Windows 7 Setup Wizard guides you step-by-step through the process of installing Windows 7. When the installation is finished, you are ready to log on to Windows 7. Be aware that your computer restarts several times during the installation process. Depending on the type of installation you need to perform, either upgrade or clean, you will have to start the Windows 7 Setup Wizard in different ways. If you need an upgrade or clean install on a Windows version, you simply start your computer and insert the Windows 7 installation DVD to start the Windows 7 setup Wizard. However, if you perform a clean install on a non-supported operating system or a blank hard disk, you need to start your computer by inserting the Windows 7 installation DVD into the DVD drive, which starts the Windows 7 setup Wizard. A clean install requires you to select additional options as you step through the wizard, but the steps are basically the same.

### Steps to follow:

1. Insert the Windows 7 DVD into your DVD drive, and then start your computer.
2. Select the language and click **Next**
3. Click **Install now**
4. Click “**I accept the license terms**” and click **Next**
5. Click the **custom** installation methods
6. Select the disk partition you want to install Windows 7 and click **Next** (New setup is installing windows 7 into your system)
7. Please wait for finish
8. Enter user name and a computer name and click **Next**
9. Type a password and click **Next**
10. Enter the product key and click **Next**
11. Click ‘**Ask me later**’ and click **next**
12. Set the system date and time and click **Next**
13. Select the computer location as a **Home network** and Click **Next**
14. After installing windows 7, you can logon it.

## 8.3 Basic Operations in Windows7

Let us have a look at the basic operations available with Windows 7. This knowledge will be helpful to you to make working with your computer easy.

First, we will learn about some required fundamental skills before performing basic operations available with your operating systems.

### Keyboard Operations

- Enter:** There is an *Enter* key in your keyboard. The command ‘Enter’ means you to press the Enter key.
- Escape:** Press the *Esc* key in your keyboard
- Move:** To move left to right or up to down use the *arrow* keys
- Control key:** There is button labeled ‘Ctrl’ you can press any keys with this ctrl key. Example Ctrl + C means press ctrl key and C button in the same time or (First press Ctrl then C but not reverse order)

### Mouse operations

- Click:** The *click* operation means you can move the cursor in to a particular place and press left button in your mouse
- Double Click:** Click the mouse left button twice quickly/consecutively
- Right click:** Click the right mouse button
- Drag:** Move the courser with the left button
- Drop:** After dragging from one place to another palace you can release the left button.

### **Log on to your computer**

The process of starting a computer session is called logging on. When you start the computer, Windows displays a Welcome screen containing links to each of the computer's active user accounts. (If your computer is part of a domain, you will need to press Ctrl + Alt + Delete to display the Welcome screen.) You select your user account and, if your account is password protected, enter your password to log on to the computer. See Figure 8.1 below for the login interface. When logging on to a computer which is part of a domain, you will always enter your domain credentials.



Figure 8.1: Windows 7 Login Interface for a single user

After a successful login, your desktop will be loaded. Figure 8.2 shows the screen layout of the first user interface of the Windows 7. The Windows 7 system mainly contains three components namely the desktop, start button, task bar & the system tray.

## 8.4 Windows 7 Interface

Let us have a look at the components of the Windows 7 Interface by means of the Figure 8.2 below.



Figure 8.2: Windows7 User Interface

Brief descriptions of each component are given below.

No	Name	Brief Description
1	Desktop	Work area on which you see your programs
2	Start Menu	Let you open programs available in your computer
3	Task Bar	Let you launch and monitor running programs
4	Notification area	A portion of the taskbar that provides a temporary source for notifications and status.
5	Task Buttons	Currently opened programs/applications
6	Desktop Icons	Icons that belongs to and leads you to important parts of the computer
7	Shortcut Icons	Easy way to access programs
8	Windows Gadgets	Popular mini-programs

Table 8.2: Components of Windows 7 User Interface

### 8.4.1 Desktop

Windows uses your screen as a *desktop*, a work area on which you see your programs. The main purpose of the Desktop is to hold shortcut icons that will help you work efficiently. The Desktop is really just a folder inside the Windows folder, so it can hold anything that any other folder can hold. It can be decorated with interesting textures or pictures.

### 8.4.2 Start menu

Clicking on the **Start Menu** brings up a list of **shortcuts** to start your programs. An item with an arrow at the right, such as Programs or All Programs, will open another list. There can be several levels of such lists. The start menu lists commands and additional menus that list most of the programs that you can run on your computer.



Figure 8.3: Start menu

Windows 7 has a new way to access additional folders on the start menu. Instead of program menus displaying to the right side of the Start menu, each subsequent menu you select, such as the Accessories menu, displays on top of the previous folder.

### 8.4.3 Task bar

Across the bottom of the screen we see the **Taskbar**. Normally it is in view all the time. The Taskbar's main job is to show what applications are currently running. The left end shows the Start button. The middle section of the bar shows a button for each open application. The right end holds the Notification area. Other toolbars, such as Quick Launch, Address, Links, Windows Media Player, may also display on the Taskbar.



Figure 8.4: Task bar

### 8.4.4 Notification area

The notification area, or tray, at the far right of the Taskbar is used to show icons for programs that are awake and hanging around in the background, like the clock, anti-virus, and scheduling programs. Such an icon lets you know for sure that the program is ready to do its thing when it is needed. Some icons mean that there is something for you to do, like view a new email message or download/install a new update. This notification area is sometimes referred to as the *system tray* as well.



Figure 8.5: Notification

### 8.4.5 Task buttons

Task buttons are the buttons on the taskbar that represent each program that is running. If a program displays more than one window, more than one task button may appear. Each task button displays the icon for the program and as much of the program name as can fit. Click a window's task button to select that window—that is, to make that window active. You can also right-click a button to see the system menu, a menu of commands that you can give regarding that window, including opening and closing the window. If the taskbar gets too full to fit task buttons for all the open windows, Windows groups the buttons together, with one button for each application.



Figure 8.6: Task bar

### 8.4.6 Desktop Icons

Some icons lead you to important parts of the computer. A number of others of this type may show on your desktop, depending on what has been installed. For example, the *My Computer*, *Recycle Bin*, and *Network* icon are the basic desktop icons that can be seen in your desktop.

### 8.4.7 Shortcut Icons

A **shortcut** points to the file that runs a program, like MS Word, or to a document, like the web page Astronomy Picture of the Day. A shortcut can be placed wherever you want to put it - on the Desktop, in a folder, in the Quick Launch area. A shortcut *may* have a small arrow  at the bottom left of the icon.



Figure 8.7: Shortcut icon

### 8.4.8 Windows Gadgets

Gadgets, the popular mini-programs introduced in Windows Vista, are now more flexible and fun in Windows 7. Based on the feedback of the user, you can stick your gadgets anywhere on the desktop. By default, Windows 7 ships with nine Windows Gadgets. These include:

**Calendar**- A simple month, year, date, and day of week display in non-configurable orange. Nice touch: Click it and you'll see the full month view.



**Clock**-A decent clock with one major advantage over virtually every downloadable clock gadget I've tried: You can set it to the time in any time zone, not just the system time. Clock is configurable with 8 clock faces, some of which are quite attractive.

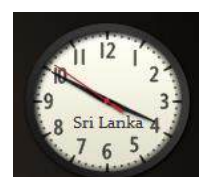

**CPU Meter**-This gadget features two simple analog-style dials measuring the current CPU utilization and memory usage, respectively. Note that CPU Meter is overly simple and can't differentiate between multiple CPUs or CPU cores.

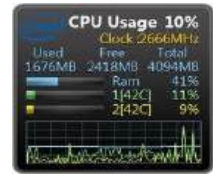

**Currency**- A simple currency converter converts an amount of input currency into target currency



**Feed Headlines**-This gadget is an RSS feed aggregator that links into the RSS feeds you've subscribed to through Internet Explorer 7. It rotates through the currently-unread feeds. If you click a headline, a pop-out window displays the entire feed. Click the feed headline in the pop-out window, and the entire post or article will be displayed in your default Web browser.



**Picture Puzzle**- A simple tile-based sliding puzzle game with 11 different images and timer.

**Slide Show**-A slideshow gadget that can be configured to display images in a particular folder, with different transition types. A View button on the gadget will open the currently displayed picture in Windows Photo Gallery.



**Weather**- A very handy and attractive weather gadget that can be configured for any location worldwide.



**Windows Media Center**-The only new gadget in Windows 7, Media Center provides a simple front-end to the Windows Media Center application. Click any of its revolving set of links--Music, Pictures, Music + Pictures, Internet TV, and many others--causes the appropriate experience to startup inside of Windows Media Player.



## 8.5 Ending a Computing Session

To end a computing session, on the start menu, click the Shut down Options button to display a list of ways you can pause or end your computing session. Windows 7 provides six options to end sessions such as Switch user, logoff, lock, restart, sleep and shutdown as shown in the Figure 8.8 below.

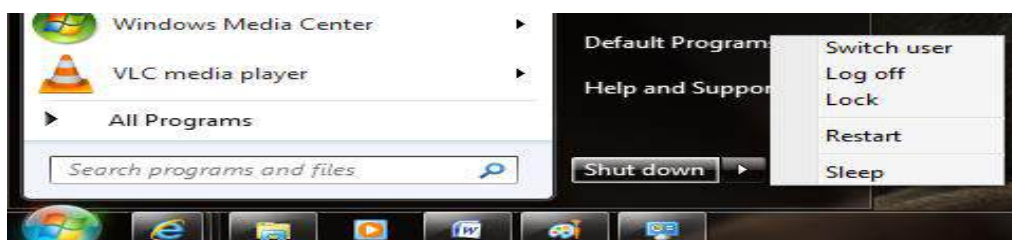

Figure 8.8: Options to End a computing session

**Switch User**

Allows you to change from the current user to another user without shutting down the computer,

**Log Off**

Allows you to log off from Windows and any network connections you have established.

**Lock**

Allows you to lock your computer so that users cannot access it, but it allows your programs to continue running. This is handy if you are downloading a large file and you need to walk away from your computer while it continues to download.

**Restart**

Shuts down Windows, and then reloads it (useful if your computer starts acting funny).

**Sleep**

Put the computer into a Sleep mode, which shuts down the hard drive and turns off the monitor to conserve power consumption. Programs remain open and your documents are automatically saved. When you awaken your computer, these devices turn back on.

**Hibernate**

Puts your computer into a power-saving mode that is similar to the Sleep mode, Hibernate is available only if you use the advanced power settings in Windows.

**Shut Down**

Shuts down Windows, Windows displays a message when you can safely turn off the computer. Don't turn off the computer until you see this message. Computers with advanced power management shut off automatically.

## 8.6 Working with Windows Programs

A program is a software which you use to accomplish a specific task, such as word processing or managing files on your computer. Windows comes with several small programs, called Accessories that are extremely useful for completing basic tasks, such as creating a written document or performing basic calculations. Windows 7 also provides a number of ways for you to resolve some common problems. For example, you can use older programs (designed to run on previous versions of Windows) on your Windows 7 computer by changing specific settings using the Accessories menu. You can run commands from a text-based interface (called a command line), and Windows provides an interface for quitting a program that has stopped responding without turning off your computer and losing information in other programs. Other special programs in Windows 7 are games. You can play games on your computer or with other people over the internet.

### 8.6.1 Start a Windows program

The most common way to start a Windows program is to use the start menu, which provides easy access to programs installed on your computer. Clicking the start button on the taskbar displays the Start menu, which lists common and recently used programs and the all Programs submenu. The figure 8.9 below shows the sub programs of the MS PowerPoint program which is a recently used program. The All Programs submenu is the master list of every program on your computer. If you start a program, such as your e-mail program, every time you start Windows, you can save some time by adding the program to the Startup folder. When you're done working with a program, you should exit, or close it, to conserve your computer's resources.



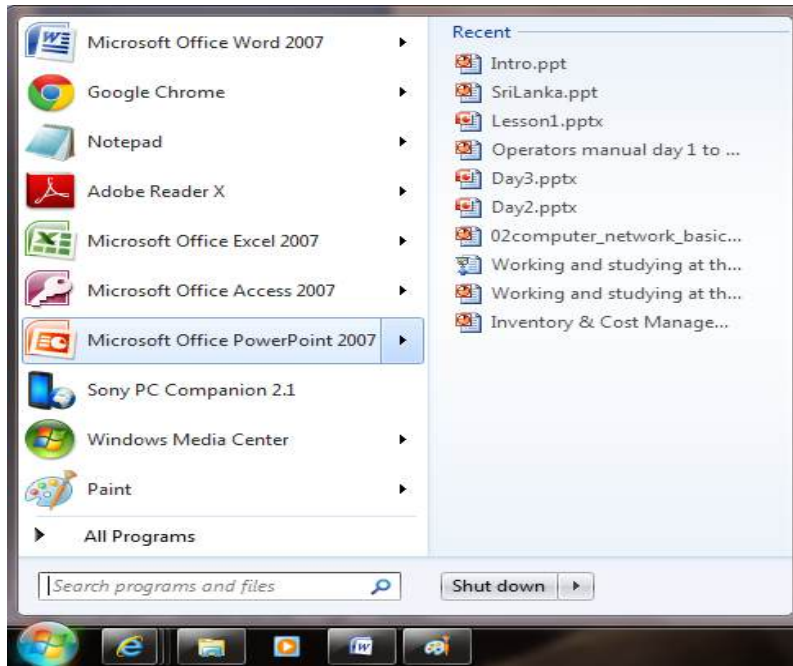

Figure 8.9: Accessing recently used programs using start menu

## 8.6.2 Using Windows Accessories

Windows comes with several accessories, built-in programs that are extremely useful for completing everyday tasks. One of the most useful features Windows offers is the ability to use data created in one file in another file, even if the two files were created in different Windows programs. To work with more than one program or file at a time, you simply need to open them on your desktop. A program button on the taskbar represents any window that is open on the desktop. When you want to switch from one open window to another, click the program button on the taskbar. If you tile, or arrange open windows on the desktop so that they are visible, you can switch among them simply by clicking in the window in which you want to work. The table 8.3 below lists some frequently used windows applications with a brief description on each.

Program	Description
Calculator	Performs arithmetic calculations
Internet Explorer	Displays Web (HTML) pages
Notepad	Creates, edits, and displays text only documents
Paint	Creates and edits bitmap pictures
Sound Recorder	Creates and plays digital sound files
Windows Calendar	Manages appointments and tasks using personal calendars
Windows Contacts	Stores names, addresses, and other contact information
Windows Defender	Helps protect your computer from spyware and other harmful intruders
Windows DVD Maker	Burns pictures and videos to DVDs
Windows Fax and Scan	Sends and receives faxes or scanned pictures and documents
Windows Live Messenger	Sends and receives instant messages to online contacts; you need to download the program

Windows Mail	Provides e-mail, newsgroup, and directory services
Windows Media Center	Provides entertainment options for digital and on-demand media
Windows Media Player	Plays sound, music, and video
Windows Meeting Space	Provides an online place to share files, programs, or your desktop
Windows Movie Maker	Creates movies using audio and video files
Windows Photo Gallery	Views, edits, organizes, and shares photos and videos
WordPad	Creates, edits, and displays text, Rich Text Format, and Word documents

Table 8.3: Common Windows Applications

## 8.7 Introduction to Windows 7 File System

### 8.7.1 The File System in general

A **file system** is a method for storing and organizing computer files and the data they contain to make it easy to find and access them. File systems may use a data storage device such as a hard disk or CD-ROM and involve maintaining the physical location of the files. They might provide access to data on a file server by acting as clients for a network protocol. There are two file systems used by the windows such as FAT and NTFS (New Technology File System) file systems.

The **FAT** (File Allocation Table) filing system, supported by all versions of Microsoft Windows, was an evolution of that used in Microsoft's earlier operating system (MS-DOS which in turn was based on 86-DOS). FAT ultimately traces its roots back to the short-lived M-DOS project and standalone disk BASIC before it. Over the years various features have been added to it, inspired by similar features found on file systems used by operating systems such as UNIX.

Older versions of the FAT file system (FAT12 and FAT16) had file name length limits, a limit on the number of entries in the root directory of the file system and had restrictions on the maximum size of FAT-formatted disks or partitions. Specifically, FAT12 and FAT16 had a limit of 8 characters for the file name, and 3 characters for the extension. This is commonly referred to as the 8.3 filename limit. VFAT, which was an extension to FAT12 and FAT16 introduced in Windows NT 3.5 and subsequently included in Windows 95, allowed long file names (LFN). FAT32 also addressed many of the limits in FAT12 and FAT16, but remains limited compared to NTFS.

**NTFS**, introduced with the Windows NT operating system, allowed ACL-based permission control. Hard links, multiple file streams, attribute indexing, quota tracking, compression and mount-points for other file systems (called "junctions") are also supported, though not all these features are well-documented.

Unlike many other operating systems, Windows uses a *drive letter* abstraction at the user level to distinguish one disk or partition from another. For example, the path C:\WINDOWS represents a directory WINDOWS on the partition represented by the letter C. The C drive is most commonly used for the primary hard disk partition, on which Windows is usually installed and from which it boots. This "tradition" has become so firmly ingrained that bugs came about in older versions of Windows which made assumptions that the drive that the operating system was installed on was C. The tradition of using "C" for the drive letter can be traced to MS-DOS, where the letters

A and B were reserved for up to two floppy disk drives. Network drives may also be mapped to drive letters.

## 8.7.2 The File Hierarchy and File management

File management is organizing and keeping track of files and folders, helping you stay organized, so information is easily located. A folder is a container for storing programs and files, similar to a folder in a file cabinet. As with a file cabinet, working with poorly managed files is like looking for a needle in a haystack. It is frustrating and time-consuming to search through irrelevant, misnamed, and out-of-date files to find the one you want. Windows 7 allows you to organize folders and files in a file hierarchy, imitating the way you store paper documents in real folders. Just as a file cabinet contains several folders, each containing related documents with dividers grouping related folders together. So, the Windows file hierarchy allows you to organize your files in folders, and then place folders in other folders. At the top of each hierarchy is the name of the hard drive or main folder. This drive or folder contains several files and folders, and each folder contains related files and folders. Please see figure 8.10 below for the File hierarchy illustration.

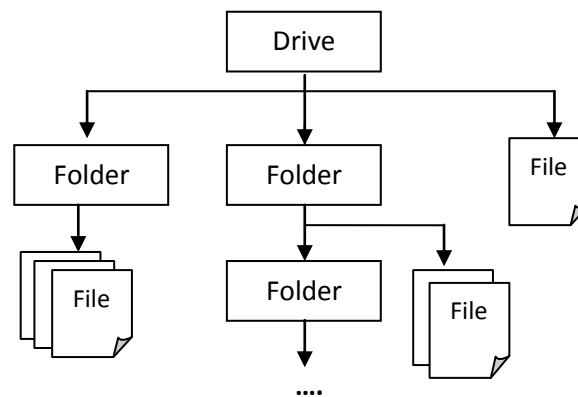

Figure 8.10: File hierarchy

**Note:** You can explore the file structure of your computer as follows:

1. Click on **Start**
2. Select **All programs**
3. Select **Accessories**
4. Select **Windows Explorer**

## 8.7.3 What is a library?

Libraries are new in Windows 7. Libraries are where you go to manage your documents, music, pictures, and other files. It is the location of your documents but more. You can browse your files the same way you would in a folder or you can view your files arranged by properties like date and type. In some ways, a library is similar to a folder. For example, when you open a library, you'll see one or more files. However, unlike a folder, a library gathers files that are stored in several locations. This is a subtle, but important, difference. Libraries don't actually store your items. They monitor folders that contain your items, and let you access and arrange the items in different ways. For instance, if you have music files in folders on your hard disk and on an external drive, you can access all of your music files at once using the Music library.

## What happens if you delete a library or the items in a library?

If you delete a library, the library itself is moved to the Recycle Bin. The files and folders that were accessible in the library are stored elsewhere and therefore aren't deleted. If you accidentally delete one of the four default libraries (Documents, Music, Pictures, or Videos: Please see figure 8.11 below), you can restore it to its original state in the navigation pane by right-clicking **Libraries** and then clicking **Restore default libraries**. If you delete files or folders from within a library, they're also deleted from their original locations. If you want to remove an item from a library but not delete it from the location it's stored in, you should remove the folder containing the item. When you remove a folder from a library, all the items in the folder will be removed (but not deleted).

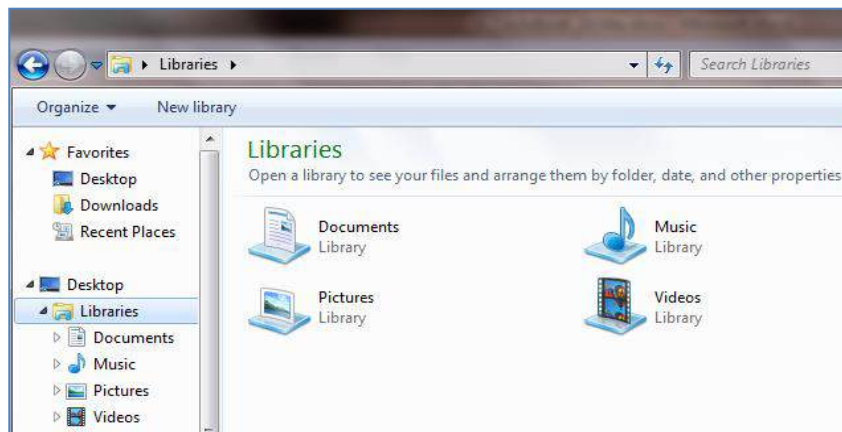

Figure 8.11: Libraries in Windows 7

### 8.7.4 The System Root in Windows 7

By default, the Windows operating system is installed in the C drive which is also called the System Root. It mainly consists of three folders namely *Windows* folder, *Program Files* folder and *Users* folder. The Windows folder contains operating system files, Program files folder contains installed programs and Users folder contains user profiles. Other folders and files are user files that are stored by users. Note that it is harmful for the computer system to change the above three folders. See Figure 8.12 below

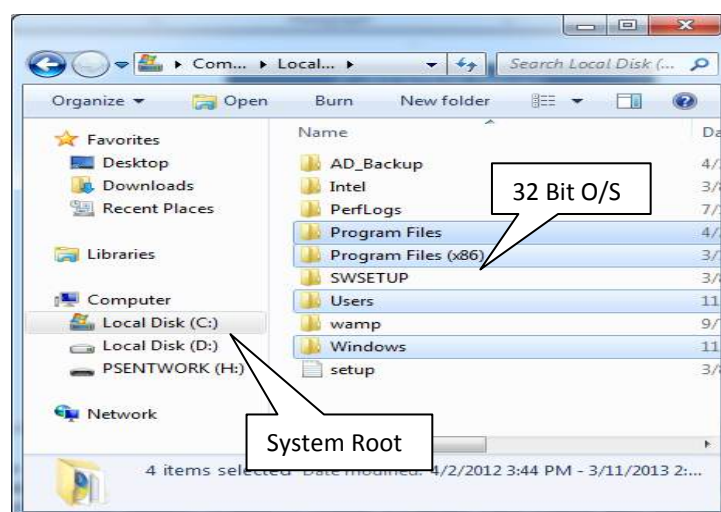

Figure 8.12: The system root folder in Windows 7

### 8.7.5 Personal Areas in Windows 7

As you learnt above, the Windows 7 Operating System stores all user profiles (All user data) in the *Users* folder in the system root drive (C :) under the relevant user name. Following Figure 8.13 shows the User profile of the user named 'Eranda' who is the administrator of that computer system. It contains some data folders such as My Documents, My Music, Desktop, Favorites, etc. these are the personal areas of the user administrator.

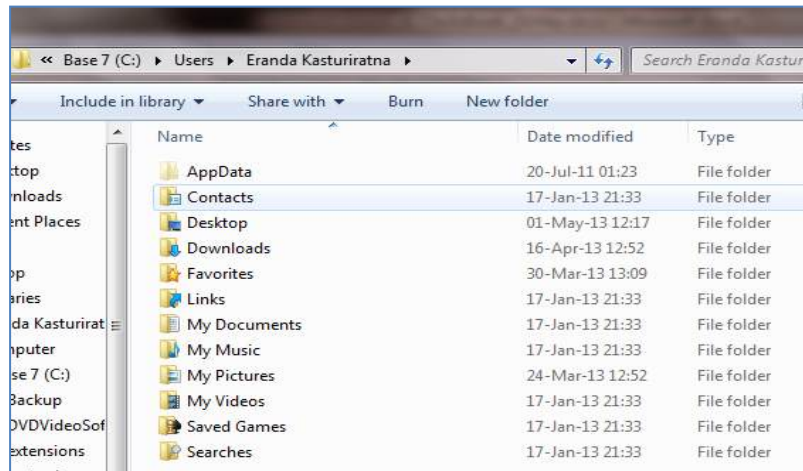

Figure 8.13: Admin User profile

Ex: If there is a user named DMCS, the desktop of the DMCS's path can be written as follows:



Note that, Administrator is the person who can manage your computer. If you are an administrator then you can see the other users' profiles. Managing user accounts in windows 7 is described in the next section.

**Example:** To see the user Saman's desktop, click *Saman* folder in the *Users* folder and then click the *Desktop*.

If you wish to format your C drive and re-install the operating system please backup your user profile. After installing the operating system please create user by same name and copy your profile in to document and setting folder. It saves your all personal data without any change.

### 8.7.6 File naming conventions

File naming conventions may differ based on the Operating System (OS) family. Following section discusses the file naming conventions used in windows OS and it is compared with the MS DOS OS.

In the windows file naming mechanism you have two components to file name. That is **name** part and **extension** part.

NAME.EXT

Name part contains a descriptive name of the file and extension part shows what type of file it is. Extension type also helps to specify the software that can be used to open the file.

In MSDOS operating system which is a command based operating system, the maximum number of characters that can be used for file name is 8 and 3 for extension. Therefore we can say it is 8.3 file naming system used in MSDOS.

Visible numbers and alphabetical characters are allowed in file name. Special symbols (#,\*,?, /, space etc.) are not allowed for file name. The letter \_ (underscore) is allowed to use in file names. All file names are not case sensitive. For example, consider the names OSCAR, Oscar, and oscar to be the same.

Therefore examples of valid and invalid filenames in MS DOS are,

Valid File Names	Invalid File Names	Reason For Invalidity
Lisa.do_	?mnd.exe	? is a special character
Priyal.dll	#mal.tx	# is a special character
Kumar.xls	Kiranthi_.txt	More than 8 characters for name
Sales.doc	Junglebook.com	More than 8 characters for name
Jinasena.tx	\$mahan.com	\$ is a special character
_desig.vbs	Palitha P.yah	Space is not allowed

Table 8.4- Valid & Invalid file names in MS DOS

Generally in windows you can give up to 255 characters including spaces to your file name. Special characters are not allowed similar to MSDOS. For example valid file names in Windows are,

Valid File names	Invalid File names	Reason For Invalidity
Kiranthi_Disanayake.txt	?mnd.exe	? is a special character
Priyal perera.doc	#mal.tx	# is a special character
Marketing Strategy Nov.xls	Disa/perera.ppt	/ cannot be used in file name
Sales Qty.doc	^for design.com	^ cannot be used in file name
Jinasena.txt	\$mahan.com	\$ is a special character
_desig.vbs		

Table 8.5: Valid & Invalid file names in Windows

## 8.8 Storing and Managing Data

### 8.8.1 Basic File/Folder Operations in Windows 7

#### Organizing files/folders

As you learnt above, Windows 7 allows organizing your files and folders with your data in a Drive other than the C: drive. The files/folders can be managed through the window you get

when you explore a particular location. This window will be similar to the Windows Explorer. Following Figure 8.14 shows the basic components/areas of your file exploring window.

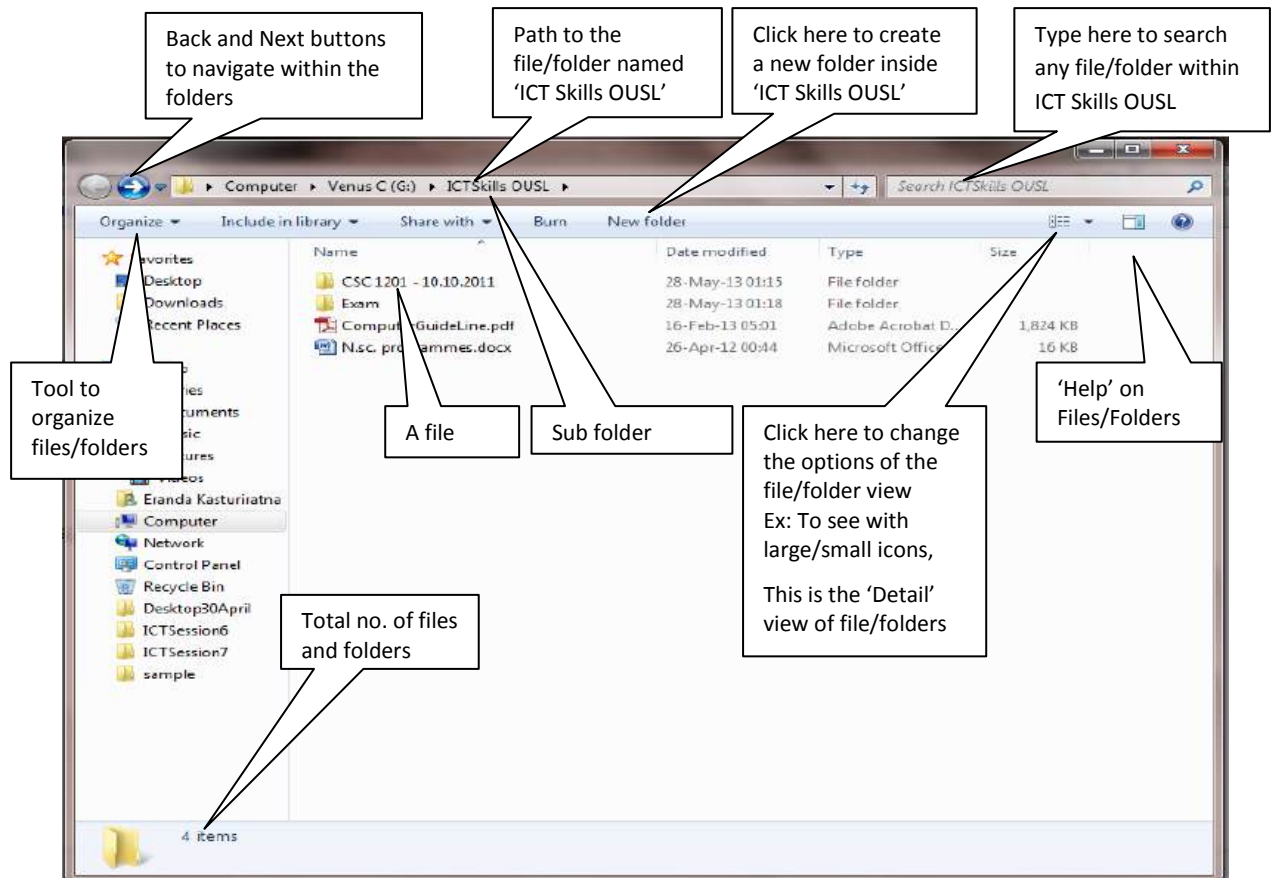

Figure 8.14: Basic areas in file exploring window

### File/Folder Select operation

You can use mouse to select a single folder or file by clicking on it. If you want to select multiple files which are close by one after another you can use mouse to encircle the files that you want to select or press shift key and down or up arrows to select files in given direction.

### Creating and Naming Folder

The keys to organizing files and folders effectively within a hierarchy are to store related items together and to name folders informatively. Creating a new folder can help you organize and keep track of files and other folders. In order to create a folder, you select the location where you want the new folder, create the folder, and then lastly, name the folder. You should name each folder meaningfully so that just by reading the folder's name you know its contents. After you name a folder or file, you can rename it at any time.

Steps to follow:

1. Open the drive or folder where you want to create a folder.
2. Click **New Folder** button on the toolbar OR Right-click on a blank area of the window, and then click New Folder.
3. With the New Folder name selected, type a new name.
4. Press Enter.

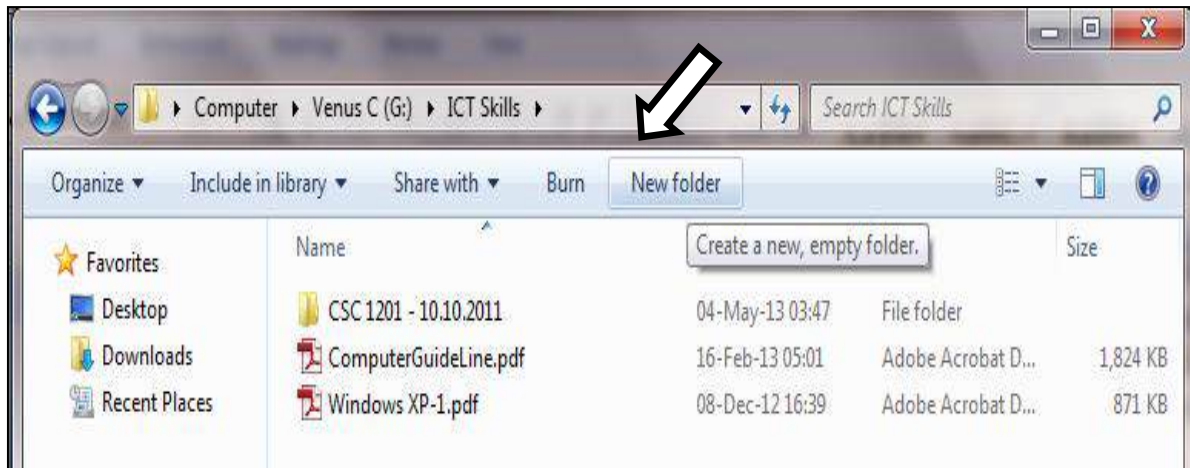

Figure 8.15: Creating and naming a folder

### Adding Properties and Tags to Files

When you create a file, Windows automatically adds properties to the files, such as name, creation date, modified date, and size. These properties are important to Windows; however, they may not be useful when you are searching for a file. You can add or modify common files properties and create or modify custom tag properties (**New!**) to make it faster and easier to locate files in the future. You can add or modify properties for most files. However, there are some exceptions, such as plain text (.txt) or rich text format (.rtf) files. You can add or modify properties using the details pane in an Explorer window (see figure 8.16 below), the details tab in the properties dialog box, or in the Save As dialog box. If you want to remove some or all of the property information in a file, you can quickly remove it using the properties dialog box.



Figure 8.16: Directly change properties of the file

Steps to follow:

1. Click the **Start** button, and then click **Documents**.
2. Click the file you want to add or modify properties.
3. In the details pane, click the tag you want to change, and then type the new tag. If the Details pane is not available, right-click the file, click **properties**, click the **Details** tab. When you are done, click **Apply**.
4. To add more than one tag, separate each entry with a semicolon.
5. To rate a file using the rating property; click the star that represents the rating you want to give the file.
6. Click **Save**.



## Copying a File/Folder

Steps to follow:

1. Open the drive or folder containing the file or folder you want to copy.
2. Select the files or folders you want to copy.
3. Click the **Organize** button on the toolbar, and then click **Copy**.
4. Display the destination folder where you want to copy the files or folder.
5. Click the **Organize** button on the toolbar, and then click **Paste**.

## Moving a File/Folder

Steps to follow:

1. Open the drive or folder containing the file or folder you want to move.
2. Select the files or folders you want to move.
3. Click the **Organize** button on the toolbar, and then click **Cut**.
4. Display the destination folder where you want to move the files or folder.
5. Click the **Organize** button on the toolbar, and then click **Paste**.

## Delete Files and Folders

Steps to follow:

1. Select the files and folders you want to delete.
2. Click the **Organize** button on the toolbar, and then click **Delete**.
3. Click **Yes** to confirm the deletion and place the items in the **Recycle Bin**.
4. On the desktop, right-click the **Recycle Bin** icon, and then click **Empty Recycle Bin**.  
(**Note:** *Your computer permanently removes the items.*)

## Restore Files and Folders

Imagine that you deleted a file/folder by mistake. Don't worry! You can get it back from the Recycle Bin into the original location where you had it, if you have not emptied the Recycle Bin.

Steps to follow:

1. Double-click the Recycle Bin icon on the desktop.
2. Select the item or items you want to restore.
3. Click the **Restore this item** or **Restore all items** button on the toolbar.
4. The restored file(s) now will be available in the original location.

## Create a Shortcut to a File or Folder

Steps to follow:

1. Open the drive or folder containing the file or folder for which you want to create a shortcut.
2. Right-click the file or folder, and then click **Create Shortcut**.
3. To change the shortcut's name, right-click the shortcut, click **Rename** from the shortcut menu, type a new name, and then press Enter.
4. Drag the shortcut to the desired location.

## Show or Hide Hidden Files and Folders

Steps to follow:

1. Right-click the file or folder you want to hide or unhide, and then click **Properties**.
2. Go to the **General** Tab
3. Select or clear the **Hidden** check box under **Attributes**.
4. Click Apply
5. Select the option 'Apply to this folder only' and confirm the above attribute change by clicking **OK**
6. Click **OK**.
7. The files or folders appear transparent or hidden.

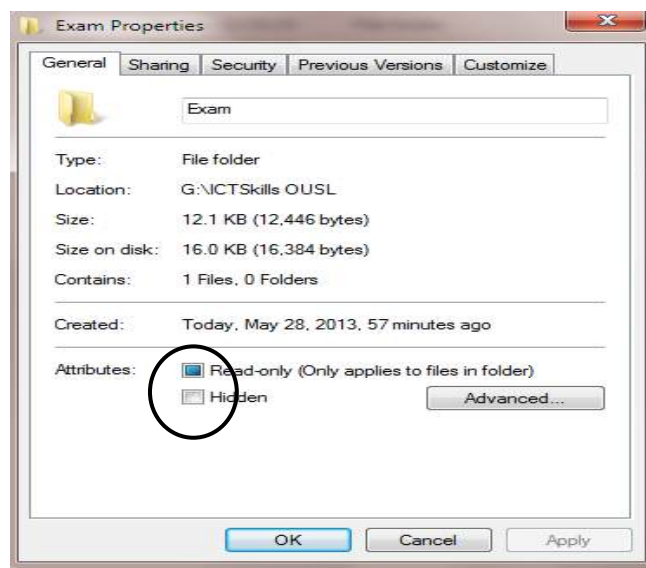

Figure 8.17: Show or hide folders

## Compressing Files and Folders

You can compress files in special folders that use compressing software to decrease the size of the files they contain. Compressed folders are useful for reducing the file size of one or more large files, thus freeing disk space and reducing the time it takes to transfer files to another computer over the Internet or network. A compressed folder is denoted by a zippered folder icon. You can compress one or more files in a compressed folder by simply dragging them onto the compressed folder icon. When a file is compressed, a copy is used in the compression, and the original remains intact. You can uncompress, or extract a file from the compressed folder and open it as you normally would, or you can open a file directly from the compressed folder by double-clicking the Compressed File icon. When you open a file directly, Windows extracts the file when it opens and compresses it again when it closes.

Steps to follow:

1. Select the files and folders you want to copy to a compressed folder.
2. Right-click one of the selected items, point to **Send To**, and then click **Compressed (Zipped) Folder**.
3. To copy additional files or folders to the compressed folder, drag the files onto the compressed folder.

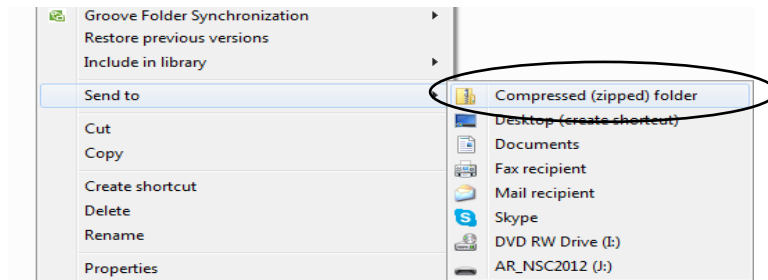

Figure 8.18: Compress files and folders

## Searching Files

Windows provides several ways to find files and folders. There isn't one best way to search. You can use different methods for different situations.

### Use the search box on the Start menu

You can use the search box on the Start menu to find files, folders, programs, and e-mail messages stored on your computer.

To find an item using the Start menu:

1. Click Start button.
2. Type a word or part of a word in the Search box.
3. Search results will appear as soon as you start typing in the Search box.

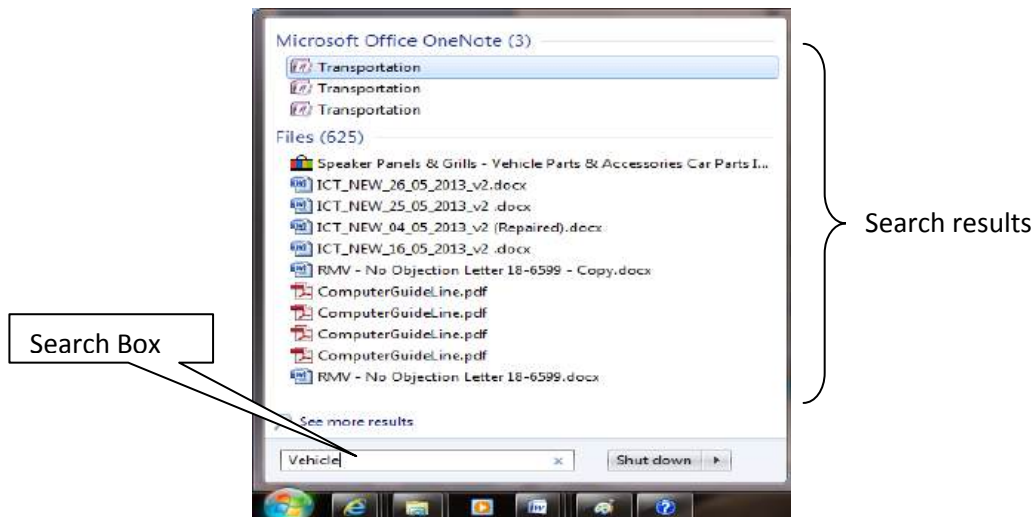

Figure 8.19: Use the search box on the start menu

As you type, items that match your text will appear on the Start menu. The search results are based on text in the file name, text in the file, tags, and other file properties. ⚠

**Note:** When searching from the Start menu, only files that have been indexed will appear in search results. Most files on your computer are indexed automatically.

### Use the search box in a folder or library

You're often likely to be looking for a file that you know is in a particular folder or library, such as Documents or Pictures. Browsing for the file might mean looking through hundreds of files and subfolders. To save time and effort, use the search box at the top of the open window.

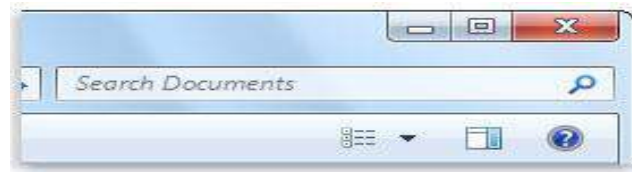

Figure 8.20: Use the search box in a folder

The search box filters the current view based on text that you type. The search looks for text in the file name and contents; and in the file properties, such as in tags. In a library, the search includes all folders included in the library as well as subfolders within those folders.

To search for a file or folder by using the search box:

- Type a word or part of a word in the search box.

As you type, the contents of the folder or library are filtered to reflect each successive character you type. When you see the file that you want, stop typing.

## 8.9 Windows 7 User Accounts

Windows 7 provides two main types of user accounts such as *administrator* and *standard*. For a domain network computer, different account types (administrator, standard user, and restricted user) provide similar permissions as the ones on a shared or workgroup computer.

The **Administrator** account is for the person who needs to make changes to anything on the computer as well as manage user accounts. An administrator can install programs and hardware, make system-wide changes, access and read all non-personal files, create and delete user accounts, change other people's accounts, change the own account name and type, change the own picture, and create, change, or remove the own password.

The **Standard user** account is for the person who needs to manage personal files and run programs. The standard user cannot install password for easy access and contains more restrictions than the standard account.

The **guest account** is disabled by default and needs to be turned on. You can also create a user group, which is a collection of user accounts that all have the same security rights. The most common user groups are the standard user and administrator. A single account can be a member of more than one group.

See Figure 8.21 below shows the main two types of user accounts: Standard user and Administrator.

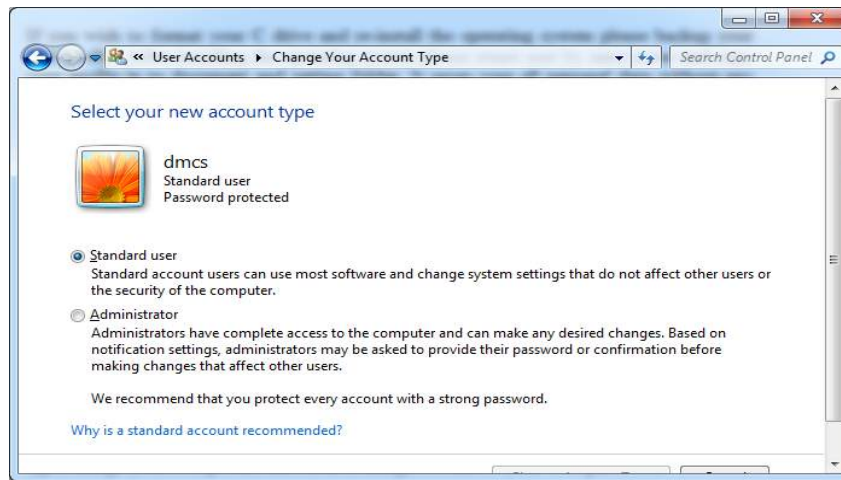

Figure 8.21: Windows 7 User Accounts

## 8.10 The System Settings

### 8.10.1 The Control Panel

Windows 7 gives you the ability to customize your work environment (your computer's desktop and other settings) to suit your personal needs and preferences. You can adjust most Windows features through the **Control Panel**, a central location for changing Windows settings. From the Control Panel you can access the individual programs for changing the properties, or characteristics, of a specific element of your computer, such as the desktop, the taskbar, or the Start menu. Each icon in the Control Panel represents an aspect of Windows that you can change to fit your own working habits and personal needs. For example, you can use the Display icon to change the background picture or color of the desktop, or the Taskbar and Start Menu icon to customize the taskbar and Start menu. Some Control Panel settings are vital to how you work (such as the Date and Time, or the Language settings) and others are purely aesthetic (such as the background picture, or which screen saver you use). The Control Panel also includes icons to setup user accounts and maintain security, and setup and manage local-area, wide-area, and wireless networks. You can access printers and faxes, add and remove programs and automatically update Windows. You can also work with hardware, such as a scanner, digital camera, modem, audio and speakers, mouse, and keyboard.

**Note:** Changing system settings through the Control Panel are described in the next session.

### 8.10.2 The Control Panel in Category View

The control panel can be viewed in two ways namely in Small Icons, in Large Icons, and by Category. In this course material we will be mainly discussing the system settings that could be done through the components of the control panel viewed by Category. Following are the steps to view the control panel in category view and the Figure 8.21 illustrates the categories of the settings in Control Panel.

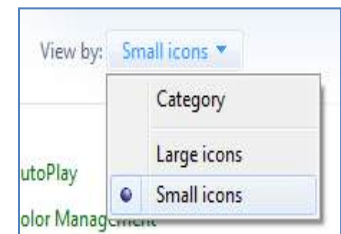

1. Click the **Start** button,
2. Click **Control Panel**.
3. In the View by options, select **Category View**.



Figure 8.22: Control Panel category view

## 8.11 Self Assessment Questions



- 8.1 Which versions/editions of Windows 7 have the following capabilities?
  - a. Create a HomeGroup
  - b. Support XP mode
  - c. Join a network domain
- 8.2 Which version of Windows 7 supports BitLocker? State the purpose of BitLocker feature.
- 8.3 What are the system requirements of Windows 7?
- 8.4 Briefly describe the six options available in Windows 7 to end a computing session.
- 8.5 Name the accessories available with windows 7 to perform the following tasks.
  - a. To display, create, and edit text only documents.
  - b. To create movies using audio/video files.
  - c. Help to protect your computer from spyware and other harmful intruders.
- 8.6 Briefly describe the purposes of following components of the Windows 7 interface?
  - a. Start Menu
  - b. Task Bar
  - c. Notification area
- 8.7 What are Windows Gadgets? Name five gadgets available in Windows 7.
- 8.8 What is a file system? Briefly describe the file system used by Windows 7.
- 8.9 What are Libraries? Name four default libraries available with Windows 7.
- 8.10 State the advantages of using compressed files.
- 8.11 State whether the following are either valid or invalid file names in Windows. Give reasons if invalid.
  - a. My sample file1.txt
  - b. \*Saman\_1.docx
  - c. Intro\_21/03/2013.pptx
  - d. 123\_saman.png

## Session 9

### Working with Windows 7

---

#### Aims:

The aim of this session is to explore the skill of the learner to manage the computer as per own and standard requirements through the windows 7 Operating system.

#### Objectives:

Having studied this session the student will be able to:

- Do the changes in the settings of your computer through the control panel options in terms of System security User accounts and Family safety, Network and Internet, Appearance and Personalization, Hardware and Sound, Clock/Language/Region, Programs and Ease of Access.
- Learn how to maintain your computer towards a better and last longer performance.



#### 9.1 How to adjust your computer's settings

As you learnt in the latter part of the previous session, you can do the adjustments in your computer's settings according to your wish. The category view of the control panel allows you to do the adjustments in the settings of the following areas and each setting changes are briefly described in the coming sections within this session.

1. System and Security
2. User Accounts and Family Safety
3. Network and Internet
4. Appearance and Personalization
5. Hardware and Sound
6. Clock, Language, and Region
7. Programs
8. Ease of Access

##### 9.1.1 System and Security

Through the category of *System and Security* in the Control panel, the user will be able to perform the following tasks,

- View and change security status.
- Backup and restore file and system settings.
- Update your computer.
- View RAM and processor speed.
- Check Firewall, and more.

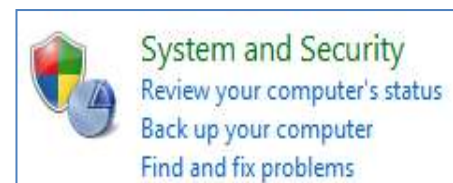

Let us take the example of viewing RAM and Processor speed. The steps to be followed are given below.

1. Go to the Category view of Control Panel.
2. Select **System and Security**.
3. Select **View amount of RAM and Processor Speed** under the topic **System**.
4. In the Window that you will meet next, the details of the RAM and Processor will be displayed as follows:

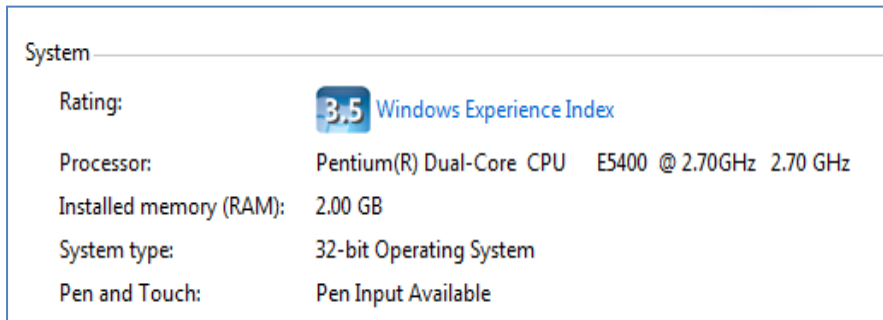

*Figure 9.1: Details of the RAM and Processor*

### 9.1.2 User Accounts and Family Safety

Through the category of *User Accounts and Family Safety* in the Control panel, the user will be able to perform the following tasks:

- Change user accounts and settings, and passwords.
- Set up parental control for users.



Let us take some example actions which are possible under this category

#### Adding and Deleting a user account

Steps to follow:

- Go to the Category view of Control Panel.
- Select **User Accounts and Family safety** icon.
- Click **User Accounts**.
- Click **Manage another account**.
- Click **Create a new account**.
- Type an account name.
- Click the Administrator option, or click the Standard option based on the type of the user that you are going to create an account for.
- Click **Create Account**.
- Click the **Close** button.

#### Change a User's Groups or Account Type

Steps to follow:

- Go to the Category view of Control Panel.
- Select **User Accounts and Family safety** icon.



- Click **User Accounts**.
- If you want to change the data related to another account, click **manage another account**, and then click **the user's account name**.
- Click Change your account type or Change the account type.
- Click **an account type** option.
- Click **Change account type**.
- Click the **close** button.

### Change an Account Picture

Steps to follow:

1. Go to the Category view of Control Panel.
2. Select **User Accounts and Family safety** icon.
3. Click **User Accounts**.
4. If you want to change the picture of another account, click **manage another account**, and then click the user's account name.
5. Click **Change your picture** or **Change the picture**.
6. Select the picture you want to have the picture of your account.
7. Click **Change Picture**, or click **Browse for more pictures** and select and double-click the picture you want.
8. Click the **Close** button.

### Create a Password

Steps to follow:

- 1 Go to the Category view of Control Panel.
- 2 Select **User Accounts and Family safety** icon.
- 3 Click **Create a password to your Account**
- 4 Type a password, and then type it again.
- 5 Type a hint that reminds you of the password.
- 6 Click **Create password**.
- 7 Click the **Close** button.

#### 9.1.3 Network and Internet

Through the category of *Network and Internet* in the Control panel, the user will be able to perform the following tasks:

- Check network status and change settings.
- Set preferences for sharing files and computers.
- Configure internet display and connection, and more

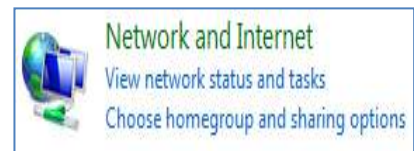

#### 9.1.4 Appearance and Personalization

Through the category of *Appearance and Personalization* in the Control panel, the user will be able to perform the following tasks:

- Change the appearance of desktop items.
- Apply a theme or a screen saver to your computer.
- Customize the start menu and the task bar.

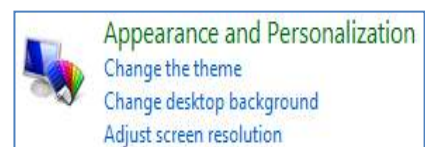

- Change folder options.
- Manage fonts installed in the computer.

Let us take some example actions which are possible under this category.

### Change the desktop background

Steps to follow:

1. Go to the Category view of Control Panel.
2. Click **appearance and Personalization**.
3. Click **Personalization**.
4. Click change **desktop background**.
5. Click the picture(s) in the given list of pictures, or click Browse to select a folder of pictures saved in your computer.
6. Select the picture(s) from the loaded pictures from the browsed location.
7. Set the Picture location.
8. Set the picture change time if you selected several pictures to be appeared in your desktop background.
9. Click **Save Changes**.

### Change the Screen Resolution

Steps to follow:

1. Go to the Category view of Control Panel.
2. Click **appearance and Personalization**.
3. Click **Display**.
4. Click **Adjust Resolution** from left pane.
5. Set the resolution from the drop down list you get under the resolution.



*Figure 9.2: Change the resolution*

### Change the Screen Saver

Steps to follow:

1. Go to the Category view of Control Panel.
2. Click **appearance and Personalization**.
3. Click **Personalization**.
4. Click **Change screen server**.
5. Click the list arrow, and then select a screen saver.
6. Click **settings**.

7. Set the options you want for the screen saver, and then click **OK**.
8. Click **preview** to see the screen saver in full-screen view, and then move your mouse to end the preview.
9. Specify the time to wait until your computer starts the screen saver.
10. Select **on resume, display logon screen** check box.
11. Click **Apply**.
12. Click **OK**.

### Change the Desktop theme

The Desktop theme allows you to change the desktop background, window colour, sounds, and screen saver all at once.

Steps to follow:

1. Go to the Category view of Control Panel.
2. Click **appearance and Personalization**.
3. Click **Personalization (Or Right-click a blank area on the desktop, and then click Personalize)**.
4. Click a theme from the listed themes.

### Change the Taskbar and Start menu properties

Steps to follow:

1. Go to the Category view of Control Panel.
2. Click **appearance and Personalization**.
3. Click **Taskbar and Start menu**.
4. Set the required changes from the **Taskbar and Start menu window**.
5. Click **Apply**.
6. Click **OK**.

### Fonts in your computer

To preview, delete, show, and hide fonts installed in your computer use the steps given below.

1. Go to the Category view of Control Panel.
2. Click **appearance and Personalization**.
3. Click **Fonts**.
4. Right click on the selected font to be deleted/hidden/copied/previewed.
5. Select **delete/hide/copy/preview**.

### 9.1.5 Hardware and Sound

Through the category of *Hardware and sound* in the Control panel, the user will be able to perform the following tasks:

1. Add or remove printers and other hardware.
2. Change system sounds.
3. Play CDs automatically.
4. Conserve power.
5. Change Mouse settings.
6. Update device drivers, and more.



Let us take some example actions which are possible under this category.

### Add (install) a printer

You can install a printer into your computer as follows; the printer may be a local one to be used only by your computer or it may be a networked one if it is to be used by many computers connected in the network that your computer is connected to.

Steps to follow:

1. Go to the Category view of Control Panel.
2. Click **Hardware and sound**.
3. Click **Devices and printers**.
4. Click **Add a printer**.
5. Select whether you are going to add a local printer or a network, wireless, or Bluetooth printer.
6. Click **next**.
7. Select the printer to be used from the list of existing ports or select, **create a new port** and select the type of port.
8. Click next.
9. Now it is ready to install the printer driver software.
10. Select the printer from the listed printers.
11. To install the driver from the CD you have, click **Have CD**.
12. Insert the Manufacturer CD and follow the steps as prompted until the step of getting a test page printed successfully from the new printer you added.

### Changing the default printer

Though this topic does not come under the control panel topic, it is worth to get know how to make a particular printer as the default printer among several printers installed into your computer.

**Note:** *The printer that you designate as the default destination for all print requests. If no printer name is used, the default printer is used.*

Steps to follow:

1. Click Start button.
2. Select Devices and Printers.
3. Select the printer to be made as the Default printer among the available Printers and Faxes.
4. Right click on the selected printer.
5. Select “**Set as Default**”.

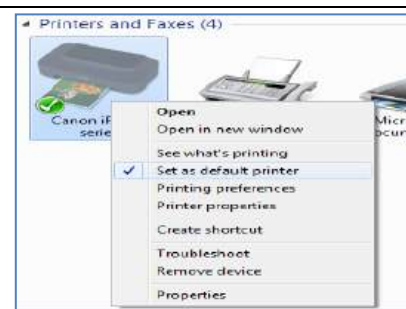

### Change system sounds

Steps to follow:

1. Go to the Category view of Control Panel.
2. Click **Hardware and sound**.
3. Click **sound**.
4. Set the changes in the sound settings from the **sounds** tab in the **sound** window that appears next as shown below.

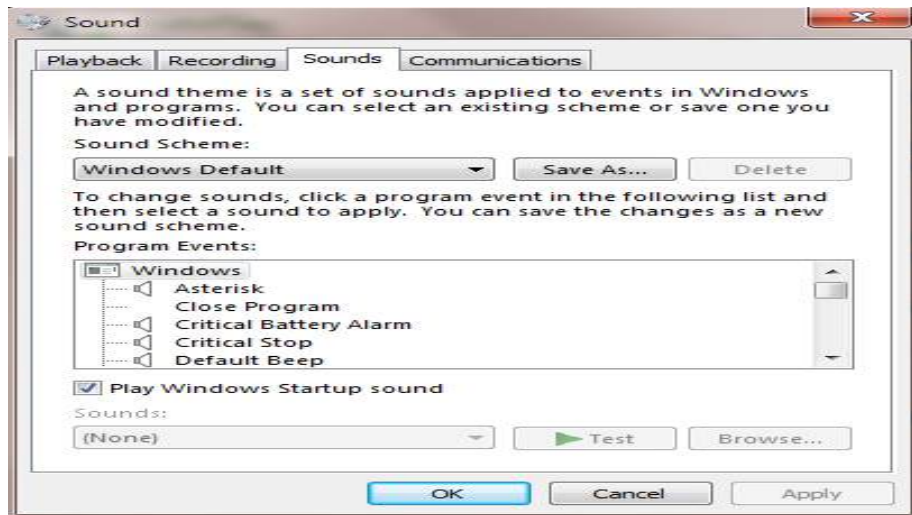

Figure 9.3: Changing the display sounds

### Adjust system volume

Steps to follow:

1. Go to the Category view of Control Panel.
2. Click **Hardware and sound**.
3. Click **Adjust system volume** appearing under the **sound**.
4. Drag and drop the sound controller to the required level.

### Adjust Mouse properties

Steps to follow:

1. Go to the Category view of Control Panel
2. Click **Hardware and sound**.
3. Click **Mouse** appearing under the **Devices and printers**.
4. Set the mouse properties such as mouse button configuration, adjust double click speed, set mouse pointer image, set mouse motion speed, etc. from the different tabs available in the Mouse properties window.

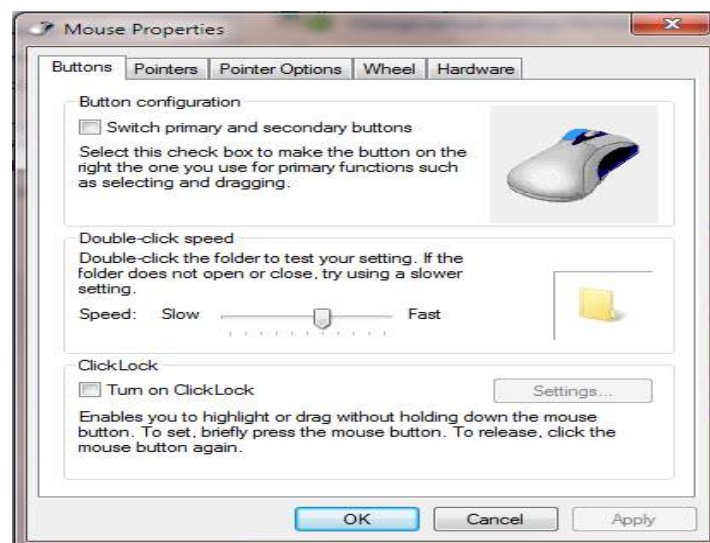
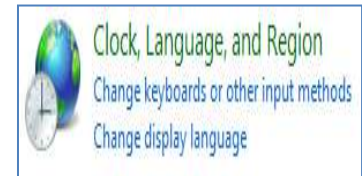

Figure 9.4: Mouse properties

## 9.1.6 Clock, language, and Region

Through the category of *Clock, language, and Region* in the Control panel, the user will be able to perform the following tasks:

1. Change the Date, time and time zone of your computer
2. Change the language to use
3. The way numbers, currencies, dates, times are displayed
4. Change keyboard or other input methods
5. Install/uninstall language packages



Let us take some example actions which are possible under this category.

### Change date and time

Steps to follow:

1. Go to the Category view of Control Panel.
2. Click **Clock, language, and region**.
3. Click **Date and Time**.
4. Select the **date and Time** tab.
5. Click **change date and time**.
6. Set the new date and time as you wish from the following window that appears next.

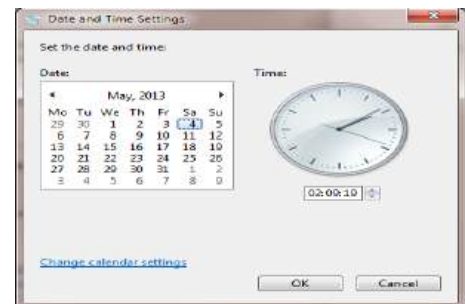

### Change the time zone

Steps to follow:

1. Go to the Category view of Control Panel.
2. Click **Clock, language, and region**.
3. Click **Date and Time**.
4. Select the **date and Time** tab.
5. Click **change time zone**.
6. Select the new time zone from the down arrow list of the following window that appears next.

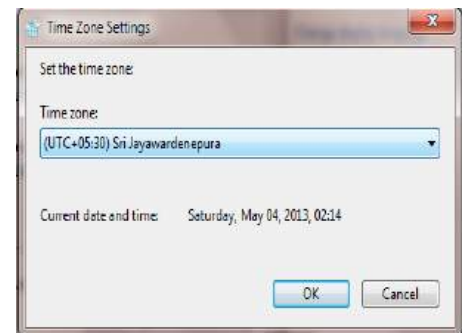

### Install/Uninstall Language packages

When you have installed different language packages such as Sinhala, Tamil, etc. you will be able to display text in your chosen language and it will support speech and handwriting recognition.

Steps to follow:

1. Go to the Category view of Control Panel.
2. Click **Clock, language, and region**.
3. Click **Region and Language**.
4. Select the **Keyboard and Languages** tab.
5. Click **Install/Uninstall Languages**.
6. Choose to install or uninstall languages.
7. If install, follow the next steps by identifying the method to install saying whether you are going to

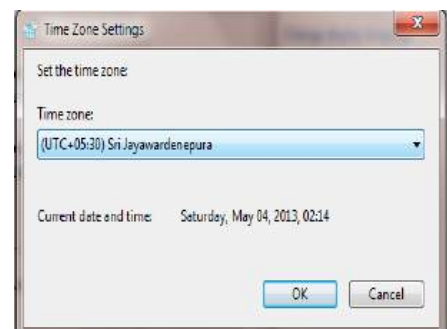

install the language by downloading from internet or by browsing the file saved in your computer.

### 9.1.7 Programs

Through the category of *Programs* in the Control panel, the user will be able to perform the following tasks:

- Uninstall programs or windows features
- Uninstall windows gadgets
- Get new programs from the network or online, and more

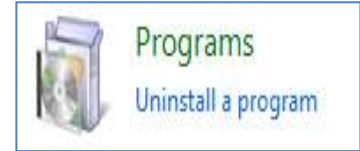

Before moving onto some example actions such as uninstalling programs under this category, we will look at the reasons for deciding to uninstall a program or an application from your computer first.

#### Reasons for uninstalling an application

There may be several reasons as listed below that lead you to decide to uninstall a particular program from your computer.

- Application being outdated.
- You are not in a position to pay more if the application is a paid one.
- Application does not function well/buggy/not working as intended.
- You are done with using the application (ex. computer games, if you feel that you do not need play it anymore, you may decide to remove it from your computer).
- You don't feel safe with your application.
- Your application is too big in size and you are in need of more space.
- Your application doesn't have good reviews.
- User refused to accept terms and conditions of the application.

#### Uninstalling an application

Steps to follow:

1. Go to the Category view of Control Panel.
2. Click **Programs**.
3. Click **Programs and Features**.
4. Select **uninstall a program** listed under the above selection.
5. Select the application/program to be uninstalled/changed/or repaired from the listed all programs installed in your computer.
6. Click the relevant command change/uninstall/repair.  
(For an example, let us uninstall the 'Madhura dictionary' application)
7. You will see that the uninstallation process in progress as follows,

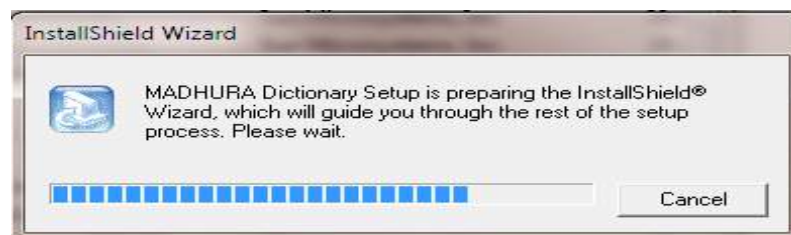

Figure 9.5: uninstallation process of MADURA DICTIONARY

8. Then you will be prompted to the Install shield wizard and decide from this window whether you really want to **modify**, **repair**, or **remove** that application.
9. Imagine that you want to remove it, the select the option **remove**.
10. Click **Next**.



Figure 9.6: Install Shield Wizard

11. Then confirm the file deletion by giving the answer to the next question as **OK** “Do you want to completely remove the selected application and all of it components”.
12. The system will completely removes the application from your computer now.

### 9.1.8 Ease of Access

Through the category of *Ease of Access* in the Control panel, the user will be able to perform the following tasks:

- Adjust your computer settings for vision, hearing, and mobility
- Use speech recognition to control your computer with voice command

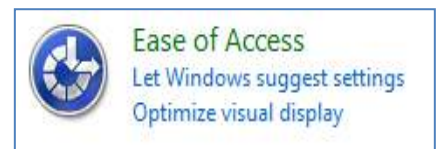

## 9.2 Preventive Maintenance of Your Computer

### 9.2.1 What is Preventive Maintenance?

Under the section 3.14.1, you learnt several factors that may affect the performance of your computer such as the speed of the processor, capacity of the hard disk, capacity of RAM etc. However, not only those technical factors, a good maintenance of the computer will also affect the performance of your computer. Let us discuss what this ‘Maintenance’ is.

Preventive Maintenance (PM) is to serve the reliability of the equipment we use through careful inspection, cleaning, and maintenance. Well maintained computer workstations will perform better and last longer than those that are neglected. It also allows us to detect serious problems that may arise with our computer before they occur and perhaps prevent system crashes and reduce equipment down time. We can identify a list of such actions to be taken to take care of or



computer. Such actions usually need to be done periodically. It is recommended that you should never really go more than 30 days without performing a solid PM on a personal computer.

Let us see the identified actions to be taken under PM.

### 9.2.2 PM Procedures

It is recommended to follow the following schedule (Table 9.1) to maintain your computer well. The actions are categorized based on how frequently you need to attend on it.

Frequency	Device/component involved	Action
<b>Daily</b>	System	Run a virus scan of the memory and hard disk
	Hard disk	Create a backup if important changes were done to data/programs
<b>Monthly</b>	Casing	External cleaning
	Hard disk	Recover lost clusters and de-fragment
	Keyboard	Clean and check for stuck keys
	Mouse	Clean and check for wear
	Monitor	Clean, degauss, and adjust
	Printer	Clean and dust
	System	Do a diagnostic quick test
	System	Install OS and software patches and update
<b>On failure</b>	CD ROM	Clean the pickup lens
<b>Yearly</b>	Casing	Open and dust
	Mainboard	Check chips for chip lift and reseal if necessary
	CMOS	Test the backup battery
	Adapter cards	Clean contacts with contact cleaner and reseal
<b>As required</b>	CMOS	Record and backup CMOs setup configuration
	System	Keep written record of hardware and software configuration of PC system

*Table 9.1: PC Maintenance Schedule*

Some important procedures tabled above are described below.

### 9.2.3 Run a Virus scan

Update the virus scan and daily check for virus is more important to prevent your computer from viruses.

Follow the steps below to update the virus scan.

1. Click the System tray and select the virus guard.



2. Check the status of your virus guard.

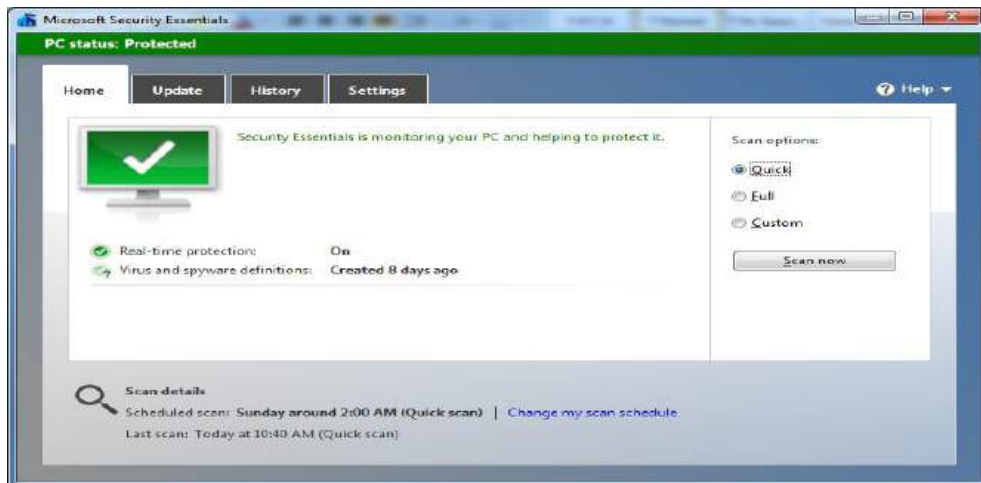

If it is not in the protected mode, update the virus guard.

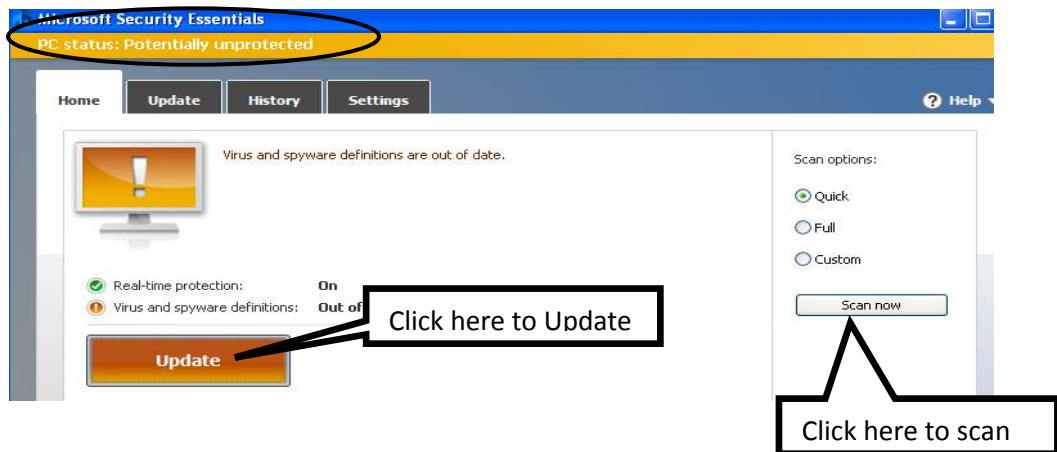

Figure 9.7: Run a Virus scan

### Scan your computer daily

To scan your computer use the following steps

1. Click the System tray and select the **virus guard**.
2. In the Home tab click **Scan**.

The Following figure shows the process of the virus scanning.

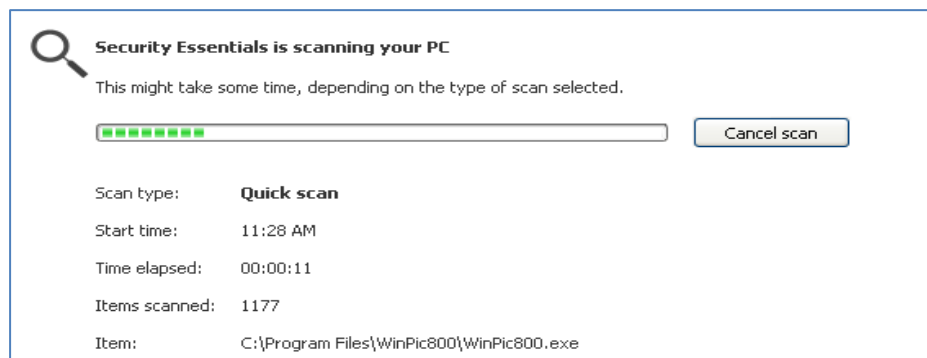

Figure 9.8: virus scanning

## How to remove detected viruses from your PC

1. In the virus guard go to the History tab.
2. In the History tab, select the detected items.

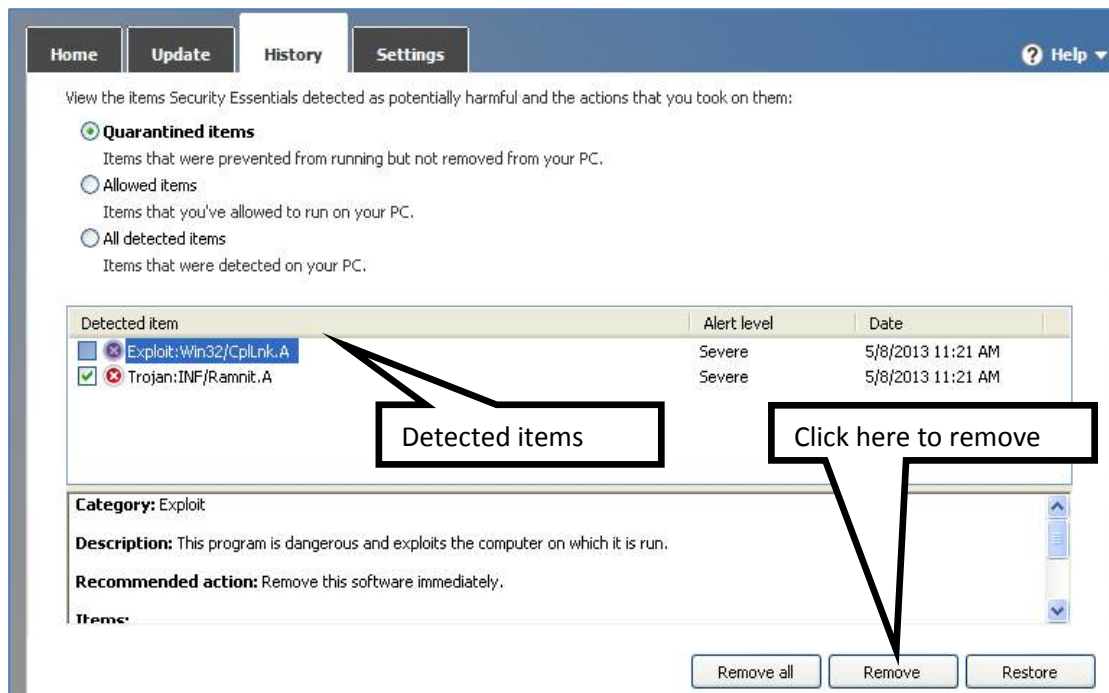
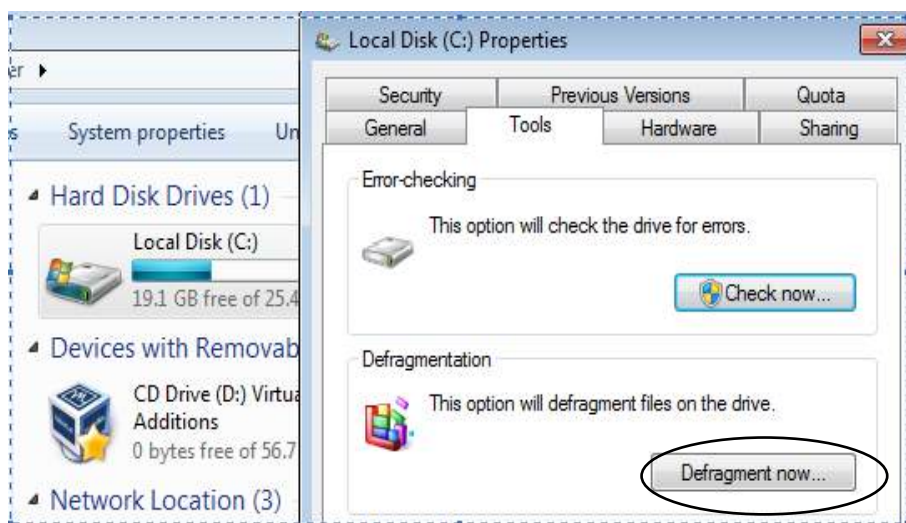

Figure 9.9: Remove the detected viruses

### 9.2.4 Recover lost clusters and Defragmentation

To Defragment your Hard disk, perform the following steps

1. Right click on hard drive you need to defragment.
2. Click **Properties**.
3. In the properties Window select **tool** tab.
4. Then click **defragment now**.



Now defragment Window appears. Select the drive and Click **defragment disk**.

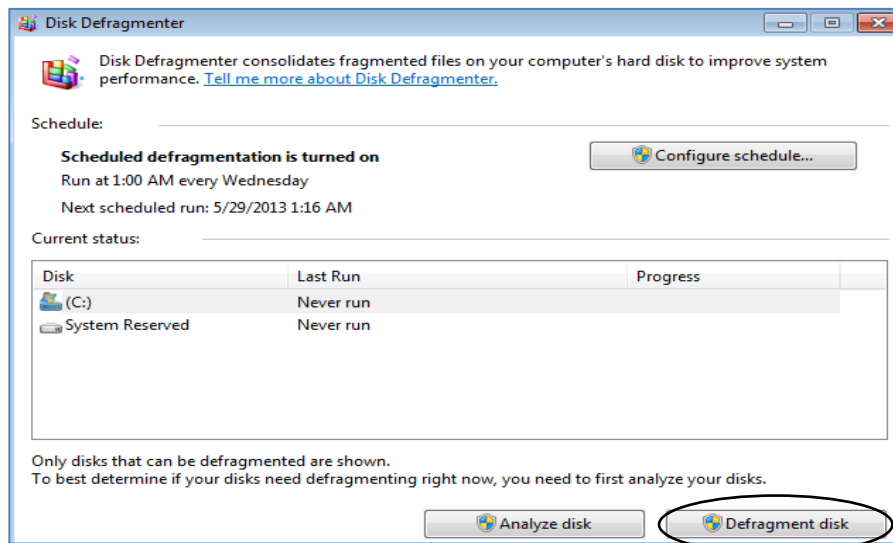

Figure 9.10: Defragmentation

### 9.2.5 Cleanup a Disk

To cleanup a selected disk, perform the following steps

1. Click the **Start button**, point to **All Programs**.
2. Click **Accessories**.
3. Click **System Tools**, and then click **Disk Cleanup**.
4. Select the files to clean (delete).

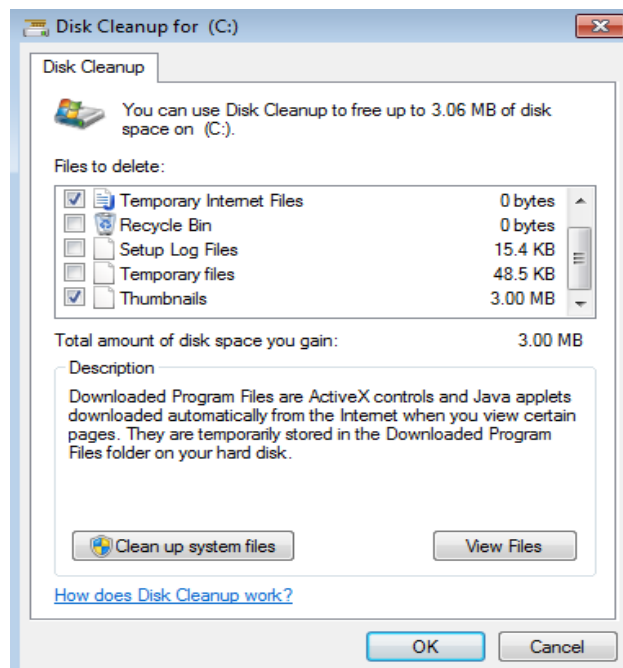

Figure 9.11: Disk Cleanup for C drive

5. To view the contents of a folder, click **View Files**, and then click the Close button.
6. Click **OK**, and then click **Yes**.

## 9.2.6 Install OS and software patches and update

To install software patches and updates, perform the following steps

1. Click the **Start** button, point to **All Programs**.
2. Click **Windows update**.
3. In the Windows update windows Click **Turn on Automatic update**.



4. Now system automatically searches for Windows updates.

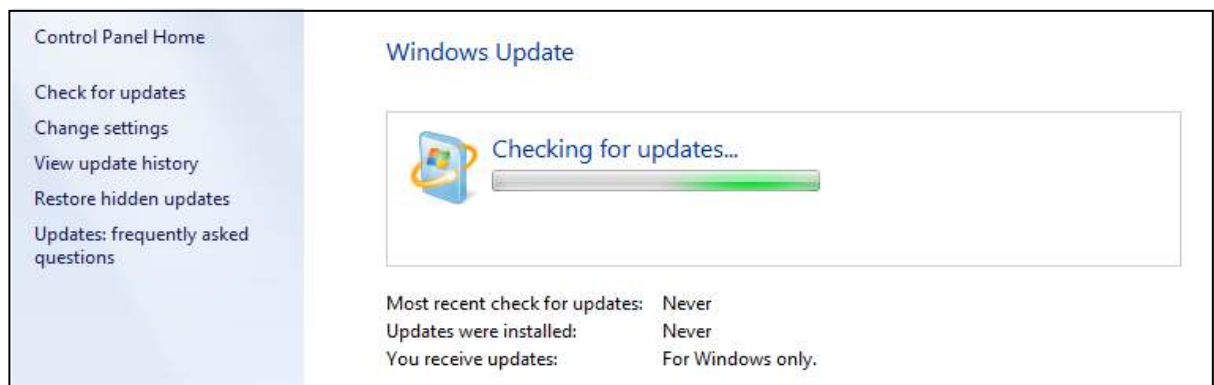

## 9.3 Self Assessment Questions



- 9.1 List the tasks that a user can perform through the following categories of the control panel.
  - a. System and Security
  - b. User Accounts and Family Safety
  - c. Network and Internet
  - d. Appearance and Personalization
  - e. Hardware and Sound
  - f. Clock, Language, and Region
  - g. Programs
  - h. Ease of Access
- 9.2 What may be the reasons for uninstalling an application from your computer?
- 9.3 What are the benefits of disk cleanup?
- 9.4 Why is it import to scan your computer daily?
- 9.5 What is the importance of preventive maintenance of your computer?
- 9.6 What are the recommended maintenance schedules that can be performed monthly to maintain the hard disk, key board, mouse, and monitor of your computer?

## Session 10

### Introduction to Word Processing and MS Office 2007

---

#### Aims:

Aim of this session is to introduce the user to the concept of an electronic *word processing* package and to make the user proficient in the use of the *Microsoft Office 2007*.

#### Objectives:

Having studied this session you can get idea about:

- What word processing is
- What the available word processors are.
- How to work with Keyboard to enhance the word processing skills.
- How to improve your typing speed.



#### 10.1 What is Word Processing?

Word processing is the creation of documents using a word processor. In computers, a word processor is a computer application used for the production, including composition, editing, formatting, and possibly printing of any sort of printable material. In general, word processor is a type of stand-alone office machine which was popular in the 1970s and 80s, combining the keyboard text-entry and printing functions. Type writers were commonly used in offices before the computers came more popular as a word processing device. At present, these type writers are out of date and all these functions of the type writers are done by the computer and word processing applications. *Figure 10.1* shows a manual type writer and an electronic type writer.



*Figure 10.1: Manual typewriter and electronic typewriter*

Computer based word processor is a computer software that can be used to word processing. At present there are thousands of word processing packages available all over the world. Compared to others Microsoft word, OpenOffice.org Writer, KWord and AbiWord are some of the popular word processing packages. These packages contain their own characteristics and features. Some common characteristics and features of the word processing packages are listed below.

### **10.1.1 Characteristics and features of Word processing software**

There are some characteristics in word processing such as,

- Batch mailing, using a form letter template and an address database (mail merging)
- Index of keywords and their page numbers
- Table of contents with section titles and their page numbers
- Table of figures with caption titles and their page numbers
- Cross referencing with page numbers.
- Bibliographical References
- Maintain page numbers and footnote information
- Auto Correct
- Auto Complete
- Styles and Formatting
- Text Frames and Linking

Some popular word processing packages are briefly described below.

## **10.2 Existing word processing packages**

There are several word processors available. These word processors can be categorized as Free/open source software (FOSS), Commercial software, and Online Word Processors. Let us look about each category.

### **10.2.1 Open source word processors**

Open source software is free software which you can use freely. There are several Open sources word processor; AbiWord, KWord, LyX, and OpenOffice.org Writer are most popular word processors.

#### **AbiWord**

*AbiWord* is a free software word processor and it runs on Linux, Mac OS X (PowerPC), Microsoft Windows, and other operating systems. AbiWord has a comprehensive language database with multiple languages. It also has support for tables and footnotes, as well as a spell checker and an advanced grammar checking system.

*AbiWord* is a package with several import/export filters, including HTML, Microsoft Word (DOC), Office Open XML (DOCX)[2][3], OpenDocument (ODT) and Rich Text Format (RTF). LaTeX is supported for export only. Plug-in filters are available to deal with many other formats, notably WordPerfect documents. The native file format is .abw. You can freely download AbiWord at <http://www.abisource.com/download/>

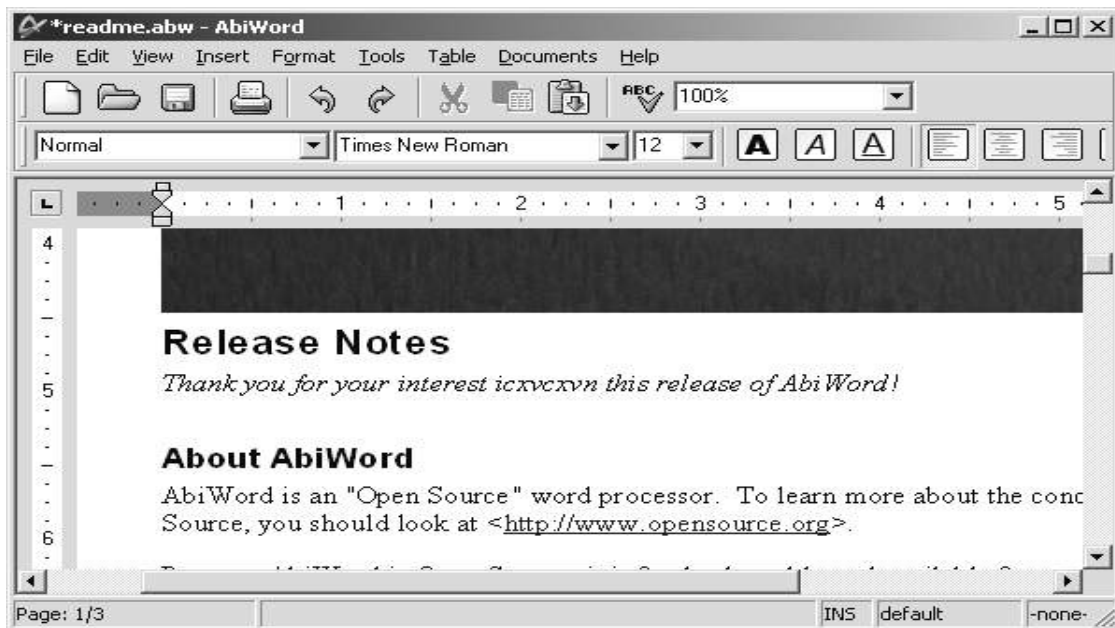

Figure 10.2: AbiWord Interface

## KWord

KWord is a frame-based word-processing and desktop publishing application and it is capable of creating, demanding and professional looking documents. KWord is a word processor based on frames. This can be used to place components in precise locations, as with many professional Desktop Publishing applications. KWord can also handle huge amounts of texts and allows you to do professional markup with ease. It has special features such as;

- Uses the standard ISO 26300 Open Document format.
- Paragraph style sheets (borders, alignment, spacing, indentation, bullet points, tab stops, page breaks, and font type, style, color and size), together with a stylist to edit, add, remove and update styles (a number of predefined styles are provided)
- A frame orientation, suitable for simple desktop publishing (DTP)
- Numerous preset as well as custom page sizes
- Multiple columns per page
- Headers and footers (including different first page headers/footers)
- Variables, such as page number, company name, user name, document summary, date and time or a custom variable
- Tables
- Embedding of text frames, images and clip-art (.wmf and .svg files)
- Chapter numbering
- auto-generation of table of contents
- auto-correction and spell checking
- templates

You can freely download KWord on <http://www.koffice.org/download/>



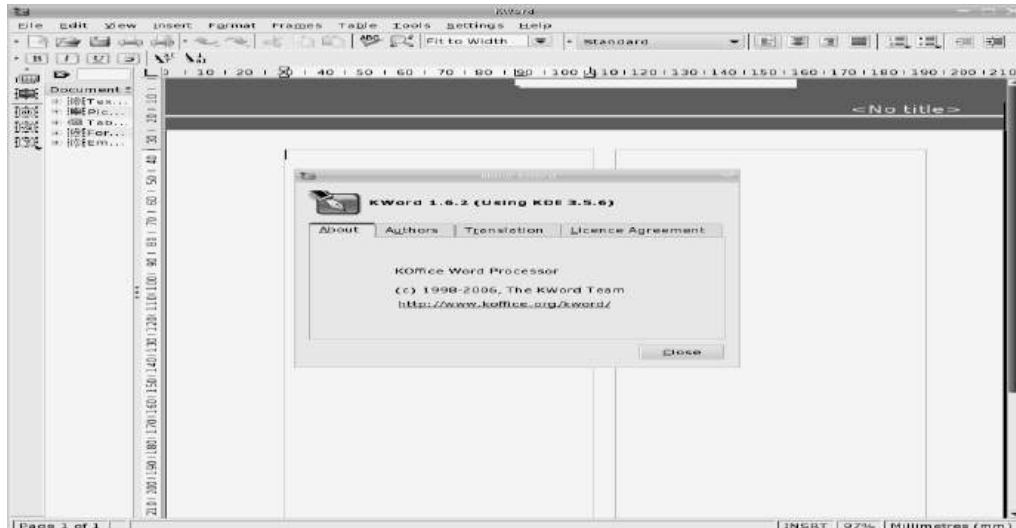

*Figure 10.3: KWord Interface*

## **OpenOffice.org Writer**

OpenOffice.org Writer is a word processor component of the OpenOffice.org software package. Writer is a word processor similar to Microsoft Word and Corel's WordPerfect, with some of their features. As with the entire OpenOffice.org suite, Writer can be used across a variety of platforms, including Mac OS X, Microsoft Windows, Linux, FreeBSD, IRIX and Solaris. Writer is a free software, which is released under the terms of GNU Lesser General Public License. Writer is capable of opening and saving documents in a number of formats, including the OASIS Open Document Format 1.1 (its default format), Microsoft Word's DOC, DOCX, RTF and XHTML. Writer provides a number of features not present in Word, including the ability to export to the PDF format natively. It also includes a word completion mechanism for predictive writing that is not available in Microsoft Word as of June, 2008.

Features include:

- AutoCorrect
- AutoComplete
- Styles and Formatting
- Text Frames and Linking
- Tables of Contents
- Indexing
- Bibliographical References
- Illustrations
- Tables
- Though OpenOffice.org Writer has a spell checker, it lacks a built-in grammar checker, which is available only as an extension since version 3.0.
- Writer's mail merge functions, although substantially rewritten in 2.0, are still less flexible than those of other word processors.

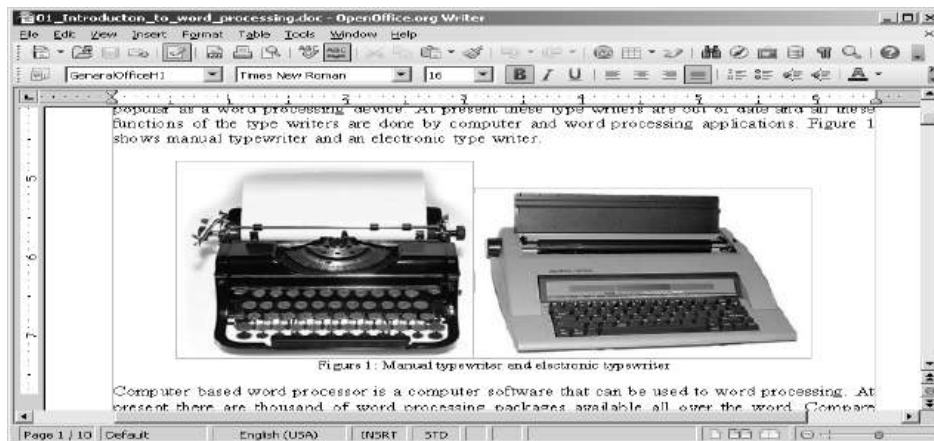

Figure 10.4: OpenOffice.org writer Interface

### 10.2.2 Commercial software

AppleWorks, Texmaker, Word Perfect, and Microsoft Word are some popular commercial word processors. In this section we consider only the Microsoft word 2007.

#### Microsoft Word

Microsoft Word is Microsoft's word processing software. It was first released in 1983 under the name **Multi-Tool Word for Xenix Systems**. The latest releases are Word 2013 for Windows and Word 2011 for Mac OS X. Microsoft Word's native file formats are denoted either by .doc or .docx file extension. Word has a built-in spell checker, thesaurus, dictionary and an Office Assistant.

### 10.2.3 Online word processors

Online word processors are special type of word processors that can be run in online. This means no needs any installation. You need to visit the website and use it. There are several online word processors such as Zoho, gOffice, Writely, Ajax Write and ThinkFree. Zoho is one of the online word processing package and you can use at <http://www.zoho.com/>

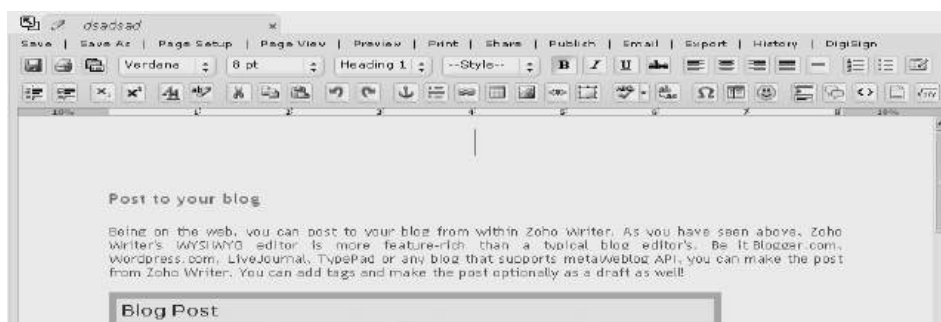

Figure 10.5: Online word Processor

Now you have some idea about what are the word processors available. Before starting the word processing you are required to get an idea about followings.

- Good knowledge about Operating system and keyboard layout
- Good typing speed
- Creative mind.

Rest of this session gives more about computer keyboard and some tips for improve your typing speed. This will be very useful for you.

### 10.3 Improve your typing Skills

#### 10.3.1 Keyboard and its' layout

Keyboard is an input device that can be used to input the data. The keyboard layout is a map where the letters available in the keyboard. Figure 10.6 shows common English and Sinhala computer key board layout, use in computer keyboard. In your normal keyboard contain function keys, character keys, control keys etc. These keys are used to do a lot of works. If you have a sound knowledge about keys then you can work without using a mouse. It will be actually faster than normal working using mouse.



Figure 10.6: English and Sinhala Computer Keyboard layout

#### Function Keys

Function keys are available in front of the keyboard. In this key layout there are 14 Function Keys Such as Esc, F1, F2.. F13. These function keys are use to run Specific functions in your Application. Example: F1 is used to show help, F2 is used to save your document etc.

#### Control Keys

There are three control keys such as Control key, Alt key and Shift key. The Control key is a modifier. When pressed in conjunction with another key, will perform a special operation (for example, Control-Alt-Delete).

Key combination	Microsoft Windows/KDE
Ctrl+A	Select all
Ctrl+B	Bold
Ctrl+U	Underline
Ctrl+C	Copy
Ctrl+V	Paste
Ctrl+Esc	Show start menu

Table 10.1: Special Operations

#### Alt key

The Alt key on a computer keyboard is used to change (alternate) the function of other pressed keys. The Alt key is a modifier key, used in a similar fashion to the Shift key. For example, simply pressing "A" will type the letter a, but if you hold down either Alt key while pressing A, the computer will perform an "Alt-A" function, which varies from program to program.

## Character keys

There are two types of character keys such as letters and symbols. Letters have their own meaning. But there are several symbols. Table 10.2 shows some symbols and its meanings.

Symbol	Explanation
~	Tilde
`	Acute, Back quote, grave, grave accent, left quote, open quote
!	Exclamation mark, Exclamation point, or Bang
@	At or At symbol
#	Octothorpe, Number, Pound, sharp, or Hash
\$	Dollar sign
%	Percent
°	Degree
^	Caret or Circumflex
&	Ampersand or And
*	Asterisk and sometimes referred to as "star".
(	Open parenthesis
)	Close parenthesis
-	Hyphen, Minus or Dash
_	Underscore
+	Plus
=	Equals
{	Open Brace
}	Close Brace
[	Open bracket
]	Close bracket
	Pipe, Or, or Vertical bar
\	Backslash or Reverse Solidus
/	Forward slash, Solidus, Virgule, or Whack
§	Section
:	Colon
;	Semicolon
"	Quote, Quotation mark, or Inverted commas
'	Apostrophe or Single Quote
<	Less Than or Angle brackets
>	Greater Than or Angle brackets
,	Comma
.	Period, dot or Full Stop
?	Question Mark

*Table 10.2: Symbols*

### 10.3.2 Working with Computer Keyboard

Now you are ready to work with the computer keyboard. It is required to improve following skills.

- Basic knowledge about computer keyboard
- Improve your typing speed

- Ability to work with English, Sinhala or Tamil key layout
- Some basic idea about shortcut keys and other facilities

These skills are very important to work with word processing packages. As a first step there are number of keyboard testing software available in the web. You can use these software and improve your typing skills.

### **Example 1: Improve English typing speed by using Typing Master**

Typing Master is a professional typing tutor that helps you to double your typing speed. You can freely download typing Master in the following URL <http://www.typingmaster.com/>. This program provides you to complete introduction about computer keyboard and how it work with best performance.

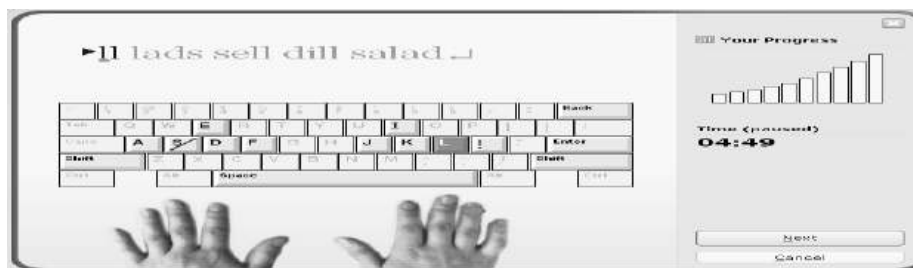

*Figure 10.7: Screen layout of the Typing Master*

It is strongly recommended you to use these programs and try to improve your typing abilities. Many people use two or three fingers to work with keyboard. It is important that try to use at least four or six fingers to typing. Typing Master is good assisting software for you. (Try to complete two three lessons to improve your typing ability using this program).

### **Example 2: Working with computer without using a mouse**

Now keep your mouse away from your desk. Don't touch it, while finishing this lesson. Now try to work with your computer without using a mouse. Try the following operations.

1. Open a program.
2. Close a program.
3. Copy or move some document.
4. Move to other applications.
5. Logoff your computer.

## **10.4 Introduction to MS Office 2007**

### **10.4.1 What is Microsoft Office?**

Microsoft Office is a software that consists of different applications that perform different activities. This software package is developed from the Microsoft Corporation, which is available for the computers with either the Microsoft Windows or Apple Mac OS X operating systems. The windows based first office program was develop in 1990. The first version of Office contained only Microsoft Word, Microsoft Excel, and Microsoft PowerPoint. The current versions are Office 2013 for Windows and Office 2011 for Mac OS. The windows based Office 2013 was launched on January 29, 2013. At present, it has introduced a number of programs available with Microsoft Office packages. However, Microsoft word, Excel, PowerPoint and Outlook Express are the common office programs.

### 10.4.2 History of Office Versions

Since 1992 Microsoft provides set of office packages. The table 10.3 shows year and the release name of the Office packages for Windows O/S.

Year	Name	Description
1992	Office 3.0	CD-ROM version: Word 2.0, Excel 4.0, PowerPoint 3.0, Mail 3.0
1994	Office 4.0	Word 6.0, Excel 4.0a, PowerPoint 3.0
1996	Office 97	published on CD-ROM
1999	Office 2000	Last version to support Windows 95, and last version that lacks Product Activation
2001	Office XP	Last version to support Windows 98, ME and NT 4.0. Improved support for working in restricted accounts under Windows 2000/XP.
2003	Office 2003	Last version to support Windows 2000
2007	Office 2007	Broadly released alongside Windows Vista
2011	Office 2010	Introduced extended file formats
2013	Office 2013	Latest version to support Windows 8

*Table 10.3: History of the Microsoft Office*

In this course unit, we will be mainly working with MS Office 2007. Therefore, it is worth to look at the features introduced / enhanced with MS Office 2007.

### 10.4.3 Microsoft Office 2007

The Microsoft Office 2007 system is the most recent version of Microsoft's productivity suite. It was released to business customers on November 30, 2006 and was made available to retail customers on January 30, 2007 which was the same day of the formal launch to retail customers of Windows Vista. Office 2007 contains a number of new features, new applications and server-side tools.



#### Features

There are number of new features in Microsoft office 2007 namely User interface, Smart Art, new File formats, User Assistance System, Collaboration features and Themes, Quick Styles etc. Some of these features are described below.

**New user interface:** The new result-oriented User Interface (UI) is featured in the core Microsoft Office applications: Word, Excel, PowerPoint, Access and the item inspector are used to create or edit individual items in Outlook. Also, the default font used in this edition. Some of the new component are describes below.

**Office 2007 button:** The Office 2007 button, which is located on the top-left of the window. It replaces the File menu (Office 2003) and provides access to functionality common across all Office applications, including but not limited to Opening, Saving, Printing, and sharing a file. Users can also choose colour schemes for the interface.

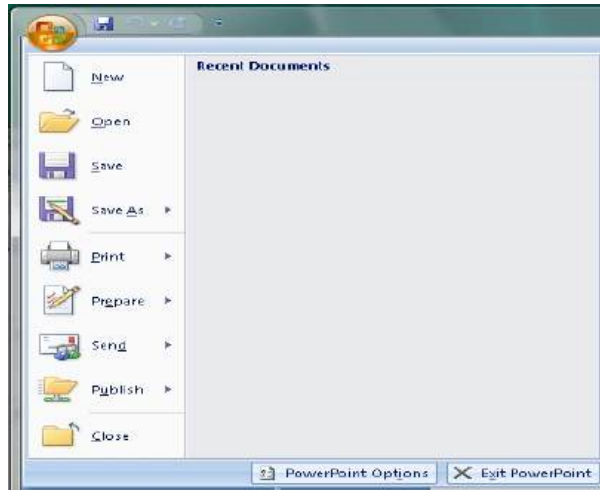

Figure 10.8: Office button in Microsoft power point

**Ribbon:** The Ribbon is a panel that houses the command buttons and icons, organizes commands as a set of Tabs, each grouping relevant commands. Each application has a different set of tabs which expose the functionality that application offers.



Figure 10.9: The ribbon on PowerPoint 2007

**Contextual Tabs:** Some tabs, called Contextual Tabs, appear only when certain objects are selected. Contextual Tabs expose functionality specific only to the object with focus.

**Live Preview:** Microsoft Office 2007 also introduces a feature called "Live Preview", which temporarily applies formatting on the focused text or object, when any formatting button is moused-over. The temporary formatting is removed when the mouse pointer is moved from the button. This allows users to have a preview of how the option would affect the appearance of the object, without actually applying it.

**Mini Toolbar:** The new "Mini Toolbar" is a type of context menu that is automatically shown (by default) when text is selected. The purpose of this feature is to provide easy access to the most-used formatting commands without requiring a right-mouse-button click as necessary in older versions of the software.

**New File formats:** Microsoft Office uses a new file format, called Office Open XML, as the default file format. Word documents (without macro extensions) are now saved using a .docx extension rather than the traditional .doc extension. Word 2007 can also save documents in the old format so that they will still be usable in previous versions of Word. Open XML is based on XML and uses the ZIP file container. According to Microsoft, documents created in this format are up to 75% smaller than the same documents saved with previous Microsoft Office file formats, owing to data compression. Also it will support to export the Portable Document Format (PDF) in Office 2007.

**User Assistance System:** In Microsoft Office 2007, the “new help system” is the extensive use of Super Tooltips which explains in about one paragraph what each function performs. Some of them also use diagrams or pictures. These appear and disappear like normal tooltips, and replace normal tooltips in many areas.





#### 10.4.4 System requirements for Office 2007

Microsoft Office 2007 needs minimum of following system requirements,

- 1) **Computer and processor:** 500 megahertz (MHz) processor or higher
- 2) **Memory:** 256 megabyte (MB) RAM or higher
- 3) **Hard disk:** 1.5 gigabyte (GB); a portion of this disk space will be freed after installation if the original download package is removed from the hard drive.
- 4) **Drive:** CD-ROM or DVD drive
- 5) **Display:** 1024x768 or higher resolution monitor
- 6) **Operating system:** Microsoft Windows(R) XP with Service Pack (SP), Windows Server 2003 with SP1, or later operating system

#### 10.4.5 Programs Available in Office 2007

The 2007 Microsoft Office system is distributed in several editions summary of the each edition is given below.

Edition	Packages
 Microsoft Office Home and Student 2007	PowerPoint ,Word, Excel, OneNote
 Microsoft Office Basic 2007	Outlook, Word, Excel
 Microsoft Office Small Business 2007	Outlook , Publisher, PowerPoint, Word,
 Microsoft Office Professional 2007	Outlook, PowerPoint, Word, Excel, Access, Publisher

*Table 10.4: Several editions of Ms Office*



### 10.5 Self Assessment Questions

- 10.1 What is a word processor?
- 10.2 What is the advantage of using a computer as a word processor than using a type writer?
- 10.3 What are the features and facilities commonly available in a word processor?
- 10.4 What are the differences between an online word processor and a Commercial word processor?
- 10.5 How do you improve your typing speed? Explain briefly.
- 10.6 What are the new features introduced in Office 2007?
- 10.7 What are the new features introduced in Word 2007?
- 10.8 Briefly explain the system requirements to install office 2007.
- 10.9 “Microsoft Office is a commercial office package”. Justify the above statement.



# Session 11

## Microsoft Word 2007

---

### Aim:

To provide an introduction about Microsoft Office 2007

### Objectives:

Having studied this session you will be able to get an idea about:

- What Microsoft Office Word 2007 is
- Word 2007 user interface
- Working with word 2007



### 11.1 Getting started with Microsoft Office Word 2007

Microsoft Office Word 2007 is one of the most sophisticated word-processing programs available today. With Word 2007, it is easier than ever to efficiently create a wide range of business and personal documents, from the simplest letter to the most complex report. Word includes many desktop publishing features that you can use to enhance the appearance of documents so that they are appealing and easy to read. In this lesson, we will be discussing about MS Word 2007 to make you familiarized with it.

#### 11.1.1 Start Microsoft Office Word 2007

This section describes how to start Word 2007. There are different ways to start Word 2007. By default, MS Office is installed in *C:\Program files\ Microsoft Office* and short cuts are available in the start menu. To start Microsoft Word you can use the Start button as follows,

Click Start button → All Programs → Microsoft Office → Microsoft Office Word 2007

OR

Double Click the above **MS WORD** icon on any place



#### 11.1.2 Create a new Word Document – Method 1

After starting MS Word as given above, you can create a new word document.

Click **Start button** → click **New (New document** window will be appeared)



- Select the template : **blank and recent**
- Select **blank document** and Click **create**

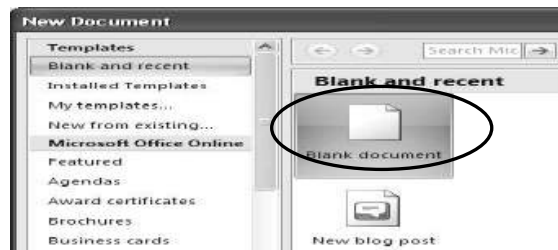

### 11.1.3 Create a new word document - Method 2

There is another method to create a new document.

- Click the **mouse cursor** in the location where you want to create the **new** document.
- Right click and get the short cut menu.
- Select **New**.
- Click **Microsoft Office Word Document** .

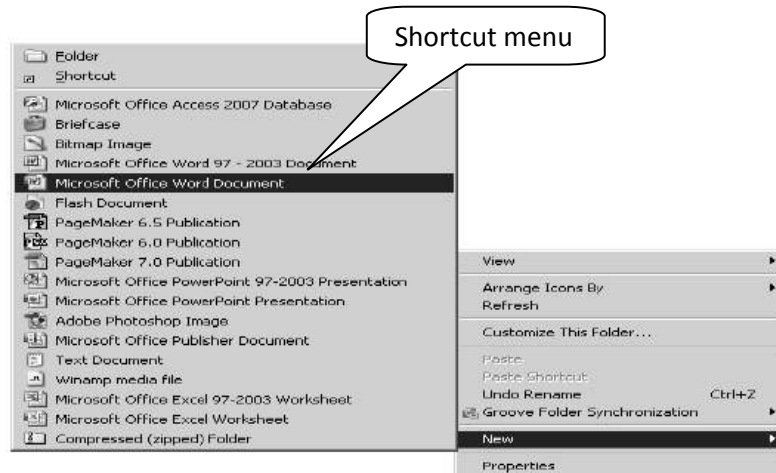

Figure 11.1: The Shortcut menu

- A new Word document will be created for you without a specific name.
- Rename/give a name for the created new word document.



Figure 11.2: Rename the created new document

- To Open Word, double click on the WORD icon.

Now you can see the Microsoft Word 2007 user interface with a new document.

## 11.2 Getting familiarized with the MSWord 2007 user interface

Before start working with Word 2007 you should be familiar with Microsoft Office 2007 user Interface. Microsoft Word 2007 user interface is shown in figure 11.3. Word 2007 introduces many new features and some of them were described in the previous session. However this section gives some of the useful tips that will be used to work with MS word 2007. Now you know that ribbon is the most useful tool which is available in the Office 2007 package and it includes many development tools with groups together. The 'Text area' is the area you can enter your text. Figure 11.3 shows some common tools and objects available in the Word 2007 user interface such as Office button, Quick Access tool bar, Ribbon, Title bar and status bar etc.

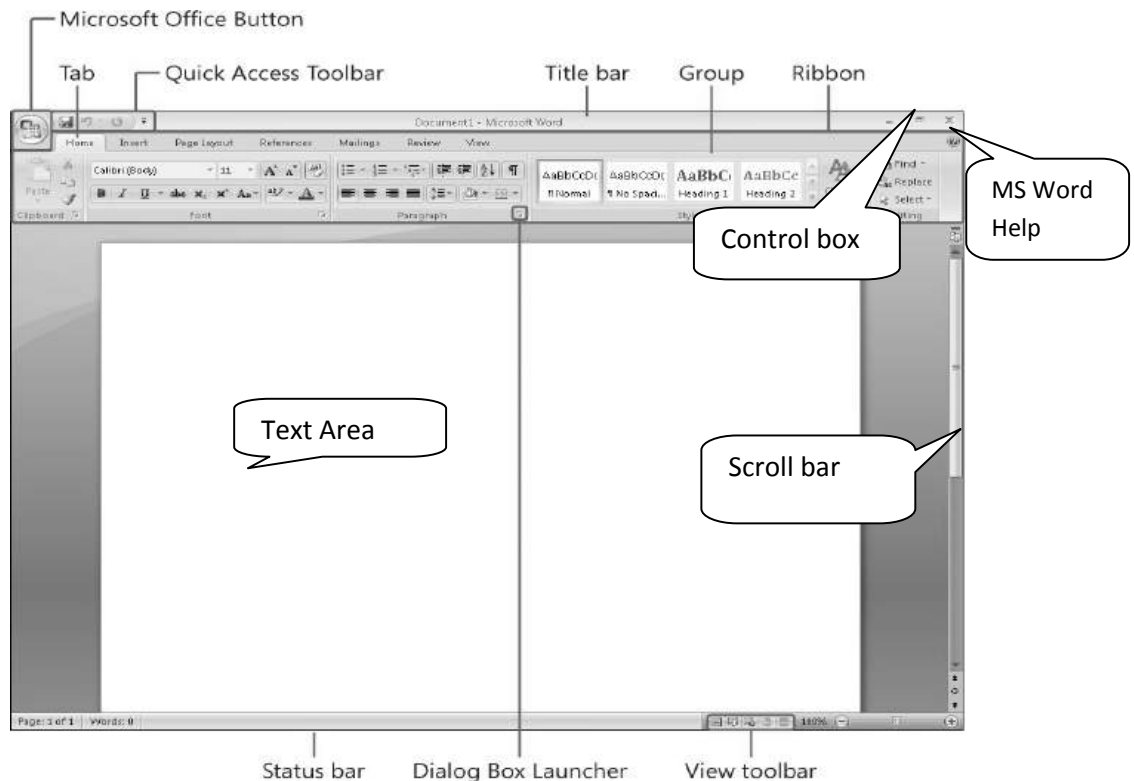





Figure 11.3: Microsoft word 2007 user interface

### Control box

There are three buttons in the right top corner in your Word 2007 window. The minimize  button is used to minimize your window and maximize  button is used to maximize and close button  is used to close your current window.

### Microsoft Office button

The Microsoft Office button is newly introduced in Office 2007. It shows all the basic actions in your Word 2007 window such as New, Open, Save, Close etc.

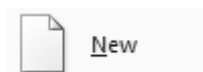

Using this **New** button you can create a new word document.

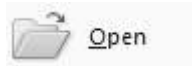

Using this **Open** button you can open an existing word document.



Using this **Save** button you can save your document. The **save as** button can be used to save your document as a new copy.

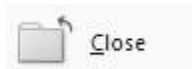

Using this **Close** button you can close the currently opened document without closing the Microsoft Word 2007.

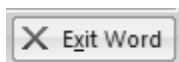

Using this exit word button you can exit from your word program.

## The Ribbon

The Ribbon contains all the tools available in the Word 2007. By default, the ribbon is consisting of seven tabs namely Home, Insert, Page layout, References, Mailings, Review, and View. You can click on each tab. Then the Ribbon will be appeared with the tools available under the selected tab. The Figure 11.4 below shows the Ribbon in Home tab.

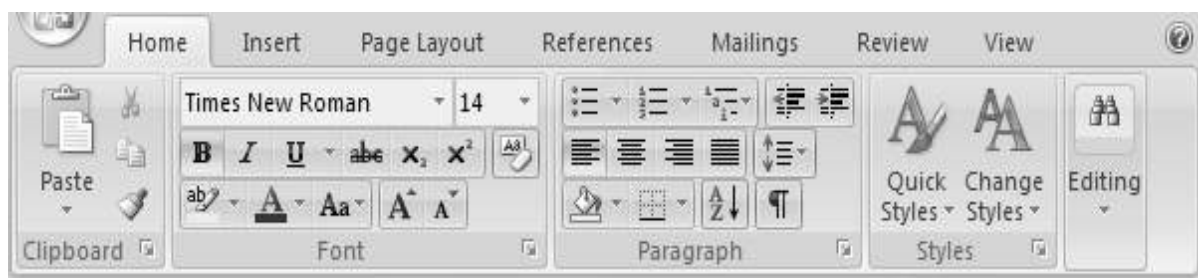

*Figure 11.4: Microsoft Word 2007 Ribbon – Home tab*

## 11.3 Using MS Word Help

The MS Office suite provides assistance for using its all applications such as MS Word, Excel, Access, PowerPoint, etc. with a comprehensive Help menu. In MS Word interface, right under the three control buttons you can see the Help menu with the icon shown below.



*Figure 11.5: Help Menu icon*

Click on the above Help menu icon or press F1 key from the key board to open the Word Help window. Figure 11.6 shows the Word Help window.

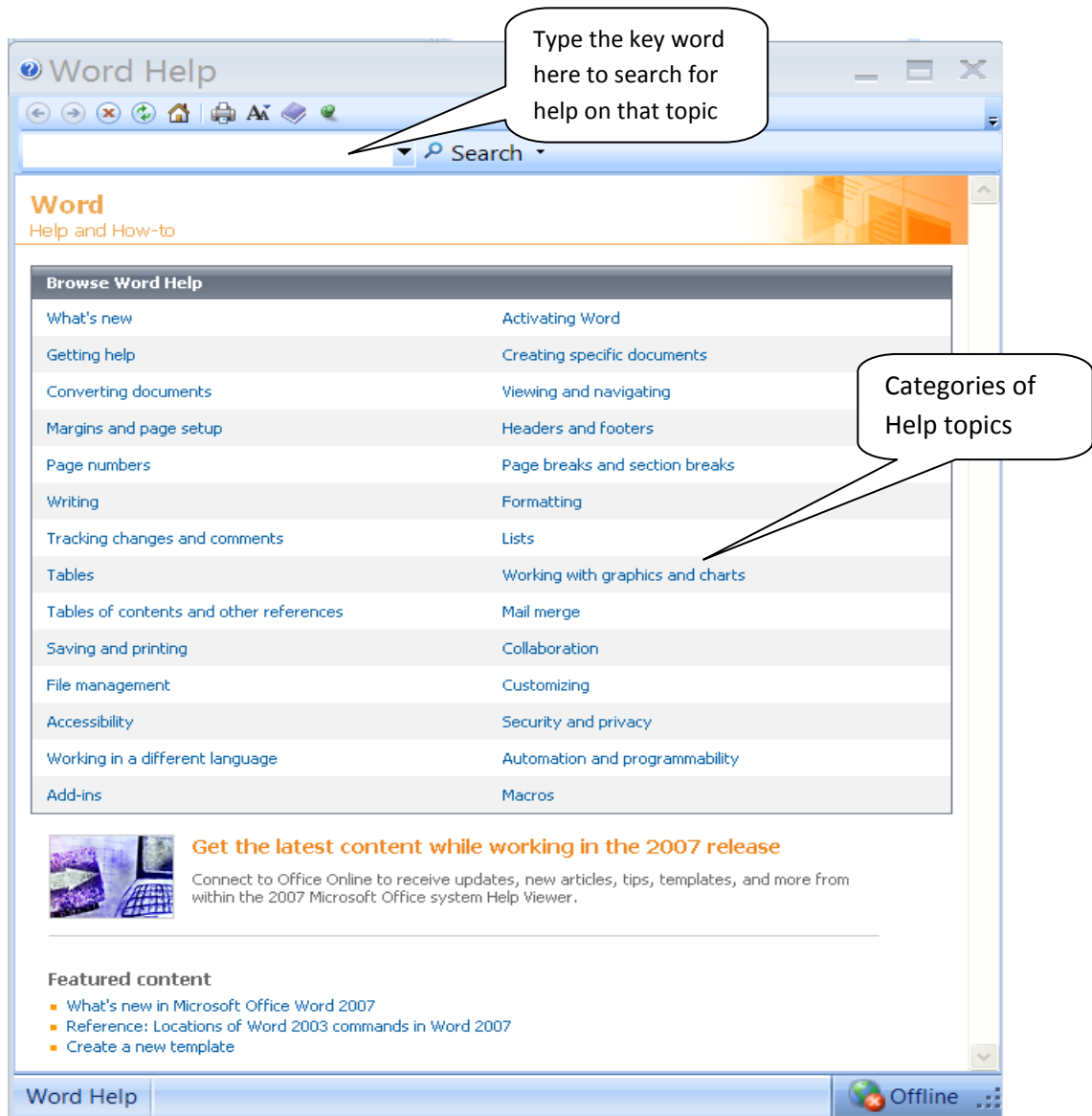

Figure 11.6: Word Help window

**Example:** Imagine that you want to learn how to insert Page numbers into your document. So you need to click on the help topic “Page Numbers” and then click on “Insert page numbers”. Word Help will give you a very comprehensive description on how to insert page numbers with some examples. From the same window, you can search for other related topics such as how to remove page numbers, how to change the format of page numbers, etc. through the links given there. See Figure 11.7.

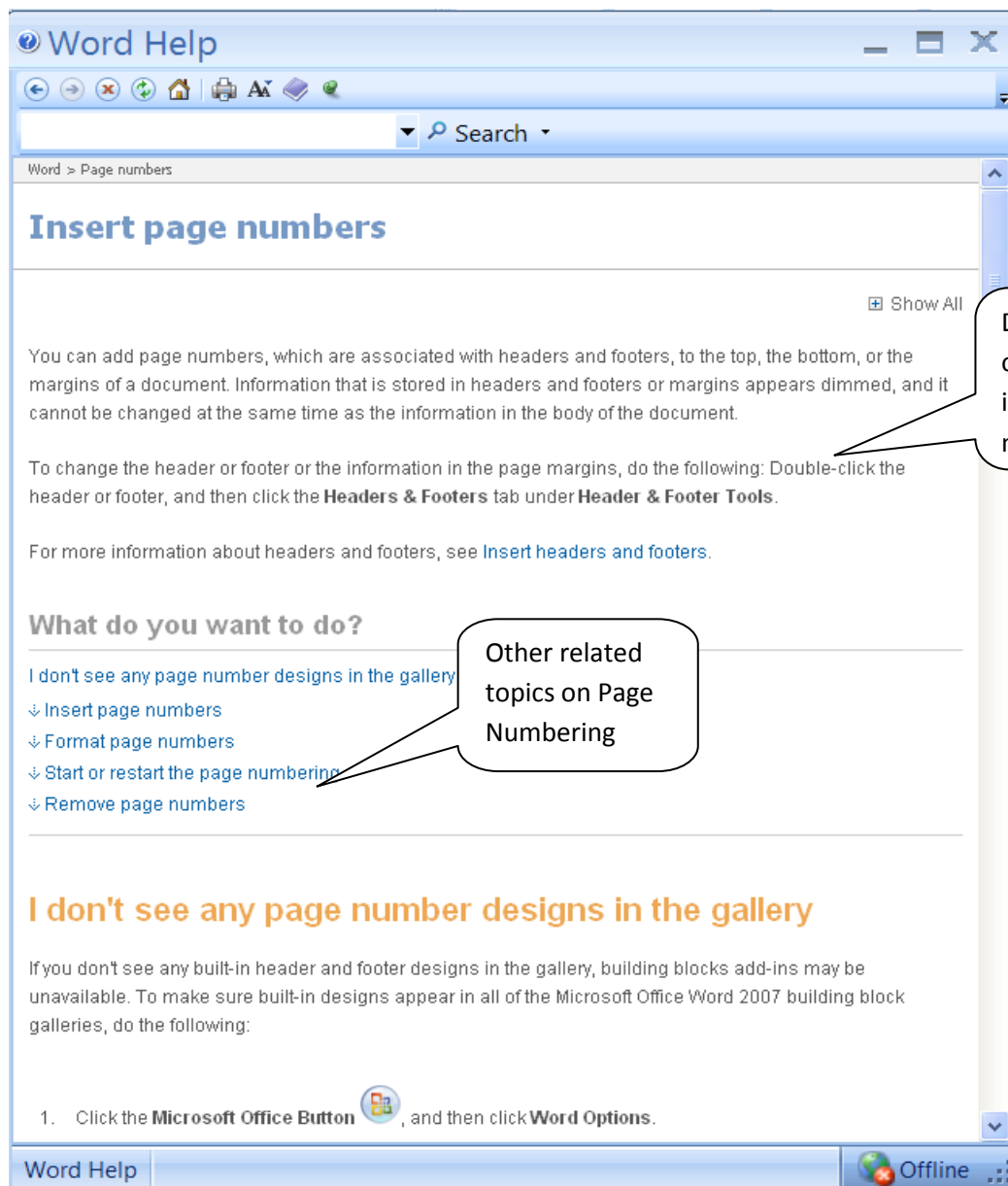

Figure 11.7: Word Help on "How to insert page numbers"

## Start entering text into your blank document

This activity describes how to enter a text into your document. Type the following text on your created document.

### Useful Hints:

- Type the Enter key to insert blank line within the two paragraphs.
- Use the Space key to insert spaces between two words.
- While you are entering data using the keyboard, use the Enter key only for inserting paragraphs or to insert a new line.
- Use the Space Key only for Single spaces such as separating two words.
- Use the Tab key to set the position/indent of the text.

Computer hardware is the physical part of a computer, including the digital circuitry, as distinguished from the computer software that executes within the hardware. Most computer hardware is not seen by normal users. It is in embedded systems in automobiles, microwave ovens, electrocardiograph machines, compact disc players, and other devices. A typical personal computer consists of a case or chassis in a tower shape (desktop) and the following parts:

- Mother board
- Processor
- Memories

After entering the text into your Word document you must save your document. Otherwise the inserted data can get lost. (However MS Office provides auto recovery and auto saving facilities to save your document. But we encourage you to save your document then and there as you type it or change it)

## 11.4 Some useful basic operations in MS Word

### 11.4.1 Changing the typing modes

When you type using the key board, there are two key inserting methods available namely **Insert** mode and the **Overtyp**e mode .Identify the button named **Insert** in the key board. By using this button, you can change these modes in previous word packages such as word 2000 word 2003 etc. However, Word 2007 removes these **insert** button action and introduces new methods. To change these modes, you can perform the following steps.

Right-click the **status bar** and then click **Overtyp**e to display the **Insert** mode status at the left end of the status bar.

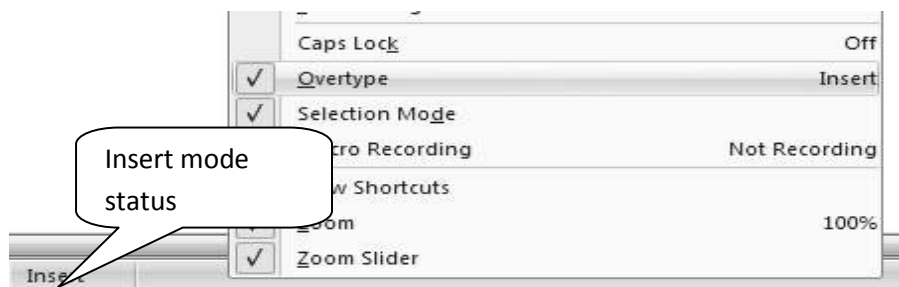

Figure 11.8: Changing the typing mode by Overtyp Mode

To change the **Overtyp**e mode again click on the **insert** button. Then it replaces the mode into Overtyp. When you click again on overtyp then it changes into insert mode.

### 11.4.2 Show/ Hide non-printable characters

Non-printing characters such as Enter, Tab etc. are not visible in the document, to show/hide these characters,

1. Click **Home** tab.
2. Point **Paragraph** group.
3. Click the **Show/Hide** button.



### 11.4.3 Save your word document

To save your Word document, there are several methods.

1. Click **Microsoft Office** button.
2. Then Click **Save**.  
OR Click **save button** In the **Quick Access tool bar** (see figure 11.9 below)  
OR Press **Ctrl + S** Buttons.
3. Then the **File Save as window** will be appeared.
4. Select the location to save.
5. Enter a file name.
6. Click **Save**.

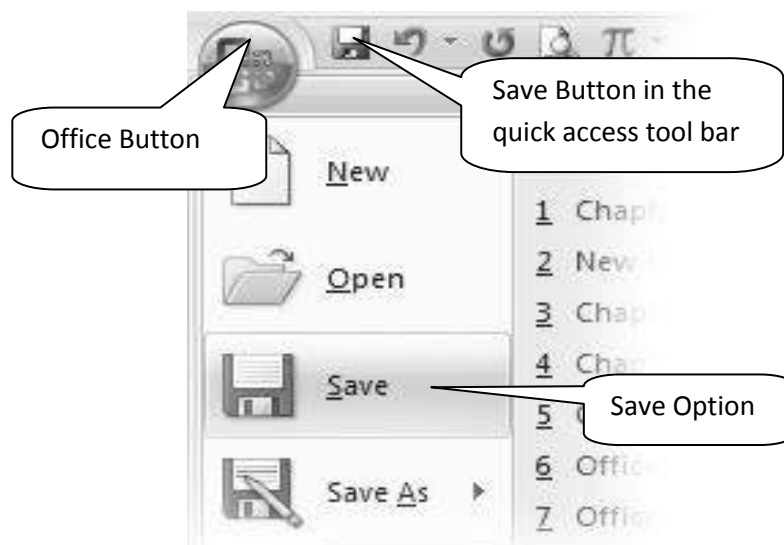

Figure 11.9: Save a document

### 11.4.4 Close already opened word document and exit from Microsoft Word

To close your opened document, perform the following steps,

1. Click **Office** button.
2. Click **Close**.

To exit from Microsoft word;

1. Click **Office** button.
2. Click **Exit** button.

### 11.4.5 Opening an existing MS Word document

To open an existing known MS Word document, follow the steps given below;

1. Click Office button.
2. Click open (File opening window will be appeared)

In the File open window,

3. Find the location.
4. Select the file name.
5. Click **Open**.



### 11.4.6 Displaying different views of a document

In Word, you can view a document in different ways such as **print layout** view, **full screen reading** view and **web outline** view etc. A brief description on each view is given below.

- **Print Layout view:** This view displays a document on the screen the way it will look when printed. By using this view you can see some elements such as margins, page breaks, headers and footers, and watermarks.
- **Full Screen Reading view:** these view displays as much of the content of the document as will fit on the screen at a size that is comfortable for reading. In this view, the Ribbon is replaced by a single toolbar at the top of the screen with buttons that you can use to save and print the document, access references and other tools, highlight text, and make comments. You can also move from page to page and adjust the view.
- **Web Layout view:** This view displays a document on the screen the way it will look when viewed in a Web browser. You can see backgrounds, AutoShapes, and other effects. You can also see how text wraps to fit the window and how graphics are positioned.
- **Outline view:** This view displays the structure of a document as nested levels of headings and body text, and provides tools for viewing and changing its hierarchy.
- **Draft view.** This view displays the content of a document with a simplified layout so that you can type and edit quickly. You cannot see layout elements such as headers and footers.

By using the layout viewer (Bottom right hand on your MS Word window layout viewer will be appeared). You can change the document view as you need. Click each view and see the difference. Figure 11.10 shows the different views.

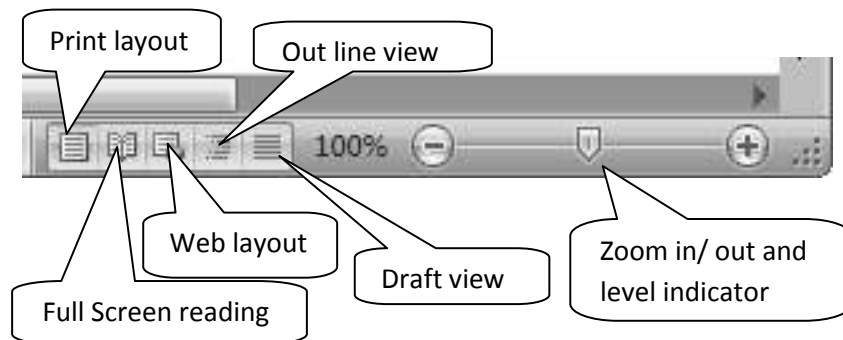

Figure 11.10 Different layouts

### 11.4.7 Previewing and printing a document

After you create your document you can get a print by using a printer installed into your computer. To print your documents, perform the following steps;

- Click the **Microsoft Office Button**, point to **Print**.

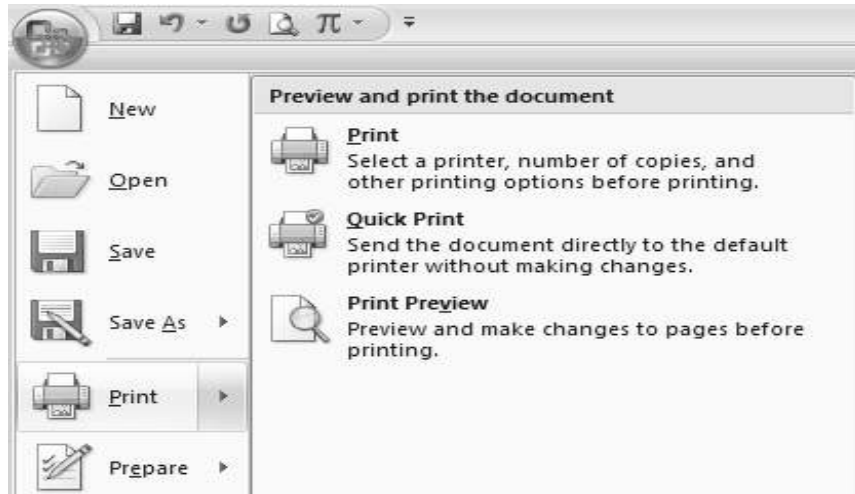

Figure 11.11: Word 2007 Print options

There are three printing options available namely **Print**, **Quick Print** and **print preview**. Let us see the differences among them briefly.

**Print:** if you click 'Print' then the print dialog box will appear. (Screen shot in print dialog box is given below; By using this dialog box you can select printer name, set number of copies and set page range to print as you wish such as All : print all pages in your document Current: print only the current page and Pages: range: 3 – 4 page range you wish to print. After selecting each option click OK to print. Figure 11.12 shows print setup window.

**Quick Print:** you can directly print your document by using default print option. In this method you can't see the print dialog box.

**Print Preview:** Here the window's title bar indicates that the preview of the document and the Print Preview tab appears on the Ribbon.

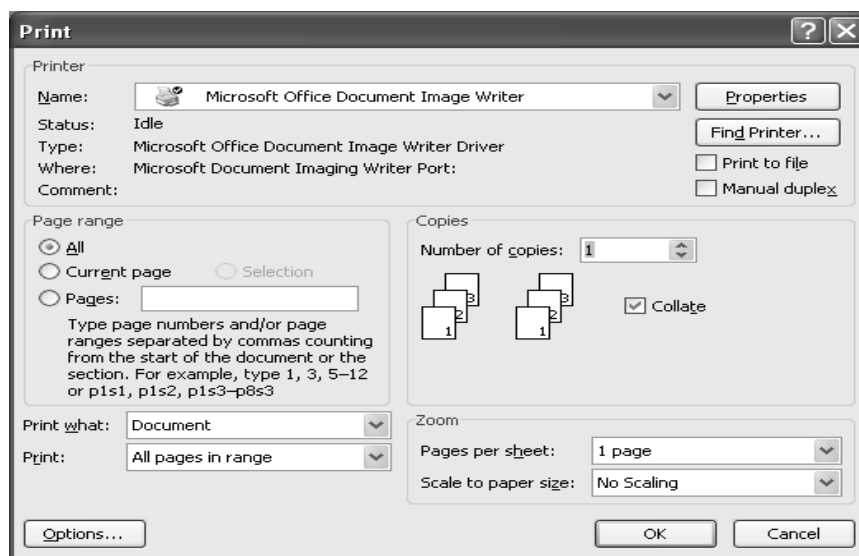

Figure 11.12: Print setup window

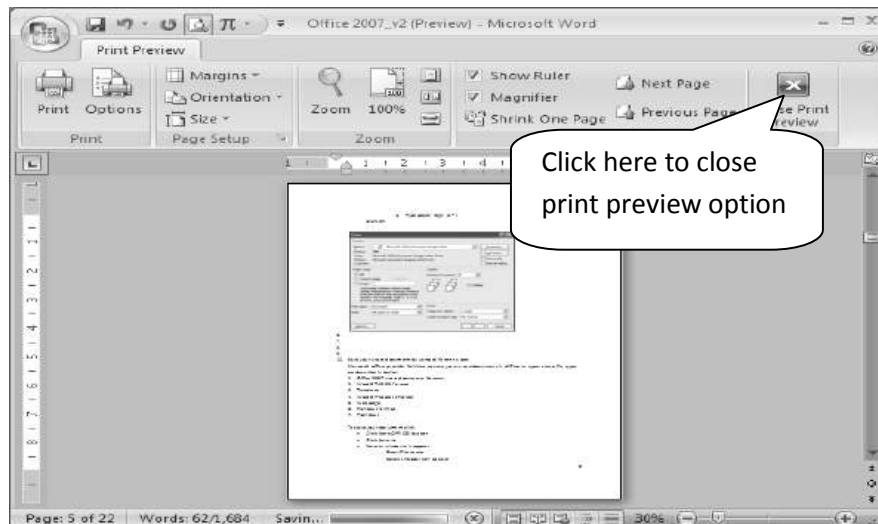

Figure 11.13: Preview of the document

By using Print preview you can preview your printout. Also it provides some facilities to change your document as you wish.

You can exit from print preview option by clicking **Close Print Preview** button

#### 11.4.8 Secure your document from others

You can encrypt your document so that others cannot access your document without the password set by you. Use the following steps;

1. Click **Office** button.
2. Click **Prepare**.
3. Click **Encrypt document**.

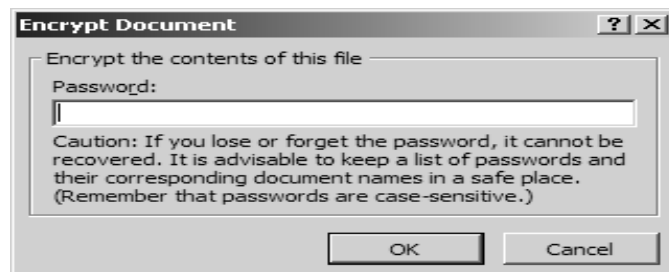

4. Enter Encrypt password.
5. Re-enter the password to confirm.
6. Close your document.
7. Re-open the document.  
(You are required to enter the password to open the document)

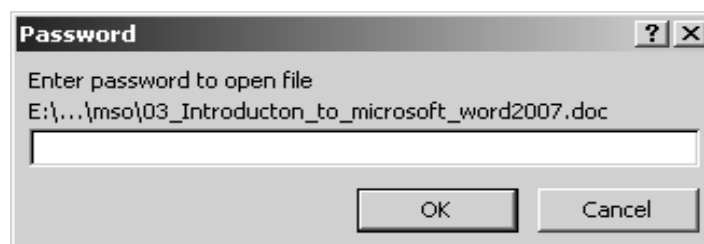

### 11.4.9 Save your document in a different file format

Microsoft word provides several file formats. You may try saving your document using all file formats available with Office 2007.

1. Click **Office** button.
2. Click **Save As**.
3. Enter file name 'sample1'.
4. Select save as type.
5. Click **Save**.

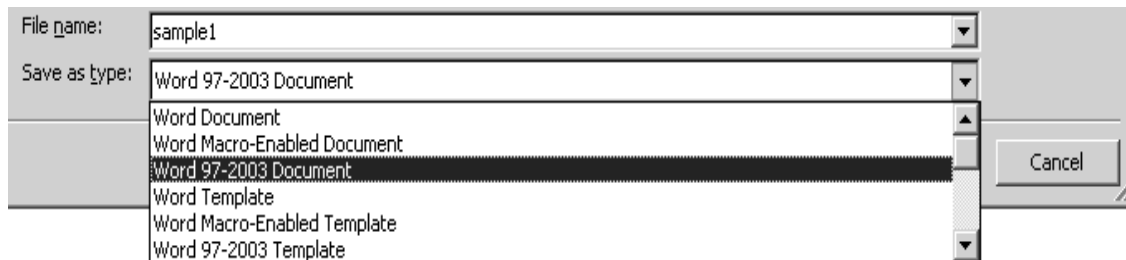

Following table shows file format and size of the sample files.

Name	Size	Type
sample1_files		File Folder
sample1	22 KB	Microsoft Office Word 97 - 2003 Document
sample1	10 KB	Microsoft Office Word Macro-Enabled Document
sample1	10 KB	Microsoft Office Word Document
sample1	22 KB	Microsoft Office Word 97 - 2003 Template
sample1	10 KB	Microsoft Office Word Macro-Enabled Template
sample1	10 KB	Microsoft Office Word Template
sample1	21 KB	Firefox Document
sample1	28 KB	MHTML Document
sample1	31 KB	Rich Text Format
sample1	1 KB	Text Document
sample1	5 KB	WPS File
sample1	31 KB	XML Document

Figure 11.14: File format and Size of the sample size

When you work with windows office, following operations will useful to create the document easily.

### 11.4.10 Show/Hide ruler

To Show/Hide ruler

1. Click **View** Tab.
2. Point out **show/hide** group.
3. Click **ruler**.



The Ruler will be useful to identify the current position of the document you work with and to set the tab positions as you wish.

### 11.4.11 Insert a page break

To insert a page break,

1. Go to the place where you want break the content into a new page.
2. Click **Insert** tab.
3. Select **Pages** group.
4. Click **Page break**.

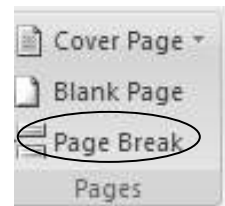

The rest of the document will be available in a new page.

### 11.4.12 Insert date and time

To insert a date and time

1. Move the cursor where you want to insert the date/time.
2. Click **Insert** tab.
3. Select **Text** group.
4. Select **Date and Time**.



Having followed the basic operations now you are familiarized with MS word. The next session will deeply discuss on creating Word documents.



## 11.5 Self Assessment Questions

- 11.1 Write down two possible ways of starting MS Word.
- 11.2 Name five features of the standard user interface of an office 2007 application.
- 11.3 Where do the facilities located together to open, close, and save documents in office applications?
- 11.4 What is the purpose of having the “Help menu” in MS office applications? Which function key will take you to the “Help” screen?
- 11.5 How could you secure your word document from other users? Write down the steps you need to follow.
- 11.6 How could you save an existing document with a different name?
- 11.7 What is the difference between two options ‘Print’ and ‘Quick Print’ that you find when taking a printout of your document?
- 11.8 Imagine that you place the insertion point in the middle of a paragraph and start typing, but new text deletes the existing text. What could be the problem occurred here? How do you fix it?
- 11.9 What is the default alignment on a MS Word document?
- 11.10 What do the red and green wavy lines under some words stand for?

## Session 12

# Editing , Proofing, and Formating Text with MS Word 2007

---

### Aims:

This session aims to give an idea of Editing, Proofing and Formating With MS Word 2007, to the student.

### Objectives:

Having studied this session the student will be able to:

- Edit the text
- Proof the text
- Format the text and paragraphs
- Format pages of a word document.



## 12.1 Editing, Proofing, and Formatting text

### 12.1.1 Editing your text in a document

In the previous session you created a simple text document. In this lesson we will discuss how to edit proof and format the text document as you wish or as you require. Learning on Editing and proofing is very important for compiling a document as it saves your time to create the document and it increases the quality of your document.

### Selecting a Text or Paragraph

**Using Mouse:** Double click on the text which you want to select or move the cursor while pressing the left button

**Using Keyboard:** To select a text or paragraph by using keyboard move the cursor by using arrow keys while pressing the **shift** button

### Cut/Copy / Paste operations



To copy a selected text or paste a selected text you can use these tools.

### **Cut the selected text**

After selecting the text as described above, press **Ctrl + X** to cut the selected text

*OR*

Click on the Home tab, Clipboard group and click the **cut** icon



### **Copy the Selected text**

After selecting the text press **Ctrl + C** to copy the selected text

*OR*

Click on the Home tab, in the Clipboard group, click the **copy** icon



### **Paste the Selected text**

Move the cursor where you want to paste the cut/copied text previously and press **Ctrl + V** to paste the text

*OR*

Click on the Home tab, in the Clipboard group, click the **paste** icon



### **Move text**

To move texts from one place to another place use the following steps.

1. Select Text.
2. **Cut** selected text.
3. Click **Paste**.

### **Find and replacing a text**

You can find or/and replace a given text throughout your document by using the following steps.

To find a word/text in your document,

1. Click **Home** tab.
2. Point the **Editing** group.
3. Click the **Find** button.
4. Type the word you need to search for.
5. Click **Find Next** to find the detected words one by one.

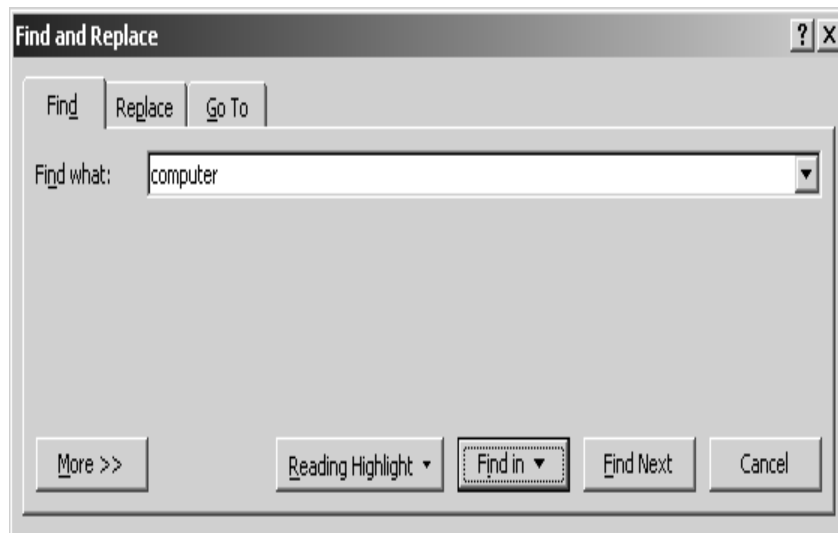

Figure 12.1: Find and replace window

Same as finding the word, you can replace the word found by using **replace** tab.

### **Example: Find and replace a text**

Using find and replace option replace the word “computer” with the word “PC” in the following text.

Von Neumann introduced PC model with memory. This architecture is a PC design model that uses a processing unit and a single separate storage structure to hold both instructions and data. The modern digital PC uses this architecture to implement. It contains

Memory unit

Central Processing Unit (processor)

Output devices (video terminal, printer, etc.)

Input devices (keyboard, mouse, etc.)

## **12.1.2 Proofing your text**

### **Check Spelling and Grammar**

To check spelling and grammar on the text of your document you can use the **Proofing** tool available in Office 2007.

- Create a new word Document.
- Type the following sentence (it has some spelling mistakes).

A **commputor** is a man-made, programmable electronic machine that can store, retrieve, and process data according to a given set of instructions.

- Click **Review** panel.



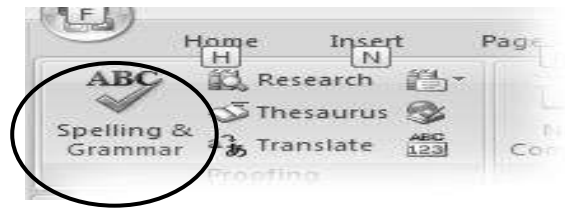

Figure 12.2: Review panel

- Click **Spelling & Grammar** (Spelling and grammar correcting window will be appeared)

By using this tool you can automatically correct the spelling and grammar errors.

There are several options available for correcting the errors. Function of each button is given below.

- **Ignore Once:** you can ignore this word only at this position
- **Ignore All:** ignore this word in all places
- **Change:** change the selected word in the selected place only
- **Change All:** change the selected word into the corrected word in all places
- **Auto correct:** apply a suitable correction automatically
- **Add to Dictionary:** you can add this word into word dictionary

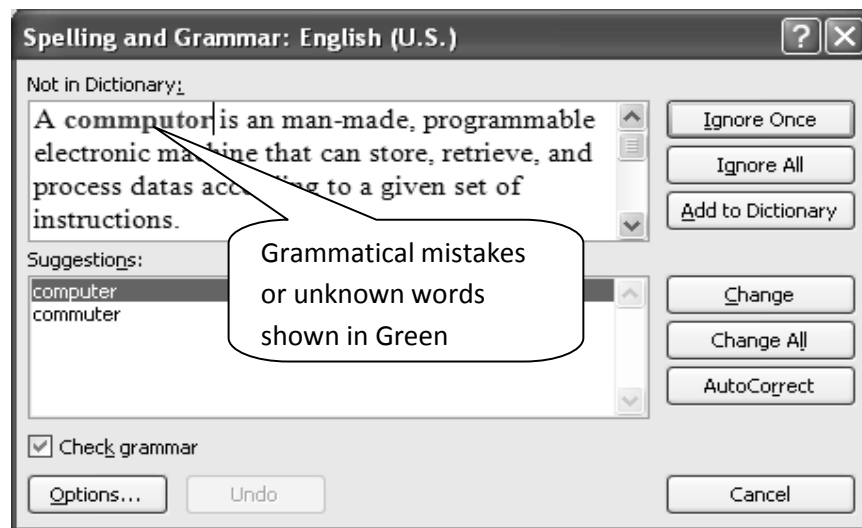

Figure 12.3: Spelling and grammar correcting tool

### Find the synonyms/antonyms for a selected word

You can find synonyms or antonym for a selected word as follows.

1. Select a word.
2. Right Click on your mouse.
3. Click **synonyms**.

A list of synonyms to the selected will be appeared. If you need, you may select any of them to replace the selection with the synonym.

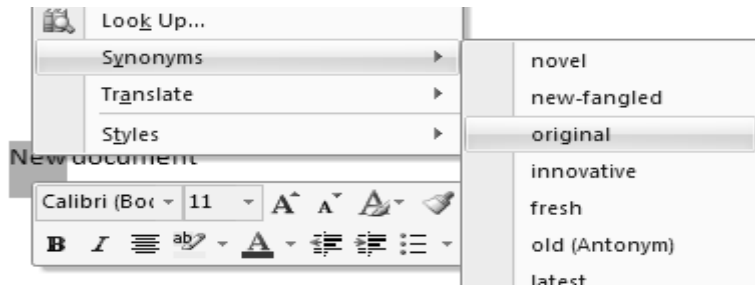

Figure 12.4: Finding the Synonyms

### Translate the Selected word

You can translate a selected word into a different language by using following steps.

1. Select the word to be translated.
2. Right Click on your mouse (Cursor is on the selected word)
3. Click **Translate**.
4. Select the translation language.
5. Translation pane will be appeared in the right hand side of your screen which gives results of your translation.

### 12.1.3 Formatting your text

#### Change the style of a text

Word 2007 introduces a number of new features, as well as enhancements to existing features that makes the process of formatting content effortless. And many common formatting buttons are available on the Mini toolbar that appears when you point to the selected text. To change the font style you can use the font group in a home tab or quick formatting menu. A tool available in font group is given below.

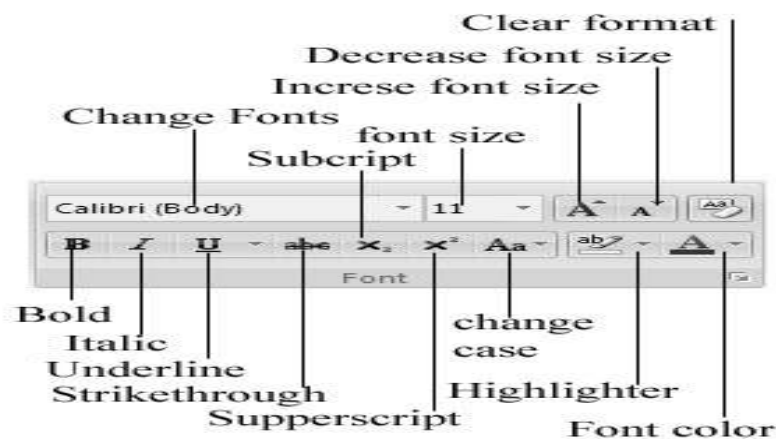

Figure 12.5: Font group icons

#### Change the attributes of the font

Fonts are the type of letters in your document. Font is used to change the letters in your document such as Sinhala, Tamil etc. Each font has several attributes such as name, size style etc. to change these attributes you can follow the steps given below;

**Name and size:** Each font has a name and the size. In word 2007 the default font is Calibri and the default size is 12. To change the font name and size you can click two combo boxes in the font group.



**Font Style:** Every font comes in a range of font styles. The most common are regular (or plain), italic, bold, and bold italic. To change the font style you can use available tools such as Bold, Italic and Underline etc.



**Effects:** Fonts can be enhanced by applying font effects, such as underlining, small capital letters (small caps), or shadows. You can change this effect by clicking font dialog box launcher. Font dialog box launcher and the font dialog box are shown below.



Figure 12.6: Font Dialog Box launcher

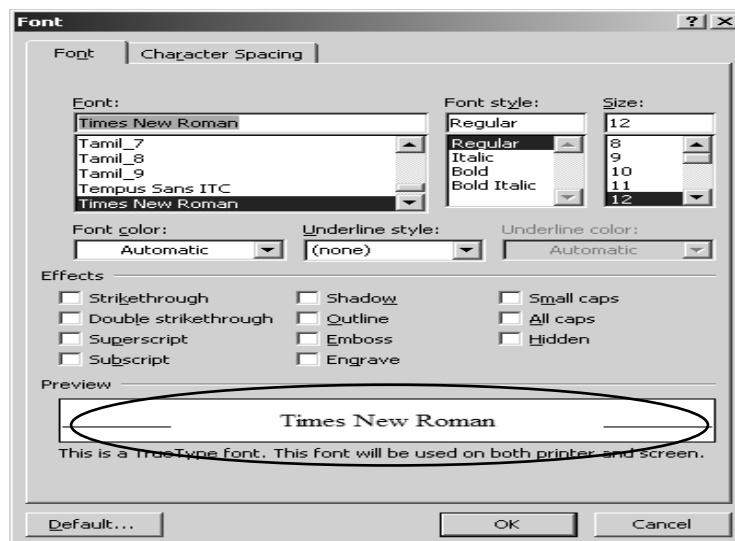

Figure 12.7: Font setting window

By ticking off each effect you can apply these effects to your text.

### Change case

You can change the case of the text in a sentence so that your text into upper case, lower case or other common capitalizations as follows

- Select the text which you want to change the case.
- Go to the **Home** tab.
- Point to **Font** group.
- Click the down arrow to open the available case conversions.

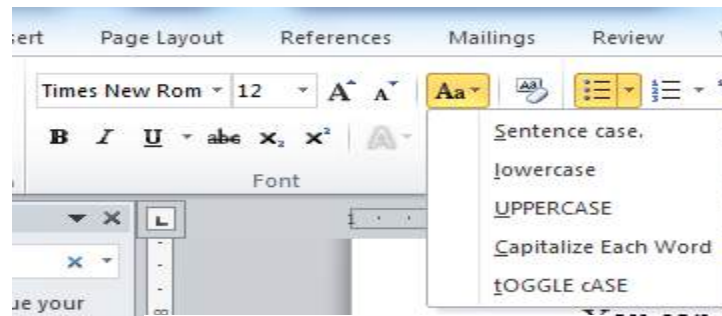

Figure 12.8: Changing the Case

**Example:** Let us change the case of the following sentence in available different case changes. Then you will learn where to apply appropriate case changes.

**Original Sentence**

The Computer is a man-made Electronic machine.

**Sentence case**

The Computer is a man-made Electronic machine.

**Lower case**

the computer is a man-made electronic machine.

**Upper case**

THE COMPUTER IS A MAN-MADE ELECTRONIC MACHINE.

**Capitalize each word**

The Computer Is A Man-Made Electronic Machine.

**Toggle case**

tHEcOMPUTER IS A MAN-MADE eLECTRONIC MACHINE.

**Change the font colour**

Sometimes you need to change the font colour in your document. To change the font color of a text, the following steps can be followed.

1. Select the text.
2. Click Font colour tool in a font group (The colour selecting window appears).
3. Select a colour from the colour palate.
4. Click on the colour.

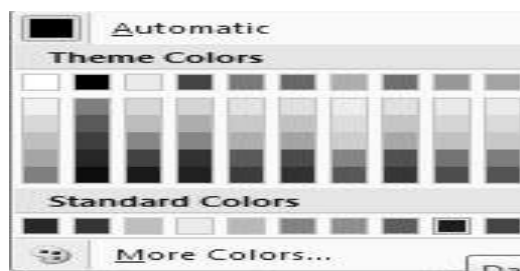

Figure 12.9: Font Colour changing Window

OR

5. Click **More colours** to select any colour you need to add. Then an enhanced colour selecting window with a variety of shades and colours will appear. By using the colour selecting window you can easily change the text colour or background colour. To change the colour you have to click on any colour appeared in the window.

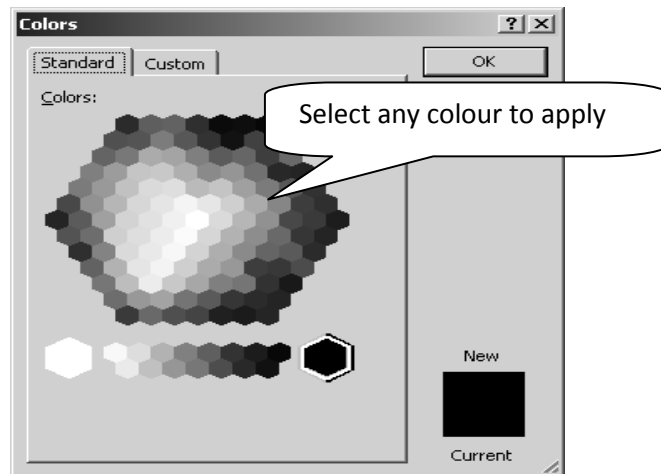

Figure 12.10: Color selecting window

### Change the highlight color

To change the text highlight colour in the selected text the following steps can be followed.

1. Select a text.
2. Click Highlight tool in a font group.

### Clear the text formatting

To clear text format applied to any text;

- Select a text.
- Click Clear format tool (it sets text format into your default text format).

### Character spacing

You can change the character space by clicking the Character spacing tab in font dialog box.

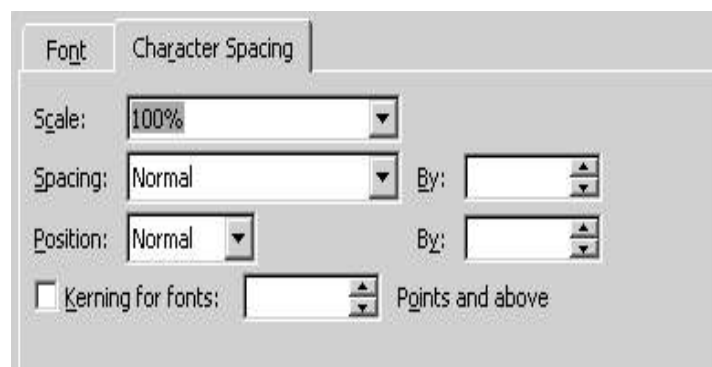

Figure 12.11: Character Spacing window

By changing the value in the above dialog box check how you can set the character spacing by yourself.

**Example: Change the text format**

**Computer Modem**

Computer Modem is a device that encodes digital information over an *analog* signal (such as a phone line or radio), and also decodes the analog signal to recover the digital information. The most familiar example is a typical computer modem that turns the digital 1<sup>s</sup> and 0<sup>s</sup> of a personal computer into sounds that can be transmitted over the telephone lines. You can have one Computer Modem that sends and receives information from the Internet, or a pair of modems can communicate via the phone line to form a closed network. Modems are generally classified by the amount of data they can send in a given time, normally measured in bits per second, or "bps". They can also be classified by Baud, the number of distinct symbols transmitted per second.

**12.2 Format a Paragraph**

As you know, you can create a paragraph by typing text and then pressing the Enter key. Ex: the text entered till you press the Enter key is identified as a single paragraph. The paragraph can be a single word, a single sentence, or multiple sentences. You can change the appearance of a paragraph by changing its alignment, its line spacing, and the space before and after it. You can also put borders around it and shade its background. Collectively, the settings you use to vary the appearance of a paragraph are called paragraph formatting. Tools available in a paragraph group are shown below.

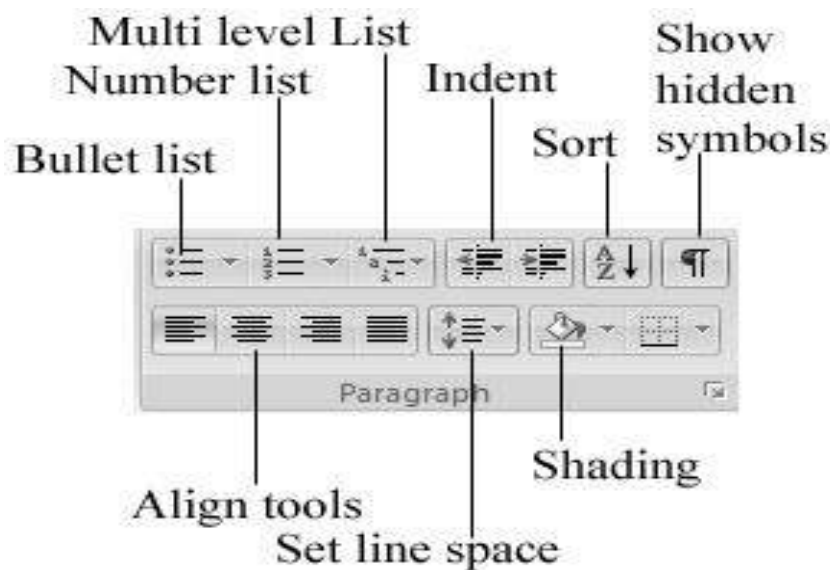
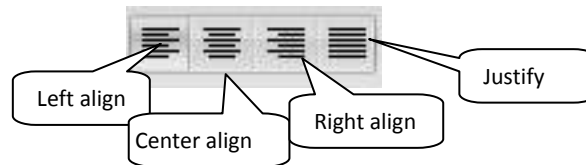

Figure 12.12: Tools in Paragraph

Brief description of the each tool is given below.

### 12.2.1 Align text

You can align lines of a text in different locations across the page by using tab stops. The easiest way to set tab stops is to use the horizontal ruler. By default, Word sets left-aligned tab stops every 0.5 inch, as indicated by gray marks below this ruler. To set a custom tab stop, you start by clicking the Tab button located at the left end of the ruler, until the desired tab appears.



### Examples for text alignments

#### Left align

The computer is an electronic device, which operates under the direction of an operating system by processing arithmetically and logically, accepting input and producing output. All computers – desktop, workstations, mainframes, and super computers – have the same processing cycles: input, process, and output.

#### Center Align

The computer is an electronic device, which operates under the direction of an operating system by processing arithmetically and logically, accepting input and producing output. All computers – desktop, workstations, mainframes, and super computers – have the same processing cycles:  
input, process, and output.

#### Right Align

The computer is an electronic device, which operates under the direction of an operating system by processing arithmetically and logically, accepting input and producing output. All computers – desktop, workstations, mainframes, and super computers – have the same processing cycles:  
input, process, and output.

#### Justify

The computer is an electronic device, which operates under the direction of an operating system by processing arithmetically and logically, accepting input and producing output. All computers – desktop, workstations, mainframes, and super computers – have the same processing cycles:  
input, process, and output.

### 12.2.2 Set Line space between two line in a paragraph

To change the line spacing of the text, follow the steps given below.

- Select line space icon 
- Select suitable line space OR Select line space options
- Set After and before spaces that are needed
- Then set line space as you wish: single, double 1.5 etc.
- You can check what are the other tools provided in this window such as indentation.

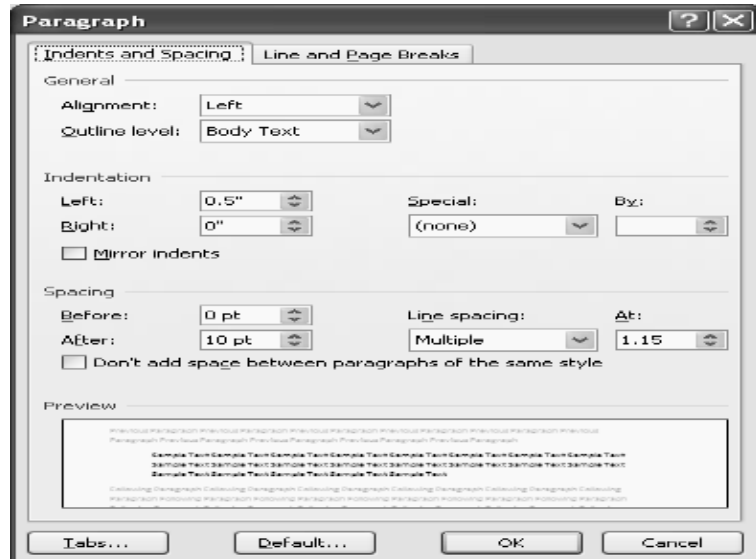
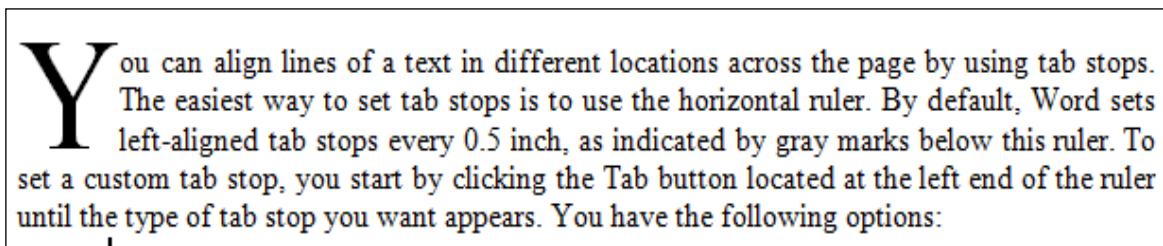

Figure 12.13: Paragraph window

### 12.2.3 Drop Cap

To drop the first letter in a paragraph from the rest of the sentences as shown in the Figure below, follow the steps given here.



1. Leave the cursor somewhere within the paragraph of which the first letter to be dropped.
2. Go to **insert** tab.
3. Under the **Text** group, select **Drop Cap**.
4. Give the options of the drop cap in the Drop cap window.
5. Click **OK**.

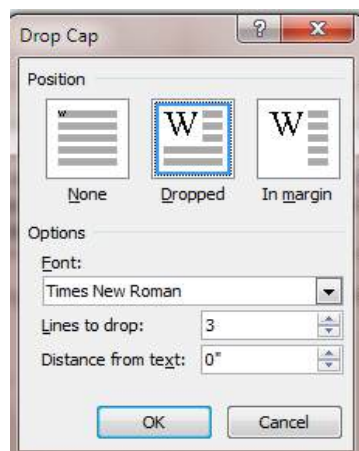

Figure 12.14: Drop Cap



### 12.2.4 Create a bulleted list

To create a bulleted list of items, perform the following steps

1. Click Bullet list icon (word automatically create a list)
2. Type the list items.
3. To add sub list press tab button.
4. To move to the top of the list press **Backspace**.
5. After enter all the list item press '**Enter button**' twice.



### Change the bullet

To change the bullet of the list, perform the following operations.

1. Click the down Arrow of the bullet icon.
2. Select the other bullet icon from the window.

### Define a new bullet

To create a new bullet list, perform the following options.

- Click the down Arrow of the bullet icon.
- Select a new bullet to change with.
- Click **define a new bullet** if you need to create your own bullet.

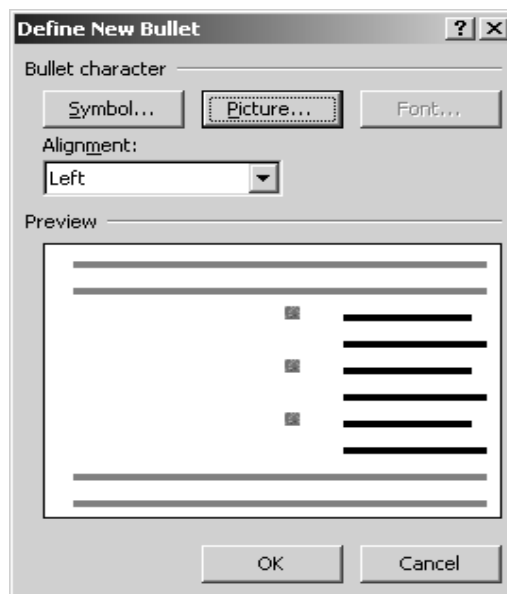

Figure 12.15: Define a new bullet

- Select a symbol or picture to set as a bullet.
- Click **OK**.

### 12.2.5 Sorting a given list

To sort an entered list

1. Select the list.
2. Click **sort** button on the paragraph group



3. Select the order by selecting either Ascending or Descending.

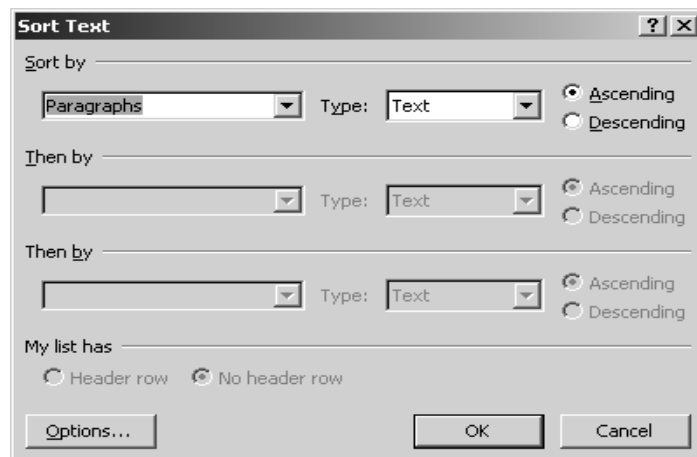



Figure 12.16: Sort text window

The selected list will be sorted based on the alphabetical order of the characters.

### 12.2.6 Create a new numbered list

To create a new numbered list, perform the following steps.

1. Click Number list icon (word automatically create a list ) 
2. Type the list items.
3. To add sub list press tab button.
4. To move to the top of the list press Backspace.
5. After enter all the list item press 'Enter button' twice.

### Create a new number format for a numbered list

To create a new number format for a number list, perform the following steps.

1. Click down arrow of the **Number list icon** (word automatically creates a list ) 
2. Select Define new number format.
3. Select number format, Number style and alignment.
4. Click **OK**.

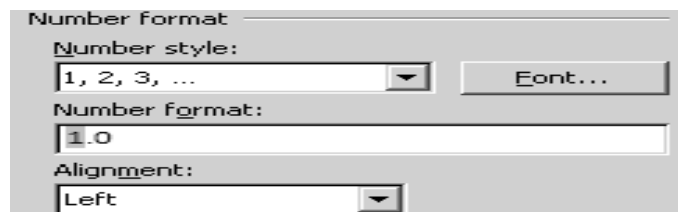

Figure 12.17: Number formatting window

### 12.2.7 Column setting

Though you usually type the text in a paragraph from one end to the other end of the page as a single column, there are some instances where we want to divide the text in few columns something similar to the way the news articles are given in newspapers. See figure 12.18 below.

## 1.1 What is Word Processing?

Computers can be used to create or edit documents very easily; such as write a letter create a presentation etc. This is known as word processing. Word processing is the creation of documents using a word processor. In computer, a word processor is a computer application used for the

production, including composition, editing, formatting, and possibly printing of any sort of printable material. In general, word processor is a type of stand-alone office machine, popular in the 1970s and 80s, combining the keyboard text-entry and printing functions. Type writers are commonly used in

office before the computers are came more popular as a word processing device. At present these type writers are out of date and all these functions of the type writers are done by computer and word processing applications. *Figure 1.1* shows manual type writer and an electronic type writer.

*Figure 12.18: Columns setting of a paragraph*

Follow the steps below to make the content of your paragraph into two or three (or more) columns.

1. Select the paragraph to be partitioned.
2. Go to the **Page Layout** tab.
3. Under the **Page setup** group, select the down arrow of the column tool.
4. Select the number of columns from the given diagrams.

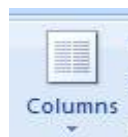

*Figure 12.19: Column tool*

## 12.3 Page Formatting

Page formatting is a method to organize your document pages such as change your page margins and page size etc. This section shows how to change your page margins and page size, how to insert headers and footers, and how to add page numbers.

### 12.3.1 Format your documents using page setup window

Page setup is the best option to format your document as you need. To Start Page setup:

- Click **Page layout** tab.
- Click **page setup** icon.

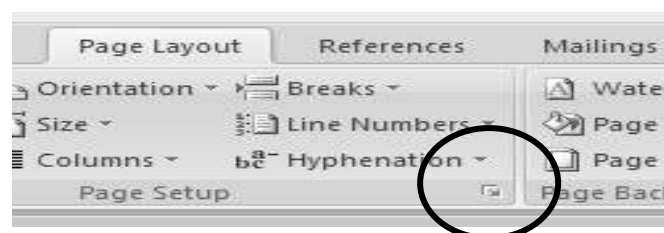

*Figure 12.20: Page set up*

Now you can see page setup window. This window contains tree sub options such as set page margins, set paper and set page layout.

### 12.3.2 Set Page Margins using page setup

To set your document's margin, click the margin tab. By using margin tab you can change Margins, Orientation, and pages as well.

**Margin:** you can set Top, left, right and bottom margins. Just need only type appropriate values.

**Orientation:** page orientation can be set as portrait or landscape.

**Where can we apply these settings:** Created page settings can be applied to whole document or selected pages.

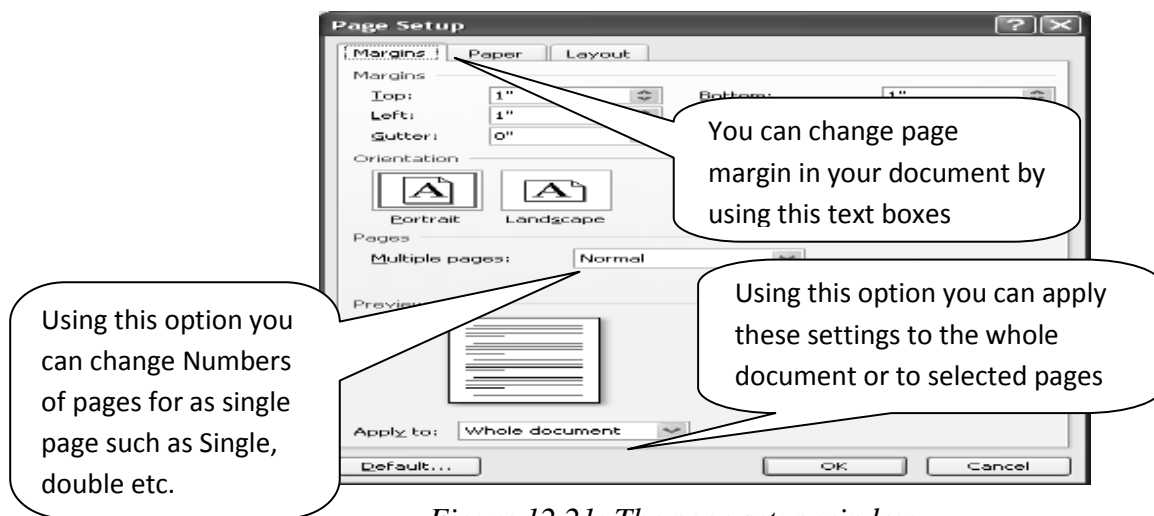

Figure 12.21: The page setup window

### 12.3.3 Set Page Size using Page Setup

To set the page size, click the **paper tab** in the page setup window. Then select a standard **page size** such as letter, A4, legal etc. Also you can change paper size manually. The figure 12.23 shows page selecting layout of the page setup. Also you can select paper source where it can collected to print. If your printer has number of trays then you can select suitable tray to collect papers. Also this setting can be applied to whole document or selected pages by selecting apply to option.



Figure 12.22: Applying the setting

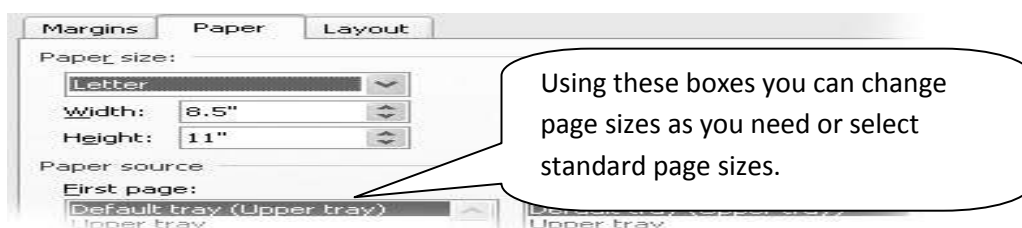

Figure 12.23: Paper Options in the page setup

### 12.3.4 Set Page Layout by using Page Setup

One single page contains three areas such as **text area**, **page header** and the **page footer**. You can set these areas by using layout option. You can set page header area and the page footer area. Other area is automatically assigned to the text area. To change the area of the page header and the footer click **layout tab** and set the header footer margin. Then you can set the vertical alignment see the figure 12.24.

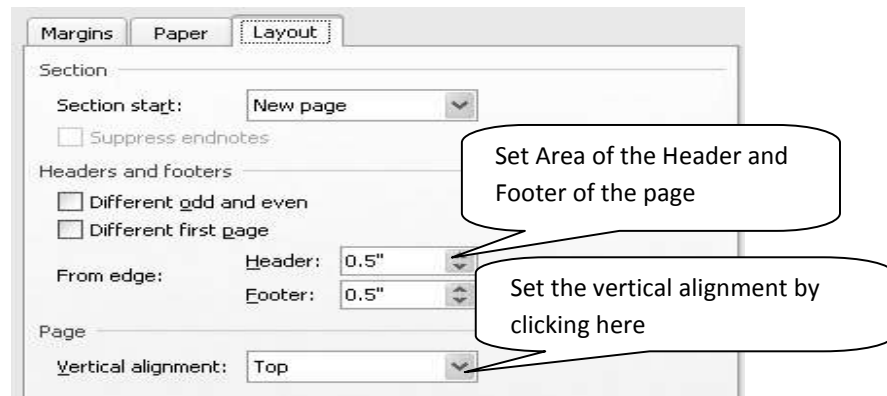

Figure 12.24: layout options in the page setup

### 12.3.5 Set page borders by using Page Setup

You can insert page borders by using page setup. To insert page borders follow these steps

- Click **layout** tab in the page setup.
- Click **borders**.



Then border and shading window will be appeared (Figure 12.25)

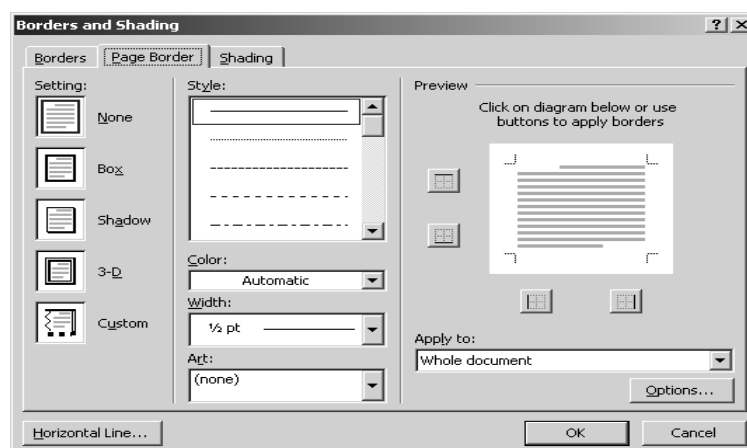

Figure 12.25: Border and Shading window

- Click Border settings such as Box, Shadow etc.
- Select the border style or select the art type to fill your border.
- Click **OK**.

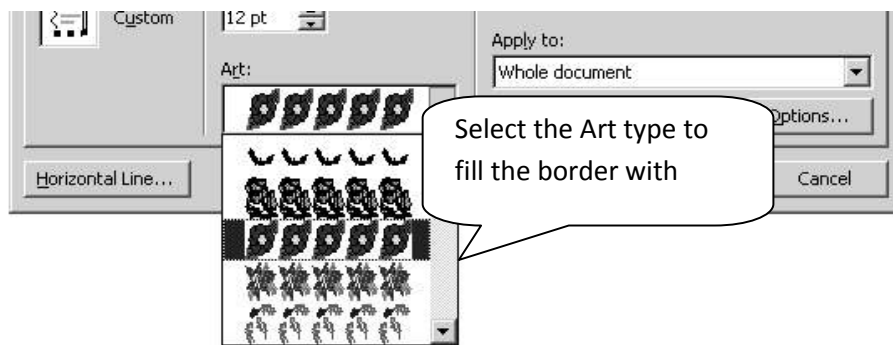

Figure12.26: Selecting the Art type

**Example:** Format your document as follows.

Create a document by using the following page layout and save it as “mytemplate”

- Page size - A4
- Margins - left 25mm , right 30mm
- Orientation- portrait
- Set Vertical alignment as Top
- Set a suitable page border

### 12.3.6 Insert Headers, Footers and Page Numbering



#### To insert Header

1. Click **Insert** Tab.
2. Click **header** in the Header & Footer group.
3. Select one of the built-in header formats.
4. Type your text to be appeared in the header area.

#### To insert Footer

1. Click **Insert** Tab.
2. Click **Footer** in the Header & Footer group.
3. Select one of the built-in Footer format.
4. Type your text.

#### To insert Page Number

1. Click **Insert** Tab.
2. Click **Page Number** in the Header & Footer group.
3. Select place where you want to put the page number.
4. Select the sample.

### Example: Create a document with Header, Footer and Page Number

Create a document by using the following page layout and save it as “mytemplate2”

- Page size A4
- All margins except left 25mm, left margins 30mm

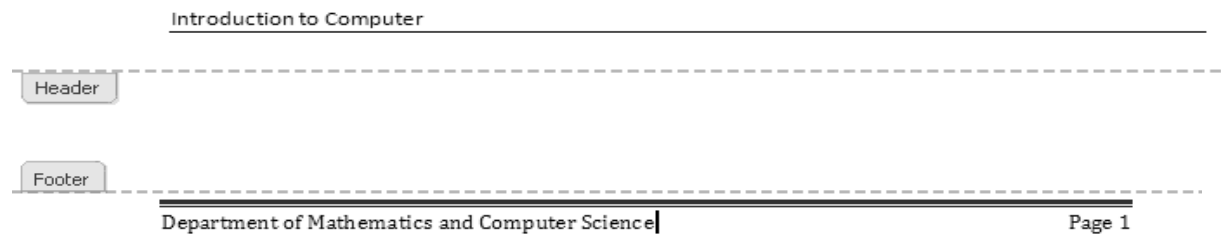

### Change the format of the Page Number

You can follow these steps to Format page number

1. Click **Insert** Tab.
2. Click **page number** in the Header and Footer group.
3. Click Format page number (Page number format window is appeared).

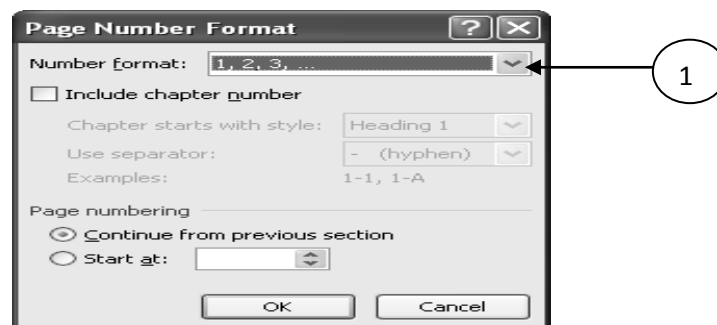

Figure 12.27 Page number formatting window

4. Select Number format [1].
5. If you want to start page number in any number then select “**start at**” and type the number.
6. Click **OK**.

### 12.3.7 Insert a watermark

You can follow these steps to insert a watermark in to the page(s) of your document.

1. Click **page layout** tab.
2. Click **watermark** in the page background group.
3. Select one of the built-in watermarks.

#### To create a custom watermark

1. Click **page layout** tab.
2. Click **watermark** in the page background group.

3. Click **custom watermark**.
4. Select **text watermark**.
5. Select text language as English.
6. Type the text you need to display.
7. Set Font type and size as you wish.
8. Set the font color.
9. Click **Apply**.
10. Click **OK**.



Figure 12.28 Page number formatting window

## Remove Watermark

You can follow these steps to remove watermark.

1. Click **page layout** tab.
2. Click **watermark** in the page background group.
3. Click **remove watermark**.

## 12.4 Self Assessment Questions



- 12.1 What are the shortcut keys that can be used to perform following activities?
  - a. Copy a selected text.
  - b. Cut a selected text.
  - c. Paste a selected text.
  - d. Save a document.
- 12.2 What is the purpose of having “Proofing Tool” in MS Word?
- 12.3 Name five changes that can be applied to fonts in MS Word?
- 12.4 What are the tools available for paragraph formatting?
- 12.5 What is the function of “Format Painter”?
- 12.6 What are the two things where the “Shift Key” can be used in typing?
- 12.7 How could you highlight text without using the mouse?
- 12.8 What is the purpose of having a header and footer in your document?
- 12.9 How many margins can be set for a page? What are them?
- 12.10 What are the options available under the ‘orientation’ of a page?



## Session 13

### Working with Tables, Illustrations, and Mail Merge

#### Aim:

To provide an introduction to tables, pictures, clipart, shapes, SmartArt charts, and Mail Merge.

#### Objectives:

Having studied this lesson you will be able to get an idea about:



- Working with tables
- Working with pictures and clipart.
- Creating images using shapes
- Designing a charts using smart Art
- Working with charts
- Generate multiple copies of documents with mail merge facility.

#### 13.1 Working with tables

Tables are used to format/summarize your data. Building block in a table is a cell. There can be one or many cell in the table.

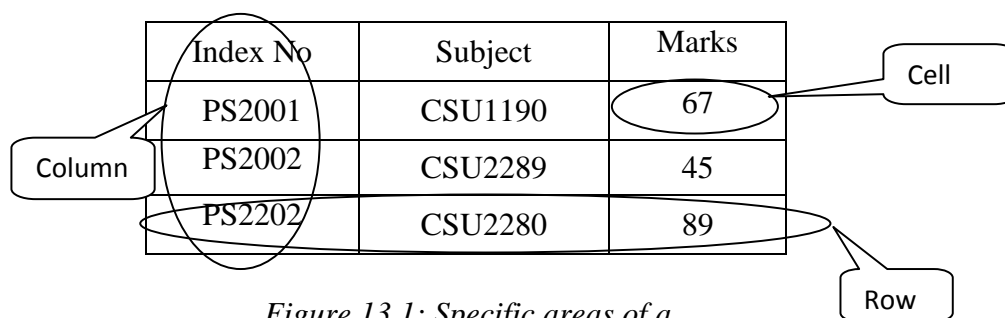

Figure 13.1: Specific areas of a

##### 13.1.1 Creating a table

- Click **Insert**.
- Click **Table**.

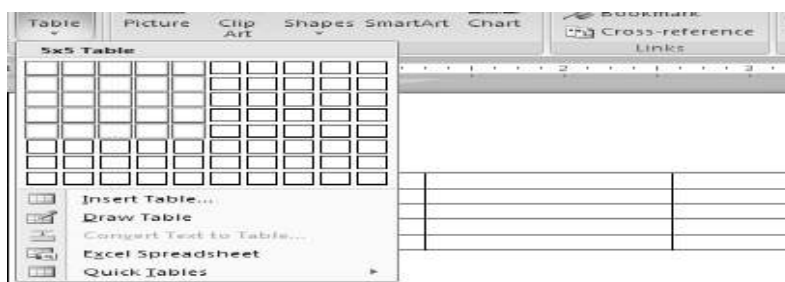

Figure 13.2: Insert Table Window

- By using mouse Select number of rows and columns (while you selecting the row or column sample format can be seen in the word document).

OR

- Click **Insert table**.
- Then type number of rows and columns in your table.

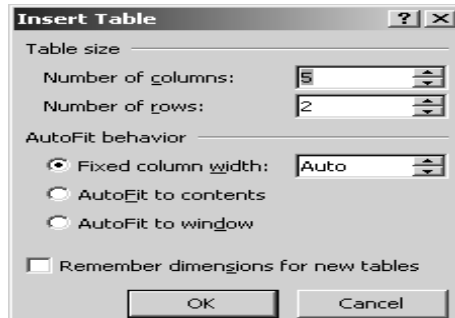

Figure 13.3: Type number of rows and

- Enter data

### 13.1.2 Format your table

After inserting a table you can easily format it. To format your table,

1. Click inside the table (In the ribbon you can see the table tools such as design and layout).



Figure 13.4: Format the table

2. Select the table style using tool bar.
3. Set table border and the shading colour.

### 13.1.3 Setting Text Alignment inside the table

There are one or more cell/cells in a table. Cell is a one box in a table you can align your text in a cell. To align a text in a table cell

- Click inside the cell or cells as you wish to set align.
- Set **layout tab** in the menu (in the table tools).

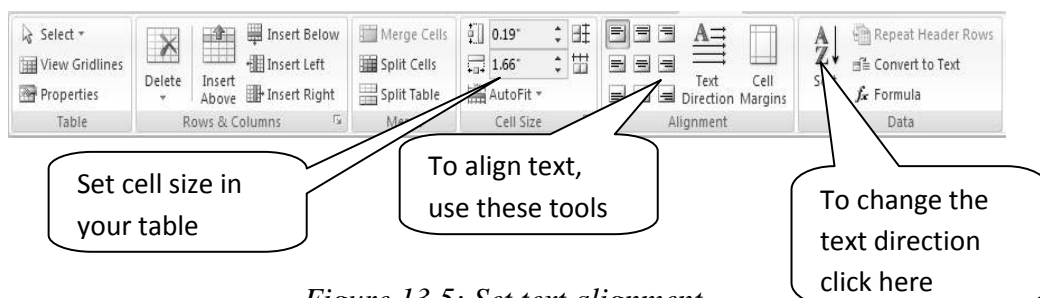

Figure 13.5: Set text alignment

- Point out alignment group.
- Click suitable alignment tool.

### 13.1.4 Insert a row/column to the existing table

After creating the table, there are some instances where you need to insert more columns/rows other than what you specified at the time of creating it. Follow the steps given below.

- Move the cursor inside a specific column/row.
- Right click.
- Point to Insert.
- Select the option as required depending on the position where your cursor was at (See figure below).
- A new column/row will be inserted to the left/right or above/below of the current column/row.

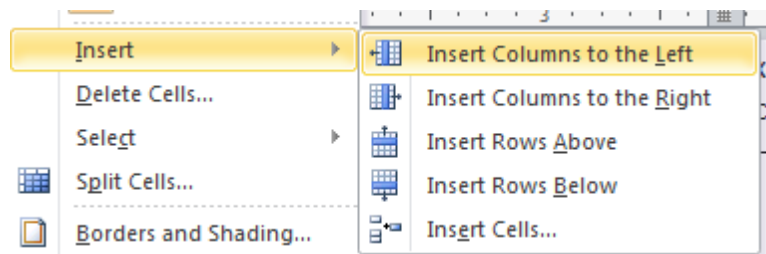

Figure 13.6: Inserting a column to the existing table

### 13.1.5 Delete a row/column to the existing table

Sometimes, you may want to delete an existing column/row from the table no matter whether it contains text or not. Follow the steps given below.

- Select the entire column/row using the mouse.
- Right click (See figure below).
- Select Delete Column/row.

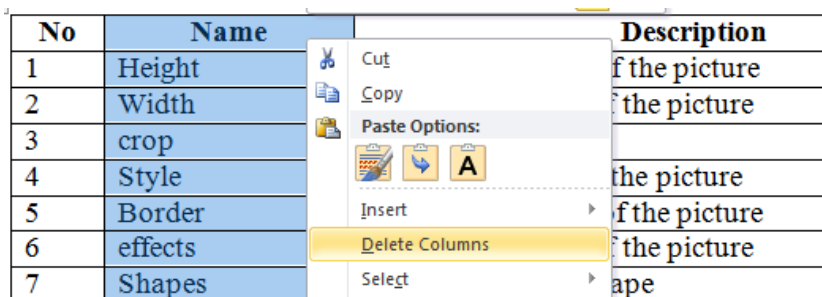

Figure 13.7: Deleting a Column

## 13.2 Different types of Illustrations

Microsoft Office Word 2007 provides several facilities to work with image objects. This session describes how to work with Office Illustrations such as pictures, clipart, shapes, SmartArt and charts. Figure 13.8 shows Illustration tools of the word 2007.

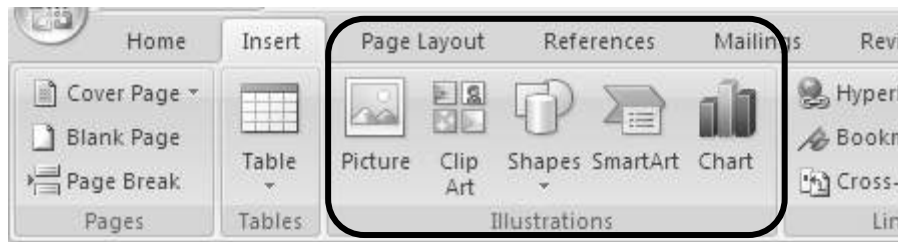

Figure 13.8: Illustration tools

### 13.3 Working with Images

Image is a visual representation of an object, scene, person or abstraction produced on a surface. These images are used to display visual things. This section describes how to work with images in the word 2007.

#### 13.3.1 Insert pictures into your document

To insert picture in to your document

13. **Set cursor position** where you want to insert a picture.
14. Click **insert tab**.
15. Click **picture**.
16. Select a picture.
17. Click **insert button**.



Figure 13.9: Inserting a Picture

As you select your picture, word shows the picture format to work with the picture very easily.

#### The Picture Format Tool bar

The Picture format tool bar provides various facilities to manage pictures. Using these tools you can easily perform many picture operations such as change the picture size, picture style, picture background, and add more effect to the picture etc. Some basic operations are describes below.

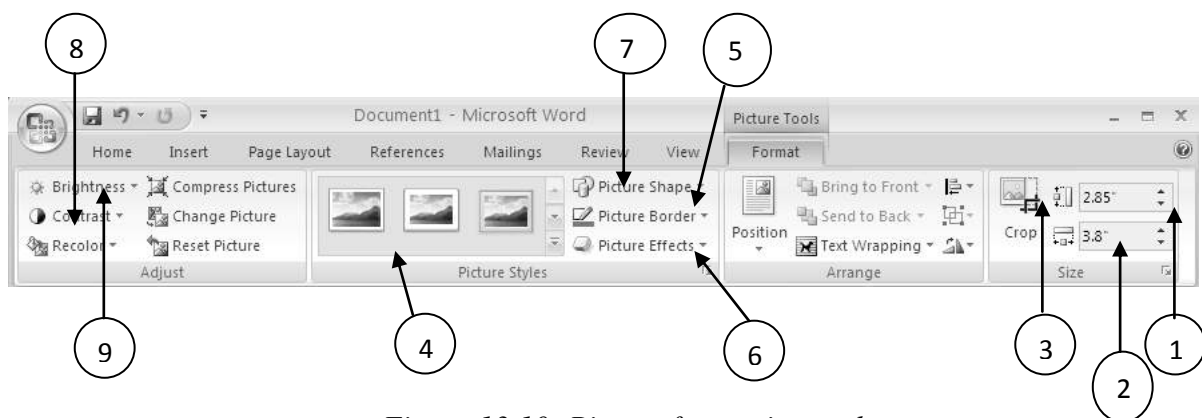

Figure 13.10: Picture formatting tools

No	Name	Description
1	Height	Change the height of the picture
2	Width	Change the width of the picture

3	Crop	Crop the picture
4	Style	Change the style of the picture
5	Border	Change the border of the picture
6	Effects	Change the effect of the picture
7	Shapes	Insert the picture shape
8	Contrast	Change the picture contrast
9	Brightness	Change the picture brightness

*Table 13.1: Formatting tools*

### **Change the Picture size**

To change the size of your selected picture follows the steps given below,

- Click picture tools.
- Set height of the picture in the size section.
- Set width of the picture in the size section.

*OR*

1. Select the picture.
2. Click **crop** tool.
3. Resize the picture using mouse.

### **Change the Picture Style**

To change the picture style,

1. Click picture tools.
2. Click on the suitable picture style.

### **Change the picture Border**

To change the picture style,

1. Click picture tools.
2. Click **picture border** icon in the picture style group.
3. Select the themes colour OR click “more outline colours” to select more colours.

### **Change the picture effects**

To change the picture effect, follow the steps given below.

1. Click picture tools.
2. Click **picture effect** icon in the picture style group.
3. Select the suitable effect.

### **Change the picture shape**

To change the picture shape, follow the steps given below.

1. Click picture tools.
2. Click picture shape icon in the picture style group.
3. Select a shape.

## Change the contrast of the picture

To change the picture contrast, follow the steps given below.

1. Click picture tools.
2. Click contrast icon on the picture adjust group.
3. Change the contrast.

## Change the brightness of the picture

To change the picture brightness, follow the steps given below.

1. Click picture tools.
2. Click brightness icon on the picture adjust group.
3. Change the brightness.

## 13.4 Working with ClipArt

Clip art, in the graphic arts, refers to pre-made images used to illustrate any medium. This section describes how to work with ClipArt.

### 13.4.1 Insert a ClipArt

To insert a clip art, perform the following operations,

- **Set cursor position** where you want to insert a clip Art.
- Click **insert tab**.
- Click **clip art** (Clip art selection window will appear).

Figure 13.11 shows clip art selection window.

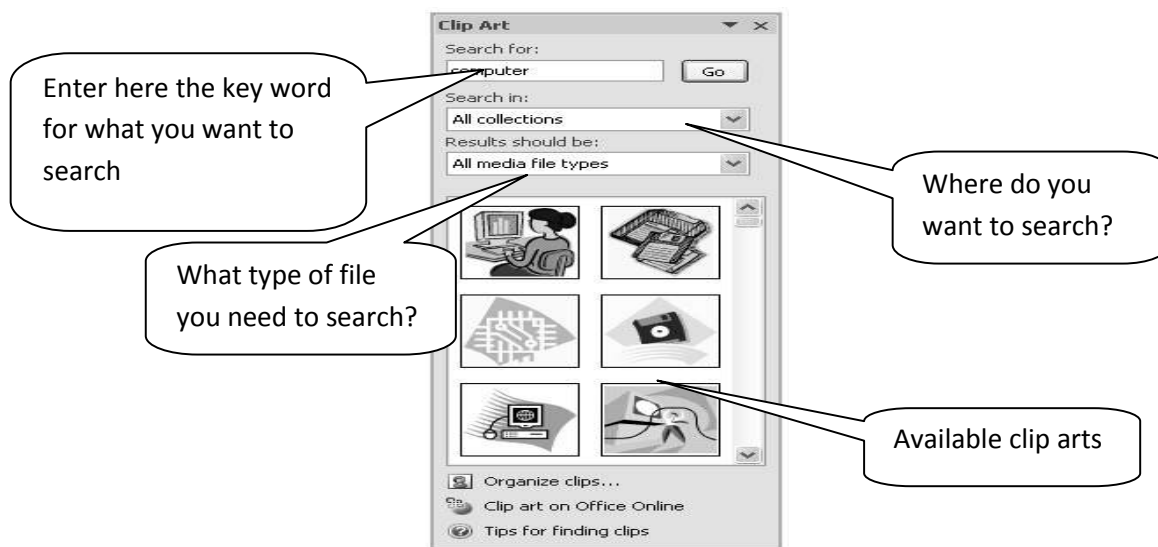

Figure 13.11: Clip Art Selection window

- After selecting the clip art, click on the picture (Clip art will be inserted as a picture into your document).

### 13.4.2 Insert clipart on Office Online

If you have the internet connectivity, you can insert more clip arts from online other than the collection available in the MS Office clipart gallery. To insert a clip art online, perform the following operations

1. **Set cursor position** where you want to insert a clip Art.
2. Click **insert tab**.
3. Click **clip art** (Clip art selection window will appear).
4. Click clip art on **Office online (Office.com)**
5. Select suitable clip art on the web.
6. Copy/save selected image.
7. Paste/insert into your word document.

### 13.5 Working with Shapes

MS office provides a huge collection of shapes categorized into different categories such as lines, basic shapes, block arrows, Flow charts, callouts, Stars and Banners as shown below.

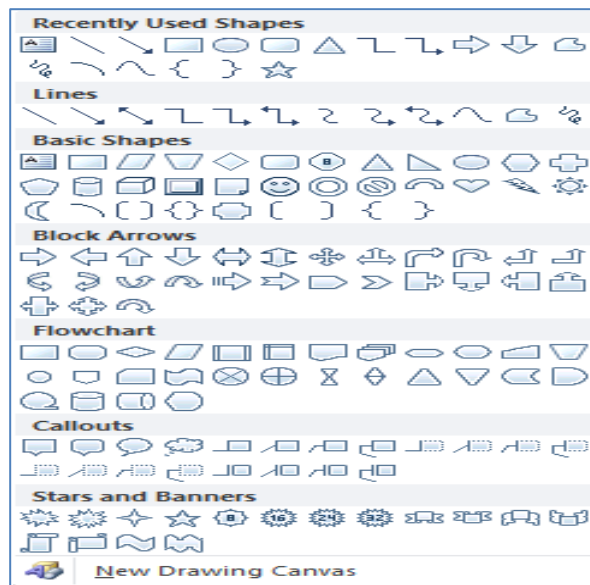

Figure 13.12: Shapes Window

#### 13.5.1 Insert a shape

To insert a shape, perform the following operations,

1. **Set cursor position** where you want to insert a shape.
2. Click **insert tab**.
3. Click **shapes**.

Several types of shapes are available such as basic shapes, flowcharts, block arrows, start and banners etc.

4. Select and click suitable shape that you want to install.
5. Now cursor will be changed it into + sign then you can draw a shape by using a drag and drop method.

When you select your shape, word activated the drawing format tool bar.

## The Drawing format Tool

The drawing format tool bar provides various facilities to manage shapes. Using these tools you can easily work with your shapes such as change the size of the shape, shape style, change shape effect etc. Some basic operations describe below.

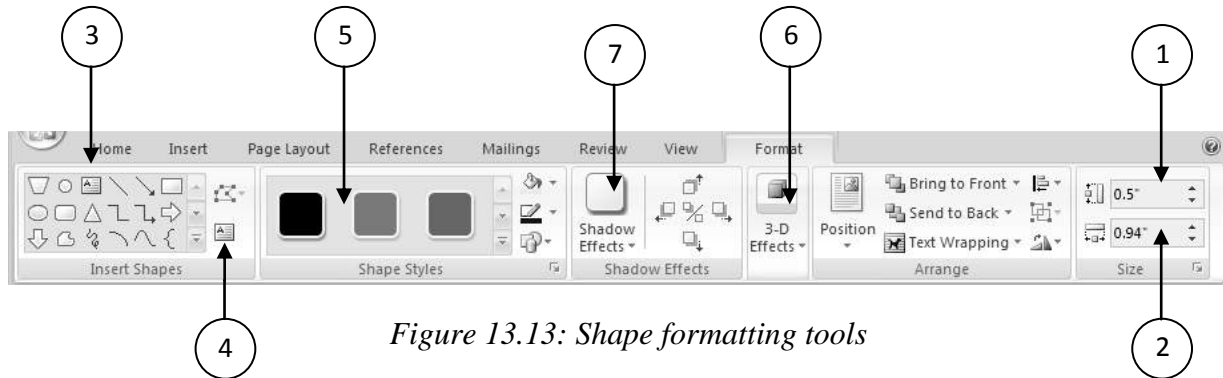

Figure 13.13: Shape formatting tools

No	Name	Description
1	Height	Change the height
2	Width	Change the width
3	Insert	To insert new shapes
4	textbox	To insert new textbox
5	Style	Change shape styles
6	effects	Change the 3D effect
7	Shadow	Insert the shadow effects

Table 13.2: Formatting tools

### 13.5.2 Change the size of the Shape

To change the shape size,

1. Click **Drawing format** tool
2. Set height of the shape.
3. Set width of the shape.

### 13.5.3 Insert a new shape

To insert a new shape,

1. Click **Drawing format** tool
2. Click on the suitable shape in the insert shape section.
3. Click on the document.

### 13.5.4 Add/Edit a text in a shape

To add/edit a text,

1. Select a shape.
2. Click drawing format tool.
3. Click edit text tool on the insert shape section
4. Type the test



**Example:** Creating a diagram.

Design the following diagram using suitable shapes

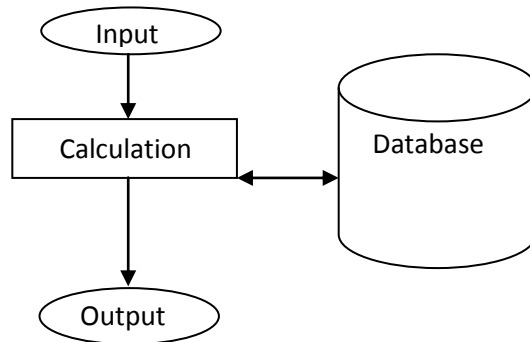

### 13.5.5 Create a group of shapes

To create a group using multiple shapes,

1. Select shapes.
2. Click drawing format tool.
3. Click group tool on the arrange section.

*OR*

1. Right click on the mouse.
2. Click grouping.
3. Click group.



### Ungroup/Regroup created group

To ungroup/regroup

1. Select shapes (Already grouped).
2. Click drawing format tool.
3. Click ungroup/regroup tool on the arrange section.

*OR*

1. Right click on the mouse.
2. Click grouping.
3. Click group.

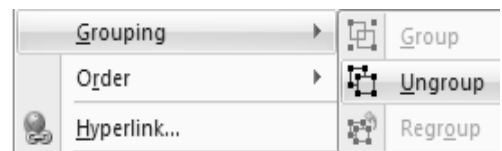

### 13.5.6 Insert 3D effect into a shape

To insert a 3D effect into a shape

1. Click drawing format tool.
2. Click 3D effect.
3. Select one of the available formats.

### 13.5.7 Insert Shadow effect into a shape

To insert a shadow effect into a shape

1. Click drawing format tool.
2. Click shadow effect.

3. Select one of the available effects.
4. Click on that.

### **Change the shadow effect into a shape**

To change the shadow effect into a shape,

1. Click drawing format tool.
2. Click shadow effect.
3. Change the shadow effects.

### **13.5.8 Change the shape style**

To change the shape style,

1. Click drawing format tool.
2. Click on the shape style.

### **13.5.9 Change the fill colour**

To change the fill colour of the shape,

1. Click Drawing format tool
2. Click on the Shape fill tool.
3. Select the colour.

### **13.5.10 Change the shape**

To change the existing shape with a different shape,

1. Click drawing format tool.
2. Click on the change shape tool.
3. Select another shape.

### **13.5.11 Change shape position**

To change the shape position

1. Click Drawing format tool
2. Click position tool.
3. Select the suitable position.

### **13.5.12 Change the visible order of the shapes**

To change the visible order of the shape,

1. Select a shape.
2. Click drawing format tool.
3. Click bring to front tool

*OR*

1. Select a shape.
2. Click drawing format tool.
3. Click send to back tool

## 13.6 Working with SmartArt

### 13.6.1 Insert a smart Art

To insert a SmartArt, perform the following operations,

1. Set cursor position where you want to insert a SmartArt.
2. Click **Insert** tab.
3. Click **SmartArt**.
4. Select a type of the SmartArt.
5. Click **OK**.

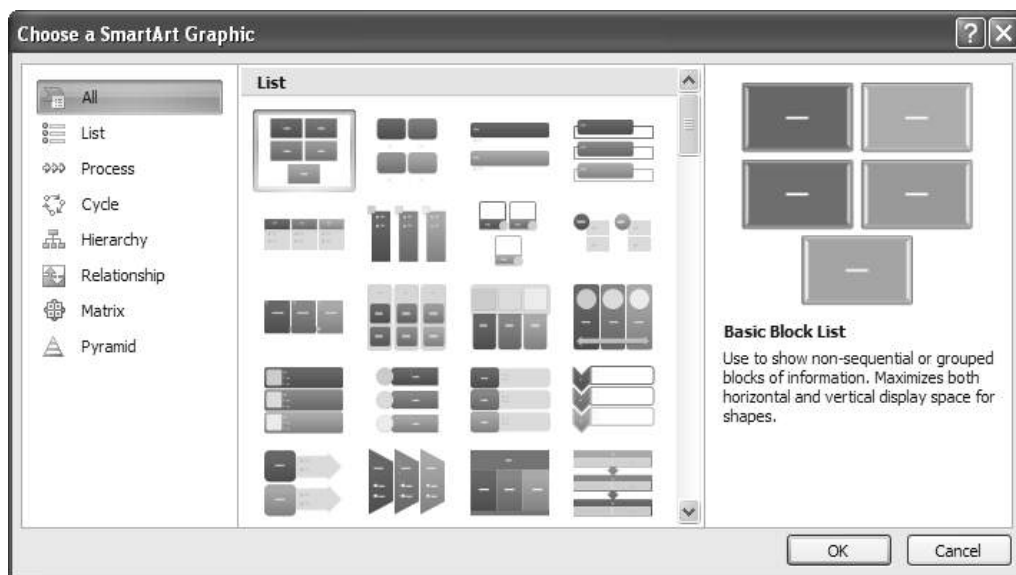
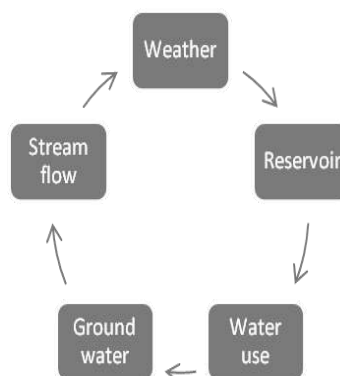

Figure 13.14: SmartArt Selection window

#### Activity 01: Create a Simple diagram by using SmartArt

Create the following diagram by using SmartArt



#### Steps:

1. Set cursor position where you want to insert a SmartArt.
2. Click **inset** tab.
3. Click **SmartArt**.

4. Select a type as cycle

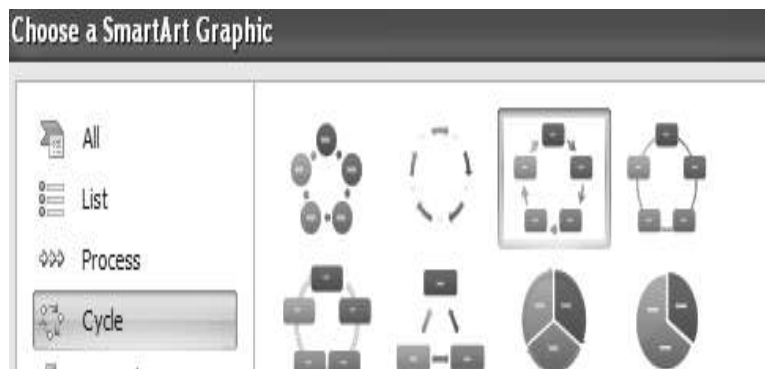

5. Type the text in the “Type your text here window”

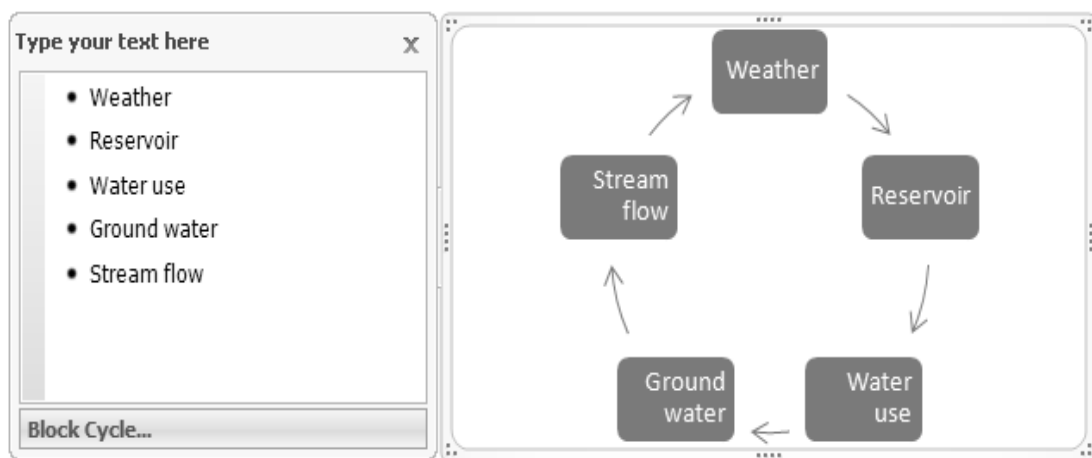

### 13.6.2 Working with SmartArt tools

There are two type of SmartArt menu available in the Word 2007 namely Design and Format. When you select the smart art tool, SmartArt tools are appeared.

#### The SmartArt Design tool

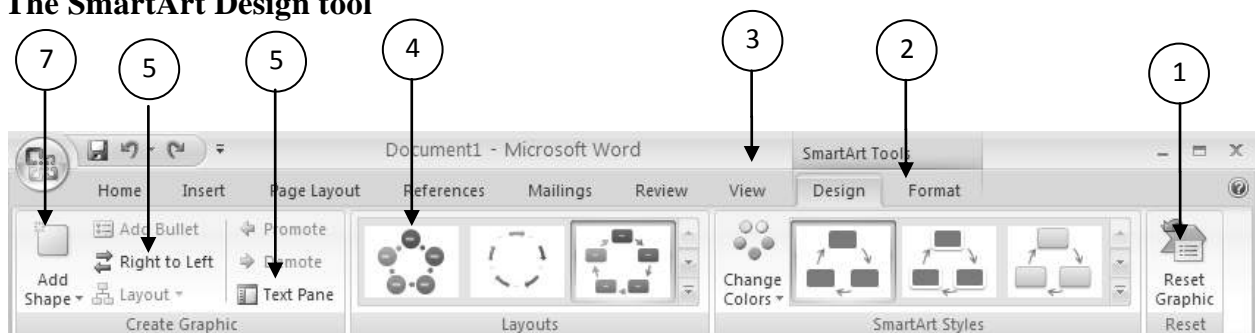

Figure 13.15: SmartArt Design tools

No	Name	Description
1	Reset	Reset the graphics shapes
2	style	Change the SmartArt Style
3	Colours	Change the SmartArt colour
4	layout	Change the SmartArt layout

5	Text pane	Insert new text pane
6	Order	Change the graphics order
7	Add	Add new shapes

*Table 13.3: SmartArt design tools*

### **Change the layout style of the SmartArt**

To change the layout style in the SmartArt,

1. Click the SmartArt.
2. Click SmartArt design tool.
3. Click one of the layouts in the layout group.

### **Change the SmartArt Styles**

To change the layout style in the SmartArt,

1. Click the SmartArt
2. Click SmartArt design tool
3. Click one of the SmartArt styles in the SmartArt styles group

### **Discard all the format changes**

To discard all the format changes you have done, follow the steps given below:

1. Click the SmartArt.
2. Click SmartArt design tool.
3. Click reset graphics.

### **Show/ hide text pane of the SmartArt**

To show or hide text pane,

1. Click the SmartArt.
2. Click SmartArt design tool.
3. Click text pane in the create graphics section.

### **Change the order of the design**

To change the order of the design

1. Click the SmartArt.
2. Click SmartArt design tool.
3. Click “Right to left” tool in the create graphics section.

## **13.7 Working with Charts**

### **13.7.1 Insert a chart into your document**

To insert a chart to your document

1. Set cursor position where you want to insert a chart.
2. Click **insert** tab
3. Click chart (Insert chart window is appeared).

4. Select the type of the chart.
5. Click **OK**.
6. System automatically loads Microsoft Excel and display the sample chart.

	A	B	C	D
1		Series 1	Series 2	Series 3
2	Category 1	4.3	2.4	2
3	Category 2	2.5	4.4	2
4	Category 3	3.5	1.8	3
5	Category 4	4.5	2.8	5
6				

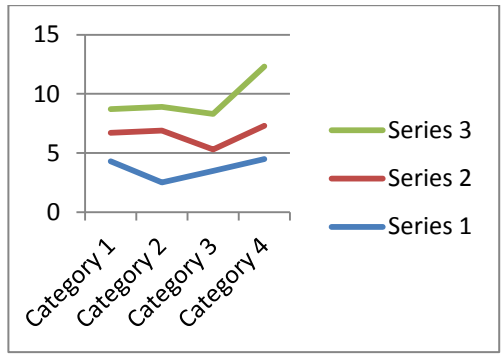

7. Enter the following data.

Index No	CHEMISTRY	PHYSICS	MATHS
AS001	4.3	0.3	1.6
As002	2.5	4.4	2.1
AS003	3.5	1.8	3.2
AS004	4.5	2.8	2.6

8. Close the Excel document.

**Note:** More about charts will be discussed under the Microsoft Excel 2007.

### 13.8 Insert a WordArt

To insert word Art, do following operations.

1. **Set Cursor Position** where you want to insert a text.
2. Click **Insert** tab.
3. Click **Word Art**.  
There are several types of word Arts are available.
4. Select and click the suitable word Art.
5. 'Edit word Art text' window will be appeared.  
After Selecting the suitable font type and font size Enter/type your text that you want to display in the given text box.
6. Click **OK**.



Figure 13.16: Edit word Art text window and the word Art

Now select your word Art, then Office shows word Art format tool bar in the ribbon. Using this tool bar you can design your word easily.

### The word Art Format tool bar

The word art format tool bar can be used to design your word Art text. This tool contains several facilities such as change size, change text effects, text position word style etc.

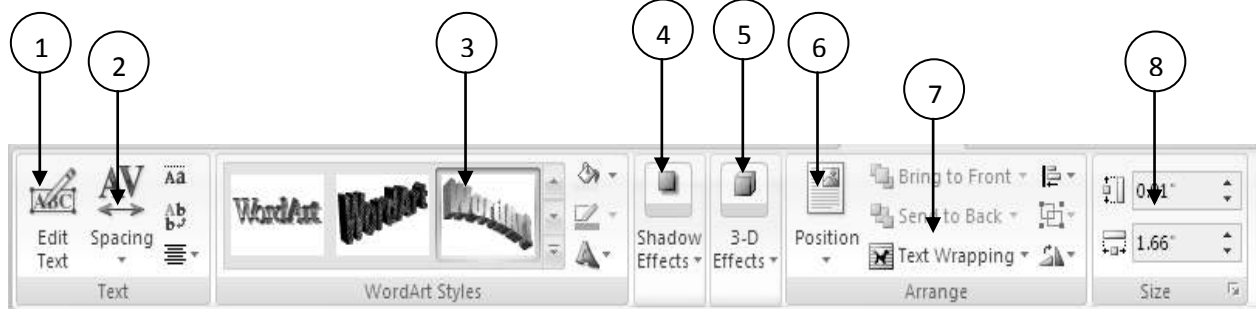

Figure 13.17: Picture formatting tools

No	Name	Description
1	Edit text tool	Edit your word Art
2	Spacing	Change the spacing between the letters of the text
3	Style	Change the text style
4	Shadow effect	Add shadow effect to the word art
5	3D-Effects	Add 3D effect to the text
6	Position	Change the word Art position
7	Text wrapping	Change the way text wraps around the selected text
8	Size	Change text size of the word Art

Table 13.4: Word Art formatting tool commands

## 13.9 Working with Text boxes

To insert Text box, perform the following operations,

1. **Set cursor position** where you want to insert a text.
2. Click **insert** tab.
3. Click **Text Box** (There are several types of built-in textbox types available).
4. Select and click the suitable text box.
5. Type the text.
6. Click **OK**.

This is a text box

After creating your text box select it. Then text box formatting window is appeared

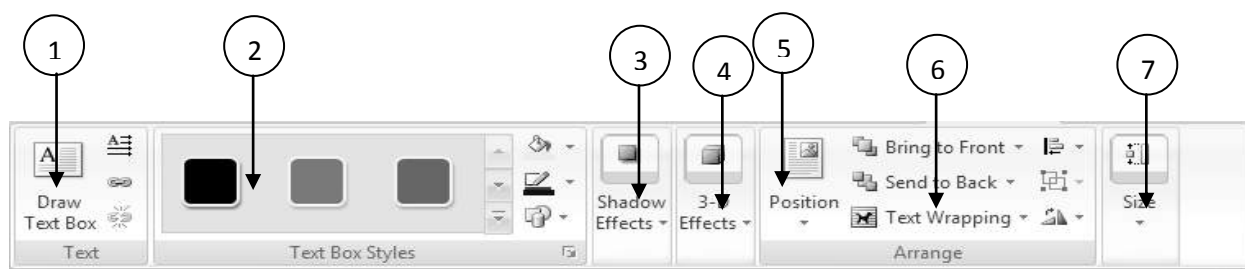

Figure 13.18: Text box formatting tool commands

No	Name	Description
1	Draw text Box	Create a new text box
2	Style	Change the text box style
3	Shadow effects	Add shadow effect to the text box
4	3D-Effects	Add 3D effect to the text box
5	Position	Change the text box position
6	Arrange text	Change the text Arrangement
7	Size	Change the text size

Table 13.5: Word Art formatting tool commands

### Draw a text box

To create a new text box follow the steps given below

- Click Draw text box tool.
- Click the **cursor** where you want to insert a new text box.
- Type the text.

## 13.10 Working with equations

When you want to insert some equations in to your document, you can use the *equation tool*. To create a new equation,

- Set cursor position where you want to insert the equation.
- Click **Inset** tab.
- Click **Equation**

Now equation design tool appears in the ribbon



Figure 13.19: Equation design

Also several tools appear in the equation editor to create any type of equations. Only you needs click and type as you need.

**Example 1: Create the following equations by using equation tool**

$$AX^2 + BX^3 = 2$$



Sample steps are as follows,

1. Put the cursor where you want to type the equation.
2. Click **Insert** tab and Click equation, you can see the place to type your equation.



Start to type your equation on the above box and type **A**.

Then click the script button and select the subscript pattern.

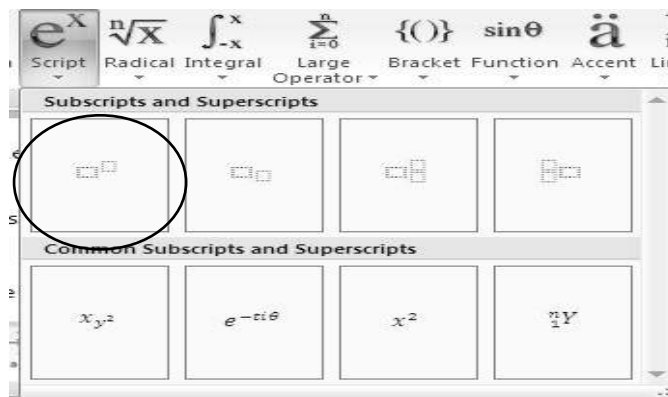
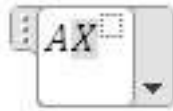

Figure 13.20: Selecting the subscript pattern

3. Type the value **X** on the big rectangle and type the **2** on the small rectangle. Then click the right arrow key to exit the small rectangle. Then type **+** Sign.



4. Type other values as same.
5. Press Enter to exit the equation mode.

**Example 2: Create the following equations by using equation mode**

$$1. (ax + b) = a_0 + \sum_{n=1}^{\infty} \left( a_n \cos \frac{n\pi x}{L} + b_n \sin \frac{n\pi x}{L} \right)$$

$$2. \cos \alpha + \cos \beta = 2 \cos \frac{1}{2}(\alpha + \beta) \cos \frac{1}{2}(\alpha - \beta)$$

### 13.11 Inserting Symbols

To insert a symbol, perform the following operations,

1. Set cursor position where you want to insert a text.
2. Click **insert** tab.

3. Click **Symbol**.
4. Click the symbol.

OR

1. Click more symbols (Symbol window is appeared).
2. Select Symbol on the list.
3. Click insert (Change the Font and subset to search other symbol).

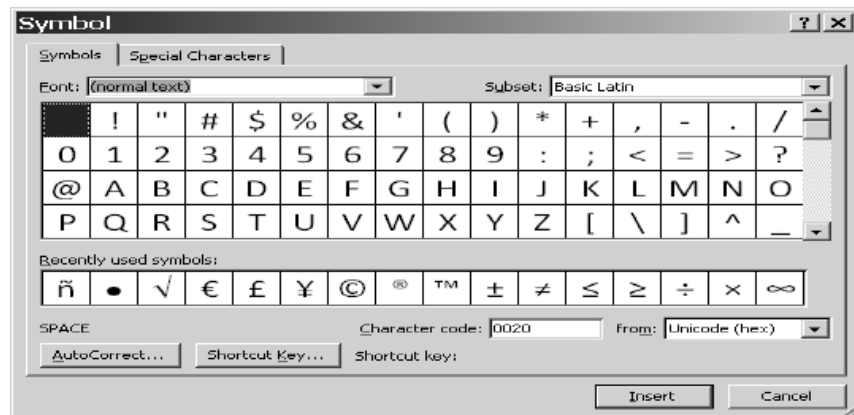

Figure 13.21: The insert symbol window

### Create a shortcut key

To create a new shortcut key follow the steps given below,

1. Click **insert**.
2. Click **Symbols**.
3. Select more symbols (Symbol window is appeared).
4. Select the symbol you want to use as a shortcut.
5. Press **Shortcut Key**.

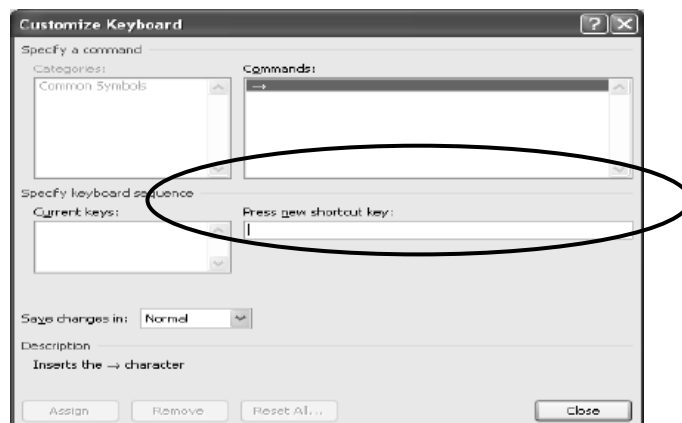

Figure 13.22: Customize the insert symbol window

### Insert a special character

To insert a special character, follow the steps given below,

- Click **insert**.
- Click **Symbols**.

- Select **more symbols** (Symbol window is appeared).
- Click the **special character tab**.
- Select the character from list.
- Click **insert**.

## 13.12 Word Templates

Templates are a special type of Microsoft Word document that can hold text, styles, macros, keyboard shortcuts, custom toolbars and AutoText entries. A document created using a template will have access to all of these features and so a large part of your development and document creation job will be done for you.

### 13.12.1 Create a new word template

To create a new word template

1. Create a new document
2. Do some on it (Change the page layout, enter header, Footer, page number etc.)
3. Click **Save As**.
4. Select **word Template**.
5. Enter file name.
6. Click **Save**.

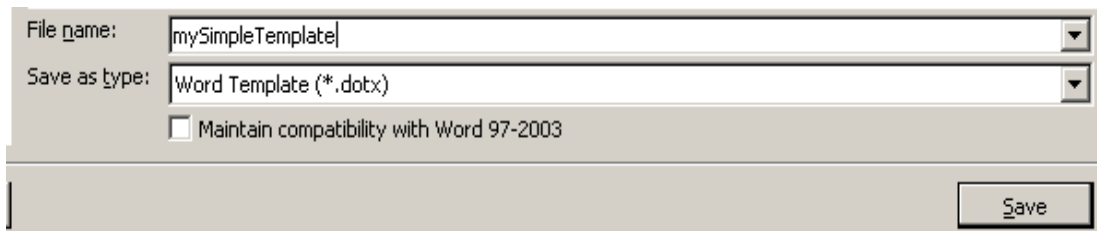

### 13.12.2 Working with installed templates

To Work with installed templates,

1. Click **office** button.
2. Click new (New document window is appeared).
3. Select **installed template**.
4. Select one of the install templates.
5. Click **Create**.

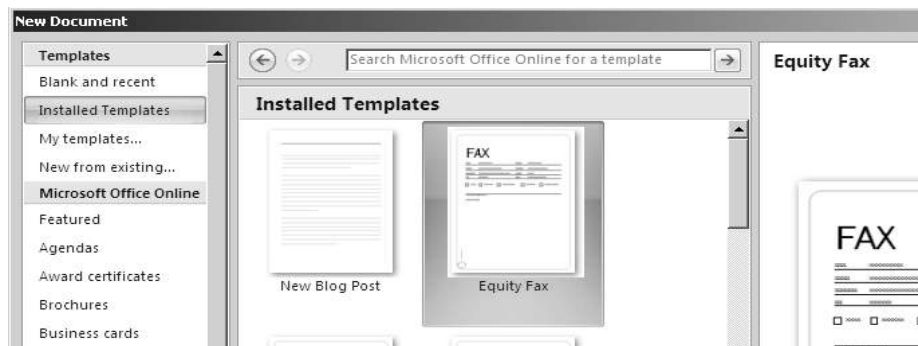

Figure 13.23: Create an install template using new document window

**Activity 01:** Create the following FAX document by using the installed templates.

<h1>FAX</h1>	
<b>To:</b> <u>Head/Department of <u>Mathamatics</u></u>	<b>From:</b> <u>Mathematics student</u>
<b>Fax:</b> <u>0112343434</u>	<b>Pages:</b> <u>5</u>
<b>Phone:</b> <u>077121212121</u>	<b>Date:</b> <u>12.9.2009</u>
<b>Re:</b> <u>No</u>	<b>CC:</b> <u>No</u>
<input checked="" type="checkbox"/> Urgent <input type="checkbox"/> For Review <input type="checkbox"/> Please Comment <input type="checkbox"/> Please Reply <input type="checkbox"/> Please Recycle	

**Steps:**

- Click **Office** button.
- Click **New**.
- Select install templates in the new window.
- Select the suitable document template.
- Click **Create**.

**Example:** Working with Microsoft Office online templates

You can use hundreds of templates by using MS Office online templates. To do this, follow the steps given below;

1. Click **Office** button.
2. Click **New**.
3. Select online templates in the new document window.
4. Select the suitable document template.
5. Click **Create**.

### 13.13 Working with Mail Merge

Mail merge is a software function describing the production of multiple documents from a single template form and a structured data source. This helps to create personalized letters and pre-addressed envelopes or mailing labels for mass mailings from a word processing document which contains fixed text, which will be the same in each output document, and variables, which act as place holders that are replaced by text from the data source.

To start mail merge, perform the following steps,

1. Create a new word document.
2. Select **Mailings** tab on the ribbon.

3. Click down Arrow of the **Start mail merge** icon.  
Click **Step by Step mail merge wizards** (The mail merge wizard is appears)

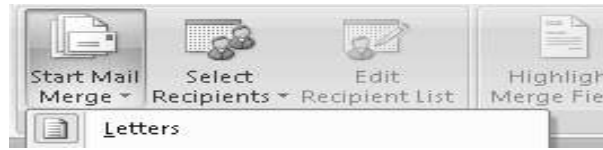
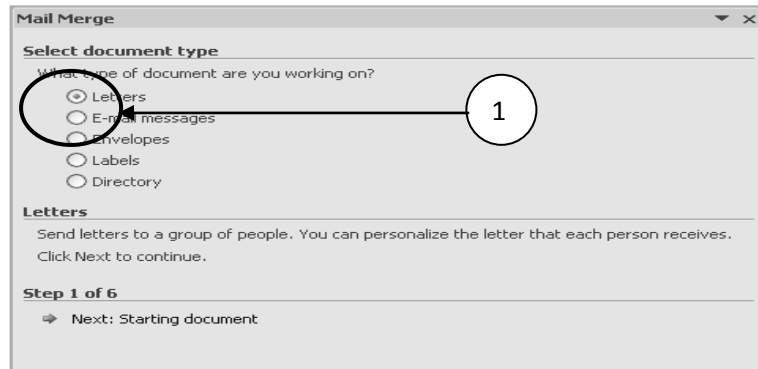
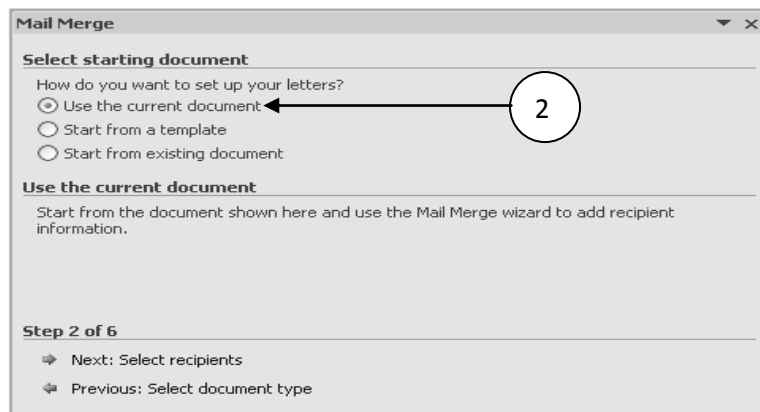

Figure 13.24: Start Mail Merge icon

4. Select the working document type as letters. Then click **next Starting document**.



5. Select the starting document as current document.



6. Click Select recipient.

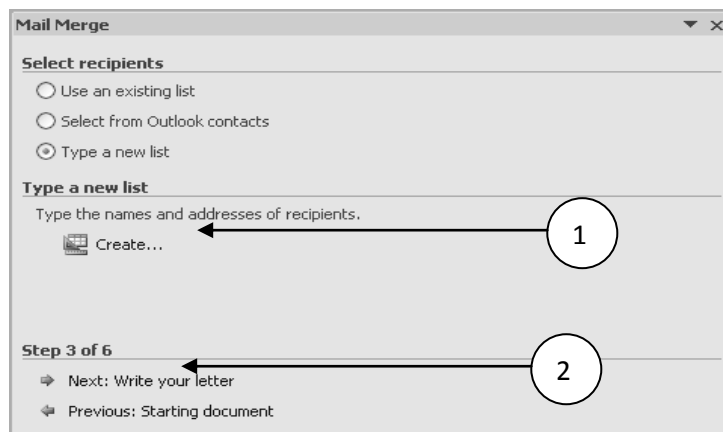

7. Select **type a new list** and Click **Create** (Add new address list window is appeared).
8. Enter the following information on the list.

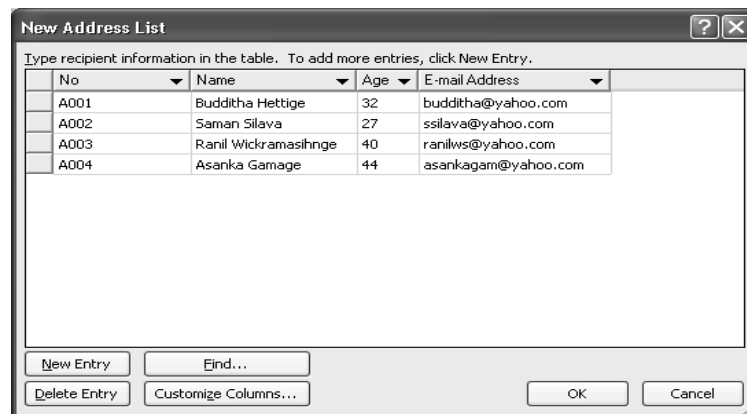

9. Click **OK**.
10. Click **Next: Write on your letter**.
11. Click **more items** (Insert message field window is appeared).



12. Go to the place where you want to insert data.
13. Select the item.
14. Click **Insert**.

No: «No» , «Name» , «Age» , Email: «Email\_Address»

15. Click **preview your letter**.
16. Click **Complete** the merge.
17. Click **Edit individual letter**.

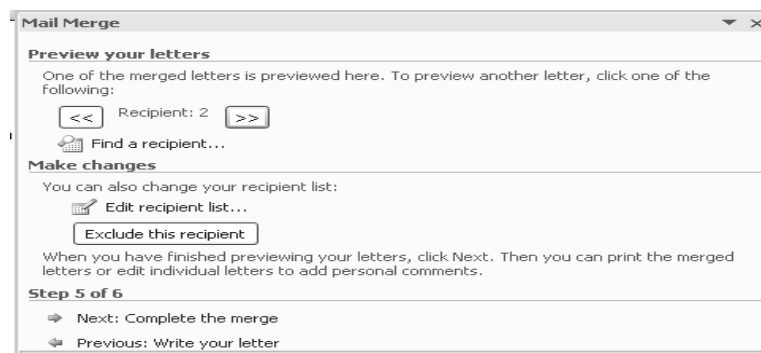

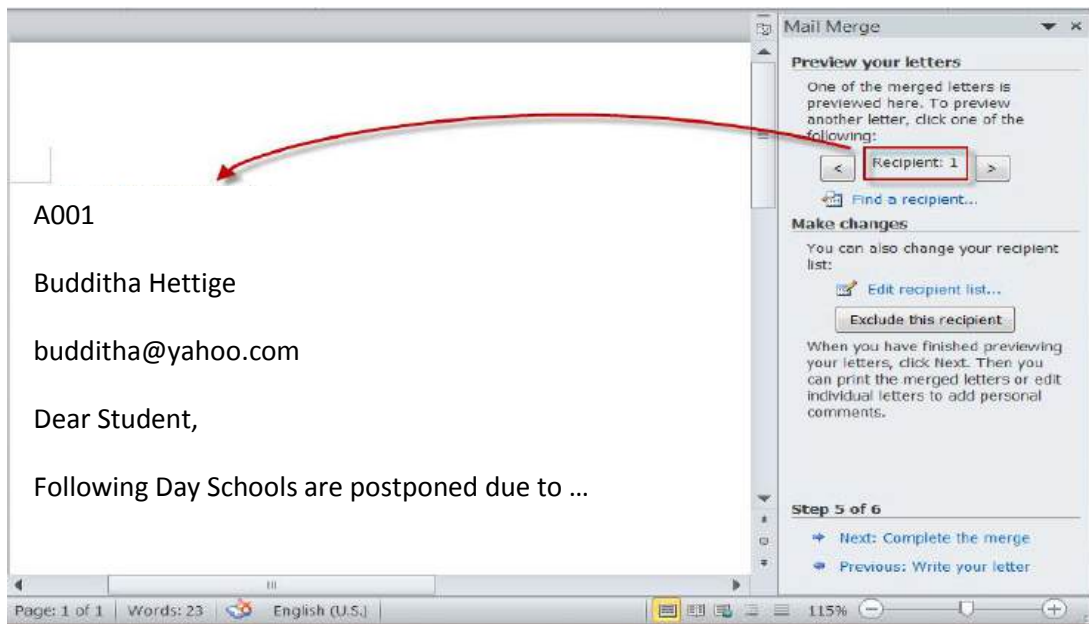

Figure 13.25: Merged Letter

Also, you can mail merge with Excel document or the MS Access database.

Note that, mail merge facilities are very useful facilities for the office members. Assume that, you are a staff member of a particular company and you need to send 100 letters for a group of applicants calling them for a particular interview. Using mail merge facility, you can create 100 letters in 5 minutes. Otherwise it takes five more hours.



### 13.14 Self Assessment Questions

- 13.1 What is the purpose of having a tab called “Table Tools”?
- 13.2 List five activities that the “Layout” tab allows you to do while working with tables.
- 13.3 Which keys can be used to move the cursor from one cell to the next in a table?
- 13.4 What are the tools available under “Illustrations”? State the functions of them?
- 13.5 What does the “Crop” tool do when formatting a picture?
- 13.6 What are the two search options that can be specified when using clipart?
- 13.7 When you select a shape, which tool bar is going to be activated automatically?
- 13.8 What is meant by the “text wrap”?
- 13.9 What is the purpose of having a tool called “WordArt” in Text formatting?
- 13.10 Which tab can be used to create a large capital letter at the beginning of the paragraph?
- 13.11 Which key on the keyboard could use to highlight all the pieces of a drawing, in order to group them together?
- 13.12 Which page orientation you will select if you wish to print in wide format?
- 13.13 What is a Word Template? What is the file extension of a Word Template file?
- 13.14 What are the benefits that can be gained from using the mail merge facility?

# Session14

## Introduction to MS Excel 2007

---

### Aims:

This session aims to extend the student's knowledge and skills in Microsoft Excel to a high level.

### Objectives:

Having studied this session you will be able to get an idea about:



- The capabilities found in Excel 2007
- Excel 2007 user interface
- Working with Excel work books

### 14.1 Introduction

Microsoft Excel (Microsoft Office Excel) is a spread sheet application written and distributed by Microsoft for Microsoft Windows and Mac OS. A spreadsheet is a rectangular table (grid) of information, often financial information. Excel has some features namely calculation, graphing tools, pivot tables and a macro programming language called VBA (Visual Basic for Applications). Excel is one of the most popular microcomputer applications to date.

Earlier version of Excel contained the program's more than 1,000 commands in a series of menus, toolbars, task panes, and dialog boxes. And, as it turns out, there were some functions that didn't appear by default on any of the menus or toolbars. In Excel 2007, there is only one place to look for the tools you need to use it; the user interface Ribbon at the top of the program window.

Table 14.1 summarizes some of the expanded data storage and other capabilities found in Excel 2007.

Description	Excel 2007
Columns in a worksheet	16,384
Rows in a worksheet	1,048,576
Number of different colors allowed in a work book	4.3 billion
Number of conditional format conditions applied to a cell	Limited by available memory
Number of sorting levels of a range or table	64
Number of items displayed in an AutoFilter list	32,768
Total number of characters displayed in a cell	32,768
Total number of characters per cell that Excel can print	32,768
Total number of unique cell styles in a workbook	65,536
Maximum length of a formula, in characters	8,192
Number of nested levels allowed in a formula	64
Maximum number of arguments in a formula	255
Number of characters that can be stored and displayed in a cell	32,768



with a text format	
Number of columns allowed in a PivotTable	16,384
Number of fields displayed in the PivotTable Field List task pane	16,384

Table 14.1: Capabilities found in Excel 2007

### 14.1.1 Start Excel 2007

To start using Microsoft Excel, there are various ways that you can use.

- i. Click Start → All Programs → Microsoft Office → Microsoft Office Excel 2007.
- ii. If you are using My Computer or Windows Explorer, you can open the Program Files folder in the C drive, then Microsoft Office, then Office, and double-click Excel.exe file (Directly run the excel application).
- iii. You can create an empty document on your desktop and use it to launch Microsoft Excel. To do that, you would right-click an empty area on the desktop, position the mouse on New → Microsoft Office Excel Worksheet, type a name for the document, such as Time Sheet, and press Enter twice.
- iv. Double-clicking on any already created Excel file.

## 14.2 Microsoft Excel 2007 User Interface

Before start excel 2007 this is the best time to learn about office excel 2007 user interface. Figure 14.1 shows user interface of the excel 2007.

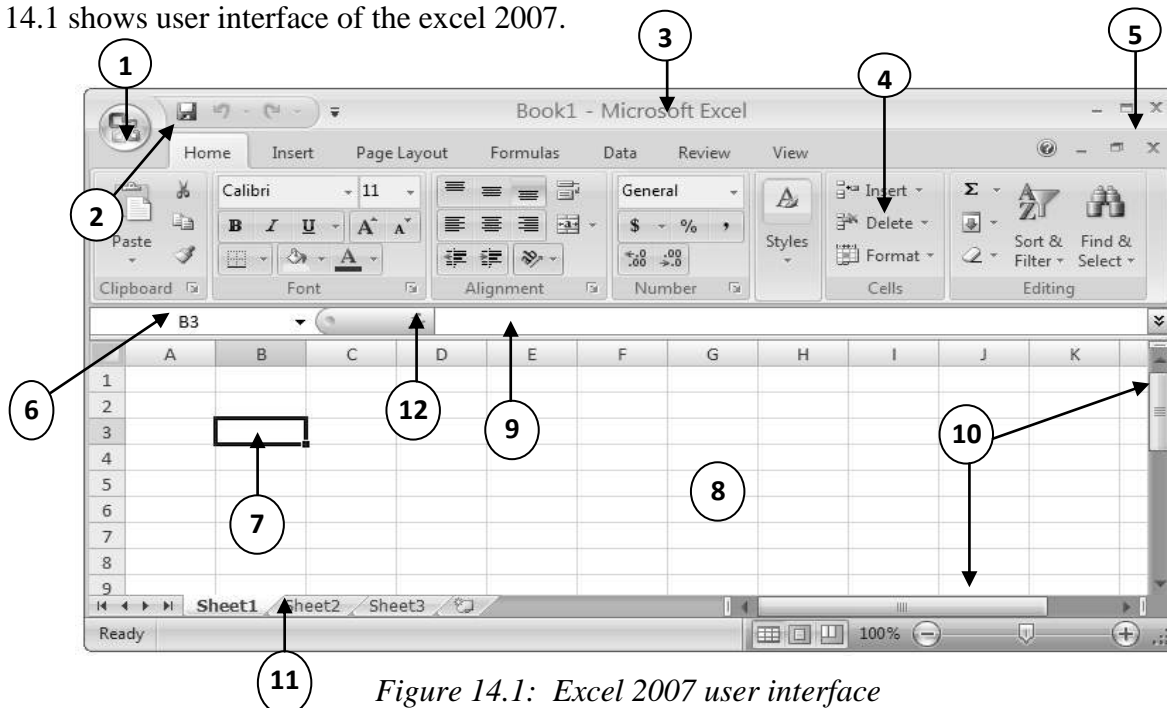

Figure 14.1: Excel 2007 user interface

No	Name
1	Office button
2	Quick Access tool bar
3	Work sheet title
4	Ribbon
5	Control keys (Close   resize   Minimize )

6	Name box
7	A cell
8	Work sheet
9	Formula bar
10	Scroll bars
11	Status bar
12	Insert Function Button

Table 14.2: Major components of the Excel 2007 user interface

## 14.3 Working with workbooks

### 14.3.1 Create a new workbook (Method 1)

After starting MS Excel you need to create a new workbook to start working with MS Excel.

1. Click **Office button** → click **New** (New document creation window is appeared).



2. Select template: **blank and recent.**
3. Select blank work book and Click **Create.**

### 14.3.2 Create a new work book (Method 2)

There is another method to create a new work book.

1. Click the **mouse cursor** where you want to create the New document
2. Right click in the mouse and get short cut menu.
3. Select **New.**
4. Click Microsoft Office Excel work sheet.

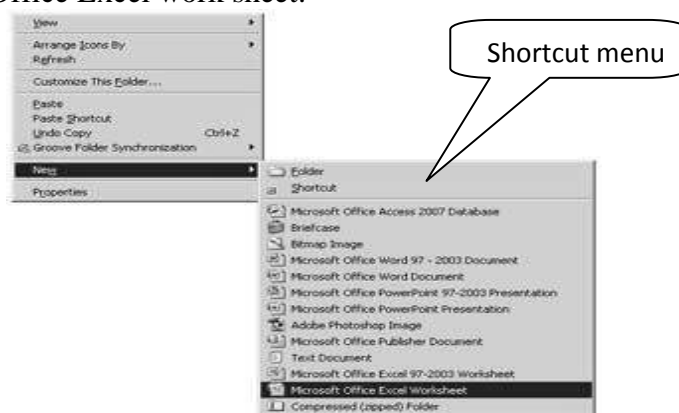

5. Rename/give a name for the created new excel work sheet document.



6. To Open Excel, double click on the EXCEL icon.

The workbook can contain several **work sheets**. By default it has only three (3) work sheets namely sheet1, sheet2 and sheet3.

## 14.4 Working with a work sheet

Now you are ready to work with work sheets. In this section we will discuss how to delete, rename, or create a new work sheet in a work book.

### 14.4.1 Delete a worksheet

To delete a worksheet, follow the steps given below;

1. Right click on the sheet tab which is to be deleted.
2. Click **Delete** on the shortcut menu.

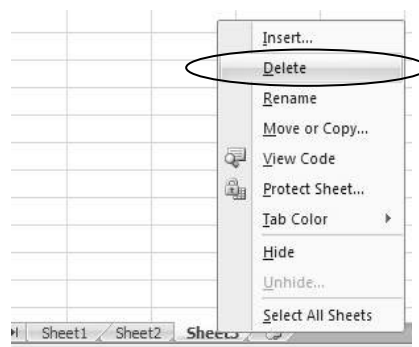

Figure 14.2: Delete a worksheet

### 14.4.2 Rename an existing worksheet

To rename an existing a worksheet, follow the steps given below;

1. Right click on the sheet tab.
2. Click **Rename** on the shortcut menu.
3. Give a new name for the work sheet.

### 14.4.3 Insert a new work sheet

1. Right click on 'Insert Work sheet' tab.
2. A new work sheet will be created for you. Rename the created worksheet with a name you desire.



**Example:** Create a new data sheet.

Create a new work book named “mysample1” then rename sheet1 as ‘mysheet1’. Enter the following values into the ‘mysheet1’.

	A	B	C
1	Customer	Month	Salary
2	S. M. Perera	January	10000
3	S. M. Perera	February	12000
4	S. M. Perera	March	13500
5	S. M. Perera	April	10000
6	S. M. Perera	May	9750
7	S. M. Perera	June	13350
8	S. M. Perera	July	11000
9	S. M. Perera	August	10500
10	S. M. Perera	September	10700
11	S. M. Perera	October	12000
12	S. M. Perera	November	10000
13	S. M. Perera	December	9800

*Figure 14.3: Sample data for mysheet1*

Entering the sequence January, February, March, and so on repeatedly can be handled by copying and pasting the first occurrence of the sequence, but there's an easier way to do it: use AutoFill.

## 14.5 Data entry techniques

The following table summarizes the existing data entry techniques.

Method	Action
AutoFill	Enter the first value in a recognized series and use the fill handle to extend the series.
Fill Series	Enter the first two values in a series and use the fill handle to extend the series.
AutoComplete	Type the first few letters in a cell, and if a similar value exists in the same column, Excel 2007 suggests the existing value.
Pick from Drop-down List	Right-click a cell, and from the shortcut menu that appears, choose Pick From Drop-down List. A list of existing values in the cell's column appears. Click the value you want to enter into the cell.

*Table 14.3: Data entry techniques*

### 14.5.1 AutoFill option

To AutoFill, you enter the first element in a recognized series, grab the fill handle at the lower-right corner of the cell, and drag the fill handle until the series extends far enough to accommodate your data.



Figure 14.4: AutoFill options

Click the Auto Fill Options button to display a list of several actions. Some options in the list are summarized in the following table.

Option	Action
Copy Cells	Copies the contents of the selected cells to the cells indicated by the Fill operation.
Fill Series	Fills the cells indicated by the Fill operation with the next items in the series.
Fill Formatting Only	Copies the format of the selected cell to the cells indicated by the Fill operation, but does not place any values in the target cells.
Fill Without Formatting	Fills the cells indicated by the Fill operation with the next items in the series, but ignores any formatting applied to the source cells.
Fill Days, Weekdays, etc.	Changes according to the series you extend. For example, if you extend the cells Wed, Thu, and Fri, Excel 2007 presents two options, Fill Days and Fill Weekdays, and enables you to select which one you intended. If you do not use a recognized sequence, the option does not appear.

Table 14.4: AutoFill Options

**Example:** Enter data by using Data entry techniques

Use a new worksheet “mysheet2” and enter the following

	A	B	C	D
1	Number	Name	year	Increment
2	1	A. B. Gamage	1999	250
3	2	A. B. Gamage	2000	300
4	3	A. B. Gamage	2001	350
5	4	A. B. Gamage	2002	400
6	5	A. B. Gamage	2003	450
7	6	A. B. Gamage	2004	500
8	7	A. B. Gamage	2005	550
9	8	A. B. Gamage	2006	600
10	9	A. B. Gamage	2007	650
11	10	A. B. Gamage	2008	700

Figure 14.5: Sample data

## 14.6 Moving Data within a Workbook

You can move a cell in a lot of ways, but the most direct method is to click the cell to which you want to move. Then your selected cell becomes an active cell(s). (The active cell is the cell that is currently selected and open for editing). Then copy it and paste it elsewhere in the workbook.

The Paste Options button appears next to data you copy from a cell and paste into another cell. Clicking the Paste Options button displays a list of actions that Excel 2007 can take regarding the pasted cells.

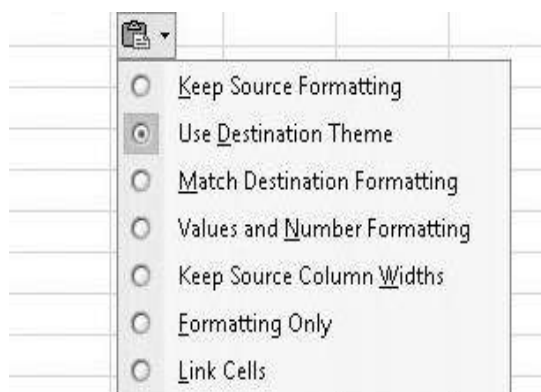

Figure 14.6: Paste Option button

The options in the list are summarized in the following table.

Option	Action
Use Destination Theme	Pastes the contents of the Clipboard (which holds the last information selected via Cut or Copy) into the target cells and formats the data using the theme applied to the target workbook.
Match Destination Formatting	Pastes the contents of the Clipboard into the target cells and formats the data using the existing format in the target cells, regardless of the workbook's theme.
Keep Source Formatting	Pastes a column of cells into the target column; applies the format of the copied column to the new column.
Values Only	Pastes the values from the copied column into the destination column without applying any formatting.
Values and Number Formatting	Pastes the contents of the Clipboard into the target cells, keeping any numeric formats.
Values and Source Formatting	Pastes the contents of the Clipboard into the target cells, retaining all the source cells' formatting.
Keep Source Column Widths	Pastes the contents of the Clipboard into the target cells and resizes the columns of the target cells to match the widths of the columns of the source cells.
Formatting Only	Applies the format of the source cells to the target cells, but does not copy the contents of the source cells.

Table 14.5: Paste options

**Example:** Move Data on the workbook.

	G	H	I
5	Customer	Month	Salary
6	S. M. Pere	January	10000
7	S. M. Pere	February	12000
8	S. M. Pere	March	13500
9	S. M. Pere	April	10000
10	S. M. Pere	May	9750
11	S. M. Pere	June	13350
12	S. M. Pere	July	11000

**Steps to follow:**

1. On the “mysheet1” worksheet, select cells A1:C8.
2. On the Home tab, in the Clipboard group, click the Copy button. Excel 2007 copies the contents of cells A1:C8 to the Clipboard.
3. On the tab bar, click the mysheet2 sheet tab. The ‘mysheet2’ worksheet appears.
4. Select cell G5.
5. On the Home tab, in the Clipboard group, click Paste. Excel 2007 pastes the values into cells G5:I12.
6. Click the Paste Options smart tag and then click Keep Source Formatting. Excel 2007 retains the cells' original formatting.

## 14.7 Defining data set as a Table

Excel has always enabled you to manage lists of data effectively, enabling you to sort your worksheet data based on the values in one or more columns.

**Example: Define a table**

You will create a data table from existing data, add data to a table, add a Total row, change the Total row's summary operation, and rename the table.

1. Select cell A1.
2. On the Home tab, in the Styles group, click Format as Table and then select a table style. The Format as Table dialog box appears. Click Format as a table.

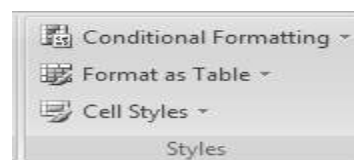

## 14.8 Some useful tips

Here, some operations are described which are identified as useful to work with Excel 2007 more easily.

### 14.8.1 Displaying Different Views of an Excel sheet

In Excel 2007, you can view a document in three ways namely **normal view**, **print view** and **page break preview**. By using the layout viewer (appearing next to the status bar, right bottom on your MS Excel window) you can change Excel document view as you need. Click each view and see the difference. The layout viewer is shown below.

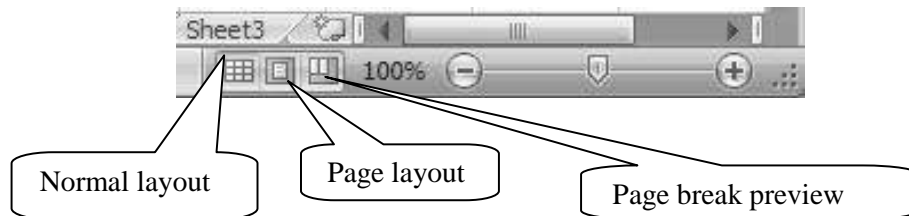

Figure 14.7: Different Views of an Excel sheet

### 14.8.2 Window Operations

By using MS Excel you can use/open more than one work books and you can work with several windows simultaneously. Some window operations that will be useful when working with windows are described below;



Figure 14.8: Multiple window operations

#### Switch to other Excel Document

Microsoft Excel 2007 supports multiple documents. Therefore you can use multiple Excel work books in the same time. By default you can see only the active excel document and can easily switch to other documents. To switch to other document

1. Click on the View tab on the Ribbon.
2. Point the Window group.
3. Click **switch Windows**

#### Close the current document window

Click the **Close** button, appearing at the right end of the Document window's title bar.



#### Maximize the window

Click the **Maximize** button, appearing at the right end of the Document window's title bar.



#### Freezing/Unfreezing panes

Imagine that you have entered data into your worksheet under different column headings and the number of data rows entered is too high, such that it goes beyond the limit of a visible single page. Obviously, to refer the data in lower rows you need to scroll down the page. When scrolling down to the 2<sup>nd</sup> page and onwards, you will lose the titles appearing as the column



headings. So, it will be terrible for you to read the data in the rows as you can't see what the meaning of that data under a particular column as the heading is not visible and you will have to scroll up again to view the headings, come back to the row reading. Obviously this is a difficult task for you.

In such cases, you can freeze the top row of the work sheet by keeping the top row visible while scrolling through the rest of the work sheet. You can do the similar operation for the left most columns as well such that it keeps both rows and columns visible while scrolling. Follow the steps below to freeze or unfreeze the panes as explained above.

- Go to the **View** tab.
- Go to the **Window** group.
- Select the option among Freeze panes, Freeze row, freeze column, or Unfreeze panes as you wish.

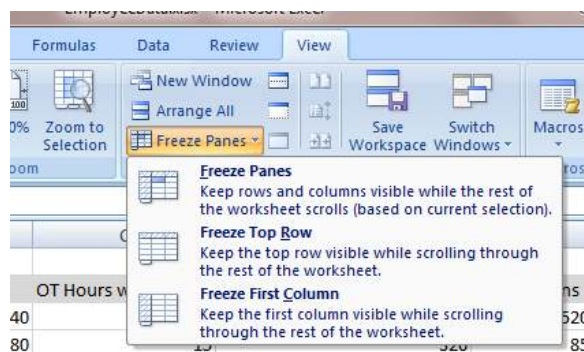

## 14.9 Setting, Previewing, and Printing a document

### 14.9.1 Setting/Clearing printing area

Sometimes, though your worksheet is full of work done across the pages horizontally and vertically you don't need to have the entire working in the printout. It will reduce the paper wastage as well. In such situations you can set the printing area by covering a particular number of rows and columns. Follow the steps given below.

- Select the area to be printed by dragging and dropping the mouse over a rectangular area across the rows and columns.
- Go to the **Page Layout** tab.
- Go to the **Page Setup** group.
- Select the options under **Print area** by clicking the down arrow.

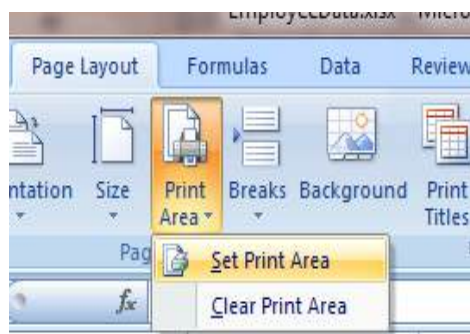

## 14.9.2 Previwing and Printing your work

After you create your Excel document you can get a print of it by using a printer. To print your documents follow the steps given below;

1. Click the Microsoft Office Button, point to print.

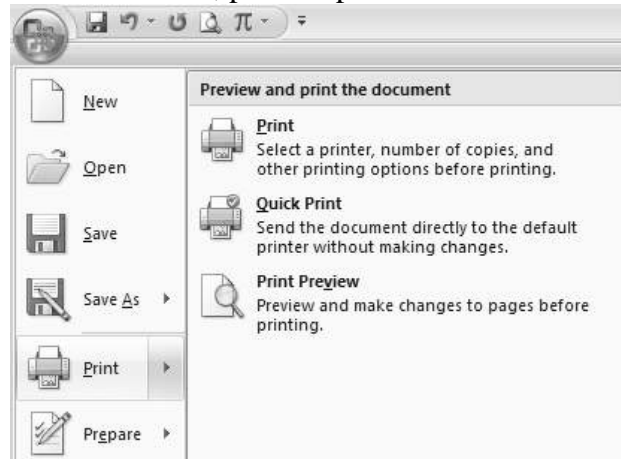

Figure 14.9: Word 2007 Print options and printer setup window

There are three options available namely **Print**, **Quick Print**, and **Print Preview**

**Print:** if you click 'Print' then the print dialog box will appear. (Screen shot in print dialog box is given below) By using this dialog box you can select printer name, set number of copies and set page range to print as you wish such as All : print all pages in your document Current: prints only the current page and Pages: rage: 3 – 4 page range you wish to print. After selecting each option click OK to print.

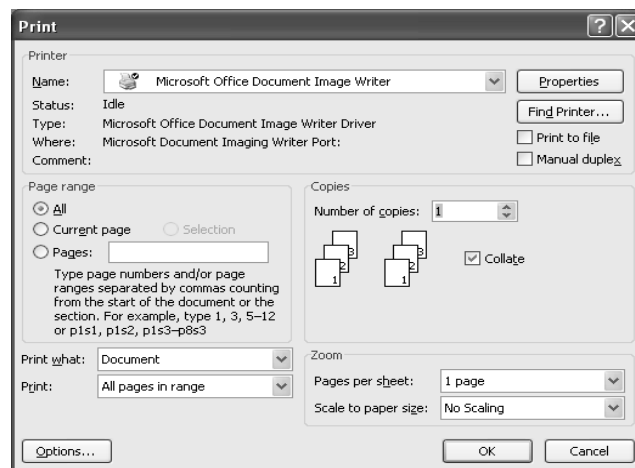
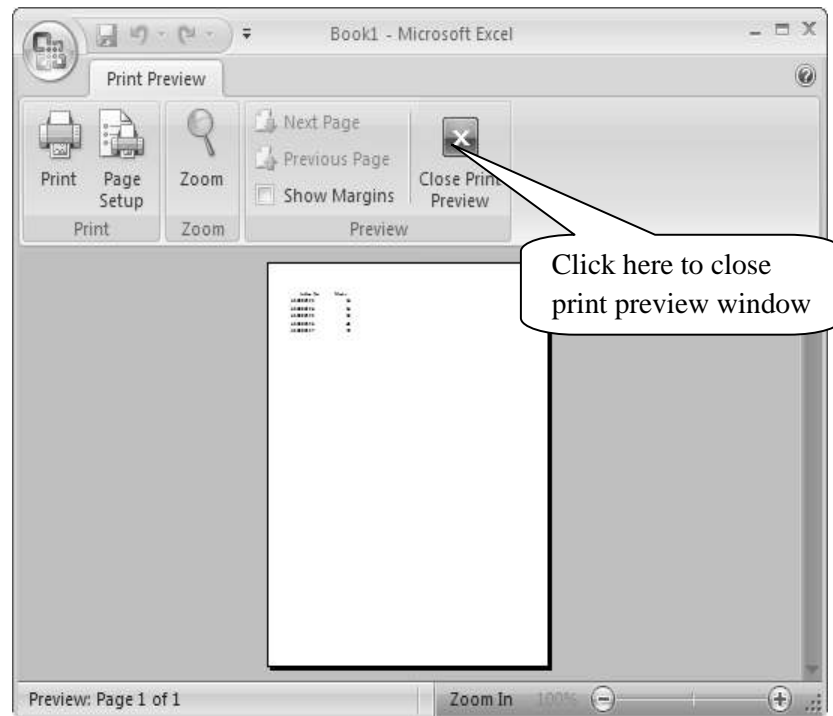

Figure 14.10: Print Dialog

**Quick Print:** you can directly print your document by using default print option. In this method you will not get the print dialog box as in the previous case.

**Print Preview:** Here the window's title bar indicates the preview of the document, and the print preview tab appears on the Ribbon. The appearance of the document that will be in the printout is displayed on the screen so that you can do the changes or give the command to proceed with printing.



*Figure 14.11: Print preview window*

By using print preview you can see a preview of your printout. Also it provides some facilities to change your document as you wish. You can exit from print preview option by clicking **Close Print Preview** button.

## 14.10 Self Assessment Questions



- 14.1 What are the advantages of using computerized Spreadsheets?
- 14.2 Define the following terms.
  - a. Spreadsheet
  - b. Worksheet
  - c. Workbook
- 14.3 Briefly explain the existing data entry techniques in MS Excel 2007.
- 14.4 What is meant by 'Freezing panes' in an Excel work sheet?
- 14.5 How do you prevent other users making changes to your worksheet?
- 14.6 What is the feature that allows you to see, how your printed worksheet will looks like?
- 14.7 How do you print only a part of your Excel worksheet?

## Session 15

### Manupulating Data in MS Excel 2007

---

#### Aims:

To provide a knowledge and skill in performing calculations on the entered data using formulas and basic functions available in MS Excel and sorting/filtering out required data from an excel work sheet.

#### Objectives:



Having studied this session the student will be able to:

- Insert formulas by using arithmetics operations with contents of the cells.
- Use the basic functions SUM, AVERAGE, MAX, MIN, IF, COUNTIF, etc.
- Sort a given list of data into a given criteria.
- Filter the required data from a data set satisfying a given condition(s).

#### 15.1 Performing Calculations on Data

Microsoft® Office Excel® 2007 workbooks give you a handy place to store and organize your data, but you can also do a lot more with your data in Office Excel 2007. One important task you can perform is to calculate total, average, finding the minimum/maximum, etc. for the values in a series of related cells.

In this session, you'll learn how to streamline references to groups of data on your worksheets and how to create formulas.

##### 15.1.1 Define and use cell range names in formulas

By using names, you can make your formulas much easier to understand and maintain. You can define a name for a cell range, function, constant, or table. Once you adopt the practice of using names in your workbook, you can easily update, audit, and manage these names.

1. Select the cell, range of cells, or nonadjacent selections that you want to name.
2. Click the Name box at the left end of the formula bar.
3. Type the name that you want to use to refer to your selection. Names can be up to 255 characters in length.
4. Press ENTER.

*OR*

1. Select the cell, range of cells, or nonadjacent selections that you want to name.
2. Right Click on the selection.
3. The **New Name** dialog box will be appeared. Type the name that you want to use to refer to your selection.
4. Give comments (optional).

5. Click **OK**.



Figure 15.1: Define a new group name

## 15.2 Working with Excel Formulas

A formula is a set of instructions for performing a calculation. Excel enables you to create a very wide range of formulas for performing whatever type of calculations you need. Each formula has a **cell reference** and starts with the '=' (equal) sign.

To create a formula, you can perform the following steps

1. Select a cell where you want to display answer.
2. Click the formula bar.
3. Type '=' Sign.
4. Type the function.
5. Press Enter.

**Example:** This simple example shows how to add two numbers.

1. Enter 34 in cell A2, and 56 in cell B2.
2. Select cell C2.
3. Type = (A2+B2).
4. Press Enter.

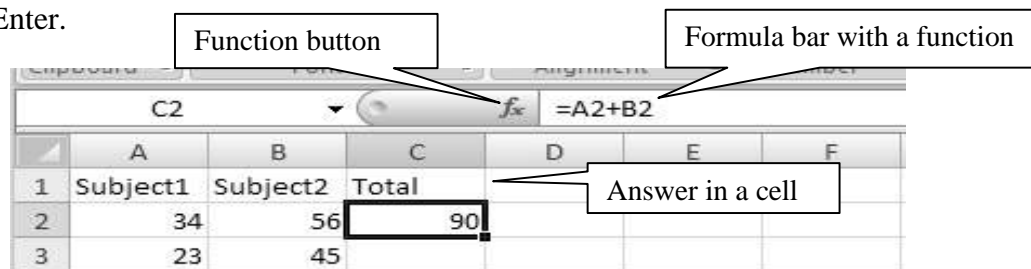

Figure 15.2: Formula bar and cells

Excel displays the result in cell C2.

Note that, each formula has **operand** and **operators**. The operand in a formula specifies the data you want to calculate. Operand may be,

- A constant value (for example **23 + 14**)
- A cell address or address range
- A work sheet function

Excel uses arithmetic operators, logical operators, reference operators and text operators as tabled below.

Operator	Explanation
<b>Arithmetic Operators</b>	
+	Addition (A1+B1)
-	Subtraction (A1-B1)
*	Multiplication (A1*B1)
/	Division (A1/B1)
%	Percentage
^	Exponentiation
<b>Logical Operators</b>	
=	Equal to
<>	Not equal to
>	Greater than
>=	Greater than or equal to
<	Less than
<=	Less than or equal to
<b>Reference Operators</b>	
:	Range of contiguous cell
,	Range of noncontiguous cell
[space]	The cell or range shared by two reference
<b>Text Operator</b>	
&	concatenates

Table 15.1: Arithmetic operators in Excel 2007

**Example:** Working with formulas.

Open the workbook named 'mybook' and use the 'Results' data sheet. Then insert following three data fields (see Figure 15.3).

1. Find the Total of the each 3 subjects.

$f_x$  =E2+F2+G2

2. Find the Average marks.

$f_x$  =(E2+F2+G2)/3

3. Add additional 5 marks for the each Average marks.

$f_x$  =(E2+F2+G2)/3+5

	A	B	C	D	E	F	G
1	NO	Index NO	Course Code	Marks	Subject 1	Subject 2	Subject 3
2	1	AS2009125	CSU 1140	34	90	56	89
3	2	AS2009126	CSU 1140	23	34	48	65
4	3	AS2009127	CSU 1140	56	78	63	78
5	4	AS2009128	CSU 1140	32	32	74	34
6	5	AS2009129	CSU 1140	67	90	76	95
7	6	AS2009130	CSU 1140	89	67	93	67
8	7	AS2009131	CSU 1140	78	43	34	45
9	8	AS2009132	CSU 1140	12	89	56	23
10	9	AS2009133	CSU 1140	94	76	32	43
11	10	AS2009134	CSU 1140	45	69	89	89
12	11	AS2009135	CSU 1140	37	56	49	34
13	12	AS2009136	CSU 1140	57	34	72	56

Figure 15.3: Formula bar and cells

### 15.2.1 Copying formulas

Sometimes when we enter a formula, we need to repeat the same formula for many different cells. In the spreadsheet we can use the copy and paste command. The cell locations in the formula are pasted relative to the position we Copy them from.

Cells information is copied from its relative position. In other words in the original cell (C1) the equation was (A1+B1). When we paste the function it will look to the two cells to the left. So the equation pasted into (C2) would be (A2+B2). And the equation pasted into (C3) would be (A3+B3).

	A	B	C
1	5	6	=A1+B1
2	2	3	=A2+B2
3	7	1	=A3+B3
4	5	4	=A4+B4

Often we have several cells that need the same formula (in relationship) to the location it is to be typed into. There is a short cut that is called **Fill Down**. There are a number of ways to perform this operation. One of the ways is to,

1. Select the cell that has the original formula.
2. Hold the mouse in right down corner in the cell (+).
3. Drag the cell box.

### 15.2.2 Absolute Positioning

Sometimes it is necessary to keep a certain position that is not relative to the new cell location. This is possible by inserting a \$ before the Column letter or a \$ before the Row number (or both). This is called Absolute Positioning.

	A	B	C
1	5	6	=\$A\$1+\$B\$1
2	2	3	=\$A\$1+\$B\$1
3	7	1	=\$A\$1+\$B\$1
4	5	4	=\$A\$1+\$B\$1

If we were to fill down with this formula we would have the exact same formula in all of the cells C1, C2, C3, and C4. The dollar signs lock the cell location to a FIXED position. When it is copied and pasted it remains EXACTLY the same (no relative).

### 15.2.3 Paste your formula using “paste special” method

1. Select the cell.
2. Copy the cell content.
3. Select the target cell.
4. Right click on mouse and select **paste special** on the shortcut menu.  
(Now you can see the paste special window)

- Using paste special window select what you need. For example, if you select ‘Values’ the paste operations gives pasting the values only. There will be no cell reference pasted. I.e.: it will paste the values containing in the copied cells but not the formulas.
- Click **OK**.

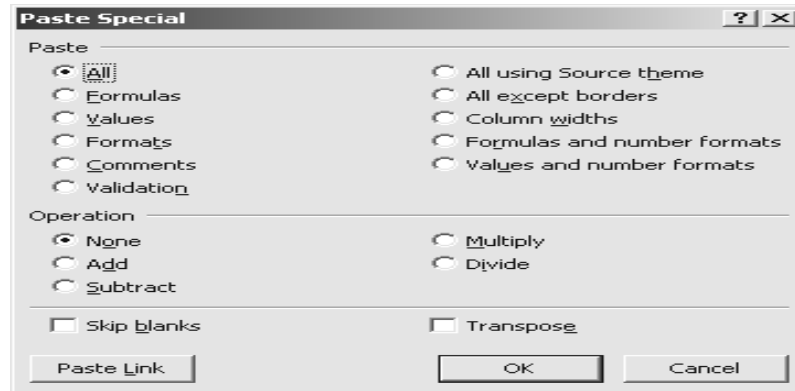

Figure 15.4: The paste special window

### 15.3 Working with Excel functions

A function is a small assignment that is performed to produce a result that can be reliably used without caring as to how the function works or how it was created. Built-in functions in Excel can be used to perform calculations on spreadsheet data. While most people use only those functions specific to their needs, there are many functions such as SUM, COUNT, AVERAGE, MAX, MIN, and the IF function that just about everyone uses.

To use a function in your spreadsheet, you can display its result in a cell. Because a cell is just a box, ready to display anything.

**Example:** Get the Summation of a number list using a Formula.

fx = =E2+F2+G2			
E	F	G	H
Subject 1	Subject 2	Subject 3	
90	56	89	235

#### SUM Function

Probably the most popular function in any spreadsheet is the SUM function. The Sum function takes all of the values in each of the specified cells and gives the total value of them.

The syntax is as follows:

=SUM (first value, second value, etc.)

In the first and second spots you can enter any of the following (constant, cell, range of cells).

**Note:** Blank cells will return a value of zero to be added to the total.  
Text cells cannot be added to a number and will produce an error.

fx = =SUM(E2:G2)			
E	F	G	H
Subject 1	Subject 2	Subject 3	
90	56	89	235



## More about SUM function

We will look at several different specific examples that show how the typical SUM function can be used! Notice that in Cell A4 there is a TEXT entry. This has NO numeric value and cannot be included in a total. Following table shows difference Method to use 'SUM' function.

A4	
	A
1	25
2	50
3	75
4	test

Function	Cells	Value
=sum(A1:A3)	A1, A2, A3	150
=sum(A1:A3,100)	A1, A2, A3 and 100	250
=sum(A1:A4)	A1, A2, A5	150

## AVERAGE function

The **Average** function finds the average of the specified data. (*Simplifies by add all the indicated cells together and divide by the total number of cells.*)

The syntax is as follows.

=AVERAGE (first value, second value, etc.)

Text fields and blank entries are not included in the calculations of the Average Function.

Following figure shows how average function is used to calculate the average value of the data range E2: G2.

fx =AVERAGE(E2:G2)				
E	F	G	H	I
Subject 1	Subject 2	Subject 3		
90	56	89	235	78.33333

## The MAX Function

The next function we discuss is **Max** (which stands for *Maximum*). This will return the largest (maximum) value in the selected range of cells.

The syntax is as follows:

=MAX (first value, second value, etc.)

A6	fx	=MAX(A1:A5)
----	----	-------------

Blank entries and text entries are not included in the calculations of the Max Function.

## The MIN Function

The next function we will discuss is **Min** (which stands for minimum). This will return the smallest (Min) value in the selected range of cells. Blank & text entries are not included in the calculations of the Min Function.

The syntax is as follows.

=MIN (first value, second value, etc.)



### The COUNT Function

The next function we will discuss is **Count**. This will return the number of entries (actually counts each cell that contains) in the selected range of cells. Blank and text entries are not counted.

The syntax is as follows.

=COUNT (first value, second value, etc.)



### IF Function

IF statement is used in Excel to do certain actions, only if something is true. For example, you might want to print out the message "Pass" if marks  $\geq 40$  in a particular result sheet. Otherwise, you just want to print out "Fail"

The **IF function** lets you to take this kinds of value based decisions. This section will show you couple of basic examples of how you can make use of the *IF function*. Syntax of the if function can be described as follows;

The IF function has three parts:

- The condition to be checked for satisfaction.  
Ex: We will use **C3 > 40** in the example below. This is a comparison.
- What to be done if the condition checked is satisfied. i.e. the condition is **true**
- What to be done if the condition checked is not satisfied. i.e. the condition is **false**

**Example:** Create a function to print the message "PASS" under the column with the heading "Results" if Marks is greater than 40. Else, print "FAIL"

=IF (C3>40,"PASS","FAIL")

The image shows an Excel spreadsheet with columns A through G and rows 1 through 6. The formula bar at the top shows '=IF(C3>40,"PASS","FAIL")'. The spreadsheet data is as follows:

	A	B	C	D	E	F	G
1							
2		No	Marks	Result			
3		1	56	PASS			
4		2	23	FAIL			
5		3	45	PASS			
6		4	67	PASS			

### Create an if function using Function Wizard

Excel has a built in wizard to help you make your own If functions.

1. Click function button (near the formula bar).

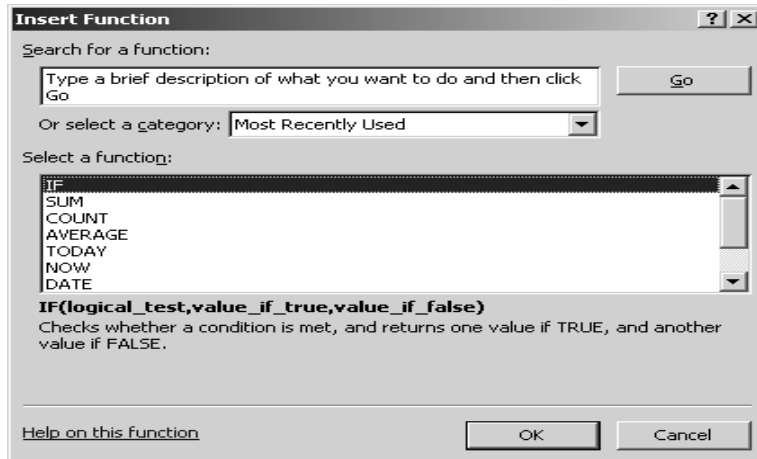

Figure 15.5: Insert function wizard

2. Click **OK**.  
(IF function wizard is appeared)
3. There are three places appear in the function wizard that are used to set logical test and the true or false values.
4. Put  $C3 > 40$  in **logical test** field.
5. Put "PASS" in to **value if true** field.
6. Put "FAIL" in to **value if false** field.

Then press OK to add if function.

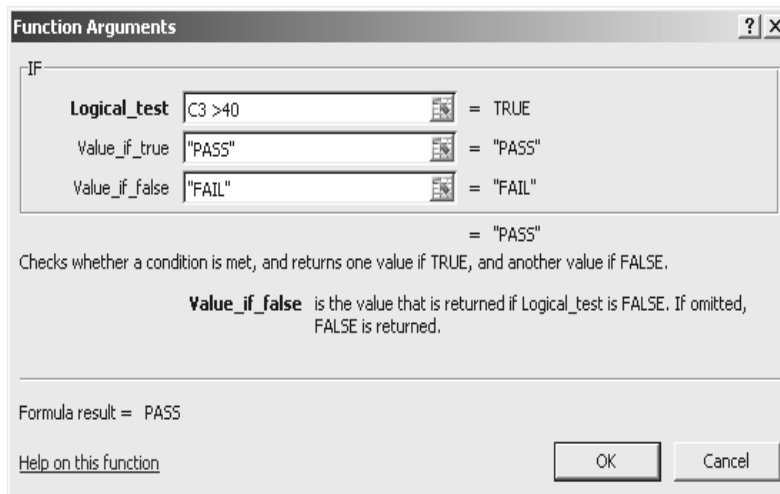

Figure 15.6: Function Arguments selecting window

**Example:** Create an if function to calculate the grade based on the marks of a given subject

Mark	Grade
Mark $\geq 75$	A
Mark $< 75$ & Mark $\geq 60$	B
Mark $< 60$ & Mark $\geq 55$	C
Mark $< 55$ & Mark $\geq 40$	S
Mark $< 40$	F

To do this, you can use a nested if function. When we use one or more if functions inside another if function, we call it as a **nested If function**.

=IF (A2>=75,"A", IF (A2>=60,"B", IF (A2>=55,"C", IF (A2>=40,"S","F"))))

	A	B	C	D	E	F	G	H	I	J
1	Marks	Grade								
2	30	F								
3	45	S								

### 15.3.1 Other functions available in Excel 2007

Though we learnt a few functions above, MS Excel has capability of using a vast collection of functions categorized into different categories based on the functionality of them. You can see all the functions available from the **Formulas** tab of the ribbon as shown below.

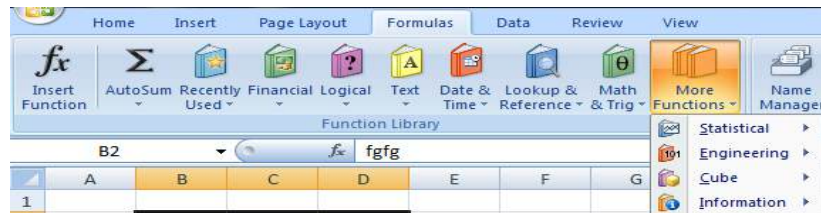

Figure 15.7: More Functions

### 15.3.2 Exploring more on functions

You can explore about the Functions available in MS Excel by using the Excel Help. The help menu gives you the descriptions on each function together with good examples for you to learn how to use them.

## 15.4 Sort and filter your data

When you work with a large data set, sometimes you might want to sort the records in a particular order, in order to make your working easy. Or you may feel easy to locate a particular data if the entire data set is sorted in a required order. Similarly, if the data set is quite large, sometimes you may want to filter out some data from the entire set. Following sections discuss how to **Sort** your data and how to **Filter** your data in MS Excel 2007.

### 15.4.1 Sorting your data

To sort your data, follow the steps given below.

1. Select your data set.
2. Select **Data** tab in the ribbon.
3. Point **Sort & Filter** group.
4. Click **Sort**.

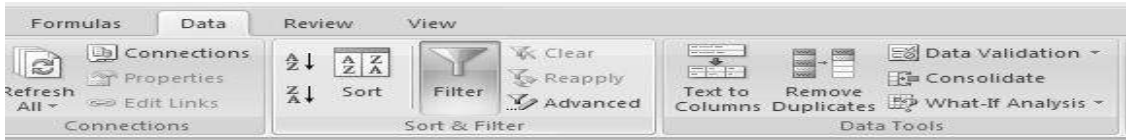

Figure 15.8: Excel 2007 ribbon for Sort and Filter data

**Example:** Sort your data set according to the Marks obtained by the students such that the student with the highest mark will come as the top row. (I.e. based on the Descending order of the Mark)

Follow the steps given below:

1. Select the entire data set including the column headings such as No, Index No, Course Code, and Marks

	A	B	C	D
1	<b>NO</b>	<b>Index NO</b>	<b>Course Code</b>	<b>Marks</b>
2	1	AS2009125	CSU 1140	34
3	2	AS2009126	CSU 1140	23
4	3	AS2009127	CSU 1140	56
5	4	AS2009128	CSU 1140	32
6	5	AS2009129	CSU 1140	67
7	6	AS2009130	CSU 1140	89
8	7	AS2009131	CSU 1140	78
9	8	AS2009132	CSU 1140	12
10	9	AS2009133	CSU 1140	94
11	10	AS2009134	CSU 1140	45
12	11	AS2009135	CSU 1140	37
13	12	AS2009136	CSU 1140	57

2. Go to the **Home** Tab.
3. Under the Editing group, click on the down arrow of Sort & Filter.
4. Select **Custom Sort**.



Sort window will be appeared as follows:

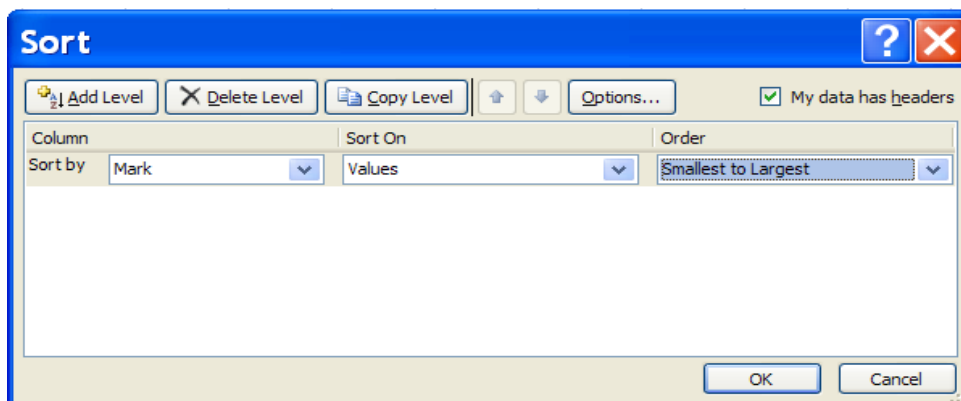

5. Select **Mark** from the Sort by list.
6. Select **Largest to Smallest** from the Order list.
7. Click **Ok**.

Your entire data set will be re-arranged as follows:

No	Index No	Course code	Mark
9	AS2009133	CSU 1140	94
6	AS2009130	CSU 1140	89
7	AS2009131	CSU 1140	78
5	AS2009129	CSU 1140	67
12	AS2009136	CSU 1140	57
3	AS2009127	CSU 1140	56
10	AS2009134	CSU 1140	45
11	AS2009135	CSU 1140	37
1	AS2009125	CSU 1140	34
4	AS2009128	CSU 1140	32
2	AS2009126	CSU 1140	23
8	AS2009132	CSU 1140	12

### 15.4.2 Filter your data

To filter your data, you can use the following steps,

1. Select your data set.
2. Select **data** tab in the ribbon.
3. Point **sort and filter** group.
4. Click **Filter**.

**Example:** filter you data set to display only who have obtained Marks greater than or equal to 75. Follow the steps given below:

1. Select the data set.
2. Click **filter** button in the sort and filter groups. Now you can see the column headings are changed as follows.

	A	B	C	D
1	NO	Index NO	Course Cod	Mark
2	8	AS2009132	CSU 1140	12

3. Click the down arrow in the marks column as shown above.
4. Select **number filters**.
5. Select **greater than or equal to** (Now custom filter will be appeared as follows).

	A	B	C	D	E	F	G
1	NO	Index NO	Course Cod	Mark	Subject 1	Subject	Subject
2	8	AS			90	56	89
3	2	AS			34	48	65
4	4	AS			78	63	78
5	1	AS			32	74	34
6	11	AS			90	76	95
7	10	AS			67	82	67
8	3	AS					
9	12	AS					
10	5	AS					
11	7	AS					
12	6	AS					

Figure15.9: Shortcut menu to filter data

6. Change the values as given below and click **OK**.

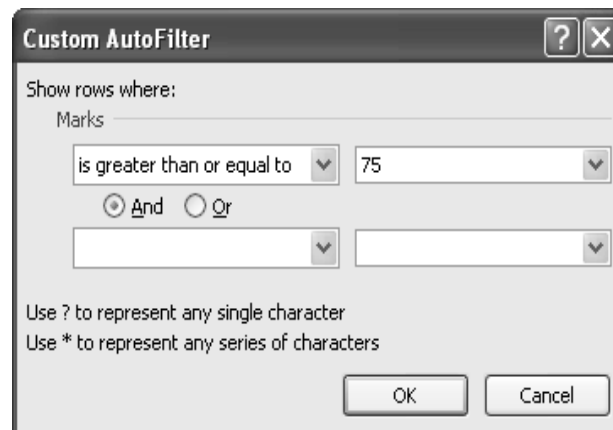

Figure 15.10: Custom Auto Filter Window

The output or the filtered data set will be displayed as follows. The other records will be hidden temporarily. Or you may copy the entire data set into a different location and perform the necessary filtering tasks if you need to compare the output with the original data set.

	A	B	C	D
1	NO	Index NO	Course Cod	Mark
11	7	AS2009131	CSU 1140	78
12	6	AS2009130	CSU 1140	89
13	9	AS2009133	CSU 1140	94
14				

Figure 15.11: Filtered data set

### Remove Filters in your data set

To remove the applied filters, perform the following steps:

1. Click the down arrow in the Marks Column.
2. Click **Clear Filter** from “Marks”.

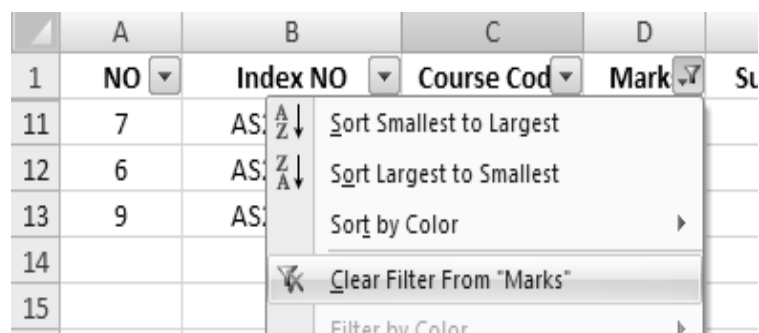

Figure 15.12: Remove filter in the data set

## 15.5 Errors in cells

When you work with Microsoft Excel you will meet the following common sources of errors appearing on the cells of your worksheet. Refer to the description given below to get an idea what that error is and what to be done if the error occurs.

Error	Description
#####	There is nothing wrong with your formula; the cell simply isn't big enough to display the result. Widen the column.
#DIV/0	You are trying to divide by zero. Correct the divisor or If the divisor is a cell reference, check to make sure the cell isn't empty.
#NAME?	There is a name in the formula that Excel doesn't recognize. If you used a natural language name, check the spelling or If you typed in a function, check the spelling or verify that the function exists or If you are performing operations on text, enclose the text in double quotation marks.
#REF!	A cell reference is not valid. Re-enter the formula.
#VALUE!	The formula uses the wrong type of operand or argument. Check to see that you're not performing math operations on labels or that arguments of functions that need to numeric are not referring to cells containing labels.

Table 15.2: Common function Errors



## 15.6 Self Assessment Questions

- 15.1 What do you type first in an empty cell to start a formula?
- 15.2 What are the four different types of operators use in Excel 2007? Give examples for each type.
- 15.3 What is the best way to display the result of a formula in another location on the worksheet?
- 15.4 How could you rearrange the data in ascending or descending order?
- 15.5 The quality of a product of a company is defined based on the number of deficiencies found in a sample of 100 products as given in the table below. Build a nested “IF” functions to be used to find the Quality of the product.

Deficiencies per 100products	Quality of the product
0	Excellent
In between 1 and 5	Good
In between 6 and 8	Satisfactory
Greater than 9	Bad

- 15.6 What does it mean if the following errors are appearing in some cells of your work sheet? How do you fix each error?
  - a. #####
  - b. #DIV/0
  - c. #NAME?



## Session 16

### Setting Document Appearance and working with Charts

---

#### Aims:

This lesson aims to give an idea on document appearance setting and will provide the basic ideas on charts.

#### Objectives:



Having studied this session you will be able to:

- Format the cells and the contents
- Change the document appearance by applying themes
- Create Charts for a given data set
- Customize the features of charts

### 16.1 Changing Document Appearance

#### 16.1.1 Format a cell by using cell formatting window

When you enter data into cells, the content will be displayed according to the default settings. For an example, if you enter the data '015' in a cell, by default Excel will recognize it as a numerical value and will be automatically displayed it as '15' by omitting the beginning zero and it will be right aligned in the cell as shown below.

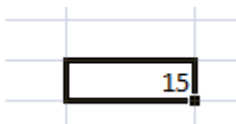

*Figure 16.1: Default Excel appearance*

Therefore, there will be instances where you need to format into special arrangements according to the requirement. To format your cells, follow the steps given below:

- Select a cell/ a range of cells.
- Right click.
- Select **format cell**.

Now, the **Format Cells** window will appear as follows.

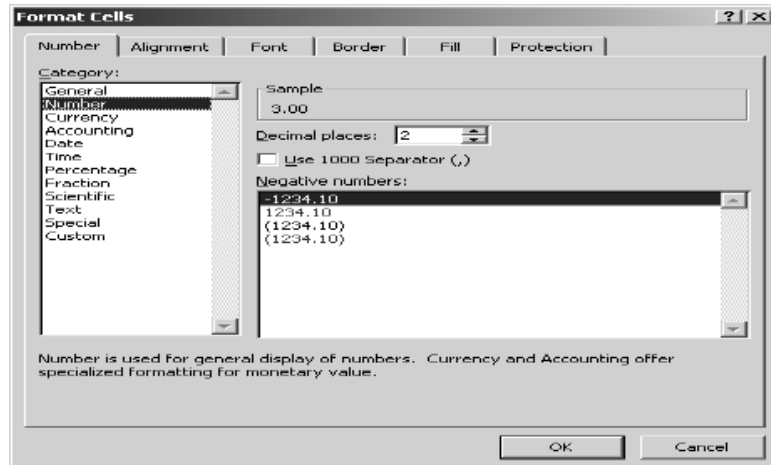

Figure 16.2: Format Cells window

By using this window you can format any cell or selected cells more easily. The cells can be formatted with respect to number formats, alignments, font, borders, fill, and protection of the content of the cell(s) using the tabs in the window.

**Example 1: Format your cell using a given number format**

1. Select **Number** tab in the cell formatting window.
2. Select the category **Currency**.
3. Set decimal places as 2 and Symbol as \$.

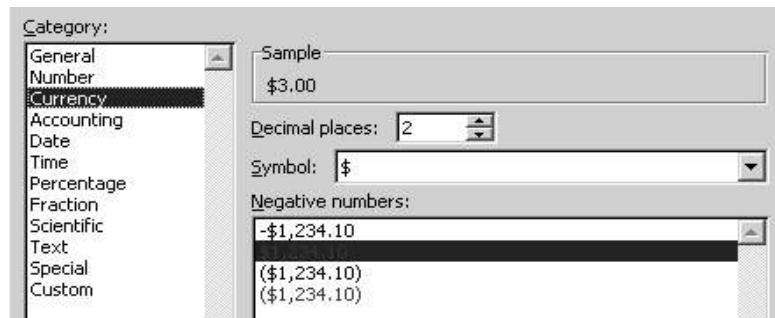

Figure 16.3: Available currency formats

**Example 2: Align the content of the cell**

You can align a cell text by clicking **Alignment** tab in a cell formatting window.

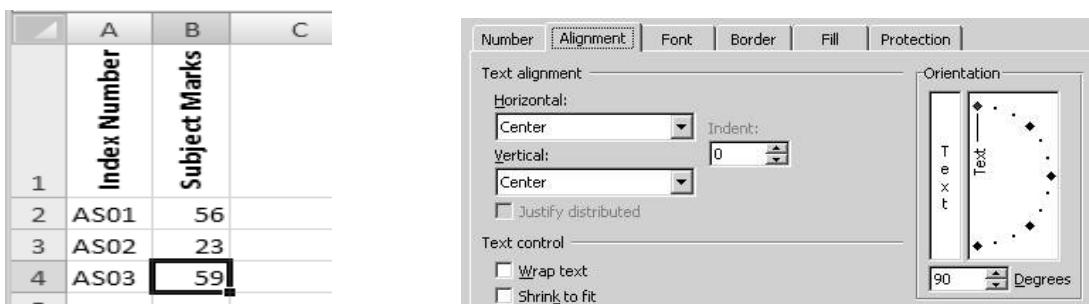

Figure 16.4: Aligning a cell text

To align the text in a cell, perform the following operations:

1. Select the cell(s) of which the alignment is to be set.
2. Select **Alignment** tab in the cell format window.
3. Set text alignment as center.
4. Set text orientation as 90 Degrees (to align the text as shown in above A1 and A2 cells)
5. Press **OK**.

### 16.1.2 Change font effect in a cell

1. Select the cell(s) of which the font is to be formatted.
2. Select the **font** group in the home tab.
3. Change the font effect as you need with respect to the font type, font style, colour, size, etc. You can preview the effects that you have applied under 'preview' as shown in the figure 16.5.



Figure 16.5: Change the fonts

**Example 3:** Insert the following heading to your personal data sheet. Font size -16, Style- bold and underline

	A	B	C	D
1	<b><u>Department of Mathamatics &amp; Computer Science</u></b>			
2				
3	<b>NO</b>	<b>Index NO</b>	<b>Name</b>	<b>Year</b>
4	1	AS2009125	Perera A. B.	2009

### 16.1.3 Change Border of a cell/range of cells

1. Select the **border** group in a home tab.
2. Change the Border style effect as you need.

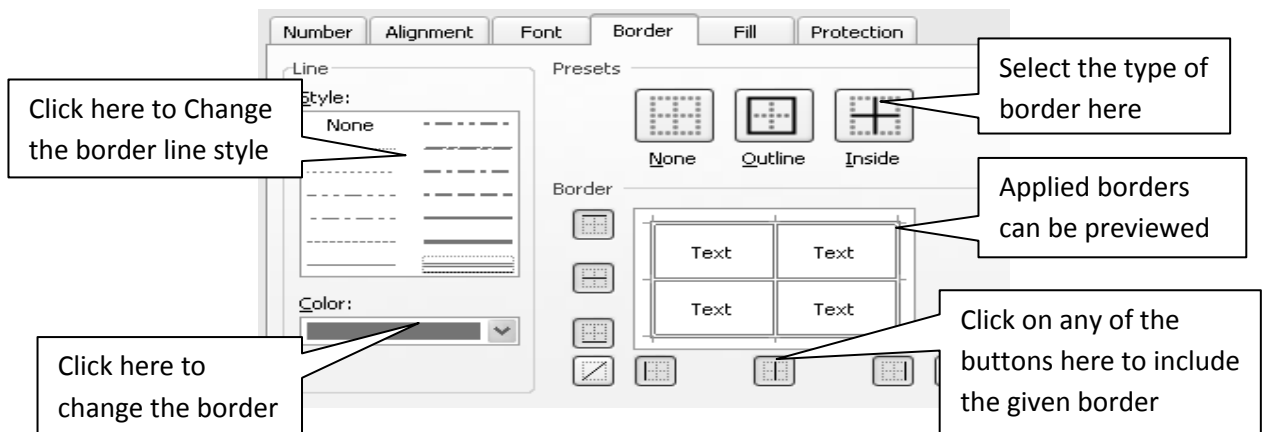

Figure 16.6: Change the border

**Example:** Add borders to the cell range as shown below.

	A	B	C	D
1	<b>Department of Mathamatics &amp; Computer Science</b>			
2				
3	<b>NO</b>	<b>Index NO</b>	<b>Name</b>	<b>Year</b>
4	1	AS2009125	Perera A. B.	2009
5	2	AS2009126	Gamage S. I.	2009
6	3	AS2009127	Hettige B. L.	2009
7	4	AS2009128	Namalage S. M. L.D	2009
8	5	AS2009129	Fernando S. N. I.	2009
9	6	AS2009130	Silva K. A.	2009
10	7	AS2009131	Silva S. H.	2009
11	8	AS2009132	Samarasinghe S. G.	2009
12	9	AS2009133	Samaraweera F. J.	2009
13	10	AS2009134	Sumanasekara D. J.	2009
14	11	AS2009135	weerasinge W. F.	2009
15	12	AS2009136	Gunawardene J. D.	2009

Figure 16.7: Sample data

#### 16.1.4 Change the fill style of a cell(s)

1. Select the **Fill** group in a home tab.
2. Change the Fill style effect as you need with respect to background color, pattern color if the cell(s) are to be filled with a pattern, and the pattern style.

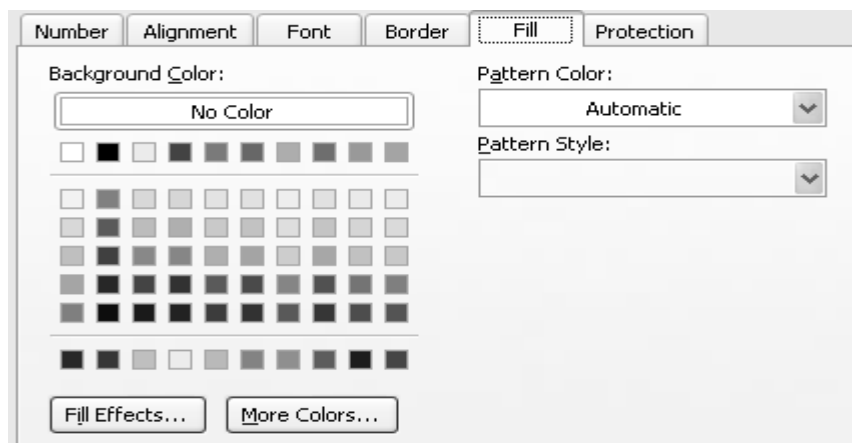

Figure 16.8: Cell Fill styles

### 16.1.5 Set row height

1. Select the row.
2. Right click on it.
3. Select **row height** in the Shortcut menu.
4. Set the row height by typing the preferred value.
5. Press **OK**.

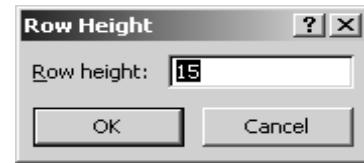

Figure 16.9: Row Height Window

### 16.1.6 Set the column width

1. Select the Column.
2. Right click.
3. Select **column width** in the Shortcut menu.
4. Set column width by typing the preferred value.
5. Press **OK**.

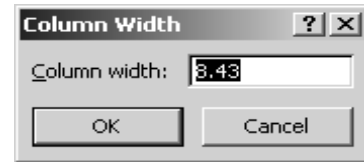

Figure 16.10: Column Width Window

### 16.1.7 Merge two or more cells

Two or more cells can be merged together so that the combination will act as a single cell.

1. Select the cells you need to merge.
2. Right Click on the selection.
3. Click **merge and center** icon.



Figure 16.11: Merging cells

### 16.1.8 Change the cell style

Excel has defined a set of styles to be applied to cells in order to differentiate them among other cells. A cell style is a defined set of formatting characteristics, such as fonts and font sizes, number formats, cell borders, and cell shading. To prevent anyone from making changes to specific cells, you can also use a cell style that locks cells.

To apply/change the cell styles, follow the steps given below,

1. Select the cell(s).
2. Click **home tab** in the ribbon.
3. Click on the down arrow to get the drop down list in the **styles** group.
4. Select a cell style.



Figure 16.12: Cell styles in the home tab

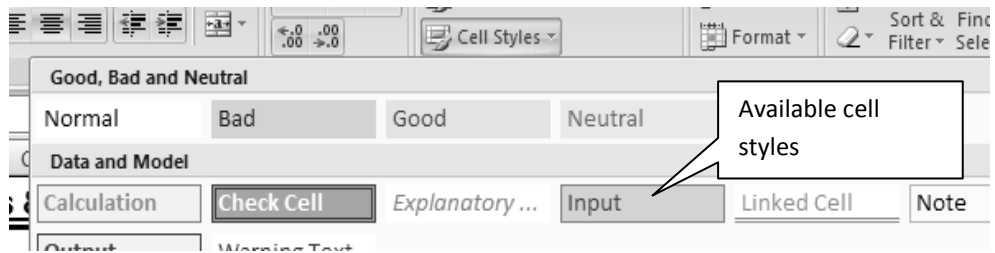

Figure 16.13: Available Cells

## 16.2 Conditional formatting of cells

You can format a range of cells such that the required data cells are appeared in a different manner according to the condition you specify. The **Conditional Formatting** facility helps you to do this. Similarly you can highlight interesting cells, emphasize unusual values, and visualize data in cells using Data Bars, Colour Scales and Icon Sets based on given criteria.

**Example:** Format the marks column of the above data set such that the marks which are above the average of the entire group of students are filled with a different colour so that the best group of students in the class can be identified at a glance.

Follow the steps below.

1. Select the Marks column.
2. Go to the **Home Tab**.
3. Click down arrow of **Conditional Formatting** in the **Styles** group.
4. Select **Top/Bottom Rules**.
5. Select **Above Average**.
6. Select the color filling option under the ‘for the selected range with’ in the next window.
7. Click **OK**.
8. The marks which are above the average of the class will be highlighted in a different colour as shown below.

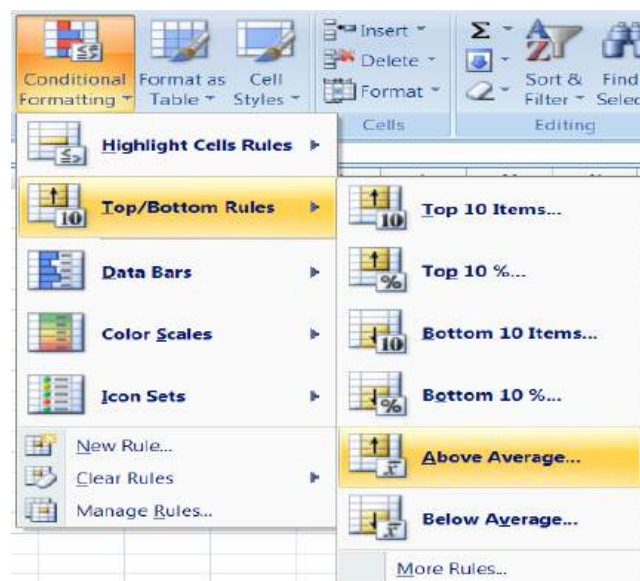

Figure 16.14: Selecting the condition preferred to format



Figure 16.15: Selecting the color filling option to apply

A	B	C	D
No	Index No	Course code	Mark
1	AS2009125	CSU 1140	34
2	AS2009126	CSU 1140	23
3	AS2009127	CSU 1140	56
4	AS2009128	CSU 1140	32
5	AS2009129	CSU 1140	67
6	AS2009130	CSU 1140	89
7	AS2009131	CSU 1140	78
8	AS2009132	CSU 1140	12
9	AS2009133	CSU 1140	94
10	AS2009134	CSU 1140	45
11	AS2009135	CSU 1140	37
12	AS2009136	CSU 1140	57

Figure 16.16: Conditionally formatted dataset

### 16.3 Applying Workbook Themes

The 2007 Microsoft Office system includes powerful new design tools that enable you to create attractive, professional documents quickly. The Excel 2007 product team implemented the new design capabilities by defining themes. By applying a theme, it will uniformly format all the text and graphics in the work sheet. You will see a clear difference in the colour scheme used after changing the theme.

To apply built-in themes into the worksheet, follow the steps given below

- Click **page layout** tab in the ribbon.
- Click **Themes** under the themes groups.
- Select the built-in style.

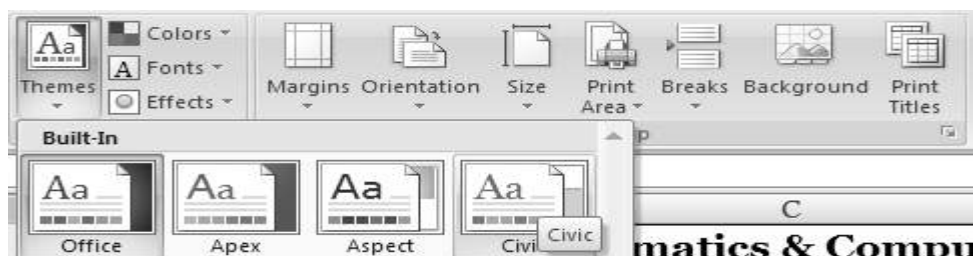

Figure 16.17: Cell fills data

## 16.4 Working with Charts

MS Excel is the best application to learn about Charts. Charts are usually used to give an illustration on the behavior of data at a glance, to the viewer, rather than reading the entire data set to study the behavior. For an example, a column chart can be used to illustrate the Marks obtained for Mathematics in the class. So that the student who is most good in Mathematics in the class can be identified at a glance as it will be the column with the greatest height among all other columns, which represent different marks obtained by different students in the class for mathematics.

MS Excel provides facilities to draw the following types of charts. You are required to decide which type will be most suitable to illustrate your data set depending on the nature of the data.

- Column charts
- Line charts
- Bar charts
- Pie charts
- Area charts
- Scatter charts
- Stock
- Surface
- Radar
- Bubble
- Doughnut

Following sections discuss more about charts.

### 16.4.1 Create a Chart using Chart tool

Microsoft excel 2007 provides easy way to create charts that you need. To create a chart, follow the steps given below steps.

1. Select the data set on which the chart to be drawn.

Name	Physics	Mathematics	Chemistry
A. F. Perera	45	67	89
A. C. Kumara	34	28	23
D.F Silva	23	48	45
N.M. Silva	56	72	76
S.K. Fernando	78	55	45
S.J. Gamage	93	84	66
K. N. Peris	42	93	45
R. S. Roza	37	67	76
S. J. Silva	84	53	38
H.B. Zoyza	56	87	95

2. Click Insert tab.
3. Click Chart.
4. Select the suitable chart type in a chart group and click on it.



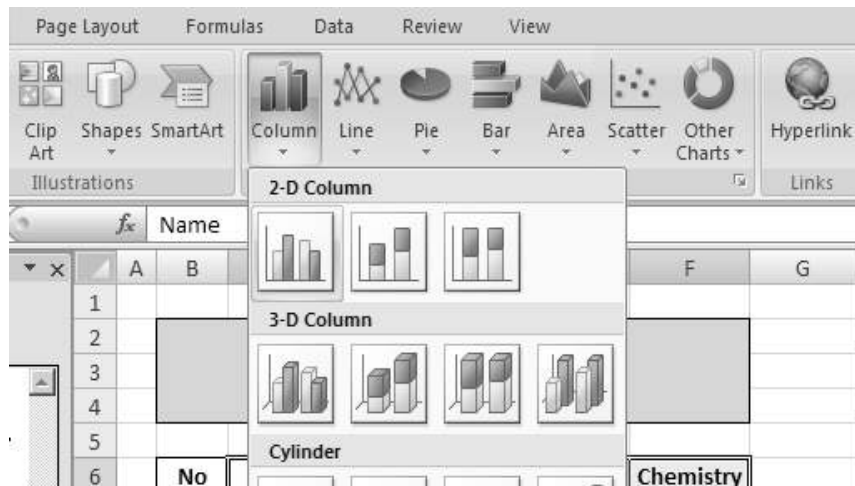

Figure16.18: Graphs types

Now you can see the sample chart and there is a chart tool is active in the ribbon also graphs will be displayed on your excel sheet. Now you can modify your charts.

#### 16.4.2 Modify chart Layout

1. Select your chart.
2. Click **design** tab in a chart tool and click.
3. Click **chart layout**.
4. Select suitable chart layout.
5. Modify titles as you need.

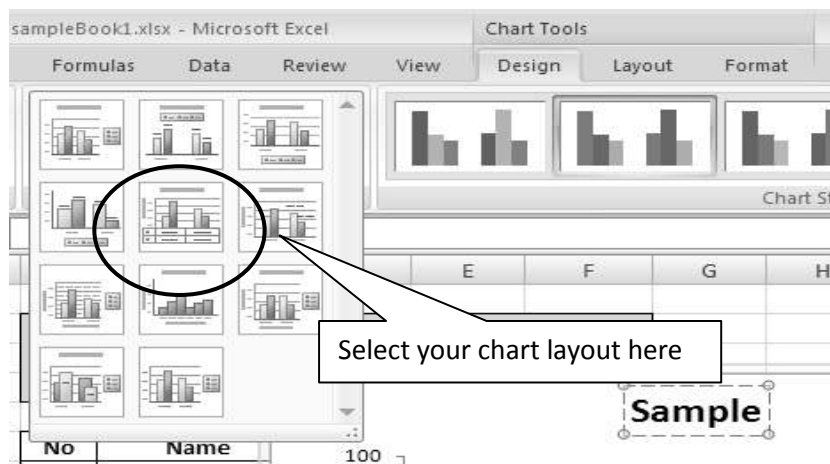

Figure16.19: Available Chart types

#### Example:

Change the chart title as “Mid-term test result”

Change the X axis title as “Student name”

Change the Y axis title as “Marks”

Your output will look like as follows:

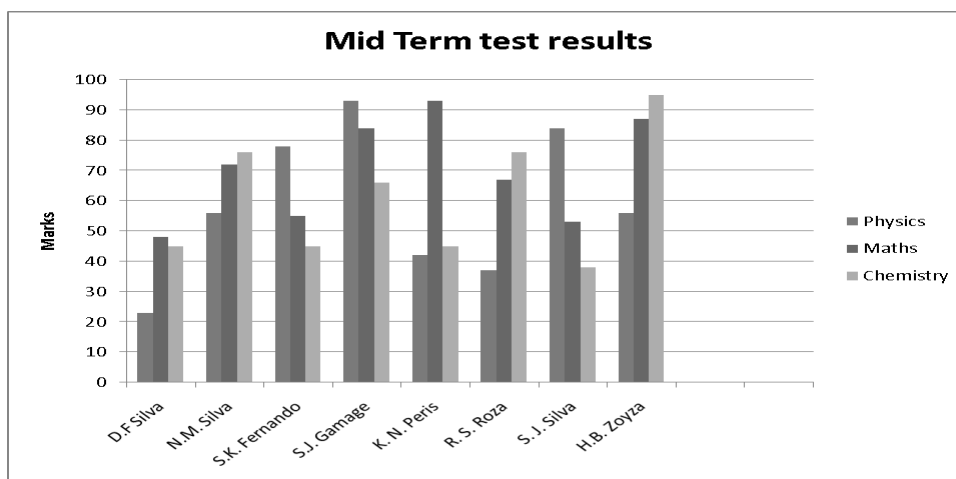

Figure 16.20: Sample output

### 16.4.3 Customize the appearance of a chart

Microsoft Excel 2007 provides easy way to customize charts as you need. To do this Excel 2007 provides 3 tools namely design, layout, and format tools.

### 16.4.4 The Chart design tool

The chart design tool can be used to change the data set layout and style in your data sheet. Brief description of the each tool is listed below.

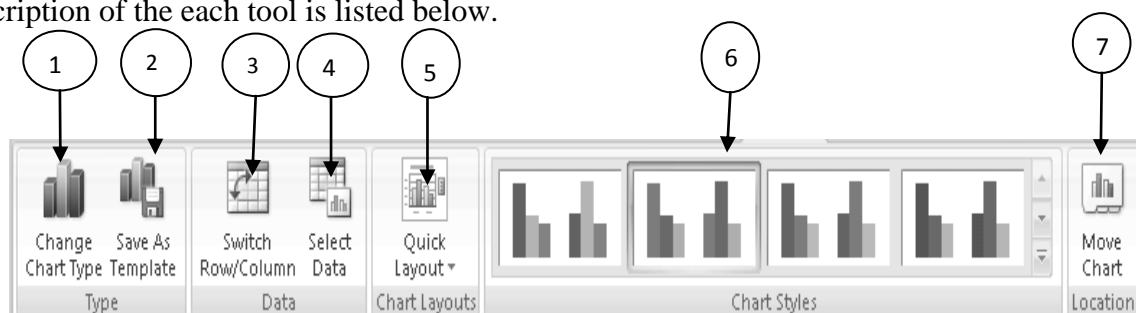

Figure 16.21: Chart Design tool

No	Name	Description
1	Chart Change tool	Change your chart type
2	Save as template tool	Save your chart as a chart template
3	Switch Row/column	Change the Row / Column of the Chart
4	Select Data	Change the data set of the chart
5	Quick layout	Change the chart layout
6	Style	Change the Chart style
7	Move Charts	Move your chart as a new sheet or object in a given sheet

Table 16.1: Tools available in the design tool

### 16.4.5 The Chart Layout tool

The chart layout tool contains number of tools to change the layout of your chart. Some useful tools are listed below.

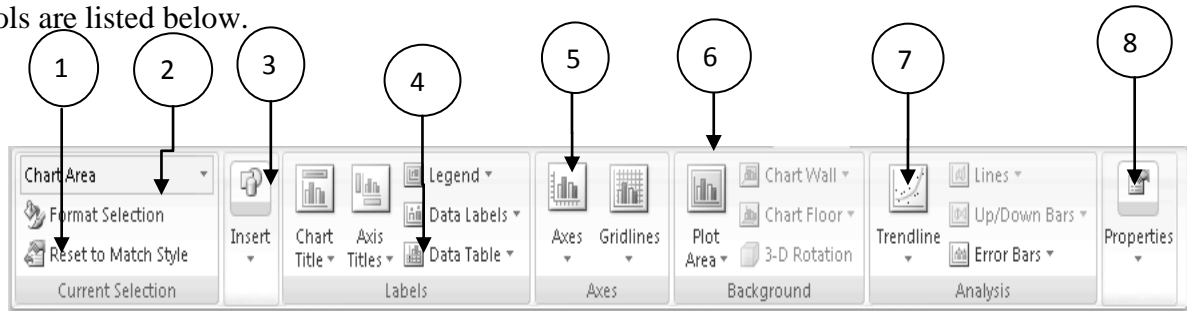

Figure 16.22: Chart Layout Tool

No	Name	Description
1	Current selection	Change the selected area of the chart
2	Format selection	Format the selected are of the Chart
3	Insert	Insert picture/shapes to your Chart
4	Labels	Change the label position and the style
5	Axes	Change the Axes of the chart
6	Plot Area	Change the Style of the plot area
7	Trend line	Insert a Trend line into your chart
8	Properties	Change the properties of the chart

Table 16.2: Tools available in the Layout tool

### 16.4.6 The Chart Format tool

The chart format tool is use to format your chart.

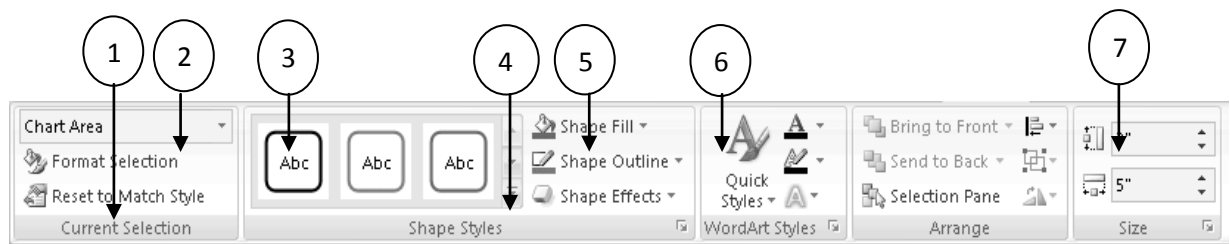

Figure 16.23: Chart format tool

No	Name	Description
1	Current selection	Change the selected area of the chart
2	Format selection	Format the selected are of the Chart
3	Style	Change the chart style
4	Shape effects tool	Change the effects of the shape
5	Shape fill	Change the chart fill properties
6	Quick style	Change the style of the chart quickly
7	Size	Change the chart size

Table 16.3: Tools available in the Format tool

## 16.5 Self Assessment Questions



- 16.1 What is the use of Excel conditional formatting?
- 16.2 What is the purpose of applying a theme to a worksheet?
- 16.3 Suppose that you want to create your expense sheet for the last month and wants to view the data in a graph. Which tool will you use to represent the data through a graph?
- 16.4 When creating the above expense sheet, what is the most suitable chart can be inserted to show the portions spent on each expense in last month?
- 16.5 What are the available tools in Excel 2007 to customize charts?

# Session 17

## Introduction to Microsoft PowerPoint 2007

---

### Aim:

To provide an overview of the Microsoft PowerPoint 2007

### Objectives:

Having studied this session you will be able to get an idea of:

- Introduction about MS PowerPoint 2007
- Working with Microsoft PowerPoint 2007
- Creating better presentations
- Formatting presentations



### 17.1 Introduction

Microsoft PowerPoint is a presentation program developed by Microsoft. This is used to produce professional-looking presentations. It is an application that comes with the Microsoft Office suit. Microsoft PowerPoint runs on Microsoft Windows and the Mac OS computer operating systems. Microsoft PowerPoint 2007 introduced several new features. Some of these features are listed below,

- Get better results faster with a redesigned user interface.
- Create powerful, dynamic SmartArt Diagrams.
- Easily reuse content with Office PowerPoint 2007 slide libraries.
- Communicate with users across platforms and devices.
- Use custom layouts to assemble presentations more quickly.
- Accelerate your review processes.
- Dramatically modify shapes, text, and graphics with new tools and effects.
- Add more security to your Office PowerPoint 2007 presentations.
- Reduce your document sizes and improve damaged file recovery at the same time.

In addition to the MS PowerPoint, there are so many other presentation programs which are computer software packages which can display information normally in the form of a slide show. Apple Keynote, Corel Presentations, Google Docs (web-based), OpenOffice.org Impress (open source), SlideRocket are some examples for them.

## 17.2 Working with MS PowerPoint 2007

### 17.2.1 Starting MS PowerPoint 2007

Do you know how we can open Microsoft PowerPoint 2007? There are various ways to do this. Let's have a look at some of the common ways used to launch Microsoft PowerPoint 2007

- Click **Start**→**All Programs**→**Microsoft Office**→**Microsoft Office PowerPoint 2007**
- If you are using My Computer or Windows Explorer, you can open the Program Files folder, then Microsoft Office, then Office, and double-click power point icon.
- You can create an empty document on your desktop and use it to launch Microsoft power point. To do that, you would right-click an empty area on the desktop, position the mouse on **New**→**Microsoft Office power point presentation**, type a name for the document, and press Enter twice.
- Double-clicking the any power point file.

### 17.2.2 Creating a new presentation (Method 1)

After starting MS Power point, you need to create a new presentation.

Click **Start button** → Click **New** (New document creation windows will appear)



*Figure 17.1: New document creation Window*

- Select the template: blank and recent.
- Select blank **presentation**.
- Click **Create**.

### 17.2.3 Creating a new presentation (Method 2)

In addition to the above method, you may follow the method given below as well to create a new presentation file.

Go to the location where you want to create the presentation file (Ex. Inside the **My PowerPoint work** folder in the E:\ drive)

1. Right click in the blank area of the location.
2. Select **New**.
3. Select **MS PowerPoint presentation**.

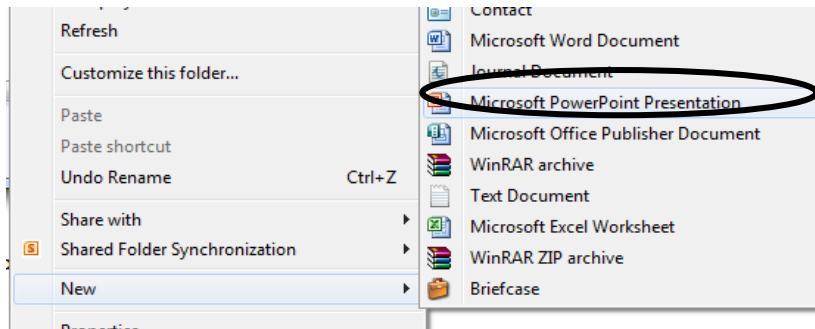

Figure 17.2: Creating a new presentation

### 17.3 Getting Familiarized with MS Power point 2007 user Interface

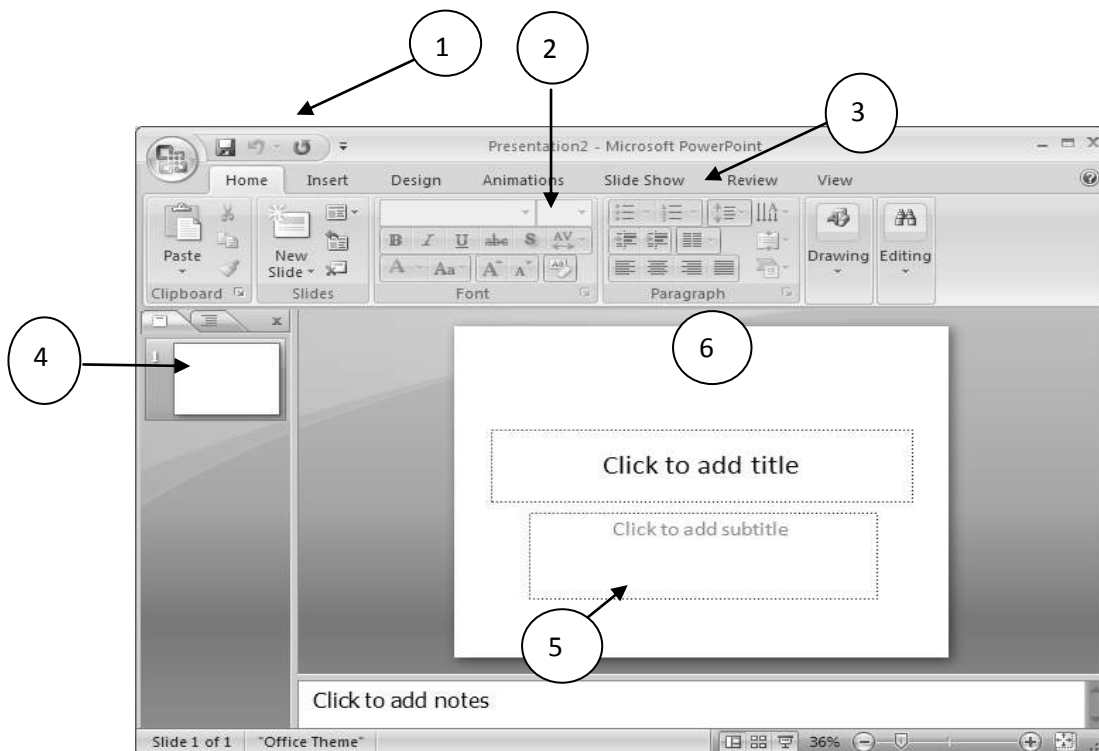

Figure 17.3: Microsoft power point user interface

No	Name	Description
1	Quick Access Tool Bar	The standard quick access tool bar (can customize its items)
2	Ribbon	The Standard ribbon for PowerPoint
3	Tabs	Heading Tabs in the Ribbon
4	Slide/Outline pane	Shows slides one under the other with the content outline
5	Notes section	Section for adding speaker notes
6	New Slide	Currently working slide selected from the slide pane

Table 17.1: MS PowerPoint User interface components

## 17.4 Start your presentation

### 17.4.1 Starting with the first slide

In PowerPoint 2007 a **Slide Layout** named **Title Slide** always appears first. Assuming that the presentation needs a title at the beginning the first slide, by default is called a **Title Slide**. The title part in this slide appears as the main section of the screen.

Your screen will look like the image below.

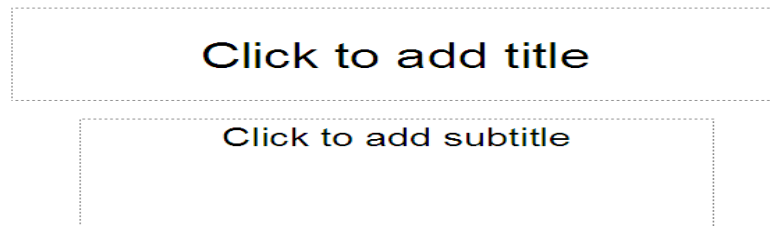

Place your cursor in the “**Click to add title**” box and **click** the left mouse button to start inserting the text in this formatted text box, we simply enter (**type-in**) the title:

*Example:* “Introduction to Computers” assuming that you are going to present about Computers to a group of students in a class.

Now, **click** in the second box “**Click to add sub-title**” and type the sub title to your presentation:

*Example:* Presented by: Ms. C.Y. Munasinghe  
The Open University of Sri Lanka

### 17.4.2 Inserting a new slide

Now it’s time to create the next slide in your presentation. To do this, we need to find the **New Slide** button. At the top left of the screen, in the **Home Tab** you will see a **New Slide** “**button**” which looks like the Figure 17.4.

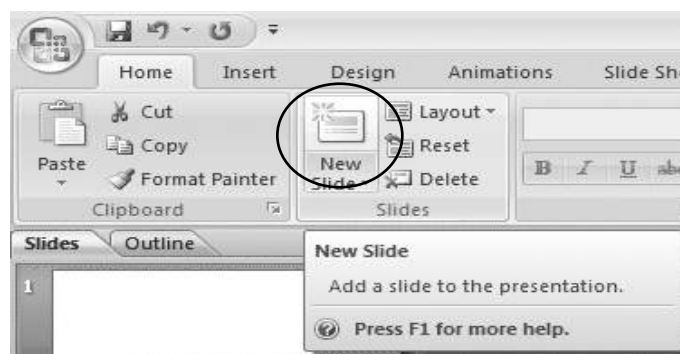

Figure 17.4: Inserting a new Slide

Your new **Slide 2** should look like the image below – even if you did not click the arrow.

The layout of the slides except the first one will look like the image shown below.



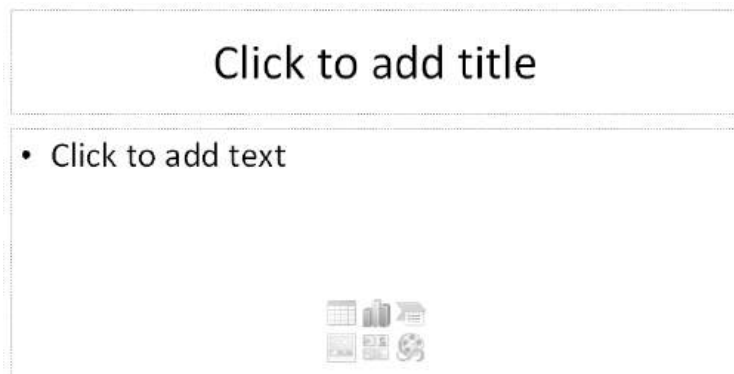

Figure 17.5: Layout of the second slide

**Example:**

Now click “Click to add title” box and type: “Parts of a Computer”.

Click in the “Click to add text” box and type:

- Processor (type Enter)
- Motherboard (type Enter)
- Hard Disk (type Enter)
- RAM

Note that the items you type in the text area will be automatically displayed as a bulleted list. The bullet can be customized as you wish. The Font properties also can be customized as you wish. The steps will be same as what you followed to format your text in MS Word session.

### 17.4.3 Deleting a Slide

To delete a slide, right click on the slide from the slide navigation pane at the left side of your screen and select Delete Slide.

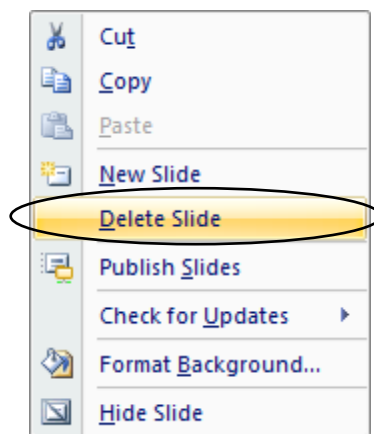

Figure 17.6: Deleting a Slide

### 17.4.4 Open an existing presentation

To open existing presentation, you have several options.

Locate and double click on any power point presentation file to be opened.

OR

Click the **Microsoft Office Button** and **Open** → then select the power point presentation you looked for → then Click **Open**.

### 17.4.5 Change the slide view

There are several ways to display your presentations namely as *normal view*, *slide sorter*, *notes page* and *slide show*. Brief description of the each view is given below.

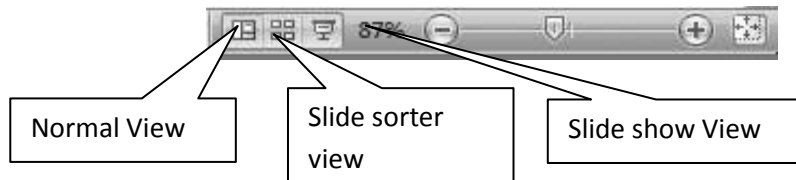

Figure 17.7: Slide Views

#### Normal View

Gives you a view of the **entire slide** as well as the “mini-previews” of each slide in the left area. This is the one we have been using so far.

#### Slide Sorter View

You can see small images of each slide. **In this view** you can **left click**-on a **slide** and, while **holding down the left mouse button, drag your slide to any position in your show that you desire**. This view assists you in arranging your slides in the order that you desire for your presentation. This view is sort of like the old, round 35mm slide show trays where you pulled-out and stuck-in slides, in the order you desired.

#### Slide Show view

Anytime you want to view your presentation, click-on this button. If you click on it now, you will see how the slide, on which you are working, will look. Give it a try if you desire. When you are finished looking at your slide, tap the **Esc button/key** in the **top-left** part of your **Keyboard**. This will take you back to the View in which you were working.

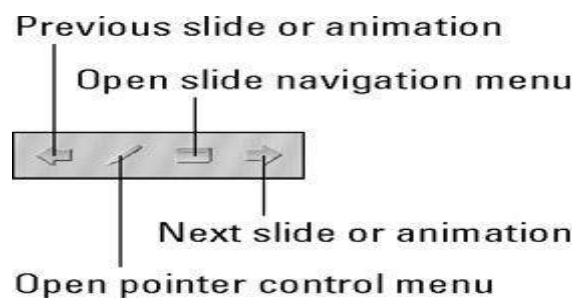

Figure 17.8: Slide show buttons

### 17.4.6 Hiding the slides

Sometimes you might want a slide to be included in a presentation but not in the slide show. You can hide the slide using the following steps.

- Go to “Slide” tab in the pane which contains ‘Slides’ and ‘Outline’.
- Right-click the slide you want to hide and click ‘Hide Slide’.



Figure 17.9: Hiding the slides

You will be able to see a hidden mark in the hidden slides as indicated in the image below.

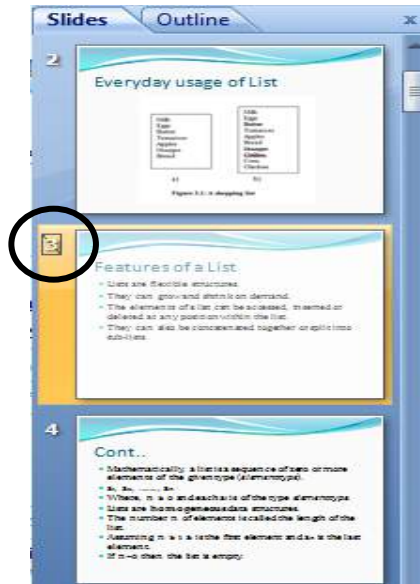

Figure 17.10: Hidden Mark

To show the slide which you have hidden earlier, right click and select ‘**Hide Slide**’ again.

## 17.5 Adding more components to the slides

Let us start out with an example slide presentation to discuss more on components that can be added into your slide.

### 17.5.1 Adding text and images in a single slide

**Example:** Insert a new slide into your presentation by Clicking on the New Slide tool and selecting Two Content as the layout of the slide to be inserted as shown below.

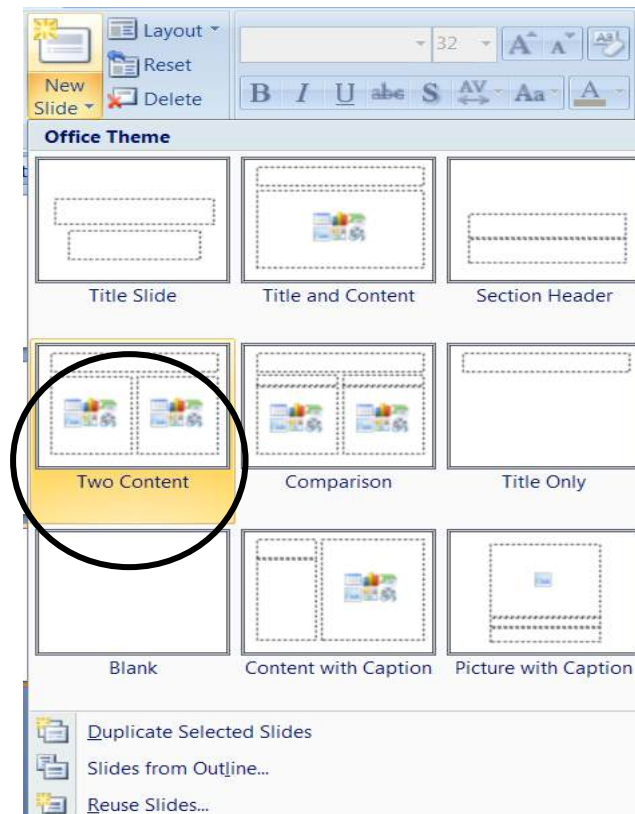

Figure 17.11: New slide with Two Content layout

1. Click in the top text box, Click to add title and type: **Processor types**
2. Click in the left Text or Content Box , Click to add text and type:

**Intel (tap Enter)**

**Intel Celeron (tap Enter)**

**AMD**

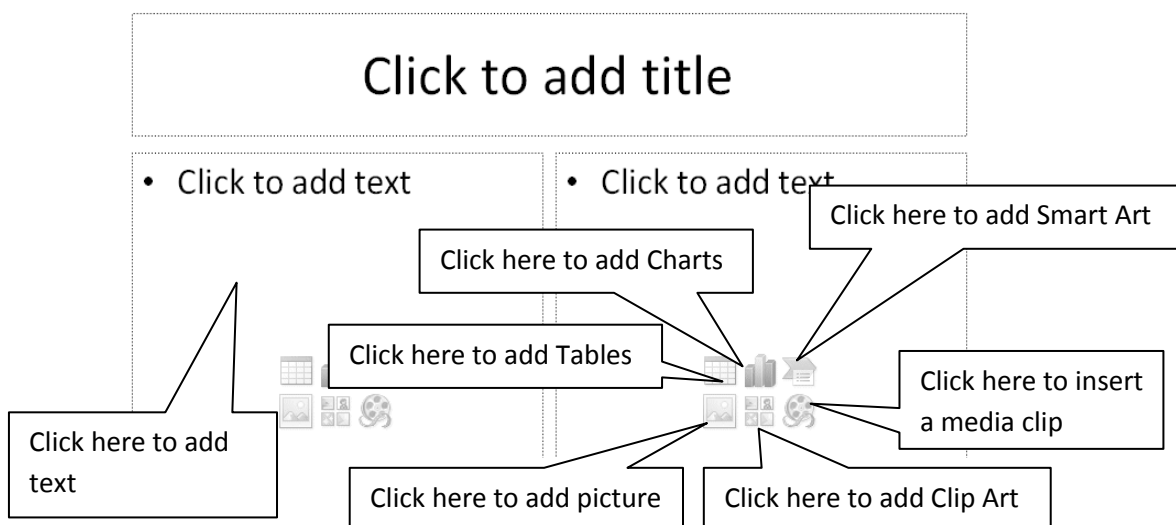

Figure 17.12: Components of the Slide

3. Click in the right text box - Click insert picture from file.



Figure 17.13: Insert picture from file

4. Select a suitable picture saved in your computer and press insert. Now your Slide will appear like this.

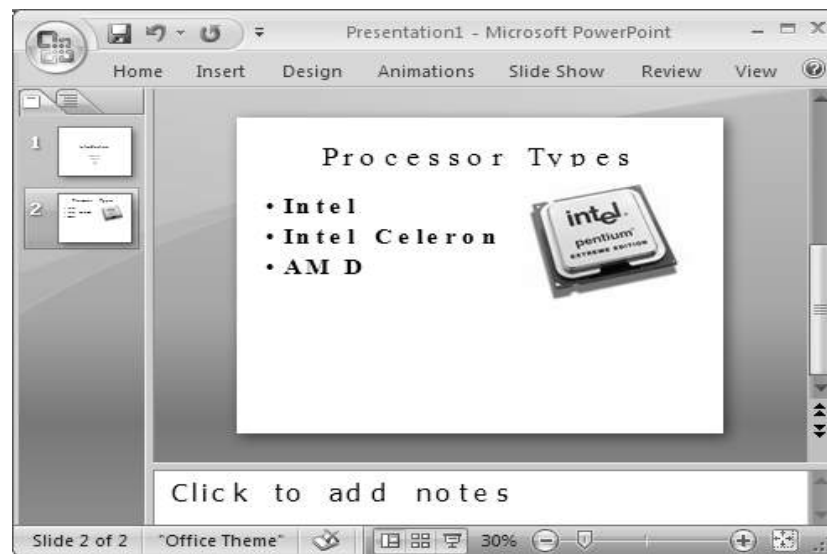

Figure 17.14: A sample completed slide

### 17.5.2 Adding hyperlinks

In PowerPoint, hyperlink is used to connect one slide with another slide in the same presentation or a slide in another presentation, an e-mail address, a Web page or a file.

You can create a hyperlink from text or from an object, such as a picture, graph, shape or WordArt.

1. Select the text or an object that you want to hyperlink.
2. Click **Hyperlink** in the Links group of the insert menu.



3. Give the location of the document or website in the address field.

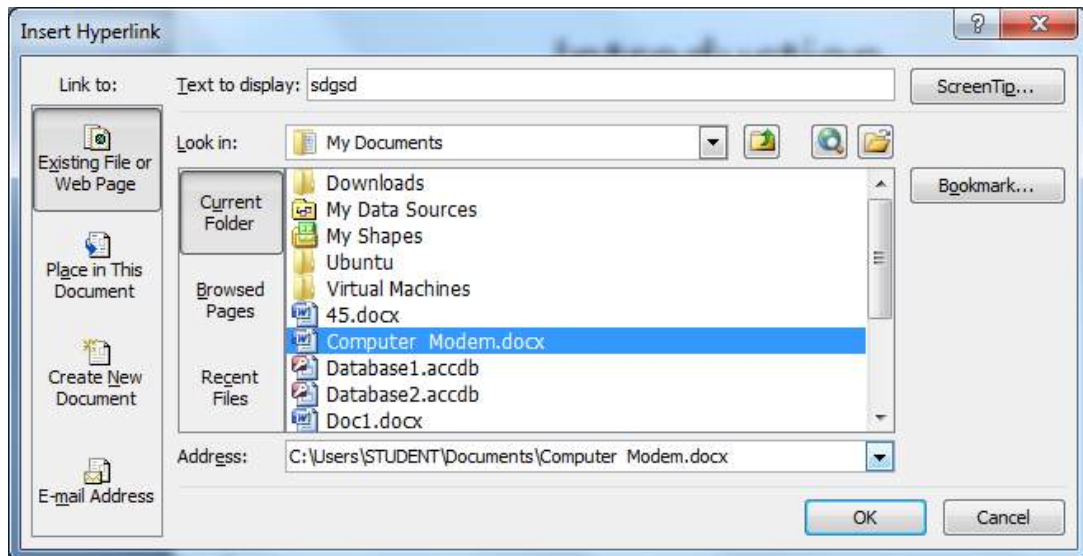

Figure 17.15: Selecting the location

4. Click **OK**.

If the colour of the text has changed to blue and underlined then it means that it has worked creating the link. Double check it by clicking the link.

## 17.6 Formatting Presentations

In this section, we will briefly describe some operations that can be used to format your presentation slides such as modifying the fonts and change the background.

### 17.6.1 Inserting a text box

Text is the main part of your presentation. It represents anything of your presentation. You can use textbox to represent the text.

Click **Insert** menu on the ribbon and click **Text box** on the **Text** group.

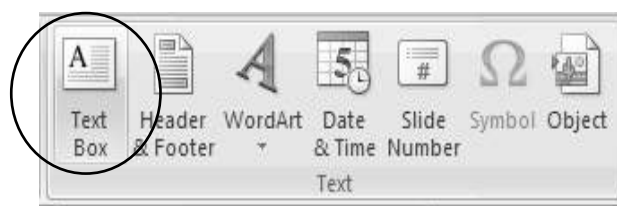
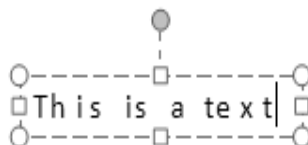

Figure 17.16: Insert a Text box

Place cursor to where you need to insert a new text box and type some text.



**Note:** You can format your inserted Text Box as similar to the steps you followed at MS Word.

## 17.6.2 Insert WordArt

To insert a WordArt, follow the steps given below.

1. Click **WordArt icon** in the text group of the insert menu.
2. Select suitable **WordArt type** and click.
3. Type some text.

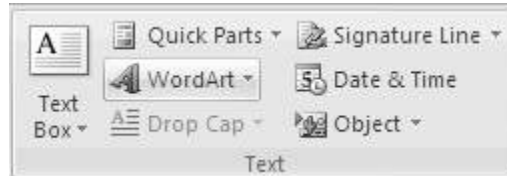

Figure 17.17: Insert a WordArt

**Note:** *Formatting the fonts and paragraphs will be similar to what we have learnt in Ms Word. Further, you can follow the same methods we have used in Ms Word, when working with bullets and numbered lists. Refer to the relevant sections we learnt under MS Word.*

## 17.6.3 Insert a Footer and Slide numbers

To insert a footer and slide numbers, follow the steps given below:

1. Click **Header and Footer icon** in the **text** group.
2. Click (tick off) Slide number and footer check boxes in the Header and Footer window.
3. Add some text in to footer area such as 'Introduction to MS Power point'.
4. Click Apply or "Apply to All".

**Note:** *You can insert Date and Time too to your slides using the above dialog box.*

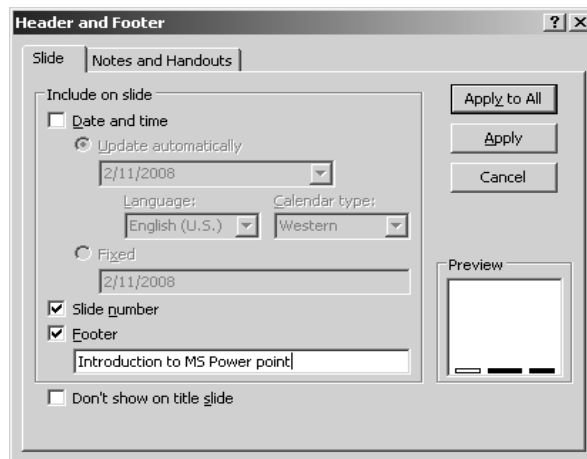

Figure 17.18: Insert header and footer window

## 17.7 Formatting backgrounds and layout

The **background** is the colour, texture, pattern, or image that is applied to the entire slide (or slide master), on which everything else sits. It's important to understand the distinction between a background and a background graphic because even though most themes contain both, they are set up differently, and making the change you want to the overall appearance of your slides often involves changing both.

To Change the background, follow the steps given below,

1. Right click on the any slide (Shortcut menu will be appeared).
2. Click Format background (Format background window will be appeared).

You have two ways to fill your slide background, such as fill effect of picture. To add colour effect select fill and change the background colour as you wish.

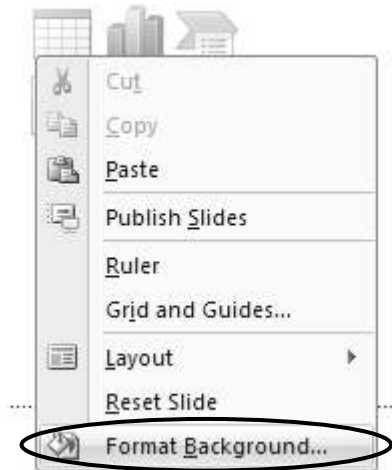

Figure 17.19: Format Background

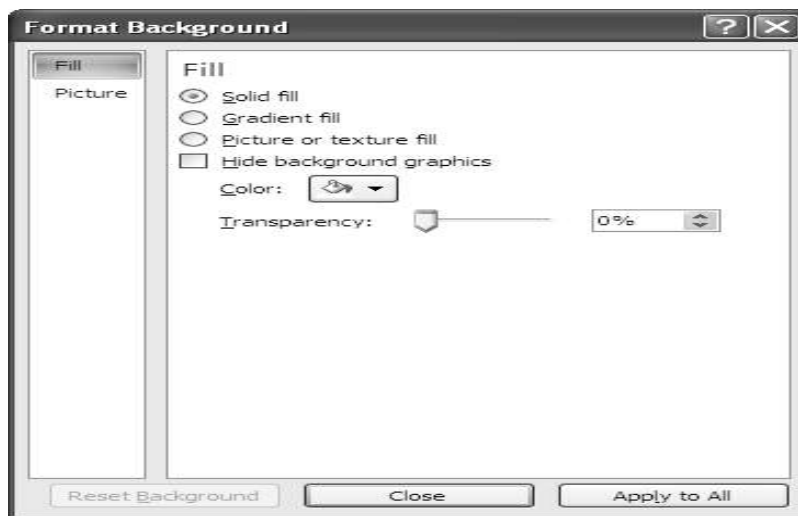

Figure 17.20: Background selection Window

3. If you need to apply this effect on the all slide click **Apply** to all otherwise click **Close**.

In order to change the background style we can use two methods.

### 17.7.1 Change the background style using Ribbon

On the **right side** of the **Design Tab/Ribbon** you'll see a **Background Styles** choice. **Click** the **down arrow** to the **right** of **Background Styles**. The menu screen on the right will appear.



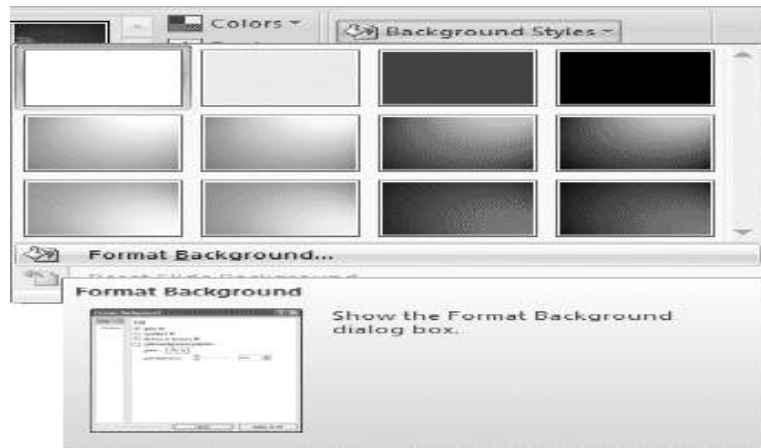

Figure 17.21: Select a Background style

### 17.7.1 Change the background using Format Background menu

Right click on the selected slide and click **Format Background** in the shortcut menu.

The **Format Background** menu screen will appear. Notice that there are several choices: **Solid fill**, **Gradient fill**, and **Picture or texture fill**. Click and try out each.

### 17.7.2 Change the Slide Layout

When you change the layout, it will change the type and/or positioning of the placeholders on it. To switch a slide to a different layout, follow these steps:

1. Select the slide(s) to affect.
2. On the Home tab, click **Layout**. A menu of layouts appears.
3. Click on the desired layout.

## 17.8 Applying Themes

The structure of the slide including the background colours, artworks, fonts, text positions, etc. will vary depending on the Theme you have applied in to your slide(s). For those who are familiar with previous versions of PowerPoint, Themes are similar to the Design Templates. For those using PowerPoint for the first time, we'll show you how to use Design Templates on individual slides, or on all of the slides in your presentation. If you are not on the Design Tab/Ribbon, **click the Design Tab**. You will see the **Themes Group**.

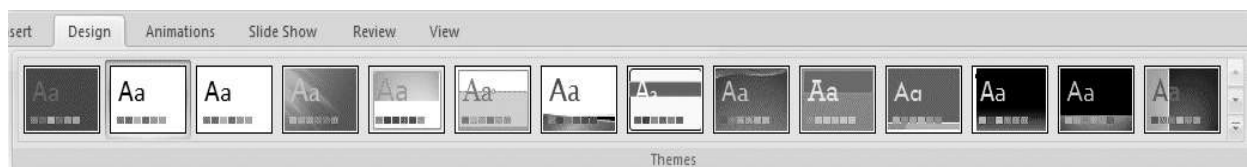

Figure 17.22: Themes Group

### 17.8.1 Insert Themes in to all slides

Click the Design Tab. You will see the Themes Group, select suitable themes and click on the selected themes.

## 17.8.2 Insert Themes in to Selected Slides

Click the Design Tab. You will see the Themes Group, select suitable themes and right click on the selected themes. Click Apply to Selected Slides in the shortcut menu.

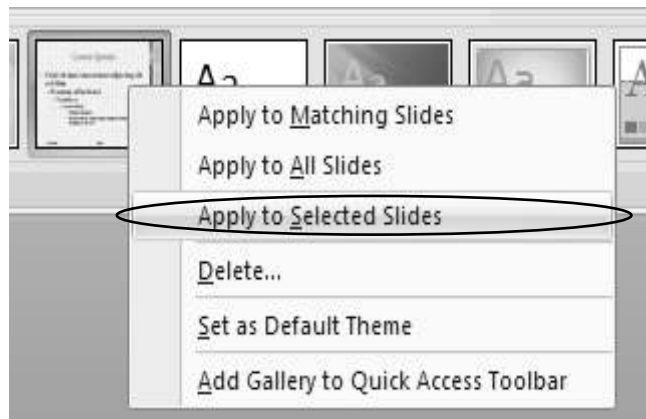

*Figure 17.23: Insert Themes to selected slides*

## 17.9 Using Slide Master

Let's review the relationship one more time between slide masters and themes. A theme is a set of formatting spaces. Themes are not applied directly to slides—they are applied to slide masters, which are then in turn applied to slides. The slide masters exist within the presentation file itself. You can change them by applying different themes, but they are essentially "built in" to the presentation file. When you change to a different theme for all of the slides in the presentation, your slide master changes its appearance. You can manage the changes to be done for the appearance of all slides using the Slide Master View. As long as all of the slides in the presentation use the same theme, you need only one slide master. However, if you apply a different theme to some of your slides, you need another master, because a master can have only one theme applied to it at a time. PowerPoint automatically creates the additional master(s) for you, and they are all available for editing in Slide Master View.

If you later reapply a single theme to all of the slides in the presentation, you do not need multiple masters anymore, so the unused one is automatically deleted. In addition to all this automatic creation and deletion of slide masters, you can also manually create and delete slide masters on your own. Any slide masters that you create manually are automatically preserved, even if they aren't always in use. You must manually delete them if you don't want them anymore. In the following sections, you will learn how to create and change slide masters manually.

### 17.9.1 Creating a Slide Master

To create/change slide master, follow the steps given below,

1. Click **View**.
2. Click **Slide master** (Slide master view will be appeared).
3. Click insert Slide master/ Edit the slide master.
4. Click Close master view.

## 17.9.2 Slide Master Tools

There are several tools available in the slide master view. Brief description of each tool is given below.

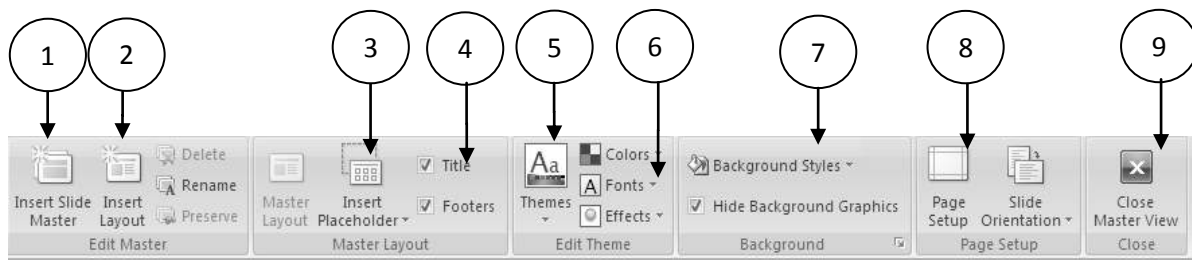

Figure 17.24: Tools available in the Slide master

No	Name	Description
1	Insert Slide master	To insert slide master click here
2	Insert layout	To insert new layout click here
3	Insert placeholder	To insert place holder click here there are several types such as continents, text, picture, smart Art etc.
4	Insert title and footers	Click here to insert title and footer
5	Themes	Click here to insert new themes
6	Edit themes	Click here to edit themes such as colors, Fonts and effects
7	Background style	Click here to change background style
8	Page setup	Click here to change the page setup
9	Close Master view	Click here to close slide master view

Table 17.2: Tools available in the Master View

## 17.9.3 Working with slide masters

The easiest way to make the same change to all slides or slides that use a specific layout is to change the slide master, also called the master slide. For example, imagine that you like a theme, but want to change a specific design element of the theme. You may want a different bullet style, slide titles that are center-aligned instead of left-aligned, or an accent line under each slide title. You can quickly make these changes and more by modifying the slide master.

### Slide Master View

To View the Slide Master:

- Select the View tab.
- Click the Slide Master View command in the Presentation Views group.

The slide master view appears similar to normal view; however, in slide master view master slides are displayed in the task pane rather than actual slides. The first thumbnail image in the task pane on the left is the slide master that controls all the slides (See Figure 17.25 below). If you want to make a change to all the slides in a presentation, you can do so by changing this slide.

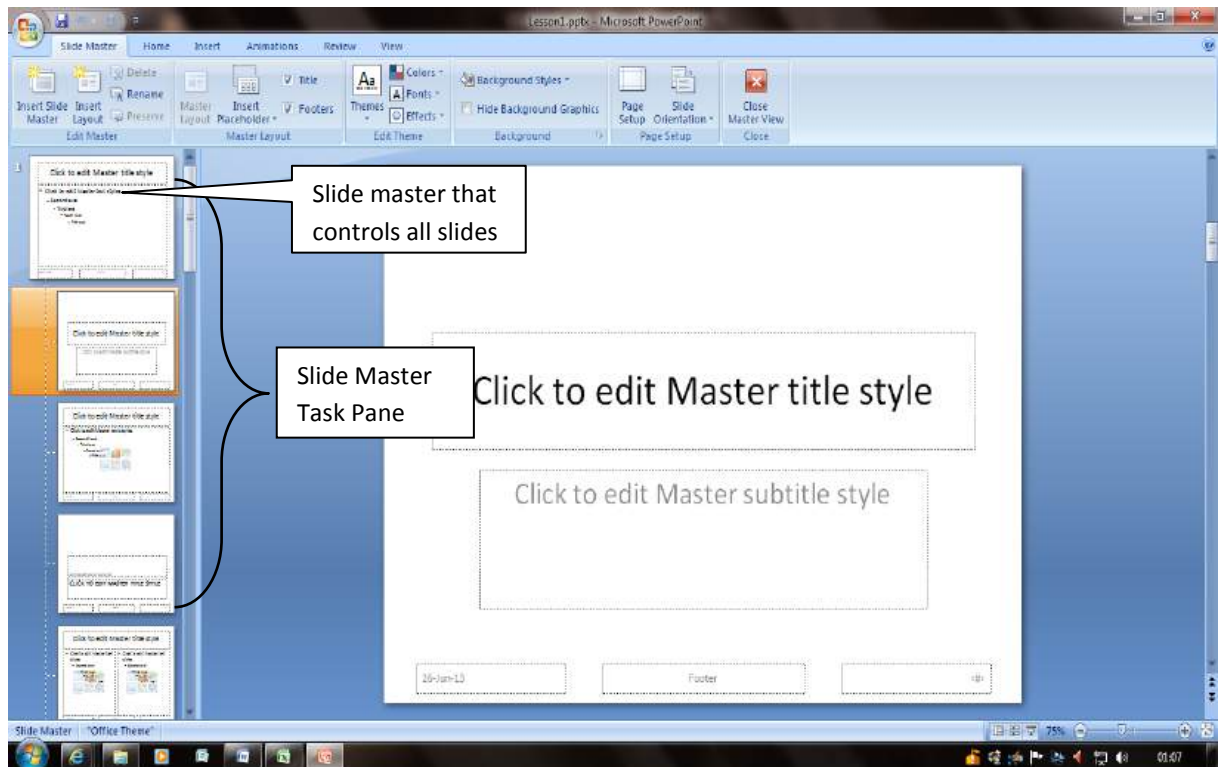

*Figure 17.25: Slide Master View*

## Changing all slides via slide master

Any change that you can make to a slide in normal view can be made to the slide master so the change will be reflected on all the slides in the presentation. The following examples will show how you can make these changes, and move from the Slide Master tab to other tabs on the Ribbon while the presentation remains in slide master view.

To Insert a Picture on All Slides

1. Select the **View** tab.
2. Click the **Slide Master View** command in the Presentation Views group. The Slide Master tab will appear.
3. Select the **slide master** for all the slides, if it is not currently selected.
4. Select the **Insert** tab.
5. Click the **Picture** command in the Illustrations group. The Insert Picture dialog box will appear.
6. Locate the picture file on the computer.
7. Select the picture file.
8. Click **Insert**. The picture will appear on the slide master.
9. Position the picture as you wish.

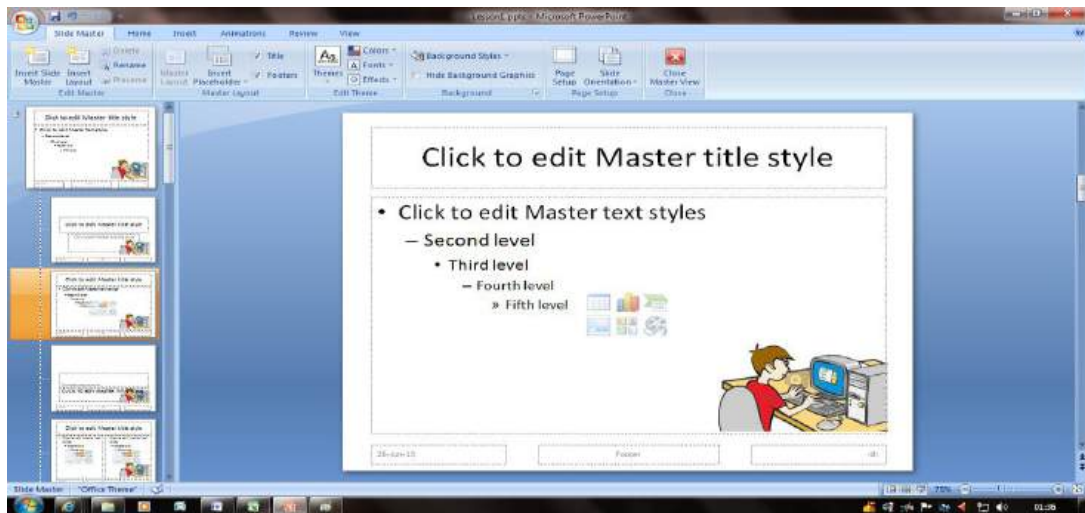

Figure 17.26: Changing Slides via Slide Master View

10. Click the **Slide Show View** or **Normal View** command at the bottom of the window to exit slide master.
11. View and see the changes in the presentation slides.  
(You will see that the picture has been inserted into all slides in the same location)

**Note:** Similarly, you can do the changes with the text, images or any other component in the slides using the slide master as described above.

### Making Changes to Specific Layouts

In addition to changing design elements on all slides, you can change design elements on slides that use a **specific layout**. For example, you can apply different formatting to the Title and Content or Section Header layouts. By customizing specific slide layouts, you have more control over the slides and the presentation, as a whole.



### 17.10 Self Assessment Questions

- 17.1 What is PowerPoint? State the use of it.
- 17.2 State five new features introduced in MS PowerPoint 2007.
- 17.3 What are the available views to display the PowerPoint presentations? Briefly describe them.
- 17.4 Which view is used to create and edit slides in MS PowerPoint?
- 17.5 In PowerPoint, what is the use of hyperlinks?
- 17.6 How could you insert the date and time into your slides?
- 17.7 Describe the relationship between the slide masters and themes in PowerPoint?
- 17.8 How could you make a logo to appear on every slide in a presentation?
- 17.9 What is the default file extension for MS PowerPoint 2007 files?

# Session 18

## Advanced Features and Delivering Your Presentation

### Aim:

To make your presentation more attractive with advanced features of MS PowerPoint and to deal on how to present your show to an audience with supporting printed material.

### Objectives:

Having studied this session, the student will be able to get an idea about:



- Working with images, clipart, and smart arts
- Working with Audio and video clips
- Working with multimedia
- Adding animations to your presentation
- Delivering the presentation
- Printing the slides

### 18.1 Working with Graphics, Images and Clips

Microsoft Office PowerPoint 2007 provides several facilities to work with image objects. This session describes more on how to work with pictures, cliparts, shapes, SmartArt, and charts. You already saw that these items can be added through the tools provided with the Slide layout that you added newly into your show. However, the similar work can be done by using the group “Illustrations” appearing under the PowerPoint ribbon.

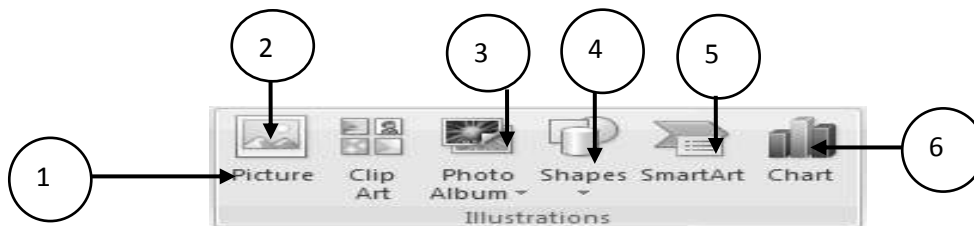

Figure 18.1: Illustrations group

Item No.	Description	Functionality
1	Picture	Insert a picture from a file
2	Clip Art	Insert a Clip Art into the document, including drawings, movies, sounds, or stock photography to illustrate a specific concept
3	Photo Album	Create or edit a presentation based on a set of pictures
4	Shapes	Insert ready-made shapes, such as rectangles and circles, arrows, lines, flowchart symbols, and callouts.

5	Smart Art	Insert SmartArt graphics range from graphical lists and process diagrams to more complex graphics, such as Venn diagrams and organization charts.
6	Chart	Insert a chart to illustrate and compare data.

*Table 18.1: Illustration group*

### 18.1.1 Insert Pictures into your slide

To insert a picture in to your slide,

1. **Set cursor position** to where you want to insert a picture.
2. Click **insert** tab.
3. Click **picture**.
4. Select a picture.
5. Click **insert** button.



*Figure 18.2: Picture icon in illustration group*

As you select your picture, (i.e. click on the picture) then you will be able to see that the picture format tool bar is activated. Using this tool bar you can do modifications to the picture very easily. Please re-call what you have learnt under images under the MS Word sessions.

### 18.1.2 Insert a Picture from Clip Art gallery

To insert a picture from Clip Art follow the steps below:

1. Click **New Slide Button**.
2. Click ClipArt picture in the new slide



*Figure 18.3: Clip Art picture in New slide*

3. Now ClipArt selection windows will be appeared.

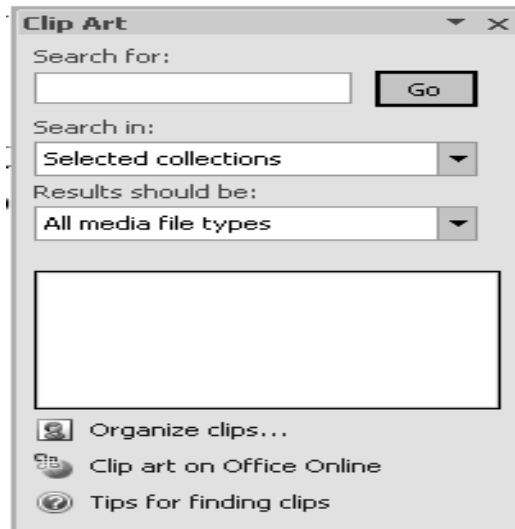

Figure 18.4: Clip Art selection Window

4. Set the **select in** as **all collection**.
5. Set **result should be**, **all media file types**.
6. Then Click **Go** button.
7. After showing the all clips select one of them, click on it.

**Note:** *The inserted picture/clip art can be modified as similar to what you learn under the MS Word sessions. Please refer back to the relevant sections.*

### 18.1.3 Insert a Smart Art

Same as Microsoft word 2007 you can insert a Smart Art into your presentation. To Insert a SmartArt, perform the following operations

1. **Set cursor position** where you want to insert a SmartArt.
2. Click **inset tab**.
3. Click **SmartArt**.
4. Select a type of the SmartArt.
5. Click **OK**.
6. Type the text.
7. Click **OK**.

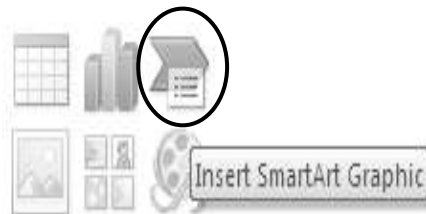

Figure 18.5: Insert SmartArt

**Note:** *The inserted SmartArt can be modified as similar to what you learn under the MS Word sessions. Please refer back to the relevant sections*



### 18.1.4 Insert a Table into your presentation

Tables are used to categorize data from many views. To insert table to your presentation, follow the steps given below,

1. Create a new slide.
2. Click the table in the new slide.
3. Insert numbers of columns and rows.
4. Click **OK**.
5. Enter data as you need.
6. Select the table style from Design – table style.
7. Click **OK**.

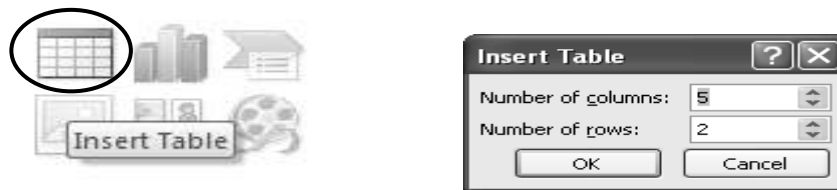

Figure 18.6: Insert Table

## 18.2 Working with Multimedia

PowerPoint creates complete multimedia presentations, which means that not only you can include pictures and sounds but also movies and animations. In this section, you'll learn how to select the appropriate video type, how to insert clips, and how to control when they are played.

### 18.2.1 Different Types of Videos

The following sections discuss the types of videos that PowerPoint supports.

#### Animated GIFs

As you may already know, GIF is a file format for static graphics files. One of the advantages of it over other graphic file formats is that you can create animated versions. These are not really videos in the traditional sense; they are a collection of still graphics stored in a single file under one name. You cannot control the animation of an animated GIF through PowerPoint, nor can you set it up to repeat a certain number of times. That information is contained within the GIF file itself. PowerPoint simply reads that information and plays the GIF accordingly.

#### Live-Action Videos

Now you learn about the "real videos." Recorded videos have a live origin. Someone went out with a video camera and pointed at something in the world. You can get live-action videos from the Internet, but in most cases for business presentations you will want to record it yourself with a camera to suit your purpose.

#### Video File Formats

PowerPoint can accept videos with the following file formats:

- Motion Picture Experts Group (.mpg, .mpeg, .m1v, .mp2, .mpa, and .mpe)
- Microsoft streaming format (.asf and .asx)

- Microsoft Windows Media Video (.wmv)
- Audio Video Interleave (.avi)
- QuickTime (.mov or .qt) versions 1 and 2.x

### 18.2.2 Insert a Movie Clip

You can insert a clip file in several ways.

If you need to insert video clip or audio clip into your presentation follow the steps given below.

1. Click **insert** tab.
2. Click Movie icon in the Media Clips groups.



Figure 18.7: Movie icon

3. Select a Movie file and click **OK**.

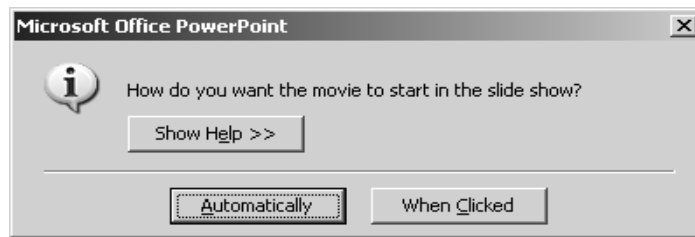

Figure 18.8: Movie File Start Option

4. Click the Movie file start option (Automatically or when click).
5. Set the place of the movie clip.

Note that, same as a movie clip, sound clips can also insert into user presentation. Click the sound clip icon and insert a sound file into your presentation. Before you insert any file you must save each file into your presentation folder.

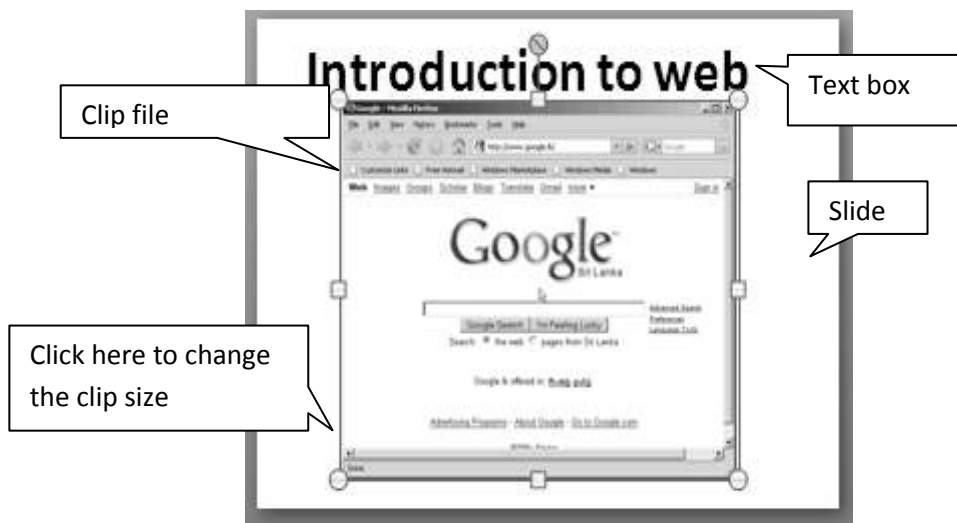

Figure 18.9: Slide of the presentation

You can insert a clip file in several ways.

### Insert a movie file using insert Media method

1. Click **insert**.
2. Click **Object**.

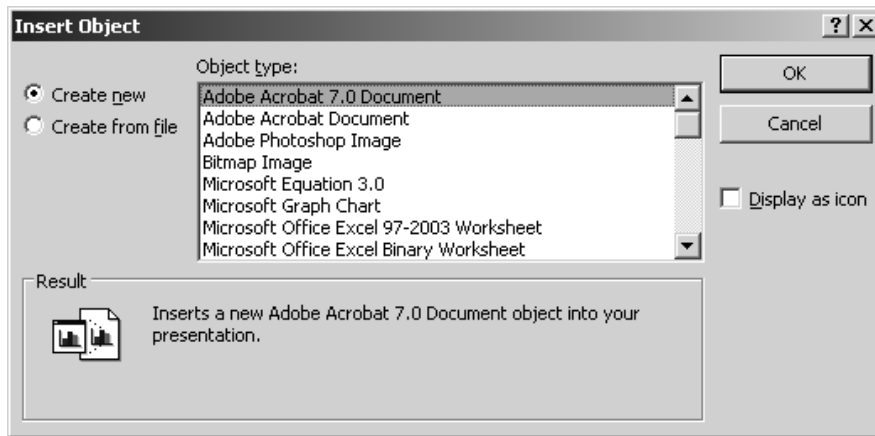

Figure 18.10: Insert Object Window

3. Select the object type as **Windows media player**.
4. Select a file.
5. Click **insert**.

## 18.3 Inserting Sound and Narration

There are several ways to add audio to your PowerPoint presentation. In this session, we are going to explain about some of these ways in brief.

Click on the **Sound** button which is in the **Insert** ribbon.

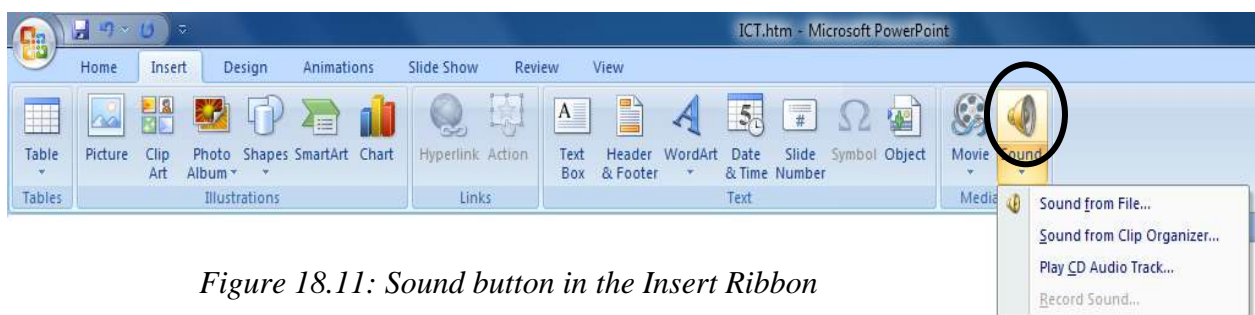

Figure 18.11: Sound button in the Insert Ribbon

If you want to insert a sound file which is saved in your computer you can give the location of the file after selecting 'Sound from file'.

If you want to insert a file from the Clip Organizer, click on 'Sound from Clip Organizer'. This is similar to 'clip art' which is used to include images.

In addition you can insert an audio track from a CD and also can include recorded narrations.

Let's see how we can include narrations in a presentation.

When you record a narration, you run through the presentation and record on each slide. You can pause and resume recording.

1. In Normal view, select the slide that you want to start the recording.
2. On the Slide Show tab, in the Set Up group, click Record Narration.
3. Click Set Microphone Level, follow the directions to set your microphone level, and then click **OK**.
4. Do one of the following:
  - To embed the narration, click **OK**.
  - To link the narration, select the Link narrations in check box, click **Browse**, click a folder in the list, and then click Select.

## 18.4 Delivering Presentations

### 18.4.1 Using animations

In PowerPoint, *animation* is the way that individual objects enter or exit into/from a slide. On a slide with no animations set, all of the objects on the slide simply appear at the same time when you display it. For an example, in a bulleted list, you can apply animation to the slide so that the bulleted points fly in from the left, one at a time, and the graphic drops down from the top afterward.

A *transition* is another kind of animation. A transition refers to the entry or exit of the entire slide, rather than of an individual object on the slide.

Here are some ideas for using animation effectively in your presentations:

- Animate parts of a chart so that the data appears one series at a time. This technique works well if you want to talk about each series separately.
- Set up questions and answers on a slide so that the question appears first, and then, when you click the question, the answer appears.
- Dim each bullet point when the next one comes into view, so that you are, in effect, highlighting the current one.

### 18.4.2 Animation tools

There are various tools available for the animation tab. Please refer to the table next to the image below for the descriptions of each component in the Animation Tools.

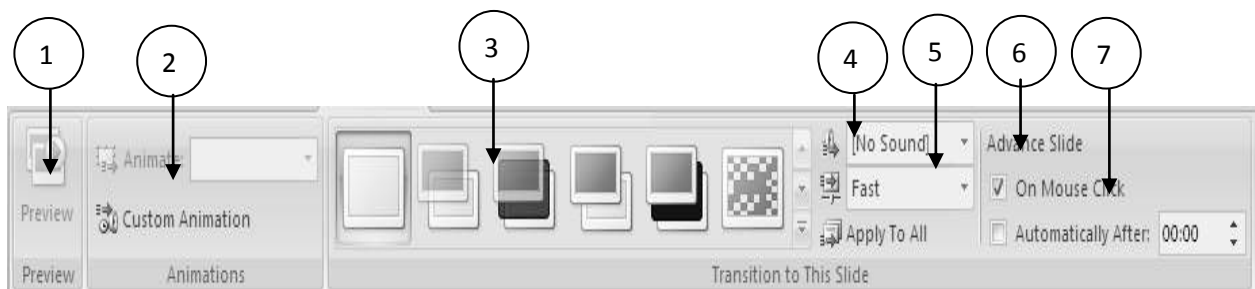

18.12: The animation tools

No	Name	Description
1	Preview	Click here to preview the animation
2	Custom animation	To add new custom animations
3	Transition	To add the slide transition
4	Sound	Click here to insert sound file
5	Speed	Click here to change the animation speed
6	Mouse on click	Set Animation effect apply after the mouse click
7	Automatically after	Set Animation effect apply after the given time period

Table 18.2: Animation tools

### 18.4.3 Add Slide transition

This section describes how to create a slide transition. You can add Animation to the slides using Slide transition.

Animation effect can be added to your presentation for transition slides.

Steps to follow:

1. Go to the slide you need to add effect.
2. Click **Animation** tab and select **Transition to This Slide** group.
3. Select the **transition** in the **transition** groups after previewing each.



Figure 18.13: Transition to This Slide group

4. Set a sound into the slide transition if you wish.
5. Select a sound from the available sounds.

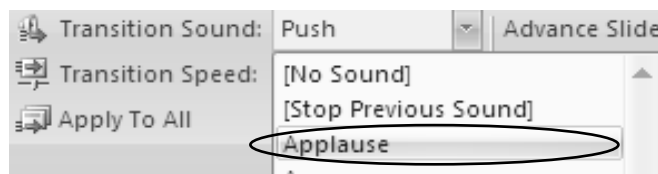

Figure 18.14: Select a Sound

OR

1. Select the **other sounds**. Select a suitable sound file.
2. Set transition speed as Slow, Medium, or Fast.

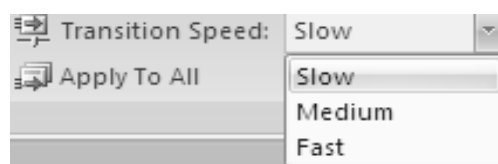

Figure 18.15: Set transition Speed

3. Set transition option either as **On Mouse Click** if you need to appear the next slide upon your mouse click or **Automatically after** if you need to appear the next slide

automatically after a particular time such as 05 seconds after the previous slide automatically without waiting for your manual mouse click.



Figure 18.16: Set transition Option

## 18.5 Animating Objects of your slide

In a slide of your presentation, there are several objects included such as text, images, shapes, video clips, etc. You can animate each object as you wish. Following sections describe you the available types of animations that you can apply to the selected object in a slide, how to apply animations, and how to customize them as you wish.

### 18.5.1 Types of Animations

There are four categories of animation effects. Each effect has a specific purpose, as well as a different icon colour:

- **Entrance (green):** The item's appearance on the slide is animated. Either it does not appear right away when the rest of the slide appears, or it appears in some unusual way (such as flying or fading), or both.
- **Emphasis (yellow):** The item is already on the slide, and is modified in some way. For example, it may shrink, grow, wiggle, or change color.
- **Exit (red):** The item disappears from the slide before the slide itself disappears, and you can specify that it does so in some unusual way.
- **Motion Paths (gray):** The item moves on the slide according to a preset path.

### 18.5.2 Adding Animation effects for an object or an object group

To add animation effect for an object, follow the steps given below;

1. Select the object.
2. Click **Add effect** button in the **Custom Animation** windows.
3. Among the four types of animations given based on the effect namely Entrance, Emphasis, Exit and Motion Path, Click **Entrance**.
4. Select the Entrance effect you wish.

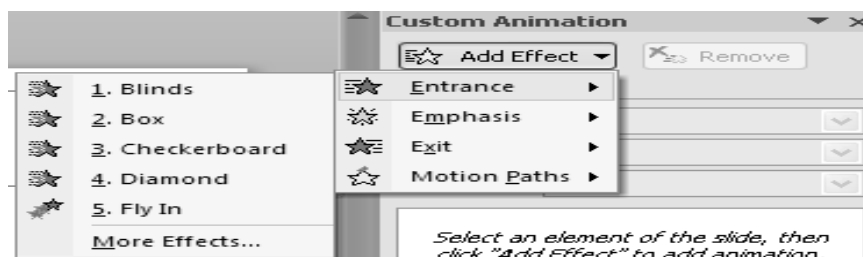

Figure 18.17: Adding animation

5. Change the Start position as **on click** if the animation to be activated on clicking the mouse.

6. Set the Direction as **Horizontal**.
7. Set the Motion speed as **very fast**.

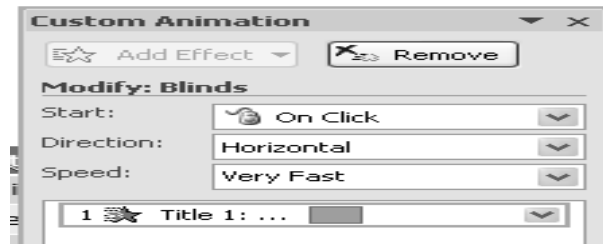

Figure 18.18: Change Start position, Direction and Motion Speed

- **Start position:** There are three options such as **on click** (Add effect after the mouse click), **with previous** (play effect with the previous effect), **after previous** (to play effect after a given time)
- **Direction:** There are two directions Horizontal or vertical.
- **Speed:** Speed may be slow, medium, fast etc.

### 18.5.3 Custom Animation in depth

The Custom animation gives you full control over how the objects on your slides are animated. You can not only choose from the full range of animation effects for each object, but you can also specify in what order the objects appear and what sound is associated with their appearance.

A good way to learn about custom animation is to start with an animation preset and analyzes it in the Custom Animation pane to see how it works. Consider the following example.

1. Select a slide that contains a title and at least two bullet points.
2. Click the **Custom Animation** button on the Animations tab to display the Custom Animation pane, as shown in below.



Figure 18.19: Custom Animation Path

3. Select the object that you want to animate.

4. In the pane, click **Add Effect**. A menu appears, containing four categories of effects: Entrance, Emphasis, Exit, or Motion Paths. This example uses an Entrance effect.
5. A submenu appears, containing effects for that category. Select one of these effects, as shown in below.

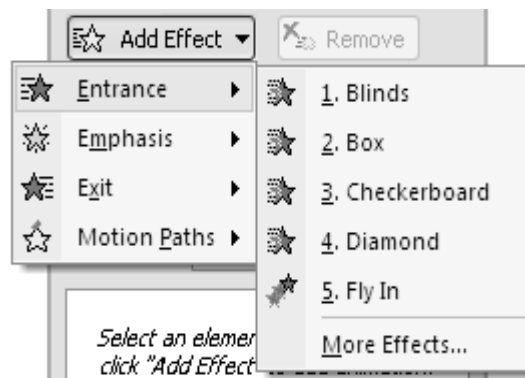

Figure 18.20: Select one effect

Select one of the animation effects. After selecting the effect, your custom animation windows will be appeared as follows.

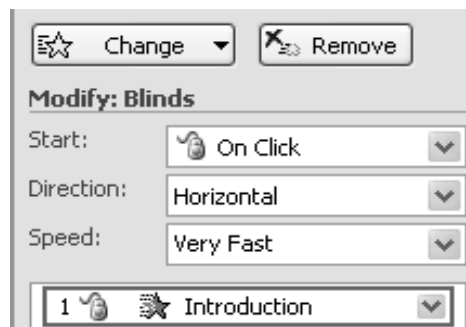

Figure 18.21: Custom animation Window

You can change **start** option, **direction** and **speed** of the animation. In the **Start** section, there are three options such as

- **With Previous:** Runs the animation simultaneously with any previous animations on the slide. For example, you can set up two different objects to animate at the same time by setting the second of the two objects to With Previous.
- **After Previous:** Runs the animation immediately after the previous animation that is on the slide ends. If there is no previous animation, PowerPoint treats the appearance of the slide as the previous event and runs the animation immediately after the slide appears.
- **On Click:** Runs the animation when a user clicks the mouse. This is useful when you want to build a slide item-by-item with each click, or for an exit effect.

### Changing to a Different Animation Effect

If you change your mind about an animation for an object, you do not have to remove the animation and reapply it; you can simply change it. To change to a different animation for an object, follow the steps given below:

1. Display the **Custom Animation** pane.



2. Select the animation effect from the pane-not on the slide-and then click the **Change** button. The same menus appear as when you originally applied the effect.
3. Select a different animation. You can either choose from the menus or select **More Effects** to display the dialog box that contains the full selection of effects.

Besides choosing a different animation effect, you can also fine-tune its settings at any time, such as changing its speed or other properties.

4. Click **OK**.

#### 18.5.4 Setting Animation Timing

You can adjust the timing settings for an animation. Timing refers to the speed of the effect, the delay before it starts, and how many times it should repeat, if any.

To set timing for a custom animation effect, follow the steps given below:

1. On the Custom Animation pane, click the effect whose timing you want to set. A down arrow appears to the right of the effect.
2. Click the down arrow and choose Timing. A dialog box appears, with the Timing tab displayed,

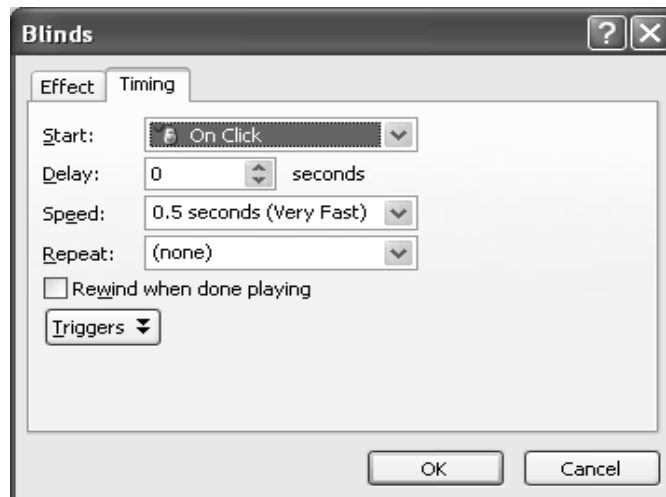

Figure 18.22: Setting Animation Timing

3. You can choose from the following settings to control the animation timing:
  - **Start** is the same as the Start setting in the Custom Animation pane.
  - **Delay** refers to the amount of delay between the beginning or end of the previous animation and the start of the current animation. For example, if you set the animation effect to *After Previous*, the delay is the number of seconds between the *end* of the previous event and the beginning of the animation. If you set the animation effect to *With Previous*, the delay is the number of seconds between the *beginning* of the previous event and the beginning of the animation. By default, the delay is set to zero.
  - **Speed** is the overall speed of the animation. This is the same setting as in the Speed drop-down list in the Custom Animation pane. The choices range from Very Fast (0.5 seconds) to Very Slow (5 seconds). Unlike in the Custom Animation pane, the number of seconds associated with each choice appears on the Timing tab.
  - **Repeat** is the number of times that the animation should repeat. The default setting is **none**. You would rarely set a text animation to repeat because this makes it

harder for the audience to read (although this effect is useful when you want a graphic to flash until the end of the slide).

- **Rewind when done playing** pertains mostly to video clips; this setting is available for animation effects, but you will not see much difference between the on and off settings.
  - **Triggers** enable you to set up an animation to occur when the user clicks a particular object. This object does not necessarily have to be the object that is being animated.
4. Click **OK** when you are done. Then test the new animation settings by clicking Play or Slide Show in the Custom Animation pane.

## 18.6 Adding Action effects

You can set some objects in your slide such as a text or a shape which will take you to a totally different section such as a different slide in the same presentation slides, or to a web page, or to a word document, etc. upon clicking on that object. We call that we set an action to the given object.

To add an action effect, follow the steps given below,

- Select the text or object that you need to add action.
- Click **insert – Action** (The Action setting window will be appeared).



18.23: The Action settings window

- Select **Hyperlink to** and choose the slide name to activate.  
OR
- Select **Run program** if you need to run a given program.
- After selecting the action click **OK**.

**Example:** Insert an action button with the caption “Play video” in a slide such that it will open a video clip when you click on the action button.

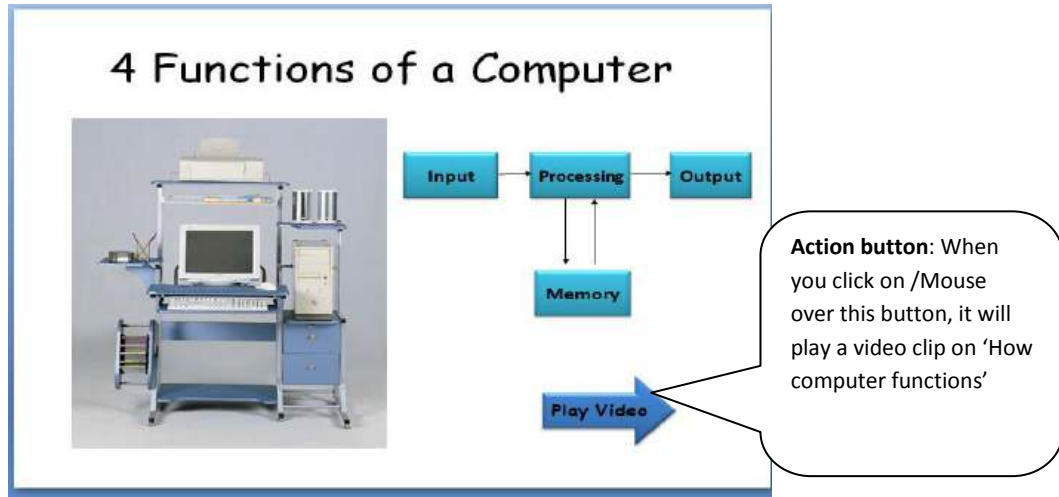

## 18.7 Getting prepared for a Live Presentation

You can practice using PowerPoint's slide-show controls before you go to a live presentation. It is more useful for you. Following sub sections discuss about the things that you should be thorough on before presenting your slide show to an audience.

### 18.7.1 Starting and Ending a Show

To start a show, do any of the following:

- Click the Slide Show View button in the bottom-right corner of the screen.
- On the View tab, click Slide Show.
- Press F5.
- Press Shift+F5.

These methods are not all exactly alike. For example, if you click the Slide Show View button in the bottom-right corner, or press **Shift+F5**, the first slide to appear is the currently selected one in PowerPoint. If you click the Slide Show button on the View tab or press F5, it starts with the first slide in the presentation, regardless of which slide was selected.

To end the show, do any of the following:

- Right-click and choose **End Show**.
- Press **Esc**, **-** (minus), or **Ctrl+Break**.

If you want to temporarily pause the show while you have a discussion, you can blank the screen by pressing W or, (comma) for a white screen, or B or '.' (Period) for a black screen. To resume the show, press any key.

### 18.7.2 Using the On-screen Show Controls

When you display a slide show, the mouse pointer and show controls are hidden. To make them appear, you can move the mouse. When you do this, very faint buttons appear in the bottom-left corner of the slide show.



Figure 18.24: On-screen Show Control buttons

You can toggle the pointer and these buttons on and off by pressing A or = (equals). Ctrl+H hide the pointer and buttons. When you toggle this feature on, the following buttons appear:

- **Back**, the leftmost button, takes you back to the previous slide, or to the previous animation event if the present slide contains animation.
- **Pen**, next to Back, opens a menu for controlling the appearance of the pen or pointer.
- **Slide**, which displays a box icon, opens a menu for navigating between slides. You can also open the navigation menu, shown in bellow.



Figure 18.25: Navigation Menu

- **Forward**, the rightmost button moves you to the next slide. Normally, you can just click to go to the next slide, but if you are using the pen (covered later in this chapter), then clicking it causes it to draw, rather than advance the presentation. In such a situation, you can use the Forward button.

### 18.7.3 Moving from Slide to Slide

The simplest way to move through a presentation is to move to the next slide. To do so, you can use any of these methods:

- Press any of these keys: N, Spacebar, right arrow, down arrow, Enter, or Page Down.
- Click the left-mouse button.
- Right-click and then choose Next.
- Click the right-pointing arrow button in the bottom-left corner of the slide.

If you have animated any elements on a slide, these methods advance the animation, and do not necessarily move to the next slide. For example, if you have animated your bulleted list so that the bullets appear one at a time, then any of the actions in this list make the next bullet appear, rather than making the next slide appear. Only after all of the objects on the current slide have displayed does PowerPoint advance to the next slide. If you need immediately advance to the next slide, you can use the on- screen show controls.

To come back to the previous slide, use any of these methods:

- Press any of these keys: P, Backspace, left arrow, up arrow, or Page Up.
- Click the left-pointing arrow button on the bottom-left corner of the slide.
- Right-click and then choose Previous.

You can also go back to the last slide that you viewed. To do this, right-click and choose **last viewed**. Although you would think that the last slide viewed would be the same as the previous slide, this is not always the case.

#### 18.7.4 Jumping to Specific Slides

There are several ways to jump to a particular slide rather going from one slide to the next slide as usual. One of the easiest ways is to select the slide by its title. To do so, follow these steps:

1. During the slide show, right-click to display the shortcut menu.
2. Select **Go to Slide**. A submenu appears, listing the titles of all of the slides in the presentation, as shown in bellow. Parentheses around the slide numbers indicate hidden slides.

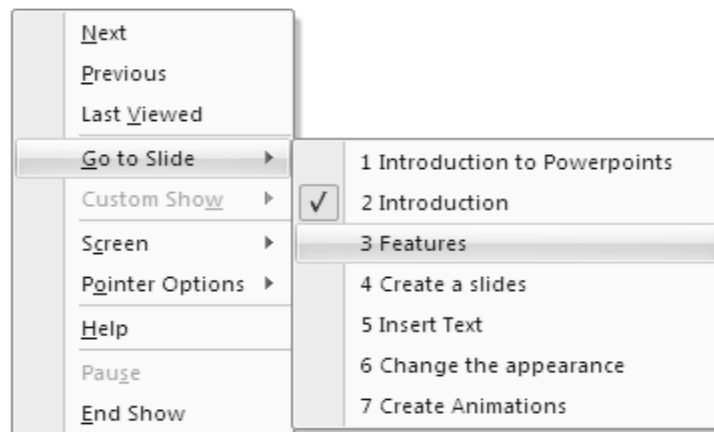

*Figure 18.26: Submenu with titles of slides*

3. Click the slide title to which you want to jump.

#### 18.7.5 Blanking the Screen

Sometimes during a live presentation there may be a delay. Whether it is a chatty audience member with a complicated question, a fire drill, or just an intermission, you will have to pause playing the show. If you have set the slides for manual transition, then whatever the slide you stopped will remain on the screen until you resume. However, you may not want this. For example, it may be distracting to the audience, especially if pause is to allow someone to get up and speak in front of the screen. A solution is to turn the screen into a blank expanse of black or white. To do this, type **W** or a comma (for white) or **B** or a period (for black), to return to the presentation, you can press the same key, or press any key on the keyboard.

#### 18.7.6 Using the On-Screen Pen

A certain point may become really important during presenting a slide so that you want to emphasize it. In this case, you can circle it or underline it with the pen cursor.

You can choose your pen colour as follows:

1. Move the mouse or press A to make the buttons appear.
2. Click the Pointers button (the one that looks like a pen). A menu appears.
3. Select Ink Colour and then click the colour you want, as shown in below.

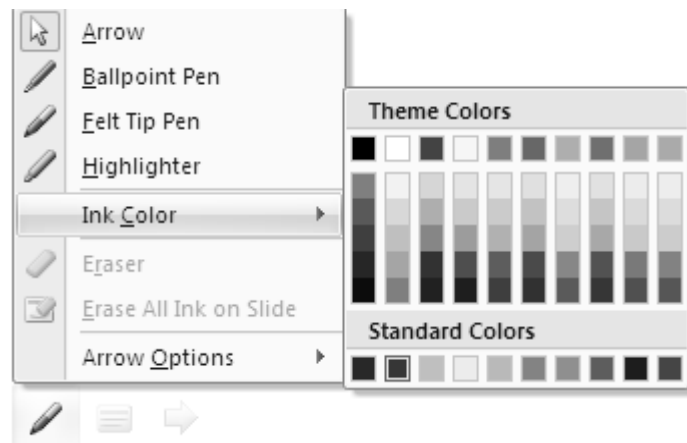

Figure 18.27: Select Ink colour

You can turn on the type of pen that you want, as follows:

1. Click the Pointers button again.
2. Click the type of pen that you want:
  - **Ballpoint:** A thin line
  - **Felt Tip Pen:** A thicker line
  - **Highlighter:** A thick, semi-transparent line

You can also turn on the default pen type (Felt Tip) by pressing Ctrl+P, and then return to the arrow again by pressing Ctrl+A or Esc.

After enabling a pen just drag-and-draw on the slide to mark something, you should practice drawing lines, arrows, and other shapes using the pen as described above because it takes a while to master.

## 18.8 Using Custom Shows

Many slide shows have a linear flow: First you show slide one, and then slide two, and so on, until you have completed the entire presentation. This format is suitable for situations where you are presenting clear-cut information with few variables, such as a presentation about a new insurance plan for a group of employees. However, when the situation becomes more complex, a single-path slide show may not suffice. This is especially true when you are presenting a slide show to convince a critical message to a group of decision makers; you want to predict their questions and needs for more information and have many backup slides, or even entire backup slide shows that are prepared additionally to be used in case.

### 18.8.1 Ideas for Using Custom Shows

Here are some ideas to start how and why you might want to include some custom shows in your presentation files:

- **Avoiding duplication:** If you have several shows that use about 50 percent of the same slides and 50 percent different ones, then you can create all of the shows as custom shows within a single presentation file. This way, the presentations can share the 50 percent of the slides that they have in common.

- **Managing change:** By creating a single presentation file with custom shows, you make it easy to manage changes. If any change will occur in your company that will affect any of the common slides, then making the change once in your presentation file will automatically makes the change to each of the custom shows immediately.
- **Overcoming objections:** You can anticipate your client objections to your sales pitch and prepare several custom shows, each of which addresses to a particular objection. Then, whatever the reason your potential customer gives you for not buying your product, you have a counteractive argument in hand.
- **Covering your backside:** If you think that you may be asked for specific figures or other information during a speech, you can have this information ready in a custom show (or on a few simple hidden slides, if there is not a lot of information) to display if needed. No more going through the embarrassment of saying, "I'm not sure, but let me get back to you on that."

## 18.8.2 Creating Custom Shows

To create a custom show, first create all of the slides that should go into it. Start with all of the slides in the main presentation. Then follow these steps:

1. On the Slide Show tab, click **Custom Slide Show**, and then click **Custom Shows**. The Custom Shows dialog box opens.
2. Click **New**. The Define Custom Show dialog box opens.
3. Type a name for your custom show in the Slide Show Name text box, replacing the default name.
4. In the Slides in Presentation pane, click the first slide that you want to appear in the custom show.
5. Click **Add** to copy the slides to the Slides in Custom Show.

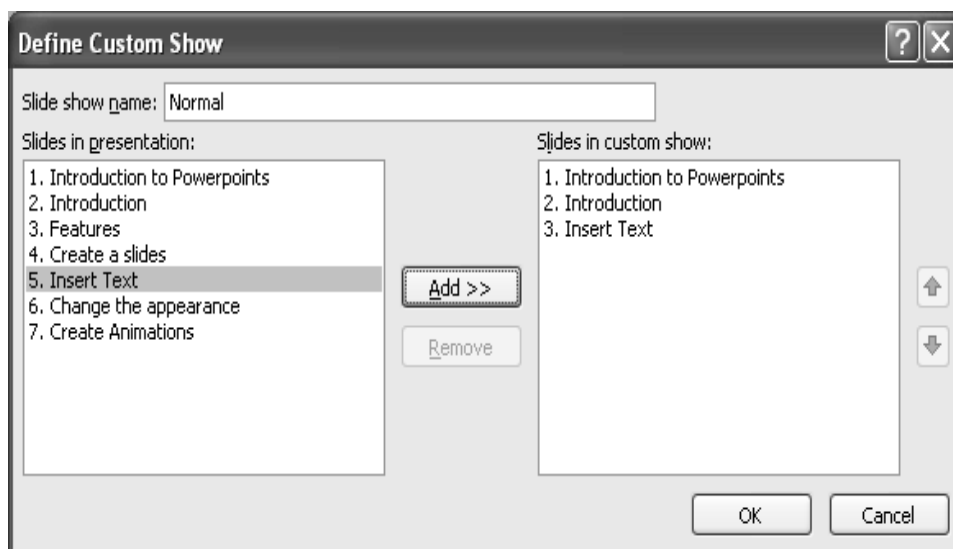

Figure 18.28: Choose a format for sending the presentation to Word

6. When you are finished building your custom show, click **OK**. The new show will appear in the **Custom Shows** dialog box.
7. To test your custom show, click the **Show** button. Otherwise, click **Close** to close the Custom Shows dialog box.

### 18.8.3 Editing Custom Shows

You can manage your custom shows from the Custom Shows dialog box, the same place in which you created them. This includes editing, deleting, or making a copy of a show. To change which slides appear in a custom show and in what order, follow these steps:

1. On the Slide Show tab, click **Custom Slide Show** and then click **Custom Shows**. The Custom Shows dialog box appears.
2. If you have more than one custom show, then click the one that you want to edit.
3. Click **Edit**. The Define Custom Show dialog box reappears.
4. Add or remove slides, as needed. To add a slide, select it in the left pane and click **Add**. To remove a slide, select it in the right pane and click **Remove**.
5. Rearrange slides as needed with the up-and down-arrow buttons.
6. Click **OK**. PowerPoint saves your changes.
7. Click **Close** to close the Custom Shows dialog box.

### 18.8.4 Copying Custom Shows

A good way to create several similar custom shows is to create the first one and then copy it. You can then make small changes to the copies as necessary. To copy a custom show, follow these steps:

1. On the **Slide Show** tab, click **Custom Slide Show** and then click **Custom Shows**. The Custom Shows dialog box appears.
2. If you have more than one custom show, then select the show that you want to copy.
3. Click **Copy**. A copy of the show appears in the dialog box. The filename includes the words *Copy of* so that you can distinguish it from the original.
4. Edit the copy; change its name and content.
5. When you are finished, click **Close** to close the Custom Shows dialog box.

### 18.8.5 Deleting Custom Shows

It is not necessary to delete a custom show when you do not want it anymore; it does not do any harm remaining in your presentation. Because custom shows do not display unless you call for them, you can simply choose not to display it. However, if you want to make your presentation more orderly, you can delete a custom show that no longer wants. Follow these steps:

1. On the **Slide Show** tab, click **Custom Slide Show** and then click **Custom Shows**. The Custom Shows dialog box appears.
2. Select the show that you want to delete.
3. Click **Remove**. The show disappears from the list.
4. Click **Close** to close the Custom Shows dialog box.

### 18.8.6 Displaying a Custom Show

To start your presentation with a custom show, on the Slide Show tab, click Custom Slide Show and then click the name of the custom show on the drop-down menu. The custom show runs. You can also call up the custom show at any time during your main presentation. There are two ways to do this: you can navigate to the custom show with PowerPoint's regular presentation controls, or you can create a hyperlink to the custom show on your slide.



## Navigating to a Custom Show

During a presentation, you can jump to any of your custom shows by following these steps:

1. Open the shortcut menu in Slide Show view by right-clicking or by clicking the navigation button.
2. Choose Custom Show and then select the custom show that you want. The custom show starts.

When you start a custom show, you are no longer in the main presentation. To verify this, open the shortcut menu again, choose **Go to Slide**, and check out the list of slides. This list shows only the slides that belong to the custom show.

## Navigating Back to the Main Show

To return to the main show, follow these steps:

1. Press **Ctrl+S** to open the All Slides dialog box.
2. Open the Show drop-down list and choose All Slides.
3. Select the slide that you want to go to. You can choose one from all of the slides in the entire presentation.
4. Click **Go To**.

## Creating a Hyperlink to a Custom Show

Hyperlinks are hot links that you place on your slides. When you click a hyperlink, the current display jumps to some other location.

One way to gain quick access to your custom shows in a presentation is to create hyperlinks for them on certain key slides that act as jumping-points. You can insert a text hyperlink into any text box, and its text becomes the marker that you click to jump to a different location related to the text. You can create hyperlinks on slides that display custom shows.

Follow these steps:

1. If you are attaching the hyperlink to another object or some text, then first select the object or text.
2. On the **Insert** tab, click **Hyperlink**. The Insert Hyperlink dialog box appears.
3. Click the **Place in This Document** icon along the left side of the screen.
4. In the Select a Place in This Document pane, scroll down to the Custom Shows list.
5. Click the custom show that you want to jump to with this hyperlink, as shown in below.

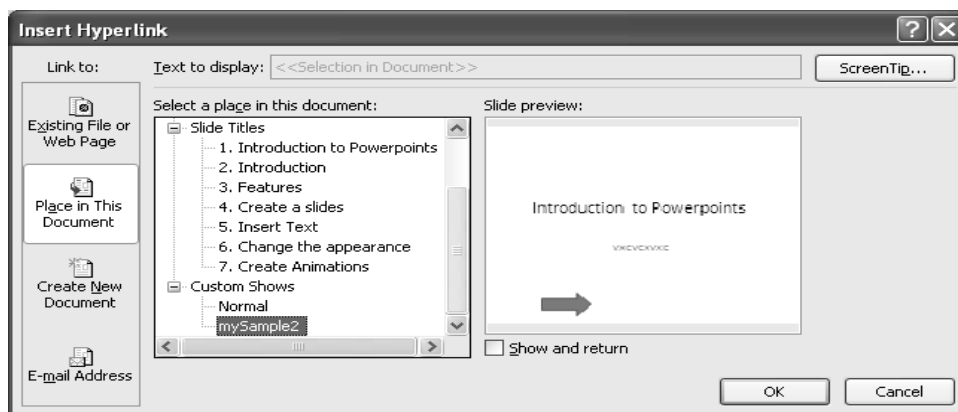

Figure 18.29: Create a Hyperlink to custom slide show

1. If you want to return to the same spot that you left in the main presentation after viewing this custom show, then select the **Show and Return** check box. If you do not select this option, the presentation will simply end when the custom show ends.
2. If you want to specify a ScreenTip for the hyperlink, click the ScreenTip button to create one.
3. Click **OK**.

## 18.9 Saving your Presentation

When making a presentation you might want to do some other work or you might want to have a break in the middle. To come back and start from where you have left, you need to save your file. Now let us have a look at the way to save your work and how you can retrieve your file later.

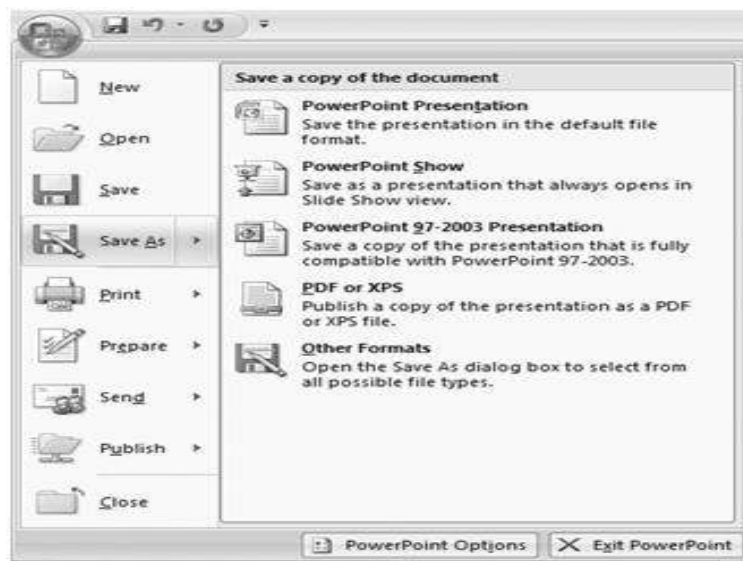



Figure 18.30 Save as window

- You have the **small save diskette**  in the **Quick Access Toolbar** click it.
- OR
- Click **Office button** → **Save**.

## 18.10 Protecting a file with a password

If a presentation consists of any sensitive or confidential data, you can encrypt the file and protect it with a password. Encryption is a type of "scrambling" done to the file so that nobody can see it, either from within PowerPoint or with any other type of file-browsing utility.

To manage a file's passwords and other security settings, follow the steps given below:

1. Save the file as you normally would from the **Save As** dialog box.
2. Click **Tools**, and choose **General Options**. The General Options dialog box opens.

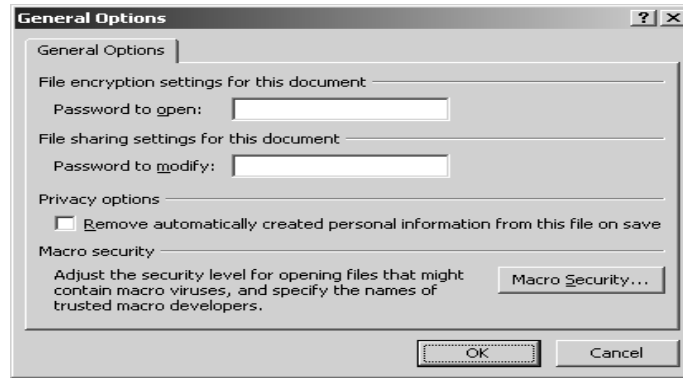

Figure 18.31: General Options Dialog box

3. If you want an Open password, enter it in the “**Password to Open**” box.
4. If you want a Modify password, enter it in the “**Password to Modify**” box.
5. Click **OK**.
6. If you specified a password in step 3, a confirmation box appears for it. Retype the same password and then click **OK**.
7. If you specified a password in step 4, a confirmation box appears for it. Retype the same password and click **OK**.
8. Continue saving normally.

**What is the difference between “Password to Open” and “Password to Modify”?**

“Password to Open” means that the person who wants to open the document should enter the password. Once you open the document you can edit and read the document without any problem.

“Password to Modify” is that the way to protect a document by only giving permission to read the document, but to make changes in a document one should know the Modify password.

### 18.10.1 Saving a Presentation in Other Formats

Click the **Microsoft Office Button** and the **menu** on the right will appear. Notice that we purposely moved our cursor over **Save As** and it would turn into orange. On the right side of the menu screen under “**Save a copy of the document**” you can see various options to save a document.

You have several new choices for saving your presentation.

**PowerPoint Presentation** – saves your presentation as an .XML (Extensible Markup Language) file. This is a new saving format that creates a smaller file size. However, this file type is not compatible with older versions of Power Point. So, if you share your XML presentation with someone they will have to download a Compatibility Pack. They will see a message similar to the one below when they try to open this file.

Microsoft added new file formats to Microsoft Word, Excel and PowerPoint 2007 to reduce the size of the file, improve security and also to enhance the integration with external sources. This Compatibility Pack works with files created by Office 2010 and the Office 2007.



Figure 18.32: Sample message box

If you click “Yes” – it should be taken you to a Microsoft Compatibility Page site for this download.

“The presentation they see may not look exactly like the one you created if it contains features from PowerPoint 2007 that they don’t have. But they can open, edit, and save it in the format for PowerPoint 2007.” (2007 Microsoft Office Preview webpage)

**PowerPoint 97-2003 Presentation**– as indicated, this choice is totally compatible with older versions of PowerPoint.

**PDF or XPS** – You can now save your presentations as PDF Files!

**Example:** Saving as a web page

1. Click on the office button.
2. Select ‘Save as’ and ‘Other formats’.

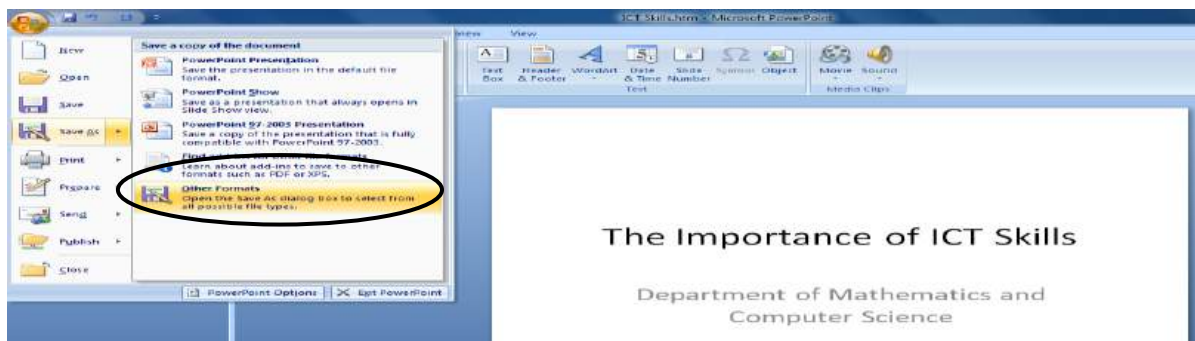

Figure 18.33: Save in another format

3. Select ‘Web Page’ in ‘Save as type’ and give a suitable name for the file.

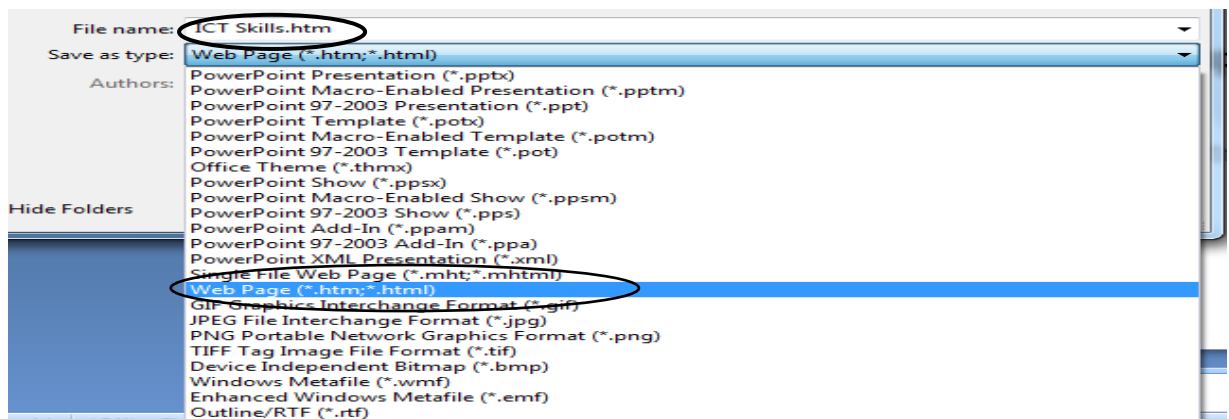

Figure 18.34: Save as a web page

4. Click 'Save'.

Now you can open the file using your browser simply by giving the location of the file.

## 18.11 Printing your slides

MS PowerPoint gives a number of ways that will change the appearance of the document when a printout is taken. Following sections describe them briefly.

### 18.11.1 Creating Handouts

To create handouts, you simply decide on a layout (a number of slides per page) and then choose that layout from the Print dialog box as you print.

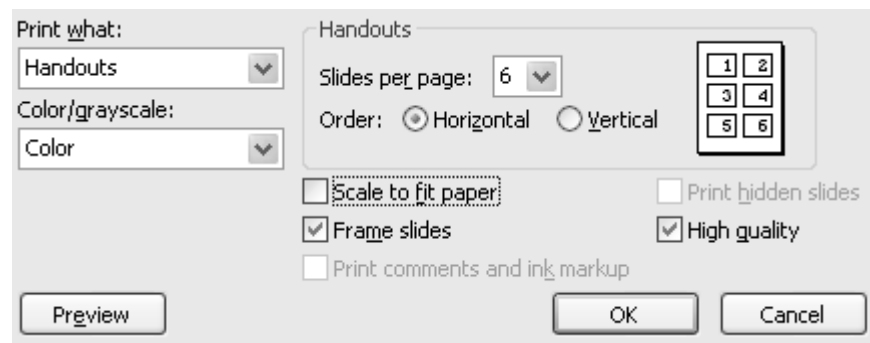

Figure 18.35: Handout creating options

Steps to follow:

1. Click print on the Office button.
2. Click **print** (Print dialog window is appeared).
3. Change 'print what' as **Handouts**.
4. Set Slide per page as 1 – 9.

**1:** Places a single slide vertically and horizontally "centered" on the page.

**2:** Prints two big slides on each page. This layout is good for slides that have a lot of fine print and small details or for situations where you are not confident that the reproduction quality will be good. There is nothing more frustrating for an audience than not being able to read the handouts!

**3:** Makes the slides much smaller-less than one-half the size of the ones in the two-slide layout. But you get a nice bonus with this layout: lines to the side of each slide for note-taking. This layout works well for presentations where the slides are big and simple, and the speaker is providing a lot of extra information that isn't on the slides. The audience members can write the extra information in the note-taking space provided.

**4:** Uses the same size slides as the three-slide layout, but they are spaced out two-by-two without note-taking lines. However, there is still plenty of room above and below each slide, so the audience members still have lots of room to take notes.

**5:** Uses slides the same size as the three-slide and four-slide layouts, but crams more slides on the page will reduce the space that can be used to take notes. This layout is good for presentation with big, simple slides where the audience does not need to take

notes. If you are not sure whether the audience will benefit at all from handouts being distributed, consider whether this layout would be a good compromise. This format also saves paper, which might be an issue if you need to make hundreds of copies.

**6:** Makes the slides very tiny, almost like a Slide Sorter view, so that you can see nine at a time. This layout makes them very hard to read unless the slide text is extremely simple. I don't recommend this layout in most cases, because the audience really will not get much out of such handouts.

5. Mark any desired check boxes at the bottom of the dialog box:

**Scale to Fit Paper:** Enlarges the slides to the maximum size they can be and still fit on the layout.

**Frame Slides:** Draws a black border around each slide image. Useful for slides being printed with white backgrounds.

**Print Comments:** Prints any comments that you have inserted with the Comments feature in PowerPoint.

**Print Hidden Slides:** Includes hidden slides in the printout. This option is not available if you don't have any hidden slides in your presentation.

**High Quality:** Optimizes the appearance of the printout in small ways, such as allowing text shadows to be print.

6. Click **OK**.

### 18.11.2 Creating Speaker Notes

Speaker notes are like handouts, but for you, the presenter. Only one printout format is available for them: the **Notes Pages layout**. It contains a slide on the top half (the same size as in the two-slides-per-page handout) with a blank space below it to take notes by the presenter.

You can type your notes for a slide in **Normal view** (in the notes pane), or in **Notes Page view** (**View** tab → click 'Notes Page' under 'presentation views group'). The latter shows the page more or less as it will look how it will be when you print your notes pages; this can help if you need to gauge how much text will fit on the printed page.

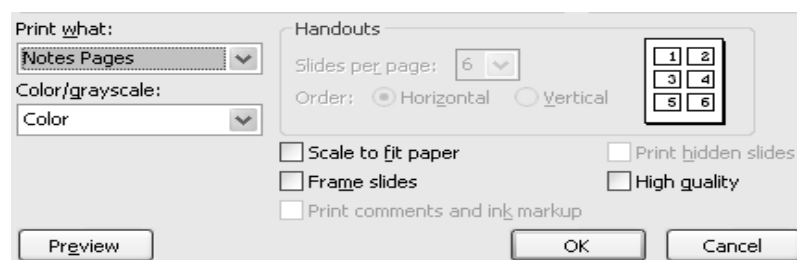

Figure 18.36: Notes creating options

Steps to follow:

1. Click the **Office** button.
2. Click print on the **Office Button**.
3. Change **print what** as **Notes pages**.
4. Click **OK**.

### 18.11.3 Printing Outline

If text is the main part of your presentation, you might prefer to print an outline instead of mini-slides. You can use the outline for speaker notes, audience handouts, or both. To print the text from Outline view, follow these steps:

1. Click the **Office button**.
2. Click print on the **Office Button**.
3. Change **print what** as **Outline**.
4. Click **OK**.

Note that, the outline will not contain text such that you've typed in manually placed text boxes or any other non-text information, such as tables, charts, and so on.

### 18.11.4 Exporting Handouts or Notes Pages to Word

One of the drawbacks in PowerPoint is that the notes and handouts pages are not fully formattable. There is a lot you can't do without them-such as set margins, or change the sizes of the slide images for handouts. To get around this, you will have to create your handouts in Microsoft Word.

To send your presentation to Word, follow these steps:

1. Click on the **office button**.
2. Click the **publish**.
3. Click **Create Handouts in Microsoft Office Word**. The **Send to Microsoft Office Word** dialog box appears.



Figure 18.37: Choose a format for sending the presentation to Word.

4. Choose one of the formats. You can send to Word in a variety of formats. Some formats are more appropriate for handouts, others for speaker notes. Here are some suggestions:

For Handouts	For Speaker Notes
Blank Lines Next to Slides	Notes Next to Slides
Blank Lines Below Slides	Notes Below Slides
Outline Only	Outline Only

5. If you want to maintain a link between the PowerPoint file and the Word file, choose **Paste Link**. Otherwise, select **Past**. If you maintain a link, then the changes you make to the PowerPoint file are reflected in the Word file.
6. Click **OK**.

### 18.11.5 Create a Package for a CD

This is a really nice feature in PowerPoint 2007. It enables to save your PowerPoint 2007 presentation in a CD and take it anywhere to present. And when you take the presentation with you, you won't need PowerPoint 2007 to show the presentation! When the CD is created it includes a PowerPoint viewer that will show your CD, regardless of the computer which you are using!

To use this feature, click the **Microsoft Office button** and move your cursor over **Publish**. On the right side of the menu screen click **Package for CD**. See Figure 18.38.

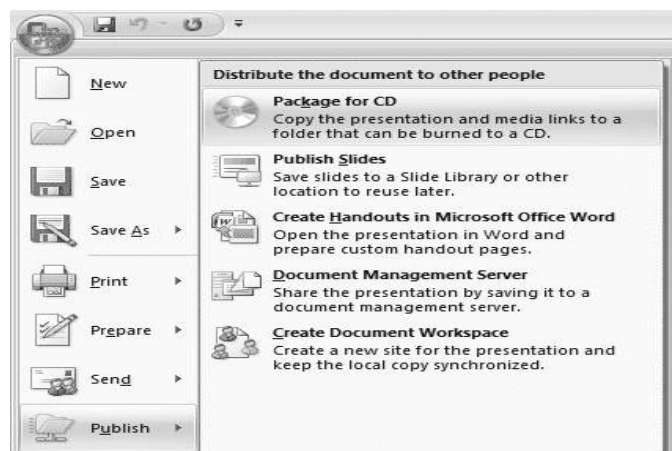

Figure 18.38: Select Package for CD

The **Package for CD** menu screen will appear (See Figure 18.39). Package for a CD will **create a folder** either **on your computer** or copy the folder **directly to a CD** (if your CD creation program allows for this).

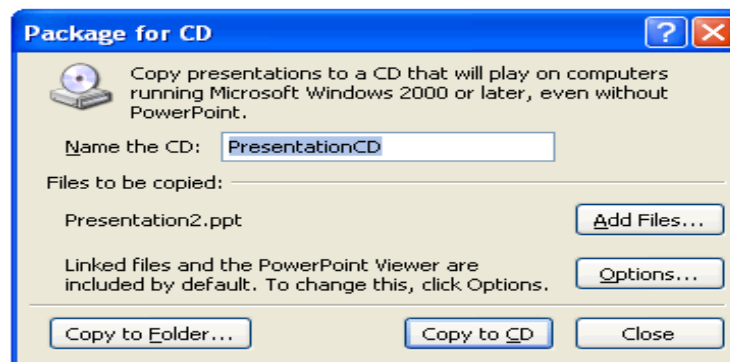

Figure 18.39: Package for CD dialog box

The first thing we have to do is give a name for our folder and type-it in the **Name the CD:** area on the Package CD menu.



We chose “Presentation CD” (as seen in figure 18.39). Next, we decided to save this folder in C: drive. Then, we chose **Copy to Folder...** in the menu screen. When we clicked on Copy to Folder... the Copy to Folder menu screen appeared.

The name of our Folder is shown in the **Folder name:** area (created in the previous menu screen). We chose to save the Folder to C: hard disk drive, so we typed C:\ in the **Location:** area. You can also choose the Browse button so that you can “browse” any drive on your computer to save the Folder. When you have made your selections, click **OK**.

After you click OK, your computer will “run” for a few minutes and then return to the **Package for CD** menu screen. When this occurs, simply click the **Close** button and the menu screen will disappear.

You may see the Microsoft Office PowerPoint screen below. If you do click **Yes**.

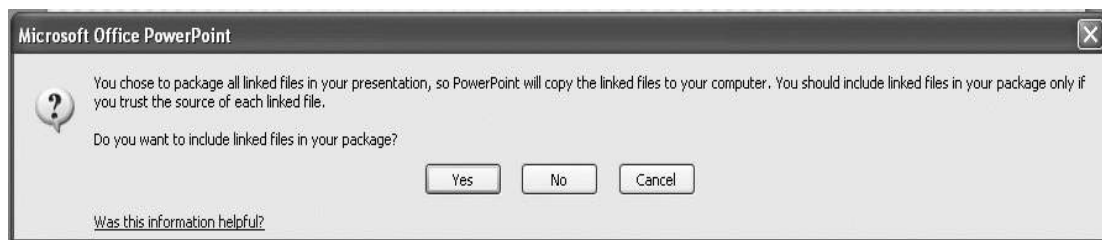

Then go to the drive on which you saved your folder, you will see a folder icon having the same name which we used. You can either double-click quickly on the folder to open it, or you can right click on the folder and select **Open**.

When your folder opens, you are able to see the files created by **PowerPoint Package for CD**; (see figure 18.40). If you go to another computer which has PowerPoint 2007, How to make presentation2.ppt, the sample power point file that we copied into the CD in this example will be available for you. If the computer does not have PowerPoint 2007, you can use the PPTVIEW.EXE file to show your presentation.



*Figure 18.40: Files created by PowerPoint package for CD*



## 18.12 Self Assessment Questions

- 18.1 What is GIF? What are the advantages of GIF over other graphic file formats?
- 18.2 In PowerPoint, what are animations? Name four categories of animation effects. Briefly describe the purposes of them.
- 18.3 What is meant by “transition” in PowerPoint?
- 18.4 Explain the three ways of starting an animation in custom animation window.
- 18.5 Write down four possible ways to start a slide show.
- 18.6 Write down two possible ways to end a slide show.
- 18.7 What are “on-screen show control” buttons? Briefly explain the functionality of them.
- 18.8 How do you move from one slide to next slide in a PowerPoint presentation?
- 18.9 How do you come back to the previous slide in a PowerPoint presentation?
- 18.10 Briefly explain why you might want to include “Custom Shows” in your presentation files.
- 18.11 Briefly describe the importance of creating hyperlinks on slides in a PowerPoint presentation.
- 18.12 What is the importance of creating Speaker Notes in PowerPoint?

# Session 19

## Introduction to Databases and Microsoft Access 2007

---

### Aim:

To provide an overview about Database Management Systems(DBMS) and introduce you to one of DBMS: MS Access 2007

### Objectives:



Having studied this session, you will be able to get an idea about:

- What a database is
- What a Database Management System is
- Microsoft Access 2007
- Creating a database using MS Access
- Working with MS Access databases

### 19.1 Introduction to Databases

A database is a structured collection of records or data. A computer database is a kind of software to organize the storage of data. Databases help you organize this related information in a logical fashion for easy access and retrieval. To develop a database, there are several models used such as Hierarchical model, Network model, Relational model, Object-Oriented model etc. Though discussing about these models in details is beyond the level of this course unit, for the sake of completion, some models are briefed below.

#### 19.1.1 Hierarchical model

In a hierarchical model, data is organized into an inverted tree-like structure. This structure arranges the various data elements in a hierarchy and helps to establish logical relationships among data elements of multiple files. Each unit in the model is a **record** which is also known as a **node**. Each record has a single parent.

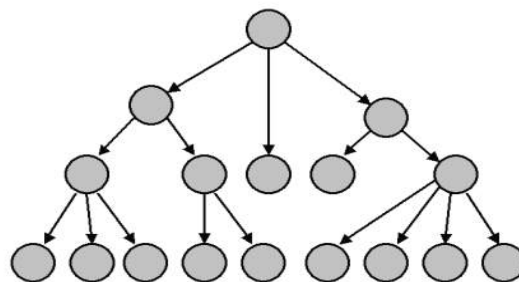
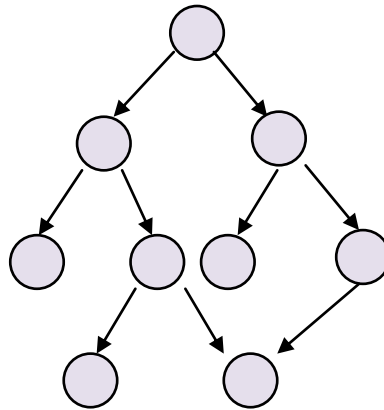

Figure 19.1: Hierarchical Model

### 19.1.2 Network model

The network model tends to store records with links to other records. Each record in the database can have multiple parents, i.e., the relationships among data elements can have a many to many relationships. So this model is an expansion to the hierarchical structure, allowing many-to-many relationships in a tree-like structure that allows multiple parents.

The network model provides greater advantage than the hierarchical model in that it promotes greater flexibility and data accessibility.



*Figure 19.2: Network Model*

### 19.1.3 Relational model

The relational model for the database management is a database model based on relations. The basic data structure of the relational model is a **table** where information about a particular **entity** (say, a student) is represented in columns and rows. The columns enumerate the various **attributes** (i.e. characteristics) of an **entity** (e.g. student name, address, registration \_number). The rows (also called records) represent **instances** of an entity (e.g. specific student).

We will be following the relational database model within this course and designing and using such databases will be covered within the next two sessions.

### 19.1.4 Object –Oriented model

In this Model we have to discuss the functionality of the object oriented Programming. It takes more than storage of programming language objects. It provides full-featured database programming capability, while containing native language compatibility. It adds the database functionality to object programming languages. This approach is the analogical of the application and database development into a constant data model and language environment. Applications require less code, use more natural data modeling, and code bases are easier to maintain. Object developers can write complete database applications with a decent amount of additional effort. But object-oriented databases are more expensive to develop.

## 19.2 Database Management System

A Database Management System (DBMS) is computer software designed for the purpose of managing databases based on a variety of data models. A DBMS is a complex set of software programs that controls the organization, storage, management, and retrieval of data in a database. DBMS are categorized according to their data structures or types, sometime DBMS is also known as a *Database Manager*. Data management tasks fall into one of four general categories as given below:

- Entering data into the database.
- Housekeeping tasks such as updating data, deleting obsolete records, and backing up the database.
- Sorting the data: arranging or re-arranging the database's records.
- Obtaining subsets of data.

There are several advantages in DBMS such as reduced data redundancy and inconsistency, enhanced data integrity, improved security etc.

## 19.3 Basic terminology in Databases

These terms are used often in Database Management Systems, so you need to become familiar with them before using the database management system, MS Access in this session. A brief and a simple description on some basic terms are given below.

### 19.3.1 Database

A database is an organized collection of the related information.

### 19.3.2 Object

An object is a component in the database such as a table, query, form, report, or macro, etc.

### 19.3.3 Table

A table is a group of related data organized in fields (columns) and records (rows) on a datasheet. By using a common field in two tables, the data can be combined. Many tables can be stored in a single database.

### 19.3.4 Field

A field is a column on a datasheet and defines a data type for a set of values in a table. For a mailing list table might include fields for first name, last name, address, city, and telephone number.

### 19.3.5 Record

A record is a row on a datasheet and do fields define a set of values. In a mailing list table, each record would contain the data for one person as specified by the intersecting fields.

Let's see some of the above items in the following table.

Table/Entity name: **Employee**

<u>Employee ID</u>	<u>Name</u>	<u>Sex</u>	<u>Address</u>	<u>Joined Date</u>
001	Mala Perera	Female	Colombo	05-04-00
002	Kamal Perera	Male	Colombo	04-01-05
003	Sanath Mahawela	Male	Matara	07-07-99
004	Gayana Weerawewa	Male	Galle	04-09-00
005	Leela Wijetunga	Female	Ambilipitiya	16-04-08
006	Kolitha Gallege	Male	Galle	09-09-10
007	Sarani Perera	Female	Matara	08-04-08
008	Gayana Peris	Male	Panadura	04-04-06
009	Gunapala Desilva	Male	Panadura	07-07-01
010	Kamal Perera	Male	Meegama	11-03-09

Figure 19.3: Table 'Employee'

### 19.3.6 Primary key

A primary key is used to uniquely identify each row in a table. It can either be a part of the actual record itself, or it can be an artificial field (one that has nothing to do with the actual record). A primary key can consist of one or more fields on a table. When multiple fields are used as a primary key, they are called as a composite key.

### 19.3.7 Foreign key

A foreign key is a field (or fields) that points to the primary key of another table. The purpose of the foreign key is to ensure referential integrity of the data.

### 19.3.8 Relationships

Two tables/entities in a database may relate to each other using one or more common attribute. There are three types of relationships among tables namely, One-to-one, one-to-many, many-to-many.

#### One to one relationship

Table A has a relationship to table B in that each entry in A has one and only one corresponding entry in B.

For an example, think of a university database which maintains tables of data related to a University. This database may contain tables as follows:

Table/Entity name	Description	Attributes
Lecturer	Stores data related to all lecturers of the university	Lecturer ID, Name, Sex, Faculty joined, Date joined
Faculty	Stores data related to all faculties in the University	Faulty ID, Name, Location, Dean ID, Year established
Student	Stores data related to all students in the University	Student ID, Name, Age, Courses follow
Dean	Stores data related to all Deans of the University	Dean ID, Name, Faculty ID,

Table 19.1: Tables in the University Database

Consider the two entities, **Faculty** and the **Dean** in the above university database. The data item comes under the attribute *Dean ID* of the *Science faculty* is found in only one place of the *Dean* table under the attribute *Dean ID*. In other words, the table Faculty has one and only one corresponding entry in table Dean. In simple words, one faculty has only one Dean and one dean is holding the deanship in only one faculty. Therefore, we say that the relationship between the two entities Faculty and Dean is of type **One-to-one**. This relationship can be illustrated by a diagram as follows.

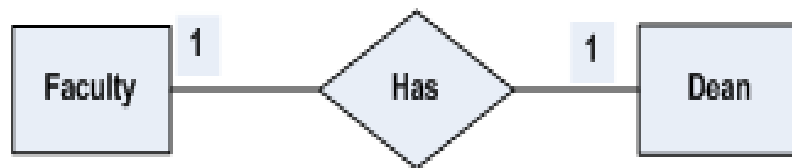

Figure 19.4: One-to-one relationship

### One-to-Many relationship

Table A has a relationship to table B such that many entries in B can refer to one entry in A. Consider the above University database. Think of the relationship between the two entities **Faculty** and **Lecturer**. Each faculty may have many lecturers but each lecturer is joined only in one faculty. Therefore, we say that the relationship between the two entities Faculty and Lecturer is of type **One-to-many**. This relationship can be illustrated by a diagram as follows.

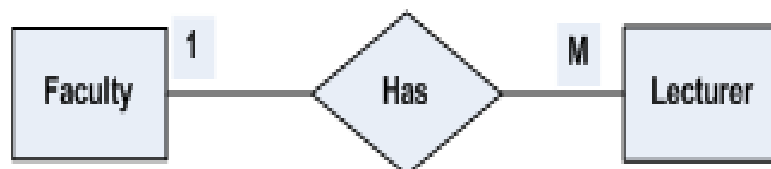

Figure 19.5: One-to-Many Relationship

### Many-to-Many relationship

Table A has a relationship to table B such that many entries to A can map to many entries in B. Consider the above University database. Think of the relationship between the two entities **Lecturer** and **Student**. Each lecturer teaches many students and each student is taught by many

lecturers. Therefore, we say that the relationship between the two entities Lecturer and Student is of type **Many-to-many**. This relationship can be illustrated by a diagram as follows.



*Figure 19.6: Many-to-Many Relationship*

## 19.4 Different Database Management Applications

There are several different database management applications which are not only meant for entering and retrieving information but also they facilitate simultaneous updates and queries from multiple users.

Some of the database management applications are listed below:

1. Oracle
2. MySQL/ SQL Server
3. Microsoft Access
4. IBM DB2
5. Sybase

## 19.5 Introduction to Microsoft Access 2007

Microsoft Office Access is a relational database management system which is a production from Microsoft that combines the relational Microsoft Jet Database Engine with a graphical user interface and software development tools. It is a member of the Microsoft Office 2007 suit.

### 19.5.1 Start Microsoft Access

1. Click **Start ->All programs ->Microsoft Office ->Microsoft Office Access 2007**  
*OR*
2. Double click the icon shown below found in any location (an Access file will be created on that location).



*Figure 19.7: Microsoft Office Access 2007 icon*



### 19.5.2 Create a new database

After opening Access, you will be presented with the window shown below. Select **Blank Database** in the **New Blank Database** category. Enter the database file name and select the path where you want to save your database and click **Create**.



Figure 19.8: Select Database type

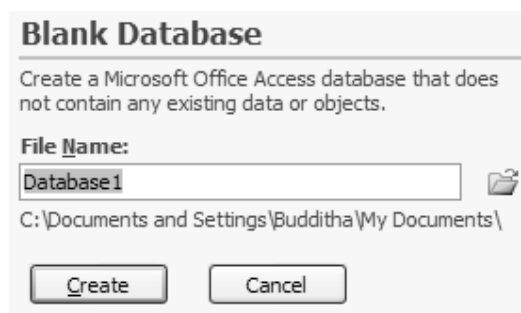

Figure 19.9: Create a Database

### 19.5.3 User interface of MS Access 2007

By default, Microsoft Access starts with the following user interface.

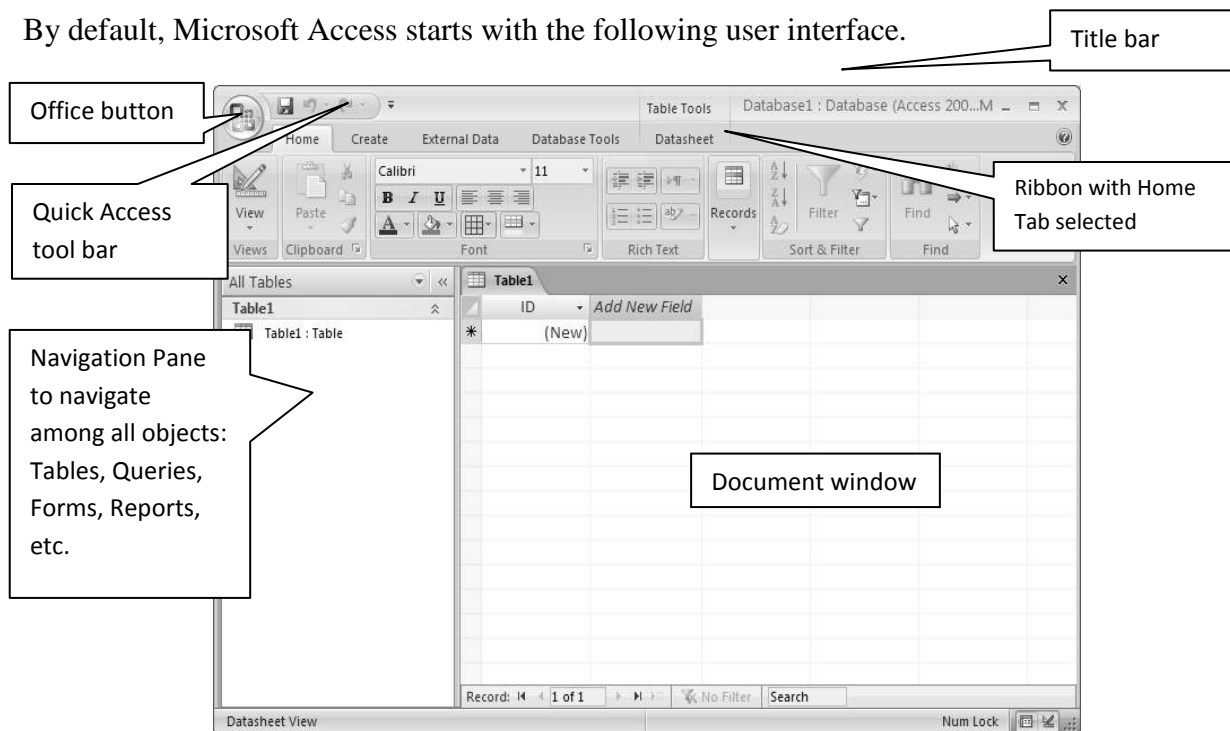

Figure 19.10: Microsoft Access 2007 user interface

### 19.5.4 Opening an Existing Database

When you start Access without opening a database, you will see the Getting Started with Microsoft Office Access window. To open an existing database, follow the steps given below.

1. Open Microsoft Access 2007.
2. Select **Local Templates**.
3. Select one of the local template categories.



*Figure 19.11: Local Templates*

For an example, we can use “Students” template.

4. Give a file name.
5. Click **Create**.

### 19.5.5 Closing an Existing Database

To close the already opened data base:

1. Make sure that you have saved all changes done.
2. Click **Office button**.
3. Click **Close database**.

### 19.5.6 Objects available in Access 2007

You can create tables, forms, reports, queries, macros, and modules in a Microsoft Access 2007 database. Some of the objects that will be discussing deeply within this course material are briefed below.

**Tables:** Tables are the core database objects. Their purpose is to store information. The purpose of every other database object is to interact in some manner with one or more tables.

**Queries:** Queries are database objects that locate specific information stored in a table and allow you to view and manipulate the results. The results of a query can be used as the basis for forms, reports, and data access pages.

**Reports:** A database object used to display table information in a formatted, easily accessible manner, either on the screen or on paper. It can include items from multiple tables and queries, values calculated from information in the database, and formatting elements such as headers, footers, titles, and headings.

**Forms:** A form is a way to pass data into your Access tables.

## 19.6 Exploring Tables

Every Access object has two or more views. For tables, the two most common views are the Datasheet view, in which you can see and modify the table's data, and the Design view, in which you can see and modify the table's structure.

### 19.6.1 Open a table in Datasheet view

To open a table in datasheet view, follow the steps given below,

1. Either double-click its name in the Navigation Pane, or right-click its name.
2. Click **Open**.

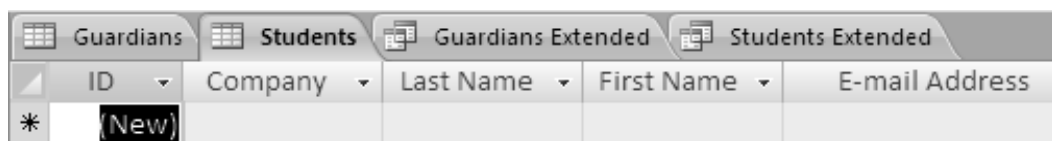

Figure 19.12: Table in Datasheet view

### 19.6.2 Open a table in Design view

To open a table in Design view:

1. Go to the Left navigation pane and right click on the name of the table to be opened.
2. Click 'Design view'.

After an object is opened, you can switch between views by clicking one of the View icons in the lower-right corner of the program window, or by clicking the View arrow in the Views group on the Home tab, and then selecting a view from the list. If you simply click the View button Access switches between different views in a logical manner as it is not opting the user to select the required view'. If the current view is not the Design view, it switches to Design view. If you click it again, the table switches to Datasheet view. When other database objects are active, clicking the View switches between views in a similar manner.

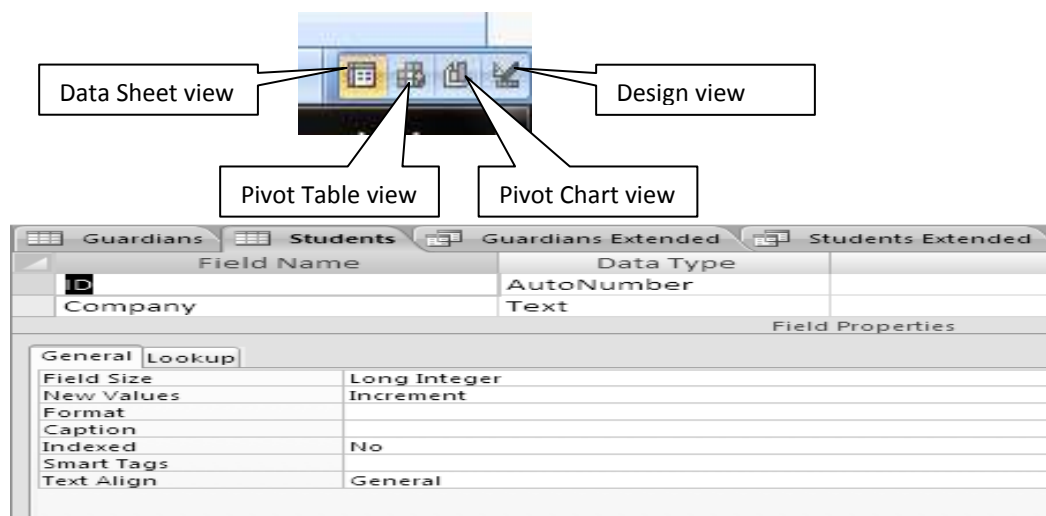

Figure 19.13: Design view of Student table

**Note:** More descriptive details on working with tables are given in the next session (Session 20).

## 19.7 Exploring Queries

You can locate specific information stored in a table, or in multiple tables, by creating a query specifying the parameters of the information you want to find.

### 19.7.1 Opening a Query

To open a Query,

1. In the Navigation Pane, click **Queries** (The database window displays all the queries that have been saved as part of this database).
2. Right-click the selected query, and then click **Open**.



Figure 19.14: Opening a Query

### 19.7.2 Open a Query in design view

To open a Query in design view,

1. In the Navigation Pane, Right click **Queries**.
2. Click **design view**.

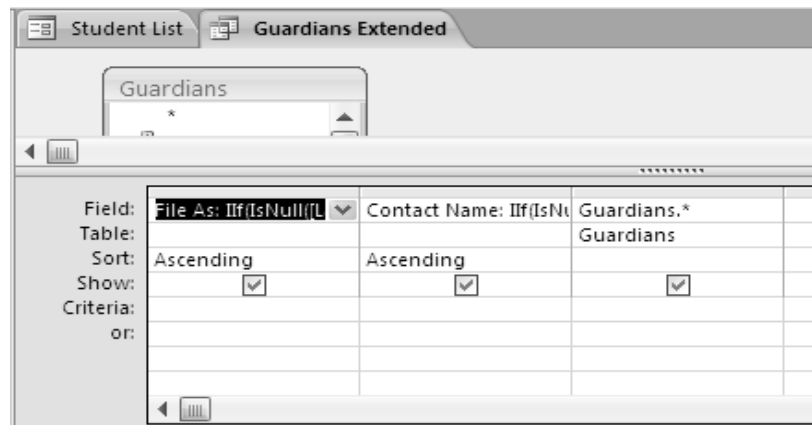

Figure 19.15: Design View of a Query

**Note:** More descriptive details on working with Queries are given in the next session (Session20)

## 19.8 Exploring Forms

A form is essentially a window containing controls that either display information to people or accept information that people enter. Access provides a collection of standard Windows controls, such as labels, text boxes, option buttons, and check boxes. With a little ingenuity, you can create forms that look and work much like the dialog boxes in all Windows applications.

A form acts as a friendly interface for a table. Through a form, you can display and edit the records of the underlying table, or create new records. As with tables and queries, you can display forms in several views.

The three most common views are:

- **Form view**, in which you enter data.
- **Datasheet view**, which looks essentially like a table.
- **Design view**, in which you work with the elements of the form to refine the way it looks and works.

### 19.8.1 Opening a Form

To open a Form, select a Form and Right Click on the mouse and then Click Open.

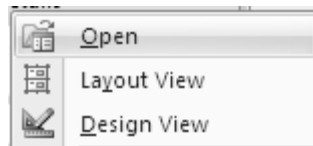

Figure 19.16: Opening a Form

### 19.8.2 Open a Form in design view

To open a Form, select a form and Right Click on the mouse and then Click Design view.

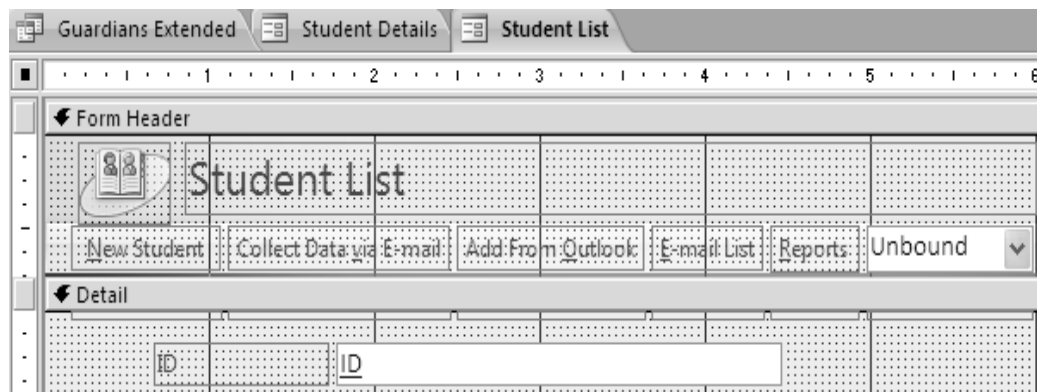

Figure 19.17: Design view of a Form

**Note:** More descriptive details on working with Forms are given in the Session 21.

## 19.9 Exploring Reports

The different sections of a report such as header, footer, details, titles... can be formatted as you wish such that the report gives your information taken from table(s) in a more readable and attractive manner.

You can look at reports in four views:

- **Design View**, in which you can manipulate the design of a report in the same way that you manipulate a form.
- **Report View**, where you can scroll through the information in the report without the page breaks inserted when it is printed.
- **Print Preview**, in which you see your report exactly as it will look when printed.
- **Layout View**, which displays the data in the report (similar to Print Preview) but enables you to edit the layout.

### 19.9.1 Opening a Report in the Layout view

To open a Report, select a report and right click on the mouse then click open.



Figure 19.18: Opening a Report

**Note:** More descriptive details on working with Reports are given in the Session 21.

### 19.10 Save your database in other formats

Microsoft 2007 basically supports with three database formats such as Access 2007 database format, Access 2002-2003 database format, and Access 2000 database format.

To save Access database in other formats, follow the steps given below:

1. Click **Office button**.
2. Click **Save As**.
3. Select the suitable access database file format and Click.

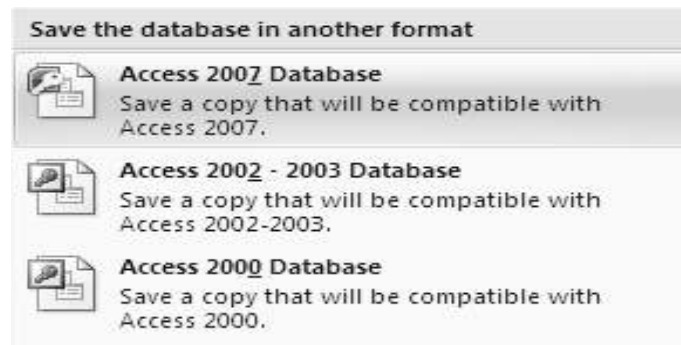

Figure 19.19: Save Database in another format

### 19.11 Encrypt with a password

You can secure your database by Encrypting with a password. Follow the steps given below.

1. Click **Database tools**.
2. Click **Encrypt password** (Set Database Password window will be appeared).



Figure 19.20: Set Database Password

3. Enter your password twice (the latter is to confirm your entry).
4. Click **OK**.

## 19.12 Decrypt the database

Once you encrypted your database, you can decrypt it by following the steps given below.

1. Open your database as exclusive mode.
2. Click **Database tools**.
3. Click **Decrypt database** (Unset Database Password window will be appeared as shown here).



*Figure 19.21: Decrypt Password*

4. Enter your password.
5. Click **OK**.



## 19.13 Self Assessment Questions

- 19.1 What is a Database? Briefly describe the four types of database models.
- 19.2 Briefly describe the following key components of relational database model.
  - a. Entity
  - b. Attribute
  - c. Relationship
- 19.3 What is Database Management System (DBMS)? State the advantages of it.
- 19.4 Give five examples for Database Management applications.
- 19.5 What is MS-Access? Briefly describe the objects available in MS-Access 2007.
- 19.6 What are the differences between a form and a report in MS Access?
- 19.7 When working with tables, what is the purpose of having “Datasheet view” and the “Design view”?
- 19.8 Define the following terms.
  - a. Primary key
  - b. Foreign key
- 19.9 Using suitable examples, define the possible types of relationships between two tables or entities in a database?
- 19.10 What is the difference between the “Print Preview” and “Layout view” of an Access report?

## Session 20

### Working with Tables and Queries

---

#### Aim:

Aim of this session is to provide an introduction about database tables and queries.

#### Objectives:

Having studied this session you will be able to:

- Get know the data types supported by Access 2007
- Create a table using the design view
- Work with tables
- Import data from other sources
- Understand what Queries are
- Create a query using the query wizard
- Create a query using the Query design tool
- Learn what SQL statements of queries are



#### 20.1 Creating Tables

As you are already aware, the tables are the grid like structures that store information in a database similar to the way an Excel worksheet stores information in a workbook. Access provides different ways to create a table.

##### 20.1.1 Creating table – method 1

There is a tool with an icon of a “Table” under the create tab. Double-click on the “Table” icon to create a table. You can start creating your table by using either datasheet view or design view.

##### 20.1.2 Creating table – method 2

To create a table by using entering data, follow the steps given below;

1. Click **Create**.
2. Click **table**.
3. Select **datasheet view** in a view group.
4. Enter data into the cells.
5. Click the **Save** button.
6. Give a table name.
7. Click **OK**.



Enter the following data and save your table as **student**.

No	Name	Index No
1	A.C. Abesinghe	AS23001
2	F. R. Silva	AS23002
3	Z. K. Gamage	AS23003
4	D.D.R. Fenando	AS23004
5	S. T. K. Gunasekara	AS23005

### 20.1.3 Create table in Design view

This is the most common way of creating a table. To create a table using the design view, perform the following steps,

1. Click **Create** in the ribbon.
2. Click **table** (automatically a sample table is created with name table X; X is reference to a number).

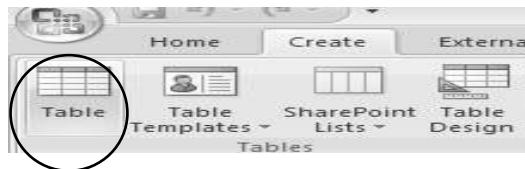

Figure 20.1: Table icon

3. Right click on the table heading (Short cut menu will be appeared).
4. Select and click **the design view**.

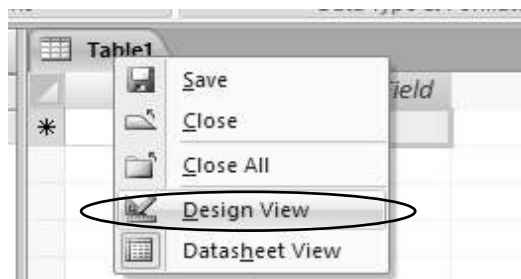

Figure 20.2: Design view on Short cut Menu

5. Give a name to your table (This example uses 'results') and Click **OK**.



Figure 20.3: Save As dialog box

6. Then Table Design view will be appeared.

Design view contains three columns namely field name, data type and description as shown below.

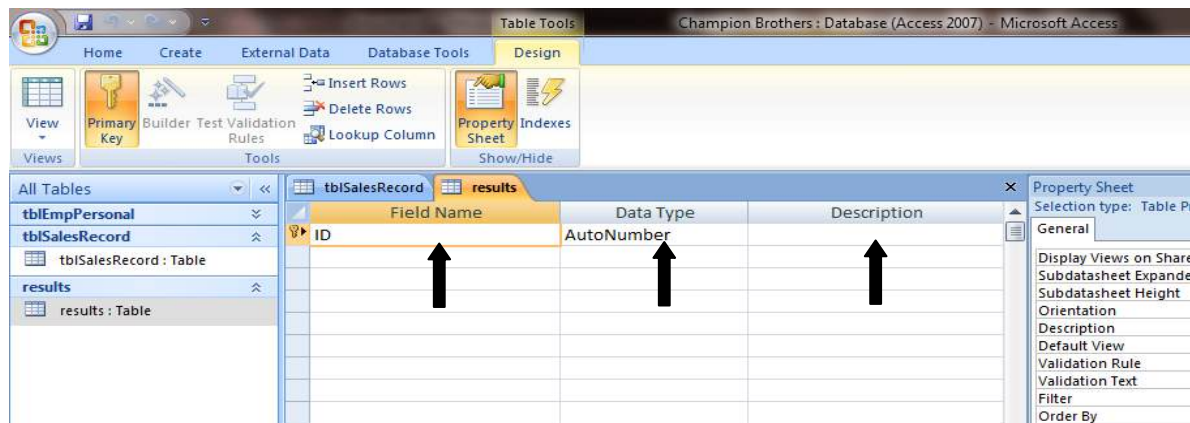

Figure 20.4: Design view of the table

### Field name

This is the Name of the data field. By default it gives the field names as Field1, Field 2... for the first table. Note that, there is a good convention that you may follow to identify the field name, which is to insert first three letters in the table name and add the field name after that. Original name of the field starts with the capital letter and do not use any space between two words.

**Example:** for the fields of the table named ‘Student’ the field names shall be as follows:

Student name: stuName

Student Age: stuAge

### Data types

Before creating a table you must get a clear idea about the fields and the data types of the fields of your table.

Data Type of a particular field is the type of the values that will be entered into that field. There are various data types available in the Access database system. Following table gives you an idea of them.

Data Type	Example	Description
Text	Saman Kumara	The default type, text type allows any combination of letters and numbers up to a maximum of 255 characters per field record
Memo	A lengthy Paragraph in text format	A type of text that stores up to 64,000 characters.
Number	12334	Any number can be stored.

Date/Time	28.11.2005	A date, time, or combination of both.
Currency	Rs, \$	Monetary values that can be set up to automatically include a dollar sign (\$) and correct decimal and comma positions
Auto Number	566060606	When a new record is created, Access will automatically assign a unique integer to the record in this field. From the General options, select <b>Increment</b> if the numbers should be assigned in order or <b>random</b> if any random number should be chosen. Since every record in a datasheet must include at least one field that distinguishes it from all others, this is a useful data type to use if the existing data will not produce such values.
Yes/No	yes	Use this option for True/False, Yes/No, On/Off, or other values that must be only one of two.
OLE Objects		An OLE (Object Linking and Embedding) object is a sound, picture, or other object such as a Word document or Excel spreadsheet that is created in another program. Use this data type to embed an OLE object or link to the object in the database.
Hyperlink		A hyperlink will link to an Internet or Intranet site, or another location in the database. The data consists of up to four parts each separated by the pound sign (#):

*Table 20.1: MS Access 2007 data types*

**Example:** Using the design view, create a table named ‘tblEmpDetails’ that store the following information.

- Employee ID
- Employee Name
- Address
- Date of birth
- Age
- Department
- Salary

Create the fields, enter the field name, data type, description and set properties of the data type as follows.

**Note:** Please follow the instructions of your teacher at the hands on practical sessions to get a good idea on setting field properties.

Field Name: EmpName (do not use space between two words)  
Data Type: Text  
Description: Employee name.  
Properties: there are so many properties. But you may change field size into 50

Field Name: EmpAddress  
Data Type: Text  
Description: Employee address.  
Properties: field size -70

Field Name: EmpAge  
Data Type: Number  
Description: Age of an Employee  
Properties: Field size -integer  
Default value -0, Decimal places - 0

Field Name: EmpID  
Data Type: Number  
Description: Employee ID  
Properties: Field size -long integer  
Default value - 0 Decimal places -0

Set the EmpID field as a **Primary key**. To create a primary key follow the steps given below.

1. Select EmpID field.
2. Click right button of the mouse and.
3. Click **primary key**.

Now save your table name “tblEmpDetails”. Enter five sample values.

#### 20.1.4 Delete a Table

To delete a created table, follow the steps given below (To delete the Student table).

1. Select the table that you need to delete.
2. Right click on the table.
3. Click **Delete**.
4. Then system asks you to confirm action “do you want delete the table student”.
5. Click **YES**.

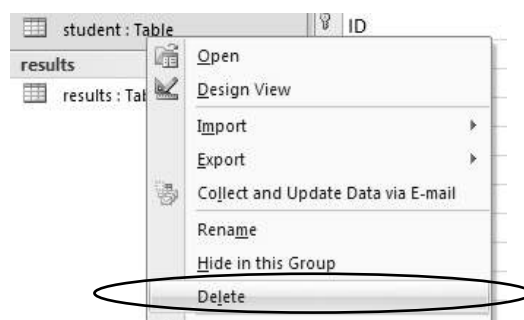

Figure 20.5: Delete Table

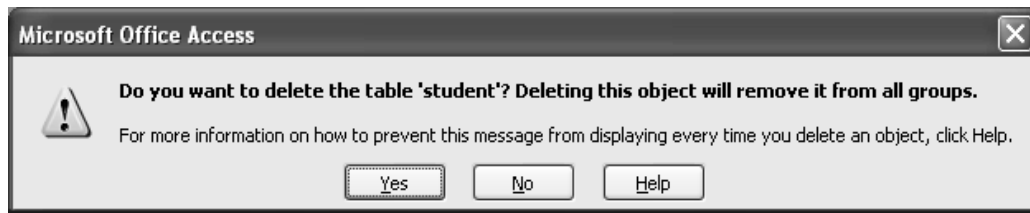

Figure 20.6: Confirm action

### 20.1.5 Create another table

Imagine that you have a table named **tblEmpDetails** created in the database named “ABC Holdings”. Create a new table named **tblEmpWorks** with the fields EmpID, Date, Work and Num of Hours (use the table design view).

Now you have two tables namely, tblEmpDetails and tblEmpWorks. Add some suitable records for the above two tables.

## 20.2 Creating Relationships between two tables

Now you have two tables (tblEmpDetails and tblEmpWorks) to create a relationship between them.

Please recall that there are three types of relationships namely *one-to-one*, *one-to-many* and *many-to-many*.

To create a relationship between two tables follow the steps given below;

1. Click **Relationships** icon in the **Database tools** tab
2. “Show table” window will be appeared.

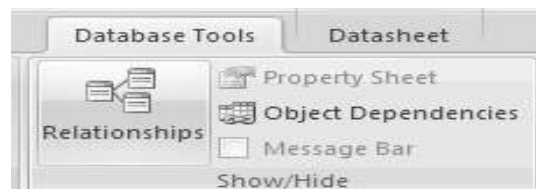

Figure 20.7: Relationship icon

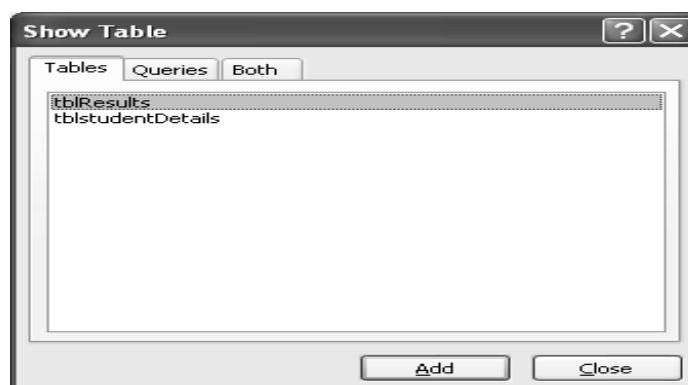

Figure 20.8: Show Table Window

3. Add the two (or more) tables to be related by selecting the table name and then clicking the **Add** button.
4. Click **Close**.

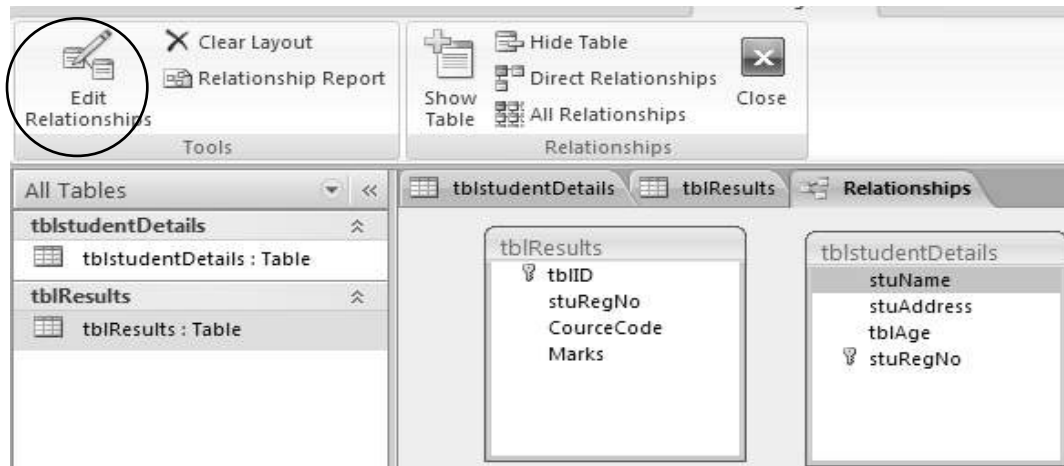

Figure 20.9: Edit relationships window

Select “EmpID” field in the tblEmpDetails table, drag and drop into EmpID field in the tblEmpWorks table. Now “Edit Relationship” Window will be appeared as shown below.

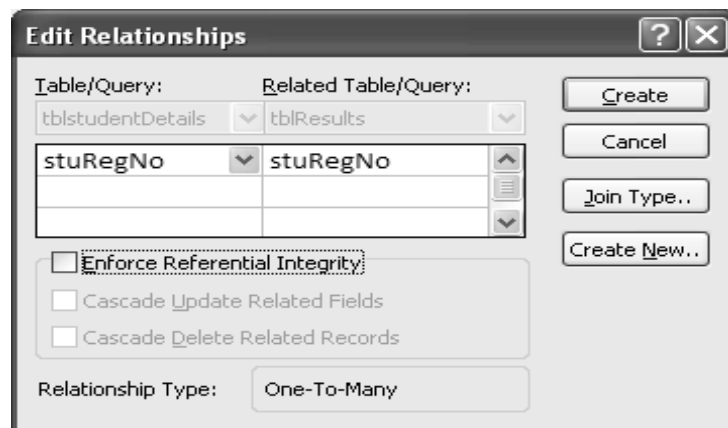

Figure 20.10: Edit Relationships Window

5. Click **Join Type**.
6. Select the join type **3** and click **OK**.

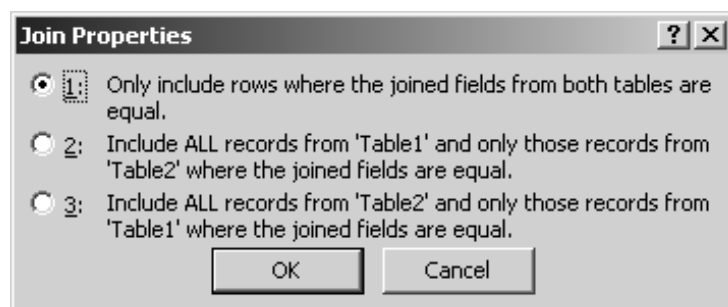

Figure 20.11: Edit relationship

To create different types of Relationships follow the steps given below;

7. Click **Join types**.
8. Select the suitable relationship type.
9. Click **OK**.
10. Select '**Enforce referential integrity**' option.
11. Click **Create**.

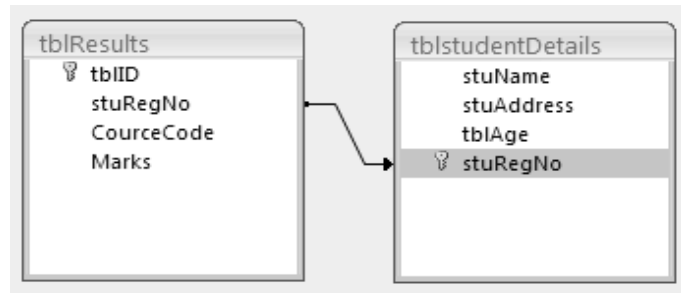

Figure 20.12: Relationship

### 20.2.1 Relationship design tool

Relationship design tool is used to manipulate the relationships built.

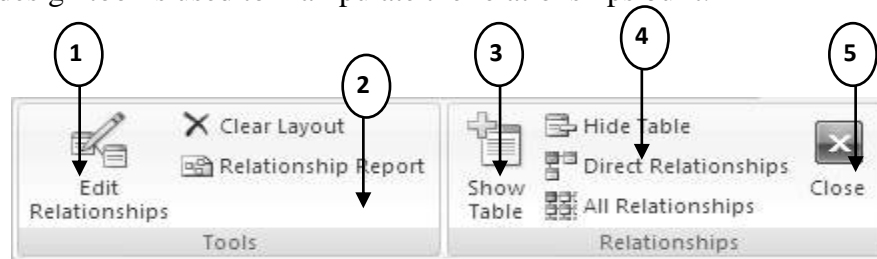

Figure 20.13: Relationship design tool

No	Name	Description
1	Edit Relationship	Click here to edit relationship types
2	Relationship Report	Click here to create a relationship report
3	Show Table	Click here to the 'show table' window to add/delete tables to the relationships
4	Hide Table	Click here to hide table
5	Close	Close relationship window

Table 20.2: Relationship design tools

## 20.3 Modifying your tables

### 20.3.1 Delete Records from a table

Microsoft Access 2007 provides easy way to delete a record (s) in your table. You just need to,

1. Right Click the Row.
2. Click **Delete**.

**Note:** When the tables are inter-related using Relationships, Access will check for effect of deleting a record from a table to maintain the required relationship. If deletion affects the relationship, it will block you deleting such records.

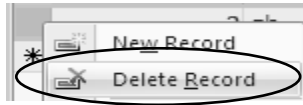

Figure 20.14: Delete Record

### 20.3.2 Insert a new field

To insert a new data field, follow the steps given below.

1. Right Click on a column.
2. Click **Insert Column**.

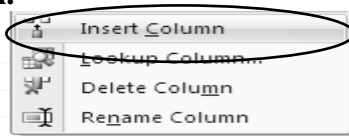

Figure 20.15: Inserting Column

### 20.3.3 Rename a Column/field

To rename an existing column, follow the steps given below.

1. Right Click the Column to be renamed.
2. Click **Rename Column**.

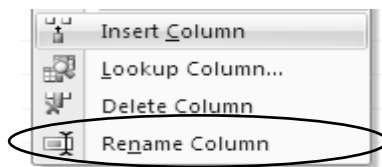

Figure 20.16: Rename Column

### 20.3.4 Delete a column/field

To delete an existing column, follow the steps given below.

1. Right Click the column to be deleted.
2. Click **Delete column**.

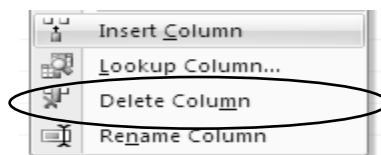

Figure 20.17: Delete Column

**Note:** Access will block you deleting the Primary key of the table.



## 20.4 Queries

Queries select records from one or more tables in a database. So they can be viewed, analyzed, and sorted on a common datasheet. The resulting collection of records, called a **dynaset** (dynamic subset), is saved as a database object and can therefore be easily used in the future. The query will be updated whenever the original tables are updated. There are several types of queries. They are: **select queries** that extract data from tables based on specified values, **find duplicate** queries that display records with duplicate values for one or more of the specified fields, and **find unmatched** queries display records from one table that do not have corresponding values in a second table.

There are two methods to create a query,

1. Create a query by using wizard
2. Create a query in design view

### 20.4.1 Create a Query using Wizard

Follow these steps to create a new simple query by using Query Wizards.

**Example:** Create a Simple query to display Index Number and name of the student. It is assumed that there is a table named 'personalData' created with some data in it.

1. Select **Create** tab in the ribbon.
2. Select **Other** group.
3. Click **Query wizard**.
4. Select **Simple Query Wizard** and Click **OK**.
5. In the Simple Query wizard select the table '**personal Data**'.
6. Select the fields '**Index No**' and '**Name**'.
7. Click **next**.
8. Add a name to the query.
9. Click **Finish**.

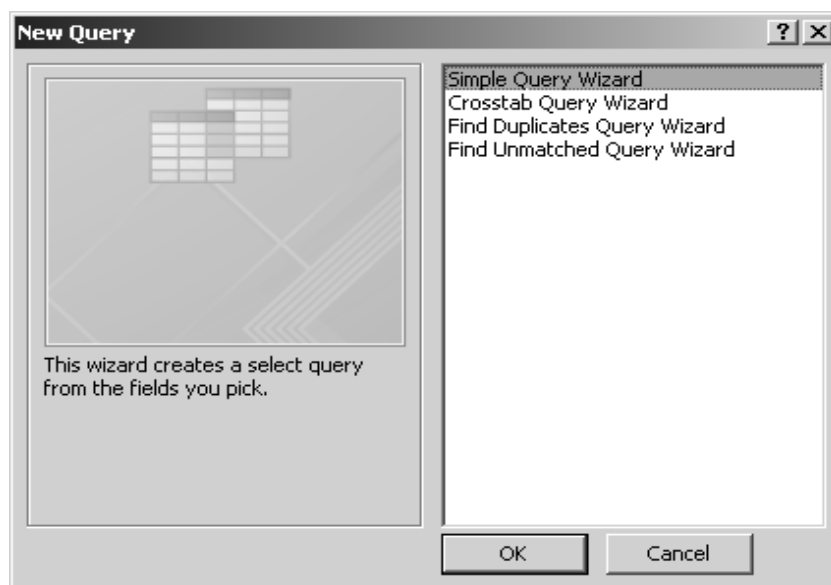

Figure 20.18: New Query Window

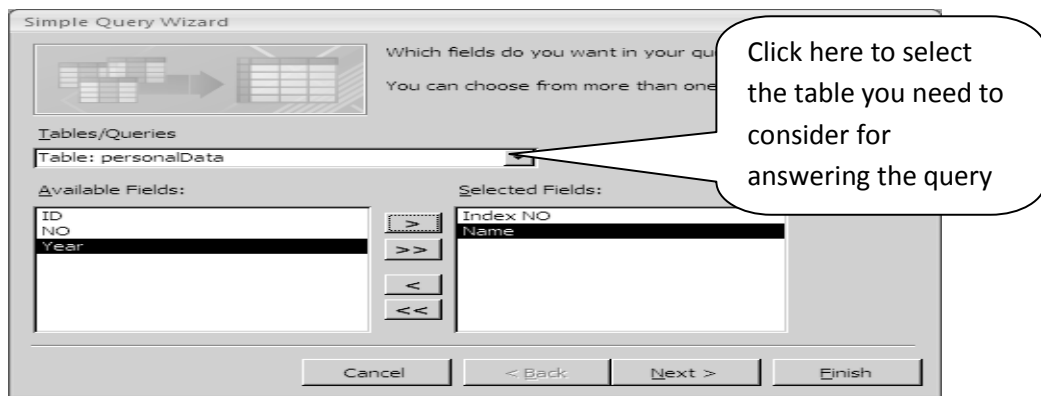

Figure 20.19: Simple Query Wizard

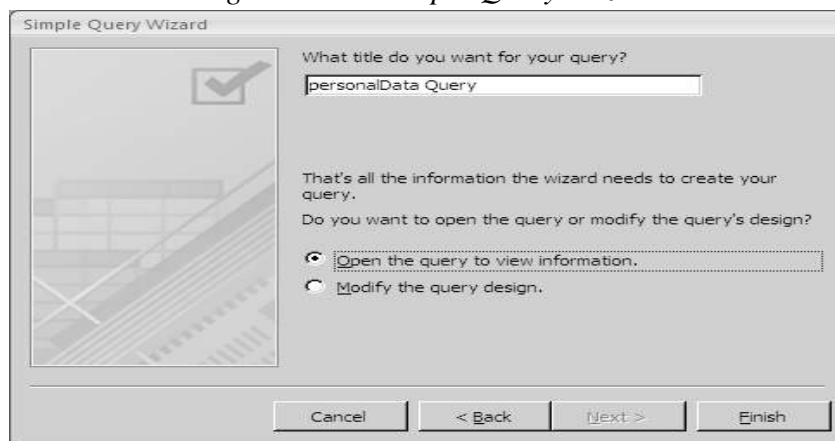

Figure 20.20: Query wizards

Then the following will be displayed as the query output.

Index NO	Name
AS2009125	Samarasinghe !
AS2009126	Gamage S. I.
AS2009127	Hettige B. L.

Figure 20.21: Query Output

#### 20.4.2 Create a Query using design view

Before you start creating a query using query design view, do some minor modifications into your personalData table. Add a new data field named “Age” into personalData table.

**Example:** Create a query (Using design view) to display name and age of the students, whose age is greater than 32 years.

1. Select **Create Tab** in the ribbon.
2. Select **Other** Group.
3. Click **Query Design** (Query design view is appeared).
4. Add **PersonalData** table to the Query from the **Show Table** window.
5. Click **Close**.

The “Query design tool” contains five fields for designing a query namely field, table, sort, show, and criteria

- Field*            *Field in your table/ tables*
- Table*            *Table/tables in your data base*
- Sort*             *sort order (ascending/ descending)*
- Show*            *Show this record*
- Criteria*         *How data are selected/conditions to be satisfied to get the required output.*

Add fields from the tables to the new query by double-clicking the field name in the table boxes or selecting the field from the **Field:** and **Table:** drop-down menus on the query form. Specify sort orders if necessary.

1. Create two columns for student name and student age. Then type ‘>35’ in the **criteria** section of the student age field.
2. Click **Run** in the **Result** group.

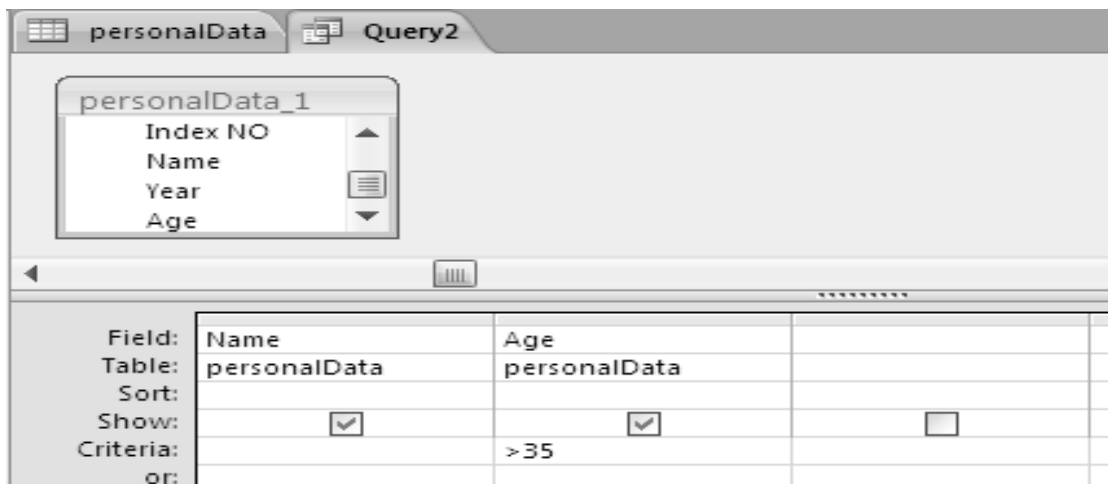

Figure 20.22: Quick Design Tool



Figure 20.23: Create and run a query using query design tool

Name	Age
Samarasinghe S. G.	45
Samaraweera F. J.	41
Sumanasekara D. J.	37
*	

Figure 20.24: Query Output

### 20.4.3 More about criteria sections in the Query design tool

The **criteria** section is the most useful section in query designing. If you need to create an advance query, you need to add more on criteria section. More details about criteria section is given below.

Example with wildcard/ Operator	Explanation
? Street	The question mark is a wildcard that takes the place of a single letter.
43th *	The asterisk is the wildcard that represents a number of characters.
<100	Value is less than 100
>=1	Value should be greater than or equal to 1
<>"FL"	Not equal to FL
Between 1 and 10	Numbers between 1 and 10
Is Null Is Not Null	Finds records with no value or all records that have a value
Like "a*"	All words beginning with "a"
>0 And <=10	All numbers greater than 0 and less than 10
"Saman" Or "Kamal"	Value should be equal to either Saman or Kamal

Table 20.3: Query Wildcards and Expression Operators

### 20.4.4 Creating advance queries by using query design tool

Consider the two tables *Student* and *Result*. The student table contains student's name and index number. The result table contains Index No, Course Code, and Mark. Create above two tables into your access database. Then create a suitable relationship between these two tables.

Index NO	Name
AS2009125	Perera A. B.
AS2009126	Gamage S. I.
AS2009127	Hettige B. L.
AS2009128	Namalage S. M. L.D
AS2009129	Fernando S. N. I.
AS2009130	Silva K. A.
AS2009131	Silva S. H.
AS2009132	Samarasinghe S. G.
AS2009133	Samaraweera F. J.
AS2009134	Sumanasekara D. J.
AS2009135	weerasinge W. F.
AS2009136	Gunawardene J. D.

Table 20.4: Student table

Index NO	Course Code	Marks
AS2009132	CSU 1140	12
AS2009126	CSU 1140	23
AS2009128	CSU 1140	32
AS2009125	CSU 1140	34
AS2009135	CSU 1140	37
AS2009134	CSU 1140	45
AS2009127	CSU 1141	56
AS2009136	CSU 1141	57
AS2009129	CSU 1141	67
AS2009131	CSU 1141	78
AS2009130	CSU 1141	89
AS2009133	CSU 1141	94

Table 20.5: Result table

**Task 1:** Create a simple query to display the Student name and marks obtained for the subject CSU1140.

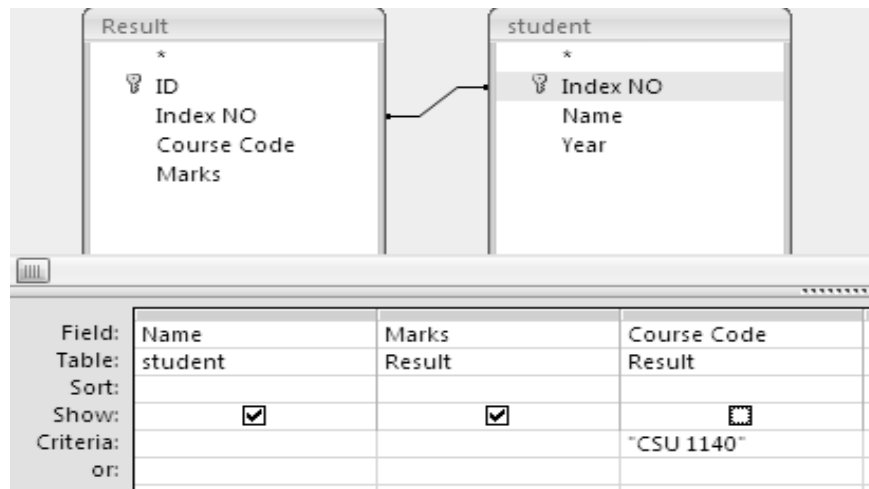

Figure 20.25: Query design tool

Name	Marks
Samarasinghe	12
Gamage S. I.	23
Namalage S. M	32
Perera A. B.	34
weerasinghe W.	37
Sumanasekara	45

Figure 20.26: Query Output

**Task 2:** Add another section to the above query to display the name and the marks of the students who have got more than 40 marks. The required design of the query should be as follows:

Field:	Name	Marks	Course Code	Marks
Table:	student	Result	Result	Result
Sort:				
Show:	<input checked="" type="checkbox"/>	<input checked="" type="checkbox"/>	<input type="checkbox"/>	<input checked="" type="checkbox"/>
Criteria:			"CSU 1140"	>40
or:				

Figure 20.27: Query Design Tool

#### 20.4.5 Viewing the SQL statements of created queries

Note that, normally Queries are developed by using *Structured Query Language (SQL)*. To develop more advance queries, programmers are required to have a sound knowledge in SQL. To see the SQL code for your query, follow the steps given below.

1. Click down Arrow of the **view results** group.
2. Select **SQL view**.

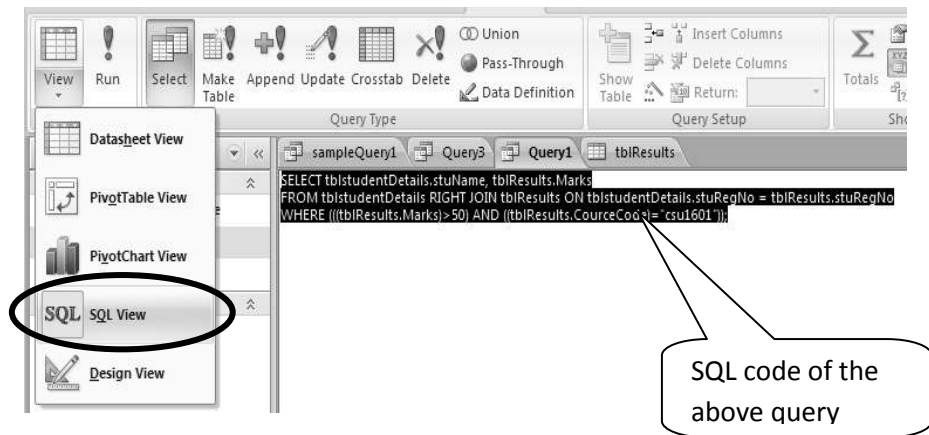

Figure 20.28: SQL view

**Note:** Describing details on SQL statements is beyond the scope of this course. However, if you are interested, please refer to SQL statements more.

## 20.5 Self Assessment Questions



- 20.1 What is meant by data types? List five available data types in MS Access 2007.
- 20.2 What are the different ways to create a table in an Access database?
- 20.3 What is meant by the 'default value' of a field in an Access table?
- 20.4 What is a Dynaset?
- 20.5 Name some object operations that a user must know when working with databases?
- 20.6 What does SQL stands for? Describe the importance of SQL.
- 20.7 What are the available methods to create a query?
- 20.8 Briefly describe the purpose of following types of queries.
  - a. Select queries
  - b. Find duplicate queries
  - c. Find unmatched queries

# Session 21

## Working with Forms and Reports

---

### Aim:

To provide an introduction about forms and reports in MS Access 2007

### Objectives:

Having studied this session you will be able to get an idea about:

- What a form is and its usage
- How to create a form by using wizard
- The form controls
- How to create a form by using design view
- What reports are and their usages



### 21.1 Working with Forms

Forms are used to display the data stored in tables/queries in a visual environment. By using the forms you can add, edit or delete records in a table easily.

There are two ways to create a form:

- Create form by using wizard
- Create form in design view

#### 21.1.1 Create a form by using Form Wizard

This example shows how to create a form for *personalData* table by using wizard.

To create a form by using wizard, follow the steps given below,

1. Click **Create**.
2. Select **More Forms** in the **form** group.
3. Click **Form Wizard** (The form wizard will be appeared).
4. Select the table **personalData**.
5. Click >> button to select all fields from the selected table (i.e. personalData)
6. Click **Next**.

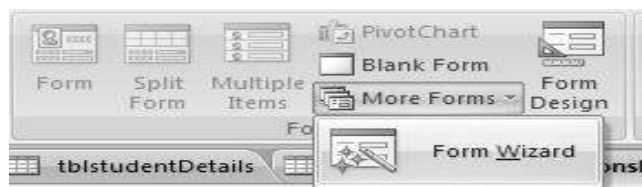

Figure 21.1: Form Wizard under More Forms

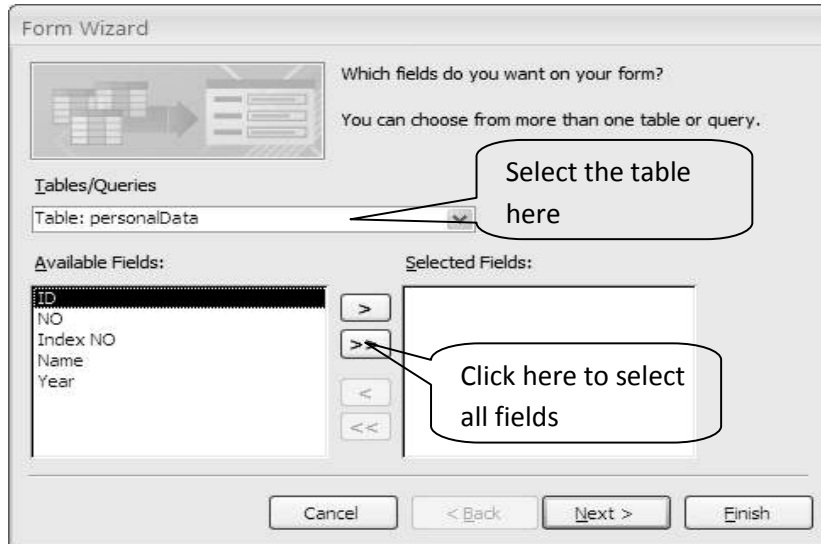

Figure 21.2: Create a form using wizard

7. Select the layout as **columnar**.
8. Click **Next**.
9. Select the form style as **Access 2007**.
10. Click **Next**.
11. Add the form title as “**Student Details**”.
12. Click **Finish**.

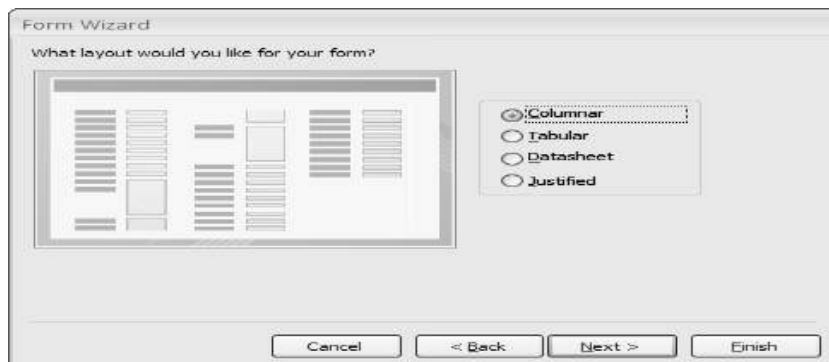

Figure 21.3: Select the form layout

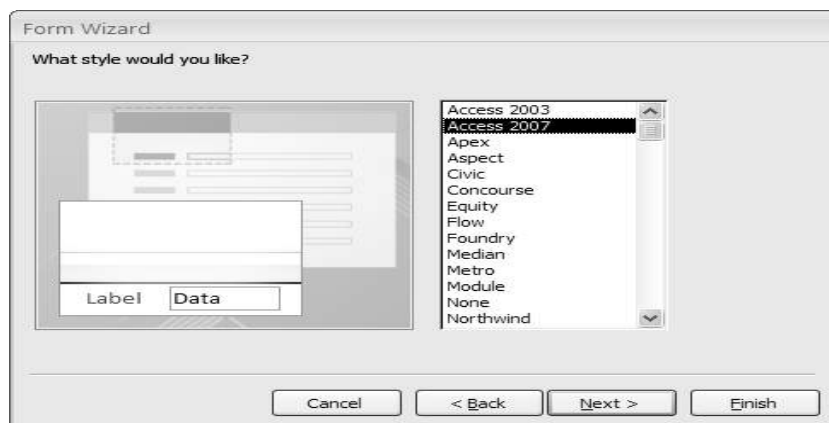

Figure 21.4: Select the form style



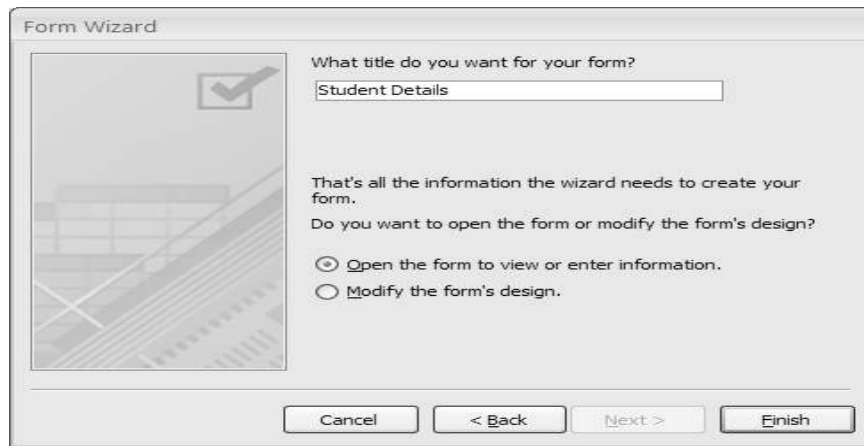

Figure 21.5: Add a title to the form

Sample output of the form is given below.

personalData	
ID	1
NO	1
Index NO	AS2009125
Name	Perera A. B.
Year	2009

Figure 21.6: Output of the form

### 21.1.2 Control Buttons in a form

There is a control box in the bottom of the form that is used to work with records accessed by the form. The operations available with this Control box are shown below.

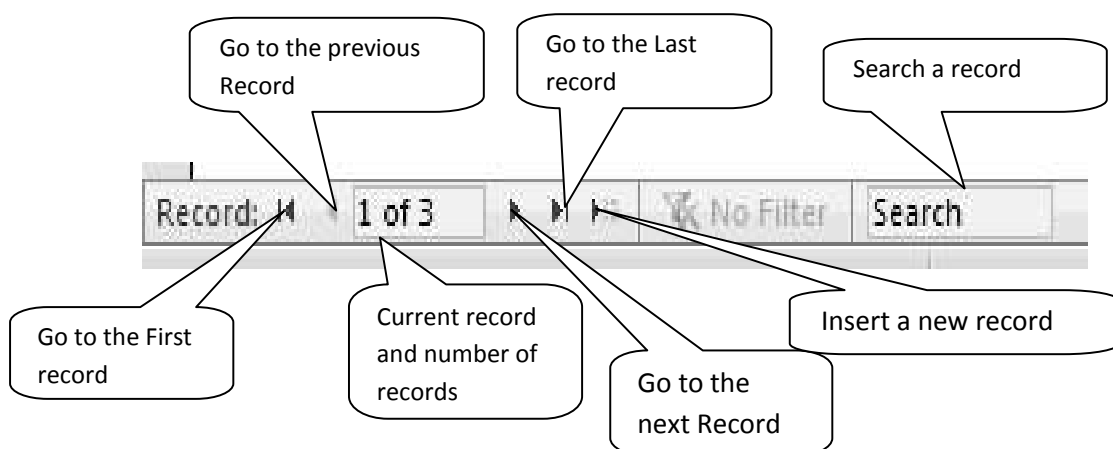

Figure 21.7: Control Box

### 21.1.3 Form views

Forms can be viewed in three ways namely as *Form view*, *layout view* and *design view*. To change the view of your currently viewed form;

1. Right Click on the form.
2. Select the view.

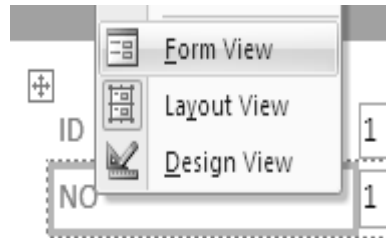

Figure 21.8: Select view

### 21.1.4 Create a form by using the Design View

In Microsoft Access 2007, you can create default form for each table very easily. To create a default form you needed only to click “create” icon on the ribbon and select “forms”. However, Microsoft Access provides the design view to create a form as you wish by customizing its features. You can use the **form design view** to create more advanced forms. The following section describes how to create a form by using design view.

To create a form by using design view, follow the steps given below:

1. Click **Create**.
2. Click **Form design** in form group.

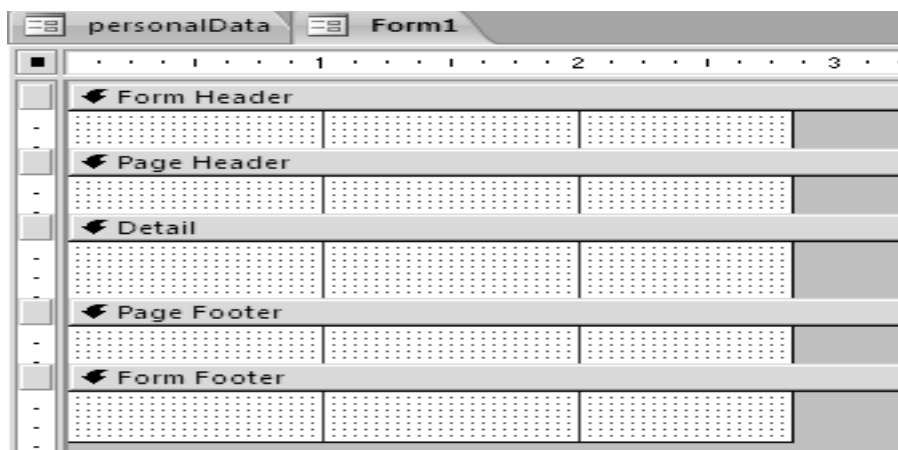

Figure 21.9: Form Design Window

A form contains five sections. They are Form header, Page Header, Detail section, Page Footer and the Form Footer. You can show/hide these sections by Right click on the form and Select Page header/Footer or Form Header/Footer.

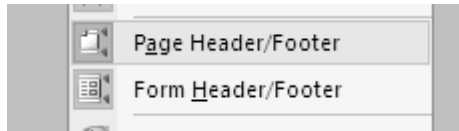

Figure 21.10: Show/ Hide sections

Access provides facilities to manipulate the form created in design view. The form design tool available in the ribbon is used to change such features of the created form. There are several controls available in this tool such as Textbox, label, button etc. you can place each control into your form as you wish. Some form controls available in the design tool are listed below.

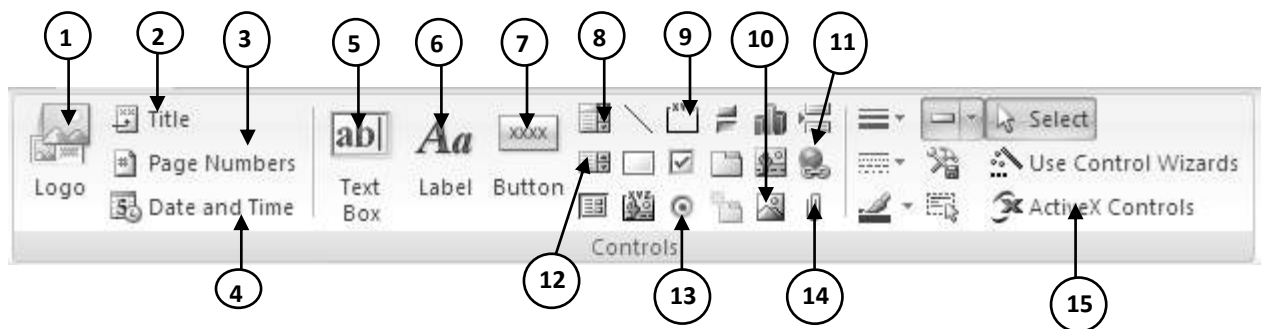

Figure 21.11: Form Design Tool

No	Name	Description/usage
1	Logo	To insert a logo to the form
2	Title	To insert a form title
3	Page Numbers	To insert page number into your form
4	Date and Time	To insert date and time
5	Text box	To insert a textbox
6	Label	To insert a label
7	button	To insert a button
8	Combo box	To insert a combo box
9	Option Group	To insert a group of options as a single unit
10	Image	To insert an image
11	Hyper link	To insert a Hyper link
12	List box	To insert a list box
13	Option button	To insert an option button
14	Attachment	To insert an attachment
15	ActiveX control	To insert an active X control

Table 21.1: Form controls

Some of the commonly used form controls are described below.

### Add a Label into a form

Labels are used to display messages such as form title, caption of the data fields, etc. To insert a label, follow the steps given below.

1. Click **label** icon in the form controls.

2. Click on the form (where you want to place the label).
3. Type the text.

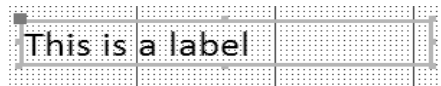

Figure 21.12: Label

4. Change the fonts and styles as you wish.
5. Change the position of the label, if required.

### Add a textbox into a form

Text box are used to display values in the data fields. To insert a text box follow the steps given below,

1. Click **Textbox** icon in the form controls.
2. Click on the form (where you want to insert a text box).

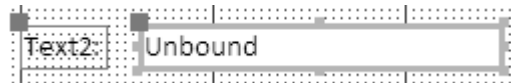

Figure 21.13: Textbox

3. Click **property sheet** on the tool bar.
4. Change the control source on the data tab.



Figure 21.14: Change Control Source

OR

1. Go to the location where you want to insert a text box.
2. Click **property sheet** on the tool bar as shown here.

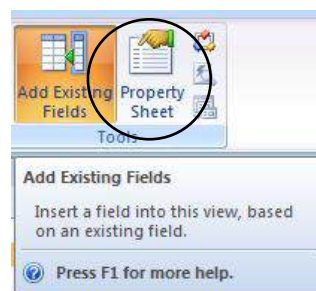

3. Double Click on the required field in the Field list window that will appear on the right hand side of your screen as shown in the sample below.

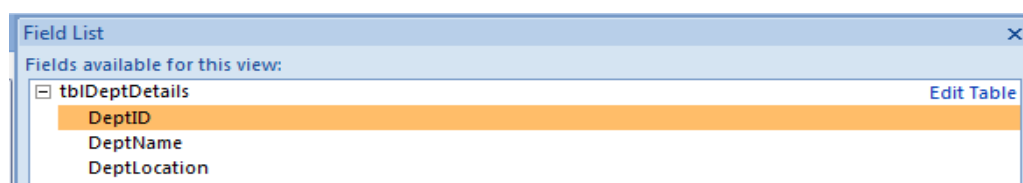

## Add a Combo box into a form

Combo boxes are used to choose a value from a drop down list. To insert a combo box, follow the steps given below.

**Note:** On the Design tab, in the Controls group, ensure that **Use Control Wizards** is not selected.

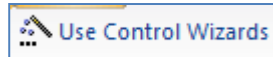

1. Click **Combo box** icon in the form controls.
2. Click on the form (where you want to place the combo box)

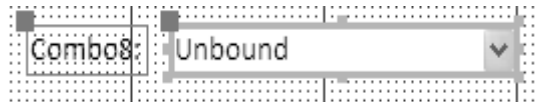

Figure 21.15: Combo Box

Now you need to bind your data source into a data field. This example shows how to bind data into a combo box. Assume that, *PersonalData* table contains personal information about persons. Now we'll bind the **name** field into a combo box.

3. Change the **row source** type as **table/query**.
4. Select the table name (*PersonalData* where your list of items is saved as a field named 'Name') in the drop down list given under the **row source**.
5. Click browser button  in the row source (A message box will be appeared).



Figure 21.16: Microsoft Office Access Message Box

6. Click **Yes** (Query builder will be appeared).
7. In the Query builder, select the field as name and the table as personalData and tick off the **show** section.

Simply, drag and drop the field name from the table to the **Field** of the query design are as shown below

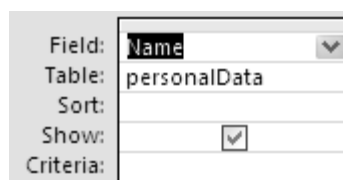

Figure 21.17: Query Builder

8. Click **Close**.

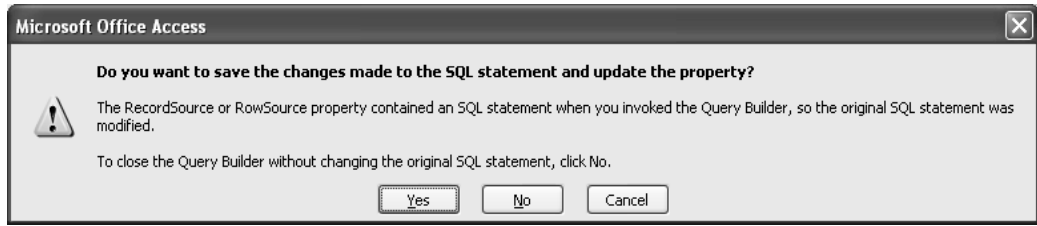
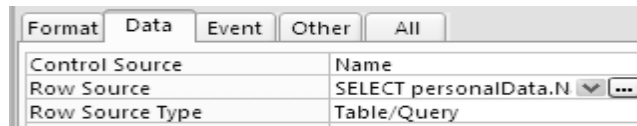

Figure 21.18: Access Message Box

9. Click **Yes**.



10. Right click on the form.

11. Change the view as **form view**.

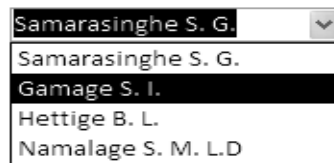

Figure 21.19: Combo Box

Now your combo box will be appeared as above.

### Add a Combo box into a form to display 'Male/Female' option

To insert a combo box of two value choice, follow the steps given below.

1. Click Combo box icon in the form controls.
2. Click on the form (where you want to place the combo box).

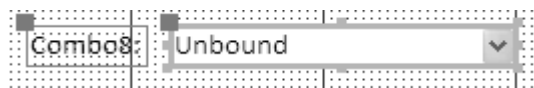

Figure 21.20: Combo Box

3. Change the row source type as **Value List**.
4. Click browse button in the row source (Edit list items window will be appeared).

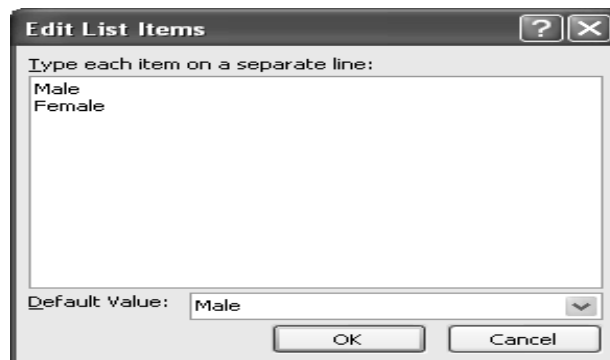
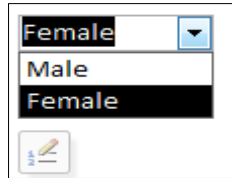

Figure 21.21: Edit List Item Window

5. Type the values as 'Male' and 'Female'
6. Select the default value as "Male"
7. Click **OK**.
8. Right click on the form.
9. Change the view as form view.



Now your combo box will be appeared as above.

**Note:** Similar to the combo box, you can easily insert a list box into your form.

### Insert an ActiveX control

To insert an ActiveX control, follow the steps given below.

1. Click **ActiveX control** icon in the form controls (Insert ActiveX control window will be appeared).
2. Select the **control** from list (in this example, we use the windows media player).
3. Click **OK**.

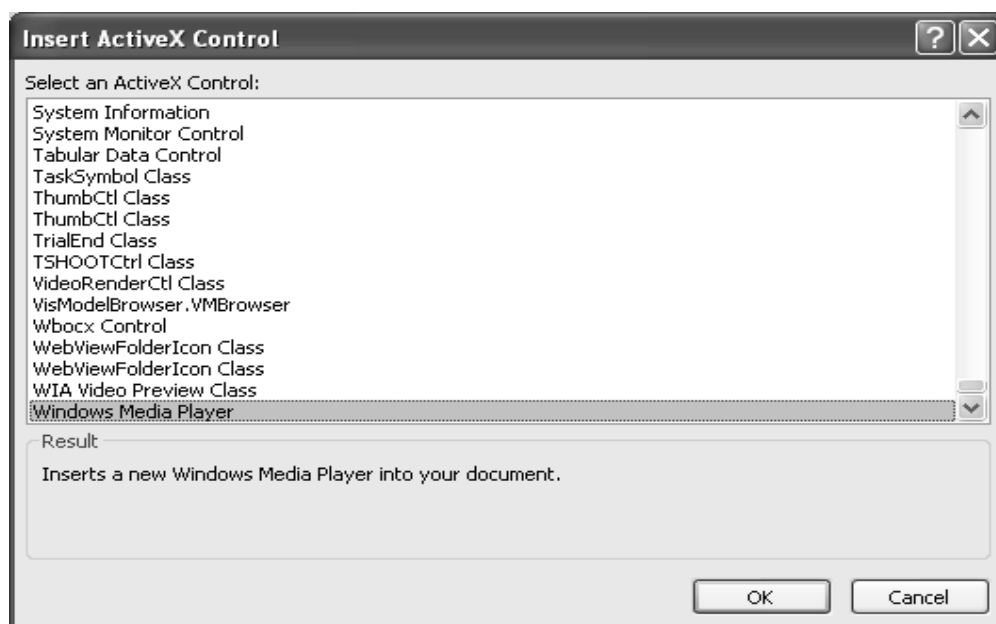

*Figure 21.22: Insert Active X control Window*

4. Place the control where you want show it.
5. In the **property sheet**, Click the browse button of the **Custom** property available under the **Other** tab. (Media player property window will be appeared)
6. Browse for the media file (File name or URL).
7. Click **OK**.
8. Right click on the form.
9. Change the view as form view.
10. Press the play button of the media player to play the file you inserted.

## Insert date and time

To insert date and time into a preferred location of your form, follow the steps given below:

1. Move to the location where you want to have the date and time.
2. Click **date and time** icon on the form controls.
3. Click **include date**
4. Click **include time**
5. Choose the date/time format you prefer.
6. Click **OK**.

## Insert Page number

If your form goes for more than a single page, to insert page numbers into your form, follow the steps given below:

1. Select the form you want to insert page numbers.
2. Click **insert page number** icon on the form controls.
3. Select the page number format as you wish.
4. Click **OK**.

### 21.1.5 Format your form

After creating a form you can further format your form as you wish. To do this, you need to view your form in **layout view** or **design view**.

#### Format your form by using Auto format wizard

You can create your form with various formats. There are several built-in formats available in Access 2007. You can use these formats by using Auto-Format tool.

1. Select the form you want to format.
2. Click the down arrow of **Auto Format wizard** icon on the **auto format** group appearing under the **Arrange tab** of **Form Design Tool** and select **Auto Format Wizard** (Auto format window will be appeared).

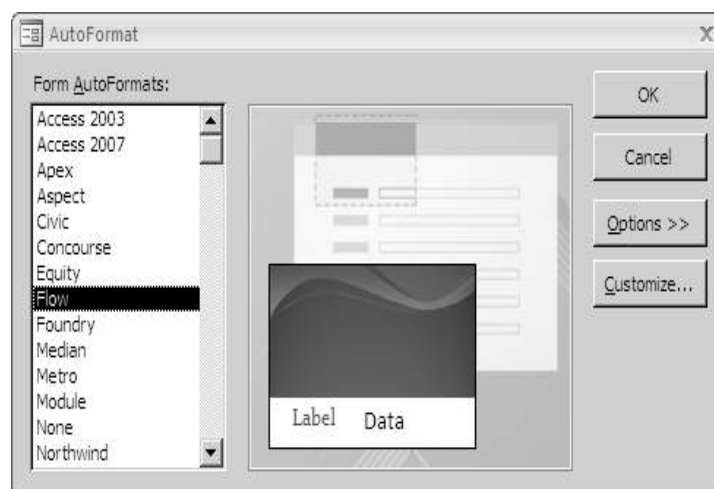

Figure 21.23: Auto Format Wizard



3. Select one of the auto format layouts.
4. Click **OK**.

### Format your form by using Form formatting tools

Access 2007 provides form formatting tools to format your form easily. There are several tools available in the arrange group.

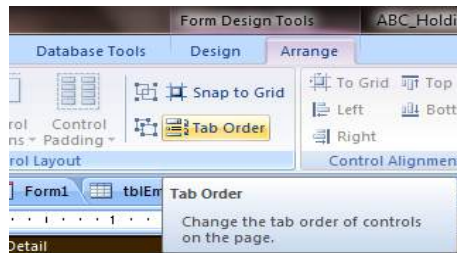

Figure 21.24: Arrange Group

### Change the tab order

To change the tab order of the form, follow the steps given below:

1. Select the form whose tab order to be changed.
2. Click the **tab order** icon in the **control layout** group appearing under the **Arrange Tab** of **Form Design Tools** as shown below (Tab order window will be appeared).



(Tab order window will be appeared as shown below)

3. Change the tab order as you prefer.
4. Click **OK**.

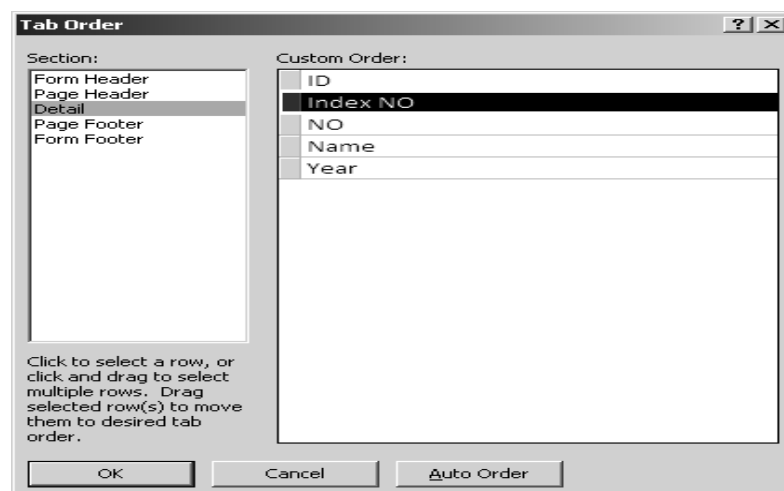

Figure 21.25: Tab Order Window

## Change the control size by using Size to fit tool

To change the control size and position by using size to fit tool, follow the steps given below:

1. Select the form control.
2. Click size **to fit** tool appearing under the Size group of the **Arrange** tab of the **Form Design Tools**.

## Number format

To change the format of the number used in the form, follow the steps given below:

1. Select the form control.
2. Go to the **Form Layout view** to make the **form layout tools** available in the ribbon.
3. Select the number format in the **formatting** group (Standard, General, Number, Currency etc.) under the **Format** tab of the **Form Layout tools**.
4. Click the number format (currency, percent or comma format).
5. Increase or decrease decimal places as you wish.

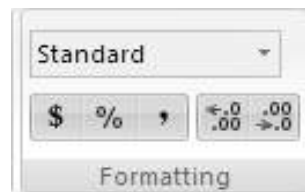

Figure 21.26: Format Number

## 21.2 Working with Reports

A report is used to format and organize the data to be presented. Usually the report gives the printable layout to the data you consider. Most database management systems include a report writer that enables you to design and generate reports. The Microsoft Access 2007 provides reasonable report facilities to you.

As mentioned above, the reports will organize and group the information available in a table(s) or query (ies) and provide a way to print the data in a database. There are two options to design a report in MS Access 2007.

1. Create report by using wizard.
2. Create report in design view.

These methods are described below.

### 21.2.1 Create a report using Report wizard

To create a report by using wizard, perform the following steps. In this example we create a backup by using “personalData” table, which is created previously.

1. Click **Report Wizard** under the **reports** group of the **Create tab**. Now you can see the report wizard window.

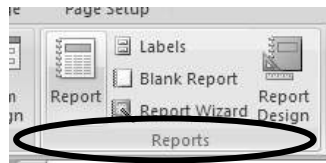

Figure 21.27: Report wizard in Report group

2. In the Report Wizard, select the fields that you want to display in the report. In this example, we select all the fields in the “personalData” table. Then Click **Next**.

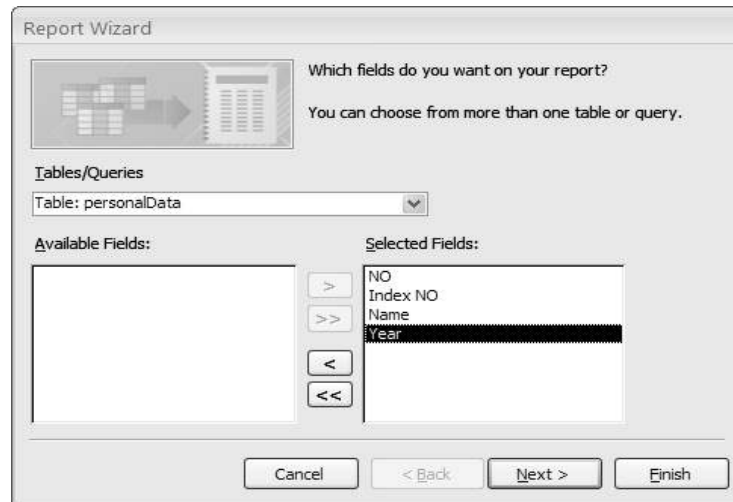

Figure 21.28: Report wizard window

3. Now wizard asks about any grouping levels in your dataset. Click **Next** (thinking that no additional grouping is needed for this data set)

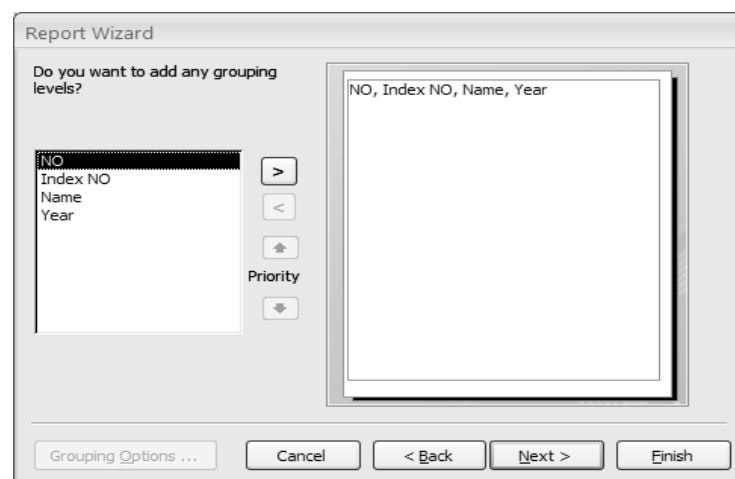

Figure 21.29: Report wizard window-Grouping report contents

4. Select the fields on which the content is to be sorted in the report. (ex. Index No)

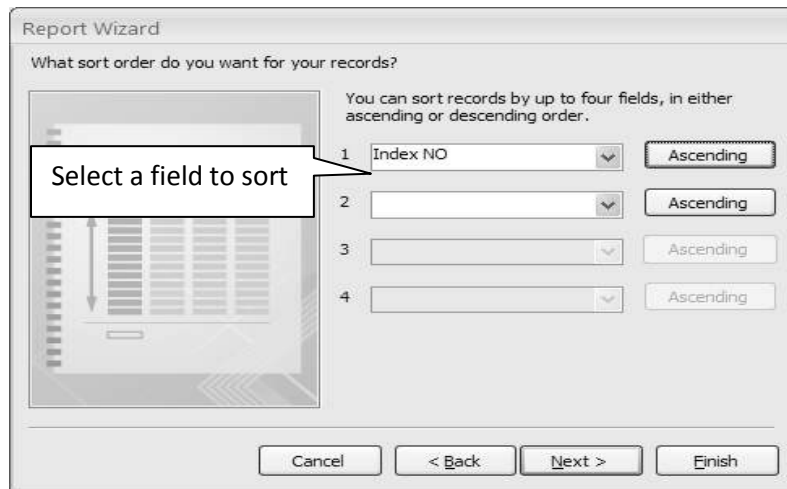

Figure 21.30: Wizard window- Sorting report content

5. Select the **output layout** and **page orientation** of your report. Then Click **next**



Figure 21.31: Wizard report window

6. Select a suitable **style** for your report and Click **Next**.

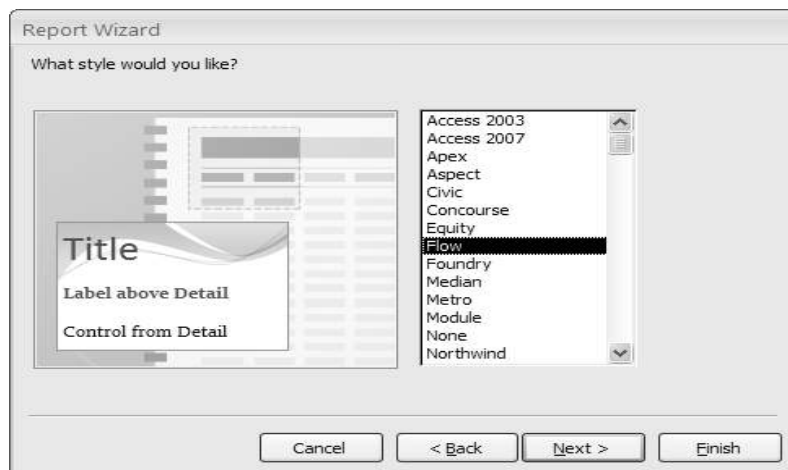

Figure 21.32: Wizard report window

7. Give a **title** for the report and Click **Finish**.

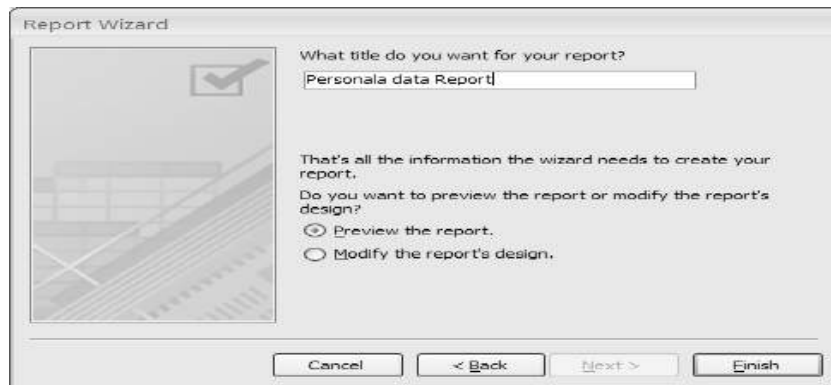

Figure 21.33: Wizard report window

Your report output will be displayed as follows;

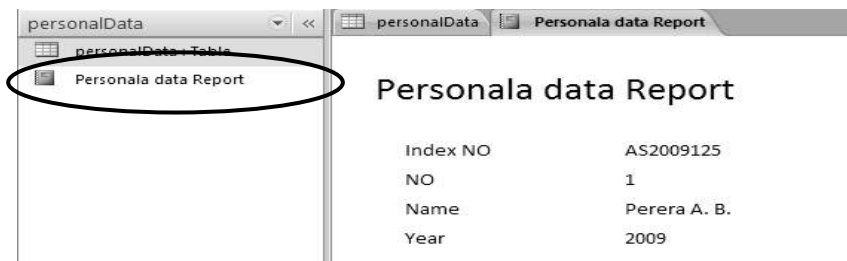

Figure 21.34: Sample Output of a created report

In the above example we created a report to display records of an existing table. Also you can create a report to display data on your created queries. The following example shows how to create a report for an existing query by using wizard.

### 21.2.2 Create a report for a created query by using wizard

To create a report for a created query by using wizard, perform the following steps.

1. Double click the query.
2. Click **Report Wizard** in report group.
3. Select the **query** and select the fields that you want to add to the report. Then Click **next**.

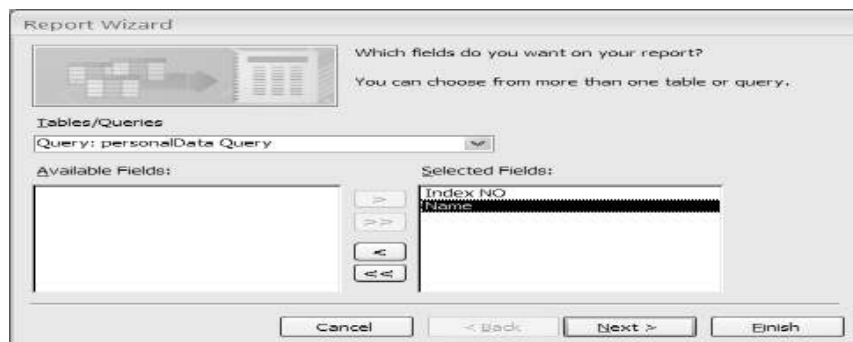

Figure 21.35: Wizard report window

All other steps will be same as the previous example that we did to create a report for a table. Note that, by using wizard you can create a report easily. However, you can use only the given formats. By using the design view you can design a report freely as you wish.

### 21.2.3 Create a Report by using Design View

To create a report by using report design view, perform the following steps. First, click **report design** icon on the report group.

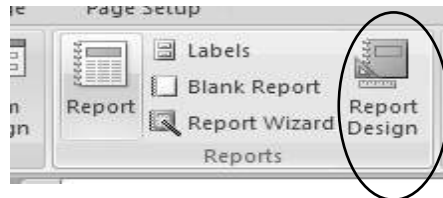

Figure 21.36: Report Design Icon

Following figure shows the user interface of the report design view. In a report, there are few sections such as report header, report footer, page header, page footer, group header group footer and the details section. By default it appears only the page header, detail, and the page footer sections.

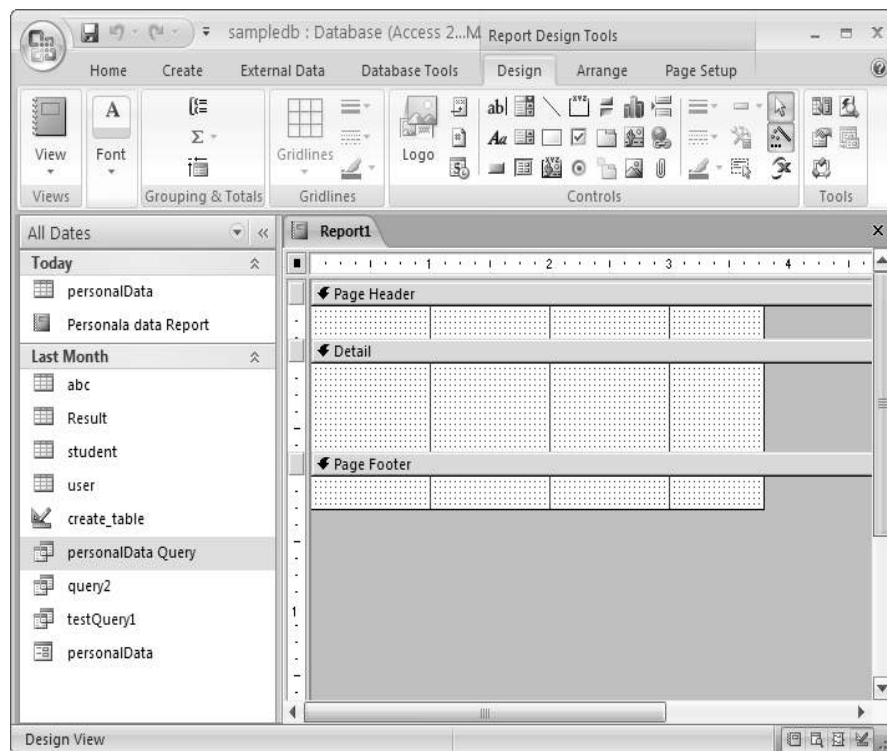

Figure 21.37: User interface of the report design

When you start to design the report, the report designing tools will be activated on the ribbon.

### 21.2.4 Report Design Tools

Before going to start report designing this is the best time to learn about report designing tools.

## Page setup tool

Before start report designing you must need to do a page setup using this tool.

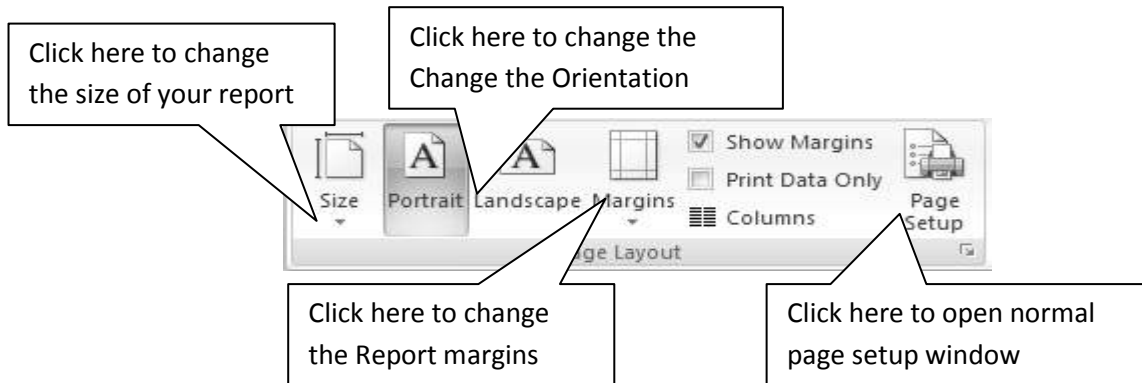

Figure 21.38: Page Setup tools

## 21.2.5 Report design window

There are several tools and keys available for report designing.

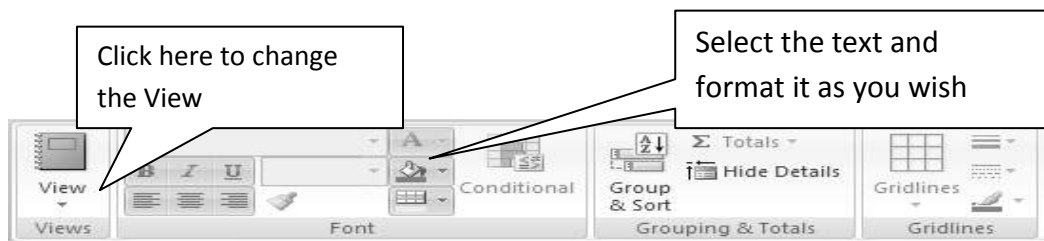

Figure 21.39: Report Design Tools

## Change into different Views

There are four views available namely Report view, Print preview, Layout view and Design view. The report view shows output of your report. Print preview shows how your report will be appeared in the printed hardcopy. The layout view shows the layout of your report. And design view provides the facilities to customize and design your report.

To change the view of your report, you just need to click on the preferred view.

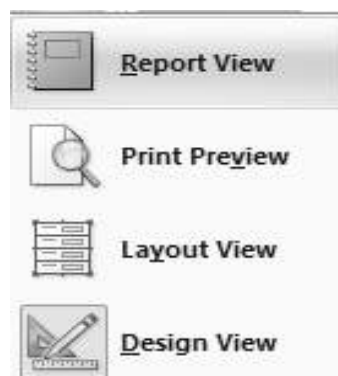

Figure 21.40: Available views

## 21.2.6 Working with report controls

There are several tools and keys available for report designing. Access provides facilities to create report in design view. Now you can see design tool in the ribbon. Similar to the tools available for the forms, there are several controls available for reports such as Textbox, label, button etc. You can insert each control into your report.

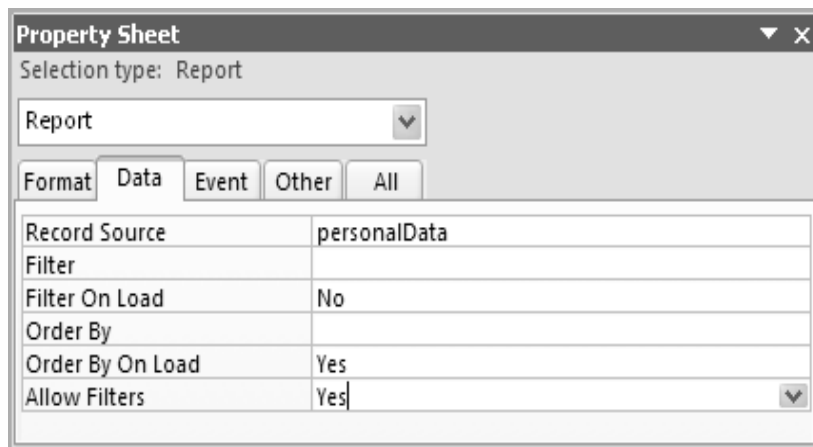

Figure 21.41: Controls group in the Design Ribbon

## 21.2.7 Create a report by using design view

The following example shows how to create a report by using **report design view**. Now we create a simple report for the personalData table. To do this, follow the steps given below,

1. Open a new report by using design view.
2. Open a property sheet in the report change the selection type as “report”
3. Select the record source as **Personal data**.



4. Add following three labels into the page header section.

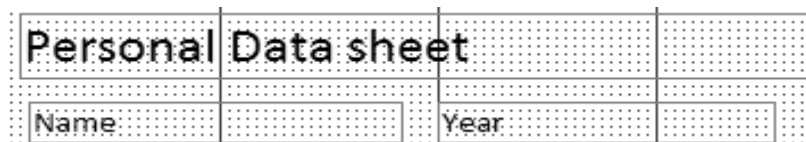

5. Add a textbox field to the details section as shown below.

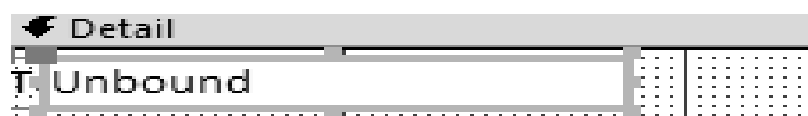



- In the property sheet, under the **Data** tab, change the **control source** as **Name**.

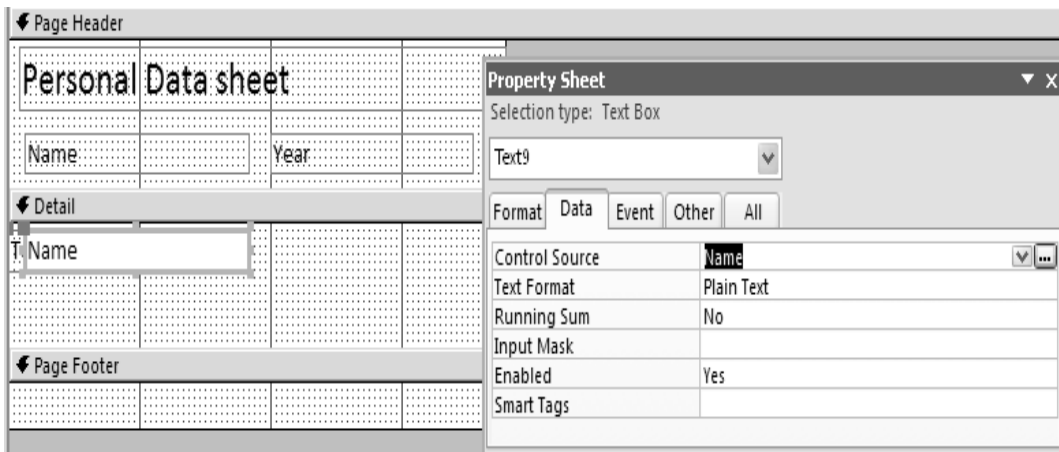

Now Textbox will be changed as Name.

- Same as the step 6 add another text box in to details section and change the control, source as **Year**.
- Save your report.
- Change the view of your report. Now you can see the output of your report as similar to the one given below.

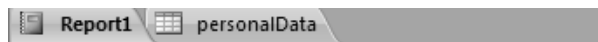

### Personal Data sheet

Name	Year
Perera A. B.	2009
Gamage S. I.	2009

## 21.2.8 Working with more report controls

The following steps show how to work with more report control components.

- Create new two tables named “result” and “attendance” in the database.
- Create the relationship between the “Personal data” table and the “result” table.
- Create a query to show the Name, Course Code, and Marks.
- Create a report by using design view using the following steps
  - Insert two labels to display “Result sheet” and the name of the department.
  - Create three labels in the Page Header section to show the captions “Name”, “Course Code” and the “Marks”.
  - Create three text boxes to display Name, Course Code and Marks in the details section.
  - Add Date and Time and Page Numbers into the Page Footer section.

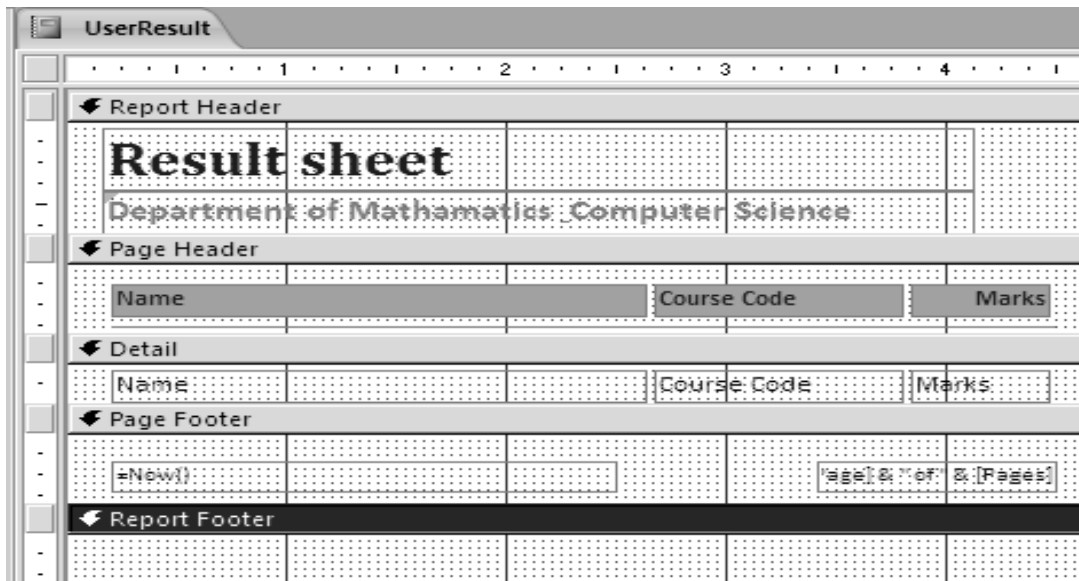

Figure 21.42: Sample report format

Now you are ready to add additional calculated information in to your report such as Total marks, Min, Max or Average. To do this, there is a tool available in the **Grouping & Totals** section.

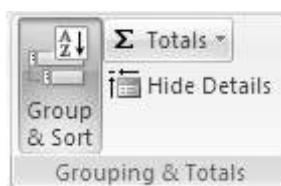
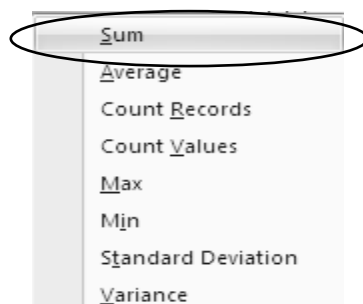
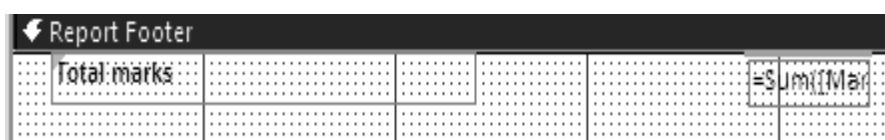

Figure 21.43: Grouping & Totals group

5. Select the mark field in the details section in the report.
6. Click the **Totals** tool and select the sum (Automatically the field will be added to the report footer area).



7. Add a label into the page footer and set the caption as **Total marks**.



8. Save your report.
9. Change the view and see the output.

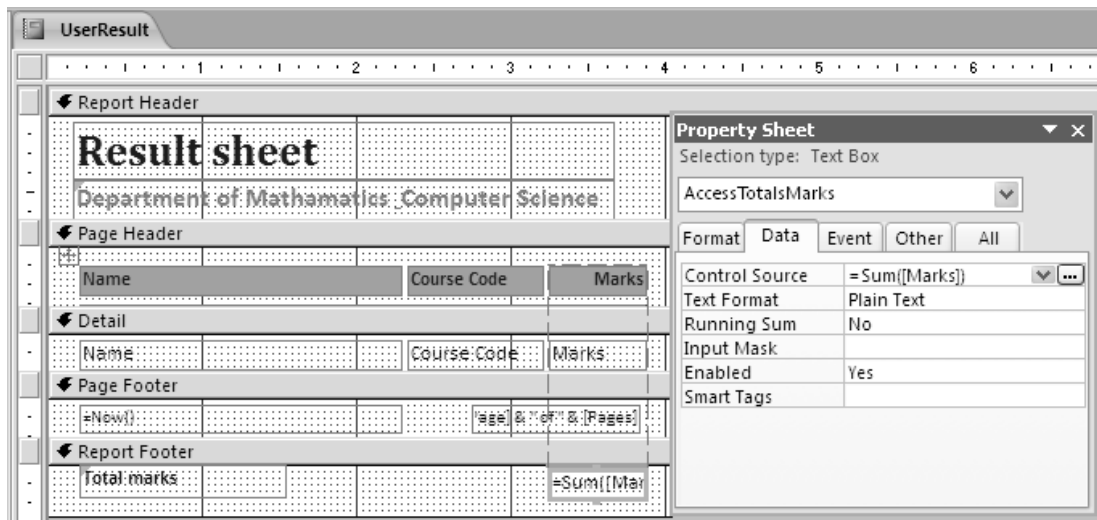

Figure 21.44: Sample report design view

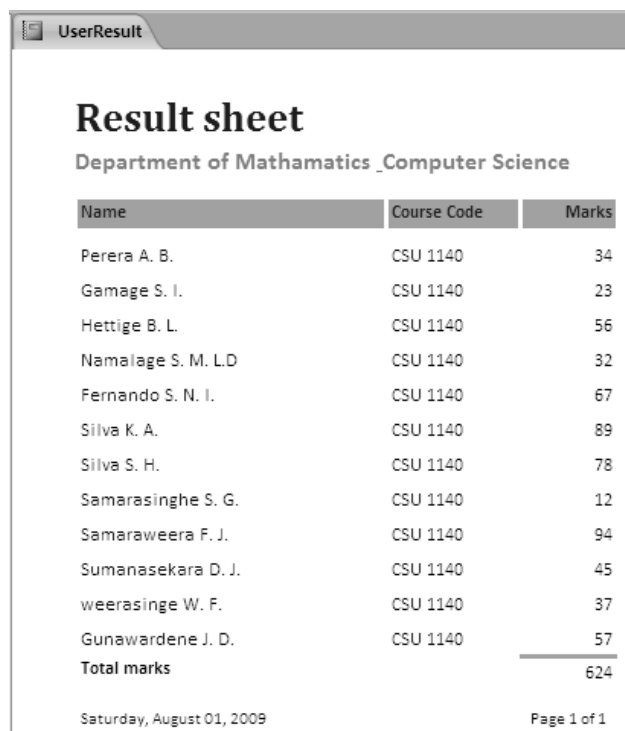

Figure 21.45: Sample report in the report view

## 21.3 Formatting Reports

### 21.3.1 Format your report by using Auto format wizard

You can create your report with various formats. There are several built-in formats available in Access 2007. You can use these formats by using Auto-Format tool.

1. Select the report you want to format.
2. Click **Auto Format wizard** icon on the auto format group (Auto format window will be appeared)

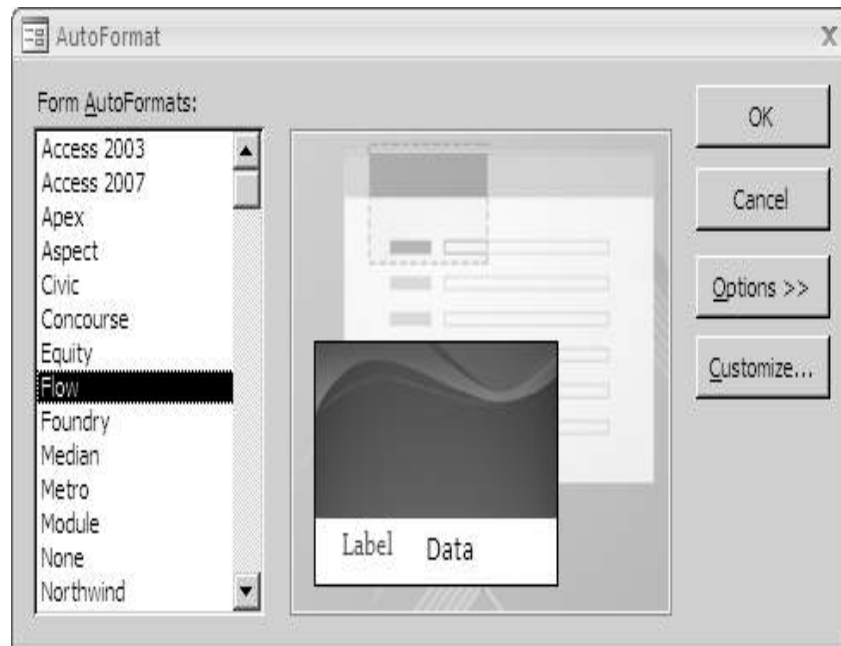

3. Select one of the auto format layouts.
4. Click **OK**.



## 21.4 Self Assessment Questions

- 21.1 What are the available ways to create a new form in MS Access 2007?
- 21.2 State the importance of control buttons in the control box of a form?
- 21.3 What are the available form views in MS Access 2007? Briefly describe them.
- 21.4 What is the use of form design window?
- 21.5 State the use of following controls in forms.
  - a. Labels
  - b. Text box
  - c. Combo Box
- 21.6 Briefly describe the use of reports in MS Access. What are the ways of designing a report?
- 21.7 Why is the Report Design view important?
- 21.8 What are the different sections of a report? Briefly describe them.
- 21.9 What is the purpose of having Auto format wizard when working with reports?

## Session 22

### Introduction to the Internet

---

#### Aims:

Introduce Internet to the student.

#### Objectives:

Having studied this session the student will be able to:

- Define what Internet is
- List facilities/benefits of Internet
- Describe the ways to connect to Internet



#### 22.1 The Internet: an introduction

Each day the number of Internet users is increasing rapidly and the Internet has indeed become an integral part of our day-to-day life. The Internet can be compared to an Aladdin's magic lamp which fulfills your requirements. If you are new to the Internet then it's time to get your hands dirty and learn how you can use the Internet and get things done within seconds.

Let's see some interesting quotes on Internet by some well known personalities:

*The Internet is becoming the town square for the global village of tomorrow.*

Bill Gates

*The Internet could be a very positive step towards education, organization and participation in meaningful society.*

Noam Chomsky

*A lot of things you want to do as part of daily life can now be done over the Internet.*

Marc Andreessen

Whether you are a novice Internet user or an expert in handling the Internet services efficiently, this would be an interesting learning experience.

##### 22.1.1 What is Internet?

The Internet,

- is a **global system** of interconnected computer networks
- is a network of networks
- uses the standard Internet protocol suite (TCP/IP) to serve billions of users worldwide
- is a product with no owner

Having considered the above key features, the **Internet** can be defined as the network of networks which is interconnected with millions of computers all over the world including small domestic computers, academic, business and government networks. Internet connects these different computers using TCP/IP. TCP/IP is the abbreviation for Transmission Control Protocol/Internet Protocol.

**Note:** TCP/IP

TCP/IP is the communication protocol for the Internet. TCP/IP defines the rule which computers must follow to communicate with each other over the internet. Even though TCP/IP uses several protocols the two main protocols are TCP and IP.

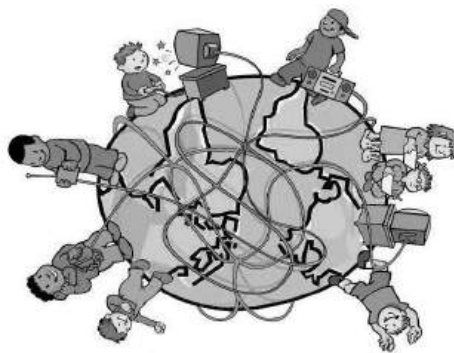

In other words, The Internet also can be described as massive data storage which is accessible to anyone at any time which carries various information and services, such as electronic mail, online chat, file transfer and the interlinked web pages and other resources of the World Wide Web (WWW). Apart from these, there are some special features which are worth knowing regarding the internet. Do you know who owns the Internet? The answer is that the Internet has no owner. Another key fact is that the Internet is Multimedia-based and retrieving information and giving information is cheap and fast. To accomplish these tasks, the Internet has large number of servers.

To clearly understand the operations of the Internet, it's essential to know the concept of **client/server**. You have already learnt about this terminology under the session on 'Computer Networks' within this course material. A **client** is an application or system that requests a service from a **server** or access a service made available by a server. Apparently you may guess the functionalities of the server from this. A server is a computer system which responds to the requests made by the clients. Figure 22.1 shows the interaction between a client and a server.

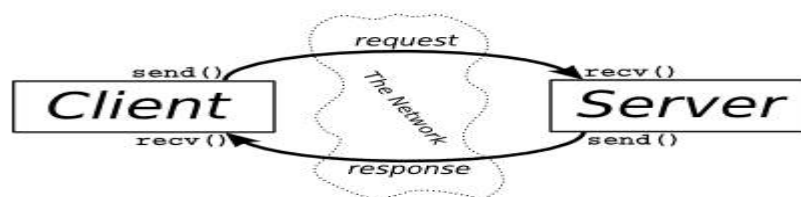

Figure 22.1 Client - Server interaction

Although normally clients and servers communicate over a computer network, there are some conditions where the client and the server reside in the same system. A client does not share any of its resources instead it requests a server's content or service function. Thus millions of clients are connected to the servers to acquire these services. The transmission between the clients and servers takes place by a digital networking communication method called "**Packet switching**". All the data which are to be transferred, regardless of its content, structure and type is grouped into blocks called *packets*. A communication protocol called **Internet Protocol (IP)** is used for relaying these network packets across the Internet.

Therefore in short, we can say that the internet is a client-server system which transmits data by packet switching using the standard Internet Protocol (IP).

### **22.1.2 The history of the Internet**

*"Great things are not done by impulse, but by a series of small things brought together."*

*Gogh, Vincent Van.*

Do you know that the Internet has a fascinating story behind it? Let's look at some of the key events which took place in the history of the Internet.

In the 1960s computers were situated in different locations and the information stored in one computer that could not be retrieved from a computer which is in another location. Sharing data amongst different Universities was considered as a tedious task by the scientists and some researchers who were involved in researches from different locations. In the late 1960s, some of the far-sighted experts in the U.S. Department of Defense predicted that this could be a serious problem if they encounter a natural disaster or an enemy attack in a particular location. They initiated a project named ARPANET with the intention of establishing a computer network nationally, so that they could withstand any destruction in a particular location because they can easily retrieve the data from other locations.

ARPANET served as a test-bed for the new networking technologies. The primary goal of this project was to create a computer network with multiple paths using telephone lines. The next thing which was taken into consideration was that to allow people to share the resources in their computers from remote locations.

ARPANET started with connecting the computer systems and databases of most business institutions, schools and Government organizations from faraway places. Starting with only a handful of users ARPANET expanded rapidly and spread widely. A host is similar to a network server and it provides services to all the computers which are connected to it. At the beginning there were four primary host computers. The number of hosts increased and this led to a rapid growth in the usage of the ARPANET. In 1973, people began to use ARPANET in Europe and the usage of this network grew even faster. The National Science Foundation joined the project in the mid-1980s expecting that the supercomputers' users can use ARPANET to obtain access. They discovered that the existing network could not handle the load and created a new network with higher capacity as a counterpart to the ARPANET. This led to a concept called the Internet.

The connection between ARPANET, NSF net and other network were collectively called as the “networked network” – being internetworked and the name the Internet derived from this concept.

The system which was initiated to survive the nuclear war evolved itself to cater individuals who use computers from home and of course to the business. This brought an astounding expansion in the usage of the Internet. Today we see online advertisements, online order processing, online buying and these have not only made our lives easy going but also had improved the quality of living to a greater extent.

### 22.1.3 Differences between Internet and World Wide Web

Although the Internet and www are blend with each other and we tend to use these two words interchangeably in day to day life, they are technically different from each other.

Let’s imagine that we go to a restaurant to have a lunch. Usually every restaurant has a popular dish which is popular and unique only to that particular restaurant. Sometimes we call that restaurant by the dish name instead of the actual name of it. Wondering how is this related to the Internet and the www! Let’s see the following explanations.



Figure 22.2: The Internet Hotel

### Internet Protocols

Internet Protocol	Refers to	Description	Internet Services
SMTP	Simple Mail Transfer Protocol	A protocol for sending e-mail messages between servers	Email
POP3	Post Office Protocol version 3	Used by local e-mail clients to retrieve e-mail from a remote server over a TCP/IP connection	email
FTP	File Transfer Protocol	This is used to transfer files from one host to another host over a TCP-based network, such as the Internet.	Transferring files



HTTP	Hyper Text Transfer Protocol	Defines how messages are formatted and transmitted, and what actions Web servers and browsers should take in response to the wide range of commands.	World Wide Web(www)
HTTPS	Hyper Text Transfer Protocol Secure	Provides authentication of the web site and associated web server and protects against man-in-the-middle attacks.	World Wide Web(www)
VoIP	Voice over Internet Protocol	This enables people to use the Internet as the transmission medium for telephone calls.	Online chat(there are exceptions)

*Table 22.1: The Internet Protocols*

The Internet uses a variety of languages to transmit information from one place to the other. These languages are called **protocols**. Using these protocols we can acquire the services from the Internet. Each protocol has a specific functionality and www is considered to be the largest service acquired amongst the services provided by the Internet. If we take the above analogy in the hotel, we have seen in many hotels that even though there are so many dishes available, only one of these dishes will be popular. Likewise although there are so many services available in the Internet the most popular dish on the menu is www.

Internet is an interconnection of computer networks all around the world. In other words, it is the hardware which forms the physical layer to these connections is what we refer to as the Internet. Hence, the Internet comprises of network of computers, fiber-optic cables, copper wires and wireless networks. But www is the software which is used to access the information from the Internet. It consists of files, folders and the documents which are stored in different computers. Now it is crystal clear to you that the www depends on the Internet to work.

#### **22.1.4 Introducing the Internet buzz words**

##### **World Wide Web**

WWW is a part of the Internet which functions using HTML. WWW operates under a protocol called HTTP.

##### **Browser**

A browser is a computer software which can be used to view documents on the Internet. Web browsers interpret HTML code and display images and text.

## Search Engine

Search engine is an automated web-site which is programmed to search specified keywords and give the websites and Internet based documents as a result.

## Client

A computer which is capable of receiving the information from the server in the Internet is called a client. A home PC is an ideal example for this.

## Server

Client computers download files in the Internet from the Server. These servers are directly linked to the internet and consist of a lot of documents.

## Domain

The Domain is the top level identification string for a particular server (yahoo.com). There are various types of domains. It can be categorized using one or more extensions.

## URL

URL stands for Uniform Resource Locator. This is a standard address format that constitutes a reference to an Internet resource. Each URL starts with a protocol followed by a colon followed by two slashes.

URLs are case sensitive and do not contain any spaces. URLs or web addresses can be broken down into various components Access protocol, Service, Server, Domain and the country.

The structure of the URL is shown in the figure below.

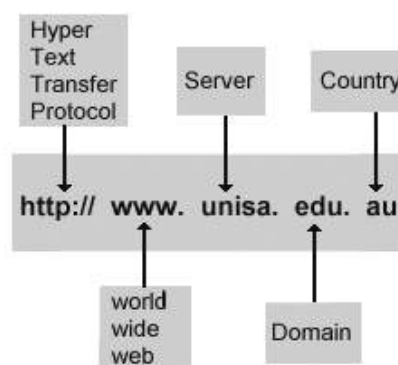

*Figure 22.3: Structure of the URL*

There are several domains available in the web such as:

- edu = education institute
- com = commercial enterprise
- gov = government
- org = organization
- net = network provider
- mil = military

## **FTP**

FTP is a standard Internet protocol which refers to the File Transfer Protocol. Using this protocol we can transfer files from one computer to the other via Internet. This is the simplest way to exchange files between computers on the Internet. FTP is an application protocol that uses the Internet's TCP/IP protocols. FTP is commonly used to transfer Web page files from their creator to the computer that acts as their server for everyone on the Internet. It's also commonly used to download programs and other files to your computer from other servers.

`ftp://ftp.microsoft.com/`

## **HTML**

HTML is the abbreviation for Hyper Text Markup Language. The web pages are called hypertext documents because when you click a word or a picture which is hyper linked you can go to another location. From there you can jump to another webpage. This is made possible because HTML allows the document's author to embed hyperlinks.

## **HTTP**

HTTP is the foundation of data communication for the World Wide Web. HTTP (Hypertext Transfer Protocol) is the set of rules for transferring files (text, graphic images, sound, video, and other multimedia files) on the World Wide Web. When the browser user enters file requests by either "opening" a Web file (typing in a Uniform Resource Locator or URL) or clicking on a hypertext link, the browser builds an HTTP request and sends it to the Internet Protocol address (IP address) indicated by the URL. The HTTP daemon in the destination server machine receives the request and sends back the requested file or files associated with the request.

Example URL: **http://www.yahoo.com**

## **HTTPS**

HTTPS stands for "Hyper Text Transfer Protocol Secure". This means that the data transferred electronically is encrypted and cannot be accessed by unauthorized people. HTTPS provides authentication of the web-site and related web server which is interacting with thus protecting against *Man-in-the middle attacks*.

## **22.2 Identifying facilities/benefits of Internet**

The Internet provides a wide spectrum of services which supports us in many ways. We'll discuss these facilities in detail now. The Internet not only enables you to look at the documents and images but also you may listen to sound files and watch videos. You are not limited to a small circle of facilities like obtaining information from the massive collection of data but you can go beyond that and publish your own creations and others will be able to acquire those without any problem. Hence transferring files from one place to other had made things easier for those who live in geographically dispersed locations. This kind of global distribution of the Internet is certainly an advantage for international communication.

Now let's have a brief look at the different facilities available in Internet.

### **22.2.1 WWW**

You don't have to go to the library situated miles away and exhausted. The Internet had brought a revolution in accessing information. Accessing the information is made simple and easy, now. By surfing the web browser users can acquire the necessary information quickly and accurately.

### **22.2.2 E-mail**

This is one the most frequently used Internet services. A mail can be sent by directly typing the e-mail message using the keyboard or by attaching the files in the disk. E-mail system is included in most Main frames, Mini computers and computer networks. Refer Session 24 for further details.

### **22.2.3 Chat**

Users can send and respond to messages in real time that is there is no waiting period between sending and receiving messages as in e-mail. Usually this communication takes place within two people, but there can be groups as well.

### **22.2.4 Telnet**

Telnet is a network protocol which provides a bidirectional interactive text oriented communication facility. You will be able to control the server and interact with the other servers on the network. A telnet session is commenced by logging into a server using a username and password. This is well known to control Web servers remotely.

### **22.2.5 VoIP**

This is the abbreviation for Voice over Internet Protocol. VoIP systems allow voice data to travel over the Internet thus by-passing the regular telephone service.

Now let's have a look at some benefits of Internet in detail.

One of the main benefits of the Internet is that the communication is made easy. Not only has it facilitated human interaction to become simple but also it has improved the quality of communication to a greater extent. Sending emails, chatting, sending SMS through the Internet and the usage of VoIP are some of the services provided by the Internet to upgrade the quality communication.

Next benefit is the availability of an immense knowledgebase. Searching relevant information is made easy by using www, News group and discussion groups.

File transferring using the FTP and advertising are some other well-known benefits.

## 22.3 Connecting to the Internet

Internet which is accessed by many people and businesses has now become the aspiration in the commercial world. People have enhanced facilities like they can work while they are at home. So it is apparent that the Internet had made things simple.

If you are willing to enjoy the facilities in the Internet the first thing you need to do is that you need to have an Internet connection. There are several ways to obtain access to the Internet. The way by which the users connect to the Internet is called the Internet Access. Are you keen to know the different methods to connect to the Internet? Let's discuss about them.

### 22.3.1 Dial-up Connections

Basic dial-up packages are used in some businesses. Several Internet Service Providers (ISP) provide access to the Internet and they charge a fixed amount for such a service. This is appropriate when we need the Internet access for a longer period.

Let's see how we connect to the Internet in a Dial-up connection.

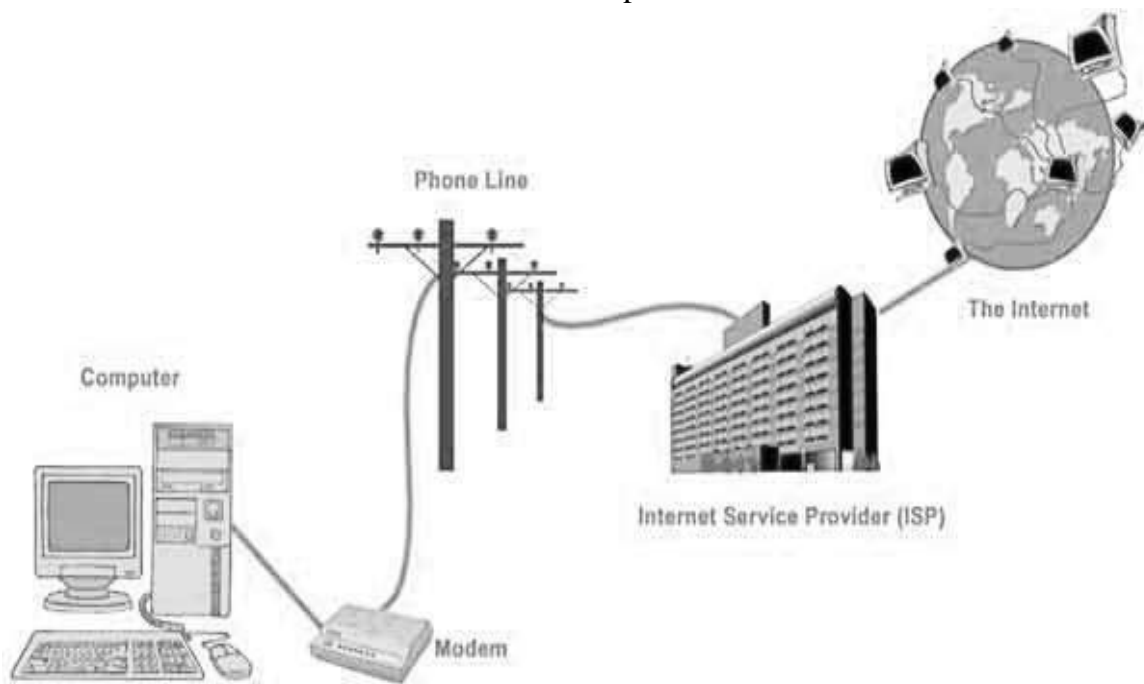

*Figure 22.4: Dial-up internet Connection*

We can access Internet by using a **modem** and a telephone line. This type of Internet access method is common in homes and small businesses. We can easily create this connection by setting up an inexpensive account. Hence this type of connection saves money. More than that by using the dial-up connection we can save a lot of time, and it's quiet convenient. Inadition dial-up connections provides new services to the users.

### 22.3.2 Landline



Figure 22.5: Landline

This is also called as **mainline** or **fixed line**. The data is transferred through the solid medium either through a metal wire or optic fiber. This has a significant difference from the mobile cellular service. In a cellular line the medium used is air but the landline uses a solid medium.

Landline has some advantages when compared to a mobile cellular line. Landline cost less than the mobile cellular line. Furthermore, landline has a better voice quality. We can use this in the areas where we do not have the cellular service or where we need no mobility. Since the landline cannot be interrupted without physical access, this is considered to be a more secure mode of communication.

### 22.3.3 T-lines

T-lines are telephone lines comprised of either fiber optic or copper wires that offer 24 individual channels. Each of these channels supports data and voice transmissions at speed of 64Kbits per second.

Some of the telephone companies offer some of these lines called fractional T-1 access.

### 22.3.4 Wi-Fi

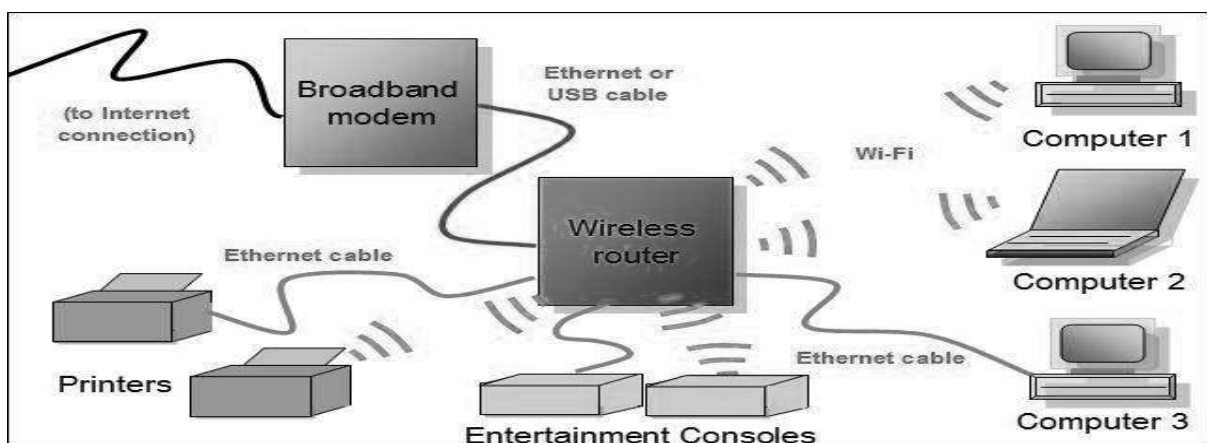

Figure 22.6: The Wi-Fi technology

Wi-Fi is a technology where we can exchange data wirelessly using radio waves. This technology band is owned by the Wi-Fi alliance.

Let's have a look at some of the common applications of Wi-Fi.

Most of these applications are carried out using smart phones. Internet, playing games, VoIP

phone access, and network connectivity for televisions, digital audio player, cameras and DVD players are good examples for such applications.

- Internet
- VoIP phone access
- gaming
- network connectivity for consumer electronics (Televisions, DVD players and digital cameras)

### 22.3.5 Satellite



*Figure 22.7: Satellite*

Satellite is a specialized wireless receiver or a transmitter. Satellite is launched by a rocket and placed in an orbit around the earth. Since this has a higher communication rate, it is expensive. Satellites can be used to forecast the weather conditions, to telecast TV programmes and broadcast radio programmes especially amateur radio programmes, Internet communications. We are all well aware of the uses of **Global Positioning System (GPS)**. A GPS Satellite is used by a variety of people. The different uses of GPS are aiding in navigation for general aviation, surveying, providing emergency roadside assistance for automobiles and also for some recreational activities. Most sophisticated system of GPS is that it shows your position in the street map. The following figure shows an application of GPS, a vehicle tracking system.

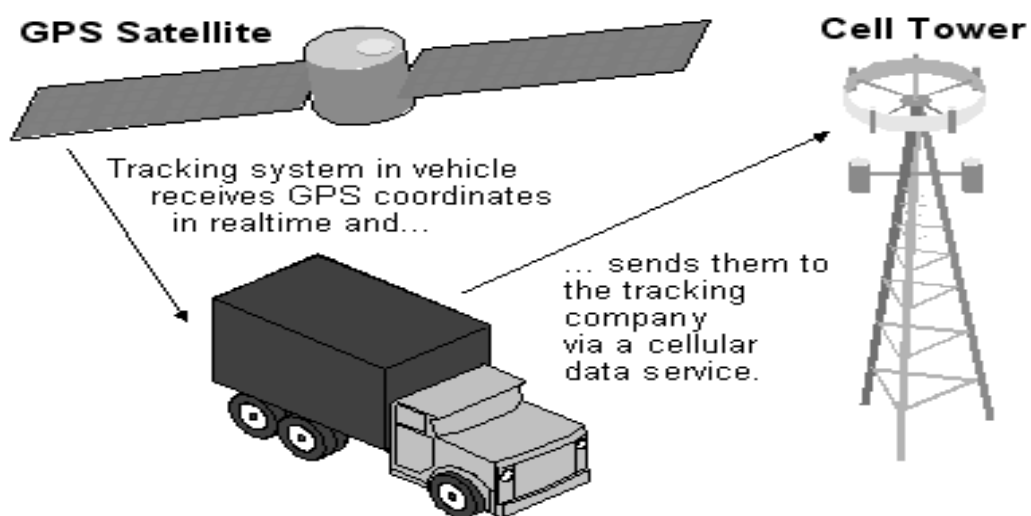

*Figure 22.8: GPS Vehicle Tracking System*

### 22.3.6 Cell phones

Mobile phone is a long way electronic communication mechanism. There are lots of facilities made available in a mobile phone. We can send text messages which are called SMS. We can also send photos and videos using MMS. In addition using packet switching we can access Internet and enjoy the facilities provided by the Internet such as email and search information.

You might have heard or used mobile phones with 2G, 3G, and 4G technologies. We can use these phones to access the Internet. Mobile phones using 2G (Second Generation) technology for data connection do not have an inbuilt modem. 3G which is more advanced finds application in wireless voice telephony, mobile Internet access, fixed wireless Internet access, video calls and mobile TV. Some phones have a built-in dongle (using 3.2/7.2 HSPDA technology) and you can find some basic functionalities of a computer in such phones. In addition recent advancements in the mobile technology have made life easier. Today's mobile phones can have data connection with several other devices only by turning the phone into a portable Wi-Fi hotspot.

The following table summarizes the different methods of Internet connectivity discussed above.

Method	Advantage	Disadvantage	Best suited for
<b>Dial-up Connections</b>	<ul style="list-style-type: none"> <li>• Low cost</li> <li>• Safety</li> <li>• Availability</li> </ul>	<ul style="list-style-type: none"> <li>• Slow in speed</li> <li>• Unstable</li> <li>• Need a phone line</li> <li>• Phone will be engaged when using the Internet</li> </ul>	Places where Internet access is needed for a longer period
<b>Landline</b>	<ul style="list-style-type: none"> <li>• Low cost</li> <li>• better voice quality</li> <li>• more secure mode of communication</li> </ul>	<ul style="list-style-type: none"> <li>• Can only be used in fixed locations</li> </ul>	Areas where we do not have the cellular service or where we need no mobility
<b>T-lines</b>	<ul style="list-style-type: none"> <li>• High speed</li> <li>• Flexible</li> <li>• Can be installed wherever a land line telephone can be installed</li> </ul>	<ul style="list-style-type: none"> <li>• T-1 lines for a single business would be very costly.</li> </ul>	Businesses that require a lot of phone time, Internet activity and general uploading and downloading.



<b>Wi-Fi</b>	<ul style="list-style-type: none"> <li>• No need for wires</li> <li>• Very convenient to access since it can be accessed from any place.</li> <li>• Connecting to Wi-Fi is easy (Simply by turning on Wi-Fi)</li> </ul>	<ul style="list-style-type: none"> <li>• Quality is greatly influenced by the environment</li> <li>• limited radius of action</li> </ul>	Places where the wiring is not possible or even unacceptable.
<b>Satellite</b>	<ul style="list-style-type: none"> <li>• Available virtually everywhere in the regional serving area - Coverage over a large geographical area</li> <li>• Can be cheaper over long distances</li> </ul>	<ul style="list-style-type: none"> <li>• Sensitive to the heavy rainy day</li> <li>• Huge initial cost</li> <li>• Noise and interference</li> <li>• Propagation delay</li> </ul>	A remote location - which does not have terrestrial Internet access or the quality of access available, is poor and unreliable.
<b>Cell phones</b>	<ul style="list-style-type: none"> <li>• Instant Access everywhere</li> <li>• Portable</li> </ul>	<ul style="list-style-type: none"> <li>• Lack of security</li> <li>• Small screen size</li> <li>• Incompatibility of some web-sites</li> </ul>	Those who travel around and for personal usage.

Table 22.2: Methods of internet Connectivity

## 22.4 Self Assessment Questions



- 22.1 What is the Internet? Briefly describe the advantages and disadvantages of the internet.
- 22.2 Briefly explain the interaction between a client and a server.
- 22.3 What is meant by 'Packet switching'?
- 22.4 Briefly explain the functionality of TCP/IP.
- 22.5 What is meant by an 'internet protocol'? Briefly describe five of them.
- 22.6 Define the following terms.
  - a. Browser
  - b. Domain
  - c. URL
- 22.7 Briefly describe four facilities provided by the Internet.
- 22.8 What type of telecommunications hardware allow you to access the internet?
- 22.9 Briefly describe the Wi-Fi technology.
- 22.10 What are the advantages and disadvantages of using satellite as a method of internet connectivity?

## Session 23

# Web Browsers & Search Engines

---

### Aim:

Aim is to give a brief idea on Web Browsers and Search Engines.

### Objectives:

Having studied this session the student will be able to:

- Use a web browser to surf the Internet.
- Use search engines to find information on the Internet.



## 23.1 Web Browsers

You might have used web browsers like Internet explorer, Google chrome, Mozilla Firefox and Netscape Navigator etc. to browse the Internet. A web browser is a software application which is enabled to find hypertext documents and is used for retrieving, presenting and traversing information in the World Wide Web. This application is stored in your computer's hard disk. Although the web browsers with graphical user interface are popular among the general public it is important to keep in mind that there are many text-based Web browsers too, which are used in non-graphical operating systems.

The important feature of the Web is that they are created in a format known as hypertext which enables them to be linked together. A large collection of data including text files, pictures, sounds, movies and more can be accommodated by this Hypertext system.

Before launching your web browser you need to connect to the Internet. When you have established the Internet connection, follow these steps to launch your browser.

1. Click the **Start button** on the Windows taskbar. You will see the start menu unveiled.
2. Click **All Programs**.
3. Click **Internet Explorer** or any other browser name installed in your computer.

### 23.1.1 Introducing different web browsers

Let's see some examples of web browsers. See Figure 23.1 given below.



*Figure 23.1: Common Web Browsers*

Although there are different types of web browsers they have one functionality in common, they all transfer hypertext. Browsers consist of a toolbar which comprises of various functions. Some of these functions are listed below.

- Book mark your favorite webpage for future reference.
- The first page of a web-site is called Home page. You'll be able to go back to the home page while you are in some other page of that web-site.
- Print the required information from the web.
- Check the sites we have visited using History.

Now let us see how you can install the browser. We are going to show you Mozilla Firefox installation procedure here. You can try out installing other browsers based on the experience you gain here.

Check the system requirements to check whether your machine is compatible with the features in the browser. You can check the system requirements in the Firefox website.

The System requirement for Firefox 20 is given below. We have only included the requirements needed in a Windows operating system. If you are using any other operating system please visit the following web link:

<http://www.mozilla.org/en-US/firefox/20.0/system-requirements/>

### **Windows Operating Systems**

- Windows XP SP2
- Windows Server 2003 SP1
- Windows Vista
- Windows 7
- Windows 8

Please note that while the 32-bit and 64-bit versions of Windows Vista and Windows 7 can be used to run Firefox 20, only 32-bit builds of Firefox 20 are supported at this time.

### **Recommended Hardware**

- Pentium 4 or newer processor that supports SSE2
- 512MB of RAM
- 200MB of hard drive space

Now it is time to learn how we can install Mozilla Firefox to your computer.

**Step 1:** Visit the Firefox Download Page at <http://www.mozilla.com/firefox/> in any browser (such as Microsoft Internet Explorer).



Figure 23.2: Firefox Download Page

**Step 2:** Click the download button as indicated in figure 23.2 and the setup file will begin to download to your computer. Once the download completes, it is recommended that you exit all your running programs before running the installation.

**Step 3:** Double-click the file to start the Firefox install wizard and click **Run** (See Figure 23.3).

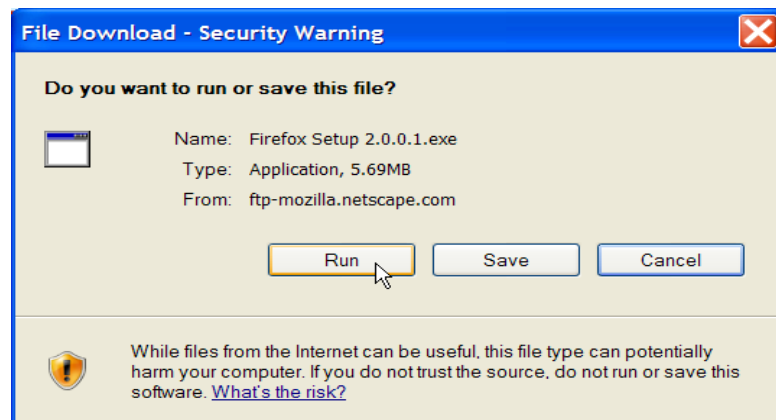

Figure 23.3: Firefox install wizard

Firefox setup will be downloaded to a temporary folder as shown in the Figure 23.4.

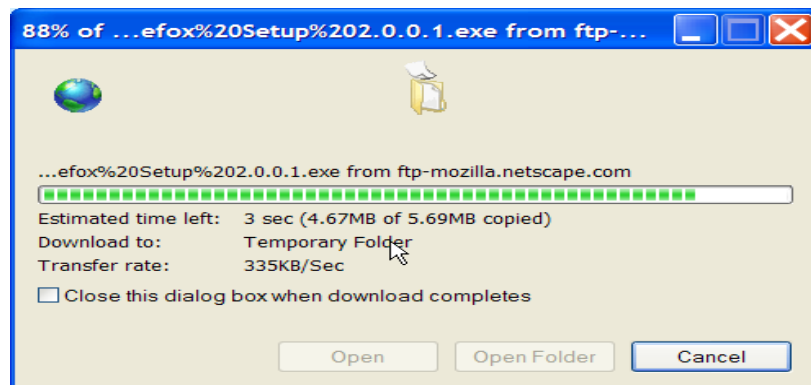

Figure 23.4: downloading Firefox setup

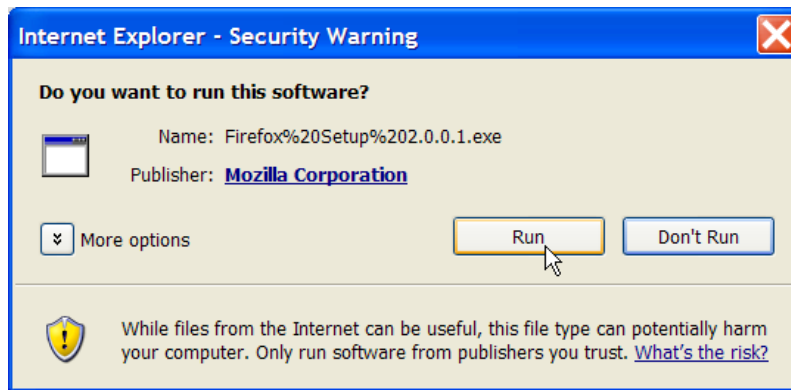

Figure 23.5: Internet Explorer- Security Warning Window

**Step 4:** A welcome screen appears. Click **Next** to continue.



Figure 23.6: Welcome Screen

**Step 5:** Read the License agreement and click on “**I accept the terms in the License agreement**” and click “**Next**”.

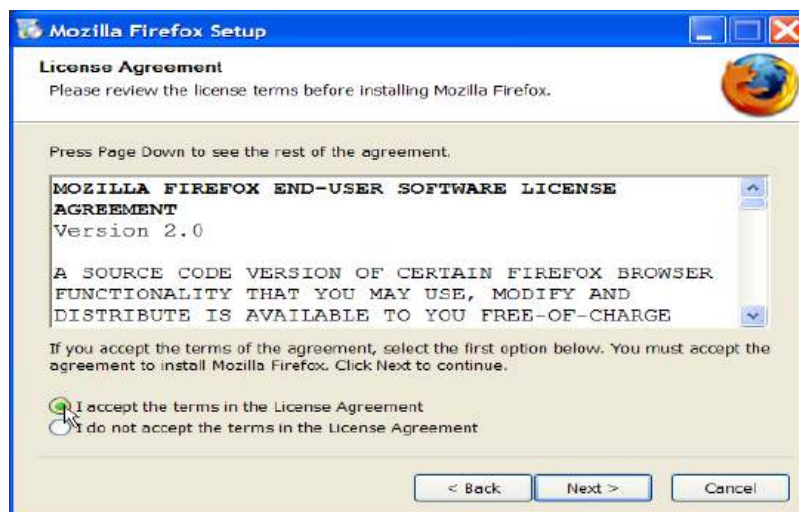

Figure 23.7: License Agreement

**Step 6:** The **Setup Type** screen appears. A "Standard" setup is selected by default (using the custom option is only recommended for experienced users).



*Figure 23.8: Selection of Firefox setup type*

Firefox will now be installed.

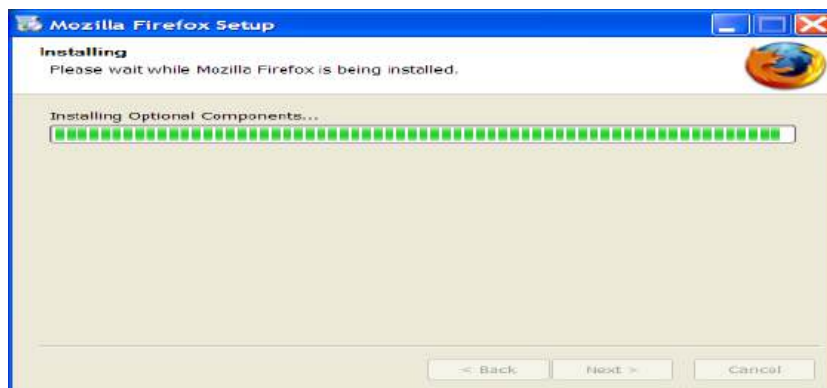

*Figure 23.9: Installation of Firefox*

**Step 7:** Click on **Finish**. Now you will be able to see a Firefox shortcut button on your desktop. Click on that and check whether it works.



*Figure 23.10: Completing the Firefox setup*

## 23.2 User Interfaces of Web Browsers

Most of the web browsers have common user interface elements. The following figure (Figure 23.11) shows you the common interface of Mozilla Firefox. The important components are labeled and each labeled component is briefly described in Table 23.1 below.



Figure 23.11: User interface of Firefox

No	Name	Description
1	Menus	Provide various commands for using Firefox.
2	Browse Buttons	Used when browsing the web. These include Back, Forward, Refresh, Stop, and Home buttons.
3	Toolbars	Used for navigation and bookmarking, among many other functions.
4	Location Bar	Text box for typing the URL of a web page.

5	Edit Bookmark Tools	Enable you to remove, name, move, or tag a bookmark.
6	Search Box	Text box for typing a search term, with a menu of search engines to select from.
7	Tabbed Pages	Allow you to open multiple web pages at the same time and switch between them by clicking on a tab.
8	Status Bar	Shows the current status of the web page, such as security alerts.
9	Main Content Pane	Shows the currently displayed web page.

*Table 23.1: Important components of Firefox Interface*

We are now going to look at some elements of well-known browsers.

### 23.2.1 Internet Explorer

Internet explorer is one of the commonly used web browsers. It has a friendly user interface. See the following Figure 23.12. Search facilities are improved and you can search by clicking on the search icon on the Toolbar.

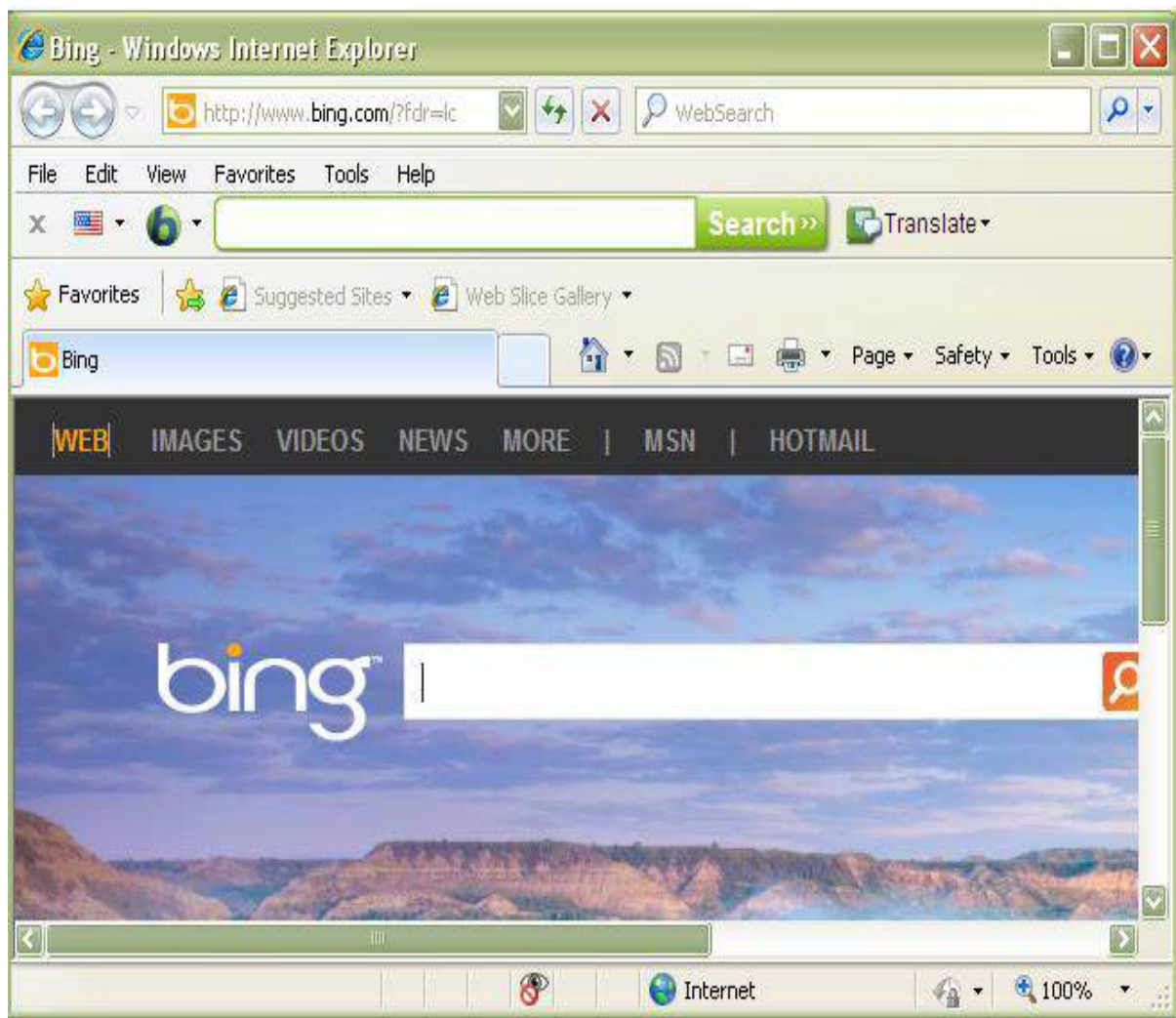

*Figure 23.12: User interface of Internet Explorer*



Let's see the following table to identify the functionality of each icon in the main menu.

Menu item	Description
File	The properties of the web pages can be opened, saved or printed using this icon.
Edit	Cut, copy, paste, undo and find icons are included in this.
View	The different ways in which the website can be viewed are included inside this.
Favorites	You can include the websites you visit regularly in the Favorites and return to those sites regularly.
Tools	You can view the sites you have visited using History. Furthermore you have filtering certain sites. Popup blockers and Internet option enhances the security risk and gives more added facilities.
Help	Provides online support to those who are new to Internet Explorer.

Table 23.2: Functions of icons

### 23.2.2 Mozilla Firefox

This is an open source software. Different sites can be opened simultaneously in different tabs. Additionally users can reopen the closed browser windows. This capability is called the session storage.



Figure 23.13: Mozilla- Home

### 23.2.3 Google Chrome

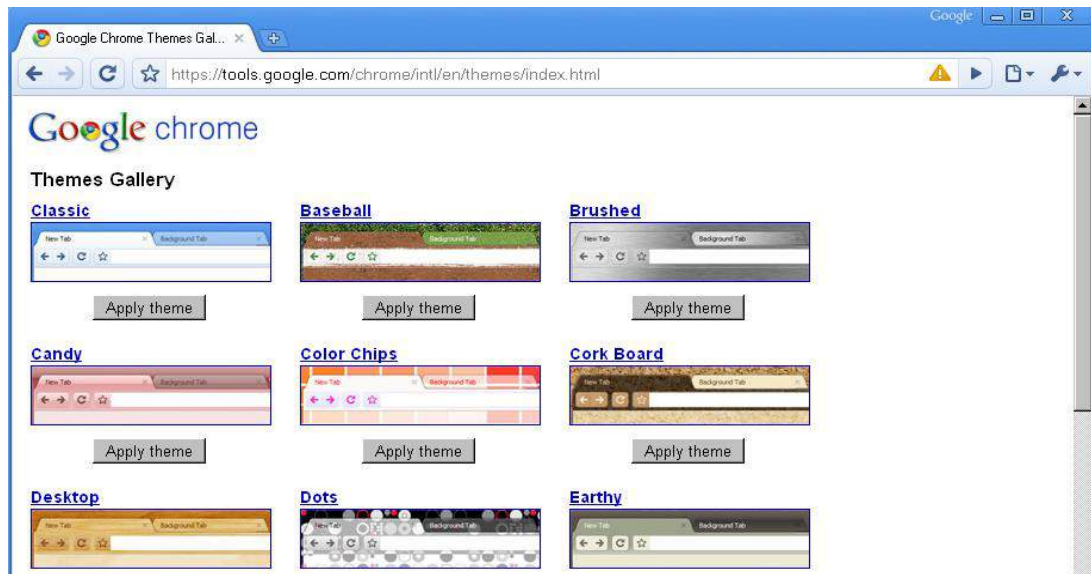

Figure 23.14: Google Chrome

### 23.2.4 Saving the contents opened from the web browser

When browsing the Internet you might want to save some files in your computer. Let's see how we can save a web page with its' content so that you can refer to that later on.

#### To save web page in Mozilla Firefox:

1. Click on File.
2. Select "Save Page As".
3. Give the location where you want to save the particular file.
4. Click on **Save**.

#### To save web page in Internet Explorer

1. Click on **File**

**(Note:** If the File menu is not visible in the version of IE you use, just press the 'Alt' key to view it. To permanently enable it now click in the VIEW option and choose toolbars → menu bar).

2. Select "Save Page".
3. Give the location where you want to save the particular file.
4. Click on **Save**.

### 23.2.5 Downloading different contents from the Internet

We can browse images, audio files, video files and even more. Now let's see how we are going to download these different types of files from the Internet.

Some of the commonly downloaded file types are mentioned below.

1. A text document – tutorial, application form for a job/examination
2. A Software

3. An audio – eg: music, speech
4. A video file – eg: movie, a TV programme

### How to download a Text Document?

As a student you might want to download text documents like tutorials or assignments from a web-site. People from different sectors use text documents by downloading the documents from the Internet. These documents vary from a .txt format which merely consists of text, to pdf format which comprises of images. Suppose you are a B.Sc. student of OUSL and you want to download the Programme Guide for BSc Degree programme offered by the Faculty of Natural Sciences. This is available in the Faculty of Natural Sciences page in the Open University web-site. Let's see how we can do this.

As shown in Figure 23.15, first go to the relevant page where you can find the text document.

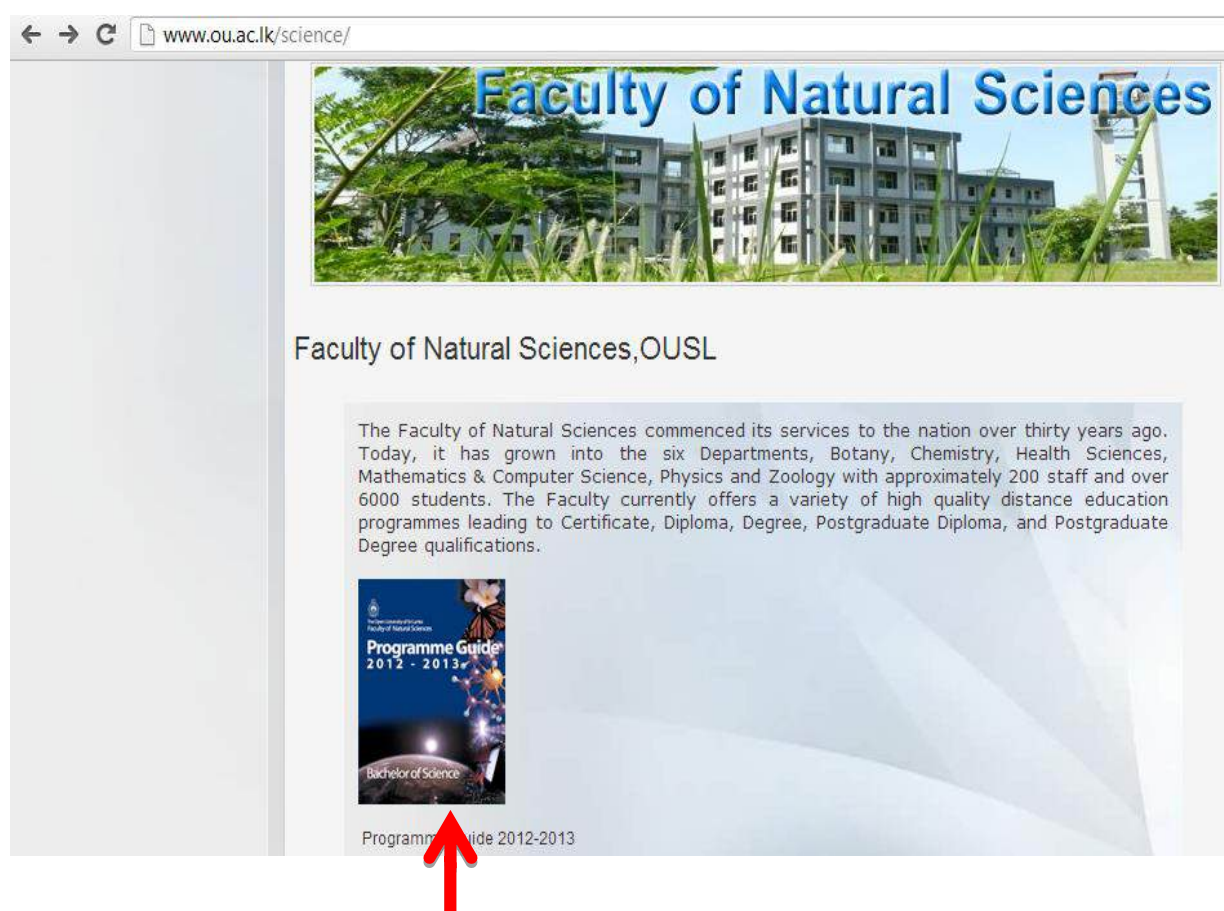

Figure 23.15: Locating the required text file

When you place the cursor on the hyperlink you will see a hand sign. This indicates that if you click on it you will be linked to another webpage. Click on the text “Programme Guide 2012-2013” to open the text document. You will see the following web-page as shown in Figure 23.16. Click on “Save a Copy”. This is pointed by the arrow at the bottom.

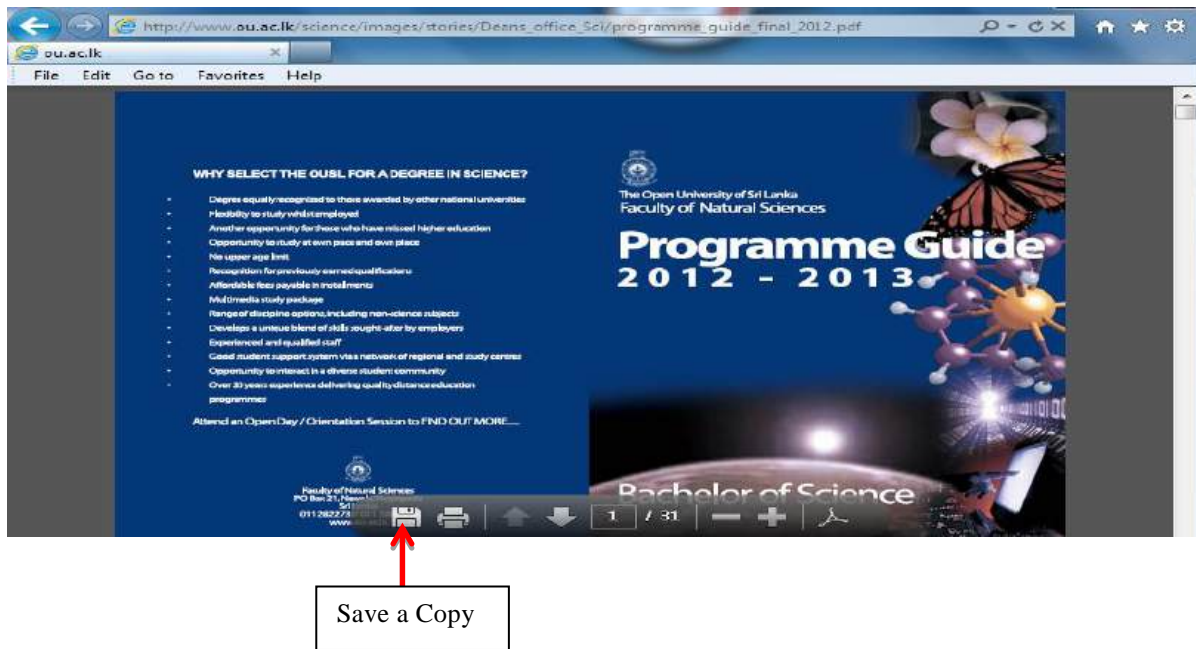

Figure 23.16: The required text file will be opened with the relevant reader software

Then you need to give the location in your computer, where you want to save it and click “Save” (Figure 23.17).

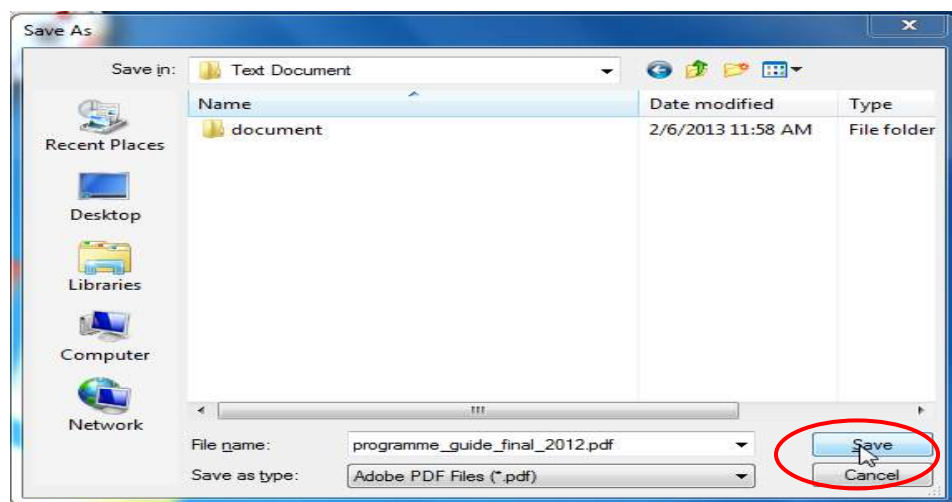

Figure 23.17: Saving a copy of the downloaded file

### How to download a Software file?

Software can be downloaded and installed from the web. There are so many open source software. Aren't you interested to know how we can download software and install it in your computer?

Downloading software is so much similar to downloading a text file. After downloading a file you have to install it to start its performance. The installation process might vary for different software. You need to pay attention to the instructions and proceed with it according to your requirement.

We will show you how to download and install software, by using an example. AVG antivirus software is freely downloadable and it prevents the computers from harmful virus attacks. Before starting to download any software, prepare your computer to carry out the installation by reading the installation guide carefully. The official web-site of AVG is shown in figure 23.18. You can download the software by clicking the “Download” button.



*Figure 23.18: AVG Official web-site*



*Figure 23.19: Downloading a Software*

After that the installer file will start to download. When it is fully downloaded locate the installer file and double click on it to open. Authorize the installer by clicking “Yes” or “Run”. Read the instructions and tailor the software according to your requirements.

In a similar way we can download music files, animations and video files and save them in the preferred location in your computer.

### **Firefox Download Manager**

To begin with, the download manager organizes downloads into active and completed ones, which makes it easier to browse files and control transfers. The tiny buttons on the right "Pause", "Retry" and "Cancel" enables the user to pause the download, download it again when necessary and terminate download respectively (See Figure 23.20).

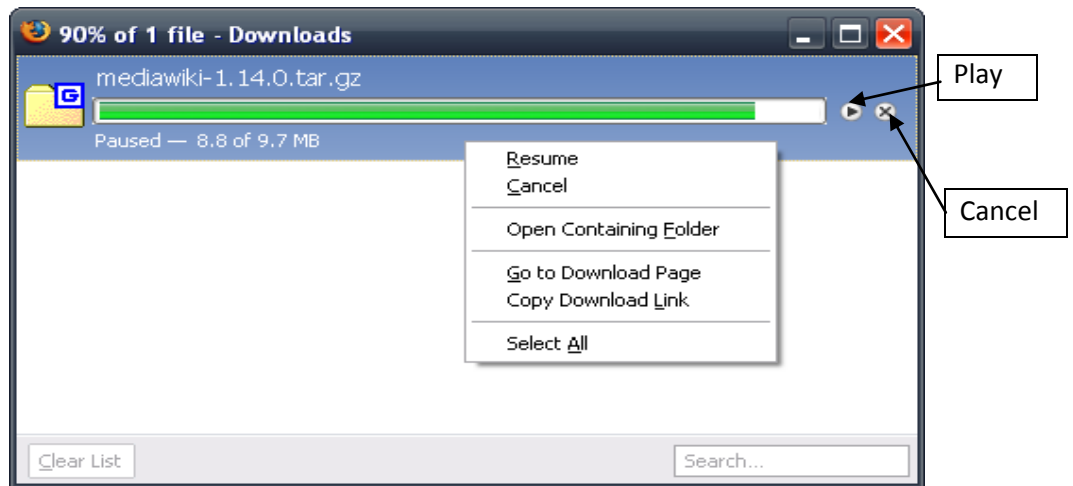

Figure 23.20: Downloading in progress

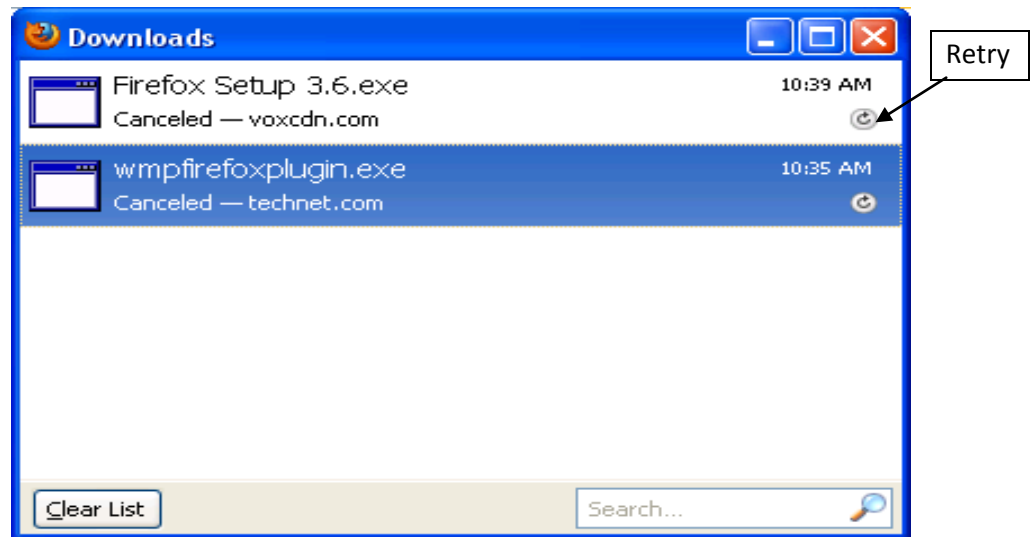

Figure 23.21: Cancelled files at Downloading process

After installing double click on the file to open it. (Figure 23.22)

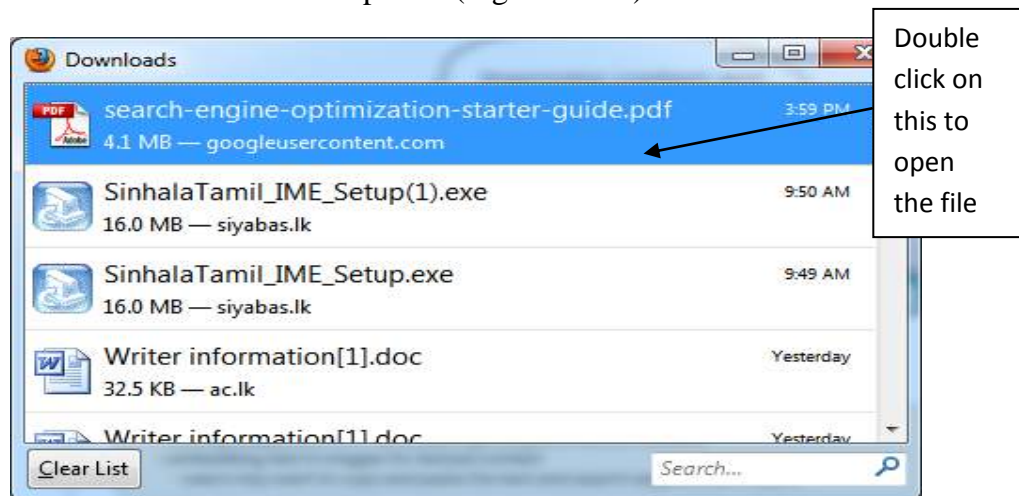

Figure 23.22: Opening a successfully downloaded file

## 23.3 Search Engines

Search engines, as its name implies, search and present a list of web-sites which are closely connected to the key word in which we were seeking. There are so many search engines in the web. We are going to see some of the popular search engines now.

### 23.3.1 Introducing different search engines

#### Google (www.google.com / www.google.lk)

Google is a popular search engine. There are a lot of improved features in it. As you can see in the Figure 23.23 given below, searching is made easy by categorizing type of document you are searching. If you are searching for an image of a computer, you can click on the images and type the key word and get the images you desire so quickly. You do not have to view each and every document and waste your time on searching. You can even search a specific file using the advanced features. This would save your precious time and money.

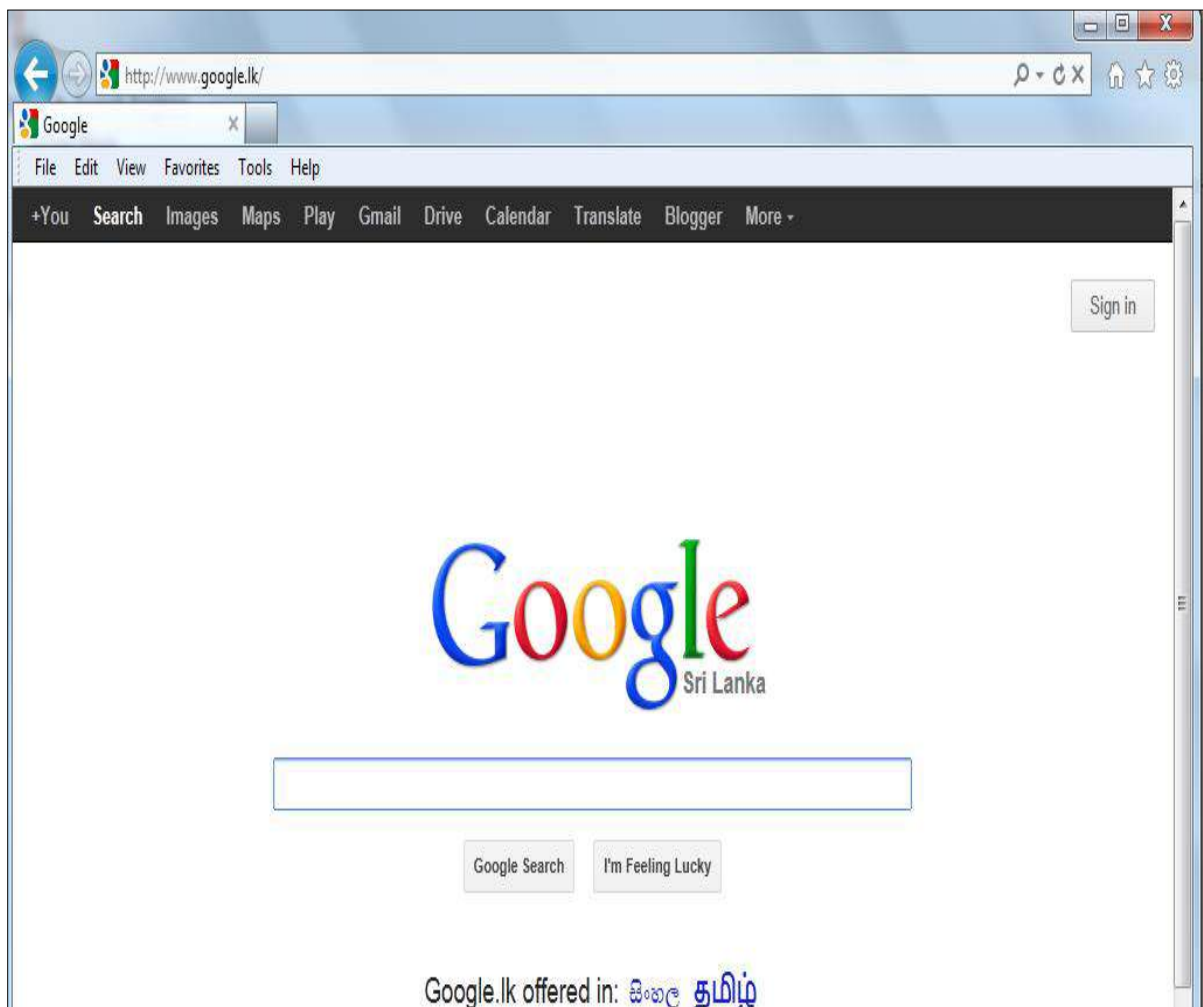

Figure 23.23: Interface of Google Search Engine

## Yahoo (www.yahoo.com)

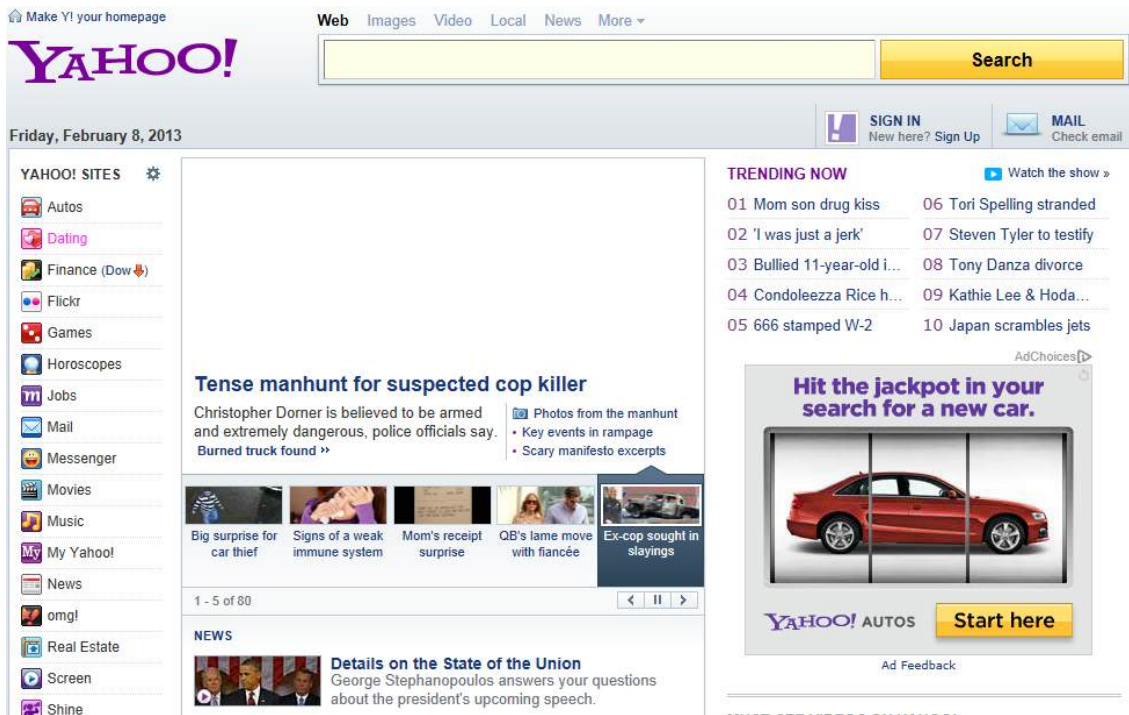

Figure 23.24: Interface of Yahoo Search Engine

## Altavista (www.altavista.com)

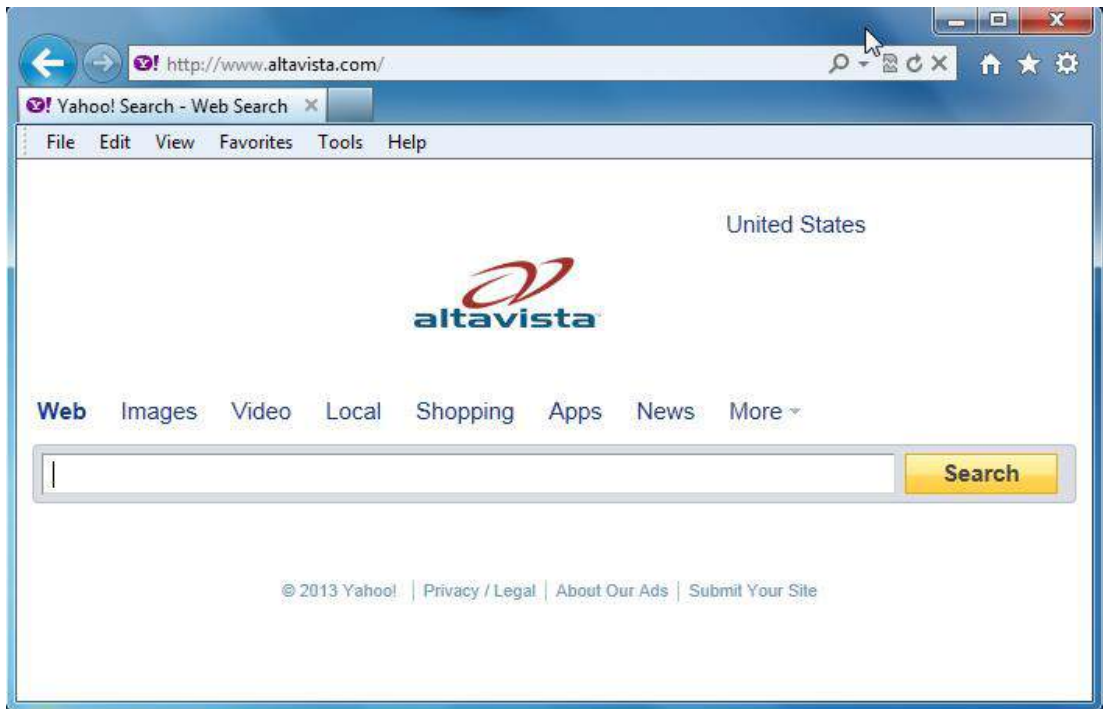

Figure 23.25: Interface of AltaVista Search Engine



## Ask (www.ask.com)

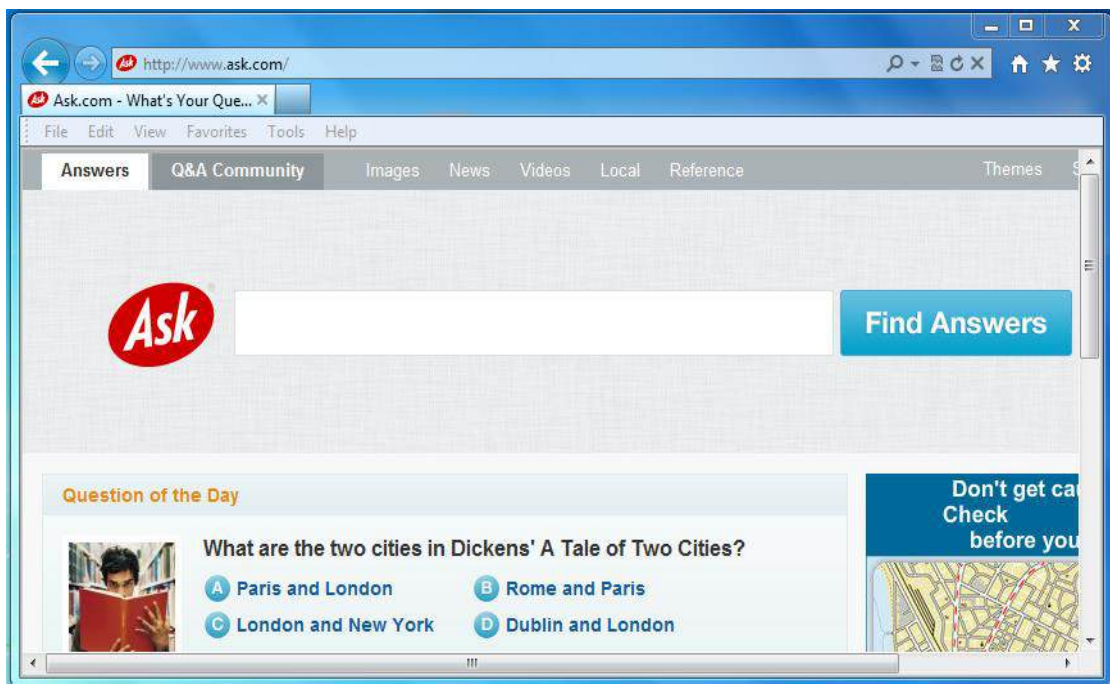

Figure 23.26: Interface of Ask.com

## Bing (www.bing.com)

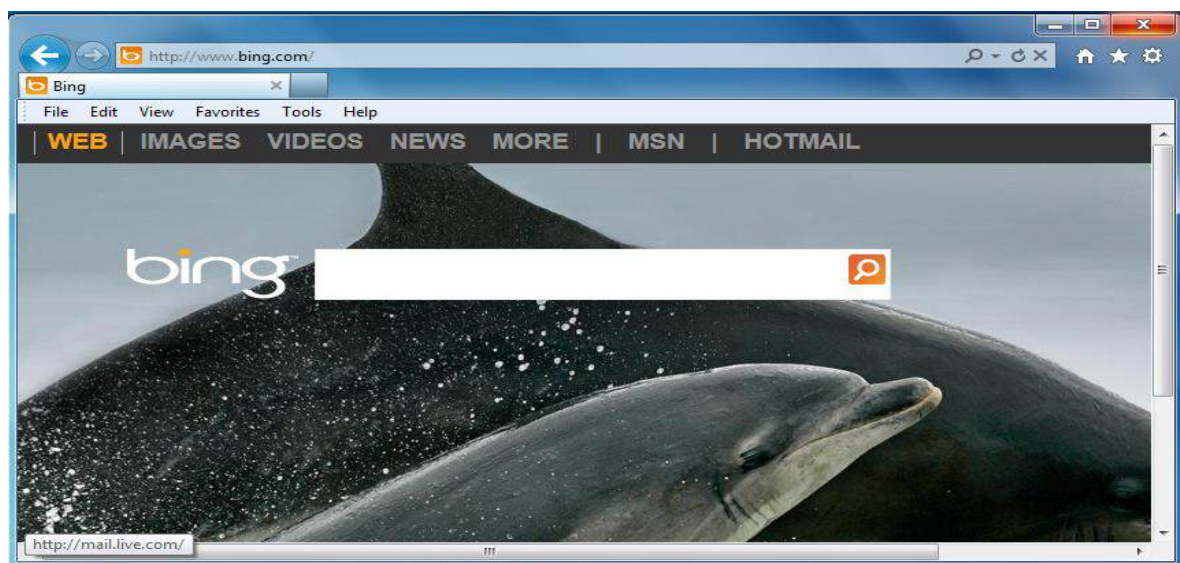

Figure 23.27: Interface of Bing Search Engine

### 23.3.2 Finding information using search engines

We have dealt with some of the search engines in the previous section. We are going to use Google search engine to demonstrate how you can find information using search engines.

**Step 1:** Type [www.google.lk](http://www.google.lk) in the address bar and search. The Google home page given in figure 23.23 will appear.

**Step 2:** Type the key words you want to find. Suppose you want to know how to play chess, so all what you need to do is you have to type “How to play chess” and click “Google Search” or click the search button.

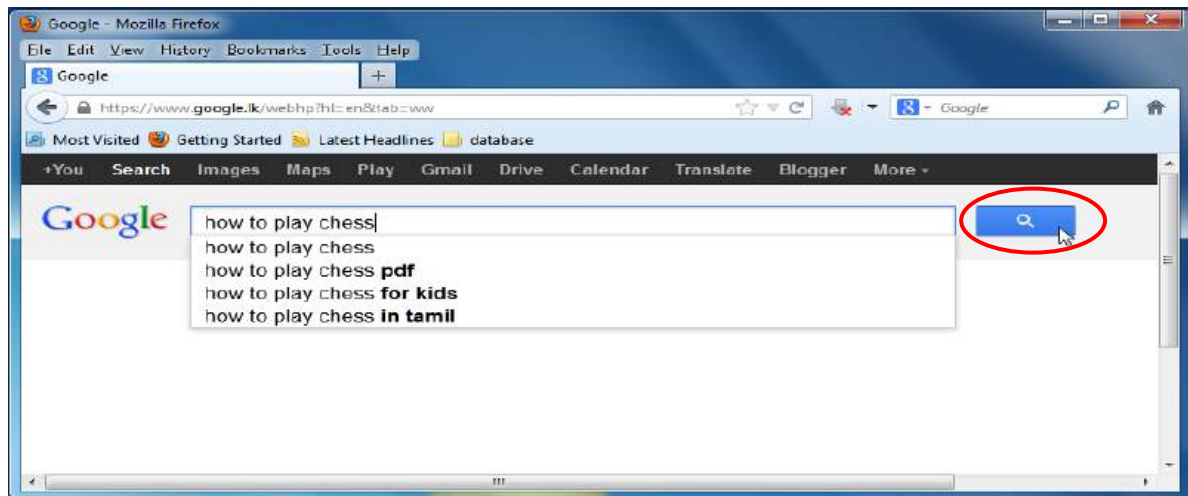

*Figure 23.28: Searching information with the keywords typed*

**Step 3:** Now you can see the list of hyperlinks related to the keywords. Select the most suitable one. You can search specifically for images and maps by clicking on “Images” and “maps” respectively from the top.

### 23.3.3 Searching more efficiently in Google

You might know some of the techniques to search efficiently. But there are some others which are lesser-known, and others are known but not often used.

Now it is time to learn more about, or be reminded of, some of the best ways to get exactly what you're looking for, and quickly.

#### 1. Either/or

Google normally searches for pages that contain all the words you type in the search box, but if you want pages that have one term or another (or both), use the OR operator -- or use the "|" symbol.(Ex: Information | Technology.) this would search either information or technology or both words together.

#### 2. Quotes

If you want to search for an exact phrase, use quotes. [Information "communication technology"] will only find that exact phrase. This will find pages that contain the word information and the exact phrase "communication technology".

#### 3. Not

If you don't want a term or phrase, use the "-" symbol. Suppose you want to search information about Mars which is one of the planets and you do not want to mix it up with Mars chocolate, type as follows [Mars-chocolate] will return pages that contain only information regarding the planet Mars (Note: Put a space before the minus sign but do not put a sign between the minus sign and the word or phrase you want excluded).

#### 4. Similar terms

Use the "~" symbol to return similar terms. [~flower -rose] will get you pages that contain "flowers" but not "rose".

You can even use this as a mean of include as in this example:

Suppose you directly want to access Department of Mathematics and Computer Science webpage in the Open University web site. Although you know the URL of the Open University, you do not know the exact URL. What you can do is, type

www.ou.ac.lk~Mathematics and computer Science

Then see what happens. Yes, you will be directly given the web pages relevant to the Department of Mathematics and Computer Science. Without wasting time by clicking links to access a particular page, isn't it easy to type the keywords in a website and search for it?

#### 5. Wildcard

Google treats the asterisk (\*) as a placeholder for 1 or more words – it can also be referred to as a single or multiple word wildcard operator, because Google treats the asterisk as a placeholder for any unknown term(s) for which it tries to find the best match(es). Google “fills in the blanks” wherever there is an asterisk.

Here is an example:

You need to browse all the Power point presentations regarding the history of the Internet. You can type,

**“Internet History” \* .ppt**

in the search bar. Now you can see all the links to the Power point presentations related to the history of the Internet

#### 6. Advanced search

If you can't remember any of these operators, you can always use Google's advanced search. Click on “Advanced Search” to use the advanced search options. (Figure 23.29)

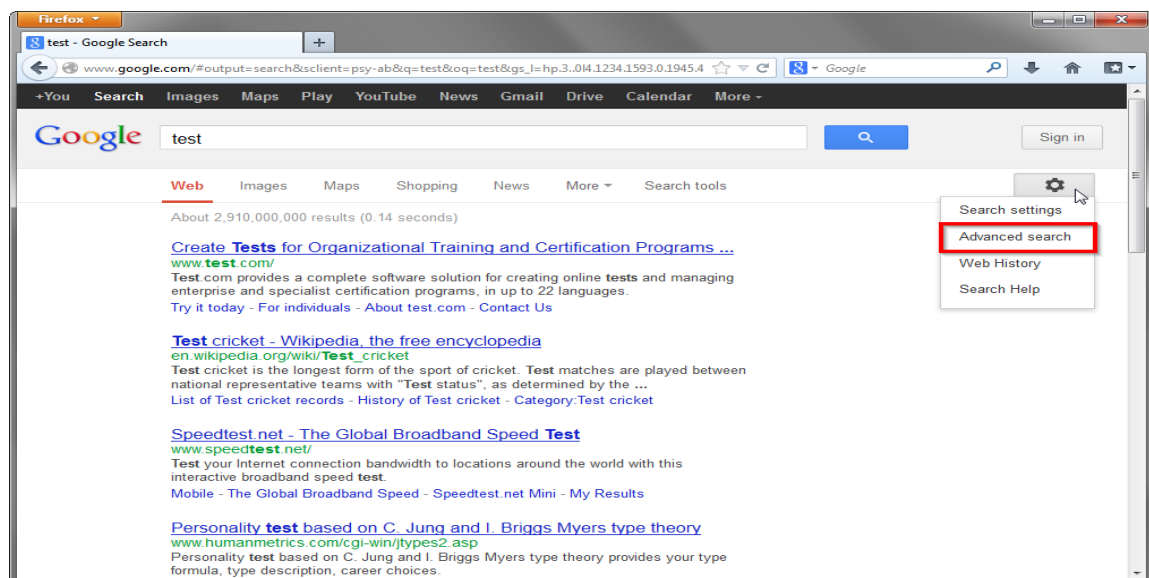

Figure 23.29: Advanced Search in Google

You can use these options to optimize your search. (See Figure 23.30 below)

The image shows the Google Advanced Search interface. At the top left is the Google logo, followed by the text "Advanced Search" and links for "Advanced Search Tips" and "About Google". Below this is a search bar with a "Google Search" button. The main section contains several filter categories: "Find results" with options for "with all of the words", "with the exact phrase", "with at least one of the words", and "without the words"; "Language" set to "any language"; "Region" set to "any region"; "File Format" set to "any format"; "Date" set to "anytime"; "Numeric Range" with two empty input boxes; "Occurrences" set to "anywhere in the page"; "Domain" set to "Only" with a "More info" link; "Usage Rights" set to "not filtered by license" with a "More info" link; and "SafeSearch" with radio buttons for "No filtering" (selected) and "Filter using SafeSearch". Below this is a "Page-Specific Search" section with two rows: "Similar" and "Links", each with a description, an input box, and a "Search" button. The "Similar" row has an example: "e.g. www.google.com/help.html".

Figure 23.30: Advanced Search options

For further details regarding the Google Advanced Search

[http://www.googleguide.com/sharpening\\_queries.html](http://www.googleguide.com/sharpening_queries.html)

Other than these there are some more features too to make searching an easy task. Try out the things we have studied and search and find out the other techniques which can be used to make your search more effective and efficient.

## 23.4 Browser Customization

### 23.4.1 Setting up a Homepage

The webpage that the browser loads when first opened is referred to as the homepage. You can set your homepage to whatever webpage you like. But when the homepage you use is the website you use on a regular basis, you can save quiet a lot of time. Here we are going to show how you can set your home page in Mozilla Firefox. Try out and see how this can be done in other web browsers such as Google chrome, Internet Explorer and Netscape Navigator.

Suppose you want to have [www.google.lk](http://www.google.lk) as your home page in Mozilla Firefox. Follow the steps below:

1. Open Firefox, and click on **Tools->Options**.

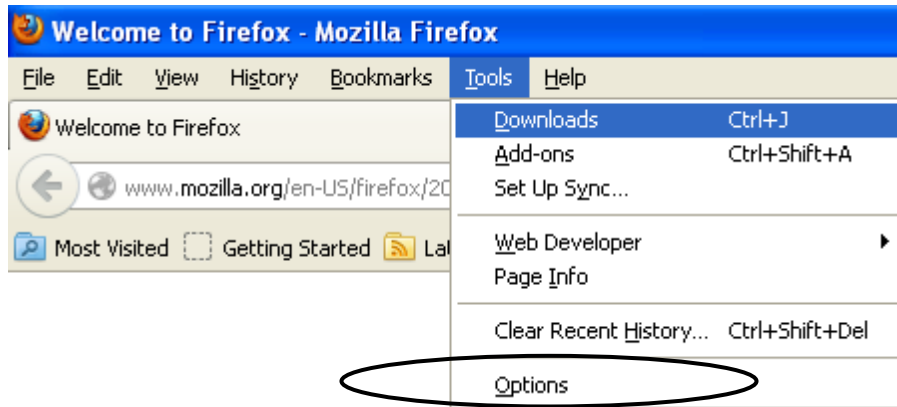

2. Go to "General" tab and type <http://www.google.lk/> (You can use any URL you like to be the home page to visit)

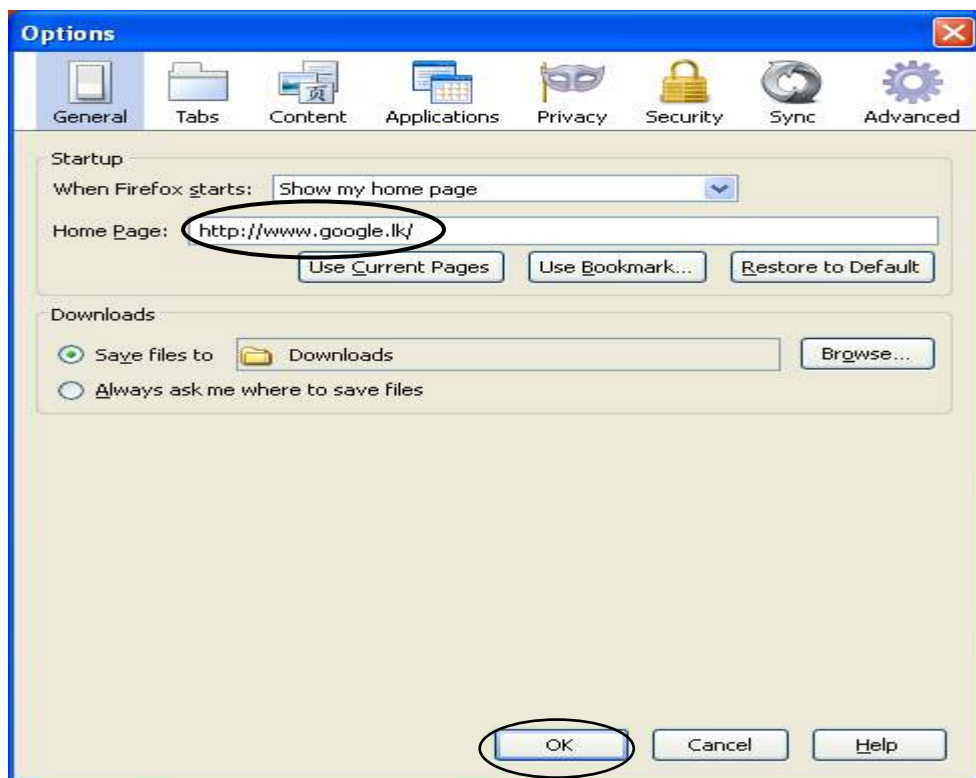

3. Click **OK**.

Now you will be able to see this web site whenever you open up the browser (Mozilla Firefox).

### Steps to set-up home page in Internet Explorer

1. Open the web browser.
2. Select **tools**.

3. Click on **Internet Options**.
4. Select **General** button.
5. Insert the URL.
6. Click **Apply**.
7. Click **OK**.

### 23.4.2 How to set up a Proxy for Firefox 3?

Setting up a proxy for Firefox is pretty simple. Follow the procedure as mentioned below:

1. Open Firefox, and click on **Tools**→**Options**.
2. Go to the **Advanced** Tab.
3. Under the '**Advanced**' tab section, click on *Network*.
4. Then under the “*Connection*” section, click ‘Settings’ button – see Figure 23.31

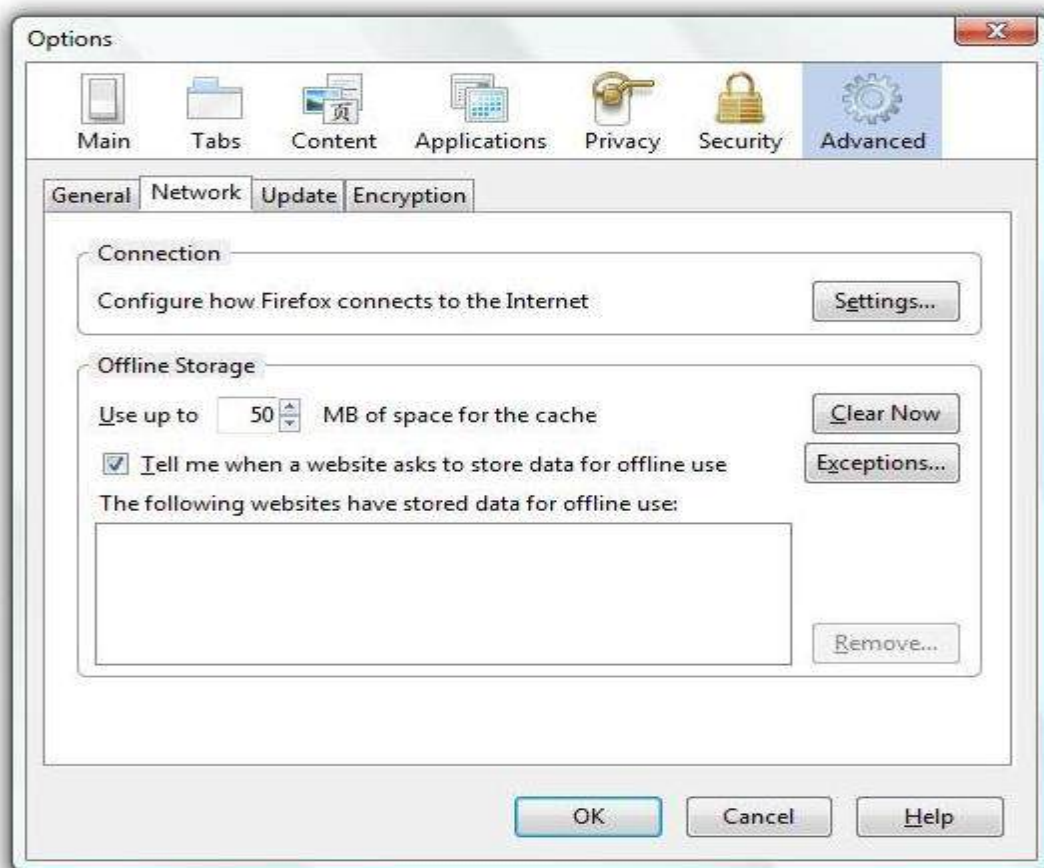

*Figure 23.31: Configure Browser Proxy*

5. Click on the “Manual Proxy Configuration” button in the ‘connection setting’ dialog box as shown in Figure 23.32 below.
6. Now copy/paste the proxy address and port in their respective sections.

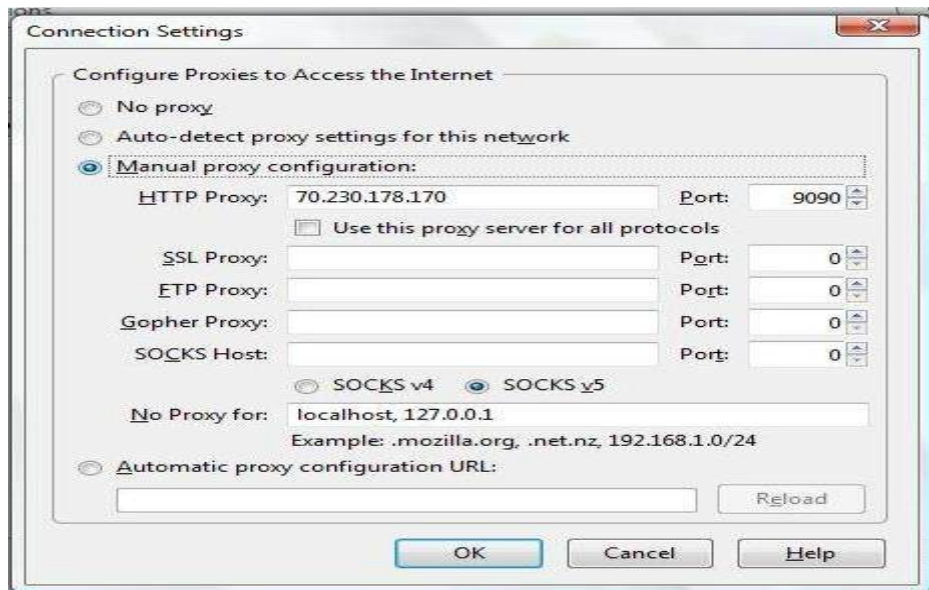

Figure 23.32: Connection Setting Dialog Box

7. Click 'OK'.

### 23.4.3 Changing the 'Content' in Options

The **Content** tab contains settings that allow you to change how Firefox handles certain content on the internet. The only setting required on this tab is the **Enable JavaScript** option. This setting must be enabled in order for MLS Listings (and other websites in general) to work properly. Not having this setting enabled may cause problems.

If you are concerned about enabling JavaScript for security reasons, consider changing the settings in the Advanced... consider the advanced Java Script Settings available as shown in Figure 23.33 below.. Firefox allows you to disable some of the actions that JavaScript can perform.

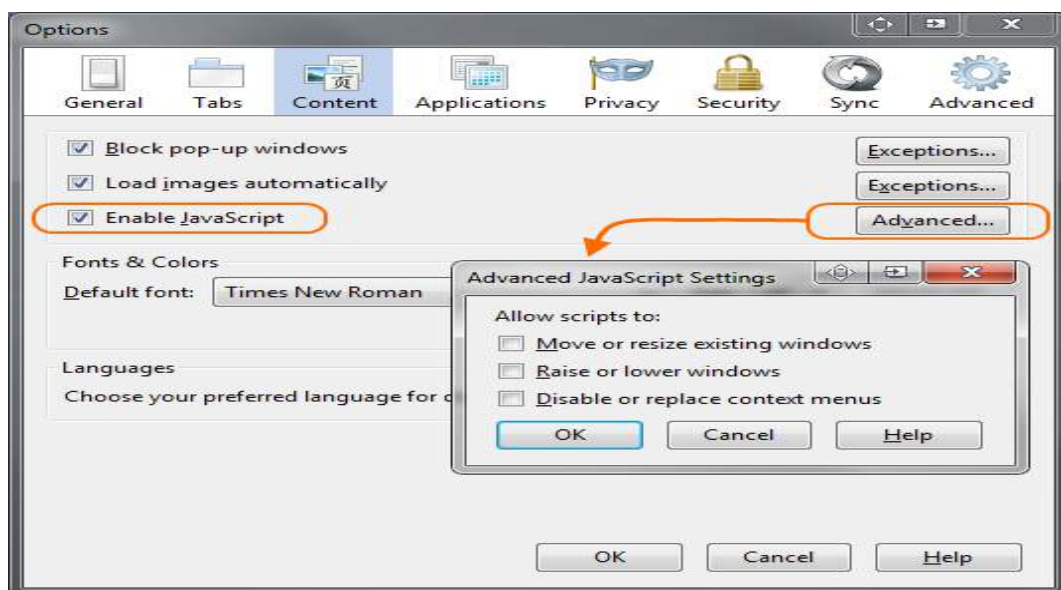

Figure 23.33: Changing Content

Hope you enjoyed in trying out these activities. Are you curious to know more services available in the Internet? If yes, in your answer the next session would provide details of more facilities available in the Internet.

### 23.5 Self Assessment Questions



- 23.1 What are Web Browsers? List five commonly used web browsers.
- 23.2 What do you call the first page of a web site?
- 23.3 Before installing a browser how can you confirm whether your machine is compatible with the features in that browser?
- 23.4 State the use of following components in the user interface of a web browser.
  - a. Location Bar
  - b. Search Box
  - c. Main content Pane
- 23.5 When installing a web browser in your PC, what is the difference between two setup types called 'standard setup' and 'custom setup'?
- 23.6 What are Search Engines? Name three commonly used search engines.
- 23.7 How can you search for an exact phrase in Google?
- 23.8 What is the use of "Advance Search" in Google?
- 23.9 What is the function of wildcard operator when searching for information in Google?
- 23.10 What is the difference between "No proxy configurations" and "Manual proxy configuration" in connection setting dialog box of the internet options of your browser?
- 23.11 What is the purpose of having the "content" tab in internet options of your browser?



## Session 24

### Introduction to the E-mail

---

#### Aim:

This session aims to provide an introduction to the e-mail.

#### Objectives:

Having studied this session the student will be able to:

- Create and use an e-mail account
- Describe the security and risks involved in Internet



### 24.1 E-mail

In the previous session we dealt with one of the most important usage of the Internet. We are going to discuss another here. It is all about the **Electronic Mail** or simply **e-mail**.

#### 24.1.1 Snail mail Vs. E-mail

Before going into details about e-mails let us have a glance about what actually happens in a regular postal mail.

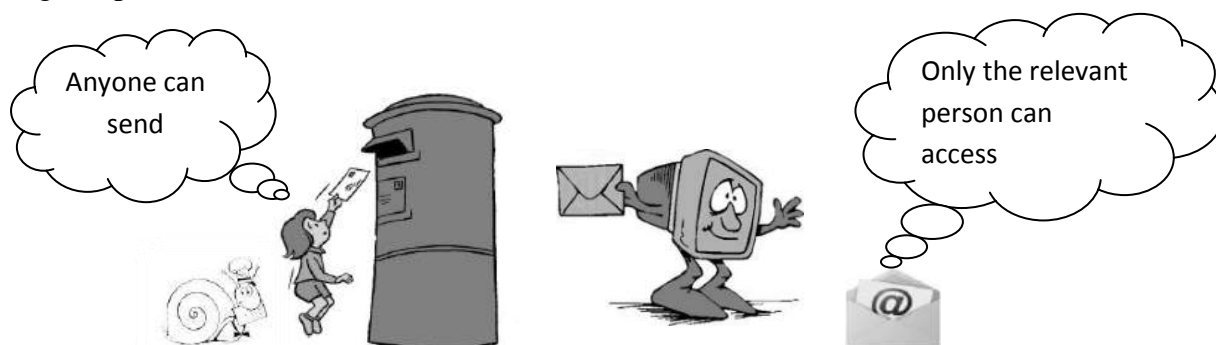

*Figure 24.1: Snail mail Vs. E-mail*

Anybody can post letters to a particular person if they know his/her postal address. But only the relevant who belongs to that particular address will receive the mail. We call such a postal mail as 'snail mail' because it usually takes several days or even weeks to reach the specified location. Since the technology has advanced rapidly and we expect things to happen with a single click, the electronic mail is the choice of the most.

A person can exchange his/her messages digitally through e-mail. E-mail has so many similarities with the postal mail. Similar to a postal mail, e-mail too can be sent from anyone but the mail will be received by the person who owns a particular **e-mail address**. Of course, you would have used e-mail to convey messages to a person living in another part of the world. Let's discuss this in detail.

### 24.1.2 How e-mail works in brief

The mails you send will be temporarily saved in your mail server. Email servers accept, forward, deliver, and store messages. Neither the users nor their computers are required to be online simultaneously; they need connect only to an e-mail server, to send or receive messages. **Mail server** is also used to mean a computer acting as a Mail Transfer Agent (MTA) that is running the appropriate software.

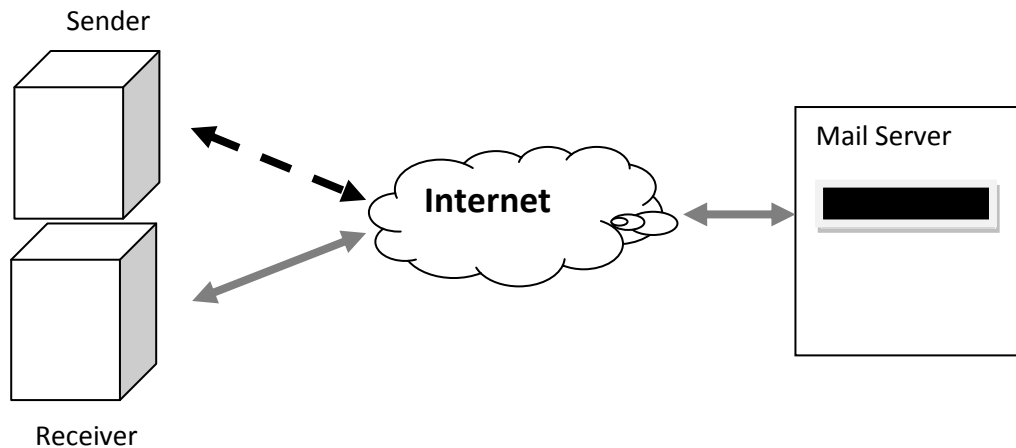

Figure 24.2: Email operations across the Internet

Let us see a real world analogy to understand the basics of this connectivity. We have not dealt the process in deep details here since it would be beyond the scope of this course.

Suppose Amali wants to send a mail to Sanath. Amali sends the mail to the MTA which is also can be referred to the **Mail Server**. Then the message is routed from server to server through the Internet. At last, Sanath receives the message from the Mail Server and reads it (See Figure 24.3 below).

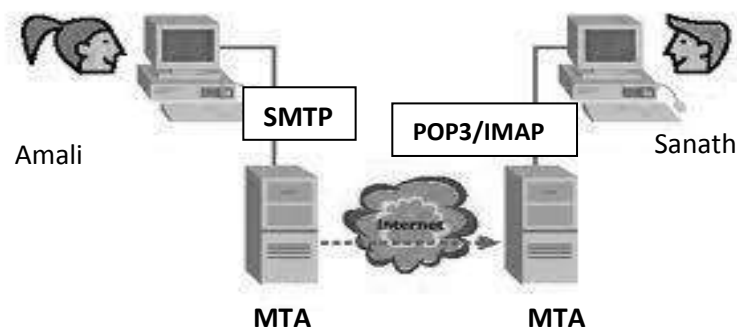

Figure 24.3: Flow of the E-mail through the Internet

## 24.2 More about E-mailing concepts

### 24.2.1 E-mail clients

An **email client** is a computer program used to access and manage a user's email. It is also referred to as an **e-mail reader** or a **Mail user Agent (MUA)**. It can refer to any system capable of accessing the user's email mailbox, regardless of it being a mail user agent, a relaying server, or a human typing on a terminal. In addition, a web application that provides message

management, composition, and reception functions of emails is also sometimes considered an email client, but more commonly referred to as **webmail**.

Examples for some popular locally installed email clients:

- Microsoft Outlook
- IBM Lotus Notes
- Pegasus Mail
- Mozilla's Thunderbird
- KMail in the Kontact suite
- Evolution
- Apple Inc.'s Mail.

Examples for some popular web-based email clients:

- Gmail
- Yahoo!
- Mail
- mail.com
- Lycos mail
- Outlook.com

Many internet service providers provide a webmail client as part of the email service included in their internet service package.

### 24.2.2 The SMTP Server

When we send an email, our computer connects to our email service's mail server. A *server* is a centralized computer which manages a specific type of service. An email server for instance, handles emails. The email server responsible for sending emails is called the **SMTP** (Simple Mail Transfer Protocol) server. One SMTP server can pass on the mail to another SMTP server and relay it to the destination through several hops.

Every email has the sender's address (e.g. *sender@sendermail.com*) and the recipient's in the *To* Field (e.g. *recipient@recipientmail.com*). When an email is sent, the email client connects to the SMTP server of the sender's email service (e.g. *mailserver.sendermail.com*). The client transmits the address of the sender, the address of the recipient and the content of the message.

The SMTP server goes to work at locating the whereabouts of the recipient. Using the recipient's **mail ID** (i.e. *recipient@recipientmail.com*) it locates the domain name – e.g. *recipientmail.com*.

**Note:** If the recipient's mail ID had the same domain name as the sender, then the process would be simpler. The SMTP server would have transferred the mail to its local outgoing mail server (POP3 or IMAP).

Each domain name represents a unique Web address, called an **Internet protocol (IP) address**. Think of it as postal addresses of the internet. The link between domain names to their IP addresses is stored in the **Domain Name Registry**. The SMTP server then contacts the server

where the registry is kept (The **DNS Server**). The DNS server sends back the address to the SMTP server.

The SMTP server then proceeds to hand over the email to the SMTP server of the recipient's email service (let's call it mailserver.recipientmail.com). This SMTP server checks and confirms that the mail addressed to recipient@recipientmail.com belongs to it and hands it over to its counterpart, the POP3 server (or the IMAP server).

### 24.2.3 The POP3 Server

**Post Office Protocol (POP3)** servers are the servers that do the job of receiving mails. The number '3' is the version number of the protocol in use. POP3 servers have mail accounts (our email IDs). Each mail account is mapped to a username-password combination. Once the message is handed over to the POP3 server, it is kept and stored in the mail account till the recipient logs in and checks the mail.

### 24.2.4 The IMAP Server

An email client connects to the POP3 server and tells it to allow download of the email. Once downloaded to the local machine, POP3 mailboxes do not retain a copy of the email. Thus, you cannot check your emails from another PC as it has already been downloaded. To tack this difficulty, IMAP was introduced. IMAP (Internet Message Access Protocol version) simply retains a copy of the emails on the server. This allows you to access your e-mail from any location with an internet connection.

The Following Table 24.1 differentiates POP from IMAP in terms of their advantages and disadvantages.

	Advantage	Disadvantage
POP	<ul style="list-style-type: none"> <li>• Local Storage.</li> </ul> <p>When not connected, the user can still access and read downloaded email.</p> <ul style="list-style-type: none"> <li>• Server Saving.</li> </ul> <p>POP frees server disk space because it downloads emails and attachments then deletes them from the server.</p>	<ul style="list-style-type: none"> <li>• Single Computer and Client.</li> </ul> <p>Despite the "leave-mail-on-server" enhancements of newer POP servers and clients, POP is primarily designed for use with a single email client on a single computer. When implemented, the "leave-mail-on-server" feature forces the downloading of the same emails multiple times, taking huge bandwidth, server resources and client disk space on multiple machines.</p>

<p>IMAP</p>	<ul style="list-style-type: none"> <li>• Multiple Client Support. Messages can be viewed on any computer with an IMAP client.</li> <li>• Public and group folders. Because they are on the server everyone can see and use them.</li> <li>• Configurability. It has dozens of options based on all three mail delivery models</li> </ul>	<ul style="list-style-type: none"> <li>• Server Intensive. Consumes server CPU and disk resources.</li> </ul>
-------------	------------------------------------------------------------------------------------------------------------------------------------------------------------------------------------------------------------------------------------------------------------------------------------------------------------------------------------------------------	-------------------------------------------------------------------------------------------------------------------

Table 24.1: Advantages and Disadvantages of POP and IMAP

### 24.3 Different e-mailing methods

First of all it is essential to know the anatomy of an email message. Basically email contains 2 parts: the **header** and the **body**.

In order to have a better understanding about the emails, let's take a real life example. If you want to send a letter to someone what will you do? Firstly, you'll be writing the letter and then put it into an envelope. Then you'll write the recipient's name and address on the envelope, and then post it. The letter you write can be compared to the body and the envelope is comparable to the header.

Sending an email is very much similar to this scenario but really with more advantages. You don't need a pen and a paper anymore. Documents are exchanged swiftly without any delays. But you need a computer, internet connectivity and an email account and the recipient's email address to send an email.

We have already learnt that an email has two parts namely a header and a body. Let's discuss this in detail with the help of the following figure which shows a typical layout of an email.

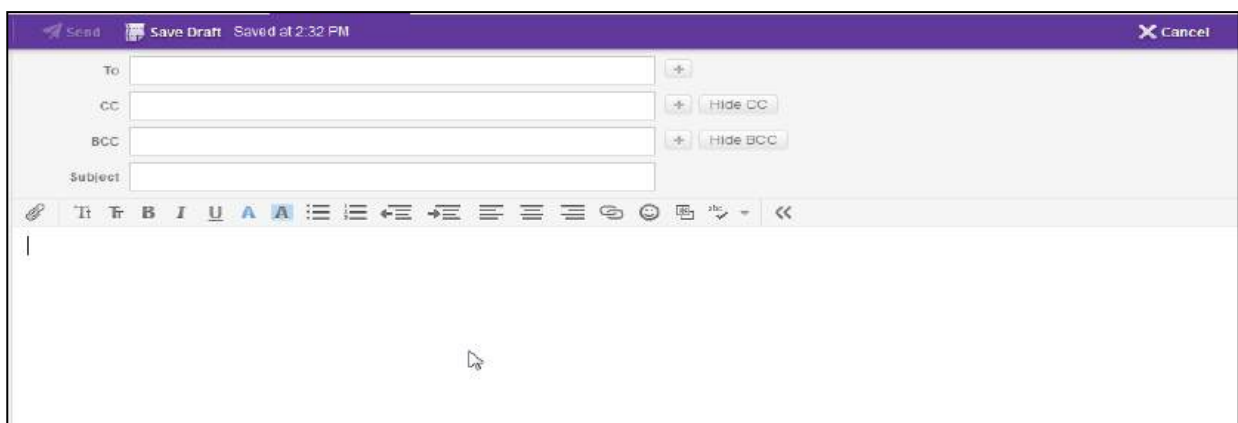

Figure 24.4: Layout of an e-mail

We think that a clear understanding about the types of the header is very worthwhile. So let's see the different headers you need to be concerned about.

- **To:** This of course is obvious to all. Yes, it contains the email address of the person to whom you are sending the mail.
- **From:** This contains the senders email address. Since most of the email clients fill the senders email address in this field automatically, we need not have to worry much about this field.
- **Subject:** In the subject field you are expected to write a short description about the message you are going to write.
- **CC:** This refers to the Carbon Copy where you send mails to a main person and include the email addresses of all the others here.
- **BCC:** BCC stands for Blind Carbon Copy. This is like what we have discussed in the CC but the main difference is that the name of the recipient would not appear in the message.
- **Attachments:** You attach a complete document in this field.

You'll be simply typing your message in the body of your email. It is possible to change the colour and the type of the text you have typed. In addition you may include emoticons in the body of the email.

## 24.4 Need of Email etiquettes

Do you know that similar to dining etiquette, we need to follow some etiquette when sending emails which is important especially in business purposes.

*'By requiring employees to use appropriate, businesslike language in all electronic communications, employers can limit their liability risks and improve the overall effectiveness of the organization's e-mail and Internet copy in the process'*

- 'Writing Effective E-mail', by Nancy Flynn and Tom Flynn

Let's have a look at the important email etiquettes which you can follow. The following table 24.2 shows the email etiquette and the reason for doing so.

Etiquette	Reason
1. Message should be concise and to the point.	Reading a long mail will give a boring experience to the reader and it will be a de-motivating fact too.
2. Be polite and courteous as you would be face-to-face.	
3. Avoid writing in CAPITALS.	Typing in capital letters is considered as SCREAMING and it is offensive.

4. The subject should be meaningful.	If it is a short description of the mail you are writing then it will give a brief idea to the reader.
5. In order to make it clear break-up your mails into paragraphs.	Small chunks are better understood by the human brain than long paragraphs.
6. Make it more personal.	It will draw more attention from the reader.
7. Before sending your mail read your mail again and again.	Because there is a chance for improvement always, isn't it?
8. Make sure whether the reader to whom you are sending the mail will understand the abbreviations and emoticons you have used.	Abbreviations like BTW (By the way) and LOL (Laugh Out Loud) are certainly easier for you to type but sometimes it might be difficult for the person who is reading it.

*Table 24.2: Email etiquettes*

## 24.5 Using emails

### 24.5.1 Email address

An Email address has 3 parts in it. If we type an email address, it will be in the following format.

Eg:      `username@hostname`  

1:-The first part identifies the user. Usually case sensitive.

2:- The @ sign which comes in between

3:- The third part refers to the computer which stores mail for user. Not case sensitive.

### 24.5.2 Creating a free e-mail account

Creating an email account is a simple procedure and this can be done within few minutes. As an example let us see how to create a yahoo mail account. Follow the steps given below.

**Step 1:** open your web browser (ex. Mozilla Firefox) and log on to the Yahoo web site ([www.yahoo.com](http://www.yahoo.com))

**Step 2:** Click on Sign-up indicated by the arrow in the figure below.

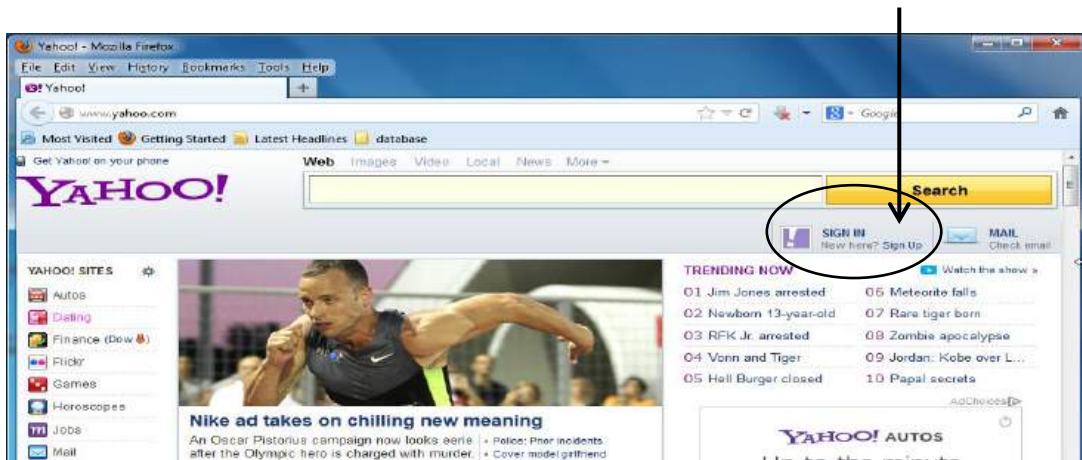

**Step 3:** Enter the details in the allotted cages.

**YAHOO!**

Some basics to get you started

My name is

Pick a Yahoo! ID **shiranibandara@yahoo.com** [Change](#)

Pick a password  Strong

Retype password

**Step 4:** After entering the details, click on “Create my account”.

A little personal info so we can serve you better

I was born on

My gender

Language

Country

If you can't sign in, we can help you using these options

Mobile phone

Alternate email

By proceeding, I agree to the [Yahoo! Terms of Service](#), [Yahoo! Privacy Policy](#) and [Communications Terms](#). To deliver product features, relevant advertising and abuse protection, Yahoo!'s automated systems scan and analyze all email, IM, and other communications content.

**Step 5:** Now select two secret questions and answer them.





In case if you lose your password you can use these questions to login to your account with a new password. Make sure that the password is memorable.

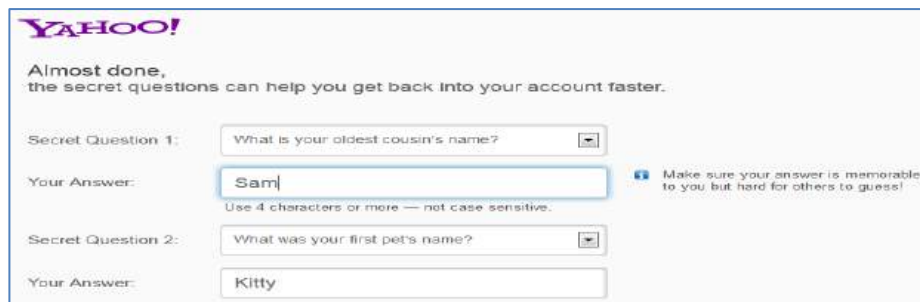

**Step 6:** Type the code which is displayed in the cage provided as shown in the figure below. Then click on “Done”.



**Step 7:** Now click on “Get Started”.

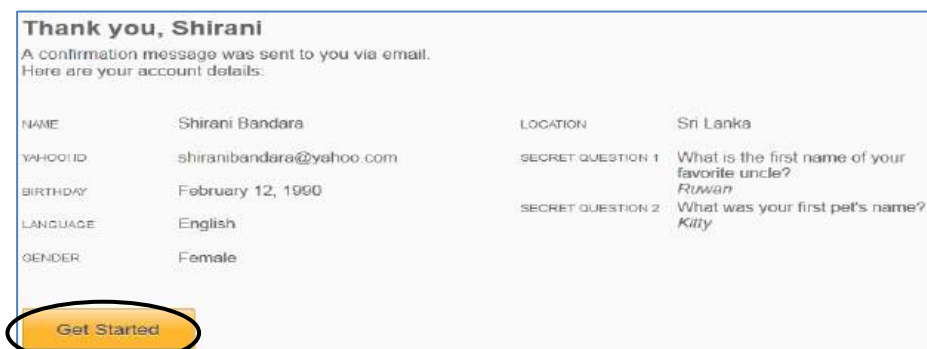

**Step 8:** Now you have created an e-mail account successfully. You can see your user name appearing in the top right hand corner. See the circled area in the figure below.

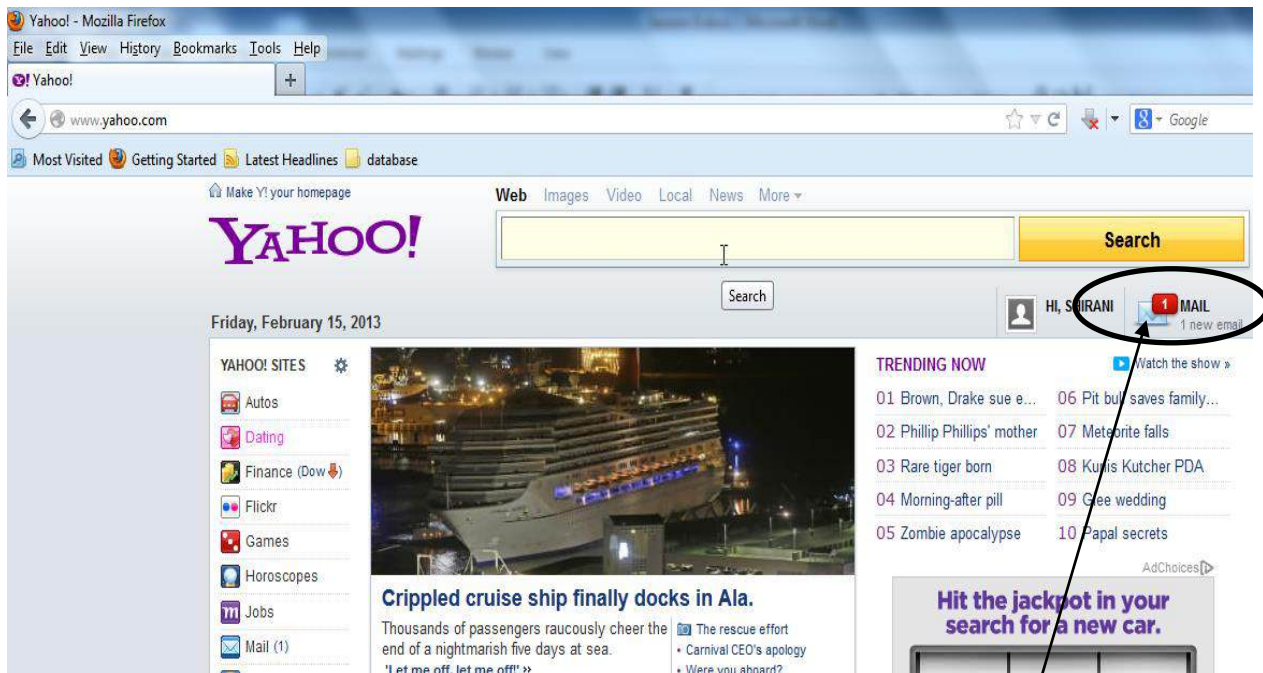

Click on Mail

**Note:** If you are interested in creating a Gmail account, please follow the link below:  
<http://www.wikihow.com/Create-a-Gmail-Account>

### 24.5.3 Receiving e-mail

First click on the **Inbox** to view the e-mails and click on each subject to open and view the mail in full. Let's use an example for this. Once you create a new email account you will be able to see a welcome message in your inbox. Click on that to read the message, as shown in Figure 24.5 below.

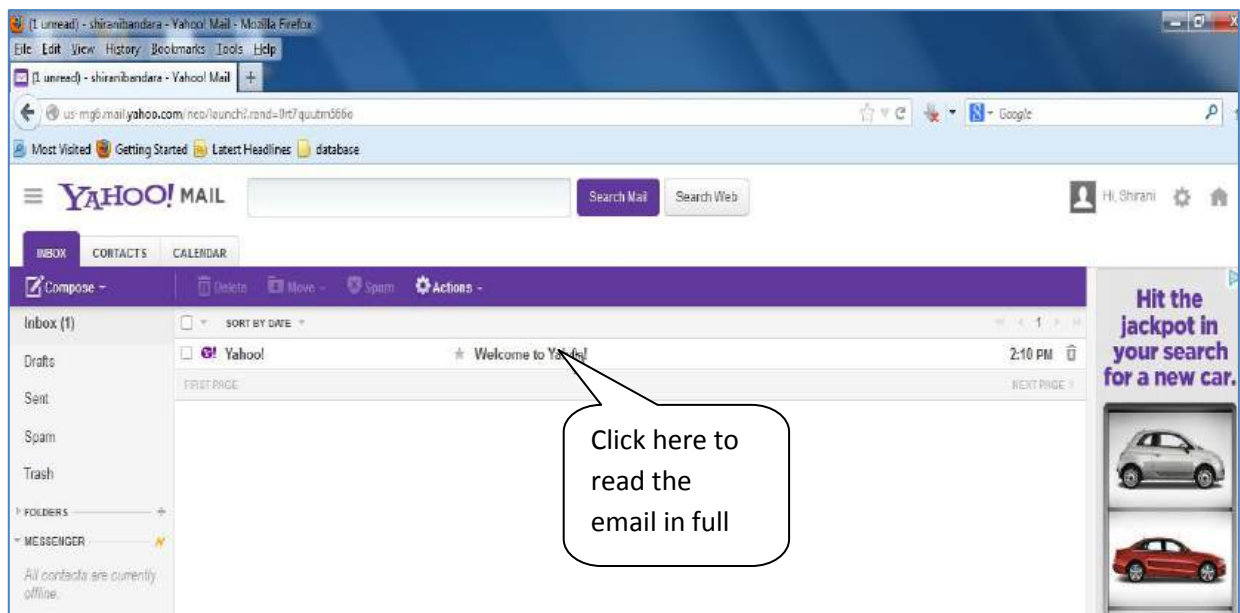

Figure 24.5: First ever email to your Inbox

## 24.5.4 Sending e-mail

Please follow the steps below to send a basic email.

1. You can see a button called “**Compose**” at the left hand-side after the Inbox. Please locate the exact location of ‘compose’ as shown by a ‘hand sign’ in Figure 24.6 below. You need to click on it to send mails. You will see the web-page shown in Figure 24.7 next.

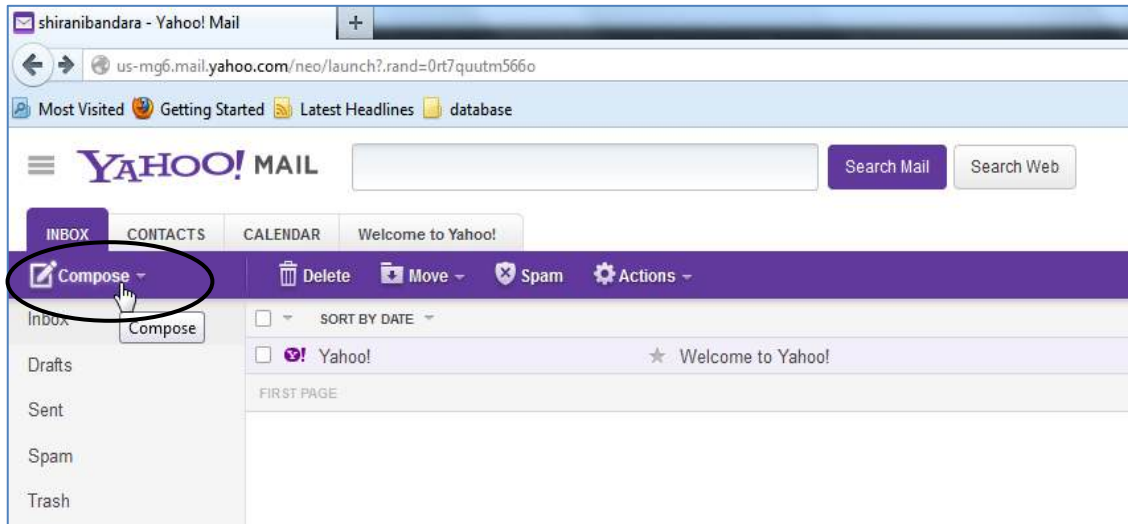

Figure 24.6: Compose Button

2. Type the email address of recipient.
3. Type the title/subject of your mail.
4. Type the entire content of the mail in the body section. You can make it lengthy as you wish.
5. Make sure that everything is ok and Click on **send** button

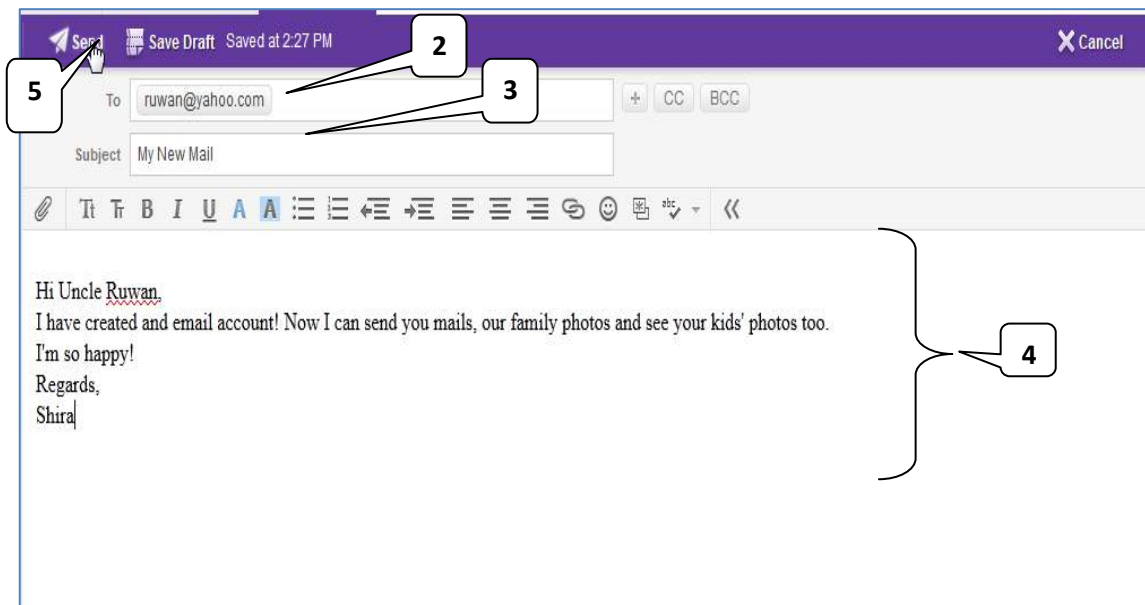
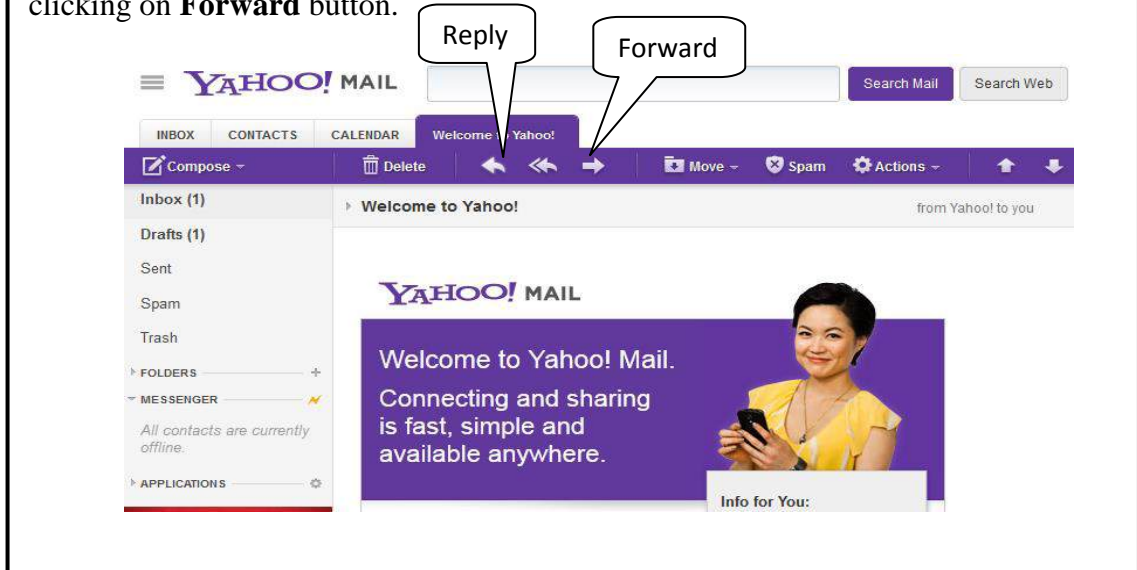

Figure 24.7: Composing email

## Activity:

Ask your friend to send a message to you. Check your Inbox and send a reply to your friend by clicking on **Reply** as shown below.

Similarly forward the same message received from your friend to another friend by clicking on **Forward** button.



### 24.5.5 Sending/receiving attachments

In addition to the basic content you type on the body of the email, you can attach a file along with your email. This file can be of any format allowed by the particular e-mail client and the size of the attachment will also be limited by the e-mail client. For an example, the Gmail does not allow sending executable files (.exe files) as attachments as a security measure to prevent potential viruses, also currently the maximum file size that can be attached with a Gmail is 25 MB.

Follow the steps below to send attachments:

1. Click on the “**attach**” button as shown below or drag and drop the files to be attached into that.

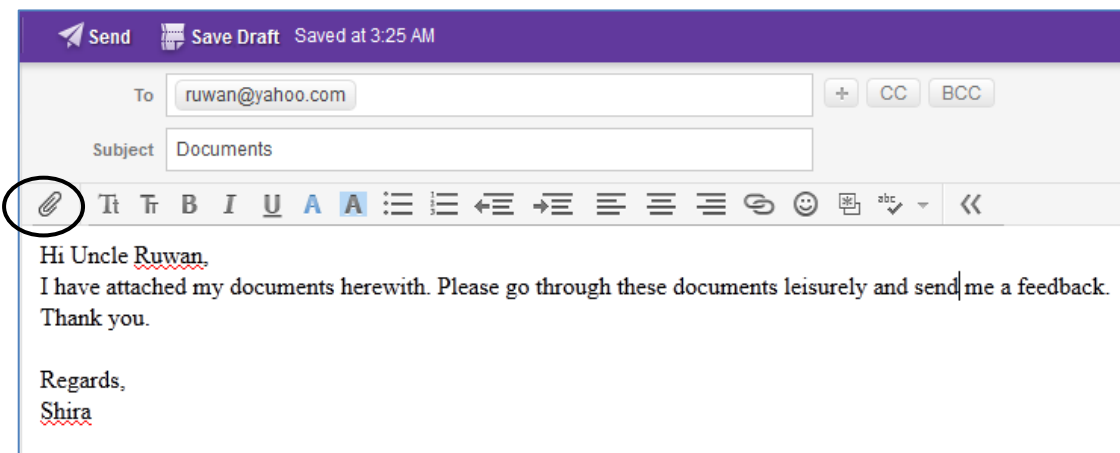

2. Select the file to be attached with the mail by locating the file correctly and click on “**Open**” button.

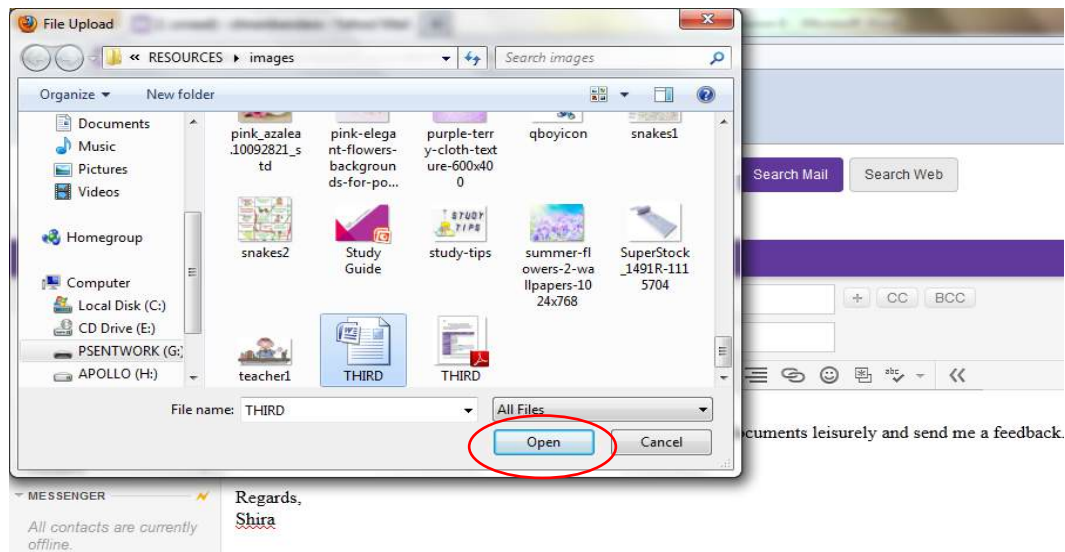

3. You will see the selected file gets attached within few seconds or minutes. This depends on the capacity and the speed of the Internet connection. Finally you can send your mail along with the attachments by clicking on “**send**” button.

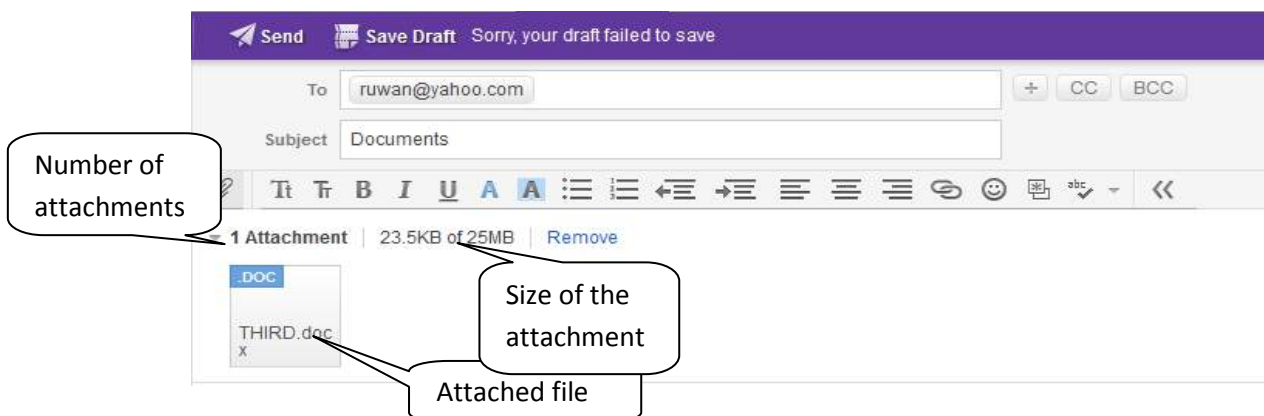

### 24.5.6 Set up an Address Book Group for List Mailing in Yahoo

Do you send emails to more than one recipient often? Are the recipients often the same? Then there is a more effective way to handle your tasks. Let us discuss how we can create a group for list mailing from existing contacts in Yahoo:

1. Follow the **Addresses** link in the Yahoo! Mail Classic navigation bar.
2. Tick the checkboxes next to the address book entries you want to become members of your mailing list.
3. Make sure **Send Email** is selected in the toolbar listing possible actions.
4. Click **OK**.
5. Under **Add Contacts to a List**, select **Add contacts to a new list**:
6. Enter a list name.
7. Click **Compose**.

Yahoo! Mail Classic automatically sets up a new mailing list containing the selected address book entries.

With your groups set up and populated, you can now send messages to all members easily and quickly.

To add contacts to a contact group:

1. Sign in to Yahoo! Mail.
2. Click the **Contacts** tab.
3. Check the box next to a contact to select it.
4. Click **Assign to Lists**.
5. Check the box next to one or more lists.
6. Click **Done**.

## 24.6 Security and risk in Internet

We are well aware that people all around the world enjoy the benefits of the Internet. We can never reject the fact that our lives are made easy by the Internet because we have all been given access to information and we can obtain information which we want from anywhere in the world. Communication is made very easy not only among individuals but also amongst groups. Internet had paved a way to a new era in the business world by making commercial transactions simple and swift.

Although there are numerous benefits of the Internet there are also a handful of issues associated with the Internet. The issues associated with the Internet are not only a problem which is talked in terms for technical ground it has to be considered as a legal, social and cultural problem between different countries. Different countries take different actions to encounter this problem.

Pornography, defamation and spam are regarded as the three common issues encountered by the professionals as well as the beginners of Internet users. Every country is governed by certain laws and legislations which are unique to that particular country. An act which is legitimate in one country can be considered as an offence in another country. Since internet crosses the national boundaries it is not abide by the law of one particular country. So this increases the chances of materials which violates the law and order of a country, to flow easily into the country. The Internet Service Providers play a key role in addressing these issues. We have to look at the problems in different legal systems in order to address the major issues related to implementation of law in spite of accessing.

### 24.6.1 Security settings in web browsers/e-mail client software

Let's see how you can change your security settings in your web browser. We assume that you are using Mozilla Firefox as your browser. Follow the steps below:

1. Click on the **Tools** menu.
2. Click on **Options**.

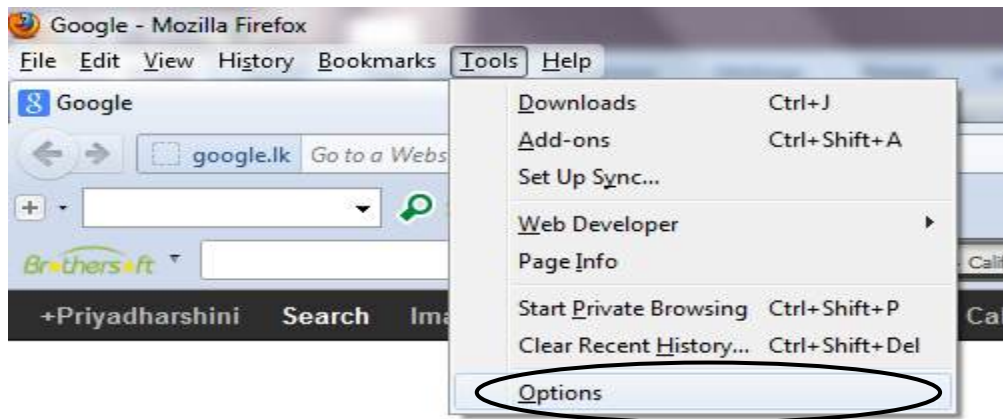

3. Select **Security** Tab.

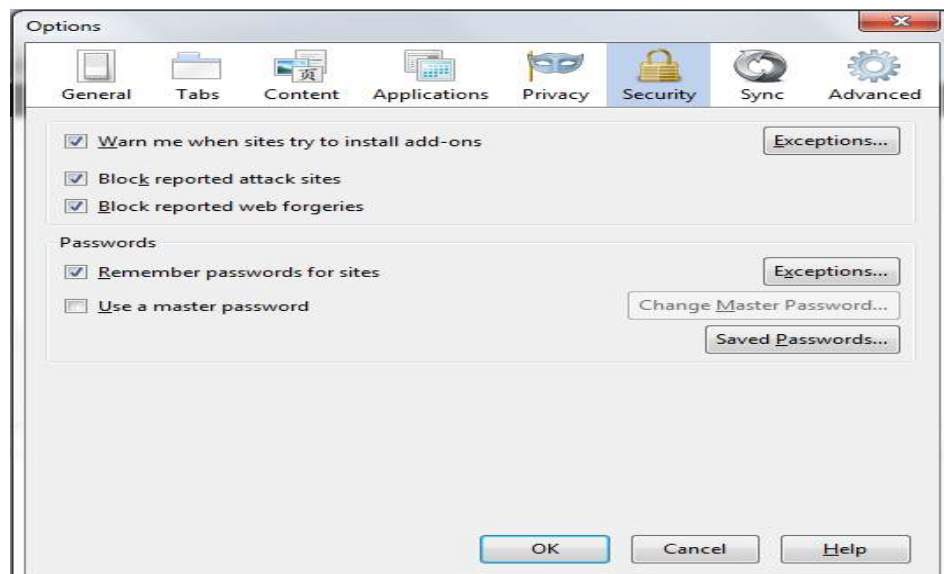

4. Change the security settings according to your usage and at the end click “**OK**”.

### 24.6.2 Taking precautions when using the Internet

Similar to any other resource, the Internet too can be misused or it even can bring harmful contents to your computer disabling the functionality of your computer partially or completely. We always know an old proverb which says that “Prevention is better than cure”. So we are going to look at taking precautionary methods to a safe use of Internet.

- The first basic precaution a user should take is to back up the important files. This will not prevent a security incident or hardware failure or the data stored on your computer would probably be lost if the machine was stolen or destroyed by fire, but it may reduce the impact to a greater extent.
- You need to have the updated anti-virus software in your computer and you have to scan your computer, frequently. Moreover it is essential to scan the files you download from the Internet.
- Having a good password for the access controls to their network is considered to be more important. Unlike backing up files, this action may prevent a security incident.

- Other types of information traveling across the Internet are sensitive user identifications, and files whose content is sensitive to the user. Users should take one of two precautions, either **encrypt the information** or don't send it across the Internet. Sensitive user identifications such as address, phone number, personal data, and perhaps most sensitive of all, credit card numbers should not be sent across the Internet unless they are encrypted at the source before sending it to the Internet. For example if you are sending a sensitive document containing personal information or sensitive work related information such as a newly set examination paper, ensure whether this information is kept confidential, then it must either be encrypted, or sent some other way.

## 24.7 Self Assessment Questions



- 24.1 What is a 'mail server'? Describe how to send an e-mail between two people.
- 24.2 What is an e-mail client? Name two types of e-mail clients with examples.
- 24.3 Define the following terms.
  - a. SMTP
  - b. DNS Server
- 24.4 What are the advantages of POP sever and IMAP server?
- 24.5 When sending an e-mail what is the difference between CC and BCC?
- 24.6 How can you attach a document to your e-mail?
- 24.7 List three e-mail etiquettes and give reasons for doing them.
- 24.8 What are the three parts of an e-mail address?
- 24.9 When creating an e-mail account what is the purpose of typing a given code in the cage provided?
- 24.10 What is the purpose of "inbox" in an e-mail account?
- 24.11 Which button is used to send a copy of a received e-mail to someone else?
- 24.12 What is the purpose of having two buttons call "Reply" and "Reply All" in e-mail account?
- 24.13 When writing an email, contacts can be added from your address book or contact list or their email address can be typed out. Give reasons for adding a contact is better than typing out their address.
- 24.14 Describe the advantages and disadvantages of using e-mail.



## Session 25

### Current and Future Trends in the Internet

---

#### Aim:

To provide an introduction about e-commerce and e-learning, identify the benefits and the future trends of the Internet

#### Objectives:



Having studied this you will be able to:

- Define what e-commerce is
- Describe the direct benefits of e-commerce and provide suitable examples
- Describe what e-learning is and the advantages of it
- Understand what would be the future trends of the Internet

#### 25.1 Introduction

We are living in an era where we use computers to do major tasks quickly which took hours to complete a couple of decades ago. Paper driven processes are replaced by electronic means. Above all, the global access to information has made a revolution in all sectors. Information is enriched and customized to serve target groups.

Here we are going to discuss about these current developments and the future trends of the Internet.

Today, almost everything is reengineered into electronic means. The revolution in the Internet had made an immense impact not only in our day-to-day life but also in the business process and the learning environment. Businesses are transformed into e-businesses; learning is transformed into e-learning etc. Because of this transformation, there is a significant change in the way we do things. We are not doing different things but we are doing things in a different way, which is more efficient and effective, aren't we?

Now, let us see how we can use E-commerce and make our lives easy.

#### 25.2 Introduction to E-commerce

Electronic commerce or E-commerce is a type of industry. This consists of buying and selling of products or services over electronic systems such as the Internet and other computer networks. The quality of business transactions has improved with the usage of telecommunications and data processing technology.

Before explaining what E-commerce is in detail, let us see some simple examples of how E-commerce is being used.

- Individual purchasing books on the Internet.
- Tourist booking a hotel room from another country over the Internet.
- An organization buying computers using the seller's interactive online system.
- A firm buying office supplies through an online auction.
- An individual transferring money from his account to his friend's account using Internet banking.

Here are some E-commerce technologies used by most of the business organizations.

- Mobile commerce
- Electronic funds transfer
- Supply chain management
- Internet marketing
- Online transaction processing
- Electronic data interchange (EDI)
- Inventory management systems
- Automated data collection systems. etc.

**Does e-commerce only mean buying and selling of goods and services over the Internet?**

No. It's not limited to mere handling of business transactions. The e-commerce includes a larger functionality consisting of a complete system of services which supports the sales processes and provides total account management.

Modern E-commerce usually uses the World Wide Web at least at one point in the transaction's life-cycle. It may also make use of a wider range of technologies such as e-mail, mobile devices, social media, and telephones as well.

E-commerce is commonly considered to be the sales aspect of e-business. It mainly consist the data to facilitate the financing and payment aspects of business transactions. If you want to start up a business, E-commerce would be useful to carry out your transactions in an effective and efficient way. Let us examine some of the benefits of e-commerce both for the buyer and seller.

### **25.3 The benefits of e-commerce**

It is apparent that there are numerous advantages of using E-commerce. Because of the technological breakthrough the web had reached millions of people quicker when compared to television, radio and telephone. Here, we are going to discuss some benefits of E-commerce to the business worlds and to the consumers as well.

Some benefits of e-commerce are listed below.

### Benefits to the Business organization/seller:

- Improved Productivity
- Streamlined Business Processes
- Opportunities for New Businesses
- Global market place
- Low start-up and running cost

### Benefits to the customer/buyer:

- 24/7 trading
- Search facilities

### Benefits to both:

- Cost Savings
- Better Customer Service

Let us see the above benefits in detail.

### **Improved Productivity**

By using E-commerce we can save a great deal of time. We can create, transfer and process a business transaction easily using the electronic medium. Quite a lot of time that was spent in entering and re-entering the data in the earlier decades is minimized. Human errors and redundancy are eliminated which has led to an accurate data retrieval in quick time, ultimately resulting in high productivity.

### **Cost Savings**

Since we can communicate efficiently and since the time taken between the submissions of a program for execution is quicker, it'll be cost effective. Moreover, the businesses can reach out the market so easily and this would also cut down the cost to a great extent. The transaction cost too had plummeted down because of the usage of e-commerce.

### **Streamlined Business Processes**

Most businesses have taken a step to reach the ultimate goal by using the maximum benefits from e-commerce. This can be achieved mainly by adapting the internal business processes and back end legacy systems.

### **Better Customer Service**

Customers can communicate with the seller efficiently. They can go through the details of the product and choose the better options which suit their requirement from home itself. On the other hand, the seller is also benefitted by marketing the product and providing a better customer service online which is much easier than dealing the customers directly in a busy business environment.

## Opportunities for New Businesses

Since the business over the Internet reaches the customers in the global arena, there will be better opportunities for the business to expand and establish themselves amongst a wide range of customers.

### Global market place

The E-commerce web-site serves as a global market place because people tend to buy the products not only from different parts of the country but also from different parts of the world.

### 24/7 trading

You can purchase items at any time. Only what you have to do is to place an order and the product will be delivered to your home within a couple of days/week. This will be beneficial to those who are working because they can buy products from home or wherever they are and during whenever they want. Moreover, a person from Sri Lanka can buy a product from America without any trouble. You can purchase from anywhere around the world and during anytime you want.

### Low start-up and running cost

You do not have to open a shop. Instead, all you have to do is to buy servers to build and maintain your web-site online. This will cost less than the money that you would pay for rent when you have a shop. Furthermore, it is not necessary to have a huge staff to maintain the website. As a whole, it costs less than running a shop.

### Search facilities

Most of the E-commerce web-sites have an efficient search facility where you can find the required product without spending much time.

As shown in figure 25.1, there are numerous other benefits that can be gained by using E-commerce.

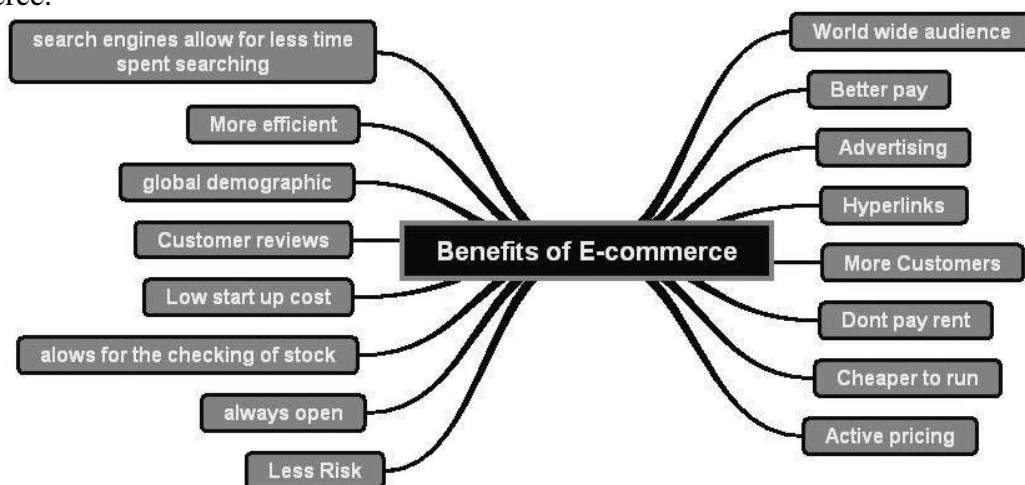

Figure 25.1: Benefits of E-commerce

## 25.4 Types of Electronic Commerce

The most common participants in e-commerce are the businesses, consumers and the government. Based on the nature of the participants e-commerce can be subdivided into the following:

- B2C – Business to Consumer
- B2B – Business to Business
- B2G – Business to Government
- C2C – Consumer to Consumer
- C2B – Consumer to Business
- G2G – Government to Government
- G2C, G2B, C2G etc.

Let us discuss the four major types in detail.

### 25.4.1 B2C – Business to Consumer

B2C can be described as the business between companies and the consumers. Since the revolution of e-transformation unfolded, consumer-business interaction was limited to a great extent. In the past, consumers contacted the information officer to acquire business information. But now this process has changed. Consumers as well as the information officer could gather business information via the Internet. Consumers when they want to buy a product or a service they can do it over an electronic network. This makes the business process much easier.

We all know that there is a sudden explosion in the number of Internet users in the past few years. Profits making companies thought of utilizing this opportunity to market and sell their products. The business process in B2C is shown in figure 25.2.

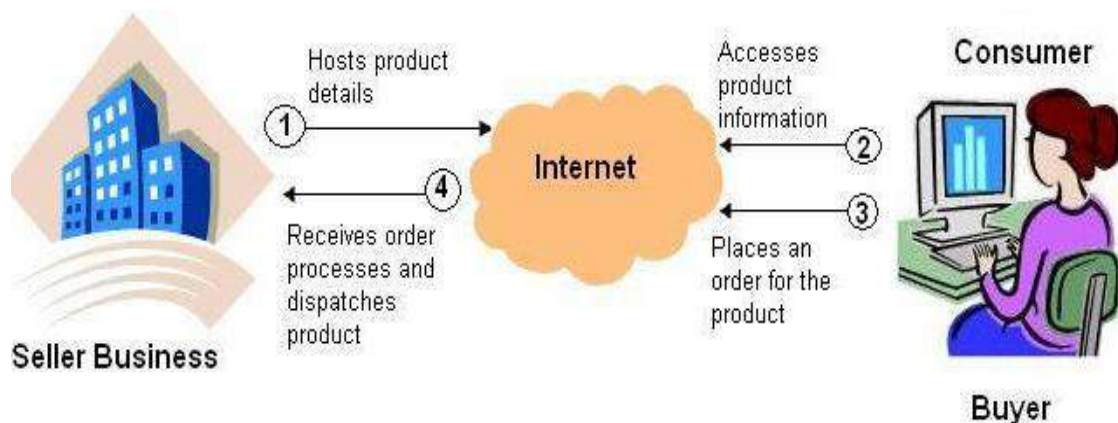

Figure 25.2: Business to Customer E-Commerce (B2C)

Here are some examples of B2C

- (a) *Dell* selling a laptop to a person in Sri Lanka
- (b) *Amazon* selling books to a person in Colombo (figure 25.3)

Amazon is one of the largest booksellers, joining the top ranks among the other leading bookstores, in a short period of time. You can view large numbers of books, along with the extra information, such as readers' comments. Although, there are a millions of books included in the web-site, the books are not stored in the warehouse physically. This also can be called as “Virtual Bookshop”.



Figure 25.3: Amazon website (B2C)

A few E-commerce websites which are popular in Sri Lanka are listed below:

1. iBuy.lk
2. Tradenet.lk (B2B and C2C trading portal)
3. myTrader.lk
4. WoW.lk
5. lkman.lk
6. www.echannelling.com
7. www.sarasavi.lk
8. www.me.lk
9. Anything.lk (Figure 25.4) etc.



Figure 25.4: Anything.lk page

## A brief Note on E-banking

E-banking includes Internet banking mobile banking etc. E-banking offers value added services that you do not normally enjoy at the banking counters. Most of the popular banks in Sri Lanka have introduced many fascinating facilities to their customers. Online access to any of the account, transfer of funds to the customer's own accounts or to the preferred accounts of other Sri Lankan banks, ability to bank online especially when they hold a joint account, balance inquiry, inquiry about cheque book or request for new cheque book or stop payments online, acquire visa card settlements, transactions and balances, Interest & exchange rates and the ability to make payments of utility bills/scheduling bill payment and transfers on future dates are some of such facilities offered by the banks.

### 25.4.2 C2B – Consumer to Business

Consumer-to-Business (C2B) is a business model in which consumers create value, and firms consume this value created by consumers. This is also called as a **reverse auction** or **demand collection model**. Here the buyers are enabled to claim their own prices generating a demand and the websites in turn gather bids and then offers the bids to the participating sellers.

Let's look into the electronic commerce business model, in which consumers offer products and services to companies and the companies pay them. Doesn't it look like the reversal model to the traditional business model where companies offer goods and services to consumers (business-to-consumer - B2C)?

The following figure 25.5 shows an example of C2B website – Priceline.com.



Figure 25.5: Priceline website (C2B)

### 25.4.3 B2B – Business to Business

In this category, the companies do business with each other such as manufacturers selling to distributors and wholesalers selling to retailers. Pricing is based on quantity of order and is often negotiable.

Figure 25.6 shows the process of B2B.

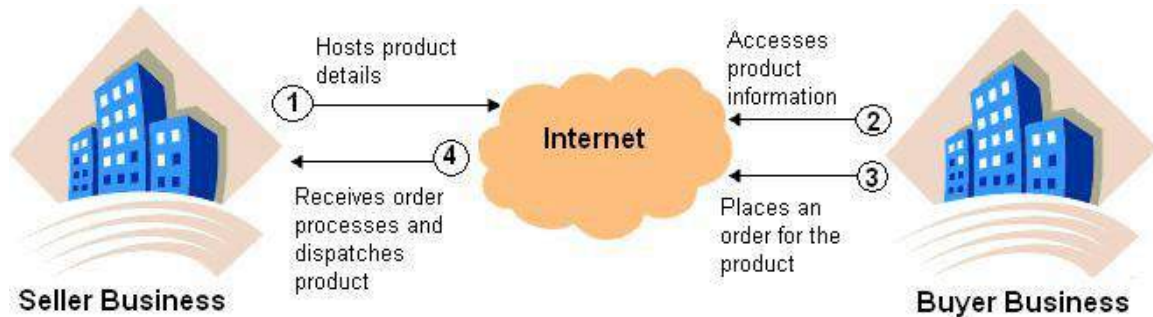

Figure 25.6: Business to Business (B2B)

Figure (25.7) shows an example of B2B website.



Figure 25.7: Cisco website (B2B)



#### 25.4.4 C2C – Consumer to Consumer

In this category, consumer sells directly to another consumer. E-bay is one good example for such kind of web. You can see this category if a consumer, who purchases jewelry, wants to sell to another consumer via the Web. The following figure depicts the process of C2C.

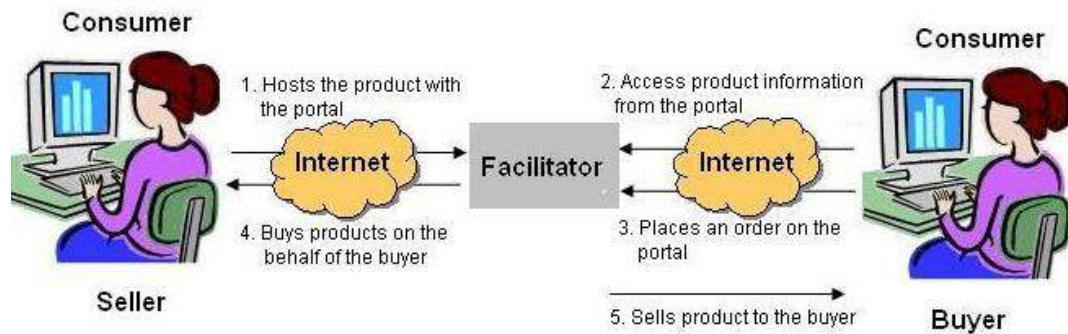

Figure 25.8: Customer to Customer E-Commerce (C2C)

Following are some examples for C2C websites.

1. [www.ebay.com](http://www.ebay.com)

‘ebay’ is like a world's online marketplace; a place for buyers and sellers to come together and trade almost anything. A seller can list any item on eBay. In an online auction, the bidding opens at a price the seller specifies and remains on eBay for a certain number of days. Buyers then place bids on the item. At the end, the buyer with the highest bid wins.

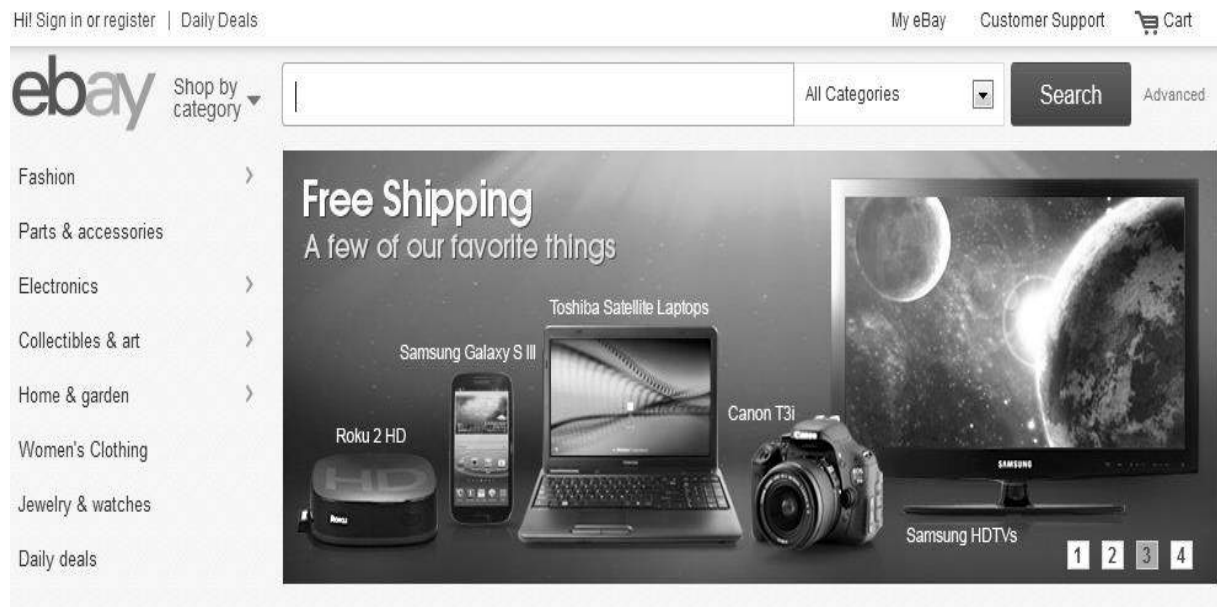

Figure 25.9: ebay website (C2C)

2. [www.ikman.lk](http://www.ikman.lk)

ikman.lk is a website where you can buy and sell almost everything. The best deals are often done with people who live in your own city or in your own street. Buying and selling local

products to the local consumers is made easy. Further, ikman.lk has a wide selection of popular second hand items all over Sri Lanka, which makes it easy to find exactly what you are looking for. So if you're looking for a car, mobile phone, house, computer or maybe a pet, you will find the best deal on ikman.lk.

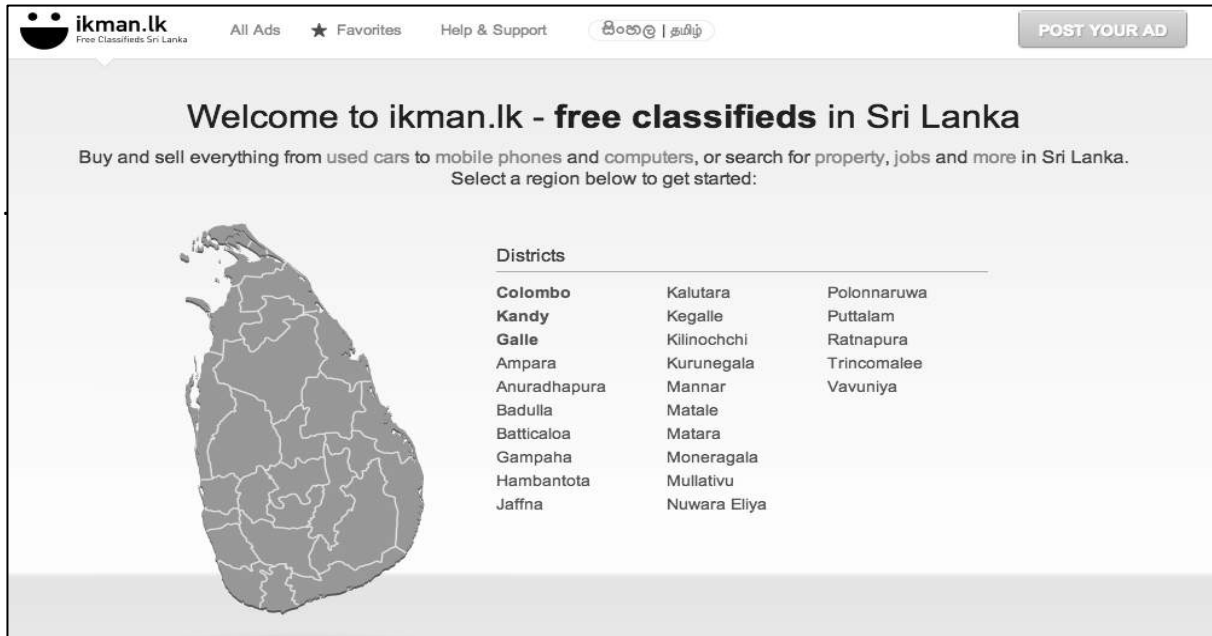

Figure 25.10: ikman.lk website (C2C)

**Are there any differences between e-business and e-commerce or can these two terms be used interchangeably?**

Although these two terms are often used synonymously, e-business covers a broader area which involves business processes covering the entire value chain namely electronic purchasing and supply chain management, processing orders electronically, handling customer service, and cooperating with business partners.



Figure 25.11: E-commerce as a sub-set of e-business

## 25.5 Basic Functions in the E-Commerce Site

Here we are going to look at some features commonly seen in the e-commerce web-site taking *Dell* as an example.

### Catalog Display

Businesses use the product catalog to display and order products in the e-commerce website. Products can be shown in a block view or list view, from which you can navigate to the product details.

- Block View(B2C)

The block view format displays a detailed upfront presentation of catalog products. The block view displays more information about a product at first glance for the customer than the list view does. For example, you can display basic eye-catcher texts and hyperlinks about product details, in the block view.

- List Views (B2B and B2C)

The list view format displays products in the catalog in a list in the B2B and the B2C Web sites.

Let us assume that you want to buy a laptop from Dell for your personal use. So you need to know the configuration of the laptops and you have to compare them with your requirements and you can go for a machine which is within your budget. Here is how you can view such details.

1. Go to [www.dell.com](http://www.dell.com) (Figure 25.12)

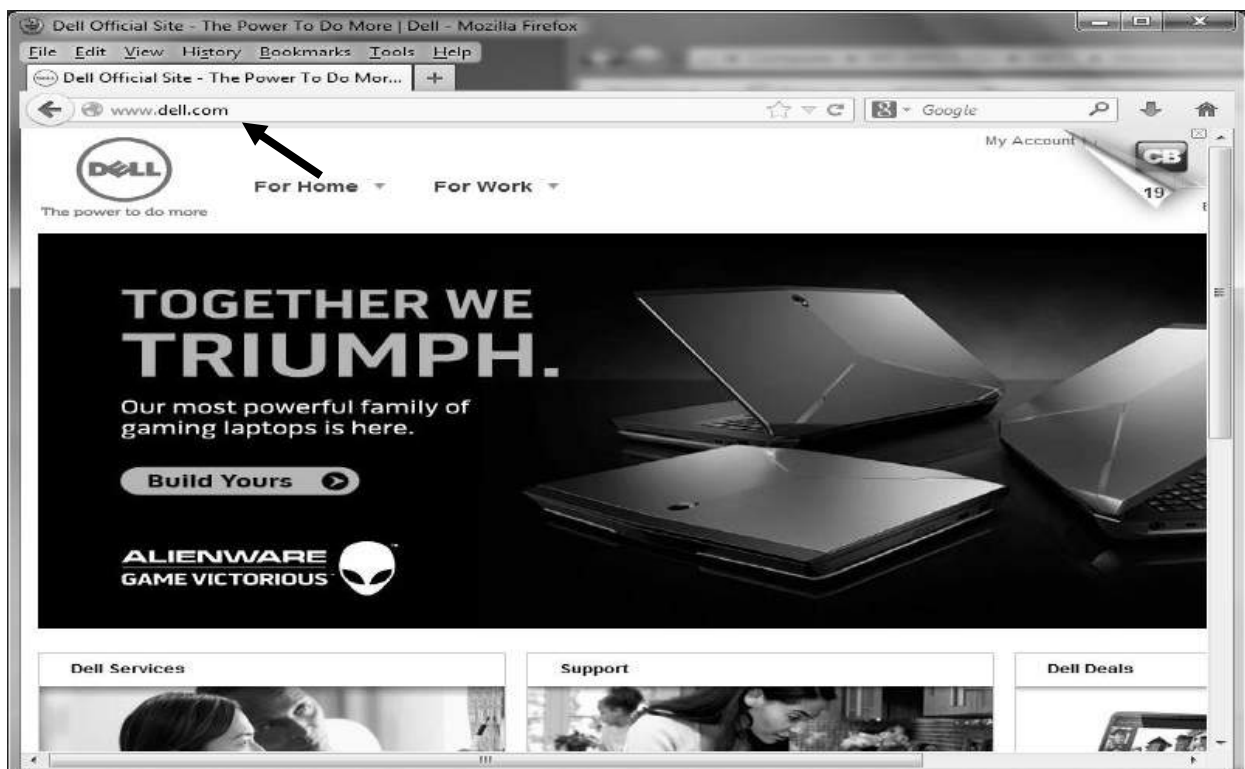
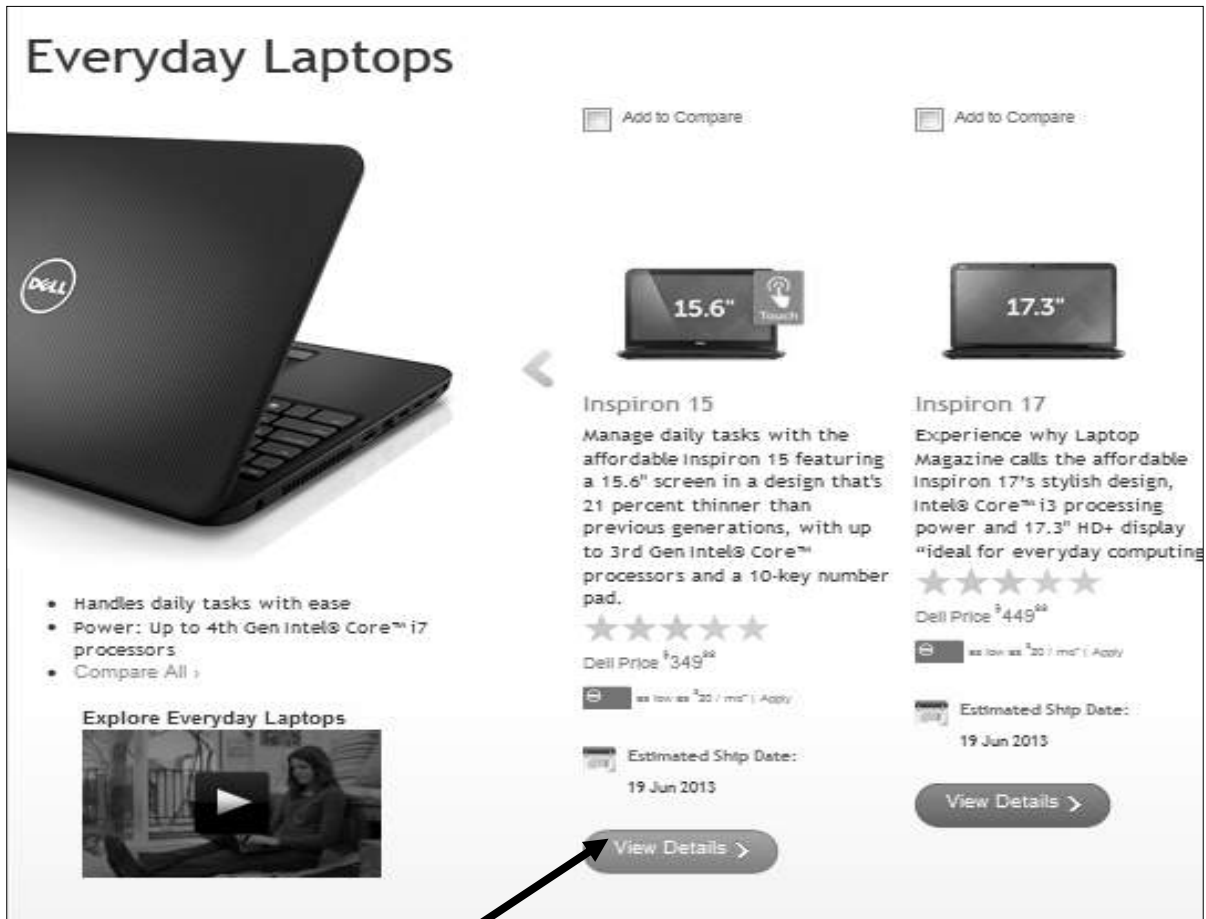
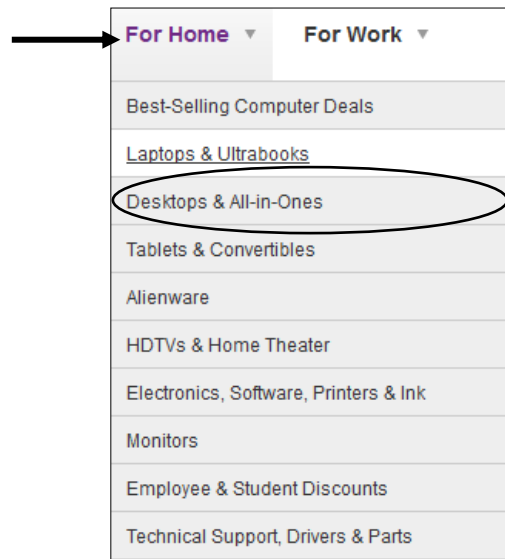

Figure 25.12: DELL website (B2C)

2. Browse the details and the configuration of the laptops by clicking on “For Home” and then selecting “Laptops and Ultra books” and clicking on “View details” as shown below.



Click here

Figure 25.13: DELL Catalog Display in block view

- If you want to buy you can select it and personalize it and follow the instructions to buy. See the image given below.

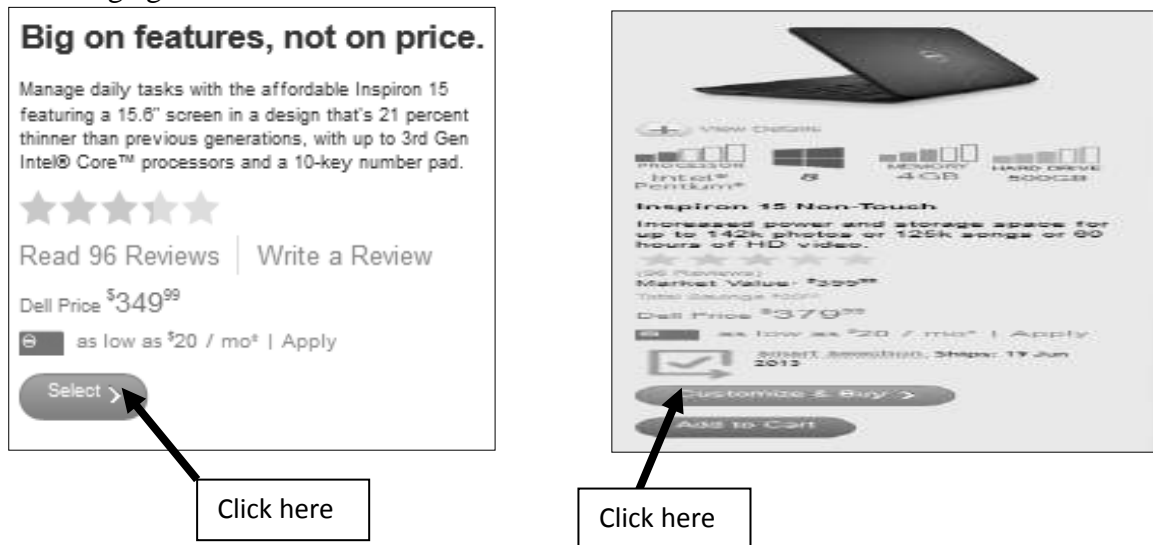

## Shopping Cart

A shopping cart is a piece of e-commerce software on a web server that allows visitors to a web site to select items for eventual purchase.

Shopping cart which is also named as the **shopping bag** or **shopping basket** keeps track of the items you have selected and allows customers to view the content of it, add new items or remove items. To order an item you need to simply click on that item. The required details of the item (price, product number, other identifying information) are stored automatically in the cart. It is also possible to remove the unwanted items by unselecting the items before completing the transaction. When you are ready to conclude the shopping session, click of a button executes the purchase transaction. Then it displays a screen that asks shipping and billing information and that confirm the order. Some shopping cart software allows you to fill a shopping cart with purchases, put the cart in virtual storage, and come back days later to confirm and pay for the purchases. (Figure 25.14)

4 items in cart [View cart/checkout](#) **Subtotal: \$72.60**

### Your shopping cart

1 item added (Medium Box).

Remove	Part #	Item	Quantity	Price per item	Handling	Total
	MBK	Mattress Bag - King	<input type="text" value="1"/>	\$4.95	\$0.00	\$4.95
	7007	<a href="#">Chair Covers</a>	<input type="text" value="4"/>	\$3.95	\$0.00	\$15.80
	FT60	<a href="#">Shipping/Strapping Tape</a>	<input type="text" value="1"/>	\$4.85	\$0.00	\$4.85
	MED	<a href="#">Medium Box</a>	<input type="text" value="20"/>	\$2.35	\$0.00	\$47.00

[Continue shopping](#) [Update subtotal](#) **Subtotal: \$72.60**  
(Total before shipping and handling)

[Checkout](#)

**Free standard shipping on all orders over \$25.**

Save some money! Spend \$25 or more and you'll get free standard shipping on all items. \*Not valid in Alaska or Hawaii

Figure 25.14: Typical shopping basket/Shopping Cart page

## Transaction Processing

By clicking a checkout button the transaction processing occurs when the shopper proceeds to the virtual checkout counter. This is the most complex part of the online sale. The e-commerce performs the calculations like volume discounts, sales tax, and shipping cost at the transaction processing stage. One of the important things is, at the checkout the customer's Web browser and the seller's Web server switch into a secure state of the communication. Other calculation complications such as provisions for coupons, special promotions, and time-sensitive offers can be happen at this stage. Some shopping cart software designed for small and midsize companies provide connections to accounting software so that Web sales can be entered simultaneously in the company's accounting system.

### 25.6 What is e-learning?

When you hear the word e-learning what comes first into your mind? You might be thinking of an online learning process or a web-based learning. But e-learning comprises of distributed learning, network or web-based learning.

Since the letter "e" stands for electronic, e-learning activities occur by electronic means. This can be performed by individuals or groups, working online or offline.

There are plentiful value added services in the Internet. They are also called as the **high level services**. All these services run on top of the basic protocols. E-learning is also a value added service which contributes a lot to the education. E-learning can be described as any form of technology enhanced learning mechanism.

E-learning had paved a path to an easier way of teaching and learning. In the modern world people give priority to jobs and don't have much time to spend on education. Moreover, people tend to choose their courses depending on their limited budgets. So the ultimate goal of e-learning is to overcome the limitations such as time, distance and resources. Thus the knowledge and skills are transferred via Internet, intranet, extranet, audio or video tape CD-ROM or even it can be a satellite TV. The content can contain a text document, an image file or it can be an animation, audio or video. It can be a self-paced learning or it can be led by an instructor. As you can see there are different types of e-learning methods and we are going to talk about this in the next topic.

#### 25.6.1 Types of e-learning

E-learning can be applied partially or in some occasions education is completely based on it. In blended learning face-to-face classroom sessions are combined along with the computer mediated activities. In contrast there are instances where the learning process absolutely relies on electronic means. Such systems are supportive in non-face-to-face distant based education.

E-learning can be categorized based on some criteria. Some of such criteria are listed below:

- Underlying pedagogical assumptions
- Content model employed

- Size
- Distribution and level of network

E-learning has evolved in many ways in order to support a variety of users' needs. We can classify the types of e-learning as follows:

1. Traditional e-learning
2. Rapid e-learning
  - a. Asynchronous
  - b. Synchronous

### **1. Traditional e-learning**

Traditional e-learning is described as a content which consists of an in-depth knowledge with a great preparation and probably produced by an expert.

### **2. Rapid e-learning**

This is classified into two.

- a. Synchronous

In this type of e-learning, learner and the instructor have a set time where they have the internet classroom. During this prescribed time, the students log in and they can contact and discuss problems related to the subject.

- b. Asynchronous

The content is based on one aspect which is liable to change. Users can log in whenever they want to do so and can access information any time. Some of the examples of asynchronous e-learning are CDs, DVDs, Networks, Intranet and Internet.

## **25.6.2 Advantages and Disadvantages of e-learning**

It is apparent that e-learning has innumerable advantages not only to the learner but also to the teacher. Let's discuss some of these advantages now.

If we consider a student, e-learning is very flexible, convenient and more interactive. E-learning is accessible from anywhere, during anytime and to anyone. This sort of availability is an added advantage to the learners who are working. Furthermore, the E-learning materials make the visualization easy and aid in delivering a better understanding. In the teacher's perspective updating the contents is made easier. If there is a change in the content he/she can modify it immediately and changes will appear in all course contents all around the world. Both the learner and the teacher need not have to spend time and money on travelling. Instead they can access Internet from home and learn in a hassle-free environment.

Although e-learning provides countless advantages, it has some disadvantages as well. It is difficult to customize the course contents according to the learners' requirement in e-learning. Besides it requires an infrastructure to acquire the materials and carry out operations facilitated by E-learning.

### 25.6.3 Traditional Classroom learning Vs. E-learning

Shall we compare a traditional classroom learning and E-learning to get a better understanding? It is going to be interesting for sure!

Even though there are more advanced interactive animations and videos encompassed in the E-learning activity some are of the opinion that there is no personal touch as in a classroom.

In a classroom learning the teacher will pay an individual attention towards each student. This would motivate the students to a greater extent. Teachers too can observe the students' reaction and assume whether they have understood what they have learnt. Students can get into groups and do their activities as a team. Working in teams increases student engagement and this collective work of committed individuals would ultimately give a completely different experience to the students.

On the other hand, in a classroom there can be only limited participants and this requires a space and regular time table.

## 25.7 Introduction to E-Government

**E-Government** is the digital interaction among the Government, citizens, and the commercial institutions. We can say that E-Government is a generalized term for state sector computerization. Information technology is applied to different public institutions with the intention of improving the effectiveness and efficiency of their service.

Legislature, judiciary and administration are some of the public services which can be upgraded using ICT. This would add quality to the service to the general citizens, government agencies and businesses.

Some of the examples of e-government websites in Sri Lanka are listed below:

- Department of Examinations – Sri Lanka: <http://www.doenets.lk/exam/>
- Sri Lanka Railways: <http://www.railway.gov.lk/>
- Government Information Center: <http://www.gic.gov.lk/gic/>

#### **E-Sri Lanka**

The Information and Communication Technology Agency (ICTA) of Sri Lanka is the single apex body involved in ICT policy in the nation. This is owned by the Government of Sri Lanka and this organization is intended to use ICT as a powerful source to enhance economical and social advancement in Sri Lanka by re-engineering the way the government thinks and works. ICTA is transforming the nation to e-Sri Lanka. As a step towards its goal ICTA had developed a website for Government Information Center (<http://www.gic.gov.lk/gic/>).



## 25.8 Introduction to E-entertainment

If we see the websites worldwide there is a huge demand for entertainment services by almost all age groups. This urge for innovative ideas for the purpose of entertainment had resulted in flourishing abilities and creativity. What is more, this is considered to be one of the largest industries online, internationally.

We have mentioned some online entertainments below which would take new dimensions:

- Online Radio
- Online TV
- Online movies
- Computer games
- Online News
- Online magazines

## 25.9 Future of Internet

As mentioned in the previous section, definitely, the e-entertainment is taking a new dimension rapidly in the internet. In addition to that there are some other concepts which initiate and evolve in the near future with the emergence of latest internet technologies. However, predicting of internet is not an easy task. But for the sake of your knowledge and for the completion of this session some identified future trends in the internet as per the sources available on the web are extracted for you as follows.

Source: [http://readwrite.com/2007/09/05/10\\_future\\_web\\_trends](http://readwrite.com/2007/09/05/10_future_web_trends)

### 25.9.1 Top Ten Future Trends- The Internet by 2020

Take a minute to remember how different life was in 1991. If you wanted to call a friend you would have to use a landline, because mobile technology was still many years away from hitting the mainstream. If you wanted to send a written message to relatives overseas you would have to use the post office. It will be quite a while before **domain names** like hotmail become synonymous with email technology. So much has changed in the last 20 years, but how will the world be different in 2020?

You can guarantee that the most innovative and revolutionary changes will take place in the digital sector. So what will the internet look like in 2020?

#### 1. More Centralized

We can see this trend developing at the present moment. Facebook, Google and Microsoft are becoming incredibly powerful on the internet. Every few months we hear the same story – Microsoft has bought Skype, Google has acquired YouTube; and there is little sign of these digital giants slowing down.

#### 2. More Open Source Development

In response to the growing influence of the big digital firms, open source technology is expected to rapidly increase as small-time developers become more and more sophisticated. Expect to see hundreds of high quality open source software suites on the market by 2020.

### **3. The Internet Will Be Faster and Cheaper**

Expect to see broadband rates decrease in the near future. Web hosting and **dedicated servers** will be much cheaper as well.

### **4. Writing and Reading**

On a more personal level, the influence of the internet by 2020 is expected to dramatically change the way we read and write. Gone are the days of lengthy essay-like blog entries – a more likely scenario is that shorthand will begin to dominate the online sphere. Twitter users are very familiar with this phenomenon.

### **5. Lack of Online Anonymity**

Because of the growing influence of hackers and websites like Wikileaks, it is likely that by 2020 the internet will be much more closely monitored.

### **6. More Wired Applications**

By 2020, it is expected that almost every device will be wired to the internet – from microwaves to sofas. Furthermore, more applications will be specifically designed to be net friendly.

### **7. Personal ID Number**

With growing security concerns regarding online behavior, many security analysts predict that by 2020 some nations will have implemented a personal ID number for online users.

### **8. Mobile Internet**

Mobile internet technology is very new, but many feel that by 2020 it will be the most popular way to browse the web. Many sites will be specifically catered towards mobile devices.

### **9. More Processes Will Move Online**

Although you can do your grocery shopping online, many people still prefer to buy their groceries in person. This is expected to change by 2020, with more internet savvy customers choosing to utilize online processes.

### **10. Cloud Computing**

Cloud computing has only just hit the mainstream with the recent release of Apple's iCloud. By 2020 you can expect that millions of internet users will store all of their non-vital information on the cloud.

The future is never easy to predict, but current trends are all pointing to a 2020 that is more connected but more centralized.



## 25.10 Self Assessment Questions

- 25.1 Define 'e-commerce'. What are the benefits of using e-commerce?
- 25.2 Briefly describe four types of consumer oriented applications of e-commerce.
- 25.3 To which e-commerce model that the Amazon.com belongs?
- 25.4 What is a product catalog? Differentiate Block View and List View.
- 25.5 Briefly describe the use of 'shopping cart' with respect to e-commerce.
- 25.6 What is meant by 'traditional e-learning'?
- 25.7 Briefly describe the two categories of 'rapid e-learning'.
- 25.8 State the advantages and disadvantages of e-learning.
- 25.9 Using suitable examples, briefly explain the concept of 'e-government'.
- 25.10 What is meant by 'cloud computing'?
- 25.11 Explain the application of e-commerce in following fields
  - a. Banking
  - b. Entertainment
  - c. Shopping