



National Aeronautics  
and Space Administration

Educational Product	
Educators	Grades 5-8
EG-2001-01-122-HQ	

# Space-Based Astronomy

AN EDUCATOR GUIDE WITH ACTIVITIES FOR SCIENCE, MATHEMATICS, AND TECHNOLOGY EDUCATION

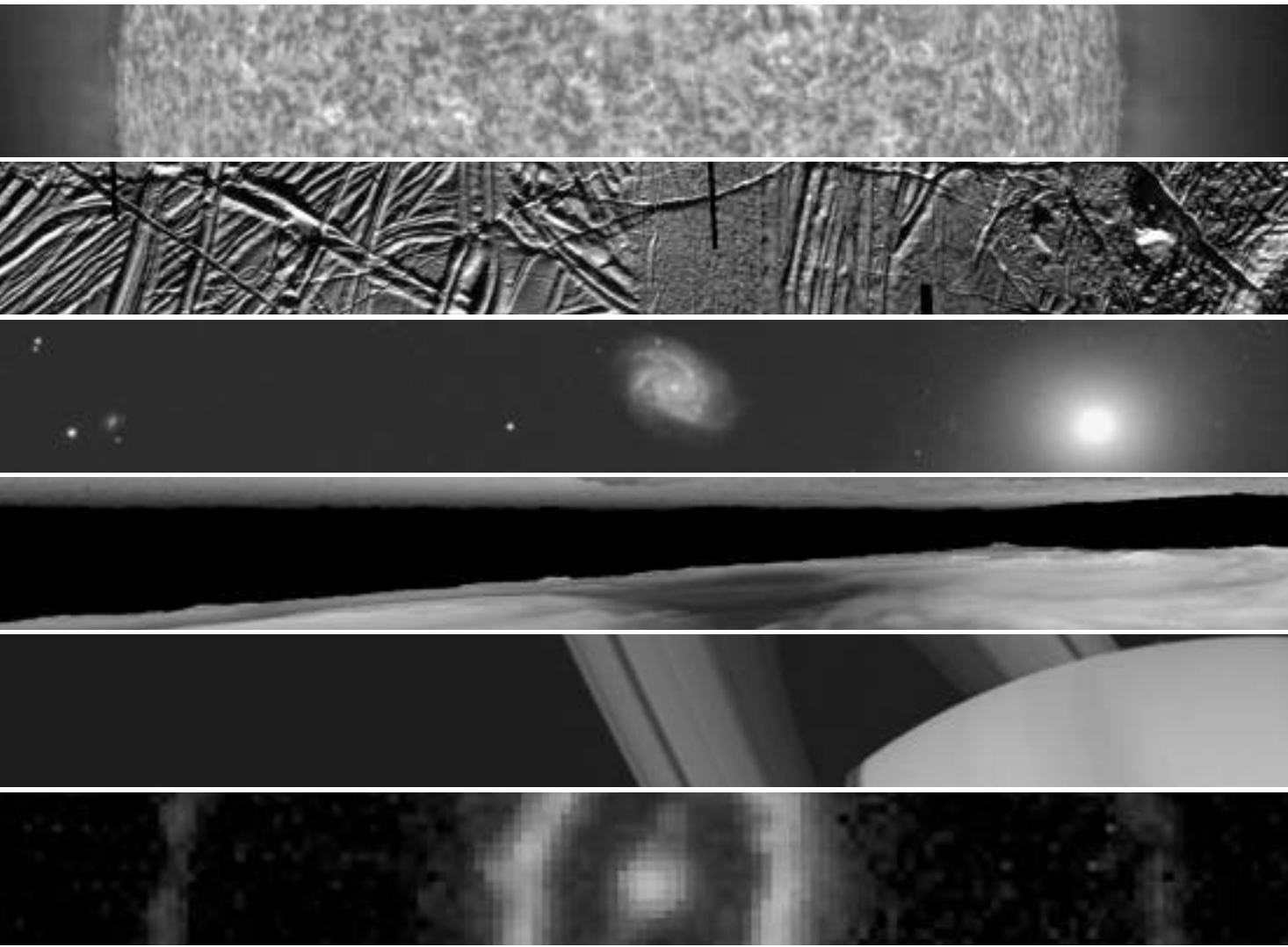



*Space-Based Astronomy—An Educator Guide with Activities for Science, Mathematics, and Technology Education* is available in electronic format through NASA Spacelink—one of the Agency's electronic resources specifically developed for use by the educational community.

The system may be accessed at the following address:  
*<http://spacelink.nasa.gov>*

# Space-Based Astronomy

AN EDUCATOR GUIDE WITH ACTIVITIES FOR SCIENCE, MATHEMATICS, AND TECHNOLOGY EDUCATION

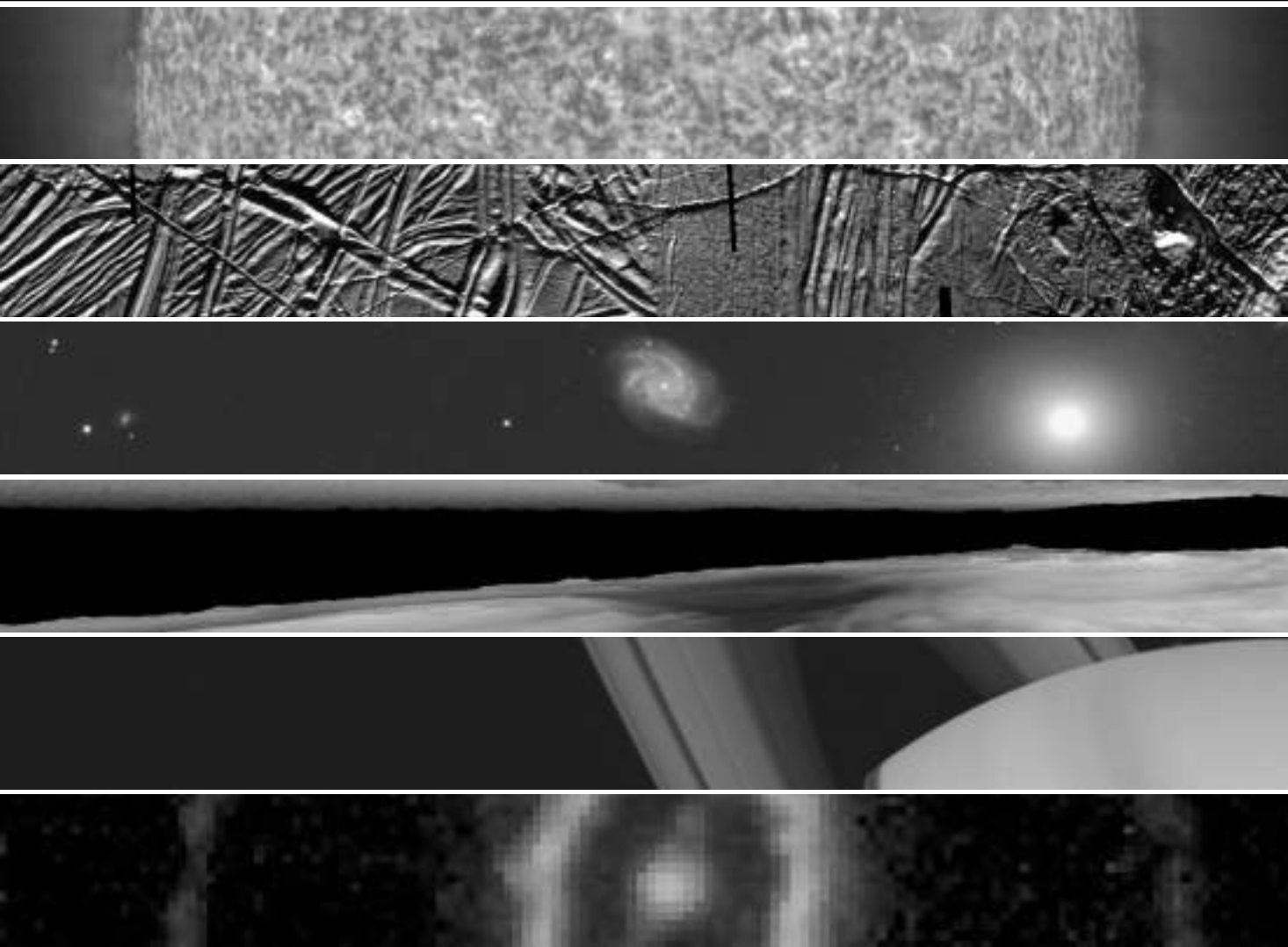

NATIONAL AERONAUTICS AND SPACE ADMINISTRATION | OFFICE OF HUMAN RESOURCES AND EDUCATION | EDUCATION DIVISION | OFFICE OF SPACE SCIENCE

This publication is in the Public Domain and is not protected by copyright. Permission is not required for duplication.

EG-2001-01-122-HQ

## About the Cover Images

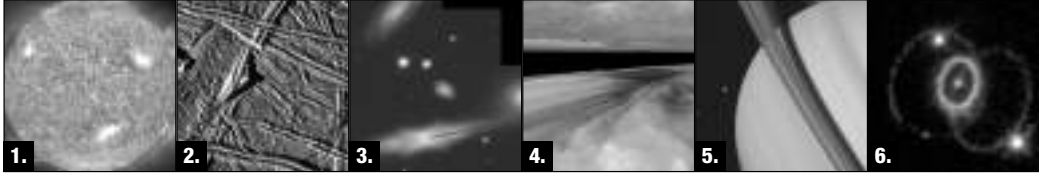

1. EIT 304Å image captures a sweeping prominence—huge clouds of relatively cool dense plasma suspended in the Sun's hot, thin corona. At times, they can erupt, escaping the Sun's atmosphere. Emission in this spectral line shows the upper chromosphere at a temperature of about 60,000 degrees K. *Source/Credits: Solar & Heliospheric Observatory (SOHO). SOHO is a project of international cooperation between ESA and NASA.*
2. This mosaic shows some of the highest resolution images obtained by the Solid State Imaging (SSI) system on NASA's Galileo spacecraft during its eleventh orbit around Jupiter. The sun illuminates the scene from the left, showing hundreds of ridges that cut across each other, indicating multiple episodes of ridge formation either by volcanic or tectonic activity within the ice. *The Jet Propulsion Laboratory, Pasadena, CA, manages the mission for NASA's Office of Space Science, Washington, DC. JPL is a division of California Institute of Technology.*
3. A Minuet of Galaxies: This troupe of four galaxies, known as Hickson Compact Group 87 (HCG 87), is performing an intricate dance orchestrated by the mutual gravitational forces acting between them. The dance is a slow, graceful minuet, occurring over a time span of hundreds of millions of years. *Image Credit: Hubble Heritage Team (AURA/ STScI/ NASA).*
4. Frames from a three dimensional visualization of Jupiter's equatorial region. These features are holes in the bright, reflective, equatorial cloud layer where warmer thermal emission from Jupiter's deep atmosphere can pass through. The circulation patterns observed here along with the composition measurements from the Galileo Probe suggest that dry air may be converging and sinking over these regions, maintaining their cloud-free appearance. *The Jet Propulsion Laboratory, Pasadena, CA, manages the Galileo mission for NASA's Office of Space Science, Washington, DC. JPL is an operating division of California Institute of Technology.*
5. This image of the planet Saturn and natural satellites Tethys and Dione was taken on January 29, 1996, by Voyager 1.
6. This striking NASA Hubble Space Telescope picture shows three rings of glowing gas encircling the site of supernova 1987A, a star which exploded in February 1987. The supernova is 169,000 light years away, and lies in the dwarf galaxy called the Large Magellanic Cloud, which can be seen from the southern hemisphere. *Credit: Dr. Christopher Burrows, ESA/STScI and NASA.*

To find out more about these images and projects, please visit <http://spacescience.nasa.gov>

## ACKNOWLEDGMENTS

*Many thanks to the NASA Aerospace Education Services Program, NASA Teaching From Space Program, NASA Educator Resource Center Network, and NASA Office of Space Science for their contributions to the development of this guide.*

Writer:

Gregory L. Vogt, Ed.D.  
Teaching From Space Program  
NASA Johnson Space Center  
Houston, TX

# TABLE OF CONTENTS

---

Acknowledgments	.ii
Introduction	.1
How to Use This Guide	.3
The Space Age Begins	.5
Astrophysics	.7
A Brief History of United States Astronomy Spacecraft and Crewed Space Flights	.9
Activity Units	
Unit 1: The Atmospheric Filter	.17
Unit 2: The Electromagnetic Spectrum	.23
Unit 3: Collecting Electromagnetic Radiation	.53
Unit 4: Down to Earth	.71
Unit 5: Space-Based Astronomy on the Internet	.91
Glossary	.94
Suggested Reading	.97
NASA Educational Resources	.99
Reply Card	.101

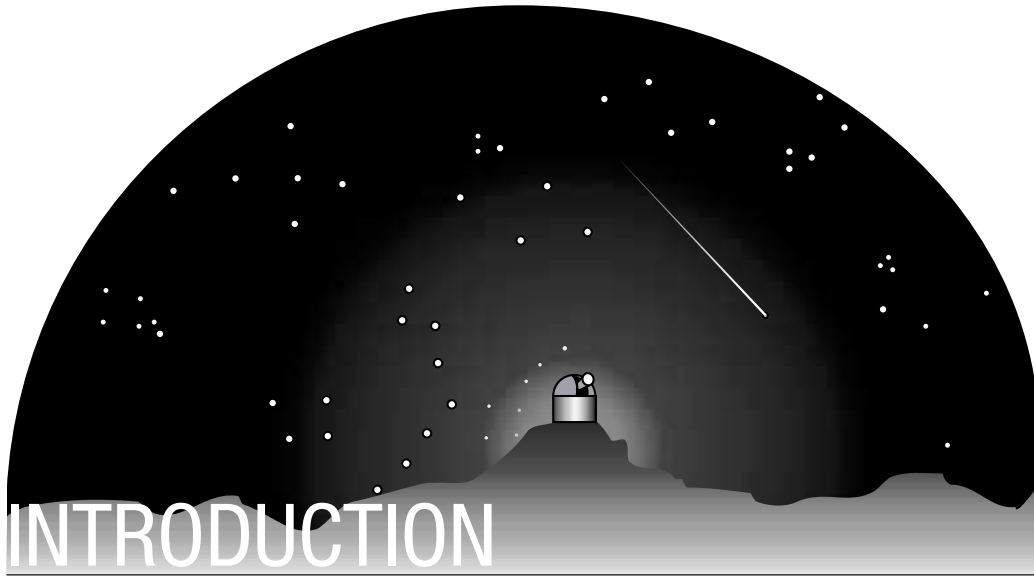

If you go to the country, far from city lights, you can see about 3,000 stars on a clear night. If your eyes were bigger, you could see many more stars. With a pair of binoculars, an optical device that effectively enlarges the pupil of your eye by about 30 times, the number of stars you can see increases to the tens of thousands. With a medium-sized telescope with a light-collecting mirror 30 centimeters in diameter, you can see hundreds of thousands of stars. With a large observatory telescope, millions of stars become visible.

It would seem that when it comes to observing the universe, the larger the instrument, the better. This is true up to a point, but there are limits—limits not imposed by technology but by nature itself.

Surrounding Earth is a life-sustaining atmosphere that stands between our eyes and the radiation that falls upon Earth from outer space. This radiation is comprised of a very broad spectrum of energies and wavelengths. Collectively, they are referred to as the electromagnetic spectrum. They range from radio and microwave radiation on the low energy (long wavelength) end through infrared, visible, ultraviolet, and x-rays to gamma rays on the high energy (short

wavelength) end. Gases and other components of our atmosphere distort, filter, and block most of this radiation permitting only a partial picture, primarily visible radiation and some radio waves, to reach Earth's surface. Although many things can be learned about our universe by studying it from the surface of Earth, the story is incomplete. To view celestial objects over the whole range of the electromagnetic spectrum, it is essential to climb above the atmosphere into outer space.

From its earliest days, the National Aeronautics and Space Administration (NASA) has used the emerging technology of rockets to explore the universe. By lofting telescopes and other scientific

ic instruments above the veil of Earth's atmosphere, NASA has delivered a treasure house of information to astronomers, leading them to

rethink their most fundamental ideas about what the universe is, how it came to be, how it functions, and what it is likely to become.

# HOW TO USE THIS GUIDE

---

This curriculum guide uses hands-on activities to help students and teachers understand the significance of space-based astronomy—astronomical observations made from outer space. It is not intended to serve as a curriculum. Instead, teachers should select activities from this guide that support and extend existing study. The guide contains few of the traditional activities found in many astronomy guides such as constellation studies, lunar phases, and planetary orbits. It tells, rather, the story of why it is important to observe celestial objects from outer space and how to study the entire electromagnetic spectrum. Teachers are encouraged to adapt these activities for the particular needs of their students. When selected activities from this guide are used in conjunction with traditional astronomy curricula, students benefit from a more complete experience.

The guide begins with a survey of astronomy-related spacecraft NASA has sent into outer space. This is followed by a collection of activities organized into four units: The Atmospheric Filter, The Electromagnetic Spectrum, Collecting Electromagnetic Radiation, and Down to Earth. A curriculum matrix identifies the curriculum areas each activity addresses. Following the activities is information for obtaining a 35 mm slide set with descriptions showing current

results from NASA spacecraft such as the Hubble Space Telescope (HST), Compton Gamma Ray Observatory (CGRO), and the Cosmic Background Explorer (COBE). The guide concludes with a glossary, a reference list, a NASA Resources list, and an evaluation card. Feedback from users of this guide is essential for the development of future editions and other classroom supplementary materials.



# THE SPACE AGE BEGINS

---

Within months of each other, the United States and the Soviet Union launched their first artificial satellites into orbit around Earth. Both satellites were small and simple. Sputnik 1, a Soviet spacecraft, was the first to reach orbit. It was a 58-centimeter-diameter aluminum sphere that carried two radio transmitters, powered by chemical batteries. The satellite reached orbit on October 4, 1957. Although an extremely primitive satellite by today's standards, Sputnik 1 nevertheless enabled scientists to learn about Earth's magnetic field, temperatures in space, and the limits of Earth's atmosphere.

A much larger Sputnik 2 followed, carrying a small dog as a passenger. Although primarily investigating the response of living things to prolonged periods of microgravity, Sputnik 2 did sense the presence of a belt of high-energy charged particles trapped by Earth's magnetic field. Explorer 1, the United States' first satellite, defined that field further.

The cylindrical, 13.6 kilogram Explorer 1 rode to space on top of a Juno I rocket on January 31, 1958. It was launched by the United States Army in association with the National Academy of Sciences and the Jet Propulsion Laboratory of

the California Institute of Technology. NASA was not created formally by an act of Congress until the following October.

Explorer 1 carried scientific instruments designed by Dr. James Van Allen of the University of Iowa. Circling Earth in an orbit ranging from 360 to 2,531 kilometers, the satellite radioed back radiation measurements, revealing a deep zone of radiation surrounding Earth.

Born of the technology of World War II and the tensions of the Cold War, the space age began in

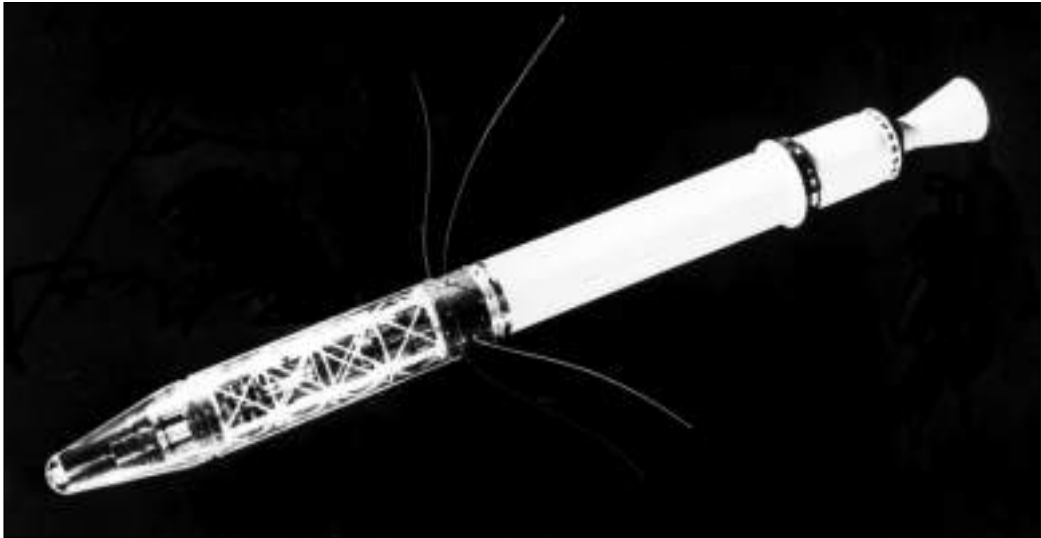

Artist's concept of *Explorer 1* in space

---

the peaceful pursuit of scientific discovery. In the more than 35 years that have followed, thousands of spacecraft have been launched into Earth orbit, to the Moon, and to the planets. For

the majority of those spacecraft, the goal has been to learn about Earth, our solar system, and the universe.

# ASTROPHYSICS

---

Just a few decades ago, the word astronomy was a general term that described the science of the planets, moons, Sun and stars, and all other heavenly bodies. In other words, astronomy meant the study of anything beyond Earth. Although still an applicable term, modern astronomy, like most other sciences, has been divided and subdivided into many specialties. Disciplines that study the planets include planetary geology and planetary atmospheres. The study of the particles and fields in space is divided into magnetospheric physics, ionospheric physics, and cosmic and heliospheric physics. The Sun has its own solar physics discipline. The origin and evolution of the universe is the subject of cosmology.

Generally, objects beyond our solar system are handled in the field of astrophysics. These include stars, the interstellar medium, other objects in our Milky Way Galaxy, and galaxies beyond our own.

NASA defines astrophysics as the investigation of astronomical bodies by remote sensing from Earth or its vicinity. Because the targets of the astrophysicist are generally beyond human reach even with our fastest rockets, astrophysicists concentrate solely on what the electro-

magnetic spectrum can tell them about the universe. NASA's astrophysics program has three goals: to understand the origin and fate of the universe; to describe the fundamental laws of physics; and to discover the nature and evolution of galaxies, stars, and the solar system. The investigations of astrophysicists are carried out by instruments aboard free-flying satellites, sounding rockets that penetrate into space for brief periods, high-flying aircraft and high-altitude balloons, and Space Shuttle missions.

# A BRIEF HISTORY OF THE UNITED STATES ASTRONOMY SPACECRAFT AND CREWED SPACE FLIGHTS

---

The early successes of Sputnik and the Explorer series spurred the United States to develop long-range programs for exploring space. Once the United States became comfortable with the technical demands of spacecraft launches, NASA quickly began scientific studies in space using both crewed and non-crewed spacecraft launches.

Teams of scientists began their studies in space close to home by exploring the Moon and the solar system. Encouraged by those successes, they have looked farther out to nearly the beginning of the universe.

Observing the heavens from a vantage point above Earth is not a new idea. The idea of placing telescopes in orbit came quite early—at least by 1923 when Hermann Oberth described the idea. Even before his time, there were a few attempts at space astronomy. In 1874, Jules Janssen launched a balloon from Paris with two aeronauts aboard to study the effects of the atmosphere on sunlight. Astronomers continue to use balloons from launch sites in the Antarctic; Palestine, Texas; and Alice Springs,

Australia. After launch, scientists chase the balloon in a plane as the balloon follows the prevailing winds, traveling thousands of kilometers before sinking back to Earth. A typical balloon launch yields many hours of astronomical observations.

Rocket research in the second half of the 20th century developed the technology for launching satellites. Between 1946 and 1951, the U.S. launched 69 V-2 rockets. The V-2 rockets were captured from the Germans after World War II and used for high altitude research. Several of those flights studied ultra-

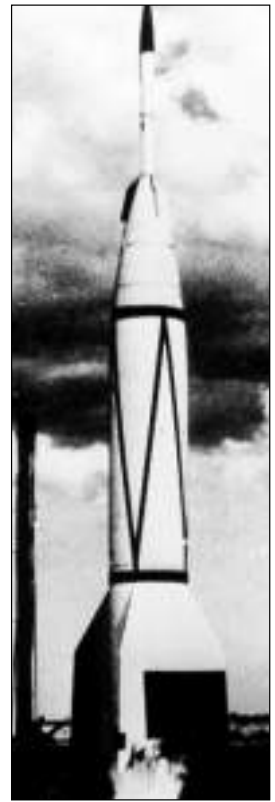

U.S. V-2 rocket launch

violet and x-ray emissions from the Sun. Today, sounding rockets are used primarily by universities. They are inexpensive and quick, but provide only a few minutes of observations.

To conduct its current research, NASA uses big rockets like Atlas, Delta, Titan, and the Space Shuttle as well as small rockets launched from a B-52 aircraft to lift satellites into orbit. Except for the largest rockets, which are launched in Florida and California, rocket research and launches occur at many places around the United States. NASA also uses the Kuiper Airborne Observatory (KAO) that carries a 0.9-meter telescope inside a C-141 aircraft. It flies above the densest part of the atmosphere and observes in the far-infrared and submillimeter wavelengths. KAO flies approximately 80 times a year. KAO can reach an altitude of 13,700 meters with a normal flight time of 7.5 hours.

In the near future, NASA will begin flying the Stratospheric Observatory for Infrared Astronomy (SOFIA). SOFIA is a 747 aircraft modified to



NASA's Kuiper Airborne Observatory

accommodate a 2.5 meter reflecting telescope, which is slightly larger than the Hubble Space Telescope (HST) at 2.4 meters. Like KAO, SOFIA will conduct infrared astronomy and fly at an altitude of 13,000 meters for 8 hours.

Over the years, NASA space probes have sent back detailed images of the planets Mercury, Venus, Mars, Jupiter, Saturn, Uranus, and Neptune. Mariner 2 was the first spacecraft to explore another planet when it flew past Venus in 1962. The missions to the planets have redefined the picture of our solar system. Scientists have an incredible set of data from almost every planet in the solar system.



Black Brant sounding rocket ready for launch to study Supernova 1987A



Final inflation of an instrument-carrying helium balloon before launch from Palestine, TX

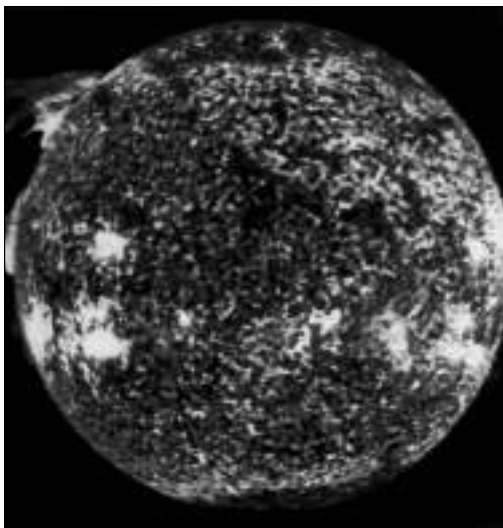

*Skylab 4* picture of the Sun in ionized helium light

We learned that Venus is hotter than Mercury. Data from satellites in orbit around Venus have told us about the atmosphere and terrain of the planet. By monitoring Venus' atmosphere, scientists can study the effects of a runaway greenhouse effect. Several Russian spacecraft have explored the surface of Venus as well as the Moon and Mars.

Although spacecraft have mapped the surface of Mars, the Mars Viking mission gently deposited two landers on the surface that sent back data. They still sit on the surface there. The two interplanetary travelers, *Voyager 1* and *2* (launched in September and August 1977, respectively) visited Jupiter, Saturn, Uranus, and Neptune and are now leaving the solar system on their way into interstellar space. They sent back new data on these gas giant planets. Their discoveries included volcanoes on Io (a satellite of Jupiter), storms on Neptune, and ring shepherd satellites around Saturn. The two *Voyager* missions represent an incredible success story. They provided unique glimpses of the planets and redefined the history of our solar system.

Beginning in 1962, NASA launched a series of nine orbiting observatories to observe the Sun. Astrophysicists began to understand the interior

of our nearest star. In the 1970's, *Skylab* astronauts brought back from orbit a wealth of data on the Sun, using x-rays to study its activity.

In 1978, one of the most successful astronomical satellite missions, the International Ultraviolet Explorer (IUE), was launched. This satellite has an ultraviolet telescope that has been used to study the universe in the ultraviolet portion of the electromagnetic spectrum. Many scientists continue to use IUE simultaneously with other satellites and Earth telescopes to gather multi-wavelength data on astronomical objects.

Other NASA satellites have carried x-ray detectors into space. One of the first (1970)—called *Uhuru* (Swahili for freedom)—mapped the entire sky in x-ray wavelengths. Later (1978), the second High Energy Astrophysics Observatory (HEAO-2), called *Einstein*, imaged many objects in x-ray light. Today a satellite called *ROSAT* (a name honoring the physicist who discovered x-rays, Dr. Wilhelm Roentgen) continues the study of individual sources of x-rays in the sky. All of these satellites added new objects to the astronomical zoo and helped scientists understand the processes that make x-rays in space. The sheer number of high-energy objects discovered by these satellites surprised and excited the scientific community.

The Infrared Astronomical Satellite (IRAS) was launched in 1983. It mapped the sky in infrared wavelengths. IRAS scientists have discovered thousands of infrared sources never seen before. The infrared part of the spectrum tells about molecules in space and gas and dust clouds where new stars are hidden until they are bright enough to outshine their birth cloud.

The Space Shuttle is used to introduce instruments into low Earth orbit. Satellites like the HST orbit about 600 kilometers above Earth's surface. This is a low Earth orbit and accessible to the Shuttle. To put satellites into high Earth orbit, an upper stage must be carried in the

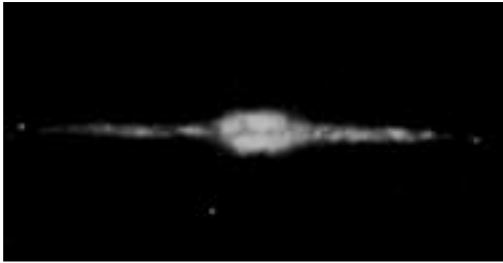
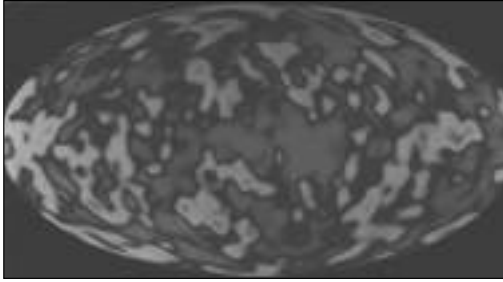

Top: Thermal background radiation measured by the COBE spacecraft

Bottom: Image of the Milky Way taken by the COBE spacecraft

Shuttle's payload bay or the satellite is lofted with one of several different kinds of non-crewed launch vehicles. For example, the Geostationary Operational Environmental Satellite (GOES) orbits about 40,000 kilometers above Earth's surface. A Delta rocket was used to put GOES into high orbit. The choice of altitude—high Earth orbit or low Earth orbit—depends on the data to be measured.

## Recent and Multi-Mission Programs

### Magellan

In May 1989, the Magellan spacecraft was released from the Space Shuttle and sent on its way to orbit Venus. The atmosphere of Venus is unfriendly to humans with its thick sulfuric acid clouds, high pressures, and high temperatures. Magellan used radar to penetrate Venus's dense atmosphere and map the planet's surface.

### Galileo

In October of that same year, another Shuttle mission launched Galileo on its way to visit the planet Jupiter. On its way out to Jupiter, Galileo (named after Galileo Galilei, an Italian



The *Hubble Space Telescope* attached to the Space Shuttle *Endeavour* during the 1993 service mission

astronomer of the 17th century) took pictures of several asteroids. The Galileo spacecraft was designed to study Jupiter's atmosphere, satellites, and surrounding magnetosphere. The spacecraft is currently orbiting Jupiter and performing an extended study of the planet's moons.

### Cosmic Background Explorer (COBE)

Just a month later, in November 1989, the Cosmic Background Explorer (COBE) was launched from a Delta rocket. This satellite surveyed the entire sky in microwave wavelengths and provided the first precise measurement of variations in the background radiation of the universe. The distribution of this radiation does not follow the predictions of the Big Bang Theory.

### The Hubble Space Telescope (HST)

In April 1990, the crew of the Space Shuttle Discovery launched the HST. This telescope combines ultraviolet and optical imaging with spectroscopy to provide high quality data of a variety of astronomical objects. Although the primary mirror aboard the satellite was later discovered to be slightly flawed, astronomers were able to partially compensate for the slightly out-of-focus images through computer processing. In December 1993, the Hubble servicing mission

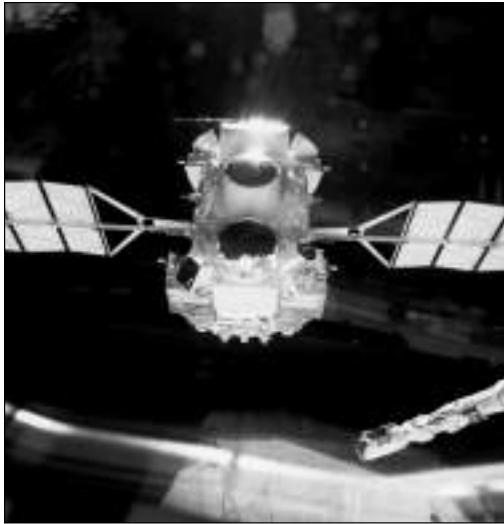

Deployment of the *Compton Gamma Ray Observatory* from the Space Shuttle *Atlantis* in 1991

permitted astronauts to add compensating devices to the flawed mirror, to readjust its focus, and to replace or repair other instruments and solar arrays. The servicing mission has led to images of unprecedented light sensitivity and clarity.

### **Astro-1 and the Broad-Band X-ray Telescope (BBXRT)**

In December 1990, the crew of the Space Shuttle Columbia conducted two experiments during its flight. The Astro-1 instrument platform and the Broad-Band X-ray Telescope (BBXRT) both study the x-ray and ultraviolet emissions of astronomical objects.

### **Compton Gamma Ray Observatory (CGRO)**

A few months later, in April 1991, the Compton Gamma Ray Observatory (CGRO) was launched from the Space Shuttle. CGRO is the second of NASA's Great Observatories. During its lifetime, CGRO made some of the most important discoveries in the field of gamma-ray astronomy:

- Gamma ray bursts (short-lived, but extremely powerful explosions) are evenly distributed across the sky, and thus outside the Milky Way galaxy;

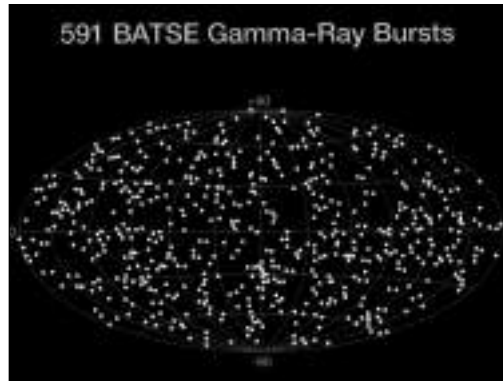

Gamma ray bursts detected by the *Compton Gamma Ray Observatory*

- Gamma ray loud blazars (quasars with particle jets aimed at us) to be a new class of objects; and
- The galactic center glows in antimatter radiation.

CGRO was safely and flawlessly de-orbited over the Pacific Ocean on June 4, 2000.

### **Extreme Ultraviolet Explorer (EUVE)**

In May 1992, a Delta rocket boosted the Extreme Ultraviolet Explorer (EUVE) into orbit. This satellite, which concluded its mission in December 2000, studied the far ultraviolet part of the spectrum. One unexpected result from this mission was the distances at which ultraviolet sources were seen. The scientists expected to see ultraviolet radiation only from within 50 light years of the Sun. EUVE detected extreme ultraviolet emissions from distant galaxies in its first year of operation.

### **Cassini-Huygens**

Launched in October 1997, the Cassini-Huygens mission will do a detailed study of Saturn, its rings, its magnetosphere, its icy satellites, and its moon Titan. The Cassini Orbiter's mission consists of delivering the Huygens probe (provided by the European Space Agency) to Titan to study its clouds, atmosphere, and surface, and then remaining in orbit around Saturn for detailed studies of the planet and its rings and satellites. Cassini will arrive at Saturn on July 1, 2004.



### **Chandra X-ray Observatory**

Launched in July of 1999, Chandra is the third of NASA's Great Observatories, after the HST and CGRO. It is performing an exploration of the hot turbulent regions in space and has 8-times greater resolution than previous x-ray telescopes enabling it to detect sources more than 20-times fainter than previous observations. Chandra's improved sensitivity will make possible more detailed studies of black holes, supernovas, and dark matter and increase our understanding of the origin, evolution, and destiny of the universe.

### **The Discovery Program**

Discovery represents the implementation of "Faster, Better, Cheaper" planetary missions. The philosophy of Discovery is to solicit proposals for an entire mission, put together by consortia comprised of industry, small businesses, and universities. The goal is to launch many, smaller missions that do focused science with fast turnaround times and for which the entire mission cost (design, development, launch vehicle, instruments, spacecraft, launch, mission operations, and data analysis) is minimal. Discovery missions selected to date include:

- Near Earth Asteroid Rendezvous (NEAR)
- Mars Pathfinder
- Lunar Prospector
- Stardust
- Genesis
- Comet Nucleus Tour (CONTOUR)
- ASPERA-3
- Deep Impact
- Mercury Surface Space Environment Geochemistry and Ranging mission (MESSENGER)

### **The Explorer Program**

The Explorer Program began with the launch of Explorer 1 in 1958, and became a sustained program beginning in 1961. Over 70 "Explorer" missions have been launched successfully, pioneering space research on micrometeoroids, the Earth's magnetosphere, x-ray astrophysics, the cosmic microwave background and many other fields of space science investigation. In addition,

the Explorer program has a long history of providing scientific instruments as part of other nations' missions. Current Explorer missions include:

- Submillimeter Wave Astronomy Satellite (SWAS)
- Advanced Composition Explorer (ACE)
- Transition Region and Coronal Explorer (TRACE)
- Fast Auroral Snapshot Explorer (FAST)
- Solar Anomalous and Magnetospheric Particle Explorer (SAMPEX)
- Far Ultraviolet Spectroscopic Explorer (FUSE)
- Imager for Magnetopause-to-Aurora Global Exploration (IMAGE)
- High Energy Transient Explorer-2 (HETE-2)
- High Energy Solar Spectroscopic Imager (HESSI)
- Microwave Anisotropy Probe (MAP)
- Cooperative Astrophysics and Technology Satellite (CATSAT)
- Galaxy Evolution Explorer (GALEX)
- Cosmic Hot Interstellar Plasma Spectrometer (CHIPS)
- Inner Magnetosphere Explorer (IMEX)
- Two Wide-Angle Imaging Neutral-Atom Spectrometer (TWINS)
- Swift
- Full-Sky Astrometric Mapping Explorer (FAME)
- Coupled Ion-Neutral Dynamics Investigations (CINDI)

### **The Mars Surveyor Program**

The Mars Surveyor program reflects a long-term commitment to the exploration of the Red Planet. NASA intends to launch one or two spacecraft to Mars whenever Mars' orbit allows, approximately every 26 months. The first spacecraft in this series was the Mars Global Surveyor in 1996. The Mars '98 Orbiter and Lander were launched in December 1998 and January 1999 but were lost during their journey to Mars. The 2001 Mars Odyssey orbiter is scheduled to arrive at Mars in late 2001 and is expected to produce exceptional science mapping the mineralogy of the Martian surface. Currently under development are twin scientific exploration rovers scheduled for launch in 2003. Each of the rovers will

## Astronomy Space Missions (partial list)

Year	Mission	Target
1957	Stratoscope I	Sun
1961	Explorer 11	gamma rays
1962	Arobee	X-ray sources
1962	Mariner 2	Venus
1963	Mars 1	Mars
1965	Mariner 4	Mars
1967	OSO-3	gamma rays
1968	RAE-1	radio
1968	OAO-2	UV sky
1969	Vela 5A	gamma rays
1969	Apollo 11	Moon
1970	SAS-1	X-ray sky
1971	Explorer 43	solar wind/ radio
1971	Mariner 9	Mars
1972	Pioneer 10	deep space
1972	Copernicus	UV sky
1973	Pioneer 11	deep space
1973	Skylab	Sun
1973	Explorer 49	radio sources
1974	Mariner 10	Mercury
1975	SAS-3	X-ray sources
1975	Viking 1 & 2	Mars
1976	Viking 1 & 2	Mars
1977	Voyager 2	outer planets
1977	Voyager 1	outer planets
1978	IUE	UV sky
1978	Pioneer Venus-A	radar studies
1978	HEAO-2	X-ray sky

Year	Mission	Target
1983	IRAS	infrared sky
1985	Spacelab-2	infrared sky
1989	Magellan	Venus
1989	Galileo	Jupiter/asteroids/ Earth/Venus
1989	COBE	microwave sky
1990	HST	UV sky
1990	ROSAT	X-ray sky
1990	Ulysses	Sun
1990	ASTRO-1	X-ray and UV sky
1990	ROSAT	X-ray sky
1991	Yohko	Sun in X-rays
1992	Extreme UV Explorer	X-ray sky
1994	Wind	Solar wind
1994	Clemintine	Moon
1995	Infrared Telescope in Space	IR sky
1995	Infrared Space Observatory	IR sky
1995	Rossi X-ray Timing Explorer	X-ray sky
1995	Solar Heliospheric Observatory	Sun
1995	ASTRO-2	UV sky
1996	Mars Global Surveyor	Mars
1996	Near Earth Asteroid Rendezvous	Asteroid
1996	Mars Pathfinder	Mars
1997	Cassini	Saturn
1998	Lunar Prospector	Moon
1999	Stardust	Comet
1999	Mars Climate Orbiter	Mars
1999	Mars Polar Orbiter	Mars
1999	Chandra X-ray Observatory	X-ray sky

be delivered to the surface protected by inflated airbags similar to the successful Mars Pathfinder. Each rover will be equipped with an integrated suite of instruments (cameras, spectrometers, microscopes, and abrasion tool) that will allow it to behave as a robotic field geologist. They will have an exploration range of up to 1 kilometer during their 90 days of operational life on the surface of Mars. In 2005, NASA plans to launch a powerful scientific orbiter. This mission, the Mars Reconnaissance Orbiter, will focus on analyzing the surface at new spatial scales and in new spectral regions in an effort to follow the potential evidence of water from the Mars Global Surveyor images and to bridge the gap between surface observations and measurements from orbit. The next step in the Mars exploration program strategy will be to send a long-range, long-duration mobile science laboratory to Mars (at least by 2009, and as early as 2007). This “smart lander” will be a major leap in surface measurements and pave the way for a future sample return mission.

### New Millennium Program

NASA has an ambitious plan for space exploration in the next century. It envisions a scenario in which spacecraft will have revolutionary new capabilities compared to those of today. Spacecraft are envisioned as flying in formation, or in fleets, or having artificial intelligence to provide the kind of capability that can answer the more detailed level of questions that scientists have about the universe. Missions include:

- Deep Space 1
- Deep Space 2
- Starlight
- Earth Observing 1
- Earth Observing 3
- Space Technology 5
- Space Technology 6

The goal of the New Millennium Program (NMP) is to identify and test advanced technologies that will provide spacecraft with the capabilities they need in order to achieve NASA's vision.

Technologies such as solar electric propulsion and artificial intelligence promise a great leap forward in terms of future spacecraft capability, but they also present a risk to missions that use them for the first time. Through a series of deep space and Earth orbiting flights, NMP will demonstrate these promising but risky technologies in space to prove that they work. Once validated, the technologies pose less of a risk to missions that would like to use them to achieve their scientific objectives.

### **International Solar Terrestrial Physics (ISTP) Program**

Collaborative efforts by NASA, the European Space Agency (ESA), and the Institute of Space and Astronautical Science (ISAS) of Japan led to the International Solar-Terrestrial Physics program, consisting of a set of missions being carried out during the 1990's and into the next century. This program combines resources and scientific communities on an international scale using a complement of several missions, along with complementary ground facilities and theoretical efforts, to obtain coordinated, simultaneous investigations of the Sun-Earth space environment over an extended period of time. Missions include:

- Wind
- Polar
- Geotail
- The Solar and Heliospheric Observatory (SOHO)
- Ulysses
- Advanced Composition Explorer (ACE)
- IMP-8
- EQUATOR-8

### **Living With A Star (LWS)**

Living With A Star (LWS) is a NASA initiative that will develop the scientific understanding necessary to effectively address those aspects of

the coupled Sun-Earth system that directly affect life and society on Earth. LWS missions include:

- Solar Dynamics Observatory (SDO)
- Sentinels
- Radiation Belt Mappers (RBM)
- Ionospheric Mappers (IM)

### **Scientific Balloon Program**

Balloons offer a low-cost, quick response method for doing scientific investigations. Balloons are mobile, meaning they can be launched where the scientist needs to conduct the experiment, and can be readied for flight in as little as six months. Balloon payloads provide us with information on the atmosphere, the universe, the Sun, and the near-Earth and space environment. NASA launches about 30 scientific balloons each year.

### **Sounding Rocket Program**

Experiments launched on sounding rockets provide a variety of information, including chemical makeup and physical processes taking place in the atmosphere; the natural radiation surrounding the Earth; and data on the Sun, stars, and galaxies. Sounding rockets provide the only means of making in-situ measurements at altitudes between the maximum altitudes for balloons (about 30 miles or 48 kilometers) and the minimum altitude for satellites (100 miles or 161 kilometers).

Using space-borne instruments, scientists now map the universe in many wavelengths. Satellites and telescopes provide data in radio, microwave, infrared, visible, ultraviolet, x-ray, and gamma ray. By comparing data from an object in the sky, in all wavelengths, astronomers are learning more about the history of our universe. Visit <http://spacescience.nasa.gov>, for more information about NASA Space Science missions and programs.

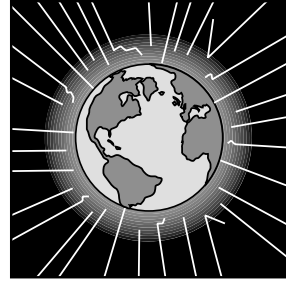

# UNIT 1

## THE ATMOSPHERIC FILTER

---

### Introduction

Earth's atmosphere is essential to life. This ocean of fluids and suspended particles surrounds Earth and protects it from the hazards of outer space. It insulates the inhabitants of Earth from the extreme temperatures of space and stops all but the larger meteoroids from reaching the surface. Furthermore, it filters out most radiation dangerous to life. Without the atmosphere, life would not be possible on Earth. The atmosphere contains the oxygen we breathe. It also has enough pressure so that water remains liquid at moderate temperatures.

Yet the same atmosphere that makes life possible hinders our understanding of Earth's place in the universe. Our only means for investigating distant stars, nebulae, and galaxies is to collect and analyze the electromagnetic radiation these objects emit into space. However, most of this radiation is absorbed or distorted by the atmosphere before it can reach a ground-based telescope. Only visible light and some radio waves, infrared, and ultraviolet light survive the passage

from space to the ground. That limited amount of radiation has provided astronomers enough information to estimate the general shape and size of the universe and categorize its basic components, but there is much left to learn. It is essential to study the entire spectrum rather than just limited regions of it. Relying only on the radiation that reaches Earth's surface is like listening to a piano recital on a piano that has just a few of its keys working.

## Unit Goal

- To demonstrate how the components of Earth's atmosphere absorb or distort incoming electromagnetic radiation.

## Teaching Strategy

The following demonstrations are designed to show how components of Earth's atmosphere filter or distort electromagnetic radiation. Since we cannot produce all of the different wavelengths of electromagnetic radiation in a classroom, the light from a slide or overhead projector in a darkened room will represent the complete electromagnetic spectrum. A projection screen will represent Earth's surface and objects placed between the projector and the screen will represent various components of Earth's atmosphere. All of the demonstrations can be conducted in a single class period. Place the projector in the back of the classroom and aim it towards the screen at the front. Try to get the room as dark as possible before doing the demonstrations.

## ACTIVITY: Clear Air

### Description:

Students observe some of the problems inherent in using astronomical telescopes on Earth's surface through a series of brief demonstrations given by the teacher.

### Objectives:

To demonstrate how Earth's atmosphere interferes with the passage of electromagnetic radiation.

### National Education Standards:

Science

Evidence, models, & explanation

Transfer of energy

Technology

Understand troubleshooting, R & D, invention, innovation, & experimentation

### Materials and Tools:

For all demonstrations

Darkened room

Overhead or slide projector

Worksheet for each student

- Demonstration 1  
Small sheet of clear glass or Plexiglass™  
Emery paper (fine) to smooth sharp edges of glass or plastic
- Demonstration 2  
Shallow dish or pie tin  
Empty coffee can  
Ice  
Spray bottle and water  
Cloud cutout (cardboard or other material)
- Demonstration 3  
Stick matches  
Eye protection
- Demonstration 4  
Food warmer fuel (e.g. Sterno™) or electric hotplate  
Matches if using fuel  
Eye protection if using fuel  
Aluminum foil  
Sewing pin
- Demonstration 5  
150 to 200 watt light bulb  
Uncovered light fixture  
Star slide (see demonstration 4)

### Background:

Earth's atmosphere appears to be clear to the naked eye. On a dark, cloud-free night far from city lights, thousands of stars are visible. It is hard to imagine a better view of the sky when the wisps of the Milky Way Galaxy are visible stretching from the northern to the southern sky. In spite of the apparent clarity, the view is flawed. Many wavelengths are blocked by the atmosphere and visible light is filtered and distorted.

The demonstrations that follow are designed to show how Earth's atmosphere interferes with the passage of electromagnetic radiation. Visible light is used as an example of all wavelengths since most other wavelengths of electromagnetic radiation are difficult and even dangerous to produce in the classroom. Make sure students understand that the demonstrations are examples of what happens across the entire electromagnetic spectrum.

### Management and Tips:

To make effective use of the demonstrations, it is necessary to have a room that can be darkened. A projection screen will represent Earth's surface and the light cast by an overhead or slide projector will represent all the wavelengths of electromagnetic radiation coming to Earth from space. The demonstrations are things that you do between the screen and the projector to represent phenomena occurring in Earth's atmosphere.

The actual demonstrations will take approximately 15 minutes to complete. Allow time to discuss the significance of each demonstration with your students. The most important thing to know is that Earth's atmosphere only allows a small portion of the electromagnetic spectrum to reach Earth's surface and astronomers' telescopes. The information astronomers can collect is incomplete and thus the story of the universe they are able to construct from this information is also incomplete. Conclude the discussion with the question "What can astronomers do about it?" The answer is to move observatories off the surface of Earth into outer space.

### Procedures:

#### Demonstration 1 – The Air Is Not Clear

In this demonstration you will hold up a sheet of "clear" glass between the projector and screen. The glass represents the gases in Earth's atmosphere. Light from the projector is interrupted by the glass in its passage to the screen. Notice the faint shadow the "clear" glass casts on the screen. The shadow is evidence of a small amount of absorption of light by the glass. Also look for a reflection from the glass back in the direction of space. Photographs of Earth from space show a thin bluish layer of gas surrounding Earth. Being able to see the atmosphere from space indicates that some of the electromagnetic radiation falling on it from space is reflected back out into space.

#### Demonstration 2 – Water in the Air

To begin this demonstration, fill a coffee can with ice cubes. The can is set in the middle of a dish or pie tin and left undisturbed. In a few minutes, the

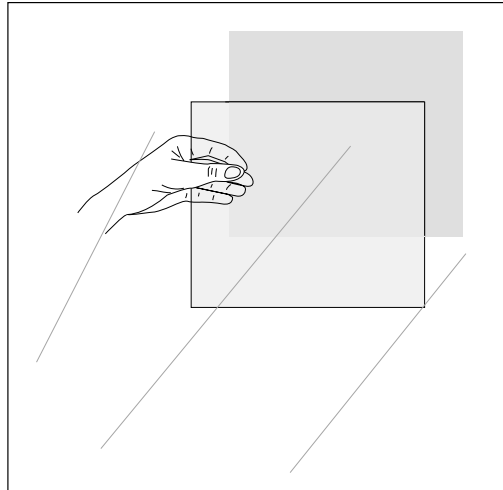

outer surface of the can will begin "sweating." This is evidence that the air in the classroom holds moisture that condenses out when it comes in contact with a cold surface.

In the second part of the demonstration, spray a fine mist of water in the air between the projector and the screen. This illustrates how fine water droplets suspended in the air will block electromagnetic radiation. High humidity casts a haze in the sky that blocks incoming visible light.

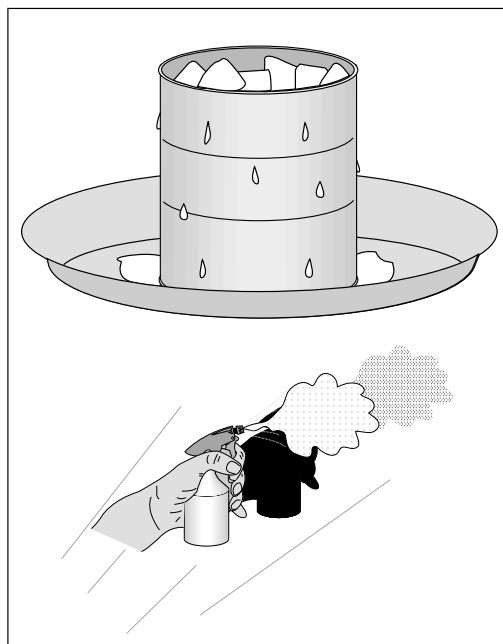

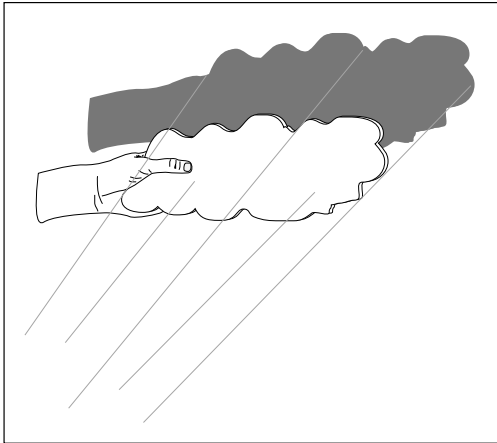

Finally, hold up the cloud cutout. The cloud shows what happens when moisture condenses in the air around small dust particles. The shadow cast by the cloud shows how clouds can substantially block visible light coming to Earth from space.

### Demonstration 3 – Pollution

While wearing eye protection, strike a match and then blow it out right away. The smoke particles released from the match head will produce a noticeable shadow on the screen. Pollution from a variety of sources (human-made and natural) block some of the incoming visible light.

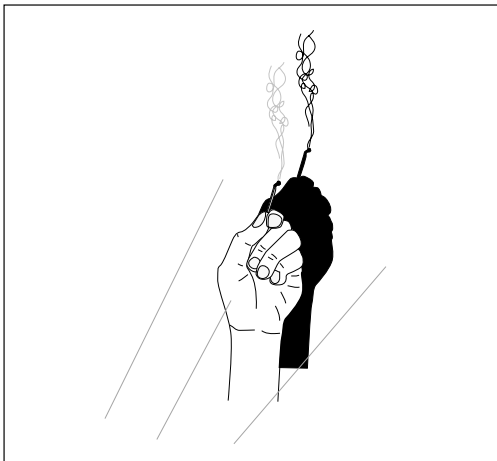

### Demonstration 4 – Heat Currents

Prior to the demonstration, create a star slide. If you are using a slide projector, obtain a plastic slide mount in which the film can be removed. Slip a small square of aluminum foil into the

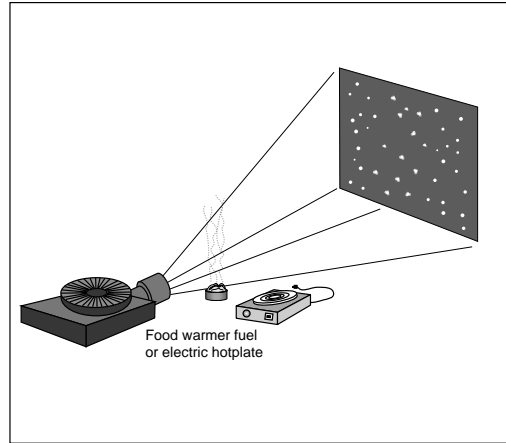

slide frame and use a pin to randomly prick about 30 holes into the foil. If you are using an overhead projector, prepare a star slide from a large square of aluminum foil. The square should cover the entire stage of the projector. Poke about 100 holes through the foil.

Project light through the slide you prepared. A small star field will be displayed on the screen. While wearing eye protection (not necessary if using an electric hot plate), place the warmer very near and just below the beam of the projector. Stars will show a twinkling effect on the screen. This demonstration shows how heat currents in Earth's atmosphere can distort the images of astronomical objects.

### Demonstration 5 – Day/Night

Use the star slide you prepared in the previous activity. Hold up the lamp with the light bulb

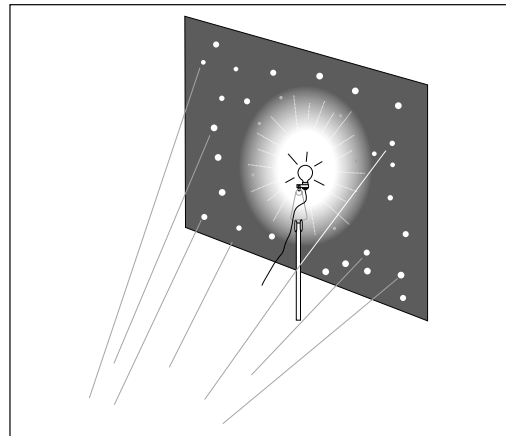

near the screen. Turn on the bulb. Many of the stars on the screen near the bulb will disappear. This demonstration shows how the Sun's light overpowers the fainter stars. Sunlight brightens the gases, water, and particles in Earth's atmosphere so that the distant stars are not visible. If the Sun's light could be dimmed, other stars would be visible at the same time.

**Assessment:**

Collect student sheets. Compare the answers the students have given but focus on the last question in which students must propose solutions to the atmospheric problems associated with Earth-

based observatories. Students may be aware of new strategies for improving the observations of Earth-based telescopes such as adaptive mirrors that change their shape slightly many times each second to compensate for air currents. However, no advanced telescope design technique will make up for electromagnetic radiation that does not reach Earth's surface.

**Extensions:**

- Have students research new Earth-based telescope designs on the Internet. Use search terms such as observatory, telescopes, and astronomy.



## Clear Air

Name: \_\_\_\_\_

1. Earth's atmosphere creates problems for astronomers. Identify and explain 3 ways Earth's atmosphere interferes with astronomical observations.

A.

B.

C.

2. How might these problems affect the discoveries and conclusions astronomers reach through their observations?

3. Why are most astronomical observatories built on remote mountains?

4. What can astronomers do to capture the missing electromagnetic radiation for study?

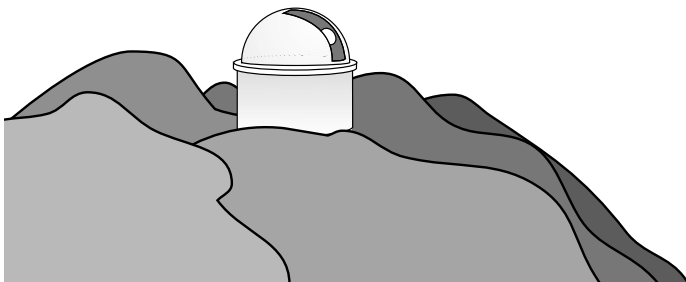

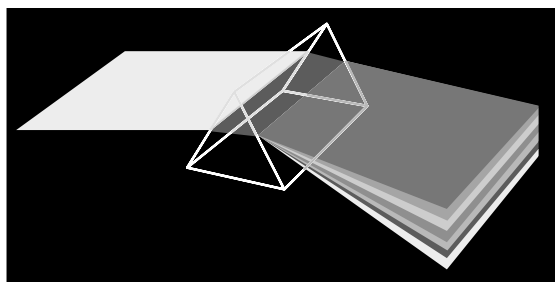

# UNIT 2

# THE ELECTROMAGNETIC SPECTRUM

---

## Introduction

Contrary to popular belief, outer space is not empty space. It is filled with electromagnetic radiation that crisscrosses the universe. This radiation comprises the spectrum of energy ranging from radio waves on one end to gamma rays on the other. It is called the electromagnetic spectrum because this radiation is associated with electric and magnetic fields that transfer energy as they travel through space. Because humans can see it, the most familiar part of the electromagnetic spectrum is visible light—red, orange, yellow, green, blue, and violet.

Like expanding ripples in a pond after a pebble has been tossed in, electromagnetic radiation travels across space in the form of waves. These waves travel at the speed of light—300,000 kilometers per second. Their wavelengths, the distance from wave crest to wave crest, vary from thousands of kilometers across (in the case of the longest radio waves) to fractions of a nanometer, in the cases of the smallest x-rays and gamma rays.

Electromagnetic radiation has properties of both waves and particles. What we detect depends on the method we use to study it. The beautiful colors that appear in a soap film or in the dispersion of light from a diamond are best described as waves. The light that strikes a solar cell to produce an electric current is best described as a particle. When described as particles, individual packets of electromagnetic energy are called photons. The amount of energy a photon of light contains depends upon its wavelength. Electromagnetic radiation with long

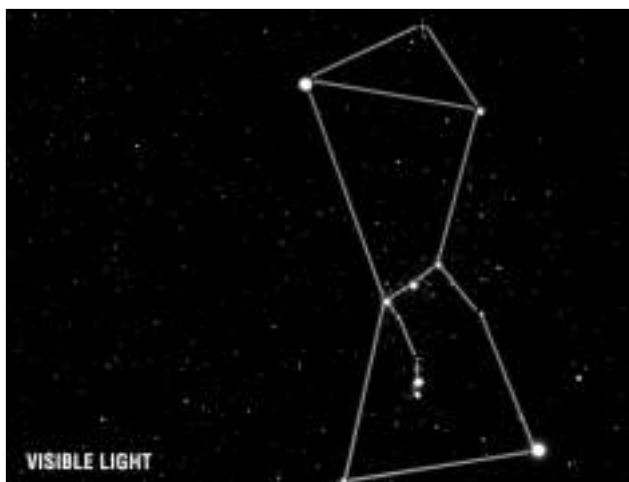
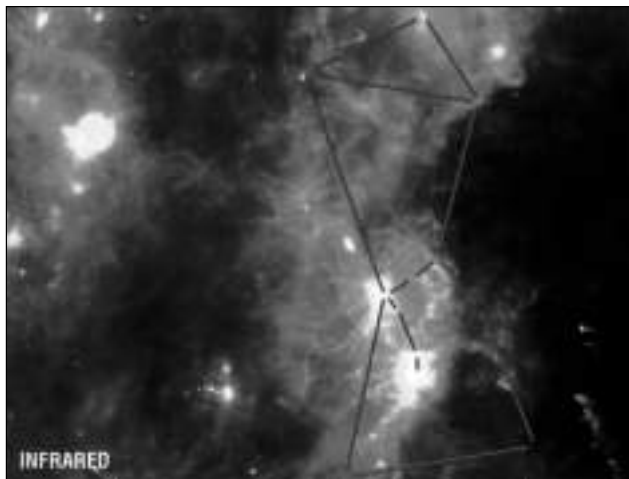

These two views of the constellation Orion dramatically illustrate the difference between what we are able to detect in visible light from Earth's surface and what is detectable in infrared light to a spacecraft in Earth orbit. Photo Credits: Akira Fujii—visible light image; Infrared Astronomical Satellite—infrared image.

wavelengths contains little energy. Electro-magnetic radiation with short wavelengths contains a great amount of energy.

Scientists name the different regions of the electromagnetic spectrum according to their wavelengths. (See figure 1.) Radio waves have the longest wavelengths, ranging from a few centimeters from crest to crest to thousands of kilometers. Micro-waves range from a few centimeters to about 0.1 cm. Infrared radiation falls between 700 nanometers and 0.1 cm. (Nano means one

billionth. Thus 700 nanometers is a distance equal to 700 billionths or  $7 \times 10^{-7}$  meter.) Visible light is a very narrow band of radiation ranging from 400 to 700 nanometers. For comparison, it would take 50 visible light waves arranged end to end to span the thickness of a sheet of household plastic wrap. Below visible light is the slightly broader band of ultraviolet light that lies between 10 and 300 nanometers. X-rays follow ultraviolet light and diminish into the hundred-billionth of a meter range. Gamma rays fall in the trillionth of a meter range.

The wavelengths of x-rays and gamma rays are so tiny that scientists use another unit, the electron volt, to describe them. This is the energy that an electron gains when it falls through a potential difference, or voltage, of one volt. It works out that one electron volt has a wavelength of about 0.0001 centimeters. X-rays range from 100 electron volts (100 eV) to thousands of electron volts. Gamma rays range from thousands of electron volts to billions of electron volts.

## Using the Electromagnetic Spectrum

All objects in space are very distant and difficult for humans to visit. Only the Moon has been visited so far. Instead of visiting stars and planets, astronomers collect electromagnetic radiation from them using a variety of tools. Radio dishes capture radio signals from space. Big telescopes on Earth gather visible and infrared light. Interplanetary spacecraft have traveled to all the planets in our solar system except Pluto and have landed on two. No spacecraft has ever brought back planetary material for study. They send back all their information by radio waves.

Virtually everything astronomers have learned about the universe beyond Earth depends on the information contained in the electromagnetic radiation that has traveled to Earth. For example, when a star explodes as in a supernova, it emits energy in all wavelengths of the electromagnetic spectrum. The most famous supernova is the stellar explosion that became visible in 1054 and produced the Crab Nebula. Electromagnetic

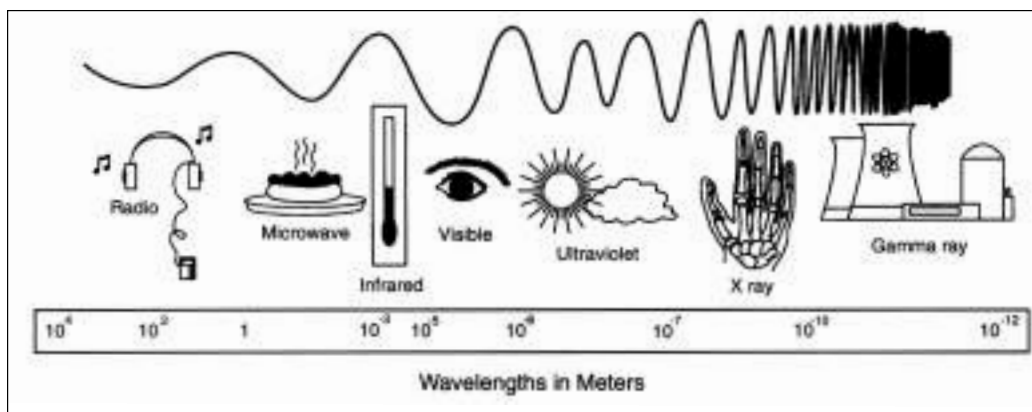

Figure 1: Electromagnetic Spectrum

radiation from radio to gamma rays has been detected from this object, and each section of the spectrum tells a different piece of the story.

For most of history, humans used only visible light to explore the skies. With basic tools and the human eye, we developed sophisticated methods of time keeping and calendars. Telescopes were invented in the 17th century. Astronomers then mapped the sky in greater detail—still with visible light. They learned about the temperature, constituents, distribution, and the motions of stars.

In the 20th century, scientists began to explore the other regions of the spectrum. Each region provided new evidence about the universe. Radio waves tell scientists about many things: the distribution of gases in our Milky Way Galaxy, the power in the great jets of material spewing from the centers of some other galaxies, and details about magnetic fields in space. The first radio astronomers unexpectedly found cool hydrogen gas distributed throughout the Milky Way. Hydrogen atoms are the building blocks for all matter. The remnant radiation from the Big Bang, the beginning of the universe, shows up in the microwave spectrum.

Infrared studies (also radio studies) tell us about molecules in space. For example, an infrared search reveals huge clouds of formaldehyde in space, each more than a million times more massive than the Sun. Some ultraviolet light comes from powerful galaxies very far away. Astronomers

have yet to understand the highly energetic engines in the centers of these strange objects.

Ultraviolet light studies have mapped the hot gas near our Sun (within about 50 light years). The high energy end of the spectrum—x-rays and gamma rays—provide scientists with information about processes they cannot reproduce here on Earth because they lack the required power. Nuclear physicists use strange stars and galaxies as a laboratory. These objects are pulsars, neutron stars, black holes, and active galaxies. Their study helps scientists better understand the behavior of matter at extremely high densities and temperatures in the presence of intense electric and magnetic fields.

Each region of the electromagnetic spectrum provides a piece of the puzzle. Using more than one region of the electromagnetic spectrum at a time gives scientists a more complete picture. For example, relatively cool objects, such as star-forming clouds of gas and dust, show up best in the radio and infrared spectral region. Hotter objects, such as stars, emit most of their energy at visible and ultraviolet wavelengths. The most energetic objects, such as supernova explosions, radiate intensely in the x-ray and gamma ray regions.

There are two main techniques for analyzing starlight. One is called spectroscopy and the other photometry. Spectroscopy spreads out the different wavelengths of light into a spectrum for study. Photometry measures the quantity of light in specific wavelengths or by combining all

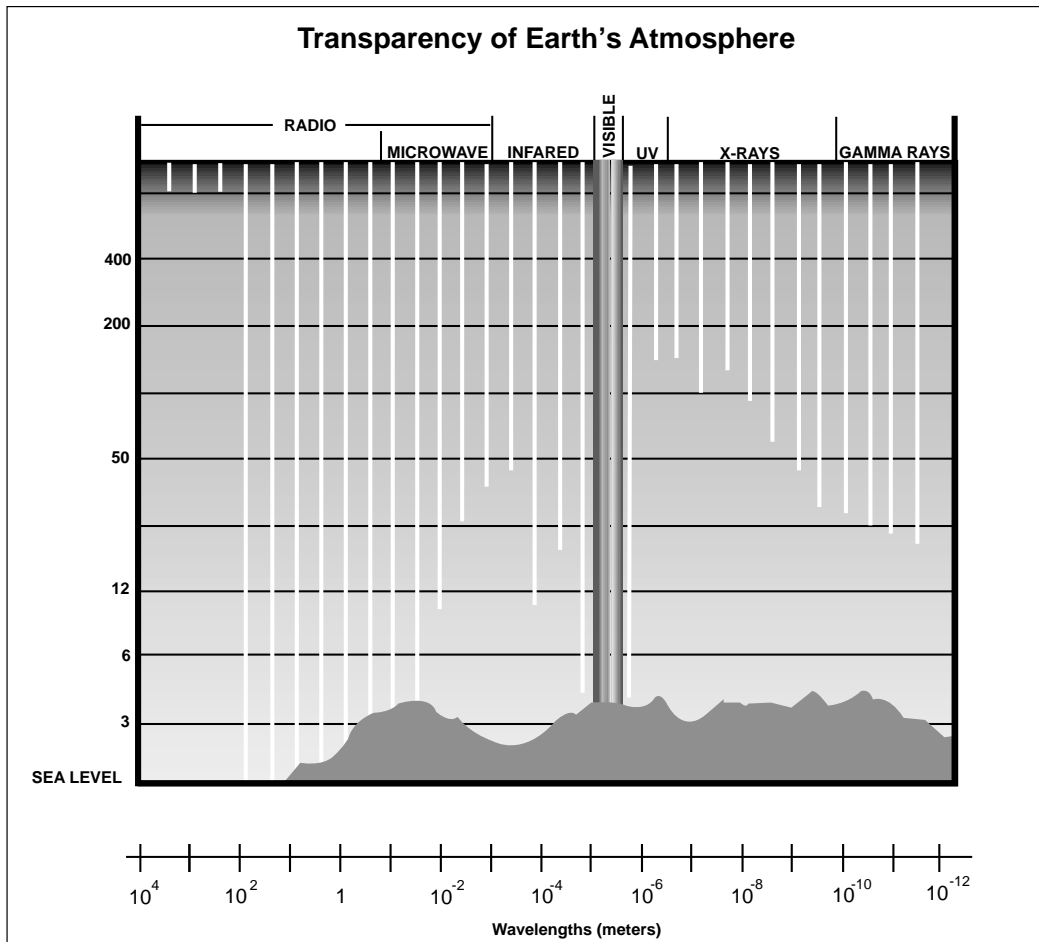

Figure 2: Transparency of Earth's Atmosphere

wavelengths. Astronomers use many filters in their work. Filters help astronomers analyze particular components of the spectrum. For example, a red filter blocks out all visible light wavelengths except those that fall around 600 nanometers (it lets through red light).

Unfortunately for astronomical research, Earth's atmosphere acts as a filter to block most wavelengths in the electromagnetic spectrum. (See Unit 1.) Only small portions of the spectrum actually reach the surface. (See figure 2.) More pieces of the puzzle are gathered by putting observatories at high altitudes (on mountain tops) where the air is thin and dry, and by flying instruments on planes and balloons. By far the best viewing location is outer space.

## Unit Goals

- To investigate the visible light spectrum.
- To demonstrate the relationship between energy and wavelength in the electromagnetic spectrum.

## Teaching Strategy

Because of the complex apparatus required to study some of the wavelengths of the electromagnetic spectrum and the danger of some of the radiation, only the visible light spectrum will be studied in the activities that follow. Several different methods for displaying the visible spectrum will be presented. Some of the demonstrations will involve sunlight, but a flood or spotlight may be substituted. For best results, these activities should be conducted in a room where there is good control of light.

## ACTIVITY: Simple Spectroscope

### Description:

A basic hand-held spectroscope is made from a diffraction grating and a paper tube.

### Objective:

To construct a simple spectroscope with a diffraction grating and use it to analyze the colors emitted by various light sources.

### National Education Standards:

Mathematics

Measurement

Connections

Science

Systems, order, & organization

Change, constancy, & measurement

Abilities necessary to do scientific inquiry

Abilities of technological design

Technology

Understand engineering design

### Materials:

Diffraction grating, 2-cm square (See management and tips section.)

Paper tube (tube from toilet paper roll)

Poster board square (5 by 10-cm)

Masking tape

Scissors

Razor blade knife

2 single-edge razor blades

Spectrum tubes and power supply (See management and tips section.)

Pencil

### Procedure:

- Using the pencil, trace around the end of the paper tube on the poster board. Make two circles and cut them out. The circles should be just larger than the tube's opening.
- Cut a 2-centimeter square hole in the center of one circle. Tape the diffraction grating square over the hole. If students are making their own spectroscopes, it may be better if an adult cuts the squares and the slot in step 4 below.
- Tape the circle with the grating inward to one end of the tube.
- Make a slot cutter tool by taping two single-edge razor blades together with a piece
- of poster board between. Use the tool to make parallel cuts about 2 centimeters long across the middle of the second circle. Use the razor blade knife to cut across the ends of the cuts to form a narrow slot across the middle of the circle.

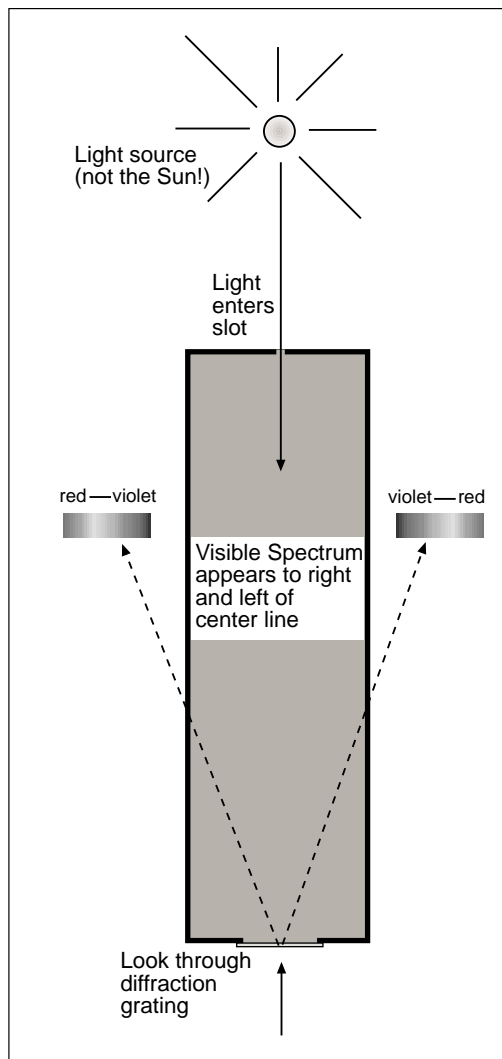

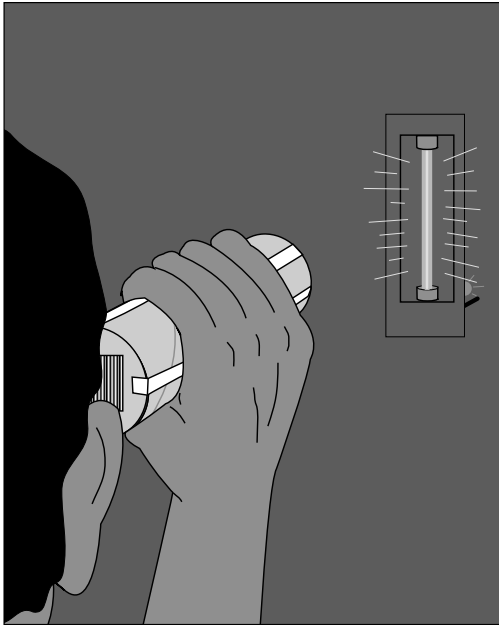

6. Examine various light sources with the spectroscope. If possible, examine nighttime street lighting. Use particular caution when examining sunlight. Do not look directly into the Sun.

### Background:

Simple spectroscopes, like the one described here, are easy to make and offer users a quick look at the color components of visible light. Different light sources (incandescent, fluorescent, etc.) may look the same to the naked eye but will appear differently in the spectroscope. The colors are arranged in the same order but some may be missing and their intensity will vary. The appearance of the spectrum displayed is distinctive and can tell the observer what the light source is.

### Management and Tips:

The analytical spectroscope activity that follows adds a measurement scale to the spectroscope design. The scale enables the user to actually measure the colors displayed. As will be described in greater detail in that activity, the specific location of the colors are like fingerprints when it comes to identifying the composition of the light source. Refer to the background and management tips section for the Analytical Spectroscope activity for information on how diffraction gratings produce spectra.

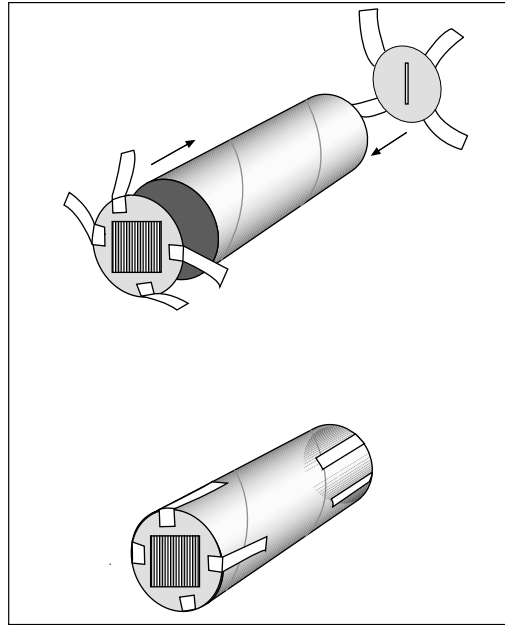

Spectroscopes can be made with glass prisms but prisms are heavy. Diffraction grating spectroscopes can do the same job but are much lighter. A diffraction grating can spread out the spectrum more than a prism can. This ability is called dispersion. Because gratings are smaller and lighter, they are well suited for spacecraft where size and weight are important considerations. Most research telescopes have some kind of grating *spectrograph* attached. Spectrographs are spectroscopes that provide a record, photographic or digital, of the spectrum observed.

Many school science supply houses sell diffraction grating material in sheets or rolls. One sheet is usually enough for every student in a class to have a piece of grating to build his or her own spectroscope. Holographic diffraction gratings work best for this activity. Refer to the note on the source for holographic grating in the next activity. A variety of light sources can be used for this activity, including fluorescent and incandescent lights and spectra tubes with power supplies. Spectra tubes and the power supplies are available from school science supply catalogs. It may be possible to borrow tubes and supplies from another school if your school does not have them. The advantage of spectrum tubes is that they

provide spectra from different gases such as hydrogen and helium. When using the spectroscope to observe sunlight, students should look at reflected sunlight such as light bouncing off clouds or light colored concrete. Other light sources include streetlights (mercury, low-pressure sodium, and high-pressure sodium), neon signs, and candle flames.

**Assessment:**

Compare student drawn spectra from different light sources.

**Extensions:**

- How do astronomers measure the spectra of objects in space? What do those spectra tell us about these objects?
- Investigate other applications for the electromagnetic spectrum.



# Student Sheet - Simple Spectroscope

Name: \_\_\_\_\_

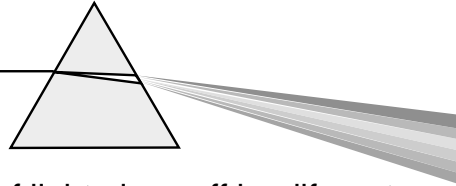

Use your spectroscope to analyze the colors of light given off by different sources. Reproduce the spectra you observe with crayons or colored markers in the spaces below. Identify the light sources. **(When using the Sun as a light source, do not look at it directly with your spectroscope. You can harm your eye. Instead, look at sunlight reflected from a white cloud or a sheet of white paper.)**

Light Source: \_\_\_\_\_

Light Source: \_\_\_\_\_

Light Source \_\_\_\_\_

1. Describe how the spectra of the three light sources you studied differed from each other. How were they similar?
  
  
  
  
  
2. Would you be able to identify the light sources if you only saw their visible spectra?

## ACTIVITY: Projecting Visible Spectra

### Description:

Two methods for projecting the visible spectrum are explained.

### Objective:

To study the range of colors in the visible spectrum.

### National Education Standards:

Mathematics

Measurement

Connections

Science

Change, constancy, & measurement

Abilities necessary to do scientific inquiry

### Materials:

#### Method 1

Flashlight (focusing kind)

Stiff poster board

2 single-edge razor blades  
tape

Glass prism

Projection screen

#### Method 2

Overhead projector

Holographic diffraction grating (See next  
page for sources.)

2 sheets of opaque paper

Tape

Projection screen

### Procedure: Method 1

1. Make a partition with a narrow slot in its center to block all but a narrow beam from the flashlight. Cut out a 4 by 1-centimeter vertical rectangle out from a 10 by 10-centimeter piece of poster board. Tape the two single-edge razor blades to the poster board so that their edges face each other and there is a 1- to 2-millimeter gap between them.
2. Darken the classroom (the darker the better).
3. Brace the partition so that it stands upright with the gap in the vertical direction.
4. Aim the flashlight beam at the screen and focus it into a tight beam. Direct the beam of the flashlight directly through the gap in

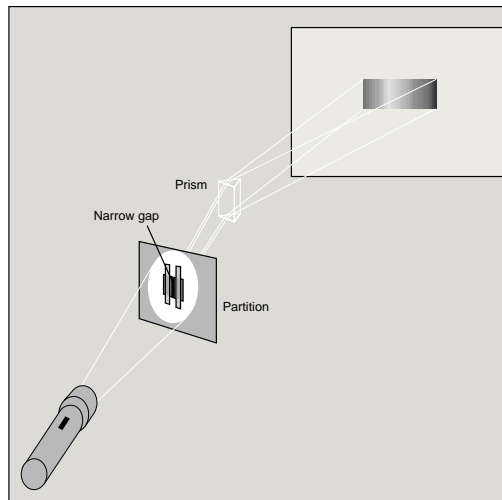

the partition so that a narrow vertical slot of light falls on the screen.

5. Stand the glass prism upright and place it in the narrow beam of light on the opposite side of the partition.
6. Slowly rotate the prism until the narrow slot of light disperses the visible spectrum. Depending upon the exact alignment, the spectrum may fall on a wall rather than on the screen. Adjust the setup so that the spectrum is displayed on the projection screen.

### Procedure: Method 2

1. For this method, you must obtain a piece of holographic diffraction grating—a grating produced by accurate holographic techniques. See page 33 for the source of the grating. **Note:** Method 2 will not work well with a standard transmission grating.
2. Place two pieces of opaque paper on the stage of an overhead projector so that they are almost touching. There should be a narrow gap between them that lets light through. Aim the projector so that a narrow vertical beam of light falls on the projection screen.
3. Hang a square of holographic grating over the projector lens with tape.
4. Darken the classroom (the darker the better).
5. Look for the color produced by the grating. It will fall on the screen or the wall on both sides of the center line of the projector. You may have to adjust the aiming of

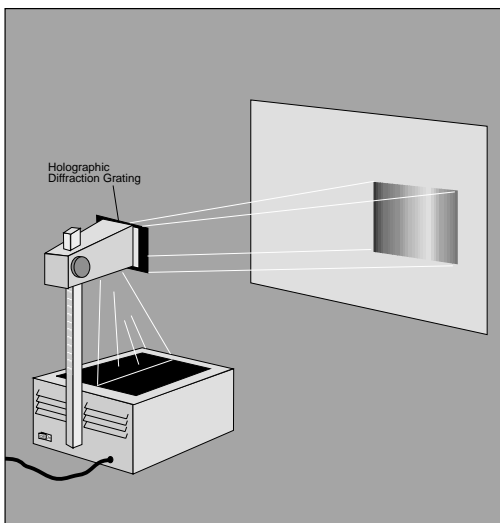

the projector to have one of the two spectra produced fall on the screen.

6. If the spectra produced is a narrow line of color, rotate the holographic film 90 degrees and remount it to the projector lens so that a broad band of color is projected.

### Background:

Visible light, passing through a prism at a suitable angle, is dispersed into its component colors. This happens because of *refraction*. When visible light waves cross an interface between two media of different densities (such as from air into glass) at an angle other than 90 degrees, the light waves are bent (refracted). Different wavelengths of visible light are bent different amounts and this causes them to be dispersed into a continuum of colors. (See diagram.)

Diffraction gratings also disperse light. There are two main kinds of gratings. One transmits light directly. The other is a mirror-like reflection grating. In either case, diffraction gratings have thousands of tiny lines cut into their surfaces. In both kinds of gratings, the visible colors are created by constructive and destructive interference. Additional information on how diffraction gratings work is found in the Analytical Spectroscope activity and in many physics and physical science textbooks.

### Management and Tips:

When projecting spectra, be sure to darken the room as much as possible. If it is not possible to darken the room, a large cardboard box can be used as a light shield for method 1. Cut a small peep-hole to examine the spectra. Method 2 produces a much larger spectra than method 1. In both cases, the size of the spectral display can be enlarged by increasing the distance from the prism or diffraction grating to the screen. The disadvantage of enlarging the display is that only so much light is available from the light source and increasing its dispersion diminishes its intensity. A better light source for method 1 is the Sun. If you have a window with direct sunlight, you can block most of the light except for a narrow beam that you direct through the gap in the partition. You will probably have to place the partition with the slot on its side to display a visible spectra. A slide projector can also be used as a light source for method 1. Refer to the Analytical Spectroscope activity for more information on how the diffraction grating works.

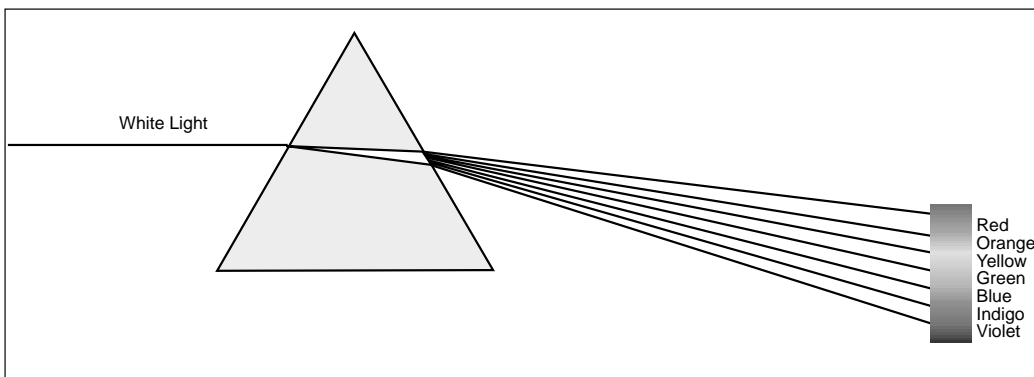

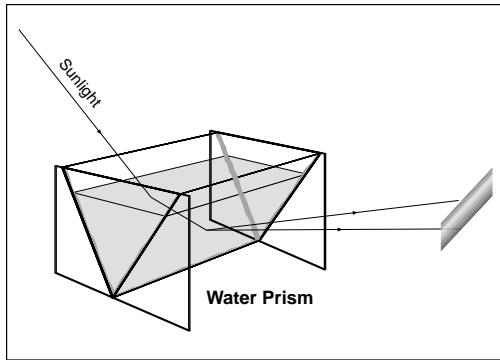

### Assessment:

Have students use crayons or marker pens to sketch the visible spectrum produced. Ask students to identify each color present and to measure the widths of each color band. Have them determine which colors bend more and which bend less as they come through the prism or diffraction grating.

### Extensions:

- Who discovered the visible spectrum? How many colors did the scientist see?
- A compact disk acts like a reflection diffraction grating. Darken the room and shine a strong beam of white light from a flashlight on the disk. The beam will be dispersed by the grating and be visible on a wall.
- Construct a water prism out of four sheets of glass. Glue the sheets together as shown in the illustration with clear silicone aquarium cement. When the cement is dry, fill the V-shaped trough with water and check for leaks. Set the finished water prism in a window with direct sunlight. A visible spectrum will appear

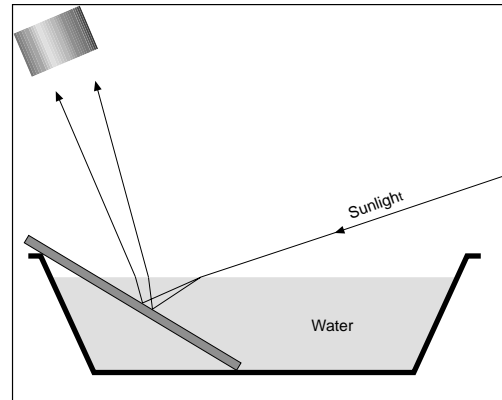

somewhere in the classroom. You can reposition the visible spectrum by bouncing the sunlight off a mirror before it enters the prism in order to change the sunlight angle.

- A pocket mirror placed in a shallow pan of water can also project a spectrum. Set up the mirror and pan as shown in the illustration.

### Sources:

Diffraction gratings are available from most school science catalogs. Holographic diffraction gratings are available from:

Learning Technologies, Inc.  
40 Cameron Avenue  
Somerville, MA 02144  
Phone: 1-800-537-8703

### Reference:

Sadler, P. "Projecting Spectra for Classroom Investigations," *The Physics Teacher*, October 1991, 29(7), pp423–427.

# Projecting Spectra

Name \_\_\_\_\_

Using colored markers or crayons and the chart below, reproduce the electromagnetic spectrum as you see it. Be sure to maintain the proportions of the color widths. Write the names of the colors beneath the chart.

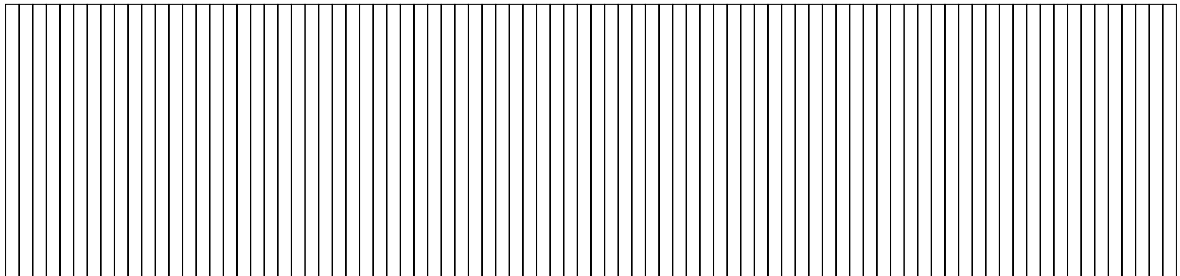

Which color bent the most after passing through the prism or diffraction grating? Why?

Which color bent the least? Why?

## ACTIVITY: Cereal Box

### Analytical Spectroscope

#### Description:

A spectroscope is constructed (from a cereal box and diffraction grating) that permits the analysis of visible light.

#### Objective:

To construct an analytical spectroscope and analyze the spectrum produced when various substances are heated or excited with electricity.

#### National Education Standards:

Mathematics

Measurement

Data analysis, statistics, & probability

Science

Change, constancy, & measurement

Abilities necessary to do scientific inquiry

Abilities of technological design

Understandings about science & technology

Technology

Understand relationships & connections among technologies & other fields

Understand engineering design

#### Materials:

Cereal box (13-15 ounce size)

Holographic diffraction grating (See the Projecting Spectra activity for the source.)

Aluminum foil

Measurement scale

Marker pen

Ruler

Masking tape

Scissors

Razor blade knife

Cutting surface

Spectrum tubes and power supply (See the background and management tips section for information on sources.)

#### Procedure:

1. Cut a 2 by 2-centimeter window from the bottom lid of the cereal box. The window should be near one side.
2. Cut a second window from the upper box lid directly above the lower window.

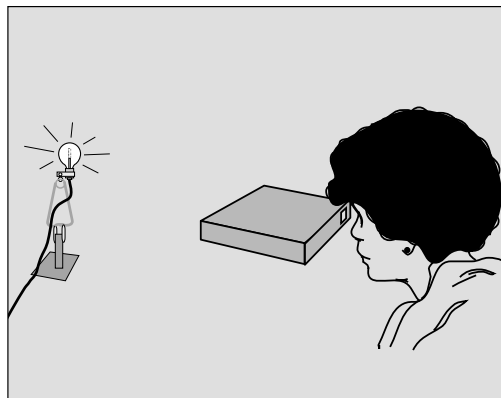

3. Cut a third window in the upper lid. This window should be 1.5 by 10-centimeters in size. Refer to the cutting diagram for placement information of the window.
4. Cut a piece of diffraction grating large enough to cover the window in the box bottom. Handle the grating by the edges if possible; skin oils will damage it. Look at a fluorescent light through the grating. Turn the grating so that the rainbow colors you see appear in fat vertical bars to the right and left of the light. Tape the grating in place.

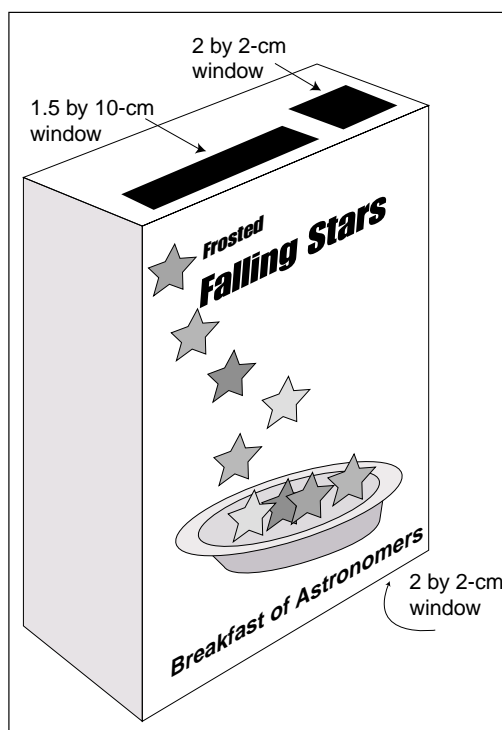

5. Place a 4 by 4-centimeter square of aluminum foil on a cutting surface. Cut a narrow slot into the foil with the razor blade knife. If you made the slot-cutting tool for the simple spectroscope activity, use it here for cutting slots as well.
6. Tape the foil over the upper 2 by 2-centimeter hole in the box lid. The slot should be positioned directly over the hole and aligned perpendicular to the cereal box front.
7. Copy the black measurement ruler on an overhead projector transparency. Several rulers are reproduced in the guide to reduce the number of transparencies needed.
8. Lightly tape the measurement ruler over the rectangular window in the box lid. When you look through the diffraction grating into

the box, you should be able to read the numbers on the ruler with 400 on the right and 700 on the left.

#### Adjusting and Calibrating the Spectroscope:

1. Aim the slot end of the spectroscope towards a fluorescent light. Look through the diffraction grating. A continuous spectrum will be seen off to the side of the spectroscope falling under or partially on top of the measurement ruler. If the spectrum appears as a narrow rainbow-colored line, remove the diffraction grating from the window and rotate it 90 degrees. Tape it back in place.
2. While looking at the fluorescent light, check the position of the measurement ruler. There will be a bright green line in the green portion

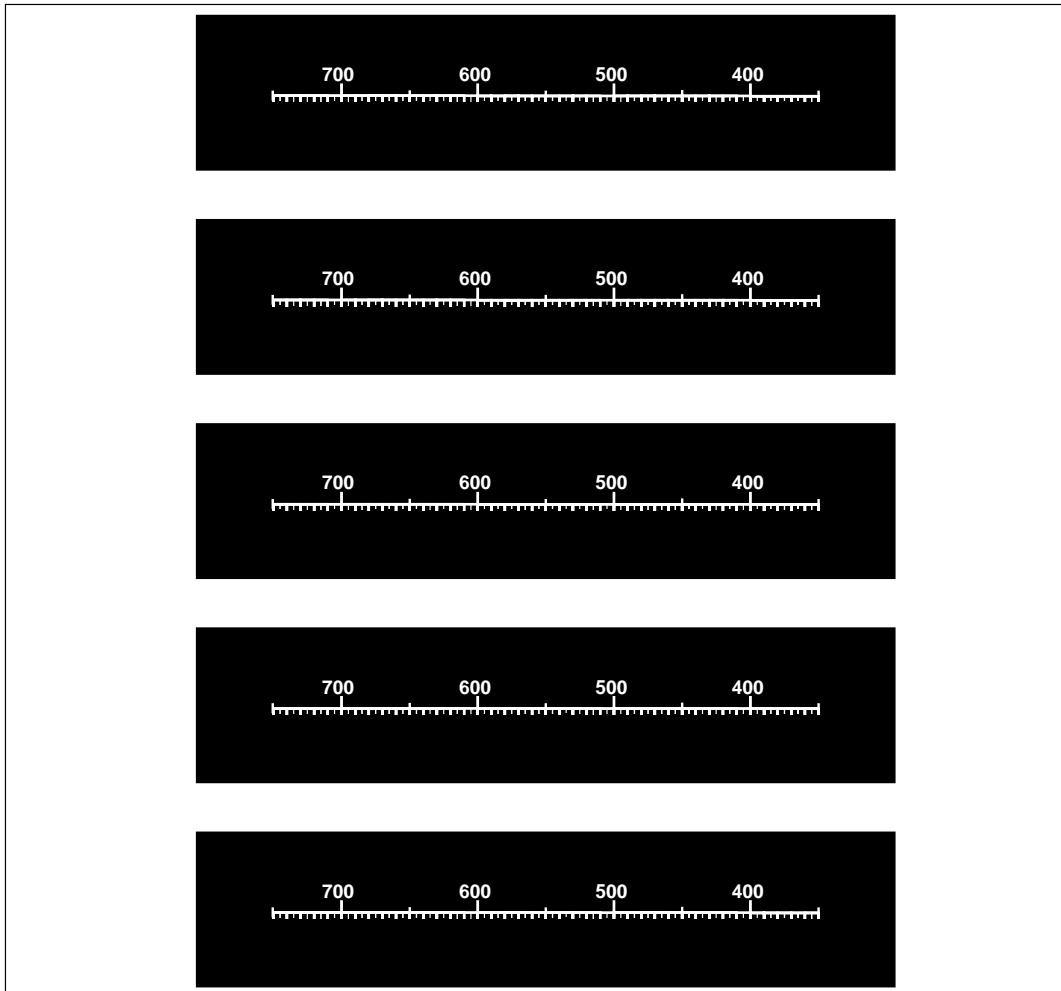

of the spectrum. Adjust the position of the ruler so that the line falls between 540 and 550 on the ruler. Tape the ruler permanently in place. The spectroscope is calibrated.

**Background:**

Unlike a prism, which disperses white light into the rainbow colors through refraction, the diffraction grating used in this spectroscope disperses white light through a process called interference. The grating used in this activity consists of a transparent piece of plastic with many thousands of microscopic parallel grooves. Light passing

between these grooves is dispersed into its component wavelengths and appears as parallel bands of color on the retina of the eye of the observer.

Spectroscopes are important tools for astronomy. They enable astronomers to analyze starlight by providing a measure of the relative amounts of red and blue light a star gives out. Knowing this, astronomers can determine the star's temperature. They also can deduce its chemical composition, estimate its size, and even measure its motion away from or toward Earth (See the activity Red Shift, Blue Shift.)

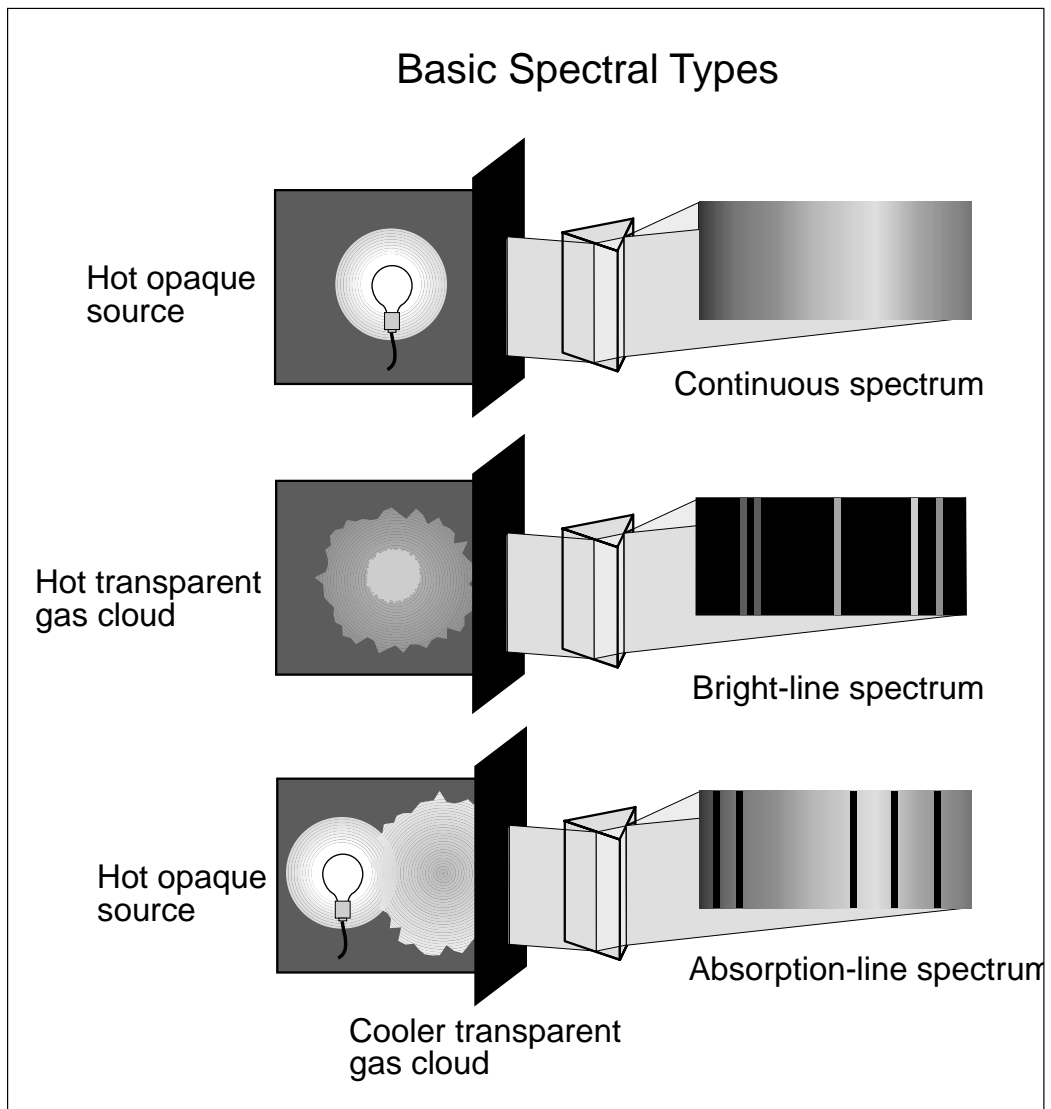



Starlight (photons) originates from the interior of a star. There, pressures are enormous and nuclear fusion is triggered. Intense radiation is produced as atoms, consisting of a surrounded nucleus, collide with each other millions of times each second. The number of collisions depends upon the temperature of the gas. The higher the temperature, the greater the rate of collision.

Because of these collisions, many electrons are boosted to higher energy levels. This process is called excitation. The electrons spontaneously drop back to their original energy level. In doing so, they release energy as photons. This is what happens to the filament of an electric light bulb or to an iron bar when it is heated in a furnace. As the temperature of the filament rises, it begins to radiate reddish light. When the filament becomes much hotter, it radiates bluish light. Thus, the color it radiates is an indicator of the filament's temperature. Stars that radiate a great amount of red light are much cooler than stars that radiate a great amount of blue light. Stellar spectra therefore serve as star thermometers.

Excitation of electrons can also occur if they absorb a photon of the right wavelength. This is what happens when certain materials are exposed to ultraviolet light. These materials then release new photons at different wavelengths. This is called fluorescence.

One of the important applications of spectroscopes is their use for identifying chemical elements. Each element radiates light in specific wavelength combinations that are as distinctive as fingerprints. Knowing the "spectral signatures" of each element enables astronomers to identify the elements present in distant stars by analyzing their spectra.

There are three kinds of spectra: continuous, absorption, and emission. The continuous spectrum appears as a continuous band of color ranging from red to violet when observed through a spectroscope. An absorption spectrum occurs when the light from a star passes through a cloud of gas, hydrogen for example, before reaching the spectroscope. As a result, the hydrogen atoms

absorb some wavelengths of light. This selective absorption produces a spectrum that is a broad band of color interrupted by dark lines representing certain wavelengths of light that were absorbed by the hydrogen cloud. Such a situation occurs when a star is located inside or behind a gas cloud or nebula. An emission spectrum is observed when energy is absorbed by the gas atoms in a nebula and is re-radiated by those atoms at specific wavelengths. This spectrum consists of bright lines against a black background. The light from fluorescent tubes and neon lights produce emission spectra.

Stellar spectra allow astronomers to determine star temperature, chemical composition, and motion along the line of sight. This enables astronomers to classify stars into spectral categories and estimate their age, reconstruct their histories, and postulate their future evolution. When available, astronomers prefer stellar spectra collected by orbiting spacecraft over spectra collected by Earth-based telescopes since they are not affected by atmospheric filtering and are therefore more accurate. Included in the spectra collected by spacecraft are infrared, ultraviolet, x-ray, and gamma ray bands that simply do not reach ground-based spectroscopes.

### **Management and Tips:**

This spectroscope works better with a holographic diffraction grating than with standard diffraction gratings. Refer to the source for holographic gratings listed in the Projecting Spectrums activity. The spectroscope can be used to analyze the wavelengths of light from many light sources. Compare incandescent light, fluorescent light, and sunlight. If you have spectrum tubes and a power supply (available from science supply houses), examine the wavelengths of light produced by the different gases in the tubes. Many high school physics departments have this equipment and it may be possible to borrow it if your school does not. Use the spectroscope to examine neon signs and streetlights. Science supply houses sell spectrum flame kits consisting of various salts that are heated in the flame of a Bunsen burner. These kits are much less expensive than spectrum tubes but are

more difficult to work with because the flames do not last very long.

This spectroscope can also be used to study the spectrum of the Sun. Do not look directly at the Sun with the spectroscope as this could damage your eye. Instead, look at reflected sunlight such as a white cloud or piece of white paper in sunlight (but not in a mirror!). When using the spectroscope in a very dark environment with spectrum tubes, it may be difficult to read the measurement scale. A small flashlight aimed at a white wall behind the spectrum power supply will provide just enough light to read the ruler.

The first student page requires the use of spectrum tubes and a power supply. Have students make spectrographs of five different spectrum tubes. Randomly select one of the five tubes and ask students to make a spectrograph of it. Tell the students to identify this unknown element from their previous spectrographs. The second student page shows several typical bright line spectra from spectrum tubes. This worksheet can be done without the tubes. It is important that students identify more than one line from each element shown in the spectrograph. Some elements have several lines in common. It is the entire combination of lines that makes the identification possible.

### **Work Sheet 2 answers:**

Spectrograph A: Hydrogen, Helium

Spectrograph B: Sodium, Barium, Lithium

Spectrograph C: Calcium, Helium, Hydrogen, Oxygen, Krypton

### **Assessment:**

Examine student spectroscopes to see if the gratings are properly aligned and the measurement ruler is calibrated. Collect the student sheets and compare student answers.

### **Extensions:**

- Compare the solar spectrum at midday and at sunset. Are there any differences? Caution: Be careful not to look directly at the Sun.
- What do spectra tell us about the nature of stars and other objects in space?
- Show how temperature and radiation are related by connecting a clear light bulb to a dimmer switch. Gradually increase the current passing through the filament by turning up the dimmer. Observe the color and brightness of the filament as the temperature of the filament climbs with increasing current.

# Mystery Spectra

Name: \_\_\_\_\_

Use your spectroscope to examine the five elements displayed to you by your teacher. Make sketches of the bright lines visible in the spaces below.

Element Name: \_\_\_\_\_

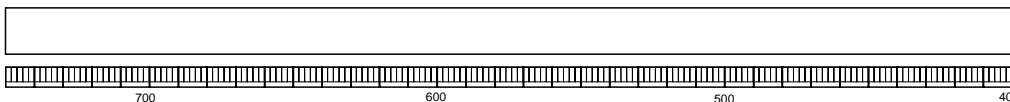

Element Name: \_\_\_\_\_

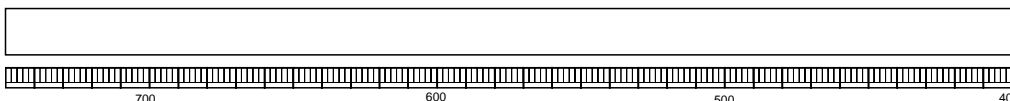

Element Name: \_\_\_\_\_

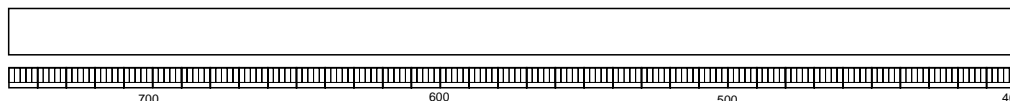

Element Name: \_\_\_\_\_

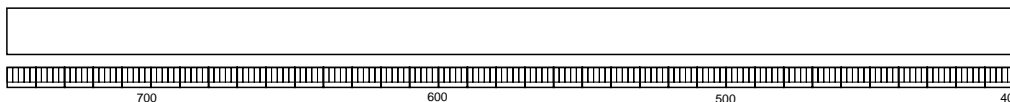

Element Name: \_\_\_\_\_

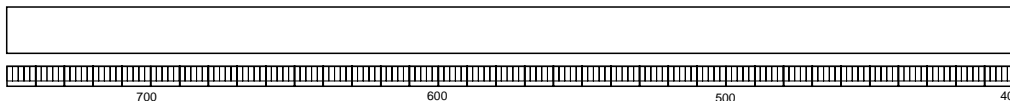

Use your spectroscope to examine the unknown element displayed to you by your teacher. Make a sketch of the bright lines visible in the space below. Compare your unknown element to the spectra above. Identify the element.

Element Name: \_\_\_\_\_

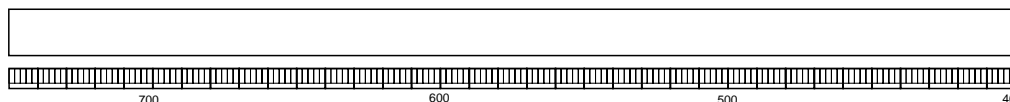

# Mystery Spectra

Name: \_\_\_\_\_

Identify the elements in spectra A, B, and C by comparing the bright lines present with the bright lines in the spectra for know elements.



Spectra A Elements: \_\_\_\_\_



Spectra B Elements: \_\_\_\_\_



Spectra C Elements: \_\_\_\_\_



## ACTIVITY: Red Shift, Blue Shift

### Description:

A Whiffle® ball containing a battery-operated buzzer is twirled in a circle to demonstrate the Doppler effect. This same effect causes starlight to shift toward the blue or red end of the spectrum if a star is moving towards or away from us.

### Objective:

To demonstrate how stellar spectra can be used to measure a star's motion relative to Earth along the line of sight.

### National Education Standards:

Mathematics

- Patterns, functions, & algebra
- Geometry & spatial sense
- Measurement
- Data Analysis, statistics, & probability
- Connections

Science

- Change, constancy, & measurement
- Abilities necessary to do scientific inquiry
- Motions & forces

Technology

- Understand relationships & connections among technologies & other fields

### Materials:

- Plastic Whiffle® ball (12-15 cm in diameter)
- Microswitch\*
- Small buzzer\*
- 9-volt battery\*
- Cord (3 meters long)
- Solder and soldering iron
- Sharp knife or hacksaw blade
- Masking tape

\* See Management Tips note about electronic parts.

### Procedure:

1. Splice and solder the buzzer, battery clip, and microswitch in a series circuit. See the wiring diagram for details on the connections. Be sure to test the circuit before soldering. Many small buzzers require the electric current to flow in one direction and will not work if the current flows in the other direction.
2. Split the Whiffle® ball in half along the seam

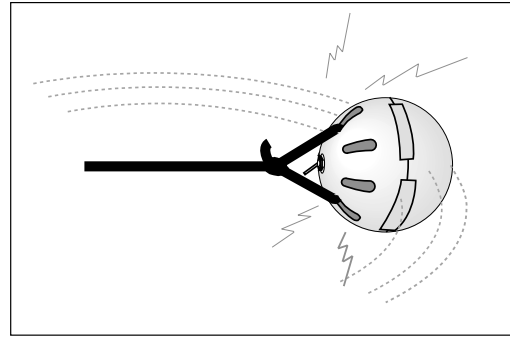

3. Remove the nut from the microswitch and insert the threaded shaft through one of the holes as shown in the diagram. If a hole is not present in the location shown, use a drill to make one the correct diameter. Place the nut back over the threaded shaft on the microswitch and tighten.
4. Join the two halves of the ball together with the switch, buzzer, and battery inside. Tape the halves securely together.
5. Tie one end of the cord to the ball as shown.
6. Station students in a circle about 6 meters in diameter. Stand in the middle of the students, turn on the buzzer, and twirl the ball in a circle. Play out 2 to 3 meters of cord.
7. Ask the students to describe what they hear as the ball moves towards and away from them.
8. Let different students try twirling the ball. Ask them to describe what they hear.

As an alternate suggestion to the Whiffle® ball, cut a cavity inside a foam rubber ball and insert the battery and buzzer. The ball can then be tossed from student to student while demonstrating the Doppler effect.

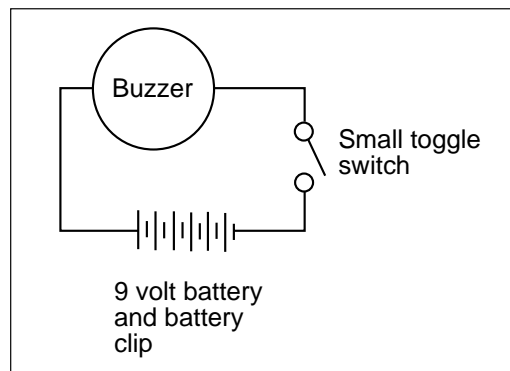

### Background:

This is a demonstration of the phenomenon called the Doppler effect. It results from the motion of a source (star) relative to the observer and causes its spectra to be shifted toward the red (going away) or toward the blue (coming towards) end of the spectra.

Like light, sound travels in waves and therefore provides an excellent model of the wave behavior of light. The number of waves reaching an observer in one second is called the frequency. For a given speed, frequency depends upon the length of the wave. Long waves have a lower frequency than short waves. As long as the distance between the source of the waves and the observer remains constant, the frequency remains constant. However, if the distance between the observer and the source is increasing, the frequency will decrease. If the distance is decreasing, the frequency will increase.

Imagine that you are at a railroad crossing and a train is approaching. The train is ringing a bell. The sound waves coming from the bell are squeezed closer together than they would be if the train were still, because of the train's movement in your direction. This squeezing of the waves increases the number of waves (increases the frequency) that reach your ear every second. But after the train's engine passes the crossing, the frequency diminishes and the pitch lowers. In effect, the sound waves are stretched apart

by the train's movement in the opposite direction. As the observer, you perceive these frequency changes as changes in the pitch of the sound. The sound's pitch is higher as the train approaches and lower as it travels away. The illustration below provides a graphical representation of what happens.

$$\frac{V_r}{C} = \frac{\Delta\lambda}{\lambda_0}$$

$V_r$  - radial velocity of the source with respect to the observer.

$c$  - speed of light ( $3 \times 10^5$  km/sec)

$\Delta\lambda$  the amount of the shift in nanometers

$\lambda_0$  - unshifted wavelength in nanometers

$$V_r = \frac{0.1 \text{ nm} \times 3 \times 10^5 \text{ km/sec}}{600 \text{ nm}} = 50 \text{ km/sec}$$

For example, if a line in a spectrum should fall at 600.0 nanometers but instead lies at 600.1, what would the radial velocity be?

The solution to this equation only tells us the velocity of the source relative to the spectroscope. Whether the distance is increasing or decreasing is revealed by the direction of the shift to the red or blue end of the visible spectrum. It does not tell, however, if one or both objects are moving relative to some external reference point.

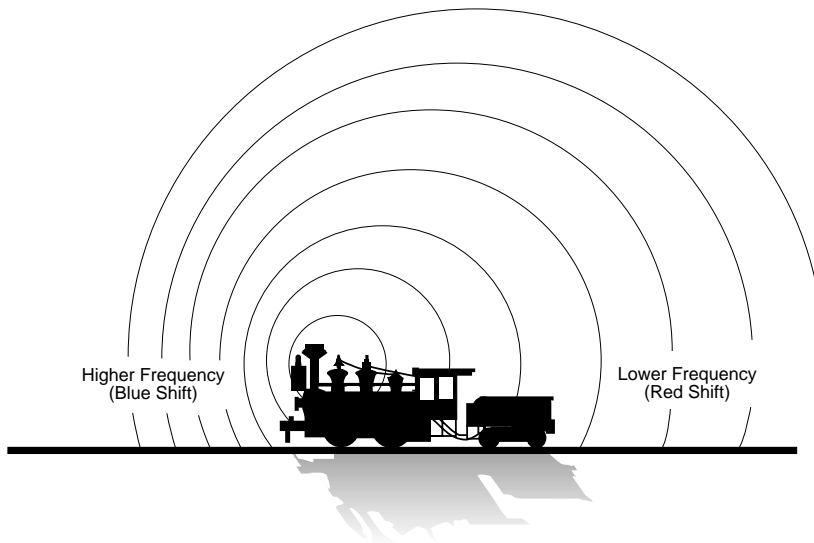

### Management and Tips:

The amount of pitch change as the buzzer twirls is directly related to how fast you twirl the buzzer. Twirling the buzzer faster means that the buzzer approaches and travels away from the observer faster. The person twirling the buzzer does not hear the pitch change no matter how fast the buzzer is twirled; it remains the same distance from the twirler. The observers standing away from the twirler will hear the pitch change as the buzzer goes toward and away from the observer's ear.

### Note About Electronic Parts:

The electronic parts for this device are not specified exactly since there are many combinations that will work. Go to an electronic parts store and select a buzzer, battery holder, battery, and switch from what is available. Remember to purchase parts that will fit in a Whiffle® ball. The store clerk should be able to help you make a workable selection if you need assistance. If possible, test the buzzer before purchasing it to determine if it is loud enough. Test the buzzer and battery before soldering connections. The buzzer may be polarized. Reverse the connections if you do not hear a sound the first time.

### Answers to Work Sheets:

Sheet 1

1. The greater the difference in the pitch above or below the normal pitch, the faster the vehicle is moving.
2. A – lower, B – higher, C – the same
3. Stars moving toward us become slightly bluer. Stars moving away become slightly redder.

4. Astronomers look at the spectrograph of a star and compare the position of bright lines in the spectrograph with where the lines should be if the star were not moving at all. A shift to the red end of the spectrum indicates a star is moving away and a shift toward the blue end indicates the star is moving towards us. The amount of the shift indicates relative velocity. The greater the shift, the greater the velocity.
5. No. The movement can be determined if the distance to the star is known. How fast the star moves against the background of more distant stars can be measured and the speed of the star calculated.

Sheet 2

Star 1 – 100 km/sec away

Star 2 – 260.7 km/sec toward

Star 3 – 418.6 km/sec away

### Assessment:

Collect student worksheets and compare the answers.

### Extensions:

- Can the red/blue shift technique be used for objects other than stars? Can you tell which way an emergency vehicle is traveling by the pitch of its siren?
- Transverse velocity is a motion that is perpendicular to radial velocity. Can this motion be detected by the Doppler effect?
- What has the Doppler effect told astronomers about the size of the universe?

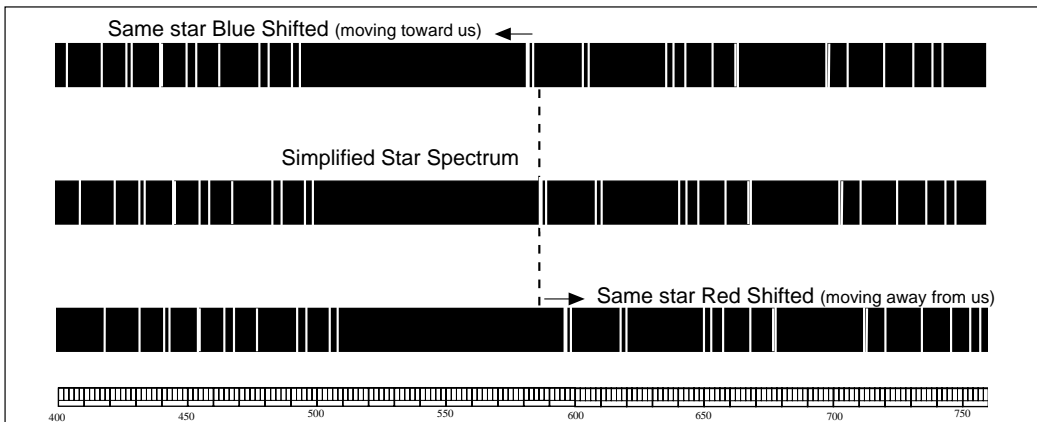

## Red Shift, Blue Shift

Name: \_\_\_\_\_

1. How can you estimate the speed of a car that has passed you just by listening to the pitch of its whine?

2. Label the diagram below and tell if the observer perceives a pitch that is higher, lower, or just the same as the pitch heard by the driver.

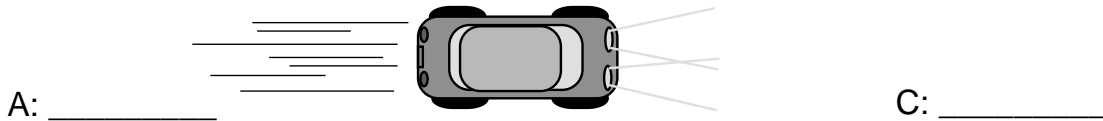

3. How does the doppler shift affect the color of a star?

4. Describe how astronomers can use the doppler shift to determine if a star is moving toward us or away and how fast?

5. If a star is moving perpendicular to our line of sight, can you use the doppler shift to determine its speed? If not, how might you determine its speed?



## Red Shift, Blue Shift

**Name:** \_\_\_\_\_

Use the equation below to determine the velocity of several stars whose spectra have shifted. Are the stars moving toward or away from us? Show your work on the back side of this page.

$$V_r = \frac{\Delta\lambda \times C}{\lambda_0}$$

$V_r$  = radial velocity

$C$  = speed of light ( $3 \times 10^5$  km/sec or 300,000 km/sec)

$\Delta\lambda$  = amount of shift in nanometers

$\lambda_0$  = unshifted wavelength in nanometers

**Star 1:** The spectrum has shifted from 600.0 to 600.2 nm

Velocity = \_\_\_\_\_ km/sec

Moving toward or away from us? \_\_\_\_\_

**Star 2:** The spectrum has shifted from 575.3 to 574.8 nm

Velocity = \_\_\_\_\_ km/sec

Moving toward or away from us? \_\_\_\_\_

**Star 3:** The spectrum has shifted from 501.6 to 502.3 nm

Velocity = \_\_\_\_\_ km/sec

Moving toward or away from us? \_\_\_\_\_

## ACTIVITY: Wavelength and Energy

### Description:

Shaking a rope permits students to feel the relationship between wavelength, frequency, and energy.

### Objective:

To demonstrate the relationship between wave frequency and energy in the electromagnetic spectrum.

### National Education Standards:

Mathematics

Measurement

Data analysis, statistics, & probability

Science

Evidence, models, & explanation

Change, constancy, & measurement

Abilities necessary to do scientific inquiry

Motions & forces

Transfer of energy

Technology

Understand relationships & connections among technologies & other fields

### Materials:

Rope – 50-ft. length of cotton clothesline

Tape measure

Stopwatch or clock with second hand

### Procedure:

1. Select two students to hold the rope. Have each student stand in an aisle or in opposite corners of the classroom so that the rope is taut between them.
2. While one end of the rope is held still, have the other student shake the opposite end up and down at a moderate but steady rate.

3. Ask other students to observe the wave patterns created in the rope. Point out wave crests and troughs. Ask your students to measure the *wavelength* and *frequency* of waves reaching the other student. The wavelength is the distance from wave crest to wave crest (or wave trough to wave trough). The wavelength can be measured by having one student stand next to the rope where a wave crest is repeatedly formed and having a second student stand where the next crest is formed. Measure the distance between the students. Frequency is the number of waves reaching the far end of the rope each second. Frequency can be estimated by counting the number of times the student shakes the rope each second.
4. Tell the student shaking the rope to shake it faster. Again estimate the wavelength and frequency.
5. Tell the student shaking the rope to shake the rope as fast as he or she can. Again, estimate the wavelength and frequency.
6. Stop the demonstration and ask the student shaking the rope if it is easier to produce low frequency (long wavelength) or high frequency (short wavelength) waves.

### Background:

This activity provides a graphic demonstration of the relationship between energy and wavelength. The student shaking the rope will find that creating many waves each second takes much more energy than producing only a few waves per second. High-frequency waves (short wavelength) represent more energy than low-frequency (long wavelength) waves. Astronomers find the relationship between wavelengths, frequency, and energy very useful. Radio waves

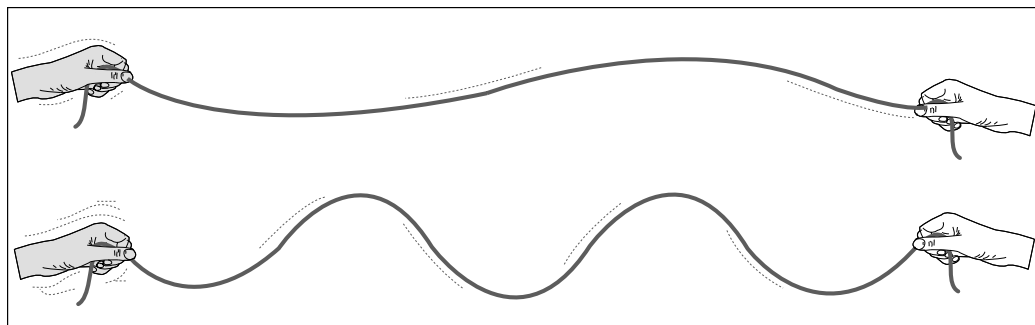

$$E = \frac{hc}{\lambda}$$

$$E = hf$$

Planck's Constant =  $6.63 \times 10^{-34}$  J · s

$f$  is the frequency in hertz

$\lambda$  is the wavelength in meters

from astronomical objects have very long wavelengths and low frequencies. The waves are generated by relatively quiet processes. Gamma rays, on the other end of the electromagnetic spectrum, have very short wavelengths and high frequencies and represent the most violent processes in space. The frequency of electromagnetic energy coming from an object tells astronomers much about how that object was created and what was happening at the time the energy was emitted into space.

#### Management and Tips:

The quality of the demonstrations can be greatly enhanced by using a wave demonstration spring. These springs are available from school science supply catalogs for a few dollars. The springs are long coils and when stretched and

agitated, produce excellent waves. The increased mass of the spring over the cotton clothesline enhances the wave motions. If a strobe light is available, the appearance of the wave motions can be enhanced by playing the light on the moving rope or spring and adjusting the strobe frequency. A Slinky® can also be used to demonstrate wave motion but it will work best if the Slinky® is placed on a long table and the spring is shaken from side to side.

Permit other students to shake the rope so they can feel, as well as see, the relationship between frequency, wavelength, and energy.

#### Assessment:

Make sure students understand the relationship between frequency and wavelength and the amount of energy required to produce the waves. Collect and compare the student sheets.

#### Extensions:

- Invite a hospital medical imaging specialist to talk to the class about the use of high-frequency electromagnetic waves in medical diagnosis.
- Make an overhead projector transparency of the spectrum chart on page 00. Ask the students to relate energy to the electromagnetic wavelengths depicted.

## ACTIVITY: Resonating Atmosphere

### Description:

Students construct a paper and tape device that demonstrates the property of resonance.

### Objective:

To show how atoms and molecules of gas in Earth's atmosphere absorb electromagnetic energy through resonance.

### National Education Standards:

Mathematics

Measurement

Science

Evidence, models, & explanation

Change, constancy, & measurement

Motion & forces

Transfer of energy

Structure of the Earth system

### Materials:

Used lightweight file folder

Cardboard sheet about 20 by 30 cm

Masking tape

Scissors

### Procedure:

1. Cut two strips of paper from the file folder. Each strip should be 3 cm wide. Make one strip approximately 30 cm and the other 35 cm long.
2. Curl each strip into a cylinder and tape the ends together.
3. Tape the cylinders to the cardboard as shown in the diagram.
4. Holding the cardboard along one of its edges, slowly shake the rings back and forth. Observe the movements of the rings as you gradually increase the frequency (rate) of the shaking.

### Background:

All objects and materials have a natural frequency at which they vibrate. With some materials, the vibration is easily observed. Many students have discovered that a plastic ruler extended over the edge of a desk will vibrate when it is deflected and released. If the extension of the ruler over the desk edge is reduced, the frequency of the

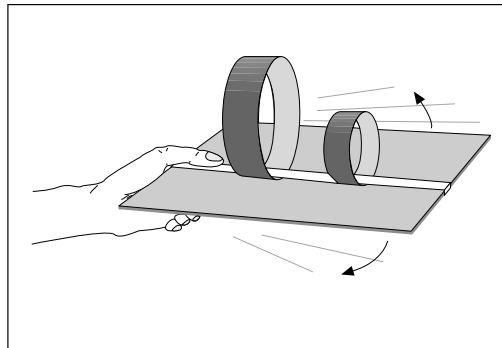

vibration is increased. When students shake the cardboard and paper rings, the number of times it moves back and forth in a second is the frequency. At first, the movement of the rings will be erratic. However, by increasing or decreasing the frequency of the shaking, the students will eventually match the natural frequency of one of the rings. That ring will begin bouncing back and forth in time with the shaking. The movement of the other ring will continue to be erratic until its frequency is matched. When that happens, the first ring's movement will become erratic again. As the frequency of one of the rings is matched, it absorbs some of the energy the student is adding into the system through shaking. The absorption only occurs when the correct frequency is reached. This effect is called resonance. Resonance takes place when energy of the right frequency (or multiples of the right frequency) is added to an object causing it to vibrate.

When electromagnetic radiation enters Earth's atmosphere, certain wavelengths match the natural frequencies of atoms and molecules of various atmospheric gases such as nitrogen and ozone. When this happens, the energy in those wavelengths is absorbed by those atoms or molecules, intercepting this energy before it reaches Earth's surface. Wavelengths that do not match the natural frequencies of these atmospheric constituents pass through.

Resonance is important to astronomy for another reason. All starlight begins in the center of the star as a product of nuclear fusion. As the radiation emerges from the photosphere or surface of the star, some wavelengths of radiation may be missing. The missing components produce dark

lines, called *absorption lines*, in the star's spectra. The lines are created as the radiation passes through the outer gaseous layers of the star. Some of that radiation will be absorbed as various gas atoms present there resonate. Absorption lines tell what elements are present in the outer gaseous layers of the star.

**Management and Tips:**

Students may experience a little difficulty in making the paper ring resonator work at first. The main thing is to be consistent in the shaking of the rings. Although they will be changing from low to high frequencies, after the changes are made, the frequencies should be held constant and vary significantly. Erratic shaking will produce erratic movement in the rings.

See the extensions below for other ways of demonstrating resonance.

**Assessment:**

Ask students to explain the concept of resonance and how it applies to electromagnetic radiation coming to Earth from space.

**Extensions:**

- Resonance can be demonstrated in a number of ways. If you have sympathetic tuning forks (available from school science supply companies), arrange the bases so that they face each other. Strike one fork and the other fork, set to the same frequency, will begin vibrating as well. Touch the first fork to dampen its vibration and you will hear the

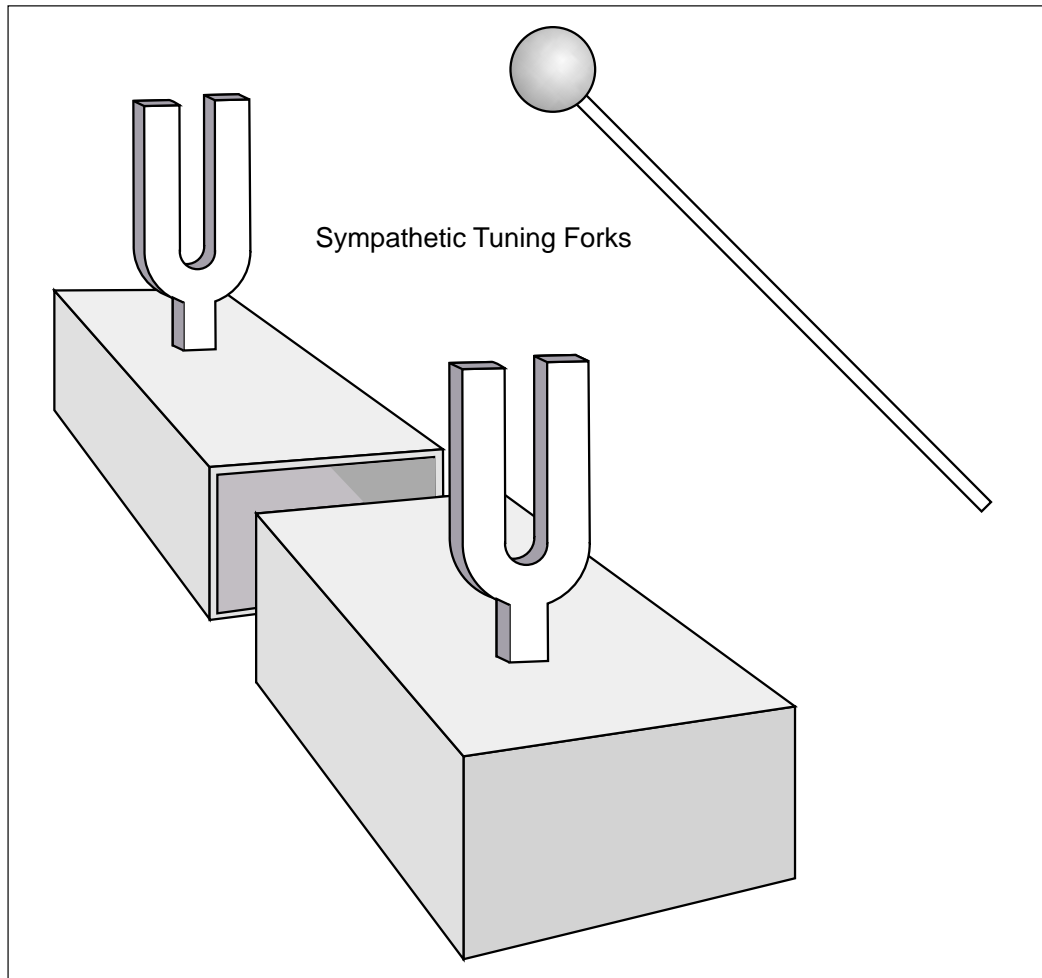

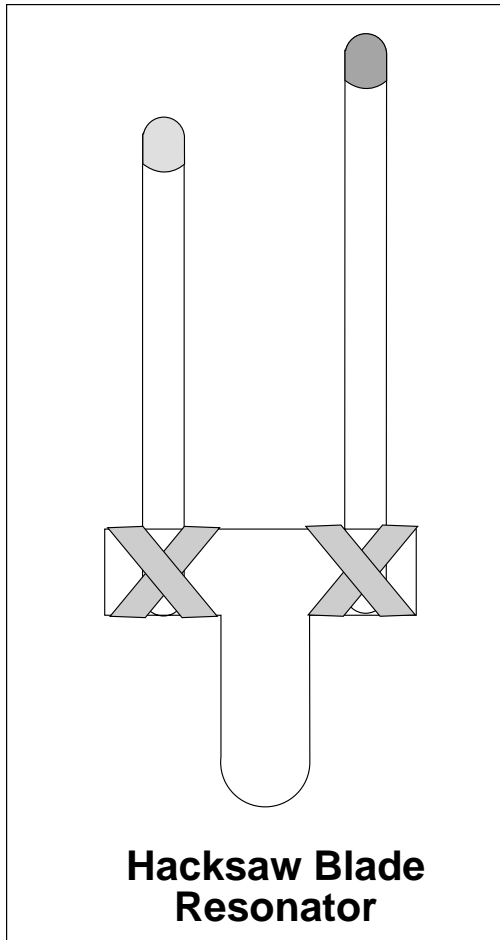

sound produced by the second fork even though you did not strike. The second fork will absorb energy from the first fork and begin vibrating as well.

- Construct a hacksaw blade resonator. Make a small handle of 1/4-inch plywood or 1/8-inch masonite. Tape two hacksaw blades to the handle as shown. Use a 10-inch and a 12-inch hacksaw blade. Add colored tape or paint the ends of the blades to make them more visible. Shake the handle from side to side. The handle should be held vertically so that the flat side of the blades is perpendicular to the movement. Like the paper ring device, the blades will begin moving when their natural frequencies are matched.
- Investigate the natural frequencies of various objects such as bells, wine goblets, and tuning forks.
- Why has the playing of the song “Louie, Louie” been banned at several college football stadiums? Why do marching soldiers crossing a bridge “break cadence?”
- What gas in Earth’s upper atmosphere blocks ultraviolet radiation? Why is that important?

## Resonating Atmosphere

Name: \_\_\_\_\_

1. Describe what happened to the paper rings as you shook the cardboard base back and forth.
2. What happened when you increased the frequency of the shaking motion?
3. What happened when you decreased the frequency of the shaking motion?
4. Which ring requires the higher-frequency to move in phase with the shaking motion?  
Which ring moves in phase with the lower-frequency shaking motion?  
Circle the correct answer.

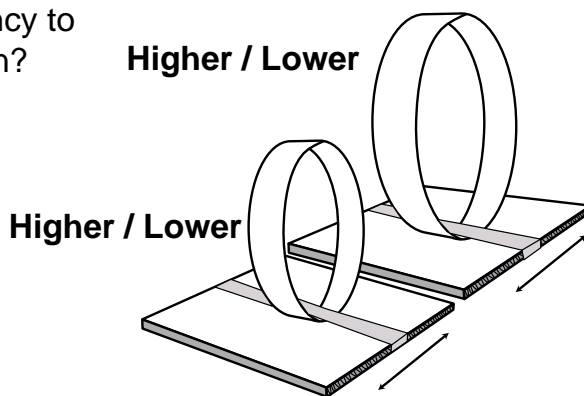

5. Define resonance. You may use the experiment with the paper rings in your explanation.
6. Explain how resonance of some of the atoms and molecules in Earth's atmosphere interferes with astronomical observations.

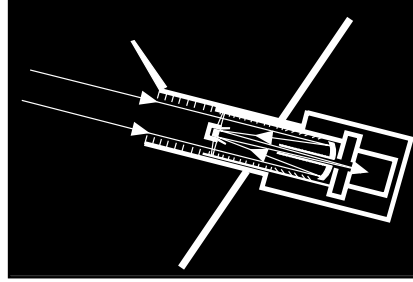

# UNIT 3

## COLLECTING

# ELECTROMAGNETIC RADIATION

---

### Introduction

Except for rock samples brought back from the Moon by Apollo astronauts, cosmic ray particles that reach the atmosphere, and meteorites and comet dust that fall to Earth, the only information about objects in space comes to Earth in the form of electromagnetic radiation. How astronomers collect this radiation determines what they learn from it. The most basic collector is the human eye. The retina at the back of the eye is covered with tiny antennae—called rods and cones—that resonate with incoming light. Resonance with visible electromagnetic radiation stimulates nerve endings, which send messages to the brain that are interpreted as visual images. Cones in the retina are sensitive to the colors of the visible spectrum, while the rods are most sensitive to black and white.

Until the early 1600s, astronomers had only their eyes and a collection of geometric devices to observe the universe and measure locations of stellar objects. They concentrated on the movements of planets and transient objects such as comets and meteors. However, when Galileo Galilei used the newly invented tele-

scope to study the Moon, planets, and the Sun, our knowledge of the universe changed dramatically. He was able to observe moons circling Jupiter, craters on the Moon, phases of Venus, and spots on the Sun. Note: Galileo did his solar observations by projecting light through his telescope on to a white surface—a technique



that is very effective even today. **Never look directly at the Sun!**

Galileo's telescope and all optical telescopes that have been constructed since are collectors of electromagnetic radiation. The objective or front lens of Galileo's telescope was only a few centimeters in diameter. Light rays falling on that lens were bent and concentrated into a narrow beam that emerged through a second lens, entered his eye, and landed on his retina. The lens diameter was much larger than the diameter of the pupil of Galileo's eye, so it collected much more light than Galileo's unaided eye could gather. The telescope's lenses magnified the images of distant objects three times.

Since Galileo's time, many huge telescopes have been constructed. Most have employed big mirrors as the light collector. The bigger the mirror or lens, the more light could be gathered and the fainter the source that the astronomer can detect. The famous 5-meter-diameter Hale Telescope on Mt. Palomar is able to gather 640,000 times the amount of light a typical eye could receive. The amount of light one telescope receives compared to the human eye is its light gathering power (LGP). Much larger even than the Hale Telescope is the Keck Telescope that has an effective diameter of 10 meters. Its light gathering power is two and a half million times that of the typical eye. Although NASA's Hubble Space Telescope, in orbit above Earth's atmosphere, has only a LGP of 144,000, it has the advantage of an unfiltered view of the universe. Furthermore, its sensitivity extends into infrared and ultraviolet wavelengths.

Once a telescope collects photons, the detection method becomes important. Telescopes are collectors, not detectors. Like all other telescopes, the mirror of the Hubble Space Telescope is a photon collector that gathers the photons to a focus so a detector can pick them up. It has several filters that move in front of the detector so images can be made at specific wavelengths.

In the early days, astronomers recorded what they saw through telescopes by drawing pictures

and taking notes. When photography was invented, astronomers replaced their eyes with photographic plates. A photographic plate is similar to the film used in a modern camera except that the emulsion was supported on glass plates instead of plastic. The emulsion collected photons to build images and spectra. Astronomers also employed the photo-multiplier tube, an electronic device for counting photons.

The second half of this century saw the development of the Charge Coupled Device (CCD), a computer-run system that collects photons on a small computer chip. CCDs have now replaced the photographic plate for most astronomical observations. If astronomers require spectra, they insert a spectrograph between the telescope and the CCD. This arrangement provides digital spectral data.

Driving each of these advances was the need for greater sensitivity and accuracy of the data. Photographic plates, still used for wide-field studies, collect up to about five percent of the photons that fall on them. A CCD collects 85 to 95 percent of the photons. Because CCDs are small and can only observe a small part of the sky at a time, they are especially suited for deep space observations.

Because the entire electromagnetic spectrum represents a broad range of wavelengths and energies (see illustration on page 55), no one detector can record all types of radiation. Antennas are used to collect radio and microwave energies. To collect very faint signals, astronomers use large parabolic radio antennas that reflect incoming radiation to a focus much in the same way reflector telescopes collect and concentrate light. Radio receivers at the focus convert the radiation into electric currents that can be studied.

Sensitive solid state heat detectors measure infrared radiation, higher in energy and shorter in wavelength than radio and microwave radiation. Mirrors in aircraft, balloons, and orbiting spacecraft can concentrate infrared radiation onto the detectors that work like CCDs in the infrared range. Because infrared radiation is

## Transparency of Earth's Atmosphere

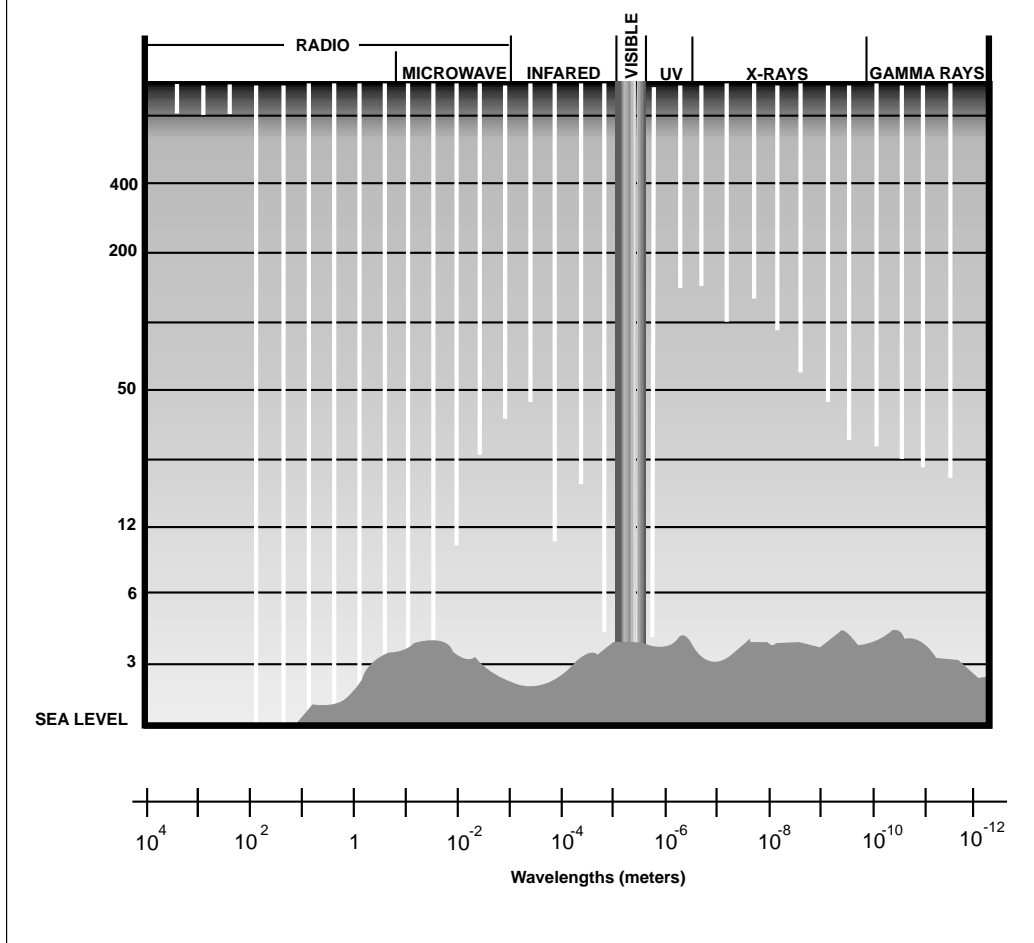

associated with heat, infrared detectors must be kept at very low temperatures lest the telescope's own stored heat energy interferes with the radiation coming from distant objects.

A grazing-incidence instrument consists of a mirrored cone that directs high-energy radiation to detectors placed at the mirror's apex. Different mirror coatings are used to enhance the reflectivity of the mirrors to specific wavelengths.

X-ray spacecraft, such as the Chandra X-ray Observatory, also use grazing-incidence mirrors and solid state detectors while gamma ray spacecraft use a detector of an entirely different kind.

The Compton Gamma-Ray Observatory has eight 1-meter-sized crystals of sodium iodide that detect incoming gamma rays as the observatory orbits Earth. Sodium iodide is sensitive to gamma rays but not to optical and radio wavelengths. The big crystal is simply a detector of photons—it does not focus them.

Today, astronomers can choose to collect and count photons, focus the photons to build up an image, or disperse the photons into their various wavelengths. High-energy photons are usually detected with counting techniques. The other wavelengths are detected with counting (photometry), focusing methods (imaging), or dis-

persion methods (spectroscopy). The particular instrument or combination of instruments astronomers choose depends not only on the spectral region to be observed, but also on the object under observation. Stars are point sources in the sky. Galaxies are not. So the astronomer must select a combination that provides good stellar images or good galaxy images.

Another important property of astronomical instruments is resolution. This is the ability to separate two closely-spaced objects from each other. For example, a pair of automobile headlights appears to be one bright light when seen in the distance along a straight highway. Close up, the headlights resolve into two. Since telescopes, for example, have the effect of increasing the power of our vision, they improve our resolution of distant objects as well. The design and diameter of astronomical instruments determines whether the resolution is high or low. For stellar work, high resolution is important so the astronomer can study one star at a

time. For galaxy work, the individual stars in a galaxy may often not be as important as the whole ensemble of stars.

### **Unit Goals**

- To demonstrate how electromagnetic radiation can be collected and detected through the use of mirrors, lenses, and infrared detectors.
- To illustrate how the use of large instruments for collecting electromagnetic radiation increases the quantity and quality of data collected.

### **Teaching Strategy**

Because many of the wavelengths in the electromagnetic spectrum are difficult or dangerous to work with, activities in this section concentrate on the visible spectrum, the near infrared, and radio wavelengths. Several of the activities involve lenses and mirrors. The Visible Light Collector activity provides many tips for obtaining a variety of lenses and mirrors at little or no cost.

## ACTIVITY: Visible Light Collectors

### (Telescopes)

#### Description:

A simple refractor telescope is made from a mailing tube, Styrofoam tray, rubber cement, and some lenses and the principle behind a reflector telescope is demonstrated.

#### Objectives:

To build a simple astronomical telescope from two lenses and some tubes.

To use a concave mirror to focus an image.

#### National Education Standards:

Mathematics

Measurement

Connections

Science

Change, constancy, & measurement

Abilities of technological design

Understanding about science & technology

History of science

Technology

Understand relationships & connections among technologies & other fields

Understand cultural, social, economic, & political effects of technology

Understand the influence of technology on history

Understand, select, & use information & communication technologies

#### Materials:

Paper mailing tube (telescoping—1 inside tube and 1 outside tube)

Styrofoam trays (1 thick and 1 thin)

Lenses (1 large and 1 small. See note about lenses.)

Metric ruler

Razor blade knife

Cutting surface

Marker pen

Rubber cement

Fine grade sandpaper

Concave makeup mirror

Electric holiday candle or other small light source

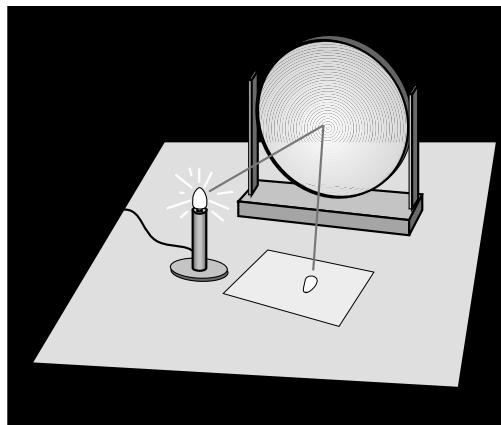

Dark room

Sheet of white paper

Assorted convex lenses (See section on Obtaining and Making Lenses and Mirrors.)

#### Part 1 - Procedure for Making a Refractor Telescope:

1. Cut a short segment from the end of the outside mailing tube. This circle will be used for tracing only. Place the circle from the larger tube on the thick tray. Using a marker pen, trace the inside of the circle on to the bottom of the tray three times.
2. Lay the large (objective) lens in the center of one of the three large circles. Trace the lens' outline on the circle.
3. Cut the circle with the lens tracing from the tray using the razor blade knife. Be sure to place the Styrofoam on a safe cutting surface. Cut out the lens tracing, but when doing so, cut inside the line so that the hole is slightly smaller than the diameter of the lens.
4. Before cutting out the other two large circles, draw smaller circles inside them approximately equal to  $7/8$ ths of the diameter of the large lens. Cut out both circles inside and out.
5. Coat both sides of the inner circle (the one that holds the lens) with rubber cement and let dry. Coat just one side each of the other two circles with cement and let dry. For a better bond, coat again with glue and let dry.
6. Insert the lens into the inner circle. It will be snug. Press the other circles to either side. Be

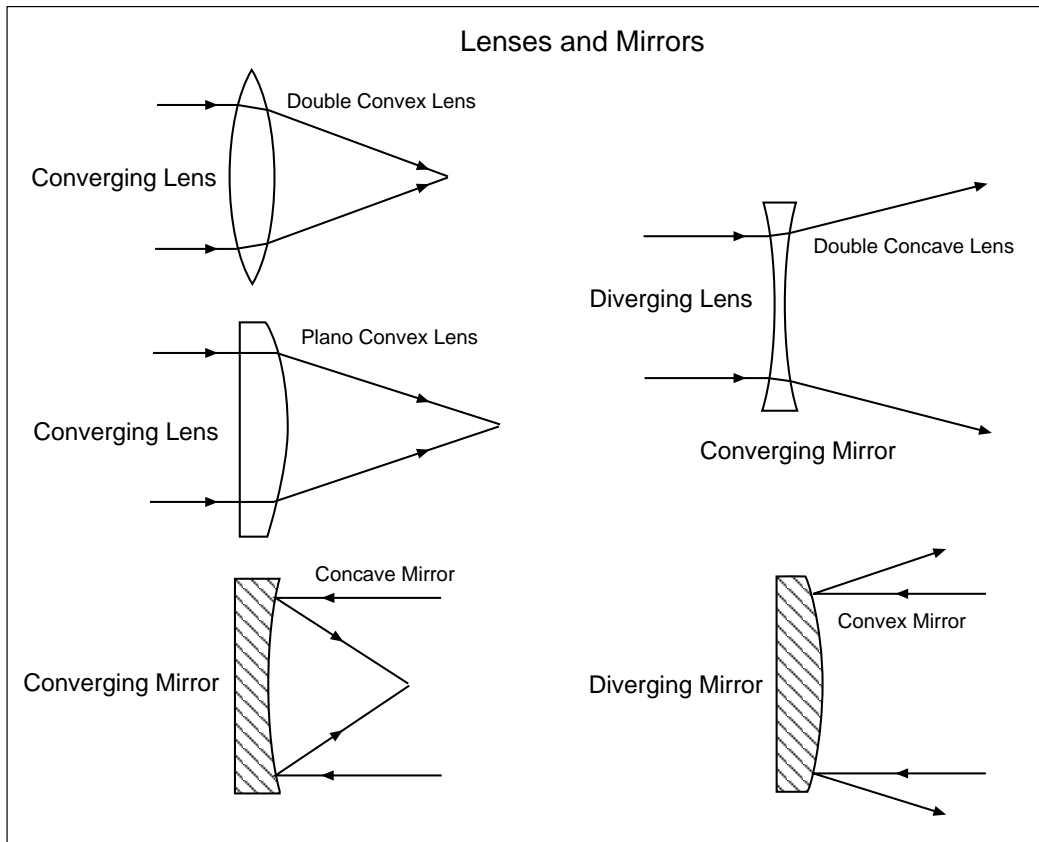

careful to align the circles properly. Because the outside circles have smaller diameters than the lens, the lens is firmly held in place. You have completed the objective lens mounting assembly.

7. Repeat steps 1- 6 for the inside tube and use the smaller lens for tracing. However, because the eyepiece lens is thinner than the objective lens, cut the inner circle from the thin tray.
8. After both lens mounting assemblies are complete, lay the fine sandpaper on a flat surface and gradually sand the edges of each completed lens mounting assembly to make them smooth. Stop sanding when the assemblies are just larger than the inside diameter of the corresponding tube. With a small amount of effort, the assembly will compress slightly and slip inside the tube. (Do not insert them yet.) Friction will hold them in place. If the lens assemblies get too loose, they can be held firmly with glue or tape.
9. Hold the two lens assemblies up and look through the lenses. Adjust their distances apart and the distance to your eye until an image comes into focus. Look at how far the two lenses are from each other. Cut a segment from the outside and the inside tube that together equal two times the distance you just determined when holding up the lenses. Use the sandpaper to smooth any rough edges on the tubes after cutting.
10. Carefully, so as not to smudge the lenses, insert the large lens assembly into one end of the outside tube and the eyepiece lens assembly into the end of the inside tube. Slip the inside tube into the outside tube so that the lenses are at opposite ends. Look through the eyepiece towards some distant object and slide the small tube in and out of the large tube until the image comes into focus.
11. (Optional) Decorate the outside tube with marker pens or glue a picture to it.

**Background:**

The completed telescope is known as a refractor. Refractor means that light passing through the objective lens is bent (refracted) before reaching the eyepiece. Passing through the eyepiece, the light is refracted again.

This refraction inverts the image. To have an upright image, an additional correcting lens or prism is placed in the optical path. Astronomers rarely care if images are right-side-up or up-side-down. A star looks the same regardless of orientation. However, correcting images requires the use of extra optics that diminish the amount of light collected. Astronomers would rather have bright, clear images than right-side-up images. Furthermore, images can be corrected by inverting and reversing photographic negatives or correcting the image in a computer.

**Management and Tips:**

Refer to the end of this activity for ideas on how to obtain suitable lenses. PVC plumbing pipes can be used for the telescoping tubes. Purchase tube cutoffs of different diameters at a hardware store. Make sure the cutting of the outside circles in the Styrofoam is precise. A circle cut too small will fall through the tube. If students do cut circles too small, the diameter of the circles can be increased by adding one or more layers of masking tape.

**Part 2 - Procedure for Demonstrating the Reflector Telescope Principle:**

1. Light the electric candle in a darkened room.
2. Bring the concave makeup mirror near the candle flame and tilt and turn it so that reflected light from the lamp focuses on a sheet of white paper.
3. Experiment with different lenses to find one suitable for turning the makeup mirror into a simple reflector telescope. Hold the lens near your eye and move it until the reflected light from the mirror comes into focus.

**Background:**

Many reflecting telescopes gather light from distant objects with a large concave mirror that directs the light toward a secondary mirror which

then focuses the light onto a detector. The concave mirror used in this demonstration shows how a concave mirror can concentrate light to form a recognizable image. The image produced with a makeup mirror will not be well focused because such mirrors are inexpensively produced from molded glass rather than from carefully shaped and polished glass. Furthermore, proper focusing requires that the mirror be precisely shaped in a parabolic curve.

Reflecting telescope mirrors can be made very large and this increases the amount of light they can capture. Refer to the telescope performance activity that follows for information on light gathering power. Small telescopes can only detect bright or nearby stars. Large telescopes (over 4 meters in diameter) can detect objects several billion times fainter than the brightest stars visible to our naked eyes.

Large astronomical telescopes do not employ eyepieces. Rather, light falls on photographic film, photometers, or charged coupled devices (CCDs). This demonstration shows how an image forms on a flat surface. Covering the

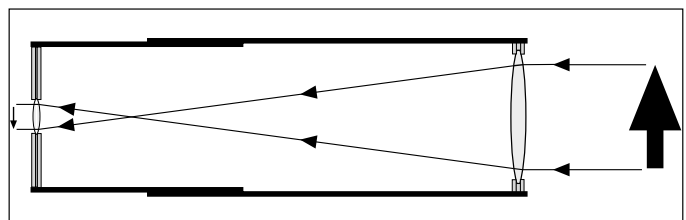
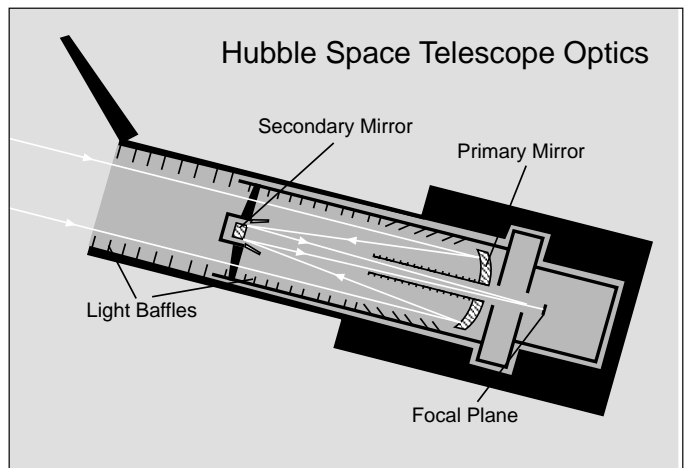

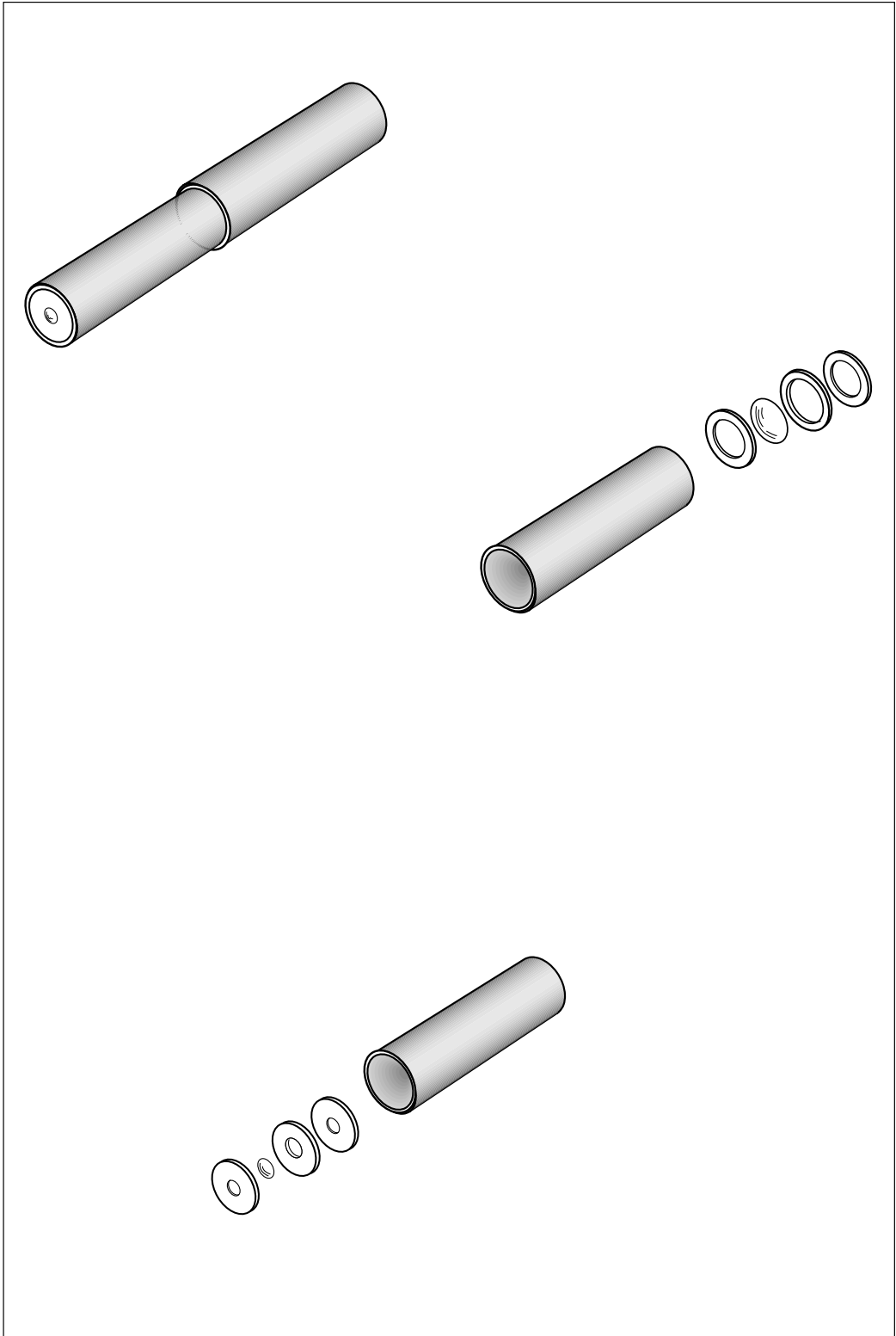

surface with photographic film will produce a crude picture. Although astronomers have converted to CCDs for most observations, photography is still employed for some applications. Rather than film, astronomers usually prefer photographic emulsions on sheets of glass, which are more stable over time.

### **Assessment:**

Examine the telescope for construction technique. Are the lenses parallel or canted to each other? Can the telescope focus on an image? Use the telescopes made here as samples for the telescope performance activities that follow.

### **Extensions:**

- Bring commercially-made telescopes, spy-glasses, and binoculars into the classroom. Compare magnification, resolution, and light gathering power to that of the telescope made here. Learn how these optical instruments function.
- Invite local amateur astronomy clubs to host “star parties” for your students.
- Why are the largest astronomical telescopes made with big objective mirrors rather than big objective lenses?
- Find out how different kinds of reflecting telescopes such as the Newtonian, Cassegrain, and Coude work.

### **Obtaining and Making Lenses and Mirrors:**

An amazing collection of lenses and mirrors can be obtained at little or no cost through creative scrounging. Ask an optometrist or eyewear store if they will save damaged eyeglass lenses for you. Although not of a quality useful for eyewear, these lenses are very suitable for classroom experimentation. Bifocals and trifocals make fascinating magnifying lenses. Fill a spherical glass flask with water to make a lens. Water-filled cylindrical glass or plastic bottles make magnifiers that magnify in one direction only. Aluminized mylar plastic stretched across a wooden frame makes a good front surface plane mirror. A Plexiglas mirror can be bent to make a “funhouse” mirror. Low-reflectivity plane mirrors can be made from a sheet glass backed with black paper. Ask the person in charge of audiovisual equipment at the school to save the lenses from any broken or old projectors that are being discarded. Projector and camera lenses are actually made up of many lenses sandwiched together. Dismantle the lens mounts to obtain several usable lenses. Check rummage sales and flea markets for binoculars and old camera lenses. A wide assortment of lenses and mirrors are also available for sale from school science supply catalogs and from the following organization:

Optical Society of America  
2010 Massachusetts Avenue, NW  
Washington, D.C. 20036  
(202) 223-8130



## ACTIVITY: Telescope Performance

### Description:

Students compare and calculate the light gathering power of lenses.

### Objective:

To determine the ability of various lenses and mirrors to gather light.

### National Education Standards:

#### Mathematics

- Patterns, functions, & algebra
- Geometry & spatial sense
- Measurement
- Problem solving
- Connections

#### Science

- Change, constancy, & measurement
- Abilities necessary to do scientific inquiry
- Understandings about science & technology

#### Technology

- Understand characteristics & scope of technology
- Understand, select, & use information & communication technologies

#### Materials:

- Gray circles on page 00
- White paper punchouts from a three-hole paper punch
- White paper
- Double convex lenses of different diameters
- Metric ruler
- Small telescope from previous activity
- Binoculars (optional)
- Overhead projector
- Transparency copy of master on page 00
- Resolving Power chart on page 00
- Astronomical telescope (optional)

### Procedure – Light Gathering Power:

1. Have students examine several different double convex lenses.
2. Compare the ability of each lens to gather light by focusing the light from overhead fixtures onto a piece of white paper. Which lens produces a brighter image? Be sure to hold the lenses parallel to the paper.
3. Compare the light gathering power of five

imaginary lenses (gray circles) by placing small white paper circles (punchouts) on each. The number of punchouts represents the number of photons collected at a moment of time. Students may draw their own circles with compasses for this step.

4. What is the mathematical relationship between the number of punchouts that a circle can hold and the circle's diameter? How did you arrive at this conclusion?

### Procedure – Magnification:

1. Make an overhead transparency of the grid on page 68. Project the transparency on a screen so that it is as large as possible and position the projector to reduce the “keystone” effect.
2. Roll a paper tube the same diameter as the front end of the telescope or binocular lens you are using. The length of the tube should be the same length as the telescope or binocular. Because binoculars use prisms to reduce their size (see illustration), make the tube two times longer than the distance between the front and rear lenses of the binoculars.
3. Have students stand in the middle or rear of the room. They should stand at a distance that will permit the telescope or binoculars to focus on the screen. Many optical instruments have minimum focal distances.
4. Looking first through the tube, have students count the number of squares they can see at a time from one side of the tube to the other.
5. Using the binoculars (one eye only) or the telescope, have students repeat the counting of squares.
6. The ratio of the number of squares seen in the tube versus the number seen in the binoculars is a rough approximation of the magnification power of the instrument. For example, if the student can see three squares with the tube and only one with the telescope, the magnification power of the telescope is approximately 3 because a single square spanned the telescope instead of three squares with a tube of a similar diameter and length.

### Procedure – Resolving Power:

1. Tape page 63 to the front board.
2. Have students stand near the rear of the room

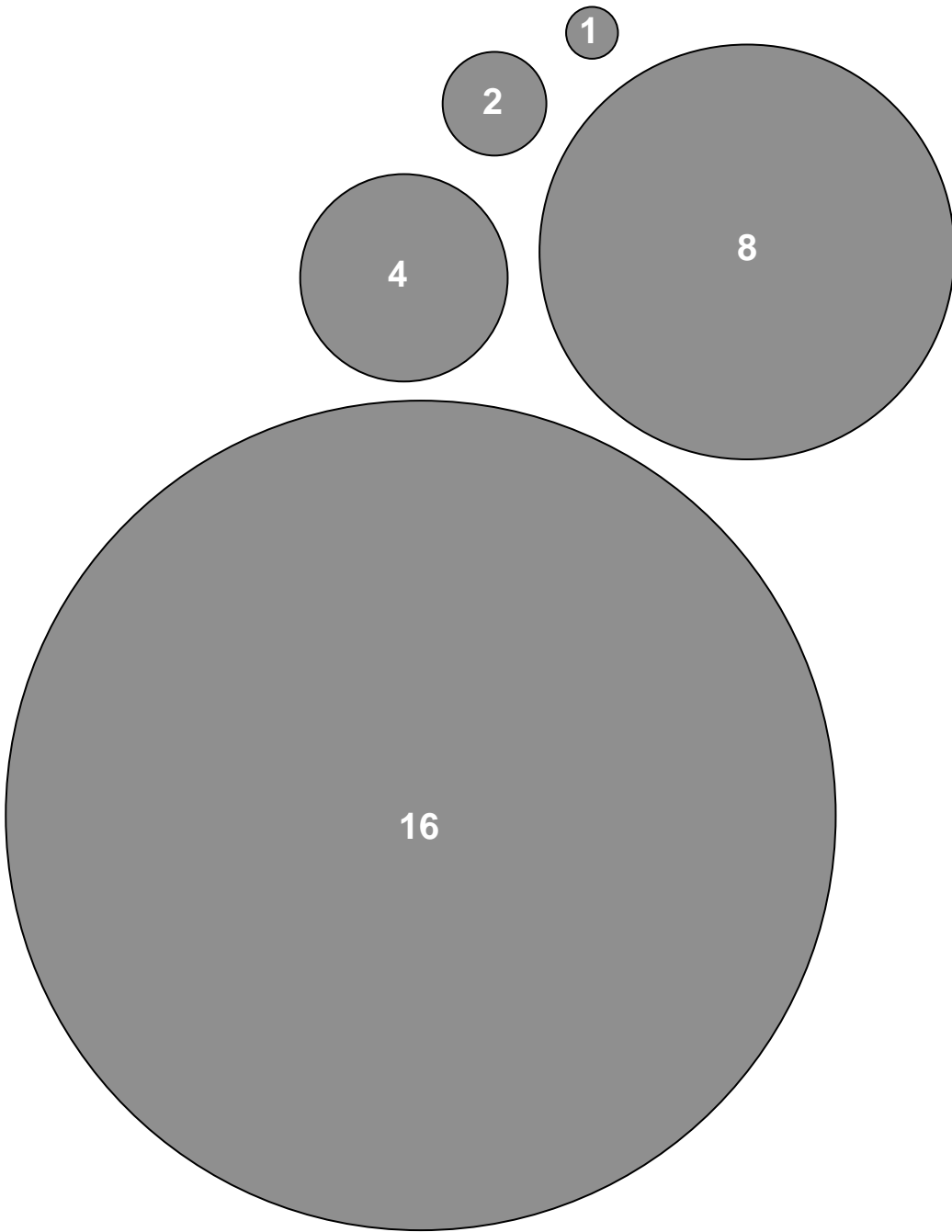

# Magnification Grid

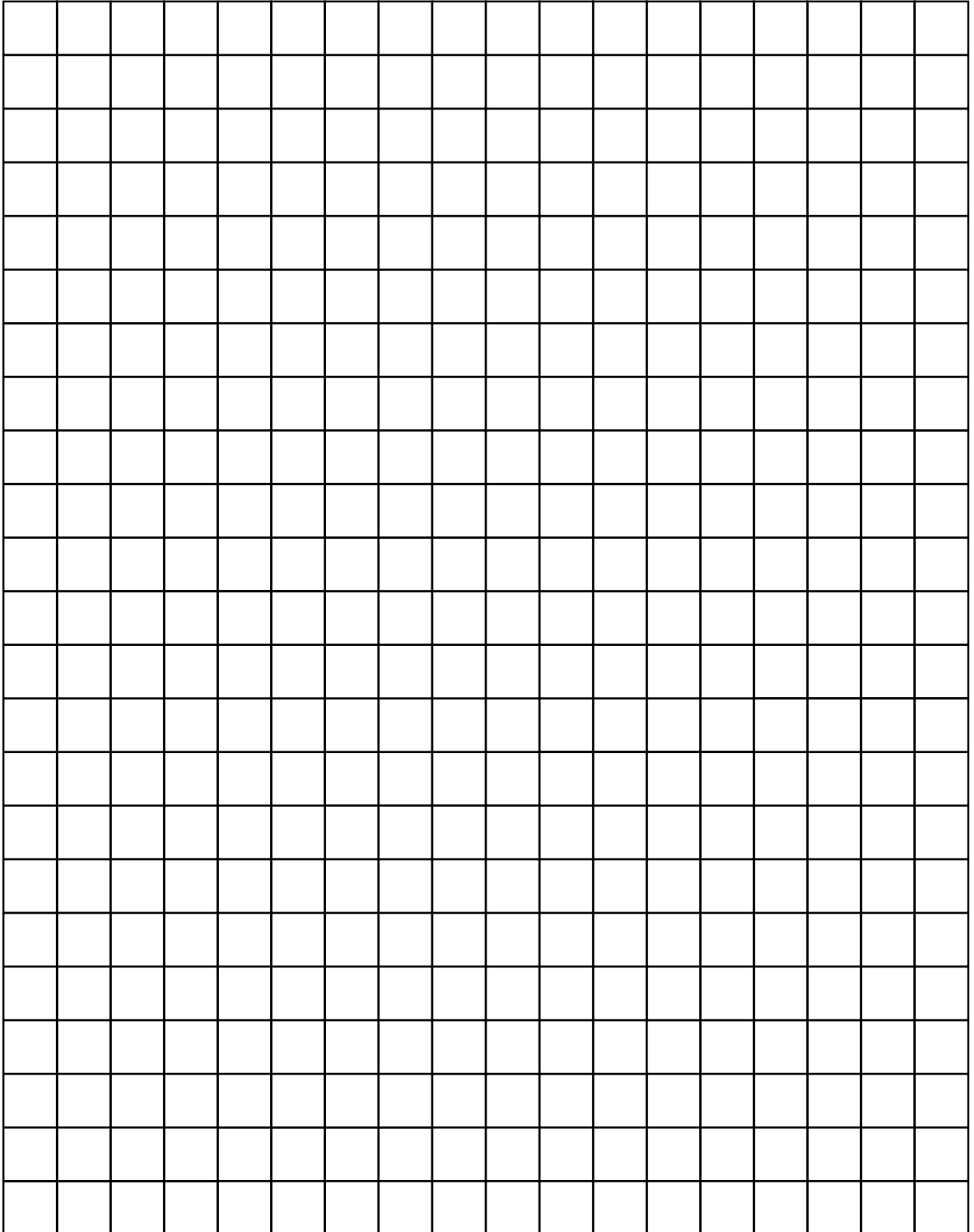

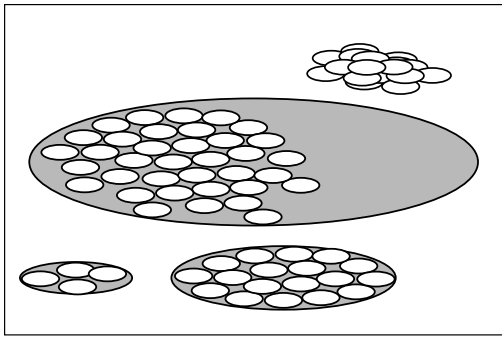

and look at the dots. Ask them to look at the squares and state how many dots they see.

3. Have students repeat the observation with the aid of a telescope or binoculars.

### Background:

*Light Gathering Power* – In a dark room, the pupil of the eye gets bigger to collect more of the dim light. In bright sunlight, the pupil gets smaller so that too much light is not let into the eye. A telescope is a device that effectively makes the pupil as large as the objective lens or mirror.

A telescope with a larger objective lens (front lens) or objective mirror collects and concentrates more light than a telescope with a smaller lens or mirror. Therefore, the larger telescope has a greater light gathering power than the smaller one. The mathematical relationship that expresses *light gathering power* (LGP) follows:

$$\frac{\text{LGP}_A}{\text{LGP}_B} = \left( \frac{D_A}{D_B} \right)^2$$

In this equation, A represents the larger telescope and B the smaller telescope or human eye. The diameter of the objective lens or mirror for each telescope is represented by D. Solving this equation yields how much greater the light gathering power (LGP) of the bigger telescope is over the smaller one. For example, if the diameter of the large telescope is 100 cm and the smaller telescope is 10 cm, the light gathering power of the larger telescope will be 100 times greater than that of the smaller scope.

Light gathering power is an important measure of the potential performance of a telescope. If an astronomer is studying faint objects, the telescope

$$\frac{\text{LGP}_A}{\text{LGP}_B} = \left( \frac{100 \text{ cm}_A}{10 \text{ cm}_B} \right)^2 = \frac{10,000}{100} = 100$$

used must have sufficient light gathering power to collect enough light to make those objects visible. Even with the very largest telescopes, some distant space objects appear so faint that the only way they become visible is through long-exposure photography or by using CCDs. A photographic plate at the focus of a telescope may require several hours of exposure before enough light collects to form an image for an astronomer to study. Unfortunately, very large ground-based telescopes also detect extremely faint atmospheric glow, which interferes with the image. Not having to look through the atmosphere to see faint objects is one of the advantages space-based telescopes have over ground-based instruments.

*Magnification* – Magnification is often misunderstood as a measure of a telescope's performance. One would think that a telescope with a higher magnification power would perform better than a telescope with a lower power. This is not necessarily so. A telescope with a high magnification power but a low light gathering power will produce highly magnified images that are too faint to see. A rule of thumb in obtaining a telescope is that the magnification of the telescope should be no greater than 25 times the diameter of the large (front) lens in centimeters. For example, a telescope with a front lens with a diameter of 5 centimeters should have a maximum magnification of no more than 125. Anything beyond that will produce a very poor view.

$$M = \frac{F_o}{F_e}$$

The magnification of a telescope is calculated by dividing the focal length of the front lens by the focal length of the eyepiece. The focal length is the distance from the center of the lens to the focal point. With astronomical telescopes, the focal lengths of the various lenses are marked on the housing.

$$\alpha = \frac{11.6}{D}$$

**Resolving Power** – With telescopes as powerful as the Hubble Space Telescope, resolving power becomes important. Resolving power is the ability of a telescope to separate two closely spaced objects. For example, a bright star to the naked eye might actually be two closely-spaced stars in a telescope. Resolving power is measured in arc seconds. An arc second is 1:3,600th of a degree.

**Management and Tips:**

In this light gathering power activity, younger students can use larger objects such as pennies, washers, or poker chips in place of the paper punchouts. Discs can be eliminated entirely by drawing the circles directly on graph paper and counting the squares to estimate light gathering power of different sized lenses and mirrors. When students notice that the punchouts do not entirely cover the circles, ask them what they should do to compensate for the leftover space.

For the activity on magnification and resolving power, use the small telescope constructed in the previous activity. Because of their minimum focal distance, astronomical telescopes will not work for this activity. A toy spyglass and spotter scopes should work.

**Assessment:**

Collect student sheets and compare answers.

**Student Work Sheet Answers:**

- 1A. The ratio of the amount of light a telescope can gather compared to the human eye.
- 1B. The ability of a telescope to make distant objects appear larger.
- 1C. The ability of a telescope to distinguish between two closely spaced objects.
- 2. 100
- 3. 100
- 4. 0.058 arc seconds

**Extensions:**

- Compare the light gathering power of the various lenses you collected with the human eye. Have students measure the diameters, in centimeters, of each lens. Hold a small plastic ruler in front of each student's eye in the class and derive an average pupil diameter for all students. Be careful not to touch eyes with the ruler. If you have an astronomical telescope, determine its light gathering power over the unaided human eye.
- If an astronomical telescope is available, have students calculate the actual magnification power of the telescope with its various lenses.
- Have students calculate the focal length of the lenses used in the light gathering power portion of this activity. The students should focus light from overhead fixtures on the desk top and measure how far above the desk the lens is. This is the focal length.

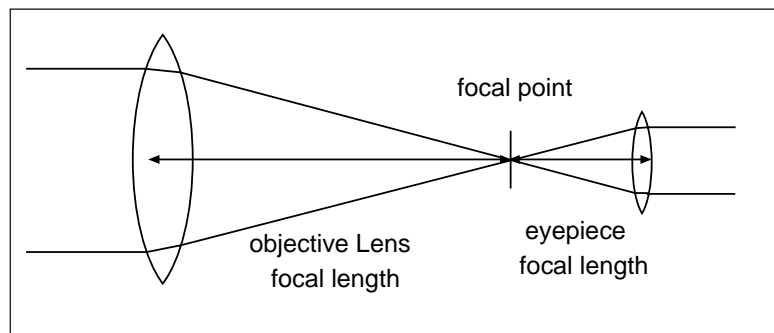
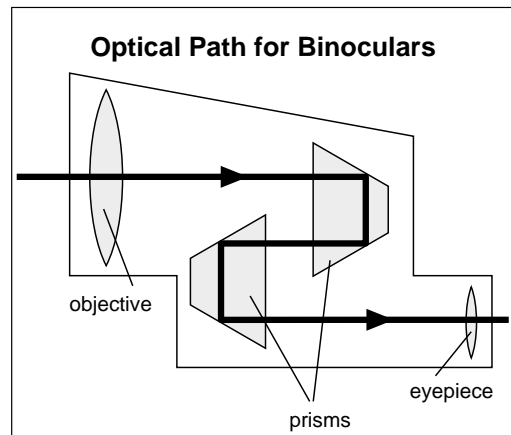

## Resolution Chart

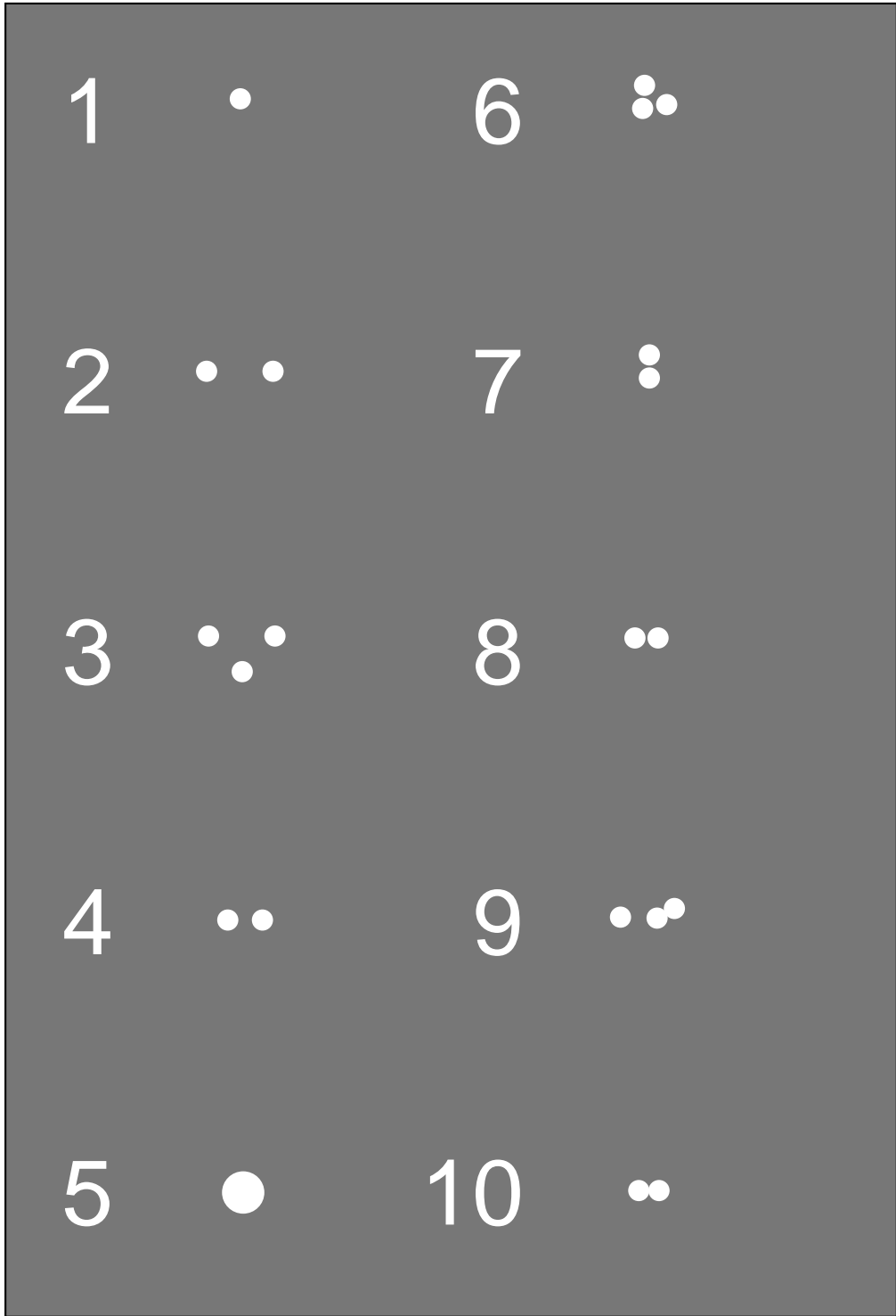

## Telescope Performance

Name: \_\_\_\_\_

1. What do each of these terms mean?
  - A. Light gathering power
  - B. Magnification
  - C. Resolving power
  
2. A telescope has a diameter of 10 centimeters. The iris of your eye has a diameter 1 centimeter. What is the light gathering power of the telescope compared to your eye. Show your work below.
  
  
  
  
  
  
  
  
  
  
3. Explain how to measure the focal length of a lens.
  
  
  
  
  
  
  
  
  
  
4. A telescope has an objective (front) lens with a focal length of 1,000 mm and an eyepiece with a focal length of 10 mm. What is the magnification power of the telescope? Show your work below.
  
  
  
  
  
  
  
  
  
  
5. A telescope has an objective lens with a diameter of 200 centimeters. What is the telescope's resolving power? Show your work below.

## ACTIVITY: Liquid Crystal IR Detector

### Description:

Students simulate the detection of infrared radiation using a liquid crystal sheet.

### Objective:

To experiment with one method of detecting infrared radiation.

### National Education Standards:

Science

- Evidence, models, & explanation
- Properties & changes of properties in matter
- Transfer of energy
- Understandings about science & technology

Technology

- Understand relationships & connections among technologies & other fields
- Understand, select, & use information & communication technologies

### Materials:

- Liquid crystal sheet (available at museums, nature stores, and science supply catalogs)
- Table top

### Procedure:

1. Have a student touch his or her fingertips on a tabletop for 30 seconds. Make sure the student has warm hands.
2. While handling the liquid crystal sheet only by its edges, place it where the fingertips touched the table. Observe what happens over the next several seconds.

### Background:

Infrared telescopes have a detector sensitive to infrared light. The telescope is placed as high up in the atmosphere as possible on a mountaintop, in an aircraft or balloon, or flown in space because water vapor in the atmosphere absorbs some of the infrared radiation from space. The human eye is not sensitive to infrared light, but our bodies are. We sense infrared radiation as heat. Because of this association with heat, telescopes and infrared detectors must be kept as cool as possible. Any heat from the surroundings will create lots of extra infrared signals that interfere with the

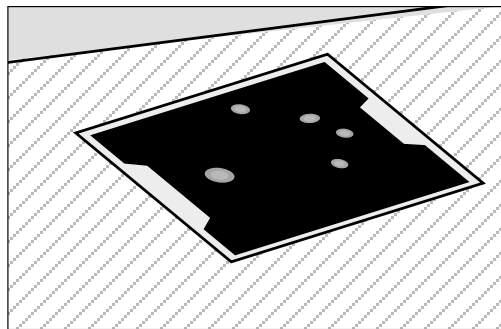

real signal from space. Astronomers use cryogenics such as liquid nitrogen, liquid helium, or dry ice to cool infrared instruments.

This activity uses a liquid crystal detector that senses heat. Also known as cholesteric liquid crystals, the liquid inside the sheet exhibits dramatic changes in colors when exposed to slight differences in temperature within the range of 25 to 32 degrees Celsius. The sheet detects the heat associated with infrared rays.

In the case of an infrared telescope in space, the energy is detected directly by instruments sensitive to infrared radiation. Usually, the data is recorded on computers and transmitted to Earth as a radio signal. Ground-based computers reassemble the image of the objects that created the radiation.

### Management and Tips:

Liquid crystal sheets come in many forms. The best sheets for this activity are large enough to fit an entire hand. These sheets also come as postcards and as thermometers. You may be able to find a forehead thermometer made of a strip of liquid crystals.

Do not allow the sheet to come into direct contact with very hot materials as they may damage the sheet. It is important that the student has hands warm enough to leave a heat signature on the tabletop. Also, it is important that the tabletop be relatively cool to start with. If the table is already warm, the image of the fingertips will be masked by the tabletop's heat. This is similar to the situation that would occur inside a spacecraft that is not cooled. Stray infrared signals from the



spacecraft would cloud the infrared image from distance objects.

**Assessment:**

Ask your students why it is important to keep infrared telescopes very cool for accurate observations.

**Extensions:**

- How was infrared radiation discovered?
- Why do infrared detectors have to be kept cold?
- Learn about cholesteric liquid crystals. An Austrian botanist Freidrich Reinitfer discovered them in 1888.
- Obtain an infrared thermometer for measuring temperatures from a distance. Such thermometers are available from science supply companies. Use the thermometer to measure the temperature of various objects such as a candle flame, beaker of warm water, or ground surfaces in and out of the sunlight.
- Invite a thermal scanning company to demonstrate their equipment to your students. These companies use infrared scanners to form infrared images of homes to isolate areas of heat loss.

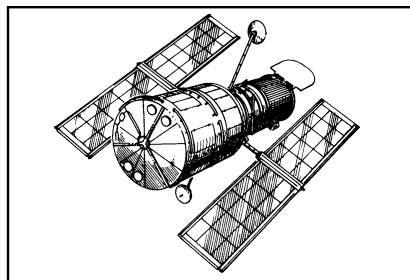

# UNIT 4

## DOWN TO EARTH

---

### Introduction

Although astronomers who work with ground-based telescopes have to deal with bad weather and atmospheric filtering, they do have one advantage over astronomers working with instruments in space. The ground-based astronomers can work directly with their instruments. That means that they can constantly check and adjust their instruments first-hand. Astronomers working with satellite-based instruments must do everything remotely. With the exception of telescopes mounted in the Space Shuttle's payload bay, astronomers can only interact with their instruments via radio transmissions. That means that the instruments have to be mounted on a satellite that provides radio receivers and transmitters, electric power, pointing control, data storage, and a variety of computer-run subsystems.

Data collection, transmission, and analysis are of primary importance to astronomers. The development of photomultiplier tubes and charged coupled devices (CCDs) provides astronomers with an efficient means of collecting data in a digital form,

transmitting it via radio, and analyzing it by computer processing. CCDs, for example, convert photons falling on their light sensitive elements into electric signals that are assigned numeric values representing their strength. Spacecraft subsystems con-

vert numeric values into a data stream of binary numbers that are transmitted to Earth. Once received, computers reconvert the data stream to the original numbers that can be processed into images or spectra.

If the satellite is geostationary, these data may be transmitted continuously to ground receiving stations consisting of one or more radio antennas and support equipment. Geostationary satellites orbit in an easterly direction over Earth's equator at an elevation of approximately 40,000 kilometers. They orbit Earth in one day, the same time it takes Earth to rotate, so the satellite remains over the same location on Earth at all times.

Satellites at other altitudes and orbital paths do not stay above one point on Earth. As a result, they remain visible to a particular ground station for a short time and then move out of range. This requires many widely spaced ground stations to collect the satellite's data. In spite of this, the satellite still spends much of its time over parts of Earth where no stations exist (oceans, polar regions, etc.). For this reason, one of the subsystems on astronomical satellites are tape recorders that store data until they can transmit it to ground stations.

In the mid-1980's, NASA began deploying the Tracking and Data Relay Satellite System (TDRSS) into geostationary orbit. The purpose of this system is to relay data to ground stations. Because of their high orbits and their widely

spaced station points over Earth's equator, the TDRSS satellites serve as relay points for lower satellites and the Space Shuttle. The system provides nearly continuous contact with spacecraft as they orbit Earth. TDRSS satellites relay data to a receiver at White Sands, New Mexico. From there, the data travel via telephone lines, fiber optic cable, or commercial communications satellites to its destination. Most astrophysics data travels from White Sands to the NASA Goddard Space Flight Center in Maryland for distribution to scientists.

## Unit Goal

- To demonstrate how astronomical satellites use technology to collect optical data, transmit that data to Earth, and reassemble it into images.

## Approach

The activities in this unit demonstrate the imaging process of astronomical satellites such as the Hubble Space Telescope. Use the Magic Wand and Persistence of Vision activities together or as alternates. The Magic Wand activity shows how images can be divided and reassembled. The Color activity shows how astronomy satellites collect color data and how that data can be reassembled on the ground. The Binary Number and Paint by the Numbers activities familiarize students with the process of data transmission to Earth and its re-assembly into images.

## ACTIVITY: Magic Wand

### Description:

A recognizable image from a slide projector appears while a white rod moves rapidly across the projector's beam.

### Objective:

To demonstrate how an image falling on a CCD array is divided into individual pieces.

### National Education Standards:

#### Science

- Evidence, models, & explanation
- Motions & forces
- Understandings about science & technology

#### Technology

- Understand relationships & connections among technologies & other fields
- Understand, select, & use information & communication technologies

### Materials:

- Slide projector
- Color slide of clearly defined object such as Saturn, a building, etc.
- 1/2-inch dowel, 3 feet long
- Sheet of white paper
- White paint (flat finish)
- Dark room

### Procedure:

1. Paint the dowel white and permit it to dry. (A piece of 3/4-inch PVC water pipe from a hardware store can substitute for the dowel and white paint, and so can a painted meter stick.)
2. Set up the slide projector in the back of the classroom and focus the image of the slide at a distance of about 4 meters away from the projector. Hold the sheet of paper in the beam at the proper distance for easy focusing. Be sure the focus point you select is in the middle of the room and not near a wall.
3. Arrange the students between the focus point and the projector. Darken the room. Hold the dowel in one hand and slowly move it up and down through the projector beam at the focal point. Ask the students to

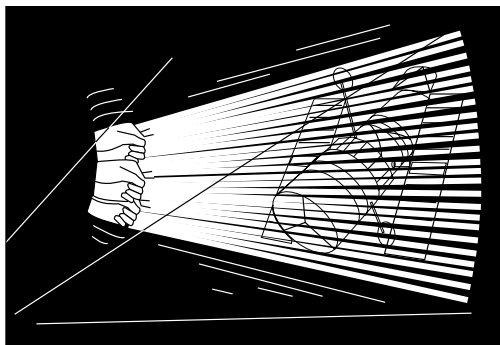

try to identify the image that appears on the dowel.

4. Gradually, increase the speed of the dowel's movement.
5. When the dowel moves very fast, the image becomes clear.

### Background:

Because astronomy spacecraft operate in space for many years, the data they collect cannot be recorded on camera film. There is simply no easy way to deliver the film to Earth for processing and to resupply the spacecraft with fresh film. Rather, the satellite instruments collect light from objects and divide it into discrete bits of information and radio them to Earth as a series of binary numbers. This activity demonstrates how images can be divided into many parts and then reassembled into a recognizable picture. By slowly moving the dowel across the slide projector's beam, small fragments of the image are captured and reflected ("radioed") towards the students. Because more and more fragments are sent as the dowel is moved, the image quickly becomes confused in the student's minds. However, as the rod is moved more rap-

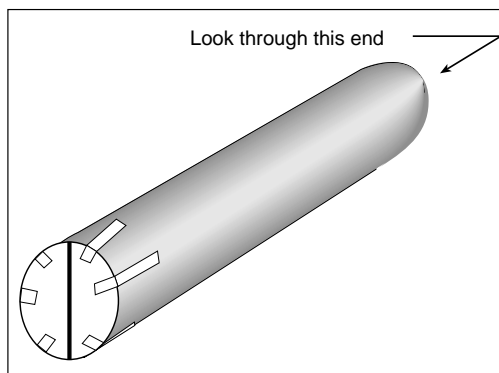

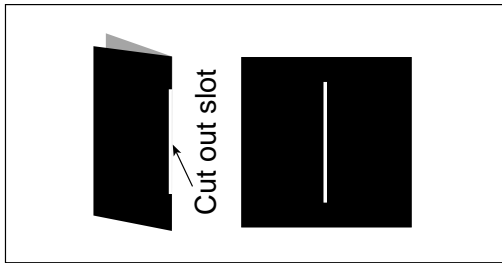

idly, an important property of the eye and brain connection comes into play; light images are momentarily retained. This property is called persistence of vision. As the dowel's movement increases, single lines of the image remain just long enough to combine with the others to form a recognizable image. In this manner, the rapidly moving rod simulates the CCD and the eye/brain interaction simulates the final imaging computer that receives the radioed data and reassembles it for use.

#### Management and Tips:

By setting up the projector so that its projected image is focused in the middle of the room, the light from the image that falls on the far wall will be out of focus. This will make it more difficult for students to recognize the image until the dowel is passed through the light beam. Be sure to point out that the rod sends ("radios") a fragment of the entire image. When the rod is moved, another image fragment is received. Challenge your students to memorize each fragment as they receive it. The fragments will be quickly forgotten as new fragments are added. It is only when the rod is moved very fast that they will be able to recognize the image. However, if the fragments were received by a computer in a digital form, each fragment would be recorded and an image would be built up at any speed. Relate this activity to the Paint by the Numbers activity on pages 00-00.

#### Assessment:

Ask students to explain the imaging process as it is demonstrated here and use examples of images in other applications where the images consist of small parts that combine to make a whole.

#### Extensions:

- How do television studios create and transmit pictures to home receivers?
- How does a CCD work?
- Project some slides. Magnify them as much as possible on a projection screen to see how the complete image consists of many discrete parts.
- Construct a persistence of vision tube. Close off the end of a cardboard tube except for a narrow slit. While looking through the open end of the tube, wave the tube back and forth. A recognizable image will form at the other end of the tube. Use the tube to examine fluorescent lights. Why do slightly darker bands appear across the lights? **Hint:** Fluorescent lights do not remain on continuously. The light turns on and off with the cycling of AC current. Will using the tube to view an incandescent light have the same effect? Use the tube to examine the picture on a television screen. Why is the TV picture reduced to lines? **Hint:** Television pictures consist of scan lines.
- A simpler version of the persistence of vision tube can be made with a 10 by 10-centimeter square of black construction paper. Fold the paper in half. Using scissors, cut a narrow slit from the middle of the fold. Open the square up and quickly pass the slit across one eye while looking at some distant objects.

## ACTIVITY: Colors

### Description:

Students identify the actual colors of objects bathed in monochromatic light and learn how three colors of light can be combined to produce colors ranging from black to white.

### Objectives:

- To identify the actual colors of objects bathed in monochromatic light.
- To demonstrate how three colored lights can be combined to produce a wide range of secondary colors.
- To show how space observatories make use of monochromatic filters to collect data on the color of objects in space.

### National Education Standards:

#### Science

Evidence, models, & explanation

Change, constancy, & measurement

#### Abilities necessary to do scientific inquiry

Properties & changes of properties in matter

Transfer of energy

Understandings about science & technology

#### Technology

Understand relationships & connections among technologies & other fields

Understand troubleshooting, R & D, invention, innovation, & experimentation

Understand, select, & use information & communication technologies

### Materials:

Indoor/outdoor floodlights (red, green, and blue)

Adjustable fixtures to hold the lights

Projection screen

Various colored objects (apple, banana, grapes, print fabrics, etc.)

Dark room

### Procedure Part 1 - Color Recognition:

1. Prior to class, set up the three floodlights in a row at a distance of about 4 meters from the projection screen so that they each point to the center of the screen. The lights should be spaced about 1 meter apart. When properly aimed, the three lights should blend to produce

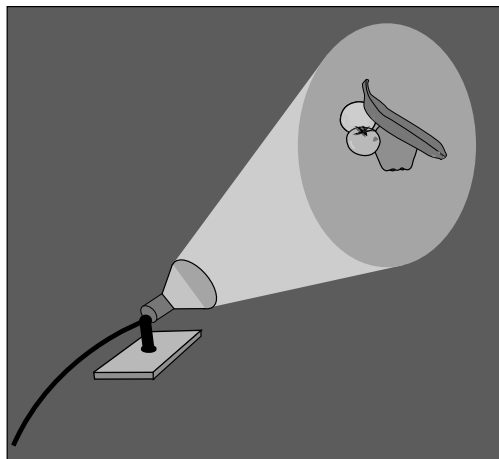

a nearly white light falling on the screen. Move one or more lights closer to or farther away from the screen to achieve a proper balance.

2. Darken the classroom and turn on the red lamp.
3. Hold up the colored objects one at a time. Ask students to make notes on the Color Table as to how bright or dark the objects appear in the red light.
4. Turn off the red light and turn on the green light and repeat with the same objects. Repeat again, but this time use the blue light.
5. Turn on the room lights and show the students the actual colors of the objects.
6. Challenge the students to identify the colors of new objects. Show them the unknown objects in the red, green, and then blue lights. By using their notes, the students should be able to determine the actual colors of the objects.
7. Hold up a Granny Smith or Golden Delicious apple to see if the students can correctly judge its actual color or will instead jump to an erroneous conclusion based on shape.

### Procedure Part 2 - Color Shadows:

1. Using the same light and screen setup, darken the room and turn all the floodlights on, hold up your hand between the lights and the screen. Three colored shadows appear—yellow, cyan, and magenta.
3. Move your hand closer to the screen. The shadows will overlap and produce additional colors—red, blue, and green. When all the

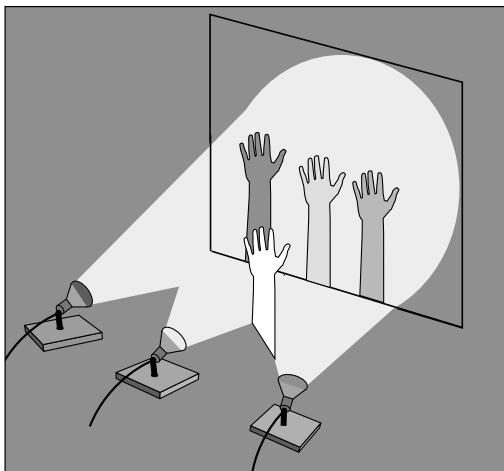

shadows overlap, there is no color (light) left and the shadow on the screen becomes black.

4. Invite your students to try their “hand” at making shadows.

### Background:

Astronomical spacecraft, working in the visible region of the electromagnetic spectrum, collect images of stars and galaxies in various colors. Color filters rotate into the light path so that the detector sees one color at a time. The image in each of these colors is transmitted to Earth as a series of binary numbers. Image processing computers on Earth take each of the images, color them, and combine all the images to reconstruct a multi-colored image representing the true colors of the object. To enhance details in the images, astronomers will use artificial colors or boost the color in one or more wavelengths.

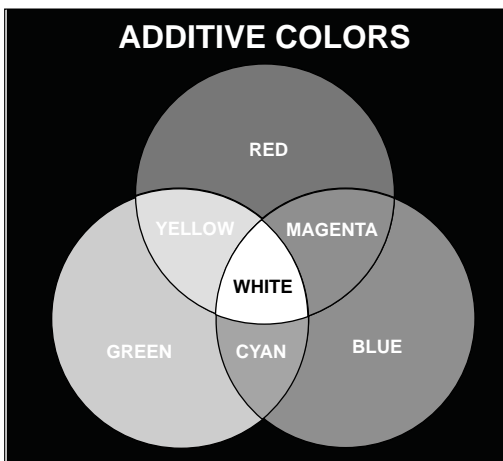

Part 1 of this activity demonstrates the data collection part of the color imaging process. By examining various objects in red, green, and then blue light, the students note that the brightness varies with the illuminating. Using colored lights is equivalent to observing the objects through colored filters. The way each object appears relates to its “real” colors as seen in normal light. By noting subtle differences in brightness in each of the three colored lights, the actual colors of the objects can be identified.

Part 2 of this activity demonstrates how a few basic colors can produce a wide range of colors and hues. When the three lamps are set up properly, the screen appears whitish. When all shadows overlap, they become black; black is the absence of light. In between white and black are red, green, blue, cyan, yellow, and magenta. By moving the floodlights forward and back, a wide range of hues appears.

### Management and Tips:

It is difficult to get a pure white screen with indoor/outdoor floodlights. The colors produced by them are not entirely monochromatic. Using much more expensive lamps produces a better white but the whiteness is not significantly enhanced. An alternative to the colored lamps is to obtain red, green, and blue theatrical gels (filters) and place them (one each) on the stage of three overhead projectors. Aiming each of the three projectors to the same place on the screen produces the same effect as the lamps, but the colors are more uniform across the screen and the white is purer.

### Assessment:

Collect the color tables of the students. Hold up colored objects in different monochromatic lights and have the students try to identify their white light colors.

### Extensions:

- Look at color magazine pictures. How many colors do you see? Examine the pictures with a magnifying glass. How many colors do you see? Also examine the picture on a color television screen.
- What common devices use red, green, and blue to produce colored pictures?

# Color Filter Wheel

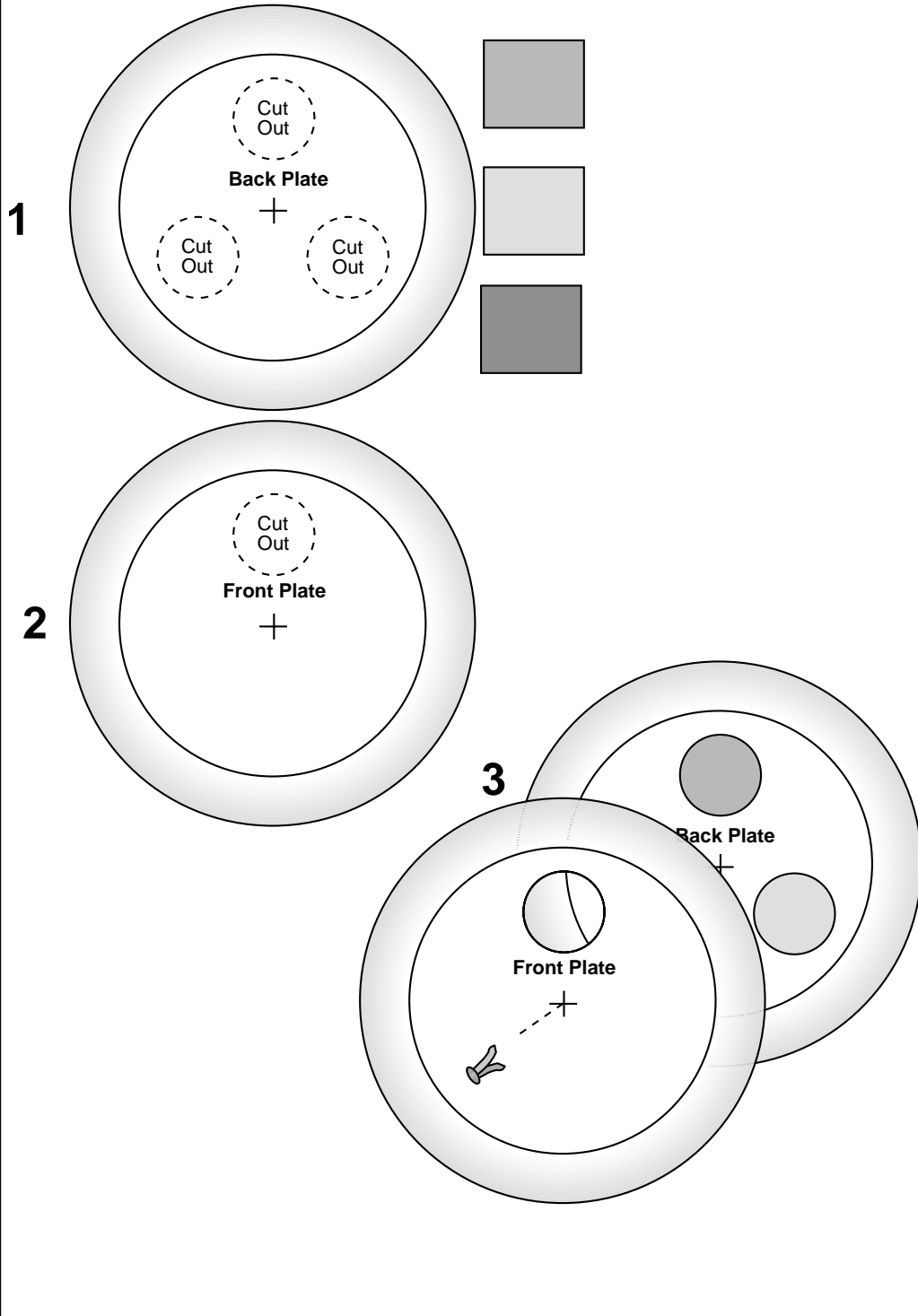



## Color Image Process

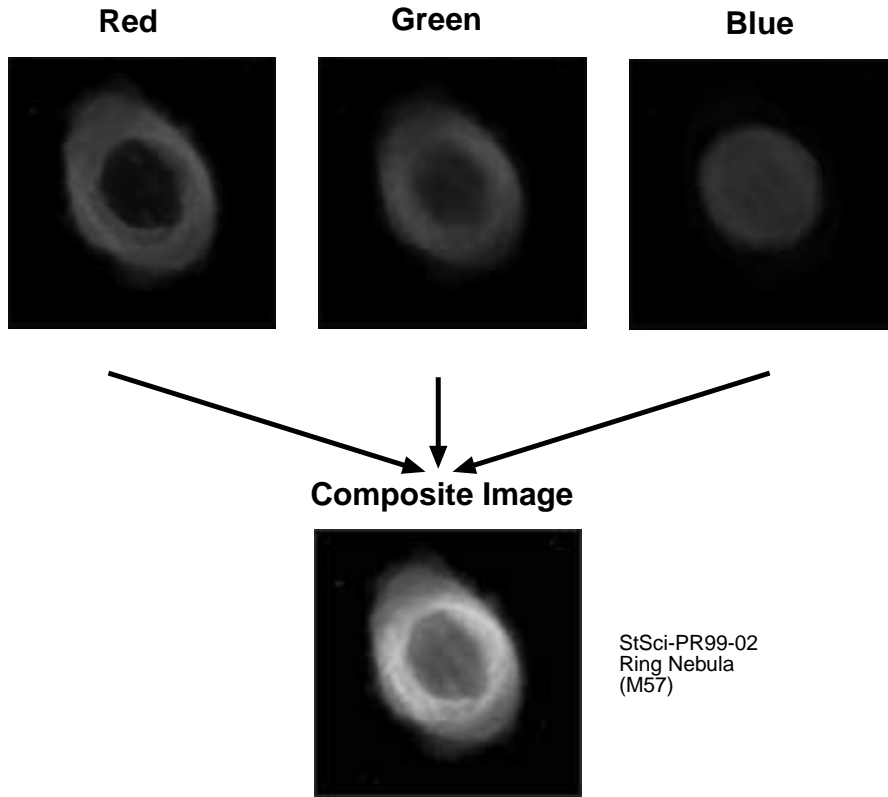

This simulation of the imaging process of the Hubble Space Telescope required three separate images, each taken through a different filter. The M57 Ring Nebula looks very different in each of the exposures. To create the color composite image, each image is colored in red, green, or blue and combined.

- Is there any difference in the results of mixing colored lights and colored paints?
- Punch a 2-centimeter hole in an opaque piece of paper. Adjusting the distance of the paper to the screen may help students investigate the color additive process.
- This activity also works using colored acetate filters taped over small windows cut into file cards. Sheets of red, green, and blue acetate can be purchased at art supply stores. Students can make their own filter cards and take them home to look through the windows at a variety of objects. Better quality filters, that transmit “purer” colors, can be

obtained from theatrical supply stores at a cost comparable to acetate filters. If your school has a theater department, you may be able to obtain filters (gels) from them.

- The following reference describes further activities with the filters:

Sneider, C., Gould, A., & Hawthorne, C., “Color Analyzers Teacher’s Guide,” *Great Explorations in Math and Science (GEMS)*, Lawrence Hall of Science, University of California at Berkeley, 1991. (Available from the museum or the National Science Teacher’s Association.)

# Color Table

Name \_\_\_\_\_

## Known Colors

Object	Red	Green	Blue	True Color

## Unknown Colors

Object	Red	Green	Blue	True Color ?
1				
2				
3				
4				
5				

## ACTIVITY: Binary Numbers

### Description:

Two flashlights are used to demonstrate how astronomy spacecraft transmit images and other scientific data to Earth.

### Objective:

To use the binary number system to transmit messages.

### National Education Standards:

#### Mathematics

- Number & operation
- Patterns, function, & algebra
- Measurement
- Data analysis, statistics, & probability
- Communication
- Connections
- Representations

#### Science

- Evidence, models, & explanation
- Change, constancy, & measurement
- Understandings about science & technology

#### Technology

- Understand relationships & connections among technologies & other fields
- Understand cultural, social, economic, & political effects of technology
- Understand, select, & use:
  - Medical technologies
  - Agricultural technologies & biotechnologies
  - Energy & power technologies
  - Information & communication technologies
  - Transportation technologies
  - Manufacturing technologies
  - Construction technologies

### Materials:

- Two flashlights with pushbutton switches
- Binary code and data sheets

### Procedure:

1. Explain how astronomical spacecraft use the binary system to transmit, via radio waves, images and other scientific data from spacecraft to Earth. Refer to the background section for details on how the system works.
2. Distribute the data sheet and substitution code page to every student. Tap out a six

number sequence of the push buttons on the two flashlights. Your right hand flashlight will represent a 1 and your left hand flashlight will represent a 0. As the lights flash, each student should check off the appropriate box in the practice column. To make sense later, the students must check off the boxes representing right or left flashes in the exact sequence of the flashing lights. Refer to the sample on the next page to see how to make the checks.

3. For the practice columns, total up the numbers each sequential flash represents. For example, if all flashes are with the left flashlight, the value is  $0+0+0+0+0+0 = 0$ . If six flashes are all with the right flashlight, the value of the binary number is 63. The first right flash represents a 1, the second is 2, the third is 4, the fourth is 8, the fifth is 16, and the sixth is 32 ( $1+2+4+8+16+32=63$ ). The following sequence of flashes is 37: Right, Left, Right, Left, Left, Right. After the boxes are filled in, the students total the numbers in the two columns. The answer will give students the total value of the number that was transmitted. (In this activity, the number will represent a letter in a message. With the Hubble Space Telescope, the number will represent the brightness of a particular point on an image.)
4. After the students become familiar with the method, transmit a message to the them. Create the message by referring to the substitution code in the following pages. Replace each word in your message with the corresponding code number. For example, "Hello!" would convert to 7, 4, 11, 11, 24, 38. Next, convert each code number into a binary number. Seven, for example, becomes Right, Right, Right, Left, Left, Left and 24 becomes Left, Left, Left, Right, Right, Left. As you will note in the substitution code, only the first 40 of the 64 possible numbers are used. The remaining numbers can be assigned to common words of your choosing such as "the" and "but," and to short sentences such as "How are you?" Transmit the message by flashing the lights in the proper sequence. Every six flashes represents a binary number

that can be converted into a letter or word through the code. Students receive the message by checking the flashes on the data sheet, determining the binary numbers they represent, and then changing the numbers into letters or words.

5. Discuss how a picture could be translated through binary code. (Refer to the activity *Paint by the Numbers*.)

### **Background:**

Because astronomical spacecraft operate in orbit around Earth, the images they collect of objects in space have to be transmitted to the ground by radio signals. To make this possible, the light from these objects is concentrated on a light sensitive charged coupled device (CCD). The Hubble Space Telescope uses four CCDs arranged in a square. The surface of each CCD is a grid consisting of 800 vertical and 800 horizontal lines that create a total of 640,000 light sensitive squares called pixels for picture elements. With four CCDs, the total number of pixels in the Hubble Space Telescope CCD array is 2,560,000.

Photons of light fall on the CCD array and are converted into digital computer data. A numerical value is assigned to the number of photons received on each of the more than two million pixels. This number represents the brightness of the light falling on each pixel. The numbers range from 0 to 255. This range yields 256 shades of gray ranging from black (0) to white (255).

These numbers are translated into a binary computer code on board the spacecraft. A binary number is a simple numeric code consisting of a specific sequence of on and off radio signals. They are the same codes that are used in computers. A binary number radio transmission can be compared to a flashing light. When the light is on, the value of the signal is a specific number. When the light is off, the value is 0. (In this activity the right flashlight is the 1 and the left flashlight is the 0. Although the activity could be done with 1 flashlight, it would be difficult for students to determine how many 0's are being transmitted when the light is off. Computers precisely time the interval to determine how

many 0's are in the sequence. Using a second flashlight for 0's makes it easy for students to determine the number of 0's.)

A binary number usually consists of 8 bits (1 byte). The first bit in the sequence represents a 1. The second bit represents a 2. The remaining 6 bits represent 4, 8, 16, 32, 64, and 128 respectively. If all bits are "on" the value of the binary number is the sum of each bit value—255. If all bits are "off," the value is 0. A sequence of on, off, on, on, off, off, on, and off represents the numbers  $1+0+4+8+0+64+0$ , or 77. To save classroom time, the binary system has been simplified in this activity by using a 6-bit binary code. The total value of a 6-bit code is 64, or  $1+2+4+8+16+32$ .

After the image of the space object is encoded, the binary bits are transmitted by radio waves to a receiving station on the ground. The photons of light that fall on each of the 2,560,000 pixels are now represented by a data set consisting of 20,480,000 binary bits. The computer will convert them to a black and white image of the space object. If a colored image is desired, at least two more images are collected, each one taken through a different colored filter. The data from the three images are combined by a computer into a composite image that shows the actual colors of the object being observed.

Because images collected by the HST and other astronomy spacecraft are digital, astronomers can use computers to manipulate images. This manipulation is roughly analogous to the manipulation of color, brightness, and contrast controls on a television set. The manipulation process is called enhancement and it provides astronomers with a powerful tool for analyzing the light from space objects.

To learn more about the imaging process, refer to the following activities in this guide: *Paint by the Numbers* and *Colors*.

### **Management and Tips:**

Students may be confused by right and left flashlights when you face them. The right (1) and left (0) flashlights refer to the student's right and left.

Look at the columns of marks for each letter you transmit. If the mark is in the right-hand box and represents an on (1) signal, flash the right flashlight. Students will read this as a 0. If the mark is in the left-hand box and represents an off (0) signal, flash your left flashlight. Students will read this as a 1.

Students will sometimes lose track of the light sequence by concentrating on their paper. If you can dim the room lights a bit, which flashlight beam is turned on is easier to see out of the corner of the eye. Also, you can use the light fixtures used in the color activity for the code. Use the green lamp on for a 1 and the red lamp on for a 0.

Students may also become confused by using one number to represent another number. Make sure they understand the sequence of 1's and 0's is the code. The on-off (1-0) code is what is used in the process. However, other things could be used for the 1-0 such as the words "on-off" or even words like "pickle-pineapple." It is the sequence of the words or numbers used that is important.

If you have visually impaired students, you can substitute tapping two different surfaces to make two different sounds for them to listen to and interpret as 1's or 0's.

If you wish to use materials other than flashlights for transmitting data, you can make two cards with a large 1 on one card and a 0 on the other. Raise and lower the cards in sequence to represent a binary number.

**Assessment:**

Check the student sheets to see if they have correctly received the message.

**Extensions:**

- Have students code binary numbers with a binary coder consisting of several paper desert plates or shallow cups and markers

such as jelly beans or breakfast cereal pieces. Arrange the plates in a row and number the first one "1". Mark the plate to the left "2" and the plate to the left of that one "4", etc. Place a small group of markers in the 1 plate. To code the markers into binary numbers, follow these rules: If a plate has two or more markers, remove two markers. Place one of the markers in a discard pile and place the other one in the plate immediately to the left. Continue removing markers from the 1 plate until there is only 1 or 0 left. If plate 2 has 2 or more markers, remove two. Discard one and place the other one in the plate to the left. Continue until all plates have only 1 or 0 markers in them. Starting on the left, write the binary number. Put down a 0 for a plate with no markers in it and a 1 for a plate with a marker in it. To check your work, add up the numbers on all the plates with markers. It should be the same as the number of markers you started with.

- Transmit binary numbers by having four students stand in a row in front of the class. Give each student a card with a 1 on one side and a 0 on the other. Quietly tell the students to transmit the number 7 to their classmates. The four students will have to determine between them who holds up a 0 and who holds up a 1. The binary sequence for 7 is 0111. The remainder of the students should try to decode the binary number. With more students in the row, higher numbers can be transmitted.
- Have students transmit other scientific data with binary numbers. For example, students can measure the temperature of a liquid or the mass of an object and transmit the results to another student.
- How are binary numbers used in computers?
- How high can you count with a binary number consisting of 10 bits? 12?

# Data Sheet

Name: \_\_\_\_\_

### Sample

32	16	8	4	2	1
<b>0</b>	<b>1</b>	<b>0</b>	<b>1</b>	<b>1</b>	<b>0</b>

(16 + 4 + 2 = 22) = 22  
Total

### Practice

32	16	8	4	2	1
<b>0</b>	<b>0</b>	<b>1</b>	<b>1</b>	<b>0</b>	<b>1</b>

= \_\_\_\_\_  
Total

### Practice

32	16	8	4	2	1
<b>1</b>	<b>1</b>	<b>0</b>	<b>1</b>	<b>1</b>	<b>0</b>

= \_\_\_\_\_  
Total

(Practice answers at bottom of page)

### Start

32	16	8	4	2	1

= \_\_\_\_\_  
Total

32	16	8	4	2	1

= \_\_\_\_\_  
Total

32	16	8	4	2	1

= \_\_\_\_\_  
Total

32	16	8	4	2	1

= \_\_\_\_\_  
Total

32	16	8	4	2	1

= \_\_\_\_\_  
Total

32	16	8	4	2	1

= \_\_\_\_\_  
Total

32	16	8	4	2	1

= \_\_\_\_\_  
Total

32	16	8	4	2	1

= \_\_\_\_\_  
Total

32	16	8	4	2	1

= \_\_\_\_\_  
Total

32	16	8	4	2	1

= \_\_\_\_\_  
Total

32	16	8	4	2	1

= \_\_\_\_\_  
Total

32	16	8	4	2	1

= \_\_\_\_\_  
Total

32	16	8	4	2	1

= \_\_\_\_\_  
Total

32	16	8	4	2	1

= \_\_\_\_\_  
Total

32	16	8	4	2	1

= \_\_\_\_\_  
Total

32	16	8	4	2	1

= \_\_\_\_\_  
Total

32	16	8	4	2	1

= \_\_\_\_\_  
Total

32	16	8	4	2	1

= \_\_\_\_\_  
Total

32	16	8	4	2	1

= \_\_\_\_\_  
Total

32	16	8	4	2	1

= \_\_\_\_\_  
Total

32	16	8	4	2	1

= \_\_\_\_\_  
Total

32	16	8	4	2	1

= \_\_\_\_\_  
Total

32	16	8	4	2	1

= \_\_\_\_\_  
Total

32	16	8	4	2	1

= \_\_\_\_\_  
Total

32	16	8	4	2	1

= \_\_\_\_\_  
Total

32	16	8	4	2	1

= \_\_\_\_\_  
Total

32	16	8	4	2	1

= \_\_\_\_\_  
Total

32	16	8	4	2	1

= \_\_\_\_\_  
Total

32	16	8	4	2	1

= \_\_\_\_\_  
Total

32	16	8	4	2	1

= \_\_\_\_\_  
Total

### Finish

Work down

Go to top

Go to top

## ACTIVITY: Paint by the Numbers

### Description:

A pencil and paper activity demonstrates how astronomical spacecraft and computers create images of objects in space.

### Objective:

To simulate how light collected from a space object converts into binary data and reconverts into an image of the object.

### National Education Standards:

#### Mathematics

- Number & operation
- Patterns, function, & algebra
- Measurement
- Data analysis, statistics, & probability
- Communication
- Connections
- Representations

#### Science

- Evidence, models, & explanation
- Change, constancy, & measurement
- Earth in the solar system
- Abilities of technological design

#### Technology

- Understand cultural, social, economic, & political effects of technology
- Ability to use & maintain technological products & systems
- Understand, select, & use:
  - Medical technologies
  - Agricultural technologies & biotechnologies
  - Energy & power technologies
  - Information & communication technologies
  - Transportation technologies
  - Manufacturing technologies
  - Construction technologies

### Materials: (per group of two students)

- Transparent grid
- Paper grid
- Picture of house
- Pencil

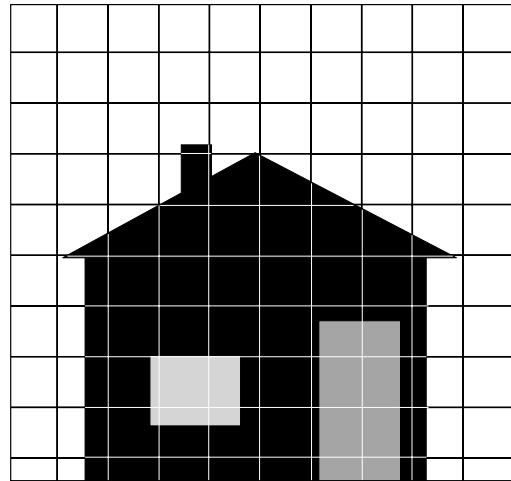

### Procedure:

1. Divide students into pairs.
2. Give one student (A) in each pair the paper copy of the blank grid on the next page. Give the other student (B) in each pair the picture of the house on the next page. Instruct student B not to reveal the picture to student A. Also give student B a copy of the transparent grid. (See notes about making student copies of the picture and grids on the next page.)
3. Explain that the picture is an object being observed at a great distance. It will be scanned by an optical device like those found on some astronomical satellites and an image will be created on the paper.
4. Have student B place the grid over the picture. Student B should look at the brightness of each square defined by the grid lines and assign it a number according to the chart above the picture. Student B will then call out the number to student A. If a particular square covers an area of the picture that is both light and dark, student B should estimate its average brightness and assign an intermediate value to the square such as a 1 or a 2. Note: The letters and numbers on two sides of the grid can assist the receiving student in finding the location of each square to be shaded.
5. After receiving a number from student B, student A will shade the corresponding square on the grid. If the number is 0, the square should be shaded black. If it is 3, the square should be left as it is.

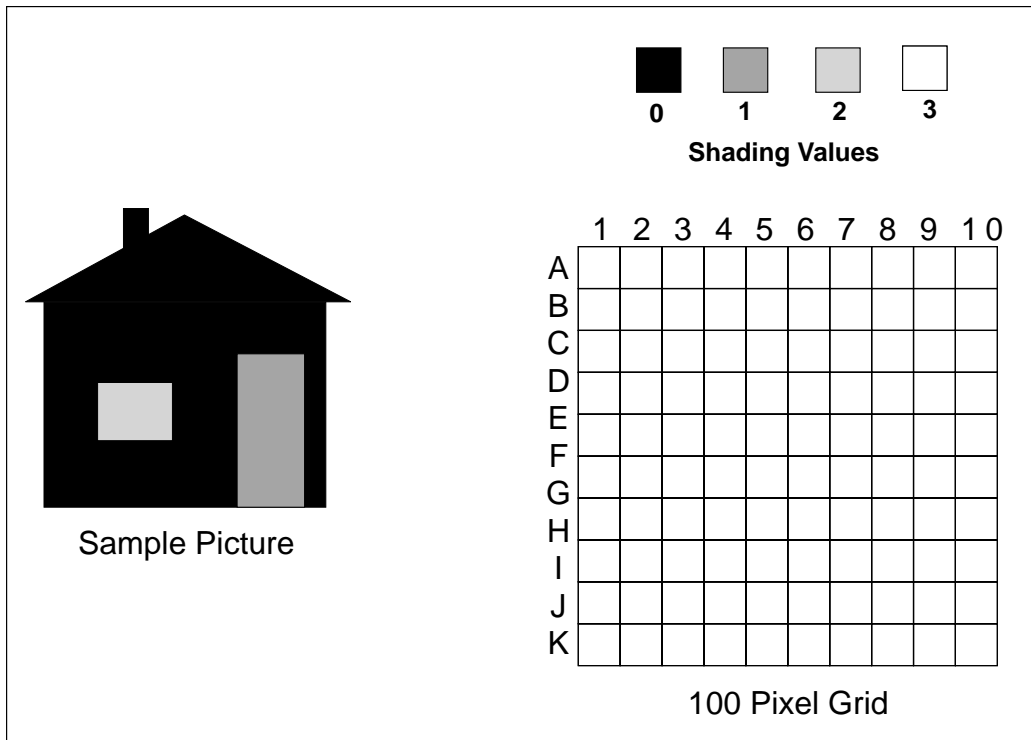

- Compare the original picture with the image sketched on the paper.

**Background:**

This activity simulates the process by which an astronomy spacecraft such as the Hubble Space Telescope collects light from an astronomical object and converts the light into a digital form that can be displayed on Earth as an image of the object. The student with the transparent grid represents the spacecraft. The picture is the object the spacecraft is trying to collect from. The student with the paper grid represents the radio receiver on the ground and the image-processing computer that will assemble the image of the object.

The image created with this activity is a crude representation of the original picture. The reason for this is that the initial grid contains only 64 squares (8 x 8). If there were many more squares, each square would be smaller and the image would show finer detail. You may wish to repeat this activity with a grid consisting of 256 squares (16 x 16). However, increasing the number of squares will require more class time. If you wish

to do so, you can select a single student to represent the spacecraft and transmit the data to the rest of the class.

With the HST, the grid consists of more than 2.5 million pixels and they are shaded in 256 steps from black to white instead of just the 4 shades used here. Color images of an object are created by the HST with color filters. The spacecraft observes the object through a red filter, a blue filter, and then a green one. Each filter creates a separate image, containing different information. These images are then colored and combined in a process similar to color separations used for printing colored magazine pictures.

**Management and Tips:**

Students can provide their own pictures for this activity. It is important for the pictures to show strong contrast. The smaller the grid squares, the more detail that will appear in the image. However, simply going from a grid of 10 x 10 to a grid of 20 x 20 will quadruple the length of time it takes to complete the image. Refer to the Color Recognition and Colored Shadows activi-



ties for more details on how color filters work and how to combine colors.

**Assessment:**

Collect the pictures of the house drawn by the student receivers. Compare the original drawing with the student images. Discuss with your students possible strategies for improving the detail of the images.

**Extensions:**

- Transmit and reconstruct the image of Saturn shown on the next page. This more advanced picture uses six shades and smaller grid squares.
- Examine printed copies of drawings made with a computer art program. Notice how the pictures are constructed of individual points. Also notice how the size of the points contributes to the fineness of detail in the picture.
- Examine pictures drawn on a computer. Use the magnifying tool to move to the maximum magnification possible. Compare the two views.
- Obtain Hubble Space Telescope images from the Internet sites given in Unit 5. Examine them closely for the pixel structure. Alternately enlarge and reduce the image size on your computer screen to see the effect on the fineness of detail.

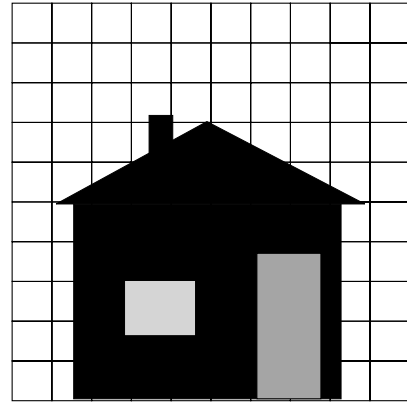

100 Pixel Grid Over House

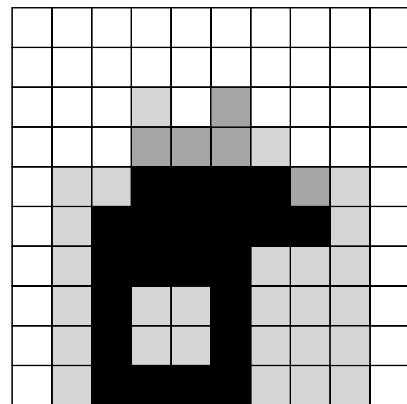

100 Pixel Grid

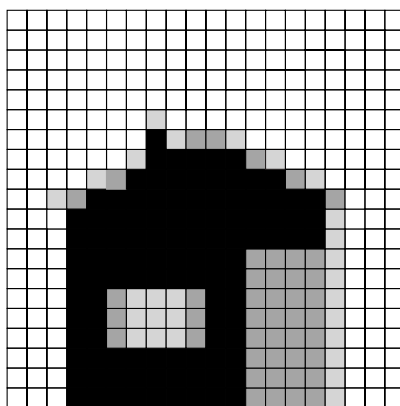

400 Pixel Grid

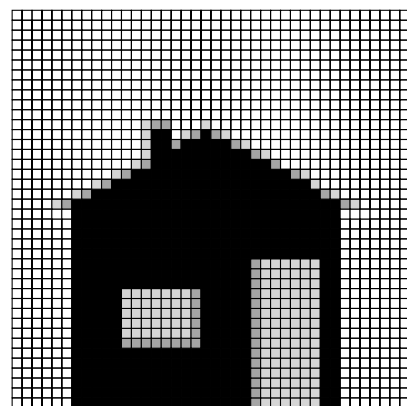

1,600 Pixel Grid

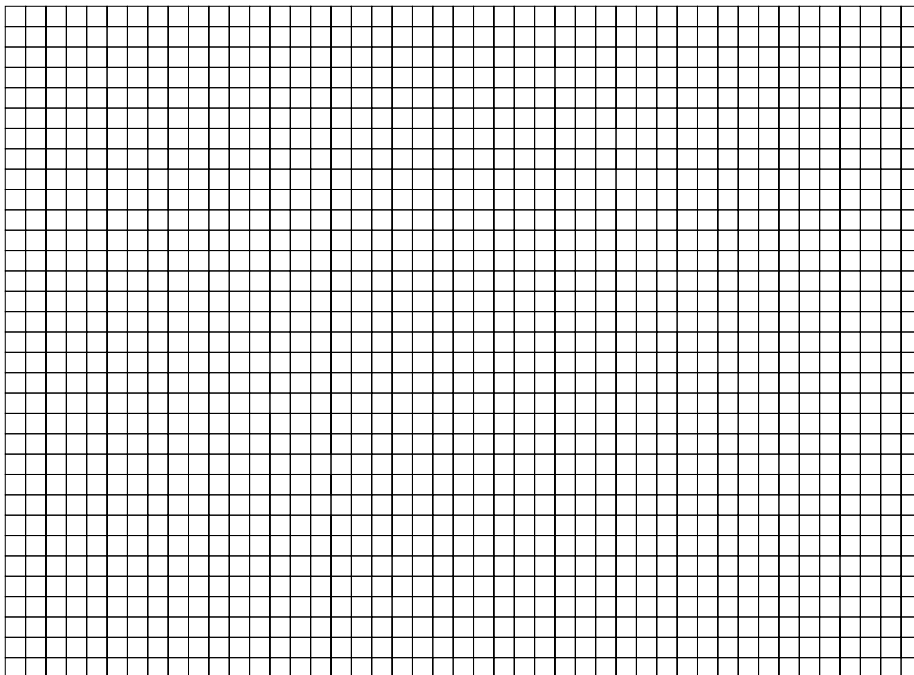
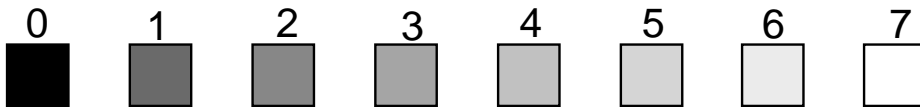
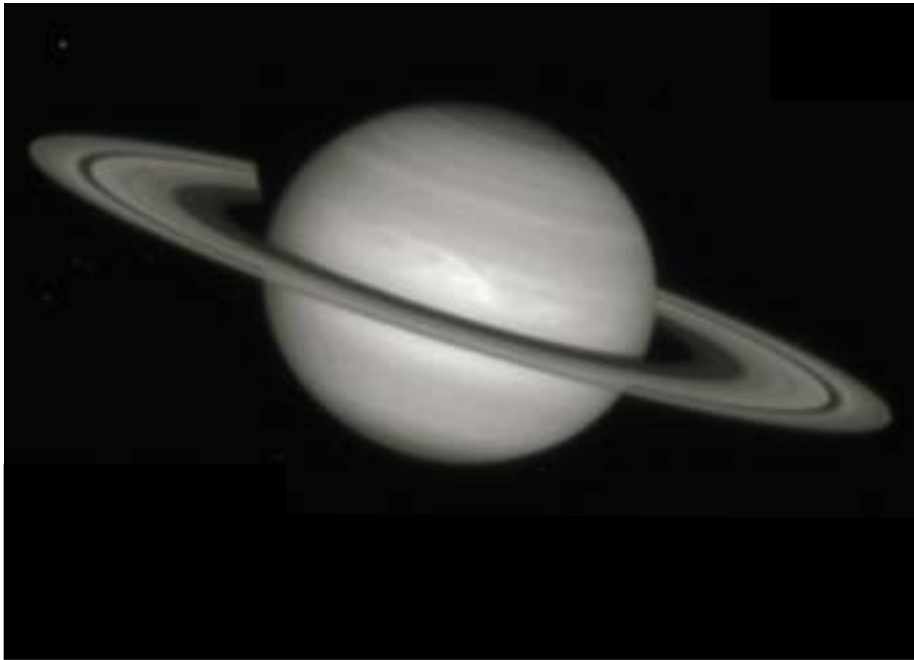

# UNIT 5

## SPACE-BASED ASTRONOMY ON THE INTERNET

---

### Introduction

Activities in the previous units centered on the problems caused by Earth's atmosphere, the nature and uses of the electromagnetic spectrum, visible and infrared radiation collectors, and the imaging process. Once students gain a basic understanding of the nature and methods of space-based astronomy, the only thing left is to do space-based astronomy. This requires obtaining images to study.

Fortunately, obtaining images is very easy to do through the many astronomy Web sites available on the Internet. The list below provides several excellent resources. It must be remembered, however that Web site addresses sometimes change but old addresses will have a forwarding message leading the user to the new site. Furthermore, most sites link to other sites and the actual resources available on-line are much greater than shown here.

NASA maintains extensive Web sites related to astronomy. On the Office of Space Science site there are links to many astronomy spacecraft Web sites. Missions that have flown or are currently operating, such as the SOHO, Voyager, or Galileo missions will have many images to retrieve.

**Unit Goal:**

Students will use data found on Internet Web sites to investigate astronomical objects.

**National Education Standards:**

Mathematics

Connections

Science

Evidence, models, & explanation

Structure of the Earth system

Earth is the solar system

Technology

Understand relationships & connections among technologies & other fields

Understand cultural, social, economic, & political effects of technology

Understand, select, & use information & communication technologies

**Teaching Strategy:**

Using the Internet, students may retrieve Hubble Space Telescope and Compton Gamma Ray Observatory images as well as pictures from many other satellite observatories. The objects in the images can be examined by unaided visual inspection and compared to pictures taken of the same objects by ground-based observatories. However, the advantage of using computers to retrieve the images is that the same computers can be used to analyze the image with image processing programs. The images can be opened in public domain programs such as NIH Image (for

the Macintosh), Scion Image (for Windows-based computers), and various commercial image manipulation programs. These programs permit students to change the colors of selected parts of the image in order to enhance the contrast and reveal structures that might not be visible to the unaided eye. Measurement tools can be used to determine the size of objects if the distance to them is known, measure the relative brightness of stars, map distributions of objects, and so on.

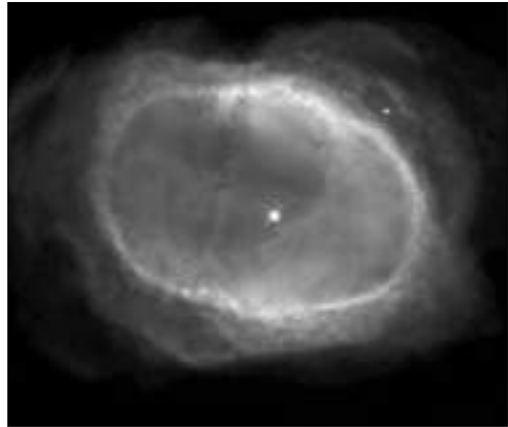

StSci-PR98-39: Planetary Nebula NGC 3132

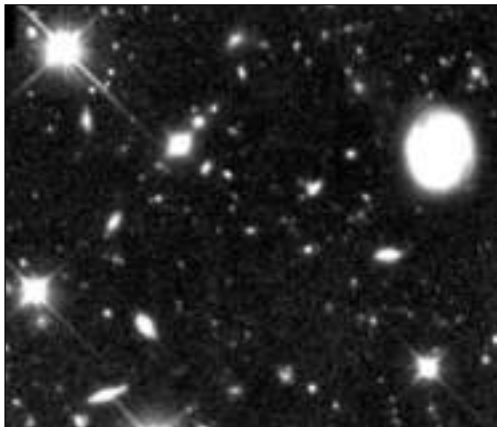

StSci-PR99-02: Combined Deep View of Infrared and Visible Light Galaxies

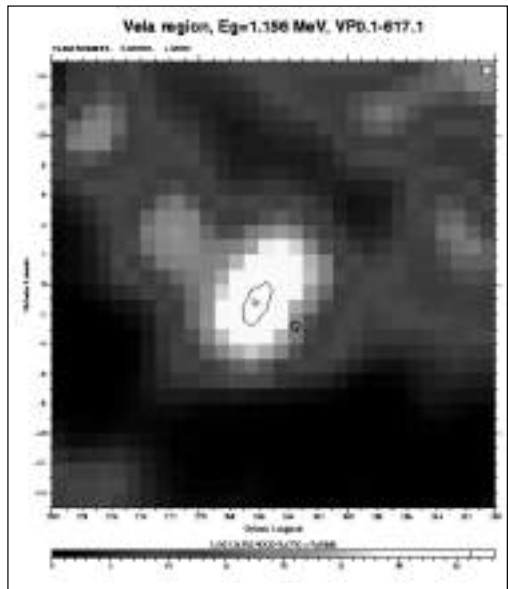

CGRO-Supernova: Supernova detected by the Compton Gamma Ray Observatory

In addition to the analysis of images, students also have access to telescopes that can be controlled remotely. Furthermore, many sites provide background information on a wide range of astronomical topics for research reports. Descriptions of proposed new spacecraft are also available as well as the research questions astronomers are trying to answer with them.

From the NASA Office of Space Science Web site comes the following list of fundamental questions they are trying to answer with their astronomy spacecraft. Some of these questions may inspire students into particular lines of research.

**Fundamental Questions:**

1. How did the Universe begin and what is its ultimate fate?
2. How do galaxies, stars, and planetary systems form and evolve?
3. What physical processes take place in extreme environments such as black holes?
4. How and where did life begin?
5. How is the evolution of life linked to planetary evolution and to cosmic phenomena?
6. How and why does the Sun vary and how do the Earth and other planets respond?
7. How might humans inhabit other worlds?

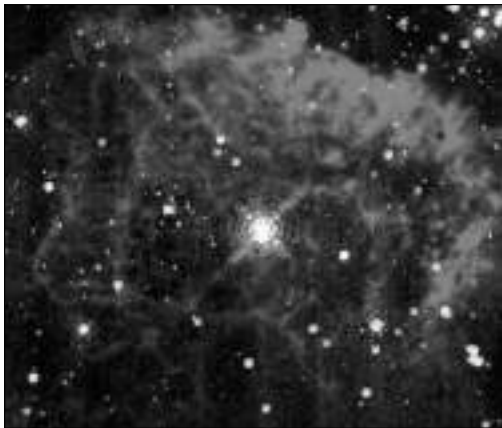

STSci-PRC97-33: One of the brightest stars in the Milky Way Galaxy glows with the radiance of 10 million Suns.

---

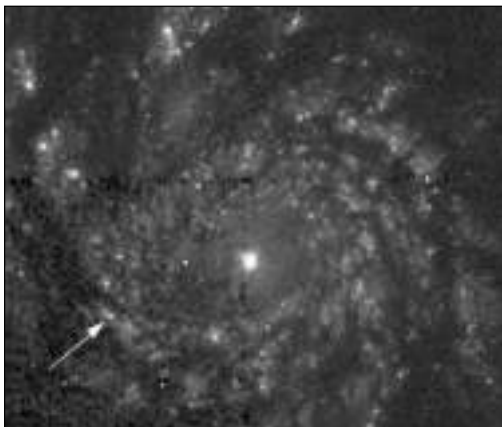

SN 19941: Supernova in galaxy M51

---



BRB 971214: Hubble Space Telescope view of the site of a gamma ray burst detected by the Keck 10-meter telescope

---

## Deep Space Astronomy Web sites

### NASA Resources

NASA Office of Space Science

<http://spacescience.nasa.gov>

<http://spacescience.nasa.gov/missions/index.html>

Planetary Photojournal

<http://photojournal.jpl.nasa.gov>

Images From High-Energy Astrophysics missions

[http://heasarc.gsfc.nasa.gov/Images/pretty\\_pictures.html](http://heasarc.gsfc.nasa.gov/Images/pretty_pictures.html)

Imagine the Universe

<http://imagine.gsfc.nasa.gov/docs/homepage.html>

StarChild Learning Center for Young Astronomers

<http://starchild.gsfc.nasa.gov/docs/StarChild/StarChild.html>

Astronomy & Astrophysics at the National Space Science Data Center

<http://nssdc.gsfc.nasa.gov/astro>

Telescopes in Education

[http://learn.ivv.nasa.gov/products/k12/jpl\\_tie.html](http://learn.ivv.nasa.gov/products/k12/jpl_tie.html)

Compton Gamma Ray Observatory

<http://cosscl.gsfc.nasa.gov/cosscl/PR.html>

### Non-NASA Resources

AstroWeb

[http://www.stsci.edu/astroweb/astroweb.html](http://www.stsci.edu/astroweb/astroweb/astroweb.html)

Chandra Xray Observatory Center

<http://xrtpub.harvard.edu>

Space Telescope Science Institute

<http://oposite.stsci.edu/pubinfo>

Amazing Space Web-Based Activities

<http://amazing-space.stsci.edu>

National Astronomy Education Projects

<http://www.aspsky.org/html/naep/naep.html>

Stardate

<http://www.visionx.com/dd/main/star.htm>

Hubble Space Telescope Information

[http://www.ncc.com/misc/hubble\\_sites.html](http://www.ncc.com/misc/hubble_sites.html)

SEDS Messier Catalog

<http://www.seds.org/messier>

Astronomy Sites

<http://www.inlink.com/~tfc/stars.html>

NIH Image and Scion Image

<http://cipe.com/Software/Soft.html>

# GLOSSARY

---

**Absorption lines** - Dark lines that are produced in a spectrum because intervening atoms absorbed photons of specific wavelengths.

**Angstrom** - A unit of wavelength measure equivalent to  $10^{-12}$  meters.

**Astronomy** - The branch of science focusing on celestial objects, dealing with their size, location, composition, dynamics, origin, etc.

**Astrophysics** - Investigation, through remote sensing, of the physical principles of astronomical objects.

**Binary numbers** - A system of numbers that has two as its base and can be used for numerical coding of data.

**Black hole** - Any object (usually a collapsed star) whose surface gravity is so great that neither matter nor light can escape from it.

**Charged coupled device (CCD)** - An electronic device that consists of a regular array of light sensitive elements that emit electrons when exposed to light. CCDs are used as the light-detecting element in telescopes, television cameras, etc.

**Concave lens or mirror** - A lens or mirror that presents an inward curvature to the objective.

**Continuous spectrum** - A spectrum unbroken by absorption or emission lines.

**Convex lens or mirror** - A lens with an outward curvature.

**Diffraction** - The spreading out of light waves as they pass by the edge of a body or through closely spaced parallel scratches in a diffraction grating.

**Dispersion** - Breaking up of light into its component colors.

**Doppler shift (effect)** - Changes in the wavelengths of sound or light as the distance between the emitter and the receiver changes.

**Earth-based telescope** - Telescope mounted on the surface of Earth.

**Electromagnetic spectrum** - The complete range of all wavelengths of electromagnetic radiation.

**Enhancement (computer)** - Boosting the color or contrast of a faint image through computer processing.

Excitation - The state that occurs when electrons are raised by an external input, such as light or an electronic current, to higher energy levels.

Fluorescence - A spontaneous emission of a photon of light that occurs when an electron drops down from a higher energy level (See excitation) to its original level in an atom.

Frequency - The number of waves that pass a point in one second. Frequency is usually expressed in units of Hertz (waves or cycles per second).

Gamma rays - Electromagnetic radiation with wavelengths shorter than  $10^{-12}$  meters.

Geostationary satellite - A satellite placed in an orbit 35,900 kilometers over Earth's equator that remains in the same place relative to Earth.

Infrared - Electromagnetic radiation with wavelengths ranging from approximately  $10^{-4}$  to  $10^{-6}$  meters.

Light gathering power (LGP) - The ability of an optical instrument to collect light.

Long wave UV - Ultraviolet light with wavelengths (about  $10^{-7}$  meters) just shorter than the optical range of the electromagnetic spectrum.

Microwaves - Electromagnetic radiation with wavelengths ranging around  $10^{-3}$  meters.

Nanometer - One billionth of a meter ( $10^{-9}$  m).

Neutron star - A star, about 10 kilometers in diameter, composed of neutrons.

Objective lens or mirror - The large lens or mirror of a telescope. Sometimes referred to as the primary lens or mirror.

Ozone layer - A region in Earth's upper atmosphere (between 15 and 30 kilometers) where small concentrations of ozone absorb ultraviolet radiation from the Sun and other celestial bodies.

Persistence of vision - Momentary visual retention of signal in the visual cortex of the brain.

Photometry - Measurement of the intensity of light.

Photon - A quantum or individual packet of electromagnetic energy.

Photosphere - The visible surface of the Sun.

Pixels - The smallest element of a picture.

Planck's Constant - A universal constant ( $h$ ) which gives the ratio of a quantum of radiant energy ( $E$ ) to the frequency ( $\nu$ ) of its source. It is expressed by the equation  $E=h\nu$  and its approximate numerical value is  $6.626 \times 10^{-34}$  joule second.

Pulsars - A stellar radio source that emits radio waves in a pulsating rhythm.

Radio waves - Electromagnetic radiation with wavelengths ranging from approximately  $10^{-4}$  to  $10^2$  meters.

Refraction - Bending of light rays as they pass through the interface between two transparent media.

Resolution - The degree to which fine details in an image can be seen as separated or resolved.

Resonance - Sympathetic vibration of one body when exposed to vibrations or electromagnetic radiation emanating from another.

Scientific Notation - Scientific notation, or powers of 10, which can simplify writing large numbers. Numbers with positive powers mean the decimal point moves to the right (e.g.,  $3 \times 10^6 = 3,000,000$ ). A number with a negative power means that the decimal moves to the left (e.g.,  $3 \times 10^{-6} = 0.000,006$ ).

Short wave UV - Ultraviolet light with wavelengths nearest the x-ray range (around  $10^{-8}$  meters) of the electromagnetic spectrum.



Space-based astronomy - Astronomical investigations conducted from above Earth's atmosphere.

Spectrograph - An instrument used for dispersing and recording specific wavelengths of the electromagnetic spectrum.

Spectroscopy - The study of spectra.

Speed of light - The speed at which light travels—300,000 kilometers per second.

Supernova - A stellar explosion which increases the brightness of a star by a factor of several million in a matter of days.

Ultraviolet (UV) - Electromagnetic radiation with wavelengths ranging from approximately  $10^{-7}$  to  $10^{-8}$  meters.

Visible light - Electromagnetic radiation with wavelengths ranging from approximately 400 to 700 nanometers.

Wavelength - The distance between one wave crest to the next wave crest (or one trough to the next trough).

White dwarf - A small star that is actively fusing helium into carbon and oxygen.

X-rays - Electromagnetic radiation with wavelengths ranging from approximately  $10^{-8}$  to  $10^{-11}$  meters.

# SUGGESTED READING

---

These books can be used by students and teachers to learn more about space-based astronomy.

Bonnet, R. & Keen, G. (1992), *Space & Astronomy, 49 Science Fair Projects*, TAB Books, Blue Ridge Summit, PA.

Clarke, D. (1998), *Shoebox Spectroscopy, The Science Teacher*, v65n7, pp. 28-31.

Moeschl, R. (1989), *Exploring the Sky; 100 Projects for Beginning Astronomers*, Chicago Review Press, Chicago, IL.

Pethoud, R. (1993), *Pi in the Sky: Hands-on Mathematical Activities for Teaching Astronomy*, Zephyr Press, Tucson, AZ.

Porcellino, M. (1991), *Young Astronomer's Guide to the Night Sky*, TAB Books, Blue Ridge Summit, PA.

Schaff, F. (1992), *Seeing the Deep Sky; Telescopic Astronomy Projects Beyond the Solar System*, John Wiley & Sons, Inc., New York, NY.

Schaff, F. (1991), *Seeing the Solar System; Telescopic Projects, Activities, & Explorations in Astronomy*, John Wiley & Sons, Inc., New York, NY.

Schaff, F. (1990), *Seeing the Sky; 100 Projects, Activities & Explorations in Astronomy*, John Wiley & Sons, Inc., New York, NY.

Smith, P. (1992), *Project Earth Science: Astronomy*, National Science Teacher's Association, Arlington, VA.

Sneider, C., et al. (1989), *Color Analyzers*, Lawrence Hall of Science, Berkeley, CA.

Sneider, C., Gould, A. (1988), *More than Magnifiers*, Lawrence Hall of Science, Berkeley, CA.

Sneider, C. (1988), *Earth, Moon, and Stars*, Lawrence Hall of Science, Berkeley, CA.

Van Cleave, J. (1991), *Astronomy for Every Kid: 101 Easy Experiments that Really Work*, John Wiley & Sons, Inc., New York, NY.

Vogt, G. (1992), *The Hubble Space Telescope*, The Millbrook Press, Brookfield, CT.

Wood, R. (1991), *Science for Kids: 39 Easy Astronomy Experiments*, TAB Books, Blue Ridge Summit, PA.

# NASA RESOURCES FOR EDUCATORS

---

NASA's Central Operation of Resources for Educators (CORE) was established for the national and international distribution of NASA-produced educational materials in audiovisual format. Educators can obtain a catalogue and an order form by one of the following methods:

- NASA CORE  
Lorain County Joint Vocational School  
15181 State Route 58  
Oberlin, OH 44074-9799
- Toll Free Ordering Line: 1-866-776-CORE
- Toll Free FAX Line: 1-866-775-1401
- E-mail: [nasaco@leeca.org](mailto:nasaco@leeca.org)
- Home Page: <http://education.nasa.gov/core>

*AK, HI, ID, MT, NV, OR, UT, WA, WY,  
Northern CA*

NASA Educator Resource Center  
Mail Stop 253-2

**NASA Ames Research Center**  
Moffett Field, CA 94035-1000  
Phone: (650) 604-3574

*CT, DE, DC, ME, MD, MA, NH,  
NJ, NY, PA, RI, VT*

NASA Educator Resource Laboratory  
Mail Code 130.3

**NASA Goddard Space Flight Center**  
Greenbelt, MD 20771-0001  
Phone: (301) 286-8570

## **Educator Resource Center Network (ERCN)**

To make additional information available to the education community, NASA has created the NASA Educator Resource Center (ERC) network. Educators may preview, copy, or receive NASA materials at these sites. Phone calls are welcome if you are unable to visit the ERC that serves your geographic area. A list of the centers and the regions they serve includes:

*CO, KS, NE, NM, ND, OK, SD, TX*

Space Center Houston  
NASA Educator Resource Center for  
**NASA Johnson Space Center**  
1601 NASA Road One  
Houston, TX 77058  
Phone: (281) 244-2129

*FL, GA, PR, VI*

NASA Educator Resource Center  
Mail Code ERC  
**NASA Kennedy Space Center**  
Kennedy Space Center, FL 32899  
Phone: (321) 867-4090

*VA and MD's Eastern Shores*

NASA Educator Resource Center  
Visitor Center Building J-17  
**GSFC/Wallops Flight Facility**  
Wallops Island, VA 23337  
Phone: (757) 824-2298

*KY, NC, SC, VA, WV*

Virginia Air & Space Center  
Educator Resource Center for  
**NASA Langley Research Center**  
600 Settlers Landing Road  
Hampton, VA 23669-4033  
Phone: (757) 727-0900 x 757

*IL, IN, MI, MN, OH, WI*

NASA Educator Resource Center  
Mail Stop 8-1  
**NASA Glenn Research Center**  
21000 Brookpark Road  
Cleveland, OH 44135  
Phone: (216) 433-2017

*AL, AR, IA, LA, MO, TN*

U.S. Space and Rocket Center  
NASA Educator Resource Center for  
**NASA Marshall Space Flight Center**  
One Tranquility Base  
Huntsville, AL 35807  
Phone: (256) 544-5812

*MS*

NASA Educator Resource Center  
Building 1200  
**NASA Stennis Space Center**  
Stennis Space Center, MS 39529-6000  
Phone: (228) 688-3220

*AZ and Southern CA*

NASA Educator Resource Center for  
**NASA Dryden Flight Research Center**  
45108 N. 3rd Street East  
Lancaster, CA 93535  
Phone: (661) 948-7347

*CA*

NASA JPL Educator Resource Center  
Village at Indian Hill  
1460 East Holt Avenue, Suite 20  
**NASA Jet Propulsion Laboratory**  
Pomona, CA 91767  
Phone: (909) 397-4420

**Regional Educator Resource Centers** offer more educators access to NASA educational materials. NASA has formed partnerships with universities, museums, and other educational institutions to serve as regional ERCs in many states. A complete list of regional ERCs is available through CORE, or electronically via NASA Spacelink at <http://spacelink.nasa.gov/ercn/>

**NASA's Education Home Page** serves as a cyber-gateway to information regarding educational programs and services offered by NASA for the American education community. This high-level directory of information provides specific details and points of contact for all of NASA's educational efforts, Field Center offices, and points of presence within each state. Visit this resource at the following address: <http://education.nasa.gov>

**NASA Spacelink** is one of NASA's electronic resources specifically developed for the educational community. Spacelink serves as an electronic library to NASA's educational and scientific resources, with hundreds of subject areas arranged in a manner familiar to educators. Using Spacelink Search, educators and students can easily find information among NASA's thousands of Internet resources. Special events, missions, and intriguing NASA Web sites are featured in Spacelink's "Hot Topics" and "Cool Picks" areas. Spacelink may be accessed at: <http://spacelink.nasa.gov>

NASA Spacelink is the official home to electronic versions of NASA's Educational Products. A complete listing of NASA's Educational Products can be found at the following address: <http://spacelink.nasa.gov/products>

**NASA Television (NTV)** features Space Station and Shuttle mission coverage, live special events, interactive educational live shows, electronic field trips, aviation and space news, and historical NASA footage. Programming has a 3-hour block—Video (News) File, NASA Gallery, and Education File—beginning at noon Eastern and repeated five more times throughout the day. Live feeds preempt regularly scheduled programming.

Check the Internet for program listings at: <http://www.nasa.gov/ntv>

For more information on NTV, contact:  
 NASA TV  
 NASA Headquarters  
 Code P-2  
 Washington, DC 20546-0001  
 Phone: (202) 358-3572

<b>NTV Weekday Programming Schedules</b> (Eastern Times)		
<b>Video File</b>	<b>NASA Gallery</b>	<b>Education File</b>
12–1 p.m.	1–2 p.m.	2–3 p.m.
3–4 p.m.	4–5 p.m.	5–6 p.m.
6–7 p.m.	7–8 p.m.	8–9 p.m.
9–10 p.m.	10–11 p.m.	11–12 p.m.
12–1 a.m.	1–2 a.m.	2–3 a.m.

How to Access Information on NASA's Education Program, Materials, and Services EP-2000-09-345-HQ

This brochure serves as a guide to accessing a variety of NASA materials and services for educators. Copies are available through the ERC network, or electronically via NASA Spacelink.

**Space-Based Astronomy**  
**An Educator Guide with Activities**  
**for Science, Mathematics, and Technology Education**  
**EDUCATOR REPLY CARD**

To achieve America's goals in Educational Excellence, it is NASA's mission to develop supplementary instructional materials and curricula in science, mathematics, and technology. NASA seeks to involve the educational community in the development and improvement of these materials. Your evaluation and suggestions are vital to continually improving NASA educational materials.

**Please take a moment to respond to the statements and questions below. You can submit your response through the Internet or by mail. Send your reply to the following Internet address:**

*[http://ehb2.gsfc.nasa.gov/educats/educator\\_guide](http://ehb2.gsfc.nasa.gov/educats/educator_guide)*

**You will then be asked to enter your data at the appropriate prompt.**

Otherwise, please return the reply card by mail. Thank you.

1. With what grades did you use the educator guide?

Number of Teachers/Faculty:

\_\_\_\_\_ K-4 \_\_\_\_\_ 5-8 \_\_\_\_\_ 9-12 \_\_\_\_\_

College/University - \_\_\_\_\_ Undergraduate \_\_\_\_\_ Graduate

Number of Students:

\_\_\_\_\_ K-4 \_\_\_\_\_ 5-8 \_\_\_\_\_ 9-12 \_\_\_\_\_

College/University - \_\_\_\_\_ Undergraduate \_\_\_\_\_ Graduate

Number of Others:

\_\_\_\_\_ Administrators/Staff \_\_\_\_\_ Parents \_\_\_\_\_

\_\_\_\_\_ General Public \_\_\_\_\_ Civic Groups \_\_\_\_\_ Other \_\_\_\_\_

2. What is your home 5- or 9-digit zip code? \_\_\_\_\_

3. This is a valuable educator guide?

Strongly Agree  Agree  Neutral  Disagree  Strongly Disagree

4. I expect to apply what I learned in this educator guide.

Strongly Agree  Agree  Neutral  Disagree  Strongly Disagree

Fold along line and tape closed.

5. What kind of recommendation would you make to someone who asks about this educator guide?

Excellent  Good  Average  Poor  Very Poor

6. How did you use this educator guide?

Background Information  Critical Thinking Tasks  
 Demonstrate NASA Materials  Demonstration  
 Group Discussions  Hands-On Activities  
 Integration Into Existing Curricula  Interdisciplinary Activity  
 Lecture  Science and Mathematics  
 Team Activities  Standards Integration  
 Other: Please specify: \_\_\_\_\_

7. Where did you learn about this educator guide?

NASA Educator Resource Center  
 NASA Central Operation of Resources for Educators (CORE)  
 Institution/School System  
 Fellow Educator  
 Workshop/Conference  
 Other: Please specify: \_\_\_\_\_

8. What features of this educator guide did you find particularly helpful?

\_\_\_\_\_

\_\_\_\_\_

9. How can we make this educator guide more effective for you?

\_\_\_\_\_

\_\_\_\_\_

10. Additional comments:

\_\_\_\_\_

\_\_\_\_\_

Today's Date: \_\_\_\_\_

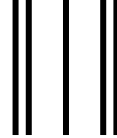
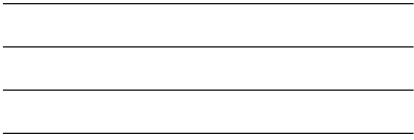

Please Place  
Stamp Here  
Post Office  
Will Not Deliver  
Without Proper  
Postage

**NATIONAL AERONAUTICS AND SPACE ADMINISTRATION  
EDUCATION DIVISION  
MAIL CODE FE  
WASHINGTON DC 20546-0001**



---

Fold along line and tape closed.