

## **B.Sc. COSTUME DESIGN AND FASHION**

### **FASHION DESIGNING AND SEWING TECHNOLOGY**

<u>UNITS</u>	<u>PAGE NUMBERS</u>
UNIT 1	03
UNIT 2	48
UNIT 3	91
UNIT 4	126
UNIT 5	166

#### CONTENTS

UNIT NO.	LESSON NO.	TITLE OF THE LESSON	PAGE NO.
UNIT I	1	PRINCIPLES OF FASHION	03
	2	FASHION PRODUCERS	15
	3	FASHION DESIGNING & ACCESSORIES	22
	4	PRINCIPLES OF DESIGNING	40
UNIT II	5	COLOUR	48
	6	COLOUR HARMONIES & APPLICATION	60
	7	DRESS DESIGNING	71
UNIT III	8	SEWING MACHINES	91
	9	SPECIAL MACHINES	99
	10	SEWING MACHINE ATTACHMENTS	110
	11	SEWING MACHINE CARE AND MAINTENANCE	116
UNIT IV	12	STITCHING MECHANISM	126
	13	FEEDING MECHANISM	141
	14	SPREADING	150
	15	CUTTING	156
UNIT V	16	MARKING	166
	17	PRESSING	174
	18	SEWING FEDERAL STANDARDS FOR SEAM	181
	19	SEWING FEDERAL STANDARDS FOR STITCH	188
	20	SEWING THREAD	199

## UNIT – I

### LESSON – 1: PRINCIPLES OF FASHION

#### CONTENTS

- 1.0 AIM AND OBJECTIVES
- 1.1 INTRODUCTION
- 1.2 FASHION
  - 1.2.1 Fashion design terms
  - 1.2.2 Areas of fashion
  - 1.2.3 Fashion flow chart
  - 1.2.4 Fashion in Cloths
- 1.3. CLASSIFICATION OF FASHION
  - 1.3.1 Style
  - 1.3.2 Basic or classics
  - 1.3.3 Fad
  - 1.3.4 Fashion Forecasting
  - 1.3.5 Trends
- 1.4 CHIC
- 1.5 COSTUME MADE
- 1.6 COLLECTION
- 1.7 MANNEQUINS
- 1.8 FASHION SHOWS:
  - 1.8.1 Formal fashion shows
  - 1.8.2 Designer trunk shows
  - 1.8.3 Department fashion shows
  - 1.8.4 Informal fashion shows
- 1.9 FASHION CYCLES
  - 1.9.1 Length of cycles
- 1.10 LET US SUM UP
- 1.11 LESSON END ACTIVITIES
- 1.12 POINTS FOR DISCUSSION
- 1.13 REFERANCES

## 1.0 AIM AND OBJECTIVES

The aim of this lesson is to give better knowledge to students about the field of fashion & related terms and fashion cycles.

- Here we discussed all the area of fashion field which includes terms of fashion, fashion sources and fashion cycle.
- In fashion cycle point of view, it deals the principles of fashion, peak, decline, length of fashion cycle
- Fashion show and its type, fashion forecasting and classification of fashion will give idea about fashion.

## 1.1 INTRODUCTION

Fashion in the narrow sense of the world means the changing form of clothing. These originate from peoples need to be adorned and admired nut also allow the opportunity to enhance personal style or indicate a position in society. Fashion is not the only consideration in developing a garment for a market. The overall appearance (style) as well as the utility value (fitness for purpose, aftercare) also have.

Here we studied about introductory concept of fashion, fashion terms and fashion forecasting. In this lesion we will go through another important function of fashion cycle, classification of fashion and fashion shows.

## 1.2 FASHION

**Fashion** is a term that usually applies to a prevailing mode of expression, but quite often applies to a personal mode of expression that may or may not apply to all. Inherent in the term is the idea that the mode will change more quickly than the culture as a whole. The terms "fashionable" and "unfashionable" are employed to describe whether someone or something fits in with the current popular mode of expression. The term "fashion" is frequently used in a positive sense, as a synonym for glamour and style. In this sense, fashions are a sort of communal art, through which a culture examines its notions of beauty and goodness.

### 1.2.1 FASHION DESIGN TERMS

- A fashion designer conceives garment combinations of line, proportion, color, and texture. He or she may or may not know how to sew or make patterns. Formal training is always essential, yet most fashion designers are formally trained (apprenticed) and schooled.
- A patternmaker drafts the shapes and sizes of a garment's pieces with paper and measuring tools, and, some times, an AutoCAD computer software program, or by draping muslin on a dress form, the original way. The resulting pattern pieces must compose the intended design of the garment and they must fit the intended wearer. Formal training is essential for working as a pattern marker.
- A tailor makes custom designed garments made to the client's measure; suits (coat and trousers, jacket and skirt, et cetera).

- A textile designer designs fabric weaves and prints for clothes and furnishings. Most textile designers are formally trained as apprentices and in school.
- A stylist is the person who co-ordinates the clothes, jewelry, and accessories used in fashion photography and catwalk presentations of clothes collections. A stylist also is a designer whose designs are based upon extant things, trends, and the collections of other designers.
- A buyer orders stocks of clothes for shops, chain stores, and other types of stores. Most fashion buyers are trained in business studies.
- A seamstress sews seams wither manually or with a sewing machine, either in a garment shop or as a sewing machine operator in a factory. She (or he) may not have the skills to make (design and cut) the garments, or to fit them on a model. A seamstress is not synonymous with *dressmaker*.
- A teacher of fashion design teaches the art and craft of fashion in art schools and in fashion design school.
- A custom clothier makes custom-made garments to order, for a given customer.
- A dressmaker specializes in custom-made women's clothes: day, cocktail, and evening dresses, business clothes and suits, trousseaus, sports clothes, and lingerie.
- An illustrator draws and paints clothes for commercial use.
- A model wears and displays clothes at fashion shows and in photographs.
- A fashion journalist writes fashion articles describing the garments presented, for magazines or newspapers.
- An alterations specialist (alterationist) adjusts the fit of completed garments, usually ready-to-wear, and sometimes re-styles them. NOTE: despite tailors altering garments to fit the client, not all alterationists are tailors.
- A wardrobe consultant or fashion advisor recommends styles and colors that are flattering to the client.
- A photographer photographs the clothes on fashion models for use in magazines, newspapers, or adverts.

### 1.2.2 AREAS OF FASHION

Fashions are social phenomena common to many fields of human activity and thinking. The rises and falls of fashions have been especially documented and examined in the following fields:

- Architecture, interior design, and landscape design
- Arts and crafts
- Body type, clothing or costume, cosmetics, grooming, hair style, and personal adornment
- Dance and music
- Forms of address, slang, and other forms of speech
- Economics and spending choices, as studied in behavioral finance
- Entertainment, games, hobbies, sports, and other pastimes
- Etiquette
- Management, management styles and ways of organizing
- Politics and media, especially the topics of conversation encouraged by the media

- Philosophy and spirituality (One might argue that religion is prone to fashions, although official religions tend to change so slowly that the term cultural shift is perhaps more appropriate than "fashion")
- Social networks and the diffusion of representations and practices
- Sociology and the meaning of clothing for identity-building
- Technology, such as the choice of programming techniques

Of these fields, costume especially has become so linked in the public eye with the term "fashion". The more general term "costume" has been relegated by many to only mean fancy dress or masquerade wear, while the term "fashion" means clothing generally, and the study of it. This linguistic switch is due to the so-called fashion plates which were produced during the Industrial Revolution, showing novel ways to use new textiles. For a broad cross-cultural look at clothing and its place in society, refer to the entries for clothing and costume.

### 1.2.3 FASHION FLOW CHART

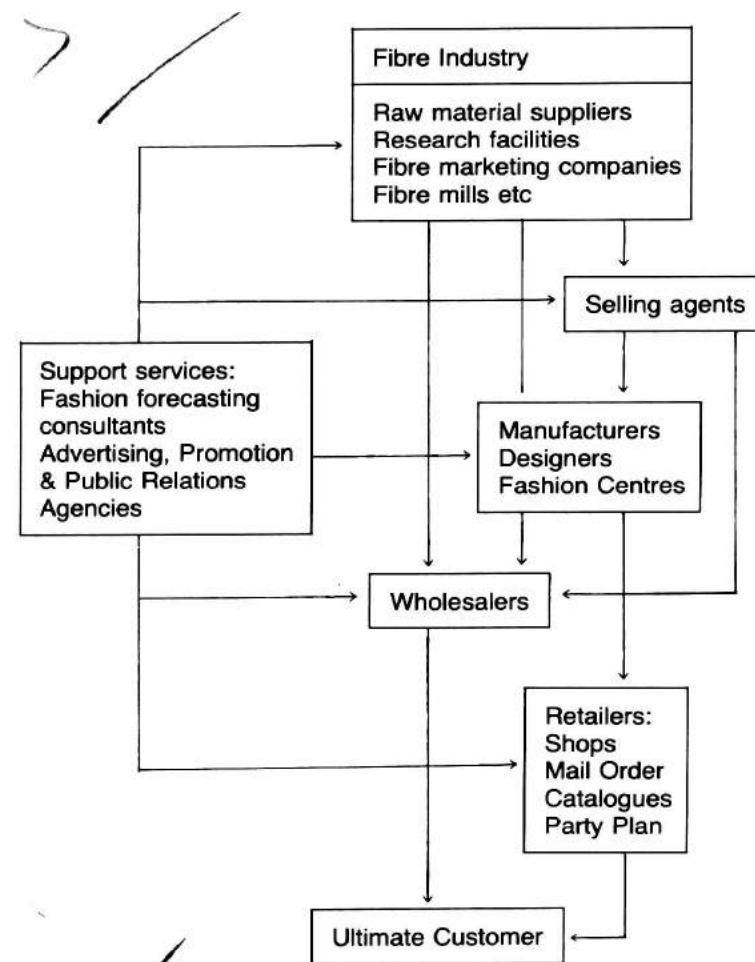

Fashion flow chart.

### **1.2.4 FASHION IN CLOTHS**

Fashion in clothes has allowed wearers to express emotion or solidarity with other people for millennia. Modern Westerners have a wide choice available in the selection of their clothes. What a person chooses to wear can reflect that person's personality or likes. When people who have cultural status start to wear new or different clothes a fashion trend may start. People who like or respect them may start to wear clothes of a similar style.

Fashions may vary significantly within a society according to age, social class, generation, occupation and geography as well as over time. If, for example, an older person dresses according to the fashion of young people, he or she may look ridiculous in the eyes of both young and older people. The terms "fashionista" or "fashion victim" refer to someone who slavishly follows the current fashions (implementations of fashion).

### **1.3. CLASSIFICATION OF FASHION**

The duration of fashion's importance is a critical fashion designers or manufactures concern. A fashion can be brief or of long duration. Once having identified this characteristic, a designer is in a position to assess a fashions importance to the retail inventory.

Fashion is classified into many types, such as:

- Style
- Basic or classic
- Fad
- Fashion Forecasting
- Trends

#### **1.3.1 STYLE**

Style is always constant. It does not change whereas fashion changes. It is not constant. It is the modification of fashion. Style is the basic outline of any garment. When we ass a different neckline and different sleeves with some trimming here and there over a basic garment then the basic garment is modified into a different look or a different outfit, this modification ferment will become fashion, when it is accepted by people.

The term style is a popular word in fashion and refers to a sub-division within fashion. By definition, it is that which has certain characteristics that distinguish it from other designs. For example, the fashion could be pleated skirt, yet the style is box pleat. It is a common fallacy to believe that the famous designers create fashions. They create styles which they hope will be accepted. When and if there is consumer support the style then becomes fashion. It is repetitious but important to stress that fashion is synonymous with acceptance.

#### **1.3.2 BASIC OR CLASSICS**

When a fashion is constant or long lasting, such as, salwar kameez and saree, it is called Basic or Classic. It is similar to a standard music. The salwar kameez and saree are part of fashion scene. A customer has one or more in her wardrobe, to be worn to suit different

occasions. In certain times, the basic becomes the most important promotable fashion, but, in or out, they remain as a part of the fashion scene. There are many outfits that fall into this classification, such as, chudidhar, kurta, dupattas, shirt and trousers, plain or pleated skirts and denims, etc. there are general fashions that lasts for years, such as, the saree, the single breasted men's suit

Basics or Classics are the outfits which stays in the fashion scene for a long period of time that is from past to present and even in future it stands

When we watch old movies as well as the new movies which are released just, we can see the saris and salwar kameez worn in it may be with a slight change or modification accordingly.

### **1.3.3 FAD**

A Fad is something which can either make a designer's life more interesting or tenser. Very often something appears on the fashion scene that captures the imagination, only to fizzle out in short duration.

Overall, Fad can be defined as short lived fashion, lasting for a very little time or period, acceptable by only a certain group of people. For example, hippies – their clothing, accessories, hairstyles, etc.

As Fad is short lived fashion, it stays for a very short period, because they are very costly and every one cannot afford to buy it. For example, dhoti salwar, tube shirts and so on.

A fashion expert is a selection for consumers – selecting what is more likely to be accepted going overboard for short lived fashion – Fad can be costly

### **1.3.4 FASHION FORECASTING**

This is the important part of fashion scenario because when any new garment is designed by the designer and worn, it will not create fashion by itself. It needs the media to spread fashion and this media which spread fashion and gets the fame and name to the designers is Fashion Forecasting.

Fashion Forecasting is done through many communicating media, such as, cinema, fashion shows, press, magazines, newspapers and window display.

It includes

- Market research
- Consumer research
  - Surveys
  - Consumer focus groups
  - In-store informal interviews
- Shopping
- Sales Records
- Evaluating the collections
- Fashion Trends
- Trend for Target Markets

Fashion Forecasting is done where crowd is formed in such occasion, so that it can create fashion.

### **1.3.5 TRENDS**

Fashion trends are the styling ideas that major collections have in common. They indicate the direction in which fashion is moving. Fashion forecasters look for the styles they think are prophetic, ideas that capture the mood of the times and signal a new fashion trend.

Several designers may use a similar fashion idea because they have been inspired by common sources. The trend may appear in a fabrication, a silhouette, or another design element that appears in several collections. Very often, a new trend appears in small doses until it spreads to other collections. As the press notices similarities between collections and highlights them, the media exposure also helps establish the trends.

Evaluating the collections becomes one way a designer, working for a mainstream manufacturer, can research fashion direction. As designers are not invited to the shows, they must evaluate by shopping in major fashion capitals or using design services, magazines, and newspapers.

For retail buyers, it is becoming a huge challenge to figure out which trends will become fashion basics, like capris, and which are only fads, such as pony prints. Buyers have to become very flexible in their buying patterns and cautious about inventory management. If the market becomes flooded with a new trend, consumers may react negatively to the overexposure.

Empowered by the Internet and television, global trends are moving at an accelerating pace. The life-span of a trend is now about five months instead of a year. For the junior market, the span is only three months.

### **1.4 CHIC**

Chic is a French word, established in English since at least the 1870s, that has come to mean smart or stylish. Over the years "chic" has been applied to, among other things, social events, situations, individuals, and modes or styles of dress. Recurring generic terms included designer chic (associated with the styles of particular coutouriers - the 1980s became known as the "designer decade") and retro-chic (adopting elements of fashion from the past: e.g. "Victorian chic", "sixties chic", "Georgian chic", "1920s Riviera chic")

### **1.5 COSTUME MADE:**

The elaborate detail and intricate and dressmaking at that time required an enormous amount of painstaking hand labor. All clothes were not only hand make but also custom-made. Each garment was made to fit the customer's exact measurements. Dresses and suits were individually sewn by dressmakers or tailors to their employers specifications. The identities of personal dressmakers were secrets guarded by the wealthy. No one wanted to share the talents of clever dressmakers for fear of losing them.



## **1.6 COLLECTION**

Each season, the design and merchandising departments of each division are responsible for creating a new line, the seasonal collection that the manufacturer will sell to retail store buyers. The terms are synonymous: Collection is used primarily in Europe and for high-period apparel in the United States. Line is used more often in the United States for moderately and popularly priced fashion.

## **1.7 MANNEQUINS**

Mannequins change with fashion trends and are made in the image of the current ideal of beauty. For elegant fashion, perfectly coiffed, traditional life-like Mannequins are preferred. However, they are very expensive to buy and to maintain. To save money, many stores have replaced them with less expensive papier-mâché torsos or unpainted “Mannequins alternatives.”

## **1.8 FASHION SHOWS:**

Fashion shows are special events that communicate a fashion story. The selection and organization of the fashions and model bookings may be done by the fashion office, whereas invitations and other arrangements may be handled by the special events department. There are four possible ways to organize these presentations: formal shows, department shows, designer trunk shows, or informal modeling.

### **1.8.1 FORMAL FASHION SHOWS**

Formal fashion shows take a great deal of advance planning involving booking models and fittings and arranging for a runway, scenery, lighting, microphones, music, seating, and assistants. Clothes are generally grouped according to styling, color, or other visual criteria. Models and music are selected to complement the clothes and set a mood.

### **1.8.2 DESIGNER TRUNK SHOWS**

Designer trunk shows are done in cooperation with a single vendor and are a popular way to sell expensive collections. Invitations are sent to the best customers according to records kept by sales associates. The designer or a representative travels from store to store with the collection, which is usually shown on models in the designer collections department. Customers get to see the entire collection unedited by a buyer and may order from the samples in their size. Although some designers and retailers do 50 percent of their total business through trunk shows, others find them time-consuming, exhausting work, and have given them up.

### **1.8.3 DEPARTMENT FASHION SHOWS**

Department fashion shows, on a much smaller scale, are produced in store to generate immediate sales. Usually, a platform is set up directly in the department that carries the clothes.

### 1.8.4 INFORMAL FASHION SHOWS

Informal fashion shows are the easiest to produce. A few models walk through the store showing the fashions that they are wearing to customers who are shopping or having lunch in the store's restaurant. The models can take their time, and customers enjoy asking them questions. This is often done in conjunction with a trunk show or special promotion.

### 1.9 FASHION CYCLES

Consumers are exposed each season to a multitude of new styles created by designers. Some are rejected immediately by the press or by the buyer on the retail level, but others are accepted for a time, as demonstrated by consumers purchasing and wearing them.

The way in which fashion changes is usually described as a fashion cycle. It is difficult to categorize or theorize about fashion without oversimplifying. Even so, the fashion cycle is usually depicted as a bell shaped curve encompassing five stages: introduction, rise in popularity, peak of popularity, decline in popularity, and rejection. The cycle can reflect the acceptance of a single style from one designer or a general style such as the miniskirt.

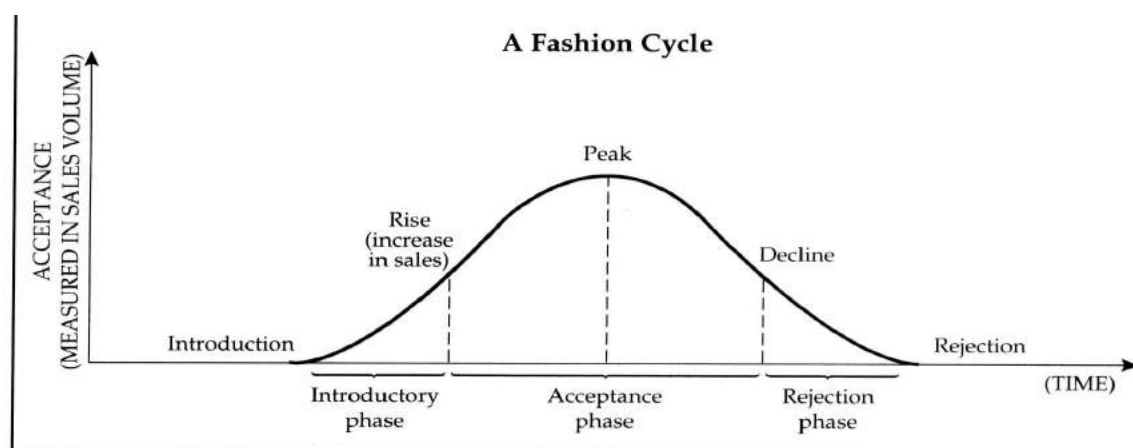

#### 1. Introduction of a style:

Designers interpret their research and creative ideas into appeal or accessories and then offer the new styles to the public. Designers create new designs by changing elements such as line, shape, color, fabric, and details and their relationship to one another. New creations referred to as the "latest fashions" may not yet be accepted by anyone. At this first stage of the cycle, fashion implies only style and newness.

Most new styles are introduced at a high price level. Designers who are globally respected for their talent may be given financial backing and be allowed to design with very few limitations on creativity, quality of raw materials, or amount of fine workmanship. Naturally, production costs are high, and only a few people can afford the resulting garments. Production in small quantities gives a designer more freedom, flexibility, and room for creativity.

## 2. Increase in popularity:

If a new style is purchased, worn, and seen by many people, it may attract the attention of buyers, the press, and the public. In self-defense, most couture and high – priced designers now have secondary bridge and or diffusion lines that sell at lower prices, so that they can sell their designs in greater quantities.

The popularity of a style may further increase through copying and adaptation. Some designers or stylists may modify a popular style to suit the needs and price range of their own customers. Some manufacturers may copy it with less expensive fabric and less detail in order to sell the style at lower prices.

## 3. Peak of popularity:

When a fashion is at the height of its popularity, it may be in such demand that many manufacturers copy it or produce adaptations of it at many price levels. Some designers are flattered by copying and others are resentful. There is very fine line between adaptations and knockoffs.

Volume production requires a likelihood of mass acceptance. Therefore, volume manufacturers carefully study sales trends because their customers want clothes that are in the mainstream of fashion.

## 4. Decline in popularity:

Eventually, so many copies are mass produced that fashion –conscious people tire of the style and begin to look for something new. Consumers still wear garments in the style, but they are no longer willing to buy them at regular prices. Retail stores put such declining styles on sale racks, hoping to make room for new merchandise.

## 5. Rejection of a style or obsolescence:

In the last phase of the fashion cycle, some consumers have already turned to new looks, thus beginning a new cycle. The rejection or discarding of a style just because it is out of fashion is called *consumer obsolescence*. As early as 1600, Shakespeare wrote that “*fashion wears out more apparel than the man*”.

### **1.9.1 LENGTH OF CYCLES**

Although all fashions follow the same cyclical pattern, there is no measurable timetable for a fashion cycle. Some fashions take a short time to peak in popularity, others take longer; some decline slowly, other swiftly. Some last a single selling season, others last several seasons. Certain fashions fade quickly; others never completely disappear.

#### 1. Classics:

Some styles never become completely obsolete, but instead remain more or less accepted for an extended period. A classic is characterized by simplicity of design, which keeps it from being easily dated. An example is the Chanel suit, which peaked in fashion in the 1950s, as well as other manufacturers, have produced variations of these suits for a small, dedicated clientele.

Other examples of classics include blazer jackets, twin sets, polo shirts, jeans, ballet flats, and loafers.

## 2. Fads:

Short – lived fashions, or fads, can come and go in a single season. They lack the design strength to hold consumer attention for very long. Fads usually affect only a narrow consumer group, begin in lower price ranges, are relatively simple and inexpensive to copy and therefore flood the market in a very short time. Because of market saturation, the public tires of them quickly and they die out.

## 3. Cycles within Cycles:

Design elements (such as color, texture, silhouette, or detail) may change even though the style itself remains popular. Jeans became a fashion item in the late 1960s and remained classics. Therefore, their fashion cycle was very long. However, various jean silhouettes – including bell and baggy – came and went during that time.

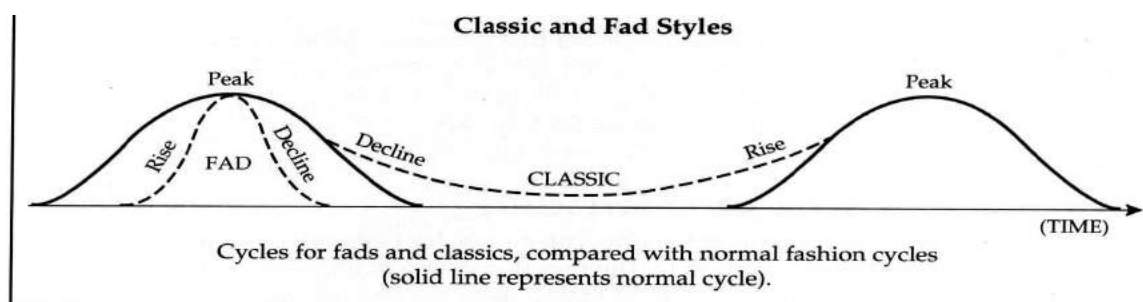

## 4. Interrupted Cycles:

Consumer buying is often halted prematurely because manufacturers and retailers no longer wish to risk producing or stocking merchandise that will soon decline in popularity. This is obvious to consumers who try to buy summer clothes in August.

Sometimes the normal progress of a fashion cycle is interrupted or prolonged by social upheaval, economic depression, or war. Consider the large shouldered, wedge shaped silhouette in women's fashion which began in the 1930s. Because people were concerned with things more important than fashion during World War II, the same silhouette continued, without the normally expected decline, for the duration of the war. The new look of 1947 with its sloping shoulders tiny waists and longer skirts was a radical change because the old cycle had been unnaturally prolonged.

## **5. Recurring Cycles:**

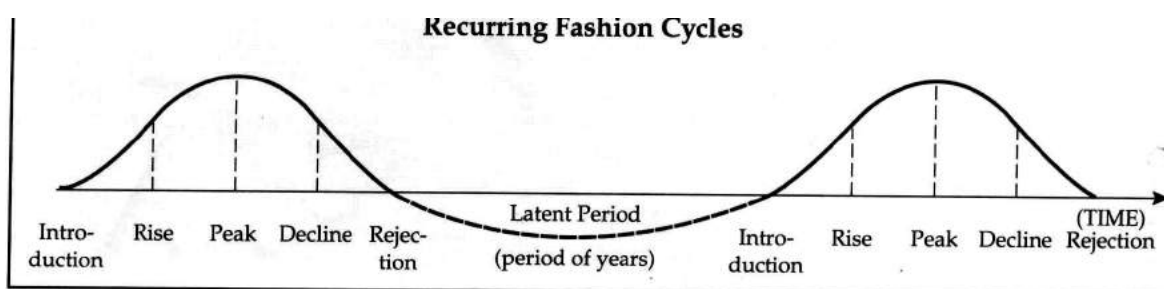

After a fashion dies, it may resurface. Designers often borrow ideas from the past. When a style reappears years later, it is reinterpreted for a new time, a silhouette or proportion may recur, but it is interpreted with a change in fabric and detail. Nothing is ever exactly the same – yet nothing is totally new. As the century and millennium draw to a close, designers are showing many nostalgic looks of the 1940s, 1950s, 1960s, 1970s and even the 1980s. However, the use of different fabrics, colors, and details make the looks unique to the turn of the century.

### **1. 10 LET US SUM UP**

In this lesson we have learned how fashion get importance in our field, the area of fashion and the fashion flowchart. The classification of fashion gives the concept and idea has to be follow for the designer. We have also seen the trends for the fashion and fashion forecasting techniques. In this lesson the concept of fashion shows are explained with its types.

### **1.11 LESSON END ACTIVITIES**

The students may do the following activities based on this lesson.

- Interact with boutique shop owners and fashion designers
- Analyze how to conduct the fashion shows
- Forecast the upcoming fashions

### **1.12 POINT FOR DISCUSSION**

Here the students are asked to discuss about the following points

- Discuss the growth and importance of fashion
- Analyze the life time of particular fashion

### **1.13 REFERENCES:**

- The art and everyday life
- Elements of fashion and apparel designing, by Sumathi G.J., New Age International Pvt. L.t.d..
- Inside the fashion business, by Macmillan publication company
- Fashion from concept to consumer, by Cini stephens Frings, Low price edition

## LESSON – 2: FASHION PRODUCERS

### CONTENTS

- 2.0 AIM AND OBJECTIVES
- 2.1 INTRODUCTION
- 2.2 THE COUTURIER
- 2.3 HAUTE COUTURE
- 2.4 PRÊT-À-PORTE
- 2.5 FASHION DIRECTION
- 2.6 FASHION EDITORS
- 2.7 LINE
- 2.8 KNOCKOFFS
- 2.9 AVANT GRADE
- 2.10 BRIDGE
- 2.11 BUYING HOUSE
  - 2.11.1 International Buying Houses:
- 2.12 MERCHANDISING
  - 2.12.1 Scheduling
  - 2.12.2 Seasons
  - 2.12.3 The Merchandise Plan
- 2.13 LET US SUM UP
- 2.14 LESSON END ACTIVITIES
- 2.15 POINTS FOR DISCUSSION
- 2.16 REFERANCES

### 2.0 AIM AND OBJECTIVES

After going through this unit, you should be able to have a clear idea of the following

- What is Couture and haute couture?
- Fashion Direction and Fashion Editors
- Define the basic functions of Line & Knockoffs
- Concept of Buying House
- Different function of Merchandising

### 2.1 INTRODUCTION

The early lesson we have studied the fashion and its corresponding terms with necessary types. In this lesson we will study the fashion management and merchandising.

The fashion management gives an idea about fashion direction and fashion editors. The term buying house is still used in the industry; its role has greatly expanded to fill a wide variety of functions. The two primary types of buying house are indicated here.

In merchandising we are going to cover the merchandising scheduling, season and the plan to be executed.

## **2.2 THE COUTURIER**

“Fashion is a very important economic sector for our country, and couture is the flagship of French fashion”, explained Dominique Strauss-Khan, the former French minister of industry. Couture is simply the French word for fine, custom dress design, made to measure for a particular customer. A couturier is a male couture designer; a couturiere is his female counterpart.

The couturier Charles Frederick Worth (October 13, 1826–March 10, 1895), is widely considered the father of haute couture as it is known today. Although born in Bourne, Lincolnshire, England, Worth made his mark in the French fashion industry. While he created one-of-a-kind designs to please some of his titled or wealthy customers, he is best known for preparing a portfolio of designs that were shown on live models at the House of Worth. Clients selected one model, specified colors and fabrics, and had a duplicate garment tailor-made in Worth's workshop. Worth combined individual tailoring with standardization more characteristic of the ready-to-wear clothing industry, which was also developing during this period.

## **2.3 HAUTE COUTURE**

Haute couture the type of fashion design which predominated until the 1950s was "made-to-measure" or haute couture, (French for high needlework). The term made-to-measure may be used for any garment that is created for a specific client. Haute couture, however, is a protected term which can only be officially used by companies that meet certain well-defined standards set by the Chambre Syndicale de la Couture. Nonetheless, many ready-to-wear, and even mass market labels, claim to produce haute couture, when in fact, according to established standards, they do not. A couture garment is made to order for an individual customer, and is usually made from high-quality, expensive fabric, sewn with extreme attention to detail and finish, often using time-consuming, hand-executed techniques. Look and fit take priority over the cost of materials and the time it takes to make

The term can refer to:

- The fashion houses or fashion designers that create exclusive and often trend-setting fashions
- The fashions created

Haute couture is made to order for a specific customer, and it is usually made from high-quality, expensive fabric and sewn with extreme attention to detail and finish, often using time-consuming, hand-executed techniques



## **2.4 PRÊT-À-PORTE**

However, the term *haute couture* has been misused by successive ready-to-wear brands and high street labels since the late 1980s so that its true meaning has become blurred with that of prêt-a-porter (the French term for ready-to-wear fashion) in the public perception. Every haute couture house also markets prêt-à-porter collections, which typically deliver a higher return on investment than their custom clothing. In fact, much of the *haute couture* displayed at fashion shows today is rarely sold; it is created to enhance the prestige of the house. Falling revenues have forced a few *couture* houses to abandon their less profitable *couture* division and concentrate solely on the less prestigious *prêt-à-porter*. These houses, such as Italian designer Antonio Capucci, all of whom have their workshops in Italy, are no longer considered haute couture.

Many top designer fashion houses also use the word for some of their collections.

## **2.5 FASHION DIRECTION:**

Fashion direction is established to maintain cohesive fashion merchandising in line with a distinctive store image. In single-unit stores, the owner usually acts as fashion director and buyer. In large stores or chains, management may employ a fashion director. The fashion director is the bridge between corporate marketing policy and actual merchandise-buying decisions. He or she works with merchandise managers, buyers, and promotion executives to suggest what merchandise to choose and how to present it.

Along with management and designer collection buyers, the fashion director may attend European and American collection openings to study fashion trends. These trends are analyzed in relation to the store's image, and this information is passed on to buyers as a guide to merchandise planning and advertising. The fashion director may also work with buyers to select appropriate merchandise, to develop the store's private label, and to coordinate their buys with merchandise in other departments. A fashion director also prepares seasonal fashion presentations for sales associates so that they can understand the new fashion concepts and the store's merchandising approach and, therefore, better help their customers.

## **2.6 FASHION EDITORS:**

The role of the fashion editors is to educate the public, to provide fashion information from all phases of the industry in all parts of the world; to make the industry or the consumer aware of all that is available; and to help the consumer make wise and suitable styling and/or buying decisions.

Fashion editors, together with journalists, stylists, and photographers, act as the eyes and ears of the consumer. They let the nation or the community know where to find the fashions that are currently on the market, and they report on how new fashions should be worn and accessorized.



The fashion editors of prominent newspapers and fashion magazines attend the collection openings, take notes on what they like best, and report on what directions they believe are important they may request sketches or photographs of their favorite garments to use in their articles.

In between openings, fashion editors write articles on topics that they think are noteworthy. They sift through the news releases that come into their offices to help them write a story. Editors may ask to borrow samples for simply use a photo sent to them in a publicity release. Sometimes sketched illustrations are used, depending on the mood or effect to be achieved. Garment and fabric descriptions may be included as well as a list of stores that carry the merchandise described in the article.

## 2.7 LINE

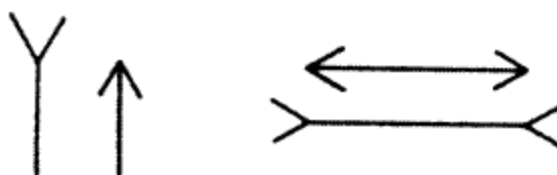

Fig 2.1

After selecting the fabric, the designer must consider the other elements of good design. In this section, the term line refers to the direction of visual interest in a garment created by construction details such as seams, openings, pleats, gathers, tucks, topstitching, and trims. (It is confusing that the apparel industry also uses the term line to refer to a collection of garments.) Line direction (Fig 2.1) should flow from one part of the garment to another and should not be meaninglessly cut up.

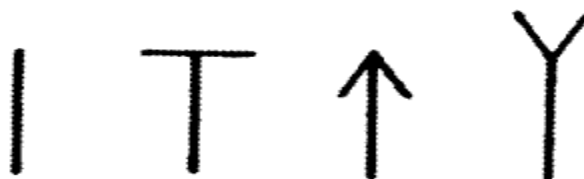

Fig 2.2

Straight lines (Fig 2.2) suggest crispness, such as that of tailored garments; curved lines imply fluidity. However, a garment designed with only straight lines is too severe; a garment with all curves is too unstable. For optimal beauty, the two should work together. Straight lines are softened by the curves of the body, and full curves must be restrained to be compatible with the human form.

## 2.8 KNOCKOFFS

A knockoff is a copy of someone else's design, usually a garment that is already a best-seller for another manufacturer. Knockoff companies simply buy a particular garment, make a pattern from it, order large quantities of the same or similar fabric, and have the garment manufactured. Production and fabric costs are lower because of the huge quantities made.

The knockoff producer must have:

- (1) An acute awareness of what garments are selling well at the retail level,
- (2) Rapid production capabilities to capitalize on the success of the style while it lasts,
- (3) Lower prices. Now, in an age of instant global communications, copies often reach stores before the originals and at a fraction of the cost.

## 2.9 AVANT GRADE:

Some fashion leaders actually create fashion. They may be designers themselves or just want to express their own individual style. These fashion leaders constantly look for interesting new styles, colors, fabrics, and ways to accessorize their clothes. They try to find unique fashion in small boutiques or vintage clothing stores, or they design their own clothes. They are discerning shoppers who like to wear beautiful or unusual apparel. They may give impetus to a certain style by discovering and wearing it. They may be referred to as avant grade.

## 2.10 BRIDGE:

This styling and price range was created to give consumers a less expensive alternative to designer fashion. Bridge is simply a step down in price from designer, achieved by using less expensive fabric or different production methods. Some designers have secondary lines such as CK from Calvin Klein, Donna Karan's DKNY, Versus from Versace, or Emporio from Armani. Other collections, such as Ellen Tracy or Dana Buchman, cater specially to the bridge market.

## 2.11 BUYING HOUSE:

Although the term buying house is still used in the industry, its role has greatly expanded to fill a wide variety of functions. The two primary type of buying house are independent and store owned.

- **An associated buying house** is jointly owned and operated by a group of stores. Member stores usually have similar sales volume, store policies, and target customers but are in no competing locations. Operating expenses are allocated to each member store on the basis of the store's sales volume and the amount of services rendered. Associated Merchandising Corporation (AMC) is a well-known example.
- **A corporate buying house** is owned and operated by the parent organization of a group or chain of stores. At Federated Department Stores, 70 percent of the buying for member stores is done centrally by the parent company, while the other 30 percent is done by individual member stores.

### **2.11.1 INTERNATIONAL BUYING HOUSES:**

Many large retail stores have their own buying house abroad or use foreign commissionaires, agents representing stores in foreign market centers. These offices are equipped to handle import-export transactions in the language of the country, check quality control, figure currency exchange rates, provide a consolidated center for shipping, and wade through customs red tape.

### **2.12 MERCHANDISING:**

Merchandising is planning to have the right merchandise at the right time in the right quality and at the right price to meet the needs of the company's target customers. It is also the manner in which a group or line of garments is presented to the public; the way the line will look in the stores.

The merchandiser or product manager is basically a process manager, developing the blueprint of the line. Merchandising activities, which vary from company to company, usually include setting financial goals, budgets, and price points; making the merchandising plans; planning line size; planning fabric purchases; sourcing; scheduling production and deliveries; controlling product flow; presenting the finished line to the sales staff; and sometimes preplanning assortments for stores.

#### **2.12.1 SCHEDULING:**

Merchandising is responsible for integrating all the phases of product development, including design and production. The merchandiser, or product manger, sets up a schedule of deadlines for styling, finished samples, and production to meet the required shipping dates. These dates are, of course, co-ordinate with the production department. Merchandisers meet regularly with designers, the sales staff, and production managers to discuss company goals, budget requirements, line size, delivery dates, sizes, and so on.

#### **2.12.2 SEASONS:**

Each season, the design and merchandising departments of each division are responsible for creating a new line, the seasonal collection that the manufacturer will sell to retail store buyers. The terms are synonymous: Collection is used primarily in Europe and for high-period apparel in the United States. Line is used more often in the United States for moderately and popularly priced fashion.

Work on a new line begins approximately eight months before the selling season (a velvet dress to be worn in December must be designed in May).

Designers and merchandisers also work on two or more lines at once, designing a future collection while checking samples from one that is about to be produced. They are finished work on the spring line while beginning fabric research for summer. It is a continual process of creating new merchandise, a "seamless" product development.

### **2.12.3 THE MERCHANDISE PLAN:**

Each season, merchandisers have to develop a merchandise plan or business plan. They must decide how many apparel or accessory groups are needed to meet both the demands of retailers and consumers and the financial goals of the manufacturer. The previous year's actual sales are used as a basis for projected sales goals for each group. Spreadsheets are created to show what needs to be produced and sold per month to reach sales and profit goals.

The merchandiser has to determine the number of groups, fabrics, and styles required to meet those sales goals.

### **2.13 LET US SUM UP**

In this lesson we looked the different types of buying houses and the role of buying house in the field of fashion. Then we studied the concept of fashion merchandising and its role in fashion field. In connection to fashion direction and fashion editor the fashion merchandising play a vital role.

The line gave great idea to the new designer to create their own design based fabric grain, the way of design selection and the method of design formation.

### **2.14 LESSON END ACTIVITIES**

The students may do the following activities based on this lesson

- Interact with the field persons like merchandisers
- Go through the history and developments of fashion

### **2.15 POINTS FOR DISCUSSION**

Here the students are asked to discuss about the following points

- The role of merchandisers
- Setting a buying house

### **2.16 REFERENCES:**

- Fashion sketching book, by Bina Abling, Fai child publication.
- Inside the fashion business, by Macmillan publication company
- Elements of fashion and apparel designing, by Sumathi G.J., New Age International Pvt. L.t.d..
- The art and everyday life
- Fashion from concept to consumer, by Cini stephens Frings, Low price edition

## LESSON – 3: FASHION DESIGNING & ACCESSORIES

### CONTENTS

- 3.0 AIM AND OBJECTIVES
- 3.1 INTRODUCTION
- 3.2 FASHION DESIGN
  - 3.2.1 Designing a collection
  - 3.2.2 Designing a garment
  - 3.2.3 Areas of work
  - 3.2.4 Areas of fashion design
- 3.3 ELEMENTS OF DESIGN
  - 3.3.1 Line
  - 3.3.2 Shapes
  - 3.3.3 Space
  - 3.3.4 Colour and Texture
- 3.4 TYPES OF DESIGN
- 3.5 TRIMMINI AND DECORATION
- 3.6 FASHION ACCESSORIES
  - 3.6.1 Footwear
    - 3.6.1.1 Design and product development
  - 3.6.2 Handbags
    - 3.6.2.1 Design and product development
  - 3.6.3 Hats
    - 3.6.3.1 Design and product development
  - 3.6.4 Ties
- 3.7 LET US SUM UP
- 3.8 LESSON END ACTIVITIES
- 3.9 POINTS FOR DISCUSSION
- 3.10 REFERANCES

### 3.0 AIM AND OBJECTIVES

After going through this unit, you should be able to have a clear idea of the following

- To summaries the principles of fashion designing.
- Describe the various activity of fashion designing and the elements of designing.
- Analysis the fashion accessories like hats, bags, foot wear and ties

### 3.1 INTRODUCTION

You have come across the word “Design and designers” very often. You always wanted to know about the design professionals. Dress, therefore, is only one of the forms in which fashion finds expression. There are countless creators of form, or design.

Design is concerned with how needs are identified, related and in some cases stimulated. It affects the ways in which our materials, energy, skills and other resources are employed to satisfy them fully, it calls upon enterprise and enthusiasm, inventiveness and ingenuity, scientific discovery and technical knowledge, power of visualization together with knowledge of human capabilities and aesthetic sensibility.

Creating or styling the appearance of a person with reference to clothing, accessories and beauty in corresponding with the personality of any individual is fashion designing.

### 3.2 FASHION DESIGN

**Fashion design** is the applied art dedicated to the design of clothing and lifestyle accessories created within the cultural and social influences of a specific time.

Fashion design differs from costume design due to its core product having a built in obsolescence usually of one to two seasons. A season is defined as either autumn/ winter or spring/ summer. Fashion design is generally considered to have started in the 19th century with Charles Frederick Worth who was the first person to sew their label into the garments that they created.

#### 3.2.1 DESIGNING A COLLECTION

- Planning a collection: Every collection is very carefully researched and planned so that all the items in it complement each other, and have the particular fashion look which the company is known for.
- Predicting trends: One of the hardest skills a fashion designer has to master is predicting future trends. To do this, they look at what the fashion directions have been in previous seasons, keep an eye on what others in the fashion business are doing, and read fashion forecasting magazines. They also rely on knowledge of their own customers to see which styles succeeded and which were less popular in past seasons. Perhaps most importantly, designers use their imaginations to come up with new ideas. They often choose a theme to provide inspiration.
- Choosing a theme: The theme of a collection can be a period in history, a foreign place, a range of colors, and a type of fabric - anything which has a strong visual impact.

#### 3.2.2 DESIGNING A GARMENT

- The design: Different designers work in different ways. Some sketch their ideas on paper, others drape fabric on a dress stand, pinning, folding and tucking it until the idea for a garment emerges. A third method is to adapt their own patterns from previous seasons (this method can give continuity to a fashion studio's output).
- Making a toile or muslin: After making a rough paper pattern, or life-size 2-D plan, of the garment, a sample machinist (or skilled sewing machine operator) then makes a trial

version of the garment from plain-colored calico. The toile (called a muslin in the U.S.) is put on to a dress stand (or a model) to see how it fits and whether it hangs properly.

- Making a card pattern: When the designer is completely satisfied with the fit of the toile (or muslin), they show it to a professional pattern maker who then makes the finished, working version of the pattern out of card. The pattern maker's job is very precise and painstaking. The fit of the finished garment depends on their accuracy.
- The finished dress: Finally, a sample garment is made up in the proper fabric.

### 3.2.3 AREAS OF WORK

There are three main ways in which designers can work:

- Working freelance: Freelance designers work for themselves. They sell their work to fashion houses, direct to shops, or to clothing manufacturers. The garments bear the buyer's label.
- Working In-house: In-house designers are employed full-time by one Fashion Company. Their designs are the property of that company, and cannot be sold to anyone else.
- Setting up a company: Fashion designers often set up their own companies. Many designers find this more satisfying than working for someone else, as their designs are sold under their own label.

### 3.2.4 AREAS OF FASHION DESIGN

Many professional fashion designers start off by specializing in a particular area of fashion. The smaller and the more specific the market, the more likely a company is to get the right look and feel to their clothes. It is also easier to establish oneself in the fashion industry if a company is known for one type of product, rather than several products. Once a fashion company becomes established (that is, has regular buyers and is well-known by both the trade and the public), it may decide to expand into a new area. If the firm has made a name for the clothes it already produces, this helps to sell the new line. It is usually safest for a company to expand into an area similar to the one it already knows. For example, a designer of women's sportswear might expand into men's sportswear. The chart below shows the areas of many designers choose to specialize in.

Area	Brief	Market
Women's Day wear	Practical, comfortable, fashionable	Haute couture, ready-to-wear, mass market
Women's Evening wear	Glamorous, sophisticated, apt for the occasion	Haute couture, ready-to-wear, mass market
Women's Lingerie	Glamorous, comfortable, washable	Haute Couture, ready-to-wear, mass market
Men's Day wear	Casual, practical, comfortable	Tailoring, ready-to-wear, mass market
Men's Evening wear	Smart, elegant, formal, apt for the occasion	Tailoring, ready-to-wear, mass market

<b>Area</b>	<b>Brief</b>	<b>Market</b>
Boys' Wear	Practical, hard-wearing, washable, inexpensive	Ready-to-wear, mass market
Girls' Wear	Pretty, colorful, practical, washable, inexpensive	Ready-to-wear, mass market
Teenage Wear	Highly fashion-conscious, comfortable, inexpensive	Ready-to-wear, mass market
Sportswear	Comfortable, practical, well-ventilated, washable	Ready-to-wear, mass market
Knitwear	Right weight and color for the season	Ready-to-wear, mass market
Outerwear	Stylish, warm, right weight and color for the season	Ready-to-wear, mass market
Bridal wear	Sumptuous, glamorous, classic	Haute couture, ready-to-wear, mass market
Accessories	Striking, fashionable	Haute couture, ready-to-wear, mass market

### **3.3 ELEMENTS OF DESIGN**

In creating a design one of the components which interact is the Art Elements

The elements and principles of design are flexible and should be interpreted within the context of current fashion. A design can be defined as an arrangement of lines, shape, colours and texture that create a visual image. The principles of design are the rules that govern how elements are combined. The elements are therefore the raw materials that must be combined successfully.

The following are the different elements of Design:

- Line
- Form
- Shape
- Texture and
- Colour

These elements are considered as “Plastics” in art language because they can be manipulated or arranged by the designer to create desired illusions.

#### **1.3.1 LINE**

It provides the visual dimensions of length and width. When lines combine, space is enclosed and forms and shapes are defined. Lines offered a path of vision for the eyes when is wearing an object/outfit. The arrangement of lines in clothing design can cause to appear heavier or thinner than what actually is

1. Horizontal line
2. Vertical line



3. Oblique line
4. Diagonal line.
5. Curved line etc.

Lines within a garment are created by darts seams and decorative details. Each kind of line produces its own special effect. Straight line's and shapes denote force and strength and have a masculine quality; curved lines are the lines of nature, they are gracefully and gives a feminine effect.

Lines are the greatest devices of fashion designers. Since lines create illusion of height and width, they can be used to one's requirement to tone down or exaggerate a particular figure type.

#### 1) Vertical line

In Fig 3.1 these produce an illusion of added height to the outfit design by adding and contrasting coloured vertical bank in the centre or a centre panel added with vertical line gives an added height to the outfit. These lines end to make a short person look tall.



Fig 3.1

These produce an illusion of added height to the outfit design by adding and contrasting coloured vertical bank in the centre or a centre panel added with vertical line gives an added height to the outfit. These lines end to make a short person look tall.

#### 2) Horizontal lines



Fig 3.2

These lines (Fig 3.2) adds width to the garment and decrease the apparent height, for example a wide contrasting coloured belt shortens the height of the figure by cutting the garment into two segments, however the belt has the effect of slimming the waist line, the coloured will not shorten the height of the outfit as well as the wearer.

### 3) Diagonal lines

These lines can add or decrease the height of the wearer depending on their slope. Long uninterrupted diagonals tilting almost vertically are the most lengthening and most dramatic of all lines.

Diagonal lines should be combined with vertical or horizontal lines. If they are used alone for the entire dress the effect will be disturbing.

### 4) Curved lines

These lines are more romantic and pensive by nature. Curved lines can be a full circle or may even appear almost straight. Curved lines are considered graceful and feminine; those in a diagonal direction are the most graceful and can be seen in the soft folds of material in a draped dress or a ruffled collar.

### 5) Line movements

The arrangement of vertical, horizontal and oblique lines produce line movements characterized by opposition, transition or radiation.

### 6) Opposition

In a design where the vertical line is opposed by a horizontal line opposing oblique lines are used.

### 7) Transition

When one line direction slips smoothly into another, the movement is transitional (e.g., curved lines). Curved lines should not be over done. They are at their best when stiffened by some straight lines, example round yoke with vertical pin tucks within it.

### 8) Radiation

When a design is created with radiating lines at the neckline, it will attract attention to the face. These radiating lines are produced by stitching decorative darts on the right side of the garment.

### 9) Form

It is an object having three dimensions like length, width and depth. The human body is a form and by viewing it analytically, its various perspectives are revealed. The human form changes visually with clothing, especially as fashion changes.

## **3.3.2 Shapes**

It describes the outer dimensions or contour of an object. Shape also encloses space and imparts a certain character to the object viewed. Through clothing design, the shape of the human body is often revealed in a natural way, but sometimes even distorted. The shape of clothing in a human body, communicates silently, the messages about the wearer.

Every fashion period, a shape emerges slowly or evolved suddenly, whatever it is, every period has a specific shape of garment which once determined can be modified and re-styled for variation in design without changing the basic shape of the garment, it is either flare or tight, circular or straight, a line or raglan. It has been observed that an easy fitting shape of the garment is easily accepted and largely varies as well as has longevity of stay; whereas a tight fitting garment is generally short lived since it is suitable to only perfect figure types. It is therefore advisable that the designer chooses an easy silhouette to keep on creating for a longer duration.

### BASIC SHAPES

In dress designing there are seven basic shapes — each season adaptations of one or more of these predominates the fashion picture. They are as follows:



Fig 3.3



Fig 3.4



Fig 3.5

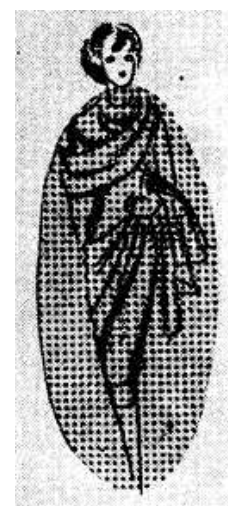

Fig 3.6



Fig 3.7



Fig 3.8



Fig 3.9

#### 1. Rectangle (Fig 3.3)

Examples: Long, straight, hanging in loose, graceful folds, such as in Greek and Roman styles; straight line sheaths; tailored suits. Styles with these lines are slenderizing and suitable for the well proportioned, heavier woman.

#### 2. Triangle (Fig 3.4)

Examples: Spanish styles. Fitted bodice, bell shaped gently widening skirt.

#### 3. Inverted Triangle (Fig 3.5)

Examples: Wide shoulders, narrow skirt, dolman or raglan sleeves. Good fashion design style for large bust.

#### 4. Oval (Fig 3.6)

Examples: Draped and softly molded, very feminine and decorative. Good for well proportioned, ideal figure. Suitable especially for afternoon and evening wear.

#### 5. Square (Fig 3.7)

Examples: Straight or boat shaped neckline, boxy jackets, capes. Generally this style is very good for the very thin figure, however, with proportions well planned and good design, can camouflage various figure irregularities.

#### 6. Round (Fig 3.8)

Examples: Wide, crinoline lined skirts, petal shapes, puffed sleeves. Suitable for formal wear or afternoon frocks. This *fashion design* is the most attractive on the very young and the very thin figure.

#### 7. Hourglass (Fig 3.9)

Examples: Wide shoulders, leg of mutton sleeves. Natural or wasp waist. Smooth fit over hips and full skirt at bottom. Good fashion design for the tall, thin figure.

#### 8. Combinations

Examples: Outline of any current fashion silhouette can be altered and combined with another, and adapted for the specific figure type. Thus irregularities or lack of ideal figure proportions can be minimized while the general effect of current fashion design style is preserved.

### **3.3.3 SPACE**

It is generally considered to be the area seen between the shapes. Busy space in clothing becomes distractive and fatiguing to view where an interesting space may go unnoticed or appear monotonous.

Lines in a costume provide a path of vision along which the eye travels. Curving lines relates more naturally to human bodies. Vertical lines tend to slenderize the body. Horizontal lines suggest width.

Both repetition and extreme contrast of a line, shape, space or form produce emphasis.

### 3.3.4 COLOUR AND TEXTURE

When we talk of principles of designing, or when we start off with a given design theme the first thing to occur to our minds is the colour and texture of the fabric. Every season or now and then a colour emerges in the fashion scene which is decided by the leading manufacturers, exporters and textile experts of the fashion world. It is advisable to the amateur to work on the colour in vogue: and to add to its creativity, collaborate with a textile designer and develop a new dimension to the existing patterns. To co-ordinate with an idea of creation will be infinite. Also while choosing a colour one must be utmost careful as colour creates the first impression and hence can glorify or destroy one's appearance. Even simple silhouette may be enhanced by using effective colour schemes. As texture is the feel, drape and degree of stiffness and softness of the fabric, it also creates a visual effect upon the wearer, given a small swatch of fabric, the designer can visualize the texture and the fall of fabric which helps him to design further.

### 3.4 TYPES OF DESIGN

There are two kinds of design.

1. Structural design
2. Decorative design

#### 1. Structural design

When an object's structure is an integral part of the design is structural design. Structural design is those that are made wide the size for colour, texture of an object. For eg: weaving different kinds of weave as examples of structural design. Structural design details in a dress include collar sleeves, yokes, pockets, skirts, position of seam lines etc.

#### Requirements of Good Structural Design:

- It should be suited to the purpose
- It should be simple.
- It should be well proportion
- It should be suited to the material with which it is made.
- It is far more importance than decorative design because it is essential to every object or garment whereas decorative is the luxury of design.

Structural design depends on the form and fabric. It is also created by the construction details as a design. It is inherit in all garments. Because it creates in construction details together including seams, collars, pockets and texture of the fabric. Any detail that is an integral part of the garment is a structural design. It may be very simple or to be very elaborate simple or to be very elaborate.

The basic requirements of a good structural design for clothing are as follows:

- Silhouette pleasingly related to the body structure and expressive of that time.
- Design appropriate to its use and to the needs of the wearer.
- Well proportion individual parts that offer unity with variation.
- Character and individuality in line, form or texture.



## 2. Decorative Design

It is the surface enrichment of structural design any line, colour of material that has been applied on structural design for the purpose of adding a richer quality is a decorative design. Beauty is the structure of design. Decorative design is only the luxury. e.g.: After weaving, when the impart design it is decorative: e.g.: Applique, embroidery, painting or any trimmings.

### Requirements of Good Decorative Design:

- It should be used in moderation
- It should be placed at a structural points and should strengthen the shape of the object
- The decorative design should be suitable for the material and for the type of service it must give.
- There should be enough background space to give an effect of simplicity and dignity to design.
- Surface pattern should cover the surface quietly

### **Types of Decorative Design:**

They are 5 types of decorative design.

- a. Naturalistic
- b. Conventional
- c. Abstract
- d. Historic
- e. Geometric

a. Naturalistic Design: When objects from nature are selected and are reproduced exactly with photographic correction it is known as naturalistic design. eg: Flowers, leaves, animals and landscape.

b. Conventional Design: When an object from nature is adopted to suit the purpose of the object and be decorative the motif ceases to be naturalistic.

c. Abstract Design: Motif which does not have the nature as the source but the combination of lines producing irregular form i.e. not easily recognized. The modern art is an abstract design.

d. Historic Design: It refers to the famous monuments or building of historic importance. eg: Temple, Taj Mahal

e. Geometric Design: It is not derived from nature. It is derived from circles, rectangle, triangle, parallel lines and so on.

The basic requirements of a good decorative design for clothing are as follows:

Applied and design should reinforced the basic design concept created in the construction of the garment. This is achieved when the placement of trims is created to the structural design. Decorative design is very attractive when it is created in size and structure to the textile of the garment. Suitable combination of textures includes:

- Fine embroidery for fine fabric
- Ricrac for medium weight cotton
- Sequence for shiny fine material

### **3.5 TRIMMINI AND DECORATION**

Fabric trimmings are used as ornamentation and to enhance to beauty of the garment.

#### **1. Fabric Bows**

Fabric bows are trimmings that can be made from any kind of fabric. The size of the bow must be altered to suit the weight of the fabric. Bows can be used to embellish pelmets, valances, drapes and swags etc. Small bows can be used on tiebacks to enhance their effect. Bows can be used to compliment or contrast the color of the central fabric and color. They can be used to highlight a certain color in a setting that has numerous colors. The size of the bow will depend on the effect you want the bow to have. A large bow will have a dramatic effect

Making a tied bow- if ribbon or braid is to be finished with a bow, or for a sash where the two ends are tied, a neat bow is essential or the whole effect is spoiled. Make a single knot in the usual way, keeping the two ends even in length. Make the first loop with the lower piece, then bring the other end down and round the first loop, making a knot. Now hold the first loop , in place, make a second loop and pull it through. Both loops can be pulled tight so that the bow is even in size and the two loose ends are more or less even.

Arrange the knot so that it lies flat.

Making a tailored bow – this kind of bow is made up and sewn together, not re-tied each time the garment is worn. Use a finely woven ribbon.

#### **2. Tassels**

They may be bought or made, and applied singly or in rows. To make tassels- cut a piece of cardboard the required width and lay a double strand of the yarn across the top of the card, wind yarn then tie the double strand round the yarn and remove the card. Tie another double thread round the yarn and remove the card. Tie another double thread round the yarn about 13mm below the top. Cut the lower loops.

#### **3. Fringing**

Bought fringing and tassels can be more economical with time and money than hand-made ones, especially if a large quantity is needed. Most lampshade fringing is very reasonably priced and used cleverly will not be recognized for stoles or ponchos to give them a luxury look for evening wear. Like braid, fringing often looks best in two or more rows.

To make fringe- wind any number of yarns round a length of double folded heavy tracing paper the depth of fringe required, inserting a piece of seam binding along one edge. When enough yarn has been wound, sew two or three tows of machining along one edge through yarn, tape and paper.

Self fringe- most soft, thick fabrics can have threads pulled out t make a self fringe. Try it on a scrap of the fabric to see if the effect is attractive. Straighten the edge to be fringed by cutting along the grain. Decide how deep the fringe needs to be then pull out a cross thread on this line.

Machine with a narrow zigzag stitch along this line so that the lengthwise threads are secured in place, then pull out all the crosswise threads below the stitching.

Fringe made with sewing machine- The rug fork that is available for use with sewing machines may also be used to make fringes. Yarn is wound around the fork and stitched using a zipper foot directly onto seam tape on fabric as each section is wound. After one section has been stitched the fork is slipped out carefully until it is almost out of the loops exposed part of the fork is rewound and the loops stitched down and so on, until the required amount has been made. Loops may be left as they are or cut.

#### **4. Ric-rac**

Available in a vast number of colours and sizes and relatively inexpensive. Many rows may be used together or two pieces may be “wound around” one another to form one braid with an unusual effect. It is available with a matt effect for day wear or in shining metallic form for evening clothes.

To apply it, either stitches straight along the centre or slipstitch it into place along either side- sometimes it may only be necessary to catch down the points. It may be inserted into seams or used under the edges of garment sections so that only the points show. Make sure that the thread matches exactly when only surface stitching is used.

#### **5. Appliqués**

Appliqué's are a quick, eye-catching embellishment just right for fleece fabrics. Layer appliqué's for a three-dimensional effect, choosing easy shapes such as flowers, geometric shapes, even lettering. Show off your artistic side on ponchos, jackets, hats and more. When sewing appliqué's to fleece, you can use a highly visible stitch that becomes part of the design, such as a hand blanket or running stitch in a contrast color thread

##### Appliqué Tips-

- For multi-layer appliqué's, like a two-tone flower with a round center, layer the components and appliqué the smaller on to the larger one. When the layering is complete, treat it as a single appliqué, stitching it to the garment around the edges of the largest layer. You can also attach multi-layer appliqué's in the center only, leaving the edges free, to create a 3-dimensional affect.
- When positioning the appliqué's on the garment, be sure to clear all seam allowances, zippers, buttonholes and other garment details.
- For hand stitching around the appliqué's, several stitches can be used. Try several threads together, or embroidery floss, so stitches will be visible, and use a large eyed needle.
- Pom-poms
- Make them in the same way as for tassels above, but with much more yarn. Otherwise wind the yarn round two or three fingers, then tie yarn around the middle and cut both ends.

### **3.6 FASHION ACCESSORIES**

Fashion accessories and their jewelry counterpart referred to as costume jewelry are items that used as fashion's complementary. Accessories help to bring up the spot that one wants to



highlight in a dress or apparel. They can also help to hide some weaknesses' part of a dress. Trends are continuously set by adding accessories to different outfits. Take belts for example, a few years ago girls all started wearing really thick belts that would never fit into belt loops, but this fashion accessory made it big time. Soon everyone was seen wearing them, today big is out, and maybe ribbon belts are in. But these things change an entire look, from handbags to shoes to chandelier earrings and dangle earrings to 80's leg warmers.

### 3.6.1 FOOTWEAR:

Footwear, including shoes, sandals, and boots, is the largest category of accessories. More than seven billion pairs of shoes are produced worldwide each year. Both functional and fashionable, shoes come in assorted materials, including calf, kid, suede, and reptile skins; imitation leathers; and fabrics such as canvas or nylon.



Fig 3.10

Today the shoe industry caters to both dress and casual trends. As a result of the enormous popularity of sport shoes, comfort has become an important element of shoe design. A number of popular shoe brands, from Florsheim to Ferragamo, have tried to combine style with the comfort of athletic shoes.

#### 3.6.1.1 DESIGN AND PRODUCT DEVELOPMENT

Most dress shoe (Fig 3.10) design direction comes from Europe. Creative international shoe designers such as Manolo Blahnik and Robert Clergerie set international trends for women's fashion shoes. Shoe designers study fashion trends so that their shoes will coordinate with apparel.

Many shoe company designers or line builders (product managers) attend the shoe fairs in Dusseldorf, Germany, and Bologna and Milan, Italy, to get ideas for a new shoe collection. Like an apparel merchandiser, the line builder begins with concepts for groups and works with designers who develop individual shoe styles. Designers are primarily concerned with materials, color, shape and proportion. They must consider the view of the shoe from all angles. Many shoe companies are using computer-aided design(CAD) systems that are capable of both two-dimensional design(design of uppers and size grading) and three-dimensional design(design of the last, a foot shaped form, and projection of the drawing on the last.

Sometimes the line builder will buy prototypes (sample shoes) from a modielista (model maker) at a studio or shoe fair. Or, the line builder might forward a designer's sketches to a modelista, who makes the first model. If the line builder and modelista live in different countries, ideas and samples must be sent back and forth by the Internet or via fax. The sample shoes are edited to form a balanced collection. Duplication is then made for the sales staff, showroom, and trade shows.

### 3.6.2 HANDBAGS:



Fig 3.11

Handbags must be both decorative and functional (Fig 3.11); it must hold necessities conveniently as well as fit into the fashion picture. Large bags such as totes, satchels, portfolios, or backpacks tend to be functional; smaller bags such as clutches or envelopes are usually decorative. Handbag styles range from classic, constructed types to soft shapes. Leather, including suede and reptile, still represents approximately half of handbag material; vinyl, fabric (tapestry, rug prints, needlepoint, silk, wool, nylon, and canvas), and straw make up the other half. Prada and Gucci are among the trendsetters in handbag design. Major trends include a wide variety of shapes in an array of colors, some with beading or embroidery.

#### 3.6.2.1 DESIGN AND PRODUCT DEVELOPMENT

The elements of fabrication (leather or fabric), silhouette, and color, as well as current trends in ready-to wear and footwear, are the most important components of handbag design. From an initial sketch, a sample is made from muslin or imitation leather. A final sample is made up in leather or fabric with appropriate supportive stays (made of treated paper). Felt, foam, and fabric interlinings are layered around the stays to give the bag a nice hand and cushion. Ornaments, closures, and/or handles must be chosen to complement the shape and fabrication. Linings differ with each type of bag and each fabrication.

The product development team, designer, pattern-maker, sample-maker, production manager, and sales managers, critique the samples. The most successful are chosen for the collection. Within the collection, groups may be based on fabrications, silhouettes, or themes.

Usually, a variety of silhouettes are included, perhaps in various fabrications (types of leather). Several groups create a well-rounded collection.



Fig 3.12

Handles, Zippers, Pockets, Frames and Tabs.... Select from hundreds of Pre-drawn elements to enhance any handbag design. In Fig 3.12 One basic silhouette can take on thousands of additional looks simply by adding fashion components.

### 3.6.3 HATS:

In the past, the most important accessory was a hat. A woman bought a new hat to add a bright spot to her wardrobe; a businessman was never seen on the street without one. The trend toward more casual life-styles changed that, and the millinery industry suffered a severe setback. Of course, functional hats to protect against the cold weather remained a necessity.



Fig 3.13

Today, hats are enjoying somewhat of a comeback. Part of this rise in sales is caused by fashion, and the other is because of an increased demand for sun protection.

#### 3.6.3.1 DESIGN AND PRODUCT DEVELOPMENT

Hat manufactures produce two seasonal collections per year. The spring collection is centered on a wide variety of straws and fabrics, such as cotton and linen. Fall collections are dominated by felt and fabrications of velvet, velveteen, fake fur, and corduroy.

Hat collections are usually divided into groups organized around fabrications, color schemes, themes, or price ranges. Hat designers are aware of fashion trends, especially color projections, and use many of the same design sources as apparel designers.

### 3.6.4 TIES

The tie is an accessory. It adds to the look. A tie can be the center piece. It can be a 'piece of color' in the center. or it can be short tie.. a piece of color around the neck i.e. a short wide piece of color. A tie is an accessory but it can be an accessory which aims to add color



Fig 3.14

Ties are for men or for women (Fig 3.14) who want to dress like men. Women want to have the tailored sleek look so they wear ties. But ties are also for women who want to be women. Sleek, skinny ties look good with the secretary look. It adds to the 'separates' i.e. the shirt/skirt or the shirt/trousers.

With the boyish chic look last year and the androgynous look previously, the tie was certainly important. But this is the office look. What about wide ties instead of the skinny ones. When we come to the summer season, can a tie be important for the look i.e. a wide glossy, 'glam' tie which gives the 'color' to a look. For men the tie was the 'color'; it added color. The boyish look was important in 2006, the tie was important for this. Now as fashion moves on from the boyish chic and the military before this, ties can still be important but maybe they will be the great wide ties, which give color and glamour! When we think of ties, it is men's ties, the ties that go with suits.

### 3.7 LET US SUM UP

Through this lesson, we have learnt how to create a design based on the different position shapes of lines. The direction of lines gives a great idea about the size of figure. The concept of fashion design and the area of designing explained the professional fashion designers

specialization in a particular area of fashion. Also we discussed the fashion accessories and the way to develop and design the accessories.

### **3.8 LESSON END ACTIVITIES**

The students may do the following activities based on this lesson

- Collect various fashion designs according to your idea and analyze it.
- Practice the fashion figures based on its elements.
- Prepare your own trimming and decoration for your garments.

### **3.9 POINTS FOR DISCUSSION**

Here the students are asked to discuss about the following points

- Interact the concepts of fashion designing with your friends.
- Different new methods of trimmings and decorations

### **3.10 REFERENCES:**

- Fashion sketching book, by Bina Abling, Fai child publication.
- Inside the fashion business, by Macmillan publication company
- Elements of fashion and apparel designing, by Sumathi G.J., New Age International Pvt. L.t.d..
- The art and everyday life
- Fashion from concept to consumer, by Cini stephens Frings, Low price edition

## LESSON – 4: PRINCIPLES OF DESIGNING

### CONTENTS

- 4.0 AIM AND OBJECTIVES
- 4.1 INTRODUCTION
- 4.2 PRINCIPLES OF DESIGN
  - 4.2.1 Balance
    - 4.2.1.1 Formal Balance
    - 4.2.1.2 Informal Balance
    - 4.2.1.3 Radial Balance
  - 4.2.2 Emphasis
  - 4.2.3 Harmony
  - 4.2.4 Proportion or Scale
  - 4.2.5 Rhythm
- 4.3 LET US SUM UP
- 4.4 LESSON END ACTIVITIES
- 4.5 POINTS FOR DISCUSSION
- 4.6 REFERENCES

### 4.0 AIM AND OBJECTIVES

After going through this unit, you should be able to have a clear idea of the following

- Basic principles of design
- Balancing of the silhouettes.
- Selection and area of design
- Proportions of fashion designing

### 4.1 INTRODUCTION

The wish to decorate or beautify the human body has been existed from the stone age when the early man painted his face and his body. Even though the beauty standards have changed, the desire remains constant. The principles design creating lot of creation, expression in an artistic manner. This unit includes all aspect of designing to develop a different form of figure, proportion of figure, balancing of figure, harmony of figure, emphasis and rhythm of figure.

### 4.2 PRINCIPLES OF DESIGN

The principles of design are useful in creating different forms of expression in an artistic manner, which are pleasing and attractive to the eye. Following are the principles of designing

1. Balance
2. Emphasis
3. Harmony

4. Proportion
5. Rhythm

#### 4.2.1 Balance



Fig 4.1

In clothing balance refers Fig 4.1 to a visual attribution of weight, from a central area. Balance implies a sense of equilibrium. Pleasing balance brings about a satisfying relationship among all design parts to produce visual harmony. In clothing designs, three kinds of balance are observed.

##### 4.2.1.1 FORMAL BALANCE:

Formal Balance occurs when object appears to equalize each other by repetition and arranged at equi-distance from the centre. The upper and lower portions of the design are so arranged, as to give an effect of balance.

Thus there should not be the effect of too much of weight at the bottom or a heavy appearance. For Example, dark coloured skirt over lighter shade of pants make a short person shorter.



Fig 4.2

Fig . 4 . 2 <http://www.vintagesewing.info/1920s/26-fcm/fcm-illus/39-05&06.jpg> is an <http://www.vintagesewing.info/1920s/26-fcm/fcm-illus/39-05&06.jpg> example of good formal balance. It notices that both sides of the dress are exactly alike. The plaiting on either side is of the same width and amount, and is placed the same distance from the center line running from the head to the feet, thereby creating a perfect balance. The jacket, too, has the same ornament on either side so it does not disturb the balance. The dress is equally well balanced about the waistline, for the jacket above balances the plaiting below.



Fig 4.3

Fig.4.3 illustrates an example of formal balance which could be improved upon by moving the monogram to the center of the dress. Located as it is it throws the dress slightly out of balance.

#### 4.2.1.2 INFORMAL BALANCE:

Occurs when objects appear to equalize each other but not through repetition and the arrangement is in a haphazard manner. Here design of different sizes and shapes and of different attraction are arranged. The larger and more attractive designs are kept as far away from the center. If used correctly, informal designs can be effective in being attractive.





Fig 4.4

A good example of informal balance may be seen in Fig 4.4. Both sides of the dress are different. The large sash placed near the center lines is balanced by the small ornament on the shoulder which is placed as far as possible from the center line.

on the other hand, fig. 4.5 i <http://www.vintagesewing.info/1920s/26-fcm/fcm-illus/39-07&08.jpgs> a <http://www.vintagesewing.info/1920s/26-fcm/fcm-illus/39-07&08.jpg>poor example of informal balance, because of all the weight being on one side of the dress, thereby making the dress very one-sided.



Fig 4.5

It may be said to be fairly well balanced above and below the center line, as the small bow far removed from the center line balances the large bow close to it, just as the small bow far out on the teeter-totter balances the large bow close to the center. If a dress is to appear balanced it must create in your mind the impression that the distribution of weight, both above and below the center and on either side are equal, so that it is not top heavy or one-sided. You are less likely to make mistakes in formal balance than in informal balance because in the former case each line and decoration is repeated on both sides of the center line.

Of course, formal balance should not be used for all dresses, as it tends to be rather too severe for some occasions. It is most fitting for street dresses and sport clothes, whereas informal balance lends itself to the afternoon and evening gown.

#### 4.2.1.3 RADIAL BALANCE:

Occurs when major parts of the design radiate from the central part. Formal balance is the least expensive to produce apparel in mass production. Informally balanced garment is more difficult to produce. For each section of the garment cuts will have to be probably handled differently.

#### 4.2.2 EMPHASIS:

Emphasis involves the concentration of interest in the selected area of design with other centre of interest subordinated. Emphasis as such, should not be placed at an area that one wishes to minimize attention drawn on. Designers often create emphasis partially though the careful arrangement of line, texture and colours.

It could also be called as focal point. Each design needs some note of interest that catches the eye or attracts the attention on a specific area of the garment. Contrasting colour for example could be used to emphasize an area.

A black dress with white collar and cuffs will direct the eye to the face and hands. There can be several centers of interest although one or two will be more dominant than the others and will arrest the attention longer and draw the eye back to it more frequently the lesser centers of interest.



Fig.4.6



Fig.4.7

Fig. 4.6 shows a very <http://www.vintagesewing.info/1920s/26-fcm/fcm-illus/39-11&12.jpg>satisfactory <http://www.vintagesewing.info/1920s/26-fcm/fcm-illus/39-11&12.jpg>example of emphasis. The bow at the neckline emphasizes this part of the dress; thereby the attention is attracted to the head where the center of interest should be.

By contrast, Fig. 4.7 is a very bad example of emphasis. The large, curved, meaningless design on the dress does not go well with the V-shaped neck. It would be better to do away with

this design entirely or at least substitute one which would not tend to emphasize the center portion of the dress to such an excessive extent, but instead carry a little of the interest to the head.

**Some methods of lay emphasis could be**

- Grouping of design units.
- Using contrast of hues
- by leading lines
- A combination of any of the above
- Repeating details such as tucks, gathers, button etc
- Unusual shapes and textures
- Applied design on a contrast background

The placement of dart spots on a lighter colour background (or) vice versa could emphasize the body part they are placed over. While enhancing the design by concentrating on a focal point the designer must bear in mind the figure and personality of the wearer.

**4.2.3 HARMONY:**

Harmony otherwise called unity. If the principle of proportion, balance, rhythm and emphasis are applied creatively, the resultant design is said to have the harmony. Unity means that all elements of the design work together to produce a successful visual effects. If anyone of the principles is not applied the resulting design will also lack harmony which means; if the principle of structural/decorative design with balanced proportion and quantitative and qualitative emphasis creating a rhythm of its own, give an outcome of harmony of unity. It is a result or an achievement which every designer should keep in mind while designing or drawing or arranging various elements or design for achieving/creating particular purpose of design.

Lack of application of any one principles of design, will result in a design which is not harmonious or not in harmony.

**4.2.4 PROPORTION OR SCALE:**

Relationship in size between a part and the whole is defined to as proportion. For way design, an artist or a designer should aim for a sense of order of unity or oneness among the principles of design.

Proportion includes planning of the basic shape within a design. It may involve the scale of the forms within the design like diversion of space to create attractive space relationship where the variety of shapes, sizes and the general idea of unity of principles of designs are to be expressed. Optical illusion is created by changing partial arrangements to enhance the attractive portion that one wishes to enhance. e.g., puffed in the shoulders or increased width in sleeves etc.,

In the principles of design that involves phasing relationships between all parts of a design with respect to each other. This may include:

- Planning of the basic shapes

- Division of spaces for a good relationship

Creating an optical illusion that will give an impression of proportion, when it is not possible to change the basic design.

#### 4.2.5 RHYTHM:

Directs the movements of the eyes as one uses the details of a design. Therefore a rhythmic pattern needs to be established to give a costume unity.

There are no pre-requisite rules for establishing rhythm in a design. Rhythm is most effective when it is experienced in a quiet way.

It is the repeated use of lines or shapes to create pattern. Uniform rhythm is the repetition of the same space and is known as the order lines of rhythm. In progressive or graduated rhythm the size of the unit increases or decreases as it is repeated. Unequal rhythm is an unequal use of space and this rhythm is an unequal use of space and this is called as un-orderliness of rhythm. In this type of rhythm the proportions are unbalanced; creating a larger space for enhancing the design and this finally calls in for expertise. This type of rhythm gives though provoking designs. The emphasis in such designs could be traced successfully by using unequal (or) un-orderliness of rhythm. This reflects to a greater extent on the creativity of the designer and how an unequal division of space could bring out the best impact of the design with the emphasis shown within the design. Rhythm can be achieved through the combination of lines, shape, colour and texture by the following aspects in designing.

1. By regular repeats or trims, (button etc..) texture, and fabric design and prints.
2. Progression or radiation in sizes of trims, colours textures and fabric designs.
3. Radiation or movement from the central point occurring within structural details such as gathers, folds, tucks darts etc.
4. Continuous flowing lines such as those in bands of colours, textures and fabric designs.



Fig. 4.8



Fig. 4.9

Fig. 4.8 shows good <http://www.vintagesewing.info/1920s/26-fcm/fcm-illus/39-09&10.jpg> rhythm <http://www.vintagesewing.info/1920s/26-fcm/fcm-illus/39-09&10.jpg> of line, as the eye can trace easily over the curved lines of the skirt which tends to raise the interest

toward the upper part of the dress. There is nothing about the lines which conflict, causing the eye to be uncertain whether to go around the dress or up and down. This is not the case in Fig. 4.9, which shows very poor rhythm of line, for the curved lines of the upper and lower parts of the dress cut across the lines running around the dress.

### **4.3 LET US SUM UP**

In this unit we clearly understood about principle of design. It covers the balancing of silhouettes. Here we saw three different types of balancing with figure for your clear understand.

Through emphasis, how the designer uses the line, texture and colour based on the season and interest. The unity (harmony) gives the idea to use of proportion, balance, rhythm and emphasis in creative applications. Even though we may have a good creative idea, we must know the scale and proportion of a figure and it was explained in this lesson through the topic of scale by planning, basic shape size and the method of division of spaces.

### **4.4 LESSON END ACTIVITIES**

The students may do the following activities based on this lesson

- Analyze the different forms of figure
- Make your own balanced fashion figure

### **4.5 POINTS FOR DISCUSSION**

Here the students are asked to discuss about the following points

- The procedure for making the figure based on the principle of designing.

### **4.6 REFERENCES:**

- Fashion sketching book, by Bina Abling, Fai child publication.
- Wardrobe strategies for women, by Judith rasband, Delmar publication.
- The art and everyday life
- Fashion from concept to consumer, by Cini stephens Frings, Low price edition
- Inside the fashion business, by Macmillan publication company

## UNIT – II

### LESSON – 5: COLOUR

#### CONTENTS

- 5.0 AIM AND OBJECTIVES
- 5.1 INTRODUCTION
- 5.2 COLOUR
- 5.3 PRANG COLOUR SYTEM
  - 5.3.1 Primary colours
    - 5.3.1.1 Subtractive colours
    - 5.3.1.2 Additive colours
  - 5.3.2 Secondary colours
  - 5.3.3. Tertiary colors
- 5.4 MUNSEEL COLOUR SYSTEM
- 5.5 COLOUR WHEEL
  - 5.5.1 Complementary colours
- 5.6 DIMENSIONS OF COLOUR
  - 5.6.1 Hue (symbol h)
    - 5.6.1.1 Neutral colours:
    - 5.6.1.2 Powerful colour combination:
  - 5.6.2 Value
  - 5.6.3 Intensity (Symbol I) Or Chroma (Symbol C)
- 5.7 LET US SUM UP
- 5.8 LESSON END ACTIVITIES
- 5.9 POINTS FOR DISCUSSION
- 5.10 REFERANCES

#### 5.0 AIM AND OBJECTIVES

After going through this unit, you should be able to have a clear idea of the following

- Discussed about the colour, dimension of colour and application of colour.
- Different colour systems.
- Colour wheel with different system.

#### 5.1 INTRODUCTION

Now comes to the interesting subject of color. If one can combine colors well in the selection of clothing, it will not be difficult to apply it to the redecoration of the living room,

selecting material for draperies, glass curtains, fancy pillows and little things that help to make a house a real home.

The main object of color in a costume is to obtain a beautiful combination, which will grow more so the longer one looks at it. One problem is to get good color combinations in the use of materials, for texture is as important as color.

When you plan a dress or blouse you are building a picture in which, just as in a painted picture, or in a large building, designed by some famous architect, the lines and color must be well organized, rhythmically balanced, proportionate and fitting the purpose intended. It is the proper choice in the putting together of color effects that you, as an artist in dress, will and must reveal in order to be a real success.

## 5.2 COLOUR

Colour has been investigated and used for more than 2000 years. Throughout history, different civilizations have experimented and learned more about colour. We are still learning today about how colour affects us and its importance in our lives.

Colour is simply light of different wavelengths and frequencies and light is just one form of energy made up from photons.

Colour is a visual language. It is personal and universal sending a message of endless variation. It evokes our feeling and affects our life. The apparel of colour is to use it beautifully. It is one of the basic components of fashion, the other being, texture, details and silhouettes. They are inter-related to one other.

The study of colour may be approached from any one of the following five angles.

- Physiologist: The physiologist is concerned with the way in which the eye receives the sensation of colour.
- Chemist: The chemist studies the chemical properties of the natural and the artificial colouring materials used for the manufacture of dyes and prints.
- Physicist: To the physicist the significance of colour is merely its wavelength and its intensities.
- Psychologist: the psychologist shows the effect of colours on persons and on each other.
- Artist: The artist is the persons who play with colours and are those who mix paints and dyes.

The first two is not necessary, as they do not affect the ordinary problems in the use of colours. Fifth and fourth is more important for use of (fashion) the many theories of colours in pigment. Two are in common use, Prang colour system and Munsell colour system. The prang colour theory only will be used when explaining the properties and classes of colour to avoid confusion for beginning students.



## 5.3 PRANG COLOUR SYTEM

Basically colours are divided into three groups.

1. Primary colours
2. Secondary colours
3. Tertiary Colours

### 5.3.1 PRIMARY COLOURS

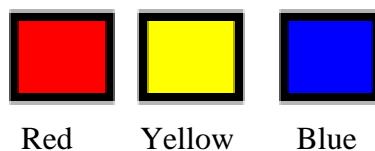

Fig 5.1

There are three Primary colours: RED, YELLOW and BLUE (Fig 5.1). Primary colours cannot be created by mixing other colours.

Contrary to popular belief, there are actually two types of primary colours - Subtractive and Additive.

Subtractive colours are colours that are used in conjunction with reflected light. In this case the subtractive colours are blue red and yellow, (cyan, magenta and yellow where printing and coatings are concerned). These are the colours we are probably most familiar with the as the primary colours from school.

Additive colours are colours that are used in conjunction with emitted light. In this case the additive primary colours are red, green and blue. These are the colours we are probably most familiar with in association with television, and computer displays.

#### 5.3.1.1 SUBTRACTIVE COLOURS

These are the colours that are associated with the subtraction of light and used in pigments for making paints, inks, coloured fabrics, and general coloured coatings that we see and use every day.

All printing processes use subtractive colours in the form of cyan (blue) magenta (red) yellow and black. This is known as CMYK (cyan, magenta, yellow, black) the K stands for black in the printing process. If all three of the subtractive primary colours were combined together, they would produce black.

Some examples where subtractive primary colours are used:

- textiles
- clothes
- furnishings
- printing
- paints
- coloured coatings

### 5.3.1.2 ADDITIVE COLOURS

These are the colours that are obtained by emitted light. The additive primary colours are red, green and blue.

If all three of the additive colours were combined together in the form of light, they would produce white.

Some examples where subtractive primary colours are used:

- television
- theatrical lighting
- computer monitors

### 5.3.2 SECONDARY COLOURS

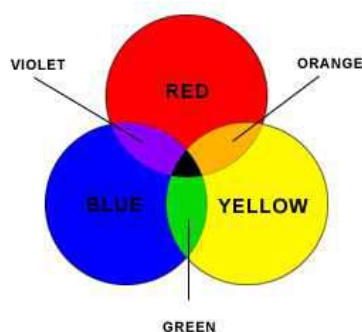

Fig 5.2

A colour created by mixing two primary colours is called a secondary colour.

For example: orange is a secondary colour which is created when the subtractive primary colours red and yellow are mixed together (Fig5.2). Secondary colours can only be created by mixing true primary colours.

### 5.3.3. TERTIARY COLORS

Tertiary colors (Fig 5.3) are combinations of primary and secondary colors. There are six tertiary colors; red-orange, yellow-orange, yellow-green, blue-green, blue-violet, and red-violet.

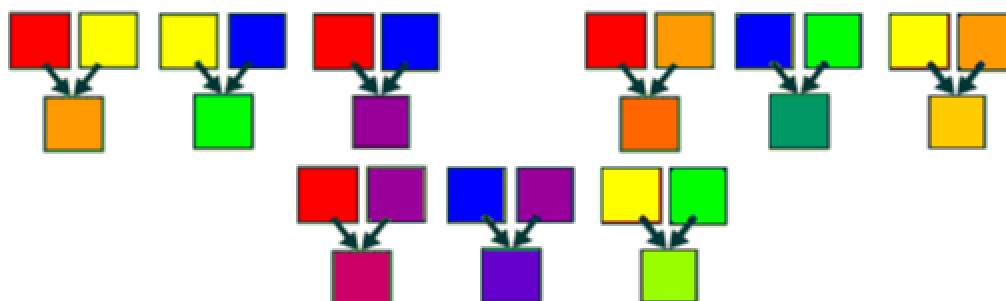

Fig 5.3

An easy way to remember these names is to place the primary name before the other colour. So, the tertiary colour produced when mixing the primary colour blue with the secondary colour green, is called 'blue-green'

#### 5.4 MUNSELL COLOUR SYSTEM

In colorimetry, the Munsell color system is a color space that specifies colors based on three color dimensions, hue, value (lightness), and chroma (color purity or colorfulness). It was created by Professor Albert H. Munsell in the first decade of the 20th century.

Several earlier color order systems had placed colors into a three dimensional color solid of one form or another, but Munsell was the first to separate hue, value, and chroma into perceptually uniform and independent dimensions, and was the first to systematically illustrate the colors in three dimensional space.<sup>[1]</sup> Munsell's system, and particularly the later renotations, is based on rigorous measurements of human subjects' visual responses to color, putting it on a firm experimental scientific basis. Because of this basis in human visual perception, Munsell's system has outlasted its contemporary color models, and though it has been superseded for some uses by models such as CIELAB ( $L^*a^*b^*$ ) and CIECAM02, it is still in wide use today.

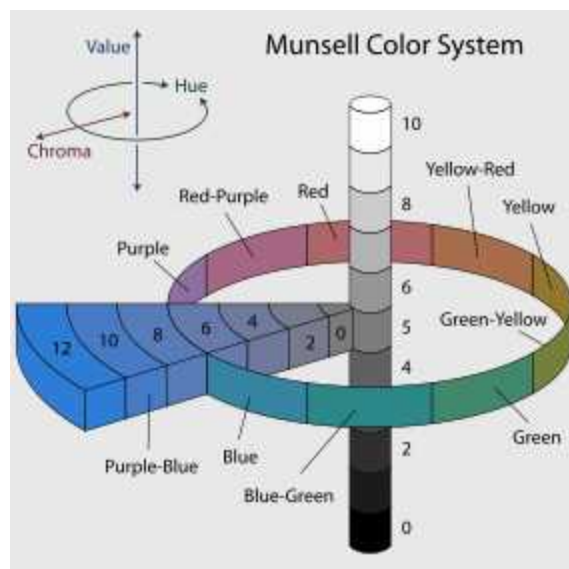

Fig 5.4

The system consists of three independent dimensions which can be represented cylindrically in three dimensions as an irregular color solid: hue, measured by degrees around horizontal circles; chroma, measured radially outward from the neutral (gray) vertical axis; and value, measured vertically from 0 (black) to 10 (white). Munsell determined the spacing of colors along these dimensions by taking measurements of human visual responses. In each dimension, Munsell colors are as close to perceptually uniform as he could make them, which makes the resulting shape quite irregular.

### **As Munsell explains:**

Desire to fit a chosen contour, such as the pyramid, cone, cylinder or cube, coupled with a lack of proper tests, has led to many distorted statements of color relations, and it becomes evident, when physical measurement of pigment values and chromas is studied, that no regular contour will serve.

A color is fully specified by listing the three numbers for hue, value, and chroma.

#### 1. Hue:

Each horizontal circle Munsell divided into five principal *hues*: Red, Yellow, Green, Blue, and Purple, along with 5 intermediate hues halfway between adjacent principal hues. Each of these 10 steps is then broken into 10 sub-steps, so that 100 hues are given integer values. Two colors of equal value and chroma, on opposite sides of a hue circle, are complementary colors, and mix additively to the neutral gray of the same value. The diagram below shows 40 evenly-spaced Munsell hues, with complements vertically aligned.

#### 2. Value:

Value, or lightness, varies vertically along the color solid, from black (value 0) at the bottom, to white (value 10) at the top. Neutral grays lie along the vertical axis between black and white.

Several color solids before Munsell's plotted luminosity from black on the bottom to white on the top, with a gray gradient between them, but these systems neglected to keep perceptual lightness constant across horizontal slices. Instead, they plotted fully-saturated yellow (light), and fully saturated blue and purple (dark) along the equator.

#### 3. Chroma:

Chroma, measured radially from the center of each slice, represents the "purity" of a color, with lower chroma being less pure (more washed out, as in pastels). Note that there is no intrinsic upper limit to chroma. Different areas of the color space have different maximal chroma coordinates. For instance light yellow colors have considerably more potential chroma than light purples, due to the nature of the eye and the physics of color stimuli. This led to a wide range of possible chroma levels—up to the high 30s for some hue-value combinations (though it is difficult or impossible to make physical objects in colors of such high chromas, and they cannot be reproduced on current computer displays).

## 5.5 COLOUR WHEEL

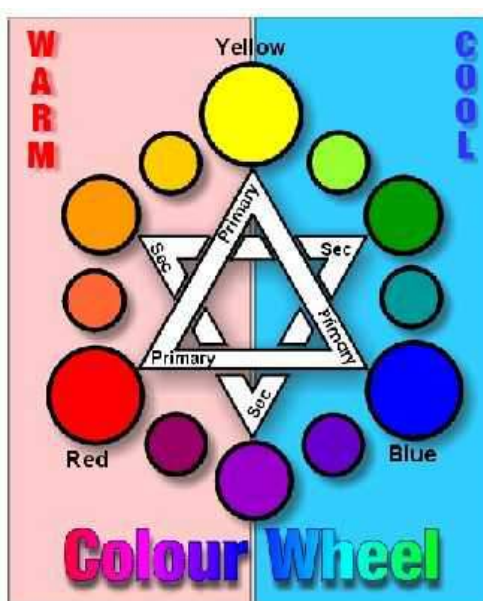

Fig 5.5

The Colour wheel is a useful pictorial representation of the spectrum of colours and can be used to simplify the understanding of the interaction of colours used in a painting. It can also help with selection of a palette of colours, colour mixing, the natural greying of colours, and colour perspective (also called aerial perspective).

The simplified wheel opposite consists of the primary, secondary and tertiary colours explained in Fig 5.5. The three primary colours Red, Yellow and Blue are shown in the large circles. Between each of the primary colours are the secondary colours, shown in the middle sized circles, which result from mixing the two adjacent primaries. The tertiary colours obtained from mixing the primaries with their respective secondary colours are shown in the small circles. As the colours progress around the wheel in any direction, each one is a gradual change from its adjacent colour.

The colours on the right of the wheel shown opposite are known as cool colours - colours which are blue or have a leaning towards blue (yellow-green to blue-violet)

The colours on the left, are known as warm colours - colours which are red or have a leaning towards red (yellow-orange to red-violet)

### 5.5.1 COMPLEMENTARY COLOURS

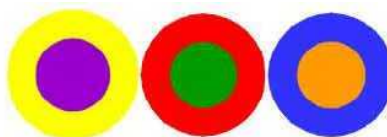

Fig 5.6

Complementary colours are those which are opposite each other on the colour wheel. For example (Fig 5.6), red is opposite green. Green is made from the other two primary colours so it contains no red. When these complementary colours are put together in a picture the result is striking - think of poppies in a green field. Each colour makes the other 'sing' and have vibrancy.

Each primary has a secondary colour which is its complementary and vice versa:

- Orange is the complementary of Blue.
- Green is the complementary of Red and
- Violet is the complementary of Yellow,

## 5.6 DIMENSIONS OF COLOUR

There are three properties or qualities which may be called the dimensions of colour and which are just us distinct form one another as the length, breadth and thickness of an object. These colour dimensions are:

1. The Hue or name of the colour(their warmth or coolness)
2. The value of the colour(their tightness or darkness)
3. The intensity of the colour(their brightness or dullness)

All these three are present in every colour, just as every object has length, breadth and thickness.

### 5.6.1 HUE (SYMBOL H)

Hue is the term used to indicate the name of colour, such as red, blue or green. Light travels in waves of different lengths and at different rates of speed and these waves produce in the eye, the sensation that we call as “colour”. Objects have a property called as “colour quality”, which makes it possible for them to reflect some of these wavelengths and to absorb others. The object is supposed to possess the colour that is nor absorbed by it but reflected out. When the object reflects all the wavelengths, it is seen as white in colour. When the object absorbs all the wavelengths, the object is seen as black in colour.

There are three fundamental hues—red, yellow and blue—which are commonly called the primary colors and from these all the other hues may be made, if mixed in the proper amounts. The triangle shown in Fig. 5.7 indicates the primary colors. Between the corners of the triangle, as for example the red and yellow, additional hues may be inserted, which really are the result of the combination of primary colors.

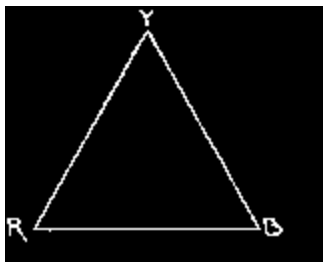

Fig 5.7

By the mixing of red and yellow we produce orange; yellow and blue combined gives green; and blue and red makes purple or violet. These colors, green, orange and violet are called

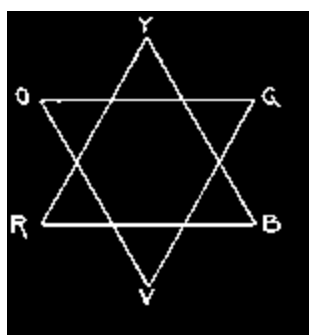

Fig 5.8

the secondary or binary colors. As you will notice we are developing a color chart and are indicating the secondary colors by the second triangle which is placed over the first triangle as shown in Fig. 5.8. In order to produce one of these secondary colors, it is necessary that we use the two required primaries in equal amounts.

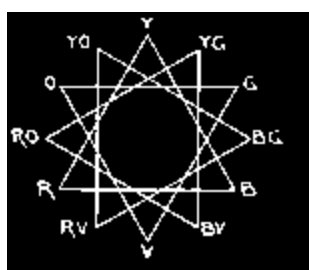

Fig 5.9

There are further hues known as the intermediate colors which we obtain by mixing equal amounts of a primary and a secondary and which will fall between the points of Fig.5.9. Thus we finally have the completed color diagram.

### 5.6.1.1 NEUTRAL COLOURS:

Grey is formed when black is combined with white. Grey is also got when equal amounts of complimentary colours form the colour wheel are mixed. It is also formed when all the three primary colours are mixed together. When the three pigments are concentrated, it results in black, white and shades of grey are called natural colours, because they have no colour of hue.

Hue is the measurable properties of colour in terms of temperature e.g. hot, warm, cold and cool colours

1. Hot colour – refers to red hue in its full saturation. They are strong and aggressive and seem to vibrate within their own space.
2. Warm colour – are cheerful, welcoming and stimulating. They radiate outwards and surround every thing in reach. They are the hues of range by the combination of red and



yellow e.g. RO, O, YO. Warm hues, as they will make objects appear larger and nearer to the observer (advancing colour).

3. Cold colour – refers to fully saturated blue. It is dominating and strong its brightest. The feelings generated by cold colours are the direct opposite of those generated by hot colours. Cold hue slows the body metabolism and increases ones sense of calm. But too much of cold colour may be depressing.
4. Cool colour – hues such as YG, G&BG, which are obtained by mixing yellows and blues. Cold colours have a reverse effect of warm colours. They are calm and restful. They make an object appear in a reduced size since it is a recoding colour.

#### **5.6.1.2 POWERFUL COLOUR COMBINATION:**

Hot and cold colours when placed adjacent to each other, forms a powerful combination. They vibrate like fire and ice. Powerful combination symbolizes the strongest emotions & control and sends a message of vitality, awareness and attracts attention.

Thus knowledge of hue enables the colour user to accomplish the following

1. Identify the names of colours.
2. Recognize advancing and recoding colours.
3. Place a colour in-group such as warm, cold etc.

#### **5.6.2 VALUE**

Value the second dimension describes the lightness or darkness of a colour, which is the relative amount of black or white in a hue. Value can be changed by adding white or water to lighten and by adding more pigment or black to darken them. Every hue is capable of being lowered to a value just above black and of being raised to a value just under white. The incremental addition of white to hue results in lighter values of the hue called tints. The incremental addition of black to hue results in darker values of the hue called shades.

Light colours are the palest pastels i.e. with 90-95% of white 5-10% of colour. Its degree of lightness is determined by the absence of visible colour in their composition. Light values seem to increase to size of an object. Small rooms may be made to appear larger if they are decorated in light colours as light colours create the impression of distance and a person looks larger in white or very light clothing as light colours recede.

Dark colours are the darkest shades with maximum amount of black. Dark values seem to decrease the size of an object. Therefore dark colours would be a poor choice for the background of small rooms and a good choice for clothing for large people as they are advancing in nature. While white and light colours suggest foreground or nearness.

In store display dark values should be used below, rather than above the light values, for if they are seen above the light colours the display will appear unstable. Black and very dark colours absorb the colour of objects seen against them. Black also has a power to unify colours and helps to bring harmony into an arrangement. When a number of bright colours are used together.

For e.g... In a ballroom the gay colours of the women's gowns are harmonized by the masses of black of the men's clothes.

Colours themselves in their original form vary in their values. Dr. Donnan. W. Ross has given the names and symbols of eight steps of value, with the lightened being white and darkened being black

### **5.6.3 INTENSITY (SYMBOL I) OR CHROMA (SYMBOL C)**

The degree of brightness or dullness existing in a colour is called intensity i.e. its strength or its weakness. Intensity is the quality of colour that makes it possible for a certain hue –to whisper, to shout, or to speak in a gentlemanly tone. In other words it is the property describing the distance of colour from grey or neutrality.

The colours in the outer circle of the intensity chart are found to be of full intensity because they are as bright as each colour can be. As colours go down in their brightness toward neutral grey or no-colour, to the centre of the circle, they are found to become duller and are said to be of low intensity, chroma or neutralized.

A colour may neutralize or destroyed or changed in its intensity, by mixing it with its complement or grey.

A complement may be used to neutralize a colour because of the fact that a complement of a colour has the other two primary hues, which is not present in the colour, therefore resulting in neutralization. Example, when red is mixed with its complement green (Y+B), the presence of all the 3 primary colours results in neutralization. Neutral grey itself has a neutralizing effect and may be used instead of a complement to dull a colour.

When a colour in its full intensity has had enough of its complement or grey, mixed with it, to make half as bright as it can be, it is halfway between full intensity and neutrality. This can denoted as to be one half neutralized ( $1/2 N$ ) or one half-intense ( $1/2 I$ ). Like this, the steps towards neutralization can be denoted as I (denoting hue with full intensity),  $1/4 N$  or  $3/4 I$ ,  $1/2 N$  or  $1/2 I$ ,  $3/4 N$  or  $1/4 I$  and lastly N or C (denoting the neutralization of a hue to grey or chroma).

Texture plays so important a part in colour use that it cannot be ignored. Surfaces having more or less roughness reflect light in tiny accents and throw little shadows that have the effect of dulling the intensity of a colour. The texture of a smooth surface seems to blend colours used together and give the appearance of vibrating colour on a shiny surface.

## **5. 7 LET US SUM UP**

In order that you may always have beautiful clothes which will be the envy of everyone who looks at them and which will increase your natural attractiveness, the choosing of colors and the combination of them must be carefully considered. When you have learned to do this you will have accomplished one of the most important steps in the art of beautiful clothes-making. It is just as essential to fully understand and make use of the proper application of color in design as is the application of any of the other elements of design.

The proper use of color values is of the greatest importance in dress designing, for just as the warm or cold hues add to or detract from the appearance of size, so do the color values. By hue we mean the name of the color such as red, yellow or blue. The difference in the warmth in the color is a variation in hue, or in other words, as red changes toward the orange it has become red orange and has changed its hue.

### **5.8 LESSON END ACTIVITIES**

The students may do the following activities based on this lesson

- Prepare your own colour chart according to the colour theory
- Draw a fashion figure based on the colour theory

### **5.9 POINTS FOR DISCUSSION**

Here the students are asked to discuss about the following points

- Applications of Dimension of colours on fashion figure

### **5.10 REFERENCES:**

- Inside the fashion business, by Macmillan publication company
- Elements of fashion and apparel designing, by Sumathi G.J., New Age International Pvt. L.t.d..
- The art and everyday life
- Fashion from concept to consumer, by Cini Stephens Frings, Low price edition
- Fashion sketching book, by Bina Abling, Fai child publication.

## LESSON – 6: COLOUR HARMONIES & APPLICATION

### CONTENTS

- 6.0 AIM AND OBJECTIVES
- 6.1 INTRODUCTION
- 6.2 COLOR HARMONIES
  - 6.2.1 Harmonies of related colours.
  - 6.2.2 Harmonies of contrasting colours.
- 6.3 APPLICATION OF COLOUR ON FASHION FIGURE
- 6.4 BASIC PRINCIPLES OF COLOUR IN DESIGN
- 6.5 APPLICATION OF COLOUR ON DRESS DESIGNING
- 6.6 LET US SUM UP
- 6.7 LESSON END ACTIVITIES
- 6.8 POINTS FOR DISCUSSION
- 6.19 REFERANCES

### 6.0 AIM AND OBJECTIVES

After going through this unit, you should be able to have a clear idea of the following

- Color harmonies and pleasing combinations of hues.
- The use of color on the figure and figure size.
- Color in a costume.

### 6.1 INTRODUCTION

Now that you know all about color and harmony, and you have found out just which styles most become your type of figure. And it is just this harmony that we must strive to achieve in dress—for without harmony there can be no beauty. A dress may look beautiful on a model but entirely unattractive on a human figure. This is because each one of us has distinct personality, each one of us has little peculiarities of line and coloring that require special thought and consideration.

Colors play a large part in the creating of fashion. An otherwise charming gown may be completely marred by the use of a wrong color. On the other hand, the simplest gown can be enhanced by the use of the right color. If you want to be truly well-dressed, find out now from the following chart just what colors most become you—and avoid those that do not.

Color in dress should be considered from two points of view. The first is the harmonious combination of colors in the costume itself. Second is the becomingness of the colors of the costume to personal coloring, hair and eyes of the wearer. One is as important as the other and through ignorance of the first; a most unpleasant effect may be thrust upon a sensitive public; while disregard of the latter means a loss in personal beauty.

## 6.2 COLOR HARMONIES

Harmony can be defined as a pleasing arrangement of parts, whether it be music, poetry, color, or even an ice cream sundae.

Color theory has long had the goal of predicting or specifying the color combinations that would work well together or appear harmonious. The color wheel has been adopted as tool for defining these basic relationships. Some theorists and artists believe juxtapositions of complementary colors are said to produce a strong contrast or tension because they annihilate each other when mixed; others believe the juxtapositions of complementary colors produce harmonious color interactions. Colors next to each other on the color wheel are called analogous colors. They tend to produce a single-hued or a dominant color experience. Harmony has been sought in combinations other than these two. A split complementary color scheme employs a range of analogous hues, "split" from a basic key color, with the complementary color as contrast. A triadic color scheme adopts any three colors approximately equidistant around the hue circle. Printers or photographers sometimes employ a duotone color scheme, generated as value gradations in black and a single colored ink or color filter; painters sometimes refer to the same effect as a monochromatic color scheme.

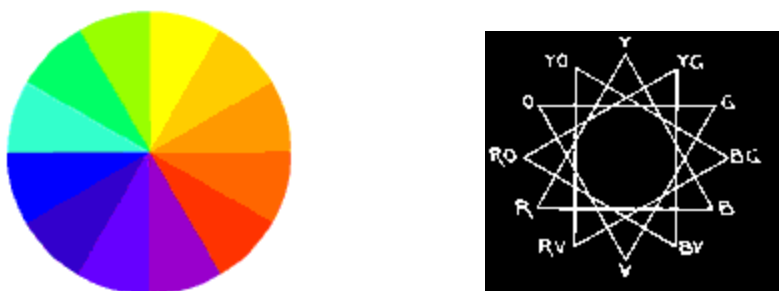

Fig 6.1

The color wheel (Fig.6.1) harmonies have had limited practical application simply because the impact of the color combinations is quite different, depending on the colors involved: the contrast between the complementary colors purple and green is much less strident than the contrast between red and turquoise. They can suggest useful color combinations in fashion or interior design, but much also depends on the tastes, lifestyle and cultural norms of the consumer. When the schemes have proven effective, this is often because of fundamental contrast is between warm and cool hues (in this instance meaning hues on the opposite sides of the color wheel), contrast of value with darks and lights, contrast of saturated and unsaturated colors, or contrast of extension, when one color is extended over a large area contrasting another color extended over a very small area.

In the 20th century color theory attempted to link colors to particular emotional or subjective associations: red is an arousing, sensual, feminine color; blue is a contemplative, serene, masculine color, and so on. This project has failed for several reasons, the most important

being that cultural color associations play the dominant role in abstract color associations, and the impact of color in design is always affected by the context.

### Create colour harmony with a colour wheel

The standard colour harmonies may be divided into two main groups.

- Harmonies of related colours.
- Harmonies of contrasting colours.

#### **6.2.1 HARMONIES OF RELATED COLOURS:**

Related color harmonies have one hue in common

##### 1. Complementary Harmony:

Complementary Harmony results from using hues opposite each other in the color wheel.



Fig .6.2

Blue and orange, red and green, yellow orange and blue-violet are an example of complementary harmony shown in Fig 6.2. Simple complementary schemes of two hues can be extended by using tints, tones, or shades of the selected hues.

When complementary hues are used in their full strength (light chroma) and in equal quantities, they intensify each other and produce sharp contrasts. This causes a vibration that is often painful to the eye. Red will seem redder when placed next to its complement, green, than when red is used with yellow. Green appears greener next to red than when used next to yellow. This phenomenon is called simultaneous contrast. The effect of the vibrations caused by these complements can be lessened by using a smaller amount of intense color or by substituting a tone or shade of the desired hue.

##### 2 Split complement harmony:

Split complement harmony occurs when a hue is used with the colors on either side of its complement.



Fig 6.3

An example Fig 6.3 of a split complementary color scheme would be yellow joined with red-violet and blue –violet

3. Triad harmony:



Fig 6.4

A Triad harmony uses three hues placed equidistant on the color wheel. In Fig 6.4 sample triad color schemes are yellow, red, and blue or orange, purple, and green.

### 6.2.2 CONTRASTING COLOR HARMONIES

Contrasting color Harmonies have no hue in common.

1. Analogous Harmony:

Analogous Harmony uses colors that appear next to each other on the color. wheel.

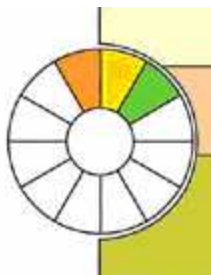

Fig 6.5

Colors such as yellow-orange, yellow, and yellow-green make up an analogous harmony. When one of the hues is allowed to predominate and when values and chromas are varied, striking effects can be achieved. This harmony creates sweater. The length of the sweater will determine the line of value contrast. If the hemline of the sweater falls at the largest part of the



hipline, this will be the point of emphasis. Value contrast at the hipline would be avoided if the pants and sweater were of the same color or of different, yet close in value, hues. Value contrasts that emphasize are found in many clothing designs.

White or very light-colored shoes are in direct contrast to dark, suntanned legs or dark hosiery, this shoe is contrasted against the dark walking surfaces. Because of the advancing quality of light values, white, light on shuny hosiery also seem to increase the size of the leg and feet. Other contrasts that attract attention are contrasting belts, buttons, trims, or fabric colors.

## 2 Monochromatic Harmonies:

Monochromatic Harmony uses one hue.

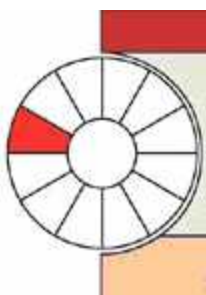

Fig 6.6

Various tints, tones, and shades of one hue are used in Monochromatic Harmony (Fig 6.6) for instance, light pink, rose, maroon, and watermelon. If value and chroma gradations are too close together, the effect may be unpleasing because of ambiguity of colors, giving the impression of a mismatch. These schemes require noticeable differences to achieve the various necessary to avoid a fatiguing and monotonous effect.

## 3. Achromatic colour scheme:

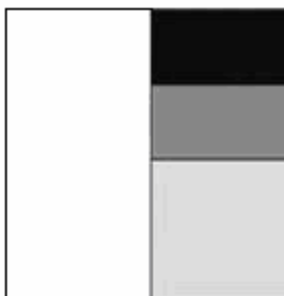

Fig 6.7

Achromatic means absence of colour. This scheme has white and black at the two extremes with tones of grey in between.

## **6.3 APPLICATION OF COLOUR ON FASHION FIGURE**

Color is one of the first things people notice about clothing. The use of color can create illusions of the figure size in the same way line does. Color should be selected on the basis of complexion-hair, skin, and eyes-as well as on figure size.

Colors should complement the complexion. A complexion that tends to be sallow (yellow tones) should wear colors that bring out the pink/red tones of the skin. A complexion that is florid (red/blue tones) should avoid colors that emphasize the redness of the skin.

Matching of color to the complexion is a very personal matter. Old adages like "redheads should never wear pink" are not always valid. Careful selection of the value and intensity of a color, its placement and the complements used with the color can allow its use by almost everyone.

Colors are classified as warm-reds, yellows, and oranges-or cool-blues, and greens. Warm colors tend to create an illusion of greater size. Cool colors tend to create an illusion of reduced size.

The brightness or dullness and the lightness and darkness of colors also affect the illusion created. Dull and dark colors seem to recede and make the figure appear smaller. Bright and light colors have the opposite effect.

In addition to these general characteristics of colors, how they are used will also influence the illusion created. Contrasting colors in tops and bottoms create a horizontal line where they meet and tend to shorten the figure. A single color outfit gives a vertical feeling and creates an illusion of height and slimness.

## **6.4 BASIC PRINCIPLES OF COLOUR IN DESIGN**

### 1. Dominant or Controlling Color:

Decide on the dominant or controlling color, which may dominate by covering a large area or by strength of color in a smaller area. Decide whether the foundation or background color is to be the dominant or a secondary color. Plan to use a large amount of quiet background color, a small amount of bold, strong color. All large foundation areas should be in light or grayed tones.

### 2. Graying:

Clear colors are gayer, more cheerful, but grayed tones are more restful, their harmonies more subtle. Mixing gray with bright colors brings them into relation with other colors in the room. As red and yellow in bright tones seem to clash. Mixed with gray, they become rose and tan and go very well together. Use this principle also in buying materials. Avoid too much graying. It gives muddy tones, dirty grays, flat greens. A little gray goes far.

### 3. Relief and Contrast Colors:

Decide on relief and contrast colors and bring them into all parts of the room composition. Remember the order in the amount of space allowed each one, foundation, then relief, then contrasts. All colors including background colors should be keyed to the dominant color. Soften strong contrast colors with white. Contrast is less in lighter tints. Soften darker contrasts with grey.

#### 4. Accent Colors:

Use pure bright intense colors only in accessories, etc., Distribute them so they will not be spotty. The smaller the area the brighter the color may be. The larger the area the softer the tone should be. Don't use large amounts of pure bright color.

#### 5. Keying:

This is another means of creating harmony. A key color is the one about which the color scheme is built- the dominant or controlling color. All other colors in the room must be "keyed" with it- harmonized. Two colors in which any part of a third color is present will be linked together. Example, to key red and yellow to each other, mix them both with a little of the third primary hue - blue. Violet and green will result, and these are harmonious to use with our strong tones.

### **6.5 APPLICATION OF COLOUR ON DRESS DESIGNING**

Garments have combined design elements of texture, color and line, each must be selected in relation to your figure and how they affect each of the other elements. The effects of texture in fashion influence how colors appear and how design lines function.

When several colors are used in a single outfit, the amount, placement, and contrast between the colors used will determine the effect. If the color is printed in the fabric design, the size of the design, as well as the colors used must be considered. Generally, the size of print should be selected in relation to the figure size. Small figures look best in fabrics with small designs. Large figures look best in fabrics with large designs. These guidelines are especially true if the colors used are bright and contrast strongly.

The main object of color in a costume is to obtain a beautiful combination, which will grow more so the longer one looks at it. One problem is to get good color combinations in the use of materials, for texture is as important as color.

#### 1. Beautiful Colors Correctly Used:

In order that always have beautiful clothes which will be the envy of everyone who looks at them and which will increase natural attractiveness, the choosing of colors and the combination of them must be carefully considered. It is just as essential to fully understand and make use of the proper application of color in design as is the application of any of the other elements of design.

#### 2. Color Types:

It is quite difficult to lay down hard and fast rules as to the colors which different individuals may wear. This may be readily understood, as hardly any two people are identical as to color of hair, eyes, skin and general contour of features and body. All of these points have a direct bearing on the colors which are suitable to be worn. For example the small, frail, flaxon-haired blonde may be ever so attractive wearing certain colors which on the blonde of practically the same coloring, but having a very large figure, would be most displeasing.

It will be necessary for in applying colors in the making of clothes for yourself or for others to study carefully the effect produced by colors of different values and intensity in the particular case with which you are dealing.

### 3. The Blonde:

In choosing clothes the blonde must be especially careful about color. Some blondes work by the rules of contrast, that dark colors make their pale coloring seem even more delicate. It is commonly thought that this idea really works.

For blondes with gray blue or green eyes, there seems to be the opinion that grayish colors, that is, blues, greens and violets, are far more becoming than the warm brownish tones. This isn't true when speaking of the fair-haired, brown-eyed person, whose skin is somewhat inclined toward the brunette type and who usually, looks well in shades of brown.

Of course, if the blonde has golden hair and the right complexion she may wear bright blue or red, even shades of rose may be chosen and worn well. Pale blondes want to be ever so careful to avoid colors which make them look dull or very pale.

As a rule, the blonde should not wear tailored clothes. She is not at all the masculine type, so she will look much better in simple, soft effects. She should not wear tweeds or very heavy materials. Her type calls for jersey, crepes, kashas, velveteens and chiffons which are much more suitable.

Heavy jewelry should be avoided by blondes. She should select small beads, dainty chains and stones such as jade, amethyst, turquoise and topaz.

### 4. Titian Haired Blonde:

The titian haired girl, that is the one whose hair may be of the so-called auburn shade or red, should be careful not to intensify this feature to too great an extent, but on the other hand, she must not detract from the beauty of her hair.

The complement of a color tends to emphasize it; therefore she should avoid the light shades of green which from your color chart you will see is the complement of red. Some of the very darkest shades of green may be very becoming. The bright blues also tend to bring out the redness of the hair and should therefore be avoided. Navy or midnight blue and the soft, silent tones should be very pleasing. The deep shades of brown, also black and the cream and ivory hues, will be found to be very good.

### 5. The Brunette:

If the brunette has a clear skin or good color, any shade is possible. If she is pale she should avoid colorless dull or pastel shades. The brunette having an olive complexion, especially if she is young, should never wear dark colors as they tend to make her look older. The warmer tones by contrast emphasize the luster of the dark hair and are therefore desirable. It is generally best for the brunette to use the warm colors such as reds, red orange, yellow, etc.

Whenever a brunette chooses to wear very dark shades such as dark brown, black, or midnight blue, some bright color should be added such as orange or certain shades of red.

#### 6. The Gray or White Haired:

Very frequently the gray-haired lady tends to wear black, which is very good, but she must not forget that a touch of white in the form of a yoke or collar to relieve the black near the face is most necessary. White of course, being a neutral color, is very good for this type.

Purple in certain shades is generally quite becoming, but inasmuch as the complexion of older people frequently tends toward the yellow, bright purples should be avoided, for being the complement of yellow it tends to emphasize that color. A person who when younger found the warm colors the more becoming must remember that as the hair begins to turn gray and the color of the skin is not so clear that the cooler shades should be more and more used. Some of the dull warm shades may also be pleasing, if the color of the eyes and the features warrant their use.

#### 7. A Sallow Complexion:

A sallow complexion great care must be taken in the choice of colors. Of course there are certain colors that will help a great deal. In fact, it is far better to select those which will reflect color in the cheeks, and in order to do these choose warm tints such as red, shades of rose, a gray color having a tint of pink or colors of this particular type.

Do not do this for the purple only helps to bring out the shallowness of the skin. Likewise black should not be worn by this particular type of persons. If the complexion is very sallow avoid yellow, tans or browns for it only tends to make the complexion look yellow.

Shades of blue green, navy and might blue will help to bring out the color in the cheeks and in this way make the skin look less sallow. However, be very careful in the choice of shades of green, for bright greens are hard to wear by most types and should be carefully avoided by this particular one.

#### 8. Florid Complexion:

A florid complexion, do not select red or shades of red. A repetition of the same color, even though the tones and shades are different will bring out the color. Bright colors must be omitted if a person having a florid complexion wishes to distract the attention from that fact. It is hard to do this for a little red or pink for trimming is ever so tempting and it really takes a great deal of self-control to keep from choosing these colors when one loves to wear them.

However, purples may be worn, also dark blues, dark brown or black can be worn. To be sure, light shades are attractive for some people, but for this type of person usually darker shades should be chosen.

#### 9. Colors for Sports Clothes:

As to colors, here again any color you like and can wear well will be appropriate for the sports costume. While some of the darker shades are meeting with approval, there is a decided liking for the bright hues. Royal blue, scarlet and greens are favorites, as well as beige, coral, grays and other colors. Some of the most attractive dresses are made from striped or barred jerseys. Occasionally there is a clever weaving of silk which gives a decided richness to the material. Metal threads, woven to form stripe effects in jersey dresses are most pleasing.

## 10. Choose Of Colors

Just as there are certain colors which are usually pleasing and becoming, there are others which nearly all people find rather trying and hard to wear. As a general thing we must all avoid the pure hues having the full intensity. All of the bright shades of purple are trying to most complexions. Bright reds and blues can be worn by very few people, whereas the duller shades of these colors are found to be quite pleasing to many types.

### **6.6 LET US SUM UP**

With harmony, style, color and personality, clothes require only the final touch of correct workmanship to make them perfect. Here we saw the colour harmony with respect to distance, texture, complementary, personal reaction, colour contraction and triads' harmony.

Beautiful combination, which gave longer one, looks at it. Color combinations in the use of materials, for texture is as important as color.

### **6.7 LESSON END ACTIVITIES**

The students may do the following activities based on this lesson

- Create a fashion figure for different colour harmonies
- Collect swatches with different colour

### **6.8 POINTS FOR DISCUSSION**

Here the students are asked to discuss about the following points

- The methods of applying colour harmonies on a dress
- The basic principle of dress designing with colour concept

### **6.19 REFERENCES:**

- Inside the fashion business, by Macmillan publication company
- Elements of fashion and apparel designing, by Sumathi G.J., New Age International Pvt. L.t.d..
- The art and everyday life
- Fashion from concept to consumer, by Cini stephens Frings, Low price edition
- Fashion sketching book, by Bina Abling, Fai child publication.

## LESSON – 7: DRESS DESIGNING

### CONTENTS

7.0	AIM AND OBJECTIVES
7.1	INTRODUCTION
7.2	FOUR ESSENTIALS IN DRESS DESIGN
	7.2.1 Choice of Material
	7.2.2. Choice of Color
	7.2.3. The Design or Structure
	7.2.4. Decoration
7.3	THE PROPORTION OF FIGURE
7.4	UNUSUAL FIGURES
7.5	LET US SUM UP
7.6	LESSON END ACTIVITIES
7.7	POINTS FOR DISCUSSION
7.8	REFERANCES

### 7.0 AIM AND OBJECTIVES

After going through this unit, you should be able to have a clear idea of the following

- Steps involve designing of a dress.
- Studying the proportions of the body
- General figure, shape of the face, coloring, etc.
- Type of dress and look.

### 7.1 INTRODUCTION

To wear beautiful, becoming clothes is not enough. To wear clothes that are an expression of one's individuality is not enough. There is something that is more important than fashion, attractiveness, personality—something more significant than any or all of these.

And so we find that in addition to our knowledge of fabrics, design, the creating of clothes and the conforming to certain individual types

To the artist, the human figure is the most beautiful in the world. The designer of clothes must take this attitude also, if she wishes her creations to be truly beautiful. There are no straight lines in the body. All are gently curved. And all parts of the body bear certain general relations to one another.

For the study of design, you must know the figure, its contour, its curves, its general outline. You must know the relation of the form to the gown you are draping—the form must be your background, your landscape, your canvas, your very foundation. An invariable rule of design is that all lines must closely follow the lines of the body.



## 7.2 FOUR ESSENTIALS IN DRESS DESIGN

Let us see exactly what the designing of a dress involves—exactly what we must take into consideration.

- The study of the structural lines of the human figure.
- The requirements of individual types. Suitability.
- The selection of materials, with reference to color, texture and weave.
- Detail—which is ornamentation and shaping, and an analysis of the laws of design embracing proportion, rhythm, harmony and the perfect balance of line, mass and color.

In general the designing of garment for a different person can be classified in four categories.

1. Choice of Material
2. Choice of Color
3. The Design or Structure
4. Decoration

### 7.2.1 CHOICE OF MATERIAL

The first point to be considered when designing a dress is the occasion for which the dress is planned, as this will dictate the kind of material of which the garment is to be constructed, the appropriate color, the form or design and the type and amount of ornamentation.

In regard to the material which is to be chosen, remember that stiff hard fabrics do not drape well and should be used where more tailored effects are desired. Also take the individual into consideration in the selection of materials, for the large person should avoid stiff, wiry, hard surfaced materials as they seem to make one look stouter.

Just as soft dull fabrics tend to reduce the appearance of size in a large person, so do the materials which do not cling to the figure tend to make the small, slender person appear larger.

All of the material used in a particular dress should be of approximately the same quality; that is, avoid using cheap cotton material on a dress largely composed of very fine voile. Some materials which are quite different, such as certain wool fabrics, may be used with satin, or frequently spring or summer suits of wool are ornamented with linen or pongee. Combinations of this kind lend variety to the dress or suit so that they are not too severely plain or monotonous.

The small person may look well in a dress made of such material, but even so it is desirable that the pattern or design of the goods is not too conspicuous. Large figured patterns in dress material just as in rugs, wall paper, etc., grow tiresome after a short time. Plain fabrics or materials having small figures giving a quiet effect can as a rule be safely worn by everyone.

We can create these lines by means of ruffles or tucks around the figure or by means of panels or plaits running up and down, and likewise by the use of the design in the material of which the dress is made, this same effect is produced. If the person had chosen stripes running the other way she would have been made to look taller and not nearly so stout.

### **7.2.2. CHOICE OF COLOR**

Color in costume attracts or repels at once. No costume, however correct in line and design, can be beautiful when made of a color or combination of colors that are discordant. The combination of colors in dress is as much an art as mixing pigments and applying them to the canvas.

For a cool combination choose the gray and blue of an autumn sky. The summer sky shows nature in one of her most beautiful moods, we have combinations of gray and lavender, pink and blue, gray and rose. In the woods, nature chooses russet and brown and dull yellows as her favorites, and adds a splash of green here and there to give inspiration to the artist.

We have already gone into the subject of color, and will therefore not discuss the subject here to any great extent.

Study the individual carefully and select a color which will bring out those desirable features and will tend to obscure and make less noticeable those which are not so desirable. Be careful in choosing too bright colors, for there are few people who can wear them well. What is good for the young, highly colored brunette is not so suitable for the more mature, delicately colored blonde. Also remember that the use to which the dress is to be put or the occasion on which it is to be worn has a bearing on the color of the material selected.

### **7.2.3. THE DESIGN OR STRUCTURE**

This will, of course, be influenced by the type of dress, that is, whether it is a house dress, an afternoon frock or a formal evening gown. The silhouette or general outline should follow the lines of the figure, but of course not too closely.

Structural lines and decorative designs should be so placed as to avoid the monotony of space divisions. For example, the dress should not be divided into two equal parts by a sash or belt; an uneven division is much more interesting.

The curved line is the line of force and beauty and all lines of the human figure are at least slightly curved. So in planning the dress remember to so construct it as to show some degree of curve.

The design or structure of a dress must be made up of parts that show a proper relationship to the human figure, that bring out one's good features and that skillfully cover the poor ones.

### **7.2.4. DECORATION**

Frequently you have seen an apparently well-designed and proportioned dress of beautiful material which just seemed to lack something. Very often it is a simple decoration properly placed which would transform the appearance of the dress. It might be only a pin, buckle or tie of contrasting color, which in itself would seem trivial yet, is the key to the whole scheme. On the other hand, should avoid overdoing the matter of decoration or trimming, for it is just as easy to mar a beautiful gown through an oversupply as with a lack of it.

Splendid effects may be had by way of decoration with tucks, plaits, ruffles, tiers and bands of the same material as the dress. As a rule the question of decoration is not so much a matter of material as it is a choice of quantity and the proper application of the decoration selected.

The decoration which must be in keeping with the material of which the dress is made. Coarse materials permit greater freedom in the matter of decoration than do fine textured fabrics.

### 7.3 THE PROPORTION OF THE FIGURE

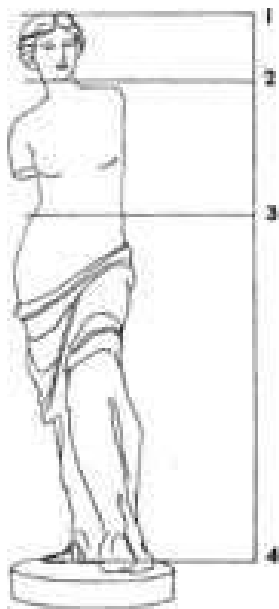

Fig 7.1

Figure 7.1 illustrates the structural lines and proportions of the human figure.

Point 1 is the top of the head. Point 2 is the chin. From points 2 and is the most important structural part of the garment. Point 3 illustrates the correct structural waistline.

Correct proportion of figure can be gained by using the head as a unit of measurement. The body, from top of head to feet, is ordinarily 8 heads. From the chin to waist line is ordinarily from  $2\frac{1}{2}$  to 3 heads. Across the shoulders is  $1\frac{1}{2}$  to  $1\frac{3}{4}$  heads.

After studying the proportions of the body, the structural points, and experimenting with the heads as a unit of measurement, find the structural points of your own figure and see whether or not your height is eight times the measurement of your head. Perhaps you are only 6 heads high instead of eight. If so, you are shorter than the average person. Perhaps you are ten heads instead of eight.

In either case, find the best structural point to remedy the discrepancy in the body measurements. It may require a change in line between points 2 and 3, or a change in line

between the points 3 and 4. For instance, a deep V line between points 2 and 3 will give the appearance of length and add to the height of the body. On the other hand, if the figure is ten heads high, many ruffles or circles between points 3 and 4 will detract from the height.

## 7.4 UNUSUAL FIGURES

Few people are as perfect as to general figure, shape of the face, coloring, etc., that they are able to wear almost any type of dress and look well. Many of us have certain peculiarities such as narrow shoulders, flat chest or round shoulders, a large bust, or our face may be very square, so that we must use care in the design and selection of our dress.

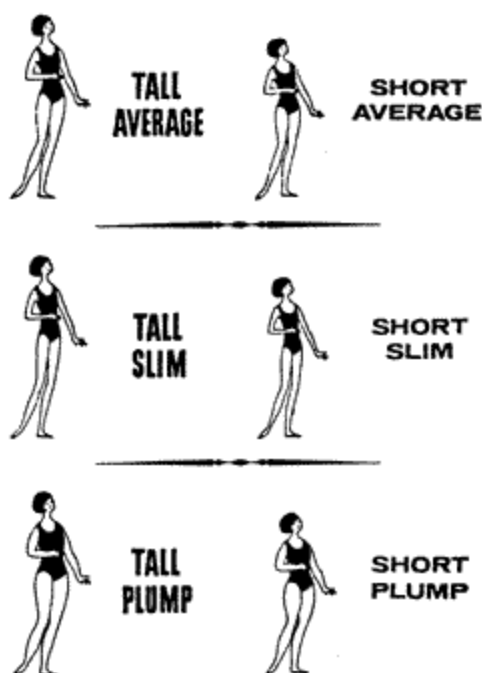

Fig 7.2

The unusual figures are classified in to two groups.

1. Becoming
2. Unbecoming

These two classifications are based on the following figure types.

### 1 THE THIN FIGURE

Choose materials which do not cling to your figure and remember what has been said about shiny materials increasing the appearance of size. The lines of the silhouette should not be continuous. Create the effect of horizontal movement in the lines of the dress as has been suggested by the use of ruffles, tucks, etc. A wide girdle will cut down our height, and clothing which is light in color will make you look stouter.

If the bones of the neck are rather prominent, be careful not to wear the dress too low. A blouse which fits too tight across the front will make look thinner, so it must be avoided.

### **Becoming**

- Lustrous materials, unless the person is too angular
- Materials that stand out somewhat from the figure
- The silhouette of the dress shown broken, rather than long beginning line
- Horizontal movement in the line of the dress
- Wear loose clothing
- Broken lines and curved lines
- The soft, full line of drapery in the waist
- Use short collars
- The sleeves gathered in to tight
- Use patch pocket
- Wear cap
- Light furs, if becoming to the complexion
- Long haired furs. If the person is small, the scarf must not too large
- Hats wit low crowns
- hats with drooping brims
- Hats of average size
- Hates with regular lines

### **Unbecoming**

- Severely straight lines
- Angle in the lines of the dress
- Long narrow skirt
- Flat tight waists
- Sleeves so short that the bones of the arm are conspicuous
- High hates
- Angle in the line of the hates
- Stiff trimmings as wings or standing out from the hat

## **2 The Stout Figure**

It is not only the thin person who has her troubles, for her plump sister also has her dress problems. It has been said of the use of soft materials having a dull rather than a shiny surface and of colors which are not too bright, as being more becoming to the stout figure.

Never try to make look thin by wearing a dress which is too tight for you, because this merely emphasizes your figure. Just as the thin person must create a horizontal movement of line, the stout person must obtain a vertical movement by the use of devices which will cause the eye to travel up and down rather than across the dress.

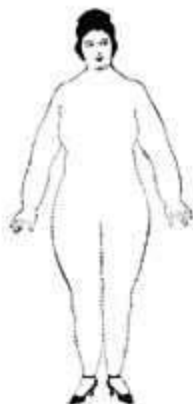

Fig 7.3

The stout person (fig 7.3) should avoid the extremes in dress, as, for example—very short or very long skirts, very tight sleeves, or the flowing variety. A long V line to the neck is always desirable. When selecting a fur coat, never take a raccoon or any long-haired fur, for it has a bulky appearance. Mink, squirrel or seal are much better.

### **Becoming**

- One material or color, used throughout the costume rather than breaking it up into separate parts.
- Soft yet not clinging fabrics.
- Fabrics with dull surfaces.
- Dull colors in large areas.
- Black, or very dark colors if the silhouette is good. if the outline of the figure is poor, use fairly dark colors to reduce size, but not so dark that they will call attention to the silhouette.
- An unbroken silhouette, if the figure is normal.
- Semi fitted, rather than tight effects in the dress as a whole but molded to the hips with some fullness below.
- Transitional lines in the dress rather than extreme curves or angles.
- Vertical movement in the lines of the dress.
- The emphasis on the dress up and down the center front, with the principle accent at the throat and, if possible a subordinate one at the bottom of the skirt.
- A long diagonal line in the waist is excellent for a stout figure, provided the diagonal is not directed too far out toward the hips. Carried too far it will broaden the waist and hips.
- Panels of moderate width, Pleats, panels, etc., that starts above or below a point where the figure is large.
- Comparatively long skirts.
- Skirts that flare a little in center front with a straight silhouette.
- A normal waist line or slightly above or below it.
- No belt or narrow belt.
- Slim, long set-in sleeves.
- Normal armhole, or trifle higher if the shoulders are broad.

- Sleeves that are slit vertically to show the length of the arm and only a portion of the width.
- Simple neck lines, preferably long lines and long collars.
- Short jackets the same color as the skirt.
- Long coats and jackets.
- Flat, short-haired furs.
- Dark furs.
- Hats of moderate size.
- Hats that suggest an upward movement.
- Hats with irregular lines in the brim and a rather high crown.
- Hats with transitional lines rather than extreme curves or angles.
- Hair dressed high.
- Hair well groomed. It may have a wave with rather large undulations.

### **Unbecoming**

- Lustrous fabrics, taffetas, and other stiff fabrics.
- Plaids, or may large or outstanding surface pattern.
- Heavy, bulky fabrics.
- Fabrics that take round lines.
- Bright colors in large areas.
- Unnecessarily full, long garments.
- Foundation garments that produce bulges above and below the garment.
- Very full or tight garments.
- Ruffles.
- Horizontal movement in the lines of the dress.
- Exaggerated curves or angles, for the curves repeat the lines if the figure and the angles contradict them, therefore both call attention to the size.
- Very wide or extremely narrow panels.
- Panels, pleats or overskirts that spread or flutter as one walks,.
- Pleats, panels, or any trimming ending or starting at a point where the figure is large.
- Very narrow lines of trimming.
- Thin piping.
- Fluffy fichus.
- Large circles on hats or dresses.
- Short skirts.
- Skirts which flare all around.
- Yokes on skirts.
- A high waist line, since it makes the waist appear broader.
- An extremely long waist line, for it makes the upper part of the figure too heavy for the lower part.
- Belts or sashes which are conspicuous in width or in color.
- Entire sleeve tightly fitted.
- Flowing sleeves.
- Transparent sleeves.
- Sleeves lighter than the dress.
- Kimono sleeves which give an effect of breadth, owing to looseness under the arm.
- Ribbons or trimming extending beyond or hanging from the sleeves.



- Sleeves ending at a place of unusual width on the figure.
- Wide, light cuffs on a dark dress for the eye will travel across the figure, adding width.
- Tight broad collars, or short collars.
- Short jackets that contrast with the skirt.
- Freakish or conspicuous shoes.
- Shoes with slender, high heels.
- Small hats.
- Big hats.
- Flat hats.
- Round hats.
- Hats with long lines or brims drooping on both sides.
- Contrasting colors and values in hats, hose, and shoes.
- A low or broad style in hair dressing.
- Small tight waves or “bushy” hair.
- Thin or very small pieces of jewelry.
- Tiny trimmings for hats and dresses.
- Very small accessories.

### 3 LONG WAISTS, SLENDER FIGURE

#### **Becoming**

- The effect of a slight blouse at the underarm seam.
- Long lines in the skirt.



Fig 7.4

#### **Unbecoming**

- A long, diagonal line in the waist.
- Tight bodice.

### 4 NARROW SHOULDERS

#### **Becoming**

- Padded or broadened shoulders.
- Broad lines in yokes, collars, and lapels.
- Armhole seams placed slightly out (or lower than normal)

### **Unbecoming**

- A panel or vest effect that starts wide at the waist or hips and becomes narrower toward the neck. This makes a triangle with the point at the neck and the base at the waist and hips, thus narrowing the shoulders and broadening the waists and hips.
- Armhole seams placed higher or farther in than normal.

## **5 BROAD SHOULDERS**

### **Becoming**

- Lengthwise pleats, folds, or tucks extending from the shoulders to the waist, placed somewhat toward the center line in order to narrow rather than broaden the figure.
- Hat with a relatively high crown and a fairly wide brim

### **Unbecoming**

- Wide or horizontal structural lines in yokes, collars, and lapels
- Very small hats.

## **6 ROUND SHOULDERS**

### **Becoming**

- Set-in sleeves.
- The shoulder seam placed about one-half inch back of the normal shoulder line.
- Collars that will appear to straighten the curve of the back. Either have the collar long enough to hang loose from the neck to below the highest point of the curve, or have it short enough to fill in the space between the neck and the beginning of the curve. Then build out the waist line by having the waist full and loose in order to fill in below the prominent curve. This may be done by the use of a panel that hangs from the neck to the waist, turning back under a loose belt, or by the use of a bolero jacket.

### **Unbecoming**

- Kimono sleeves
- Raglan sleeves
- Collars that end at the curve of the back.
- Collarless dresses that are tight at the waist line
- Hat with a long dropping brim in back that forms a continuous line between the crown and the curve of the shoulders.

## **7 LARGE BUSTS**

### **Becoming**

- Panels or vests
- Silhouette built out at waist and hips if not already large.
- A yoke line, jewelry, or some other conspicuous line that stops above or below the bust line.
- Long flat collars and jabots.

### **Unbecoming**

- The waist line drawn in.
- High fitted waist,
- Wide belts.
- Trimming at, or near, the bust line.

## **8 FLAT CHESTS**

### **Becoming**

- Full, soft collars.
- Jabots and fichus.

- Fullness over the chest by means of tucking or shirring the material into the shoulder seam.

**Unbecoming**

- Tight waists

**9 LARGE HIPS**

**Becoming**

- Emphasis up and down the center front of the dress.
- Oblique lines from hem to waist that end slightly at one side of the center front.
- Narrow belt placed slightly below natural waist line.
- Average amount of fullness in the skirt.
- The skirt flared slightly from the hips.
- The skirt blouse at the waist line.

**Unbecoming**

- A one-piece, belt less dress hanging straight from the shoulders.
- Pockets at the hip line.
- Horizontal lines on the skirt placed near the hip line.
- short skirts
- tight skirts
- very full skirts
- Skirts that are narrowest at the hem
- Tight, closely fitted waist.

**10 LARGE ABDOMENS**

**Becoming**

- Waist slightly loosed
- Long, simple jabot of moderate fullness of reverses that end slightly below the waist line.
- Coats that build out the sides of the figure.

**Unbecoming**

- Waist and upper part of skirt fitted tightly.
- Sash or belt tied at the center front.

**11 SMALL FACES**

You may have a small face which is somewhat out of proportion to the rest of your body. If this is the case the hats you wear must be rather small if they are to be becoming. Large and rather "showy" trimming on the hat will make your face appear even smaller by contrast. The principles you have learned in the study of proportion will come into play here to solve your problem.

**Becoming**

- Hat that are rather small
- Trimmings that is rather fine in texture and in scale.
- A relatively small hair dress.

**Unbecoming**

- Large hats.
  - Heavy hats.
- Too large a hair dress, for, by contrast, it will make the face seem too small

## **12 LARGE FACES**

### **Becoming**

- Hats sufficiently large to form an adequate frame for the face.
- A hair dress of moderate size.

### **Unbecoming**

- Hats smaller than the widest part of the face.
- Trimmings that is too small.
- Too large a hair dress, since it may make the head look too heavy for the body.
- Too small a hair dress, which will emphasize the size of the face.

## **13 SQUARES OR BROAD FACE**

### **Becoming**

- Hat with an irregular line.
- Hair dressed rather high and with a soft, irregular line.
- Rouge placed in toward the center of the face and blended up and down.

### **Unbecoming**

- Lines in the hat or at the neck that repeat the lines of the face.
- Lines that oppose the lines of the face
- Hair dressed wide over the ears.
- Hair parted in the middle.

## **14 ROUND FACE**

### **Becoming**

- Collar or scarf worn close to the neck in back and with a long line in front
- Necklines that give an oval effect.
- Hats with slightly irregular effects.
- Hats with lines that carry the eye upward.
- Rouge placed rather high toward the nose and blended down.
- Hair worn in an irregular line.
- Ears covered unless neck is short.
- In that case leave the lower part of the ear exposed.
- Hair parted toward the side and arranged in an irregular line.
- Hair dressed high.

### **Unbecoming**

- Hats with round shapes and lines that repeat the curves of the face.
- Hair parted in the center and drawn tightly back.
- Hair dressed wide over the ears.
- Hair dressed in rounded shapes and lines.

## **15 NARROW POINTER FACE**

### **Becoming**

- Short necklaces.
- Hat with medium-sized brim.
- Hat with slightly drooping brim.
- Hair worn low on the forehead and in soft irregular lines.
- Moderate size in hair dress.
- Hair worn back from the cheeks.
- Rouge placed high out on the cheek bone and blended toward the nose and quit close to the hair.

### **Unbecoming**

- High hats.
- Tall, angular trimmings.
- Hair worn in a high, pointer knot at the top of the head.
- Hair so dressed as to cover some of the cheeks.

## **16 PROMINENT CHIN AND JAW**

### **Becoming**

- Rather large hats.
- Hats with soft, irregular lines.
- Hair worn in a large mass at the top of the head and wide at the sides, above the ears.
- Rough placed high on the cheeks and toward the nose.

### **Unbecoming**

- Small hats.
- Severely tailored hats.
- Hair puffed out below the ears.

## **17 RECEDING CHIN AND SMALL JAW**

### **Becoming**

- Hats of average size.
- A hat with a brim.
- A very small amount of rouge on each side of the chin.
- Small hair dress.
- Hair worn low at the neck.

### **Unbecoming**

- Large hats.
- Hats that turn sharply away from the face.
- Hair dressed to widen the upper part of the head and face.

## **18 PROMINENT FOREHEADS**

### **Becoming**

- Hat with a brim.
- Hat worn low on the head.
- Hair dressed low over the forehead to conceal some of it.
- A broken irregular line in the hair dress.

### **Unbecoming**

- Hair pulled straight back from the forehead.
- Hair dressed wide over the ears and temples.

## **19 LOW FOREHEADS**

### **Becoming**

- Hair drawn back from the forehead.
- Hair dressed rather high.

### **Unbecoming**

- Hair parted in the middle.

## **20 LARGE WAIST AND HIPS**

If your waist and hips are large and out of proportion to the rest of your figure, then you must dress in such a way as to attract the interest away from that defect. As has been said before, the head should be the center of interest and this is particularly true in such a case. If you will so construct the dress that the lines and trimmings carry the eyes toward the head, your large waist

and hips will not be so noticeable. Resort to the same methods as has been suggested for the stout figure to give height to your figure.

**Becoming**

- Built-out shoulders.
- The center of interest kept at the face and away from the waist and hips
- Long skirts, in order to add height.
- Hats of average size or slightly larger

**Unbecoming**

- Broad panel effects.
- Sashes or wide girdles
- Small hats.

**21 SHORT WAISTS**

When analyzed the proportions of figure and found that measurements from the waist to the neck were shorter than the average, if when making a dress you will lower the waistline below the normal position, will improve the proportions of figure.

The short-waist woman, for instance, is usually of generous proportions. She has a full, high bust and very probably a short neck. If she does not exert care in the choice of silhouette which is, in other words, the choice of a correct style outline, she will present a clumsy, awkward, bulky appearance.

She should avoid yoke lines or cross trimming lines that tend to cut the figure in two, and also tight belts at the waistline. Instead, her silhouette should be based on long, slightly pointed lines that carry the eye down rather than around the figure. It should be remembered that long, vertical lines give the appearance of great height and slimness. The straight up-and-down silhouette is by all means the best for this type of figure.

**Becoming**

- Waist line dropped below the normal line, especially for people whose hips are low

**Unbecoming**

- Built-up waist lines

**22 LOW WAISTS**

On the other hand, if your measurements from the waist to the neckline are longer than the average, raise the waistline and you will notice a great improvement in the looks of your dress.

**23 LONG NECKS**

Doubtless she was wearing a very flat collar or a dress having a V neckline which so emphasized the fact as to bring it to your attention. If this person had but known that a fluffy collar or one having a soft roll would greatly detract from this effect it is very likely you never would have noticed it.

**Becoming**

- Collars with high or medium roll.
- Round neck lines, especially those which fit closely to the base of the neck
- Fluffy collars or fichus or furs.
- High close collars.

- Scarfs.
- Short necklaces, especially bulky ones.
- Hair worn low at the neck
- Hair worn over the ears.

**Unbecoming**

- Collarless, without a necklace.
- V-necks.
- Hat with upturned brim
- Hat with high trimming
- Hair worn high

**24 HIGH-HIPPED**

The short-yoke effect dress tends to emphasize the "bad point" of the high-hip figure. The waistline should be so located that it will impart a well-balanced appearance to the figure about three inches below the normal waistline is usually the correct place for the belt or waistline. A straight vertical silhouette from the shoulders to the low waistline terminating in a full-plaited or shirred skirt is the most becoming style for this figure.

**25 SWAY BACK**

**Becoming**

- Blouse at back of waist.
- Fullness between the waist line and the hips.
- Belts which swing from loops at the side and which do not hug the waist line too closely.
- Devices which build out the waist line in the back, as bows.
- Thick jackets.
- Boleros which come down far enough to conceal part of the back.

**Unbecoming**

- Garments fitted tightly in the back, including tightly belted dresses.

**26 SHORT OR THICK NECK**

**Becoming**

- Flat collars.
- Collarless dresses.
- V-necks.
- Flat furs.
- Narrow-brimmed hats.
- Hair dressed high.
- Hair worn to show the ears, or at least the base of the ears.

**Unbecoming**

- Collars with high roll
- Broad neck lines
- Necklace worn close around the throat.
- Drooping hats.
- Hats with broad brims.

**27 RETROUSSE NOSES**

**Becoming**

- A hat with a brim.
- Lines of the hair that do not repeat the line of the nose.



**Unbecoming**

- A hat that turns away from the face.

**28 PROMINENT NOSES**

**Becoming**

- Hat with a brim. The brim may be somewhat wider in the front.
- Trimming in the front of the hat.
- Hair built out in a soft, rather large mass.
- Hair built out over the forehead, in order to balance the nose.
- Hair parted on the side.

**Unbecoming**

- Turbans.
- Severe, tailored hats.
- Hair parted in the middle.
- Hair drawn straight back from the forehead.
- Hair dressed high on the head.
- The large mass of the hair directly opposite the nose. So that the eye moves across that line when the profile is seen.

**29 SHARP ANGULAR FEATURES**

**Becoming**

- Hats of medium size.
- Irregular lines in the hat.
- A brim that droops very slightly.
- Hair worn in a soft, irregular line.
- Soft large waves in the hair.

**Unbecoming**

- Severely tailored hats.
- Sharp, angular trimmings, as wings, quills, and sharp bows.
- Stiff fabrics.
- Harsh textures.
- Hair drawn severely back.
- Hair in tight waves, because it emphasizes by contrast.

**30 LARGE FEATURES**

**Becoming**

- Hair worn in a broken line around the face.
- hair worn smooth or in large, loose waves
- coiffure rather large

**Unbecoming**

- Hair curled in small, close waves
- hair drawn tightly back
- Coiffure extremely large

**7.5 LET US SUM UP**

It is really a study in itself—this consideration of correct dress. We all want to know exactly what to wear and when it should be worn. This lends ease of manner and a sense of poise that is never manifested by the person who is uncertain as to the right kind of costume to be worn.

In selection of our dress, many of us have certain peculiarities such as narrow shoulders, flat chest or round shoulders, a large bust, or our face may be very square, so that we must use and this lesson gone through based on this.

### **7.6 LESSON END ACTIVITIES**

The students may do the following activities based on this lesson

- Draw different types of unusual figure and design
- The principle methods of applying colour for unbecoming figures

### **7.7 POINTS FOR DISCUSSION**

Here the students are asked to discuss about the following points

- The reason for preparing different dress for unusual figures
- The key methods for developing a dress for unusual figures

### **7.8 REFERENCES:**

- Fashion sketching book, by Bina Abling, Fai child publication.
- The art and everyday life
- Fashion from concept to consumer, by Cini Stephens Frings, Low price edition
- Inside the fashion business, by Macmillan publication company

## UNIT – III

### LESSON – 8: SEWING MACHINES

#### CONTENTS

- 8.0 AIM AND OBJECTIVES
- 8.1 INTRODUCTION
- 8.2 SEWING
- 8.3 HOW IT CAME ABOUT
- 8.4 TYPE OF SEWING MACHINE BED
- 8.5 SEWING MACHINE CLASSIFICATION
- 8.6 SINGLE NEEDLE SEWING MACHINE
  - 8.6.1 How it works
- 8.7 DOUBLE NEEDLE LOCK STITCH MACHINE
- 8.8 LET US SUM UP
- 8.9 LESSON END ACTIVITIES
- 8.10 POINTS FOR DISCUSSION
- 8.11 REFERANCES

#### 8.0 AIM AND OBJECTIVES

After going through this unit, you should be able to have a clear idea of the following

- It traces the development of sewing machine and its classification.
- Give an idea on fundamental operation and the method of stitch formation through the various sewing machines.
- It covers the studies on different industrial sewing machine for garment construction.

#### 8.1 INTRODUCTION

On reading this lesson the students can learn about the basics of sewing machine, classification of sewing machine and lock stitch machine.

Special and temporary purposes, hand sewing can be best suited one. In mass produced of the garments we focused onto the machine sewing. Materials like woven and knitted fabrics machine sewing used.

#### 8.2 SEWING

Before the invention of a useable machine for sewing, everything was sewn by hand. Most early attempts tried to replicate this hand sewing method and were generally a failure. Some looked to embroidery, where the needle was used to produce decorative, not joining stitches.

This needle was altered to create a fine steel hook - called an *aguja* in Spain. This was called a *crochet* in France and could be used to create a form of chain stitch.

The ultimate look of the garment depends on how the patterned parts are attached together by means of sewing. Any variation in sewing will lead to defective material. Sewing is as tough as making pattern for any difficult style. Hence much concentration is to be paid while doing this job. Sewing can be classified into two groups and they are

- Hand sewing,
- Machine sewing

Hand sewing can be best suited for some special and temporary purposes, it is not being dealt here, as most of the garments are machine made and mass-produced. Our main emphasize is focused onto the machine sewing.

Generally machine sewing is carried out on materials like woven and knitted fabrics, particularly in textile application. Again this may be on various fabrics having different quality parameters.

### **8.3 HOW IT CAME ABOUT**

- As with most innovations, the sewing machine was invented in stages.
- In 1755, Charles T. Wiesenthal of the United States patented a double-pointed sewing needle, which did not need to be turned around between stitches.
- In 1830, a Frenchman, Barthelemy Thimonnier, attached Wiesenthal's needle to a connecting rod to make a sewing machine. (I can't see how this would have worked, and I haven't been able to find more detail.)
- In 1846, Elias Howe (an American) created the lock-stitch sewing machine. This used the modern mechanism, as described below. Because the lock-stitch mechanism is the core of the function of the modern sewing machine, Howe is generally credited with its invention. However, his machine was difficult to use well, and too expensive for home use.
- In 1849, the American Benjamin Wilson introduced an automatic feeding mechanism, which solved the main usability problem with Howe's machine.
- In 1851, Bostonian Isaac Meritt Singer patented two refinements to the sewing machine: a fixed arm structure still used today, and the presser foot. He began manufacturing a sewing machine priced for home use. His company, Singer, is still the largest sewing machine manufacturer in the world.
- The sewing machine predates electricity. Early machines used a hand crank or a treadle to drive them. These turned out to be easily electrified, and many are still in use today.
- Later innovations (apart from electricity) include the ability to zigzag and to make more sophisticated stitching patterns. The latest machines have LCD screens, microprocessors, and pre-programmed fonts for monogramming. (All cute, but unnecessary).

### 8.4 TYPE OF SEWING MACHINE BED

Type of sewing machine	Stitch type
Flat bed sewing machine(basic)	Lock stitch, chine stitch
Raised bed machine	Lock stitch, chine stitch
Post bed machine	Lock stitch, chine stitch
Cylinder bed machine	Lock stitch, chine stitch
Side bed machine	Chine stitch, over edge stitches.

### 8.5 SEWING MACHINE CLASSIFICATION

Machine types	Applications
<ol style="list-style-type: none"> <li>1. Lock stitch machine</li> <li>2. Chine stitch machine</li> <li>3. Double chine stitch machine</li> </ol>	* Straight seams, zigzag seams
<ol style="list-style-type: none"> <li>1. Blind stitch machine</li> <li>2. Linking machine</li> </ol>	* Blind stitch machine for blind stitch & hemming * Linking machine attaching trimming and cuff of knitted fabrics
<ol style="list-style-type: none"> <li>1. Over edge machine</li> <li>2. Safety stitch machine</li> </ol>	* Edge neatening, combined neatening and seam closing * Safety stitching
<ol style="list-style-type: none"> <li>1. Buttonhole machine</li> <li>2. Button sewing machine</li> <li>3. Bar tack machine</li> </ol>	* Specific sewing operation
<ol style="list-style-type: none"> <li>1. Profile sewer</li> <li>2. Pocket sewer</li> </ol>	* Automatic, complex sewing operation

### 8.6 SINGLE NEEDLE SEWING MACHINE

A machine for sewing fabric, leather, etc. Specifically, one that uses two threads (an upper and a lower, or bobbin thread) and is best at sewing woven materials.

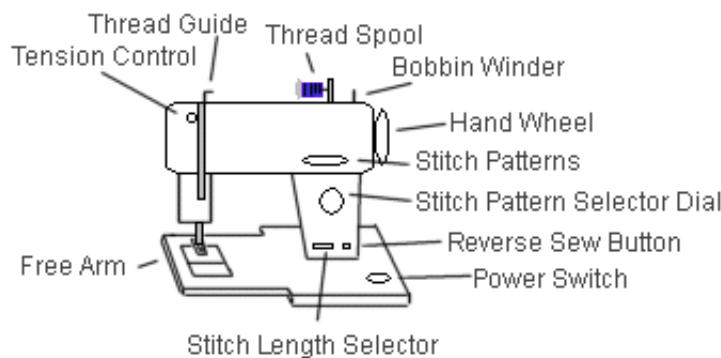

**Typical Machine**

Fig 8.1

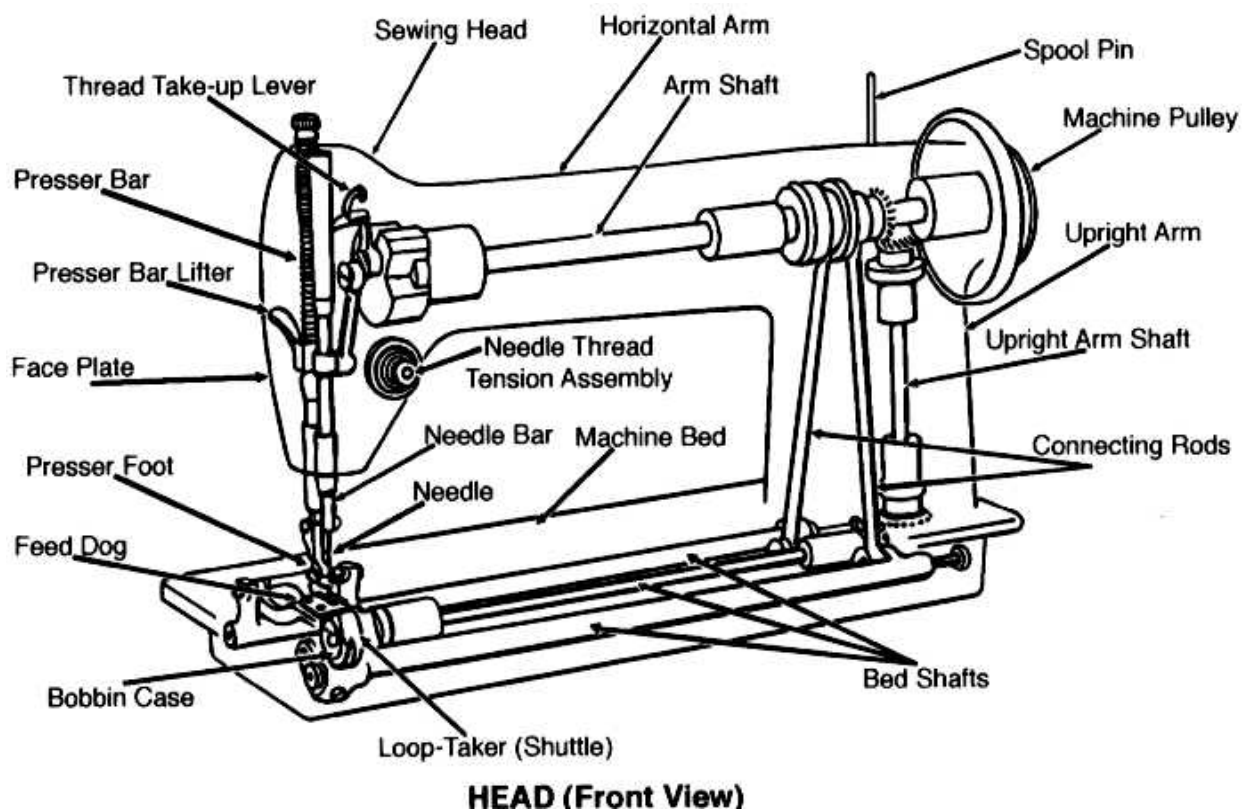
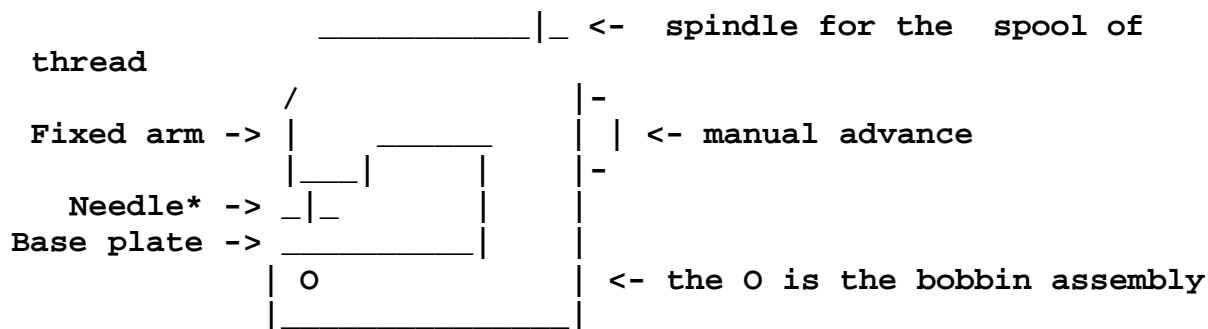

Fig 8.2

- **Terms used to describe parts of the sewing machine**
- **Head** - The complete sewing machine without cabinet or carry case.
- **Bed** - The flat surface of the sewing machine. A flat bed machine has one level to sew on. A free-arm bed has a removable U-shaped part of the bed to reveal an arm or tub used for sewing hard-to-reach areas like a pant cuff or sleeve.
- **Hand wheel** - the wheel located on the right side of the sewing machine. This wheel is driven by the motor, but may be turned by hand to adjust needle height.
- **Bobbin Winder** - Mechanism used to wind bobbins.
- **Bobbin** - Low spool that provides the lower thread.
- **Thread take-up** - Arm that pulls up slack in thread.
- **Thread guide** - Device which carries thread to a certain location.
- **Upper tension** - Mechanism which controls delivery of upper thread.
- **Lower tension** - Provided by the bobbin case. Controls delivery of the bottom thread.
- **Bobbin Case** - Device which hold the bobbin and provides tension to the lower thread.
- **Pressure Foot** - Foot that presses down on fabric to stabilize its movement.
- **Feed Dog** - Mechanism which controls motion of the fabric.
- **Needle Plate** - Plate under pressure foot with slots to allow feed dog to reach fabric and opening for the needle to move up and down.
- **Hook** - Device which picks the thread off of the needle.
- **Feed drop** - Adjustment used to take the feed dog out of play for free hand work.
- **Stitch length** - Adjustment used to determine length from front to back of the stitch.

### 8.6.1 HOW IT WORKS

Here's a diagram to help you visualize.



\* Note the presser foot on either side of the end of the needle

Fig 8.3 shows the needle has its eye at the sharp end. The other end is attached to a rod that goes up and down inside a fixed arm. The arm also holds a presser foot, which can be raised or lowered manually, but which is kept down when sewing. Its role is to press the fabric against a base plate. The needle plunges into the fabric from the top, through a hole in the presser foot. There is a thread which goes from a spool, through a thread tensioning mechanism, and through the eye of the needle.

There is another thread, which comes up from under the fabric being sewn. This is the bobbin thread, which was wound onto its bobbin before sewing. The bobbin sits in a bobbin case, which is not fixed to the sewing machine case. It floats in its own casing (this is important).

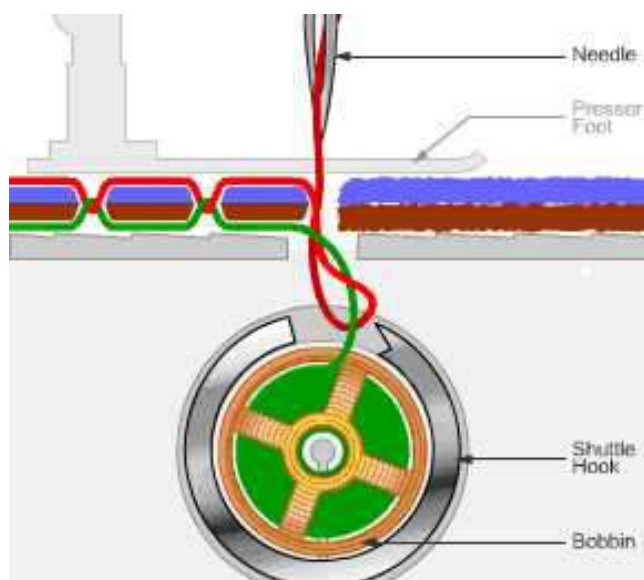
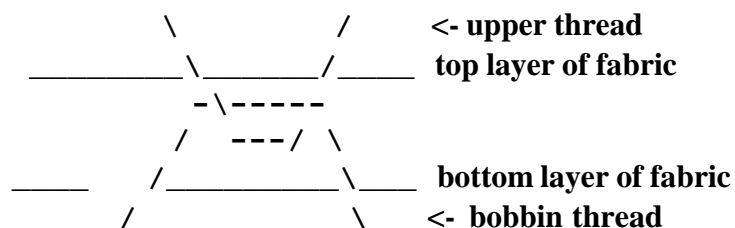

Fig 8.3

To begin sewing, the needle plunges through the fabric, taking a loop of the top thread with it. Here's the clever bit. A small hook on the bobbin case catches the needle thread. The bobbin case rotates, effectively passing the entire bobbin through the loop of top thread. These



yarns twist the bobbin thread with the top thread, making the stitch. The needle is then pulled back up. If your thread tension is correct, the twist between the top and bobbin threads is pulled into the fabric you're sewing as it goes.



Once the needle is out of the way, the feed dogs, which are located in the base plate, push the fabric up against the smooth underside of the presser foot. As they then slide backward, they push the fabric with them to make a visible stitch.

There is also a backstitch lever on the machine. When that is pressed, everything happens as described above except that the feed dogs push the fabric toward you rather than pulling it away from you.

## 8.7 DOUBLE NEEDLE LOCK STITCH MACHINE

This machine (Fig 8.4) is similar to single needle lock stitch machine. But here all components are having two sets .i.e. two sets of bobbin case, pensioner ,take ups, thread guides, spool pin, needle holders. In this the bobbin case are fixed one. The bobbin only taken out from the machine



Fig 8.4

This machine adopts two straight needles, vertical-axis rotating hook with self-lubricating feature for catching thread loops and sliding cam take-up to produce two lines of double lockstitch. The needle bar can be engaged and disengaged mechanically and the arm shaft and hook shaft are supported by ball bearing. It is provided with synchronous tooth belt for driving and plunger pump for lubricating, and knob-type stitch regulator and lever type reverse feeding mechanism. A bobbin thread pullback spring in the bobbin case guarantees the unanimous result

of sewing between the bottom thread and upper thread. It is suitable for stitching shirt, uniform, jeans, overcoat or similar clothing.

### **8.8 LET US SUM UP**

Look of the garment depends attachments of different parts of garment together by means of sewing. The variation in sewing will lead to defective material. The place of hand sewing and machine sewing were clearly explained here. When we want to do a single row of stitches we can use the single needle lock stitch machine and for uniform double row of stitches double needle machines are used.

### **8.9 LESSON END ACTIVITIES**

The students may do the following activities based on this lesson

- Prepare a chart for the classification of sewing machine
- Compare the different stages and developments of sewing machine
- Collect a data file for different sewing machine based on the manufactures

### **8.10 POINTS FOR DISCUSSION**

Here the students are asked to discuss about the following points

- Working principles of a sewing machine
- Demand of lock stitch sewing machine
- Classification of sewing machine
- Difference between single and double needle sewing machine

### **8.11 REFERENCES:**

- Fundamentals of textile and their care, Susheela Dantigi, Published by orient Longman L.t.d..
- Practical Clothing construction- part 1 & 2, Mary Mathews, Cosmic press.
- The complete book of sewing, by Dorling Kindersley, Dorling Kindersley L.t.d...
- Readers Digest Sewing Guide, The Readers Digest Association
- The technology of Clothing Manufacturing, Harold Carr and Barbara Latham.
- Clothing Technology, Europ Lehrmilied, Vollmer GmbH & Co.

## Lesson – 9: SPECIAL MACHINES

### CONTENTS

- 9.0 AIM AND OBJECTIVES
- 9.1 INTRODUCTION
- 9.2 OVERLOCK MACHINE
  - 9.2.1 The formation of an overlock stitch
  - 9.2.2 Developments
  - 9.2.3 Usages of the overlock stitch
  - 9.2.4 Some examples of applications are
- 9.3 BAR TACKING MACHINE
- 9.4 BUTTON HOLE SEWING MACHINES
  - 9.4.1 Button hole machine types
- 9.5 BUTTON SEWING MACHINE
- 9.6 THE FEED OF ARM MACHINE
- 9.7 BLIND STITCH MACHINE
- 9.8 LET US SUM UP
- 9.9 LESSON END ACTIVITIES
- 9.10 POINTS FOR DISCUSSION
- 9.11 REFERANCES

### 9.0 AIM AND OBJECTIVES

After going through this unit, you should be able to have a clear idea of the following

- Hemming or seaming by over lock machine.
- Sewing dense tack by bar tacking machine.
- Making button hole by button hole machine.
- Sew the button by button sew machine.
- Stitching hem by blind stitch machine.

### 9.1 INTRODUCTION

It's hard to imagine now how revolutionary the sewing machine is. Before its invention, everything was sewn by hand. Every massive hoopskirt from the antebellum American South, every lacy shirt and brocaded coat from the court of the Sun King, every curtain in every palace, every flag, represented hours of painstaking labor. Most people had two outfits - one for working in, one for Sunday best. Now, with our closets stuffed with clothing, we take machine sewing for granted.

A sewing machine is a mechanical (or electromechanical) device that joins fabric using thread. Sewing machines make a stitch, called a sewing-machine stitch, usually using two threads although machines exist that stitch using one, three, four or more threads.

An innovation (apart from electricity) of sewing machine includes the ability to zigzag and to make more sophisticated stitching patterns. The latest machines have LCD screens, microprocessors, and pre-programmed fonts for monogramming.

## **9.2 OVERLOCK MACHINE**

An overlock stitch sews over the edge of one or two pieces of cloth for edging, hemming or seaming. Usually an overlock sewing machine Fig 9.1 will cut the edges of the cloth as they are fed through (such machines are called ‘sergers’), though some are made without cutters. The inclusion of automated cutters allows overlock machines to create finished seams easily and quickly. An overlock sewing machine differs from a lockstitch sewing machine in that it utilizes loopers fed by multiple thread cones rather than a bobbin. Loopers serve to create thread loops that pass from the needle thread to the edges of the fabric so that the edges of the fabric are contained within the seam. Overlock sewing machines usually run at high speeds, from 1000 to 9000 rpm, and most are used in industrial setting for edging, hemming and seaming a variety of fabrics and products.

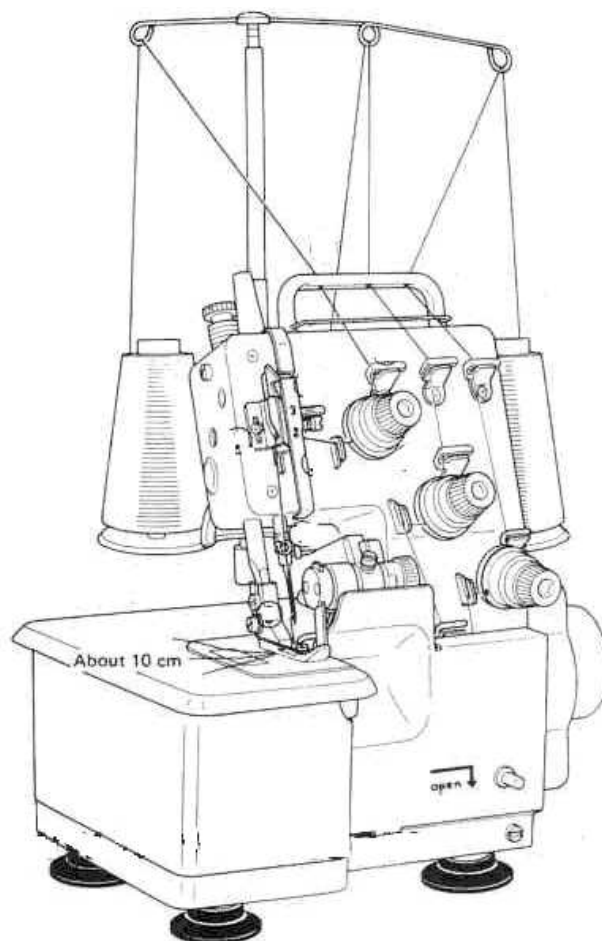

Fig 9.1

Overlock stitches are extremely versatile, as they can be used for decoration, reinforcement, or construction. Overlocking is also referred to as “overedging”, “merrowing” or “serging”. Though “serging” technically refers to overlocking with cutters, in practice the four terms are used interchangeably.

### 9.2.1 THE FORMATION OF AN OVERLOCK STITCH

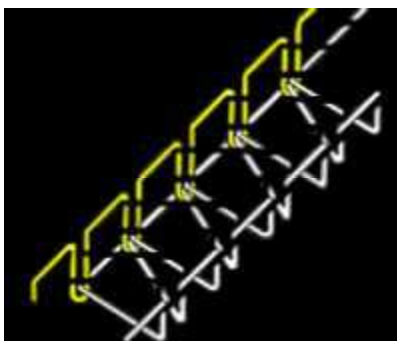

Fig 9.2

1. When the needle enters the fabric, a loop is formed in the thread at the back of the needle.
2. As the needle continues its downward motion into the fabric, the lower looper begins its movement from left to right. The tip of the lower looper passes behind the needle and through the loop of thread that has formed behind the needle.
3. The lower looper continues along its path moving toward the right of the serger. As it moves, the lower thread is carried through the needle thread.
4. While the lower looper is moving from left to right, the upper looper advances from right to left. The tip of the upper looper passes behind the lower looper and picks up the lower looper thread and needle thread.
5. The lower looper now begins its move back into the far left position. As the upper looper continues to the left, it holds the lower looper thread and needle thread in place.
6. The needle again begins its downward path passing behind the upper looper and securing the upper looper thread. This completes the overlock stitch formation and begins the stitch cycle all over again.

### 9.2.2 DEVELOPMENTS

Following the development of the industrial overlock machines, many companies began competing for the home market. The development and formation of the stitch are similar to the industrial models with some significant exceptions.

- The home machine sews at approximately 800 stitches per minute (spm) whereas the industrial models sew up to 9500 spm.
- Home machines are designed to sew several stitch types (variations of the overlock) whereas the industrial models are designed to sew one type.

### 9.2.3 USAGES OF THE OVERLOCK STITCH

Overlock stitches are typically used for:

**1-thread:** End-to-end seaming of piece goods for textile finishing.

**2-thread:** Finishing seam edges, stitching flatlock seams, stitching elastic and lace to lingerie, and hemming.

**3-thread:** Sewing pintucks, creating narrow rolled hems, finishing fabric edges, Decorative edging, and seaming knit or woven fabrics.

**4-thread:** Decorative edging and finishing, seaming high-stress areas.

**5-thread:** Seam construction in apparel manufacturing.

### 9.2.4 SOME EXAMPLES OF APPLICATIONS ARE:

- Sewing Netting
- Butt-seaming
- Edging emblems
- Purl Stitching
- Decorative edging

## 9.3 BAR TACKING MACHINE

The bar tacking machine fig 9.3 has much application in the garment manufacturing industry. One of them is sewing dense tack around the open end of the button hole.

These machines are sewing a number of stitches across the point to be reinforced and then sew covering stitches at right angle over to the first stitches. The variable is the number of tacking stitches and the number of covering stitches.



Fig 9.3

Some of the bar tacking are fitted with the following special attachments.

- Signals are available and it controlled by special mechanism, when the bobbin thread is below a certain level.
- Automatic thread cutters are available.
- A pedal which opens and close the work clam.

This machine is used for the following application in garment industry.

- Closing the end of the button hole.
- Reinforcing the ends of pocket opening.
- To finish the bottom of files.
- Sewing on belt loops.

#### **9.4 BUTTON HOLE SEWING MACHINES**

Button hole machines are used for making button hole in the garment and to finish the edges and make the button hole in neat finish. These come in a variety of types according to type of Button hole needle on garment. The simplest Button hole are used on shirt, blouses & other light weight garment & the more complex one on the heavier tailor garments. The various nesses in button hole machines are form in side button hole. The stitch type, the stitch density whether the button hole is cut before or after sewing & the presents or absence of gimp.



Fig 9.4

Button hole machine fig 9.4 may form a simple circle where the stitches radiate from the centre of an eyelet hole, 2 legs on either side of a straight out with bar tack on both ends as in shirt, a continuous line of sewing up one leg, round the end & down the other without the cut as in shank Button hole on the cups of Jacques a button hole similar in form but larger in length with the hole partially on hole cut & the separate bar-tack closing of end, a button hole with 2 legs & an eyelet hole at one end with a separate bar-tack closing of other end as in front of Jacques overcoats, a variation in which the 2<sup>nd</sup> leg is sewn over the 1<sup>st</sup> stitches of 1<sup>st</sup> legs to close the end as frequently on the knit wear & an end as eyelet the edges of which one lightly over sewed known as cut and serge which they no more than provide a firm edge to receive a hand sewn bottom hole known increasing rare.

The choice between lock stitch and chain stitch is affective by security requirements or hole the finish appeared require and the relative causes are involved. In general button hole on tailor outward make use of the 2 thread chain stitch the chain affect giving an attractive purl appearance to button hole. The simpler shape of button hole on shirts and other light weight garment is often used with single thread chain stitch and in some cases the sewing is done inside on the garment. So that the purl side of back of stitch is on right side increasing used is being made of lock-stitch button holes sewing to give greater security on these types of garments for shirts.



The work button hole is slipped in fabric finished with either hand or machine stitches. It has 2 sides equal in length to the button hole opening and 2 ends finished with bar tacks or with a fascinate arrangement of stitches. A hand work button hole is slip lot stitched. A machine work button hole is stitched the slit. The match of actual button hole opening and for the stitch Button hole are however difference. The finished length of worked Button hole will equal the opening plus extra 3mm for stitches used for the stitches work to finish each end.

There are various ways in which the machine work button hole may be made. One way is wilt button hole stitches that come with the machine by means of a few movements of a weaver or turn of gain. A Button hole with finish end is stitched. There is no need to turn the fabric by hand. This method is used when the machine has a built in and zigzag stitch capability.

A second method makes use of a special attachment the plane on to needle bar and pressure food of the machine. This attachment moves the fabric in button hole shape while the machine with zigzag stitching attachments will vary from machine to machine. But in most cases the since and of the button hole is determined by button placed in the attachment. The button hole size is limited by a capability of attachments.

### 9.4.1 BUTTON HOLE MACHINE TYPES



1. Size and shape of the button hole.
2. Stitch type.
  - a) Lock stitch,
  - b) Chain stitch.
3. Stitch density.
4. Type of button hole.
  - a) Button hole cut before stitch,
  - b) Button hole cut after stitch.
5. Presence or absence gimp.

#### 1. Stitch type

**Lock stitch:** It is used more commonly than the chain stitch because of its greater strength and security.

**Chain stitch:** these types of stitch are give more neat finish but it does not provides strength to the button hole. So the use of this type of stitch is less popular than lock stitch.

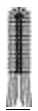
#### 2. Size and shape of the button hole.

	Eyelet Buttonhole	Straight Buttonhole
Standard		
Taper Bar		

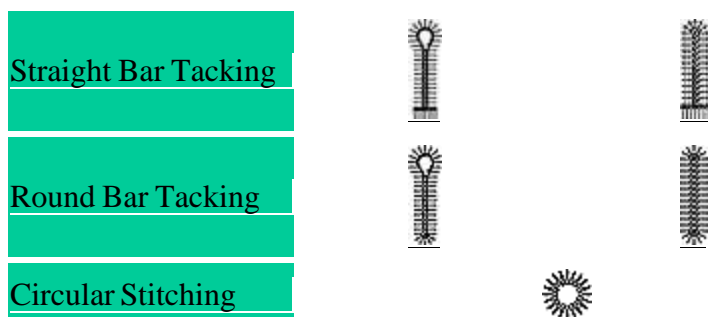

### 3. Type of button holes.

There are two type of button hole and they are

- a) Button hole cut before stitch,
- b) Button hole cut after stitch.

#### **a) Button hole cut before stitch.**

The button hole is cut first and then finished with stitches. The stitches are radiate from the center of the button hole to the outer edge of the button hole.

It gives neat appearance with the thread covering the raw edges of hole effectively. But this type has some set back. The position of the button hole cannot be change if sewing cycle is started. Sometimes the fabric edges will not be properly finished.

#### **b) Button hole cut after stitch.**

As the name indicates, the button hole edges are finished first and then it will be slashed. In this type are made by sewing a continuous line of sewing round the end and then the hole is cut subsequently.

It has the merits of, the edges of the fabric give some protection to the thread and the position of the button hole can be changed. The main demerits are, the finished hole not is neat with cut ends of fibres or yarns are protruding between the stitches.

### 4. Presence or absence gimp.

Gimp is the stiff thread positioned at the edge of the button hole under the stitches. It gives more bulkiness or raised effect to the button hole.

## **9.5 BUTTON SEWING MACHINE**

Without damaging the garment this machine (fig 9.5) is used to sew the button in the garment. Button with two holes, four holes or shanks canal be sewn on the same machine by simple adjustments to the button clamp and the spacing mechanism. The sewing action consists of a series of parallel stitches whose length is equal to the spacing between the centers of the holes. The needle has a vertical movement only and the button is moved from side to side by the button clamp.



Fig 9.5

Button can be sewn on with one or two threads, the number of stitches depending on the type of machine used. Each machine has a maximum number of stitches, i.e. 16,24 or 32, and can be adjusted to sew the full amount or half. Generally decorative button would be sewn on with half the number of stitches used for functional buttons.

Hopper feed is a special attachment which is automatically feeds the button to the clamp of needle point of the machine. Here the button and needle can be automatically poisoned and the threads are clipped.

Where a 'neck' is required between the under side of the button and the garment, the stitch length between the button and the garment is increased and this surplus length can be left as it is, or 'whipped'. The whipping operation can be incorporated as a second, successive operation on the button sewing machine.

## 9.6 THE FEED OF ARM MACHINE

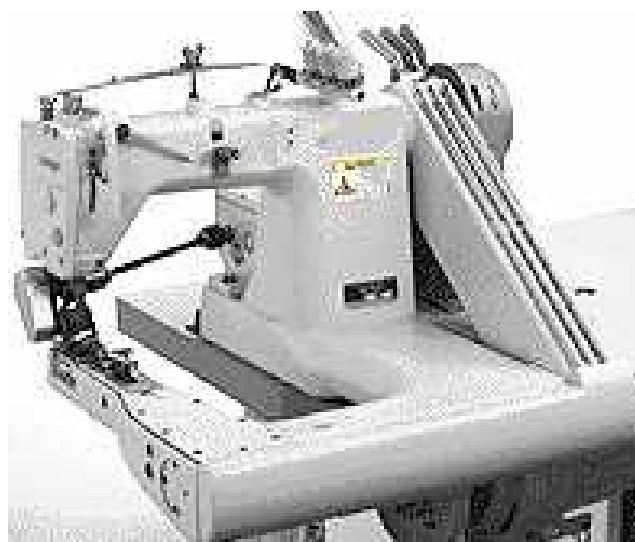

Fig 9.6

The feed of the arm machine fig 9.6 is used to stitch a narrow tubular seam on the outer edge of the trousers and shirt. This machine is used where a lapped seam has to be closed in such a way that the garment parts become a tube. These are in common in jeans production where the out side leg seam is normally the type known as lap felled and it is joined after the inside leg seam in the sequence of construction. The operator wraps the part to be seam around the machine bed. It is fed away from operator, off the end of the bed as the operator sews.

It can use for shirts and blouses of light to medium weight fabric. Unit features a specially designed arm and bed for easy material handling. Low tension stitching prevents puckering and enhances sewing quality

### **9.7 BLIND STITCH MACHINE**

Blind stitch machine fig 9.7 is used to stitch hem in a knitted fabric. As the hem stitch is too small in right side of the garment and it is invisible. Some time the machine can be set to skip stitch that is to pick up the fabric on alternate stitches only. But this type is reduces the durability of the stitches.



Fig 9.7

Zigzag stitches or lock stitches with a side to side width as well as a stitch length. In mechanical machines basic stitch formation is dictated mainly by a stitch pattern cam maximum pattern width is established by stitch width regulator. Stitch length is selected or for straight stitching and is the same for both stitch types at the same setting but occurs eye as a distance between points and than actual stitch measurement. The cams built into mechanical machine control stitch formation by means of in their outer edges. A stitch pattern selector positions a finger like follower on appropriate cam. The follower connected to the needle bar cracks those indentations moving the needle from side to side. In most electronic machines the zigzag stitch is programmed by a micro computer which controls movement of stepping motor to

direct zigzag movement of needles. Besides the control mentioned most machine have needle position selector which places stitches to left or right of normal position.

Zigzag patterns uses straight stitches as a part of the design. An ex is in blind stitch. Length and width variations affect practical uses. For example when stitch length of land stitch is shortened there is more zigzag to catch the fabric. A consideration on hemming. When the stitch is widened the zigzag extends further from straight stitches to cover wider.

The needle used in this machine is slightly curved (fig 9.8) because it does not penetrate through the fabric completely, but penetrate partially

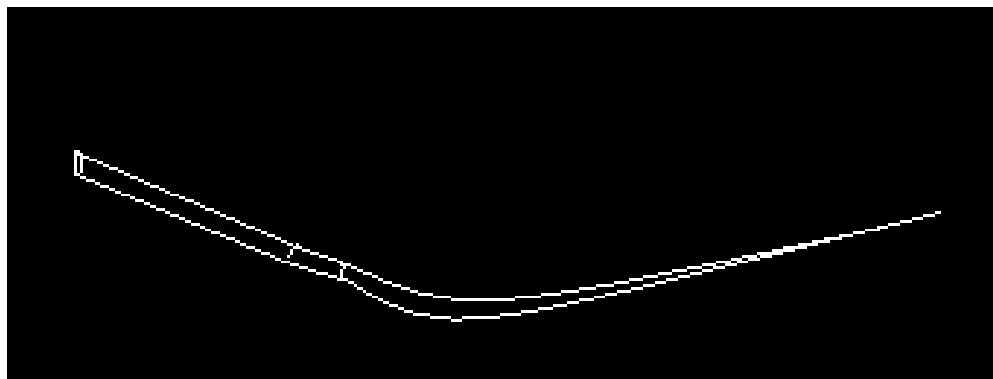

**Curved Needle (Fig 9.8)**

Based on the application and fabric the stitch can be grouped in to two types. First one is for fine fabric producing long and narrow stitches. Second is for heavy fabric with short and wide stitches. Again, the level of insecurity is often high but can be improved by the use of slightly hairy rather than smooth sewing threads.

## **9.8 LET US SUM UP**

More than any other aspect of sewing, sewing machine takes practice. It's hard to get them even, and it looks terrible if you mess up.

Sewing machines can make a great variety of plain or patterned stitches. They include means for gripping, supporting, and conveying the fabric past the sewing needle to form the stitch pattern. Modern machines are computer controlled and use stepper motors or sequential cams to achieve very complex patterns.

## **9.9 LESSON END ACTIVITIES**

The students may do the following activities based on this lesson

- Visit any one garment unit and practice with all kind of sewing machine
- Collect the details of different kind of sewing machine

### 9.10 POINTS FOR DISCUSSION

Here the students are asked to discuss about the following points

- The developments and the maximum number of threads used in various types sewing machine based on its applications.
- Short story about over lock machine
- Button hole machine and the type of button holes
- End use and application of blind stitch machine

### 9.11 REFERENCES:

- Practical Clothing construction- part 1 & 2, Mary Mathews, Cosmic press.
- The complete book of sewing, by Dorling Kindersley, Dorling Kindersley L.t.d...
- Readers Digest Sewing Guide, The Readers Digest Association
- The technology of Clothing Manufacturing, Harold Carr and Barbara Latham.
- Clothing Technology, Europ Lehrmilied, Vollmer GmbH & Co.
- Fundamentals of textile and their care, Susheela Dantysi, Published by orient Longman L.t.d.

## LESSON – 10: SEWING MACHINE ATTACHMENTS

### CONTENTS

- 10.0 AIM AND OBJECTIVES
- 10.1 INTRODUCTION
- 10.2 FABRIC INSPECTION MACHINE
- 10.3 SPECIAL ATTACHMENTS
  - 10.3.1 Hemmers
  - 10.3.2 Ruffler
  - 10.3.3 The Binder
  - 10.3.4 Tucker
  - 10.3.5 Cloth guide
  - 10.3.6 Cording foot or zipper foot
  - 10.3.7 Gathering foot
  - 10.3.8 Feed cover plate
  - 10.3.9 Circular Attachment
- 10.4 LET US SUM UP
- 10.5 LESSON END ACTIVITIES
- 10.6 POINTS FOR DISCUSSION
- 10.7 REFERENCES

### 10.0 AIM AND OBJECTIVES

After going through this unit, you should be able to have a clear idea of the following

- Inspect the defects through the fabric examine machine.
- Easier and decorative sewing by special attachments.

### 10.1 INTRODUCTION

The sewing machine plays an important part in the twentieth century method of clothes-making. It saves a tremendous amount of time. Remarkable little steel attachments that can be quickly and easily snapped into place perform in a few minutes the work that used to take hours to do by hand. Ten yards of material transformed into the finest pin-tucks in ten minutes and it used to take our grandmothers a full day! Shirring, plaiting, ruffling, bindings, even braided designs can now be made right on the sewing machine with amazing rapidity.

Throughout this lesson you will be taught how to make use of the various attachments that came with your sewing machine in applying trimmings and giving a smart, tailored finish to the clothes you make.

## 10.2 FABRIC INSPECTION MACHINE



Fig 10.1

The fabric examine machine fig 10.1 are use to check and examine the fabrics. Through this machine we can inspect the defects like major and minor defects. The machine can be grouped in the following way.

- Manual fabric examine machine
- Semi automatic
- Fully automatic.

It has a big inspection table (72"x 30") with light source from top and bottom. The unit if fitted with electronic chokes for instant illumination. It has forward as well as reverse operation and has a variable speed control unit.

There is a foot switch for ease of operation. The unit is fitted with a digital fabric length counter and a digital fault counter. Tensioning device for fabrics is an important feature of the machine along with dual mode operation and continuous checking operation for all types of fabrics.

## 10.3 SPECIAL ATTACHMRNTS

Some machine attachment may be supply along with the machine when may be purchased it. Other may be available at additional cast. Attachment make sewing machine easier and provide opportunities for decorative sewing. After deciding which attachments you need get, the dealer to demonstrate the operation of each or the booklets give an instruction for using them. Most of the fabric must be fixed to the presser bar in the place of the presser foot. The



attachment that to fast in the presser bar will have prompt similar to presser foot in shade. Some attachment has hook end and that rest on the needle clamp.

The attachment most commonly used straight stitch machine and they are listed bellow.

### **10.3.1HEMMERS**

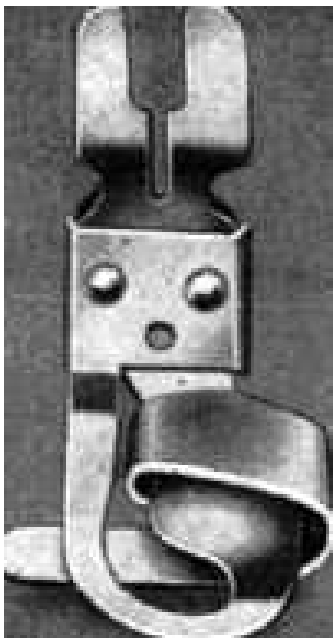

**The Hemmers**

Hemmers make hems from three-sixteenths of an inch to seven-eighths of an inch wide, right on the machine. They really do beautiful work, infinitely more rapid than you could ever expect to do it by hand, and they should be used whenever the material permits.

Machine hemming with the hemmer attachments means hours saved from hand turning and basting. The hem is turned by the hemmer, and at the same time the line of stitching is guided close to the edge of the hem. Always remember, when hemming by machine, to leave threads at the end sufficiently long to thread a hand needle and fasten the end of the hem. Otherwise it is likely to fray.

There are various widths of hems which can be made with the hemmers, suitable for the usual requirements. But any hem that is more than seven-eighths of an inch in width must be turned and basted first, and then stitched on the machine in the ordinary way

### **10.3.2 RUFFLER**

This attachment is capable of taking gathered or pleated frills, and will take and apply frills to another section at the same time. It is useful in making children's clothes and curtains.



*Ruffler attachment*

It is one of the most valuable attachments in sewing machine, and reflects a great deal of credit upon the inventors of these remarkable time-and-money-saving bits of steel. The method of using the ruffler attachment varies with different machines.

### **10.3.3 THE BINDER**

Another very valuable attachment in your box of sewing-machine attachments is the binder. Of course fine bindings can be made by hand, but the modern, time-saving method is to make them on the sewing-machine with the aid of the rapid little binder. With this tiny bit of mechanical steel you can make ten yards of binding in ten minutes.

<http://www.vintagesewing.info/1920s/26-fcm/fcm-illus/09-05.jpg>

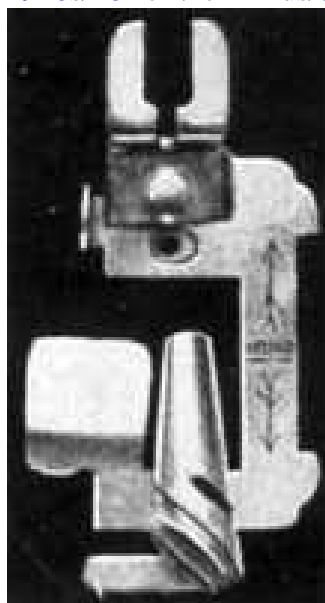

*Binder*

This is used for applying ready made or self made bias binding to a straight or curved edge and is a useful attachment for trimming dresses etc.

#### **10.3.4 TUCKER**



*Making the Tuck*

This is used for making uniform tucks from 1/8 inches to 1 inch in width. Finest pin tucks, or those three-quarters of an inch in width, they can be very easily made without any basting

#### **10.3.5 CLOTH GUIDE**

This is the device which is useful and guiding fabric for uniform stitching.

#### **10.3.6 CORDING FOOT OR ZIPPER FOOT**

This is design for stitching close to a raised edge. It used for applying, cording in to seam and the application of zipper.

#### **10.3.7 GATHERING FOOT**

This attachment gathers the fabric as it is stitch with fullness locked in every stitch.

#### **10.3.8 FEED COVER PLATE**

This is used to cover the feed dog while doing machine embroidery and darning.

#### **10.3.9 CIRCULAR ATTACHMENT**



**Circular Attachment**

The Circular Stitcher is the ideal attachment for sewing circles using straight stitch, zigzag, decorative stitches or even lettering. Circles up to 26cm in diameter are stitched perfectly using this very popular attachment so essential for craft and decorative work. - Suitable for most top loading machines

The additional that can be made to basic sewing machine are many and they come under the general term work aids. Work aids are devices which are built into machine and added to them afterwards attached alone side or made. Use what ever ways a resourceful engineer can device to improve productivity improve and maintain quality standards. Produce time and minimized fatigue.

#### **10.4 LET US SUM UP**

To check and examine the fabrics, the fabric examine machine are used. Through this machine the defect of the fabric can easily found by the different methods of manual, automatic and semi automatic. The machine attachment provides opportunities for decorative sewing and these attachments are easy to attach to the machine. Based on the application, different attachments are available.

#### **10.5 LESSON END ACTIVITIES**

The students may do the following activities based on this lesson

- Collect the defective fabric samples and analyze its reason
- Functions of different attachments

#### **10.6 POINTS FOR DISCUSSION**

Here the students are asked to discuss about the following points

- The reason for fabric defects
- Needs of special attachment today's garment construction
- Various special sewing machine attachments

#### **10.7 REFERENCES:**

- Practical Clothing construction- part 1 & 2, Mary Mathews, Cosmic press.
- The complete book of sewing, by Dorling Kindersley, Dorling Kindersley L.t.d...
- Readers Digest Sewing Guide, The Readers Digest Association
- The technology of Clothing Manufacturing, Harold Carr and Barbara Latham.
- Clothing Technology, Europ Lehrmilied, Vollmer GmbH & Co.

## LESSON – 11: SEWING MACHINE CARE AND MAINTENANCE

### CONTENTS

- 11.0 AIM AND OBJECTIVES
- 11.1 INTRODUCTION
- 11.2 CARE AND MAINTENANCE OF SEWING MACHINE
  - 11.2.1 General cleaning
  - 11.2.2 Bobbin Area
  - 11.2.3 Upper Thread Tension
  - 11.2.4 Hand wheel Area
  - 11.2.5 Face plate Area
  - 11.2.6 Bobbin and Hook Area
  - 11.2.7 Oiling and lubricating the machine
- 11.3 COMMON PROBLEMS AND REMEDIES
- 11.4 LET US SUM UP
- 11.5 LESSON END ACTIVITIES
- 11.6 POINTS FOR DISCUSSION
- 11.7 REFERENCES

### 11.0 AIM AND OBJECTIVES

After going through this unit, you should be able to have a clear idea of the following

- Sewing machine problems
- Guidelines for care and maintenance of sewing machine
- Cleaning the machine.
- Use oil lubricant to use machine oiling
- common trouble and their possible remedies

### 11.1 INTRODUCTION

Always keep your sewing machine well oiled. All dust should be removed from the exposed parts at least once every week, and the important parts of the machine should be oiled twice during the week if the machine is used moderately. Use a good quality of machine oil, but only in small quantities so that it does not soil your material when you are sewing.

If your machine becomes gummed, oil it with kerosene, running unthreaded for a few minutes. Then cleanse all parts thoroughly and oil with good machine oil. This attention to your machine will prolong its life and keep it running smoothly and easily.

Many problems can be resolved by a simple change of needle or other easy switch. If you don't find the answer you need here.

## 11.2 CARE AND MAINTENANCE OF SEWING MACHINE

Most sewing machine problems that encounter can be traced to poor general maintenance or neglect. But with some simple tools and just a few minutes daily, weekly, or monthly depending on how much our sewing machine, we can help keep our machine running smoothly. Here are my guidelines for care that should keep sewing machine happy and out of the repair shop.

### 11.2.1 GENERAL CLEANING

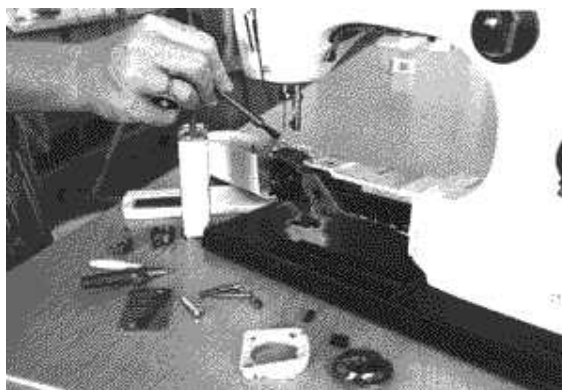

Fig 11.1

Cleaning the machine fig 11.1, it is best to clean one area at a time. Remove only the parts that are involved and be sure to note where each part is from, its position, and which side is top.

Remove all the parts possible in order to clean the machine thoroughly. Keep the parts in order to make it easier to replace them.

When using a screw driver, put the pressure on the push, not on the twist. If a screw will not loosen easily, soak it with cleaning fluid. Then set the screw driver in the slot and tap sharply with a hammer before attempting to loosen. The screwdriver blade should be as wide as the slot in the screw is long. Always use a wrench-not pliers-on bolt.

First, remove the needle, presser foot, slide plate, throat plate, bobbin case, and the face plate (if it comes off). Put them in the pan and cover with cleaning fluid. Set aside to soak while cleaning other areas.

Next, wrap the motor (if necessary) and wire with plastic wrap to protect them from oil and cleaning solvent. Be sure the machine has been unplugged.

Now, it is time to begin work to clean the machine head. With a sharp pointed tool, clean out all oil holes. Then, with your hand, turn the hand wheel to run the machine. At the same time, squirt cleaning fluid into all the oil holes, on all bearings and on all other places where one part rubs against or turns within another.

### 11.2.2 BOBBIN AREA

If possible, remove the bobbin case to remove all lint and stray threads.



Fig 11.2

If the machine begins to run hard, it is a sign that dirt or lint has jammed inside a bearing. Continue running the machine and flushing with cleaning fluid until the dirt and gummed oil are washed from the bearing. When the machine runs easily again, tip the head and flush the parts underneath the machine—all oil holes, bearing and places that rub against or within another. Continue running the machine by hand until it functions smoothly.

### **11.2.3 UPPER THREAD TENSION**

Pull a piece of cloth soaked in solvent back and forth between discs to clean

To remove any remaining dirt and oil, dip a cloth or brush in cleaning fluid and scrub all parts of machine that can be reached. Use a needle, knife or other pointed instrument to dig or scrap away any remaining gummed dirt or lint in the feed dog, around the bobbin case, and in other areas.

Check the lower tension of the bobbin case and the upper thread tension discs. Pull a thread under the tension of the bobbin to remove dirt. Pull a piece of cloth soaked in cleaning fluid back and forth between the discs of the upper tension. Repeat with a dry cloth to be sure no lint or thread is caught between them.

In addition to general cleaning, three areas need special attention. They include the hand wheel bearing and the clutch assembly, the needle -bar and presser foot, and the hook and bobbin areas assembly. When the hand wheel assembly gets gummy and dirty, it must be cleaned for the clutch to work properly. The clutch disengages the needle-bar when winding a bobbin.

Some new sewing machines refill the bobbin in its regular position and a clutch is not necessary. In such machines, it is not often necessary to remove the hand wheel to clean this area.

### **11.2.4 HAND WHEEL AREA**

To remove the clutch and hand wheel, loosen the small screw in the face of the locknut (the locknut is the part that is turned to the left to release the clutch for operating the bobbin winder). Next, unscrew the locknut, and remove the washer and hand wheel. Most machines will have a washer that looks like one of the three shown. Some makes will be slightly different. Notice the position of the washer so it can put it back in the same position.

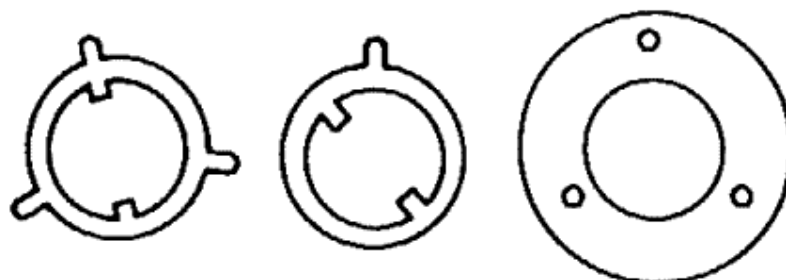

Fig 11.3

Clean the hand wheel, washer, and shaft. Lubricate the shaft with two drops of oil and place a small amount of grease on all gears. Reassemble the hand wheel and clutch. If the clutch fails to operate, either because it will not hold or fails to release, remove the locknut again and turn the washer one half turn (180 degree) and reassemble. The clutch should then work properly.

After thoroughly cleaning these areas, reassemble the machine and run it by hand. It should run soothly if all parts have been replaced correctly

### 11.2.5 FACE PLATE AREA

The face plate on most machines is held in place with one or two screws. By removing these, the plate can be easily removed for cleaning of the needle-bar and presser foot bar.

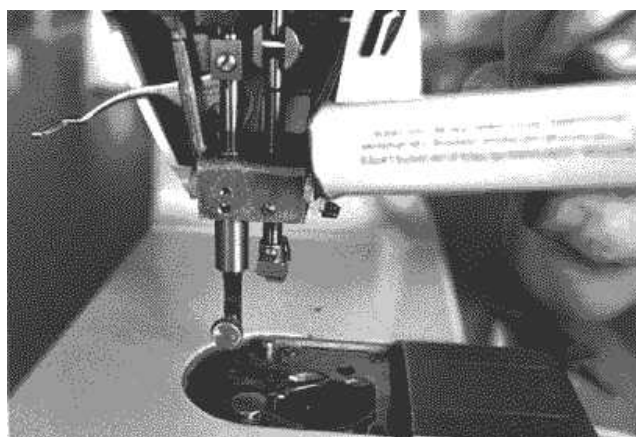

Fig 11.4

On some of the newer machines, the face plate is a part of a housing that is mounted on hinges, which makes it easy to move the entire housing away from the bars and mechanisms



behind it. No other parts need to be removed for cleaning in this area. First use a dry brush to clean out all lint and other foreign material. A small piece of cloth with a little solvent on it can be used to clean the needle-bar and presser bar of any gummy grease.

After thoroughly cleaning, place a drop or two of oil on each shaft where it slides through the housing. Oil all other moving parts according to instruction book before replacing face plate.

### **11.2.6 BOBBIN AND HOOK AREA**

Lint is the primary offender in this area. The bobbin case can be removed on all makes of machines. Use a dry brush to clean out all lint. Remove any thread that may be wound up around the hook shaft. On many machines, the hook assembly can also be removed for more complete cleaning. Place one drop of oil on the exterior perimeter of the hook and the bobbin race to lubricate if after cleaning.

### **11.2.7 OILING AND LUBRICATING THE MACHINE**

Allow the machine to stand overnight so excess cleaning fluid can evaporate before oiling and lubricating it. Check the machine instruction booklet to determine the type of oil lubricant to use and where to use them.

Some machines have bearings that are nylon or graphite-impregnated bronze and do not require oil or lubricant. Also, some machines do not need oiling because they are designed with oil impregnated in the bearing castings. If the machine does not require oil, do not use it.

Do not oil the tension discs, the hand wheel release or the belts and rubber rings on any machine.

In the holes designated, and on all parts that rub against or within another, squirt a little oil. Run the machine by hand to distribute the oil into all the bearings. Use oil freely because all oil has been removed in the cleaning process. If there is any wool or felt pads that feed oil to parts, be sure they are well-oiled.

For later oiling, one drop of oil on each bearing and in each oil hole is enough. It is a good practice to oil the machine after each day's work or after 8 to 10 hours of use. Even if do not use the machine often, oil it occasionally to keep the oil from drying and gumming.

If the machine requires a lubricant, lubricate the areas suggested. Use the lubricant recommended for the machine for best results.

After oiling and lubricating the machine, wipe away excess oil and reassemble the machine. As replace the parts that have been soaking in the pan, do not force screws or parts into place. Check to be sure it is in the correct location.

### 11.3 COMMON PROBLEMS AND REMEDIES

The common trouble and their possible remedies are listed below.

Symptom	Root Cause	Corrective Action
<ul style="list-style-type: none"> <li>• Sewing machine suddenly stops during sewing.</li> <li>• Light is on, and hand wheel can be turned easily by hand.</li> </ul>	<ul style="list-style-type: none"> <li>• Sewing machine has been run at a low speed for an extended period of time.</li> <li>• To prevent overheating, motor power is automatically turned off.</li> </ul>	<ul style="list-style-type: none"> <li>• Turn power off and wait about 20 minutes. Safety device will reset, and machine will be ready to operate.</li> </ul>
<ul style="list-style-type: none"> <li>• Needle will not move.</li> </ul>	<ul style="list-style-type: none"> <li>• Upper thread has run out.</li> <li>• Presser foot is up.</li> <li>• Bobbin winder shaft was left in winding position.</li> <li>• Buttonhole lever was not lowered when machine was placed in buttonhole mode.</li> </ul>	<ul style="list-style-type: none"> <li>• Replace empty spool and thread machine.</li> <li>• Lower presser foot.</li> <li>• Move bobbin winder shaft back fully to left.</li> <li>• Lower buttonhole lever.</li> </ul>
<ul style="list-style-type: none"> <li>• Sewing machine will not run.</li> </ul>	<ul style="list-style-type: none"> <li>• Presser foot is not correct one, and needle hits presser foot.</li> <li>• Needle has come out and is in hook of machine.</li> </ul>	<ul style="list-style-type: none"> <li>• Replace presser foot with new one.</li> <li>• Remove needle and insert new one.</li> </ul>
<ul style="list-style-type: none"> <li>• Upper thread breaks.</li> </ul>	<ul style="list-style-type: none"> <li>• Threading is not correct.</li> <li>• Thread has a knot in it.</li> <li>• Thread tension is too tight.</li> <li>• Needle is bent or blunt or has a sharp eye.</li> <li>• Needle is wrong size.</li> <li>• Needle has been inserted wrong.</li> <li>• Needle and thread does not match.</li> <li>• Starting to stitch too fast.</li> <li>• Thread take-up lever has not been threaded.</li> </ul>	<ul style="list-style-type: none"> <li>• Correctly thread machine.</li> <li>• Remove knot.</li> <li>• Correct thread tension.</li> <li>• Replace needle.</li> <li>• Replace needle with correct size.</li> <li>• Properly insert needle.</li> <li>• Start machine at a medium speed.</li> <li>• Use proper thread or needle.</li> <li>• Check threading order.</li> </ul>
<ul style="list-style-type: none"> <li>• Bobbin thread breaks.</li> </ul>	<ul style="list-style-type: none"> <li>• Bobbin has not been fully inserted in bobbin case.</li> <li>• Bobbin has been incorrectly threaded.</li> <li>• Bobbin does not turn smoothly in bobbin case.</li> <li>• Lint in bobbin case or shuttle.</li> </ul>	<ul style="list-style-type: none"> <li>• Securely install bobbin into bobbin case.</li> <li>• Correctly thread bobbin case.</li> <li>• Check to see that bobbin has been wound evenly.</li> <li>• Clean bobbin case and shuttle.</li> </ul>

- |   |  |  |
|---|--|--|
| <ul style="list-style-type: none"><li>• Skipped stitches.</li></ul>                 | <ul style="list-style-type: none"><li>• Thread tension is too tight.</li><li>• Needle is bent or blunt.</li><li>• Needle is wrong size.</li><li>• Needle and thread does not match.</li><li>• Thread take-up lever has not been threaded.</li><li>• Light pressure on presser foot.</li><li>• Incorrect setting of needle.</li></ul> | <ul style="list-style-type: none"><li>• Correct thread tension.</li><li>• Replace needle.</li><li>• Replace needle with correct size.</li><li>• Use proper thread or needle.</li><li>• Check threading order.</li><li>• Increase pressure on presser foot.</li><li>• Reset needle.</li></ul>                               |
| <ul style="list-style-type: none"><li>• Stitches are not formed properly.</li></ul> | <ul style="list-style-type: none"><li>• Thread has not been pulled into thread sensor guide.</li><li>• Threading is not correct.</li><li>• Bobbin case has been threaded wrong.</li><li>• Spool cap is wrong size for thread spool.</li></ul>  | <ul style="list-style-type: none"><li>• Fully pull thread into thread sensor guide.</li><li>• Correct threading.</li><li>• Correctly thread bobbin case.</li><li>• Replace the cap with correct size.</li></ul>  |
| <ul style="list-style-type: none"><li>• Irregular stitches.</li></ul>               | <ul style="list-style-type: none"><li>• Incorrect size needle.</li><li>• Improper threading.</li><li>• Loose upper thread tension.</li><li>• Pulling fabric.</li><li>• Light pressure on presser foot.</li><li>• Loose presser foot.</li><li>• Unevenly wound bobbin.</li></ul>  | <ul style="list-style-type: none"><li>• Choose correct size needle for thread and fabric.</li><li>• Rethread machine.</li><li>• Tighten upper thread tension.</li><li>• Do not pull fabric; guide it gently.</li><li>• Increase pressure on presser foot.</li><li>• Reset presser foot.</li><li>• Rewind bobbin.</li></ul> |
| <ul style="list-style-type: none"><li>• Fabric puckers.</li></ul>                   | <ul style="list-style-type: none"><li>• Stitch length is too long for material.</li><li>• Needle point is blunt.</li><li>• Incorrect thread tension.</li><li>• Light pressure on presser foot.</li><li>• Fabric is too sheer or soft.</li><li>• Using two different sizes or kinds of thread.</li></ul>                              | <ul style="list-style-type: none"><li>• Decrease stitch length.</li><li>• Replace needle.</li><li>• Reset thread tension.</li><li>• Increase pressure on presser foot.</li><li>• Use underlay of tissue paper.</li><li>• Upper thread and bobbin thread should be the same size and kind.</li></ul>                        |
| <ul style="list-style-type: none"><li>• Bunching of thread.</li></ul>               | <ul style="list-style-type: none"><li>• Upper and lower threads not drawn back under presser foot.</li><li>• Feed dog down.</li></ul>  | <ul style="list-style-type: none"><li>• Draw both threads back under presser foot.</li><li>• Raise feed dog.</li></ul>   |

- |  |   |  |
|--|---|--|
| <ul style="list-style-type: none"><li>• Needle breaks.</li></ul>   | <ul style="list-style-type: none"><li>• A thin needle was used for sewing a heavy weight material.</li><li>• Needle has not been fully inserted into needle bar.</li><li>• Needle clamp screw is loose.</li><li>• Presser foot is not correct one.</li><li>• Presser foot is loose.</li><li>• Pulling on fabric as you sew.</li></ul> | <ul style="list-style-type: none"><li>• Use correct size needle.</li><li>• Properly insert needle.</li><li>• Securely tighten needle clamp screw.</li><li>• Use correct presser foot.</li><li>• Reset presser foot.</li><li>• Do not pull fabric, guide it gently.</li></ul>   |
| <ul style="list-style-type: none"><li>• Loud noise is heard.</li><li>• Knocking noise, machine jammed.</li></ul>   | <ul style="list-style-type: none"><li>• Dust has accumulated in feed dogs.</li><li>• Lint is in hook.</li><li>• Thread caught in shuttle.</li></ul>   | <ul style="list-style-type: none"><li>• Clean machine.</li><li>• Clean machine.</li><li>• Disassemble machine and clean shuttle.</li></ul>   |
| <ul style="list-style-type: none"><li>• The machine does not feed material.</li></ul>  | <ul style="list-style-type: none"><li>• The stitch length has been set to zero.</li><li>• The presser foot pressure is too low.</li><li>• Feed dogs are lowered.</li><li>• Threads are knotted under fabric.</li></ul>  | <ul style="list-style-type: none"><li>• Reselect the proper stitch pattern and length.</li><li>• Set presser foot pressure adjustment lever to "normal".</li><li>• Raise feed dogs.</li><li>• Place both threads back under presser foot before beginning to stitch.</li></ul> |
| <ul style="list-style-type: none"><li>• Threading cannot be done.</li><li>• The needle threader will not turn.</li><li>• The threading hook will not enter needle eye.</li></ul> | <ul style="list-style-type: none"><li>• The needle is not in highest position.</li><li>• The needle threader is designed not to turn to protect it if the needle is not up.</li><li>• The needle has not been fully inserted into needle bar.</li></ul>   | <ul style="list-style-type: none"><li>• Turn hand wheel until needle reaches its highest position.</li><li>• Properly insert needle.</li></ul>   |
| <ul style="list-style-type: none"><li>• Needle threader cannot be returned and the sewing machine stops.</li><li>• The threading hook is left in the needle eye.</li></ul>       | <ul style="list-style-type: none"><li>• Sewing machine was accidentally started while threading hook was still in needle eye (during threading).</li></ul>  | <ul style="list-style-type: none"><li>• Slightly turn handle clockwise and remove threader.</li></ul>  |

## 11.4 LET US SUM UP

This lesson gives guidelines for care that should keep sewing machine run at good condition without any repair.

It deals the procedure to clean the machine. The method of dismantling the machine parts before cleaning and assembling the machine parts after machine cleaning which was clearly explained here. Cleaning the machine, at a right time and right parts is very important. We have to remove only the parts that are involved and be sure to note where each part is from.

Sewing machine requires a lubricant, and machine manual suggested the areas to be lubricate. The lubricant recommended for the machine for best results. It reduces the lot of problems.

## 11.5 LESSON END ACTIVITIES

The students may do the following activities based on this lesson

- Prepare a maintenance program for different sewing machine
- List the various possible practical problems and find a solution for it

## 11.6 POINTS FOR DISCUSSION

Here the students are asked to discuss about the following points

- The methods of preparing the maintenance chart of an sewing machine
- Problem and the remedies of a sewing machine

## 11.7 REFERENCES:

- Fundamentals of textile and their care, Susheela Dantygi, Published by orient Longman L.t.d.
- Practical Clothing construction- part 1 & 2, Mary Mathews, Cosmic press.
- The complete book of sewing, by Dorling Kindersley, Dorling Kindersley L.t.d.
- Readers Digest Sewing Guide, The Readers Digest Association
- The technology of Clothing Manufacturing, Harold Carr and Barbara Latham.
- Clothing Technology, Europ Lehmilied, Vollmer GmbH & Co.

## UNIT – IV

### LESSON – 12: STITCHING MECHANISM

#### CONTENTS

- 12.0 AIM AND OBJECTIVES
- 12.1 INTRODUCTION
- 12.3 NEEDLE
  - 12.3.1 Types of sewing needles
- 12.3 BOBBIN AND BOBBIN CASE
- 12.4 BOBBIN WINDING
- 12.5 LOOPERS
  - 12.5.1 Types of loopers
- 12.6 LOOP SPREADER
- 12.7 THREAD FINGER
- 12.8 THREADING
  - 12.8.1 Upper threading
  - 12.8.2 Lower threading
- 12.9 STITCHING AUXILIARY
- 12.10 THROAT PLATE
- 12.11 SETTING PROPER TENSION
  - 12.11.1 Needle thread tension
  - 12.11.2 Bobbin tension
  - 12.11.3 Type of tension device
- 12.12 STITCH LENGTH AND WIDTH
- 12.13 THREAD TAKE UP
  - 12.13.1 Types of take up levers
- 12.14 LET US SUM UP
- 12.15 LESSON END ACTIVITIES
- 12.16 POINTS FOR DISCUSSION
- 12.17 REFERANCES

#### 12.0 AIM AND OBJECTIVES

After going through this unit, you should be able to have a clear idea of the following

- Different parts and function of a sewing machine is discussed here.
- It explains the operations of spreading and its method.

- A clear picture of cutting and different cutting equipments.

## 12.1 INTRODUCTION

In these lesson gives knowledge of parts and functions sewing machine and also discussed the different types of sewing machines parts available in market.

Learning what the parts are and what they do, will help you understand how they work and why you would use different types of sewing machine.

## 12.3 NEEDLE

The way in which fabric is penetrated by the needle during sewing has a direct effect on seam strength and on garment appearance and wearable life.

### 12.3.1 TYPES OF SEWING NEEDLES

1. Hand sewing needles
  - Sewing needle
    - i. Standard
    - ii. Long
  - Embroidery needle
    - i. Pointed
    - ii. Round
  - Darning needle
2. Machine sewing needles
  - Round point needle
    - Ball point
    - Set point
  - Cutting point needle

#### 1. HAND SEWING NEEDLE

For hand sewing fig 12.1 the needle should be large enough to carry the thread easily. If a needle that is too small it will cut the thread, and a too-large needle may tear the cloth. For basting we suggest the long needle used by milliners.



Fig 12.1

The needles commonly used in dressmaking are called Sharps. In your sewing basket you should keep a supply of Sharps Nos. 5, 6, 7, 8, 9 and 10. For very heavy work use Nos. 5 and 6 with threads 20 to 40 (or silk C. D. and E.) Use needles 7 and 8 for threads Nos. 60 to 90, and needles 9 and 10 for threads Nos. 100 to 150.

## 2. MACHINE NEEDLE

All sewing machine needles fig 12.2 have the same basic parts. The variation in needles is caused by the shape of the parts and the length of the parts.

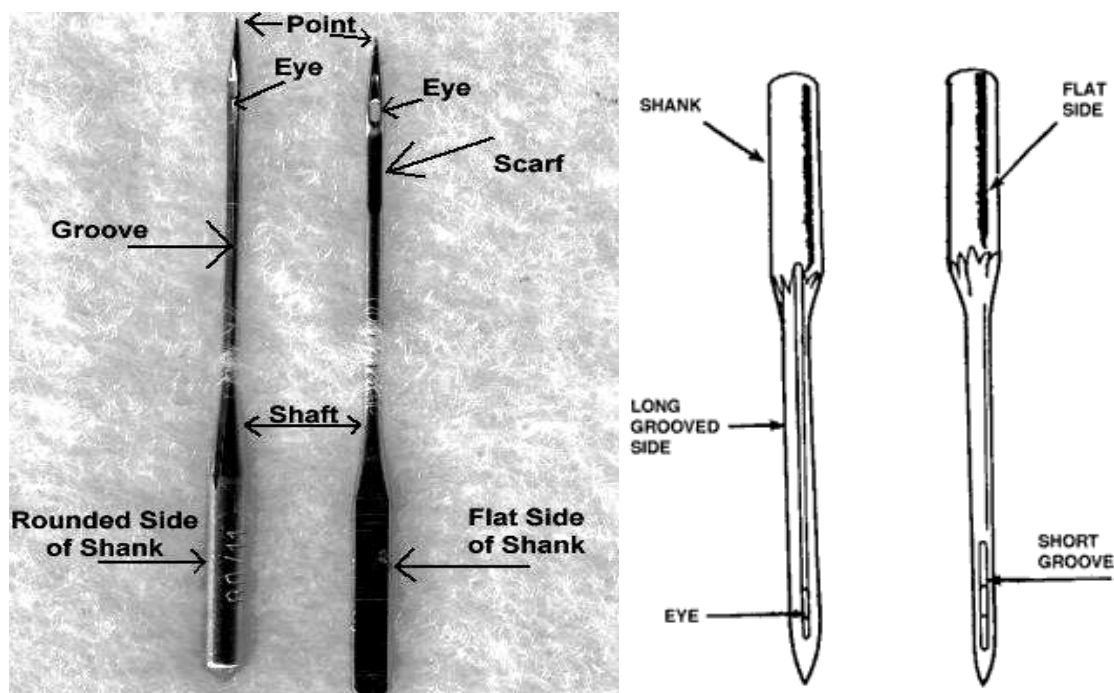

Fig 12.2

The function of the sewing machine needle is general are:

- To produce a hole in the material for the thread to pass through and to do so without causing any damage to the material.
- To carry the needle thread through the material and there form a loop which can be picked up by the hook on the bobbin case in a lockstitch machine or by the looper or other mechanism in machine.
- To pass the needle thread through the loop formed by the looper mechanism on the machines other than lockstitch.

### Shank

- The upper thick part of a sewing machine needle is called the shank. This part of the needle is inserted in the machine. Home sewing machine needles are composed of a flat and a round side, to assist in always having the needle in the correct position.
- Always refer to your sewing machine manual for the correct way to insert the needle in your machine.
- Industrial machine needles have a completely round shaft and the groove is used to know which direction to put a new needle in the machine.

### Shaft

- The shaft of a sewing machine needle is the area from the bottom of the shank to the point. The shaft contains the groove, scarf, eye and point of the needle.

### Groove



- A groove is in the side of the needle leading to the eye. The groove is a place for the thread to lay into the needle.
- Use your fingernail and feel the groove of the needle on various sizes to understand why a different size thread would be needed for heavier thread.

### Scarf

- The scarf is a groove out of one side of the needle. The scarf allows the bobbin case hook to intersect with the upper thread and form stitches.

### Eye

- The eye of the needle carries the thread so the machine can keep forming stitches.
- The size of the eye can vary and works in conjunction with the groove of the needle.
- Using a needle with an eye that is too small or too large can cause your thread to shred and break.

### Point

- The point of the needle is the first contact with the fabric and responsible for how the needle pierces the fabric.
- The most common types of point are sharps, ballpoint and universal.
  - **Sharp needles** are for all woven fabric. The sharp point is especially helpful when sewing straight lines and tasks such as tops stitching.
  - **Ballpoint needles** are designed for knit fabric so that the point glides between the loops of a knit fabric without disturbing the fibers that make up the fabric. Ball point needles do not form as straight stitching as sharp needles. The non-straight stitching is more apt to stretch with the fabric.
  - **Universal needles** can be used with woven or knit fabric. The point of a universal needle is sharp yet very slightly rounded giving it the characteristics of a sharp and a ballpoint needle. If you are not happy with the stitches your machine is forming, try switching the needle to either a ball point or sharp.

## Needles Used in Regular Sewing

FABRIC	THREAD	TYPE	SIZE
<b>Very Light-Sheer Woven</b> Batiste, Chiffon, Lace, Crepe d' Chine, Georgette, Netting, Organdy, Voile, and Silk	Polyester, Cotton, and Silk	S	9/65
<b>Light Weight Woven</b> Batiste, Broadcloth, Calico, Challis, Chambray, Crepe, Eyelet, Gingham, Lawn, Handkerchief Linen, Microfiber-Peachskin, Rayon, Ripstop Nylon, Satin, Muslin, and Silk	Polyester, Cotton, and Silk	S	9/65, 11/70

<p><b>Medium Weight Woven</b> Broadcloth, Cotton, Calico, Chino, Challis, Denim, Felt, Flannel, Muslin, Linen-Linen types, Poplin, Rayon, Satin, Twill, Raw Silk</p>	<p>Polyester, Cotton, and Silk</p>	<p>S, J, U</p>	<p>80/12, 90/14</p>
<p><b>Heavy Weight Woven</b> Canvas, Cotton Duck, Denim, Coat Fabric, Drapery Fabric, Fake Fur, Sail Cloth, Tapestry, Upholstery, and Wool-Wool Blends</p>	<p>Polyester, Cotton</p>	<p>J, U</p>	<p>90/14, 100/16</p>
<p><b>Light-Medium Weight Knits</b> Cotton Knits &amp; Blends, Jersey Knits, Tricot, Lycra &amp; Swimwear Fabric, Spandex, Stretch Velour &amp; Stretch Velvet</p>	<p>Polyester</p>	<p>B, ST</p>	<p>80/12, 90/14</p>
<p><b>Medium- Heavy Weight Knits</b> Double Knits, Stretch Terry, Stretch Velour, Stretch Velvet, Sweater Knits, Sweatshirt Fabric, and Spandex</p>	<p>Polyester</p>	<p>B, ST</p>	<p>80/12, 90/14</p>
<p><b>Non-Woven Fabrics</b> Leather, Synthetic Leather, Genuine-Synthetic Suede, Plastic, and Vinyl</p>	<p>Polyester</p>	<p>L, U</p>	<p>80/12, 90/14</p>

S = Sharp

ST = Stretch

U = Universal

J = Jeans Sharp

L = Leather

E = Embroidery

B = Ball Point

B = Ball Point

MT = Metafil/Metallica

## 12.3 BOBBIN AND BOBBIN CASE

### 1. BOBBIN

A bobbin is a spindle or cylinder, with or without flanges, on which wire, yarn, thread or film is wound. Bobbins are typically found in sewing machines, cameras.

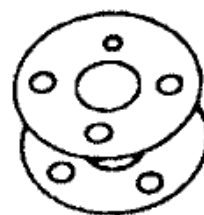
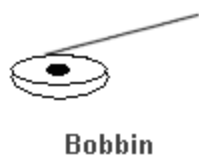

Fig 12.3

The piece of your sewing machine that holds the bottom threads (the bobbin thread) and is placed in the bobbin case. It generally is under the area the needle penetrates and it loops with the needle thread to form a locked stitch.

## 2. BOBBIN CASE

It holds the bobbin in position which provides the lower thread and it rotate with the shuttle hook.



Fig 12.4

### **Types of bobbin case**

1. Removable bobbin case
2. Built in bobbin case

#### **1. Removable bobbin case**

It is used in a single needle machine and can be removed from the machine

#### **2. Built in bobbin case**

It is attached with the machine and cannot be removed

## **12.4 BOBBIN WINDING**

For most machines, the thread must be taken out of the needle in order to wind the bobbin. There is normally a bobbin holder on top of the machine. The thread runs from the spool through a sequence of hooks etc. that are specific to the type of machine and on to the spool. The needle is disengaged when the bobbin is winding. This is done automatically (when the bobbin is in position for winding) or manually, depending on the machine. After the bobbin is wound, the machine is re-threaded, the needle is engaged and the bobbin is placed in its area under the throat plate. It shows in fig 12.5.

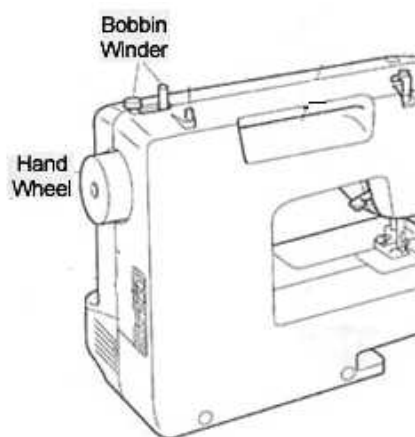

Fig 12.5

If bobbin is not wound smoothly and evenly there will be an uneven run of thread from the shuttle, which will undoubtedly result in uneven stitching.

## 12.5 LOOPERS

It is dull pointed metal piece which has a definite motion cycle to grasp the thread from the needle and helps to form a loop of stitches.

### 12.5.1 TYPES OF LOOPERS

There are two main type of loopers based on its shape.

1. Eye loopers
2. Blind loopers

#### 1. Eye loopers

Eye loopers is used for the machine that has bobbin and bobbin case and used mainly for class 400, class 600 and for all class 500 stitches other than class 501. These types of loopers are carrying the sewing thread through the eye.



Fig 12.6

It does two important functions.

- To grasp the thread from the needle.
- To inter lock the bobbin thread with the needle thread.

#### 2. Blind loopers

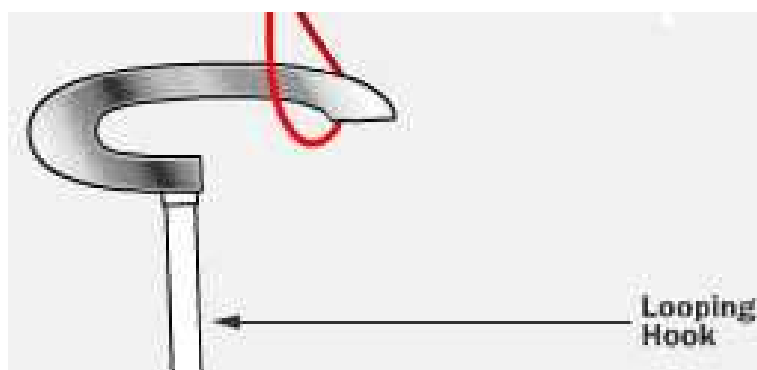

Fig 12.7

Blind loopers only do the function of grasping the thread from the needle. It is used for sewing machine without bobbin and bobbin case. Mainly it is used in class 100,101,102 and some class 500. These types of loopers are not carrying the threads because of no eye, but it guide the thread as shown in fig 12.7.

Based on the **loppers function** it can classify in to two types.

- Oscillating loopers
- Rotating loopers

## **12.6 LOOP SPREADER**

Loop spreader or snub massed or dull pointed metal piece which assist the looper in making the stitches. Some blind loopers also have loop spreader. These blind loopers have two dull pointed, the point which grabs the needle thread from the needle is the looper point. The other point which spreads the needle thread loop, which the loop spreader pointed.

The action of loop spreader is coordinate with the loopers. Some machine has multi edged loop spreaders which coordinate with more than one loopers. Some loop spreader are fixed readily there looper mechanism and parallel to looper action. It is used to form the stitch classes of 400,500 and 600 stitches.

## **12.7 THREAD FINGER**

Thread fingers function in the position of needle above the presser foot shoe. It is a metal link with an eye.

These fingers may be static or dynamic. In static links guide the covering thread, were as the dynamic links carry thread back and forth across the needle path. It is used to form a 600 class stitches.

Thread fingers hooks are assist the finger in interlacing its thread between or among the thread of two or more needles in the machine. The action of the thread fingers hooks are synchronized with the thread fingers and needle.

Most of the thread fingers mechanisms are located in the upper arm of the machine which holds the needle mechanism.

## **12.8 THREADING**

### **12.8.1 UPPER THREADING**

Machines vary as to how exactly they are threaded, but all have certain common features. The thread runs from the spool holder, through a tension device and down through the needle. The tension device controls the tension on the thread. It consists of a groove that the thread slides through. The mechanism for setting the tension may be a dial or buttons (computerized machines).

With the machine on the left, below, the thread runs from the spool to a hook at the top of the tension area, down the right groove and up the left groove, over a little hook and down the left groove again, and on to the needle. The dial is turned to set the tension.

With the machine on the right below, the thread runs from the spool to a hook at the top of the tension area, down and up the left groove and down the right groove to the needle.

The thread runs from the tension device, down to the needle area. There are usually small grooves in the arm that holds the needle, for the thread to pass through. This holds the thread close to the needle arm. The thread then runs down to and through the eye of the needle. Refer to your machine manual for proper threading of your machine.

### 12.8.2 LOWER THREADING

Once the bobbin is in place and the machine is threaded, gently turn the wheel of the machine while holding the needle thread off to the side (it should go from the needle under the presser foot and off to the side). This will bring down the needle. The needle will pass down through the throat plate and the needle thread will catch the bobbin thread and pull it up through the throat plate when it comes back up again.

### 12.9 STITCHING AUXILIARY

Stitching auxiliaries are not carrying the thread but it helps the formation of perfect stitches. There are three types of stitching auxiliaries are available.

**Knife:** It trim the edges of fabric before sewing and it can be found in over lock machines.

**Positioner:** Before stitching the materials are positioned by these type positioner.

**Piercing:** It pierce the fabric before stitching and it is used in the button hole machine to form a button hole.

### 12.10 THROAT PLATE

The throat plate (also called needle plate) fig 12.8 covers the area that holds the bobbin. It has an opening for the needle to pass through, as well as lines that serve as sewing guides. The needle may be a single hole, used for straight stitching, or an oblong hole, which allows the needle to make stitches that have width (such as zigzag stitches).

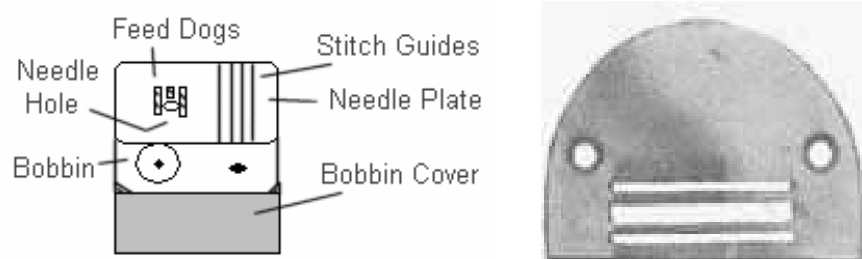
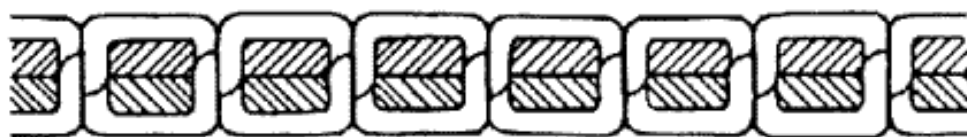

Fig 12.8

Be careful when using a straight stitch throat plate. If you accidentally change to a zigzag (or other stitch that has a width) while the straight stitch throat plate is in place, you will **BREAK YOUR NEEDLE**. A straight stitch throat plate is the best one to use, however, when making a straight stitch (regular sewing stitch). It helps prevent the fabric from being pulled down into the machine (having a needle that is sharp enough helps prevent this also, although you must use a ball-point needle for knits).

## 12.11 SETTING PROPER TENSION

Tension refers to the force that is applied by the machine on your thread. You can also effect tension by the amount of pull or push you apply to the fabric as you feed it through under the needle - you should not apply force. Instead, just use your hands to guide the fabric through. Let the feed dogs actually feed the fabric through.



**Perfectly Locked Stitch** (fig 12.9)

There are two areas in which you can adjust tension. The upper thread (needle thread - coming from the spool) and the bobbin thread each have tension.

### 12.11.1 NEEDLE THREAD TENSION

This is the most likely place to find a problem. Generally the tension ranges from low to high in number, with high being the tightest.

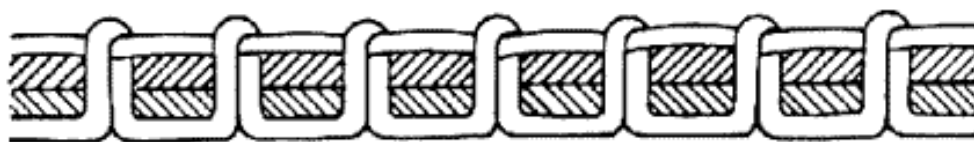

**Upper Tension Too Tight** ( fig 12.10)

### 12.11.2 BOBBIN TENSION

With some machines, a screw is present which controls the bobbin tension. Usually, the bobbin does not need to be adjusted, and some machine does not even allow you to do this. In all of my time sewing, I have never adjusted bobbin tension.

Too little tension can cause weak seams, which can be pulled apart easily. Adjust to a higher tension. Too much tension causes a seam that is too tight and causes your fabric to pucker. Adjust to a lower tension.

When both threads have an even amount of tension, a smooth, "balanced" stitch is produced. The needle and bobbin threads are locked between the two layers of fabric with no loops on top or bottom and no puckers.

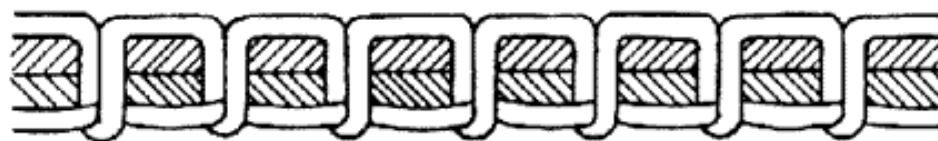

### **Upper Tension Too Loose (fig 12.11)**

The relationship between the bobbin thread tension and the upper thread tension, in combination with the thickness of the fabric being sewn, affects the appearance (and effectiveness) of the stitching. Since bobbin thread tension cannot be changed on the fly, and you're presumably using your fabric for a reason, the upper thread tension is the one to adjust.

If you suspect your upper thread tension is wrong, make a sample line of stitching through all the thicknesses you intend to sew. Look at the stitches you've produced.

- If stitching on the top of the fabric looks normal (like a dashed line), but the underside has a bunch of little loops with the bobbin thread running through them, your top thread is too loose. Increase your thread tension. Note, however, that this is the ideal adjustment for gathering fabric.
- If the top of the fabric shows little loops, decrease your thread tension.
- If both sides show normal stitching, then you've got the right thread

### **12.11.3TYPE OF TENSION DEVICE**

1. Direct
  2. Indirect
  3. Auxiliary
1. Direct

It has two canvas disc, tension spring and tension screw to provide tension to thread

2. Indirect

These are cylindrical and conical in shape with a hook which is placed over the tension disc to provide extra tension.

3. Auxiliary

These are placed somewhere between the actual tension disc and needle to provide extra tension to the thread.

### **12.12 STITCH LENGTH AND WIDTH**

Stitch length refers to how long each individual stitch is.



- \* Regular 11 - 12 stitches per inch
- \* Basting 6 stitches per inch (i.e. a longer stitch, so fewer per inch)
- \* Gathering 6 - 8 stitches per inch

Generally, heavier fabrics work best with a longer stitch length, and finer fabrics are best with a shorter stitch length. Proper stitch length is important and is a first place to start if you do not like the look of your stitching. For example, a slightly puckered seam in the fine fabric could be caused from too long of a stitch length - the feed dogs are feeding too much fabric through each stitch, making a puckered look. To correct this, a shorter stitch length should be used (also check tension - more on this later). Remember that the higher number of stitches per inch translates to a short, tighter stitch.

Stitch width refers to how wide the stitch is. A regular straight stitch has no width, but a zigzag or decorative stitch can be set to any number of widths.

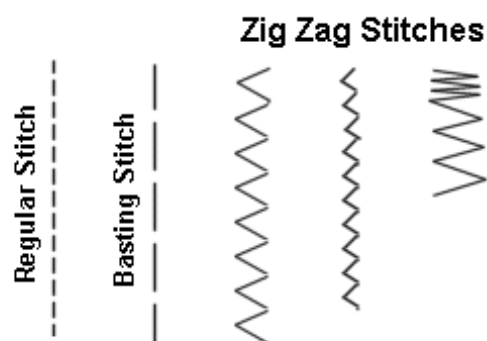

Fig 12.12

### 12.13 THREAD TAKE UP

After the bobbin hook contacts the needle thread, the threads is pulled up in order to make the stitch tight and this action is done by the take up lever. It also helps the bobbine hook to receive the thread freely and quickly.



Fig 12.13

### 12.13.1 TYPES OF TAKE UP LEVERS

1. Oscillating levers
2. Rotating levers

#### 1. Oscillating levers

It is used in a single needle machine and the gap will be 1 inch for oscillating of take up lever

#### 2. Rotating levers

This type lever which rotate to provide the thread looser and tighter.

### 12. 14 LET US SUM UP

In this lesson, we learned a lot regarding the machine parts. Here we are not only discussed a single machine parts or lock stitch machine parts. The lesson is common to all kind of stitch forming sewing machine. Almost all parts of single and double needle machine were discussed here. The loop spreader and loopers are comes in the over lock machine. Through the fashion maker machine we can set different stitch length and stitch width. With line diagrams we gave a good idea about the thread tension and its impotents on sewing machine.

### 12.15 LESSON END ACTIVITIES

The students may do the following activities based on this lesson

- Analyze the sewing machine parts and function
- Influence of thread tension on garment constructions

### 12.16 POINTS FOR DISCUSSION

Here the students are asked to discuss about the following points

- The cycle of stitch formation in sewing machine
- Sewing machine needle and its parts

- Passage of upper and lower thread in a machine
- Loopers and its type

#### **12.17 REFERENCES:**

- Practical Clothing construction- part 1 & 2, Mary Mathews, Cosmic press.
- The complete book of sewing, by Dorling Kindersley, Dorling Kindersley L.t.d...
- Readers Digest Sewing Guide, The Readers Digest Association
- The technology of Clothing Manufacturing, Harold Carr and Barbara Latham.
- Clothing Technology, Europ Lehrmilied, Vollmer GmbH & Co.

## LESSON – 13: FEEDING MECHANISM

### CONTENTS

- 13.0 AIM AND OBJECTIVES
- 13.1 INTRODUCTION
- 13.2 PRESSER FEET
- 13.3 FEEDING MECHANISM
- 13.4 TYPES OF FEED MECHANISM
  - 13.4.1 Manual feed or Free Motion or Freehand or Darning Feed
  - 13.4.2 Drop feed
  - 13.4.3 Differential feed
  - 13.4.4 Needle feed
  - 13.4.5 Compound feed
  - 13.4.6 Unison feed
  - 13.4.7 Puller, roller feed
  - 13.4.8 Cup feed
- 13.5 LET US SUM UP
- 13.6 LESSON END ACTIVITIES
- 13.7 POINTS FOR DISCUSSION
- 13.8 REFERANCES

### 13.0 AIM AND OBJECTIVES

After going through this unit, you should be able to have a clear idea of the following

- Presser foot and its function
- Use of feeder mechanism to pull fabric through a sewing mechanism.
- Feed mechanism classification and detailed explanation.

### 13.1 INTRODUCTION

One of the controls on a sewing machine. Surprisingly enough, it controls the length of the stitching. More specifically, it controls the amount of fabric the feed dogs push through before the needle comes down again.

To achieve the best results with your sewing machine, you need to use the correct foot for the task at hand. We have to select the correct foot while inserting a pin tuck embellishment or attaching a button will be critical to the final results.

Whether your machine takes Low, High, Slant, or Super High Presser feet, Sew Fancy carries all are available in market.

## 13.2 PRESSER FEET

The presser foot fig 13.1 can be raised and lowered with a small lever at the back of, or beside, the needle. When up, it allows free movement of the fabric. When down, it presses the cloth against a base plate. The base plate has a couple of textured moving parts (the feed dogs) that keep the material moving past the needle at an even rate. (You can sew with the presser foot up, but you tend to get very uneven stitches. This is because you have to move the fabric yourself, and keeping it moving at an even rate is almost impossible.)

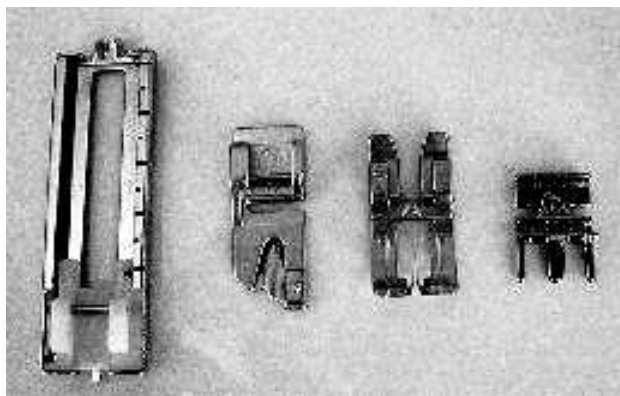

Fig 13.1

Presser feet hold down the fabric and help guide it through. They also serve various special functions. Examples of special feet are the rolled hem foot, which causes the fabric to roll, and the appliqué foot, which has an opening in the back to allow the bulk of the satin stitch to pass through. Other special feet that are commonly used include the zipper foot and buttonhole foot. Knowing what types are available, and when to use them, can make all the difference in the quality of your work. These special feet also take a lot of the frustration out of sewing.

Special sewing functions can be performed using other specialty feet such as: appliqué foot, bias binder, pin tuck feet, felling foot, cording foot, special hemmers ( fig 13.2) and many more.

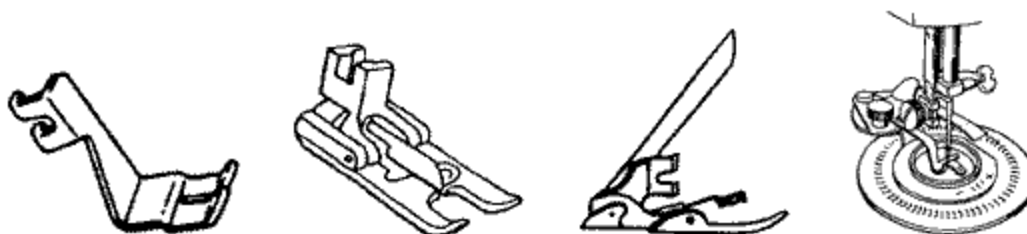

Fig 13.2

## 13.3 FEEDING MECHANISM

In a sewing machine, feed dogs are the feeder mechanism which is typically used to pull fabric through a sewing mechanism.



Fig 13.3

A set of feed dogs fig 13.3 typically resembles two or three short, thin metal bars, crosscut with diagonal furrows, which move back and forth in grooves slightly larger than the bars. The type of motion used (forward, then down, then backwards, then up) serves to pull the fabric through, since the "dogs" are in contact with the material on the forward stroke, and are pulled down below the main plate on the backward stroke by the sewing machine's mechanism. The result is that, between stitches, the fabric is pulled along in discrete steps.

Most sewing machines using feed dogs can pull fabric forwards or backwards at various stitch lengths; this is typically controlled by a stitch lever on the front of the machine.

### 13.4 TYPES OF FEED MECHANISM

Based on the end use and application the feed mechanism can be classified in the following types.

- Manual feed or Free Motion or Freehand or Darning Feed.
- Drop feed
- Differential feed
- Needle feed
- Compound feed
- Unison feed
- Puller, roller feed
- Cup feed

#### 13.4.1 MANUAL FEED OR FREE MOTION OR FREEHAND OR DARNING FEED

- Operator moves work under needle. Freehand motion.
- Machine may have a vertical motion foot that clamps the goods before the needle enters the material, and releases to allow the operator to manipulate the goods between each stitch.
- Darning, Embroidery, freehand Quilting, etc.

### 13.4.2 DROP FEED

Drop Feed fig 13.4 utilizes a feeder below the plate that raises up through the plate, compresses the fabric against the presser foot to advance the fabric one stitch, then drops below the plate to return to the original position.



Fig 13.4

- \* Incorporates a feed dog.
- \* The most common feed system.
- \* Also called four-motion feed dog or four-motion drop feed.

### 13.4.3 DIFFERENTIAL FEED

Differential Feed fig 13.5 utilizes a two piece feeder below the plate that rises up through the plate, compresses the fabric against the presser foot and then advances the fabric.

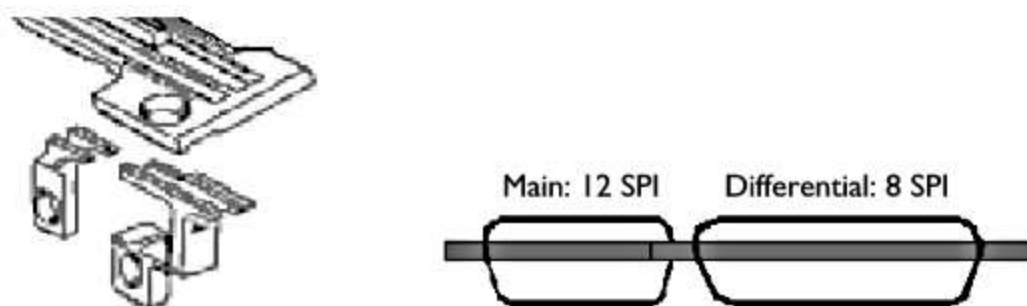

Fig 13.5

The front (main) feeder and rear feeder can be set to move the same or different distances. When the rear feeder is set to move farther than the front, the fabric is stretched. When the rear feeder is set to move less than the front, the fabric is gathered (shirring)

#### 13.4.4 NEEDLE FEED

Needle Feed fig 13.6 utilizes a feeder below the plate that raises up through the plate, compresses the fabric against the presser foot, in conjunction with the sewing needle which, drops through the fabric, then both move one stitch to advance the fabric. Then the separate and return to the original position for the next stitch.

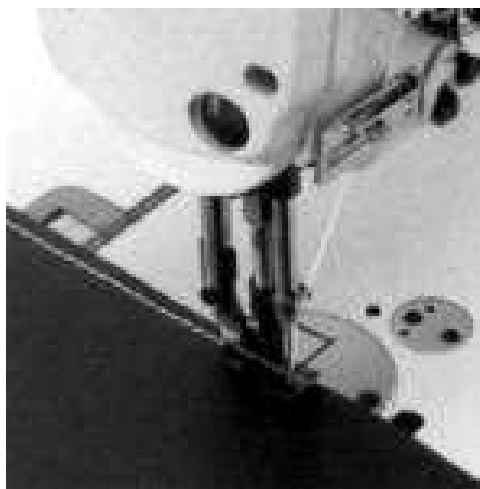

Fig 13.6

- \* Needle enters goods and remains in the goods while moving perpendicular to the needles' normal direction of travel, thereby feeding the goods, or assisting in feeding the goods.
- \* Can assist in preventing upper, middle, and lower layers of material from slipping in relation to each other.
- \* Does not necessarily require pressure against the planar surfaces of the material to feed, and can be used where material should not be marked by the action of a feed dog and/or upper feed.
- \* Is often used in conjunction with drop feed and/or with upper feed.

**It has three types.**

1. Upper pivot needle feed
2. Central pivot needle feed
3. Parallel drive needle feed

#### 13.4.5 COMPOUND FEED

A combination of synchronized drop feed and needle feed. Feeding occurs whilst the needle is still in the material by combined motion of needle bar and feed dog. Compound Feed fig 13.7 utilizes a feeder below the plate that raises up through the plate, compresses the fabric against the



presser foot in conjunction with a feeder above the plate which both pinch the fabric and both move one stitch to advance the fabric together.

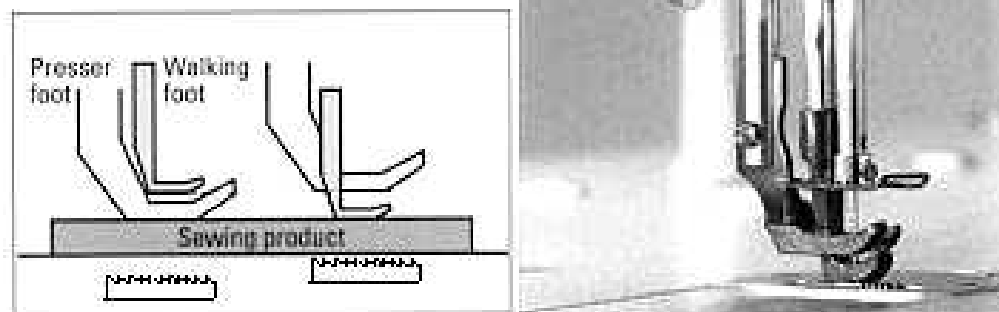

Fig 13.7

#### **Upper and lower feed.**

- \* A combination of any upper feed system and a feed dog or drop feed.
- \* The term "walking foot" (see "Upper feed" heading above) is often used to mean a vibrating presser foot in combination with compound feed, or in conjunction with a drop feed.

#### **Compound feed.**

- \* A combination of needle feed and drop feed.
- \* The term is often used erroneously to indicate any combination of feed systems.

#### **13.4.6 UNISON FEED**

Unison feed fig 13.8 combines Needle Feed with Compound Feed. The Needle penetrates the fabric, the top and bottom feed dogs compress on the fabric, and they all advance the fabric one stitch, all release as the presser foot drops to hold the fabric, and all return for the next stitch.

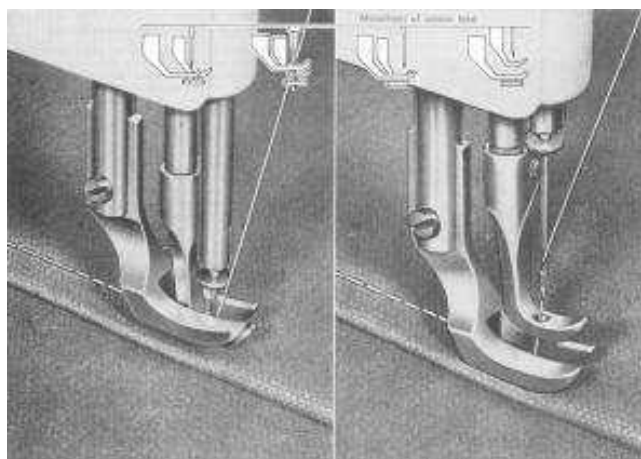

Fig 13.8

- \* This term is used in two different ways.
- \* One usage of this term is its application to any of two or more feed systems working in combination.
- \* A second usage of this term is to describe the uncommon feed system of a vibrating presser foot or alternating presser feet, along with needle feed, and a drop feed or feed dog, working in combination, but operating from a one-piece frame. The frame extends from the presser foot/needle feed mechanism, through the machine casting, to the drop feed/feed dog. This is the only system, when in good repair, where it is impossible for the upper and lower feed mechanisms to become out of synchronization. All other feed systems are synchronized by linkage or by electronic control.

#### 13.4.7 PULLER, ROLLER FEED

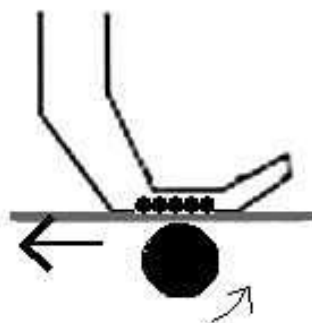

Fig 13.9

Wheel Feed utilizes a roller that advances the fabric one stitch length at a time, in a ratcheting motion. The presser foot has small rollers to permit easy movement. Wheel feed is used when the material being sewn would be damaged by tooth feeders. Examples are vinyl plastic and some leather products

- \* A rotary wheel with a movement in the direction of feed.
- \* Incorporates a friction surface or clamping surface that feeds or assists in feeding the goods.
- \* Has either an intermittent motion or a continuous motion.
- \* Continuous motion wheel feed must work in unison with a needle feed.

#### **Upper and lower wheel feed.**

- \* Wheel feed system where an upper and lower wheel is both driven.
- \* The material is fed between the wheels.
- \* There is positive feeding pressures both the top and bottom of the material at the same time.

#### **13.4.8 CUP FEED**



Fig 13.10

Cup Feed fig 13.10 utilizes one or two cup shaped wheels that pinch the edge of the material, permitting the needle to sew across the edge of the material. Often called a "fur machine", as this machine is ideal for sewing the narrow strips together to create a fur coat.

#### **13.5 LET US SUM UP**

Most sewing machines using feed dogs can pull fabric forwards or backwards at various stitch lengths; this is typically controlled by a stitch lever on the front of the machine. Feed dogs are the feeder mechanism which is typically used to pull fabric through a sewing mechanism.

The type of motion used (forward, then down, then backwards, then up) serves to pull the fabric through, since the "dogs" are in contact with the material on the forward stroke, and are pulled down below the main plate on the backward stroke by the sewing machine's mechanism. The result is that, between stitches, the fabric is pulled along in discrete steps.

### **13.6 LESSON END ACTIVITIES**

The students may do the following activities based on this lesson

- Analyze and check your machine pressure foot and feed mechanisms
- collect various type and shape of presser foot

### **13.7 POINTS FOR DISCUSSION**

Here the students are asked to discuss about the following points

- How to alter the amount of presser act on the fabric based on the fabric types
- Function of feed mechanisms

### **13.8 REFERENCES:**

- Practical Clothing construction- part 1 & 2, Mary Mathews, Cosmic press.
- The complete book of sewing, by Dorling Kindersley, Dorling Kindersley L.t.d...
- Readers Digest Sewing Guide, The Readers Digest Association
- The technology of Clothing Manufacturing, Harold Carr and Barbara Latham.

## LESSON – 14: SPREADING

### CONTENTS

- 14.0 AIM AND OBJECTIVES
- 14.1 INTRODUCTION
- 14.2 SPREADING
- 14.3 THE REQUIREMENTS OF THE SPREADING PROCESS
- 14.4 METHODS OF SPREADING
  - 14.4.1. Spreading by hand
  - 14.4.2 Spreading using a traveling machine
- 14.5 LET US SUM UP
- 14.6 LESSON END ACTIVITIES
- 14.7 POINTS FOR DISCUSSION
- 14.8 REFERANCES

### 14.0 AIM AND OBJECTIVES

After going through this unit, you should be able to have a clear idea of the following

- Number of plies of fabric made by spreading.
- Requirement and the methods of spreading process.

### 14.1 INTRODUCTION

The most important department of the garment industry is discussed here, i.e. the heart of the department in a garment industry is cutting. In this cutting department spreading play a vital role. When compare to cutting the high dwell time of fabric is consumed by this spreading. Once we made a quick spreading we can pass the material to the next department quickly.

Spreading machines can be classified by application, semi- or fully automated threading methods, as well as fabric feeding methods. Various loading devices, air cushion tables and conveyor zed transfer tables can be combined to automate the entire process from loading, spreading, to cutting and off-loading.

### 14.2 SPREADING

The objective of spreading is to place the number of plies of fabric that the production planning process has dictated, to the length of the marker plan, in the colours required, correctly aligned as to length and width, and without tension. There are a number of prices to be paid for this saving in the rime and cost of cutting and the cost of materials.

First, the spreading of multi-size lays of many plies demands strongly constructed tables, usually with steel legs and braced frames, a heavy laminated, smooth wood top, and sometimes centre legs. A 10 meter lay of shirting fabric with 200 plies can weigh up to 600kg and with

150cm wide fabric can exert a downward pressure of up to approximately 40kg per square meter on the table surface. The table may also bear the weight of a spreading machine, traveling on steel rails at the edge of the table. The type of table surface is critical for the spreading and cutting operations.

Second, spreading is itself a time-consuming operation. With the highest lays it can consume more time in total than cutting, especially if the cutting is by computer-controlled knife. Just as with the marking and cutting operations, the efforts of engineers have produced sophisticated equipment designed to reduce spreading time and make the operation more automatic.

A study of spreading must include the following considerations:

1. the requirements of the spreading process
2. methods of spreading
3. The nature of fabric packages.

### **14.3 THE REQUIREMENTS OF THE SPREADING PROCESS**

Spreading must achieve a number of specific objectives:

#### **1. Shade sorting of cloth pieces**

Lays commonly require more than one roll of cloth and lays which include several colours normally require more than one roll of each colour to achieve enough plies in total. It is likely that cloth pieces that are nominally the same colour will have been dyed separately and are not an exact shade match. A garment made from parts cut from these different pieces would be likely to show a shaded effect between its different panels. Thus when deliveries of a number of rolls of cloth of the same colour are received, they should be sorted into batches such that shade differences between them are undetectable.

#### **2. Correct ply direction and adequate lay stability**

These two factors must be considered together as the opportunities for achieving them are related. They depend on fabric type, pattern shape and the spreading equipment that is available.

Methods of spreading which lay alternate plies in different directions can only be used for either way fabrics. In this case the pattern pieces can face in either direction in the marker and the following opportunities are available:

- a) For symmetrical pattern pieces, and fabric which is suitable spread face to face, the fabric can be spread along face up and immediately back again face down.
- b) For symmetrical as well as asymmetrical pattern pieces, and fabric which is stable spread all the same way up, the fabric can be spread along and immediately back again but the roll must be turned on a turntable before returning.
- c) For asymmetrical as well as symmetrical pattern pieces, and fabric which is stable all the same way up, the spreader spreads in one direction only and 'dead heads' back to spread the next ply in the same direction.
- d) For symmetrical pattern pieces, and fabric which is stable face to face, the spreader spreads in one direction only but after 'dead heading' back, a turntable is required to rotate the roll before the next ply is spread in the same direction.

**(3) Alignment of plies:**

Every ply should comprise at least the length and width of the marker plan, but should have the minimum possible extra outside those measurements.

**(4) Correct ply tension**

If the plies are spread with too slack a tension they will lie in ridges with irregular fullness. If plies are spread in a stretched state they will maintain their tension while held in the lay, but will contract after cutting or during sewing, thus shrinking the garment parts to a smaller size than the pattern pieces. In a non-stretch fabric practically all elongation of the fabric occurs in such a manner that rapid relaxation and recovery ensues.

**(5) Elimination of fabric faults**

Fabric faults (flows, holes, stains, etc.,) may be identified by the fabric supplier, and additional faults may be detected during examination of the fabric by the garment manufacturer prior to spreading.

**(6) Elimination of static electricity**

In spreading plies of fabric containing man-made fibres, friction may increase the charge of static electricity in the fabric. Friction may be reduced by changing the method of threading the fabric through the guide bars of the spreading machine. Humidity in the atmosphere of the cutting room may also be increased, thus allowing the static electricity to discharge continuously through the atmosphere.

**(7) Avoidance of distortion in the spread**

A layer of glazed paper, laid glazed side down, is normally placed at the bottom of the spread. This helps to avoid disturbing the lowest plies of material in the spread when the base plate of a straight knife passes underneath, and also gives stability to the lay if it is to be moved on a flotation table. In addition, it prevents snagging of the fabric on the table surface which often becomes roughened with use.

**(8) Avoidance of fusion of plies during cutting**

Cut edges of thermoplastic fibre fabrics may fuse together during cutting if the cutting knife becomes hot as a result of friction with the fabric. In this case, anti-fusion paper may be used in the same way as interleaving paper. It contains a lubricant which lubricates the knife blade as it passes through the spread, thus reducing the increase in temperature of the blade arising from friction.

## **14.4 METHODS OF SPREADING**

The methods of spreading which the industry uses can be divided into:

1. Spreading by hand
2. Spreading using a traveling machine

\* classified by application

- Semi automatic
- Fully automatic

### 14.4.1. SPREADING BY HAND

It is time-consuming method, requiring an operator at each side of the table. the fabric is drawn from its package which, if it is a roll, may be supported on a frame, and carried along the table where the end is secured by weights or a clamp. The operators work back from the end, aligning the edges and ensuring that there is no tension and that there are no wrinkles. The ply is normally cut with hand shears or with a powered circular knife mounted on a frame, though a few fabrics are ripped at the end of the ply to discover the exact weft grain and enable some straightening of a slightly crooked fabric to take place. Typical fabrics which must be spread by hand are checks, crosswise stripes and other regularly repeating patterns, as well as those with a repeating design at intervals of a permanent length. If accurate 'stacking up' of the design vertically through the spread is necessary, the fabric may be 'spiked' on to a series of sharp spikes set vertically on the spreading table.

### 14.4.2 SPREADING USING A TRAVELING MACHINE

Spreading machines carry the piece of fabric from end to end of the spread, dispensing one ply at a time onto the spread. Their basic elements consist of a frame or carriage, wheels traveling in guide rails at the edge of the table, a fabric support, and guide collars to aid the correct unrolling of the fabric. In the simpler versions, the operator clamps the free end of fabric in line with the end of the spread, pushes the spreader to the other end, cuts off the ply in line with that end, clamps the beginning of the next ply, pushes the spreader to the other end and so on.

More advanced spreading machines fig 14.1 may include a motor to drive the carriage, a platform on which the operator rides, a ply-cutting device with automatic catcher to hold the ends of the ply in place, a ply counter, an alignment shifter actuated by photo-electric edge guides, a turntable, and a direct drive on the fabric support, synchronized with the speed of travel, to reduce or eliminate tension in the fabric being spread.



Fig 14.1



The advent of microprocessor control has enabled the development of more automatic functions on spreading machines. Thus a spreader can be pre-set to a selected number of plies, emitting an audible signal when it has reached the selected number or has come to the end of a piece of fabric. Automatic turn tabling gives automatic spreading even for corduroys which are normally spread face to face. With robotic spreading, when the piece is finished, the spreader returns to an auto-lifter at the end of the table, transfers the empty centre bar to the lifter which then advances the next piece to the spreader. It repeats the process until it achieves the required number of plies. This method requires automatic sensing of previously marked flaws and damages.

#### **14.5 LET US SUM UP**

Lying of fabric is called as spreading. We can say this sentence very simple. But the spreading operation is not a simple one. We have to consider lot of aspects before and during spreading. That and all are discussed in this lesson elaborately. Here we deal the requirement of spreading the direction of plies.

The different methods are available. Already we discussed the required for spreading is higher than the cutting. To meet the high speed of material flow, we have to recommend some modern machinery.

#### **14.6 LESSON END ACTIVITIES**

The students may do the following activities based on this lesson

- Visit any garment industry and analyze the role and importance spreading

#### **14.7 POINTS FOR DISCUSSION**

Here the students are asked to discuss about the following points

- Factors influencing the length and width of the spread
- Factors influencing the height of the lay
- Requirement of spreading
- The various methods of spreading

#### **14.8 REFERENCES:**

- The technology of Clothing Manufacturing, Harold Carr and Barbara Latham.
- Clothing Technology, Europ Lehrmilied, Vollmer GmbH & Co.

## LESSON – 15: CUTTING

### CONTENTS

- 15.0 AIM AND OBJECTIVES
- 15.1 INTRODUCTION
- 15.2 CUTTING
- 15.4 METHODS OF CUTTING
  - 15.4.1 Hand shears
    - 15.4.1.1 Cutting tools and equipments
  - 15.4.2 Straight Knife Cutting Machine
  - 15.4.3 Band Knife Cutting Machine
  - 15.4.4 Round Knife Cutting Machine
  - 15.4.5 Die Cutters
  - 15.4.6 Notches
  - 15.4.7 Drills and Thread Marker
  - 15.4.8 Computer Controlled Cutting
- 15.5 LET US SUM UP
- 15.6 LESSON END ACTIVITIES
- 15.7 POINTS FOR DISCUSSION
- 15.8 REFERANCES

### 15.0 AIM AND OBJECTIVES

After going through this unit, you should be able to have a clear idea of the following

- The term cutting and its use.
- Different cutting tools and equipments.
- Several possible types cutting process and methods.

### 15.1 INTRODUCTION

Cutting is the word is very important in our garment industry and it is not only used for cut the fabric. Once we are not maintain or not having proper control in this word of cutting i.e. cutting room, it will cut the industry profit.

In garment industry, heart of the department is cutting. This is the only place we can control the fabric consumption per garment and we can save the fabric.

All industry the raw materials play a vital role and it consumed major part of in cost of production. Once we reduce the raw material cast the profit will increased. The raw material for garment industry is fabric. Reducing the amount of fabric used per garment will increase the profit.

## 15.2 CUTTING

The use of the term cutting can present a difficulty. It is used in the sense of ‘cutting room’, an area which normally includes the activities of marker planning, spreading and preparation for sewing, as well as being used to refer to the actual cutting out of garment parts from the lay.

### 1. Precision of cut

Garments cannot be assembled satisfactorily, and they may not fit the body correctly, if they have not been cut accurately to the pattern shape. The ease with which accuracy is achieved depends on the method of cutting employed and in some cases on the marker planning and marker making. In manual cutting using a knife, accuracy of cut, given good line definition, depends on appropriate, well maintained cutting knives and on the skill and motivation of the cutter. In both the cutting and computer-controlled cutting, the achievement of accuracy comes for the equipment.

### 2. Clean edges

The raw edge of the fabric should not show fraying or snagging. Such defects come from an imperfectly sharpened knife.

### 3. Unscorched, unfused edges

The build-up of heat in the knife blade comes from the friction of the blade passing through the fabric. This, in extreme cases, leads to scorching of the fabric and, more frequently, to the fusing of the raw edges of thermoplastic fibre fabrics, such as those containing polyamide or polyester. The cutter cannot separate individual plies from the pile of cut parts. Forced separation causes snagged edges, and, on any case, the hard edge is uncomfortable in wear. Solutions to this problem lie in a well-sharpened blade, a blade with a wavy edge, the use of anti-fusion paper during spreading, spraying the blade and reducing the height of the lay.

### 4. Support of the lay

The cutting system must provide the means not only to support the fabric but also to allow the blade to penetrate the lower ply of a spread and sever all the fibres.

### 5. Consistent cutting

The cutting system should not be limited in the height or plies it will cut, because of progressive deterioration in cutting quality, though there may be mechanical or human reasons, such as topping or leaning, for the height of lay being limited.

## 15.3 METHODS OF CUTTING

Majority of cutting rooms today, the cutting process makes use of hand shears, a mechanized knife blade in one of several possible types, or a die press which stamps out the garment shapes.

1. Hand shears
2. Straight knife
3. Band knife
4. Round knife

5. Die cutters
6. Notches
7. Drills and thread marker
8. Computer control cutting knife
9. Laser cutting
10. Plasma cutting
11. Water jet cutting
12. Ultrasonic cutting

### 15.3.1 HAND SHEARS



Fig 15.1

Hand shears fig 15.1 is normally used when cutting only single or double plies. The lower blade of the shears passes under the plies, but the subsequent distortion of the fabric is only temporary and accurate cutting to the line can be achieved with practice. Left-handed shears are available since the cutting line will not easily be seen if right-handed shears are used by a left-handed person. This method is flexible enough to accommodate any fabric construction and pattern shape. The obvious disadvantage of any method lies in the time it consumes and the consequent high labour cost per garment, but it appropriate for made-to-measure garments.

#### 15.3.1.1 CUTTING TOOLS AND EQUIPMENTS

##### 1. Scissors

These have round handles and the blades are usually less than 6 inches. They are designed mainly for snipping thread and trimming seams. However, scissors with 5 inch blade can be used by beginners for cutting fabric as well. For embroidery and for cutting button holes sharp pointed scissors with blades  $\frac{1}{2}$  inch to one inch long are very useful . the best types of scissors have blades of uneven width. They should be held so that the wider blade is above the narrower blade.

##### 2. Dress maker's shears

For cutting fabric, shears are more satisfactory than scissors. Shears differ from scissors in that they have one small ring handle for the thumb and a large ring handle for the second, third and fourth fingers. They also have longer blades (6 to 12 inches). It is better to select bent-handled shears made of high quality steel and having blades joined with a bolt or screw rather than a rivet. Take good care of your shears and use them only for cutting fabric. Do not drop them or leave them out to rust.

### 3. Pinking Shears

These are useful for finishing the edges of seams and other raw edges of fabric. They produce a notched (zigzag) cutting line which prevents raveling of firmly woven fabrics. Pinking gives a neat appearance to the inside of garments.

### 4. Buttonhole scissors

These can be adjusted so as to cut buttonholes in any size you require. They are useful if you are an expert in tailoring and need to make many buttonholes.

### **15.3.2 STRAIGHT KNIFE CUTTING MACHINE:**

The Straight knife cutting machine fig 15.2 & fig 15.3 consists of a base plate, an up right stand to hold the vertical blade, motor, a handle for moving assembly, a sharpening device and a handle to transfer the whole assembly from one place to another.

Two kinds of power are required to operate a straight knife. Motor power drives the reciprocating blade and operator power drives the knife through the lay. Normally the available blade heights vary from 10 cm to 33 cm and normally available strokes vary from 2.5 to 4.5 cm. The greater the blade movement the faster the blade cuts the fabric and more easily the operator can move the machine.

The most important consideration is selecting a straight knife is the power required from the operator to move the knife is the power required for the operator to move the knife through the lay. Operator effort is affected by the weight of the motor, the shape of the stand, handle height, stroke, sharpness of blade and the base plate movement.

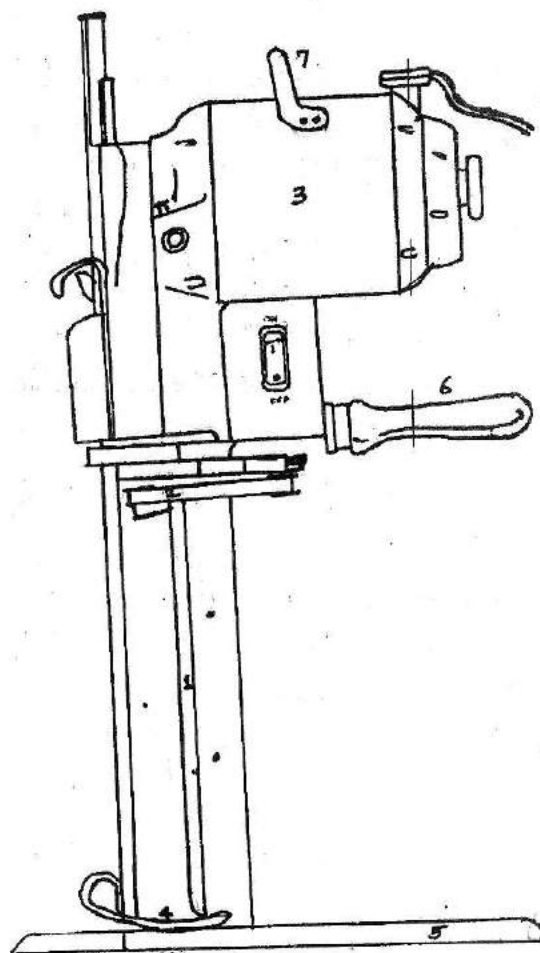

1. Knife
2. Sharpener
3. Motor
4. Fabric Presser
5. Base Plate
6. Moving Handle
7. Transport Handle

Fig 15.2

The normal blade has a straight edge that varies from coarse to fine depending upon the type of fabric being cut. Wavy edged knives are used to reduce the heat generation and hence can be used for cutting synthetic materials without fusing difficulties. The speed of the blades can also be adjusted by having variable speed mechanism.



Fig 15.3

The straight knife is a common means of cutting lays in conventional cutting rooms because it is versatile,, portable, chapter than a band knife and easy to maintain. Even if a band knife is used for main cutting operation, a straight knife will be used to separate the lay into sections for easier handling.

### 15.4.3 BAND KNIFE CUTTING MACHINE

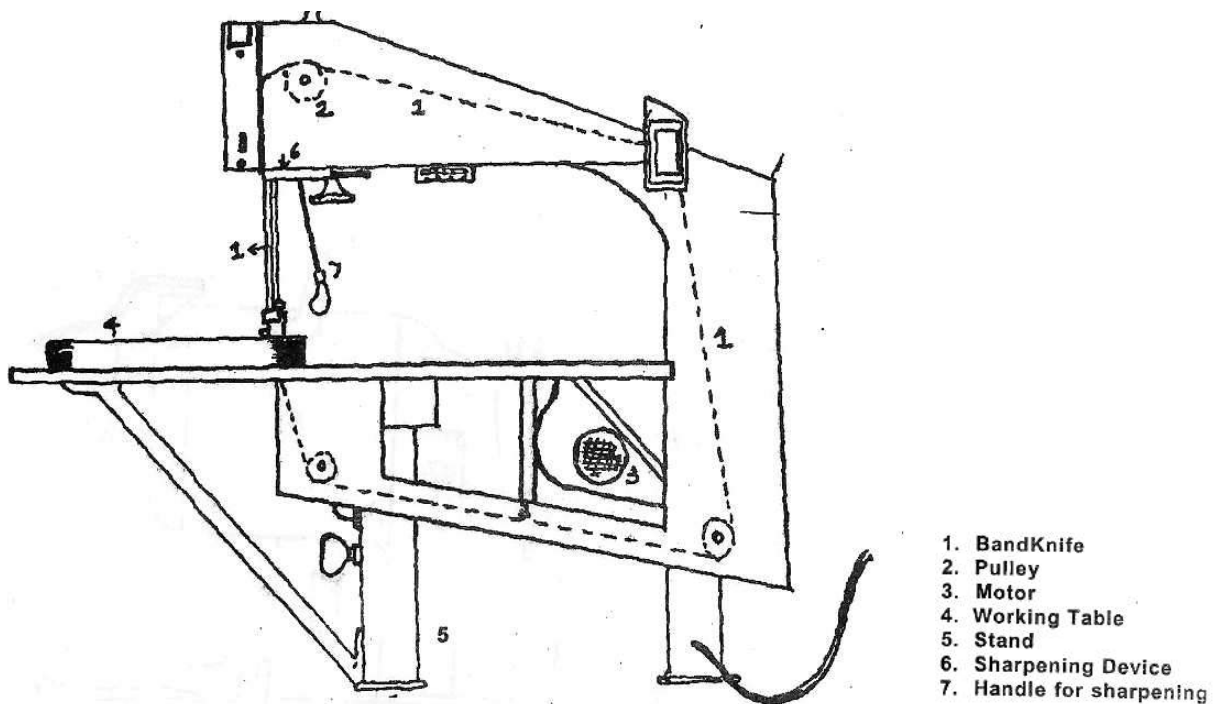

Fig 15.4

A band knife comprises a series of three or more pulleys powered by an electric motor. With a continuously rotating steel blade mounted on them, one edge of the blade is sharpened. The principle of operation is different from a straight knife, in that the band knife passes through a slot in the cutting table, in a fixed position and the section of lay to be cut is moved past it. The blade is usually narrower than on a straight knife.

Band knives fig 15.4 are used when a higher standard of cutting accuracy is required that can be obtained with a straight knife. Space must be left around garment parts when marking so that they can be cut from the lay using a straight knife and then cut exactly using the band knife.

When small parts such as collars, cuffs and pockets are cut, a template of metal or fibre board in the shape of the pattern piece may be clamped to the section of lay on top of the marking which is then drawn past the band knife blade, cutting exactly along the hard edge. Band knife cutting machines are used more in men's wear than in women's wear and are often used to cut large garment parts such as the large panels of jackets and over coats.

#### 15.4.4 ROUND KNIFE CUTTING MACHINE



Fig 15.5

The elements of a Round knife cutting machine fig 15.5 are a base plate, above which is mounted an electric motor, a handle for the cutter to direct the blade, and a circular blade rotating so that the leading edge cuts downwards into the fabric. Blade diameters vary from 6 cm to 20cms. Round knives are not suitable for cutting curved lines in high lays because the blade does not strike all the plies simultaneously at the same point as a vertical blade does. Therefore a round knife is used only for straight lines or lower lays of relatively few plies. It is naturally much more difficult for a circular blade to cut a tight curve, such as an armhole.

#### 15.4.5 DIE CUTTERS

In contrast to the fast-moving blades used in the methods of cutting previously described, die cutting involves pressing rigid blade through the lay of fabric. The die (called a clicker in the shoe industry) is a knife in the shape of a pattern periphery, including notches. One or more tie



bars secure its stability. Free standing dies generally fall into two categories. They can be of strip steel, manufactured by bending the strip to the shape required and welding the joint. These cannot be sharpened and must be replaced when worn. Alternatively, they can be heavier gauge, forged dies which can be re-sharpened but which are about five times the price of strip steel. The position of the tie bars determines the depth of cut which is generally greater with forged dies.

Free standing dies cut the small parts of larger garments such as collars and trouser pocketing or the parts of smaller garments such as bras. They can also be used for part of a larger garment part, such as the neck area, of a coat front. They provide a high standard of accuracy of cutting but, because of the cost of the dies, they are only appropriate to situations where large quantities of the same pattern shape will be cut. Die cutting also offers much faster cutting than knife cutting for the same depth of cut. It is proportionally more economic for small parts which have a greater periphery in relation to their area than do large parts. In addition, the level of accuracy demanded of small parts is not only greater but correspondingly more difficult to achieve with conventional knives.

The die press generally has a cutting arm supported by a single pillar at the back of the machine; it swings to the side to allow the placing of dies on top of the fabric. The downward cutting stroke of the press should be so controlled that the edge of the die just penetrates the cutting pad or surface in order that the fibres of the lowest ply are completely separated. Die presses are of two types: impact, which makes a single press on the die, and, more commonly, hytronic (hydraulic and electronic) which exerts continuous pressure on the die until it has cut the fabric and made contact with the soft metal or nylon pad. Once the pad, after repeated cutting, reaches an unsatisfactory state of wear, its surface is re-cut and re-levelled.

For die cutting, the spreader spreads a lay to the required number of plies and may place a marker on top to guide the placement of dies. The spread is cut into sections to allow transport to the cutting pad. In some cases, no marker is used, the operator placing the dies by eye to the correct grain line and as close together as this method allows.

One important disadvantage of die cutting is its greater use of fabric. When the die press forces the dies through the fabric it also forces a narrow wedge of fabric between the dies. The narrow wedge exists because the sharpened cutting edge of the die is necessarily of narrower gauge than the top of the die. Thus if dies are butted together, they touch at the top but show a small gap at the level of the cutting edges. The action of the press will compress this narrow wedge of fabric to the point where it will rupture the dies. Hence it is necessary to leave a significant gap between two dies, say 2 to 3 mm. Similarly a single die will not cut satisfactorily if placed closer than 3 to 4 mm to a previously cut edge.

Large area die cutting presents a number of technical problems. A complete lay of free dies several meters long on top of the fabric could be cut by a twin pillar or four pillar press extending across the lay. For economic and engineering reasons the depth of the press is limited.

### **15.4.6 NOTCHES**

Many garment parts require that notches are cut into the edges of them to enable alignment during sewing with other garments parts. The previous four methods of cutting can be used to cut notches, but accuracy depends of the operator. Specialized notching equipment provides greater accuracy because a guide lines up the notcher with the cut edge to give consistent depth of notch at a consistent right angle to the edge. Both straight notches and vee notches are available. A further machine, the hot notcher, incorporates a heating element in order that the blade may slightly scorch the fibres adjacent to the notch in order to prevent it fraying and disappearing. This cannot be used with thermoplastic fibres or certain unlined garments. One fabric requiring it may be loosely woven tweed.

### **15.4.7 DRILLS AND THREAD MARKER**

Where reference marks are needed away from the edge of a garment part, such as for the position of pockets, darts and similar features, a hole is often drilled through all the plies of fabric on the lay. The drill mounting includes a motor, a base plate with a hole to allow the drill to pass through, and a spirit level to ensure that the base is horizontal and hence the drill vertical. On many fabrics the drill is used cold and the hole remains visible until the sewing operator comes to use it. On looser weave fabrics, where the hole may close up, a hot drill is used, which will slightly scorch or fuse the edges of the hole.

A hypodermic drill may also be used which leaves a small deposit of paint on each ply of fabric. If it is important that no mark remains on the fabric, a long thread may be passed through the lay which is then cut with scissors between each ply, leaving a few centimeters visible on each garment panel. All drill holes must eventually be concealed by the construction of the garment.

### **15.4.8 COMPUTER CONTROLLED CUTTING**

This methods provides the most accurate possible cutting, at high speed, and to keep the larger systems fully occupied they are frequently used in a central cutting facility that supplies an umber of separate sewing factories. Increasingly, though smaller, cheaper systems are being developed which are suitable for companies wanting to cut lower lays of smaller quantities of garments and these are appropriate for a single-factory operation.

A typical computer system has a table with cutting surface consisting of nylon bristles which support the fabric lays but are flexible enough to permit penetration and movement of knife blade which is supported only at the top. The bristles also allow the passage of air through the table to create a vacuum, reducing the height of the lay and holding it in place. The carriage supporting the cutting head has two synchronized servo-motors which drive it on tracks on the edges of the table. A third servo-motor positions the cutting head on a beam across the width of this carriage. These two movements are co-ordinate to give a knife position at any point on the table. The cutting head contains a knife, automatic sharpener and a further servo-motor which rotates the knife to position it at a tangent to the line of cut on curves. A further facility controls the deflection of the knife which inevitably occurs on curves by adjusting the angle to equalize

the pressure on each side of the blade. This ensures accurate cutting through all layers. A sheet of airtight polyethylene covers the top of the lay which assists the creation of a vacuum and allows significant compression of the lay. A control cabinet houses the computer and the electrical components required to drive the cutter, its carriage and the vacuum motor.

The spreader spreads the lay on a conventional cutting table equipped with air flotation. Paper is spread below the bottom ply so that the lay can be moved onto the cutting table without distortion and so that the bottom plies are supported during the cutting operation. This paper is performed to enable the vacuum on the cutting table to operate to compress the lay.

After loading the disc into the computer, the operator positions the cutting head's origin light over the corner of the spread. This provides the computer with a reference point. A lift and plunge feature enables the knife to negotiate sharp corners and straight or vee-shaped notches can also be cut. A motorized drill behind the cutting head can provide drill hole as required. Different system is available which are designed to cut different heights of compressed plies. The maximum height is usually 7.5 cm when compressed, with the height before compression and hence the number of plies, being dependent on the nature of the fabric.

Different arrangement of cutting room tables is possible, but they must allow for the fact that in this situation the cutting process takes very much less time than spreading and somewhat less time than bundling. A typical arrangement would consist of four spreading tables supplying each cutting table. The cutting table and its carriage and cutting head is able to move between the spreading tables by means of tracks on the floor and has, beyond it, four bundling tables onto which the cut garments are moved.

### **15.5 LET US SUM UP**

As we discussed above in this lesson each cutting has its own merits and demerits. Some equipment like drills and thread marker and notches are used for special applications. Now days there are variety of methods provides the most accurate possible cutting. Not only the computerized cutting machine, there are some ultra modern machines are available. Laser cutting machine, plasma cutting machine water jet cutting machine are the few example for it

### **15.6 LESSON END ACTIVITIES**

The students may do the following activities based on this lesson

- Visit any garment industry and analyze the role and importance of cutting

### **15.7 POINTS FOR DISCUSSION**

Here the students are asked to discuss about the following points

- Role of cutting department in a garment industry
- The modern developments in cutting equipments

### **15.8 REFERENCES:**

- The technology of Clothing Manufacturing, Harold Carr and Barbara Latham.
- Clothing Technology, Europ Lehrmilied, Vollmer GmbH & Co.

## UNIT – V

### LESSON – 16: MARKING

#### CONTENTS

- 16.0 AIM AND OBJECTIVES
- 16.1 INTRODUCTION
- 16.2 THE MARKER
- 16.3 THE REQUIREMENTS OF MARKER PLANNING
  - 16.3.1. The nature of the fabric and the desired result in the finished garment
  - 16.3.2 The requirements of quality in cutting
  - 16.3.3 The requirements of production planning
- 16.4 EFFICIENCY OF THE MARKER PLAN
- 16.5 METHODS OF MARKER PLANNING AND MARKER
  - 16.5.1 Manual marker planning with full size patterns
    - 16.5.1.1 Marker duplicating
  - 16.5.2 Computerized marker planning
- 16.6 LET US SUM UP
- 16.7 LESSON END ACTIVITIES
- 16.8 POINTS FOR DISCUSSION
- 16.9 REFERENCE

#### 16.0 AIM AND OBJECTIVES

After going through this unit, you should be able to have a clear idea of the following

- The methods of marker planning and the way of preparing the marker.
- Factors to consider while marker planning.
- Importance and marker efficiency

#### 16.1 INTRODUCTION

The amount of fabric consumed per garment and the total profit of the garment unit is decided by the marker planning and marker making. The length and width of the marker is very important here. Based on this marker only the spreading length will decide. The fabric consumption and fabric wastages all are depends on this marker making. Once we got a very good marker efficiency, reduction in fabric cost.

## 16.2 THE MARKER:

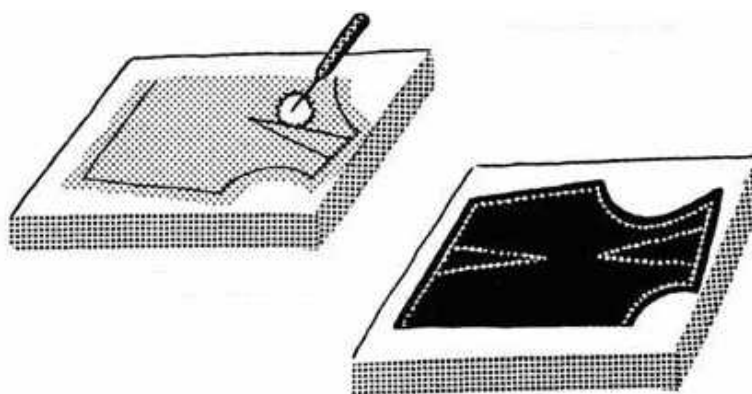

Fig 16.1

It is useful to break marker making down into:

- **Marker planning**, or the placement of pattern piece to meet technical requirements And the needs of material economy, and
- **Marker utilization**, which may include drawing the marker plan directly onto fabric, drawing it onto a paper marker by pen or automatic plotter, or, where the cutting method allows it, recording pattern piece information on the paper marker or on the fabric without actually drawing pattern lines on it. Provision may have to be made for the same marker plan to be used many times.

## 16.3 THE REQUIREMENTS OF MARKER PLANNING

The industry has always paid great attention to marker planning, because when the cutting room cuts cloth it spends around half the company's turnover. Any reduction in the amount of cloth used per garment leads to increased profit.

Marker planning is a conceptualizing, intuitive, open and creative process, in contrast to making up a jigsaw puzzle, which is an analytical, step-by-step and closed process. There is no final solution to a marker planning problem, only a more tightly packed and therefore shorter marker the more time is spent on it. The work of the marker planner is subject to a number of constraints. These relate to:

1. the nature of the fabric and the desired result in the finished garment;
2. the requirements of quality in cutting;
3. the requirements of production planning

### 16.3.1. The nature of the fabric and the desired result in the finished garment

#### (a). Pattern alignment in relation to the grain of the fabric

Pattern pieces normally carry a grain line. When pattern pieces are laid down the piece of cloth, as is commonest with large pattern pieces, the grain line should lie parallel to the line of the warp in a woven fabric or the Wales in a knitted fabric. Where pattern pieces are laid across the piece, the grain line should lie parallel to the weft or course direction. In bias cutting, which is often used in large pattern pieces as part of the garment style in ladies dresses and lingerie, as

well as in small pattern pieces such as satisfactory garment assembly, the grain lines will (normally) be at 45° to the warp.

**(b). Symmetry and asymmetry**

Many fabrics can be turned round (though 180o) and retain the same appearance and these are designed ‘either way’ or ‘symmetrical’. They require no special action on the part of the marker planner. More restricting are fabrics known as ‘one way-either way’ or ‘asymmetrical’. In this case, if a fabric ply is turned round it does not retain the same appearance, especially when the two opposite ways are sewn together.

**(c). The design characteristics of the finished garment**

For example, if a vertical stripe does not show a complete mirror image repeat, the right and left sides of a garment may be designed to be mirror images of each other. In this case, a marker is planned which uses a half set of patterns, and the required effect is created in the spreading of the fabric which places pairs face to face.

**16.3.2 THE REQUIREMENTS OF QUALITY IN CUTTING**

- a. For the majority of cutting situations where a knife blade is used, the placements of the pattern pieces in the marker most give freedom of knife movement and not restrict the path of the knife so that it leads to inaccurate cutting. A blade, which has width has width cannot turn a perfect right angle in the middle of a pattern piece and space must always be allowed for a knife to turn such corners. Also, in practice, a curved part of a pattern such as a sleeve head, when placed abutting a straight edge, leads to either a shallow gouge in the straight edge or the crown of the curve being straightened. The amount of space which must be left will depend on the actual cutting method employed.
- b. Correct labeling of cut garment parts is essential if, in sorting and bundling a multi-size lay after cutting, operators are to identify correctly the parts which make up whole garment sizes. It is the responsibility of the marker planner to code every pattern piece with its size as the marker is planned.

**16.3.3 THE REQUIREMENTS OF PRODUCTION PLANNING**

When an order is placed for a quality of garments, it normally specifies a quantity of each size and colour, the former often given as a ratio. The requirements of production planning and control will be to supply the sewing room with an adequate amount of cut garments at sufficiently frequent intervals, consistent with availability of fabric and the best utilization of cutting room resources. Among the latter considerations is that, for a given quantity of garments, a high lay rather than a low lay gives a lower cutting labour cost per garments. The higher lay will, of course, also be shorter, giving a lower overall cutting time which is important if the sewing room requires the cut work urgently. The shorter lay will also require a shorter marker.

**16.4 EFFICIENCY OF THE MARKER PLAN**

The marker planner measures his success by the efficiency of the marker plan created. A formula describes this:



$$\frac{\text{Area of patterns in the marker plan}}{\text{Total area of the marker plan}} \times 100 \%$$

Since the reduction in fabric cost is so important, the company expects the planner to discover opportunities for improvements in marker efficiency by suggesting alterations to patterns and cloth, the two elements brought together in market planning. The first sort of opportunities is commonly designated pattern engineering. Chief among these is an examination of seam location to ensure the best possible placement of patterns in the marker. In one case the shift of a seam might allow the placement of small parts in areas otherwise wasted, for instance in the armhole of a jacket or shirt lying next to the edge of a marker. In another case the seam is moved to enable the better placement of large panels across the whole width of the fabric.

The second sort of opportunity arises in the influence the marker planners has on the selection of fabric widths where a choice is available. The 'best' width depends among other factors on the costs of various fabric widths per square meter, the typical number of sizes in a marker, the potential pattern engineering changes at various widths and the marker efficiency of a series of test markers.

## 16.5 METHODS OF MARKER PLANNING AND MARKER

The **methods of marker** are basically classified in to two categories.

1. Manual marker
2. Computerized marker

But say about, the **marker type** can be classified in to two types.

- i) Paper marker
- ii) Fabric marker

### 16.5.1 MANUAL MARKER PLANNING WITH FULL SIZE PATTERNS

Prior to the development of computerized marker planning systems, all markers were planned by working with full size patterns. For many companies in the industry this method is still used, because the more modern alternatives are expensive, and because these companies make only short or single size markers and the planner can see the whole of the plan relatively easily. The planner works by moving around the full size patterns until a satisfactory plan is obtained.

In a few clothing companies this planning is done directly on the fabric to be cut and the pattern shapes marked in immediately. This can only be done when the length of the marker is predictable and in marking directly onto fabric, the necessary accurate reproduction of the pattern and good definition of line can be difficult to achieve. Patterns are usually made from card and it is important that the edges do not become worn and that the pattern is held firmly while drawing takes place. Various chalk or wax materials can be used to draw with but whatever is used needs to be easily held and readily sharpened. The quality of the line also depends on the surface nature of the fabric.

This method takes considerable skill to achieve accuracy and it takes considerable time, but it is economical for single garments and also for check fabric since it allows the patterns to be manipulated during the marking process. In many companies, more than one lay is cut using the same marker plan. If the plan is drawn directly onto the fabric, this process of drawing round the patterns has to be repeated for each lay.

It is much more common for a paper marker to be used for cutting and in this case the pattern lines and style and size information are usually drawn on spot and cross paper to ensure adherence to grain lines. It is still essential that patterns do not become worn but a satisfactorily fine line is easier to achieve than when marking directly onto fabric as a pencil or a ballpoint pen can be used. Again, multiple copies of the paper marker are normally needed. These copies can either be made when the marker plan is first drawn, or the master marker can be reproduced as needed by a variety of methods.

#### **16.5.1.1 MARKER DUPLICATING:**

Again, multiple copies of the paper marker are normally needed. These copies can either be made when the marker plan is first drawn, or the master marker can be reproduced as needed by a variety of methods.

There are different duplicating systems available.

- a) Carbon duplicating:
- b) Spirit duplicating or hectograph carbon system
- c) Diazo photographic method:
- d) Perforator marker

##### **(a) Carbon duplicating**

For copies to be made as the original is drawn, and where small numbers of copies only are needed, use can be made of carbon paper, usually double-sided, or the same effect can be achieved with special NCR-type (no carbon required) paper. In either case, 6-8 copies can be made without too great a deterioration in the fineness of the line.

##### **(b) Spirit duplicating or hectograph carbon system**

In this process, the master marker is drawn on paper with a layer of special hectograph paper underneath it. This paper transfers a blue line onto the back of the master as it is drawn. The master is then used to make one copy at a time in a duplicating machine. The machine uses alcohol to wet a plain white paper which is then passed with the master between two rollers, transferring the lines onto the copy. It is a messy process but many copies can be produced.

##### **(c) Diazo photographic method**

This process makes as many copies of the marker as are needed, one at a time, following the drawing of a master marker. The master marker and a light-sensitive paper are passed under high intensity ultraviolet light and the light-sensitive paper is developed using ammonia vapour. The lines remain visible. It is a clean process which can make unlimited numbers of copies with good



definition but it must be used with ample ventilation to remove ammonia fumes. The paper is expensive but the equipment is comparatively cheap.

#### **(d) Perforator marker**

An alteration method of paper marker is perforator marker from the initial hand-drawn version by means of a punch perforator. This has been used in the clothing industry but is more commonly used for cutting upholstery fabrics.

### **16.5.2 COMPUTERIZED MARKER PLANNING**



Fig 16.2

This method is normally part of an integrated system which includes digitizing or scanning of full-size patterns into the computer, facilities for pattern adaptation, and, by inputting appropriate grade rules, the means to generate all the sizes required. The planner uses a visual display unit with keyboard, tablet and data pen, puck or mouse.

The planner specifies the exact make-up of the marker plan: the width of the fabric, the pattern pieces to be used, the sizes to be included and all constraints to be applied, including any matching of checks. The system produces a marker plan automatically or interactively. Automatic marker planning involves calling up data defining the placement of pieces in markers previously planned, and selecting from a series, that marker conformation which gives the highest marker efficiency.

Interactive marker planning is more common and is the process by which the operator plans markers by interacting directly with the system through a VDU screen. All the pattern pieces are displayed in miniature at the top of the screen. In the middle of the screen are two horizontal lines defining the marker width and a vertical line at the left representing the beginning of the marker. The right end is for the moment open. At the bottom of the screen is written marker identification, with marker length and efficiency constantly updated during the planning process.

A data pen (or puck or mouse), tablet and the computer keyboard are used to manipulate the pattern pieces. A combination of movements of the pen and commands via the keyboard enable pattern pieces to be moved about the screen and positioned in the marker. The system finally positions the pattern pieces precisely according to the marking rules specified. After selecting the most economical marker plan devised in the time available, the computer will provide an accurate piece count, calculate a marker plan efficiency percentage and total the length of the pattern peripheries. When the marker plan is complete, it will be stored in a marker plan file for future retrieval.

The quality of marker planning is more consistent than with manual methods, because instructions regarding grain lines are always followed, because the butting of pattern piece is precise with no overlapping, and the pattern count is automatic, a boon in complex markers.

It is difficult to compare the capital cost of the computer system used in marker planning with the other methods described previously because in all cases the computer system provides a pattern development and grading facility as well. It also enables the reproduction of as many copies of a marker as are required without resorting to additional methods of reproduction such as the manual methods require. However, the fact that the cost of such a package of computer equipment is many times that of a manual marker planning.

After planning the marker on the computer (fig 16.2), the marker planner instructs the computer to plot the marker automatically onto paper.

As an alternative to plotting even this amount of information on a marker, it is possible, when cutting will be by computer-controlled knife, not to plot any of the marker but to attach adhesive labels to the top ply of fabric to give the information necessary to section garment parts into bundles. This saves both the time of plotting and the cost of plotter and paper.

## **16.6 LET US SUM UP**

In marker planning, industry has always paid great attention. Because around half the company's total turnover is based on the cutting room. Any reduction in the amount of cloth used per garment leads to increased profit. For this purpose we are giving great attention for marker planning.

To make quality marker planning, we are creating different opportunities and best possibility of pattern arrangement. When compare to manual marker planning the computerized one give better results.

## **16.7 LESSON END ACTIVITIES**

The students may do the following activities based on this lesson

- Prepare patterns for any one garment and set a marker.
- Visit any one garment unit and go through the methods of creating economic marker
- Discuss the role of marker with the industry persons

## **16.8 POINTS FOR DISCUSSION**

Here the students are asked to discuss about the following points

- Analyze the requirement of marker
- Importance of marker in a garment industry
- The methods of preparing the markers

## **16.9 REFERENCES:**

- The technology of Clothing Manufacturing, Harold Carr and Barbara Latham.
- Clothing Technology, Europ Lehrmilied, Vollmer GmbH & Co.
- Practical Clothing construction- part 1 & 2, Mary Mathews, Cosmic press.
- Fundamentals of textile and their care, Susheela Dantygi, Published by orient Longman L.t.d.
- The complete book of sewing, by Dorling Kindersley, Dorling Kindersley L.t.d..

## LESSON – 17: PRESSING

### CONTNETS

- 17.0 AIM AND OBJECTIVES
- 17.1 INTRODUCTION
- 17.2 PRESSING
- 17.3 THE PURPOSE OF PRESSING
- 17.4 PRESSING EQUIPMENT AND METHODS
  - 17.4.1 Iron
  - 17.4.2 Steam presses
    - 17.4.2.1 Carousel press
    - 17.4.2.2 Trouser pressing
  - 17.4.3 Steam air finisher
  - 17.4.4 Steam tunnel
  - 17.4.5 Pleating
  - 17.4.6 Permanent press
- 17.5 LET US SUM UP
- 17.6 LESSON END ACTIVITIES
- 17.7 POINTS FOR DISCUSSION
- 17.8 REFERANCES

### 17.0 AIM AND OBJECTIVES

After going through this unit, you should be able to have a clear idea of the following

- Contribution pressing and its methods.
- Different purpose of pressing.
- Several type of pressing equipment.

### 17.1 INTRODUCTION

A variety of parts and shapes of garments has to be pressed, neat appearance of garments and thus attractiveness at the point of sale. The creases and crushing occur in garments during its construction by way of handling and transporting.

These problems can be rectified several type of pressing equipment to achieve satisfactory and economical pressing

## 17.2. PRESSING



Fig 17.1

Pressing fig 17.1 makes a large contribution to the finished appearance of garments and thus attractiveness at the point of sale.

### 17.3. THE PURPOSE OF PRESSING

1. To smoothing away unwanted creases and crush marks

In garment manufacture, creases and crushing occur in garments as a result of operator handling and these are particularly bad where garments are handled between operations in bundles, whether tied up tightly or piled on trolleys or in boxes.

2. To make creases where the design of the garment requires them

Creases are obvious design features in trousers, skirts (where a series of creases is often referred to as pleating and some collar styles. Creases are less obvious but still require pressing when they are hems and cuff edges, front edges, top edges of waistbands, pocket flaps and patch pocket edges as well as pressed open seams, which from a pressing point of view are two creases sewn together.

3. To mould the garment to the contour of the body

It is mainly affected in wool or wool-rich fabrics in the types of garment referred to as tailored. This sort of moulding involves two kinds of deformation (together or separate): shrinking and stretching. After moulding it is not possible to unpick the seams and return garment parts to their former flat state.

4. To prepare garments for further sewing

The term 'under pressing' is reserved for pressing operations on partly constructed garments, while top-off-or final pressing is used for completed garments, the actual term varying according to the sector of the industry. The stages at which a garment is under pressed will depend on many factors. It normally takes place when several sewing stages have been completed but are still accessible by the press equipment.

5. To refinish the fabric after manufacturing the garment

Especially during under pressing, the surface of the fabric may be temporarily changed. A common symptom is gloss or glazing, induced by extreme pressure of press or iron in order to

achieve a firm edge or seam. The surface fibres are heavily flattened in such a way as to form a partial mirror.

## 17.4 PRESSING EQUIPMENT AND METHODS

In practice, many companies combine the use of several type of pressing equipment to achieve satisfactory and economical pressing. The following are the different pressing equipments used in garment industry.

- Iron
- Steam presses
- Steam air finisher
- Steam tunnel
- Pleating
- Permanent press

### 17.4.1 IRON

The traditional form of iron, heated by a gas flame inside the metal casting, had its last stronghold in the touching up of men's jackets. Temperature was estimated only by the rate of saliva evaporation from its bottom surface. A damp rag provided moisture wand a piece of linen was the drying agent.

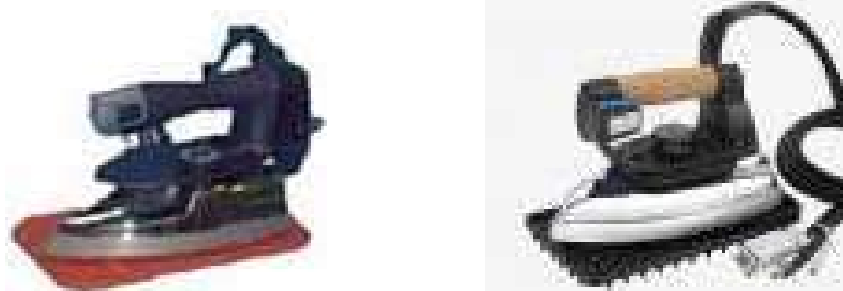

Fig 17.2

The most common type of iron fig 17.2 in general use nowadays is steam electric. The iron is heated by an electric element, controlled by a thermostat, and supplied with steam, either from the factory's main steam supply, or from a small boiler adjacent to the pressing unit. The steam function of the iron is activated by the touch of a button, when a powerful jet of dry steam is produced. At extremes, the weights of irons vary from about 2 to 15 kilos. Several shapes are available including a roughly triangular one similar to a domestic iron, the 'tailor's shape' which has a pointed nose and parallel sides, and a narrow one used for operations such as seam opening on sleeves and trouser legs.

There is a range of workplaces available for ironing. In a situation where a variety of parts and shapes of garments has to be pressed, a simple pressing table, similar in shape to a domestic ironing board, is used. Modern tables have a supply of vacuum to hold the garment in position and dry and set it after ironing. This vacuum facility can also be used as a work aid in the sense

that the term was used earlier. A section of a flat garment part can be held in place while the operator moves the remainder of the part to create a fold or pleat which she then presses. The position of the fold can be marked on the press cover for accuracy. The flat table can be fitted with swivel arms, which present bucks of varied shapes to allow the laying of sleeves, shoulders and collars without distortion or the danger of creasing.

Each of these has the vacuum facility. Alternatively, the basic table may consist of a very large flat area, or a smaller curved surface, each with additional sections to be swing into position if required. The principle is one of flexibility, with some units able to accept a change of pressing surface so that the most suitable shape is always available for the production of a particular batch of garments. Allowing function is also available on some of these pressing surfaces which gives a billowing surface on which to press. This enables some difficult materials, such as thin, hard rainwear fabrics, to be pressed with less risk of seam impressions showing.

Self contained units, incorporating a steam boiler and electrically driver vacuum and air blowing facilities, are increasingly used both in the under pressing of tailored garments and the pressing of unstructured garments, because they can be moved from place to place at much less cost than conventional steam supply. This means that they can be sited within a production line of sewing operations to enable under pressing to be undertaken at minimum cost.

#### **17.4.2 STEAM PRESSES**

A steam press fig 17.3 consists of a static buck and a head of complementary shape which closes onto it, thus sandwiching the garment to be pressed A general-purpose, manually operated press consists of a frame carrying the buck, which is generally rounded in shape for pressing a variety of garments, linkages to close the head by a scissors action, a pipe system distributing steam to head and buck, a vacuum system to provide suction through the buck, a table around the buck to aid handling of the garment, and foot controls for head closure and vacuum, with hand and/or foot controls for steam. There is also a means of varying head pressure.

When pressing a garment such as a skirt, a typical pressing cycle might be: steam from the buck is applied, the head is locked to press the garment, further steam from the head or the buck may be applied, and the head is then released and vacuum applied to cool and dry the garment before it is moved around the buck for the next part of it to be pressed. When pressing is completed, the garment is hung on a hanger. Adequate time of application of vacuum is essential if the garment is not to remain damp and to distort at this stage.

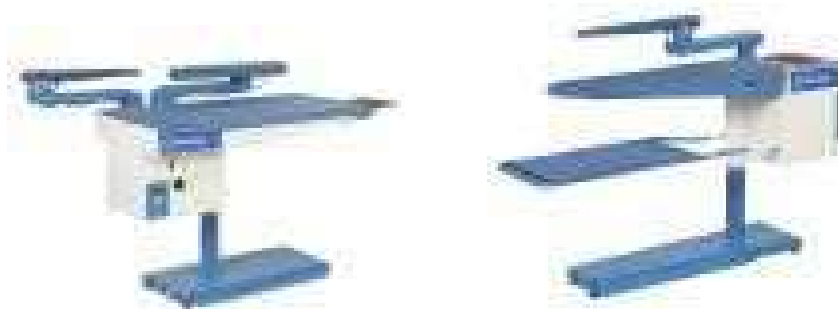

Fig 17.3

In many cases, an iron is available beside the press for the operator to touch up local areas of the garment before pressing with the head of the press. This facility can also be used to add sections of fusible interlining to partly constructed garments, especially tailored jackets.

Manually operated scissor-action presses have been improved considerably by the use of electronically controlled pneumatic power. The compressed air takes the heavy, fatiguing work of closing the press from the operator, and allows the introduction of automatic timing of the pressing cycle.

Another improvement is in the mechanical principle in the operation of steam presses. This employs a vertical head movement instead of a scissors action, giving the benefits of much finer control and a more even distribution of pressure over the whole surface of the buck, especially where contoured shapes have to be aligned. At the same time additional functions can be incorporated such as head vacuum and air blowing from the buck. The combination of these three factors enables easier pressing of fabrics such as gabardines.

#### **17.4.2.1 CAROUSEL PRESS**

A development in press operation is the carousel press. Here a pair of bucks rotates between the operator and either a single or a double head, depending on whether the bucks are identical or an opposite pair for pressing the left and right of a garment part. The operator loads the garment onto one buck which is then moved away to be aligned under the head, often behind a screen that keeps steam away from the operator.

#### **17.4.2.2 TROUSER PRESSING**

Trouser pressing is conventionally carried out in two operations, in addition to the under pressing of the seam; legging on a flat press which sets and creases the legs, and topping in a series of lays around the top of the trouser on a contoured press. If the trouser features a pleat at the waistband, the leg crease must be run into it accurately.

#### **17.4.3 STEAM AIR FINISHER**

This equipment is often referred to as a 'puffer', a form press or a 'dolly' press. It consists of a frame carrying a steam distribution system, compressed air distribution system and a



pressing form which is a canvas bag in the approximate shape of the garment to be pressed that is, a body shape but with no sleeves. There are controls for steam and air release, and timers controlling the steam and air cycles. The equipment aims to reduce the positioning and re-positioning in pressing operations by pressing the whole garment at the same time, though finishing is a better term in this situation since very little pressure is applied to the garment. The operator pulls the garment on to the form from above, and the form is then expanded to its full size and shape as steam is blown through it from the inside. A cycle of, perhaps, 8 seconds steaming is followed by a further period of hot air drying, also by blowing from the inside.

This equipment can remove accidental creases and refinish the fabric, but will not form creases or mould the garment. It is extremely useful for garments such as nightdresses, tee shirts and blouses, and is sometimes worth using for simple dresses, even though the hem might have to be pressed flat separately with an iron or a steam press.

#### **17.4.4 STEAM TUNNEL**

Another garment finishing process where pressure is not applied to the garments but where handling during the process is reduced is in steam tunnel finishing. It can be used for a variety of simple garments in man-made fibres and blends. Some garments would be on hangers, fed under automatic control through a cabinet on a motorized rail, and passing through sections with superheated steam and drying by air blowing. Alternatively, tee shirts and similar knitwear are loaded onto frames and passed through the tunnel on a conveyor. The tunnel reduces the need for any other pressing process before or after its operation and sometimes eliminates it. The aim of the steam is to relax natural fibres, that of the heat to relax man-made fibres. With the garments on hangers or frames, gravity or tension pulls out the wrinkles, and the turbulence of air blowing provides additional energy to relax wrinkles in woven fabrics. Such turbulence should be restricted with fabrics such as acrylics, since excessive agitation makes the fabric pliable and subject to deformation. This fabric responds well to infra-red drying, a feature of some tunnels.

#### **17.4.5 PLEATING**

Pleating is a special type of pressing, the aim of which is to produce an array of creases in a garment, of some durability and according to a geometrical pattern. This may be an overall pattern of small pleats, formed as a result of machine pleating a complete roll of cloth, or larger pleats formed by hank pleating of garment sections which have been previously cut to shape and, in the case of skirt sections, hemmed. Examples of machine pleating are fluting and crystal pleating and of hand pleating, box pleats and the fan-shaped pleats which taper to nothing at the waist and are known as sunray pleats. Like other forms of pressing, the means of pleating are heat, moisture and pressure.

Machine pleating is of two types. The first is a rotary machine in which the rollers are fitted with complementary dies similar to gears. Second is a blade machine in which pleats are formed



by the thrust action of a blade or blades. The pleats are set by heat and pressure as they pass between a pair of mangle-type rollers.

#### **17.4.6 PERMANENT PRESS**

The process known as ‘permanent press’ was developed some years ago as a way of giving good crease recovery after washing to cellulose fabrics. It declined with the rise in popularity of polyester/cotton and polyester/viscose blends, where the polyester content assists crease recovery and improves fabric strength. More recently, in an attempt to compete with man-made fibres, the process has been marketed again with 100 percent cotton fabrics of high enough initial strength to allow for some degradation.

#### **17.5 LET US SUM UP**

Creases are obvious design features in some kind of garments but some other cases crease has to remove from the garment. So pressing is used based on the application only. Variety of pressing equipment are available that all discussed in this lesson. Type of pressing and the methods are varying according to the end uses.

#### **17.6 LESSON END ACTIVITIES**

The students may do the following activities based on this lesson

- Visit one garment unit and absorb the operations of pressing

#### **17.7 POINTS FOR DISCUSSION**

Here the students are asked to discuss about the following points

- The requirement of pressing
- Methods of constructing a steam pressing for an garment unit
- Importance of pressing

#### **17.8 REFERENCES:**

- The technology of Clothing Manufacturing, Harold Carr and Barbara Latham.
- Clothing Technology, Europ Lehrmilied, Vollmer GmbH & Co.
- Practical Clothing construction- part 1 & 2, Mary Mathews, Cosmic press.
- Fundamentals of textile and their care, Susheela Dantysi, Published by orient Longman L.t.d.
- The complete book of sewing, by Dorling Kindersley, Dorling Kindersley L.t.d...

## LESSON – 18: SEWING FEDERAL STANDARDS FOR SEAM

### CONTNETS

- 18.0 AIM AND OBJECTIVES
- 18.1 INTRODUCTION
- 18.2 SEAM
  - 18.2.1 Class 1 (Superimposed seam)
  - 18.2.2 Class 2(Lapped seam)
  - 18.2.3 Class 3(Bound seam)
  - 18.2.4 Class 4(Flat seams)
  - 18.2.5 Class 5(Decorative stitching)
  - 18.2.6 Class 6 (Edge neatening)
  - 1 8.2.7 Class 7
  - 18.2.8 Class 8
- 18.3 LET US SUM UP
- 18.4 LESSON END ACTIVITIE
- 18.5 POINTS FOR DISCUSSION
- 18.6 REFERANCES

### 18.0 AIM AND OBJECTIVES

After going through this unit, you should be able to have a clear idea of the following

- Designation and identification of seams.
- International standards
- Classifications of seams and their description
- Features and application of each seam class

### 18.1 INTRODUCTION

The aim of this lesson is to teach you the different kinds of seams that are used in the making of fashionable clothes. Every good dressmaker knows and uses these various seams to achieve smart finishing touches and neat edges. By the time you have completed this lesson, you will be able to make each one of these seams without any trouble whatever. We have taken particular pains to simplify them as much as possible and to make them all easy to follow.

The seam, you know, is the corner-stone of all good dress construction—just as the outline sketch is the base upon which all good art work is built. Without the right kind of seams the dress will not hang correctly, it will not appear smart or well-finished. Without the right kind of seams, the blouse will not withstand many washings and re-washings, and it will soon lose the smartness of its style. A dress may be beautiful when you finish it, but without the right seams in the right places, its beauty will be short lived

## 18.2 SEAM

The choice of seam type is determined by aesthetic standards, strength, durability, comfort in wear, convenience in assembly in relation to the machinery available, and cost. BS 3870: Part 2: 1991, referred to above, allows for eight different classes of seam, including some where only one piece of fabric is involved.

The British Standard divides stitched seams into eight classes according to the minimum number of parts that make up the seam. These parts can be the main fabrics of the garment or some additional item such as a lace, braid or elastic.

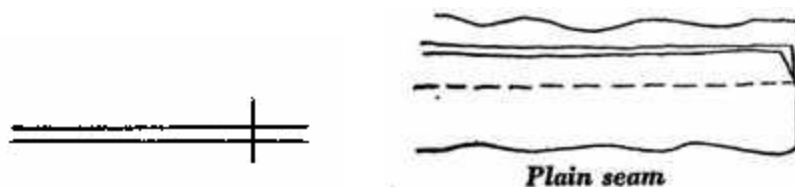

Fig 18.1

To indicate how the various seam types are formed, several styles of diagram fig 18.1 can be used. The one which most clearly relates to garment parts as sewn shows a perspective view of a section of the seam, and, when the various stitch types are being discussed, it is useful to show a section of the reverse side of the stitch.

Once familiarity with seam types has been established, it is often sufficient to draw the diagrams in a shorthand version which shows a cross-section through the fabric represented by lines, with short lines at right angles showing the point of needle penetration of the stitch.

Six seam classes were included in the 1965 British Standard and at that stage they were given names which usefully describe their constructions. Two more classes were added with the publication of the 1983 edition, but without the descriptive names, and the total of eight continues in the 1991 edition.

### 18.2.1 CLASS 1 (SUPERIMPOSED SEAM)

This class is the commonest construction of seam and it has the following types.

- Superimposed seam
- French seam
- Piped seam

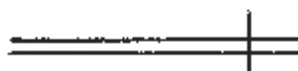

Fig 18.2

The simplest seam type fig 18.2 within the class is formed by superimposing the edge of one piece of material on another. A variety of stitch types can be used on this type of seam, both for joining the fabrics and for neatening the edges or for achieving both simultaneously.



Fig 18.3

The diagrams normally show the final version and it should be clear from the positions of the needles and the folding of the fabric if it was constructed in one step or several. An example of this is the type of superimposed seam known as a French seam fig 18.3 which is done in two stages.



Fig 18.4

An example of a superimposed seam with an additional component would be one that contained an inserted piping fig 18.4, and even here more than one construction is possible.

### 18.2.2 CLASS 2(LAPPED SEAM)

This class has the following types.

- Lapped seam
- Lap felled seam
- Welted seam



Fig 18.5

In practice, this simple seam (lapped seam fig 18.5) is not common in clothing because it causes problems with raw edges and at least one of the edges must be neaten in a decorative manner. Sail fabrics are very finely woven and fray very little,



Fig 18.6

Much more common on long seams on garments such as jeans and shirts is the so-called lap-felled seam fig 18.6, sewn with two rows of stitches on a twin needle machine equipped with a folding device. This provides a very strong seam in garments that will take a lot of wear though there is a possibility that the thread on the surface may suffer abrasion in areas such as inside leg seams.

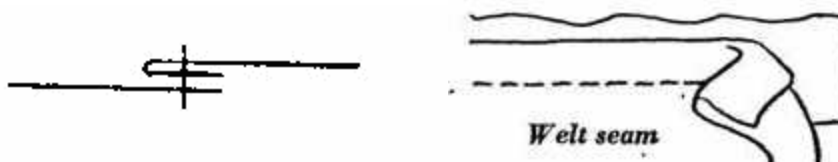

Fig 18.7

The type of raised, topstitched seam often used down skirt panels is also technically a lapped seam although at the beginning of its construction it appears to be a superimposed seam. It is often referred to as a welted fig 18.7 or a raised and welted seam.

### 18.2.3 CLASS 3(BOUND SEAM)

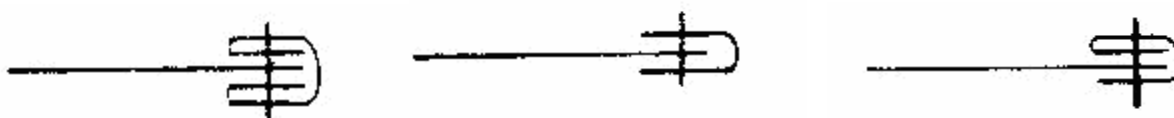

Fig 18.8

In this class, the seam consists of an edge of material which is bound by another fig 18.8, with the possibility of other components inserted into the binding.

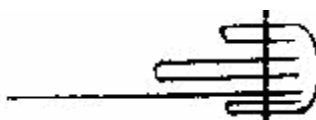

Fig 18.9

The simplest version of this class is again unusual as it cannot be constructed with self-fabric binding because of the problem of raw edges. It can, however, be made with a binding which has been constructed to a specific width. A folding device turns the edges under and wraps the strip over the edge of the main fabric. Bias cut strip would normally be used, unless the fabric had an element of stretch fig 18.9. A bound seam is often used as a decorative edge and the binding may continue off the edge if the ferment to provide tie ends.

### 18.2.4 CLASS 4(FLAT SEAMS)



Fig 18.10

In this class, seams are referred to as flat seams fig 18.10 because the fabric edges do not overlap. They may be butted together without a gap and joined across by a stitch which has two needles sewing into each fabric and covering threads passing back and forth between these needles on both side of the fabric. Knitted fabrics are most commonly used because the advantage of this seam is that it provides a join that is free from bulk in garments worn close to the skin such as knitted underwear.

### 18.2.5 CLASS 5(DECORATIVE STITCHING)



Fig 18.11

This is the first of the two classes of seam which, in the old British Standard, were not regarded as seams at all and were given the name 'stitching'. The main use of the seam is for decorative sewing on garments where single or multiple rows of stitches are sewn through one or more layer of fabric (fig 18.11). These several layers can be folds of the same fabric. The simplest seam in the class has decorative stitching across a garment panel. One row would have little effect but multi needle stitching is common. Other possibilities, given the right folding device, are pin tucks, often sewn in multiples, and channel seams.

### 18.2.6 CLASS 6 (EDGE NEATENING)

This is the other seam class that was called a stitching. Seam types in this class include those where fabric edges are neatened by means of stitches (as opposed to binding with another or the same fabric) as well as folded hems and edges. The simplest is the fabric edge inside a garment which has been neatened with an over edge stitch.



Fig 18.12

In fig 18.12 is typical of dress or a pair of trousers in a woven fabric which has been neatened might be omitted. A folding device is used in the construction of the hem of shirt or a skirt lining.



Fig 18.13

In fig 18.13 shown a method of folding and this is sometimes used on the buttonhole front of shirt.

### 18.2.7 CLASS 7

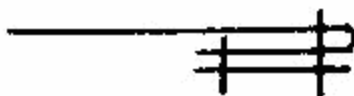

Fig 18.14

Seams in this class relate to the addition of separate items to the edge of a garment part. They are similar to the lapped seam except that the added component has a definite edge on both sides. Examples fig 18.14 would be a band of lace attached to the lower edge of a slip as in figure, elastic braid on the edge of a bra and inserted elastic on the leg of swimsuit.

An example where the additional item is self-fabric plus interlining is another version of the buttonhole band on a shirt.

### 18.2.8 CLASS 8

The final seam (fig 18.15) class in the British Standard is another where only one piece of material need be involved in construction the seam. The commonest seam type in this class is the belt loop as used on jeans, raincoats.



Fig 18.15

The use of the belt loop of the stitch type mentioned before which has two needles and a bottom covering thread ensures that the raw edges are covered over on the underside while showing two rows of plain stitching on the top.

## 18.3 LET US SUM UP

Seam and stitch are interrelated. Both give an equal contribution of fabric seam strength. The method of placing the fabric and the types of fold gives the different classes of seams. In this lesson we discussed the classification based on the British standard.

## 18.4 LESSON END ACTIVITIES

The students may do the following activities based on this lesson

- Practice and if possible prepare the samples for all the different seams

### **18.5 POINTS FOR DISCUSSION**

Here the students are asked to discuss about the following points

- Different classes of seams based on its federal standards

### **18.6 REFERENCES:**

- The technology of Clothing Manufacturing, Harold Carr and Barbara Latham.
- Clothing Technology, Europ Lehrmilied, Vollmer GmbH & Co.
- Practical Clothing construction- part 1 & 2, Mary Mathews, Cosmic press.
- Fundamentals of textile and their care, Susheela Dantysi, Published by orient Longman L.t.d.
- The complete book of sewing, by Dorling Kindersley, Dorling Kindersley L.t.d...
- Readers Digest Sewing Guide, The Readers Digest Association



## LESSON – 19: SEWING FEDERAL STANDARDS FOR STITCH

### CONTENTS

- 19.0 AIM AND OBJECTIVES
- 19.1 INTRODUCTION
- 19.2 STITCHES
  - 19.2.1 Definition:
  - 19.2.2 Stitch formation:
- 19.3 TIMED SEQUENCE IN LOCK STITCH FORMATION:
- 19.4 STITCH TYPES
  - 19.4.1 Class 100: Chain stitches
  - 19.4.2 Class 200: Stitches originating as hand stitches
  - 19.4.3 Class 300: Lockstitches
  - 19.4.4 Class 400: Multi-thread chain stitches
  - 19.4.5 Class 500: Overedge chain stitches
  - 19.4.6 Class 600: Covering chain stitches
- 19.5 LET US SUM UP
- 19.6 LESSON END ACTIVITIES
- 19.7 POINTS FOR DISCUSSION
- 19.8 REFERANCES

### 19.0 AIM AND OBJECTIVES

After going through this unit, you should be able to have a clear idea of the following

- Designation and identification of stitches.
- International standards
- Classifications of stitches and their description
- Mechanism of stitch formation
- Features and application of each stitch class

### 19.1 INTRODUCTION

Someone once said that dressmaking was the art of making different stitches to hold different materials together. This might be true if color, harmony and style were not forgotten! But we all admit that the dressmaking stitches are very important indeed, and that they must be known before the construction of dress can begin. You see how very important these stitches are, how largely the success of clothes-making is dependent upon them.

And so we urge you to study these stitches carefully, that you may already know the first simple stitches such as basting and hemming. The important in apparel manufacturing is the clear understanding of stitch types; various terms used and thread consumption in stitches.

Mechanism involved in formation of each stitch type is another vital area, a technologist must know. Identification of correct stitch types to be used for different materials and end uses, decides the durability of seams and appearance of stitched article. This lesson focuses on these.

## 19.2 STITCHES

There is a need for stitches which join and stitches which neaten, for machines with more than one needle and for stitches which form a covering layer over the fabric. Certain stitch types can also aid economical garment production by performing several functions at once such as join and neatening or by adding decoration at the same as either of those.

### 19.2.1 DEFINITION:

One unit of conformation resulting from one of more strands or loops of thread in to a material. The stitch can also defined as, Stitching consists of a sequence of stitches for finishing the edge or for ornamental purpose or both in preparing parts for assembling.

### 19.2.2 STITCH FORMATION:

The stitches are formed based on the following three principles.

1. Intralooping
2. Interlooping
3. Interlacing

- **Intralooping** is the passing of a loop of thread through another loop formed by the same thread.

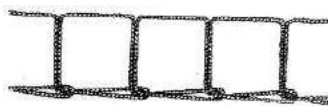

- **Interlooping** is the passing of a thread through another loop formed by a different thread.

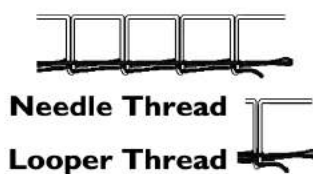

- **Interlacing** is the passing of thread over or around thread or loop of another thread.

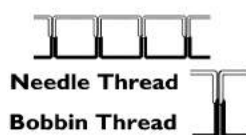

### 19.3 TIMED SEQUENCE IN LOCK STITCH FORMATION:

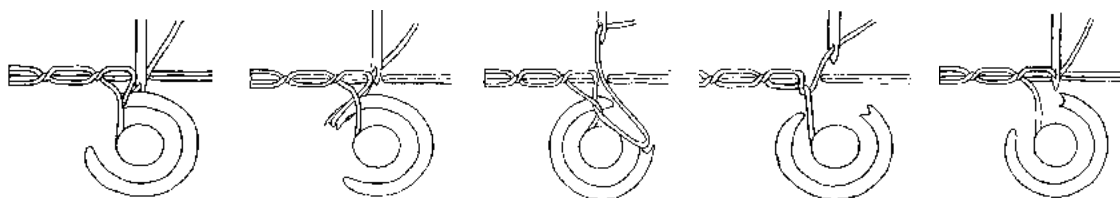

Fig 19.1

Fig 19.2

Fig 19.3

Fig 19.4

Fig 19.5

Fig 19.1 - Needle penetrates the fabric to bring top thread into bobbin area.

Fig 19.2 - As needle raises, top thread forms a loop for shuttle hook to catch.

Fig 19.3 - Shuttle hook carries thread loop around and under the bobbin case.

Fig 19.4 - Threads are pulled up and are set into the fabric as a lock stitch.

Fig 19.5 - Needle penetrates the fabric to bring top thread.

### 19.4 STITCH TYPES:

A series of recurring stitches of one configuration is defined as a stitch type. BS 3870 divides the many types which are available into six classes which variously cover the demands of joining fabrics together, neatening raw edges, or providing decoration, or offer the economy of doing more than one these at a time.

The six classes of stitch included in the British Standard are as follows:

1. Class 100 Chain stitches
2. Class 200 Hand stitches
3. Class 300 Lock stitches
4. Class 400 Multi-thread chain stitches
5. Class 500 Over edge chain stitches
6. Class 600 Covering chain stitches

#### 19.4.1 CLASS 100: CHAIN STITCHES

The stitch types in this class are formed from one or more needle threads, and are characterized by intralooping. One or more loops of thread are passed through the material and secured by intralooping with a succeeding loop or loops after they are passed through the material (fig 19.6).

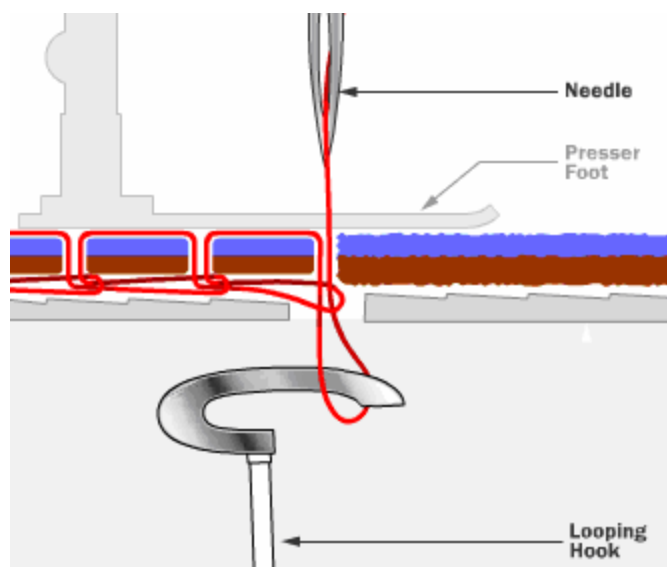

Fig 19.6

Since each loop is in this way dependent on the succeeding one, stitches in this class are insecure and if the finishing end of thread is not passed through the last loop or separately through the fabric, or if a stitch is broken, it unravels very easily.



Fig 19.7

One of the simplest of all stitch types is 101 (fig 19.7), which is formed from a single thread.

Precisely because of its insecurity, it can be easily removed, and it is used for 'basting' operations in tailored menswear and women wear garments, using a white, soft cotton thread. It can only be used where the marks of needle penetration close up afterwards in pressing. A basting operation, in positions such as edges, flaps, collars and so on, is a temporary stitch, allowing accurate placement of permanent stitching.

It is too insecure to be used for seams involving the joining of fabrics but it is widely used in multi-needle machines. A range of decorative effects can be achieved using some or all of an any of closely spaced needles which may number as many as sixty-five. If elastic thread is used in the needles, and sewn into the fabric in a stretched state, it then relaxes and draws the fabric in, enabling garment features such as elasticized waists and cuffs to be created.

This stitch type cannot be chained-off, that is, sewn without fabric, nor can the stitching be brought to a halt and the needles removed from the fabric in the middle of a garment part. In the construction of a garment it is necessary to start and finish at a fabric edge, and that edge may need to be a small piece of temporary fabric held to the garment edge by the stitches. The fabric edges must then be joined securely through the ends of the chain stitching in order to prevent the stitches running back.

Another common use of class 100 stitches is in the special sewing processes of button sewing, buttonholing and blind hemming or feeling. The blind stitching version, 103, utilizes a curved needle in order to, successively penetrate partially into the fabric, and then into the hem edge, while showing minimally or not at all on the right side of the garment. Again, the level of insecurity is often high but can be improved by the use of slightly hairy rather than smooth sewing threads.

#### 19.4.2 CLASS 200: STITCHES ORIGINATING AS HAND STITCHES

The stitch types in this class originated as hand stitches and are characterized by a single thread which is passed through the material as a single line of thread, and the stitch is secured by the single line of thread passing in and out of the material.

Hand stitching (fig 19.8) is used at the expensive end of garment production because the consumer expects it at that price, the skills are available and it may be the only way to a perfect finish.

In some cases, machines have been developed to simulate hand stitching, the best example being stitch type 209 which is used around the outer edges of tailored jackets. This is referred to as pick stitching.

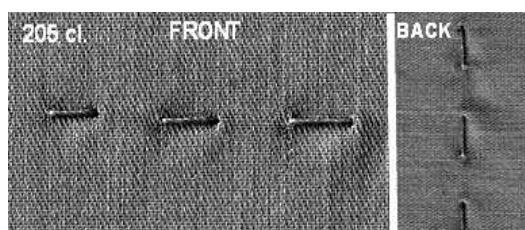

Fig 19.8

A double-pointed, centre-eyed, needle sews short lengths of thread in a near-perfect simulation of the hand-sew version. The machine can be set to shoe a longer stitch on the top than the bottom or vice versa. A button sewing version is also available which both sews the button and wraps the shank.

The machines are not fast by lockstitch standards, achieving a maximum of a few hundred stitches per minute, but this is considerable higher than the rate achieved in hand sewing and a consistently high quality standard is guaranteed.

### 19.4.3 CLASS 300: LOCKSTITCHES

The stitch types in this class are formed with two or more groups of threads, and have for a general characteristic the interlacing of the two or more groups. Loops of one group are passed through the material and are secured by the thread or threads of a second group. One group is normally referred to as the needle threads and the other group as bobbin threads. The interlacing of thread in stitches of this class makes them very secure and difficult to unravel.

Straight lockstitch, 301 figs 19.9, with a single needle thread and a single bobbin thread, is still the commonest stitch used in the clothing industry.

#### 301 Lockstitch

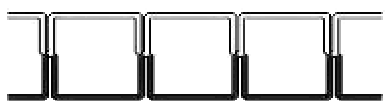

**Needle Thread**



**Bobbin Thread**

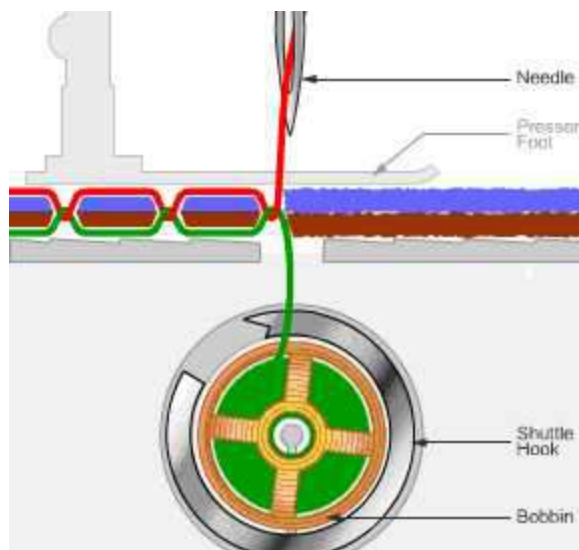

Figs 19.9

Lockstitch has enough strength for most purposes, provided that suitable thread is used, and enough stretch, when correctly balanced, for conventional and comfort stretch fabrics stretching up to 30 percent or even more. It has the same appearance on both sides, an advantage denied to virtually all other stitch types.

The stitch is secure because the breaking of one stitch in wear will not cause the whole row to unravel and additionally the end of a line of stitching can be secured by reversing or 'backtracking'.

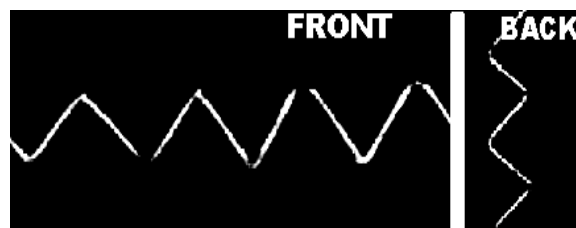

Fig 19.10

Zigzag version, type 304 (fig 19.10), it is commonly used for attaching trimmings such as lace and elastic where a broad row of stitching but no neatening is needed. Stitch type 306 provides a lockstitch blind stitch. This is more secure than the traditional 103.

The main disadvantage of the lockstitch is that it uses a bobbin to provide the lower thread and this bobbin can only contain a limited length of that thread. Changing bobbins is time-consuming in production as in the unpicking of topstitching when a thread runs out as a point where a join is visually unacceptable. Where garments are sewn with twin or multi-needle machines, especially where complicated fabric folding is involved, the loss of stitching on one row because of one bobbin running out would be a major problem. Multi-needle stitching with many closely spaced needles is not actually possible of the space that the bobbin would require. Two is the maximum number of needles commonly in use on lockstitch machines.

The other disadvantages of lockstitch are its limited stretch for today's high stretch fabrics and its unsuitability for edge neatening.

#### 19.4.4 CLASS 400: MULTI-THREAD CHAIN STITCHES

### 401 Chainstitch

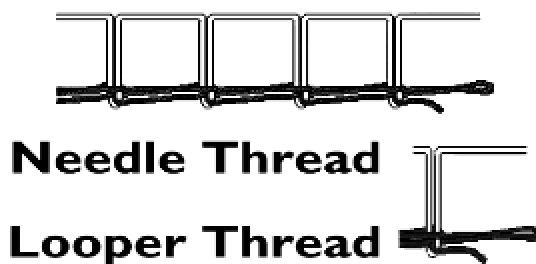

Fig 19.11

The stitch types in this class are formed with two or more groups of threads, and have for a general characteristic the interloping of the two groups. Loops of one group of threads are passed through the material and are secured by interlacing and interloping with loops of another group. One group is normally referred to as the needle threads and the other group as the looper threads.

The simplest version of this class of stitch, 401 is shown in Fig 19.11. It has the appearance of lockstitch in the top but has a double chain effect formed by a looper thread in the underside. The chain generally lies on the under surface of the material, the needle thread being drawn through to balance the stitch.

Stitches in this class are sometimes referred to as 'double-locked' stitches (not to be confused with class 300 lockstitch) because the needle thread is interconnected with two loops of the under thread. A Two-thread chain stitch is stronger than a similar lockstitch and, with no threads interlocking within the fabric it is less likely to cause the type of pucker that arises when closely woven fabrics are distorted by the sewing thread. Its great advantage is that both the threads forming the stitch are run from large packages on top of the machine so there are no

problems with bobbins running out. It is frequently used on long seams in garments such as trousers. 1 cm of thread chain should be left. The stretch with this stitch is about the same as with lockstitch.

Typical maximum speeds to be lockstitch would be 6,000spm whereas with two-thread chain stitch 8,000spm can be achieved.

Another increasingly used stitch in this class is 406 which uses two needles and has a looper thread covering the fabric between them on the underside. It is used for attaching lace and braid trimmings to garments. Both 406 and the three needle version, 407, are used for attaching elastic edging to briefs. The straight or zigzag version of 401 decorative effects 411

#### 19.4.5 CLASS 500: OVEREDGE CHAIN STITCHES

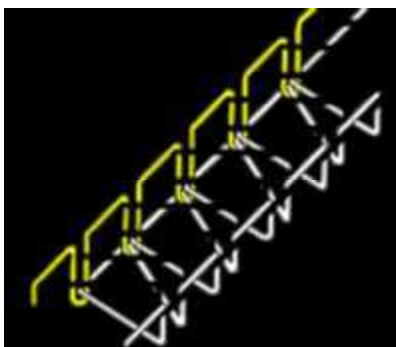

Fig 19.12

The stitch types in this class are formed with one or more groups of threads (fig 19.12), and have as a general characteristic that loops from at least one group of threads pass around the edge of the material. The most frequently used of these stitch types have one or two needle threads and one or two looper threads and they form a narrow band of stitching along the edge of the fabric with threads intersecting at the edge and preventing the fabric from fraying. All have high elasticity, they do not unravel easily, and a trimming knife on the machine ensures a neat edge prior to sewing. This knife can also allow excessive amounts to be trimmed off, thus altering the dimensions of the garment. These stitches are commonly referred to as 'overlocking'; although the term derives from a trade mark and is only really correct when used in relation to a particular machine. The correct term is 'overedging'

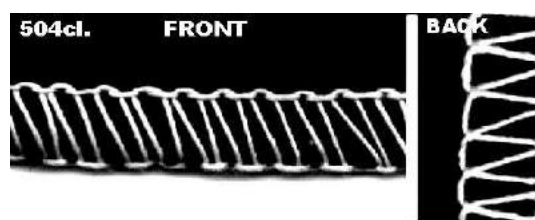

Fig 19.13

Stitch type 504 figs 19.13, is formed from one needle thread and two looper threads and is used for neatening edges and, in knitted fabrics, for joining seams. The seam ends on the edge of



the garment it may be necessary to secure the thread chain and the seam end by means of a short lockstitch tack or a bar-tack, or a short zigzag of stitching if fixed length.

This stitch type can also be used to provide a decorative neatened edge if sewn with a high stitch density and a narrow bight over an edge which, after the usual trimming, has been rolled under to the width of the stitch, usually 2 mm.



Fig 19.14

Stitch type 503 (fig 19.14), formed with one needle thread and only one looper thread, is less versatile and is used mainly for edge neatening, often referred to as serging, especially in menswear.



Fig 19.15

Stitch type 512 and 514 which use two needles and a total of four threads provide a wider bight (fig 19.15). A combination of 401 and 503 or 504, sewn simultaneously on one machine, is very common where a joined and neatened seam is required that does not need to be pressed open. It is referred to as safety stitch and provides an economical seam.

Overlock stitches are classified in a number of ways. The most basic classification is by the number of threads used in the stitch. Industrial overlock machines are generally made in 1, 2, 3, 4, or 5 thread formations. Each of these formations has unique uses and benefits: 1-thread formations are used for end-to-end seaming, or 'butt-seaming'. Two- and three-thread formations, also known as 'merrowing', are the most common, used for edging and seaming, especially on knits and woven. Four-thread formations are called mock safety stitches and create extra strength while retaining flexibility. 5-thread formations, which utilize 2 needles, are called safety stitches, creating a very strong seam used for apparel manufacturing.

#### 19.4.6 CLASS 600: COVERING CHAIN STITCHES

Stitch types in this class are formed with three groups of threads shown in fig 19.16, and have for a general characteristic that two of the groups cover both surfaces of the material. Loops of the first group of threads (the needle threads) are passed through loops of the third group already case on the surface of the material, and then through the, material where they are outer looped with loops of the second group of threads on the underside of the material. The second

and third groups are usually referred to as the top cover threads and the bottom cover or looper threads.

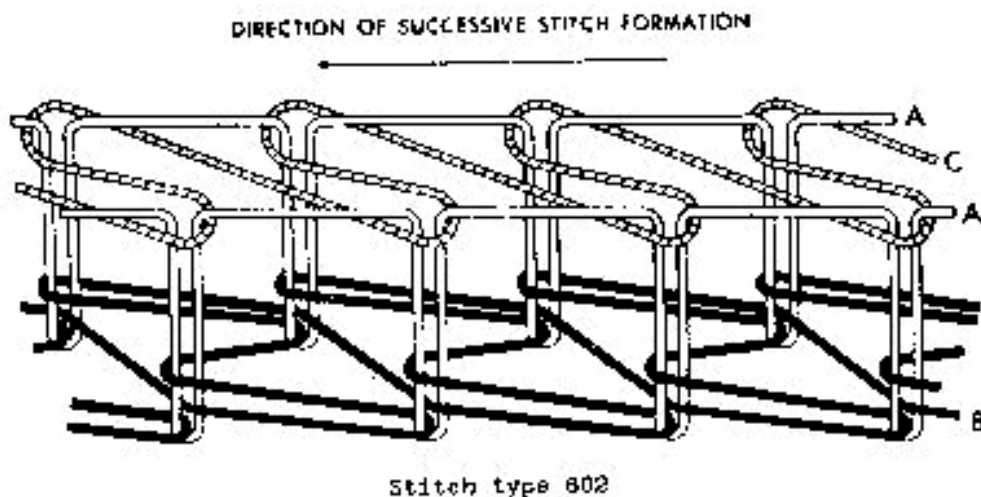

Fig 19.16

Stitches in this class are the most complex of all and may have up to nine threads in total including four needle threads making a broad, flat, comfortable joining of elastic, braid of binding to the edges of garments such as briefs with the scope for a decorative top cover stitch as well as the functional bottom cover over the raw edge of the garment fabric.

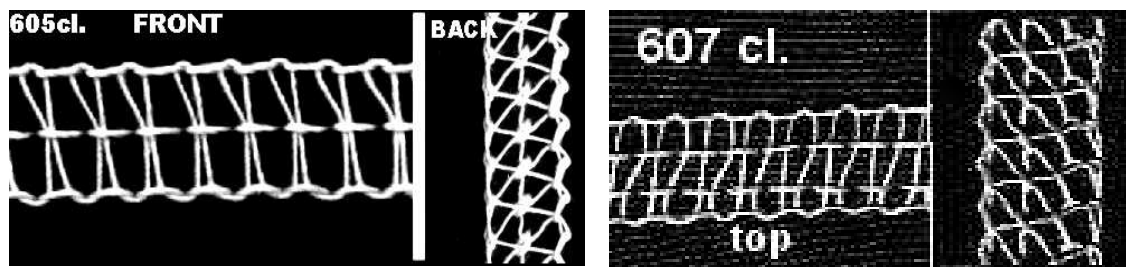

Fig 19.17

The most complicated stitch type in this class, 606, which is known as flat lock, can be used to join fabrics which are butted together in what used to be called, in the old British Standard, a flat seam. Two trimming knives ensure that neat fabric edges butt together and four needles and nine threads provide a smooth join with good extensibility. It is used on knitted fabrics, especially underwear fabrics, to give a seam with low bulk that can be worn comfortably against the skin. With the top cover thread in a contrast colour, it can be used decoratively in other knitted leisurewear. With this class of stitch a chain end is left at the end of the seam which must be secured if not crossed by another seam.

### **19.5 LET US SUM UP**

Stitches are used for putting row stitch on the fabric. But we have six classifications of stitches which were recommended by British standard. These six classes of stitches are used based on the method of placing the fabric, the types of fold and some special applications.

In this lesson we have gone through the three basic principles of stitches, sequence of stitch formation in lock stitch machine and chine stitch machine with line diagrams.

### **19.6 LESSON END ACTIVITIES**

The students may do the following activities based on this lesson

- Practice and if possible prepare the sample for all the above stitches

### **19.7 POINTS FOR DISCUSSION**

Here the students are asked to discuss about the following points

- Different classes of stitches based on its federal standards

### **19.8 REFERENCES:**

- The technology of Clothing Manufacturing, Harold Carr and Barbara Latham.
- Clothing Technology, Europ Lehrmilied, Vollmer GmbH & Co.
- Practical Clothing construction- part 1 & 2, Mary Mathews, Cosmic press.
- Fundamentals of textile and their care, Susheela Dantysi, Published by orient Longman L.t.d..
- The complete book of sewing, by Dorling Kindersley, Dorling Kindersley L.t.d...
- Readers Digest Sewing Guide, The Readers Digest Association

## Lesson – 20: SEWING THREAD

### CONTENTS

- 20.0 AIM AND OBJECTIVES
- 20.1 INTRODUCTION
- 20.2 SEWING THREAD
- 20.3 CLASSIFICATION OF SEWING THREADS
- 20.4 SEWING THREAD REQUIREMENT
  - 20.4.1. Functional requirements
  - 20.4.2. Serviceability
  - 20.4.3. Aesthetic
  - 20.4.4. Cost consideration
  - 20.4.5. Other sewing thread properties
- 20.5 FIBRE TYPE SEWING THREAD
  - 20.5.1 Nature Fibre Sewing Threads
  - 20.5.2 Regenerated fiber sewing threads
  - 20.5.3 Synthetic fiber sewing threads
- 20.6 SEWING THREAD CONSTRUCTION
  - 20.6.1 Cotton Thread
  - 20.6.2 Spun Synthetic
    - 20.6.2 Mono-filament
    - 20.6.3 Multi-filament
  - 20.6.4 Core spun
  - 20.6.5 Textured
- 20.7 TWIST ON SEWING THREAD
- 20.8 APPLICATIONS OF SEWING THREADS
- 20.9 PERFORMANCE ASSESSMENT OF SEWING THREADS
- 20.10 LET US SUM UP
- 20.11 LESSON END ACTIVITIES
- 20.12 POINTS FOR DISCUSSION
- 20.13 REFERANCES

### 20.0 AIM AND OBJECTIVES

After going through this unit, you should be able to have a clear idea of the following

- Sewing thread classification based on fibres.
- Performances of the sewing thread are influenced by material.

- Sewing thread manufacturing
- Twist balance of sewing thread.
- Application of sewing thread.

### 20.1 INTRODUCTION

The seam performances of the garment are influenced by sewing thread and sewing techniques and the end use desired. These yarns are differing from other threads. We are taking more care to construct the sewing thread, because sewing threads are having some special character.

Almost all type fibres can be used as raw materials for sewing thread construction. According to the end uses the thread are available in all colours and having some special finishes.

### 20.2 SEWING THREAD

Sewing thread are special kinds of yarns. They are engineered and designed to pass through a sewing machine rapidly. To form a stitch efficiently and to function while in a sewn products without breaking or becoming distorted for at least the useful life of the product.

### 20.3 CLASSIFICATION OF SEWING THREADS

Sewing threads can be classified according to the fibre and thread construction used to make it

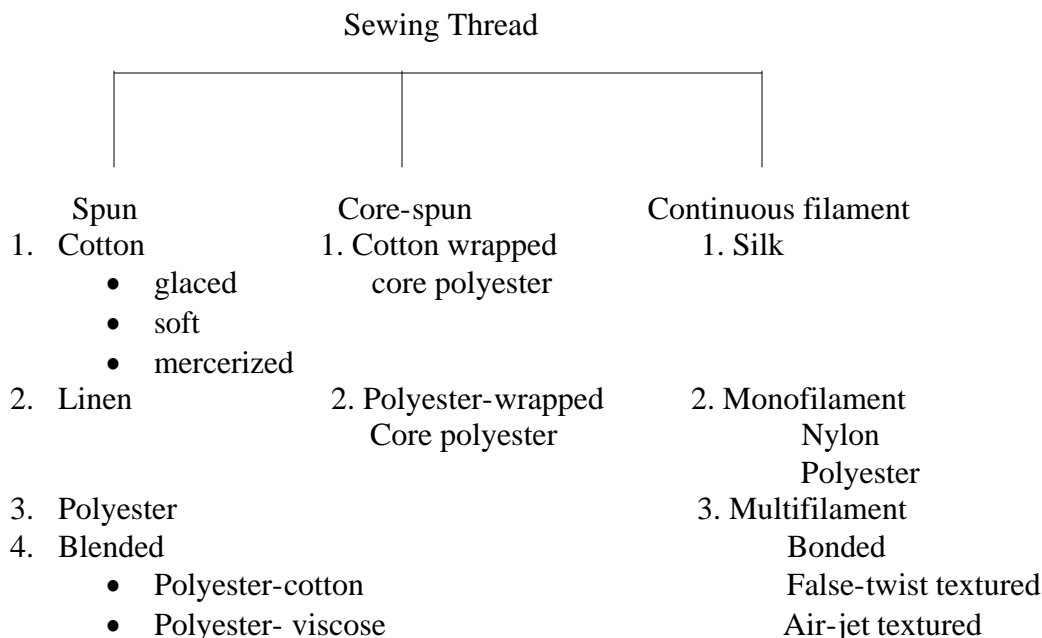

### 20.4 SEWING THREAD REQUIREMENT

The sewing seam performances of the sewing thread are influenced by material to be sewn, sewing techniques and the end use desired.

The requirements can be defined as:

- The ability of sewing thread to meet functional requirements of producing desired seam effectively.
- Ability to provide desired aesthetics and serviceability in the seam.
- Cost of the sewing thread and that of resultant seam.

#### **20.4.1. FUNCTIONAL REQUIREMENTS**

**Tensile properties:** Sewing thread should have high tenacity with moderate tension. For better loop formation characteristics, the elastic modulus of the sewing thread should be high.

**Friction:** There should be uniformity of friction over long length. Factors are responsible for giving maximum possible tension fluctuation of the yarn components in the cross section and the length.

**Passage through needle eye:** There should be no sudden shocks when thread passes through the eye of the needle. Needle temperature is critical for sewing thread of man made fibres.

**Free from knots and faults:** Sewing thread should be free from knots and faults to give smooth performance.

#### **20.4.2. SERVICEABILITY**

During sewing, threads are subjected to abrasion over needles and fabric threads. There is a lose of strength during and after sewing during fabric use. Sewing thread should have high abrasion resistance so that lose strength is minimum. For a good serviceability, seam must be firm. A seam strength test could be performed. Different stitches are applied to different application. Fabric properties affect seam strength along with loop and abrasion strength of sewing thread and the amount damage due to sewing. To avoid puckering of garments around the seams, the thread shrinkage should be generally less then 2% during washing.

#### **20.4.3. AESTHETIC**

Co lour, shade, luster, smoothness, fitness are some of aesthetic related characteristics of sewing threads. Certain amount of hairiness in sewing thread has to positive effect on sewing but this effect has to be sacrificed for appearance. There is a tendency to use dyed sewing thread for appearance.

#### **20.4.4. COST CONSIDERATION**

From the raw material aspect, sewing thread of natural silk is expensive. A higher melting sewing thread may be expensive. but, it should have a judicious use in the sense that the fabric for which it is used should also have a high melting points as the hot needles not only attack the sewing thread but the fabric also.

#### **20.4.5. OTHER SEWING THREAD PROPERTIES**

In addition to the essential properties, some of the applications may be required for sewing threads to have special properties like, resistance to flexing in seams in shoes, discontinuous surface to provide grip and avoid slippage in the seam for high seam strength applications.

#### **20.5 FIBRE TYPE SEWING THREAD**

The fibres are grouped in to three categories.

1. Natural fibre
2. Regenerated fibre
3. Synthetic fibre

##### **20.5.1 NATURE FIBRE SEWING THREADS**

###### 1. Cotton:

The natural fibre in commonest use is cotton. They provide good sewing performance in terms of ease of loop formation and lower sewing needle temperature. They are soft, having a high wet shrinkage. This may cause seam puckering. Glazed threads have smoother surface and better resistance to abrasion than unglazed cotton threads. The mercerized cotton threads are also used as they have increased luster and higher tenacity.

###### 2. Linen:

Linen gives stiff threads for heavy seaming and button sewing.

###### 3. Silk:

Threads of silk give good sewing performance. They are used in couture and bespoke tailoring. They also find application in short lengths, for pick stitching the edges of men's jackets.

##### **20.5.2 REGENERATED FIBER SEWING THREADS**

Sewing thread from viscose does not have high strength or durability of synthetic fibres. But they are preferred to be high luster to use in embroidery.

Synthetic fibres

##### **20.5.3 SYNTHETIC FIBER SEWING THREADS**

There is a growing demand of synthetic fibers due to some distinct advantages over natural fibres, such as high strength, high adjustable extensibility, very low laundry shrinkage, very low dry heat shrinkage and high abrasion resistance.

Synthetic sewing threads are briefly discussed below:

###### 1. Polyester:

Polyesters considered being the best fibre for most sewing applications having low cost, high strength, good chemical properties, favorable elastic characteristics and good dye fastness.

### 2. Polyamide:

It has high strength and extension characteristics. Its lower modulus and higher extension makes it unsuitable as a general-purpose sewing thread.

### 3. Aramid:

They are expensive and used in fire resistant garments so that the garment remains intact so long as the fabric withstands heat.

### 4. PTFE:

These costly threads have specified industrial applications where complete non-flammability non-melting and high resistance to chemicals is required.

## **20.6 SEWING THREAD CONSTRUCTION**

### **20.6.1 COTTON THREAD**

Cotton fibres are aligned and twisted together in S direction to form a single yarn. Two more single yarns are ply-twisted in reverse direction (Z direction) for twist balancing and to eliminate snarling.

### **20.6.2 SPUN SYNTHETIC**

The fibres used for spun synthetic threads are normally polyester staple fibres similar to cotton. Heat setting is required to control their shrinkage and extensibility. Their higher strength and abrasion resistant compared to cotton threads are advantageous. They are available in a wide variety of colors and sizes. Spun polyester thread is one of the most widely used threads and is least expensive.

### **20.6.3 MONO-FILAMENT**

When threads are made directly from continuous filaments as in polyester and nylon, we can have a single filament having larger size than normal. This is called as mono filament. Its normal color and translucent appearance blend with the color of most fabrics. It is strong and more uniform so breakage during sewing is minimal. It is too stiff and place excessive wear on machine parts. Its holding power is limited and tends to unravel from the seams. Its use is limited to stitching of hems in low budget garments, draperies and upholstered furniture.

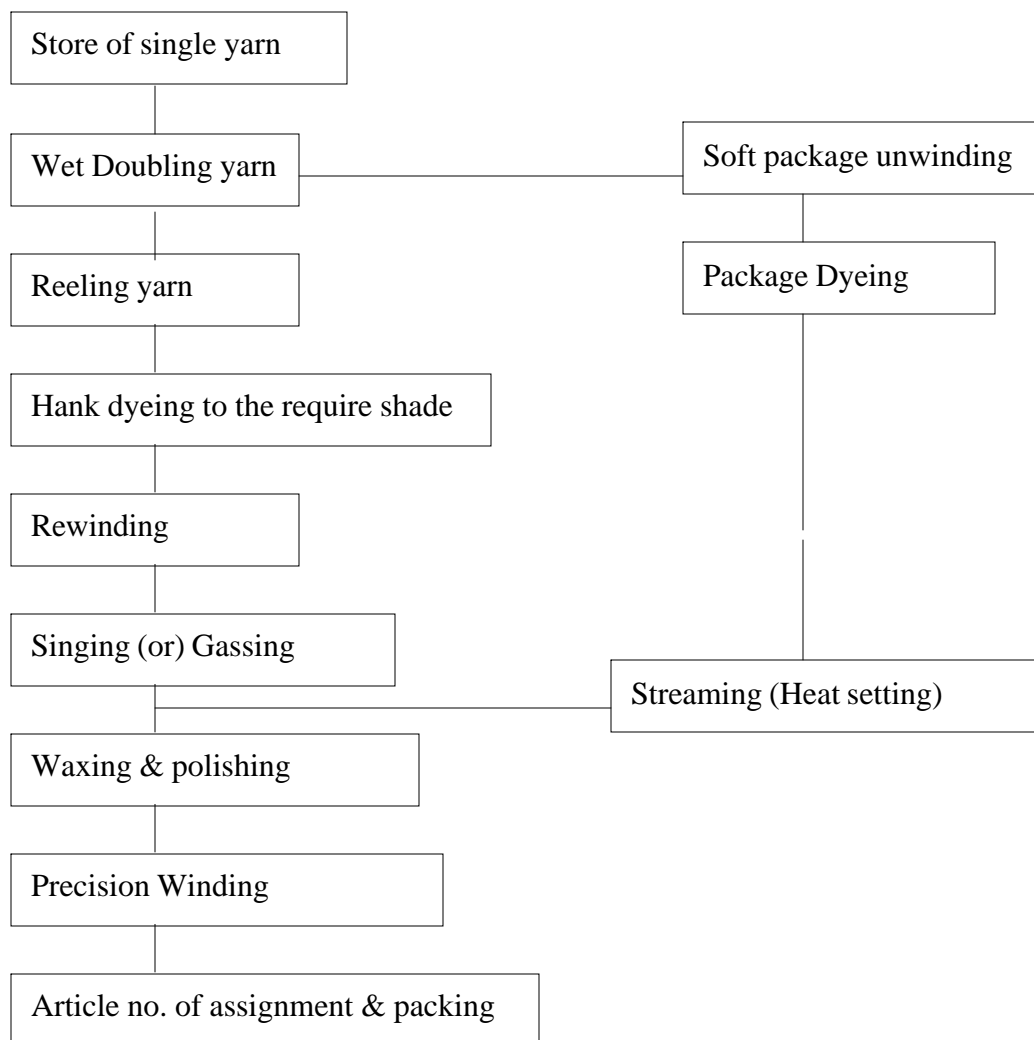

**Flow chart manufacturing spun sewing thread****20.6.4 MULTI-FILAMENT**

This is the most conventional way of constructing continuous filament sewing threads. They can be either in singles or plied or corded. They are popular because of better utilization of fiber strength, low fault rates and a consistent, even thread at reasonable cost. They are invariably used where strength of the steams is a primary requirement such as sew shoes, leather garments, tents, awnings and boat covers.

**20.6.5 CORE SPUN**

To combine the advantage of both the synthetics ad naturals, we can have continuous filament polyester wrapped around with a sheath of cotton fibres. This thread structure gives the strength of filament polyester and sew abilities of cotton. However careful dyeing is needed to obtain the same shade on both sheath and core, which requires two dye baths. Polyester or

viscose rayon or cotton may be used as sheath. Polyester wrapped core spun thread is subject to needle heat and may not be desirable in terms of colour. Cotton wrap is most widely used core spun threads are costlier and have high strengths than spun polyester threads.

### **20.6.6 TEXTURED**

Various types of textured yarns can be used as sewing threads. These yarns overcome the main drawback of smooth and slippery flat filament yarns. Threads made from airjet textured yarn are used for heavy applications such as furniture and jeans but it has less demanding sewing operations

### **20.7 TWIST ON SEWING THREAD**

The creation of sewing threads from the natural and man-made fibres already described can take a variety of forms. Where the fibres occur naturally in short lengths or have been cut or broken into short lengths, they must be twisted together, initially into a single yarn, and then that twist must be balanced by applying a reverse twist as two or three such yarns are combined to form the thread construction. The twist in the single yarn consolidates the strength and flexibility provided by the fibres themselves. Without the reverse twist, known as finishing twist, a conventional thread could not be controlled during sewing. The individual plies would separate during their repeated passages through the needle and over the sewing machine control surfaces. Twist is defined as the number of turns inserted per cm of yarn or thread produced. If the twist is too low the yarns may fray and break; if too high, the resulting liveliness in the thread may cause snarling, loop knots or spillage from the package of thread.

The frictional forces acting on a thread during its passage through a sewing machine also tend to insert some twist, predominantly in one direction. In a lockstitch machine, during normal straight sewing, the needle and hook tend to insert some Z twist reaches equilibrium as it resists further tightening up of the twist. A thread with an S twist becomes untwisted by the action of the machine and then frays and breaks. Because the lockstitch machine type is the most severe in its handling of thread, the majority of threads intended for use in machine sewing are constructed with a finishing Z twist. There are only a few machines, such as flatlock, for which this is not suitable and special threads, two, three or occasionally four component yarns are twisted together to form 2, 3 or 4 ply thread. Subsequent twisting operations may be used to produce heavier or 'corded' thread, with the direction of twist reversing each time.

## 20.8 APPLICATIONS OF SEWING THREADS

<b>Applications of sewing threads</b>	
<b>Fabric</b>	<b>Thread</b>
Delicate Tulle, chiffon, fine lace, organza	Fine mercerized cotton Fine synthetic thread Silk
Light weight organza, jersey, voile, crepe, chiffon, velvet Plastic films	Mercerized cotton Silk Synthetic thread
Medium weight Satin, fine corduroy, suiting, Knits, deep pile fabric	Mercerized cotton Cotton Silk Synthetic thread
Medium heavy Gabardine, tweed, sail cloth, denim coating, vinyl, Furnished fabric, deep pile fabric	Heavy duty mercerized cotton Cotton Synthetic thread
Heavy Over coating, dungaree, upholstery, canvas fabric	Heavy duty mercerized cotton Cotton Synthetic thread
All weights Decorative loop stitching	Silk Polyester
All weights Decorative hem stitching	Mercerized cotton Silk Synthetic thread
Synthetic Knit and stretch fabrics Polyester double knit, nylon tricot, jersey, penne, velvet	Nylon Mercerized cotton Cotton Silk
Leather Suede, kidskin, capeskin, lambskin	Mercerized cotton Silk Synthetic thread

## 20.9 PERFORMANCE ASSESSMENT OF SEWING THREADS

The Performance assessment of sewing threads is of major importance during sewing as it has a profound effect on the quality of the seam and the cost of production. During sewing operation, thread is subjected to tensile, bending, cyclic, compression, shear and surface stresses. The various parameters to be considered for sewing threads are as follows:

- Diameter
- Length per thread holder:
- Strength and elongation:
- Shrinkage
- Twist balance
- Elasticity
- Setting temperature
- Coefficient of friction

### **20.10 LET US SUM UP**

When we studied sewing thread, we should pay major importance during its manufacturing, fibre selection and the type of finishing. Based on the application and end uses of the thread the above factors will change. Not only is this twist also a important one in the case of sewing thread.

So we discussed the method of manufacturing of sewing thread, the types of fibres involved for the production of thread, importance and direction of twist applied on the thread. Finally we saw the performances and application of thread on the different materials.

### **20.11 LESSON END ACTIVITIES**

The students may do the following activities based on this lesson

- Collect the different sewing treads based on the different manufactures and go through the specifications of each

### **20.12 POINTS FOR DISCUSSION**

Here the students are asked to discuss about the following points

- Essential properties of sewing thread
- Influence of twist on sewing thread
- Sewing thread and its classification
- Methods of manufacturing the sewing thread

### **20.13 REFERENCES:**

- Fundamentals of textile and their care, Susheela Dantigi, Published by orient Longman L.t.d..
- The complete book of sewing, by Dorling Kindersley, Dorling Kindersley L.t.d...
- Readers Digest Sewing Guide, The Readers Digest Association
- The technology of Clothing Manufacturing, Harold Carr and Barbara Latham.
- Clothing Technology, Europ Lehrmilied, Vollmer GmbH & Co.