

LECTURE NOTE
ON
CIVIL ENGINEERING MATERIALS
AND
CONSTRUCTION

COURSE CODE: BCE03002: 3.0.0 (CR 03)

Third Semester, B Tech, Civil Engineering

Dr. S K Panigrahi
Associate Professor
Deptt. of Civil Engg
VSSUT BURLA

SYLLABUS

Civil Engineering Materials and Constructions (BCE03002)

Module-I

Basic Building Materials I

Aggregate: Classification, Physical and mechanical properties, soundness, alkali-aggregate reaction, thermal properties of aggregate **Bricks and Masonry Blocks:** Types, properties and field and laboratory tests to evaluate quality **Lime:** classification, properties **Cement:** types, Portland cement: chemical composition of raw material, bogue compounds, hydration of cement, role of water in hydration, testing of cements, **fly ash:** properties and use in manufacturing of bricks and cement.

Module-II

Mortar: Types and tests on mortars. **Concrete:** Production, mix proportions and grades of concrete, fresh, mechanical and durability properties of concrete, factors affecting properties of concrete, tests on concrete, **admixtures**, **Special concrete:** light weight concrete, high density concrete, vacuum concrete, shotcrete, steel fiber reinforced concrete, polymer concrete, Ferro cement, high performance concrete, self-compacting concrete.

Module-III

Basic Building Materials II

Building stone: classifications, properties and structural requirements; **Wood and Wood products:** Introduction to wood macrostructure, sap wood and heart wood, defects and decay of timber, seasoning and preservation of timber, fire resisting treatment, introduction to wood products- veneers, plywoods, fibre board, particle board, block board, batten boards. **Metals:** Steel: Important properties and uses of Iron (Cast iron, wrought iron and steel), Important tests on steel rebar, aluminum and copper. **Glass:** types and uses, **gypsum:** source, properties, uses; **plastic:** properties and uses, **paint:** types, distemper, varnish, **Adhesive:** Types, **Bitumen:** types, properties and tests.

Module-IV

Basic Building Constructions

Foundation: purpose, types of foundation- shallow, deep, pile, raft, grillage foundation. **Masonry:** **Brick Masonry:** types of bonds, relative merits and demerits of English, Single Flemish and Double Flemish bond. **Stone Masonry:** General principles, classification of stone masonry and their relative merits and demerits, **Cavity wall:** components and construction, **Arches:** Terminology and classifications Doors and Windows: Types, materials used

Module-V

Finishing, Services and Special constructions

Wall Finishes: Plastering, pointing, distempering and painting: Purpose, methods, defects and their solutions. **Vertical communication:** Stairs: Terminology, requirements of good staircase, classification; ramps, lifts and escalators. **Damp proofing:** causes, effects, prevention and treatments, **Fire resistant construction:** Fire resistant properties of common building materials, requirements for various building components.

Reference Books:

1. A Text-Book of Building Construction, S.P.Bindra and S.P.Arora, Dhanpat Rai Publications
2. Building Materials and Construction, Jena and Sahu, Mc. Graw Hill.
3. Materials for Civil and Construction Engineers, Mamlouk and Zaniewski, Pearson
4. Building Materials and Building Construction, by P C Verghese
5. Building Construction, by B. C. Punmia, , Laxmi Publicaton

Civil Engineering Materials and Constructions (BCE03002)

Module-I

Basic Building Materials I

Module I Syllabus

***Aggregate:** Classification, Physical and mechanical properties, soundness, alkali-aggregate reaction, thermal properties of aggregate **Bricks and Masonry Blocks:** Types, properties and field and laboratory tests to evaluate quality **Lime:** classification, properties **Cement:** types, Portland cement: chemical composition of raw material, bogue compounds, hydration of cement, role of water in hydration, testing of cements, **Fly ash:** properties and use in manufacturing of bricks and cement.*

Subject to Revision

1. AGGREGATE:

Classification, Physical and mechanical properties, soundness, alkali-aggregate reaction, thermal properties of aggregate

Aggregates are the important constituents of the concrete which give body to the concrete and also reduce shrinkage. Aggregates occupy 70 to 80 % of total volume of concrete. So, we can say that one should know definitely about the aggregates in depth to study more about concrete.

Classification of Aggregates as per Shape and Size:

Aggregates are classified based on so many considerations, but here we are going to discuss about their shape and size classifications in detail.

i) Classification of Aggregates Based on Shape:

We know that aggregate is derived from naturally occurring rocks by blasting or crushing etc., so, it is difficult to attain required shape of aggregate. But, the shape of aggregate will affect the workability of concrete. So, we should take care about the shape of aggregate. This care is not only applicable to parent rock but also to the crushing machine used.

Aggregates are **classified according to shape** into the following types

- Rounded aggregates
- Irregular or partly rounded aggregates
- Angular aggregates
- Flaky aggregates
- Elongated aggregates
- Flaky and elongated aggregates

Rounded Aggregate:

The rounded aggregates are completely shaped by **attrition** (the resistance of a granular material to wear) and available in the form of seashore gravel. Rounded aggregates result in the **minimum percentage of voids (32 – 33%)** hence gives **more workability**. They require a **lesser amount of water-cement ratio**. They are **not** considered for **high-strength** concrete because of **poor interlocking** behavior and **weak bond strength**.



Irregular Aggregates:

The irregular or partly rounded aggregates are partly shaped by attrition and these are available in the form of **pit sands and gravel**. Irregular aggregates may result **35- 37% of voids**. These will give **lesser workability** when compared to rounded aggregates. The **bond strength is slightly higher** than rounded aggregates but **not as required** for **high strength concrete**.



Angular Aggregates:

The angular aggregates consist **well defined edges** formed at the intersection of roughly planar surfaces and these are obtained by **crushing the rocks**. Angular aggregates result **maximum percentage of voids (38-45%)** hence gives **less workability**. They give **10-20% more compressive strength** due to development of **stronger aggregate-mortar bond**. So, these are useful in **high strength concrete** manufacturing.



Flaky Aggregates:

When the **aggregate thickness is small** when compared with **width and length** of that aggregate it is said to be **flaky aggregate**, or on the other, when the least dimension of aggregate is less than the 60% of its mean dimension then it is said to be flaky aggregate.



Elongated Aggregates:

When the **length of aggregate is larger** than the other two dimensions then it is called elongated aggregate or the length of aggregate is greater than 180% of its mean dimension.



Flaky and Elongated Aggregates:

When the aggregate length is larger than its width and width is larger than its thickness then it is said to be flaky and elongated aggregates. The above 3 types of aggregates are **not suitable for concrete mixing**. These are generally obtained from the **poorly crushed rocks**.



ii) Classification of Aggregates Based on Size:

Aggregates are available in nature in different sizes. The size of aggregate used may be related to the **mix proportions, type of work** etc. The size distribution of aggregates is called **grading of aggregates**. Following are the classification of aggregates based on size:

Aggregates are classified into **2 types** according to size

- Fine aggregate
- Coarse aggregate

Fine Aggregate:

When the aggregate is sieved through a **4.75mm sieve**, the aggregate passed through it called **fine aggregate**. Natural sand is generally used as fine aggregate, silt and clay also come under this category. The **soft deposit** consisting of sand, silt, and clay is termed as **loam**. The purpose of the fine aggregate is to **fill the voids in the coarse aggregate** and to act as a **workability agent**.

<u>Fine aggregate</u>	Size variation (mm)
Coarse Sand	2.0mm – 0.5mm
Medium sand	0.5mm – 0.25mm
Fine sand	0.25mm – 0.06mm
Silt	0.06mm – 0.002mm
Clay	<0.002

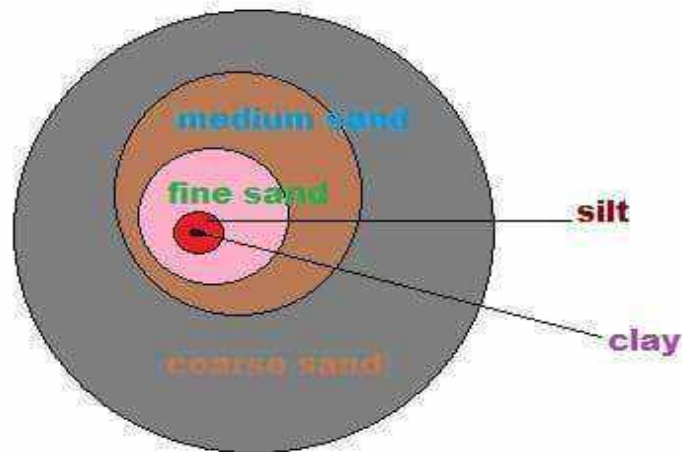

Coarse Aggregate:

When the aggregate is sieved through **4.75mm sieve**, the **aggregate retained** is called **coarse aggregate**. Gravel, cobble and boulders come under this category. The maximum size aggregate used may be dependent upon some conditions. In general, **40mm size aggregate** used for **normal strengths**, and **20mm size** is used for **high strength concrete**. The size range of various coarse aggregates given below.

Coarse aggregate	Size variation (mm)
Fine gravel	4mm – 8mm
Medium gravel	8mm – 16mm
Coarse gravel	16mm – 64mm
Cobbles	64mm – 256mm
Boulders	>256mm

1.1 Physical Prosperities of Aggregate:

1.1.1 Grading:

- Grading is the **particle-size distribution** of an aggregate as determined by a **sieve analysis** using wire mesh sieves with **square openings**.

As per IS:2386(Part-1):

- Fine aggregate:** 6 standard sieves with openings from 150 μm to 4.75 mm. (150 μm , 300 μm , 600 μm , 1.18mm, 2.36mm, 4.75mm)

- **Coarse aggregate:** 5 sieves with openings from 4.75mm to 80mm. (4.75mm, 10mm, 12.5mm, 20mm, 40mm)
- Grain size distribution for concrete mixes that will provide a **dense strong mixture**.
- Ensure that the **voids between the larger particles are filled with medium particles**. The remaining voids are filled with still smaller particles until the smallest voids are filled with a small amount of fines.



Grading Limit for Single Sized Coarse Aggregates:

(Based on Clause 4.1 and 4.2 of IS: 383- 1970)

IS Sieve ↓	<u>Percentage passing</u> for single sized aggregates of nominal size (mm)					
	63 mm	40 mm	20 mm	16 mm	12.5 mm	10 mm
80 mm	100	-	-	-	-	-
63 mm	85 – 100	100	-	-	-	-
40 mm	0 - 30	85 - 100	100	-	-	-
20 mm	0 - 5	0 - 20	85 - 100	100	-	-
16 mm	-	-	-	85 - 100	100	-
12.5 mm	-	-	-	-	85 - 100	100
10 mm	0 - 5	0 - 5	0 - 20	0 - 30	0 - 45	85 - 100
4.75 mm	-	-	0 - 5	0 - 5	0 - 10	0 - 20
2.36 mm	-	-	-	-	-	0 - 5

Grading Limits for Fine Aggregates:

(Based on Clause 4.3 of IS: 383 - 1970)

IS Sieve Designation	<u>Percentage Passing</u>			
	Grading Zone I	Grading Zone II	Grading Zone III	Grading Zone IV
10 mm	100	100	100	100
4.75 mm	90 – 100	90 – 100	90 – 100	95 – 100
2.36 mm	60 – 95	75 – 100	85 – 100	95 – 100
1.18 mm	30 – 70	55 – 90	75 – 100	90 – 100
600 microns	15 – 34	35 – 59	60 – 79	80 – 100
300 microns	5 – 20	8 – 30	12 – 40	15 – 50
150 microns	0 – 10	0 – 10	0 – 10	0 – 15

1.1.2 Fineness Modulus:

- The **results of aggregate sieve analysis** is expressed by a **number** called **Fineness Modulus**. Obtained by adding the **sum of the cumulative percentages by mass of a sample aggregate retained** on each of a specified series of sieves and **dividing the sum by 100**.
- The following limits may be taken as guidance:
- Fine sand: Fineness Modulus: 2.2 - 2.6
- Medium sand: F.M.: 2.6 - 2.9
- Coarse sand: F.M.: 2.9 - 3.2
- A sand having a fineness modulus **more than 3.2** will be **unsuitable** for making satisfactory concrete.

1.1.3 Flakiness Index:

- The flakiness index of aggregate is the **percentage by weight** of particles in it whose **least dimension** (thickness) is **less than three-fifths of their mean dimension**.
- The test is not applicable to sizes **smaller than 6.3 mm**.
- The flakiness index is taken as the total weight of the material passing the various thickness gauges expressed as a percentage of the total weight of the sample taken.
- The below table shows the standard dimensions of thickness and length gauges.

- The **flakiness index** of aggregate is the **percentage by weight** of particles in it whose **least dimension** (thickness) is **less than three-fifths** of their **mean dimension**.

1.1.4 Elongation Index:

The elongation index on an aggregate is the **percentage by weight** of particles whose **greatest dimension** (length) is **greater than 1.8 times** their **mean dimension**.

- The elongation index is **not applicable** to sizes **smaller than 6.3 mm**.
- The elongation index is the total weight of the material retained on the various length gauges expressed as a percentage of the total weight of the sample gauged. The presence of elongated particles in excess of 10 to 15 per cent is generally considered undesirable, but no recognized limits are laid down.

1.2 Mechanical Properties of Aggregate

- Property # 1. Toughness:
- Property # 2. Hardness:
- Property # 3. Specific Gravity:
- Property # 4. Porosity and Absorption of Water by Aggregate:
- Property # 5. Bulking of Sand:

1.2.1 Toughness: It is defined as the **resistance of aggregate to failure by impact**. The impact value of bulk aggregate can be determined as per I.S. 2386, 1963.

Procedure: The aggregate shall be taken as in the case of crushing strength value test i.e., the aggregate should pass through 12.5 mm I.S. sieve and retained on 10 mm I.S. sieve. It should be oven dried at 100°C to 110°C for four hours and then air cooled before test.

Now the prepared aggregate is filled upto 1/3rd height of the cylindrical cup of the equipment. The diameter and depth of the cup are 102 mm and 50 mm respectively. After filling the cup upto 1/3rd of its height, the aggregate is tamped with 25 strokes of the rounded end of the tamping rod.

After this operation the cup shall be further filled upto 2/3rd of its height and a further tamping of 25 strokes given. The cup finally shall be filled to over flowing and tamped with 25 strokes and surplus aggregate removed and the weight of aggregate noted. The value of weight will be useful to repeat the experiment.

Now the hammer of the equipment weighting 14.0 kg or 13.5 kg is raised till its lower face is 380 mm above the upper surface of the aggregate and., allowed to fall freely on the aggregate and the process is repeated for 15 times.

The crushed aggregate is now removed from the cup and sieved through 2.36 mm I.S. sieve. The fraction passing through the sieve is weighed accurately.

Let the weight of oven dry sample in the cup = W kg.

Weight of aggregate passing 2.36 mm sieve = W_1 kg.

Then impact value = $[(W_1/W) \times 100]$

1.2.2 Hardness:

It is defined as the *resistance to wear by abrasion*, and the aggregate abrasion value is defined as the **percentage loss in weight** on abrasion.

Deval Attrition Test:

This test has been covered by IS 2386 Part (IV)-1963. In this test particles of known weight are subjected to wear in an iron cylinder rotated 10,000 (ten thousand) times at the rate of 30 to 33 revolutions per minute. After the specified revolution of the cylinder the material is taken out and sieved on 1.7 mm sieve and the percentage of material finer than 1.7mm is determined. This percentage is taken as the attrition value of the aggregate. The attrition value of about 7 to 8 usually is considered as permissible.

Dorry Abrasion Test:

This test has **not been covered by Indian standard** specifications. In this test a cylindrical specimen having its diameter and height of 25 cm is subjected to abrasion against a rotating metal disk sprinkled with quartz sand. The loss in weight of the cylinder after 1000 (one thousand) revolutions is determined.

Then the hardness of rock sample is expressed by an empirical relation as follows:

Hardness of sample = $20 - \text{Loss in weight in grams}/3$

For good rock this value should not be less than 17. The rock having this value of 14 is considered poor.

Los-Angeles Test:

This test has been covered by IS 2386 (Part-IV) 1963. In this test, aggregate of the specified grading is placed in a cylindrical drum of inside length and diameter of 500 mm and 700 mm respectively. This cylinder is mounted horizontally on stub shafts. For **abrasive charge**, steel balls or cast-iron balls of approximately **48 mm** diameter and each weighting **390 grams to 445 gram** are used. The **numbers of balls** used vary from **6 to 12** depending upon the grading of the aggregate. For **10 mm size aggregate 6 balls** are used and for aggregates **bigger than 20 mm size usually 12 balls** are used.

PROCEDURE: For the conduct of test, the sample and the abrasive charge are placed in the Los-Angeles testing machine and it is rotated at a speed of *20 to 33 revolutions per minute*. For aggregates up to 40 mm size the machine is rotated for 500 revolutions and for bigger size aggregate 1000 revolutions. The charge is taken out from the machine and sieved on **1.7 mm** sieve.

Let the weight of oven dry sample put in the drum = W Kg.

Weight of aggregate passing through 1.7 sieve = W_1 Kg.

Then abrasion value = $[(W_1/W) \times 100]$

The abrasion value **should not be more than 30%** for wearing surfaces and **not more than 50%** for concrete used for other than wearing surface. The results of Los Angeles test show good correlation not only the actual wear of aggregate when used in concrete, but also with the compression and flexural strength of concrete made with the given aggregate.

1.2.3 Specific Gravity and Water Absorption:

The specific gravity of a substance is the **ratio** of the **weight of unit volume** of the substance to the **unit volume of water** at the stated temperature. In concrete making, aggregates generally contain pores both **permeable** and **impermeable** hence the term specific gravity has to be defined carefully. Actually, there are several types of specific gravity. In concrete technology specific gravity is used for the calculation of quantities of ingredients. Usually, the specific gravity of most aggregates varies between **2.6 and 2.8**.

Specific gravity of certain materials as per concrete hand book CA-1 Bombay may be assumed as shown in Table 4.9.

Table 4.9. Specific gravity of cement and aggregate

<i>Material</i>	<i>Specific gravity</i>
Cement	3.15
Average sand	2.00
Granite	2.80
Gravel	2.66
Sand	2.65

Absolute Specific Gravity:

It can be defined as the ratio of the **weight of the solid**, referred to vacuum, to the **weight of an equal volume of gas free distilled water** both taken at the standard or a stated temperature, usually it is not required in concrete technology. Actually, the **absolute specific gravity** and particle density refer to the **volume of solid material excluding all pores**, while ***apparent specific gravity*** and apparent particle density refer to the **volume of solid material including impermeable pores**, but *not the capillary pores*. In *concrete technology apparent specific gravity* is required.

Apparent Specific Gravity:

It can be defined as the **ratio** of the **weight of the aggregate** *dried in an oven at 100°C to 110°C for 24 hours* to the **weight of water** *occupying a volume equal to that of the solid including the impermeable pores*. This can be determined by using **pycno-meter** for solids *less than 10 mm in size* i.e., sand.

Bulk Specific Gravity:

It can be defined as the **ratio of the weight in air of a given volume** of material (*including both permeable and impermeable voids*) at the standard temperature to the **weight in air of an equal volume of distilled water** at the same standard temperature (20°C). The *specific gravity* of a material *multiplied by the unit weight of water* gives the *weight of 1 cubic metre of that substance*. Sometimes this weight is known as *solid unit weight*. The weight of a given quantity of particles divided by the solid unit weight gives the solid volume of the particles.

Solid vol. in m³ = 3 wt. of substance in kg/specific gravity x 1000

Bulk Density:

The weight of aggregate that would fill a container of unit volume is known as bulk density of aggregate.

Voids:

With respect to a mass of aggregate, the term voids refers to the space between the aggregate particles. Numerically this voids space is the difference between the gross volume of aggregate mass and the space occupied by the particles alone. The knowledge of voids of coarse and fine aggregate is useful in the mix design of concrete.

Percentage voids = $[(G_s - g)/G_s] \times 100$

where G_s = specific gravity of aggregate and g is bulk density in kg/litre.

Unit Weight:

The weight of a unit volume of aggregate is called as unit weight. For a given specific gravity, greater the unit weight, the smaller the percentage of voids and better the gradation of the particles, which affects the strength of concrete to a great extent.

Method of Determination of Specific Gravity of Aggregate:

Specific gravity test of aggregates is done to measure the **strength** or **quality** of the material while **water absorption** test determines the **water holding capacity** of the coarse and fine aggregates. The main objective of these test is to,

1. To measure the strength or quality of the material.
2. To determine the water absorption of aggregates

Specific Gravity is the ratio of the weight of a given volume of aggregate to the weight of an equal volume of water. It is the measure of strength or quality of the specific material.

Aggregates having low specific gravity are generally weaker than those with higher specific gravity values.

Observations of Test

Weight of saturated aggregate suspended in water with basket = W_1 g
Weight of basket suspended in water = W_2 g
Weight of saturated surface dry aggregate in air = W_3 g
Weight of oven dry aggregate = W_4 g
Weight of saturated aggregate in water = $W_1 - W_2$ g
Weight of water equal to the volume of the aggregate = $W_3 - (W_1 - W_2)$ g

Formulas:

(1) Specific gravity = $W_3 / (W_3 - (W_1 - W_2))$

(2) Apparent specific gravity = $W_4 / (W_4 - (W_1 - W_2))$

(3) Water Absorption = $((W_3 - W_4) / W_4) \times 100$

The size of the aggregate and whether it has been artificially heated should be indicated.

Though high specific gravity is considered as an indication of high strength, it is not possible to judge the suitability of a sample aggregate without finding the mechanical properties such as aggregate crushing, impact and abrasion values.

1.2.4 Porosity and Absorption of Water by Aggregate:

All aggregates, particles have pores within their body. The characteristics of these pores are very important in the study of the properties of aggregate. The porosity, permeability, and absorption of aggregates influence the resistance of concrete to freezing and thawing, bond strength between aggregate and cement paste, resistance to abrasion of concrete etc.

The size of pores in the aggregate varies over a wide range, some being very large, which could be seen even with naked eye. The **smallest pore** of aggregate is generally **larger** than the **gel pores in the cement paste**, *pores smaller than 4 microns* are of special interest as they are believed to affect the *durability of aggregates* subjected to alternate *freezing and thawing*. Some of the pores are wholly within the body of the aggregate particles and some of them are open up to the surface of the particle.

The cement paste due to its viscosity cannot penetrate to a great depth into the pores except the largest of the aggregate pores. Therefore, for the purpose of calculating the aggregate content in concrete, the gross volume of the aggregate particles is considered solid. However, water can enter these pores, the amount and rate of penetration depends upon the size, continuity and total volume of pores.

When all the pores in the aggregate are full with water, then the aggregate is said to be **saturated and surface dry**. If this aggregate is allowed to stand in the laboratory, some of the moisture will evaporate and the aggregate will be known as air **dry aggregate**. If aggregate is dried in

oven and no moisture is left in it, then it is known as **bone dry aggregate**. Thus the ratio of the increase in weight to the dry weight of the sample, expressed as a percentage is known as **absorption**.

The knowledge of absorption of aggregate is important in adjusting water-cement ratio of the concrete. If water available in the aggregate is such that it contributes some water to the dilution of cement paste, in that case the water-cement ratio will be more than the required and the strength will go down.

On the other hand, if the aggregate is so dry that it will absorb some of the mixing water, in that case the mix will have lower water-cement ratio and the mix may become unworkable. Hence, while deciding the water-cement ratio, it is assumed that the aggregate is in **saturated but surface dry condition**, i.e. neither it will add water to cement paste, nor it will absorb water from the mix.

Surface Water:

While using aggregate in the concrete, water on the surface of the aggregate should be taken into account, as it will contribute to the water in the mix and will affect the water-cement ratio of the mix, causing **lower strength** of the concrete. It is **difficult to measure surface water of the aggregate**.

1.2.5 Bulking of Sand:

The moisture present in fine aggregate causes **increase in its volume**, known as **bulking** of sand. The moisture in the fine aggregate develops a **film of moisture around the particles** of sand and due to **surface tension** pushes apart the sand particles, occupying greater volume. The bulking of the sand affects the mix proportion, if mix is designed by volume batching. Bulking results in smaller weight of sand occupying the fixed volume of the measuring box, and the mix becomes deficient in sand and the resulting concrete becomes honeycombed and its yield is also reduced.

The extent of bulking depends upon the percentage of moisture present in sand and its fineness. The increase in volume relative to that occupied by a saturated and surface dry sand increases with an increase in the moisture content of the sand upto a value of 5 to 8%, causing bulking ranging from 20 to 40%.

As the **moisture content increases**, the **film of water** formed around the sand particles merge and the water moves into the voids between the particles so that the total volume of sand **decreases**, till the sand is **fully saturated**. The volume of fully saturated sand is same as that of the dry sand for the same method of filling the container.

Soundness:

It is the **percentage loss of material from an aggregate blend during the sodium or magnesium sulfate soundness test**. This test, which is specified in ASTM C88 and AASHTO T104, estimates the *resistance of aggregate to in-service weathering*. It can be performed on both **coarse** and **fine** aggregate.

Alkali-silica reaction (ASR):

In most concrete, aggregates are more or less **chemically inert**. However, some **aggregates** react with the *alkali hydroxides* in concrete, causing **expansion** and **cracking** over a period of many years. This alkali-aggregate reaction has two forms: **alkali-silica reaction (ASR)** and **alkali-carbonate reaction (ACR)**. Alkali-silica reaction (ASR) is the chemical reaction that occurs between **alkali cations and hydroxyl ions** in the **pore solution of hydrated cement paste and certain reactive silica phases** present in the aggregates used in concrete.

Alkali-silica reaction (ASR), more commonly known as "**concrete cancer**", is a **deleterious swelling reaction** that occurs over time in concrete between the highly **alkaline cement paste** and the reactive amorphous (i.e., non-crystalline) **silica** found in many common aggregates.

Alkali-silica reaction (ASR) is of more concern because aggregates containing **reactive silica** materials are more **common**. In ASR, aggregates containing certain forms of **silica** will react with **alkali hydroxide** in concrete to form a **gel**. These gels can induce enough **expansive pressure** to damage concrete.

Typical indicators of ASR are random map cracking and, in advanced cases, closed joints and attendant spalled concrete. Cracking usually appears in areas with a frequent supply of moisture, such as close to the waterline in piers, near the ground behind retaining walls, near joints and free edges in pavements, or in piers or columns subject to wicking action. Petrographic examination can conclusively identify ASR.

Alkali-silica reaction can be controlled using certain supplementary cementitious materials. In proper proportions, silica fume, fly ash, and ground granulated blast-furnace slag have significantly reduced or eliminated expansion due to alkali-silica reactivity. In addition, lithium compounds have been used to reduce ASR. Although potentially reactive aggregates exist throughout North America, alkali-silica reaction distress in concrete is not that common because of the measures taken to control it. It is also important to note that not all ASR gel reactions produce destructive swelling.

Alkali-carbonate reaction (ACR) is observed with certain dolomitic rocks. Dedolomitization, the breaking down of dolomite, is normally associated with expansion. This reaction and subsequent crystallization of brucite may cause considerable expansion. The deterioration caused by alkali-carbonate reactions is similar to that caused by ASR; however, ACR is relatively rare because aggregates susceptible to this phenomenon are less common and are usually unsuitable for use in concrete for other reasons. Aggregates susceptible to ACR tend to have a characteristic texture that can be identified by petrographers. Unlike alkali carbonate reaction, the use of supplementary cementing materials does not prevent deleterious expansion due to ACR. It is recommended that ACR susceptible aggregates not be used in concrete.

Prevention of Alkali-Silica Reaction in New Concrete

Follow the steps in the flowchart below to determine if potential for ASR exists and to select materials to control it. For more information move your mouse over the individual flowchart boxes.

1.3 Thermal Properties of Aggregates

The properties of concrete that are needed for *fire-resistance analysis* are thermal, mechanical, deformation, and special properties, such as fire-induced spalling. Thermal properties include:

- Thermal conductivity,
- Specific heat,
- Thermal diffusivity,
- Thermal expansion, and

1.3.1 Thermal conductivity:

The **thermal conductivity** of a material is a measure of its **ability to conduct heat**. Heat transfer occurs at a **lower rate** in materials of **low thermal conductivity** than in materials of high thermal conductivity. For instance, metals typically have high thermal conductivity and are very efficient at conducting heat, while the opposite is true for insulating materials like Styrofoam. Correspondingly, materials of high thermal conductivity are widely used in heat sink applications, and materials of low thermal conductivity are used as thermal insulation.

1.3.2 Specific heat:

Specific heat, **the quantity of heat** required to **raise the temperature** of one gram of a substance by one Celsius degree. The units of specific heat are usually **calories** or **joules per gram per Celsius degree**. For example, the specific heat of water is 1 calorie (or 4,186 joules) per gram per Celsius degree. It is the **heat capacity** of a sample of the substance **divided** by the mass of the sample. The heat required to raise the temperature of 1 kg of water by 1 Kelvin is 4184 joules, so the specific heat capacity of water is $4184 \text{ J}\cdot\text{kg}^{-1}\cdot\text{K}^{-1}$.

1.3.3 Thermal diffusivity:

The concept of Thermal diffusivity is frequently confused with that of thermal conductivity. They are closely related concepts; however, thermal conductivity appears to be more prevalent in the scientific community. Even as the less popular of the two heat transfer measurements, thermal diffusivity still plays an important role in influencing the movement and behavior of heat.

Thermal diffusivity is a measure of the **rate at which heat disperses throughout an object** or body. Thermal conductivity is a measure of **how easily one atom or molecule of a material accepts or gives away heat**. The main idea behind thermal diffusivity is the **rate** at which **heat diffuses** throughout a material.

1.3.4 Thermal expansion:

Thermal expansion is the **tendency** of matter to **change** its **shape, area, volume, and density** in response to a change in **temperature**, usually not including phase transitions. When a substance is **heated**, molecules begin to vibrate and move more, usually **creating more distance** between themselves. Substances which **contract** with **increasing temperature** are unusual, and only occur within limited temperature ranges (see examples below). The **relative expansion** (also called strain) **divided** by the **change in temperature** is called the material's **coefficient of linear thermal expansion** and generally varies with temperature. As energy in particles increases, they start moving faster and faster weakening the intermolecular forces between them, therefore expanding the substance.

Following are three thermal properties of aggregate relevant to the performance of concrete:

- Coefficient of thermal expansion
- Specific heat
- conductivity
 - Specific heat and conductivity of aggregate are of interest in mass concrete to which insulation is applied, but usually not in ordinary structural work
 - The difference between coefficients of thermal expansion of aggregate and cement paste is important for the durability of concrete
 - If the difference between coefficients of thermal expansion of aggregate and cement paste is smaller, durability of concrete is not adversely affected within a temperature range of 4 to 60 °C
 - If the difference between coefficients of thermal expansion of aggregate and cement paste is more than $5.5 \times 10^{-6}/^{\circ}\text{C}$, durability of concrete subjected to freezing and thawing may be adversely affected
 - The coefficient of thermal expansion for: hydrated cement paste lies between 11 and $16 \times 10^{-6}/^{\circ}\text{C}$ and rocks commonly used for aggregate lies between 5 and $13 \times 10^{-6}/^{\circ}\text{C}$

2 BRICKS AND MASONRY BLOCKS:

Types, properties and field and laboratory tests to evaluate quality

BRICK:

A **brick** is a type of block used to build walls, pavements and other elements in masonry construction. Properly, the term *brick* denotes a block composed of dried clay, but is now also used informally to denote other chemically cured construction blocks. Bricks can be joined using mortar, adhesives or by interlocking them. In India, standard brick size is **190 mm x 90 mm x 90 mm** as per the recommendation of BIS. With mortar thickness, the dimension of the brick becomes 200 mm x 100 mm x 100 mm which is also known as the nominal size of the modular brick.

Block is a similar term referring to a rectangular building unit composed of similar materials, but is usually **larger than a brick**. Lightweight bricks (also called lightweight blocks) are

made from expanded clay aggregate. In India, most commonly used, rectangular, standard size of solid concrete block is 4”(100 mm), 6”(150 mm) and 8” (200 mm) thick CMU.

2.1 Types of Bricks:

a) Classification of Bricks *Based on Quality*:

1. **First Class Brick:** The size is standard. The color of these bricks is uniform yellow or red. It is **well burnt, regular texture, uniform shape**. The **absorption capacity is less than 10%**, crushing strength is, 280 kg/cm² (mean) where it is 245 kg/cm² (minimum). It doesn't have efflorescence. It emits a metallic sound when struck by another similar brick or struck by a hammer. It is hard enough to resist any fingernail expression on the brick surface if one tries to do with a thumbnail. It is free from pebbles, gravels or organic matters. It is generally used-
 - in a building of long durability, say 100 years
 - for building exposes to a corrosive environment;
 - for making coarse aggregates of concrete.
2. **Second Class Brick:** The size is standard, color is uniform yellow or red. It is well burnt, slightly over burnt is acceptable. It has a regular shape; efflorescence is not appreciable. The absorption capacity is more than 10% but less than 15%. Crushing strength is 175kg/cm²(mean) where the minimum is 154 kg/cm². It emits a metallic sound when struck by another similar brick or struck by a hammer. It is hard enough to resist any fingernail expression on the brick surface if one tries to do with a thumbnail. It is used for the construction of one-storied buildings, temporary shed when intended durability is not more than 15 years.
3. **Third Class Brick:** The shape and size are not regular. The color is soft and light red colored. It is under burnt, slightly over burnt is acceptable. It has extensive efflorescence. The texture is non-uniform. The absorption capacity is more than 15% but less than 20%. The crushing strength is 140kg/cm²(mean) where the minimum crushing strength is 105kg/cm². It emits a dull or blunt sound when struck by another similar brick or struck by a hammer. It leaves fingernail expression when one tries to do with the thumbnail.

First Class	<ol style="list-style-type: none"> 1. Cement of lime mortar is used, 2. The surface and edges of bricks are sharp, 3. And the thickness of mortar joints doesn't exceed 10mm
Second Class	<ol style="list-style-type: none"> 1. Ground moulded bricks are used, 2. Bricks are rough and shape is slightly irregular, 3. The thickness of mortar joint is 12 mm
Third Class	<ol style="list-style-type: none"> 1. Bricks are not hard, rough surface with distorted shape, 2. Used for temporary structures, 3. Used in places where rainfall is not heavy

b) *Classification of Bricks Based on **Building Process**:*

1. **Unburnt Bricks:** These are half burnt bricks. The color is yellow. The strength is low. They are used as surki in lime terracing. They are used as soiling under RCC footing or basement. Such bricks should not be exposed to rainwater.
2. **Burnt Bricks:** Burnt bricks are made by burning them in the kiln. First class, Second-Class, Third-Class bricks are burnt bricks.
3. **Over Burnt or Jhama Brick:** It is often known as the vitrified brick as it is fired at high temperature and for a longer period of time than conventional bricks. As a result, the shape is distorted. The absorption capacity is high. The strength is higher or equivalent to first class bricks. It is used as lime concrete for the foundation. It is also used as coarse aggregate in the concrete of slab and beam which will not come in contact with water.

c) *Classification of Bricks Based on **Manufacturing Method**:*

1. **Extruded Brick:** It is created by forcing clay and water into a steel die, with a very regular shape and size, then cutting the resulting column into shorter units with wires before firing. It is used in constructions with limited budgets. It has three or four holes constituting up to 25% volume of the brick.
2. **Molded Brick:** It is shaped in molds by hand rather being in the machine. Molded bricks between 50-65mm are available instantly. Other size and shapes are available in 6-8 weeks after the order.
3. **Dry pressed Brick:** It is the traditional types of bricks which are made by compressing clay into molds. It has a deep frog in one bedding surface and shallow frog in another.

d) *Classification of Bricks Based on **Raw Materials**:*

1. **Burnt Clay Brick:** It is obtained by pressing the clay in molds and fired and dried in kilns. It is the most used bricks. It requires plastering when used in construction works.
2. **Fly ash clay Brick:** It is manufactured when fly ash and clay are molded in 1000 degree Celsius. It contains a high volume of calcium oxide in fly ash. That is why usually described as self-cementing. It usually expands when coming into contact with moisture. It is less porous than clay bricks. It proved a smooth surface so it doesn't need plastering.
3. **Concrete Brick:** It is made of concrete. It is the least used bricks. It has low compression strength and is of low quality. These bricks are used above and below the damp proof course. These bricks are used can be used for facades, fences and internal brickworks because of their sound reductions and heat resistance qualities. It is also called mortar brick. It can be of different colors if the pigment is added during manufacturing. It should not be used below ground.
4. **Sand-lime Brick:** Sand, fly ash and lime are mixed and molded under pressure. During wet mixing, a chemical reaction takes place to bond the mixtures. Then they are placed in the molds. The color is greyish as it offers something of an aesthetic view. It offers a smoother finish and uniform appearance than the clay bricks. As a result, it also doesn't require plastering. It is used as a load bearing members as it is immensely strong.
5. **Firebrick:** It is also known as refractory bricks. It is manufactured from a specially designed earth. After burning, it can withstand very high temperature without affecting its shape,

size, and strength. It is used for the lining of chimney and furnaces where the usual temperature is expected to be very high.

e) Classification of Bricks Based on Using Location:

1. **Facing Brick:** The façade material of any building is known as facing brick. Facing bricks are standard in size, are stronger than other bricks and also have better durability. The color is red or brown shades to provide a more aesthetic look to the building. There are many types of facing bricks which use different techniques and technology. Facing bricks should be weather resistant as they are most generally used on the exterior wall of buildings.
2. **Backing Brick:** These types of brick don't have any special features. They are just used behind the facing bricks to provide support.

f) Classification of Bricks Based on Weather-resisting Capability:

1. **Severe Weather Grade:** These types of bricks are used in the countries which are covered in snow most of the time of year. These bricks are resistant to any kind of freeze-thaw actions.
2. **Moderate Weather Grade:** These types of bricks are used in tropical countries. They can withstand any high temperature.
3. **No Weather Grade:** These bricks do not have any weather resisting capabilities and used on the inside walls.

g) Classification of Bricks Based on Their Using:

1. **Common Bricks:** These bricks are the most common bricks used. They don't have any special features or requirements. They have low resistance, low quality, low compressive strength. They are usually used on the interior walls.
2. **Engineering Bricks:** These bricks are known for many reasons. They have high compressive strength and low absorption capacity. They are very strong and dense. They have good load bearing capacity, damp proof, and chemical resistance properties. They have a uniform red color. They are classified as Class A, class B, class C. Class A is the strongest but Class B is most used. They are used for mainly civil engineering works like sewers, manholes, ground works, retaining walls, damp proof courses, etc.

h) Classification of Bricks Based on Shape:

1. **Bullnose Brick:** These bricks are molded into round angles. They are used for rounded quoin.
2. **Airbricks:** These bricks contain holes to circulate air. They are used on suspended floors and cavity walls.
3. **Channel Bricks:** They are molded into the shape of a gutter or channel. They are used in drains.
4. **Coping Bricks:** They can be half round, chamfered, Saddleback, angled varied according to the thickness of the wall.
5. **Cow Nose Bricks:** Bricks having double bullnose known as Cow Nose Bricks.
6. **Capping Bricks:** These bricks are used to cap the tops of parapets or freestanding walls.
7. **Brick Veneers:** These bricks are thin and used for cladding.

8. **Curved Sector Bricks:** These are curved in shape. They are used in arcs, pavements, etc.
9. **Hollow Bricks:** These bricks are around one-third of the weight of the normal bricks. They are also called cellular or cavity bricks. Their thickness is from 20-25mm. These bricks pave the way to quicker construction as they can be laid quickly compared to the normal bricks. They are used in partitioning.
10. **Paving Bricks:** These bricks contain a good amount of iron. Iron vitrifies bricks at low temperature. They are used in garden park floors, pavements. These bricks withstand the abrasive action of traffic thus making the floor less slippery.
11. **Perforated Bricks:** These bricks contain cylindrical holes. They are very light in weight. Their preparation method is also easy. They consume less clay than the other bricks. They can be of different shapes like round, square, rectangular. They are used in the construction of the panels for lightweight, structures, and multistoried frame structures.
12. **Purpose Made Bricks:** For specific purposes, these bricks are made. Splay and can't bricks are made for doors and window jambs. Engineering bricks are made for civil engineering constructions such as sewers, manholes, retaining walls. Fire bricks are made for chimneys and fireworks. Ornamental bricks are made to use for cornices, corbels. Arch bricks are used in arcs.

*i) Classification of Bricks Based on **Region**:*

1. **Cream City Bricks:** These bricks are from Milwaukee, Wisconsin.
2. **London Stock:** These bricks are used in London.
3. **Dutch:** These are from the Netherlands.
4. **Nanak Shahi Bricks:** These are from India.
5. **Roman:** These are used in Roman constructions,
6. **Staffordshire Blue Brick:** These are from England.

MASONRY BLOCKS:

Masonry block is an important component in construction and building materials in many parts of the world. Concrete block is made from **Portland Cement, aggregates and water**. It is also known as a concrete masonry unit (**CMU**). As a building material, concrete offers several attractive characteristics to designers and builders. Standard size of

Brick—A solid or hollow manufactured masonry unit of either concrete, clay or stone.

Concrete brick—A concrete hollow or solid unit smaller in size than a concrete block

Concrete block—A hollow or solid concrete masonry unit. Larger in size than a concrete brick.

Block walls have higher density as compared to brick constructions and hence they offer more soundproofing. Their efficient acoustic insulation is a big help if your home is constantly surrounded by noise that could keep you from getting a sound sleep.

Types of Concrete Blocks or Concrete Masonry Units (CMU) Used in Construction:

- Types of Hollow Concrete Blocks:
- Concrete Stretcher Blocks.
- Concrete Corner Blocks.
- Concrete Pillar Blocks.
- Jamb Concrete Blocks.

- Partition Concrete Block.
- Lintel Blocks.
- Frogged Brick Blocks.



2.2 Field Tests on Brick:

A field test on bricks gives the idea about its basic quality based on its shape, size and colour at first observation without any big appliances. They are the very common and easiest way to check the quality of brick. Field tests of brick are very helpful on the site. Some very common tests of brick that is followed to find if brick is good at first observation are as follows:

- ***Shape and Size*** of Clay Bricks:

The clay bricks should have a **uniform rectangular** plan surface, as per standard size and sharp straight edges. BSI recommends the standard size of brick is **190 mm x 90 mm x 90 mm** and constructional size is **200 mm x 100 mm x 100 mm**.

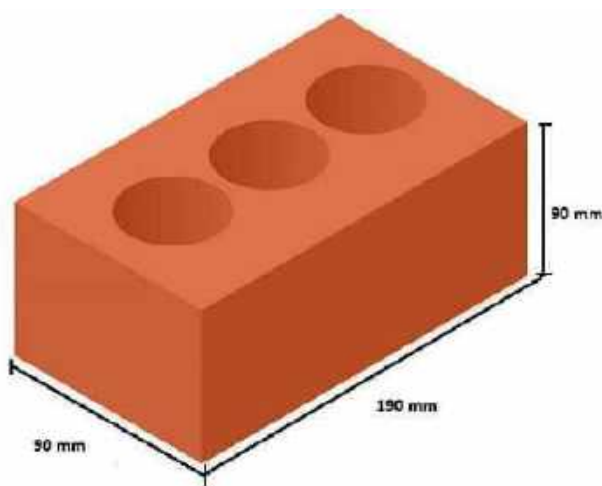

- ***Visual inspection:***

In this test bricks are closely inspected for its shape. The bricks of good quality should be **uniform in shape** and should have **truly rectangular shape with sharp edges**.

- ***Hardness*** of Clay Bricks:

The clay bricks should be **sufficiently hard** when **scratched** by a **finger-nail no impression** should be left on the brick surface.

- **Colour** of Clay Bricks:

The clay bricks should have a **uniform deep red colour** throughout. It indicates the *uniformity of chemical composition* and the *quality of burning* of the bricks.

- **Texture and compactness** of Clay Bricks:

The surfaces should **not** be so **smooth** to cause *skidding of mortar*. The clay brick should have a pre-compact, homogeneous and uniform texture. A broken surface should be free from cracks, holes, grits or lumps of lime.

- **Soundness** of Clay Bricks: When two clay bricks are **stuck** together, a **metallic ringing sound** should come.

- **Structure:**

A brick is **broken** and its **structure** is **examined**. It should be **homogeneous, compact** and **free** from any **defects** such as **holes, lumps** etc.

- **Thermal Conductivity** of Clay Bricks:

Generally, we are **not conducting** any test for thermal conductivity because the thermal conductivity of clay brick is **low**, i.e., it **protects from heat**.

- **Basic Strength** of Clay Bricks:

When dropped flat on the hard ground from a height of about one meter, clay bricks **should not break**.

2.3 Laboratory Tests on Brick:

Laboratory tests on brick determine the mechanical properties of brick and give a scientific approach to ensure the quality of bricks. It is essential while purchasing the brick and examine the properties for the quality of construction.

Following brick tests are performed in the laboratory to determine the quality of brick.

1. Water Absorption of Bricks:

The brick is porous by nature and Porosity is the ability to release and absorb moisture. Therefore, it tends to absorb the water or moisture. It's an important and useful property of brick. But if brick absorbs more water than the recommended result, than it affects the strength of brick as well as durability of the structure and of course will damage plaster and paint over walls.

- (a) Use of Water Absorption of Bricks:

Water absorption test is performed to know the percentage of water absorption of bricks.

- (b) Recommended Result of Water Absorption of Bricks:

Water absorption of bricks should not more than 20 % by its dry weight.

- (c) Why Bricks Fails in Water Absorption? & What if Test Fails?

If brick fails in the water absorption test, possible reasons are like manufacturing error, insufficient burning, error in clay composition etc. and If brick fails in water absorption as well as efflorescence than never never never use those bricks because you will land in permanent problems and it will be very difficult to solve them.

(d) Standard Guidelines for Water Absorption Test of Bricks:

There various standard guidelines available for water absorption test of bricks such as IS 3495 (Part 2) 1992, ASTM C 67, BS 3921:1985.

(e) Apparatus of Water Absorption Test of Brick:

Water bath, weight balance, and oven are required for performing this test

2. Compressive Strength of Brick:

The compressive strength of the brick is the most essential property of the bricks because in the construction, bricks are widely used in masonry and it also plays a significant role as a load bearing component.

When bricks are used in any structure, the bottom-most layer of the brick will be subjected to the highest compressive stress. Therefore, it is essential to know that any particular brick will be able to withstand that load or not.

(a) Use of Compressive Strength of Brick:

This test is performed to know the strength of bricks because it affects the overall structure in the way of quality, durability and serviceability.

(b) Recommended Result of Compressive Strength Test of Brick:

Test result recommendations are as follows:

- For first class bricks, it should not less than 10 N/mm² (102 kg/cm²).
- For second class bricks, it should not less than 7 N/mm² (71 kg/cm²).
- For third class bricks, it should not less than 3.5 N/mm² (36 kg/cm²).

In India, the northern and the eastern region produce bricks having good compressive strength than the western region because the western region has black cotton soil, while the soil is good in Gangetic region.

Why Compressive Strength Test Fails? & What if Test Fails?

If the test result is not as per recommendation, there are many reasons behind it such as the clay composition, degree of burning like over burning or insufficient burning, error in the testing appliance or testing procedure etc.

If bricks fail in strength as well as water absorption test than do not use it. If bricks are irregular in some minor shape/size than it can be corrected with mortar. If not then you can consult your brick supplier or brick manufacturer for replacing it.

3. Efflorescence:

This test should be conducted in a well-ventilated room. The brick is placed vertically in a dish **30 cm x 20 cm** approximately in size with **2.5 cm** immersed in distilled water. The whole water is allowed to be **absorbed** by the brick and **evaporated** through it. After the bricks appear **dry**, a similar quantity of water is placed in the dish, and the water is allowed to **evaporate as before**. The brick is to be examined after the second evaporation and reported as follows:

- Nil: When there is no perceptible deposit of salt
 - *Slight: When **not more than 10%** of the area of brick is covered with salt*
 - *Moderate: When there is heavy deposit covering **50% of the area** of the brick but **unaccompanied by powdering** or flaking of the surface.*
 - Heavy: When there is heavy deposit covering more than 50% of the area of the brick accompanied by powdering or flaking of the surface.
 - Serious: When there is heavy deposit of salts accompanied by powdering and/or flaking of the surface and this deposition tends to increase in the repeated wetting of the specimen.
- Bricks for general construction should not have more than slight to moderate efflorescence.

4. Dimension tolerance:

Twenty bricks are selected at random to check measurement of **length, width and height**. These dimensions are to be measured in **one** or **two** lots of **ten** each as shown in figure. Variation in dimensions is allowed only within narrow limits, **±3% for class one** and **±8% for other classes**.

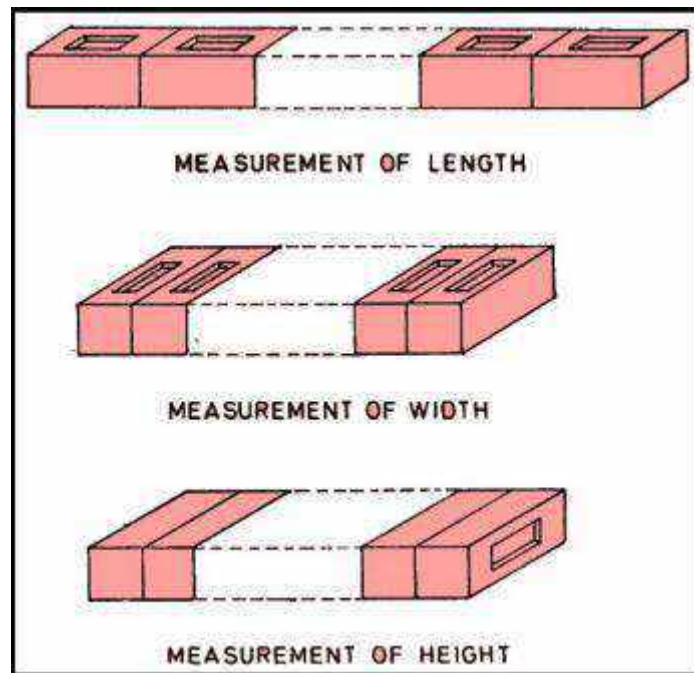

2.3 Properties of Brick:

The essential properties of bricks may be conveniently discussed under the following **four headings**: physical, mechanical, thermal and durability properties.

(1) *Physical Properties of Bricks:*

These properties of bricks include **shape, size, color, and density** of a brick.

(i) Shape:

The standard shape of an ideal brick is truly **rectangular**. It has Well defined and **sharp edges**. The surface of the bricks is **regular** and **even**.

(ii) Size:

The size of brick used in construction varies from country to country and from place to place in the same country.

In India, the recommended standard size of an ideal brick is **19 x 9 x 9 cm** which with **mortar joint** gives net dimensions of **20 x 10 x 10 cm**.

These dimensions have been found very convenient in **handling** and making **quantity estimates**. ***Five hundred such bricks will be required for completing 1 m³ brick masonry.***

(iii) Color.

The most common color of building bricks falls under the class **RED**. It may vary from **deep red to light red to buff and purple**.

Very dark shades of red indicate **over burnt bricks** whereas **yellow color** is often indicative of **under-burning**.

(iv) Density.

The density of bricks or **weight per unit volume** depends mostly on the type of clay used and the method of brick molding (soft-mud, Stiff-mud, hard-pressed etc.).

In the case of **standard bricks**, density varies from **1600 kg/m³ to 1900 kg/m³**. A single brick (19 x 9 x 9 cm) will weigh between **3.2 to 3.5 kg**, depending upon its density.

(2) Mechanical Brick Properties.

(i) Compressive Strength of Bricks:

It is the most important property of bricks especially when they are used in **load-bearing walls**.

The compressive strength of a brick depends on the **composition** of the **clay** and **degree of burning**. It may vary from 3.5 N/mm² to more than 20 N/mm² in India.

It is specified under the I.S. codes that an ordinary type building brick must possess a **minimum compressive strength of 3.5 N/mm²**.

The **first** and **2nd** class bricks shall have a compressive strength **not less than 7 N/mm² and 14 N/mm²** respectively.

(ii) Flexure Strength:

Bricks are **often used** in situations where **bending loads** are possible in a building. As such, they should possess sufficient strength against transverse loads.

It is specified that the flexural strength of a common building brick shall **not be less than 1 N/mm²**. Best grade bricks often possess flexural strength over 2 N/mm².

Similarly, it is required that a good building brick shall possess a **shearing strength** of 5-7 N/mm².

(3) Thermal Properties of Building Bricks:

Besides being hard and strong, ideal bricks should also provide an **adequate insulation** against **heat, cold and noise**.

The **heat and sound conductivity** of bricks vary greatly with their **density and porosity**.

Very **dense and heavy bricks conduct heat and sound** at a **greater rate**. They have, therefore, **poor thermal and acoustic (sound) insulation qualities**.

For this reason, bricks should be so designed that they are **light and strong** and give **adequate insulation**.

(4) Durability:

By durability of bricks, it is understood that the **maximum time** for which they remain unaltered and **strong** when used in construction.

Experience has shown that **properly manufactured bricks** are among the **most durable** of man-made materials of construction. Their life can be counted in **hundreds of years**.

The **durability** of bricks depends on some factors such as: **absorption value, frost resistance, and efflorescence**.

(i) Absorption Value.

This property is related to the **porosity** of the brick.

True Porosity is defined as the **ratio** of the **volume of pores** to the **gross volume** of the sample of the substance.

Apparent porosity, more often called Absorption value or simply absorption, is the **quantity of water absorbed** by the (brick) sample. This is expressed in percentage terms of the dry weight of the sample: $Absorption = \frac{W_2 - W_1}{W_1} \times 100$.

Where W₂ is weight after **24 hours of immersion** in water and **W₁ is the oven dry weight** of the sample.

The absorption values of bricks vary greatly. It is, however, recommended that for **first class bricks**, they shall **not be greater than 20 percent** and for **ordinary building bricks**, **not greater than 25 percent**.

The **absorption characteristic** of bricks affects their quality in many ways:

Firstly: **higher porosity** means **fewer solid materials**; hence, **strength is reduced**.

Secondly: **higher absorption** will lead to other water-related defects such as **frost-action** and **efflorescence**.

Thirdly: **higher absorption** results in **deeper penetration** of water which becomes a source of **dampness**.

(ii) Frost Resistance:

Water on **freezing expands** by **about 10%** in volume and exerts a pressure on the order of 14 N/mm². When bricks are used in cold climates, their decay due to this phenomenon of “**frost action**” may be a common process.

This is especially so because bricks are **quite porous** materials (apparent porosity = 20-25%). It is, therefore, essential that bricks in these areas should be properly protected from rain to minimize absorption.

(iii) Efflorescence:

It is a common disfiguring and deteriorating process of bricks in hot and humid climates. Brick surface gets covered with **white or grey coloured patches of salts**. These salts are present in the **original brick clay**.

When **rain water penetrates** into the bricks, the **salts get easily dissolved**. After the rains, **evaporation** starts.

The **salts move out** along with the water and form thin **encrustations** on the surface of the bricks.

Salts which are **commonly precipitated** during efflorescence are: *sulphates of calcium, magnesium, sodium and potassium*.

It is why great emphasis should be laid while testing the chemical composition of the clay for brick manufacturing.

SUMMARY (Properties of Bricks).

1. It should have a **rectangular** shape, regular surface and red colored appearance.
2. It should conform in size to the specified dimensions (19 x 9 x 9 cm).
3. It should be properly **burnt**. This can be ascertained by holding two bricks freely, one in each hand, and striking them. A sharp metallic sound indicates good burning whereas a dull thud would indicate incomplete burning.
4. A good building brick should not **absorb water** more than 20 percent of its dry weight. Absorption should not exceed 25 percent in any case.
5. A good building brick should possess requisite **compressive strength**, which in no case should be less than 3.5 N/mm². A rough test for the strength of the brick is to let it fall freely from a height of about **one meter on to a hard floor**. It should **not break**.
6. Brick should be **hard** enough so that it is **not scratched** by a finger nail.
7. A good brick has a **uniform colour** and structure through its body. This can be checked by taking a brick from the lot and breaking it into two parts. The **broken surface in both the halves** should **have same appearance and structure**.

3. LIME: (A Building Material for use in Construction)

Classification, Properties

3.1 Classification:

Lime is the versatile mineral. Various forms of lime are used in **environmental, metallurgical, construction, and chemical/industrial applications**, etc. **Lime**, or **calcium oxide (CaO)**, is derived from high quality natural **deposits of limestone**, or calcium carbonate (**CaCO₃**). **Limestone** is a **sedimentary rock** that formed millions of years ago as the result of the *accumulation of shell, coral, algal, and other ocean debris*. Lime is produced when limestone is subjected to **extreme heat**, changing **calcium carbonate** to **calcium oxide**.

Lime is commonly referred to by a number of terms including **quicklime, calcium oxide, high calcium lime**, or **dolomitic lime**. All refer to the same material, lime. *Dolomitic lime* contains magnesium oxide (**MgO**) derived from the presence of magnesium carbonate (**MgCO₃**) in the initial stone referred to as dolomitic limestone. Dolomitic limestone contains two forms of carbonate, calcium carbonate and magnesium carbonate. *High calcium lime* is almost *pure calcium carbonate*. The use of lime surrounds our everyday life making the *water we drink safe, the air we breathe cleaner, our steel purer and construction projects more stable*. It goes into *glass production, paper manufacturing, agricultural practices, chemical processes, plaster, mortar and other building materials*, to name a few.

In construction applications, lime and lime-based reagents can *dry wet soils to eliminate downtime, increase productivity and keep projects moving*. They quickly modify weak soils to make work cleaner, safer, faster and easier. Soil modification provides an improved working platform that keeps materials coming to the job site. Lime derived products can also be used to stabilize soils providing long term, permanent strength gains.

Lime is one of the basic building materials used mainly as **lime mortar** in construction. The broad category of lime is **non-hydraulic** (*quick lime, fat lime or white lime or as lump lime*) and **hydraulic lime**. *Hydraulic lime sets under water and non-hydraulic lime do not set under water*. *Quick Lime* is a form of lime is manufactured by the *burning of stone* that has calcium carbonate within it. The burning temperature varies, say **900 degrees Celsius** and above for several hours. This process is called as **calcination**. The solid product that remains after the removal of carbon dioxide in the calcium carbonate is called as the quicklime.

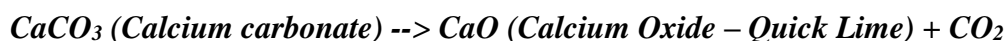

The quick lime is used as **hydrated lime** (quick lime with water). This is because it *is unstable and hazardous in nature*. There is heat liberated when a small quantity of water is added to the quicklime. After this hydration product, a fine dry white powder is obtained, which is called as calcium hydroxide or slake lime. Now this process is defined as the **slaking of lime**. The slaking of lime is a process that varies depending upon the extent and type of use. For example, the use of lime in plasters or in mortars, make use of lime in dry or putty form.

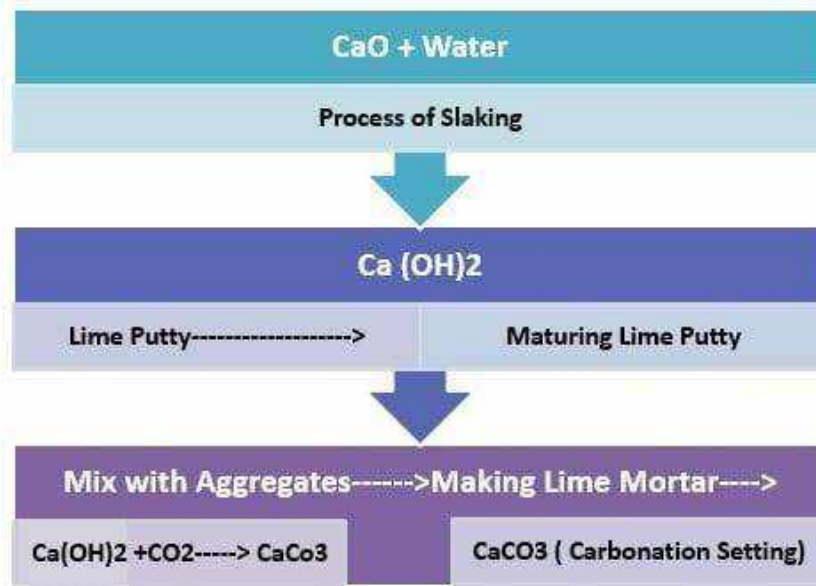

Putty is formed by the addition of a *large quantity of water* (two to three times its weight). This process promotes a chemical reaction that makes the whole system to boil. A semi-fluid mass is obtained as a stiffened mass on cooling, which is called as the putty. This material after proper screening is used as the material for construction.

Hydraulic lime is a factor-based product. These have **natural pozzolana or added Pozzolana** in it that sets under water. The **raw material** for hydraulic lime is **limestone** which is impure, that contains calcium carbonate and impurities of clay. These are also **calcinated at 900 to 1000 degree Celsius**. The reaction is as follows Calcium carbonate + clay impurities ($\text{Al}_2\text{O}_3 + \text{Si}_2\text{O}_3$) \rightarrow CaO (calcium oxide) + carbon dioxide + Monocalcium silicate (CA), Monocalcium aluminates dicalcium silicate (C_2S), dicalcium alumino-ferrite (C_2AF)

Products:

Lime can be manufactured in a number of different end products.

- **Pebble Lime**, with sizes ranging from 2-inch down to ¼-inch, is used in many applications including steel manufacturers and other industrial areas as a fluxing agent or slaked as part of a larger process.
- **Pulverized Lime** is a graded material with a controlled particle size distribution formed from crushed pebble lime.
- **Lime Fines**, generally less than ¼-inch in size, are often used in construction markets. The small particle size of this quicklime product helps to increase the speed at which it can dry, modify and stabilize soils.
- **Lime kiln dust**, a co-product of lime manufacturing, is a mix of calcium and magnesium oxides and pozzolans.
- **Hydrated Lime** is produced when quicklime is carefully mixed with water to yielding hydrated lime ($\text{Ca}(\text{OH})_2$), also known as slaked lime or calcium hydroxide. This

process forms a very fine white powder that is very useful in a number of applications, especially asphalt.

- **Quicklime slurry** is a suspension of calcium hydroxide in water. This free-flowing product offers a solution for customers requiring a liquid or if they are particularly concerned with dusting.

Precautions:

If handled properly lime is a very safe product. There are several precautions working with lime.

- **Eye irritation:** Safety glasses should be worn when working with lime-based products. In dusty and/or windy conditions gasketed safety glasses or goggles should be worn.
- **Skin irritation:** When lime is exposed to moisture, or sweat, a very hot chemical reaction take place that could cause chemical burns. Appropriate clothing covering exposed skin is recommended.
- **Respiratory Irritation:** The use of a respirator can minimize breathing dust.

3.1.1 Four Different Types of Limes Used in Construction:

Different types of limes are used for building construction. It is not generally found in the free state. Lime is a product which is obtained by **burning lime stone**, a raw material, found in **lime stone hills or lime stone boulders** in the beds of old river, *kankar* found below ground level, or *shells* of sea animals.

1. QUICK LIME

It is also known as **caustic lime**. It is obtained by **calcination** (i.e. *heating to redness*) of comparatively **pure lime stone**. It is amorphous in nature, highly caustic and possesses great affinity to moisture.

2. SLAKED LIME

It is also known as **hydrate of lime**. It is obtained by **slaking** (i.e. *chemical combination of quick lime with water*) of **quick lime**. It is ordinary pure lime, in white powder form, available in market. It has got the tendency of absorbing carbonic acid from the atmosphere in presence of water.

3. FAT LIME

It is also known as **high calcium lime** or **pure lime** or **rich lime** or **white lime**. It is popularly known as *fat lime* as it slakes vigorously and its *volume is increased* to about **2 to 2.5 times** that of *quick lime*. This lime is used for various purposes as **white washing, plastering** of walls, as **lime mortar** with sand for **pointing** in masonry work, as a **lime mortar with surkhi** for thick masonry walls, foundations, etc.

4. HYDRAULIC LIME

It is also known as **water lime**. This lime contains **clay** and some amount of **ferrous oxide**. It **sets** under **water** and hence also known as **water lime**. Depending upon the **percentage of clay**, IS has divided hydraulic lime in **three classes** namely:

- Class A – Eminently hydraulic
- Class B – Semi Hydraulic
- Class C – Non-hydraulic (or Fat lime)

CLASS A – EMINENTLY HYDRAULIC

This lime contains about **25% clay content** and **sets readily under water** within a day or so. This lime slakes with difficulty. The mortar and lime concrete prepared from this lime is very useful for **construction under water** or in damp places.

CLASS B – SEMI HYDRAULIC

Semi-hydraulic lime contains about **15% clay content** and **sets under water at a slower rate** within a week or so. The mortar and concrete prepared from this lime is strong and used for **superior type of masonry work**.

CLASS C – NON-HYDRAULIC (OR FAT LIME)

This lime contains about **7.5% of clay content** and is prepared from **pure lime stone**. This **slakes vigorously** within few minutes but does not set under water. This is used for **white washing and colour washing**.

USES OF BUILDING LIME:

Lime in building industry is used for various **purposes** such as

- A matrix for **lime concrete** used in building foundations and filling where early setting is not required
- For preparing **mortar** for bedding bricks and stones in masonry works
- As a **cementing material** in plaster for covering walls and pointing in preserving joints
- For **white washing** and **colour washing**

PREPARATION OF SLAKED LIME:

The **procedure** behind the making of **slaked lime** is described in the following steps:

- The required quantity of fat lime or quicklime is placed over a platform which is wooden or masonry, free of moisture. The quicklime is produced by the burning of limestone and shells.
- Water is then sprinkled over this heap of quick lime, till it gets reduced to powder form. During the addition water, thorough mixing is done along with this, until no more water is required to completely reduce the quicklime to the powdered form.
- The final mixture is allowed to pass through the sieve of 3.35mm dimension. The residue is rejected. The final product is called the slaked lime.

Preparation of **Lime Putty** Before the use of **quicklime** in **lime mortar**, it is made **into lime putty**. The **procedure of lime putty preparation** is explained in the following procedures:

- Initially, two tanks are made of 50 and 80 cm deep (Tank 1 and Tank 2 respectively). The former tank is constructed at a higher level compared to the latter, to ensure proper flow of fluid from tank 1 to tank 2.
- Initially, the tank 1 is filled with water to its half. Quick lime is then added to this, till the half depth of the tank 1 is filled. It is kept in mind to add lime to the water and not water to lime.
- Proper stirring is carried out, keeping in mind that no exposure to the air above the water level is carried out. The mixing will be continued for few minutes (around 5 minutes), till the moment the boiling ends and the whole mixture starts to thicken.
- The mixture is then allowed to flow to the tank 2, located at the lower height. For this to happen with ease, more water can be added.
- The tank 2 takes this mixture for a minimum time of 72 hours. The lower tank (tank 2) is made up of dry brick masonry, whose joints are filled with sand alone. This would facilitate the absorption of water from the slurry. This is the way, how the excess water is removed and lime putty is obtained in the paste form.
- If the exposure to the atmosphere is avoided, it can be stored for a period of say 2 weeks.

The addition of water in a gradual means will make the hydraulic lime slaked. When compared to quicklime, the hydraulic lime requires lesser water. The fat quick lime is said to slake by an amount of twice, in the powder form and by one and a half parts of paste. The hydraulic lime slakes by an amount of one and half in the powder form and by the same quantity in the paste form.

3.2 Properties of Lime for Use in Construction:

The white powdered slaked lime has a wide range of applications in construction. The properties of lime are:

1. **Cementing capability**- This is obtained by their carbonation with carbon dioxide. Lime is used as lime mortar for brick masonry construction.
2. Have a **higher acid resistance**- due to its alkaline nature
3. Gain **Pozzolanic activity**- this gives cementitious products
4. **Sealing of micro cracks**- This is done by the precipitation made by the calcium carbonate when carbon dioxide passes through the lime mortar mix.

Properties of Lime

- It should possess **good plasticity**.
- It should be **flexible** and easily **workable**.
- When used in mortar, it should provide **greater strength** to the masonry.
- It should **solidify in less time** and become hard

Factors affecting Properties of Lime Mortar:

1. The **free calcium** amount present in the lime mortar
2. The **free lime content** and porosity are directly proportional
3. The fat lime or nonhydraulic lime does not set under water, it sets with time
4. The hydraulic lime sets after the addition of water. This rate depends on the **type** as well as the characteristic composition of hydraulic lime.

Advantages of Lime in Construction:

1. **Provides building breathing property**- the lime was regarded as a material by the society for protection against the depletion of ancient buildings. This material let the building to be vapor permeable, thus allowing to breathe. This reduces the chances of trapped moisture and the damage of the building.
2. **Renders Comfortable Environment**- Absorbing moisture by the lime, stabilize internal humidity
3. **Ecological Benefits**- energy conservation than cement, small scale production of lime is possible
4. **Protection of adjacent materials**- Porous texture of lime handle the moisture movement, without affecting the adjacent materials
5. Provides good workability
6. Durability is high
7. Beautiful finish for the building
8. **Self-healing properties**- Any movement of the building made of lime, creates micro-cracks. Presence of moisture make the free lime active to precipitate and heal these micro cracks

4. CEMENT:

Types, Portland cement: Chemical composition of raw material, Bogue Compounds, Hydration of cement, Role of water in hydration, Testing of cements

4.1 CEMENT:

A cement is a **binder**, a substance used for construction that **sets, hardens, and adheres** to other materials to bind them together. *Cement is seldom used on its own*, but rather to bind **fine aggregate** (sand) and **coarse aggregate** (gravel) together. Cement mixed with fine aggregate produces **mortar** for masonry, or with fine aggregate and coarse aggregate, produces **concrete**. Concrete is the **most widely used material in existence** and is **behind only water** as the planet's most-consumed resource.

Cements used in construction are usually **inorganic**, often **lime** or **calcium silicate** based, which can be characterized as **non-hydraulic** or **hydraulic** respectively, depending on the **ability of the cement to set in the presence of water.**

Non-hydraulic cement does *not set in wet conditions* or under water. Rather, it *sets as it dries* and *reacts with carbon dioxide* in the air. It is *resistant to attack by chemicals after setting*.

Hydraulic cements (e.g., Portland cement) *set and become adhesive due to a chemical reaction between the dry ingredients and water*. The *chemical reaction results in mineral hydrates* that are *not very water-soluble* and so are *quite durable in water and safe from chemical attack*. This allows *setting in wet conditions* or under water and further protects the hardened material from chemical attack. The *chemical process for hydraulic cement* was found by *ancient Romans* who used *volcanic ash (pozzolana)* with *added lime* (calcium oxide).

The word "**cement**" can be traced back to the *Ancient Roman term opus caementicium (Roman concrete, also called opus caementicium, was a material used in construction in Ancient Rome. Roman concrete was based on a hydraulic-setting cement. It is durable due to its incorporation of pozzolanic ash, which prevents cracks from spreading)*, used to describe masonry resembling modern concrete that was made from crushed rock with burnt lime as binder. The volcanic ash and pulverized (reduce to fine particles) brick supplements that were added to the burnt lime, to obtain a *hydraulic binder*, were later referred to as *cementum, cimentum, cäment,* and *cement*. In modern times, organic polymers are sometimes used as cements in concrete.

World *production* is about *four billion tonnes per year*, of which about half is made in China. If the cement industry were a country, it would be the third largest carbon dioxide emitter in the world with up to *2.8 billion tonnes*, surpassed only by China and the United States. The initial *calcination reaction (at or above the thermal decomposition temperature)* in the production of cement is responsible for about 4% of global CO₂ emissions. The overall process is responsible for about 8% of global CO₂ emissions, as the *cement kiln* in which the reaction occurs is typically fired by *coal or petroleum coke* due to the luminous flame required to heat the kiln by radiant heat transfer. *As a result, the production of cement is a major contributor to climate change.*

HYDRAULIC CEMENT:

By far the most common type of cement is **hydraulic cement**, which hardens by **hydration of the clinker minerals** when **water** is added. Hydraulic cements (such as Portland cement) are made of a mixture of *silicates* and *oxides*. The *four main mineral phases* of the clinker, abbreviated in the cement chemist notation, being:

C₃S: Tri Calcium Silicate (Alite) (3CaO·SiO₂);

C₂S: Di Calcium Silicate (Belite) (2CaO·SiO₂);

C₃A: Tri Calcium Aluminate (celite) (3CaO·Al₂O₃);

C₄AF: Tetra Calcium Alumino Ferrite (Brownmillerite) (4CaO·Al₂O₃·Fe₂O₃).

The **silicates** are responsible for the cement's **mechanical properties** — the **tricalcium aluminate** and **Tetra Calcium Alumino Ferrite** are essential for the formation of the **liquid phase** during the *sintering (firing) process* of **clinker** at *high temperature* in the kiln. The chemistry of these reactions is *not completely clear* and is still the *object of research*.

First, the **limestone** (calcium carbonate) is burned to *remove its carbon*, producing **lime** (calcium oxide) in what is known as a **calcination reaction**. This single chemical reaction is a major emitter of global carbon dioxide emissions.

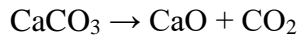

The **lime** reacts with **silicon dioxide** to produce **dicalcium silicate** and **tricalcium silicate**.

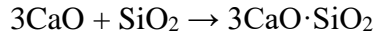
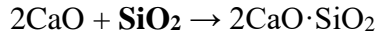

The **lime** also reacts with **aluminum oxide** to form **tricalcium aluminate**.

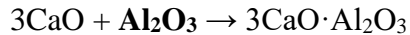

The **lime** also reacts together with **aluminum oxide**, and **ferric oxide** to form **cement**.



NON-HYDRAULIC CEMENT:

A less common form of cement is **non-hydraulic cement**, such as **slaked lime** (*calcium oxide mixed with water*), hardens by *carbonation* in contact with carbon dioxide, which is present in the air (~ 412 vol. ppm \approx 0.04 vol. %). First *calcium oxide* (lime) is produced from *calcium carbonate* (limestone or chalk) by **calcination** at temperatures above 825 °C (1,517 °F) for about **10 hours** at atmospheric pressure:

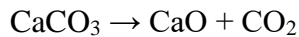

The *calcium oxide* is then *spent* (slaked) mixing it with *water* to make **slaked lime** (calcium hydroxide):

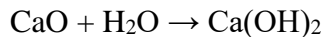

Once the *excess water is completely evaporated* (this process is technically called **setting**), the carbonation starts:

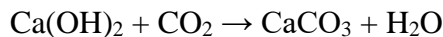

This reaction is **slow**, because the *partial pressure of carbon dioxide in the air is low* (~ 0.4 millibar). The carbonation reaction requires that the *dry cement be exposed to air*, so the **slaked lime is a non-hydraulic cement and cannot be used under water**. This process is called the **lime cycle**.

4.2 PORTLAND CEMENT:

Portland cement, a form of **hydraulic cement**, is by far the most common type of cement in general use around the world. This cement is made by **heating limestone** (calcium carbonate) with other materials (such as **clay**) to **1,450 °C** (2,640 °F) in a **KILN**, in a process known as **calcination** that *liberates* a molecule of *carbon dioxide* from the *calcium carbonate* to form **calcium oxide**, or **quicklime**, which then chemically combines with the other materials in the mix to form **calcium silicates** and other **cementitious compounds**. The resulting hard substance, called '**clinker**', is then *ground* with a small amount of **gypsum** into a *powder* to make *ordinary Portland cement*, the most commonly used type of cement (often referred to as **OPC**). Portland cement is a **basic ingredient of concrete, mortar**, and most non-

specialty **grout**. The most common use for Portland cement is to make concrete. Concrete is a **composite material** made of cement, aggregate (gravel and sand), and water. As a construction material, concrete can be cast in almost any shape, and once it hardens, can be a structural (load bearing) element. Portland cement may be grey or white.

PORTLAND CEMENT BLEND:

Portland cement blends are often available as inter-ground mixtures from cement producers, but similar formulations are often also mixed from the ground components at the concrete mixing plant.

Portland blast-furnace slag cement, or blast furnace cement (ASTM C595 and EN 197-1 nomenclature respectively), contains up to **95% ground granulated blast furnace slag**, with the rest Portland clinker and a little gypsum. All compositions produce **high ultimate strength**, but as **slag** content is **increased, early strength is reduced**, while *sulfate resistance increases and heat evolution diminishes*. Used as an economic alternative to *Portland sulfate-resisting and low-heat cements*.

Portland-fly ash cement contains up to **40% fly ash** under ASTM standards (ASTM C595), or 35% under EN standards (EN 197–1). The fly ash is **pozzolanic**, [*Pozzolans are a broad class of siliceous and aluminous materials which, in themselves, possess little or no cementitious value but which will, in finely divided form and in the presence of water, react chemically with calcium hydroxide ($\text{Ca}(\text{OH})_2$) at ordinary temperature to form compounds possessing cementitious properties. The quantification of the capacity of a pozzolan to react with calcium hydroxide and water is given by measuring its pozzolanic activity. Pozzolana are naturally occurring pozzolans of volcanic origin. A siliceous volcanic ash used to produce hydraulic cement / Any of various powdered substances that react with lime to form strengthening or enhancing compounds in cement. Both natural (Volcanic ashes and pumices) and artificial (man-made, eg. metakaolin, fly ash, silica fume, rice husk ash, etc) materials show pozzolanic activity and are used as supplementary cementitious materials (SCM)*], so that ultimate strength is maintained. Because fly ash addition allows a lower concrete water content, early strength can also be maintained. Where good quality cheap fly ash is available, this can be an economic alternative to ordinary Portland cement.

Portland pozzolan cement includes fly ash cement, since fly ash is a pozzolan, but also includes cements made from other natural or artificial pozzolans. In countries where volcanic ashes are available (e.g., Italy, Chile, Mexico, the Philippines), these cements are often the most common form in use. The maximum replacement ratios are generally defined as for Portland-fly ash cement.

Portland silica fume cement. Addition of *silica fume* can yield exceptionally *high strengths*, and cements containing 5–20% silica fume are occasionally produced, with 10% being the maximum allowed addition under EN 197–1. However, silica fume is more usually added to Portland cement at the concrete mixer.^[45]

Masonry cements are used for preparing brick laying mortars and stuccos (decorative coating for walls and ceilings, exterior walls), and must not be used in concrete. They are usually complex proprietary formulations containing Portland clinker and a number of other ingredients that may include limestone, hydrated lime, air entrainers, retarders, water proofers, and coloring agents. They are formulated to yield workable mortars that allow rapid and consistent masonry work. Subtle variations of masonry cement in North America are plastic cements and stucco cements. These are designed to produce a controlled bond with masonry blocks.

Expansive cements contain, in addition to Portland clinker, expansive clinkers (usually *sulfo-aluminate clinkers*), and are designed to offset the effects of drying shrinkage normally encountered in hydraulic cements. This cement can make concrete for floor slabs (up to 60 m square) without contraction joints.

White blended cements may be made using white clinker (containing little or no iron) and white supplementary materials such as high-purity metakaolin.

Colored cements serve decorative purposes. Some standards allow the addition of pigments to produce *colored Portland cement*. Other standards (e.g., ASTM) do not allow pigments in Portland cement, and colored cements are sold as *blended hydraulic cements*.

Very finely ground cements are cement mixed with sand or with slag or other pozzolan type minerals that are extremely finely ground together. Such cements can have the same physical characteristics as normal cement but with 50% less cement, particularly due to their increased surface area for the chemical reaction. Even with intensive grinding they can use up to 50% less energy (and thus less carbon emissions) to fabricate than ordinary Portland cements.¹

4.3 TYPES OF CEMENT (Other cements)

1. Ordinary Portland Cement (OPC)
2. Portland Pozzolana Cement (PPC)
3. Rapid Hardening Cement
4. Quick setting cement
5. Low Heat Cement
6. Sulfates resisting cement
7. Blast Furnace Slag Cement
8. High Alumina Cement
9. White Cement
10. Colored cement
11. Air Entraining Cement
12. Expansive cement
13. Hydrographic cement

Ordinary Portland Cement (OPC)

The **principal raw materials** used in the manufacture of Ordinary Portland Cement are:

1. **Argillaceous** or silicates of alumina in the form of **clays** and **shales**.
2. **Calcareous** or calcium carbonate, in the form of **limestone**, **chalk** and **marl** which is a mixture of clay and calcium carbonate.

The ingredients are mixed in the proportion of about two parts of calcareous materials to one part of argillaceous materials and then crushed and ground in ball mills in a dry state or mixed in wet state. The dry powder or the wet slurry is then burnt in a rotary kiln at a temperature between 1400 degree C to 1500-degree C. the clinker obtained from the kiln is first cooled and then passed on to ball mills where gypsum is added and it is ground to the requisite fineness according to the class of product.

Portland Pozzolana Cement (PPC):

Portland Pozzolana cement is **integrated cement** which is formed by synthesising (combining) OPC cement with pozzolanic materials in a certain proportion. It is commonly known as PPC cement. In this article we discuss about the properties, manufacture, characteristics, advantages and disadvantages of Portland Pozzolana cement.

Rapid Hardening Cement:

Rapid hardening cement is a particular type of cement that is used in **exceptional cases of concrete pouring**. As the name implies, rapid hardening cement needs the shortest time to set up and consolidate. It achieves higher strength on lesser days. With such, it can attain seven days strength in only three days.

Quick setting cement:

Quick Setting Cement (QSC) is a **special cement formulation that develops a rapid compressive strength and significantly reduces the waiting on cement (WOC) time** compared to traditional cement systems. This cement loses its plasticity quicker than ordinary Portland cement, but does not achieve a higher rate of strength.

Low Heat Cement:

Low heat cement is a **special tailored cement which generates low heat of hydration during setting**. It is manufactured by modifying the chemical composition of normal Portland cement. In this article we discuss about the composition, properties, characteristics, uses and advantages of low heat cement.

Sulphate resisting cement:

The sulphate resisting cement is the **cement which has the capability to resist against sulphate attack by introducing low C₃A and relatively low C₄AF content in the cement**. The specification for sulphate cement content should not allow C₃A content more than 5 percent.

Blast Furnace Slag Cement:

Blast furnace slag cement is the mixture of ordinary **Portland cement and fine granulated blast furnace slag** obtained as a by-product in the manufacture of steel with percent under 70% to that of cement. Ground granulated blast furnace slag cement (GGBFS) is a fine glassy granule which contain cementitious properties.

High Alumina Cement:

High alumina cement refers to a fast-hardening, high-strength, heat-resistant and corrosion-resistant cementitious material. All clinker based on calcium aluminate and alumina content of about 50% and ground hydraulic cementitious material are called high alumina cement.

White Cement:

The manufacturing process of white cement is same as that of grey cement, but the selection of raw material is an important part in the manufacturing process. The oxides of chromium, manganese, iron, copper, vanadium, nickel and titanium imparts the grey colour to the cement. In white cement manufacture, these raw materials are kept to least percentage. Limestone and clay are used as a prominent raw material for the manufacture

of white cement. The manufacture process is same as that of OPC cement, the only differences are the heat required for the burning of raw material is more and fineness is more.

Coloured cement:

Coloured Cement may be obtained by intimately mixing **mineral pigments** with ordinary cement. The amount of colouring material may vary from 5 to 10 per cent. If this percentage exceeds 10 per cent, the strength of cement is affected.

1. The chromium oxide gives green colour.
2. The cobalt imparts blue colour.
3. The ton oxide in different proportions gives brown, red or yellow colour
4. The manganese oxide is used to produce black brown coloured cement

The **coloured cements** are widely used for finishing of floors, external surfaces. artificial marble, window sill slabs, textured panel faces, stair treads, etc.

Air Entraining Cement:

Air-entrained portland cement is a special cement which has air bubbles introduced in the cement or concrete that provides the space for expansion of minute droplets of waters in the concrete due to freezing and thawing and protects from cracks and damage of concrete. In this article we discuss about manufacture, air entraining agents, properties, advantages and disadvantages.

Advantages of Air-Entrained Cement

- Workability of concrete increases.
- Use of air entraining agent reduces the effect of freezing and thawing.
- Bleeding, segregation and laitance in concrete reduces.
- Entrained air improves the sulphate resisting capacity of concrete.
- Reduces the possibility of shrinkage and crack formation in the concrete surface.

Expansive cement:

Expansive cement is special type of cement when mixed with water, which forms a paste that tends to increase in volume to a significantly greater degree than Portland cement paste after setting. The expansion of the cement mortar or concrete is compensated for the shrinkage losses. In this article we study about the manufacture, properties, types and uses of expansive cement.

Hydrographic cement:

Hydrographic cement Hydrographic cement **prepares by mixing water-repelling chemicals and has high workability and strength.** It has the property of repelling water and unaffected during monsoon or rains. Hydrophobic cement mainly uses for the construction of water structures such as dams, water tanks, spillways, water retaining structures, etc.

4.4 CHEMICAL PROPERTIES OF PORTLAND CEMENT ARE AS FOLLOWS:

Lime (CaO)	60 to 67%
------------	-----------

Silica (SiO ₂)	17 to 25%
Alumina (Al ₂ O ₃)	3 to 8%
Iron oxide (Fe ₂ O ₃)	0.5 to 6%
Magnesia (MgO)	0.1 to 4%
Sulphur trioxide (SO ₃)	1 to 3%
Soda and/or Potash (Na ₂ O+K ₂ O)	0.5 to 1.3%

Physical Properties of Ordinary Portland Cement

Properties	Values
Specific Gravity	3.16
Normal Consistency	29%
Initial Setting time	65min
Final Setting time	275 min
Fineness	330 kg/m ²
Soundness	2.5mm
Bulk Density	830-1650 kg/m ³

BOGUES COMPOUNDS:

When **water** is **added** to **cement**, it react with the ingredients of the cement chemically and results in the formation of **complex chemical compounds** terms as **BOGUES compounds**.

1. Tri-Calcium Aluminate (3CaO.Al₂O₃ or C₃A) -----8-12%
2. Tetra Calcium Alumino Ferrate (4CaO.Al₂O₃.Fe₂O₃ or C₄AF)-----6-10%
3. Tri-Calcium Silicate (3CaO.SiO₂ or C₃S)-----30-50%
4. Di-Calcium Silicate (2CaO.SiO₂ or C₂S)-----20-45%

1. Tri-Calcium Aluminate (3CaO.Al₂O₃ or C₃A)

Formed in **24 hrs** of addition of water

Maximum evolution of heat of hydration

Check setting time of cement

2. Tetra Calcium Alumino Ferrate (4CaO.Al₂O₃.Fe₂O₃ or C4AF)

Formed within **24 hrs** of addition of water

High heat of hydration in initial periods

3. Tri-Calcium Silicate (3CaO.SiO₂ or C3S)

Formed within *week*

Responsible for **initial strength** of cement

Contribute about 50-60% of strength

Content increase for the pre-fabricated concrete construction, Cold weathering construction.

4. Di-Calcium Silicate (2CaO.SiO₂ or C2S)

Last compound formed during hydration of cement

Responsible for progressive **later stage strength**

Structure requires later stages strength proportion of this component increase

e.g. hydraulic structures, bridges.

HYDRATION OF CEMENT:

When cement, water, aggregate, and additives are mixed together, a significant **heat increase** occurs. This is due to the exothermic process in the reaction between cement and water (called hydration).

Measuring the concrete temperature over time enables you to know how far the concrete is in the hydration process (Concrete Maturity) and thereby also an estimated concrete strength. The hydration process is divided into **five phases**:

Phase 1: Initial Mixing Reaction

Initial after mixing the cement and water comes into contact with each other, a peak in temperature happens. The aluminate (C₃A) reacts with H₂O (Calcium and sulfate ions) to form **ettringite** (aluminate hydrate). The release of the energy from these reactions causes the initial peak.

Phase 2: Dormancy

A result of the reaction described in phase 1 is a **surface coating** of the cement particles. This coating keeps increases, but also slows down the reaction (hydration) as the access to H₂O isn't as good as when the concrete was mixed. The amount of hydrated concrete keeps increasing on a steady level while the surface of the concrete keeps fluid.

This is why this phase is used for transporting and pouring the concrete, as the concrete stays on a fluid level. The length of this period depends on each individual concrete mix and can, therefore, be optimized depending on the application like winter concreting, length of transport, etc.

This phase ends with an initial set of the concrete.

Phase 3: Strength Acceleration

A **heat increase** happens due to the reaction between **calcium silicate** (C₃S and C₂S) which creates the **silicate hydrate CSH** (heat increase also caused by other minor reactions). The creation of CSH also has a major impact on the concrete strength during this phase.

In the case of for example mass concrete application, it can be very important to monitor the internal temperature variances, as the concrete temperature during this phase can increase rapidly to reach internal temperatures like 70-80C (in some cases even higher). It is normally not recommended to exceed temperatures at around 70C.

Phase 4: Speed reduction

A maximum temperature has now been reached and the availability of free particles is now reduced and therefore slows down the temperature increase.

This phase often ends with the desired strength and the formwork around the concrete can now be removed. Monitoring of concrete maturity and temperature and therefore enable the user with the exact time where this is possible.

Phase 5: Steady Development / Post Formwork

The hydration process is now slowed down and will continue slowly to finish the remaining available cement and water particles. The formwork is now often removed and the concrete will now over time (can take a long time) finish the hydration process and reach final strengths (can take weeks or months).

Testing of cements:

Laboratory Tests of Cement:

1. Fineness Test
2. Consistency Test
3. Setting Time Test
4. Strength Test
5. Soundness Test
6. Heat of Hydration Test
7. Tensile Strength Test
8. Chemical Composition Test

Fineness test on cement

The fineness of cement is responsible for the rate of hydration, rate of evolution of heat and the rate of gain of strength. Finer the grains more is the surface area and faster the development of strength.

The fineness of cement can be determined by Sieve Test or Air Permeability test.

Sieve Test: Air-set lumps are broken, and the cement is sieved continuously in a circular and vertical motion for a period of 15 minutes. The residue left on the sieve is weighed, and it should not exceed 10% for ordinary cement. This test is rarely used for fineness.



Air Permeability Test: Blaine's Air Permeability Test is used to find the specific surface, which is expressed as the total surface area in sq.cm/g. of cement. The surface area is more for finer particles.

Consistency test on cement

This test is conducted to find the setting times of cement using a standard consistency test apparatus, Vicat's apparatus.

Standard consistency of cement paste is defined as that water content which will permit a Vicat plunger of 10 mm diameter and 50 mm length to penetrate depths of 33-35 mm within 3-5 minutes of mixing.



The test has to undergo three times, each time the cement is mixed with water varying from 24 to 27% of the weight of cement.

This test should be conducted at a constant temperature of 25°C or 29°C and at a constant humidity of 20%.

Setting Time of cement

Vicat's apparatus is used to find the setting times of cement i.e., initial setting time and final setting time.

Initial Setting Time: For this test, a needle of 1 mm square size is used. The needle is allowed to penetrate into the paste (a mixture of water and cement as per the consistency test). The time taken to penetrate 33-35 mm depth is recorded as the initial setting time.



Final Setting Time: After the paste has attained hardness, the needle does not penetrate the paste more than 0.5 mm. The time at which the needle does not penetrate more than 0.5 mm is taken as the final setting time.

Strength test of cement

The strength of cement cannot be defined directly on the cement. Instead the strength of cement is indirectly defined on cement-mortar of 1:3. The compressive strength of this mortar is the strength of cement at a specific period.

Soundness test of cement

This test is conducted in Le Chatelier's apparatus to detect the presence of uncombined lime and magnesia in cement.



Heat of Hydration Test

During the hydration of cement, heat is produced due to chemical reactions. This heat may raise the temperature of concrete to a high temperature of 50°C. To avoid these, in large scale constructions low-heat cement has to be used.

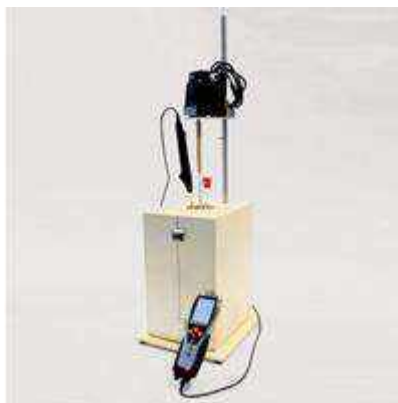

This test is carried out using a *calorimeter* adopting the principle of determining heat gain. It is concluded that Low-heat cement should not generate 65 calories per gram of cement in 7 days and 75 calories per gram of cement in 28 days.

Tensile Strength of Cement

This test is carried out using a cement-mortar briquette in a tensile testing machine. A 1:3 cement-sand mortar with the water content of 8% is mixed and moulded into a briquette in the mould.



This mixture is cured for 24 hours at a temperature of 25°C or 29°C and in an atmosphere at 90% relative humidity.

The average strength for six briquettes tested after 3 and 7 days is recorded.

Chemical Composition Test

Different tests are conducted to determine the amount of various constituents of cement. The requirements are based on IS: 269-1998, is as follows:

- The ratio of the percentage of alumina to that of iron oxide should not be less than 0.66.
- Lime Saturation Factor (LSF), i.e., the ratio of the percentage to that of alumina, iron oxide and silica should not be less than 0.66 and not be greater than 1.02.
- Total loss on ignition should not be greater than 4%.
- Total sulphur content should not be greater than 2.75%.
- Weight of insoluble residue should not be greater than 1.50%.
- Weight of magnesia should not be greater than 5%.

Field Tests of Cement

The following tests should undergo before mixing the cement at construction sites:

Colour Test of Cement

The colour of the cement should not be uneven. It should be a uniform **grey** colour with a light greenish shade.

Presence of Lumps

The cement should not contain any hard lumps. These lumps are formed by the absorption of moisture content from the atmosphere. The cement bags with lumps should be avoided in construction.



Cement Adulteration Test

The cement should be *smooth if you rubbed it between fingers*. If not, then it is because of adulteration with sand.



Float Test

The particles of cement should flow *freely in water* for some time before it sinks.

Date of Manufacturing

It is very important to check the manufacturing date because the strength of cement decreases with time. It's better to use cement *before 3 months* from the date of manufacturing.

5. FLY ASH:

Properties and use in manufacturing of bricks and cement

Fly ash is a **heterogeneous by-product** material produced in the combustion process of **coal used in power stations**. It is a fine **grey** coloured powder having **spherical glassy particles** that rise with the flue gases. As fly ash contains **pozzolanic** materials components which react with lime to form **cementitious materials**. Thus, FLY ASH is used in concrete, mines, landfills and dams.

Chemical Composition of Fly Ash:

The chemical composition of fly ash depends upon the **type of coal** used and the **methods** used for **combustion of coal**.

Chemical composition of fly ash of different coals

Component	Bituminous Coal	Sub bituminous Coal	Lignite Coal
SiO ₂ (%)	20-60	40-60	15-45
Al ₂ O ₃ (%)	5-35	20-30	20-25
Fe ₂ O ₃ (%)	10-40	4-10	4-15
CaO (%)	1-12	5-30	15-40
LOI (%)	0-15	0-3	0-5

5.1 Physical Properties of Fly Ash:

Fineness of Fly Ash

As per ASTM, the fineness of the fly ash is to be checked in both dry and wet sieving. The fly ash sample is sieved in **45 micron** sieve and the percentage of retained on the 45 micron sieve is calculated. Further fineness is also measured by LeChatelier method and Blaine Specific Surface method.

Specific Gravity of Fly Ash

The specific gravity of fly ash ranges from a low value of 1.90 for a sub-bituminous ash to a high value of 2.96 for an iron-rich bituminous ash.

Size and Shape of Fly Ash

As the flyash is a very fine material, the particle size ranges in between **10 to 100 micron**. The shape of the fly ash is usually spherical glassy shaped.

Color

The color of the fly ash depends upon the chemical and mineral constituents. Lime content in the fly ash gives tan and light colors whereas brownish color is imparted by the presence of iron content. A dark grey to black color is typically attributed to an elevated un-burned content.

5.2 Fly ash Bricks:

Fly Ash Bricks are manufactured using Major percentage of fly ash generated from Thermal Power stations. Other raw materials used along with Fly Ash are **lime** and calcined **gypsum**. Fly ash is a **fine, glass-like powder** recovered from **coal-fired electric power generation**. They consist mostly of silicon dioxide (SiO₂), aluminum oxide (Al₂O₃) and iron oxide (Fe₂O₃).

Products and Its Application

Fly ash lime bricks are chemically bonded bricks manufactured by utilizing **80- 82% of fly ash**, which is a major waste by-product of pulverized *coal fired* in *Thermal Power Stations*, 9-10% of **lime**, 9-10% of **sand and accelerator**. The process know-how has been developed by Central Fuel Research Institute.

Various special *features* of fly ash lime bricks are:

- Being machine finished these are uniform in size and shape.
- Consumes 20-25 percent less cement mortar.
- Stronger than Class-I, burnt clay building bricks.
- Outside wall plastering is not essential as these bricks have cement gray color, smooth surface and low water absorption capacity.
- Resistance to salinity.
- Being lighter in weight in comparison to the conventional red bricks, the dead building load and the transportation cost will be less.
- Adoption of this process helps to conserve invaluable top soil of agricultural land.
- By consuming 80-82% fly ash, the cause of environmental pollution and hazards due to disposal is minimized.
- As firing of the bricks is not needed thus pollution due to firing is eliminated.

Raw Material Requirements

Fly ash forms the major component of the raw materials for Fly ash bricks. Therefore, it controls to a large extent the properties of the finished product. As the ash is **non-plastic**, a **binder** must be added either **plastic clay** or **Portland cement**. Fly ash content ranges from 60 to 80%. **Lime** is another raw material required for the production of fly ash bricks. It is generally desirable to use a high calcium lime of reasonable purity as it is the most important constituent which reacts with silica and alumina etc. present in the fly ash to form the binder under hydrothermal conditions. Lime content range from 20 to 30%.

Manufacturing Process

Lime is finely ground in a ball mill. **Fly ash**, finely ground **quick lime** and **sand** in requisite proportions are fed in double roll paddle mixer or U-shaft mixer (Double shaft mixer) by means of a feeder. Then 4% **water** is added and intimate mixing is done. The mixing proportion is generally 40-50% Fly Ash, 50-40% Sand 10% lime and 4% water. Fly ash reacts with lime in the presence of moisture to form **calcium silicate hydrate** which is the binder material. The raw mix is molded in the molding press/machine, pressed under a pressure into bricks. The bricks are then with drawn from the molding machine and they are air dried under the sun and kept for 1 day. The bricks are autoclaved in which curing is done by steam at normal pressure and cured for 6 - 8 hours.

5.3 Cement-Fly Ash Based:

The Portland Pozzolana Cement is a kind of **Blended Cement** which is produced by either inter-grinding of *OPC clinker* along with gypsum and pozzolanic materials in certain proportions or grinding the OPC clinker, *gypsum* and *Pozzolanic materials* separately and thoroughly blending them in certain proportions. **Pozzolana** such as fly ash is essentially a **siliceous material** which while in itself possessing *little* or *no cementitious* properties will, in *finely divided form* and in the *presence of water*, react with *calcium hydroxide* at ambient temperature to form *compounds* possessing *cementitious properties*. The manufacture, physical and chemical requirements of Portland pozzolana cement using only fly ash pozzolana shall conform to the IS: 1489-1 (1991) as given below.

1. Raw Materials:

- **Pozzolana:** Fly ash used in the manufacture of Portland-pozzolana cement shall conform to IS 3812: 1981
- Portland Cement **Clinker:** The Portland cement clinker used in the manufacture of Portland-pozzolana cement shall comply in all respects with the chemical requirements of IS 269: 1989
- Portland **Cement:** Portland cement for blending with fly ash shall conform to IS 269: 1989
- Other **admixtures:** Not more than 1 percent may be added

2. Manufacture:

Portland-pozzolana cement shall be manufactured either by intimately inter-grinding Portland cement clinker and fly ash or by intimately and uniformly blending Portland cement and fine fly ash. The **fly ash** constituent shall not be less than 10 percent and **not more than 25 percent** by mass of Portland-pozzolana cement.

3. Chemical Requirements:

Portland-pozzolana cement, shall comply with the chemical requirements given below.

Chemical requirement as per IS: 1489-1 (1991)

Sl No.	Characteristic	Requirement	Method of Test Ref to IS
(1)	(2)	(3)	(4)
i)	Loss on ignition, percent by mass, <i>Max</i>	5.0	4032 : 1985
ii)	Magnesia (MgO), percent by mass, <i>Max</i>	6.0	4032 : 1985
iii)	Sulphuric anhydride (SO ₂), percent by mass, <i>Max</i>	3.0	4032 : 1985
iv)	Insoluble material, percent by mass, <i>Max</i>	$x + \frac{4.0(100-x)}{100}$	4032 : 1985

where *x* is the declared percentage of flyash in the given Portland-pozzolana cement

4. Physical Requirements:

- a. **Fineness:** When tested by the air permeability method described in IS 4031 (Part 2): 1988, the specific surface of Portland-pozzolana cement shall be not less than 300 m²/kg.
- b. **Soundness:** When tested by 'Le Chatelier' method and autoclave test described in IS 4031 (Part 3): 1988, unaerated Portland-pozzolana cement The average drying shrinkage of mortar bars shall not have an expansion of more than 10 mm and 0.8 percent respectively.
- c. **Setting Time:** The setting time of Portland-pozzolana cement, when tested by the Vicat apparatus method described in IS 4031 (Part 5): 1988, shall be 30min (Minimum) for initial setting time and 600min (Maximum) for final setting time
- d. **Compressive strength:** The average compressive strength tested in the manner as described in IS 4031 (Part 6): 1988 shall be as follows:

At 72 ± 1hr	16 MPa, Min
At 168 ± 2hrs	22 MPa, Min
At 672 ± 4hrs	33 MPa, Min

- e. **Drying shrinkage:** The average drying shrinkage of mortar bars prepared and tested in accordance with IS 4031 (Part 10): 1988 shall not be more than **0.15 percent**.

#####

Civil Engineering Materials and Constructions (BCE03002)

Module-II

Basic Building Materials I

Module II Syllabus

Syllabus: Mortar: Types and tests on mortars. Concrete: Production, mix proportions and grades of concrete, fresh, mechanical and durability properties of concrete, factors affecting properties of concrete, tests on concrete, Admixtures, Special concrete: light weight concrete, high density concrete, vacuum concrete, shotcrete, steel fiber reinforced concrete, polymer concrete, Ferro cement, high performance concrete, self-compacting concrete.

Subject to Revision

1. MORTAR

(Types and tests on mortars)

Several different tests are needed to estimate the stability and strength of a structure, from the soil it will stand on to the bricks or concrete that will form it. But what about mortar, the material that binds it all together? There are a variety of ways to perform mortar testing, many of which are similar to how you would test aggregates, concrete or cement.

1.1 Types of Mortar:

1. Cement Mortar
2. Lime Mortar
3. Surki Mortar
4. Gauged Mortar
5. Mud Mortar

Cement Mortar

Cement mortar is a type of mortar where **cement** is used as binding material and **sand** is used as fine aggregate. Depending upon the desired strength, the cement to the sand proportion of cement mortar varies from **1:2 to 1:6**.

Lime Mortar

Lime mortar is a type of mortar where **lime** (fat lime or hydraulic lime) is used as binding material and **sand** is used as fine aggregate. The lime to the sand proportion of cement mortar is kept 1:2. The pyramids at Giza are plastered with lime mortar.

Gauged Mortar

Gauged mortar is a type of mortar where **cement and lime** both are used as binding material and **sand** is used as fine aggregate. Basically, it is a **lime mortar** where cement is added to gain higher strength. The process is known as **gauging**. The **cement to the lime** proportion varies from 1:6 to 1:9. **Gauged mortar** is **economical** than cement concrete and also possess **higher strength** than lime mortar.

Surki Mortar

Surkhi is an **artificial pozzolanic material** (i.e. **Pozzolans** are a broad class of siliceous or siliceous and aluminous materials which, in themselves, possess little or no cementitious value but which will, in finely divided form and in the presence of water, react chemically with calcium hydroxide at ordinary temperature to form compounds possessing cementitious properties (The **pozzolanic reaction** is the chemical reaction that occurs in portland cement upon the addition of pozzolans) **made by powdering bricks or burnt clay balls**. Surkhi is used for making waterproof cement mortars and concrete. They also make the concrete more resistant to alkalis and salt solutions. Surkhi is used as a substitute for sand for concrete and mortar, and

has almost the same function as of sand but it also imparts some strength and hydraulicity. Surkhi is made by grinding to powder burnt bricks, brick-bats or burnt clay; under-burnt or over-burnt bricks should not be used, nor bricks containing high proportion of sand. When clay is especially burnt for making into surkhi, an addition of 10 to 20 per cent of quick lime will improve its quality; small clay balls are made for burning.

Surki mortar is a type of mortar where **lime** is used as binding material and **surki** is used as fine aggregate. **Surki mortar** is economic.

Mud Mortar

Mud mortar is a type of mortar where **mud** is used as binding material and **sawdust, rice husk** or **cow-dung** is used as **fine aggregate**. Mud mortar is useful where lime or cement is not available.

Is Mortar Testing Necessary?

While there are ASTM methods specifically designed for masonry mortar testing, there is not a code requirement for testing mortar. Neither the International Building Code (IBC) nor the Masonry Building Code call for mortar testing on job sites or in labs. Some specifiers will still call for mortar strength testing, so it can be performed on a case-by-case basis. Mortar may only play a small part in contributing to structural capacity, but it's still important to determine whether it meets the physical property requirements of a project, including strength.

1.2 Types of Mortar Testing

There are several tests that can be performed on both plastic and hardened mortar to determine ideal mix ratios and strength. The tests listed below are a high-level overview, so be sure to consult ASTM C 780, which outlines the specifics of each, to help you learn more about a mortar sample's physical properties.

1. Air Content

Air content tests are commonly specified for concrete and cement in areas that are prone to frost they can also be specified for mortar. Repetitive tests using pressure meters or "roll-o-meters" help determine if air content levels change due to mixing consistency and mixing time in order to find the ideal level of air content both in the field and in the lab.

2. Board Life

Board life is an especially crucial form of mortar testing because it describes the time frame of usability for mortar after it's removed from a mixer and placed on a mortarboard. Mortar begins to **lose moisture** and **stiffen** once it's in **open air**, so it needs to be placed quickly to ensure it bonds properly. While time frame determination is important, this test also reveals whether mortar will be acceptable for use once completely hardened — if it's too stiff, it won't work.

3. Compressive Strength

Compressive strength tests are performed on mortar once it has hardened, and can help determine the load a sample will be able to bear. These tests are better suited to a laboratory since field testing may indicate less approximate mortar strengths.

4. Consistency

Consistency testing helps identify variations between batches of mortar mix, both in mix materials and mix time. Mortar testing equipment, like a mortar penetrometer, is generally used to determine consistency based on the depth it can penetrate into the mortar sample. While inconsistent batches don't indicate that the materials used are improper, they can suggest that poor control was exercised during mortar batching and mixing.

5. Mortar-Aggregate Ratio

This test helps determine whether cement, sand and water are added properly and consistently to each batch of mortar, a bit like the consistency test. But, while the tests might be similar, mortar-aggregate ratio testing is performed solely in a laboratory, after mortar mix samples are obtained from a job site and sent in to be measured.

6. Water Retention

Water retention tests measure the plastic life of mortar. The longer the plastic life, the greater the amount of time a mason has to lay and adjust the mortar/masonry unit before the mortar hardens. These tests are performed in a laboratory.

2. CONCRETE

(Production, mix proportions and grades of concrete, fresh, mechanical and durability properties of concrete, factors affecting properties of concrete, tests on concrete)

Concrete, in construction, structural material consisting of a hard, chemically inert particulate substance, known as aggregate (usually sand and gravel), that is bonded together by cement and water.

2.1 Production Process of Concrete:

A good quality concrete is essentially a **heterogeneous** mixture of **cement**, **coarse** and **fine** aggregates and **water** which consolidates into a hard mass due to **chemical action** between the cement and water. Each of the **four constituents** has a specific function. The coarser aggregate acts as a **filler**. The fine aggregate **fills up the voids** between the paste and the coarse aggregate. The cement in conjunction with water acts as a **binder**. The mobility of the mixture is aided by the cement paste, fines and nowadays, increasingly by the use of **admixtures**.

Most of the properties of the hardened concrete depend on the care exercised at every stage of the manufacture of concrete. A rational proportioning of the ingredients of concrete is the essence of the **mix design**. However, it may not guarantee of having achieved the objective of the quality concrete work. The aim of quality control is to ensure the production of concrete of uniform strength from **batch to batch**. This requires some rules to be followed in the various stages of concrete production and are discussed as follows. The stages of concrete production are:

1. Batching or measurement of materials
2. Mixing

3. Transporting
4. Placing
5. Compacting
6. Curing
7. Finishing

1. Batching of Materials

For good quality concrete a proper and accurate quantity of all the ingredients should be used. The aggregates, cement and water should be measured with an accuracy of 3 percent of batch quantity and the admixtures by 5 per cent of the batch quantity. There are two prevalent methods of batching materials, the **volume batching** and the **weigh batching**. The factors affecting the choice of batching method are the **size of job**, required **production rate**, and required **standards of batching performance**. For most important works **weigh batching** is recommended.

- a) Volume Batching
- b) Weigh Batching

2. Mixing

- Hand Mixing
- Machine Mixing
- Tilting Mixers
- Non-tilting Mixer
- Reversing Drum Mixer
- Pan-type or Stirring Mixer
- Transit Mixer

3. Transporting

Concrete should be transported to the place of deposition at the earliest without the **loss of homogeneity** obtained at the time of mixing. A **maximum of 2 hours** from the time of mixing is permitted if **trucks with agitator** and **1 hour** if trucks **without agitators** are used for transporting concrete. Also it should be ensured that **segregation** does not take place during transportation and placement. The methods adopted for transporting concrete depend upon the **size and importance of the job**, the **distance of the deposition** place from the mixing place, and the **nature of the terrain**. Some of the methods of transporting concrete are as below:

- Mortar Pan
- Wheel Barrow
- Chutes
- Dumper
- Bucket and Ropeway

- Belt conveyor
- Skip and Hoist
- Pumping

4. Placing

To achieve quality concrete, it should be placed with utmost care securing the uniformity achieved during mixing and the avoidance of **segregation in transporting**. Research has shown that a delayed placing of concrete results in a gain in ultimate compressive strength provided the concrete can be adequately compacted. For **dry mixes in hot weather** delay of **half to one hour** is allowed whereas for **wet mixes in cold weather** it may be **several hours**. The various situations in which concrete is placed are discussed below.

- **Foundations (Sub Structure)**

Concrete foundations for walls and columns are provided below the ground surface. Before placing the concrete in the foundation all the loose earth, roots of trees etc., are removed. If the surface is found dry it is made wet so that earth does not absorb water from concrete. On the other hand if the foundation bed is wet the water and mud is removed and cement is sprinkled before placing concrete.

- **Beams, Columns, and Slabs (Super Structure)**

Before placing the concrete, the **forms** must be examined for correct alignment. They should be adequately rigid to withstand the weight of concrete and construction loads without undue deformation. Forms should be light enough to avoid any loss of mortar resulting in honeycombed concrete. The insides of the forms should be **cleaned** and **lubricated** (oiled) before use to avoid any **sticking** of concrete with the forms and making their **stripping** off difficult.

Concrete should not be **dropped** but placed in position to prevent **segregation**. It should be dropped vertically from as small height as possible. It should be placed at one point in the formwork and allowed to flow side ways to take care of honeycombing.

Laitance formation should be avoided. It can be checked by restricting thickness of layer of concrete by 150-300 mm for R.C.C work. Laitance, however, if formed must be removed before placing the next layer of concrete. Several such layers form a lift, provided they follow one another quickly enough to avoid cold joints. The surface of the previous lift is kept rough and all the laitance removed before placing the next lift.

The reinforcement should be checked for tightness and clean surface. The loose **rust or scales** if any, are removed by **wire brush**. Paint, oil or grease if found should be removed. The **minimum cover** for reinforcement should be checked before concreting.

- **Mass Concreting**

When the concrete is to be laid in mass as for raft foundation, dam, bridge, pier etc., concrete is placed in layers of **350-450 mm thickness**. Several such layers placed in quick succession form a lift. Before placing the concrete in the next lift, the surface of the previous lift is cleaned thoroughly with water jets and scrubbing by wire brush. In case of dams, sand blasting is done.

The laitance and loose materials are removed and cement slurry is applied. When the concrete is subjected to lateral thrust, *bond bars* or *bond stones* are provided to form a key between different layers.

- **Concreting Highways and Runways**

Concrete is laid in bays for highway, runway, or floor slabs. First the ground on which concrete is to be laid is prepared and all the loose materials and grass etc., are removed. The earth is wetted and compacted. The subgrades over which concrete is to be laid should be properly compacted and damped to avoid any loss of moisture from concrete. Concrete is then laid in alternate bays. This allows the concrete to undergo sufficient shrinkage and cracks do not develop afterwards. Concrete is not placed in heap at one place and then dragged, instead it is placed in uniform thickness.

- **Concreting Underwater**

Concrete may be placed underwater with the help of bottom dump buckets. The concrete is taken through the water in water-tight bucket. On reaching the place of deposition the bottom of the bucket is made to open and the concrete is dumped. In this process certain amount of cement is washed away causing a reduction in strength of concrete. Another way of concreting underwater is by filling cement bag with dry or semi-dry mix of cement and aggregates and lowering them to the place of deposition. The drawback of this method is that the concrete will be full of voids interspersed with participle gunny bags.

The best method of placing concrete underwater is by the use of **termite pipe**. The concrete is poured into it through funnel. The bottom end of the pipe is closed with a thick polythene sheet, with the bottom end of the pipe at the place of deposition. The concrete (slump 150-200 mm) is poured into funnel till the whole pipe is filled with concrete. The pipe is slightly lifted and given a jerk, the polythene sheet cover falls and concrete discharged. It should be ensured that the end of pipe remains inside the concrete so that water does not enter the pipe. The pipe is again filled with concrete through funnel and the process repeated till the concrete level comes above the water level. No compaction is required for underwater concrete as it gets compacted by the hydrostatic pressure of water. Concrete can also be placed underwater with the help of pipes and pumps.

5. Compacting

After concrete is placed at the desired location, the next step in the process of concrete production is its compaction. Compaction consolidates **fresh concrete** within the **moulds** or **frameworks** and around embedded parts and reinforcement steel. Considerable quantity of **air is entrapped** in concrete during its production and there is possible **partial segregation** also. Both of these adversely affect the quality of concrete. Compaction of the concrete is the process to get rid of the entrapped air and voids, elimination of segregation occurred and to form a uniform dense mass. It has been found that **5 per cent voids** in hardened concrete reduce the strength by over **30 per cent** and **10 per cent voids** reduce the strength by over **50 per cent**. Therefore, the **density** and consequently the **strength** and **durability** of concrete largely depend upon the

degree of compaction. For maximum strength driest possible concrete should be compacted 100 per cent.

The **voids** increase the **permeability** of concrete. **Loss of impermeability** creates easy passage of moisture, oxygen, chlorides, and other aggressive chemicals into the concrete. This causes **rusting** of steel and **spalling** (disintegration) of concrete i.e., **loss of durability**. Easy entry of **sulphates** from the environment causes **expansive reaction** with the **tricalcium aluminate** (C_3A) present in cement. This causes **disintegration** of concrete and **loss of durability**. Entry of **carbon dioxide** causes **carbonation of concrete** i.e., **loss of alkalinity** of concrete or loss of the **protective power** that concrete gives to the reinforcement or other steel embedded in it. Once the **carbonation depth exceeds the thickness of concrete cover** to the embedded steel, steel becomes vulnerable to the attack of moisture. This expedites rusting of steel as the protective concrete cover remains no longer alkaline in nature.

Voids also reduce the contact between embedded steel and concrete. This results in loss of **bond strength** of reinforced concrete member and thus the member **loses strength**. **Voids** such as **honeycombs** and **blowholes** on the exposed surface produce visual blemish. Concrete surface is not good to look with all such blemishes. Concrete with smooth and perfect, surface finish not only looks good but is also stronger and more durable.

Compaction is achieved by imparting **external work** over the concrete to overcome the internal friction between the particles forming the concrete, between concrete and reinforcement and between concrete and forms and by reducing the air voids to a minimum. The compaction of concrete can be achieved by the following methods.

1. Hand Compaction
2. Compaction by Vibration
 - a. Needle Vibrator:
 - b. Formwork Vibrator
3. Compaction by Spinning
4. Compaction by Jolting
5. Compaction by Rolling

6. Curing

Cement gains strength and hardness because of the chemical action between cement and water. This chemical reaction requires moisture, favorable temperature and time referred to as the curing period. The variation of compressive strength with curing period is shown in Fig. 10.11 (a, b). Curing of freshly placed concrete is very important for optimum strength and durability. The major part of the strength in the initial period is contributed by the clinker compound C_3S and partly by C_2S , and is completed in about three weeks. The later strength contributed by C_2S is gradual and takes long time. As such sufficient water should be made available to concrete to allow it to gain full strength. **The process of keeping concrete damp for this purpose is known as curing.** The object is to prevent the **loss of moisture** from concrete due to evaporation or any other reason, supply additional moisture or heat and moisture to accelerate the **gain of strength**. Curing must be done for at least three weeks and in no case for less than ten days.

Approximately **14 liters of water is required to hydrate each bag of cement**. Soon after the concrete is placed, the increase in strength is **very rapid** (3 to 7 days) and continues slowly thereafter for an indefinite period. Concrete moist cured for 7 days is about 50 per cent stronger than that which is exposed to dry air for the entire period. If the concrete is kept damp for one month, the strength is about double than that of concrete exposed only to dry air.

- **Methods of Curing**

Concrete may be kept moist by a number of ways. The methods consist in either supplying additional moisture to concrete during early hardening period by ponding, spraying, sprinkling, etc. or by preventing loss of moisture from concrete by sealing the surface of concrete by membrane formed by curing compounds. Following are some of the prevalent methods of curing.

- Water Curing
- Steam Curing
- Curing by Infra-Red Radiation
- Electrical Curing
- Chemical Curing

7. Finishing

Concrete is basically used because of its high compressive strength. However, the finish of the ultimate product is not that pleasant. In past couple of decades efforts have been made to develop surface finishes to give a better appearance to concrete surfaces and are as follows.

- Formwork Finishes
- Surface Treatments
- Applied Finishes

2.2 Mix Proportions and Grades of Concrete

- **Nominal Concrete Mix Ratios**

In the past the specifications for concrete prescribed the proportions of cement, fine and coarse aggregates. These mixes of fixed **cement-aggregate ratio** which ensures adequate strength are termed nominal mixes. Nominal mixes offer simplicity and under normal circumstances, have a margin of strength above that specified. However, due to the variability of mix ingredients the nominal concrete for a given workability varies widely in strength. Nominal mix ratios for concrete are 1:2:4 for M15, 1:1.5:3 for M20 etc.

Standard Mixes or Ratio

The nominal mixes of fixed **cement-aggregate ratio** (by **volume**) vary widely in strength and may result in **under or over-rich mixes**. For this reason, the minimum compressive strength has been included in many specifications. These mixes are termed standard mixes. **IS 456-2000** has designated the concrete mixes into a number of grades as **M10, M15, M20, M25, M30, M35 and M40**. In this designation the letter M refers to the mix and the number to the specified 28 day cube strength of mix in N/mm². The mixes of grades M10, M15, M20 and M25 correspond approximately to the mix proportions (1:3:6), (1:2:4), (1:1.5:3) and (1:1:2) respectively.

- **Designed Mix Ratio of Concrete (IS 10262: 2019)**

In these mixes the performance of the concrete is specified by the designer but the mix proportions are determined by the producer of concrete, except that the minimum cement content can be laid down. This is most rational approach to the selection of mix proportions with specific materials in mind possessing more or less unique characteristics. The approach results in the production of concrete with the appropriate properties most economically. However, the designed mix does not serve as a guide since this does not guarantee the correct mix proportions for the prescribed performance. For the concrete with undemanding performance nominal or standard mixes (prescribed in the codes by quantities of dry ingredients per cubic meter and by slump) may be used only for very small jobs, when the **28-day strength** of concrete does not exceed 30 N/mm². No control testing is necessary reliance being placed on the masses of the ingredients. Following table provides details of different types of concrete mix ratios and their strengths.

Concrete Grade (Nominal Mix)	Mix Ratio	Compressive Strength	
		MPa (N/mm ²)	psi
Normal Grade of Concrete			
<i>M5</i>	<i>1 : 5 : 10</i>	<i>5 MPa</i>	<i>725 psi</i>
<i>M7.5</i>	<i>1 : 4 : 8</i>	<i>7.5 MPa</i>	<i>1087 psi</i>
<i>M10</i>	<i>1 : 3 : 6</i>	<i>10 MPa</i>	<i>1450 psi</i>
<i>M15</i>	<i>1 : 2 : 4</i>	<i>15 MPa</i>	<i>2175 psi</i>
M20	1 : 1.5 : 3	20 MPa	2900 psi

Standard Grade of Concrete			
M25	1 : 1 : 2	25 MPa	3625 psi
M30	Design Mix	30 MPa	4350 psi
M35	Design Mix	35 MPa	5075 psi
M40	Design Mix	40 MPa	5800 psi
M45	Design Mix	45 MPa	6525 psi
High Strength Concrete Grades			
M50	Design Mix	50 MPa	7250 psi
M55	Design Mix	55 MPa	7975 psi
M60	Design Mix	60 MPa	8700 psi
M65	Design Mix	65 MPa	9425 psi
M70	Design Mix	70 MPa	10150 psi

2.3 Properties of Fresh Concrete:

Concrete remains in its fresh state from the time it is mixed until it sets. During this time the concrete is handled, transported, placed and compacted. Properties of concrete in its fresh state are very important because they influence the quality of the hardened concrete.

The fresh concrete has the following procedure.

- 1. Consistency**
- 2. Workability**

3. Settlement & Bleeding

4. Plastic shrinkage

5. Loss of consistency

1. Consistency

Consistency of a concrete mix is a measure of the stiffness or sloppiness or **fluidity of the mix**. For effective handling, placing and compacting the concrete, consistency must be the **same for each batch**. It is therefore necessary to measure consistency of concrete at regular intervals. **Slump test** is commonly used to measure consistency of concrete.

2. Workability

The workability of a concrete mix is the relative ease with which concrete can be placed, compacted and finished without separation or segregation of the individual materials.

Workability is not the same thing as consistency. Mixes with the same consistency can have different workabilities, if they are made with different sizes of stone – the smaller the stone the more workable the concrete.

It is not possible to measure workability but the slump test, together with an assessment of properties like stone content, cohesiveness and plasticity, gives a useful indication.

3. Settlement and Bleeding

Cement and aggregate particles have densities about three times that of water. In fresh concrete they consequently tend to settle and displace mixing water which migrates upward and may collect on the top surface of the concrete. This upward movement of mixing water is known as **bleeding**; water that separates from the rest of the concrete is called **bleed water**.

4. Plastic Shrinkage

If water is removed from the compacted concrete before it sets, the volume of the concrete is reduced by the amount of water removed. This volume reduction is called **plastic shrinkage**.

Water may be removed from the plastic concrete by evaporation or by being absorbed by dry surfaces such as soil or old concrete or by the dry wooden **form work**.

5. Slump Loss

From the time of mixing, fresh concrete gradually loses consistency. This gives rise to the problems only if the concrete becomes too stiff to handle, place and compact properly.

Slump loss in concrete is caused due to the following reasons.

- Hydration of cement (generating more heat)
- Loss of water by evaporation
- Absorption of water by dry aggregates

- Absorption of water by surfaces in contact with the concrete.

2.4 Mechanical properties of concrete

Performance of concrete is evaluated from mechanical properties which include shrinkage and creep, compressive strength, tensile strength, flexural strength, and modulus of elasticity.

- *Shrinkage and Creep*

When concrete is subjected to compressive loading it deforms instantaneously. This immediate deformation is called instantaneous strain. Now, if the load is maintained for a considerable period of time, concrete undergoes additional deformations even without any increase in the load. This time-dependent strain is termed as **creep**.

Shrinkage is the **reduction in the volume** of hardened concrete due to **loss of moisture by evaporation**.

There are several similarities and dissimilarities between creep and shrinkage. First, the source for both the effects are the same, which is **loss of adsorbed moisture** from the hydrated cement paste. In shrinkage, the loss is due to difference in the relative humidity of concrete and the environment, in creep it is due to sustained applied stress. Second, the **strain-time** curves of both the phenomenon are very similar.

The factors that affect creep also effects shrinkage. They both increase with: higher cement content, higher water content, lower aggregate content, low relative humidity, high temperature, small thickness of the member, etc.

- *Compressive strength*

Compressive strength is the maximum compressive stress that, under a gradually applied load, a given solid material can sustain without fracture. The formula for calculating compressive strength is:

$$CS = F / A$$

Where in compressive strength (CS) is equal to the force (F) at the point of failure divided by the cross sectional area. Compressive strength tests must be performed with equal opposing forces on the test material. Test materials are normally in cylinders, cubes or spheres.



Tensile strength

Tensile strength, maximum load that a material can support without fracture when being stretched, divided by the original cross-sectional area of the material. Tensile strengths have dimensions of force per unit area and in the English system of measurement are commonly expressed in units of pounds per square inch, often abbreviated to psi. When stresses less than the tensile strength are removed, a material returns either completely or partially to its original shape and size. As the stress reaches the value of the tensile strength, however, a material, if ductile, that has already begun to flow plastically rapidly forms a constricted region called a neck, where it then fractures.

Flexural strength

The flexural strength of a material is defined as the maximum bending stress that can be applied to that material before it yields. The most common way of obtaining the flexural strength of a material is by employing a transverse bending test using a three-point flexural test technique.

Flexural strength is also known as bending strength, modulus of rupture or transverse rupture strength.

Modulus of elasticity

The ratio of the stress in a body to the corresponding strain.

Quality Tests on concrete

Each quality test conducted on concrete determines their respective quality result of concrete. Hence, it is not possible to conduct all the test to determine the quality of concrete. We have to choose the best tests that can give good judgment of the concrete quality. The primary quality test determines the variation of the concrete specification from the required and standard concrete specification. The quality tests ensure that the best quality concrete is placed at the site so that concrete structural members of desired strength are obtained. Below mentioned are the quality tests conducted on fresh and hardened concretes.

Fresh Concrete

Most Common Quality Tests on Fresh concrete are:

1. Workability Tests

Workability of concrete mixture is measured by, Vee-bee consistometer test, Compaction factor Test, and Slump test.

2. Air content

Air content measures the total air content in a sample of fresh concrete but does not indicate what the final in-place air content is, because a certain amount of air is lost in transportation Consolidating, placement, and finishing.

3. *Setting Time*

The action of changing mixed cement from a fluid state to a solid state is called “Setting of Cement”. **Initial Setting Time** is defined as the period elapsing between the time when water is added to the cement and the time at which the needle of 1 mm square section fails to pierce the test block to a depth of about 5 mm from the bottom of the mold. **Final Setting Time** is defined as the period elapsing between the time when water is added to cement and the time at which the needle of 1 mm square section with 5 mm diameter attachment makes an impression on the test block.

Other tests conducted on fresh concrete are:

1. Segregation resistance
2. Unit weight
3. Wet analysis
4. Temperature
5. Heat generation
6. Bleeding

Hardened Concrete

Most Common Quality Tests on hardened concrete are:

1. Compressive strength (MECHANICAL PROPERTY)

The compressive strength of concrete cube test provides an idea about all the characteristics of concrete. Compressive strength is the ability of material or structure to carry the loads on its surface without any crack or deflection. A material under compression tends to reduce the size, while in tension, size elongates.

Compressive Strength = Load / Cross-sectional Area

Calculations of Compressive Strength

Size of the cube = 15cm x 15cm x 15cm

Area of the specimen (calculated from the mean size of the specimen) = 225 cm²

Characteristic compressive strength (f_{ck}) at 7 days =

Expected maximum load = f_{ck} x area x f.s

Range to be selected is.....

Similar calculation should be done for 28 day compressive strength

Maximum load applied =tones =N

$$\text{Compressive strength} = (\text{Load in N} / \text{Area in mm}^2) = \dots\dots\dots \text{N/mm}^2$$

$$= \dots\dots\dots \text{N/mm}^2$$

2. Tensile strength (MECHANICAL PROPERTY)

The tensile strength of concrete is one of the basic and important properties which greatly affect the extent and size of cracking in structures. Moreover, the concrete is very weak in tension due to its brittle nature. Hence. It is not expected to resist the direct tension. So, concrete develops cracks when tensile forces exceed its tensile strength. Therefore, it is necessary to determine the tensile strength of concrete to determine the load at which the concrete members may crack. Furthermore, splitting tensile strength test on concrete cylinder is a method to determine the tensile strength of concrete. The procedure based on the ASTM C496 (Standard Test Method of Cylindrical Concrete Specimen) which similar to other codes lik IS 5816 1999. Finally, different aspects split cylinder test of concrete specimen will be discussed in the following sections.

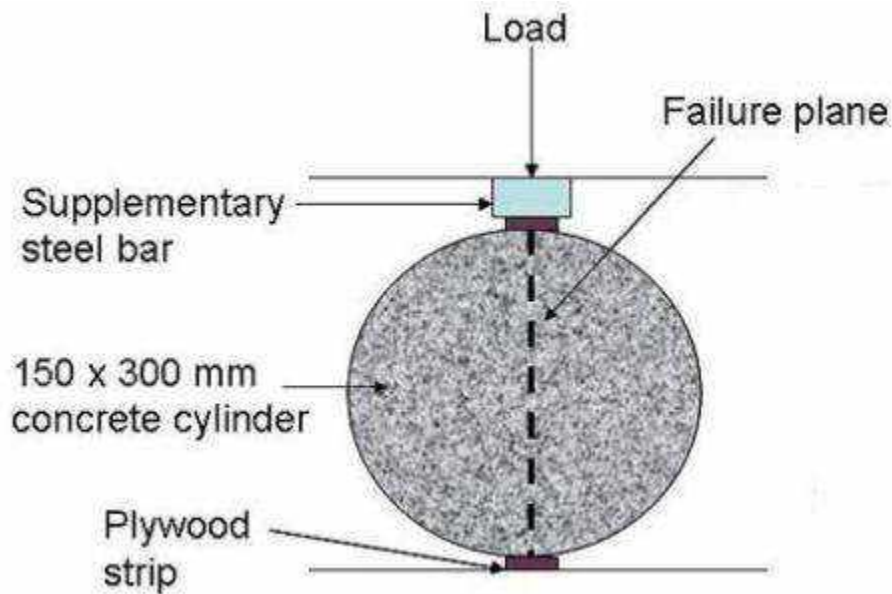

Calculations

Calculate the splitting tensile strength of the specimen as follows: $T = \frac{2P}{\pi LD}$ Where: T = splitting tensile strength, MPa P: maximum applied load indicated by the testing machine D: diameter of the specimen, mm L: length of the specimen, mm.

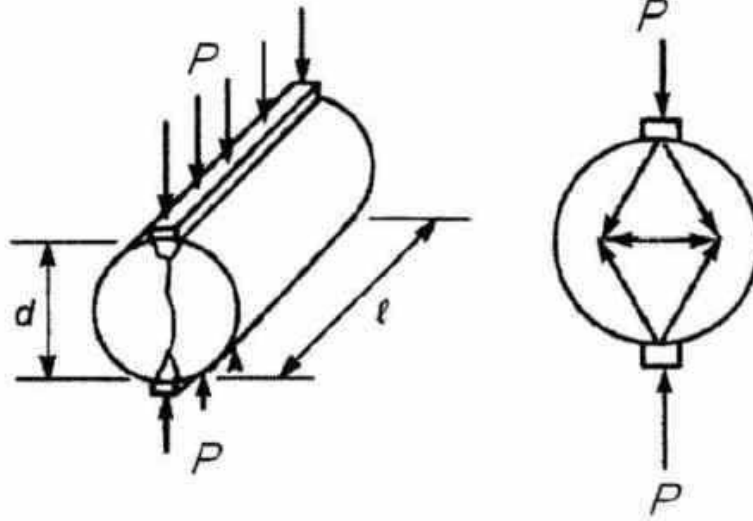

3. Modulus of elasticity (MECHANICAL PROPERTY)

Modulus of elasticity of concrete is defined as the ratio of stress applied on the concrete to the respective strain caused. The accurate value of modulus of elasticity of concrete can be determined by conducting a laboratory test called compression test on a cylindrical concrete specimen.

In the test, the deformation of the specimen with respect to different load variation is analyzed. These observations produce Stress-Strain graph (load-deflection graph) from which the modulus of elasticity of concrete is determined. The slope of a line that is drawn in the stress-strain curve from a stress value of zero to the compressive stress value of $0.45f_{ck}$ (working stress) gives the modulus of elasticity of concrete.

Calculation

Slope of Initial Tangent gives:

Initial tangent modulus = stress/strain

Slope of tangent at working stress gives:

Tangent modulus at working stress = stress/strain

Slope of Line joining initial tangent point and point of working stress gives:

Secant modulus = stress/strain

2.5 Durability Property

a) Permeability Tests on Concrete

When concrete is permeable it can cause corrosion in reinforcement in presence of oxygen, moisture, CO_2 , SO_3^{2-} and Cl^- etc. This **formation of rust** due to **corrosion** becomes nearly 6

times the volume of steel oxide layer, due to which cracking develops in reinforced concrete and spalling of concrete starts.

The durability of concrete structures depends on the permeability of reinforcement cover by concrete. It is this thin layer of concrete over reinforcement on which life of a structure depends. The **permeability tester** for concrete cover is a **non-destructive instrument** for the determination of **air permeability** of cover concrete. The permeability of concrete cover depends on the condition of concreting at site such as segregation and bleeding, finishing and curing, the formulation of micro-cracks, etc. The composition and properties of the cover concrete may differ very considerably from those of the good quality of cover concrete. In addition, the concrete test specimens used for quality controls can never represent the quality and properties of the cover concrete since they are produced and stored in a completely different manner. Durability of concrete structure under aggressive environmental influences depends essentially on the quality of a relatively thin surface layer (20 – 50 mm). This layer is intended to protect the reinforcement from corrosion which may occur as a result of carbonation or due to ingress of chlorides or other chemical effects. The influence mentioned is enhanced by damage due to frost/thaw or frost/thaw/salt. There is no generally accepted method to characterize the pore structure of concrete and to relate it to its durability. However, several investigations have indicated that concrete permeability both with respect to air and to water is an excellent measure for the resistance of concrete against the ingress of aggressive media in the gaseous or in the liquid state and thus is a measure of the potential durability of a particular concrete. There is at present no generally accepted method for a rapid determination of concrete permeability and of limiting values for the permeability of concrete exposed to different environmental conditions. The Permeability Tester permits a rapid and non-destructive measurement of the quality of the cover concrete with respect its durability. The general arrangement of the permeability tester is shown in fig below:



b) **Acid Attack** (Acid resistance of concrete was determined in terms of **weight loss** and residual compressive strength. For this test, concrete cubes of size 150 mm x 150 mm x 150 mm were

cast and stored in a place at a temperature of 27°C for 24 hrs and then the specimens were water cured for 28 days.)

c) **Sulphate attack** (As regards chemical reactions, the only test that indirectly determines the resistance of a cement to sulfate is **ASTM C 1012** through measuring the **expansion** of a specimen immersed in a sulfate solution (usually sodium sulfate). This test requires measurements for 6 months to a year.)

d) **Chloride attack:** (When considering durability of concrete, chloride attack is the most imminent enemy. It is responsible for almost 40% of failure of concrete structures. In the presence of **oxygen and water**, chloride attack corrodes the steel reducing the strength of the structure drastically)

e) **Sorptivity:** (Ability of concrete to **absorb and transmit** water through it via **capillary suction** and provides an engineering measure of microstructure)

f) **RCPT** (Rapid chloride permeability test): Used to determine the resistance to **penetration** of **chloride ions**

g) **Water permeability test:** determines the resistance of concrete against water under hydrostatic pressure

2.6 Other quality tests are conducted to test the following:

1. Modulus of rupture
2. Density
3. Shrinkage
4. Creep
5. Freeze/thaw resistance
6. Resistance to aggressive chemicals
7. Resistance to abrasion
8. Bond to reinforcement
9. Absorption

2.7 Factors affecting properties of concrete:

Concrete strength is affected by many factors, such as quality of raw materials, water/cement ratio, coarse/fine aggregate ratio, and age of concrete, compaction of concrete, temperature, relative humidity and curing of concrete.

- **Quality of Raw Materials**

- **Cement:** Provided the cement conforms to the appropriate standard and it has been stored correctly (i.e. in dry conditions), it should be suitable for use in concrete.
- **Aggregates:** Quality of aggregates, its size, shape, texture, strength etc. determines the strength of concrete. The presence of salts (chlorides and sulphates), silt and clay also reduces the strength of concrete.
- **Water:** frequently the quality of the water is covered by a clause stating “The water should be fit for drinking”. This criterion though is not absolute and reference should be made to respective codes for testing of water construction purpose.
- **Water / Cement Ratio:** The relation between water cement ratio and strength of concrete is shown in the plot as shown below:

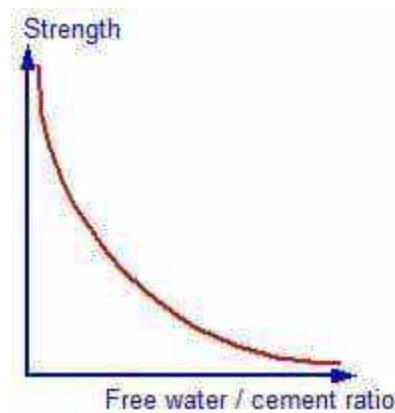

The higher the water/cement ratio, the greater the initial spacing between the cement grains and the greater the volume of residual voids not filled by hydration products. There is one thing missing on the graph. For a given cement content, the workability of the concrete is reduced if the water/cement ratio is reduced. A lower water cement ratio means less water, or more cement and lower workability. However if the workability becomes too low the concrete becomes difficult to compact and the strength reduces. For a given set of materials and environment conditions, the strength at any age depends only on the water-cement ratio, providing full compaction can be achieved.

- **Coarse / fine aggregate ratio**

Following points should be noted for coarse/fine aggregate ratio:

- If the proportion of fines is increased in relation to the coarse aggregate, the overall aggregate surface area will increase.
- If the surface area of the aggregate has increased, the water demand will also increase.
- Assuming the water demand has increased, the water cement ratio will increase.

- Since the water cement ratio has increased, the compressive strength will decrease.

- **Aggregate / Cement Ratio**

Following points must be noted for aggregate cement ratio:

If the volume remains the same and the proportion of cement in relation to that of sand is increased the surface area of the solid will increase.

If the surface area of the solids has increased, the water demand will stay the same for the constant workability.

Assuming an increase in cement content for no increase in water demand, the water cement ratio will decrease.

If the water cement ratio reduces, the strength of the concrete will increase.

The influence of cement content on workability and strength is an important one to remember and can be summarized as follows:

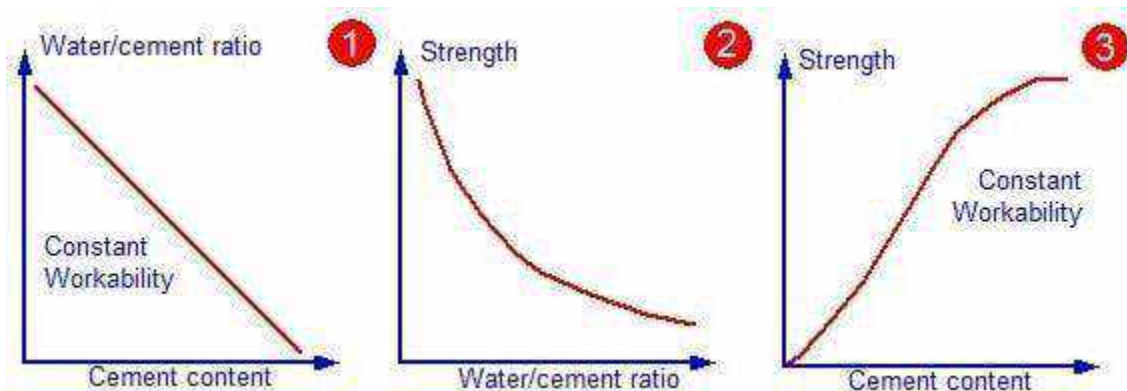

1. For a given workability an increase in the proportion of cement in a mix has little effect on the water demand and results in a reduction in the water/cement ratio.
2. The reduction in water/cement ratio leads to an increase in strength of concrete.
3. Therefore, for a given workability an increase in the cement content results in an increase in strength of concrete.

- **Age of concrete**

The degree of hydration is synonymous with the age of concrete provided the concrete has not been allowed to dry out or the temperature is too low. In theory, provided the concrete is not allowed to dry out, then it will always be increasing albeit at an ever reducing rate. For convenience and for most practical applications, it is generally accepted that the majority of the strength has been achieved by 28 days.

- **Compaction of concrete**

Any entrapped air resulting from inadequate compaction of the plastic concrete will lead to a reduction in strength. If there was 10% trapped air in the concrete, the strength will fall down in the range of 30 to 40%.

- **Temperature**

The rate of hydration reaction is temperature dependent. If the temperature increases the reaction also increases. This means that the concrete kept at higher temperature will gain strength more quickly than a similar concrete kept at a lower temperature. However, the final strength of the concrete kept at the higher temperature will be lower. This is because the physical form of the hardened cement paste is less well-structured and more porous when hydration proceeds at faster rate. This is an important point to remember because temperature has a similar but more pronounced detrimental effect on permeability of the concrete.

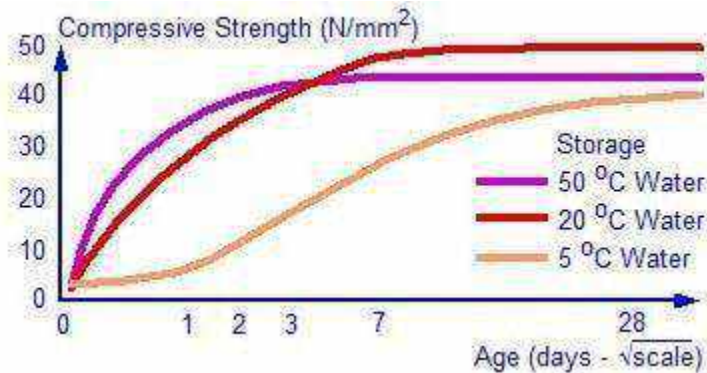

- **Relative humidity**

If the concrete is allowed to dry out, the hydration reaction will stop. The hydration reaction cannot proceed without moisture. The three curves shows the strength development of similar concretes exposed to different conditions.

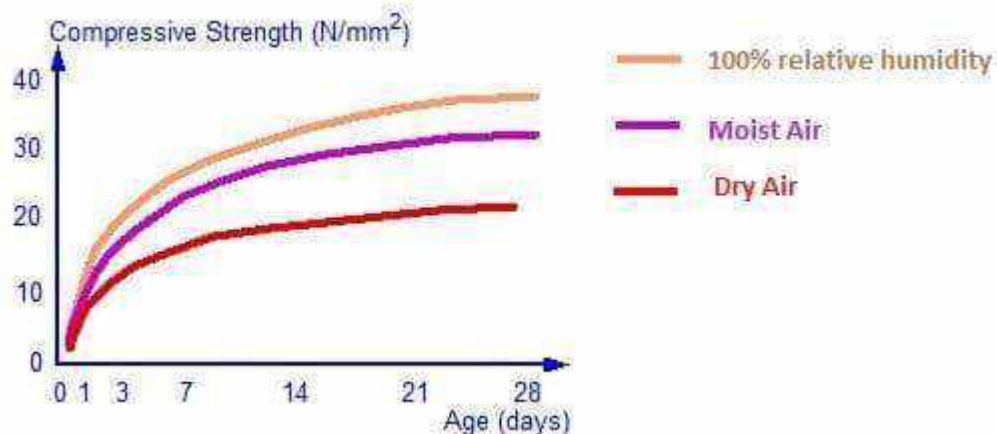

- **Curing**

It should be clear from what has been said above that the detrimental effects of storage of concrete in a dry environment can be reduced if the concrete is adequately cured to prevent excessive moisture loss.

3. CONCRETE ADMIXTURES

They are **natural or manufactured chemicals or additives added during concrete mixing** to enhance specific properties of the fresh or hardened concrete, such as workability, durability, or early and final strength.

a Chemical Admixtures:

ASTM C494 specifies the requirements for **seven** chemical admixture types.

They are:

- Type A: Water-reducing admixtures:
- Type B: Retarding admixtures
- Type C: Accelerating admixtures
- Type D: Water-reducing and retarding admixtures
- Type E: Water-reducing and accelerating admixtures
- Type F: Water-reducing, high range admixtures
- Type G: Water-reducing, high range, and retarding admixtures

b Mineral Admixtures:

Mineral admixtures make mixtures more economical, reduce permeability, increase strength, and influence other concrete properties.

Mineral admixtures affect the nature of the hardened concrete through hydraulic or pozzolanic activity. Pozzolans are cementitious materials and include natural pozzolans (such as the volcanic ash used in Roman concrete), fly ash and silica fume.

They can be used with Portland cement, or blended cement either individually or in combinations

Types of Admixtures (according to function) There are five distinct classes of chemical admixtures:

- **Air-Entraining Admixtures:**
- **Water-Reducing Admixtures:**
- **Retarding Admixtures:**
- **Accelerating Admixtures:**

- **Plasticizers (Superplasticizers):**

4. SPECIAL CONCRETE

1) *Light weight concrete:*

Lightweight concrete mixture is made with a lightweight coarse aggregate and sometimes a portion or entire fine aggregates may be lightweight instead of normal aggregates. Structural lightweight concrete has an in-place density (unit weight) on the order of 1440 to 1840 kg/m³.

Normal weight concrete a density in the range of 2240 to 2400 kg/m³. For structural applications the concrete strength should be greater than 17.0 MPa.

Lightweight aggregates used in structural lightweight concrete are typically expanded shale, clay or slate materials that have been fired in a rotary kiln to develop a porous structure. Other products such as air-cooled blast furnace slag are also used.

There are other classes of non-structural LWC with lower density made with other aggregate materials and higher air voids in the cement paste matrix, such as in cellular concrete.

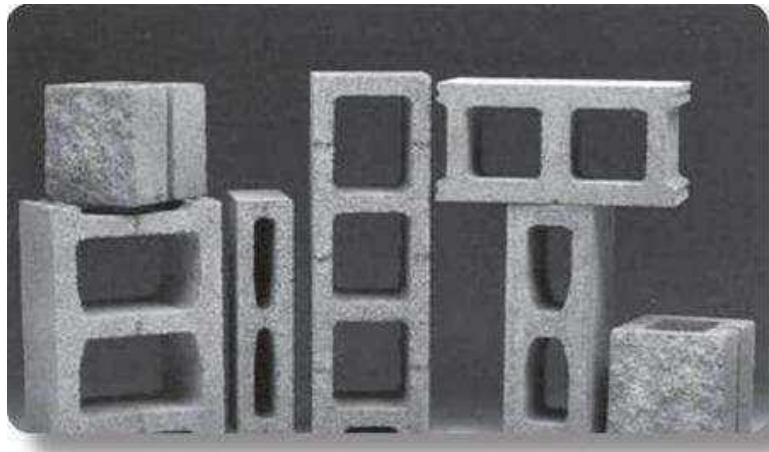

Classification of Lightweight Concrete

It is convenient to classify the various types of lightweight concrete by their method of production. These are:

1. By using porous lightweight aggregate of low apparent specific gravity, i.e. lower than 2.6. This type of concrete is known as lightweight aggregate concrete.
2. By introducing large voids within the concrete or mortar mass; these voids should be clearly distinguished from the extremely fine voids produced by air entrainment. This types of concrete is variously knows as aerated, cellular, foamed or gas concrete.
3. By omitting the fine aggregate from the mix so that a large number of interstitial voids is present; normal weight coarse aggregate is generally used. This concrete as no-fines concrete.

LWC can also be classified according to the purpose for which it is to be used: it can distinguish between structural lightweight concrete (ASTM C 330-82a), concrete used in masonry units (ASTM C 331-81), and insulating concrete (ASTM C 332-83).

This classification of structural lightweight concrete is based on a minimum strength: according to ASTM C 330-82a, the 28-day cylinder compressive strength should not be less than 17 MPa (2500 psi).

The density (unit weight) of such concrete (determined in the dry state) should not exceed 1840 kg/m³, and is usually between 1400 and 1800 kg/m³. On the other hand, masonry concrete generally has a density between 500 and 800 kg/m³ (30 and 50 lb/ft³) and a strength between 7 and 14 MPa (1000 and 2000 psi).

Types of Lightweight Concrete

i) Lightweight Aggregate Concrete

In the early 1950s, the use of lightweight concrete blocks was accepted in the UK for load bearing inner leaf of cavity walls. Soon thereafter the development and production of new types of artificial LWA (Lightweight aggregate) made it possible to introduce LWC of high strength, suitable for structural work.

These advances encouraged the structural use of LWA concrete, particularly where the need to reduce weight in a structure was an important consideration for design or for economy.

Listed below are several types of lightweight aggregates suitable for structural reinforced concrete:-

1. **Pumice** – is used for reinforced concrete roof slab, mainly for industrial roofs in Germany.
2. **Foamed Slag** – was the first **lightweight aggregate** suitable for reinforced concrete that was produced in large quantity in the UK.
3. **Expanded Clays and Shales** – capable of achieving sufficiently high strength for prestressed concrete. Well established under the trade names of Aglite and Leca (UK), Haydite, Rocklite, Gravelite and Aglite (USA).
4. **Sintered Pulverised** – fuel ash aggregate – is being used in the UK for a variety of structural purposes and is being marketed under the trade name Lytag

ii) Aerated Concrete

Aerated concrete has the lowest density, thermal conductivity and strength. Like timber it can be sawn, screwed and nailed, but there are non-combustible. For works in-situ the usual methods of aeration are by mixing in stabilized foam or by whipping air in with the aid of an air entraining agent.

The precast products are usually made by the addition of about 0.2 percent aluminum powder to the mix which reacts with alkaline substances in the binder forming hydrogen bubbles.

Air-cured aerated concrete is used where little strength is required e.g. roof screeds and pipe lagging. Full strength development depends upon the reaction of lime with the siliceous aggregates, and for the equal densities the strength of high pressure steam cured concrete is about twice that of air-cured concrete, and shrinkage is only one third or less.

Aerated concrete is a lightweight, cellular material consisting of cement and/or lime and sand or other silicious material. It is made by either a physical or a chemical process during which either air or gas is introduced into a slurry, which generally contains no coarse material.

Aerated concrete used as a structural material is usually high-pressure steam-cured. It is thus factory-made and available to the user in precast units only, for floors, walls and roofs. Blocks for laying in mortar or glue are manufactured without any reinforcement.

Larger units are reinforced with steel bars to resist damage through transport, handling and superimposed loads. Autoclaved aerated concrete, which was originally developed in Sweden in 1929, is now manufactured all over the world.

iii) No Fines Concrete

The term no-fines concrete generally means concrete composed of cement and a coarse (9-19mm) aggregate only (at least 95 percent should pass the 20mm BS sieve, not more than 10 percent should pass the 10mm BS sieve and nothing should pass the 5mm BS sieve), and the product so formed has many uniformly distributed voids throughout its mass.

No-fines concrete is mainly used for load bearing, cast in situ external and internal wall, non-load bearing wall and under floor filling for solid ground floors (CP III: 1970, BSI). No-fines concrete was introduced into the UK in 1923, when 50 houses were built in Edinburgh, followed a few years later by 800 in Liverpool, Manchester and London.

This description is applied to concrete which contain only a single size 10mm to 20mm coarse aggregate (either a dense aggregate or a light weight aggregate such as sintered PFA). The density is about two-third or three quarters that of dense concrete made with the same aggregates.

No-fines concrete is almost always cast in situ mainly as load bearing and non-load bearing walls including in filling walls, in framed structures, but sometimes as filling below solids ground floors and for roof screeds.

No-fines concrete is thus an agglomeration of coarse aggregate particles, each surrounded by a coating of cement paste up to about 1.3 mm (0.05 in.) thick. There exist, therefore, large pores within the body of the concrete which are responsible for its low strength, but their large size means that no capillary movement of water can take place.

Although the strength of no-fines concrete is considerably lower than that of normal-weight concrete, this strength, coupled with the lower dead load of the structure, is sufficient in buildings up to about 20 storeys high and in many other applications.

Types of Lightweight Concrete Based on Density and Strength

LWC can be classified as:-

- a Low density concrete
- b Moderate strength concrete
- c Structural concrete

a. Low Density Concrete

These are employing chiefly for insulation purposes. With low unit weight, seldom exceeding 800 kg/m^3 , heat insulation value are high. Compressive strength are low, regarding from about 0.69 to 6.89 N/mm^2 .

b. Moderate Density Concrete

The use of these concrete requires a fair degree of compressive strength, and thus they fall about midway between the structural and low density concrete. These are sometimes designed as 'fill' concrete. Compressive strength are approximately 6.89 to 17.24 N/mm^2 and insulation values are intermediate.

c. Structural Concrete

Concrete with full structural efficiency contain aggregates which fall on the other end of the scale and which are generally made with expanded shale, clay, slates, slag, and fly-ash. Minimum compressive strength is 17.24 N/mm^2 .

Most structural LWC are capable of producing concrete with compressive strength in excess of 34.47 N/mm^2 .

Since the unit weight of structural LWC are considerably greater than those of low density concrete, insulation efficiency is lower. However, thermal insulation values for structural LWC are substantially better than NWC.

Uses of Lightweight Concrete

1. Screeds and thickening for general purposes especially when such screeds or thickening and weight to floors roofs and other structural members.
2. Screeds and walls where timber has to be attached by nailing.
3. Casting structural steel to protect it against fire and corrosion or as a covering for architectural purposes.
4. Heat insulation on roofs.
5. Insulating water pipes.
6. Construction of partition walls and panel walls in frame structures.

7. Fixing bricks to receive nails from joinery, principally in domestic or domestic type construction.
8. General insulation of walls.
9. Surface rendered for external walls of small houses.
10. It is also being used for reinforced concrete.

Advantages of Lightweight Concrete

1. Reduced dead load of wet concrete allows longer span to be poured un-propped. This save both labor and circle time for each floor.
2. Reduction of dead load, faster building rates and lower haulage and handling costs. The eight of the building in term of the loads transmitted by the foundations is an important factor in design, particular for the case of tall buildings.
3. The use of LWC has sometimes made it possible to proceed with the design which otherwise would have been abandoned because of excessive weight. In frame structures, considerable savings in cost can be brought about by using LWC for the construction floors, partition and external cladding.
4. Most building materials such as clay bricks the haulage load is limited not by volume but by weight. With suitable design containers much larger volumes of LWC can haul economically.
5. A less obvious but nonetheless important characteristics of LWC is its relatively low thermal conductivity, a property which improves with decreasing density in recent years, with the increasing cost and scarcity of energy sources, more attention has been given the formerly to the need for reducing fuel consumption while maintaining, and indeed improving, comfort conditions buildings. The point is illustrated by fact that a 125 mm thick solid wall of aerated concrete will give thermal insulation about four times greater than that of a 230 mm clay brick wall.

Durability of Lightweight Concrete

Durability is defined as the ability of a material to withstand the effect of its environment. In a building material as chemical attack, physical stress, and mechanical assault:-

Chemical attack is as aggregate ground-water particularly sulfate, polluted air, and spillage of reactive liquids LWC has no special resistant to these agencies: indeed, it is generally move porous than the ordinary Portland cement. It is not recommended for use below damp-course. A chemical aspects of durability is the stability of the material itself, particularly at the presence of moisture.

Physical stresses to which LWC is exposed are principally frost action and shrinkage and temperature stresses. Stressing may be due to the drying shrinkage of the concrete or to differential thermal movements between dissimilar materials or to other phenomena of a similar

nature. Drying shrinkage commonly causes cracking of LWC if suitable precautions are not taken.

Mechanical damage can result from abrasion or impact excessive loading of flexural members. The lightest grades of LWC are relatively soft so that they subject to some abrasion were they not for other reasons protected by rendering.

2) High density of concrete

As the name suggests, the density of this concrete varies from 3360 kg/m^3 to 3840 kg/m^3 , whereas the density of normal concrete is of the order of 2400 kg/m^3 . The density of light weight concrete is about 1900 kg/m^3 . Thus the density of high density concrete is about 50% more than the density of conventional concrete. However this concrete can be produced of density up to 5200 kg/m^3 using iron as both fine and coarse aggregate.

With the advent of the **nuclear energy**, there is a considerable demand of the concrete technologists in the market. Due to the use of nuclear energy producing reactors, large scale production of penetrating radiation and radioactive materials also has taken place.

Thus all nuclear energy producing units such as **nuclear reactors, particle accelerator, industrial radiography, x-ray and gamma ray therapy** units require nuclear shielding material for the protection of the operating personnel against the biological hazards such as radiation. The normal as well as high density concrete is effective and economical for the construction of permanent shield against radiation.

Types of Radiation in High Density Concrete:

The radiation can be classified into two groups as follows:

These radiations are considered in the design of biological shields.

a. Electro-Magnetic Waves:

These waves are of high frequency and have high energy. These waves are known as X and gamma rays. These are the only electro-magnetic waves which need shields for the protection of personnel. Though they are similar to high rays, but possess higher energy and greater penetrating power. X and gamma rays are identical, but their sources of production are different. Both these rays have high penetration power, but they can be adequately absorbed by an appropriate thickness of concrete shield.

b. Nuclear Particles:

Nuclear particles consist of nuclei of atoms or their fragments. These fragments are known as neutrons, protons, alpha and beta particles. Except neutrons all the other particles possess an electric charge. On the other hand neutrons are un-charged and remain un-affected by electric field, until they interact by collision with a nucleus. They have no definite range and some of them may penetrate any shield.

Alpha, beta and proton particles carry electrical charge, which interact with electric field, surrounding the atom of the shielding material and lose their energy considerably. Generally

these particles do not create a separate shielding problem, though accelerated protons at high energy levels may require heavy shielding comparable to that required for neutrons.

Thus X and gamma rays, and neutrons need protection shield. As stated above X and gamma rays are similar except in energy and origin. The biological hazards of radiation arise from the fact that the radiation interact with human tissues. In the process of interaction some of the energy of the human tissues is lost.

The energy loss is sufficient to ionize the atoms of the cells, upsetting the delicate chemical balance and causing the death of cells. If enough cells are affected, the organism dies. Thus the radiation must be reduced or weekend sufficiently, so that the remainder or left out radiation may not cause permanent damage to the persons exposed to it.

Apart from biological hazards, a very high temperature is also generated by the nuclear reaction. Thus the shielding is necessary to protect the electronic and other sensitive equipment in the vicinity.

Shielding Ability of High Density Concrete:

Due to the following characteristics, concrete has been found an excellent shielding material:

1. It has sufficient capacity to absorb the radiation both of neutron and gamma rays, reducing the radiation to a very weak state.
2. It has good mechanical properties as strength and durability.
3. When green, it can be moulded into any shape. Thus the ease of construction makes concrete a specially suitable material for radiation shielding.
4. Its initial and maintenance cost is also relatively low.

Disadvantages:

Its disadvantages are as follows:

1. As the sections of the structure are heavy, they need more space. Thus the use of concrete as shielding against radiation needs more space.
2. The weight of shielding concrete is very high in the range of 3360 to 3840 kg/m³.

Aggregates to be used in Shielding High Density Concrete:

For making shielding concrete heavy weight aggregate having a specific gravity between 3.5 to 4.0 is needed. There are many aggregates whose specific gravity is more than 3.5 for making a heavy weight concrete.

Some of natural commercially used aggregates are as follows:

1. Barite

2. Magnetite
3. Ilmenite
4. Limonite, and
5. Hematite etc.

Barite is the most common natural aggregate having a specific gravity of 4.1 with 95% purity. Steel and iron aggregates in the form of shots and punching scrap for use as a heavy weight aggregate are also available in the market. They are known as artificial aggregate.

While selecting the aggregate to be used, the availability of the aggregate locally and their physical properties should be considered. In general the heavy weight aggregate should be strong, clean, inert and relatively free from deleterious materials which might impair the strength of concrete.

The capacity of various heavy aggregates to absorb gamma rays is directly proportional to their density. Also the heavier elements are more effective in absorbing fast neutrons by inelastic collisions than the lighter one. Therefore as heavy aggregate as possible should be used for the construction of shield.

However, density is not the only factor to be considered in the selection of an aggregate for neutron concrete shield. The desired increase in hydrogen content required to slow down the fast neutrons, can be accomplished by the use of hydrous ores. These materials contain a high percentage of water of hydration. On heating the concrete, some of this fixed water in the aggregate may be lost. Limonite and goethite are reliable sources of hydrogen as long as shield temperature does not exceed 200°C, whereas serpentine is good upto 400°C. The physical properties of high density aggregate are shown in Table below.

Physical properties of high density aggregate concrete

Aggregate	Limonite		Barite		Magnetite	Iron limonite
	Conventional	Pre packed	Conventional	Pre packed	Conventional	Pre packed
Density (kg/m ³)	2960	3360	3620	3680	3580	4370
Compressive strength MPa	42.0	33.0	44.0	24.0	41.0	23.0
Modulus of elasticity GPa	32.0	36.0	31.0	26.0	31.0	39.0
Shrinkage %	0.021	0.023	0.029	0.029	0.018	0.013

Requirements of Radiation Shielding Concrete:

The important requirements of radiation shielding concrete are as follows:

1. High density of the concrete — the higher the density of the concrete, higher the absorption of radiation. The radiation shielding quality of concrete can be increased by increasing its density.

2. The other important requirement of radiation shielding concrete is its structural strength even at high temperature.

Thus to produce high density and high strength concrete, it is necessary to control the water/cement ratio very strictly. Appropriate admixture and proper vibrators for good compaction should be employed, after that good quality control should be followed.

High density concrete used for shielding differs from normal weight concrete in the following respects.

High density concrete should contain sufficient material of light atomic weight, which produces hydrogen. Sometimes in high density concrete serpentine aggregates are used due to their ability to retain water of crystallisation at high temperatures which assure a source of hydrogen. The availability of water of crystallisation in all heavy weight aggregate is not necessary.

High density concrete may contain high content of cement-and may exhibit increased creep and shrinkage. Due to the high density of aggregate, it has a tendency of segregation. Coarse aggregate used may be of only high density mineral aggregate, or a mixture of mineral aggregate and steel particles or only steel particles, Experiments have shown that if only smooth cubical pieces of steel or iron ore are used as coarse aggregate, the compressive strength will not be more than 21 MPa, regardless of the water/cement ratio or grout mixture ratio.

If sheared reinforcing bars are used as aggregate along with good grout, normal strength will be obtained. The grout used in high density pre placed aggregate concrete should be somewhat richer than that used in normal density pre placed concrete. High modulus of elasticity, low thermal expansion, and low elastic and creep deformation are the ideal properties for both high density and normal concrete.

Properties of High Density Concrete:

Following properties of high density concrete have been observed:

1. The strength of this concrete measured on standard cylinders has been found 42 MPa at 28 days for a water/cement ratio 0.58 and 24 MPa at water/cement ratio 0.9.
2. The density of this concrete for a mix of 1:4.6:6.4 with water/cement ratio of 0.58 has been found as 3700 kg/m³.
3. The coefficient of thermal expansion of barite concrete measured in the range of temperature of 4°C to 38°C is found about twice that of normal concrete.
4. The modulus of elasticity and poisson's ratio of high density concrete and normal concrete are approximately the same.
5. Shrinkage of high density concrete is about 1/4 to 1/3 of the normal concrete.
6. Thermal conductivity, diffusivity etc. of high strength concrete is considerably lower than corresponding values for normal aggregate concrete.
7. Concrete made with barite aggregate does not stand well to weathering.

8. Fine barite aggregate delay the setting and hardening process of the concrete, hence trial mixes are advisable.

9. No entrained air should be permitted in this concrete. However use of de-entrain agent is suggested.

3. Vacuum concrete:

Vacuum concrete is the one from which **water is removed** by vacuum pressure after placement of concrete in structural member. Vacuum concrete has **high strength and durability** than normal concrete. Water-cement ratio is detrimental for concrete. We always try to restrict the water-cement ratio in order to achieve higher strength. The chemical reaction of cement with water requires a water-cement ratio of less than 0.38, whereas the adopted water-cement ratio is much more than that mainly because of the requirement of workability. Workability is also important for concrete, so it can be placed in the formwork easily without honeycombing. After the requirement of workability is over, this excess water will eventually evaporate leaving capillary pores in the concrete. These pores result into high permeability and less strength in the concrete. Therefore, workability and high strength don't go together as their requirements are contradictory to each other. **Vacuum concrete** is the effective technique used to overcome this contradiction of opposite requirements of workability and high strength. With this technique both these are possible at the same time. In this technique, the excess water after placement and compaction of concrete is sucked out with the help of vacuum pumps. This technique is **effectively used in industrial floors, parking lots and deck slabs of bridges** etc. The magnitude of applied vacuum is usually about 0.08 MPa and the water content is reduced by up to 20-25%. The reduction is effective up to a depth of about 100 to 150 mm only.

Technique and Equipment for Vacuum Concrete:

The main aim of the technique is to extract extra water from concrete surface using **vacuum dewatering**. As a result of dewatering, there is a marked reduction in effective water-cement ratio and the performance of concrete improves drastically. The improvement is more on the surface where it is required the most. Mainly, **four components are required in vacuum dewatering of concrete**, which are given below:

1. Vacuum pump
2. Water separator
3. Filtering pad
4. Screed board vibrator

Vacuum pump is a small but strong pump of 5 to 10 HP. Water is extracted by vacuum and stored in the water separator. The mats are placed over fine filter pads, which prevent the removal of cement with water. Proper control on the magnitude of the water removed is equal to the contraction in total volume of concrete. About 3% reduction in concrete layer depth takes place. Filtering pad consists of rigid backing sheet, expanded metal, wire gauze or muslin cloth sheet. A rubber seal is also fitted around the filtering pad as shown in fig.1. Filtering pad should have minimum dimension of 90cm x 60cm.

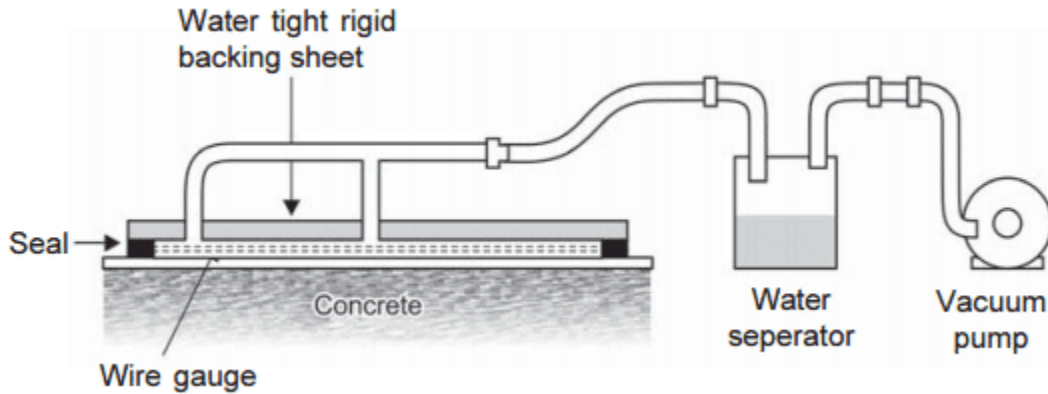

Fig. 1: Vacuum dewatering of concrete

Advantages of vacuum concreting:

- Due to dewatering through vacuum, both workability and high strength are achieved simultaneously.
- Reduction in water-cement ratio may increase the compressive strength by 10 to 50% and lowers the permeability.
- It enhances the wear resistance of concrete surface.
- The surface obtained after vacuum dewatering is plain and smooth due to reduced shrinkage.
- The formwork can be removed early and surface can be put to use early.

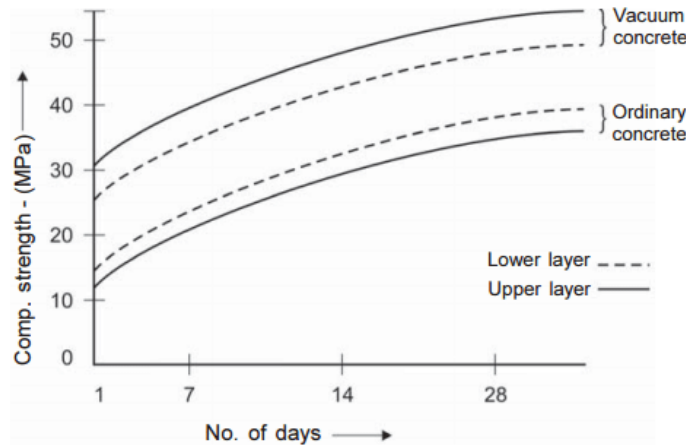

Fig. 2: Effect of vacuum dewatering of concrete

The advantages of dewatering are more prominent on the top layer as compared to bottom layer as shown in fig. 2 above. The effect beyond a depth of 150mm is negligible.

4. Shotcrete:

Shotcrete is a method of applying concrete projected **at high velocity** primarily on to a vertical or overhead surface. The impact created by the application consolidates the concrete. Although the hardened properties of shotcrete are similar to those of conventional cast-in-place concrete, the nature of the placement process results in an excellent bond with most **substrates**, and rapid or instant capabilities, particularly on complex forms or shapes. The shotcrete process requires less formwork and can be more economical than conventionally placed concrete. Shotcrete is applied using a wet or dry-mix process. The wet-mix shotcrete process mixes all ingredients, including water, before introduction into the delivery hose. The dry-mix shotcrete process adds water to the mix at the nozzle.

5. Steel Fiber Reinforced Concrete (SFRC):

Steel fiber reinforced concrete is a composite material having fibers as the additional ingredients, dispersed uniformly at random in small percentages, i.e. between 0.3% and 2.5% by volume in plain concrete. SFRC products are manufactured by adding steel fibers to the ingredients of concrete in the mixer and by transferring the green concrete into moulds. The product is then compacted and cured by the conventional methods. Segregation or balling is one of the problems encountered during mixing and compacting SFRC. This should be avoided for uniform distribution of fibers. The energy required for mixing, conveying, placing and finishing of SFRC is slightly higher. Use of pan mixer and fiber dispenser to assist in better mixing and to reduce the formation of fiber balls is essential. Additional fines and limiting maximum size of aggregates to 20mm occasionally, cement contents of 350 kg to 550 kg per cubic meter are normally needed.



Steel fibers are added to concrete to **improve the structural properties**, particularly **tensile and flexural strength**. The extent of improvement in the mechanical properties achieved with SFRC over those of plain concrete depends on several factors, such as shape, size, volume, percentage and distribution of fibers. Plain, straight and round fibers were found to develop very weak bond and hence low flexural strength. For a given shape of fibers, flexural strength of SFRC was found to increase with aspect ratio (ratio of length to equivalent diameter). Even though higher

ratios of fibers gave increased flexural strength, workability of green SFRC was found to be adversely affected with increasing aspect ratios. Hence aspect ratio is generally limited to an optimum value to achieve good workability and strength. Grey suggested that aspect ratio of less than 60 are best from the point of handling and mixing of fibers, but an aspect ratio of about 100 is desirable from strength point of view. Schwarz however suggested aspect ratio between 50 and 70 is more practicable value for ready mix concrete. In most of the field applications tried out to date, the size of the fibers varies between 0.25 mm and 1.00mm in diameter and from 12mm to 60mm in length, and the fiber content ranged from 0.3 to 2.5 percent by volume. Higher contents of fiber up to 10% have also been experimented. Addition of steel fibers up to 5% by volume increased the flexural strength to about 2.5 times that of plain concrete. As explained above, mixing steel fibers considerably improves the structural properties of concrete, particularly tensile and flexural strength. Ductility and post cracking strength, resistance to fatigue, spalling and wear and tear of SFRC are higher than in the case of conventional reinforced concrete. SFRC is therefore found to be a versatile material for the manufacture of wide varieties of precast products such as manhole covers, slab elements for bridge decks, highways, runways, and tunnel linings, machine foundation blocks, door and window frames, piles, coal storage bunkers, grain storage bins, stair cases and break waters. Technology for this manufacture of SFRC light, medium and heavy duty manholes covers has been developed in India by Structural Engineering Research Centre, Chennai. Field experiments with two percent of fiber content indicated that SFRC runway slabs could be about one half the thickness of plain concrete slabs for the same wheel load coverage. Cement Research Institute of India (CRI) also demonstrated the use of SFRC in one of the jet bays at Delhi airport. Other field experiments in which SFRC has been used are the slabs of parking garage at Heathrow airport in London, spillway deflectors in Sweden, mine cribbing in Utah, USA.

6. Polymer concrete:

Polymer cement concrete is a **composite concrete** that consist of synthetic polymer within the binding material. Polymer concrete has advantages of higher properties, low energy requirements and low labor costs. It is also called as **Polymer Portland cement concrete (PPCC)** or **latex-modified concrete (LMC)**. The composition, properties and applications of polymer cement concrete are explained below.

Composition of Polymer Cement Concrete (PCC)

To the Portland cement a **prepolymer** (monomer) of a dispersed polymer is incorporated to make PCC. This combination creates a polymer network in situ during the curing process of the concrete. The use of typical vinyl monomers can interfere with the hydration process or can get degraded. So the use of prepolymers are found more effective as perform the function required. In order to improve the mechanical properties of the PCC, these prepolymers can be added in higher proportions. As this concrete property is based on the incorporation of a polymer, special care and attention is taken while adding the latex. The emulsion employed increases the lubrication properties of the mix. Hence, only less amount of water is required for workability of the mix.

Requirements of Polymers used in PCC

1. The latex under ambient conditions must be able to form a film so that it properly coats the cement and the aggregate particles. This helps to create a strong bond between the aggregate and the cement matrix.
2. A growing micro crack must be intercepted by the polymer network formed. This is done by dissipating energy through the formation of a micro fibril.

Polymer Latex used in PCC

Poly (Vinyl esters)

Poly Epoxies (Vinylidene – chloride)

Copolymers

Styrene Butadiene

Properties of Polymer Cement Concrete

a. Highly Impermeable

The polymer phase in the concrete will help reduce the porosity and microcracks that are formed in cement matrix. This acts as an additional binding material other than the Portland cement used.

b. High Durability

A dense and water tight concrete is obtained by the use of PCC. This prevents chemical attacks, water penetration and hence no chance of corrosion. The internal micro cracks in cement matrix too is prevented. This increases the life of the structure.

c. Resistance to weathering Conditions

The PCC structure being impermeable they are less affected by the changing weather conditions.

Considerations in Polymer Cement Concrete Construction

1. PCC overlays have excellent long-term performance.
2. Mixing of PCC must be done in a concrete mobile mixer.
3. Handling, placing, and finishing of PCC is to be completed in less than 30 min.
4. PCC requires one to two days of moist curing followed by air drying.
5. Styrene-butadiene PCC has excellent durability for exterior exposures or environments where moisture is present.

6. Surface discoloration occurs when the concrete is exposed to UV light, except for acrylic polymers.
7. It is used as overlay of bridge decks, floors, and patching of any concrete surfaces ranging in thickness from 4 to 100 mm for concretes.
8. Acrylic latexes are used for floor repair and patching and in cases where color retention is important.
9. These overlays produce high-strength wearing surface that is very durable against weathering.
10. PCC must be placed and cured at 7 to 30 °C.
11. Mobile, continuous mixers, fitted with an additional storage tank for the latex must be used for large applications of polymer modified concrete.
12. The mixing time is limited to 3 min for small batches or for mortar mixers.
13. PMC has a tendency for plastic shrinkage cracking during placement and special precautions are necessary when the evaporation rate exceeds 0.5 kg/m²/h.
14. The modulus of elasticity is generally lower compared to conventional concrete and hence its use in axially loaded members must be evaluated accordingly.
15. Polyvinyl acetate mixtures must not be exposed to moisture.
16. Epoxy emulsions are more expensive.

Applications of Polymer Cement Concrete

a. Bridge deck coverings

The use of PCC helps to provide highly impermeable and water tight surface that will prevent the ingress of moisture and chlorides thus avoiding reinforcement corrosion, spalling and micro cracks.



Fig: Polymer Concrete Overlay for Bridge Deck

b. Floor construction

Increased chemical resistance properties, high physical and mechanical properties make it best choice for industrial floor construction. These are also used in pavement construction where the area is subjected to heavy traffic.

c. Precast construction

Good workability and heat curing characteristics demand it for precast operations. PCC units with a less water cement ratio can be obtained.



Fig.: Precast Sanitary PCC Units

d. Used as patching compounds

PCC can be used for patching and repair works of ordinary Portland cement concrete. This increases the strength and life of existing structure. PCC must be applied only after the removal of old material.

7. Ferro Cement:

Ferro cement is a construction material consisting of **wire meshes and cement mortar**. Applications of ferro cement in construction is vast due to the **low self-weight, lack of skilled workers, no need of framework** etc.

It was developed by **P.L.Nervi**, an Italian architect in 1940. Quality of ferro cement works are assured because the components are manufactured on machinery set up and execution time at work site is less. Cost of maintenance is low. This material has come into widespread use only in construction in the last two decades.

Properties of Ferro cement

- Highly versatile form of reinforced concrete.

- It's a type of thin reinforced concrete construction, in which large amount of small diameter wire meshes uniformly throughout the cross section.
- Mesh may be metal or suitable material.
- Instead of concrete Portland cement mortar is used.
- Strength depends on two factors quality of sand/cement mortar mix and quantity of reinforcing materials used.

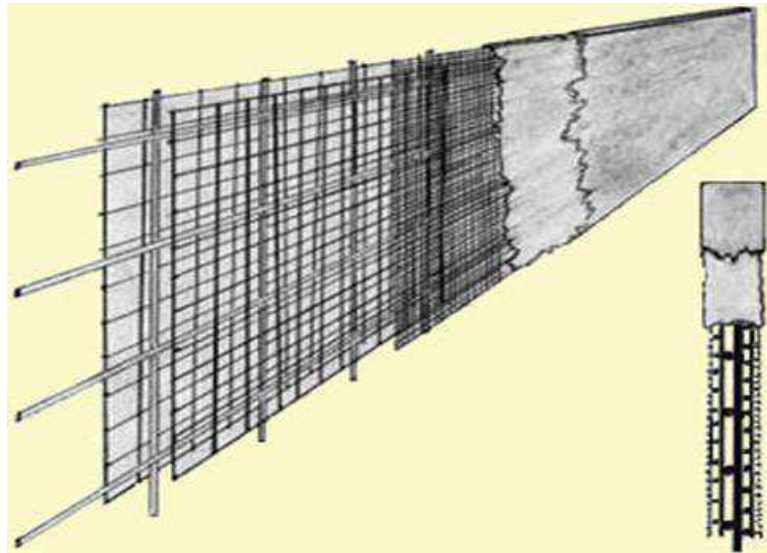
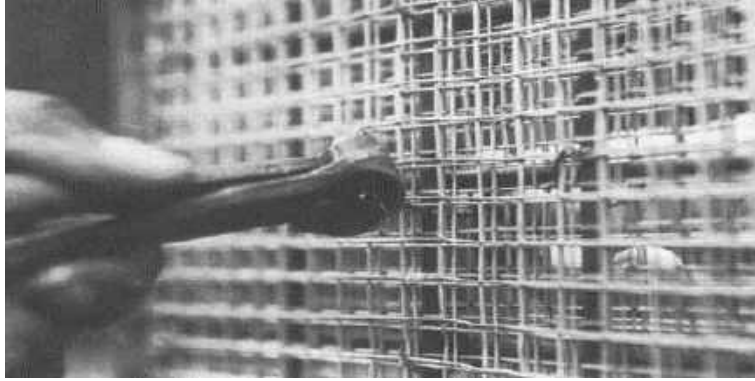

Fig: Typical cross section of Ferro cement structure.

Constituent Materials for Ferrocement

- Cement
- Fine Aggregate
- Water
- Admixture
- Mortar Mix
- Reinforcing mesh
- Skeletal Steel
- Coating



Reinforcing Mesh

Advantages and Disadvantages of Ferrocement

Advantages

- Basic raw materials are readily available in most countries.
- Fabricated into any desired shape.
- Low labour skill required.
- Ease of construction, low weight and long lifetime.
- Low construction material cost.
- Better resistance against earthquake.

Disadvantages

- Structures made of it can be punctured by collision with pointed objects.
- Corrosion of the reinforcing materials due to the incomplete coverage of metal by mortar.
- It is difficult to fasten to Ferro cement with bolts, screws, welding and nail etc.
- Large no of labors required.
- Cost of semi-skilled and unskilled labors is high.
- Tying rods and mesh together is especially tedious and time consuming.

Process of Ferro cement Construction

- Fabricating the skeletal framing system.
- Applying rods and meshes.
- Plastering.
- Curing

Applications of Ferro cements in Construction

- Housing
- Marine
- Agricultural
- Rural Energy
- Anticorrosive Membrane Treatment.
- Miscellaneous.

Cost Effectiveness of Ferro cement Structures

- The type of economic system.
- Type of applications.
- Relative cost of labor.
- Capital and local tradition of construction procedure.
- Doesn't need heavy plant or machinery.
- Low cost of construction materials.

Recent Applications:

- Residential and Public Buildings.
- Industrial Structures.
- Agricultural structures.
- Transportation Structures.

8. High performance concrete:

High-performance concrete (HPC) is produced by careful selection and proportioning of its constituents namely cement, sand, gravel, **cementitious materials** such as fly ash; silica fume; and slag, and **chemical admixtures** for instance high range water reducing admixtures. The strength and durability of the high-performance concrete exceed that of ordinary concrete.

Therefore, the composition of high-performance concrete is almost the same as that of conventional cement concrete. However, it has many features such as high strength, smooth fracture surface, low permeability, discontinuous pore, etc. which are different from those of ordinary concrete.

This is due to low water to cementitious material ratio, and the presence of cementitious materials and chemical admixtures. Curing of HPC is considerably important and critical curing period runs from placement or finishing up to 2 to 3 days later.

Composition of High-Performance Concrete

The composition of high-performance concrete usually consists of the following materials:

a. Cement

Chemical and physical properties of cement can help in selecting desired cement to produce high-performance concrete. For instance, cement with low C3A is the most desired type of cement to produce high-performance concrete because the C3A creates incompatibility of cement with a superplasticizer.

Additionally, the rheology of cement containing low C3A can be controlled easily. Nonetheless, a certain quantity of C3A is important for cement from a strength point of view.

b. Water

Water is a crucial component in high-performance concrete which should be compatible with cement and mineral/chemical admixtures.

c. Fine Aggregate

Coarse fine aggregate is desired compared to finer sand to produce high-performance concrete since finer sand increases the water demand of concrete.

d. Coarse Aggregate

The selection of coarse aggregate is crucial since it may control the strength of high-performance concrete.

e. Superplasticizer

It is an essential component of high-performance concrete that is added into the concrete mix to reduce water to cement ratio.

f. Cementitious Materials

The cementitious component of high or any combination of cementitious material such as slag, fly ash, silica fume.

f.1 Silica Fume

Silica fume is a waste by-product of the production of silicon and silicon alloys. Silica fume is available in different forms, of which the most commonly used now is in a densified form. In developed countries, it is already available readily blended with cement.

It is possible to make high strength concrete without silica fume, at compressive strength of up to 98 MPa. Beyond that strength level, however, silica fume becomes essential. With silica fume, it is easier to make HPC for strengths between 63-98 MPa.

f.2 Fly Ash

Fly ash has been used extensively in concrete for many years. Fly ash is, unfortunately, much more variable than silica fumes in both their physical and chemical characteristics. Most fly ashes will result in strengths of not more than 70 MPa.

Therefore, for higher strengths, silica fume must be used in conjunction with fly ash. For high strength concrete, fly ash is used at dosage rates of about 15 % of cement content.

f.3 Ground Granulated Blast Furnace Slag (GGBFS)

Slags are suitable for use in high-strength concrete at dosage rates between 15-30 %. However, for very high strengths, more than 98Mpa, it is necessary to use the slag in conjunction with silica fumes.

f.4 Others

Sometimes, quartz flour and fiber are the components as well for HPC having ultra-strength and ultra-ductility, respectively.



Fig: Composition of High Performance Concrete

Features of High-Performance Concrete

- Compressive strength > 80 MPa ,even up to 800 MPa
- High-performance concrete is quite brittle but the introduction of fibers and can improve ductility.
- High durability
- Water binder ratio (0.25-0.35), therefore very little free water

- Reduced flocculation of cement grains
- Wide range of grain sizes
- Densified cement paste
- Low bleeding and plastic shrinkage
- Less capillary porosity is achieved through the use of low water to cementitious materials that produce dense microstructure, hence migration of aggressive elements would be difficult. Hence, durability improved greatly.
- Discontinuous pores
- Stronger transition zone at the interface between cement paste and aggregate
- Low free lime content
- Endogenous shrinkage
- Powerful confinement of aggregates
- Little micro-cracking
- Smooth fracture surface
- Low heat of hydration

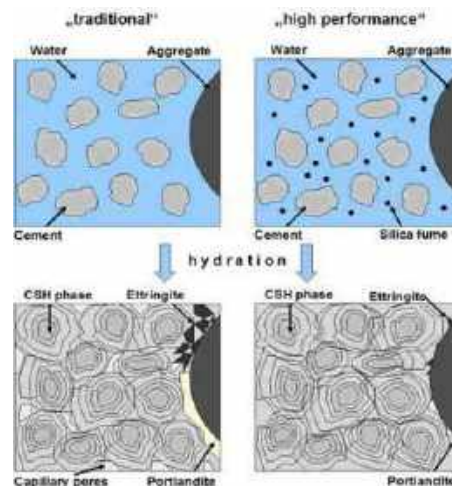

Fig: Hydration of Normal Concrete versus High Performance Concrete

9) Self-Compacting Concrete:

Self-compacting concrete (SCC) can be defined as fresh concrete that flows under its own weight and does not require external vibration to undergo compaction. It is used in the construction where it is hard to use vibrators for consolidation of concrete. Filling and passing ability, segregation resistance are the properties of self-compacting concrete. SCC possess superior flow

ability in its fresh state that performs self-compaction and material consolidation without segregation issues. The materials, tests and properties of self-compacting concrete are explained in the below sections.



Fig: Self Compacting Concrete (SCC)

Composition of Self-Compacting Concrete (SCC) are:

a. Cement

Ordinary Portland cement either 43 or 53 grade cement can be used.

b. Aggregates

The size of the aggregates used for SCC design is limited to 20mm. If the reinforcement employed for the structure is congested, the aggregate size used can be in the range 10 to 12mm. Well graded aggregates either round or cubical shape are a best choice. The fine aggregates used in SCC can be either natural aggregates or manufactured aggregates (M- Sand) with a uniform grade. The fine aggregates with particle size less than 0.125mm are generally employed.

c. Water

The quality of water used is same that followed for reinforced concrete and prestressed concrete construction.

d. Mineral Admixtures

The mineral admixtures used can vary based on the mix design and properties required. Mentioned below are the different mineral admixtures that can be used and their respective properties they provide. Ground Granulated Blast Furnace Slag (GGBS): The use of GGBS helps to improve the rheological properties of the self-compacting concrete. Fly ash: The fine fly ash particles help to improve the filling of the internal concrete matrix with fewer pores. This improves the quality and durability of the SCC structures. Silica Fumes: The use of silica fumes

helps to increase the mechanical properties of the self-compacting concrete structure. Stone Powder: The use of stone powder in SCC is used to improve the powder content of the mix.

e. Chemical Admixtures

New generation superplasticizers are commonly used in SCC mix design. In order to improve the freeze and thaw resistance of the concrete structure, air entraining agents are used. To control the setting time, retarders are employed.

<i>ORDINARY CONCRETE</i>		<i>SCC</i>
GRAVEL	Aggregate	GRAVEL
SAND		SAND
CEMENT	Binding material	CEMENT + CHEMICAL ADMIXTURES
WATER (+ PLASTICIZER)		Fluid

Fig.: Material Composition of Ordinary Concrete and SCC

Tests and Properties of Self Compacting Concrete

The requirements of the self-compacting concrete are achieved by the properties in its fresh state. The three main properties of SCC are:

1. **Filling Ability:** This property of the concrete is the ability to flow under its own weight without any vibration provided intentionally.
2. **Passing Ability:** This property is the ability of the concrete to maintain its homogeneity.
3. **Segregation resistance:** This is the resistance of the concrete not to undergo segregation when it flows during the self-compaction process.

Different tests are conducted to determine the above mentioned properties of Self compacting concrete. The tests conducted for Self compacting concrete can be categorized into three categories:

1. Filling Ability Tests
2. Passing Ability Tests
3. Segregation Resistance Test

The tests coming under the above mentioned categories are tabulated below.

Filling Ability Tests	Passing Ability Tests	Segregation Resistance Tests
Slump flow test	L-Box Test	V- funnel test at T5 minutes
T50cm Slump Flow	J- ring test	GTM screen stability Tests
Orimet	U- Box Test	
V-funnel Test	Fill – Box Test	

Table: Different Tests conducted on Self Compacted Concrete

Advantages of Self Compacting Concrete

The main advantages of self-compacting concrete are:

1. The permeability of the concrete structure is decreased
2. SCC enables freedom in designing concrete structures
3. The SCC construction is faster
4. The problems associated with vibration is eliminated
5. The concrete is placed with ease, which results in large cost saving
6. The quality of the construction is increase
7. The durability and reliability of the concrete structure is high compared to normal concrete structures
8. Noise from vibration is reduced. This also reduce the hand arm vibration syndrome issues

Disadvantages of Self Compacting Concrete

SCC construction face the following limitations:

1. There is no globally accepted test standard to undergo SCC mix design
2. The cost of construction is costlier than the conventional concrete construction
3. The use of designed mix will require more trial batches and lab tests
4. The measurement and monitoring must be more precise.

5. The material selection for SCC is more stringent

Applications of Self Compacting Concrete

The major applications of self-compacting concrete are:

1. Construction of structures with complicated reinforcement
2. SCC is used for repairs, restoration and renewal construction
3. Highly stable and durable retaining walls are constructed with the help of SCC
4. SCC is employed in the construction of raft and pile foundations

#####

Civil Engineering Materials and Constructions (BCE03002)

Module-III

Basic Building Materials II

Module III Syllabus

Building stone: classifications, properties and structural requirements; **Wood and Wood products:** Introduction to wood macrostructure, sap wood and heart wood, defects and decay of timber, seasoning and preservation of timber, fire resisting treatment, introduction to wood products- veneers, plywoods, fibre board, particle board, block board, batten boards. **Metals:** Steel: Important properties and uses of Iron (Cast iron, wrought iron and steel), Important tests on steel rebar, aluminum and copper. **Glass:** types and uses, **Gypsum:** source, properties, uses; **Plastic:** properties and uses, **Paint:** types, distemper, varnish, **Adhesive:** Types, **Bitumen:** types, properties and tests

Subject to Revision

1. BUILDING STONES:

(Classifications, properties and structural requirements)

A **building stone** is a piece of rock quarried and worked into a required size and shape for a particular purpose. A building stone may be defined as a sound rock that can be safely used in some situation in the construction as a massive dressed or undressed unit. Granites and marbles used in the form of finely dressed blocks or slabs or columns in monumental and costly buildings, are good building stones.

Similarly, sandstones and limestones used in forts, retaining walls and boundary walls and also as blocks in stone houses and bungalows are typical building stones. Slates used in many areas as roofing material for ordinary constructions and in pavements also fall in the category of building stones.

Stone masonry is an engineering art that is preserved in many historical buildings in all parts of the world. This skill is still used, though on a lesser scale (because of the advent of concrete) in the construction of common residential houses and palatial buildings in many places. The *Taj Mahal* at Agra, the *Red Fort* in Delhi and temples of Lord *Jagannath puri* are some of the best known stone marvels of India. Such examples may be compiled from all countries of the world and the number may run into many hundreds.

1.1 Classification of Building Stone:

- Physical classification
 - Stratified stone
 - Unstratified stone
- Geological classification
 - Igneous Rocks
 - Sedimentary Rocks
 - Metamorphic Rocks
- Scientific or engineering classification
 - Silicious Rocks
 - Argillaceous Rocks
 - Calcareous Rocks
- A particle of stone Classification
 - Granite
 - Sandstone
 - Limestone
 - Slate

Physical classification:

Stratified Stones

These stones are derived from **sedimentary rocks**. These stones are found in **layers**, one above another. Limestone and sandstones are the stratified stones.

Unstratified Stones

These stones **do not show any types of layers**. Granite, marble, trap, etc. are the unstratified stones.

Geological classification:

Igneous Rocks

These are formed by the **cooling of molten lava**. The structure of stone depends upon the rate of cooling of lava. This lava becomes hard on cooling and forms igneous rocks. These rocks are durable, hard, massive and stronger than other stones. Example: *Basalt, Trap, Andesite, Rhyolite, Diorite, Granite*.

Sedimentary Rocks

These are formed by the **deposition of sediments** due to the *action of air and water*. Due to the action of high-speed wind and heavy rain, igneous rocks are disintegrated and deposited in layers, one on the earth's crust and form sedimentary rocks. Example: *Limestone, Sandstone, Dolomite and Slate* are the sedimentary rocks.

Metamorphic rocks

These rocks are either the sedimentary rocks or the igneous rocks whose physical and chemical properties are changed due to the action of *high temperature and pressure*. Dolomite, slate, marble, gneiss are the metamorphic rocks. Example: *Gneiss, Quartzite, Marble, Slate*.

Scientific or engineering classification:

Silicious Rocks

These have *silica* as the principal constituent. These rocks are **hardly affected by weathering action**. These are **very hard** and also **durable**. Granite, sandstone, gneiss, basalt, trap, syenite are the siliceous rocks.

Argillaceous rocks

These have *clay* as the principal constituent. These stones are **hard** and **durable** but **brittle** in nature. Slate and laterite are the argillaceous rocks.

Calcareous Rocks

These have carbonate of lime as the principal constituent. Limestone, marble, kankar, dolomite, and gravel are the calcareous rocks.

A particle of stone Classification:

Granite

The formation of **minerals** of granite is quartz, feldspar, and mica. It's also having specific gravity 2.63 to 2.75. They also having light or dark grey, pink or reddish color. It's also having a crushing strength of 1000 to 1400 kg/m².

It also having light or dark grey, pink or reddish color. They also have a crushing strength of 1000 to 1400 kg/m². It is very strong heavy, hard durable. It contains silica 60 to 80%.

Sandstone

Sandstone is composed of **sand grains**, cemented together by calcium or magnesium carbonate or silicic acid, alumina, and also oxide of iron. It also has a specific gravity 2.25. They are also white, grey, brown, or red in color. It's having a crushing strength of 400 to 800 kg/m².

These strong under pressure, but it is flaky when it contains mica. These are hard, non-absorbent, strong, and heavy. They are easily workable and also resists the weathering in a better way. They use to face work and ornamental work.

Limestone

These are **carbonate** of lime intermixed with other minerals and impurities such as silica, magnesium carbonate, aluminum, and iron. It's also having yellow, brown, grey or violet color. It's also having specific gravity 2.56. They having crushing strength 300 to 500 kg/m².

These are soft and absorbent and so they do not resist the weathering action well. Chalk, marbles are examples of limestone.

Slate

These are also composed of **silica and alumina**. These are also usually grey-black or dark blue. It's also having specific gravity 2.8. It's also having crushing strength 700 to 2100 kg/m².

When these are hard and tough, laminar in nature. It's useful for roofing as well as flooring.

Some of the common building stones which are used for different purposes in India.

1. Granite

- It is a deep-seated igneous rock, which is hard, durable and available in various colours.
- It has a high value of crushing strength and is capable of bearing high weathering.
- Granite is used for bridge components, retaining walls, stone columns, road metal, and ballast for railways, foundation, stone work and for coarse aggregates in concrete. These stones can also be cut into slabs and polished to be used as floor slabs and stone facing slabs.
- Granite is found in Maharashtra, Rajasthan, Uttar Pradesh, Madhya Pradesh, Punjab, Assam, Tamil Nadu, Karnataka and Kerala.

2. Basalt and Trap

- They are originated from igneous rocks in the absence of pressure by the rapid cooling of the magma.

- They have the same uses as granite. Deccan trap is a popular stone of this group in South India.

3. Limestone

- It is a sedimentary rock formed by remnants of seaweeds and living organisms consolidated and cemented together.
- It contains a high percentage of calcium carbonate.
- Limestone is used for flooring, roofing, and pavements and as a base material for cement.
- It is found in Maharashtra, Andhra Pradesh, Punjab, Himachal Pradesh and Tamil Nadu.

4. Sandstone

- This stone is another form of sedimentary rock formed by the action of mechanical sediments.
- It has a sandy structure which is low in strength and easy to dress.
- They are used for ornamental works, paving and as road metal. It is available in Madhya Pradesh, Rajasthan, Uttar Pradesh, Himachal Pradesh and Tamil Nadu.

5. Gneiss

- It can be recognised by its elongated platy minerals usually mixed with mica and used in the same way as granite.
- They can be used for flooring, pavement and not for major purposes because of its weakness.
- It is found in Karnataka, Andhra Pradesh, Tamil Nadu and Gujarat.

6. Marble

- It is a metamorphic rock which can be easily cut and carved into different shapes.
- It is used for ornamental purposes, stone facing slabs, flooring, facing works etc.
- It is found in Rajasthan, Gujarat and Andhra Pradesh.

7. Slate

- It is a metamorphic rock which can be split easily and available in black colour.
- It is used for damp-proofing flooring and roofing.

8. Quartzite

- It is a metamorphic rock which is hard, brittle, crystalline and durable.
- It is difficult to work with and used in the same way as granite but not recommended for ornamental works as it is brittle.

9. Laterite

- It is decomposed from igneous rocks; occur in soft and hard varieties.
- It contains a high percentage of iron oxide and can be easily cut into blocks.
- The soft variety is used for walls after curing while the hard blocks are used for paving the pathways.

1.2 Properties and Structural requirements of building stone:

The following properties of the stones should be looked into before selecting them for engineering works:

- i. Strength
- ii. Hardness

- iii. Durability
- iv. Toughness
- v. Percentage Wear
- vi. Porosity and Absorption
- vii. Weathering
- viii. Seasoning
- ix. Workability
- x. Resistance to Fire
- xi. Density/specific gravity
- xii. Structure
- xiii. Texture
- xiv. Appearance
- xv. Ease in Dressing
- xvi. Cost

I) STRENGTH

Strength is an important property to be looked into **before selecting stone** as a building block. Indian standard code recommends, a **minimum crushing strength of 3.5 N/mm²** for any building block.

Table below shows the crushing strength of various stones. Due to the *non-uniformity* of the material, usually, a ***factor of safety of 10*** is used to find the permissible stress in a stone.

Hence, even laterite can be used safely for a single storey building because in such structures expected load can hardly give stress of 0.15 N/mm².

However, in stone masonry buildings, care should be taken to check the **stresses** when the *beams (Concentrated Loads) are placed on laterite wall.*

Generally, most of the building stones have high strength to resist the load coming on it. Therefore, it is not of prime concern when it comes to check the quality of stones.

Table 1: Crushing strength of common building stone

Name of Stone	Crushing Strength in N/mm²
Trap	300 to 350
Basalt	153 to 189
Granite	104 to 140

Slate	70 to 210
Marble	72
Sand Stone	65
Lime Stone	55
Laterite	1.8 to 3.2

II) HARDNESS

It is an important property to be considered when a stone is used for **flooring, pavement** or **aprons of bridges**, they become subjected to wearing and abrasive forces caused by movement of men or machine over them.

The *coefficient of hardness* is to be found by conducting a test on a standard specimen in **Dory's testing machine**.

For **road works** coefficient of hardness should be at least **17**. For building works stones with a coefficient of hardness less than **14** should not be used.

III) DURABILITY

Building stones should be capable to resist the adverse effects of natural forces like wind, rain and heat.

It must be durable and should not deteriorate due to the adverse effects of the above natural forces.

IV) TOUGHNESS

Toughness of stones means its **ability to resist impact forces**. It is determined by the **impact test**. Stones with **toughness index more than 19** are preferred for **road works**.

The vibrations may be due to the machinery mounted over them or due to the loads moving over them. The stone aggregates used in the road constructions should be tough. Building stones should be tough enough to sustain stresses developed due to vibrations.

V) PERCENTAGE WEAR

It is measured by the **attrition test**. It is an important property to be considered in selecting aggregate for road works and railway ballast. A good stone should not show the **wear of more than 2%**.

VI) POROSITY AND ABSORPTION

All stones have **pores** and hence **absorb water**. The reaction of water with a material of stone cause **disintegration**. The absorption test is specified as the **percentage of water absorbed** by the stone when it is **immersed underwater for 24 hours**.

For a good stone it should be **as small as possible** and in **no case more than 5**.

Porosity of building stones depend upon the **mineral constituent and structural formation** of the parent rock.

If stones used in building construction are porous then rain water can easily enter into the pore spaces and cause damage to the stones. Therefore, building stone should not be porous.

Water absorption of stone is **directly proportional** to the porosity of rock. If a stone is more porous then it will absorb more water and cause more damage to stone.

In **higher altitudes**, the **freezing** of water in pores takes place and it results into the **disintegration** of the stone.

VII) WEATHERING

Rain and wind cause **loss of the good appearance** of stones. Hence stones with *good weather resistance should be used for face works*.

VIII) SEASONING

The stones obtained from the quarry contain **moisture in the pores**. The **strength** of the stone **improves** if this **moisture is removed** *before using* the stone.

The **process of removing moisture from pores is called seasoning**. The best way of seasoning is to **allow it to the action of nature for 6 to 12 months**. This is very much required in the case of laterite stones.

Good stones should be free from the quarry sap. Lateritic stones should not be used for 6 to 12 months after quarrying. They are allowed to get rid of quarry sap by the action of nature. This **process of removing quarry sap is called seasoning**.

IX) WORKABILITY

Stone is said to be workable when the work involved in stone working (such as cutting, dressing & shaping) is economical and *easy to conduct*.

X) FIRE RESISTANCE

Stones should be free from calcium carbonate, oxides of iron, and minerals having different coefficients of thermal expansion.

Igneous rock show marked disintegration principally because of quartz which disintegrates into small particles at a temperature of about 575°C.

Limestone, however, can withstand a little higher temperature; i.e. up to 800°C after which they disintegrate.

Sand-stones resist fire better. Argillaceous materials, though poor in strength, are good in resisting fire.

XI) DENSITY / SPECIFIC GRAVITY

Denser stones are stronger. Light-weight stones are weak. Hence stones with a *specific gravity less than 2.4 are considered unsuitable* for buildings.

The more the specific gravity of stone, the heavier and stronger the stone.

Therefore, stones having **higher specific gravity** values should be used for the construction of dams, retaining walls, docks and harbours.

The specific gravity of good building stone is between **2.4 and 2.8**.

XII) STRUCTURE

The structure of the stone may be **stratified** (layered) or **unstratified**. Structured stones should be *easily dressed* and suitable for super-structure. **Unstratified** stones are **hard** and **difficult** to dress. They are **preferred** for the **foundation** works.

XIII) TEXTURE

Fine grained stones with **homogeneous** distribution look **attractive** and hence they are used for **carving**. Such stones are usually **strong** and **durable**.

XIV) APPEARANCE

A stone with **uniform and attractive colour is durable** if **grains** are **compact**. Marble and granite get a very good appearance, when polished. Hence, they are used for face works in buildings.

In case of the stones to be used for face works, where appearance is a primary requirement, its colour and ability to receive **polish** is an important factor.

Light colour stones are *more preferred* than **dark colour stones** as the colour are likely to fade out with time.

XV) EASE IN DRESSING

Giving required shape to the stone is called dressing.

The cost of dressing contributes to cost of stone masonry to a great extent. The **dressing is easy** in stones with **lesser strength**.

Hence an engineer should look into sufficient strength rather than high strength while selecting stones for building works.

XVI) COST

Cost is an important consideration in selecting a building material. The **proximity of the quarry** to the building site **brings down** the cost of transportation and hence the cost of stones comes down.

2. WOOD AND WOOD PRODUCTS

(Introduction to wood macrostructure, sap wood and heart wood, defects and decay of timber, seasoning and preservation of timber, fire resisting treatment, introduction to wood products- veneers, plywoods, fibre board, particle board, block board, batten boards)

2.1 WOOD MICROSTRUCTURE:

- Wood possesses a **cellular, three-dimensional microstructure** and is described as a natural composite material with orthotropic elastic properties.
- The orientation of micro fibrils has a direct influence on elastic properties of the wood cell wall and varies as a function of position in the tree and within annual rings.

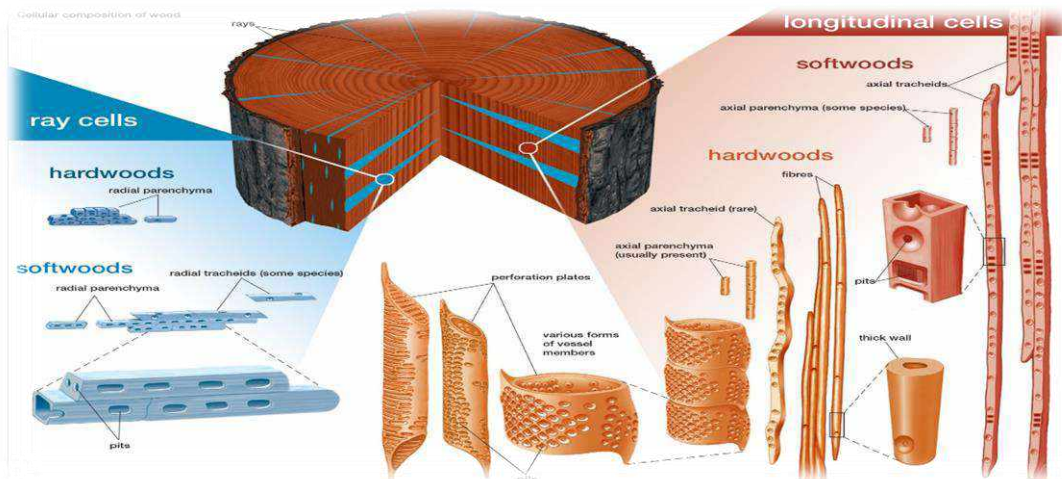

2.2 SAPWOOD AND HEARTWOOD

Heartwood and sapwood are **parts of every tree**. These two play very special roles in the **formation of a tree**.

Heartwood is a term used to describe the wood that is at the **center of a tree**. There are two primary categories used to depict the naturally occurring wood of a tree: **heartwood** and **sapwood**. For all intents and purposes, heartwood is considered to be the **deadened core** of the tree that is the result of a **chemical transformation** which occurs to strengthen the **center** of a tree as it grows in girth. The **outer layers** of wood that are still in the **process of expanding** are referred to as **sapwood**. The creation of **heartwood** is a **naturally occurring process** that **transforms the properties of the wood at the core** of the tree in order to aid in its **resistance to decay**.

Some projects are constructed entirely out of **heartwood** because of its **extreme density and strength**. **Sapwood** requires a **drying period** even after it has been cut into boards. **Heartwood** does not contain nearly as much moisture and is therefore less likely to warp. Though heartwood can be purchased exclusively, it is more expensive. Heartwood is also highly sought-after for its unique color qualities. Because heartwood is chemically different from a tree's sapwood, the color quality will also be noticeably different.

Heartwood, also called **duramen**, **dead, central** wood of trees. Its cells usually contain **tannins** or other substances that make it **dark** in colour and sometimes **aromatic**. Heartwood is

mechanically **strong, resistant to decay**, and less easily **penetrated** by **wood-preservative** chemicals than other types of wood.

HEARTWOOD

Heartwood occurs in the central portion

Cells are comparatively older

Also called as 'Duramen'

Heartwood is dark coloured

SAPWOOD

Sapwood occurs in the peripheral (outer)

Cells are comparatively younger

Also called as 'Alburnum'

Sapwood is light coloured

Sapwood:

- The soft outer layers of recently formed wood between the heartwood and the bark, containing the functioning vascular tissue.
- When a tree is **young** certain **cell** with in the wood are **alive** and capable of conducting **sap** or **storing nutrients**, and the wood is referred to as **sapwood**.
- The sapwood also termed as Alebernum.

Heartwood:

- Heartwood also called as duramen, dead central wood of trees.
- As new sapwood is formed under the bark, the inner sapwood changes to heartwood.
- In the wood undergoing this change the living cells die.

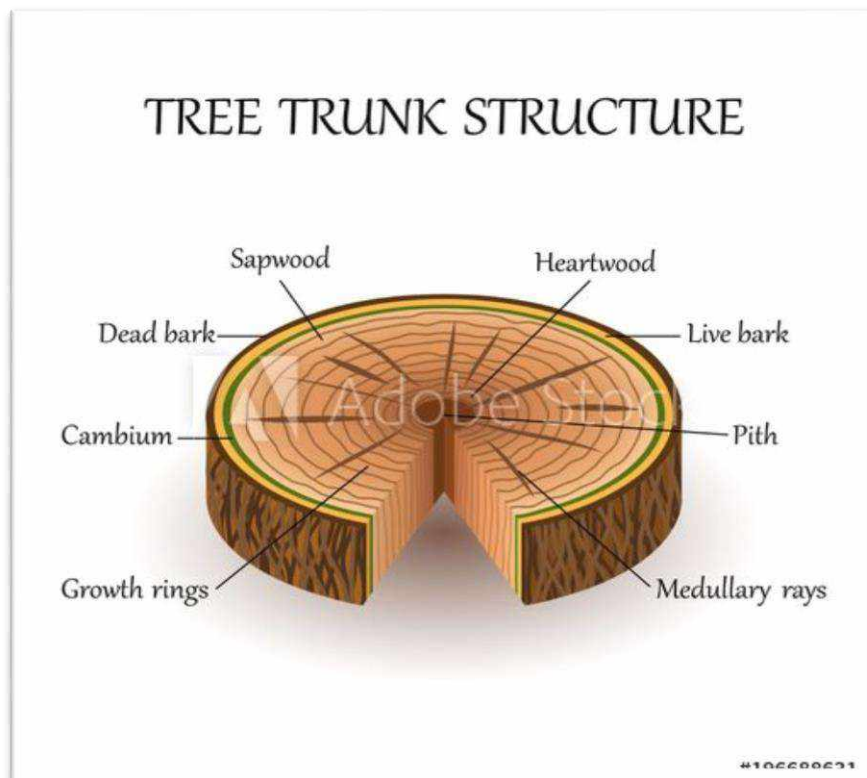

2.3 DEFECTS AND DECAY OF TIMBER:

- Timber is a **natural** product and every natural product has some **imperfections**.
- Most of the defects in timber cause **weakness** or others sorts of difficulties. However, some defects can be **beneficial** for a specific type of work.

The followings are the **five main types of defects** in timber:

1. Defects due to Natural Forces
2. Defects due to Attack by Insects
3. Defects due to Fungi
4. Defects due to Defective Seasoning
5. Defects due to Defective Conversion

1) Defects in timber due to Natural Forces

Following defects are caused by natural forces:

- Burls
- Callus
- Chemical stain
- Coarse Grain
- Deadwood
- Druxiness
- Foxiness
- Knots
- Rind galls
- Shakes

- **Burls:**

These formed when a tree has received shock or injury, the growth of the tree is completely upset and irregular projections appear on the body of timber.

- **Callus:**

It indicates soft tissue or skin which covers the wound of a tree.

- **Chemical strain:**

The wood is sometimes discolored by the chemical action caused by some external agency. This is known as the chemical strain.

- **Coarse grain:**

If a tree grows rapidly, the annual rings are widened. It is known as coarse-grained timber and such timber possesses less strength.

- **Deadwood:**

The timber which is obtained from dead standing trees contains dead wood. It is indicated by lightweight and reddish color.

- **Druxiness:**

This defect is indicated by white decayed spots that are concealed by healthy wood. They are probably formed for the access of fungi.

- **Foxiness:**

This defect is indicated by red or yellow tinge (a colour) in wood or reddish-brown stain or spots round the pith of tree discolored the timber. It is caused either due to poor ventilation during storage or by the commencement of decay due to over-maturity or due to the growth of the tree in marshy soil.

- **Knots**

These are the bases of branches or limbs which are broken or cut off from the tree. The portion from which the branch is removed receives nourishment from the stem for a pretty long time and it ultimately results in the formation of dark hard rings which are known as the knots. As continuity of wood fibers is broken by knots, they form a source of weakness.

- **Rind galls:**

The rind means bark and gall indicates abnormal growth. It is an irregular growth cause the fibers on wound fell after the branches have been cut off in an irregular manner.

- **Shakes:**

These are cracks that partly or completely separate the fibers of the wood. The following are the different varieties of shakes.

Cup shakes

Heart shake

Ring shake

Star shake

Radial shake

2) Defects of timber due to insects:

Following are the insects which cause the decay of timber:

- Termites.
- Beetles.
- Marine Borers

Termites:

These are popularly known as the white ants and they are found in abundance in tropical and sub-tropical countries. These insects live in a colony and they are very fast in eating away the wood from the core of the cross-section.

They make tunnels inside the timber in different directions and usually do not disturb the outer shell or cover.

Beetles:

These are small insects and they cause rapid decay of timber. They form pin-holes of size about 2mm diameter in wood. They attack the sapwood of all species of hardwoods.

Marine borers:

These are generally found in salty water. Most of the varieties of marine borers do not feed on wood. But they make holes or bore tunnels in wood for taking shelter.

3) Defects of timber due to Fungi:

The fungi are minute microscopic plane organisms.

Following defects of timber are caused in the timber by the fungi:

- Dry rot
- Wet Rot
- Brown rot
- White rot
- Heart Rot
- Sap strain
- Blue stain

Dry rot:

The term rot is used to indicate the decay or disease of timber. The fungi of certain types feed on Wood and during feeding, they attack on wood and convert it into dry powder form. This is known as dry rot.

The dry rot occurs at places where there is no free circulation of air. The fungus rapidly dies on exposure to air or sunlight. The unseasoned softwoods and sapwood are easily attacked by dry rot.

When part of the timber is seriously affected by dry rot, the damaged portion may be completely Removed and the remaining unaffected portion should be painted with a solution of copper sulphate.

Wet rot:

When timber is subjected to alternate wet and dry conditions, decomposition of its tissue Takes place and the timber is said to have been attacked by wet rot. The attacked part of timber gets Reduced to a grayish brown powder Standing tree or timber exposed to rain is subjected to attack

Wet rot can be avoided by the use of well-seasoned timber treated with preservatives.

Brown rot:

The fungi of certain types remove cellulose compounds from wood and hence the wood comes brown in color. This is known as brown rot.

White rot:

The fungi of certain types of attack wood and the wood become a white mass consisting of cellulose compounds.

Heart rot:

This is formed when the heartwood is exposed to the attack of atmospheric agents. Due to this, the tree becomes weak and it gives out a hollow sound when struck with a hammer.

Sap stain:

The fungi of certain types do not bring about the complete decay of timber. But they feed on cell contents of sapwood and the sapwood loses its color. This is known as the sap stain and it generally occurs when moisture content goes beyond 25 percent or so.

Blue stain:

The sap of wood is stained to bluish color by the action of certain types of fungi.

4) Defects of timber due to seasoning:

Seasoning of Timber is a **hydrothermal** treatment of Timber, involving **evaporation** of moisture content in required proportion i.e. *controlled reduction of moisture from the wood*. Timber Seasoning **increases** the **strength of timber**, eliminates wood rot, prevents changes in the dimensions and shape of the articles made of timber, and ultimately **improves the quality** of finishing of timber.

This is necessary for reducing the unnecessary weight of timber, for effecting an increase in its strength, to improve its workability, to reduce the possibility of development of shrinkage defects and to ensure durability or long life of timber. The moisture content of standing trees may be as high as 40-60 percent or even more.

After careful seasoning, it could be brought down to 4-6 percent by (kiln seasoning) or 14-16 percent by (air seasoning).

Methods of Seasoning of Timber

There are two methods of Seasoning of timber which are explained below

1. Natural seasoning (**Air**/water seasoning)
2. Artificial seasoning (Kiln seasoning)

Both methods require the timber be stacked and separated to allow the full circulation flow of air, etc. around the stack.

Natural Seasoning of Timber

Natural seasoning is the process in which timber is seasoned by subjecting it to the natural elements such as air or water. Natural seasoning may be water seasoning or air seasoning.

Water Seasoning

Water seasoning is the process in which timber is immersed in water flow which helps to remove the sap present in the timber. It will take **2 to 4 weeks** of time and after that the timber is allowed to dry. Well-seasoned timber is ready to use. Sometimes logs are placed in running water before subjecting to air seasoning. This helps in replacement of “sap” from wood cells by water. The water-saturated wood dried quicker as compared to sap-rich wood. The process of placing timber logs in water is sometimes referred to *water-seasoning*.

As already said trees contain a lot of moisture in the standing condition. The mode of occurrence of water in wood tissue is rather complex and must be understood thoroughly.

It is because a number of important properties of wood and timber depend on its moisture content and the way in which it is present in the wood.

The wood tissue stores water in cell walls and the cell cavities.

(a) The water present in the cell walls is called the bound water, the hygroscopic water or the imbibed water. It is this water, loss or gain of which will affect the dimensional stability of the timber. It makes 25-30 percent of the dry weight of the wood tissue when all the cell walls are fully saturated with water. This situation, in which all the cell walls of wood are fully saturated with water (and the cavities are empty) is termed as fiber saturation point.

(b) The water present in the cell cavities of the wood tissue is called the free water. Its presence effects the mechanical properties of the timber.

If the total moisture content in a species of timber is 75 percent, and its fiber saturation point is 30 percent, then, the free water is 45 percent. Whenever a freshly cut wood log is laid for drying, it is the free water (from the cell cavities) that is lost first. Once cell cavities are empty, and drying is continued, then the water from the cell walls will start moving out due to drying effect. And it is only the loss of water from the cell walls that will cause shrinkage in the wood. Similarly, if a dry piece of wood is left out in a humid atmosphere, wood will start absorbing moisture. (Because, as already said, wood is a hygroscopic material). Supposing the original moisture content of the dry wood is only 6 percent and the humidity of the atmosphere is 40 percent, then the wood will go on absorbing moisture till its moisture content is the same as that of the atmosphere in which it is exposed. This is called the “equilibrium moisture content” of the wood.

When water is absorbed by the wood, it is the cell walls that must be saturated before the cell cavities are allowed to get any water.

This is the reason doors and windows made of wood show swelling effect during rainy seasons immediately after a few days of rains, especially when they are located where rain water can fall directly on them.

Air Seasoning

In the process of air seasoning timber logs are arranged in layers in a shed. The arrangement is done by maintaining some gap with the ground. So, platform is built on ground at 300mm height from ground. **In air seasoning**, timber in properly cut forms is stacked in a proper manner in the open air for losing moisture by process of evaporation.

The Stacks are so constructed to allow free circulation of air around each part as far as possible. The stacks are properly sheltered from direct sun and winds and rain. It may take 6 months to 4 years for bringing down the original moisture content to allowable limits of 14-16 percent by this method.

Artificial Seasoning of Timber

Natural seasoning gives good results but takes more time. So, artificial seasoning of timber is developed nowadays. By artificial seasoning, timber is seasoned with in 4-5 days. Here also different methods of artificial seasoning are there and they are as follows.

- Seasoning by Boiling

Seasoning by boiling wood logs **in hot** water is called seasoning by boiling. Drying is done after proper boiling. For a large amount of wood, it is done in an enclosed place where hot steam is passed.

- Chemical seasoning

In case of chemical seasoning, **timber is stored in** suitable salt solution for some time. The salt solution used has the tendency to absorb water from the timber. So, the moisture content is removed and then timber is allowed to drying. It affects the strength of the timber.

Disadvantages:

Chemical seasoning agents **can reduce the strength of wood and sometimes cause problems in gluing and finishing or corrosion during use.** Although large quantities of wood treated with such chemicals have been used successfully for a variety of purposes, some consideration should be given to these disadvantages

- Kiln seasoning

In kiln seasoning, timber is dried for specific periods and under **very controlled conditions of temperature and humidity** in specially designed kilns. Tunnel type kilns can also be used for this purpose. Among the other methods of seasoning of timber and wood, the chemical seasoning and electric seasoning are of some importance. Timber can also be made fire proof to some extent by giving external coats and treatment of fire retarding chemicals like sodium silicate, sodium arsenate or borax.

- Electrical seasoning

The resistance of timber against electricity is measured at every interval of time. When the required resistance is reached seasoning, process is stopped because resistance of timber increases by reducing moisture content in it. It is also called as **rapid seasoning** and it is uneconomical.

Objectives of Seasoning of Timber:

We may Summarize the objectives of seasoning of timber in five sentences:

1. Reduces much of the useless weight of timber;
2. Increases its strength considerably;
3. Improves the workability of the timber;
4. Decreases the chances of development of shrinkage defects, and,
5. Increases the life of timber, i.e. makes it more durable.

Following defects occur in the seasoning process of wood:

- Cup
- Case-hardening
- Check
- Collapse
- Honey-combing

- Radial slakes
- Split
- Twist
- Warp

Cup:

This defect is indicated by the curvature formed in the transverse direction of timber.

Case-hardening:

The exposed surface of timber dries very rapidly. It therefore shrinks. The **interior** surface which has not completely dried is under **tension** case-hardening and it usually occurs in timbers which are placed at the bottom during seasoning.

Check:

A check is a **crack** that separates fibers of the wood. It does not extend from one end to the other. Checks Surface checks: Shallow cracks extending along the grain on the face or edge.

Collapse:

Due to uneven shrinkage, the wood sometimes flatters during drying. This is known as the collapse

Honey-combing:

Due to stresses developed during drying, the various radial and circular cracks developed in the interior portion of timber. The timber thus assumes the honey-comb texture and the defect so developed is known as the honey-combing.

Radial shakes:

These are radial cracks.

Split:

When a check extends from one end to the other, it is known as a split.

Twist:

When a piece of timber has spirally distorted along its length, it is known as a twist.

Warp:

When a piece of timber has twisted out of shape, it is said to be warped

Defect in Timber due to Defective Seasoning

During seasoning of timber, exterior or surface layer of the timber dries before the interior surface. So, stress is developed due to the difference in shrinkage.

- Bow:** Curvature formed in direction of the length of the timber is called bow.
- Cup:** Curvature formed in the transverse direction of the timber is called a cup.
- Check:** Check is a kind of crack that separates fibers, but it doesn't extend from one end to another.
- Split:** Split is a special type of check that extends from one end to another.
- Honey Combing:** Stress is developed in the heartwood during the drying process or seasoning. For these stresses, cracks are created in the form of honeycomb texture.

5) Defects due to Defective Conversion:

During the process of converting timber to the commercial form, the following defects may occur:

- Chip mark
- Diagonal grain

(iii) Torn grain

(iv) Wane

(i) Chip Mark:

This defect is indicated by the marks or signs placed by chips on the finished surface of timber. They may also be formed by the parts of a planning machine.

(ii) Diagonal Grain:

This defect is formed due to improper sawing of timber. It is indicated by diagonal mark on straight grained surface of timber.

(iii) Torn Grain:

This defect is caused when a small depression is formed on the finished surface of timber by falling of a tool or so.

(iv) Wane:

This defect is denoted by the presence of original rounded surface on the manufactured piece of timber.

Defects of Timber due to Defective Conversion

- a. **Boxed Heart:** This term is applied to the timber, which is sawn in a way that the pith or the centre heart falls entirely within the surface throughout its length.
- b. **Machine Burnt:** Overheating is the main reason for this defect.
- c. **Machine Notches:** defective holding and pulling causes this defect.
- d. **Miscut:** erroneous cutting or sawing of wood causes this defect. Lack of experience in sawing and carelessness is the main reason for erroneous cutting.
- e. **Imperfect Grain:** Mismatch in grain alignment.

2.4 PRESERVATION OF TIMBER

Preservation of timber is carried out to **increase the life of timber**. Preservation is done using different types of **preservatives**. Methods and different materials used for preservation of timber is discussed. Increasing life makes timber more durable and it can be used for longer periods. Preservation also helps the timber to get rid of insects and fungi etc. If preservation is not done, then wood will be diseased and damaged badly.

Properties of Good Preservative for Timber

The preservative used to protect the timber should contain following requirements or properties.

- It should be effortlessly and cheaply available.
- It should not contain any harmful substances, gases etc.
- It should cover larger area with small quantity. Hence, it should be economical.
- Decorative treatment or any surface treatment should be allowed on timber after the application of preservative.

- Strength of timber should not be affected by the preservative.
- It should not contain any unpleasant smell.
- It should not get affected by light, heat, water etc.
- It should not get affected by fungi, insects etc. and should also efficient to kill them.
- It should not generate flame when contacts with fire.
- It should not corrode metals when it makes a contact with them.
- The depth of penetration of preservative in wood fibers should be minimum 6mm to 25mm

Different Types of Preservatives for Timber

- Coal tar
- ASCU
- Chemical slats
- Oil paints
- Solignum paints
- Creosote oil

Coal Tar for Preservation of Timber

Coal tar is heated and obtained liquid hot tar is applied on timber surface using brush. Coal tar contains unpleasant smell and does not allow paint on it. So, it is used for door frames, window frames etc. It is very cheap and has good fire resistance.

ASCU Preservative for Timber

ASCU is a special preservative which is available in powder form. It is dissolved in water to get preservative solution. It should be added 6 parts by weight of ASCU in 100 parts by weight of water. The final solution is applied on timber by spraying. This solution does not contain any odor. It is useful mainly to get rid of from white ants. ASCU contains hydrated arsenic pent oxide, copper sulphate or blue vitriol and sodium dichromate or potassium dichromate in it. After applying ASCU, the timber can be coated with paint, varnished etc.

Chemical Slats for Preservation of Timber

Chemical salts like copper sulphate, mercury chloride and zinc chloride are used as preservative which can be dissolved in water to get liquid solution. They are odorless and do not generate flames when contact with fire.

Oil Paints Preservatives for Timber

Oil paints are suitable for well-seasoned wood. They are generally applied in 2 or 3 coats. Oil paints prevents timber from moisture. If timber is not seasoned, then oil paints may lead to decay of timber by confining sap.

Solignum Paints for Preservation of Timber

Solignum paints are applied in hot condition using brush. They are well suitable for preserving timber from white ants. Solignum paints can be used by adding color pigments so, the timber has good appearance.

Creosote Oil for Preservation of Timber

Creosote oil is prepared by the distillation of tar. It is black or brown in color. It contains unpleasant smell. It is applied in a special manner. Firstly, the timber is well seasoned and dried. Then, it is placed in airtight chamber and inside air is pumped out. Finally creosote oil is pumped into the chamber with high pressure about 0.7 to 1 N/mm² at a temperature of 50°C. After allowing it for 2 hours, the timber absorbs creosote oil sufficiently and taken out from the chamber. Creosote oil is flammable so, it is not used for timber works in fireplaces. It is generally used for wood piles, poles, railway sleepers etc.

Methods of Timber Preservation

- Brushing
- Spraying
- Injecting under pressure
- Dipping and stepping
- Charring
- Hot and cold open tank treatment

Brushing of Timber Preservatives

Brushings the simplest method of applying preservatives. For well-seasoned timber, oil type preservatives are applied with good quality brushes. For better results, the applied preservative should in hot condition. Multiple coats should be applied and certain time interval should be maintained between successive coats.

Spraying of Timber Preservatives

Spraying is an effective technique than brushing. In this case, preservative solution is sprayed on to the surface using spray gun. It is time saving and quite effective.

Preservative Injecting Under Pressure

The preservative is injected into the timber under high pressure conditions. Generally, creosote oil is applied in this manner which is already discussed above. It is costly treatment process and required special treatment plant.

Dipping and Stepping Method of Timber Preservation

Dipping is another type of preserving in which, timber is dipped directly in the preservative solution. Hence, the solution penetrates the timber better than the case of brushing or spraying. In Some case, the stepping or wetting of timber with preservative solution is allowed for few days or weeks which is also quite effective process.

Charring Method of Timber Preservation

Charring is nothing but burning of timber surface, which is quite an old method of preservation of timber. In this method, the timber surface is wetted for 30 minutes and burnt up to a depth of 15mm from top surface. The burnt surface protects the inner timber from white ants, fungi, etc. This method is not suitable for exterior wood works so, it is applied for wood fencing poles, telephone pole bottoms etc.

Hot and Cold Open Tank Treatment of Timber

In this method, the timber is placed in an open tank which contains preservative solution. This solution is then heated for few hours at 85 to 95 degree Celsius. Then, the solution is allowed to cool and timber gets submerged with this gradual cooling. This type of treatment is generally done for sap wood.

2.5 FIRE RESISTING TREATMENT OF WOOD

Flame retardant treatment used to coat a wood surface or penetrate it into the wood to achieve specific properties mainly include dipping, coating, spray, cover, hot pressing, ultrasonic wave assistance and a high energy injection method.

As a general rule, the structural elements made of timber ignite and get rapidly destroyed in case of a fire. Further, they add to the intensity of a fire. But the timber used in **heavy sections** may attain high degree of fire-resistance because the timber is a very bad conductor of heat. This is the reason why time is required to build up sufficient heat so as to cause a flame in the timber.

With respect to the fire-resistance, the timber is classified as

1. Refractory Timber
2. Non-refractory Timber

Refractory Timber

The refractory timber is **non-resinous** and it **does not catch fire easily**. The examples of refractory timbers are sal, teak, etc.

Non-refractory Timber

The non-refractory timber is **resinous** and it **catches fire easily**. The examples of non-refractory timbers are chir, deodar, fir, etc.

To make timber more fire-resistant, the following methods are adopted:

A. Application of Special Chemicals:

The timber surface is coated with the solution of certain chemicals. The fire resistance of timber can be enhanced by phosphates of ammonia, a mixture of ammonium phosphates and ammonium sulphate, borax and boric acid, sodium arsenate etc. It is

found that two coats of solution of borax or sodium arsenate with strength of 2 per cent are quite effective in rendering the timber fire-resistant.

These special chemicals are known as the fire protection compounds or antipyrines and they are more reliable. When the temperature rises, they either melt or give off gases which hinder or forbid combustion. When the wood is treated with antipyrine, it does not inflame even at high temperature, but it merely smoulders i.e. burns slowly without flame. The antipyrines containing salts of ammonium or boric and phosphoric acids are considered to be the best in making the timber fire-resistant.

B. Sir Abel's Process:

In this process, the timber surface is cleaned and it is coated with a dilute solution of sodium silicate. A cream-like paste of slaked fat lime is then applied and finally, a concentrated solution of silicate of soda is applied on the timber surface. This process is quite satisfactory in making the timber fire-resistant.

2.6 WOOD PRODUCTS:

1. VENEERS:

Timber veneer is a **decorative building material** comprising **thin slices of timber glued onto wooden board, particle board or fibreboard**. It has been favoured by builders and designers since ancient times as the finest and most efficient use of the valuable timbers. Veneer is produced as a thin layer of timber that is uniform in thickness. The veneer is normally between **0.5 and 0.85mm** thick. Timber veneer is from a natural and renewable resource competing with non-renewable commodities like steel, aluminium and plastics. The **surface coverage** of veneer is approximately **forty times more than 25mm timber**, which makes it the most economical way of utilising precious wood. One cubic metre of log produces around 1,000 square metres of real timber in veneer form. No other form of wood working material results in such an efficient use with minimal wastage.

Veneer is produced by slicing or peeling logs. It is sliced at approximately 0.6mm or can be peeled at various thicknesses. Several cut methods are used to create various wood grain patterns. The most commonly produced grains are: Crown, Quarter, and Rotary. However, other cuts exist and highlight specific features such as Birdseye, Quiltes, Pommele or Burl/Burr.

Different ways of slicing wood to get veneers are

I. Rotary cut:

The log is cantered on a lathe and turned against a broad cutting knife set into the log at a slight distance.

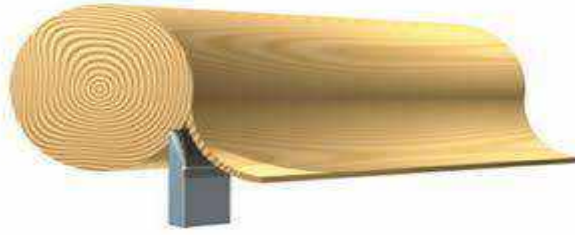

- II. Quarter slicing:
 The slicing is made perpendicular to the annual growth rings of the tree. This creates a straight grain appearance.

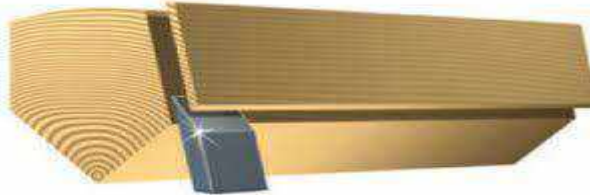

- III. Lengthwise slicing:
 This is done from a board of flat sawn lumber rather than from a log. A variegated figure is created with this slice.

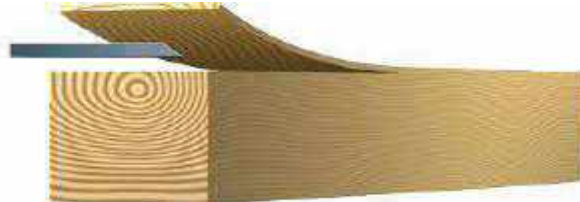

- IV. Plain slicing:
 By slicing parallel to the centre of the log, a raised “cathedral effect” is formed by the innermost growth rings.



- V. Half round slicing:
 Sliced on an arc parallel to the centre of the log, this cut achieves a flat-cut veneer appearance.

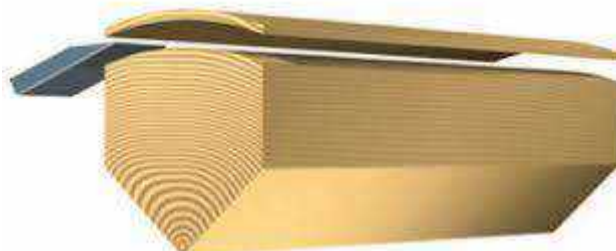

- VI. Rift cut:
 This straight grain cut is derived by slicing red and white oak at a slight angle to minimize the irregularities in the wood.



2. **PLYWOODS:**

Plywood is an engineered wood sheet material made up of **fine layers or flimsy strands of wood veneers** attached together placing wood grains 90 degrees to one another. It is one type of manufactured board which can be described as a mixture of Medium Density Fibreboard (MDF) and Chip Board (Particle Board). It is a complex material and attaches resin and fibre sheets of wood.

Plywood has become popular through this decade because it's relatively low moisture content which makes various tasks easy to perform with this. Mostly for outdoor uses plywood has become very important to use.

Following are the different types of Plywood.

- Softwood Plywood
- Hardwood Plywood
- Tropical Plywood
- Aircraft Plywood
- Decorative Plywood
- Flexible Plywood
- Marine Plywood

Softwood Plywood

Softwood Plywood which is also known as spruce-pine-fir or SPF because it's from spruce, pines, and fir. Though it can be made from cedar, douglas fir. If made from spruce the prominent grains are coated by a system so that this kind of plywood becomes more effective as hard as concrete and used for shuttering strands and construction.



Softwood Plywood

Hardwood Plywood

Hardwood Plywood is made from angiosperms. This type of plywood is identified by its firmness, hardness on surface, inflexibility, resistance quality. This can be used to bear heavy weight.



Tropical Plywood

Different types of timbers of tropical area are mixed to make this type of plywood. Though previously it was only collected from the Asian region, now also from Africa and America it is collected. Tropical plywood popular for some special qualities like

- Strength
- Density
- Evenness
- Inflexibility
- Resistance quality
- Thickness



Aircraft Plywood

Woods from Mahogany, Spruce, Birch are used to make Aircraft Plywood. The African mahogany gives usable structural aircraft plywood. Among birch trees European birch is good. This type is famous for strength. This type is also made from Mahogany, Spruce, Birch but the special quality is that this is resistant to heat.



Decorative Plywood

Decorative plywood is also called overlaid plywood. Usually made from woods of ash, oak, Red oak, birch, Maple, mahogany, Philippine mahogany also called seraya, rosewood.



Flexible Plywood

As the name goes Flexible Plywood is used for making flexible furniture or structures. The furniture of eighteenth century was mostly of curved structures. These are made from Baltic Birch.

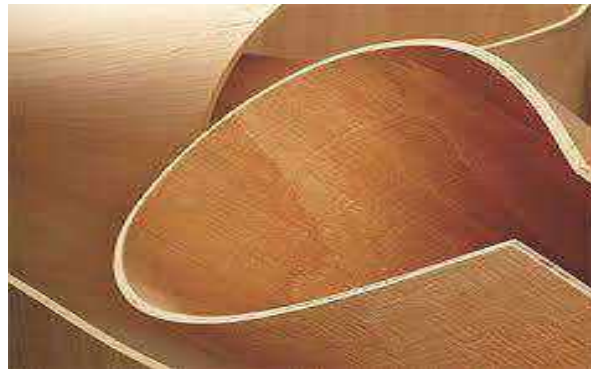

Marine Plywood

The type of plywood which can be used in moisture, humid, wet environment is called marine plywood. Even it can be used in moisture for long period. The layers of marine plywood bear too small core gap to feel that doesn't permit the wood to fix water inside the gaps. It is also fungal resistant.



3. FIBRE BOARDS:

Fibreboard is an engineered wood wallboard made of wood chips, plant fibres, softwood flakes, sawdust and other recycled materials such as cardboard or paper, all

bonded with a synthetic resin under high pressure and heat and then compacted into rigid sheets.

After the raw materials have been collected and chopped into small pieces, all the metallic impurities are removed with the use of a magnet. Next, fibres are blended with wax and synthetic resin and then compressed into a defibrator machine under heat, in order to become usable. Finally, they are pressed into rigid sheets to produce fibreboard. It was first manufactured in the U.S.A during the beginning of 1960s and it is mainly used in the construction industry and for making furniture and cabinets.



4. **PARTICLE BOARDS:**

There are many kinds of engineered wooden products used to make furniture and other wooden items for interior and external usage. Particle board is also one of the many engineered wooden products. It is also known as low-density fibreboard or chipboard. It is a **waste wood product** made by binding wood chips, sawdust or saw-mill shavings with a synthetic resin or some other binder. Urea Formaldehyde is commonly used as glue for binding the wooden chips. Particle board can be used as a substitute for plywood for making furniture, interior lining of walls and ceilings, substrate for countertops, floor decking, roof sheathing, underlayment, interior decorative panelling, etc.

There are the various types of particle board available in the market:

i. Single layer particle board:

Single layer particle board consists of wood particles of same sizes which are pressed together. It is a flat and dense board which can be veneered or plastic laminated but not painted. This is a water-resistant type of particle board but is not waterproof. Single layer particle boards are suitable for interior applications.



ii. Three-layer particle board:

Three-layer particle board consists of a layer of large wood particles sandwiched between two layers made of very small and highly dense wood particles. The amount of resin in the outer layer is more than in the inner layer. The smooth surface of a three-layer particle board is ideal for painting.



iii. Graded-Density particle board:

Graded-Density particle board consists of a layer of coarse wood particles which is sandwiched between two layers made of fine wood particles. This type of particle board is used to make cabinets and wooden furniture.



iv. Melamine particle board:

Melamine particle board is made by fixing a decor paper infused with melamine on the surface of the particle board under high heat and pressure. The wood particles in a melamine particle board are bonded using melamine-urea formaldehyde resin and wax emulsion. This makes it water resistant. Melamine particle board resists scratches. It comes in a plethora of colours and textures. Applications of melamine particle board include wall panelling, furniture, wall cladding, wardrobes and modular kitchen.



v. Cement-bonded particle board:

Cement-bonded particle board has magnesium-based cement or Portland cement as the bonding agent. Cement content is 60% while the wooden particles such as wooden shavings, sawdust and wooden chips make up 20% of the composition. Remaining 20% is water. Due to presence of cement, this type of particle board is resistant against moisture, fire, and termites and rotting. High moisture resistance makes them suitable for constructing false ceilings, walls and permanent coverings for concrete floors and walls for buildings located in areas with high humidity. They are also used for making fire-resistant furniture products.



vi. Veneered particle board:

Veneered particle board means that it has a thin slice of wood called veneer attached to its surface. Veneered particle board appears like a natural wooden

board. Furthermore, a veneered particle board is also more resistant against warping as compared to a conventional particle board.



vii. Laminated particle board:

When a thin laminate sheet is attached to the surface of a plain particle board, it becomes a laminated particle board. Laminate sheet not only improves the aesthetics of the particle board but also increases its durability.



5. **BLOCK BOARD:**

Block board is a type of plywood that is engineered in a special way. It is pressured in such a way that the softwood strips are found between two layers of the wood veneers in the core of the sheet. This contributes to the dimensional stability of the board. The presence of softwood strips ensures that the board is able to hold nails and screws better than the other engineered boards. Though it is lighter than plywood, it does not split or splinter while cutting because of the presence of softwood in its core.



Types of Block Boards

The block boards can be classified into different types. The types of block boards include:

Types based on quality and where they can be used

- **Interior grade block board**– This is meant for use only in the interiors. They are referred to as MR Block boards. MR denotes moisture resistant.
- **Exterior block board**– This type of block board is of special quality and is meant for use in the exteriors as well. They are referred to as BWP grade block boards or BWR grade block boards. Where BWP denotes boiling waterproof and BWR denotes boiling water resistant block boards.

Types of block board based on the raw wood that is used in the core

- **Softwood block board**– In this type of block board, the veneers of hardwood are pressed together with strips or battens of softwood in between them. This type of block board is usually meant for use in the interiors and the MR grade block boards are those that usually have softwood core.
- **Hardwood block board**– In this type of block board hard, dense and expensive hardwood strips are glued and pressed together under high pressure. The glue used is also one that is meant for use in the exteriors. The BWR and BWP block boards have hardwood sheets in their core.

6. **BATTEN BOARDS:**

A compound wood board consisting of boards of softwood placed side by side and sandwiched between veneer panels, often of hardwood, considered to be of lower quality than block board.

Board and batten is a siding and panelling style that uses narrow strips of wood placed over the joints of wide boards for a geometric, layered effect.



3. STEEL:

Steel is an alloy of iron and carbon containing less than 2% carbon and 1% manganese and small amounts of silicon, phosphorus, sulphur and oxygen. Steel is the world's most important engineering and construction material. It is used in every aspect of our lives; in cars and construction products, refrigerators and washing machines, cargo ships and surgical scalpels. It can be recycled over and over again without loss of property.

Properties of steel

Steel has a number of properties, including: hardness, toughness, tensile strength, yield strength, elongation, fatigue strength, corrosion, plasticity, malleability and creep.

HARDNESS is the material's ability to withstand friction and abrasion. It is worth noting that, while it may mean the same as strength and toughness in colloquial language, this is very different from strength and toughness in the context of metal properties.

TOUGHNESS is difficult to define but generally is the ability to absorb energy without fracturing or rupturing. It is also defined as a material's resistance to fracture when stressed. It is usually measured in foot lbs. per sq. in or Joules per sq. centimetre. It is important to distinguish this from hardness as a material that severely deforms without breaking, could be considered extremely tough, but not hard.

YEILD strength is a measurement of the force required to start the deformation of the material (i.e. bending or warping).

TENSILE strength is a measurement of the force required to break the material.

ELONGATION (or Ductility) is the "Degree" to which the material can be stretched or compressed before it breaks. It is expressed as a percent of the length being tested and is between the tensile strength and yield strength (i.e. what percent does the material bend before breaking).

FATIGUE strength is the highest stress that a material can withstand for a given number of cycles without breaking.

CORROSION is the irreversible deterioration and destruction of the steel material and its vital properties due to the electrochemical or chemical reaction of its surface to environmental factors such as acids, moisture and oxygen.

PLASTICITY is the deformation of a material undergoing non-reversible changes of shape in response to applied forces.

MALLEABILITY describes the property of a metal's ability to be distorted below compression. It is a physical property of metals by which they can be hammered, shaped and rolled into a very thin sheet without rupturing.

CREEP is a type of metal deformation that occurs at stresses below the yield strength of a metal, generally at elevated temperatures.

Uses of steel:

- Steel is environment-friendly & sustainable. It possesses great durability.
- Compared to other materials, steel requires a low amount of energy to produce lightweight steel construction.
- Steel is the world's most recycled material which can be recycled very easily. Its unique magnetic properties make it an easy material to recover from stream to be recycled.
- Steel can be designed into various forms. It gives better shape and edge than iron which is used to make weapons.
- Engineering steels are used for general engineering and manufacturing sectors.
- Steel is highly used in the automobile industry. Different types of steels are used in a car body, doors, engine, suspension, and interior. The average 50% of a car is made of steel.
- Steel reduces CO₂ emissions.
- All types of energy sectors demand steel for infrastructure and resource extraction.
- Stainless steels are used to produce offshore platforms and pipelines.
- Steels are used for packaging and protecting goods from water, air and light exposure.
- Most of the household appliances like fridge, TV, oven, sinks, etc are made of steel.
- Steels are used for producing industrial goodies like farm vehicles and machines.
- Stainless steel is used as a cutlery material.
- Because of its easily welding capability and attractive finishing, steel has become a prominent feature in modern architecture.
- Stainless steel gives a hygienic environment. That's why it is used for surgical implants.
- Steel has a wider range of temperature which is used to make large sheets.
- Renewable energy resources like solar, hydro and wind power use the stainless steel components.
- Mild steel is used for building construction. It is also a highly favoured building frame material.

Various tests done on STEEL REBAR are:

1. Tensile test
2. Compression test
3. Bending test
4. Brinell hardness test
5. Rockwell hardness test
6. Impact test
7. Torsion test

1. TENSILE TEST:

This tensile test process is one of the important tests of the steel bars. A tension test of steel materials is a damaging procedure that gives data about the elasticity, tensile strength and yield strength of the sample. This tensile test is done to decide how the material responds when you apply a force to it. Generally, by pulling the metal, one has to recognize the material's rigidity, yield quality just as the amount it will extend. Tension test is the basic criteria where one present a steel bar test to tension which is under control until failure stage.

2. COMPRESSION TEST:

The compressive quality is the most extreme compressive stress a material is equipped for withstanding without crack. Brittle materials crack during testing and have a definite compressive strength value. The compressive strength of flexible materials is dictated by their level of bending during testing. Compressive quality test, mechanical test estimating the greatest measure of compressive burden a material can tolerate before breaking.

3. BENDING TEST

Bend testing a material takes into consideration that materials resistance to fracture, ductility, fracture strength and bend strength. These qualities can be utilized to decide if a material will fail under pressure and are important in any construction procedure including ductile materials loaded with bending forces. If a material starts to break or totally cracks during a bend test it is valid to accept that the material will fail under a similar in any application, which may prompt to catastrophic failure.

4. BRINELL HARDNESS TEST

The Brinell test was the first broadly utilized standardised steel hardness test. It requires a huge test piece and leaves a huge space; hence, it is constrained in its usefulness. Actually brinelling has come to mean the permanent indentation of any hard surface. These Brinell hardness test involves a large, heavy ball, which is pushed against steel at a predetermined level of force.

5. ROCKWELL HARDNESS TEST

The Rockwell test is commonly simpler to perform, and more exact than different kinds of hardness testing techniques. The Rockwell steel test strategy is utilized on all kinds of metals, with the exception of in conditions where the test metal structure or surface conditions would present an excessive amount of varieties; where the indentations would be unreasonably enormous for the application; or where the sample size or test shape forbids using.

6. IMPACT TEST

Impact test decides the amount of energy consumed by a material during crack. This absorbed energy is a measure of a given material's strength and goes about as a device to consider temperature-dependent weak flexible progress. It is to decide if the material is fragile or malleable in nature. Impact testing of metals is performed to decide the effect opposition or durability of materials by figuring the measure of energy absorbed during fracture. The impact test is performed at different temperatures to reveal any consequences on impact energy. These

services give test results that can be helpful in evaluating the suitability of a material for a specific application and in predicting its expected service life.

7. TORSION TEST

The reason for a torsion test is to decide the behaviour a material or test shows when turned or under torsional forces because of applied moments that cause shear stress about the axis. Measurable values include: the modulus of ductility, ultimate shear strength, elasticity in shear modulus of rupture in shear, yield shear strength and torsional fatigue life. These values are similar but not the same as those measured by a tensile test and are significant in assembling as they might be utilized to simulate the service conditions, check the item's quality and structure, and guarantee that it was made effectively.

4. CAST IRON:

Cast iron is a group of iron-carbon alloys with a carbon content of more than 2%. Its usefulness derives from its relatively low melting temperature. Iron alloys with lower carbon content are known as steel. Cast iron tends to be brittle, except for malleable cast irons.

Use of cast iron:

- It is used in making pipes, to carry suitable fluids.
- It is used in making different machines.
- It is used in making automotive parts.
- It is used in making pots pans and utensils.
- It is used in making anchor for ships.

5. WROUGHT IRON

Wrought iron is a soft, ductile, fibrous variety that is produced from a semi-fused mass of relatively pure iron globules partially surrounded by slag. It usually contains less than 0.1 percent carbon and 1 or 2 percent slag. It is superior for most purposes to cast iron, which is overly hard and brittle owing to its high carbon content.

Use of wrought iron:

- It is used to make decor items like table base, candle holder, curtain rods etc.
- It is used in making pipes.
- It is used in making fences and gates.
- It is used in making nuts, bolts, rivets etc.
- It is used in making chains.
- It is used in making crane hooks.
- It is used in making plates.
- It is used in making handrails.
- It is used in making carpenter tools.
- It is used in general forging applications.
- It is used in making railway couplings.

6. ALUMINIUM:

Aluminium is a silvery-white metal, the 13 element in the periodic table. It's the most widespread metal on Earth, making up more than 8% of the Earth's core mass. It's also the third most common chemical element on our planet after oxygen and silicon.



Uses of aluminium

- Aluminium is widely used in the packaging industry for the production of coils, cans, foils, and other wrapping materials.
- It is also a component of many commonly used items such as utensils and watches.
- In construction industries, aluminium is employed in the manufacture of doors, windows, wires, and roofing.
- It is used in the transport industry for the production of cycles, spacecraft, car bodies, aircraft and marine parts.
- Many coins are made up of alloys that contain aluminium.
- Aluminium also finds applications in the production of paints, reflective surfaces, and wires.

7. COPPER:

It is a metallic chemical element that is easily formed into sheets and wires and is one of the best-known conductors of heat and electricity.



Uses of copper

- Copper sulphate is used widely as an agricultural poison and as an algacide in water purification.
- While one may not consider copper being used for something other than coins, it is a crucial element in the creation of bronze.
- Historically, copper was the first metal to be worked by people. The discovery that it could be hardened with a little tin to form the alloy bronze gave the name to the Bronze Age.

- It is used for a whole range of goods, from cans, cooking foil and saucepans through to electricity cables, planes, and space vehicles.
- Electrical conductivity is especially important because wire accounts for more than 50% of copper consumption worldwide.
- Chemical vapour deposition, which is used in semiconductor manufacture, involves the deposition of thin copper films from a gas- phase precursor.
- Copper is used largely as an alloy of gold and silver, and it is often plated with one or the other.

8. GLASS:

Glass is an inorganic solid material that is usually transparent or translucent as well as hard, brittle, and impervious to the natural elements. Glass has been made into practical and decorative objects since ancient times, and it is still very important in applications as disparate as building construction, house wares, and telecommunications. It is made by cooling molten ingredients such as silica sand with sufficient rapidity to prevent the formation of visible crystals.



TYPES OF GLASS

1) Annealed Glass

Annealed glass is a basic product formed from the annealing stage of the float process. The molten glass is allowed to cool slowly in a controlled way until it reaches room temperature, relieving any internal stresses in the glass. Without this controlled slow cooling, glass would crack with relatively little change in temperature or slight mechanical shock. Annealed glass is used as a base product to form more advanced glass types.

2) Heat Strengthened Glass

Heat Strengthened Glass is semi tempered or semi toughened glass. The heat strengthening process involves heating annealed glass back up to about 650 to 700 degrees Celsius and then cooling it quickly, although not as fast as with toughened glass. The heat strengthening process increases the mechanical and thermal strength of annealed glass, making it twice as tough as annealed glass.

When it breaks the fragments are similar in size to annealed glass, but with a greater likelihood of staying together.

This glass is not often used in balustrades or similar structural applications because of its limited strength compared to tempered or toughened glass, although is sometimes specified when there is concern about tempered glass fracturing into thousands of small pieces.

3) Tempered or Toughened Glass

This is the most common type of glass used in balustrades or similar structural applications. Annealed glass is heated to about 700 degrees Celsius by conduction, convection and radiation. The cooling process is accelerated by a uniform and simultaneous blast of air on both surfaces. The different cooling rates between the surface and the inside of the glass produces different physical properties, resulting in compressive stresses in the surface balanced by tensile stresses in the body of the glass.

This process makes the glass four to five times stronger and safer than annealed or untreated glass.

The counteracting stresses or surface compression gives toughened glass its increased mechanical resistance to breakage, and when it does break, causes it to produce small, regular, typically square fragments rather than long, dangerous shards that are far more likely to lead to injuries.

4) Laminated Glass

Any one of the above types of glass can be laminated. The most commonly used finished product is two sheets of toughened glass, laminated together with a 1.52mm thick Polyvinyl Butyral (PVB) interlayer.

Laminated glass offers many advantages. Safety and security are the best known of these, so rather than shattering on impact, laminated glass is held together by the interlayer. This reduces the safety hazard associated with shattered glass fragments, as well as, to some degree, the security risks associated with easy penetration.

Glass is used for following

- Packaging (jars for food, bottles for drinks, flacon for cosmetics and pharmaceuticals)
- Tableware (drinking glasses, plate, cups, bowls)
- Housing and buildings (windows, facades, conservatory, insulation, reinforcement structures)
- Interior design and furniture (mirrors, partitions, balustrades, tables, shelves, lighting)
- Appliances and Electronics (oven doors, cook top, TV, computer screens, smart-phones)
- Automotive and transport (windscreens, backlights, light weight but reinforced structural components of cars, aircrafts, ships, etc.)
- Medical technology, biotechnology, life science engineering, optical glass
- Radiation protection from X-Rays (radiology) and gamma-rays (nuclear)
- Fibre optic cables (phones, TV, computer: to carry information)
- Renewable energy (solar-energy glass, wind turbines)

9. GYPSUM:

Gypsum is a soft sulfate mineral composed of calcium sulfate dihydrate, with the chemical formula $\text{CaSO}_4 \cdot 2\text{H}_2\text{O}$. It is widely mined and is used as a fertilizer and as the main constituent in many forms of plaster, blackboard/sidewalk chalk, and drywall.



Sources of gypsum

- Gypsum can be mined from deposits or derived as a by-product from industrial processing.
- Synthetic gypsum can come from citric and lactic acid processing plants, phosphoric acid processing plants, or water treatment plants.
- It can also come from commercial power plants when calcium carbonate is used to neutralize acid solutions or capture sulphuric oxides for exhaust gases.
- Some of these synthetic gypsum products are similar to mined gypsum in terms of their dihydrate equivalent however some sources can contain metal or radioactive contaminants and shouldn't be land applied.

Properties of Gypsum

- Gypsum is a soft mineral that is moderately soluble in water. The water solubility of this mineral is affected by temperature. Unlike other salts, gypsum becomes less soluble in water as the temperature increases. This is known as retrograde solubility, which is a distinguishing characteristic of gypsum.
- Gypsum is usually white, colourless, or gray in colour. But sometimes, it can also be found in the shades of pink, yellow, brown, and light green, mainly due to the presence of impurities.
- Gypsum crystals can be transparent or translucent with vitreous to pearly luster. Sometimes, gypsum crystals can be quite large, and are considered to be some of the largest crystals found in nature.
- Some crystals can be flexible, which can be bent by applying pressure. But, when the pressure is released, the crystals do not return to their original shape, as they are not elastic.

- Gypsum crystals are sometimes found to occur in a form that resembles the petals of a flower. This type of formation is referred to as 'desert rose', as they mostly occur in arid areas or desert terrains.

Uses of Gypsums – Some of the Important Uses of Gypsums Include:

1. Building materials industry:

The largest user of gypsums is the building materials industry, which is used to produce all kinds of building materials and as raw materials for cement and cementing materials.

The production of gypsum partition board, load-bearing inner wallboard, external wall block, wall covering board, ceiling and so on.

2. Model plaster:

Model gypsum can be used in foundry, art, ceramics and other industries.

3. Agriculture:

It can be used to produce sulphuric acid and ammonium sulfate fertilizer.

Anhydrite can adjust soil pH, improve the soil environment, and provide calcium, sulfur and other nutrients for various fertilizers.

4. Food industry:

In terms of food, gypsum can coagulate soybean milk into tofu, and it can also be used as a coagulant in canned tomatoes.

5. Pharmaceutical industry:

Plaster external fixation is still the basic method for clinical treatment of fractures and various orthopaedic diseases.

It has the functions of maintaining, fixing and maintaining the special posture of the affected limb, reducing or eliminating the weight-bearing of the affected area, and so on.

6. Fillers for plastics and rubber:

After processing, anhydrite can be used as a filler for plastics and rubber.

The modified anhydrite filler can improve the mechanical strength, heat resistance and dimensional stability of the polymer.

7. Production of calcium sulfate whisker:

Gypsum can be transformed into a calcium sulfate whisker in an aqueous medium under the conditions of high temperature and high pressure.

Calcium sulfate whisker can be used as reinforced filler in resin matrix composites, friction materials, binders and other industries.

10. PLASTIC:

Plastics are a wide range of synthetic or semi-synthetic materials that use polymers as a main ingredient. Their plasticity makes it possible for plastics to be moulded, extruded or pressed into solid objects of various shapes. This adaptability, plus a wide range of other properties, such as being lightweight, durable, flexible, and inexpensive to produce, has led to its widespread use. Plastics typically are made through human industrial systems. Most modern plastics are derived from fossil fuel-based chemicals like natural gas or petroleum; however, recent industrial methods use variants made from renewable materials, such as corn or cotton derivatives.



Properties of Plastics

- They are light in weight and is chemically stable.
- Easily moulded into different shapes and sizes.
- Good insulation and low thermal conductivity.
- Good impact resistance and they do not rust.
- Good transparency and wear resistance.
- Poor dimensional stability and can be easily deformed.
- Low processing cost.

Different Types of Plastic

Plastics are of Two Types:

1. Thermoplastics
2. Thermosetting Plastic

Thermoplastics:

The term 'thermoplastic' refers to plastics that do not undergo any chemical changes when subjected to high temperatures. These plastics do not undergo any changes in their chemical structures and chemical compositions when subjected to heat and can be changed into a soft state and remoulded multiple times.

Examples: Polystyrene, Teflon, Acrylic, Nylon, etc.

Thermosetting Plastics:

They are also known as thermosets, and are plastics that can be moulded only once and do not change shape on applying heat. These plastics can only be moulded once and they cannot be softened on further heating. These plastics undergo degradation and become damaged when exposed to a large amount of heat.

Examples: Vulcanized rubber, Bakelite, Polyurethane, Epoxy resin, Vinyl ester resin, etc.

Uses of Plastics

Plastics are highly durable, lightweight and most importantly can be moulded into any form or shape. These properties account for the largest usage of plastics. plastics are extremely versatile materials and can be used for a wide variety of purposes. Some usage of plastics are given below:

1. The ability to be moulded makes plastic an ideal packaging material. Plastics in packaging help to keep foods safe and fresh.
2. Being durable and lightweight, plastics have helped in the electronic field. From computers and cell phones to television and microwave, almost all appliances around us make some use of plastic.
3. Plastics are used to make safety gear like helmets, goggles etc. Plastics are used in the construction industry due to their low maintenance and high durability.
4. Plastic is strong and lightweight, that is why it is useful in making toys, electrical switches and other household products.
5. Being non-reactive with air and water, plastic is used to store water in plastic bottles and other chemicals in chemical laboratories.
6. Plastic is a poor conductor of electricity and heat. Its insulation property is used for coating the electric wire and to make handles of cooking utensils and various household products.

11. PAINTS:

Paint is a substance used as the final finish to all surfaces and as a coating to protect or decorate the surface. Paint is a pigmented opaque material that completely covers and hides the surface to which it is applied. Paint is available in oil-based and water-based formulae. It is used as a protective coating and is normally sprayed or brushed on. Paint prevents corrosion. It is a combination of pigments with suitable thinners or oils to provide decorative and protective coatings. Painting protects a surface from weathering effects and also prevents corrosion of metals.

Constituents of Paint:

The essential constituents of paints are:

1. Base
2. A vehicle

3. A pigment
4. A drier
5. A thinner

1. Bases: It is a principal constituent of paint. It also possesses the binding properties. It forms an opaque coating. Commonly used bases for paints are white lead, red lead, zinc oxide, iron oxide, titanium white, aluminium powder and lithophone. A lead paint is suitable for painting iron and steel works, as it sticks to them well. However it is affected by atmosphere action and hence should not be used as final coat. While zinc forms good base but is costly. Lithophone, which is a mixture of zinc sulphate and barytes, is cheap. It gives good appearance but is affected by day light. Hence it is used for interior works only.

2. Vehicles: The vehicles are the liquid substances which hold the ingredients of paint in liquid suspension and allow them to be applied on the surface to be painted. Linseed oil, Tung oil and Nut oil are used as vehicles in paints. Of the above four oils, linseed oil is very commonly used vehicles. Boiling makes the oil thicker and darker. Linseed oil reacts with oxygen and hardens by forming a thin film.

3. Pigment: Pigments give required colour for paints. They are fine particles and have a reinforcing effect on thin film of the paint. The common pigments for different colours are:

Black—Lamp black, suit and charcoal black.
Red—venedion red, red lead and Indian red.
Brown—burned timber, raw and burned sienna.
Green—chrome green, copper sulphate.
Blue—Prussian blue and ultra marine.
Yellow—ochre and chrome yellow.

4. The Drier: These are the compounds of metal like lead, manganese, cobalt. The function of a drier is to absorb oxygen from the air and supply it to the vehicle for hardening. The drier should not be added until the paint is about to be used. The excess drier is harmful because it destroys elasticity and causes flaking.

5. The Thinner: It is known as solvent also. It makes paint thinner and hence increases the coverage. It helps in spreading paint uniformly over the surface. Turpentine and naphtha is commonly used thinners. After paint applied, thinner evaporates and paint dries.

Properties of an Ideal Paint

1. It should be possible to apply easily and freely.
2. It should dry in reasonable time.
3. It should form hard and durable surface.
4. It should not be harmful to the health of workers.
5. It should not be easily affected by atmosphere.
6. It should possess attractive and pleasing appearance.

7. It should form a thin film of uniform nature i.e., it should not crack.
8. It should possess good spreading power.
9. It should be cheap.

Types of Paints:

Depending upon their constituents there are various types of paints. A brief description of some of them which are commonly used are given below:

1. **Oil Paint:** These paints are applied in three coats-primer, undercoat and finishing coat. The presence of dampness while applying the primer adversely affects the life of oil paint. This paint is cheap and easy to apply.
2. **Enamel Paint:** It contains white lead, oil, petroleum spirit and resinous material. The surface provided by it resists acids, alkalis and water very well. It is desirable to apply a coat of titanium white before the coat of enamel is applied. It can be used both for external and internal walls.
3. **Emulsion Paint:** It contains binding materials such as polyvinyl acetate, synthetic resins etc. It dries in 1,5 to 2 hours and it is easy to apply. It is more durable and can be cleaned with water. For plastered surfaces, first a coat of cement paint should be applied and then the emulsion point. Emulsion paint needs sound surfaces.
4. **Cement Paint:** It is available in powder form. It consists of white cement, pigment and other additives. It is durable and exhibits excellent decorative appearance. It should be applied on rough surfaces rather than on smooth surfaces. It is applied in two coats. First coat is applied on wet surface but free from excess water and allowed to dry for 24 hours. The second coat is then applied which gives good appearance.
5. **Bituminous Paints:** This type of paint is manufactured by dissolving asphalt or vegetable bitumen in oil or petroleum. It is black in colour. It is used for painting iron works under water.
6. **Synthetic Rubber Paint:** This paint is prepared from resins. It dries quickly and is little affected by weather and sunlight. It resists chemical attack well. This paint may be applied even on fresh concrete. Its cost is moderate and it can be applied easily.
7. **Aluminium Paint:** It contains finely ground aluminium in spirit or oil varnish. It is visible in darkness also. The surfaces of iron and steel are protected well with this paint. It is widely used for painting gas tanks, water pipes and oil tanks.

8. **Anti-corrosive Paint:** It consists essentially of oil, a strong dyer, lead or zinc chrome and finely ground sand. It is cheap and resists corrosion well. It is black in colour.

Application of Paint

Preparation of surface for application of paint is the most important part in painting. The surface to be painted should not be oily and it should be free from flakes of the old paint. Cracks in the surface should be filled with putty and then with sand paper. Then primer is applied. Painting work should be carried out in dry weather. The under coats and first coats must be allowed to dry before final coat is applied.

12. DISTEMPER:

Distemper is a water based paint in which the binding medium consists essentially of either glue or casein, or similar sizing material. The major constituents of distemper are chalk, lime, water and some colouring agents if necessary. They are also known as cement paint. This is called so because such kind of paint can be applied directly on cement walls without any other coating on them. They are a cheaper option and they stay good for more than 5 years. Distempers are used for both interior and exterior walls usually needing two coatings.



Properties of Distemper

1. They are generally light in colour.
2. The coatings are generally thick.
3. They give reflective coating.
4. They are less durable than oil paints but are cheaper.

13. VARNISH:

Varnishes are more or less transparent liquids which are used to provide a protective surface coating in much the same way as paints do. At the same time they allow the original surface to show but add a lustrous and glossy finish to it. All varnishes have basically the same components as paints. Varnish is a transparent, hard, protective finish or film primarily used in wood finishing but also for other materials. Varnish is traditionally a combination of a drying oil, a resin, and a thinner or solvent. Varnish finishes are usually glossy but may be designed to produce satin or semi-gloss sheens by the addition of "flatting" agents.

Based on the different solvents used, varnishes are classified under the following categories:

(1) Water Varnish

They consist of lac dissolved in hot water with borax, ammonia, potash or soda just enough to dissolve the lac. Varnish so made withstands washing. It is used for painting wall paper and for delicate work.

They are used for varnishing wall paper, maps, pictures, book jackets for delicate work.

(2) Polyurethane Varnish

These varnishes are typically hard, absorption resistant and durable coating.

They are popular for hardwood floors but are considered by some wood finishers to be difficult or unsuitable for finishing furniture or other detailed pieces.

(3) Oil Varnish

These are made by dissolving hard resins like amber or copal in oil. They are slow to dry but are hardest and most durable of all varnishes. They are suited for being used on exposed surfaces requiring polishing or frequent cleaning and for superior works.

(4) Turpentine Varnish

These are made from soft resins like mastic, common resin is dissolved in turpentine oil.

- These varnishes used as solvent in which soft resin such as Gunc dammar, mastic and Rosin are dissolved.
- They dry quickly but not so durable.
- These are cheaper than oil varnishes.

(5) Spirit Varnish

Varnishes in which spirit is used as a solvent as known as spirited varnish or French Polish. Shellac is dissolved in spirit and the product is applied in a thin layer. This varnish gives a

transparent finish thus showing the grains of the timber. These however, do not weather well and as such are used for polishing wood work not exposed to weather.

(6) Acrylic varnish or Gloss Varnish

Acrylic Varnishes, made from 100% acrylic polymer emulsions, form durable films when dry. They have excellent flexibility and resistance to chemicals, water, abrasion and ultraviolet radiation. Use them to provide lasting protection for artwork.

14. ADHESIVE:

An adhesive may be defined as a material which can join the surfaces together and resist their separation. Adhesives can be defined as non-metallic materials capable of joining permanently to surfaces by an adhesive process. The use of adhesives in construction offers certain advantages over other binding techniques. These include the ability to bind different materials together, the more efficient distribution of stress across a joint, the cost-effectiveness of an easily mechanized process, and greater flexibility in design.

There are different kinds of adhesives used in construction; some of them are given below.

Polymer adhesives

A polymer adhesive is a synthetic bonding substance made from polymers and is considered to be stronger, more flexible, and has greater impact resistance than other forms of adhesives. These bonding products are used in multiple industries including automotive, aerospace, aviation, construction, electronics, and electrical. Polymer adhesives are broadly classified as thermoplastic, or thermosetting, depending on the molecular structure. Many polymer adhesives are dispersed in water and are suitable for use with both solid and engineered wood flooring.



Hot melt adhesives

Hot melt adhesive (HMA), is a form of thermoplastic adhesive that is commonly sold as solid cylindrical sticks of various diameters designed to be applied using a hot glue gun. The gun uses a continuous-duty heating element to melt the plastic glue, which the user pushes through the gun either with a mechanical trigger mechanism on the gun or with direct finger pressure. In industrial use, hot melt adhesives provide several advantages over solvent-based adhesives. Volatile organic compounds are reduced or eliminated, and the drying or curing step is eliminated. Hot melt adhesives have a long shelf life and usually can be disposed of without special precautions. Some of the disadvantages involve a thermal load of the substrate, limiting use to substrates not sensitive to higher temperatures, and loss of bond strength at higher temperatures, up to complete melting of the adhesive. Hot melt adhesives can also be applied by dipping or spraying, and are popular with hobbyists and crafters both for affixing and as an inexpensive alternative to resin casting.



Acrylic adhesives

Acrylic adhesives are key to large sections of modern industry, providing high strength bonds that work well as an alternative to rivets or other more mechanical joining techniques. Acrylic adhesives are useful for a wide range of surfaces; they can also be used to join acrylics. Acrylic adhesives are either thermoplastics, which can be moulded above a certain temperature or thermosetting polymer, which ‘cure’ once and cannot be remoulded. Acrylic adhesives have traditionally been used for their strong structural adhesive properties. As a good structural adhesive, acrylic adhesives are naturally in high demand. As an inexpensive structural adhesive, they can be very useful to very many projects! Acrylic adhesives also look good and bond easily to several different materials. This gives them great flexibility in terms of applications.



Resin adhesives

Resin adhesive provides superior bonding capabilities. It is manufactured in powdered, spray, emulsion, and liquid forms. Resin adhesives are used to enhance the retention of both composites and compomers and hence prevent bacterial micro leakage. It can be used with various materials, including, wood, fabric, glass, china or metal. It's important to note, however; the epoxy resin is not considered to be water-resistant. Repeated moist or wet conditions can cause deterioration over time which will affect durability.



Anaerobic adhesives

Anaerobic adhesives are one-part adhesives composed of dimethacrylate monomers that cure only in the absence of air. They are less toxic than other acrylics, have a mild, inoffensive odour, and are not corrosive to metals. Anaerobic adhesives are stored in partially filled polyethylene containers, in which the ratio of air-exposed surface to volume is high. Anaerobic adhesives are used for structural bonds, primarily with materials such as metals and glass and to a lesser extent, wood and plastic (thermosets and some thermoplastics). An activator is applied to one or both joint surfaces; adhesive is then applied to one surface to begin curing. Joints produced using anaerobic adhesives can withstand exposure to organic solvents and water, weathering, and temperatures of up to about 200°C.



Epoxy adhesives

Epoxy adhesives can adhere to a wide variety of materials, their high strength, their resistance to chemicals and environments, and their ability to resist creep under sustained load, epoxies are the most widely used structural adhesive. They are available in one component, heat curing and two-component, room temperature curing systems. Unmodified epoxies cure hard, brittle solids. Most adhesive formulations include modifiers to increase the flexibility or toughness of the cured adhesive. This results in bond lines that can resist more peel and cleavage stress as well as impact. As the most widely used structural type adhesive, epoxy adhesives are commonly offered as either one component or two-component systems. One component epoxy adhesives are generally cured at temperatures between 250-300°F, conditions that engineer a product of high strength, excellent adhesion to metals, and outstanding environmental and harsh chemical resistance.



Pressure adhesives

Pressure adhesives remain viscous. As a result, they remain permanently tacky and can wet surfaces on contact. Bonds are made by bringing the adhesive film in contact with the substrate and applying pressure. If inadequate pressure is applied or the processing temperature is too low, bonding faults such as bubbles or detachment can occur. Since these adhesives are not true solids, the strength of pressure-sensitive adhesives decreases when the temperature is increased. Pressure-sensitive adhesives also tend to undergo creep when subjected to loads. They are typically formulated from natural rubber, certain synthetic rubbers, and polyacrylates.



Electrically conductive adhesives

Modern electrically conductive adhesives provide excellent adhesion and reliability. They cure in times of less than two minutes, and in-line processing capability for exceptionally high throughput. An electrically conductive adhesive is an adhesive made of conductive particles suspended in a sticky compound. With about 80% of the mass of the adhesive made of the conductive particles, they are spaced closely enough to each other to allow a substantial current to pass. The composition of conductive adhesives can vary greatly from one product to another. The base adhesive is typically a 2-component epoxy, although acrylate and polyester are also quite common. The conductive component plays a huge role in determining the cost of a conductive adhesive: inexpensive ones use iron, which has poor conductivity, while the most expensive ones use either silver or copper.



Phenolic resin adhesives

Phenolic resin adhesives are the condensation products of phenol and formaldehyde and are an important class of adhesives. They are relatively inexpensive and are manufactured as liquid compositions and films. Thermosetting phenolic resins withstand high temperatures both under mechanical load and in severe environments with minimal deformation and creep. The primary use of phenolic resins is as a bonding agent. Phenolic resins readily penetrate and adhere to many organic and inorganic fillers and reinforcements, and when cross-linked throughout the fillers and reinforcements, provide excellent mechanical, thermal, and chemically resistant properties. Their exceptional compatibility with cellulose fillers makes them the ideal binder for particleboard, plywood, hardboard, and oriented strand board (OSB).



Plastisol adhesives

Plastisol are single-component adhesives that are applied as a paste to the substrate. The paste consists of solid polyvinyl chloride (PVC) particles dispersed in plasticizer. To form a bond, the applied adhesive is heated so that the thermoplastic PVC swells and can take up the plasticizer. Plastisols have high flexibility and good peel resistance. They can be flexible or rigid depending on the type and amount of plasticizer added and give good adhesion to most types of (oiled) metals, and plastics. They are often the preferred material for applications where low-flammability at a low cost is required or advantageous. They are also easy to apply, require no meter mixing, and allow for fast processing.



Reactive adhesives

Reactive adhesives require a chemical reaction for bonding two surfaces. These adhesives are classified into one- and two-component reactive adhesives and have been used in applications where substrates require substantial permanency and high strength adherence such as high-tech devices. Highly reactive adhesives with quick gelling and hardening behaviour and steep increases in bonding strength even at a low degree of chemical curing. Its mixes are produced by including accelerators, special hardeners, cross linkers and other materials.



Solvent-Based adhesives

These are called binding agents and are dispersed in an organic solvent. When the solvent evaporates, the adhesive changes from liquid to its final solid form – the pure bonding substance remains. The function of the relatively highly volatile solvents is to facilitate easy transport and application of the adhesive: They ensure that the binding agents stay liquid and can, therefore, be processed. Also, the solvents influence key adhesive characteristics such as adhesion, by promoting the wetting of the substrate or by biting the substrate surface or dwell time and open time, depending on how fast they evaporate. The performance of solvent-based adhesives is largely determined by the polymer system in the formulation. The choice of adhesive type depends on the specific substrates and environmental resistance needed – temperature resistance, oil and plasticizer resistance, etc.



Thermoset adhesives

Thermoset adhesives are cross linked polymeric resins that are cured using heat and/or heat and pressure. Due to their superior strength and resistance, thermosets are widely used for structural load-bearing applications. Thermoset adhesives have very high strength, excellent gap filling ability, and resistance to moisture and heat. Most thermoset adhesives are supplied as a two-component system although one-part adhesives are used as well. Two-component adhesives are typically made up of a resin and a hardener, in liquid or gel form, which are mixed to initiate the curing process.



UV Curing adhesives

UV glue curing is gaining popularity over other methods of bonding such as drying or exposure to chemicals. Bonding with heat or drying works by evaporation, this can be inconsistent and can also take time for the inks to dry. Chemical treatment can be costly to purchase materials and may expose employees to harmful inhalants or respiratory contaminants. UV glue curing is quick and consistent, providing an instantly hardened surface with no harmful chemical exposure. One big advantage to the finishes with UV curing is that it dries clear, allowing multiple layers if need be while sanding down the finish will provide an invisible 'liquid plastic' unbreakable bond. Paint or stain can be applied to the finish, giving endless options for applications with various products.



Water-based adhesives

Water-based (or more commonly referred to as waterborne) adhesives are typically formulated from natural polymers and soluble synthetic polymers. These adhesives may be supplied as solutions or formulated as dry powders which must be mixed with water before application. The strength of the adhesive is attained when water is lost from the glue line by evaporation or absorption by the substrate. Because of this requirement, the use of these adhesives requires that at least one substrate is permeable. Where neither substrate is permeable, it is possible to apply a thin coat of adhesive, allow it to dry, and then activate the adhesive by lightly wiping with a wet brush or roller or spraying with water.



13. BITUMEN:

Bitumen, also known as asphalt, is a substance produced through the distillation of crude oil that is known for its waterproofing and adhesive properties. Bitumen production through distillation removes lighter crude oil components, such as gasoline and diesel, leaving the “heavier” bitumen behind. Bitumen is a petroleum based material, used for binding stones and sands and producing asphalt for road construction.

In the normal process of an oil refinery, crude oil is heated in an atmospheric distillation column. This will lead to the separation of various parts of crude oil according to their molecular weight. The heaviest part of the oil that remains at the bottom of the distillation column is called Vacuum Bottom and forms the raw material for producing refined bitumen.

The bitumen can be classified into the following grade types:

- Penetration Grade Bitumen
- Oxidized Bitumen Grades
- Cut Back Bitumen
- Bitumen Emulsion
- Polymer Modified Bitumen

Penetration Grade Bitumen

The penetration grade bitumen is refinery bitumen that is manufactured at different viscosities. The penetration test is carried out to characterize the bitumen, based on the hardness. Thus, it has the name penetration bitumen. The penetration bitumen grades range from 15 to 450 for road bitumen. But the most commonly used range is 25 to 200. This is acquired by controlling the test carried out i.e. the distillation process. The partial control of fluxing the residual bitumen with the oils can help in bringing the required hardness.



Oxidized Bitumen

The refinery bitumen is further treated by the introduction of processed air. This will give us oxidized bitumen. By maintaining a controlled temperature, the air is introduced under pressure into soft bitumen. Compounds of higher molecular weight are formed by the reaction of this introduced oxygen and bitumen components. Thus, the Asphaltenes and the Maltenes content increases resulting in a harder mix. This harder mix has a lower ductility and temperature susceptibility. The oxidized bitumen is used in industrial applications such as roofing and coating for pipes. By this method of processing, the bitumen that has a lower penetration can be manufactured, which can be employed for paving roads.



Cutback Bitumen

These are a grade of bitumen that comes under penetration grade bitumen. This type of bitumen has a temporarily reduced viscosity by the introduction of a volatile oil. Once after the application, the volatile material is evaporated and bitumen gains its original viscosity. The penetration grade bitumen is a thermoplastic material. It shows the different value of viscosity for different temperature. In areas of road construction, it is necessary for the material to be fluid in nature at the time of laying i.e. during surface dressing. It is also essential for the material to regain back to its original hardness and property after setting. This is ensured by cutback bitumen. The fluidity is obtained for any bitumen by raising the temperature. But when it is necessary to have fluidity at lower temperatures during surface dressing, cutback bitumen is employed. The time for curing and the viscosity of cutback bitumen can be varied and controlled by the

1. Dilution of volatile oil, and
2. The volatility of the oil added.

70/100 or 160/220 pen bitumen that is diluted with kerosene is the main composition of bitumen in the construction of roads in the UK. The standard tar viscometer is used to test the standard viscosity.



Bitumen Emulsion

This type of bitumen forms a two-phase system with two immiscible liquids. One of them is dispersed as fine globules within the other liquid. When discrete globules of bitumen are dispersed in a continuous form of water, bitumen emulsion is formed. This is a form of penetration grade bitumen that is mixed and used for laying purposes. An emulsifier having a long hydrocarbon chain with either a cationic or anionic ending is used for dispersing the bitumen globules. This emulsifier provides an electrochemical environment. The ionic part of the chain has an affinity towards water and the bitumen is attracted by hydrocarbon part.



Polymer - Modified Bitumen

Polymer modified bitumen is the type of bitumen obtained by the modification of strength and the rheological properties of the penetration graded bitumen. Here for this 2 to 8% of polymer is added. The polymer used can be either plastic or rubber. These polymers vary the strength and the visco-elastic properties of the bitumen.



Following are the properties of Bitumen

1. Adhesion
2. Resistance to Water
3. Hardness
4. Viscosity and Flow
5. Softening Point
6. Ductility
7. Specific Gravity
8. Durability
9. Versatility
10. Economical
11. Strength

Adhesion:

The adhesive property of bitumen binds together all the components without bringing about any positive or negative changes in their properties. Bitumen has the ability to adhere to a solid

surface in a fluid state depending on the nature of the surface. The presence of water on the surface will prevent adhesion.

Resistance to Water:

Bitumen is insoluble in water and can serve as an effective sealant Bitumen is water resistant. Under some conditions water may be absorbed by minute quantities of inorganic salts in the bitumen or filler in it.

Hardness:

To measure the hardness of bitumen, the penetration test is conducted, which measures the depth of penetration in tenths of mm. of a weighted needle in bitumen after a given time, at a known temperature. Commonly a weight of 100 gm is applied for 5 sec at a temperature of 77 °F. The penetration is a measure of hardness. Typical results are 10 for hard coating asphalt, 15 to 40 for roofing asphalt and up to 100 or more for water proofing bitumen.

Viscosity and Flow:

The viscous or flow properties of bitumen are of importance both at high temperature during processing and application and at low temperature to which bitumen is subjected during service. The flow properties of bitumen vary considerably with temperature and stress conditions. Deterioration, or loss of the desirable properties of bitumen, takes the form of hardening. *Resultantly*, decrease in adhesive and flow properties and an increase in the softening point temperature and coefficient of thermal expansion.

Softening point:

This property make us to know whether given bitumen can be used at the particular place i.e. softening point value should be higher than pavement temperature otherwise bitumen present in the layer get soften and come out.

Softening point is the temperature at which a steel ball falls a known distance through the bitumen when the test assembly is heated at a known rate. Usually the test consist of a (3/8) in dia. steel ball, weight 3.5 gm, which is allowed to sink through a (5/8) in dia, (1/4) in thick disk of bitumen in a brass ring. The whole assembly is heated at a rate of 9 °F per min. Typical

values would be 240 °F for coating grade asphalts, 140 °F to 220 °F for roofing asphalt and down to 115 °F for bituminous water proofing material.

Ductility:

Ductility test is conducted to determine the amount bitumen will stretch at temperature below its softening point. A briquette having a cross sectional area of 1 in² is placed in a tester at 77 °F. Ductility values ranges from 0 to over 150 depending on the type of bitumen.

Presence of ductility means the formation of the film and coating would be proper.

Specific Gravity

Specific gravity of a binder does not influence its behaviour. But all the same, its value is needed in mix design. The property is determined at 27° C.

Durability:

Bitumen durability refers to the long-term resistance to oxidative hardening of the Material in the field. Although, in-service, all bitumen harden with time through reaction.

With oxygen in the air, excessive rates of hardening (poor durability) can lead to premature binder embrittlement and surfacing failure resulting in cracking and chip loss. Bitumen lives upto twenty years if maintained properly throughout the pavement life.

Versatility:

Due to versatility property of Bitumen it is relatively easy to use it in many applications because of its thermoplastic property. It can be spread easily along the underlying pavement layers as it liquefies when heated making the job easier and hardens in a solid mass when cooled.

Economical:

It is available in cheaper rates almost all over the world which makes it feasible and affordable in many applications.

Strength:

Though the coarse aggregates are the main load bearing component in a pavement, bitumen or asphalt also play a vital role in distributing the traffic loads to the layers beneath.

General Properties of Bitumen

- Most bitumen are colloidal in nature.
- Bitumens are thermoplastics.
- They have no specific melting, boiling or freezing point.
- Bitumens are insoluble in water.
- They are highly impermeable to the passage of water.
- They are generally hydrophobic. They are chemically inert.
- Bitumen oxidises slowly.

Tests on bitumen

There are a number of tests to assess the properties of bituminous materials. The following tests are usually conducted to evaluate different properties of bituminous materials.

1. Penetration test
2. Ductility test
3. Softening point test
4. Specific gravity test
5. Viscosity test
6. Flash and Fire point test
7. Float test
8. Water content test
9. Loss on heating test

Penetration test

It measures the hardness or softness of bitumen by measuring the depth in tenths of a millimetre to which a standard loaded needle will penetrate vertically in 5 seconds. BIS had standardised the equipment and test procedure. The penetrometer consists of a needle assembly with a total weight of 100g and a device for releasing and locking in any position. The bitumen is softened to a pouring consistency, stirred thoroughly and poured into containers at a depth at least 15 mm in excess of the expected penetration. The test should be conducted at a specified temperature of 25 ° C. It may be noted that penetration value is largely influenced by any inaccuracy with regards to pouring temperature, size of the needle, weight placed on the needle and the test temperature. A grade of 40/50 bitumen means the penetration value is in the range 40 to 50 at standard test conditions. In hot climates, a lower penetration grade is preferred. The Figure shows a schematic Penetration Test setup.

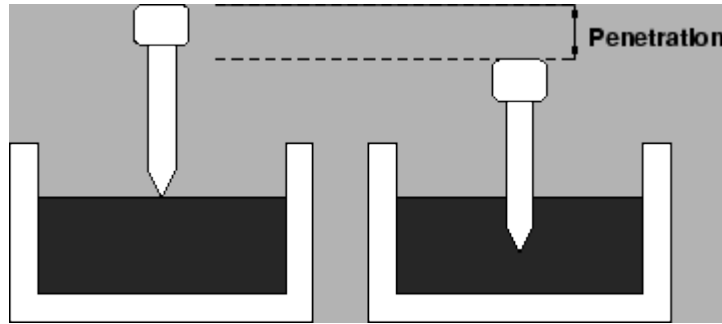

Ductility test

Ductility is the property of bitumen that permits it to undergo great deformation or elongation. Ductility is defined as the distance in cm, to which a standard sample or briquette of the material will be elongated without breaking. Dimension of the briquette thus formed is exactly 1 cm square. The bitumen sample is heated and poured in the mould assembly placed on a plate. These samples with moulds are cooled in the air and then in water bath at 27 ° C temperature. The excess bitumen is cut and the surface is levelled using a hot knife. Then the mould with assembly containing sample is kept in water bath of the ductility machine for about 90 minutes. The sides of the moulds are removed, the clips are hooked on the machine and the machine is operated. The distance up to the point of breaking of thread is the ductility value which is reported in cm. The ductility value gets affected by factors such as pouring temperature, test temperature, rate of pulling etc. A minimum ductility value of 75 cm has been specified by the BIS. Figure shows ductility moulds to be filled with bitumen.

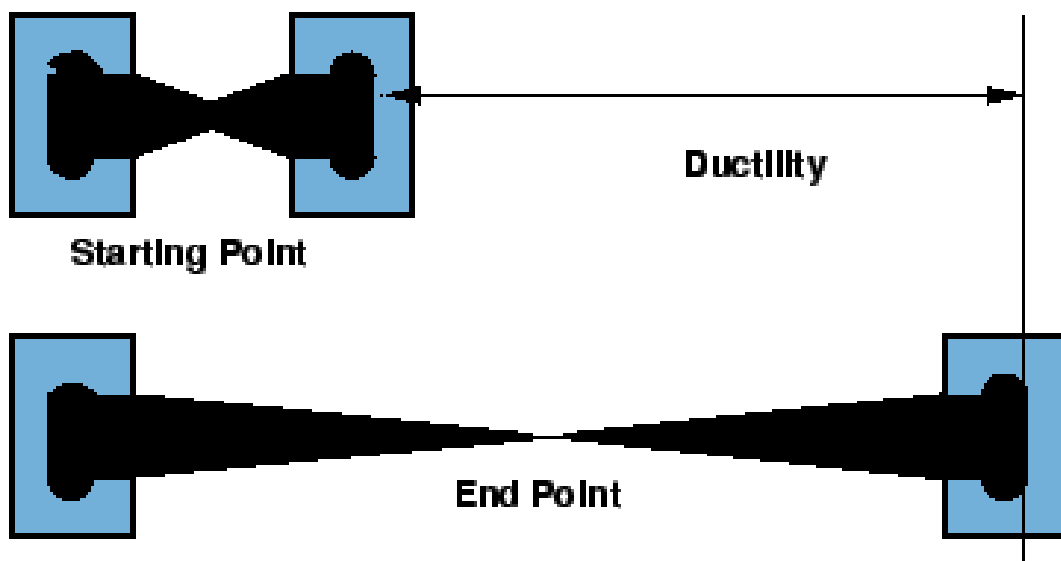

Softening point test

Softening point denotes the temperature at which the bitumen attains a particular degree of softening under the specifications of test. The test is conducted by using Ring and Ball apparatus. A brass ring containing test sample of bitumen is suspended in liquid like water or glycerine at a given temperature. A steel ball is placed upon the bitumen sample and the liquid medium is heated at a rate of 5°C per minute. Temperature is noted when the softened bitumen touches the metal plate which is at a specified distance below. Generally, higher softening point indicates lower temperature susceptibility and is preferred in hot climates. Figure shows Softening Point test setup.

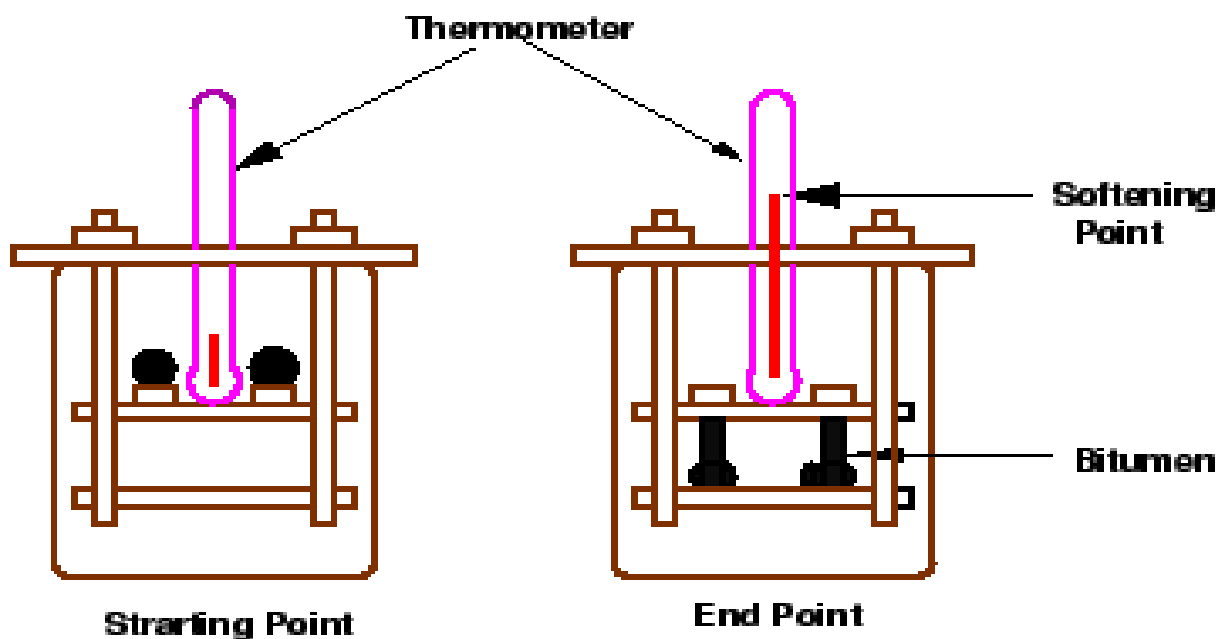

Specific gravity test

In paving jobs, to classify a binder, density property is of great use. In most cases bitumen is weighed, but when used with aggregates, the bitumen is converted to volume using density values. The density of bitumen is greatly influenced by its chemical composition. Increase in aromatic type mineral impurities cause an increase in specific gravity.

The specific gravity of bitumen is defined as the ratio of mass of given volume of bitumen of known content to the mass of equal volume of water at 27°C . The specific gravity can be measured using either pycnometer or preparing a cube specimen of bitumen in semi solid or solid state. The specific gravity of bitumen varies from 0.97 to 1.02.

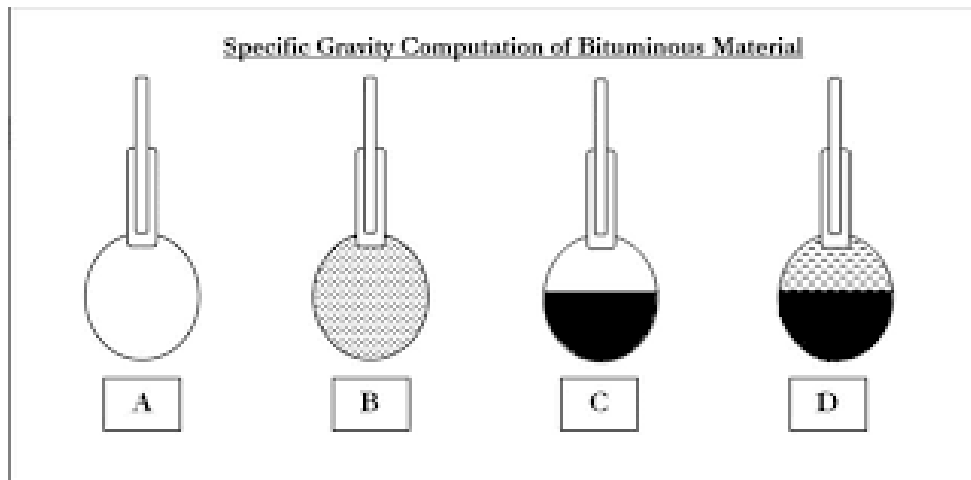

Viscosity test

Viscosity denotes the fluid property of bituminous material and it is a measure of resistance to flow. At the application temperature, this characteristic greatly influences the strength of resulting paving mixes. Low or high viscosity during compaction or mixing has been observed to result in lower stability values. At high viscosity, it resists the compactive effort and thereby resulting mix is heterogeneous, hence low stability values. And at low viscosity instead of providing a uniform film over aggregates, it will lubricate the aggregate particles. Orifice type viscometers are used to indirectly find the viscosity of liquid binders like cutbacks and emulsions. The viscosity expressed in seconds is the time taken by the 50 ml bitumen material to pass through the orifice of a cup, under standard test conditions and specified temperature. Viscosity of a cutback can be measured with either 4.0 mm orifice at 25 ° C or 10 mm orifice at 25 or 40 ° C.

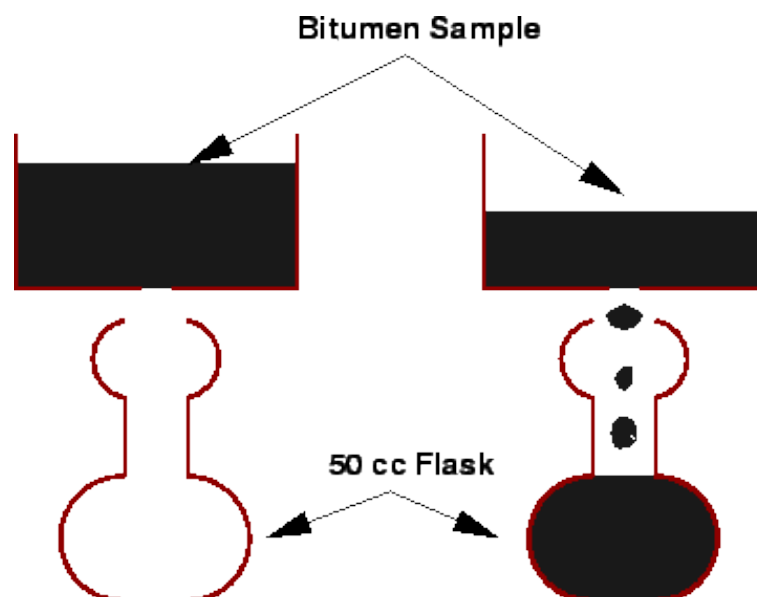

Flash and fire point test

At high temperatures depending upon the grades of bitumen materials leave out volatiles. And these volatiles catch fire which is very hazardous and therefore it is essential to qualify this temperature for each bitumen grade. BIS defined the flash point as the temperature at which the vapour of bitumen momentarily catches fire in the form of flash under specified test conditions. The fire point is defined as the lowest temperature under specified test conditions at which the bituminous material gets ignited and burns.

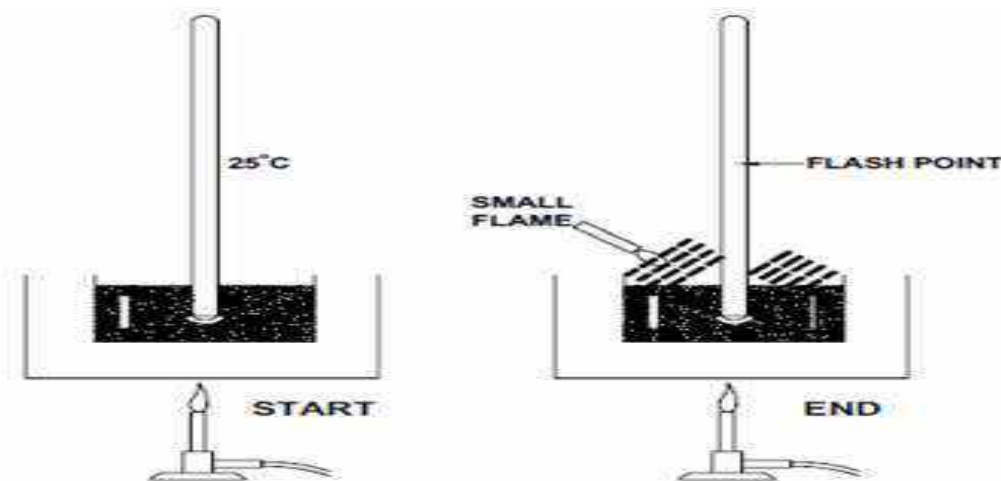

Float test

Normally the consistency of bituminous material can be measured either by penetration test or viscosity test. But for certain range of consistencies, these tests are not applicable and Float test is used. The apparatus consists of an aluminium float and a brass collar filled with bitumen to be tested. The specimen in the mould is cooled to a temperature of 5 °C and screwed in to float. The total test assembly is floated in the water bath at 50 °C and the time required for water to pass its way through the specimen plug is noted in seconds and is expressed as the float value.

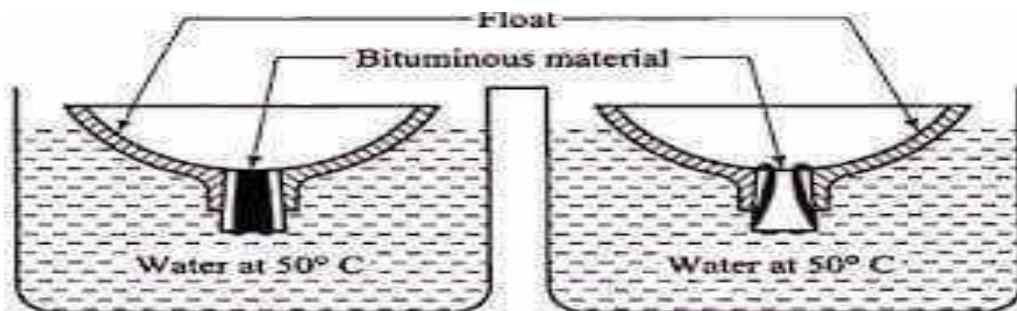

Float test
FIG. 17-2

Water content test

It is desirable that the bitumen contains minimum water content to prevent foaming of the bitumen when it is heated above the boiling point of water. The water in a bitumen is determined by mixing known weight of specimen in a pure petroleum distillate free from water, heating and distilling of the water. The weight of the water condensed and collected is expressed as percentage by weight of the original sample. The allowable maximum water content should not be more than 0.2% by weight.



Loss on heating test

When the bitumen is heated it loses the volatility and gets hardened. About 50gm of the sample is weighed and heated to a temperature of 163 °C for 5hours in a specified oven designed for this test. The sample specimen is weighed again after the heating period and loss in weight is expressed as percentage by weight of the original sample. Bitumen used in pavement mixes should not indicate more than 1% loss in weight, but for bitumen having penetration values 150-200 up to 2% loss in weight is allowed.



#####

Civil Engineering Materials and Constructions (BCE03002)

Module-IV

Basic Building Construction

Module IV Syllabus

Foundation: purpose, types of foundation- shallow, deep, pile, raft, grillage foundation. Masonry: Brick Masonry: types of bonds, relative merits and demerits of English, Single Flemish and Double Flemish bond. Stone Masonry: General principles, classification of stone masonry and their relative merits and demerits, Cavity wall: components and construction, Arches: Terminology and classifications, Doors and Windows: Types, materials used

Subject to Revision

1. FOUNDATION: -

It is a part of structural system that supports and anchors the superstructure of a building and transmits its loads directly to the earth. Foundation of a building as the name implies is the starting of a building construction on site really. Types of building, nature of soil and environmental conditions are the major determinant of type of foundation. Choosing a kind of foundation depends on, ground conditions, groundwater conditions, site – the environment (the buildings nearby) and structure of our building.

Purpose:-

There are numerous reasons a foundation is provided, some of which are:

- The most crucial purpose of providing Foundation is Structural Stability. Strength of the foundation determines the stability of the structure to be constructed.
- A properly designed and the constructed foundation provide an even surface for the development of superstructure at a proper level at over a firm bed.
- A well-designed foundation prevents the lateral movement of the supporting material (which is the soil in this case) and thus ensuring the safety of the superstructure from the detrimental effects of the lateral movements of soil.
- The foundation serves the purpose of completely distributing the loads from the structure to a large base area, and then the soil underneath. This uniform transfer of loads helps in avoiding unequal settlement of the building, which is one of the detrimental defects in building construction.

Types of Foundation:-

1. Shallow foundation: If the depth of foundation is less than the width of foundation then it is known as Shallow or stepped Foundation. It can be used where the bearing capacity of soil on which the structure is to be constructed is maximum. Minimum depth of this Foundation is 800mm and maximum depth not to be taken more than 4 meters.
2. Deep foundation: If the depth of footing greater or equal to the Width of footing, it is known as the deep Foundation. Deep Foundation is used where the bearing capacity of the soil is very low. The load coming from the superstructure is further transmitted vertically to the soil.

Difference between Foundation and Footing:

- Foundation is a structure which transfers the loads from the superstructure to the ground, while footing is the foundation which is in contact with the earth.
- A foundation can be shallow and deep, while a **footing** is a type of a **shallow foundation**. so, all footings are foundations but all foundations cannot be footings.

Types of foundation

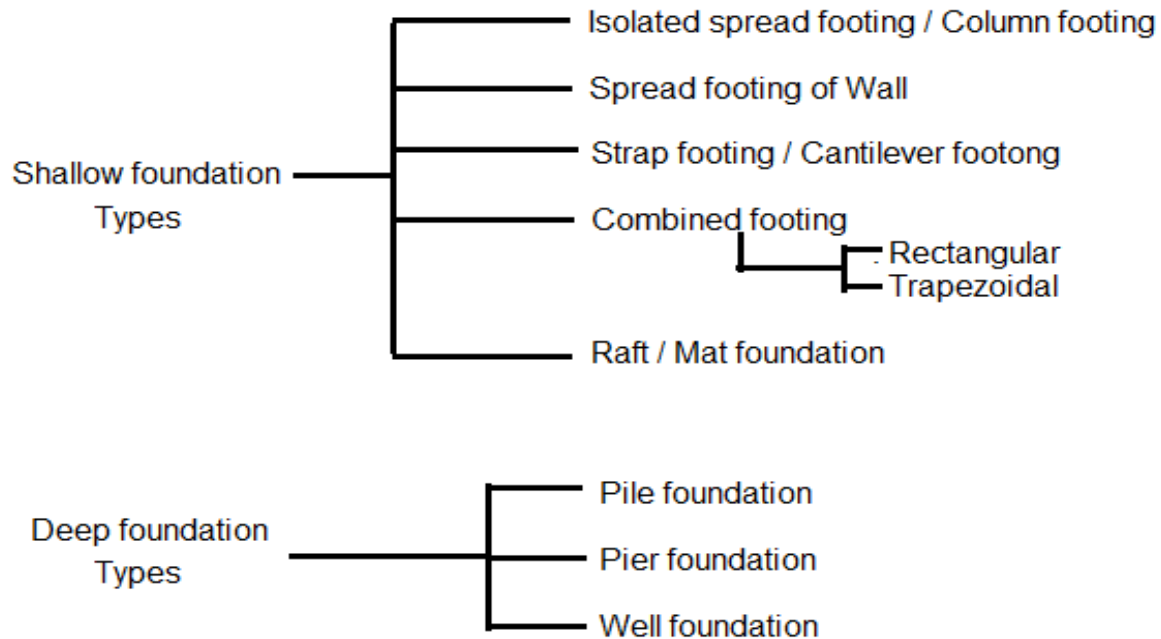

SHALLOW FOUNDATIONS

- They are usually located no more than 6 ft below the lowest finished floor.
- A shallow foundation system generally used when
 - The soil close to the ground surface has sufficient bearing capacity
 - Underlying weaker strata do not result in excessive settlement.
- The shallow foundations are commonly used most economical foundation systems
- **Types of spread footing: (either for Column or for Wall)**
 - a) Single pad footing.
 - b) Stepped footing for a column.
 - c) Sloped footing for a column.
 - d) Wall footing without step.
 - e) Stepped footing for walls.
 - f) Grillage foundation.

- (a) **Isolated spread footings** under individual columns which can be square, rectangular or circular.

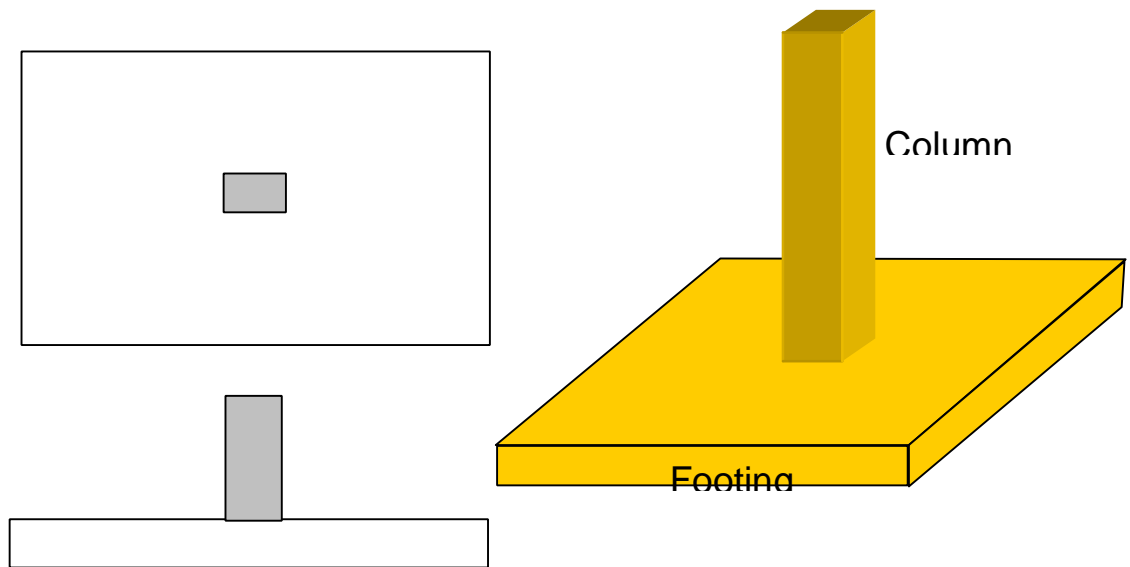

- (b) **Wall footing** is a continuous slab strip along the length of wall

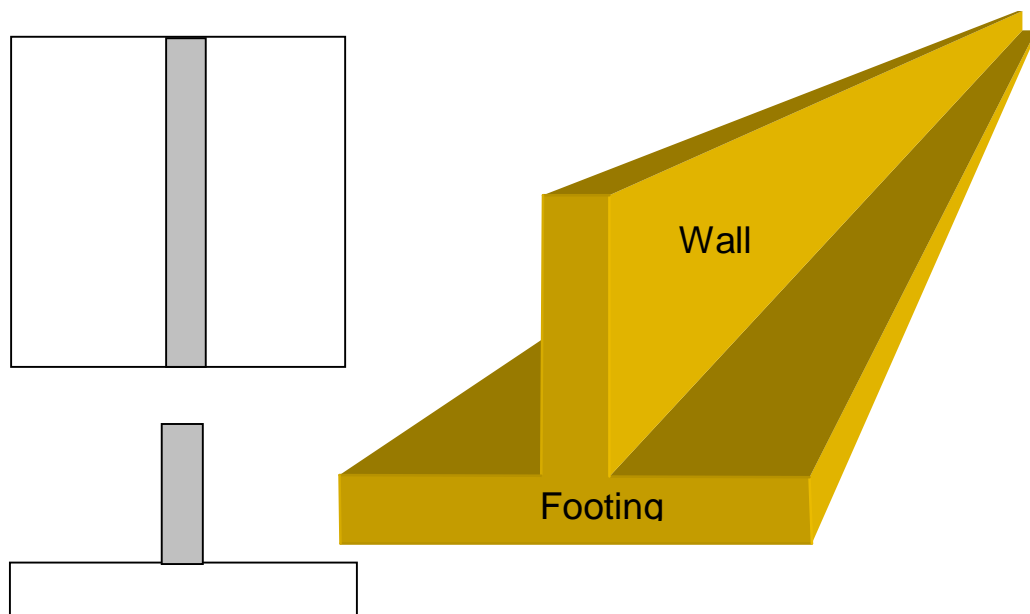

- (c) **Combined footings** support two or more columns. These can be rectangular or trapezoidal in plan.

- A combined footing is necessary in following **three reasons**:
- Columns are placed **very close to each other** so that their individual footings overlap each other
 - When **bearing capacity of soil is less** so it is required to have a more spread area for footing and so footing of adjacent column may overlap
 - When external column is **close to property line**, it is not possible to provide isolated footing for that column because it may be extended beyond the property line and so combined footing solves the problem

- The **essential condition** to satisfy in **combined footing** is that, **centroid of footing area should coincide with resultant of column loads** so that **soil pressure distribution is uniform under soil**.
- **Types of combined footing:**
 - Combined footing (Rectangular):
 - Combined footing (Trapezoidal):
If outer column near property line carries a heavier load
 - Strap footing
 - Raft / mat foundation

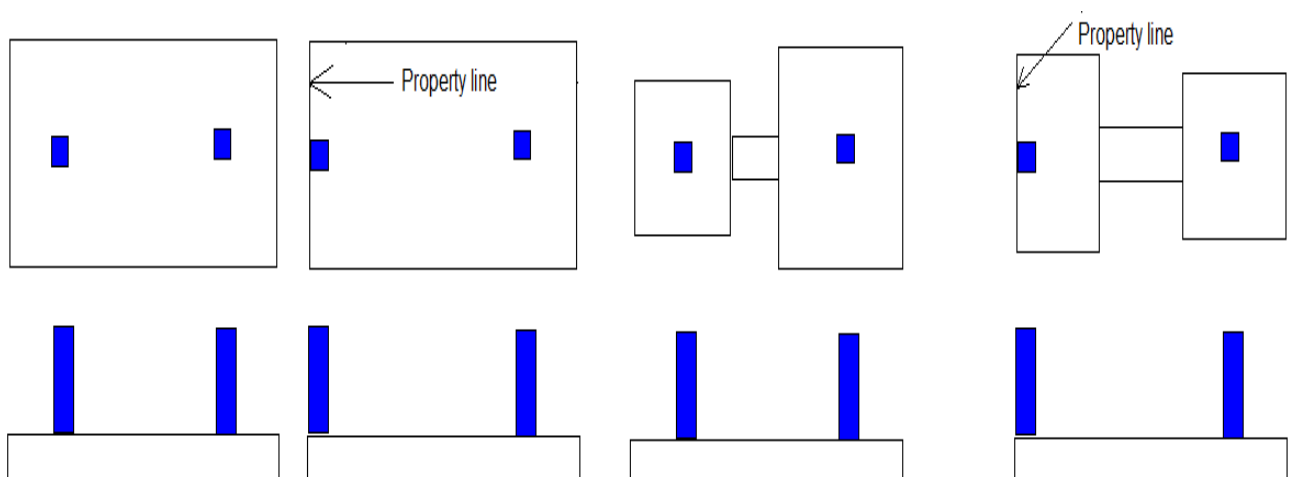
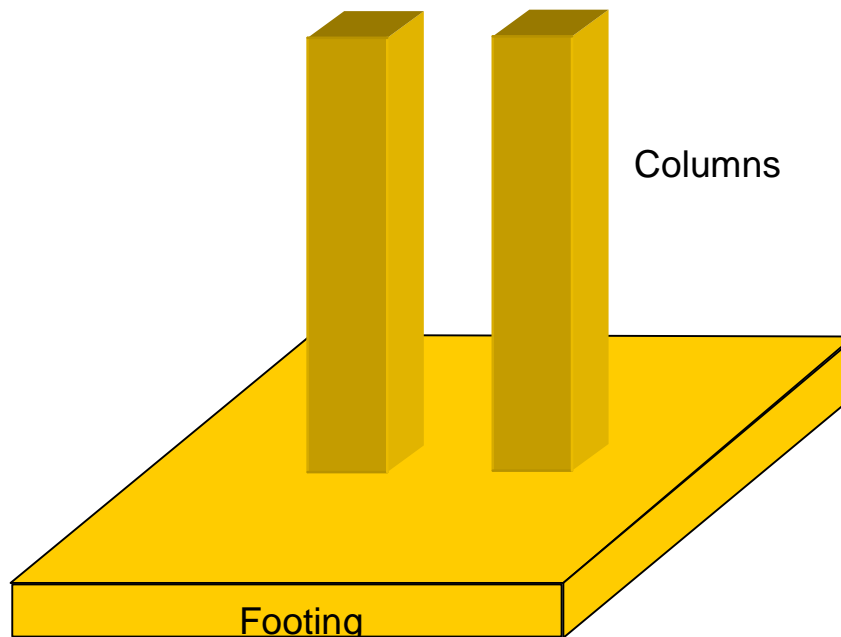

Combined footing

Strap footing

Combined footing

(d) **Strap or Cantilever Footing**

- Strap footings are similar to combined footings.
- Reasons for considering or choosing strap footing are identical to the combined one.
- In *strap footing*, the foundation under the columns is built individually and connected by a **strap beam**.
- Generally, when the **edge of the footing cannot be extended beyond the property line**, the **exterior footing is connected by a strap beam with interior footing**.

(e) **Raft / mat foundation:**

- This is a large continuous footing supporting all the columns of the structure.
- This is used when soil conditions are poor but piles are not used.
- Raft foundation is provided
 - When **load** transmitted by **columns** are so **heavy** or **allowable soil pressure** are so small that individual footings if provided would **cover more than about half** of the area, then it is better to provide a continuous footing called raft foundation under all columns and walls
 - Raft foundations are used to reduce settlement of structure located above heavy compressible deposits i.e. they control differential settlement
- **Types of raft foundation:**
 - **Solid raft** (A continuous slab covering all the columns)
 - **Ribbed raft** (mat with a central hollow region when all the columns are connected by a continuous beam which gets supported on the raft slab)

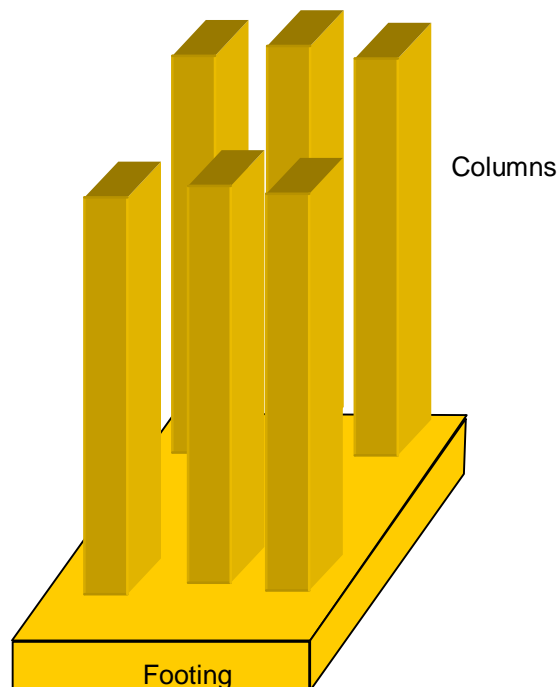

Raft foundation

Mat or Raft

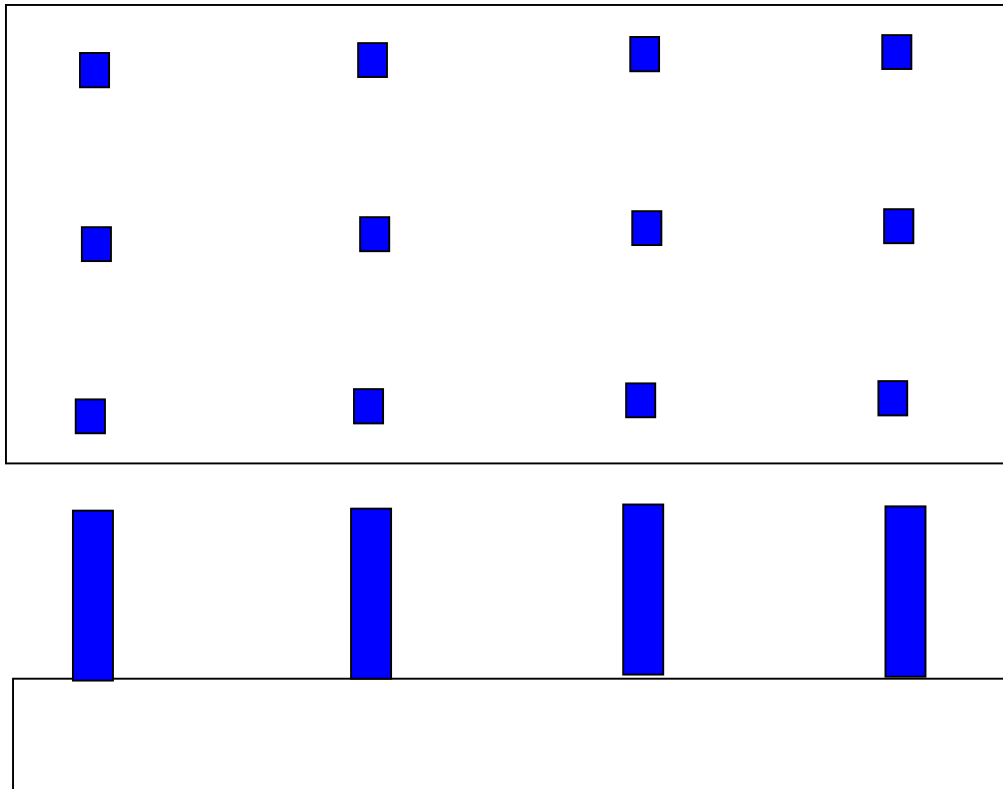

DEEP FOUNDATION

1. PILE FOUNDATION

- A **pile** is a **slender column** provided with a **cap** to receive the **column load** and transfer it to **undelaying soil layer / layers**.
- **Pile foundation** is a common type of deep foundation.
- Pile is a slender member with a small cross-sectional area compared to its length.
- It is used to transmit foundation loads to a deeper soil or rock strata when the bearing capacity of soil near the surface is relatively low.
- Pile transmits load either by skin friction or bearing.
- Piles are also used to resist structures against uplift and provide structural stability against lateral and overturning forces.
- They are used to reduce cost, and when as per soil condition considerations, it is desirable to transmit loads to soil strata which are beyond the reach of shallow foundations.
- Pile foundations are economical when

Soil with higher **bearing capacity** is at a greater depth.

When the foundation is subjected to a **heavily concentrated load**

The foundation is subjected to **strong uplift force**

Lateral forces are relatively pre dominant

When there are chances of construction of **irrigation canals** in the nearby area.

Expansive soil like **black cotton soil** are present at the site

In **marshy places** where soil is wet soil/ soft soil/ water logged/ low laying area

When the **topsoil layer** is **compressible** in nature.

In the case of bridges, when the **scouring** is **more** in the **river bed**.

When it is very expensive to provide **raft** or **grillage**.

2. PIER FOUNDATION

- Pier is a deep foundation structure above ground level that transmits a more massive load, which cannot be carried by shallow foundations.
- It is usually shallower than piles.
- Pier foundation is a cylindrical structural member that transfer heavy load from superstructure to the soil by end bearing.
- Unlike piles, it can only transfer load by end bearing only and by not skin friction.

Difference between Pile and Pier foundation

Pile	Pier
Piles are always below the ground level	Piers are always above the ground
Larger in length and smaller in diameter	Smaller in length and larger in diameter
Adopted when there is no hard bearing strata of soil available at reasonable depth	Adopted when there is hard bearing strata of soil available at reasonable depth but other types of foundation construction is not economical
Piles are driven through overburden soil into load bearing strata	Pier is drilled by drilling machine
Transfers full load through both bearing and friction action only	Transfers full load through bearing action only
Constructed at greater depth	Constructed at shallower depth
Resist greater intensity of load	Resist smaller intensity of load

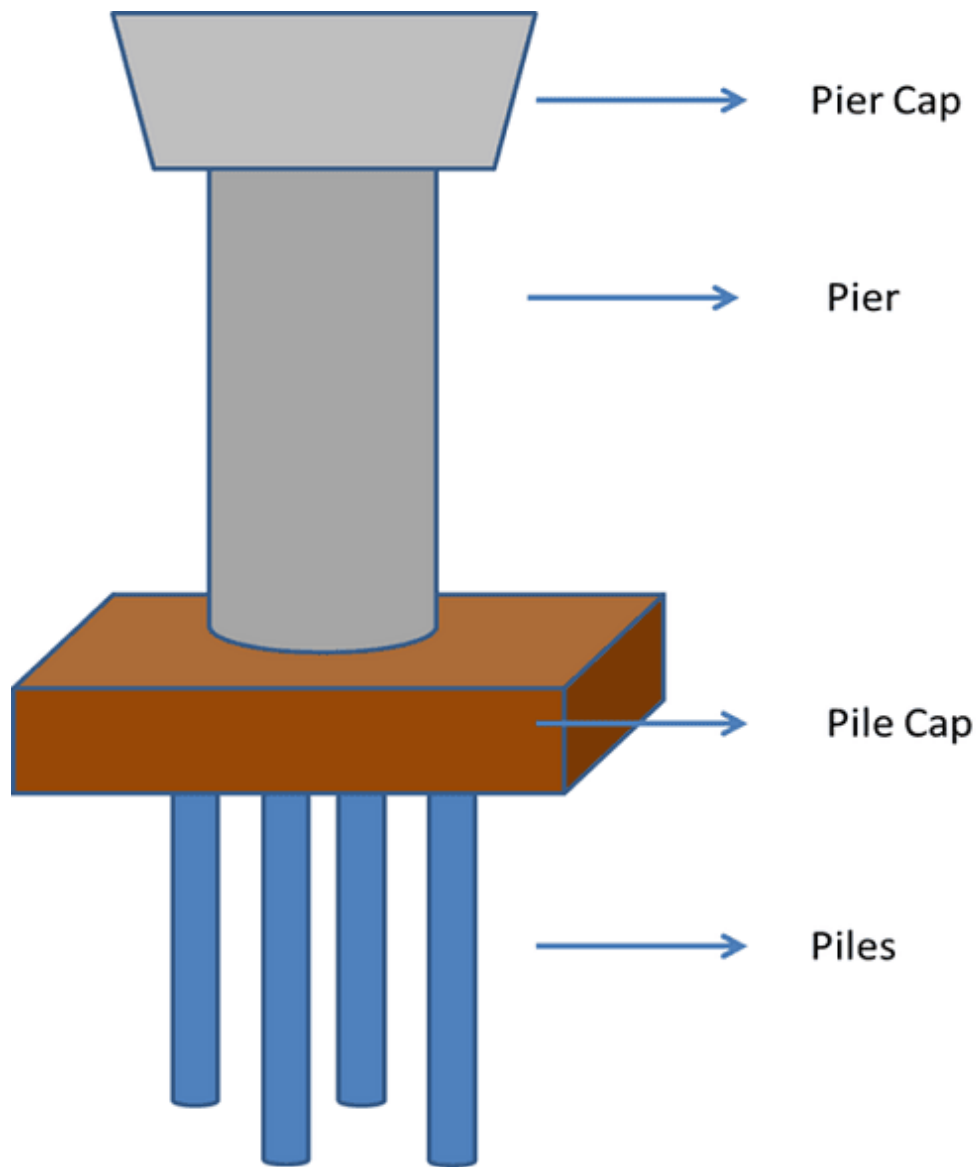

PIER foundation with PILE

3.WELL / CAISSON FOUNDATION

- Caisson foundation is a watertight retaining structure used as a bridge pier, construction of the dam, etc.
- It is generally used in structures that require foundation beneath a river or similar water bodies.
- The reason for choosing the caisson is that it can be floated to the desired location and then sunk into place.
- Caisson foundation is a ready-made hollow cylinder depressed into the soil up to the desired level and then filled with concrete, which ultimately converts to a foundation.
- It is mostly used as bridge piers.

- Caissons are sensitive to construction procedures and lack construction expertise.
- There are several types of caisson foundations.
 1. Box Caissons.
 2. Floating Caissons.
 3. Pneumatic Caissons.
 4. Open Caissons.
 5. Sheeted Caissons.
 6. Excavated Caissons.



CAISSON Foundation

DETAILS OF PILE AND PILE CAP

Classification of Pile foundation:

1. Based on Function or Use:

a) End Bearing Piles:

These are the pile used to transfer loads through water or soft soil to a suitable bearing stratum.

b) Friction Piles:

This type of pile utilizes the frictional resistance force between the pile surface and adjacent soil to transfer the superstructure load.

c) Combined end bearing and friction pile:

This pile transfers the super-imposed load both through side friction as well as end bearing. Such piles are more common, especially when the end bearing piles pass through granular soils.

- d) **Compactor Piles:**
These are used to compact loose granular soil thus increasing their bearing capacity.
- e) **Batter pile:**
A pile driven at an angle with the vertical to resist a lateral force
- f) **Sheet Piles:**
Used as impervious cut-off to reduce seepage and uplift under hydraulic structures.
They are rarely used to furnish vertical support but are used to function as retaining wall
- g) **Anchor pile:**
It provides anchorage against horizontal pull from sheet piling

Anchor piles can transfer both **compressive** and **tensile** forces as well as **bending moments** to the ground, making them ideal as anchors for offshore moorings, basements, and tunnels, etc. Moored floating offshore structures impose a variety of load conditions on the anchor system.
- h) **Tension/uplift pile:**
It anchors down the structures subjected to uplift due to hydro static pressure, seismic activity or due to overturning moment

2. **Based on Materials:**

- a) Timber Piles
- b) Concrete Piles
- c) Steel Piles
- d) Composite Piles

3. **Based on construction process:**

- a) Bored Piling:
Bored piles are installed by auguring into the ground forming a hole into which concrete can be poured, thereby casting the pile in position.
- b) Driven Piling:
Driven piles are driven or hammered into the ground with the use of vibration
- c) Screw Piling
Screw piles are wound into the ground, much like a **screw** is wound into wood. This is an efficient means of installation and coupled with their mechanism of dispersing load, provides effective in-ground performance in a range of soils, including earthquake zones with liquefaction potential
- d) Mini Piling
Mini piling is a variation on piling that uses a narrower diameter. This makes them light and inexpensive whilst still being able to support considerably heavy loads. For the most common type of mini piling a hollow steel shaft is screwed or drilled into the ground
- e) Sheet Piling
Sheet pile walls are retaining walls constructed to retain earth, water or any other filling materials. These walls are thinner in section compared to

masonry walls. Sheet pile walls are generally used for following: Water front structures, i.e. in building wharfs, quays and piers.

4. Classification of Piles based on the effect of Installation:

- a) **Displacement** pile:(eg: **Driven** Cast in Situ concrete pile and Driven Precast concrete pile)
- b) Non- Displacement pile: (eg: **Bored** Cast in Situ concrete pile, Bored Precast concrete pile)

5. Classification of Concrete piles:

- a) Driven cast in-situ (CIS) piles (IS 2911-P1-S1-2010)
- b) Bore cast in-situ (CIS) piles (IS 2911-P1-S2-2010)
- c) Driven precast (PC) piles (IS 2911-P1-S3-2010)
- d) Precast (PC) pile in pre bore hole (IS 2911-P1-S4-2010)

File foundation:

In this type of foundation, the load is transmitted by a vertical member. This vertical member is known as a pile. These piles are generally made of steel, concrete and wooden. These days precast members are used but we can create these members on site as well.

According to function pile foundation are of following types.

- a) Bearing pile
- b) Friction pile

Bearing pile:

They are driven till hard Strata or layer of Rock beds. The load is transmitted by columns to the hard layer of soil.

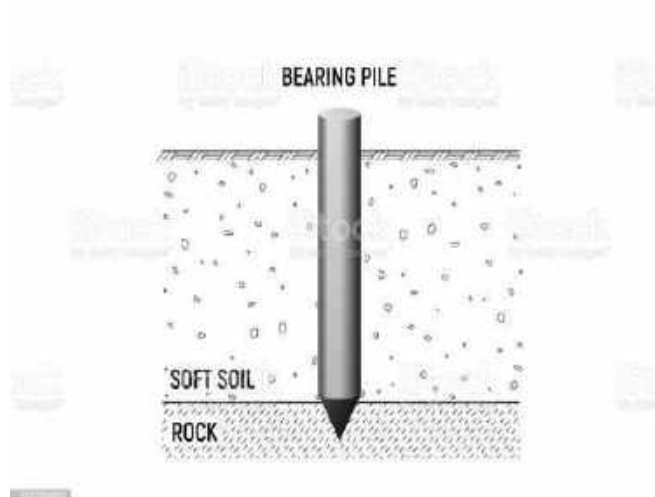

Friction pile:

These piles are used where the soil is soft at a considerable depth. The load is transferred to the soft soil due to the friction produced between the soft soil which is in contact with these piles.

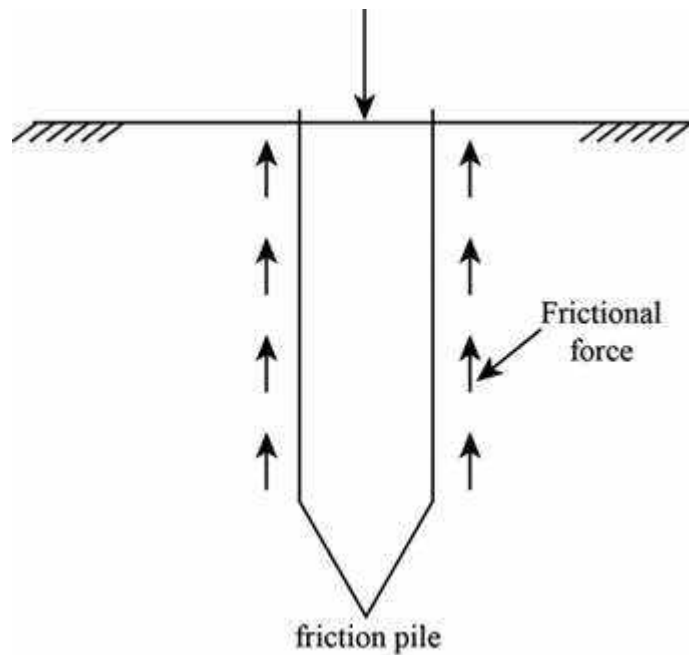

According to material piles are as follow

- a) Concrete pile
- b) Wooden pile or Timber pile
- c) Steel pile
- d) Composite pile

Concrete pile:

These piles are made up of concrete. The diameter of these pile varies from 30 to 50 cm. Minimum length of these pile is not taken less than 20 meters and maximum it can be taken till 30 meters. Concrete piles are manufactured either by precast or cast in situ method.



Wooden pile or Timber pile:

As the name suggests these piles are made up of wood. For these piles, seasonal Timber wood is used. The diameter of the timber pile varies in between 20 to 50 cm. Length of a pipe

is taken 20 times that of its diameter. The maintenance cost of these piles is more because as it is wood if it comes in contact with water then it can be damaged by fungus or white ants. So care has to be taken.



Steel pile:

These files are generally in shape of 'I' or hollow section. It can be easily driven in the soil because it has a very small cross-sectional area. These piles can be used as a bearing pile but cannot be used as friction piles because if we use them as a friction pile it can sunk in the soil due to structural load.



Composite pile:

When the piles are made from more than one material they are known as composite pile. These piles are made from concrete and wood. These piles are used in those areas where the water table is up. These piles are used in such conditions just because concrete and wood both are good water absorbers.



Raft foundation:

The raft foundation is a very commonly used type of foundation system. Raft foundation is also known as Mat foundation. Raft foundation is actually a thick concrete slab resting on a large area of soil reinforced with steel, supporting columns or walls and transfer loads from the structure to the soil. Usually, mat foundation is spread over the entire area of the structure it is supporting.

Raft foundation is generally used to support structures like residential or commercial buildings where soil condition is poor, storage tanks, silos, foundations for heavy industrial equipment etc.

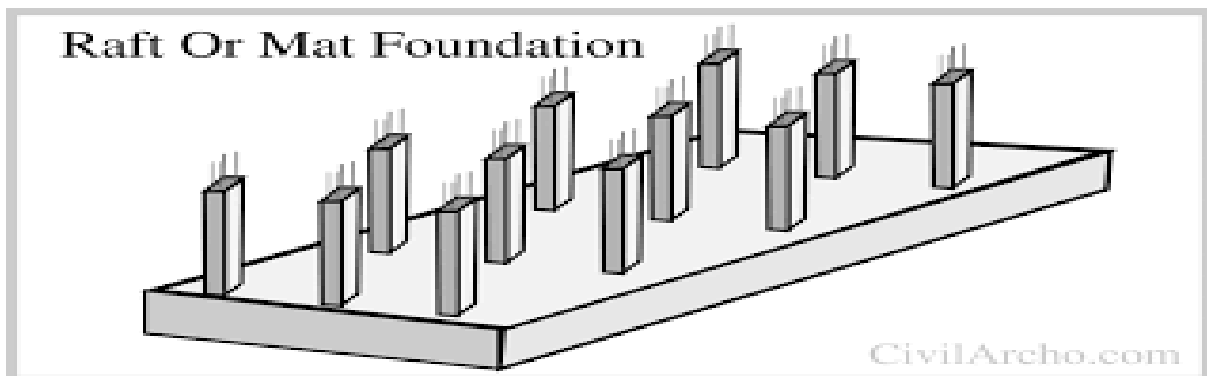

Raft foundation is preferred when: -

- The soil has a low bearing capacity.
- Load of the structure has to be distributed over a large area.
- Individual or any other foundation area would approximately cover 50% of the total ground area beneath the structure.
- The columns or walls are placed so closely that the individual footings would overlap.
- Stress on soil needs to be reduced.
- There is a possibility of differential settlement in case individual footing is used.

- When soil strata are unpredictable and contain pockets of compressible soil.
- Basement is to be constructed.
- Any other type of footing cannot be used advantageously.

Grillage foundation:

A foundation made of two or more than two-tier beams superimposed in a concrete layer to distribute the load over a large area refer to grillage foundation. The beams are placed at the right angle to disperse the load evenly. It is suitable when the load transmitted by a column or wall is hefty, and bearing capacity of the soil is deficient. It also helps to eliminate the deep excavation for the foundation. It is provided at column's base.

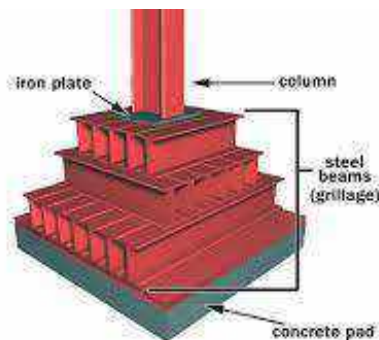

Based on material there are two types of grillage foundation.

- a) Steel grillage
- b) Timber grillage

Steel grillage:

This foundation consists of one or two-tier of RSJ (Rolled Steel Joints) embedded in cement concrete. RSJs used in this foundation are also known as grillage beams. In this foundation the depth is limited to 1m to 1.5m, and the width is increased considerably to pressure the soil with in the permissible limit.

Timber grillage:

Timber grillage consists of timber planks, and timber beams can also be used to support heavy loads on weak soils. This foundation is suitable for the ground that always remains water logged. In this foundation, no concrete block is used, but instead, the timber platform is used that consists of 50mm to 75 mm thick wood planks installed touching each other.

2. BRICK MASONRY:

Masonry is bricks or pieces of stone which have been stuck together with cement as part of a wall or building. **Masonry** is the bricks and pieces of stone that are used to make a building.

Brick masonry is defined as the placement of bricks in a systematic manner using mortar to bind the bricks together and create a solid mass that can withstand a great deal of pressure.

General principle

1. Good brick masonry should utilize bricks, which are sound, hard, well burnt and tough with uniform colour, shape and size.
2. The bricks should be compact, homogeneous, free from holes, cracks, flaws, air-bubbles and stone lumps and soaked in water for at least two hours before use.
3. In the brickwork, the bricks should be laid on their beds with the frogs pointing upwards.
4. The brick courses should be laid truly horizontal and should have truly vertical joints.
5. As far as possible the use of brick – bats should be discouraged.
6. As far as possible the brick wall should be raised uniformly less than 1.5m in day with proper bond.
7. When the mortar is green the face joints should be raked to a depth of 12 to 19mm in order to have a proper key for plastering or pointing.
8. In order to ensure continuous bond between the old and new, the wall should be stopped with a toothed end.
9. Finished brick work should be cured for a period of 2-3 weeks for lime mortar and 1-2 weeks for cement mortar.

Characteristics of brick bond or rules for bonding:

1. The brick masonry should have bricks of uniform shape and size.
2. For satisfactory bondage the lap should be one-fourth of the brick along the length of the wall and half brick across thickness of the wall.
3. The vertical joints in the alternate courses should coincide with the centre line of the stretcher.
4. The alternate courses the centre line of header should coincide with the centre line of stretcher, in course below or above it.
5. The stretcher should be used only in the facing while hearting should be done in the headers only.

Types of bond:

- a) **Stretcher Bond**: It is the most commonly used bond. In this a pattern is made only using stretchers, with the joints on each course centred above and below by half a brick. This type of bonding is not particularly strong.

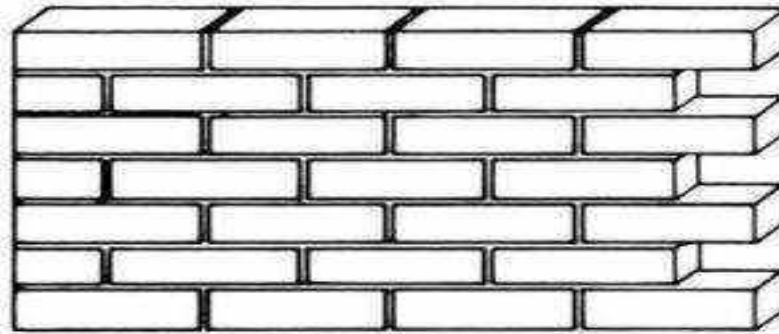

Stretcher bond

- b) English Bond: This is a pattern formed by laying alternate courses of stretchers and headers. The joints between the stretchers are centred on the headers in the course below. This is one of the strongest bonds but requires more facing bricks than other bonds.

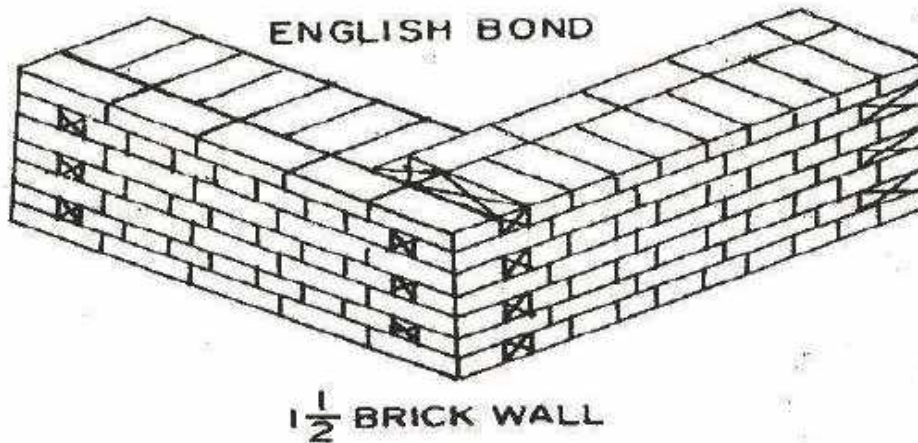

- c) English Garden Wall: This is similar to the English bond but with one course of headers for every three courses of stretcher. The headers are centred on the headers in course below. This gives quick lateral spread of load and uses fewer facings than an English bond.



- d) English Cross Bond: This alternates courses of stretchers and headers, with the alternating stretcher course being offset by half a brick. The stretchers are centred on the joints between the stretchers below them, so that the alternating stretcher courses are aligned. Staggering stretchers enables patterns to be picked out in different texture or coloured bricks.

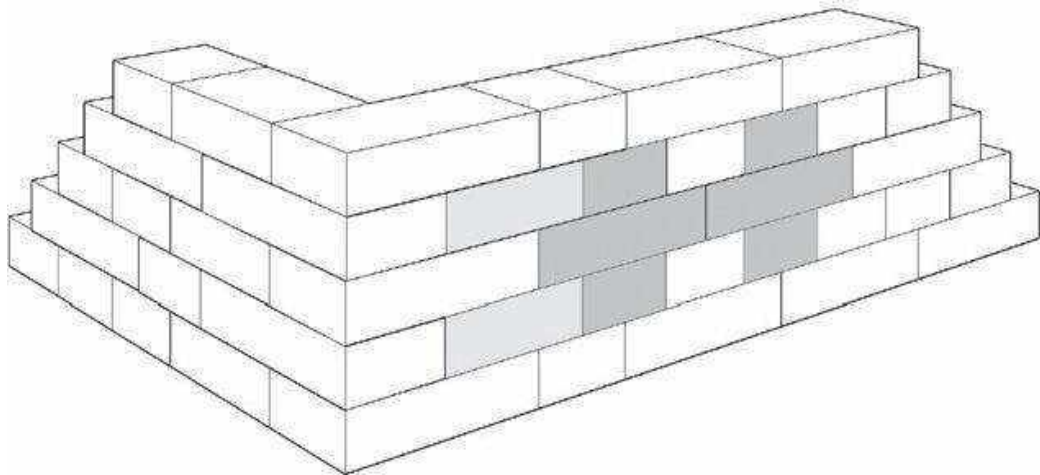

e) Flemish Bond:

This is formed by laying headers and stretchers alternately in each course. The headers of each course are centred on the stretchers of the course below. This bond is strong and often used for walls which are two-bricks thick.

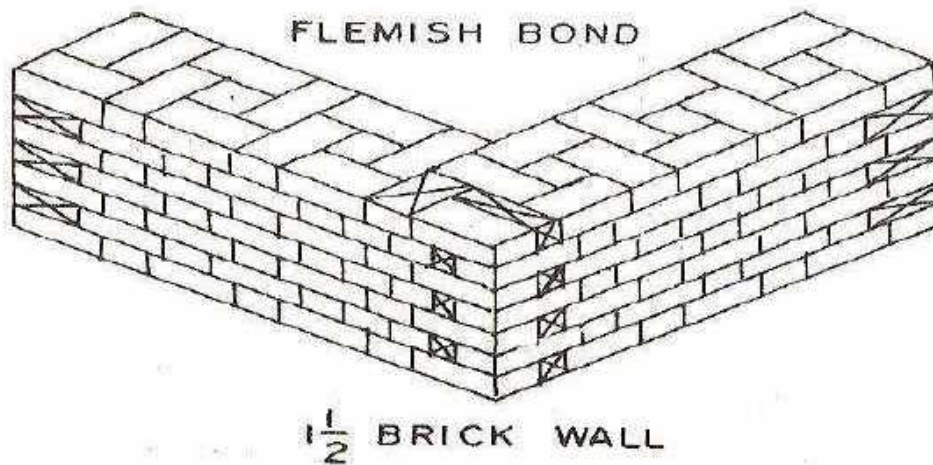

f) Double Flemish Bond:

In this type, alternate heads and stretchers are laid in each course. The facing and backing are of the same appearance brickbats and queen closers are used.

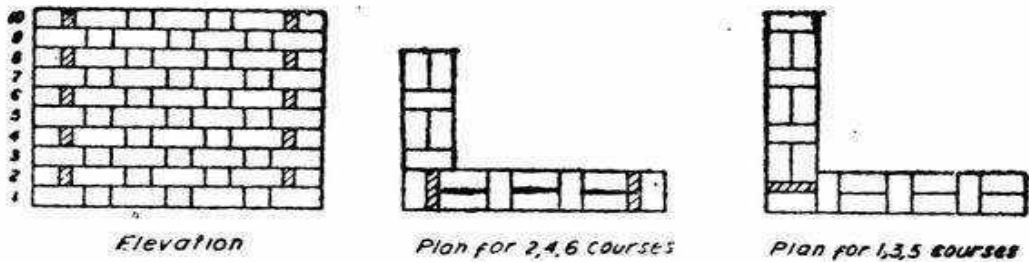

One-brick wall double flemish bond.

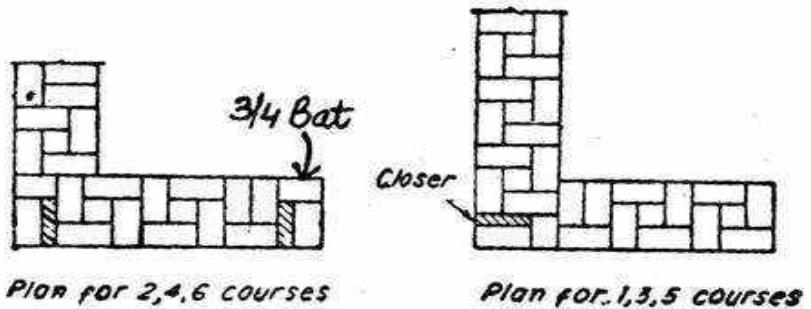

One-and-a-half-bricks double flemish bond.

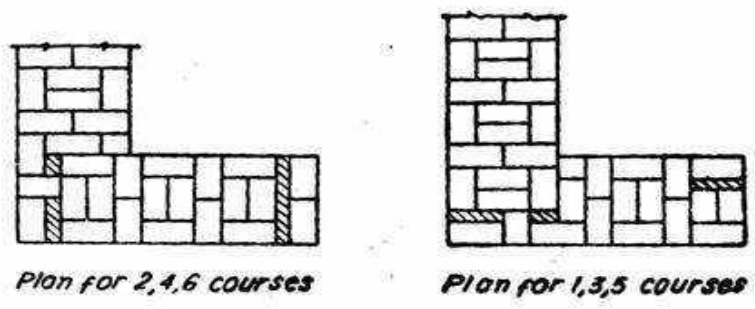

Two-bricks double flemish bond.

g) Flemish Garden Wall:

This is also called as Sussex Bond. This variant of Flemish bond uses one header to three stretchers in each course. The header is centred over the stretcher in the middle of a group of three in the course below.

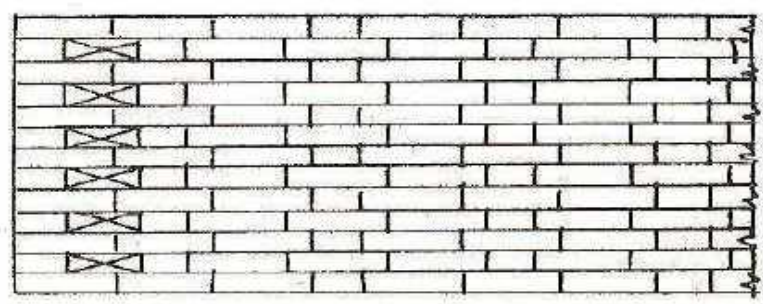

Elevation of wall in Flemish garden wall bond

- h) Monk Bond: This variant of Flemish bond involves two stretchers between the headers in each course. The headers are centred over the join between the two stretchers in the course below.

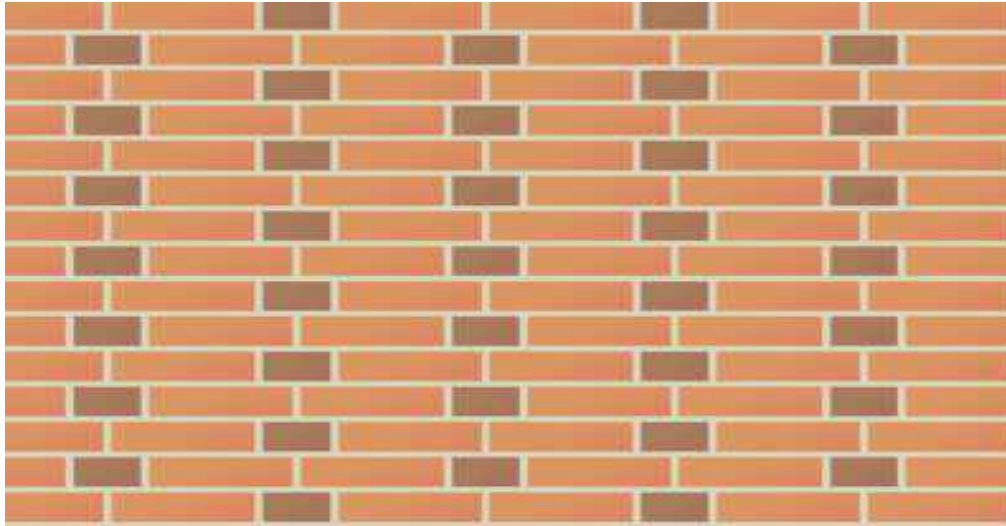

- i) Header Bond: This bond features courses of headers offset by half a brick. It is similar to the stretcher bond but with headers instead of stretchers.

HEADER BOND

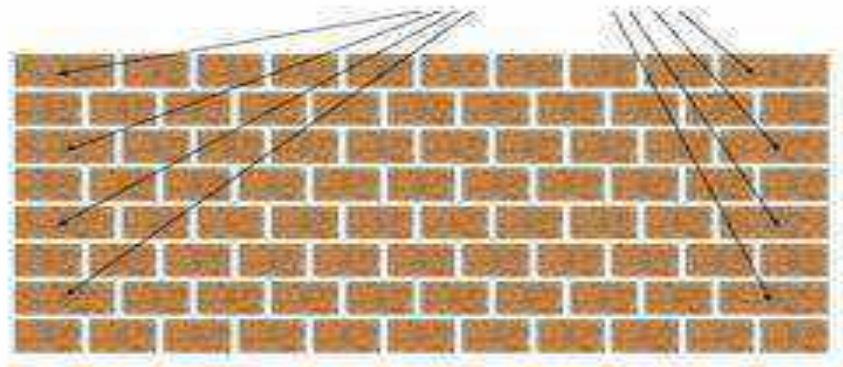

Merits of English bond

1. Avoids repetition of header faces in each course.
2. Often distinctly different from the colour of stretcher faces.
3. Provides good strength.
4. Provides good stability.
5. No strict supervision and skill is demanded.
6. Can be preferred if plastering of finished wall is to be done.

Demerits of English Bond

1. Penetration of damp through transverse joint.
2. The appearance is not good as Flemish bond.
3. Quick oxidation.
4. Expensive as compared to Flemish bond.

Merits of single Flemish bond

1. It provides better appearance.
2. It can be made more economical by using cheap quality of bricks on the back of the wall.
3. Economical as compared to English bond.
4. Can be preferred if only pointing is to be done to the finished wall.

Demerits:

1. It weakens the overall strength of the wall because of maximum use of brick bats and existence of continuous vertical joints.
2. It cannot be provided in walls having thickness less than one and half brick.
3. Less strong and compact compared to English bond.
4. Requires good workmanship and careful supervision.

Merits of double Flemish bond

1. Each Course has headers and stretchers placed alternately.
2. The facing and backing of the wall have the same appearance.
3. In alternate courses, quoin closers are placed next to quoin headers.

Demerits

1. Comparatively weaker than English bonds
2. Requires skilled labour.

3. STONE MASONRY:

The construction of stones bonded together with mortar is termed as stone masonry.

General Principle of Stone masonry

- The stones which are used in the construction of stone masonry should be hard, tough, and durable.
- The pressure which is acting on the stones should be in the vertical plane.
- The heads and the stones should not be of dumb bell shape.
- The stone should be dressed properly as per the requirements.
- A large flat stone should be used under the ends of girders and trusses to uniformly distributed loads.
- The water which is used in the construction of the stone masonry should be of good quality.

- The plumb bob should be used to check the accurate verticality of the stone masonry walls.
- Stonemasonry should be design to take the compressive stresses and not tensile stresses.
- The stone masonry section should always be designed to take compression and not the tensile stresses.
- The properly wetted stones should be used to avoid mortar moisture being sucked

Points to remember for stone masonry: -

1. Try to lay sedimentary stones (limestone and sandstones) so their natural bedding planes (BP) are horizontal, not vertical with the natural cleft (NC) face exposed.
2. No stone should be laid taller than it is long, except at corners.
3. Avoid block or running joints only one stone on at least one side of a vertical joint.
4. Avoid setting more than three stones against a riser.
5. Risers should be evenly distributed throughout the wall. Grouping together of like-sized stones should be avoided.
6. Avoid using more than two stones of the same size on top of each other.
7. Unless by design, avoid the lining up of vertical joints in alternate courses.
8. Generally, risers should never touch except at corners and openings (jambs).
9. Don't allow horizontal joints to run more than four or five feet. If possible, break up the horizontals on short stretches between windows and doors.
10. Try to provide a substantial bonding lap. A minimum of a quarter, and ideally a third, of the length of a stone being set should cross the joint between the stones below it.

Types of stone masonry

Based on the arrangement of the stone in the construction and degree of refinement in the surface finish, the stone masonry can be classified broadly in the following two categories

1. Rubble masonry
2. Ashlar masonry

Rubble Masonry

In this category, the stones used are either undressed or roughly dressed having wider joints. This can be further subdivided as uncoursed, coursed, random, dry, polygonal and flint.

- I. Uncoursed Rubble Masonry: This is the cheapest, roughest and poorest form of stone masonry. The stones used in this type of masonry very much vary in their shape and size and are directly obtained from quarry. Uncoursed rubble masonry are again subdivided into following type.
 - a) Uncoursed random rubble
 - b) Uncoursed square rubble

Uncoursed random rubble

The weak corners and edges are removed with mason's hammer. Generally, bigger stone blocks are employed at quoins and jambs to increase the strength of masonry.

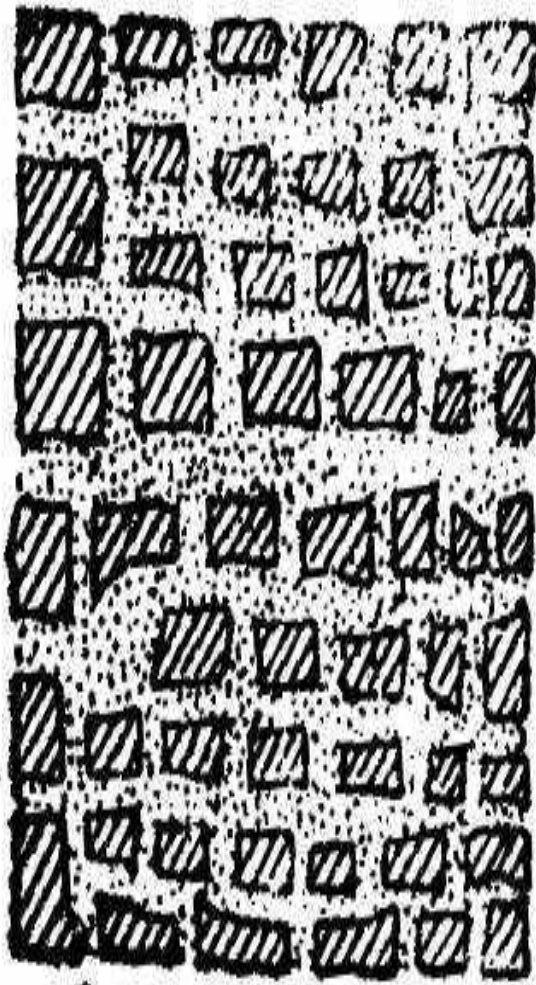

Elevation



Section

(Uncoursed random rubble masonry)

Uncoursed square rubble

In this type the stone blocks are made roughly square with hammer. Generally the facing stones are given hammer-dressed finish. Large stones are used as quoins. As far as possible the use of chips in bedding is avoided.

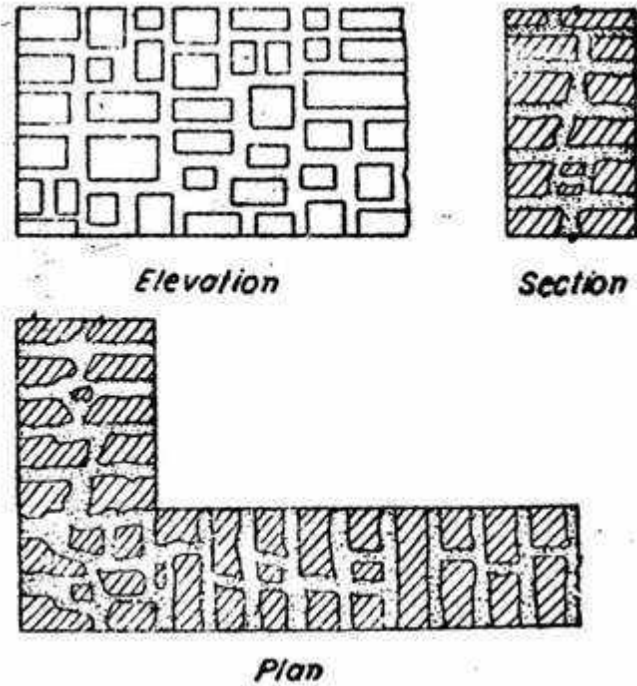

(Uncoursed square rubble masonry)

- II. Coursed Rubble Masonry: This type of masonry is commonly used in the construction of low height walls of public buildings, residential buildings, abutment and piers of ordinary bridges. The stones of 5 to 20cm size are used in each course.

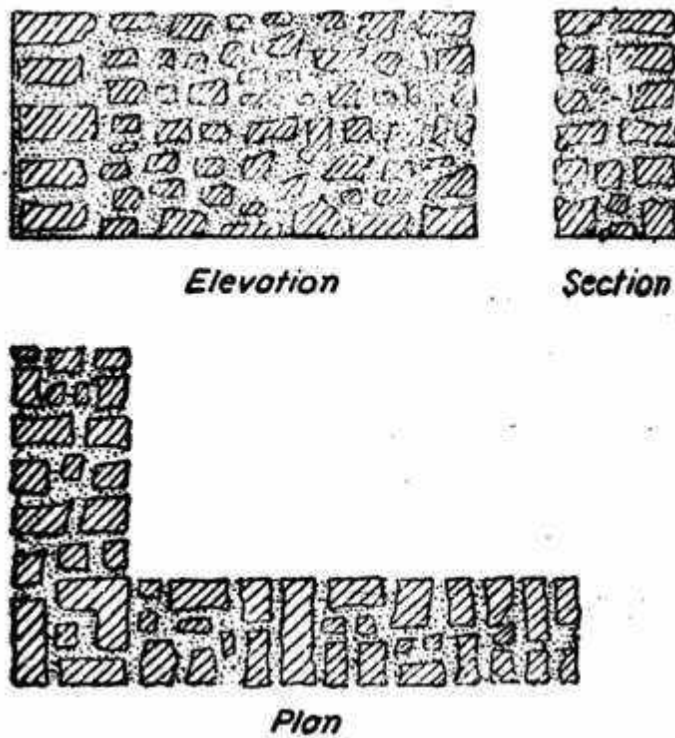

(Coursed Rubble Masonry)

- III. Coursed Square Rubble: This type of masonry is made up of hammer squared stones facing with bonded backing of uncoursed random rubble masonry. The stones employed in each course are of equal height. The backing and facing construction should be carried simultaneously. In order to avoid thick mortar joints, small chips may be used.

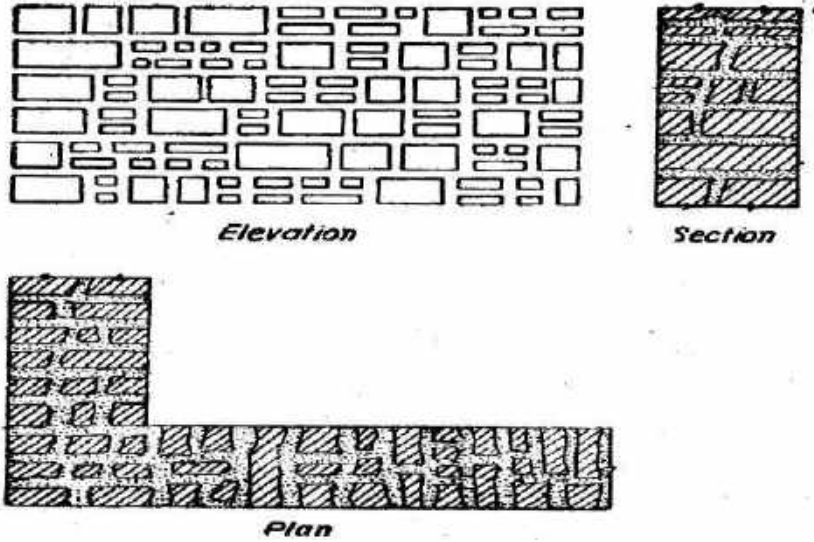

(Coursed Square Rubble)

- IV. Built to regular course: In this type of stone masonry the uniform height stones are used in horizontal layers not less than 13cm in height. Generally, the stone beds are hammered or chisel dressed to a depth of at least 10cm from the face. The stones are arranged in such a manner so that the vertical joints of two consecutive course do not coincide with each other.

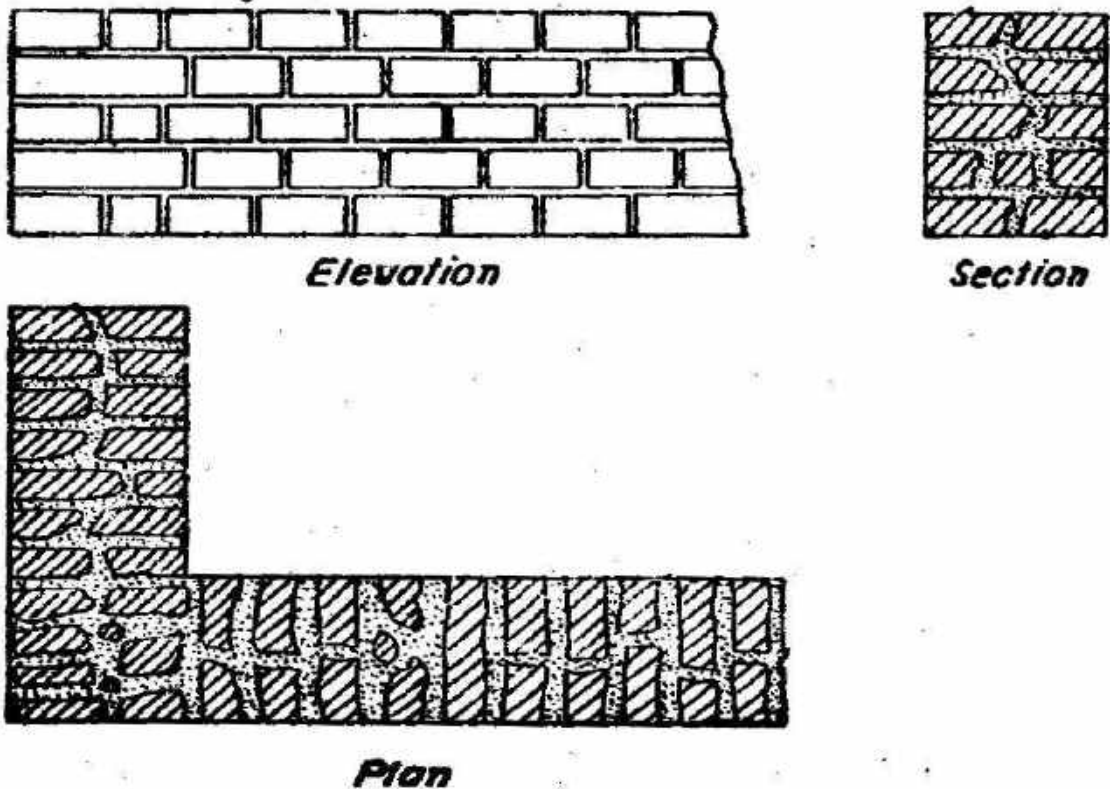

(Built to regular course)

- V. Polygonal rubble masonry: In this type of masonry the stones are roughly dressed to an irregular polygonal shape. The stones should be so arranged as to avoid long vertical joints in face work and to break joints as much as possible. Small stone chips should not be used to support the stones on the facing.

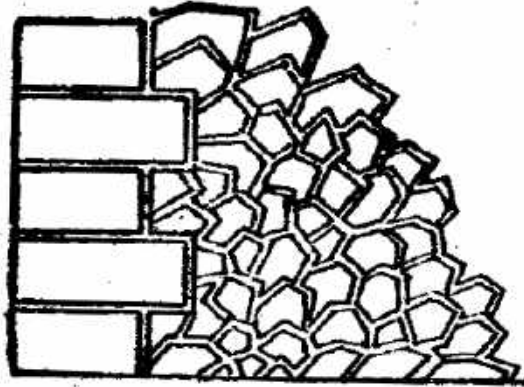

Inferior

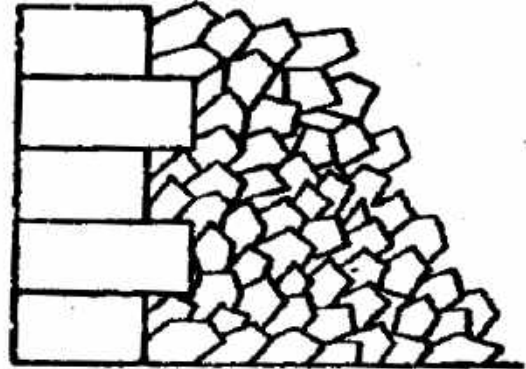

Superior

(Polygonal rubble masonry)

- VI. Flint rubble masonry: This type of masonry is used in the areas where the flint is available in plenty. The flint stones varying in thickness from 8 to 15cm and in length from 15 to 30 cm are arranged in the facing in the form of course or uncoursed masonry.

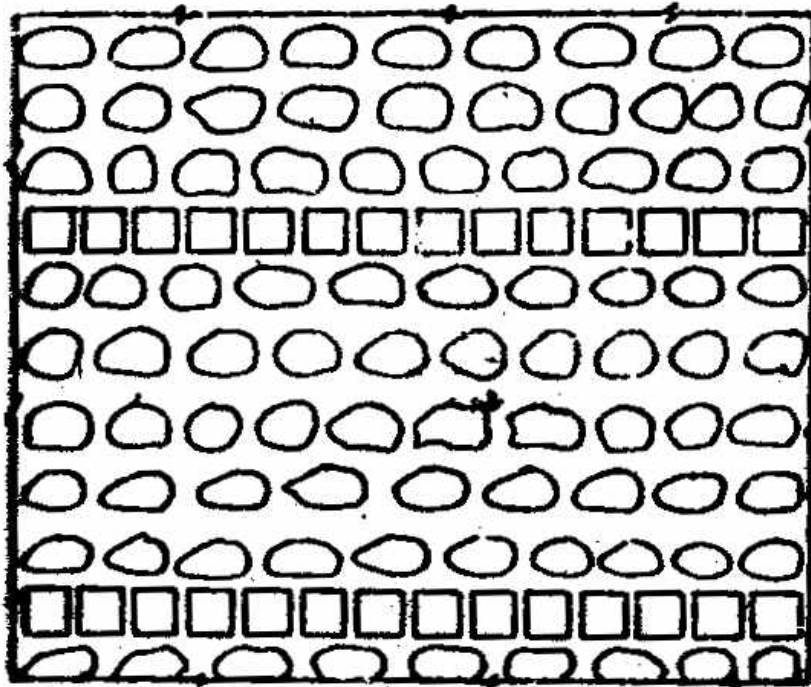

Elevation

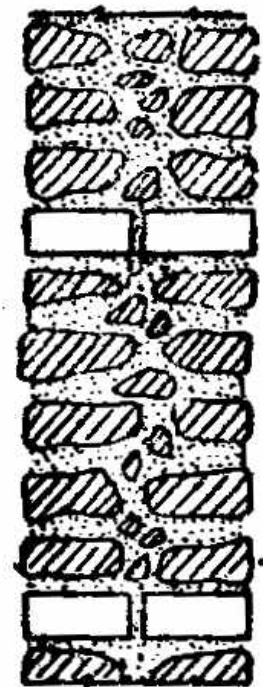

Section

(Flint rubble masonry)

VII. Dry rubble masonry: This type of masonry is used in the construction of retaining walls pitching earthen dams and canal slopes in the form of random rubble masonry without any mortar. The hallow spaces left around stones should be tightly packed with smaller stone pieces.

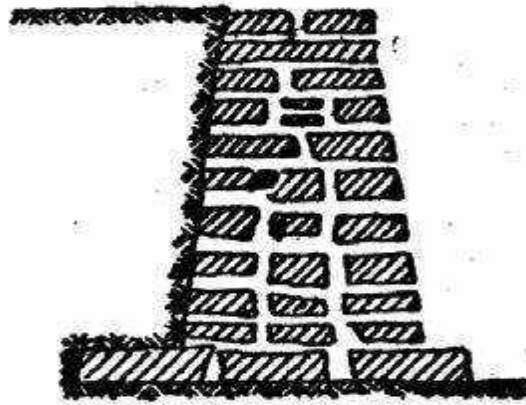

(Dry rubble masonry)

Ashlar Masonry:

This type of masonry is built from accurately dressed stones with uniform and fine joints of about 3mm thickness by arranging the stone blocks in various patterns. The backing of ashlar masonry walls may be built of ashlar masonry or rubble masonry. The size of stones blocks should be in proportion to wall thickness. The various types of masonry can be classified under the following categories.

- (i) Ashlar fine
- (ii) Ashlar rough
- (iii) Ashlar rock or quarry faced
- (iv) Ashlar facing
- (v) Ashlar chamfered
- (vi) Ashlar block in course

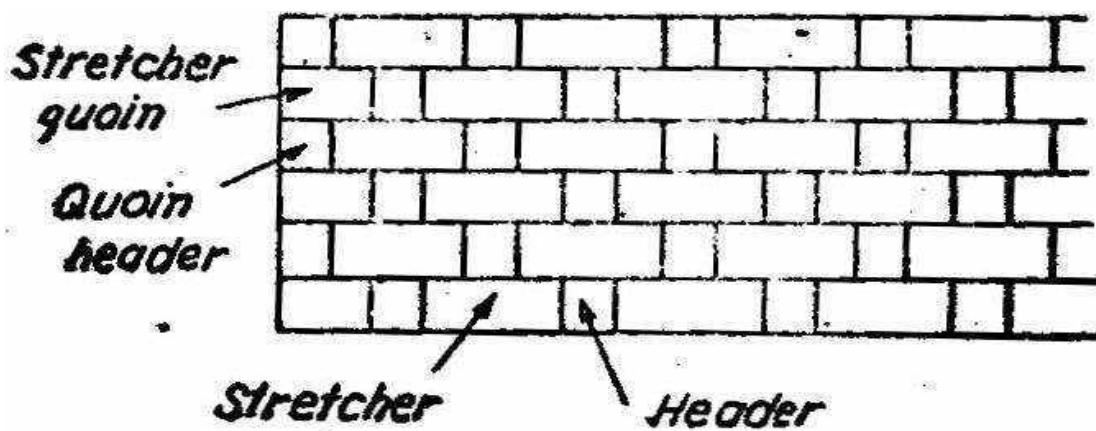

(Ashlar fine)

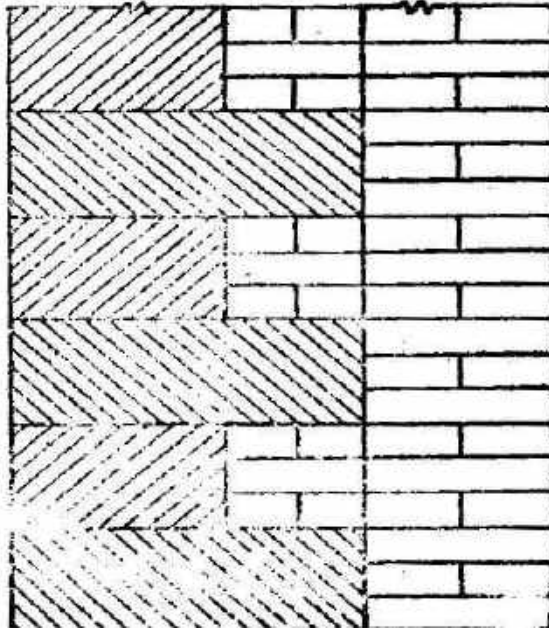

(Ashlar facing)

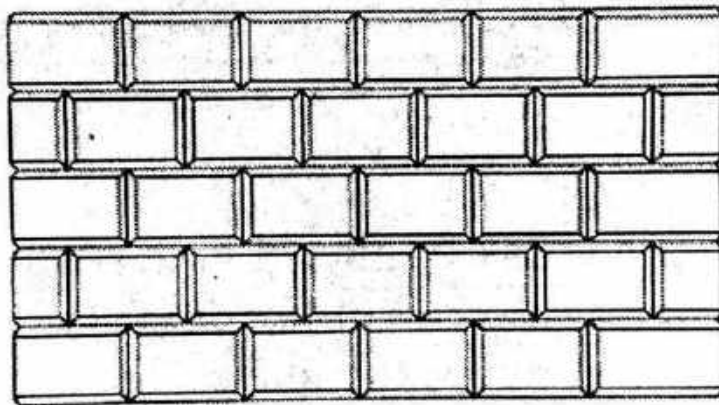

(Ashlar chamfered)

Merits of stone masonry

1. Provides great strength.
2. Offers good resistance to weather effects.
3. As stone is able to withstand wear, pressure, and damage it provides good durability.
4. Stones come in a variety of textures, sizes, and even colours so provides variety of option for aesthetical purpose.
5. Due to its durability, the buildings constructed through stone masonry require very little maintenance.

Demerits:

1. The stones used are heavy and produce thick walls.
2. It requires skilled worker.
3. Due to the thickness and heavyweight of the stones, handling these aspects can be challenging and accidents can easily happen.
4. The construction cost of stone masonry is a bit on the higher side because of the skilled labour required, the expensive equipment to be used and many other costs incurred.
5. Stones are mostly found in designated areas such as quarries and therefore, transportation of these stones to the sites is necessary. This is then more costly because of the weight of the stones.
6. The total construction period takes a lot of time.

4. CAVITY WALL:

Cavity walls are constructed with two separate walls for single wall purpose with some space or cavity between them. These two separate walls are called as leaves of cavity wall. The inner wall is called as internal leaf and outer wall is called as external leaf. Cavity wall is also called as Hollow wall.

For non-load bearing cavity wall, two leaves are of equal thickness or sometimes internal leaf with more thickness is provided. The cavity size should be in between 4 to 10cm. The internal and external leaves should have at least 10mm thickness. The two leaves are interconnected by metal ties or links

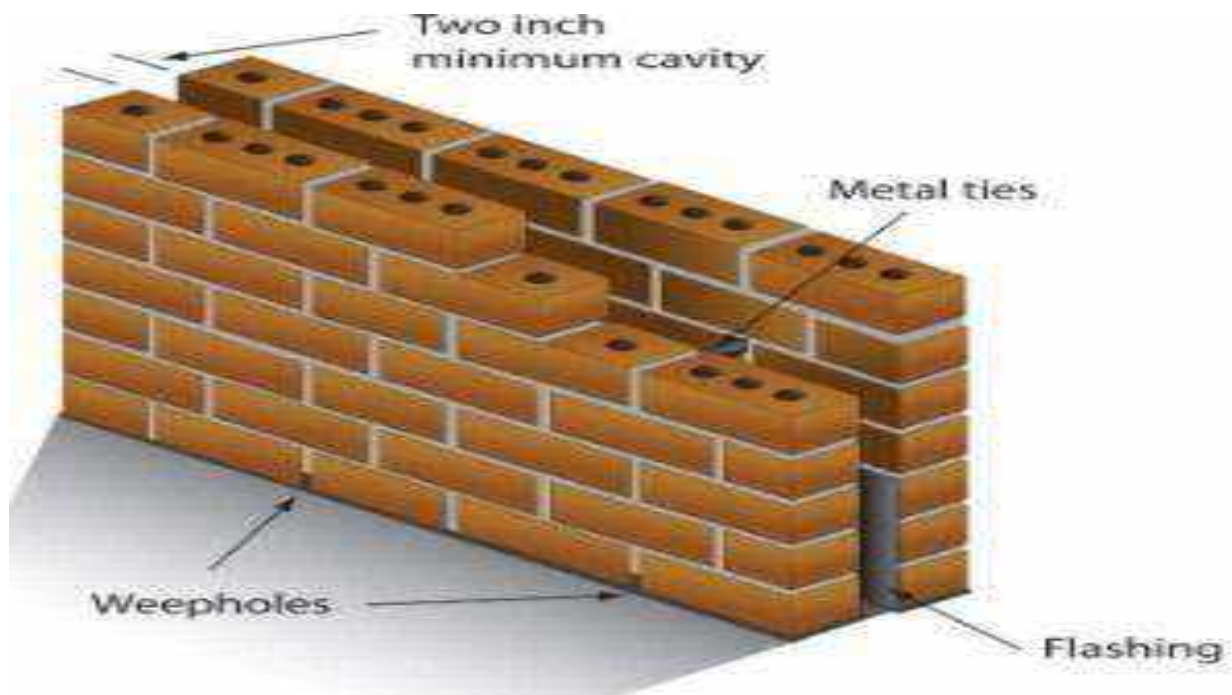

Construction of cavity wall

In general, cavity wall doesn't require any footings under it, just a strong concrete base is provided on which cavity wall is constructed centrally. Two leaves are constructed like

normal masonry, but minimum cavity must be provided in between them. The cavity may be filled with lean concrete with some slope at top up to few centimetres above ground level.

Weep holes are provided for outer leaf at bottom with an interval of 1 m. Normal bricks are used for inner leaf and facing bricks are used for outer leaf. Different masonry is also used for cavity wall leaves. The leaves are connected by metal ties or wall ties, which are generally made of steel and are rust proof.

The maximum horizontal spacing of wall ties is 900mm and maximum vertical spacing is 450mm. The wall ties are provided in such a way that they do not carry any moisture from outer leaf to inner leaf. Different shapes of wall ties.

To prevent mortar dropping in cavity, wooden battens are provided in the cavity with suitable dimensions. These battens are supported on wall ties and whenever the height of next wall tie location is reached, then the battens are removed using wires or ropes and wall ties are provided.

Two leaves should be constructed simultaneously. Spacing should be uniform and it is attained by predetermining the location of wall ties. Damp proof course is provided for two leaves separately. In case of doors and windows, weep holes are provided above the damp proof course.

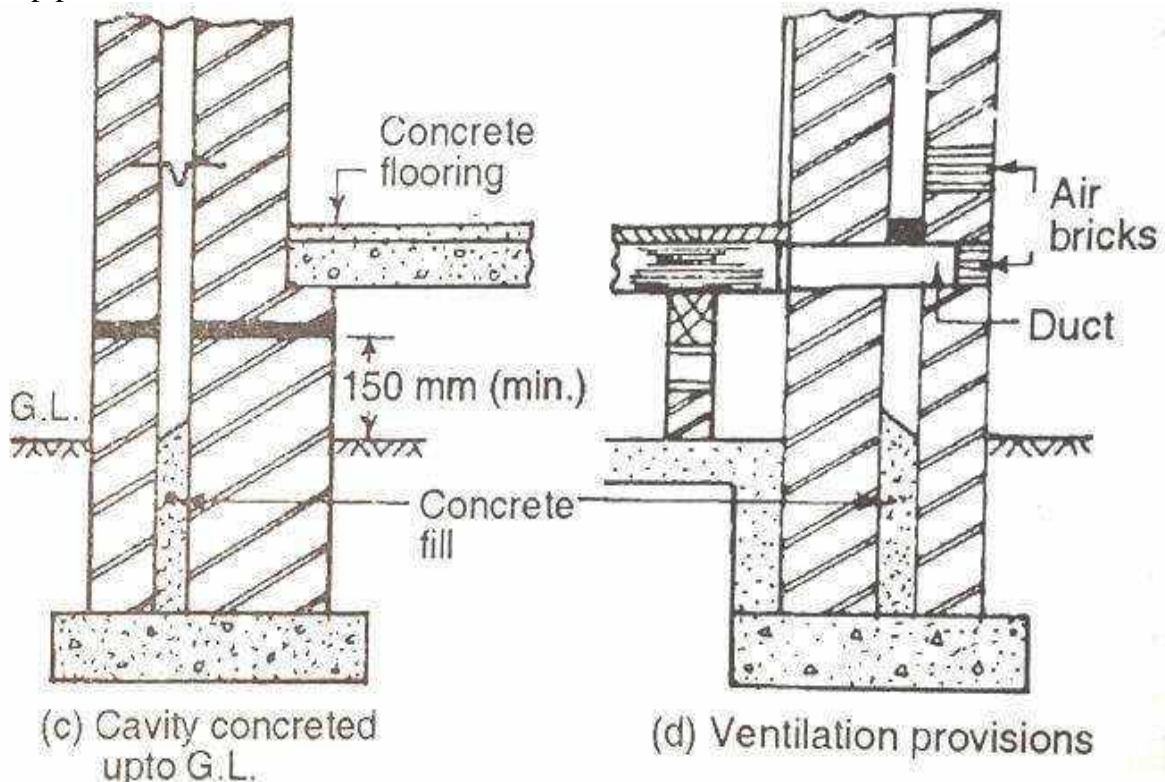

Components

Cavity wall consists of 3 main parts

1. The outer leaf, which is the exterior part of the wall
2. The cavity, the continuous open air space
3. The inner leaf, which is the interior part of the wall.

Purpose of providing cavity wall is:

1. Damp prevention
2. Thermal insulation
3. Sound insulation
4. Efflorescence

5. ARCH:

An arch is a vertical curved structure that spans an elevated space and may or may not support the weight above it, or in case of a horizontal arch like an arch dam, the hydrostatic pressure against it.

Terminologies

1. Intradose: This is the inner curve of arch.

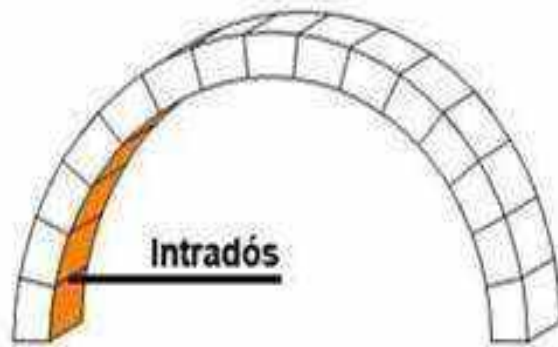

2. Soffit: This is the inner surface of the arch.

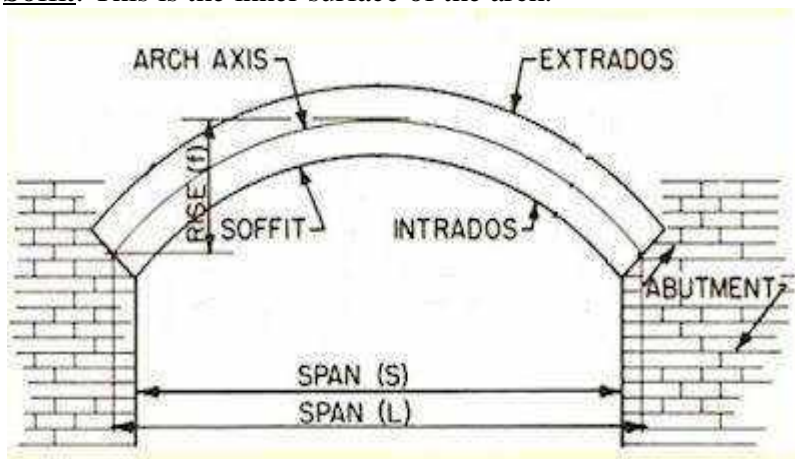

3. Extrados or Back: This is the external curve of an arch.
4. Voussoirs: These are the wedge-shaped units forming the courses of an arch.

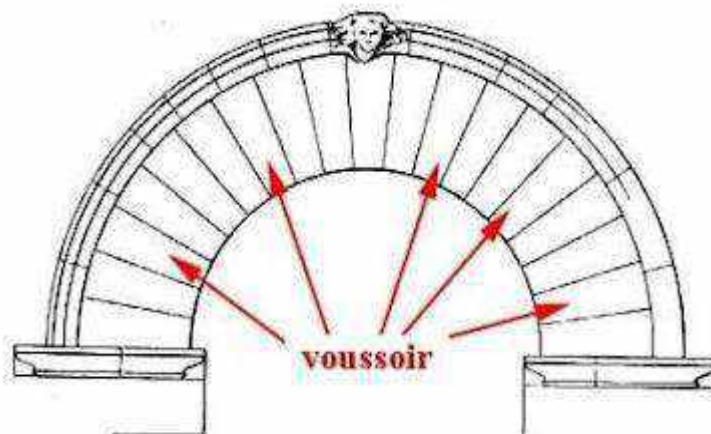

5. Crown: This is the highest point of the extrados.

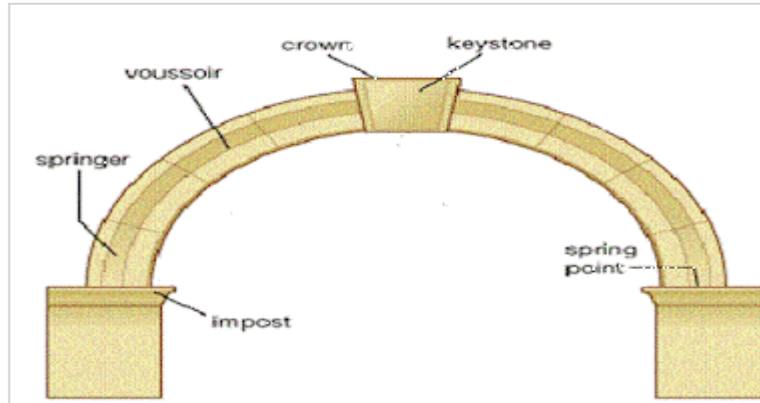

6. Key: This is the wedge-shaped unit at the crown of an arch.

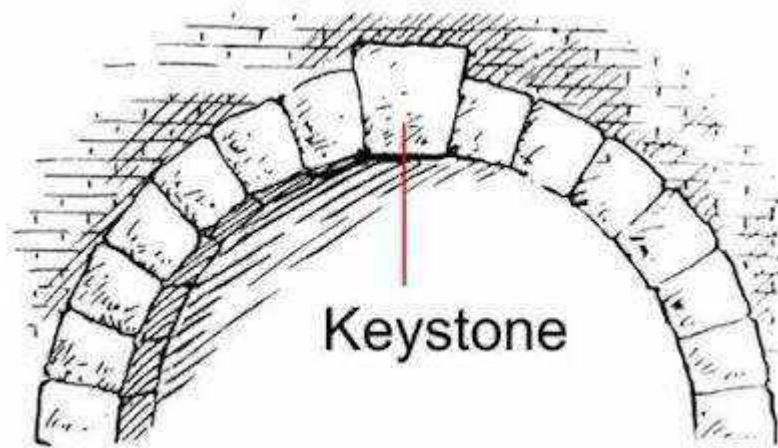

7. Arcade: This is a row of arches supporting a wall above & being supported by the piers.
8. Abutment: This is the end supports of an arcade.
9. Piers: These are the intermediate supports of an arcade.

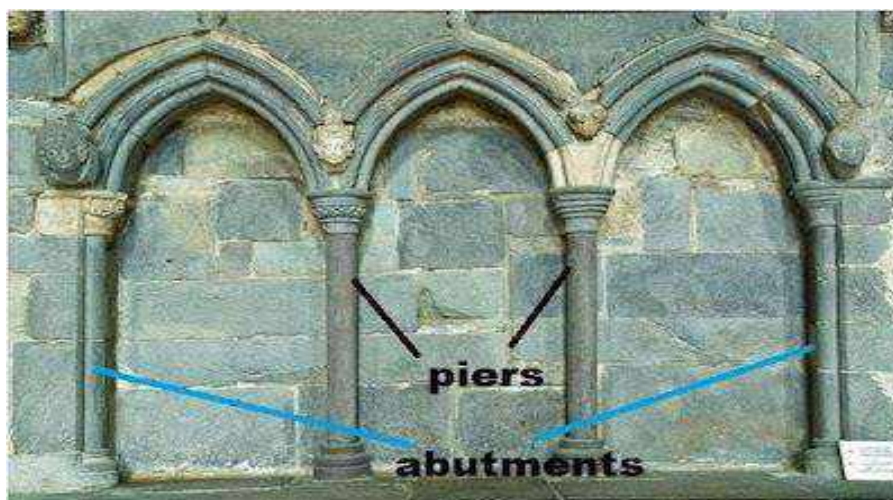

10. Springing point: These are the points from which the curve of an arch springs.

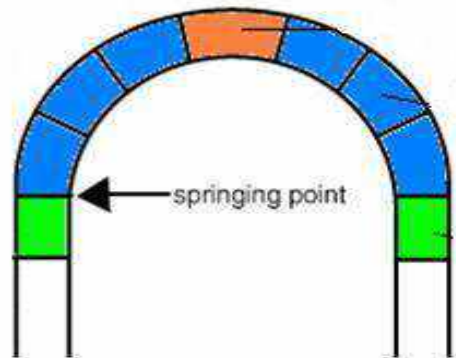

11. Springing line: This is the imaginary horizontal line joining the two springing points.

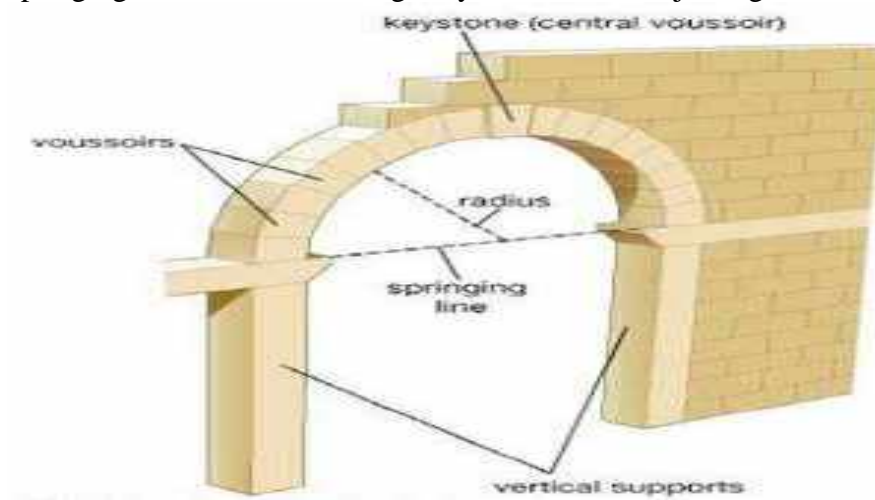

12. Skewback: This is the inclined or splayed surface on the abutment.



13. Springer: This is the first voussoir at springing level on either side of an arch & it is immediately adjacent to the skewback.

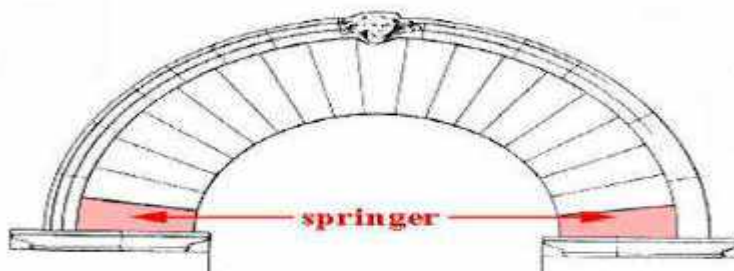

14. Span: This is the clear horizontal distance between the supports.

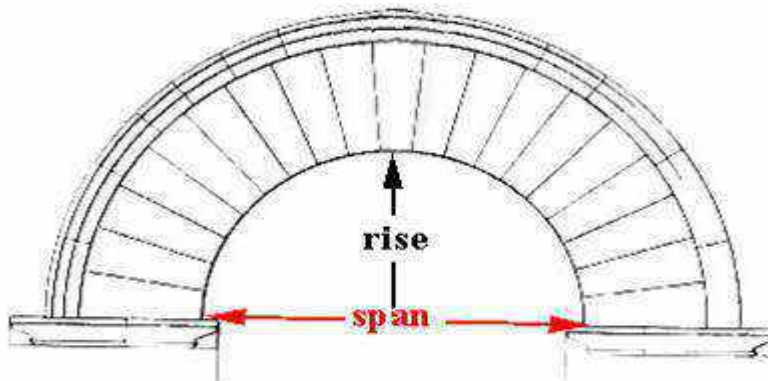

15. Rise: This is the clear vertical distance between the highest point on the intrados & the springing line.

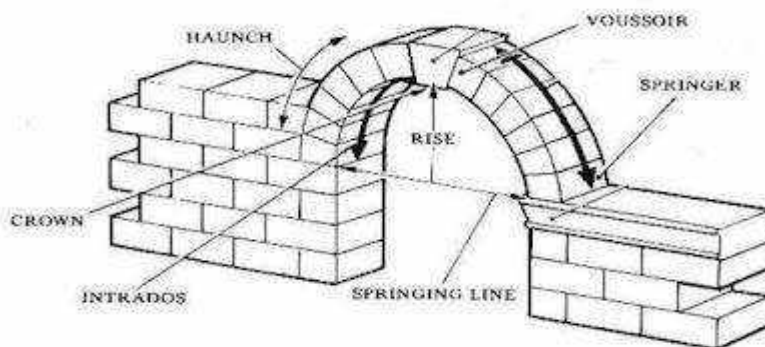

16. Centre: This is the geometrical centre of the curve of an arch.

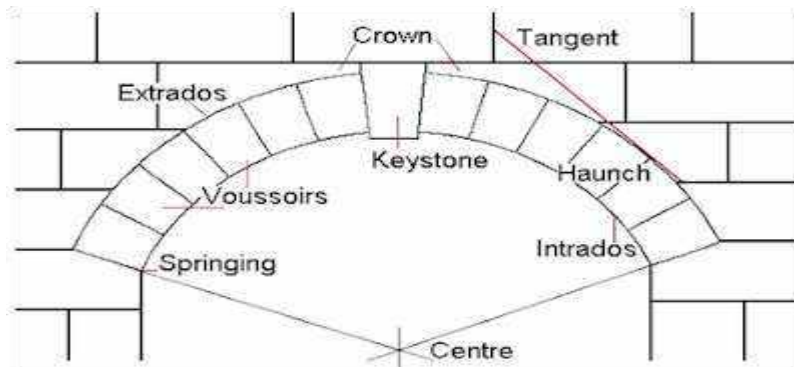

17. Ring: This is the circular course forming an arch.

18. Depth or height: This is the perpendicular distance between the intrados & extrados.

19. Spandrel: This is the irregular triangular space formed between the intrados & extrados.

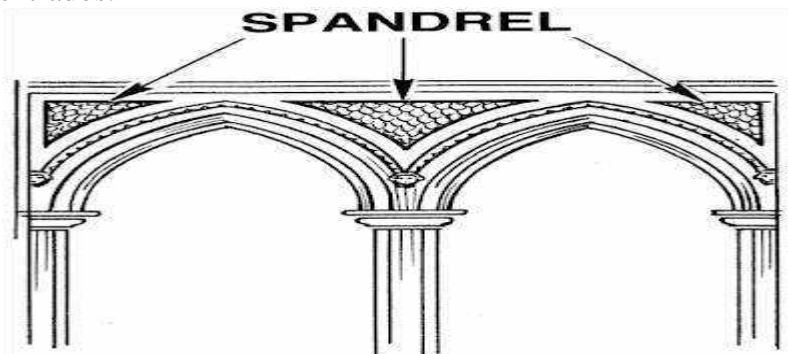

20. **Haunch:** This is the lower half portion of the arch between the crown & the skewback.
21. **Thickness or breadth of soffit:** The horizontal distance measured perpendicular to the front & back faces of an arch is known as the thickness or breadth of soffit.
22. **Impost:** The projecting course at the upper part of a pier or an abutment to stress the springing line is called the impost.

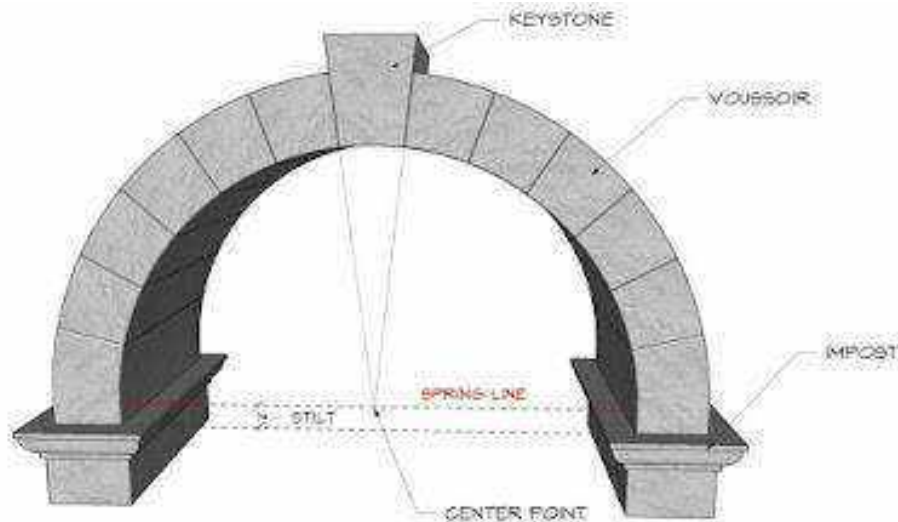

Types of arches

According to shape

- a) **Pointed shape:** The pointed shape arch carries two arcs of the circle which fulfil at the apex and sets a triangle.
- b) **Horseshoe shape:** its shape is like a horseshoe that curves better than the semicircle. The horseshoe arches are normally utilized for architectural provisions.
- c) **Flat arch:** The Flat arch creates an equilateral triangle within Intrados as a base at an angle of 60° degrees. The Flat arch is normally utilized for the construction of light load structures. The Extrados in the Flat arches is straight and Flat. The intrados is similarly Flat and provided a slight increase of camber of about 10 mm to 15 mm. A flat arch is generally the weakest arch.
- d) **Segmental arch:** The segmented arch is a type of arch in which a circular arc is less than 180° degrees. This type of arch is recognized as a Syrian arch. The segmental arch is one of the toughest arches which has a decent capacity to withstand thrust.
- e) **Semi circular arch:** The semi-circular arch is in the centre will lie on the spring line. In the semi-circular arch, the thrust transmitted to the abutment is completely in a vertical direction. The shape of the arch looks like a semi-circle.
- f) **Venetian arch:** A Venetian arch is a three-centred arch. It has a deeper depth at the crown than the springing line. Venetian arch is another form of the pointed arch. It includes four centres, all placed on the springing line.

- g) **Semi elliptical arch** : The semi-elliptical arch has a form of a semi-ellipse which has either 3 or 5 centres. The semi-elliptical arch is similarly recognized as the basket-handle arch.
- h) **Stilted arch**: The stilted arch is the type of arch in which the curve starts above the impost line. This arch contains a semicircular arch with two vertical parts at springing. The centre of the stilted arches on the straight line.
- i) **Relieving arch**: This type of arches is created above the Flat arch or on a wooden lintel. The major purpose of the Relieving arch is to give greater strength. The ends of this arch should be taken adequately into the abutments.

According to material used

- a) **Stone arches**: The stone arches are similarly sub-classified into two types as
 - Ashlar arches
 - Rubble arches
- b) **Brick arches**: these are also 3 types
 - Rough brick arch
 - Fine axed brick arch
 - Gauged brick arches
- c) **Concrete arches**: these are also 2 types
 - Monolithic concrete arches
 - Precast concrete arches

According to number of centres

1. One centred arch: The one-centred type of arches has simply one special centre. These types of arches which arrive under the classification of types of arches are semicircular arches, Flat arches, horseshoe arches, and segmental arches, etc.
2. Two centred arches: The two-centred type of arches has simply two centres. The pointed arches or gothic arches or lancet arches come under the category of two centred arches. Semi elliptical arches similarly come under this classification.
3. Equilateral arch: An Equilateral Arch possesses a two-centre. The Curves surface creates 2 Centre Points. The shape arrives at an equilateral Arch so-called an equilateral Arch.
4. Lancet arch: Lancet Arch appears in Two Centre Arch. The curved surface creates 2 centre points.
5. Venetian arch: Venetian Arch possesses 2 centres. Its curved surface is responsible for creating two numbers of centre points.
6. Three centred arch: These types of arches contain three centres. The elliptical arches as well as equilateral arches approach under the classification of three centred arches.
7. Four centred arch: These types of arches contain four centres. The Venetian arches come under the classification of four centre arches which have a sum of four centres. Tudor similarly comes under this category.
8. Five centred arches: The Five centre arches possess a total of five centres and it enables in getting a decent semi-elliptical shape.

6. DOORS:

A door is a movable barrier secured in an opening, known as the doorway, through a building wall or partition for the purpose of providing access to the inside of a building or rooms of a building. A door is held in position by doorframes, the members of which are located at the sides and top of the opening or doorway.

TYPES OF DOORS BASED ON PLACING OF COMPONENTS

1. Battened and legged doors

- Battens are vertical bonds which are having grooves are attached together by horizontal supports called ledges as shown in below figure.
- General Dimensions of batten are 100-150mm width and 20-30mm thick.
- General dimension of ledges are 100-200mm width and 25-30mm thick.
- This type of battened and ledged doors suitable for narrow openings.



2. Battened, legged and braced doors

- To make more rigid, braces are provided diagonally in addition to battens and ledges as shown in figure.
- Braces are having 100-150mm width and 25-30mm thickness are preferable.
- Braces should place upwards from handing side, then they acts as struts and take compression.
- These types of doors can be used for wider openings.



3. Battened, legged and framed doors

- For the simple battened and legged door, frame work is provided in the form of two verticals, known as stiles.
- Stiles are generally 100mm wide and as far as thickness is concerned, the thickness of stile should be equal to the combined thickness of ledge and batten. Preferably 40 mm.

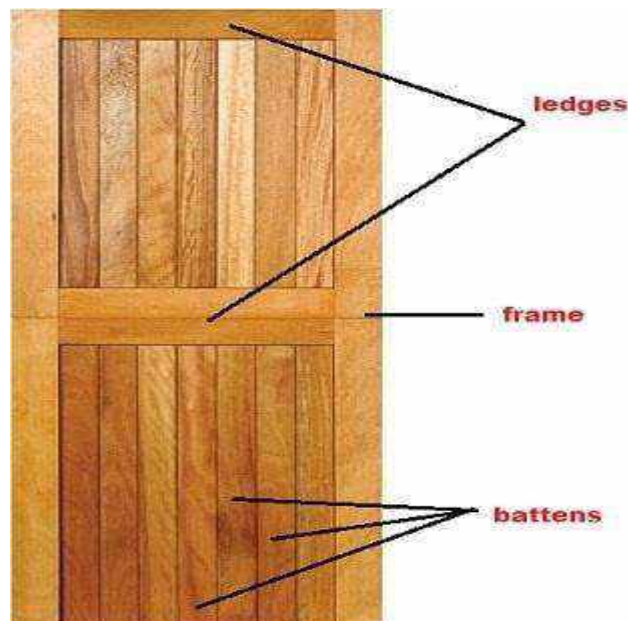

4. Battened, legged, braced and frame doors

- In this type, the door made up of battens, ledges, stiles and braces. So, it is more rigid.
- The braces are connected diagonally between the ledges, at about 40mm from the stiles.

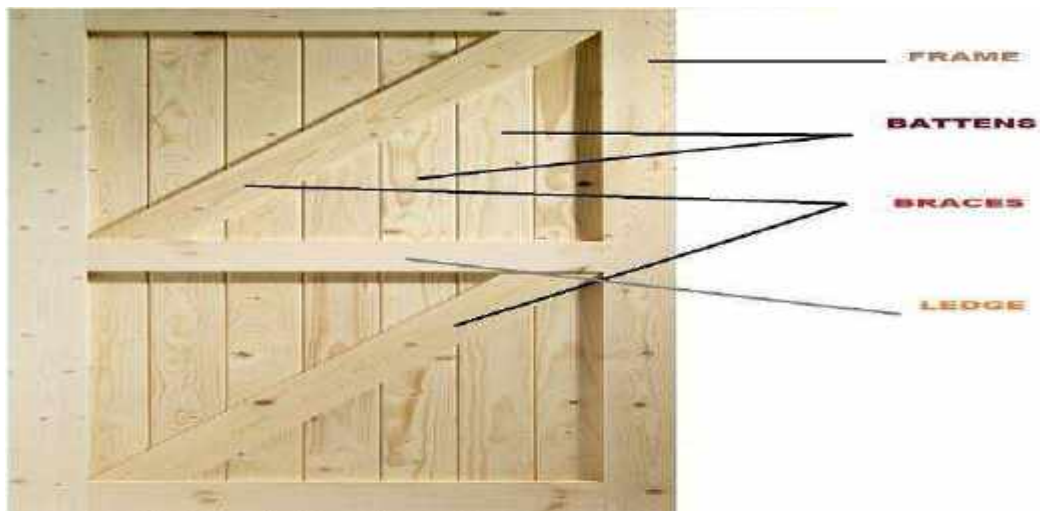

5. Framed and panelled doors

- These are very strong and will give good appearance when compared to battened doors. These are the widely used doors in almost all types of buildings.
- Stiles, vertical members and rails, horizontal members are grooved along the inner edges of frame to receive the panels.
- The panels are made up of timber or plywood or A.C. sheets or glass.
- These doors may be single leaf for narrow openings and double leaf for wider openings.
- Minimum width of stile should be 100mm and minimum width of bottom and locked rail should be 150mm.

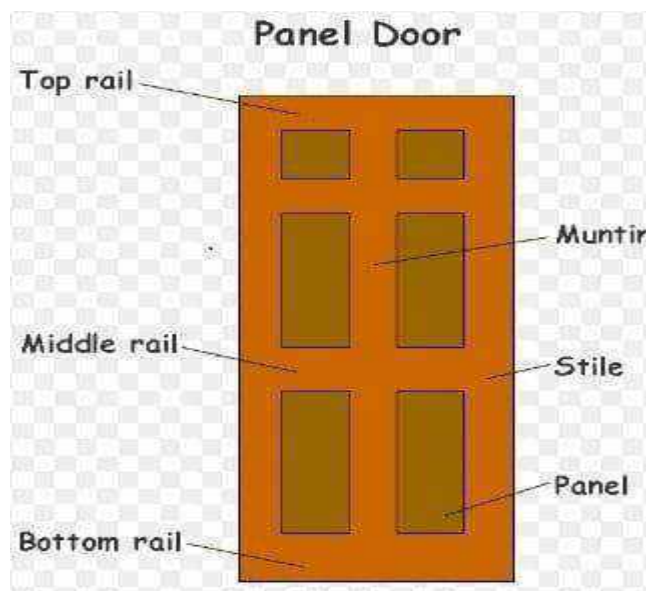

6. Glazed doors

- Glazed doors are generally provided in interior wall openings or in hospitals, colleges etc.

- The interior of room is visible through glazed doors and light also passes through glazed portion of the door.
- These may be fully glazed or partly glazed and partly panelled. Glass panels are provided for glazed doors.



7. Flush doors

In flush doors, a solid or semi-solid or core portion is covered on both sides with plywood or face veneer. Now days these types of doors are widely used because of good appearance, economic, ease of construction and greater durability.

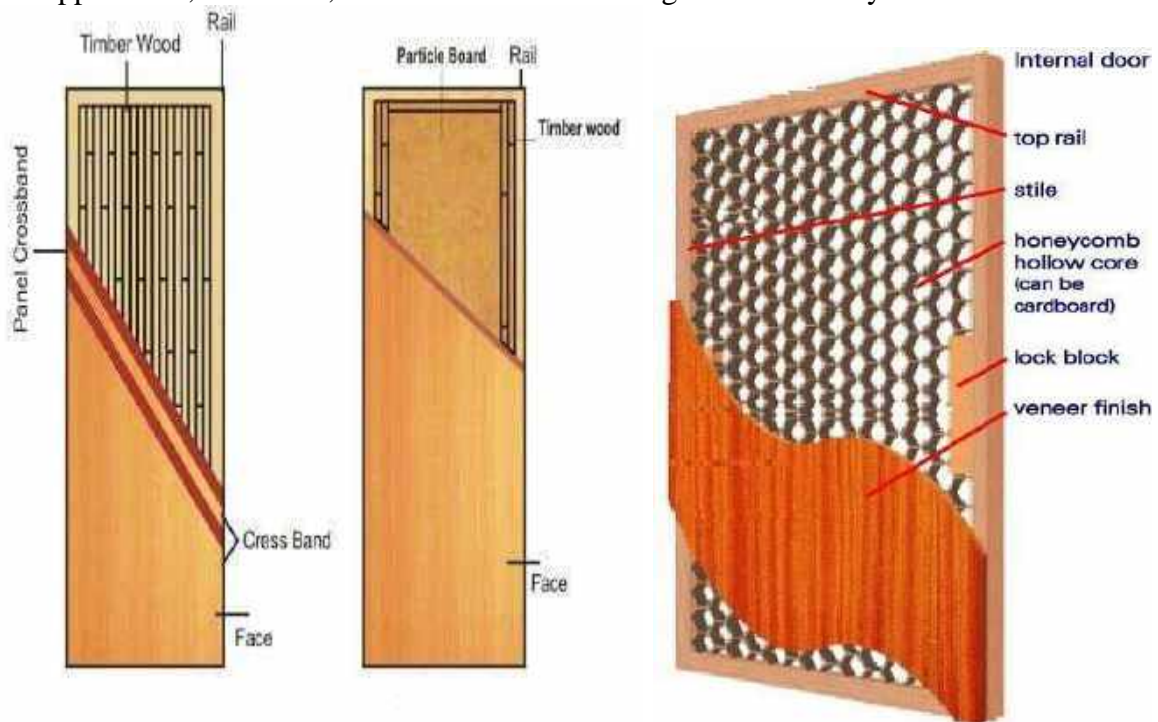

(SOLID CORE)

(HOLLOW CORE)

8. LOUVERED DOORS

- The louvers permit natural ventilation when the door is closed and also provide privacy in the room.
- These are generally used for toilets of residential and public buildings.
- The door may be fully louvered or partly louvered.
- Louvers are made up of timber or glass or plywood and these may be either fixed or movable.



9. Wire gauged doors:

Wire gauged doors permits natural ventilation and restricts the entry of flies, mosquitoes, insects etc. These doors are commonly used in hotels, restaurants and for cup boards containing eatables.

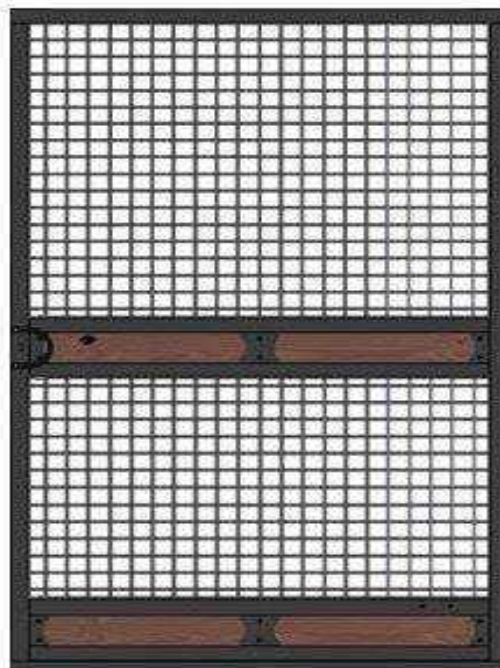

Types of door based on working operation

1. Revolving doors

Revolving doors are only provided in public buildings like museums, banks, libraries etc., because of constant visitors. It consists mullion at its centre to which four radiating shutters are attached.



2. Sliding doors

In this type, with the help of runners and guide rails the door slides to the sides. The door may have one or more sliding shutter depending up on the opening available.

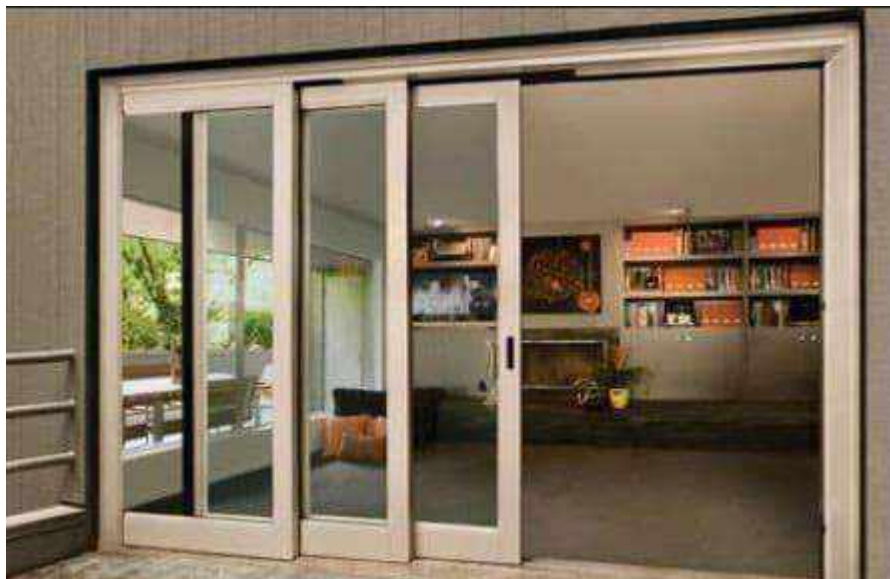

3. Swing doors:

In this case, the shutter is attached to frame by double action spring which helps the shutter to move inwards as well as outwards.

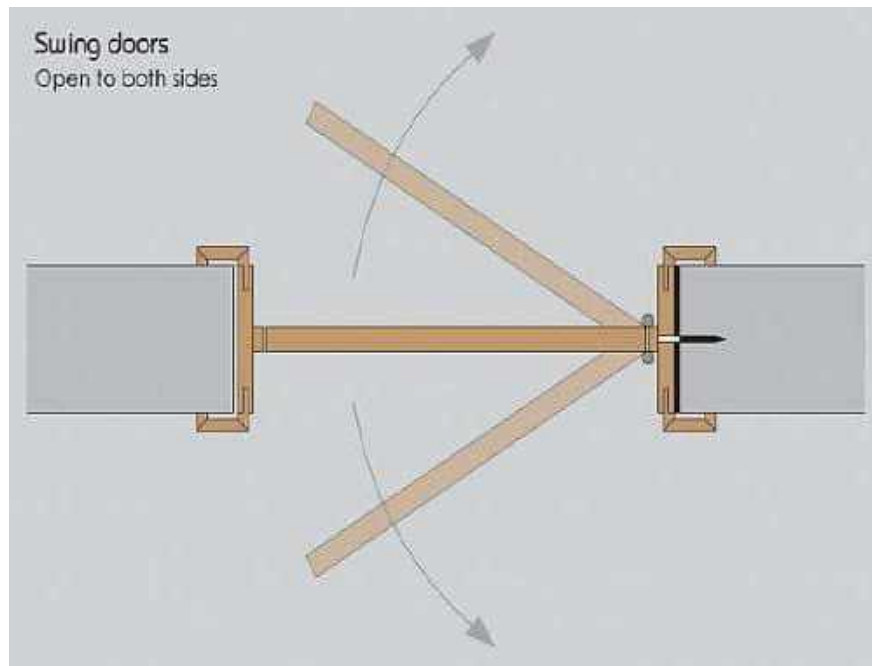

4. Collapsible steel doors:

Collapsible steel doors are generally used for workshops, sheds, warehouses etc. It acts like a steel curtain which will be opened or closed by horizontal pull or push. Vertical double channel units of (20x10x2 mm) are spaced at 100 to 120 mm thick and are braced flat iron diagonals 10 to 20mm wide and 5mm thick.



5. Rolling steel shutter doors

Rolling steel shutter doors are commonly used for warehouses, garages, shops etc.. These are very strong and offer proper safety to the property. The door consists frame, drum and a shutter of thin steel plate inter locked together. A horizontal shaft is provided in the drum which helps to open or close the shutter.



7. WINDOWS

A window is a vented barrier provided in a wall opening to admit light and air into the structure and also to give outside view. Windows also increases the beauty appearance of the building.

TYPES OF WINDOWS

1. Fixed windows;

Fixed windows are fixed to the wall without any closing or opening operation. In general, they are provided to transmit the light into the room. Fully glazed shutters are fixed to the window frame. The shutters provided are generally weatherproof.

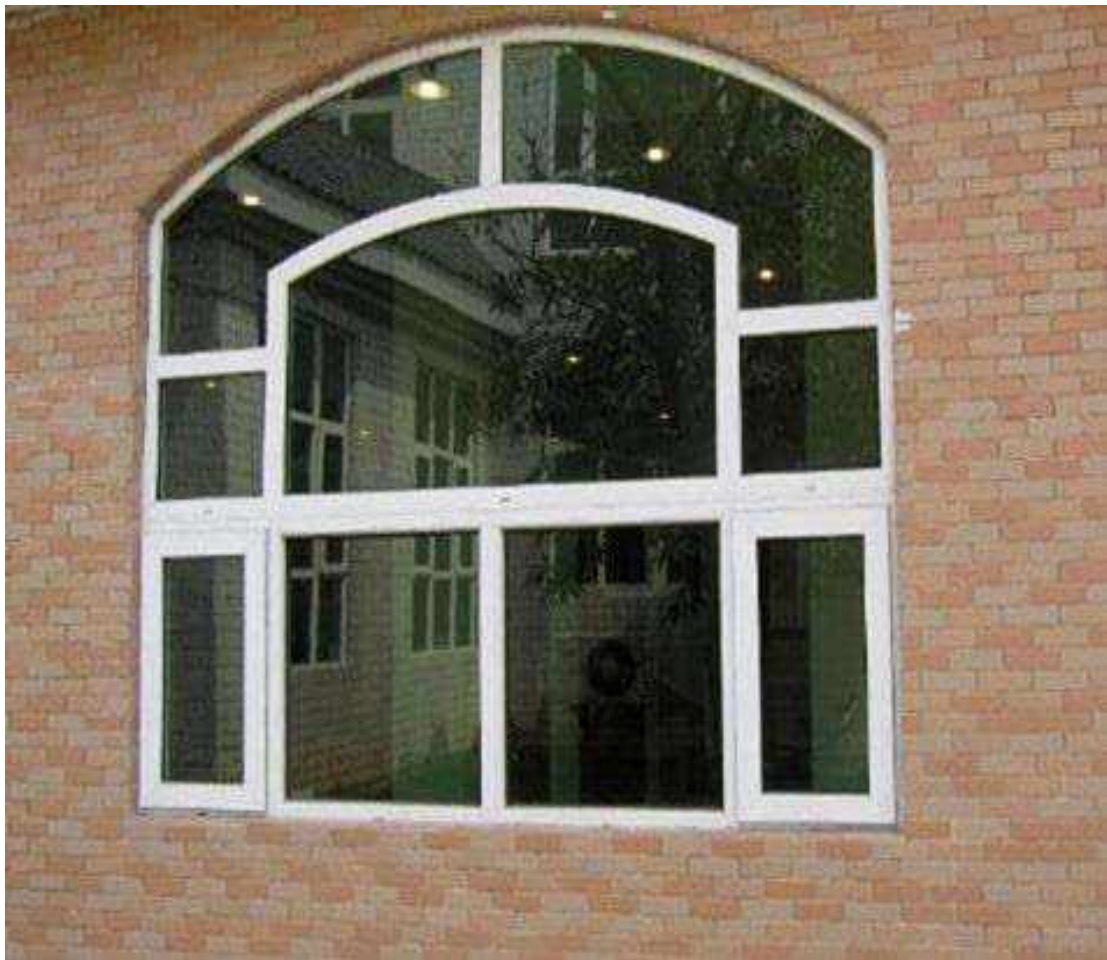

2. Sliding windows:

In this case, window shutters are movable in the frame. The movement may be horizontal or vertical based on our requirements. The movement of shutters is done by the provision of roller bearings. Generally, this type of window is provided in buses, bank counters, shops, etc.

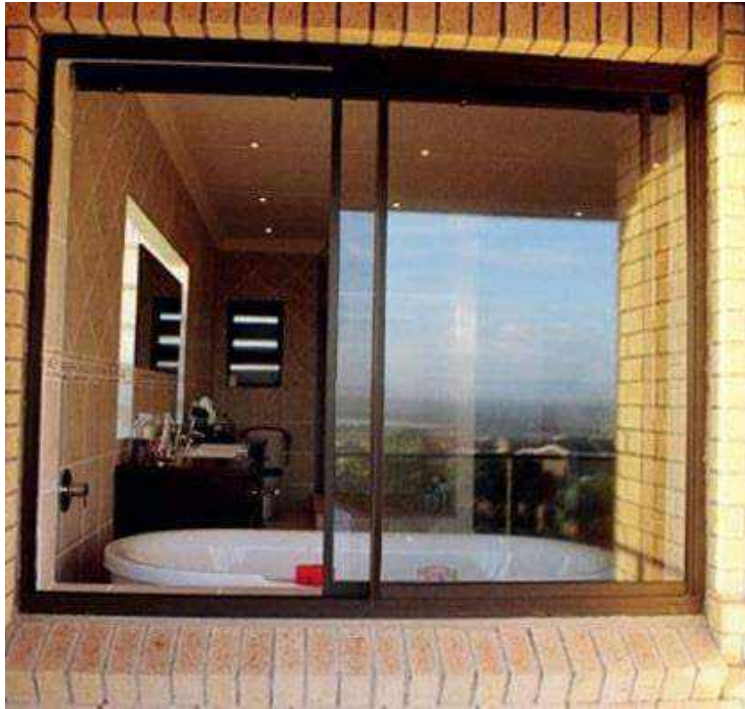

3. Pivoted windows:

In this type of windows, pivots are provided to window frames. Pivot is a shaft which helps to oscillate the shutter. No rebates are required for the frame. The swinging may either horizontal or vertical based on the position of pivots.



4. Double Hung windows:

Double hung windows consist of pair of shutters attached to one frame. The shutters are arranged one above the other. These two shutters can slide vertically within the frame. So, we can open the windows on top or at bottom to our required level. To operate the double hung windows, a chain or cord consisting metal weights is

provided which is connected over pulleys. So, by pulling the weights of cord the shutters can move vertically. Then we can fix the windows at our required position of ventilation or light etc.



5. Louvered windows:

Louvered windows are similar to louvered doors which are provided for the ventilation without any outside vision. The louvers may be made of wood, glass or metal. Louvers can also be folded by provision of cord over pulleys. We can maintain the slope of louvers by tilting cord and lifting cord. Recommended angle of inclination of louvers is about 45° . The sloping of louvers is downward to the outside to run-off the rain water. Generally, they are provided for bathrooms, toilets and privacy places etc.



6. Casement windows:

Casement windows are the widely used and common windows nowadays. The shutters are attached to frame and these can be opened and closed like door shutters. Rebates are provided to the frame to receive the shutters. The panels of shutters may be single or multiple. Sometimes wired mesh is provided to stop entering of flies.



7. Metal windows:

Generally mild steel is used for making metal windows. These are very cheap and have more strength. So, now days these are widely using especially for public buildings, private building etc. Some other metals like aluminium, bronze, stainless steel etc. also used to make windows. But they are costly compared to mild steel windows. For normal casement windows also, metal shutters are provided to give strong support to the panels.



8. Sash windows:

Sash window is type of casement window, but in this case panels are fully glazed. It contains top, bottom and intermediate rails. The space between the rails is divided into small panels by mean of small timber members called sash bars or glazing bars.



9. Bay windows:

Bay windows are projected windows form wall which are provided to increase the area of opening, which enables more ventilation and light from outside. The projections of bay windows are of different shapes. It may be triangular or rectangular or polygonal etc. They give beautiful appearance to the structure.



10. Lantern windows:

Lantern windows are provided for over the flat roofs. The main purpose of this window is to provide the more light and air circulation to the interior rooms. Generally, they are projected from the roof surface so, we can close the roof surface when we required.



11. Gable window:

Gable windows are provided for sloped roof buildings. These windows are provided at the gable end of sloped roof so; they are called as gable windows. They also improve the appearance of building.



#####

Civil Engineering Materials and Constructions (BCE03002)

Module-V

Basic Building Construction

Module V Syllabus

Finishing, Services and Special constructions

Wall Finishes: Plastering, pointing, distempering and painting: Purpose, methods, defects and their solutions. ***Vertical communication:*** Stairs: Terminology, requirements of good staircase, classification; ramps, lifts and escalators. ***Damp proofing:*** causes, effects, prevention and treatments, ***Fire resistant construction:*** Fire resistant properties of common building materials, requirements for various building components.

Subject to Revision

1. WALL FINISHES:

1.1 PLASTERING:

Definition of Plastering:

plastering is a layer provide over masonry or concrete surface for the purpose of protect wall and other concrete element against the atmospheric effect, and also provide finishing surface.

Purpose of Plastering

- 1)Plastering is a method that is used to increase the durability of the wall. The purpose of plastering is to decorate the structures of the walls. Plastering of external walls refers to the process of covering the uneven surface and rough walls with the help of a plastic material named as plaster.
- 2)The plaster is prepared by mixing sand and lime or cement concrete along with water. There are various requirements of a plaster that must be fulfilled while doing plastering of external walls.
- 3)To prevent water ingress into brickwork / blockwork, since both bricks and blocks absorb water from outside. This is the reason why most stoneworks are left un-plastered.
- 4)In case of walls - to make up the issues in underlying brickwork / blockwork - like plumb-outs, diagonal-outs, etc.
- 5)To prepare a proper base for further painting works (Putty application, paint application, wall paper application, etc.)

Requirement of Good Plaster

- The surface of plaster should be smooth
- The surface of plaster should be non-absorbent
- The plaster surface should not wash by water
- Plaster should not shrink when it dries or freezes
- The shrinkage cracks is not developed in plaster

- The plaster should be firmly attached to the masonry surface
- The fire resistance of plaster should be good
- The plaster should be sound insulated
- The surface of the plaster should be paintable

Methods of Plastering

Plaster is applied in the manner mentioned below. To get uniform 150 x 150 mm and 10 mm thick dots are prepared on the surface at a lower level.

Those dots are transferred on the upper level with a plumb bob, so the dots of the upper level and lower come in one and vertical surface.

In this, any dots are applied on all the surface of the wall at 1500 to 2000 mm. Four dots are covered masonry with the help of screed, and plaster is applied properly. Lime plaster is applied in these coats or in three coats or in two coats. The background is prepared before applying plaster.

Different Layers of plaster:

1) Three Coat Plaster

- Application of Rendering Coat
- Application of Floating Coat
- Application of Finishing Coat

2) Two Coat Plaster

3) Cement Plaster and Cement Lime Plaster

4) Single Coat Plaster

5) Plaster on Lath

- Wooden Laths
- Metal Lath

1) Three Coat Plaster

The procedure of applying three-coat plaster is similar to two-coat plaster only difference is that an intermediate coat is known as a floating coat. The purpose of this coat is to bring the plaster to an even surface. In the case of 3-coat plaster, the first coat is known as rendering coat, the second coat is known as a floating coat, and third coat is known as setting coat or finishing coat. The rendering coat is applied, and scratches are made. The floating coat is applied, and after seven days finished coat is applied, after 6 hours of applying a floating coat.

-Application of Rendering Coat

The mortar is applied forcibly on the surface of wall. With masons trowel and pressed well into joints and over the surface. The thickness of the coat should be such as to cover all inequalities of the surface normally this thickness is 12mm.

This coat is allowed to harden slightly a then scratch marks are made on the surface with the help of trowel ledge. During this period, the surface is curved and then allowed to dry completely

-Application of Floating Coat

The first coat is prepared properly to apply the second coat, i.e., a floating coat. All dirt and dust are cleared. It is wetted properly. 10 cm wide strips or 15 cm x 15 cm patches are applied at a suitable distance. These patches or strips act as a gauge for thickness of floating coat. The mortar is dashed with mason's trowel, spread, and rubbed to the required plain surface with a wooden float. The floating coat is beaten with floats edge at the close spacing of cm. Then it is allowed to dry completely. The thickness of floating coat is 6 to 9 mm.

-Application of Finishing Coat

The third coat is called a finishing coat. In the Case of lime-sand mortar, the finishing coat is applied immediately after the floating coat cream of lime and sand in 4:1 are applied with a steel trowel and rubbed and finished smooth.

2) Two Coat Plaster

The joints are ranked at a depth of 20 mm. The surface is cleaned, and water is sprinkled properly on it. Before the first coat is applied preliminary coat is applied to make an uneven surface in le.

Then, the first coat is applied. The first coat is raked as a rendering coat. The thickness first coat is kept 2 to 3 mm less than a total thickness of plaster. To maintain interim thickness and vertically of plaster 15 cm * 15 cm dots or are provided, Then a vertical strip of mortar known as the spread is formed at a distance of 2 m. spacing. Then the spaces between screeds are filled with mortar and properly finished. Scratches are made on rendering coat to provide mechanical key before it hardens. The rendering coat is watered for 2 days and then dried.

Before applying the final/coat, the rendering coat is damped well. The final coat is applied with wooden floats to a true even surface with steel trowels. The thickness of the final coat may vary from 2 to 3 mm.

3) Single Coat Plaster

This is used only in interior quality work. It is applied similar to two coat plaster except that the rendering coat as applied fro two-coat plaster is finishing off immediately after it has sufficiently hardened

4) Cement Plaster and Cement Lime Plaster

For interior work single coat plaster is applied. For good quality works, either two coat or three coat plaster is applied. But two coat plaster is more common sow shall discuss it first.

5) Plaster on Lath

Thin partition walls and ceilings are plastered using laths. Laths are provided as a foundation to receive plasterwork. Laths may be.

-Wooden laths

-Metal laths

Wooden laths are well seasonal wooden strips 25 mm wide and 1 to 1.2 m long. Wooden laths are used and ceilings. Laths are fixed in a parallel line with a clear spacing of 10 mm and secured to the surface with galvanized iron nails.

Metal laths are available under various patent names. The plain expanded metal lath(exam) is commonly metal laths are fixed to the surface by G.I Staples. In the case of concrete or masonry surfaces, wooden plugs have to be embedded for fixing the lath. After fixing the lath, the surface is plastered, usually, in there coats, cement mortar is usually used.

Plaster Defects and their Solution:

Plaster is a common material used in construction all around the world. Easy to work with and also easier to repair. However, there will be times when your plaster starts to show signs of wear and tear or other problems. If the plaster quality is not good enough it can cause many problems later.

1). Blistering of Plastered Surface

Blistering is the formation of small patches of plaster, swelling out beyond the plastered surface, arising due to late slaking (addition of water to lime) of lime particles in the plaster. This defect is usually caused due to the uneven mixing of plaster.

How to prevent it: This can be prevented by ensuring appropriate mixing between cement and its components used to form plaster.

2) Plaster De-bonding

De-bonding occurs when a plaster is separated from the wall. It can be caused by an excessively thick plaster layer, inadequate substrate preparation or may be due to a dusty, oily or dry substrate.

How to prevent it: To prevent de-bonding of plaster, we need to take care of the following things during plastering.

- Remove dust & oil from the substrate before plastering.
- Allow substrate to reach correct moisture content.
- If necessary, you should use bonding chemical.

3) Cracks on Plastered Surface

One of the most common problems you would have observed in plastering is the crack. Cracks on the plastered surface can be in different forms:

Crazing – It is a network of fine cracks like spider web. They are usually very fine and do not extend through the whole depth of the plaster. It occurs due to presence of excess fine content in the sand or due to dry base on which plaster is applied – when base absorbs the water and fines accumulate on the surface, it leads to crazing.

Separation crack at joints – It usually occurs at joints of two different materials for example at junction of RCC & Brick work. It occurs due to differential thermal movement.

Crack with Hollowness – This crack occurs due to hollowness in plaster. Other reasons could be extra water in the plaster mix or due to poor workmanship.

How to prevent it: Mainly cracks occur due to bad workmanship or expansion and shrinkage in the plaster during drying. Below are few tips to prevent cracks:

- Ensure the addition of water in mortar done is by skilled mason and not by unskilled labour to ensure desired workability in terms of handling and application.
- It can be avoided by proper curing of the plaster in order to slow down any rapid drying.
- Taking care of workmanship and material quality issues will help in preventing cracks.

4) Efflorescence on Plastered Surface

When a newly constructed wall dries out, the soluble salts are brought to the surface and they appear in the form of a whitish crystalline substance. This is called efflorescence. Efflorescence is formed on plasters when soluble salts are present in plaster making materials as well as building materials such as bricks, sand, cement etc. Even water used in the construction work may contain soluble salts. It seriously affects the adhesion of paint with the wall surface and causes further problems.

How to prevent it:

All Construction materials used for wall should be free from salt.

Ensuring that the surface is moisture-free.

5). Falling Out of Plaster

This defect can happen in two forms – Flaking of plaster and peeling off plaster.

- Flaking of plaster: The formation of a small loose mass on the plastered surface is known as flaking. It is mainly due to bond failure between successive coats of plaster.
- Peeling off plaster: The plaster from some portion of the surface comes off and a patch is formed. This is termed as peeling. It is also mainly due to bond failure between successive coats of plaster.

How to prevent it: Both defects can be prevented with proper material selection and surface preparation. Imperfect adhesion can be minimized by good workmanship.

6) Popping of Plaster

Popping is the formations of conical like holes that break out of the plaster. It is caused due to the presence of contaminant particles such as burnt lime or other organic materials in the mix of mortar.

How to prevent it: To prevent popping in plastering, you need to ensure that no contaminant particles are present in the mortar mix.

7) Loose Plaster

When the plaster gets displaced on external impacts like application of material or tapping, etc, it is termed as loose plaster. This is caused mainly due to improper mixture and inadequate curing.

How to prevent it: Good workmanship will help in avoiding this problem.

Apart from the above defects, Uneven or undulation also occurs at plastered surface. The plastered surface should be in perfect plumb and without any undulations. Unevenly plastered surface happens due to poor workmanship² of the plastering work.

1.2 POINTING:

Definition of pointing: Pointing is the finishing of mortar joints in brick or stone masonry construction. Pointing is the implementing of joints to a depth of 10 mm to 20 mm and filling it with better quality mortar in desired shape. It is done for cement mortar and lime mortar joints.

Purpose of pointing:

Pointing is adopted due to the following purposes.

- * For the protection of exposed surface from adverse effects due to atmospheric action like rain, sun, wind, snow etc.
- * To hide the interior mortar and inferior quality.
- * To develop a decorative impact or to enhance the appearance.

Methods of pointing:

*Mortar joints of the surface (Brick Masonry or Stone Masonry) to be pointed are raked out to a depth of about 13 to 20 mm.

*The raked joints are cleaned from loose mortar and completely wetted. Mortar is taken in small flat rectangular plates made of iron.

*Pointing should be finished as per the expected finishing with the help of the particular tool.

*Curing should be done on the pointed surface for at least three days in case of lime mortar and ten days in case of cement mortar.

Types of pointing:

1. Flush Pointing

Flush pointing is the most accessible type of pointing and is generally utilised in brick masonry and stone masonry. In flush pointing, mortar is pushed into the raked joints and joints are made flush with the edge of the stone or brick to provide a uniform appearance.

After that, with the help of a trowel and straight edge, edges are precisely trimmed. This type of pointing doesn't have a good appearance, but it doesn't have any space for dust and water which make it long-lasting.

2. Recessed Pointing

Recessed pointing has a vertical pointing face and provides a better appearance. A recessed pointing mortar is pushed back inside the surface of the wall with a vertical pointing face with the help of a suitable pointing tool.

3. Beaded Pointing

Beaded pointing is made with the help of a steel or iron rod having a concave edge. Beaded pointing provides a better appearance, but it is susceptible to damage and maintenance is difficult.

4. Struck Pointing

In struck pointing, have inclined or sloping pointing face as shown in the image. The upper edge of the joint is about 3 to 6 mm pushed back inside from the face of the brick. This joint helps to dispose of water quickly. When the lower edge of the joint is kept inside from the face of brick or

stone, it is called overhand struck pointing. But it will not make an adequate joint because water may collect in the joint.

5. Rubbed, Keyed or Grooved Pointing

In tuck pointing, a channel or groove of 5mm width and 3 mm depth is created at the middle of the mortar joint. Then the groove or track is packed up by white cement putty having a projection of 3 mm. If the groove is made in the mortar, it is known as bastard pointing or half – tuckpointing.

6. Tuck Pointing

In this case mortar is pressed in the raked joint first and finishing flush with the face. While the pressed mortar is green, groove or narrow channel is cut in the center of groove which is having 5mm width and 3mm depth. This groove is then filled with white cement putty, kept projecting beyond the face of the joint by 3 mm. if projection is done in mortar, it is called bastard pointing or half tuck pointing.

7. V- Grooved Pointing

This type of point is similar to keyed or grooved pointing except that instead of a normal groove, v groove is formed using a suitable shaped steel rod.

1.3 DISTEMPERING:

Distemper: Distemper is a water based paint in which the binding medium consists essentially of either glue or casein, or similar sizing material. The major constituents of distemper are chalk, lime, water and some coloring agents if necessary. They are also known as cement paint. This is called so because such kind of paint can be applied directly on cement walls without any other coating on them. They are a cheaper option and they stay good for more than 5 years. Distempers are used for both interior and exterior walls usually needing two coatings.

Ingredients of Distemper:

Distemper is composed of base, carrier, colouring pigments and size. For base, the whiting or chalk is used and for carrier, the water is used. Thus it is more or less a paint in which whiting or chalk is used as base instead of white lead and the water is used as carrier instead of linseed oil.

The distempers are available in powder form or paste form. They are to be mixed with hot water before use. The oil-bound distempers are a variety of an oil paint in which the drying oil is so treated that it mixes with water. The emulsifying agent which is commonly used is glue or casein. As the water dries, the oil makes a hard surface which is washable.

It should be remembered that most of the manufacturers of ready-made distempers supply complete directions for use of their products. These directions are to be strictly followed to achieve good results.

Properties of Distempers:

- (i) On drying, the film of distemper shrink. Hence it leads to cracking and flaking, if the surface to receive distemper is weak.
- (ii) The coatings of distemper are usually thick and they are more brittle than other types of water paints.
- (iii) The film developed by distemper is porous in character and it allows water vapour to pass through it. Hence it permits new walls to dry out without damaging the distemper film.
- (iv) They are generally light in colour and they provide a good reflective coating.
- (v) They are less durable than oil paints.
- (vi) They are treated as water paints and they are easy to apply.
- (vii) They can be applied on brickwork, cement plastered surface, lime plastered surface, insulating boards, etc.

(viii) They exhibit poor workability.

(ix) They prove to be unsatisfactory in damp locations such as kitchen, bathroom, etc.

Process of Distemping:

The application of distemper is carried out in the following way:

(1) Preparation of Surface:

The surface to receive the distemper is thoroughly rubbed and cleaned.

The important facts to be kept in mind are:

(i) The new plastered surfaces should be kept exposed for a period of two months or so to dry out before distemper is applied on them. The presence of dampness on the surface results in failure of distemper coating.

(ii) The surface to receive distemper should be free from any efflorescence patches. These are to be wiped out by clean cloth.

(iii) The irregularities such as cracks, holes, etc. of the surface are to be filled by lime putty or gypsum and allowed to become hard before distemper is applied on the surface.

(iv) If distemper is to be applied on the existing distempred surfaces, the old distemper should be removed by profuse watering.

(2) Priming Coat:

After preparing the surface to receive the coats of distemper, a priming coat is applied and it is allowed to become dry. For ready-made distempers, the priming coat should be composed of materials as recommended by the makers of distempers. For local made distempers, the milk is used for priming coat. One litre of milk will cover about 10 m² of the surface.

(3) Coats of Distemper:

The first coat of distemper is then applied on the surface. It should be of a light tint and applied with great care. The second coat of distemper is applied after the first coat has dried and become hard.

Following facts are to be remembered:

- (i) The distemping should be done in dry weather to achieve better results.
- (ii) The oil-bound distemper or washable distemper adheres well to oil-painted walls, wood, corrugated iron, etc. But a priming coat of pure milk should be applied before distemping is done on such surfaces.
- (iii) The application of distemper by a spraying pistol is superior to that by brushes. The spraying affords smooth and durable film of distemper.

Defects in Distemping:

The following are the defects which may occur in distemping work.

- 1. Blistering:** It is the defect caused due to the formation of bubbles under the distemping film. The bubbles are formed by water vapours trapped behind the surface.
- 2. Bloom:** In this defect, dull patches are formed on the finished surface. This may be due to the defect in distemping material or bad ventilation.
- 3. Crawling or sagging:** This defect occurs due to the application of too thick a distemping coat.
- 4. Flaking:** Flaking is the loosening of some portion of the distemped surface.
- 5. Fading:** This is the gradual loss of colour of distemper, due to the effect of sunlight.
- 6. Flashing:** It is the formation of glossy patches on the surface, resulting from bad workmanship.
- 7. Grinning:** This defect is caused when the final coat does not have sufficient opacity so that background is clearly seen.

1.4 PAINTING:

Paints are coatings of fluid materials which are applied as a final finish to surfaces like walls, ceiling, wood and metal works.

Painting is done to protect the surface from the effects of weathering, to prevent wood from decay and metal from corrosion, to provide a decorative finish and to obtain a clean, hygienic and healthy living atmosphere.

Purpose of painting:

1. Decoration to Interiors and Exteriors of a Building
2. They are used to enhance the interior and exterior of a building by adding pigments, lightness or darkness
3. Reflective surfaces can be also be obtained
4. Now a days textures are also added for different designs Protective Layer
5. Paint are used to protect the outer surfaces of a building or metals to protect them against:
 - Sunlight
 - Dampness
 - Dust
 - Abrasion
 - Weathering
 - Ease of Cleaning
 - To provide easily cleanable surfaces
 - To keep the substrates clean and tidy

Methods and Process of Painting on Different Surfaces

- New wood work

- Repainting Old wood surface
- New iron and steel surfaces
- Repainting of old steel and iron surfaces
- Galvanized iron surface
- Metals
- Plastered surfaces
- Painting on New Wood Work

Following are the steps for painting new wooden surfaces:

- Surface preparation
- Knotting
- Priming
- Stopping
- Under coating
- Finishing

1. Surface Preparation of Wooden Works

The surface should be well cleaned without any dust, spots, greasy matter etc. The nails used in the wood work should be punched up to 3mm below the surface. The wood in wood work should be well seasoned and should not contain more than 15% of moisture content. The surface should be dry.

2. Knotting

Knots present in the wood may eject resins from wood. So, knots are killed or covered in this knotting process. Knotting can be done by two ways as follows: 1. In this first method, two coats

of solutions are applied on surface. First coat consists 15g of red lead, 2 liters of water and 225 grams of glue. After adding these three, mixture is heated and applied and left for 10 minutes. After that second coat is applied which consists red lead ground in boiled linseed oil and thinned with turpentine oil. 2. In this method, hot lime coat is applied on surface and left it for 24 hours. After that the layer is scrapped off from the surface.

3. Priming of New Wooden Surface

Priming is nothing but applying prime coat or first coat on surface. In this case, the surface is smoothed with abrasive paper and then first coat of paint is applied to fill all the pores in the surface. The ingredients used in this prime coat is same as subsequent coats but the quantity or composition ratio may vary.

4. Stopping

After filling all the pores of wooden surface in priming, it's time to fill up nail holes, dents, cracks, etc. Putty is used as the fill material. When putty is dried, then the whole surface is rubbed with glass paper or pumice stone. This process of rubbing sown the wooden surface is called stopping.

5. Under Coating of New Wooden Surface

In general, for good quality works, 4 coats of paints are applied (prime + under coatings + finishing). For inferior quality works 2 to 3 coats can be used. So, under coatings are nothing but second and third coats of good quality works which provides same look or shade as finishing coat. For better results, enough time should be allowed for each coat.

6. Finishing of New Wooden Surface

Finishing is the last coat applied on surface which is generally applied on the under coatings. It should be applied in smooth, uniform manner. It decides the whole final look of surface, so, skilled workers is required for better results.

Repainting of Old Wooden Surface

Old wood work can be repainted but the previous paint work should be removed. The removal is more important which can be done by many ways as follows:

Prepare a solution of 1 kg caustic soda in 5 liters of water and apply on the old painted surface.

When this solution is applied on the surface, the old paint gets dissolved and removed easily.

Another method is, prepare a hot solution consisting of soft soap, potash, quicklime in the ratio 1:2:1. This solution is applied on old surface and washed with hot water.

1:1 mixture of washing soda and quick lime is prepared and applied on old paint surface and then washed with water.

After applying any of the three methods described above, the surface is ready for fresh painting.

Before that the surface is rubbed with pumice stone or glass paper and then 2 to 3 coats of paints are applied.

Painting of New Iron and Steel Surfaces

Painting of iron and steel surfaces will resist the rust formation due to weathering. Before painting the surface must be cleaned. If there is any rust or scales, should be wiped off using steel brushes etc. stains on surface can be washed with benzene or lime water. Before applying prime coat, the surface should be treated with phosphoric acid to get better adhesive nature. Now prime coat is applied which consists 3kg of red lead in 1 liter of boiled linseed oil. This should be applied using brush. After that, two or more under coats are applied which consist 3 kg of red lead in 5 liters of boiled linseed oil. After drying up, smooth finishing coat of desired paint is applied.

Repainting of Old Steel and Iron Surfaces

Repainting of steel and iron surfaces is as same as new surfaces but cleaning of old paint is most important. Oxy acetylene flame is used to burn off the paint surface and then it is scrapped with brushes.

Painting of Galvanized Iron Surface

In general, Galvanized iron surface does not contain adhesive nature with paint. So, it is difficult to apply paint on it without any special action. That special treatment may be applying different solutions on surface. The solutions are 40 grams of copper acetate in one liter of water or 13 grams each of copper chloride, copper nitrate, muriatic acid and ammonium chloride in 1 liter of water. Any one of these two solutions are mixed in earthen vessel and applied on surface. When the surface turns into black, then prime coat is applied after it dries, finishing coat is applied.

Painting of Plastered Surfaces

Painting of newly plastered surfaces is difficult because of moisture content present in the plaster material. Heat of hydration of cement also causes severe problems for paints especially oil based paints and distempers are liable to alkali attack. To overcome this, alkali resistant primer is used in prime coat. The plastered surface contains pores in it, and whenever the paint is applied, liquid from the paint is absorbed by these pores which is called as suction. The suction of surface depends upon type of paint, prime coat composition, etc. Suction should be uniform throughout the surface. So, the preparation of surface depends upon the type of paint used on the surface. For different paints, different types of pretreatments are adopted on the surface which is described below.

Type of paint	Preparation of surface
Oil paint	A coat of thin primer or prime sealer
Emulsion paint	A coat of paint thinned with water

Dry distemper	Same distemper thinned with water
Size bound distemper	A Coat of clearcole
Cement paint and lime wash	Just wet the surface before applying.

DEFECTS:

The common defects that should be avoided in painting are:

Blistering: These are formed by water vapour trapped inside non-breathing types of paints.

Bloom or Flashing: These are formation of dull patches usually due to the defect in paint or bad ventilation.

Brush marks: These occur due to defective work.

Cracking: It occurs due to the defect of paint and fast drying.

Crawling or sagging: It occurs due to application of too thick a paint.

Flaking: It occurs due to poor adhesion of paint to the surface.

Lack of opacity or body: It happens due to overthinning of paint or inadequate stirring of paint during its application.

Pin holes: These are formed when there are small holes present in the surfaces such as walls even before painting. The air from these holes can burst forth and create holes . Surface should be levelled with putty before painting.

Slow Drying: It can occur due to a moist unhardened undercoat ,bad quality of paint or painting in damp weather on a greasy surface.

Its solutions:

- Employ good surface preparation before the application of paint. Ensure that substrate should be free from sand, dirt or any dust.

- Moisture content on the painting surface should not exceed 6% as it helps to avoid efflorescence.
- Apply adequate primer to seal the surface before going for undercoat and topcoat.
- Use appropriate coating methods and select colours that are more stable to avoid deterioration.
- Use non-yellowing paints, which does not affect by environmental situations. For areas exposed to extreme weather conditions, prefer weather-resistant paints.
- Protect and treat all the metal parts to avoid rust stains or corrosion.
- Avoid details with very rough textures and use algae-resistant paint to prevent algae and fungi growth.

2. VERTICAL COMMUNICATION

2.1 STAIRS: Staircase is an important component of a building providing access to different floors and roof of the building. It consists of a flight of steps and one or more intermediate landing slabs between the floor levels. Stairs can be defined as series of steps suitably arranged for the purpose of connecting different floors of a building. It may also be defined as an arrangement of treads, risers, stringers, newel post, hand rails, and baluster, so designed and constructed as to provide an easy and quick access to the different floors. Stairs can be made of concrete, stone, wood, steel or combination of any of these.

TERMINOLOGY USED IN STAIRS:

The common terms used in simple stairs are :

Going: It is the horizontal distance between faces of two successive risers.

Tread: It is the horizontal portion of the steps on which we put our steps to climb the staircase.

Rise: It is the vertical distance between two successive treads.

Riser.:It is the vertical portion of a step that supports the tread.

Handrail: It is the member placed on top of baluster to hold our hands while climbing the stairs.

Baluster:It is the member supporting the handrail. Balustrade. It is the system consisting of balusters and the handrail.

Newel: It is the post usually provided at the beginning and end of the flights supporting the handrail. It gives stability to the handrail and should be properly anchored.

Nosing:It is the projection of the tread beyond the face of the riser to provide as wide a space for the tread as practicable. It is usually rounded off beyond the face of the riser to avoid a sharp edge. It is also customary to provide nosing by sloping the riser.

Scotia: It is the moulding provided under the nosing to improve the elevation of steps and, in some cases, to strengthen the nosing.

Soffit: It is the underside of a staircase.

Flight: A flight of steps is the uninterrupted series of steps between landings. **Headroom:** It is the minimum clear vertical distance between the tread and overhead ceiling or floor.

Pitch or slope: It is the angle of rise of the stair to the horizontal. It can be defined by the line joining the nosings.

Stairwell or well: It is the space provided between the flights of a half turn or quarter turn staircase.

Strings or stringers: These are the sloping members provided in wooden staircases to support the steps in the stairs.

Winders: These are the tapered treads provided at the turnings of the landing space to reduce the number of steps required in the other straight portions of the stairs and thus economize the length required for the staircase.

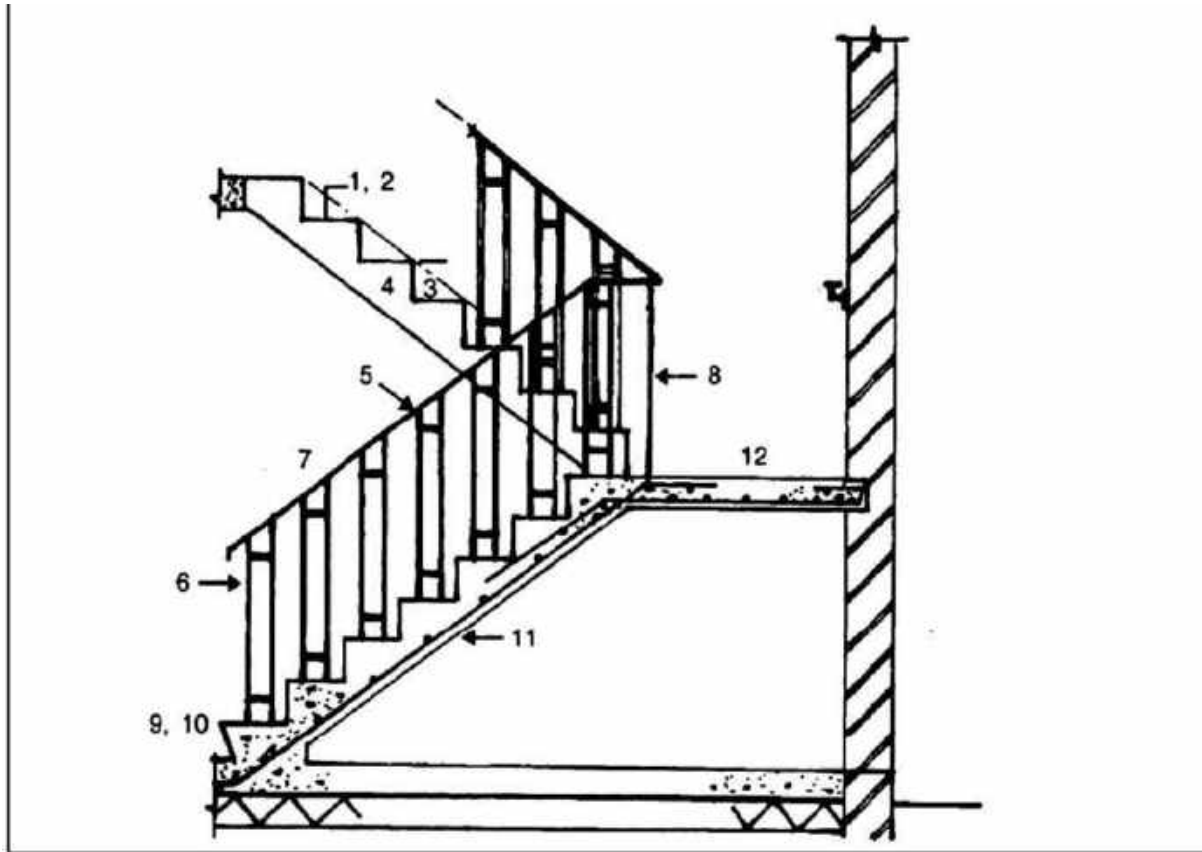

Cast-in-situ reinforced concrete doglegged half-turn stairs: 1. Tread, 2. Going, 3. Riser, 4. Rise, 5. Handrail, 6. Baluster, 7. Balustrade (baluster and handrail), 8. Newel, 9. Nosing, 10. Scotia (moulding under nosing), 11. Soffit, 12. Landing.

Requirement of a good staircase:

- Provide an access from one floor to another.
- Provide a safe means of travel between floors.
- Provide a degree of insulation where part of a separating element between compartments in a building.
- Provide a suitable means of escape in case of fire.
- Provide a mean of conveying fittings and furniture between floor levels.

Types of staircases:

Straight flight stairs: This is a straight run with or without landing in between.

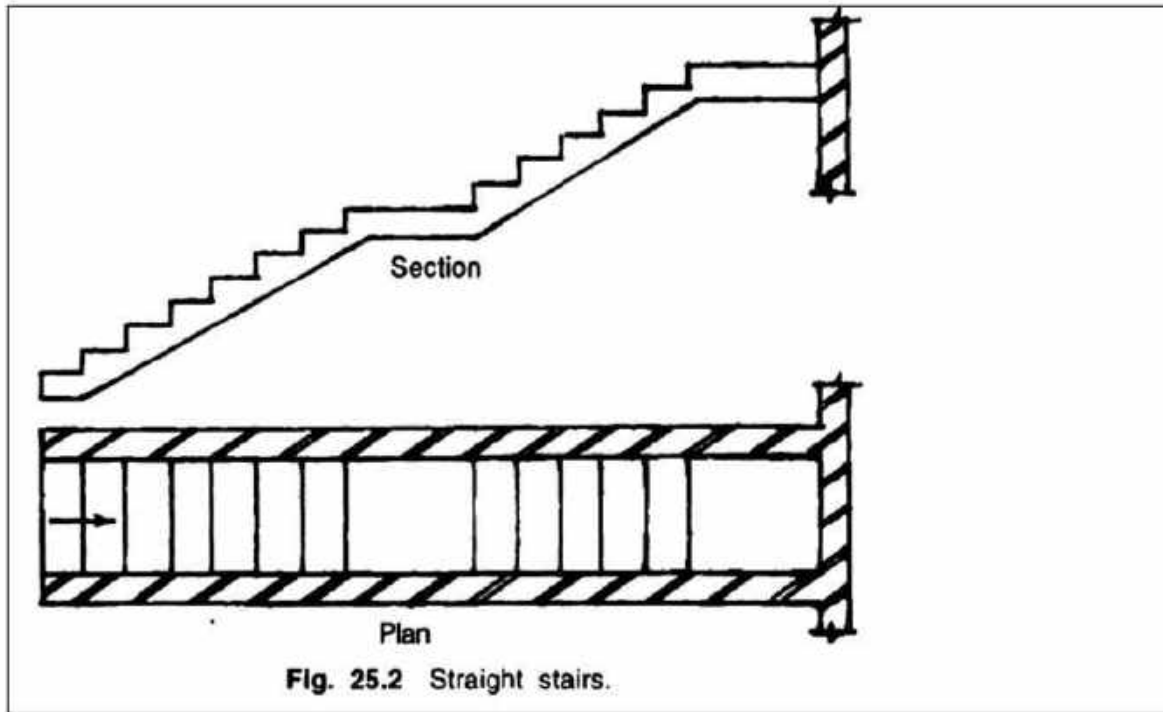

Quarter-turn stairs: In this arrangement, the turning at the landing is only 90 degrees. The landing is known as quarter-space landing. Quarter-turn stairs can be of three types

- (a) **Open well quarter-turn stairs:** These have two turns with three flights and go around a well.
- (b) **Newel quarter-turn stairs with winders:** These have only one turn and two flights.
- (c) **Geometrical quarter-turn stairs**

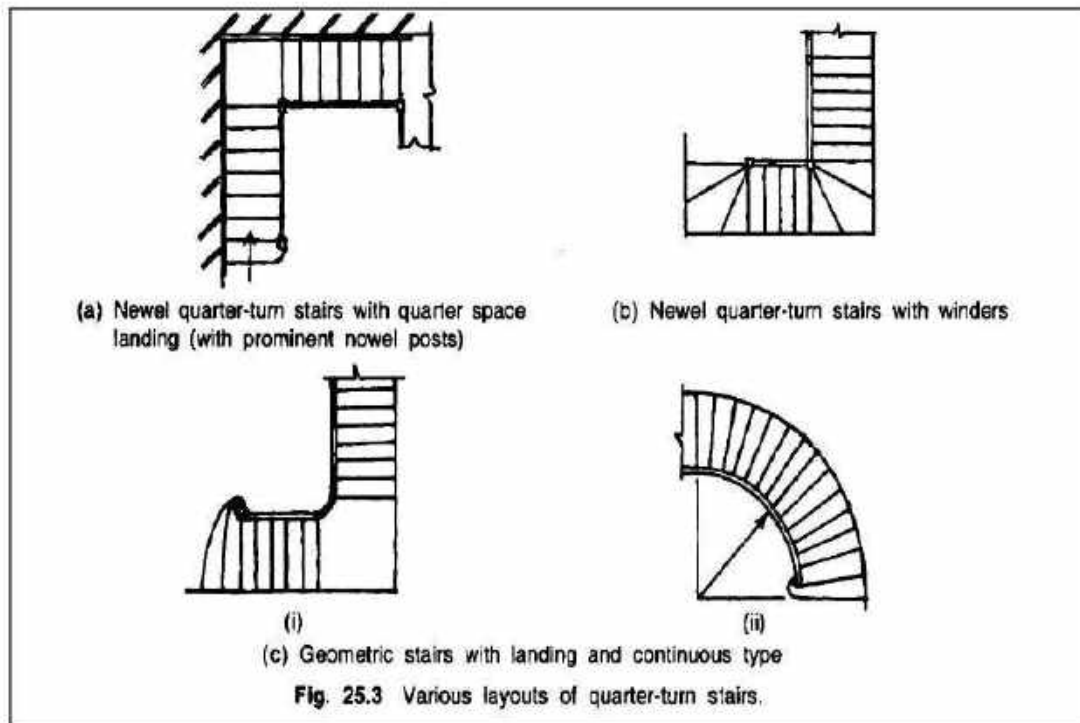

Half-turn stairs: In this system, the direction of climbing at the landing is reversed through 180° .

This type of landing is called half-space landing. There can be three types of such stairs:

- (a) Doglegged (or newel) half-turn stairs with no well
- (b) Open well half-turn stairs with a well
- (c) Geometrical half-turn stairs

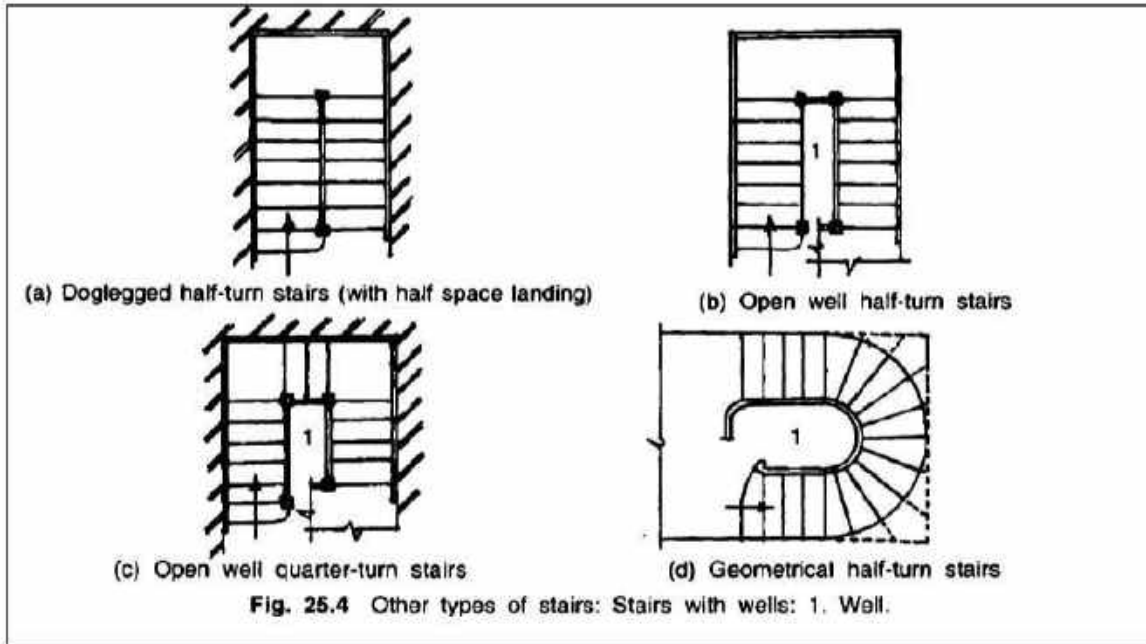

Note: Half-turn stairs can be built in many ways. It can be in the form of concrete slabs or they can be slabs supported on a central beam or individual steps may cantilever from walls of the staircase room. Thus we can have a very large number of types of staircases to choose from.

Other types: In addition to the above common types, there are many other special types of staircases. Some of them are given below:

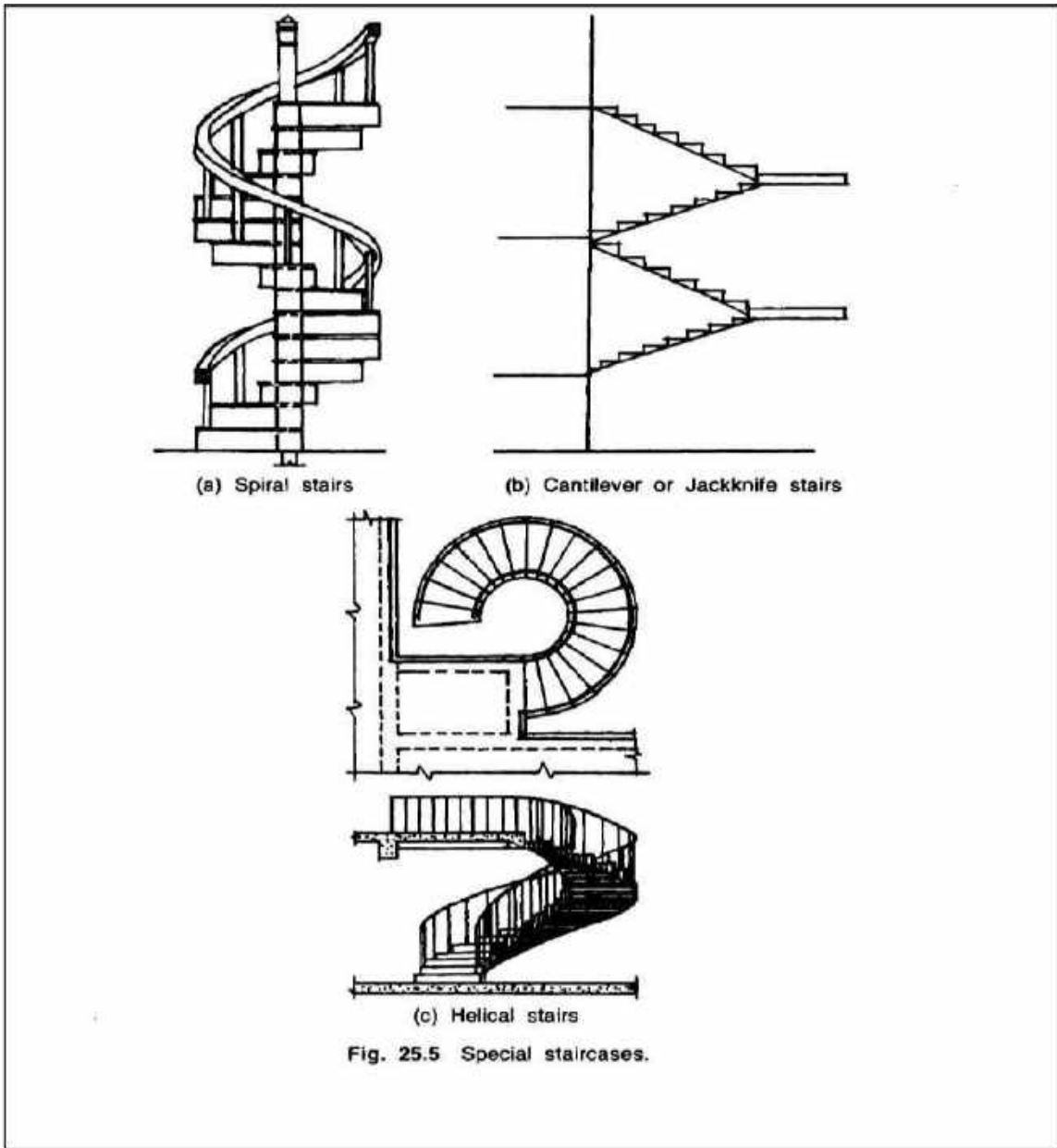

(a) Circular staircase

(b) Spiral staircase rising around a central core with separate horizontal steps.

(c) Cantilever (or jackknife) staircase which are usually doglegged staircases that fully cantilever from the building without support .

(d) Helical (helicoidal) stairs with an open well at the centre which is a continuous slab staircase without a central core.

Spiral stairs have separate steps describing a helix around a central column whereas a helical stair has an open well. A helicoid is a warped surface generated by a line wrapped around a central imaginary core. It will be like the curve of a screw. The slab is like an inclined plane. It can be circular or elliptical (it has no central structure). Spiral stairs are generally provided at the back of buildings as emergency exit and as access to working people to the various floors. Helical staircases are very aesthetic, more difficult to design and are generally provided as an ornamental feature in libraries, assembly halls and also in very luxury buildings.

REINFORCED CONCRETE (RC) STAIRS:

Nowadays reinforced concrete is the preferred material for stairs in residential as well as in office and other public buildings. For ornamentation, the concrete structures are sometimes covered with wood. Steel staircases are common in factories especially in chemical plants. We will study in a little more detail the simple doglegged reinforced concrete stairs, which are used in most residential buildings.

- **Layout Requirements of RC Stairs:** The following are the general requirements to be met when we plan the layout of a staircase.
- **Width of stair:** It depends on its use. The recommended values are a minimum of 90 cm (3 ft) in residences and 1.5 to 2 m in public buildings. Length of flight: Generally the number of steps in one flight (to the landing) should not exceed 12 to 16 and not be less than 3.
- **Pitch of stair:** The pitch or slope of the stair depends on the rise and tread adopted. They should depend on the use of the building. Public buildings should have larger treads or going and smaller rise than in dwelling houses.

The values usually recommended for tread and rise are as follows:

(a) In residences, we give a tread or going of 250 mm (9 to 10 inches) and a rise of 160 to 175 mm (6½ to 7 inch) approximately.

(b) Public buildings should have longer treads and smaller rise. Treads of 270 mm to 300 mm and rises of 100 to 150 mm are usually given.

(c) Rises and treads of all the steps should be the same. It is very important that we should not change the dimensions of tread and rises from the start to the finish of the stairs. Sudden changes in dimensions can lead to accidents.

The following empirical formula between going and rise is usually used:

$(2R + G) > 550 \text{ mm but } < 700 \text{ to } 600 \text{ mm (approximately)}$

Head room: The clear distance between the tread and the soffit of a flight immediately above or between the tread and floor above should not be less than 2.1 to 2.3 m (say 7 feet 4 inch) so that a person can use the stairs with a luggage on his head. This provision of head room is very important.

Height of handrail: The height of the top of the handrail from the tread should be between 850 to 900 mm (about 3 ft) to make it easy for a person of average height to hold on to it by hand.

Stairs to open terrace: Where the staircase leads to an open terrace, the level of the upper landing slab should be 30 cm (1 ft) higher than top of roof slab so that there will be a clear difference in height of about 15 cm after the weathering course is laid. (This need not be so if another storey is envisaged in future.)

Staircase room dimension: The minimum clear width of staircase room in residential buildings should be 2.1 m (7 ft) so that there will be a clear width of staircase of 90 cm

with enough width for the balustrade of 15 cm and a well of 15 cm (90 + 90 + 15 + 15 210 cm). In public buildings, the minimum width of staircase room should be 2.85 m (9'6").

Note: The height to the bottom of the upper floor of most residences is about 3.2 m. If we provide 19 steps, the rise will be about 170 mm (7 inches). In many cases, we may also provide a store, washbasin or bathroom under the landing of the half space landing. This may require about 12 to 13 steps in the first flight of the stairs to reach a height to provide at least 2 m under the landing slab.

Construction of Simple Concrete Stairs:

There are many ways in which the simple concrete staircase can be constructed. Two of them- inclined slab construction and cantilever slab construction-are discussed further.

Inclined slab construction: These types of stairs can be built in two ways. Firstly the inclined slab and steps can be built together with reinforced concrete. Steps are built with proper shuttering. Alternatively, in cheaper construction, only the inclined slab is first built in concrete and the steps are later constructed with brickwork. This latter procedure considerably reduces shuttering costs and is commonly used for residences.

Cantilever slabs: It was remarked that the stairs can be built in many ways. In residences, where the traffic is light, the individual steps can be cantilevered from the surrounding walls of a staircase room. Otherwise for very wide stairs, the individual steps can be centrally supported and cantilevered from a central cast-in-situ spine beams specially built as part of the stairs. The latter type of construction is very common in office buildings where a wide staircase is planned. When they are cantilevered from walls as in residences, it will be desirable to have a concrete beam in the wall connecting all the ends of the slabs of the stairs to improve stability with long term use. Otherwise the fixing ends may get loose due to vibrations and long term use.

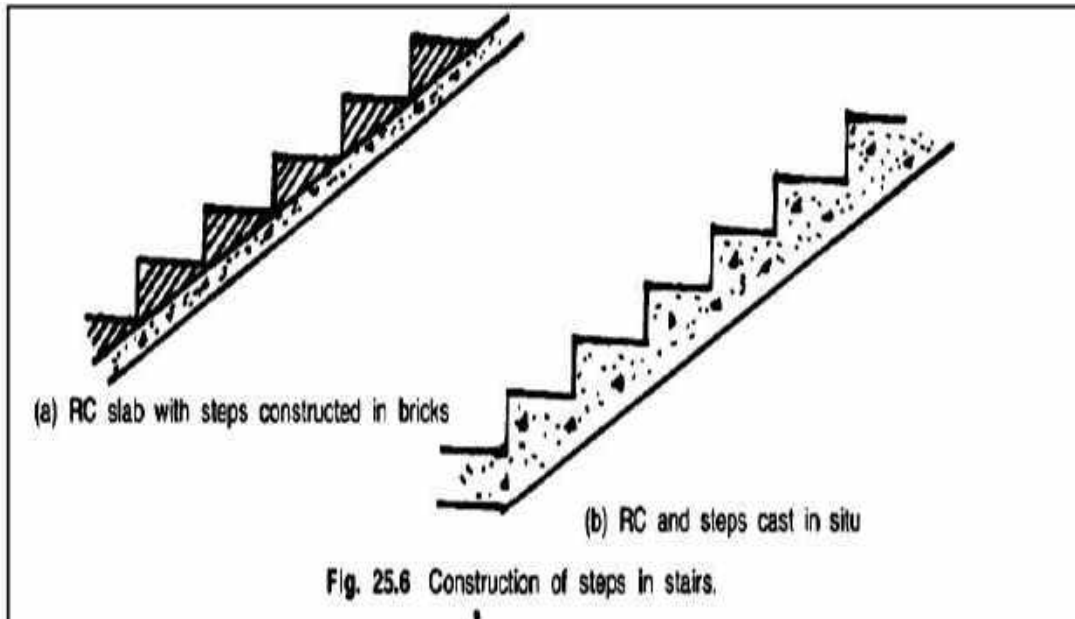

2.2 RAMPS:

Ramps are provided where large numbers of persons or vehicles have to be moved from floor to floor. It is also provided for the convenience of the old and the invalids in places wherever they are necessary. Multi Storey car parks that are generally provided in the heart of the cities are usually provided with ramps or lifts for taking cars to and from the upper floors. Ramp is a uniformly sloping surface or inclined plane. However, they occupy much larger space than stairs and lifts for construction. In India, many cinema halls and low rise hospitals are provided with ramps instead of stairs. It is easier for sick people to climb a ramp than a series of steps.

2.3 ELEVATORS OR LIFTS:

According to the present building regulations, it is mandatory to provide lifts or elevators in all public buildings for the convenience of the elderly and the invalids (physically challenged). The main components of lifts are the following:

- The lift car moving on guide rails.
- Machine room with winding machine with electric motor and other memory mechanisms.
- Suspension ropes (steel wire ropes with factor of safety 12 to 20)

- Counterweight on pulleys to balance the car with 40 to 50% of maximum live load. This is provided usually at the back of the car.
- Buffers for the car in the lift pit floor. Spring buffers are used for low velocity lifts and oil buffers for speed in excess of 1.5 metre per second.
- Specially operating landing for entry and exit .
- The passenger capacity of a lift is usually rated assuming the weight of a person as 68 kg.

Structural Components of Lifts:

The civil work components necessary to accommodate a lift are usually made of RCC and are as follows:

1. A lift well of suitable size, usually extending up to 1600 to 2600 mm, below the bottom landing.
2. Openings of height of 2 metres for entry of people at every floor level. The breadth of opening will depend on the width of the lift well and number of passengers to be handled. (Hospital lifts, for example, will be wide.)
3. An upper machine room on top of the lift to suit the lift size chosen and according to the specification of the supplier of the lift. IS 14665, Parts I to IV, can be used for their design.

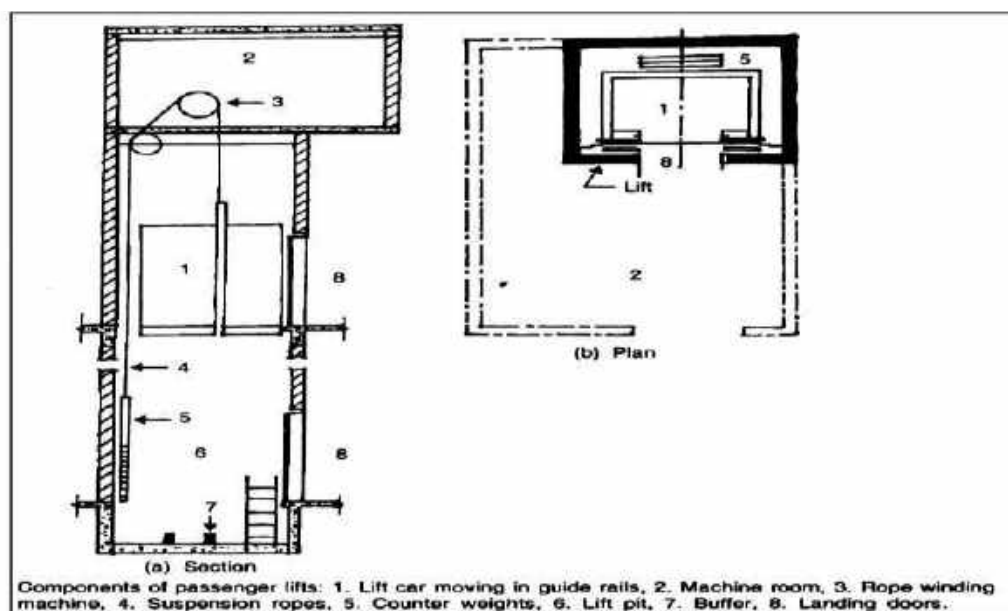

Elevators are used in buildings having more than four storeys. They are used for providing vertical transportation of passengers or freight. They can be either electric traction elevators or hydraulic elevators. Electric traction elevators are used exclusively in tall buildings. Hydraulic elevators are generally used for low-rise freight service which rise up to about six storeys. Hydraulic elevators may also be used for low-rise passenger service. The different components of an electric traction elevator are the car or cab, hoist wire ropes, driving machine, control equipment, counter weight, hoistway rails, penthouse, and pit. The car is a cage of light metal supported on a structural frame, to the top of which the wire ropes are attached. The ropes raise and lower the car in the shaft. They pass over a grooved motor-driven sheave and are fastened to the counter weights. The paths of both the counterweights and the car are controlled by separate sets of T-shaped guide rails. The control and operating machinery may be located in a penthouse above the shaft or in the basement. Safety springs or buffers are placed in the pit, to bring the car or counterweight to a safe stop. Elevators, serving more than three floors, should be provided with means for venting smoke and hot gases from the hoistways to the outer air in case of fire. Vents may be located in the enclosure just below the uppermost floor, with direct openings to the outside or with non-combustible duct connections to the outside.

Vent area should be at least 3.5% of the hoistway cross sectional area.

A few important terms, generally, used in ELEVATOR description, are defined below:

1. Annunciator. This is an electrical device which indicates, usually by lights, the floors at which an elevator landing signal has been registered.
2. Buffer. This is a device for stopping a descending car or counterweight beyond its bottom terminal by absorbing and dissipating the kinetic energy of the car or counterweight. The absorbing

medium may be oil, in which case the buffer may be called an oil buffer, or a spring, in which case the buffer may be referred to as a spring buffer.

3. Bumper. This is a device other than a buffer stopping a descending car or counterweight beyond its bottom terminal by absorbing the impact.

4. Car. This is the load carrying element of an elevator, including car platform, car frame, enclosure and car door or gate.

5. Car-door Electric Contact. This is an electrical device for preventing normal operation of the driving machine unless the car door or gate is closed.

6. Car Frame. This is the supporting frame to which the car platform guide shoes, car safety, hoisting ropes or hoisting rope sheaves, or the plunger of a hydraulic elevator are attached in a car by which an operator actuates the control.

7. Control. This is the system governing the starting, stopping, direction of motion, acceleration, speed and retardation of the car.

8. Generator Field Control. This employs individual generator for each elevator, with voltage applied to the driving machine motor adjusted by varying the strength and direction of the generator field.

9. Multi Voltage Control. This impresses successively on the armature of the driving machine motor at various fixed voltages, such as those that might be obtained from multi-commutator generators common to a group of elevators.

10. Rheostatic Control. This varies the resistance or reactance of the armature or the field circuit of the driving machine motor.

12. Single Speed Alternating Current Control. This governs a two-speed driving machine induc

13. Dispatching Device. This is a device which operates a signal in a car to indicate when the car should leave a designated floor or to actuate the car's starting mechanism when the car is at a designated floor.

14. Emergency Stop Switch. This is a car-located device that, when operated manually, causes the car to be stopped by disconnecting electric power from the driving machine motor.

15. Hoistway. This is a shaft for travel of one or more elevators. It extends from the bottom of the pit to the underside of the overhead machine room or the roof. A blind hoistway is the portion of the shaft that passes floors or other loadings without providing a normal entrance.

16. Hoistway Access Switch. This is a switch placed at a landing to permit car operation with both the hoistway door at the landing and the car door open.

17. Hoistway-door Electric Contact. This is an electrical device for preventing normal operation of the driving machine unless the hoistway door is closed.

18. Hoistway-door Locking Device. This is a device for preventing the hoistway door or gate from being opened from the landing side unless the car has stopped within the landing zone.

19. Levelling Device. This is a mechanism for moving a car that is within a short distance of a landing towards the landing and stopping the car there. An maintaining two-way levelling device will keep the car floor level with the landing during loading and unloading.

20. Machine. This is the power unit for raising and lowering an elevator car.

21. Non-stop Switch. This is a device for preventing a car from making registered sanding stops.

22. Operating Device. This is the car switch, push button level, or other manual device used to actuate the control.

23. Operation. The method of actuating the control.

24. Car-Switch Operation. This starts and stops a car in response to a manually operated car switch or continuous pressure buttons in a car.
25. Pre-register Operation. This is one in which signals to stop are registered in advance by buttons in a car or loadings and then at the proper points as a car, travel are given to an operator in the car who initiates the stop, which is completely automatic.
26. Signal Operation. This starts and stops a car automatically as landings are reached, in response to actuation of buttons in cars or at landings, irrespective of direction of car travel or sequence in which buttons are actuated, but the car can be started only by a button or starting switch in the car.
27. Parking Device. This is a device for opening from the landing side the hoistway door at any landing when the car is within the landing zone.
28. Pit. This is a portion of a hoistway below the lowest landing.
29. Position Indicator. This is a device for showing the location of a car in the hoistway.
30. Rope Equalizer. This is a device installed on a car or counterweight to equalize automatically the tensions in the hoisting ropes.
31. Runby. This is the distance a car can travel beyond a terminal landing without striking a stop.
32. Safety. This is a mechanical device attached to the counterweight or to the car frame or an auxiliary frame to stop or hold the counterweight or the car, whichever undergoes a free fall, or if the hoisting ropes should slacken.
33. Safety Bulkhead. This is in a cylinder of a hydraulic elevator, a closure, at the bottom of the cylinder but above the cylinder head, with an orifice for controlling fluid loss in case of cylinder-head failure.
34. Signal Registering Device. This is a button or other device in a car or at a landing that causes a stop signal to be registered in a car.

35. Signal Transfer Device. This is a manually operated switch for accomplishing the same function as a signal transfer device.

36. Slack Rope Switch. This is a device that automatically disconnects electric power from the driving machine when the hoisting ropes of a winding drum machine become slack.

37. Starter's Control Panel. This is an assembly of devices with which an elevator starter can control the way in which one or more elevators function.

38. Terminal Speed-Limiting Device (Emergency). This is a device for automatically reducing the speed of a car approaching a terminal landing, independently of the car operating device and the normal terminal stopping device if the latter fails to slow the car as intended.

39. Terminal Stopping Device. This is a device for slowing or stopping a car automatically at or near a terminal landing, independently of the car operating device. A final terminal stopping device after a car passes a terminal landing, disconnects power from the driving apparatus, independently of the operating device, normal terminal stopping device or emergency terminal speed limiting device. A stop motion switch, or machine final terminal stopping device, is a final terminal stopping device operated directly by the driving machine.

40. Transom. This comprises one or more panels that close the opening above the hoistway entrance.

41. Travel (Rise). This is the vertical distance between top and bottom terminal landings.

42. Travelling Cable. This is a cable containing electrical conductors for providing electrical connections between a car and a fixed outlet in a hoistway.

43. Truck Zone. This is a limited distance above a landing within which the truck zoning device permits movement of a freight elevator car with its door or the hoistway door open.

44. Truck Zoning Device. This is a device that permits a car operator on move, within a specified distance above a landing, a freight-elevator car with its door or the hoistway door open.

2.4 ESCALATORS:

These are **powered stairs**. They are used when it is necessary to move a large number of people from floor to floor. These stairs have continuous operation without the need for operators. They have large capacity with low power consumption. These escalators are in the form of an inclined bridge spanning between floors. The components of an escalator consist of a steel trussed framework, handrails and an endless belt with steps. At the upper ends of an escalator there is a pair of motor-driven sprocket wheels and a worm-gear driving machine. At the lower end is a matching pair of sprocket wheels. Two precision made roller chains travel over the sprockets pulling the endless belt of steps around the steps which move on an accurately made set of tracks attached to the trusses with each step supported on four resilient rollers. Escalators are reversible in direction. They are generally operated at a speed of 30 or 40 m/min. Slope of the stairs is standardized at 30°. For a given speed of travel, the width of step determines the capacity of the powered stairs.

Escalators should be installed where traffic is heaviest and convenient for passengers. In the design of a new building, adequate space should be allotted for powered stairs. Structural framing should be made adequately to support them.

Escalators are generally installed in pairs. One of them is used for carrying up-going traffic and the other for traffic moving down. The arrangement of escalators in each storey can be either parallel or criss-cross. Criss-cross arrangement is more compact. It reduces walking distance between stairs at various floors to a minimum. That is why a criss-cross arrangement is preferred over parallel arrangement. The floor openings of an escalator not serving as required if exist must

be protected. The following protection methods are generally used in buildings not completely protected by a standard supervised sprinkler system.

Sprinkler-vent method. This is a combination of an automatic fire or smoke detection system, automatic air-exhaust system and an automatic water curtain.

Spray-nozzle method. This is a combination of an automatic fire or smoke detection system and a system of high velocity water-spray nozzles.

Rolling shutter method. In this an automatic, self-closing, rolling shutter is used to enclose completely the top of each escalator.

Partial enclosure method. In these kiosks, with self-closing, fire-doors, provide an effective barrier to the spread of smoke between floors.

3. DAMP-PROOFING (i.e., D.P.C.) TREATMENTS IN BUILDINGS

The use of damp-proofing courses (D.P.C.), for the treatment of buildings, against dampness, can be grouped into the following categories:

1. Treatment of foundations' dampness from adjacent ground.
2. Treatment of foundations on bad (poor) soils.
3. Treatment of basements.
4. Treatment of floors.
5. Treatment of walls.
6. Treatment of flat roofs, parapets and copings.
7. Treatment of pitched roofs

1. Treatment of Foundations' Dampness from Adjacent Ground. In case the moisture rises up the walls through the foundations where water is percolating from the adjacent ground, this may be treated by providing air drains and damp-proof course or by D.P.C. alone. Sub-soil drainage

may also be provided to solve this problem. An air drain is a narrow dry space (20 to 30 cm width) which is provided on the outer face of the wall below the ground level. It is formed by a thin outer wall resting on the base slab of foundation and carried little above the ground level (usually by 15 cm) to prevent water entering the drain. Openings with gratings are provided at a regular spacing for the passage of air. The top of the air drain is covered either with R.C.C. slab or stone slab and due provisions for examination and clearing this drain are made. Damp-proof courses (D.P.C.) are also provided horizontally and vertically as shown in Fig. 10.4. An air drain with wall ties may also be used.

2. Treatment of Foundations on Bad (Poor) Soils. Where the foundations of basements are not properly drained (in dry or peat soil) and hence subjected to great hydrostatic pressure, then in such cases the structure should be disconnected from the face of the ground excavation and a trench made all around for width of about 30 cm taken down to a point as low as under side of the concrete footings. This becomes essential, because the mere provision of continuous D.P.C. may not give satisfactory results. The bed of the trench should be provided with a good slope at each end and the trench filled with coke, gravel, or stone, graded with fines to fill the voids. Moreover, in such cases the basement is relieved of hydrostatic pressure by suitably draining the sub-soil water. Sub-soil water may be drained by providing open jointed land drain at the bottom of trench and also drainage-pipes below the concrete base. The open jointed pipes or drains are given a bed slope so that the water is discharged in an outlet outside the building from where the collected water is allowed to flow away in some natural drain. The gravel bed helps to accumulate the sub-soil water seepage and percolate the same in the pipes. The details of horizontal and vertical D.P.C. (either mastic asphalt or bituminous felt) under the floors and through the external walls,

3. Treatment of Basements. To ensure the dryness, the whole of the structure below ground level should be provided with a continuous membrane of asphalt (t.e., D.P.C.) either mastic asphalt or bituminous felt supported on the inside. This is achieved by spreading a layer of an impervious material (i.e., D.P.C.) over the whole area of the floor and continuing the same (i.e., Horizontal D.P.C.) through the external walls extending vertically up, forming a sort of water-proof tank . The details of asphalt tanking or waterproof or D.P.C. tank and sequence of operations in providing D.P.C. for basements in buildings, have been shown in Figs. 10.6 and 10.7 but the following points require due consideration in asphalt tanking.

- (i) D.P.C. basement buildings should be provided in the dry season when sub-soil water is at its lowest level.
- (ii) D.P.C. is provided on the outside of walls and under floors of basements and underground structures, in such a way that the latter may provide support necessary to withstand such water pressure as may be exerted on the outer faces of the structures.
- (iii) Horizontal D.P.C. is laid continuous and extended vertically up through the walls. This vertical D.P.C. should either be taken to the ground for a minimum distance of 15 cm or may end in a horizontal D.P.C. if necessary.
- (iv) An adequate dewatering arrangement for pumping out sub-soil water should be installed in order to keep water level below the operating level or working level.
- (v) Suitable shuttering should be provided to prevent the excavation from collapsing.
- (vi) D.P.C. is laid over the entire base slab of concrete including the projection of 15 cm.
- (vii) A protective flooring of brick flat on cement concrete (1: 3: 6) is laid to protect D.P.C. from damage during the construction of the floor. The structural walls and floors are then constructed to withstand the anticipated water pressure.

(viii) Sufficient care should be exercised to ensure a perfect bond between the D.P.C. on the base slab and that on the outside of walls.

(ix) The gap between thin protective brick wall (half-brick) and structural wall should be grouted so as to ensure that no air is trapped between the D.P.C. and the walls.

N.B. 1. In case of deep basements, the D.P.C. should be applied on the outside of walls (rather than through the walls) in stages of convenient heights and the construction of the protective wall as well as back filling the earth is completed progressively.

2. Types of damp-proofing treatments above and below the ground level have been recommended as below:

A. ***D.P.C. above ground level*** shall be according to either (a) or (b), below:

(a)

- (i) Hot applied blown bitumen @ 1.5kg/sq.m.
- (ii) Hessian base self-finished felt type 3, grade 2.
- (iii) Hot applied blown bitumen @ 1.5 kg/sq.m.

(b)

- (i) Hot applied blown bitumen @ 1.5kg/sq.m.
- (ii) Fibre base self-finished felt type 2, grade 3. (iii) Hot applied blown bitumen @ 1.5 kg/sq.m.

B. ***D.P.C. for basements and structures below ground level***: The multiple layer D.P.C. shall be according to either (a) Two layers of felt (for light treatments), or (b) Three layers of felt (for heavier treatments) as given below:

(a) (i) Primer.

(ii) Hot applied blown bitumen @ 1.5 kg/sq.m.

- (iii) Fibre base self-finished felt type 2, grade 3.
- (iv) Hot blown bitumen @ 1.5 kg/sq.m..
- (v) Fibre base self-finished felt type 2, grade 3. (vi) Hot applied blown bitumen @ 1.5 kg/sq.m.
- (b) (i) Primer.
- (ii) Hot applied blown bitumen @ 1.5 kg/sq m.
- (iii) Fibre base self-finished felt type 2, grade 3,
- (iv) Hot applied blown bitumen @ 1.5 kg/sq m.
- (v) Fibre base self-finished felt type 2, grade 3,
- (vi) Hot applied blown bitumen @ 1.5 kg/sq m.
- (vii) Fibre base self-finished felt type 2, grade 3,
- (viii) Hot applied blown bitumen @ 1.5 kg/sq m.

4. Treatment of Floors. For dry locations, generally, a filling of 7.5 cm to 15 cm of dry coarse sand under the floor masonry is specified. A hardcore filling of stones with smaller stones to fill in voids is also quite suitable. The filling should be well rammed but not unduly consolidated. It is observed that a thin layer of cinders and coal tar under a tiled floor acts as a good D.P.C. to prevent the moisture as well as efflorescence.

In case, there is a possibility of moisture penetrating the floor, it will be necessary to lay a waterproofing membrane of mastic asphalt or fibrous asphalt felt, before a concrete floor is laid. It happens, because porous concrete attracts moisture from the wet soil and is also aided by capillary action. Even a dense concrete with waterproofing compound is not found to be a perfect barrier to moisture. Hence, generally, over a dry concrete bedding, a priming coat of hot liquid asphalt is first given and then mastic asphalt is applied in two coats.

In case, there is a possibility of the floor being subjected to excessive uplift pressures due to soil and water table characteristics, then concrete floor should be reinforced. The D.P.C. of mastic asphalt or felt laid over the slab should be covered with a concrete wearing coat.

5. Treatment of Walls. In case of basements, the outer face of the wall is well grouted with a water-proofed cement plaster. This forms the base for the asphalt layer (i.e., vertical D.P.C.) which is continued from the basement floor and extended vertically up covering the whole area of the external wall face. This vertical D.P.C. is further protected by a thin skin wall or protective wall. The horizontal D.P.C. in external walls is generally provided at least 15 cm above the ground level. It is further essential to provide a vertical D.P.C. between the floor level and the D.P.C. level on the inside of external walls. In internal walls, the D.P.C. is provided in level with the upper surface of the concrete floor. The continuity of D.P.C. between the internal and external walls is attained by way of cement concrete blocks on bituminised bricks.

If the D.P.C. is to be provided in an existing wall, then a cut about 15 cm or more above the ground is made at the corner of the wall: loose bricks on materials above the cut are removed; and a damp proof membrane of bituminous felt is inserted inside the cut. This process of cutting the slots and inserting the damp-proof membrane is continued, till the entire length of wall is completed. The removed materials like bricks are relaid and the wall surface is plastered or pointed. D.P.C. details in cavity walls have already been shown in Figs. 10.2 and 10.3. In this, a horizontal D.P.C. is laid at least 15 cm above the ground. A layer of lead sheet, copper sheet or asphalt felt is brought down from the inner wall to the head of the floor or window, to protect the openings. To protect the window sills, D.P.C. of bituminous felt or lead sheet can be inserted between the inner wall covering and the sill. Generally, a porous external treatment of plaster, having proportions (1 cement: 1 lime: 6 sand) to the walls is recommended to safeguard against dampness.

6. Treatment of Flat Roofs, Parapets and Copings. In case of flat roofs, the rain water enters either through the defective parapet wall, or cracked roofing tiles or broken pointing, etc. The water proofing treatment given to flat roofs in the various regions of the country (India) is of three types, namely; (i) Lime concrete terracing, (ii) Lime concrete terracing with flat tiles, and (iii) Mud phuska terracing with tiles.

1st method of waterproofing, i.e., lime concrete terracing has been recommended for 'Hot and Humid Regions' in India, viz., Kolkata, Mumbai, Chennai, etc. The process consists of laying the lime concrete at an adequate slope; application of hot prime coat of bitumen over dried lime concrete and finally laying sheet of bitumen over the primed surface.

the 2nd method of waterproofing, i.e., lime concrete terracing with flat tiles has also been recommended for hot and humid regions mentioned above, where the roof is to be used for sleeping or such other purposes. In such cases, the roof is strengthened by covering the lime concrete with two courses of brick tiles laid in cement mortar to withstand the wear and tear effects due to traffic. The process of laying consists of various operations (See Fig. 10.8): Laying the D.P.C. of hot bitumen @ 1.70 kg/m² roof surfaces; spreading over the hot bitumen a layer of coarse sand @0.6 m³ of sand per 100 m² of roof surface; laying lime concrete proper slope in average thickness of 10 cm and, finally, laying two courses of flat tiles (each course having thickness from 13 to 20 mm) in cement mortar (1 cement: 3 sand). The joints of the top course of the tile are pointed with cement mortar having mix proportions 1 : 3 and 5% of crude oil, based on the weight of cement. Instead of flat tiles, pressed tiles or precast cement concrete tiles or 25 mm thick Shahabad stone can also be used based on availability.

3rd method of waterproofing, i.e., Mud phuska terracing with tiles has been recommended for 'Hot and Arid Regions' in India, e.g., Delhi, Punjab, Rajasthan, U.P., etc. The process of laying consists

of various operations (See Fig. 10.9), viz., laying the D.P.C. of hot bitumen @1.70 kg/m² of roof surface; spreading over the hot bitumen, a layer of coarse sand @ 0.6 m³ per 100 m² of roof surface; laying a layer of mud phuska prepared from puddled clay or lime concrete if locally available; covering the mud phuska layer with mud-gobar mortar (3 mud : 1 cow dung) and finally the flat tiles are laid with cement mortar (1 cement: 3 sand) and the joints grouted.

N.B. 1. The following requirements in water proofing of roofs should be ensured:

(i) Shuttering should be either of steel or of strong wood with the joints made water-tight. R.C.C. slabs should be made as dense as possible by the use of vibrators.

(ii) Top surface of R.C.C. slab should be finished with cement mortar (1:3) immediately after laying the cement concrete.

(iii) Before laying terracing, the surface of the seals should be cleaned with a rag soaked in kerosene oil and treated with two coats of hot bitumen.

(iv) Bitumen pads should be used between the slabs and junctions of slabs with walls.

(v) Finished surface of the roof should have a slope of 1 in 50 to ensure good drainage.

(vi) Junctions of roofs and parapets should be paid special attention.

2. Lime concrete specifications adopted for water proofing of Roofs: (7.5 cm to 12 cm thick, average thickness= 10 cm).

(1) 2 lime: 2 surkhi: 7 brick ballast 25 mm gauge (Mumbai and Kolkata regions). 1 lime with 2 1/2 brick ballast 20 mm gauge

(ii)(Madras region). br

(iii) 25 mm gauge brick ballast with 50% lime ac mortar consisting of 1 lime: 2 surkhi (Delhi,U.P., Punjab and Rajasthan regions).

To check the penetration through the parapets and copings, they should be protected from the weather by providing D.P.C. at various locations. such as: (i) A D.P.C. (asphalt layer) covering the whole of the roof and then extending up the junction against the parapet wall at least upto 15 cm height; (ii) A D.P.C. for parapet wall at this height (i.e. above junction at least 15 cm) is laid for

7. Treatment of Pitched Roofs. In case of pitched roofs or sloping roofs, the main causes, in general, of water penetration are: (i) In sufficient lap of tiles or roofing sheets; (ii) Insufficient roof slopes or flat pitches; and (iii) Inadequacy of rainwater gutters. First two causes are taken care of by proper design and construction as per recommendations. For treating rainwater gutters, they should be of sufficient capacity, water-tight and capable of accommodating variations due to temperature changes without leakage. There should not be any over-flowing of the rain water or leakage through the walls. The tiles should project beyond the edge of the gutter. Lead flashing (D.P.C.) provided in the gutter should be extended up the surface of the parapet wall and should be taken inside partly the body of the wall Like flat roofs, the parapet wall should itself be protected by means of a coping of stone or well burnt bricks with a D.P.C. under neath.

TREATMENT OF DAMPNESS

Before applying any remedial measures to the dampness problems at any point in a building, the real cause of dampness should be identified. It is essential, because a cause should be cured rather than the effect.

Method for Laying Damp-proof Course in Existing Buildings.

- Generally the need for laying damp-proof course in existing buildings arises because of the fact that they have been constructed without damp-proof course and the rise of moisture through their walls, calls for remedial measures. The method usually adopted is to insert the damp-proof course after underpinning the walls. This method is not only expensive but

also time-consuming. CBRI, Roorkee, has developed a quicker and more satisfactory method which consists of cutting through a selected course in the brickwork and inserting bitumen felt immediately after the cut is completed.

- To cut or saw through the brick walls, masonry saws have been developed in two sizes, the smaller saw is 35 cm x 8 cm x 3 mm (thick) used for starting the cut initially and the bigger one is 120 cm x 10 cm x 3 mm (thick) operated by two persons for regular cutting. The saw is made of steel blade, with inserts of satellite (4 mm x 4 mm) in the slots made on one of the edges of the blades are brazed with latter so as to remain fixed in position.
- The cut is started at a corner of the wall at the bed joint about 15 cm above the floor or the ground whichever is higher. The sawing is done in lengths of 60 cm or so at a time and fibre based bitumen felts conforming to Indian Standards cut in lengths of the slot cut and width equal to the wall thickness + 5 mm projection on each side of the wall is inserted immediately after the cut is completed. The successive pieces of felt overlap by 10 cm thereby providing an effective barrier to the rising dampness. The little gap between the opened cut joint and the felt is filled with 1:3 (cement : sand) mortar grout and finally finished flush on both sides of the wall. This is simple in operation and carried out even when buildings remain occupied and in use. Apart from saving time, it saves 40 percent in cost as compared to underpinning method. Asbestos cement offer great resistance to cracking, swelling or disintegration when subjected to fire. 11. Plaster or Mortar. It is an incombustible material and hence used for protecting the walls and ceilings of buildings from fire-risks. Cement plaster is better than lime plaster as the latter is likely to be calcined. The fire resistance of the plaster to fire hazards can be increased by using it in a thicker layer or reinforcing the plaster with metal lathes. Gypsum plaster is also applied on

steel columns and other steel members to increase their fire-resistive qualities. The use of cement mortar with surkhi or pozzolana is preferred from the viewpoint of fire-resistance

4. FIRE-RESISTANT CONSTRUCTION

Every region develops its own standards for fire-resistance of buildings based on fire tests. In India, National Building Code classifies the construction into four classes, namely, type 1, type 2, type 3 and type 4 on the basis of fire-resistance offered by building components for 4-hours, 3-hours, 2-hours, and 1-hour respectively. All the structural components of a building should be constructed in such a way and of such materials that they withstand as an integral member of the structure, for the period desired according to the type of construction, in the event of fire. To achieve this objective, due considerations should be made in design and construction of the following structural elements of a structure, and use of combustible material should be avoided as far as possible in the construction.

1. Wall and columns;
2. Floor and roofs;
3. Wall openings; and
4. Building fire escape elements, e.g., stair, stair cases, corridors, entrances, etc.

The fire resistant or fire-proof construction of these above elements will now be discussed in the following pages.

1. Walls and Columns. The load bearing walls or columns of masonry should be thicker in section so that they can resist fire for a longer time and act as vertical barriers to the passage of heat and fire.

If the construction is of solid bearing walls, bricks should be preferred to stones. If it happens to be a framed structure then R.C.C. frames are preferred to those of steel frames. If the use of steel

only is to be made due to specific reasons then it should be protected by embedding it in concrete or by covering it with some other fire-insulating material, such as burnt clay blocks or terra-cotta. Walls of light-weight concrete are preferred to dense concrete as far as fire-resisting qualities are concerned. Both load-bearing and non-load bearing walls should be plastered with fire-resistive mortar to improve fire resistance. Normally, 20 cm thickness of common wall (i.e., wall separating two buildings) is sufficient from a fire-resistance point of view but it should be raised above the roof level by at least 90 cm. This is necessary to protect the adjacent building from fire-hazards.

The partition walls should similarly be of fire resistant materials such as, R.C.C. or reinforced brickwork, or hollow concrete, or burnt clay tiles, or reinforced glass, or asbestos cement board, or metals lath covered over with cement plaster. In case the wooden partitions are employed, they should be covered with metal lath and plaster. Cavity wall construction also offers good resistance against fire and has already been illustrated in Figs. 10.3 and 10.4. For columns and girders, the desirable fire grading is of 4-hours whereas for beams it is of 3-hours. Therefore, as already mentioned,

R.C.C. framed structures are preferred to steel structures for this purpose. As steel columns are liable to twist or distort under intense fire and hence should be protected by way of insulating materials like concrete, hollow clay tiles, bricks, metal lath followed by plaster, etc. In modern buildings, the columns are made fire-proof with concrete and then encased in masonry. The combination of terra-cotta and concrete is most suitable for fire-proofing of steel columns. The sufficient cover to R.C.C. members like beams or columns, should be provided to enable them to function satisfactorily, under fire for a maximum time. It has been recommended that a cover of at least 50 mm. outside the main reinforcement of structural members, like columns, girders, trusses, etc. of 38 mm for ordinary beam, long span slabs, arches, etc. and 25 mm for partition walls, short

span slabs, etc. should be provided. The fire-proofing treatments, which can possibly be given to concrete and steel columns construction, are illustrated in Fig. 10.13.

2. Floors and Roofs. The floors and roofs should be made of fire-resisting materials as they act as horizontal barriers to spread heat and fire in a vertical direction. For fire-resistant construction, the floor such as concrete Jack Arch floors with steel joists embedded in concrete (See Fig. 10.14), hollow tiled ribbed floor (See Fig. 10.15), R.C.C. floors, etc. should be used.

Flooring of material, like concrete, ceramic tiles and brick, is regarded to be most suitable from the viewpoint of fire-resisting qualities. The use of terrazzo, marble and slate as floor surfaces is also quite satisfactory. In case usage of combustible materials, like wood, cast-iron, rubber, linoleum, cork, carpet, etc. in flooring, becomes unavoidable due to financial or practical considerations, then the following points should be given due consideration:

- (i) In case of wooden joist floors, joists at a greater spacing should be used to limit the deflection within allowable limits in the event of fire.
- (ii) Fire stops or barriers in wooden floors should be provided at suitable intervals.
- (iii) While using combustible materials, like cast iron, wrought iron, cork, carpet, etc They should be protected by a covering of insulating material like ceramic tiles, plaster, terra-cotta, bricks, etc.

3. Wall Openings. From a fire-resistant construction point of view, firstly the openings in the walls should be restricted to a minimum and secondly they should be protected by suitable arrangements in case of fire. These openings serve as means of escape in fire if properly protected, otherwise, they provide the passage for the spread of fire in the horizontal direction. Doors and windows should be made of steel. These days wire glass panels are preferred for windows, whereas steel rolling shutters are becoming popular for doorways and window openings in garages, godowns, shops, etc. due to their ability in preventing the spread of fire.

The following points should be given due consideration for protecting the openings:

- (i) Solid timber doors having a minimum thickness of 4 cm should be used where some degree of fire resistance is desired.
- (ii) All those openings which are used for communication, should have double fire-proof doors and other openings may have single fire-proof doors. (Fire-proof doors are considered to be of superior type when made of steel plate with a minimum thickness of 6 mm and of inferior type when made of composite material, i.e., 4 cm thick timber panel sandwiched by iron sheets of 3 mm on either side.
- (iii) Any window exposed to the roof of the structure should be protected by fire-proof shutters.
- (iv) If any structure has a separation less than 6 metres from the adjoining structure, then all doors, windows or exposed sides should be made of fire-proof construction.
- (v) All escape doors should be such as to provide free circulation to the persons in passages, lobbies, corridors, stairs, entrances, etc. and be made of fire-proof materials.
- (vi) Windows, if carried down the floor, should have suitable barrier, like projecting slab beyond the outer face of the building.

#####