

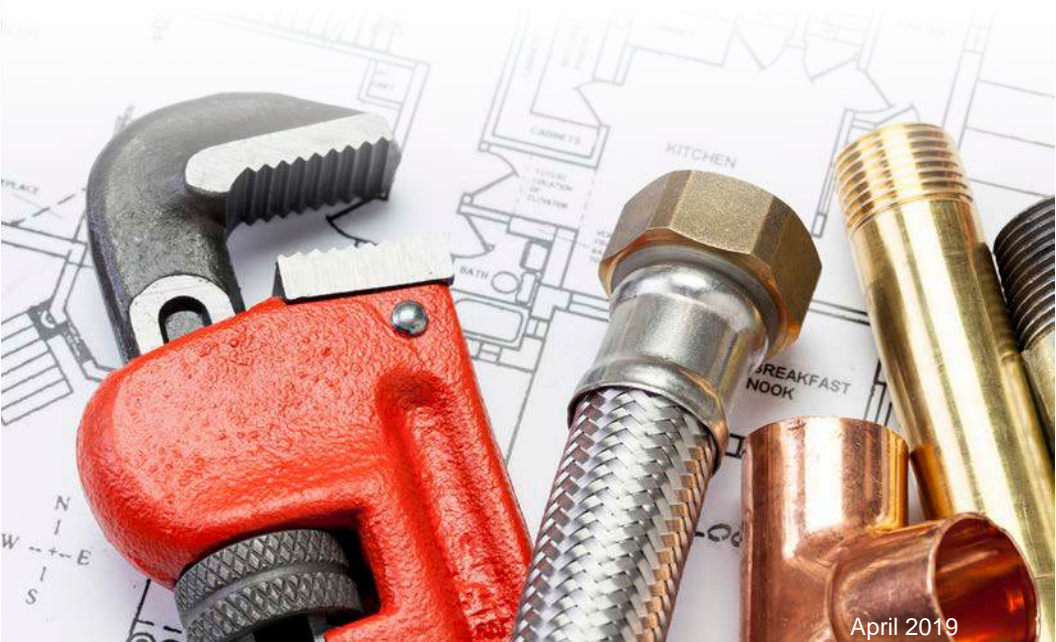

PLANNING, PROPERTY  
& DEVELOPMENT  
DEPARTMENT

# PLUMBING INSTALLATIONS

**A homeowner guide to  
plumbing requirements for  
single-family dwellings**



April 2019

**Permit Requirements ..... 3**

**Inspection Requirements ..... 4**

**Plumbing Code Requirements ..... 4**

**New Drain and Vent Installations ..... 5**

**Potable Water Systems ..... 16**

**Protection From Contamination  
By Cross Connections ..... 17**

**Note:**

This booklet has been written to:

- 1) Provide homeowners with a summary of some more common plumbing regulations; and
- 2) Provide information on the extent to which the plumbing work must be completed before requesting an inspection.

It is recommended that the applicable sections of this booklet be reviewed before commencing the project. Please note that this booklet is not intended to cover all of the plumbing regulations. Complete plumbing requirements are covered in the Manitoba Plumbing Code.

Every effort has been made to ensure the accuracy of information contained in this publication. However, in the event of a discrepancy between this publication and the governing City of Winnipeg By-law, the By-law will take precedence.

# Permit Requirements

---

A plumbing permit must be obtained from the City of Winnipeg Planning, Property and Development Department, Unit 31 - 30 Fort Street whenever:

- a) a plumbing system is constructed, extended, altered, renewed or repaired, and
- b) water supply lines in a building are replaced.

A plumbing permit is not required when:

- a) a stoppage in the drainage system is cleared;
- b) a leak is repaired in a water distribution system;
- c) a fixture is replaced (like for like) without any change to the drainage system; or
- d) a replacement is made to existing faucets, or service water heaters.

Plumbing permits can be issued only to:

- a) a person who holds a valid plumbing contractor's license from the City of Winnipeg authorizing that person to carry out business or trade in the City of Winnipeg, or
- b) a person who owns and resides at the single family dwelling where the work is being done. The owner must personally do the work. The permit would be issued to the owner provided the Manager of Development & Inspections is confident the work will be done competently.

**A plumbing permit is not transferable.**

## Inspection Requirements

Before calling for the initial inspection, all drains, vents and water supply lines must be completely roughed in. The work must not be covered or concealed before inspection. If any part of the plumbing work is found deficient during inspection, alterations or replacement must be made as necessary. You must call for a re-inspection of corrected defects within 30 days of the original inspection.

Prior to covering any new work, you must schedule an inspection by completing the housing inspection request form online found at [www.winnipeg.ca/housinginspection](http://www.winnipeg.ca/housinginspection) or by calling the Housing Inspection office at **204-986-5300** between 8:30 am and 4:00 pm, Monday to Friday. Please be aware that wait times vary for phone-in requests.

Before calling for a final inspection, all fixtures and equipment must be installed, operational and ready for use. If a fixture drain has been roughed-in for future use, it must be sealed with an approved plug or cap.

## Plumbing Code Requirements

### Slope of drains

All drains must be installed to provide a minimum slope away from the fixture of at least 6 mm (1/4 in.) for every 300 mm (1ft) of pipe length. See **FIGURE 1**.

FIGURE 1 - Minimum Slope of Drains

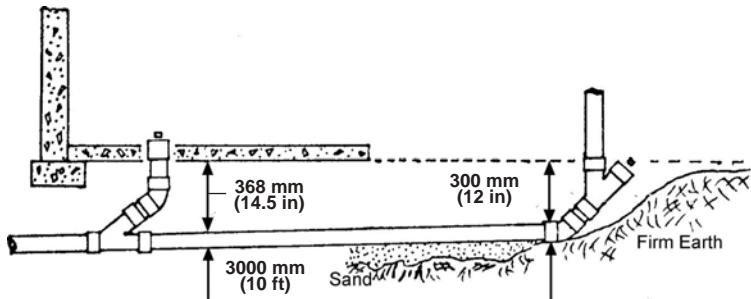

Support of drains

Underground drains must be supported by a full firm base and any supports used to support the drain prior to the installation of granular material must remain in place.

Above ground horizontal pipes shall be supported every 1,200 mm (4 ft).

Trap arms

Except for a water closet (maximum 1000 mm), the total fall from the trap to the vent must not exceed the diameter of the fixture drain. See **FIGURE 2**.

FIGURE 2 - Fall of a Trap Arm

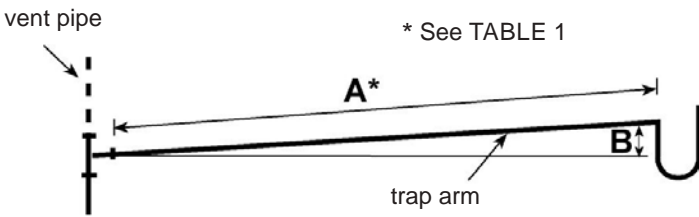

Developed length "A" must be at least twice the size of the trap arm. Fall "B" must not be greater than the size of the trap arm.

The maximum distance between a vent pipe and a fixture trap must not exceed the distances shown in **TABLE 1**. See **FIGURE 3**.

TABLE 1 - Trap Arm Slope (see Figure 2)

Pipe Size (B) (in.)	Slope	Total Allowable Length (A)
1 1/4	1/50	1500 mm (5 ft.)
1 1/2	1/50	1800 mm (6 ft.)
2	1/50	2400 mm (8 ft.)
3	1/50	3600 mm (12 ft.)

FIGURE 3 - Lengths of Fixture Drains and Expansion Joint

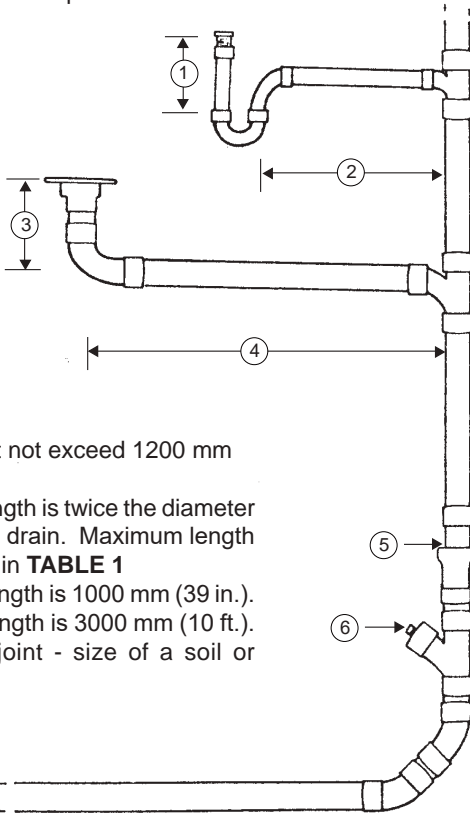

1. Length must not exceed 1200 mm (4 ft.)
2. Minimum length is twice the diameter of the fixture drain. Maximum length is as shown in **TABLE 1**
3. Maximum length is 1000 mm (39 in.).
4. Maximum length is 3000 mm (10 ft.).
5. Expansion joint - size of a soil or waste stack.
6. Cleanout.

**Expansion joints**

The design and installation of every piping system must, where necessary, include means to accommodate expansion and contraction of the piping system caused by temperature change and soil movement. Therefore, expansion joints must be installed at the base of every soil or waste stack. See **FIGURE 3**.

Approved cleanout fittings must be installed at the following locations:

- a) as close as practicable to the point where the building drain leaves the building;
- b) at the base of every soil or waste stack;
- c) to permit the cleaning of a fixture drain from the trap to the vent.
- d) at every change of direction of more than 45 degrees in sink drains. See **FIGURE 4**.

**FIGURE 4 - Building Drainage System With Cleanout Fittings**

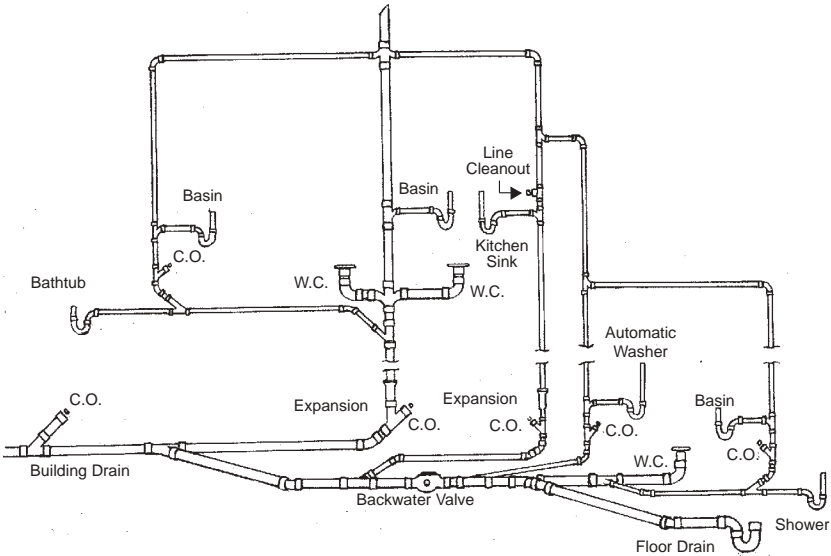

**Use of “TY” and “Y” fittings**



Tee fittings or 90 degree elbows must not be used in the horizontal portion of a drainage system. All changes of direction must be made with the use of “Y” and 45 degree bends. Except that a 90-degree elbow or “TY” fittings may be used to change the direction of horizontal drains when the direction of flow is down to the vertical. “TY” fittings may be used to make the connections to vent pipes. See **FIGURE 5** and **FIGURE 6**. (Exceptions see **FIGURE 7**).

FIGURE 5 - Permitted Use of Sanitary "TY" Fittings - Part 1

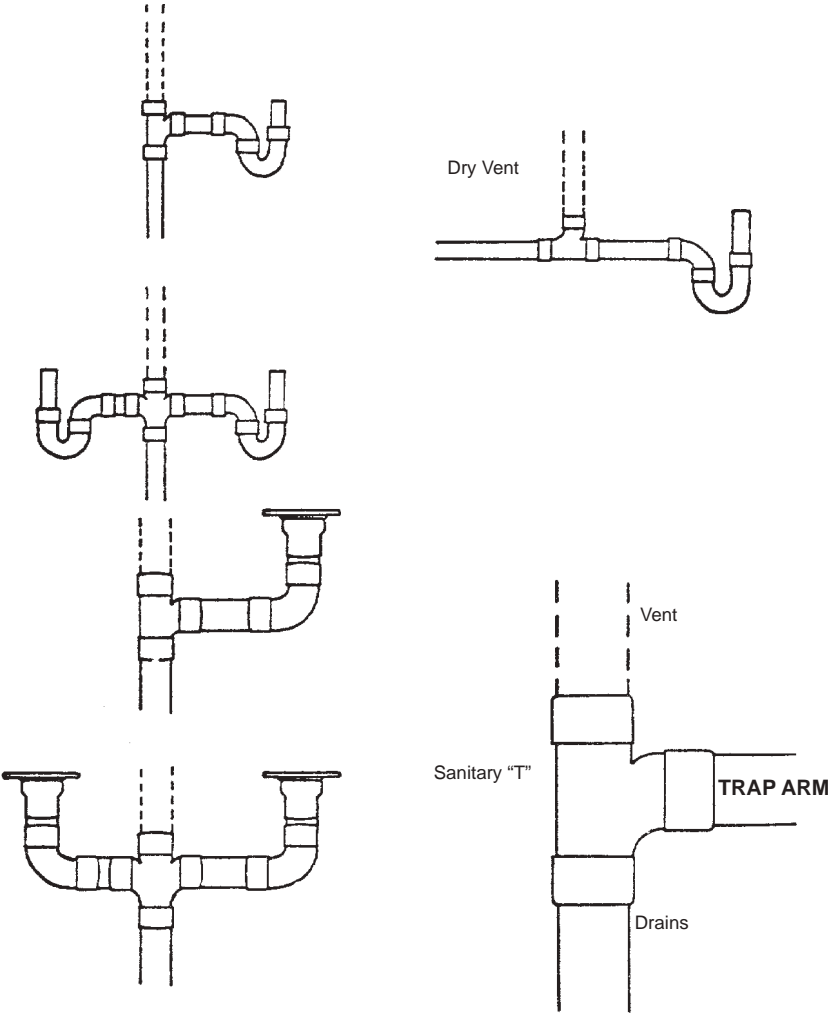



FIGURE 6 - Permitted Use of Sanitary "TY" Fittings - Part 2

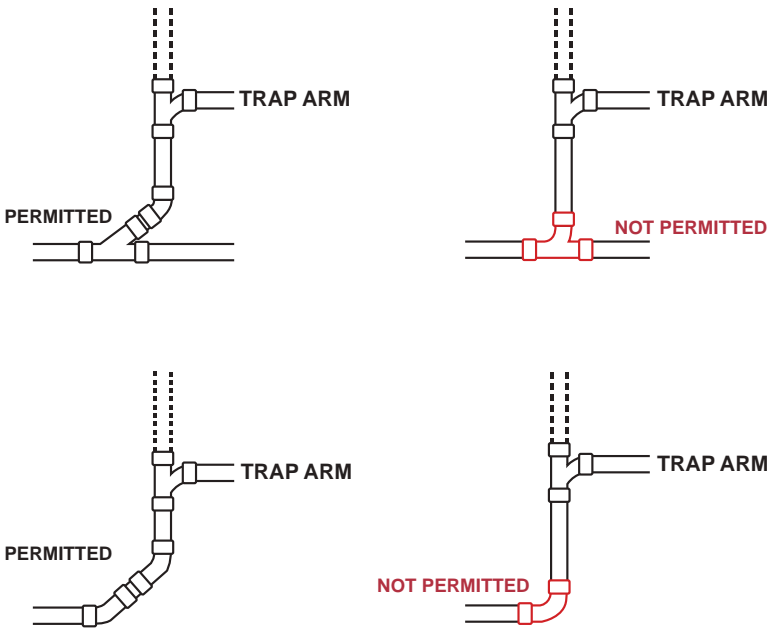
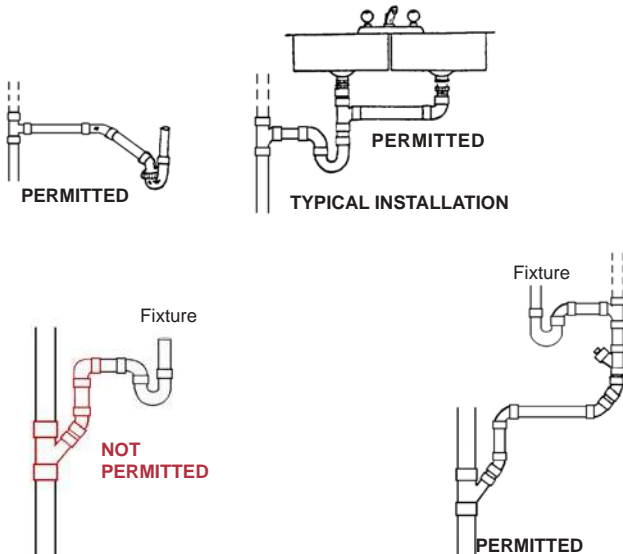

FIGURE 7 - Permitted Use of Sanitary "TY" Fittings - Exceptions



### Piping in exterior walls

Where piping may be exposed to freezing conditions, it must be protected. No drainage or water system can be installed in any exterior wall of a building. Vent pipes are permitted in exterior walls provided they are protected from frost..

### Wet venting

A soil or waste pipe may serve as a wet vent if:

- a) the number of water closets does not exceed two;
- b) water closets are installed downstream of all other fixtures;
- c) if two water closets are installed on the same wet vent a double "TY" fitting must be used for a vertical installation and a double "Y" fitting for a horizontal installation;
- d) trap arms and fixture drains connected to the wet vent cannot exceed 2" except for emergency floor drains;
- e) where a wet vent extends through more than one storey the discharge from any one storey above the first does not exceed 4 fixture units (see **TABLE 2** on page 15), and
- f) a wet vent cannot be reduced in size except for an emergency floor drain portion.

See **FIGURES 8, 9, 10A & 10B.**

**FIGURE 8 - One Storey Venting (Back to Back)**

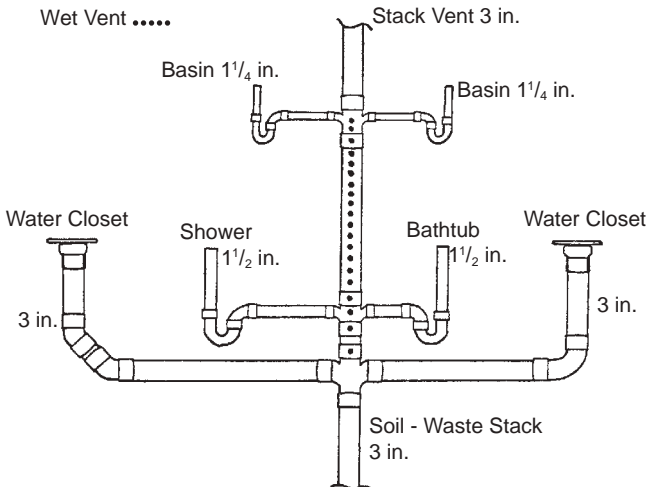
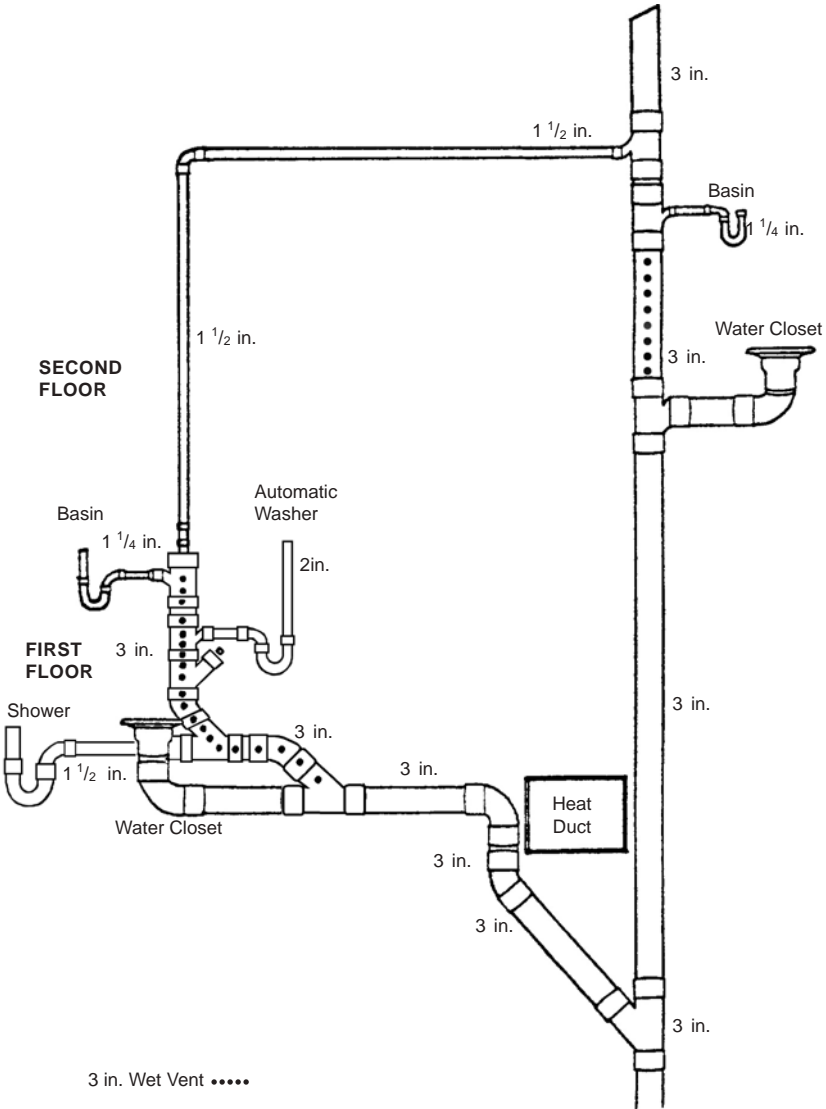

FIGURE 9 - Two Storey Venting



new drain & vent installations

### Backwater valves

All fixtures installed below street level must be protected by a backwater valve arranged to prevent sewer back-up. The backwater valve must be installed to protect the branch drain serving below grade fixtures only.

See FIGURES 4, 10A, & 10B.

FIGURE 10A - Typical Basement Plumbing Installation Showing Venting Method, Backwater Valve & Attachment to "Cast-Iron" Piping

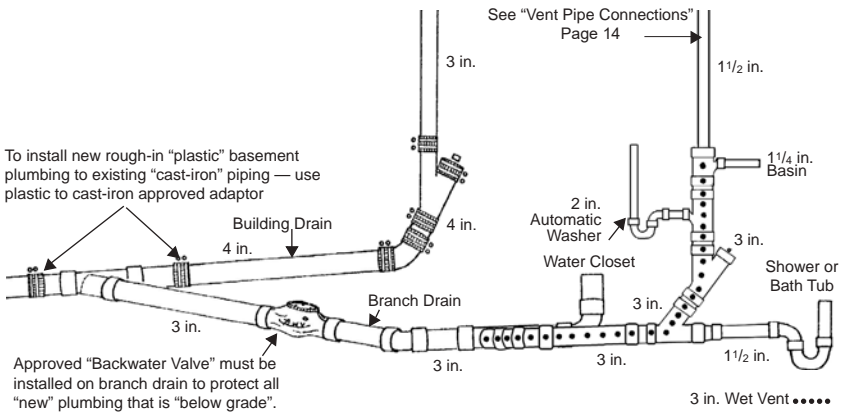
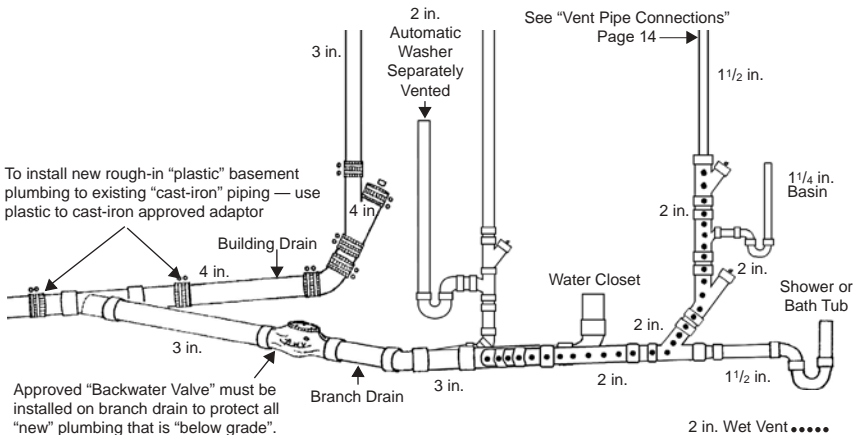
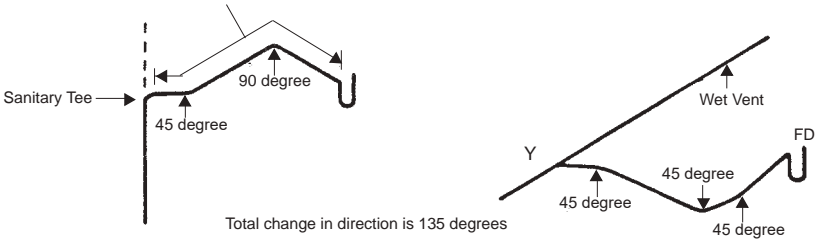

FIGURE 10B - If the washer drain will not be installed on the wet vent with the bathroom group the size of the wet vent can be reduced to 2"



**FIGURE 11 - Location of Vent Pipes Cumulative Change in Direction**

Max. fall of trap arm is equal to pipe size  
 Max. developed length must not exceed distances shown in TABLE 1  
 Min. Developed length is two times pipe size



### Change in direction between trap and vent

The cumulative change of direction between a fixture trap and a vent must not exceed 135 degrees except for a water closet trap arm which cannot exceed 225 degrees.

See **FIGURE 11**.

### Venting

- a) Where a vent pipe passes through the roof, it must be protected from frost closure by increasing the pipe size to at least 75 mm (3 in.) in diameter immediately before penetrating the roof.
- b) A vent located in attic spaces must be insulated.
- c) Vent pipes must be installed without depressions in which moisture can collect.
- d) A vent pipe must extend vertically above the flood level rim of every fixture that it serves before being connected to another vent pipe.

See **FIGURE 12**.

FIGURE 12 - Vent Pipe Connections

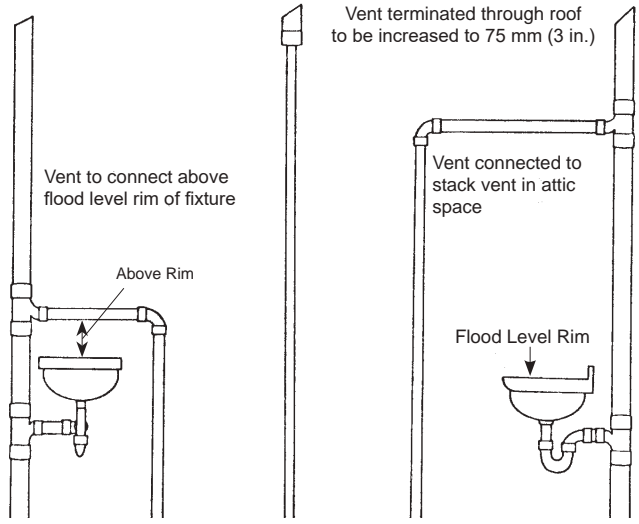

**Drain pipe sizing**

The sizes of all fixture outlet pipes must comply with **TABLE 2**. See **FIGURE 13**.

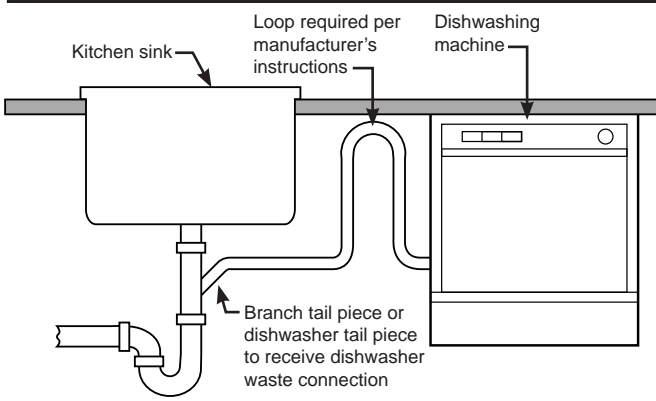
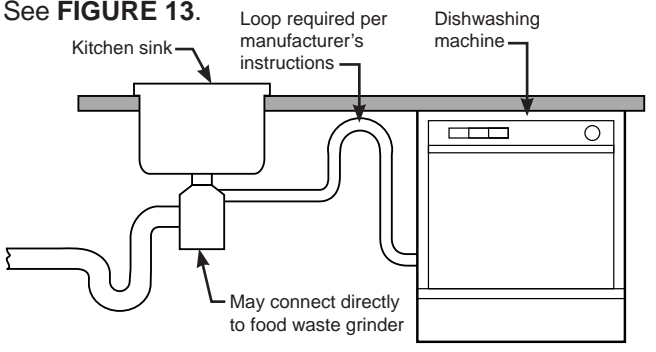
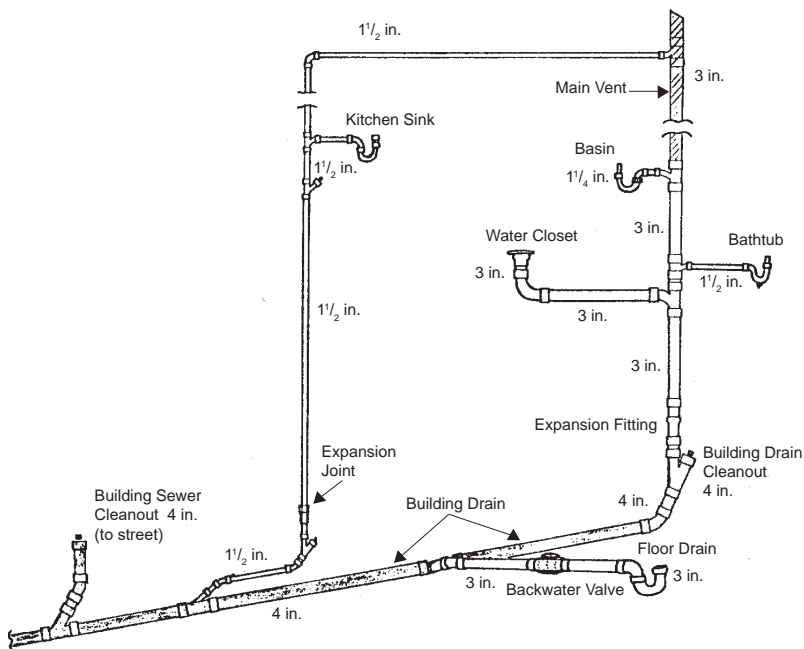

Table 2 - Fixture Size Requirements

FIXTURE	MIN. SIZE OF FIXTURE OUTLET PIPES (inches)
Bathtub (with or without shower) .....	1 1/2
Bidet .....	1 1/4
Clothes Washer .....	2
Dishwashers (no load when connected to a garbage disposal unit or a kitchen sink trap) .....	1 1/2
Garbage disposal units - residential type .....	1 1/2
Laundry sinks .....	1 1/2
Lavatories (basin) .....	1 1/4
Shower Drain (with one shower head) .....	1 1/2
Shower Drain (with two or three shower heads) .....	2
Shower Drain (with more than three shower heads) .....	3
Sink - one and two compartments .....	1 1/2
Water Closet .....	3

FIGURE 13 - Typical Drainage & Vent Sizing



**Note:** Every building drain must be at least 100 mm. (4 in.) in size and must be terminated by a vent at least 75 mm (3 in.) in size.

### **Potable water system**

All potable water systems must meet the following standards:

- a) Every water service pipe must be provided with a shut-off valve where the pipe enters the building.
- b) A water distribution system must be installed so that the system can be drained or blown out with air
- c) Every fixture supplied with hot and cold water controls must have the hot water control on the left and the cold water control on the right.
- d) Every water closet must be provided with a shut-off valve on the water supply pipe.
- e) Every pipe that passes through an exterior wall to supply water (i.e., lawn service) must be provided with a frost-proof hydrant with vacuum breaker or a stop-and-waste valve placed inside the building close to the outside wall or other approved location. Also, a hose bib vacuum breaker must be installed on a hose bib located outside a building or inside a garage to protect against backflow.
- f) All shower valves must be pressure-balance or thermostatic-mixing valves conforming to CSA B125, "Plumbing Fittings".



## Protection from contamination by cross connection

A hose bib vacuum breaker must be installed on every hose bib located outside a building or in a garage to isolate garden hose applications thus protecting the potable water supply from contamination. Connections to potable water systems must be designed so that non-potable water, foreign matter, foreign chemicals or substances that may render the water non-potable cannot enter the system. A cross connection is a direct arrangement of piping which allows the potable water supply to be connected to a line that contains a contaminant. The purpose of a hose bib is to permit easy attachment of a hose for outside watering purposes. The ordinary garden hose is the most common offender as it can be easily connected to the potable water supply and used for a variety of potentially dangerous applications. A garden hose can:

- a) be left submerged in a swimming pool, puddle or other vessel containing non-potable water;
- b) have chemical sprayers attached, for spraying pesticides or herbicides;
- c) be lying on ground that may be contaminated with fertilizer, and garden chemicals;
- d) be attached to a laundry tub with the end of the hose submerged in a tub full of detergent; or
- e) be connected to the supply lines of bottom fed tanks, and boilers, etc. See **FIGURE 14**.

**FIGURE 14 - Back Siphonage & Backflow Prevention**

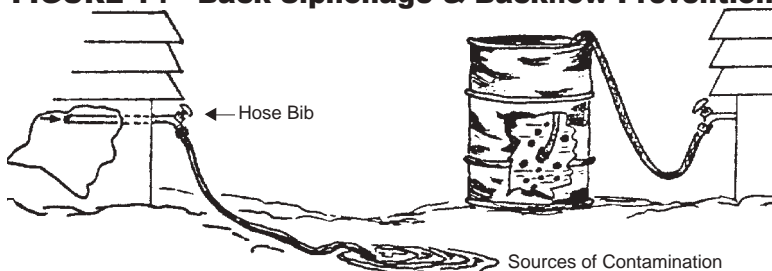

### What is Back Siphonage?

A reversal of normal flow in the system caused by a negative pressure (vacuum or partial vacuum) in the supply piping.

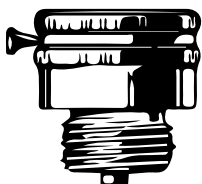

Vacuum breaker

**In-Person Customer Service Hours:**

Tuesday to Friday 8:30 am to 4:30 pm - All Zoning, Permits and Plan Examination services are available at Unit 31 - 30 Fort Street.

Mondays 8:30 am to 4:30 pm are reserved for telephone inquiries and completed application drop-offs. This enables Zoning and Permits staff to process building and development applications received throughout the week.

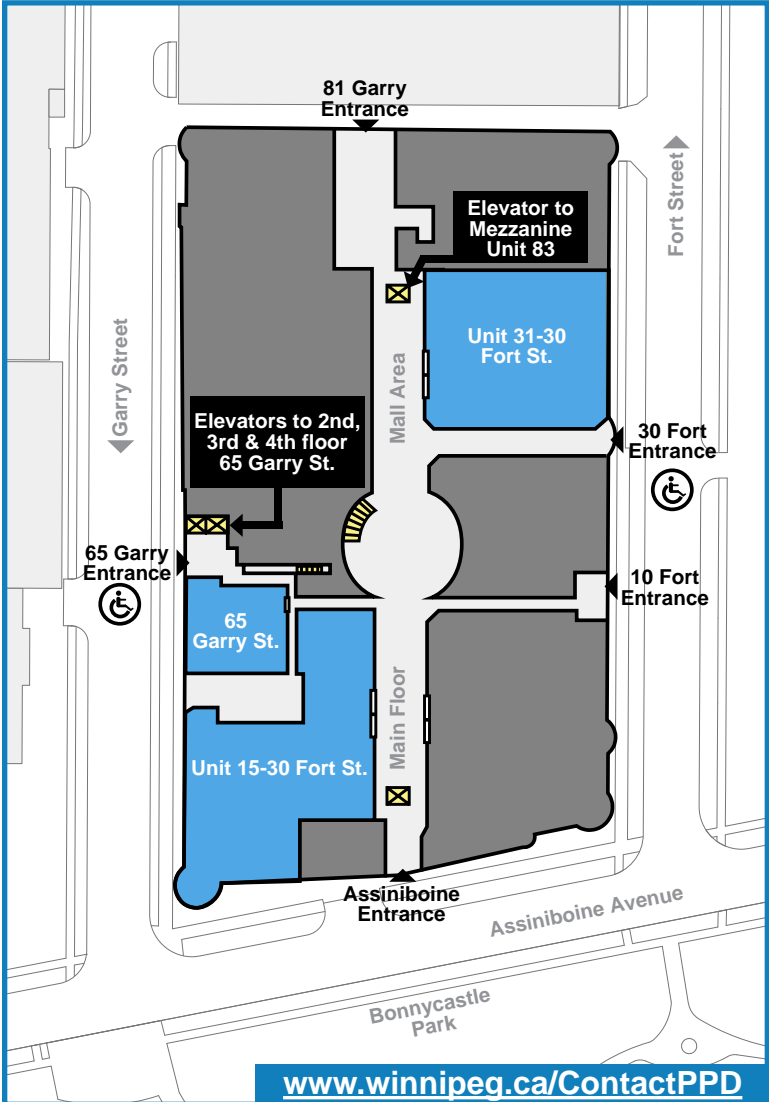





For more information, please call  
the Zoning & Permits Branch:

**204-986-5140**

Planning, Property & Development Department  
Zoning & Permits Branch  
Unit 31 - 30 Fort Street  
Winnipeg, MB R3C 4X7

[www.winnipeg.ca/permits](http://www.winnipeg.ca/permits)