

USHA TAILORING COURSE

Keeping in mind the emerging consciousness of changing fashion trends, Usha International, the renowned company for sewing machines has introduced this course in its schools across the country. This course has been specially designed for those people who have an interest in sewing not only as an outlet for their creative urges but also those who want to supplement the family income and are learning sewing as a means of livelihood. An adept garment maker needs to be creative and imaginative like an artist and at the same time be neat and systematic in his work. Knowledge and understanding of fabric types, color theory, decorative stitching, correct method for measurement taking, economical layout and drafting, updated knowledge of fashion trends etc is of prime importance for a successful garment constructor and pattern maker. The Usha cutting and tailoring course lays great emphasis on all these basic tenets of garment construction and fashion technology. Detailed instructions have been given for some basic and some fashionable outfits for men, women and children. We firmly believe that after completing this course, any student can become a skillful garment maker.

Straight Stitch Sewing Machines



HISTORY OF GARMENTS

To know about the evolution of anything/event/being is what is known as history. To understand the present and to plan the future, knowledge of the past is a must. Like other trades in the industry the garment industry also has a specific history - The history of how the art of cutting and tailoring evolved over the ages. Unlike many other trades this had a slow but steady evolution over time. In the beginning man was not a social and knowledgeable being, but as time passed his sense of social science developed and along with it came modern thoughts, knowledge and specific rules about eating, dressing up his whole philosophy towards life changed and so changed the way mankind dressed themselves to present their best features to society.

INTRODUCTION TO GARMENTS

The evolution of garments is associated with the different historic periods it passed through. **1. Ancient period 2. Agricultural period 3. Gupta period 4. Mughal period 5. The British age 6. Modern day.**

1. **Ancient period:** In the beginning, residing in jungles and not being aware of his sense of shame, man used to roam around without any covering for his body. But as the earth started to warm/ get cool and mankind realized the differences in temperature, he started to use the bark of trees, leaves and other natural coverings to protect his body. But as soon as cultivation started and man discovered other means of clothing, this period came to an end.
2. **Agricultural period:** Cultivation of crops led to an increase in awareness of flax and cotton, which gave mankind the access to fibre and thread.
3. **Gupta period:** Knowledge of garments underwent a big change in this period. Cloth was being woven by this time but stitching was mainly done by hand. Hence loose garments were the norm of the day. There was no knowledge of button sewing/ button holing, hence tie-ups were used to hold garments together. The popular garments of this period were - lehenga choli, chogas, with tie-ups for women, lungis etc.
4. **Mughal period:** This was a period when India was being invaded by foreign armies. The influence that these armies brought had many effects on the overall social structure of the country, including garments. The art of weaving saw an increase in knowledge levels. The art of printing, use of *zari* and other decorative materials became popular. This was mainly a mughal influence as the mughals coming from colder regions were used to wearing tightly knit clothes. This was the age also known as the “Golden Age”. This period witnessed the maximum surge in knowledge levels across various fields.
5. **British period:** The defeat of the Mughals and the subsequent British rule brought along with it a revolutionary change in garment technology. They came with superior knowledge and were familiar with machines and technology. Slowly the influence took over the garment industry which also became mechanized as opposed to hand woven cloth. Mr. Wampun started the trend of a standardized method for taking measurements and drafting garments according to standard sizes. The methods introduced by Mr. Wampun form the basis of all modern day garment construction technology and hence he is known as the **Father of garment technology**. In the year 1866, Sir Charles – II was responsible for introducing the waist coat to the world of fashion. Soon Bruggell evolved this into the ‘long suit coat’. The British period also saw the introduction of specific sports related garments.
6. **Modern day or present day:** During the British rule mechanized weaving machines had firmly established themselves. Indian populace had also started spending a considerable amount of time and money bothering about the way they dressed and presented themselves to the world. Hence these machines made fabrics and clothes gained rapidly in popularity due to the ease of obtaining and the speed with which they could be made available. Looking at way modern day youngsters are becoming more and more conscious about the way they look, garment and fashion technology is surely one of the more important industries that will see tremendous growth in the years to come.

CHAPTER 3

KIT FOR PATTERN MAKING AND SEWING

To work efficiently, the patternmaker must have the proper tools and supplies. The following tools should be part of the pattern making kit.

- 1. French Curves** : For shaping armholes and necklines and for a variety of other shaping needs
- 2. Pencil & Sharpener** : Necessary for pattern making.
- 3. Other Pencils & Pens** : Use red and black coloured pencils to identify pattern changes. Use felt-tip pens in green and blue for pattern information.
- 4. Notcher** : Cuts notches on pattern. Indicates guide marks such as seam allowance, ease and dart intake.
- 5. Tracing Wheel** : Transfers muslin pattern to paper and paper pattern to fabric
- 6. Straight Metre Scale** : For measure / Measuring on fabric
- 7. Eraser** : Non-dust eraser.
- 8. Weights** : To hold pattern in place while making or tracing. Anything that is heavy will do.
- 9. Marking Chalk** : Used for marking fabric.
- 10. Tracing Paper** : To transfer muslin pattern shapes or to make copies of original patterns.
- 11. Paper Scissors** : To cut paper patterns
- 12. Fabric Scissors** : To cut fabrics
- 13. Triangle (Set Square)** : Can be with or without measurements.
- 14. Hip Curve** : Shapes hip, hem, elbows and lapels.
- 15. L Scale** : For making the patterns
- 16. Inseam Curve** : Shapes inseams
- 17. Measuring Tape** : For measuring form or figure.
- 18. Oil Pins** : To keep fabrics in place
- 19. Scotch Tape** : To hold the fabric in place
- 20. Notebook** : To make notes
- 21. Muslin Cloth** : To check the pattern before making actual garment
- 22. Stapler with Pins**
- 23. Board Pins**
- 24. Cutting Table**
- 25. Hand Punch** : Punches holes for storing patterns
- 26. Compass** : For drawing circles and arcs
- 27. Pattern Paper**

Kit for Sewing

- 1. Bobbin**
- 2. Machine Sewing Needles**
- 3. Hand Sewing Needles**
- 4. Thimble**
- 5. Seam Opener**
- 6. Thread**
- 7. Oil Pins**
- 8. Measuring Tape**
- 9. Marking Chalk**
- 10. Fabric Scissors**
- 11. Pinking Shears**

BASIC STITCHING TOOLS

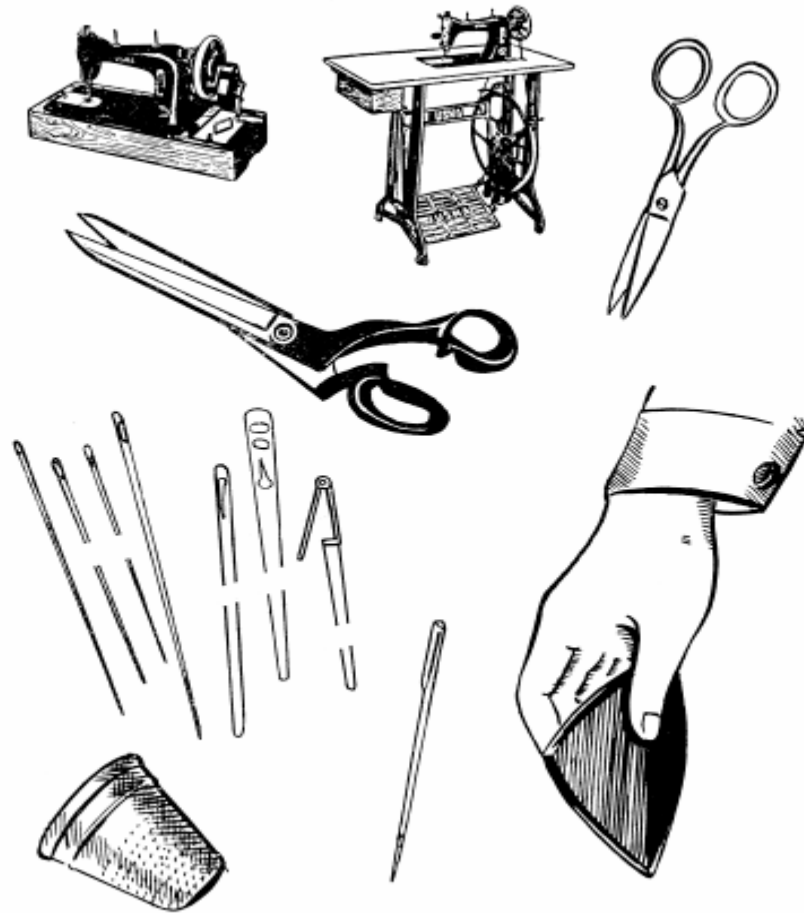

PICTURE HEADINGS

Hand Machine, Foot Machine, Ordinary scissors, Shears, Marking chalk, Thimble, Hand needles, cruel needle, darning needle, hand needles.

BASIC STICING TOOLS

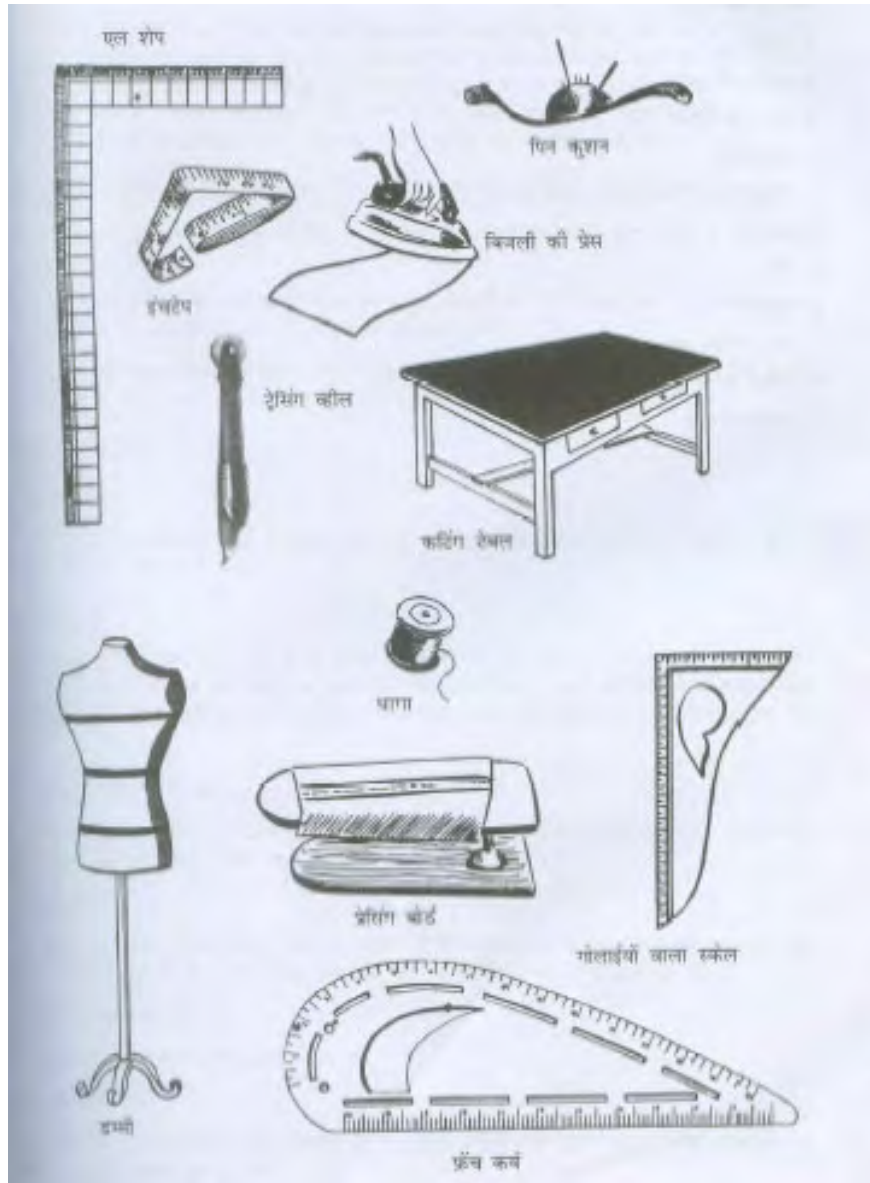

PICTURE HEADINGS

Lshape scale, pin cushion, measuring tape, electric iron, tracing wheel, cutting wheel, thread, Dummy, pressing board, French curve, shaping scale.

BASIC STITCHES

To stitch a beautiful garment various steps have to be undertaken. After taking measurements and cutting the cloth accordingly, we need to stitch the various pieces together with the help of different types of stitches. Attaching two or more pieces of cloth together with the help of a needle and thread, by taking the threaded needle up and down through two pieces of cloth is what forms a stitch. Care should be taken to thread only a requisite amount of thread through the needle so that it does not tangle at the time of forming stitches. Like any other profession, tailoring also has some basic rules and tenets following which is an absolute must, and following are some of these rules:

It is necessary to have knowledge about basic stitches before proceeding to construct a garment because:

- a) To make cut pieces of fabric into a garment one has to attach them with the help of stitches like basting.
- b) There are various types of fabric available in the market today. To be able to stitch all of them successfully, we need to hold them together temporarily. For e.g. Nylon cloth, silks etc.
- c) At times the basic stitches are used to give a neat finish to the garment like hemming.

TYPES OF STITCHES

TEMPORARY STITCHES

Temporary stitches are those that are used to loosely attach two pieces of cloth to ensure that pieces fit together, darts are appearing at the right points. These stitches are opened out after stitching the garment. These also help to keep pieces in places while being stitched. These are of various types, like:

Basting stitch: This is used to join two pieces of cloth together. This helps to keep slippery material in a straight line together while stitching.

Method: Basting is done using a single thread. After threading the needle with an appropriate length of thread, the needle is taken in and out of the two pieces of cloth at some distance, throughout the required length.

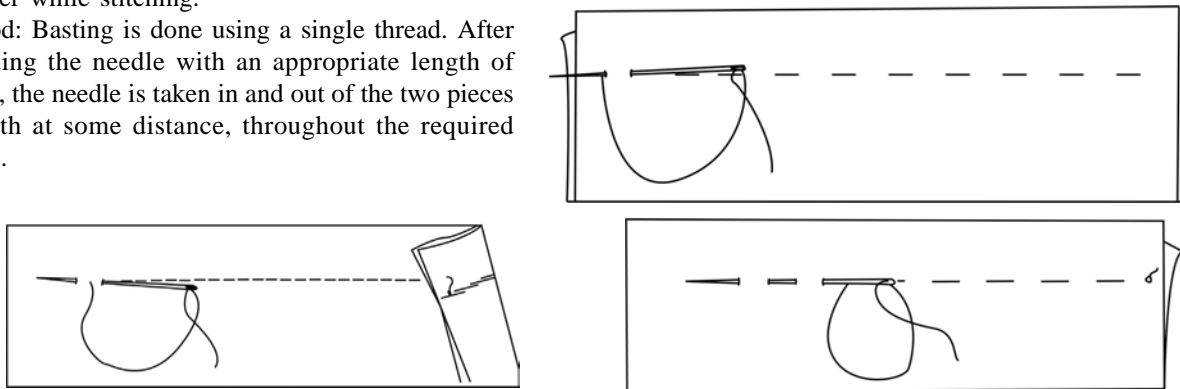

- 1a. **Even basting:** All stitches are of equal length. This is achieved by taking an equal quantity of thread for the upward as well as downward stitch, at equal distances.
- 1b. **Uneven basting:** All the stitches are at varying distance but of the same length, i.e. the length of thread taken for upward and downward stitch is the same but at different distance from each other.
- 1c. **Zigzag basting:** When the cloth is slippery or a lining cloth is to be attached, then this zigzag stitch is used to keep the two pieces together.

2. **THREAD MARKS:** This is a type of temporary stitch, which is removed after the garment is stitched. This is used in situations where you cannot use a pencil or chalk, to mark the cloth. Sewed in a very loose manner, one stitch is small, and the next one larger, Used mainly on garments where many trials etc are required before final fitting. It is usually made with a double thread, but is always made on a double layered cloth. The stitches are adjoining to each other. Made in a loose manner, the needle is taken out from a determined distance and then again inserted in the same position and then the second stitch taken with a certain looseness in the thread

PERMANENT STITCHES

1. **HEMMING:** Used on almost every garment. Can be replaced by a simple running stitch also, but to enhance the beauty of a garment, hemming is used as a most important stitch. This is almost invisible on the right side of the garment and as very small stitches on the wrong side.

Method: As single thread is put in the needle and a very small margin of the cloth is taken or a single strand taken from the turned in surface. The needle is passed through the single strand and through the surface of the cloth to give a neat edge and finishing touch. Used on sleeves, neck, skirts etc.

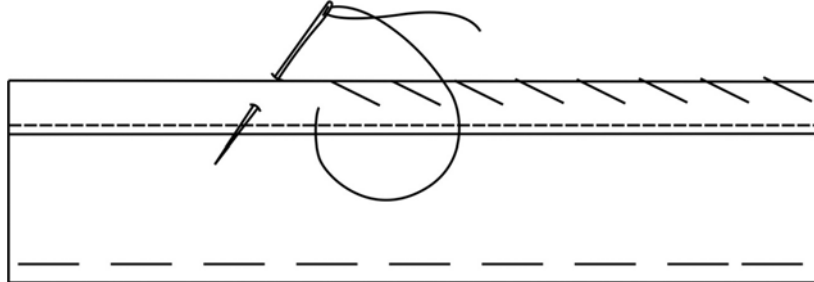

2. **SLIP HEM:** Similar to simple hemming but the stitches are taken at a little distant from each other. It's usually used on slippery materials like silk, nylon etc.

Method: As the name signifies, this stitch is similar to hemming but in a more lateral (slipping) position. Used to finish cuffs, necklines etc.

3. **NARROW HEM:** Stitches taken very close together. Usually to finish men's garments like shirts, coats etc. It is considered to be very strong.

Method: Stitches are put very close together using a single thread. The turned in part is firmly stitched in place using this method of taking the needle in and out of the turned in and rest of the garment.

4. **BLIND HEM:** As the name suggests this stitch is almost invisible to the naked eye. It has to be done with great care to give a neat finish. It is used mainly in men's wear.

Method: The turned in part is so closely stitched to the main body of the garment so as to take only one strand of thread at a time giving it almost an invisible feel.

5. **ROLLED HEM:** Used on fine materials. Edging of saris, edges of rills, puff sleeves etc are finished using rolled hem.

Method : Similar to simple hemming but instead of taking a straight band of cloth as the trend in portion a small edge is rolled between the thumb and forefinger and the stitch is put on the inside surface.

6. **CIRCULAR HEM:** A type of hem only, but used on bias cut cloth. When one needs to turn a straight edge on a bias cloth, it is difficult to do so, that is when this stitch comes in handy. Used on umbrella cut frocks etc. when the edge of the garment is always cut on bias.

Method: Bias cut cloth is once turned inside used. The amount of cloth to be turned is turned and a temporary stitch is put in loosely. The thread is then pulled a little to give small gathers. The gathers are then spread out and then hemmed into place.

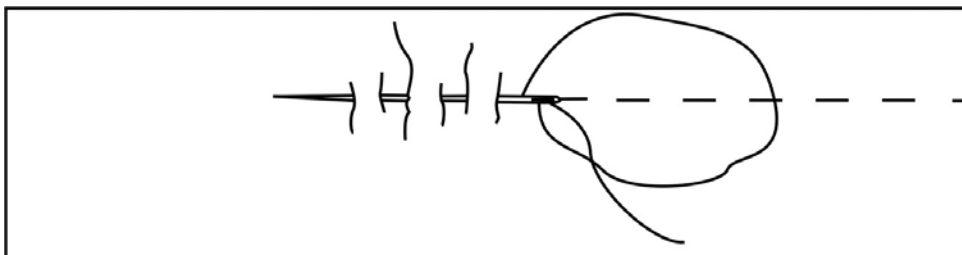

7. **FINE RUNNING STITCH:** One can see only fine dots of this stitch from the right side of the garment. Used mainly for finishing fine garments like sari edges.

Method: The needle is taken out from a predetermined distance. The place from where the needle comes out, then determines the point from where a single strand of thread is picked up for the next stitch. The shape of the garment has to be kept in mind while unraveling this stitch

8. **PADDING STITCH:** Used to set layers of cloth. It is used mainly in coats.

Method: Put at an angle this stitch resembles a temporary stitch. The first line is taken at a certain angle and in the next line the angle is in the opposite direction. The stitch seems like it is standing up.

9. **SAARJOO:** Used in materials where the strands of cloth come out. The garment is not stitched in these cases. Used in tricot trousers etc. This stitch is usually not opened. It is used to keep allowance in garments.

Method: Used with a single thread in the needle. The needle is taken out at an angle. Stitches are taken at some distance from each other and kept loose. You should keep in mind that the thread does not come out at the time of pulling the thread.

10. **BACK STITCH:** Used to attach two pieces of cloth together, by using a handmade stitch. It has been used since the time when the machine was not yet invented. This is believed to have greater flexibility and is very strong. This stitch can also be used easily on a bias cloth. Most important use is on churidar pajamas, the stitch is different from its right and wrong side.

Method: A crease is created on the edge of the two pieces of cloth that need to be joined together. A small margin is taken on top and bottom and small stitches taken close together.

11. **BUTTON HOLE:** Of utmost importance in the tailoring trade, as it is used on almost all types of garments – ladies, men's and children. There is a need to keep an opening somewhere on the garment for ease of wearing and taking off. Most of such openings are closed with the help of buttonhole stitches. The button hole is always made on the top portion. The buttonhole stitch is used to finish the button hole. It is made on two or more layers of cloth. The button hole has a slight curve on one side known as the fan and an edge on the other known as the bar.

Method: First choose the distance between each button hole. Then keeping the diameter of the button in mind, use the tip of a scissor to cut holes in the cloth. To ensure that no, loose strands come out finish the edge with a temporary stitch. Always cut the button hole in the direction of the grain line. Then using a single thread finish the edge with a buttonhole stitch keeping a little extra tension on the 'fan' side to make a kind of chain stitch is then pressed down once the buttonhole is finished.

12. **HOOK EYE:** An opening can be closed with other methods apart from a button and buttonhole. One of these is the hook and eye. There are hooks of different sizes available to suit different purposes and garments like trousers or blouses. The hook is usually fixed half a point behind the edge of the belt. This is fixed using the buttonhole stitch. It is fixed from two edges below and one point above like a bow. The simple hooks are best used with an eye made from thread by hand, using a button hole stitch. The big hooks used for trousers usually come with a ready made eye of metal which is also affixed using a buttonhole stitch.

13. **PRESS BUTTONS:** These are metal buttons with one part having a hole and the other a nail to fit into the hole. The nail part is always put on the top and the one with the depression on the bottom. This is also affixed using the button hole stitch.

14. **BUTTONS:** The various types of buttons available in the market differ in that they have different number of holes – 2 or 4. The method for fixing them remains the same. The spot where the button needs to be fixed is determined and then the needle is taken out first from one and then the other to properly fix the button. There should be a little looseness in the stitch so that the button can be easily passed through the button hole.

TAKING CARE OF SEWING MACHINE

Parts of Sewing Machine:

It is important for the beginner to know and recognize the different parts of the sewing machine.

Arm	: The horizontal upper part of the head which has the mechanism for handling upper thread and driving the needle.
Back Stitch Lever	: A lever located at the lower right hand side of the machine and its basic function is to form the stitches in reverse direction.
Bed	: The lower portion of the machine i.e. stands under which the mechanism for handling lower thread including the shuttle and feed are mounted.
Bobbin	: A small metal spool that holds the lower thread supply.
Bobbin Case	: The metal case that holds the bobbin. It has the tension spring that controls the pressure on the bobbin thread.
Bobbin Winder	: It is a simple mechanism for winding the thread on the bobbin and is located at the right hand side near the wheel.
Feed Dog	: A small metal device under the presser foot which has teeth which carries the material along as it is stitched. It moves the material forward, by one stitch length, after each stitch has been drawn.
Hand Wheel	: Hand wheel is located on the right side of the machine. It is driven by hand or belt in the domestic machine and with the help of belt in the industrial machine. It controls the movement of the needle bar and drives the machine.
Hand Lifter	: To lift the presser foot by hand.
Head	: The upper part of the machine above the stand. It is a complete sewing machine without the bed.
Knee Lifter	: To lift the presser foot by knee.
Needle Bar	: A bar at the end of which the needle is attached.
Pan	: It is the metal pan under the head that catches oil, lint, broken threads.
Presser Foot	: A foot which is used to hold the fabric while stitching. It is detachable and different types of foot are available for different functions e.g. zipper foot, plastic foot.
Presser Foot Lifter	: A lever attached to the presser bar to lift up & down the presser foot.
Shuttle	: A device that carries the needle thread around the bobbin and forms the lock on the lock stitch.
Stitch Regulator	: The length of the stitches is determined by graduation marks on the stitch regulating screw. As you increase the numbers on regulator the number of stitches per inch increases i.e. the size of the stitches decreases and vice-versa.
Tension Regulator	: It is a mechanism which controls the tension of upper thread and the quality of stitches. The tension of the thread is adjusted with the help of spring and nut which controls the pressure on the disc.
Thread Stand or Spool Pin	: It is a metal rod fitted either on top or on side of the stand to hold the thread spool.
Thread Take Up Lever	: A bar/lever which is located above the tension regulator. It moves up and down. It has a hole through which the thread passes. It feeds thread to the needle and it also tightens loop formed and locks it.
Throat Plate	: A semicircular disc with a hole to allow needle to pass through it and also has marking in some cases which are used as guidelines while stitching.

Straight Stitch Machine

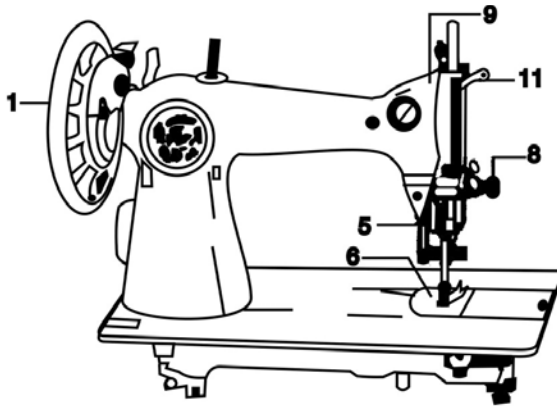

IDENTIFICATION OF PARTS

1. Balance Wheel
2. Disconnecting screw
3. Stop motion screw
4. Presser foot
5. Presser foot lifter
6. Needle Plate
7. Needle clamp screw
8. Thread tension unit
9. Presser bar screw
10. Thread Guide

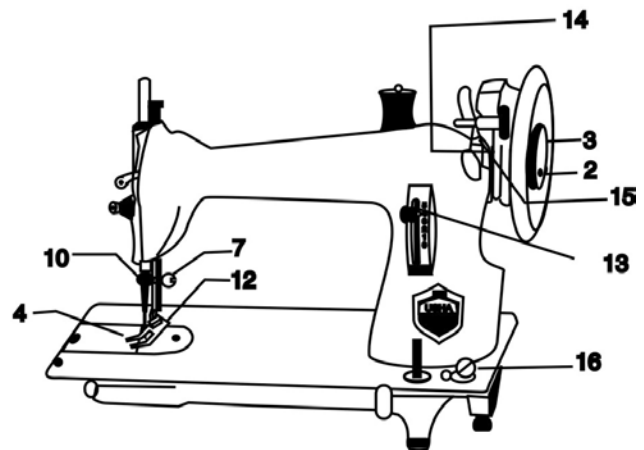

Shuttle System

11. Take up Lever
12. Feed dog
13. Stich regulator knob
14. Bobbin spindle
15. Rubber ring
16. Tension angle
17. Bobbin
18. Bobbin case
19. Shuttle
20. Shuttle race

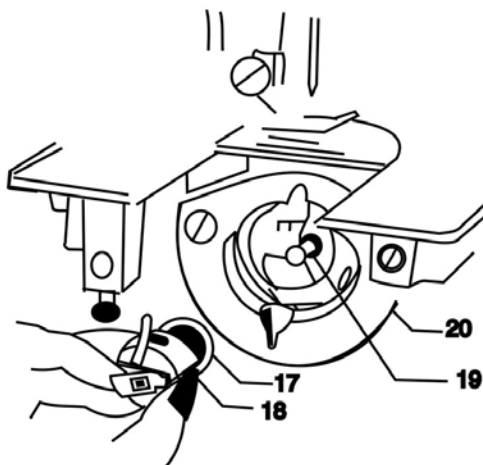

COMMON MACHINE PROBLEMS

The student needs to understand the common problems that may be there while sewing and should be able to rectify these as they are common and irritating and slow down the sewing process. A person operating the machine should be able to rectify these and solve the problems.

1. Bobbin

1. Does not wind :

- Make sure the thread is wrapped around the bobbin in proper direction.
- Check to see if bobbin has been placed properly in the winder.
- The rubber ring might be worn out and needs to be replaced.

2. Winds unevenly :

- The thread may not be inserted in the thread guide.
- You may be running the machine too fast.
- The tension spring may need adjustment.

3. The Needle moves up and down during winding :

- Needle has not been disengaged

2. Fabric

1. Layers feed unevenly :

- Presser foot pressure incorrect
- May need to stitch slowly
- The fabric may be very light weight use tissue paper while stitching

2. Does not feed in straight line :

- Presser foot may be loose or bent
- Pressure of the presser foot may be incorrect
- Needle may be bent
- There may be a defect in the machine feed
- You may be pushing or pulling the fabric

3. Puckers when stitched :

- Many fabrics pucker when stitch in a single layer
- The stitch length may be not in correct relation to the fabric type
- If the fabric is sheer or light weight, the presser foot tension may need to be regulated
- Thread may be too thick
- Needle may be coarse
- Bobbin thread may be uneven
- Stitch tension may be unbalanced
- Feed dog may be worn out

4. Shows feed mark on the underside :

- Presser foot pressure may be too heavy. You may need to put tissue paper between the fabric and the feed
- The feed may be damaged or set too high

5. Fabric is damaged or holes around the stitches :

- Needle may be blunt or too coarse or wrong type for the fabric
- Check for the nick in the throat plate, foot or feed

3. Machine

Motor does not run :

1. Cord is not plugged.
2. Power switch off.
3. Knee or foot accelerator may be jammed or improperly attached to power source.

Motor runs but hand wheel does not turn :

- Thread or lint may be caught or tangled in the bobbin case area.

Motor runs, hand wheel turns, but needle does not move :

1. The needle may have been disengaged for bobbin winding and not tightened back to sewing position
2. If needle has been tightened but still does not move, the motor belt is slipping because it is loose or worn.

Motor, hand wheel and needle moves but fabric does not feed :

1. Make sure the presser foot is down
2. Check the stitch length regulator
3. The pressure regulator may at the least/ light pressure. If fabric is heavy, more pressure may be necessary for fabric to feed.
4. The feed dog may be in the lowered or “down” position

Motor, hand wheel, needle and fabric moves but no stitch is formed :

1. Thread may have come out of the needle.
2. Needle may be threaded in the wrong direction.
3. Needle may be inserted backward or may not be pushed all the way up into the clamp.
4. Needle may be the wrong length for the machine.
5. Machine may be threaded incorrectly
6. Bobbin may be empty
7. Bobbin and / or case may be inserted incorrectly
8. The timing of the machine might be off

Runs sluggishly :

1. Bobbin winder may still be engaged
2. Knee or foot control might be improperly positioned
3. Machine may be in need of oiling and / or cleaning

Runs noisily :

1. Machine probably needs oiling and / or cleaning
2. The needle could be bent and hitting against foot or throat plate
3. Bobbin and / or case may not be tight enough
4. Bobbin may be almost out of thread.

Will not stitch in reverse :

1. If machine is very old, it may not have this capability
2. If it is a recent model, check the stitch control. It may be set for “stretch stitch” or “buttonhole”, sometimes these stitches cannot be reversed manually.

4. Needle**Unthreads :**

1. Insufficient thread may have been pulled through the needle before the seam was started
2. Machine may be out of top thread

Breaks :

1. You may be using the incorrect presser foot
2. Presser foot and / or throat plate may be loose or improperly fastened.
3. Needle might have become bent and hit the presser foot and /or throat plate
4. Needle may be incorrectly inserted
5. Needle might be too fine for the fabric being sewed and for the job being done
6. You may have pulled too hard on fabric while stitching
7. Check machine settings.
8. Needle may be defective

5. Stitches

Are uneven lengths :

1. You might be pushing or pulling the fabric too much
2. Pressure on the presser foot could be either too light or too heavy for the fabric
3. There could be lint or other clog between the teeth of the feed dog

Have loops between them :

1. If the loops are large, the machine is improperly threaded
2. If loops are small tensions are unbalanced
3. Bobbin may be wound unevenly
4. There may not be enough pressure to hold the fabric taut during stitch formation

Skip here and there :

1. Needle may be blunt or bent
2. Needle may be inserted backward or it might not be all the way up into the clamp
3. There may be insufficient pressure on the presser foot
4. Throat plate may be wrong for the purpose
5. You may be stitching at an uneven speed
6. While stitching, you may be pulling too hard on the fabric

6. Thread

Needle thread breaks :

1. Usually this is caused by the needle being inserted backward or threaded backward
2. Thread may be caught in the spool notch or it could be wrapped around the spindle
3. There may be a rough or burred place on a thread guide
4. The needle may be blunt
5. Needle may not be all the way up into the clamp
6. Needle may be too fine for the thread, causing it to fray-often the case with silk buttonhole twist

Bobbin thread breaks :

1. Bobbin case may not be threaded properly and / or the case not inserted properly
2. Bobbin may be too full
3. Check for dirt or clog in the bobbin case
4. Bobbin tension may be too tight

Bobbin thread cannot be raised through hole in throat plate :

1. Bobbin case may be improperly threaded.
2. It may not have been properly inserted

IMPORTANT TERMS FOR CUTTING & TAILORING

1. **BALANCE MARKS:** Marks made on the various pieces of the garment to maintain a balance while stitching. Sometimes the pieces not marked may not be matched properly at the time of stitching giving the garment an odd shape. Used mainly to keep a balance when joining knees, waist, hip etc. A balanced garment fits well and hence it is essential to use these marks, even when one has become a master at tailoring.
2. **BALANCE NOTCHES:** These are small cuts made at the time of tracing the pattern. Made mainly to mark out pleats, darts, overlapping. Also used at times to mark the side seams, waist, and knees.
3. **BALANCE MARKING:** Points marked with the help of a tracing wheel are known as balance marks. Sometimes one needs to put the marks on the right side of the fabric, putting these marks with tailor chalk or a marking pencil, may spoil the cloth. That is when the tracing wheel is used. The tracing wheel can also be used to mark various layers of cloth at one go – for pocket positions etc.
4. **BAGGING:** Garments that take the shape of a bag like slacks, pyjamas, which are tight at the knee or elbow. These are always in the danger of the crease opening at the elbow/knee joint due to movement. A small bag like pouch is formed at these places, if the garment is too tight. This is known as bagging.
5. **BRIDLE:** When the lapel turns outwards in a collar, like in a coat the large fold is cut on bias, and to avoid it flapping a straight tape is attached at the edge. This is known as the bridle.
6. **LAPEL:** When the collar hangs separately from the over lapping and is folded outwards, it is known as lapel.
7. **CUT ON DOUBLE:** When the fabric is folded before cutting, it is known as cut on double or on fold. Most parts of the garment –front, sleeve, back are cut in this manner.
8. **LAYING:** The fabric is first out spread out properly, without any creases or folds and only then is the pattern traced out and the fabric cut. The laying of the fabric properly is known as laying.
9. **LAYOUT:** To put the different pattern pieces on the cloth is known as layout. This helps in checking if the cloth is enough or if a patterned cloth has different pieces with matching pattern.
10. **CLOSING:** Means attaching a means of closing an opening – it could be a hook, a button, a zip or a cord.
11. **FACING:** Finishing an edge of the garment- neckline, armhole, or other opening by attaching a separate piece of cloth (of same or different fabric). This piece is cut in the same shape as that of the opening.
12. **FALSE FACING:** A broad strip of cloth attached to an edge and turned inside to finish the edge instead of hemming is known as false facing. A thinner strip of cloth being attached is known as false hem.
13. **DART:** Without spoiling the shape of the garment, and in order to give a perfect fit, a small amount of cloth is folded and stitched with a single strand till the other end. This process is called putting a dart. It is used at various places on the garment like bust dart, waist dart etc. to give fitting or fullness to shape.
14. **FISH DART:** This is put at the back in lower body garments like shorts, trousers, slacks. Its shape is like a fish, hence the name. It takes an angular shape after being put straight for some distance.
15. **PLEATS:** A fold taken from the inside of a garment and held in place by a stitch is known as a pleat. These are of many types like straight pleats, inverted pleats etc. These are used either as a design element or to provide fullness or fitting.
16. **TUCKS:** Folding the cloth a little from the right side and stitching in a straight line is known as putting a tuck. This is also used to enhance the beauty of the garment or to provide a better fit. If these stitched lines appear of the thickness of a pin then they are known as pin tucks.
17. **VENT:** A type of closing which is stitched at the top but open at the bottom. Generally put at the back. The two pieces of the garment being held together by this seem to overlap each other. The stitch is not visible from outside.
18. **SLIT:** A type of opening which does not have any overlapping. Used in women's garments like shirts, skirts etc.
19. **WELT:** Also known as fitch. This is a broad band on the pocket of a coat. This is stitched from both sides. A pocket which has the stitch on the outside is used on shorts, trousers, slacks, T-shirts etc.
20. **OPENING:** The space kept in the garment for ease of wearing and taking off, generally without any overlapping is known as opening.

21. **PLACKET:** An opening finished by keeping an overlap is known as a placket. Examples are a frock back or a kurta neck.
22. **STAND OF COLLAR:** When the collar is put against the garment and the place where the fold happens-the part that comes beneath is known as stand of collar. This is the part that touches the neck.
23. **FALL OF COLLAR:** The part of collar that is attached above the band or the broad part that falls below or outwards from the band or stand is known as the fall of collar.
24. **FLAIR:** These are of two types – Straight and umbrella cut. The straight flair is attached at the waist by the help of gathers, tucks or pleats and the part that is left loose is called the flair. Also used to describe lower body garments which have a big opening at the bottom and no demarcation for knees.
25. **GATHERING:** Means to put pleats or to gather a piece of cloth by putting a loose running stitch and then pulling the thread. Look good when used on puff sleeves, skirts, ladies garments and children’s garments according to fashion.
26. **JETTING:** When an extra piece of cloth is attached to give strength to a pocket and then to hide this extra piece, another piece of the same fabric as that of the main garment is attached, then it is known as Jetting.
27. **BUTTON STAND:** The piece of band on top of which a button is affixed is known as button stand.
28. **BUTTON HOLE:** The opening made through which a button can be passed is known as button-hole.
29. **POCKET STAY:** The straight tape attached to the inside of a pocket opening to keep it upright is known as pocket stay. This tape is the straight selvedge side.
30. **YOKE:** The part of the garment from the waist upwards, given a particular shape like round, square, triangular and attached separately is known as yoke.
31. **LINING:** An extra cloth attached under the main garment is known as lining. Used mainly under transparent materials, lining gives the garment extra strength as well as finishing.
32. **INTER LINING:** An extra layer put in between the main garment and the lining is known as inter lining. For e.g. Buckram, Tetron etc.
33. **SHEARING:** To shorten a part of a garment, without cutting off the extra piece of material, one can create folds on the top half and then hide them by attaching a trim like lace, piping, or a cord. This process is known as shearing.
34. **SMOCKING:** Creating a design on a piece of cloth by first putting loose stitches in straight lines with the help of a graph paper, pulling gently on the threads and then embroidering over the gathers thus created, is known as smocking. Used as a decorative stitch.
35. **HONEY COMB:** A variation of smocking. The amount of material required for this is a little less than that for smocking. The space between stitches in smocking is a little less, whereas here the distances are greater. Embroidering over the gathers to hold them in place is done here also. This takes the shape of a honey comb upon finishing.
36. **SCYE UP AND SCYE LOWER:** Used particularly for coat sleeves. The point where the armhole attaches to the sleeves to maintain the correct balance of a sleeve is known as scye. The point at the back is known as scye up and the front part is known as scye lower.
37. **INLAYS:** The extra cloth kept after the looseness in a garment is known as inlays. This helps in increasing the size of the garment if so required. .
38. **TURNING:** The extra margin kept at the edges for turning in and finishing the garment is known as turning.
39. **SEAM ALLOWANCE:** The margin kept for stitching the garment is known as seam allowance. This means that after drafting the neck, armhole, waist and chest, about 4cm margin is kept and then another line drawn which is the stitching guide – this is known as the seam allowance.
40. **MARGIN:** The extra cloth kept apart from the turning is known as margin. This helps to increase the length of a garment.
41. **FORE PITCH:** The notch kept in the forward arm hole before joining a coat sleeve is known as fore pitch.

42. **BACK PITCH:** The back notch kept for joining the coat sleeve to the armhole is known as back pitch.
43. **GORGE:** The depth of the neck is known as gorge. This is used to alter either the breadth or the length of the neck.
44. **BUTTON NECK:** When extra thread is wound around the bottom of the button but above the band, then it is known as button neck.
45. **SLEEVE HEAD/SLEEVE CROWN:** The top portion of the sleeve where the curve happens is also known as the sleeve crown or sleeve head.
46. **TRY/TRIAL/FITTING:** When a garment is first fitted on to a dummy to check for fit or tried on the person for whom it is being stitched before putting in the final stitches, then the process is known by either of these names- try, trial or fitting.
47. **DUMMY:** A cloth figure made in the shape of a normal human figure is called dummy. This is used to check for fitting etc.
48. **BIAS:** A square cloth folded into the shape of a triangle and then cut at an angle to the weave is known as bias.
49. **OVER LAPPING:** When the cloth of one side of an opening comes over the other, then it known as overlapping.
50. **BUTTON HOLE FAN:** The rounded edge of a button hole is known as the button hole fan.
51. **BUTTON HOLE BAR:** The last action at the time of finishing a button hole where the stitch is finished is known as the button hole bar.
52. **SELVEDGE:** The finished edge of the cloth which is a self finished edge at the time of weaving is known as selvedge.
53. **CREASE EDGE:** The edge of a garment created by giving a crease is known as crease edge.
54. **PLAIN WEAVE:** An ordinary weave with no interwoven designs is known as a plain weave.
55. **TWILL WEAVE:** When the cloth is woven with a slanted thread to give a self design effect then it known as twill weave. The right side of this weave is plain and smooth while the wrong side is rough to the touch. E.g. Satin, Taffeta.
56. **PADDING:** When an extra pad is inserted in any part of the garment to enhance that part, then it is known as padding – this may be done on the shoulders, bust or hips. This is made using cotton wool or even a sponge.
57. **WARP:** The lengthwise direction of the thread while weaving is known as warp.
58. **WEFT:** The breadth wise weave is known as weft.
59. **CANVAS:** Available in many types like cotton, woolen etc. Used for interlining especially in coats.
60. **FORK LINE:** The part where the fly is attached in shorts or trousers.
61. **SEAT PIECE:** The place in a trouser where the two legs meet is joined together using a bias cut piece of cloth – this is known as seat piece. This is attached to give a better fit and to ensure that the seams do not open upon wear and tear of the garment.
62. **BACK PIECE:** A 3”-4” piece of cloth kept as an extra piece at the back of trousers and attached under the belt.
63. **MANIPULATION:** When the seat of a trouser is pressed into place after stitching by using a hot iron or steam.
64. **TEXTURE:** The surface of a cloth is known as texture.
65. **BODY RISE:** When the crotch breadth is increased in the curved area, the process is known as body rise.
66. **PEAK POINT:** The neck at the back being raised by about 2 cm to give a better shape and fit to a collar or a band.
67. **MASS PRODUCTION:** When clothes are produced on a large scale like in a factory, then the process is known as mass production.
68. **PANELS:** Strips of cloth joined in a garment for fashion or to increase the width are known as panels.
69. **SUPPRESSION:** A hot iron is used to shrink the cloth in places wherever necessary like a waist in a coat or above the hip in a trouser etc.

-
70. **CROTCH:** The part where a lower body garment is joined with a curve is known as crotch.
 71. **C.P. G:** A special measuring tape which allows a tailor to take three/four measurements at the same time.
 72. **POCKET HANG:** A straight band kept above a coat pocket which extends till the shoulder, along the side seam to avoid the pocket mouth from hanging out, is known as pocket hang.
 73. **FLAP:** An extra piece of cloth attached to the outside of a pocket as a covering for the mouth is known as a flap. Attached on men's shirt, coat pocket etc.
 74. **SHOULDER FLAP:** A flap attached on top of the shoulder, mostly on shirts of scout or army personnel etc. Sometimes used as a fashion element also.
 75. **SEAM:** These are of many types. Used to attach two pieces of cloth. To give a piece of cloth the shape of a garment is the magic of seams. Seams are the basis of a garment. After cutting the various parts of the garment from a piece of cloth it is these seams either sewn by hand or with the help of a machine which give those various pieces of cloth the shape of a garment.
 76. **IRON SPEAKING:** A few drops of water sprinkled on the hot surface of an iron to test its readiness to use, turning to steam and letting out a hissing sound is known as iron speaking.
 77. **GORE:** To increase the flair of a bell bottom, a small triangular piece is joined at the bottom opening. This is a type of small panel.

BASIC RULES OF STITCHING

Before you have complete knowledge of running a sewing machine, it is advisable not to attempt running a sewing machine. Before threading a needle, before lowering the pressure foot, learn the correct way of putting your feet on the foot pedal of the sewing machine. Only then start practicing running the sewing machine on a rough piece of cloth or paper. After you have mastered the correct speed of running the machine, only then you should proceed further.

1. Sit at a height appropriate enough, so that your feet reach the foot pedal comfortably.
2. Sit straight while stitching. Do not bend your head over the sewing machine while stitching. Throw light on the sewing area from your left side.
3. Sit in front of the machine in such a manner such that the centre of your body is in line with the needle.
4. Place your left foot on the upper edge and right foot on the lower edge of the foot pedal and then start operating the machine.
5. Only once you have mastered running the sewing machine smoothly, you should start practicing by running the needle on a plain piece of paper. There should be no jerks while running the machine.
6. Before trying your hand for stitching a piece of cloth, you should have adequate practice in running the machine on a piece of paper, by running the machine over straight lines and curves drawn on a piece of paper.
7. Take care that you keep fingers away from the pressure foot and needle while the sewing machine is in operation.
8. You should first familiarize yourself with the technique of threading a machine and only then with running the machine. The wheel of the machine should always run towards you. Practice running the machine smoothly.
9. Remember to keep your machine oiled perfectly. For this, you should put one or two drops of oil on all moving parts everyday. Some people believe in putting a lot of oil on the machine, but this does not serve any purpose, albeit results in making your sewing cloth messy. It is instead advisable to put only a few drops of oil, but to do it on a regular basis.
10. The thread from the top and bottom should not hang out more than 10-12 cms or 4-5 inches.
11. After opening a wrong seam wash the cloth so that the holes formed by the needle get closed up.
12. Before beginning to sew a garment, mark out all the pieces carefully and arrange your lining, matching thread and buttons. These markings should be with tailor's chalk on the wrong side of the garment. They will also help to identify wrong side from right, apart from helping you match the different pieces and seams.
13. Iron all the pieces of the cloth before beginning to sew.
14. You should keep the left and right side of the garment in mind while sewing.
15. The major part of the cloth should be left hanging on the outer, i.e. left side. Keeping the cloth on the right side, interferes with sewing and also has the danger of the cloth getting entangled in the belt or oil drops soiling the cloth. The cloth may also fall on the footrest and interfere with sewing.
16. While sewing, never pull the cloth by hand. It should move forward on its own. Pulling the cloth may either tear the cloth or break the needle.
17. While nearing the end of the stitching edge, slow down the machine gradually or else the seam might slip ahead. This is not advisable. Moreover, put a double seam near the edge to give more strength.
18. After finishing the seam, raise the pressure foot and cut the thread with a scissors. Do not pull the thread with your hand.
19. If it is heavy cloth, the stitch length should be longer, similarly if it is fine cloth keep the stitch length short. There is a stitch regulator in every machine. Study the markings on the regulator carefully and loosen or tighten the screw accordingly to alter the stitch length. You should alter the thread and needle also according to the thickness of cloth. To know the relation between needle, thread and cloth, study the accompanying table.
20. Before beginning to sew, keep two/three bobbins filled with thread ready for use, so that work flow does not get affected if a bobbin finishes.

21. Thread should be matching with the cloth and the thread in the bottom bobbin and top should be of the same shade.
22. If you are using a machine with hand attachment, the machine should be kept at a height of at least 15 to 30 cm (6 to 12 inches). Do not keep the machine on the floor. Always use a stool so that it is easy to move the handle of the machine. The height should be such so that you do not have to bend over the machine.
23. Keep the machine on a straight surface. Keeping the machine on a rough surface, may cause the parts to be spoiled.
24. After finishing stitching for the day, keep a piece of cloth, in the machine, so that no dust enters the machine.
25. Always loosen the stop motion of the machine after finishing sewing so that no child may run the machine by mistake.
26. Take care to keep the cloth to be stitched as well as the clothes you are wearing away from the wheel of the foot machine.
27. There should be more cloth hanging outside and less towards the inside so that no unnecessary creases are formed.
28. If working by hand the cloth should be held between three fingers and your thumb, never between the knees.
29. Always use a thimble, while working by hand, so that it is easier to push the needle and your fingers do not get spoiled.
30. Hold the needle in your right and cloth in your left hand. The thread in the needle should not be more than 27 inches long. If you need to put a double thread, first fold the thread and then put, do not double the thread once you have threaded the needle.

SEWING MACHINE PRACTICE

LEARN SEWING LIKE THIS

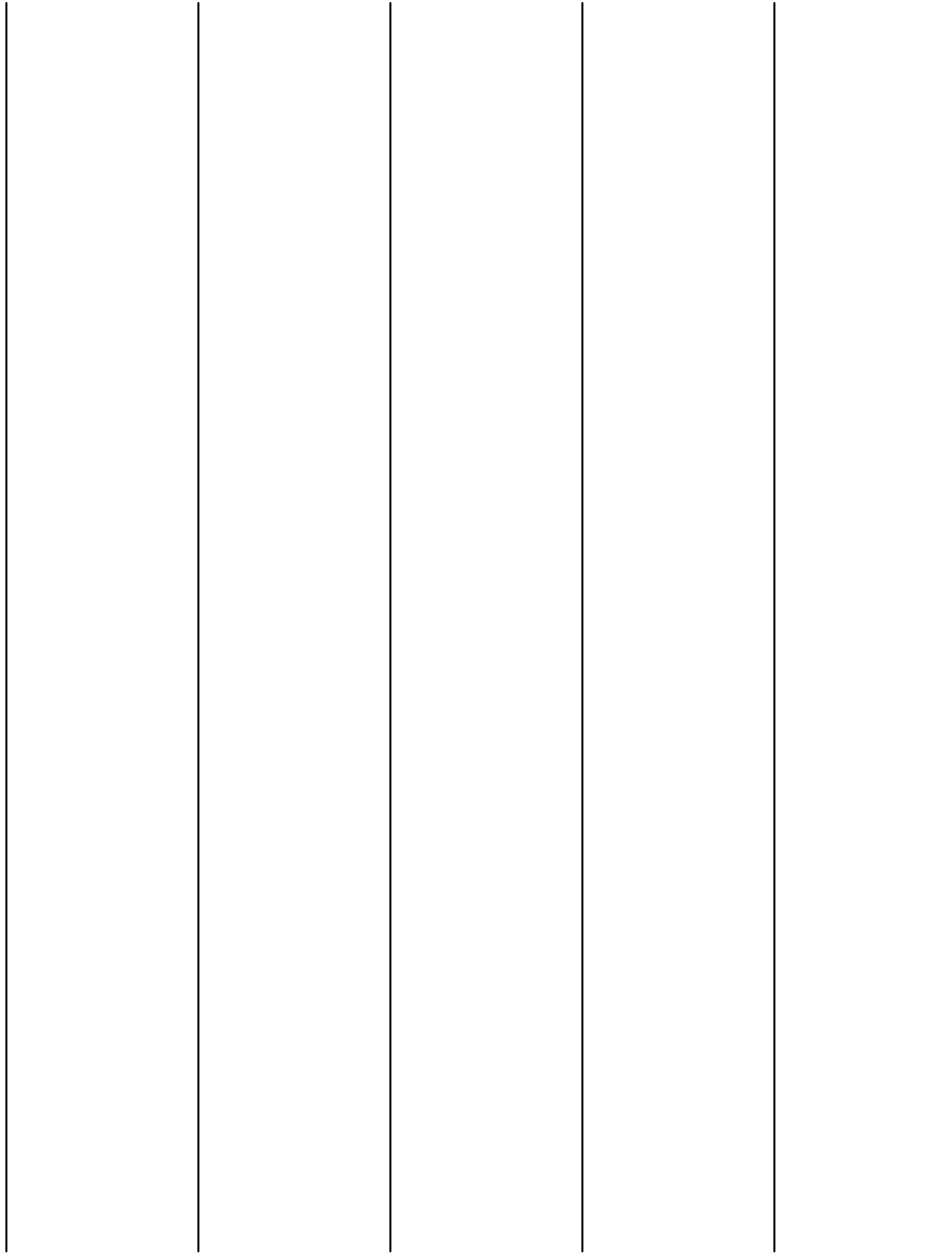

LEARN SEWING LIKE THIS

37

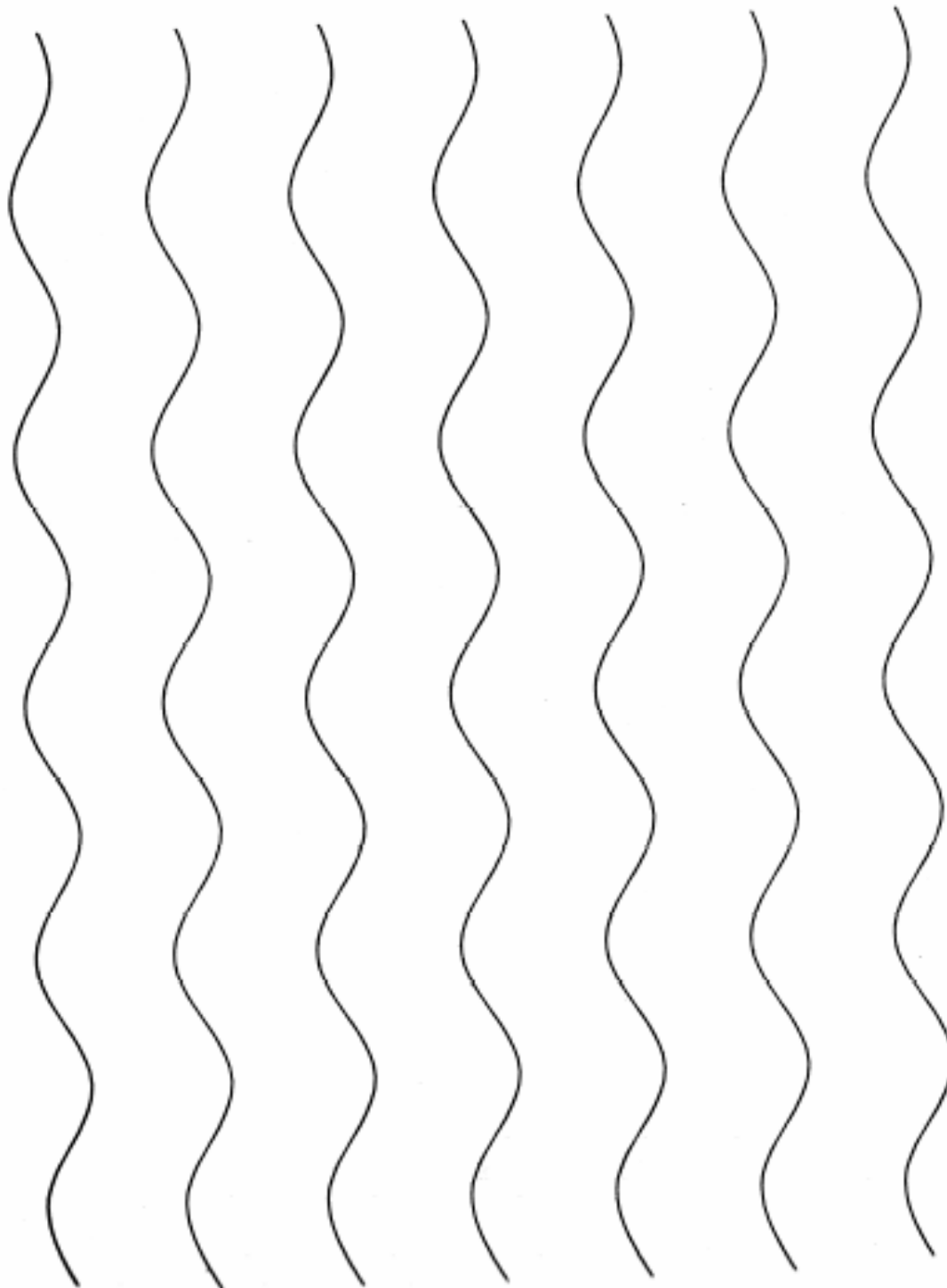

LEARN SEWING LIKE THIS

36

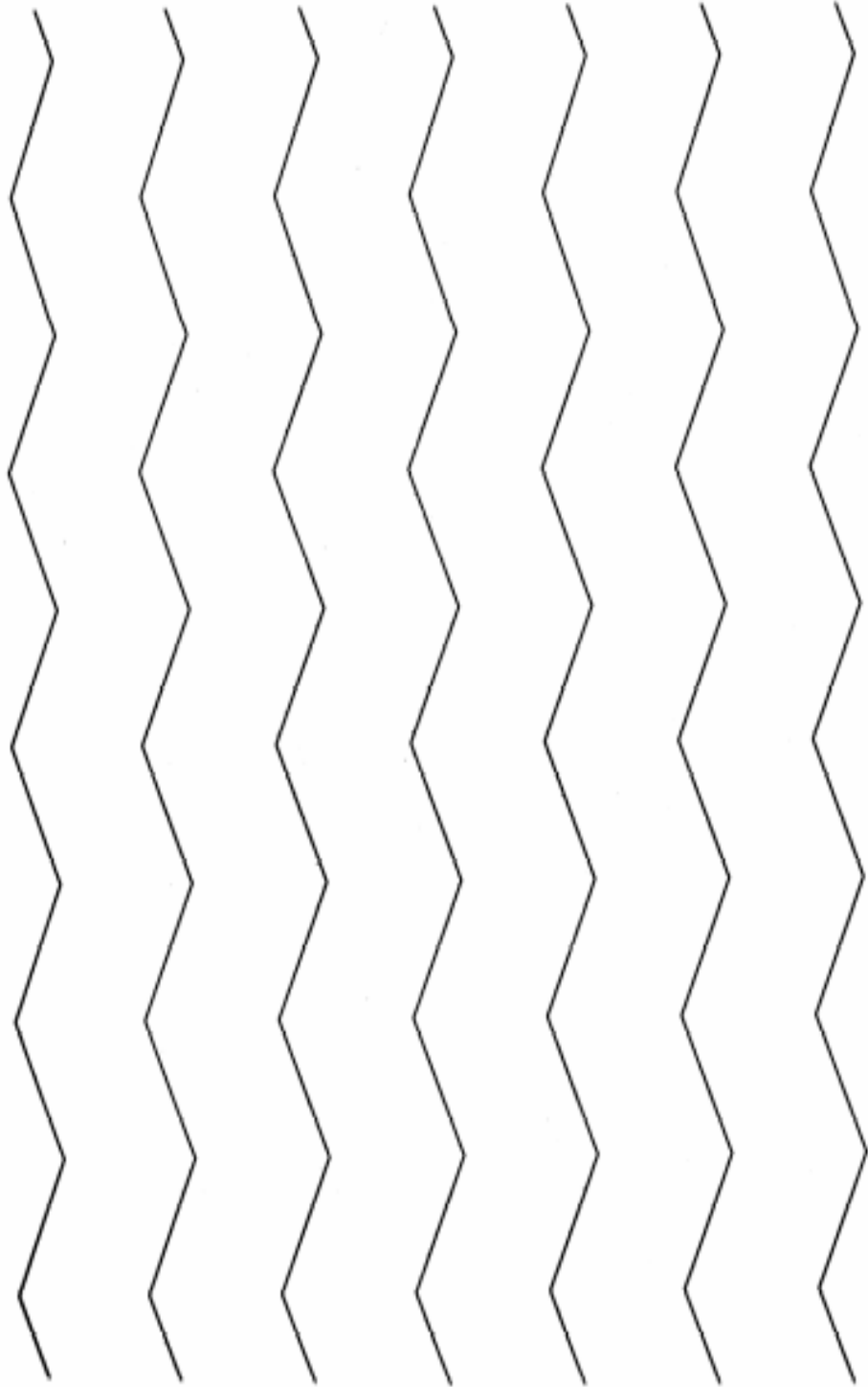

LEARN SEWING LIKE THIS

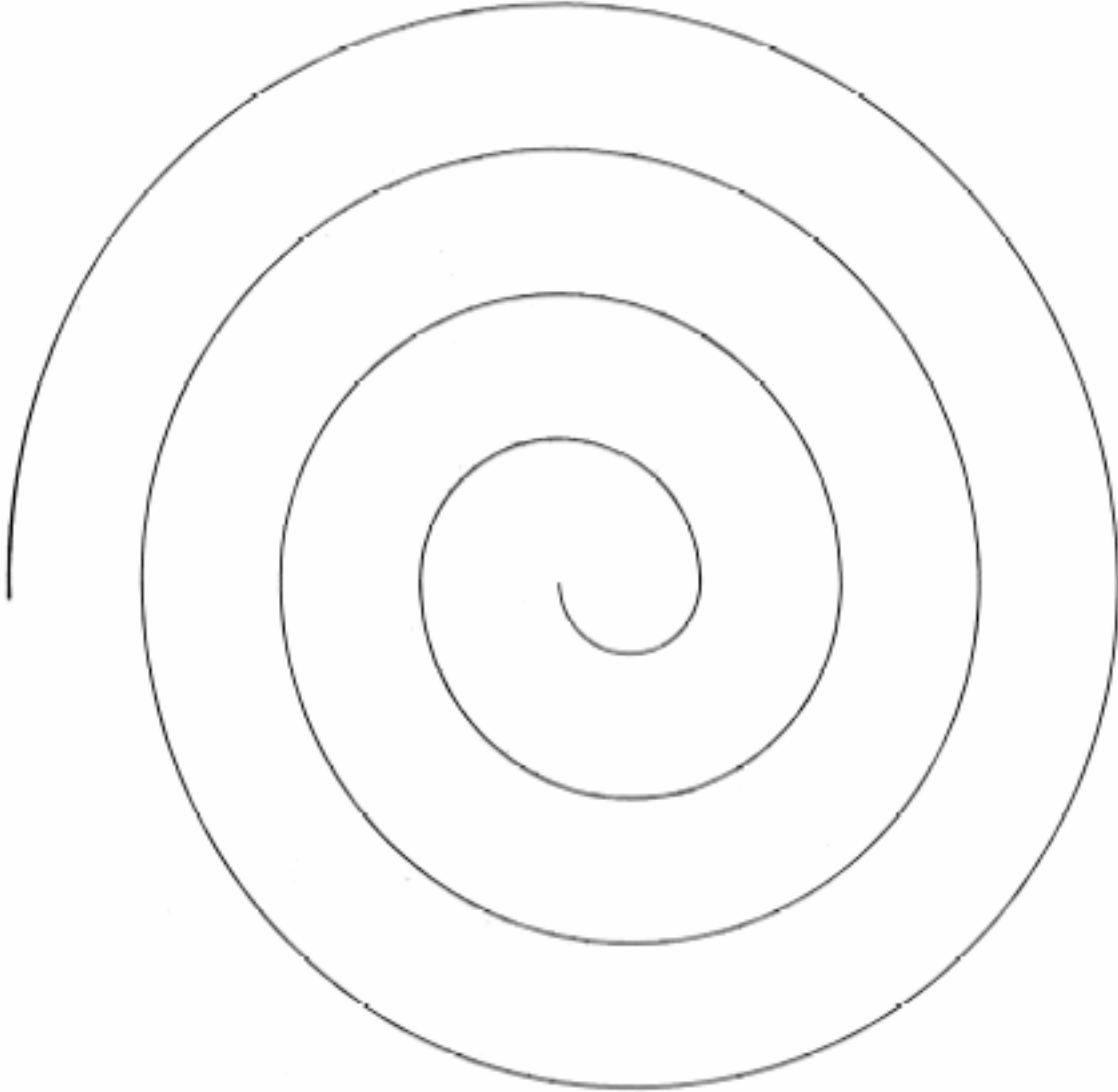

LEARN SEWING LIKE THIS

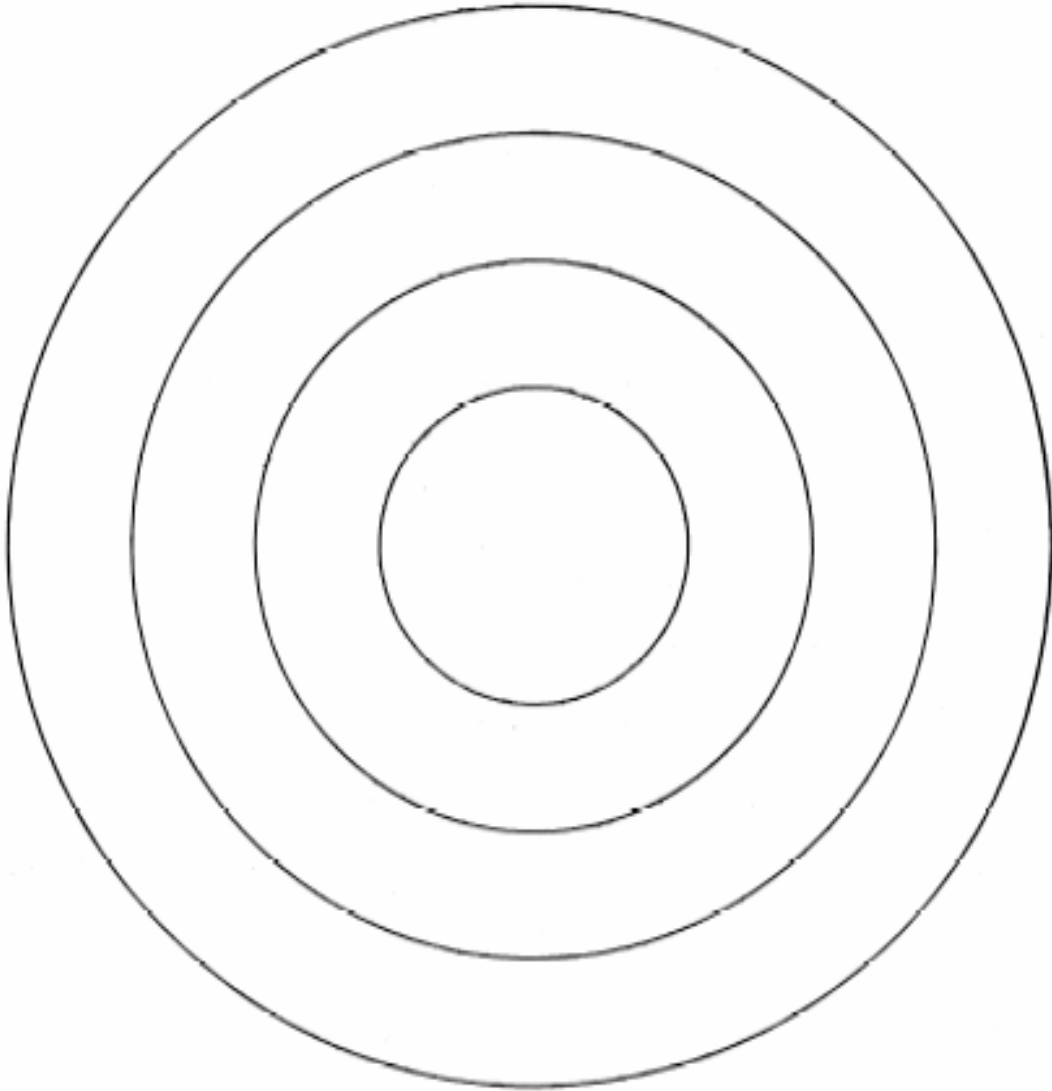

FABRIC TERMINOLOGY STUDY

Fiber and Yarn

A fiber is the smallest part of a fabric. It is an individual, fine hair-like substance. Fibers are generally grouped and twisted together into continuous strands, which are called yarns. Yarns are then used to make various materials like woven fabrics, knitted fabrics, and lace. Fibers can also be used directly to make a fabric without first being made into yarns. Examples of such fabrics are felt and non-woven fabrics.

Sewing Threads

Sewing threads are special kinds of yarns. They are made in such a way so as to pass through a sewing machine quickly, so as to form a stitch properly, and to function while in a sewn product without breaking for at least the useful life of the product. This would depend upon proper thread selection for the chosen fabric

There are several features common to all woven fabrics. Knowledge of these fabric characteristics is needed to understand fabric structure and suitability in particular uses. These features are as follows:

1. Selvage
2. Grain
 - a) Warp (Lengthwise Grain)
 - b) Weft (Crosswise Grain)
 - c) Bias
 - d) True Bias
3. Face and Back
4. Top and Bottom

1) SELVAGE

The selvedge is a lengthwise edge of any fabric. It generally is $\frac{1}{4}$ to $\frac{1}{2}$ inch wide and exists on both the edges of the cloth.

The main purpose of the selvedge is to ensure that the edge of the fabric does not tear when the cloth is subject to any kind of stress and strain, during the finishing process. Various techniques are used to make the selvedge stronger than the main fabric. This includes using heavier warp yarns; more warp yarns per inch, plied warp yarns, greater twist in the yarns, and use of different weaves. The selvedge is easy to identify, since it is constructed differently from the body.

2) GRAIN

Grain is the direction in which the yarn is woven or knit (lengthwise grain or warp, crosswise grain or weft).

a) Warp (Lengthwise Grain)

Yarns parallel with selvage and at right angles to the crosswise grain. It is the strongest grain and drapes best when perpendicular to the floor. Warp yarns can be distinguished from the weft yarns in the following ways:

- ◆ Selvage : The warp yarns will always be parallel to the selvage.
- ◆ Yarn Sizes : The warp yarns will usually be thinner.
- ◆ Yarns per Inch : There are usually more warp yarns per inch than weft yarns per inch, making the fabric stronger in the lengthwise direction.
- ◆ Stretchability : There is generally more stretchability in the widthwise direction.

b) Weft (Crosswise Grain)

Yarns woven across the fabric from selvage to selvage. It is the filling yarn of woven fabrics. Crosswise grain yields to tension.

c) Bias

A slanting or diagonal line cut or sewn across the weave of the cloth.

d) True Bias

The angle line that intersects with the lengthwise and crosswise grains at a 45-degree angle. True bias has maximum give and stretch, easily conforming to the figure's contours. Flares, cowls and drapes work best when cut on true bias.

3) FACE AND BACK

Fabrics have a face side and a backside. The face side has a better appearance and usually forms the outside of any garment. However, sometimes the back of the fabric is used as the outside of a garment for giving a special effect. Fabrics are generally packed so that the face side is protected during handling and storage. When the fabric is rolled or folded, the backside generally forms the outer surface of the bolt or roll.

4) TOP AND BOTTOM

Besides having a face and back, some fabrics have a top and bottom on the face side. This is caused generally by the weave or finish. Fleece, which is a fabric with a long nap, has a top and bottom to the face. It is made into garments with the nap brushed downwards. In fabrics like velvet and corduroy, the pile is not perfectly erect, but lies at an angle. The colour may turn from dark to light as the fabric is turned on a flat surface because of the difference in the angle of light reflection. With fabrics having an obvious top and bottom, the garment must be made with all its parts in the same top down or bottom down direction.

A fabric with a woven or printed figure in an upright position, however, can be cut in only one direction because in every piece forming the garment, the figure must be in upright position. Printed fabrics, which can only be used in one direction, are called directional prints.

WARP & WEFT OF CLOTH

There are many different cloth mills in our country, giving us a variety of designs, differing widths and types of woven cloth. It is important to buy material according to the type of garment to be stitched.

Width

There are mainly two types of widths available – single and double

Single: varies between 29” to 39”, for e.g. Poplin.

Double: From 46” to 60” or 102 cm to 152 cm for e.g. silk, drill, denim etc.

Right side of cloth: The right side of a cloth can be recognized from the selvedge (kanni).

There are punch hole marks on this edge of the cloth- the side on which these are in an upwards direction, is generally the right side of the cloth.

Printed cloth

If you are using a printed cloth with a flowery pattern or uneven design, then always mark and cut the cloth from the wrong side. Ways of recognising the wrong side of the garment are: a) punch marks b) the print will be slightly lighter. As soon as you recognise the wrong side of the cloth, put a cross 'x' mark on that side with a marking chalk.

Self design cloth

This is woven using various shades of the same color and/or different thickness of the thread used for weaving. The wrong side can be recognised by virtue of being brighter.

Corduroy

The weave is such that one can see a raised rib on the right side of the cloth. One also needs to recognise the right way up for this type of a weave. You should gently rub your hand across the cloth. The direction in which the grains look like they are sitting should be the downward direction.

Warm cloth

This is always folded with the right side in. It is therefore easy to recognise by its crease marks. Apart from this the colour and texture of the cloth is also different.

Direction of weave of the cloth determines the lengthwise and breadth wise direction.

At 45degrees the cloth is known as true bias. The entire length is folded across the entire width of a square piece of cloth, to give a true bias. If it is folded at less than 45degrees then it is not a true bias. Generally garments are cut on the lengthwise direction of the cloth.

NEEDLE AND THREAD

Machine needles are selected according to the weight and other characteristics of the fabric, as well as the thread type being used for construction. Generally, a needle should be fine enough to penetrate the fabric without damaging it and yet have an eye, which is big enough so that the thread does not fray or break. Needles come in various sizes, from very fine (**size 9**) for lightweight fabrics to thick (**size 18**) for very heavy weight and dense fabrics.

Needles also come in three different tips/ points:

- **Regular sharp needle:** this is ideal for mostly all woven fabrics because it helps produce even stitching with minimum puckering.
- **Ball-point needle:** the slightly rounded tip is recommended for all knit fabrics and elastic fabrics as the needle pushes between the fabric yarns instead of piercing them. Available in **sizes 9-16** where the point is rounded to, in proportion to the needle size, points of larger sizes being more rounded than finer ones.
- **Wedge point needle:** this needle has been specially designed for leather and vinyl, as it easily pierces these fabrics to make hole that closes back upon itself. This avoids unattractive holes in the garment and also reduces the risk of stitches tearing the fabric. Available in **sizes 11-18**, size 11 is used for soft and supple leather and size 18 being used for heavy or multiple layers of leather.

Needles should be chosen carefully for different fabrics. If a needle is of the wrong size, the machine stitch formation is affected. If it is too fine the thread might fray. If it is too coarse it may damage the fabric and the stitches will look imbalanced.

Care should also be taken to ensure that the needle is neither damaged nor dirty. A needle that has a burr on the point, eye, or the groove may cause the thread to break or fray or even the fabric might get damaged. A blunt or bent needle can cause a thumping noise in the sewing machine as it penetrates the fabric and may also result in pulling the fabric or in skipped stitches in the seam lines.

With the wide and ever increasing range of fabrics available in the market, it is important to know the right **sewing thread** for the various types of fabrics. The right kind of thread is important in sewing as the both the thread and the garment should share the same characteristic, as they have to be laundered and ironed together, they should shrink and stretch together. In the Chapter Fibres & fabrics (Chapter 14) you will learn the characteristics of various fabrics and fibres.

Types of threads: The **natural fibre threads** available in the market are cotton and silk. Cotton thread comes in two varieties mercerised and unmercerised. Mercerised cotton is stronger and has lustre. Silk thread is an all-purpose thread and combines strength with elasticity, but is not easily available in India in small spools. It is generally used for over- lock machines in the industry. The **synthetics threads** are usually made from polyester and Terylene thread. This thread is stronger than the natural thread and has an important feature of being elastic, which is particularly important while stitching knits or Lycra based fabrics. There is tremendous amount of strain on seams in active sports wear, swimwear or during movement, use of this thread minimises the chance of broken stitching. Synthetic thread is also useful in stitching of leather as it has a good deal of stretch in it. But **cottons or linens** should not be stitched with synthetic thread, as the thread will not be able to withstand the heat while being ironed. **Wool and silk** should preferably be stitched either with mercerised cotton or silk threads only. **Blended fabrics** may be stitched with synthetic thread suitable to the dominant fibre in its content.

Threads whether natural or synthetic are produced in **various thickness:** higher the number finer is the thread and smaller the number coarser is the thread. The threads are available in sizes 30-60. It is important to remember that the same thread should be used for the bobbin and top spool.

Threads for decorative stitching: For decorative stitching such as saddle stitching, topstitching a special thread called buttonhole twist (it is also sold in the market as no. 20/30 thread) is used, to emphasis stitching. It may only be used in spool or bobbin; this is an exception to the rule. Use a 40 size mercerised cotton thread as a companion to it. The yellow coloured top stitching thread used on denim jeans is a commonly used buttonhole twist thread.

Always choose a thread a shade or two darker than the fabric as in the long run; it will look the same as the fabric colour. Buy good quality and branded thread even if it is expensive, as it will last longer and be cost effective. Before one starts sewing, a test of the seam strength should be done on a double scrap of the same fabric, to check if it has right appearance, correct tension and if it is a pucker-less seam. Puckering will mean that either the needle is not correct or there are too many stitches per inch. Adjust the tension of the machine and test till one is satisfied. It will be worth an effort.

Given below is a Table for easy reference of needle sizes, threads and stitches per inch for various fabrics:

S. No.	FABRIC	FIBRE	THREAD	NEEDLE	STITCH LENGTH
1.	<p>Fine Woven: lawn, voile, organdie, silk chiffon, organza, crepe de chine, georgette, fine lace, tulle</p> <p>Knits: lingerie tricot, cut velvet</p> <p>Metallic fabrics</p>	<p>Synthetics & blends</p> <p>Cotton & Linen</p> <p>Wool</p> <p>Silk</p>	<p>Synthetic 60</p> <p>Mercerised 50</p> <p>Mercerised 50/60</p> <p>Silk</p>	<p>9-11</p> <p>9-11</p> <p>9-11</p> <p>9-11</p> <p>10/11 ballpoint for knits and metallic fabrics</p>	<p>10-15</p> <p>10-14</p> <p>10-15</p> <p>10-14</p>
2.	<p>Light weight Woven: poplin gingham, silk, chambray, crepe, cotton, corduroy,</p> <p>Knits: jersey, stretch terry, soft double knits, soft sweater knits</p> <p>Metallic fabrics</p>	<p>Synthetics & blends</p> <p>Cotton & Linen</p> <p>Wool</p> <p>Silk</p>	<p>Synthetic 60</p> <p>Mercerised 50</p> <p>Mercerised 50/60</p> <p>Silk</p>	<p>11-14</p> <p>11-14</p> <p>11-14</p> <p>11-14</p> <p>11-14 ballpoint for knits and metallic fabrics and velveteen.</p>	<p>12-15</p> <p>10-15</p> <p>10-14</p> <p>10-15</p> <p>10-14</p>
3.	<p>Medium weight Woven: silk, brocade, taffeta, linens, some denims, tweed, gaberdine, water proof fabrics</p> <p>Knits: double knits, bonded knits</p> <p>Metallic fabrics</p>	<p>Synthetics & blends</p> <p>Cotton</p> <p>Linen</p> <p>Wool</p> <p>Silk</p>	<p>Synthetic 60</p> <p>Mercerised 50</p> <p>Mercerised 40</p> <p>Mercerised 50/60</p> <p>Silk</p>	<p>11-14</p> <p>11-14</p> <p>11-14</p> <p>11-14</p> <p>11-14</p> <p>11-14 ballpoint for knits and metallic fabrics</p>	<p>10-12</p> <p>12-15</p> <p>12-14</p> <p>12-14</p> <p>10-12</p>
4.	<p>Heavy weight Woven: suiting, thick corduroy, double-faced wool, denim, canvas, heavy furnishing fabrics.</p> <p>Knits: velour, fleece, jacquards double knits</p> <p>Metallic fabrics</p>	<p>Synthetics & blends</p> <p>Cotton</p> <p>Linen</p> <p>Wool</p> <p>Silk</p>	<p>Synthetic 40</p> <p>Mercerised 40</p> <p>Mercerised 40</p> <p>Mercerised 40/50</p> <p>Silk</p>	<p>16-18</p> <p>14-14</p> <p>14-18</p> <p>14-16</p> <p>14-16</p> <p>14-16 ballpoint for knits and metallic fabrics</p>	<p>10-12</p> <p>10-12</p> <p>10-12</p> <p>10-12</p> <p>10-12</p> <p>8-12</p>
5.	Fine Leather and PVC		Synthetic 40	11 wedge-point for leather	8-12
6.	Medium Leather		Synthetic 40	14 wedge-point for leather	8-10
7.	Heavy Leather		Synthetic 30	16 wedge-point for leather	6-10

TOP STITCHING

S. NO.	PROCEDURE & FABRICS	NEEDLE	THREAD	STITCH LENGTH
1.	Top stitching straight Woven Knit Vinyl	16-18 14/16 ballpoint 16 wedge-point for leather	Heavy duty cotton wrapped polyester thread (normal bobbin thread)	6-12
2.	Top stitching zigzag Woven Knit	14-16 14/16 ballpoint	Heavy duty cotton wrapped polyester thread (normal bobbin thread)	8-12 (length) 2-4 (width)

DECORATIVE ITEMS USED FOR SEWING

Trims enhance the garment appearance. Trims are generally decided by the fashion trend. As they help in creating an effective look with very less effort. Trims such as ribbons, braids, laces, and other narrow fabric trims are widely used to adorn kids wear, night wear, lingerie etc. These help in creating a soft look in the garment and without too much effort makes it look dressy.



A garment is not only made from the apparel fabric but also various accessory items form part of it. These have to be chosen in such a manner, that they compliment the garment both aesthetically, in terms of decoration, and practically, in terms of ensuring that the garment performs as expected in its intended end use. There are a large variety of trims available in the market. They can be broadly divided into two categories **Functional** trims and **Decorative** trims. Functional trims are those which have a definitive purpose like closures, edge finishes but they might work as decorative trims, like buttons on the side of the jacket sleeve. The decorative trims are for embellishment only, like laces, ribbons, braids etc. There are trims that one can buy in the market and there are trims that can be made at home by an individual.

The type of trim and the amount of trim used would depend on current trends in fashion, cost of the garment and individual taste. Although a trim generally enhances the garment appearance but a trim that ravels, falls off, shrinks, fades, bleeds or discolours ruins the entire outfit. Hence one has to be very careful in selecting and in purchasing the trim. One must always go in for the trims that match with the basic characteristic of the fabric, which is being used for the garment. Like one must never use a cotton lace on a polyester garment as they do not have matching ironing temperatures.

There are trims that can be glued on and there are trims that can be stitched on the garments. The first variety is not readily available in the market. There are trims that are attached by hand to achieve a softer look, especially the old laces which need to be attached with invisible seams.

The various types of trims available in the market have been described in detail.

The Trims and their uses:

Laces: Lace is a narrow lace fabric (in contrast to the all over lace fabric from which whole garments are constructed). Lace can be very expensive, depending on its fibre content, intricacy and complexity, width and if it is gathered, fullness.

Some of the popular laces are:

- **Insertion lace:** a flat lace trim that has two finished sides. It is inserted between two edges.
- **Gallon lace:** a flat lace that has two scalloped edges
- **Edge lace:** Any lace with one scalloped edge and one straight edge.
- **Ribbon pass lace:** any lace trim through which a ribbon is threaded.
- **Medallion:** any individual lace motif, for example an appliqué, collar or a cuff.
- **Embroidered Lace:** a lace that has embroidered edge on it.



Braids: Intertwining a set of yarns according to definite pattern forms braids. Braids are used on women's wear and children wear and sometimes are also used on uniforms as decorations. They are top stitched on the garment and are also used on accessories like Pea Caps. Broader braids are occasionally used as belts. Some of the popular braids are:

- **Loop Braid:** a braid that consists of many loops
- **Scrolling:** a wavy braid
- **Gimp Braid:** a complex highly decorative braid made from a cord used to decorate a high price jacket.
- **Rickrack:** a zigzag shaped trim used chiefly on kids wear, it can be edge stitched and also inserted. Broad rickrack is called Jumbo rickrack and narrow one is baby rickrack.

Ribbons: Ribbon is a narrow, woven fabric used as a trim and to make ties and bows. It is available in a variety of widths ranging from 1/8th of an inch to 6" wide. Ribbons that feel papery and crease when folded is cheaper, inexpensive and of low quality. They do not last long, so should be carefully chosen. Ribbons can be top stitched, passed through a ribbon pass lace, or used as edge finish inside knits, or even at hems. Types of Ribbons available are:

- **Grograin ribbon** (pronounced as growgrain): has a dull ribbed appearance. It can be used as a decoration or as facing inside a button placket in a cardigan.
- **Satin Ribbon:** is shiny and smooth and is made using satin weave.
- **Velvet Ribbon** has a soft smooth, three-dimensional pile surface.
- **Novelty ribbon** is made with unusual design and weaves.

Fringes: Fringe is a trim that has dangling yarns .It is usually attached as an edge finish and is commonly used on duppattas, scarves and on upholstery.

Shimmy fringe: A shiny fringe that moves when the wearer moves.

Kiran: A fringe made with metallic yarn widely used in Indian bridal and trousseau wear.

Tassel fringe: Groups of fringes tied together into tassels at intervals. Used in upholstery.



Twill tapes: A twill weave tape used to trim casual garments and also to reinforce seams in knits. Other common tapes are seam tape or hem tape, which has a smooth ribbon like finish, used to finish inner seam and hems. Bias tape are bias cut fabric might be in contrasting colours used as decorative binding both inside and outside the garment.



Appliqués: are decorative patches applied to the garment. They are generally die cut from fusible fabrics may be embroidered. They can be ironed on and then permanently stitched. These can be in the form of emblems for school /college uniforms. As decorations on armed forces uniforms or even be ornamental motifs for kids wear. These can be Zari motifs for formal wear.

The following are non-fabric trims that are available in the market:

Beads: can be cylindrical called bugle (Nalki) or round called seed (Moti Dana). These are embroidered on to the formal wear as motifs or spread over as individual pieces on the garment. Nowadays, rhinestones are also very popular on garments. In past royal families used to wear clothes with real pearls and stones including diamonds embroidered on their clothes but today only very high fashion and very expensive garments have real pearls, most of the ornamentations used today are in plastic or glass. Swarovski crystals are also becoming increasingly popular in India they are not real diamonds but are quite expensive; these can be stitched or ironed on to the garments.

Sequins: can be shiny or in matt finish, can be flat or slightly three-dimensional. These are also embroidered on to the garments.

Studs and rivets: are metallic may or may not be studded with stones, popularly used on jeans, bags, belts, leather jackets, shoes etc. they are simply attached by fitting the two pieces together with a stud gun, or can be nailed into the garment. A wide variety of designs are available in the market.

Feathers: not very popular in India, but are quite in demand in European countries both the real ones as well as fake ones. They are attached on garments as embellishments.

Closures: are the fasteners that secure garment openings. Closures unfasten to enlarge the garment and fasten to make the garment fit the body. There is a wide variety of closures readily available in the market. Closures include Buttons, Zippers, Snaps, Hooks and Eyes and other fasteners. To a certain extent, tradition governs the use of particular fastener in a garment. For example formal shirts for men will always have buttons, whereas technically there is nothing wrong in using zippers for the same.

Buttons: have widely been used as garment closure from the middle Ages. Most buttons have dual functions in the garment of being functional closure and a decorative detail. However, some buttons inside a concealed placket, or inside a double-breasted garment are completely functional. But, buttons on the side of jacket sleeve are completely decorative. There are several other examples of decorative button usage in kids wear, and women's wear.

Buttons are made in several materials like plastic, wood, shell, nylon, animal horn, leather, nuts, beads, glass, fabric and metal etc. The plastic buttons are more popular than in natural materials as they are more uniform than in natural material and are cheaper too. Plastic buttons often imitate the one in natural material.

Polyester Buttons are resistant to heat and dry-cleaning. They are produced in large quantities for all kinds of clothing.

Nylon Buttons are made in large number of shapes and in a wide variety of colours.

Metal buttons are made in brass, nickel and aluminum with an engraved or stamped face. Used for blazers, jeans and jackets etc.

Leather or leather like buttons are sensitive to moisture and abrasion. Used mostly in apparel made of leather and sports jackets.

Wood buttons are made from a variety of woods, are lightweight and sensitive to heat. Traditionally used in Gujarat and Rajasthan for Indian wear, they are also used in knitted jackets.

Mother of pearl or shells buttons are made from mussel shells; their uneven and beautiful surface makes them very expensive decorative buttons. Traditionally used for western Bridal wear and lingerie.

Before selecting the appropriate buttons for the garment, care should be taken to ensure that if the garment requires ironing, it should have heatproof buttons. The appropriate number of buttons on a garment depends upon the size of the button and fit of the garment. Garments designed to fit the body loosely require fewer buttons than a garment closely conforming to the body, since the latter requires closely spaced buttons to prevent the garment from gaping. An example of this is that a 6" fly opening of jeans requires the same number of buttons as an 18" front of a loose shirt.

Buttons either have holes on the top called **eyes** or have a loop at the back called **shank**; these are meant for attaching the button to a garment. Eyed buttons have either two or four holes. Shank buttons have a stem of plastic, metal or cloth built into it. Shank buttons are more bulky than eyed buttons.

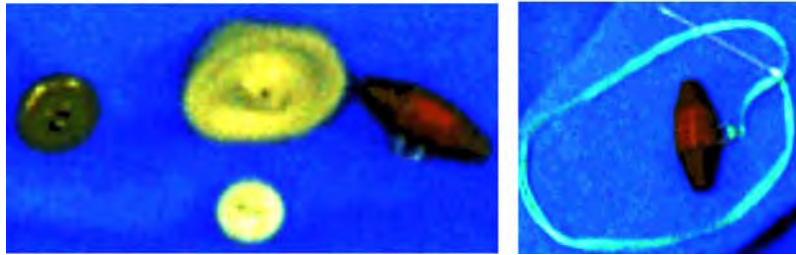

Button loops: are used in some garments instead of buttonholes to fasten the garment. In these garments, two sides of the placket do not overlap. These loops can be made of tubes of bias fabric; strips of cording; braid, elastic or thread chains. Sometimes buttons too are made of fabric or cord that has been elaborately knotted.

Zippers are fast and easy means of getting in and out of garments. They have been widely used in garments in the West since the 1930's but have come to India at a much later date. They are continuing to grow much lighter, more supple and less obvious with the advent of new technology. Zippers are usually more smooth and comfortable to lean on than buttons, so they are preferred to buttons for back open garments. Zippers close the garment completely, so they are preferred to buttons in closer fitting garments. However, for decorative purposes, buttons are still preferred over zippers being more decorative and that has a wider variety to provide larger choice.

Zippers are available as:

Plastic zipper the teeth of the zipper are made of plastic.

Metallic zipper the teeth of the zipper are made of metal.

Invisible zipper cannot be seen after it is attached on the garment.

Separate zipper is the one where two sides of the zipper get separated and can be easily put together by the wearer. These are used in front open jackets or any garment where two sides of the garment have to be separated for the garment to be easily worn.

Double slider Zipper is the one with two sliders that can be opened from both top and bottom.

Zipper slider is the piece that glides up and down. The slider or pull is usually plain but occasionally these come as decorative details. Mostly all the zippers have lock mechanism, either it is automatic or the wearer may need to pull the tab flat down to engage it.

Snap Fasteners: are of two types one is called the sewn on variety that is stitched on the garment popularly known as *Tich* buttons, they have holes in them with which they are attached on lightweight fabrics. The other type is called mechanically attached variety that is used on medium to heavy weight fabrics. Mechanically attached ones have two parts for each side of the button, where one piece goes inside the fabric and second goes on top and these are attached with help of a press machine.

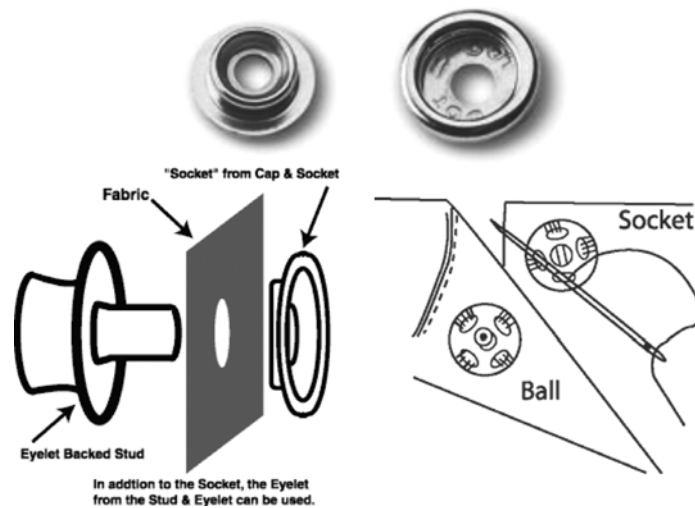

Hooks and Eyes: consist of two parts, a hook and an eye (which can be made of thread/ can also be of metal). Hooks and eye offer the advantage of being small and easy to conceal but can carry a heavy stress load. A hook and eye closure is stronger than snap closure of similar type. Hooks and eyes should be used in area of heavy strain. The majority of hooks and eye closure are concealed closures but visible hooks are used in bras and some sports wear. Hooks and eyes come in various sizes and are chosen depending on the areas of strain and the weight of the garment. Buckles used in waistbands of skirts and trousers are also on the same principle of hook and eye and are part of the same family.

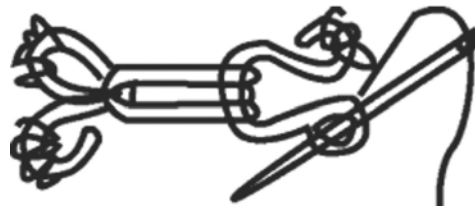

Hook and loop tape: popularly known as Velcroâ tape is a ready-made tape that is in two parts that stick to each other on the same principle as the burr from plants that stick to your clothing after a walk in the woods after rain. It is based on the principle of hook and loop. The part that is hook is scratchy and the loop is softer. The tape closes when pressed together and to open one has to pull it apart. It is a very functional closure for easily fitted garments, pocket flaps, especially on sports wear and heavy winter jackets. It is very convenient on smaller children clothing or people who have difficulty in fastening the closures that require lot of effort. A major disadvantage of the hook and loop tape is that it adds considerable stiffness and bulk to the garment and hence is incompatible with the soft and lightweight fabrics. On the other hand it is a boon for people with arthritis and other disabilities.

Other miscellaneous closures are belt buckles that come in various materials, shapes and sizes; cord and ties commonly used in infant clothing and upholstery.

The Trims one can make on the machine are:

- Piping- in same colour or contrasting colour fabric cut on bias.
- Tucks- commonly used ones are like pin, space, broad and scalloped tucks.
- Frills- gathered strip of same fabric or different fabric or lace attached as a decorative or functional piece.
- Pleats- several kinds of pleats are added to garments providing fullness as well as for design detail, like knife pleats, box pleats, inverted box pleat to name a few.
- Decorative top stitching- done on top of a seam to highlight, it is both decorative and functional as apart from visual appeal it provides strength to the seam. It can be done with same colour or in a contrasting colour in straight stitches or in variety of stitches that may be offered as attachments by the manufacturer of sewing machine.
- Edge stitching- same as decorative stitching.
- Embroidery- can be done with hand or machine in variety of placements, colours, threads and motifs that is primarily done for visual appeal.
- Monograms- same as embroidery.
- Cut work- same as embroidery but has cut out pieces in the motifs:

The above list is only indicative and is basically there to make the sewing enthusiast start taking the initiative and exploring.

METHODS AND SEQUENCE FOR MEASUREMENT TAKING

Care should be taken to take accurate measurements in order to achieve a good fit. It is extremely important to understand the dress form before starting to take dress form measurements. One should carefully observe the shape of the body, where it is hollow, how shoulder slopes etc.

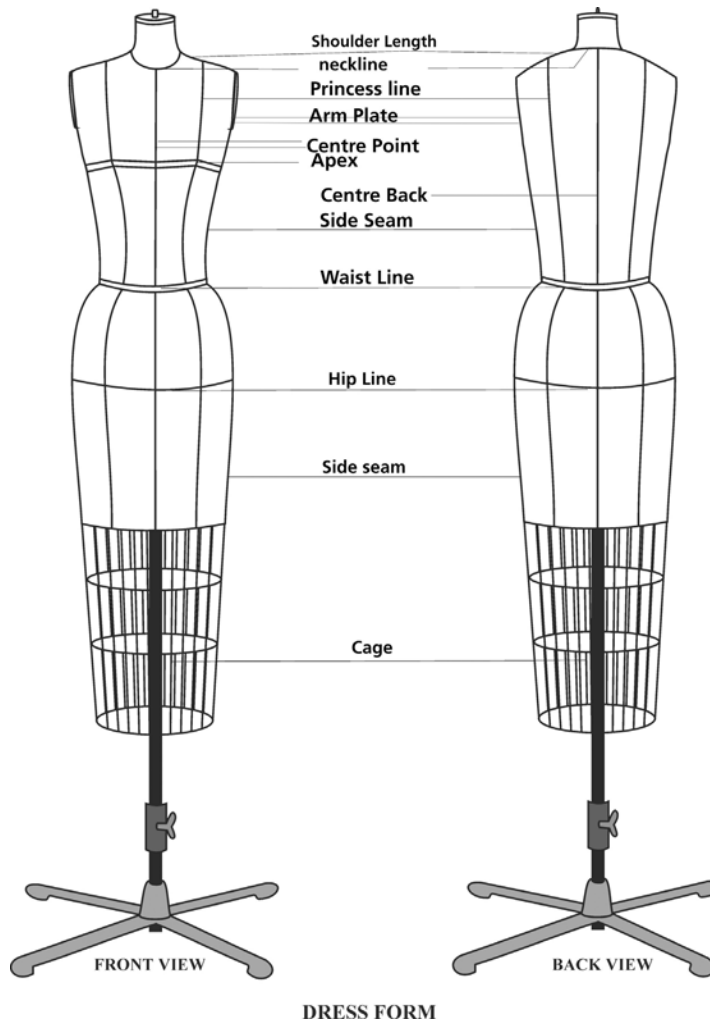

Measurements

1. Front length - Shoulder neck intersection to waistline over the bust, take care to measure with a hand under the bust.
2. Centre front length - Centre front neck intersection to centre front waist intersection.
3. Shoulder to waistline - Shoulder tip to side seam waistline intersection (over the sides)
4. Underarm seam - From a point X, 1" below the armhole to waistline intersection at the side seam.
5. Shoulder length - From shoulder neck intersection to princess line and from princess line to shoulder tip.
6. Width of bust - Width of bust measurement is from centre front over the bust to point X on side seam.
7. Front waistline - From centre front waistline intersection to side seam waistline Intersection.

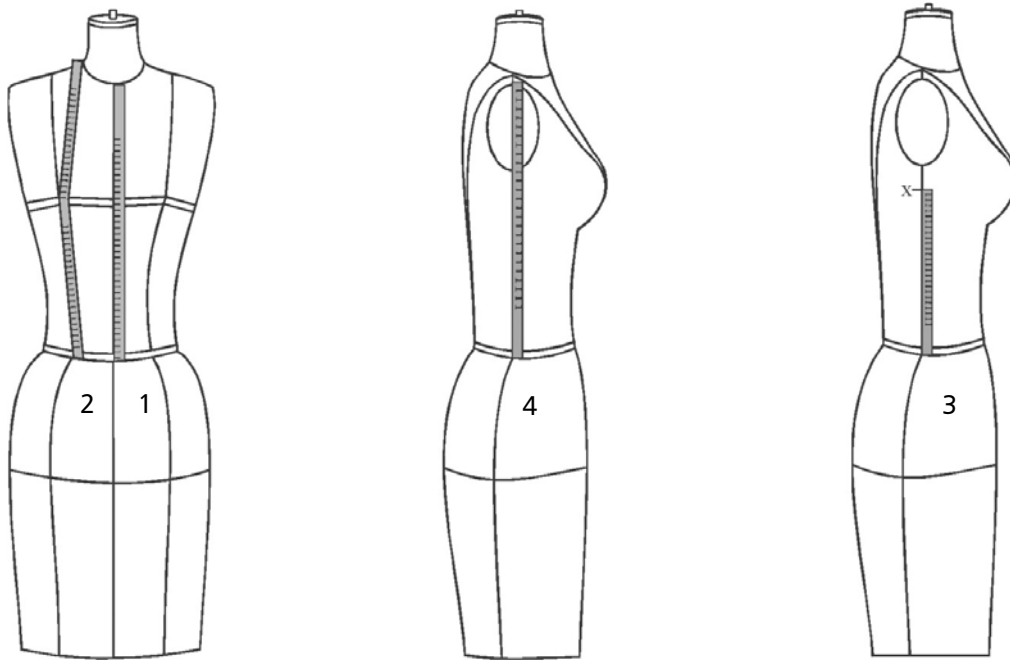

8. Front hipline -Place a pin at 7" below the waistline on centre front line. Using this measurement from floor up mark it horizontally on the dress form continuing to centre back (keeping it uniform throughout). Put a style tape for reference and call it hip line. On this line measure centre front intersection to side seam intersection.
9. Apex measurement - From the centre front to the high bust point keeping the tape parallel to the floor.
10. Centre Front to the Princess line - From centre front intersection to princess line intersection at waistline.

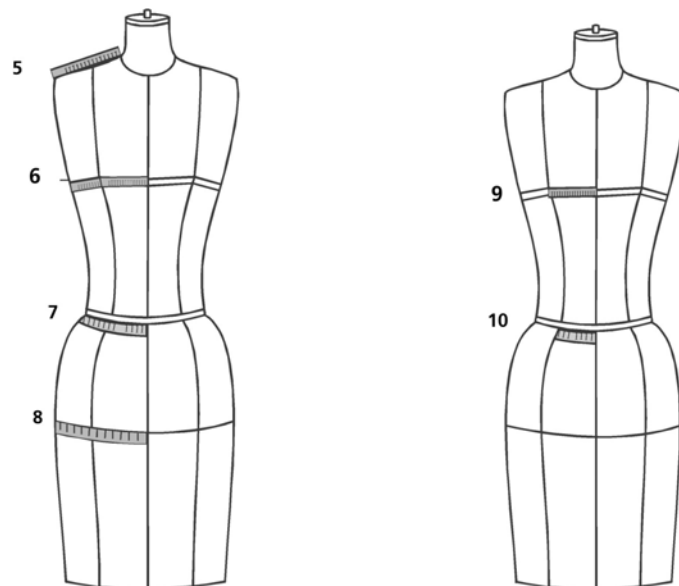

11. Shoulder blade - Mark a point Y on centre back such that, centre back neck intersection to point Y is equal to 1/4th of centre back length. Shoulder blade measurement is taken from point Y to armhole ridge keeping the tape parallel to the floor.
12. Width of back - From point X to centre back keeping the tape parallel to the floor.

- 13. Back waistline - From centre back waistline intersection to side seam waistline intersection.
- 14. Back hip line - From centre back intersection to side seam intersection on hip line.
- 15. Centre Back length - From centre back neck intersection to centre back waistline intersection.
- 16. Centre back to - From centre back intersection to princess line intersection at the Princess Line waistline.

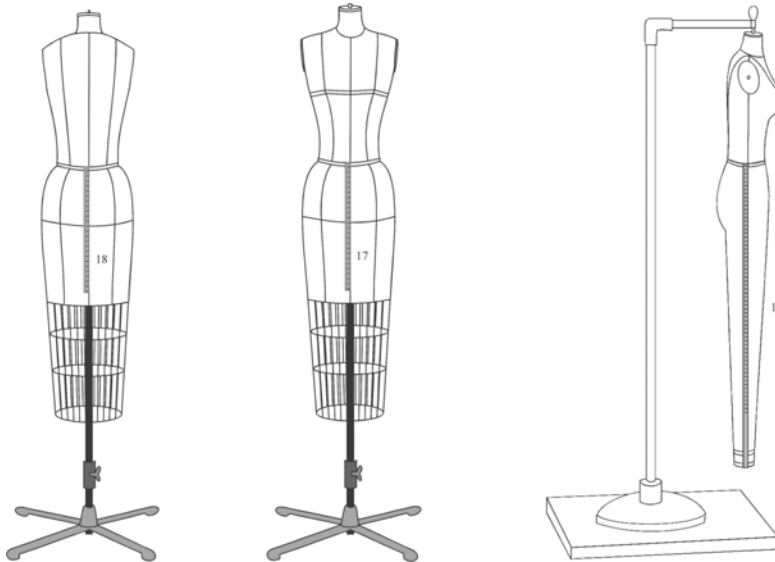
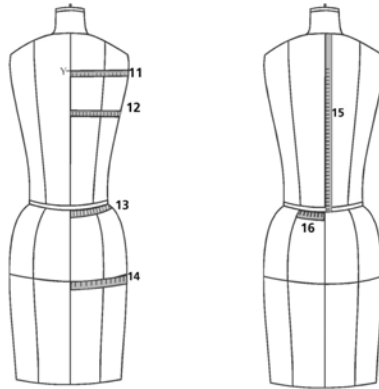

- 17. Centre Front length for lower garment - From centre front waistline intersection at centre front down to the desired length.
- 18. Centre Back length for lower garment - From centre back waistline intersection at centre back down to the desired length.
- 19. Side Seam Length - From waistline intersection at side seam over the hip to ankle.
- 20. Crotch depth
 - (a) On dress form - Place an L-square between legs of form and note the measurement at waistline. This measurement includes 1 1/4" ease as the L-square is generally 1 1/4" wide.
 - (b) On body - In seated position, measure from waistline intersection at side seam over the figure to the seat of the chair. (One needs to add ease here.)

- 21. Knee Circumference - Round measurement over the knee bone.
- 22. Ankle Circumference - Round measurement over the ankle bone.

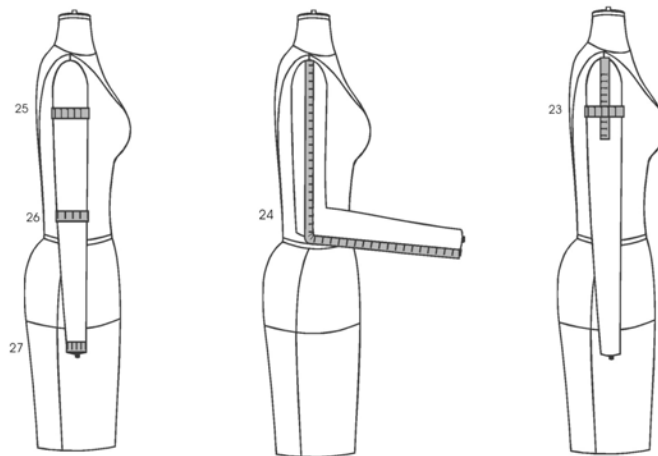
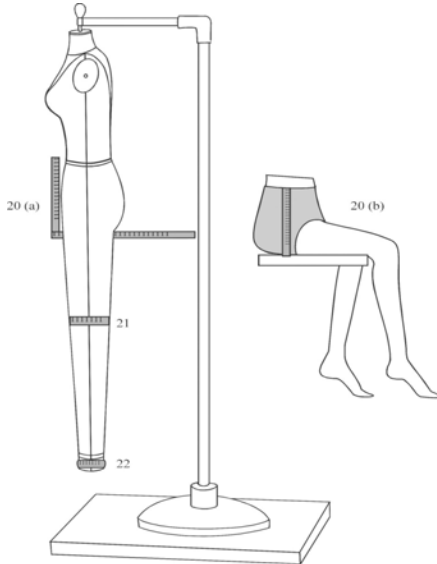

- 23. Cap height - Tie a tape around the biceps of arm close to the armpit. Cap height is from shoulder intersection to the top of the tape.
- 24. Sleeve length - From shoulder intersection over the bent elbow to the wrist.
- 25. Bicep Circumference - Round measurement over the fullest part of the arm.
- 26. Elbow Circumference - Round measurement over the elbow.
- 27. Wrist Circumference - Round measurement over the wrist bone.

WOMEN'S SIZE CHART
SIZE : MEDIUM

S.NO.	SPECIFICATIONS	MEASUREMENTS (in Inches)
1	Chest	36
2	Waist	28
3	Shoulder	15
4	Half Sleeve Length	7
5	Half Sleeve Girth	12 ½
6	Full Sleeve Length	21
7	Full Sleeve Girth	10
8	Salwar Length	41
9	Salwar Bottom Opening	13 ½
10	Hip	37
11	Trouser Length	42
12	Round Neck	15
13	Waist Level from Shoulder	15
14	Crotch	10
15	Knee	21

MEN'S SIZE CHART
SIZE : MEDIUM

S.NO.	SPECIFICATIONS	MEASUREMENTS (in Inches)
1	Chest	38
2	Waist	32
3	Shoulder	19
4	Half Sleeve Length	9
5	Full Sleeve Length	24
6	Waist Level from Shoulder	18
7	Round Neck	16
8	Half Sleeve Opening	7 ½
9	Full Sleeve Opening	6
10	Hips	36
11	Total Trouser Length	42
12	Trouser Bottom Opening	18
13	Churidar Bottom Opening	12
14	Pajama Bottom Opening	16
15	Crotch	11 ¼
16	Knee	22

SIZE CHART FOR KIDS (IN INCHES)

AGE	3-9 MNTS	1 YR	2 YR	3 YRS	4 YRS	5 YRS	6 YRS	7 YRS	8 YRS	10 YRS
CHEST	19	20	21	22	23	24	24 ½	25	26	28
WAIST	19	19 ½ -20	20-21	21 ½	22	23	24	24 ½	25	26
CROSS BACK	8	8 ½	8 ¾	9	9 ½	10	10 ½	11	11 ½	12 ½
WAIST LENGTH	6	7	8	9	9 ½	10	10 ½	11	11 ½	12 ½
SHORT SLEEVE LENGTH	2 ¾	3	3 ¼	3 ½	4	4 ½	4 ¾	5	5 ½	6 ½
LONG SLEEVE LENGTH	6 ½	7	8	8 ¾	9 ½	11	11 ½	12	12 ½	13 ½
FINISHED DRESS LENGTH	14	15	17	19	21	22	23	24	25	27

SEAM ALLOWANCES

Collar: 2 piece collar- $\frac{1}{4}$ " all side
Chinese collar- $\frac{1}{4}$ " all side
Arm hole: $\frac{1}{2}$ " on the curve
Placket: $\frac{1}{4}$ "- $\frac{1}{2}$ "
Hemming: $\frac{1}{2}$ " – 2"
Sleeve: $\frac{1}{2}$ " on the curve and 1" on the under arm seam
Sleeve Hem: without cuff: $\frac{3}{4}$ "-1"
With cuff: $\frac{1}{4}$ "
Cuff: $\frac{1}{4}$ "
Pocket Body: $\frac{1}{2}$ "
Upper: $\frac{3}{4}$ "
Flap: $\frac{1}{2}$ "
Side seam: $\frac{1}{2}$ " – 1"
Yoke: $\frac{1}{4}$ "
Patch: $\frac{1}{4}$ "

FOR THE BOTTOM

Waist band: $\frac{1}{4}$ "
Fly: $\frac{1}{4}$ "
Side seam: $\frac{1}{2}$ "-1"
In seam: $\frac{1}{2}$ "
Hemming: $\frac{1}{2}$ "-1"
Pocket: $\frac{1}{4}$ "- $\frac{1}{2}$ "
Patch: $\frac{1}{2}$ "
Divider flap: 1"

NOTE:

- To join two pieces, always keep $\frac{1}{2}$ " seam allowance
- Keep $\frac{1}{4}$ " extra allowance for over-lock.
- For finishing the side seam keep $\frac{3}{4}$ " seam allowance.

MEASUREMENT FROM A GARMENT

Measurements that are needed for a pattern and how to take measurements properly have been covered in another topic. In this, one is going to learn to measure and draft a pattern from an existing garment. This requires a person to have the ability to measure correctly and accurately on a body and dress form. This is an advance skill and requires thorough knowledge of pattern development, as it is essential to understand the importance of the crucial areas. The higher skill is needed to be able to measure the flat fabric that has been converted into a three dimensional body.

Why do we need to measure an old / existing garment?

One may have a favourite shirt or a well-fitted sari blouse or any other garment, and that one has not been able to replicate or find the same fit again. The same fit has never been achieved; this may be due to a well-adjusted pattern or fitting or a different method of pattern drafting of the original garment. Another case may be that the person is unable to personally to give measurements and sends a garment as a sample. In any case the garment has to be measured for the purpose of getting the measurements.

There are two methods that can be followed to accomplish this:

- 1. Tracing the garment:** If it is an old garment, and one has not achieved sufficient level of proficiency in pattern making then it is advisable to open the garment very carefully, with the help of seam ripper and separate each individual piece of the garment, at seams, darts, pleats and other types of fullness taking care so as not to tear of any seam allowance. All the seams like princess seam, yoke seam, darts or panels should also be opened. The pockets or decorations if any should be removed.



The separate pieces should be then carefully labelled and grain lines marked specially in case, pieces that need to be cut on Bias grain as in the case of *Choli* blouse, where the two front piece are always cut on bias for a better Fit. Use these cut-apart-sections as guide for your new pattern. The garment should be copied on muslin as an intermediate step and then transferred on thick pattern making paper. The garment should be well ironed before starting the procedure.

All the pieces should be cut on the same grain as the original piece; hence the grain of the pieces should be marked on the sketch as this will ensure that the garment has the same fall as the original.

It is worth the effort to carefully mark out the seam allowances, hemline folds and turn-backs like self-facings with tailors chalk. In case of a style, that one may want to make repeats of or that is to be cut on an expensive or a slippery fabric, then these allowances should be thread traced. Thread tracing is with basting stitches a seam allowance is marked, this is the permanent method of marking seam lines. This is generally done for silk fabrics or fabrics on which tailors chalk does not show.

Place marks at top of the sleeve and underarm seams, at the front and back armholes of sleeve and bodice and the corresponding notches of both sleeve and bodice this point would be where the curve changes from over arm to underarm.

Mark placement of buttonholes, buttons, pockets, points at which collars and cuff joins the garment. Mark any other garment detail that might be there.

The pieces then should be laid out on the fabric in the same manner as one would layout a paper pattern. Remember to do it with least wastage, pieces should be laid out together in such a manner that they fit within the confines of the fabric width as closely and efficiently as possible. For a more efficient and professional approach the same should be first traced on the thick pattern making paper and a muslin test fit done before one proceeds on the final fabric.

Remember this pattern has all the seam allowance and sufficient ease has been added to it. Hence, there is no need of adding any ease or allowance for stitching.

2. **Drape the garment method:** A similar method is followed as the one for tracing the garment. This requires an additional skill of draping the garments. In this method each section of the garment is copied. Cut a piece of muslin larger than the part to be copied. Straighten the lengthwise and crosswise grains of the muslin. Place the lengthwise grain on the right side of the length of the garment like centre front or back and p" Pin in any darts, tucks, pleats or other fullness by the same amount that may be there in the garment and also in the same position. Locate and place a row of pins on all seam lines and edges. Mark the position of the buttonholes, buttons, plackets, collars and any other design detail that may be there. Mark the grain. Transfer all the seam lines, darts and others that are pinned with marking chalk or tailors chalk. When all the lines are in place, unpin the muslin from the garment. True the straight lines and curved lines with appropriate tools like ruler, French curve or hip curve. Add seam and hem allowances. Transfer the corrected muslin to paper. Place an identifying mark on each pattern piece.
3. **Measurement Method:** If the garment is a sample and cannot be opened out in separate pieces then one has to measure it carefully and measurements are to be recorded in the same manner, as one would measure the body or dress form. It is of paramount importance to do it in a systematic and careful manner. All the length-wise measurements should be recorded first and width-wise measurements be recorded next in order.

The length wise measurements that are needed to be measured are the maximum length of the garment, neck to waist, shoulder to neck depth, dart points if any, centre front length, centre back length, waist length if it is required, waist to hip measurement if required, hip to hem, for trousers inner leg seam and seat length are also required. For the sleeve measure, sleeve length, sleeve cap, cuff length or hem fold if required.



The width wise measurements that are needed to be measured are the maximum width of the garment (whichever part of the garment it may be), Shoulder length, cross back, neck width, armhole to armhole measurement, front width, back width, front waist, back waist, front hip, back hip, front hem, back hem, dart lengths, dart widths, for trousers measure width at crotch level, knee level and hem. For sleeves measure sleeve width at bicep, elbow and wrist.

One may choose to make the pattern from any method the **important points** that one would need to keep in mind while taking measurements are as follows:

1. The measurements required should be carefully noted. A list should be prepared before one begins to measure the garment so that, none of the required measurements is left out.
2. Lay the garment on a flat surface; check whether the garment is flat or three-dimensional.
 - a) If the garment is flat, proceed, as you would have done on a body, as these garments do not have additional focal points.
 - b) If the garment is **three-dimensional** then check where the garment has the third dimension; e.g. the bust point in a close fitted blouse. If one is to measure the width of the front, start on the side seam, measure till the bust point and then measure across to the centre front, remember to hold the garment in such a manner that one does not lose out the third dimension of the blouse. A simple method to ensure this is to hold the garment in hand and then measure the garment. The lengthwise measurement over a focal point is also taken in the same manner. If one is careless the measurement would be shorter and the garment would never fit the intended wearer.
3. Note the number of individual pieces in the garment. A beginner should always make a little sketch and mark the pieces and number them, so as to remember all the pieces and the sketch would ensure at the time of cross checking if all the pieces have been cut.
4. Check if the garment is symmetrical or asymmetrical, i.e. is the garment identical on two sides of centre front and centre back. If it is symmetrical it is possible to cut it on the fold with only one piece each for front, back and sleeve. If it is asymmetrical then check the number of front, back or sleeves that may be required and make a note of them.
5. Note the number of lengthwise panels that may be there. Compare it with design that you are working on if it is identical or are there changes in the new design. In case of any variation note the changes that may require any alteration in the measurements, e.g. a sample piece might have princess panels running through the bodice, but the new garment may not have them, then one needs to add the measurements of the two or three panels to get the final measurement for the new design. Make a note of these changes and ensure that one makes least amount of mistakes as possible.



6. A princess bodice may have a dart that has been converted into a seam; this requires a trained eye to decipher the pattern manipulation that may have been done to achieve the fit of the sample garment. In case a princess seam is there measure the width of the garment at several points like starting of the panel, at the bust point level where the body is fullest, at the waist level, at the hip level and also at about $3\frac{1}{2}$ " below the bust. This is the point at which the dart is maximum for the under bust shaping especially in very close fitted garments, like contoured garments.

7. Note the number of width wise panels that may be there. Compare it with design that you are working on if it is identical or are there changes in the new design. In case of any variation note the changes that may require any alteration in the measurements follow as for the above, e.g. if the sample garment has no waist seam and the new garment has a waistline, study the sample and mark the waistline. Generally a garment is narrowest at the waist. The same method would be used for garments with yokes and hipline seams.
8. Note it is important to measure only till the line where the garment will close i.e. till the centre front or centre back for placket opening as the additional is just the overlap for the closures. In case the garment has a zipper as a closure then it is necessary to zip up the garment and then measure it.
9. Measure from seam line to seam line only; do not measure dart widths in the total bust or waist measurement. If there is a panel in between measure for seam line to the panel and from panel to the next seam line. Do not try to measure in shortcuts.
10. It is easy to measure the lengths of the garments that have basic neckline, the problem starts when the style departs from the standard shape. All the garments that are worn over other garment are automatically dropped slightly from the neckline for ease.
11. Note placement of buttonholes, buttons, pockets, points at which collars and cuff joins the garment. Note any other garment detail that might be there.

The following points have to be kept in mind before you begin making a pattern from these measurements.

1. All the pattern pieces include ease, as these are the final/ ready measurements of the garment. While making the pattern remember not to add any additional allowance for ease.
2. If the new design has different pieces than the original then the same should be carefully marked and noted.
3. Make a small sketch of the garment before starting the pattern.
4. All the pieces should be cut on the same grain as the original piece hence the grain of the pieces should be marked on the sketch as this will ensure that the garment has the same fall as the original.

After recording all the measurements required, draft the pattern and check if the ready measurements are exactly the same or not. Make the necessary corrections and proceed with the final garment. If the new garment is different than the original, then it is recommended that a basic pattern may be drafted and test fitted before developing the style variations. This may take little more time but in the long run is more economical in terms of time and money saving.

Any method that one may choose to make a garment from a sample, there is an important suggestion that should be taken note of; i.e. it is important to make a trial muslin from the completed paper pattern as a test for accuracy of reproduction and for fit. Make all the necessary changes before cutting the final fabric. Use the corrected paper pattern for cutting, as it is more dependable than muslin.

FABRIC REQUIREMENT

A major question that arises in one's mind at the time of purchasing fabric for any garment is how much to buy? It is a very important question and to be able to give an objective reply, it requires a person to be an expert in pattern development and an expert in making an economical layout. For the garment industry, this is of crucial importance, as even minimal saving of 5cms of fabric in a shirt would result in 50 meters being saved in a lot of 1000 shirts. At Rs. 80 per meter it would save Rs. 4000/-, which is a substantial amount of saving for a producer. Generally an expert is able to save as much as 25 - 30cms in a garment easily even for a single shirt that is a big saving in the made to measurement sector of the apparel industry.

Imagine a stage where one buys minimum of 50cms extra than the required amount, so that one does not run short of fabric while cutting. The amount of money that is being spent on extra fabric, which goes waste and is thrown out or that collects dust is tremendous.

How to calculate fabric required?

For any garment, that one is going to make one needs to know its two major dimensions i.e. maximum length and the maximum round width. For any garment one needs a minimum of two lengths plus seam allowances. The fabric has two grains lengthwise grain and width wise grain. One should cut the garment lengths along the length wise grain as this is the stronger grain (which you have learnt in earlier chapters) and the fall of the garment would be far better on this grain. One is able to cut the garment in less fabric only if the width of the fabric is wide enough to fit two length of the garment in one length of the fabric.

The patterns representing all the individual pieces of the garment should be laid out together in such a manner that they fit within the confines of the fabric width as closely and efficiently as possible. This minimises the wastage in fabric. This is a **pattern lay**.

How to make a layout?

In the industry, this is the specialised task for which most of the companies that work on developing, pattern making softwares for the clothing industry have been working for a long time and have successfully created a number of dedicated softwares. On the computer all the pattern pieces of the garment are either digitized or drafted and a lay of the garment is made. A rectangle of the dimensions of the fabric is made and the pattern pieces are placed on it in exactly the same manner as one would on a fabric keeping in mind whether a piece is to be cut on fold, on bias or on a cross grain. One can do this exercise manually by cutting or drawing a similar rectangle on a small scale and placing or drawing the pattern pieces also on small scale in it. This exercise would be more scientific, precise and accurate for fabric calculation. An example of the same is given below:

It takes time and effort to fit together all the pieces of pattern. It is like playing a giant puzzle. The game is to place all the pattern pieces on grain in such a manner so as to be able to use the entire width and the length most economically. For such purposes it is advisable to keep on hand several lengths of wrapping paper cut to standard widths of fabric on scale.

Place the fabric on a flat surface. Line up its straightened edges with the straight edges of the cutting surface. Place the pattern in position. Start with one end of the fabric. Support the weight of the cloth at the other end of the cutting area. When the pattern pieces have been temporarily pinned on the material check if you could adjust the pattern pieces and save more fabric.

Remember to place the pieces on the right grain and close to each other. Spaces between them may result in wastage of as much as five to six inches of fabric. Always place the largest piece first, then the ones that may need to be cut on fold. Fit in the smaller pieces. Fit in the shapes against each other, locking them whenever possible. This saves a lot of fabric. Arrange the pattern pieces in such a manner that if any fabric is left, it is in one usable piece, either at an end or middle.

The pattern pieces have to be laid out in such a way that it takes into account directional properties of fabric, such as fabric design and fabric grain. The quality of a product is affected significantly by the accuracy of fabric matching also called mitering that is very important for fabrics with checks or stripes. Mitering is the perfect matching of check or stripes even other directional prints on the side seam, centre back and centre front seam or any seam that might be running across in the garment like a yoke or waistline seam. This might require more fabric consumption and great deal of time and effort, for a perfectly mitered garment is a joy and pride of a designer and master tailor.

Given below are **methods of fabric calculations** for some of the popular categories of garments. These have been given on an assumption that one would be using readily available 36" width fabric. These are just indicative and have been done for basic or classical styles in the category and are in no way conclusive as it is expected that this should be combined with practical exercises at every step. This is a practical subject and more learning happens with hands on experience.

Shirt - For buying fabric for a man's shirt, one needs to know the shirt length, the round chest, and sleeve length whether full or half. One needs to buy fabric piece for two lengths of the shirt plus the seam allowances and one length of the sleeve with seam allowance. Care should be taken to place the centre front on selvedge, as not only this saves fabric but also will save one operation, as the placket would have a ready finished edge. In case one is making a shirt in a fabric that has one way print one may need at least two lengths of the shirt and sleeve length.

Trouser – A trouser is generally made in the thicker fabric, which most of the times is available in a larger width of 60". Hence, one requires fabric piece for one length of the trouser plus 25cms, since two legs of the trousers have 4 pieces which can be cut two at one time by placing them in opposite directions on a fabric that is, folded half width wise. In case one is making a trouser in a fabric that has one way print one would need at least two lengths of the trouser.

Salwar – A Salwar has 6 pieces for the legs and a belt. 4 side leg pieces of the Salwar are cut in the most economical manner by placing them in opposite directions with no wastage of fabric whatsoever. The other two pieces of the leg and belt are simple rectangles but basically Salwar is much wider than the trouser. For the Salwar one requires fabric piece for two lengths of the Salwar and one seat length. . In case one is making a Salwar in a fabric that has one-way print one would need minimum four lengths of Salwar fabric.

Kameez –A woman's kameez is worn over a Salwar. One needs fabric piece for two lengths of the kameez and one sleeve length. If trends in fashion were for a big flare at the hem then, more than two lengths would be required. This depends on number of panels of the required width, which would be needed, to cut the pattern according to the design. In case one is making a kameez in a fabric that has one-way print one may not need extra fabric in basic styles but for larger flare in the hem or a kameez with princess panel an extra length would be required.

Kalidar Kurta – A Kalidar Kurta has two simple rectangles for back and front, which have the dimension of cross back plus seam allowance by the length of the Kurta plus the seam allowance. It has two sleeves, the length of which depend on design and generally has four kali. The kali's are cut in the same manner as the Salwar side panels. Generally the kali is added after the sleeve in the Kurta but in some designs it may start from shoulder. In case the fabric width is sufficient (depending on the width of the kali required) you need fabric piece for one length of the Kurta, one length of the kali and one length of the sleeve. Otherwise, you would need two lengths of the Kurta and one length of the kali. In case the number of kali's is more then the fabric required would increase proportionately.

Pajama- is a trouser like in its pattern but is generally much wider for comfort and easy fit. Generally it requires fabric piece for two lengths of pajama plus seam allowance.

Churidar Pajama – is a variation of a simple pajama that has extra length, which gathers around the ankle of the wearer. This pajama is cut on bias for a better fit. The fabric required for this is $2\frac{1}{2}$ times the required length of the wearer (This is the measurement of the person and not the pajama).

Sari Blouse – For sari blouse, you need fabric piece for one length of the blouse and one sleeve length plus the seam allowance. In case of a bigger size, one may need to buy two lengths of the blouse. Since the sari blouses are generally made in 2 x 2 rubia that comes only in 36" width.

Skirt – Skirt generally has one back piece, one front piece and a waistband. You need fabric piece for two lengths of the skirt. There are tremendous possibilities of design variation in skirt. So the generalization may not work for skirts with bigger flares, more panels, different fits and skirts with yokes holding pleats or gathers. The amount of gathers or pleats in the skirt generally determine the fabric required.

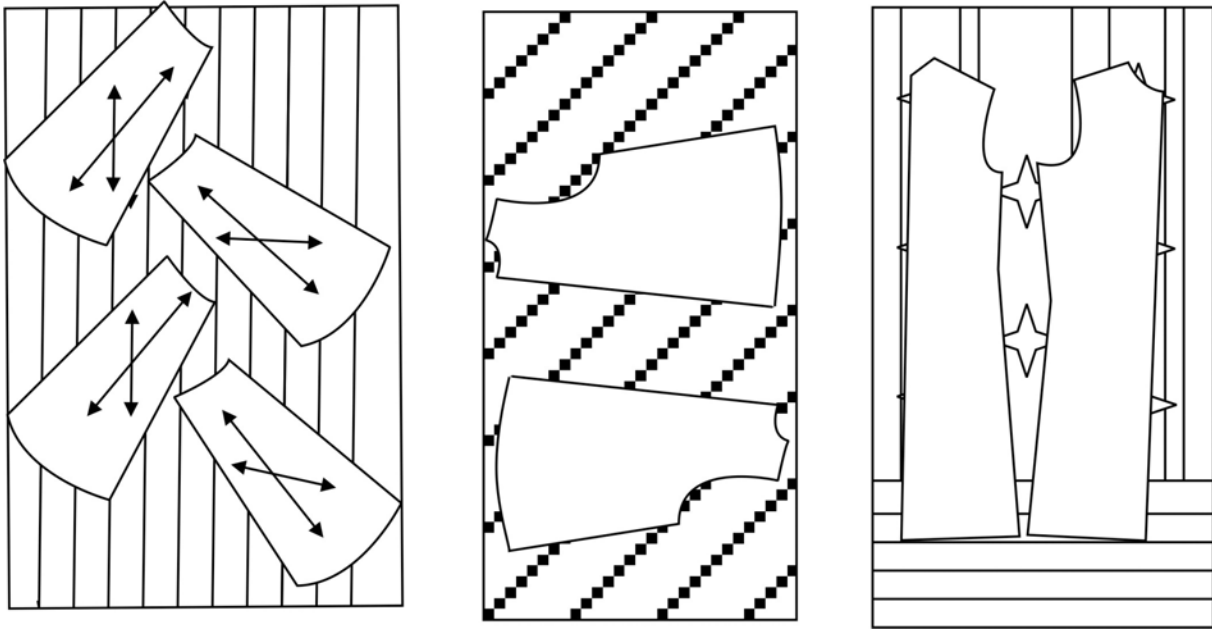

Nightie – Like a shirt you need two lengths of the Nightie and one sleeve length.

All the above are indicative measurements and requirements. It is recommended that one learns to make a pattern layout. As explained in the beginning layout is a process similar to the actual cutting of fabric one needs to layout on an imaginary fabric with the required pieces as one would on an actual fabric for the sake of fabric calculation.

For the beginner it is important to do a simple exercise as a learning point and should progress into more complicated ones later. Conversion chart of fabrics with various widths has been prepared and that is to be used after one has calculated the fabric required for a garment in 36" width (which is a most common width available in the Indian market). A beginner needs to buy at least 25cms extra, as it is only with experience that one is able to make a layout economical and accurate. Another reason is that as a beginner one may make some mistakes in marking or cutting the right grain or dimensions and run short of fabric. After gaining experience, one must do some complicated layouts to gain confidence.

Conversation Chart

Fabric width/ ----- Yardage required	32"	35"-36"	39"	41"	44"-45"	50"	52"-54"	60"
	1 ⁷ / ₈	1 ³ / ₄	1 ¹ / ₂	1 ¹ / ₂	1 ³ / ₈	1 ¹ / ₂ 1 ¹ / ₄	1 ¹ / ₈	1
	2 ¹ / ₄	2	1 ³ / ₄	1 ³ / ₄	1 ⁵ / ₈	1 ¹ / ₂	1 ³ / ₈	1 ¹ / ₄
	2 ¹ / ₂	2 ¹ / ₄	2	2	1 ³ / ₄	1 ⁵ / ₈	1 ¹ / ₂	1 ³ / ₈
	2 ³ / ₄	2 ¹ / ₂	2 ¹ / ₄	2 ¹ / ₄	2 ¹ / ₈	1 ³ / ₄	1 ³ / ₄	1 ⁵ / ₈
	3 ¹ / ₈	2 ⁷ / ₈	2 ¹ / ₂	2 ¹ / ₂	2 ¹ / ₄	2	1 ⁷ / ₈	1 ³ / ₄
	3 ³ / ₈	3 ¹ / ₈	2 ³ / ₄	2 ³ / ₄	2 ¹ / ₂	2 ¹ / ₄	2	1 ⁷ / ₈
	3 ³ / ₄	3 ³ / ₈	3	2 ⁷ / ₈	2 ³ / ₄	2 ³ / ₈	2 ¹ / ₄	2
	4	3 ³ / ₄	3 ¹ / ₄	3 ¹ / ₈	2 ⁷ / ₈	2 ⁵ / ₈	2 ³ / ₈	2 ¹ / ₄
	5	4 ³ / ₄	4	3 ⁷ / ₈	3 ⁵ / ₈	3 ¹ / ₄	2 ⁷ / ₈	2 ³ / ₄

DARTS, PLEATS GATHERS

Darts

The dart is one of the most flexible and creative parts of the pattern. The space between the dart legs can be used in a variety of creative ways and is limited only by the imagination of the designer.

Types of darts:

- Shoulder dart
- Bust dart
- Armhole dart
- Centre front dart
- Waist dart in skirt



Pleats

A pleat is an unstitched, folded dart held securely along joining seamline. It is a fold in the fabric that releases fullness. Pleats are used to increase stride room, or can also be used as a design. Pleats are found on skirts, bodices, sleeves, dresses, jackets etc. they are formed in a variety of ways. They may be folded and left unpressed or pressed, stitched or left unstitched. They may be grouped together with even or uneven spacing. Pleat depth may be single, doubled or tripled.

Types of pleats:

- Knife pleats - Pleats are grouped and face in one direction.
- Box pleats - Pleats are folded away from each other on right side of the garment
- Inverted pleats - Pleats are folded to meet each other on the right side of the garment.
- Accordion pleats - Pleats have folds resembling the bellows of an accordion. The pleats are close together and depth is equal from waist to hem.
- Sunburst pleats - Pleats fan out and graduate from the waist. They are generally used on circle skirts.

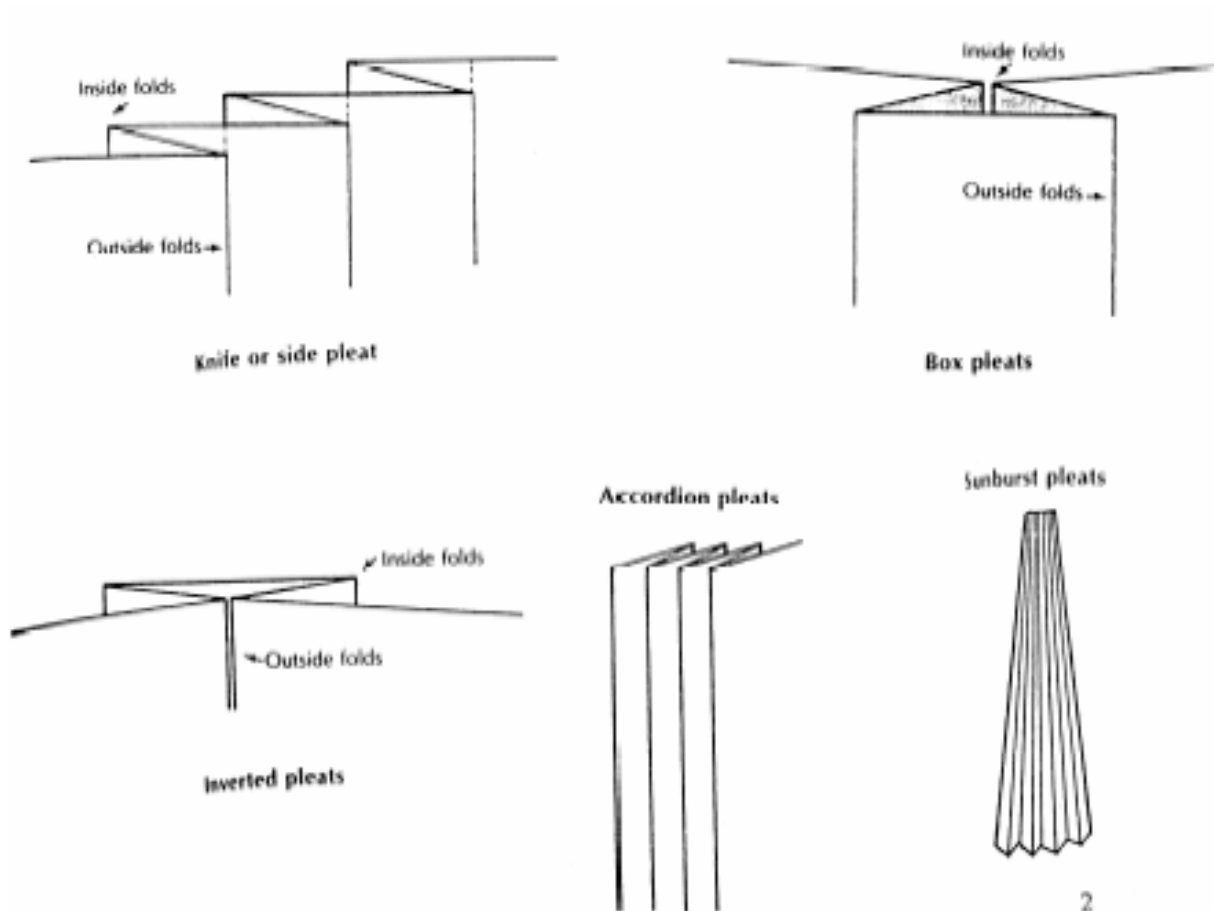

Gathers

Gathers change the look of the basic garment, but do not affect the fit.

Types of gathers:

- Gathers at shoulder
- Gathers at centre front bust
- Gathers at waist
- Gathers at neckline



TUCKS, PLACKETS FACINGS, COLLORS AND SLEEVES

Tucks

A tuck is a stitched fold on the right side of the fabric resembling a pleat. Tucks are used as design details and can be placed on any garment (top, skirt, dress, sleeve, pants etc.). Tucks can be placed in any direction (vertical, horizontal and diagonal) and may be of any width. They can be spaced close or far apart for varying effects.

Types of tucks:

- Pin tucks
- Shell tucks
- Release tucks
- Cross tucks
- Space tucks

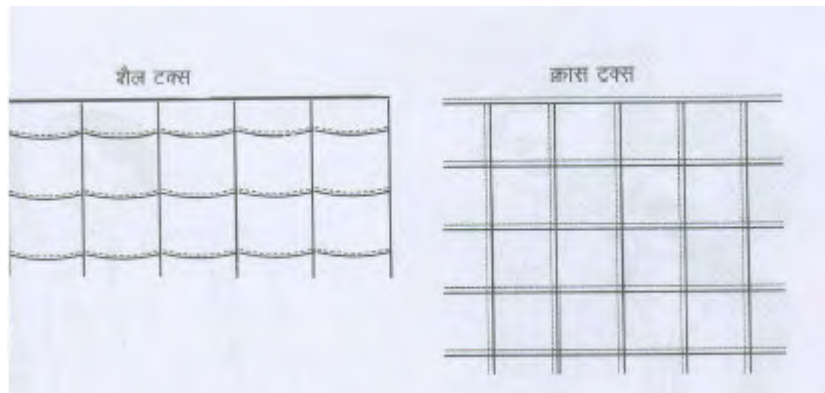
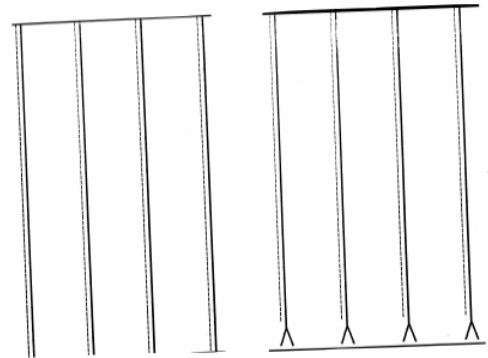
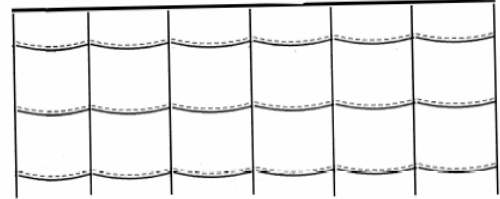

Plackets

Plackets are finished slits or faced openings designed on all types of garments-bodice, sleeve, skirt, dress, jacket, pant etc. plackets can be of any length and width, with rounded, pointed, stylized or blunt ends. Some plackets have buttons and buttonholes, others may not. The measurement can vary to create different effects.

Types of plackets:

- Regular shirt placket (for men)
- Half pointed placket
- Slit opening with placket
- Wing collar placket

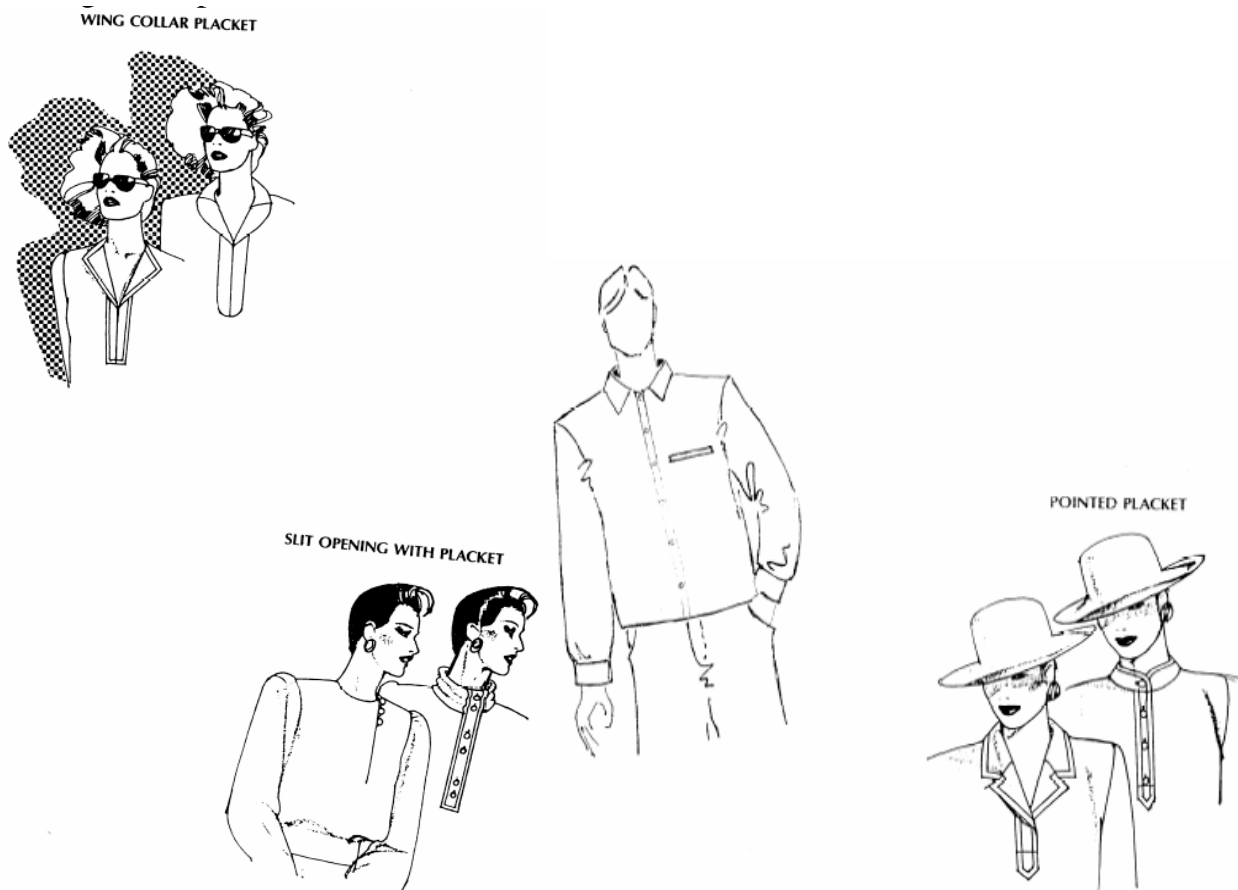

Facing

A facing is a duplicate-shaped piece of fabric stitched to the outside edge of a garment and folded over to conceal the raw edges. Facings control the fit of the garment when the cut edge is bias or crosses the hollow areas above the bust.

Facings are planned as part of the pattern plotting. They are placed from the pattern before or after the design pattern has been developed. They vary in width and shape but generally are from 1 ½ to 2 inches around the neck and armhole.

Types of facings:

- Separate facings : Individual facings for armhole and/or neck.
 1. V neck facing
 2. Square neckline facing
 3. Scoop neckline facing
- Combined facing : All-in-one armhole and neck facing.

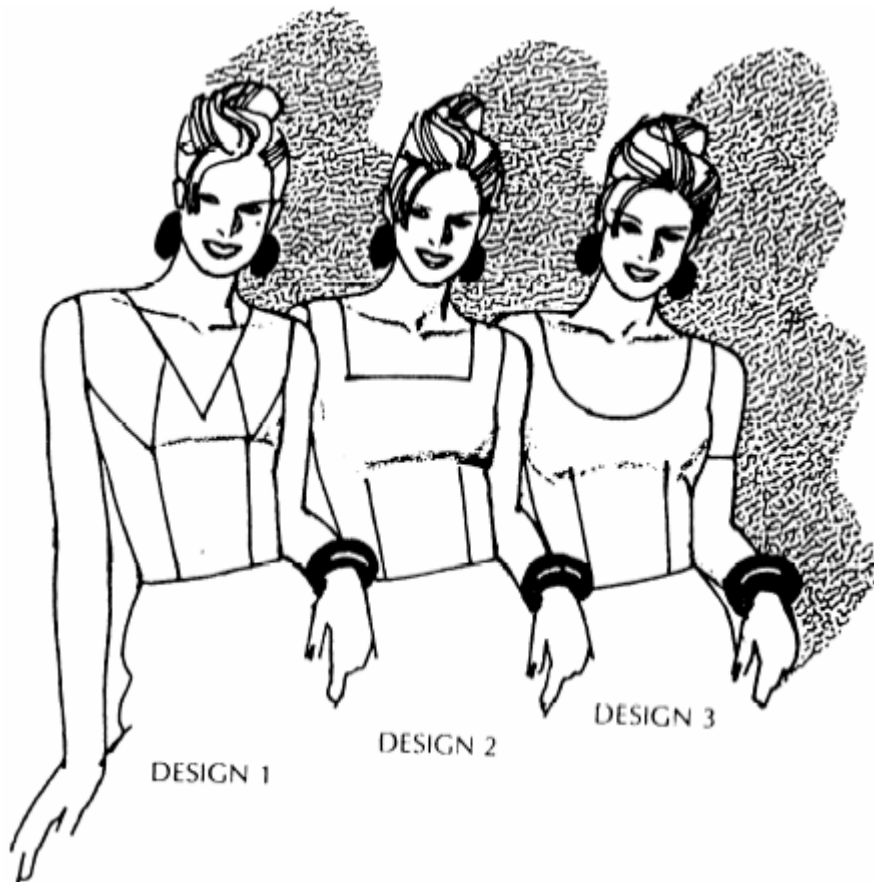

Collars

A collar is the part of a garment that encircles the neck and frames the face, offering great opportunities for design variations. Collars can be developed close to or away from the neckline. They can be wide, narrow, flat, or high, and with or without an attached stand. The collar edge may be stylized or may follow a basic shape (round, curved, scalloped, square, pointed etc.).

Collars can be convertible (can be worn closed and open, so that it lies flat across the chest when opened) or nonconvertible (stay in the same location whether garment is buttoned or unbuttoned).

Types of collars:

- Peter pan collar
- Sailor collar
- Chinese collar
- Shirt collar
- Collar for square neck

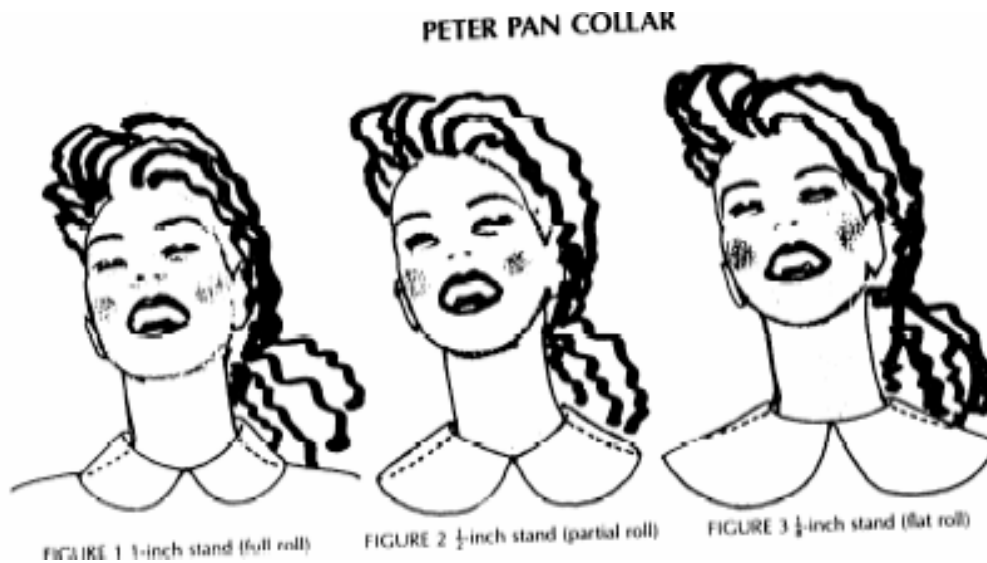

SAILOR COLLAR



COLLAR FOR SQUARE NECK



MANDARIN COLLAR



Sleeves

Sleeves have always been used for changing the silhouette of a garment. Important sleeve silhouettes keep appearing, disappearing and reappearing over a period of time. There are two major classifications of sleeves: the set in sleeve cut separately and stitched into the armhole of the bodice, and the sleeve combined with part or the entire bodice.

Types of sleeves:

- Cap sleeve - These jut away from the arm and can be shaped in a variety of ways. It is usually designed for a bodice, dress or blouse.
- Puff sleeve - Puff sleeves are developed by adding fullness to the sleeve's width. Puff sleeves can be of any length desired.
- Bell sleeve - Bell sleeves have a smooth cap and an unconfined hemline flaring out in the shape of a bell. The bell may be developed into any length and flare desired.
- Leg-of-Mutton Sleeve - This sleeve is developed by enlarging the biceps and cap area, tapering the fullness towards the elbow level.
- Raglan sleeve - The raglan sleeve pattern is developed by including part of the neckline and armhole to complete the sleeve draft. The raglan sleeve can be designed for bodice, dress, blouse, jacket, coat etc.

CAP SLEEVES



LEG-OF-MUTTON SLEEVE



RAGLAN SLEEVE



BELL SLEEVES



PUFF SLEEVES

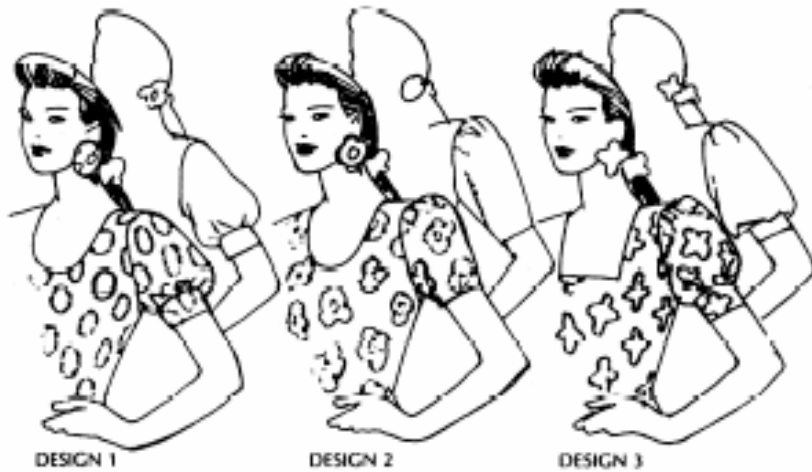

FABRIC CARE

The proper care of clothes ensures that the garments last longer and gives one value for money and look great after a number of washings. The garments that can be washed have been explained in the chapter “Fibre and Fabrics”. In this chapter the topics covered are maximum ironing temperatures and spots and stain removal from various fabrics. These are important for proper care of garments and fabrics.

Pressing or ironing

To get wrinkles out of the handkerchief one pushes the iron along, this is ironing - a gliding motion. Pressing is an up and down motion. Lower the iron, press, and lift and move on to another section of the fabric. Then again lower the iron, press and lift the iron; this is the pressing motion. As ironing has long strokes it is done on flat surfaces. Pressing is done on small surfaces using various pads to suit the shape of different pieces and parts of the garment. For the shaped three-dimensional garments it is advisable to use small shaped pads for pressing. For better finishing, it is advisable to press each and every dart and press-open every seam while stitching. Press open every enclosed seam before turning the facing back to the underside.

It is so much easier to topstitch an edge when it has been pressed flat. It is far easier to insert a zipper after seam allowance has been pressed back first. Do not press over pins or basting as they leave marks.

Safe pressing temperatures limits for fabrics

Fabrics	Temperatures
Natural Fibres	
Cotton	400° -425° F
Linen	450° F
Silk	300° F
Wool	300° F
Manmade Fibres	
Acetate	250° -350° F (Press on wrong side)
Acrylic	300° F
Metallic	cover with pressing cloth
Nylon	300° -350° F
Polyester	325° F
Rayon	350° -375° F
(Press on wrong side)	
Rubber	Do not press
Spandex	300° F
Vinyl	Do not press
Blends/mixed	lowest for the fibre
Fibres	type

Pressing special fabrics

- a) *Crepe weave fabric*- Crepe weave fabrics tend to shrivel when damp and stretch with pressure. Place a press pad under the fabric and a press cloth over the fabric to retain the crinkle. Press lightly at required temperature depending on the type of fibre.
- b) *Furs*- They require very little or no pressing. Press from the wrong side, if you choose to press, use a self-fabric or a thick pile fabric like toweling as a press cloth.
- c) *Napped fabrics*- same as for furs using either a self fabric or a thick pile fabric like toweling as press cloth.

- d) *Slubbed, looped, ribbed fabrics*- Place the right side of the material against the right side of self-fabric or terry cloth. Using a light touch steam the fabric.
- e) *Wool*- press lightly using a press cloth with moderately hot iron and steam lightly, if required.
- f) *Metallic fabrics*- ironing should be avoided as they may get permanently creased while being ironed. If necessary, press lightly with a warm iron over a dry press cloth.
- g) *Leather or leather-like and coated fabrics*- should not be ironed.
- h) *Lace fabrics*- in order to preserve the raised structure of lace, place it over a thick towel and cover with press cloth and steam iron lightly.

SPOTS AND STAIN REMOVAL

Many common stains can be removed by just washing the garment, especially if the stains are fresh. Some laundry products contain special ingredients such as enzyme or oxygen bleach to aid in removing stains.

If the stains have aged, it would be best to pre-soak the garments in warm water. This should be followed by regular laundering. Often old, unknown stains can be removed and many yellowed fabrics restored by this method.

Oxygen bleach is mild bleach, which can be easily used on fabrics that cannot withstand chlorine bleach; it will be most effective in removing stains when used in hot water. Use the water at maximum temperature, which the fabric can stand. There are stains, which even the best products cannot remove.

The information you need to have before you start stain removal

1. Know the fibre content.
2. Do not use chlorine bleach on silk, wool or spandex.
3. Do not treat leather, take it to a professional dry cleaner.
4. If stain remains repeat the treatment.

Although no guarantees can be given about the following methods but experience has shown them to be effective in most of the cases.

1. **Alcoholic beverage:** Sponge with cold water, then with glycerine and water. Rinse with vinegar water before laundering.
2. **Blood:** Soak in cold water for about thirty minutes. If stain remains soak in lukewarm
3. **Ammonia water:** (3 Tbs. of ammonia to half a bucket of water)/ club soda. Launder.
4. **Chewing gum:** Put the article in plastic bag and place it in freezer. Gum may be removed with a blunt knife.
5. **Coffee:** Sponge with cold water immediately or soak in cold water for at least 30 minutes. Rub with soap and rinse thoroughly.
6. **Crayons:** Loosen stain with kitchen shortening. Apply detergent and baking soda, working until the outline of the stain is removed. Launder and use bleach if safe.
7. **Deodorant:** On silk they can't be removed except maybe by dry cleaning, on cottons rub lemon juice on to the stain and launder normally.
8. **Eggs:** Sponge with cold water. Work in soap or detergent if stain remains. Scrape if egg has dried before working with soap.
9. **Fruit stains:** Stretch the fabric over a bowl and pour hot water through it. Sponge with lemon solution if stain persists.
10. **Gravy stains:** Sponge in lukewarm water. Launder in warm soapy water. In some fabrics it may be necessary to work soap / detergent well into the stain and allow it to stand for few hours. If the gravy has turmeric work detergent/ soap well into the stain, the stain will turn red in colour and keep the garment in the sun till the stain disappears, rinse in water to remove soap.
11. **Grass:** Work detergent into the stain and rinse.
12. **Grease:** Place a towel under the stain, pour cleaning fluid through stained area, and launder in hot water.
13. **Ice cream:** Sponge in cold water, apply vinegar water.

14. **Ink:** Soak the stained area in cold milk and wash after half an hour. If it persists rub with lemon and wash normally.
15. **Ketchup:** On washable articles, sponge with cold water let it sit for 30 minutes. Work in detergent and rinse.
16. **Lipstick:** Lessen stain with cold cream or glycerine. Wash as usual in undiluted detergent or pour liquid detergent through spray on it.
17. **Milk/ cream/ Ice cream:** Launder washable fabrics with plenty of soap.
18. **Mud:** Allow it to dry, then brush lightly and launder.
19. **Nail polish:** Clean with nail polish remover on all fabrics except acetate. Acetate needs to be sponged with amyl acetate.
20. **Oil/ ghee:** Sprinkle liberally with talcum powder let it stay for at least ½ an hour, then brush the powder lightly. Rub with soap or detergent into the stain and wash with warm water if stain persists.
21. **Perfume or cologne:** Wash immediately in solution of detergent and hot water. Do not allow the stain to age.
22. **Soft drinks:** Sponge immediately with cold water. Rub in glycerine and rinse after 30 minutes.
23. **Soup:** Sponge immediately with cold water. If stain remains rub in soap or detergent and allow it to dry. Rinse after few hours.
24. **Vegetable stains:** on washable fabrics sponge with cold-water let it stay for 30 minutes, work in the detergent and rinse.
25. **Urine:** Soak in enzyme detergent and launder using safe bleach as per fabric requirement.
26. **Water:** Launder the fabric.
27. **Wax:** Scrape off as much as possible. Then place the fabric between two paper towels and press with warm iron. Sponge final traces of the stain with a solution of water (2 parts) and alcohol (1 part).
28. **Wax Polish:** Rub with soap or detergent and rinse with warm water. Sometimes you may need to use grease solvent.
29. **Wine:** Soak in enzyme detergent in hot water (as hot as possible according to the fabric) and launder using bleach if it is safe for the fabric.

Prompt treatment helps in more effective stain removal. Hence it is wise to store some of the supplies on hand.

Bleaches: Chlorine bleach; fabric colour remover; oxygen type bleach (non-chlorine for all fabrics).

Detergents: Enzyme pre soak product; Liquid detergent; powder detergent; spray type pre treatment products

Soap: Laundry soap; white bar soap

Miscellaneous stain removers: Ammonia, rust stain remover; white vinegar

Solvents: Nail polish remover; turpentine oil

Other supplies: Clean white cloth and white paper towels

GARMENT FITTING

Fit refers to how well a garment conforms to the three-dimensional human body. Good fit is crucial to one's satisfaction. However, it is often easier to find clothes in right colours, prices and style that one likes than a well-fitted garment. The effect of a stunning design, gorgeous fabric and exquisite workmanship are destroyed if the finished garment doesn't fit well to the intended wearer. Fit problems may be caused due to careless design, construction or may be the result of individual characteristics of an individual's body. No two bodies are alike, and sometimes even the left and right halves of the same body are not mirror images of each other.

New technology promises to overcome these problems; a new computer system can optically measure an individual's body in three dimensions. This data is then converted to a computerised, individual pattern, a man's suit designed by this method is ready to be cut out and ready to sew within 7 minutes of receipt of the measurement data. The resultant garments fit accurately as the computerised scanner detects subtle nuances in the shape of the body that normal measurement systems are unable to read. These systems are on the stage of trial; but they would be costly and would take a long time to be readily available.

There are varying opinions on what comprises a good fit. Personal preferences regarding fit are governed by current fashion trends, cultural influences, age, sex, figure type, and lifestyle. The intended end use of the garment also affects the desired fit. For example, a person needs more ease for active sportswear than for spectator sportswear like in a tracksuit.

Elements of Fit: an evaluation of Fit is based on five classical elements:

Grain: for a good fit the garment should be cut on the right grain or in other words *on grain*. (This has already been explained on *How to calculate fabric*). An *on grain* garment hangs evenly and appears symmetrical. If the garment is *off-grain*, it will not hang straight. The garment and seam lines may twist or hang crooked because the fabric on each half of the garment behaves differently. Deviation in the grain line is a result of wrong cutting or stitching or even due to a poor posture of the wearer or figure irregularities that may interfere with the grain of the garment as it hangs on the body.

Set: refers to a smooth fit without any undesirable wrinkles. Wrinkles caused by poor set cannot be ironed out, but result from the way the garment fits the wearer. Set wrinkles usually occur because the garment is too large or too small for the wearer and the garment hangs or sags when worn.

Line: refers to the alignment of the structural lines of the garment with the natural lines of the body. Side seams of the garment should hang like a plumb line down the centre of the side of the body. It should be perpendicular to the floor. Centre front and centre back likewise should fall centre of the front and back of the body and be perpendicular to the floor. Darts and seams such as shoulder seams should visually appear to be straight lines that follow the body part they are intended to fit. Other seam lines should be gradually curving lines like necklines, waistlines, hiplines and armholes. Poor design or construction can result in an *out of line* garment. Even figure irregularities can distort the lines of the garment.

Balance: occurs when the garment is in equilibrium. The right and left side of the garment appear evenly balanced or symmetrical, when viewed from front, back or side of the garment. A skirt is balanced if the legs of the wearer are in the centre and are not touching the front or back of the skirt. Balance relates to grain and line in the garment. A garment is out of balance when it is cut off grain, causing it to hang unevenly. Also if the line of the garment does not follow the line of the body, it will hang out of balance. Poor posture or lack of symmetry in the wearer's body is another likely cause of it.

Ease: refers to the amount of roominess in a garment. Ease is the difference between the measurements of the body of the intended wearer and the measurements of the garment. There are two kinds of ease: **fitting ease** and **design ease**. A garment must contain adequate ease beyond the actual measurements of the wearer to allow room for ordinary movements like walking, sitting, reaching out and even breathing. Ease in this context is called Fitting ease. Design ease is the extra style fullness added to the fitting ease. All the garments have fitting ease but design ease is optional as it is added purely for the sake of appearance and giving the garment its style.

Evaluating fit

In evaluating the fit of the garment, all the sides of the garment must be examined. The fitting should start from the top and move downwards. The following body parts should appear as:

Shoulders: should appear smooth and feel comfortable. Seam should lie on top of the shoulder. In regular styles the arm syce seam should fall on edge of the wearers shoulder. The shoulders of the garment should be wide enough so that the sleeves hang smoothly. If the shoulders are too narrow, the sleeves will pull across the upper arm and cause wrinkles. If fashion trends require the shoulders to be narrow or wider the pattern still should allow sufficient movement. The shoulder slope of the garment should match the shoulder slope of the wearer.

Bust/Chest: if the garment is too small, the seams or closures are at the centre front or back are going to pull and gape open. A larger bust or highly developed chest often causes the button closure to gape open at centre front or back, also the garment may ride up because the larger bust curves takes up more length. A well-fitted dart always points towards the fullest part of the of the body curve it is intended to fit. The tip of the dart should end about an inch before the fullest part of the curve. Darts that are too short or darts that extend beyond the fullest part of the curve result in a bubble at the dart tip. Darts occurring anywhere in the garment follow the same principle. The practise of eliminating darts to speed construction creates diagonal wrinkles on the bodice front.

Neckline: necklines should be large enough to fit without pulling or chafing but not so large that it doesn't lie flat against the body in front and back. The front of the basic neckline should always be lower than that of the back.

Collar: the most important factor in the fit of the collar is the neck circumference. The circumference of the collar should be at least 1/4th of an inch bigger than that of the neckline or just large enough for one to insert two fingers between the neck and collar. A properly fitted collar should be smooth and stays in place when the wearer moves. It should not be so tight that it pulls. A tight collar is uncomfortable and makes the neck look large. But neither should it be so loose that it gapes.

Armsyces: must fit well for the garment to be comfortable and attractive. The circumference of the arm syce should be large enough so they do not pull at the front and back of the garment, but not so large that it gapes. In well-fit armsyces, the base of the arm syce is cut close to the armpit, but not so close to the armpit that it bites into the armpit. It should be cut about an inch below the armpit. This provides adequate comfort, room for movement, and close fit without wrinkles in the armsyce area. If the armsyces are too tight they are snug and uncomfortable. Armsyces in the front should be more deeply cut than at the back as most of the movements are in the front.

Sleeves: that fit well are attractive and comfortable. The circumference of the basic sleeve should be loose enough so that it does not bind nor has wrinkles horizontally around the arm. A tight sleeve apart from being uncomfortable makes normal arm movements impossible. Sleeves can be as loose as one wants but only problem would be to wear the garment under a fitted jacket. A well-set jacket sleeve hangs with a slight angle towards the front. The crosswise grain at the bicep should lie parallel to the floor.

Waistline: fit is essential for comfort. The waistline of the garment should not be so tight that it binds and rolls. It should have plenty of room for breathing and eating and it should return to its position after the arms are raised or lowered. It should not be so loose that it stands away from the body, droops, or adds bulk when a top or shirt is tucked in or worn under another garment. The narrowest part of the garment should fall at the wearer's waist. If there are buttons at the waist the garment should not pull or strain at the closure. A jacket should be big enough at the waist so that a person can sit even when it is buttoned.

Hips: the fit of the hip area is critical when fitting skirts or trousers. If there is adequate room in the hip area other parts of the garment can easily be altered to fit. Garments with enough room in the hip, thigh and abdomen area fit smoothly without pulling, wrinkling or riding up. Pocket, pleats or vents that open up indicate that garment is tight in the hip or abdomen area. If the garment has excess ease in hip or thigh area it will result in vertical folds.

Crotch/seat: trousers and other bifurcated garments require a well-fitted crotch for comfort or durability. A properly fitted crotch doesn't cut or bind the wearer between the legs and conforms to the shape of the buttocks. There should be slight but not excessive ease in the crotch area. Crotch length generally has one inch of ease in the crotch area. The back of the crotch seam should be longer and more deeply curved than the front as the backside of the buttocks are more curved than the front. Bigger sizes require longer and deeper curved crotch lengths at the back. Diagonal wrinkles radiating from the crotch area are the result of, crotch curve not long

enough to accommodate the size of the buttocks. Diagonal wrinkles in the front may also be due to the wearer's big abdomen. Wrinkles emanating upward from the crotch area indicate a too tight and high crotch, resulting in chafing and discomfort. Wrinkles emanating downwards from the crotch area indicate a low and loose crotch; it bags and sags, restricts walking and has increased probability of ripping from strain of movement. If the rise may be lengthened or shortened, the waistband should also be raised or lowered. Rise should not be lengthened or shortened in the crotch length as the same may lead to problems where none existed.

Another important **rule** of the fitting apart from knowing how to fit is when not to fit. Clothes must not only fit but need to flatter as well. There is absolutely no need to fit a garment so close to the body that it looks bad, also there is no need to stick to the design if it does not flatter the body. The real expertise lies in the fact that one is able to strike a balance between the lines of the design and the lines of the figure. The ability to do this is a skill that one learns by training the eye to see and judge as to what flatters the body.

Fitting is like sculpturing it creates a three dimensional form. Another question that is frequently asked is how many times one should fit; the answer to this is as many times as it takes to fit well.

Why and how to fit?

Mathematical calculations and pattern corrections alone cannot guarantee the fine fit of the garment. They can only provide an approximation of ones figure needs. The other points to be considered are:

- The style of the garment whether it suits oneself or not.
- The necessary and sufficient ease in the garment.
- The posture and the individual shape of the wearer.

These can truly be evaluated only on a fabric test fit. Since only minor changes can be made once the garment has been cut on the fabric. Hence a test fit can save lot of wastage. There are times when test fit is not necessary, those are when one is sure of the style, know from experience how to adjust the pattern, have sufficient material to recut if necessary and have sufficient seam allowances to borrow in emergencies. But if one has any doubts whatsoever, then test fitting is a must.

Commonly used test material is muslin, bleached or unbleached, should be used in a similar weight to that of the final fabric. Any other solid coloured plain weave fabric like poplin in a similar weight to final fabric would do. A plain surface is recommended as this clearly shows all seams, darts and other style details. Layout the pattern cut and mark your test fit fabric with equal amount of care as you would your final garment fabric.

Put the trial muslin together. The quickest way to get the effect of the finished garment without actual stitching is to overlap and pin all the seams lines. Pinning gives the same result and information, that one wants without going to the machine. It is so much faster and easier to unpin and then re-pin than to rip stitching and re-stitching.

Pins should be placed at right angle to the seam line, as in this method there is least amount of strain or pull on the seam, and it does not gape. When test-fitting trousers remember to baste stitch the crotch seam.

Check the test fit muslin and make correction till fully satisfied. Mark all the corrections and the same should be transferred on the pattern for it is the paper pattern that one should use to cut the final fabric and not the test fit muslin. Mark new notches as the old ones may not hold good after the alterations. Check the lengths of two matching seams to ensure that the alterations have not created more problems, e.g. if you have corrected the dart intake of side seam dart in the front, check to ensure that both the side seams are still equal or not and if required make the necessary changes.

Methods of fit

There are two kinds of fitting:

One is the first test fit that is done on muslin at the time when the pattern is made. A basic test fit is done to check the pattern fitting; the pattern is cut with relevant seam allowances and pinned in place for test fitting. Make sure that seams and darts are in place. This fitting is always done from the right side of the garment, as it is easier to make changes and corrections. These corrections become the new seam lines for the garment. Check the garment for ease and fullness. It is important to mark buttons and buttonholes at right places in this fit.

The second is after the garment has been stitched before final finishing. Stitch the garment with relevant interfacing/

or underlining in place press it well and test fit to check the position of darts, seams, puckers if any and locate the position of outer seams. This type of fitting refines and perfects the fit of the garment.

Other times when refitting becomes necessary are if the garment has been purchased readymade from the market some alterations may be required for it to be fitted to an individual's size and also if there are changes in the body size, like if some one has grown thin or has put on weight or if a child has gained height, refitting may become necessary. The methods by which each pattern seam or area is to be corrected and altered depends on the type of problems and nature of the fitting defect. The major problem areas have been earlier identified and detailed explanation has been given subsequently. There are areas that require minor alterations those have been explained and those that require some pattern manipulation have been shown with figures and explained briefly.

Given below are some of the fitting problems that would necessitate pattern alterations.

1. Waist alterations-

- a) *Thick waists* reduce the size of the darts and or add at the side seam.
- b) *Slim waists* increase the size of the darts and take some at the side seam. If difference is a small amount then the adjustments may be made in either in the darts or on the side seam. But in case the amount is sufficiently large then half of it should be altered in the dart and half in the side seam.

2. Shoulder alterations- since the clothes hang from the shoulder their correct fit establishes the lines and shaping of the rest of the garment.

- a) *Sloping shoulders-* on front and back pattern draw slash lines from neck to armhole edges. Slash and overlap the pattern at armhole edges to the needed amount. Pin the pattern piece or scotch-tape it to the required position. Redraw the armhole curves, lowering them at underarm by the same amount that you have taken in for corrections.
- b) *Square armholes-* on front and back pattern, draw slash lines from neck to armhole edges. Slash and spread the pattern at armhole edges to the needed amount. Raise the armhole curve by the correction amount. Redraw the pattern on a new sheet or add paper to fill the gap
- c) *Round armholes-* on front and back pattern, draw slash lines from neck to armhole edges. Slash and overlap the pattern at armhole edges to the needed amount. Redraw the armhole curves, lowering them at underarm by the same amount that you have taken in for corrections.
- d) *Broad shoulders-* on front and back pattern draw L-shaped slash lines from mid shoulder to notches on the armhole. Slash and spread the pattern at shoulder to the needed amount. Redraw the pattern or insert paper in the gap. Correct the shoulder lines.
- e) *Narrow shoulders-* on front and back pattern; draw L-shaped slash lines from mid shoulder to notches on the armhole. Slash and overlap the pattern at shoulder to the needed amount. Redraw the shoulder line.

3. Sleeve alterations: the sleeve hangs from the shoulder and setting of the sleeve starts at the shoulder. Check that the armhole is neither too tight nor too loose otherwise a sleeve will not set in properly.

- a) *Wrinkling, pulling, straining, binding-* this may be due to insufficient width across the sleeve cap, across the chest or back. Unpin the sleeve. Use some of the sleeve seam allowances at the armhole and sleeve cap for more width.
- b) *Tight armhole-* drop the armhole by requisite amount. Add width at both the armhole and sleeve edge. Use some of the under arm seam allowances at sleeve and side seam.
- c) *Short sleeve stands out at the hem-* this is due to insufficient length of the sleeve cap. Draw a slash line across the cap. Slash and spread to the needed amount. Correct the armhole curve.
- d) *Sleeve cap wrinkles across the top of the sleeve-* this indicates too much length at sleeve cap. Draw a slash line across the cap. Slash and overlap to the needed amount. Correct the armhole curve.
- e) *Heavy arm-* draw an inverted slash line on each side of the sleeve starting at under arm to the lower edge of the sleeve. Slash and spread the pattern to half the needed amount to each side at the underarm and tapering to nothing at the lower edge. Make corresponding changes in the armhole seam of the front and back bodice. Draw a slash line from the underarm to waistlines in front and back bodice. Slash and spread the pattern to the same amount as that added on each side of the sleeve, starting at the underarm and tapering to nothing at the lower edge.
- f) *Tight upper arm-* slash the sleeve at the centre from shoulder point to the lower edge. Spread at the cap the necessary amount tapering at the lower edge.

4. Bust alterations: since the bust area is the most difficult to fit being the curviest part of the body. Check the garment; it is neither too tight nor too loose as big alterations are not very effective in this area especially for closer fitting garments.

(a) *Bust with a large cup*-as you are aware women with the same bust size have different cup sizes. This causes the garment to be tight over the bust area. Draw a vertical slash line from the shoulder passing through the bust point to the other edge of the pattern, passing through the waistline dart. Draw a perpendicular to this line at the bust point from centre front to the side seam. Slash on all lines and spread the pattern adding at the bust area without increasing at the shoulder. The added width at the side seam and waistline should be taken in a dart. If the dart intake is very big it is advisable to convert it into two darts.

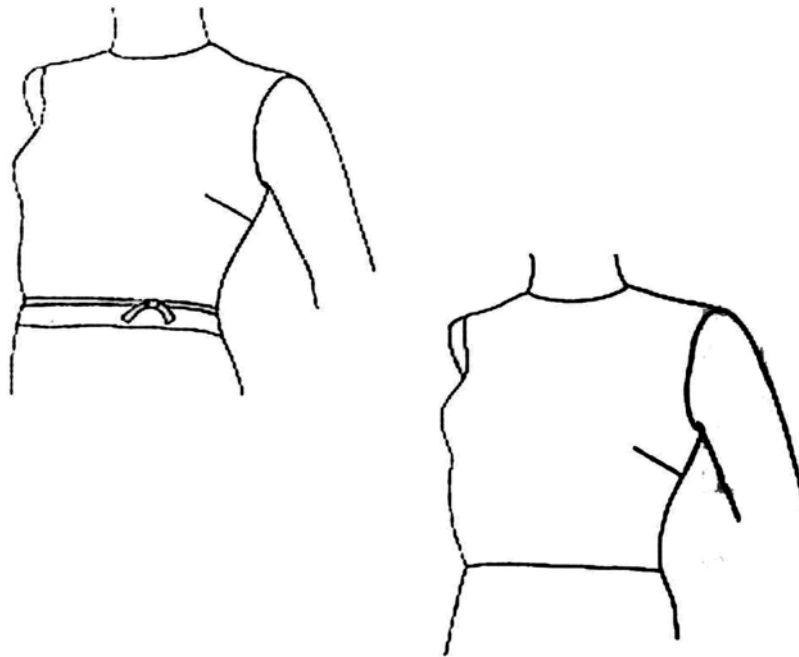

b) *Bust with a small cup*- Draw a vertical slash line from the shoulder passing through the bust point to the other edge of the pattern, passing through the waistline dart. Draw a perpendicular to this line at the bust point from centre front to the side seam. Slash on all lines and overlap the pattern without reducing on the shoulder.

5. Hip pattern alterations: fitting problems in this are manifest themselves in wrinkling, pulling, sagging and uneven hemlines.

a) *Small hips*- Draw a vertical slash line from the waist to the hem of the skirt pattern. Draw a horizontal line from centre back to the side seam passing through the fullest part of the hip. Slash the pattern on both the lines and overlap width wise to remove excess without loosing at the waist, unless the dart intake can be taken out for ease. Overlap length wise to remove excess without loosing at the side seam. True the seam lines.

b) *Large hips*- Draw a vertical slash line from the waist to the hem of the skirt pattern. Draw a horizontal line from centre back to the side seam passing through the fullest part of the hip. Slash the pattern on both the lines and spread width wise to fullness; the added ease may be taken in the dart intake. Spread length wise to add fullness without adding at the side seam. True the seam lines.

Given below are some of the common fitting problems that would necessitate pattern alterations with illustrated solutions by draping method.

- Problem-* Folds below the bust dart.
Solution- Undo the dart and part of the side seam. Lift shoulder a little, re-pin a bigger dart and pin the side seam to take out the excess fabric.

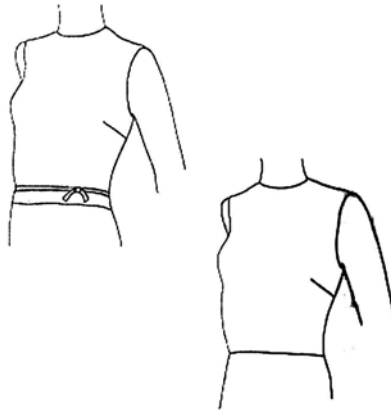

- Problem-* Low waist.
Solution- Tie a band around the waist and remark the waistline. Remove and re-pin the skirt to new waistline.

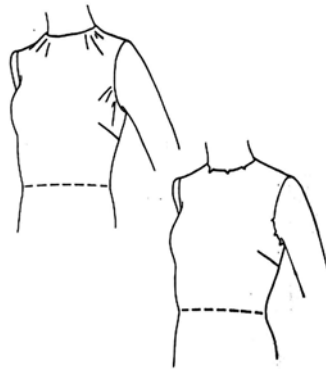

- Problem-* Baggy below the hip.
Solution- Raise the skirt at back only and re-pin

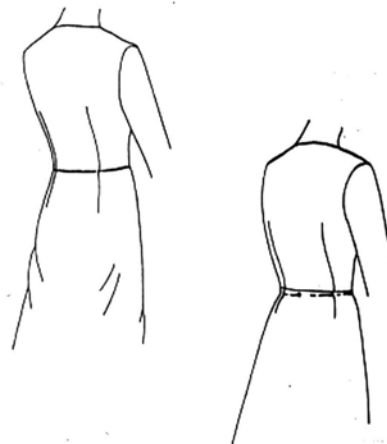

4. *Problem-* Gaping armhole

Solution- undo dart and pin a bigger dart. Making sure that it points towards the bust point. One may need to lift shoulder seam at the armhole.

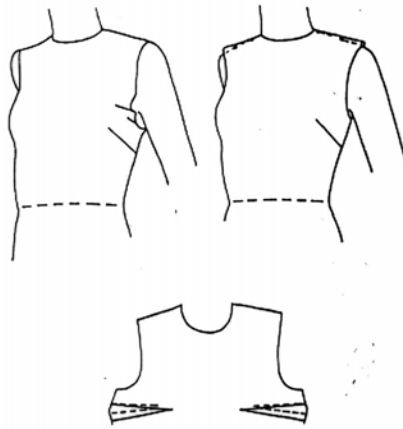

5. *Problem-* Low neckline gapes.

Solution- Lift at the front shoulder seam. Lower the dart point if necessary.

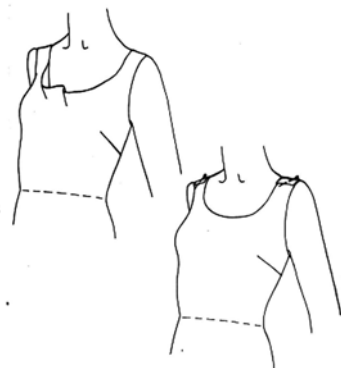

6. *Problem-* Folds in the dress below the waist.

Solution- Undo the side seam from below the armhole and ease out until the garment hangs smoothly.

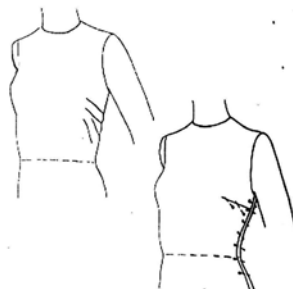

7. *Problem-* Tight neck or armhole.
Solution- slash and snip seam allowance to release tension. If it is not enough, mark a new seam line that is lower than before.

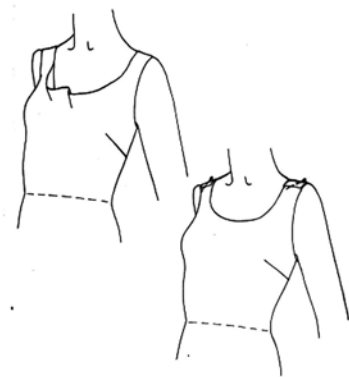

8. *Problem-* Neckline stands away and folds below.
Solution- release shoulder seam and let it out at the armhole edge.

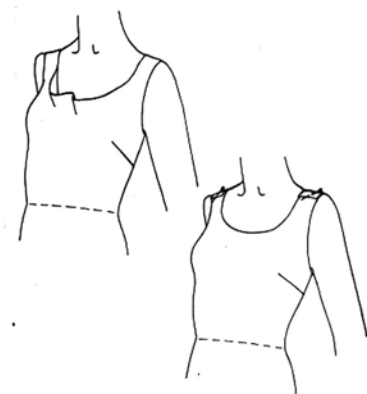

9. *Problem-* Shoulder seam lies towards the front of the shoulder.
Solution- Undo shoulder seam and release front seam allowances only.

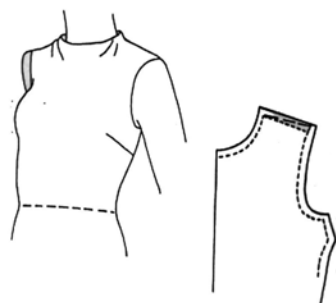

10. *Problem-* Folds across sleeve at the top.

Solution- Mark a new fitting line below the existing one to reduce cap height.

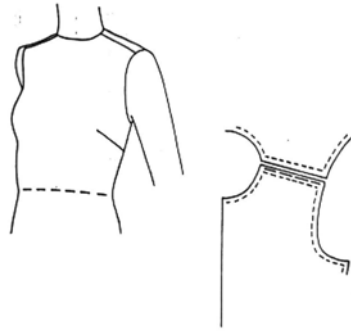

11. *Problem-* Sleeve hangs towards the back.

Solution- Remove the sleeve and re-pin by moving the notch at the centre of the sleeve toward the back so that the sleeve may hang towards the front.

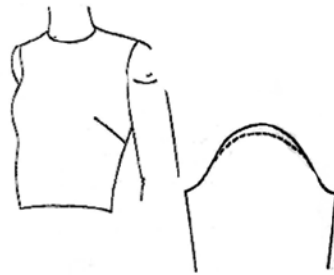

12. *Problem-* Wrinkles and creases around the upper arm.

Solution- Release the underarm seam allowance and add the ease.

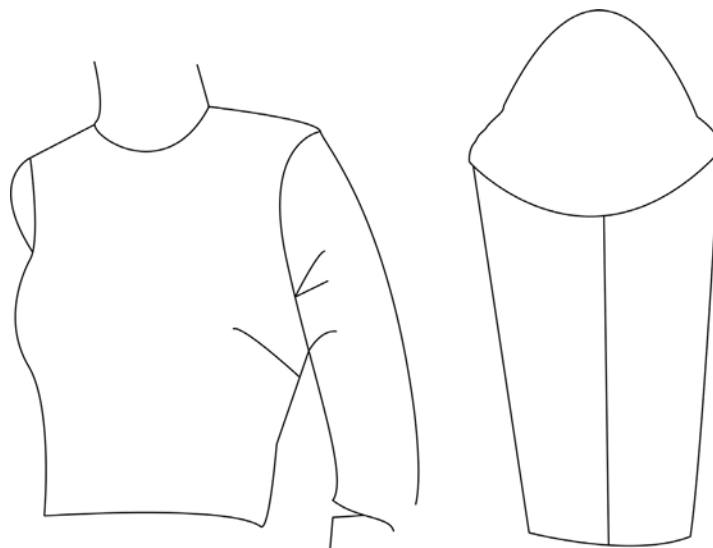

13. *Problem-* Sleeve pulls at the back armhole.
Solution- Unpin the sleeve and release the seam allowance on both the armholes of sleeve and bodice.

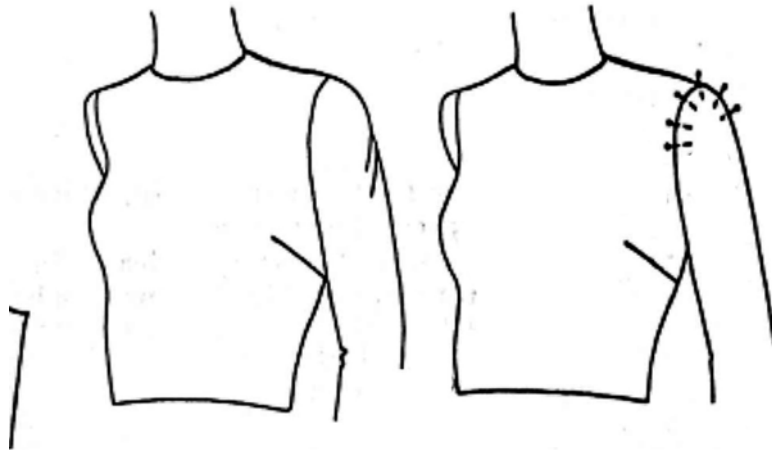

14. *Problem-* Trousers are loose at waist, hip or leg. Creases on leg and trousers stands away at waist.
Solution- Take excess fabric at side and pin at original seam lower down. For larger hip increase the dart intake. Pin the excess towards the outer seam.

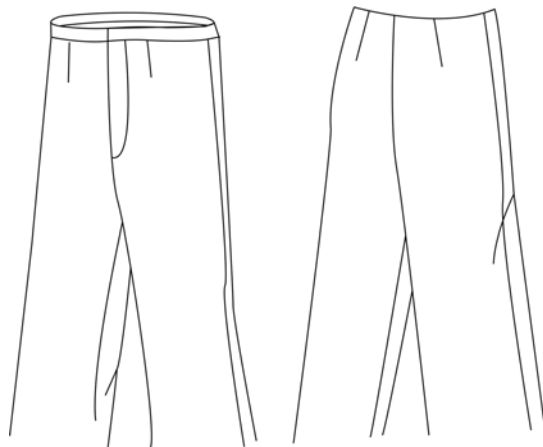

15. *Problem-* Trousers tight below the waist, crease around abdomen.
Solution- Release darts and reduce their width and length, also release some ease on the outer seams and re-p"

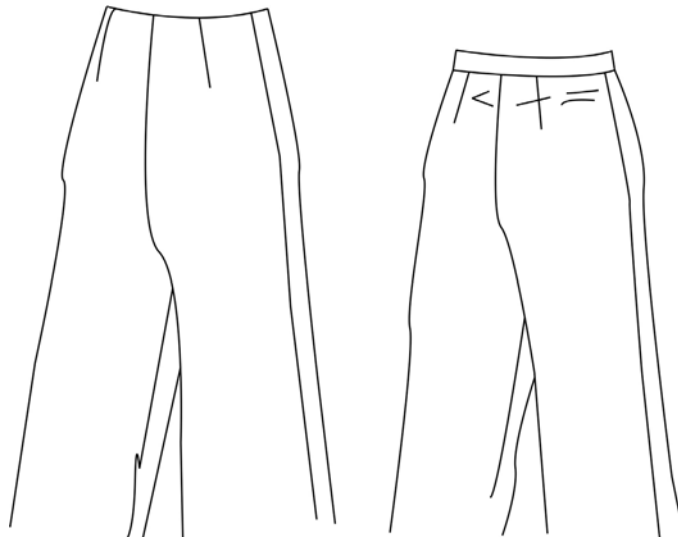

Patternmaking & Sewing
Household Items/Accessories

TABLE MATS, COASTERS & NAPKINS

FABRIC REQUIRED

- 30 cms white bizzzy lizzy fabric
- 25 cms black bizzzy lizzy fabric

ADDITIONAL MATERIAL REQUIRED

- 1 metre red satin tape
- 1.5 metre grey tape
- 25 cms paper fusing

TABLE MAT: Cut a rectangular piece of cloth having width 11" & length 16"

COASTERS: Cut a square piece of cloth measuring 6" X 6"

PATCH FOR TABLE MAT: cut a triangular piece of cloth having $OA = 7"$ & $OB = 4\frac{1}{2}"$

PATCH FOR COASTER: Cut a triangular piece of cloth having $CD = CE = 1\frac{1}{2}"$

NAPKIN: Cut a square piece of cloth measuring 11" X 11"

PATCH FOR NAPKIN: cut a triangular piece of cloth having $FG = FH = 5"$

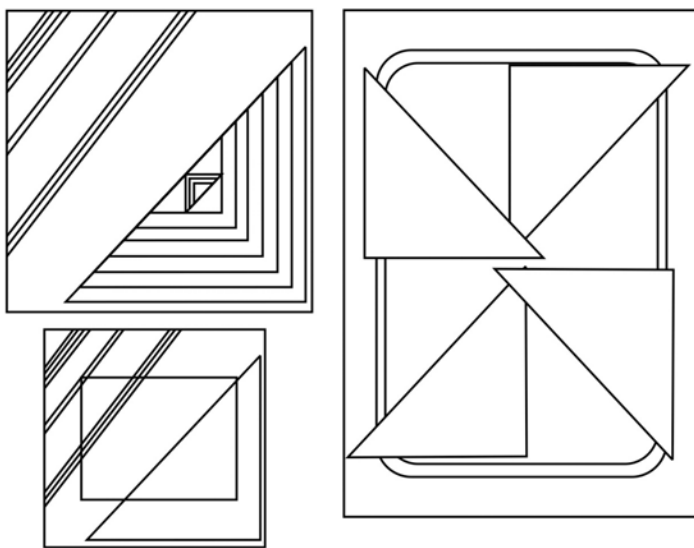
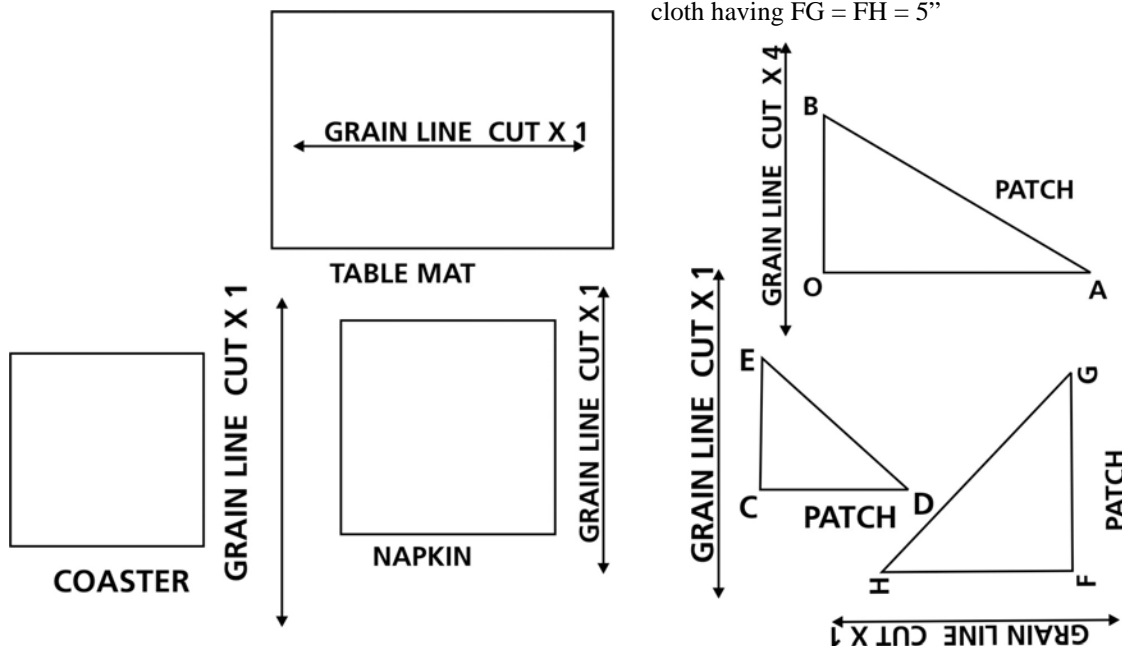

CUSHION COVER

FABRIC REQUIRED

- 0.5 meter maroon lizzy bizzy fabric
- 0.25 meter orange short silk
- 0.5 meter sunshine yellow lizzy bizzy fabric
- 0.25 meter cotton lining

ADDITIONAL MATERIAL REQUIRED

- 0.25 meter foam (1/8" thickness)
- 3 medium sized wooden buttons

FRONT PANELS

Panel 1 = 16" X 9 1/2" & panel 2 = 16" X 8"

BACK PANEL

Square piece of cloth measuring 16" X 16"

PATCH

Triangular piece of cloth with third side curved, having $AB = AC = 8 \frac{1}{2}"$

FRILL

DE = 16" & FG = 19 1/2"

FRILLS TO BE QUILTED WITH DECORATIVE STITCHES AND CUT THE EXTRA EDGES (IF ANY).

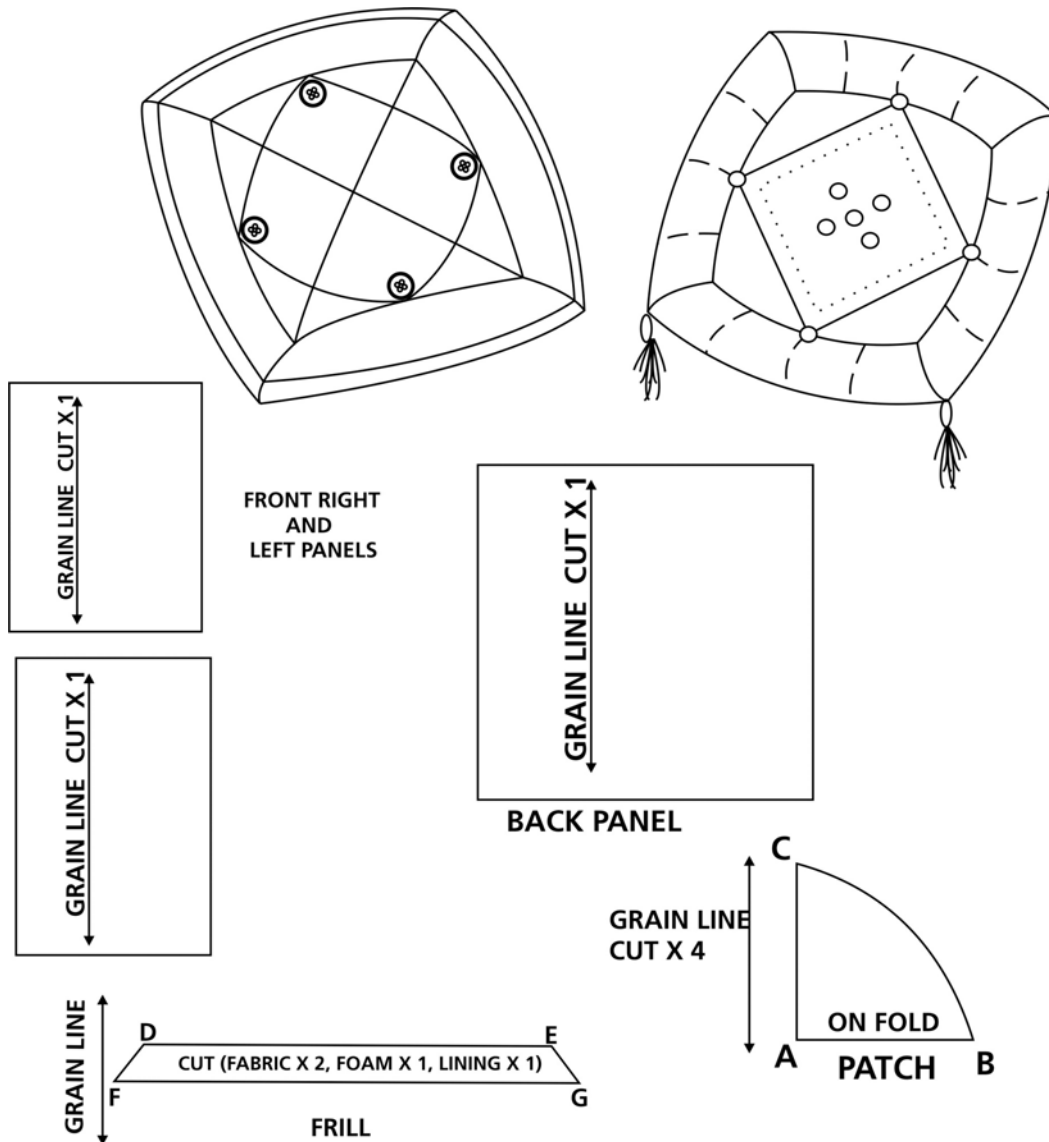

Women's Wear

CHAPTER 22

SIX PANELLED PETTICOAT

MEASUREMENTS TO BE TAKEN

- Waist
- Hip
- Total length

FABRIC REQUIRED

- 2.25 mts. Width = $36" = 2L + \text{belt} + \text{fold}$

STEP No.	REFERENCE POINT	DETAILS
1.	O – A	Full length Petticoat – belt 2"
2.	O – B	Hip/2
3.	B – C	Equal – O – A
4.	B – E	Hip/12 + 1"
5.	A – D	Hip/6
		Join E – D
6.	B – F	½" joint to E – F

Waist Belt

1.	I – J	2" (on fold)
2.	I – L	Waist/2+3" (on fold)

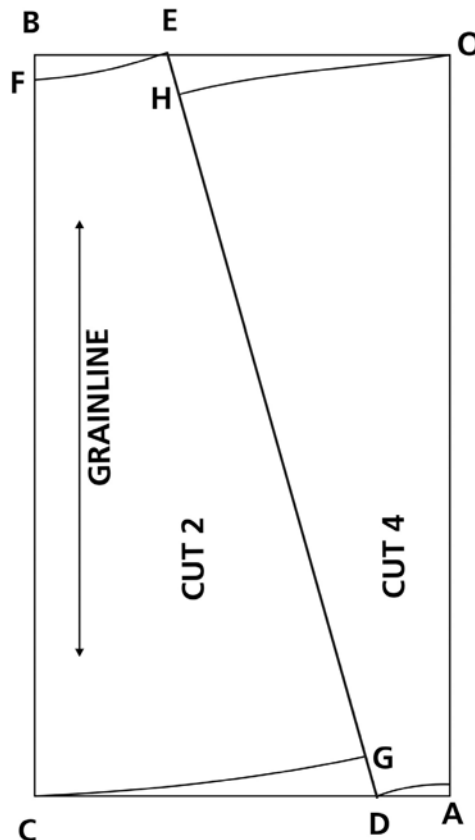

CHAPTER 23

SIMPLE PAJAMA

MEASUREMENTS TO BE UNDERTAKEN

- Hip: 36"
- Full length: 40"
- Bottom opening: 9"

MATERIAL REQUIRED

2.25 meter cloth

FRONT & BACK

STEP NO.	REFERENCE POINT	DETAILS
1	O-A	Full length + 3" for turning
2	O-D	Hip/3 + 1" (equal to crotch length or body)
3	D-E	Hip/3 + 1.5" broad
4	A-G	Round bottom/2
5	A-H	Draw a line at half of AD + 1"
6	H-F	Hip/4 + 0.5"
7	B-I	1" Join till IE
8		Join EF to FG in a curve

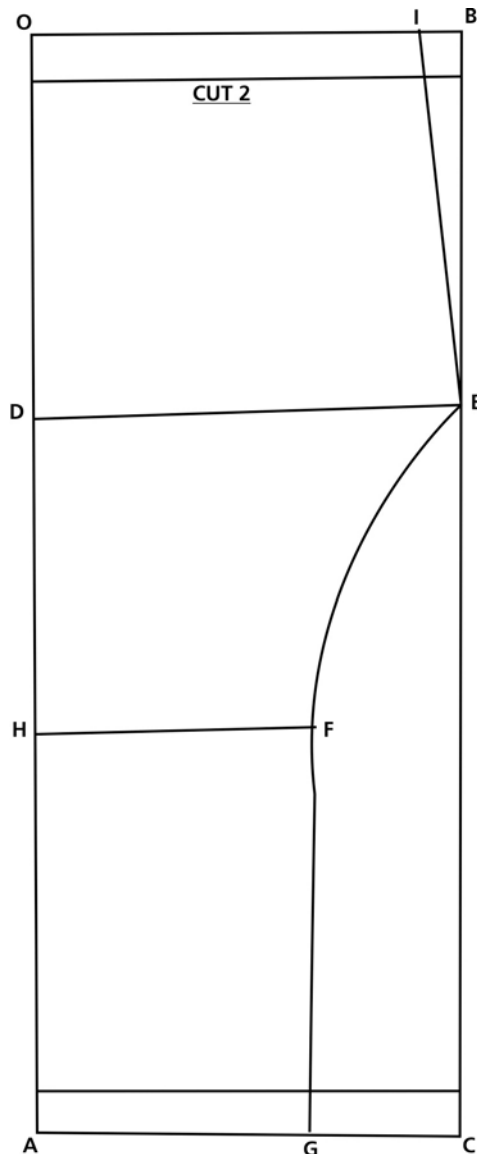

CHAPTER 24

KAAFTAAN

MEASUREMENTS TO BE UNDERTAKEN

- Chest
- Shoulder to Waist
- length

MATERIAL REQUIRED

- 3 meter cloth
- 2.5 meter lace

STEP NO.	REFERENCE POINT	DETAILS
1	O-A	Full length (on fold) = 54"
2	O-B	Half of fabric width
3	O-I	Shoulder to waist (NW) = 15"
4	O-D	Chest/4
5	D-G	Chest/4+1.5"
6	G-H	Chest/12 + 1/2"
7	E-F	E above F at 1"
8	C-J	1" inside
9	O-K	Chest/12 +0.5" for neck width
10	O-L	Chest/12 = neck depth
11	O-M	Chest/6, front neck depth

Keep margins for stitching and hemming/finishing.

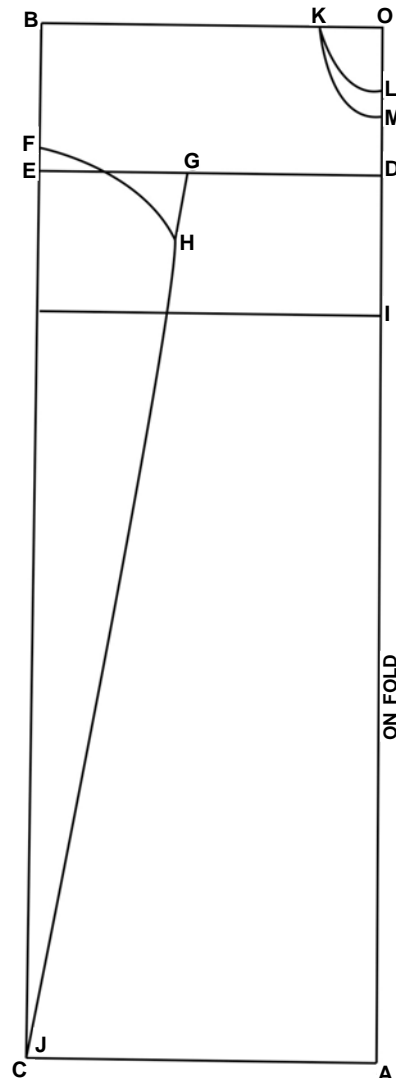

CHAPTER 25

SHAMIEZ

MEASUREMENTS TO BE UNDERTAKEN

- Chest : 32"
- Length : 35"
- Waist : 26"
- NW: 13.5"

MATERIAL REQUIRED

- 1.5 meter doth

STEP NO.	REFERENCE POINT	DETAILS
1	O-A	Full length
2	O-D	Chest/4 -1"
3	O-B	Chest/6
4	D-I	Chest/4 + 1.5" =EH
5	C-B	Chest/6 - 1.5"
6	O-E	Shoulder to waist 13.5"
7	D-D'	2" below
8	G-H	Join 2" inside, 0.5" above
9	HGD	Join giving shape
10	DCI	Give shape
11	D'GH	Give gathers in front
12	F-A	= JK
13	J-K	Hip/4+1"
14	E-K	Ch/4

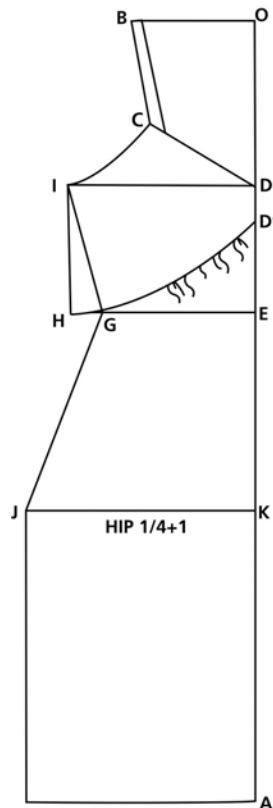

CHAPTER 26

LADIES PLAIN SALWAR

Measurement

Hip : 36"

Full length : 40"

Bottom opening : 9"

Material required : 2.25 mt cloth

Front & Back

Sr. No.		Description
1	O-A	Full length
2	OB = AC	8"
3	OA = BC	Full Length
4	D-E	Equal to (OA & BC)
5	D-H1	Hip/3 + 3"
6	H1-G	Crotch length = Hip/3 + 2.5"
7	E-F	3"

PLAIN SALWAR - LADIES

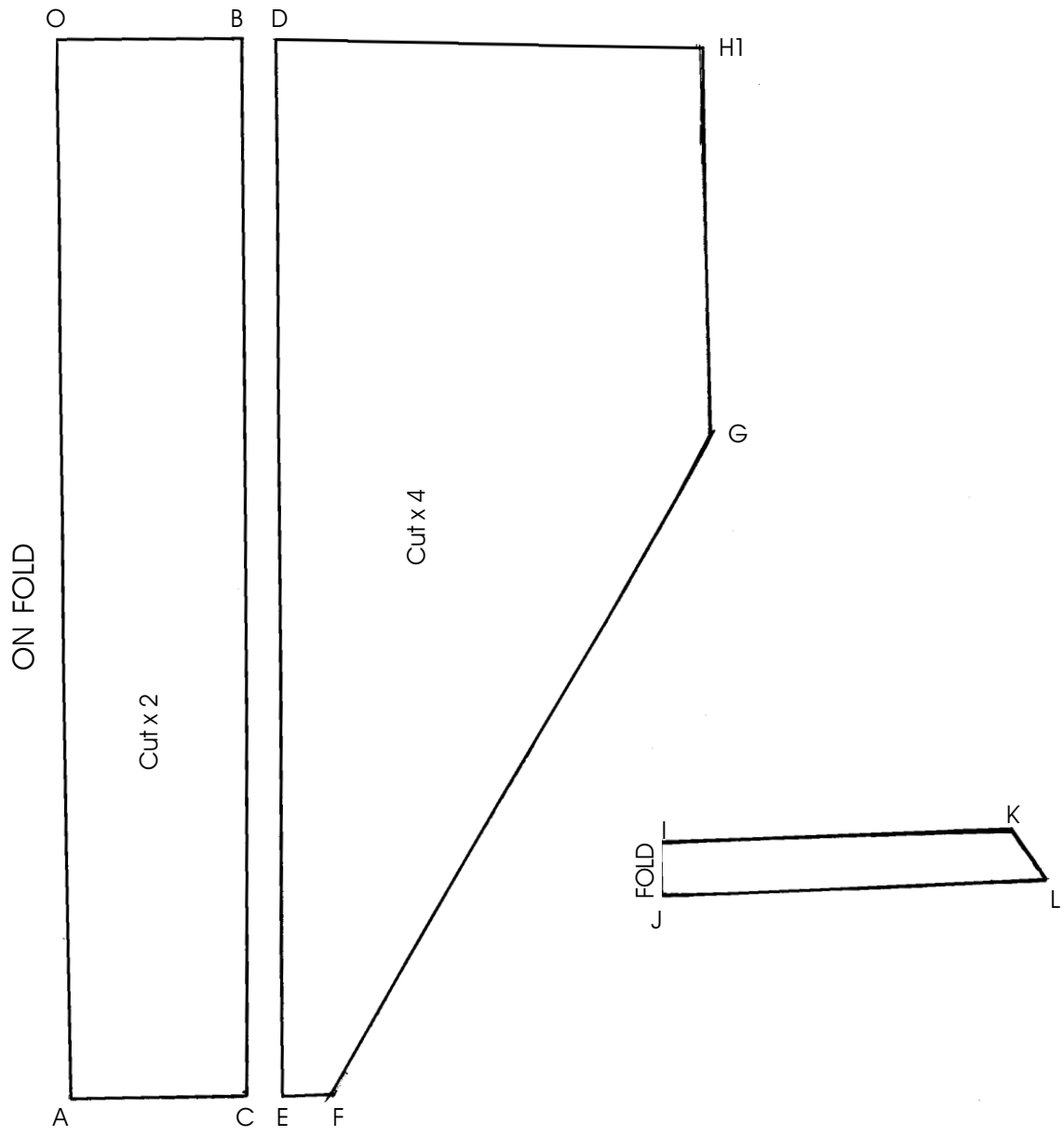

CHAPTER 27

LADIES SALWAR WITH BELT

MEASUREMENTS TO BE TAKEN

- Hip
- Length of Salwar
- Bottom Opening

ADDITIONAL MATERIAL REQUIRED

- Soft Buckram

AMOUNT OF FABRIC REQUIRED

- 2.25 m

BELT

STEP No.	REFERENCE POINT	DETAILS
1.	O	Starting point
2.	O – A	Hip/6 + 1"
3.	O – C	Hip/2+5"

FRONT

STEP No.	REFERENCE POINT	DETAILS
1.	H – L	8"
2.	L – K	Total length – width of belt
3.	H – I	LK – 2 ¾ "
4.	K – J	6 ¾ " (½ bottom opening)

BACK

STEP No.	REFERENCE POINT	DETAILS
1.	D – E	Hip/3 + 2 - Belt
2.	D – G	Hip/3
3.	G – F	Equal length as H – I in front

PONCHA

STEP No.	REFERENCE POINT	DETAILS
1.	M – N	6 ¾"
2.	P – Q	7 ¼"
3	M – Q	1"

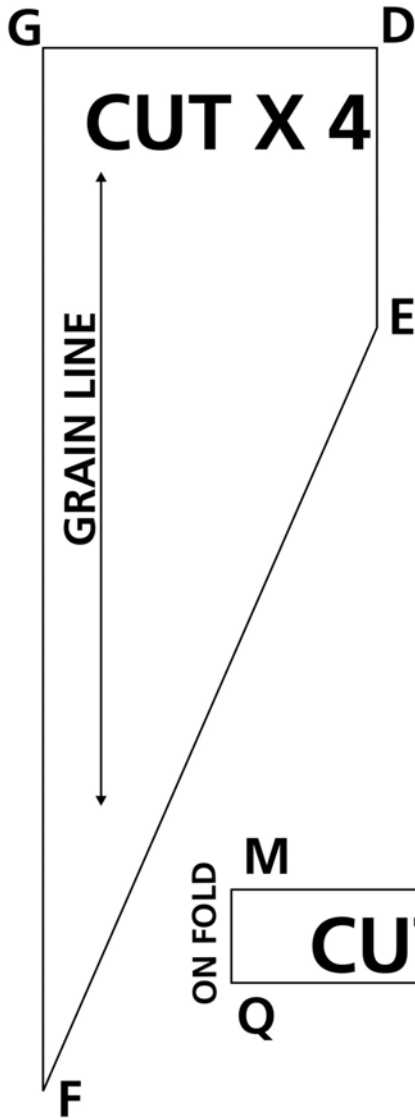
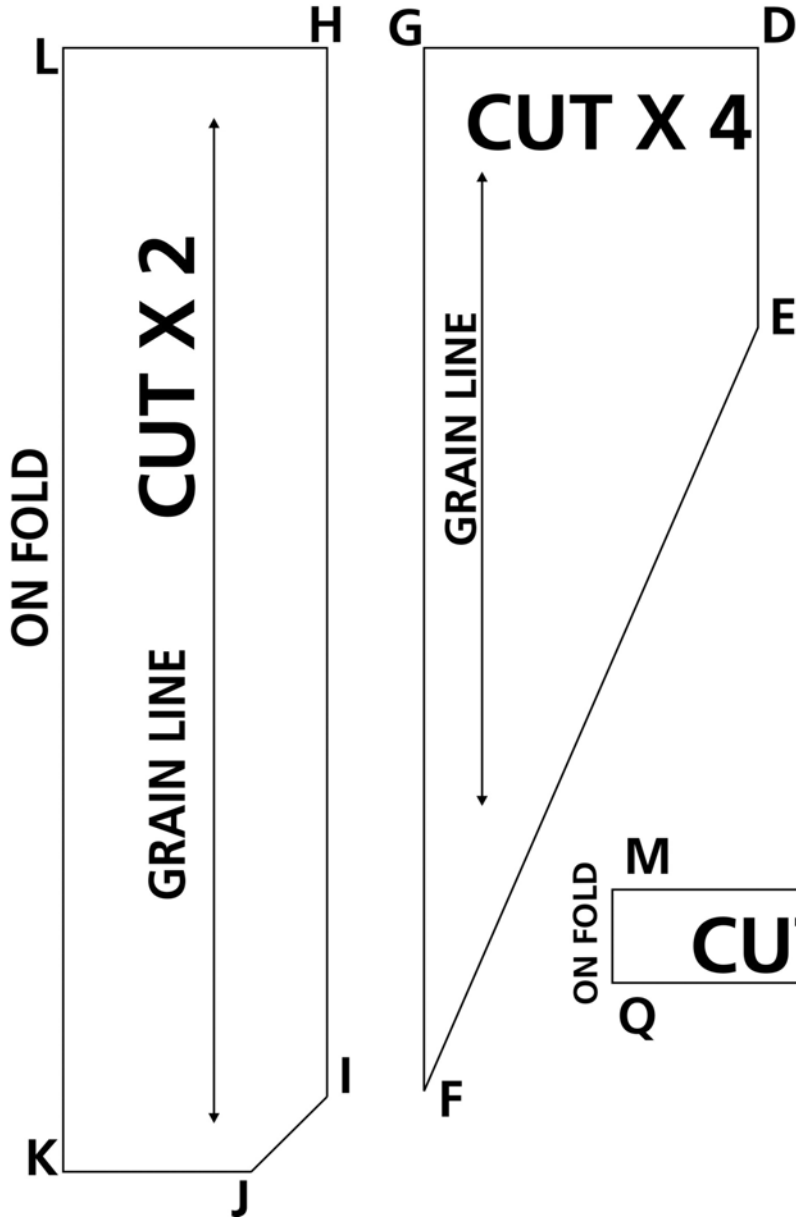
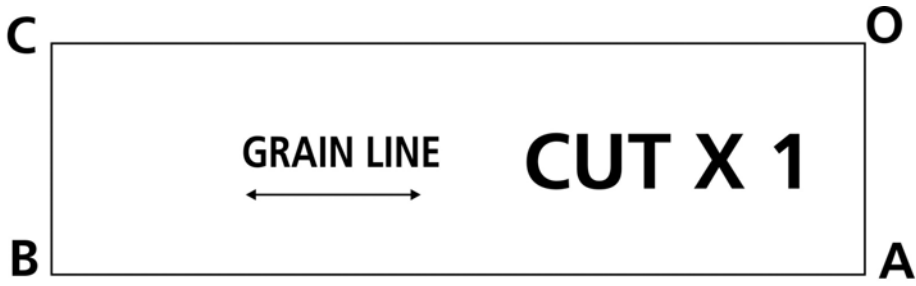

CHAPTER 28

PRINCESS SHIRT (LADIES)

MEASUREMENTS TO BE UNDERTAKEN

- | | |
|---|--|
| <ul style="list-style-type: none"> • Chest: 32" • Across shoulder: 14" • Length: 40" • Sleeve length • Sleeve hole | <ul style="list-style-type: none"> • Waist • hip <p><u>MATERIAL REQUIRED</u>
2.25 meters cloth</p> |
|---|--|

FRONT

STEP NO.	REFERENCE POINT	DETAILS
1	O-A	Full length
2	O-B	Across shoulder/2
3	B-N	Chest/4 – 1"
4	C-D	Chest/4 + 1"
5	O-E	Waist length =14"
6	E-F	Waist/4+1.5"
7	G-H	At hip level, hip/4 +1"
8	O-G	Hipline
9	A-I	14" or as desired according to fashion
10	K-D	Armhole shape using curve scale
11	O-M	Chest/12 +0.5" or as desired (front neck width)
12	O-P	Chest/6 or as desired (front neck depth)
13	E-L	Chest/12+0.5", GQ=EL
14	A-J	Chest/6 or as per design
15	R-R'	8" (length of dart)
16	B-K	¾"
17	M-R	Chest/4 +1.5"
18	L-R	Join giving curve
19.	N-L	1 ½" above bust line

BACK

STEP NO.	REFERENCE POINT	DETAILS
1	O-A	Full length
2	O-B	Across shoulder/2
3	B-N	Chest/4-1"
4	C-D	Chest/4 + 1"
5	E-F	Waist/4 + 1.5"
6	A-I	14", equal to front
7	O-M	Chest/12, or as desired

SLEEVE

STEP NO.	REFERENCE POINT	DETAILS
1	O-A	Full length
2	O-B	$\text{Chest}/12+0.5''$
3	D-O	Give shape
4	A-E	$\text{Chest}/6$ or half of sleeve hole
5	B-B1	$\text{Chest}/4-1''$

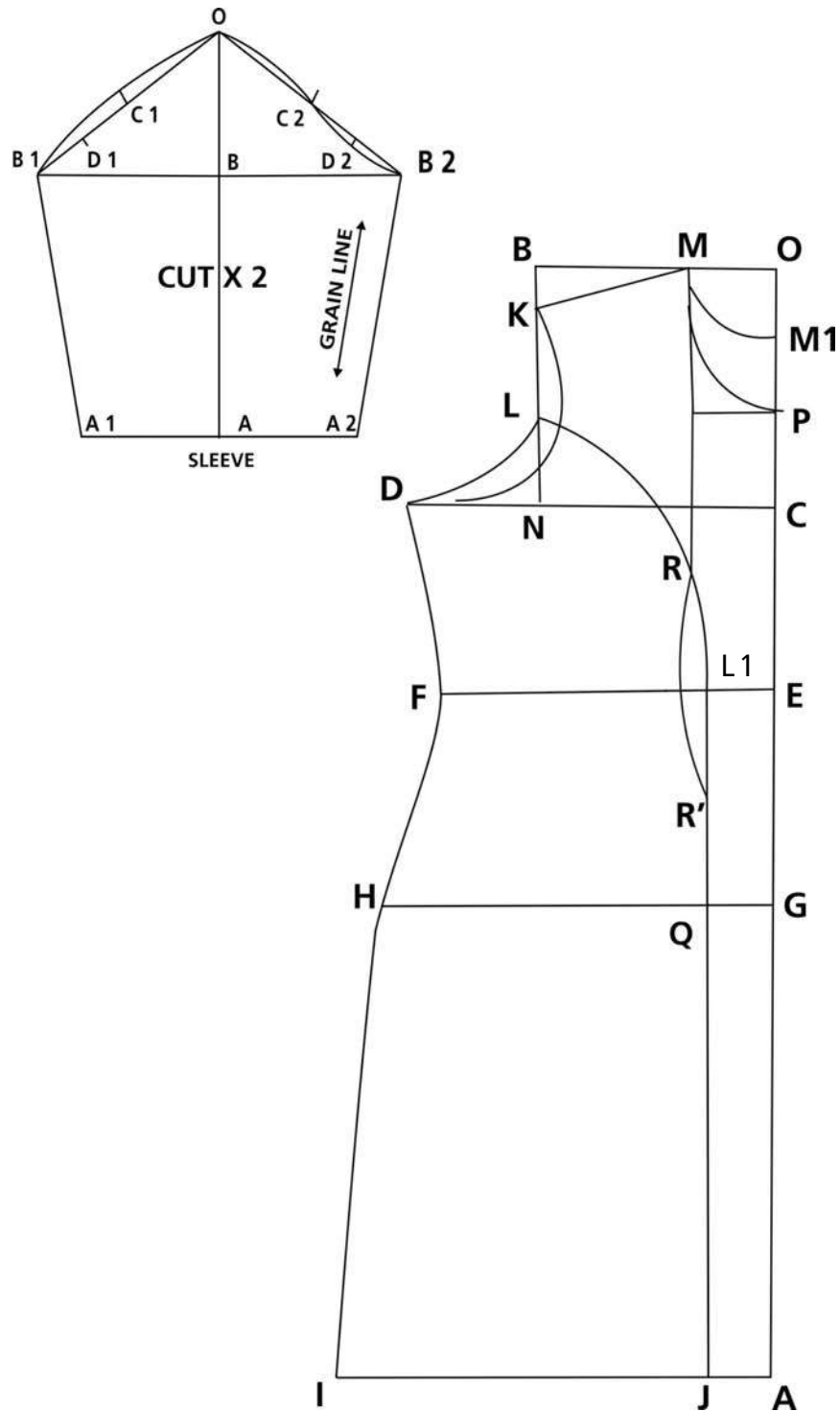

CHAPTER 29

SIMPLE LADIES KURTA WITH NECK AND SLEEVE OPTIONS

MEASUREMENTS TO BE TAKEN

- Across shoulder
- Chest
- Length of Kurta: 40"

FABRIC REQUIRED

2.5 meters

BASIC BLOCK (FRONT)

STEP No.	REFERENCE POINT	DETAILS
1.	O	Starting point
2.	O – A	Total length of Kurta
3.	O – B	$\frac{1}{4}$ th of chest – 1"
4.	O – C	Ch/6
5.	O – Q	Waist level and Q-R = $\frac{1}{4}$ waist + 1"
6.	O – S	Hip Length & S-T = Hip/4 + 1"
7.	Q - S(HBL)	Hip/4+1"
8.	O – D	Shoulder drop = $\frac{3}{4}$ "
9.	O – E	$\frac{1}{12}$ th of chest
10.	E – F	Join E – F parallel to O – C
11.	D – G	$\frac{1}{2}$ of shoulder & join E – G
12.	B – H	$\frac{1}{4}$ of chest + 1"
13.	G – H	Join using French curve
14.	E – C	Join using French curve

FOR NECK, FOLLOW VARIATIONS AS IN MAIN PATTERNS

BASIC BLOCK (BACK)

STEP No.	REFERENCE POINT	DETAILS
1.	O – L	$\frac{1}{2}$ "; draw a line parallel to O – E
2.	E – P	Draw a curve using French curve
3.	G – H	Draw a curve using French curve

FULL SLEEVE

STEP No.	REFERENCE POINT	DETAILS
1.	O	Starting point
2.	O – A	Length of sleeve
3.	O – B	$\frac{1}{12}$ th of chest
4.	B – B1	$\frac{1}{4}$ of chest, also equal to B – B2
5.	A – A1	5 "ALSO = A – A2
6.	—————	Join B1 – O; A1 – B1
7.	C 1 & C2	Mid of O – B1 & O – B2
8.	D1 & D2	Mid of C1 – B1 & Mid point of C2 – B2

HALF SLEEVE

STEP No.	REFERENCE POINT	DETAILS
1.	O	Starting point
2.	O – A	Length of sleeve
3.	O – B	1/ 12 th of chest
4.	B – B1	¼ of chest, also equal to B – B2
5.	A1 – A	6" also = A – A2
6.	—————	Join B1 – O; A1 – B1; B2 – O; A2 – B2
7.	C1 & C2	Mid of O – B1 & Mid point of O – B2
8.	D1 & D2	Mid of C1 – B1 & Mid point of C2 – B2

NOTE: Always remember that the armhole of front block is deeper than the armhole of back block.

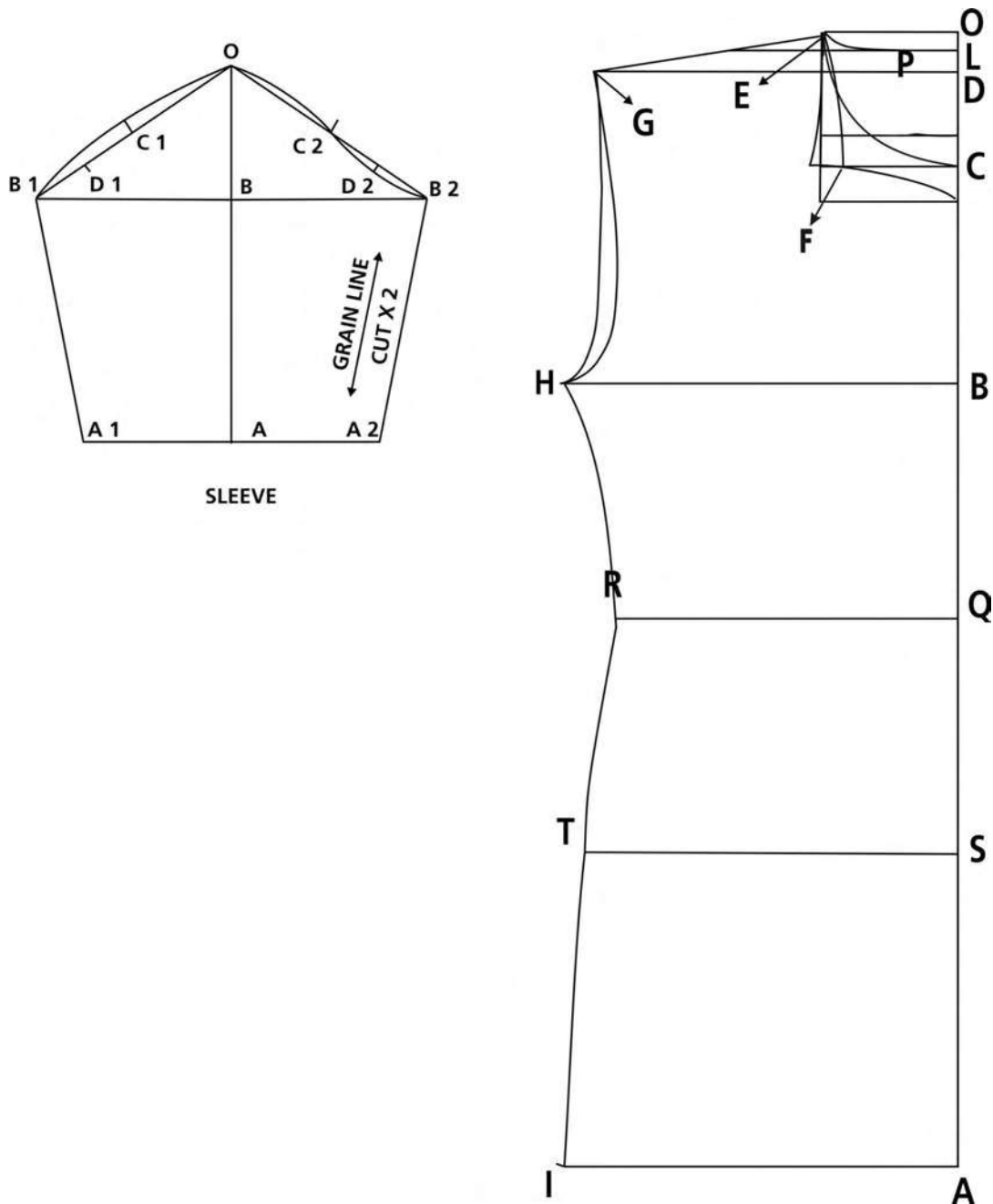

CHAPTER 30

CHURIDAR PAYJAMA

MEASUREMENTS TO BE TAKEN

- Waist
- Hip
- Length of Churidar
- Crotch Length

AMOUNT OF FABRIC REQUIRED

- 2.50 m

FRONT

STEP No.	REFERENCE POINT	DETAILS
1.	O	Starting point
2.	O – B	Total length of churidar – 5" - belt
3.	O – C	8 ½ "or Hip/4 – ½"
4.	C – D	¼ hip + 5 ½ "
5.	B – E	5" or Hip/6-1"
6.	O – H	Equal to CD
8.	B – A	21" or Hip/2 (can be customized)
9.	F – A	5" or Hip/6-1"
10.	O-J	Knee length – belt
11.	J-K	½ of knee width + 1"

BELT

STEP NO.	REFERENCE POINT	DETAILS
1.	A-C =BD	6" OR HIP/6
2.	AB=CD	Hip/4 + 3"

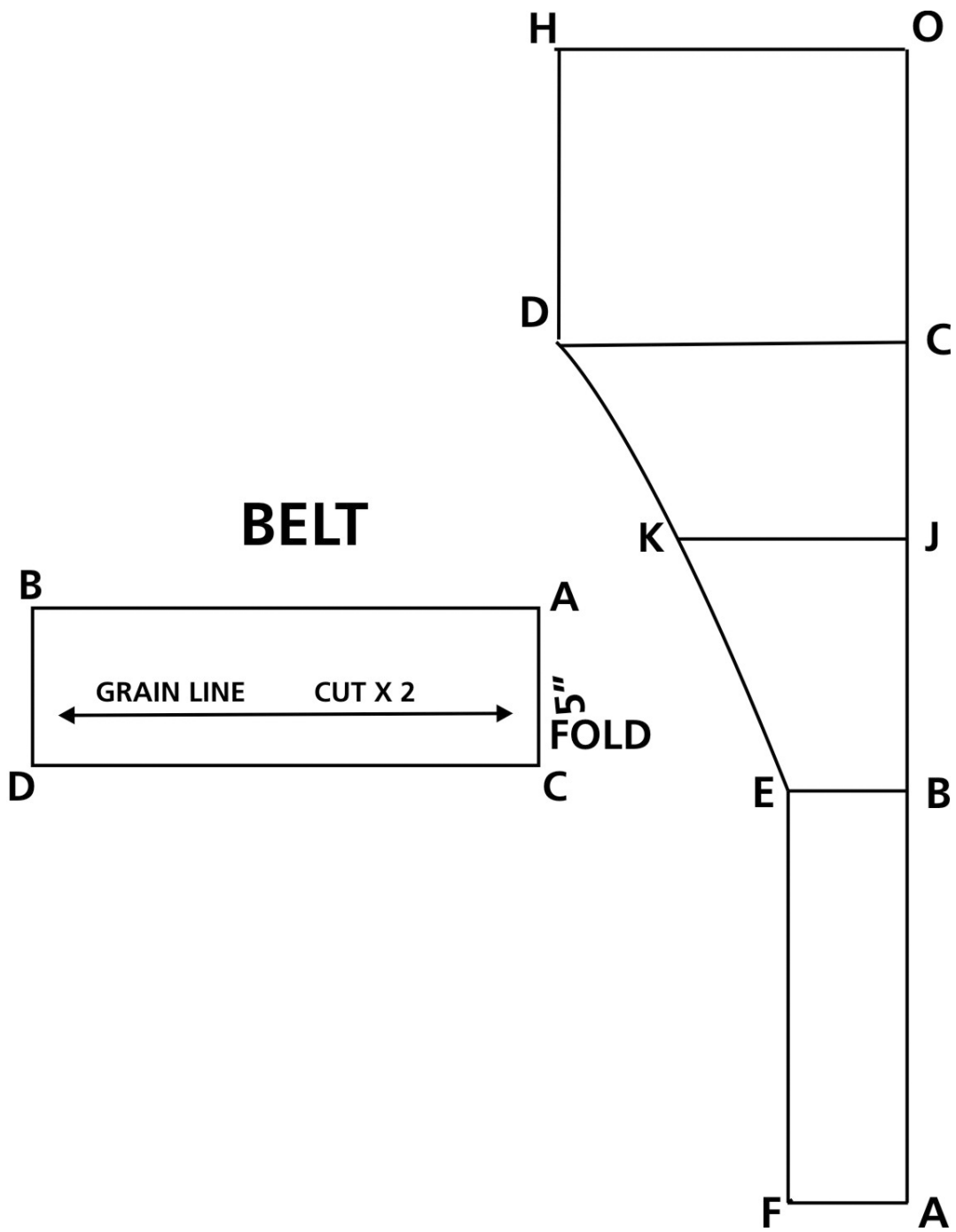

CHAPTER 31

PLAIN BLOUSE WITHOUT LINING

MEASUREMENTS TO BE TAKEN

- Round neck (just for reference)
- Across shoulder
- Chest
- Waist
- Length of blouse – 14

FABRIC REQUIRED

1) 1 meter

ADDITIONAL MATERIAL

1) 6 hooks

BASIC BLOCK (BACK)

STEP No.	REFERENCE POINT	DETAILS
1.	O	Starting point
2.	O – A	Total length of basic bodice
3.	O – B	Ch/6 + 1" or ½ upper arm round
4.	B – H	¼ chest + 1"
5.	O – E	1/12 chest
6.	O – D	¾"
7.	D – G	Shoulder / 2
8.	O – L	¾ " or 5"
9.	A – I	Waist / 4 + 1 ½"
10.	A – K	Ch/12 + ½" (Dart length = 1" below from the chest line)
11.	E – P	Join using French curve
12.	H-I	Join HI
13.	G-H	Join using French curve
14.	E – E'	Tuck Length

BASIC BLOCK (FRONT)

STEP No.	REFERENCE POINT	DETAILS
1	O – C	Ch/6
2	B – H'	¼ of chest + 1"
3	X-K	Ch/12 + ½" length = from E point to apex point (Ch/4 + 1 ½")
4	X-I'	Waist/4 + 1 ½"
5	H'-Z	Ch/8 + 1 ½"
6	W	Highest point on armhole (dart = 3" X ¾")
7	E – C	Join using French curve
8	G – H	Join using French curve
9	A – X	¾"
10	E-M	Apex point (Ch/4 + 1 ½")
11	B-Y	Equal to apex point

SLEEVE		
STEP No.	REFERENCE POINT	DETAILS
1.	O	Starting point
2.	O – A	7 “
3.	O – B	1/ 12 th of chest + ½”
4.	B – B1	1/6 th chest + 1”
5.	—————	Join B1 – O; A1 – B1; B2 – O; A2 – B2
6.	C1 & C2	Mid of O – B1 & Mid point of O – B2
7.	D1 & D2	Mid of C1 – B1 & Mid point of C2 – B2
8.	A – A1	5 ¼ ”

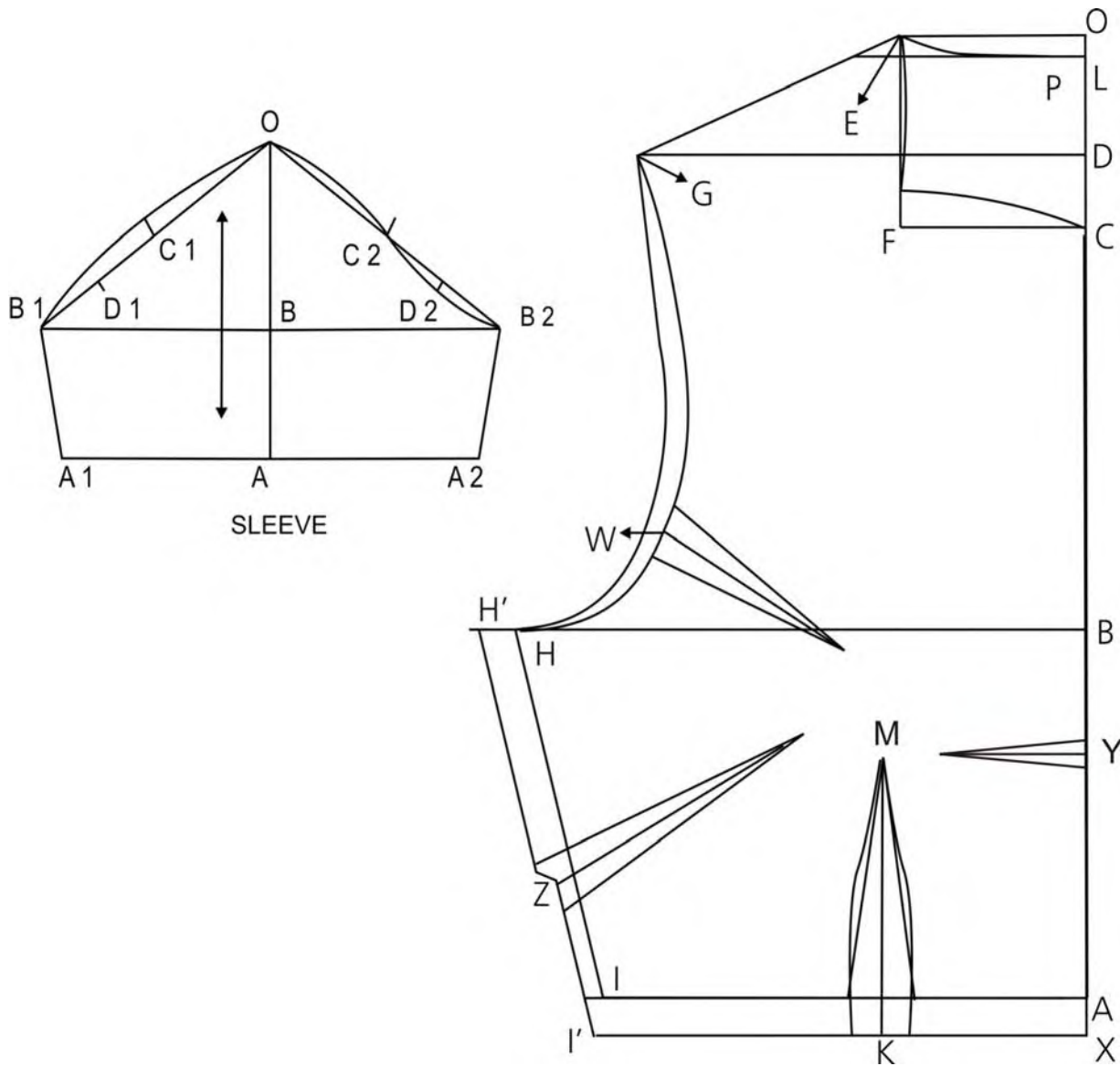

FITTED SHIRT

Measurement to be taken

Chest = 32"

Length = 40"

Across shoulder = 14"

Waist = 26"

Required material

2.25 mtr cloth

25cm buckram or fusing

FRONT & BACK

Sr. No.		Description
1	O-A	Full length
2	O-B	Across shoulder/2
3	B-L	Chest/4-1"
4	C-D	Chest/4+1"
5	O-E	14", shoulder to waist
6	E-F	Waist/4 + 1.5"
7	E-G	At hip level, hip/6+1"
8	G-H	Hip/4 +1"
9	A-I	Chest/4 +4" or as desired
10	O-J	Chest/12
11	O-K	Chest/6 for neck, OM as per fashion, or as desired
12	J-N	BN-3/4" for shoulder shape
13	N-D	Back shoulder shape, take 0.5" extra for front shoulder shape
14	P-U+U'	3/4" Fold Pleat

FITTED SHIRT

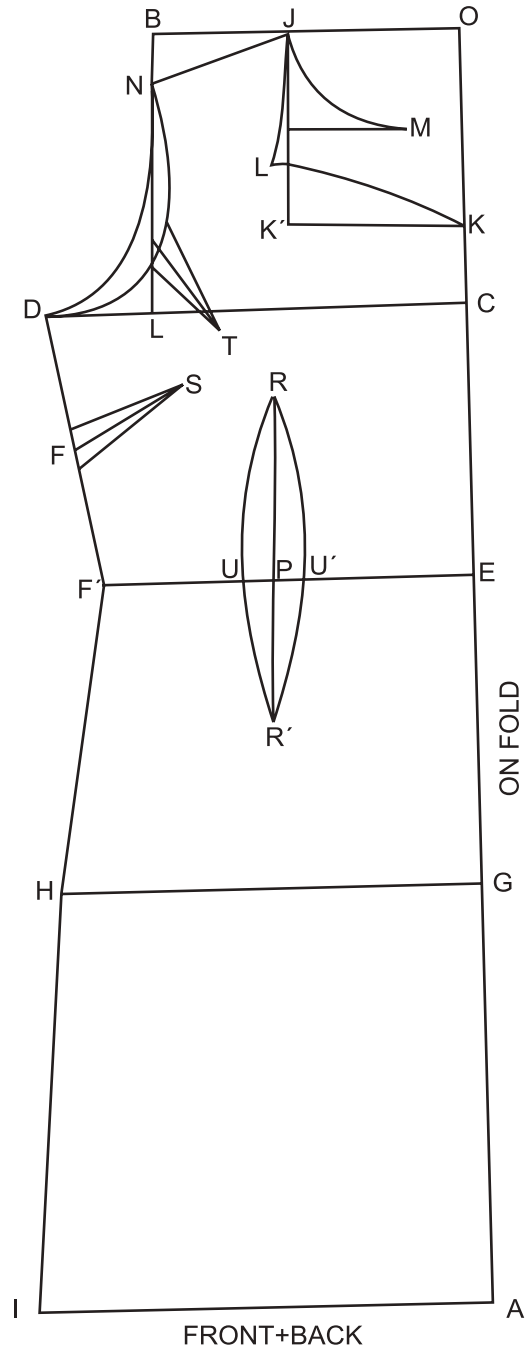

FITTED SHIRT

WAISTDART

Sr. No.		Description
1	J-R	Chest/4 + 1"
2	E-P	Chest/12 +0.5"
3	R-R	8" = dart length
4	R-S	1.5"
5	T-R	Chest /12 - 1/2"

SLEEVE

7	O-A	Full length of sleeve
8	O-D	Chest/4 -1"
9	D-C	Chest/12 +0.5", give shape to CO
10	A-F	Chest/6 or half of sleeve opening

FITTED SHIRT

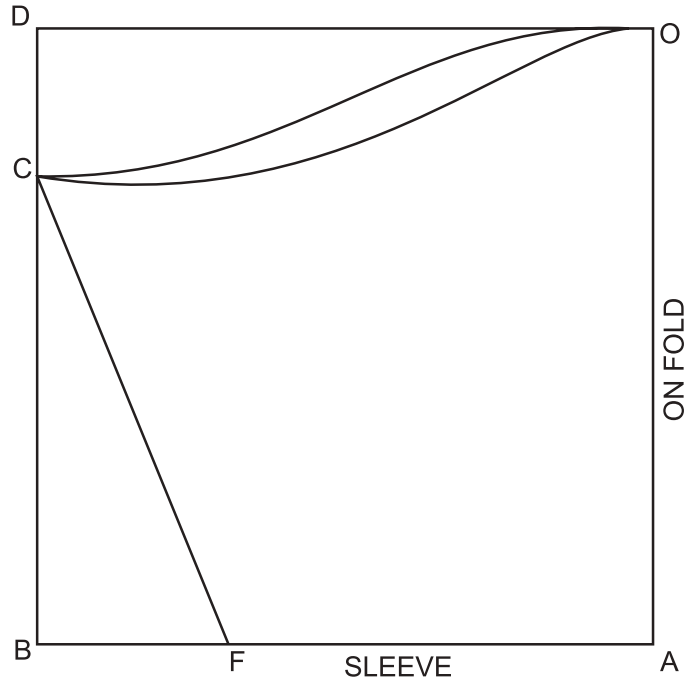

CHAPTER 33

NIGHTIE

MEASUREMENTS TO BE TAKEN

- Across shoulder
- Chest
- Length of Nightie – 56"

FABRIC REQUIRED

- 3.25 meters

FRONT

STEP No.	REFERENCE POINT	DETAILS
1.	O	Starting point
2.	O – A	Total length of Nightie
3.	O – B	¼th of chest
4	O – D	Shoulder drop = ¾ "
5	O – E	1/12 th of chest = O – C (Neck depth or as required)
6	E – F	Join E – F parallel to O – C
7	E – C	Join with French curve
8.	D – G	½ of shoulder + ½"
9.	B – H	¼ of chest + 3"
10	G – H	Join using French curve
11	A – I	14 ½" or as desired

BACK

STEP No.	REFERENCE POINT	DETAILS
1	O – L	¾"; draw a line parallel to O – E
2	G – H	Draw a curve using French curve
3.	E - P	Draw a curve using French curve

SLEEVE

STEP No.	REFERENCE POINT	DETAILS
1.	O	Starting point
2.	O – B	Ch/12 + 1"
3.	O – A	1/ 12 th of chest + 3"
4.	B – B1	¼ of chest + ¼"
5.	A – A1	7 ½ "
6.	—————	Join B1 – O; A1 – B1; B2 – O; A2 – B2
7.	C1 & C2	Mid of O – B1 & Mid point of O – B2
8.	D1 & D2	Mid of C1 – B1 & Mid point of C2 – B2

PLACEMENT OF DORI: 13" form the nape of the neck.

NOTE: Always remember that the armhole of front block is deeper than the armhole of back block.

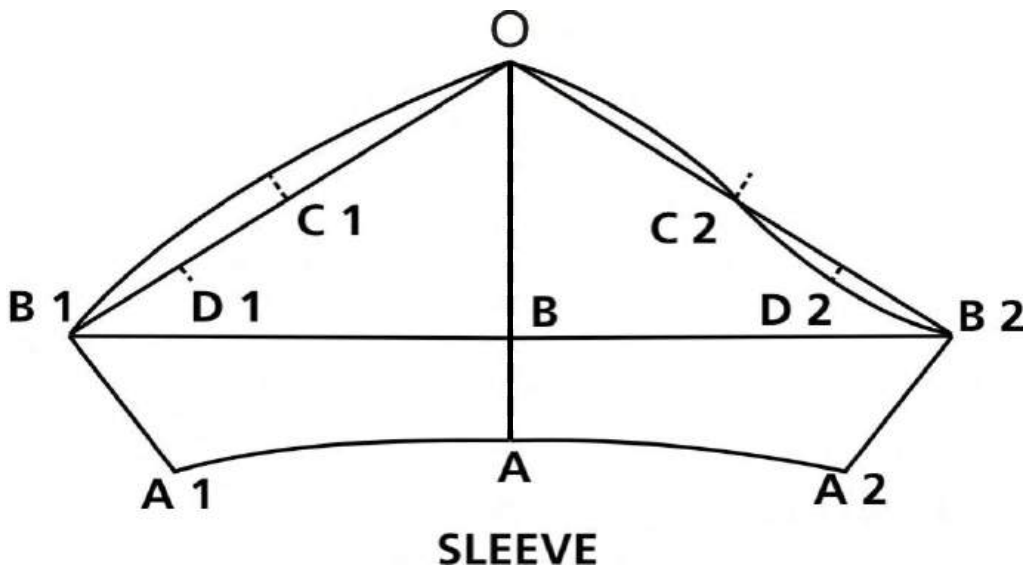
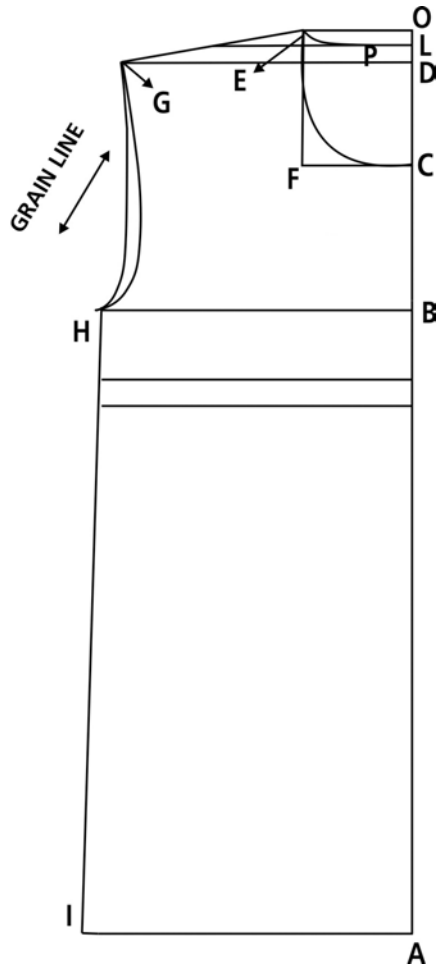

CHAPTER 34

NIGHTIE AND GOWN SET (2 piece)

MEASUREMENTS TO BE UNDERTAKEN

- Across shoulder
- Chest
- Length of Nightie – 56 in

MATERIAL REQUIRED

- 3.25 meters for gown
- 3.0 meters for Nightie

GOWN (BACK)

STEP NO.	REFERENCE POINT	DETAILS
1	O	Starting point
2	O-A	Full length
3	O-B	Chest/4
4	B-H	Chest/4 + 2.5 inch
5	O-D	Drop shoulder = $\frac{3}{4}$ inch
6	O-E	Chest/12 + 0.5 inch
7	D-G	Across shoulder/2 + 0.5 inch
8	O-L	0.5 inch
9	A-I	14 inches or as desired
10	G-H	Shape back armhole

GOWN (FRONT)

STEP NO.	REFERENCE POINT	DETAILS
1	E-C	14 inches
2	J-A	3.25 inches
3	G-H	Shape front armhole

GOWN (SLEEVE)

STEP NO.	REFERENCE POINT	DETAILS
1	O	Starting point
2	O – A	Sleeve length
3	O – B	Chest/12
4	B – B1	$\frac{1}{4}$ of chest = B-B2
5	A – A1	Chest/6, equals A-A2
6		Join B1 – O; A1 – B1
7		C1 & C2 Mid of O – B1 & Mid point of O – B2
8		D1 & D2 Mid of C1 – B1 & Mid point of C2 – B2



OUTTER

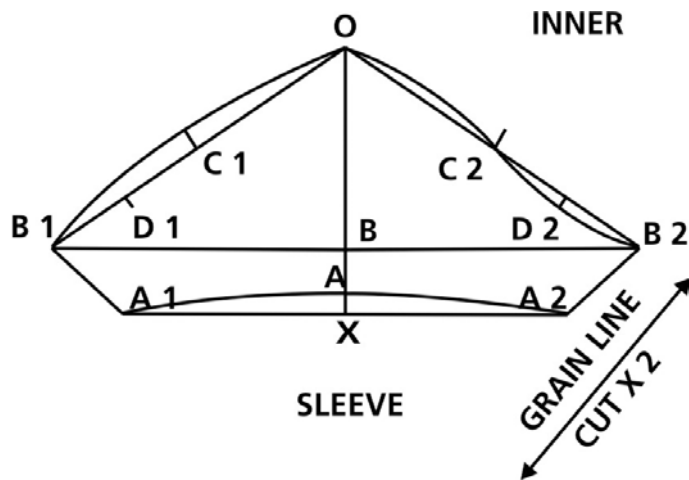
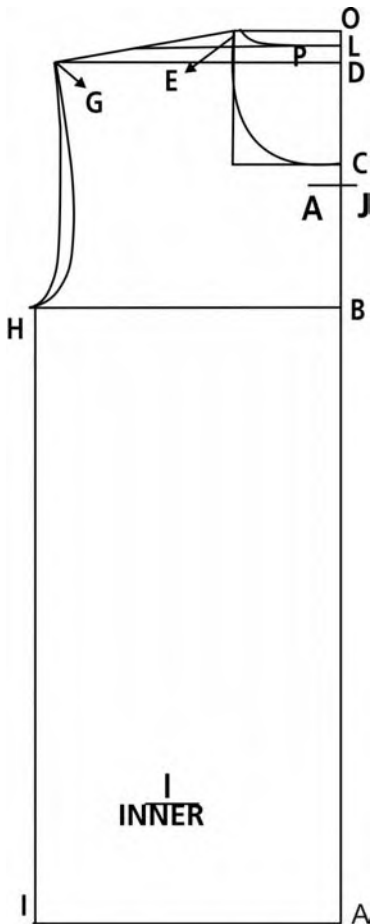
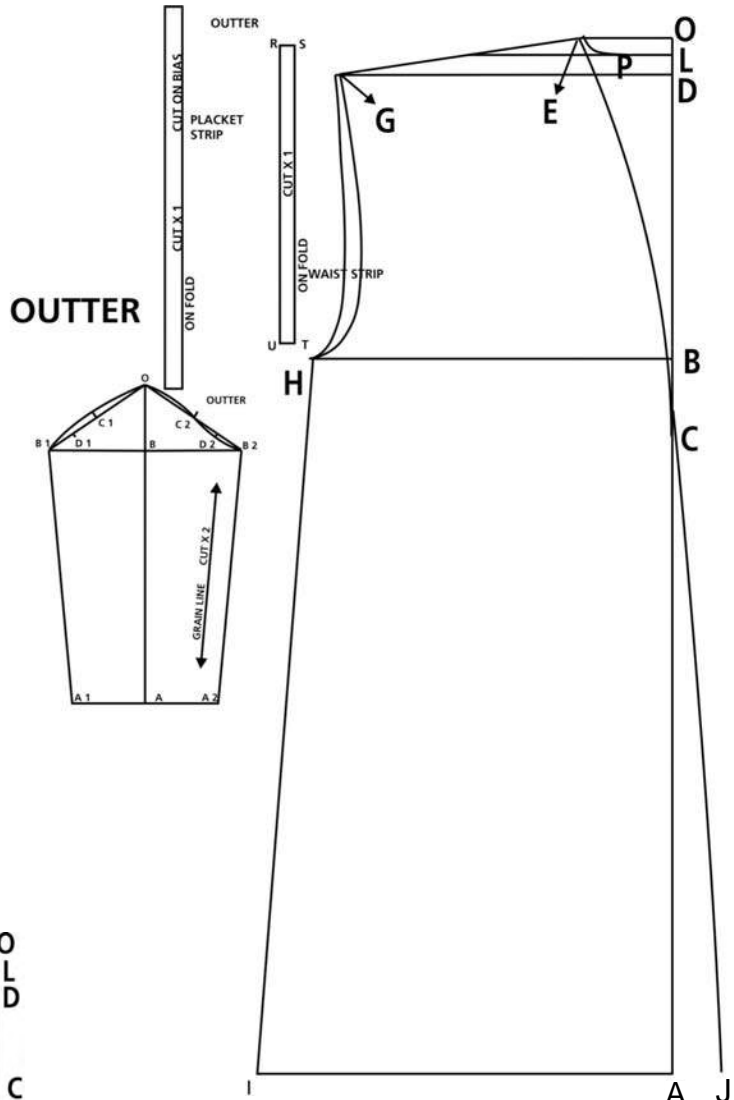

Men's Wear

CHURIDAR PYJAMA

MEASUREMENTS TO BE TAKEN

- Waist
- Hip
- Length of Churidar
- Crotch Length

AMOUNT OF FABRIC REQUIRED

- 2.50 M
- 21 + 50 CM.

AMOUNT OF FABRIC REQUIRED

- 2.50 m

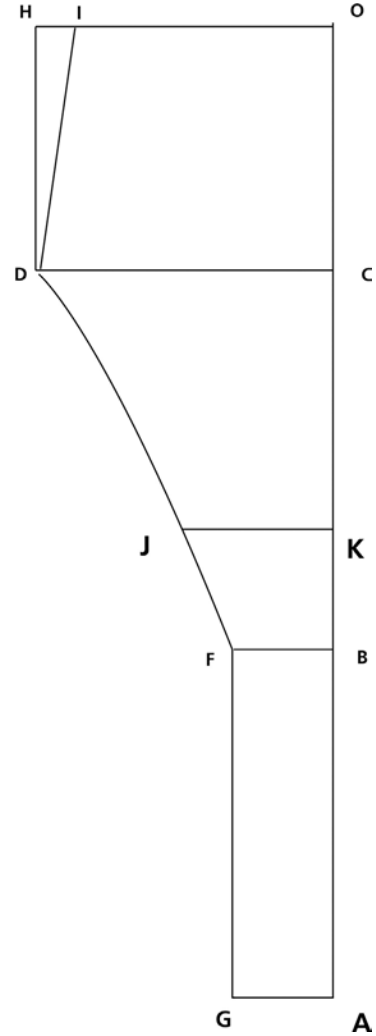

FRONT

STEP No.	REFERENCE POINT	DETAILS
1.	O	Starting point
2.	O – B	Total length of churidar – 5 in.
3.	O – C	Crotch length Hip / 3+2"
4.	C – D	H 1/3 + 2inch
5.	J – K	Knee 1/2 + 1 inch
6.	O – H	H 1/3 + 1inch
7.	H – I	1"
8.	B – A	Hip/2 (for churi)
9.	A – G	Bottom 1/2
10.	D – J	Join D-J
11.	O – K	Hip 2+3"

GUSSET

STEP No.	REFERENCE POINT	DETAILS
1.	O – A	Hip 1/4"
2.	A – B	Hip / 24
3.	A – C	A – B equal

Join B – O and O – C

CHAPTER 36

BENGALI KURTA

MEASUREMENTS TO BE UNDERTAKEN

- Chest : 36"
- Full length : 36" Across back : 17"
- Sleeve length : 24"
- Sleeve opening: 9"
- Neck : 15"
- Shoulder to waist : 16"

MATERIAL REQUIRED

- 2 lengths of Kurta + 1 sleeve length + 5" of a 36" width cloth

Front

STEP NO.	REFERENCE POINT	DETAILS
1	O-A	Full length (ON FOLD)
2	O-B	Half of across back
3	O-D=B-C	Chest/4-0.5"
4	D-E	Chest/4 + 2"
5	O-K	Length of shoulder to waist
6	O-J	Chest/3 + 1"button placket
7	A-G	Chest/4 + 4"
8	O-M	Neck / 6
9	O-R	Neck / 6
10	B-J	$\frac{3}{4}$ "
11	J-E	Arm Hole Shape
12	K-L	Chest/4 + 1.5"
13	E-M	Chest/6 + 1"

BACK

STEP NO.	REFERENCE POINT	DETAILS
1	O-R	Neck/6
2	O-L	Neck/ 2
3	D-E	Back shoulder shape

SLEEVE

STEP NO.	REFERENCE POINT	DETAILS
1	O-A	Length of sleeve (on fold)
2	O-B	Chest /4 – 0.5"
3	B-C	Chest/12
4	A-E	Half of sleeve opening
5	E-F	Side placket opening for sleeve chest/6-1"

POCKET

STEP NO.	REFERENCE POINT	DETAILS
1	O-A=B-G	Length of pocket, chest/2
2	O-B=E-DGF=AC	chest/6
3	A-G	Turn so that it touches DE
4	C-F	Will come on fold.

Sewing margins and turning margins at the bottom and sleeve ends should be kept separately.

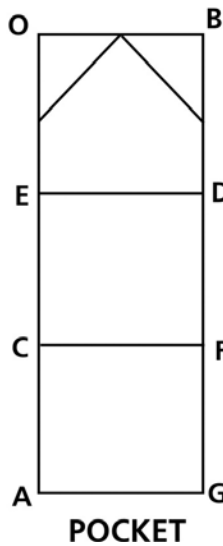
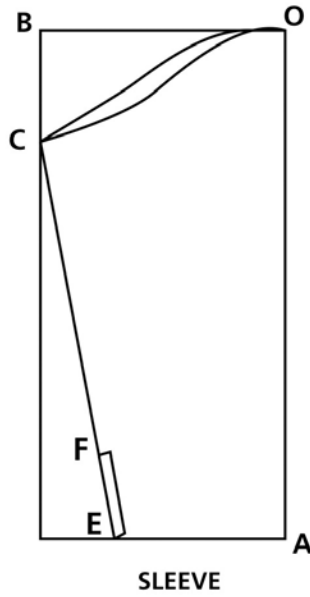
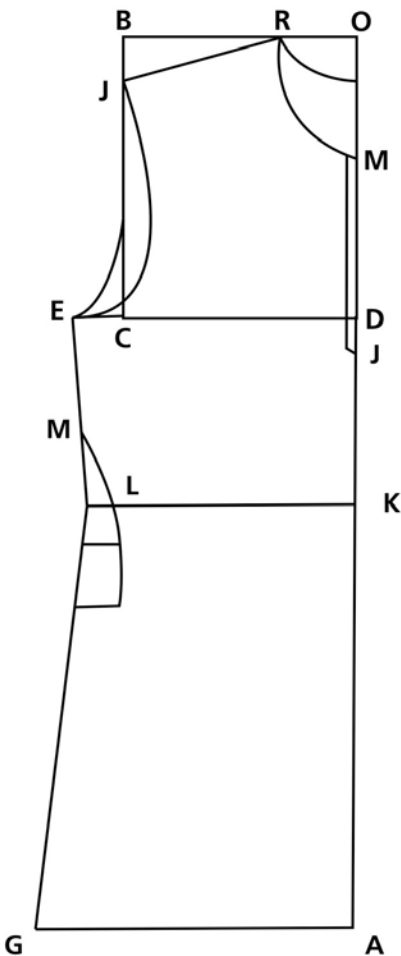

CHAPTER 37

KALIDAR KURTA

MEASUREMENTS TO BE TAKEN

- Round neck
- Across shoulder
- Chest
- Length of Kurta: 45"

FABRIC REQUIRED

- 2.80 meters

ADDITIONAL MATERIAL REQUIRED

- 4 buttons

KALIDAR (FRONT)

STEP No.	REFERENCE POINT	DETAILS
1.	O	Starting point
2.	O – A	Total length of Kalidar Kurta
3.	O – B	¼th of chest
4.	O – C	1/12 th of chest
5.	O – D	Shoulder drop = 1 ½"
6.	O – E	1/12 th of chest; = O – C
7.	E – F	Join E – F parallel to O – C
8.	D – G	½ of shoulder & join E – G
9.	G – I	Straight to bottom
10.	E – C	Join using French curve
11.	N – Q	Mark "Q" 13" away from the "N" on the center front line

KALIDAR (BACK)

STEP No.	REFERENCE POINT	DETAILS
1	O – L	½"; draw a line parallel to O – E
2	M – N	½ " Parallel & equal from GE; MG & NE perpendicular to GE
3	N – P	Draw a curve using French curve
4	M – I	Straight to bottom
5	O – D	1" Back Neck

SLEEVE

STEP No.	REFERENCE POINT	DETAILS
1.	O	Starting point
2.	O – A	Length of the sleeve
3.	A – B	6 ½ "/ Chest/4-1"
4.	O – D	¼ of chest -3/4 TH "
5.	D – C	½"
6	D – E	1/12 of chest

KALI

STEP No.	REFERENCE POINT	DETAILS
1	X-W	1/12 CH
2	Y-Z	1/6 CH
3	W- Y	Full length of kurta –chest/4

GUSSET

STEP No.	REFERENCE POINT	DETAILS
1	W-Z	7 ¼"
2	X-Y	5 ¼"
3	W	1" above the centre point of XY

POCKET

Pocket opening starts 1/6 chest + 1"

NOTE: Always make Kali using the chest line and the base line

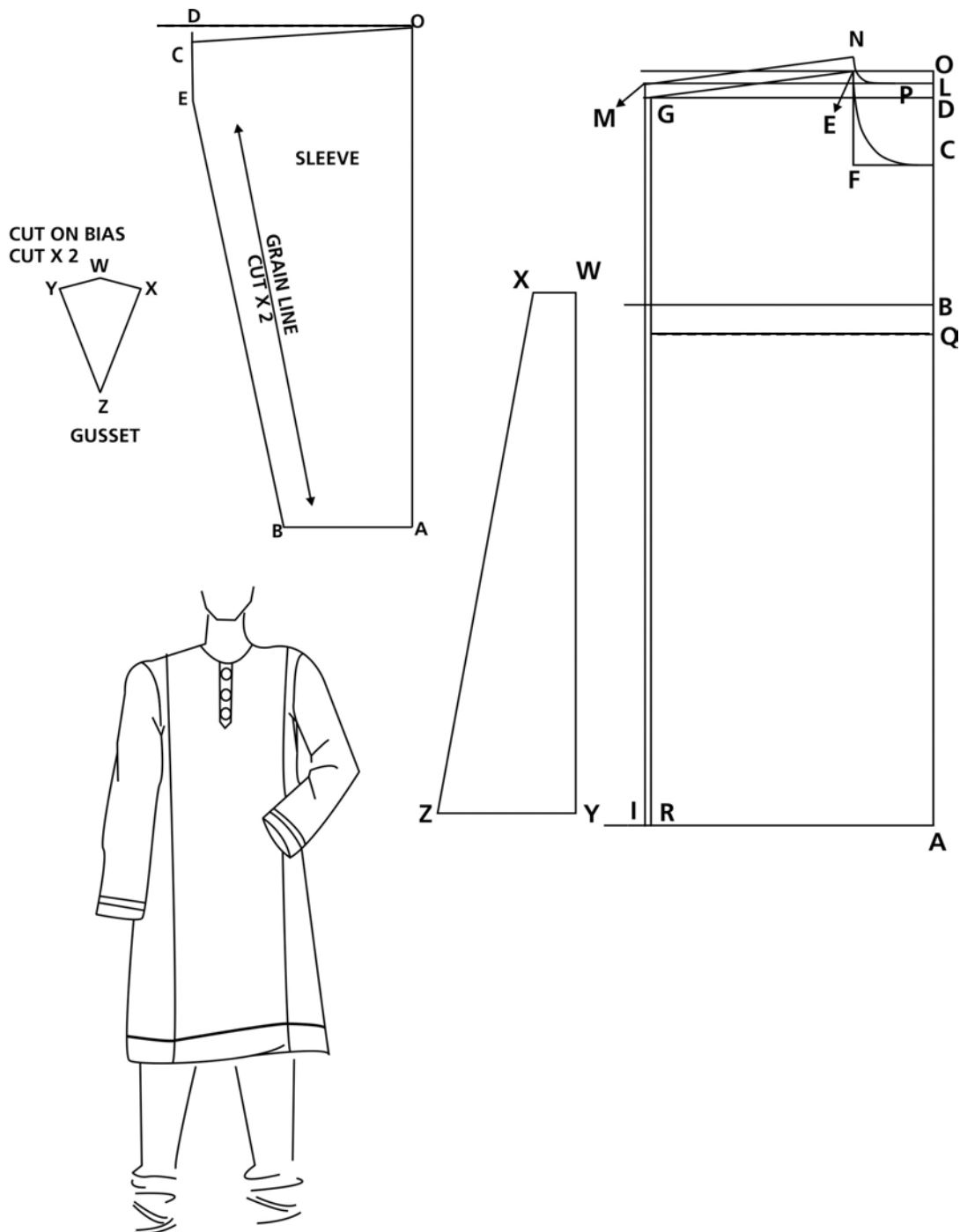

CHAPTER 38

NEHRU KURTA

MEASUREMENTS TO BE UNDERTAKEN

- Chest = 36"
- Across shoulder = 18"
- Length = 38"
- Neck = 15"
- Length of sleeve = 24"

MATERIAL REQUIRED

- 2.5 meter cloth
- 4 buttons
- Buckram
- Matching thread

FRONT

STEP NO.	REFERENCE POINT	DETAILS
1	O-A	Full length = 38"
2	O-B	Across shoulder/2
3	B-E	Chest/4, BM 1" below for shoulder shape
4	D-C	Chest/4 + 2"
5	A-H	Chest/4 + 4"
6	O-K	Chest/12
7	O-N	Chest/12, give shape from N to K
8	O-I	Chest/3
9	F-G	Chest/6
10	O-P	15"
11	P-Q	Chest/4 + 1.5"

BACK

STEP NO.	REFERENCE POINT	DETAILS
1	O-A	Full length
2	O-B	Across shoulder/2
3	B-E	Chest/4
4	D-C	Chest/4 + 2"
5	A-H	Chest/4 + 4"
6	O-K	Chest/12, JK 1"

SLEEVE

STEP NO.	REFERENCE POINT	DETAILS
1	O-A	Full length = 24"
2	O-B	Chest/4, BD chest/12, give shape
3	C-A	Chest/6 + 1/2"

POCKET

Step no.	Reference points	Details
1	A-C	Full length, chest/2
2	A-B	Chest/6

BAND

STEP NO.	REFERENCE POINT	DETAILS
1	D-C	$\text{Neck}/2 + 0.5" = 15"/2 + 0.5"$
2	B-C	1.25"

Remember to keep sewing margins

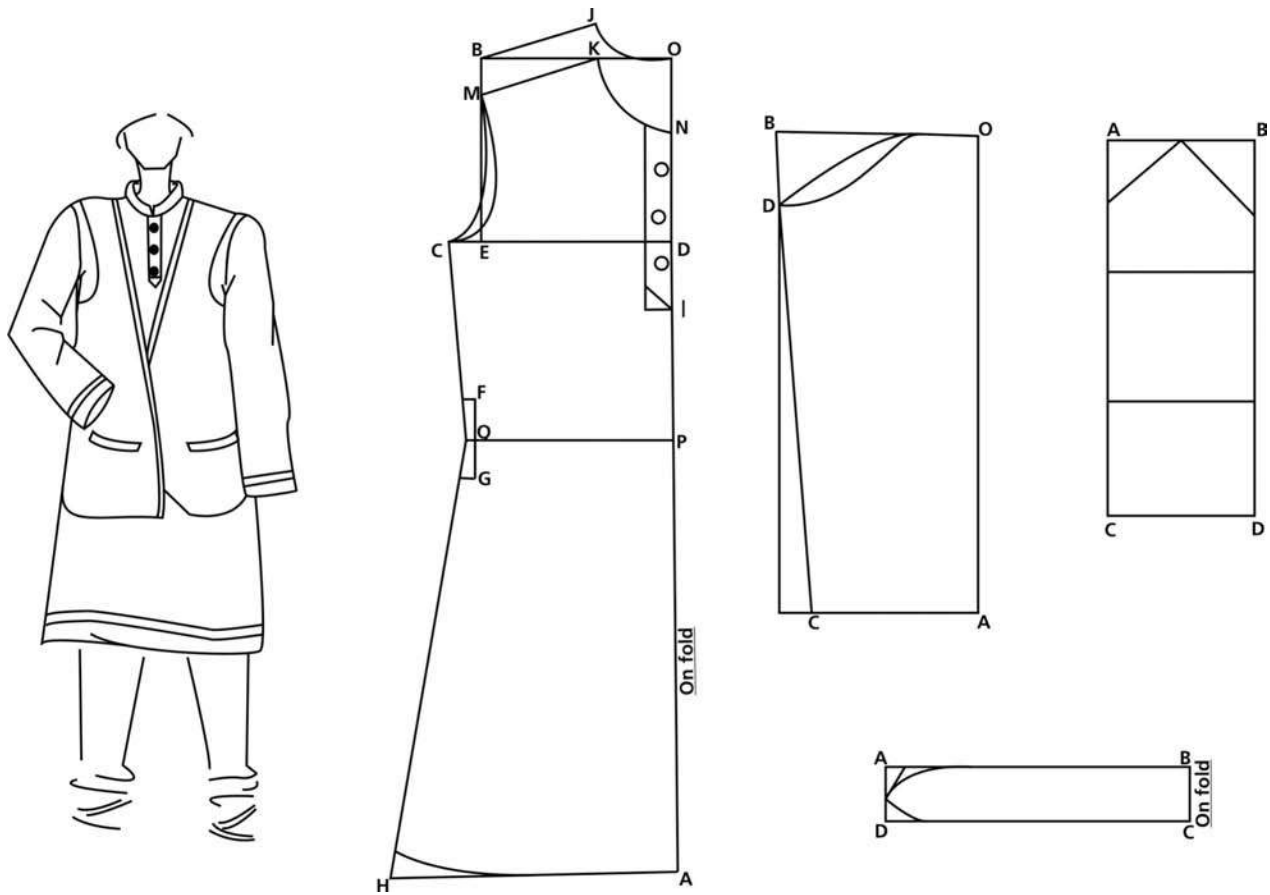

CHAPTER 39

FULL SLEEVE FORMAL SHIRT

MEASUREMENTS TO BE TAKEN

- Round neck (just for reference)
- Across shoulder
- Chest
- Waist
- Length of bodice – 29"

ADDITIONAL MATERIAL REQUIRED

- Collar fusing for collar
- Collar fusing for collar band
- Collar fusing for cuff
- 6 buttons for front placket
- 2 buttons for cuff

AMOUNT OF FABRIC REQUIRED

- 2.5 m

BASIC SHIRT (FRONT)

STEP No.	REFERENCE POINT	DETAILS
1.	O	Starting point
2.	O – A	Total length of basic shirt
3.	O – B	¼th of chest
4.	O – C	1/12 th of chest -3/4"
5.	O – D	Shoulder drop = 1 ½ "
6.	O – E	1/12 th of chest;- ¾"
7.	E – F	Join E – F parallel to O – C
8.	D – G	½ of shoulder + ½ " & join E – G
9.	B – H	¼ of chest +1 ½"
10.	H – I	Perpendicular to HB, join till total length
11.	G – H	Join using French curve
12.	E – C	Join using French curve
13.	X – Y	2" away, parallel to CA (for placket)

BASIC SHIRT (BACK)

STEP No.	REFERENCE POINT	DETAILS
1.	O – L	1½ in.; draw a line parallel to D - G
2	L– M	Parallel & equal to GD
3	M – H	Draw a curve using French curve

SLEEVE

STEP No.	REFERENCE POINT	DETAILS
1.	O	Starting point
2.	O – A	Length of sleeve – width of cuff
3.	O – B	1/ 12 th of chest
4.	B – B1	¼ of chest, also equal to B – B2
5.	A – A1	1/6 th of chest, also equal to A – A2
6.	—————	Join B1 – O; A1 – B1
7.	C 1& C2	Mid of O – B1 & O – B2
8.	D1 & D2	Mid of C1 – B1 & Mid point of C2 – B2

COLLAR & COLLAR BAND

STEP No.	REFERENCE POINT	DETAILS
1.	O	Starting point
2.	O – A	1" (on fold)
3.	O – B	½ of neck + ½ "; also OB = OC
4.	—————	Convert lines OB & OC into curves& blend them as shown in fig.
5.	D – E	O – A + ¼ "(on fold)
6.	C – F	Customized length & shape

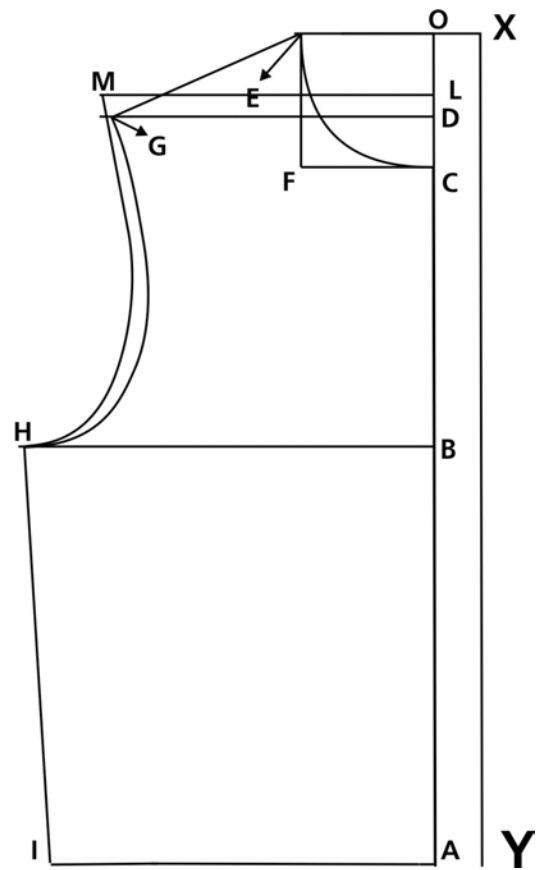
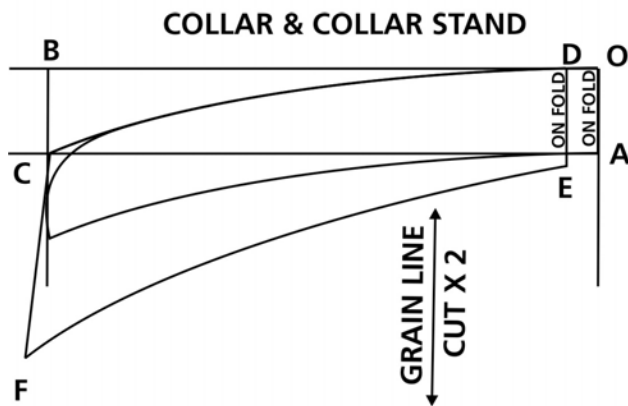
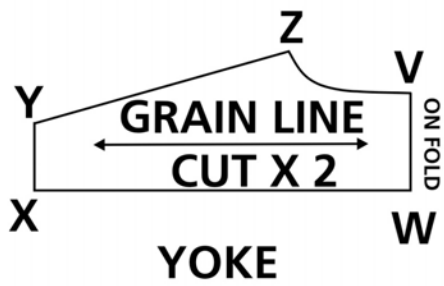
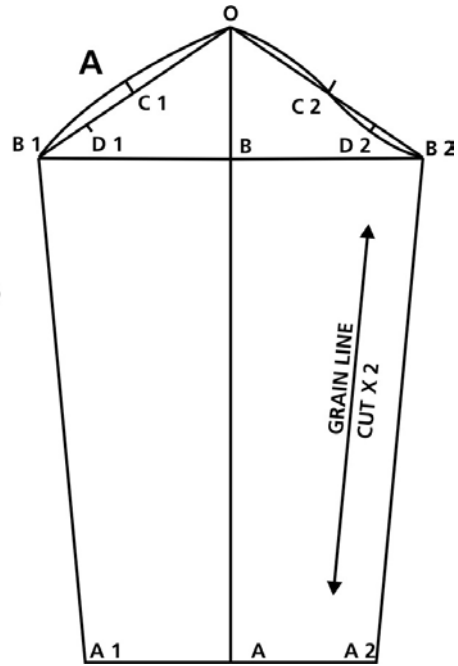
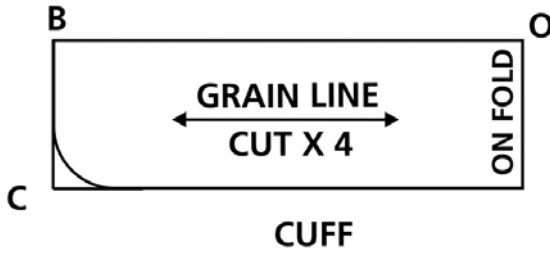

CHAPTER 40

MEN'S FLAT FRONT TROUSER

MEASUREMENTS TO BE TAKEN

- Waist
- Hip
- Outer length
- Inner length
- Knee length
- Bottom opening
- Total length of trouser : 42"
- Crotch = outer – inner length

ADDITIONAL MATERIAL REQUIRED

- Trouser fusing for waistband
- 1 button for waistband
- 1 button for back pocket
- 1 8" zip

FABRIC REQUIRED

- 1.20 m

FRONT BLOCK

STEP No.	REFERENCE POINT	DETAILS
1.	O	Starting point; take measurements from the 1-½" mark on the tape, for length, knee and crotch.
2.	O – A	Total length of trouser
3.	O – B	Knee length
4.	O – C	Crotch length
5.	C – D	¼ of hip + 2"
6.	D – E	2"
7.	E – J	Perpendicular to CD touching the guide line
8.	F	Mid point of CD
9.	F – G	Extend perpendicular to CD till guide line below
10.	G – H	1/4 th of bottom opening, also equal to GI
11.	J – K	½" & join KO
12.	K – O	¼" of waist + ½"
13.	F – M	1/12 th of hip
14.	M – N	Join MN and make EN = 1.1"

BACK BLOCK

STEP No.	REFERENCE POINT	DETAILS
1.	C – P	½"
2.	Q – P	CD + 2 ½"
3.	K – Y	1 ½"
4.	Y – S	1 ½", join SO
5.	S – T	¼ of waist + 1 ½"
6.	O – U	½ of OC & U touches the back curve
7.	U – V	¼ of hip + 1 " ; join SV & extend; blend line SV till Q

DART AT CENTRE OF WAIST LINE: 4" X 1"

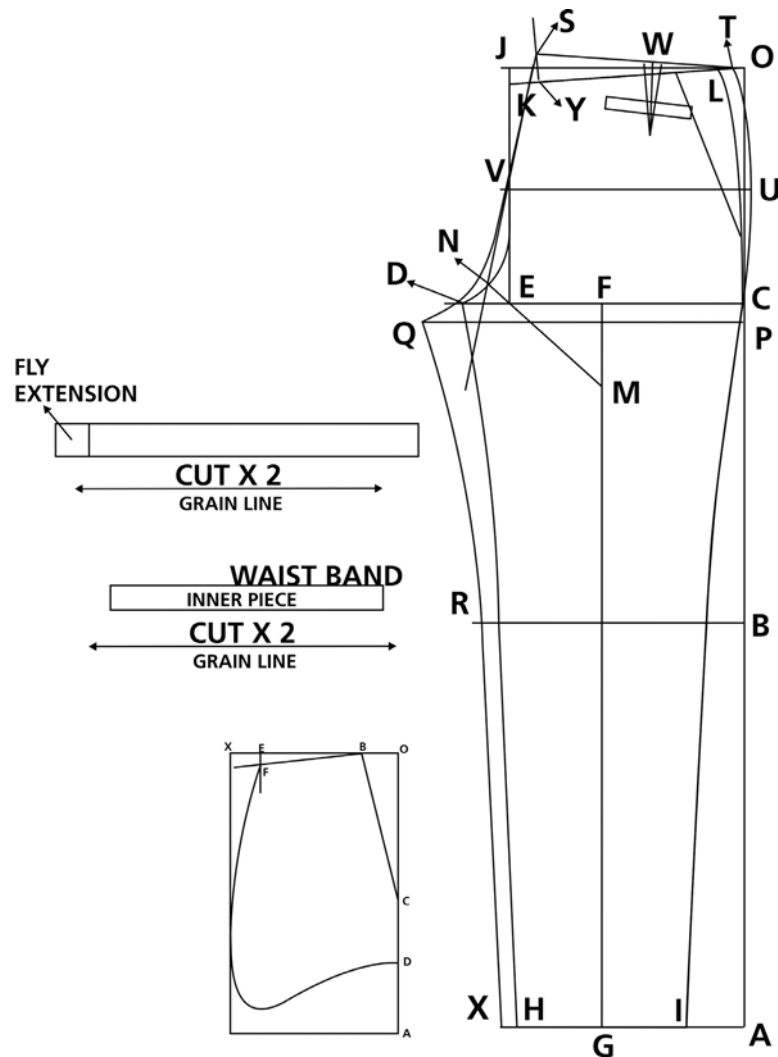

CROSS POCKET BAG

STEP No.	REFERENCE POINT	DETAILS
1.	—————	Make a rectangle 13" X 7" and mark a point O
2.	O – A	13"
3.	O – B	1 ½ "
4.	B – C	7 ½ "
5.	C – D	2"
6.	X – E	1"
7.	E – F	½ "
8.	—————	Make curves as shown in the pattern.

NOTE:

- Join XR parallel to front block with leg curve & join RQ with hip curve.
- Join LC & TC with hip curve
- Join CI with leg curve

WAISTBAND & FLY PIECE

Follow the patterns, as given

POCKET PLACEMENT

FOR FRONT: 2-½ " from waist & 2" from side. (Width = 4 " & height = ½ ")

FOR BACK: on dart 2-½ " from waist (width = 4 " & height = ½ ")

For welt pocket cut rectangular block measuring 14" X 5"

CHAPTER 41

PANT CUT PYJAMA

Measurement

Hip : 36"

Length : 40"

Crotch : 28"

Bottom opening : 21"

Required material : 2.5 meters

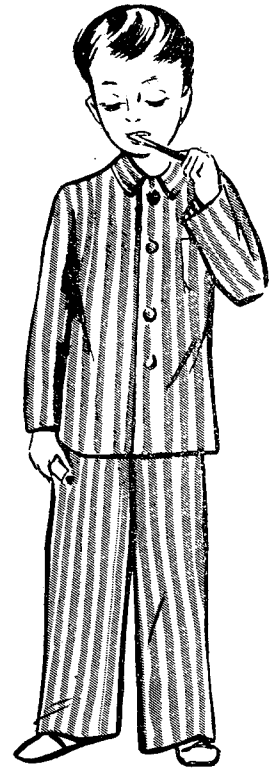

STEP No.	PRFERENCE POINT	DETAILS
1	O - A	Full length
2	O - B	Hip/3 + 1' 1/2"
3	B - C	Hip/3 + 2"
4	C - D	Hip/12
5	C	Join till E
6	D-E	1"
7	B-A	Length of leg
8	A - I	B/2
9	G - H	B/2+0.5"

BACK

STEP No.	PRFERENCE POINT	DETAILS
1	C-J	Hip/16
2	K-L	1"
3	JK1K2KL	Join giving shape for back crotch
4	H-H'	1"
5	I-I'	1"

POCKET

STEP No.	PRFERENCE POINT	DETAILS
1	O-A	Hip/3 +1" (on fold)
2	O-B	Hip/6
3	B-D	0.5"
4	C-E'	GH/12
	C-G	Hip/12

