

# READING MATERIAL

ON

## BASIC HYDRAULICS

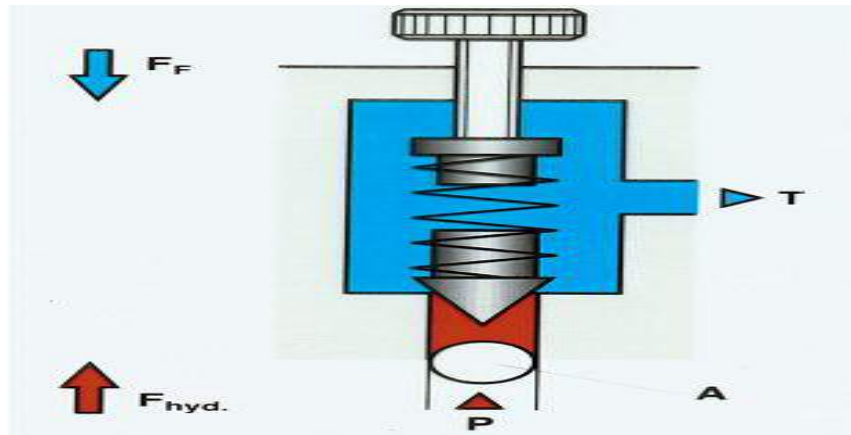

HUMAN RESOURCE DEVELOPMENT CENTRE

ROURKELA STEEL PLANT

# ***Contents***

<b>Sl. No.</b>	<b>ITEMS</b>	<b>PAGES</b>
<b>1</b>	<b>Introduction to Hydraulics</b>	<b>01</b>
<b>2</b>	<b>Reservoir</b>	<b>03</b>
<b>3</b>	<b>Hydraulic pumps</b>	<b>03</b>
<b>4</b>	<b>Check Valves</b>	<b>04</b>
<b>5</b>	<b>Relief Valves</b>	<b>05</b>
<b>6</b>	<b>Accumulators</b>	<b>06</b>
<b>7</b>	<b>Direction Control Valves</b>	<b>06</b>
<b>8</b>	<b>Flow Control Valves</b>	<b>08</b>
<b>9</b>	<b>Filters</b>	<b>08</b>
<b>10</b>	<b>Pressure Switch</b>	<b>09</b>
<b>11</b>	<b>Hydraulic Actuators</b>	<b>10</b>
<b>12</b>	<b>Hydraulic Fluids</b>	<b>11</b>
<b>13</b>	<b>Block Diagrams</b>	<b>13</b>
<b>14</b>	<b>Hydraulic Circuits</b>	<b>14</b>
<b>15</b>	<b>Maintenance Tips</b>	<b>17</b>
<b>16</b>	<b>Hydraulic Symbols</b>	<b>18</b>

# HYDRAULICS

## **INTRODUCTION**

Transmission & control of forces & movements by means of fluids is called **hydraulics**. Fluids under pressure can be used for Power Transmission. Fluids means gases (air) and liquids (oil or water etc). The system which uses air as working medium is called pneumatics and which uses oil/water is called Hydraulic system.

## **Pressure**

Force is the effort required to do the work. Pressure means force exerted per unit area, generally measured in psi, or kg/sq cm, or bars\*.

## **Atmospheric Pressure**

At sea level the whole column of atmospheric air exerts a weight or force of 14.7 pounds for every square inch i.e. a pressure of 14.7psi or 1.03kg/sqcm. This is called atmospheric pressure.

1 Atmospheric Pressure = 1.03 Bar =14.7 psi

Flow & Pressure are inter-related. Flow is responsible for causing the motion of piston in a cylinder. It is the movement of hydraulic fluid caused by a difference in pressure at two points. When we open the kitchen tap the pressure difference (between the water tank at height and tap) pushes the water out, or causes the water to flow. In a hydraulic system flow is usually produced by the action of the hydraulic pump. If the pressure is not sufficient to take the load on the cylinder, it will not move.

## **GENERAL POINTS**

1. Oil is most commonly used hydraulic fluid, because it acts as lubricant for all moving parts of hydraulic system.
2. Generally the weight of hyd. Oil is around 55-58 pounds/cubic feet. One foot of oil causes a pressure of 0.4 psi. A 10 m column of water causes a pressure of 1 kg/sq cm.
3. There must be a pressure drop across an orifice/restriction to cause flow. If there is no flow, there is no pressure drop and vice versa.
4. Force exerted by a cylinder is dependent on pressure of oil supplied & piston area
5. Speed of the cylinder is dependent on piston area and the rate of fluid flow into it.
6. Fluid velocity through a pipe varies inversely to the square of inside diameter.
7. Friction in pipes results in pressure drop
8. Air is compressible, where as oil is incompressible practically.
9. Pump only transfers the fluid. It is the resistance which develops pressure.
10. It is the atmospheric pressure which is responsible for pushing of oil from tank to the suction chamber of the pump.

## **Pascal's Law**

PRESSURE APPLIED ON A CONFINED FLUID IS TRANSMITTED UNDIMINISHED IN ALL DIRECTIONS AND ACTS WITH EQUAL FORCE ON EQUAL AREAS AND AT RIGHT ANGLES TO THEM (If a force  $F$  is applied on a piston of area  $A$ , (over a confined fluid ) then it gives a pressure  $P = F/A$ . This pressure will be uniform in the entire confined fluid at rest.

## **Hydraulic Press (BRAMAH PRESS)**

Since pressure in the confined fluid is uniform throughout and by applying this pressure on large areas large forces can be developed. This is the starting point for development of Hydraulics (see the fig below).

If two cylindrical chambers which are connected and fitted with pistons of area  $A_1$ ,  $A_2$  and if a Force  $F_1$  acts on piston of area  $A_1$ , it develops a pressure  $p$  in the confined fluid. This pressure will be uniform in the entire fluid in double cylinder arrangement, and develops a force  $F_2 = P \times A_2$ . Hence forces will be proportional to the area of the pistons. There is no energy creation and work done will be same by both the pistons. The displacements (lengths of travel of pistons  $S_1$ ,  $S_2$ ) will be inversely proportional to the areas of the pistons.

$$\mathbf{F = P * A}$$

$$\mathbf{P = F / A}$$

$$\mathbf{A = F / P}$$

The length of piston travel is inversely proportional to area.

Work done  $W_i = F_i \cdot d_i$

$W_o = F_o \cdot d_o$

## **Bernoulli's Principle**

This is nothing but law of conservation of energy. If the flow rate is constant, the total energy at any point of continuous path of flowing fluid is same as at any other point. (Sum of motion energy, pressure energy, and potential energy is constant.). To know the pressure or flow velocity at any point in the circuit, this principle is used widely.

## **ADVANTAGES OF HYDRAULIC SYTEMS**

Due to limitations of other power transmission system such as electrical, electromechanical and pneumatic etc. hydraulic power transmission is preferred. Large forces can be transmitted to long distances with high pressure stability and quick response. There are multiple application possibilities which is suitable for use where large forces with infinitely variable speeds are to be applied in given directions. Hydraulic equipments give smooth operation for longer period with very less maintenance cost. Normally oil contamination control and leakage control may give long life to hydraulic components.

Other advantages of hydraulic system are:

1. **Highly compact**- Power to weight ratio is very high. A hydraulic motor weighs about 1/7 th of an electric motor of same power
2. **Precise control**- depending on different requirements we can get exact speed, force and position of user,
3. **Over load protection**- in case there is over load in pipe line or user, there is provision of relief valve set at a certain maximum pressure to take care of it,
4. **Suspension of load for long period**- by providing a pilot operated non-return valve in pipeline, load may be suspended for a longer period,
5. **Flexibility in design**- As per needs of production, scheme of hydraulic circuit may be changed easily only with addition of a few components,
6. **Easy maintenance**- its maintenance is easy. Only oil contamination control will fulfill major portion of maintenance work. For this monitoring of set parameters and inspections of pipe lines, religiously is necessary
7. **Variable Speed Controls**: - We can get infinitely variable speeds and positions as per need of users.
8. **Stalling of loads**:- The loads can be stalled to zero speed without any damage to the equipments

$d_o = A_i$   
 $d_i A_o$   
 $F_o = A_o$   
 $F_i A_i$

## **COMPONENTS OF HYDRAULIC SYSTEM AND THEIR FUNCTIONS**

**RESERVOIR:** The tank which stores the working medium (oil) and supplies to pump and also takes back the return and drain oil in a hydraulic system and protects the medium from external contamination is called Reservoir. It also allows the oil to cool through its walls and allows contaminants to settle and air to separate. Generally in many cases it houses cooler, return filters, air breather( a device which allows air to move in and out of a container to maintain atmospheric pressure), level indicator, level switches (float switches). It is also provided with drain plugs to drain oil, manhole (for maintenance and cleaning purpose), baffle plates which allow the return oil to settle and cool before entering the pump through suction line.

**SUCTION LINE:** The pipe line connecting tank to pump generally with a shut off valve in between is called suction line. Without opening this valve, pump should not be started. Generally a hose or rubber bellows is provided in this line to isolate the vibrations of the pump.

**PUMP:** The element which transfers oil/fluid from one point to another point or which gives flow is called pump. Pump only gives flow, but the resistance to flow develops pressure. In hydraulics only positive displacement pumps are used. In these pumps there is positive sealing between suction and delivery. For every revolution of pump, a fixed amount of oil is transferred from suction to delivery irrespective of load conditions. Practically there will be minor internal leakages which are negligible. This fixed amount of

oil transferred is called Displacement of pump. The displacement when multiplied by speed of the electric motor driving the pump, gives Discharge of the pump (flow of the pump) Centrifugal pumps (non positive displacement type) are not used in hydraulic systems. In this if delivery is closed, pressure will not build up beyond a particular limit. Safety valve is not required. Most commonly used positive displacement pumps used in hydraulics are Gear, piston and vane types are popular. A positive displacement pump should never be started without opening the suction valve. There should be sufficient oil level in tank so that air does not enter the pump. If air enters the pump, it will run with high noise and it will be damaged very soon. This is called aeration. Even though sufficient oil is there, aeration can occur due to any loose pipe joints in suction line. Pump is always followed by a relief valve (safety valve), pressure gauge, check valve and shut off valve ( These are required for pressure setting and isolating).

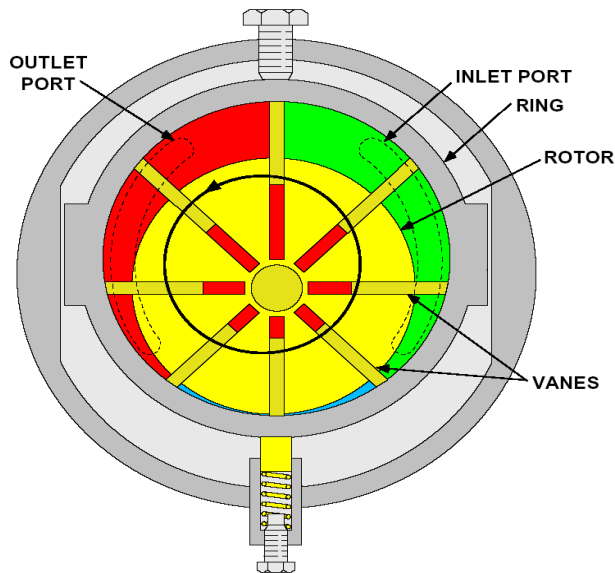

**CHECK VALVE/NON-RETURN VALVE:** It is a valve which allows flow in one direction only. Generally provided after the pump in most of the cases to take care of reverse rotation of pump. It is also used in many places of the circuit as a bypass etc. Check valve and non-return valve are same.

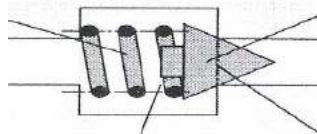

**PRESSURE GAUGE:** It is provided to know the pressure and for setting of various valves, pressure switches.



**PRESSURE RELIEF VALVE:**

it is the most important component of Hydraulic system. It limits the maximum pressure in the system so that elements, hoses, cylinders, pipes etc does not burst due to high pressure. It also protects the equipment and system from over loading. When the system pressure increases beyond the set point, the safety valve opens and relieves the excess oil to tank.

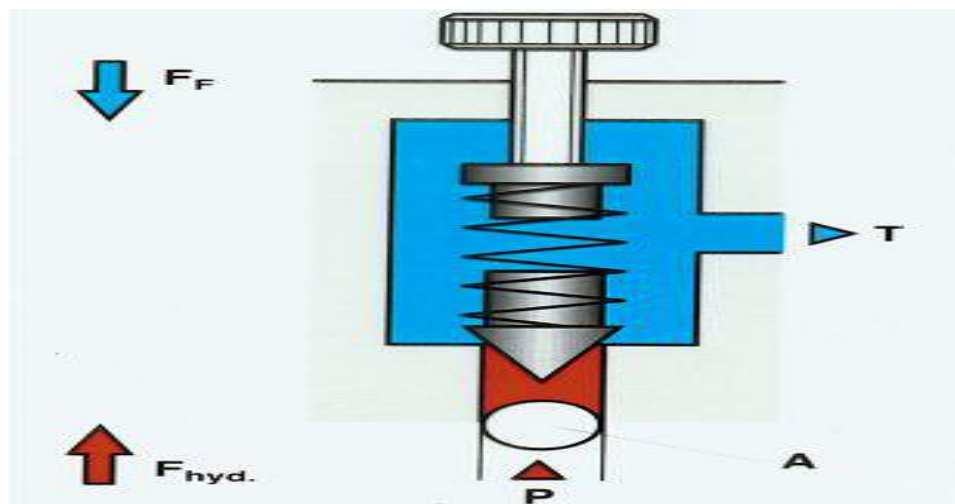

**ACCUMULATOR:** It is a reservoir of pressurized hydraulic fluid i.e. storage of energy by means of spring or compressed nitrogen, dead weight. It is basically a pressure vessel. No welding is allowed on this. 1. Bladder type (most commonly used) 2. Piston type 3. Dead weight type 4. Direct gas loaded type.

Nitrogen is generally used in accumulators but never use oxygen as it may result in explosion. You should never open a pressure line with accumulator in line. Always isolate/ preferably drain the accumulator before starting the job.

Accumulator is used (a) for smooth functioning of HS without pressure and flow fluctuations (b) as an emergency power source for essential operations in case of power failure. (c) for holding pressure for long times in a circuit (d) a big pump can be replaced by a small pump ( cost & energy saving) and many other purposes.

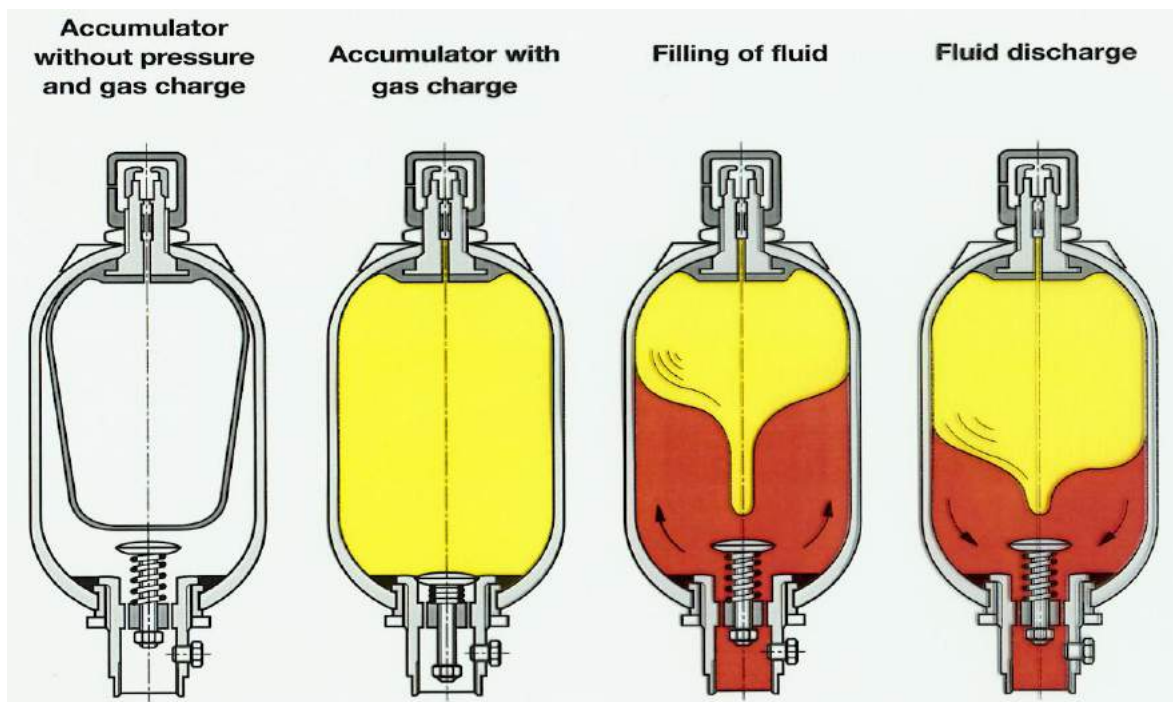

**DIRECTION CONTROL VALVES:** Distributor/Master valve / DC valve are all same. If a pump supplies oil directly to a cylinder, it is not possible or convenient to control the load or to change the direction of motion. Hence a dc valve is provided in between pump and



the load cylinder to stop/start /reverse the motion of the load. DC valve can be activated by a lever, cam, solenoid, pedal, pneumatic/hydraulic pressure depending on the design and requirement. Most commonly used are solenoid operated and they are having two/ three positions. If you are using a two position valve you cannot stop the cylinder in between .There are many varieties of dc valves.

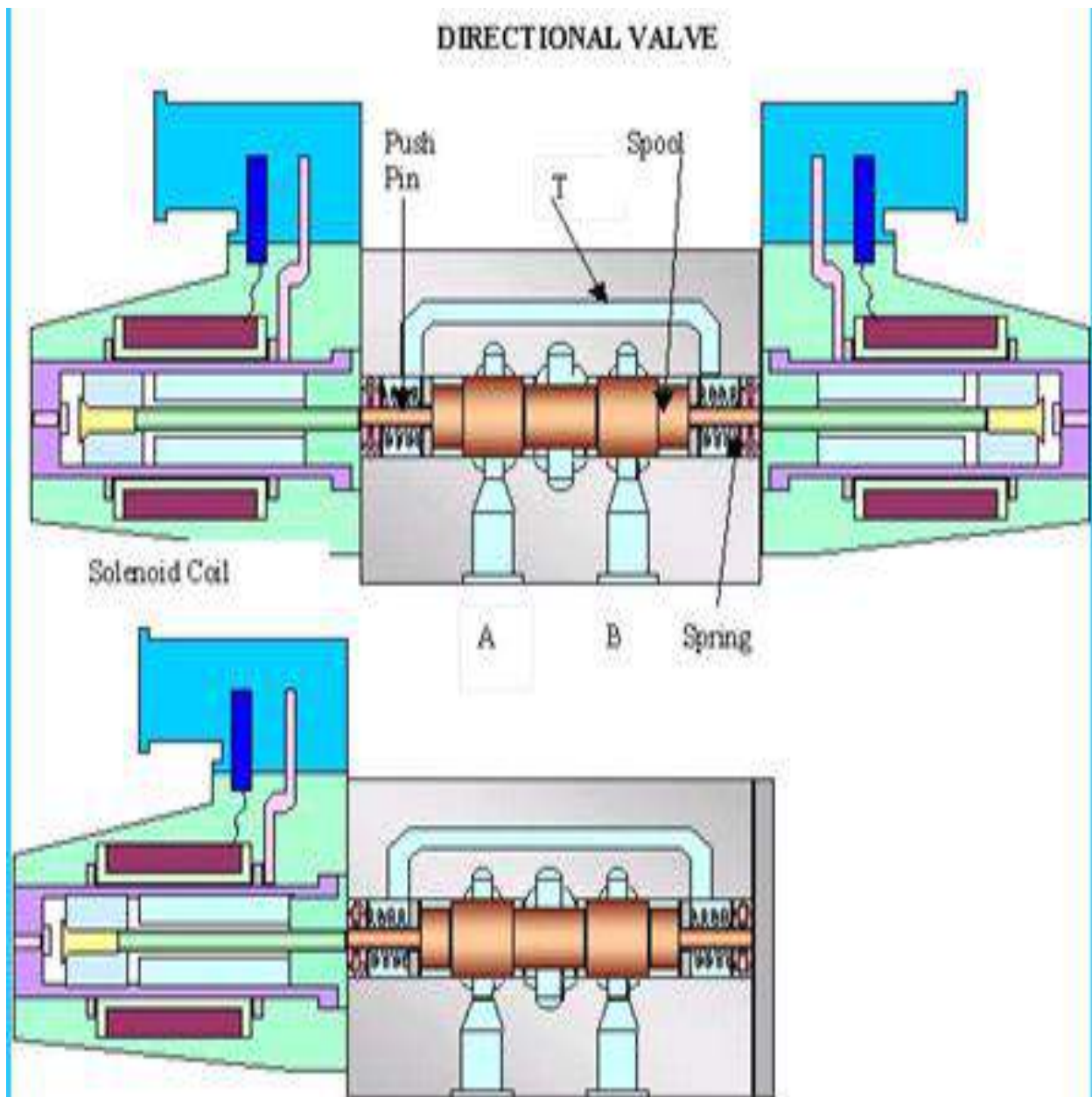

**FLOW CONTROL VALVES:** To control the speed of the actuator /load, the amount of oil flowing into the cylinder is controlled by means of these valves. Generally these are provided before the cylinder or in branch circuits where flow is to be controlled. Simple

needle/globe valve can also be used as flow control valve in some cases.

## FLOW CONTROL VALVES

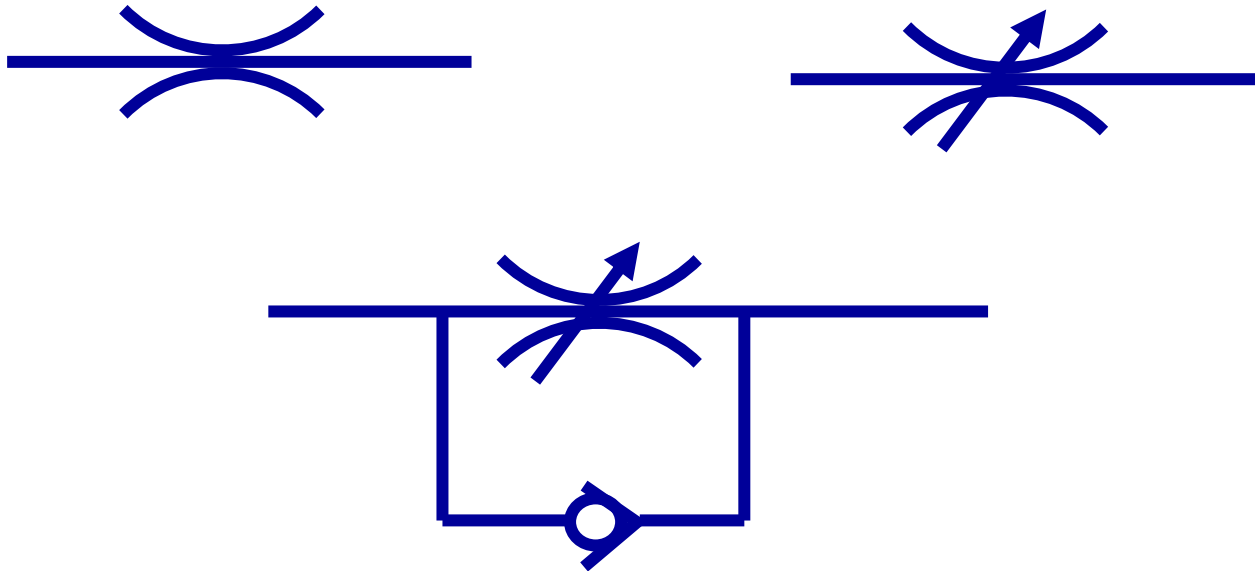

**SEQUENCE VALVE:** In a simple punching machine, the job is held in position by a clamping cylinder at low pressure and then a hole is punched by another cylinder at a high pressure. Now these two cylinders are always to be operated in definite sequence only. This sequence can be achieved by electrical/mechanical or by hydraulic means through a valve called sequence valve. Hydraulic sequencing is most common and versatile. A dc valve supplies oil to cylinder-1 and through a sequence valve to cylinder -2. (After cylinder -1 is operated completely, pressure will buildup and then sequence valve gets opened and oil goes to the cylinder -2 at a higher pressure. The sequence valve is tuned and set to achieve the sequence). It is almost similar to a safety valve but not same.

**PRESSURE REDUCING VALVE:** In some HS many cylinders are working at different pressures ,but a few cylinders does not require full pressure and can work at a low pressure .Then all these selected cylinders are supplied oil through a valve known as pressure reducing valve. In pressure reducing valve, the output pressure cannot go beyond a particular limit. This setting will be lower than the safety valve setting.

**FILTERS:** All hydraulic elements work under close tolerances and they are precision items with mirror surface finish .Contaminants and dust are the single largest enemy of the HS as they cause malfunctioning and jamming of valves and fast wear out of elements. The contaminants are internally generated in the system and some are external to

the system. Working medium is to be regularly cleaned from these contaminants. Hence oil filters are used in suction line, pressure line and return line and before an important precision valve/pump as per the need. This will improve the performance of the system. The coarse filter used in suction line of pump sometimes is called STRAINER. Hydraulic systems are most reliable, if the contamination is kept under control, and breakdowns can be minimized.

In a filter the hydraulic oil is allowed to pass through a porous medium (like clay, paper, wire mesh, synthetic fiber etc) so that the dust particles and other contaminants are retained and only clean oil goes ahead into the system.

Offline filtration (mostly portable) systems are also used for up keeping the system depending on the criticality. Electrostatic Liquid cleaners are also used nowadays. These are very simple to operate and cheap.

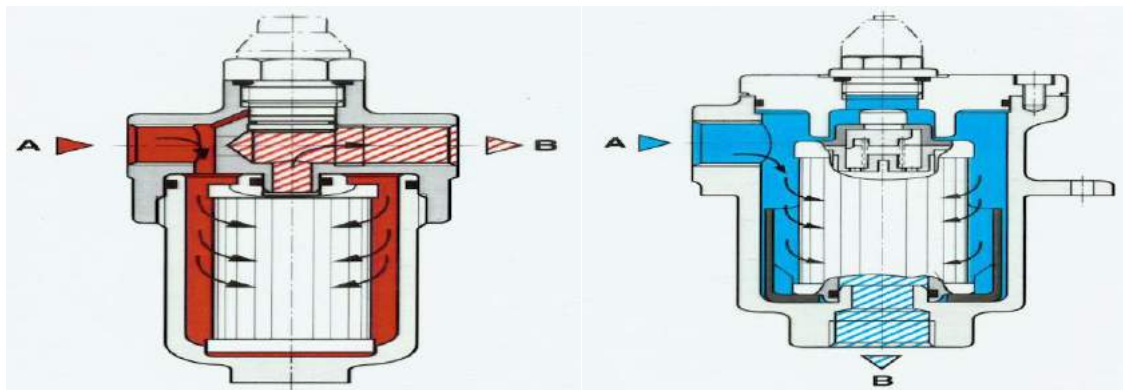

**PRESSURE SWITCH:** The hydraulic oil under pressure pushes a small plunger which in turn makes/breaks an electrical contact. These are provided in the system for safety and efficient operation or for achieving a particular logic sequence. Contact Manometer is a pressure gauge with electrical contacts, which does almost the same job, but they are less reliable and less robust.

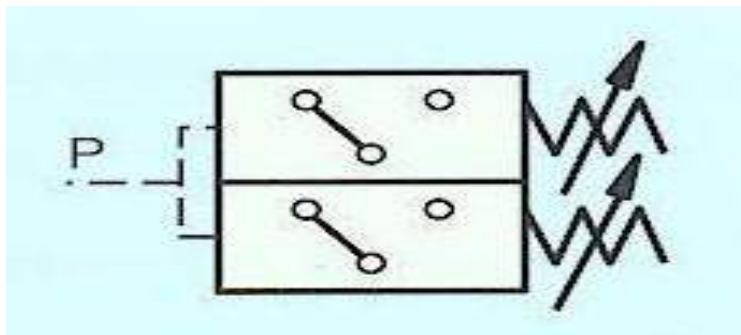

**LEVEL SWITCHES:** Generally the reservoir is provided with low level and high level float switches, so that they give alarm of low oil level/ high level and can be used for interlocking purpose. Float switch operates due to buoyancy in oil. Generally the low level

switch is interlocked with the drive of pump, so that when there is no oil due to any reason, the pump will trip or will not allow the pump to start.

**ACTUATORS:** Generally the hydraulic cylinders and hydraulic motors are called actuators. These actuators do the actual job of lifting/lowering/pushing/rotating /holding etc. Hydraulic motor replaces many applications of electric motors due to many advantages like speed control, over load protection etc. Hydraulic motors are almost similar to pumps. When these are supplied oil at pressure, they will give rotary output. Generally gear/vane /piston motors are in use.

Generally two types of Hydraulic cylinders are commonly used viz, a) Double acting cylinders, which can be used for pulling and pushing ,consists of piston , piston rod, body , covers, seals and fasteners, eye . Basically a sealed piston with rod reciprocates inside a cylindrical body under the pressure of oil. B) Single acting cylinder. These types can only push/lift a load. The single acting cylinder cannot retract due to hydraulic force. It retracts due to weight/spring/ load. Hydraulic jacks are generally single acting type.

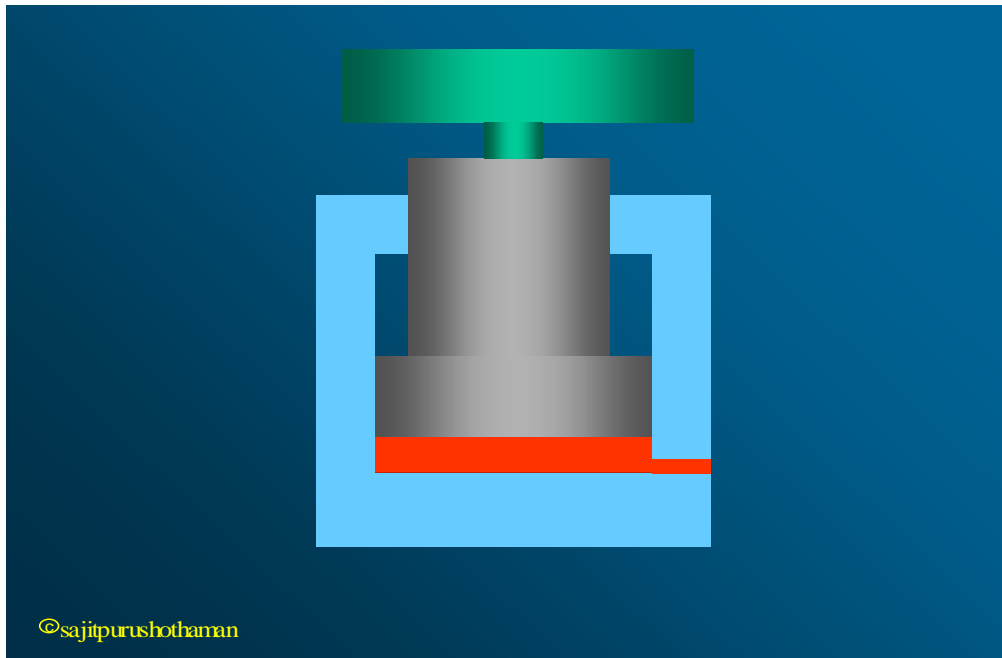

**SEALS:** The component which prevents the motion of the fluid in the undesired direction is called seal/packing. Can also be defined as that component that separates two fluids. The functions of the seal are a) to seal the hydraulic fluid in a closed chamber , b) Maintains pressure , c)stops dirt/water/contamination from entering the system d) separates two fluids, e) performs any combination of the above functions. In simple terms a seal stops internal or external leakages. Cost of the seal is a small fraction, but determines the efficiency of the system.

Problems associated with seals: Wastage of fluid leaked, fire hazards, slippery floor, makes equipment and products dirty, environment pollution, depleting natural resources. Leather, cork, ropes are the oldest seals, which are widely used in the earlier days. Then

natural rubbers, synthetic rubber (ELASTOMERS), PTFE, Polyurethane, POM etc are used nowadays. Seals should be handled delicately, and sharp tools should not be used.

**PIPES, FITTINGS, CLAMPS:** Generally pickled, flushed seamless pipes are used in hydraulic systems. For maintenance convenience and ease of laying, pipe joints are provided at suitable places. For small pipes union joints are used and in bigger pipes flange joints are used. There is large variety of pipe joints of different standards and designs are available. Care should be taken that different fittings do not get mixed up. Also while doing maintenance on fittings thread type/seat design/size etc should be matched. Otherwise lot of problems will result. Pipes should be properly clamped and supported; otherwise the joints get loosened during working due to vibrations. Pipe clamps are made of wood/ Aluminium/ synthetic materials. Wooden clamps are to be avoided due to environment protection. Aluminium clamps are used where high temperatures are there. Synthetic clamps are commonly used nowadays. While laying hose pipes, the layout should be smooth, and they should not crisscross/twist/entangle and rub each other.

### **WORKING MEDIUM**

Hydraulic power system may be operated with fluids produced from different base fluids:

- 1) Mineral oil
- 2) Vegetable oil
- 3) Synthetic oil
- 4) Water

**Mineral oil** - Most hydraulic systems use hydraulic fluid based on mineral oil. Since base oils do not have all the characteristics which a high performance hydraulic fluid should have, different types of additives are dissolved in base oil to improve the properties

**Vegetable oil** - These fluids are biodegradable and so are being used more frequently in installations that are subjected to strict antipollution regulations.

**Synthetic oil** - These fluids are most commonly used in systems where there are special demands on hydraulic fluid such as fire hazardous zones (furnace area)

**Water** - Pure water is seldom used as the fluid in hydraulic system. It can be used as emulsion adding oil in it or adding water to oil.

Following are the important properties which hydraulic oil should possess:

- a) Oxidation Stability
- b) Protection from Corrosion
- c) Anti Wear
- d) Viscosity & Viscosity Index, (viscosity index should be high so that viscosity variation with temperature will be less)
- e) Demulsibility (ability to resist formation of emulsion when mixed with water)
- f) Anti Foaming Characteristics
- g) Thermal and high pressure stability
- h) Good Lubricant
- i) Compatible with Seals and Hoses, and Metals
- j) High Flash Point (the minimum temperature at which oil just takes fire and do not burn continuously) & Fire points (the minimum temperature at which oil catches fire and burns continuously). Fire point should be always slightly more than the flash point.

## **OIL CONTAMINATION CONTROL**

Oil contamination is number one enemy of hydraulic system. Therefore, oil contamination control is the first requirement of any hydraulic system to get a trouble free smooth service. It enhances the life of different components. To keep oil clean is part of hydraulic system maintenance. It is just not possible to keep oil free from contamination in any industry due to various reasons. What we can do is to monitor oil contamination level regularly by cleanliness determination methods and take corrective steps including changing of filters. If situation does not improve, tank oil should also be changed as hydraulic valves especially proportional and servo valves are very dirt sensitive.

### **Sources of oil contamination**

- a) With the oil filled in the oil tank itself.
- b) Due to wear and tear of internal parts of components such as pump, control valves, cylinders.
- c) Due to wear of oil seals, o-rings.
- d) Due to wear of inside of pipelines.
- e) Due to generated debris after welding of metallic pipes.
- f) Through piston rods of hydraulic cylinders.
- g) Through ambient atmosphere.
- h) Due to poor upkeep of filters and reconditioning system.
- i) Due to use of cotton waste in revisioning or repairing of hydraulic components.

Filters should be provided in oil filling line, reconditioning line, pressure line after pump with clogging indicator, pilot line and return line. Periodically pressure differences across filters should be monitored otherwise in case of high pressure difference filters wall may collapse and oil may pass without filtering or flow rate will reduce.

There are two methods of determination of oil cleanliness class:

1. NAS 1638
2. ISO 4406

To decide oil cleanliness class required for different applications, the table given under may be used as guide line-

### **System type/Range of application Needed Cleanliness Class**

According to standards

NAS 1638 ISO 4406

Heavy duty servo system, High pressure

System with long service life

4-6 15/11

Proportional valve 7-8 16/13

Medium pressure system 7-9 18/14

Low pressure system 9-11 19/15

## **OIL LEAKAGE CONTROL**

Oil is life blood of hydraulic system, hence leakages should be prevented. Major portion of mineral oil to be used in our country is imported for which we have to pay heavy price. Besides loss oil leakage may damage the soil and hence ground water and plant life. Consequently it damages animal life and human life also. Leakage in fire hazardous zones may result in fire which may damage property besides unnecessary production delay due to burning and damage of especially electrical wires and equipments. It is therefore necessary to control oil leakage to the extent possible. For this regular inspection followed by corrective measures such as tightening of loose connections and pipe supports, changing of even partially damaged oil-rings(o-rings), hoses and corroded steel pipes is necessary. Hydraulic hoses in fire hazardous zones should be periodically changed even though these are not damaged.

## **BLOCK DIAGRAM OF HYDRAULIC SYSTEM**

**Every hydraulic system can be traced back to a common basic circuit containing only the main function as under**

- Hydraulic Cylinders /**
- Hydraulic Motors**
- Pressure Control Valves /**
- Flow Control Valves**
- Direction Control Valves**
- Pressure Relief Valve**
- Hydraulic Pump**
- User**
- Distributor /**
- Controller**
- Energy Source**

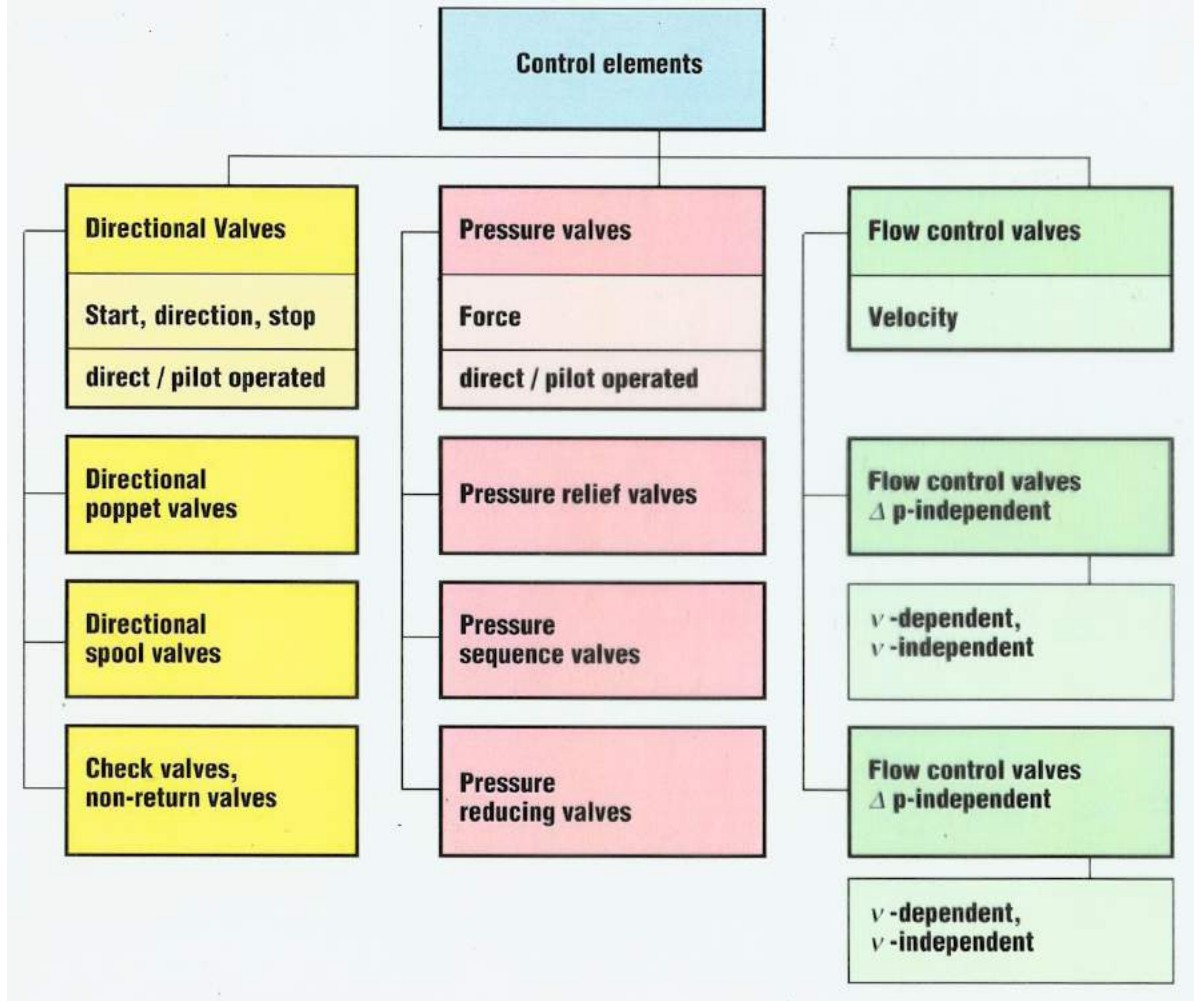

### **SIMPLE HYDRAULIC CIRCUIT (OPEN CIRCUIT)**

Here we have a hydraulic system in its most simple form. A pump with fixed flow sucks fluid from a tank and feeds it into the system connected to it. In zero position of the manually operated direction control valve the hydraulic fluid, circulates almost without pressure from the pump to the tank. The dc valve is spring centered. When the dc valve is operated into its left switching position, (parallel arrows) fluid reaches the piston chamber of cylinder. The piston rod travels outwards. The speed of the outward travel depends on the pump flow and the cylinder size (piston area). The force available at the piston rod is dependent on the piston area and the maximum system pressure. The maximum system pressure and thus the loading of the hydraulic system is set at the pressure relief valve. The actual pressure available, determined by the resistance to be overcome at the user, can be read at the pressure gauge.



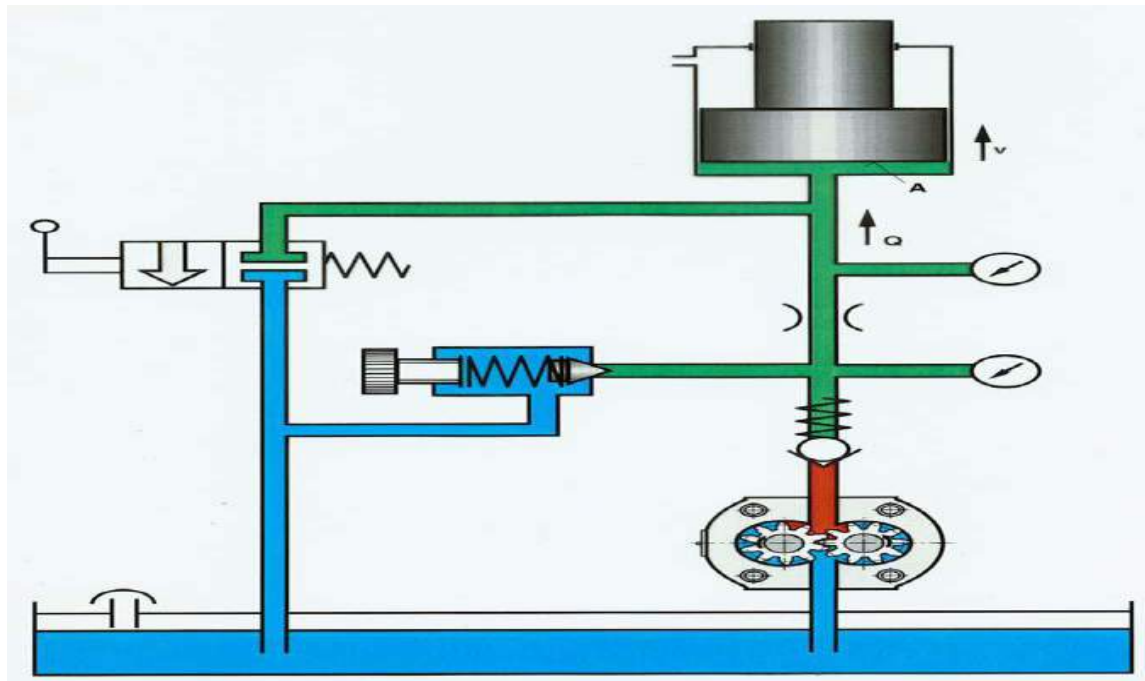

## APPLICATION OF HYDRAULIC SYSTEMS IN STEEL PLANTS

There are various applications of Hydraulics in Steel Plants. Some of the important applications are:

1. Roll Balancing and Spindle Balancing, Hydraulic Manipulators, Slab Extractors, Walking Beam Furnaces for Heating of Slabs and Blooms, Automatic Gauge Control for controlling thickness of plates/sheets, Rail Welding Machine, Roll Assembly Machine etc in Rolling Mills
2. Electrode Movement Control in Electric Arc Furnaces (VAD, Ladle Furnace)
3. Mobile Cranes and Earth Moving Equipment
4. Coke Oven Pusher Cars, Door Extractors and Charging Cars
5. Blast Furnace BLT Equipments, Mud gun, Drilling Machine
6. Stacker cum Reclamers in Ore Handling Plants
7. L&T Mechanism, Segments closing/ opening, Pinching Actions in CCS
8. Hydraulic Presses and Various Machine Tools etc.

## SOME IMPORTANT TERMS

### Cavitation

In any liquid flows, a localized condition within a liquid stream which occurs when the pressure is reduced to the vapour pressure of the liquid. Lots of vapour bubbles will form and these will be carried along with the flow and burst at some other point. This condition is highly harmful to the pump and all hydraulic elements. Generally this is taken care of at design stage that at any point of the hydraulics system the vapour pressure should not be so low to cause cavitation. The pump gives very high sound when under cavitation and it

should be stopped immediately and eliminate the root cause. Reasons may be for example, many bends were introduced/ lower size pipe was introduced in the suction line during the repairs.

### **Aeration**

When air enters the suction line of the pump and passes through it, lot of sound will come, which is similar to cavitation. This will also damage the pump and it should not be allowed to run. If grease is applied on suction line joints, the sound of the running pump will be suppressed immediately, confirming that particular joint is loose. That joint is to be tightened and packing/seal to be changed if required. Excessive aeration will cause the fluid to appear milky and the components will operate erratically.

If the air bubbles generated in the tank or air enters the pump due to low level of oil, the same problem will come.

### **Compressibility**

The change in volume of unit volume of a fluid when it is subjected to a unit change in pressure.

### **Decompression**

The slow release of confined fluid under pressure to gradually reduce the pressure is called decompression.

### **Hydraulic Hammering**

In a hydraulic system, the sudden transition of Kinetic Energy into Potential Energy and vice versa due to sudden opening/closing of valve, results in pressure surges and vibrations. This may result in bursting of pipe lines etc.

### **Cracking Pressure**

The lowest pressure at which pressure relief valve starts opening.

### **Pressure Override**

The difference between the cracking pressure of a valve and the pressure reached when the valve is passing the full flow.

### **Bypass**

A secondary passage for fluid flow.

## **MAINTENANCE OF HYDRAULIC SYSTEMS**

### **Breakdown Maintenance (Catastrophic Failure)**

- Safely Shutting Down the Hydraulic System
- Component Replacements by Identifying Model Code
- Pipe Line Replacements & Clamping
- Seal Changing

### **Preventive Maintenance (Schedule Repair)**

- General Inspection
- Oil Changing / Pouring
- Pipe Clamping
- Filter Replacement
- Heat Exchanger Cleaning

### **Predictive Maintenance (Checking Physical Attributes)**

- Temperature Monitoring
- Vibration checking in Pipelines
- Oil Cleanliness Checking
- Accumulator Gas Pressure Checking



















### **Proactive Maintenance (Eliminating Root Cause)**

- Contamination Control

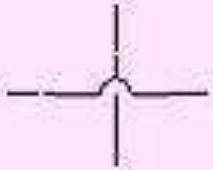
## **General Maintenance Tips**

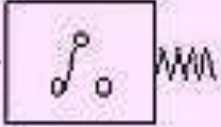
1. Always follow the standard shut down procedure for starting any kind of repair work in Hydraulic System.
2. Hydraulic System should be kept neat and clean so that no contamination enters the system. The system should never be kept open unattended.
3. Some contamination is also generated within the system. Hence regular cleaning /changing of filters or inspection of offline filtration systems to be done.
4. All flange joints/union joints, clamps foundation bolts etc should be regularly tightened, so that pipes do not vibrate excessively.
5. Hoses should be replaced condition based or time based.
6. All cylinders, valves, pumps and hose connections should be sealed and/ or capped until just prior to use.
7. Do not use Teflon tape or compound on pipe threads.
8. Never allow cooling water to enter the system and monitor the condition of heat exchangers.
9. Timely replace all the seals/ packing so that oil leakages will be minimum. If not done timely, fire accidents may take place or persons may fall down resulting in an accident.
10. Pressure gauges should be in working condition.
11. Regular check the oil level in the tank and always maintain prescribed oil level in the tanks.
12. Ensure tank low level switch is interlocked with the pump motor and it is in working condition.
13. Good maintenance procedures make it mandatory to keep the hydraulic fluid clean. A daily/ weekly or monthly log should be kept on the hydraulic fluid condition.
14. Seals should be handled delicately while replacing/storing and kept in cool dry places.
15. Maintain the temperature of the system with in allowable limits
16. Always try to do unit replacement of valves, cylinders, pumps etc. Repair of these items are to be done leisurely in workshop/ testing lab under good conditions.

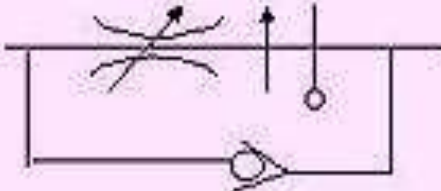
# HYDRAULIC STANDARD GRAPHICAL SYMBOLS

LINE		PRESSURE GAUGE	
PILOT LINE		TEMPERATURE GAUGE	
DRAIN		FLOW METER	
CONNECTOR		FILTER OR STRAINER	
FLEXIBLE LINE		OIL COOLER	
JOINING LINE		RESTRICTION FIXED THROTTLE	
PASSING LINE		RESTRICTION VARIABLE	
DIRECTION OF FLOW		PRESSURE SWITCH	
LINE TO TANK above oil level		TEMPERATURE & PRESSURE COMPENSATED FLOW CONTROL VALVE	
LINE TO TANK below oil level			
PLUG			

## BASIC VALVE SYMBOLS

CHECK VALVE



MANUAL SHUT OFF VALVE

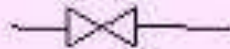

VALVE SINGLE FLOW PATH NORMALLY CLOSED

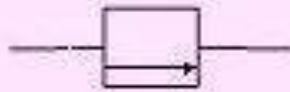

VALVE SINGLE FLOW PATH NORMALLY OPENED



PRESSURE RELIEF VALVE

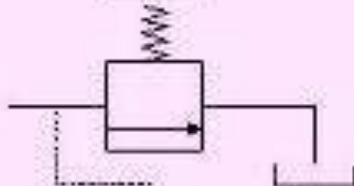

PILOT OPERATED UNLOADING VALVE

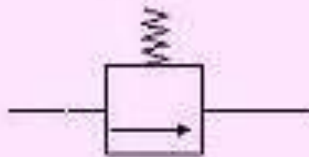

PRESSURE REDUCING VALVE

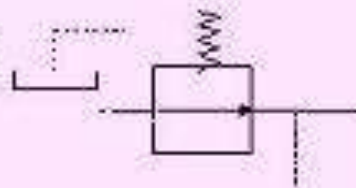

SEQUENCE VALVE EXTERNALLY DRAINED

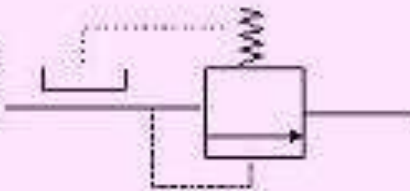

MECHANICALLY OPERATED VALVE

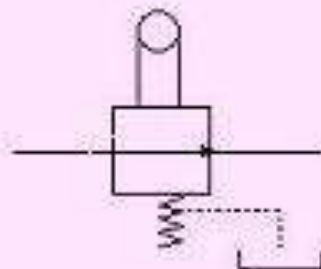

## PUMP, MOTOR, CYLINDERS ACCUMULATOR - SYMBOLS

ELECTRIC MOTOR



SINGLE PUMP FIXED DISPLACEMENT



SINGLE PUMP VARIABLE DISPLACEMENT



HYDRO-MOTOR FIXED DISPLACEMENT



HYDRO-MOTOR VARIABLE DISPLACEMENT



CYLINDER SINGLE ACTING

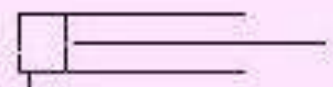

CYLINDER DOUBLE ACTING

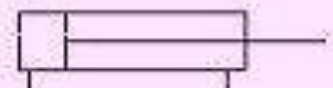

CYLINDER DIFFERENTIAL ROD

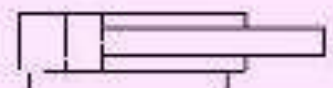

PRESSURE INTENSIFIER

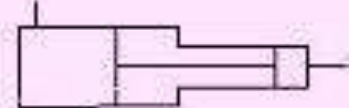

ACCUMULATOR GAS CHARGED DIAPHRAGM



ACCUMULATOR GAS CHARGED



**METHODS OF OPERATION SYMBOLS**

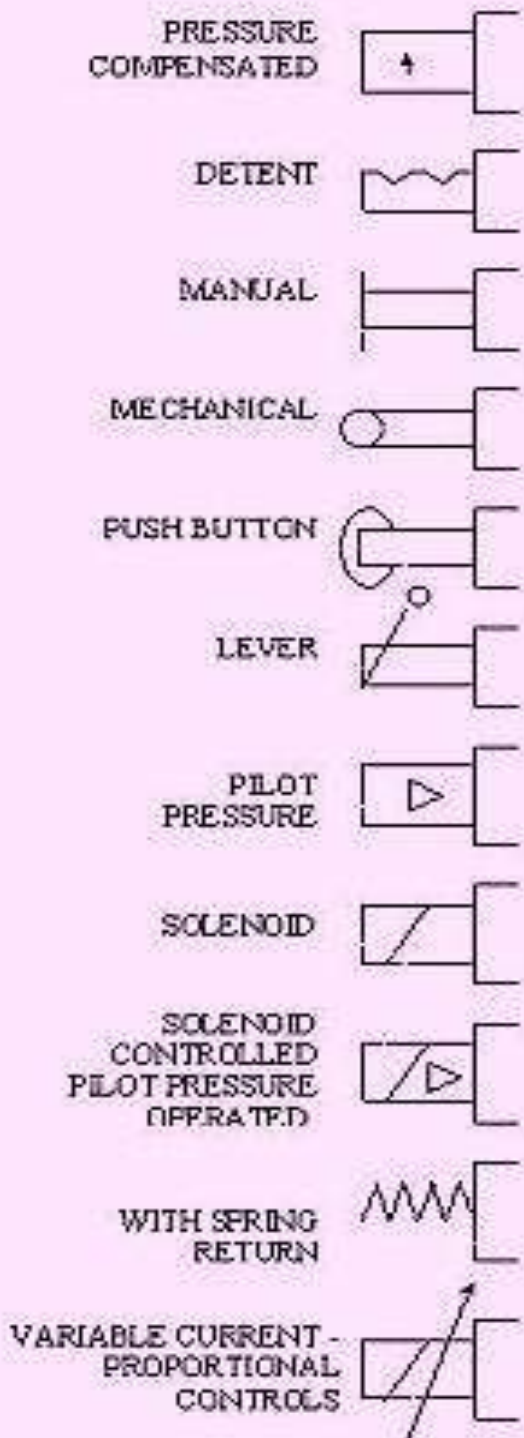

**DIRECTIONAL VALVE- SYMBOLS**

