

LECTURE NOTE

ON

BASIC OF CIVIL ENGINEERING

COURSE CODE: BCE02001: 3.0.0 (CR 03)

Second Semester, B Tech, Civil Engineering



DR. SAUBHAGYA KUMAR PANIGRAHI

ASSOCIATE PROFESSOR

DEPTT. OF CIVIL ENGG

VSSUT BURLA

Syllabus for Second Semester, B Tech, Civil Engineering
BASIC OF CIVIL ENGINEERING (BCE02001)

Module-I

Introduction to Civil Engineering – Various disciplines of Civil engineering, Importance of Civil engineering in infrastructure development of the country.

Introduction to types of buildings as per NBC, Selection of site for buildings, Components of a residential building and their functions, Introduction to Industrial buildings and types.

Building Planning – Basic requirements, elements, introduction to various building area terms, computation of plinth area, carpet area.

Module-II

Surveying – Principle and objectives, Instruments used, Horizontal measurements, Ranging (direct ranging only), Instruments used for ranging, Leveling – Definition, Principles, Instruments, Preparation of level book, problems on leveling, Modern surveying instruments – EDM, Total station, GPS (Brief discussion)

Building Materials – Bricks, properties and specifications, Cement – Types, properties, grades, other types of cement and uses, Cement mortar – Constituents, Preparation, Concrete – PCC and RCC, Grades, Steel – Use of steel in buildings, types.

Module-III

Building Construction – Foundations, Classification, Bearing Capacity of Soil and related terms (definition only), Masonry Works – classifications, definition of different technical terms, Brick masonry – types, bonds, general principle, Roofs – functional requirements, basic technical terms, roof covering material, Floors – function, types, flooring materials (brief discussion), Plastering and Painting – objectives, types, preparation and procedure of application.

Module-IV

Basic Infrastructure services – air conditioning & purpose, fire protection & materials, Ventilation, necessity & functional requirements, Lifts, Escalators.

Introduction to planning and design aspects of transportation engineering, Transportation modes, Highway engineering – historical development, highway planning, classification of highway, Railway Engineering – cross section of rail track, basic terminology, geometric design parameter (brief discussion only).

Module-V

Airport engineering – development, types, definition, characteristics of aircraft, basic terminology, Traffic engineering – traffic characteristics, traffic studies, traffic operations (signals, signs, markings), Urban engineering – classification of urban road.

Irrigation & Water Supply Engineering – Introduction, Types of Irrigation, different types of hydraulic structures, dam and weirs, types of dam, purpose and functions.

Text Books:

- Basic Civil engineering, Gopi, S., Pearson Publication
- Basic Civil Engineering, Bhavikatti, S. S., New Age.

Reference Books:

- Construction Technology, Chudley, R., Longman Group, England
- Basic Civil and Environmental Engineering, C.P. Kausik, New Age.
- American Society of Civil Engineers (2011) ASCE Code of Ethics – Principles Study and Application

BASIC OF CIVIL ENGINEERING (BCE02001)

Module-I

Module I Syllabus

Introduction to Civil Engineering – Various disciplines of Civil engineering, Importance of Civil engineering in infrastructure development of the country.

Introduction to types of buildings as per NBC, Selection of the site for buildings, Components of a residential building and their functions, Introduction to Industrial buildings and types.

Building Planning – Basic requirements, elements, introduction to various building area terms, computation of plinth area, carpet area.

Subject to Revision

1.1 INTRODUCTION TO CIVIL ENGINEERING :-

Civil engineering is a professional engineering discipline that deals with the design, construction, and maintenance of the physical and naturally built environment, including public works such as roads, bridges, canals, dams, airports, sewage systems, pipelines, structural components of buildings, and railways.

Civil engineering is traditionally broken into a number of sub-disciplines. Civil engineering is the application of physical and scientific principles for solving the problems of society, and its history is intricately linked to advances in the understanding of physics and mathematics throughout history. Because civil engineering is a broad profession, including several specialized sub-disciplines, its history is linked to knowledge of **structures, materials science, geography, geology, soils, hydrology, environmental science, mechanics, project management**, and other fields.



1.2 DISCIPLINES OF CIVIL ENGINEERING-

The various disciplines of civil engineering are-

1. ARCHITECTURE AND TOWN PLANNING

An art of **shaping** and **guiding** the **physical growth** of the town creating buildings and environments to meet the various needs such as social, cultural, economic and recreational etc. and to provide healthy conditions for both rich and poor to live, to work, and to play or relax, thus bringing about the social and economic well-being for the majority of mankind is known as town planning.

OBJECTIVES OF TOWN PLANNING-

- To create and promote **healthy conditions and environments** for all the people.
 - To make **right use of the land** for the right purpose by zoning
 - To ensure **orderly development**
 - To **avoid encroachment** of one zone over the other.

2. BUILDING MATERIALS TECHNOLOGY

All the building structures are composed of various types of materials. These materials are either referred to as building materials or materials of construction.

A builder, perhaps an architect or engineer, or a contractor needs to become familiar totally with these building materials. These are some of the most commonly used building materials -

1. Stones
2. Bricks
3. Cement
4. Sand
5. Mortar
6. Concrete
7. Timber
8. Metals
9. Glass
10. Ceramics
11. Miscellaneous Building Materials



3. CONSTRUCTION TECHNOLOGY AND MANAGEMENT

It focuses on the knowledge and skills required for the **planning, coordination** and successful **implementation of large Projects** such as design and construction of structures and buildings, ship structures, aircraft, dams, roads, and bridges etc. It is a fusion of **engineering and management**.

4. ENVIRONMENTAL ENGINEERING:-

- This field is concerned with the study of the necessary methods and techniques of **environment protection** as well as the availability of the basic life elements such as water and air with a specific level of quality to protect the mankind health and environment.
- This includes design and construction of **water distribution networks, wastewater and storm water collection systems, water treatment plants and wastewater treatment** for reuse in industrial and agricultural fields.
- Environmental engineering involves also the study of the different techniques of **controlling air, water and soil pollution** as well as the **proper disposal or recycle of solid and hazardous wastes**.

5. GEOTECHNICAL ENGINEERING:-

- This field is concerned with the study of the **soil properties** of the construction site and its **bearing capacity**.
- Geotechnical engineering is concerned also with the **suitable solutions for any problem in the soil** as well as the choice of the best and secured methods of design and construction of the foundation of engineering structures.

6. HYDRAULICS AND WATER RESOURCES ENGINEERING-

- This field covers the basic concepts of **water science** and its related theorems and applications. This includes the methods of **transporting water from sources to distribution sites** through channels and pipelines, water sources and storage system, types of dams and their design methods.
- It involves also the study of **seawater movements and shore protection**.

- Hydraulic engineering consists of the application of fluid mechanics to water flowing in an isolated environment (pipe, pump) or in an open channel (river, lake, ocean).

7. REMOTE SENSING ENGINEERING-

Remote sensing is the process of **detecting and monitoring the physical characteristics** of an area by measuring its **reflected and emitted radiation** at a distance (typically from satellite or aircraft).

Some specific uses of remotely sensed images of the Earth include:

- **Large forest fires** can be mapped from space, allowing rangers to see a much larger area than from the ground.
- **Tracking clouds** to help predict the weather or watching erupting volcanoes, and help watching for dust storms.
- **Tracking the growth of a city and changes in farmland or forests** over several years or decades.
- Discovery and mapping of the rugged topography of the ocean floor (e.g., huge mountain ranges, deep canyons, and the “magnetic striping” on the ocean floor).

8. STRUCTURAL ENGINEERING:-

- This discipline deals with the **analysis and design of concrete and steel structures**, such as multi-story buildings, bridges, towers....etc. It deals also with the study of the **durability and resistibility** of such structures for live loads, wind and earthquake.
- The study involves also the study of the properties of building materials according to the international specifications.

9. SURVEYING:-

Surveying typically involves measurements of **horizontal and vertical distances** between points. It also includes descriptions of the **exact characteristics of the land structure and surface**.

A **surveying engineer** also works to:

- provide the proper design and development of infrastructure
- protect the surrounding natural environment
- maximize the efficiency of the proposed structures

10. TRANSPORTATION ENGINEERING:-

Transportation engineering is a branch of civil engineering that involves the **planning, design, operation, and maintenance of transportation systems** to help build smart, safe, and liveable communities.

Any system that moves people and goods from one place to another falls under the scope of transportation engineering, which includes:

- Highways and roadways
- Railways
- Oil pipelines
- Public transport systems
- Traffic control systems
- Automated transport systems
- Space transport systems

1.3 Importance of Civil Engineering in Infrastructure Development of the Country:-

Civil Engineers play a major role in the **infrastructure development** of a country. All structures constructed in the past exhibit the path of civilization and current infrastructures development express the practices followed by civil engineers.

Infrastructure can be defined as activities that provide society with services necessary to conduct daily life and to engage in productive activity and development in a country's economy.

In a country like India, the major infrastructural. Factors that are most significant in accelerating the pace of economic development are energy, transport, irrigation, finance, communications, education, and health.

The knowledge of basic areas of civil engineering can be of great use in providing the infrastructural facilities where constructional aspects are involved for development of regions.

- Good surface communication links such as tar or concrete roads.
- Provision of water supply distribution system i.e., construction of water storage reservation or sumps, laying of underground pipes etc.
- Provision of a drainage system which may include construction of surface drains as subsurface drains for the disposal of wastewater.
- Supply of electrical power for which construction of transmission line towers, construction of electrical substations.

- Providing inland communications lines, i.e., telephone lines etc.
- Construction of recreational places e.g., gardens, parks etc.

1.4 TYPES OF BUILDING AS PER NBC (NATIONAL BUILDING CODE):-

Any structure made for whatsoever purpose with any material, used for human habitation or not which included foundation, plinth, walls, floor, roofs, chimney, plumbing, and building services, Verandah, Balcony, and cornice, etc. is called a building. Buildings are classified based on **occupance** and **type of construction**:

- A. RESIDENTIAL
- B. EDUCATIONAL
- C. INSTITUTIONAL
- D. ASSEMBLY
- E. BUSINESS
- F. MERCANTILE (included **retail** and **wholesale** store)
- G. INDUSTRIAL (low, moderate and high fire hazards)
- H. STORAGE
- I. HAZARDOUS

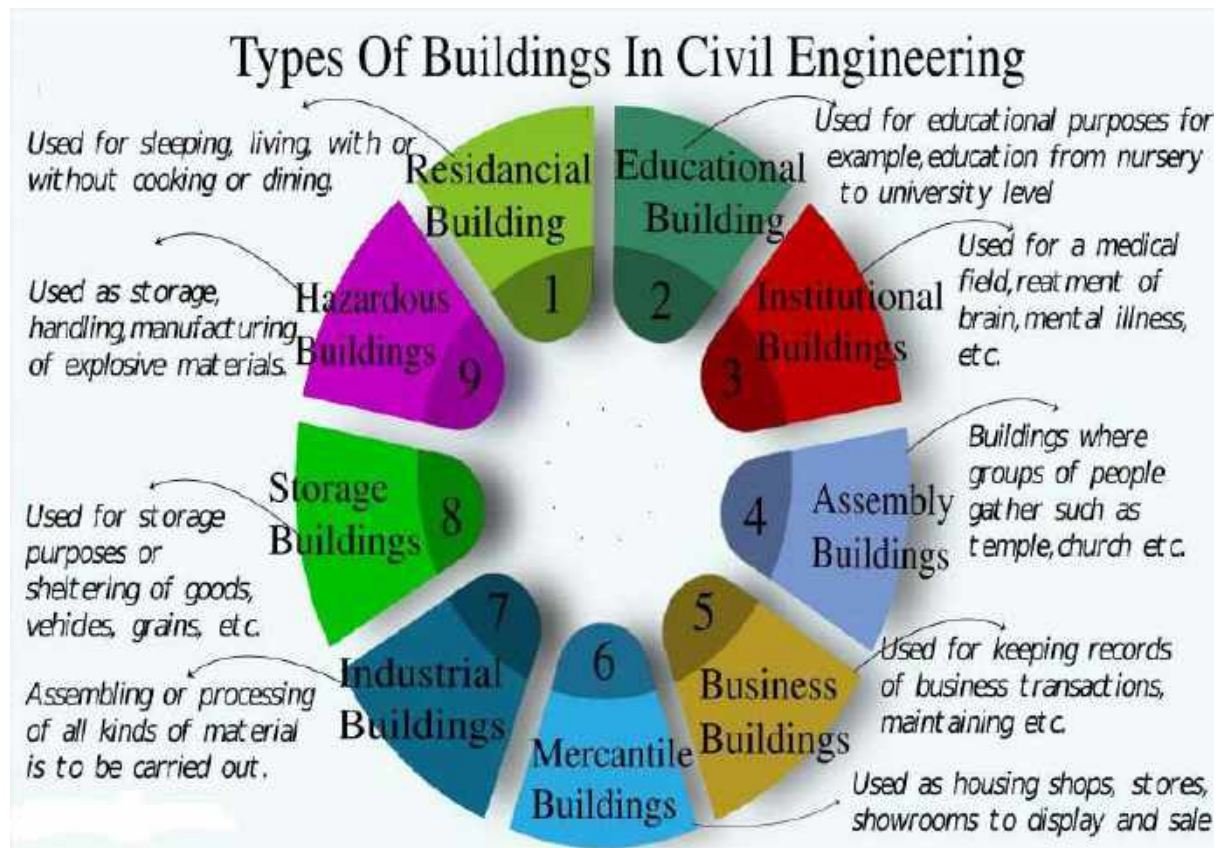

1. Residential Buildings-

Any building in which **sleeping accommodation** is provided for **normal residential purposes with or without cooking/dining**. These are further classified as:

Group A-Residential

- A1: Lodging or rooming houses.
- A2: One or two-family private dwellings
- A3: Dormitories
- A4: Apartment houses
- A5: Hotels (upto 4 star category)
- A6: Hotels (**Starred**- five star and above)

- (i) **Lodging and rooming houses-** These are buildings in which separate **sleeping accommodation with or without a dining facility** but **without a cooking facility** is provided. For instance, Inns, Clubs, Motels, and Guesthouses.
- (ii) **One or two-family private dwelling-** A private dwelling which is occupied by members of one or two-family. Maximum sleeping accommodation is provided for **20 persons**.
- (iii) **Dormitories-** Any building in which group sleeping accommodation is provided with or without dining facilities. e.g., School and College Dormitories, Hostels, and Military Barracks.
- (iv) **Apartment Houses-** Buildings in which living quarters are provided for **three or more families** having independent cooking facilities and living independently of each other. e.g., apartments, Mansions, and Chowls.
- (v) **Hotels -**Buildings in which sleeping accommodation is provided with or without dining facilities for up to four-star categories (hotels).
- (vi) **Hotels (Starred)** Normally five star and above by local authority.

2. Educational Buildings

Any building used for school, college, and other training institutions having a minimum of 20 students.

- (i) Schools up to Senior Secondary level Minimum students should be 20.
- (ii) All others/training institute Minimum students should be 100.

3. Institutional Buildings-

Buildings that are used for medical or other treatment, care of persons suffering from physical and mental illness, care of infants, for inmates etc are called institutional buildings

- (i) Hospital and Sanatoria -Any building which is used for the treatment of patients e.g., hospitals, sanatoria, infirmaries, and nursing homes.
- (ii) Custodial Institutions Any building used for custody and care of a person for instance children, old age homes, orphanages, etc
- (iii) Penal and mental institutions Any building which is used for housing persons whose liberty is restricted e.g., jails, prisons, mental hospitals, etc.

4. Assembly Buildings

Any building in which a minimum of **50 persons** gathers for recreational, amusement, social, religious, patriotic purposes e.g., theatres, assembly halls, exhibition halls, museums, estaurants, places of worship, etc.

These are classified into 7 types:

- (i) The building having **theatrical or motion pictures** or any other stage having fixed seats for **over 1000** persons.
- (ii) The building having **theatrical or motion pictures** or any other stage having fixed seats for **up to 1000** persons.
- (iii) Buildings without a **permanent stage** having an accommodation for **300** or more persons but no permanent seating arrangements.
- (iv) All other structures including **temporary structures** designed for assembly of peoples.
- (v) Buildings having **mixed occupancies** of assembly and mercantile
- (vi) **Underground and elevated mass rapid transit** system.

5. Business Buildings

Any buildings used for the **transaction of business, professional establishments, service facilities**, etc. are termed as business buildings.

These are further divided into 5 types –

- (i) Offices, banks, professional establishments etc.
- (ii) Laboratories, clinics, research establishments and libraries etc.
- (iii) IT parks, call centers etc.
- (iv) Telephone exchange
- (v) Broadcasting stations, TV stations and air traffic control towers.

6. Mercantile Buildings

Any building which is used as a **shop, store, market**, etc. is known as mercantile buildings.

These are further classified as:

- (i) Shops, stores, departmental stores, markets (covered area **up to 500 sq. m**).
- (ii) Shops, stores, departmental stores, markets (covered area **more than 500 sq. m**).
- (iii) Underground shopping centres, storage and service facilities

7. Industrial Buildings

Any building in which products or materials are **fabricated, assembled, manufactured, or processed**. For instance, assembly plants, industrial laboratories, power plants, pumping stations, etc.

- Buildings for **low hazard industry** –
 - Buildings in which those things are manufactured that have low combustibility.
- Buildings for **moderate hazard industry**-
 - Buildings in which those things are manufactured which will burn with moderate rapidity.
- Buildings for **high hazard industry**-
 - Buildings in which those things are manufactured which will burn with extreme rapidity and results in hazardous situations.

8. STORAGE BUILDINGS

- Any building which is used for **storage of goods**, ware or merchandise, vehicles or animals. e.g., warehouse, cold storage, garages, stables, etc.

9. HAZARDOUS BUILDINGS

- Buildings which are used for storage, handling, manufacture, or processing of highly combustible or explosive material. For instance, manufacture of explosives and fireworks, storage of highly flammable liquids, storage of LPG, rocket propellants, etc.

1.5 SELECTION OF SITE FOR BUILDINGS :-

1. The soil of site should have good bearing capacity. Hard strata should be available at reasonable depth, around 1.2m to 1.5m depth from ground level.
2. The site should be on elevated ground. It should have slope towards front street to afford good facility of drainage.
3. Sites nearer to ponds ,pools of water, water logged areas must be avoided as they remain in damp condition .
4. Sites near to high voltage power transmission lines are avoided.
5. Sites very nearer to big shopping complexes , markets, railway station ,airport are avoided
6. The surrounding of site should be pleasing and calm.
7. The orientation of site should be such that it receives natural light and air in plenty.
8. The location of site is such that the common facilities like school, transportation, medical facilities etc are within reasonable range.
9. Sites in developed colonies should be preferred.
10. The layout of the colony should be approved by local authorities. This will help in getting essential facilities like water , drainage ,electricity, telephone connection etc easily.

1.6 COMPONENTS OF RESIDENTIAL BUILDING

Building component means any subsystem, subassembly, or other system designed for use in, or as part of, a structure, which may include structural, electrical, mechanical, plumbing, and fire protection systems and other systems affecting health and safety.

The basic function of a building is to provide **structurally sound and environmentally controlled spaces** to **house and protect** occupants and contents. A building is combination of various components. A Civil Engineer should have good knowledge of execution of each and every component with respect to design layouts given by Architect.

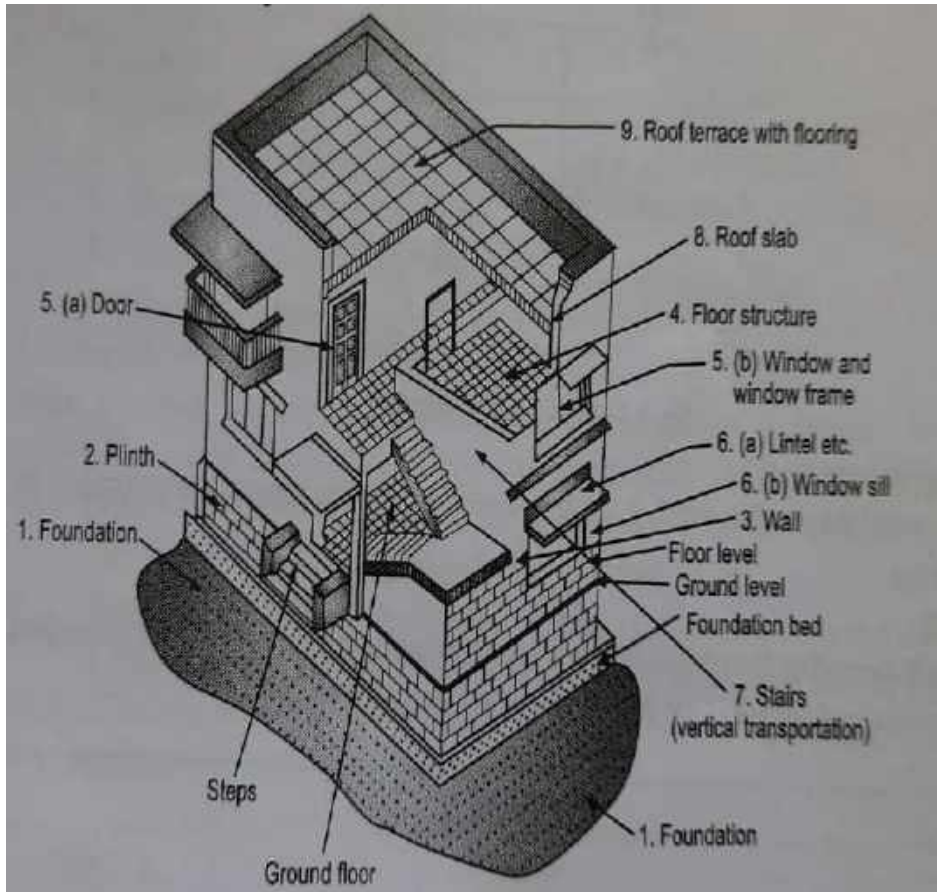

The following are the basic component parts of a **residential building**:-

1. Foundation
2. Plinth
3. Walls and columns
4. Sills, lintels and chejjas
5. Doors and windows
6. Floors
7. Roofs
8. Steps, stairs and lifts
9. Finishing work
10. Building services.
11. Parapet

The functions of these elements and the main requirement of them are discussed below-

1. Foundation:

Foundation is the most important part of the building. Building activity starts

with digging the ground for foundation and then building it. It is the lower most part of the building. It transfers the load of the building to the ground. Its main functions and requirements are:

- (a) Distribute the load from the structure to soil evenly and safely.
- (b) To anchor the building to the ground so that under lateral loads building will not move.
- (c) It prevents the building from overturning due to lateral forces.
- (d) It gives level surface for the construction of super structure.

2. Plinth:

- The portion of the wall between the **ground level** and the **ground floor level** is called **plinth**. It is usually of stone masonry. If the foundation is on piles, a plinth beam is cast to support wall above floor level. At the top of plinth, a damp proof course is provided. It is usually 75 mm thick plain concrete course.

- The function of the plinth is to keep the **ground floor above ground level, free of dampness**. Its height is **not less than 450 mm**. It is required that plinth level is at least **150 mm above the road level**, so that connections to underground drainage system can be made.

3. Walls and Columns:-

The function of walls and columns is to transfer the load of the structure vertically downwards to transfer it to foundation. Apart from this wall performs the following functions also:

- (a) It encloses building area into different compartments and provides privacy.
- (b) It provides safety from burglary and insects.
- (c) It keeps the building warm in winter and cool in summer.

4. Sills, Lintels and Chejjas:-

- A **window frame should not be directly placed** over masonry. It is placed over **50 mm to 75 mm thick plain concrete course** provided over the masonry. This course is called as **sill**.
- **Lintels** are the **R.C.C. or stone beams** provided **over the door and window openings** to **transfer the load transversely** so as to see that door or window frame is **not stressed unduly**. The width of lintels is equal to the width of wall while thickness to be provided depends upon the opening size.

- **Chejja** is the projection given **outside the wall to protect doors and windows** from the rain. They are usually made with R.C.C. In low cost houses stone slabs are provided as chejjas. The projection of chejja varies from 600 mm to 800 mm. Sometimes drops are also provided to chejjas to improve **aesthetic** look and also to get additional protection from sun and rain.

5. Doors and Windows:-

- The function of a **door** is to give access to different rooms in the building and to deny the access whenever necessary. Number of doors should be minimum possible. The size of the door should be of such dimension as will facilitate the movement of the largest object likely to use the door.
- **Windows** are provided to get light and ventilation in the building. They are located at a height of 0.75 m to 0.9 m from the floor level. In hot and humid regions, the window area should be 15 to 20 per cent of the floor area. Another thumb rule used to determine the size and the number of windows is for every 30 sq. m of inside volume there should be 1 sq. m window opening.

6. Floors:-

- Floors are the important component of a building. They give working/useful area for the occupants. The ground floor is prepared by filling brick bats, waste stones, gravel and well compacted with not less than 100 mm sand layer on its top. A lean concrete of 1 : 4 : 8, 100 mm thick is laid. On this a damp proof course may be provided. Then floor finishing is done as per the requirement of the owner.
- Cheapest floor finish for a moderate house is with 20 to 25 mm rich mortar course finished with red oxide. The costliest floor finish is mosaic or marble finishing. Other floors are usually of R.C.C. finished as per the requirements of the owner.

7. Roof:-

- Roof is the top most portion of the building which provide top cover to the building. It should be leak proof. Sloping roof like tiled and A.C. sheet give leak proof cover easily. But they do not give provision for the construction of additional floor. Tiled roof gives good thermal protection. Flat roofs give provision for additional floors. Terrace adds to the comfort of occupants. Water tanks can be easily placed over the flat roofs.

8. Step, Stairs and Lifts:-

- **Steps** give convenient access from ground level to ground floor level. They are required at doors in the outer wall. 250 to 300 mm wide and 150 mm rise is ideal size for steps. In no case the size of two consecutive steps be different. Number of steps required depends upon the difference in the levels of the ground and the floor.
- **Stairs** give access from floor to floor. They should consist of **steps of uniform sizes**. In all public buildings lifts are to be provided for the conveniences of old and disabled persons.
- In hostels **G + 3 floors can be without lifts**. Lift is to be located near the entrance. Size of the lift is decided by the number of users in peak hours. Lifts are available with capacity 4 to 20 persons.

10. Finishing:-

- Bottom portion of slab (ceiling), walls and top of floor need smooth finishing with plaster. Then they are provided with white wash, distemper or paints or tiles. The function of finishing work is:
 - Give protective cover
 - Improve aesthetic view
 - Rectify defective workmanship
 - Finishing work for plinth consists in pointing while for floor it consists in polishing.
- **Building Services:-**
- **Water supply, sanitation and drainage works, electric supply work and construction of cupboards and show cases** constitute major building services.
- For storing water from municipal supply or from tanker a **sump** is built in the house property near street. From the sump water is pumped to overhead tanks placed on or above roof level so as to get water all the 24 hours. Plumbing work is made so as to get water in kitchen, bathrooms, water closets, sinks and garden taps. For draining rain water from roofs, down take pipes of at least 100 mm diameters should be used. Proper slopes should be given to roof towards down take pipe. These pipes should be fixed at 10 to 15 mm below the roof surface so that rain water is directed to the down take pipe easily.

- The **sanitary fittings** are to be connected to stone ware pipes with suitable traps and chambers. Stone ware pipes are then connected to underground drainage of municipal lines or to the septic tank.
- Many **carpentry works** are required for building service. They are in the form of showcases, cupboards, racks etc.
- **Electric supply** is essential part of building services. The building should be provided with sufficient points for supply of lights, fans and other electric gadgets.

11.Parapet:-

- The parapet is a minor wall around the edge of a roof, balcony, terrace, or stairway, usually covering the roof's perimeter. It protects the top and pre-built structures from corrosion and degradation.

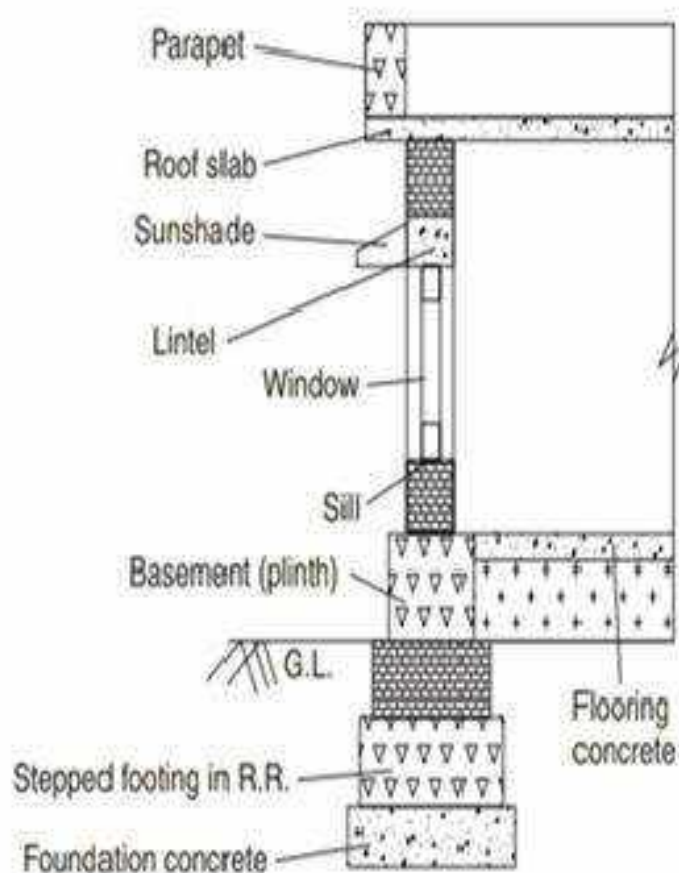

1.7 INTRODUCTION TO INDUSTRIAL BUILDING AND TYPES-

- Any building structure used by the industry to **store raw materials or for manufacturing products** of the industry is known as an industrial building.



- Industrial buildings are generally used for steel plants, automobile industries, utility and process industries, thermal power stations, warehouse, assembly plants, storage, garages, etc.

Factors Considered while Selecting Site For Industrial Building:-

- Site should be located on an arterial road.
- Local availability of raw material.
- Facilities like water supply, electricity
- Topography of an area
- Soil conditions with respect to foundation design
- Waste disposal facilities
- Transportation facilities
- Sufficient space for storage of raw materials

Types of Industrial Building

1. Warehouses
2. Cold Storage Buildings

3. Telecom Centres or Data Hosting Centres
4. Flex Buildings
5. Light Manufacturing Buildings
6. Research And Development Set up

1. Warehouse

- There are buildings that are used for **storing goods on behalf of other companies**. These are called warehouses. Although warehouses can be of different sizes, they are usually large and are located outside city limits. They can have more than one storey and can have loading docks, huge parking lots of big trucks. They can also have a small office set up inside the premises.
- These typical single-story warehouses range in size from 5,000 to hundreds of thousands of square feet and are used for the storage and transport of goods. Ceilings are generally at least 60 feet high because of the necessary racking and storage systems concealed beneath its roof. Loading docks, big truck doors, and parking areas for semi-trailers used for distribution are among the other important elements of an industrial building.



2. Cold Storage Buildings-

- Refrigeration and cold storage facilities are distribution centres dedicated to food items like meat, produce, and dairy. These buildings provide rooms for cooling and freezing in order to maintain goods at the right temperatures before they are sent out. Other key features include docks with special seals to keep products cool, as well as insulated overhead doors that keep them frozen.
- These are especially built to store large amounts of food products and keep them under refrigerated conditions for long periods. These buildings are located mostly along state and national highways and in places where there is good supply of electricity.



3. Telecom/Data Hosting Centers (Switching Centers, Cyber Centers, Web Hosting Facilities, Telecom Centers)

- These highly specialized industrial buildings are located close to major communications trunk lines to allow for access to an extremely large and redundant power supply capable of powering extensive computer servers and telecom switching equipment.

4. FLEX BUILDING:-

- This is the newest addition to the category of industrial segment of industrial real estate and is a result of the evolving needs of modern times. These flex building have **more than one usage and can accommodate a Rand D facility**, an office set up, light manufacturing and even showroom spaces. They are flexible in nature and some of the uses can be changed by making simple modifications.



- **FLEX Building** Systems is committed to providing flexible, superior building systems for a variety of applications. Flex buildings often incorporate different areas or spaces in a design, optimised for different purposes and needs. This can be either an uninsulated or insulated **warehouse, workshop, garage or even a showroom**, often in combination with one or more offices. The buildings often have to balance complex solutions for production, cold storage and heating. Flex space buildings are mainly of three types - **Research and Development buildings, Data centre buildings, and Show rooms**.

5. LIGHT MANUFACTURING BUILDING:-

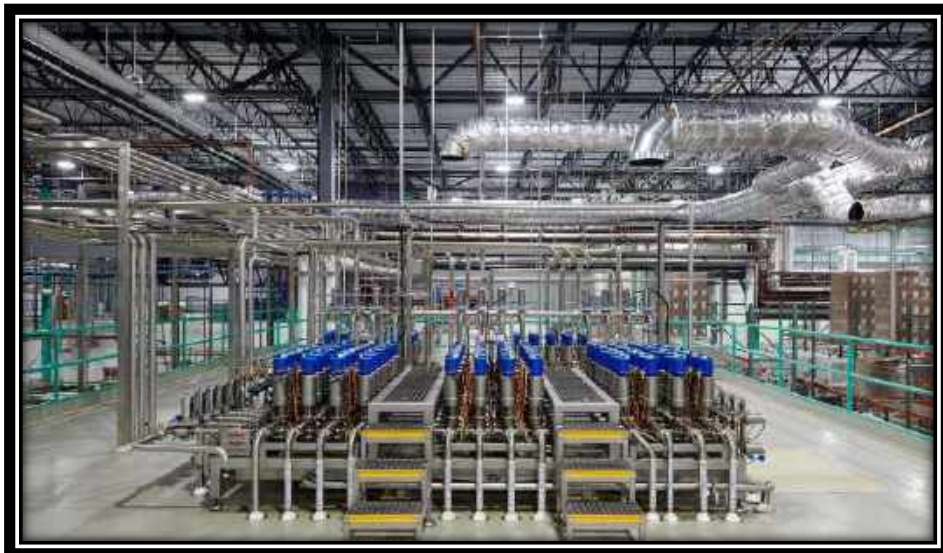

These buildings can be used in processing **food items or assembly of light machinery like fans, water pumps, gadgets**, etc. These are generally small in size as compared to heavy industrial buildings and do not have blast furnace, high capacity exhaust systems etc. These

buildings can sometimes find alternative uses like a unit making water pumps can be converted in to assembly unit for gadget by making changes in the some of the installed machinery.

6. RESEARCH AND DEVELOPMENT BUILDING:-

Research and Development (R&D) forms an integral part of many businesses and they like to set up their own R&D centres which cater to their specific requirements. A lot of life sciences companies have their R&D centres which are usually owned by them. These centres are generally not in the centre of the city. Companies can house their scientists and other staff in these centres and hence there are residential elements in this kind of a set up. There can also be elements of office buildings in a R&D centre. Sometimes these centres run on rented buildings also but the lease period is usually long.



7. SHOWROOM BUILDINGS:-

A showroom, also referred to as a gallery, is a large space used to display products or show entertainment. A showroom is a large space used to display products for sale, such as automobiles, furniture, appliances, carpet or apparel. It is a retail store of a company in which products are on sale in a space created by their brand or company. There are many types of showroom buildings like jewellery shops, malls, large vehicle showroom, furniture showrooms etc.



1.8 BUILDING PLANNING AND BASIC REQUIREMENTS:-

Every family needs a building to reside in. Apart from residential purposes, buildings are required for educational, institutional, business, assembly, and industrial purposes. Buildings are necessary for the storage of materials also. This article will discuss the basic requirements of a building concerning **orientation**, the **utility** of space, **energy efficiency**, and other **requirements**,etc.



“The concept of positioning all the elements and units of a building in a systematic and practical manner to have the **maximum and best utilization of the available space, area and facilities** is termed as **Principles of Building Planning.**”

1.8.1 PRINCIPLES OF BUILDING PLANNING:-

“The concept of positioning all the elements and units of a building in a systematic and practical manner to have the **maximum and best utilization of the available space, area and facilities** is termed as **Principles of Building Planning.**”

There are several principles that affect the planning of a building. This article will give you a brief knowledge of all those principles.

Factors Affecting Building Planning

1.8.2 FACTORS AFFECTING THE PLANNING OF THE BUILDING:-

1. The **function** of the building e.g. residential, industrial, public, commercial, etc.
2. **Shape and size of the plot**

3. **Topography**
4. **Climatic** condition
5. Building by-Laws etc.

1.8.3 REQUIREMENTS OF BUILDING PLANNING AND THE CONSTRUCTION:

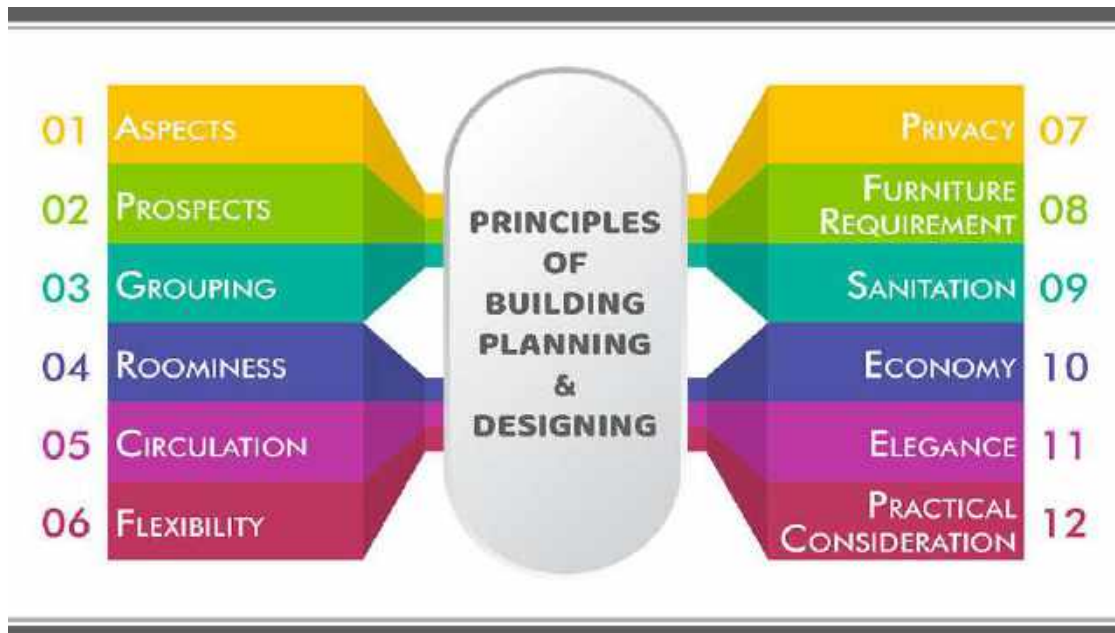

01. What is an ASPECT in building planning?

A building is a complete constitute of different rooms and blocks in it. All the rooms are located according to the standard **use** of components considering the **proper access of natural resources**, i.e., **sunlight** and **wind**. ASPECT is defined as a significant **arrangement of doors and windows** in abuilding, which are enough and efficient to provide **sunlight, hygiene, wind, and eco-friendly environment**. There must be sufficient **light** and **ventilation** in each room and across the house.

The aspect of building can be achieved by **arranging** the rooms, kitchen, veranda, and many other components in **proper directions**. The ways to cover the direction with advisable aspect is given below:

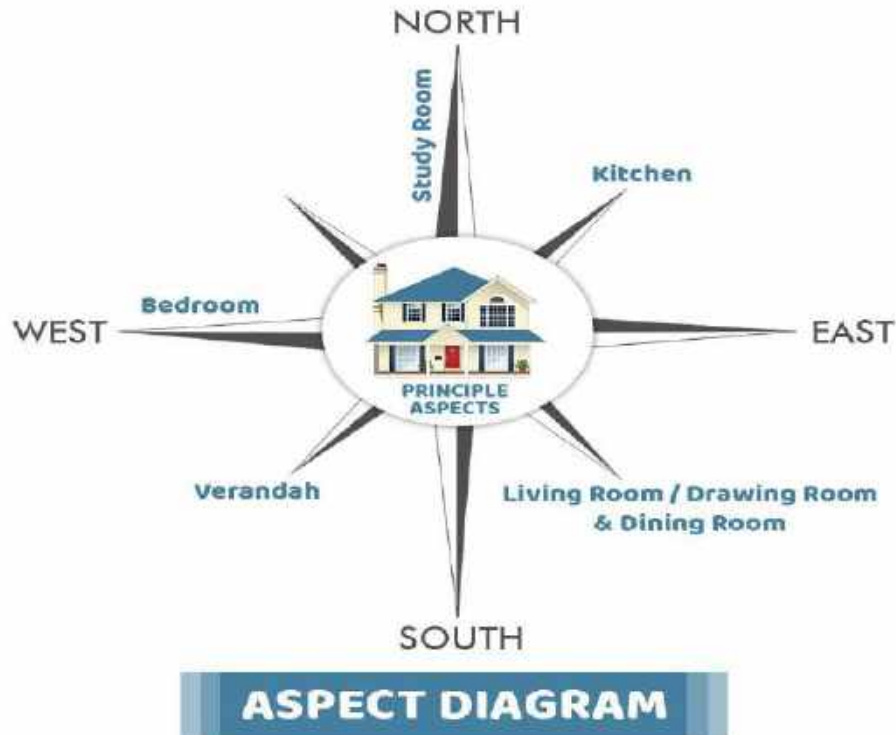

The above diagram indicates the appropriate directions which should be preferred for the **positioning** of various rooms in a house.

02. What are the PROSPECT principles in building planning?

In these modern times, all the buildings and constructions are aimed to achieve an **aesthetically appealing look** from both **exteriors** and **interior** considerations. The appearance of a house or a building is defined as **PROSPECT**.

The standards are raised to accomplish the building's **pleasant look** by locating doors and windows at an **accurate location** to view nature's beauty and avoid unwanted attributes from getting entry into the house.

One of the other factors of the prospect is to have a pleasant view outside a house from doors, windows, balconies as clearly as possible, as shown in the above image.

03. What does the GROUPING mean in building planning?

GROUPING: It is to organize the different rooms in such a way that they are adequately **interconnected with each other** to form a functional and practical layout of the house. The **accessibility** of all the rooms is **interlinked** with each other, and this provision can be satisfied by grouping.

To understand the theory of grouping, let us consider an example. In a simple sense, the dining room should be near the kitchen so that both the units can be easily used for the service. Similarly, water closets should be close to the bedrooms and living room but not close to the kitchen.

An idea of the grouping is applicable not only in a residential building but also applies to commercial and industrial buildings. In industries, the storage rooms must be near the road to ease the loading and unloading of the goods.

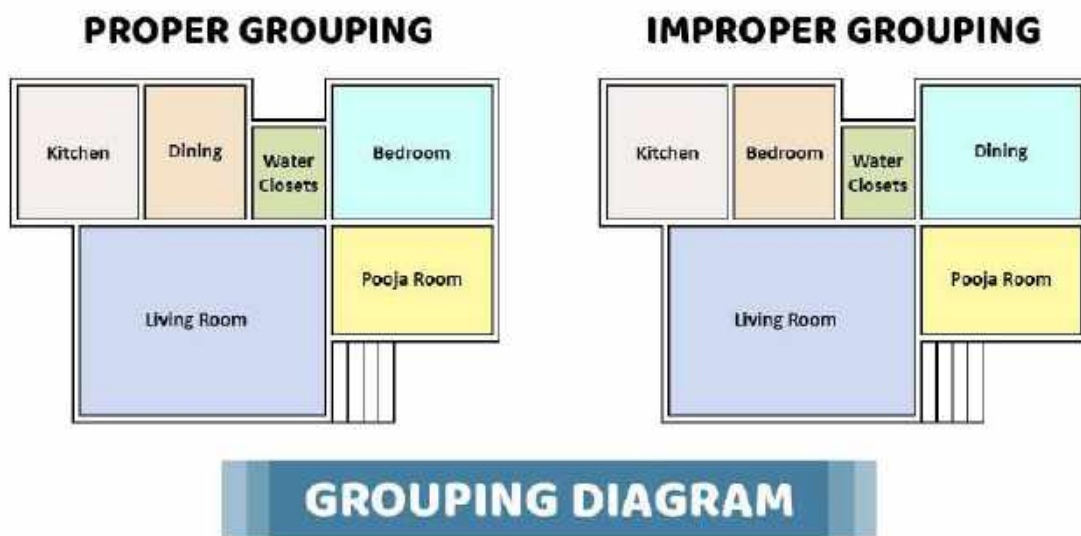

The above figure indicates the common groups of rooms, which should be combined together while planning a residential building.

04. How ROOMINESS can be a principles of building planning?

- The meaning of ROOMINESS is to **maximize the advantage of the available space** from the **minimum dimension** of a room. Both the size and shape of the room play a vital role in providing roominess.

POINTS TO UNDERSTAND THE ROOMINES

- A square room seems small in size when compared to a rectangular room.
- It is always advisable to plan a rectangular room with a proportion of **1.2 to 1.5 times the ratio of the length to the breadth**. The increase in ratio due to length gives the tunnel experience as it looks longer.

- Also, the **height** should neither be too high nor too less that the ceiling becomes a hindrance.
- Floors, ceilings, walls, ceiling, lifts, furniture, and all such elements should be appropriately placed to offer more space in the rooms.

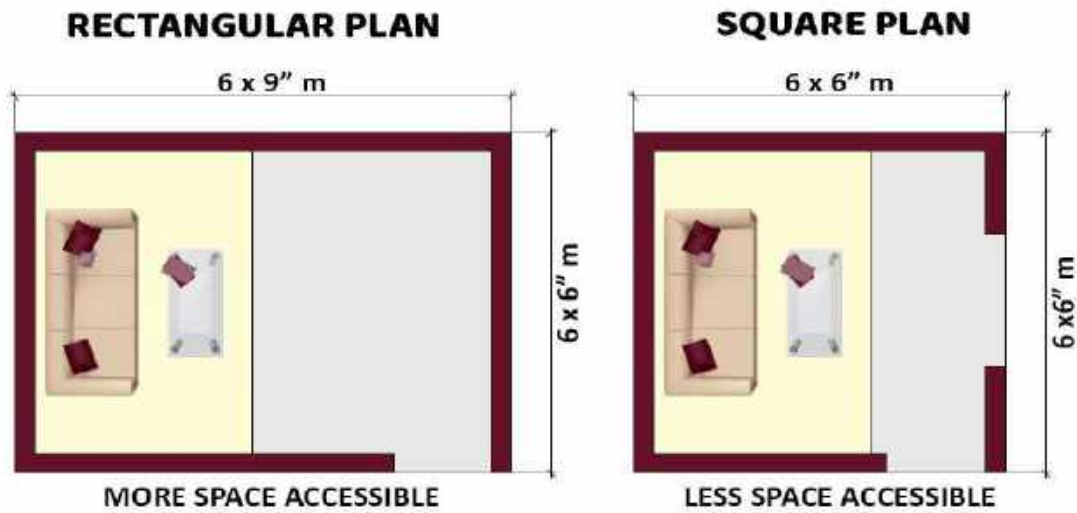

ROOMINESS DIAGRAM

05. How CIRCULATION act as a principle of building planning?

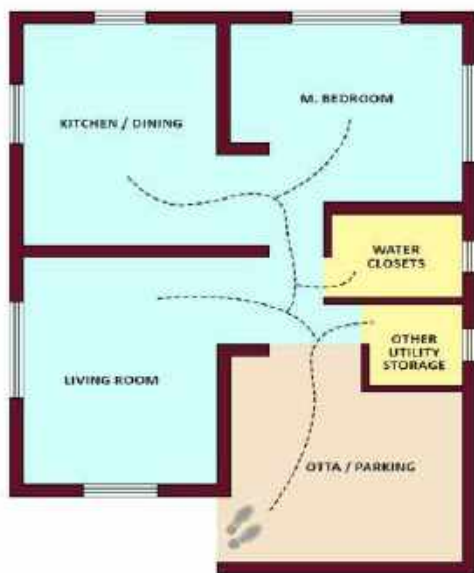

**HORIZONTAL CIRCULATION
IN A ROOM**

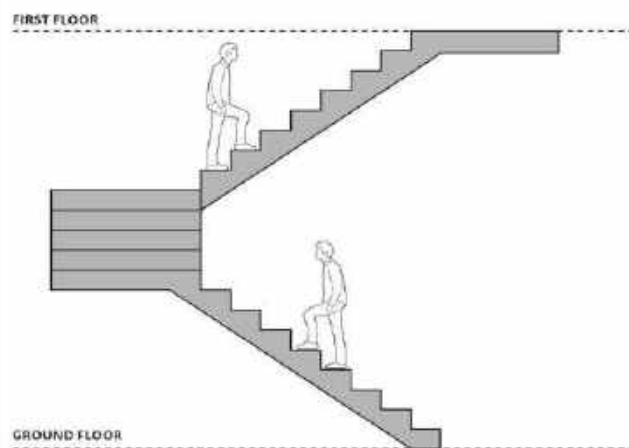

**VERTICAL CIRCULATION
IN A ROOM**

CIRCULATION IN A ROOM

The **internal access in a room in both ways** i.e. in **horizontal and vertical** directions of a building is defined as **CIRCULATION**. The movement from one room to another on the same floor can be described as **horizontal circulation**. Likely, the movement from one floor to the other floor is termed as vertical circulation. To have the efficient circulation in a building, passages, corridors and foyer etc should be provided in such a way that these elements are neither too **narrow nor too large**. They must have **good lighting and ventilation**. Some better options are highlighted in the diagram which reflects the ways of good circulation in a house.

06. What is Flexibility in building planning?

Flexibility means “to **allow use of the particular element in another way possible to fulfil a specific purpose**. An element is initially designed for one **particular reason**, but later the same element is **used differently**.”

Let us take an example to understand the concept of the flexibility. One storey residential house has a dining and drawing hall on the ground floor, separated with a fibre partition wall in it. For various events and gatherings, both **dining** and **drawing** hall can be **combined** and converted into a **banquet hall** by removing partition wall. Also, future expansions of converting one unit to another must be kept in mind as it is one of the basic principles of construction.

07. What does Privacy means in building planning?

Privacy is an important factor that needs prior attention. Usually, the privacy can be considered in two ways:

01. Internal Privacy: This deals with the privacy inside a house, amongst the rooms. It covers the privacy between rooms and water closets, corridors, passage lobbies etc.

02. External Privacy: Privacy of a building with respect to other buildings and the things outside the building- such as streets, roads, etc., is external privacy.

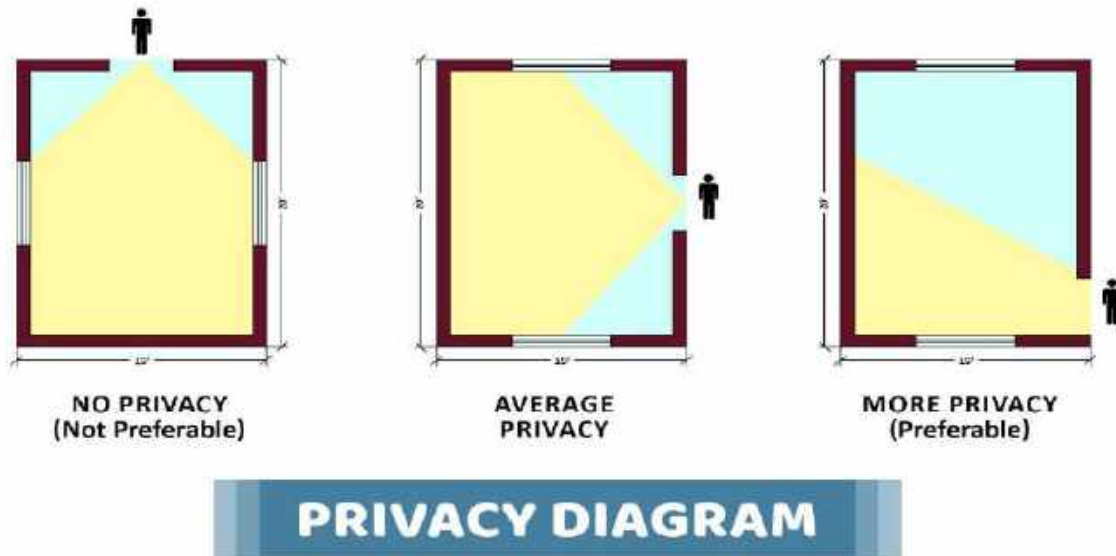

08. How FURNITURE influence principles of building planning?

According to rooms' functions, the type of furniture varies. The architects and planner must consider the **furniture's relative positions** to **avoid the congestion** of space. The furniture should match the purpose of the room and justify the **effective use of a room and furniture** as well.

There are many points to consider while choosing furniture for your house.

09. What is SANITATION in building planning?

The **hygiene maintenance** in a building is crucial. **Light, ventilation, and sanitary conveniences**, are essential factors that provide good sanitation in a building. Adequate sanitation can be achieved by placing **doors, windows, and ventilators** appropriately. Installing **exhaust fans, lighting lamps, suitable absorbent flooring, and improvised plumbing equipment** can lead to better sanitation.

It is studied that for **proper lighting**, the **least area of window** should **not be less than 1/10th of floor area** in residential building. This ratio can be raised to **1/5th for buildings other than residential** ones.

11. What is the importance of ECONOMY in building planning?



The economy is also one of the major factors to keep in mind while planning a structure. The building should not be **too expensive**. However, having said that, the cost cutting should not happen by **compromising on the safety and the building principles**. Often, the cost of the construction at the initial stage is higher as standard designs and materials are used, but it reduces the cost of maintenance and repair in the future.

11. What is ELEGANCE in building planning?

The elegance has a direct connection with the **appearance and layout** of a plan. It has become a trend nowadays to construct **attractive elevations**, which gives a pleasant sense of visibility. Straight, it depends on the **materials used** for construction in the exterior portion and relies on the positions of the door, windows, chhajja, balconies, and many such factors. All these components aim to enhance the look and thus it is necessary to give more footage to it while building planning.



12. What are the PRACTICAL CONSIDERATIONS in building planning?

While **designing and planning** a building, there are several practical points to be considered for better results. These practical considerations are briefly mentioned as follows:



Life of a Building:

Having considered all the above important attributes a common question that arises is how long a building will survive and sustain and will remain serviceable? It is generally said that, a building has a **100 years life**, but this is not always true. The life of a building does not only deal with the **physical life** but also focuses on **economic** as well as **functional life**.

1.9 BUILDING AREA TERMS:-

Plot area:

The area which is **surrounded by a boundary line** (fencing) is called as Plot Area.

Plinth area or Built-up area

The **total building area** in plot area is referred as **Built up area**. In simple, Area **excluding empty space** around the building is called Built up area or Plinth area.

Built up Area = Carpet area+ Thickness of All walls + balcony

The **plinth area** is the area that lies within the **outer-to-outer dimensions** of the walls of the building and is obtained by multiplying the out-to-out dimensions of the building at any floor level. The **space** covered by **pillars, pilasters, and other intermediate support** are not calculated in the floor area.

The built-up area and plinth area may or may not be the same.

Carpet Area:

It is the area that can **actually be covered by a carpet**, or the area of the apartment **excluding the thickness of inner walls**. Carpet area does **not include** the space covered by common areas such as **lobby, lift, stairs, play area, etc.** **Carpet area** is usually around **70%** of the **built-up area**.

Setback area:

The **empty space** around the building is called **Setback area**. The setback area is decided by Municipal Authority. In India, we **leave 4 ft from all the sides of the building**. The reason behind leaving setback area is to make ease for moving **vehicles, ventilation and during emergency purposes**. However set back area increases for High rise building and may go up to several meters.

Setback area = Plot area – Built-up Area

Built-Up Area:

Built-up area is the area that comes after adding **carpet area (70%) and wall area (30%)**. Now, the **wall area** does not mean the surface area, but the **thickness of the inner walls** of a unit. The area constituting the **walls is around 20% of the built-up area** and totally changes the perspective.

The built-up area also consists of other areas mandated by the authorities, such as a **dry balcony, flower beds, etc.**, that add up to **10%** of the built-up area. So, when you think about it, the usable area (carpet area) is only **70% of the built-up area**.

Super Built-Up Area:-

It is the area calculated by adding the **built-up area and common area** that includes the **corridor, lift lobby, lift, etc.** In some cases, builders even include amenities such as a **pool, garden and clubhouse** in the common area. A developer/builder charges you on the basis of the **super built-up area** which is why it is also known as '**saleable**' area.



COMPUTATION OF PLINTH AREA/BUILT UP AREA -

- Plinth area = building carpet area + wall area (both internal and exterior walls) + parasitic area + elevator openings, etc.
- The plinth area is the space between the building's exterior and outer bounds or its walls.
- The **plinth area is 10 to 20% greater than the carpet area.**

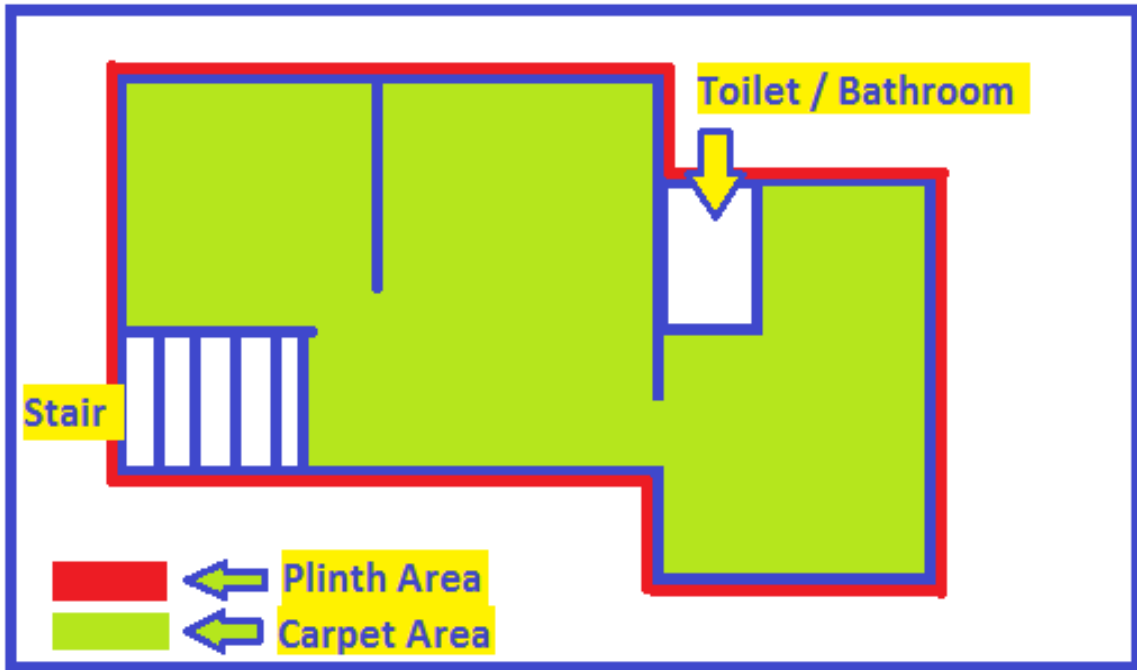

COMPUTATION OF CARPET AREA/LIVABLE AREA-

- Calculated by subtracting the area of the **outer and inner walls** of the building from the **total floor area of the building**. **Carpet Area = Built-up area – Area of walls.**
- For example, if the built area of a property is 2000 sq ft, then its carpet area would be 1400 sq ft.
- The carpet area is the sum of the **actual areas of the rooms that you can carpet**
- The carpet area is smaller than the plinth area by 10 to 20%.

#####

Module-II

Module II Syllabus

Surveying - Principle and objectives, Instruments used, Horizontal measurements, Ranging (direct ranging only), Instruments used for ranging, Leveling – Definition, Principles, Instruments, Preparation of level book, problems on leveling, Modern surveying instruments – EDM, Total station, GPS (Brief discussion)

Building Materials - Bricks, properties, and specifications, Cement – Types, properties, grades, other types of cement and uses, Cement mortar – Constituents, Preparation, Concrete – PCC and RCC, Grades, Steel – Use of steel in buildings, types.

Subject to Revision

SURVEYING

Principle and objectives, Instruments used, Horizontal measurements,

Ranging (direct ranging only), Instruments used for ranging,

Leveling: Definition, Principles, Instruments, Preparation of level book, problems on leveling,

Modern surveying instruments – EDM, Total station, GPS (Brief discussion)

Surveying is the art of determining the **relative positions on, beneath, or above the surface of the ground or earth** by the direct or indirect way of measurements of **distance, direction, and elevation**.

Surveying principle:-

Two basic principles of surveying are:

- Always work from **whole to the part**
- To locate a **new station** by **at least two measurements** (Linear or angular) from a fixed reference points. The area is first enclosed by main stations (i.e. Control stations) and main survey lines.

Objectives of Surveying

Surveying is the means of determining the **relative position of points** and the **relative distances**. It is very important in the field of Civil Engineering. We can find uses of surveying in all civil engineering projects. The objectives of surveying may vary depending on the type of project. The main objectives of surveying are discussed below.

- To determine the **relative position** of any objects or points of the earth.
- To determine the **distance** and **angle** between different objects.
- To prepare a **map** or **plan** to represent an area on a horizontal plan.
- To develop methods through the knowledge of modern science and the technology and use them in the field.
- To solve **measurement problems** in an optimal way.

Station: A **definite point on the Earth** whose **location** has been **determined** by surveying methods. Usually, but not always, **marked on the ground** using a monument of special construction, or by a natural or-artificial structure. The station's origin or purpose is usually described in its name.

Datum: An **assumed surface** used as a **reference** for the measurement of heights and depths. A line to which dimensions are referred on engineering drawings, and from which measurements are calculated **Horizontal datums** measure **positions** (latitude and longitude) on the **surface of the Earth**, while **vertical datums** are used to measure **land elevations** and **water depths**.

Bench mark: A **post** or other **permanent mark** established at a **known elevation** that is used as the **basis for measuring the elevation** of other topographical points.

Reduce level: Reduced level refers to **equating elevations of survey points with reference to a commonly assumed datum**. It is a vertical distance above or below the datum plane. The most common datum used is Mean Sea Level. This reduced level is the term used in levelling.

Surveying Instruments

Surveying instruments are used to assist in measuring land, including vertical distance, horizontal distance, and volume of excavated material. A land surveyor uses surveying instruments to make precise measurements of the earth's surface. Instruments used in surveying include:

HORIZONTAL MEASUREMENTS

- A. DIRECT LINEAR SURVEYING
- B. SETTING OUT RIGHT ANGLES
- C. SETTING OUT DIRECTIONS
- D. SETTING OUT ANGLES

A. Instruments for DIRECT LINEAR SURVEYING

1. MEASURING TAPES



Measuring Tape

It is made up of cotton, coated linen, or any other synthetic material. Centimeters or decimeters are marked on the tape.

They are available in lengths of 20, 30, or 50 meters.

Metallic tape: Available in lengths 2, 5, 10, 20, 30, and 50 meters. Except for 2 and 5-meter tapes, other tapes have a small ring fastened at the ends which is of the same width as that of the tape for protection and are supplied in a leather or metal case with a winding device.

Steel tape: Available in lengths 1, 2, 10, 20, 30, and 50 meters. Except for 1 and 2-meter tapes, other tapes have a small brass ring fastened at the ends. These tapes are supplied in a corrosion-resistant metal case or a leather case with a winding device.

Invar tape: Available in lengths of 20, 30, and 100 meters. Made up of an alloy of nickel and steel with a low thermal coefficient of expansion.

Used for linear measurements that require high precision. It should be kept on reels of high diameter as they can be easily bent and damaged.

2. SURVEYING CHAINS



Surveying Chains

Use

- The chain is used to measure the distance on the **ground**. It gives much **more accurate measurements** as compared to tape.
- A chain is a surveying instrument that is made up of connecting **links** of galvanized mild steel. The mild steel wire is bent into a ring and joined to each other with three small circular or oval rings. Each connecting link measures 20 cm.
- A tally marker or a special joint is also installed sometimes to mark the distance of 5 meters.
- The total length of the chain is 20 meters or 30 meters, which also includes a **brass handle** on each end. The handles are provided with swivel joints so they can be easily turned during surveying without being twisted.

3. ARROW:-



Arrows

Use

- Arrows are used for **marking** and are made up of hardened, and tempered **steel wire** of good quality.
- **10 arrows are usually sold with a chain.** Its length is about **25-50 cm.** One of its ends is **sharpened** while the other end is bent into a **circular loop.**
- To mark the chain length on the ground, an arrow is inserted at the end of the chain.

4. PEG



- Pegs are mostly made of **timber.** They are also used to **mark** out the locations on the ground at terminal points or the end of the survey line.
- They are 2.5-3 square centimeters and are of **15cm** length with a tapered end. A **hammer** is used to drive the peg into the ground.

5. RANGING RODS



Ranging Rods

- Ranging rods are **2-3 meters** in length and are painted with **alternate bands** of **two colors** like **white and black, red and white** in succession. Each band is kept at a length of 20 centimeters.
- Ranging rods are made of **well-seasoned timber**. Their cross-section is kept either circular or octagonal with a 3 cm nominal diameter.
- They are used to **range an intermediate point** on a **survey line**.

6. OFFSET RODS

- It is similar to a ranging rod but is of a **3 m length**. They are also wooden rods, circular in cross-section. Its one end is pointed with an iron shoe and at the other, a notch or hook is provided.
- It is used to take **rough offsets** in the nearby regions. Also, the **right angles** can be set out with its help as it has **two narrow slots** at its center.

7. PLUMB BOB

- It is used to **transfer the points** to the **ground** on a slope while **chaining**. It is also used to make the **ranging poles vertical**.
- In theodolites, compasses, plane tables, and other surveying instruments, it is used for **centering purposes**.



Plumb Bob

B. Instruments for SETTING OUT RIGHT ANGLES

1. CROSS STAFF

It is the simplest instrument for **setting out right angles** on a survey line. It has a frame containing **two pairs of opposite slits** mounted on a pole. The pole can be used to fix the instrument on the ground.

Types of cross staff:

- **Open cross-staff:** Two pairs of vertical slits are present which gives two lines of sight at right angles.
- **French cross-staff:** It has a hollow octagonal box set up on a pole. On each face, vertical slits are cut in the middle for sighting. The lines of sight are at an angle of 45° to one another.
- **Adjustable cross-staff:** It has two cylinders of equal diameter with sighting slits placed on each other. The upper box can be rotated and is provided with a vernier to take measurements. The lower box has graduations of degrees and subdivisions. Any angle can be set out with the help of this instrument.

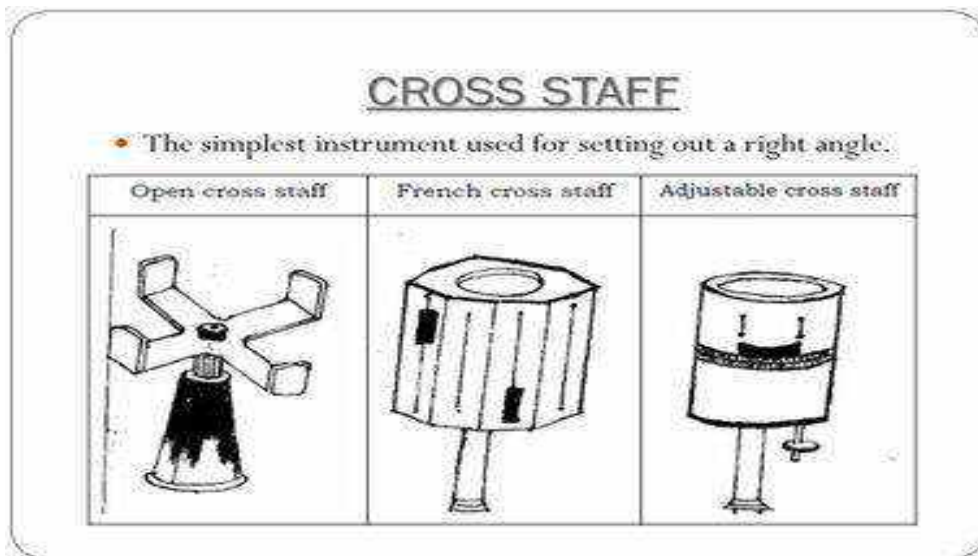

2. OPTICAL SQUARE



Optical Square

- It is **more accurate** than a cross-staff. Also, it is convenient to use for setting out right angles. It has a circular box with three slits.
- The instrument is set on the line whose perpendicular is to be set out. Two slits point towards the ranging rod at the end of the survey line.
- Then another ranging rod is to be set at such a point that the two images coincide with each other. This point is perpendicular to the initial line.

3. PRISM SQUARE

- The principle of the prism square is similar to that of the optical square. However, it is **more precise** as compared to the optical square.
- It can be used in a similar manner as an optical square. Unlike the optical square, **adjustment is not required**, as the angle between the reflecting surfaces does not vary.



Prism Square

C. Instruments for SETTING OUT DIRECTIONS:

1. PRISMATIC COMPASS

It comprises a **magnetic needle** attached to a graduated circular ring made up of aluminum. The needle orients itself to the magnetic meridian if it is on the pivot. Object vane and eye slit are attached to the compass box and help in locating the line of sight.

It is a magnetic compass that measures the **magnetic meridian** (circle of **constant longitude** passing through a **given place** on the earth's surface and the terrestrial poles). It is portable and hence convenient too. It can be either used in the palm or fixed on a tripod.



Prismatic Compass

The south end corresponds to 0° while the west end corresponds to 90° and so on. Thus, the north end is at 180° while the east end is at 270° .

2. SURVEYOR'S COMPASS

The graduated ring is directly attached to the box instead of the needle in the surveyor's compass. The needle is allowed to float freely over the pivot, but it does not orient itself to the magnetic meridian as in the case of a prismatic compass.



Surveyor's Compass

- The object vane and eye vane are similar to that of the prismatic compass, however, no prism is provided. The instrument is to be fixed on a tripod.
- The readings through this compass are taken against the north end of the needle by looking through the top glass vertically. When the line of sight coincides magnetic meridian, the north and south ends are at 0° . While the east and west end corresponds to 90° .

D. Instruments for SETTING OUT ANGLES

1. THEODOLITE

- It is the most precise instrument for the measurement of **horizontal and vertical angles**. It is popular in various surveying applications.

- There are two **types of theodolite**- transit, and non-transit. **non-transit theodolites have become obsolete** these days.
- **Transit** theodolite is such theodolite in which the **telescope** can be revolved by 180° in the vertical plane.



2. TOTAL STATION

- It is an **electronic transit theodolite with an electronic distance meter (EDM)**.
- The crosshairs on the reflector of TS are aligned to the ranging rod and the vertical and horizontal angles are measured along with slope distances simultaneously.



Total Station

Total Station is used to take the measurement of-

1. **Horizontal angles:** The rotation of the optical axis of TS from the instrument north in a horizontal plane gives the horizontal angle.
2. **Vertical angle:** The inclination of the optical axis of TS from the local vertical gives a vertical angle.
3. **Slope distance:** The distance between TS and the target gives the slope distance.

TS can store data too as some have inbuilt internal electronic data storage, which can be uploaded to the computer, and the data analysis can be done with the help of various applications.

HORIZONTAL DISTANCE MEASUREMENT

Horizontal distance means the distance between two points measured at a zero percent slope.

Horizontal distance means the distance between two points measured at a 0% slope.

Method of horizontal distance measurements

Direct: using chain (chaining) or tape (taping)

Low precision work: chaining

High precision work: taping or bars

Engineer's chain: 100 ft long, 100 links each 1 ft, at every 10 links brass tags are fastened.

Notches on the tag indicates the number of 10 link segment between th tag and the end of the chain.

Gunter's chain: 66 ft long, 100 links, each ft.

distances are recorded in chains and links.

Indirect: the distances are not measured directly on the field but are computed indirectly using observed quantities.

EDM: electromagnetic distance measuring instrument.

The principal methods of measuring distance are the

- pacing.
- odometer.
- chain (chaining) or tape (taping)
- stadia(Tacheometer)
- optical range finder.

TAPING

Taping is the **linear measurement** of the horizontal distance between two points using a surveyor's tape. Observation of horizontal distances by taping consists of applying the known length of a graduated tape directly to line a. number of times.

CURRENT TAPING EQUIPMENT

Surveyor's and Engineer's Steel Tapes

Standard lengths 100, 200, 300, and 500 ft

30, 60, 100, and 150 m

Other Tapes

- **Builder's Tapes** -- common construction tape measures, usually marked in feet and inches
- **Cloth Tapes** -- inexpensive linen with fine copper wires for strength, not for precise work
- **Fiberglass Tapes** -- inexpensive flexible tapes wound on a reel, used like steel tapes
- **Invar Tapes** -- made of 35% nickel/65% steel and do not expand as much as steel with heat, but are 10X more expensive than steel tapes

TAPING ACCESSORIES

- **Chaining/Taping Pins** -- used to mark tape lengths, especially when it is required to "break tape" or when measuring over 100 feet, usually painted red and white
- **Hand Level** -- helps to keep tape level over sloping or uneven ground
- **Tension Handles** -- helps you to hold on to tape when pulling it taut
- **Pocket Thermometer** -- helps you figure expansion and contraction of tape due to temperature
- **Range Poles** -- long poles used to mark points over long distances to help keep tape aligned properly
- **Plumb Bobs** -- help you locate tape directly over point being measured

SURVEYING

Surveying is a scientific method that determines the three-dimensional positions and angles of relative points on the surface of the earth. Different types of surveying methods and their classification are used in construction which is described below.

TYPES OF SURVEYING:

Surveying may be divided into two general categories.

1. Geodetic Surveying and
2. Plane Surveying.

1. Geodetic Surveying:

Geodetic surveying is a particular type of surveying where the **curvature of the earth is taken into account**. Since the earth has a spherical shape, the line connecting any two points on the earth's surface is **curved** or is an **arc**.

Hence it involves spherical trigonometry. In geodetic surveying, large distances and areas are measured and its degree of accuracy is comparatively high.

2. Plane Surveying:

Plane surveying is a specific type of surveying where the **surface of the earth is considered as a plane** and the curvature of the earth is not taken into account. The line connecting any two points is a **straight line** and the angles of polygons are **plane angles**.

This type of surveying is suitable for **small and flat areas**, and its degree of accuracy is comparatively low. The limit for treating a surface as a plane is about 250 km².

CLASSIFICATION OF SURVEYING:

A. CLASSIFICATION BASED ON THE NATURE OF THE FIELD:

1. Land Surveying.
 2. Marine Surveying.
 3. Astronomical Surveying.
1. **Land surveying** can be sub-divided into the following categories:
- Topographical Surveys.
 - Cadastral Surveys.
 - City Surveys.
 - Engineering Surveys.
 - **Topographic Surveying**-It determining the relative locations of points (places) on the earth's surface by measuring horizontal distances, differences in elevation and directions.
 - **A cadastral survey** is a classification of land surveying conducted to determine the boundary of a location for a purpose. It specialize in the establishment and re-establishment of real property boundaries. Hence, cadastral survey is necessary for legal creation of properties.
 - **The engineering survey** is the process used to determine the exact position of objects on the Earth's surface (whether natural or artificial) by collecting, evaluating and recording various data on the ground

NOTE-Land surveying mainly deals with the natural and artificial features of a country such as hills, rivers, buildings, towns, villages, etc.

- 2. Marine Surveying:** Marine or hydrographic survey deals with bodies of water for purpose of navigation, water supply, harbor works or for determination of mean sea level. The work consists in measurement of discharge of streams, making topographic survey of shores and banks, taking and locating soundings to determine the depth of water and observing the fluctuations of the ocean tide.
- 3. Astronomical Surveying:** The astronomical survey offers the surveyor means of determining the absolute location of any point or the absolute location of and direction of any line on the surface of the earth. This consists in observations to the heavenly bodies such as the sun or any fixed star.

B. CLASSIFICATION BASED ON THE OBJECT OF THE SURVEY:

1. Archaeological survey.
2. Geological Survey.
3. Mine Survey.
4. Military Survey.

C. CLASSIFICATION BASED ON THE INSTRUMENTS:

1. Chain Surveying:

Chain surveying is the simplest method of surveying in which linear measurements are directly taken in the field and angular measurements are not taken. This type of surveying is used over small and leveled areas.

2. Plane Table Surveying:

In plane table surveying, the fieldwork and plotting are done using a graphical method. It is mostly adapted for small and medium scale mapping where great accuracy is not required.

3. Compass Surveying:

In this type of surveying, a compass is used to determine the direction of survey lines, and the length of survey lines is measured by a chain or tape, or laser range finder. The compass is generally used to run a traverse line. There are three types of compass used in surveying:

- Prismatic compass
- Surveyor's compass
- Level compass

4. Tacheometric Surveying:

Tacheometric surveying is a method of surveying in which the horizontal and vertical distances of relative points are determined without using any sophisticated instruments such as chains, tape, etc.

5. Theodolite Surveying:

The theodolite is an instrument that is used to measure horizontal and vertical angles. It allows surveyors to “triangulate” the position of objects in a specific area. Theodolite is two types i.e transit theodolite and non-transit theodolite. Theodolite surveying is commonly used for

- i) Prolongation of survey lines,
- ii) Finding the difference in elevation, and
- iii) Setting out engineering works that require higher precision, i.e., ranging highway and railway curves, aligning tunnels, etc.

6. Photographic and Aerial Surveying:

These types of surveying are done by taking photographs from elevated ground stations. It deals with the production of maps such as topographic or planimetric maps by compiling number of photographs taken in that area.

D. CLASSIFICATION BASED ON THE METHODS OF SURVEY:

1. Triangulation Surveying

Triangulation is a method of surveying that measures the angles in a triangle formed by three survey control points. Using the trigonometry formula and the measured one side’s length, the other distances in the triangle are calculated respectively.

2. Traverse Surveying

It is also a well-known method of surveying. A traverse is a series of connected lines whose lengths and directions are measured with the help of an angle measuring instrument and tape or chain, respectively.

RANGING IN SURVEYING

<<*Ranging (direct ranging only), Instruments used for ranging*>>

The process of establishing an **intermediate point on a straight line** between two endpoints is known as ranging.

It is used when a **survey line** is **longer** than a **chain length**. It is necessary to **align intermediate points** on the **chain line** so that the measurements are along the line.

Ranging is the process of establishing **many intermediate points** to measure the survey lines in **linear measurement**. This can be done by ranging rods, offset rods, and ranging poles. The first step in any construction work is Surveying. Ranging is one of the important aspects of Surveying.

When the length of the surveying line is longer than the length of the measuring chain, the line can be measured by using intermediate points along with it by ranging.

Types of Ranging

Ranging can be of two types

1. Direct ranging: If two survey stations are **inter-visible**
2. Reciprocal or Indirect ranging: If two If two survey stations are not **inter-visible**

Direct ranging

Direct ranging is adopted when the two survey stations are **inter-visible** i.e. the **two end points** of the survey line are **visible**. It can be further of two types

- **Ranging by eye:** It is done with the help of the **eyes**. For example, A and B are the two inter-visible points at the survey end line. Surveyor stands at **point A concerning point B**. Then, another person takes the **ranging rod and fixes** or establishes an intermediate point **C between the line AB**. The surveyor at point A then signals **another person at the intermediate points** so that the ranging rod is in perfect line with the **endpoints A and B**. Hence, the intermediate points are determined.
- **Ranging by line ranger:** Here intermediate points are fixed directly utilizing an instrument known as **line ranger**. The major advantage of this method over the eye judgment method is that this method can be conducted easily by **one person**. The **accuracy** achieved by this method is also **higher**.

Direct ranging

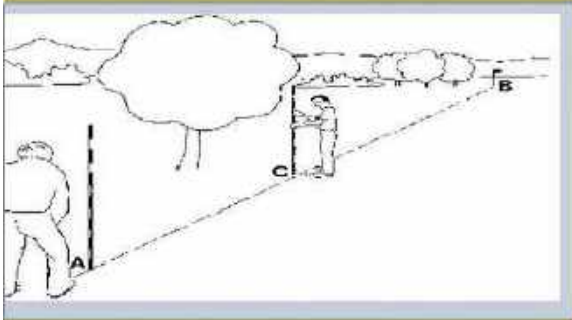

Ranging by eye

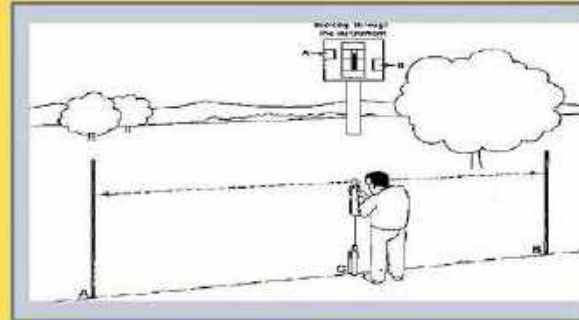

Ranging by line ranger

Direct ranging and its types

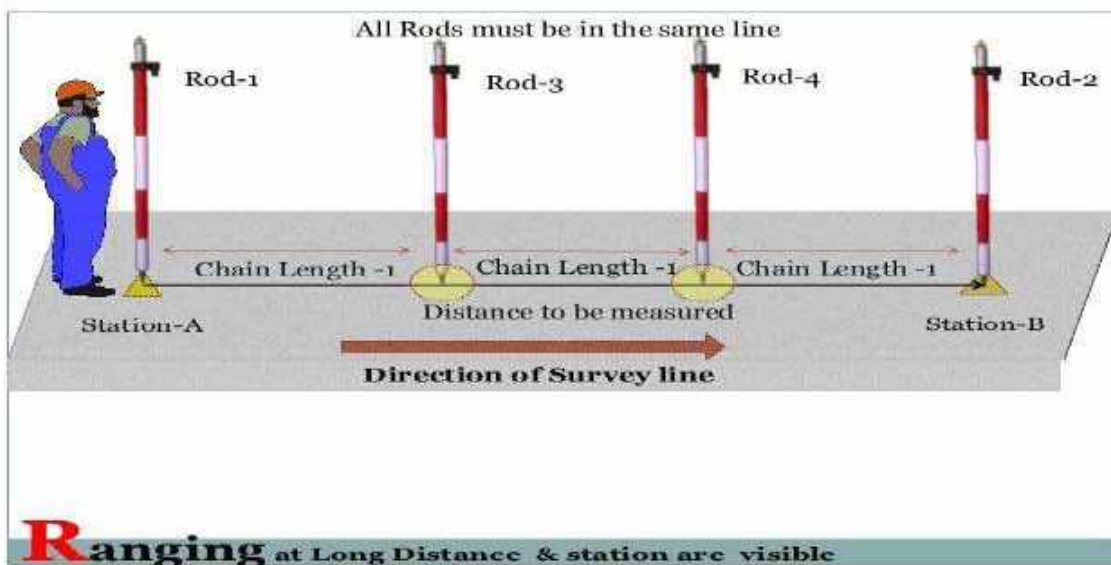

INSTRUMENTS USED FOR RANGING

Ranging can be done by using the following instruments:

- Ranging rods
- Offset rods
- Chain or Tapes
- Line Ranger

RANGING ROD

- **Ranging rods** are **vertical rods** used to **mark survey intermediate points** on the survey line having 2-3 m height. it is painted with bands of red and white 20 cm each.
- The **process of establishing an intermediate point** on a straight line between two endpoints is known as **ranging**. It is used when a **survey line is longer than a chain length**. It is necessary to align intermediate points on the chain line so that the measurements are along the line.

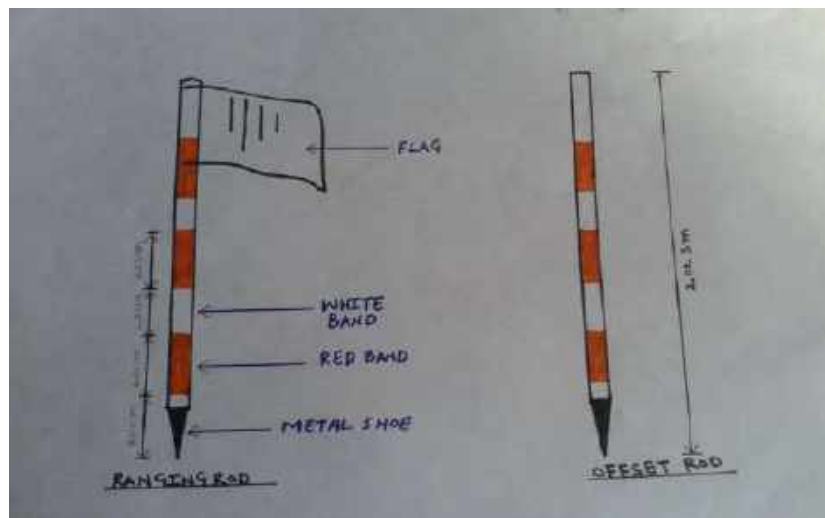

RANGING BY LINE RANGER

Ranging by Line Ranger is the type of **direct ranging method** in which the **intermediate points are fixed** directly utilizing an **instrument** known as **line ranger**.

The **line ranger** is an instrument that has either **two plane mirror** arrangements or **two isosceles prisms** that are placed one over the other

Ranging by Line Ranger

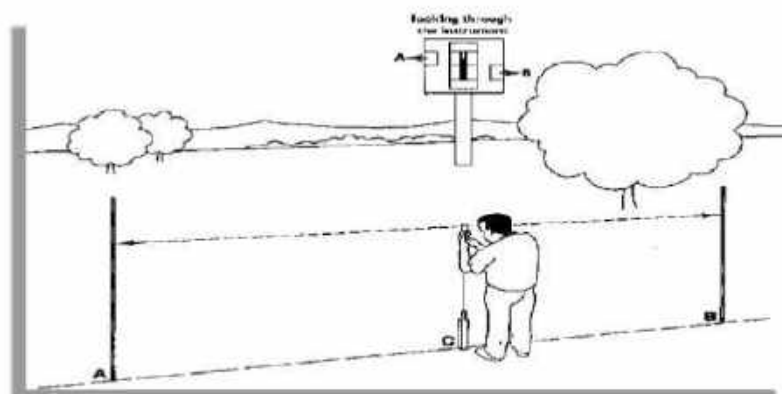

OFFSET ROD:

Offset rod in surveying is a tool used to make **measurements at an angle or distance from a reference point**. It is usually composed of a **pole or rod** with a **measuring stick attached at a right angle**. The offset rod is used to help surveyors measure accurate distances between points or features on the ground.

Offset rod is **similar to ranging rod** except instead of **flag**, a **hook** is provided at the **top for pushing and pulling the chain or the tape**. It is used too for **measuring small offsets**.

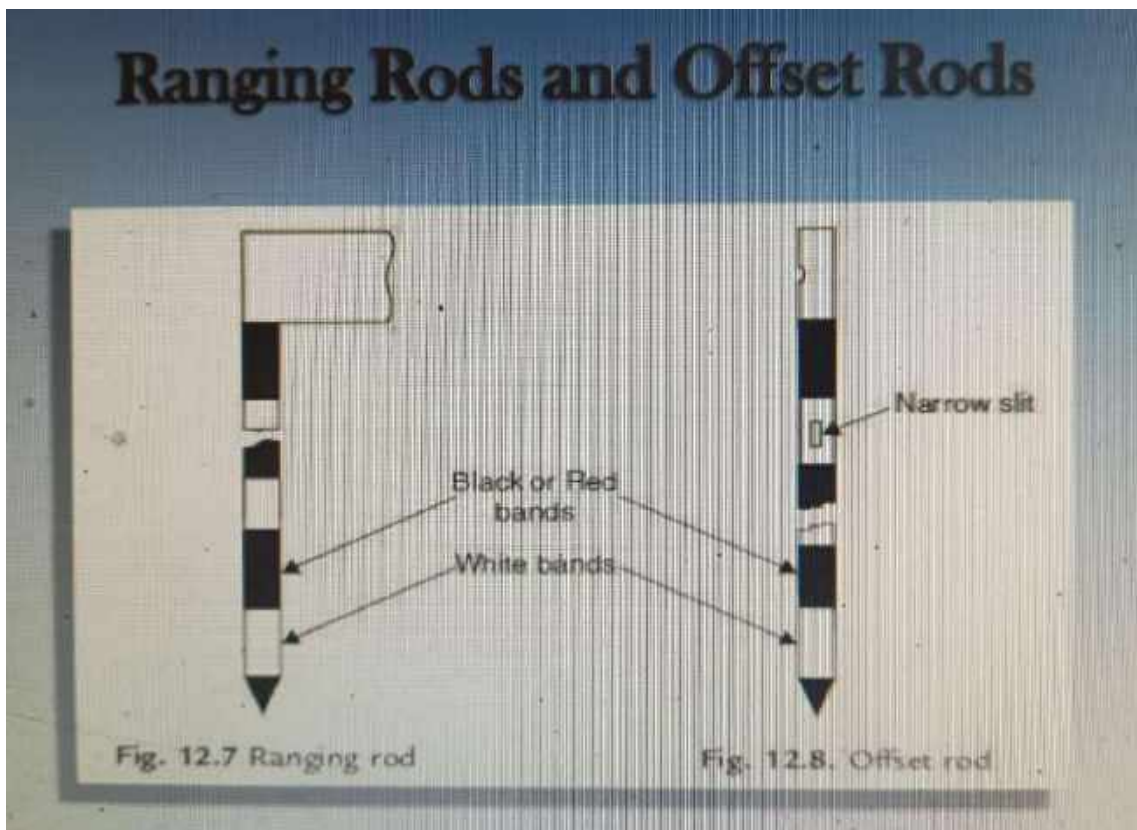

SURVEYING CHAINS TYPES

Following are the various types of chain in common use in surveying:

1. Metric chains (20m/65ft or 30 m/100ft)
2. Gunter's chain or surveyors chain (66ft)
3. Engineers chain (100ft)
4. Revenue chain (33ft)

1. Metric Chain:

- Metric chains are made in lengths 20m and 30m. **Tallies** are fixed at every **five-meter** length and **brass rings** are provided at **every meter length** except where tallies are attached.

2. Gunter's Chain

- Length = 66' (22 yards), No of links = 100, Each link = .66'
- Used for measuring **distances in miles or furlongs** (220 yards), **acres** (Area).

3. Engineer's Chain

- Length = 100', No of links = 100, Each link = 1'
- Used in all **Engineering Surveys**.

4. Revenue Chain

- Length = 33', No of links = 16
- Commonly used for measuring fields in **cadastral Survey** i.e. **Survey relating to land boundaries**.

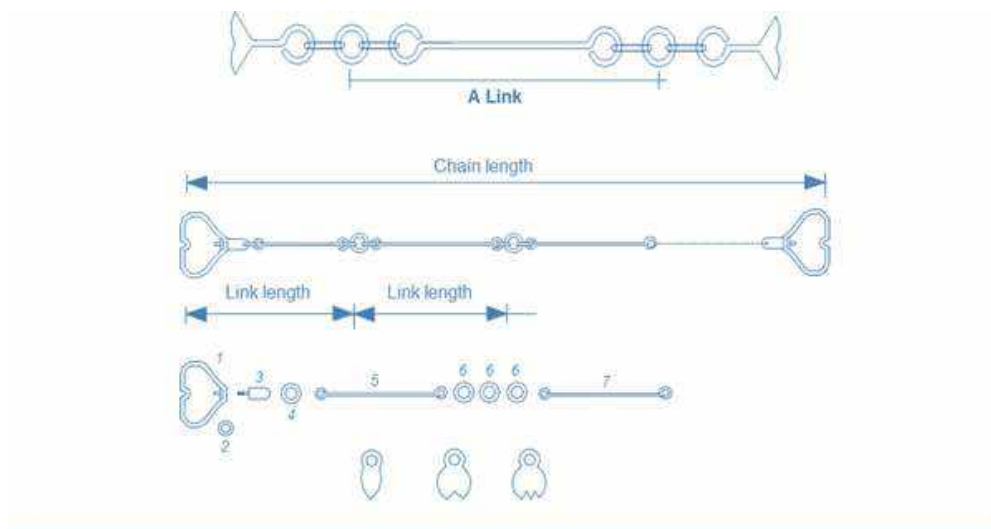

Components of a chain

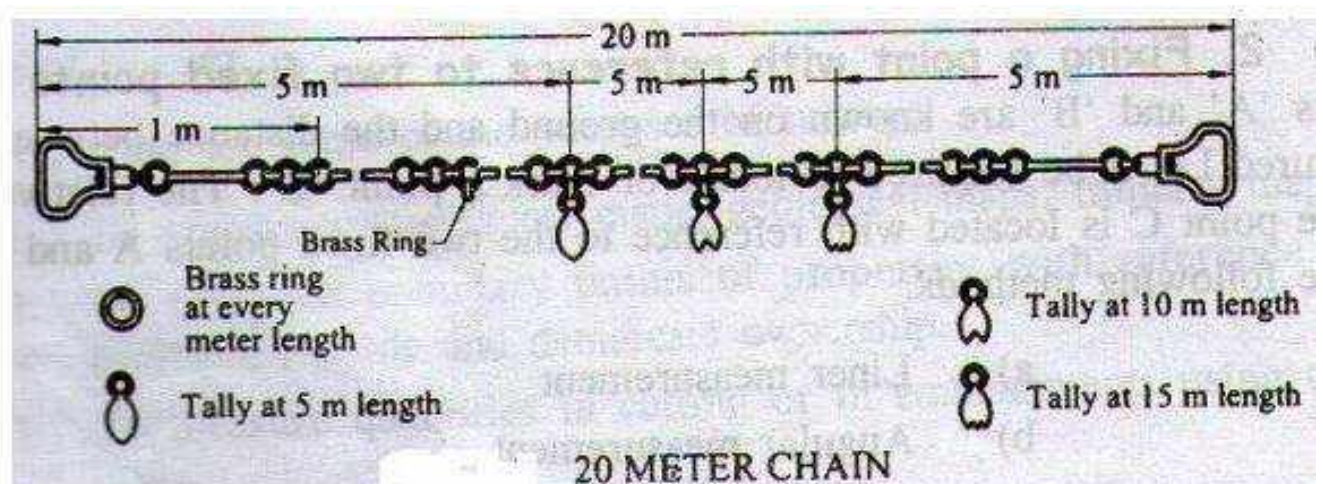

LEVELLING

<<Leveling: Definition, Principles, Instruments, Preparation of level book, problems on levelling>>

The technique of determining the **relative altitude** of a point **on the earth's surface** or **below the earth's surface** is called **LEVELLING**.

Levelling or leveling is a branch of surveying, the **objective** of which is to **establish** or **verify** or **measure** the **height** of **specified points** relative to a **datum**.

It is widely used in cartography (the science or practice of drawing maps) to measure **geodetic height** (height of a point on the **physical surface** of the earth **above** or **below** the ellipsoid, measured along a line that passed through the point on the earth and is normal to the surface) and in construction to measure **height differences** of construction **artifacts** (object made by a human being, typically one of cultural or historical interest).



PRINCIPLE OF LEVELLING

The **principle of levelling** is to obtain a **horizontal line of sight** at which the **vertical distance** of a point **above** or **below** this **line of sight** is found.

THE PURPOSE OF LEVELLING

The main purpose of balancing in the survey is:

- Find the **heights** of the given **points** in relation to the given data.
- Establishing **points at given heights** or at different heights in relation to given or considered data.

Instruments used in levelling in surveying

1. Levels

A level is basically a **telescope** attached to an accurate **leveling device**, set upon a **tripod** so that it can **rotate horizontally through 360°**. The following figure shows the level and its components.

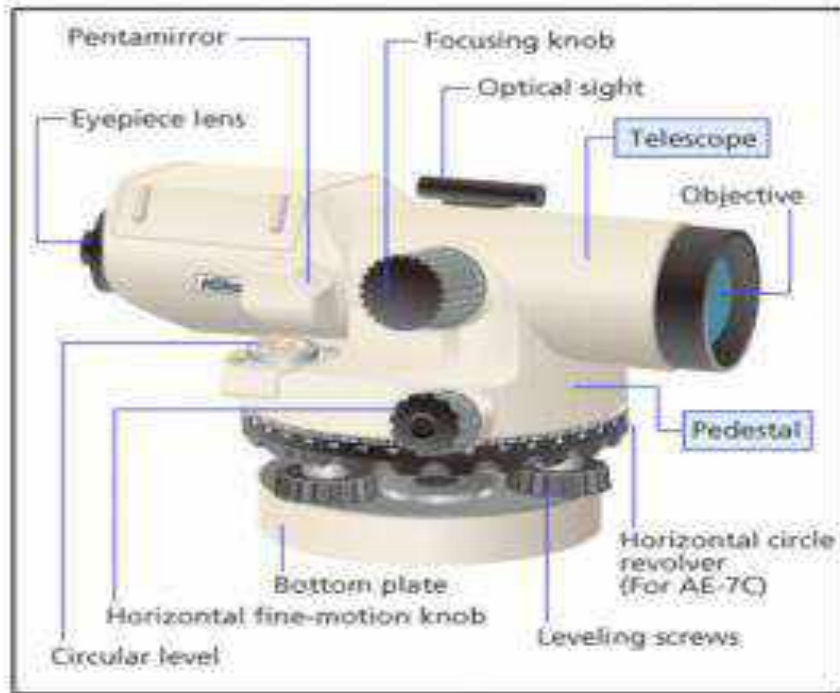

2. Tripod

The tripod consists of three legs and a head where the level instrument is mounted. The tripod could be of aluminum or wood material. When leveling the level instrument, the tripod head must be set approximately level beforehand by adjusting the tripod legs.



3. Leveling staff

The one of the main instrument used in levelling is levelling staff. The leveling staff is a box section of aluminum or wood, which will extend to 3 or 5 m in height by telescoping, hinging or addition of sections. One face has a graduated scale attached for reading with the cross-hairs of the level telescope.

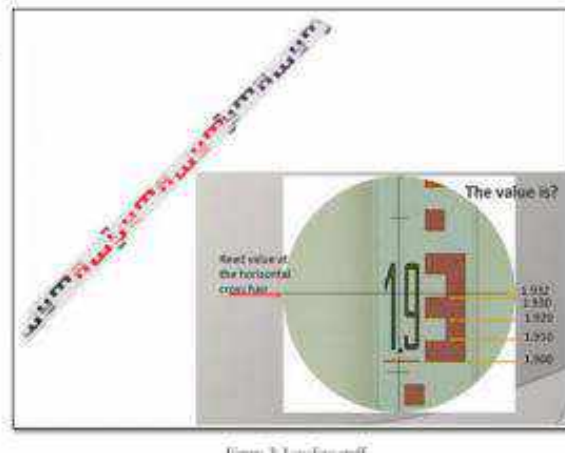

4. Staff bubbles

These are generally a small **circular bubble on an angle plate** which is held against one corner of the staff to ensure that the staff is held in a **vertical position**. If the staff is not held vertical, the reading will be too **large** and may be significantly in **error**.

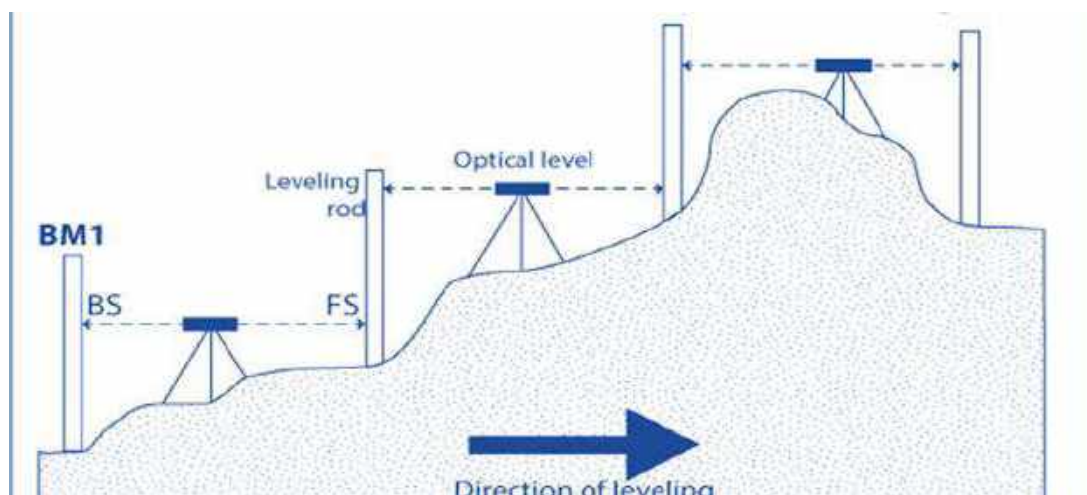

Terms used in Levelling

1. DATUM:

Data plane refers to the **arbitrary position of a level surface** or other line or surface that calculates any size.

2. **REDUCED LEVEL (RL):**

The **height or depth of a point above or below** the considered data is called the **reduced level**.

3. **BENCH MARK (BM):**

B.M. is the **fixed reference point of known height**. It can be of the following types.

- **GTS Benchmark (Geodetic Triangulation Survey):** This benchmark is set by state agencies such as the Survey of India. They are set to the **highest precision**. The **location and altitude above the MSL** are listed in a special catalogue called GTS Maps (100 km apart).
- **Permanent Benchmark:** This is a **fixed reference point** set by referring to the **GTS benchmark** (10 km intervals).
- **Arbitrary Benchmark:** This is the **reference point** where the **altitude** is assumed to be **random**. For most engineering projects, the elevation difference is more significant than the reduced level with respect to the MSL provided in a special catalogue known as GTS Maps (100 Km. Interval).

4. **Mean Sea Level (M.S.L.):**

Mean sea level is an **average level of the surface** of one or more of **Earth's bodies of water** from which heights such as elevation may be measured.

5. **Line of Collimation:**

Line joining the **intersection of the cross-hairs** to the **optical centre** of the objective and its continuation. It is also known as **Line of sight**.

6. **Line of sight:** is defined as the intersection of the crosshairs and the optical centre of the objective lens.

6. **Height of Instrument (HI):**

The **height** of the **line of sight** with the considered **data** is called the **HI**.

7. **Back sight (BS):**

The first sight taken on a **levelling staff** held at a point of known elevation. BS enables the surveyor to obtain **HI or sight** i.e. Height of Instrument or line of sight.

$$BS = HI - RL / BM$$

8. **Fore Sight (F.S.):**

It is the **last staff reading** taken from a **setting of the level**. It is also termed as **minus sight**. Foresight is the sight taken on a **levelling staff held at a point of unknown elevation** to ascertain the amount by which the point is **above or below** the line of sight.

This is also called **minus sight** as the foresight reading is always subtracted from the height of the Instrument. $FS / IS = HI - RL$

9. **Change Point (C.P.):**

The **point** at which both **foresight and rear view are taken** during the levelling process is called the change or shift point.

10. **Intermediate Sight (IS):**

The foresight taken on a levelling staff held at a point between **two turning points**, to determine the **elevation of that point**, is known as **intermediate sight**.

PREPARATION OF LEVEL BOOK

Field Book or Level Book Calculations are carried out on the readings noted during a Survey Operation called Levelling. We will first understand the Levelling process in detail and then will look at how to calculate a reduced level in the Field book.

Field Book

All observations and measurements taken during chain surveying are to be recorded in a standard field book. It is an oblong book of size **200 mm × 120 mm**, which can be carried in the pocket. There are two forms of the book

- single line
- double line.

The pages of a single line field book are having a **red line along the length of the paper** in the **middle** of the width. It indicates the **chain line**. All **chainages** are **written across** it. The space on either side of the line is used for **sketching the object** and for **noting offset distances**.

In the **double line** book, there are **two blue lines** with a space of 15 to 20 mm in the middle of each book. The space between the two lines is utilized for noting the **chainages**. Figure shows typical pages of field books.

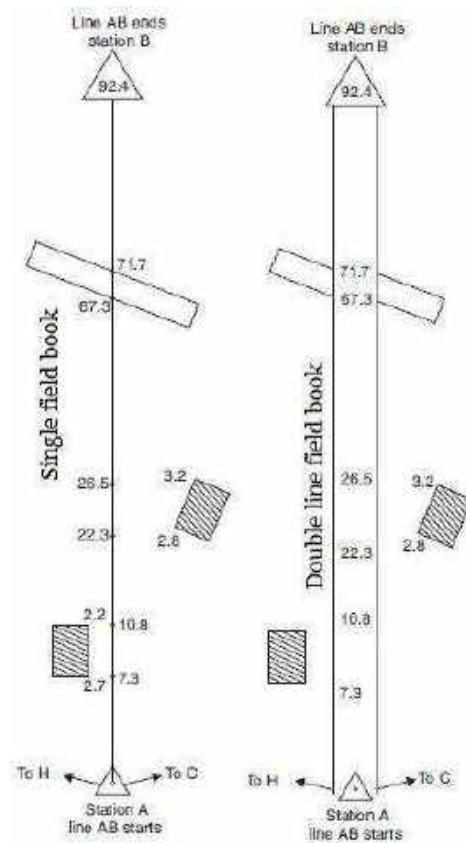

CLASSIFICATION OF LEVELLING

1. Simple Levelling
2. Differential Levelling

SIMPLE LEVELLING

Simple levelling can be defined as the operation of levelling used to determine the difference in elevation between two points, **if not too great apart** and which are **visible from a single position of level**.

Procedure of Simple Levelling:

Objective: Suppose points A and C are two points whose difference in elevation is required with a level set up at B.

1. Instrument is correctly levelled at B.
2. Telescope is directed towards staff held at first point say A. It is properly focused to obtain clear graduations.
3. Ensuring that bubble is central, reading is taken by observing where central horizontal hair of diaphragm cuts the staff. (**Back sight** reading)
4. Staff is shifted to the other point, say C and focus the telescope on staff held at C.
5. Check if the bubble is central, if not it is adjusted by using foot screw nearest to the telescope and micrometer screw in case of a tilting level.

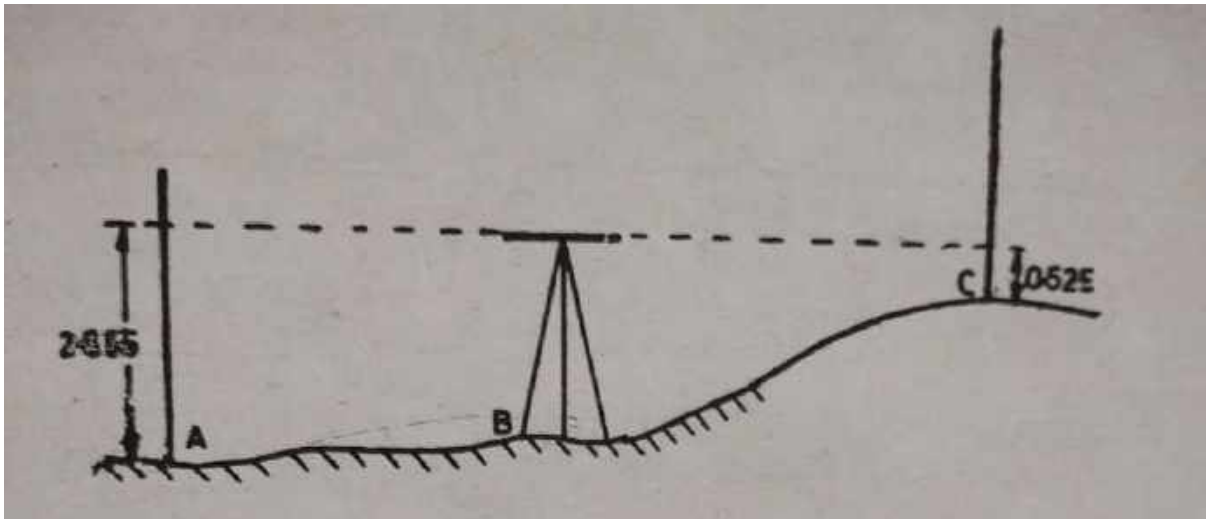

Question 1 (simple levelling):

1. Two points A and C are visible from a single point on earth 'B'. Keeping the instrument at B, it is observed that staff readings on A and C are 2.855 and 0.525 respectively. If R.L. of A is 500m what is the R.L. of B? Also find the difference of elevation between the two points.

Solution

Difference in elevation between two points = $2.855 - 0.525 = 2.330$ m

R.L. of point A = 500 m

R.L. of line of sight = $500 + 2.855 = 502.855$ m

So, R.L. of point B = $502.855 - 0.525 = 502.330$ m

DIFFERENTIAL LEVELLING

- This method of levelling is used for determining the difference in elevation between two points that **too far apart**, i.e. **not visible from a single point** on earth or obstructed by **intervening grounds**.
- It is the process of measuring the **vertical distances** from a known elevation point (bench mark) to find the elevation of unknown points.
- Here, the leveling instrument is set up at **different points** and the difference in elevation between successive points is measured.
- This method of levelling is also known as **fly, compound** or **continuous levelling**.
- **Procedure of Differential Levelling:**
Objective: Let two point A and B are **too far apart** and the *difference in their elevations* is to be determined through differential levelling.

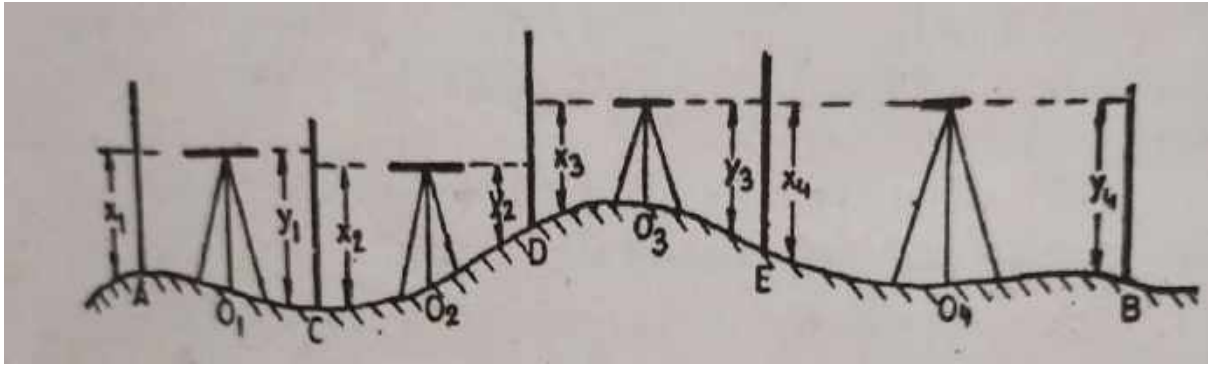

1. Set up the instrument at **O₁**. Ensuring that it intersects with staff at **A**, take **Back sight** reading at A. Let it be X_1 .
2. Shift the staff to **C** (**equidistant** from O_1), such that $A-O_1 = O_1-C$ ensuring that the instrument is correctly levelled, take **foresight** reading at C. Let it be Y_1 .
3. Now, keeping the staff constant at C, the instrument is shifted to **O₂**, and **back sight** reading of **C** is taken. Let it be X_2 .
4. Staff is shifted to point **D** such that $C-O_2 = O_2-D$ and take **Foresight** reading at D. Let it be Y_2 .
5. The above procedure is repeated till **final foresight** reading at point **B** is observed.
6. **Difference in elevation** between points **A** and **B** can be given by,

$$\Sigma \text{B.S readings} - \Sigma \text{F.S readings}$$

$$= (X_1 + X_2 + \dots + X_n) - (Y_1 + Y_2 + \dots + Y_n)$$

✓ **Note:**

- The points where **two readings are taken** at successive points C, D, E etc. are called **change points**.
- **Staff from a change point must not be removed** till **back sight** reading is obtained from **next instrument station**.
- Level must be set up on **firm ground** otherwise it may sink

There are **two widely used** methods for **differential leveling**: HI method, Rise and Fall method

1. Rise and Fall method (**RF method**)
2. Height of Instrument method/ Height of collimation method (**HI method**)

1. RISE AND FALL METHOD

- In this method the difference of level between two consecutive points for each setting of the instrument is obtained by comparing their staff readings.
- The difference between staff readings indicates a **Rise** if Back-sight reading is more than Fore sight reading.
- The difference between staff readings indicates a **Fall** if Back-sight reading is less than Fore sight reading.
- The rise and fall worked out for all points give the vertical distance of each point relative to the preceding one.
- If R.L. of back staff point is known, then R.L. of following point may be obtained by adding its rise or subtracting its fall from R.L. of preceding point.

✓ Arithmetic Checks

The difference between sum of back sights and sum of foresights should be equal to difference of sum of rises and sum of falls. This must also be equal to the difference between Last R.L. and First R.L.

$$\Sigma BS - \Sigma FS = \Sigma \text{Rises} - \Sigma \text{Fall} = \text{Last R.L.} - \text{First R.L.}$$

✓ Note:

- $BS > IS/FS = \text{Rise}$
- $IS/FS > BS = \text{Fall}$

Questions 2: (Rise and fall method)

The following consecutive readings were taken with a dumpy level:

0.795, 1.655, 2.890, 3.015, 0.655, 0.625, 0.955, 0.255, 1.635, 0.860, 2.375

The instrument was shifted after the fourth and eighth readings. Rule out a page of level field book and enter the following readings. Calculate the R.L. of stations by Rise and Fall method if the first reading was taken on a B.M. whose R.L. is 550.605 meters. Also apply Arithmetic checks.

Solution

First reading must be a back sight reading.

As instrument was shifted, Fourth and Eighth reading must be fore-sight readings.

So, Fifth and Ninth reading must be back sight readings.

Last reading must be a foresight reading.

SL.NO.	B.S.	I.S	F.S.	Rise	Fall	R.L.	Remarks
1	0.795					550.605	B.M.
2		1.655			0.860	549.745	
3		2.890			1.235	548.510	
4	0.655		3.015		0.125	548.385	C.P.
5		0.625		0.03		548.415	
6		0.955			0.33	548.085	
7	1.635		0.255	0.7		548.785	C.P
8		0.86		0.775		549.560	
9			2.375		1.515	548.045	
TOTALS	3.085		5.645	1.505	4.065		

ARITHMETIC CHECKS:

1. $\Sigma BS - \Sigma FS = 3.085 - 5.465 = -2.560$

2. $\Sigma Rises - \Sigma Fall = 1.505 - 4.065 = -2.560$

3. $Last\ R.L. - First\ R.L. = 548.065 - 550.605 = -2.560$

So, $\Sigma BS - \Sigma FS = \Sigma Rises - \Sigma Fall = Last\ R.L. - First\ R.L.$ Hence, O.K.

2. HEIGHT OF INSTRUMENT METHOD

- In this method, **height of instrument (H.I.)** is obtained for **each setting** of the **instrument** by adding the **back sight** to the elevation of Bench mark (**B.M**)
- The **reduced level of first station** is obtained by **subtracting** its **foresight** from instrument height (**H.I.**).
- For the **second setting of the instrument**, **height of instrument** is obtained by **adding back sight** taken on the **first station** to its R.L.
- The **reduced level of last point** is obtained by **subtracting** the **fore sight** of last point from **H.I.** at the **last setting**.
- If an **intermediate sight** is observed to an **intermediate station**, its **R.L.** is obtained by **subtracting** its **FS** from **H.I.** for that setting.

✓ Arithmetic Checks

The **difference** between **sum** of **back sights** and **sum** of **foresights** should be **equal** to **difference** of the difference between **R.L. of last station** and **R.L. of first station**.

In this method there is no check on intermediate sights.

$$\Sigma BS - \Sigma FS = \text{Last R.L} - \text{First R.L.}$$

$$HI = RL / BM + BS$$

$$RL = HI - FS / IS$$

Question 3: (Height of Instrument method)

The following consecutive readings were taken with a dumpy level and 4 m long levelling staff on a continuously sloping ground.

0.755, 1.545, 2.335, 3.545, 3.655, 0.525, 1.275, 2.650, 2.895, 3.565, 0.345, 1.525, 1.850, 2.675, 3.775.

The first reading was taken on a bench mark whose R.L. is 200 meters. Rule out a page of level field book and enter the following readings. Calculate the R.L. of stations by Height of Instrument method. Also apply arithmetic checks.

Solution

As the ground is continuously sloping and maximum staff height is 4 m,

So, the readings 3.655, 3.565, 3.775 must all be foresight readings.

The first reading must be a back sight reading.

SL.NO.	B.S	I.S.	F.S	Height of Instrument	R.L.	Remarks
1	0.755			200.755	200	B.M.
2		1.545		.	199.210	
3		2.335		.	198.420	
4		3.545		.	197.210	
5	0.525		3.655	197.625	197.100	C.P.
6		1.275		..	196.350	
7		2.650		..	194.975	
8		2.895		..	194.730	
9	0.345		3.565	194.405	194.060	C.P.
10		1.525		...	192.880	
11		1.850		...	192.555	
12		2.675		...	191.730	
13			3.775	...	190.630	
TOTALS	1.625		10.995			

ARITHMETIC CHECKS:

1. $\Sigma BS - \Sigma FS = 1.625 - 10.995 = -9.370$

2. $\text{Last R.L} - \text{First R.L.} = 190.630 - 200 = -9.370$

So, $\Sigma BS - \Sigma FS = \text{Last R.L} - \text{First R.L.}$ Hence, O.K.

▪ **Comparison between Rise and Fall method and Height of Instrument method**

HEIGHT OF INSTRUMENT METHOD	RISE AND FALL METHOD
1. It is rapid and saves considerable amount of time and labour.	1. It is laborious as staff reading of each station is obtained to get a rise or fall
2. It is well adopted for reduction of levels for constructional works such as longitudinal or cross sectional levelling.	2. It is well adopted for determining the difference of levels where precision is required
3. There is no check on reduction of levels on intermediate stations.	3. There is complete check on reduction of levels on intermediate stations.
4. There are two arithmetic checks.	4. There are three arithmetic checks.
5. Errors if any at intermediate sights are not detected.	5. Errors if any at intermediate sights are detected as they are used to find rise or fall.

MODERN SURVEYING INSTRUMENTS

<<Modern surveying instruments: EDM, Total station, GPS (Brief discussion)>>

Following are the modern surveying instruments which are used for surveying:

- Electronic Distance Measurement (EDM) Instruments
- Total Station
- Global Positioning System (GPS)

ELECTRONIC DISTANCE MEASUREMENT (EDM) INSTRUMENTS

EDM is a method of determining the **length between two points** using **electromagnetic waves**. EDM is commonly carried out with digital instruments called **theodolites**. EDM instruments are highly reliable and convenient pieces of surveying equipment and can be used to measure distances of up to **100 kilometers**.

- An **Electronic Distance Measurer (EDM)** can be used to **place objects or points in three dimensions** in relation to the unit. The EDM emits a beam of **infrared light** that is controlled at a controlled rate.

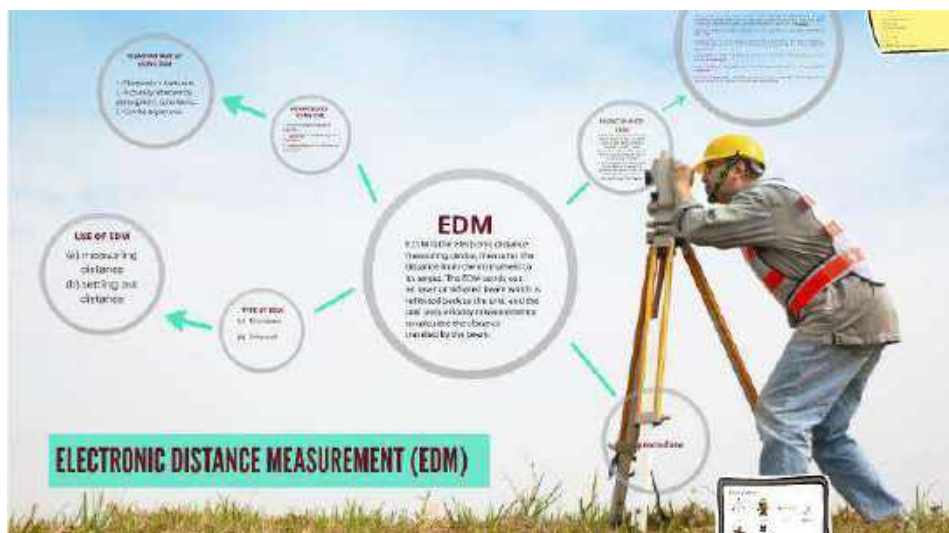

- Direct **measurement of distances** and their **directions** can be obtained by using electronic instruments that rely on **propagation, reflection** and **reception** of either **light waves** or **radio waves**. They may be broadly classified into **three types**: a. **Infrared wave** instruments b. **Light wave** instruments c. **Microwave** instruments

a) Infrared Wave Instruments

- These instruments measure **distances** by using **amplitude** modulated **infrared waves**. They include thermocouples, Bolometers, thermistors Golay cells, as well as pyroelectric detectors. At the end of the line, prisms mounted on target are used to reflect the waves. These instruments are **light** and **economical** and can be mounted on **theodolites** for **angular measurements**. The range of such an instrument will be **3 km**. It is a **very small, compact EDM**, particularly useful in **building construction** and other Civil Engineering works, where distance measurements are **less than 500 m**. It is an EDM that makes the **measuring tape redundant**. To measure the distance, one has to simply point the instrument to the reflector, touch a key and read the result.



b. Visible Light Wave Instruments

Uses **modulated light waves** to measure up to a specific range.

- These are the instruments which measures **distances** based on **propagation of modulated light waves**. The accuracy of such an instrument varies from **0.5 to 5 mm/km distance** and has range of **nearly 3 km**. Eg: **Geodimeter**.



- **Geodimeter** is an instrument which works based on the propagation of modulated light waves. The instrument is more suitable for **night time observations** and requires a prism system at the end of the line for reflecting the waves. It can be used both during day and night. **Eg. Tellurometer**

c. Microwave Instruments

A **microwave radiometer** (MWR) is a radiometer that measures energy emitted at one millimeter-to-metre wavelengths (frequencies of 0.3–300 GHz) known as microwaves. Microwave radiometers are very **sensitive receivers** designed to measure thermally-emitted electromagnetic radiation. The **Microwave Instruments** also called **tellurometers**, these instruments use microwaves.

Tellurometer It is an EDM which uses **high frequency radio waves** (micro-waves) for measuring distances. It is a **highly portable** instrument and can be worked with 12 to 24-volt battery. For measuring distance, two Tellurometers are required, one to be stationed at each end of the line, with two highly skilled persons, to take observations. One instrument is used as a master unit and the other as a remote unit. Just by pressing a button a master can be converted into remote unit and vice-versa. A speech facility (communication facility) is provided to each operator to interact during measurement.

TOTAL STATION (TS)

A total station is an **optical instrument** used in modern surveying.

It is a **combination** of an **electronic theodolite** (transit), an electronic distance measuring device (**EDM**) and **software** running on an external computer, such as a laptop or data collector.

A **total station (TS)** or **total station theodolite (TST)** is an electronic/optical instrument used for **surveying and building construction**. It is an **electronic transit theodolite** integrated with electronic distance measurement (**EDM**) to measure both **vertical** and **horizontal angles** and the **slope** distance from the instrument to a particular point, and an on-board computer to collect data and perform triangulation calculations. Total Station can perform the following functions:

- **Distance** measurement
- **Angular** measurement
- Data processing
- Digital display of point details
- Storing data is an electronic field book



The important features of total station are,

1. Keyboard-control - all the functions are controlled by operating key board.
2. Digital panel - the panel displays the values of distance, angle, height and the coordinates of the observed point, where the reflector (target) is kept.
3. Remote height object - the heights of some inaccessible objects such as towers can be read directly. The microprocessor provided in the instrument applies the correction for earth's curvature and mean refraction, automatically.
4. Traversing program - the coordinates of the reflector and the angle or bearing on the reflector can be stored and can be recalled for next set up of instrument.
5. Setting out for distance direction and height -whenever a particular direction and horizontal distance is to be entered for the purpose of locating the point on the ground using a target, then the instrument displays the angle through which the theodolite has to be turned and the distance by which the reflector should move.

GLOBAL POSITIONING SYSTEM (GPS)

The **Global Positioning System (GPS)**, originally **Navstar GPS**, is a satellite-based radionavigation system owned by the United States government and operated by the United States Space Force. It is one of the **global navigation satellite systems (GNSS)** that provides **geolocation and time information** to a GPS receiver anywhere on or near the Earth where there is an unobstructed line of sight to four or more GPS satellites. It does not require the user to transmit any data, and operates independently of any telephonic or Internet reception, though these technologies can enhance the usefulness of the GPS positioning information. It provides critical positioning capabilities to military, civil, and commercial

users around the world. Although the United States government created, controls and maintains the GPS system, it is freely accessible to anyone with a GPS receiver.

Global Positioning System (GPS) is developed by U.S. Defense department and is called Navigational System with Time and Ranging Global Positioning System (NAVSTAR GPS) or simply GPS. For this purpose U.S. Air Force has stationed 24 satellites at an altitude of 20200 km above the earth's surface. The satellites have been positioned in such a way, at least four satellites will be visible from any point on earth.

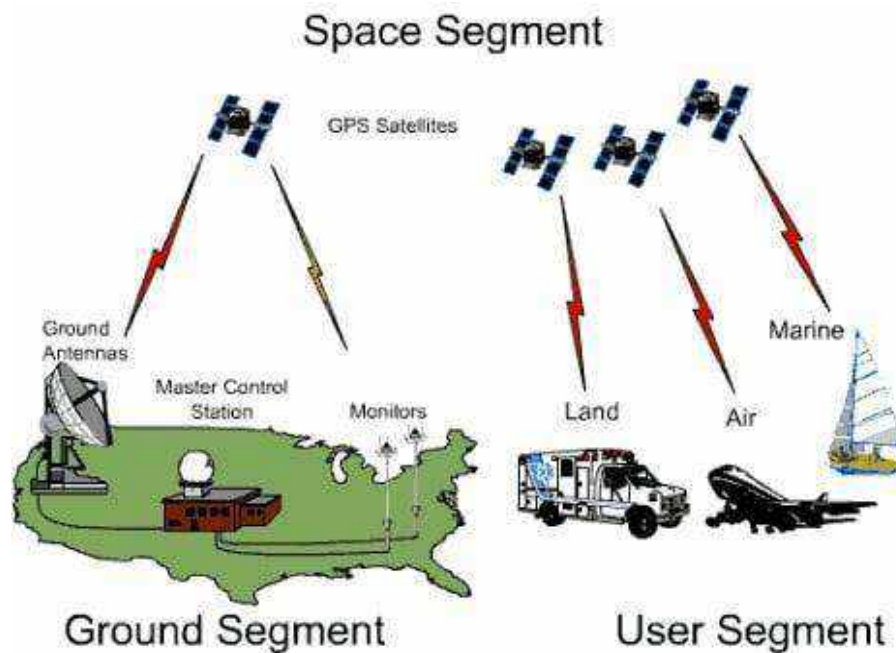

The user needs a **GPS receiver** to **locate the position** of any point on **ground**. The receiver processes the signals received from the satellite and compute the **position (latitude and longitude)** and **elevation** of a point with **reference to datum**.

The Global Positioning System (GPS) is a **U.S.-owned utility that provides users with positioning, navigation, and timing (PNT) services**. This system consists of three segments: the **space** segment, the **control** segment, and the **user** segment.

The Global Positioning System (GPS) has changed the way the world operates. This is especially true for marine operations, including search and rescue. GPS provides the fastest and most accurate method for mariners to **navigate, measure speed, and determine location**

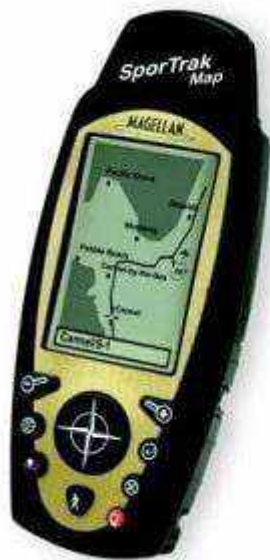
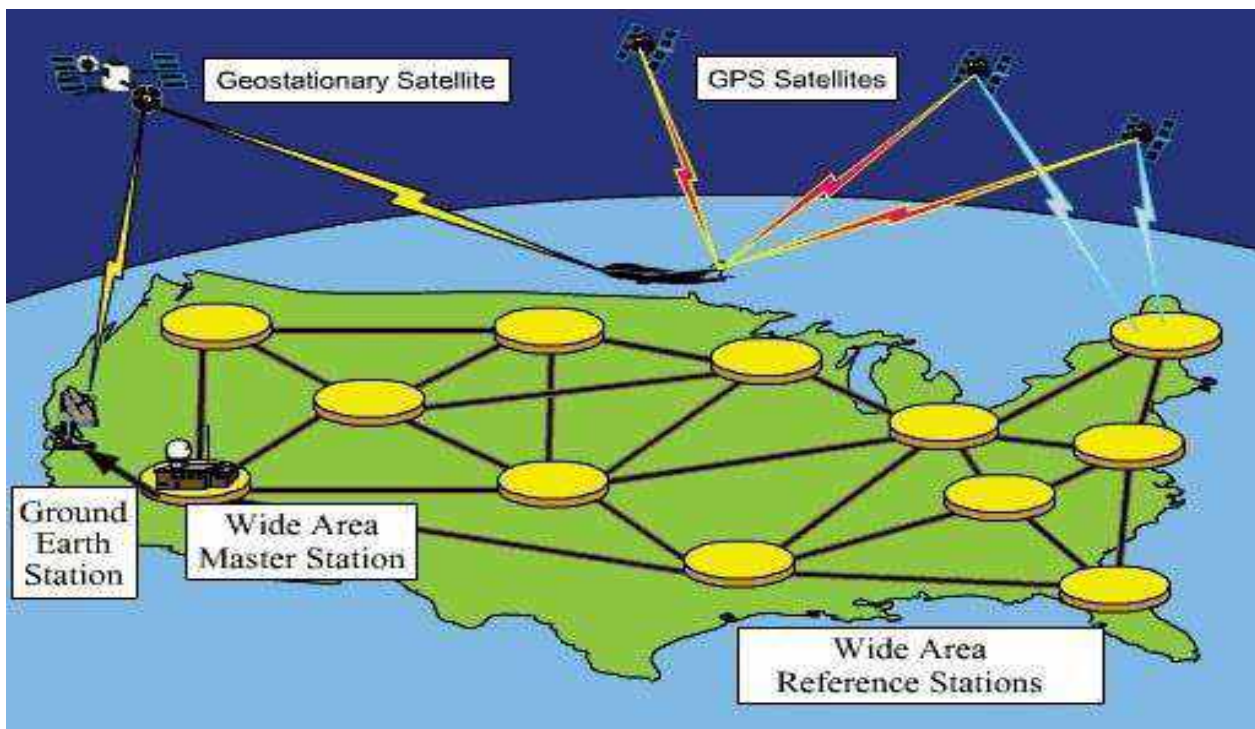

BUILDING MATERIALS

Contents of Bricks: Properties and specifications

BRICK: A brick is a type of block used to build walls, pavements and other elements in masonry construction. Properly, the term brick denotes a block composed of dried clay, but is now also used informally to denote other chemically cured construction blocks. Bricks can be joined using mortar, adhesives or by interlocking them. Bricks are produced in numerous classes, types, materials, and sizes which vary with region and time period, and are produced in bulk quantities.



Percentage of Constituents of Brick (Weight Basis)

There are six major ingredients of brick. The general percentage of these ingredients in brick is given below:

Ingredient	Percentage in brick
Silica (SiO ₂)	55%
Alumina (Al ₂ O ₃)	30%
Iron Oxide (Fe ₂ O ₃)	8%
Magnesia (MgO)	5%
Lime(CaO)	1%
Organic Matter	1%

Chief Ingredients of Brick and Their Functions

Silica (Sand) and **Alumina (Clay)**, these two are the most prominent ingredients in brick clay. When **mixed with water** in proper proportions, it gains **plasticity**. The plastic mass can be easily molded and dried. It should not go through **cracking, shrinkage** or **warping**.

Alumina

Alumina is the main constituent of clay. It acts as a cementing material in raw brick. Brick clay is plastic due to the presence of alumina. This plasticity ensures that bricks can be molded. An excess amount of alumina in clay may cause the bricks to shrink, warp or crack on drying and burning as any other cementing material.



Figure: Clay for Brick formation

Silica

Good quality bricks contain 50-60% silica. It is present in both free and combined form. As free sand, it remains mechanically mixed with clay. In combined form, it reacts with alumina to form aluminosilicates. Silica prevents raw bricks from cracking, shrinking and warping. The higher the proportion of sand, the more shapely and uniform in texture will be the brick. Although, excess silica destroys cohesion between the brick clay particles and makes brick brittle and weak. The durability of bricks largely depends upon the proper proportion of silica and alumina.



Figure: Sand

Lime

Bricks should contain a little amount of finely powdered lime. It enables silica (of a required portion) to melt at the furnace temperature of 1650°C and binds the particles of brick together resulting in strong and durable bricks. At about 1100°C , lime acts as a catalyst to elevate the furnace temperature to 1650°C at which silica fuses. This slightly fused silica works as a strong cementing material. Excess lime in brick clay will cause vitrification of bricks. It causes bricks to melt, as more than the required amount of silica will fuse. The bricks then lose their shape and become disfigured.



Figure: Powdered Lime

Iron Oxide

Bricks contain a small quantity of Iron Oxide. Iron Oxide acts a flux like lime, thus helps silica to fuse at low temperature. It imparts a red color to bricks upon burning. Iron also increases the durability and impermeability of the bricks.



Figure: Iron Oxide powder

Magnesia

A small proportion of magnesium decreases shrinkage and gives a yellow tint to the bricks. An excess amount of it causes bricks to decay.

Harmful Ingredients of Brick

Lime

Excess lime melts the bricks and disfigures it. If CaCO_3 exists (in the purest form, i.e., if it contains at least 95% CaO) in lime-lump in brick clay, it converts into quicklime on burning. When these bricks come in contact with water, quicklime slakes and expands. And causes **disintegration of bricks**.

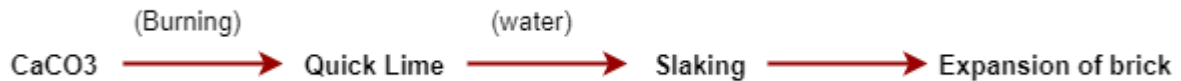

Alkalis

Alkalis are mainly salt of Sodium (Na) and Potassium (K). It acts as a flux in the kiln and causes **fusion**, **warping**, and **twisting** of bricks. Alkalis absorb moisture from the atmosphere and cause **dampness** and **efflorescence** in bricks (because of the presence of hygroscopic salts, e.g., CaCl_2 , MgCl_2 , etc.).

Pebbles, Stones & Gravels

Their presence does not allow thorough **mixing of earth**, thus the bricks produced are weaker. Such bricks cannot be broken at the desired section and they break very irregularly.



Figure: Pebbles, Stones, and Gravels

Iron Pyrites (FeS)

Iron Pyrites causes **crystallization** and **disintegration** of bricks while burning. It discolors bricks in the form of black slag.

Organic Matter

Organic matter in bricks makes bricks porous resulting in low density and weaker bricks.

CLASSIFICATION OF BRICKS:

- Sun-dried bricks
- Burnt clay bricks
- Fly ash bricks
- Concrete bricks
- Engineering bricks
- Calcium silicate bricks
- Eco bricks

Sun-dried bricks:

These are un-burnt bricks made of clay. They are moulded and left under the sun to dry.

Burnt clay bricks: These are made of clay and put into the kiln for burning. They are used for building walls, foundations, and columns, among others. There are four different types of burnt clay bricks:

- **First class:** Quality with excellent edges
- **Second class:** *Ground moulded* and a bit irregular in shape
- **Third class:** Rough-edged and *ground moulded*, used for temporary construction
- **Fourth class:** Over-burnt and highly irregular, dark in colour with no water resistance feature

Fly ash bricks:

Also called Self-cementing brick, these bricks contain Class F or Class C fly ash as a part of the formula.

Concrete bricks:

These bricks are made using solid concrete. The concrete is prepared using sand, coarse aggregates, water, and cement.

Engineering bricks:

This type of brick offers high compressive strength. They are used for construction where low porosity, frost resistance, acid resistance, and strength are mandatory.

Calcium silicate bricks:

Also called sand lime bricks, they are made by mixing fly ash, lime, and sand. It is used for masonry and ornamental works in different construction projects.

Eco bricks:

Porotherm **hollow bricks** are suitable walling solutions. They offer significant thermal insulation and make walls stronger.

PROPERTIES OF BRICKS

1. Physical Properties of Bricks

These properties of bricks include shape, size, color, and density of a brick.

➤ **Shape.**

1. The standard shape of an ideal brick is truly rectangular. It has Well defined and sharp edges. The surface of the bricks is regular and even.
2. These are generally modifications of rectangular shapes.

➤ **Size.**

1. The size of brick used in construction varies from country to country and from place to place in the same country.
2. **In India**, the recommended standard size of an ideal brick is 19 x 9 x 9 cm which with mortar joint gives net dimensions of 20 x 10 x 10 cm.

➤ **Colour.**

1. The most common color of building bricks falls under the class RED. It may vary from deep red to light red to buff and purple.
2. Very dark shades of red indicate over burnt bricks whereas yellow color is often indicative of under-burning.

➤ **Density.**

1. The density of bricks or weight per unit volume depends mostly on the type of clay used and the method of brick molding (soft-mud, Stiff-mud, hard-pressed etc.).
2. In the case of standard bricks, density varies from 1600 kg/cubic meter to 1900 kg/cubic meter.

2. Mechanical Brick Properties.

Under this heading of properties of bricks, compressive strength and flexure strength are included.

➤ **Compressive Strength of Bricks.**

1. It is the most important property of bricks especially when they are used in load-bearing walls.
2. The compressive strength of a brick depends on the composition of the clay and degree of burning. It may vary from 35 kg/cm² to more than 200 kg/cm² in India.

➤ **Flexure Strength.**

1. Bricks are often used in situations where bending loads are possible in a building. As such, they should possess sufficient strength against transverse loads.
2. It is specified that the flexural strength of a common building brick shall not be less than 10 kg/cm².
3. Best grade bricks often possess flexural strength over 20 kg/cm².

➤ **Thermal Properties of Building Bricks.**

1. . Besides being hard and strong, ideal bricks should also provide an adequate insulation against heat, cold and noise.
2. The heat and sound conductivity of bricks vary greatly with their density and porosity.
3. Very dense and heavy bricks conduct heat and sound at a greater rate. They have, therefore, poor thermal and acoustic (sound) insulation qualities.
4. For this reason, bricks should be so designed that they are light and strong and give adequate insulation

▪ **Specification of Bricks**

A brick is small block of burnt clay with a size that can be held in one hand conveniently. Brick should be thoroughly burnt, of uniform color, having plane rectangular faces, sharp straight, right angle edges.

- Standard **Modular size** of common building brick is **190X90X90** mm
- The size of a **Non-Modular brick** is 9"X4-3/8"X2-11/16" (229X111X70 mm).But it is specified as **230X110X70** mm.
- The weight of a brick is about **3 to 4 kg**.

Recommended Sizes of Bricks

Type of Bricks	Normal Size (mm)	Actual Size (mm)
Modular Bricks	200x100x100 mm	190x90x90 mm
Non -Modular Bricks	229x114x70 mm	230x110x70 mm

Visual Characteristics of Brick

- Good bricks should be *burnt thoroughly* so that they become hard and durable.
- Satisfactory burning of the bricks is ascertained by *hard ringing sound* when two bricks are struck together.
- The bricks should have smooth and rectangular shapes with sharp corners and uniform colors.
- The bricks should be free from cracks, chips, warp age, large particles of lime and organic matters.

Water Absorption of Brick

Average water absorption of bricks after 24 hours of immersion in cold water should **not be more than 20% of its own dry weight.**

The acceptable water absorption for clay bricks are between 12% and 20%. If you are using engineering bricks the closer you are to the 12% the better the result will be. When the water absorption is too low, i.e. below 12%, it may be difficult to obtain a proper bond between the mortar and the bricks.

Raw Materials for Brick

Sufficient samples of the earth available must be tested to check if the soil is suitable for composition of bricks and available abundantly in neighborhood. It is reasonable uniformity of composition in the soil. Mechanical composition of the soil may preferably confirm the following requirements.

- **Clay 20 to 35 %**
- **Silt 20 to 35%**
- **Sand 35 to 45 %**

Types of Bricks used in Construction



1. Burnt Clay Brick



2. Sand Lime Brick



2. Fire Brick



2. Fly Ash Brick



2. Air Brick



2. Hollow Brick

CEMENT

Contents: Cement Types, properties, grades, other types of cement and uses

A **cement** is a binder, a chemical substance used for construction that sets, hardens, and adheres to other materials to bind them together.

The principal raw materials used in the manufacture of Ordinary Portland Cement are:

1. *Argillaceous* or silicates of **alumina** in the form of **clays** and **shales**.
2. *Calcareous* or calcium carbonate, in the form of **limestone**, **chalk** and **marl** which is a mixture of **clay** and calcium carbonate.

Gypsum is added to control the “**setting of cement**”. If not added, the cement will set immediately after mixing of water leaving no time for concrete placing.

Chemical Composition

Components	Percentage of mass
Calcium Oxide (CaO)	66.33
Silica(SiO ₂)	18.6
Ferric Oxide(Fe ₂ O ₃)	4.03
Alumina(Al ₂ O ₃)	3.77
Sulphuric anhydride (SO ₃)	2.67
Magnesium oxide (MgO)	2.13
Sodium oxide (Na ₂ O)	1.39
Potassium Oxide (K ₂ O)	0.46

Properties of Cement

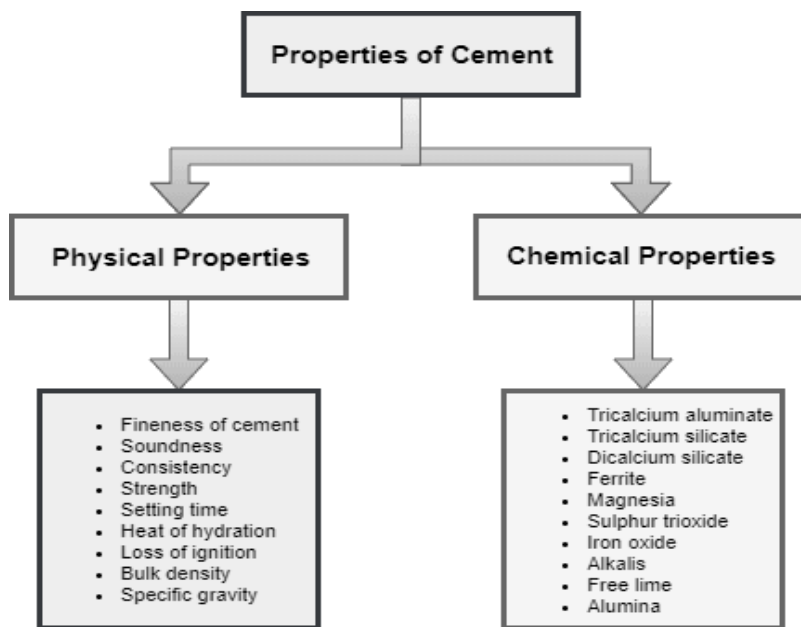

Physical Properties of Cement

Different blends of cement used in construction are characterized by their physical properties. Some key parameters control the quality of cement. The physical properties of good cement are based on:

- Fineness of cement
- Soundness
- Consistency
- Strength
- Setting time
- Heat of hydration
- Loss of ignition
- Bulk density
- Specific gravity (Relative density)

These physical properties are discussed in details in the following segment. Also, you will find the test names associated with these physical properties.

Fineness of Cement

The size of the particles of the cement is its fineness. The required fineness of good cement is achieved through grinding the clinker in the last step of cement production process. As hydration rate of cement is directly related to the cement particle size, fineness of cement is very important.



Soundness of Cement

Soundness refers to the ability of cement to not shrink upon hardening. Good quality cement retains its volume after setting without delayed expansion, which is caused by excessive free lime and magnesia.

Consistency of Cement

The ability of cement paste to flow is consistency.

It is measured by Vicat Test.

In Vicat Test Cement paste of normal consistency is taken in the Vicat Apparatus. The plunger of the apparatus is brought down to touch the top surface of the cement. The plunger will penetrate the cement up to a certain depth depending on the consistency. A cement is said to have a normal consistency when the plunger penetrates 10 ± 1 mm.

Strength of Cement

Three types of strength of cement are measured – compressive, tensile and flexural. Various factors affect the strength, such as water-cement ratio, cement-fine aggregate ratio, curing conditions, size and shape of a specimen, the manner of molding and mixing, loading conditions and age. While testing the strength, the following should be considered:

Cement mortar strength and cement concrete strength are not directly related. Cement strength is merely a quality control measure.

The tests of strength are performed on cement mortar mix, not on cement paste.

Cement gains strength over time, so the specific time of performing the test should be mentioned.



Strength of Cement

Compressive Strength

It is the most common strength test. A test specimen (50mm) is taken and subjected to a compressive load until failure. The loading sequence must be within 20 seconds and 80 seconds.

Tensile strength

Though this test used to be common during the early years of cement production, now it does not offer any useful information about the properties of cement.

Flexural strength

This is actually a measure of tensile strength in bending. The test is performed in a 40 x40 x 160 mm cement mortar beam, which is loaded at its center point until failure.

Setting Time of Cement

Cement sets and hardens when water is added. This setting time can vary depending on multiple factors, such as fineness of cement, cement-water ratio, chemical content, and admixtures. Cement used in construction should have an initial setting time that is not too low and a final setting time not too high. Hence, two setting times are measured:

Initial set: When the paste begins to stiffen noticeably (typically occurs within 30-45 minutes)

Final set: When the cement hardens, being able to sustain some load (occurs below 10 hours)

Again, setting time can also be an indicator of hydration rate.



Heat of Hydration

When water is added to cement, the reaction that takes place is called **hydration**. Hydration generates heat, which can affect the quality of the cement and also be beneficial in maintaining curing temperature during cold weather. On the other hand, when heat generation is high, especially in large structures, it may cause undesired stress. The heat of hydration is affected most by **C₃S and C₃A** present in cement, and also by **water-cement ratio**, fineness and curing temperature. The heat of hydration of Portland cement is calculated by determining the difference between the dry and the partially hydrated cement (obtained by comparing these at 7th and 28th days).

Loss of Ignition

Heating a cement sample at **900 - 1000°C** (that is, until a constant weight is obtained) causes **weight loss**. This loss of weight upon heating is calculated as **loss of ignition**. ***Improper and prolonged storage or adulteration*** during transport or transfer may lead to **pre-hydration** and **carbonation**, both of which might be indicated by increased loss of ignition.

Bulk density

When cement is mixed with water, the water replaces areas where there would normally be air. Because of that, the **bulk density of cement is not very important**. Cement has a varying range of density depending on the cement composition percentage. The density of cement may be anywhere from 3150 kg/ m³.

Specific Gravity (Relative Density)

Specific gravity is generally used in mixture proportioning calculations. Portland cement has a specific gravity of 3.15, but other types of cement (for example, portland-blast-furnace-slag and portland-pozzolan cement) may have specific gravities of about 2.90.

Chemical Properties of Cement

The raw materials for cement production are limestone (calcium), sand or clay (silicon), bauxite (aluminum) and iron ore, and may include shells, chalk, marl, shale, clay, blast furnace slag, slate. Chemical analysis of cement raw materials provides insight into the chemical properties of cement.

1. TricalciumAluminate(C₃A)

Low content of C₃A makes the **cement sulfate-resistant**. **Gypsum reduces the hydration of C₃A**, which liberates a lot of heat in the early stages of hydration. C₃A does not provide any

more than a little amount of strength.

Type I cement: contains up to 3.5% SO_3 (in cement having more than 8% C_3A)

Type II cement: contains up to 3% SO_3 (in cement having less than 8% C_3A)

2. **Tricalcium silicate (C_3S)**

C_3S causes **rapid hydration** as well as hardening and is responsible for the cement's **early strength gain** an initial setting.

3. **Dicalcium silicate (C_2S)**

As opposed to tricalcium silicate, which helps early strength gain, dicalcium silicate in cement helps the **strength gain after one week**.

4. **Ferrite (C_4AF)**

Ferrite is a fluxing agent. It **reduces** the **melting temperature** of the raw materials in the kiln from 3,000°F to 2,600°F. Though it hydrates rapidly, it does not contribute much to the strength of the cement.

5. **Magnesia (MgO)**

The manufacturing process of Portland cement uses magnesia as a raw material in dry process plants. An **excess** amount of magnesia may make the cement **unsound** and **expansive**, but a little amount of it can add **strength** to the cement. Production of MgO -based cement also causes less CO_2 emission. All cement is limited to a content of 6% MgO .

6. **Sulphur trioxide**

Sulfur trioxide in excess amount can make cement **unsound**.

7. **Iron oxide/Ferric oxide**

Aside from adding strength and hardness, iron oxide or ferric oxide is mainly responsible for the **color** of the cement.

8. **Alkalis**

The amounts of potassium oxide (K_2O) and sodium oxide (Na_2O) determine the alkali content of the cement. Cement containing large amounts of alkali can cause some difficulty in regulating the **setting time** of cement. Low alkali cement, when used with calcium chloride in concrete, can cause discoloration. In slag-lime cement, ground granulated blast furnace slag is not hydraulic on its own but is "activated" by addition of alkalis. There is an optional limit in total alkali content of 0.60%, calculated by the equation $\text{Na}_2\text{O} + 0.658 \text{K}_2\text{O}$.

9. **Freelime**

Free lime, which is sometimes present in cement, may cause **expansion**.

10. **Silica fumes**

Silica fume is added to cement concrete in order to improve a variety of properties, especially **compressive strength, abrasion resistance and bond strength**. Though **setting time** is

prolonged by the addition of **silica fume**, it can grant exceptionally high strength. Hence, Portland cement containing 5-20% silica fume is usually produced for Portland cement projects that require high strength.

11. Alumina

Cement containing high alumina has the ability to withstand frigid temperatures since alumina is chemical-resistant. It also quickens the setting but weakens the cement.

Mechanical Properties of Cement

The primary mechanical properties that determine the performance of concrete include

Compressive Strength: It describes the material's capacity to withstand compression forces.

Young's Modulus (Elastic Modulus): It describes the cement's capacity to withstand persistent deformation when pressure is applied.

Tensile Strength: It describes the capacity to withstand breaking when exposed to tension forces.

Poisson's Ratio: It describes the relationship between a material's response to an applied force in one direction (vertically) and a change in dimension in another direction (horizontal).

13 Types of Cement

- Ordinary Portland Cement (OPC)
- Portland Pozzolana Cement (PPC)
- Rapid Hardening Cement
- Quick setting cement
- Low Heat Cement
- Sulphate resisting cement
- Blast Furnace Slag Cement
- High Alumina Cement
- White Cement
- Colored cement
- Air Entraining Cement
- Expansive cement
- Hydrographic cement

Ordinary Portland Cement (OPC)

In usual construction work, Ordinary Portland Cement is widely used.

Portland cement clinker is a hydraulic material which shall consist of at least two-thirds by mass of calcium silicates, ($3 \text{ CaO} \cdot \text{SiO}_2$, and $2 \text{ CaO} \cdot \text{SiO}_2$), the remainder consisting of aluminium- and iron-containing clinker phases and other compounds. The ratio of CaO to

SiO₂ shall not be less than 2.0. The magnesium oxide content (MgO) shall not exceed 5.0% by mass.

The composition of Ordinary Portland Cement:

- Argillaceous or silicates of alumina (clay and shale)
- Calcareous or calcium carbonate (limestone, chalk, and marl)

Uses of Ordinary Portland Cement

- It is used for general construction purposes.
- It is also used in most of the masonry works.

Portland Pozzolana Cement (PPC)

Pozzolans are natural or synthetic materials that contain silica in reactive forms. It reacts with calcium hydroxide generated by hydrating cement to form additional cementations materials when it is finely divided. The composition of Portland Pozzolana Cement:

- OPC clinker
- Gypsum
- Pozzolanic Materials (Fly ash, volcanic ash, and Calcined clay or silica fumes.)

Uses of Portland Pozzolana Cement

- PPC is usually used in hydraulic structures, marine structures, construction near the seashore, dam construction, etc.
- It is also used in pre-stressed and post-tensioned concrete members.
- As it gives a better surface finish, it is used in decorative and art structures.
- It is also used in the manufacture of precast sewage pipes.

Rapid Hardening Cement

When finely grounded Tri-calcium silicate (C₃S) is present in OPC with higher content, it **gains strength more quickly** than OPC. This type of OPC is called Rapid Hardening Cement. It's initial Setting Time 30 minutes and Final Setting Time 600 minutes.

Uses of Rapid Hardening Cement

- Rapid hardening cement is mostly used where rapid construction is needed like the construction of pavement.

- It also gives high strength.

We have published three articles on rapid hardening cement on our website. In case you want to learn more about RHC, you can visit the following link.

Quick Setting Cement

Quick setting cement is the cement which sets in a very short time. The initial setting time is 5 minutes and the final setting time is 30 minutes. The composition of Quick Setting Cement:

- Clinker
- Aluminum sulfate (1% to 3% by weight of clinker)
- The aluminum sulfate increases the hydration rate of silicate.

Uses of Quick Setting Cement

- It is used in underwater construction.
- It is also used in rainy & cold weather conditions.
- It is used a higher temperature where water evaporates easily.
- Used for anchoring or rock bolt mining and tunnelling

Low Heat Cement

It is a special type of cement which produces low heat of hydration during the setting. Some chemical composition of Ordinary Portland Cement is modified to reduce the heat of hydration. The chemical composition of low heat cement:

- A low percentage (5%) of tricalcium aluminate (C3A)
- A higher percentage (46%) of clauding silicate (C2S).

Uses of Low Heat Cement

- It is used for the construction of dam's large footing, large raft slabs, and wind turbine plinths.
- It is also used for the construction of chemical plants.

Sulphate Resisting Cement

Sulfate resisting cement is used to resist sulfate attacks in concrete. Due to the lower percentage of Tricalcium aluminate, the production of calcium sulpho-aluminates gets reduced.

Uses of Sulphates resisting Cement

- Construction in contact with soils or groundwater having more than 0.2% or 0.3 % g/l sulfate salts respectively.
- Concrete surfaces subjected to alternate wetting and drying such as bridge piers, concrete surface in the tidal zone, apron, Building near the seacoast.
- Effluent treatment plans, Chimney, Chemical industries, water storage, sumps, drainage works, Cooling towers, Coastal protective works such as sea walls, breakwaters, tetrapods, etc.

Blast Furnace Cement

Portland cement clinker and granulated blast furnace slag are intergraded to make blast furnace cement. A maximum of 65 percent of the mixture could be comprised of blast furnace slag.

Uses of Blast Furnace Cement

- It is highly sulfate resistant
- Frequently used in seawater construction.

High Alumina Cement

High Alumina cement is obtained by mixing calcining bauxite (it's an aluminum ore) and ordinary lime with clinker during the manufacture of OPC. In which the total amount of alumina content should not be lesser than 32% and it should maintain the ratio by weight of alumina to the lime between 0.85 to 1.30.

Uses of High Alumina Cement

- It is used where concrete structures are subjected to high temperatures like workshops, refractory, foundries, etc.
- It also used where the concrete is subjected to frost and acidic action.

White Cement

White cement is quite similar to Ordinary Portland Cement except for color. Amounts of iron oxide and manganese oxide are low in White Cement. It is expensive than OPC so not economical for ordinary work.

Uses of White Cement

- It is usually used in decorative work.
- It can also use for traffic barriers, tile grouts, swimming pools, roof tiles patching materials, and terrazzo surfaces.

Colored Cement

To make 5 to 10 percent of suitable pigments are ground with OPC. Types of pigments are selected according to the desired color.

Uses of Colored Cement

- Colored cement is used for different decorative work.

Air Entraining Cement

It is seen that entrainment of air or formation of gas bubbles while applying cement increases resistance to frost action, fire, scaling, and other similar defects. Air-entraining cement is a special type of cement which entrains tiny air bubbles in concrete.

It is produced by grinding minute air entraining materials with clinker by adding some resinous materials e.g. vinsol resin to ordinary portland cement.

When the water in concrete gets frizzed due to low temperature, it expands. When air-entraining cement, the air voids in concrete provides space for water to expand without cracking concrete. But this type of cement does not provide high strength in concrete.

Uses of Air-Entraining Cement

- Especially it is used in areas where the temperature is very low.
- It also resists the Sulphet attack.
- It is used where the de-icing chemical is used.

Expansive Cement

In the hydration process, the expansive cement expands its volume. It can be possible to overcome shrinkage loss by using expansive cement.

Uses of Expansive cement

- It is used in the construction of the pre-stressed concrete component.
- It is also used for sealing joints and grouting anchor bolt.
- In the construction of different hydraulic structures, this type of cement is used.

Hydrophobic Cement

To resist the hydration process in the transportation or storage stage, clinkers are ground with water repellent film substance such as Oleic Acid or Stearic Acid. These chemicals form a layer on the cement particle and do not allow water to mix and start the hydration process. When cement and aggregate are thoroughly mixed in the mixer, protective layers break and start normal hydration with some air-entrainment which increases workability.

Uses of Hydrophobic Cement

- Usually, it is used in the construction of water structures such as dams, spillways, or other submerged structures.
- It is also used in the construction of underground structures like tunnel etc.

Uses of Cement

Following are the different uses of cement in construction works:

1. To prepare cement mortar
2. To prepare cement concrete
3. To build fire proof and thermal proof structures
4. To build hydrographic and frost resistant structures
5. To build chemical proof structures
6. As a grout material
7. To construct Cement concrete roads
8. To manufacture precast members
9. For aesthetic concrete construction

MORTAR

Contents: Cement mortar: Constituents, Preparation

Mortar is an intimate mixture of binding material, fine aggregate and water. When water is added to the dry mixture of binding material and the inert material, binding material develops the property that binds not only the inert material but also the surrounding stones and bricks.

TYPES OF MORTAR

- CEMENT MORTAR
- LIME MORTAR
- SURKI MORTAR
- GAUGED MORTAR
- MUD MORTAR

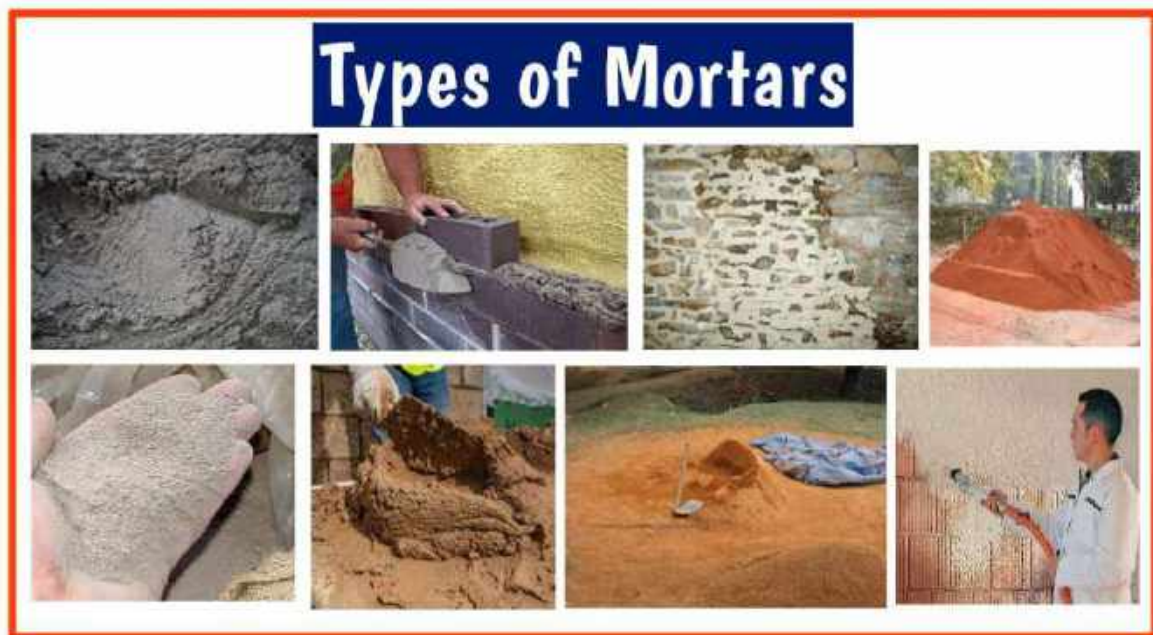

CEMENT MORTAR

Cement mortar composite has wide application in masonry work, plastering, repairing damaged concrete, patching or filling, rendering, floor leveling, and the development of precast products. The composite is composed of binder, sand, water, and fibers with a maximum size of fine-grain material of 2 mm. The binder may be cement, mineral with polymeric or chemical admixtures.



CONSTITUENTS OF CEMENT MORTAR:-

Cement mortar should be composed of cement, sand, and water, be well-mixed, and have the proper consistency to obtain a dense, homogeneous lining that will adhere firmly to the substances surface. Cement-mortar lining should be applied by spinning, mechanical placement (line traveling), the pneumatic process (shotcrete or gunite), and hand troweling.

PREPARATION:-

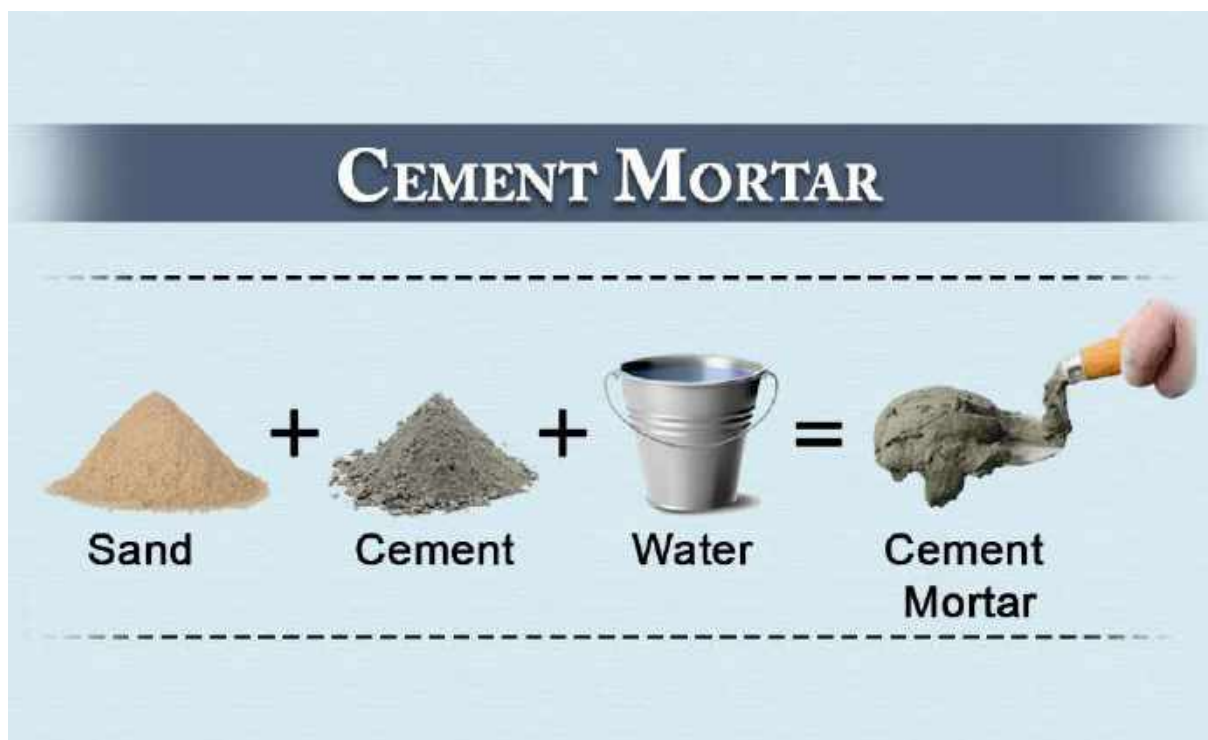

- Selection of Raw Materials
- Proportion of cement mortar
- Mixing of ingredients

1. SELECTION OF RAW MATERIALS:-

- The production of cement mortar can be done with a variety of materials, but it is important to choose the correct ones for the job based on the construction's kind and intended use.
- Mortar is created using Portland cement. For most construction tasks, ordinary Portland cement is best. Lime is Sand must be of good quality and devoid of contaminants like clay, dust, iron oxide, etc. Before combining it with cement, it needs to be thoroughly cleaned. used to make composite mortars.
- Sand gives concrete strength and resistance to breaking and shrinkage. It gives mortars bulk, which makes it affordable. It would be not only very expensive but also useless to use simply cement.

2. PROPORTION OF CEMENT MORTAR:-

The Proportion means the relative quantity of different components to be mixed to make good mortar, or simply the ratio between different materials.

Following are the proportions of cement mortar which is commonly recommended for different works:

01. Masonry Construction:-

- For ordinary masonry work with brick/ stone as a structural unit. – 1:3 to 1:6
- For reinforced brick work – 1:2 to 1:3.
- For all work in moist situations – 1:3
- For Architectural work – 1:6
- For load bearing structures – 1:3 or 1:4

02. Plaster Work:-

- For External Plaster and Ceiling Plaster – 1:4
- Internal Plaster (If sand is not fine i.e. Fineness Modulus > 3) – 1:5
- For Internal Plaster (if fine sand is available) – 1:6

03. Flooring Work:

- Mortar ratio of 1:4 to 1:8 (cement: sand, water to be judgmental), for 5 to 7 times thickness of verified tiles, should be given as bed between RCC floor and tiles.

04. Pointing Work:

- For pointing work proportion of cement mortar should be 1:1 to 1:3

3. MIXING OF INGREDIENTS:-

- Sand and cement are appropriately combined in a dry environment to create cement mortar. After that, water is gradually added and combined using a shovel. Clay and other pollutants should not be present in the water. Either manually (Hand Mixing) or mechanically mixing cement mortar is an option (Machine Mixing). Hand mixing is frequently employed in modest projects. When mortar is needed in big amounts and must be used continuously, mechanical mixing is necessary.

Cement vs. Concrete vs. Mortar		
<ul style="list-style-type: none">- Binding element in both concrete & mortar- Made of limestone, clay, shells, & silica sand- Sets & hardens when combined with water	<ul style="list-style-type: none">- Made of cement, sand, & gravel- Used for building: foundations, slabs, patios, & masonry- Most flexible, forming into any mold & rock hard	<ul style="list-style-type: none">- Made of cement & sand- Used as the glue to hold bricks, blocks, etc. together- Various types available for specific applications

CONCRETE

Contents: Concrete types:PCC and RCC, Grades of Concrete

Concrete is a composite material composed of fine and coarse aggregate bonded together with a fluid cement (cement paste) that hardens (cures) over time. Concrete is the second-most-used substance in the world after water, and is the most widely used building material.

PLAIN CEMENT CONCRETE

Plain concrete, also known as plain cement concrete or PCC, is most commonly used for paving and flooring.

Major ingredients of concrete are:

- Binding materials (like cement, lime, polymer)
- Fine aggregate (sand)
- Coarse aggregate (crushed stone, jelly)
- Water

A small quantity of admixtures like air entraining agents, water proofing agents, workability agents etc. may also be added to impart special properties to the plain concrete mixture.

The objective of plain cement concrete alias PCC is **to arrange a firm impermeable bed to RCC in the foundation where the soil is soft and flexible**. It is mostly applied over brick flat soling or devoid of brick flat soling. It is also known as Cement Concrete (CC) or Blinding Concrete.



RCC

Reinforced concrete, **concrete in which steel is embedded in such a manner that the two materials act together in resisting forces.** The reinforcing steel—rods, bars, or mesh—absorbs the tensile, shear, and sometimes the compressive stresses in a concrete structure.



- Reinforced concrete is used for construction on a large scale, such as bridges, dams, piers, tall buildings and stadiums. It is most commonly used in domestic construction for the footings and foundations of smaller everyday dwellings.
- Reinforced concrete (RC), also called reinforced cement concrete (RCC) and ferroconcrete, is a composite material in which concrete's relatively low tensile strength and ductility are compensated for by the inclusion of reinforcement having higher tensile strength or ductility.

NOTE

- Depending upon the proportion of ingredient, strength of concrete varies. It is possible to determine the proportion of the ingredients for a particular strength by mix design procedure. In the absence of mix design the ingredients are proportioned as 1:1:2, 1:3/2:3, 1:2:4, 1:3:6 and 1:4:8, which is the ratio of weights of cement sand to coarse aggregate.
- In proportioning of the concrete, it is kept in mind that voids in coarse aggregates are filled with sand and the voids in sand are filled with cement.
- In terms of strength, naturally, **RCC is stronger** because the reinforcement helps in load-carrying capacity. PCC is weaker and is only used for layering surfaces like plastering work or flooring and most importantly in the layering if excavation to cast footings.

Concrete Grades

Classification of Grades of Concrete			
Designation	Mix Proportion (Cement: Sand: Coarse aggregate)	Characteristic Compressive strength in N/mm ²	Group
M5	1 ; 5 ; 10	5	Lean concrete
M7.5	1 ; 4 ; 8	7.5	
M10	1 ; 3 ; 6	10	
M15	1 ; 2 ; 4	15	Ordinary concrete
M20	1 ; 1.5 ; 3	20	
M25	1 ; 1 ; 2	25	Standard concrete
M30	Design mix	30	
M40		40	
M50		50	
M55		55	
M60		60	
M80		80	High strength concrete

- Proportion of ingredients usually adopted for various works are shown in table below.

S. No.	Proportion	Nature of Work
1	1:1:2	For machine foundation, footings for steel columns and concreting under water.
2	1:1 $\frac{1}{2}$:3	Water tanks, shells and folded plates, for other water retaining structures.
3	1:2:4	Commonly used for reinforced concrete works like beams, slabs, tunnel lining, bridges
4	1:3:6	Piers, abutments, concrete walls, sill of windows, floors.
5	1:4:8	Mass concretes like dam, foundation course for walls, for making concrete blocks.

Functions of Various Ingredients

Concrete Ingredients

Concrete has been used as a building material for thousands of years. The main ingredients have been the same, but new admixture technologies allow designers and engineers to finely tune the final properties of the fully set concrete.

Four Main Ingredients

Concrete is made up of four main ingredients: water, Portland cement, aggregates, and air. The ratio of the ingredients changes the properties of the final product, which allows the engineer to design concrete that meets their specific needs. Admixtures are added to adjust the concrete mixture for specific performance criteria.



Water



Cement

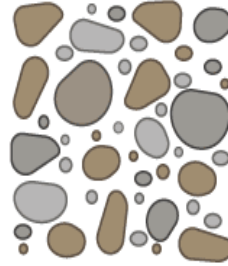

Aggregate



Air

Water + Cement + Aggregate + Air

Concrete ingredients: water, cement, aggregate, and air

Water

- The water in the concrete mix should be clean and free of impurities. The amount of water relative to the amount of cement changes how easily the concrete flows, but also affects the final strength of the concrete. More water makes for easier flowing concrete, but also makes for lower strength concrete upon curing.

Portland Cement

- Cement hardens when mixed with water, which binds all of the ingredients together. Portland cement is the most common cement used and is composed of alumina, silica, lime, iron, and gypsum. Small amounts of other ingredients are also included.

Aggregates

- The majority of a concrete mixture is made up of both coarse and fine aggregates, which help increase the strength of the concrete beyond what cement can provide on its own. Sand, gravel, and crushed stone are used as aggregates. Recycled materials, including blast furnace slag, glass (mostly for decorative purposes), and ground-up concrete are starting to be used as concrete aggregates.

Air

- The fourth main ingredient of concrete is entrained air. While it usually isn't considered an ingredient, the fact is that a concrete mix includes anywhere from 1% to 9% entrained air. Higher quantities of air should be included when the concrete will be exposed to very cold or freezing conditions.

Admixtures

- Admixtures accomplish a variety of goals. This can be as simple as adding a pigment to color the concrete. Other admixtures are used for faster curing times in cold

weather, creating extremely high-strength concrete, or for increasing the flowable nature of concrete without compromising the strength. Unfortunately, admixtures can generate unwanted results such as poor adhesion of finish-flooring. For this reason, many structural engineers and architects are hesitant to use admixtures. We have an article that covers a number of different admixtures.

Hydration: A Chemical Reaction

- While the moisture content reduces as the concrete sets, it is important to know that concrete doesn't "dry." Rather, concrete sets through a chemical reaction called hydration. This is why concrete can be placed under water.
- The concrete starts to set as soon as water is added to the mix. Therefore, the mix should be constantly moved to help keep the particles from binding together (thus rotating concrete trucks.) Most job sites require the concrete to arrive and be placed within 90 minutes from initial mixing, but admixtures can extend that time.

Green Concrete and Hardened concrete

- Concrete has completely different properties when it is in its plastic stage. Concrete in its plastic stage is known as also green concrete.
- The properties of green concrete include:

1. Workability
2. Segregation
3. Bleeding
4. Harshness

The properties of hardened concrete include:

1. Strength
2. Resistance to wear
3. Dimensional changes
4. Durability
5. Impermeability

STEEL

Contents: Use of steel in buildings, types

Steel is an important alloy of iron and carbon. It is highly elastic, ductile, malleable and weldable. Steel has high tensile and compressive strength and also stands wear and tear much better.

USE OF STEEL IN BUILDING WORKS:

Steel can be used for various purposes in building works –

1. As structural material in trusses , beams, etc
2. As non-structural material for grills, doors, windows etc
3. In steel ,pipes , tanks etc
4. In sanitary and sewer fittings, rainwater goods etc
5. Corrugated sheets
6. As reinforcement for concrete

STEEL AS A REINFORCEMENT IN CONCRETE-

Although plain concrete is very strong in compression , it is very weak in tensile strength .So, steel is being used in concrete reinforcement . It is equally strong in compression and tension. The steel for reinforcing bars of other forms of round bars varying in diameter from 5 to 40 mm , sometimes bars of other forms as mentioned above are also used. Reinforced cement Concrete (RCC) is more rigid, highly durable and fire resistant. It posses high tensile strength and it is economical in ultimate cost.

TYPES OF STEEL SECTION:

1.Mild Steel-

- It has a carbon content of about 0.23 -0.25% .
- For bars with a diameter of minimum 20mm, a higher value of this carbon content is acceptable.
- Size ranges from 6mm up to 32mm (6,12,16,20,25 &32mm) depending on length and diameter.
- The ultimate tensile strength is 250 N/mm² & young modulus is 2×10^5 N/mm² for this material.
- Reinforcement in concrete was a typical usage for it window bars , grills & steel gates are example of this type of materials.

2.HYSD bars-

- High yielding strength deformed bars
- Two types of HYSD bars termed as Fe-415 and Fe-500 tensile strength N/mm².
- Have ribs on the surface make bond between concrete and steel greater.
- Bars come in diameter 8,10,12,16,20,22,25,28 & 32mm
- The bars are now being used as reinforcement instead of mild steel bar because their higher strength in tensile & bond is stronger. These are called wind bars.

3.HIGH TENSILE BARS-

- Made with 0.8% carbon and .6% manganese as well as small amount of silicon, sulphur, phosphorous to make them strong.
- The bars have tensile strength as high as 1400 to 1900 n/m² . The young modulus steel is also same as that of mild steel.
- In prestressed concrete, reinforcing is provided by high tensile bars.

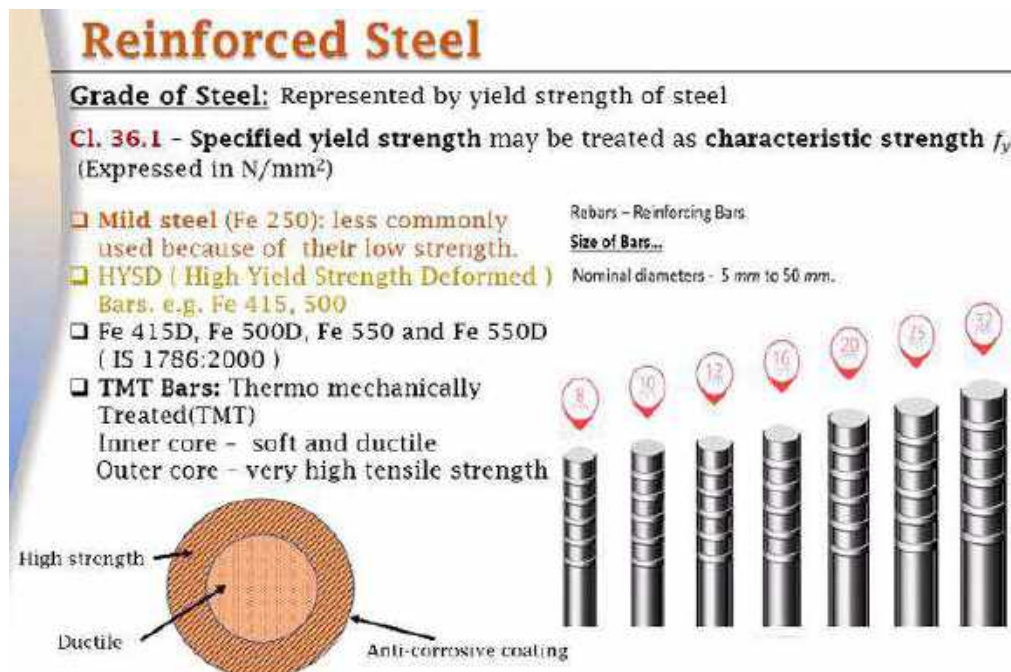

Fig- Types of steel

MARKET FORMS OF STEEL :

1.Angle Section-

Angle section may be of equal legs or unequal legs. Equal angles available in sizes 20mm*20mm*3mm to 200mm*200mm*25mm . The corresponding weights per meter lengths are .95Kg to 73.60 kg. Unequal angles varies size forms 30mm*20mm*3mm to 200mm*150mm*18mm. Corresponding weights are from 1.10kg to 46.90 kg. Angle sections are extremely used in structural steel work especially in the construction of steel roof trusses and filler joist floors.

2.Channel Section –

Channel section consist of a web and two flanges. A channel section is designated by the height of the web and width of flanges. It varies size from 100mm*45mm to 400mm*100mm . The corresponding weight per meter length are respectively 5.80 kg to 49.40 kg. The ISI has classified channel sections as junior channel, light channel and medium channel. It used as structural members in steel framed structures.

3.Corrugated Sheets –

These are formed by passing steel sheets through grooves. These grooves bend and press steel sheets and corrugations are formed on the sheets. They are usually galvanized and known as GI sheets. They are usually used in roof covering.

4.Expanded metal –

This form of steel is available in different shapes and sizes. It is prepared from sheets of mild steel, which are machine cut and drawn out or expanded. These are widely used for reinforcing concrete in foundation , roads, floors and bridges etc.

5. Flat bars –

These are available in suitable widths varying from 10mm to 400mm with thickness varying from 3mm to 40mm. They are widely used in construction of steel grillwork for windows and gates.

6. I sections –

These are known as rolled steel joists and beams. The two flanges connected through a web. They are available sizes from 75mm*50mm at 6.10kg to 600mm *210mm at 99.50Kg. Beams are suitable for columns are available in H sections 150mm*100mm to 600mm*250mm size.

7.Plates-

The plate sections of steel varies from 5 to50 mm thickness. They are mainly used for purposes-

- To connect steel beams for extension of the length
- To serve as tension members of steel roof truss.
- To form a built up sections of steel.

8. Ribbed torsteel beams-

They are varies from 6 to 50 mm size. They are widely use in reinforcement in concrete structure such as buildings , bridges, roads, irrigation works. These bars have ribs on their surface and they are produced by controlling twisting.



Fig- Various c/s of steel

9. T-sections –

It consists of flanges and web. They are available from size 20mm*20mm*3mm to 150mm*150mm*10mm size. These sections are widely used as members of steel root truss and to form built up sections.



Fig- Steel T-Section

#####

BASIC OF CIVIL ENGINEERING (BCE02001)

Module-III

Module III Syllabus

Building Construction - Foundations, Classification, Bearing Capacity of Soil and related terms (definition only), ***Masonry Works***- Classifications, the definition of different technical terms, ***Brick masonry***- types, bonds, general principle, ***Roofs***-Functional requirements, basic technical terms, roof covering material, ***Floors***- Function, types, flooring materials (brief discussion), ***Plastering and Painting***- Objectives, types, preparation, and procedure of application.

Subject to Revision

FOUNDATION

<Foundations, Classification, Bearing Capacity of Soil and related terms (definition only)>

FOUNDATION:

It is a part of structural system that supports and anchors the superstructure of a building and transmits its loads directly to the earth. Foundation of a building as the name implies is the starting of a building construction on site really. Types of building, nature of soil and environmental conditions are the major determinant of type of foundation. Choosing a kind of foundation depends on, ground conditions, groundwater conditions, site – the environment (the buildings nearby) and structure of our building.

Purpose:-

There are numerous reasons a foundation is provided, some of which are:

- The most crucial purpose of providing Foundation is Structural Stability. Strength of the foundation determines the stability of the structure to be constructed.
- A properly designed and the constructed foundation provide an even surface for the development of superstructure at a proper level at over a firm bed.
- A well-designed foundation prevents the lateral movement of the supporting material (which is the soil in this case) and thus ensuring the safety of the superstructure from the detrimental effects of the lateral movements of soil.
- The foundation serves the purpose of completely distributing the loads from the structure to a large base area, and then the soil underneath. This uniform transfer of loads helps in avoiding unequal settlement of the building, which is one of the detrimental defects in building construction.

Types of Foundation:-

1. Shallow foundation: If the depth of foundation is less than the width of foundation then it is known as Shallow or stepped Foundation. It can be used where the bearing capacity of soil on which the structure is to be constructed is maximum. Minimum depth of this Foundation is 800mm and maximum depth not to be taken more than 4 meters.
2. Deep foundation: If the depth of footing greater or equal to the Width of footing, it is known as the deep Foundation. Deep Foundation is used where the bearing capacity of the soil is very low. The load coming from the superstructure is further transmitted vertically to the soil.

Difference between Foundation and Footing:

- Foundation is a structure which transfers the loads from the superstructure to the ground, while footing is the foundation which is in contact with the earth.

- A foundation can be shallow and deep, while a **footing** is a type of a **shallow foundation**. so, all footings are foundations but all foundations cannot be footings.

Types of foundation

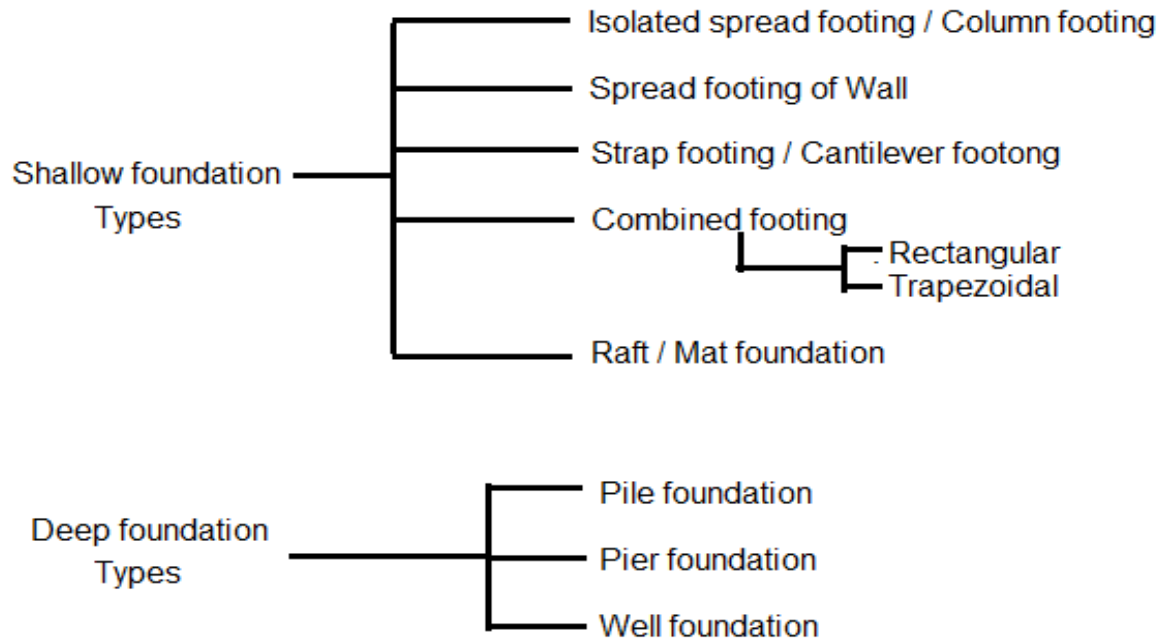

SHALLOW FOUNDATIONS

- They are usually located no more than 6 ft below the lowest finished floor.
- A shallow foundation system generally used when
 - The soil close to the ground surface has sufficient bearing capacity
 - Underlying weaker strata do not result in excessive settlement.
- The shallow foundations are commonly used most economical foundation systems
- **Types of spread footing: (either for Column or for Wall)**
 - a) Single pad footing.
 - b) Stepped footing for a column.
 - c) Sloped footing for a column.
 - d) Wall footing without step.
 - e) Stepped footing for walls.
 - f) Grillage foundation.

- (a) **Isolated spread footings** under individual columns which can be square, rectangular or circular.

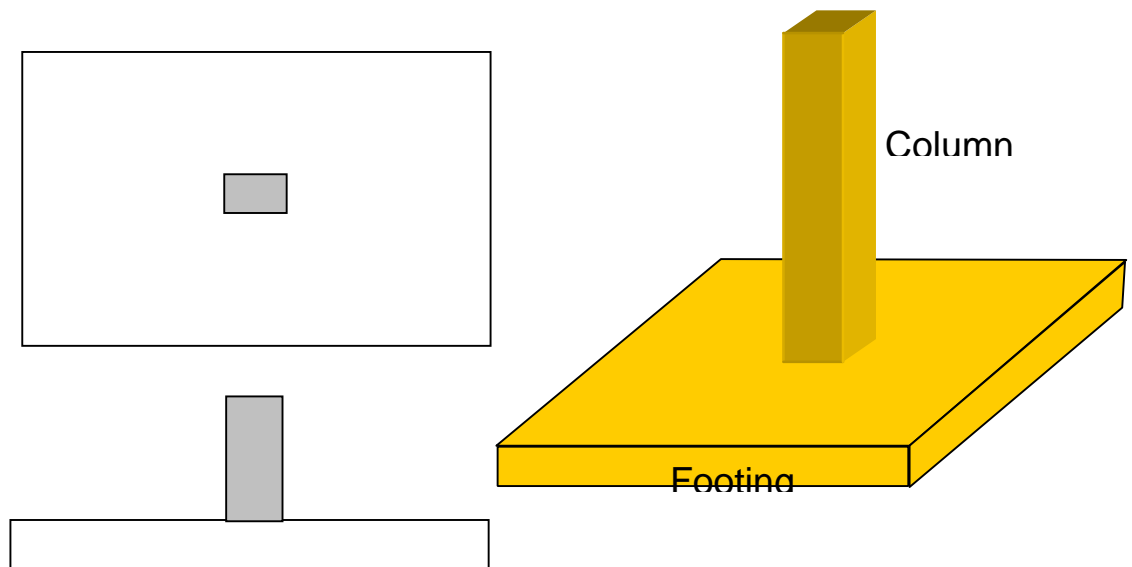

- (b) **Wall footing** is a continuous slab strip along the length of wall

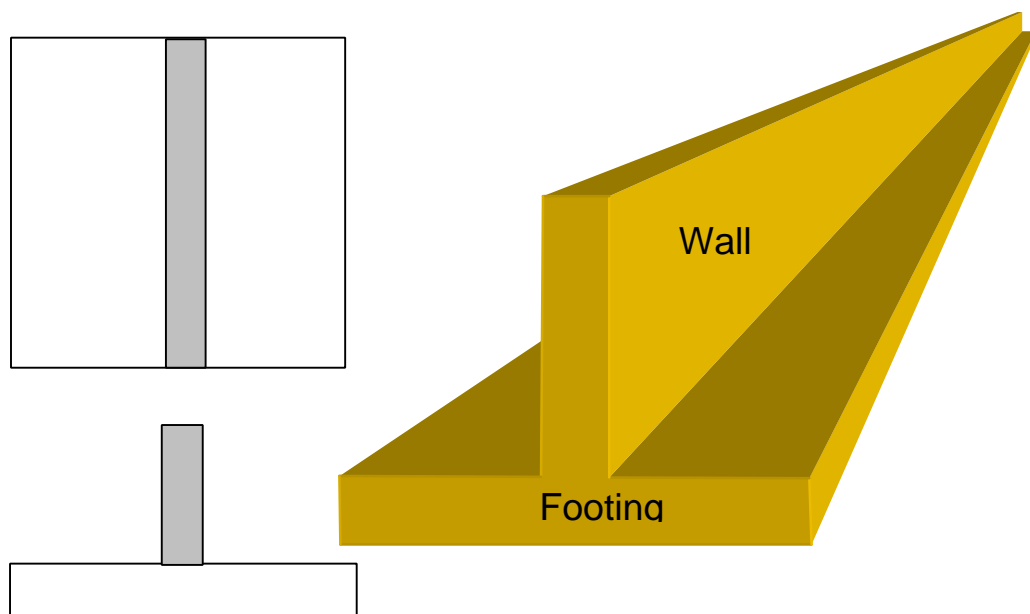

- (c) **Combined footings** support two or more columns. These can be rectangular or trapezoidal in plan.

➤ A combined footing is necessary in following **three reasons**:

- Columns are placed **very close to each other** so that their individual footings overlap each other
- When **bearing capacity of soil is less** so it is required to have a more spread area for footing and so footing of adjacent column may overlap
- When external column is **close to property line**, it is not possible to provide isolated footing for that column because it may be extended beyond the property line and so combined footing solves the problem

- The **essential condition** to satisfy in **combined footing** is that, **centroid of footing area should coincide with resultant of column loads** so that **soil pressure distribution is uniform under soil**.
- **Types of combined footing:**
 - Combined footing (Rectangular):
 - Combined footing (Trapezoidal):
If outer column near property line carries a heavier load
 - Strap footing
 - Raft / mat foundation

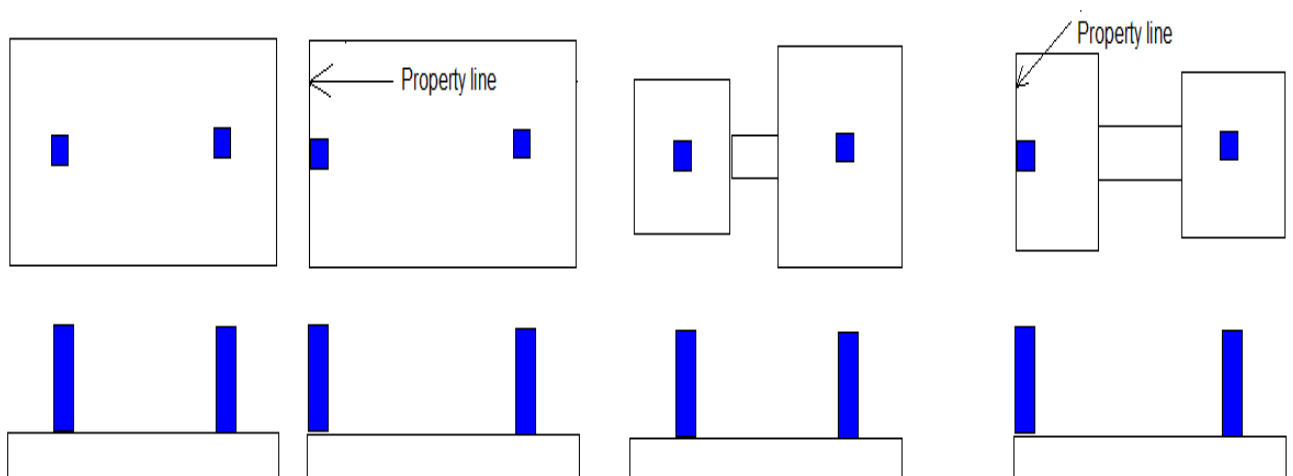
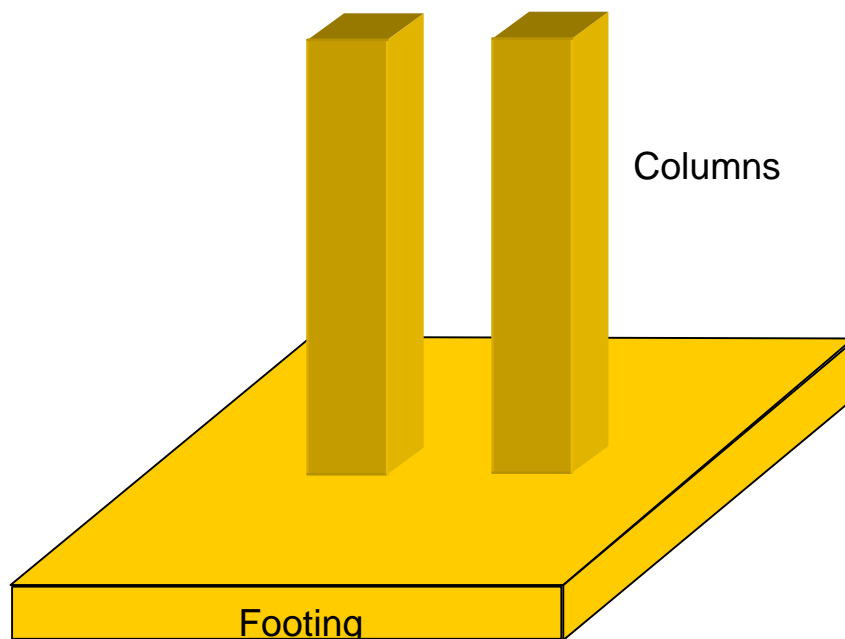

Combined footing

Strap footing

Combined footing

(d) **Strap or Cantilever Footing**

- Strap footings are similar to combined footings.
- Reasons for considering or choosing strap footing are identical to the combined one.
- In *strap footing*, the foundation under the columns is built individually and connected by a **strap beam**.
- Generally, when the **edge of the footing cannot be extended beyond the property line**, the **exterior footing is connected by a strap beam with interior footing**.

(e) **Raft / mat foundation:**

- This is a large continuous footing supporting all the columns of the structure.
- This is used when soil conditions are poor but piles are not used.
- Raft foundation is provided
 - When **load** transmitted by **columns** are so **heavy** or **allowable soil pressure** are so small that individual footings if provided would **cover more than about half** of the area, then it is better to provide a continuous footing called raft foundation under all columns and walls
 - Raft foundations are used to reduce settlement of structure located above heavy compressible deposits i.e. they control differential settlement
- **Types of raft foundation:**
 - **Solid raft** (A continuous slab covering all the columns)
 - **Ribbed raft** (mat with a central hollow region when all the columns are connected by a continuous beam which gets supported on the raft slab)

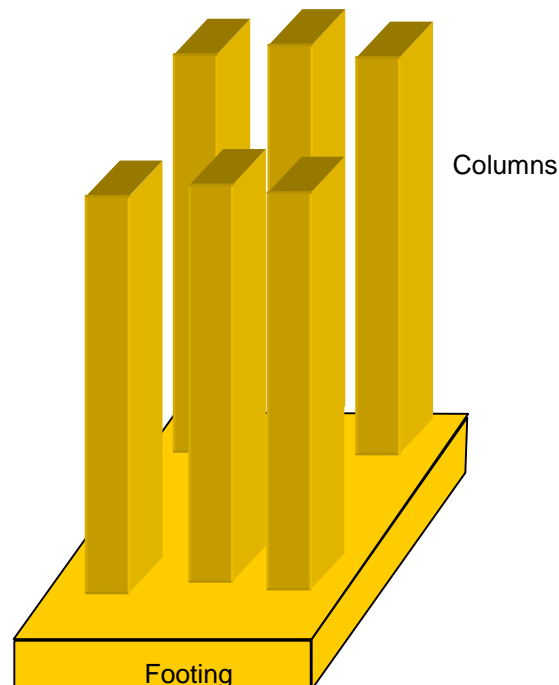

Raft foundation

Mat or Raft

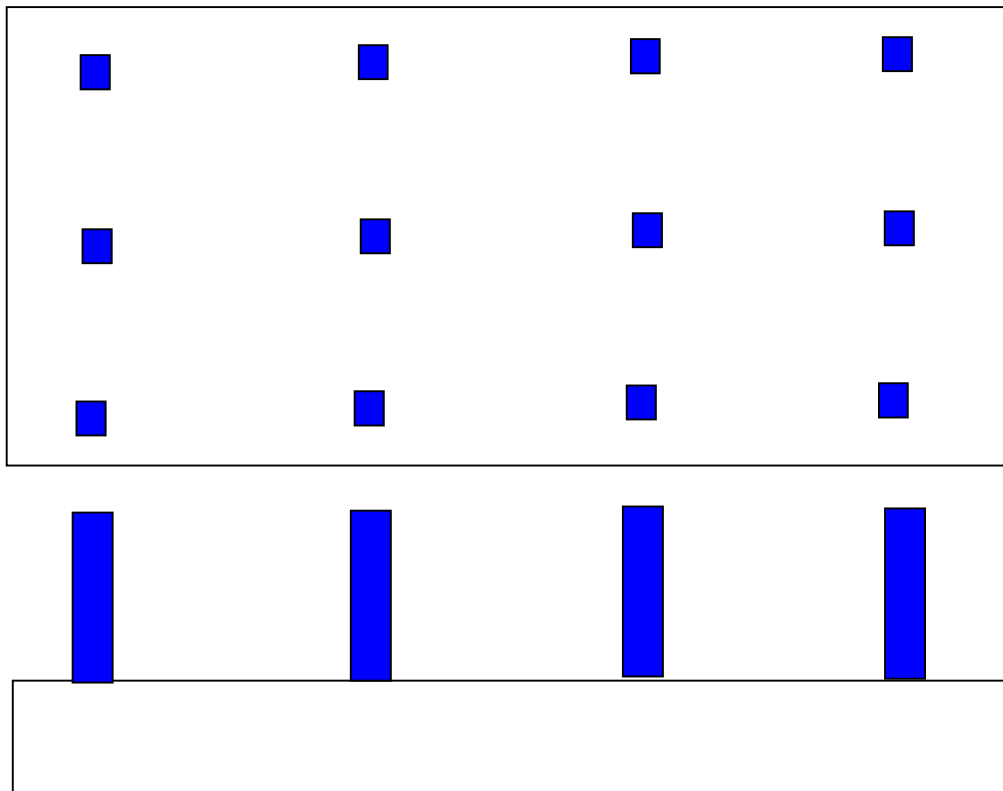

DEEP FOUNDATION

1. PILE FOUNDATION

- A **pile** is a **slender column** provided with a **cap** to receive the **column load** and transfer it to **undelaying soil layer / layers**.
- **Pile foundation** is a common type of deep foundation.
- Pile is a slender member with a small cross-sectional area compared to its length.
- It is used to transmit foundation loads to a deeper soil or rock strata when the bearing capacity of soil near the surface is relatively low.
- Pile transmits load either by skin friction or bearing.
- Piles are also used to resist structures against uplift and provide structural stability against lateral and overturning forces.
- They are used to reduce cost, and when as per soil condition considerations, it is desirable to transmit loads to soil strata which are beyond the reach of shallow foundations.
- Pile foundations are economical when
 - Soil with higher **bearing capacity** is at a greater depth.
 - When the foundation is subjected to a **heavily concentrated load**
 - The foundation is subjected to **strong uplift force**
 - Lateral forces are relatively pre dominant
 - When there are chances of construction of **irrigation canals** in the nearby area.

- Expansive soil like **black cotton soil** are present at the site
- In **marshy places** where soil is wet soil/ soft soil/ water logged/ low laying area
- When the **topsoil layer** is **compressible** in nature.
- In the case of bridges, when the **scouring** is **more** in the **river bed**.
- When it is very expensive to provide **raft** or **grillage**.

2. PIER FOUNDATION

- Pier is a deep foundation structure above ground level that transmits a more massive load, which cannot be carried by shallow foundations.
- It is usually shallower than piles.
- Pier foundation is a cylindrical structural member that transfer heavy load from superstructure to the soil by end bearing.
- Unlike piles, it can only transfer load by end bearing only and by not skin friction.

Difference between Pile and Pier foundation

Pile	Pier
Piles are always below the ground level	Piers are always above the ground
Larger in length and smaller in diameter	Smaller in length and larger in diameter
Adopted when there is no hard bearing strata of soil available at reasonable depth	Adopted when there is hard bearing strata of soil available at reasonable depth but other types of foundation construction is not economical
Piles are driven through overburden soil into load bearing strata	Pier is drilled by drilling machine
Transfers full load through both bearing and friction action only	Transfers full load through bearing action only
Constructed at greater depth	Constructed at shallower depth
Resist greater intensity of load	Resist smaller intensity of load

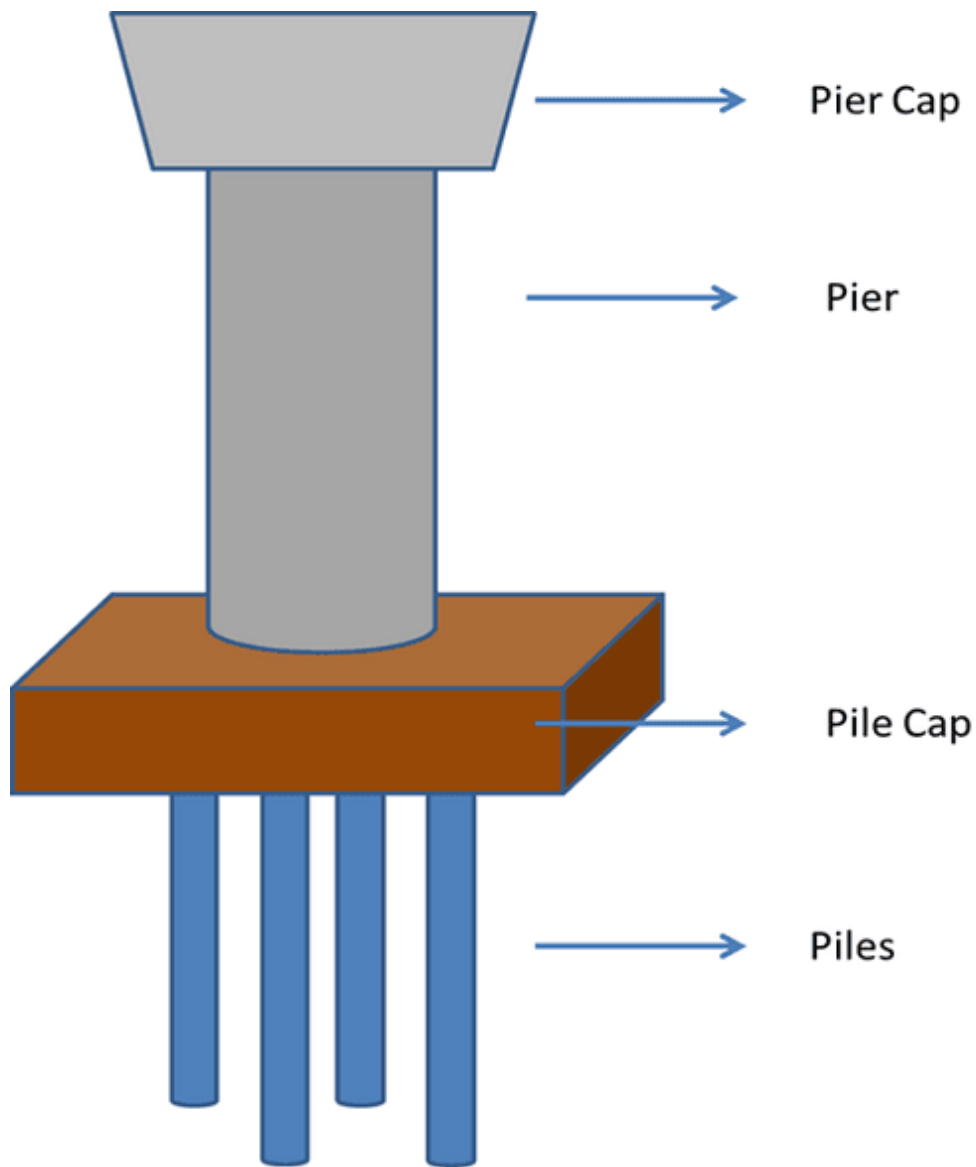

PIER foundation with PILE

3.WELL / CAISSON FOUNDATION

- Caisson foundation is a watertight retaining structure used as a bridge pier, construction of the dam, etc.
- It is generally used in structures that require foundation beneath a river or similar water bodies.
- The reason for choosing the caisson is that it can be floated to the desired location and then sunk into place.
- Caisson foundation is a ready-made hollow cylinder depressed into the soil up to the desired level and then filled with concrete, which ultimately converts to a foundation.
- It is mostly used as bridge piers.

- Caissons are sensitive to construction procedures and lack construction expertise.
- There are several types of caisson foundations.
 1. Box Caissons.
 2. Floating Caissons.
 3. Pneumatic Caissons.
 4. Open Caissons.
 5. Sheeted Caissons.
 6. Excavated Caissons.



CAISSON Foundation

DETAILS OF PILE AND PILE CAP

Classification of Pile foundation:

1. Based on Function or Use:

a) End Bearing Piles:

These are the pile used to transfer loads through water or soft soil to a suitable bearing stratum.

b) Friction Piles:

This type of pile utilizes the frictional resistance force between the pile surface and adjacent soil to transfer the superstructure load.

c) Combined end bearing and friction pile:

This pile transfers the super-imposed load both through side friction as well as end bearing. Such piles are more common, especially when the end bearing piles pass through granular soils.

d) Compactor Piles:

These are used to compact loose granular soil thus increasing their bearing capacity.

e) **Batter pile:**

A pile driven at an angle with the vertical to resist a lateral force

f) **Sheet Piles:**

Used as impervious cut-off to reduce seepage and uplift under hydraulic structures.

They are rarely used to furnish vertical support but are used to function as retaining wall

g) **Anchor pile:**

It provides anchorage against horizontal pull from sheet piling

Anchor piles can transfer both **compressive** and **tensile** forces as well as **bending moments** to the ground, making them ideal as anchors for offshore moorings, basements, and tunnels, etc. Moored floating offshore structures impose a variety of load conditions on the anchor system.

h) **Tension/uplift pile:**

It anchors down the structures subjected to uplift due to hydro static pressure, seismic activity or due to overturning moment

2. **Based on Materials:**

- a) Timber Piles
- b) Concrete Piles
- c) Steel Piles
- d) Composite Piles

3. **Based on construction process:**

a) Bored Piling:

Bored piles are installed by auguring into the ground forming a hole into which concrete can be poured, thereby casting the pile in position.

b) Driven Piling:

Driven piles are driven or hammered into the ground with the use of vibration

c) Screw Piling

Screw piles are wound into the ground, much like a **screw** is wound into wood. This is an efficient means of installation and coupled with their mechanism of dispersing load, provides effective in-ground performance in a range of soils, including earthquake zones with liquefaction potential

d) Mini Piling

Mini piling is a variation on piling that uses a narrower diameter. This makes them light and inexpensive whilst still being able to support considerably heavy loads. For the most common type of mini piling a hollow steel shaft is screwed or drilled into the ground

e) Sheet Piling

Sheet pile walls are retaining walls constructed to retain earth, water or any other filling materials. These walls are thinner in section compared to masonry walls. Sheet pile walls are generally used for following: Water front structures, i.e. in building wharfs, quays and piers.

4. **Classification of Piles based on the effect of Installation:**

- a) **Displacement** pile:(eg: **Driven** Cast in Situ concrete pile and Driven Precast concrete pile)
- b) Non- Displacement pile: (eg: **Bored** Cast in Situ concrete pile, Bored Precast concrete pile)

5. Classification of Concrete piles:

- a) Driven cast in-situ (CIS) piles (IS 2911-P1-S1-2010)
- b) Bore cast in-situ (CIS) piles (IS 2911-P1-S2-2010)
- c) Driven precast (PC) piles (IS 2911-P1-S3-2010)
- d) Precast (PC) pile in pre bore hole (IS 2911-P1-S4-2010)

Pile foundation:

In this type of foundation, the load is transmitted by a vertical member. This vertical member is known as a pile. These piles are generally made of steel, concrete and wooden. These days precast members are used but we can create these members on site as well.

According to function pile foundation are of following types.

- a) Bearing pile
- b) Friction pile

Bearing pile:

They are driven till hard Strata or layer of Rock beds. The load is transmitted by columns to the hard layer of soil.

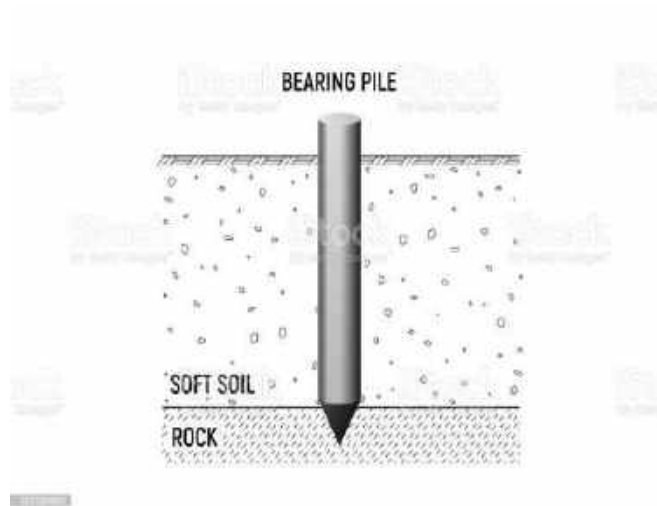

Friction pile:

These piles are used where the soil is soft at a considerable depth. The load is transferred to the soft soil due to the friction produced between the soft soil which is in contact with these piles.

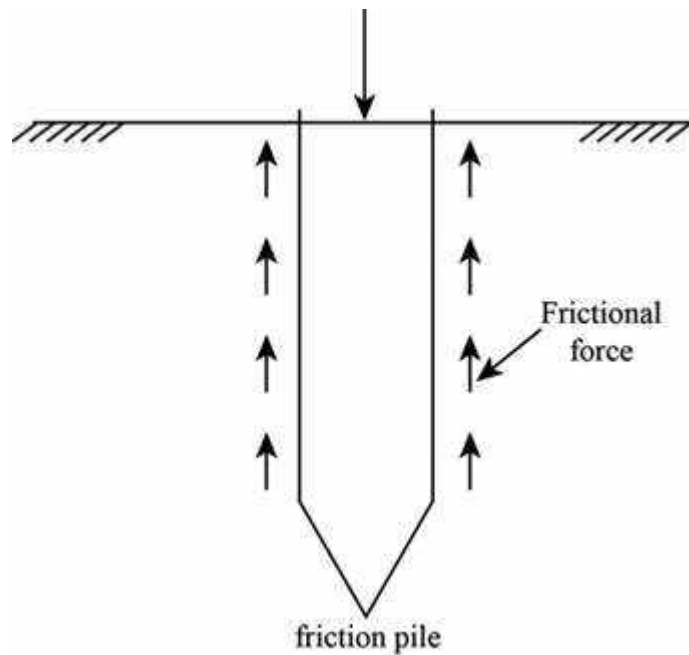

According to material piles are as follow

- a) Concrete pile
- b) Wooden pile or Timber pile
- c) Steel pile
- d) Composite pile

Concrete pile:

These piles are made up of concrete. The diameter of these pile varies from 30 to 50 cm. Minimum length of these pile is not taken less than 20 meters and maximum it can be taken till 30 meters. Concrete piles are manufactured either by precast or cast in situ method.



Wooden pile or Timber pile:

As the name suggests these piles are made up of wood. For these piles, seasonal Timber wood is used. The diameter of the timber pile varies in between 20 to 50 cm. Length of a pipe is taken 20 times that of its diameter. The maintenance cost of these piles is more because as it is wood

if it comes in contact with water then it can be damaged by fungus or white ants. So care has to be taken.



Steel pile:

These files are generally in shape of 'I' or hollow section. It can be easily driven in the soil because it has a very small cross-sectional area. These piles can be used as a bearing pile but cannot be used as friction piles because if we use them as a friction pile it can sunk in the soil due to structural load.



Composite pile:

When the piles are made from more than one material they are known as composite pile. These piles are made from concrete and wood. These piles are used in those areas where the water table is up. These piles are used in such conditions just because concrete and wood both are good water absorbers.

Composite Piles



Concrete - H-pile



Pipe - H-pile

Bearing Capacity of Soil

- ✓ When subjected to stress from loading, the soil has a tendency to distort. The soil's ability to resist displacement is influenced by a number of different variables, including its moisture content, relative density, internal friction angle and the way in which force is transmitted to the soil.
- ✓ The term “bearing capacity of soil” refers to **the maximum weight per unit area** that soil can support without succumbing or being displaced.
- ✓ If the soil underneath a building cannot support the weight of the structure being constructed, the structure may become unstable, which can result in fractures and other forms of damage.
- ✓ As a result, in order to circumvent this problem, the bearing capacity of soil must be taken into consideration while designing the foundation.

Soil Type	Allowable Bearing Capacity
Rock	3240
Soft Rock	440
Course Sand	440
Medium Sand	245
Fine Sand	440
Stiff Sand	100
Soft Clay	100
Very Soft Clay	50

❖ Types of Bearing Capacity of Soil

1. Ultimate bearing capacity (q_u)

The **gross pressure** at the base of the foundation at which soil fails is called ultimate bearing capacity.

2. Net ultimate bearing capacity (q_{nu})

By **neglecting the overburden pressure** from ultimate bearing capacity we will get net ultimate bearing capacity.

3. Net safe bearing capacity (q_{ns})

By considering only shear failure, **net ultimate bearing capacity** is **divided** by certain **factor of safety** will give the **net safe bearing capacity**.

$$q_{ns} = q_{nu} / F$$

4. Gross safe bearing capacity (q_s)

When **ultimate bearing capacity** is **divided** by **factor of safety** it will give gross safe bearing capacity.

$$q_s = q_u / F$$

5. Net safe settlement pressure (q_{np})

The pressure with which the soil can carry without exceeding the allowable settlement is called net safe settlement pressure.

6. Net allowable bearing pressure (q_{na})

This is the pressure we can use for the design of foundations. This is equal to net safe bearing pressure if $q_{np} > q_{ns}$. In the reverse case it is equal to net safe settlement pressure.

❖ *Factors Affecting Bearing Capacity of Soil*

1. Foundation width

Soil with little cohesiveness might have its bearing capacity reduced if the foundation is too narrow. In cohesionless soil, where internal friction contributes significantly to soil shear strength, a wider foundation will support a greater load. Soil with infinite depth, consistent shear strength, and cohesive properties may support loads of any width foundation.

2. Foundation depth

A deeper foundation is necessary for increased bearing capacity. This is most noticeable in cohesive-free soil when the texture is homogeneous. The opposite is true if the foundations are pushed into a poor soil layer, which reduces their carrying ability.

Unless the building is anchored by under-consolidated soil or compressible soil that is vulnerable to wetness, appropriate bearing capacity is typically assured by foundations set at depths where the weight of the structure matches the weight of the displaced soil.

3. Surcharge and soil weight

One cannot exclude the bearing capacity contribution of water table-influenced surcharge and subsurface soil. Construction, seepage, and elevation issues may be avoided if the water table is kept below the foundation's base. There will be no effect on the bearing capacity of soil from water table levels below the failure surface.

4. Spacing between foundations

When designing a foundation, it is advised that a minimum separation between footings that is 1.5 times the width of the foundation be taken into consideration. This will help prevent a loss in the foundation's carrying capacity.

5. Dynamic motion and earthquake

The bearing capacity of soil might diminish due to repeated movement, which would raise pore pressure. Earthquakes, vibrating equipment, and several other factors such as transportation, explosion, and pile driving all contribute to cyclic motions.

When pore pressures are higher than the soil confining tension, the foundation soil may become liquefied. The effective stress drops to zero due to liquefaction, leading to significant deformation and a decrease in bearing capacity.

6. Frost action

Changes in the bearing capacity of soil may occur gradually over time due to frost heave in particular soils that are in proximity to water and are exposed to subzero weather. Materials with a low cohesiveness, such as those made up of a lot of silt-sized particles, are more vulnerable to the effects of frost.

7. Subsurface voids

The bearing capacity of soil is diminished when subsurface voids are present within a crucial depth under the foundation. The critical depth is determined by the depth at which the pressure exerted by the foundation on the soil is no longer significant.

8. Collapsible and expansive soils

When the soil is somewhat dry, its sturdiness and bearing capacity may increase significantly, despite its tendency to collapse and expand. However, because of changes in moisture content, the proportion of these soils might shift. As a result, there will be shifts in the structure's base on a global and regional scale. Soil movement brought on by rain and dry spells may cause long-term, severe damage to buildings.

9. Potential heave

Consolidometer testing, carried out in line with ASTM D 4546, may reveal the presence of a possible heave. The findings of this test are taken into account when deciding how to prepare the foundation soils so that they are better able to resist or isolate the anticipated soil heave.

10. Soil reinforcement

The bearing capacity of weak or soft soil may be significantly boosted by the installation of different types of reinforcement in the soil. These reinforcements can take the shape of metal links, strips, arrays, geotextile fabrics, or coarse aggregates.

11. Seepage and soil erosion

Seepage and erosion of the soil surrounding and beneath foundations may both lower the bearing capacity of the foundation soil and ultimately lead to its collapse.

MASONRY WORKS

<Classifications, the definition of different technical terms>

- Masonry is used to indicate the art and craft of building and fabricating in **stone, clay, brick, or concrete block**.
- The masonry wall is built of individual blocks of materials such as **stones, bricks, concrete, hollow blocks, cellular concrete** and **laterite**, usually in horizontal courses cemented together with some form of mortar.

❖ CLASSIFICATION OF MASONRY



1. Brick Masonry Construction

Brick is the most popular material for masonry. They are known to be durable, long lasting, and have a classic look that has lasted the test of time. Bricks can come in a wide variety of textures and colors. Due to the unique way that bricks are made, it can be difficult to match color correctly.

2. Stone Masonry Construction

Stone is the most **durable, strong** and **weather-resistant** construction material compared with any others. These are less affected by daily wear and tear. Masonry structures made out of stone hence last for a longer period. It has a life period of 300 to 1000 plus years. Due to its numerous advantageous, it is widely used in masonry construction.

Stone masonry can be either **dressed or undressed**. When undressed stone masonry is laid, it has a less clean and irregular pattern but it provides an authentic and natural look. When dressed stone is laid, it looks much more like a pattern and comes in specific sizes.

3. Concrete Masonry Construction

In concrete masonry construction, the **concrete blocks** are pressed on the top of other similar to brick masonry construction. This creates a staggered formation. The dimension of concrete blocks is **larger** compared to bricks, so **less time** is required to lay concrete blocks.

4. Veneer Masonry Construction

This masonry construction is a type mainly used for **remodeling** and to provide **interior finish**. It gives the appearance of a **stone or brick wall** with a better economy and insulation. Veneer masonry units can be placed on the **existing concrete wall** giving a better appearance.

5. Gabion Masonry Construction

Gabions are baskets made out of zinc protected steel or so-called **galvanized steel** that is filled with **medium-sized fractured stones**. These gabions act as a single unit. It behaves like a revetment or retaining wall.

6. Composite Masonry Construction

A composite masonry construction makes use of **two or more types** of building materials for the construction. These masonry constructions are employed to increase the appearance of the building and to use available material resources with the utmost economy.

❖ Various Terminologies

1. **Face and Facing** The outer or exposed face of the wall is called face and the material used on the face is called facing.
2. **Hearting and Filling** The **interior portion of wall** between the face and back is called hearting and filling.
3. **Prepeds** These are **imaginary lines containing vertical joints** of the masonry.
4. **voids** These are **spaces left between the blocks** of stone in the masonry.
5. **Spalls** These are **chips or stone pieces** used for backing up or filling the interstices in stone masonry.

6. **Cornice** It is the **projecting ornamental course**, usually moulded to add to the appearance of the wall. A cornice is placed in a wall, at the junction of wall and roof.
7. **Coping** The **top of a parapet wall** is finished with a special course to protect it from rain water. This course is called coping
8. **Drip course** To facilitate the **drainage of water** from the **coping**, a **groove is cut** on the underside which is called drip course.
9. **Parapet** It is a **low wall built round a terrace** in the case of buildings with **flat roofs**. It is intended primarily to act as a fence wall.
10. **Course** One horizontal layer of bricks or stones is called a course.
11. **Jambs** These are **vertical sides** of door and window openings on the back side. These may be either square or splayed and are provided with recesses to receive door and window frames.
12. **Reveals** These are **exposed vertical surfaces** which are left on the sides of an opening in front of the door or window frame.
13. **Sill** This is the horizontal member of stone, concrete or timber provided to **support the vertical members** of door or window frame.
14. **Stretcher** When the brick or stone block is laid in such a way that in the elevation its **length and thickness** is visible, it is said to be laid as stretcher.
15. **Header** When the brick or block of stone is laid in such a way that its **breadth and thickness** is visible, it is said to be laid as header.
16. **Quoin** The **corner stone** or brick is called quoin. This brick or stone block is used at the corner of two walls meeting at right angles.
17. **Queen closer** It is the name given to **the half brick** which is provided just near the quoin to displace pends to provide the required lap at joints.
18. **Brick Bat** It is a half brick cut along its length.
19. **King closer** It is a **brick cut** in such a way that the width of one of its ends is half that of a full brick.

BRICK MASONRY

<Types, bonds, general principle>

Brick masonry is a highly durable form of construction. The **systematic arrangement of laying bricks and bonding** together with mortar to form a unique mass, which can transmit the load without failure, is known as brick masonry.

- ✓ Brick masonry offers durability, fire protection and ease of construction while maintaining a warm, decorative appearance.

❖ **Types of Bricks used in Construction**

There are different types of brick used in the construction of brick masonry which include:

1. Common Burnt Clay Bricks
2. Concrete Bricks
3. Sand Lime Bricks (Calcium Silicate Bricks)
4. Fly ash Clay Bricks
5. Engineering Bricks
6. Other Brick Types include bullnose, channel, coping, cownose and hollow bricks.

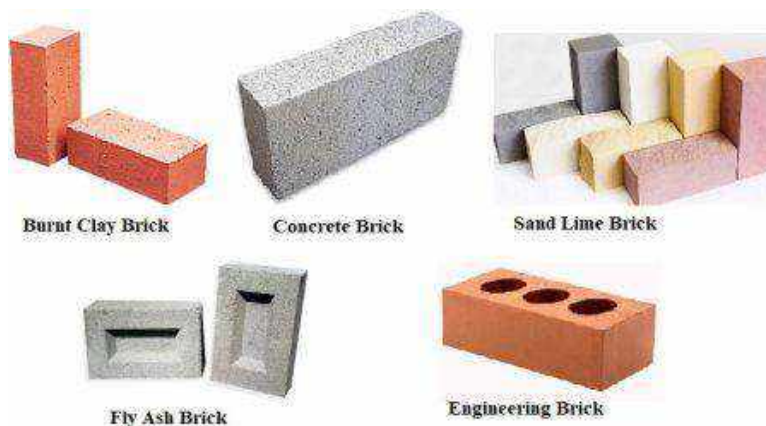

❖ **Characteristics of good quality bricks**

Some of the major properties of good quality bricks include:

1. Good bricks are **sound, hard, and well burnt.**

2. They have a **fine compact texture** and a **uniform colour**.
3. They have a **metallic ringing sound** when struck with a hammer or another brick.
4. They should **not absorb more water than 20%** of their own weight.
5. When **dropped** on another brick from a height of one metre, they should **not break**.
6. They should **not contain** any **water-soluble sulphates or chlorides**.

❖ *Benefits Of Brick Masonry*

1. Due to the relatively **regular shape and size** of the bricks, the construction process is not a particularly difficult one. Consequently, there is no requirement for expert workers for the building job.
2. Brick masonry often makes use of **lightweight bricks** because of the nature of the material. In contrast to bricks made of clay, there are numerous types of bricks that may be purchased on the market that have a low overall weight. They are constructed using a variety of components, including fly ash, powdered aluminium, quartz sand, and so on. Because of this, working with bricks on a building site is a lot less difficult than working with stone when it comes to masonry.
3. Brick masonry has a lower dead load when contrasted with stone masonry and masonry constructed from aerated concrete blocks.
4. In contrast to stone masonry, brick masonry makes it possible to **create brick walls** that are far thinner.
5. Brick is among the most valuable assets that can be used in the building industry. Bricks are often the material of choice in any kind of building activity. As a result, you shouldn't have any trouble **tracking down the bricks in any part of the city**. When compared to stone masonry, they are only **accessible in locations** that have stone quarries.
6. In comparison to other types of masonry construction, brick masonry often has **fewer mortar joints**. As a result, the total **cost** is **cut down** by a significant amount. In addition to this, they have a **high resistance to both fire and severe weather**. They are suitable for use in any wall construction, including those that prohibit the use of stones and concrete block masonry.
7. In a structure that is being constructed out of brick masonry, it is simple to **cut apertures** for **doorways** and **window openings** throughout the construction process.

❖ *Disadvantages of brick masonry*

1. Masonry that is made of brick is **not earthquake-resistant**. It is vulnerable to the destruction that an earthquake might wreak.
2. The building procedure is one that takes a **lot of time**. Bricks have been replaced by Autoclave Aerated Concrete (**AAC**) **blocks** as the material of choice in situations when quick building is required.
3. In contrast to **stone** masonry, it does not possess the same levels of **strength** and **durability**.
4. **Plastering** is required in the context of brick masonry buildings in order to achieve a smooth finish, which may lead to a **rise in the amount of construction**.
5. Bricks have a natural ability to **absorb water**; as a result, there is a chance of moisture inside brick walls. **Plaster and paint are vulnerable** to deterioration as a result of this factor.

❖ *Types Of Brick Masonry:-*

1. **Brick Work in Mud**

- ✓ The mud is used to fill up various joints brick masonry work.
- ✓ Thickness of the mortar joint is 12 mm.
- ✓ it is the cheapest type of brick masonry
- ✓ employed for construction of walls with maximum height of 4 m.



Fig. Brick work in mud

2. Brick Work in Cement

- ✓ This type of brick masonry is construction by laying bricks in cement mortar rather than mud which is used in brick work in mud.
- ✓ There are three major classes of brick work in cement which are summarized in the table below.

Classes	Descriptions
First Class	<ol style="list-style-type: none">1. Cement of lime mortar is used,2. The surface and edges of bricks are sharp,3. And the thickness of mortar joints doesn't exceed 10mm
Second Class	<ol style="list-style-type: none">1. Ground moulded bricks are used,2. Bricks are rough and shape is slightly irregular,3. The thickness of mortar joint is 12 mm.
Third Class	<ol style="list-style-type: none">1. Bricks are not hard ,rough surface with distorted shape,2. Used for temporary structures,3. Used in places where rainfall is not heavy.

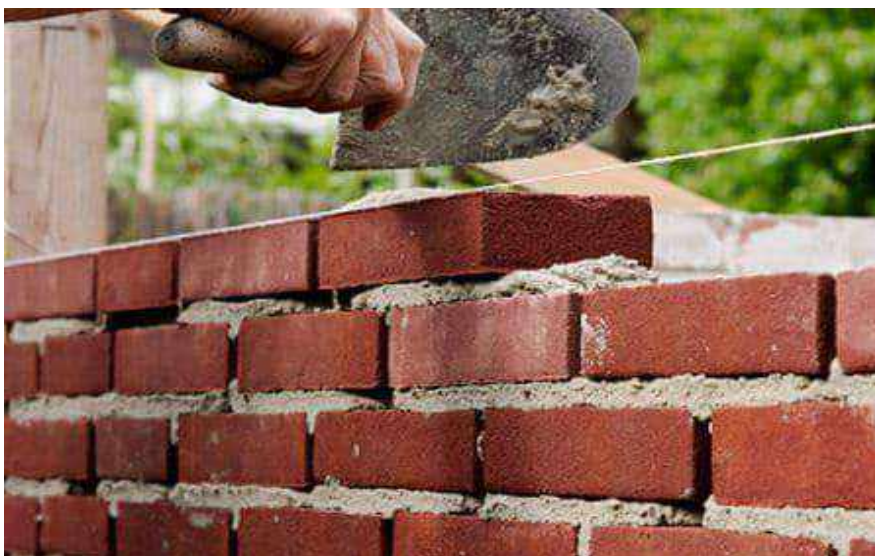
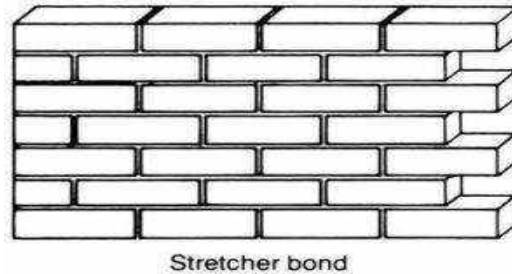

Fig. Brick work in cement

❖ *TYPES OF BONDS IN BRICK MASONRY*

1. Stretcher bond



- The stretcher is the term used to describe the **long section of the brick**. With a stretcher bond, just the portion of the bricks that will be used to extend the wall outward is exposed to the mortar.
- Due to the fact that it has a constant running pattern, the Stretcher bond is also often known as the **running bond**. Garden facades, retaining walls, dividing walls, chimney stacks, etc., are often built using stretcher bonds as a foundation for the underlying masonry structure. For reinforced concrete framed buildings, it may be utilised for outside walls as well.

✓ *Advantages:*

- i. It is **simple** and uncomplicated to put together.
- ii. It is not necessary to use **skills labourers** in order to create a stretcher bond.

✓ *Disadvantages:*

- i. Stretcher bond is only appropriate for walls that are **one-half the thickness of a brick**, for example, the partition walls, thus it cannot be applied in the event of full-width brick walls that are thick.
- ii. It is not possible to build masonry walls by using a stretcher bond when the building has a **long span or a high height** since this kind of bond cannot handle the loads that are applied.
- iii. Stretcher bond is not acceptable for use in landscape masonry construction or **architectural masonry building**.

2. Header bond



- To create a header bond, the **brick's header face** is used, as the name suggests. When looking at a brick from above, the smaller square face is the header.
- Unlike the stretcher bond, in which the header portions of the bricks remain hidden, the header bond displays the bricks' header faces. **Header bond, as opposed to stretcher bond**, is used for walls of full brick thickness.
- The term "header bond" is also sometimes used interchangeably with "heading bond." The bricks are laid out in such a way that the overlapping is approximately half of the brick's breadth. This is achieved by employing three-quarter brickbats for structural features, which means that the offsets are created by utilising half a brick.

✓ *Advantages:*

- It is **quick** and **straightforward** to put together.
- It is **not** necessary to use **skilled labour** to complete the structure as you would with a stretcher bond.

✓ *Disadvantages:*

- It **lacks substantial power** when pointed towards the wall.
- It's not something you want to use while building visually significant masonry structures.

3. *English bond*

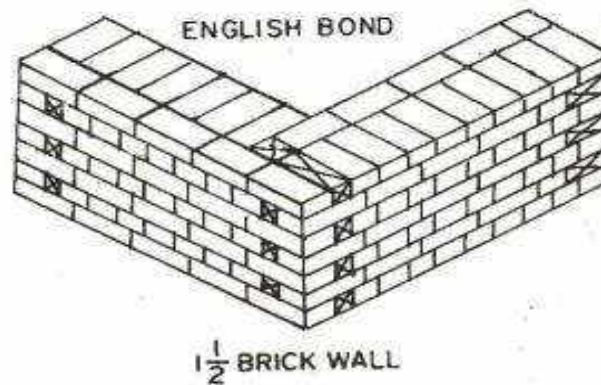

- Bricks in English bonds are laid in a pattern with **alternating header and stretcher** courses. The English bond crossover is made by placing a queen closer adjacent to a quoin heading.
- It has **two alternating courses of stretchers and headers**.
- In comparison to the traditional header and stretcher bond, this one is much **more strong** and **long-lasting**.

✓ *Advantages:*

- It has a high degree of **tensile** and **shear** strength.
- It is suitable for use in the building of masonry walls, including almost **any thickness**.
- **Skilled labor** not required

✓ *Disadvantages:*

- It does **not** have a very **attractive visual appearance**.
- A rather **high cost** is associated with the development of these types of bonds.
- There is a greater chance of **moisture getting in via the traverse joints** because of this.

4. Flemish bond

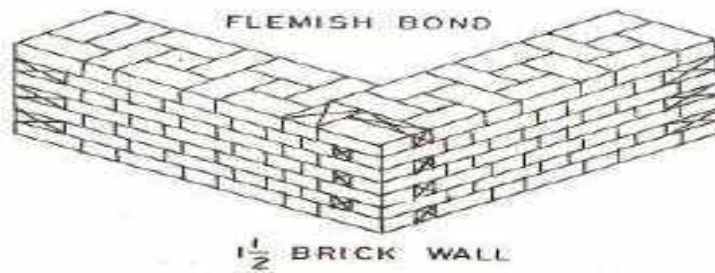

- Flemish bond is a kind of brick bond in which the **headers and stretchers of each course are swapped**. Consequently, the bond is established by alternating the placing of the **header face** and also the **stretcher face** in mortar, with the quoin header starting each alternate course.
- Quoin closer is positioned in opposite directions from the quoin header to create a face lap. Using central support, the header face of a Flemish bond is held up above the stretcher.
- **Quoin header: A quoin which is a header in the face of a wall and a stretcher in the face of the return wall.**
- **Queen closure: A closer that is less than half a brick. specifically : a brick of full length and thickness but half width that is used at the end of a course next to the quoin header**

✓ *Advantages:*

- It is quite **cost-effective**.
- In terms of its **visual attractiveness**, it is of the highest calibre.

✓ *Disadvantages:*

- Skilled labor required.
- It doesn't have the **same strength** as the English bond.

ROOFS AND ROOF COVERINGS

<Functional requirements, basic technical terms, roof covering material>

A roof may be defined as the uppermost structural element of a building provided to protect it from the damaging effects of weather elements such as rain, wind, heat, snow, etc.

❖ Functions Of Roofs

✓ Functions of roofs are as follows.

1. To prevent from dampness, heat, sound, etc...
2. To carry loads from the roofs, live load and dead load.
3. To provide protection from weather for workers working under any construction.
4. To allow light and air in and out of the building.
5. To place conduits.
6. Useful for future renovations.

❖ Classification of roofs

All roofs provide protection from the elements: sun, rain, wind, dust, heat, cold, and animals and insects. But each different kind of roof protects against something better than others. In addition the different roof styles vary in their durability and ease of construction.

✓ Roofs can be classified into three types.

1. Flat roofs
2. Sloped roofs
3. Curved roofs.

1. Flat Roof



- ✓ Flat roofs are suitable in plains where the rainfall is moderate and heat is great. A gentle slope (say upto 10°) is given to the flat roof to drain away the rain water.
- ✓ The construction and maintenance of flat roofs is easy.
- ✓ They are fire resistant and have better insulating properties. They can resist high. wind loads.
- The most commonly used flat roofs are Madras Terrace roof and R.C.C roof are explained below.

i. Madras Terrace Roof

- (i) It is an old type of flat roof and it is not constructed now-a-days. Since this type of roofing was widely used in Madras it is called Madras Terrace Roof. The construction of Madras Terrace Roof is explained below:
- (ii) Wooden joists are placed over the walls or beams along the shorter span at a spacing of 450 mm to 500 mm. A course of well burnt terrace bricks of size 150mm x 50mm x 25mm is placed on edge in lime mortar laid diagonally across the joists.
- (iii) After the brick course is set, brick bat concrete (3 parts of brick bats, one part of gravel and sand and 50% of lime mortar by volume) is laid to a thickness of 100mm and is then compacted to 75mm thickness by wooden hand beaters.
- (iv) The surface is kept wet for about 3 days for curing. After the brick bat concrete has set, three layers of flat tiles are laid in cement mortar 1:3 over the concrete. The top surface is plastered with three coats of lime mortar and is polished. The bottom ceiling is plastered with cement mortar 1:3 to a thickness of 12mm.

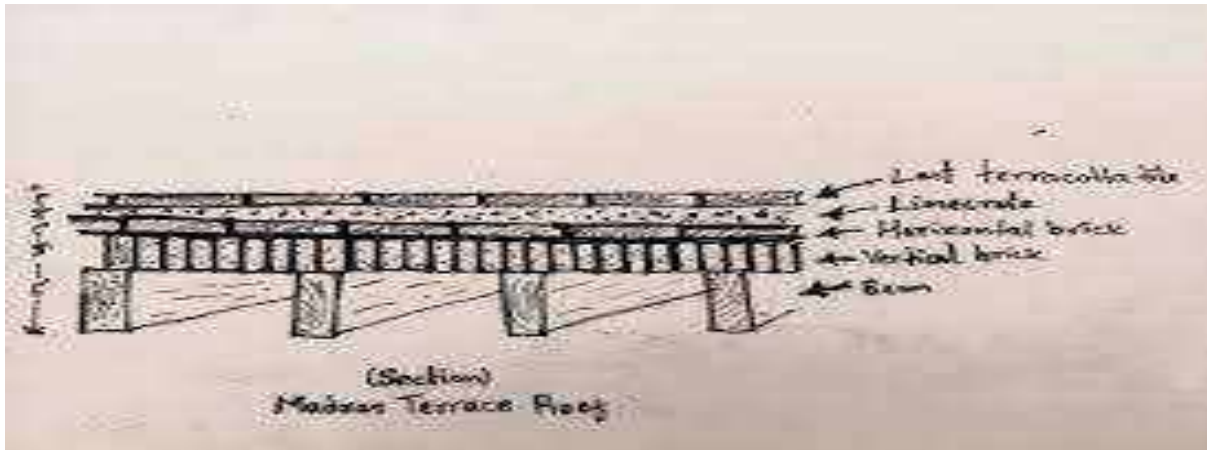

ii. Reinforced Cement Concrete Roof (R.C.C Roof)

- R.C.C. roof is becoming very popular now-a-days because of its strength and durability. For small spans of roofs (upto 4m) a simple R.C.C. slab may be used. When the spans are larger (more than 4m), the length is divided into bays and the slabs are stiffened with beams at intervals.
- Construction of R.C.C. roof is carried out as follows:
 - (i) Centering sheets of steel or timber are placed over the supports
 - (ii) The reinforcement (steel rods) is placed in the form of grid on the centering sheets. A minimum clear cover of 15 mm is maintained by using pre-cast cover blocks made of cement mortar of mix at least 1: 2.
 - (iii) The cement concrete of mix 1:2:4 is mixed thoroughly and placed on the reinforcement and is well consolidated by means of hand rammers or with mechanical vibrator.
 - (iv) The concrete is cured for at least 7 days.
 - (v) After the concrete has sufficiently hardened, the centering sheets are removed.

R.C.C. roofs are required to be protected against weathering agencies such as rain, snow, heat etc by providing a weathering course. Weathering course consists of lime concrete with broken brick aggregate in the ratio of 1:2.5 (1 part of lime and 2.5 parts of brick aggregate) and two course of flat files set in cement mortar of mix 1:3. The thickness of the weathering course is about 75 mm. This layer makes the roof leak-proof.

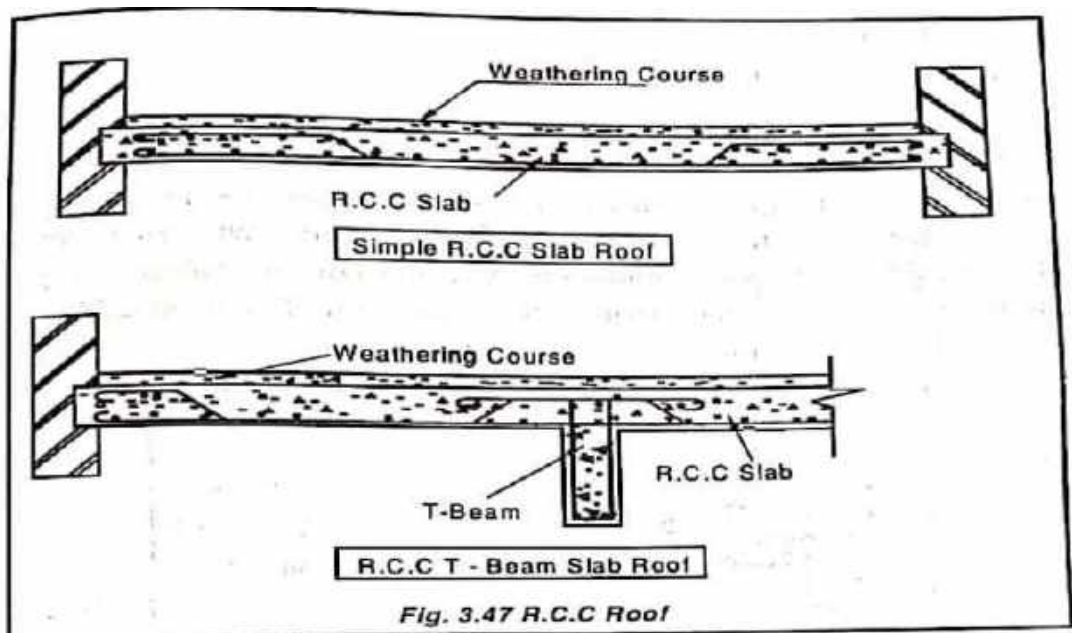

2. Sloping or Pitched Roof



✓ Sloping roofs are suitable in those areas where rainfall is very heavy. The different types of sloping roofs are;

(a) Single roofs

(b) Double or purlin roofs

(c) Trussed roofs

(a) Single roofs

Single roofs consist of only common rafters which support the roof covering material. The types of single roofs are:

(i) Lean-to-roof

(ii) Coupled roof

(iii) Couple close roof

(iv) Collar beam roof

(i) Lean-to-roof :- Lean-to-roof consists of common rafters **sloping to one side only**. They are supported on wall plates at both ends. Wooden battens are fixed to the rafters at about 150mm c/c. The roof covering material is placed on the battens. The maximum span of this types of roof is about 2.5m. These type of roofs are used for verandah and sheds.

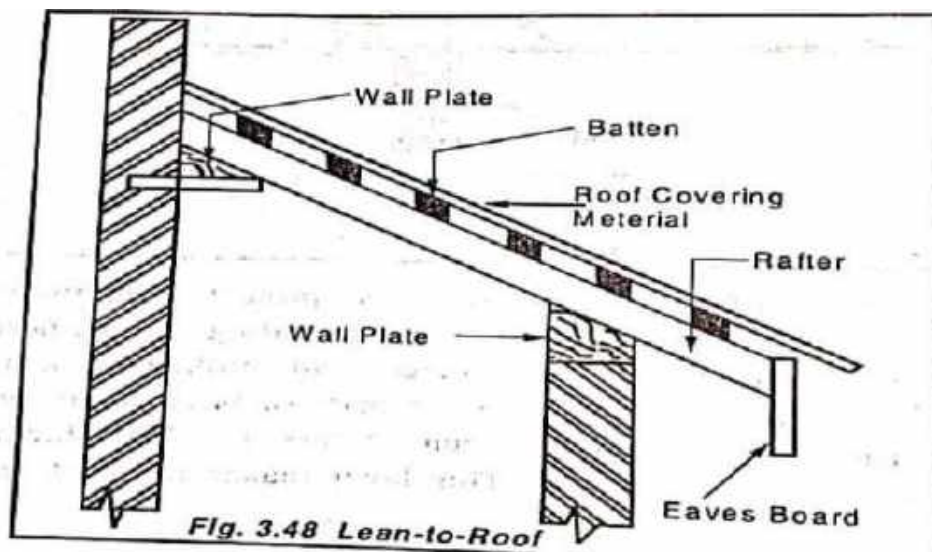

(ii) **Coupled roof**: This type of roof consists of **two rafters sloping upward** from the walls and they are connected at the top by means of a ridge piece. The ridge piece is wooden member which runs horizontally at the apex. The maximum span of coupled roof is about 3.5m.

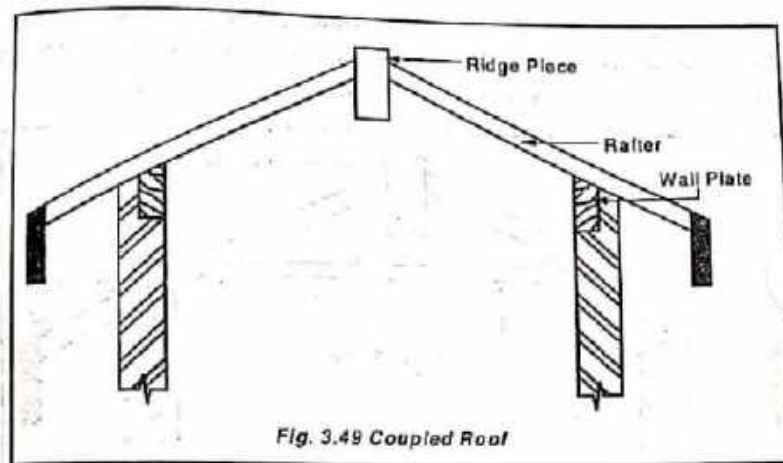

5/9

(iii) **Coupled close roof:** Coupled close roof is similar to coupled roof except that the common rafters are connected by a tie beam at the bottom. The tie beam prevents the common rafters **spreading from their supports**. This type of roof is suitable for spans upto 4.2m.

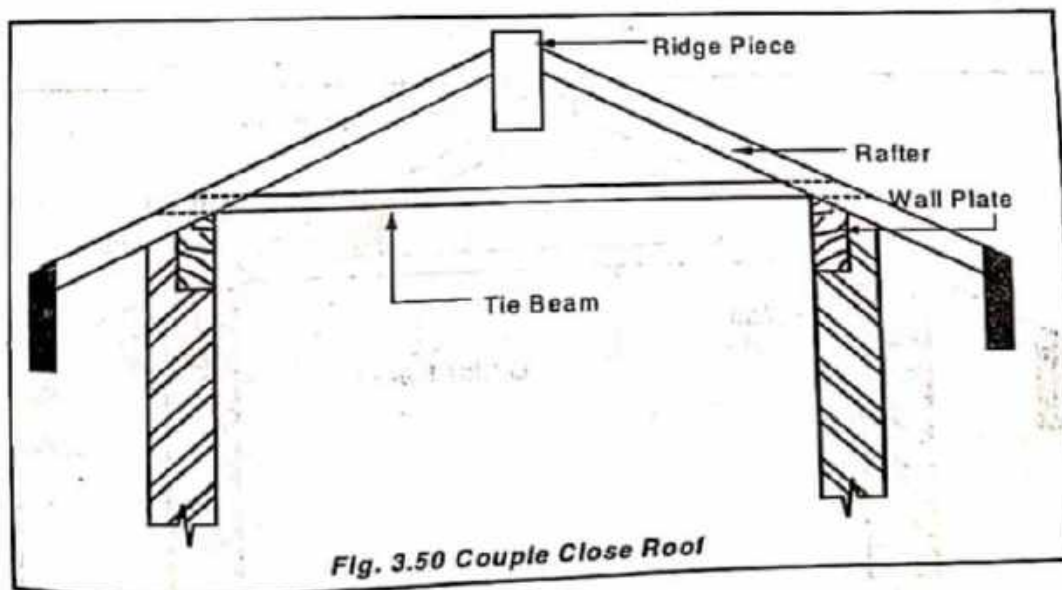

(iv) **Collar beam roof:** In collar beam roof, the tie beam is raised to the middle of the rafters to **prevent the rafters from bending in the middle**. This type of roof is suitable for spans upto 5.0m.

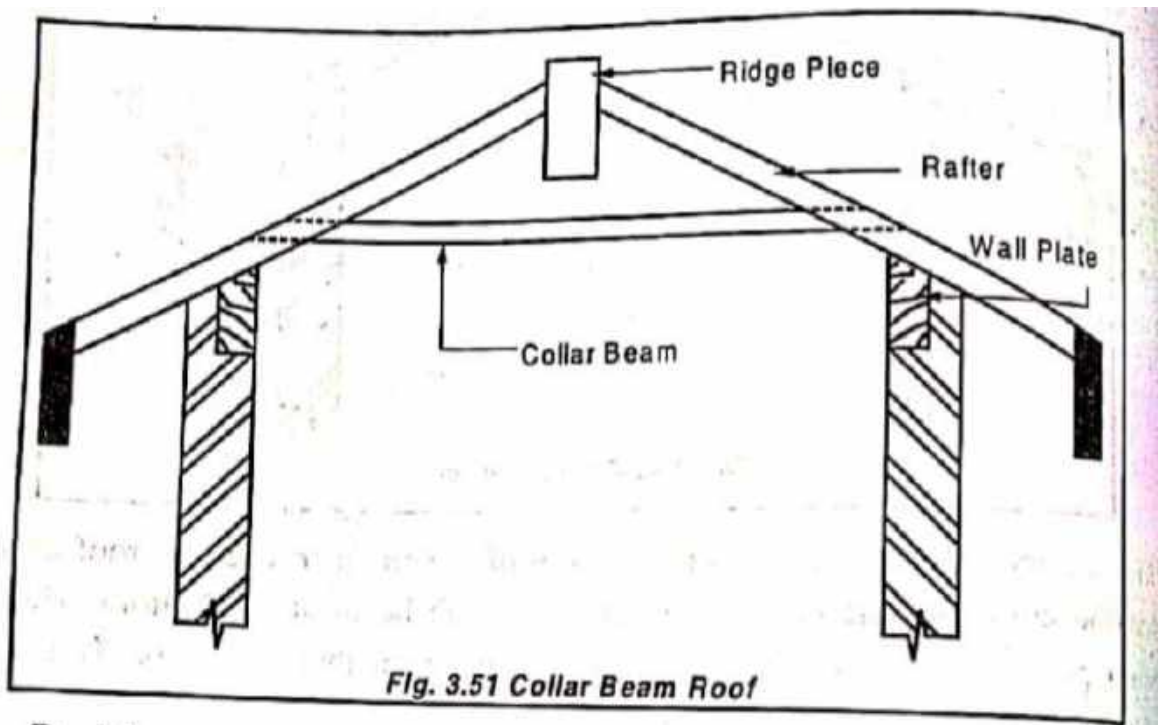

(b) Double or Purlin roofs :-

These roofs consist of rafters and purlins. The **purlins provide intermediate support** to the rafters. Each rafter is supported at three points

- (i) at the bottom on the wall plate
- (ii) (ii) at the middle by a purlin and
- (iii) at the top by the ridge piece. This type of roof is suitable for spans upto 5.5m.

(c)

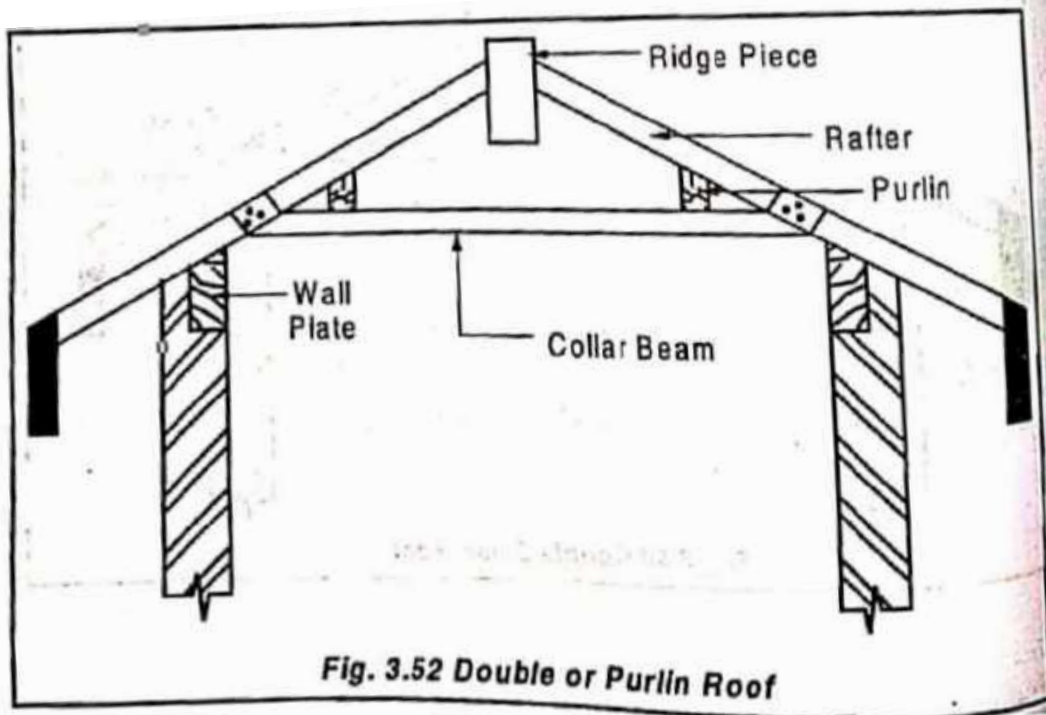

C) Trussed roofs:-

When the **span of the roof exceeds 5m**, it is preferable to use trusses in the sloped roofs. A truss is a framework consisting of vertical, horizontal and inclined members. The spacing of the wooden trusses is generally 3m. The various types of trusses in use are;

- (i) King-post truss
- (ii) Queen-post truss
- (iii) Mansard truss
- (iv) Bel-fast truss

- (i) **King-post truss:** A king-post truss consists of a **tie beam**, **two inclined principal rafters**, **two struts** and a **vertical post** (king-post) The spacing of the king-post truss is about 3m. The struts are the compression members which prevent the sagging of principal rafters. The king-post prevents the sagging of the tie beam at its centre. The purlins are placed at certain interval on the principal rafter to support the common rafters, King-post truss roof is suitable for spans varying from 5 to 9m.

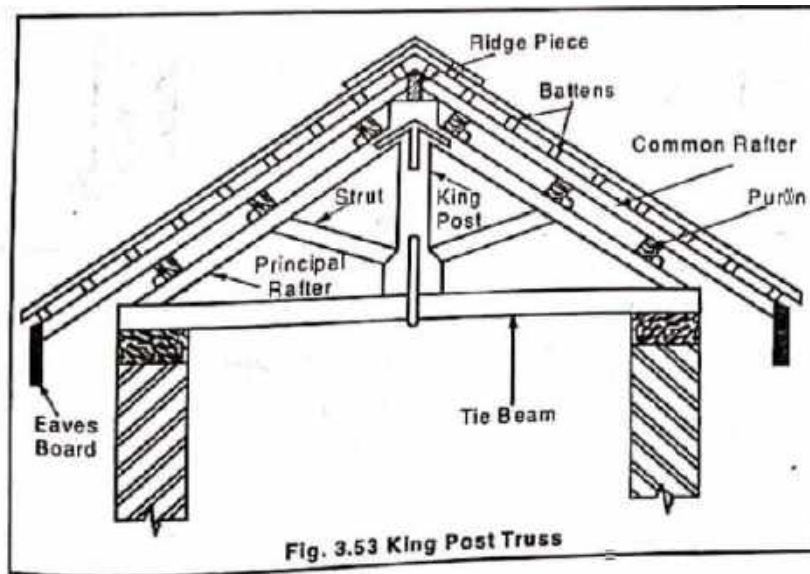

- (ii) **Queen post truss:** Queen-post truss consists of **two vertical posts** (queen posts) instead of **one as in king-post truss**. The queen posts are connected at the top by a straining beam and at the bottom by a straining sill. The straining sill is used to counteract the thrust from the inclined strut. Queen-post trusses are suitable for spans upto 12m.

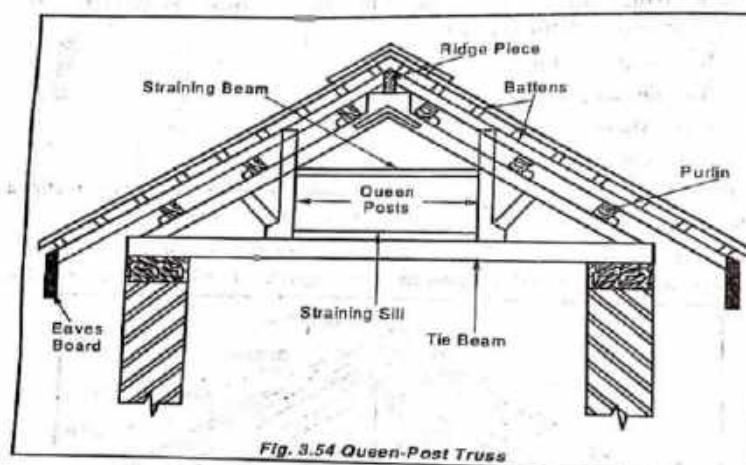

(iii) **Mansard roof truss:** It is a combination of **king-post** and **queen-post** trusses, the upper portion consisting of king-post truss and the lower portion

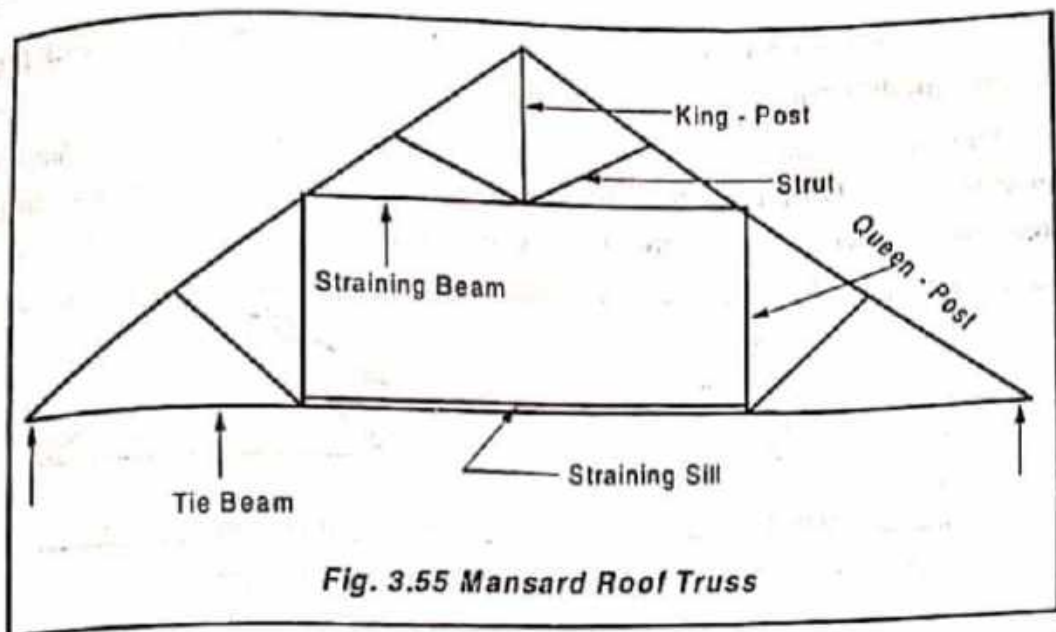

of queen-post truss. These trusses are suitable for spans upto 18m.

(iv) **Bel-fast roof truss:** This truss consists of this section of timber, with its **top chord curved**. The span of this type of truss is about 30m.

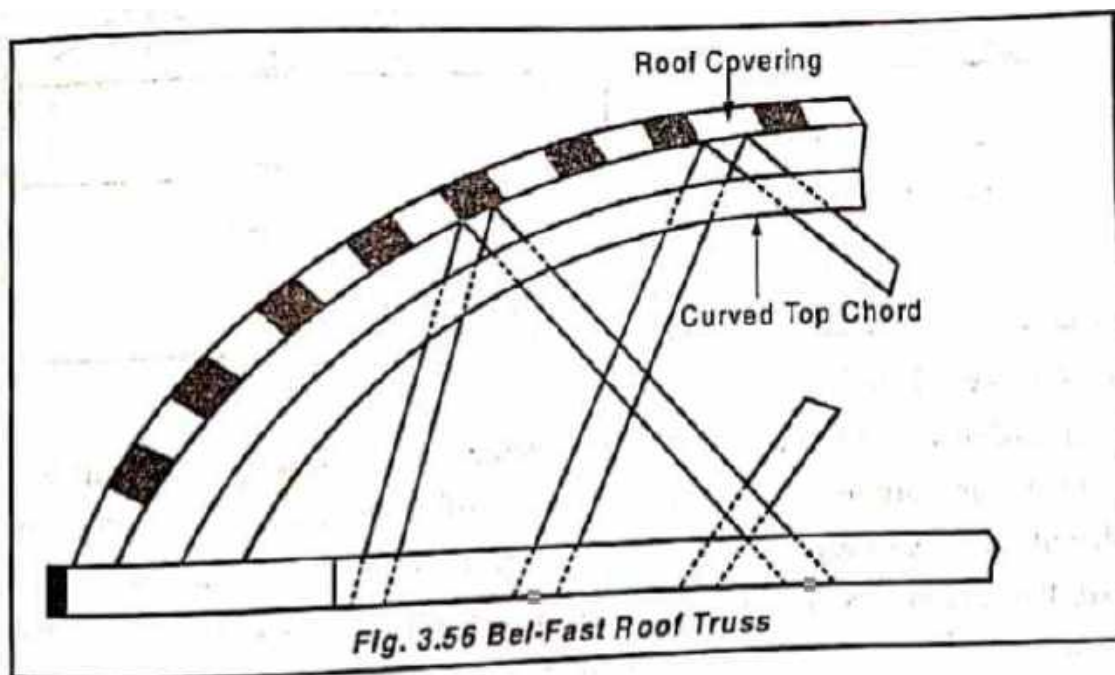

(v) Steel Sloping Roof Trusses :-

The use of steel trusses prove to be economical for spans greater than 12 metres. Steel trusses are **light in weight** and can be fabricated in different shapes and sizes to suit the **structural** as well as **architectural requirements**.

The erection of steel trusses is very easy, rapid and economical. Steel truss roofs are suitable for factories, workshops, warehouses, etc.

The most suitable sections for steel truss roofs are angles, as they can effectively resist both compression and tension stresses. The various shapes of steel trusses with their spans are given below:

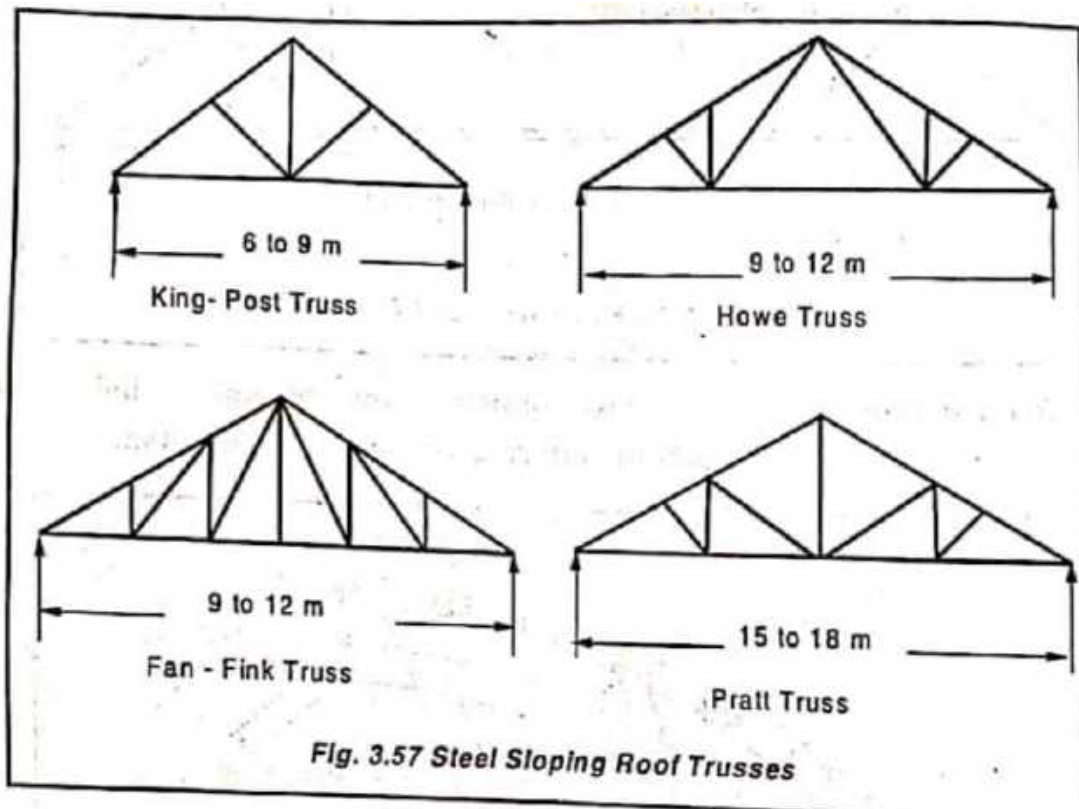

3. Curved Roof



- ✓ In order to provide architectural effects to buildings, the top surface of the roofs are sometimes curved. Such roofs are termed as curved roofs.
- ✓ Cylindrical and parabolic shells, shell domes, doubly curved shells, etc are some of the examples of curved roofs.
- ✓ These types of roofs are suitable for public buildings like libraries, theatres, recreation centres etc.

❖ *Components Of Roof*

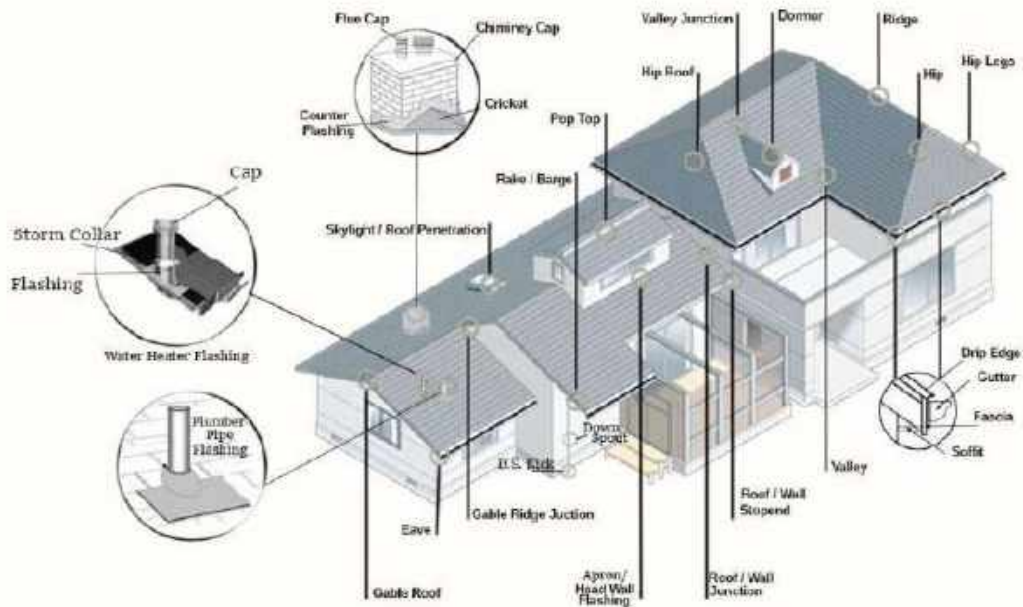

- 1. Ridge Board:** A **horizontal timber or metal resting at the peak of the roof**. The rafters and trusses are connected to the ridge board for a cohesive framework.
- 2. Solid Decking:** A **composite decking** made of solid materials. It resembles real wood and particularly strong and stable for bearing heavy load.
- 3. Felt Underlayment:** It is a **waterproofing layer** made of regular felt, stacked above the solid decking board and then completely covered by the shingles or other roofing materials.
- 4. Shingles:** **Roof covering** typically of flat and rectangular shapes and made of various materials such as slate, wood, flagstone, plastic, metal and composite materials.
- 5. Vent Pipe Flashing:** An **external installation on the roof** that uses the **vent pipe** system to **prevent water seeping** in and create damage.
- 6. Skylight:** A **window** installed on the **roof** or ceiling for the purpose of **daylighting**.
- 7. Chimney Flashing:** A **waterproofing seal** installed at the intersection of the roof and chimney and used to prevent moisture penetration.
- 8. Chimney:** A **vertical structure through the roof that ventilates** smoke and combustion gases from a fireplace, boiler or stove to the outside atmosphere.
- 9. Collar Beam:** The **horizontal beam** connecting **two rafters** that intersect at the **ridge**.
- 10. Rafter:** One of a series of **diagonal members of the truss** that meet at the apex in order to support the roof deck and its loads.
- 11. Valley Flashing:** A waterproofing seal installed along the roof's valley line.
- 12. Valley Underlayment:** A waterproofing layer that protects the roof valleys from leaking.
- 13. Spaced Sheathing:** Also called Skipped Decking, it refers to the installation of the flat panels by spaces apart and results to a ladder-type appearance.
- 14. Fascia:** The **sheath covering** the ends of the rafters.
- 15. Lookout:** The **horizontal joist** projecting in cantilever from the wall plate.
- 16. Rake:** The **inclined sides of a gable end**.
- 17. Gutter:** A **duct for water discharge** system for a building.
- 18. Downspout:** The **channel that transports rainwater** from the gutter.
- 19. Splash Block:** Found underneath the downspout and used to transport the rainwater from the gutter in a direction away from the house

❖ *Roof Coverings*

- ✓ A roof covering is a material which is placed over a **sloping roof** to safeguard the roof against the weathering elements.
 - ✓ The roof requires a cover to **protect the house** from adverse goods of the environment.
 - ✓ The roof cover should be kept clear of leaves, accumulated dirt, etc. Metal roofing can provide a home with the look of any other common roofing material. A roof must have thermal sequestration, fire resistance, and sound sequestration the various types of materials general in the markets in different shapes and sizes.
- There are several different types of roofs with pictures materials.

1. Thatch
2. Tiles
3. Solar shingles
4. Wood shingles
5. Asbestos cement sheet

1. **Thatch covering:** This is the cheapest roof-covering, commonly used in **villages**. It is very light, but is highly combustible. It is unstable against high winds. It absorbs moisture and is liable to decay.



Thatch

- ✓ *Advantages of Thatch Roof*
 - Thatched roofs give excellent sequestration.
 - Thatched roofs are generally veritably durable and long-lasting.
 - Thatch is one of the most environmentally pleasant accoutrements used for a roof

- Thatched roofs also progress veritably well and will shape into natural forms.

✓ *Disadvantages of Thatch Roof*

- Thatched roofs keep to regular conservation is needed. The quantum of conservation demanded will depend on the accoutrements.
- Thatched roof is advanced Insurance because of the advanced threat of fire damage.

2. **Tiles:** Use of tiles for roofing is one of the **oldest**, and is still preferred for **residential buildings**. Tiles are named according to their shapes and pattern. The different types of tiles generally used are: Flat tiles, curved tiles, half-round country tiles, spanish tiles, mangalore tiles etc.



Tiles

✓ *Advantages of Tile Roofs*

1. Roof tiles are relatively a sight to see. They can transfigure a house into an awful masterpiece with the beauty they give.
2. Roof tiles have a long life expectancy.
3. Pipe roofs offer protection against nonentity boring and rotting, which also helps to promote.
4. Pipe roofs are made from a fire-resistant material.

✓ *Disadvantages of Tile Roofs*

1. Tiles roofs have a delicate. It isn't recommended to walk on the pipe due to the possibility of it breaking.
2. The pipe is known to be heavy. This is a major debit of getting a pipe roof.
3. Tiles roofs needed conservation.

4. One of the biggest problems with pipe roofs is the underlayment paper and the proper ventilation.
3. **Solar Roof tiles or Solar Shingles** :Solar roof tiles are known as solar shingles, aren't only used as a roofing material but also generate electricity. Solar roof tiles or solar shingles are photovoltaic modules, and it produces electricity by landing sun. These tiles are commercially available in the request.

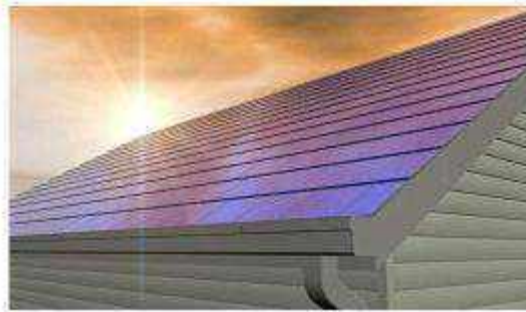

Solar Roof tiles or Solar Shingles

✓ *Advantages of Solar Shingles*

1. They look like regular shingles and come in numerous sizes and styles; they can round nearly any structure scenery.
2. They exclude the need for a large installation area that traditional solar panels bear.
3. Installation is simple and hassle-free.
4. They can be combined with traditional shingles to cover large or complex roofs.

✓ *Disadvantages of Solar Shingles*

1. Solar shingles cannot store energy, and also they won't give power at night or during storms.
2. The roof may be at the correct angle for the shingles to catch the sun.
3. There must be sufficient face area to install solar shingles to collect enough light to produce electricity.

4. **Wood Shingles:** Wood shingles are a **thin timber board** around 1 cm thick. They are generally thick in shape. The length and breadth of this board vary from 30 to 40 cm and 6.5 cm to 25 cm singly. Shingles are not common paraphernalia for the roof covering as they are liable to decay or crack under the atmospheric goods. This type of roof covering material is mainly used in place of ducts or swaths and where it's available in a wide range.



Wood Shingles

✓ *Advantages of Wood Shingles*

1. This type of roof covers visually appealing roof styles.
2. Wood shingles have continuity and energy effectiveness.
3. Advantage of wood shingles resistant to severe storms.

✓ *Disadvantages of Wood Shingles*

1. One of the disadvantages of wood shingles needed regular conservation.
2. Wood shingles have been brought effectively.

5. **Asbestos Cement sheets** Asbestos cement sheets are another type of roof covering material and are considerably used for the canted roof. It consists of an amalgamation of cement and pulverized asbestos. This amalgamation is ultimately converted into a thin distance or ducts, and it's well known as asbestos cement sheets or A. C sheets.

- There are mainly two kinds of A. C sheets that are available in the request. One is the 'Big six type,' and the other is 'Trafford.' Asbestos sheets are available in different lengths varying from 1.5 to 3m.



Asbestos Cement sheets

✓ *Advantages of Asbestos Cement Sheets*

1. Asbestos cement sheets are a veritably good thermal insulator and increase the energy effectiveness of the structure.
2. It's largely resistant to fire and doesn't burn fluently.
3. It formed a veritably strong material when mixed with cement and was used as a cumulative to form a compound material called asbestos cement.
4. It's a veritably affordable and veritably cost-effective material, hence extensively used.
5. It's considerably used as a defensive roofing material in corrugated form.
6. It's largely durable and rainfall evidence. It's resistant to damage from termites.
7. Asbestos cement sheets are veritably easy to clean and maintain but delicate to repair.

✓ *Disadvantages of Asbestos Cement Sheets*

1. The major disadvantage of utilizing asbestos is that it's seriously dangerous to health.
2. Due to this major disadvantage, new accouterments are being manufactured as a relief to asbestos.
 - Straw board
 - Aluminum and sword

Floors

<Function, types, flooring materials (brief discussion)>

- Floor are the **horizontal elements** of a building structure which divide the building into **different levels** for the purpose creating more accommodation within a limit space. The floor consists of the following **two components** :-
 1. A **subfloor** (or base course) – The purpose of this component is to impart **strength** and **stability** to support floor covering and all other super imposed loads.
 2. **Floor covering** (or flooring) – This is the covering over the subfloor and is meant to provide a **hard ,clean ,smooth, impervious,durable,and attractive** surface to the floor.
- Purpose of flooring is to get a good hard , level ,&beautiful surface for living. The floors directly resting on the ground are known as ground floors while the floors of each storey are known as upper floors.
- The **selection of flooring** can be made considering the **following factors** :-

i. Initial cost	vi. Hardness	xi. Sound
ii. Thermal insulation	vii. Durability	insulation
iii. Appearance	viii. Comfortability	xii. Maintainance
iv. Smoothness	ix. Damp resistance	
v. Cleanliness	x. Fire resistance	

✓ Functions Of Flooring:

1. Floors must **withstand loads** that will be imposed on them. The ground floor of buildings, depending on whether it is for residential purpose (where the use is restricted to persons and furnitures), or for industrial purposes (where much heavier loads from equipment are anticipated), should be strong enough to withstand the loads. The

strength of ground floors is assured by the provision of hardcore bed which helps to reduce the amount of rising water, provide clean surface for the concrete oversite and impacts the floor with the required stability .

2. Floors must **prevent the growth of vegetable** matter inside the building, this is achieved by the provision of an oversite concrete bed for the ground floor.
3. Floors must **prevent damp penetrating** inside the building. By the provision of DPM of rubber emulsion and polyethene film sheets below the floor screed, damp is eliminated from solid ground floors. In the case of suspended timber ground floor, under floor ventilation is provided to prevent stagnant moist air accumulating below it.
4. Floors must provide **thermal insulation**. This is taken care of by incorporating a layer of insulating material to reduce the heat loss into the ground below. The material which is of high thermal resistance e.g. mineral fiber is incorporated below the DPM and the floor screed.
5. Floors must provide an **acceptable surface finish** which will meet the needs of users in terms of comfort, safety, cleanliness e.t.c. A floor screed will meet this requirement, and as well provide falls for drainage purposes and give thermal insulation.
6. Floors must provide **adequate sound insulation**. The reduction in sound transmission will depend on the mass of floor construction.

✓ *Types Of Flooring :*

The various types of commonly used ground floor finishes are as follows :-

1. **Mud & Moorum Flooring** - These floorings are used in **low cost housing**, specially in villages. Over the hard layer of earth filling mud or moorum layer is provided. The floor needs a thin wash of cow dung at least once a week.



- 2. Brick Flooring** - This is also a **cheap floor construction**. It is commonly used in godowns and factories. Bricks are laid flat or on edges. Bricks of good quality should be used for the construction. Brick layer is provided on sand bed or on lean concrete (1 : 8 : 16) bed. In both cases joints are rendered flush and finished with cement mortar.



- 3. Stone Flooring** - Laminated sand stones or slates of 20 mm to 40 mm thick in the form of slabs of 300 mm \times 300 mm or 450 mm \times 450 mm or in the form of rectangles of size 450 mm \times 600 mm are used as floor finishes. The stone slabs are laid on 20 to 25 mm thick mortar spread over concrete bed. The joints are to be finished with rich mortar.



- 4. Concrete Flooring** - It is modestly **cheap** and **durable floor** and hence commonly used in residential, commercial and industrial buildings. It consists of two courses-base course and wearing coat. Base course is laid over well compacted soil. Its thickness is usually 75 mm to 100 mm. It consists of lean cement concrete mix (1 : 4 : 8) or lime concrete containing 40% of 1 : 2 lime mortar and 60% of coarse aggregate of 40 mm size. After base course is hardened wearing coat of 40 mm is laid. It consists of panels of 1 m \times 1 m, 2 m \times 2 m or 1 m \times 2 m. Alternate panels are laid with 1 : 2 : 4 concrete using wooden, glass or asbestos strip separators of 1.5 mm to 2.0 mm thickness. To get good bond between base course and wearing coat cement slurry wash is given before laying wearing coat panels. After 34 days of laying of one set of panel, another alternate panels are laid. Top of these panels are finished by tamping the surface with wooden floats and tapping with trowels, till cement slurry appears on top. It needs curing for 7 to 14 days.



- 5. Granolithic Flooring** - Granolithic is also known as **granolithic paving** and **granolithic concrete** is a type of construction material composed of cement and fine aggregates, such as granite or other resistant rocks. It is generally used as a floor or paving. It has a similar appearance to concrete and is used to provide a durable surface, where texture and appearance are generally not important. It is usually placed as a table.

Tables are a type of floor placed on top of the structural element to provide a level surface on which the “worn floor” is placed.



- 6. Terrazzo Flooring** - Terrazzo finishing coat is applied over **concrete flooring** to get **pleasing** appearance. Terrazzo finish consists of 75 to 80% of surface marble chips embedded in cement mortar.



- 7. Mosaic flooring** - It consists of a **finishing coat** of small pieces of broken tiles of China glazed or of marble arranged in different patterns set in lime-surkhi or cement mortar. The base coarse is concrete flooring and on it 30 to 40 mm mortar layer is provided. On this mortar layer broken pieces of **China glazed** or **marble** are set to get

different attractive patterns. After 20 to 24 hours of drying the top is rubbed with carborundum stone to get smooth and polished surface.



- 8. Marble Flooring** Marble slabs are cut to get marble tiles of 20 to 25 mm thickness. They are laid on floors similar to other tiles. With power driven machine surface is polished to get even and shining surface. This type of flooring is widely used in hospitals and temples.

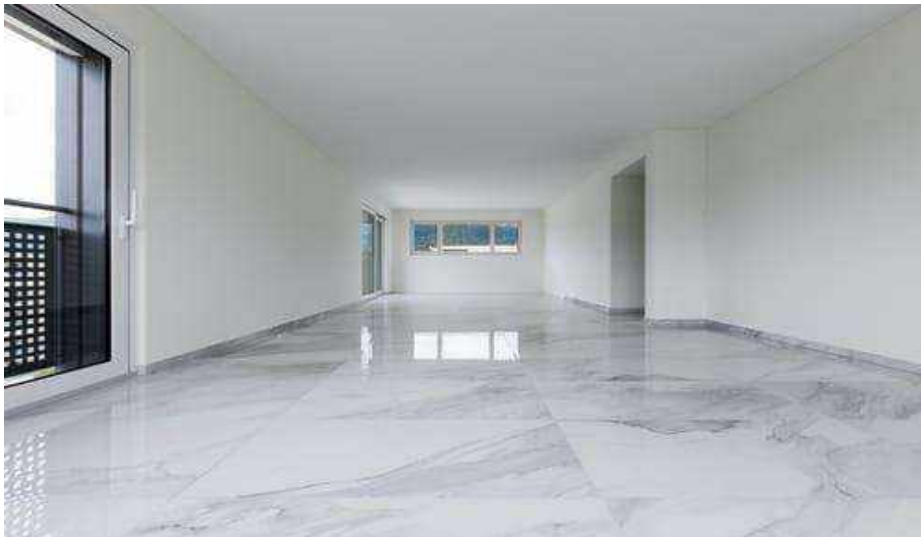

- 9. Wood Or Timber Flooring** - Timber flooring are used in **dancing halls** and in **auditoriums**. **Timber plates** may be directly placed on **concrete bed** or may be

provided over timber frame work. In latter case it is necessary to provide proper ventilation below the floor. This flooring is costly.



10. Granite Flooring - When it comes to flooring types, **granite is an elegant option**. A naturally occurring stone available in a variety of colours in the Indian market, granite flooring can bring a note of sophistication to any setting. Due to its **high stain-resistance** and durability, this is one of those types of flooring that is fairly easy to maintain. You only need to protect it from scratches. The stone keeps cool for most parts of the year, making it amongst the best flooring for house in India.



11. Asphalt Flooring - This floor is **water-resistance, unclean, junction, acid-resistance** and charming in look and like pretty famous nowadays and this floor are even anti-skid

and soundless. Asphalt flooring is a flat plane coating produced from a combination of asphalt, chrysotile, paint, and glass beads. It is generally about 1/8 or 3/16 inch flat and is impenetrable, flameproof, low-price, and straightforward. Asphalt flooring will grow for humid and basic guidelines, whereas linoleum does not take so long, and it is virus-resistance, acidic and oils, and animal oil. It can apply where the floor climate is lower than 80 degrees Fahrenheit.



FLOORING MATERIALS

Flooring is laid over the base floor. The different materials used for flooring are :-

- Mud and moorum
- Plastic or PVC
- Stones
- Tiles
- Bricks
- Rubber
- Wood and timber
- Linoleum
- Concrete
- Granolite
- Mosaic
- Cork
- Terrazzo
- Magnesite
- Asphalt
- Glass
- Marble

PLASTERING AND PAINTINGS

<Objectives, types, preparation, and procedure of application>

❖ **PLASTERING**

- Plastering work is a crucial part of construction projects; the reason for plastering in the first place is to cover uneven surfaces of the blockwork or masonry work. The purpose of the plastering is to cover blockwork, masonry work, columns & the structure of the building with cement sand mortar.
- Plaster helps with the protection of the wall from fire, rainwater, leakages of water on the ceiling area. Just like RCC & blockwork, Plastering plays an important role to make a structure sustainable.



✓ *Objectives Of Plastering:-*

1. To provide an even, smooth, regular, clean and durable finished surface.
2. To protect the surfaces from atmosphere influenced by acting as protective layer.
3. To conceal defective workmanship and covers up cheap quality material.
4. To protect the internal surfaces against dust and vermin.
5. To form a good base for white washing, color washing, painting or distempering.

✓ *IS Code For Used For Plastering Work:*

Indian standards (BIS codes)

- IS 1661 : 1972 (reaffirmed 2001) : Code of practice for application of cement & cement-lime plaster finishes.
- IS 1542 : 1992 (reaffirmed 2003) : Sand for plaster
- IS 1489 for portland pozzolona cement.
- IS 8112 for grade 43 OPC.

✓ *Cement- Sand ratio used in Plastering*

1:3 – Normally used for rich fill mortar which required to fill the cracks, repair work and sometimes in first coat of external walls.

A. 1:4 – Usually used for **external** walls of the building

B. 1:5 & 1:6 – Usually used in **internal** plaster works.

✓ *Types Of Plastering Mortar:-*

1. **Cement mortar:** The ideal mortar for outdoor plastering work is cement mortar. It is made out of cement, sand, water in a specific ratio. The typical cement mortar mix used for plastering ranges from 1:4 to 1:6.
2. **Lime mortar:** It is made up of right amount of water, sand and either fat lime or hydraulic lime
3. **Cement-lime mortar:** It contain properties of both the lime as well as cement mortar
4. **Gypsum mortar plaster:** White cementing material is made of gypsum or partly dehydrated, usually added to special retarders or hardeners. Used in a plastic state (with water), it hardens by setting the gypsum back into the water.
5. **Clay plaster:** It is a blend of clay and sand, making it a beautiful and environmentally friendly alternative to conventional plaster and paint. It is natural, non-toxic, durable and beautiful. Unlike most paints, it does not contain VOCs (harmful chemicals emitted during and after use).

6. **Water-proof mortar:** It is composed of one part cement, two parts sand, and 12kg/m³ of crushed alum. In addition to this soap water containing about 75 gm of soft soap/litre of water, is added.



✓ *Procedure Adopted For Plastering :-*



- The surface that needs to be plastered needs to be thoroughly cleaned, degreased and moistened for a few hours.
- One, two or three coatings of plaster can be put however two are usually sufficient. Three coats would be used only on wood or metal lathing on a very rough, uneven back ground.
- The thickness of the first coat should be just sufficient to cover the entire surface. No single coat should be thicker than 12mm. Lower coats should be thicker than upper coats.
- Under coats must be allowed to completely dry before adding additional applications. When applying another coat of plaster, the previous plastered surface should be scratched or roughened before it is fully hardened to form a mechanical key.

- The method of application of mix influences the adhesion; if thrown on the mix will stick better than applied by trowel. A trowel is used to polish the surface. After that the plastered surface needs to cure for roughly seven days.

❖ **PAINTING**

Painting is the practice of applying paint, pigment, color or other medium to a solid surface (called the "matrix" or "support"). The medium is commonly applied to the base with a brush, but other equipments can be used.



✓ **OBJECTIVES OF PAINTING:-**

1. To protect the surface from the effects of weathering
2. To prevent wood from decay and metal from corrosion
3. To provide decorative finish and to obtain a clean, hygienic and healthy living atmosphere.

✓ **Types Of Paints In Civil Engineering**

- 1) **OIL PAINT:-** Three layers of paint are used to cover these surfaces: primer, undercoat, and finishing coat. The longevity of oil paint is negatively impacted by the presence of moisture while applying the primer. This paint is inexpensive and simple to use.

- 2) **ENAMEL PAINT:-** White lead, oil, petroleum spirit, and resinous substance are all present. Its surface offers excellent resistance to water, acids, and alkalis. Prior to applying the layer of enamel, it is preferable to apply a coat of titanium white. It may be utilized for both exterior and interior walls.
- 3) **EMULSION PAINT:-** It has binding materials including synthetic resins and polyvinyl acetate, among others. It is simple to apply and dries in 1 ½ to 2 hours. It is more resilient and washable with water. Cement paint should be applied to plastered surfaces first, followed by the emulsion point. Sound surfaces are required for emulsion paint.
- 4) **CEMENT PAINT:-** It is available in powder form. It consists of white cement, pigment and other additives. It is durable and exhibits excellent decorative appearance. It should be applied on rough surfaces rather than on smooth surfaces. It is applied in two coats. First coat is applied on wet surface but free from excess water and allowed to dry for 24 hours. The second coat is then applied which gives good appearance.
- 5) **BITUMINOUS PAINT:-** Asphalt or vegetable bitumen is dissolved in oil or petroleum to create this sort of paint. It has a black colour. It is utilised for underwater painting of iron works.
- 6) **SYNTHETIC RUBBER PAINT:-** Resins are used to make this paint. It dries rapidly and is not significantly impacted by the sun or the environment. It holds up well against chemical attack. Even newly laid concrete can receive this paint. It is reasonably priced and simple to use.
- 7) **ALUMINIUM PAINT:-** Finely ground aluminium with oil or spirit varnish is present. It is also noticeable in the dark. This paint does a good job of protecting steel and iron surfaces. It is frequently used to paint water pipelines, oil tanks, and gas tanks.
- 8) **ANTI-CORROSIVE PAINT:-** Essentially, it is made up of lead or zinc chrome, finely crushed sand, a powerful drier, and oil. It is cheap and resists corrosion well. It is black in colour.

✓ *Procedure Of Applying Paint*

1. **Priming the Surface:** For certain surfaces (POP Punning zone and drywall), one layer of primer is to be applied before the putty and painting. Due to the preliminary's cement quality, it makes the ideal surface for putty.

2. **Coat of Putty:** Wall Putty is a compound blend of certain components, for example, white concrete, chalk, and so forth 2-3 layers of putty give a smooth base to the roof and walls for painting.
3. **Sanding the Uneven Surface:**We utilize fine-grit sandpaper, as 150-grit or 180-grit, and go over the walls daintily in a roundabout movement to expel the free and little particles. At the point when the coarseness of one area gets secured with dust, we change to an unused segment and proceed, after this, we wipe down the walls with a dry material to expel any residue..
4. **One Coat of Primer:**Primer makes a smooth base for the last paint shading and it's likewise savvy to prime before painting. It prevents stains from seeping through. It additionally improves paint attachment, bringing about diminished rankles and stripping.
5. **2-3 Coats of Paint:**We start painting the roof and walls later. We move rapidly starting with one area and then onto the next to ensure the paint along the edge doesn't dry before we paint the adjoining segment. This causes us to dodge the laps marks. We need to wait for the primary layer of paint to dry totally. We paint second and individual coats with similar considerations and methods.



#####

BASIC OF CIVIL ENGINEERING (BCE02001)

Module-IV

Module IV Syllabus

Basic Infrastructure Services-Air conditioning and purpose, fire protection & materials, Ventilation, necessity & functional requirements, Lifts, and Escalators.

Introduction to planning and design aspects of transportation engineering- Transportation modes, Highway engineering – historical development, highway planning, classification of the highway, Railway Engineering – a cross-section of rail track, basic terminology, geometric design parameter (brief discussion only).

Subject to Revision

Basic Infrastructure Services

<Air conditioning and purpose>

< Fire protection and materials>

<Ventilation, necessity and functional requirements>

<Lifts, and Escalators>

(A) Air Conditioning and Purpose

- Air-conditioning is the process of **treating air to maintain its temperature, humidity, purity, and distribution simultaneously** in order to fulfil the requirements of the conditioned area, such as **human comfort and health, industrial process needs**, and the **efficient operation** of commercial premises.
- An air conditioner provides **cold air** inside your home or enclosed space by actually **removing heat and humidity** from the indoor air. It returns the **cooled air** to the indoor space, and transfers the unwanted heat and humidity outside.

✓ *Purpose of Air Conditioning*

Below are the major functions of an air conditioning system in modern houses:

1. The primary purpose of air conditioning is to create a **room climate comfortable** for humans.
2. Some special type of conditioning system is used to **cool the temperature of electric devices**.
3. It controls the **humidity of a room as 30 to 65%** is permitted while the **temperature** should be between **20 and 26 degrees Celsius**.
4. Air conditioning system affects the room air to **comfort people** and their **productivity** is not impeded.
5. The **condition** of the **air** is **characterized** by **temperature, pressure and humidity**. The air pressure is not changed.
6. Air conditioning system can be for heating, dehumidifying, cooling, and humidifying.

✓ **Types Of Air Conditioning**

1. Ducted Air Conditioning.
2. Split System Air Conditioning.
3. Multi Split Air Conditioning.
4. Controls.

✓ **Major Components of Air Conditioners**

1. Compressor
2. Condenser coil
3. Thermostat
4. Evaporator
5. Air Handling and Machine unit
6. Valves

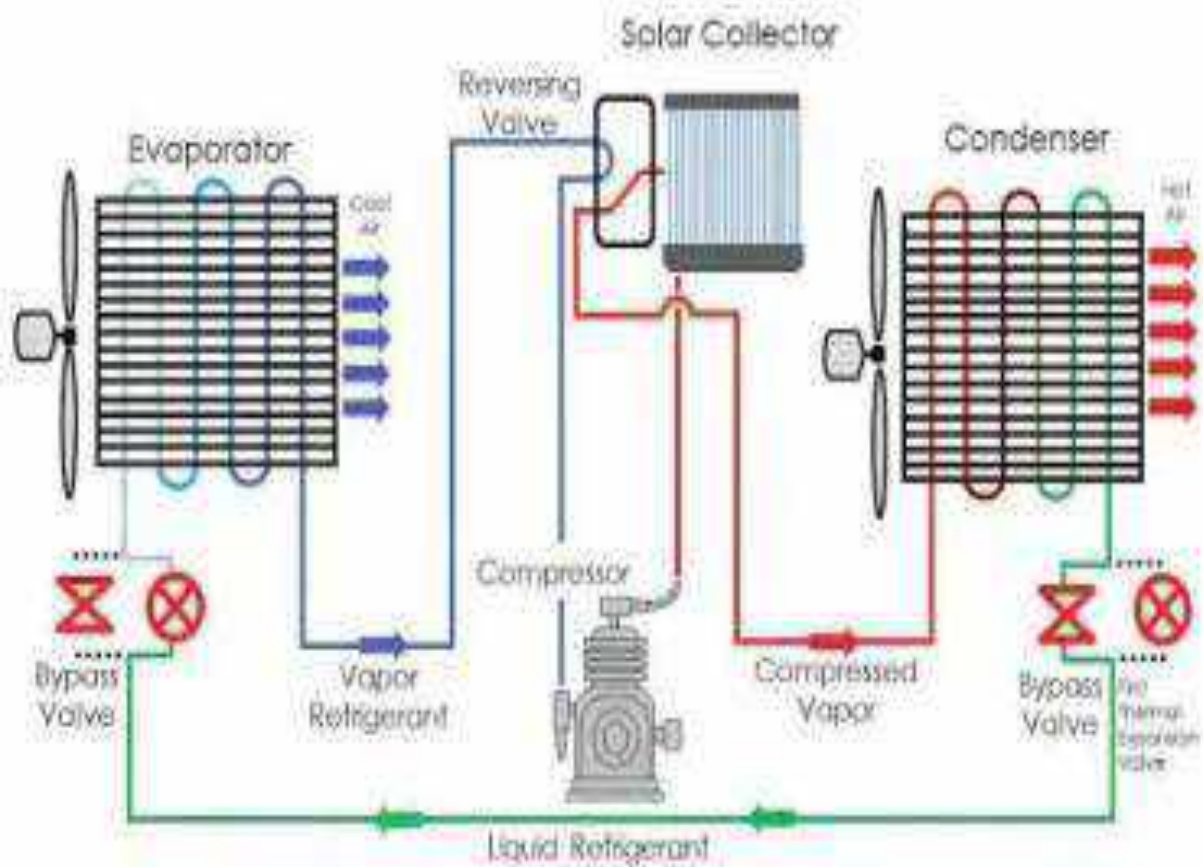

(B) Fire Protection and Materials

- Fire protection is the study and practice of mitigating the unwanted effects of **potentially destructive fires**.
- It involves the study of the **behaviour, compartmentalisation, suppression** and **investigation** of fire and its related emergencies, as well as the research and development, production, testing and application of mitigating systems.
- Fire protection within a structure is a system that **relies** on all of its **components**. The building is designed in compliance with the local building code and fire code by the architect and other consultants.

✓ *Modes of Fire Protection*

Fire protection in land-based buildings, offshore construction or on board ships is typically achieved via all of the following:

1. **Passive fire protection** - The **installation of firewalls** and **fire rated floor assemblies** to form fire compartments intended to **limit the spread of fire, high temperatures, and smoke**.
2. **Active fire protection** - **Manual** and **automatic detection** and **suppression** of fires, such as fire sprinkler systems and (fire alarm) systems.
3. **Education** - The provision of information regarding passive and active fire protection systems to building owners, operators, occupants, and emergency personnel so that they have a working understanding of the intent of these systems and how they perform in the fire safety plan.

• *Basic Requirements of Buildings for Fire safety:*

Regarding achieving resistance to fire, the basic requirements laid down in the codes are:

- The structure should **not ignite** easily.
- Building orientation should be such that **spread of fire is slow**.
- In case of fire, there should be means of **easy access to vacate** building quick.

✓**The following points should be given due consideration for protecting the openings:**

- (i) Solid timber doors having a **minimum thickness of 4 cm** should be used where some degree of fire resistance is desired.
- (ii) All those openings which are used for communication, should have **double fire-proof doors** and other openings may have **single fire-proof doors**. (Fire-proof doors are considered to be of superior type when made of steel plate with a minimum thickness of **6 mm** and of inferior type when made of composite material, i.e., **4 cm** thick timber panel sandwiched by iron sheets of 3 mm on either side.
- (iii) Any window exposed to the roof of the structure should be protected by **fire-proof shutters**.
- (iv) If any structure has a separation less than **6 metres** from the **adjoining structure**, then all doors, windows or exposed sides should be made of fire-proof construction.
- (v) All escape doors should be such as to provide **free circulation** to the persons in passages, lobbies, corridors, stairs, entrances, etc. and be made of fire-proof materials.
- (vi) **Windows**, if carried down the floor, should have **suitable barrier**, like projecting slab beyond the outer face of the building.

✓***Materials for fire protection***

- Wall and columns;
- 2. Floor and roofs;
- 3. Wall openings; and
- 4. Building fire escape elements, e.g., stair, stair cases, corridors, entrances, etc.

Brick and Mortar

Stone

Timber

Steel

Concrete

Glass

Cast iron

(C) Ventilation

<Ventilation, necessity and functional requirements>

Ventilation is defined as a process of **removing or supplying air** by natural or mechanical means to and from an air source or any space.

✓ ***Building ventilation has three basic elements/ Functional requirements:***

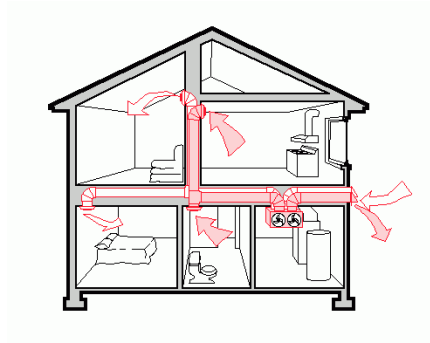

1. ***Ventilation rate*** — The **amount of outdoor air** that is provided into the space, and the quality of the outdoor air.
2. ***Airflow direction*** — The overall airflow direction in a building, which should be from **clean zones to dirty zones**; and
3. ***Air distribution or airflow pattern*** — The external air should be delivered to each part of the space in an efficient manner and the airborne pollutants generated in each part of the space should also be removed in an efficient manner.

➤ ***Necessity of Ventilation***

1. To **prevent an undue concentration** of body odours, fumes, dust, and other industrial products
2. To prevent an **undue concentration of bacteria** carrying particles
3. To **remove products of combustion**, and to **remove body heat** and the **heat liberated** by the operation of electrical and mechanical equipment.
4. To **create air movement**, to **remove the circulated air** and its replacement by the fresh air.
5. To create **healthy living conditions** by preventing the **undue accumulation** of **carbon dioxide** and **moisture**, and depletion of the oxygen content of the air. For **comfortable working conditions**, the content of **carbon dioxide** should be limited to about **0.6% volume (in air)**.

(D) Lifts, and Escalators

LIFTS

- An **elevator** or **lift** is a machine that **vertically transports** people or freight between levels.
- They are typically powered by **electric motors** that drive traction cables and counterweight systems such as a hoist, although some pump hydraulic fluid to raise a cylindrical piston like a jack.
- **Elevators** are used in buildings having **more than three storeys**. They are either electric traction elevators or hydraulic elevators.
- **Electrical traction elevators** are used exclusively in **tall buildings**.
- **Hydraulic elevators** are generally used for **low-rise freight** service till **six storeys**.

✓ **Various Design Parameters for Manufacturing of Lifts/Elevators**

1. **Population** (The total building population & its future projections are required)
2. **Quantity of service** (Handling capacity- It is the measure passenger handling capacity)
3. **Quality of service** (or interval – time interval a passenger has to wait).

✓ **Types of Lifts**

1. Passenger lift
2. Hospital lift
3. Goods lift
4. Service lift
5. Fireman's lift.

✓ **Working Principle of an Elevator/Lift**

- Basically, an elevator is a **metal box** in different shapes which is connected to a **very tough metal rope**.
- The **tough metal rope** passes through a **sheave** on the elevator in the **engine room**.
- The working principle of an elevator or lift is similar to the **pulley system**.
- Here a sheave is like a wheel in pulley system for clutching the metal rope strongly. This system can be operated by a motor.

- When the switch is turned ON, the motor can be activated when the elevator goes up and down or stops.

❖ **ESCALATORS**

- An escalator is a **moving staircase** which carries people **between floors** of a building or structure. It consists of a **motor-driven chain of individually linked steps** on a track which cycle on a pair of tracks which keep the step tread horizontal.

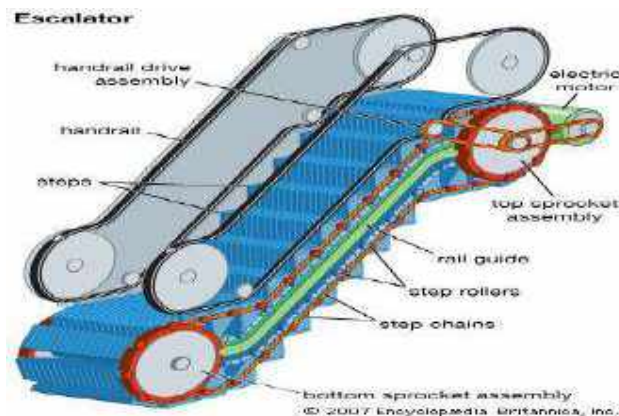

- Escalators are often used around the world in places where **lifts would be impractical**, or they can be used in **conjunction with them**.
- Principal areas of usage include department stores, shopping malls, airports, transit systems (railway/railroad stations), convention centers, hotels, arenas, stadiums and public buildings.

✓ **Types of Escalator**

1. Parallel
2. Crisscross
3. Multiple Parallel
4. Curved

➤ **Working Principle of Escalators**

- An escalator is made up of a set of **interlocking steps**, powered by an **electric motor**.

- A **pair of chains looped around two pairs of gears** rotate to move the steps along while a larger metal structure called a truss encases the entire mechanism to connect the floors.
- The steps then move about like a **conveyer belt**, entering into a special guide system at the top and bottom of the truss to create a level platform for passengers to board or exit.
- They are generally operated at a speed of **0.5 to 0.75 m/s**. **Slope of stairs is standardized at 30°**.
- For a given speed, the width of steps decides the capacity of the powered stairs. Normally a **design capacity of 3200 to 6400 person per hour** is adopted depending upon the width of the escalator.

Introduction to Planning and Design Aspects of Transportation Engineering

Transportation modes, Highway engineering – historical development, highway planning, classification of the highway, Railway Engineering – a cross-section of rail track, basic terminology, geometric design parameter (brief discussion only).

❖ *Modes of transportation*

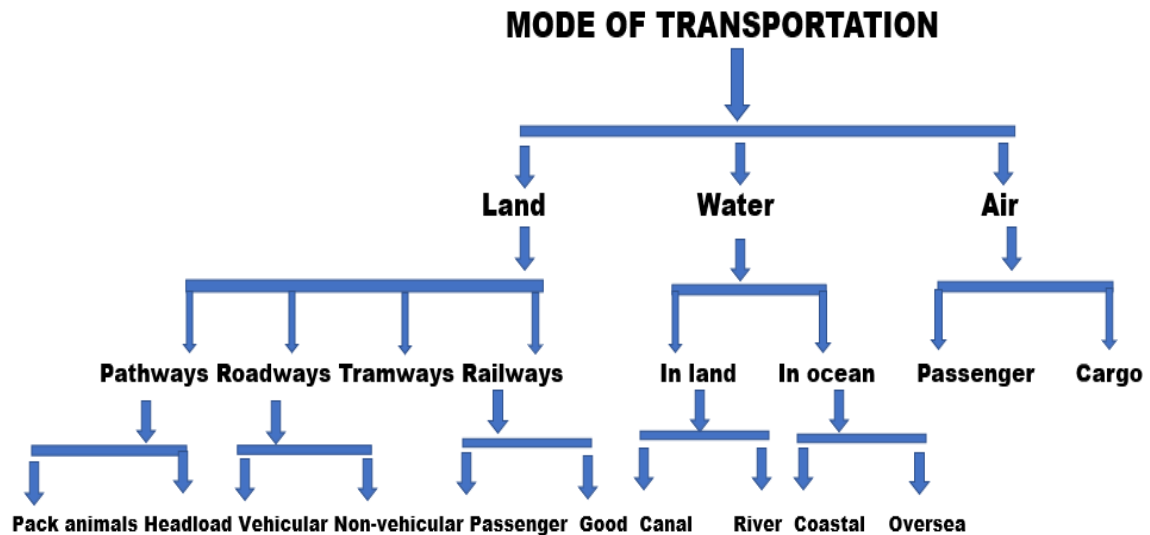

- In general, transportation is used for moving of people, animals, and other goods from one place to another.
- The different modes of transport are air, water, and land transport (rails or railways, highways and off-road transport).

❖ *Components of a mode of transport*

A transport mode is a combination of the following:

1. Transportation infrastructure: Thoroughfares, networks, hubs (stations, bus terminals, airport terminals), etc.
2. Vehicles and containers: motor vehicles, automobiles, motorcycles, trucks, wagons, trains, ships, and aircraft
3. A stationary or mobile workforce
4. Propulsion system and power supply (traction)
5. Operations: driving, management, traffic signals, railway signalling, air traffic control, etc.

❖ Highway Engineering

<Historical development, highway planning, classification of the highway>

- Highway engineering is an engineering discipline branching from civil engineering that involves the **planning, design, construction, operation, and maintenance of roads, bridges, and tunnels** to ensure safe and effective transportation of people and goods.

✓ *Historical Highways*

The beginning of road construction could be dated to the time of the **Romans**. With the advancement of technology from carriages pulled by **two horses** to vehicles with **power** equivalent to 100 horses, road development had to follow suit. The construction of modern highways did not begin until the late 19th to early 20th century.

I. Roman Roads

- Romans recognized that the fundamentals of good road construction were to provide **good drainage, good material and good workmanship**. Their roads were very **durable**, and some are **still existing**. Roman roads were always constructed on a formed **subgrade**, strengthened where necessary with **wooden piles**. The roads were bordered on both sides by **longitudinal drains**.
- The next step was the construction of the **agger**. This was a **raised formation** up to a **1-meter-high** and **15 m wide** and was constructed with materials excavated during the **side drain** construction. This was then topped with a sand levelling course. The agger contributed greatly to moisture control in the pavement.
- The pavement structure on the top of the agger varied greatly. In the case of heavy track, a surface course of large 250 mm thick hexagonal ag stones were provided. The main features of the Roman roads are that they were built straight regardless of gradient and used heavy foundation stones at the bottom.

Roman Road

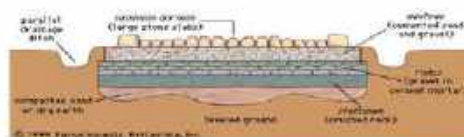

II. French Roads

- The next major development in the road construction occurred during the regime of **Napoleon**. The significant contributions were given by Tresaguet in 1764. He developed a cheaper method of construction than the lavish and locally unsuccessful revival of Roman practice.
- The pavement used **200 mm pieces** of quarried stone of a more compact form and shaped such that they had at least one flat side which was placed on a compact formation. Smaller pieces of broken stones were then compacted into the spaces between larger stones to provide a level surface.
- Finally the running layer was made with a layer of 25 mm sized broken stone. All this structure was placed in a trench in order to keep the running surface level with the surrounding country side. This created major drainage problems which were counteracted by making the surface as impervious as possible, cambering the surface and providing deep side ditches.
- They gave much importance for drainage. He also enunciated the necessity for continuous organized maintenance, instead of intermittent repairs if the roads were to be kept usable all times. For this he divided the roads between villages into sections of such length that an entire road could be covered by maintenance men living nearby.

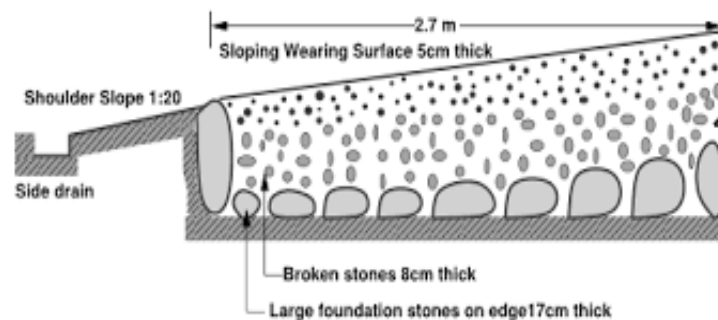

III. British Roads

- The British government also gave importance to road construction. The British engineer John Macadam introduced what can be considered as the first scientific road construction method. Stone size was an important element of Macadam recipe.
- By empirical observation of many roads, he came to realize that 250 mm layers of well compacted broken angular stone would provide the same strength a better running surface than an expensive pavement founded on large stone blocks. Thus he introduced an economical method of road construction.

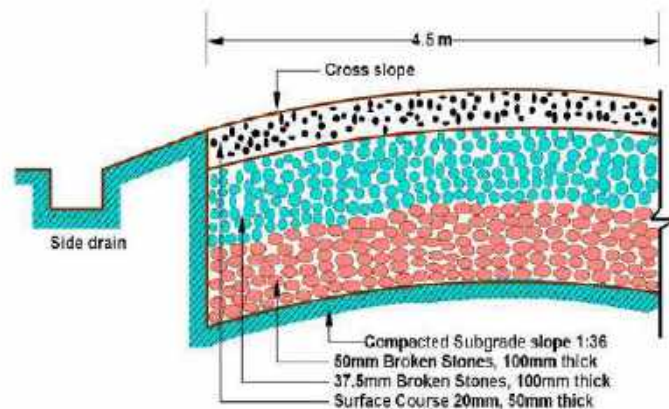

✓ Highway Planning and Development

- Highway planning involves the **estimation** of **current** and **future traffic volumes** on a road network.
- The Highway planning is also a **basic need** for the Highway development.
- Highway engineers strive to predict and analyse all possible **civil impacts** of highway systems.

✓ *The Objectives of Highway Planning:*

- i. Planning a highway network for **safe**, **efficient** and **fast** movement of people and goods.
- ii. The **overall cost** of **construction** and **maintenance** of the roads in the network.
- iii. **Planning** for future development and **anticipated traffic needs** for a specific design period.
- iv. **Phasing road development** programmes from considerations of utility and importance as also of financial resources.
- v. Evolving a financing system compatible with the cost and benefits.

✓ *The Basic Principles Highway planning:*

- The proposed **road links** should be a part of the **planned road network** for the state/nation.
- The importance of the road shall be based on the **traffic demand**, and hence its type should fall under the standard classification.
- The **maintenance** needs of the roads should receive prompt attention by setting aside funds for this purpose.
- **Statutory provisions** for traffic regulation should be in place.

✓ *Steps in Planning*

1. **Monitoring** existing condition and forecasting future population and employment growth, including assessing projected land uses in the region and identifying major growth corridors.
2. **Identifying current and projected future** transportation problems and needs and analysing through detailed planning studies.
3. Developing **long range plans** and **short range programme** of alternative capital improved and operation strategic for moving people and goods
4. Estimating the impact recommended future improvements to the transportation system on environment features, including air quality and
5. Developing a financial for security sufficient revenue to cover the costs of implementing strategic.

➤ *Classification of Highways*

The Indian Road Congress or **IRC** is the prime body that looks over the road development in the country. Established by the government in 1934, this apex body consists of qualified highway engineers.

The IRC offers the following classification of roads in India.

- National highways
- State highways
- District roads
- Rural roads

1) **National highways in India**

- National highways are the roads that stretch between the **cities in the country**. These are the main roads that connect the **capitals of most states** with each other. Some national highways even connect **India with other neighbouring countries** and make many famous **tourist destinations** easily accessible.

➤ A highway is typically a **large-width, well-designed road with traffic signs, lights, bridges, etc., at appropriate locations**. These roads are indicated by “NH” with a hyphen and a numeral code like “NH-1”, “NH-10”, etc.

➤ The following are the types of national highways in India.

- Single-lane highway
- Double-lane highway
- Four-lane highway
- Six-lane highway
- Eight-lane highway

➤ The following authorities take care of the development, management and maintenance of national highways in India.

1. National Highways Authority of India or NHAI

2. National Highways and Infrastructure Development Corporation Limited or NHIDCL

2) State highways in India

➤ State highways include roads that connect all **major cities in a state**. At the same time, they offer connectivity with neighbouring state highways and national highways. These highways are indicated by “SH” along with a designated state code.

➤ Some of the largest shares of state highways are in Maharashtra, Karnataka, Gujarat, Rajasthan, and Tamil Nadu. The development and maintenance of these highways fall on the authorities of their respective states.

3) District roads in India

➤ District roads or urban roads in India connect **different parts of a city**. Hence, locals use these roads to travel to offices, markets, educational institutions, hospitals, etc. These roads also allow connectivity with neighbouring state/national highways.

➤ Based on the location and function, district roads are divided into **major and minor** roads. Major roads in a district offer connectivity with the main locations of neighbouring districts. On the other hand, minor roads in a district connect all major areas inside that district.

4) **Other district roads in India**

- Some of the roads connect **major parts of a rural area** to a district.
- These roads are highly important to enable the transportation of goods and raw materials required for people living in rural towns.
- Similarly, it allows farmers from rural towns to transport their produce to the markets situated in neighbouring districts.

5) **Village/rural roads in India**

- The rural roads in India are found in the **villages** and **rural** towns.
- These are not as sophisticated as national or state highways but offer connectivity for the villagers to commute to markets, farms, fields, offices, residences, etc.

❖ Railway Engineering

<A cross-section of rail track, basic terminology, geometric design parameter
(brief discussion only)>

✓ *Components of a Railway Track*

- A railway track is a combination of **rails**, **sleepers**, **ballast**, and **subgrades**. The systematic rails fit on a number of sleepers. This sleeper rests on ballast supports by subgrades.

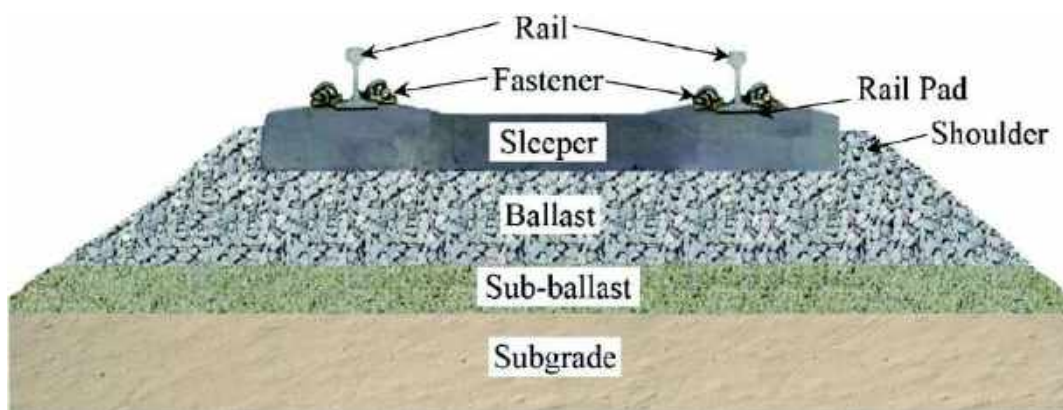

1. RAILS

The rail provide a hard, smooth and unchanging surface for the passage of heavy moving loads. Rails are made of **high carbon steel** to withstand **wear and tear**. Flat footed rails are mostly used in railway track.



✓ *Function Of Rails*

1. Rails provide a continuous and level surface for the movement of the trains with minimum friction with steel wheels of the rolling stock
2. Rails provide strength, durability and lateral guidance to the track
3. Rails transmit the axle load to sleepers, which transfer the same load to the underlying ballast and formation
4. Rails bear the stresses developed due to heavy vertical loads, braking forces and temperature variance.

2. Sleepers

The support which keeps the rails apart at required distance, supports the rail and distribute the load to the ballast are called as sleepers. Sleepers are of different materials such as wood, steel, cast iron, RCC and Prestressed concrete.



✓ *Functions Of Sleepers*

The important functions of sleepers are,

- i. To **hold** the rails to proper gauge in all situations. That is, exact gauge along straights and flat curves, slightly loose on sharp curves and slightly tight in diamond crossings.
- ii. To **support** the rails firmly and evenly throughout
- iii. To distribute the load transmitted through rails over large area of ballast underneath or to the bridge girders.

- iv. To hold the rails to proper level in turnouts and crossovers, and at 1 in 20 in ward slope along straight tracks
- v. To provide an **elastic medium between the rails and ballast** and also to absorb the vibrations caused due to moving axle loads
- vi. To **maintain proper alignment** of the track. On curves proper cant is provided by raising the outer rail and tamping the required quantity of ballast below the rails
- vii. To provide the **general stability** of the permanent way throughout
- viii. To provide the **insulation of track** for the electrified for signaling
- ix. To provide easy replacement of the rail fastenings without any serious traffic disturbances.

3. Ballast

Ballast is the broken stone placed or packed below the sleepers to transmit load from sleeper to the formation and at the same time allowing drainage of the track.

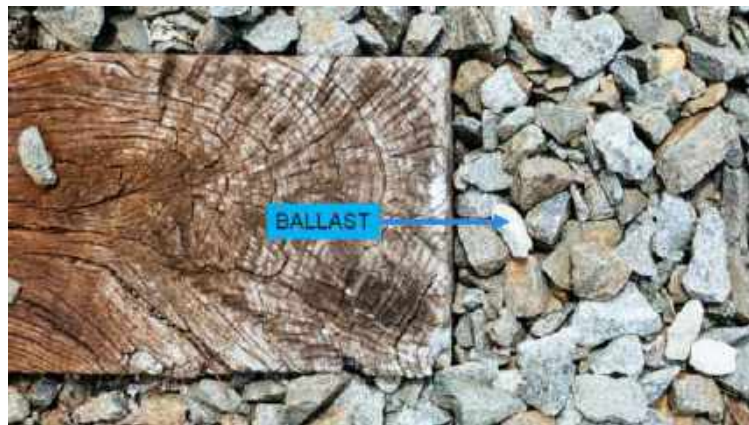

✓ *Functions of Ballast*

- i. To provide **firm and level bed** for the sleepers to rest on
- ii. To allow for maintaining **correct track level** without disturbing the rail road bed
- iii. To **drain off the water** quickly and to keep the sleepers in dry conditions
- iv. To **discourage the growth** of vegetation
- v. To **protect the surface of formation** and to form an elastic bed
- vi. To **hold the sleepers** in position during the passage of trains
- vii. To **transmit and distribute the loads** from the sleepers to the formation
- viii. To **provide lateral stability** to the track as a whole

4. Railway Fastenings

Fastening in railway is used to connect the rails and sleepers together in their proper positions.

The fixtures and fastening used in track fittings are:

- Fish plates
- Spike
- Bolts
- Chairs
- Blocks
- Keys
- Plates

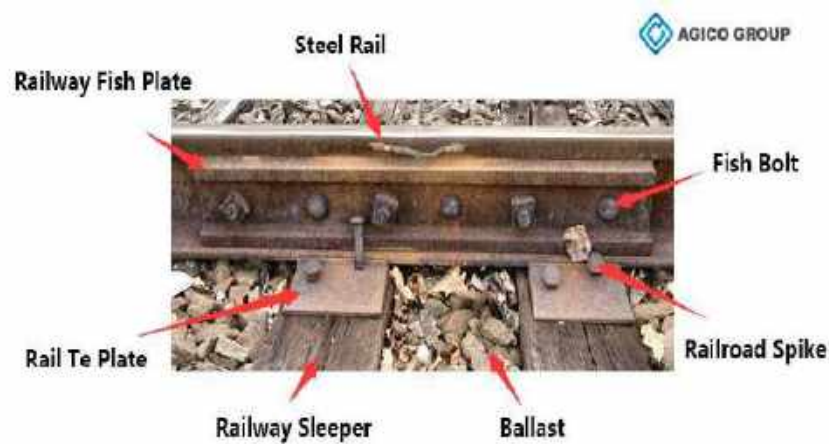

✓ *Functions of Fastening in Railway*

- i. Join the rails end to end to form full length of track
- ii. To fix the rails to sleepers
- iii. To maintain the correct alignment of the track
- iv. To provide proper expansion gap between rails
- v. To maintain the required tilt of rails
- vi. To set the points and crossings in proper position.

5. Subgrade

- These are natural soils on the bottom of a track.
- These are the foundations of tracks.

- It holds rails, sleepers, ballast and the entire track together.
- It supports the railway track from the bottom layer.

✓ ***Basic Terminologies***

- 1) **Gauge:-** Clear distance between **two parallel rails**, is termed as Gauge. Depending on terrain condition the gauge may be classified as:
 - a) Standard gauge - 1435 mm.
 - b) Broad Gauge - 1676 mm or 1524 mm.
 - c) Cape Gauge - 1067 mm
 - d) Meter gauge - 1000 mm
 - e) Narrow gauge - 762 mm or 610 mm
- 2) **Rails :-** Rails are steel girders which provide the hard and smooth surface for movement of wheels of a locomotive and railway vehicle.
- 3) **Fish plates or fish bolts:-** These are used to **connect the rails** from end to end.
- 4) **Sleepers :-** These are the transverse members over which the rails are firmly placed.
- 5) **Ballast :-** The sleepers are bedded and packed in a granular material such as broken stone, gravel etc. which is known as ballast.
- 6) **Formation of subgrade :-** Which may be constructed in embankment, cutting or at ground level, according to the topography of the area.
- 7) **Bearing plate :-** The plates which are placed in between the flat footed rails and wooden sleepers on a railway track are known as bearing plate.
- 8) **Chairs :-** The devices which are used for **holding the double headed and bull headed rails** in the required positions are called chairs.
- 9) **Bolts :-** These are used to connect the fish plates to the rails at each joint, bearing plates and chairs to wooden sleepers etc.
- 10) **Broad Gauge :-** The gauge of a track in which the distance between the running faces of two track rails is 1.676 metres.
- 11) **Metre Gauge :-** The gauge of a track in which the distance between the running faces of two track rails is 1 metre.
- 12) **Coaches :-** The passenger compartments are called coaches.
- 13) **Wagons :-** For transportation of goods, wagons are provided in a goods train.
- 14) **Goods Yard –** A yard in which goods wagons are shunted and sorted for loading and unloading.

- 15) **Level Crossing** – A place where the **road** and **railway** line cross each other at the same level.
- 16) **Points & Crossing** – These are provided to help transfer railway vehicles from **one track to another**.
- 17) **Adhesion of Wheels** – It is the **resistance** offered by the **friction** between the **metal surface of the rail and the wheel**.
- 18) **Bearing Plates** – To reduce the intensity of pressure, particularly on soft variety of sleepers, a rectangular plate of mild steel or cast iron is introduced between the rails and the sleepers.
- 19) **Creep of Rail** – Creep is the **longitudinal Movement** of rails in a track.
- 20) **Cant or Super-elevation** - is the amount by which **one rail is raised above** the other rail. It is **positive** when the **outer rail on a curved track is raised** above inner rail and is negative when the inner rail on a curved track is raised above the outer rail.

PARAMETERS FOR GEOMETRIC DESIGN OF RAILWAYS

Geometric design of a railway track discusses all those **parameters** which affect the **geometry** of the **track**. These parameters are as follows:

1. **Gradients** in the track including **grade compensation, rising gradient, and falling gradient**.
2. **Curvature** of the track, including **horizontal** and **vertical** curves, **transition** curves, **sharpness** of the curve in terms of **radius** or **degree** of the curve, **cant** or **super elevation** on curves, etc.
3. **Alignment** of the track, including **straight** as well as **curved** alignment.

NECESSITY FOR GEOMETRIC DESIGN

It is very important for tracks to have **proper geometric design** in order to ensure the **safe** and **smooth running** of **trains** at **maximum permissible speeds**, carrying the **heaviest axle loads**. The speed and axle load of the train are very important and sometimes are also included as parameters to be considered while arriving at the geometric design of the track. The need for **proper geometric design** of a track arises because of the following considerations:

- To ensure the **smooth** and **safe running** of trains
- To achieve **maximum speeds**

- To carry **heavy axle loads**
- To **avoid accidents** and **derailments** due to a **defective permanent way**.
- To ensure that the track requires **least maintenance**
- For **good aesthetic**

The geometric design of a railway track includes all those parameters which determine or **affect the geometry of the track**. These parameters are as follows.

1. GRADIENTS IN THE TRACK

Gradients are provided to negotiate the **rise or fall** in the level of the railway track. A rising gradient is one in which the **track rises in the direction of movement of traffic** and in a **down or falling gradient** the track **loses elevation the direction of movement of traffic**.

A gradient is normally represented by the **distance travelled for a rise or fall of one unit**. Sometimes the gradient is indicated as per **cent rise or fall**. For example, if there is a rise of **1 m in 400 m**, the gradient is **1 in 400** or **0.25 per cent**.

Gradients in the track, including grade compensation, rising gradient, and falling gradient.

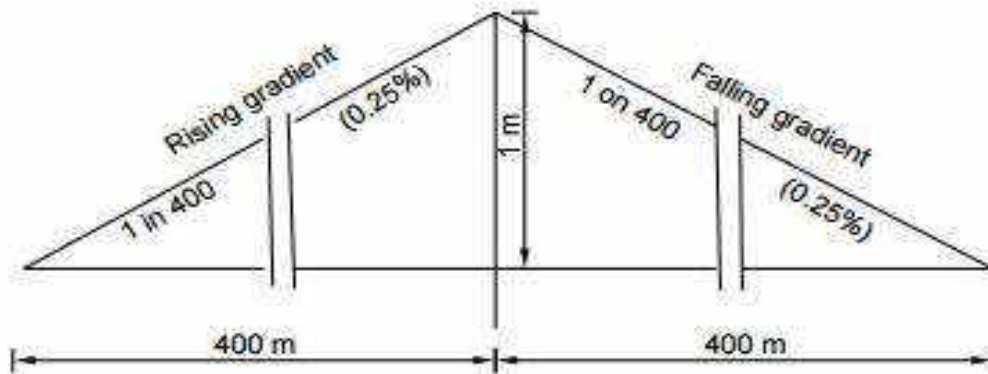

Objectives of providing Gradients:

- To reach various stations at different elevations
- To follow the natural contours of the ground to the extent possible
- To reduce the cost of earthwork

The following types of gradients are used on the railways:

- Ruling gradient
- Pusher or helper gradient
- Momentum gradient
- Gradients in station yards

1. **Curvature of the track**, including **horizontal** and **vertical curves**, **transition curves**, **sharpness** of the **curve** in terms of **radius** or **degree** of the curve, cant or superelevation on curves, etc.
2. **Alignment of the track**, including straight as well as curved alignment.
3. **The speed and axle load of the train** are very important and sometimes are also included as parameters to be considered while arriving at the geometric design of the track.

RULING GRADIENT

The ruling gradient is the **steepest gradient** that exists in a section. It determines the **maximum load** that can be hauled by a locomotive on that section. While deciding the ruling gradient of a section, it is not only the **severity of the gradient**, but also its **length** as well as its **position** with respect to the gradients on both sides that have to be taken into consideration. The power of the locomotive to be put into service on the track also plays an important role in taking this decision, as the locomotive should have adequate power to haul the entire load over the ruling gradient at the maximum permissible speed.

In plain terrain: 1 in 150 to 1 in 250

In hilly terrain: 1 in 100 to 1 in 150

Once a ruling gradient has been specified for a section, all other gradients provided in that section should be **flatter** than the **ruling gradient** after making due **compensation** for curvature.

The extra force P required by a locomotive to pull a train of weight W on a gradient with an angle of inclination q is

$$P = W \sin q = W \tan q \text{ (approximately, as } q \text{ is very small)}$$

$$= W \times \text{gradient}$$

MOMENTUM GRADIENT

The momentum gradient is also **steeper** than the ruling gradient and can be overcome by a train because of the **momentum** it gathers while **running on the section**. In valleys, a falling gradient is sometimes followed by a rising gradient. In such a situation, a train coming down a falling gradient acquires good speed and momentum, which gives additional kinetic energy to the train and allows it to negotiate gradients steeper than the ruling gradient.

- In sections with momentum gradients there are no obstacles provided in the form of signals, etc., which may bring the train to a critical juncture.
- **Steeper than ruling gradient**, but **do not determine the maximum load** of train

- Train need to acquire **sufficient momentum** to negotiate this gradient before reaching it
- Signals should not be provided at momentum gradients

PUSHER OR HELPER GRADIENT

In hilly areas, the **rate of rise** of the terrain becomes very important when trying to **reduce the length of the railway line** and, therefore, sometimes, gradients **steeper than the ruling gradient** are provided to **reduce the overall cost**. In such situations, one locomotive is not adequate to pull the entire load, and an **extra locomotive** is required.

When the gradient of the ensuing section is so steep as to necessitate the use of an **extra engine** for pushing the train, it is known as a **pusher or helper gradient**.

Gradient **steeper than ruling gradient** requiring **extra locomotive**.

- It reduces the length of a railway section.
- It also reduces the overall cost.

GRADIENTS IN STATION YARDS

The gradients in **station yards** are **quite flat** due to the following reasons:

- It **prevents standing vehicles** from rolling and moving away from the yard due to the combined effect of gravity and strong winds.
- It **reduces the additional resistive forces** required to start a **locomotive** to the extent possible. It may be mentioned here that generally, yards are **not levelled completely** and certain **flat gradients** are provided in order to ensure good drainage. The **maximum gradient** prescribed in **station yards** on Indian Railways is **1 in 400**, while the **recommended gradient** is **1 in 1000**.

GRADE COMPENSATION ON CURVES

- If a **curve** is provided on a track with **ruling gradient**, the **resistance of the track** will be **increased** on this curve. In order to **avoid resistance beyond the allowable limits**, the **gradients** are **reduced** on **curves** and **this reduction in gradient** is known as **grade compensation** for **curves**.

In India, Compensation for curvature is given by.

- BG track: 0.04% per degree of curve
- MG track: 0.03 % per degree of curve
- NG track: 0.02 % per degree of curve

2. CURVATURE OF THE TRACK

The **measurement of curvature** of curved track is expressed in **radius**. The **shorter** the radius, the **sharper** the curve is. For sharper curves, the **speed limits are lower** to prevent an **outward horizontal centrifugal force** to overturn the trains by directing its weight toward the outside rail.

Therefore, **curvatures** are provided inevitably on a railway track to **bypass obstacles**, to provide **longer and easily traversed gradients** and to pass a railway line through **desirable location**.

- **Horizontal curves** are provided when a change in the **direction of the track** is required
- **Vertical curves** are provided at points where **two gradients meet** or where **a gradient meet level ground**

DISADVANTAGE IN PROVIDING CURVATURE

- **Restriction in speed, limiting** the length of **trains** and **prevent** the use of **heavy type of locomotive**
- **Maintenance cost of track increases** due to **increase** in the **wear and tear** of parts of track
- **Danger of collision, derailment** or other form of **accident** is increased
- **Running** of train is **not smooth**

RESTRICTION OF PROVIDING CURVATURE

- Bridge and tunnel
- Approaches to bridges
- Steep gradient
- Stations and yards
- Level crossing

DEGREE OR RADIUS OF CURVATURE

- A simple curve is designated either by its degree or by its radius
- The degree of a curve (θ) is the angle subtended at its centre by a chord of 30 m length

SUPER-ELEVATION OR CANT

- When a train is moving on a **curved path**, it has a constant **radial acceleration** which produces **centrifugal force**.

- In order to **counteract this force**, the **outer rail of the track is raised slightly higher** than the **inner rail**. This is known as *Super-elevation or Cant*.

PURPOSE OF PROVIDING SUPERELEVATION

- To ensure **safe** and **smooth movements** of passengers and goods on the track
- It **counteracts** the effect of the **centrifugal** force by producing **centripetal** force on the train
- It prevents **derailment** and **reduces the creep** and as well as **side wear** of rails
- It provides **equal distribution of wheel loads** on two rails
- It results in the **decrease of maintenance cost** of the track

3. ALIGNMENT OF THE TRACK

The **direction** and **position** given to the **centre line** of the railway track on the **ground** is called **track alignment**.

- **Horizontal alignment** refers to the **direction** of the **railway track** in the plan including the **straight path** and the **curves** it follows.
Includes- **Straight path, width, deviation in width, and horizontal curves**.
- **Vertical alignment** refers to the **direction** it follows in a **vertical plane** including the **level track, gradients, and vertical curves**.
Includes- **Change in gradient and vertical curves**

#####

BASIC OF CIVIL ENGINEERING (BCE02001)

Module-V

Module V Syllabus

Airport engineering- Development, types, definition, characteristics of aircraft, basic terminology, ***Traffic engineering*** – traffic characteristics, traffic studies, traffic operations (signals, signs, markings), ***Urban engineering*** – classification of urban road.

Irrigation and Water Supply Engineering – Introduction, Types of Irrigation, different types of hydraulic structures, dam and weirs, types of dam, purpose, and functions.

Subject to Revision

AIRPORT ENGINEERING

<Development, types, definition, characteristics of aircraft, basic terminology>

- **Airport engineering:** It is the branch of civil engineering concerned with the **planning, designing, construction, operation, and maintenance** of facilities such as landing and take-off, loading and unloading, servicing, maintenance, and storage of aircraft.
 - The major phases of airport engineering are **airport planning, design, construction, and aircraft operation and maintenance**.
 - Airport Engineers must consider the impact and demands of aircrafts in their design of airport facilities.

- **Airport:** It is the **location** where an **aircraft takes off and lands**, it connects both **passengers and cargo** with other airports. Generally, airport has **runways, hangars, and terminal** buildings.
 - An airport must handle many **different types of aircrafts** including **light and heavy** aircrafts of both **military and civilian** segments.
 - The technology, design and load carrying capacity of aircraft keeps improving rapidly and the airport must improve its technological capability so as to stay side by side with the current demand.

❖ **DEVELOPMENT OF AIRPORTS IN INDIA**

- ✓ The development of airports in India has been a significant undertaking over the past few decades. India has one of the **fastest-growing aviation markets** in the world, and the government has been investing heavily in modernizing and expanding its airport infrastructure to keep up with the demand.
- ✓ The **first airport in India** was built in **1912 in Allahabad**, and since then, the country has come a long way. The Indian aviation industry has grown at a rapid pace in recent years, with both **domestic and international** air traffic increasing substantially.

- ✓ In the early years of aviation in India, most airports were under the control of the **Indian Air Force** and used for **military** purposes. However, with the growth of **commercial aviation**, the government recognized the need for dedicated civil airports.
- ✓ The **Airports Authority of India (AAI)** was established in **1995** to manage and develop **civil airports** in the country. Since then, the AAI has been responsible for the development of airports across India, both in metropolitan cities and smaller towns.
- ✓ Over the years, the government has invested heavily in the **modernization** and **expansion** of airports across the country. This has included the construction of new terminals, runway extensions, and the installation of state-of-the-art technology and equipment. Several airports have also undergone significant upgrades to meet international standards.
- ✓ The Indian government has also launched the **Regional Connectivity Scheme (RCS)**, also known as **UDAN (Ude Desh Ka Aam Naagrik)**, to improve **air connectivity** to **smaller towns** and **cities**. Under this scheme, the government provides financial incentives to airlines to operate flights to remote and underserved airports. This has led to the development of several new airports in the country.
- ✓ In conclusion, the development of airports in India has been a significant undertaking, and the country has come a long way in building world-class airport infrastructure. With the growing demand for air travel in the country, the government's continued focus on modernizing and expanding airports is crucial to ensure that India remains a major player in the global aviation industry.
- ✓ Civil engineering has played a significant role in the development of airport infrastructure, from the design of **runways** and **terminals** to the construction of **parking** areas and the incorporation of **sustainable technologies**. The continued advancement of civil engineering in airport development will be crucial in meeting the growing demands of air travel and ensuring the safety and efficiency of airport operations.

❖ **HISTORY OF AIR TRANSPORT IN INDIA**

1. **1911** – First Air flight in India was used to carry mail from **Allahabad** to Nainital.
2. **1912** – Flight between **Delhi** and **Karachi**
3. **1927** – **Civil Aviation department** was established

4. **1932** – **Tata Airways** Ltd was set up.
5. **1946** – Air Transport Liaising board was established
6. **1947** – **Tata** changed its name to **Air India** Ltd.
7. **1972** – **International Airport Authority of India** (IAAI) was set up
8. **1994** – **Airport Authority of India** (AAI) was formed.

❖ **TYPES OF AIRPORTS IN INDIA**

i. International Airport

It has a connection with many other airports around the world and furnished with facilities like **customs** and **immigration**. These airports are usually massive with **longer runways** and **larger aircraft**.

ii. Domestic Airport

It is an airport which connects flights **within the country**, these airports have **shorter runways** when compared with **international airports** with no facilities like customs and immigration.

iii. Regional Airports

A regional airport is an airport serving traffic within a relatively **smaller lightly populated** geographical area. These airports tend to have smaller businessjets or private aircraft.

iv. Military Airports

An airport used by the military for training, transport, and other **military-related activities**.

v. Relief Airport

An airport built to relieve **congestion at larger airports** or to provide **emergency landing** facilities in case of a **disaster**.

vi. Cargo Airport

An airport that specializes in handling **cargo** and **freight** operations.

❖ **BASIC TERMINOLOGIES IN AIRPORT ENGINEERING**

1. **Runway:** A **paved strip of land** on an **airport** used for aircraft take-off and landing.



2. **Taxiway:** A paved area used by aircraft to move between the runway and the airport terminal or parking area.

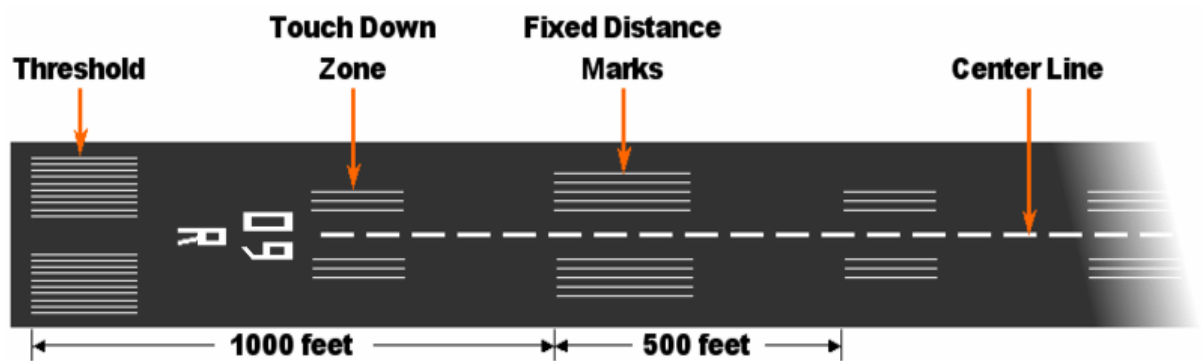

3. **Apron:** A paved area on an airport used for parking, loading, and unloading of aircraft.



4. **Terminal Building:** A building at the airport where passengers can check-in, wait for their flights, and board the aircraft.



5. **Air Traffic Control Tower (ATC):** A tower on an airport from where **air traffic controllers monitor and manage** air traffic movements.



6. **Hangar:** It is a large shed built at the airport to **store and repair** aircraft.

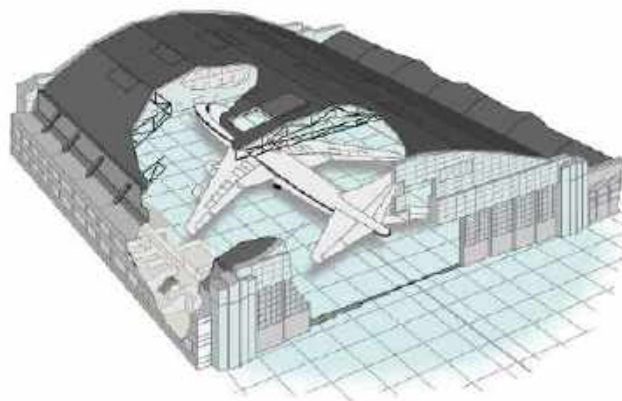

7. **Airfield Lighting:** **Lighting installed** on the airport's runways, taxiways, and aprons to facilitate safe aircraft operations during the night and low visibility conditions.
8. **Aircraft Parking Guidance System:** A system that **guides aircraft to the correct parking area** on the apron.

9. **Jet Blast Deflector:** A structure that helps to **deflect the high-pressure air from aircraft engines during take-off to protect ground personnel and other aircraft.**
10. **Instrument Landing System (ILS):** A system that provides **guidance to pilots** during the **approach** and **landing** phase of flight.
11. **Aircraft Rescue and Firefighting (ARFF):** A specialized **emergency service** at airports that provides **rapid response** to aircraft accidents and fires.
12. **Aerodromes** are basic spaces where flight operations can function. Aerodromes include small general aviation airfields, military airbases.
13. **Airports** include small local airports, heliports, large commercial airports, seaplane base

❖ **CHARACTERISTICS OF AN AIRCRAFT FOR AIRPORT DESIGN**

The following characteristics of aircraft can influence airport design, size, and type:

1. **Size:** Size of an aircraft is an important factor in airport designs. It includes:
 - ✓ **Span of Wings:** It decides the width of the Taxiway, size of aprons and hangars.
 - ✓ **Height:** It decides the height of the hangar gate and installations inside the hangar.
 - ✓ **Wheelbase:** It decides the minimum taxiway radius.
 - ✓ **Tail width:** Required for the size of the parking and apron.
2. **Minimum turning radius:** To determine the radii at the **ends of the taxiways** and to ascertain the position on the loading apron.
3. **Take-off and landing distances:** These include several factors which influence the take-off and landing distances such as:
 - ✓ Altitude of the airport
 - ✓ Gradient of the runway
 - ✓ Direction and intensity of the wind, temperature
 - ✓ The manner of landing and take-off.
4. **Tyre Pressure and Contact Area:** It governs the thickness of the pavement.

❖ **KEY COMPONENTS OF AN AIRCRAFT**

Aircraft are complex machines composed of many different parts, each with a specific function. Here are some of the main parts of an aircraft:

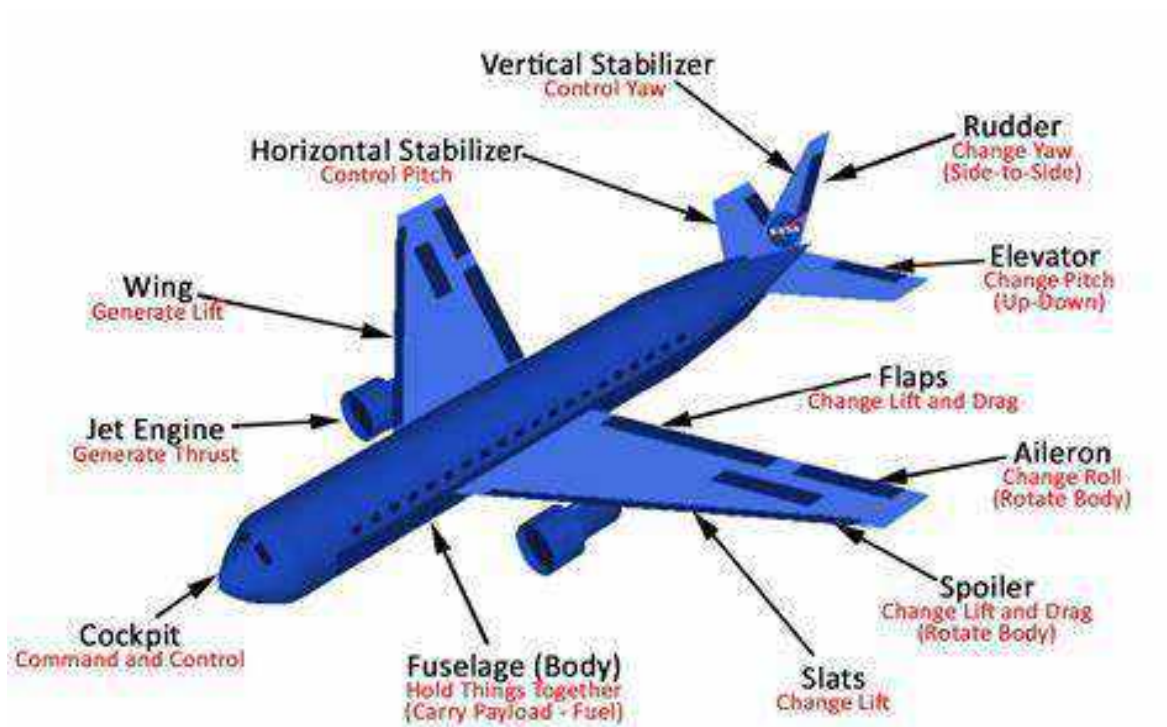

1. Fuselage: The fuselage is the **main body of the aircraft** that houses the cockpit, passenger cabin, cargo area, and other critical components. It is typically **cylindrical** in shape and contains the **wings, tail, and engines**.

2. Wings: Wings are the **primary lifting surfaces** of an aircraft and are responsible for **generating lift** that keeps the aircraft in the air. They are typically attached to the fuselage and are shaped to produce the necessary lift.

3. Empennage: The empennage, also known as the **tail section**, includes the horizontal stabilizer, vertical stabilizer, and rudder. These components provide stability and control for the aircraft during flight.

4. Engines: The engines provide the **power to propel** the aircraft through the air. Depending on the type of aircraft, it can have one or more engines mounted on the wings or fuselage.

5. Landing Gear: The landing gear is the system that **supports the weight of the aircraft** during take-off, landing, and taxiing on the ground. It includes wheels, struts, and other components that absorb the impact of landing and provide stability during ground operations.

6. Cockpit: The cockpit is the area of the aircraft where the **pilots sit and control** the aircraft's flight. It contains the controls, instruments, and displays necessary to operate the aircraft safely.

7. Avionics: Avionics are the **electronic systems** used to operate an aircraft, including communication, navigation, and surveillance systems. These systems are essential for the safe and efficient operation of an aircraft.

8. Fuel System: The fuel system **stores, distributes, and manages** the fuel used to power the aircraft's engines. It includes fuel tanks, pumps, filters, and other components.

9. Environmental Control System: The environmental control system maintains a **comfortable cabin environment** by controlling temperature, pressure, humidity, and ventilation. It includes air conditioning, heating, and pressurization systems.

10. Emergency Equipment: Emergency equipment, such as **oxygen masks, life vests, and emergency slides**, are essential for the safety of passengers and crew in case of an emergency.

TRAFFIC ENGINEERING

<Traffic characteristics, traffic studies, traffic operations (signals, signs, markings)>

- ✓ Traffic engineering is that branch of civil engineering which deals with the application of scientific principles tools techniques and findings for a **safe rapid convenient economic movement** of people and goods.
- ✓ It focuses mainly on research for **safe** and **efficient traffic flow**, such as road geometry, sidewalks and crosswalks cycling infrastructures traffic sign road surface parking and traffic lights. Traffic engineering deals with the functional part of transportation system, except the infrastructure provided.
- ✓ The basic object of traffic engineering is to **achieve efficient, free and rapid flow of traffic** with least no of accidents.

❖ **TRAFFIC CHARACTERISTICS AND STUDIES**

- Characteristics and studies focus on **data collection and analysis** that is used to characterize traffic, including (but not limited to) traffic **volumes** and **demands, speed** and travel **time, delay, accidents, origins and destinations, modal** use, and other **variables**.

✓ **Traffic Characteristics:**

- The traffic characteristics includes **road user's characteristics** and **vehicular characteristics**.
- Road user's characteristics: The **physical, mental** and **emotional** characteristics of human being are to be given particular attention.
- The vehicular characteristics include study of various parameters of vehicle like **dimensions, weight, maximum turning radius, speed barking system, lighting system**, tyres, etc.
- Generally, traffic characteristics are classified into 2 types such as:
 - i. Road user characteristics
 - ii. Vehicular Characteristics

1. **Road User Characteristic:**

Road user characteristics further classified into four types:

- i. **Physical characteristic** – Vision, Hearing, Strength, Reaction to traffic situation.
- ii. **Mental characteristics** – knowledge, skill, intelligence, experience literacy.
- iii. **Physiological characteristics** - emotional factors such as fear, anger, anxiety
- iv. **Environmental factors** - traffic stream conditions, atmospheric condition, facilities to the traffic locality etc.

2. Vehicular Characteristics:

Traffic which affects the design and traffic performance. For economic feasibility the standards of vehicles should be kept uniform. The regular characteristics are classified as:

- i. **Static characteristics** - It involves dimensions of vehicles (length width and height wheel base, departure and ramp angles the front rear and centre clearance) weight and maximum turning angle.
- ii. **Dynamic characteristics**–These are speed, acceleration, power and breaking characteristics.

✓ Traffic Studies:

- Traffic studies or surveys are carried out to **analyse the traffic characteristic**. These studies help in deciding the **geometric design feature** and **traffic control** for safe and **efficient traffic movements**. The traffic surveys for collecting traffic data are also called traffic census.
 - Traffic studies also called as Traffic census or surveys.
 - These studies help in deciding the geometric design features traffic control for safe and efficient traffic movement.
 - The **following traffic studies** are carried out in civil engineering:
 1. ***Traffic volume study***
- ✓ **Traffic volume** is the **number of vehicles** crossing a **section** of road per **unit time** at any **selected period**. The unit for traffic count is generally taken as vehicles per day or vehicles per hour.
 - ✓ Traffic volume study are used for various purposes. They are used for **road improvement and expansion, traffic operation and control structural design of payments, in geometric design planning and designing new facilities** etc.
 - ✓ Counting of traffic volume can be done in two ways-

- i.) Mechanical counters
- ii.) Manual Counts

2. *Speed Studies:*

- ✓ Speed studies are necessary because the **actual speed of vehicles over a particular** may vary depending on various factors such as geometric features, traffic condition, time, place, environment, and driver. Speed studies can be studied under the following heads-
 - i. **Travel time-** is the reciprocal of speed and it simple measure of how well road network is operating.
 - ii. **Spot speed-** is the instantaneous speed of a vehicle at specified section or location.
 - iii. **Average speed-** is the average of spot speed of all the passing vehicles at a given point on the highway.
 - iv. **Running speed-** is the average speed maintained by the vehicle over a particular stretch of road, while the vehicle is in fast motion.
 - v. **Overall speed and travel speed-** is the effective speed with which a vehicle transverse is a particular route between two terminals.

3. *Origin and Destination Studies:*

The origin and destination studies (OD) carried out mainly to:

- ✓ Plan the road network and other facility for vehicular traffic
- ✓ Plan the schedule of different modes of transportation for the trip demands of commuters.
- ✓ The origin and destination give information like the actual direction of travel, section of roads and length of the trips.
- ✓ It also provides the basic data for the determining the desired direction of the flow or the desire lines.

4. *Traffic Flow Characteristics:*

- ✓ Traffic system generally has flow and counter flow along the common root unless the stream is separated by one way flow by the proper design and regulation.
- ✓ The basic traffic manoeuvres are diverging merging and crossing.

- ✓ Study of traffic flow characteristics include both transverse and longitudinal distribution of vehicles in the traffic stream and is useful in geometric design features such as traffic capacity volume number of lanes and width of carriageways.
- ✓ The study is also very much needed to decide traffic regulatory measure for the design of traffic control methods.

5. *Traffic Capacity Studies:*

- ✓ **Traffic capacity** is the ability of a road to accommodate traffic volume it is expressed as the maximum number of vehicles in a lane or a road that can pass at a unit time. capacity and volume are measures of traffic flow and half same units.
- ✓ **Traffic volume** is the number of vehicles moving in a specified direction on the given lane or roadway that pass a given point or a cross section during says specified unit of unit of time.
- ✓ **Basic capacity** is the maximum number of passenger cars that can pass a given point on a lane or roadway during one hour under the most nearly ideal roadway and traffic condition which can possibly be attend. Basic capacity is the theoretical capacity.

6. *Parking Studies:*





















Parking studies are useful to evaluate the facilities available. Various aspects to be investigated during parking studies

- ✓ **Parking demand**- this can be evaluated by the different methods.Parking studies is by counting the number of vehicles in the park the area under study during different periods of the day.
- ✓ **Parking characteristics**- the study is directed to note the present parking practices prevalent in the area under consideration and general problem in parking.

❖ **TRAFFIC OPERATIONS**

- ✓ Traffic operation involves measures that influence overall **operation** of traffic facilities, such as one-way street systems, transit operations, curb management, and surveillance and network control systems.
- ✓ Traffic signs in India can be classified into **three** categories, **mandatory** signs, **cautionary** signs, and **informatory** signs.

i. **Mandatory signs** are those that convey an **obligatory instruction** or a prohibition.

 STOP	 GIVE WAY	 STRAIGHT PROHIBITOR NO ENTRY	 PEDESTRIAN PROHIBITED	 HORN PROHIBITED
 NO PARKING	 NO STOPPING OR STANDING	 SPEED LIMITED	 RIGHT HAND CURVE	 LEFT HAND CURVE
 RIGHT HAIR PIN BEND	 LEFT HAIR PIN BEND	 NARROW ROAD AHEAD	 NARROW BRIDGE	 PEDESTRIAN CROSSING
 SCHOOL AHEAD	 ROUND ABOUT	 DANGEROUS DIP	 HUMP OR ROUGH	 BARRIER AHEAD

ii. **Cautionary signs**, indicate potential **hazards** or **dangers** that road users may encounter.

 Right Hand Curve	 Left Hand Curve	 Right Hair Pin Bend	 Left Hair Pin Bend	 Right Reverse Bend
 Left Reverse Bend	 Steep Ascent	 Steep Descent	 Narrow Road Ahead	 Road Wideness Ahead
 Narrow Bridge	 Slippery Road	 Loose Gravel	 Cycle Crossing	 Pedestrian Crossing
 School Ahead	 Men at Work	 Cattle	 Falling Rocks	 Ferry

- iii. **Informatory signs**, as the name **suggests**, provide **information** about the **location, distance, and directions** to **specific destinations**. Understanding the different types of traffic signs is critical to ensuring the safety of all road users.

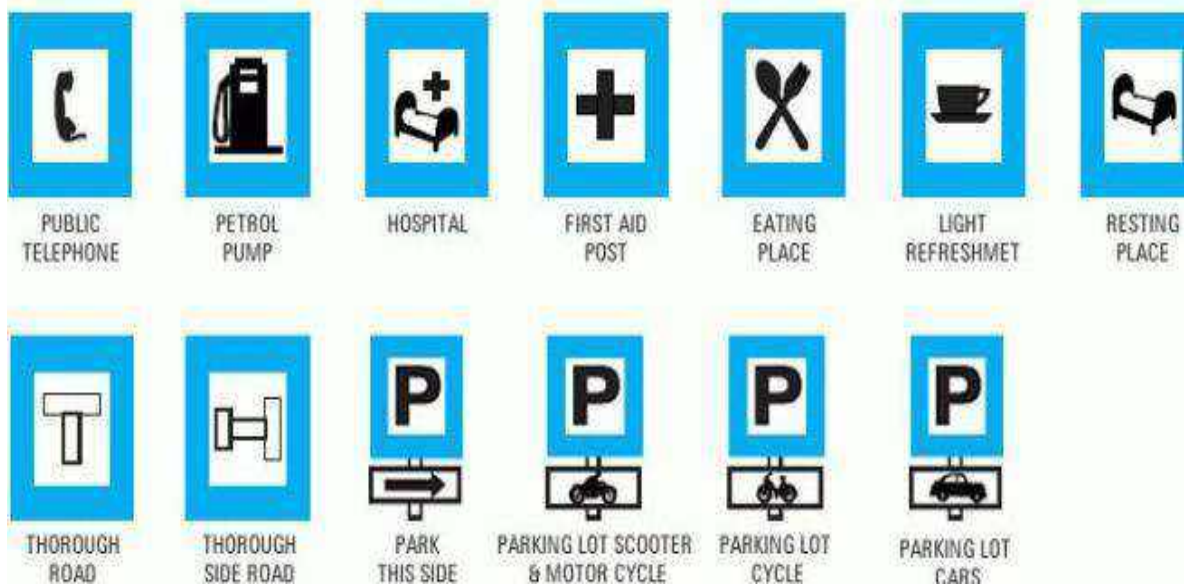

URBAN ENGINEERING

<Classification of urban road>

- ✓ Urban engineering can more properly be described as the branch of engineering that covers all the **civil** and **environmental** engineering **services** related to the range of complex problems associated with **infrastructure**, **services**, **buildings**, **environmental** and **land-use** issues generally encountered in **urban areas**.

CLASSIFICATION OF URBAN ROADS:

- ✓ Urban roads can be classified based on their **function**, **location**, and **design characteristics**. Here are some common classifications:

1. **FREEWAYS:**

These are **high-speed roads** with **limited access points**, designed to handle large volumes of **through-traffic**. Freeways usually have **multiple lanes** in **each direction** and are **separated** from **other roads** by **barriers or medians**.

2. **EXPRESSWAYS:**

Expressways are **high-speed roads, for heavy traffic** with **limited access points**, but they may have **fewer lanes** or be designed for **lower traffic volumes**.

- For Speedy and heavy traffic.
- Pedestrians are not allowed.
- Connect main markets, important places
- Complete separation of opposite moving traffic by a divider or median.
- Level crossings, sharp curves, and steep gradients avoided
- Telephone facility, Highway Police, Servicing Stations, and Refreshment Facility available at regular intervals

3. **ARTERIAL STREETS:**

These are **major roads** designed to handle **high volumes of traffic and connect major centres** such as **downtowns, commercial districts, and industrial areas**. Arterial roads usually have **multiple lanes** and **traffic signals at intersections**.

- For the heavy/important traffic inside the city.
- Usually along the expressways serving as principal network of traffic flow.
- Join the central business district with outside residential areas.
- Parking, loading, and unloading prohibited.
- Pedestrians are allowed to cross only at intersections.

4. **SUB-ARTERIAL STREETS:**

- Less traffic than arterial streets
- Pedestrians are allowed to cross only at intersections.
- Spacing varies from 0.5 km in central business areas to 3 to 5 km in residential areas.
- Parking, loading, and unloading are usually restricted and controlled.

5. **COLLECTOR STREETS:**

These roads are designed to collect traffic from local streets and feed them into arterial roads. Collector roads usually have one or two lanes and are typically found in residential neighbourhoods.

- Meant for collecting the traffic from local streets to arterial streets.
- Full access allowed from properties alongside.
- Situated in residential, commercial, and industrial areas.
- Few parking restrictions except for peak hours.

6. **LOCAL STREETS:**

These are low-speed streets that provide access to individual properties and are primarily used by local residents. Local streets usually have a single lane in each direction and may have speed bumps or traffic calming measures to discourage speeding.

- Open access from residents, businesses, or other properties.
- Does not carry a large volume of traffic.
- Unrestricted parking and pedestrians allowed.

7. **BUS-ONLY LANES:**

These are **dedicated lanes** for **public transit vehicles**, such as **buses** or **streetcars**. They are typically located in the **center of the roadway or along the side**.

8. **BICYCLE LANES:** These are designated lanes for **cyclists**, typically separated from **motor vehicle traffic** by a **painted buffer** or **physical barrier**.

9. **PEDESTRIAN-ONLY STREETS:** These are streets that are closed to **motor vehicle traffic** and reserved for **pedestrians**. They are typically found in **shopping districts** or **tourist areas**

✓ Recommended land width for different urban roads is shown below:

Category of street	Recommend land width(m)
Expressways	50-60
Arterial streets	50-60
Sub-arterial streets	30-40
Collector streets	20-30
Local streets	10-20

IRRIGATION AND WATER SUPPLY ENGINEERING

<Introduction, Types of Irrigation, different types of hydraulic structures, dam and weirs, types of dam, purpose, and functions>

▪ **IRRIGATION**

- ✓ The process of **supplying water artificially** to the **crops** in an adequate amount for cultivation is known as Irrigation. Crops require water for their production at frequent intervals but in a **controlled manner**.

▪ **ASPECTS OF IRRIGATION**

1. Engineering Aspects

- i.** Storage, diversion, lifting
- ii.** Conveyance of water to field
- iii.** Water application in Field
- iv.** Drainage and relieving water logging
- v.** Water power generation

2. Agricultural Aspects

- i.** Water depth maintenance in crop field
- ii.** Uniform periodic water distribution in field
- iii.** Irrigation with respect to soil capacity
- iv.** Reclamation of waste and alkaline land

▪ **ADVANTAGES OF IRRIGATION**

- i.** **Increase in food production.**
- ii.** Optimum **benefits (max crop yield** with minimum use of water)
- iii.** **Elimination of mixed cropping**
- iv.** General **prosperity**
- v.** **Hydro power generation** (Canal falls used for power generation)
- vi.** Domestic **water supply**
- vii.** **Communication** facilities (Irrigation channel with embankment and inspection roads)
- viii.** Inland **navigation**
- ix.** **Afforestation** (Trees along river bank)

- **DISADVANTAGES OF IRRIGATION**

- i. **Pollution** of ground water through seepage of **nitrates**, causing anaemia.
- ii. **Colder** and **damper** climate, causing malaria.
- iii. Water **logging** due to over irrigation
- iv. **Complex** and **expensive**

- **TYPES OF IRRIGATION**

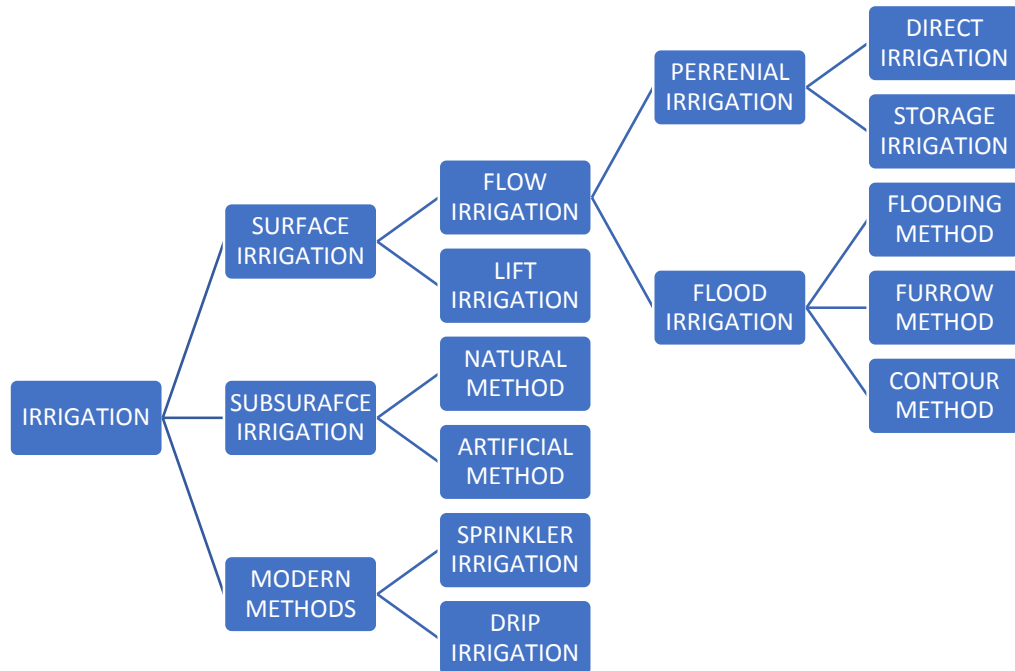

A. Surface irrigation consists of a broad class of irrigation methods in which **water is distributed over the soil surface by gravity flow**. The irrigation water is introduced into **level** or **graded furrows**[[*Furrow is a long, narrow irrigation trench made in the ground used for an optimal supply of water. Furrows can be level and are very similar to long narrow basins. However, a minimum grade of 0.05% is recommended so that effective drainage can occur following irrigation or excessive rainfall*]] or **basins**, using **siphons, gated pipe, or turnout structures**, and is allowed to **advance across the field**. Surface irrigation is best suited to **flat land slopes**, and **medium to fine textured soil types** which promote the lateral spread of water down the furrow row or across the basin.



Fig. Surface Irrigation

✓ **Surface Irrigation** is further classified into **two major types**:

1. **Flow irrigation**: Here water is supplied from **higher altitude to lower altitude** by the action of **gravity**. It can be further divided into two types:

- **Perennial Irrigation**: Here **constant** and **continuous** water supply is available to crops throughout the crop period. It can be achieved **in two ways**:

i. **Direct irrigation**: When water is **directed** into canal by constructing **weir** or **barrage** across the river. E.g.: Ganga canal system.

ii. **Storage irrigation**: When water is stored in **dams** with **reservoir** across the river, and supplied through off taking channels during low flow. E.g.: Ram Ganga Dam.

- **Flood irrigation**: It is otherwise known as inundation irrigation. Soil is kept submerged and thoroughly flooded with water.

2. **Lift irrigation**: Here water is **lifted** up by mechanical or manual means such as pumps etc.

✓ Surface irrigation can be achieved by the following methods:

i. **Flooding method** :

It is most common form of irrigation where water is **applied and distributed** over the soil surface by **gravity**. Three major types of flooding irrigation are **level basin**, **furrow**, and **border strip**.



Fig. Flooding method

ii. Furrow method:

It's probably one of the oldest methods of irrigating fields, where farmers **flow water down small trenches** running through their crops. Humans' first invention after learning how to grow plants from seeds was probably a bucket.



Fig. Furrow method

iii. Contour method:

Helps **evenly distribute the water** in the soil between the **furrows** as the **water runs slowly and adequately**. As the irrigation water runs off quite slowly but deeply into the furrows, it makes the **absorption** of water in the **soil** much better.



Fig. Contour method

B. Subsurface irrigation consists of methods whereby irrigation water is applied **below the soil surface**. The specific type of irrigation method varies depending on the **depth of the water table**. When the **water table is well below the surface**, drip or trickle irrigation emission devices can be buried below the soil surface (usually within the plant root zone).

✓ This method can be further classified as:

i. Natural sub-surface irrigation:

Leakage water from **sources** of water such as streams, lakes, ponds, canals, etc. goes underground and during the passage to the subsoil, it may irrigate crop by capillarity.

ii. Artificial sub-surface irrigation:

In this method, water is applied **beneath** the land surface through a **network of buried perforated or open jointed pipes**. As water is passed under pressure in these pipes, it comes out through open joints. The **depth of pipes should not be less than 40 cm** so that these do not cause any **interference** to the **cultivation**. **Evaporation losses** are reduced. The method is **expensive** because of the high **cost** of pipes and the installation. The water used should be of good quality so the perforation does not get clogged.



Fig. Subsurface Irrigation

C. Modern Irrigation methods:

A. **Sprinkler irrigation** is a method of irrigation in which water is **sprayed**, or **sprinkled** through the air in rain like drops. The spray and sprinkling devices can be permanently set in place (solid set), temporarily set and then moved after a given amount of water has been applied (portable set or intermittent

mechanical move), or they can be mounted on booms and pipelines that continuously travel across the land surface (wheel roll, linear move, center pivot).



Fig. Sprinkler Irrigation

B. *Drip/trickle irrigation* systems are methods of **micro-irrigation** wherein water is applied through **emitters** to the soil surface as drops or small streams. The **discharge** rate of the emitters is **low** so this irrigation method can be used on all soil types.

(Trickle irrigation involves the slow release of water to each plant through small plastic tubes. This technique is adapted both to field and to greenhouse conditions)



Fig. Drip Irrigation

▪ **TYPES OF HYDRAULIC STRUCTURES**

✓ Hydraulic structures play an important role in **drainage, irrigation, and hydraulic projects**. If hydraulic structures fail, it may cause serious damages of wealth, properties, and environment as well as losses of life and injury to economy.

✓ Hydraulic structures can be classified, based on their functions as below:

1. Flow control structures:

They are used to **regulate the flow** and pass **excess flow**. They might be **gates, spillways, valves, or outlets**.

2. Flow measurement structures:

They are used to measure **discharge**. They are **weirs, orifices, flumes** etc.

3. Division structures:

They are used to **divert the main course of water flow**. They are **coffer dams, weirs, canal headworks, intake works**.

4. Conveyance structures:

They are used to **guide the flow from one place to another**. They are **open channels, pressure conduit, pipes, canals and sewers**.

5. Collection structures:

They are used to **collect water for disposal**. They are **Drain inlets, infiltration galleries, wells**.

6. Energy dissipation structures:

They are used to **prevent erosion and structural damage**. They are **stilling basins, surge dams, check dams**.

7. River training and water stabilizing structures:

They are used to **maintain river channel and water transportation**. **Levees, cut-offs, locks, piers, culverts**

8. Sediment and quality control structures:

They are used to **control or remove sediments and other pollutants**. They are **racks, screens, traps, sedimentation tanks, filters, sluiceways**.

9. Hydraulic machines:

They are used to **convert energy from one form to another**. They are **turbines, pumps, ramps**

10. Storage structures:

They are used for the purpose of **storage of water**. These may be **dams or tanks**.

11. Shore protection structures:

They are used to **protect banks**. These are **dikes, groins, jetties, revetments**.

▪ **DAM & WEIRS**

- **Dam:** A dam is a **barrier** that **restricts** or **stops** the **flow of water**; helps **suppress floods**, as well as providing **irrigation, industrial, and aquaculture** uses. A dam holds water for **later use, irrigation, navigation, hydroelectricity, flood control, fishing, and recreation**.

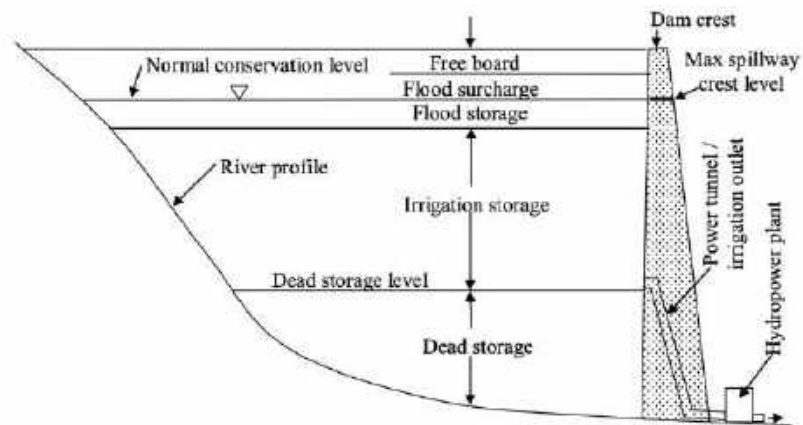

Fig. Schematic representation of Dam



Fig. Weir

- **Weir:** A weir is a **small barrier built across a stream** or river to **raise the water level** slightly on the upstream side; essentially a **small-scale dam**. Weirs allow **water to pool behind them**, while allowing water to **flow steadily over top of the weir**.

Additionally, the term **weir** can be used to refer to the **crest of a spillway** on a **large embankment dam**.

▪ **FUNCTIONS OF DAM**

- ✓ Most of the dams are **multipurpose**. Almost all dams have at least some **flood mitigation** effect in addition to their primary purpose. Flood control dams may have some of their **storage capacity** kept empty to store excess water inflow under flood conditions.

1. **Water Supply**

- Water stored in reservoirs of the dam is used to provide adequate amounts of **quality freshwater to residential, industrial facilities and mining sites**.
- Dams can be used to **regulate the flow of water** in rivers. This is to say that water can be released from the reservoir to **support wildlife and ecosystems** downstream during a **drought** and water can be released for **agricultural** uses during the same drought.

2. **Irrigation**

- In many countries, **cropland irrigation** is done using water stored behind dams.
- Example: Burrinjuck Dam, an irrigation dam of Australia, which was built as the main headwater storage for the Murrumbidgee Irrigation Area in New South Wales.

3. **Electrical Generation**

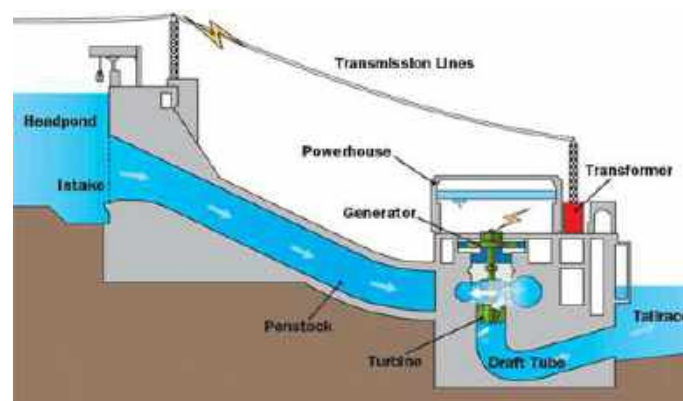

- To generate electricity in hydroelectric power stations
- Hydropower is considered clean because it does not contribute to global warming, air pollution, acid rain, or ozone depletion.

4. Flood Control

- For centuries, people have built dams to help control devastating floods. It helps to prevent the loss of life and property.
- Flood control dams impound floodwaters and then either release them under control to the river below the dam or store or divert the water for other uses.

5. Water Storage

- Dams create reservoirs that supply water for uses, including industrial, municipal, and agricultural.
- Water captured during the wet season can be stored for use during the dry season.

6. Mine Tailings

- It allows the mining and processing of coal and other vital minerals while protecting the environment.
- Mount Polley is a mine tailing dump of British Columbia, Canada.

7. Debris Control

- Dams provide enhanced environmental protection, such as the retention of hazardous materials and detrimental sedimentation.

8. Navigation

- Dams and locks provide for a stable system of inland river transportation throughout the heartland of the Nation.
- Bonneville Dam of Washington, USA is a river navigation dam.

9. Recreation

- Dams provide prime recreational facilities throughout the United States. Boating, skiing, camping, picnic areas and boat launch facilities are all supported by dams.
- Scrivener Dam is a recreation dam of Canberra, Australia.

TYPES OF DAM:

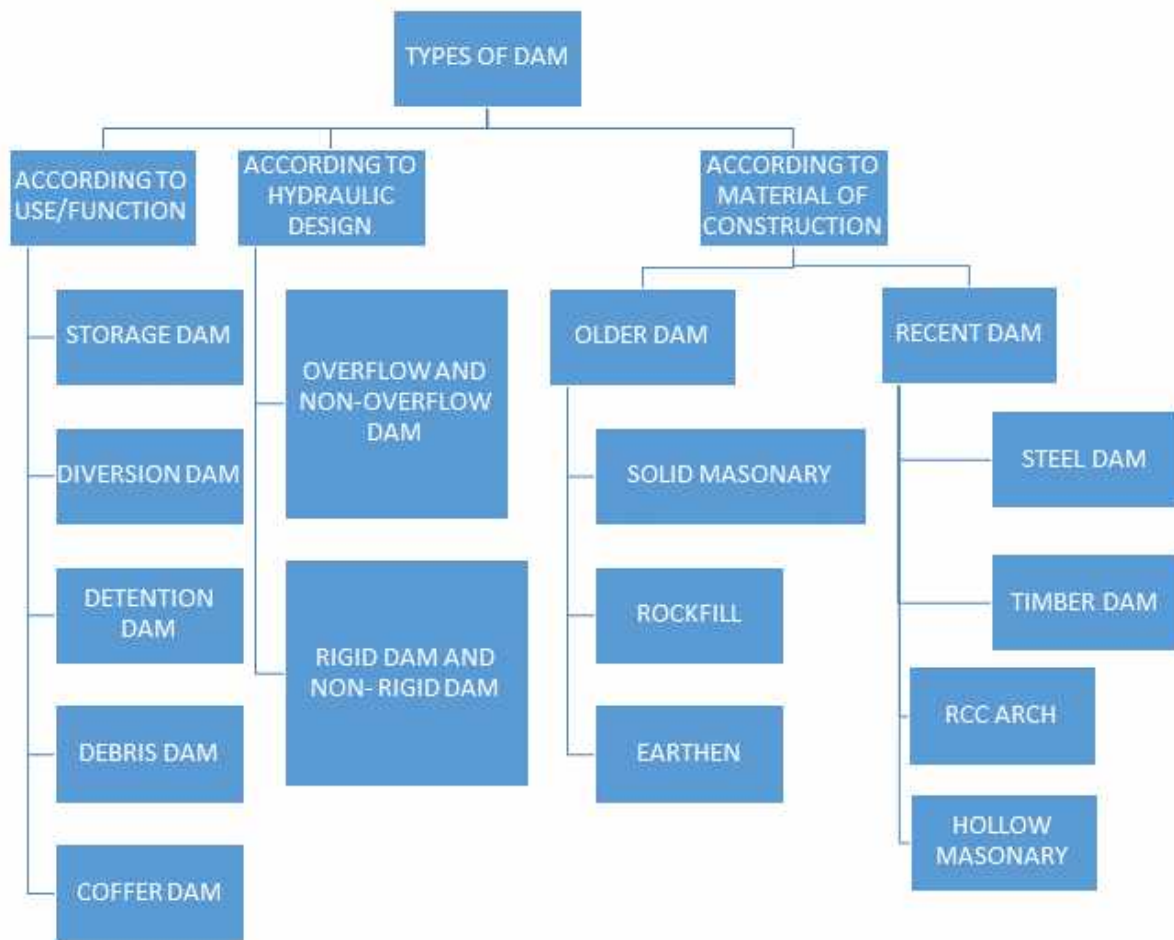

✓ Based on the *FUNCTIONS* of dam, it can be classified as follows:

- 1 **Storage dams:** They are constructed to **store water during the rainy season** when there is a large flow in the river. Many small dams impound the spring runoff for later use in dry summers. Storage dams may also provide a water supply, or improved habitat for fish and wildlife. They may store water for hydroelectric power generation, irrigation or for a flood control project. Storage dams are the most common type of dams and in general the dam means a storage dam unless qualified otherwise.



- 2 **Diversion dams:** A diversion dam is constructed for the purpose of **diverting water of the river into** an off-taking canal (or a conduit). They provide sufficient pressure for pushing water into ditches, canals, or other conveyance systems. Such shorter dams are used for irrigation, and for diversion from a stream to a distant storage reservoir. A diversion dam is usually of low height and has a small storage reservoir on its upstream. The diversion dam is a sort of storage weir which also diverts water and has a small storage. Sometimes, the terms weirs and diversion dams are used synonymously.



- 3 **Detention dams:** Detention dams are constructed for **flood control**. A detention dam **retards the flow in the river** on its downstream during floods by storing some flood water. Thus the effect of sudden floods is reduced to some extent. The water retained in the reservoir is later released gradually at a controlled rate according to the carrying capacity of the channel downstream of the detention dam. Thus the area downstream of the dam is protected against flood.

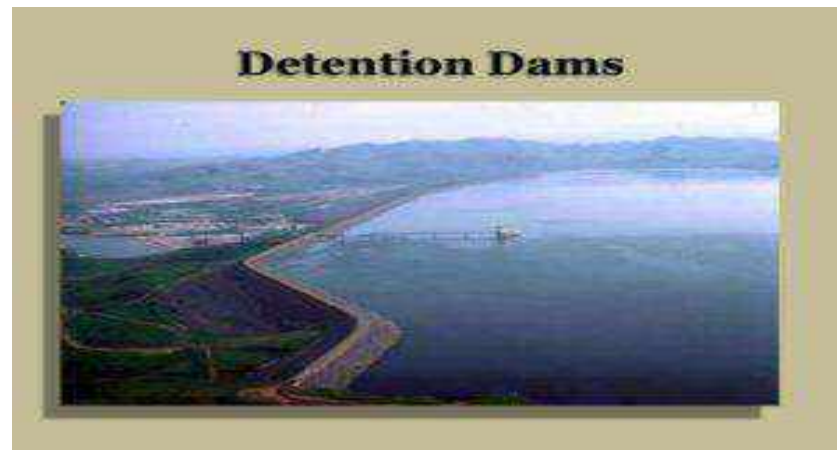

- 4 **Debris dams:** A debris dam is constructed to **retain debris such as sand, gravel, and drift wood** flowing in the river with water. The water after passing over a debris dam is relatively clear.

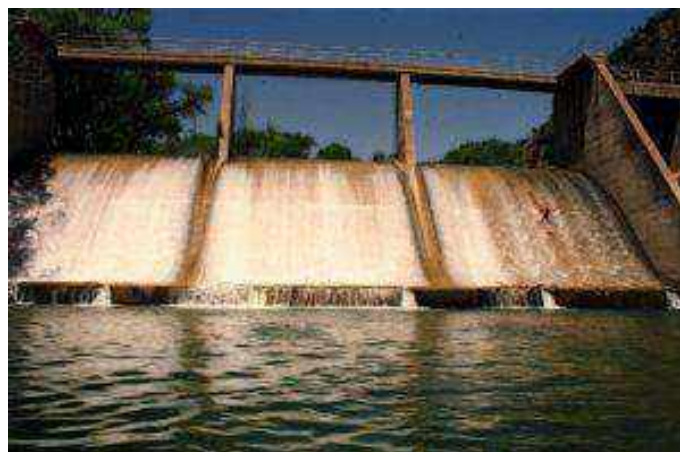

- 5 **Coffer dams:** It is an **enclosure constructed around the construction** site to exclude water so that the construction can be done in dry. A cofferdam is thus a **temporary dam constructed for facilitating construction**. A coffer dam is usually constructed on the upstream of the main dam to divert water into a diversion tunnel (or channel) during the construction of the dam. When the flow in the river during construction of the dam is not much, the site is usually enclosed by the coffer dam and pumped dry. Sometimes a coffer dam on the downstream of the dam is also required.



✓ Based on *HYDRAULIC DESIGN*, dams can be classified as:

1. OVERFLOW & NON-OVERFLOW DAM

Overflow dams: An overflow dam is designed to act as an **overflow structure**. The surplus water which **cannot be retained** in the reservoir is permitted to pass over the crest of the overflow dam which acts as a **spillway**. The overflow dam is made of a material that **does not erode** by the action of overflowing water. Generally, cement concrete is used in overflow dams and spillways. Most of the **gravity dams have overflow sections** for some length and the rest of the length as a non-overflow dam. However, sometimes the entire length of the dam of low height is designed as an overflow dam. The overflow dam is also called the spillway section.

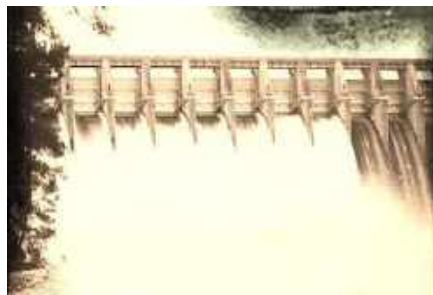

Fig. Overflow dam

Non-overflow dams: A non-overflow dam is designed such that there is **no flow** over it. Because there is no overflow, a non-overflow dam can be built of **any material**, such as **concrete, masonry, earth, rock fill, and timber**. As already mentioned, the non-overflow dam is usually provided in part of the **total length of the dam**. However, sometimes the non-overflow dam is provided for the entire length, and a **separate spillway** is provided in the flanks or in a saddle away from the dam.



Fig. Non-overflow dam

2. RIGID & NON-RIGID DAM:

Rigid dams: A rigid dam is quite **stiff**. It is constructed of **stiff materials** such as concrete, masonry, steel and timber. These dams deflect and deform very little when subjected to water pressure and other forces.

Non-rigid dams: A non-rigid dam is relatively **less stiff** compared to a rigid dam. The dams constructed of **earth** and **rock** fill are non-rigid dams. There are relatively large settlements and deformations in a non-rigid dam.

✓ Based on **MATERIAL OF CONSTRUCTION** dams can be classified as below:

A. Older Dams

- **Earth dam:** An earth dam is made of **earth** (usually local soils), it resists the forces exerted upon it mainly due to **shear strength** of the soil. Although the weight of the dam also helps in resisting the forces, the structural behaviour of an earth dam is entirely different from that of a gravity dam.
- **Gravity/Solid Masonry Dam:** resists the water pressure and other forces due to its **weight** (or gravitational forces). Thus, the stability of a gravity dam depends upon its weight. The gravity dams are usually made of cement concrete. In the past, the gravity dams were made of stone

masonry, but now the masonry dams are rarely constructed, except for very small heights.

- **Rock fill Dam:** It is made up of **loose rocks** and **boulders** piled on river beds. RCC slab is used in upstream side to make water tight. The side slopes of rock fill are usually kept equal to the angle of repose of rock, which is usually taken as 1.4:1 (or 1.3:1).

B. Modern Dams

1. **Arch Dam:** An arch dam is **curved** in plan, with its **convexity towards** the **upstream** side.

✓ **Main Features of Arch Dam:**

- An arch dam **transfers the water pressure** and other forces mainly to the **abutments** by **arch action**.
- An arch dam is quite **suitable** for **narrow** canyons with strong abutments which are capable of resisting the thrust produced by the arch action.
- The section of an arch dam is approximately triangular like a gravity dam but the section is comparatively thinner.

2. **Steel Dams:**

- These are used for major works.
- These are used as temporary coffer dams for construction of permanent dams.
- These are usually reinforced with timber or concrete.

3. **Hollow masonry/Gravity dam:** The design is the same as that of a solid masonry gravity dam. It contains 35-40% less concrete or masonry.

4. **Timber Dam:** These are suitable for agricultural areas. These dams have a short life span of less than 30 years as they deteriorate due to rotting.

▪ **FACTORS AFFECTING DAM SITE SELECTION**

The selection of the site for a dam is

1. Catchment Area

The catchment area should be able to **contribute an adequate supply of water** to the reservoir of the dam

2. Foundation Soil

Sound foundation soil should be available at the site to carry a **heavy load**. For earth dams, any type of foundation is suitable. however, for gravity or concrete or masonry dams, sound

rocks at the surface or within a reasonable depth, are essential. Foundation is important for
The selection of the site for a dam.

3. Ecology

The balance of ecology (means nature environment) should not be disturbed.

4. River Cross-Section at the site

The river cross-section at the site should have a **narrow gorge** (valley) to allow largely
should be minimum for the intended storage of water.

5. Height of the Dam

The **dam cost is proportional to the square of the dam height**. Therefore, the height
should be minimum for the intended storage of water.

6. Storage Capacity

The dam should provide **adequate storage capacity** for the reservoir

7. Costs

The dam should have **minimum construction and maintenance costs**.

8. Reservoir Silting

The site should be such that **reservoir silting is minimum**

9. Spillway

A **suitable location** for the **spillway** should be available in the near vicinity

10. Submergence

The value of the **land submerged** by the proposed dam should be **as low as possible**. It
should be **less than the benefits** expected from the dam. The rehabilitation of the people
displaced due to submergence is a problem to be tackled in the case of large dams.

11. Bed-Level

The bed level of the dam should preferably be on a **higher level than that of the river**
basin to facilitate drainage.

12. Watertight

The reservoir should be water-tight. Otherwise, the stored water may escape through its
bed and banks.

13. Topography

The topography of the site should be such that the **length of the dam should be as small
as possible**. Also, for a given height, the storage capacity should be as high as possible.
Therefore, the river valley at the site should be as narrow as possible for maximum storage
capacity.

▪ **ADVANTAGES AND DISADVANTAGES OF DAM**

▪ **Advantages of Dams**

1. Water can be stored and used for irrigation using dams.
2. Water can be distributed to the nearest places for drinking purposes.
3. Water stored in dams can be used for generating electricity.
4. During floods, dams can be used for storing or diverting water.
5. Dams also provide recreational areas like boating, parks, etc.

▪ **Disadvantages of dams**

1. When making dams much **biodiversity** near the dams are affected.
2. A huge amount of **money** is needed for construction as well as for the maintenance of the dams.
3. Many **inhabitants** near the dam construction are displaced.

#####