

Review of Thermodynamics

from Statistical Physics using Mathematica

© James J. Kelly, 1996-2002

We review the laws of thermodynamics and some of the techniques for derivation of thermodynamic relationships.

Introduction

Equilibrium thermodynamics is the branch of physics which studies the equilibrium properties of bulk matter using macroscopic variables. The strength of the discipline is its ability to derive general relationships based upon a few fundamental postulates and a relatively small amount of empirical information without the need to investigate microscopic structure on the atomic scale. However, this disregard of microscopic structure is also the fundamental limitation of the method. Whereas it is not possible to predict the equation of state without knowing the microscopic structure of a system, it is nevertheless possible to predict many apparently unrelated macroscopic quantities and the relationships between them given the fundamental relation between its state variables. We are so confident in the principles of thermodynamics that the subject is often presented as a system of axioms and relationships derived therefrom are attributed mathematical certainty without need of experimental verification.

Statistical mechanics is the branch of physics which applies statistical methods to predict the thermodynamic properties of equilibrium states of a system from the microscopic structure of its constituents and the laws of mechanics or quantum mechanics governing their behavior. The laws of equilibrium thermodynamics can be derived using quite general methods of statistical mechanics. However, understanding the properties of real physical systems usually requires application of appropriate approximation methods. The methods of statistical physics can be applied to systems as small as an atom in a radiation field or as large as a neutron star, from microkelvin temperatures to the big bang, from condensed matter to nuclear matter. Rarely has a subject offered so much understanding for the price of so few assumptions.

In this chapter we provide a brief review of equilibrium thermodynamics with particular emphasis upon the techniques for manipulating state functions needed to exploit statistical mechanics fully. Another important objective is to establish terminology and notation. We assume that the reader has already completed an undergraduate introduction to thermodynamics, so omit proofs of many propositions that are often based upon analyses of idealized heat engines.

Macroscopic description of thermodynamic systems

A *thermodynamic system* is any body of matter or radiation large enough to be described by macroscopic parameters without reference to individual (atomic or subatomic) constituents. A complete specification of the system requires a description not only of its contents but also of its *boundary* and the interactions with its *environment* permitted by the properties of the boundary. Boundaries need not be impenetrable and may permit passage of matter or energy in either direction or to any degree. An *isolated* system exchanges neither energy nor mass with its environment. A *closed* system can exchange energy with its environment but not matter, while *open systems* also exchange matter. *Flexible* or *movable* walls permit transfer of energy in the form of mechanical work, while *rigid* walls do not. *Diathermal* walls permit the transfer of heat without work, while *adiathermal* walls do not transmit heat. Two systems separated by diathermal walls are said to be in *thermal contact* and as such can exchange energy in the form of either heat or radiation. Systems for which the primary mode of work is mechanical compression or expansion are considered *simple compressible systems*. *Permeable* walls permit the transfer of matter, perhaps selectively by chemical species, while *impermeable* walls do not permit matter to cross the boundary. Two systems separated by a permeable wall are said to be in *diffusive contact*. Also note that permeable walls usually permit energy transfer, but the traditional distinction between work and heat can become blurred under these circumstances.

Thermodynamic parameters are macroscopic variables which describe the *macrostate* of the system. The macrostates of systems in thermodynamic equilibrium can be described in terms of a relatively small number of *state variables*. For example, the macrostate of a simple compressible system can be specified completely by its mass, pressure, and volume. Quantities which are independent of the mass of the system are classified as *intensive*, whereas quantities which are proportional to mass are classified as *extensive*. For example, temperature (T) is intensive while internal energy (U) is extensive. Quantities which are expressed per unit mass are described as *specific*, whereas similar quantities expressed per mole are described as *molar*. For example, the specific (molar) heat capacities measure the amount of heat required to raise the temperature of a gram (mole) of material by one degree under specified conditions, such as constant volume or constant pressure.

A system is in *thermodynamic equilibrium* when its state variables are constant in the macroscopic sense. The condition of thermodynamic equilibrium does not require that all thermodynamic parameters be rigorously independent of time in a mathematical sense. Any thermodynamic system is composed of a vast number of microscopic constituents in constant motion. The thermodynamic parameters are macroscopic averages over microscopic motion and thus exhibit perpetual fluctuations. However, the relative magnitudes of these fluctuations is negligibly small for macroscopic systems (except possibly near phase transitions).

The intensive thermodynamic parameters of a *homogeneous* system are the same everywhere within the system, whereas an *inhomogeneous* system exhibits spatial variations in one or more of its parameters. Under some circumstances an inhomogeneous system may consist of several distinct phases of the same substance separated by phase boundaries such that each phase is homogeneous within its region. For example, at the *triple point* of water one finds in a gravitational field the liquid, solid, and vapor phases coexisting in equilibrium with the phases separated by density differences. Each phase can then be treated as an open system in diffusive and thermal contact with its neighbors. Neglecting small variations due to gravity, each subsystem is effectively homogeneous. Alternatively, consider a system in which the temperature or density has a slow spatial variation but is constant in time. Although such systems are not in true thermodynamic equilibrium, one can often apply equilibrium thermodynamics to analyze the local properties by subdividing the system into small parcels which are nearly uniform. Even though the boundaries for each such subsystem are imaginary, drawn somewhat arbitrarily for analytical purposes and not representing any significant physical boundary, thermodynamic reasoning can

still be applied to these open systems. The definition of a thermodynamic system is quite flexible and can be adjusted to meet the requirements of the problem at hand.

The central problem of thermodynamics is to ascertain the equilibrium condition reached when the external constraints upon a system are changed. The appropriate external variables are determined by the nature of the system and its boundary. To be specific, suppose that the system is contained within rigid, impermeable, adiabatic walls. These boundary conditions specify the volume V , particle number N , and internal energy U . Now suppose that the volume of the system is changed by moving a piston that might comprise one of the walls. The particle number remains fixed, but the change in internal energy depends upon how the volume changes and must be measured. The problem is then to determine the temperature and pressure for the final equilibrium state of the system. The dependence of internal variables upon the external (variable) constraints is represented by one or more equations of state.

An *equation of state* is a functional relationship between the parameters of a system in equilibrium. Suppose that the state of some particular system is completely described by the parameters p , V , and T . The equation of state then takes the form $f[p, V, T] = 0$ and reduces the number of independent variables by one. An equilibrium state may be represented as a point on the surface described by the equation of state, called the *equilibrium surface*. A point not on this surface represents a nonequilibrium state of the system. A *state diagram* is a projection of some curve that lies on the equilibrium surface. For example, the *indicator diagram* represents the relationship between pressure and volume for equilibrium states of a simple compressible system.

The figure below illustrates the equilibrium surface $U = \frac{3}{2} p V$ for an ideal gas with fixed particle number. The pressure and energy can be controlled using a piston and a heater, while the volume of the gas responds to changes in these variables in a manner determined by its internal dynamics. For example, if we heat the system while maintaining constant pressure, the volume will expand. Any equilibrium state is represented by a point on the equilibrium surface, whereas nonequilibrium states generally require more variables (such as the spatial dependence of density) and cannot be represented simply by a point on this surface. A sequence of equilibrium states obtained by infinitesimal changes of the macroscopic variables describes a curve on the equilibrium surface. Thus, much of the formal development of thermodynamics entails studying the relationships between the corresponding curves on surfaces constructed by changes of variables.

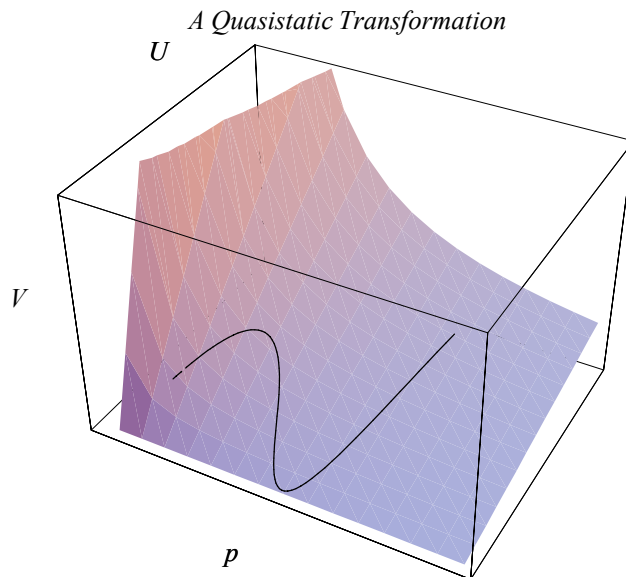

Reversible and Irreversible Transformations

A *thermodynamic transformation* is effected by changes in the constraints or external conditions which result in a change of macrostate. These transformations may be classified as *reversible* or *irreversible* according to the effect of reversing the changes made in these external conditions. Any transformation which cannot be undone by simply reversing the change in external conditions is classified as irreversible. If the system returns to its initial state, the transformation is considered reversible. Although irreversible transformations are the most common and general variety, reversible transformations play a central role in the development of thermodynamic theory. A necessary but not sufficient condition for reversibility is that the transformation be quasistatic. A *quasistatic* (or *adiabatic*) transformation is one which occurs so slowly that the system is always arbitrarily close to equilibrium. Hence, quasistatic transformations are represented by curves upon the equilibrium surface. More general transformations depart from the equilibrium surface and may even depart from the state space because nonequilibrium states generally require more variables than equilibrium states.

For example, consider two equal volumes separated by a rigid impenetrable wall. Initially one partition contains a gas of red molecules and the other a gas of blue molecules. The two subsystems are in thermal equilibrium with each other. If the partition is removed, the two species will mix throughout the combined volume as a new equilibrium condition is reached. However, the original state is not restored when the partition is replaced. Hence, this transformation is irreversible.

An Irreversible Transformation

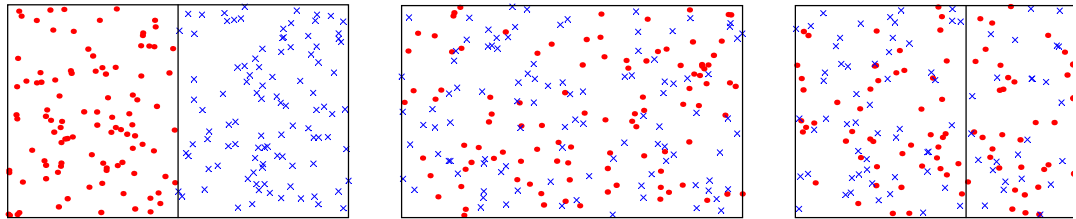

Thermodynamic transformations often are irreversible because the constraints are changed too rapidly. Suppose that an isolated volume of gas is confined to an insulated vessel equipped with a movable piston. If the piston is suddenly moved outwards more rapidly than the gas can expand, the gas does no work on the piston. Because the insulating walls allow no heat to enter the vessel, the internal energy of the system is unchanged by such a rapid expansion of the volume, but the pressure and temperature will change. If the piston is now returned to its original position, it must perform work upon the gas. Therefore, the internal energy of the final state is different from that of the initial state even though the constraints have been returned to their initial conditions. Such a transformation is again irreversible. On the other hand, if the piston were to be moved slowly enough to allow the gas pressure to equalize throughout the volume during the entire process, the gas will return to its initial state when returned to its initial volume. For this system, reversibility can be achieved by varying the volume sufficiently slowly to ensure quasistatic conditions.

The necessity of the requirement that a reversible transformation be quasistatic follows from the requirement that the state of the system be uniquely described by the thermodynamic parameters that describe its equilibrium state. Nonequilibrium states are not fully described by this restricted set of variables. We must be able to represent the history of the system by a trajectory upon its equilibrium surface. However, the insufficiency of quasistatics can be illustrated by a familiar example: the magnetization M of a ferromagnetic material subject to a magnetizing field H exhibits the phenomenon of *hysteresis*.

It is generally observed that a system not in equilibrium will eventually reach equilibrium if the external conditions remain constant long enough. The time required to reach equilibrium is called the *relaxation time*. Relaxation times are extremely variable and can be quite difficult to estimate. For some systems, it might be as short as 10^{-6} s, while for other systems it might be a century or longer. In the examples above, the relaxation time for the gas and piston system is probably milliseconds, while the relaxation time for the ferromagnet might be many years. In this sense, hysteresis occurs when the relaxation time is much longer than our patience, such that "slow" fails to coincide with "quasistatic".

Laws of Thermodynamics

■ 0th Law of Thermodynamics

Consider two isolated systems, A and B , which have been allowed to reach equilibrium separately. Now bring these systems into thermal contact with each other. Initially, they need not be in equilibrium with each other. Eventually, the combined system, $A+B$, will reach a new equilibrium state. Some changes in both A and B will generally have occurred, usually including a transfer of energy. In the final equilibrium state of the combined system we say that the subsystems are in equilibrium with each other. If a third system, C , can now be brought into thermal contact with A without any changes occurring in either A or C , then C is in equilibrium with not only with A but with B also. This postulate may be expressed as:

0th Law of Thermodynamics:

If two systems are separately in equilibrium with a third, then they must also be in equilibrium with each other.

The zeroth law may be paraphrased to say the equilibrium relationship is transitive. The transitivity of equilibrium conditions does not depend upon the nature of the systems involved and can obviously be extended to an arbitrary number of systems.

The converse of the 0th law

Converse of 0th Law of Thermodynamics:

If three or more systems are in thermal contact with each other and all are in equilibrium together, then any pair is separately in equilibrium.

is easily demonstrated. If the state of the combined system is in equilibrium, its properties are constant; but if a pair of subsystems is not in equilibrium with each other and are allowed to interact, their states will change. This result contradicts the initial hypothesis, thereby proving the equivalence between the 0th law and its converse.

The concept of temperature is based upon the 0th law of thermodynamics. For simplicity, consider three systems (A, B, C) each described by the variables $\{p_i, V_i, i \in \{A, B, C\}\}$. The condition of equilibrium between systems A and C may be expressed as an equation of the form

$$F_1[p_A, V_A, p_C, V_C] = 0$$

which may be solved for p_C as

$$p_C = f_1[p_A, V_A, V_C] = 0$$

Similarly, the equilibrium between systems B and C yields

$$p_C = f_2[p_B, V_B, V_C] = 0$$

so that

$$f_1[p_A, V_A, V_C] = f_2[p_B, V_B, V_C]$$

Finally, the equilibrium between A and B can be expressed as

$$F_3[p_A, V_A, p_B, V_B] = 0$$

If these last two equations are to express the same equilibrium condition, we must be able to eliminate V_C from the former equation to obtain

$$\phi_A[p_A, V_A] = \phi_B[p_B, V_B]$$

where ϕ_A or ϕ_B depend only upon the state variables of systems A or B independently. The democracy amongst the three systems can then be used to extend the argument to ϕ_C , such that

$$\phi_A[p_A, V_A] = \phi_B[p_B, V_B] = \phi_C[p_C, V_C]$$

for three systems in mutual equilibrium.

Therefore, there must exist a state function that has the same value for all systems in thermal equilibrium with each other. For each system, this state function depends only upon the thermodynamic parameters of that system and is independent of the process by which equilibrium was achieved and is also independent of the environment. This function will, of course, be different for dissimilar systems.

An *empirical temperature* scale can now be established by selecting a convenient thermometric property of a standard system, S , and correlating its equilibrium states with an empirical temperature θ in the form $\phi[\{x_S\}] = \theta$, where $\{x_S\}$ represents a complete set of thermodynamic parameters (other than temperature) for the standard system. The equation of state of any test system, A , can now be determined. Maintaining the standard system in a constant state, we vary the parameters of the test system in such a way as to maintain equilibrium between S and A . This set of variations then determines $\phi[\{x_A\}] = \theta$ as an equilibrium surface of A . The locus of all points (p_A, V_A) which remain in equilibrium with S at an empirical temperature θ describes a curve in the pV diagram called an *isotherm*. Several such isotherms for an ideal gas are sketched and labelled by their empirical temperatures in the indicator diagram below.

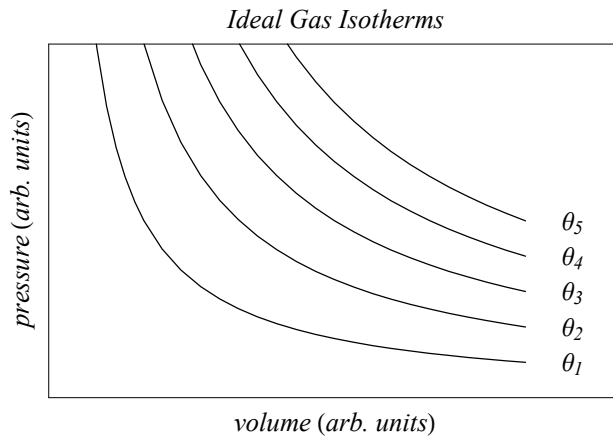

The 0th law of thermodynamics requires that the form of the isotherms be independent of the nature of the standard system S . If we had chosen a different standard system, S' , at the same empirical temperature as determined by equilibrium between S and S' , it would also have to be in equilibrium with A for all states along the isotherm. Therefore, the isotherms describe a property of the system of interest and are independent of subsidiary systems.

Several examples of suitable thermometric properties come readily to mind. First, consider the height of a mercury column in an evacuated tube, a common household thermometer. The mercury expands when heated and contracts when cooled. We may define an empirical temperature scale as a linear function of the height of the column. Second, Boyle's law states that the isotherms of a dilute gas may be described by $pV/n = \text{constant}$, where n is the number of moles. Therefore, a suitable temperature scale can be defined by any function $f[\theta]$ associated with these isotherms by $pV = nf[\theta]$. The simplest and most convenient choice, $pV = nR\theta$, is known as the ideal gas law. With a suitable choice of the gas constant, R , this empirical temperature scale is identical, in the limit $p \rightarrow 0$, with the absolute temperature scale to be discussed shortly.

It is important to realize that an empirical temperature scale bears no necessary relationship to any scale of hotness. A rigorous macroscopic concept of heat depends upon the first law of thermodynamics while the relationship between the direction of heat flow and temperature depends upon the second law.

■ 1st Law of Thermodynamics

The first law of thermodynamics represents an adaptation of the law of conservation of energy to thermodynamics, where energy can be stored in internal degrees of freedom. For thermodynamic purposes, it is convenient to define the internal energy, U , as the energy of the system in the rest frame of its center-of-mass. The kinetic energy of the center-of-mass is a problem in mechanics that we will generally ignore.

Ordinarily, one states energy conservation in the form of some variant of the statement: *The energy of any isolated system is constant*. However, applications of this law must include the concept of heat, which has not yet been developed. Therefore, it is conceptually clearer to proceed by a more circuitous route. Taking the concept of mechanical work as the foundation, we state the first law as

First Law of Thermodynamics:

The work required to change the state of an otherwise isolated system depends solely upon the initial and final states involved and is independent of the method used to accomplish this change.

The stipulation that the system interacts with the environment only through a measurable source of work is crucial — no other source of energy, such as heat or radiation, is permitted by the thermodynamic transformation described.

An immediate consequence of the first law is the existence of a state function we identify as the internal energy, U . It is customary to denote the work performed upon the system as W . The first law states that the work performed upon the system during any adiathermal transformation depends only upon the change of states effected and is independent of the intermediate states through which the system passes. Equilibrium conditions are not required. Therefore, the internal energy is a state function whose change during an adiathermal transformation is given by $\Delta U = W$.

We now consider a more general transformation during which the system may exchange energy with its environment without the performance of work. Although ΔU is then no longer equal to W , the internal energy is still a state function. The ability to change the energy of a system without performing mechanical work does not represent a defect in the law of conservation of energy. Rather, it demonstrates that energy may be transferred in more than one form. This observation leads to the definition of heat as:

Definition of heat:

The quantity of heat Q absorbed by a system is the change in its internal energy not due to work.

With this definition, energy conservation can be expressed in the form

$$\Delta U = Q + W$$

These considerations have thus produced a quantitative concept of heat that is similar to our commonplace notions.

At first glance, the argument presented above may appear circular. We stated that energy is conserved, but then defined heat in a manner that guarantees that this is true. However, this circularity is illusory. The crux of the matter is that internal energy is postulated to be a state function. This is a physical statement subject to experimental verification, rather than merely a definition. Suppose that the state of some system is changed in an arbitrary manner from state A to state B . In principle, we can now insulate the system and return to state A by performing a measurable quantity of work. The first stage of this cycle can now be repeated in some other arbitrary fashion. However, the quantity of work required to repeat the insulated return portion of the cycle must be the same if the first law is valid.

Often it is important to distinguish between proper and improper differentials. Consider a fixed quantity of gas contained within a piston. If the gas is expanded or compressed by moving the piston sufficiently slowly so that the pressure equalizes throughout the volume, the differential work done on the gas by an infinitesimal quasistatic displacement of the piston can be expressed as

$$\text{quasistatic} \implies \delta W = -p dV$$

On the other hand, if the piston is withdrawn so rapidly that there is no gas in contact with the piston during its motion, then the gas performs no work on the piston, such that $\delta W \rightarrow 0$ even though the volume changes. Therefore, we use d to indicate a *proper* differential that depends only upon the change of state or δ to indicate an *improper* differential that also depends upon the process used to change the state. The change in internal energy

$$dU = \delta Q + \delta W$$

is a proper differential because U is a state function even though both the heat absorbed by and work done on the system are improper or process-dependent differentials.

■ 2nd Law of Thermodynamics

Although the first law greatly restricts the thermodynamic transformations that are possible, it is a fact of common experience that many processes consistent with energy conservation never occur in nature. For example, suppose that an ice cube is placed in a glass of warm water. Although the first law permits the ice cube to surrender some of its internal energy so that the water is warmed while the ice cools, such an event in fact never occurs. Similarly, if we mix equal parts of two gases we never find the two gases to have separated spontaneously at some later time. Nor do we expect scrambled eggs to reintegrate themselves. The fact that these types of transformations are never observed to occur spontaneously is the basis of the second law of thermodynamics.

The second law can be formulated in many equivalent ways. The two statements generally considered to be the most clear are those due to Clausius and to Kelvin.

Clausius statement:

There exists no thermodynamic transformation whose sole effect is to transfer heat from a colder reservoir to a warmer reservoir.

Kelvin statement:

There exists no thermodynamic transformation whose sole effect is to extract heat from a reservoir and to convert that heat entirely into work.

Paraphrasing, the Clausius statement expresses the common experience that heat naturally flows downhill from hot to cold, whereas the Kelvin statement says that no heat engine can be perfectly efficient. Both statements merely express facts of common experience in thermodynamic language. It is relatively easy to demonstrate that these alternative statements are, in fact, equivalent to each other. Although these postulates may appear somewhat mundane, their consequences are quite profound; most notably, the second law provides the basis for the thermodynamic concept of entropy.

One might be inclined to regard the Kelvin statement as more fundamental because it does not require that an empirical temperature scale be related directly to direction of heat flow or to the notion of hotness. However, such a relationship is easily established in practice and is so basic to our intuitive notions of heat and temperature that such a criticism is regarded as merely pedantic. There are also more abstract formulations of the second law, notably that of Caratheodory, that can be used to establish the existence and properties of entropy with fewer assumptions, but less obvious connection to physical phenomena.

Perhaps the most common derivation of entropy is based upon an analysis of heat engines, which are also used to demonstrate that the Kelvin and Clausius statements are equivalent. This approach can be found in any undergraduate thermodynamics text. We prefer to employ a somewhat different argument that is closer to our main topic of statistical mechanics. This approach is based upon an alternative statement of the second law.

Maximum entropy principle:

There exists a state function of the extensive parameters of any thermodynamic system, called entropy S , with the following properties:

- 1. the values assumed by the extensive variables are those which maximize S consistent with the external constraints; and*
- 2. the entropy of a composite system is the sum of the entropies of its constituent subsystems.*

Using similar arguments based upon heat engines, one can show that the *maximum entropy principle* is equivalent to the Kelvin and Clausius statements, but we shall not digress to provide that demonstration. Instead, we take the maximum entropy principle as our primary statement of the second law.

Consider two systems separated by a rigid diathermal wall; in other words, the two systems are in thermal contact and can exchange heat but cannot perform work on each other. Further, suppose that the combined system is isolated, so that $U_1 + U_2 = \text{constant}$. Suppose that the two systems exchange an infinitesimally small quantity of heat, such that $dU_2 = -dU_1$. Since no work is done, this energy exchange must be in the form of heat, $dU_i = \delta Q_i$, where we use dx to represent a proper differential and δx to represent an improper differential that is infinitesimally small but depends upon the nature of the process. The net change in entropy during this process is

$$dS = dS_1 + dS_2 = \left(\frac{\partial S_1}{\partial U_1} \right)_{V_1, N_1} dU_1 + \left(\frac{\partial S_2}{\partial U_2} \right)_{V_2, N_2} dU_2 = \left(\frac{1}{\tau_1} - \frac{1}{\tau_2} \right) \delta Q_1$$

where we have defined

$$\frac{1}{\tau} = \left(\frac{\partial S}{\partial U} \right)_{V, N}$$

for each system in terms of the partial derivative of entropy with respect to energy holding all other extensive variables (volume, particle numbers, etc.) constant. Maximization of entropy at equilibrium then requires

$$dS = 0 \implies \tau_1 = \tau_2$$

for arbitrary (nonzero) values of dU_1 . However, equilibrium also requires that the temperatures of the two systems be equal. Therefore, we are inclined to identify τ with temperature T ; after all, we have the existence of empirical temperature scales but have not yet made a definition of absolute temperature. To demonstrate that this identification is consistent with more primitive notions of temperature, suppose that $\tau_1 > \tau_2$. We then expect that heat will flow spontaneously from the hotter to the cooler system, such that $\delta Q_1 < 0$. We then find that

$$\tau_1 > \tau_2, \delta Q_1 < 0 \implies dS > 0$$

demonstrates that the net entropy increases when heat flows in its natural direction from hot to cold. Heat continues to flow until the temperatures become equal, equilibrium is reached, and entropy is maximized. Therefore, this relationship between temperature and entropy is consistent with the second law of thermodynamics.

Now suppose that system 1 is the working substance of a heat engine while system 2 consists of a collection of heat reservoirs that can be used to supply or accept heat at constant temperature. Imagine a cycle in which system 1 starts in a well-defined initial state in equilibrium with a reservoir at temperature T_i and is then manipulated such that at the end of the cycle it once again returns to the same initial state at final temperature $T_f = T_i$. Hence, the internal energy and entropy return to their initial values when the system is returned to its initial state. Intermediate states of system 1 need not be in equilibrium and may require a larger set of variables for complete characterization. Although such states do not have a unique temperature, we imagine that any exchange of heat with the external environment is made by thermal contact with a reservoir that does have a well-defined temperature at every stage of the cycle and that the reservoirs are large enough to make the necessary exchange with negligible change of temperature. If necessary, we could imagine that a large collection of reservoirs is used for this purpose. According to the maximum entropy principle, the change in entropy is nonnegative, such that

$$\Delta S = \Delta S_1 + \Delta S_2 \geq 0$$

Thus, having stipulated a closed cycle for system 1, requiring its initial and final entropies to be identical, we conclude that the entropy of the environment cannot decrease when system 1 executes a closed cycle, such that

$$\Delta S_1 = 0 \implies \Delta S_2 \geq 0$$

The entropy change for the environment is related to the heat absorbed by the system according to

$$dS_2 = -\frac{\delta Q_1}{T_2} \implies \int \frac{\delta Q_1}{T_2} \leq 0$$

Focussing upon the system of interest, which undergoes a closed cycle, we can express this result in the form

$$\oint \frac{\delta Q}{T} \leq 0$$

where we interpret δQ as the heat absorbed by the system and T as the temperature of the reservoir that supplies that heat; the temperature of the system need not be the same as that of the reservoir and is often not even unique. In the special case that the reservoir also undergoes a closed cycle, such that $\Delta S_2 = 0$, we find

$$\oint \frac{\delta Q}{T} = 0 \text{ if and only if the cycle is reversible}$$

where, according to the preceding analysis, reversible heat exchange requires the temperatures of both bodies must be the same.

These results are summarized by *Clausius' theorem*

Clausius' theorem

For any closed cycle, $\oint \frac{\delta Q}{T} \leq 0$, where δQ is the heat absorbed at temperature T . Equality holds if and only if the cycle is reversible.

If a closed cycle consists only of reversible transformations, we can use

$$\oint \frac{\delta Q_{\text{rev}}}{T} = 0$$

to associate changes dS in the state function S to reversible heat exchange according to

$$dS = \frac{\delta Q_{\text{rev}}}{T} \implies T dS = \delta Q_{\text{rev}}$$

This identification does not apply to irreversible heat exchange. Suppose that a reversible transformation between states A and B is followed by an irreversible return from B to A , such that

$$\oint \frac{\delta Q}{T} \leq 0 \implies \int_A^B \frac{\delta Q_{\text{rev}}}{T} + \int_B^A dS \leq 0 \implies \int_A^B dS \geq \int_A^B \frac{\delta Q_{\text{rev}}}{T}$$

Thus, a reversible transformation entails the smallest possible change in entropy. If the states A and B are taken as infinitesimally close together, then the differentials satisfy the same relationship, such that

$$dS \geq \frac{\delta Q_{\text{rev}}}{T}$$

where equality applies only to reversible transformations. This relationship can now be used to provide an experimental definition for the change in entropy of a system. The entropy of state A can be related to that of a standard or reference state R by measuring reversible heat exchanges according to

$$S_A = S_R + \int_R^A \frac{\delta Q_{\text{rev}}}{T}$$

The *heat capacity* subject to specified constraints can now be defined by

$$C_x = \left(\frac{\delta Q_{\text{rev}}}{\delta T} \right)_x$$

where x describes the process and $\delta Q_{\text{rev}} = T dS$ is the heat absorbed during a reversible process in which the temperature change is δT . However, because the second law postulates that S is a state function that is independent of process, be it reversible or irreversible, the form

$$C_x = T \left(\frac{\partial S}{\partial T} \right)_x$$

is more fundamental — it does not depend upon the details of process, just the change in state that is actually accomplished. Therefore changes in the entropy of a system can be deduced from heat capacity measurements using

$$\Delta S = \int \frac{C[T]}{T} dT$$

where the heat capacity generally depends upon temperature.

Changes in the internal energy of a simple compressible system can be expressed in the form $dU = \delta Q + \delta W$ where we identify $\delta Q_{\text{rev}} = T dS$ as the heat absorbed and $\delta W = -p dV$ as the work performed upon the system during an infinitesimal reversible process. Therefore, we can express the energy differential as

$$dU = T dS - p dV$$

where the use of state functions liberates us from the restriction to reversible process; in other words, by expressing the energy differential in terms of state function, it becomes a perfect differential that applies to any process, reversible or not. We can now define the *isochoric heat capacity* as the heat absorbed for an infinitesimal temperature change under conditions of constant volume as

$$dV = 0 \implies T dS = dU \implies C_V = T \left(\frac{\partial S}{\partial T} \right)_V = \left(\frac{\partial U}{\partial T} \right)_V$$

where the final expression in terms of state functions is considered the fundamental definition. Similarly, the *isobaric heat capacity* under conditions of constant pressure is easily obtained by defining enthalpy

$$H = U + pV \implies dH = T dS + V dp$$

such that

$$dp = 0 \implies T dS = dH \implies C_p = T \left(\frac{\partial S}{\partial T} \right)_p = \left(\frac{\partial H}{\partial T} \right)_p$$

■ 3rd Law of Thermodynamics

For most applications of thermodynamics it is sufficient to analyze changes in entropy rather than entropy itself, but determination of absolute entropy requires an integration constant or, equivalently, knowledge of the absolute entropy for a standard or reference state of the system. Historically, attempts to formulate a general principle for determination of absolute entropy were motivated to a large extent by the need of chemists to calculate equilibrium constants for chemical reactions from thermal data alone. Several similar, but not quite equivalent, statements of the third law have been proposed.

The *Nernst heat theorem* states: *a chemical reaction between pure crystalline phases that occurs at absolute zero produces no entropy change*. This formulation was later generalized in the form of the *Nernst-Simon statement* of the third law.

Nernst-Simon statement of third law:

The change in entropy that results from any isothermal reversible transformation of a condensed system approaches zero as the temperature approaches zero.

The Nernst-Simon statement can be represented mathematically by the limit

$$\lim_{T \rightarrow 0} (\Delta S)_T = 0$$

An immediate consequence of the Nernst-Simon statement is that the entropy of any system in thermal equilibrium must approach a unique constant at absolute zero because isothermal transformations are assumed not to affect entropy at absolute zero. This observation forms the basis of the *Planck statement* of the third law.

Planck statement of third law:

As $T \rightarrow 0$, the entropy of any system in equilibrium approaches a constant that is independent of all other thermodynamic variables.

Planck actually generalized this statement even further by hypothesizing that $\lim_{T \rightarrow 0} S = 0$. However, this strong form of the Planck statement requires that the quantum mechanical degeneracy of the ground state of any system must be unity. Thus, the strong form implicitly assumes that there always exist interactions that split the degeneracy of the ground state,

but the energy splitting might be so small as to be irrelevant at any attainable temperature. Therefore, we will not require the strong form and will content to apply the weaker form stated above.

Finally, the third law is often presented in the form of the *unattainability theorem*.

Unattainability theorem:

There exists no process, no matter how idealized, capable of reducing the temperature of any system to absolute zero in a finite number of steps.

For the purposes of this theorem, a step is interpreted as either an isentropic or an isothermal transformation. The following figure illustrates the meaning of the unattainability theorem (the temperature and entropy units are arbitrary). Suppose that entropy $S[T, x]$ depends upon temperature and an external variable x , with the upper curve corresponding to $x = 0$ and the lower curve to a large value of x . For example, increasing the external magnetic field applied to a paramagnetic material increases the alignment of atomic magnetic moments and reduces the entropy of the material. Suppose that the sample is initially in thermal equilibrium at $x = 0$ with a reservoir at temperature T_0 . We slowly increase x while maintaining thermal equilibrium at constant temperature. Next we adiabatically reduce x back to zero, thereby cooling the sample. Consider the right side of the figure, in which the entropy at $T \rightarrow 0$ depends upon x . In this case an idealized sequence of alternating isothermal and isentropic steps appears to be capable of reaching zero temperature, but the dependence $\frac{\partial S[0, x]}{\partial x} \neq 0$ violates the third law. Therefore, the third law asserts that the entropy for physical systems must approach a constant as $T \rightarrow 0$ that is independent of any external variable. In the figure on left, an infinite number of steps would be needed to reach absolute zero because the entropy at zero temperature is independent of external variables, such that $\frac{\partial S[0, x]}{\partial x} = 0$, and is consistent with the third law.

Unattainability Theorem

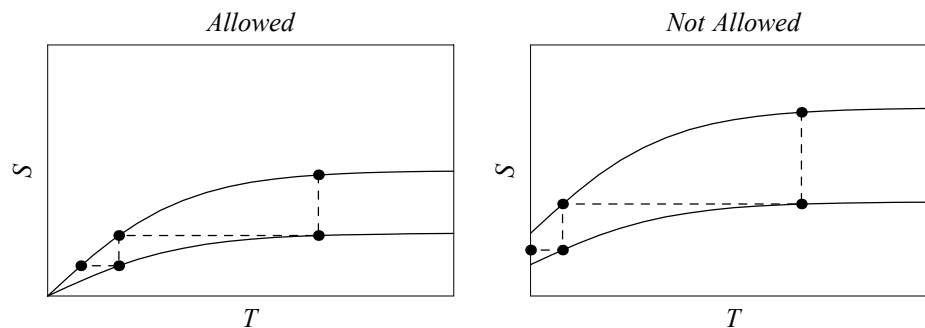

Adiabatic demagnetization is an important technique for reaching low temperatures that relies on a process similar to that sketched above. A paramagnetic salt is a crystalline solid in which some of the ions possess permanent magnetic dipole moments. In a typical sample the magnetic ions constitute a small fraction of the material and are well separated so that the spin-spin interactions are very weak and the Curie temperature very low. (The Curie temperature marks the phase transition at which spontaneous magnetization is obtained as a paramagnetic material is cooled.) For the purposes of thermodynamic analysis, we can consider the magnetic dipoles to constitute one subsystem while the nonmagnetic degrees of freedom constitute a second subsystem, even though both subsystems are composed of the same atoms. These interpenetrating systems are in thermal contact with each other, but the interaction between magnetic and nonmagnetic degrees of freedom is generally quite weak so that equilibration can take a relatively long time. The first step is to cool the sample with $B = 0$ by conventional thermal contact. In a typical demagnetization cell the sample is surrounded by helium gas. Around that is a dewar containing liquid helium boiling under reduced pressure at a temperature of about 1 kelvin. The gas serves to exchange heat between the sample and the liquid, maintaining the system at constant temperature. Next, the external magnetic field is increased, aligning the magnetic dipoles and reducing the entropy of the sample under isothermal conditions. The helium gas is then removed and the system is thermally isolated. The field is then reduced under essentially adiabatic conditions, reducing the temperature of the magnetic subsystem while the coupling between magnetic and nonmagnetic subsystems cools the lattice. This step must be slow enough for heat to be transferred reversibly between

nonmagnetic and magnetic subsystems. Nevertheless, it is possible to reach temperatures in the millikelvin range using adiabatic demagnetization that exploits ionic magnetic moments, limited by the atomic Curie temperature T_c . Even lower temperature, in the microkelvin range, can be reached by adding a nuclear demagnetization step; the Curie temperature is lower by the ratio of nuclear and atomic magnetic moments, which is approximately the ratio m_e/m_p between electron and proton masses.

Thermodynamic Potentials

Suppose that the macrostates of a thermodynamic system depend upon r extensive variables $\{X_i, i = 1, r\}$. There are then $r + 1$ independent extensive variables consisting of the set $\{X_i\}$ supplemented by either S or U , such that the *fundamental relation* for the system can be expressed in either entropic form,

$$S = S[U, X_1, \dots, X_r]$$

or energetic form

$$U = U[S, X_1, \dots, X_r]$$

These relationships describe all possible equilibrium states of the system. Changes in these state functions can then be expressed in terms of total differentials

$$\begin{aligned} dU &= TdS + \sum_i P_i dX_i \\ dS &= \frac{1}{T}dU + \sum_i Q_i dX_i \end{aligned}$$

where for reversible transformations variations of the external constraints via dX_i perform work $P_i dX_i$ upon the system (which may be negative, of course) while TdS represents energy supplied to hidden internal degrees of freedom in the form of heat. However, by expressing the total differential solely in terms of state variables, the fundamental relation applies to any change of state, reversible or not, independent of the path by which that change was made. Therefore, we can identify the coefficients with partial derivatives, whereby

$$\begin{aligned} T &= \left(\frac{\partial U}{\partial S} \right)_{X_i} = \left(\frac{\partial S}{\partial U} \right)_{X_i}^{-1} \\ P_i &= \left(\frac{\partial U}{\partial X_i} \right)_{S, X_j \neq X_i} \quad Q_i = \left(\frac{\partial S}{\partial X_i} \right)_{U, X_j \neq X_i} \end{aligned}$$

are intensive parameters which satisfy equations of state of the form

$$\begin{aligned} T &= T[S, X_1, \dots, X_r] \\ P_i &= P_i[S, X_1, \dots, X_r] \\ Q_i &= Q_i[U, X_1, \dots, X_r] \end{aligned}$$

The equation for T is called the *thermal equation of state* while the equations for P_i or Q_i are *mechanical* and/or *chemical equations of state* depending upon the physical meaning of the conjugate variable X_i . Note that the sets of P_i and Q_i are not independent because there are only $r + 1$ independent equations of state which completely determine the fundamental relation. If we choose to employ the energy representation, $U = U[S, \{X_i\}]$, the appropriate choice of intensive parameters would be $(T, \{P_i\})$ and any Q_i can be expressed in terms of $(T, \{P_i\})$.

For example, a simple compressible system is characterized completely by its energy (or entropy), volume, and particle number for a single species. The fundamental relation in the energy representation then takes the form

$$U = U[S, V, N] \implies dU = T dS - p dV + \mu dN$$

where the intensive parameter conjugate to $-V$ is clearly the pressure and the intensive parameter conjugate to N is identified as the chemical potential μ , such that

$$T = \left(\frac{\partial U}{\partial S} \right)_{V,N} \quad p = - \left(\frac{\partial U}{\partial V} \right)_{S,N} \quad \mu = \left(\frac{\partial U}{\partial N} \right)_{S,V}$$

Alternatively, in the entropy representation we write

$$S = S[U, V, N] \implies T dS = dU + p dV - \mu dN$$

such that

$$\frac{1}{T} = \left(\frac{\partial S}{\partial U} \right)_{V,N} \quad \frac{p}{T} = \left(\frac{\partial S}{\partial V} \right)_{U,N} \quad \frac{\mu}{T} = - \left(\frac{\partial S}{\partial N} \right)_{U,V}$$

where we have employed the customary definitions for the energetic and entropic intensive parameters. More complex systems require a greater number of extensive variables and associated intensive parameters. A pair of variables, x_i and X_i , are said to be conjugate when X_i is extensive, x_i intensive, and the product $x_i dX_i$ has dimensions of energy and appears in the fundamental relation for dU or dS .

It is straightforward to generalize these developments for systems with different or additional modes of mechanical work. For example, the conjugate pair $(-p, V)$ for a compressible system might be replaced by (γ, A) for a membrane with area A subject to surface tension γ . A change dX_i in one of the extensive variables requires work $P_i dX_i$ where $P_i = \frac{\partial U}{\partial X_i}$ can be interpreted as a *thermodynamic force*. [Note that the absence of a negative sign is related to the convention that positive work is performed upon the system, increasing its internal energy.] Thus, the fundamental relation for an elastic membrane is written in the form $dU = T dS + \gamma dA$, where the surface tension $\gamma = \frac{\partial U}{\partial A}$ plays the role of a thermodynamic force acting through generalized displacement dA to perform work γdA upon the membrane.

The fundamental relation must be expressed in terms of its *proper variables* to be complete. Thus, the energy features entropy, rather than temperature, as one of its proper variables. However, entropy is not a convenient variable experimentally — there exists no meter to measure nor knob to vary entropy directly. Therefore, it is often more convenient to construct other related quantities in which entropy is a dependent instead of an independent variable. This goal can be accomplished by means of the *Legendre transformation* in which a quantity of the form $\pm x_i X_i$ is added to the fundamental relationship in order to interchange the roles of a pair of conjugate variables. For example, we define the *Helmholtz free energy* as $F = U - TS$ so that for a simple compressible system we obtain a complete differential of the form

$$F = U - TS \implies dF = -S dT - p dV + \mu dN$$

in which T is now the independent variable and S the dependent variable. The fundamental relation now assumes the form $F = F[T, V, N]$ where

$$S = - \left(\frac{\partial F}{\partial T} \right)_{V,N} \quad p = - \left(\frac{\partial F}{\partial V} \right)_{T,N} \quad \mu = \left(\frac{\partial F}{\partial N} \right)_{T,V}$$

This state function is clearly much more amenable to experimental manipulation than the internal energy even if U occupies a more central role in our thinking. On the other hand, a simple intuitive interpretation of F is available also. Consider a simple compressible system enclosed by impermeable walls equipped with a movable piston and suppose that the system is in thermal contact with a heat reservoir that maintains constant temperature. The change in Helmholtz free energy when the volume is adjusted isothermally is then

$$dT = 0, dN = 0 \implies dF = -p dV$$

If the change of state is performed reversibly and quasistatically, the change in free energy is equal to the work performed upon the system, such that $dF = \delta W$. Therefore, the Helmholtz free energy can be interpreted as the capacity of the system to perform work under isothermal conditions. The free energy is less than the internal energy because some of the internal energy must be used to maintain constant temperature and is not available for external work. Hence, the free energy is often more relevant experimentally than the internal energy.

State functions obtained by means of Legendre transformation of a fundamental relation are called *thermodynamic potentials* because the roles they play in thermodynamics are analogous to the role of the potential energy in mechanics. Each of these potentials provides a complete and equivalent description of the equilibrium states of the system because they are all derived from a fundamental relation that contains all there is to know about those states. However, the function that provides the most convenient packaging of this information depends upon the selection of independent variables that is most appropriate to a particular application. For example, it is often easier to control the pressure upon a system than its volume, especially if it is nearly incompressible. Under those conditions it might be more convenient to employ *enthalpy*

$$H = U + pV \implies dH = T dS + V dp + \mu dN$$

or the *Gibbs free enthalpy*

$$G = F + pV \implies dG = -S dT + V dp + \mu dN$$

than the corresponding internal or free energies. The dependent variables are then identified in terms of the coefficients that appear in the differential forms of the fundamental relation chosen. Thus, for the Gibbs representation we identify entropy, volume, and chemical potential as

$$S = -\left(\frac{\partial G}{\partial T}\right)_{p,N} \quad V = \left(\frac{\partial G}{\partial p}\right)_{T,N} \quad \mu = \left(\frac{\partial G}{\partial N}\right)_{T,p}$$

Note that the Helmholtz free energy or Gibbs free enthalpy are often referred to as Helmholtz or Gibbs potentials, somewhat more palatable appellations. More complicated systems with additional work modes require additional terms in the fundamental relation and give rise to a correspondingly greater number of thermodynamic potentials. Similarly, if it is more natural in some application to control the chemical potential than the particle number, a related set of thermodynamic potentials can be constructed by subtracting $\mu_i N_i$ from any of the potentials which employ N_i as one of its independent variables.

If any of the thermodynamic potentials is known as a function of its proper variables, then complete knowledge of the equilibrium properties of the system is available because any thermodynamic parameter can be computed from the fundamental relation. For example, suppose we have $G[T, p]$. The internal energy $U = G + TS - pV$ can then be expressed in terms of temperature and pressure as

$$U = G[T, p] - T\left(\frac{\partial G}{\partial T}\right)_p - p\left(\frac{\partial G}{\partial p}\right)_T$$

where S and V are obtained as appropriate partial derivatives of G . An almost limitless variety of similar relationships can be developed easily using these techniques. In fact, much of the formal development of thermodynamics is devoted to finding relationships between the quantities desired and those that are most accessible experimentally. Thus, the skilled thermodynamicist must be able to manipulate related rates of change subject to various constraints. Several useful techniques are developed in the next section.

Thermodynamic Relationships

■ Maxwell relations

An important class of thermodynamic relationships, known as *Maxwell relations*, can be developed using the completeness of fundamental relations to examine the derivatives of one member of a conjugate pair with respect to a member of another pair. Consider a simple compressible system with fundamental relation

$$dU = \left(\frac{\partial U}{\partial S} \right)_V dS + \left(\frac{\partial U}{\partial V} \right)_S dV = T dS - p dV$$

The completeness of the total differential dU requires the two mixed second partial derivatives to be equal, such that

$$\frac{\partial^2 U}{\partial V \partial S} = \frac{\partial^2 U}{\partial S \partial V} \Rightarrow \left(\frac{\partial}{\partial V} \right)_S \left(\frac{\partial U}{\partial S} \right)_V = \left(\frac{\partial}{\partial S} \right)_V \left(\frac{\partial U}{\partial V} \right)_S$$

Therefore, upon identification of the temperature and pressure with appropriate first derivatives, we obtain the Maxwell relation

$$\left(\frac{\partial T}{\partial V} \right)_S = - \left(\frac{\partial p}{\partial S} \right)_V$$

The power of this relationship stems from the fact that it depends only upon the statement that the internal energy is a function solely of S and V ; hence, its validity is independent of any other specific properties of the system.

Similar Maxwell relations can be developed from each of the thermodynamic potentials expressed as functions of a different pair of independent variables. The four Maxwell relations below are easily derived (verify!) for simple compressible systems.

$$U = U[S, V] \Rightarrow \left(\frac{\partial T}{\partial V} \right)_S = - \left(\frac{\partial p}{\partial S} \right)_V$$

$$H = H[S, p] \Rightarrow \left(\frac{\partial T}{\partial p} \right)_S = \left(\frac{\partial V}{\partial S} \right)_p$$

$$F = F[T, V] \Rightarrow \left(\frac{\partial S}{\partial V} \right)_T = \left(\frac{\partial p}{\partial T} \right)_V$$

$$G = G[T, p] \Rightarrow \left(\frac{\partial S}{\partial p} \right)_T = - \left(\frac{\partial V}{\partial T} \right)_p$$

Each of these relationships is an essential consequence of the completeness of the fundamental relation and several of these relationships impose constraints upon the behavior of quantities of practical, experimental significance. In each relationship two independent variables appear in the denominators, one as for differentiation and the other as a constraint, while in each derivative the dependent variable from the opposite conjugate pair appears in the numerator. The sign is determined by the relative sign that appears in the fundamental relation for the thermodynamic potential appropriate to the chosen pair of independent variables. Any remaining independent variables (such as particle number, N) should appear in the constraints for both sides, but are often left implicit.

To illustrate the usefulness of Maxwell relations, consider the derivative of the isobaric heat capacity, C_p , with respect to pressure for constant temperature. This quantity is directly accessible to measurement. Expressing C_p in terms of S and using the commutative property of partial derivatives, we find

$$\left(\frac{\partial C_p}{\partial p}\right)_T = \left(\frac{\partial}{\partial p}\right)_T \left(T \frac{\partial S}{\partial T}\right)_p = T \left(\frac{\partial}{\partial T}\right)_p \left(\frac{\partial S}{\partial p}\right)_T$$

Use of Maxwell relation now yields

$$\left(\frac{\partial S}{\partial p}\right)_T = -\left(\frac{\partial V}{\partial T}\right)_p \Rightarrow \left(\frac{\partial C_p}{\partial p}\right)_T = -T \left(\frac{\partial^2 V}{\partial T^2}\right)_p$$

Similarly, with the aid of another Maxwell relation, the volume dependence of the isochoric heat capacity becomes

$$\left(\frac{\partial S}{\partial V}\right)_T = \left(\frac{\partial p}{\partial T}\right)_V \Rightarrow \left(\frac{\partial C_V}{\partial V}\right)_T = T \left(\frac{\partial^2 p}{\partial T^2}\right)_V$$

Note that both of these derivatives vanish for an ideal gas but in general will be finite for real gases. Hence, the principal heat capacities for an ideal gas depend only upon temperature and are independent of pressure and volume, whereas for real gases one can use the empirical equation of state to evaluate the pressure and volume dependencies of these quantities. The beauty of thermodynamics is that many useful relationships between apparently unrelated properties of a system can be developed from general principles without detailed knowledge of the dynamics of the system on a microscopic level.

Similar, but more complicated, relationships can also be developed by treating one of the thermodynamic potentials as an independent variable. For example, we can use the completeness of

$$dS = \frac{1}{T} dU + \frac{p}{T} dV$$

to identify

$$\frac{1}{T} = \left(\frac{\partial S}{\partial U}\right)_V \quad \frac{p}{T} = \left(\frac{\partial S}{\partial V}\right)_U$$

and thereby obtain the Maxwell relation

$$S = S[U, V] \Rightarrow \left(\frac{\partial}{\partial V} \frac{1}{T}\right)_U = \left(\frac{\partial}{\partial U} \frac{p}{T}\right)_V$$

■ Chain and cyclic rules for partial derivatives

Consider the set of state variables $\{x, y, z\}$, of which any two may be considered independent. The differentials dx and dy then become

$$\begin{aligned} dx &= \left(\frac{\partial x}{\partial y}\right)_z dy + \left(\frac{\partial x}{\partial z}\right)_y dz \\ dy &= \left(\frac{\partial y}{\partial x}\right)_z dx + \left(\frac{\partial y}{\partial z}\right)_x dz \end{aligned}$$

so that

$$dx = \left(\frac{\partial x}{\partial y}\right)_z \left(\frac{\partial y}{\partial x}\right)_z dx + \left[\left(\frac{\partial x}{\partial z}\right)_y + \left(\frac{\partial x}{\partial y}\right)_z \left(\frac{\partial y}{\partial z}\right)_x \right] dz$$

This relationship applies to any $\{dx, dy\}$. In particular, if we choose to make $dz = 0$, then the coefficients of dx must be equal. Hence, we obtain the familiar *chain rule*

$$\left(\frac{\partial x}{\partial y}\right)_z \left(\frac{\partial y}{\partial x}\right)_z = 1$$

which can be extended to an arbitrary number of derivatives, all evaluated with the same constraints, simply by linking each denominator with the next numerator until the chain is closed upon itself; *e.g.*

$$\left(\frac{\partial w}{\partial x}\right)_y \left(\frac{\partial x}{\partial z}\right)_y \left(\frac{\partial z}{\partial s}\right)_y \left(\frac{\partial s}{\partial t}\right)_y \left(\frac{\partial t}{\partial w}\right)_y = 1$$

Alternatively, if we choose $dx = 0$, then the coefficient of dz must vanish, so that

$$\left(\frac{\partial x}{\partial y}\right)_z \left(\frac{\partial y}{\partial z}\right)_x \left(\frac{\partial z}{\partial x}\right)_y = -1$$

This less familiar relationship is called the *cyclic rule* and can neither be shortened nor extended, but additional spectator variables common to all three partial derivatives may appear in the constraints. These two rules often come in handy when we need to connect dependencies with respect to different variables.

More generally, if one set of variables $\{y_i, i = 1, n\}$ is expressed in terms of an alternative set $\{x_i, i = 1, n\}$, the transformation Jacobian is given by the determinant

$$\frac{\partial\{y\}}{\partial\{x\}} = \frac{\partial\{y_1, y_2, \dots, y_n\}}{\partial\{x_1, x_2, \dots, x_n\}} = \begin{vmatrix} \frac{\partial y_1}{\partial x_1} & \frac{\partial y_1}{\partial x_2} & \dots & \frac{\partial y_1}{\partial x_n} \\ \frac{\partial y_2}{\partial x_1} & \frac{\partial y_2}{\partial x_2} & \dots & \frac{\partial y_2}{\partial x_n} \\ \vdots & \vdots & \ddots & \vdots \\ \frac{\partial y_n}{\partial x_1} & \frac{\partial y_n}{\partial x_2} & \dots & \frac{\partial y_n}{\partial x_n} \end{vmatrix}$$

where each variable in one set is a function of the variables in the other, such that $y_i = y_i[\{x\}]$. The generalized chain rule takes the form

$$\frac{\partial\{z\}}{\partial\{y\}} = \frac{\partial\{z\}}{\partial\{x\}} \frac{\partial\{x\}}{\partial\{y\}} = \frac{\partial\{z\}}{\partial\{x\}} \bigg/ \frac{\partial\{y\}}{\partial\{x\}}$$

Familiar partial derivatives may be expressed in terms of Jacobians by

$$\frac{\partial\{u, y, z, \dots\}}{\partial\{x, y, z, \dots\}} = \left(\frac{\partial u}{\partial x}\right)_{y,z,\dots}$$

where the numerator and denominator differ in just one term at the same position within both lists. Note that the determinant is antisymmetric with respect to odd permutations of its rows or columns, such that

$$\frac{\partial\{u, v, \dots\}}{\partial\{x, y, \dots\}} = -\frac{\partial\{v, u, \dots\}}{\partial\{x, y, \dots\}} = -\frac{\partial\{v, u, \dots\}}{\partial\{y, x, \dots\}}$$

where the ellipses are maintained with constant ordering. Thus, a more compact derivation of the cyclic rule uses

$$\frac{\partial\{x, z\}}{\partial\{y, z\}} \frac{\partial\{y, z\}}{\partial\{y, x\}} = \frac{\partial\{x, z\}}{\partial\{y, x\}} \implies \left(\frac{\partial x}{\partial y}\right)_z \left(\frac{\partial z}{\partial x}\right)_y = -\left(\frac{\partial z}{\partial y}\right)_x \implies \left(\frac{\partial x}{\partial y}\right)_z \left(\frac{\partial y}{\partial z}\right)_x \left(\frac{\partial z}{\partial x}\right)_y = -1$$

More importantly, the Jacobian method can be applied to larger sets of variables than the elementary chain and cyclic rules.

■ Euler relations

In the absence of long-range interactions between distant parts of a system, a postulate of thermodynamics stipulates that energy and entropy are extensive functions of the extensive parameters of the system. Hence, U and S must be homogeneous first-order functions of the extensive variables, such that

$$\begin{aligned} U[\lambda S, \lambda X_1, \dots, \lambda X_r] &= \lambda U \\ S[\lambda U, \lambda X_1, \dots, \lambda X_r] &= \lambda S \end{aligned}$$

for any positive value of λ . However, the extensivity postulate may fail for very small systems ($\lambda \rightarrow 0$) or for very large systems ($\lambda \rightarrow \infty$) in danger of gravitational collapse or subject to other significant long-range interactions. Considerable care must be exercised when applying thermodynamic reasoning under such circumstances; we will neglect those situations and assume that the extensivity postulate pertains.

An important consequence of the extensivity postulate is based upon the observation that for a first-order homogeneous function

$$U[S, X_1, \dots, X_r] = \frac{\partial U[\lambda S, \lambda X_1, \dots, \lambda X_r]}{\partial(\lambda S)} S + \sum_{i=1}^r \frac{\partial U[\lambda S, \lambda X_1, \dots, \lambda X_r]}{\partial(\lambda X_i)} X_i$$

for any λ , including $\lambda=1$. Hence, we obtain the *Euler relation*

$$U[S, X_1, \dots, X_r] = TS + \sum_{i=1}^r P_i X_i$$

where

$$P_i = \left(\frac{\partial U}{\partial X_i} \right)_{S, X_j \neq X_i}$$

are the intensive variables conjugate to X_i . Furthermore, comparing the differential

$$dU = TdS + \sum_i P_i dX_i + SdT + \sum_i X_i dP_i$$

with the fundamental relation

$$dU = TdS + \sum_i P_i dX_i$$

we conclude that the intensive parameters are not independent, but are constrained by the *Gibbs-Duhem relation*

$$SdT + \sum_i X_i dP_i = 0$$

Actually, the existence of a relationship of this type could have been anticipated from the zeroth law which establishes temperature as an arbiter of equilibrium, whereby all systems at a common temperature are in thermal equilibrium with each other. Hence, there must exist isothermal surfaces which relate variations among the $\{X_i, i = 1, r\}$ that are compatible with equilibrium at a common temperature.

For a simple compressible system, the Euler relation takes the form

$$U = TS - pV + \mu N$$

such that the Gibbs free enthalpy reduces to

$$G = U - TS + pV = \mu N$$

Thus, we find that the chemical potential for a single-component system can be interpreted as the free enthalpy per particle or per mole, depending upon the choice of N . Notice that G must be extensive and is proportional to N , but that its natural variables are $\{T, p, N\}$. Therefore, the chemical potential $\mu = \mu[T, p]$ is an intensive function of two intensive variables that depends upon concentration or density implicitly through its dependence upon T and p , but μ has no explicit dependence upon the size of the system or N . It is also instructive to express

$$\mu = \left(\frac{\partial F}{\partial N}\right)_{T,V} = \left(\frac{\partial U}{\partial N}\right)_{T,V} - T\left(\frac{\partial S}{\partial N}\right)_{T,V}$$

in terms of the competition between the energy needed to add a particle and the associated change in entropy under conditions of constant temperature and volume. At low temperature one might obtain either a positive or negative change in energy depending upon the interparticle interaction, but at sufficiently large temperature the increase in entropy that results from an increase in the complexity of the system will tend to dominate. Thus, one expects large negative μ in the high-temperature limit.

Simple Compressible Systems

■ Construction of the equation of state

The mechanical equation of state for a simple compressible system can be expressed in the form $V = V[T, p]$ where the particle number is treated here as a constant parameter. Experimental exploration of the equation of state involves measuring the changes in volume (or density) produced by variation of the temperature and pressure, whereby

$$dV = \left(\frac{\partial V}{\partial T}\right)_p dT + \left(\frac{\partial V}{\partial p}\right)_T dp$$

It is useful to define *response functions* which measure relative changes in volume due to changes in either temperature or pressure. Thus, the *isobaric expansivity* is defined as

$$\alpha = \frac{1}{V} \left(\frac{\partial V}{\partial T}\right)_p$$

and the *isothermal compressibility* as

$$\kappa_T = -\frac{1}{V} \left(\frac{\partial V}{\partial p}\right)_T$$

where the negative sign is included to ensure that this thermodynamic coefficient will generally be positive. Thus, the mechanical equation of state can be constructed from

$$\frac{dV}{V} = \alpha dT - \kappa_T dp$$

while construction of the fundamental relation $dU = T dS - p dV$ also requires measurement of one of the principal heat capacities

$$C_V = \left(\frac{\partial U}{\partial T} \right)_V = T \left(\frac{\partial S}{\partial T} \right)_V$$

$$C_p = \left(\frac{\partial H}{\partial T} \right)_p = T \left(\frac{\partial S}{\partial T} \right)_p$$

It is important to recognize that C_p and C_V are not independent, but are related through the mechanical equation of state.

The completeness of dS allows us to express $T dS$ in the two alternative forms

$$T dS = T \left(\frac{\partial S}{\partial T} \right)_V dT + T \left(\frac{\partial S}{\partial V} \right)_T dV = T \left(\frac{\partial S}{\partial T} \right)_p dT + T \left(\frac{\partial S}{\partial p} \right)_T dp$$

Thus, the difference between the two heat capacities becomes

$$(C_p - C_V) dT = T \left(\frac{\partial S}{\partial V} \right)_T dV - T \left(\frac{\partial S}{\partial p} \right)_T dp$$

The derivative of entropy with respect to pressure can now be eliminated in favor of quantities which are more directly accessible experimentally through the use of a Maxwell relation

$$\left(\frac{\partial S}{\partial p} \right)_T = - \left(\frac{\partial V}{\partial T} \right)_p = -\alpha V$$

Similarly, the derivative of entropy with respect to pressure can be expressed as

$$\left(\frac{\partial S}{\partial V} \right)_T = \left(\frac{\partial p}{\partial T} \right)_V$$

and then related to more accessible quantities with the aid of the cyclic rule

$$\left(\frac{\partial p}{\partial T} \right)_V \left(\frac{\partial T}{\partial V} \right)_p \left(\frac{\partial V}{\partial p} \right)_T = -1 \implies \left(\frac{\partial p}{\partial T} \right)_V = \frac{\alpha}{\kappa_T}$$

Substituting these quantities, we obtain

$$(C_p - C_V) dT = T \frac{\alpha}{\kappa_T} dV + TV\alpha dp$$

Finally, we relate dV and dp to dT using

$$dV = \left(\frac{\partial V}{\partial T} \right)_p dT + \left(\frac{\partial V}{\partial p} \right)_T dp = V(\alpha dT - \kappa_T dp)$$

to finally obtain

$$C_p - C_V = VT \frac{\alpha^2}{\kappa_T}$$

Note that the right-hand side can be evaluated from the mechanical equation of state without reference to the internal energy or entropy of the system. This is an excellent example of the kind of relationship between quantities with no obvious connection that can be derived using thermodynamic reasoning based upon the fact that state functions are completely specified by a limited number of variables.

Although it is often quite difficult to measure C_V directly, particularly for nearly incompressible condensed phases such as liquids or solids, it can nevertheless be obtained indirectly from C_p and measurements of α and κ_T , which are usually much easier. No ambiguities are encountered because the relationship between these quantities is a general

thermodynamic theorem that is independent of the properties of the particular material at hand. Also note that the fact that the isothermal compressibility is virtually always positive implies that C_p is greater than C_V :

$$\kappa_T \geq 0 \implies C_p \geq C_V$$

Finally, the fact that most solids and liquids are almost incompressible suggests that C_p is usually only a little larger than C_V for condensed phases. However, the difference generally increases with temperature and the dependence upon α^2/κ_T can provide a fairly wide range of variation.

■ Example: ideal gas

Isentropic transformations

The mechanical equation of state for an ideal gas is

$$pV = nRT \implies \alpha = \frac{nR}{pV} = \frac{1}{T} \quad \kappa_T = \frac{nRT}{p^2V} = \frac{1}{p}$$

such that

$$VT \frac{\alpha^2}{\kappa_T} = \frac{pV}{T} \implies C_p - C_V = nR$$

The thermal equation of state then gives

$$U = \frac{3}{2} nRT \implies C_V = \frac{3}{2} nR \quad C_p = \frac{5}{2} nR$$

Note that the same result for C_p is obtained from

$$H = U + pV = \frac{5}{2} nRT \implies C_p = \left(\frac{\partial H}{\partial T} \right)_p = \frac{5}{2} nR$$

It is also useful to develop an equation which describes *isentropes*, lines of constant entropy in the pV diagram. Returning to the completeness relationships

$$T dS = T \left(\frac{\partial S}{\partial T} \right)_V dT + T \left(\frac{\partial S}{\partial V} \right)_T dV = T \left(\frac{\partial S}{\partial T} \right)_p dT + T \left(\frac{\partial S}{\partial p} \right)_T dp$$

and using Maxwell relations

$$dS = 0 \implies \frac{C_V}{T} dT = - \left(\frac{\partial p}{\partial T} \right)_V dV \quad \frac{C_p}{T} dT = \left(\frac{\partial V}{\partial T} \right)_p dp$$

we recognize that

$$\gamma = \frac{C_p}{C_V} = - \frac{(\partial V / \partial T)_p}{(\partial p / \partial T)_V} \frac{dp}{dV} \implies \frac{dp}{dV} = -\gamma \frac{p}{V}$$

Therefore, if γ is constant, lines of constant entropy satisfy

$$dS = 0 \implies pV^\gamma = \text{constant}$$

where $\gamma = C_p/C_V$ is the ratio between the principal heat capacities. For a simple ideal gas with no internal molecular degrees of freedom, $U = \frac{3}{2} nRT \implies \gamma = \frac{5}{2}$, but the isentropic relation is more general and applies whenever C_V is constant. For example, at high temperatures $C_V \rightarrow \frac{7}{2} nR \implies C_p \rightarrow \frac{9}{2} nR$ for a gas of diatomic molecules, such that $\gamma = \frac{9}{7}$.

Fundamental relation

Next we construct the fundamental relation for an ideal gas using the completeness relation

$$dS = \left(\frac{\partial S}{\partial T} \right)_p dT + \left(\frac{\partial S}{\partial p} \right)_T dp = \frac{C_p}{T} dT - \left(\frac{\partial V}{\partial T} \right)_p dp$$

If we assume that the heat capacity is independent of temperature and write $C_p = \frac{\gamma}{\gamma-1} nR$ where $\gamma = C_p / C_V$, then

$$dS = \frac{\gamma nR}{\gamma-1} \frac{dT}{T} - \frac{dp}{p}$$

We can now integrate the change in entropy relative to a standard state with temperature T_0 and pressure p_0 to obtain

$$S[T, p, n] = ns_0 + nR \text{Log} \left[\left(\frac{T}{T_0} \right)^{\frac{\gamma}{\gamma-1}} \left(\frac{p_0}{p} \right) \right]$$

where, using the extensivity of entropy, the constant of integration $S[T_0, p_0, n] = ns_0$ must be proportional to the standard molar entropy $s_0 = s_0[T_0, p_0]$. The chemical potential is now obtained from the Euler relation

$$n\mu = U - TS + pV \implies \mu = T \left(\frac{\gamma R}{\gamma-1} - s_0 \right) - RT \text{Log} \left[\left(\frac{T}{T_0} \right)^{\frac{\gamma}{\gamma-1}} \left(\frac{p_0}{p} \right) \right]$$

Identifying $\mu_0 = T_0 \left(\frac{\gamma R}{\gamma-1} - s_0 \right)$ as the chemical potential for the standard state, the molar Gibbs potential becomes

$$\mu[T, p] = \frac{T}{T_0} \mu_0 - RT \text{Log} \left[\left(\frac{T}{T_0} \right)^{\frac{\gamma}{\gamma-1}} \left(\frac{p_0}{p} \right) \right]$$

We can now express entropy in terms of its natural variables as

$$S[U, V, n] = ns_0 + nR \text{Log} \left[\left(\frac{U}{U_0} \right)^{\frac{1}{\gamma-1}} \left(\frac{V}{V_0} \right) \left(\frac{n}{n_0} \right)^{-\frac{\gamma}{\gamma-1}} \right]$$

Notice that the entropy satisfies the extensivity postulate

$$\{U = \lambda U_0, V = \lambda V_0, n = \lambda n_0\} \implies S = \lambda n_0 s_0$$

but that the standard molar entropy $s_0[T_0, p_0]$ remains an undetermined function of temperature and pressure that is related to the chemical potential

$$s_0 = \frac{\gamma R}{\gamma-1} - \frac{\mu_0}{T_0}$$

for the standard state. Now that we have S or G in terms of their natural variables, it is a simple exercise to verify that the mechanical and thermal equations of state are recovered from suitable partial derivatives or to evaluate any of the other thermodynamic potentials in terms of their natural variables, up to the additive constant of integration describing the standard state.

It is interesting to observe that as the temperature approaches zero, the entropy of an ideal gas approaches $-\infty$.

$$T \rightarrow 0 \text{ or } p \rightarrow \infty \implies S \rightarrow -\infty$$

Evidently the ideal gas law cannot be applied to very low temperature or very high pressure. Classical physics fails in these circumstances and we must employ quantum statistical mechanics to calculate entropy for cold dense systems.

Fugacity

The temperature and pressure dependencies of the chemical potential

$$\mu[T, p] = \frac{T}{T_0} \mu_0 - RT \text{Log} \left[\left(\frac{T}{T_0} \right)^{\frac{\gamma}{\gamma-1}} \left(\frac{p_0}{p} \right) \right]$$

merit a second look. Note that for a dilute gas

$$T \gg T_0 \text{ or } p \ll p_0 \implies \mu \rightarrow -\infty$$

becomes large and negative, whereas if the ideal gas equation of state remains valid the chemical potential becomes large and positive for a dense gas

$$T \ll T_0 \text{ or } p \gg p_0 \implies \mu \rightarrow +\infty$$

However, at high density intermolecular interactions become important and the system might condense. Furthermore, at low temperature quantum mechanical effects limit the validity of the classical equations of state. Therefore, the chemical potential tends to be limited at low temperature and/or high density, but the dilute limit of large negative chemical potential still applies to quantum systems. At sufficiently large temperature the gain in entropy dominates over the increase energy, resulting in a large negative chemical potential.

For applications to chemistry and other multicomponent systems, it is useful to express the chemical potential in terms of *fugacity*, f , using

$$\mu = RT \text{Log}[f] + B[T]$$

where $B[T]$ is an unknown function of temperature. The term *fugacity* is derived from the same Latin root as fugitive because it provides a measure of the volatility of a substance, or its tendency to flee. For an ideal gas we find that fugacity reduces to the ratio between the pressure of the system and that of the arbitrarily chosen standard state. Since one normally chooses the standard pressure to be 1 atm, the fugacity reduces to pressure in units of atmospheres. Fugitive tendencies are clearly larger at higher pressure. Notice that for fixed N and T , pressure provides a measure of the concentration the gas. In general, one finds that fugacity depends upon the concentration of a substance but does not depend explicitly upon temperature. For small (large) fugacity we find large negative (positive) chemical potential.

Magnetic Systems

■ Magnetic work

The response of materials to magnetic fields offers a rich menu of phenomena for which relatively simple models can be used to demonstrate applications of the methods of statistical physics. Unfortunately, different conventions are sometimes used for thermodynamics and statistical mechanics. The thermodynamic definition of magnetic susceptibility is also different from that normally used in electrodynamics. Therefore, in this section we present the terminology and notation used in this course in the hope that some confusion can be avoided.

When analyzing electromagnetic systems we must be particularly careful to distinguish clearly between the system and its environment because electromagnetic fields can couple charges and currents separated by large distances. Thus, it

is frequently difficult to define the physical borders of an electromagnetic system. Furthermore, the work performed in establishing a system of charges and currents resides in fields distributed throughout space. Therefore, the energy that would have been carried by electromagnetic fields in the absence of polarizable media should be associated with the batteries or other external devices used to establish the field. The thermodynamic energy associated with a finite sample of some material is identified with the difference between the electromagnetic fields within the volume of the material that are produced by a specified configuration of external charges and currents with and without the presence of the sample. The analysis of the general case is quite difficult, but for our purposes it will suffice to motivate the thermodynamic definition of magnetic work using two simple systems.

First, consider a cylindrical sample that fills a long solenoid or a sample that fills a toroidal solenoid. In either case the magnetizing field has uniform strength throughout the volume of the material. Assume for simplicity that the magnetization of the sample is also uniform and is parallel to \vec{H} so that vectors can be replaced by scalars. A simple model for magnetization postulates a dense array of tiny current loops whose sum can be represented by a surface current density, $K = \mathcal{M}c$. Faraday's law tells us that variation of the magnetic flux Φ produces an electromotive force

$$\mathcal{E} = -\frac{1}{c} \frac{\partial \Phi}{\partial t} = -\frac{A}{c} \frac{\partial \mathcal{H}}{\partial t}$$

so that the work performed upon the surface current becomes

$$\delta W = \ell K \mathcal{E} dt = -\frac{K}{c} \ell d\Phi = -V \mathcal{M} d\mathcal{H}$$

where the factor ℓ accounts for the length of the cylindrical current sheet. This model describes the diamagnetic response of a nonpolar material, for which Lenz's law suggests that the induced current opposes the applied field. Although we represented the magnetization of the sample using a surface current, this surface current is not subject to resistive dissipation because it is actually composed of changes to atomic structure rather than to macroscopic motion of charges.

Next, suppose that we assemble a thermally isolated collection of permanent magnetic dipoles in the absence of an external magnetic field. We now ask how much the energy of this arrangement changes when an external magnetic field is applied. The interaction between a collection of magnetic dipoles $\vec{\mu}_i$ and an external magnetic field \vec{H} takes the form

$$U = -\sum_i \vec{\mu}_i \cdot \vec{H}$$

such that there are two contributions

$$dU = -\sum_i (\vec{H} \cdot d\vec{\mu}_i + \vec{\mu}_i \cdot d\vec{H}) = -V (\vec{H} \cdot d\vec{\mathcal{M}} + \vec{\mathcal{M}} \cdot d\vec{H})$$

to variation of the magnetic energy that we must classify either as heat or work. From a microscopic point of view, changes in the orientation of the elementary dipoles are considered to be changes in the population of quantum states and the resultant energy change is classified as heat whereas changes to the energy of a quantum state with constant orientation due to variation of the external field is classified as work. Thus, the work done on a system of fixed magnetic dipoles becomes

$$\delta W = -\sum_i \vec{\mu}_i \cdot d\vec{H} = -V \vec{\mathcal{M}} \cdot d\vec{H}$$

We will soon find that this allocation of energy changes is consistent with the statistical interpretation of heat altering the distribution of energy among quantum states and work changing the energy of quantum states.

For both models we find that magnetic work is represented by $\delta W = -V \vec{\mathcal{M}} \cdot d\vec{H}$ where $\vec{\mathcal{M}}$ is the magnetization density and \vec{H} is the external or applied magnetic field. Defining a simple magnetic system as one in which magnetization is the only work mode, we can now *define* the internal energy density of the sample using

$$dU = \delta Q + \delta W = T dS - \vec{\mathcal{M}} \cdot d\vec{H}$$

without need for a more general analysis of the electrodynamics of polarizable media. Recognizing that there are usually additional internal degrees of freedom that can receive energy from heat exchange, we express the heat transfer as $\delta Q = T dS$ rather than limit that term to the magnetic contribution alone. From a thermodynamic point of view it is sufficient to define the independent variables in terms of quantities which can be manipulated externally and then to analyze the response of the sample to variations of those variables. Notice that we have changed notation — here U and S represent energy and entropy per unit volume.

■ Thermodynamic description of magnetization

The fundamental thermodynamic relation for a simple magnetic system, for which magnetization is the only work mode, can be expressed in the form

$$dU = T dS - \overline{\mathcal{M}} \cdot d\overline{\mathcal{H}}$$

where U , S , and $\overline{\mathcal{M}}$ are the energy, entropy, and magnetic moment. These extensive quantities are often expressed in volumetric (per unit volume), molar (per mole), or specific (per unit mass) forms without changing notation. The magnetizing field produced by free currents in coils outside the thermodynamic system is denoted $\overline{\mathcal{H}}$, which must not be confused with similar symbols for enthalpy or Hamiltonian. It is unfortunate that similar symbols are used for very different quantities, but introduction of new notation would probably lead to more confusion; the proper interpretation should be clear from the context. The principal magnetic heat capacities are now defined as

$$C_{\mathcal{M}} = T \left(\frac{\partial S}{\partial T} \right)_{\mathcal{M}} \quad C_{\mathcal{H}} = T \left(\frac{\partial S}{\partial T} \right)_{\mathcal{H}}$$

The magnetization of the sample is obtained from the dependence of the internal energy upon external magnetic field according to

$$\overline{\mathcal{M}} = - \left(\frac{\partial U}{\partial \overline{\mathcal{H}}} \right)_S$$

which, in more conventional notation, should be interpreted as

$$\mathcal{M}_i = - \left(\frac{\partial U}{\partial \mathcal{H}_i} \right)_{S, \mathcal{H}_{j \neq i}}$$

where the i^{th} component of $\overline{\mathcal{M}}$ is obtained by differentiation with respect to the i^{th} component of $\overline{\mathcal{H}}$ holding other components, and S , fixed. Similarly, in thermodynamics we define the isothermal magnetic susceptibility as

$$\chi = \left(\frac{\partial \overline{\mathcal{M}}}{\partial \overline{\mathcal{H}}} \right)_T \iff \chi_{i,j} = \left(\frac{\partial \mathcal{M}_i}{\partial \mathcal{H}_j} \right)_T$$

For most systems the magnetization will be parallel to the external magnetic field so that the susceptibility tensor reduces to a scalar and we may replace $\overline{\mathcal{M}} \cdot d\overline{\mathcal{H}} \rightarrow \mathcal{M} d\mathcal{H}$, but for some crystalline or ferromagnetic materials it is necessary to consider the tensorial properties of the magnetic susceptibility. Note that the thermodynamic definition of magnetic susceptibility is different from that used in electrodynamics where one writes $\overline{\mathcal{M}} = \chi \cdot \overline{\mathcal{H}}$. These definitions are the same if the response to the applied field is linear, but can be appreciably different for strongly magnetized samples or near saturation.

The volumetric magnetic susceptibility χ is dimensionless in the cgs or electrostatic system, but because of the large variation among densities of common substances it is often more convenient to present susceptibility data in molar form

$$\tilde{\chi} = \frac{A}{\rho} \chi$$

where A the molecular weight in g/mole and ρ is density in g/cm^3 , such that the units of $\tilde{\chi}$ become cm^3/mole .

Many thermodynamic relationships can now be derived for magnetic systems using the same techniques applied above to compressible systems. Some of these relationships are developed in the problems at the end of this notebook.

■ Alternative form for magnetic work

We have chosen the formulation of the first law for magnetic systems that is most convenient formulation for statistical mechanics, but many textbooks on thermodynamics offer an alternative form

$$d\tilde{U} = T dS + \overline{\mathcal{H}} \cdot d\overline{\mathcal{M}}$$

In this form $\tilde{U} = \tilde{U}[S, \mathcal{M}]$ and $S = S[\tilde{U}, \mathcal{M}]$ are extensive functions of extensive variables, consistent with the postulates and methodology of thermodynamics. The external magnetic field \mathcal{H} is treated as an intensive variable, analogous to p , that is conjugate to the extensive variable \mathcal{M} , analogous to V . However, one need not be enslaved by this formal analogy — these two versions of the first law are related by a simple Legendre transformation $U = \tilde{U} - \overline{\mathcal{H}} \cdot \overline{\mathcal{M}}$. Therefore, the thermodynamic consequences of either formulation are identical: the same change in external conditions produces the same change of state. In one formulation we refer to U as energy and \tilde{U} as enthalpy while in the other formulation these names are simply interchanged.

The origin of the difference between these forms of the first law is the assignment of the field energy to the system or to the environment. To demonstrate this relationship, let us return to the example of a polarizable material filling a toroidal solenoid. The variation of the magnetic flux linking the solenoid produces a back emf upon the external coils

$$\mathcal{E} = -\frac{1}{c} \frac{\partial \Phi}{\partial t} = -\frac{A}{c} \frac{\partial B}{\partial t}$$

where $B = \mathcal{H} + 4\pi\mathcal{M}$ is the total magnetic field within the coils. The work performed by the current source is

$$\delta \tilde{W} = -NI\mathcal{E} dt = NAI dB$$

where N is the number of turns. Recognizing that the current is related to the magnetizing field by

$$I = \frac{\ell}{N} \frac{c}{4\pi} \mathcal{H} \implies \overline{d} W' = \frac{V}{4\pi} \mathcal{H} dB$$

we find that the magnetic work

$$\delta \tilde{W} = V d\left(\frac{\mathcal{H}^2}{8\pi}\right) + V\mathcal{H} d\mathcal{M}$$

contains two contributions. The first can be attributed to the work needed to establish the vacuum field \mathcal{H} that would be present in the absence of the magnetic material — it is the energy of the magnetic field. The second is the work needed to magnetize the sample given that the current in the coils is specified by \mathcal{H} . If we attribute the first contribution to the vacuum field and the second to the sample, we would conclude that the thermodynamic definition of the internal energy of the sample should be

$$d\tilde{U} = T dS + \overline{\mathcal{H}} \cdot d\overline{\mathcal{M}}$$

Our derivation of δW computed the work done on the magnetization of the sample, as represented by the surface current K , while the derivation of $\delta \tilde{W}$ computed the work on the current I in the external coils. Thus, the sample analyzed by the former consists of the sample itself, with coils and their field energy assigned to the environment, while the system analyzed by the latter also includes these coils and their field energy and limits the external environment to the current source (battery). Therefore, these two derivations obtain different results because they analyze different systems. Should we assign the field energy to the sample or to the environment? This is largely a philosophical question because

the field pervades the sample and the energy cannot be located unambiguously. Like most philosophical questions, this one causes a lot of confusion but has no dynamical consequences!

■ Survey of magnetic phenomena

All atoms exhibit some degree of *diamagnetism* in which there is a negative temperature-independent contribution to the magnetic susceptibility. A simple model of diamagnetic susceptibility suggests

$$\tilde{\chi} \approx -\frac{Z e^2 \langle r^2 \rangle}{6 m_e c^2} N_A$$

where N_A is Avogadro's number, Z is the atomic number, and $\langle r^2 \rangle$ is the atomic mean square charge radius. This model is most applicable to noble gases, which are monatomic, nonpolar, inert, and dilute. One finds that diamagnetic susceptibilities for noble gases at STP range from $-1.9 \times 10^{-6} \text{ cm}^3 / \text{mole}$ for helium to $-43 \times 10^{-6} \text{ cm}^3 / \text{mole}$ for xenon and are roughly consistent with the Langevin model. However, quantitative understanding of diamagnetism in condensed matter requires more sophisticated models. For example, atomic bismuth and lead differ by only one electron but the diamagnetic susceptibilities for solid bismuth and lead differ by a factor of about 23.

Many atoms and molecules possess permanent magnetic dipole moments, μ , which contribute a positive temperature-dependent *paramagnetic* susceptibility arising from their alignment with an applied field. The temperature dependence of the paramagnetic susceptibility is governed by the ratio $\mu \mathcal{H} / k_B T$ between magnetic and thermal energies. At "high" temperature, $k_B T \gg \mu \mathcal{H}$, paramagnetic susceptibility is described well by Curie's law

$$k_B T \gg \mu \mathcal{H} \implies \tilde{\chi} \approx \frac{N_A \mu^2}{k_B T} = \frac{\chi_0}{T}$$

where the Curie constant, χ_0 , depends upon the microscopic structure of the material. Assuming that the magnetic moment is similar to the Bohr magneton, we may estimate the typical scale for χ_0 as

$$\mu \sim \mu_B = \frac{e \hbar}{2 m_e c} = 9.27 \times 10^{-27} \text{ erg/gauss} \implies \chi_0 \sim 0.375 \text{ cm}^3 \text{ kelvin/mole}$$

but must recognize that real materials exhibit a broad range of magnetic susceptibilities. For example, at STP we find paramagnetic $\tilde{\chi} = 3.45 \times 10^{-3} \text{ cm}^3 / \text{mole}$ for O_2 compared with diamagnetic $\tilde{\chi} = -1.22 \times 10^{-5} \text{ cm}^3 / \text{mole}$ for N_2 .

As the temperature is reduced below a critical value T_c , many paramagnetic materials will experience a sudden phase transition as *spontaneous magnetization* develops in the absence of an external magnetic field. At high temperatures these materials revert to paramagnetism and obey an empirical equation of state known as the Curie-Weiss law

$$T > T_c \implies \tilde{\chi} = \frac{\chi_0}{T - T_c}$$

in which temperature is measured relative to T_c . At lower temperatures interatomic spin-spin interactions favorable to the alignment of neighboring magnetic moments overcome the randomizing influence of lattice vibrations leading to an ordered *ferromagnetic* state with spontaneous magnetization that does not require an external magnetic field. The degree of magnetization increases as the sample is cooled, or as the external field is increased, until the sample is *saturated* at its maximum magnetization \mathcal{M}_s . Iron is a typical ferromagnet with Curie temperature $T_c = 1043 \text{ kelvin}$ and room temperature saturation $\mathcal{M}_s = 1707 \text{ gauss}$. Although the saturated magnetization is easy to estimate using the density and atomic magnetic moment, the Curie temperature is more subtle. The temperature scale for magnetic spin-spin interactions, ε / k_B , can be estimated using the Bohr magneton and an interatomic spacing of about one angstrom to be

$$\frac{\varepsilon}{k_B} \sim \frac{\mu_B^2}{r^3 k_B} \sim 0.62 \text{ kelvin}$$

and is far too small to account for room-temperature ferromagnetism. The interaction responsible for ferromagnetism is actually electrostatic in nature, with characteristic temperature scale

$$\frac{\varepsilon}{k_B} \sim \frac{e^2}{r k_B} \sim 1.7 \times 10^5 \text{ kelvin}$$

for the same one angstrom separation. The apparent spin dependence of this electrostatic interaction arises from the exchange term required by the Pauli exclusion principle — it is a purely quantum mechanical consequence of permutation symmetry for identical particles that is without classical analog.

The interatomic spin-spin interaction can take either sign, favoring parallel spins for ferromagnetic systems or antiparallel spins for *antiferromagnetic* systems. At high temperatures and zero field the spins are oriented randomly, but for temperatures below a critical temperature, T_N , named after Néel, antiferromagnetic systems experience a phase transition to an ordered state that remains macroscopically unmagnetized but with local order due to alternating spins. At higher temperatures the paramagnetic susceptibility can be parametrized by

$$T > T_N \implies \tilde{\chi} = \frac{\chi_0}{T + T_P}$$

where T_P is comparable, but not necessarily equal, to T_N . For example, iron oxide (FeO) is antiferromagnetic with $T_N = 198$ kelvin and $T_P = 507$ kelvin. Clearly, these temperatures are determined by electrostatic rather than magnetostatic interactions also.

Finally, superconductors also display interesting magnetic properties. Provided that the applied field is not too strong, type-I superconductors exhibit the *Meissner effect* in which surface currents shield their volumes from magnetic fields, such that

$$T < T_c \text{ and } H < H_c[T] \implies \mathcal{M} = -\frac{\mathcal{H}}{4\pi} \implies B = 0$$

Stronger fields destroy the superconducting phase. Experimentally one finds that the boundary between superconducting and normal phases can be parametrized by

$$\frac{H_c[T]}{H_0} = 1 - \left(\frac{T}{T_c}\right)^2$$

Type-II superconductors, on the other hand, permit quantized magnetic flux tubes to penetrate their volume. Often these flux tubes are pinned by impurities or defects, but sometimes they are free to move, forming a kind of two-dimensional vortex gas. If the vortex density is high, a lattice structure may be found. The magnetic behavior of superconductors remains a very active research topic.

Constrained equilibrium

The principle of maximum entropy requires that any spontaneous transformation of an isolated system increases its entropy. Thus, if a system begins in some arbitrary nonequilibrium condition, internal changes tend to accumulate until the entropy reaches the maximum possible value compatible with the external constraints, which finally becomes the state of thermodynamic equilibrium. For the present purposes, we can consider a system to be isolated if all of its extensive quantities (such as energy, volume, and particle number) are fixed. However, the distribution of these extensive quantities is generally nonuniform in some arbitrary initial configuration. Suppose that an isolated system is divided into two subsystems which share the total internal energy, volume, particle number, and any other extensive quantities needed to characterize its state, such that

$$\begin{aligned}
U &= U_1 + U_2 \\
V &= V_1 + V_2 \\
N &= N_1 + N_2 \\
&\vdots
\end{aligned}$$

If the system is isolated, these extensive quantities are conserved, such that

$$\begin{aligned}
dU &= 0 \implies dU_1 = -dU_2 \\
dV &= 0 \implies dV_1 = -dV_2 \\
dN &= 0 \implies dN_1 = -dN_2 \\
&\vdots
\end{aligned}$$

represent the constraints. Thus, variations of the total entropy $S = S_1 + S_2$ can then be expressed as

$$\begin{aligned}
dS &= \left(\left(\frac{\partial S_1}{\partial U_1} \right)_{V_1, N_1} - \left(\frac{\partial S_2}{\partial U_2} \right)_{V_2, N_2} \right) dU_1 + \\
&\left(\left(\frac{\partial S_1}{\partial V_1} \right)_{U_1, N_1} - \left(\frac{\partial S_2}{\partial V_2} \right)_{U_2, N_2} \right) dV_1 + \left(\left(\frac{\partial S_1}{\partial N_1} \right)_{V_1, U_1} - \left(\frac{\partial S_2}{\partial N_2} \right)_{V_2, U_2} \right) dN_1 + \dots
\end{aligned}$$

Thermal equilibrium between the two subsystems requires that dS be stationary with respect to first-order variations of each variable independently, such that

$$dS = 0 \implies T_1 = T_2 \quad p_1 = p_2 \quad \mu_1 = \mu_2$$

where the fundamental relations

$$T_i dS_i = dU_i + p_i dV_i - \mu_i dN_i + \dots$$

are used to identify the intensive parameters $\{T, p, \mu, \dots\}$ conjugate to the extensive variables $\{U, V, N, \dots\}$ for each subsystems. Therefore, thermal equilibrium between two systems requires equality between their intensive parameters. These intensive parameters govern the sharing of a conserved extensive quantity between interacting subsystems. Furthermore, by choosing one of the systems to be a small but macroscopic portion of a larger system, we conclude that equilibrium requires the intensive parameters like temperature, pressure, and chemical potential to be uniform throughout the system. Any local fluctuations in these parameters would induce unbalanced forces that tend to restore equilibrium by eliminating gradients in the intensive parameters. Obviously, temperature or pressure gradients would induce heat or mass flows that tend to homogenize the system.

The maximum entropy principle can also be applied to systems that are in thermal, mechanical, or chemical contact with an environment that constrains one or more of its intensive parameters. For example, we often seek to determine the equilibrium state for a system with fixed temperature and pressure instead of fixed energy and volume. Under these conditions it is useful to consider a small subsystem with energy U_1 and volume V_1 in thermal and mechanical contact with a much larger reservoir. If the initial configuration is not in equilibrium there will be exchanges of energy and volume between the subsystem and the reservoir. We assume that the reservoir is sufficiently large that small transfers of energy or volume do not change the temperature T_0 or pressure p_0 of the reservoir. The net change in entropy for the combined system can be expressed as

$$dS = dS_0 + dS_1 \geq 0$$

where

$$dS_0 = -\frac{\delta Q}{T_0}$$

is the entropy change for the reservoir when a quantity of heat δQ is transferred to the subsystem. (The negative sign occurs because heat absorbed by the subsystem came from the reservoir.) The principle of maximum entropy then requires

$$dS \geq 0 \implies dS_1 \geq T_0 dS_0$$

such that the increase in the entropy of the subsystem is at least as large as the decrease of the entropy of the reservoir that occurs when heat is transferred from the reservoir to the subsystem. The change in the internal energy of the subsystem can be expressed as

$$dU_1 = \delta Q + \delta W = -T_0 dS_0 - p_0 dV_1 + \delta W' = T_0 (dS_1 - dS) - p_0 dV_1 + \delta W'$$

where it is convenient to divide the work into two contributions, $\delta W = -p_0 dV_1 + \delta W'$, where $\delta W'$ is nonmechanical work performed upon the subsystem in some form other than mechanical work against the constant external pressure p_0 . The requirement that the total entropy increases can now be expressed as

$$dS \geq 0 \implies dA \leq \delta W'$$

where the *availability* A is defined as

$$A = U_1 - T_0 S_1 + p_0 V_1 \implies dA = dU_1 - T_0 dS_1 + p_0 dV_1$$

Although this availability function strongly resembles the Gibbs free enthalpy G_1 for the subsystem, it is important to recognize that we do not require the temperature and pressure of the subsystem to match those of the environment; hence, T_0 and p_0 appear as fixed parameters in A .

Notice that availability describes an interaction between a system and its environment and, hence, involves external parameters T_0 and p_0 in addition to the thermodynamic variables of the system itself. Thus, there may be several variables describing internal degrees of freedom which remain implicit within U_1 and S_1 . Nevertheless, changes in availability can be expressed in terms of changes of internal state coupled to the external parameters through

$$\Delta A = \Delta U_1 - T_0 \Delta S_1 + p_0 \Delta V_1$$

If no external work W' is performed, spontaneous changes of state reduce the availability ($dA \leq 0$) until a state of minimum availability compatible with the external parameters is reached. This then is the state of constrained equilibrium. The net change in availability must be negative, $\Delta A \leq 0$.

We illustrate this principle by deriving stability conditions for a closed simple compressible system; more complicated systems can be analyzed using similar methods. Consider a large homogeneous sample of a pure substance. We can imagine that any small element constitutes a separate system in thermal contact with a reservoir at temperature T_0 and pressure p_0 . Equilibrium for this subsystem requires that its availability $A = U - T_0 S + p_0 V$ be minimized, where the subscripts identifying the subsystem can now be dropped. At equilibrium, the first derivatives of availability with respect to any of the system parameters must vanish. Furthermore, if the equilibrium is to be stable, the second derivatives must all be positive. Applying these observations to temperature and pressure, we require

$$\begin{aligned} \left(\frac{\partial A}{\partial T}\right)_p &= 0 & \left(\frac{\partial^2 A}{\partial T^2}\right)_p &\geq 0 \\ \left(\frac{\partial A}{\partial p}\right)_T &= 0 & \left(\frac{\partial^2 A}{\partial p^2}\right)_T &\geq 0 \end{aligned}$$

The conditions on the first derivatives give

$$\begin{aligned} \left(\frac{\partial U}{\partial T}\right)_p - T_0 \left(\frac{\partial S}{\partial T}\right)_p + p_0 \left(\frac{\partial V}{\partial T}\right)_p &= 0 \\ \left(\frac{\partial U}{\partial p}\right)_T - T_0 \left(\frac{\partial S}{\partial p}\right)_T + p_0 \left(\frac{\partial V}{\partial p}\right)_T &= 0 \end{aligned}$$

where T_0 and p_0 are constant. It is helpful to compare these equations with corresponding derivatives of G .

$$\begin{aligned}\left(\frac{\partial G}{\partial T}\right)_p = -S &\implies \left(\frac{\partial U}{\partial T}\right)_p - T\left(\frac{\partial S}{\partial T}\right)_p + p\left(\frac{\partial V}{\partial T}\right)_p = 0 \\ \left(\frac{\partial G}{\partial p}\right)_T = V &\implies \left(\frac{\partial U}{\partial p}\right)_T - T\left(\frac{\partial S}{\partial p}\right)_T + p\left(\frac{\partial V}{\partial p}\right)_T = 0\end{aligned}$$

Thus, we can eliminate the internal energy by subtracting corresponding pairs of equations, with the result:

$$\begin{aligned}(T - T_0)\left(\frac{\partial S}{\partial T}\right)_p - (p - p_0)\left(\frac{\partial V}{\partial T}\right)_p &= 0 \\ (T - T_0)\left(\frac{\partial S}{\partial p}\right)_T - (p - p_0)\left(\frac{\partial V}{\partial p}\right)_T &= 0\end{aligned}$$

Expressing the remaining derivatives in terms of standard thermodynamic coefficients, we find

$$\begin{aligned}(T - T_0)\frac{C_p}{T} - (p - p_0)V\alpha &= 0 \\ (T - T_0)\alpha - (p - p_0)\kappa_T &= 0\end{aligned}$$

Given that the coefficients of $(T - T_0)$ and $(p - p_0)$ are independent, and that V can be chosen arbitrarily, the only solution to this system of equations is

$$T = T_0 \quad \text{and} \quad p = p_0$$

The fact that equilibrium requires equalization of temperature and pressure was obvious *a priori*.

Stable equilibrium requires the second derivatives of availability to be positive, from which we deduce

$$\begin{aligned}\left(\frac{\partial^2 U}{\partial T^2}\right)_p - T_0\left(\frac{\partial^2 S}{\partial T^2}\right)_p + p_0\left(\frac{\partial^2 V}{\partial T^2}\right)_p &\geq 0 \\ \left(\frac{\partial^2 U}{\partial p^2}\right)_T - T_0\left(\frac{\partial^2 S}{\partial p^2}\right)_T + p_0\left(\frac{\partial^2 V}{\partial p^2}\right)_T &\geq 0\end{aligned}$$

Similarly, by differentiating G twice we find

$$\begin{aligned}\left(\frac{\partial^2 U}{\partial T^2}\right)_p - T\left(\frac{\partial^2 S}{\partial T^2}\right)_p + p\left(\frac{\partial^2 V}{\partial T^2}\right)_p &= \left(\frac{\partial S}{\partial T}\right)_p \\ \left(\frac{\partial^2 U}{\partial p^2}\right)_T - T\left(\frac{\partial^2 S}{\partial p^2}\right)_T + p\left(\frac{\partial^2 V}{\partial p^2}\right)_T &= -\left(\frac{\partial V}{\partial p}\right)_T\end{aligned}$$

Hence, by comparing these expressions for $T = T_0$ and $p = p_0$, we discover that stable equilibrium requires

$$C_p \geq 0 \quad \kappa_T \geq 0$$

In retrospect, these conditions should also be obvious. First, if any stable equilibrium existed for which removing heat resulted in an increase in temperature, we could exploit this fictitious substance to produce an engine that violated the Clausius statement of the second law. Second, if a material would contract as the pressure upon it is reduced, it would collapse spontaneously into a state of extraordinary density. Obviously, such behavior is incompatible with stability.

Once equilibrium is reached, the availability for a system in thermal and mechanical contact with a reservoir with constant temperature and pressure becomes equal to the Gibbs free enthalpy for that system. Hence, the state of minimum availability is also the state of minimum free enthalpy for constant (T, p) . Alternatively, if the volume of the system is fixed, we would define Helmholtz availability as $A = U - T_0 S$ and find that equilibrium with minimum availability is

achieved by minimizing F for constant (T, V) . Therefore, application of the maximum entropy principle to system with constraints on variables (x, y, \dots) requires extremizing the thermodynamic potential obtained from U by a Legendre transformation with respect to (x, y, \dots) . Some of the most common choices are listed below, but others can be developed by straightforward generalization or analogy.

constraints	equilibrium condition
U, V, N	maximize S
T, V, N	minimize $F = U - TS$
U, p, N	minimize $H = U + pV$
T, p, N	minimize $G = U - TS + pV$

Stability

■ Local stability

Although thermodynamic equilibrium is often defined as the state for which macroscopic parameters are effectively constant, fluctuations are an inevitable aspect of the behavior of bulk matter, especially when interactions with the environment, such as heat transfer, are considered. Thus, for any state to represent a true equilibrium, the state must be stable against small perturbations of its parameters. In other words, small changes induced by interactions with the environment or with various parts of the system must experience restoring forces which tend to return those parameters to their equilibrium values. This property of equilibrium is known as *Le Chatelier's principle*.

Le Chateliers' principle:

If a system is in stable equilibrium, any perturbation produces processes which tend to restore the system to its original equilibrium state.

In this section we use the stability requirement that perturbations produce restoring forces to derive constraints upon the response functions.

Suppose that a large system is subdivided into subsystems or cells such that the extensive quantities are obtained by summation over cells according to

$$S = \sum_i S_i, \quad U = \sum_i U_i, \quad V = \sum_i V_i, \quad \dots$$

Let $\{\tilde{U}_i, \tilde{V}_i, \dots\}$ represent equilibrium values for each cell and let S_0 be the state of maximum entropy. The principle of maximum entropy requires that $dS = 0$ and $d^2S \leq 0$ for arbitrary infinitesimal fluctuations about the equilibrium configuration. Thus, the difference in entropy $S - S_0$ resulting from infinitesimal fluctuations of cell variables about their equilibrium values can be computed using a Taylor expansion of the form

$$d^2S \approx \frac{1}{2} \sum_i \left(\frac{\partial^2 S_i}{\partial U_i^2} (dU_i)^2 + \frac{\partial^2 S_i}{\partial U_i \partial V_i} dU_i dV_i + \frac{\partial^2 S_i}{\partial V_i^2} (dV_i)^2 \right)$$

where $d^2 S$ indicates a second-order variation and where the derivatives are evaluated at the equilibrium state for each cell. In the interests of minimizing clutter, we consider only two degrees of freedom per cell and omit the constraints when writing partial derivatives. Recognizing that

$$d\left(\frac{\partial S_i}{\partial U_i}\right) = \frac{\partial^2 S_i}{\partial U_i^2} dU_i + \frac{\partial^2 S_i}{\partial V_i \partial U_i} dV_i$$

$$d\left(\frac{\partial S_i}{\partial V_i}\right) = \frac{\partial^2 S_i}{\partial U_i \partial V_i} dU_i + \frac{\partial^2 S_i}{\partial V_i^2} dV_i$$

the variation of S can be expressed as

$$d^2 S \approx \frac{1}{2} \sum_i \left(d\left(\frac{\partial S_i}{\partial U_i}\right) dU_i + d\left(\frac{\partial S_i}{\partial V_i}\right) dV_i \right) = \frac{1}{2} \sum_i \left(d\left(\frac{1}{T_i}\right) dU_i + d\left(\frac{p_i}{T_i}\right) dV_i \right)$$

where

$$\left(\frac{\partial S_i}{\partial U_i}\right)_{V_i} = \frac{1}{T_i} \quad \left(\frac{\partial S_i}{\partial V_i}\right)_{U_i} = \frac{p_i}{T_i}$$

Finally, using

$$dU_i = T_i dS_i - p_i dV_i$$

we find that fluctuations in the total entropy due to local fluctuations in the thermodynamic properties can be computed using the deceptively simple formula

$$d^2 S \approx -\frac{1}{2} \sum_i \frac{1}{T_i} (dT_i dS_i - dp_i dV_i)$$

Stability of the equilibrium state requires that any arbitrary set of local fluctuations must decrease the total entropy, such that $d^2 S \leq 0$. Suppose that we assume that $dV_i = 0$ and express fluctuations in the local entropy in terms of temperature fluctuations, such that

$$dV_i = 0 \implies dS_i = C_{V,i} \frac{dT_i}{T_i} \implies d^2 S \approx -\frac{1}{2} \sum_i C_{V,i} \left(\frac{dT_i}{T_i}\right)^2 \implies C_V \geq 0$$

Therefore, thermal stability requires

$$C_p \geq C_V \geq 0$$

Similarly, if we assume that $dT_i = 0$ and express local density fluctuations in volume in terms of pressure fluctuations, we find

$$dT_i = 0 \implies dV_i = -V_i \kappa_{T,i} dp_i \implies d^2 S \approx -\frac{1}{2} \sum_i \frac{V_i \kappa_{T,i}}{T_i} (dp_i)^2 \implies \kappa_T \geq 0$$

Conversely, if we assume $dS_i = 0$ then

$$dS_i = 0 \implies dV_i = -V_i \kappa_{S,i} dp_i \implies d^2 S \approx -\frac{1}{2} \sum_i \frac{V_i \kappa_{S,i}}{T_i} (dp_i)^2 \implies \kappa_S \geq 0$$

where

$$\kappa_S = -\frac{1}{V} \left(\frac{\partial V}{\partial p} \right)_S$$

is the adiabatic compressibility. One can easily show that $\kappa_T \geq \kappa_S$. Therefore, mechanical stability requires

$$\kappa_T \geq \kappa_S \geq 0$$

It should be obvious by now that many other conditions upon thermodynamic response functions can be derived by generalizing these stability requirements to systems with different or larger sets of independent variables.

■ Global stability

There is a simple geometrical interpretation of the local stability condition $d^2 S \leq 0$. Suppose that a uniform system is divided into two equal parts and consider the sharing of an extensive quantity X between the subsystems. For example, the total entropy $S_T[U_1, U_2] = S_1[U_1] + S_2[U_2]$ for an isolated system consisting of two systems that share energy but have fixed volumes and particle numbers can be expressed as a function of a single variable

$$U_1 = \frac{U}{2} + \Delta U, \quad U_2 = \frac{U}{2} - \Delta U \quad \implies \quad S_T[U_1, U_2] \longrightarrow S_T[X] = S_1\left[\frac{U}{2} + X\right] + S_2\left[\frac{U}{2} - X\right]$$

The figure below illustrates the change in entropy that results from a transfer ΔX from one subsystem to the other. The central point represents the equilibrium state for the composite system. If $S(U)$ is a concave function, a transfer ΔU from system 1 to system 2 reduces the entropy of system 1 more than it increases the entropy of system 2; hence, there is a net decrease of entropy. On the other hand, if $S[U]$ is a convex function, the same transfer results in a net increase of entropy. Therefore, the concave entropy function is consistent with the maximum entropy principle, but the convex function is not. A convex entropy function cannot represent a stable equilibrium state because the system can increase its entropy by redistributing one or more of its extensive quantities.

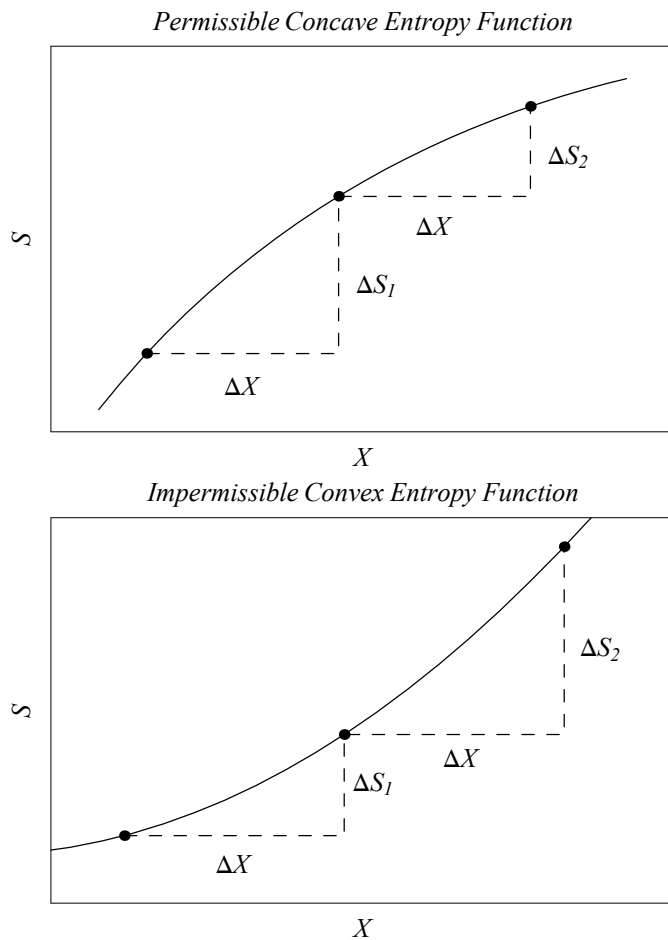

These arguments can clearly be extended to finite displacements of energy or other extensive quantities. There, global stability requires entropy to be concave with respect to arbitrarily large displacements, such that

$$\left. \begin{aligned} S[U + \Delta U, V] &\leq S[U, V] + \left(\frac{\partial S}{\partial U}\right) \Delta U \\ S[U - \Delta U, V] &\leq S[U, V] - \left(\frac{\partial S}{\partial U}\right) \Delta U \end{aligned} \right\} S[U + \Delta U, V] + S[U - \Delta U, V] \leq 2S[U, V]$$

even for finite displacements of energy. However, sometimes a model produces thermodynamic functions that are stable in some ranges of its variables but unstable in others. Under these conditions a system that is local stable may be able to increase its entropy by means of a large change even though small changes reduce the entropy.

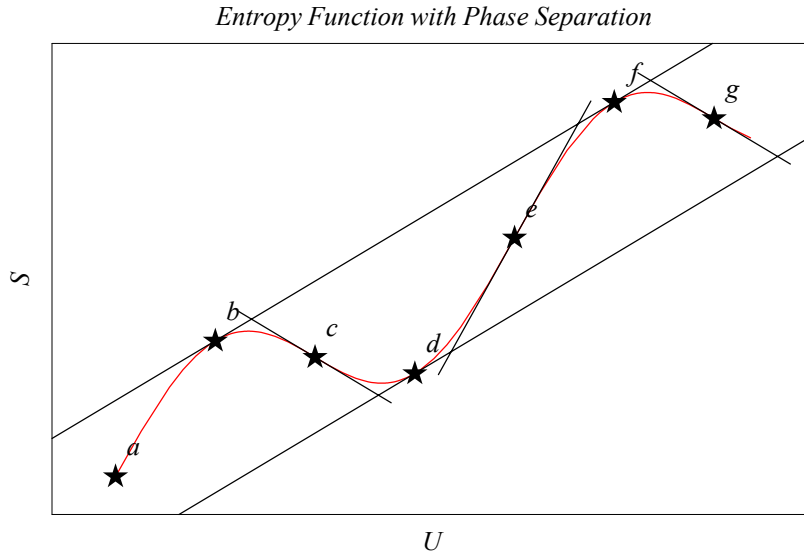

Consider the hypothetical entropy function sketched above. The entropy is locally stable in the concave regions abc and efg where it lies below its tangent lines, but is unstable in the convex region cde where it lies above its tangent lines. Suppose that the system starts near point b and that we add heat, increasing the internal energy beyond point c . What will be state of the system for energies between U_c and U_e ? This type of system can reach a stable state if it separates into two phases, with some fraction x_b near point b and the rest near point f such that

$$\left. \begin{aligned} U &= x_b U_b + x_f U_f \\ U_b \leq U \leq U_f &\implies S = x_b S[U_b] + x_f S[U_f] \\ x_f &= 1 - x_b \end{aligned} \right\} x_b = \frac{U - U_b}{U_f - U_b}, \quad x_f = \frac{U_f - U}{U_f - U_b}$$

describes an interpolation between two phases. The entropy of such a binary mixture is clearly higher than the entropy of any pure state on the entropy curve between points b and f . In particular, even though the system is locally stable on the segments bc and ef , the entropy of the mixed configuration is higher. Thus, those segments contain metastable states which appear stable for small perturbations, but the mixed configurations with the same energy represent more stable states with higher entropy. Even if the metastable state persists for some finite time, eventually one expects that a sufficiently large fluctuation will inform the system that a more stable configuration is available. The closer one approaches the unstable region, the more rapid should be the transition to the stable mixture. Therefore, the equilibrium states are represented by ab , the straight line bf , and then fg .

Phase transitions

As noted many times, most systems can exist in several phases distinguished by some internal order parameter, such as magnetization or crystalline structure. For simplicity, consider a simple compressible system with only one thermal and one mechanical degree of freedom. The chemical potential $\mu_i[T, p]$ for each phase describes an equilibrium surface in the pVT state space. If T and p are kept fixed, the stable equilibrium state is found on the surface with lowest chemical potential (Gibbs potential). Although other phases with higher potentials are not true equilibrium states, it is often possible to maintain the system in a *metastable* state on a higher surface for a long time. Under such circumstances one can extend equilibrium surfaces for metastable phases well beyond their stable regions. For example, graphite is the stable state of carbon at standard temperature and pressure, but there is little danger that metastable diamonds will soon revert to graphite! These phases are distinguished by their crystalline structures and have different chemical potentials, but there is a very large potential barrier that requires geologic time scales to overcome. Thus, graphite and diamond can be maintained in thermal contact without reaching equilibrium in any conceivable experimental period — thermodynamics governs the properties of equilibrium states but does not predict equilibration rates.

Under some conditions, two or more phases may coexist with each other in equilibrium. Coexistence between two phases then requires equality between the chemical potentials for these phases, such that the equation

$$\mu_1[T, p] = \mu_2[T, p]$$

describes a curve in the pT plane representing the intersection of two equilibrium surfaces. Such a coexistence curve is a function of a single independent variable, usually taken to be temperature. A third phase can coexist with the first two at most a single point

$$\mu_1[T_{\text{tp}}, p_{\text{tp}}] = \mu_2[T_{\text{tp}}, p_{\text{tp}}] = \mu_3[T_{\text{tp}}, p_{\text{tp}}]$$

where two equations can be solved for two unknowns, known as the triple point ($T_{\text{tp}}, p_{\text{tp}}$). This analysis can be easily generalized to multicomponent systems. Suppose that r components exist in φ phases and, for simplicity, suppose that the chemical potentials for each phase of each component depend upon only one mechanical variable, such as pressure, and one thermal variable (temperature). Equilibrium states are then specified by $(r - 1)\varphi$ variables describing the chemical composition of each phase plus two mechanical and thermal variables, for a total of $(r - 1)\varphi + 2$ intensive variables. Subtracting $r(\varphi - 1)$ constraints among the chemical potentials for each phase of each component leaves $f = r - \varphi + 2$ degrees of freedom. This result is known as *Gibb's phase rule*. The requirement that $f \geq 0$ limits coexistence to $\varphi_{\text{max}} = r + 2$ phases for an r -component system; thus, at most three phases can coexist at a triple point for a single-component system. A coexistence line represents phase equilibrium for a system with one remaining degree of freedom.

The figure below displays portions of the equilibrium surfaces for common pure substances with solid, liquid, and gas phases. Water is somewhat unusual in expanding upon freezing, such that the solid-liquid coexistence curve has a negative slope in the pT plane. The equilibrium surface and representative isotherms and isobars for a more typical substance which contracts upon freezing are shown in the lower portion of the figure, together with projections upon the pT and pV planes. The pT projection displays the coexistence curves where two distinct phases are in equilibrium at the same pressure and temperature but different densities. At low pressure and temperature, the *sublimation curve* separates pure solid and vapor phases, ending at the triple point where three phases (solid, liquid, vapor) coexist. At higher temperatures the *fusion curve* separates solid and liquid phases while the *vaporization curve* separates liquid and vapor phases. The vaporization curve ends at a *critical point* where the *critical isotherm* (BCD) has an inflection point. Beyond this temperature there is no practical distinction between liquid and vapor phases, which coalesce into a single gaseous phase. Thus, one distinguishes between vapor and gas according to whether the system can be liquefied, with the appearance of

droplets, by applying sufficient pressure at constant temperature: a vapor with $T < T_c$ can be liquefied in this manner whereas a gas with $T > T_c$ cannot be liquefied without cooling no matter how high the pressure. The absence of a critical point on the fusion curve demonstrates that there is a greater physical distinction between solid and liquid phases than there is between liquid and gas phases — neither liquid nor gas phases display long-range order while crystalline solids do.

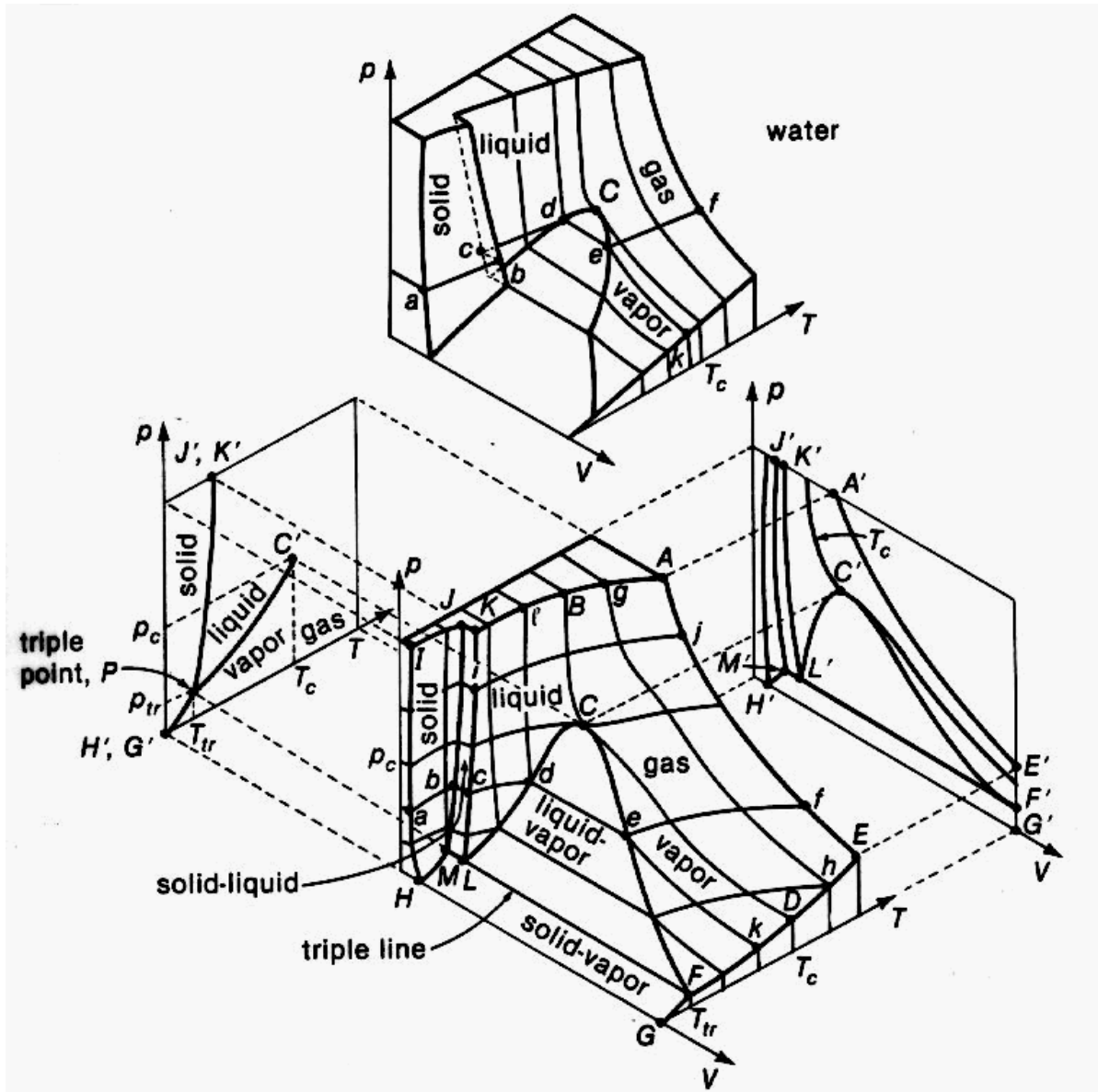

Reproduced, with permission, from Fig. 23-7 of *Physics for Science and Engineering* by J.B. Marion and W.F. Hornyak (Saunders College Publishing, Philadelphia, 1982).

Consider a typical isobar, $abcdef$, representing a process in which heat is added at constant pressure. The pure solid is gradually heated from T_a to T_b and expands slightly until the melting point is reached. Further heating does not increase the temperature, but rather melts the internal order until the solid has been entirely converted to liquid at the same temperature, $T_c = T_b$. The heat required to convert a mole of solid to a mole of liquid at constant temperature and pressure is known as the *latent heat of melting* (or *fusion* for freezing). Adding more heat to the pure liquid increases its temperature and reduces its density, somewhat more rapidly than for the solid, until the point T_d on the vaporization curve is reached. Additional heating vaporizes the liquid at constant temperature and greatly reduces the density. Once all the

liquid has been converted to vapor at constant temperature $T_e = T_f$, which requires a *latent heat of vaporization*, additional heating of the pure vapor increases its temperature and rapidly expands its volume. At temperatures above the critical temperature, it is possible to make a continuous transition between liquid and gas phases without crossing the coexistence curve and without latent heat. For pressures above the critical pressure, isobars contain only one phase transition in the range displayed, but many substances possess several distinct crystalline phases.

The figure below correlates the coexistence curves with typical isotherms. Consider the isotherm marked ℓde . The system is liquid at ℓ . As the pressure and density are reduced, the liquid-vapor coexistence region is reached at point d where the system is described as a *saturated liquid*. Heating vaporizes some of the liquid, causing the density to decrease while the temperature remains constant. No liquid remains at point e , which is described as a *saturated vapor*. The heat required to vapor the liquid under conditions of constant pressure and temperature is the *latent heat of vaporization*. Suppose that liquid is introduced into a sealed container, occupying a relatively small fraction of its volume. Some of the liquid will evaporate. If both liquid and vapor are present when equilibrium is reached, the system must be found somewhere in the coexistence region. Apart from a small correction for the surface tension of the liquid, the liquid and vapor phases will at the same pressure, referred to as the *saturated vapor pressure*, which depends only upon temperature. *Boiling* occurs in an open container when the vapor pressure becomes equal to the atmospheric pressure, permitting gas bubbles to form. When there are two or more gases that do not react chemically, their *partial pressures* add directly (Dalton's law). *Relative humidity* is the ratio between partial pressure and saturated vapor pressure at the specified temperature.

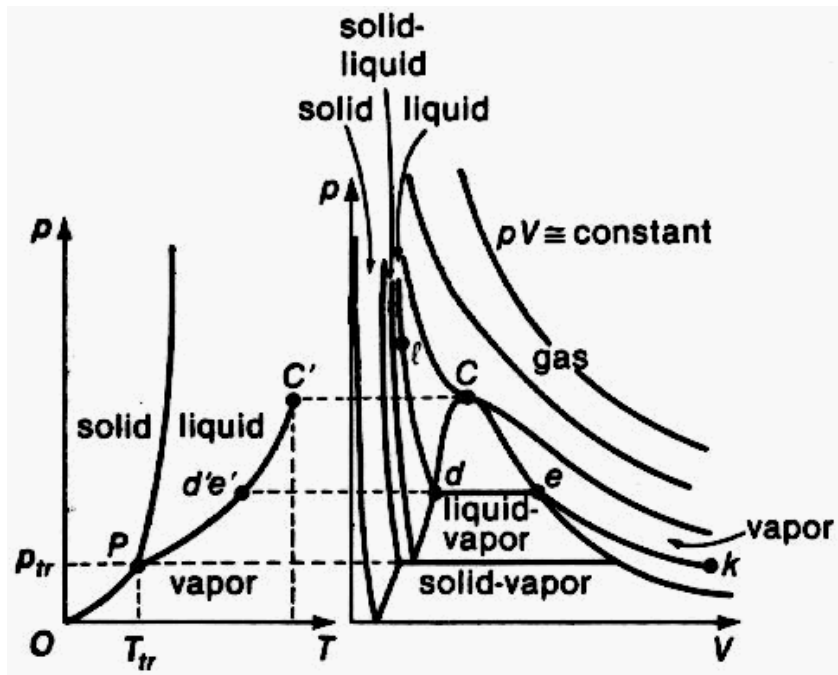

Reproduced, with permission, from Fig. 23-8 of *Physics for Science and Engineering* by J.B. Marion and W.F. Hornyak (Saunders College Publishing, Philadelphia, 1982).

The conditions which permit coexistence of two phases in equilibrium can be ascertained using the availability $A = U - T_0 S + p_0 V$. Consider a pure substance in contact with a reservoir with constant temperature T_0 and pressure p_0 . If two phases coexist, we can divide A into two contributions

$$A = n_1 \mu_1 + n_2 \mu_2$$

where n_i is the number of moles for phase i and μ_i is the molar free enthalpy for that phase. Note that $\mu_i = \mu_i[T_0, p_0]$ depends upon the temperature and pressure established by the reservoir, but is independent of n_i . Recognizing that the total mass is constant, we can minimize A with respect to variations of n_i according to

$$n_1 + n_2 = n \implies dA = \mu_1 dn_1 + \mu_2 dn_2 = (\mu_1 - \mu_2) dn_1 = 0$$

Thus, coexistence requires the chemical potentials to be equal for both phases; otherwise, the stable phase will be the one with lower μ . Therefore, the coexistence line $\mu_1 = \mu_2$ separates two regions of the state diagram with pure phases.

For each phase, we can express the fundamental relation as

$$d\mu_i = \left(\frac{\partial \mu_i}{\partial T} \right)_p dT + \left(\frac{\partial \mu_i}{\partial p} \right)_T dp = -s_i dT + v_i dp$$

where s_i and v_i are the molar entropy and volume for each phase. Along the coexistence line, equality between chemical potentials requires

$$-s_1 dT + v_1 dp = -s_2 dT + v_2 dp$$

such that

$$\frac{dp}{dT} = \frac{s_2 - s_1}{v_2 - v_1} = \frac{\Delta s}{\Delta v}$$

Finally, identifying the *enthalpy of transformation* (or *latent heat*) as

$$\Delta h = h_2 - h_1 = T \Delta s$$

we obtain the *Clapeyron equation*

$$\frac{dp}{dT} = \frac{\Delta h}{T \Delta v}$$

relating the slope of the coexistence line to the heat required to change the phase of a substance under conditions of constant temperature and pressure. For example, the heat of vaporization Δh is the heat needed to transform a mole from the liquid to the vapor phase while Δv is the difference between the molar volumes of the vapor and liquid phases at coexistence.

The Clapeyron equation is one of the most important relationships in thermodynamics. From a fundamental point of view, the validity of the Clapeyron equation provides one of the most important tests of the second law. From a practical point of view, the Clapeyron equation permits prediction of the effects of pressure upon transition temperatures and is instrumental to measurements of latent heat.

An immediate consequence of this relationship is that the slope dp/dT of the solid-liquid coexistence curve is positive for substances which expand when melting and is negative for those which contract when melting. A second application can be made to the temperature dependence of *vapor pressure*, which is the pressure of a vapor in coexistence with its liquid phase in equilibrium. Suppose that a vessel contains a liquid in coexistence with its own vapor. Unless the pressure is very large, the molar volume v_g for the gas is usually much larger than the molar volume v_l for the liquid, so that $\Delta v \approx v_g$. Furthermore, if we assume that the gas is ideal, the Clapeyron equation becomes

$$\frac{dp}{p} = \frac{\Delta h}{R} \frac{dT}{T^2}$$

Finally, if we assume that the latent heat is independent of temperature, this equation can be integrated to yield the *Clausius-Clapeyron equation*

$$p = p_0 e^{-\Delta h/RT}$$

where p_0 is a normalization constant.

Phase transitions which require finite enthalpy of transformation are traditionally described as *first-order*, according to a classification scheme introduced by Ehrenfest, but a more descriptive term is *discontinuous* because the difference

between the molar entropies for the two phases represents a finite discontinuity in entropy as a function of temperature (holding other variables constant). Conversely, *continuous phase transitions* do not require latent heat and are traditionally classified as n^{th} order, where $\frac{\partial^n G}{\partial T^n}$ is the first discontinuous derivative of G . For example, a second-order transition does not involve latent heat, but displays a discontinuous heat capacity at the coexistence curve. Important examples include the superfluid transition in liquid ^4He and spontaneous magnetization. Often a new phase that appears below a critical temperature can be described in terms of an order parameter which vanishes above and increases smoothly as the temperature is reduced below the critical temperature. For example, the order parameter for ferromagnetic systems is the degree of spontaneous magnetization, $\bar{\sigma}$, for $T < T_c$. The figure below shows the spontaneous magnetization and the magnetic contribution to the heat capacity predicted by the Weiss model of ferromagnetism. In this model, a continuous phase transition occurs at a critical temperature driven by the appearance of a long-range order parameter that measures the alignment of the spins in the system. The alignment vanishes at T_c , but grows quickly as the temperature is reduced. Nevertheless, the relative probability that neighboring spins are aligned with the average magnetization is simply the square of the probability for each spin individually, indicating the absence of short-range order in this model. The magnetic contribution to the heat capacity displays a discontinuity at the critical temperature that is characteristic of continuous phase transitions (the nonmagnetic contributions are continuous, but have been suppressed in this figure). Although both short-range order and wave phenomena modify these pictures for real materials, this simple model describes important features of ferromagnetism surprisingly well.

Weiss model of spontaneous magnetization

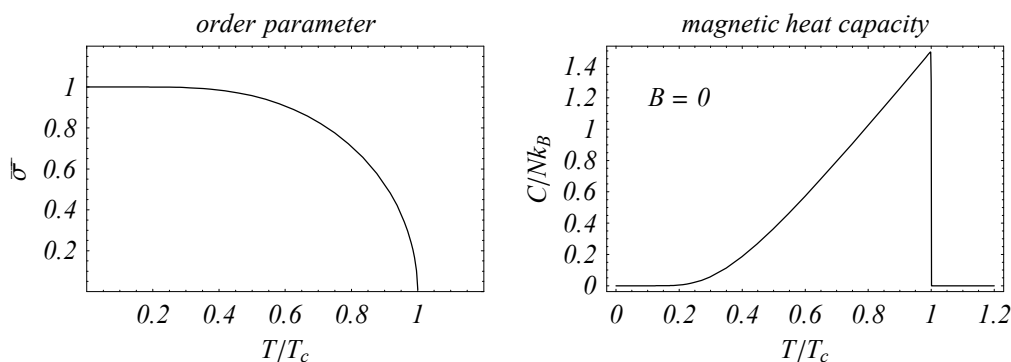

Chemical equilibrium

Consider a system that contains several species A_i described by chemical equations of the form

$$\sum_{i=1}^r \nu_i A_i = 0$$

where the ν_i are *stoichiometric coefficients* enforcing charge and mass balance. For example, the dissociation of water is described by a chemical equation $\text{H}_2\text{O} \leftrightarrow 2\text{H}^+ + \text{O}^{2-}$ containing three species $\{\text{H}_2\text{O}, \text{H}^+, \text{O}^{2-}\}$ with stoichiometric coefficients $\{-1, 2, 1\}$. Phase equilibrium can be included in this formulation if different phases of the same substance are treated as distinct species. Thus, evaporation of water would be represented by the reaction $\text{H}_2\text{O}(l) \leftrightarrow \text{H}_2\text{O}(g)$. By convention, we read the reaction equation from left to right, reactants to products, and assign positive ν_i to products and negative ν_i to reactants. The *heat of reaction* $\Delta H = \sum \nu_i H_i$ is then computed from the enthalpies for the products minus reactants. An *exothermic reaction* with $\Delta H < 0$ releases heat whereas an *endothermic reaction* with $\Delta H > 0$ absorbs heat. The

quantity of heat depends upon how the stoichiometric equation is written through its normalization factor and upon the state of the reactants. One normally studies chemical reactions under conditions of constant temperature and pressure for which the equilibrium concentrations minimize free enthalpy. Therefore, it will be useful to define the *free enthalpy of reaction* as $\Delta G = \sum \nu_i \mu_i$ where μ_i is the chemical potential for each species present.

According to *Hess' law of heat summation*, the heat of a reaction that can be written as a series of steps can be obtained algebraically using the same stoichiometric coefficients as the charge and mass balance. Because it is usually impossible to determine enthalpies in an absolute sense, we normally compare enthalpy and related quantities to those of a conveniently chosen *standard state*. Ordinarily one defines the standard state of a gas to have a partial pressure of 1 atmosphere, pure liquids or pure solids at pressures of 1 atmosphere, all at a temperature usually chosen as 298 kelvins. The standard state of a solute in solution is sometimes chosen to be very dilute (*aqueous solution*) or sometimes chosen to be 1 mole per liter (*1-molar solution*). Consider, for example, the reaction $2 \text{SO}_2(\text{g}) + \text{O}_2(\text{g}) \leftrightarrow 2 \text{SO}_3(\text{g})$. The table below shows a calculation of the heat of reaction from tabulated heats of formation. Note that because step 1) is written in reverse, we invert the sign of ΔH^0 for it; also note that the standard state for sulfur at 298 kelvins is a solid with rhombic crystalline structure while the other reactants are gaseous, as indicated.

step	reaction	ΔH^0 (kcal)	ΔG^0 (kcal)
1	$2 \text{SO}_2(\text{g}) \rightarrow 2 \text{S}(\text{s}) + 2 \text{O}_2(\text{g})$	-2×-70.76	-2×-71.79
2	$2 \text{S}(\text{s}) + \frac{3}{2} \text{O}_2(\text{g}) \rightarrow 2 \text{SO}_3(\text{g})$	2×-94.45	2×-88.52
net	$2 \text{SO}_2(\text{g}) + \text{O}_2(\text{g}) \rightarrow 2 \text{SO}_3(\text{g})$	-47.38	-33.46

We find that the reaction is exothermic and that if the initial concentration of products is small the reaction will proceed in the forward direction at room temperature because the change in free enthalpy is negative.

The Gibbs potential for some set of mole numbers $\{n_i, i = 1, r\}$ can be expressed in the form

$$G = \sum_{i=1}^r n_i \mu_i = n \sum_{i=1}^r \mu_i x_i$$

where n is the total number of moles present and $\{x_i = n_i/n, i = 1, r\}$ represent *mole fractions* for each species

$$n = \sum_{i=1}^r n_i = n \sum_{i=1}^r x_i$$

For most initial choices of $\{x_i\}$ the reaction will proceed to a new equilibrium condition of maximum entropy with different final mole numbers $\{n_i\}$ which depend upon the external constraints imposed as well as the energetics of the chemical reaction. The change in free enthalpy due to small changes in the concentration of each species is

$$dG = \sum_{i=1}^r \mu_i dn_i$$

Using the stoichiometric relationships, we can express changes in mole numbers as $dn_i = \nu_i d\zeta$ where $d\zeta$ represents the progress of the reaction parametrically. Changes in the Gibbs potential now take the form

$$dG = -\mathcal{A} d\zeta$$

where

$$\mathcal{A} = - \sum_{i=1}^r \mu_i \nu_i$$

is the *affinity* of the reaction. If the affinity is positive (negative), the reaction proceeds in the forward (backward) direction as specified by the stoichiometric equation. The final equilibrium state which minimizes the Gibbs potential is then defined by

$$dG = 0 \implies \mathcal{A} = 0 \implies \sum_{i=1}^r \mu_i \nu_i = 0$$

Here we assume, for simplicity, that no species is entirely depleted and leave more detailed considerations to chemistry texts.

It is useful to express the chemical potential in terms of *fugacity*, f , using

$$\mu_i = RT \text{Log}[f_i] + B_i[T]$$

where $B_i[T]$ is an unknown function of temperature. Recall that the term *fugacity* is derived from the same Latin root as fugitive and provides a measure of the volatility of a substance, or its tendency to flee. Alternatively, in chemistry fugacity is usually called *absolute activity*. The fugacity or absolute activity depends upon the concentration of a species but does not depend explicitly upon temperature. If we now compare μ_i for the desired pressure and concentration with μ_i^0 for the standard state of a substance at the same temperature, then

$$\mu_i = \mu_i^0 + RT \text{Log}[a_i]$$

where $a_i = f_i / f_i^0$ is known as the *activity* of that substance. For example, upon examination of our earlier results for an ideal gas, one finds that the fugacity of an ideal gas is simply its pressure so that its activity is its partial pressure in atmospheres. Similarly, the activities of substances in an *ideal mixture* are simply their mole fractions. The affinity of the reaction relative to the standard states now becomes

$$\Delta\mathcal{A} = -RT \text{Log} Q$$

where

$$Q = \left[\prod_{i=1}^r a_i^{\nu_i} \right]$$

is the *reaction quotient*. Therefore, we obtain the *law of mass action* in the form

$$Q = \text{Exp}\left[-\frac{\Delta\mathcal{A}}{RT}\right]$$

Note that although affinity is a measure of the thermodynamic drive for a reaction, it does not determine the rate at which the reaction proceeds.

Recognizing that activities have unit values in standard states while $\mathcal{A} \rightarrow 0$ at equilibrium, the standard enthalpy of reaction becomes

$$\Delta G^0 = -RT \ln K$$

where

$$K = \left[\prod_{i=1}^r a_i^{\nu_i} \right]_{\text{eq}}$$

is called the *equilibrium constant* for the reaction. Note that the equilibrium constant is independent of pressure and concentration, but still depends upon temperature. This temperature dependence

$$\frac{d(\ln K)}{dT} = -\frac{d}{dT} \left(\frac{\Delta G^0}{RT} \right) = \frac{\Delta G^0}{RT^2} - \frac{1}{RT} \left(\frac{\partial \Delta G^0}{\partial T} \right)_p = \frac{\Delta G^0}{RT^2} + \frac{\Delta S^0}{RT}$$

can now be expressed in terms of enthalpy as the *van't Hoff equation*

$$\frac{d(\ln K)}{dT} = \frac{\Delta H^0}{RT^2}$$

which closely resembles the Clausius-Clapeyron equation.

Example: vapor pressure

Vapor pressure is the partial pressure for a vapor that coexists with its liquid form. Coexistence between liquid water and water vapor is described by the reaction $\text{H}_2\text{O}(l) \leftrightarrow \text{H}_2\text{O}(g)$. The standard chemical potentials are $\mu^0 = -56.960$ kcal/mole for pure water or $\mu^0 = -54.635$ kcal/mole for water vapor at STP (standard temperature and pressure of 1 atm and 298 kelvins). Hence, the standard free enthalpy for evaporation is $\Delta\mu = 2.055$ kcal/mole. If we assume that the vapor is an ideal gas, its activity is simply its partial pressure in units of atmospheres. Given unit activity for a pure liquid, we then deduce the activity of the vapor using

$$a = \text{Exp}\left[-\frac{\Delta G^0}{RT}\right] \Rightarrow 0.031 \text{ at } 298 \text{ kelvins}$$

and conclude that the vapor pressure of water is 0.031 atmospheres at room temperature. The vapor pressure increases with temperature until it reaches atmospheric pressure, at which point the liquid boils.

Now suppose that we add a nonvolatile solute, such as salt, to the liquid. By nonvolatile we mean that very little of the solute escapes solution into the vapor phase. Adding solute to the liquid reduces the concentration of the liquid and, hence, reduces its activity. For an ideal dilute solution, we make a linear approximation to the activity, such that

$$a_l = \frac{c_l}{c_l + c_s} \approx 1 - x_s \Rightarrow K \approx \frac{a_g}{1 - x_s}$$

where c_s and c_l are the concentrations of solute and solvent, x_s is the solute mole fraction, and a_g is the vapor pressure of the liquid. The van't Hoff equation now becomes

$$dT = \frac{RT^2}{\Delta H^0} \frac{dK}{K} \approx \frac{RT^2}{\Delta H^0} \left(dx_s + \frac{dp_g}{p_g} \right)$$

where ΔH is the heat of vaporization, p_g is the vapor pressure, and where we have assumed that x_s is small. First, suppose that the temperature is held constant, such that

$$dT = 0 \Rightarrow \frac{dp_g}{p_g} = -dx_s \Rightarrow \frac{p_g[x_s]}{p_g[0]} \approx 1 - x_s$$

shows that the presence of the solute reduces the vapor pressure, a result known as *Raoult's law*. Alternatively, suppose that the vapor pressure is held constant at 1 atm, such that

$$dp_g = 0 \Rightarrow dT = \frac{RT^2}{\Delta H^0} dx_s \Rightarrow \Delta T_{\text{bp}} \approx \frac{RT_{\text{bp}}^2}{\Delta H^0} x_s$$

shows that the boiling temperature is raised by the solute because the vapor pressure is reduced. Therefore, we can cook our spaghetti at a higher temperature by adding salt to the water.

Example: temperature dependence of a reaction

An important step in commercial production of sulfuric acid involves synthesis of sulfur trioxide in the reaction $2 \text{SO}_2 + \text{O}_2 \leftrightarrow 2 \text{SO}_3$ with equilibrium constant

$$K = \frac{a_{\text{SO}_3}^2}{a_{\text{SO}_2}^2 a_{\text{O}_2}} = \text{Exp}\left[-\frac{\Delta G^0}{RT}\right]$$

where $\Delta G^0 = \Delta H^0 - T\Delta S^0$ is the standard free enthalpy for the reaction. At 298 kelvin, one finds $\Delta H^0 = -47.38$ kcal and $\Delta S^0 = -45.36$ cal/kelvin, such that $\Delta G^0 = -33.86$ kcal for 2 moles of SO_3 produced by the reaction with an equilibrium constant of about 7×10^{24} . In most cases one can safely assume that both ΔH^0 and ΔS^0 are approximately independent of temperature, but the factor of T increases the importance of entropy relative to the heat of the reaction (enthalpy) at high temperatures. Thus, at 1500 kelvins we expect $\Delta G^0_{1500} \sim 21$ kcal and $K \sim 10^{-3}$. The equilibrium constant changes by about 27 orders of magnitude as the reaction shifts from strongly forward (production of SO_3) at room temperature toward the backward direction (dissociation of SO_3) at high temperature. Such rapid variation of equilibrium concentrations and reaction rates with temperature is quite common.

Problems

▼ Thermodynamics of blackbody radiation

The electromagnetic radiation within an empty box whose walls are maintained at temperature T can be treated as a thermodynamic system. Simple arguments give $p = \frac{1}{3} u[T]$, where $u = U/V$ is the energy density. Use this result to obtain other thermodynamic properties. (Note: a remains an undetermined constant.)

- Derive the Stefan-Boltzmann law, $u = aT^4$, where a remains an undetermined constant.
- Show that $s = \frac{4}{3} aT^3$ where $s = S/V$.
- Evaluate C_p and interpret your result.
- Show that $pV^{4/3} = \text{constant}$ for an isentropic process.
- Compute the chemical potential and explain the result.

▼ Isentropes for van der Waals gas

Determine the relationships between T and v and between p and v that apply to isentropic transformations of a gas that obeys the van der Waals equation of state

$$\left(p + \frac{a}{v^2}\right)(v - b) = RT$$

where v is the volume per mole and a and b are constants related to the intermolecular interaction. Assume that c_v is constant and that $c_p - c_v \approx R$ over the relevant ranges of T and V and express your results in terms of $\gamma = c_p/c_v$.

▼ Response functions for van der Waals gas

Evaluate the isobaric expansivity, $\alpha = \frac{1}{v} \left(\frac{\partial v}{\partial T}\right)_p$, and isothermal compressibility, $\kappa_T = -\frac{1}{v} \left(\frac{\partial v}{\partial p}\right)_T$, in terms of temperature T and molar volume v for a gas that obeys the van der Waals equation of state

$$\left(p + \frac{a}{v^2}\right)(v - b) = RT$$

where b is related to the short-range repulsion and a to the long-range attraction of the intermolecular interaction. Compare with the ideal gas and discuss the roles of the interaction parameters. Make quantitative comparisons for O_2 using $a = 0.138 \text{ Pa m}^6 / \text{mole}^2$ and $b = 0.0318 \text{ m}^3 / \text{mole}$.

▼ Some relationships for simple compressible system

Prove the following relationships for a simple compressible system.

$$\begin{aligned} \text{a) } \left(\frac{\partial C_V}{\partial V}\right)_T &= T\left(\frac{\partial}{\partial T}\left(\frac{\alpha}{\kappa_T}\right)\right)_V \\ \text{b) } \left(\frac{\partial C_p}{\partial p}\right)_T &= -T\left(\frac{\partial}{\partial T}(\alpha V)\right)_p \\ \text{c) } \left(\frac{\partial U}{\partial V}\right)_T &= T^2\left(\frac{\partial}{\partial T}\left(\frac{p}{T}\right)\right)_V \\ \text{d) } \left(\frac{\partial H}{\partial p}\right)_T &= -T^2\left(\frac{\partial}{\partial T}\left(\frac{V}{T}\right)\right)_p \end{aligned}$$

where $\alpha = \frac{1}{V}\left(\frac{\partial V}{\partial T}\right)_p$ is the isobaric expansivity and $\kappa_T = -\frac{1}{V}\left(\frac{\partial V}{\partial p}\right)_T$ is the isothermal compressibility, respectively. Discuss the implications of these relationships for a gas which satisfies the van der Waals equation of state and compare with an ideal gas.

▼ Jacobian method for compressibility ratio

The isothermal and adiabatic compressibilities are defined by

$$\kappa_T = -\frac{1}{V}\left(\frac{\partial V}{\partial p}\right)_T, \quad \kappa_S = -\frac{1}{V}\left(\frac{\partial V}{\partial p}\right)_S$$

Use the Jacobian method to express κ_T/κ_S in terms of heat capacities.

▼ Adiabatic compressibility

The adiabatic compressibility is defined by $\kappa_S = -\frac{1}{V}\left(\frac{\partial V}{\partial p}\right)_S$.

- Express the difference $\kappa_T - \kappa_S$ in terms of T , V , C_p , and α . Evaluate this quantity for an ideal gas and comment.
- Express κ_T/κ_S in terms of heat capacities.
- Show that stable equilibrium requires $C_V \geq 0$ and $\kappa_S \geq 0$.

▼ Plastic rod

Suppose that the tension τ required to alter the length L of a plastic rod with relaxed length L_0 at temperature T is $\tau = aT^2(L - L_0)$ where a is a positive constant. Also suppose that when $L = L_0$ the heat capacity at constant length is $C_L[L_0, T] = bT$ where b is a positive constant.

- Construct the fundamental thermodynamic relation for this system.
- Use a Maxwell relation to find $(\frac{\partial S}{\partial L})_T$.
- Given $S_0 = S[L_0, T_0]$, compute the entropy for any other length and temperature.
- Suppose that the rod is quasistatically stretched from initial length L_i and temperature T_i to final length L_f under conditions of thermal isolation. Find an expression for the final temperature T_f and compare it to the initial temperature.
- Calculate the heat capacity $C_L[L, T]$ for arbitrary length and temperature.

▼ Soap film

A soap film is supported by a thin wire frame with constant width w . One end of the frame is a movable cross wire sliding on rails so that the length ℓ can be varied. The surface tension γ produces a force $2\gamma w$ on the movable cross wire, where the factor of 2 accounts for the two free surfaces. The surface tension depends linearly upon temperature, such that $\gamma = \gamma_0 + \gamma_1 T$ where γ_0 and γ_1 are constants independent of length and temperature.

- Express the fundamental relation for changes in internal energy dU as a function of T and ℓ . Identify the heat capacity C_ℓ .
- Compute the internal energy change $\Delta U = U[T, \ell] - U[T, 0]$ for isothermal stretching of the film.
- Compute the work and heat required for isothermal stretching of the film.

▼ Throttling of van der Waals gas

Suppose that a thermally insulated tube filled with a nonideal gas is fitted with pistons on both ends which exert pressures p_i on the left and p_f on the right. In the center of the tube is a porous plug which allows gas to flow through the tube under a constant pressure difference, $\Delta p = p_i - p_f$, between the two ends of the tube. Under conditions of steady flow the gas on either side of the plug is in thermal equilibrium, at temperatures T_i on the left and T_f on the right, but is clearly not in equilibrium within the plug itself.

- Show that the molar enthalpy, $h = u + pv$, is conserved by this throttling process, such that $h_i = h_f$ where h , u , and v are all expressed per mole of gas.
- Show that for an ideal gas the molar enthalpy reduces to a simple function of temperature alone so that $h_i = h_f \Rightarrow T_i = T_f$ for an ideal gas.
- For real gases the enthalpy also depends on pressure, such that $h = h[T, p]$, and there will usually be a temperature difference between the two sides. These temperature changes are most conveniently gauged by the Joule-Thomson coefficient, defined as $\mu_h = (\frac{\partial T}{\partial p})_h$. Given that the pressure decreases across the barrier, we expect

cooling when μ_h is positive and heating when it is negative. Show that the Joule-Thomson coefficient is given by $\mu_h = \frac{v}{c_p} (T\alpha - 1)$, where $\alpha = \frac{1}{v} \left(\frac{\partial v}{\partial T} \right)_p$ is the isobaric expansivity and $c_p = \left(\frac{\partial h}{\partial T} \right)_p = T \left(\frac{\partial s}{\partial T} \right)_p$ is the isobaric specific heat.

d) Curves of constant enthalpy drawn in the (p, T) plane are called *isenthalps*. Produce a diagram which shows isenthalps for the reduced form of van der Waals equation of state, $(p + \frac{3}{v^2})(v - \frac{1}{3}) = \frac{8}{3} T$, assuming that $c_V = \frac{3}{2} R$ is constant. Also plot the inversion curve, defined by the condition $\mu_h = 0$, which separates the region of temperature and pressure in which the gas is heated by the throttling process from the cooling region. Identify these regions and provide a physical explanation based upon the properties of the intermolecular interaction.

▼ Heat capacity from an energetic equation of state

Suppose that the internal energy and entropy are related by $U - U_0[V] = \alpha(S - S_0)^\gamma$, where S_0 , α , and γ are constants and where $U_0[V]$ is an arbitrary function of volume. Find an explicit expression for the heat capacity $C_V[T]$ as a function of temperature. Evaluate this function for the special case $\gamma = 4/3$, which applies to the Debye model of crystals.

▼ Debye model

In the Debye theory of solids, the Helmholtz free energy take the form $F = U_0[V] + T f[\theta/T]$ where $f[x]$ is a universal function and where the Debye temperature $\theta \propto V^{-\gamma}$ is a function only of volume (γ is constant). Let f' and f'' denote derivatives of $f[x]$ with respect to the dimensionless variable $x = \theta/T$.

- Find expressions for the pressure and entropy.
- Find expressions for the internal energy and heat capacity.
- Express the expansivity $\alpha = V^{-1}(\partial V / \partial T)_p$ in terms of the compressibility $\kappa_T = -V^{-1}(\partial V / \partial p)_T$, heat capacity C_V , γ , and V . [Hint: a cyclic relation may help.]

▼ Latent heats for ammonia

Near the triple point, the vapor pressure of liquid ammonia is approximately $\text{Log}[p] = 24.38 - 3063/T$ where p is expressed in pascals (N/m^2) and T in kelvins. Similarly, the sublimation curve (solid-vapor coexistence) is $\text{Log}[p] = 27.92 - 3754/T$.

- Compute the temperature and pressure at the triple point.
- Compute the latent heats of sublimation, vaporization, and fusion (melting) assuming that molar volumes in condensed phases can be neglected and that the vapor can be treated as an ideal gas.

▼ Entropy for gas leak

A leak in a tank of argon gas originally pressurized to 100 atm allows the gas to escape slowly at room temperature. Compute the entropy change per mole of escaped gas.

▼ Internal energy given isentropes $p V^\gamma$

Suppose that the isentropes of a single-component system satisfy $pV^\gamma = \text{constant}$ where γ is a positive constant. Demonstrate that the internal energy must have the form $U = \frac{1}{\gamma-1} pV + N f[pV^\gamma/N^\gamma]$ where $f[x]$ is an arbitrary function.

▼ Constraints upon $S \propto U^a V^b N^c$

Suppose that $S \propto U^a V^b N^c$. Assume, without loss of generality, that $U \geq 0$. Deduce the requirements upon the constants a , b , and c needed to ensure compatibility with the laws of thermodynamics.

▼ Entropy representation of Gibbs-Duhem relation

Using the entropy representation, $S = S[U, X_1, \dots, X_r]$, derive a Gibbs-Duhem relation of the form

$$U d\left(\frac{1}{T}\right) + \sum_{i=1}^r X_i dQ_i = 0$$

where $Q_i = \left(\frac{\partial S}{\partial X_i}\right)_{U, X_{j \neq i}}$ are the intensive parameters conjugate to the extensive variables X_i in the entropy representation. Then show that for a simple compressible system one obtains

$$d\left(\frac{\mu}{T}\right) = v d\left(\frac{p}{T}\right) + u d\left(\frac{1}{T}\right)$$

where $u = U/n$ is the molar energy and $v = V/n$ is the molar volume. Finally, use this relationship to derive the chemical potential of an ideal gas.

▼ Thermodynamics of type-I superconductor

The phase diagram for a typical type-I superconductor is sketched below.

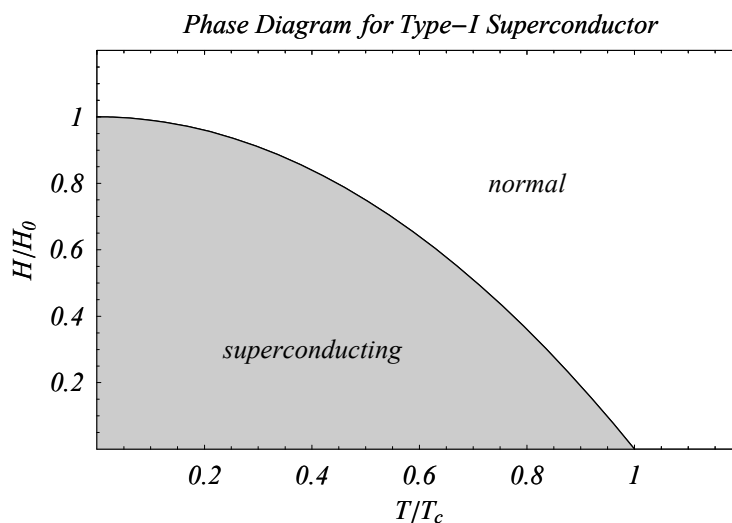

Experimentally one finds that the coexistence curve separating the normal and superconducting phases is well-approximated by the parabolic curve

$$\frac{H_c[T]}{H_0} = 1 - \left(\frac{T}{T_c}\right)^2$$

where the parameters H_0 and T_c depend on the particular metal. The metal is nonmagnetic in its normal phase but in its superconducting phase expels any applied magnetic field H smaller than the critical field $H_c[T]$. Thus, the magnetization per unit volume, M , satisfies

$$\begin{aligned} T > T_c \quad \text{or} \quad H > H_c[T] &\implies M_n = 0 \\ T < T_c \quad \text{and} \quad H < H_c[T] &\implies M_s = -\frac{H}{4\pi} \end{aligned}$$

where the subscripts n and s denote normal and superconducting phases. The fundamental thermodynamic relation for this system is

$$dF = -S dT - M dH$$

where F , S , and M are the free energy, entropy, and magnetization per unit volume.

- Calculate $F_s[T, H] - F_n[T, H_c]$ for the superconducting phase.
- Show that the superconducting phase has lower free energy than the normal phase when $H < H_c[T]$.
- Compute the latent heat of transformation between normal and superconducting phases.
- Determine the temperature dependence of the difference between the constant- H specific heats for the normal and superconducting phases, $\Delta C_H[T, H] = C_{H,n}[T, H] - C_{H,s}[T, H]$, and show that there is a discontinuity in C_H at T_c .

▼ Paramagnetic response functions

The fundamental thermodynamic relation for a simple magnetic system, for which magnetization is the only work mode, takes the form

$$dU = T dS - \vec{M} \cdot d\vec{\mathcal{H}}$$

where $\vec{\mathcal{H}}$ is the external magnetic field and U , S , and \vec{M} are the energy, entropy, and magnetic moment per unit volume. The principal magnetic heat capacities are defined as

$$C_M = T \left(\frac{\partial S}{\partial T} \right)_M \quad C_{\mathcal{H}} = T \left(\frac{\partial S}{\partial T} \right)_{\mathcal{H}}$$

For simplicity assume that $\vec{M} \cdot d\vec{\mathcal{H}} = M d\mathcal{H}$.

- Evaluate $C_{\mathcal{H}} - C_M$ in terms of the response functions $\left(\frac{\partial M}{\partial T}\right)_{\mathcal{H}}$ and $\left(\frac{\partial M}{\partial \mathcal{H}}\right)_T$.
- Evaluate the adiabatic demagnetization coefficient $\left(\frac{\partial T}{\partial \mathcal{H}}\right)_S$ in terms of $\left(\frac{\partial M}{\partial T}\right)_{\mathcal{H}}$ and $C_{\mathcal{H}}$. Compare the effects of adiabatic demagnetization upon temperature for diamagnetic versus paramagnetic materials.
- The internal energy for a paramagnetic material takes the form

$$U[T, \mathcal{H}] = U_0[T] - M\mathcal{H}$$

where U_0 is independent of \mathcal{H} and $M = f\left[\frac{\mathcal{H}}{T}\right]$ is a function of the ratio \mathcal{H}/T . Find simple expressions for C_M , $C_{\mathcal{H}}$ and $\left(\frac{\partial T}{\partial \mathcal{H}}\right)_S$. Examine the high and low temperature limits and interpret your results.

d) Curie's law, $\mathcal{M} \approx \chi_0 \frac{\mathcal{H}}{T}$, is applicable when $\mu\mathcal{H} \ll k_B T$, where μ is the atomic magnetic moment, provided that the temperature is not so low that the interatomic magnetic dipole interaction produces spontaneous magnetization in the absence of an applied field. Under what conditions may $C_{\mathcal{M}}$ be neglected in comparison with $C_{\mathcal{H}}$? Compute $C_{\mathcal{H}}$ and $(\frac{\partial T}{\partial \mathcal{H}})_S$ assuming that $C_{\mathcal{M}}$ may be neglected and that Curie's law applies.

▼ Paramagnetic isentropes

a) Derive a general relationship for $d\mathcal{M}/d\mathcal{H}$ describing isentropic curves ($dS = 0$) in the \mathcal{M} versus \mathcal{H} plane in terms of the principal heat capacities and the isothermal magnetic susceptibility.

b) Evaluate $d\mathcal{M}/d\mathcal{H}$ for a paramagnetic material satisfying Curie's law, $\mathcal{M} \approx \chi_0 \frac{\mathcal{H}}{T - T_c}$. Show that adiabats take the form $\mathcal{H}\mathcal{M}^{\nu} = \text{constant}$ if the ratio of heat capacities is constant.

c) Find approximate adiabats applicable in the high and low temperature limits. [Hint: argue that $C_{\mathcal{M}} \approx C_{\mathcal{H}}$ for high temperatures and that $C_{\mathcal{M}} \ll C_{\mathcal{H}}$ for very low temperatures. Why?]

▼ Adiabatic demagnetization using the Curie-Weiss law

The fundamental thermodynamic relation for a paramagnetic material takes the form

$$dU = T dS - \mathcal{M} d\mathcal{H}$$

where \mathcal{H} is the external magnetic field and U , S , and \mathcal{M} are the energy, entropy, and magnetic moment per unit volume. Assume that the magnetization can be expressed in the form

$$\mathcal{M}[T, \mathcal{H}] = \mathcal{H} \chi[T]$$

a) Show that the constant- \mathcal{H} heat capacity can then be expressed as

$$C_{\mathcal{H}}[T, \mathcal{H}] = C_{\mathcal{H}}[T, 0] + \mathcal{H}^2 f[T]$$

and determine the relationship between $f[T]$ and $\chi[T]$.

b) $C_{\mathcal{H}}[T, 0]$ describes nonmagnetic contributions to the heat capacity which tend to be small at very low temperature. Evaluate the adiabatic demagnetization coefficient $(\frac{\partial T}{\partial \mathcal{H}})_S$ assuming that $C_{\mathcal{H}}[T, 0]$ is negligible and that the magnetization for $T > T_c$ is described by the Curie-Weiss law

$$\chi[T] \approx \frac{\chi_0}{T - T_c}$$

where χ_0 and T_c are constants.

c) Evaluate the temperature change obtained by demagnetization $\mathcal{H}_i \rightarrow \mathcal{H}_f$. Is your result plausible? If not, why not?

▼ Another model of adiabatic demagnetization

In the high-temperature limit, Curie's law gives $\mathcal{M} \approx \frac{a\mathcal{H}}{T}$ where a is constant. Find a simple expression for T_f/T_i produced by adiabatic demagnetization $\mathcal{H}_i \rightarrow \mathcal{H}_f$ assuming that $C_{\mathcal{M}} \approx \frac{b}{T^2}$ where b is constant.

▼ Magnetic refrigerator

A magnetic refrigerator employs a paramagnetic salt as the working material in a heat engine. Here we develop the basic principle without dwelling on technical details of implementation. An ideal heat engine performs the following cycle:

- 1) The working material is in thermal contact at temperature T_1 with the sample to be refrigerated. The magnetizing field is reduced from \mathcal{H}_a to \mathcal{H}_b as the paramagnetic salt draws heat from the sample at constant temperature.
- 2) The sample is isolated from the working material and the magnetizing field is increased adiabatically from \mathcal{H}_b to \mathcal{H}_c .
- 3) The working material is placed in thermal contact with the reservoir at constant temperature T_2 ; the reservoir is usually liquid helium boiling under reduced pressure so that $T_2 \sim 1$ kelvin. The magnetizing field is increased from \mathcal{H}_c to \mathcal{H}_d as the entropy of the working material is reduced and heat is expelled into the reservoir and removed by a "high"-temperature refrigerator.
- 4) The working material is isolated again and the magnetizing field is decreased from \mathcal{H}_d back to \mathcal{H}_a , returning the working material to its original state in preparation for the next cycle.

The net result of this cycle is to transfer heat Q_1 from the cold sample to the warmer reservoir by means of the magnetic work W performed upon the paramagnetic salt during a reversible cycle. In this problem we employ simple models to estimate the heat and work on each leg of the cycle. In previous problems we proved that

$$\frac{T_f - T_c}{T_i - T_c} = \frac{\mathcal{H}_f}{\mathcal{H}_i}$$

for adiabatic transformations for a paramagnet satisfying $\mathcal{M} = \mathcal{H} \chi[T]$ and $C_H \gg C_M$. Assume for the present purposes that $\chi[T] = \frac{\chi_0}{T - T_c}$ where χ_0 and T_c are constant.

- a) Sketch the cycle in the TS plane and relate the fields \mathcal{H}_a and \mathcal{H}_c to the extreme values \mathcal{H}_b and \mathcal{H}_d .
- b) Determine the heat and work for each step of the cycle.
- c) The performance coefficient for a refrigerator is defined as the ratio between the heat absorbed from the sample and the work performed upon the working material per cycle. Compute the performance coefficient for this refrigerator.
- d) Compute the work per cycle performed on 1 cm^3 of gadolinium sulfate and the heat removed from the sample assuming that the refrigerator operates between temperatures $T_1 = 0.1$ kelvin and $T_2 = 1.0$ kelvin using fields $\mathcal{H}_b = 10$ Gauss and $\mathcal{H}_d = 1000$ Gauss. Assume that Curie's law is valid and neglect T_c . The molar susceptibility of gadolinium sulfate measured at 285.5 kelvin is $5.42 \times 10^{-2} \text{ cm}^3 / \text{mole}$. The density is 4.14 g/cm^3 and the molecular weight of $\text{Gd}_2(\text{SO}_4)_3$ is 603 g/mole.

▼ Piezoelectricity

Materials which develop a dielectric polarization in response to mechanical stress are widely used for sensors, switches, frequency stabilization and other applications. For example, your digital clock probably relies on the piezoelectric effect in a quartz crystal. In this problem we will examine some of the thermodynamic properties of such materials. For simplicity, we consider only a single longitudinal stress mode and express the properties of the material per unit volume. The energetic form of the fundamental relation then takes the form

$$du = T ds + \sigma d\epsilon + E dP$$

where u and s are internal energy and entropy density, E is the electric field, P is the dipole moment per unit volume, σ is the mechanical stress (force per area), and $d\epsilon = dL/L_0$ is the longitudinal strain where L_0 is the normal length of the unstressed material. It is customary to choose tensile stress as positive. We wish to express thermodynamic properties in terms of the electrical, mechanical, and thermal polarizabilities defined by

$$\chi_E = \left(\frac{\partial P}{\partial E} \right)_{T,\sigma} \quad \chi_\sigma = \left(\frac{\partial P}{\partial \sigma} \right)_{T,E} \quad \chi_T = \left(\frac{\partial P}{\partial T} \right)_{E,\sigma}$$

a) Find a simple relationship for the mechanical strain produced by an electric field under conditions of constant T and σ , namely $(\partial\epsilon/\partial E)_{T,\sigma}$.

b) Use the completeness of ds to express $c_{E,\sigma} - c_{P,\sigma}$ and $\alpha_E - \alpha_P$ in terms of the polarizabilities, where

$$c_{E,\sigma} = T \left(\frac{\partial s}{\partial T} \right)_{E,\sigma} \quad c_{P,\sigma} = T \left(\frac{\partial s}{\partial T} \right)_{P,\sigma}$$

are specific heats and

$$\alpha_E = \left(\frac{\partial \epsilon}{\partial T} \right)_{E,\sigma} \quad \alpha_P = \left(\frac{\partial \epsilon}{\partial T} \right)_{P,\sigma}$$

are coefficients of thermal strain under specific conditions. Provide intuitive arguments for the signs of $c_{E,\sigma} - c_{P,\sigma}$ and $\alpha_E - \alpha_P$.