

UNIT-I

Automobile electrical and electronics

Electrical components in automobile

Automobile electrical system has gradually evolved over the years and today it assimilates automatic computer control of the automotive mechanics. In the early days, automobiles electrical system comprised of only basic wiring technologies that were used for distributing power to other parts of a vehicle. It had only switches, wires, relays and controlled motors as its key components but today's electrical system includes sensors, actuators, alternators, battery, oxygen sensors, generator, starter solenoid, starter drive, high power electrical system and other devices.

Components of automobile electrical system

1. armature
2. automobile battery
3. automobile ignition system
4. automobile starting system:
5. automotive computer chips
6. automotive electrical wiring:
7. charging system
8. spark plugs

armature:

Armatures are the moving parts of an electric machine generally alternators, generator or motors of a vehicle, which vibrates when electromotive force is produced. The armature used in automobile comprises of a series of coils and groups of insulated conductors circumscribed around a core of iron. Also known as the rotating part of a dynamo, armatures are generally fixed on ball bearings and are mostly made of copper wire coiled around an iron core.



The major functions of armature are:

1. produce an electromotive force.
2. to transmit current in a rotating machines and force in a linear Machine

automobile battery:

Automobile battery refers to an electrochemical device comprising of primary and secondary cells that are used for transforming chemical energy into mechanical energy. Most of the vehicles today uses 'lead acid' batteries. Batteries are mostly of two types i.e. Non-rechargeable and rechargeable. Often called as disposable batteries, non-rechargeable batteries are used once and then dumped. While rechargeable batteries are those devices that can be easily recharged by applying electrical current that turns or reverses a chemical reaction. A normal battery has an initial voltage of about 1.6 volts and produces between 500-1000 amps. The market size of automobile battery industry is worth us \$ 48 billion a year. China, hong kong, united states, india and taiwan are the major battery manufacturing countries on the global platform.



Classification of various components of a battery includes:

battery boxes

battery cable

battery cable terminals

battery control systems

battery plates

battery trays

performance batteries

voltage regulators

ground straps

battery switches

automobile ignition system:

Automobile ignition system constitute of various devices, tools and components that are used for igniting the fuel in an internal combustion engine of a vehicle. In this system, electric current is used for burning the mixture of air and fuel with the help of coil, battery, and spark plug. Ignition system is assembled in only those automobile engines, which operates with the help of petrol or gasoline. The two main functions of automobile ignition system are to produce enough voltage so that it can easily create a spark for burning air/fuel mixture and secondly it exercises control over the timing of spark and transmit it to the apt cylinder. A typical automobile ignition system produces voltage somewhere between 20000 volts and 50000 volts from a 12-volt source. Automobile ignition system can be further classified into three main heads such as mechanical



ignition system, electronic ignition system and distributor less ignition system. Most of the vehicles today incorporate electronic ignition system in its engine.

Major components used in automobile ignition systems are:

- | | |
|--------------------------------------|----------------------------|
| <u>coil wires</u> | <u>ignition box</u> |
| <u>ignition distributor</u> | |
| <u>magneto</u> | <u>ignition switch</u> |
| <u>ignition coil parts</u> | <u>ignition coils</u> |
| <u>electronic timing controllers</u> | <u>ignition controller</u> |
| | <u>magneto</u> |

automobile starting system:

Automobile starting system is considered to be the heart of automobile electrical system. The starting system of an automobile includes those devices, which are used for initiating an engine of a vehicle. Once the key is put into the ignition switch then the current pass through battery cables to starter motor. After this, starter motor turn the engine and the downward moving piston create suction where air and fuel mixture is burned and then the engine starts.



The chief components of automobile starting system are:

- | | |
|-------------------------|-----------------------------|
| <u>starter</u> | <u>starter drive</u> |
| <u>starter solenoid</u> | <u>bendix drive starter</u> |

automotive computer chips:

Automotive computer chips also known as super chip, automotive computer chips are basically the integrated circuits made of semi conducting material that are used for storing a new engine management program in the electronic control unit of the vehicle. These chips stores the data used by engine control unit, for managing and controlling the engine functions. Oxygen sensor is one of the types of automobile computer chips that form an important part of the engine fuel control feedback loop. Automotive computer chips comprises of:



- | | |
|----------------------------------|--------------------|
| <u>engine management systems</u> | <u>sensor ring</u> |
|----------------------------------|--------------------|

oxygen sensors

Other automobile computer chips include:

Power train control modules
tuners
speedometer calibrators
flip switches

Performance monitors
performance chips
top speed eliminators
shift improvers

automotive electrical wiring:

The electrical wiring system of an automobile incorporate different types of devices, flexible electrical wires, electrical fuses, connectors, fuse blocks used for fastening one end of an automobile component to the power source device. These electrical wiring components are used for bearing mechanical loads and transmitting communication signals or electrical energy.



Apart from electrical wiring components mentioned above, there are other parts used in an automobile electrical system like:

electrical fuse

electrical fuse holders

electrical switch panels

electrical switches

fuse blocks

relay connectors

shrink sleeve tubing

wiring connector

wiring harnesses

electrical switch covers

a/c harness

ground straps

electrical switches parts

charging system:

The charging system of an automobile has three basic components such as alternator, regulator, and the interconnecting wiring. The main function of automobile charging system is to control and regulate the charge in the battery of a vehicle. Automobile charging system generally generates a voltage between 13.5 and 14.4 volts when the engine is working. It produces electrical current for operating automobile lights, music systems, heater, engine electrical system and



other electrical components.

Other components of charging system of the vehicle are:

alternator

Alternator bearing

automobile generator

alternator fans

alternator parts

spark plugs:

A spark plug is a small electrical device that is implanted into internal combustion engine cylinder for burning the mixture of air and fuel. A typical spark plug consists of a center electrode, metal casing and a ground electrode as illustrated in the figure. These plugs are used in many machines such as trucks, buses, tractors, boats, aircraft, motorcycles, scooters, industrial and oil field engines, and oil burners. The basic raw materials used for manufacturing spark plugs are aluminum oxide, steel, silver, gold, platinum, copper and other high nickel alloys. These spark plugs are available in different configurations and heat ranges to adapt to any type of engine.



Other spark plug components are:

spark plug parts

spark plug wires

spark plug tools

Electronic diesel control



Edc distributor injection pump

Electronic diesel control is a diesel engine fuel injection control system for the precise metering and delivery of fuel into the combustion chamber of modern diesel engines used in trucks and cars.

Contents

- introduction
- system overview
- components
- operation
- additional functions
- references



Introduction

Ede injection inline pump

The mechanical fly-weight governors of inline and distributor diesel fuel injection pumps used to control fuel delivery under a variety of engine loads and conditions could no longer deal with the ever increasing demands for efficiency, emission control, power and fuel consumption. These demands are now primarily fulfilled by the electronic control, the system which provides greater ability for precise measuring, data processing, operating environment flexibility and analysis to ensure efficient diesel engine operation. The edc replaces the mechanical control governor with an electro-magnetic control device.

The edc is divided into these main groups of components.

- electronic sensors for registering operating conditions and changes. A wide array of physical inputs is converted into electrical signal outputs.
- actuators or solenoids which convert the control unit's electrical output signal into mechanical control movement.
- ecm (electronic control module) or engine ecu (electronic control unit) with microprocessors which process information from various sensors in accordance with programmed software and outputs required electrical signals into actuators and solenoids.

Components]



Edc accelerator pedal assembly

sensors

- Injection pump speed sensor - monitors pump rotational speed
- Fuel rack position sensor - monitors pump fuel rack position
- Charge air pressure sensor - measures pressure side of the turbocharger
- Fuel pressure sensor
- Air cleaner vacuum pressure sensor
- Engine position sensor
- Temperature sensors - measure various operating temperatures
 - Intake temperature
 - Charge air temperature
 - Coolant temperature
 - Fuel temperature

- exhaust temperature (pyrometer)
- Ambient temperature
- Vehicle speed sensor - monitors vehicle speed
- Brake pedal sensor - operates with cruise control, exhaust brake, idle control
- Clutch pedal sensor - operates with cruise control, exhaust brake, idle control
- Accelerator pedal sensor
- Driver input switches - cruise control, idle increase /decrease, engine/exhaust brake
- Injector needle movement sensor - monitors the actual injection time and feeds the information to the ecu (as used on vm motori 2.5 and 3.1 engines)

electronic control unit



Edc control unit

The ecu collects and processes signals from various on-board sensors. An ecu electronic module contains microprocessors, memory units, analog to digital converters and output interface units. Depending upon the parameters, a number of different maps can be stored in the onboard memory. This allows the ecu to be tailored to the specific engine and vehicle requirements, depending on the application. The operating software of the ecu can be adapted for a wide variety of engines and vehicles without the necessity of hardware modification. The ecu is usually located in the cab or in certain cases, in a suitable position in the engine bay where additional environmental conditions might require cooling of the ecu as well as a requirement for better dust, heat and vibrations insulation .

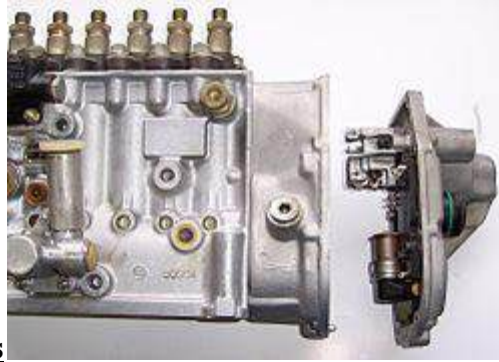

actuators and solenoids

Ede pump actuator

Electro-magnetic actuators are usually located on the fuel pump to transfer electrical signals into mechanical action in this case fuel rack actuator and or fuel stop solenoid which means that depending on requests from control unit full fuel or no fuel quantity.

- Injectors
- Boost-pressure actuator
- Intake-duct switchoff
- Throttle-valve actuator
- Exhaust-gas recirculation actuator
- Auxiliary heating
- A/c compressor
- Radiator fan
- Electronic shutoff valve
- Rail-pressure control valve
- Diagnosis lamp

Operation

The injection of fuel or the quantity of injected fuel has a decisive influence on engine starting, idling, power and emissions. The engine ecu is programmed ("mapped") with relevant data to where the fuel rack position has an equivalent signal for the amount of fuel being injected. The driver requests the torque or engine speed requirements via accelerator pedal potentiometer thereby sending a signal to the engine ecu which then, depending on its *mapping* and data

collected from various sensors, calculates in real time the quantity of injected fuel required, thus altering the fuel rack to the required position. The driver can also input additional commands such as idle speed increase to compensate e.g. For ptooperation which can be either variably set or has a preset speed which can be recalled. The road speed function can be used to evaluate vehicle speed and possibly activate a speed limiter (heavy vehicles), or maintain or restore a set speed (cruise control). Further functions can include exhaust brake operation which, when activated, will result in the fuel pump rack position being set to zero delivery or idle. The engine ecu can also interface with various other vehicle systems e.g. Traction control and carry out self monitoring duties and self diagnostic functions to keep the system working at an optimal level. To ensure the safe operation in case of failure, the limp home mode functions are also integrated into the system, e.g. Should the pump speed sensor fail the ecu can use an alternator speed signal function for engine rpms counter as a backup signal.

Additional functions

- Engine protection, cold start - when starting cold, engine rpms are limited.
 - Engine protection, overheating - when overheating, to avoid damage the engine power output is limited.
- Remote engine shutdown - when auxiliary equipment is in use e.g. Crane in case of rollover.
- Constant engine speed - the engine maintains set revs irrespective of load e.g. Pto operation

Environmental legislation for pollution

Air pollution control ordinance

This ordinance empowers the epd to control air pollution from industry, commercial operations and construction work. [motor vehicle emissions are controlled under the road traffic ordinance and the epd also helps to control these]. The apco prohibits the use of high sulphur and leaded fuels and the open burning of construction waste, tyres and cables for metal salvage.

Abatement notices are usually issued to anyone causing air pollution from a process or machinery and they will be asked to reduce or stop their emissions, or face prosecution.

Some events are prosecuted on the spot, such as construction dust or black smoke emissions. Potential polluters whose fuel consumption exceeds a certain limit must submit plans for installing or altering furnaces, ovens and chimneys. Major industrial processes, or "specified processes", are subject to tighter control. The methods and standards for assessing air pollution can be found in the technical memorandum for issuing air pollution abatement notices.

Asbestos control provisions in the ordinance require that building works involving asbestos must be conducted only by registered qualified personnel and under the supervision of a registered consultant.

Air pollution control (volatile organic compounds) regulation: the regulation prohibits import into hong kong and manufacture in hong kong regulated products with volatile organic compounds content exceeding the prescribed limits for local sale or use. The regulated products include architectural paints, vehicle refinishing paints, vessel paints, pleasure craft paints, adhesives, sealants, printing inks and six categories of consumer products (namely air fresheners, hairsprays, multi-purpose lubricants, floor wax strippers, insecticides, and insect repellents).

Air pollution control (non-road mobile machinery) (emission) regulation: this regulation covers non-road mobile machinery (nrmms) include a wide range of mobile machines (including transportable industrial equipment), or vehicles powered by internal combustion engines used primarily off-road. All regulated machines sold or leased for use in hong kong, except those exempted, are required to comply with the prescribed emission standards. Starting from 1 december 2015, only approved or exempted nrmms with a proper label are allowed to be used in specified activities and locations including construction sites, container terminals and back up facilities, restricted areas of the airport, designated waste disposal facilities and specified processes.

Air pollution control (ocean going vessels) (fuel at berth) regulation: this regulation bans ocean going vessels from using fuel with sulphur content exceeding 0.5% during berthing in hong kong.

It is prohibited to dump waste in public places or on government land, or on private premises without the consent of the owner or occupier. Apart from this general provision, there are four major provisions under the waste disposal ordinance:

waste disposal (chemical waste) (general) regulation:

anyone who produces chemical waste or causes it to be produced has to register as a chemical waste producer. The waste must be packaged, labelled and stored properly before disposal. Only a licensed collector can transport the waste to a licensed chemical waste disposal site for disposal. Chemical waste producers also need to keep records of their chemical waste disposal for inspection by epd staff.

Waste disposal (livestock waste) regulations:

livestock farmers must dispose of livestock waste without causing pollution or nuisance to the environment. Liquid waste has to be disposed of either to a soakaway-pit or treated to meet effluent standards of 50 mg/l of biochemical oxygen demand and 50 mg/l of suspended solids.

Import and export of waste control:

a permit system to control the import and export of hazardous and other waste in line with the requirements of the basel convention, is set out in this ordinance.

Waste disposal (clinical waste) (general) regulation:

clinical waste producers must properly manage their clinical waste by consigning the clinical waste to licensed clinical waste collectors for delivery to a licensed disposal facility for disposal. The waste must be packaged, labeled and stored properly before disposal. Only a licensed collector can transport the waste to a licensed clinical waste disposal site for disposal. Clinical waste producer also need to keep records of their clinical waste consignment and delivery records for inspection by epd staff.

All discharges, other than domestic sewage to a foul sewer or unpolluted water to a storm drain, must be covered by an effluent discharge licence. The licence specifies the permitted physical, chemical and microbial quality of the effluent and the general

guidelines are that the effluent does not damage sewers or pollute inland or inshore marine waters. Details of the effluent standards can be found in the technical memorandum on effluent charges.

Legal controls also apply to sewerage connections. The government is extending public sewers to some major rural areas in an effort to improve the environment there. In areas where these new sewers become available, a notice would be issued asking owners to connect their sewage to the public sewer. If necessary, a further notice may be issued asking the owner to demolish or fill in any redundant sewage treatment facilities or septic tanks and soakaway-pits.

Neighborhood noise and noise from construction, industrial and commercial activities are controlled by the noise control ordinance. Neighbourhood noise in the context of providing quick relief to the public is generally controlled by the police.

Construction noise:

noisy construction work and the use of powered mechanical equipment in populated areas is not allowed between 7pm and 7am or at any time on general holidays, unless prior approval has been granted by the epd through the construction noise permit system.

Certain equipment is also subject to restrictions when its use is allowed. Hand-held percussive breakers and air compressors must comply with noise emissions standards and be issued with a noise emission label from the epd. Percussive pile-driving is allowed on weekdays only with prior approval, in the form of a construction noise permit from the epd.

Industrial and commercial noise:

industrial and commercial noise must comply with statutory limits specified in the technical memorandum. Operators who fail to do so will be issued with a noise abatement notice asking them to reduce their noise or face prosecution for failing to comply with the conditions in the notice.

This ordinance controls the production, import and export of products containing ozone-

depleting substances, and the recycling of ozone-depleting substances, thereby giving effect to hong kong's international obligations under the 1985 vienna convention and the 1987 montreal protocol.

Anyone involved in marine dumping and related loading operations, requires a permit from the epd. All dumping vessels have to be equipped with an automatic self-monitoring system which records their position and loading and dumping operations.

The environmental impact assessment ordinance is to avoid, minimize and control the adverse impact on the environment of designated projects through the application of the environmental impact assessment process and the environmental permit system.

Designated projects, unless exempted, must follow the statutory environmental impact assessment (eia) process and require environmental permits for their construction and operation.

The ordinance regulates, through an activity-based permit system, the import, export, manufacture and use of non-pesticide hazardous chemicals that have potentially harmful or adverse effects on human health or the environment, including those regulated by the stockholm convention and the rotterdam convention.

Producer responsibility scheme (prs) is a key policy initiative under the holistic waste management system for waste reduction, recovery and recycling. Enshrining the principle of "polluter pays" and the element of "eco-responsibility", prs requires manufacturers, importers, wholesalers, retailers and consumers to share the responsibility of reducing, recovering and recycling certain products so as to minimize their environmental impact. The ordinance is a framework legislation which provides the shared core elements of all prss and the fundamental regulatory requirements in respect of individual types of product, with operational details to be set out in the ordinance and its subsidiary legislation.

The environmental levy scheme on plastic shopping bags is the first prs under the ordinance, and the law sets out the details of the operation of the prs. Starting from 1 april 2015, the prs is fully extended to cover all retail sales of goods. Sellers involving in retail

sales of goods shall charge the customer 50 cents or more for each plastic shopping bag provided directly or indirectly to the customer. Offenders may be subject to a fixed penalty of \$2,000.

The ordinance prohibits drivers from causing or permitting their vehicle engines to operate for more than 3 minutes in aggregate in any 60-minute period while the vehicles are stationary ("idling prohibition"). Drivers who contravene the idling prohibition may be issued with a penalty notice requiring them to pay a fixed penalty of \$320. Traffic wardens and environmental protection inspectors are empowered to enforce the law.

Overview of electronic system

Electrical and electronic system content in both automotive and commercial vehicles will continue to become more complex as new technologies are accepted and implemented. From vehicle level integration requirements to individual subsystem and component design validation, exponent's vehicle electronics group has significant expertise and industry experience that includes powertrain, body, chassis, safety, and entertainment electrical and electronic systems hardware and software. Our staff has experience designing and analyzing vehicle wiring and circuits, starting and charging systems, batteries, motors, switches, lamps, internal combustion and hybrid engine management systems, instrumentation, power mirrors and windows, automatic headlamp aiming, heads-up display, electric assist power steering, wireless tire pressure monitoring, electronic suspension control, antilock brakes, electronic stability control, traction control, electronic throttle control, electric brake systems, passive seat belt systems, mobile communication systems, and front and side multi-stage supplemental restraint systems. Exponent personnel are versed in the failure modes of high duty cycle sensors and actuators, both inert and detrimental effects of electromagnetic interference, and relevant mitigation methods.

Exponent engineers and scientists are trained in taguchi's robustness design practices including total cost function, control factors, and life cycle cost management. In order to optimize product design, validation, and life testing processes for vehicle electronic systems, our engineers have implemented the design of experiments and are capable of exploring factors not understood or previously considered during initial product design and development. Exponent's professionals have experience with methods for proactively reviewing designs of vehicle systems, such as failure mode and effect analysis (fmea), and with methods of failure analysis, such as fault tree

analysis (fta). We are often able to leverage our rich history of failure analysis experience to design reviews to help our clients evaluate new systems.

From vehicle-level integration requirements to individual subsystem and component design validation, exponent's professionals have significant expertise and industry experience:

- Powertrain control systems
- Body control systems
- Braking control systems
- Engine control systems
- Chassis control systems
- Safety systems
- Entertainment systems
- Vehicle power and battery systems

Our consulting services include designing and analyzing:

- Vehicle wiring and circuits
- Starting and charging systems
- Batteries
- Actuators, motors, switches, and indicators
- Internal combustion and hybrid engine management systems
- Instrumentation
- Power mirrors and windows
- Automatic headlamp aiming
- Heads-up display
- Electric assist power steering
- Seat heating systems
- Wireless tire pressure monitoring
- Electronic suspension control
- Antilock brake systems
- Electronic stability control
- Traction control
- Electronic throttle control
- Electric brake systems

- Passive seat belt systems
- Mobile communication systems
- Front and side multi-stage supplemental restraint systems

Power train sub system

Higher performing power train & engine system components

The drive to reduce emissions and improve fuel economy is urgent, making every powertrain and engine system component a candidate to improve efficiency, integrate function, reduce weight and lower cost – areas where dupont excels.

Materials play a critical role in helping to reduce emissions, boost fuel economy and improve efficiency in power train technologies. Dupont offers the broadest portfolio of materials capable of withstanding today's harsh engine environments and the most experienced and global development staff to ensure solutions developed today are on the road tomorrow.

- Increasing performance in automotive air ducts and turbocharger hoses
- Leading the metals-to-plastics revolution in transmissions and driveline
- Enhanced durability for extreme environments for sealed engine covers
- Improving power train efficiency in charged air coolers
- Thermal management through lighter weight engine cooling systems

Automotive chassis sub system

Automotive chassis is a skeletal frame on which various mechanical parts like engine, tires, axle assemblies, brakes, steering etc. Are bolted. The chassis is considered to be the most significant component of an automobile. It is the most crucial element that gives strength and stability to the vehicle under different conditions. Automobile frames provide strength and flexibility to the automobile. The backbone of any automobile, it is the supporting frame to which the body of an engine, axle assemblies are affixed. Tie bars, that are essential parts of automotive frames, are fasteners that bind different auto parts together.

automobile frames, automobile chassis automotive tie bar?

And tractor linkages parts

automobile frames ❖

Automotive frames are basically manufactured from steel. Aluminum is another raw material that has increasingly become popular for manufacturing these auto frames. In an automobile, front frame is a set of metal parts that forms the framework which also supports the front wheels. It provides strength needed for supporting vehicular components and payload placed upon it.

Types of automobile frames

bonnet

hood

bonnet:

Bonnet, an important part of automotive frame can be defined as a protective covering made up of a hinged metal part used for covering an engine of a vehicle. Usually automobile bonnets are made of steel, aluminum, fiberglass, and carbon fiber reinforced plastic.

hood:

Hood refers to a cover placed over the engine and passenger compartment of an automobile. Hoods form an important type of automotive frames. These auto frame parts are usually made of steel, aluminum, fiberglass, carbon fibre or dry carbon. A typical hood comprises of several different parts such as hood ornament, hood scope, power bulge, and wiper jets.

automobile chassis ❖

Automotive chassis is considered to be one of the significant structures of an automobile. It is usually made of a steel frame, which holds the body and motor of an automotive vehicle. More precisely, automotive chassis or automobile chassis is a skeletal frame on which various mechanical parts like engine, tires, axle assemblies; brakes, steering etc are bolted. At the time of manufacturing, the body of a vehicle is flexibly molded according to the structure of chassis. Automobile chassis is usually made of light sheet metal or composite plastics. It provides strength needed for supporting vehicular components and payload placed upon it. Automotive chassis or automobile chassis helps keep an automobile rigid, stiff and unbending. Auto chassis ensures low levels of noise, vibrations and harshness throughout the automobile. The different

types of automobile chassis include:

ladder chassis: ladder chassis is considered to be one of the oldest forms of automotive chassis or automobile chassis that is still used by most of the suvs till today. As its name connotes, ladder chassis resembles a shape of a ladder having two longitudinal rails inter linked by several lateral and cross braces.

Backbone chassis: backbone chassis has a rectangular tube like backbone, usually made up of glass fibre that is used for joining front and rear axle together. This type of automotive chassis or automobile chassis is strong and powerful enough to provide support smaller sports car. Backbone chassis is easy to make and cost effective.

Monocoque chassis: monocoque chassis is a one-piece structure that prescribes the overall shape of a vehicle. This type of automotive chassis is manufactured by welding floor pan and other pieces together. Since monocoque chassis is cost effective and suitable for robotised production, most of the vehicles today make use of steel plated monocoque chassis.

Types of automobile chassis

motorcycle chassis

car chassis

bus chassis

truck chassis

chassis parts

chassis fixings



motorcycle chassis:

An important type of automotive chassis, motorcycle chassis comprise of different auto parts and components like auto frame, wheels, two wheeler brakes and suspension. Its basically the frame for motorbikes that holds these components together. A motorbike chassis can be manufactured

from different materials. But the commonly used materials are steel, aluminum, or magnesium.

Motorcycle easy ride frame

Motorcycle headlight trim kit

motorcycle frame cover

motorcycle light visors

motorcycle frames and chassis

motorcycle rigid frame

car chassis:

The main structure of a car is known as chassis. Car chassis functions as a support for the different car parts. Automotive parts like engine, suspension & steering mechanism, braking system, auto wheels, axle assemblies and transmission are mounted on the car chassis.



bus chassis:

Bus chassis is the design and quality of bus chassis depends on the capacity of bus. It can be tailor made according to the needs and can be availed with features like transverse mounted engine, air suspension as well as anti-roll bars. A well manufactured bus chassis offers various benefits like high torque from low revs, superior brake performance and more. Bus chassis designed for urban routes differs from the one manufactured for suburban routes.

chassis parts:



Different chassis parts together comprise of automobile chassis. The different types of automobile chassis parts comprise of control arm, pitman arm, ball joint, stabilizer link, tie rod end, rack end and many other auto parts. On the basis of their functions, the automotive chassis parts are sub divided into:

chassis brackets

Chassis crossmember

chassis fixings:

Chassis fixings function as automotive fasteners used for connecting automobile chassis. These fixings hold together the varied parts of the vehicle chassis. High strength stainless steel is the most commonly used material for manufacturing chassis fixings. Besides being rust and corrosion resistance, stainless steel chassis fixings also offer desired durability.



automotive tie bar:

Tie bar refers to a metal rod or bar used for connecting pad of one lead frame to the rails of other lead frame. More precisely this type of bar that is one of the types of automotive frames is used for tying, fastening, binding or wrapping different parts or components of an automobile engine.

Different components of an automobile tie bar are:

ball hooks

uj cross

pivot pin

kingpin

tractor linkages parts:

Tractor linkage parts consist of whole ensemble of various spare auto parts and devices used for joining or assembling the main parts of a tractor.

There is a wide variety of tractor linkages parts available in the market namely:

chain assembly

link pin

leveling box

u shackle

eye bolt

shackle pin

linkage balls

lift yokes

Gulf coast environmental systems supplies a fully automatic control system designed, manufactured, and integrated into the product tailored to customer requirements. The control system consist of a gces designed safety control system (scs). The scs system is designed to optimize performance and safety per the national electric code and ul508a standards.

each scs is equipped with control logic to fully automate operation for the entire sequence of operation. The single button start/stop design eliminates the possibility of costly operator error. The scs performs automated diagnostic surveillance (self-checking) and reports system status.

The system incorporates state-of-the-art displays and graphics for reporting operational status and fault / troubleshooting messages. The fault indicator displays messages defining the reason for any departures from any operating normal operating parameters. The messages help identify corrective action quickly and accurately, thus improving reliability.

All safety control systems come with the option to interface with various plant dcs systems. Communication to each scs programmable logic controller (plc) can occur through one of many options including ethernet, fiber optics, or a modem.

Burner management systems (bms)

With each thermal oxidizer or industrial oven containing a burner system, a burner management system (bms) with flame detection is incorporated into the safety control system. A burner flame detection system consists of an arrangement of flame detectors, interlocks, and relays, and is part of the bms. The purpose of the flame detection system is to sense flame operation and to shut off any fuel supply if a hazardous condition develops. The flame detection system senses the presence of a strong flame and proper combustion. System logic uses the information to control the burner so that motors, blowers, ignition, and fuel valves are activated when needed, in the proper sequence. In the event of a lost flame signal, the flame detection system signals the bms, which then shuts down the fuel supply in order to keep unburned fuel from accumulating. Combustion controls through gce systems

Although there are many places to buy a panel, an effective and practical combustion control system requires a thorough understanding of combustion controls, and their interaction with the burner system. Today's demands are for high efficiency, low emissions, and maximum productivity. A gces designed and engineered control system can pay for itself quickly.

Gulf coast environmental systems maintains a ul approved panel shop which insures quality and on-time delivery as well as complete functional testing prior to shipment. These considerations greatly reduce field commissioning time and enhance reliability. Gulf coast environmental systems combustion design takes into account the realities of combustion control environmental factors such as temperature and elevation, process stream, dust, vibration, and electrical noise.

Driver safety

safety for the driver is paramount. The reinforced cab structure with pre-programmed front and rear crumple zones plays an important role here, as does the unique energy-absorbing cab suspension. This means that the cab moves backwards in a controlled manner if there is a rearend collision. It remains as intact as possible and is still connected to the chassis. An airbag is

available as an option. The dashboard has shock absorbing zones to limit or prevent potential injury to the knees in the event of a collision. And daf's unique night lock provides simple and effective protection against break-ins and burglary.

Safety systems

the euro 6 daf cf and daf xf are delivered as standard with vehicle stability control (vsc), which helps to prevent jack-knifing and overturning, adaptive cruise control (acc), forward collision warning (fcw) and lane departure warning (ldws). These advanced safety and comfort systems are available alongside daf's advanced emergency braking (aebs), which helps to prevent collisions or to limit their consequences. A camera/monitor system for an even better view on the front and the passenger side of the truck is also optionally available.

Daf transport efficiency

also available as an option is predictive cruise control and predictive shifting. Both innovative technologies contribute to daf's transport efficiency philosophy and can reduce fuel consumption and co² emissions by 3%, especially when driving on hilly routes. Learn more about daf transport efficiency.

UNIT-2 INTRODUCTION TO EMBEDDED SYSTEMS

Embedded Systems definition

An embedded system is a computer system with a dedicated function within a larger mechanical or electrical system, often with real-time computing constraints. It is embedded as part of a complete device often including hardware and mechanical parts. Embedded systems control many devices in common use today.

Microprocessor Embedded Systems

When developing embedded system hardware there is a choice of using a microprocessor or a microcontroller - when using a microprocessor what are the best approaches

Embedded system tutorial includes

- When developing an embedded system, one of the options is to base the computational hardware around a microprocessor, MPU rather than a microcontroller, MCU.
- Both approaches have their attractions, but generally they will be found in different applications.
- Microprocessor embedded systems will tend to be found in larger applications. Microprocessor embedded systems tend to be more suitable for higher levels of processing, where performance is key and space, power consumption and chip count are less important.

Microprocessor basics

- Microprocessors, MPUs are ideal for use in embedded systems, but their structure makes them particularly applicable to certain types of embedded systems.
- The basic MPU contains the central processing unit and possibly a few additional items but the memory and also the Input Output interface is external. Typically the program is stored in non-volatile memory, such as NAND or serial Flash, and at start-up is loaded into an external DRAM and then commences execution.

This approach enables the microprocessor system to be scaled to meet its requirements more exactly.

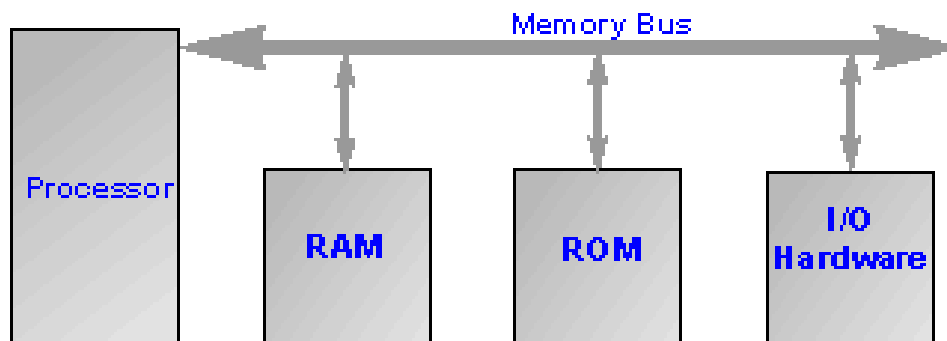

Basic embedded microprocessor system block diagram

It can be seen from this diagram that the microprocessor is essentially the CPU, with the external memory and IO connected via the data bus.

Microprocessor - Classification

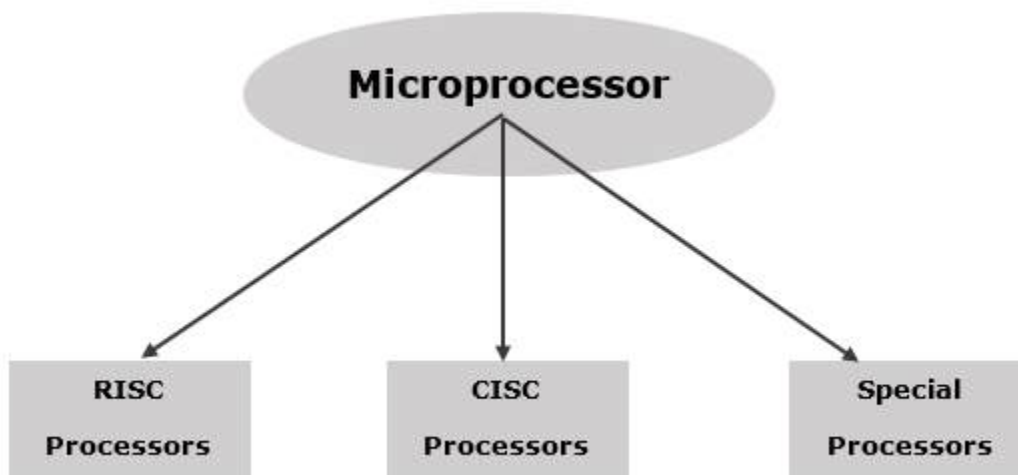

RISC Processor

RISC stands for Reduced Instruction Set Computer. It is designed to reduce the execution time by simplifying the instruction set of the computer. Using RISC processors, each instruction

requires only one clock cycle to execute results in uniform execution time. This reduces the efficiency as there are more lines of code, hence more RAM is needed to store the instructions. The compiler also has to work more to convert high-level language instructions into machine code.

Some of the RISC processors are –

- ❖ Power PC: 601, 604, 615, 620
- ❖ DEC Alpha: 210642, 211066, 21068, 21164
- ❖ MIPS: TS (R10000) RISC Processor
- ❖ PA-RISC: HP 7100LC

Architecture of RISC

RISC microprocessor architecture uses highly-optimized set of instructions. It is used in portable devices like Apple iPod due to its power efficiency.

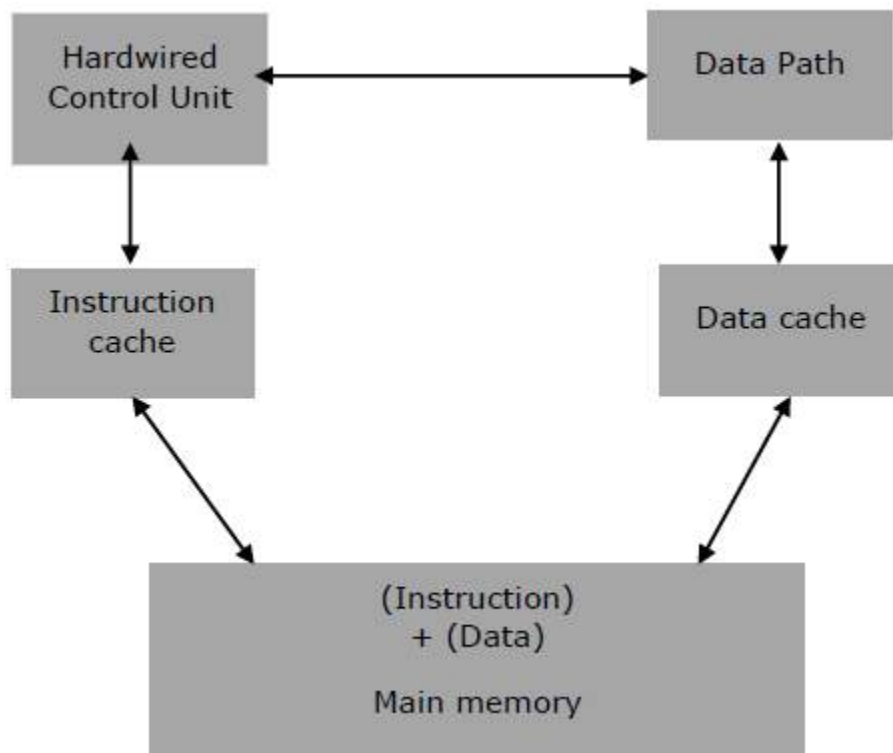

Characteristics of RISC

- ❖ The major characteristics of a RISC processor are as follows –
- ❖ It consists of simple instructions.
- ❖ It supports various data-type formats.
- ❖ It utilizes simple addressing modes and fixed length instructions for pipelining.
- ❖ It supports register to use in any context.

- ❖ One cycle execution time.
- ❖ “LOAD” and “STORE” instructions are used to access the memory location.
- ❖ It consists of larger number of registers.
- ❖ It consists of less number of transistors.

CISC Processor

CISC stands for Complex Instruction Set Computer. It is designed to minimize the number of instructions per program, ignoring the number of cycles per instruction. The emphasis is on building complex instructions directly into the hardware.

The compiler has to do very little work to translate a high-level language into assembly level language/machine code because the length of the code is relatively short, so very little RAM is required to store the instructions.

Some of the CISC Processors are –

- ❖ IBM 370/168
- ❖ VAX 11/780
- ❖ Intel 80486

Architecture of CISC

Its architecture is designed to decrease the memory cost because more storage is needed in larger programs resulting in higher memory cost. To resolve this, the number of instructions per program can be reduced by embedding the number of operations in a single instruction.

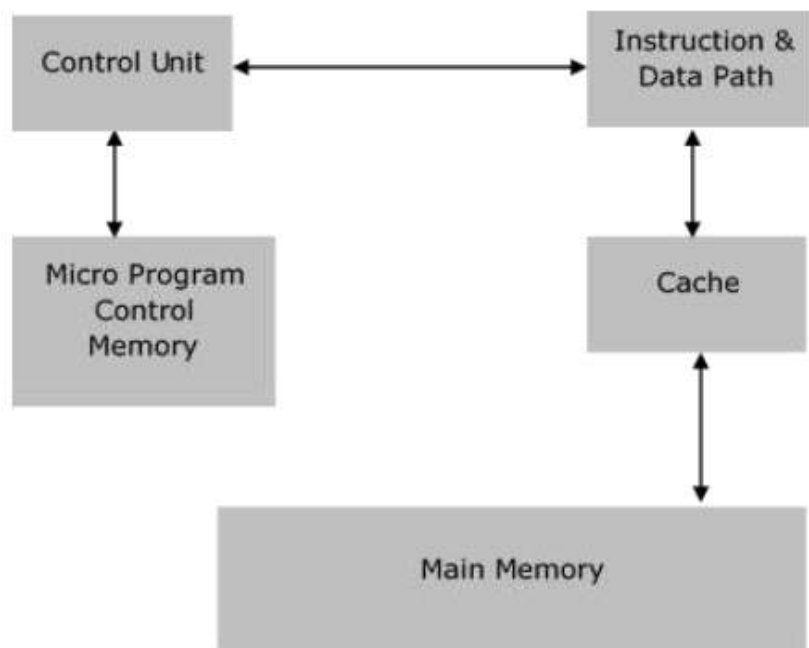

Characteristics of CISC

- ✓ Variety of addressing modes.
- ✓ Larger number of instructions.
- ✓ Variable length of instruction formats.
- ✓ Several cycles may be required to execute one instruction.
- ✓ Instruction-decoding logic is complex.
- ✓ One instruction is required to support multiple addressing modes.

Special Processors

These are the processors which are designed for some special purposes. Few of the special processors are briefly discussed –

Coprocessor

A coprocessor is a specially designed microprocessor, which can handle its particular function many times faster than the ordinary microprocessor.

For example – Math Coprocessor.

- Some Intel math-coprocessors are –
- 8087-used with 8086
- 80287-used with 80286
- 80387-used with 80386
- Input/Output Processor

It is a specially designed microprocessor having a local memory of its own, which is used to control I/O devices with minimum CPU involvement.

For example –

- DMA (direct Memory Access) controller
- Keyboard/mouse controller
- Graphic display controller
- SCSI port controller

Transputer (Transistor Computer)

A transputer is a specially designed microprocessor with its own local memory and having links to connect one transputer to another transputer for inter-processor communications. It was first designed in 1980 by Inmos and is targeted to the utilization of VLSI technology

MICROCONTROLLERS-MEMORY

There are normally 3 types of memory present in microcontrollers. These are SRAM, FLASH, and EEPROM memories. The architecture of a microcontroller may require that variables and constants be stored in different types of memory.

MICROCONTROLLER MEMORY TYPES

- Memory types in microcontrollers Architecture
- The microcontrollers units (MCUs) consist of three types of memory.
- Program Memory
- Data Memory
- Data EEPROM
- Program Memory type
- This is common which have the entire microcontroller and its purposes is to store the instructions. It consists of further four different types of memory.
- ROM (Read only memory)
- EPROM (Erasable programmable read only memory)
- OTP (On time programmable)
- FLASH EEPROM (Electrical erasable programmable read only memory)

ROM

In microcontrollers first type memory is ROM and during the manufacturing process once the program codes are set in ROM that can't be changed after the manufacturing process, therefore it is called read only memory mean just read the code but can't be changed. Due to this reason the microcontrollers which have the ROM memory are considers best for that applications where there is no need of program change only need of program read. These microcontrollers are less expensive as compared to the microcontrollers which have the OTP or FLAS programmable memory and these are ordered in large quantities. PIC16CR65 and PIC16CR72 are the examples of microcontroller which have the ROM memory and denoted by "R" in part number.

EPROM

The second type is erasable programmable read only and this is used in two different type of packages. When EPROM is used in ceramic package with quartz window then microcontroller can be erased the program many times by using ultraviolet eraser and erase time depends upon

the intensity of light. Normally the erase time is in between 5 and 30 minutes. In this the microcontroller can also reprogrammed the program. It is very expensive due to the high cost of windowed ceramic package. PIC16C74B/JW EPROM microcontroller are available in market and “JW” is denoted by windowed package.

OTP

The one-time programmable memory used the same type of die as the EPROM windowed packaged devices. Its packaging makes it unique. These microcontrollers are in an opaque plastic packing and its program can't be erase through ultraviolet light. The OTP devices are first transfer to customer side then these are programmed therefore these devices are called one time programmable. These are lowest cost devices such as PIC16C72A/P and PIC16C74B/SO are the OTP devices

Flash EPROM

This the type which provides the alternate flexibility because its program can be erased electrically and also reprogram in few seconds. It's no need of any ultraviolet light to erase the program. Once the program is erased the program can reprogram with new code. The devices which have the flash memory can also be self-program by using some special sequence of instructions. These devices also contain a small amount non-volatile data EPROM and that can be written thousands of time. PIC16F77 and PIC16F877 are examples of microcontroller which the flash memory. In these devices “F” is denoted by part number

Program Memory Architecture

The program memory architecture is explained here with some examples such as a program memory of 14-bit microcontroller which has a data limit of 8K words and each word has a single 14-bit wide instructions. In this condition the program is divided into 4 pages and each have 2K words shown in



figure

In this example the microcontroller uses the data memory to move the data among the pages. The PCLATH register is used to select the next the page where the instruction would be executing. When the CALL or GOTO instruction is executed then the PCLATH<4:3> is used to select the page branched to. When PCL is modified with the user code PCLATH<4:0> then PCLATH<4:0> is used with PCL to form the full PC address for executing the next instruction. In figure 1 you can see the page 0 have the Reset vector at location 0 (000h). After pushing the reset, the code starts executing at the reset vector. Usually the first two instructions set PCLATH are used for correct program page and the third instructions that is GOTO is used for code executing in another branch of program memory, otherwise a littler useful code can be used at the start of program memory if the interrupts are used. During the code executing when the interrupt is occurring then the next instruction address is fetched and saved in stack.

PAGE SIZE LIMIT AND ABSOLUTE ADDRESSING

The size of the program page is dictated on number of addressing bits which are encoded into branch instructions like CALL or GOTO instructions. The branch instructions first three bits indicates that this instruction can be modify the program counter. If we talk about the CALL instructions this also indicate the return address and the remaining 11-bits are loaded into 11 least significant bits (LSB) of program counter, these 11 bits for addressing allows up to 2K of

address. This defines the program memory page size and the devices which have up to 2K program memory, the 2 most significant bit (MSB) of program counter is maintain clear for keeping PCLATH clear. The devices which have 4K of program required 5th-bit in PCLATH for keeping clear, while for operating in 4-bit the pages 1 or 2 are selected and the devices with 8K of program memory required 4th and 5th-bits in PCLATH to select 1 and 4 pages. Because the whole address is entirely defined using PCLATH and address is coded in instruction therefore we can say we are using absolute addressing shown in figure 2 with PSLATH register.

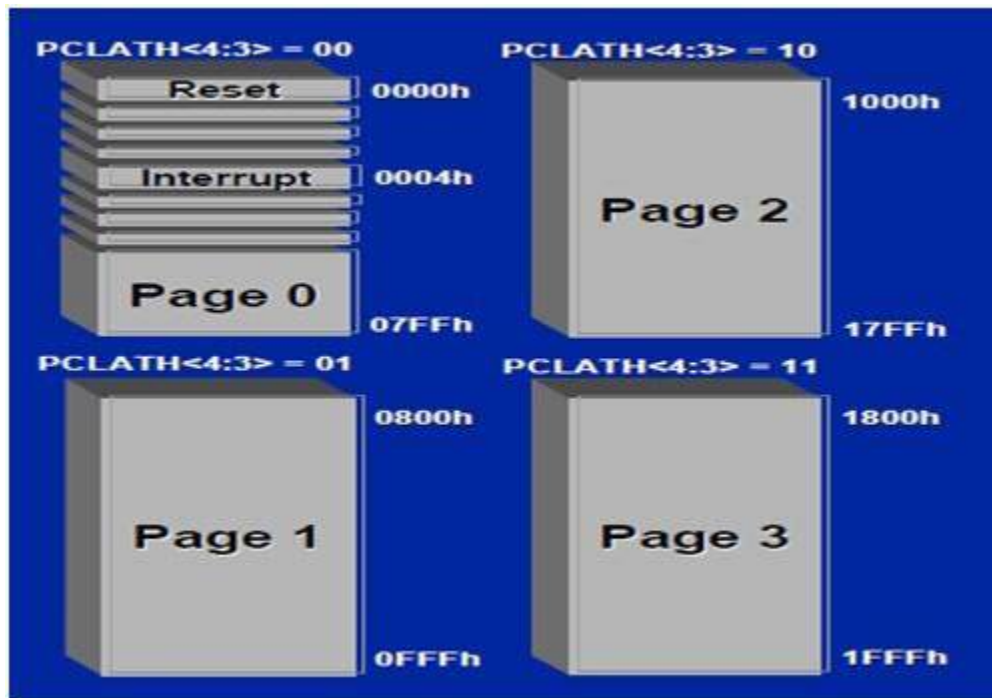

Data Memory

This is also a common in all the microcontrollers. Its consist of general purposes registers referred to as GPR and special function registers referred to as SPR. The data memory is dividing into 4 banks and each banks having a length 128 bytes. For access to each bank the bits PR1 and PR0 of status register needs to be accessed. The special function register controls the various aspects of microcontroller depend upon the process architecture of microcontroller. It controls the following functions of controller such as input, output and peripheral control, Timer, program counter, stack pointer, stack limit, condition codes and processor status. The general purpose registers store the transient type data. For example, when the program is interrupted in

its state then that value of address register, instruction register or program counter is saved in general purpose register.

Data EEPROM Memory

In addition of program and data memory some of the microcontrollers have third type of that is called data EEPROM. This is nonvolatile its data can be written in many times.

Processor Architecture

Here we take a look on the microcontroller processor architecture. It controls the structure and memory size ultimately it controls the operational speed of microcontroller. The microcontroller has two most common architectures first one is Von Neumann architecture and second one is Harvard architecture.

Von Neumann Architecture

The microcontrollers which have Von Neumann architecture have only a single memory space. This single space stores both the data and program instructions. Due to this reason the several instructions must be occur from a single memory spaces that is called fetches. The instructions which executes again and again required a several fetches to fit in a single memory space. In this condition first fetch retrieves the CPU instructions and the additional fetches retrieves the data, which is required for program instruction. By doing this decreases the bandwidth of microcontroller, because the date fetches must be wait until the program fetches instructions has completed. This is called Von Neumann bottleneck. Shown in figure 3

Harvard Architecture

PIC microcontroller units use the Harvard architecture because these microcontrollers have separate data and program memory. Therefore, in pic microcontroller units the fetching of instructions and fetching of data executes simultaneously in a single fetching operation results increased throughput. This architecture also has another advantage that it program and data bus can be tailored with performance requirements. Its data bus is always being 8-bits wide but the microchip offers the microcontroller, which have 12-, 14-, 16-bits program memory width. Increasing the width allows greater no of instructions to be fetch but still the fetching operation is in a single fetch operation

INTRODUCTION TO AN EMBEDDED BOARD (TMS470BASED/ARM9BASED) FOR HANDS ON LAB SESSIONS

Virtual classroom technology is intended to replicate the...face-to-face classroom...But one element that's missing often is the ability for the participants to key...along with the presenter or do practice activities on their own...If you scroll down on your Schedule Training Session form, notice the field for...In-session Hands-On Lab...How this works is if you reserve computers from the Hands-on Labs, you can allow...your participants to log in to a remote computer, not their own computer, but log...in to a computer that has the software and activity files they'll need to...complete their assignments during the training class....

In order to set this up and use the Hands-on Lab, talk to your system...administrator about your needs and what setup requirements you have....

About Hands-on Lab Administration

Use WebEx Hands-on Lab Administration to set up and maintain the labs and computers for Hands-on Lab sessions. With Hands-on Lab Administration you can

- Create new labs
- Edit existing labs
- Delete labs
- View lab schedules
- Set up lab computers for Hands-on Lab sessions
- Move computers to other labs
- Remove computers from a lab
- Connect to available lab computers
- Disconnect from lab computers that are in session
- View a computer's status
- Generate Hands-on Lab usage reports

The VMware Hands-On Labs demonstrate the real value of VMware solutions in real time. As a VM world attendee, you'll gain special access to the latest VMware technologies without being required to purchase equipment, software or licenses.

You'll explore a wide range of today's most exciting topics with a VMware-provided machine or your own device, all with product experts on hand to provide one-on-one guidance. Earn CloudCred points for taking labs, visiting HOL Connect and interacting with product experts, and win prizes for each level of achievement. Join us at VMworld in Hall 6, Fira Gran Via.

ABOUT OUR LABS

Self-Paced Labs:

This is our popular service where you can interact with the latest VMware products at your own pace at a traditional workstation. Many product experts are in the room ready to assist. Labs are delivered on a first-come, first-served basis and do not need to be scheduled in advance. Meet at the check-in desk for self-paced labs in the Hall 6. Afternoons typically have no wait time

Expert-Led Workshops:

These sessions are presented by the VMware product experts who develop lab content. Workshops require advance sign-up and check-in at least 5 minutes prior to start. The check-in for expert-led workshops is in Hall 6. All workshop topics are available without scheduling in the self-paced format

Hands-on Labs Tours:

These 30-minute tours provide a behind-the-scenes peek at what it takes to run our hands-on labs. The tour covers both business and technical topics focused on VMware products and solutions. You will meet lab creators and engineers running our multiple clouds. Sign up at the Hands-On Labs Tour information desk in Hall 6 and engage with labs at a whole new level.

UNIT-3

OPERATING SYSTEM IN EMBEDDED ENVIRONMENT

The OSE RTOS was designed from the ground up to satisfy the requirements of today and tomorrow's complex and mission-critical embedded systems. Today's real-time embedded systems are addressing requirements considered beyond the cutting edge only a few years ago, such as supporting scalability across multiple CPUs, providing nonstop service under all conditions, and running multiple communicating processes and applications in single-core, multi-core and distributed processing environments. These complexities can increase costs, decrease reliability, and lengthen time to market. A conventional Real-Time Operating System (RTOS) falls short when asked to provide a foundation for the next generation of embedded applications. Designers of complex embedded systems need a proven RTOS with the features to support the new generation of systems.

The OSE RTOS was designed from the ground up to satisfy the needs of today's complex and mission-critical embedded systems. Originally developed for the telecommunications industry as a platform for delivering critical communication services, it has been used in millions of products worldwide for over 15 years. System designers focusing on reliability, scalability, and simplicity are increasingly making OSE their platform of choice. OSE is a solid technical market leader. The OSE RTOS was adopted by Ericsson in 1988, by Nokia in 1990, and made available throughout Europe in 1991 and in North America in the 1990's. OSE quickly became the preferred operating system for high-availability applications and distributed systems, especially in telecommunication and wireless products. Today, OSE is at the core of millions of cellular telephones, many internet infrastructure systems and other devices.

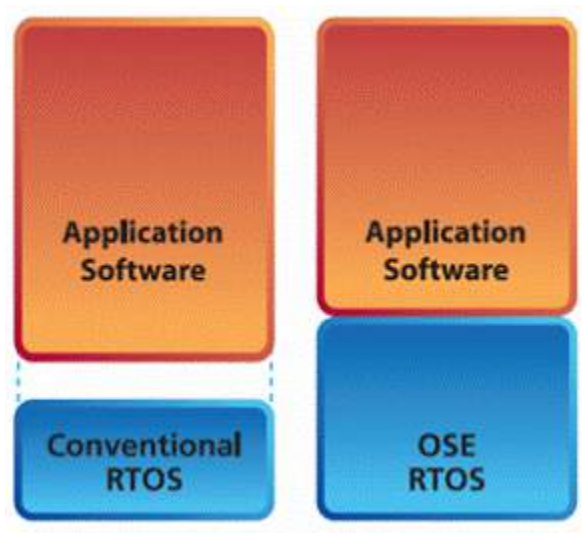

A conventional RTOS involves application software in many routine chores. The OSE RTOS makes it possible to quickly and easily create applications that operate at a higher level of abstraction and execute reliably over their lifetime. The OSE RTOS is in a class above the others.

“We wanted an operating system that was fast, robust and had strong memory management capabilities. We already knew that OSE fulfilled all of these criteria making the RTOS a natural first choice for us.” Ericsson Licensing Technology

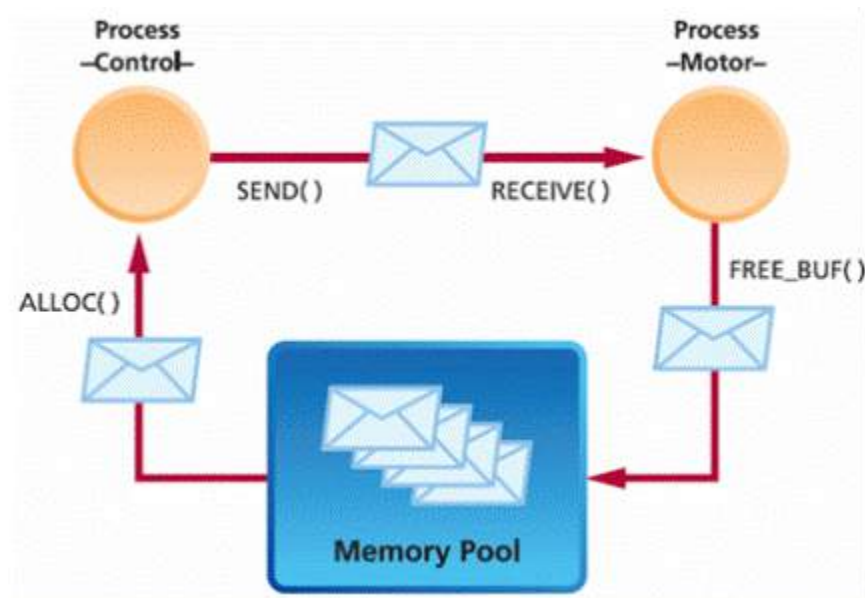

Messages are allocated from the OSE memory pool. Memory is conserved and fragmentation is avoided. OSE manages all of the details of buffer ownership

as messages are passed from task to task, relieving the application of this responsibility.

The OSE Architecture

OSE is a powerful platform for the design of real-time embedded systems. OSE’s message-based architecture instantly and seamlessly achieves powerful simplicity in complex, distributed systems. OSE’s reliable task management and dynamic runtime configuration enable faster, more reliable system deployment and maintenance. OSE’s structured, multi-level facility for error detection enables more efficient code and more reliable and consistent exception handling in the system. OSE also includes built-in monitoring of critical tasks, alerting you before a software failure brings down your entire system. OSE makes it possible to develop highly

reliable applications in far less time. Its architecture is designed specifically to meet the challenges of distributed and faulttolerant system designs.

At the heart of the OSE architecture is a direct message-passing model that provides fast, asynchronous intertask communication. Message buffers are allocated from the OSE memory pool. Memory is ecologically conserved and fragmentation is avoided. OSE manages all of the details of buffer ownership as messages are passed from task to task, relieving the application of this responsibility. As a result, applications interoperate much more intuitively and avoid many of the program errors that result with other intertask communication models. This is the OSE direct messagepassing advatage.

OSE is the Leading RTOS for Use in High-Availability Designs

OSE was designed with built-in capabilities for creating service-critical, mission-critical, and safety-critical systems. This has always been a central design feature in OSE – not an after-thought. For example, OSE has always supported essential concepts such as user-supervisor modes and hardware-enabled memory protection. Rather than executing as a single task, or multiple tasks with no inherent memory protection,

OSE enables an application to consist of a number of distributed components.

Each task can be a separate entity with its own protected resources controlled entirely by the OSE kernel. An application written for OSE can easily be divided into logical parts, each independently designed and coded, with communications between them transparently managed as messages pass across protection domain boundaries. The result is high application performance, while maintaining stability and reliability across the entire system. And OSE goes beyond supporting these essential concepts with architecture-specific mechanisms that greatly enhance system availability. The deeper you look into OSE and compare it to other offerings on the market, the more you will understand why developers choose OSE when time to market and high availability are critical.

OSE TRANSPARENTLY EXTENDS ITS MESSAGE-PASSING ACROSS CPU BOUNDARIES

OSE can put critical tasks on a watch list and automatically notify the application, should a task of interest be created or deleted. Applications can take action before a fault becomes a fatal error. With OSE you design at a higher level, creating applications that are easier to write, understand, and maintain.

OSE HAS BUILT-IN SUPERVISION MECHANISMS FOR MONITORING CRITICAL TASKS

Enea's unique OSE Link Handler technology manages the transparent connection of tasks to services regardless of their location. If one task or an entire board fails, the software can automatically reconnect clients and their services without interruption to the application.

OSE IS UNMATCHED IN ITS ABILITY TO SUPPORT DYNAMIC SOFTWARE RECONFIGURATION

Live software replacement is a reality with OSE. New versions of programs can be loaded onto the system and clients can be redirected to the new instance at any time, without rebooting. Stopping, recompiling and reloading are no longer necessary.

DESIGN ON A HIGHER LEVEL WITH OSE AND PROJECTS ARE COMPLETED FASTER AND WITH FEWER ERRORS

Developers who use other commercial RTOS have had to dig through piles of manuals to learn the low-level primitives found in most RTOS. OSE on the other hand provides a compact, well-designed set of services and simple elegant APIs for those services. OSE developers find that most applications can be managed with just eight powerful kernel APIs. With OSE you design at a higher level, creating applications that are easier to write, understand, and maintain. This has far-reaching benefits. Programmers learn and master OSE faster than other operating systems, make fewer mistakes, and find errors more quickly. This shortens development time and produces code that is more readily reused. Together with OSE's automatic error detection and built-in application-level debugging, these features greatly enhance productivity and quality.

OSE BUILDS IN AUTOMATIC ERROR DETECTION

OSE has an advanced, built-in error detection system. Should an error be detected, OSE automatically invokes a user-defined error handler specific to its task, block, or system scope. This simple-to-use, but powerful feature replaces the complex code and inconsistencies that often result when programmers handle errors differently throughout their application tasks.

WITH OSE YOU CAN DEBUG AT THE APPLICATION LEVEL, AN EASIER PLACE TO WORK

OSE's modern message-based paradigm provides the basis for powerful application-level debugging. Occurrences such as the passing of specific message types or context switching, can be followed step by step, or traced in real-time. Breakpoints can be placed on these occurrences

to stop or monitor execution. During distributed and non-stop system debugging, selected parts of the system can be stopped without halting the entire system. This type of debugging can also be applied to simulated targets that run entirely on a host

computer, through use of the OSE Soft Kernel.

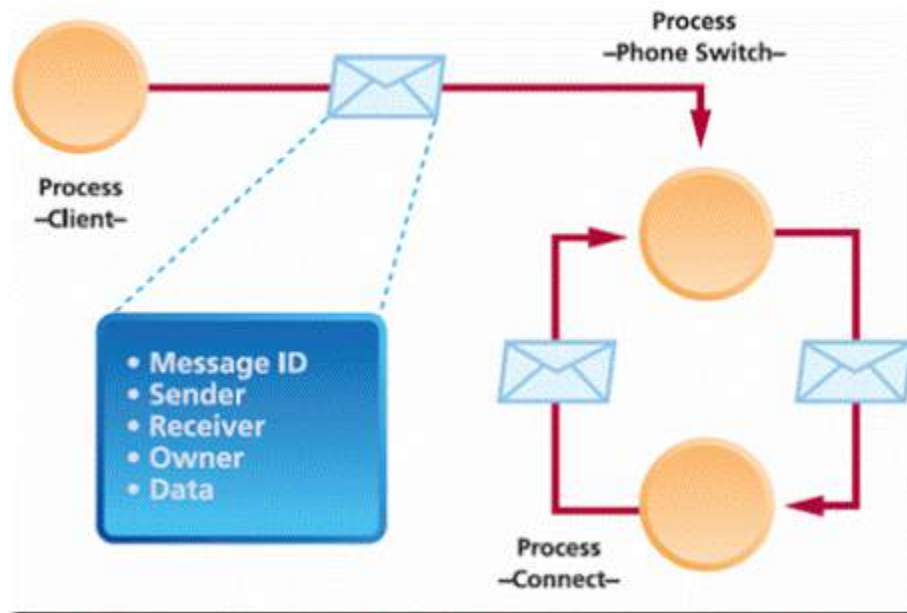

OSE messages are sent directly from one task to another. A message contains the addresses of its sender and receiver, as well as a data payload.

“We wanted to move to a more modern distributed system – without having to develop it ourselves. We also wanted the operating system to be founded on a message communication model rather than a shared memory approach.” Lucent Technologies

The OSE Platform

The OSE real-time kernel is complimented by a rich set of operating system add-on components to form a complete fault-tolerant platform for embedded computing.

OSE LINK HANDLER

The unique OSE Link Handler can connect nodes in a distributed system, and enable transparent communication and supervision among applications running on the nodes. With built in support for redundant communication paths across heterogeneous transports, OSE Link Handler provides a reliable means for connecting programs with services across any computing cluster.

OSE GATEWAY

OSE Gateway enables direct, task-to-task messagepassing between OSE and other operating

systems. OSE Gateway supports Solaris, Windows, Linux, VxWorks, Epoc and virtually any operating system.

EMBEDDED FILE SYSTEM

The OSE Embedded File System (EFS) can be used for storing program modules and for transferring data to and from many types of storage devices. Designed for distributed computing, OSE EFS is a fully distributed file system service that supports a variety of volume managers and media types including but not limited to RAM, flash, and FAT-based media.

NETWORKING ALLIANCES

OSE, in conjunction with best in class providers of advanced networking software, maximizes flexibility and choice for its customers. OSE collaborates with providers of IPv4/IPv6 stacks, management (SNMP, web based, etc), routing, security and utilities telecom protocols to deliver leading edge solutions to the market.

OSE PROGRAM HANDLER

The OSE Program Handler is a powerful utility for systems requiring high availability as it can load, modify, and remove programs during run-time. While many embedded platforms support run-time loading of new programs, most fall short when system designs require live software replacement. With the OSE Program Handler, new versions of software can replace old ones without interrupting the application's execution.

OSE BOARD SUPPORT PACKAGES

The OSE Board Support Packages (BSP) provide support for the latest standard boards from many suppliers. BSP drivers conform to the OSE device-driver specification, allowing seamless migration from board to board.

OSE MEMORY MANAGEMENT SYSTEM

The OSE Memory Management System (MMS) isolates and protects functional software units from one another and also protects the kernel from application software errors. The OSE MMS design is optimized for embedded systems with a flexible and high performance implementation.

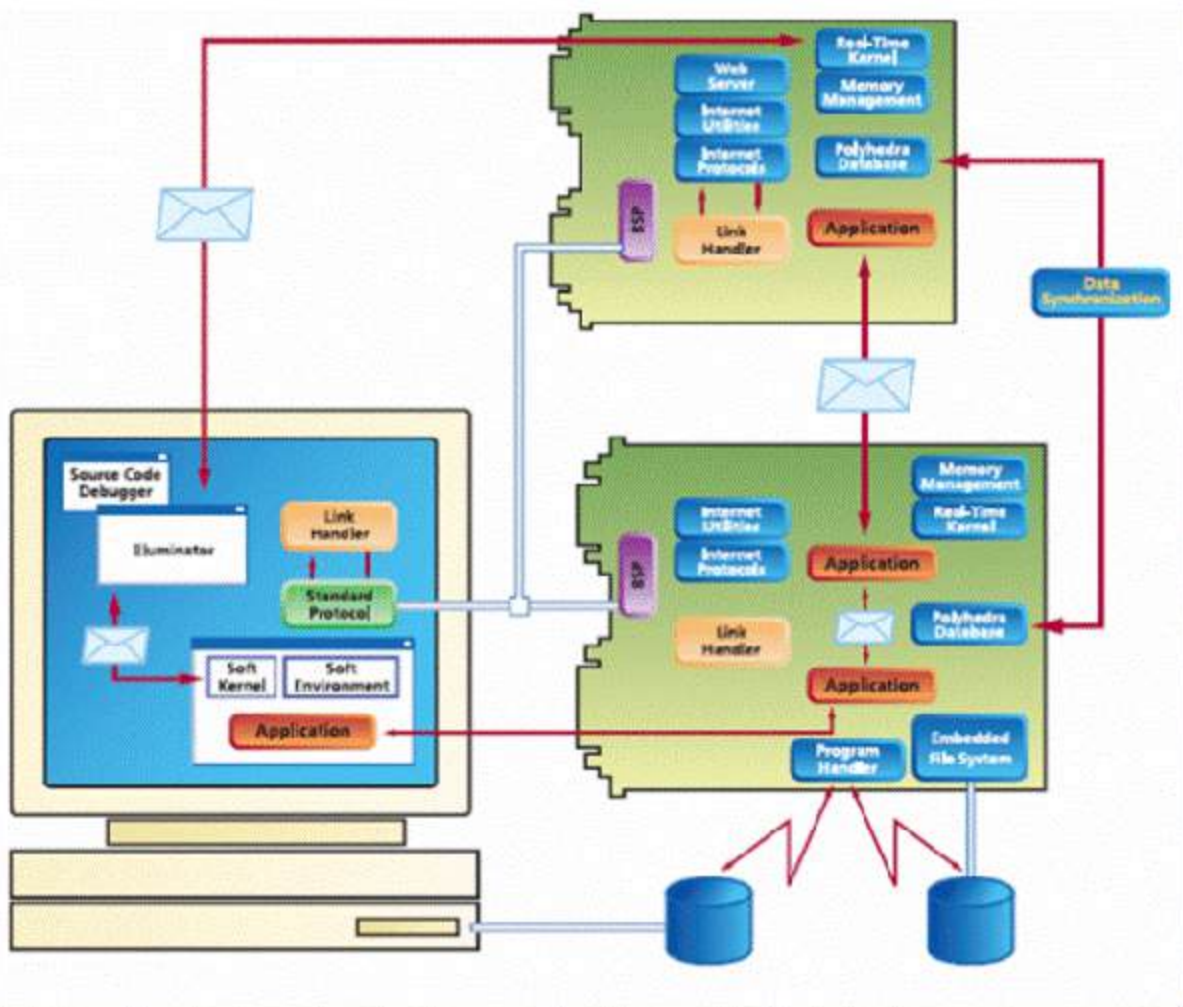

The complete OSE solution includes a target-based (on the right) operating system architecture and complete host-based (on the left) development environment for demanding, high-availability embedded applications.

The OSE real-time operating system enables customers to differentiate themselves from their competition by using the unique features and benefits found only in OSE products.

POLYHEDRA – HIGH PERFORMANCE DATA MANAGEMENT FOR EMBEDDED SYSTEMS

Today's embedded systems have increasingly demanding requirements of their data management components. Data management is now a core part of a system's infrastructure, with requirements to store and preserve mission-critical state and application data in a fault tolerant fashion. While traditional databases have failed to address these requirements, OSE Polyhedra database offers high-performance active-relational technology in a small footprint package designed specifically for this purpose. Data persistence and fault tolerance mechanisms are built into the Polyhedra

database, ensuring survival of the database service across failure of part of the system, and robust data recovery in the event of a restart. Polyhedra's unique active-relational technology provides the ability to encode application logic such as data integrity rules, directly into the database; and "Active

Queries", enabling immediate notification to applications of data change. The Polyhedral database is integrated with the OSE RTOS, using OSE messaging for communication between applications and the database server, and operates seamlessly regardless of the physical location of the tasks. The database also connects to other embedded systems, servers, or workstations over TCP/IP – while automatically handling heterogeneity issues, making database location transparent to the developer.

Superior Tools for Rapid Development

providing a modern and robust architecture for today's complex embedded systems is only half of the story. Developing reliable applications that take advantage of the features of the OSE RTOS is faster and less error prone than with a traditional RTOS, thanks to a powerful chain of OSE tools. This tool chain consists of industry-standard compilers and debuggers, powerful host-target tools, and accurate simulators, all supported by a comprehensive, integrated development and debugging environment.

OSE ILLUMINATOR

OSE Illuminator is a host-based suite of software tools for debugging and analyzing OSE applications. OSE Illuminator includes a system browser, an event-action analyser, and profiling tools. It can also integrate a variety of plug-in tools that provide additional debugging capability and system information. Illuminator also communicates with target boards through standard TCP/IP communication protocols and interconnects with source-level debuggers.

SOFT KERNEL

OSE Soft Kernel makes it possible to simulate your application on host computers. OSE Soft Kernel can simulate part of a system, a whole system, or even a distributed system including a mix of actual hardware boards and multiple OSE Soft Kernels, before moving all software to its final target.

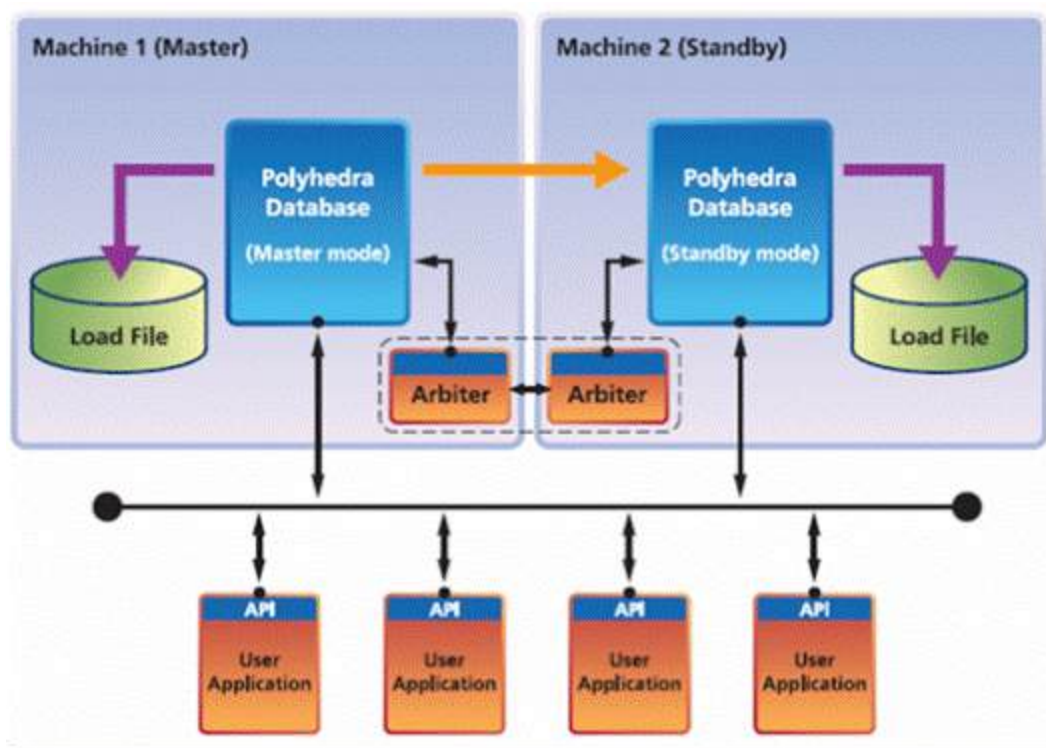

The Polyhedra database for embedded applications provides data persistence and high performance on a single system or across a distributed system.

“Speed is one of our main criteria, and OSE performed best in specification. OSE offered a more up-to-date, streamlined architecture than the competition, which offered operating systems based on more traditional technology.” ABB Environmental Systems

OSE SOFT ENVIRONMENT

The OSE Soft Environment complements the OSE Soft Kernel with tools and utilities for building a complete OSE system in a host environment. This host environment can be used to test and debug an OSE application, or even used as part of a distributed target system. The OSE Soft Environment provides users with exceptional support for the simulation of an OSE system. Examples of run-time accessories supported in the OSE Soft Environment are:

- OSE Link Handler
- OSE Embedded File System
- Internet Protocols
- Internet Utilities
- Web Server

OSE – A Complete Solution

The OSE RTOS provides a complete framework for the implementation of ultra-reliable and ultra-efficient real-time systems -from resource constrained single CPU systems to large, distributed systems. OSE includes a full suite of software development tools for building and deploying complex, mission-critical embedded systems. In addition, a full suite of simulation development components and tools allow an OSE system to run in a host environment -ideal for parallel software-hardware development. The OSE host system may also be connected to a target system for debugging, or the host system may be a part of a deployed distributed system. It is the powerful, distributed architecture of OSE combined with its higher level, dynamic design paradigm of message passing and it's built in mechanisms for fault tolerance and high availability that make OSE the clear platform choice for today's modern embedded des.

UNIT-4

EMBEDDED SYSTEM IN AUTOMOTIVE APPLICATIONS

Embedded Systems Role in Automobiles with Applications. An **embedded system** is an electronic or computer **system** which is designed to control, access the data in electronics based **systems**. This **system** includes a single chip microcontroller such as cortex, ARM and also microprocessors, FPGAs, DSPs, and ASICs

EMBEDDED SYSTEMS ROLE IN AUTOMOBILES WITH APPLICATIONS

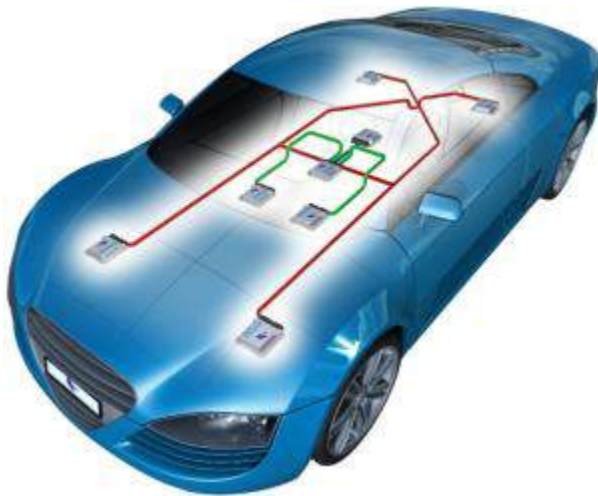

Automobiles

An embedded system is an electronic or computer system which is designed to control, access the data in electronics based systems. This system includes a single chip microcontroller such as cortex, ARM and also microprocessors, FPGAs, DSPs, and ASICs. Nowadays the usage of embedded systems is widespread. But the software that is programmed into the microcontroller is capable of solving only a limited range of problems.

An advanced embedded system in automobiles has increased rapidly in the past two decades. Every year automobile manufacturers pack embedded systems into their cars for different functionalities like ignition, security and audio systems. The technological innovations of the embedded system within the vehicle are being ambitiously challenged to make the vehicle energy efficient, network savvy and safer. In 1968, the Volkswagen used first embedded system in the automobile industry.

Embedded Systems' Applications

Embedded systems have a huge variety of applications that varies from low to high-cost consumer electronics to industrial equipments, medical devices to weapon control systems, aerospace systems and entertainment devices to academic equipments, and so on. Embedded

systems span all features of our present life. The applications of embedded systems are shown below.



Embedded systems applications

- Home Appliances: Washing machines, microwave appliances, security systems, dishwashers, DVD, HV and AC systems, etc.
- Automobile: Airbag systems, GPS, anti-locking brake system, fuel injection controller devices, etc.
- Office Automation: Copy Machine, Fax, modem, smart phone system, printer, and scanners.
- Entertainment: Video games, mp3, mind storm, smart toy, etc.
- Security: Building security system, face recognition, airport security system, eye recognition system, alarm system, finger recognition systems, etc.
- Industrial Automation: Voltage, temperature, current, and hazard detecting systems, data collection systems, assembly line, monitoring systems on pressure.
- Aerospace: Flight attitude controllers, space robotics, automatic landing systems, navigational systems, space explorer, etc.
- Medical: Medical diagnostic devices: ECG, EMG, MRI, EEG, CT scanner, BP Monitor, Glucose monitor.
- Banking and Finance: Share market, cash register, smart vendor machine, ATM
- Telecommunication: Cellular phone, web camera, hub, router, IP Phone
- Personal: Data organizer, iPhone, PDA, palmtop.

Introduction to Automobiles Industry

As far as automobile industry is concerned, a wide range of industries and companies are involved in the development, designing manufacturing and selling of cars, bikes, buses, etc. India represents one of the world's largest automobile markets. From the past few years, even the middle-class has started showing interest in buying a vast range of cars or vehicles. The growth of the Indian automobile industry has recorded tremendous potential over the years.

The industry's financial record is almost 7% of the country's gross domestic product and both directly or indirectly, automobile industry employs about 19 million people. Moreover, with the government support and a special focus on exports of two and three wheelers, small cars, auto components and multi-utility vehicles, the automobile industry produced 1.73 million vehicles in February 2013 alone including commercial, two wheeler and three wheeler vehicles and passenger vehicles as well. In February 2014, the industry produced 1.81 million vehicles.

Government proposals

- The budget of 2014-2015 added some incentives to the automobile industries to give relief. The excise duty that has got decreased till June 30, 2014 is as follows:
- For motor cycles, scooters and small cars the duty has been decreased from the current 12% to 8%.
- For SUVs and Commercial vehicles the duty has been decreased from 30% to 24%.
- For large cars the duty has been decreased from 27/24% to 24/20%.

Major Investments

- The German auto maker Volkswagen is planning to enlarge production capacity and introduce a new model. To set up a diesel engine manufacturing facility, the group is planning to invest around Rs. 1500 crores over the next five years.
- To buy the Germany's Kuepper Group of companies, Amtek Auto has signed an agreement of Rs 16.78 billion.
- Infosys has signed a contract with the Volvo cars to provide application development services.

- Piaggio vehicles are planning to assemble its super bikes locally and to sell them under the brand Aprilia.



Automobiles industry

Embedded Systems in Automobiles

In automotive systems more and more equipments are being changed from the mechanical systems to electronic systems. Embedded system is the heart of a vehicle's electronic system because of its versatility and flexibility. The revolution of electronics has manipulated in automotive design including the fuel combustion, power train crash protection, etc. Advanced usage of embedded system in vehicle can help in controlling the pollution, increasing the facility to provide systems monitoring features that consumers demand. Today a typical vehicle contains around 25 to 35 microcontrollers, and some luxury vehicles contain approximately 60 to 70 microcontrollers per vehicle.

Today, a typical automobile on the road has computer controlled electronic systems, and the most commonly used embedded systems in a vehicle include Airbags, anti-lock braking system, black box, adaptive cruise control, drive by wire, satellite radio, telematics, emission control, traction control, automatic parking, in-vehicle entertainment systems, night vision, heads up display, back up collision sensors, navigational systems, tyre pressure monitor, climate control, etc.



Embedded System in Automobiles

1. Embedded Airbag System

The below figure shows an embedded airbag system – an important safety device that provides extra protection against head-on crash – for the front seat occupants. This System works on the commands from the microcontroller. The controller of this system gets the power from the battery. If the sensors detect accident, this microcontroller operates the airbag system by operating alternator.

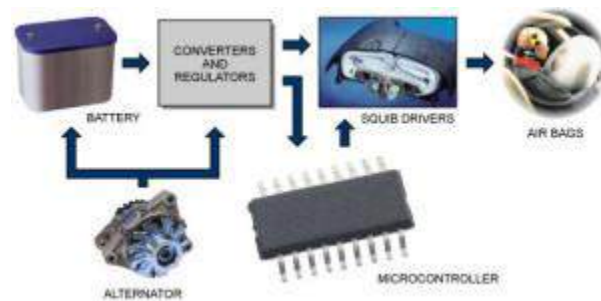

Embedded Airbag System



Automobile Navigation System

2. Embedded Navigation System

Another advancement of the embedded system in automobiles is the navigational system using GPS system. This navigational system consists of an embedded circuitry built with a GPS receiver, a gyroscope, a DVD-ROM, main controller and a display system as shown in the figure. The GPS receiver receives the current longitude and latitude values that are compared with the stored map. The Gyroscope and other sensors provide the road direction and speed.

From all the information gathered at the main controller, the display system displays a navigation or route map of the destination in the display screen.

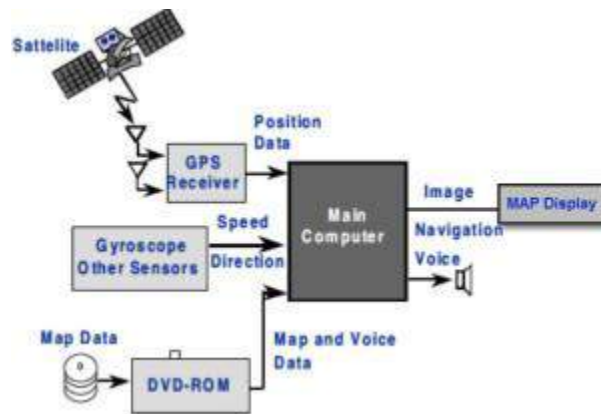

Embedded Navigational System

3. Adaptive Cruise Control

The innovation of the embedded system used in automobiles is Adaptive cruise Control technology. By using this technology we can also make driverless vehicle control in a reality and many automobile manufacturers are also already engaged in work on these concepts. This adaptive cruise control allows cars to keep safe distances from other vehicles on the busy highway roads. The driver of the car can set the speed of his vehicle and the distance between his car and other vehicles. When the traffic slows down, ACC changes vehicle speed using moderate braking.

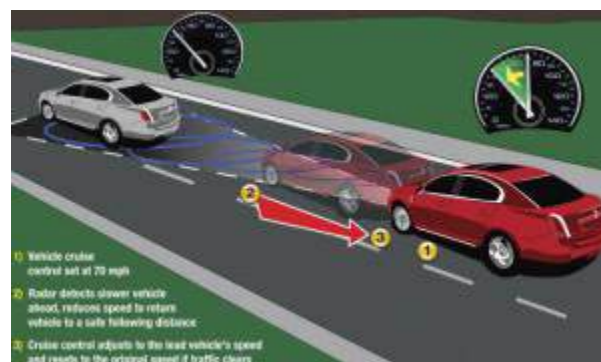

Adaptive Cruise Control

Each car has a laser transceiver or a microwave radar unit which is fixed in front of the car to find out the speed and distance of the any other vehicle in the pathway. This is works on the principle of Doppler Effect; it is nothing but change in frequency of the waves.

4. Embedded Rain-Sensing System



Embedded rain-sensing system

Embedded rain-sensing system in automobiles is another automation system implemented with use of electronic system. In this, an optical sensor is placed on small area of the front windshield glass (opposite to rear-view mirror). This optical sensor is placed at an angle to emit the infrared light which then reads amount of light by it when the light is reflected back. This light is reflected in cases where the windshield is wet or dirty. Thus the optical sensor determines necessary speed and frequency of windshield wiper depends on reflected light into the sensor.

5. Embedded Based Automatic Parking System



Embedded Based Automatic Parking System

This automatic parking system is an independent car manipulation system that moves a car from traffic lane into a parking spot to perform the parallel parking, perpendicular parking and angle parking. This system mainly uses different methods to detect objects around the car. Sensors installed on the front of the vehicle and rear bumpers acts as both a transmitter and a receiver. These sensors send a signal that will be replicated back when it meets an obstacle near the vehicle, and then the carputer will receives the time signal and bumper will use the radar to decide the position of the obstacle. The car will sense the parking space and distance from the side of the road then drive the car into the parking place.

Thus, the modern days embedded systems have marked a revolutionary change in every aspect of the automobile designing and manufacturing processes because of their adaptability and flexibility. Now the question is: Have you got the basic concept of embedded systems in automobiles? If you have got some basic understanding of this concept with a little bit of doubt on this topic, you can give your feedback and suggestions in the comment section below, and let us know how would you like to get some help or assistance from us.

SOFTWARE CALIBRATION USING ENGINE AND VEHICLE DYNAMOMETERS

ENGINE DYNAMOMETERS

Power Test water brake engine dynamometers excel at testing wide ranges of power inputs with one dynamometer. Engine dynamometers are used to test engines removed from the vehicle. We offer several configurations for different dyno test applications.

The H36-Series engine dynamometer is specifically designed to handle the high torque output of engines found in the mining, power generation and marine propulsion industries. This series has power absorption capabilities of up to 50,000 ft-lbs of torque and up to 10,000HP.

Our X-Series fixed base dynamometer may be used for continuous-duty endurance dyno tests, break-in and power verification, quality assurance tests and demanding research and development tests such as transient emissions testing. Our engine carts offer the flexibility of moving an engine within your facility, and ensure quick, precise placement to our sub bases.

Our portable water brake dynamometers connect directly to the flywheel to allow engine dyno testing in facilities with limited space.

In addition to water brake engine dynamometers, Power Test has Eddy Current engine dynamometers. The Power Test EC-Series of engine dynamometers feature in-line eddy current absorption units in a robust compact frame. They may be used for continuous-duty engine power verification, quality assurance, endurance and certification testing.

AGRICULTURAL DYNAMOMETERS FOR PTO OUTPUT

The AG-Series agricultural dynamometer system features air-cooled eddy current dynamometer absorbers designed to meet your demand for reliable, portable PTO testing. This results in lower maintenance costs for you and fewer reliability issues than those normally associated with agricultural dynamometers that typically rely on a friction brake or hydraulic pump design.

The AG-Series dynamometer is supplied to you with the Digital Power Meter (DPM) with remote load control and PC interface featuring the DPM Data Logger software. Also available to you is our popular Power Net LT Data Acquisition and Control System, and a variety of drive shafts and adapters to fit most applications.

Specifications

- **HP:** up to 250 HP Continuous
- **Speed:** 2,600 RPM Max.
- **Weight:** est. 3,500 lbs.

CUSTOM ENGINEERED SOLUTIONS

In addition to Power Test's wide variety of standard equipment, many non-standard powertrain test requirements demand sophisticated engineered solutions.

This is why Power Test formed its Custom Engineered Solutions division. This team utilizes Power Test's industry-leading engineering expertise to create a solution to fit any unique application. The Engineered Solutions team studies all aspects of the test requirement to determine the optimized test solution. The concept is taken by the team of mechanical and electrical engineers to create a new machine design. CAD designers develop solid models of the new test stand for customer review and approval prior to release to our manufacturing operations group, where the testing solution is custom-built.

ENVIRONMENTAL TESTS FOR ELECTRONIC CONTROL UNITS.

In automotive electronics, **Electronic Control Unit (ECU)** is any embedded system that controls one or more of the electrical system or subsystems in a transport vehicle.

Types of ECU include Electronic/engine Control Module (ECM), Powertrain Control Module (PCM), Transmission Control Module (TCM), Brake Control Module (BCM or EBCM), Central Control Module (CCM), Central Timing Module (CTM), General Electronic Module

(GEM), Body Control Module (BCM), Suspension Control Module (SCM), control unit, or control module. Taken together, these systems are sometimes referred to as the car's computer (Technically there is no single computer but multiple ones.) Sometimes one assembly incorporates several of the individual control modules (PCM is often both engine and transmission).

Some modern motor vehicles have up to 80 ECUs. Embedded software in ECUs continues to increase in line count, complexity, and sophistication.^[2] Managing the increasing complexity and number of ECUs in a vehicle has become a key challenge for original equipment manufacturers (OEMs). Examples of such ECUs include:

- Door control unit (DCU)
- Engine control unit (ECU) — not to be confused with *electronic* control unit, the generic term for all these devices
- Electric Power Steering Control Unit (PSCU) — Generally this will be integrated into the EPS powerpack.
- Human-machine interface (HMI)
- Powertrain control module (PCM): Sometimes the functions of the Engine Control Unit and transmission control unit (TCU) are combined into a single unit called the Powertrain Control Module.
- Seat Control Unit
- Speed control unit (SCU)
- Telematic control unit (TCU)
- Transmission control unit (TCU)
- Brake Control Module (BCM; ABS or ESC)
- Battery management system

KEY ELEMENTS OF ECU

- Core
 - Microcontroller
- Memory
 - SRAM
 - EEPROM
 - Flash
- Inputs
 - Supply Voltage
 - Digital inputs
 - Analog inputs
- Outputs
 - Relay drivers
 - H bridge drivers
 - Injector drivers
 - Logic outputs

- Communication links
 - Housing

DESIGN AND DEVELOPMENT

The development of an ECU involves both hardware and software required to perform the functions expected from that particular module. Automotive ECU's are being developed following the V-model.^[1] Recently the trend is to dedicate a significant amount of time and effort to develop safe modules by following standards like ISO 26262.^[3] It is rare that a module is developed fully from scratch. The design is generally iterative and improvements are made to both the hardware and software. The development of most ECU's are carried out by Tier 1 suppliers based on specifications provided by the OEM.

TESTING AND VALIDATING

As part of the development cycle, manufacturers perform detailed FMEAs and other failure analyses to catch failure modes that can lead to unsafe conditions or driver annoyance. Extensive testing and validation activities are carried out as part of the Production part approval process to gain confidence of the hardware and software. On-board diagnostics or OBD help provide specific data related to which system or component failed or caused a failure during run time and help perform repairs.

TUNING

Some people are eager to modify their ECU so as to be able to add more functionality to it. Most ECU's these days however come equipped with protection locks which prevent users of modifying the ECU. The protection locks are made in a way that, when circumvented, triggers DMCA liability. This in effect makes modifying the ECU by circumventing the protection illegal.^[4]

UNIT-5

EMBEDDED SYSTEM COMMUNICATION PROTOCOLS

Introduction to Control networking

An industrial control network is a system of interconnected equipment used to monitor and control physical equipment in industrial environments. These networks differ quite significantly from traditional enterprise networks due to the specific requirements of their operation. Despite the functional differences between industrial and enterprise networks, a growing integration between the two has been observed. The technology in use in industrial networks is also beginning to display a greater reliance on Ethernet and web standards, especially at higher levels of the network architecture. This has resulted in a situation where engineers involved in the design and maintenance of control networks must be familiar with both traditional enterprise concerns, such as network security, as well as traditional industrial concerns such as determinism and response time. This paper highlights some of the differences between enterprise and industrial networks, presents a brief history of industrial networking, gives a high level explanation of some operations specific to industrial networks, provides an overview of the popular protocols in use and describes current research topics. The purpose of this paper is to serve as an introduction to industrial control networks, aimed specifically at those who have had minimal exposure to the field, but have some familiarity with conventional computer networks.

EMBEDDED SYSTEM COMMUNICATION PROTOCOLS

This is a list of common protocols used in embedded systems. Eventually, this list will become hyperlinks to sources of information on each. Many of them are byte-stream protocols that can be transmitted by a variety of serial protocols on a variety of hardware.

- I²C
- RS-485 is an extremely common hardware arrangement used by many embedded protocols:
 - CAN on top of RS485
 - DeviceNet on top of CAN. Wikipedia: DeviceNet
 - NMEA 2000 on top of DeviceNet. Wikipedia: NMEA 2000

- DMX on top of RS485. Wikipedia: DMX512
- see Serial Programming/RS-485, Robotics/Computer Control/The Interface/Networks#RS485, Embedded Control Systems Design/Field busses, Embedded Systems/Serial and Parallel IO#RS-485
- MIDI. official MIDI interface schematics (1); beautiful MIDI IN schematic (2).
- BlueTooth
- InfraRed
- ZigBee
- SPI
- RS-232
- USB
- IP Over Serial Connections
- MINES (Microcontroller Interpreter for Networked Embedded Systems) was designed for very small embedded systems (see Gallery of MINES Devices).
- the Tiny Embedded Network
- IEEE Standard for Sensor Transducer Interface
- the three byte Mini SSC protocol (and another Mini SSC protocol example)
- JTAG
- NTSC / PAL television video output: w:TV Typewriter, Generating TV signal by PSoC, Generating TV signal with the PICs, PIC Breakout, ... Parallax Propeller has a video generator ...
- The low-latency Myrinet protocol is used in over 100 of the TOP500 supercomputers, as of June 2005.
- The low-latency InfiniBand protocol is used in over 100 of the TOP500 supercomputers, as of November 2010.
- The various Audio over Ethernet (AoE) protocols are generally designed to be relatively low latency.
- The LIN-Bus (w:Local Interconnect Network), a low-cost vehicle communication network
- Modbus (w:Modbus)

- Firmata is a generic protocol that allows people to completely control the Arduino from software on a host computer. Arduino reference for Firmata; Firmata wiki.
- rosserial "rosserial ... is a general protocol for sending ROS messages over serial links." Code is available for Arduino and a variety of other platforms. (It was designed for ROS, the w: Robot Operating System).
- S.N.A.P - Scalable Node Address Protocol [1] is media-independent, building on an underlying byte-oriented communication layer.
- Yet Another Scalable Protocol (YASP)
- Labor-Octet-Protocol (LOP) is a simple protocol originally implemented on AVR microcontrollers; it builds on an underlying byte-oriented communication layer and provides support for both message-oriented (all-or-nothing) and stream-oriented communication.
- Inter-Chip Serial Communications (ICSC) is a simple, high-reliability media-independent protocol originally implemented on Arduino.
- Perhaps the simplest-to-parse variable-size packet container format is the netstring format.w:netstring
- JSON (perhaps encapsulated in packets of one of the above formats) seems to be gaining popularity as a way to transmit complex data structures, in a way that is easy for humans to read and debug.[2] w:JSON

Serial Peripheral Interface Bus

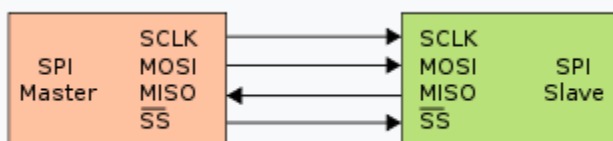

Single Master to Single Slave: basic SPI bus example.

The **Serial Peripheral Interface bus (SPI)** is a synchronous serial communication interface specification used for short distance communication, primarily in embedded systems. The interface was developed by Motorola in the late 1980s and has become a *de facto* standard. Typical applications include Secure Digital cards and liquid crystal displays.

SPI devices communicate in full duplex mode using a master-slave architecture with a single master. The master device originates the frame for reading and writing. Multiple slave devices are supported through selection with individual slave select (SS) lines.

Sometimes SPI is called a *four-wire* serial bus, contrasting with three-, two-, and one-wire serial buses. The SPI may be accurately described as a synchronous serial interface,^[1] but it is different from the Synchronous Serial Interface (SSI) protocol, which is also a four-wire synchronous serial communication protocol. SSI Protocol employs differential signaling and provides only a single simplex communication channel.

Independent slave configuration

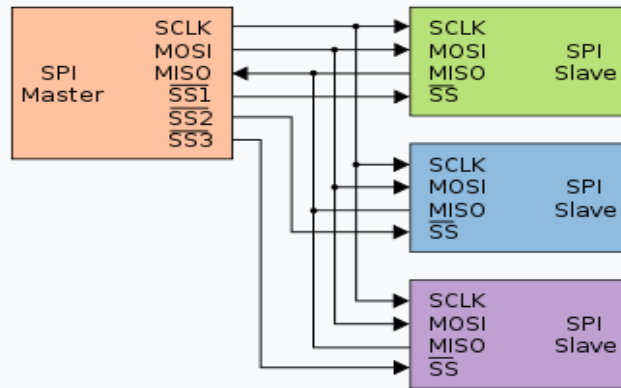

Typical SPI bus: master and three independent slaves

In the independent slave configuration, there is an independent chip select line for each slave. A pull-up resistor between power source and chip select line is highly recommended for each independent device to reduce cross-talk between devices.^[3] This is the way SPI is normally used. Since the MISO pins of the slaves are connected together, they are required to be tri-state pins (high, low or high-impedance).

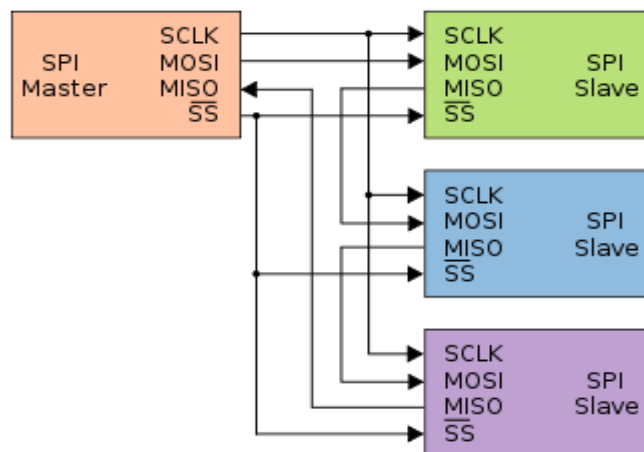

Daisy chain configuration]

Daisy-chained SPI bus: master and cooperative slaves

Some products that implement SPI may be connected in a daisy chain configuration, the first slave output being connected to the second slave input, etc. The SPI port of each slave is designed to send out during the second group of clock pulses an exact copy of the data it received during the first group of clock pulses. The whole chain acts as a communication shift register; daisy chaining is often done with shift registers to provide a bank of inputs or outputs through SPI. Such a feature only requires a single SS line from the master, rather than a separate SS line for each slave.^[4]

Applications that require a daisy chain configuration include SGPIO and JTAG.

Valid communications

Some slave devices are designed to ignore any SPI communications in which the number of clock pulses is greater than specified. Others do not care, ignoring extra inputs and continuing to shift the same output bit. It is common for different devices to use SPI communications with different lengths, as, for example, when SPI is used to access the scan chain of a digital IC by issuing a command word of one size (perhaps 32 bits) and then getting a response of a different size (perhaps 153 bits, one for each pin in that scan chain).

Interrupts

SPI devices sometimes use another signal line to send an interrupt signal to a host CPU. Examples include pen-down interrupts from touchscreen sensors, thermal limit alerts from temperature sensors, alarms issued by real time clock chips, SDIO,^[5] and headset jack insertions from the sound codec in a cell phone. Interrupts are not covered by the SPI standard; their usage is neither forbidden nor specified by the standard.

Example of bit-banging the master protocol

Below is an example of bit-banging the SPI protocol as an SPI master with CPOL=0, CPHA=0, and eight bits per transfer. The example is written in the C programming language. Because this is CPOL=0 the clock must be pulled low before the chip select is activated. The chip select line must be activated, which normally means being toggled low, for the peripheral before the start of the transfer, and then deactivated afterward. Most peripherals allow or require several transfers while the select line is low; this routine might be called several times before deselecting the chip.

I²C

I²C (Inter-Integrated Circuit), pronounced *I-squared-C* or *I-two-C*, is a multi-master, multi-slave, packet switched, single-ended, serial computer bus invented by Philips Semiconductor (now NXP Semiconductors). It is typically used for attaching lower-speed peripheral ICs to processors and microcontrollers in short-distance, intra-board communication. Alternatively I²C is spelled I2C (pronounced I-two-C) or IIC (pronounced I-I-C).

Since October 10, 2006, no licensing fees are required to implement the I²C protocol. However, fees are required to obtain I²C slave addresses allocated by NXP.^[1]

Several competitors, such as Siemens AG (later Infineon Technologies AG, now Intel mobile communications), NEC, Texas Instruments, STMicroelectronics (formerly SGS-Thomson), Motorola (later Freescale, now merged with NXP^[2]), Nordic Semiconductor and Intersil, have introduced compatible I²C products to the market since the mid-1990s.

SMBus, defined by Intel in 1995, is a subset of I²C, defining a stricter usage. One purpose of SMBus is to promote robustness and interoperability. Accordingly, modern I²C systems incorporate some policies and rules from SMBus, sometimes supporting both I²C and SMBus, requiring only minimal reconfiguration either by commanding or output pin use.

Design

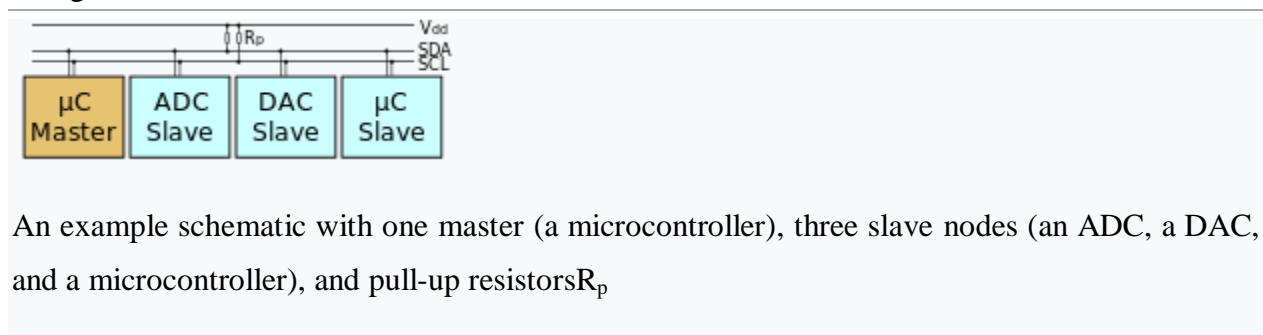

I²C uses only two bidirectional open-drain lines, Serial Data Line (SDL) and Serial Clock Line (SCL), pulled up with resistors. Typical voltages used are +5 V or +3.3 V, although systems with other voltages are permitted.

The I²C reference design has a 7-bit or a 10-bit (depending on the device used) address space.^[4] Common I²C bus speeds are the 100 kbit/s *standard mode* and the 10 kbit/s *low-speed mode*, but arbitrarily low clock frequencies are also allowed. Recent revisions of I²C can host

more nodes and run at faster speeds (400 kbit/s *Fast mode*, 1 Mbit/s *Fast mode plus* or Fm+, and 3.4 Mbit/s *High Speed mode*). These speeds are more widely used on embedded systems than on PCs. There are also other features, such as 16-bit addressing.

Note the bit rates are quoted for the transactions between master and slave without clock stretching or other hardware overhead. Protocol overheads include a slave address and perhaps a register address within the slave device, as well as per-byte ACK/NACK bits. Thus the actual transfer rate of user data is lower than those peak bit rates alone would imply. For example, if each interaction with a slave inefficiently allows only 1 byte of data to be transferred, the data rate will be less than half the peak bit rate.

The maximal number of nodes is limited by the address space and also by the total bus capacitance of 400 pF, which restricts practical communication distances to a few meters. The relatively high impedance and low noise immunity requires a common ground potential, which again restricts practical use to communication within the same PC board or small system of boards.

USB

Just about any computer that you buy today comes with one or more **Universal Serial Bus** connectors. These USB connectors let you attach mice, printers and other accessories to your computer quickly and easily. The operating system supports USB as well, so the installation of the device drivers is quick and easy, too. Compared to other ways of connecting devices to your computer (including parallel ports, serial ports and special cards that you install inside the computer's case), USB devices are incredibly simple.

In this article, we'll look at USB ports from both a user and a technical standpoint. You'll learn why the USB system is so flexible and how it's able to support so many devices so easily -- it's truly an amazing system.



CAN bus

A Controller Area Network (CAN bus) is a robust vehicle bus standard designed to allow microcontrollers and devices to communicate with each other in applications without a host computer. It is a message-based protocol, designed originally for multiplex electrical wiring within automobiles to save on copper, but is also used in many other contexts.

Introduction to the LIN bus

Background

The protocol for the Local Interconnect Network (LIN) is based on the Volcano-Lite technology developed by the Volvo spin-out company Volcano Communications Technology (VCT). Since other car corporations also were interested in a more cost effective alternative to CAN, the LIN syndicate was created. In the middle of 1999 the first LIN protocol (1.0) was released by this syndicate. The protocol was updated twice in 2000. In November 2002 LIN 1.3 was released with changes mainly made in the physical layer. The latest version LIN 2.0 was released in 2003. With LIN 2.0 came some major changes and also some new features like diagnostics. The changes were mainly aimed at simplifying use of off-the-shelves slave nodes.

Areas of use

The LIN protocol is a compliment to the CAN and the SAE J1850 protocols for applications that are not time critical or does not need extreme fault tolerance, since LIN is not quite as reliable as CAN. The aim of LIN is to be easy to use and a more cost effective alternative to CAN. Examples of areas where LIN is and can be used in a car: window lift, mirrors, wiper and rain sensors.

Learning Module FlexRay

1/32

FlexRay is a serial communication technology that is used in particular for data communication in very safety-critical use areas in the automobile.

This E-Learning module is intended for all those who wish to gain a better understanding of FlexRay communication technology.

This E-Learning module is also ideal for those planning to participate in the FlexRay workshop of the VectorAcademy. It lets you learn about the basic properties of data communications in a FlexRay network in advance of the workshop. This not only simplifies your entry into the workshop. Much of what you have acquired by E-Learning will be revisited in the workshop, and this reinforces what you have already learned.



Motivation for MOST

Automobiles have evolved from having a simple radio with perhaps a cassette or CD player to having a variety of sophisticated entertainment and information systems that need to communicate and interact with each other and with a human user. As a matter of fact, automotive systems are more feature-rich than many other A/V applications such as home A/V distribution, security A/V systems and industrial applications. MOST offers an optimized architecture for the real-time transport of audio, video, data and control. It is the backbone of modern infotainment systems.

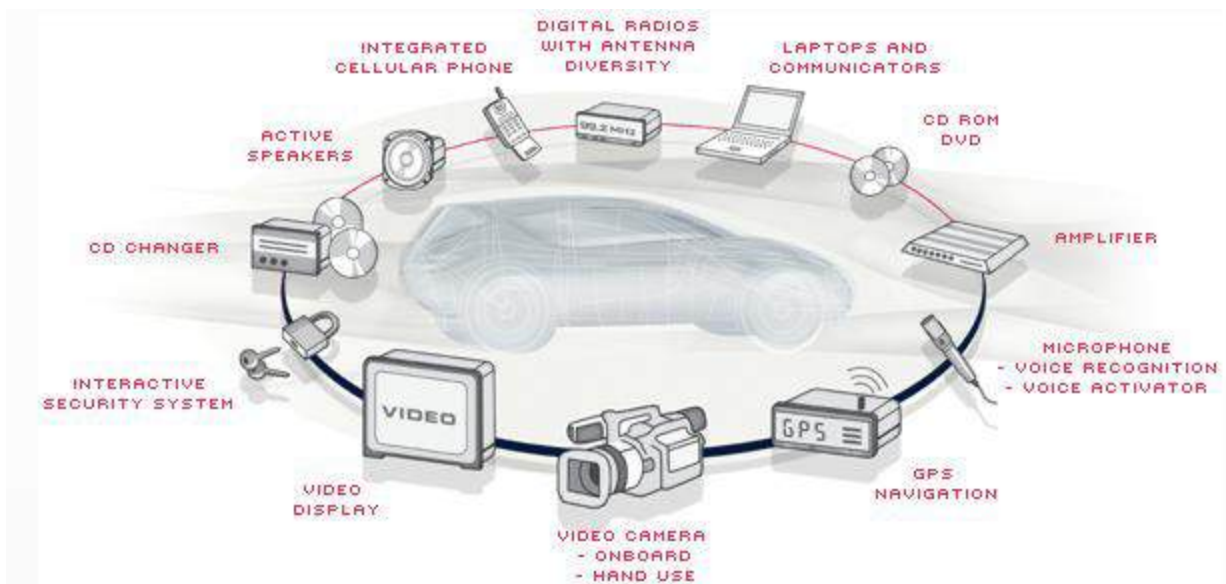

Keyword Protocol 2000

Keyword Protocol 2000, abbreviated **KWP2000**, is a communications protocol used for on-board vehicle diagnostics systems (OBD). This protocol covers the application layer in the OSI model of computer networking. The protocol is standardized by International Organization for Standardization as ISO 14230. KWP2000 also covers the session layer in the OSI model, in terms of starting, maintaining and terminating a communications session.

Commonly used physical layers

One underlying physical layer used for KWP2000 is identical to ISO 9141, with bidirectional serial communication on a single line called the K-line. In addition, there is an optional L-line for wakeup. The data rate is between 1.2 and 10.4 kilobaud, and a message may contain up to 255 bytes in the data field.

When implemented on a K-line physical layer KWP2000 requires special wakeup sequences: 5-baud wakeup and fast-initialisation. Both of these wakeup methods require timing critical manipulation of the K-line signal.

KWP2000 is also compatible on ISO 11898 (Controller Area Network) supporting higher data rates of up to 1 Mbit/s. CAN is becoming an increasingly popular alternative to K-line because

the CAN bus is usually present in modern-day vehicles and thus removing the need to install an additional physical cable.

Using KWP2000 on CAN with ISO 15765 Transport/Network layers is most common. Also using KWP2000 on CAN does not require the special wakeup functionality.

KWP2000 can be implemented on CAN using just the service layer and session layer (no header specifying length, source and target addresses is used and no checksum is used); or using all layers (header and checksum are encapsulated within a CAN frame). However using all layers is overkill, as ISO 15765 provides its own Transport/Network layers.

USB-to-CAN V2

Active USB interface

2 x CAN (High-/Low-Speed), LIN

With up to two CAN High Speed channels, one CAN Low Speed channel, and a LIN channel, depending on the device variant, a wide variety of applications can be addressed by the USB-to-CAN V2 – in both the industrial and the automotive sectors.



InstallationManuals

Features and benefits

- Cost-effective and extremely versatile
- Common driver interface for easy exchange of the PC interface type
- For industrial and automotive applications
- Galvanic isolation optional

Variants

The USB-to-CAN V2 is available in different variants. In the USB-to-CAN V2 compact variant, the CAN connection is implemented as a D-SUB 9 plug or alternatively as an RJ45 connector.

For devices with two CAN interfaces, these are implemented as RJ45 connectors. Adapter cables to sub-D9 plugs are included with the devices.

The IXXAT USB-to-CAN V2 embedded is designed without a housing, with or without a slot board and adapted USB cable for installation into a computer.

Additional options include galvanically isolated CAN interfaces, bulk variants, and support for ISO 11898-3 low-speed CAN and LIN.



Compact
D-SUB 9

Compact
RJ45

Professional

Automotive

Embedded

LIN (automotive variant)

LIN communications are supported in either LIN master or LIN slave mode. As LIN slave, the interface responds automatically to master requests it receives. The response data is updated through the PC API using a buffer. In master mode, the master calls are processed by the PC application. Incoming LIN messages are forwarded to the application with a timestamp, master request, response, and status information.

High performance and flexibility

By using powerful hardware and connecting over USB 2.0 Hi-Speed (480 MBit/sec), the USB-to-CAN V2 interfaces achieve very high data throughput with minimum latency and low power consumption. This allows them to provide the reliable, loss-free transmission and receipt of messages in CAN networks at high transmission rates and bus load. The messages are also timestamped and can be filtered and buffered directly in the USB-to-CAN V2.

Due to its extremely interesting price and compact size, the USB-to-CAN V2 interface is ideal for use in series products and in combination with the canAnalyser for development, service, and maintenance tasks.

Its newly developed, rugged housing permits easy customer-specific adaptation (custom design / brand labeling).

All USB-to-CAN V2 variants are supported by the IXXAT driver packages and higher layer protocol APIs as well as by the IXXAT tool suite. A detailed software support overview can be found [here](#).

Technical specifications

PC bus interface	USB 2.0, Hi-Speed
Microcontroller	32 bit
CAN controller	Internal; CAN 2.0 A/B
CAN baudrates	10 kBit/s ... 1 Mbit/s
CAN high-speed transceiver	TI SN65HVD251D
CAN low-speed transceiver ⁽¹⁾	TJA1055T
LIN transceiver ⁽¹⁾	TJA1020
LIN protocol ⁽¹⁾	V1.3 and V2.0
LIN baudrate ⁽¹⁾	max. 20 kBaud
Galvanic isolation	optional, 1 kV, 1 sec.
Power supply	5 V, max. 500 mA via USB port
Temperature range	-20°C ... 70°C
Fieldbus connection	according to CiA 303-1
Certification	CE, EN 55022:2010, EN61000-6-1:2007