



HMEC

Highway Materials Engineering Course

PARTICIPANT WORKBOOK

LABORATORY MANUAL



Welding



U.S. Department of Transportation
Federal Highway Administration

MODULE

C

Contents

Introduction	5
Terminology	5
Welding Demonstration and Practice – Safety Topics	6
Shielded Metal Arc Welding.....	9
Gas Metal Arc Welding	13
Flux-Cored Arc Welding	19
Submerged Arc Welding	24
Welding Inspection (Visual Tests)	27
Nondestructive Evaluation (NDE)/Nondestructive Testing (NDT).....	44
Penetrant Testing (PT)	44
Magnetic Particle Testing (MT)	48
Ultrasonic Testing (UT)	52
Radiographic Testing (RT)	54
Analyzing Weld Failures (Case Studies)	58
Incomplete Fusion (IF)	58
Incomplete Penetration (IP).....	60
Reinforcement	62
Surface (Piping) Porosity.....	64
Subsurface Porosity and Inclusions	66
Cracks	70
Undercut.....	72
Underfill, Convexity, Craters	74
Spatter	78
Arc Strike	80
Fracture-Critical Members	82

Introduction

While there are numerous welding processes utilized in highway and bridge industry, shielded metal arc welding (SMAW), flux-cored arc welding (FCAW), and submerged arc welding (SAW) are the most common. An explanation of these three, along with filler metal information follows. Selecting the proper filler metal requires an understanding of the mechanical properties desired and the weld's appearance considerations. After selecting the welding process and filler metal, the proper welding parameters must be developed and maintained. Amperage, voltage, and travel speed determine the heat input and are the key parameters to set and maintain.

The American Welding Society publishes the A5.X series of filler metal specifications. Filler metals are typically purchased by these specifications and the class of filler metal described in the appropriate specification. These classes are designated by a numbering system summarized with the description of each process.

Terminology

Electrode – a rod that is used in arc welding to carry a current through a work piece to fuse two pieces together. In some welding processes, the electrode may also act as the filler metal.

Filler metal – metal deposited into the weld to add strength and mass to the welded joint.

Flux – a chemical cleaning agent that is applied to a joint just prior to the welding process to clean and protect the metal surface from surface oxides that form as a result of heating.

Porosity – the appearance of tiny bubbles on a weld bead as a result of gas entrapment; excessive porosity can weaken a weld.

Root opening – the separation at the joint root between the base metals.

Shielding Gas – inert or semi-inert gas that is used to protect the weld puddle and arc from reacting negatively with the atmosphere.

Slag – cooled flux that forms over the top of the weld; slag protects the cooling metal and is then chipped off.

Spatter – liquid metal droplets expelled from the welding process.

Weldability – the ability of a material to be welded under prescribed conditions and to perform as intended.

Welding Demonstration and Practice – Safety Topics

Background Information

Safety is a critical consideration for any welding application. Arc welding is a safe occupation when proper precautions are taken. If safety awareness is not a priority, welders face an array of hazards that can be potentially dangerous, including electric shock, fumes, fire, explosions, and more. Knowing how to avoid the most common welding hazards ensures a safe, productive work environment.

Electric Shock

Electric shock is one of the most serious and immediate risks facing a welder. Electric shock can lead to severe injury or death, either from the shock itself or from a fall caused by the reaction to a shock.

Electric shock in welding can come from two sources. Welding machines connected to primary voltages of typically 120V, 230V or 460V pose the greatest threat. Connection and maintenance of the primary system should only be done by qualified personnel. Inside the machine, primary voltages are transformed to the secondary voltages and currents required for the welding arc. Once energized, many components of the welding operation are electrically “hot” including the electrode holder, gun or torch, the wire feeder, and the spool or coil of wire. An electrical circuit exists between these and the work connection. If welders insert themselves into this circuit, shock will occur. Care should be taken to wear the proper personal protective equipment (PPE) and assure that they are in good repair. Even heavy welding gloves, if wet, can cause shock to the welder. Welding equipment electrical systems should only be installed and repaired by qualified personnel.

Eye and Face Protection

The proper eye and face protection for welding safety varies depending on the welding process, its heat or current, and other factors. Helmets, hand shields, goggles, safety glasses, or a combination of these may be required based on the application. Arc welding requires the proper filter lens shade based on process and current settings.

According to OSHA 29 CFR 1910.252, "Helmets and hand shields shall protect the face, forehead, neck and ears to a vertical line in back of the ears, from the arc direct radiant energy and weld spatter."

OSHA requires that when arc cutting or arc welding with open arc, helmets or hand shields with filter lenses and cover plates be used by welders and welding operators. Anyone in the area

should be shielded from the arc or be wearing proper eye protection. Safety glasses with a Shade 2 lens are recommended for general-purpose protection for distant workers who may inadvertently view the arc.

Protective Clothing

According to ANSI Z49.1:2012: Welding and Cutting (4.3), appropriate protective clothing for any welding or cutting operation will vary with the size, nature, and location of the work to be performed. "Clothing shall provide sufficient coverage and be made of suitable materials to minimize skin burns caused by sparks, spatter or radiation." All parts of the body must be protected against the rays given off by the arc. Even if facing away from the arc, it is possible to be "burned" by reflected energy.

The ANSI standard requires all welders and cutters to wear protective flame-resistant gloves, such as leather welder's gloves, which provide the heat resistance needed for welding. Gloves should have cuffs long enough to cover any exposed skin and should be insulated enough to keep the heat from reaching the welder's hands.

Fumes and Gases

Many welding operations produce fumes from the base metal and its coatings and from the burning of the welding consumable. It is always important to keep your head out of the fumes. Ventilation, either natural or mechanical, is required to reduce exposure to the harmful metal oxides produced in the welding operation.

Safety data sheets are available from consumable manufacturers outlining the specific potential health effects which relate to that product.

OSHA outlines threshold limit values (TLV) and permissible exposure limits (PEL) for substances in welding fumes. These limits specify the amount of a substance to which welders can be exposed over time. Testing can be done to verify your operation is within these limits. Respirators or supplied air helmets are available to stay within these exposure limits.

Ventilation

Ventilation or "changes of air" is necessary to prevent welders and those around the welding operation from breathing high levels of fumes. Ventilation is a way of providing adequate clean air, and must be provided for all welding, cutting, and brazing applications. Adequate ventilation depends on the following factors:

- Volume of the space where the welding operations occur;

- The size and configuration of the welding space;
- The type of welding being done;
- The natural air flow in the area; and
- Location of the welders' breathing zones in relation to the fume source.

Proper ventilation can be obtained either naturally or mechanically.

Natural ventilation is considered sufficient for welding and brazing operations if the present work area meets these requirements:

- More than 10,000 ft² per welder;
- A ceiling height of more than 16 ft.; and
- The welding area is clear of any building element which restricts air flow.

Mechanical ventilation can take many forms—all of which use some method of capturing welding fumes and moving them somewhere else. The overall design concept of these systems should provide 100 ft. per minute of air flow through the entire welding area.

Fumes can be captured by ducting fixtures, fans, fixed hoods over the area, or movable “arms.” After capture, fumes may be simply exhausted in some cases or passed through a filtering system with clean air exhausted back into the area.

Note: Fumes and gases from welding and cutting cannot be easily classified. The quantity of fumes is related to the metals being welded, the welding process, and the welding consumable. Coatings and cleaning agents on the metals can also add contamination to the air. Air sampling may be required to determine needed actions. For more information, see OSHA 29 CFR 1910.252 on welding regulations, or ANSI Z49.1:2012 – Safety in Welding, Cutting, and Allied Processes, which is available for free download at aws.org. Both OSHA and AWS have fact sheets on many aspects of welding safety available for free download on their respective Web sites.

Shielded Metal Arc Welding

Background Information

Shielded metal arc welding (SMAW), also called “stick welding,” or in many other countries manual metal arc (MMA), is an arc welding process that uses a solid rod coated with flux. This rod or electrode can be made from a variety of metals and flux components, making the process one of the most versatile in welding many materials. The rod carries electric current from a power supply to create an arc that melts both the base metal and the rod. As the weld is deposited, the flux coating of the electrode provides both a shielding gas (by burning of flux components) and a slag layer that protects the molten metal from the atmosphere.

Significance and Use

SMAW dominates other welding processes in the maintenance and repair industry. Although flux-cored arc welding is growing in popularity, SMAW continues to be used extensively in the construction of steel structures and in industrial fabrication. The process is used primarily to weld iron and steels, including stainless steel, but most alloys can be welded with this method.

Procedure

The electrode is placed in an electrode holder, which is connected to one lug of a constant current welding power supply. This power supply can be operated on alternating current (AC), direct current electrode positive (DCEP), or direct current electrode negative (DCEN) depending on the type of electrode being used. A cable connected to the work is attached to the other lug. The machine is energized and the electrode is lightly touched to the work—the arc is then initiated. The welder then manually moves the electrode along the weld joint.

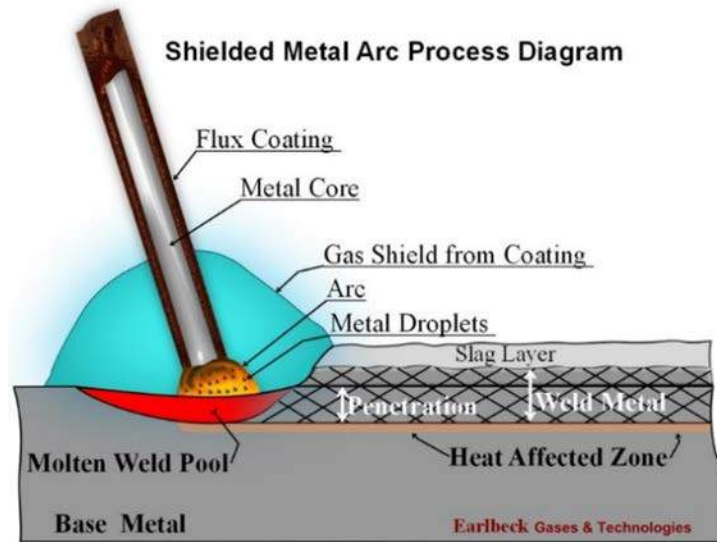

Advantages

- Wide variety of metals welded due to wide choice of electrodes
- Simple and portable equipment
- Low cost
- Adaptable to confined spaces and remote locations
- Suitable for out-of-position welding



Disadvantages

- Not as productive as continuous wire processes
- More costly to deposit a given quantity of metal due to labor costs
- Frequent stop/starts to change electrode
- Relatively high metal wastage (electrode stubs)
- Slag can become trapped in the weld

Common Discontinuities

- Slag inclusions
- Porosity
- Spatter
- Incomplete fusion
- Incomplete joint penetration
- Arc strike

SMAW Filler Metal Classification – A5.1 (Carbon Steel), A5.5 (Low Alloy)

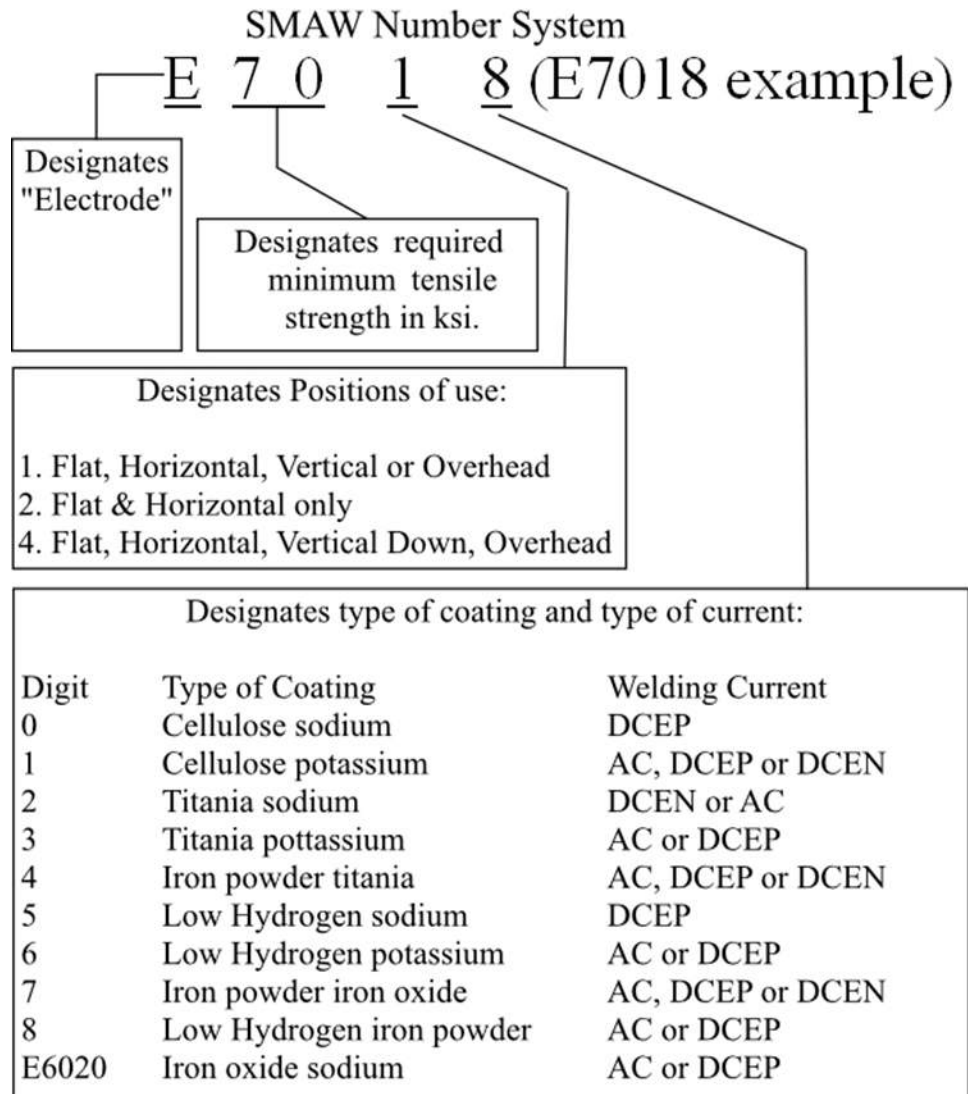

Earlbeck Gases & Technologies

Notes:

Gas Metal Arc Welding

Background Information

Gas Metal Arc Welding (GMAW) is a semi-automatic arc welding process which uses a continuously-fed and consumed solid or metal cored wire electrode and an external gas shield supplied from a cylinder. The process is commonly called MIG Welding for “Metal Inert Gas”; however, many of the gases used today are not inert. While this process is one of the easiest to do, it is often misunderstood as there are three different “modes of transfer” which is the manner in which the molten metal is melted and transferred across the arc.

Procedure

The filler metal is typically on a spool or coil mounted to a wire feeder which is connected to one lug of a constant voltage welding power supply. A cable connected to the work is attached to the other lug. The welder holds a welding gun through which the wire is fed, exiting through a contact tip sized to the wire. When the trigger on the gun is pulled, the machine is energized, gas flow begins, the wire is fed to the work from a wire feeder, and the arc is initiated. The welder then moves the electrode along the weld joint. When the welder moves the gun, the process is termed semi-automatic as the wire is being machine fed. If the gun is attached to a travel device and the welding operator just observes, the process type is considered “mechanized” or “machine welding”.

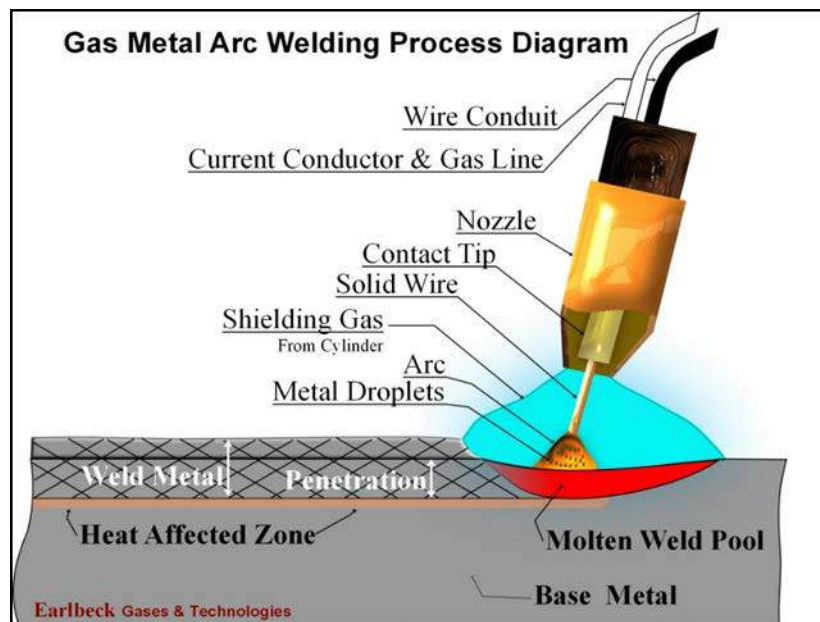

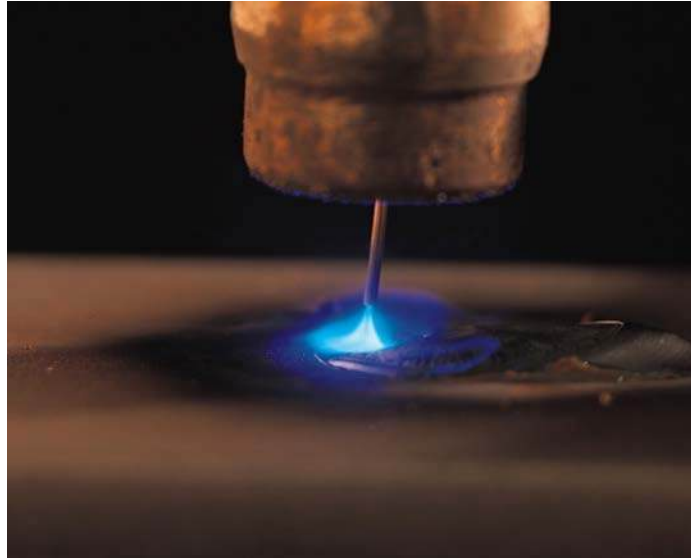

Advantages

- Semiautomatic process
- High productivity
- No slag to remove
- Clean process
- Welds most alloys

Disadvantages

- Unsuitable for windy conditions
- Little tolerance for contamination
- Usually limited to shop welding
- Equipment can be complex

Common Discontinuities

- Porosity
- Incomplete fusion
- Incomplete joint penetration

Transfer Modes

The manner in which the solid wire melts and “transfers” across the arc changes as the level of energy is applied.

Short Circuiting Transfer

At the lowest energies the wire actually touches the work forming an electrical short causing the voltage to drop and the current to rise. As the wire heats a large droplet will “pinch” off and be deposited in the weld pool. These shorts occur from 20-200 times per second and produce a distinct “bacon frying” sound. Some spatter is produced which can vary with the shielding gas used. This transfer mode is usable in all welding positions, but produces the lowest level of weld penetration and fusion.

Globular Transfer

As energy is increased the heat of the arc causes the end of the wire to form a larger ball before the wire actually shorts to the work. This ball is then flung across the arc splashing into the molten puddle creating maximum amounts of spatter. This transfer mode should be avoided.

Spray Transfer

Also called Axial Spray Transfer. As energy is again increased a “transition” level is reached where large droplets happening relatively slowly changes to very small droplets happening very rapidly. At this point an arc cone is visible and no shorting occurs. Very little spatter is produced. This mode is only usable in the flat and horizontal positions but produces the greatest level of weld penetration and fusion.

Pulsed Spray Transfer

This is not a separate transfer mode, but is Spray Transfer created by varying the weld energy between two levels. The higher level sprays off a few droplets and then the lower level “cools” the arc down. This process requires more sophisticated equipment, but produces spray transfer with lower overall heat input which becomes usable in all positions.

Gases

When considering the energy required for these transfer modes, amps and volts are not the only consideration. Different shielding gases have varying ionizing potentials which affect their ability to carry the required current. The primary gases used in GMAW are CO₂, mixes of Argon with CO₂ and mixes of Argon with Oxygen. As a rule of thumb, a minimum of 80% Argon is required to achieve spray transfer. Common gases for short circuit transfer are 100% CO₂ and 75%Argon/25%CO₂ (produces a more stable arc with less spatter than 100% CO₂). Common gases for spray transfer are 98%Ar/2%O₂ and 90%, 92%, 95%, 98% Argon-Balance CO₂. 92% or greater Argon/balance CO₂ is typically used for pulsed spray transfer.

Guidelines

Table 1 provides some estimated ideas for choice of transfer mode.

Characteristics	Short Circuit	Global	Spray	Pulsed Spray	Notes
Energy	Low	Medium	High	Any	None
Penetration	Low	Medium	High	Medium	Pulsed spray can have penetration issues.
Positions	All	Flat & Hor.	Flat & Hor.	All	None
Thickness	¼" & less	3/16" to ½"	3/16" & greater	Any	Guidelines only-not hard and fast rules.
100% CO₂	Yes	Yes	No	No	None
75% Argon 25% CO₂	Yes	Yes	No	Fair	Produces less spatter than 100% CO ₂
90-92% Ar Bal. CO₂	Yes	Yes	Yes	Yes	None
95-98% Ar Bal. CO₂	No	No	Yes	Yes	None
98% Argon 2% Oxygen	No	No	Yes	Poor	This is a spray only gas

Table 1: Choices of Transfer Modes

GMAW Filler Metal Classification – A5.18 (Carbon Steel), A5.28 (Low Alloy)

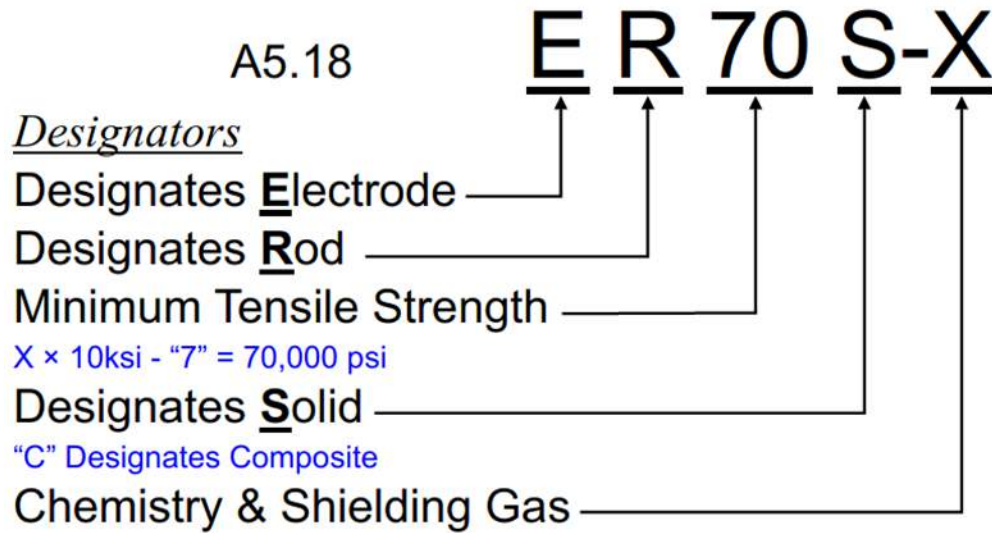

AWS A5.18 Shielding classification	Tensile Strength ksi (MPa)	Yield Strength ksi (MPa)	%Σ min.	Impact strength Min. ft-lbs at °F (J at	C	Mn	Si	P	S	Ni	Cr	Mo	Cu	Other
ER70S-2	CO ₂	70 (480)	58 (400)	22	20 at -20 (27 at -29)	0.07	.90-1.40	.40-.70	0.025	0.035	-	-	.50	Ti, Zr, Al
ER70S-3	CO ₂	70 (480)	58 (400)	22	20 at 0 (27 at -18)	.06-.15	.90-1.40	.45-.70	0.025	0.035	-	-	.50	-
ER70S-4	CO ₂	70 (480)	58 (400)	22	-	.07-.15	1.00-1.50	.65-.85	0.025	0.035	-	-	.50	-
ER70S-5	CO ₂	70 (480)	58 (400)	22	-	.07-.19	.90-1.40	.30-.60	0.025	0.035	-	-	.50	Al
ER70S-6	CO ₂	70 (480)	58 (400)	22	20 at -20 (27 at -29)	.07-.15	1.40-1.85	.80-1.15	0.025	0.035	-	-	.50	-
ER70S-7	CO ₂	70 (480)	58 (400)	22	20 at -20 (27 at -29)	.07-.15	1.50-2.00	.50-.80	0.025	0.035	-	-	.50	-
ER80S-D2	CO ₂	80 (550)	68 (470)	17	20 at -20 (27 at -29)	.07-.12	1.60-2.10	.50-.80	0.025	0.025	0.2	-	.40-.60	.50

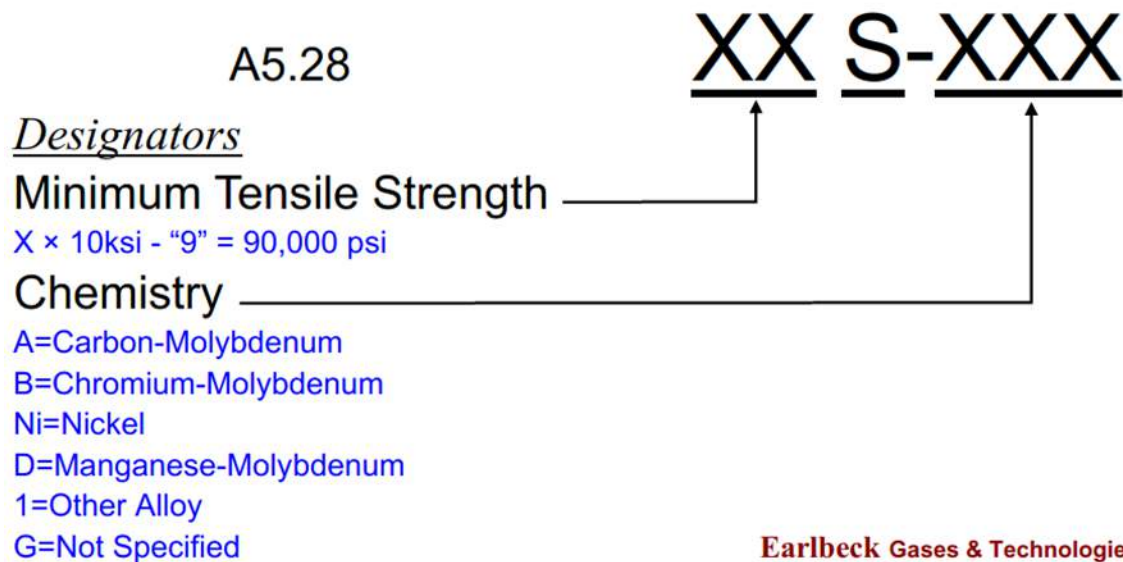

Earlbeck Gases & Technologies

Note: Carbon Steel GMAW wires utilize deoxidizers which help eliminate oxides/porosity in the weld metal. Silicon & Manganese are the most common and also make the weld puddle more fluid. Titanium, Zirconium and Aluminum are less common and make the puddle more sluggish.

Notes:



Flux-Cored Arc Welding

Background Information

Flux-cored arc welding (FCAW) is a semi-automatic arc welding process which uses a continuously-fed and consumed tubular electrode containing a flux. The electrode is somewhat like a SMAW electrode turned inside out. A strip of sheath material is rolled into a “U” shape, and fluxing agents and metal compounds are added. The strip is then rolled shut and drawn to size.

Significance and Use

The flux components can be similar enough to the coating on a SMAW electrode that no shielding gas is required. If shielding gas can be externally supplied, the core can contain elements such as iron powder to allow higher deposition rates.

Procedure

The filler metal is typically on a spool or coil mounted to a wire feeder that is connected to one lug of a constant voltage welding power supply. A cable connected to the work is attached to the other lug. The welder holds a welding gun through which the wire is fed, exiting through a contact tip sized to the wire. When the trigger on the gun is pulled, the machine is energized, the wire is fed to the work from a wire feeder, and the arc is initiated. The welder then moves the electrode along the weld joint. When the welder moves the gun, the process is termed semi-automatic since the wire is being machine-fed. If the gun is attached to a travel device and the welding operator just observes, the process type is considered “mechanized” or termed “machine welding.”

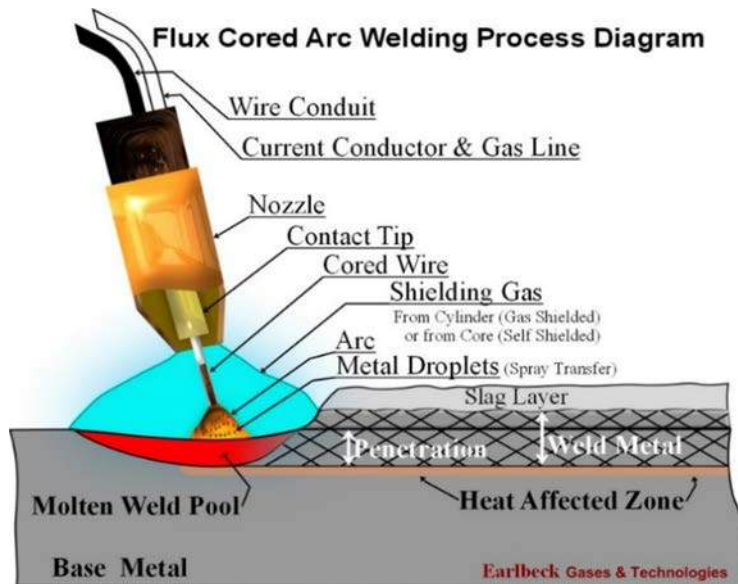

Advantages

- High productivity
- Deep penetration
- Tolerates contamination
- Suitable for field work

Disadvantages

- Slag removal
- Smoky process
- Electrode cost
- Equipment complexity

Common Discontinuities

- Slag inclusions
- Porosity
- Incomplete fusion
- Incomplete joint penetration

FCAW Filler Metal Classification – A5.20 (Carbon Steel), A5.29 (Low Alloy)

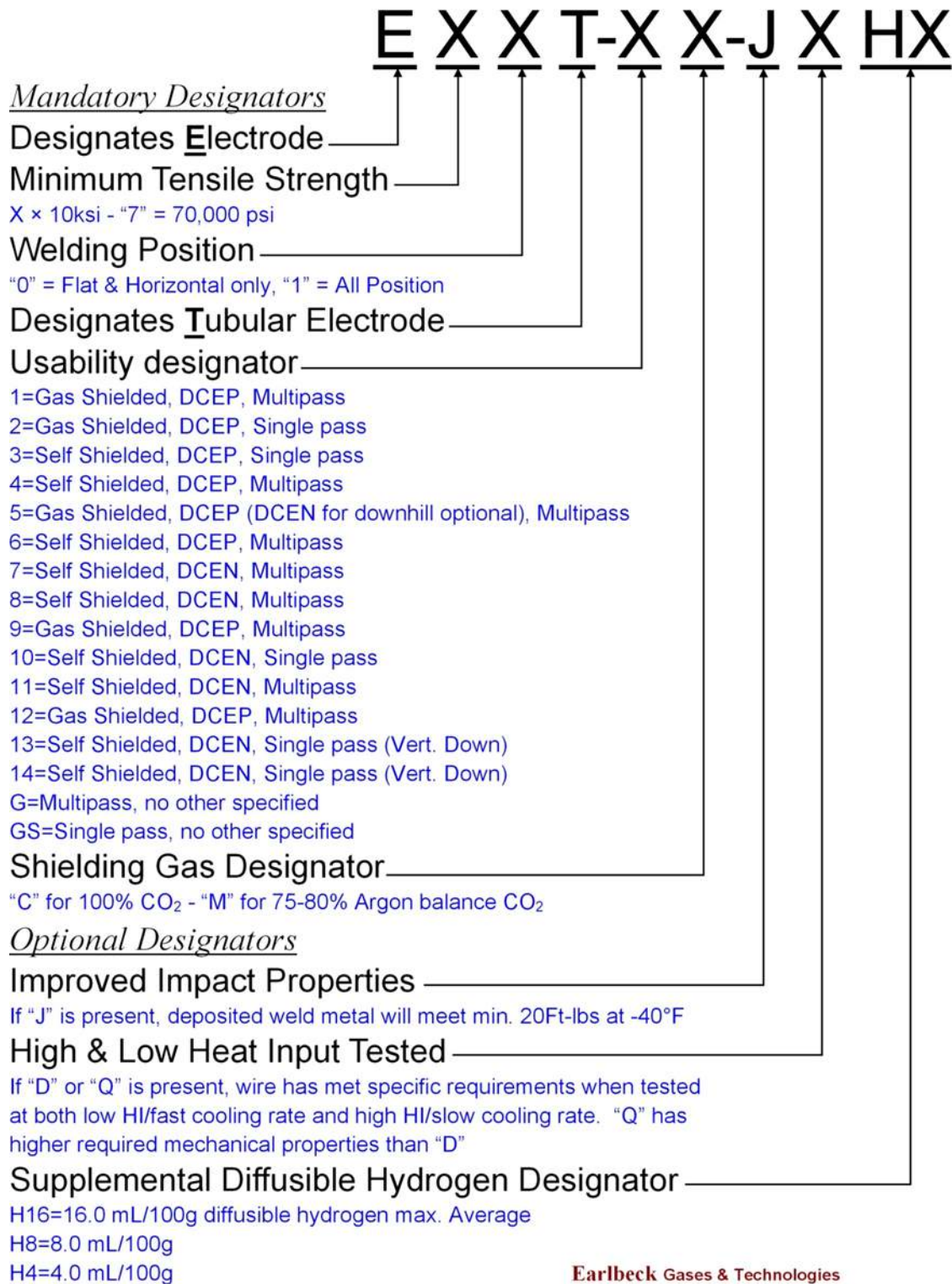

Notes:

Submerged Arc Welding

Background Information

Submerged arc welding (SAW) is a welding process similar in concept to FCAW or gas metal arc welding (GMAW). It also uses a consumed electrode which can be a solid GMAW-style wire or a cored FCAW-style wire. The large difference in this process is that shielding is provided by the arc being fully submerged under a layer of flux containing mineral components such as manganese oxide or calcium fluoride. When the arc is established, the flux melts and also becomes conductive, which provides the path for the current.

Significance and Use

The process typically operates at much higher electrical parameters, thereby increasing the volume of weld metal deposited, but it also typically restricts the process to only flat groove welds and flat, horizontal fillets.

Procedure

Like the FCAW process, the wire is fed from a spool or coil through a contact tip in a gun by a wire feeder. The system also has a cone to deposit the granular flux in front of or around the arc. Typically mechanized, the control has a start button initiated by an operator. When the wire contacts the part, the arc begins.

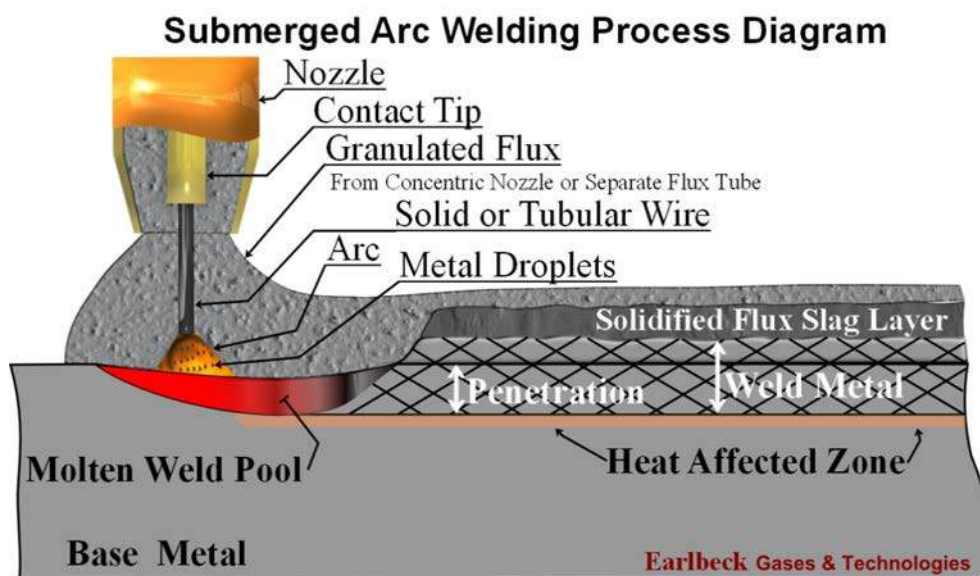

Advantages

- High deposition rate
- Deep penetration
- Mechanized process
- Good for overlay of large areas
- High operator appeal

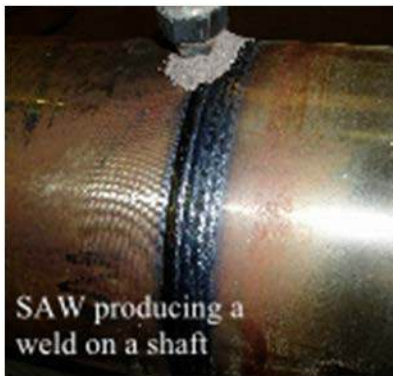

Disadvantages

- Flat or horizontal fillets only
- Extensive set-up time
- Needs positioning equipment
- Arc not visible to operator
- Slag removal

Common Discontinuities

- Slag inclusions
- Cracking (due to high depth to width ratio)

- Incomplete fusion
- Porosity

SMAW Filler Metal Classification – A5.1 (Carbon Steel), A5.5 (Low Alloy)

Submerged Arc Flux/Wire Combination Number System (AWS A5.17)

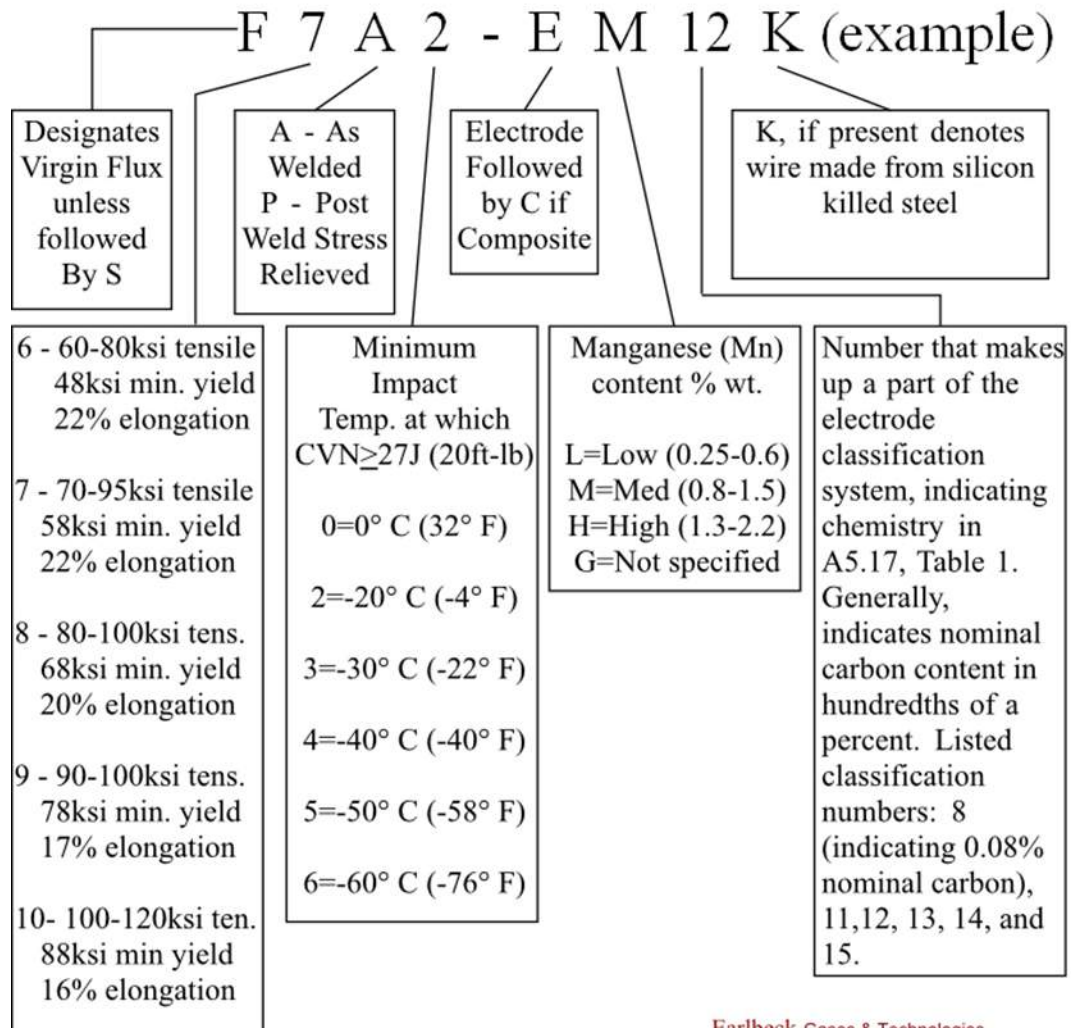

Earlbeck Gases & Technologies

Notes:

Welding Inspection (Visual Tests)

Background Information

One of the most common questions welding inspectors are asked is, “Is this a good or bad weld?” It is important that a welding inspector recognizes that there is no such thing as a good or bad weld. With a full understanding of welding codes and weld inspection, welds are either “acceptable” or “rejectable.” Welding inspectors use the acceptance criteria of the applicable welding code and measuring tools to determine whether or not a weld is acceptable. This means that just because a weld is not “pretty” or uniform, does not mean it is not acceptable in accordance with the welding code. This section will cover the terms and definitions a welding inspector needs to be familiar with, how to use weld measuring tools, and the visual inspection criteria of the AWS D1.5-2010 Bridge Welding Code.

Terms and Definitions

Before we can understand the philosophy of accepting or rejecting a weld in accordance with a code or specification, it is important to understand the terms associated with common weld discontinuities.

Discontinuity – an interruption in the typical structure of a weldment, such as a lack of homogeneity in the mechanical, metallurgical, chemical, or physical characteristics of the material or weldment.

Most welds contain some level of discontinuities such as undercut, porosity, spatter, etc. Discontinuities in a weld do not automatically make a weld rejectable. It is the weld inspector’s job to identify the discontinuity, measure it, and compare it to the applicable welding code’s acceptance criteria to determine if the discontinuity is acceptable or not.

Defect – a discontinuity that fails to meet the minimum acceptance level stated in a code or specification.

When a discontinuity exceeds what is allowed by the acceptance criteria of the applicable welding code, it is considered a defect. Defects are cause for a weld to be determined rejectable. For example, if a welding code’s acceptance criteria allows for undercut up to 1/32-inch deep and the welding inspector measures undercut that is 1/16-inch deep, then that weld is rejectable and must be repaired. However, if the undercut measured was 1/32-inch or less, then the weld would be acceptable.

All defects are discontinuities, but not all discontinuities are defects. Understanding this forms the key to proper analysis of any weld performed in accordance with the requirements of a welding code or specification.

Fusion – the melting together of filler metal and base metal, or of base metal only, which results in coalescence.

Coalescence is the growing together or growth into one body of the materials being joined. So fusion is the melting together of metal, which results in two or more separate pieces (base metal to base metal or base metal to filler metal) becoming one. Proper fusion can be identified by a weld that has a smooth, uninterrupted transition from the weld joint to the base metal and from each weld bead to the next.

Incomplete fusion – fusion which is less than complete (groove sidewall, weld root, or corner, etc.).

Below is a cross section of a multi-pass groove weld with four indications of Incomplete Fusion. Notice on the surface, that the edges of the weld look rolled over or tucked in instead of having a smooth transition to the base metal. In the center of the weld, there is a void between the weld bead passes. Towards the bottom of the weld, on the right side of the groove, there is a void between the weld bead passes and the base metal. These are all signs of incomplete fusion.

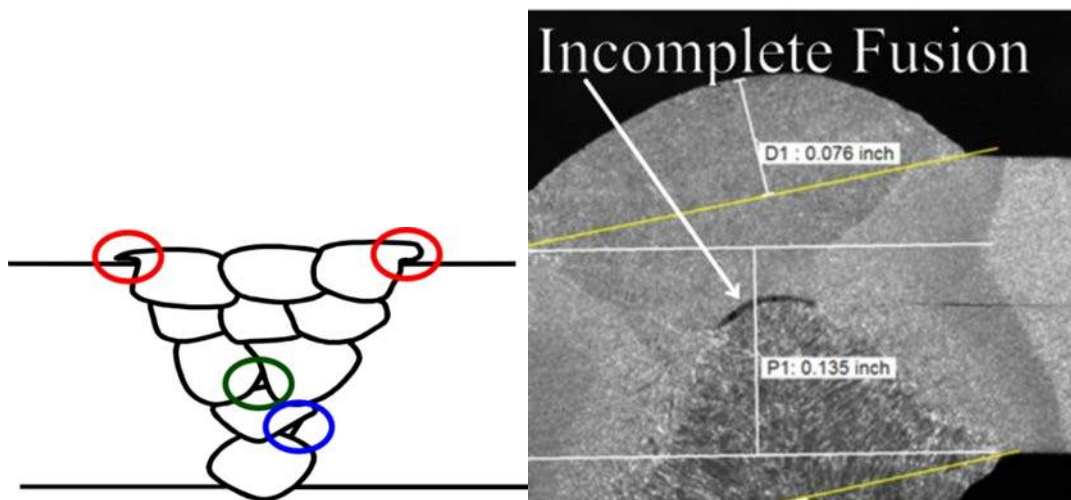

Figure 1: Incomplete fusion

Incomplete fusion can be caused by excessive travel speeds, lack of welding heat, and improper torch/electrode angle. The appropriate repair for incomplete fusion is to grind or cut out the incompletely fused metal and re-weld if necessary.

Penetration – the minimum depth a groove or flange weld extended from its face into a joint exclusive of reinforcement.

Penetration is the measurement of coalesced metal in a joint starting from the face of the weld and not exceeding the thickness of the base metal. Weld metal above the weld joint or past the thickness of the base metal is not included in penetration. Penetration that extends from the face of the weld all the way through the joint thickness is known as “complete joint penetration.”

Incomplete penetration – penetration which is less than specified.

To determine whether or not a weld has incomplete penetration, a weld inspector must first know what the welding code or drawing specifies for penetration. Assume that the joint shown in Figure 2 was specified to be a complete joint penetration weld. Notice that the weld metal does not fully extend through the base metal. This would be considered incomplete penetration. However, if the plate is 3/8-inch thick and the weld was specified to have 3/16-inch deep penetration, then no incomplete penetration exists. Incomplete penetration can be caused by too large of a root face, too narrow of a root opening, improper torch/electrode angle, too large electrode diameter, and lack of welding heat. To visually inspect for incomplete joint penetration, an inspector needs to have access to the root side of the weld. If the weld metal does not extend past the base metal and the original edge of the joint is still visible, then incomplete joint penetration is present. If the weld metal does not extend through the thickness of the base metal, but the original edges of the joint were fully consumed, then complete joint penetration was achieved. To properly repair incomplete penetration, the weld metal must be ground or cut out in the spot where the incomplete penetration exists and then re-welded.

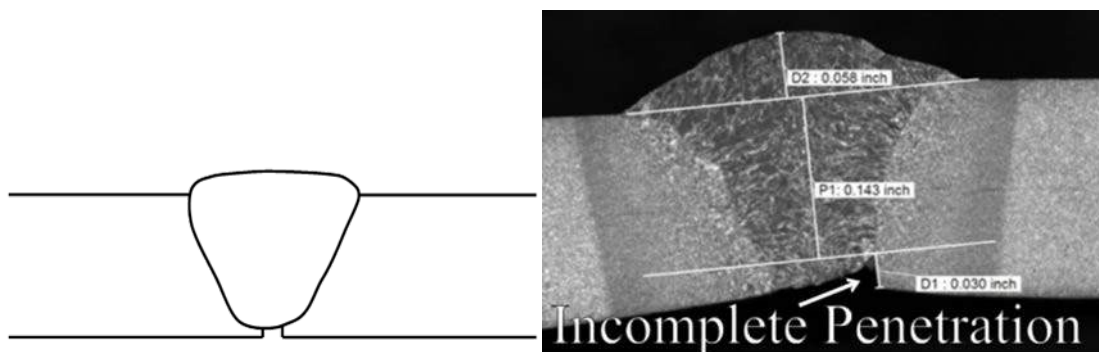

Figure 2: Incomplete penetration

Reinforcement – weld metal in excess of the quantity required to fill a joint.

Reinforcement occurs when the weld metal extends beyond the face or root of the weld. Figure 3 illustrates both face and root reinforcement. Face reinforcement is measured from the top surface of the base metal to the top of the face of the weld. Root reinforcement is measured from the bottom surface of the weld to the root surface of the weld. Excessive reinforcement is considered a defect in most welding codes. The drastic change in surface contour results in an area of stress concentration which can cause the weld to fail. Excessive reinforcement is caused by overfilling the joint with weld metal. It can be repaired by simply grinding away the excessive reinforcement until it is within the range allowed by the acceptance criteria of the applicable welding code.

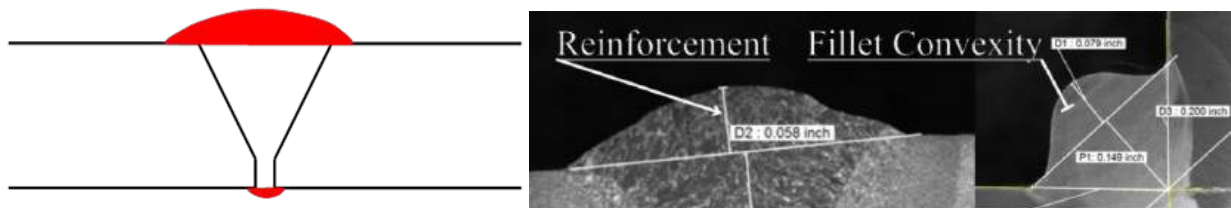

Figure 3: Root and face reinforcement

Inclusions – solid material trapped in the weld metal or between weld metal and base metal.

Inclusions are anything in the weld joint other than weld metal, trapped between the weld metal and base metal. In SMAW and FCAW, slag inclusions can be caused by improper cleaning and removal of slag between weld passes as well as improper torch/electrode angle. In GTAW, tungsten inclusions are a result of pieces of the tungsten electrode breaking off and being deposited in the molten weld puddle. They can be caused by dipping the tungsten into the weld puddle and exceeding the amperage rating of the tungsten. Inclusions are repaired by cutting or grinding away the weld metal until the inclusion is exposed, then further cutting or grinding to sound metal and re-welding. Figure 4 is an illustration of what inclusions look like in a weld cross-section.

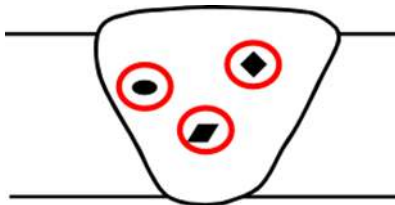

Figure 4: Inclusions

Porosity – a void or cavity formed by gas entrapment during weld solidification.

Porosity is a hollow void in the weld metal formed by gas bubbles being trapped inside molten weld puddle as it solidifies. There are different types of porosity illustrated in Figure 5 and Figure 6. Porosity is caused by improper shielding of the molten weld puddle or the presence of moisture or contaminants in the filler metal or base metal. Porosity is repaired by cutting or grinding to sound metal and re-welding.

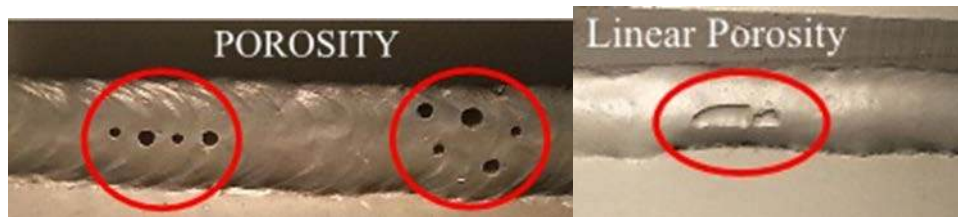

Figure 5: Types of porosity

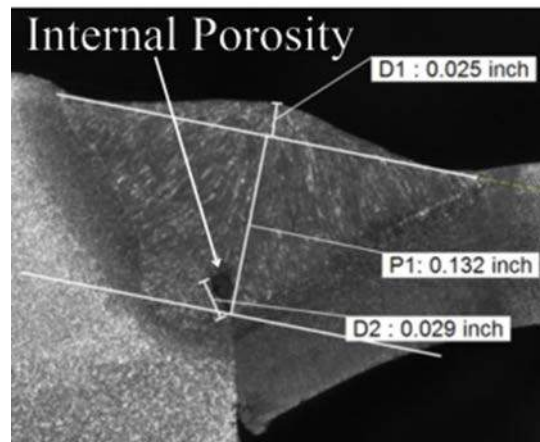

Figure 6: Internal porosity

Cracks – fracture type discontinuity with a sharp tip and high length-to-width ratio.

There are several different types of weld cracks, some of which are illustrated in Figure 7. As molten metal solidifies, it shrinks. This shrinkage causes stress in the weld joint and base metal. If the stress exceeds the strength of the metal, then a crack is formed. There are several other causes for cracks including hydrogen embrittlement, improper weld bead profile, and insufficient filler metal. Cracks are repaired by cutting or grinding down to sound metal and re-welding.

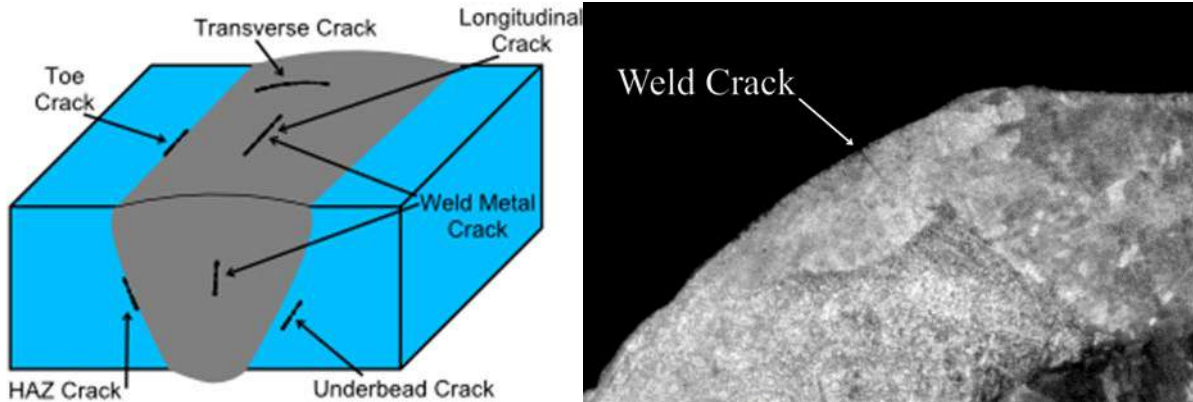

Figure 7: Welding cracks

Overlap – the protrusion of weld metal beyond the toe, face, or root of a weld, without fusion.

Overlap is a specific type of incomplete fusion. It is formed by molten weld metal that is deposited on top of unmelted base metal. When the molten weld metal solidifies, it overlaps the base metal instead of fusing with it to achieve coalescence. Improper electrode angle and travel speed can cause overlap. Overlap is repaired by grinding down the overlapped portion of weld to create a smooth transition from weld metal to base metal and re-welding if necessary.

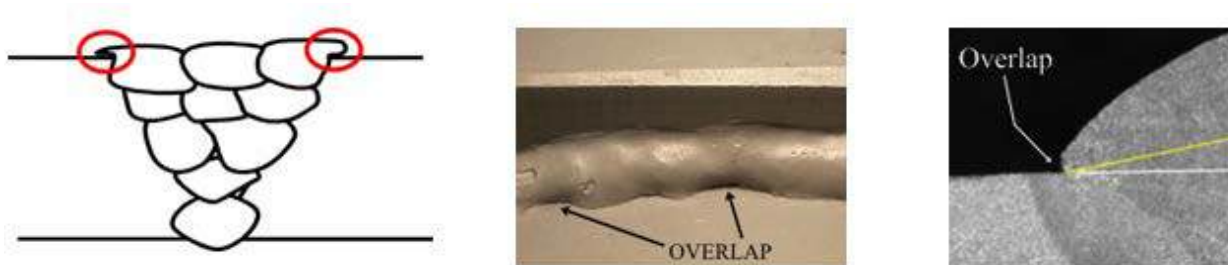

Figure 8: Fusion

Undercut – a groove melted into the base metal adjacent to the toe or root of a weld and left unfilled by weld metal.

Undercut occurs along the edges of a weld when base metal is melted away by the heat of the electrode, but no filler metal is added to fill the void. It is caused by excessive weld heat, long arc length, and improper torch/electrode angle. Undercut is repaired by welding to fill the undercut void. Figure 9 is a cross-section of a weld illustrating undercut.

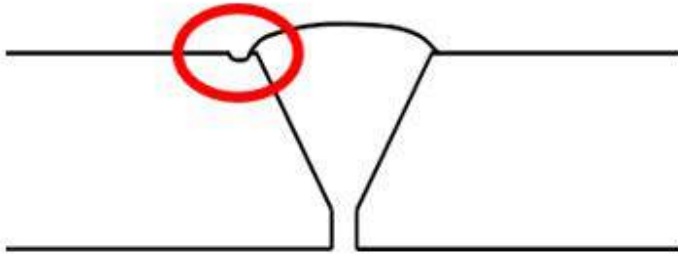

Figure 9: Undercut

Underfill – a depression on the face or root surface of a weld extending below the surface of the adjacent base metal.

Underfill occurs when not enough filler metal is added to sufficiently fill the weld joint. Most welding codes require the welding joint to be filled at least flush with the surface of the base metal. Underfill is repaired by additional welding to fill to the weld joint. Figure 10 is an illustration of a weld cross-section containing underfill.

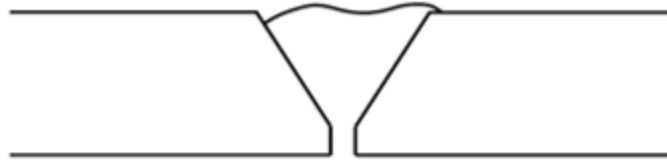

Figure 10: Underfill

Spatter – metal particles expelled during welding, which do not form a part of the weld.

Spatter, not “splatter,” are little balls of molten metal that fuse to the surface of the base metal or weld metal and solidify. They are caused by excessively long arc length and improper torch/electrode angle. Spatter is removed by chipping or grinding. Figure 11 is a picture of a weld containing spatter.



Figure 11: Spatter

Arc strike – a discontinuity consisting of any localized re-melted metal or change in the surface profile of any part of a weld or base metal resulting from an arc.

Arc strikes are common in SMAW. They are caused by dragging the electrode outside of the weld joint to initiate the arc. As the arc starts to ignite, the heat from the arc melts the base metal, leaving behind an etched trail. Arc strikes can be prevented by limiting the motion of striking an arc to a small area inside the weld joint that is welded over once the arc is initiated. Arc strikes are repaired by grinding and if necessary, welding to fill the void. Figure 12 is an image of an arc strike.



Figure 12: Arc strike

Welding Procedures and Qualifications

One of the other responsibilities of a welding inspector is to assure the welding is done in accordance with an approved welding procedure and that all of the welders engaged in the welding operation are properly qualified.

Welding procedure specification (WPS) – a document providing the required welding variables for a specific application to assure repeatability by properly trained welders and welding operators. Once qualified, this document provides proof that materials and processes will produce satisfactory weld joints.

Consider the WPS to be the recipe for making a sound weld. It lists all of the essential variables associated with the particular welding application. To qualify a WPS, a sample weld is done. The variables of the sample weld are recorded and the sample weld is then tested to the requirements of the applicable welding code.

Welding procedure qualification record (PQR) – a record of welding variables used to produce an acceptable test weldment and the results of tests conducted on the weldment to qualify a welding procedure specification.

The PQR is proof that your recipe (WPS) produces an acceptable weld. It includes all of the essential variables and test results of the sample weld.

Essential variable – a variable of the welding process that is deemed as important enough by a code committee to require proving.

Essential variables are the variables of a welding procedure that must not change during production welding. Some essential variables are given as ranges, such as “Voltage: 22-24V” and “Gas Flow Rate: 20-30 CFH.” Other essential variables are stated outright, such as “Welding Process: SMAW” and “Polarity: Electrode Positive.” Welding procedures are only applicable to welding done within ALL of the parameters of the essential variables listed in the WPS/PQR. Any change in just one essential variable requires requalification.

Evaluating WPSs and Welders

Each welder and WPS must be evaluated to ensure that the resulting weldment is suitable and conforms to applicable code requirements. For the WPS, test specimens are created by performing the weld in the same manner, and with base metal that is as thick as, or thicker than expected during production welding. The finished test specimen is first visually inspected to verify that there are no obvious defects, such as cracking or undercuts in the weldment. If the specimen appears acceptable, it is then subjected to nondestructive testing (NDT) to

further analyze its acceptability. Specifically it must pass either radiographic testing (RT) or ultrasonic testing (UT) through the entire length of the weld in the test specimen.

Finally the test specimen is cut into several pieces depending on the specific weld process. Each of these pieces is designated to undergo particular mechanical tests. Certain parts of the test specimen are bent to check the root and face of the weld, other sections of the test specimen are tension tested to determine tensile strength, and when required, portions of the specimen will undergo Charpy V-Notch tests to assess how impact affects the weld area. The number of each of these tests differs depending upon the exact specifications of the joint.

Welders also must produce test specimens for examination in order to achieve qualification. They are expected to weld their test specimens in the same manner as production welds will occur. This includes taking into account the position of the weld (flat, overhead, etc.) during the test specimen creation. The position of the weld for the test specimen may limit the positions that a welder is qualified to perform during production. Once the specimen has been created, it is subjected to the same types of inspection as the WPS test specimens. If a welder's specimen fails, they may perform an immediate retest; however, they must create two welds of each type and position, which must both pass the reevaluation. Failing a retest requires the welder to seek further training and practice prior to any more retests.

PROCEDURE QUALIFICATION RECORD (PQR)
 AASHTO/AWS D1.5 Qualification Type 5.12.1 -5.12.2 -5.12.4

Contractor/ Organization SAMPLE
 Welding Process(es) Flux Cored Arc Welding
 Type: Manual Semiautomatic
 Mechanized Automatic
 Tandem Parallel

PQR NUMBER 23xxx
 Revision 0 Date 02/05/2014 By G.L. Cramblett
 Authorized by _____ Date _____

JOINT DESIGN USED
 Single Double Weld
 Backing: Yes No Material A709 Grade 50
 Root Opening 1/4" Root Face Dimension 0
 Groove Angle 45° Radius (J-U) NA
 Backgouging: Yes No Method _____
 Root Treatment NA

POSITION
 Position of Groove 1G-Flat Fillet NA
 Vertical Progression: Up Down

ELECTRICAL CHARACTERISTICS
 Transfer Mode (GMAW): Globular Spray
 Current: AC DCEP DCEN Pulsed
 Electrical Stick Out 1"
 Other _____

BASE METALS
 Material Spec. ASTM A572/A709
 Type or Grade Grade 50
 Thickness: Groove 1" Fillet NA
 Diameter (Pipe) NA-Plate

TECHNIQUE
 Stringer or Weave Bead Stringer
 Multi-pass or Single Pass (per side) Multi-pass
 Number of Electrodes One
 Electrode Spacing: Longitudinal NA
 Lateral NA Angle NA
 Interpass Cleaning Mechanical

FILLER METALS
 AWS Specification A5.20
 AWS Classification E70T-1CJ H8
 Manufacturer Trade Name Hobart Fabco 70XHP

PREHEAT
 Preheat Temp., Min. 120°F Ambient
 Interpass Temp., Min. 239°F
 Interpass Temp., Max. 351°F

SHIELDING
 Flux NA Mfg. Trade Name NA
 Electrode-Flux (Class) NA
 Gas Composition 100% CO2
 Flow Rate 30 CFH Gas Cup Size 5/8"

POSTWELD HEAT TREATMENT
 Temp. None used Hold Time NA
 Heating/Cooling Rate NA

HEAT INPUT
 Calculated Heat Input Value: kJ/in kJ/mm
 Max. Heat Input 41.5 (cap) Min. Heat Input 38.6 (Bal.)
 No. of passes 13 Avg. Heat Input 39.26 (all)

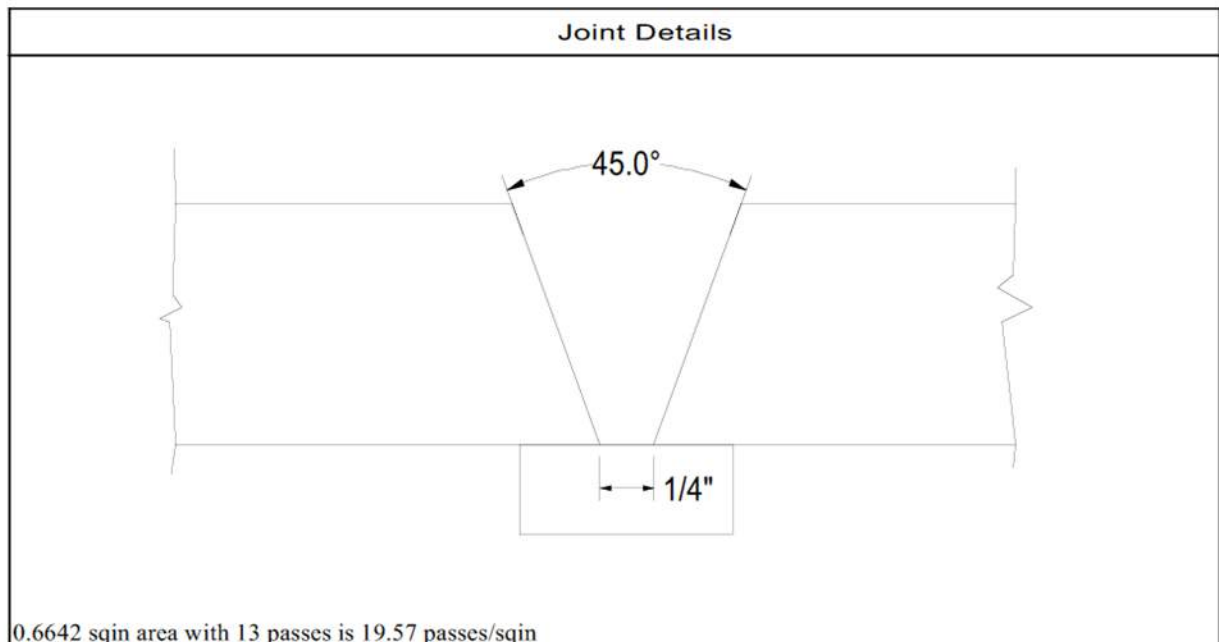

AASHTO/AWS D1.5/D1.5M:2010

WELDING PROCEDURE SPECIFICATION (WPS)
 PREQUALIFIED QUALIFIED BY TESTING
 AASHTO/AWS D1.5 Qualification Type 5.12.1 -5.12.2 -5.12.4

Contractor/ Organization SAMPLE
 Welding Process(es) Flux Cored Arc Welding
 Type: Manual Semiautomatic
 Mechanized Automatic
 Tandem Parallel

Identification D1.5 36/50 FCAW-G 70T F&H
 Revision 0 Date 02/05/2014 By G.L. Cramblett
 Authorized by _____ Date _____
 Supporting PQR No.(s) 2XXXX(1G) / 2XXXX(2F Single) / 2XXXX(2F Multi)

JOINT DESIGN

Complete Joint Penetration welds per Fig. 2.4; Partial Joint Penetration welds per Fig. 2.5;
 Single pass fillet welds 0.349" and less; Multipass fillet welds 0.579" and greater.

If welding both sides, backgouge or backgrind to sound metal before welding second side.

Groove welds shall have 14.7 to 24.5 passes/sqin. of joint area.

POSITION
 Position of Groove Flat & Horizontal Fillet Horizontal
 Vertical Progression: Up Down

BASE METALS
 Material Spec. M270M/M 270 - A709/A 709M
 Type or Grade 250, 345, 345S - 36, 50, 50S
 Thickness: Groove Unlimited Fillet Unlimited
 Diameter (Pipe) NA

ELECTRICAL CHARACTERISTICS
 Transfer Mode (GMAW): Globular Spray
 Current: AC DCEP DCEN Pulsed
 Electrical Stick Out 3/4"-1"
 Other _____

FILLER METALS
 AWS Specification A5.20
 AWS Classification E70T-1CJ H8
 Manufacturer Trade Name Hobart Fabco 70XHP

TECHNIQUE
 Stringer or Weave Bead Stringer
 Multi-pass or Single Pass (per side) Multi or Single
 Number of Electrodes One
 Electrode Spacing: Longitudinal NA
 Lateral NA Angle NA
 Interpass Cleaning Mechanical

SHIELDING
 Flux NA Mfg. Trade Name NA
 Electrode-Flux (Class) NA
 Gas Composition 100% CO2
 Flow Rate 27-45 CFH Gas Cup Size 1/2" - 7/8"

PREHEAT
 Thickness (T) $\leq 3/4"$ 50°F; $3/4" < T \leq 1.5"$ 70°F; $1.5" < T \leq 2.5"$ 150°F; $T > 2.5"$ 225°F
 Preheat Temp., Min. _____
 Interpass Temp., Min. Same as Preheat
 Interpass Temp., Max. 450°F

POSTWELD HEAT TREATMENT
 Temp. None Allowed Hold Time NA
 Heating/Cooling Rate NA

HEAT INPUT
 Calculated Heat Input Value: kJ/in kJ/mm
 Max. Heat Input See Joint Details Min. Heat Input See Joint Details

WELDING PROCEDURE

Pass or Weld Layer(s)	Process	Filler Metals Diam.	Current		Volts	Travel Speed	Joint Details
			Type & Polarity	Amps			
1 thru cap	FCAW-G	1/16"	DCEP	330 max.	32 max.	14.9 IPM min.	Maximum Heat Input of 42.43 KJ/in. Minimum Heat Input of 27.0 KJ/in. Minimum Travel Speed (Amps x Volts X .06)/42.43 Maximum Travel Speed (Amps x Volts X .06)/27.0
			Optimum	300	30	14	
1 thru cap	FCAW-G	1/16"	DCEP	270 min.	27.9 min.	16.7 IPM max.	
Cap	FCAW-G	1/16"	DCEP	330 max.	32 max.	13.9 IPM min.	
			Optimum	300	30	13	
Cap	FCAW-G	1/16"	DCEP	270 min.	27.9 min.	15.5 IPM max.	

For values of amps or volts between listed minimum and maximum, travel speed must be calculated to maintain Heat Input restrictions.

Inspection Tools and Measurements

Fillet Welds

The leg length of the largest right isosceles triangle that can be inscribed within the fillet weld cross section is the size of the fillet weld. There are two types of fillet welds: concave and convex. The fillet weld type is determined by the shape of the fillet weld. Fillet weld gauges such as the ones in Figure 13 are for specific size fillet welds and are two-sided in order to measure both concave and convex fillet welds. Be sure to use the proper side of the gauge for the fillet weld type being measured.

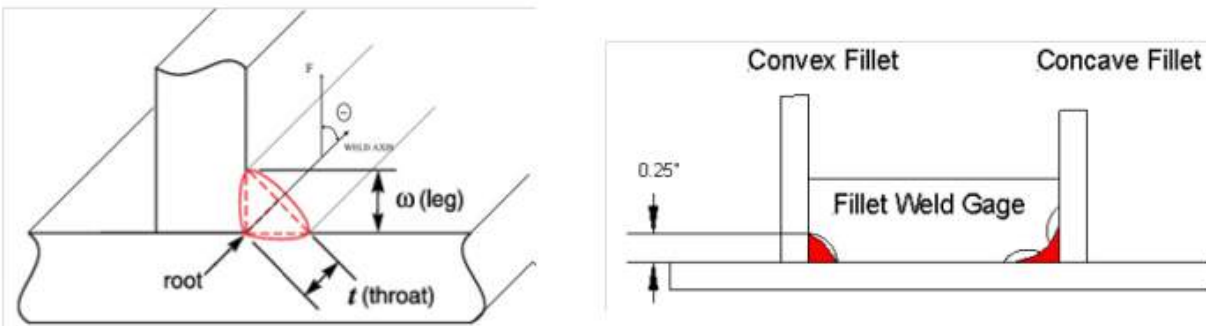

Figure 13: Fillet welds

Fillet welds can be measured using a gauge set as shown in Figure 14.



Figure 14: Weld fillet gauge

Fillet welds can also be measured using other gauges as shown in Figures 15, 16, and 17. The gauges can be used on both concave and convex fillet welds as long as the user understands how a fillet is measured. Whether measuring fillet welds or other weld features, the key to using these gauges is to make sure they are sitting flat against the surface.



Figure 15: V-WAC gauge



Figure 16: Throat measurement with cam gauge



Figure 17: Bridge cam gauge

Note: Fillet welds are designed based on their cross-sectional area, which is calculated by the throat times the length. Drawing callouts for fillet sizes are given as the leg size. It is important for the inspector to understand that concave fillet welds cannot be measured by their leg size. Concave tools measure the throat and convert this size to the equivalent leg.

Undercut

Undercut is measured from the surface of the base metal to the deepest point of the undercut. Undercut can be quickly identified by running a flashlight along the edge of weld parallel to the surface of the base metal.

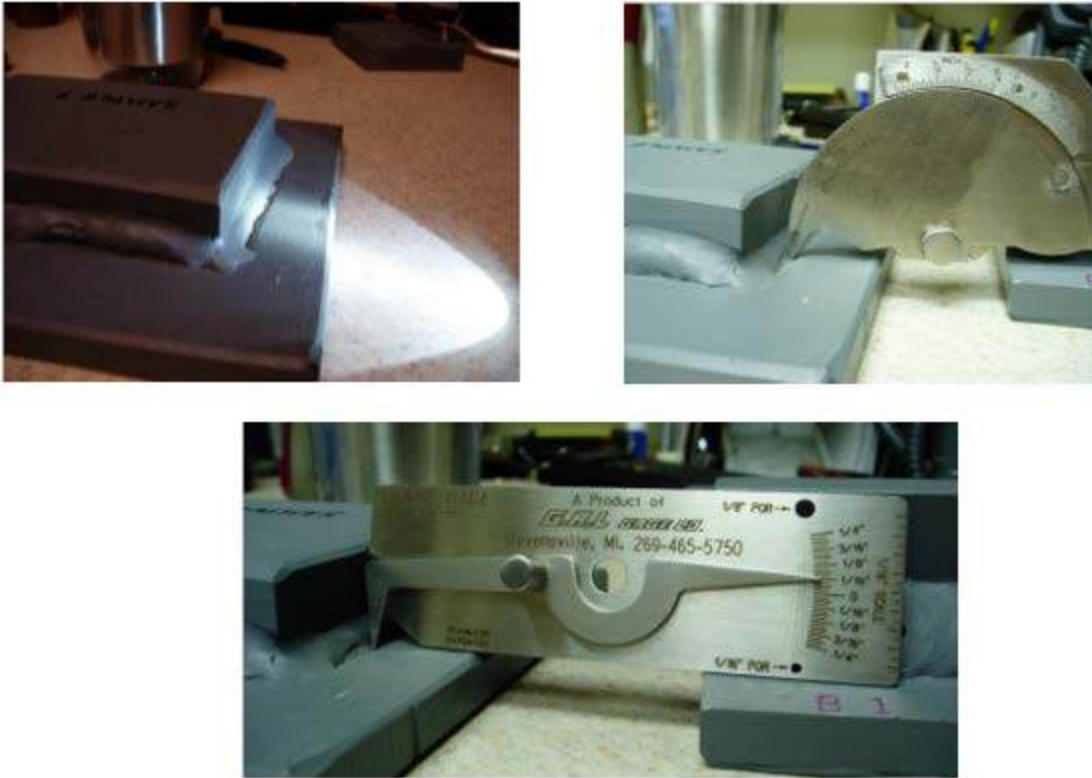

Figure 15: Undercut

Reinforcement

Face reinforcement is measured from the top surface of the base metal to the top of the face of the weld. Root reinforcement is measured from the bottom surface of the weld to the root surface of the weld.

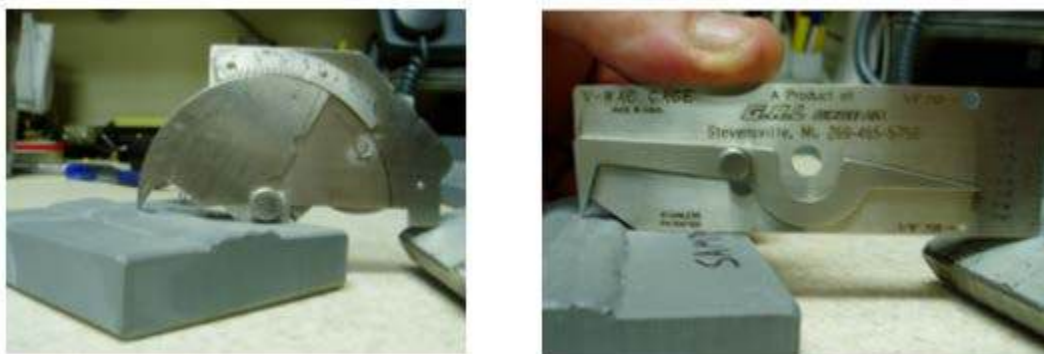

Figure 16: Reinforcement

Note: There are many other welding inspection tools available. Selection of these tools should be based on an evaluation of the attributes you are trying to verify. Practice with each selected tool is essential.

As has been described, welds are evaluated to the acceptance criteria stated in the applicable code or specification. Below are the criteria for VT from the AWS D1.5-2010 Bridge Welding Code.

<p>6.26 Quality of Welds</p> <p>6.26.1 Visual Inspection. All welds shall be visually inspected. A weld shall be acceptable by visual inspection if it conforms to the following requirements:</p> <p>6.26.1.1 The weld shall have no cracks.</p> <p>6.26.1.2 Thorough fusion shall exist between adjacent layers of weld metal and between weld metal and base metal.</p> <p>6.26.1.3 All craters are to be filled to the full cross section of the weld, except for the ends of intermittent fillet welds outside of their effective length when such welds are allowed in the design.</p> <p>6.26.1.4 Weld profiles shall be in conformance with 3.6.</p> <p>6.26.1.5 In primary members, undercut shall be no more than 0.25 mm [0.01 in] deep when the weld is transverse to tensile stress under any design loading condition. Undercut shall be no more than 1 mm [1/32 in] deep for all other cases.</p> <p>6.26.1.6 The frequency of piping porosity in the surface of fillet welds shall not exceed one in 100 mm [4 in] or six in 1200 mm [4 ft.] of weld length and the maximum diameter shall not exceed 2.4 mm [3/32 in].</p> <p>(1) A subsurface inspection for porosity shall be performed whenever piping porosity 2.4 mm [3/32 in] or larger in diameter extends to the surface at intervals of 300 mm [12 in] or less over a distance of 1200 mm [4 ft.], or when the condition of electrodes, flux, base metal, or the presence of weld cracking indicates that there may be a problem with piping or gross porosity.</p>	<p>(2) This subsurface inspection shall be a visual inspection of 300 mm [12 in] exposed lengths of the fillet weld throat after it has been ground or removed by air carbon arc gouging to a depth of 1/2 the design throat. When viewed at mid-throat of the weld, the sum of the diameters of all porosity shall not exceed 10 mm [3/8 in] in any 25 mm [1 in] length of weld or 20 mm [3/4 in] in any 300 mm [12 in] length of weld.</p> <p>6.26.1.7 A fillet weld in any single continuous weld may underrun the nominal fillet weld size specified by 2 mm [1/16 in] without correction, provided that the underrun portion of the weld does not exceed 10% of the length of the weld. On the web-to-flange welds on girders, underrun shall be prohibited at the ends for a length equal to twice the width of the flange.</p> <p>6.26.1.8 CJP groove welds in butt joints transverse to the direction of computed tensile stress shall have no piping porosity. For all other groove welds, the frequency of piping porosity shall not exceed one in 100 mm [4 in] of length, and the maximum diameter shall not exceed 2.4 mm [3/32 in].</p> <p>6.26.1.9 Visual inspection of welds in all steels may begin immediately after the completed welds have cooled to ambient temperature. Acceptance criteria for M 270M/M 270 Grades 690/690W [100/100W] (A 709/ A 709M Grades 690/690W [100/100W]) steels shall be based on visual inspection performed not less than 48 hours after completion of the weld.</p>
---	--

Note: A proper application of the fundamentals of visual welding inspection can assure successful cooperation between quality control and production and results in high-quality weldments.

Notes:

Nondestructive Evaluation (NDE)/Nondestructive Testing (NDT)

This manual section will describe the basics of four primary nondestructive examination (NDE or NDT) methods: dye penetrant testing (PT), magnetic particle testing (MT), ultrasonic testing (UT), and radiographic testing (RT).

Penetrant Testing (PT)

Background Information

Dye penetrant testing (PT), also called liquid penetrant testing, is a commonly used, low-cost inspection method used to locate defects which are open to the surface in nonporous materials. The penetrant may be applied to all metals; although for ferrous components, magnetic-particle inspection is often used instead for its ability to also find some subsurface defects. PT is used to detect welding surface defects such as hairline cracks and surface porosity. It is also used to detect leaks where the penetrant can be applied from one side and the developer on the other.

Significance and Use

PT uses a high viscosity fluid which penetrates into clean and dry discontinuities that are open to the surface by capillary action. Penetrant may be applied to the test component by dipping, spraying, or brushing. After adequate penetration (dwell) time has been allowed, the excess penetrant is removed and a developer is applied. The developer draws the penetrant out of the flaw and the indication becomes visible to the inspector. Inspection is performed under ultraviolet or white light, depending on the type of dye used—fluorescent or visible. Procedures for the process should detail the amount of lighting required.

History

The current process grew from the use of oiling railroad rails and then applying chalk to detect cracks. Visible dyes were then added to the oil and later fluorescent dyes were offered for more sensitive detection.

Procedure

Step 1

Pre-cleaning: Clean the part to be inspected thoroughly using a degreasing solvent. Process component manufacturers supply these as “cleaner” or “emulsifier.” Brushing may be required to force contaminants out of hard-to-reach areas. Use a steel wire brush only on ferrous

components and a fiber brush on aluminum and magnesium components. Use a clean rag to dry the part as much as possible. Allow the remaining solvent to evaporate in an open area before continuing the process.

Step 2

Apply Penetrant: Penetrant may be applied by spraying, brushing, wiping, or immersion. After application, a dwell time of 5 to 30 minutes is required depending on material to allow penetrant to infiltrate into the surface. During the dwell time, it is important that the penetrant remains wet.



Figure 17: Application of penetrant

Step 3

Surface Penetrant Removal: Wipe the penetrant off of the surface using a dry, clean rag. Spray solvent only onto the rag until slightly moist and remove the final penetrant. Ensure that the rag is not too moist as this can wash penetrant out of any potential cracks or defects. Never spray solvent on the part as this can wash away dye from potential indications. Solvents must be allowed to dry before application of the developer.

Step 4

Developer Application: This is most often done by spraying. Canned developers should be shaken vigorously for up to 60 seconds. Hold the spray can 8 to 12 inches away from the part and cover only small areas at a time. Spray the developer lightly over the surface of the part. Spray developers apply as a wet gray color. As the developer dries, it produces a white chalky looking thin film.

Step 5

Inspect the Developed Part Surfaces: Defects will appear as bright red lines or dots. Larger and brighter spots that continue to grow over time indicate more extensive or deep defects extending below the surface.

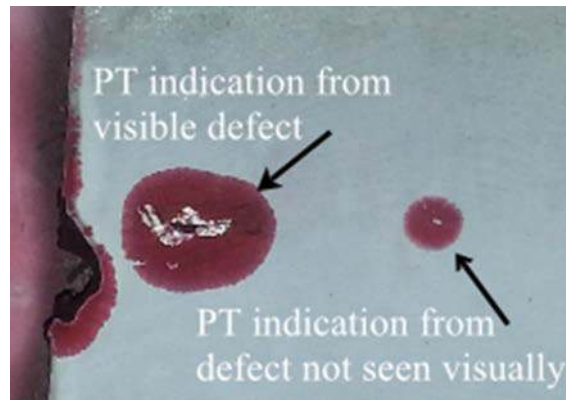

Figure 18: PT indication of welding defect

Step 6

Final Cleaning: Immediately after inspection, parts to be reused should be cleaned with solvent and a rag. Penetrant and developer become more difficult to remove with time.

Advantages

- Highly sensitivity to small surface discontinuities
- Large areas and large volumes of parts can be inspected rapidly at low cost
- Metallic and nonmetallic, magnetic and nonmagnetic, and conductive and nonconductive materials may be inspected
- Parts with complex shapes can also be inspected

Disadvantages

- Only surface defects can be detected
- Only materials with a relatively nonporous surface can be inspected
- Pre-cleaning is critical since contaminants can hide discontinuities
- The inspector must be able to clearly see the surface being inspected

Notes:

Magnetic Particle Testing (MT)

Background Information

Magnetic particle testing is a method of locating and defining discontinuities in magnetic materials. It is excellent for detecting surface defects in welds, including discontinuities that are too small to be seen with the naked eye and those that are slightly subsurface. This method may be used to inspect plate edges prior to welding, for in-process inspection of each weld pass or layer, for post weld evaluation, and to inspect repairs.

Significance and Use

Magnetic particle testing is a good method for detecting surface cracks in both the weld and adjacent base metal, subsurface cracks, incomplete fusion, undercut, inadequate penetration in the weld, and defects on the repaired edges of the base metal. MT should not be a substitute for radiography testing (RT) or ultrasonic testing (UT) for subsurface analysis. However, MT may present advantages over RT or UT in detecting tight cracks and surface discontinuities, especially in near surface discontinuities in some orientations.

History

The earliest known use of magnetism to inspect an object took place as early as the mid-1800s. Cannon barrels were checked for defects by magnetizing the barrel and then sliding a compass along the barrel's length. Cracks in the barrels formed a concentrated magnetic field detected by the compass. This form of nondestructive testing was not formalized until after World War I.

Procedure

With this method, probes or “prods” are placed on each side of the area to be inspected. Electric current is applied to create an electromagnetic field. A magnetic flux is produced at right angles to the flow of current. When these flux lines move through a discontinuity, such as a crack, they are diverted and create magnetic field concentrations on the surface. When magnetic powder is dusted onto the surface, it will cling to these leakage areas more than elsewhere, and will line up along the discontinuity as shown in the figure below.

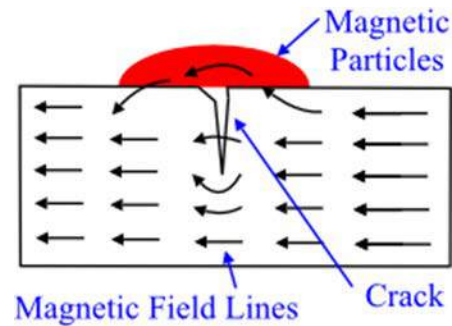

Figure 19: Magnetic particle testing (MT)

For an indication to develop, the discontinuity must be aligned nearly perpendicular to the magnetic force. When evaluating a weld, the probes must be alternated both near parallel and near perpendicular to the weld.

Although simpler and less expensive than radiographic testing, MT is limited to magnetic materials, which means it cannot be used on metals such as austenitic (stainless) steels or aluminum. If significantly magnetically dissimilar materials are joined, the variation in magnetic fields can produce false indications. MT's sensitivity decreases with the size of the defect and is also lessened with round discontinuities, such as porosity. It is great with elongated forms, such as cracks, and is limited to surface flaws and some slightly subsurface flaws. Sensitivity also decreases with material thickness as the field becomes weaker.



Figure 20: MT of throat crack

Magnetic powders may be applied dry or wet. The dry powder method is popular for inspecting heavy weldments and field inspections, while the wet method is often used in inspecting more critical components and in industrial plants. Dry powder is dusted on the part with a dusting

bag or atomizer. These magnetic particle powders are available in several colors to provide proper visibility on various materials. In the wet method, very fine red or black particles are suspended in water or light petroleum products. In the wet method, parts are usually submerged and fluorescent particles are used for increased sensitivity.



Figure 21: MT of toe crack

Advantages

- Highly sensitivity to small surface discontinuities
- Large areas and large volumes of parts can be inspected rapidly at low cost
- Parts with complex shapes can also be inspected

Disadvantages

- Only ferromagnetic materials can be inspected
- Proper alignment of magnetic field to the defect is critical
- Large currents are needed for thick parts
- Requires relatively smooth surface
- Any nonmagnetic coating will affect sensitivity
- Demagnetization and post-cleaning is usually necessary

Notes:

Ultrasonic Testing (UT)

Background Information

This method uses high frequency, electrically-generated vibrations which pass through a component. The ultrasonic waves come from a transducer (transmitter and receiver) which changes electrical energy into mechanical vibrations. As the waves pass through a part, it “echoes” off of the far side and returns to the transducer. To properly pass the waves through, a couplant is required, which is typically a film of petroleum based heavy liquid. The UT machine is calibrated on material with similar sound properties so that the time required for the waves to complete a return trip in a solid piece becomes the baseline reading on a screen. If the beam encounters a discontinuity in its path, the resultant echo will display as an additional trace on a screen at a quicker time, as shown in Figure 22.

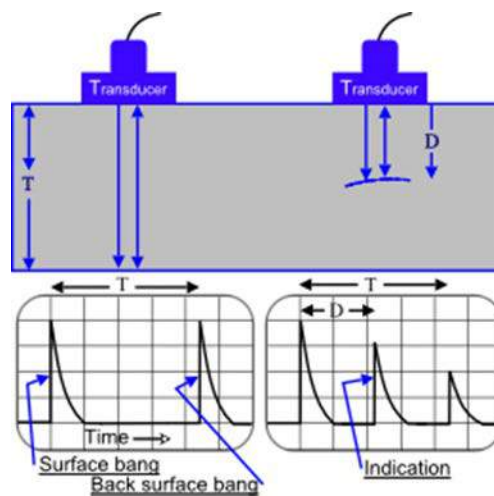

Figure 22: Ultrasonic testing (UT)

Significance and Use

One of the most useful characteristics of ultrasonic testing is its ability to determine the exact position of a discontinuity in a weld. Since the velocity of sound through any particular material is nearly constant, once a discontinuity is located it can be fully evaluated. The amplitude (height) of the indication is relative to its size and by moving the transducer around the surface the time of return can be used to calculate the depth of the indication.

This testing method requires a high level of operator training and skill. Accurate test and calibration procedures must be followed. UT can be used on ferrous and nonferrous materials, as long as the thickness is sufficient to distinguish a discontinuity from the far side of the component.

History

In 1942, U.S. Patent No. 2,280,226, titled "Flaw Detecting Device and Measuring Instrument" was granted to Dr. Floyd Firestone of the University of Michigan for the first practical ultrasonic testing device.

Since then, many advances have been made in the process and equipment. Not so many years ago a UT technician would have to perform several calculations to express the location of an indication. With modern equipment, most dimensional attributes are shown on the device. As with many other testing technologies, the current trend is toward digital equipment.

Advantages

- Depth of flaw detection is greater than other methods
- Only single-sided access is required
- Provides dimensional location of flaw for easier repair
- Minimum part preparation is required
- Good for finding cracks

Disadvantages

- Surface must be accessible to probe and couplant
- High level of operator training and skill is required
- Surface finish and roughness can interfere with inspection
- Not usable on thin parts
- Defects oriented parallel to the beam can go undetected
- Requires calibration on test block with similar sound conducting characteristics

Notes:

Radiographic Testing (RT)

Background Information

This method of weld testing makes use of X-rays, produced by an X-ray tube, or gamma rays, produced by radioactive isotopes such as cobalt-60 and iridium-192. The basic principle of radiographic inspection of welds is the same as that for medical radiography. Radiation is passed through a component including a weld and onto a photographic film, resulting in an image of the object's internal structure being deposited on the film.

Significance and Use

The amount of energy absorbed by the object depends on its thickness and density. Energy not absorbed will cause more exposure of the film. These areas will be darker when the film is developed. Areas of the film exposed to less rays remain lighter. Therefore, areas of the object where the thickness has been changed by discontinuities, such as porosity or cracks, will appear as dark outlines on the film. Inclusions of low density, such as slag, will appear as dark areas on the film while inclusions of high density, such as tungsten, will appear as light areas.

Discontinuities are evaluated by viewing the shape and variations in density of the processed film. Interpreting films properly requires much training and practice as one has to distinguish items based on varying shades of black to white.

History

X-rays were discovered in 1895 by Wilhelm Conrad Roentgen (1845–1923) who was a professor at Wuerzburg University in Germany. The use of radioactive sources was added shortly after. Industrial applications of both were developed in the early 1900s and have progressed to today's safer and more accurate systems. Digital radiography is now available, which precludes the need to develop film and can even be shot as video.

Procedure

Radiographic testing provides a permanent film record of weld quality. Typically a film pack is placed on one side of the part and the radiation source is set up at the appropriate distance on the other side. Although this is a slow and expensive method of nondestructive testing, it is a positive method for detecting porosity, inclusions, cracks, and voids in welds. It is essential that only qualified personnel conduct radiographic interpretation since false interpretation of radiographs can be expensive and interfere seriously with productivity. There are also serious safety considerations in RT work. The radiation involved is not visible and can have serious

health implications. Only suitably trained and qualified personnel should practice this type of testing. The area surrounding the RT operation must be adequately roped off and monitored.

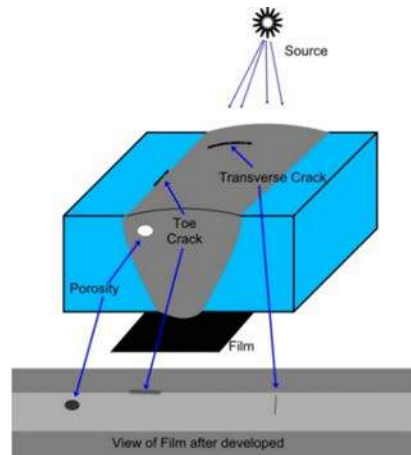

Figure 23: Radiographic testing (RT)

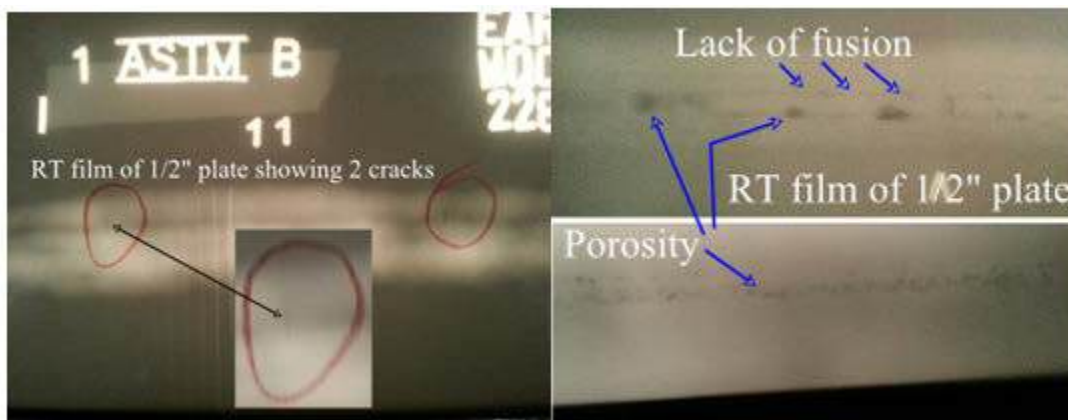

Figure 24: Defects seen in radiographic testing

Advantages

- Can be used to inspect virtually all materials
- Detects surface and subsurface defects
- Can inspect assembled components
- Minimum surface preparation required
- Sensitive to changes in thickness, voids, cracks, and density changes
- Good for finding volumetric discontinuities.
- Provides a permanent record

Disadvantages

- Extensive operator training and skill required
- Access to both sides of the weldment is usually required
- Orientation of the radiation beam to defects is critical
 - Less sensitive to planar discontinuities
- Field inspection of thick sections can be time-consuming
- Relatively expensive equipment investment is required
- Possible radiation hazard for personnel

AASHTO/AWS D1.5-2010 Bridge Welding Code NDT Requirements

D1.5-2010 requires first a 100% visual inspection of all welds. Inspection duties, qualifications applications, and requirements are outlined in Clause 6. The extent of required NDT is based on the type of joint and the designed loads. Procedural, acceptance, and methodology requirements for RT are given in Clause 6 Part B; for UT in Clause 6 Part C; and for MT in 6.7.2-6.7.6. For joints requiring RT or UT, frequency requirements are given in 6.7.1.2.

NDT requirements by weld type:

- Fillet welds and partial joint penetration (PJP) groove welds joining primary components of main members shall be tested using MT in conformance with 6.7.2.1.
- Complete joint penetration (CJP) groove welds in butt joints subject to calculated tension or reversal of stress shall be tested using RT.
- CJP groove welds in T-joints and corner joints shall be tested by UT.
- When required by contract, CJP groove welds in compression or shear may be tested by either RT or UT.

Though not required by code, 6.7.7 allows PT to be used for detecting discontinuities that are open to the surface.

Note: The basic concepts of four methods of NDT have been presented herein. Selection and use of these methods should be based on their ability to evaluate the discontinuities likely to influence the required joint quality and design. Care should be taken to balance the level of examination stipulated with the production cost of these methods. Many cases exist where NDT methods are contractually required in excess. The old adage that “you cannot inspect quality into a weld” should be kept in mind. These methods are only valuable when they are used to enhance a full quality program that involves qualified welders working to qualified welding procedures followed by rigorous visual examination of production components.

Notes:

Analyzing Weld Failures (Case Studies)

In this section we will review how a weld is inspected for various discontinuities, analyzed, and if rejectable, give practical examples of how each type of discontinuity might be repaired. To accomplish this, we will look at each type of discontinuity with respect to how it is best found, how it is measured, how it is accepted or rejected, and how it might best be repaired.

Incomplete Fusion (IF)

Description

Fusion which is less than complete (groove sidewall, weld root, or corner, etc.).

Acceptance Criteria

Thorough fusion shall exist between adjacent layers of weld metal and between weld metal and base metal.

In effect, this means no incomplete fusion is allowed. D1.5-2010 does discuss internal porosity and inclusions as “fusion discontinuities” and has some allowance for those. This will be discussed later.

Identifying

The two surface indications shown in Figure 25, especially the one on the right, will typically be found during visual inspection. Since they are on the surface, they are further defined as overlap. This trait is considered overlap when the reentrant angle (the angle at which the weld face meets the base metal at the weld toe) is greater than 90° . The condition on the left is less common and can sometimes be difficult to find visually. Either MT or PT will readily find either of these surface discontinuities.

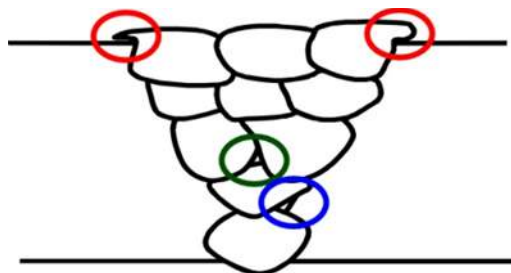

Figure 25: Surface indications

The two indications inside the weld can only be located with a volumetric process, such as UT or RT. In an RT film, they would show up as a darker area. When found using UT, the depth and extent of the discontinuities could be determined.

Common Causes

Incomplete fusion can be caused by excessive travel speeds, lack of welding heat, or improper torch/electrode angle. Welding position can contribute to the likelihood of this defect as gravity pulls the puddle down especially in horizontal welds.

Repair

3.7.2.1 Overlap or Excessive Convexity.

Excess weld metal shall be removed.

Surface indications may be repaired simply by grinding the excess deposited weld. If it can be removed to meet the weld contour requirements additional welding is not required. If grinding causes contour issues, additional welding will be required.

3.7.2.3 Excessive Weld Porosity, Excessive Slag Inclusions, Incomplete Fusion.

Unacceptable portions shall be removed (see 3.7.1) and re-welded.

Subsurface indications have to be excavated. Once located and removed, MT or PT should be employed to verify soundness before repair welds are done.

Notes:

--

Incomplete Penetration (IP)

Description

Penetration which is less than specified.

Acceptance Criteria

D1.5-2010 evaluates incomplete penetration similar to fusion and requires the depth of penetration to be as specified in the design.

Identifying

To visually inspect for incomplete joint penetration, an inspector needs to have access to the root side of the weld. If the weld metal does not extend past the base metal and the original edge of the joint is still visible, then incomplete joint penetration is present. As D1.5-2010 requires all groove welds to be either welded from one side with backing or welded from both sides, VT for this condition is typically not possible.

With UT, IP will present indications similar to IF. With RT, it is also similar to IF, but is typically a sharper indication.

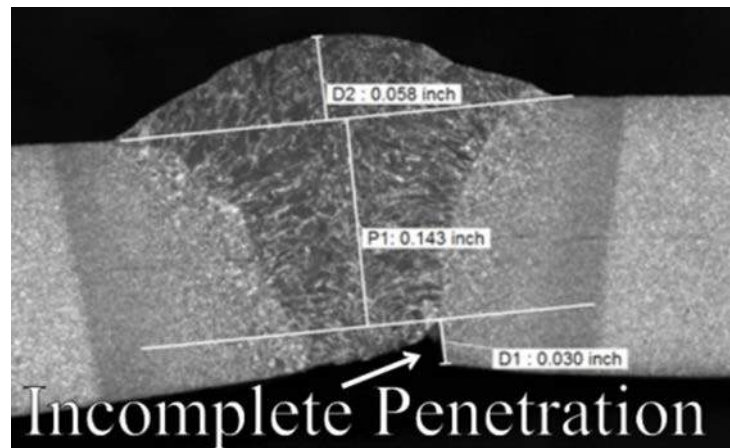

Figure 26: Incomplete penetration

Common Causes

Incomplete penetration can be caused by too large of a root face (land), too narrow of a root opening, improper torch/electrode angle, too large electrode diameter, or lack of welding heat.

Repair

To properly repair incomplete penetration, the weld metal must be ground or cut out in the spot where the incomplete penetration exists and then re-welded. Once excavated, MT or PT should be employed to verify soundness before repair welds are done.

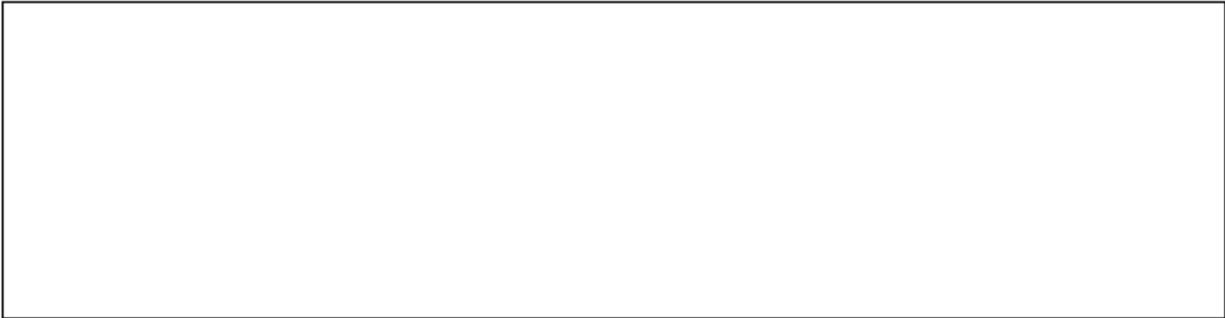
Notes:

Reinforcement

Description

Weld metal in excess of the quantity required to fill a joint.

Acceptance Criteria

3.6.2 Groove welds shall preferably be made with slight or minimum face reinforcement except as may be otherwise provided. In the case of butt and corner joints, the face reinforcement shall not exceed 3 mm (1/8 in) in height and shall have gradual transition to the plane of the base metal surface [see Figure 3.3(D)].

Most welding codes define a maximum reinforcement height since a drastic change in surface contour results in an area of stress concentration, which can cause the weld to fail.

Identifying

As reinforcement is, by definition, a surface attribute, excessive amounts are identifiable visually and can be measured by common tools.

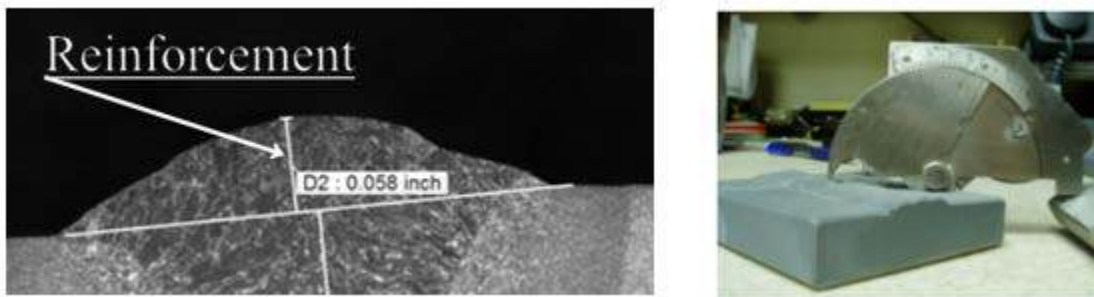

Figure 27: Measuring reinforcement

Common Causes

Excessive reinforcement is caused by overfilling the joint with weld metal typically attributable to incorrect technique or bead sequence.

Repair

Unacceptable portions of the weld shall be removed without substantial removal of the base metal (from 3.7.1).

It can be repaired by simply grinding away the excessive reinforcement until it is within the range allowed.

Notes:

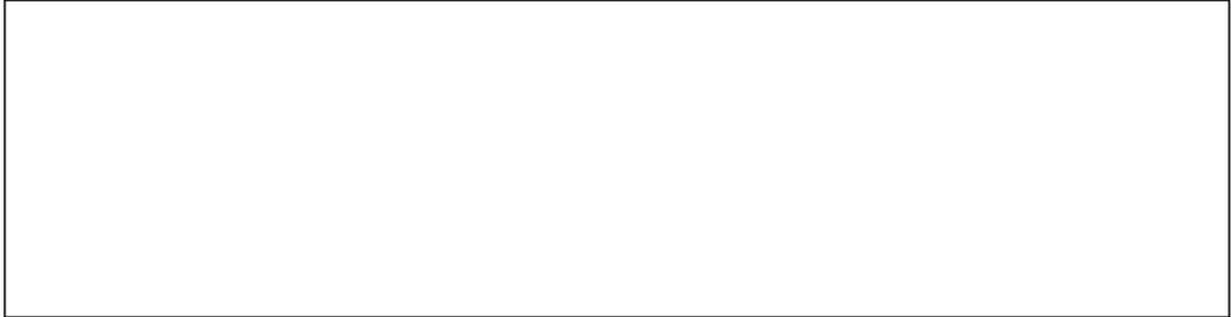

Surface (Piping) Porosity

Description

A void or cavity formed by gas entrapment during weld solidification.

Acceptance Criteria

Fillet Welds

6.26.1.6 The frequency of piping porosity in the surface of fillet welds shall not exceed one in 100 mm (4 in) or six in 1,200 mm (4 ft.) of weld length and the maximum diameter shall not exceed 2.4 mm (3/32 in).

A subsurface inspection for porosity shall be performed whenever piping porosity 2.4 mm (3/32 in) or larger in diameter extends to the surface at intervals of 300 mm (12 in) or less over a distance of 1200 mm (4 ft.), or when the condition of electrodes, flux, base metal, or the presence of weld cracking indicates that there may be a problem with piping or gross porosity.

This subsurface inspection shall be a visual inspection of 300 mm (12 in) exposed lengths of the fillet weld throat after it has been ground or removed by air carbon arc gouging to a depth of 1/2 the design throat. When viewed at mid-throat of the weld, the sum of the diameters of all porosity shall not exceed 10 mm (3/8 in) in any 25 mm (1 in) length of weld or 20 mm (3/4 in) in any 300 mm (12 in) length of weld.

Groove Welds

6.26.1.8 CJP groove welds in butt joints transverse to the direction of computed tensile stress shall have no piping porosity. For all other groove welds, the frequency of piping porosity shall not exceed one in 100 mm (4 in) of length, and the maximum diameter shall not exceed 2.4 mm (3/32 in).

Though often difficult for most to understand, surface porosity subject to certain diameter, spacing, and accumulation limits is acceptable in many codes.

Identifying

Surface porosity is noted visually and can be quantified with many conventional length measurement tools.

Common Causes

Porosity is caused by improper shielding of the molten weld puddle or the presence of moisture or contaminants in the filler metal or base metal.

Repair

3.7.2.3 Excessive Weld Porosity, Excessive Slag Inclusions, Incomplete Fusion. Unacceptable portions shall be removed (see 3.7.1) and re-welded.

Notes:

Subsurface Porosity and Inclusions

Description

Solid material trapped in the weld metal or between weld metal and base metal. As these discontinuities are evaluated to the same criteria, they will be discussed together.

Acceptance Criteria

When found by MT or RT

6.26.2.1 For welds subject to tensile stress under any condition of loading, the greatest dimension of any porosity or fusion-type discontinuity that is 2 mm (1/16 in) or larger in greatest dimension shall not exceed the size, B, indicated in Figure 29 for the effective throat or weld size involved. The distance from any porosity or fusion-type discontinuity described above to another such discontinuity, to an edge, or to the toe or root of any intersecting flange-to-web weld shall be not less than the minimum clearance allowed, C, indicated in Figure 29 for the size of discontinuity under examination.

6.26.2.2 For welds subject only to compressive stress and specifically indicated as such on the design drawings, the greatest dimension of porosity or a fusion-type discontinuity that is 3 mm (1/8 in) or larger in greatest dimension shall not exceed the size, B, nor shall the space between adjacent discontinuities be less than the minimum clearance allowed, C, indicated by Figure 28 for the size of discontinuity under examination.

6.26.2.3 Independent of the requirements of 6.26.2.1 and 6.26.2.2, discontinuities having a greatest dimension of less than 2 mm (1/16 in) shall be unacceptable if the sum of their greatest dimensions exceeds 10 mm (3/8 in) in any 25 mm (1 in) length of weld.

Identifying

As these are subsurface conditions, they are found only by volumetric techniques, except that MT may find them if near the surface being evaluated.

Common Causes

Porosity is caused by improper shielding of the molten weld puddle or the presence of moisture or contaminants in the filler metal or base metal. Inclusions can be caused by improper cleaning and removal of slag between weld passes as well as improper torch/electrode angle or inadequate weld parameters.

Repair

3.7.2.3 Excessive Weld Porosity, Excessive Slag Inclusions, Incomplete Fusion. Unacceptable portions shall be removed (see 3.7.1) and re-welded.

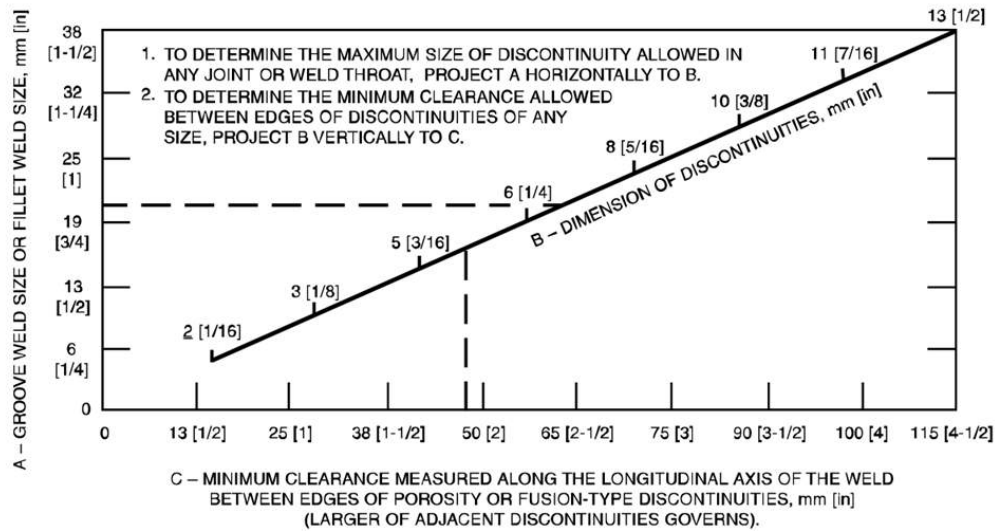

Note: Adjacent discontinuities, spaced less than the minimum spacing required, shall be measured as one length equal to the sum of the total length of the discontinuities plus the length of the space between them and evaluated as a single discontinuity.

Figure 29: Weld requirements for discontinuities occurring in tension welds

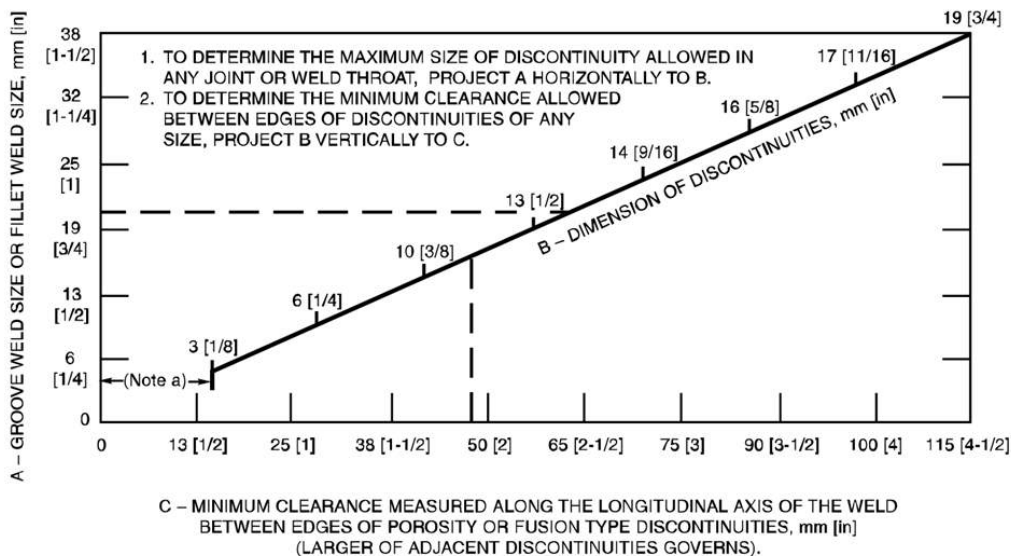

^a The maximum size of a discontinuity located within this distance from an edge of plate shall be 3 mm [1/8 in], but a 3 mm [1/8 in] discontinuity must be 6 mm [1/4 in] or more away from the edge. The sum of discontinuities less than 3 mm [1/8 in] in size and located within this distance from the edge shall not exceed 5 mm [3/16 in]. Discontinuities 2 mm [1/16 in] to less than 3 mm [1/8 in] shall not be restricted in other locations unless they are separated by less than 2 L (L being the length of the larger discontinuity); in which case, the discontinuities shall be measured as one length equal to the total length of the discontinuities and space and evaluated as shown in Figure 6.8.

Figure 28: Weld requirements for discontinuities occurring in compression welds

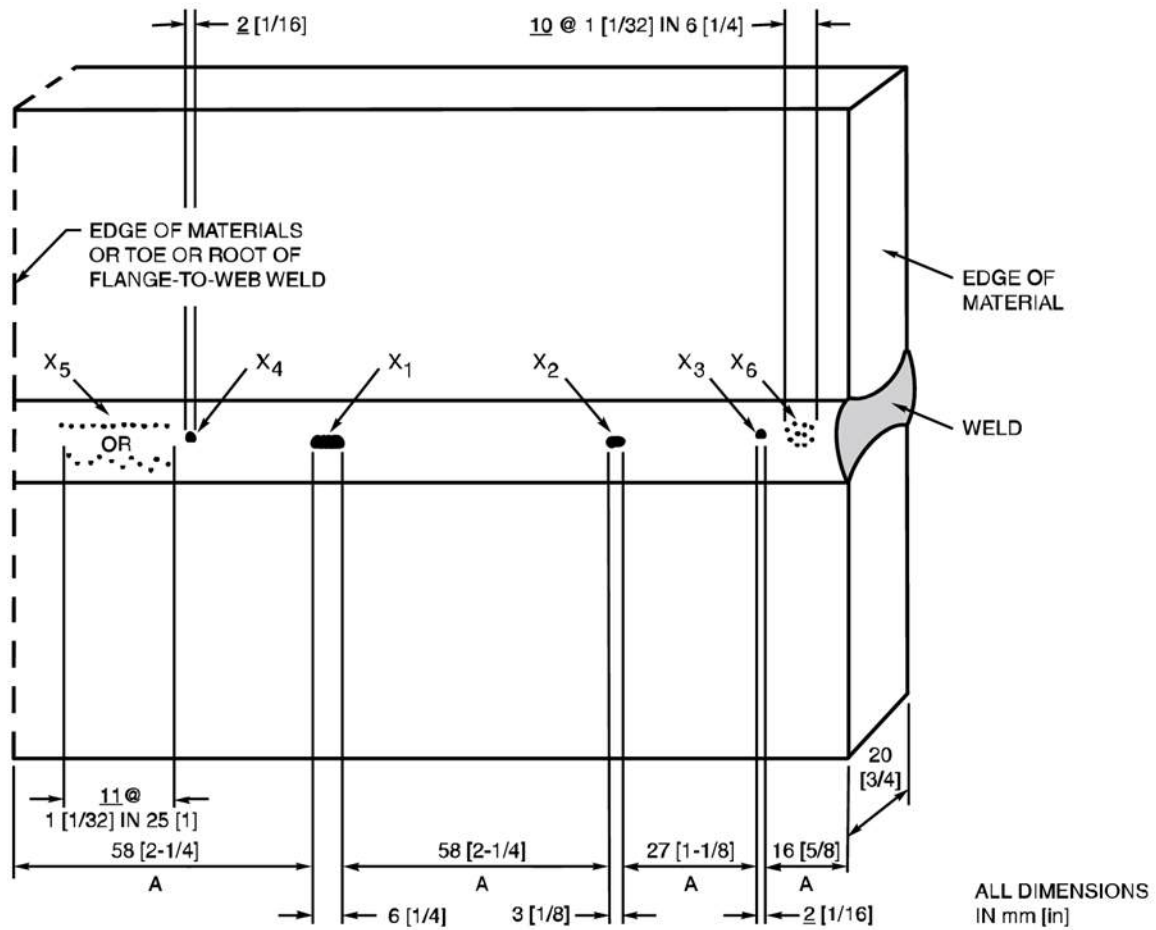

Notes:

1. A—minimum clearance allowed between edges of porosity or fusion-type discontinuities 2 mm [1/16 in] or larger. Larger of adjacent discontinuities governs.
2. X₁—largest allowable porosity or fusion-type discontinuity for 20 mm [3/4 in] joint thickness (see Figure 6.8).
3. X₂, X₃, X₄—porosity or fusion-type discontinuity 2 mm [1/16 in] or larger, but less than maximum allowable for 20 mm [3/4 in] joint thickness.
4. X₅, X₆—porosity or fusion-type discontinuity less than 2 mm [1/16 in].
5. Discontinuity size indicated is assumed to be its greatest dimension.
6. Porosity or fusion-type discontinuity X₄ is not acceptable because it is within the minimum clearance allowed between edges of such discontinuities (see 6.26.2.1 and Figure 6.8). Remainder of weld is acceptable.

Figure 30: Representation of size and spacing requirements for welds in tension (6.26.2.1) from Annex K

Notes:

Cracks

Description

Fracture type discontinuity with a sharp tip and high length to width ratio.

Acceptance Criteria

Visual Inspection

6.26.1.1 The weld shall have no cracks.

When found by MT or RT

6.26.2 RT and MT Inspection. Welds that are subject to RT or MT in addition to visual inspection shall have no cracks and shall be unacceptable if the RT or MT shows any of the types of discontinuities described in 6.26.2.1, 6.26.2.2, 6.26.2.3, or 6.26.2.4.

Identifying

Cracks open to the surface can typically be found visually but not always. MT or PT will find them readily. MT can find cracks slightly below the surface; however, most cracks internal to the weld can only be found by volumetric techniques.

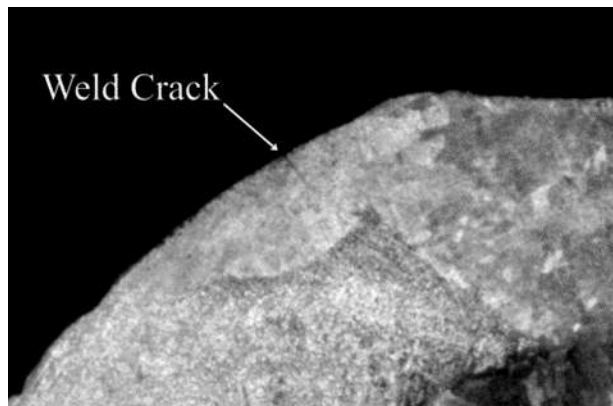

Figure 31: Identifying weld cracks

Common Causes

As molten metal solidifies, it shrinks. This shrinkage causes stress in the weld joint and base metal. If the stress exceeds the strength of the metal, then a crack is formed. There are several other causes for cracks including hydrogen embrittlement, improper weld bead profile, insufficient filler metal, incorrect preheat or in some cases, filler metal chemistry issues.

Repair

3.7.2.4 Cracks in Weld or Base Metal. The extent of the crack shall be ascertained by use of MT, PT, or other equally positive means; the metal shall be removed for the full length of the crack plus 50 mm (2 in) beyond each end of the crack, and re-welded.

Note that even if found by visual inspection, MT or PT must be employed to ascertain its extent.

Notes:

--

Undercut

Description

A groove melted into the base metal adjacent to the toe or root of a weld and left unfilled by weld metal.

Acceptance Criteria

6.26.1.5 In primary members, undercut shall be no more than 0.25 mm (0.01 in) deep when the weld is transverse to tensile stress under any design loading condition. Undercut shall be no more than 1 mm (1/32 in) deep for all other cases.

Identifying

Undercut is found with visual inspection. A good flashlight is of valuable assistance in quickly identifying undercut. A specially made gauge is available for measuring the primary member depth requirement of 0.01 inches. Several tools are available capable of measuring the non-primary requirement of 1/32 inches.



Figure 33: Visual inspection with flashlight

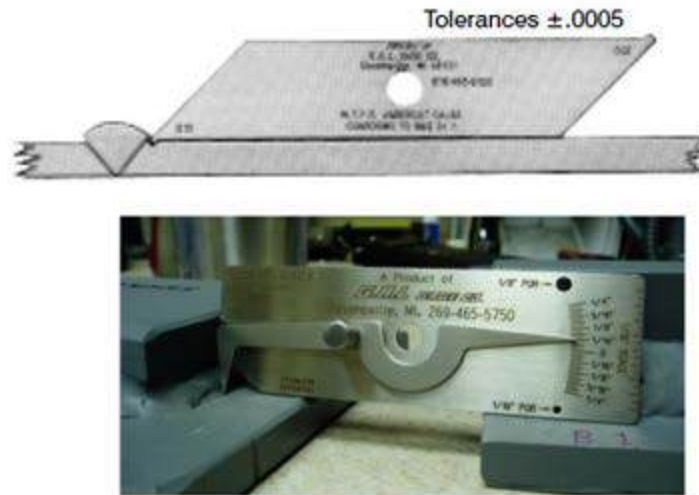

Figure 32: Gauges for measuring undercut

Common Causes

Undercut can be caused by excessive weld heat, long arc length, or improper electrode angle or manipulation. As with overlap at the bottom of a horizontal weld due to gravity, undercut can be prevalent at the top.

Repair

3.7.2.2 Excessive Concavity of Weld or Crater, Undersize Welds, Undercutting. Surfaces shall be prepared (see 3.11 “Weld Cleaning”) and additional weld metal deposited.

Notes:

--

Underfill, Convexity, Craters

Description

Underfill – a depression on the face or root surface of a weld extending below the surface of the adjacent base metal. This term typically applies to groove weld faces. When the face of a fillet weld shows a depression, it is defined as concavity and only affects the way the weld size must be measured.

Convexity – a term applying to the face of a weld with a crowned profile. In groove welds, this is evaluated to the reinforcement height requirements.

Craters – a depression in the face of a weld at the termination of a weld bead.

Acceptance Criteria

Fillet Welds

3.6.1 The faces of fillet welds may be slightly convex, flat, or slightly concave as shown in Figure 3.3(A) and (B), with none of the unacceptable profiles shown in Figure 3.3(C).

3.6.1.1 Except at outside welds in corner joints, the convexity C of a weld or individual surface bead shall not exceed 0.07 times the actual face width of the weld or individual bead, respectively, plus 1.5 mm (0.06 in) [see Figure 3.3(B)].

6.26.1.3 All craters are to be filled to the full cross section of the weld, except for the ends of intermittent fillet welds outside of their effective length when such welds are allowed in the design. (Crater requirement also applies to groove welds.)

Groove Welds

3.6.2 Groove welds shall preferably be made with slight or minimum face reinforcement except as may be otherwise provided. In the case of butt and corner joints, the face reinforcement shall not exceed 3 mm (1/8 in) in height and shall have gradual transition to the plane of the base metal surface [see Figure 3.3(D)]. They shall be free of the discontinuities shown for butt joints in Figure 3.3(E).

Groove welds are required to be filled to the full cross-section designed.

Groove welds which are required to be flushed.

3.6.3 Surfaces of butt joints required to be flush shall be finished so as not to reduce the thickness of the thinner base metal or weld metal by more than 1 mm (1/32 in) or 5% of the thickness, whichever is smaller, nor leave reinforcement that exceeds 1 mm (1/32 in). Unless

otherwise approved by the engineer, all reinforcement shall be removed where the weld forms a part of a faying surface. Any reinforcement shall blend smoothly into the plate surfaces with transition areas free from weld edge undercut. Chipping may be used, provided it is followed by grinding.

Identifying

These discontinuities are all found visually and can be measured with several of the tools already discussed.

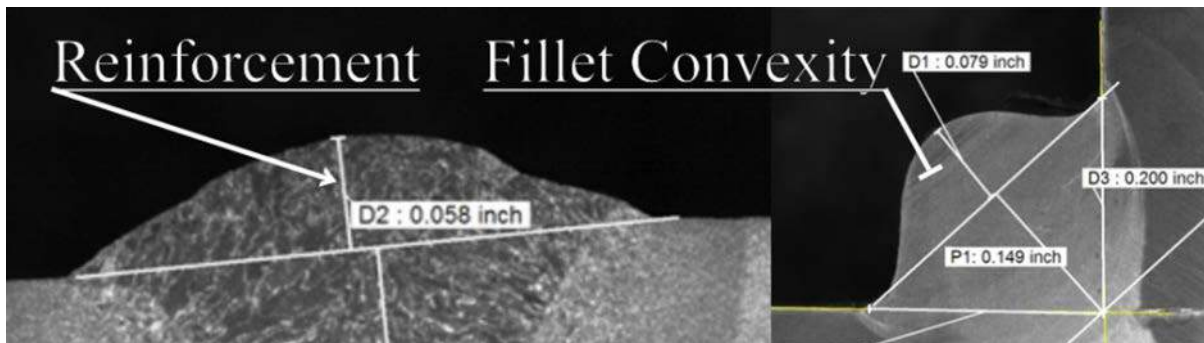

Figure 34: Identifying convexity

Common Causes

Weld face profiles can be affected by weld parameters and technique and, in the case of welds requiring finishing, excess or improper grinding.

Repair

3.7.2.1 Overlap or Excessive Convexity. Excess weld metal shall be removed.

3.7.2.2 Excessive Concavity of Weld or Crater, Undersize Welds, Undercutting. Surfaces shall be prepared (see 3.11 “Weld Cleaning”) and additional weld metal deposited.

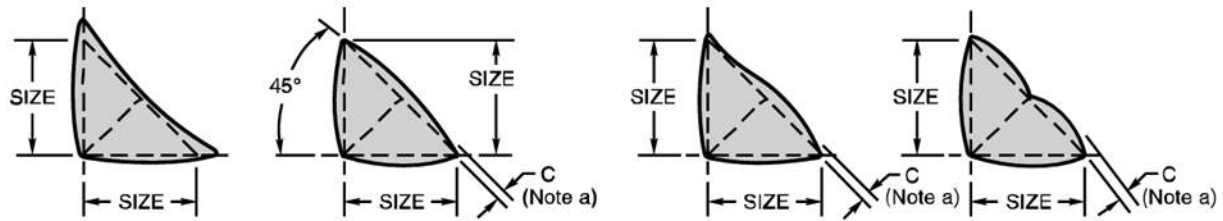

(A) DESIRABLE FILLET WELD PROFILES

(B) ACCEPTABLE FILLET WELD PROFILES

^a Convexity, C, of a weld or individual surface bead shall not exceed 0.07 times the actual face width of the weld or individual bead, respectively, plus 1.5 mm [0.06 in].

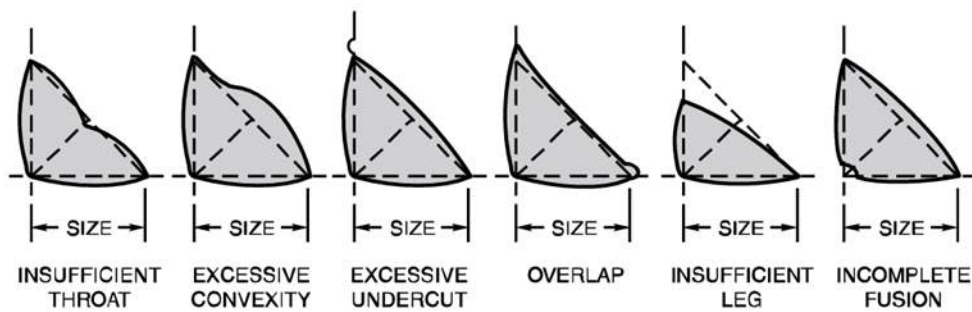

(C) UNACCEPTABLE FILLET WELD PROFILES

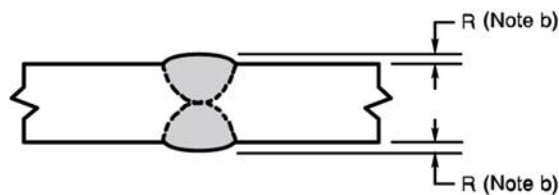

(D) ACCEPTABLE GROOVE WELD PROFILE

^b Reinforcement R shall not exceed 3 mm [1/8 in] (see 3.6.2).

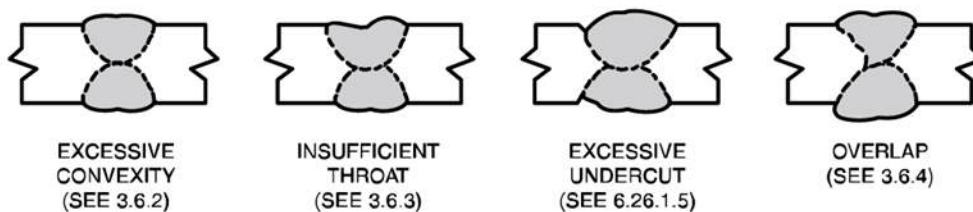

(E) UNACCEPTABLE GROOVE WELD PROFILES IN BUTT JOINTS

Figure 3.3—Acceptable and Unacceptable Weld Profiles (see 3.6)

Notes:

Spatter

Description

Metal particles expelled during welding, which do not form a part of the weld.

Acceptance Criteria

3.11.2 Cleaning of Completed Welds. Slag shall be removed from all completed welds, and the weld and adjacent base metal shall be cleaned by brushing or other suitable means. Tightly adherent spatter remaining after the cleaning operation shall be acceptable unless its removal shall be required for the purpose of NDT or painting. Welded joints shall not be painted until after welding has been completed and the weld has been accepted.

Identifying

Found by visual examination.



Figure 35: Spatter

Common Causes

Caused by excessively long arc length or improper torch/electrode angle.

Repair

3.8.2 Manual slag hammers, chisels, and lightweight vibrating tools for the removal of slag and spatter may be used and shall not be considered peening.

Notes:

Arc Strike

Description

A discontinuity consisting of any localized re-melted metal or changes in the surface profile of any part of a weld or base metal resulting from an arc.

Acceptance Criteria

3.10 Care shall be taken to avoid arc strikes outside the area of permanent welds on any base metal. Cracks or blemishes caused by arc strikes shall be ground to remove all of the defect. On tension and reversal of stress members, MT (preferably the yoke method) shall be used to determine that no cracks are present in the structure (see 6.7.6.2). Hardness tests shall be employed as stated in 3.3.7.4.

3.3.7.4 The removal of tack welds may expose unacceptably hard or cracked HAZs. Such areas on members subject to tension or reversal-of-stress shall be tested by MT (preferably by the yoke method) to assure that no cracks are present. Hardness tests are recommended to determine that HAZ remaining in the structure are not unacceptably hard. Hardness values shall not exceed Rockwell C30 in the HAZ or the hardness value measured in the unaffected base metal, whichever is higher. Since HAZ hardening generally extends less than 3 mm (1/8 in) into the base metal, unacceptable hardening can be removed by shallow grinding.

Identifying

Found by visual examination.

Common Causes

Arc strikes are most common in SMAW as the electrode is electrically “hot” when the welding power supply is energized. They are caused by dragging the electrode outside of the weld joint to initiate the arc.



Figure 36: Arc strike

Repair

Typically repaired by grinding and, if MT reveals no cracking, the base metal should be evaluated to the same requirements as groove welds required to be flushed. If base metal thickness is reduced in excess of that allowed, weld build-up will be required.

Note: Typically repaired by grinding and, if MT reveals no cracking, the base metal should be evaluated to the same requirements as groove welds required to be flushed. If base metal thickness is reduced in excess of that allowed, weld build-up will be required.

Notes:

--

Fracture-Critical Members

Additional plans and requirements for these members are found in Clause 12 of AWS D1.5-2010:

12.1 General Provisions

This clause shall apply to fracture critical nonredundant members. All steel bridge members and member components designated on the plans or elsewhere in the contract documents as fracture critical shall be subject to the additional provisions of this section.

12.3.1 Design Evaluation

The engineer shall evaluate each bridge design to determine the location of any FCMs that may exist and shall ensure that all FCMs are properly designated as required by 12.3.2. The engineer shall ensure that the contract documents contain all information necessary to order materials and properly construct FCMs as required by the design.

When members are designated as FCMs, Clause 12 adds many additional requirements on items such as drawing acceptance, consumables and their storage, welding processes, diffusible hydrogen testing, impact (CVN) testing, welding procedure specification (WPS) testing and period of effectiveness, certification of contractors and welding personnel, repairs, and post-weld treatments. Also, additional NDT is required as follows:

12.16.2 Type of Weld and NDT Required

12.16.2.1 Tension and Repaired Welds in Butt Joints. Butt joints in tension and repaired groove welds in butt joints shall be QC inspected by both RT and UT.

12.16.2.2 T- and Corner Joint Tension and Repaired Groove Welds. All tension and repaired groove welds in T- and corner joints shall be QC inspected by UT.

12.16.2.3 Fillet Weld Repairs

Fillet weld repairs shall be inspected by MT. The test length shall include 100% of the length of the repair, and, when appropriate, at least 300 mm (12 in) beyond the ends of each repair weld.

12.16.3 RT Requirements

RT shall be done using hole-type IQIs as described in Table 6.1 and Figure 6.1E.

Note: Image quality indicators (IQIs) are used to interpret the contrast sensitivity of the radiograph.

12.16.4 Cooling Times Prior to Inspection

RT and preliminary visual inspections may be performed as soon as welds have cooled. UT, MT, and final visual inspection shall be done after the welds have cooled to ambient temperature for at least the following minimum time periods:

- Fillet welds on steel with a minimum specified yield strength of 345 MPa (50 ksi) or less, 24 hours.
- Fillet welds on steel with a minimum specified yield strength greater than 345 MPa (50 ksi), 48 hours.
- Groove welds in steel with a minimum specified yield strength of 345 MPa (50 ksi) or less; 24 hours when the weld depth is 50 mm (2 in) or less, and 48 hours when the weld depth is greater than 50 mm (2 in).

Note: When involved in fabrication or inspection of bridge fracture critical nonredundant members, thorough review and comprehension of Clause 12 is required.

Notes: