

TECHNICAL REPORTS SERIES No. **393**

Nuclear Geophysics and its Applications



INTERNATIONAL ATOMIC ENERGY AGENCY, VIENNA, 1999

NUCLEAR GEOPHYSICS
AND ITS APPLICATIONS

The following States are Members of the International Atomic Energy Agency:

AFGHANISTAN	HAITI	PARAGUAY
ALBANIA	HOLY SEE	PERU
ALGERIA	HUNGARY	PHILIPPINES
ARGENTINA	ICELAND	POLAND
ARMENIA	INDIA	PORTUGAL
AUSTRALIA	INDONESIA	QATAR
AUSTRIA	IRAN, ISLAMIC REPUBLIC OF	REPUBLIC OF MOLDOVA
BANGLADESH	IRAQ	ROMANIA
BELARUS	IRELAND	RUSSIAN FEDERATION
BELGIUM	ISRAEL	SAUDI ARABIA
BOLIVIA	ITALY	SENEGAL
BOSNIA AND HERZEGOVINA	JAMAICA	SIERRA LEONE
BRAZIL	JAPAN	SINGAPORE
BULGARIA	JORDAN	SLOVAKIA
BURKINA FASO	KAZAKHSTAN	SLOVENIA
CAMBODIA	KENYA	SOUTH AFRICA
CAMEROON	KOREA, REPUBLIC OF	SPAIN
CANADA	KUWAIT	SRI LANKA
CHILE	LATVIA	SUDAN
CHINA	LEBANON	SWEDEN
COLOMBIA	LIBERIA	SWITZERLAND
COSTA RICA	LIBYAN ARAB JAMAHIRIYA	SYRIAN ARAB REPUBLIC
COTE D'IVOIRE	LIECHTENSTEIN	THAILAND
CROATIA	LITHUANIA	THE FORMER YUGOSLAV REPUBLIC OF MACEDONIA
CUBA	LUXEMBOURG	TUNISIA
CYPRUS	MADAGASCAR	TURKEY
CZECH REPUBLIC	MALAYSIA	UGANDA
DEMOCRATIC REPUBLIC OF THE CONGO	MALI	UKRAINE
DENMARK	MARSHALL ISLANDS	UNITED ARAB EMIRATES
DOMINICAN REPUBLIC	MAURITIUS	UNITED KINGDOM OF GREAT BRITAIN AND NORTHERN IRELAND
ECUADOR	MEXICO	UNITED REPUBLIC OF TANZANIA
EGYPT	MONACO	UNITED STATES OF AMERICA
EL SALVADOR	MONGOLIA	URUGUAY
ESTONIA	MOROCCO	UZBEKISTAN
ETHIOPIA	MYANMAR	VENEZUELA
FINLAND	NAMIBIA	VIET NAM
FRANCE	NETHERLANDS	YEMEN
GABON	NEW ZEALAND	YUGOSLAVIA
GEORGIA	NICARAGUA	ZAMBIA
GERMANY	NIGER	ZIMBABWE
GHANA	NIGERIA	
GREECE	NORWAY	
GUATEMALA	PAKISTAN	
	PANAMA	

The Agency's Statute was approved on 23 October 1956 by the Conference on the Statute of the IAEA held at United Nations Headquarters, New York; it entered into force on 29 July 1957. The Headquarters of the Agency are situated in Vienna. Its principal objective is "to accelerate and enlarge the contribution of atomic energy to peace, health and prosperity throughout the world".

© IAEA, 1999

Permission to reproduce or translate the information contained in this publication may be obtained by writing to the International Atomic Energy Agency, Wagramer Strasse 5, P.O. Box 100, A-1400 Vienna, Austria.

Printed by the IAEA in Austria
March 1999
STI/DOC/010/393

TECHNICAL REPORTS SERIES No. 393

NUCLEAR GEOPHYSICS AND ITS APPLICATIONS

INTERNATIONAL ATOMIC ENERGY AGENCY
VIENNA, 1999

VIC Library Cataloguing in Publication Data

Nuclear geophysics and its applications. — Vienna : International Atomic Energy Agency, 1999.

p. ; 24 cm. — (Technical reports series, ISSN 0074-1914 ; no. 393)

STI/DOC/010/393

ISBN 92-0-100699-3

Includes bibliographical references.

1. Isotope geology. 2. Radiation well logging. I. International Atomic Energy Agency. II. Series: Technical reports series (International Atomic Energy Agency); 393.

VICL

98-00215

FOREWORD

Nuclear geophysics is the study and practice of nuclear physics as applied to geology. Examples of different materials dealt with by nuclear geophysics include raw materials such as petroleum, water, metalliferous minerals and coal as well as processed materials such as glass, purified minerals and ceramics.

The methodology of nuclear geophysics started with the discovery, by Henry Becquerel in 1896, of the radioactivity in uranium sulphate. Since then it has evolved up to contemporary measurement technology which includes electronically actuated radiation sources and high resolution detectors interfaced with miniaturized, user friendly computers.

The past fifty years have witnessed an enormous development in nuclear geophysics enabled by the progress in other physical disciplines, mathematics, geology itself and information science.

Nuclear geophysics depends on the interaction of nuclear radiation with geological materials. The effects detected or measured are also radiations. What provides the practical basis for nuclear geophysics is the fact that the geological properties of the materials are factors determining the characteristics of these detected radiations.

To start with, the report discusses the essence and the development of nuclear geophysics as well as the nature and methods of carrying out nuclear geophysical measurements. It deals with translating the results of measurements that have only a physical meaning into results with a tangible significance in the context of the properties of the materials measured. Borehole logging and dynamic or static bulk analysis are the main measurement applications of nuclear geophysics and, consequently, their performance underlies much of the discussion of the report on its benefits to society. Various nuclear techniques available that are based on the use of isotopic and, where applicable, electronic sources of neutrons, gamma and X rays are discussed in these applications. One example of an important trend in borehole logging discusses the use of spectrometric backscatter gamma ray technique for quantitative logging, based on the use of radioactive sources of very low radioactivity, combining the features of effective quantitative analysis, low cost and safety.

The report aims at providing background information on the nature of nuclear geophysics, its objectives, its tools for investigation and its wide range of applications benefiting society and industry. It gives a comprehensive account of the fundamentals of nuclear geophysics and its applications to society. The report also contains additional scientific material on the interaction of nuclear radiation with geological samples, on data processing and interpretation. It concentrates on the more traditional and well established applications which are mainly related to economic progress and

to methods increasing the output yield of the desired products of industrial processes and, thereby, minimizing wastage in the resources used by these processes.

The report reviews the achievements and performance of nuclear geophysical measurements, particularly in applications to mining, industry and agriculture. It also analyses many of these important applications for their economic impact. It updates the available information on nuclear geophysics by giving an account of the most relevant achievements and concepts introduced during recent years. Also, it provides references to many of the significant recent publications in this field.

The report contains material relevant not only to scientists and technologists active in the various branches of mineral industry but, even more importantly, aims at informing both managers and people generally educated in areas outside the specialized discipline of nuclear geophysics. It seeks to inform both the general reader and the non-specialist scientist on the application and impact of nuclear geophysics in modern society.

The IAEA acknowledges the work of all those who were involved in the drafting and review and is particularly grateful to P.L. Eisler for his major contribution.

EDITORIAL NOTE

Although great care has been taken to maintain the accuracy of information contained in this publication, neither the IAEA nor its Member States assume any responsibility for consequences which may arise from its use.

The use of particular designations of countries or territories does not imply any judgement by the publisher, the IAEA, as to the legal status of such countries or territories, of their authorities and institutions or of the delimitation of their boundaries.

The mention of names of specific companies or products (whether or not indicated as registered) does not imply any intention to infringe proprietary rights, nor should it be construed as an endorsement or recommendation on the part of the IAEA.

CONTENTS

1.	INTRODUCTION	1
1.1.	Substance and nature of nuclear geophysics	1
1.2.	History of nuclear geophysical methods	2
2.	FUNDAMENTALS OF NUCLEAR PHYSICS	7
2.1.	What do we measure?	7
2.1.1.	Types of sample measures	8
2.1.2.	Natural and artificial fields	10
2.1.3.	Radiation transport	14
2.2.	How do we make measurements?	20
2.2.1.	Nuclear geophysical measuring instruments and their configurations	20
2.2.2.	Physics of nuclear radiation detection	21
2.2.3.	Radiation detection and signal processing	24
2.2.4.	Sources of radiation for nuclear applications	35
2.3.	Basic interpretation models	39
2.3.1.	Introduction	39
2.3.2.	Models	41
2.4.	Summary	54
	Reference	55
3.	PARAMETERS OBTAINED BY NUCLEAR TECHNIQUES	56
3.1.	Material parameters	59
3.2.	Primary parameters measured	62
3.3.	Types of measurement	77
3.4.	Summary	82
	References	84
4.	MEASUREMENT METHODS	87
4.1.	Introduction	87
4.2.	Scale of the methods	87
4.3.	Environment of the methods	88
4.3.1.	The subsurface	88
4.3.2.	Tracer techniques	92
4.3.3.	X rays and mineral processing	96

4.4.	Reliability of the measurements	98
4.5.	Relevance of the measurements	99
4.6.	Emerging trends	100
4.7.	Summary	108
	References	110
5.	INTERPRETATION	111
5.1.	Relevance of the environment to interpretation	111
5.2.	Scale of interpretation	112
5.2.1.	General considerations	112
5.2.2.	Relevance of technique to scale of interpretational procedures	112
5.3.	Further strategies for solving the inverse problem	113
5.3.1.	Spectral interpretation	114
5.3.2.	Interpretational relationships and statistical models	118
5.4.	Reliability	124
5.5.	Emerging trends in interpretation and measurement	126
5.5.1.	Petrophysical filtration and cyclometry	126
5.5.2.	Other forms of classification	130
5.6.	Summary	133
	References	135
6.	IMPACT OF NEW TECHNOLOGY	136
6.1.	From science to society	136
6.1.1.	What is science?	136
6.1.2.	Society, nuclear geophysics and society's comprehension of environmental issues	139
6.1.3.	Economic and developmental framework	143
6.1.4.	The why and how of nuclear geophysics — particularly in the borehole	147
6.2.	Examples of nuclear geophysical technologies and their impact	148
6.2.1.	Nuclear geophysics and the uranium mining and processing industries	149
6.2.2.	Oil well logging	153
6.2.3.	Borehole logging for the solid resources industries	158
6.2.4.	Applications of in situ analysis to civil engineering	175

6.2.5	X rays and on-line analysis in the processing of metalliferous minerals	176
6.2.6.	On-line coal analysis	178
6.2.7.	Analysis of coal slurries	182
6.2.8.	Coal and coke moisture measurements	182
6.2.9.	Various applications of nuclear geophysics to industrial processing	183
6.2.10.	Agriculture and water — Applications of isotope technology	186
6.2.11.	Measurement of radon in soil and air	188
6.2.12.	Prediction of seismic and volcanic activities by changes in the concentration of radon in soil and groundwater	189
6.3.	Future trends	189
6.3.1.	Situational problems and challenges for geophysical measurement systems	189
6.3.2.	Evolving patterns in nuclear geophysical practices	191
6.4.	Summary	193
	References	194

	CONTRIBUTORS TO DRAFTING AND REVIEW	199
--	---	-----

1. INTRODUCTION

1.1. SUBSTANCE AND NATURE OF NUCLEAR GEOPHYSICS

Nuclear geophysics is the study and practice of nuclear physics as applied to geology. It also applies to all matters and human activities connected with geology. The practice of nuclear geophysics deals with the effects which we measure as a result of the interaction of nuclear radiation with geological materials and with the various ways the measurement of these effects and its interpretation lead to the construction of new hypotheses and theories on geological issues. The theories in question can be of a theoretical nature, as, for example, cosmological theory, or of a practical one, such as the variation in the ore grade in core samples. This subject deals with what effects we measure, and how we then measure those effects that relate to the motion, or the so-called transport, of nuclear radiation through geological materials. We also measure the effects of the interaction of nuclear radiation with materials being processed from, at least partially, raw geological materials, as, for example, a coal slurry.

Examples of different materials dealt with by nuclear geophysics range from raw materials such as petroleum, water, metalliferous minerals or coal to processed materials such as glass, processed metals or ceramics. Furthermore, the materials relevant to these studies also include some types of waste products of manufacture involving the use of raw geological materials such as fly ash, carbon dioxide released from the combustion of coal and chemical effluents from mineral processing plants. This report cannot cover all these topics although they would all lend themselves to discussion.

Nuclear geophysics must also deal with the way in which we measure the effects of nuclear radiation interacting with geological materials in the various stages of the of their purification processes, in order to provide data assisting the control of these processes. Its application may assist humanity both in discovering more natural resources and in extracting these resources more effectively and efficiently. In all these aspects, the practice of nuclear geophysics may assist humanity by increasing or maintaining the distribution of resources and, on the other hand, by minimizing their waste, either during their extraction from the ground or during the stage of mineral processing.

The opening lines of this chapter state that nuclear geophysics depends on the interaction of nuclear radiation with geological materials. Then, what are these nuclear radiations and their interactions with materials, in a general sense? They are the radiations emitted as a consequence of changes in the energy states prevailing in atomic nuclei. They are, in particular, emitted when nuclei that are already in an excited state undergo de-excitation.

The following chapters give a more detailed description of the nature of these radiations. It should be mentioned, in passing, that X rays are included among the radiations relevant to nuclear geophysics, although they are emitted in the de-excitation processes of shell electrons surrounding the atomic nuclei.

The effects that are detected or measured are also radiations. These radiations are either emitted or scattered when other radiation interacts with geological materials. The practical basis of nuclear geophysics is provided by the fact that the geological properties of the material are the factors determining the characteristics of these detected radiations.

1.2. HISTORY OF NUCLEAR GEOPHYSICAL METHODS

In principle, the birth of nuclear geophysics was Henri Becquerel's discovery of radioactivity in uranium sulphate, in 1896. Indeed, one instrument, which was to be most important to nuclear geophysics, the mass spectrograph (and, later, the mass spectrometer), was fully developed by 1919. Its use in measuring the atomic weights of isotopes was not perfected until 1938, and its application to a complete laboratory scale separation of isotopes of chemical elements, including hydrogen, lithium, neon, chlorine, potassium and rubidium, was accomplished by 1940. The information available on isotopic abundances greatly relies on the use of mass spectrometry.

Since the 1930s, the golden age in the development of nuclear physics, the growth of nuclear geophysics has always nearly paralleled that of its parent science, nuclear physics, but has always remained several steps behind. This may well have been because the practical uses foreseen at that time — and during the following decades — were military and, subsequently, power generation. These were the areas of nuclear technology that received large scale governmental funding.

It was the oil industry that perceived nuclear geophysics as a possible avenue to further refining its methodology for oil exploration in boreholes; consequently, this industry gradually promoted, and increasingly invested in, this branch of applied nuclear physics. The first commercial measurements were natural gamma ray borehole logs made in the late 1930s. They were used for distinguishing between different types of rock intersected by the holes. They delineated strata very effectively and correlated well with data obtained from self-potential and resistivity logs, which had already been in use a decade earlier. At first, these measurements could only differentiate between lithologies on the basis of how much radiation each of them emitted. These instruments, which usually used Geiger-Müller counters, could not differentiate the radiations emitted on the basis of their energies. However, they also used other gas counters, i.e. ionization chambers and proportional counters. The latter are still being used successfully today in mineral beneficiation plants, to control these processes through the detection and spectrometry of the fluorescent X rays emanating

from the feed and product streams, wherever monitoring equipment is placed to assist process control.

It was in 1947 that the first downhole neutron porosity gauge appeared. This, however, was the result of the scientific revolution that led to an understanding of the transport of neutrons in materials as well as of being able to model this transport mathematically in any geometrical configuration and for most of the materials. This was a discipline that arose in nuclear weapons development projects and was later refined in the physics of nuclear reactors and nuclear engineering.

The same year saw the introduction of the modern scintillation detector, which was capable of detecting gamma rays efficiently; this implies that a good deal of those gamma rays that enter the scintillator actually interact with it. The detector can also differentiate the gamma rays detected on the basis of their energies. This development started a new period of experimental nuclear physics and, hence, of modern nuclear geophysics. The modern scintillation detector is essentially an optically coupled combination of scintillating crystal (or scintillator) and photomultiplier tube. When the radiation interacts with the scintillator material it emits a light flash whose intensity is proportional to the energy the radiation has transferred to the crystal, which, in turn, produces a commensurate electrical signal from the photomultiplier. For the first time a spectrometric detector with a high counting efficiency for energetic gamma radiation was available. It could differentiate the energies of the different radiations detected, although at the beginning the resolution achieved for this differentiation was only very approximate and the procedures required were cumbersome. However, it took only a few years before this detector was so refined that it could differentiate gamma rays and X rays according to their energies.

This step was to have an immense effect on all applied branches of nuclear physics, in particular to nuclear medicine, industrial processing and, of course, nuclear geophysics. The reason for its importance is that many of the substances that need to be measured in any of these processes, but cannot be monitored visually, can be activated so as to emit either gamma or X rays of various energies specific to the substances under investigation. As was mentioned previously, some of the substances monitored are naturally active. Others must be activated artificially, by using energetic nuclear particles emitted by sources of radioactive emissions such as powerful radioactive sources, nuclear reactors or nuclear particle accelerators.

The next important step was the development of an instrument for efficiently measuring the energy of the detected radiation. Until about 1960, there were only two techniques for doing this. One method was to carry out a number of sequential individual measurements over the energy range of the incoming radiation. This instrument was referred to as a single channel analyser (SCA), sampling a small window in the energy range of interest for a fixed time and could be used in a scanning mode, which then stepped that window up by a small increment in energy to sample again for the same time period, etc. In this way, a great number of detected

events escaped analysis so that the analyses took an inordinate amount of time. The other way was to calibrate a number of fixed level SCAs to measure regions of interest in the spectra of either gamma or X rays. This latter method of analysis is efficient but lacks sensitivity to elemental constituents under investigation if there is an interference from other elements in the region of interest.

The second major step taken in advancing nuclear measurement techniques, which was to accelerate the development of nuclear geophysics, was the multichannel analyser (MCA). It first appeared in laboratories in the late 1950s. This instrument is able to measure the energy of virtually every event detected. At first, these instruments were slow in analysing these events and would show the energy spectrum investigated with a detail of only 1/128th of its range. However, this energy differentiation and this speed were certainly adequate to the applications expected at the time. This was due to the fact that the available energy resolution of the scintillation detectors was not good enough to warrant better energy differentiation. At first, fast counting and analysing capabilities were not required either, because the main anticipated nuclear geophysical application was the analysis of gamma rays emitted by the radioisotopes occurring naturally in the ground, which are weak emissions from most of the rocks.

The rapid changes which have occurred in new electronic components and circuitry since 1960 have provided completely new possibilities of measurement in all branches of applied nuclear science. At a relatively early stage of their development, these possibilities were utilized in nuclear geophysics, particularly in downhole oil exploration nuclear geophysics. However, the concepts underlying the techniques developed in the oil industry were soon applied to controlling mineral processing, borehole logging for solid resources and airborne radiometry.

New types of gamma ray detector first appeared during the 1960s. Their production was based on the advances made in solid state physics, in particular the physics of semiconductors. The new detector was simply a crystalline piece of material, usually either silicon or germanium, which was not 'saddled' with 'moving parts', which means that there were no glass envelopes surrounding manufactured filaments and the like, as in the case of the photomultiplier component of the scintillation detector. While the original semiconductor detectors, which were made for the detection and energy differentiation of nuclear charged particles, could be operated at normal temperatures, their somewhat younger cousins developed for the detection of gamma and X rays required cooling by liquid nitrogen for satisfactory operation. This was and still is a problem for nuclear geophysics measurements of this type conducted at remote locations without infrastructural support. However, nuclear geophysicists often find the effort of organizing supplies of coolant worth while because the ability of this type of detector to resolve the energies of gamma rays is about fifty times better than that of a scintillation detector. In situations where the material has numerous elemental constituents requiring analysis, the number of gamma rays

requiring identification is likely to be enormous, as is the likelihood that only this type of detector will avoid the problem of their mutual interference. However, the capital cost of this type of detector, when compared with a scintillation detector of similar size, is enormous.

Even if cost is not an issue, the scintillation detector is a far from obsolete instrument in nuclear geophysical operations. There are many applications where the limited power of energy discrimination of the scintillator is no hindrance to the analysis required. And even when it is a hindrance there is often other information enabling the analyst to overcome this limitation.

More particularly, the scintillator is peerless in circumstances where the detectable radiation has a low rate of incidence on the detector's surface as is, for example, the case in aerial radiometric terrain surveying. In this application, each of four enormous slabs of sodium iodide scintillators, used in a modern radiometric aerial survey unit, may occupy a volume of, at least, eight litres. This provides the count rate required for good interpretation, and its capacity for good energy differentiation of gamma rays matches that of the same type of scintillator when used in the laboratory.

The progress made with supplying the radiation used for interaction with the material samples in question is another vital factor in the progress of nuclear geophysics. The commercial availability of artificial radioactive sources as are used today follows the development of nuclear weapons and nuclear reactors. Indeed, nuclear reactor technology is an essential part of the production of most of these sources, although some of them are produced by using particle accelerators. They are also relatively modern. Certainly, the neutron sources, americium–beryllium and californium, currently used for either industrial control or borehole logging, cannot be prepared without nuclear technology. The other source of neutrons, the electronically actuated neutron generator with a sealed neutron tube, was developed in the 1960s. Much of the oil well logging carried out today would be meaningless without these sources for equipping neutron porosity probes in oil search.

Research is continuing, with the aim of producing faster scintillator materials with higher stopping power for radiation and an improved temperature stability compared to the current materials.

The last great strides in technology that have driven nuclear geophysics forward are the advances in the field of computers and electronics. One application of mathematics in geophysics is the theoretical prediction of the results of particular configurations of instrument, source and sample, in terms of how this affects the radiation spatially and temporally. In many cases this is actually a most daunting if not impossible task. It is, however, the computer that has provided scientists with the alternative approach of using numerical approximations and, later on, simulations for carrying out this task. The computer, in particular the personal computer, also provides the scientist with a means of controlling measurement procedures, storage

of measurement data, processing of data and their interpretation according to certain algorithms in order to assign values to the required geophysical or geological parameters as well as the visual presentation of the results of these interpretations in the form of hard copies. This kind of output is presented as tabulated numbers or as graphs showing the variation of a parameter of interest relative to some reference frame such as the geographical location or the depth below the surface. The outputs of processing are also available as visual displays, so that it is already possible to obtain the results of geophysical monitoring measurements while they are in progress; hard copies need not be made except when really required.

This report deals with two challenges to nuclear geophysics: accessibility of its measurement technology to the potential user and its relevance.

Accessibility is ensured if several criteria including accuracy, reliability, robustness and 'user friendliness' are fulfilled. The technology has developed impressively in all these respects over the past two decades. The results obtained have not only become more accurate, but also more relevant to what the so-called clients are trying to measure in the real practical world. This is very much the consequence of advances made in conceptual issues in modelling theory, simulation and mathematical statistics. The equipment is now robust, both physically and in terms of how it operates, hence it is also 'user friendly', mainly as a consequence of the new electronics and computer technologies. However, further developments along these lines will be necessary for the technology to gain broad acceptance in new areas of application, as, for example, at the coal face, in the hands of the working miner, or, alternatively, at the side of the national park ranger in monitoring the conditions of the park's environment. These are topics on which the report concentrates. The consequences of nuclear geophysical simulation of a sample or of a rock or ore body are so complex in terms of their effects on what we measure that, in order to solve the problem at hand, it is frequently necessary to obtain additional defining relationships from other either chemical, physical, mathematical or geophysical measurements.

Relevance prevails where the technology is applied to the needs of the many. The greatest advances this technology has made so far on behalf of humanity are in the areas of resource discovery, exploitation and processing. Its relevance to the future may well be increased by applications to the protection of humanity's environment.

The report first discusses the tangible essence of nuclear geophysics, i.e. the nature and the methods of nuclear geophysical measurements. It discusses how we translate the results of measurements that only have a 'physics meaning' into a 'practical meaning' concerning the materials measured. Chapter 3 discusses the physical concepts underlying the methods of measurement, whereas Chapter 4 describes actual measurement techniques used, the scope of, and the constraints on, measurement techniques as well as the trends in equipment evolution. Chapter 5 considers the process of interpreting the results of geophysical measurements, while

the final Chapter 6 starts with a review of philosophical questions on the identity of science and then examines the economic framework in which nuclear geophysics operates. In discussing the economic framework, the chapter considers such factors as the state of the world's demonstrable economic resources and the rate of their consumption. However, the main emphasis of the final chapter is on the review of achievements and performance of nuclear geophysics, in particular, of mining and industrial applications. In considering performance, it examines (where possible) factors that are technical, economic and human. Finally, the chapter discusses evolving practices and applications of nuclear geophysics.

The report intends to provide the reader who is not scientifically trained with background information on the nature of nuclear geophysics, its current application and its economic impact. The report also contains additional material which may mainly interest the scientist who does not specialize in the field of nuclear geophysics, as e.g. discussions on the details of the interaction of radiation with matter.

The report is not, however, intended as an encyclopaedia on nuclear geophysics and its applications to society. An encyclopaedia of this type may well be an appropriate project for the future.

The potential applications of nuclear geophysics to monitoring the changes occurring in the environment is one topic of vital importance to humanity. The present report discusses this topic only superficially. It is beyond our scope, but might also be a suitable subject area for a future publication. The report concentrates on more traditional and well established applications which are mainly related to economic progress and to methods of increasing the output yield of the desired products of industrial processes and, thereby, of minimizing wastage in the resources used by these processes.

2. FUNDAMENTALS OF NUCLEAR PHYSICS

2.1. WHAT DO WE MEASURE?

The techniques of applied nuclear physics may be used to detect or to measure quantitatively the properties of any natural material available either in its raw and unprocessed state or, alternatively, in a processed state. Generally, the properties measured may be physical or chemical. The most common physical properties measured directly by nuclear geophysical techniques are the density and the porosity of rocks, soils and mineralized ores. The chemical properties usually measured by these techniques are the concentrations of chemical elements relevant to specific industrial situations.

The reason why emphasis is placed on particular chemical elements is that there is no single type of nuclear reaction that would provide a suitable, universally applicable system of quantitative analysis within a practical time frame, nor can all chemical elements be analysed by any single system of analysis. Furthermore, for those elements that can be analysed, it is impossible to do so for all concentrations in which these elements may occur in industrial samples. This constraint on suitability of the method for particular chemical elements even applies to X ray emission spectroscopy, which is unsuitable for the lightest chemical elements although its applicability covers the widest range of chemical elements. Moreover, since X ray spectroscopy suffers from self-absorption effects within the sample, it is unsuitable for quantitative bulk analysis of heterogeneous samples. However, the X ray technique can be applied effectively to the analysis of bulk samples which are known to be homogeneous, by submitting small subsamples for analysis.

Nuclear geophysical measurements are also useful if they supply parameters that are related to particular physical and chemical properties without giving the absolute values, from the analysis, of the physical and chemical properties of the matrix. For example, certain types of borehole probes, which are equipped with gamma ray sources, give an undifferentiated response to variations in the density and the overall chemical composition of a matrix. This type of probe measurement may be useful for delineating an ore body, differentiating between the mineralized zones and the strata of host rock.

2.1.1. Types of sample measures

The mass and the volume of the samples analysed by the various available nuclear geophysical techniques vary enormously. The size of the sample depends on the particular application considered. At the low end in the range of sample sizes, the samples may be crushed geological samples, accumulated specks of dust, or other filtrates retained in air samplers or other fluid samplers. The weight specimen samples of this type may range from only milligrams to several grams. These samples are generally analysed by using either an accelerator or a nuclear reactor as the radiation source facility.

At the other extreme in the range of sample sizes, the sample may be the terrain surveyed radiometrically from the air. Alternatively, the sample may comprise the geological formation intersected by boreholes, where the boreholes provide access to the nuclear geophysical probes which measure, in situ, the properties of the formation. In this case, the actual sample volume is determined only by the range of penetration of the nuclear radiation emanating from within the sample to be detected in the probe.

Between these extremes in the range of sample sizes, we find those samples for nuclear geophysical measurement that are most commonly used in the quality control

of the output from mines or beneficiation plants. The samples may consist of crushed or ground materials, weighing up to 15 kg, which have been split or riffled from large bulk samples. These subsamples are generally measured geophysically in containers of standardized form and volume.

On the other hand, the samples may take the form either of slurries of mineralized ore, which are pumped through pipes as input or output of beneficiation plants, or of crushed rock and ore, which are transported on conveyor belts. In these dynamic situations, the geophysical measurements are carried out on a mixture of materials being moved at mass transport velocities which range up to many tonnes per hour.

In other industrial situations, there is frequently a need to detect or measure the properties of the sample in isolation of the surrounding materials. For example, for the extraction phase of coal mining it is necessary to detect the coal seam directly, in order to determine its depth, width and purity profile, although the coal is frequently mixed accidentally with interbedded rock during the extraction process.

However, at a subsequent stage of coal mining operations, when either washing (for beneficiation) or blending are carried out, data are generally required on the quality of the extracted coal-rock mixture which represents the input to either of these particular processes. Because of its capability to measure rapidly and sample effectively the material in bulk, nuclear geophysics is applied advantageously to measuring the concentration of mineral impurities in the coal. In this operational phase, the samples would be measured on belts or in pipes carrying slurries.

Many industrial situations which benefit from the use of geophysical measurements require the use of a non-nuclear measurement in combination with a nuclear measurement. Again, on-line coal quality monitoring provides an example for this situation. This is because the two critical coal quality parameters, ash content and moisture, require, under particular circumstances, different measurement methods for their on-line estimation, the former requiring a nuclear method and the latter requiring either simple capacitance or microwave techniques.

The samples of the materials measured by nuclear geophysics methodologies may occur in any physical phase, i.e. the solid the liquid or the gaseous phase. However, nuclear geophysics is considered conceptually to be inapplicable to any material matrix which is synthetically fabricated, thus excluding plastics.

The materials investigated by nuclear geophysical measurements may be particulate impurities suspended in fluids such as water, air or the effluent gases discharged from industrial plants such as power stations. The samples may also be the radioactive constituents (e.g. radon) of a gaseous mixture. Furthermore, the samples may be the constituents, adsorbed on foils or filters, of gaseous mixtures released from the earth. In this case they are geological samples. However, most commonly, the samples analysed by techniques of nuclear geophysics are rock, mineralized ore and fossil fuels (occurring in all phases).

2.1.2. Natural and artificial fields

(a) *Introductory concepts*

The analytical measurements carried out are generally based on detecting changes in the nuclear radiation fields. These fields are associated with the chemical and physical characteristics of the samples being measured.

To discuss the detection of changes in the radiation field, our fundamental concept of nuclear radiation for the purpose of detecting and measuring should be understood. This is particularly important because the next section deals with the methods with which we measure nuclear radiation. The basic concept is that no matter which type of nuclear radiation is being measured, it can be visualized as a stream of particle-like objects rather than as a wave. This is a concept that applies to subatomic particles such as neutrons, protons and electrons as well as to radiations, which are without mass, i.e. X and γ rays. In the case of the γ and X rays, the 'particles' are photons.

In its motion, each 'particle' carries a specific amount of energy referred to as a quantum. When 'particles' are emitted as a result of a nuclear reaction, they will be emitted in different groups with characteristic specific emission energies. This is a property of nuclear reactions which allows the concentrations of the individual chemical elemental constituents in the geological sample to be identified and measured. The energies of the individual quanta are generally extremely small when compared with the energies expended in our day-to-day living activities. As a consequence, a special unit of energy, the electronvolt (eV), is used for this purpose, where $1 \text{ eV} = 3.8 \times 10^{-20}$ calories. Indeed, the energies of the nuclear radiations measured may range from several electrovolts to more than 10 MeV ($1 \text{ MeV} = 10^6 \text{ eV}$). Thus, even the largest quanta considered are minuscule when compared on an everyday energy scale.

The notion of a *field* in nuclear geophysical applications has been borrowed from the classical, electrical and gravitational field theories, probably because the first geophysical borehole instruments were gravimetric and electrical (e.g. the self-potential (SP) log). Although this term does not strictly apply to radiometric concepts in the sense that it applies to classical physical theories, there are palpable analogies. Certainly, in the case of a nuclear radiation field, the energy which is transferred through each unit of a cross-sectional area is spatially dependent, in a way similar to classical fields. However, the radiation field intensity cannot be defined in terms such as 'the force on a unit mass', or, alternatively, 'the force on a unit electrical charge', which are notions appropriate to classical field theory.

In general, the nuclear radiation field in a particular region or volume of a sample is measured by the intensity of the nuclear radiation intersecting each unit of the cross-sectional area in the space considered. These nuclear radiation fields can be

either natural in origin or artificially induced. The radiation intensity is measured in two different ways: by the number of radiated particles or photons that traverse each unit area in space per unit time. Alternatively, the intensity may be the time rate at which energy (i.e. power) is transported through the same area.

In order to understand the nature of radiation fields, it is essential to have some insight into the structure of the atom and the nature of its constituents, which are also important constituents of nuclear radiation.

(b) *Structure of the atom*

For the purpose of this report, the atom will be considered to consist of three kinds of particle: protons and neutrons, which form the nucleus of the atom, and electrons, which orbit the nucleus. Protons have positive charge and neutrons are electrically neutral so that the nucleus carries a net positive charge. The proton and the neutron are nearly two thousand times more massive than the electron. The numbers of electrons and protons in one atom are equal, and since their electrical charges are equal and opposite, the atom is electrically neutral. Other particles may occur in nuclear interactions. Some of the more common ones produced in the process of nuclear radiation detection will be mentioned in the following paragraphs.

To begin with, one must differentiate between the notations for atomic electrons (e^-) and β^- particles (β^-), the latter being emitted by radioactive nuclides during radioactive decay. The two notations actually refer to the same particles, i.e. electrons having the same charge and the same mass.

The positron (e^+) was discovered in cosmic radiation. It has the same mass as an electron but a positive charge. A similar, positively charged particle (β^+) was found to be emitted during radioactive β decay; hence, positively charged β particles were recognized.

The decay of the neutron and the proton are examples of β^- and β^+ decay, respectively:



where ν and $\bar{\nu}$ are the symbols for two particles, the neutrino and the antineutrino, respectively. They were postulated by Pauli in 1931 to explain an otherwise unaccountable loss of energy and angular momentum in the β decay process.

Another particle emitted in nuclear reaction processes is the α particle, which is an ionized helium atom, i.e. a helium atom that has lost both electrons. Gamma and X rays differ only in their origin; γ rays originate from the nucleus while X rays do not. The α particle is emitted as a consequence of certain reactions between fast

TABLE I. VALUES OF CHARGE AND MASS FOR COMMON NUCLEAR PARTICLES

Particle (relative)	Charge	Relative rest mass (approx.)	Symbol
Proton	+1	1	p
Neutron	0	1	n
Electron/ β particle	-1	1/1840	e^- , β^-
Positron	+1	1/1840	e^+ , β^+
α particle	+2	4	α
γ ray	not applicable	0	γ
X ray	not applicable	0	X
Neutrino	0	extremely small	ν

neutrons and the nuclei. It is also emitted as a result of the radioactive decay of the naturally occurring isotopes of the uranium and thorium series. Table I shows the charge and the mass for the particles mentioned above.

(c) *Attenuation of radiation fields*

The properties of the sample matrix affect the radiation field intensity by diminishing transmission. In other words, the material matrix attenuates the radiation. Although a later section of this report will deal with the details of radiation attenuation mechanisms in a sample matrix, it is worth noting that neutrons are attenuated in nuclear processes which are quite different from those affecting either γ ray photons, X ray photons or charged particles. This means that totally different chemical properties govern the transmission of these types of radiation either within samples or, alternatively, through shielding assemblies. Fast neutrons are elastically scattered (and thereby slowed down) most effectively by the nuclei of chemical elements having low atomic number Z , which is the number of protons in the atomic nucleus of a particular element. Hydrogen is by far the most effective element in this regard (i.e. because its nucleus contains only a single proton). At the other end of the scale, the extremely high Z elements, e.g. lead, thorium or uranium, are most effective in slowing down neutrons through inelastic rather than through elastic collisions.

The neutrons which have been slowed down by scattering, either to epithermal resonance energies or to thermal energies, are absorbed, to varying degrees, by the different nuclei in the matrix. However, scattering and absorption of photons mainly depends on the number of negatively charged particles (electrons) existing in the atom. On the other hand, the scattering of positively charged particles is determined by the positive charge of the nuclear protons.

Since the atomic positive and negative charges are balanced, all charged particle scattering mechanisms depend on the electronic charge of the atom. Details of the mechanisms causing radiation attenuation within a sample matrix will be further discussed in Section 2.1.3, which deals with radiation transport.

The natural fields result from the emission of nuclear radiation by the naturally occurring radioactive isotopes of certain chemical elemental constituents existing in the sample matrix being investigated. For all practical purposes, the natural nuclear radiation field at an air distance of more than 10 cm from the sample is largely due to the γ and X rays emitted. At closer proximity to the sample, the radiation field will also include α and β particles.

The naturally occurring radioisotopes, which produce the natural radiation fields, are associated predominantly with the chemical elements uranium, thorium and potassium. In the cases of uranium and thorium, particular parent radioisotopes (^{238}U , ^{235}U and ^{232}Th) undergo radioactive decay and generate daughter radioisotopes. However, ^{235}U contributes relatively little to the natural radiation field because of its low abundance (0.27%) compared with that of ^{238}U . The ‘daughters’ are the radioisotopes which emit the γ rays producing the measurable radiation fields. The radioactive decays of the parent radioisotopes of uranium and thorium are multistage processes in which the unstable ‘daughters’ that are produced, in turn, become ‘parents’. The decay process of each parent radioisotope eventually terminates with the production of a stable isotope of lead (Pb).

Artificial radiation fields occur where radiation sources are introduced into a particular area or region. What makes the field artificial is the fact that radiation sources are introduced, either deliberately or accidentally. The radiation fields which we encounter most commonly consist of γ rays, neutrons, X rays and energetic charged particles, e.g. protons. The radiation source facilities used may be in the form of encapsulated radioisotopic materials, nuclear reactors or electrically energized charged particle accelerators.

Irrespective of the nature of the radiation field (i.e. natural or artificial), the properties of both the radiation source and the sample matrix determine the intensity of the field at any particular point in space. Generally, in artificial fields, the field intensity diminishes with distance from the source, at a rate that is somewhat more rapid than the inverse square relationship. With the natural fields which occur inside a large homogeneous sample of naturally radioactive material, there is no spatial change of field intensity because the sample volume is in itself a distributed source.

This means that the source is everywhere within the sample volume considered. If the field intensity is measured outside a sample of naturally radioactive material, the field intensity is governed by the same laws that apply to synthetic fields.

In fact, it is the artificial radiation field that provides the by far greater scope for practical nuclear geophysical applications. The reason for this is that in order to gain the greatest available analytical sensitivity for particular chemical or physical properties, it is essential to match the source radiation with the nuclear properties of the relevant chemical elements in the sample, in order to obtain the desired nuclear reaction within the sample. Thus, the source is selected and introduced into an analytical assembly, providing an artificial field.

The use of artificial radiation fields also allows the prospect of carrying out the analysis with accuracies and speeds that are of practical use to be maximized. This is done by matching the source intensity, the type of radiation detector used and the counting efficiency of that detector with other critical parameters governing the nuclear reaction. These critical parameters for optimizing the measurement are the reaction probability, and the characteristics of the nuclear radiation which is the output from the reaction, i.e. the type of radiation and its energy distribution.

2.1.3. Radiation transport

The subdiscipline of radiation transport provides the basis for predicting the spatial and energy distributions of various types of nuclear radiation within any matrix. The nuclear radiation just referred to includes the primary radiation emitted by the source and also the secondary radiation, which is either generated or scattered within the sample matrix. Thus, for a given sample and a given source configuration, it would be possible to predict, by applying transport theory, the intensity of the radiation emanating from the sample for collection in a detector. This is the *direct modelling* described in Section 2.3. On the basis of this modelling, it is possible to arrange the configuration of source, detector and sample for an optimized response of the instrumental system.

The discussion on radiation transport in this section focuses on neutrons and γ rays. It will pay only limited attention to X rays and virtually exclude consideration of charged particles. The latter two forms of radiation are used almost exclusively, in the case of heterogeneous materials, with thin, small samples.

As was mentioned previously, achieving representative sampling is no problem if the samples used are large and homogeneous because any small subsample selected as an analytical specimen would be representative of the whole sample. In these situations, therefore, the ranges of penetration of neither the source radiation nor the excited, emitted radiation are of any consequence if sample and detector are geometrically configured for reflection of the radiation.

(a) *Basic concepts of radiation–nucleus interactions*

When γ rays, X rays or neutrons interact with the matrix of a material, they lose energy and are deflected from their initial path. In many circumstances, they are totally absorbed within the matrix. While the physical processes governing scattering and absorption differ markedly for neutrons and photons (of γ and X rays), the concepts used to describe their spatial and energy distributions quantitatively are similar. For all nuclear reactions, the nuclear reaction probability for an atom is described in terms of a parameter called the *microscopic cross-section* (σ) for the nuclear reaction. This is conceptually the area of either the atom or the nucleus which is ‘exposed’ to that particular type of reaction. The nuclear and the atomic cross-sections for the same atomic or nuclear species will vary according to the type of reaction considered. The dimension of the nuclear or atomic cross-section is cm^2 per nucleus or atom. The unit is the barn ($= 10^{-24} \text{ cm}^2$).

However, in considering the sample matrix, it is frequently essential to consider the reaction probability on a macroscopic scale rather than for nuclei and atoms individually. Then, the measure of reaction probability is the *macroscopic cross-section* (Σ), which is the cross-section per cm^3 of material and has the unit of cm^{-1} . The macroscopic cross-section is the product of the microscopic cross-section and the number of atoms per cm^3 . This atomic density is the product of the bulk density (ρ) and Avogadro’s number (N_A). *Avogadro’s number* is a universal constant indicating the number of atoms per gram-atom, i.e. the number of atoms per atomic weight (A), expressed in grams. The *atomic weight* is defined as the sum total of the number of protons and neutrons in the nucleus of a specific atom.

In the case of γ ray transmission, the macroscopic cross-section is referred to as the total linear attenuation coefficient (μ). In the case of neutrons, the same generic parameter is known as the macroscopic cross-section. For both photons and neutrons, this type of parameter determines the probability of their removal per unit path length within the matrix. The inverse of this type of parameter is the *mean free path* (λ). In either case, the mean free path is the average distance travelled before the photon or neutron enters into a status changing reaction. These are the parameters that form the basis for estimating the proportion of either bombarding or emitted γ rays or neutrons being absorbed in a given sample. In the case where neutrons are used in nuclear geophysical measurements, the variable of greatest relevance is the *neutron flux* in a specific region. The neutron flux is the time rate at which the neutrons cross the unit area at a given set of spatial co-ordinates. This variable, the flux, determines the rate at which the desired neutron initiated nuclear reactions can be propagated with samples of a given mass and in a given geometry. It also determines the type of shielding required for the protection of personnel and instrumentation.

In the case of γ and X rays, the *flux* is defined in analogy to the neutron flux. The flux variation within a matrix is best described by functions taking the form

$[B \exp(-\mu r)]/r^2$, where r is the distance from the source within the sample matrix to the point in space being considered, μ is the linear attenuation coefficient and B a 'buildup' factor for the intensity of the radiation at the source. Of course, this is the simplified case of a γ ray source embedded in a large homogeneous matrix. In cases where the transmission considered is only that of the primary γ rays, we have $B = 1$. For the transmission of both primary and scattered γ rays, $B > 1$, or, more precisely, $B = B(r)$, which is the so-called buildup factor of γ rays within the matrix.

In the case of neutrons, the functions describing the flux variation are generically similar to those quoted above for γ rays. However, the actual functions used are more complex. This is partly because the principal mechanisms for removing neutrons become effective when the neutrons have been slowed down to thermal or near thermal energies, i.e. when their energy distribution is essentially Maxwellian and the neutrons diffuse freely in the matrix before being captured.

In fact, there are two main types of competing neutron–nucleus interactions which determine the slowing down processes for neutrons: *elastic scattering* and *non-elastic scattering*. The former is like the collisions between idealized rubber balls of different sizes and masses. Here, the direction and the speed of the rebounding balls are determined solely by their initial speeds, their directions of travel and their masses. However, some of the energy of the incoming neutron is transferred to the recoiling nucleus. No energy is lost in this type of encounter. The latter, non-elastic scattering, is similar to the former in many respects, except that energy is consumed in such encounters. There are various types of non-elastic scattering mechanisms which also compete for the same type of nuclide. They include inelastic scattering, in which the consumed energy is spontaneously emitted as γ rays, and a variety of neutron–particle reactions (e.g. (n,α) , $(n,2n)$, (n,p)), in which the γ rays released carry away the nuclear de-excitation energy.

There are basically two attenuation/absorption variables in the exponential function predicting neutron flux: the slowing-down length (L_s) and the diffusion length (L_d). Both parameters are complicated functions of the macroscopic cross-sections for the processes which govern the slowing-down processes, on the one hand, and the capture of low energy, diffusing neutrons, on the other hand. However, while these two variables are very useful to predict the neutron flux variation, they are not fundamental in terms of the basic concepts of radiation transport. They are derived from several other variables which are more fundamentally related to the phenomena determining neutron flow and absorption in material media.

One of the variables that are closely related to transport concepts is the macroscopic cross-section for neutron scattering in a material. Another variable is the average *lethargy*, which is the logarithmic relative energy loss per neutron–nucleus collision in the material. It is worth noting that the lower the atomic weight, the greater the lethargy. The *diffusion coefficient* (D) is the third variable that is quite fundamentally related to radiation transport concepts and is relevant to concepts to be

further developed in the next chapter. Its value is inversely related to the *neutron transport* cross-section, where *transport* comprises both *scattering* and *absorption*. D is essentially the variable that determines the magnitude of the neutron current at any point in space (i.e. the rate of neutron flow), given a particular value of the neutron field (i.e. the spatial rate of change of the neutron flux).

(b) *Photon–atom interactions*

There are three main types of interaction between γ rays and atoms: the *photoelectric effect*, *Compton scattering* and *pair production*. In the case of X rays, the interactions are also photoelectric absorption and Compton scattering. However, the energies of X rays are too low for the occurrence of pair production.

In the photoelectric effect, the γ or X ray photon transfers all its energy to one of the atom's bound electrons. This process has by far its maximum probability when the photon energy is just above the binding energy of the electron to the atom. This energy is frequently referred to as the resonance absorption energy. In fact, the most important electrons for photoelectric absorption are the relatively highly bound inner electrons. Furthermore, the binding energies of the innermost electrons increase with atomic size: from about 3 keV for the light elements to more than 100 keV for the heaviest elements. This means that X and γ rays with energies higher than 100 keV can only be absorbed by the photoelectric effect to an appreciable extent if the absorbing atoms belong to the heavy elements of the periodic table.

Generally, the reaction cross-section for a photoelectric interaction with a particular type of atom (a measure of that reaction probability) diminishes rapidly as the photon energy increases above the electron binding energy. Also, it increases rapidly with the atomic number of the chemical element's nucleus, Z , with which the photon interacts, if we consider pure elemental target material. The atomic number represents the number of electrons (or, alternatively, of protons) for a particular type of element. As to the variation of the photoelectric cross-section with the elemental composition of the absorbing matrix, it increases rapidly with increasing atomic number so that the macroscopic cross-section varies approximately as the 3.6th power of the atomic number, i.e. to $Z^{3.6}$. This disproportionately greater sensitivity to the heavier elements is advantageous in most, but not all, analytical problems in geology and geochemistry. Chapter 3 further explores this notion as it applies to mineral compounds and mixtures.

Compton scattering is a more important interaction than photoelectric absorption if atoms and photons with intermediate energies (i.e. from 200 keV to 3 MeV) are involved. In this interaction, the photon transfers only part of its energy to one of the atomic electrons. The probability of this reaction diminishes with increasing energy far more gradually than in the case of the photoelectric effect. Also, for photons of

all energies, this interaction probability is sensitive mainly to the bulk density, with which it varies linearly. It is independent of the chemical properties of the material, i.e. independent of Z .

For photons with energies higher than 3 MeV, the principal photon–nucleus interaction is the spontaneous formation of a pair of electrons of opposite charge polarities. This effect is known as pair production. On their collision with other electrons of a charge polarity opposite to their own, the electrons originating from pair production are annihilated.

Each annihilation event results in the spontaneous emission of a photon having an energy equivalent to the rest mass energy of an electron (i.e. 0.51 MeV). This radiation is generally referred to as annihilation radiation.

This type of interaction only occurs for photons with energies higher than 1.02 MeV. However, the interaction probability rises sharply with the photon energy increasing above this threshold so that the interaction probability for 2 MeV photons with atoms of medium and large atomic weights is already significant compared with the probability of Compton scattering. In fact, the pair production reaction cross-section is proportional to Z^2 . This property is advantageous in that the response of an instrument based on this reaction is less disproportionately sensitive to the heavier elements than those depending on the photoelectric effect.

The relevance of these considerations is that, on the one hand, all three types of interaction contribute to the attenuation and absorption of γ and X rays in the samples submitted for analysis, in the detectors used in probes and in the shielding that is constructed to protect personnel or to isolate the radiation detectors used in measurements from unwanted background radiation. However, on the other hand, it is also true that there are ranges of photon energy in which each type of interaction dominates, although the actual ranges vary with the atomic weight (and number) of the elements in the matrix.

This last fact is frequently made use of in devising nuclear geophysical measurement systems based on the use of γ ray sources. One example for this is the group of spectrometric and selective γ – γ probes using either ^{60}Co or ^{137}Cs sources. Since the photon energies are 1332 keV and 1173 keV for the former isotope and 662 keV for the latter, pair production reactions are hardly significant. These probes can separately measure the γ rays in two energy ranges. In the lower energy range, the photons are capable of both photoelectric absorption and Compton scattering, responding in a way that is sensitive to both the overall chemical composition and the electron density. In the higher energy range, the photons interact with atoms almost exclusively by Compton scattering, and are sensitive to the electron density alone. For mixtures and chemical compounds containing mainly chemical elements other than hydrogen, the rock bulk density is directly proportional to the electron density. Even the presence of water in the mixture or compound does not significantly diminish the accuracy of this proportionality.

TABLE II. LINEAR ATTENUATION COEFFICIENTS OF SELECTED CHEMICAL ELEMENTS

Chemical element	Linear attenuation coefficient (cm ⁻¹)		
	0.1 MeV	1.0 MeV	5.0 MeV
Carbon	0.34	0.143	0.061
Aluminium	0.44	0.168	0.076
Iron	2.7	0.522	0.282
Lead	60	0.776	0.483

The second example is the pair production gauge used for the bulk analysis of coal purity and iron ore grade. In this case, the source is radium, which is suitable for initiating pair production in the sample, followed by the emission of annihilation radiation. Radium is suitable in this regard because it is a source of numerous γ rays with energies higher than 2 MeV. The gauge records the count rates of both the annihilation radiation and the Compton scattered photons; the latter are used for density corrections.

In view of the way the different photon reactions predominate in different energy ranges, it is worth noting typical values for the linear attenuation coefficient for different elements and different photon energies, i.e. 0.1 MeV, 1.0 MeV and 5 MeV, respectively. The linear attenuation coefficients for certain well known elements are shown in Table II.

(c) *Neutron–nucleus interactions*

As was mentioned above, there are two processes governing the spatial distribution of neutrons in a matrix where the source used emits fast neutrons (>500 keV): *slowing-down of fast neutrons* and *diffusion of thermal neutrons*. The former of these processes is the most difficult to formulate accurately. However, multigroup diffusion theory as applied to this problem generally yields quite good consistency between theory and observation. The functions predicting the thermal flux depend on the difference between the exponential functions using the slowing-down length and the thermal diffusion length as exponents. The actual exponents have, respectively, the forms $-r/L_s$ and $-r/L_d$. An approximate expression for evaluating the flux is given by the difference between these two exponents per unit of solid angle, normalized to the difference between the squares of L_s and L_d . However, typical values of L_s and L_d are more clearly intelligible to the reader than the complex but only approximate expressions available for the thermal neutron flux. It is most

TABLE III. NEUTRON TRANSPORT PARAMETERS OF SELECTED MATERIALS

Material	L_s (cm)	L_d (cm)	Comments
Dry, pure haematite	16.3	3	
5% water-haematite	11.4	~3	% water by volume
10% water-haematite	9.7	~3	% water by volume
20% water-haematite	7.9	~3	% water by volume
40% shale	12.2	~4	dry medium
60% haematite			
100% shale	8.7	6.6	dry medium
Graphite	17.3	60.3	dry medium
Pure water	4.8	2.8	

important to note that L_s diminishes very rapidly with increasing hydrogen content in the matrix, while L_d diminishes rapidly with increasing neutron capture cross-section. Table III illustrates the contrast between the values for L_d for materials with large neutron capture cross-sections, for example, an iron ore such as haematite, and for materials with small cross-sections, such as graphite, a form of pure carbon. A third distance parameter, the migration length for neutrons, L_m , is used to express the notion of how far neutrons can travel in a particular material. This parameter is equal to the square root of the sum of the squares of slowing-down and diffusion lengths.

2.2. HOW DO WE MAKE MEASUREMENTS?

2.2.1. Nuclear geophysical measuring instruments and their configurations

The instruments used for nuclear geophysical measurements commonly occur in three basic configurations of sample, source and radiation detector. In all these configurations, the radiation detected for monitoring the geophysical process may be X rays, neutrons, α particles or γ rays. In one configuration, the source of the primary radiation and the detector of the secondary radiation are external to the sample. In

many applications using this configuration, the sample is sandwiched between source and detector. In other applications, the source and the detector, separated both by distance and a radiation shield, lie on the same side of the sample. This configuration includes the nuclear geophysical instruments used for the analysis of stationary samples which may be either small or massive, i.e. bulk samples. The small samples may be in the form of pelletized filtrates, extracted in industrial processes, or dust samples collected in air filters. In these cases, the geometries of source, sample and detector are rigidly fixed. This configuration also includes equipment for the on-line analysis of ore on conveyor belts. Generally, this geometry is defined precisely in terms of the source and detector, but less so in terms of the sample proper, since it is difficult to reproduce the sample geometry accurately on a moving belt.

Examples for the second configuration include the slurry gauges where both the X ray source and the radiation detector are immersed in the slurry streams of ore beneficiation streams or coal washery circuits.

This second configuration may notionally embrace also those borehole logging probes and well logging probes that are equipped with both source and detector. However, these instruments may also be viewed as belonging to the first type of configuration, where the cylindrical mass of rock is external to either a liquid filled cavity or an air filled cylindrical cavity, which is, in turn, external to the cylindrical housing of the source and detector assembly of the probe.

As to the third type of configuration, its most common examples refer to the measurement of radioactive materials, where the radioactivity is a manifestation of either the naturally occurring constituent radioisotopes of the sample or of the sought elements in the material activated by the neutrons of a primary radiation source, at some finite time before the radiation measurement is carried out. In these cases, the material under investigation acts as the radiation source. Thus, the source is within the material and the detector outside.

2.2.2. Physics of nuclear radiation detection

One of the milestones of nuclear physics was the discovery of radioactivity by Henry Becquerel in 1896. He had stored photographic plates wrapped in lightproof paper near salts of uranium. When he developed them, he found that they blackened as if they had been exposed to light. This was the first observation of the existence of the penetrating radiation from the nucleus as well as the first method discovered of detecting this radiation, i.e. irradiation of a photographic emulsion. The second method of detection of nuclear radiation, the gas filled ionization detector, was developed following the observation that the presence of the uranium salt caused the air in its vicinity to become electrically conducting. The progress made in the field of nuclear radiation detection has been very impressive since those early days. Much work is still being carried out in this area of instrumentation in order to further refine

the existing techniques and to develop new methods. In most methods used for detecting nuclear radiation, the apparatus for detection consists of two distinct parts: the detector and the associated electronics needed to process the signal produced by the interaction of nuclear radiation and detector. The fundamental mechanism employed in a radiation detector is the dissipation of energy by a charged particle in a suitable medium. The medium can be solid, liquid or gas. The energy dissipated by the charged particle is usually converted into an electrical signal. This signal may appear as an electric charge, a voltage or a current. Therefore, one can think of a radiation detector as an energy transducer. The charged particle detected within the detector may be the primary radiation. In geophysical applications, it results more commonly from the interaction of electrically neutral primary radiation with the detector material, subsequently producing a charged particle (e.g. an electron from γ or X ray interactions; or an α particle from a neutron interaction). The energy dissipation takes place mainly via two processes: ionization and scintillation. In the ionization process, neutral atoms are stripped of orbiting electrons to form positive ions. In the scintillation process, the atoms are initially excited and when de-excitation occurs, light is emitted. There are other forms of energy dissipation such as molecular dissociation, bremsstrahlung and Cherenkov and synchrotron radiations, but a discussion of these forms would be beyond the scope of this report.

For an understanding of the details of radiation detection systems the essentials of radiation–nucleus interactions should be reviewed.

2.2.2.1. Interaction of charged particles with matter

When a charged nuclear particle, e.g. a proton or an α particle, moves through matter, it ionizes or excites those atoms which it approaches sufficiently closely. This is due to the Coulomb force, which can impart momentum to an electron as the particle passes by. The energy transferred to the electrons represents a loss of kinetic energy which makes the moving particle slow down and eventually stop. The energy transfer to the positive heavy ions created during the ionization process is negligible. Electrons lose energy in the same way as charged nuclear particles. However, having a small mass, the electron is deflected through much larger angles than the heavier particles. The slowing-down of the electron does not take place along a straight line as it does for charged heavy nuclear particles.

2.2.2.2. Absorption of γ rays

As was mentioned in Section 2.1, γ rays interact with matter by three main processes: the photoelectric effect, Compton scattering and pair production. It is worth recapitulating their main features.

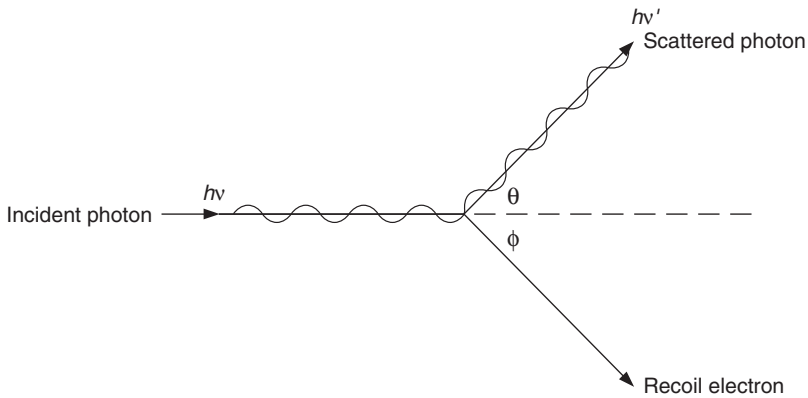

FIG. 1. Schematic of photon scattering kinematics on a nucleus.

(a) *Photoelectric effect*

In this process a γ ray photon interacts with an atom in such a way that its total energy is absorbed by one electron, which is thereby expelled. The kinetic energy of the emitted electron equals the energy of the photon minus the binding energy of the electron. If the energy of a photon is sufficiently high, a K shell electron is more likely to be expelled from an atom than electrons from other shells.

(b) *Compton effect*

At photon energies sufficiently high compared with the binding energies of the atomic electrons, the latter can be considered free. In these conditions, the scattering process between a photon and an atomic electron is known as the Compton effect. Figure 1 schematically shows the kinematics of the scattering process. As a result of this interaction, the photon is not completely absorbed in the target material; its motion continues, although in a different direction and with reduced energy.

(c) *Pair production*

In the pair production process following γ ray absorption, a positron and an electron are created with a total energy equal to the energy of the photon. This requires that the photon energy be in excess of 1.02 MeV, the sum of the rest energies of the electron and the positron.

2.2.2.3. Stopping of neutrons

The processes by which neutrons interact with matter differ markedly from those of charged particles or γ rays. Since neutrons are electrically neutral, there is no Coulomb force between neutrons and atomic electrons or nuclei. Only nuclear forces are at play between neutrons and nuclei. Neutrons with energies above thermal (0.025 eV) are slowed down by scattering with nuclei and are eventually absorbed by these in neutron capture reactions. For neutrons with energies less than 10 MeV, the slowing-down process is mainly due to scattering by protons. Since the neutron and the proton have identical masses, a neutron transfers practically all its energy to the proton if the collision is head-on. In a grazing collision with a proton, a larger fraction of the energy is transferred than in a collision with any other nucleus. This fact is utilized in certain types of neutron detectors and neutron shields.

2.2.3. Radiation detection and signal processing

The various interaction processes between nuclei and the different types of incident radiation, i.e. photons, neutrons and charged particles, which were described previously, provide the basis for detecting and measuring these particular radiations.

Essentially, there are three types of detector to be discussed in detail below. The first two types are the gaseous detectors and the solid matrix detectors, where the energy dissipation of the incoming radiation within the detector's matrix, through ionization, directly provides the measurable output signal. The third type are the scintillation detectors, where the result of dissipating the incident radiation's energy is a light flash, which the instrumentation used converts into an electrical signal. However, the common property of all three types of detector is that they output signals which are processed to form the data that are the root of all geophysical interpretation.

2.2.3.1. Data acquisition and processing

There are two basic approaches to recording and measuring the radiation detected in nuclear applications: *spectrometry* and *accumulation of total counts*. In nuclear geophysics, spectrometry means the accumulation of data which corresponds with the energy distribution of the detected radiation. The accumulation of total counts means that all signals generated in the detector are recorded without differentiating between their amplitudes or between the energies of the incoming radiation 'particles' which generated the signals.

In order to understand these two approaches, let us consider a very simple application, the measurement of the natural radioactivity of a certain material or rock. As is well known, natural radioactivity is due to the presence of the naturally occurring radioactive elements U, Th and K. We can conduct this measurement in two ways:

- (i) by measuring the signal events resulting from the total γ radiation of the material without recording the energies of that γ radiation (total counts); or
- (ii) by measuring and recording both the occurrence of each signal event and its intensity, i.e. the energy of the radiation ‘particle’ which has initiated the signal event. In this way, an energy spectrum is built up which provides as data the differentiated count rates of the γ rays detected from the emissions of U, Th and K.

Thus, the spectrometric type of measurement provides the by far greater wealth of information and is hence much more effective in geophysical applications. As we shall show in the following chapters, spectrometric information is not only most valuable in many geophysical applications, but is also essential to the solution of many geophysical problems.

The success of spectrometry in nuclear geophysical applications depends on two factors: *detection efficiency*, which determines the rate of data accumulation, and *energy resolution* of the detectors and the signal processing system. Detection efficiency is important as a constraint on the potential economic effectiveness of a technique and is determined by the geometry and material properties of the detector. Energy resolution is vital to how effectively the various radiations can be differentiated. In certain applications, γ ray photons emitted by different radioisotopes are of similar energy. In these situations, particularly good energy resolution is essential. In other situations, the photon energies may be far apart so that the requirements for high energy resolution would be less exacting. In fact, energy resolution may be considered as the factor that ultimately determines the ratio between useful information and information noise.

We shall now consider a practical example illustrating the difference between detectors of spectrometric and total count types. Scintillation detectors are used for spectral applications because the output pulse from the scintillation detector is directly proportional to the energy deposited by the incident photon within the crystal. On the other hand, the Geiger–Müller detector can only be used for total count measurements because the pulse amplitude is independent of the energy expended within the detector. Also, the scintillation detectors are the more efficient devices for γ radiation detection which allows the use of primary γ ray sources of lower activities in industrial applications. As a consequence, the trend in nuclear applications is to replace the Geiger–Müller counters with scintillation detectors.

The energy resolution of a spectrometric system has two main determinants. First, energy resolution of the detector, which is governed by the efficiency of the process which converts the energy of the radiation detected into an electrical output signal for the detector, and, second, noise generation and ‘pick-up’ in the spectrometric system and its associated equipment. These factors will be discussed in some detail below.

2.2.3.2. *Electronic systems*

Let us follow the steps taken for processing the output voltage pulse produced by a scintillation detector.

(a) *Preamplifier and amplifier*

These devices are part of the analog electronics chain. The voltage pulse produced by the photomultiplier is fed to a preamplifier which will convert it into a signal pulse. There are two reasons for feeding the pulse to a preamplifier and not directly into the main amplifier. First, the source of the signal has very high output impedance and cannot feed a long coaxial cable without seriously attenuating and distorting the pulse. Second, the signal is so weak that during its travel through the cable it cannot compete with the picked up noise. The role of the preamplifier is to match the impedance of the transmission line and to amplify the signal, thus reducing the importance of pick-up noise during transmission. The preamplifier also changes the bandwidth of the signal and only the part of the signal containing the information of interest is transmitted further. The preamplifier must be attached very close to the photomultiplier output. The pulse from the preamplifier output is then fed into the main amplifier for further amplification and processing.

The electronic systems associated with the spectrometer may generate noise, on the one hand, and assist in its minimization, on the other hand. The electronic systems currently used in nuclear applications can be divided into two successive stages: (i) analog, which is for signal processing to obtain high resolution in spectral measurements, and (ii) digital, which is for digitizing the analog pulses for data analysis and system control. The analog electronics handles input pulses of all amplitudes while digital electronics handles pulses of fixed amplitudes and other characteristics (logic pulses). The information in digital electronics is provided by the presence or absence of such pulses. In order to obtain the maximum information provided by a radiation detector a great deal of care must be taken with the electronics used in data acquisition.

In spectrometric measurements, the pulse from the output of the main amplifier is fed into a multichannel pulse height analyser (MCA), which produces the energy spectrum by sorting out the pulses received from the amplifier on the basis of their amplitudes and records the spectrum accordingly. The key elements of an MCA are:

- (i) An analog to digital converter for quantizing and digitizing the input signals; it associates each input signal with a corresponding channel of the MCA, whose sequence number is proportional to the signal amplitude. This is what enables the MCA to sort out the analog input pulses according to their amplitudes.

These amplitudes are, in turn, proportional to the energies of the nuclear particles detected.

- (ii) A data storage device which records the number of signals falling into each of the amplitude channels.
- (iii) A device which displays the data stored in the memory; in fact, this device displays the energy spectrum.

(b) *Gain stabilization*

The gain of the spectrometric system is most important in nuclear geophysical measurements based on the spectrometric approach to measurement, particularly when the detectors are of the scintillation type. The high efficiency $\text{Bi}_4\text{Ge}_3\text{O}_{12}$ (BGO) detector is particularly sensitive to variations in temperature which cause a drift in the amplitude of its output pulses. In order to function, gain stabilization requires a clear reference peak in the γ ray spectrum.

(c) *On-line computers*

The rapid changes in computer technology have had an enormous impact on nuclear applications. The personal computer (PC) is used for on-line data collection, on-line data reduction and on-line control of experimental equipment. These computers are now capable of rapidly handling large quantities of digital information generated by the detectors and associated instrumentation. The advent of the PC and state of the art electronics has paved the way for the development of more complex nuclear applications.

2.2.3.3. *Gas filled counters*

The gas filled counter is one of the oldest detectors of nuclear radiation. The detector consists of a gas filled container with a central electrode (which may be just a wire) kept at a positive electrical potential relative to the conducting wall of the container. Figure 2 shows a gas filled counter schematically.

The ionizing radiation passing through the gas will produce electrons and positive ions. The electrons, with their negative charge, will move towards the positive centre wire, and the positive ions will move towards the outside walls. This will give rise to a voltage pulse v across the resistor R , whose amplitude depends on the voltage V applied between the central wire and the walls. The relationship between $\log v$ and V is shown in Fig. 3 for both a low ionizing electron and a highly ionizing α particle.

In region I, the voltage V is low so that recombination of positive and negative ions takes place and not all the ion pairs formed by the nuclear particle contribute to v .

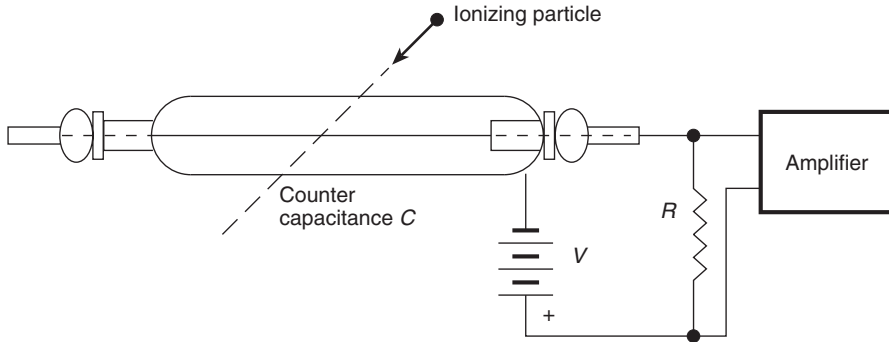

FIG. 2. Schematic of gas filled counter.

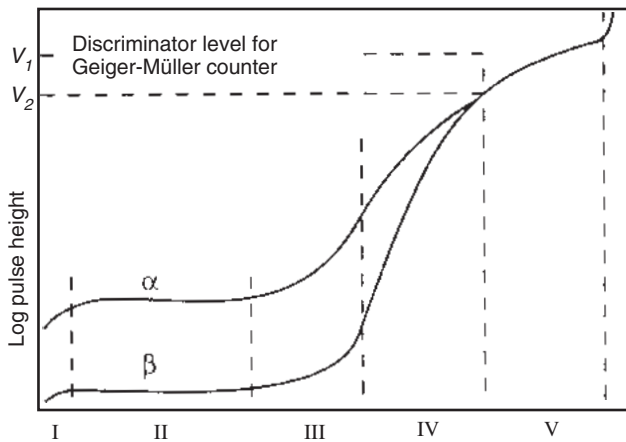

FIG. 3. Gas counter characteristics of pulse size against applied voltage.

In region II, the voltage V is sufficiently high, and the amount of recombination is negligible. This region is called the ion chamber region. At a higher voltage, corresponding to region III, the electrons approaching the positive electrode are accelerated sufficiently to produce additional ionization and the collected charge is increased by a factor of M . The multiplication for a given voltage is independent of the initial ionization, thus preserving the proportionality of the pulse sizes. This region where the collected charge is proportional to the initial ionization is called the proportional region. Region IV is a region of limited proportionality; at still higher values of V , in region V, the proportionality is lost, and even a minimum ionizing particle will produce a very large pulse. Region V is called the Geiger-Müller region.

In this region, the initial ionization triggers a complete gas breakdown which must be stopped before counting the next event. This 'quenching' can be accomplished electronically or in the gas itself. If the voltage V is increased beyond region V, spurious untriggered breakdowns occur, and at still higher voltage a continuous unquenchable discharge results. There are three types of gas filled detector which will be discussed below:

(a) *Ionization chamber counters*

The operating positive voltage between the central electrode and the chamber wall must be kept in region II of Fig. 3. The ionization chamber can be used as a charged particle spectrometer, e.g. a detector capable of counting charged particles and measuring their energies.

The resolving power is of the order of one per cent. The ionizing chamber is also used for measuring the radiation intensity, which is important in radiation safety, in particular for γ rays.

(b) *Proportional counters*

These counters operate in region III of Fig. 3. The proportionality between the pulse size and the primary ionization makes it possible to discriminate between charged particles which produce different primary ionizations. This makes it possible to count α particles in the presence of β particles.

(c) *Geiger-Müller counters*

Gas filled counters operating in region V of Fig. 3 are called Geiger-Müller tubes. They are widely used in nuclear applications because of their reliability and low cost. A Geiger-Müller counter will record all events that produce at least one ion pair and, therefore, it cannot measure the particle energy or discriminate between different types of particle.

2.2.3.4. *Scintillation detectors*

The scintillation detector is one of the most common detectors encountered in nuclear applications or nuclear research. There is a remarkable similarity between the design of the scintillation detector and that of the famous experiments on α particle scattering carried out by Rutherford and his co-workers to establish that the positive charge of the atom was concentrated in a tiny nucleus. The α particle scattering experiments were performed by viewing the scintillations caused by the α particles impinging on a zinc sulphide screen. In a scintillation detector, the human eye is

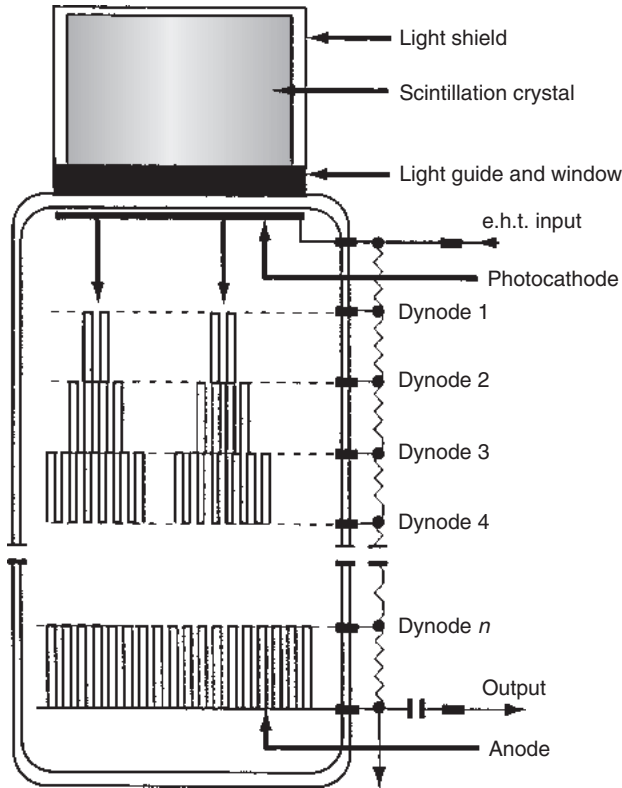

FIG. 4. Diagram of scintillation detector.

replaced by a photomultiplier tube. Figure 4 schematically shows the principle of operation of a scintillation detector.

The detected nuclear ‘particle’ produces a flash of light in the scintillator. A portion of this light is transmitted to the photocathode of the photomultiplier tube, which, in turn, produces photoelectrons. The photoelectrons are many times multiplied by the dynodes of the photomultiplier tube and produce a voltage pulse that is processed by the electronics associated with the scintillator detector. The voltage pulse is proportional to the energy transferred by the primary radiation to the crystal, thus enabling the scintillation detector to be used as a spectrometer, e.g. to record nuclear particles and measure their energies. The scintillator is surrounded by a reflector with a high coefficient of reflectivity in order to minimize the number of photons escaping the scintillator.

The scintillation detector is used particularly frequently for γ ray spectroscopy. The most common scintillators are NaI(Tl), CsI(Tl) or CsI(Na) and BGO. The

NaI(Tl) scintillator provides the most widely used detector. It operates at ambient temperatures and has the best available energy resolution. CsI has a higher density (4510 kg/m^3) than NaI (3670 kg/m^3). This makes it more efficient for high energy γ ray detection. However, the energy resolution of CsI is generally slightly inferior to that of NaI. Both NaI and CsI are hygroscopic. Improvements in photomultiplier design and packaging have increased the ability of the scintillation detector to withstand shock and large temperature variations. BGO is a more recently developed scintillation detector. It has much greater stopping power for photons than NaI or CsI, especially for high energy γ rays. The density of BGO is 7100 kg/m^3 . The BGO crystal is not hygroscopic. However, the energy resolution of the BGO scintillation detector is inferior to that of NaI and CsI. Moreover, its output signal diminishes much more rapidly with increasing temperature than is the case with the other two detectors. It is thus apparent that the choices made on the type of detector to be used will be governed by the circumstances of the application envisaged. For optimum performance, it is essential to choose the detector correctly for the particular application.

2.2.3.5. *Solid state detectors*

Solid state detectors are the analogues of the gas ionization chamber. As was mentioned above, in an ionization chamber the incoming radiation produces electron-ion pairs. In a solid, it produces *electron-hole* pairs, where a *hole* is a mobile, positively charged entity occurring within the matrix of the solid state detector. As is the case with gas filled counters, the detection of radiation in the solid becomes the problem of applying an electric field to collect the electric charge resulting from the energy dissipation of the incident radiation.

The all important feature of the solid state detector is that for the same radiation energy expenditure within the detector more electron-hole pairs are produced in a solid state detector than either electron-ion pairs in a gas detector or photoelectrons at the photocathode of a photomultiplier. Consequently, the charge pulse produced when a photon of particular energy (e.g. 100 keV) dissipates its energy within the solid matrix of a detector will be many times larger than when the same energy is dissipated in a gaseous matrix or in a scintillation detector. This increased size of the charge pulse commensurately improves the power of the spectrometric method for differentiating between incoming radiations of different energies.

In order to understand the mechanisms determining a detector's energy resolution, we must realize that for a particular expenditure of energy, by an incoming radiation, the actual size of the charge pulse is subject to random (Poissonian) statistical variations. This variation depends on the number of individual electrical charge entities produced by the radiation energy expenditure and is a consequence of the process of energy to charge conversion. (In fact, the measure of this fluctuation of the

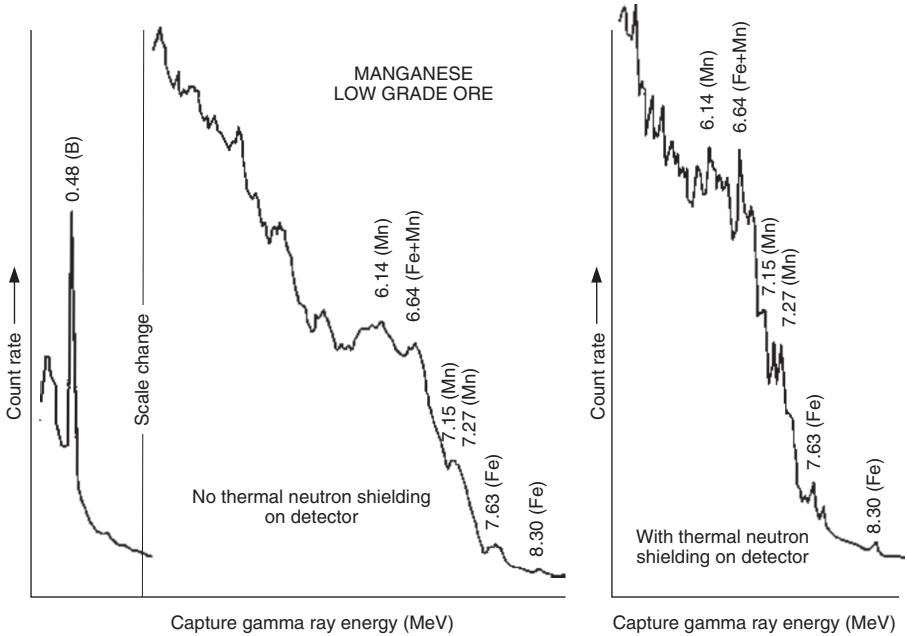

FIG.5. Prompt neutron–gamma ray spectra of low grade manganese ore recorded with and without neutron shielding for an NaI(Tl) scintillation detector.

output charge amplitude, the standard deviation, is equal to the square root of the number of the charge entities produced.) As an example enabling a comparison between solid and gaseous state detectors, the energy expended in silicon per electron–hole pair is approximately 3 eV, instead of the 30 eV that are needed to create an electron–ion pair in a gas. This means that for the same energy loss within the detector matrix of incoming radiation the charge pulse produced in the solid state detector will be ten times larger than in the gas counter. As a result of this larger charge pulse, the statistical fluctuations in the amplitudes of voltage pulses are lower by a factor greater than three. This provides the solid state detector with an energy resolution that is more than three times better than that of the ion chamber.

Whereas silicon detectors can be operated at room temperature without excessive leakage current, their low stopping power for photons restricts their use to charged particle detection. Germanium is used for γ ray detection because of its adequate stopping power. The energy resolution achieved with the germanium detector is superior to any other type of detector. However, the capital cost and maintenance costs of the germanium detector are much higher than those of the scintillation detector, and it must be operated at cryogenic temperatures, which makes its use rather cumbersome. Consequently, it is used routinely only in applications that demand extremely high energy resolution. Figures 5 and 6 show the same energy

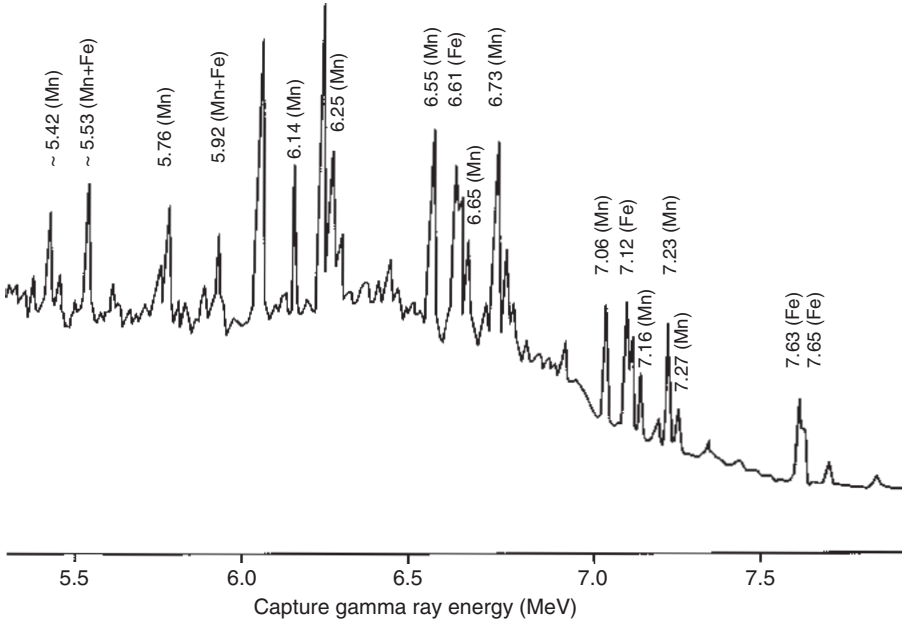

FIG. 6. Prompt neutron–gamma ray spectrum of low grade manganese ore recorded using a cooled germanium detector..

region of a prompt neutron–gamma ray spectrum for a manganese ore recorded by using, respectively, a scintillation counter and a cooled germanium detector. The contrast in resolving power is self-evident.

2.2.3.6. Neutron detection

Neutrons cannot be detected directly because they are not electrically charged and therefore do not cause ionization or emission of light, effects that are used to detect charged particles. Neutron detectors employ the production of charged secondary particles from nuclear reactions induced by neutrons. The processes involved in neutron detection are listed below.

(a) Neutron induced nuclear reactions yielding charged particle products

- (i) A common detector based on the (n,α) reaction is the boron counter for slow neutrons. This detector is based on the neutron reaction: $^{10}\text{B} + n \rightarrow ^7\text{Li} + \alpha + \gamma$. This reaction has an exceptionally large cross-section for thermal neutrons (3840 barns), i.e. for neutrons of an energy of 0.025 eV. The meaning of this

reaction is that the nucleus ^{10}B captures a thermal neutron forming a compound nucleus ^{11}B in an excited state. ^{11}B will decay instantaneously, emitting an α particle and the ^7Li recoil nucleus. Both the α particle and ^7Li have very short ranges. A boron counter is a gas counter with the inside wall lined with boron or filled with BF_3 gas, preferably enriched with ^{10}B . The counter is operated in the proportional region. The α particle and the ^7Li nucleus are stopped in the gas, and for each captured neutron a voltage pulse is produced.

- (ii) Another common neutron detector is based on the (n,p) reaction: $n + ^3\text{He} \rightarrow ^3\text{H} + p$. This reaction has a large cross-section for thermal neutrons (5400 barns). The detector operates in the proportional region. The ^3He neutron detectors are used widely in nuclear applications. They can be 'ruggedized' and used in quite hostile environments.
- (iii) Neutrons do not produce ionization directly in scintillation crystals, but can be detected through their interaction with the nuclei of the scintillator. Neutrons interact with ^6Li nuclei to produce an α particle and a triton (^3H), which may in turn be detected by the scintillation which they produce in $\text{LiI}(\text{Eu})$. The $\text{LiI}(\text{Eu})$ and $^6\text{Li}(\text{Eu})$ scintillators are readily available inorganic crystals useful for neutron counting.

(b) *Induced fission*

In the fission process, an energy of approximately 200 MeV is released as kinetic energy in the form of heavy, short range particles. ^{235}U has a large fission cross-section for thermal neutrons, and ^{238}U has a large fission cross-section for fast neutrons. A gas counter lined with natural uranium is an efficient counter for both thermal and fast neutrons. By shielding the detector with boron or cadmium the thermal neutrons will be absorbed, and only the fast neutron component is measured.

(c) *Proton recoil detectors*

These detectors work on the principle of detecting protons set in motion by collisions with neutrons. A gas counter containing a proportion of hydrogen in a gas mixture and operating in the proportional region is an efficient fast neutron detector. Nuclear emulsions and plastic scintillators are also examples of neutron detectors operating on this principle.

(d) *Neutron activation method*

Neutron activation can be used for neutron flux measurements. Several nuclides have very large absorption cross-sections for thermal neutrons and become activated after the capture of a thermal neutron. ^{115}In is such an example. The residual nucleus,

TABLE IV. COMMON RADIOISOTOPE
PRODUCTION REACTIONS

Nuclear reaction	$T_{1/2}$ (half-life) (a)
$^{59}\text{Co}(n,\gamma)^{60}\text{Co}$	5.26
$^{136}\text{Cs}(n,\gamma)^{137}\text{Cs}$	30
$^6\text{Li}(n,\alpha)^3\text{H}$	12.3
$^{55}\text{Mn}(p,n)^{55}\text{Fe}$	2.7

^{116}In , which is formed in the $^{115}\text{In}(n,\gamma)^{116}\text{In}$ reaction, is radioactive and decays emitting β particles and γ rays. The amount of ^{116}In produced is proportional to the neutron flux and can be measured with a β or γ ray detector. Other materials used for neutron flux measurements are gold, manganese and dysprosium.

(e) *Other methods of nuclear radiation detection*

The methods described above are the most common in nuclear applications and hence were described in greater detail. There are other types of detectors and detection methods, as, e.g. the photographic method, solid dielectric track detectors or spark chambers. However, these methods are not used very widely in these nuclear applications.

2.2.4. Sources of radiation for nuclear applications

Nuclear applications can be classified according to the type of nuclear source used. There are three broad types of sources for: (i) primary γ radiation, (ii) primary X ray or low energy γ radiation and (iii) primary neutron radiation. Commercially available radioisotopic sources must be sealed in chemically inert capsules. Care must be taken in choosing the most appropriate source for a specific application. The energy of the nuclear radiation and the half-life of the source are two of the most important parameters in choosing a source. Since these sources decay at an exponential rate determined by the half-life, calibration decay corrections are necessary for quantitative measurements, particularly for that of the bulk density. The decay corrections are based on the equation:

$$I(t) = I_0 \exp(-0.693t/T_{1/2}) \quad (1)$$

where I_0 is the initial source intensity at the time when the equipment was calibrated, $I(t)$ is its intensity at time t , and $T_{1/2}$ is the half-life of the source.

2.2.4.1. Gamma ray sources

Most γ ray sources used in nuclear applications do not occur in nature because their half-lives are very short on a geological time-scale. They are produced artificially by nuclear reactions, often by irradiation in a nuclear reactor, for example by neutron–gamma reactions. Some examples of radioisotope production are given in Table IV, which lists the nuclear reactions for the production of certain commonly used γ ray sources.

2.2.4.2. X ray sources

Sources of γ radiation below an energy of about 150 keV are usually referred to as X ray sources although, technically, some of them are low energy γ ray sources (e.g. ^{241}Am or ^{57}Co), because the radiation originates from the nucleus. One distinguishes three types of X ray source: (i) low energy photon sources; (ii) isotopic secondary X ray sources which rely on β or γ excitation of a target, and (iii) X ray tubes. Low energy X ray photon sources are radioisotopes sealed in a capsule.

The X rays generated by β excitation have a continuous energy spectrum known as ‘bremsstrahlung’ radiation. The sources of bremsstrahlung radiation are a combination of β emitting radioisotopes and a target material. $^3\text{H}/\text{Ti}$ and $^{147}\text{Pm}/\text{Zr–Al}$, which produce X rays of 2–10 keV and 10–60 keV, are examples of such sources. Characteristic X rays from the target atoms are also produced because of K or L shell ionization. Gamma ray excited X ray sources are a combination of a target material and a γ ray source such as ^{241}Am . The source excites the characteristic X rays from the target. One can obtain X rays of different energies by selecting different targets, e.g. Cu, Mo or Ag.

In an X ray tube, electrons emitted by a filament are accelerated by a positive high voltage of several tens of kilovolts applied on the anode. Upon striking the material embedded in the anode, bremsstrahlung X rays are produced. Characteristic X rays are also produced from the target. There are differences between isotopic X ray sources and tubes. The isotopic sources are more compact than X ray tubes and require no electronic equipment or high voltage power supplies. The X ray output is constant and needs only to be corrected for source decay. On the other hand, the X ray tubes have a higher X ray output intensity and can be turned off when not in use. Table V shows the commonly used γ ray sources and primary low energy photon sources.

2.2.4.3 Isotopic neutron sources

Isotopic sources use (i) (α, n) reactions; (ii) photo–neutron reactions or (iii) the fission process.

TABLE V. COMMON AND PRIMARY GAMMA RAY SOURCES AND PRIMARY LOW ENERGY PHOTON SOURCES

Isotope	Symbol	Half-life	Main γ ray/ X ray energies (keV)
Gamma ray sources			
Caesium-137	^{137}Cs	30 a	662
Barium-133	^{133}Ba	10.4 a	384, 356, 276, 81
Cobalt-60	^{60}Co	5.26 a	1332, 1173
Sodium-22	^{22}Na	2.6 a	1275, 511
Manganese-54	^{54}Mn	312 d	835
Selenium-75	^{75}Se	120 d	401, 280, 265, 136
Yttrium-88	^{88}Y	107 d	1836, 898
Iridium-192	^{192}Ir	74 d	468, 316, 308, 296
Low energy photon sources			
Americium-241	^{241}Am	458 a	60
Plutonium-238	^{238}Pu	86 a	13–21
Lead-210	^{210}Pb	20.4 a	47
Curium-244	^{244}Cu	17.9 a	14–21
Iron-55	^{55}Fe	2.6 a	5.7
Europium-155	^{155}Eu	1.8 a	105, 87, 43–49
Cadmium-109	^{109}Cd	453 d	88, 22–25
Samarium-145	^{145}Sm	340 d	61, 38–44
Cobalt-57	^{57}Co	270 d	122, 136
Gadolinium-153	^{153}Gd	242 d	103, 98, 41–48
Iodine-125	^{125}I	60 d	35, 27–31

(i) Neutron sources based on the (α, n) reaction

The principal reaction leading to neutron emission is the $^9\text{Be} + \alpha \rightarrow ^{12}\text{C} + n$ reaction. This source consists of an α -emitting nuclide, e.g. ^{241}Am mixed with beryllium. Since the ^{12}C nucleus is left in an excited state, 4.43 MeV γ radiation is also emitted. The α emitter and the beryllium are usually in powder form and are doubly

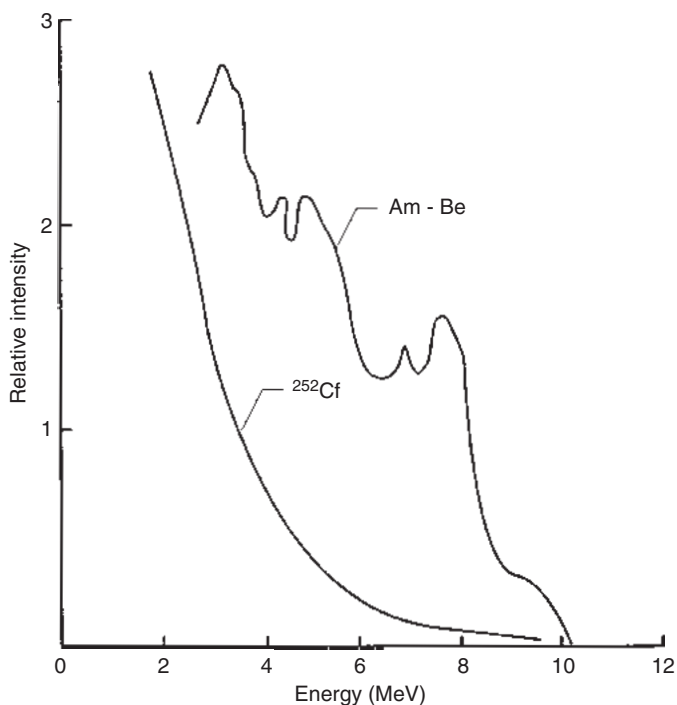

FIG. 7. Neutron energy spectra of Am-Be and the fission source ^{252}Cf .

sealed in stainless steel capsules. Am-Be is the most readily available source of this type; it has a half-life of 456 a.

(ii) *Neutrons emitted by photonuclear reactions*

Other neutron sources have been prepared with a radioactive nuclide providing the primary radiation (photo-neutron sources). For example, the binding energy of the last neutron in ^9Be is only 1.67 MeV. Neutrons can therefore be released from ^9Be by photodisintegration, i.e. by bombardment with γ rays of an energy of 1.67 MeV or higher.

(iii) *Fission sources*

^{252}Cf is the commonly used fission source which emits neutrons by spontaneous fission. The neutrons have a mean energy of about 2.3 MeV and a peak at about 1.1 MeV. The half-life of ^{252}Cf is 2.6 a. A comparison of neutron energy spectra of $^{241}\text{Am-Be}$ and ^{252}Cf is shown in Fig. 7.

The half-life and the neutron energy are two important parameters in choosing the right type of neutron source for a particular application.

(iv) *Neutron generators*

More intense neutron radiation can be obtained by bombarding various targets with charged particles from a van de Graaff accelerator or from a cyclotron.

Commercially available neutron generators use one of the following reactions:

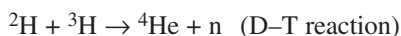
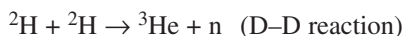

Neutron generators based on these reactions produce neutrons of energies of 2.6 and 14 MeV, respectively. They consist of an ion source which produces ionized deuterium (${}^2\text{H}$) gas and a target containing either deuterium or tritium. The deuterons are accelerated up to an energy between 100 and 200 keV by a high voltage applied to the target. The advantages of neutron generators are that they give an intense monoenergetic neutron flux and can be pulsed if necessary. The latter feature adds considerably to their flexibility. They can be switched off when not in use. The principal disadvantages of neutron generators are that complex electronics is required for their operation — which contributes to their high cost —, that their operational life is limited and that the neutron output is not as stable as that from isotopic sources. In regard to their operational life, this appears to vary from several hundreds to several thousands of hours, depending on the tube design and its components.

(v) *Other sources of neutrons*

The nuclear fission reactor provides neutron fluxes of high intensity close to the reactor core. If high accuracy assays of elements occurring at low chemical concentrations in samples are required, it is common practice to carry out neutron activation analysis with the samples placed inside the reactor core area.

2.3. BASIC INTERPRETATION MODELS

2.3.1. Introduction

The purpose of using nuclear geophysics is to construct a valid representation, from suitable measurement data, of the geological or chemical nature of the material under investigation. This section discusses the concepts currently used for

transforming the data obtained from the measurement data into values of those parameters that are of industrial significance.

As was already indicated in the previous discussion, the data are only suitable if they are representative of the sample as a whole. Therefore, the only nuclear reactions relevant to particular applications are those involving both primary and secondary radiations that readily penetrate the bulk of the samples. More specifically, the appropriate primary radiations for irradiating large massive, heterogeneous samples are neutrons and γ rays, but not X rays. However, X rays are a suitable initiating radiation for the analysis of samples which are homogeneous and of any volume as well as of heterogeneous, but thin samples.

The other necessary condition qualifying the data as suitable for objective interpretation is that the information content relevant to the desired analysis be significantly larger than the information noise. The latter may include not only the manifestations of electrical noise, but also output information from the geophysical measuring instrument that is irrelevant to the parameters sought, but is nevertheless combined with the relevant information within the data.

Two practical examples illustrating the concept of relevant information and information noise, occurring within the same data, may be drawn from γ ray spectrometry based on the use of an MCA. If the problem is simply one of noise, the resulting energy resolution may be inadequate to separate visually two spectral peaks adjacent on the energy scale. This may prevent their proper identification. However, numerical/statistical methods exist for separating them, permitting not only an identification of the peaks, but also an estimation of their areas in terms of counts recorded.

On the other hand, the response of γ ray detectors is such that spectral peaks almost invariably sit on a spectral continuum. In order to explain this, let us accept that a recorded spectral peak corresponds to the total absorption of monoenergetic γ rays emitted from a particular radionuclide. It will be recorded in a particular group of MCA channels, which will be larger or smaller, depending on the system noise. However, counts due to only the partial absorption of other γ rays with energies higher than that of the previously mentioned monoenergetic γ rays are also recorded in these channels. This is an example of the desired information combined with irrelevant one.

On inspection of the γ ray spectrometric data in the example above, what appears in the spectrum is a peak sitting on a continuum as a hill does on a sloping plateau. In this situation, since radiation detection is a random statistical process, it is impossible to determine precisely either the height of the continuum under the peak or the exact location of the base of the peak. Hence, the peak area estimate is subject to error. The magnitude of this error increases rapidly as the height of the continuum increases relative to the estimated height of the peak (both parameters being recorded in counts). Certainly, if all conditions are identical (i.e. the sample, the geometry and both the initiating and the detected radiation fluxes) and the better the spectrometric

probe system is in regard to energy resolution (i.e. noise), the narrower the spectral peaks will be. This means that they will be higher relative to the continuum. Consequently, the errors will be diminished both in estimating the number of counts in the peak and in measuring the peak position in terms of channel number, i.e. in terms of energy.

These are the types of problem that constrain the precise evaluation and processing of probe data. A great deal of scientific, statistical and mathematical effort has been invested in refining the methods needed to minimize information noise in the measurement data. However, the other challenge is how to interpret data, even if they were noiseless, in terms of the tangible industrial/geological parameters.

The main task addressed by section of the chapter is the conceptual description of the procedures for converting the raw responses of probes (to radiation) into the different parameters that are vital to the operations of many different industries. Two totally dissimilar examples of industrial parameters are the concentration of cadmium in an industrial effluent discharge and the porosity of a petroleum bearing geological formation. The ideas mentioned above are indicative of one of the main concerns of this chapter, which is *modelling*.

2.3.2. Models

The solution to any problem of this type is based on the use of a *model*. Most models used in geophysics are at least partly mathematical in nature. The mathematical models used are generalized expressions relating a set of parameters which we either observe or can postulate beforehand with other properties which we wish to predict. For example, a model may be the expression for the relationship between the count rate of a particular detector in the relevant type of probe with the porosity of oil bearing strata or the chemical concentration of iron at a particular location on a conveyor belt.

It is worth noting that the concepts elaborated in this section equally apply to the methods that use all previously discussed radiations, i.e. neutrons, γ rays, X rays and α particles.

Since the geophysicist is required to convert the raw probe data into meaningful industrial parameters, the solutions to two types of objective problem are required: the *direct problem* and the *inverse problem*. Ideally, in nuclear geophysics, the solution of direct problems provides a mathematically expressed prediction of how a particular secondary radiation varies in concert with variations in the properties of the sample material and the geometrical configuration of the probe. (Here, the term geometrical configuration refers to the geometry of the detector and the source components of the probe and the sample material which either envelops it or is wedged between the source and the detector.) Thus, the direct model provides expressions based on a physical theory for the space–time–energy distribution of a particular type

of secondary radiation (i.e. the radiation to be measured), on the basis of the interactions between the primary radiation and the nuclear properties of the material.

However, in inverse models, the properties of the investigated material are inferred from particular measurements of the radiation field recorded by an instrument. The universally apparent measured parameter is the recorded count of detected events. However, as part of the process of solving the inverse problem, this recorded count of events is transformed into relevant instrumental parameters. They may include, for example, the intensity of the radiation expressed as a count rate, its time rate of decay, or its spectral distribution as indicated by the counts recorded in each channel of the MCA for a given recorded measurement period.

2.3.2.1. *Direct models*

The theoretical physics basis for solving direct problems of this type is *radiation transport theory*. Transport theory basically states that the number of radiation ‘particles’ entering a particular space must be balanced by the sum of those leaving it and those being absorbed within it. The relevance of this theory to nuclear geophysical practice is that it enables the solution of specific forms of the transport equation which have been set up for particular configurations of geometry and various materials of interest.

Ideally, this theoretical basis would provide a quantitative prediction of the magnitude and nature of the secondary radiation produced at all times and at all points in space, the most relevant for the user being the position of the detector. While this may seem straightforward enough, the mathematical solution of these equations by classical analytical methods, for situations which simulate actual configurations, turns out to be either difficult or impossible. One reason for these difficulties is that the probe responses, which depend directly on the radiation fluxes at the detector, are governed by numerous quantum mechanical parameters which characterize the reaction of the radiation with the sample material and also the reactions of the radiation particles with the detector matrix.

The difficulties with the classical analytical methods of solution increase enormously if the system considered is a bed–borehole–probe system. In practice, the medium being analysed is usually heterogeneous and the probe–borehole–formation system has irregular symmetry and both planar and cylindrical boundaries. These boundaries may correspond to changes in bedding, cement, casing, drilling mud, mud invaded zones and the formation proper.

The attempted solution of the transport equation by the classical methods of mathematical physics is only one of the approaches available for solving the direct problem of determining the radiation flux. Additional mathematical techniques are available and are successfully used for many specific problems. They include the use of simplified, idealized versions of the probe–borehole–formation configurations,

together with mathematical approximation techniques, in particular the application of finite difference methods or finite element analysis to the radiation transport equation. Also, in most cases they require simplified representations of the heterogeneous formations as input to the computations. An alternative mathematical approach to direct modelling is a simulation of the various interactions between radiation ‘particles’ and nuclei by the Monte Carlo technique. This technique is a statistically governed simulation of all the ‘life events’ of radiation ‘particles’ along their trajectories within the matrixes of the sample and the detector.

Physical modelling is the other approach to solving the direct problem. Currently, common practice is to use it in conjunction with mathematical modelling. It complements mathematical modelling suitably for predicting instrumental responses for those sudden and complex changes in the environmental conditions of any system that would impose severely complex boundary conditions to mathematical solutions. For example, in nuclear petrophysics, the effects on radiation intensity of changes in well diameter, slope of borehole and drilling mud thickness variations are most satisfactorily dealt with by direct physical modelling (because of the difficulties in making valid simplifying assumptions for mathematical modelling algorithms).

In physical modelling, benchmark measurements of the radiation fluxes, at required points in space and time, are carried out in specific configurations for samples with known properties. This type of modelling permits the systematic variation of both the geometrical configuration and the material properties. In practice, this approach has the shortcoming that there are too many parameters governing the properties of both the sample and its environment (i.e. the borehole and its contained material) to fully and comprehensively model both the formation and the probe’s environment.

It is common practice, therefore, to combine the results of mathematical modelling for changes in the geochemistry of the rock with those from physical modelling for changes in the environment of the probe.

2.3.2.2. *Parameters determining probe responses*

The physical modelling approach has another characteristic that distinguishes it essentially from the purely mathematical methodology. This characteristic is that the ‘samples’ used have industrial parameters which are known beforehand. (They may be known because either the samples are prepared specially for calibration or are selected for their composition.) The modelling is not directly carried out on the basis of the geophysical parameters of the formation.

However, the situation governing the responses of probes is the physical environment, described by the geophysical parameters (e.g. the diffusion length). The responses are not directly governed by the industrial environment which the industrial

parameters express (e.g. the iron concentration in manganese ore). Nevertheless, the physical and the industrial parameters are highly correlated in certain industrial applications, e.g. the *porosity* of water saturated pure sandstone samples and the *neutron slowing-down length*.

Where the purely mathematical approach is taken for the solution of the transport problem, the geophysical parameters (e.g. the diffusion length or the photo-electric cross-section) serve as the inputs for the computations. The calculations made for these parameters are an essential part of the algorithmic process for resolving the interpretational relationships and are based on what is known beforehand about the properties of the particular material. The computations must also take into account the variation of the reaction cross-sections with the energy of the radiation.

The first requirement presents neither a disadvantage nor a problem. In regard to the second requirement, however, our detailed knowledge of reaction cross-sections at all energies of the different radiations is imperfect, in particular for neutrons. This knowledge gap introduces errors into the calculated values of the geophysical parameters. Consequently, the desirability of each available approach to solving the direct problem will be determined by the nature of the problem. Frequently, the best approach is to use a mixture of different modelling strategies appropriate to the application sought. For example, in a borehole logging problem, a suitable combination of approaches may include a numerical approximation applied to transport concepts that relate exclusively to the formation, and physical modelling applied to a complex fluid filled borehole environment.

For example, for nuclear petrophysics, the effects of changes in the formation on radiation intensity are amenable to solution by mathematical methods. But the effects of changes in well diameter, slope of borehole and drilling mud thickness variations are very complex for a purely mathematical approach based on transport theory and are more satisfactorily dealt with by direct physical modelling. It is common practice, therefore, to combine the results of mathematical modelling for changes in the geochemistry and physical structure of the rock with the results of physical modelling changes in the borehole environment of the probe.

Also, the mathematical modelling methods are highly dependent on the availability of accurate, detailed nuclear data for the radiations concerned, over wide energy ranges. While the accuracy of nuclear data has increased greatly in recent times, the shortcomings in the accuracy and detail of the cross-sectional data of certain chemical elements provide an argument that physical modelling, particularly for the borehole and its filling, provides better accuracy than mathematical modelling.

Physical modelling is practised for all types of measurement conditions. These conditions range from the most complex situations, where environmental conditions and geometry fluctuate rapidly and randomly, to the most straightforward situations, where the environmental conditions and the geometrical configuration of the measurement system are rigidly defined or controlled. The

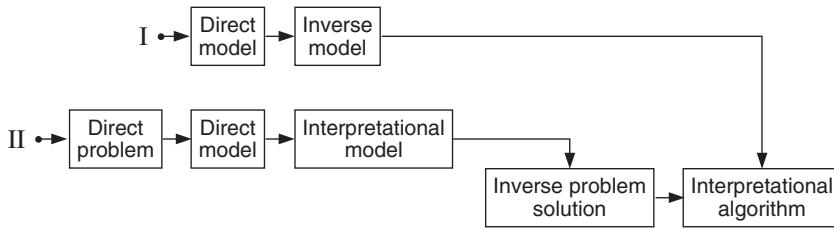

FIG. 8. Block diagram of the two different approaches to the construction of interpretational algorithms.

former are borehole–formation–probe systems, where the samples used as models are large rocks or crushed mineralized material (weighing several tonnes) selected for their lithologies, porosities and geochemical compositions. These models include a borehole of either variable or adjustable diameter which intersects the sample. Examples of the latter include the various laboratory/instrumental installations for X ray fluorescence analysis and the various technological assemblies which have been developed for the static bulk analysis of coal and metalliferous ores.

2.3.2.3. The inverse model

Whereas a great deal of scientific effort is invested in the solution of the direct problem, the practitioner in industry will understandably focus on the solution of the *inverse problem*. The reason is that this is the process that transforms the raw data ultimately into the required industrial parameters.

However, the inverse problem would defy solution without some knowledge of the variational relationships between the apparently arbitrary manifestations of the probe response (e.g. the detected count rate) and the nature of the industrial parameters sought.

In the final analysis, the solution of the inverse problem depends on the development and use of an interpretational algorithm. That algorithm may be arrived at in two different ways, which are illustrated in Fig. 8.

One way is to construct an inverse model based on a generalization of the measurement data. In particular, the sought parameters can be estimated if a high correlation exists between the probe response and the sought parameters, provided that the environmental conditions of the measurement are fairly constant.

The other way is to develop an interpretation model based on a solution of the direct problem. If this problem has a simply structured mathematical solution and is also convertible with respect to the sought industrial parameters, it is referred to as an *interpretation model*. The procedures used for converting these models are referred to as *interpretational algorithms*.

No matter how it is achieved, the aim of the practical analyst is to obtain the values of the sample materials' industrial parameters (e.g. formation porosity). In order to accomplish this, an appropriate interpretational model is necessary which either translates the responses of the probe directly (i.e. the electrical pulses resulting from the detection of radiation 'particles' by the probe), or, alternatively, translates the resulting computed geophysical parameters into the required geological and industrial parameters. The process of solving the inverse problem will therefore contain most of the following steps:

First, the electrical pulses are processed electronically to provide a registrable quantity, e.g. count rates at particular photon or neutron energies, or temporal decay rates of the count rates.

This may be followed by a translation of these primitive probe response parameters into other *instrument response* parameters, which generally have a certain degree of physical connotation. These instrumental responses have no immediate, tangible use for the analyst. Two examples for these parameters may be the computed area of a spectral peak expressed as a count rate, and the ratio of the registered count rates of two detectors located at different positions within the same probe.

Subsequently, it may be both possible and desirable to compute certain geophysical parameters, e.g. the neutron migration length. However, the geophysical parameters also lack direct industrial utility.

It is either at this stage or at the preceding one that an interpretational model is applied, i.e. to the computed geophysical parameters or to either the appropriate registered quantities or the instrumental response parameters.

The translation of the concept embodied in the model into actual geological or industrial data is accomplished by using an appropriate interpretational algorithm in order to compute *geophysical interpretation parameters*. This is the final step in solving the inverse problem, i.e. the instrument response parameters or the geophysical interpretation parameters are converted into the sought, tangible geophysical parameters. Using the examples mentioned above, we might then obtain, respectively, the concentration of chlorine in the formation fluid and mudcake and the formation porosity. Therefore, the solution of the inverse problem entails the processing and the interpretation of the data recorded from radiation measuring instruments. The basis for the latter is the interpretational model, which is elucidated by implementing the algorithms developed for the purpose.

In the case of downhole logging, it is necessary to enhance the quality of the interpretational models by incorporating geometrical factors and radial sensitivity factors into the algorithms used. The algorithms vary according to the type of probe used and the particular realistic heterogeneous situations. The heterogeneous situations include the irregular structures of the materials surrounding the probe and the probe's frequently eccentric location in the hole during operations.

These problems are aggravated by the fact that nuclear borehole techniques have a shallow depth of investigation, particularly γ ray spectral logs (GRLs) and formation density logs (FDLs). As a consequence, the measurements obtained may be grossly distorted by the effects of the materials situated between the probe and the formation.

One must recognize that in downhole logging and in the evaluation of a mined resource being carried on a belt, the properties of the medium under investigation will be evaluated on the basis of results obtained by a probe that is not sitting within that medium. In the case of the moving belt, the belt material is critical to the analysis but the variability of this material and that of the sample geometry can be controlled. However, in downhole logging the probe is located in a medium which is different from that being analysed and which is highly variable in its content and geometry.

The entire zone investigated by the borehole probe can be viewed as consisting of a series of concentric, irregular, cylindrical zones surrounding the probe. The formation being investigated is only the outermost zone of this system. The possible zones that exist closer to the probe may include either water or mud, possibly a steel or plastic casing and an associated cement filler, mud cake, a mudded zone and a fluid invaded zone.

Because of the inherently shallow depth of investigation for nuclear geophysical techniques, these inner zones may have a greater influence, pro rata (in relation to their thickness), on the probe response than the formation itself. Particular examples where the intermediate zones can dominate is the spectral γ ray logging (SGRL) technique used in a steel cased borehole. The casing in this instance may seriously and disproportionately attenuate the low energy photons emanating from the formation.

It is possible to improve the results of interpretation by comparing the probe responses obtained under different operating conditions, e.g. single to double to multispacing probes with different distances between detectors.

By mathematically processing together certain groups of these measurement data, it is possible to minimize or even to eliminate intermediate zone effects. Further, certain parameters computed in this way may also be directly correlatable with a geophysical parameter. An example for this case is the computed ratio of the thermal neutron responses obtained from a double spaced (dual detector) downhole probe. This parameter is relatively insensitive to both the borehole environmental properties and those of the near cylindrical layer. It also correlates strongly with the migration length of thermal neutrons, which in turn correlates with the formation porosity.

2.3.2.4. *Calibration and recalibration*

The strict definition of *calibration* is that it constitutes ‘the determination of the absolute values of the arbitrary indications of an instrument’ [Penguin Dictionary of

Physics, 1978]. This means that these arbitrary indications would be matched with values obtained from absolute standards. Apart from the difficulties in achieving the matching process, there are virtually insurmountable problems for obtaining absolute calibration standards in the context of many geophysical applications. A broader and more suitable definition for nuclear geophysical applications is the *determination of the nature and the magnitudes of those parameters describing standard samples which elicit the probe responses*. The parameters may be either of an instrumental, a geophysical or an industrial nature.

(a) *Standard probe response calibrations*

These are established by either using artificial samples or by surrounding the probe with artificial formations in order to effect standardized samples. This may be considered to be the ‘primary calibration’.

(b) *Electronics calibration*

The amplifying and processing electronics are matched to the output signals of the probe’s detector and preamplifier, in order to scale these signals suitably. This is the ‘electronics calibration’ and is also known as the ‘surface system alignment’ in well logging applications. This procedure is *energy calibration* where the measurement system is spectrometric, which would usually include an MCA linked with a computer. Actually, a recent development with downhole probes is to provide them with a possibility to house the MCA. This minimizes signal degradation, which is otherwise inevitable over long cables. Nevertheless, it is always essential to have control of signal amplification from the surface.

(c) *Total field system calibrations*

Calibrations for downhole logging are carried out with the probe situated within a borehole environment and operated in conjunction with all its associated field equipment (i.e. the computer located at the surface, the actual connecting cables, the downhole electronics and any auxiliary equipment, such as calibrators for producing signals of specific amplitude). The borehole environment chosen may be a test pit filled with typical crushed and compacted rocks arranged in a bed-like structure (Fig. 9), or (preferably) a real borehole at an actual mining site which intersects known geological structures.

For spectrometric aerial radiometric survey work, the calibration procedures must be analogous to those used for downhole logging although the operational situations of the two measurement applications differ markedly. In the aerial survey case, the analogue of the surface is the interior of the aeroplane.

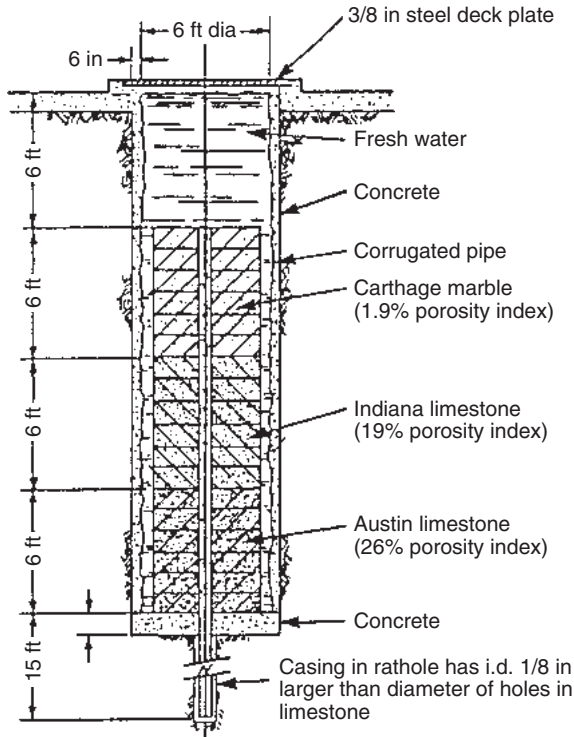

FIG. 9. Neutron calibration pit. Carthage marble, Austin limestone and Indiana limestone sections are each composed of six regular octagonal blocks, 5 ft across, 1 ft thick, with 7 1/2 in centre borehole (1 ft = 30.48 cm, 1 in = 2.54 cm) (American Petroleum Institute).

(d) Operational checks

These checks are needed of either parts of the system or of the entire logging instrumentation. They are carried out with the probe in its normal operational configuration, whether or not the probe is in a realistic operational environment. For borehole conditions (which may or may not represent realistic logging conditions), these checks are generally performed before and after the survey. The procedure is commonly referred to as *verification*.

Formation porosity simulators (FPSs), shown in Fig. 10, are used for the calibration and standardization of different neutron logging tools (mono- and multi-spacing) [2.1]. The FPS facility is a system of coaxially located tubes of different diameters fabricated from steel or polyethylene tubes. Different porosity values are simulated by changing the volume of air filled space between the tubes. The whole system is located in a water filled tank. In a sense, the FPS can be regarded as an

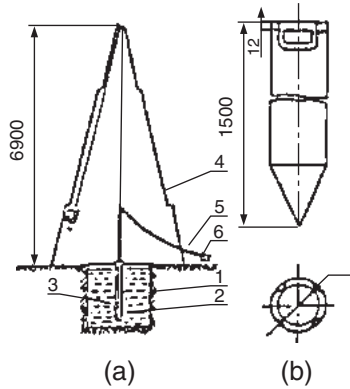

FIG. 10. General diagram of a neutron log calibration facility: (a) facility construction; (b) formation porosity simulator (FPS): 1 — tank filled with fresh water; 2 — FPS; 3 — logging tool; 4 — three pole derrick equipped with auxiliary winch; 5 — cable; 6 — surface control unit (Yu.A. Ghulin and Z.Z. Khanipov).

air filled borehole of variable diameter, surrounded by water; source and detector are positioned on the axis of this borehole.

In the application of this type of calibration technique, such diameters of the FPS are selected that correspond with those used under field conditions for the different types of neutron logging (NL) probes. Accordingly, in setting up an FPS calibration, attention must be given to the construction of the boreholes, the formation porosity ranges, the formation lithology types, and the different formation fluids and drilling mud types present. When carrying out logging in off-shore wells, it is necessary to take into account the difference between saltwater and freshwater effects.

This problem has even greater importance in connection with nuclear logging methods which are used for the quantitative measurement of the porosity and the determination of the type of fluid in the formation. The appropriate technique requires that the equipment comprise an adjustable multispaced logging probe, digital recording systems and computer based algorithmic interpretation.

2.3.2.5. Simulation and mathematical models

Where the problems requiring solution are of a complex multiparameter nature, it is frequently advantageous to conduct simulation studies. One method of simulation is physical modelling, which has the limitations mentioned previously. Another approach is based on a combination of probability theory, mathematical statistics and computational mathematics. The best known of these mathematical techniques is the Monte Carlo method (MCM).

The principal advantage of the MCM over other non-classical numerical methods and physical modelling methods is that it provides the possibility of computing or measuring the radiation flux for specific situations. Therefore, it is possible to calculate the required interpretation relationships for a set of conditions simulating real situations. The disadvantage of the simulation techniques is that they present the results of solutions as numbers (i.e. they have an empirical sense). Consequently, the additional problem remains of finding mathematical, analytical functions for expressing the interpretational relationships.

Where the aim in solving the direct problem is the optimization of the practical geophysical measurement technique, the MCM is the most efficient method available. It produces results similar to those of physical modelling for the same situations of material matrix and geometrical configuration. On the other hand, the MCM has the by far greater capacity for addressing the diversity of geometrical configurations which relate to probe, sample and sample environment.

The operation of the MCM is analogous to that of a giant mathematical 'pinball' machine in which the balls have the radiation 'particles' as their analogues and the target nuclei, with which a number of different interactions may occur, are like the traps of the machine. However, the probabilities for these different interactions vary and depend on the energy of the radiation 'particle' and the nature of the nucleus.

The MCM lacks the capacity for providing a general solution of the direct problem as do, in principle, the mathematical, analytical methods. On the other hand, Monte Carlo analyses provide numerical data about radiation fluxes in particular material matrixes for specific geometrical configurations. These configurations are selected by the potential user for specific industrial situations and environments. Valuable contributions to the scientific literature on the MCM for nuclear geophysical logging have been made at BRGM in France in terms of adapting MCM algorithms to the constraints imposed by the small personal computer.

Many practical applications demand geometrical configurations which impose on the detector only a small probability for intercepting the desired secondary radiation (as with most borehole logging measurements). The simulation of these applications with good statistical precision usually requires the accumulation of an enormous number of sequential case histories of initiating radiation 'particles'. To achieve good accuracy, therefore, this technique consumes both valuable computer time and memory, although the problems mentioned may be mitigated by using particle splitting or weighting techniques.

2.3.2.6. *Integrated data analysis*

Nuclear geophysical methods provide vital information on the elemental composition of samples, rocks and mineralized ore bodies as well as the geophysical and

petrophysical properties of formations. Hence, they play an important role in automatic systems of complex geophysical data interpretation. Modern interpretation systems are designed for processing multilevel quantitative and qualitative information. This information is very diverse, its elements being sedimentological, lithological, mineralogical, petrophysical, geophysical and geochemical.

It is worth considering the application of integrated analysis and artificial intelligence to the complex information output of what is arguably the most complex probe system, the nuclear petrophysical system. In this case, the results of data processing furnish quantitative estimates on the constituents of the formation (e.g. the fluid bulk content and its type, the clay minerals, the solid organic matter, and the mineral and polymineral matrixes).

The results must also provide information on the capacity space structure, the reservoir filtration characteristics and regularities in their variation in depth and extension. Further, the latter can be used in setting up the three dimensional field models that are necessary for the assessment of geological and recoverable reserves, the design of optimal development projects and the control of field exploitation.

The total integrated analysis system comprises hardware–software modules providing data acquisition, quality control, formatting, preliminary processing, accumulation within databases and systematization of the information. This information is both the geologico-geophysical and the petrophysical information which relate to individual borehole sites and to the field as a whole. The circulation of information flows and their intrasystem interaction are controlled by the knowledge base in the artificial intelligence system. As soon as it accumulates a sufficient level of experience, the system turns out to be informatively ‘saturated’ and can operate autonomously.

The algorithms designed for the interpretation of individual sets of logging data occurring within the framework of an expert system should possess special properties. They must be such that the expert system’s automatic operational mode is supported by a highly formalized interpretation procedure enabling:

- automatic metrological tuning and retuning of algorithms in accordance with the individual characteristics of the probes;
- information interchange between algorithms used for different probe methods (or using data and results obtained by another method; the aim is to take into account the properties predicted from a transitional phase of the individual interpretations before commencing complex interpretations);
- automatic technological tuning where a method (or combination of methods) is used in conjunction with formation stimulation technology (‘log–stimulation–log’);
- automatic petrophysical tuning (criteria for the actual petrophysical tuning are taken from results of cyclic, sedimentological and historical-genetic analysis; see the Complex Interpretation section).

The expert system with the above mentioned architecture takes into account not only the individual properties of each separate layer (characterized by a set of different response amplitudes for the different logs conducted) but also the layer's arrangement within both the section and a particular sedimentation cycle.

An evolution genetic strategy for computer aided (algorithmic) interpretation is aimed at a comprehensive analysis of the genesis of sediments under consideration.

The sedimentation analysis based on the nuclear logging data reveals the specific paragenesis which occurs within the relevant sections of the different formations, i.e. continental (alluvial-proalluvial, equalluvial, subwater deltoid) and marine (avandeltoid, wave breaking, shelf, riphogenic, etc.) formations. This analysis also permits a study of the structure and texture of formations and their associations.

Although nuclear logging methods provide a wealth of information, their shallow depth of investigation places rather strict requirements on an accounting of intermediate zone properties. The original modules designed for the individual interpretation of γ ray logging methods, which were briefly described above, enable an identification of types of the intermediate zones (i.e. mud cake, filtrate invaded zone, etc.), a determination of their properties and an elimination of their effects.

The above mentioned interpretation algorithms (modules) meet the criteria of such an expert system. They are applicable to arbitrary tool types and downhole situations and are universal from the point of view of metrological support and tuning. Since the radial symmetry of the probe can be taken into account quantitatively, it is possible to identify the type of intermediate zone. Also, in the course of this complex interpretational analysis, it is possible to solve the difficult problem of algorithmically determining the properties of the intermediate zones of individual oil wells from their recorded nuclear logs.

Information interchange between different system modules not only reduces the errors occurring in the interpretations of the individual logs recorded for each method, but also substantially enhances the accuracy of the petrophysical interpretation within the framework of the system as a whole.

The neural network is another form of artificial intelligence applied to nuclear geophysics. It has this name because its architecture imitates, however primitively, that of the brain neuron system, which is structured as an interconnected parallel processing network. Where expert systems imitate deductive processes, which they apply to the data in conjunction with a specific set of formulated rules based on both objective and subjective knowledge, neural networks develop a capacity, under tuition, for recognizing complex relationship patterns between the probe responses and the industrial or geological parameters which produce them. These formulated rules are based on a combination of relevant objective scientific knowledge and semi-subjective experience accumulated by experts and operators in the field. The advantage of the neural network is that it 'learns' overall patterns occurring in the

data, either directly under human supervision or in a 'self-learning' mode, rather than requiring a set of constraining boundary values as does the expert system.

On the other hand, the neural network operation is much slower than that of the expert system, because of its need for tuition. Certainly, where there is a problem which has clearly definable criteria, such as that of correlating multiple logs, expert systems perform most satisfactorily and quickly. However, only neural networks provide the artificial intelligence system with a capability for undertaking complex and subtle tasks (e.g. the prediction of permeability from logs) that have no agreed, clearly defined rules to guide them, governing the nature of the nuclear geophysical system. Their only rules are those by which they 'learn'.

2.4. SUMMARY

Chapter 2, which consists of three principal sections, introduces the reader to the physics and concepts underlying nuclear geophysical measurements. The first section deals, in an introductory fashion, with what nuclear geophysics actually measures. The second section describes how nuclear geophysical measurements are actually conducted, and the last section discusses the fundamental concepts underlying the interpretation of measurement data and modelling.

In regard to what nuclear geophysics measures, the first section describes the types of material properties measured, e.g. bulk density and chemical composition, the size of samples used in measurements, e.g. ranging from large bulk samples to filtrates. This section states, however, that in the final analysis, the measurements entail the detection of natural or induced nuclear radiation fields surrounding the sample which are a consequence of the sample's properties, rather than measuring the sample directly. It then describes the concept of the field and the types of radiation which constitute these fields, i.e. protons, electrons, neutrons, γ rays, X rays, etc., and their typical energies in these applications. The section also deals with the structure of the atom and the factors determining the spatial intensity of radiation fields. It introduces the concept that this intensity depends on the probability of the occurrence of a particular radiation–nucleus interaction, which is indicated by the 'reaction cross-section', where the magnitude of this parameter is governed by the natures of the radiation and the nucleus concerned. This section concludes by considering the interaction of nuclei with two specific forms of nuclear radiation, photons and neutrons.

The second section mainly describes the types of instrument used for creating and detecting radiation fields as well as the electronics and the computer support commonly used in measurement systems. The physics of radiation absorption is developed further so that the reader can understand how the different types of available detectors function. This includes brief accounts of the relevant individual

absorption mechanisms for both γ rays (e.g. Compton scattering) and neutrons (e.g. elastic scattering). The principles of operation of scintillation detectors and the different types of gas counters and solid state detectors are outlined in conjunction with the concepts of spectroscopy and a detector's energy resolution. It also describes the various types of neutron detectors and the nuclear reactions forming the bases for their operation, e.g. proton recoil, induced fission and neutron activated foil detectors. Finally, it describes the different types of radiation sources used in creating radiation fields, listing the radioisotopic γ ray, X ray and neutron sources and the electronically actuated tube sources, for X rays and neutrons.

The last section of the chapter discusses how the output data of nuclear geophysical measurements are transformed into the measurements of material properties. It discusses the criteria by which the data are considered appropriate for objective interpretation, i.e. the radiation should be sufficiently penetrating into the sample and the information content of the output data should appreciably exceed the information noise. The latter is discussed in the context of spectroscopy. In the subsection on modelling the relationships between the responses of geophysical instruments and the material properties in question, different approaches to the problem are considered: direct modelling and inverse modelling. The former approach applies theory to predicting the relationship between sample properties and the geophysical instrumental responses. The latter approach predicts the sought properties on the basis of the instrumental output data. Techniques discussed for modelling, in the context of their scope and limitations, are physical models, mathematical methods, simulation (Monte Carlo methods) and integrated data analysis, including a brief description of expert systems and neural networks. The section also discusses the various types of calibration procedures adopted at various stages of equipment utilization, i.e. calibrations for standard probe response, for electronics, for the total field operating system and for operational checks.

REFERENCE

- [2.1] KHANIPOV, Z.Z., Investigation of the Base Calibrating Facility for Serial Neutron Logging Tools, Regional Survey and Petroleum Geophysics, Express-Information VIEMS, Moscow **24** (1982) 4–14.

3. PARAMETERS OBTAINED BY NUCLEAR TECHNIQUES

Chapter 2 introduced a number of important theoretical concepts in regard to nuclear geophysics which will be developed further in the present chapter. The chapter also indicated that any nuclear geophysical technique for determining the properties of a particular material other than the natural γ ray technique entails the excitation of the nuclei or of the atomic electrons, in the case of X ray production, by using some form of nuclear radiation to provide this excitation. This initiating radiation is commonly referred to as the *primary* radiation. The other essential process for any nuclear geophysical technique is the detection of the consequent *secondary* nuclear radiation and, preferably, the measurement of certain properties of this radiation. The simplest type of measurable property is the count rate. An additional property, which provides the basis for greatly improved differentiation between material properties, is the energy distribution of the secondary radiation. Generally, any instrument aiming at the detection of secondary radiation in geological materials is termed a *probe*.

A probe using a γ ray source for the primary initiating radiation gives rise to backscattered γ radiation. This radiation is the secondary radiation within the rock or the mineral ore; it is caused by irradiation with the primary radiation. An analysis of this secondary radiation may give information on both the bulk density and the overall chemical composition of the rock. In particular, the analysis may indicate the presence of heavy elements, i.e. elements of high atomic number Z . These high Z elements may include lead (Pb), tin (Sn), iron (Fe), copper (Cu) and zinc (Zn).

Another result of the discussion in Chapter 2 is that the neutron sources used in probes emit neutrons of all energies. These sources, which, essentially, consist of small, electronically operated accelerators of charged particles, emit virtually monoenergetic neutrons of very high energy (14 MeV for those emitted from the deuterium-tritium reaction). On the other hand, the neutrons emitted from the commonly used artificial radioisotopes have energies that are continuously distributed throughout the energy spectrum, up to high energies. The target nuclei that are most effective in slowing down neutrons through elastic collisions are those of elements with low atomic numbers. In this regard, hydrogen is outstandingly effective. If the radiation detector of our probe responds either to the slow (thermal or epithermal) neutrons or to the total γ radiation induced in the rock by the neutrons, then the count rate from the probe may provide a measure of the hydrogen content of the rock, i.e. water or hydrocarbons (oil or gas), depending on the probe configuration used.

The nuclear reactions induced by fast neutrons provide important applications to measurements in rocks and ores. Of particular importance is the inelastic scattering reaction (denoted by $n, n'\gamma$) used to measure carbon (C) and oxygen (O) concentrations and thereby the C/O ratio, which is important in applications to petroleum reservoir exploration.

We have also seen in the previous chapter that fast neutrons are slowed down to thermal energies through energy losses incurred in neutron–nucleus scattering interactions. These thermalized neutrons are finally absorbed in the atomic nuclei of the material through the radiative capture process, which results in the emission of γ radiation. This γ radiation, emitted at specific energies characteristic for the different chemical elements, may provide us with data on the elemental concentrations in rocks and ores of many constituent elements, such as hydrogen (H), silicon (Si), calcium (Ca), iron (Fe), nickel (Ni), chromium (Cr), cobalt (Co), copper (Cu), sulphur (S), gadolinium (Gd), titanium (Ti), potassium (K) and chlorine (Cl), to mention only some of the elements of interest.

However, the potassium concentration, which is of particular interest in petroleum search applications, is even more suitably determined by natural gamma ray spectrometry, which also yields the concentrations of uranium and thorium. The value of the potassium concentration obtained by the natural γ ray method can be used as a constraining input for the analysis of radiative capture γ ray data [3.1]. The natural radioactivity emanating from rocks also provides important applications to the various mineral industries.

Natural γ ray well logging also provides valuable information for petroleum exploration about the content in the rocks of either shaly or clay-like materials which limit porosity and permeability. These two rock properties are, respectively, vital for assessing the capacities of the formation to hold fluids and to yield them for extraction. The use of a spectrometric method of measurement provides scope, not only for measuring the general level of rock radioactivity but also for differentiating between the different types of mineral constituents of the rocks, particularly those which are potassium rich, such as illite, from those which are relatively rich in the uranium and thorium daughters. The relevance of this differentiation process is that it provides information on the degree of rock weathering, which is inferred from the fact that potassium and uranium are generally more mobile than thorium. Thus, thorium tends to remain in the weathered rock whereas the other radioactive elemental constituents will be anomalously low in concentration.

In applications to the solid mineral industries, natural γ ray methods also enable differentiation between sedimentary and magmatic rocks, radioactive ores and barren rock and between the shaly materials in the gangue and the materials being won in the mining process, whether those materials are mineral ores or coal. The ability of a technique to make this differentiation is important both in the environment of the rock–orebody structure (i.e. borehole logging) and in that of the beneficiation processes applied to the mined product. Examples of these environments are the conveyor belts bearing the mined product, the storage stockpiles and the strata in which the resource occurs.

Consequent to the neutron irradiation of the sample matrix, the artificial radioisotopes thus formed undergo β decay to emit, after some delay, both γ radiation

TABLE VI. DECAY CONSTANTS OF DATING ISOTOPES

Isotope	Decay constant (a^{-1})
^{40}K	$\lambda_{\text{tot}} \equiv \lambda_{(\beta + \text{EC})} = 5.543 \times 10^{-10}$
^{87}Rb	$\lambda = 1.42 \times 10^{-10}$
^{147}Sm	$\lambda = 6.539 \times 10^{-12}$
^{238}U	$\lambda = 1.55125 \times 10^{-10}$
^{235}U	$\lambda = 9.8485 \times 10^{-10}$
^{232}Th	$\lambda = 4.9475 \times 10^{-11}$

and β radiation. One artificial radioisotope that is commonly used in both petroleum and solid mineral industries is ^{28}Al . It is applied to petroleum search, for assaying the aluminium content of rocks [3.2].

For the solid mineral industries, there are potential applications to estimating silica and alumina simultaneously in mined bauxite [3.3]. Neutron activation analysis also has a potential use for assaying copper in mineralized orebodies [3.4].

The simultaneous measurement of both parent and daughter isotopes in the radioactive decay of naturally occurring isotopes provides an opportunity for establishing time relationships reaching from the end of the Quaternary to as far as the Precambrian era. When a parent nucleus decays, a stable daughter isotope is formed, either directly or as a product in a decay series. As a consequence of the nuclear decay, conditions are advantageous for using this process for time measurement. The time rate of decay of a specific radionuclide is governed by the probability of decay, characterized by the decay constant λ or by its inverse, the half-time of decay, $T_{1/2}$. The radiometric clock may be compared with an hourglass. At the beginning all sand is contained in the upper reservoir. In due course it drains away, filling the lower reservoir. Similarly, with the radioisotopes, only the parent isotope is present initially, but with the progress of time, the parent isotope nuclei undergo decay and, in effect, are removed from the population of nuclei (i.e. like the 'upper reservoir'). Simultaneously with the process of removing parent nuclei, the daughter isotopes nuclei appear, just as the sand would appear in the lower reservoir of the hourglass. If we check the process at a particular time, then the ratio of parent and daughter isotopes is a measure of the time which has passed since the initial state.

The most important of these time measurement methods are K/Ar, Rb/Sr, U/Th/Pb and Sm/Nd isotope ratios, where K, Ar, Rb, Sr, U, Th, Pb, Sm and Nd, respectively, denote the elements potassium, argon, rubidium, strontium, uranium,

thorium, lead, samarium and neodymium. The time ranges for effective dating depend on the parent isotope decay constant. These constants are shown in Table VI.

For dating over shorter periods than those mentioned above, the useful radionuclides are those produced by the reactions between nuclei and cosmic radiation (cosmogenic radionuclides), e.g. ^3H , ^{14}C , ^{26}Al , ^{36}Cl , ^{10}Be , etc. They span the age range from 1 a to about 15 Ma.

3.1. MATERIAL PARAMETERS

Our knowledge of the existence of nuclear radiation stems from research carried out by Becquerel in 1896 on geological materials, in particular those containing uranium minerals. From the very beginning this work attracted interest among such scientists as J.J. Joly in France and R. Ambronn in Germany (as cited in the book by Allaud and Martin, 1977 [3.5], referring to the use of natural radioactivity in investigating geological samples). It was, however, only in 1937 that the first measurements of natural radioactivity of rocks were performed in situ, which marked the beginning of modern nuclear geophysics. The first measurements were performed in the Soviet Union in 1937 [3.6], and in the United States of America in 1938 (also cited in Ref. [3.5]). The result of their work precipitated the immediate development of nuclear geophysical techniques for routine applications, based on the use of artificial radioactive sources.

In considering the natural radioactivity of rocks, the salient parameter is the concentration of the radioactive element (or elements) in the rock. For concentrations of commercial value in mining, the corresponding relevant term is the *grade*.

As was mentioned in the previous chapter, the probability of occurrence of a particular type of radiation–nucleus (or radiation–atom) interaction is characterized by its microscopic cross-section (see Section 2.1.4). The cross-section is defined in terms of either the atom, the electron or the nucleus. Rock formations, which are mixtures of nuclei of different types, are ‘sensed’ by nuclear radiation through their macroscopic cross-sections, which are the sums of all microscopic cross-sections present in each unit volume of the rock (expressed in units of cm^3) of all the rock’s constituent nuclei (or electrons).

The application of this concept is quite straightforward for non-porous materials. However, problems emerge with the simple rock model when dealing with geological formations that are heterogeneous by their nature. A real rock sample consists of rock grains and shale. The pores will contain brine, oil or gas. Indeed, when the sample is removed from its subsurface environment, the pores will also contain air. Therefore, for estimations of the macroscopic cross-section, the value of bulk density used must be that of the real rock matrix, including all fluids contained in its pores, rather than the rock grain density. Indeed, information on the rock’s porosity

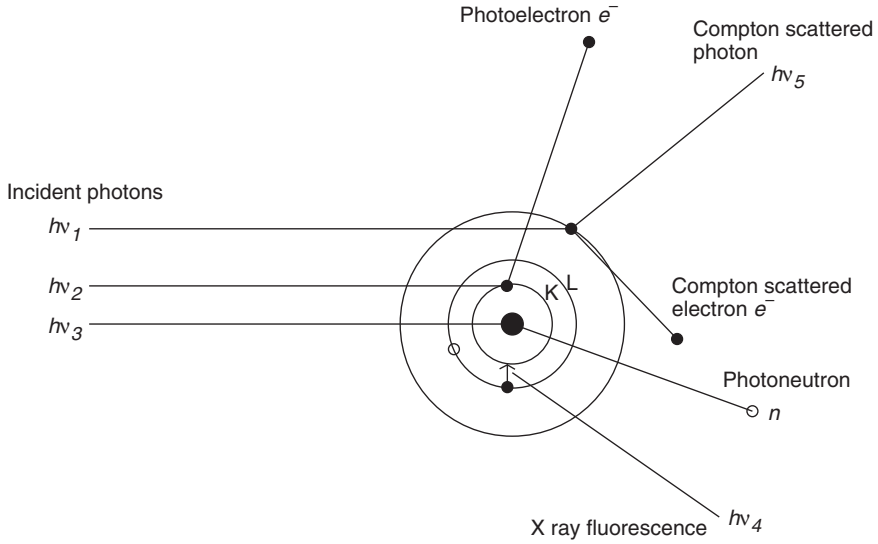

FIG. 11. Interactions of photons with an atom and its nucleus.

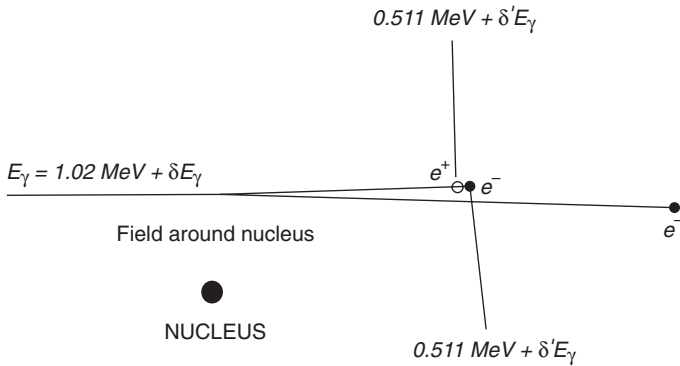

FIG. 12. Creation of an (e^-, e^+) pair by a photon and annihilation of an e^+ positron.

and the distribution of water, oil and gas in its pores is of great practical significance in that it indicates how much oil and gas can be extracted from the rock.

Another important feature of the nuclear parameters of materials is that they depend both on the type of nuclei which constitute the rock, on the energy E of the incident radiation and on the type of radiation (i.e. neutron, electron, photon, etc.). In nuclear geophysics, only some types of radiation–nucleus interactions are of practical interest. Figures 11 and 12 illustrate these interactions for gamma rays while Figures 13 and 14 show the equivalent reactions involving neutrons as the primary radiation.

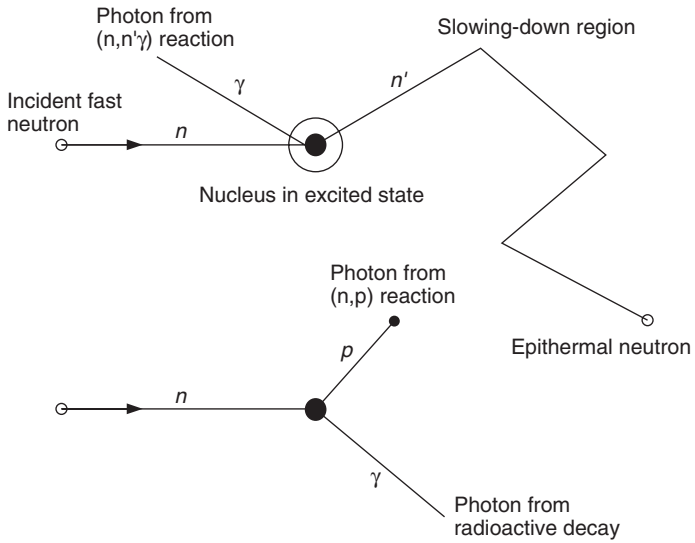

FIG. 13. Interactions of fast neutrons with nuclei.

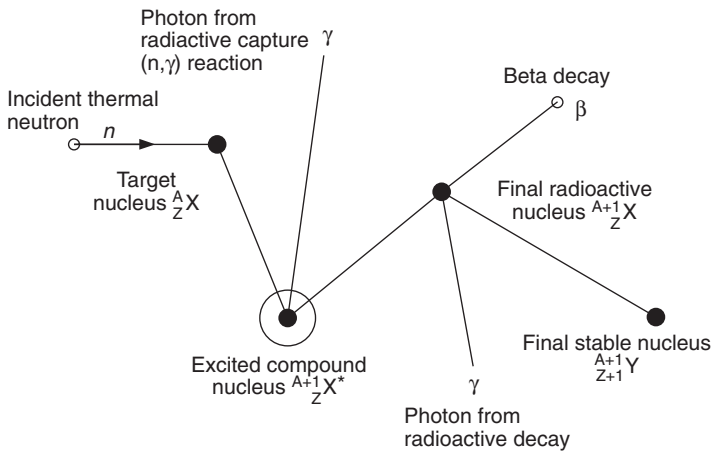

FIG.14. Interactions of thermal neutrons with nuclei.

For the primary γ radiation, the interaction processes are Compton scattering, photoelectric absorption (entailing also the emission of characteristic X rays), pair production and photon–neutron reactions.

When neutrons are the primary radiation, the processes are slowing-down and diffusion, nuclear reactions in a higher neutron energy region (inelastic scattering, n–p reactions), radiative capture of thermal neutrons, activation by thermal neutrons and nuclear fission. The data describing these interactions are collected in large nuclear databases, the best known of the databases being the ENDF (Evaluated Nuclear Data Files) of Brookhaven National Laboratory, USA.

Owing to the complexity of operations with the ENDF database, those of its parts that apply to nuclear geophysics have been transformed into formats convenient for that application. This work was carried out at RSIC (Obninsk), Los Alamos National Laboratory and other laboratories also engaged in nuclear reactor design calculations. Unfortunately, there is only variable agreement between the predictions based on the codes developed at the different laboratories [3.7].

3.2. PRIMARY PARAMETERS MEASURED

When the natural γ radiation of a geological formation is recorded (γ ray log, γ measurement on samples, wall scanning, etc.), the primary parameter influencing the tool response is the grade of the radioactive constituent. From the account given in Section 2.1, when the energies of the different γ rays which are detected can also be distinguished from one another, the type of measurement used is referred to as *spectrometric*. The spectrometric response recorded for the different γ rays depends directly upon the grade of the specific radioactive isotopes which are present in the assayed material and are emitting these particular γ rays. For geological materials and formations, the grades we measure in this way are those of uranium, thorium and potassium.

For borehole probes equipped with γ ray sources, the recorded signal, denoted by I, results from the detection of the radiation scattered from the rock walls of the borehole. However, the sources used in these applications emit primary γ rays with insufficient energy for producing pair production reactions, either generally or, in the case of ^{60}Co , at a significant level compared with Compton scattering. The signal obtained from the probe then depends upon the bulk density and the *equivalent atomic number* Z_{eq} of the geological formations [3.8].

In Section 2.1 we have learnt that the value of Z for an element is critically important in determining the intensity with which the photoelectric absorption process occurs. It was stated that the macroscopic photoelectric cross-section of an element varies approximately as the 3.6th power of the atomic number, i.e. as $Z^{3.6}$.

Geological materials are, however, in general mixtures of different chemical elements. So, for the analysis of these composite materials by techniques relying on the photoelectric effect, we must use the concept of an effective atomic number, generally called the equivalent atomic number, Z_{eq} .

The reason why Z_{eq} merits detailed discussion is that the success of one particular spectral γ - γ analysis technique hinges on this parameter. This particular technique entails the computation of a particular probe response parameter, which is virtually directly proportional to the Z_{eq} of the material under investigation.

Thus, since the photoelectric cross-sections of the constituent elements depend on exponentiated values of their atomic numbers, the parameter Z_{eq} cannot simply be an arithmetic average value of these atomic numbers of the constituent elements, weighted for their relative concentrations in the material. Actually, Z_{eq} depends on the sum of a number of weighting factors. Each weighting factor reflects the relative magnitude of the contribution which each elemental constituent makes to the macroscopic cross-section of the material. The weighting factor attached to an elemental constituent i depends, therefore, on both the corresponding value of $Z_i^{3.6}$ and its chemical concentration p_i in the material. The relationship between Z_{eq} and the atomic numbers and the concentrations of the individual constituent elements is expressed, most concisely, by the following mathematical approximation:

$$Z_{eq} = \left[\sum_{i=1}^n p_i Z_i^{3.6} \right]^{1/3.6} \quad (2)$$

An alternative useful approximate expression, which has almost the same value as Z_{eq} and can be used as a substitute for it, is given by

$$P_e = \sum_{i=1}^n p_i (Z_i / 10)^{3.6} \quad (3)$$

where P_e is known as the *photoelectric index* [3.9]. (These approximations are accurate only for materials where the ratio between the atomic number and the atomic weight is ≈ 0.5 .)

The behaviour of Z_{eq} with variations in chemical composition is vital to the analysis of mineralized ores using the spectral backscattered γ ray technique, also referred to as the γ - γ technique, for the sake of brevity. The economically desired constituents of these ores are frequently either transition elements (e.g. Fe, Cu) or heavy metals (e.g. Pb). The ores also contain those chemical elements that constitute the gangue of ores (e.g. Si, Al, Mg). In these cases, the chemical elements constituting the gangue have much lower atomic numbers than the economically desired elements.

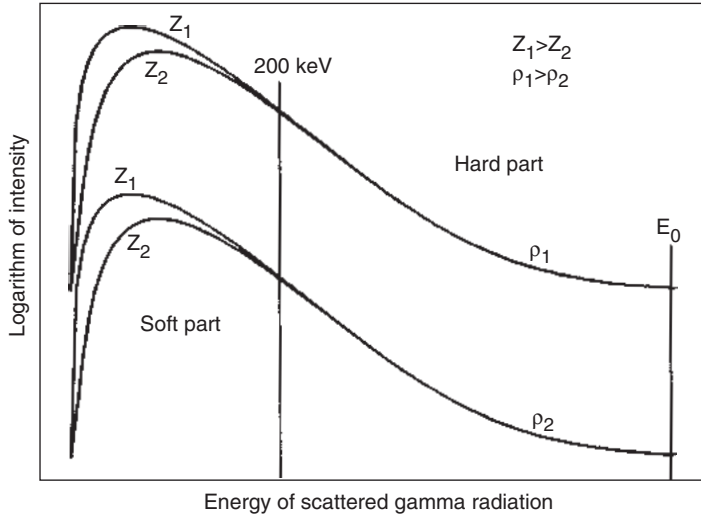

FIG. 15. Scheme of scattered radiation spectra for two different bulk density and Z_{eq} values.

It follows, from the above expressions for Z_{eq} and P_e , that any change in the concentration of the metallic elements in the ore will have a much larger effect, relatively, in changing the value of Z_{eq} than the relative change of the elemental concentrations in the material. This phenomenon is similarly important in regard to coal analysis. In the case of coal, the chemical elements making up the gangue are of a much higher atomic number than those constituting the combustible materials, which are essentially carbon and hydrogen. As a result, the gangue elements are those which govern changes in the value of Z_{eq} , rather than the constituents of economic value.

In regard to the spectral γ - γ techniques, Fig. 15 shows the variation of intensity with energy for gamma rays scattered in rocks which are different in regard to their bulk densities and atomic numbers Z_{eq} , where monoenergetic γ rays are the primary radiation of energy E_0 . The figure gives an insight into the basic pertinent ideas of how the variation of the γ ray Compton scattering and photoelectric absorption cross-sections with the properties of the materials affects the spectral shape for scattered γ rays.

The γ - γ spectra can be divided into two areas: one area represents the relatively 'soft', low energy radiation whereas the other spectral region represents the 'hard', higher energy radiation. It is evident that the density of the rock attenuates the entire energy spectrum. If the rock density increases, the intensity of the scattered radiation diminishes throughout the spectrum. By contrast, Z_{eq} influences only the 'soft' part of the spectrum.

These two facts combined are the basis for a technique based on two spectral response parameters, one parameter being sensitive to the rock density and the other one directly proportional to Z_{eq} . The technique is implemented simply by suitably setting energy windows in the recording instrumentation (by software or hardware) which correspond to regions of the spectrum of the scattered γ ray spectrum designated as 'soft' and 'hard'. In principle, probes could, therefore, be calibrated for density and equivalent atomic number, Z_{eq} , by carrying out measurements (and computing response parameters accordingly) in boreholes of a standard drilling diameter surrounded by rocks of known density and Z_{eq} , i.e. a calibration procedure as outlined in Section 2.3. The technique is based on a uniform borehole environment.

In practice, however, boreholes vary significantly in diameter over large depth intervals, even when drilled with a single standard drilling bit. Also, boreholes are mostly neither completely devoid of borehole fluid nor completely filled. The variations in borehole diameter which commonly occur may cause considerable variations in probe responses, for conditions where the bulk density and the equivalent atomic number remain constant. Therefore, the values of the response parameters on which we base predictions for the values of bulk density and equivalent atomic number will also vary according to the variation in borehole diameter, $2R$. This behaviour of the recorded signal I is expressed by the mathematical expression

$$I = I(\rho_b, Z_{eq}, 2R) \quad (4)$$

denoting the dependence of the probe response on bulk density, equivalent atomic number and borehole diameter.

However, for measurements of bulk density, it is important to bear in mind that what the probe responds to directly is the electron density. (Therefore, it responds only indirectly to the bulk density.) The electron density is the product of the bulk density, Avogadro's number and (Z'/A') , where Z' and A' are the mean values of these parameters. For all chemical elements, except for hydrogen and the heavy elements, the ratio $Z_i/A_i \approx 0.5$ to an excellent approximation. So, the electron density and the bulk density are directly proportional (to a good approximation) for mixtures and chemical compounds consisting of the most common geological elements.

For pure water, the Z'/A' ratio deviates from the 0.5 value by about 12% relative. Consequently, the error made in using the proportionality relationship is only small, even if the geological materials concerned contain chemically combined water. For this situation, the bulk density and the electron density are directly related.

For practical purposes, by using primary photons in the energy range of $200 \text{ keV} < E_\gamma < 1.3 \text{ MeV}$, the total macroscopic cross-section for Compton scattering is determined only by the rock bulk density ρ_b . Conversely, any measurement of the intensity of scattered γ rays in that energy range gives a measurement of bulk density. If the bulk density increases, the recorded signal of scattered γ radiation will decrease,

and vice versa. However, if highly accurate interpretations of density measurements are sought, it is necessary to make corrections for inadequacies in the assumption that the Z'/A' ratio is constant, no matter how the composition of the material changes.

The method of γ - γ measurements, which uses the low energy part of the detected backscattered γ radiation, was introduced by Voskoboynikov [3.10]. It was called the selective γ - γ log and is applied to detecting the presence of heavy elements. In an improved version of the selective γ - γ method, introduced by a research group from CSIRO, Australia, a response parameter P_z is computed as the ratio between the signals recorded in the soft and the hard parts of the γ ray energy spectrum. The form of this parameter has the purpose of making the parameter P_z sensitive to Z_{eq} only, by eliminating the influence of the bulk density. In this method, the effect of the bulk density is eliminated and Z_{eq} remains the only formation property still influencing P_z . Consequently, the computed probe response parameter P_z becomes a function of Z_{eq} alone. In real boreholes it is also sensitive to the borehole diameter and the fluid filling the hole. This is the basis for the improved spectral γ - γ method developed by the group at the laboratories of CSIRO in Australia, for assays of iron ores [3.11].

This method simultaneously measures P_z and the bulk density; for empty boreholes, the method automatically compensates for the sensitivity of the count rate to the borehole diameter. For this purpose, two additional spectral regions of the backscattered γ rays (referred to as windows) are selected to provide a third response parameter, which is a ratio that is sensitive to borehole diameter variation only. This parameter, the S factor, owes its selective sensitivity to the diameter to the energy locations of its windows, both in the very high energy range of the backscattered spectrum [3.12]. The relationship between the probe's γ ray response parameters and bulk density, equivalent atomic number and well diameter is found by using a special calibration procedure [3.13].

The geological materials assayed are occasionally binary mixtures of high and low atomic weight constituents. If there is a single high atomic weight component and various low ones, it is possible to calibrate directly for the grade of the high atomic weight constituent in terms of γ ray response parameters corresponding to an 'electron density' window, P_z and the S factor [3.11, 3.14]. The same type of direct calibration applies to the gangue constituent of an energy resource such as coal, where the equivalent atomic number of the coal constituents is far smaller than that of the gangue [3.15].

In regard to X rays, they may be produced when a low energy γ ray source irradiates minerals or rocks. The mechanism for their production entails the excitation of the atom when a γ ray photon or an X ray photon ejects an electron from one of the electron shells surrounding the nucleus. The X ray is emitted in the de-excitation stage of the process when another electron, from a more peripheral shell than that hit by the photon, fills the place of the ejected electron. Only photoelectric absorption events causing ionization of the inner electron shells (i.e. K to M shells) are of relevance to

nuclear geophysical methods. The probability for primary photon absorption and, therefore, for X ray production, peaks extremely sharply when the primary photon energy is just above the electron binding energy for the relevant shell. This ‘resonance’ phenomenon is critical to the X ray fluorescence spectrometric method (XRF).

There are two approaches to X ray spectrometry of geological samples. One approach, the dispersive one, has great sensitivity and resolution, but is only suited to ideal laboratory conditions.

The other approach to X ray spectrometry is referred to as non-dispersive XRF or energy dispersive XRF. This method lacks the excellent energy resolution available to the dispersive method, but the equipment is sufficiently robust to be used in industrial situations, e.g. in coal slurries or borehole probes. If the detector (e.g. the gas proportional counter, or the Si(Li) solid state detector) has sufficiently good resolution, it would be possible to detect the spectral peaks of the relatively high energy X ray lines, e.g. the K_{α} spectral lines, of elements with atomic numbers at least equal to that of calcium, and even the L_{α} lines of the heavier nuclides (e.g. gold). The X rays emitted as a result of ionizing events of the more peripheral electronic shells of the atom certainly lack sufficient energy for practical applications.

Generally, the emission energy, for the same type of emitted X rays, increases with the atomic number of the element. Examples of commonly used sources of primary radiation are ^{57}Co , ^{75}Se , ^{147}Pm , ^{170}Tm , ^{181}W and ^{241}Am . Also, the amplitude of the X ray fluorescence signal is proportional to the grade of the heavy element (Zn, Fe, Sn, Pb) in question. A more detailed description of the method can be found in the monograph by Dziunikowski [3.16].

A very specific photon–neutron reaction may be used in the exploration of beryllium. This technique is based on using primary γ ray sources which are very intense and emit γ rays of particularly high energy.

Many of the applications in practical nuclear geophysics require primary neutron radiation. It is useful for samples of any size and also with bulk rock media (well logging). The neutrons induce the emission of γ rays as a result of processes occurring in the slowing-down of neutrons and the absorption of epithermal and thermal neutrons. Specifically, these photons are produced, as is shown in Fig. 14, in the collisions of fast incident neutrons with rock nuclei. The interactions are either by neutron inelastic scattering ($n, n'\gamma$) or by fast neutron activation reactions (e.g. (n, p) and $(n, 2n)$) and by any of the possible thermal neutron–nucleus interactions.

The observed signal from the sample is proportional to the neutron flux ϕ and to a correction term, $\Sigma_{\alpha, \phi}$, for the self-absorption of radiation within the sample. The *neutron flux* (like any ‘particle’ flux) is defined as the number of neutrons passing through the unit area per second.

When neutron methods are used in the interior of a bulk medium, the entire process is more complicated, as was already discussed in Section 2.1. The neutron sources used in probes are generally fast neutron sources, so called because the

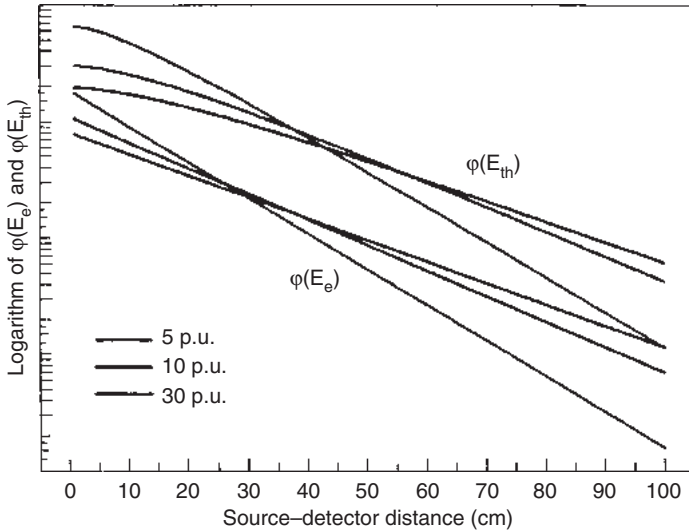

FIG. 16. Space behaviour of epithermal and thermal neutron fluxes in CaCO_3 saturated with water. Neutron source: Am-Be (p.u. = porosity unit).

emitted neutrons are of rather high energy. As was mentioned before, these sources are either of the continuously emitting type (isotopic neutron sources and neutron generator) or of the pulsed type (neutron generator only). To recapitulate: when rock is irradiated with neutrons, either in the formation or in the sample, several processes occur within it. These are neutron slowing-down, neutron diffusion and neutron activation phenomena as is shown in Figs 13 and 14.

As was shown previously, the primary fast neutrons are moderated (slowed down) by successive collisions with the nuclei of the elements in the rocks. The efficiency of neutron slowing-down, termed *moderation*, depends on the atomic masses of the target nuclei. The lower the atomic mass (i.e. A), the better the capability for nuclear slowing-down. Hydrogen nuclei are the best moderators because their masses are nearly the same as those of the neutrons. In the case of hydrogen, it is even possible to arrest the motion of an incident neutron completely if the collision is head-on.

After several collisions between neutrons and nuclei, during the slowing-down process, the initial primary fast neutron flux $\phi(E_0)$ is transformed into a flux $\phi(E_e)$ of neutrons having epithermal energies. These energies are substantially lower than the initial energy E_0 , but higher than thermal energies. At this stage of their history within the rock medium, the primary neutrons have completed the slowing-down process and have dispersed. The source neutron output Q commonly used for industrial applications ranges from about 10^7 to 10^8 n/s. The time required to achieve

completion of the slowing-down process varies from about 2 μs in a strongly hydrogenous environment to approximately 150 μs in rocks which are not only physically dry but consist of minerals containing only little chemically bonded water.

The consequence of the time delay in neutron slowing-down, and of subsequent neutron absorption, is that the concentration of low energy neutrons will build up relative to that of the primary neutrons. This is called the buildup effect, which is also observed in γ - γ methods.

When the energy of the slowing-down neutrons approaches that of the surrounding nuclei in thermal motion, the neutrons will gain or lose energy in each collision and will approach a state of thermal equilibrium with the material matrix. This stage of the neutron transport process is called the *diffusion of thermal neutrons*. Although the thermal neutrons have a broad spectrum of energies, this is a velocity spectrum of the Maxwellian type as is observed both theoretically (as in the molecular theory of gases) and experimentally with gas molecules. The spectrum is characterized by the mean energy E_{th} . At normal ambient temperatures (i.e. 20°C), the neutrons have a velocity of 2200 m/s. The energy corresponding to this velocity is $E_{\text{th}} = 0.025 \text{ eV}$.

Well logging methods capitalize on this stage of the transport process, being focused on measurements of neutron fluxes. Of specific relevance to the discussion are the epithermal flux $\phi(r, E_e)$ and the thermal neutron flux $\phi(r, E_{\text{th}})$, which exist at some particular given distance from the neutron source, r .

Figure 16 provides an idealized representation of how these two flux parameters vary with distance from the source, for several different conditions of rock moisture. These flux values are based on calculations for the situation where a point isotopic Am-Be source is embedded in an infinite, homogeneous limestone matrix (i.e. CaCO_3). Limestone has a mineralogical density of 2.72 g/cm^3 . The cases considered are for limestones of three different porosities: 5, 10 and 30%. In this example, the pores are saturated with fresh water. As the separation between source and detector is increased, the fluxes decrease at rates depending on the porosity value. The rates of decrease also vary slightly according to the type of flux, the epithermal neutron flux being always much lower than the thermal flux.

When neutrons travel through matter from the point source, their fluxes decrease with distance. This rate of decrease is governed by a particular ‘scaling unit’, which is a property of the material. Section 2.1 has introduced us to these concepts, where the ‘scaling units’ are the slowing-down length L_s , for epithermal neutrons, the diffusion length of thermal neutrons (before their absorption in the medium), L_d , and the migration length, L_m , of the neutrons from their original condition as primary neutrons to the points of their absorption in the medium.

These distance variables are related by the equation $L_m^2 = L_s^2 + L_d^2$, as was mentioned in Section 2.1. Both the slowing-down and the diffusion lengths depend on the neutron properties (neutron cross-sections) of the constituent elements of the

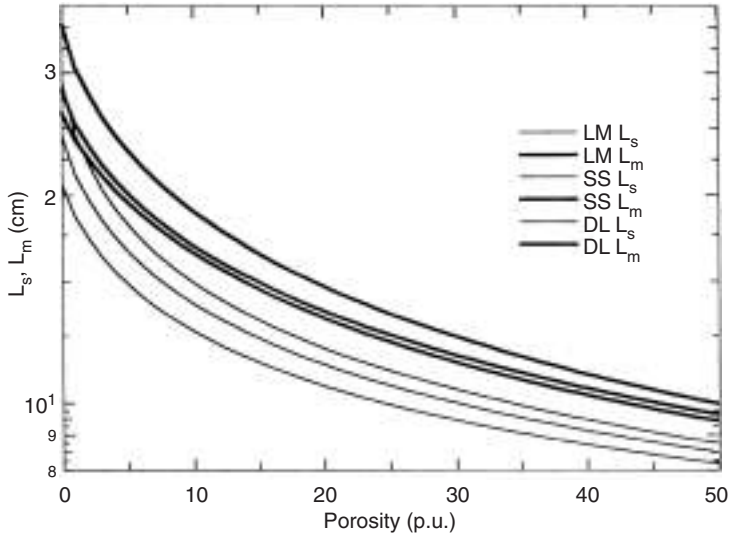

FIG. 17. Slowing-down length, L_s , and migration length, L_m , in limestone (LM), sandstone (SS) and dolomite (DL), saturated with water.

rock. The slowing-down properties are most significantly governed by the hydrogen content of the material, and the diffusion length is most strongly diminished by the presence of water (i.e. H), the transition elements (e.g. Co, Ni and Fe), the rare earth elements (e.g. In, Sm and Gd) and B (boron). While the water and the transition elements have appreciably smaller scattering and absorption cross-sections than the other elements mentioned, they are the more ubiquitous constituents of geological materials. Also, they usually occur in much greater chemical concentrations than the other elements mentioned.

For these reasons, in oil well logging applications, the values of L_s and L_d depend mainly on the porosity of the rocks since there is a certain degree of saturation of the pore space by water or hydrocarbons. Figure 16 illustrates this effect. In this figure, for the particular source–detector distances of 15 and 70 cm (which are actually typical of logging tools), both types of neutron flux will increase with porosity for the source–detector separation of 15 cm and will decrease with increasing porosity for that of 70 cm. These are the principles underlying the operation of two basic approaches to measuring the environmental porosity: the short spaced sonde being used for soil moisture determinations and the long spaced sonde being applied in borehole logging.

The parameters L_s and L_d , previously introduced in Section 2.1, are the primary rock parameters governing the operation of epithermal and thermal neutron logging tools; they are only indirectly of interest to the geologist or the well reservoir

engineer. What is of primary interest for the geological practice is the knowledge of porosities (or humidities) of investigated rocks (or soils). In practice, for petrophysical logging, this knowledge is obtained through the relationship of the rock porosity Φ with L_s and L_d , although in routine practice the tool readings are directly graduated in porosity values. This is part of the previously discussed interpretational relationship. The values of rock porosity can be calibrated directly by measuring the responses of probes using calibration facilities which consist of a series of rock blocks of known composition, porosity and water saturation. This purely experimental method of calibration is very expensive and not entirely satisfactory. The other, theoretical calibration method (using Monte Carlo computing methods) is not yet very popular nor is it simply implemented. An intermediate method of calibration goes through the calculation of rock neutron parameters, which is not a simple task, either.

A satisfactory practical solution for these calculations has been obtained by Kreft [3.17]. By using his solution, special codes have been designed to calculate the neutron parameters of rocks [3.18, 3.19]. As an example, the dependence of L_s and L_m parameters on the rock porosity is shown in Fig. 17. The different values which are observed or calculated for L_s or L_m , corresponding to different lithology types, are due to the influence of different matrix densities and matrix absorption cross-sections for thermal neutrons. In an actual borehole logging measurement, the recorded epithermal neutron signal is influenced by the borehole conditions (borehole size, etc.) and by the bulk density of the rock. However, for the thermal neutron method this signal is additionally affected by the absorption cross-section of the formation. For this reason, these two types of porosity measurements require special calibration curves (probe signal versus porosity) drawn for different borehole and lithology conditions.

The four principal types of neutron–nucleus reactions producing γ radiation, emitted during the processes of slowing-down, diffusion and post-neutron diffusion (e.g. β decay), are shown in Figs 13 and 14. On the basis of our definitions of the macroscopic cross-section and the neutron flux, the signal resulting from the detection of γ rays emitted by element n has an intensity that is proportional to the product of the macroscopic cross-section Σ_n , for the chemical element n and the neutron flux ϕ , i.e. $I_\gamma \propto \Sigma_n \phi$. It is worth noting that this relationship applies to γ rays emitted in both fast neutron scattering reactions and slow neutron absorption reactions, so that the cross-section referred to is really a general reaction cross-section for the n th element.

The significance of this formula is that, provided the neutron flux is constant, the probe signal I would be directly proportional to the elemental concentration p_n of the material. This is essentially the case in measurements of the secondary γ rays emanating from small samples irradiated from an external neutron source. Under these conditions, the neutron flux within the sample is determined by the external source and the source–sample geometry, whereas the sample–detector geometry determines the detector count rate, given a fixed neutron flux intensity.

One example for this situation is, within a nuclear reactor, the analysis of dust samples encapsulated in plastic vials of standardized volume and mass. However, for the analysis of large, rather massive samples (as in applications to bulk sample analysis or well logging), the flux of primary neutrons flux is governed not only by the strength of the source but also by the neutron properties of the rock material.

This problem should be briefly discussed in the language of physics theory in order to gain an understanding of the scope and difficulties which are associated with neutron–gamma analytical methods.

In the applications, the epithermal and thermal neutron fluxes are, in generalized terms, inversely proportional to the relevant macroscopic cross-section and directly proportional to functions F_1 and F_2 , respectively. The relevant cross-sections are the removal cross-sections for the epithermal neutrons and the absorption cross-sections for the thermalized neutrons. The magnitudes of the two functions F_1 and F_2 decrease with distance from the source r . The form of decrease taken by these two functions is inversely exponential; here, the scaling or normalization factors for the distances are: L_s for epithermal neutrons (i.e. F_1), and L_m for thermal neutrons.

Consequently, the exponents for the respective functions are $-r/L_s$ and $-r/L_m$.

Both functions also vary slightly with the diffusion coefficients D_s and D , which are parameters describing the diffusion processes occurring for epithermal and thermal neutrons.

The significance of this functional behaviour in regard to large geological samples is as follows:

- (a) Both neutron fluxes decrease exponentially with distance from the source.
- (b) The fluxes also vary with porosity (indicated mainly by L_s) and lithology (indicated largely by L_m).

However, the fluxes have a variable dependence on porosity which is determined by the distance from the source and the chemical nature of the material.

The variation of neutron flux with distance and porosity is illustrated in Fig. 16. The samples used were CaCO_3 rocks. The figure illustrates how the flux decreases with distance from the source. It also shows that each type of flux has a cross-over point for its behaviour with changing porosity. For source–detector separations smaller than the cross-over distance, the flux increases with increasing water saturated porosity. For distances larger than the cross-over, the flux diminishes with increasing water saturated porosity.

This type of information is essential to the design of probes. In fact, Fig. 16 indicates that there are source–detector separations (at the cross-over points) where the flux is virtually insensitive to changes in the porosity, i.e. 35 cm for epithermal and 45 cm for thermal neutrons.

As an example, the design parameters required for porosity measuring borehole probes would differ from those used for a probe applied to assaying the mineralized grade of an ore, where the ore varies moderately in water content, geographically and stratigraphically. The former application requires a source–detector separation that differs markedly from that of the cross-over distance, while that of the mineral assaying probe should be as close as possible to the cross-over distance (which also varies with the ore grade).

Another outcome of the theory, discussed only sketchily above, concerns the production of γ rays in neutron–nucleus reactions. The intensity of the γ ray signal, I_γ , from a reaction on the n th element of the rock can be approximated by:

$$I_\gamma = \frac{P_n}{p_n + C} \quad (5)$$

The nature of this formula also requires a semi-theoretical explanation. We can infer from it that, on the one hand, the γ ray signal recorded for the n th element, I_γ , is proportional to the concentration of that element (p_n), but it also indicates that I_γ is inversely proportional to another parameter which must always have at least the same value as p_n . The value of the denominator consists of the sum of the concentration of the n th chemical element (p_n) and the sum of other terms (C), which depend individually on the relative concentrations and reaction cross-sections of elements other than n in the mineral sample.

The significance of this fact, in the problem of mineral analysis by the emission of neutron induced γ rays, is that the intensity of the γ ray signal, I_γ , is at best only approximately directly proportional to the concentration, p_n , of the n th element. This occurs when $p_n \ll C$.

The meaning of this fact, in terms of physics, is that the approximation is only good when $p_n \Sigma_n$ is much smaller than the sum of the products of the macroscopic cross-sections and the concentrations of all other elemental constituents in the sample. When $p_n \Sigma_n$ has a relatively significant value, the curve $I_\gamma = I_\gamma(p_n)$ will reveal some saturation of I_γ as the concentration p_n increases. In an extreme situation, the curve may completely flatten out. This will occur when all neutrons in the rock are absorbed by the element in question and no other elements can enter into the reaction. In this situation, the signal is proportional to the neutron source output. It follows that a good approximation to proportionality between the intensity of the γ ray signal and the concentration of the element being analysed is possible in two situations.

The first situation is where the desired element has a smaller concentration than the other constituents of the material. This smaller concentration must not, however, be offset by the desired element (n) having a very much larger reaction cross-section than the other constituents. A typical example where the conditions for this situation are met (i.e. $p_n \ll C$) is lithology determination by the lithology logs [3.20].

The second situation has little practical application. Its relevance is mainly conceptual. It would prevail where the concentration of the desired element has a high, but not predominant concentration, but where its reaction cross-section is much smaller than for the other constituents.

In practice it would, therefore, appear that there is little sensitivity in estimating the chemical content of a major constituent of appreciable reaction cross-section on the basis of direct measurements of I_γ alone. Two examples for this are the measurement of % Fe in iron ore, where the iron concentrations in the mineralized ore body range from 10% Fe to 68% Fe. However, the expected insensitivity of I_γ to changes in chemical content of major constituents is overcome by using a measurement of I_n of the thermal neutron flux as a normalizing factor for I_γ . This means that the parameter which is correlated with variations in chemical content is I_γ/I_n .

The existence of this correlation is supported by the theory. Undoubtedly, however, there remains a question on how validly these two radiations can be measured simultaneously and at the same spatial location. Examples of borehole measurements where this was used empirically were the determinations of nickel concentrations in sulphide ores by the detection of nickel capture γ rays [3.21] and the previously mentioned work of the CSIRO group in the determination of iron by neutron capture γ ray logging. Some of the techniques used for effecting these measurements are described in Chapters 4 and 5. The technique used for measuring the neutron flux is to coat the detector crystal with ^{10}B and to measure the 478 keV γ rays emitted after the capture of the thermal neutrons on the coated crystal surface simultaneously with the capture γ rays emitted by the elements of interest. Nevertheless, this method is only reliably accurate if the water content of the formation varies only moderately [3.22].

The γ ray signals, which are emitted consequent to the neutron inelastic scattering and the neutron capture reactions, shown in Figs 13 and 14, are formed virtually concurrently with the actual neutron–nucleus interaction. This is not the case when the assayed γ radioactive nuclei are created by (n,p) or (n, γ) reactions and have a half-life of $T_{1/2}$. For the latter, the activation time, the delay time and the measurement time are essential, adjustable parameters for optimizing the measurement process, as for normal laboratory activation analysis [3.23].

The characteristic feature, in the case of continuous activation analysis conducted in the borehole logging mode, is that the logging velocity v must be chosen in accordance with the radioactive decay constant, λ , of the activated element and the source–detector separation, d . This type of logging is usually performed downhole, with the neutron source located at the end of the tool. The optimum logging velocity providing the maximum activation signal is given by:

$$V_{\text{opt}} = d\lambda = d \frac{\ln 2}{T_{1/2}}$$

The application of pulsed neutron generators to well logging creates the scope for incorporating time factors into the measurement process, which are of the order of microseconds. Figure 18 is a schematic of the time distributions for the different radiations which are produced after the injection of a burst of neutrons into the rock. The pulsed neutron generator is operated to emit these bursts at regular periods, e.g. 500 bursts/s, but the repetition time is governed by the intended application.

During a burst, γ rays resulting from inelastic scattering reactions are emitted. Also, shortly after the burst, γ rays begin to appear which result from fast neutron activation reactions and radiative capture of epithermal neutrons. The primary fast neutrons are slowed down very quickly during the slowing-down time t_s , which determines the exponential rate at which the flux of fast and epithermal neutrons decays.

The appearance of the neutrons at epithermal energies notionally provides an origin in time for the lifetimes of the much longer lived thermal neutrons. The lifetime of thermal neutrons, τ , is inversely proportional to the macroscopic absorption cross-section, Σ_a , of the rock. As a consequence, the flux of thermal neutrons decays exponentially at a rate determined by the product of t/τ (i.e. $t \Sigma_a$) and the neutron velocity, v . This decay rate of the thermal flux is expressed mathematically as $\exp(-tv \Sigma_a)$.

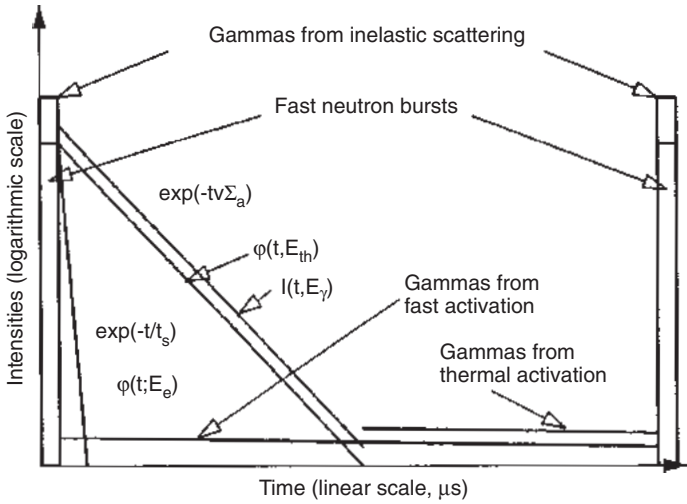

FIG. 18. Schematic of time behaviour of radiations after burst of fast neutrons injected into a rock volume.

The flux of γ radiation, resulting from the radiative capture process of thermal neutrons in the rock, will decay at precisely the same rate as the flux of thermal neutrons. Moreover, the thermal neutrons activate certain constituent isotopes. Their activity becomes apparent after the γ ray flux from radiative capture has decayed and before the onset of the next fast neutron burst. When spectrometric γ ray detectors are used in synchronism with pulsed neutron generators, the scope exists (as indicated in Section 2.2) for distinguishing between the γ rays resulting from the different nuclear de-excitation processes. The time window for detecting γ rays from neutron activation can be adjusted within the cycle period between bursts in order to optimize the detectable output of the γ rays resulting from neutron activation. The measurement performed on the basis of sequential single neutron burst cycles from a pulsed neutron generator is known as cyclic activation analysis [3.24]. A similar concept, used to increase the effectiveness of pulsed neutron activation analysis, is to apply a large number of consecutive neutron bursts with minimal delay between them, within each cycle of the measurement. The activation γ rays are detected within each cycle only after those resulting from the radiative capture process have been detected and recorded and after they have dissipated [3.22, 3.25].

The γ ray photons resulting from inelastic scattering reactions have several industrial applications. Their most common measurement application is in petrophysics, where they are used to compute the carbon/oxygen ratio, which provides quantitative information on the petroleum and water contents in the formation.

Other neutron and neutron–gamma measurements increase the petrophysical information obtained by other means. One vital measurement is the time rate of decay of the thermal neutron flux. The slope of that decay, based on direct measurement of the thermal neutron flux or the corresponding capture γ ray flux, is used to determine the neutron absorption cross-section, Σ_a , of the formation. This slope can be related to various formation parameters. In the oil industry, for example, from this slope of the neutron decay the saturation index of the formation when brine is present in the pore space is obtained. In order to use the relationship for obtaining the saturation index, it is essential to know not only Σ_a of the entire formation, but also the salinity of the brine, the formation porosity and the absorption cross-section of the rock matrix.

Data on the formation porosity are obtained by using conventional neutron logs (CNLs). The brine salinity is obtained from measurements on brine samples. However, knowledge of the matrix absorption cross-section poses a problem. One approach is to measure this cross-section on rock samples obtained from the corresponding relevant formations. Laboratory methods of measurement of the absorption cross-section on small rock samples are complicated and sometimes quite sophisticated [3.26–3.28]. However, there are several other methods of estimating this parameter; their description is beyond the scope of this report. The parameter can be obtained by using conventional neutron logs, in which epithermal or thermal neutron fluxes are measured. Alternatively, it can be obtained by measuring the slope of the

decaying epithermal neutron flux (Fig. 18). This method was recently proposed by Mills et al. [3.29].

Neutron sources can be also used to detect chemical elements by using nuclear reactions other than those shown in Figs 13 and 14. These are fission reactions on uranium nuclei initiated by fast or thermal neutrons.

Summarizing, we recall that all nuclear methods respond to the chemical and structural composition of the materials. These responses provide the basis for estimating many other chemical and geological parameters which characterize the sample or the formation investigated (e.g. chemical content, porosity, water saturation). All but one of the geological material properties measured use indirect methods. They are indirect in that the parameters sought are obtained by correlation with the data on the basis of models both physical and geological in character. Taken together, they are, however, so complex that inverse modelling is only possible through a generalization of the probe data. The one geological parameter that is detected directly, in a physical sense, is the electron density and, by inference, the formation bulk density.

3.3. TYPES OF MEASUREMENT

The subject of this report concerns three types of situation for the measurements: (a) rock samples; (b) rock outcrops, mine walls, soil surfaces; and (c) boreholes.

For rock sample assays, the problem is always choosing a suitable radiation source and a radiation detector as well as the proper configuration of the source–sample–detector system. Several approaches are used: source and detector located outside the sample; source and detector located within the sample; only the source inside the sample; or only the detector inside the sample. The radiation detected is either the primary radiation, the secondary scattered radiation or the secondary radiation produced within the sample by the primary radiation. The methods of measurement are natural radioactivity, the transmission and backscattering of γ rays and neutrons, γ ray production resulting from neutron–nucleus reactions and X ray fluorescence analysis. For the elemental analysis of rock samples, the neutron sources considered for neutron activation analysis are neutron beams from nuclear reactors, intense isotopic neutron sources (^{252}Cf , Am–Be) and neutron generators, which are used for their fast neutron output. In recent years, particle induced X ray emission (PIXE) has gained a reputation for its effectiveness in sample analysis [3.30]. These methods are borrowed from physicochemical analysis and are applied in nuclear geophysics. They offer the advantage of avoiding the exposure of personnel and samples to undesirable radiation effects. The timing of the whole procedure is not critical, and no miniaturization of hardware is required.

The disadvantage of using samples as a basis for assaying outcrops is that the samples must be collected from certain geographical locations which are chosen on

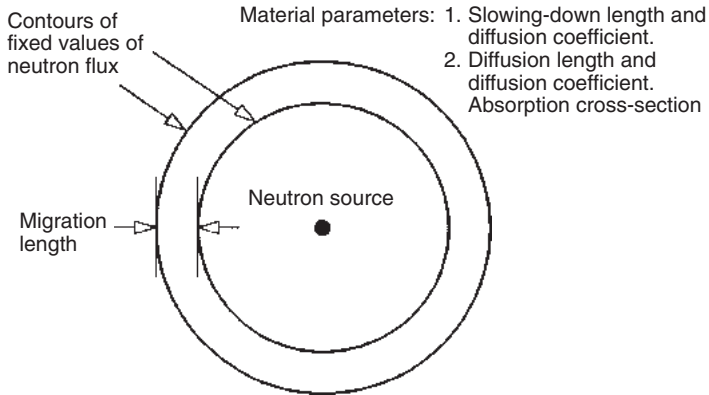

FIG. 19. Contours of the neutron flux surrounding a point isotropic source in an infinite homogeneous rock medium.

the basis of a well defined scheme. Subsequently, the arithmetic averaging of the assay results must be weighted on the basis of the heterogeneity and the geostatistical properties of the rock specimens. However, this problem is common to all laboratory methods, no matter whether the method used is nuclear, physical, chemical or anything else.

In measurements on outcrops, mining walls and soils, it is only possible to analyse the material from a single surface. These are the so-called 2π measurements. The application of these measurements is limited to ore mining, ore exploration and determinations of soil moisture and soil density. The latter are relevant to agriculture and civil engineering. In applications to mineralized ore bodies, most of the probes are various types of X ray fluorescence gauges, apart from simple γ ray detectors (of the gross count or spectrometric types) which are used in both exploration and mining control operations of the uranium industry. These X ray gauges have only moderate weight and can quantitatively assay tin, lead and other heavy metal ores. They are equipped with low energy X ray sources, which facilitates management of the radiation safety problem for personnel. The γ - γ and neutron gauges for soil density and moisture determination are configured for a virtually zero source-detector distance, which permits the use of radiation sources with very low output intensity. However, these devices are heavier than the X ray fluorescence gauges.

Borehole logging methods are performed in boreholes and petroleum wells of various dimensions. The holes vary from ones that are shallow, dry or partly water filled, narrow boreholes, drilled for soil mechanics, for underground and open cut mines, to the very deep boreholes of large diameter drilled for oil exploration. Depending on the type of environment for the intended logging operation, the equipment varies from small, portable instruments over more complex equipment

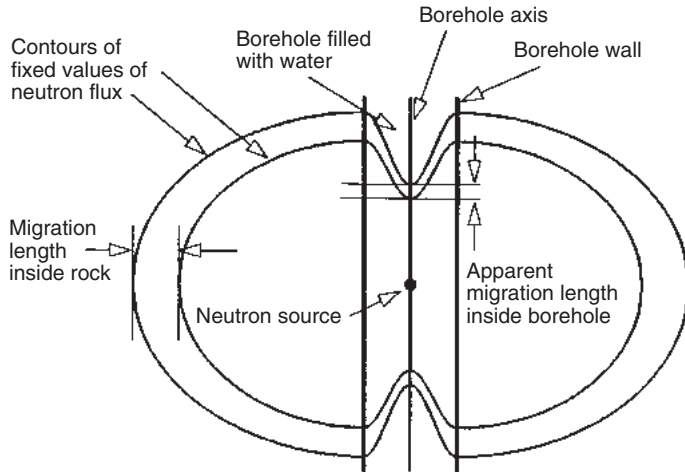

FIG. 20. Contours of the neutron flux surrounding a point isotropic source located on the axis of a water filled borehole.

requiring containment in small vehicles to very heavy equipment units mounted on large trucks. Current practice is to record the signals digitally, although the analog systems of several decades ago still find occasional commercial application.

The borehole geometry of logging measurements complicates the interpretation of the data used in determining the formation parameters. The porosity measurement by the neutron method provides an illustrative example for this. In the idealized situation where the isotropic point neutron source is embedded in an infinite homogeneous medium, the spatial flux distribution of slowed-down neutrons has perfect spherical symmetry, as is shown in Fig. 19. Where the ratio between the flux values at two radial locations (relative to the source) is $1/e$, the radial distance between these locations is (by definition) either the slowing-down length or the migration length, depending on the energy of the neutrons being considered. In such a case, it is entirely legitimate to correlate the detector signal with the appropriate 'length' parameter in order to determine the porosity by using the relationships embedded in the porosity calibration curve of Fig. 17.

Unfortunately, real logging conditions are less favourable than the idealized situation. When the same neutron source is situated at the axis of a borehole filled with water, the two spherical isoflux contours of the idealized situation, shown in Fig. 19, become deformed as is shown in Fig. 20. Inside the borehole, the two contours are much closer than in the formation. This distance is referred to as the apparent migration length, $L_{m,ap}$. The logging probe situated inside the borehole senses the neutron field through this apparent migration length $L_{m,ap}$ and not through the true one, L_m . This is the reason why any attempt to correlate the probe output directly with the true

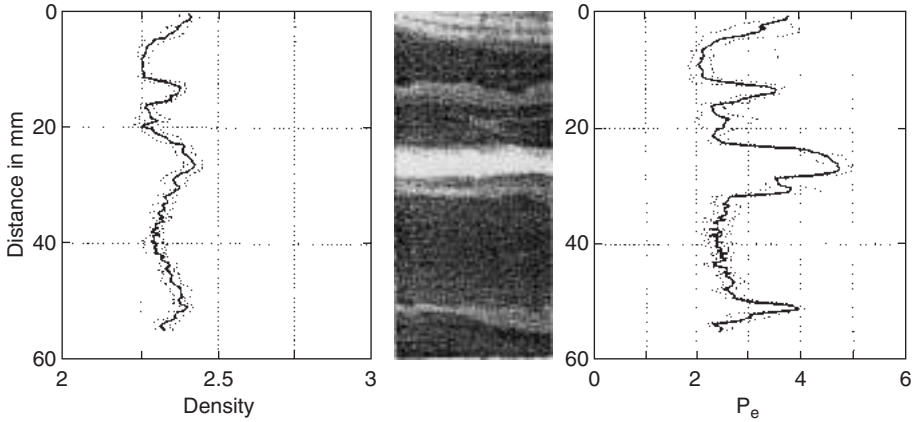

FIG. 21. Density profile (left) and P_e profile (right), averaged over the picture width of a Mesaverde 255 sample. An X ray attenuation image obtained from the CT scanner is shown at the centre. The dotted lines on both profiles represent the standard deviation.

neutron parameters of the formation fails when the borehole conditions are variable (variable borehole size, probe position within the borehole, borehole salinity, etc.). A method of overcoming this problem on the basis of the $L_{m,ap}$ parameters (obtained with a single probe detector) has been developed only recently [3.31, 3.32].

However, other probes, specially designed to minimize borehole effects and thus to improve the effectiveness of logging measurements, have been part of logging practice for some time. The main feature for this purpose was the use of dual detector (or even multidetector) probes. Density logging probes were the first to be modified in this way [3.33]. The theoretical basis for the dual spaced neutron log was developed later [3.34], although the first such probe for epithermal neutron measurement preceded the theoretical basis [3.35].

In the dual detector density log, also referred to as the compensated density log, the outputs of the detectors are processed separately. The detector which is closer to the source furnishes the density corrections needed owing to the contribution of the 'near zone' (i.e. the mud cake) to the readings of the far detector, which has the basic 'density' response. In the dual spaced neutron log, the ratio of count rates coming from the near and far detectors provides the interpretational parameter. For constant borehole conditions, this 'near to far' count rate ratio is directly correlated with the formation porosity.

For borehole logging applied to the solid, mineralized deposits and coal industries, in the exploration, mine development and production phases of these industries,

it is essential, for accurate quantitative performance, to design the probes specifically for the borehole and lithology conditions prevailing at the particular deposit or mine. The parameters determining the probe dimensions and the logging methodology are the degree of mineralization, the range of water content in the formation, the diameter and the rugosity of the hole and whether or not the hole is dry.

A number of additional techniques have been applied in nuclear geophysics; they are beyond the scope of the report because they are relatively recent in their applications or only of limited application. This is not to deny their importance or, in fact, their indispensability where they are applicable, but means that they are restricted in the breadth of their use.

Computer technology (CT) and positron emission tomography (PET) have recently been applied to a significant extent in laboratories to study samples non-invasively. These studies primarily fall into two areas: analysis of internal density and average atomic number of samples on a scale much smaller than the size of the sample, and use in experimental studies of fluid transport within media where the time evolution of displacement can be monitored without the destruction of many 'identical' samples. An example of scanning a core sample is shown in Fig. 21 [3.36]. The centre of the figure shows an X ray attenuation image of the core cross-section with structural changes of the order of a millimetre in size. By using two different X ray energies, it is possible to determine both the bulk density and the P_e related to the average atomic number of the sample. The horizontal averages of these quantities, together with their standard deviations, are shown on the sides of the figure.

As γ ray scattering, CT scanning is sensitive to changes in density or average atomic number, through its sensitivity to the photoelectric absorption cross-section. Thus studies of fluid displacement can most readily be undertaken when a saline water displaces, or is displaced by, a hydrocarbon. Variations where heavier salts, or a hydrocarbon containing a heavy element, are used can increase the complexity of the systems studied by this technique. PET scanning, with coincidence detection of annihilation radiation produced from a positron decaying isotope, does not require a contrast in density or atomic number, because the material tagged by the positron emitting nuclide is sensed directly.

Nuclear magnetic resonance (NMR) measurements are used in the laboratory as well as in the field [3.37]. Nuclear magnetic resonance was first observed in 1946. Hydrogen nuclei (protons) possess a magnetic moment and, when exposed to an externally applied magnetic field, their net magnetization will relax towards, and eventually reach, an equilibrium magnetization level. In geological materials containing fluid, it was quickly found that the amplitude of the signal was proportional to the number of protons in the sample, and it could be used to determine the fluid filled porosity of a rock. It was also quickly noticed that the relaxation of the magnetization of the hydrogen nuclei was proportional to the viscosity of the fluid (the higher the viscosity, the faster the relaxation). In addition, it was found that

liquids contained within the pores of rocks decayed more quickly than the liquids by themselves, allowing NMR measurements to provide an indication of the pore sizes in a rock. Ideally, both laboratory and field measurements will provide the same information. However, in practice, a wider range of techniques can be applied under laboratory conditions than in the field. NMR measurements can be used to determine pore size distributions and to estimate the permeability of the samples to flow, the surface relaxivity, the effect of pore surface structure and paramagnetic ion content on the relaxation of the proton spins in the liquid contained in the pores, and the probability of moving fluids which only partially saturate the rock. Current technologies of NMR measurements, under field conditions, provide a measure of the total porosity as well as the magnetic relaxation, which can be used to provide an estimate of the parameters presented above.

One class of measurement techniques that is increasingly used in nuclear geophysics, although its application is very specialized, is to record the tracks of radiation damage on a suitable surface. This radiation damage is caused by the radiation particles released as a consequence of a nuclear reaction occurring in an adjacent specimen. The technique is reliably applied to measure non-destructively the concentrations and microdistributions of heavy elements and certain light elements in rocks, alloys, minerals and meteorites; numerous solid materials are used as detectors, generally referred to as solid state nuclear track detectors (SSNTDs). This technique, based on spontaneous fission in rocks, also enables the determination of their uranium content, track age and thermal evolution.

3.4. SUMMARY

Chapter 3 discusses the connections, based on nuclear physical theory, between the geophysical parameters obtained from various probe measuring systems and the various material parameters which are used in the geosciences and their derived technologies, e.g. in the exploration industries for petroleum and mineral ores. In its first two sections, the chapter further develops, for real multi-element materials, the same concepts that Chapter 2 had introduced for single element materials. Consequently, the treatment is necessarily more detailed and sophisticated than that in the previous chapter. The analysis given depends on the concept that a primary radiation excites the samples to emit a secondary radiation which is the field detected in the measurement.

The first section introduces the relationship between the material parameters, e.g. macroscopic reaction cross-sections (of unit material volume) and the individual nuclear parameters. Other material parameters discussed here include the atomic concentrations of the different elements in the rocks, the in situ bulk density, the porosity and saturation indexes of rocks.

The second section deals with how particular primary parameters influence both the primary and secondary radiation fields. The parameter discussed in regard to naturally radioactive ores is the grade of the mineralized material; for probes fitted with γ ray sources, the parameters are the equivalent atomic number, Z_{eq} , and the bulk density; and for neutron primary radiation fields, the primary parameters are the neutron slowing-down length, the diffusion length and the diffusion coefficients, which in turn are related to the relevant macroscopic reaction cross-sections. This section explains the relationships between the intensities of the secondary radiation fields and various variables, which include the source strength, the primary parameters and the reaction cross-sections as well as the spatial and temporal parameters. In the case of neutron excited γ ray reactions, this section also describes the relationship between the intensity of the measured γ ray signal and the chemical concentration of the γ ray, demonstrating that this relationship is, at best, only approximately directly proportional. The importance of the temporal parameter is demonstrated in applications of various techniques based on using neutron sources, which include neutron activation analysis, i.e. the technique of measuring the formation porosity from the slope of the decay of the epithermal neutron flux created following the exposure of a sample to a neutron burst and the fission reactions on uranium nuclei.

The third section discusses geophysical measurements as they are applied to the three principal types of samples. The first type is that of geological material specimens; the second type includes rock outcrops, mining walls and soils; the third type is boreholes. The discussion centres on the various source-sample-detector configurations used and on the most suitable types of geophysical techniques for measuring the different sample types as well as the difficulties encountered. Techniques additional to the aforementioned natural γ ray, γ ray scattering and neutron source methods are mentioned, including particle induced X ray emission (PIXE) for specimen measurement and X ray fluorescence for rock outcrops, etc. The main difficulties and their elimination include accurate sampling in the measurement of specimen samples, the satisfactory combination of the conflicting requirements of instrumental portability with adequate source strength and safety in the case of measurements on rock outcrops, etc., and the distortion of the radiation field by the borehole and the presence of fluid and mud inside the borehole, in the case of borehole probe measurements. Other briefly discussed measurement techniques, either new or of specialized application, are computer tomography, positron emission tomography, nuclear magnetic resonance and solid state nuclear track detectors.

REFERENCES

- [3.1] GRAU, J.A., SCHWEITZER, J.S., HERTZOG, R.C., Statistical uncertainties of elemental concentrations extracted from neutron-induced gamma-ray measurements, *IEEE Trans. Nucl. Sci.* **37** (1990) 2175–2178.
- [3.2] SCHWEITZER, J.S., GRAU J.A., HERTZOG, R.C., Precision and accuracy of short lived activation measurements for *in situ* geological analyses, *J. Trace Microprobe Techniques* **64** (1988) 437–451.
- [3.3] BORSARU, M., EISLER, P.L., Simultaneous determination of silica and alumina in bulk bauxite samples by fast neutron activation, *Anal. Chem. (Wash.)* **53** (1981) 1754.
- [3.4] EISLER, P.L., HUPPERT, P., WYLIE, A.W., Logging of copper in simulated boreholes by gamma spectroscopy: 1. Activation of copper with fast neutrons, *Geoexploration* **9** (1971) 181–194.
- [3.5] ALLAUD, L.A., MARTIN, M.H., Schlumberger, *The History of a Technique*, Wiley, New York (1977).
- [3.6] SPAK, V. A., Une nouvelle méthode de différencier les roches du sondage à l'aide du compteur des gamma-impulsions, *Comptes Rendus (Doklady) de l'Acad. des Sci. de l'URSS* **16** (1937) 109–111 (French translation).
- [3.7] DWORAK, D., LOSKIEWICZ, J., A comparison of multigroup neutron cross-sections obtained from the ENDF/B-IV library with the Abagyan–Bondarenko (ABNC) library as used in geophysical calculations, *Nucl. Geophys.* **5** (1991) 1–11.
- [3.8] CZUBEK, J.A., Physical possibilities of gamma–gamma logging, *Radioisotope Instruments in Industry and Geophysics (Proc. Symp. Warsaw, 1965)*, Vol. 2, IAEA, Vienna (1966) 249–275.
- [3.9] BERTOZZI, W., ELLIS, D.V., WAHL, J.S., The physical foundation of formation lithology with gamma rays, *Geophysics* **46** (1981) 1439–1455.
- [3.10] VOSKOBOYNIKOV, G.M., Theoretical background of selective gamma–gamma log, *Bull. Acad. Sci. USSR, Geophys. Ser.* (1957) 351–362 (in Russian).
- [3.11] EISLER, P.L., CHARBUCINSKI, J., BORSARU, M., INDRANS, A.P., spectrometric gamma–gamma borehole methods for iron-ore mining, *Borehole Geophysics for Minerals, Geotechnical and Groundwater Applications (Proc. 2nd Int. Symp. Golden, CO, 1987)*, Minerals and Geotechnical Society, Houston (1987) 189–201.
- [3.12] MATHEW, P.J., ANDERSON, M.R., A gamma–gamma method for measuring the diameters of air-filled boreholes, *Geophysics for Mining and Applications (Proc. Geological Survey of Canada Symp. 1986)*, Canadian Government Publishing Centre, Ottawa, Ontario (1986) 269–275.
- [3.13] CZUBEK, J.A., Advances in gamma–gamma logging, *Int. J. Appl. Radiat. Isot.* **34** (1983) 153–172.
- [3.14] CHARBUCINSKI, J., EISLER P.L., MATHEW P.J., WYLIE, A.W., Use of back-scattered gamma radiation for determining grade of iron ores in blast holes and development drill holes, *Australas. Inst. Min. Metall., Proc.* **262**, Australas. Inst. Min. Metall., Melbourne (1977) 29–38.

- [3.15] BORSARU, M., CHARBUCINSKI, J., EISLER, P.L., YOUL, S.F., Determination of ash content in coal by borehole logging in dry boreholes using gamma–gamma methods, *Geoexploration* **23** (1985) 503–518.
- [3.16] DZIUNIKOWSKI, B., *Energy Dispersive X-Ray Fluorescence Analysis*, Elsevier, Amsterdam (1989) 201–206.
- [3.17] KREFT, A., Calculation of the neutron slowing down length in rocks and soils, *Nukleonika* **19** (1974) 145–156.
- [3.18] McKEON, D.C., SCOTT, H. D., SNUPAR — A nuclear parameter code for nuclear geophysics applications, *Nucl. Geophys.* **2** (1988) 215–230.
- [3.19] CZUBEK, J.A., Rock neutron parameters: I. Neutron slowing down parameters; II. Thermal neutron parameters, *Nucl. Geophys.* **4** (1990) 143–167; 293–304.
- [3.20] SCHWEITZER, J.S., ELLIS, D.V., GRAU, J.A., HERZOG, R.C., Elemental concentrations from gamma-ray spectroscopy logs, *Nucl. Geophys.* **2** (1988) 175–181.
- [3.21] EISLER, P.L., A new borehole logging technology for enhancing performance in metalliferous mining, *Application of Borehole Logging to Exploration and Mining* (Proc. 1st Symp. Perth, 1994), unpublished report of Australian Minerals Industries Association (A.M.I.R.A.), Melbourne (1994) 23 pp.
- [3.22] EISLER, P., CARIOU, J., BARON, J. P., BARNAVON, T., ALEXANDRE, J., HUPPERT, P., CERAVOLO, C., WADDINGTON, P., Further experimental investigation of spectrometric nuclear probe techniques for the construction and mining industries, External Rep. No. 5 (The LCPC–CSIRO Collaborative Project), CSIRO Division of Geomechanics, Melbourne (1990) 44 p.
- [3.23] DAS, H.A., FAANHOF, A., VAN DER SLOOT, H.A., *Radioanalysis in Geochemistry*, Elsevier, Amsterdam (1989).
- [3.24] GIVENS, W.W., MILLS, W.R., CALDWELL, R.L., Cyclic activation analysis, *Nucl. Instrum. Methods* **80** (1970) 95–103.
- [3.25] BARON, J.P., BARNAVON, T., ALEXANDRE, J., DEBRAY, L., On-line bulk analysis of raw material in a cement plant using the neutron irradiation and capture gamma ray technique, *Nuclear Techniques in the Exploration and Exploitation of Energy and Mineral Resources* (Proc. Symp. Vienna, 1990), IAEA, Vienna (1991) 569–583.
- [3.26] CZUBEK, J.A., A method for measurement of thermal neutron absorption cross section in small samples, *J. Phys. D: Appl. Phys.* **14** (1981) 779–792.
- [3.27] KREFT, A., BOLEWSKI, A., Jr., CIECHANOWSKI, M., An isotopic neutron source method for measuring the thermal neutron cross section of rocks using small samples, *Nucl. Geophys.* **3** (1989) 367–372.
- [3.28] TITTLE, C.W., CRAWFORD, G.W., Measuring the thermal neutron absorption cross- section of rocks, *Log Anal.* (1983) 12.
- [3.29] MILLS, W.R., ALLEN, L.S., STROMSWOLD, D.C., Pulsed neutron porosity logging based on epithermal neutron die-away, *Nucl. Geophys.* **2** (1988) 81–93.
- [3.30] WIS, R.D., Ed., *Particle induced X-ray emission and its analytical applications*, *Nuclear Instrum. Methods Phys. Res.* **B49** (1989).
- [3.31] CZUBEK, J.A., Scaling neutron fields in well logging, *Nucl. Geophys.* **6** (1992) 445–486.

- [3.32] CZUBEK, J.A., Calibration of neutron tools by a scaling procedure, *Nucl. Geophys.* **8** (1994) 261–279.
- [3.33] WAHL, J.S., TITTMAN, J., JOHNSTONE, C.W., ALGER, R.P., The dual spacing formation density log, *J. Petr. Technol.* **16** (1964) 1411–1416.
- [3.34] ALLEN, L.S., TITTLE, C.W., MILLS, W.R., CALDWELL, R.L., Dual-spaced neutron logging for porosity, *Geophysics* **32** (1967) 60–68.
- [3.35] TITTMAN, J., SHERMAN, H., NAGEL, W.A., ALGER, R.P., The sidewall epithermal neutron porosity log, *Trans. AIME* **237** (1966) 1351–1362.
- [3.36] AUZERAIS, F.M., ELLIS, D.V., LUTHI, S.M., DUSSAN, V., PINOTEAU, E.B., Laboratory characterization of anisotropic rocks, SPE 20602, paper presented at 65th Ann. Tech. Conf. and Exhibition of the Society of Petroleum Engineers, New Orleans, LA, Soc. Pet. Eng., Richardson, TX (1990).
- [3.37] KENYON, W.E., Nuclear magnetic resonance as a petrophysical measurement, *Nucl. Geophys.* **6** (1992) 153–171.

4. MEASUREMENT METHODS

4.1. INTRODUCTION

In considering the application of different measurements, it is important to understand not only their potential benefits but also their limitations. In this chapter, we attempt to present the factors that are important for providing the information that not only allows an evaluation of the potential benefits of different nuclear geophysical techniques, but also includes information that may alert potential users to situations where the benefits are not realized. The factors controlling the usefulness of various measurements under field conditions include an understanding of the environment in which the measurements are made, the spatial scale of the measurement methods, the basic reliability of the individual methods and their relevance to solving particular problems. It should be noted that many of the techniques applied under laboratory conditions are not discussed. This is because a great deal of literature is readily available which provides this information on particular methods. In addition, many of the complicating factors that occur for measurements made in the field can be controlled carefully, or eliminated completely, under laboratory conditions. The chapter also omits discussion of many of the applications used for process control in surface installations, because generally the details of these applications depend strongly on the parameters of each application, making it difficult to perform broad generalizations, even when a single measurement technique is considered. However, the chapter presents some discussion on X ray and tracer techniques in monitoring applications to mineral processing. For those readers that are interested in this area, however, the following discussion will present some general physical considerations; the technical literature on particular techniques should be consulted.

4.2. SCALE OF THE METHODS

The basic scale of nuclear geophysics methods is determined by the transport of the particles used to make the measurements. In nuclear geophysics, the particles used are generally neutrons, γ rays and X rays. X rays from atomic levels have a very short transport range because of their low energy. For the types of material encountered in nuclear geophysical applications, the mean free path ranges from hundreds of microns to several millimetres, depending on the X ray energy and the Z_{eq} of the material. Therefore, measurements involving X rays really only sample just below the surface of an extended medium. In some cases, the term X rays is also used in referring to bremsstrahlung, which has the same properties as X rays, and to γ rays of correspondingly low energies. However, this shallow depth of investigation presents

no impediment to the application of X ray fluorescence (XRF) or X ray preferential absorption (XRA) methods for the accurate analysis of homogeneous samples and slurries.

As was mentioned in the previous chapters, γ radiation, typically in the energy range from 0.5 and 10 MeV, has transport properties which depend on the energy of the radiation. However, a general rule is that the γ rays can sense a depth into the sample of some tens of centimetres. Neutron transport also depends on the energies of the neutrons. If thermal neutrons only were used, the depth sampled would be a few tens of centimetres. Higher energy neutrons, such as the 14 MeV neutrons produced in neutron generators, can travel farther. However, for all neutron energies the transport is strongly controlled by whether or not hydrogen is present in the environment. In addition, the transport of thermal neutrons depends strongly on the presence of elements with unusually high absorption cross-sections. In some situations, neutrons can sample a depth into a sample matrix of close to half a metre. It should, however, be noted that regardless of what the depth of a measurement is quoted as, most of the signal will come from much closer to the measuring equipment (source and detector) than is indicated by the depth value. This is because all transport primarily has an exponential dependence on the distance from the source.

4.3. ENVIRONMENT OF THE METHODS

4.3.1. The subsurface

As was mentioned in the previous chapter, there are several environments in which nuclear geophysical measurements are made. Two of the environments of interest are the subsurface of the terrain and the mineral processing plant. The measurement techniques chosen for discussion in these environments are neutron–gamma ray techniques for the subsurface, the radioactive tracer for both the subsurface and the mineral preparation plant and the X ray techniques for the mineral processing plant.

Most subsurface measurements are performed by placing an instrument into a borehole drilled through a rock formation that is expected to have economically recoverable economic resources. The purpose of the measurements is to determine the actual presence of the economic resource, to quantify its extent and to gain information on its geological context that may be relevant to its commercial recovery potential [4.1, 4.2].

The need to make measurements from within a borehole, however, introduces two basic constraints on nuclear techniques from the borehole environment: a geometrical constraint and the presence of uninteresting material which, therefore, contaminates the measurement. The geometrical constraints can be visualized most

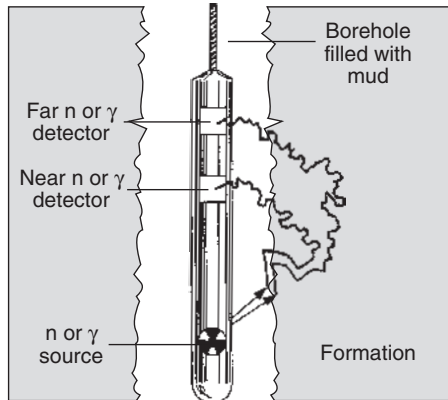

FIG. 22. Schematic representation of a generic logging tool in the borehole. The borehole is typically filled with mud.

easily, as can be seen in Fig. 22, which shows a generic nuclear logging tool located in a borehole. All equipment must be contained in a cylindrical pressure housing in order to withstand the ambient pressures. For oil and gas exploration, the pressures may be as high as 150 MPa, and the temperatures routinely reach 150°C or higher.

For the in situ borehole analysis of solid resources, the borehole depths for investigations are generally only hundreds of metres, rather than thousands of metres as for oil, so that the operating temperatures and pressures are accordingly lower. Nonetheless, they must still withstand significant pressures and temperatures, and often measurements must be made from within boreholes filled with material. The measurements are contaminated since often wells are drilled with mud present in the hole; this mud usually becomes part of the total measurement and, since a pressure gradient is maintained between the hole and the surrounding rock, a mud cake is formed on the surface of the rock. In many circumstances, a steel casing is cemented into the well in order to avoid a borehole collapse. Some, or all, of these materials may be present in a particular borehole for evaluating an economic resource. However, in some situations, the mining companies or the drilling contractors are willing to flush the hole clean of drilling mud.

Some factors complicating subsurface nuclear geophysics measurements can be illustrated by considering the apparently simple problem of determining the concentration of aluminium (Al) in the formation rock, using an interpretational relationship for the determination as was described in Section 2.3. The basis of the measurement method is the use of a ^{252}Cf neutron source and a γ ray detector to measure the delayed activity from the $^{27}\text{Al}(n,\gamma)^{28}\text{Al}$ reaction. To determine the absolute elemental concentration of aluminium from the measured count rate involves many geophysical parameters. The borehole and formation macroscopic thermal neutron absorption

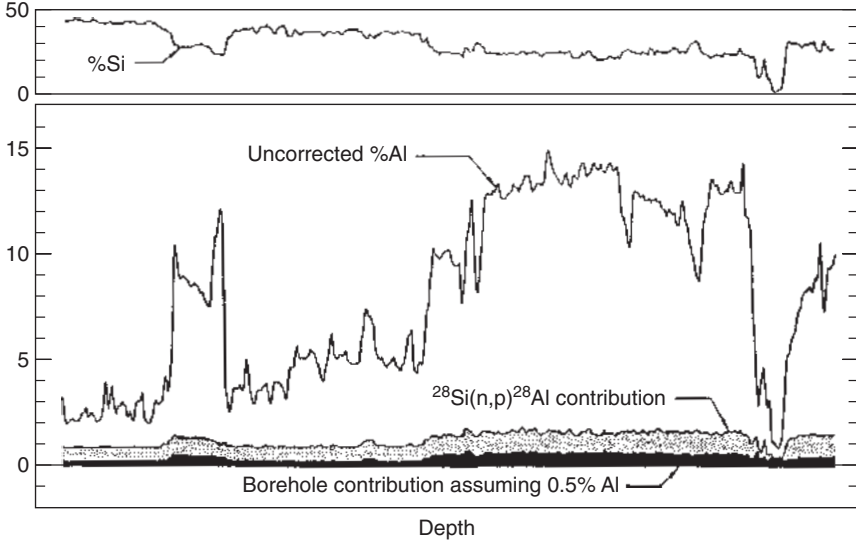

FIG. 23. Total measured contribution of delayed activity from ^{28}Al , showing the contributions from Al present in the borehole and the contribution from the $^{28}\text{Si}(n,p)^{28}\text{Al}$ reaction produced by the neutron flux in the formation with a ^{252}Cf source and with a rock Si concentration as shown in the upper curve.

cross-sections, Σ_{bh} and Σ_{form} , the neutron slowing-down length, L_s , the bulk density, ρ , the logging speed and the borehole size are all required to determine the correspondence between the detector counting rate and the aluminium content of the rock. In addition, it is necessary to ensure that the source strength and the efficiency of the detector have been calibrated carefully. After correcting the count rates for the speed of the logging tool during the measurement, the weight per cent of aluminium, η_{Al} , is given by:

$$\eta_{\text{Al}} = N (\Sigma_{\text{bh}})^{0.25} (\Sigma_{\text{form}} + 14.5) (L_s + 12.3)^2 / \rho (1 + 3.64e^{-\text{DIA}/13.9}) \quad (7)$$

where N is the background subtracted, velocity corrected counting rate and DIA is the borehole diameter in centimetres.

Thus, a proper determination of elemental concentrations requires reliable information on many geophysical parameters, as well as the specific spectroscopic information related to the individual element. In addition to the importance of this information for determining elemental concentrations, these factors also determine the accuracy and precision of the measurement. A knowledge of the accuracy and precision of elemental concentrations is important for intelligently using all types of

geophysical and elemental data. Finally, the calibration of the delayed Al activation measurement requires a laboratory formation of known Al content as an absolute standard, an on-location shop calibration procedure to account for tool-to-tool variations and a field environmental correction algorithm, as shown above, to account for variations in neutron and γ ray transport introduced by the relatively large medium of investigation.

All these procedures ensure that γ rays detected from the $^{27}\text{Al}(n,\gamma)^{28}\text{Al}$ reaction with the Al nuclei of the formation will be properly transformed into Al concentrations of the formation. There are two other sources of ^{28}Al γ rays that contribute unwanted background to the measurement: silicon in the rock and aluminium in the mud.

The ^{252}Cf source used for the delayed activation measurement has a relatively low mean energy of 2.35 MeV, but a significant fraction of neutrons are emitted above the 3.9 MeV threshold energy for the $^{28}\text{Si}(n,p)^{28}\text{Al}$ reaction. The measured Al activity will then contain some amount due to the presence of silicon in the rock. A correction must be made to the measured Al count rate before converting it into a concentration of Al. Thus, to determine the Al concentration with reasonable accuracy, it is first necessary to determine the Si concentration. Any uncertainty or inaccuracy in determining the silicon concentration further increases the uncertainty and decreases the accuracy of the Al measurement. Fortunately, for even the most siliceous rock, when the measurement is done with the ^{252}Cf source, only a small equivalent weight per cent of Al is due to Si. Figure 23 shows (in light shading) the portion of the apparent Al weight per cent which is due to the $^{28}\text{Si}(n,p)^{28}\text{Al}$ reaction for a typical well section. In shaly sands the contribution is, typically, around one weight per cent. It does not exactly track the Si concentration that is shown in the figure, as one might first expect, because the environmental corrections applied to each reaction mechanism are different. Thermal neutron environmental corrections are needed for the normal Al measurement. They are not, however, appropriate to the fast neutrons producing the (n,p) reaction, so the difference between these corrections must be accounted for when converting the silicon weight per cent obtained from a thermal neutron capture reaction to the contribution to the ^{28}Al activity produced by the (n,p) reaction on silicon.

The second problem for delayed Al activation measurements in typical boreholes is the presence of the mud, which will frequently contain Al bearing minerals. The measurement cannot separate the Al in the mud from that in the rock, thus it is necessary to correct the measured Al concentration for the contribution from the mud. The parameters needed are the Al content of the mud, determined from the input constituents of the mud system or, preferably, from a measurement of the Al content in a sample taken from the mud circulation system, and the size of the borehole. The dark shaded area in Fig. 23 is the calculation of a hypothetical borehole contribution assuming a 1.2 gm/cm^3 mud containing 0.5% Al by weight: a concentration that is

perhaps on the high side but not uncommon. While the calculated contribution for this constant borehole Al concentration varies considerably with the environment, a good rule of thumb would be that the borehole Al contribution to the apparent formation Al weight per cent is nearly equal to the weight per cent Al in the borehole fluid. Naturally, like most measurements, the amount of the correction depends strongly on the size of the borehole. An increase in the borehole size will cause a dramatic increase in the borehole contribution to the total measurement, because the amount of Al in the borehole will increase with the square of the increase in the borehole radius. Furthermore, of course, the contribution from the Al in the formation rock will decrease.

4.3.2. Tracer techniques

Radioactive tracer techniques have numerous industrial applications. They have long provided a tool for sensing specific material because the radioactive tracers emit radiation that can be detected without separating the tracer from the material in which it is present. Also, since the chemical nature of a radioactive isotope is the same as that of a non-radioactive isotope of the same chemical element, it can be incorporated into the chemical compound to be used as a tracer and will then behave in the same way as the non-radioactive compound.

In the laboratory, or in surface located industrial applications, tracers have often been used to analyse processes, for identifying inefficient components or ones that show unusual wear. In subsurface use, tracers have long been used to study hydrological systems to evaluate aquifer properties.

One sector of industry in which their applications are particularly important is the petroleum resources industry, both in exploration and production. This industry sector uses two main types of tracer techniques, the radioactive indicator method and the neutron tracer method (NTM). The radioactive indicator method introduces artificial or natural radioactivity either in solution or as radioactively labelled sands. The mode of operation for the NTM entails the injection of non-radioactive, strongly neutron absorbing substances. In the application of either technique, the range of penetration of the substance into the material matrix is determined by its permeability while the amount of material contained depends on its effective porosity. When such materials are injected into oil wells, increased porosity essentially results in an increased response of a detector monitoring the radioactivity in a borehole if the material injected was a radioactive tracer. This results in a reduced neutron detector response to a neutron source, in the case of applying NTM. In well logging, these methods are used for estimating the dynamic porosity and the permeability of the formation or may be applied in monitoring the technical and operational conditions of boreholes.

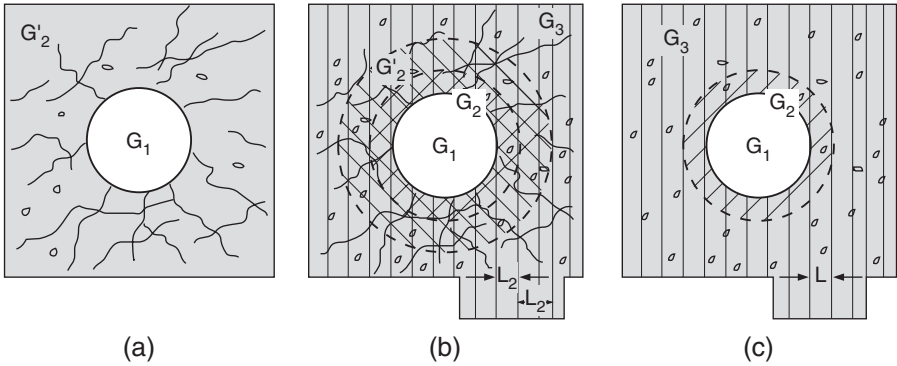

FIG. 24. Reservoir types used in the radiotracer technique petrophysical model (D.A. Kozhevnikov): (a) fractured reservoir with compacted, homogeneous, virtually impermeable matrix; (b) porous reservoir with heterogeneous, porosity cavernous matrix; (c) intergranular porous reservoir with homogeneous permeable matrix. (G_1 is the radial geometric factor (RGF) describing the borehole; G_2 is the RGF for the penetration zone of tracing fluid due to porosity channels; G_3 is the RGF for the undisturbed part of the bed.)

For the radioactive indicator method, there are a number of different strategies with their special applications. Tracers of labelled tritium (^3H) are used to determine the flow or filtration characteristics which may exist between a number of oil wells intersecting a petroleum reservoir. The filtration characteristics (i.e. speed and direction of the flow) of the inter-well matrix are determined by the arrival time of the tracer radioactivity, monitored at the production well, after injection of the tracer at a pumping borehole. This technique may also reveal the existence of structural heterogeneities in the reservoir. Figure 24 shows the types of structures encountered in oil reservoirs which are often satisfactorily interpreted through the use of these tracer methods. Other applications, using cyclic pumping into the well of short lived isotopes such as ^{24}Na and ^{82}Br , which are selected for ecological reasons, are used to determine their operational condition. Radioactive gases are used as tracers for determining the permeability and the dynamic porosity in petroleum reservoirs with complex structures and mineralizations.

The borehole tracer method for determining permeability and dynamic porosity consists of the following phases: background γ ray measurement, filling the borehole with a tracer bearing fluid, a control γ ray measurement, washing the hole itself of the tracer, and the final borehole measurement of the tracer residues left in the formation.

In the oil and gas industry, tracers have frequently been used to evaluate flow properties over long distances. As γ ray detectors and their associated electronics evolved, they became capable of detecting the individual γ rays contributing to the spectrum. This made it practical to use multiple radioactive tracers and to decompose spectroscopically the contribution of each component to the total spectrum observed.

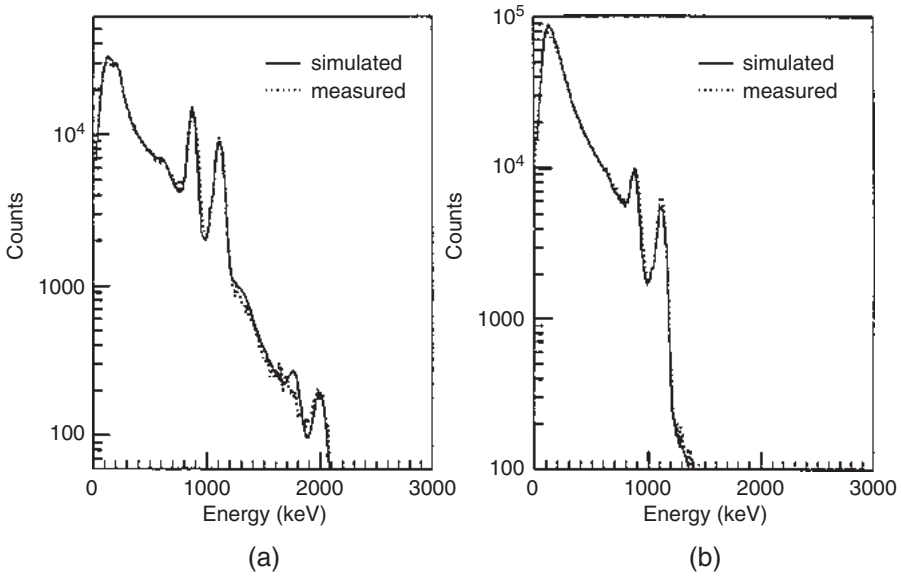

FIG. 25. Comparison of measured and numerically simulated spectra of a ^{46}Sc tracer: (a) tracer in the borehole fluid; (b) tracer in the formation.

This is has resulted in the use of these techniques to solve more complicated problems. For example, different tracers can be introduced into injection fluids in multiple injection wells, and the fluids detected at a producing well can be analysed to determine how much of the fluid reaching the producing well comes from each injection well. Radioactive tracers have also been used in conjunction with spectroscopic γ ray detection to determine the efficiency of hydraulic fracturing, to determine the efficiency of different stages of gravel packing and to monitor diameter and vertical extent of a cement column. Of particular interest in better applying such techniques was the recognition that some information on the radial distance of the tracer from the tool in a borehole can be obtained by analysing the shape of the detected spectrum [4.3]. Gamma rays that originate near the tool, i.e. in the borehole or on the surface of the rock, have higher photopeak-to-Compton ratios because they have had less opportunity to scatter in intervening material before reaching the γ ray detector in the tool. Gamma rays originating from within the formation rock are much more likely to experience one or more Compton scattering events in the intervening material before reaching the γ ray detector in the tool located in the borehole, and will have a lower photopeak-to-Compton ratio. This effect is clearly seen in Fig. 25 [4.4]. The spectra from ^{46}Sc have dramatically different photopeak-to-Compton ratios when

the tracer is in the formation than when it is in the borehole adjacent to the logging tool. The solid curves in the figures are simulations of the responses based on Monte Carlo calculations. Such a technique has been applied to determining the efficiency of attempts to fracture the formation rock hydrostatically to increase gas and oil production.

The packing of fractures with sand readily provides a simple example of this enhancement. In this application, it is frequently desired to determine the effectiveness of the fracture supporting operation based on using the sand propping technique. Therefore, it is desirable to know the heights of both the sand in the fracture and the fracture itself. In order to measure these parameters, different tracers are used in the fracturing fluid, which opens the fractures, and in the 'propanant', i.e. the sand-slurry mixture that would keep the fractures from resealing. The sand used for packing the fracture is provided with an admixture of tracer labelled sand which provides a measurable vertical marker for a natural γ ray probe. A spectrometric measurement, as a function of depth in a well, will then clearly separate the material in the borehole from that having penetrated into the formation. This enables a determination of the location of the induced open fractures in the rock which potentially produce hydrocarbons. From this measurement, it is possible to infer the radial extent of the fracture.

The use of spectrometric methods provides a better estimation of the permeability of the zones behind the borehole wall by quantitatively monitoring the penetration of an injected tracer. As has already been indicated in this chapter, the ratio of peak height to Compton continuum height varies with the path length the γ rays must take before detection. As a result, those spectra of tracers that are recorded under conditions of low tracer penetration in the medium (i.e. low matrix permeability) will reveal a much better spectral definition in terms of the peak-to-continuum ratio than those recorded for conditions of high permeability. The tracers required in these applications should emit high energy γ rays for adequate rock penetration, while conforming with ecological requirements of short isotopic half-life. Several tracers satisfying these requirements are ^{46}Sc , ^{131}I , ^{192}Ir and ^{198}Au , which have half-lives ranging from 3 to 84 days, emit γ rays in the energy range of 300–1100 keV and hence have a rock penetration of up to 30 cm [4.5]. The quantitative estimation of tracer penetration is accomplished by calibrating spectral responses in models against different conditions of simulated tracer penetration. The models are tanks of sand saturated with a tracer bearing fluid. They are assembled in the form of separate concentric regions which surround a central borehole to simulate the various identifiable zones existing behind the borehole. The annular dimensions of the zones are adjustable to simulate the varying range of tracer penetration into the formation. A library of recorded spectral responses is thus accumulated to provide the basis for deducing the range of tracer penetration which occurs in an actual field measurement, i.e. it is used for the process of deconvoluting the field data. The same technique can

be used to determine whether a tracer labelled fluid exists inside or outside the well casing.

Radioactive tracers also assist economic operation of mineral processing plants by monitoring, during a tuning operation, the efficiency of each of the various stages of the low ore grade beneficiation processes which precede smelting of the treated ore. A detailed description of the various stages of the process [4.6] is beyond the scope of this chapter. Nonetheless, it is worth noting that they comprise various iterative grinding and classification procedures, which are followed by flotation to separate the enriched ore from the gangue. The tuning operation consists of monitoring the radio-tracer in the input stream of the particular industrial unit, at the point where it is injected as a pulse, and at the output. The delay indicates the flow velocity while the dispersion of the tracer, which is apparent at the output detector, indicates the degree of mixing occurring during the particular stage of the process. The parameters characterized by this monitoring procedure are the mean residence time, the intensity of mixing, the separation coefficients and the phase flow velocity, where there are more than two phases in the mixture.

Generally, tuning operations are brief to avoid disrupting the industrial process, the radioisotopes used are short lived to minimize ecological impact and the activity is minimal to ensure safety of personnel. The tracer is monitored at the point of injection into the input of each process.

A low cost process for radioactively labelling copper ores is accomplished by neutron activating the coarse ore samples (to produce ^{64}Cu , of $T_{1/2} = 12.4$ h), which are then added to the input stream and used to monitor the materials passing through the grinding circuits. The tracer method effectively provides reliable data about the input feed rates required to achieve a good value for the fraction of ore ground successfully. This enables plant operators to decide on the appropriate balance between feed rate and power consumption to achieve the most economic operating conditions. Similarly, the flotation process is monitored for loss of still activated copper in the tailings (i.e. the gangue which sinks in the flotation plant), where the problem has as probable causes either incorrect grinding or mechanical problems in scooping off the floated copper ore rapidly enough. Also, if an undue level of radioactivity is apparent in the material captured in the hydrocyclone batteries, this material is returned for further grinding before being resubmitted for classification.

4.3.3. X rays and mineral processing

The techniques supporting the on-stream analysis in mineral and coal processing plants are X ray fluorescence (XRF) and X ray preferential absorption techniques, the latter being used to determine the concentrations of elements of high atomic numbers (Z), e.g. uranium, lead, zinc and tungsten [4.7]. The densities of the

slurry and the solids are required and are determined by X ray absorption. In addition to this, a variation of the XRF method for in-stream slurry analysis, based on the use of primary X rays of two different energies, has been devised in Poland for providing data for the control of particle size [4.8].

The most commonly used source–sample–detector assembly is of the direct excitation type in which the irradiating source is positioned between the sample and the detector, which is uppermost. The system is arranged so that the detector is shielded from the source, and a filter, between sample and detector, screens out unwanted fluorescent X rays. For example, in zinc ore slurries the desired filter is made of copper, which transmits zinc X rays to the detector but filters out as unwanted radiation the K X rays of iron and the L X rays of lead. Where processor control is required of slurries with very low concentrations of the desired mineral, appropriate balanced filters are used, which are fabricated of neighbouring elements in the periodic table. They are balanced in regard to the product of the mass absorption coefficient and the surface density of the filter, so that the use of the two filters creates a transparency band (or so-called pass band) for the X rays of interest. This transparency band lies within an absorption band that filters out the unwanted X radiation. In the case of low zinc concentrations in the slurry, the balanced filters used in separate measurements are made of copper and nickel. Then the difference between the count rates recorded using the two different filters represents the count rate of the desired X rays. The fact that separate measurements are needed means that on-stream analysis requires two separate detectors for each chemical element analysed [4.7].

An even more sensitive technique for low concentration elements includes the use of a radiator which effectively discriminates against X rays causing interference on the low energy side of the spectral peak of the X rays being measured. The purpose of the radiator is to accept, and to respond to, the fluorescent radiation emitted from the sample. If this radiation includes two X rays of nearly the same energy, with the X ray under investigation having the higher energy, the suitably selected radiator will in turn fluoresce in response to the X ray of the higher energy, but will be unresponsive to that of the lower energy. The equipment is so configured that the detector ‘sees’ only the X rays emitted by the radiator. The intensity of the higher energy X rays scattered from the sample is measured by using a second radiator with an atomic number that is appreciably larger than that of the first filter. This fluorescent X ray emission from the second filter provides a basis for compensating the absorption of the desired X rays in the matrix which contains other absorbing elements. In the case of nickel, one likely absorbing element may be iron [4.7].

Apart from the effects of filters and radiators, the performance of slurry analysers based on EDXRF technology depends on the choice of sources and detectors. The choice of sources is determined by the atomic number of the elements under investigation, and those commonly used include ^{241}Am , ^{109}Cd and ^{153}Gd , which emit radiation of energies of 59.5 keV, 22–25 keV and ~100 keV, respectively, only the

latter being applicable to the analysis of the K X rays of the heavy elements (e.g. lead). However, if analyses are required of even heavier elements (e.g. uranium) it is necessary to measure the X rays emitted through L shell de-excitation processes. Generally, the choice of the radioisotopic source and that of the filter is determined by the elemental analysis required and, also for the source, by its half-life. However, the low power X ray tube provides a feasible, attractive, if more costly and more complex alternative to the radioisotope as a radiation source. One feature is an arrangement of chemical–elemental filters so as to yield selected, almost monochromatic radiation. It enables an X ray diffraction measurement (XRD) in addition to that of XRF, in order to provide information on the different chemical forms of the investigated metal and their relative concentrations [4.9].

In the case of detectors, the choice is more complex. For most purposes, the choice lies between scintillation detectors and proportional counters. However, in addition to the normal analytical requirements, in some concentrator plants there are tailings streams requiring the high sensitivity that is only available through the high energy resolution of the liquid nitrogen cooled silicon detectors (i.e. lithium doped silicon).

4.4. RELIABILITY OF THE MEASUREMENTS

It would be nice to provide a table that has a list of the type of measurement in one column and a number that gives the quality of the measurement in the second column. Unfortunately, the preparation of such a table is essentially impossible. This is particularly so for measurements that are performed under (variable) field conditions. Therefore, instead of trying to characterize the reliability of all techniques quantitatively, we will discuss a number of common features that affect the reliability of the measurements, even though each particular factor has a different impact on each measurement technique.

The first thing that must be understood is that there are different quantities that relate to the quality of any measurement. The first of these is the accuracy which indicates whether an answer is actually correct or not. There are many different factors that can affect the absolute accuracy of a measurement, but an example for one such factor is the correctness of a calibration procedure and its tie to an absolute standard. The second factor is the precision of the measurement. The precision of a measurement reflects the fact that essentially all nuclear measurement techniques are based on a counting of events. Thus, at a particular time of a measurement, there is an uncertainty due to how well any counting of random events reflects the ‘true’ value. A third concept that is often used, but is difficult to relate directly to either accuracy or precision, is the concept of repeatability. This concept is simply stated as the difference between a set of measurements that are repeated with the same equipment. While statistical precision clearly provides a lower bound to the

repeatability, many other factors can cause it to be worse than one would expect. However, one should realize that poor repeatability does not necessarily mean that there is anything wrong with the nuclear geophysical measurements as such. It may merely reflect the inability of the measurement operation to deal with the variability in the environment of the measurement. One example for this variability could be the effect of a mineralogical heterogeneity where a small volume of investigation measurement is performed and where the equipment takes slightly different paths over the sample during repeated logging runs. The problem here may not be with the nuclear measurement technique or the equipment, but rather with the initial selection of the technique to be used for the particular problem. It should have been recognized whether a technique with a large enough volume of investigation so as to average over the heterogeneities should have been selected, or whether there is the need for an entirely different method of dealing with this type of sample.

The basic reliability of equipment is provided by the manufacturer or the group performing the service. There are real differences between equipment manufactured by different sources or run by different service organizations. It is not always easy to filter through the information to select the optimum equipment or service. However, the real problem in reliability is not the rating for equipment operated under ideal conditions, which are those that are usually specified. The real problem lies in the differences in performance obtained under severe or variable conditions. This information is generally very difficult to find without being very familiar with the technical literature. Another important feature is to know beforehand how the equipment or service will be used.

If one is working at low temperatures only, for example, there is no need to use equipment with an extremely high temperature rating. Conversely, if one requires high temperature operation, equipment that is not fully rated will never give satisfactory results. While this is a trivial and, indeed, self-evident statement, one often forgets that the use of measurements or equipment can be most efficient when they are tailored to the measurement environment. In other words, the more is known about the measurement environment and the data needed to solve the problem, the more intelligent a decision can be made with regard to selecting equipment and services. Real differences exist between different manufacturers and service organizations. The best and most economical solution to a nuclear geophysics problem can only be obtained by intelligent analysis of the problem before obtaining the equipment or service.

4.5. RELEVANCE OF THE MEASUREMENTS

Nuclear geophysics measurements and techniques have established themselves all over the world as critical components in both scientific studies and economic

development. This obviously indicates that nuclear geophysics measurements and techniques are particularly relevant to the understanding of, and the solution to, a diverse set of problems in a wide variety of subjects.

However, the fact that they are generally relevant does not alleviate the problem of deciding when they are relevant in a particular area. Unless they have already become standard practice, as has often been the case, each user must evaluate their applicability in solving new problems or in deciding whether they can be applied in a new area. Thus, there is no substitute for understanding the different techniques in order to know when they can be applied or adapted to a new situation. A reasonable level of expertise will enable the user to know when a particular measurement technique can be used. However, one often forgets that in only a very few cases does a measurement actually provide the information that is desired. As a trivial example, it is often desired to know the bulk density of a sample. However, γ ray scattering measurements actually measure the electron density, not the bulk density. Under normal circumstances in a particular environment, there is good correlation between the electron density and the bulk density. However, when used in a new environment, it would always be important to ensure that the relationship between electron and bulk densities is valid. Otherwise, excellent measurements might be obtained that are, unfortunately, completely wrong.

This situation reflects the fact that the parameters of interest in geophysics are actually not those directly measured by the measurement techniques. The relationship between what is measured and the information that is desired must always be kept in mind so that an intelligent decision can be made on the usefulness of particular measurements. The key feature to remember is that each technique measures a particular phenomenon, e.g. γ ray counting rate, neutron counting rate, particular γ ray line intensities, time responses. Generally, the phenomenon that is measured is of no interest to the users of equipment or services. The method that is used to relate what is measured to the desired information becomes critical for knowing whether any valuable data will be obtained. The assumptions that are implicit in the analytical procedure for converting the measured quantities into the quantities that are desired are critical for knowing when the measurements can be applied with some degree of validity for a particular application. (In the context of the previous chapters, the quantities measured are the instrument response parameters and the quantities desired are the industrial or geological parameters.)

4.6. EMERGING TRENDS

Trends for the future are always difficult to predict with any accuracy. Most projections turn out to be incorrect in hindsight. However, even with a low likelihood of being correct, it is often worth while to consider what is currently changing in a

technical area and to see how these changes are likely to continue into, at least, the near future. For the technical area of nuclear geophysics, a large number of topics can be examined. A primary factor is, of course, the motivation for its application. One can ask whether or not the interest in using such techniques is likely to increase or decrease. There are many technologies that are generally used in nuclear geophysics measurements. Without attempting to be complete, we quote a few areas that are central to almost all nuclear geophysics applications: sources of radiation, detectors of radiation, electronics for controlling and processing signals, and computational capabilities.

The motivations for using nuclear geophysics techniques are currently the exploration for, and the exploitation of, natural resources and the analysis and remediation of problems in the environment. A group of motivations that lies between the two principal ones just mentioned includes the desire to have more effective control of the practices of agriculture and civil engineering. Chapter 6 will give examples and will discuss how these matters are resolved.

It is clear that (apart from the naturally radioactive minerals) instrumental neutron activation analysis (INAA) is an important option in the earliest stage of exploration, i.e. in geochemical mapping. In general, the role of nuclear techniques increases (or should increase) as evaluation progresses towards an operational mine. Nuclear techniques (EDXRF, preferential absorption and γ - γ density) have an established role in on-stream analysis, and radiotracers have found an important use in the design and operation of mineral processing plants as well as in numerous applications to the petroleum industry.

It appears, therefore, that the search for raw materials will provide a slowly increasing need for improved and more extensive applications of nuclear geophysics techniques. The environmental area is more difficult to discuss quantitatively since it has only recently emerged as an area of significant concern. However, recent trends, together with our increasing understanding of the problems which have been created in the environment by unintended consequences of industrial and human activity, indicate that the needs in the environmental area may increase much more rapidly than in the longer established areas. It is likely that environmental concerns will require both less expensive and more sophisticated analytical techniques. These seemingly contradictory requirements are driven by the combination of a widely distributed extensive number of individual sites that will have to be characterized and the recognition that many environmental problems require the identification of extremely small quantities of specific materials. This will require instruments with better sensitivity than can be currently achieved. In addition, to guide remedial efforts in polluted areas, it will often be necessary to have a much more extensive knowledge of the geology of the area than is currently available. This will undoubtedly lead to new types of measurement, some of which will almost certainly use nuclear analytical techniques.

Future trends in instrumentation are somewhat easier to project. This can be done by considering both recent developments and some of the research that is currently being undertaken. The development of new techniques is not as easy to anticipate. An approach, however, that is developed for laboratory measurements will often be attempted for field or facility use if the equipment can be appropriately configured. One can start by considering the fundamental components of a system used for nuclear geophysics measurements. All except the natural radioactivity measurements require some form of source to initiate a measurement. Gamma ray sources have been used for density (and photoelectric cross-section) measurements. For density measurements, a source is desired that has an energy where the transport is dominated by Compton scattering. As was previously mentioned, the basic constraint is that the source γ rays have an energy higher than a few hundred keV and not more than one and a half MeV. While there are a number of radioactive sources that produce γ rays in this energy range, most γ ray scattering devices use ^{137}Cs ($E_\gamma = 662$ keV). Those methods that include automatic compensation for diameter variations in rough dry holes use ^{60}Co ($E_{\gamma 1} = 1170$ keV, $E_{\gamma 2} = 1332$ keV). Even those measurements that attempt to measure the photoelectric cross-section typically use the ^{137}Cs source to achieve a significant counting rate that is sensitive to more than just the rock surface.

Commonly, both isotopic and accelerator sources of neutrons have been used. The different properties of these sources govern the source selection for a particular application. Isotopic sources, such as ^{252}Cf or $^{241}\text{Am-Be}$, have generally been used for neutron scattering measurements, thermal neutron capture reactions or delayed activation produced by (n,γ) reactions. The relatively low average neutron energies of these sources (2.5–4.5 MeV) make them impractical to use for (n,n') or (n,x) reactions.

A recent trend for improved safety in the application of nuclear geophysics techniques has been the reduction in intensity of activity of sources or even the elimination of isotopic sources. One trend in density logging has been the introduction of a system that provides a satisfactory measurement with a much weaker radioactive source than has been used traditionally. Attempts have been made also to develop fieldworthy versions of an electron linear accelerator. This type of source accelerates a beam of electrons, in this case to energies of a few MeV, which is incident on a solid target, producing a continuous energy spectrum of X rays with the maximum energy corresponding to the electron beam energy. Since the X rays produced are preferentially directed in the direction of the electron beam, the flux into the formation is maximized by having the target off-axis to the tool axis and bending the beam outward just before it strikes the target. Laboratory work with other types of accelerator where the radiation disappears as soon as the power has been turned off is currently under way. Compact pulsed accelerators that produce significant fluxes of 14 MeV neutrons from the $^3\text{H}(^2\text{H},n)^4\text{He}$ reaction allow sufficient yields to be obtained from (n,n') and (n,x) reactions. Since the 14 MeV neutrons are also

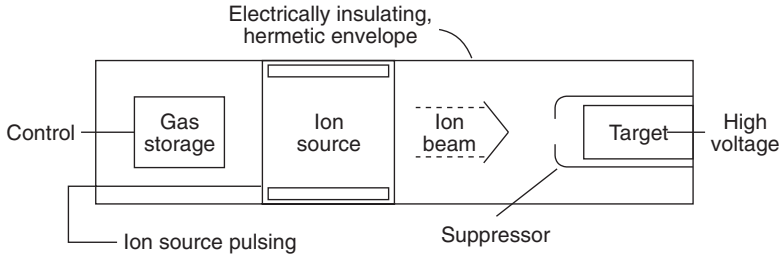

FIG. 26. Schematic representation of logging accelerator for producing 14 MeV neutrons from the (d,t) reaction. The d and/or t gas is released from a storage medium, ionized in the ion source and accelerated to a target material containing d and/or t nuclei.

moderated to thermal energies, the pulsed nature of the accelerators allows for multiple spectral measurements, gated at different times relative to the neutron burst, to heighten the sensitivity to γ rays produced by different types of reaction. The pulsed nature of these accelerators also permits unique types of measurements such as that of the thermal neutron macroscopic absorption cross-section. Much recent work has brought to the field a measurement of neutron slowing-down time, rather than of the slowing-down length, as previously used, to obtain information on porosity.

Neutron generators used for logging measurements must be small, compact, sealed devices for operating in a logging sonde. Regardless of the specific type of accelerator, they have certain features in common. High voltage must be generated internally to accelerate ions from an ion source to a target, usually a material such as scandium, that will successfully store a high density of the target species, e.g. deuterium and/or tritium. The gas must be stored in a source, such as a tungsten filament wrapped with zirconium, to maintain a good vacuum and produce the atoms to be ionized in the ion source. The beam of ions is accelerated through a suppressor, allowing for beam current monitoring, to strike the target electrode. These key elements of an accelerator used for logging measurements are shown in Fig. 26. Typical sizes for these accelerators can be as small as 2.5 cm in diameter and about 10 cm in length. Under normal conditions, outputs of about 10^8 n/s are obtained from the (d,t) reaction, using accelerating voltages of up to 120 kV. These accelerators can be run either continuously or pulsed at rates of up to a few tens of kHz. Future developments are likely to increase the reliability, lifetime, neutron output and flexibility of pulsing schemes for these types of device. Thus, in the future, one can expect that most sources of radiation used in nuclear geophysics measurements will come from devices that produce no radioactivity once the power to the devices is turned off.

A second component common to all forms of measurements is a detector, usually of neutrons or γ rays. Neutron detection is almost universally performed with

pressurized ^3He proportional counters. When epithermal neutron detection is desired, the counters are surrounded by a thin layer of a thermal neutron absorbing material such as cadmium. The ^3He absorbs an incoming thermal neutron to produce a proton and a triton having an energy of about 765 keV. These charged particles lose their energy to the counter gas by ionization. As the electrons drift to the anode wire, they encounter high electric fields, resulting in extensive ionization of the electrically neutral atoms. This multiplication process is particularly important in the logging environment, where normal shock and vibration produce microphonics in the counter. Temperature effects on the sensitivity and charge production of these counters are tied to the thermal expansion of the counter and its components. These effects are sufficiently small to maintain an accurate response over the entire range of temperatures encountered in logging. A number of other detectors have been applied to neutron detection but have not been widely used. While it is possible that other types of neutron detector will be developed with improved properties, the most likely developments with ^3He detectors are improved ruggedness, higher count rate capability and, perhaps, position sensitivity.

A great deal of research has been performed in the last decade for developing new γ ray detectors for many different areas of study. After initially using Geiger-Müller tubes, most geophysical applications started using NaI(Tl) detectors. This situation persisted for many years, and the properties of NaI(Tl) detectors defined the capabilities of remote measurements. More recently, other detectors have been used, not only for research investigations but also for commercial applications. These new detectors, primarily bismuth germanate (BGO) and cerium doped gadolinium oxyorthosilicate (GSO), have made new or improved measurements possible. Introducing a new type of γ ray detector in a field or industrial application has added difficulties when compared with using it in a laboratory application. A γ ray detector in the laboratory is considered to have invariant properties. The environmental conditions of field applications result in detector properties that are continually varying, primarily because of the variation of most detector properties with temperature. The most important of these temperature dependent properties for inorganic scintillators are the light output, the decay time and the emission spectrum. In addition, this environment usually requires maximum volumetric detection efficiency, the capacity for γ ray detection in the environment of a neutron flux, and coupling with special photomultiplier tubes whose spectral response is narrower than that of normal laboratory tubes. The light output, or scintillation efficiency, of almost all inorganic scintillators decreases with increasing temperature, although the rate of this decrease varies by almost a factor of ten. The decreased scintillation output affects the signal-to-noise ratio, the energy resolution and the gain control. The scintillation decay time also usually depends on temperature, thus affecting electronic pulse shaping and counting rate. The emission spectrum may shift with temperature and, combined with the narrower response of high temperature photocathodes,

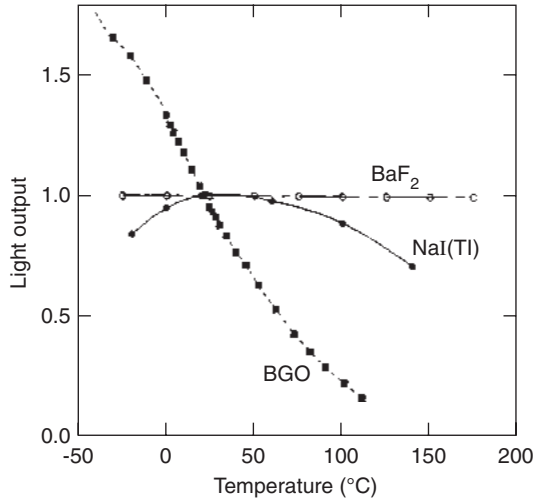

FIG. 27. Temperature dependence of the scintillation emission of three scintillators. In the case of BaF_2 , the behaviour of the 220 nm component is shown; the 325 nm component (not shown) is temperature dependent. The output of each scintillator is normalized to unity at 22°C.

requires that careful attention be paid to the compatibility of scintillator and photomultiplier. The shock and vibration encountered in the field are sufficient to damage detectors, and, consequently, mechanically rugged detectors and non-hygroscopic scintillators are preferred to avoid the need for special packaging that reduces detector size and performance.

The variation in the light output of the crystal as a function of its temperature will govern (particularly for petroleum well logging) whether the detector requires a dewar for successful operation or can be used without any cooling. Since the space for a detector is always limited, the need for a dewar restricts the size of the detector selected and puts additional constraints on its γ ray detection efficiency per unit volume.

A range of light output versus temperature responses for different types of scintillator is shown in Fig. 27. The BaF_2 scintillator, like most other scintillating chemical compounds, has more than one mode for the decay of its light output. However, the fast decay component of BaF_2 , which is of particular interest to the user, is virtually independent of temperature. The figure also shows that, by 150°C, the light output of NaI(Tl) suffers a 30% loss, while that of BGO drops by over an order of magnitude. Since the light output loss of NaI(Tl) is not severe, this scintillator is often used with a high temperature photomultiplier without any cooling. In the deep holes required for nuclear petrophysical applications, a scintillator with greater light

loss, such as BGO, requires a dewar to keep the detector from reaching ambient subsurface temperatures, which will often reach 150°C. In this case, both the crystal and the photomultiplier tube can be maintained at about 50°C or less, permitting the use of a wider variety of photocathode materials for the photomultiplier.

This temperature characteristic of BGO presents, however, few problems in most borehole logging applications to the solid minerals and coal industries. In these applications, most boreholes are relatively shallow (i.e. less than 400 m), so that the environmental temperatures are usually less than 40°C. Consequently, the maximum likely gain shift of about 30% (relative to an ambient temperature of about 20°C) is easily and automatically corrected electronically by the use of an electronic gain stabilizer.

One other detector characteristic provides a more general selection criterion: the ratio of the spectral peak area to the area of the spectral continuum. This is the factor that determines the ratio of usable information to information noise, a concept introduced in Section 2.3. It is a particularly important consideration with probe methods using spectrometry. This particular criterion depends on the following characteristics: the linear attenuation coefficient of the detector medium for γ rays, the volume of the detector and its energy resolution. Therefore, the type of application envisaged will determine the choice of detector used.

If very high energy resolution is required, as is frequently the case with X ray investigations and with certain investigations based on natural γ ray and prompt neutron γ ray spectrometries, the preferred detector is of the liquid nitrogen cooled silicon lithium type, provided that either field or laboratory site has reliable access to coolant and, also, that counting efficiency can be sacrificed. If the prime consideration in selecting a detector is the counting efficiency per unit volume for high energy γ rays (greater than 4 MeV), the total spectral count rate is only moderately high (i.e. less than 80 000 counts per second) and the temperature variation during measurement is also only moderate, BGO is probably the best choice. However, GSO is probably the better choice if a better energy resolution for γ rays is needed than BGO can offer and if some sacrifice can be accommodated (relative to BGO) on counting efficiency at high energies. Moreover, it is the more suitable detector for probe operations in a fast counting environment. Further, GSO has a temperature stability comparable with that of NaI(Tl). The scintillator with the best energy resolution is still NaI(Tl). However, unless large volume detectors are used (e.g. 10 × 10 cm), its performance may suffer from a poor peak-to-total spectral ratio for γ ray energies above 2.5 MeV.

Since data must be obtained rapidly, scintillators with shorter decay times are always preferable to allow the highest possible count rates without incurring severe pile-up losses. Two scintillators with excellent characteristics in this respect are BaF₂ and GSO. Similarly, the volume available for a detector is always limited so that detectors with intrinsically high detection efficiency per unit volume are desirable.

High detection efficiency per unit volume is primarily a result of high effective atomic number and, to a lesser degree, high density. The weight of the detectors is usually no significant factor in the selection process.

What is the outlook for the future? It appears that the research into new materials for inorganic scintillators, such as lutetium oxyorthosilicate, will result in many new detectors that can also be applied to nuclear geophysics techniques. Work on solid state devices which can replace photomultiplier tubes is well advanced for certain applications. The solid state detectors such as cadmium telluride and cadmium zinc telluride show promise for being successfully used in specific applications. Thus, it appears that the next few years will bring detectors with improved properties in that they will be more compact and will provide, thereby, improved measurement techniques or will allow previously unachievable measurements to be performed.

As was previously discussed in Section 3.3, the use of solid state nuclear track detectors (SSNTDs) enables the determination of microconcentrations and micro-distributions of particular heavy elements and particular light elements. The most common method of carrying this out is to place the sample and the detector material in close contact for irradiation with either particles or γ rays, as appropriate, to produce nuclear fission in the sample. The particular type of radiation that is suitable depends mainly on the elemental analysis required, and if more than one method is available for inducing fission, it depends also on the types of radiation beam which are available. (e.g. supplied by cyclotrons or nuclear reactors). On the other hand, the tracks found in muscovite mica caused by the spontaneous fission of ^{238}U provide data for determining the track age of the minerals which adjoined the mica, the thermal evolution of these objects and, also, their uranium concentration.

However, the most common technique involving SSNTDs is to induce fission in the samples which contain the elements under investigation and to record and count the tracks embedded in the detector material by either the fragments or the α particles released in these reactions. The track density is a measure of the elemental concentration. The most commonly used source of radiation inducing these reactions for the analytical determination of bismuth, lead, gold, platinum, iridium and osmium are beams of accelerated high energy ionized particles, e.g. deuterons, α particles and ^{16}O .

In the determination of the uranium content in rock samples, thermal neutrons are a source radiation which is conveniently used to induce fission. The fragments are released in the fission-capture reaction of thermal neutrons in the minor ^{235}U constituent isotope. This technique requires high flux irradiations by thermal neutrons, which range from 10^{13} to 10^{18} neutrons/cm², and, therefore, the use of nuclear reactor facilities. The fission fragments emanating from the surface of the sample and incident on the adjacent detector material (e.g. muscovite mica and various other crystalline materials, polycarbonates and polyterenphthalites) will record their tracks on the detector surface, which is etch treated before counting proceeds. Typically, the

sensitivity achieved for the measurement of uranium concentration is high (10^{-10} g/g).

A related but more complex technique is used for thorium determinations in the presence of uranium as the lesser constituent. It uses two irradiations: one is based on a thermal neutron irradiation to determine the uranium background content which provides the correction needed for the second irradiation, and the other one, accomplished by using very high energy γ rays, induces fission in both the uranium and thorium constituents of the samples. The sensitivity of the technique is 10^{-8} g/g, provided that uranium is a smaller constituent than thorium.

Similarly, the thermal neutron irradiation of rock samples containing boron and lithium enables the analysis for these elements because α particles are consequently emitted, thereby producing α particle tracks using α particle sensitive plastic track detectors, e.g. cellulose nitrate and CR-39.

The final area of technology with significant impact on nuclear geophysics measurements and techniques is electronics and computers. This is not an appropriate place to discuss the details of electronics and computers. The only comment that needs to be made is that developments in the electronics and computer industries are such that their incorporation into field equipment becomes continually easier and the space, time and electric power needed to perform the various logging functions are continuing to decrease. This will make it easier to implement logging results in real time from smaller instruments, a trend that can only increase the utility and application of nuclear geophysical techniques.

4.7. SUMMARY

The main objective of Chapter 4 is a discussion of the benefits and limitations of nuclear geophysical measurements, taking into consideration (in Sections 4.2 and 4.3) their scale and the environment in which they are made. In the discussion on the impact of environment, examples are drawn from particular experiences with oil well logging (i.e. the subsurface environment), the application of tracer techniques to monitoring and controlling petroleum production in an oil field and beneficiated mineralized ore in the flotation and grinding circuits of mineral processing plants, and on-stream X ray analysis of mineral slurries in mineral treatment plants. Subsequent sections of the chapter deal with reliability and relevance of the measurements, while the final section reviews future trends in nuclear geophysical measurement techniques.

In the discussion of measurement reliability, the view is taken that this term relates to the accuracy of measurement and that this depends on three different factors. One factor is the suitability of the calibration model relative to absolute

standards. Another factor is the precision of the measurement determined by the number of counts recorded, whereas the third factor is the repeatability of the measurement, which is subject not only to counting statistics but also to variations in the environment of the measurement. In the discussion on relevance, the issue taken into consideration is whether the geophysical parameter measured is related accurately to the material parameter in question. An example is given concerning the questionable relevance of the γ ray backscatter measurement of the electron density which is usually accepted as a measurement of bulk density. However, this relationship is inaccurate (i.e. not relevant) in highly hydrogenous materials. This requires caution in examining, for novel applications, the relationship between what is actually measured and the data desired.

Accurate predictions of emerging trends in nuclear geophysical measurement are difficult. They are, however, related to evolving trends in practices and applications in technical areas. The long established applications of these measurements are exploration, development and production concerning natural mineral and fuel resources and the protection of the environment. These goals will remain in high demand. New applications have appeared which include improved practices in civil engineering and agriculture.

All applications demand increased sensitivity of detector response, improved ruggedness of probe systems, greater safety for personnel and reduced impact on the environment from radioactive sources, as well as improved on-line, user friendly computer technology.

Recent improvements to the counting efficiency and ruggedness of scintillation detectors have been achieved, with the introduction of new high density inorganic scintillators (e.g. bismuth germanate), although these scintillators are frequently inferior to the long established scintillators (e.g. sodium iodide) in regard to energy resolution, temperature stability and speed of response. Developments in solid state detectors not requiring liquid nitrogen cooling (e.g. cadmium telluride) are progressing. Their utilization would enable miniaturization of probes and further improvements in detector ruggedness, although their energy resolutions are unlikely to compete with that of liquid nitrogen cooled germanium. This section also briefly discusses the solid state nuclear track detector and its applications.

The nature of the sources utilized is also changing. Electronically actuated sources are increasingly finding application instead of radioactive sources which pose threats to personnel and the environment. Two such sources, which produce no radiation without supply of electrical power, are the neutron generator, which is commonly used in oil well logging, and the linear electron accelerator for X ray production, which is currently under development. The other successful approach adopted for minimizing danger to personnel and the environment in density logging application is the use of geometrical configurations facilitating the use of extremely low activity radioactive sources.

REFERENCES

- [4.1] SCHWEITZER J.S., Nuclear techniques in the oil industry. *Nucl. Geophys.* **5** (1991) 65–90.
- [4.2] CLAYTON, C.G. SCHWEITZER, J.S., A review of aspects of nuclear geophysics, *Nucl. Geophys.* **7** (1993) 143–171.
- [4.3] GADEKEN, L.L., SMITH, H.D., Jr., A Relative Distance Indicator From Gamma Ray Spectroscopy Measurements With Multiple Radioactive Tracers, Halliburton Log Serv INC, presented at 6th SPE Middle East Oil Show (Manama, Bahrain, March 1989), *PROC* (1989) 357–356.
- [4.4] GARTNER, M.L., FU, C.C., GADEKEN, L.L., The use of nuclear simulation calculations to support applications in radioactive tracer logging, *IEEE Trans. Nucl. Sci.* **37** (1990) 943–947.
- [4.5] MILLS, W.R., ALLEN, L.S., STROMSWOLD, D.C., “Recent developments in nuclear oil well logging”, *Nuclear Techniques in the Exploration and Exploitation of Energy and Mineral Resources (Proc. Symp. Vienna, 1990)*, IAEA, Vienna (1991) 247–267.
- [4.6] PRZEWŁOCKI, K., “Radiotracer techniques in mineral processing”, *ibid.*, pp. 409–423.
- [4.7] WATT, J.S., On-stream analysis of metalliferous ore slurries, *Int. J. Appl. Radiat. Isot.* **341** (1983) 309–331.
- [4.8] HOLYYSKA, B., LANKOSZ, M., “Correction method for particle-size effect in XRF analysis of ore slurries”, *Nuclear Analytical Techniques for Mineral Exploration, Mining and Processing Plants: Working papers in connection with the final research co-ordination meeting of the IAEA, Nov. 1986, Melbourne, Australia (1987)*, IAEA/RL/139, 167–80 (internal paper).
- [4.9] VARMOLA, K., “Development towards an integrated on-stream analyser system for the mineral industry”, *Nuclear Techniques in the Exploration and Exploitation of Energy and Mineral Resources (Proc. Symp. Vienna, 1990)*, IAEA, Vienna (1991) 135–149.

5. INTERPRETATION

A theme developed in earlier chapters is that the practice of nuclear geophysics entails the stimulation of processes in atoms and, in particular, in their nuclei, using nuclear radiation for the purpose. This stimulation causes the emission and the consequent detection of radiation by a probe. The signals resulting from detection are recorded, either simply as the occurrences of events during a particular time interval or as an already transformed and processed quantity, as for instance the P_z ratio. The procedure of processing the probe responses commonly provides its output in the form of a spectrum of signal intensities corresponding with the energy spectrum of the detected radiation recorded in a specified time. Alternatively, the data may be recorded as a spectrum of the occurrence, in time, of the detected events over a particular sampling period. This chapter deals with the question of how the recorded events are interpreted, in either raw or processed form.

5.1. RELEVANCE OF THE ENVIRONMENT TO INTERPRETATION

For one of the techniques used in industry, the dynamic pair production measurement of mined iron ore product, it is interesting to note that the most important 'environmental' variable factor is the deflection of the conveyor belt, which, for good accuracy, must be minimized at the point of the measurement. A deflection in the belt of only 1 cm, during its operation, can result in an error of 1.5% Fe. The solution adopted is to stiffen the belt at the location of the measurement. Thus, even if there is only one factor as in this example, the ability to control it may make the difference between a measurement technique which is viable and one which is not.

Nevertheless, it is worth noting that there are various solutions to minimizing variations of the source-sample-detector geometry for similar types of measurement. One solution to this problem is that applied to the pair production gauge for determining the ash content of crushed mined coal. The solution taken is to contain the dimensions of the coal sample by feeding it into either a shaker tube or a chute tube from a by-line of the main conveyor belt. This strategy maintains the crushed sample in a reproducibly packed state and presents it with constant sample volume to both the detector and the source, resulting in a virtually fixed geometrical configuration for the measurement system.

However, there are other types of sample analysis problem where the environments for the measurements are totally controlled. They are usually standardized laboratory systems organized for the analysis of batch samples. The systems are standardized not only with respect to the sample-source-detector geometry, but also ambient temperature and humidity and, frequently, in regard to the power supplies for the system. These conditions assist in eliminating short term drifts in gain and zero threshold (where applicable) of detectors and associated electronic circuitry. The

drifts that persist are rather of a long term nature, mainly owing to the ageing of either the detector or the electronic components. Measures are, however, taken, as in all spectrometric systems, to compensate for any gain drifts through gain stabilization. Examples for techniques used in such standardized environments are X ray fluorescence, X ray diffraction and neutron activation analysis.

By contrast, however, the borehole logging and well logging measurements are carried out in environments where some of the fluctuations in environmental conditions can neither be controlled nor readily foreseen. The changes which cannot be predicted include 'blow-outs' in the diameter of boreholes and oil wells, caused by occurrences of caving where rocks are weakly consolidated, and constrictions of the holes where materials such as bentonitic clays have swelled when exposed to moisture after drilling. However, there are ways of either compensating for the variations or identifying the anomalous sections of the boreholes in order to 'quarantine' their data. It is also more difficult to maintain constancy of the ambient temperature of the operational environment under field conditions, which may cause some drift in the zero threshold, even if the gain of the system is stabilized.

5.2. SCALE OF INTERPRETATION

5.2.1. General considerations

The recommended scale of the interpretative process used depends on two considerations: the complexity of the relationship between the sought parameter and the probe responses, and the accuracy required by the operators in determining these industrial parameters.

There are different types of measurement giving rise to the complex relationships. One situation is where several probes are needed to supply all the necessary response parameters for the same sample. An example are the geochemical well logging systems which may contain a string of different probes for surveying the same zones of a well: a natural γ probe, a neutron capture γ ray probe and a neutron activation analysis probe. The data received from each probe are then combined into data sets which correspond to the same depth intervals of the oil well.

5.2.2. Relevance of technique to scale of interpretational procedures

The relevance or suitability of an interpretational system depends on the use which was initially planned for the geophysical measurement system and, in particular, on the degree of detail and accuracy required of the interpretational relationship. One category of applications most effectively illustrates the desirability of considering the necessary degree of accuracy and precision in designing the measurement. This is the on-line quality monitoring for accidental occurrences of

gangue in a generally high grade, mined product, using X ray fluorescence, natural γ ray or neutron capture γ ray analysis. If the aim of the measurement were good accuracy, it is likely that any of these three techniques would involve a complex relationship between ore grade and instrumental response parameters. However, the objective of only monitoring for occurrences of gangue could almost certainly be met on the basis of a single dominant instrument response parameter.

A specific example of this type of application is an on-line natural γ ray monitoring system which was tested at the Mt Newman mine in Western Australia of BHP for identifying occurrences of gangue on a conveyor belt bearing otherwise high grade iron ore. In this situation it is probably impossible to determine accurately the relationship between the impurity content and the signals measured in the system, because probably no universal relationship exists. This is because the mined product on the conveyor belt may be drawn randomly from different parts of the mine where the sedimentary rocks have different radiochemical properties. However, these different rock materials generally hold one property in common, which is that their specific radioactivities (i.e. radioactivity/rock mass) are much higher than that of the pure ore. Thus, given the objective of this application, the only capability which the interpretational system requires is to respond to statistically significant changes in the radioactive count rate and to record the time relative to a particular reference.

Also, because of the limited objectives planned for this operation, a more sophisticated interpretational system may not only be capital ineffective but may also detract from its operational performance. Nonetheless, there are other mining quality control applications which require a more detailed and more accurate analysis of the ore. Although significant radiochemical variation may exist in the non-ore mined product, this material has sufficient uniformity at certain mining sites to warrant the use of simpler interpretational models which nevertheless give the desired accuracy reliably.

On the other hand, if operators must make decisions, while operations are in progress in a coal washery plant, for matching the operating parameters of the washery to the impurity levels of the coal in its input circuit to ensure its optimal economic operation, it is appropriate to determine the ash content in real time by using the most accurate available model for the selected measurement technique. In regard to the actual measurement technique used, the selection must depend on the mineralogical characteristics of the coal and the variability of these characteristics.

5.3. FURTHER STRATEGIES FOR SOLVING THE INVERSE PROBLEM

Data interpretation has two key aspects: the separation of useful information from information noise, particularly by using spectral methods, and the solution of interpretational relationships.

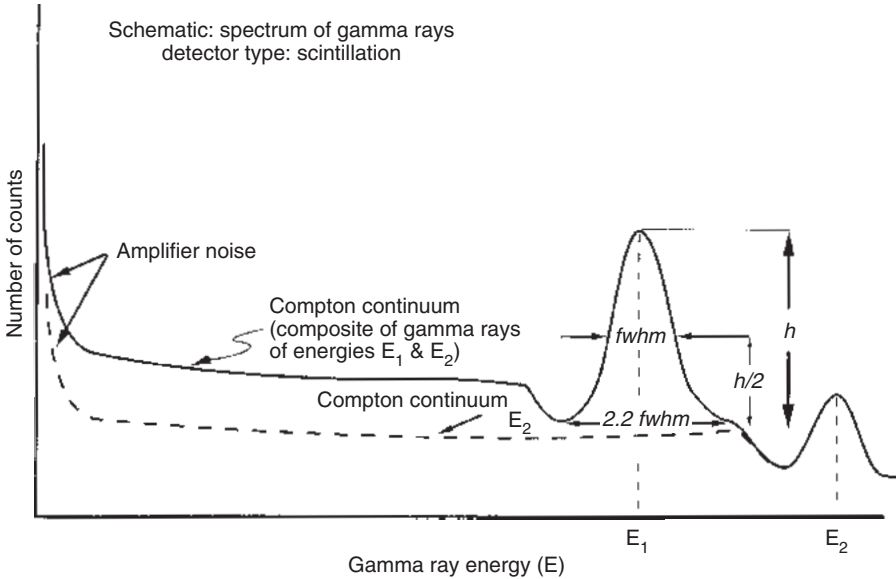

FIG. 28. Spectrum due to primary γ rays of energies E_1 and E_2 , using a scintillation detector.

5.3.1. Spectral interpretation

The current widespread practice of digitizing the analog signals output by probes has resulted in the practice of recording nuclear events spectroscopically in the form of events distributed either on the basis of their energy or as the time distribution of the events. This mode of digitally recording the information greatly facilitates further processing. The objective in using energy spectra is to identify spectral peaks and determine their area in units of count rate. The areas of the peaks represent the vital quantitative information on the concentrations of the material's chemical constituents. The spectral continuum on which the peaks sit represents the information noise because it provides no direct information on the composition of the material. Figure 28 is a schematic showing such a spectrum using a scintillation detector for γ rays of energies E_1 and E_2 .

The problem for interpretation is to separate the 'real' peak from the continuum validly and accurately. The shape of the peaks is approximately Gaussian, which makes them symmetrical to a good approximation. In principle, therefore, if the wings of the peaks are denoted by X_L and X_H , the net peak area (NPA) is the arithmetic difference between the sum of the all the peak region counts (i.e. in the

channels from X_L to X_H) and the counts in the trapezium which is represented by the expression:

$$NPA = \sum_{i=1}^n Y_i - [(Y_L + Y_H)(X_H - X_L + 1) / 2] \quad (8)$$

However, the process of accumulating counts by using nuclear methods is subject to random statistical fluctuations. In fact, the statistical processes which occur in radiation counting and, therefore, govern the precision achieved (or the error made) are random in nature and subject to the Poisson probability model. The most commonly accepted measure of the *measurement error* is the *standard deviation*, which may also be regarded as the converse of the *precision*, i.e. the smaller the error, the better the precision. The essential result which Poisson statistics provides for the evaluation of counting processes is that the standard deviation (s.d.) of the recorded count n is equal to the square root of the number of counts recorded. This is expressed mathematically as $s.d. = \sqrt{n}$.

Furthermore, the standard deviation is equal to the square root of another fundamental statistical variable, the *variance*. This is expressed mathematically by $s.d. = \sqrt{V}$, i.e. $V = n$ (in the simple case of detecting n events). However, the situation is far more complex statistically when estimating a net peak area, largely because the calculation entails the estimates for two ‘fuzzily’ defined spectral areas which arise from the detection of different γ rays.

The variance for the computed net peak area is given by

$$NPA = \sum_{i=1}^n Y_i + [(Y_L + Y_H)(X_H - X_L + 1)^2 / 2] \quad (9)$$

The s.d. for the estimated NPA is by definition given by

$$s.d. = \sqrt{V_{NPA}} \quad (10)$$

The significance of the above expression for the variance is that it represents the sum of two terms: the first term is the total count recorded in the spectral window of the peak (which is the variance of that recorded count) and the second term represents the variance of the trapezium. If the width of the peak changes, the first term only changes by as much as the continuum underlying the peak changes. The second term, however, which is the variance of the continuum contained within its trapezoidal boundary, grows as the square of the width of the peak. In fact, if the continuum is at least as high as the peak (in units of counts), which is a common situation for these spectra, the second term in the expression for the variance will predominate. Under

these circumstances, and where the height of the continuum relative to that of the peak is constant, the error (or loss in precision) will be governed by the width of the peak. If the height of the continuum rises relative to that of the peak, precision will also be lost, but this loss will be at a lower rate (pro rata) than the effect due to the increased width. Actually, the variance of the second term increases as the increase in the height of the continuum.

An actual example, including an analysis using the fwhm resolution concept (i.e. the energy resolution measured by the full width of the peak at one half its maximum height), may illuminate the points made above. This example also illustrates the concept of estimating the intensity of γ rays and X rays by the method of NPA analysis. The situation considered for the example is that of three different detectors set up to detect and record, in conjunction with an MCA, the 662 keV γ rays emitted by a ^{137}Cs source. The energy calibration used for the MCA is 3.3 keV per channel. The particular detectors used are NaI(Tl), BGO and HPGe, which have fwhm resolutions of 50, 70 and 1.5 keV, respectively. Consequently, the peaks have widths at their bases, respectively, of 110, 154 and 3.3 keV, which translate into 33, 46 and 1, respectively, in units of MCA channels. The individual measurement times are arranged so that each of the measurements will record 10 000 counts in the actual spectral peak. However, the ^{137}Cs peak sits on a spectral continuum recorded from the detection of higher energy γ rays. The counting rate from the higher energy γ rays is arranged, for each measurement, so that, when the 10 000 peak counts are recorded, the average count of the continuum per channel underlying the peaks is 125 counts for a shallow continuum and 1250 counts for a high continuum.

On this basis (using the above equations), the values of standard deviation for the case of the relatively shallow continuum, expressed as a percentage of the peak count, are 2.9, 3.9 and 1%, respectively. It is evident that the broader the fwhm resolution, the worse the precision of measurement for the same spectral counting conditions. This is even more strongly evident for the case of the high spectral continuum, where the respective s.d. values are 8.9, 11.8 and 1.1%, which also illustrate how a high spectral continuum (relative to the peak height) degrades the precision of peak area estimation, except for the case of detectors with excellent energy resolution.

This example also highlights a vital issue in spectroscopy which is related to that of the precision in estimating peak areas: the resolvability of neighbouring peaks. In nuclear geophysical applications, this problem arises most frequently in the spectra recorded from neutron γ ray reactions, mainly because of the abundance of different γ rays emitted by the constituent nuclei. Most frequently, the energies of the principal γ rays of interest are approximately a factor of ten higher than the ^{137}Cs line. This means that the fwhm resolution values are larger than those given above by a factor of about $\sqrt{10}$, i.e. they are 350, 490 and 11 keV.

No scintillation detector will permit the resolution of many of the peaks which are important in mineral analysis using neutron γ ray analysis, e.g. the 7640 and 7725 keV γ ray peaks of iron and aluminium, respectively, which are only 85 keV apart. The situation for the resolvability of peaks is further complicated by the fact that interactions between high energy γ rays and detector matrixes give rise to three spectral peaks which are spaced 510 keV apart on the energy scale. The most energetic peak corresponds to the full energy absorption of the γ ray, while the two lower energy peaks arise from the occurrence of pair production within the fabric of the detector and the consequent escape, from the detector, of either one or two photons, either having an energy of 510 keV. Although this phenomenon is important only for γ rays of energies higher than 2500 keV, for those circumstances where three statistically significant peaks arise for each characteristic γ ray, the chances are tripled for the occurrence of peak overlap.

However, the HPGe detector resolves these γ rays of neutron capture in iron and aluminium without difficulty. Moreover, a good HPGe detector can even resolve the neutron capture doublet of iron which makes up the 7640 keV peak, where the constituent peaks are 13 keV apart.

In regard to the question of quantitative analysis in similar spectral situations, it is worth noting that if two spectral peaks of equal height are closer than half the base width, they cannot be visually resolved at all. Nevertheless, if the identity of overlapping peaks which sit on a continuum is known, they can be resolved and their peak areas can be estimated by using mathematical–statistical techniques. However, the consequent errors of estimation will be much larger, pro rata, than those discussed previously, mainly because there are three fuzzy boundaries rather than the single one in the example of the single 662 keV peak. It is difficult to achieve a good precision by the net peak area estimation method using scintillation detectors for neutron capture γ ray spectrometry because there is a multitude of overlapping peaks and the ratio of peak height to continuum height for most of them is likely to be even smaller than in the example of the high spectral continuum quoted above.

Thus, if scintillation detectors must be used, owing to the need of HPGe detectors for regular supplies of liquid nitrogen coolant and because of their high cost and their vulnerability to radiation damage (particularly by neutrons), a different approach is required for quantitatively analysing spectra which are crowded with peaks. Even so, the net peak area computational strategy works well in regions of scintillation spectra where the peaks stand out clearly and have minimal interference from neighbouring peaks. Examples for these spectral situations are the 1780 keV peak of ^{28}Al in the neutron activation spectrum of aluminium and the spectral peaks of hydrogen and silicon at 2230 and 3540 keV, respectively, in the neutron capture γ ray spectra of impure coal, using a BGO detector.

If the spectrum is unduly overcrowded with peaks, so that those of relevance to NPA computations overlap with others, it may be necessary to use a strategy

alternative to that of NPA for estimating elemental or isotopic concentrations. This alternative strategy is to fit the data of the composite spectrum, accumulated for an 'unknown' medium, with a number of spectra simultaneously, where each of these spectra are obtained for either the elemental constituents or the geological and mineral constituents of 'unknown' samples. These standard constituent spectra may be recorded in a computer library. The fitting technique used in this instance is a weighted regression analysis, where the variance is minimized for the arithmetic differences between the data and the predictions of the model [5.1]. Weighting factors are applied to the counts in each channel on an individual basis, according to the number of counts in the channel, because the counts are of unequal statistical significance, as predicted by Poissonian statistics. This is a technique which works well provided that none of the spectra are distorted by the pulse pile-up phenomenon, all spectra of possible elemental constituents are represented in the reference library and the reference spectra are recorded under matrix conditions which have neutron slowing-down properties similar to those of the unknown sample. Pulse pile-up distortion occurs if the count rate is too fast for the capabilities of the electronics, and if the moderating characteristics of the samples differ markedly, the proportion of the unscattered γ rays which are incident on the detector will vary, as will the shape of the spectrum in regard to the relative proportions of the spectra which are peaks and continuum.

5.3.2. Interpretational relationships and statistical models

As was indicated previously, the process of interpretation, using interpretational relationships, is actually some combination of the processes of solving the inverse problem and the direct problem. Chapter 4 provided an example, based on the borehole logging determination of aluminium in rock, of an interpretational relationship based predominantly on the solution of a direct model. The interpretational model was then used as the vital part of the process of converting all the measurement data into the required tangible parameter, the aluminium content. In effect, this set of procedures represented the solution of the inverse problem. It is an approach that will always function accurately if all the required relationships, based on the relevant radiation transport situation and the detector responses, can be expressed in analytic form and when the values of all relevant physical parameters are known, either beforehand or as by-products of the measurement. However, as also indicated previously, there are many situations where it is impossible to take this approach.

Fortunately, even if the solution of the direct problem providing mathematically useful expressions fails, many nuclear geophysical applications remain which require only a generalized approximate expression of the direct model solution, mostly based on simplifying assumptions about the geometry. In these cases, the simplified models provide an appropriate framework for accurate interpretations of the measurement

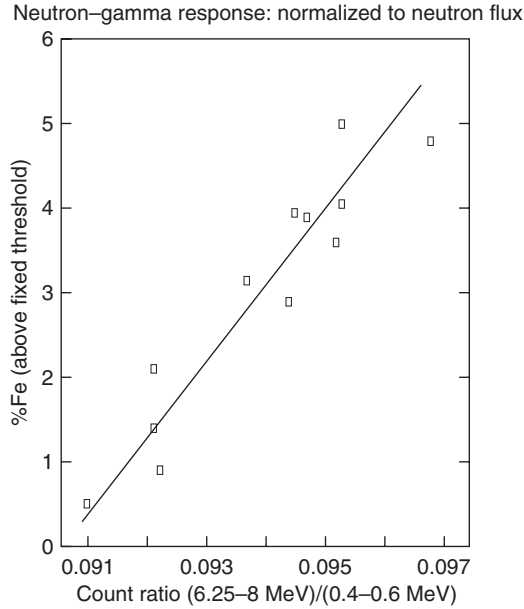

FIG. 29. Cross-plot resulting from regression analysis of %Fe (by weight) against a PGNAA probe response, using a first order linear model.

data. These models can be applied to interpretation only in situations with strong and direct correlation between a particular simple (linear) combination of the measured or transformed instrumental responses and the sought industrial or geological parameters. An additional criterion for applying this approach is that the environment of the measurement varies only moderately. In these situations, the interpretations carried out depend on the implementation of a prior calibration, by regression analysis of the industrial or geological parameters Y against the independent variables X , i.e. the instrument responses. On this basis, the simplest (linear) regression models often find application in nuclear geophysics; they take the form:

$$Y = \beta_0 + \beta_1 X_1 + \beta_2 X_2 + \dots + \beta_n X_n + \varepsilon$$

The various β coefficients are determined by the nature of the model. The response parameters X_i obtained from one or more instruments may be, in the simplest cases, the actual responses of the probes used (Z), or they could be a transformation of one or more recorded responses. The term ε is the error term for Y . It is the amount by which the calibration data in Y fall off the line or the curve described by the model. If the model chosen for fitting the data is known to describe the

relationship between Y and the X_i variables exactly, the errors would be simply the measurement errors of Y in the samples used for the calibration. If, as is the case in most geophysical measurements, the actual relationships are not known exactly, or if the exact relationships are known exactly but cannot be used practically for the regression model, the term ϵ also contains an error due to the use of an approximate model.

Those transformations that are used to compute certain X_i parameters may, for example, take the form of the inverse of the response, its square root, or the quotient of two different responses, depending on the mathematical form taken by the direct solution of the geophysical problem.

Some examples of where the regression analysis approach has been used most successfully are the numerous applications of EDXRF to sample analysis, either as individual batch samples [5.2] or on-line [5.3], the on-line analysis for coal ash by the dual energy γ ray transmission gauge [5.4] and, for iron ore, the pair production gauge [5.5]. The applications mentioned are those in which the environment of the measurement is readily controlled. It is an approach that is also used where the measurement environment varies, for example in borehole logging.

Figure 29 illustrates the points made above. It is a so-called cross-plot of the results obtained from a regression analysis of iron ore borehole logging data. The independent variable (X_1) is a computed spectral ratio in the prompt γ -neutron activation (PGNAA) spectrum of iron, labelled count ratio in the figure. The independent variable (Y) is the % Fe above a fixed threshold. The model used here is that of a directly proportional relationship between the two variables, as in the equation above. However, no other variables are shown because of the two dimensional representation of the figure. There may (or may not) be other variables. The scatter of the points may be due to the fact there are other relationships in addition to the one shown. Alternatively, the scatter may be due to errors in measurement.

In borehole logging, environmental conditions are less controllable because the borehole diameter may fluctuate erratically owing to occurrences of blow-outs of the borehole walls or constrictions of the hole due the swelling of bentonitic clays. Moreover, the lower part of the hole may contain water while the upper part remains dry. However, the use of caliper measurements will indicate the positions of anomalous wall zones, and the corresponding data are simply rejected for analysis. Alternatively, many of the spectrometric borehole logging methods yield probe response parameters which are sensitive to the diameter and, therefore, may be used as a diagnostic for borehole diameter variations and for the presence of water in the hole. Indeed, one particular set of these diameter sensitive parameters is sensitive only to diameter. They are the computed S factor responses described in Chapter 3 for the γ - γ measurement. They serve not only to diagnose for fluctuations in the hole diameter, but also to assist in the accurate measurements of either grade coal ash contents in drained boreholes, by providing one of the independent variables (X_i)

used in the algorithms for these determinations, provided there is only a moderate change in the hole diameter. In the event that the water table cuts across the mineralized zone or the coal zone, it is necessary to calibrate the probe independently for water filled and dry conditions of the hole and then apply these calibrations accordingly in the measurements.

The simple calibration model above, which may nevertheless require a quite sophisticated interpretation strategy, may be based on a number of response variables X , depending on the complexity of the sample, which are all obtained from a single spectrometric measurement system. Ideally, these response parameters would be independent in the sense that they are based on the areas (per second) of spectral peaks corresponding with the full absorption in the probe detector of γ rays emitted by different species of nuclei. They are only independent if they are separated effectively from the spectral continuum or any overlapping spectral peak, i.e. if the information noise is removed from the desired information.

XRF analysis may be based on one of the simple forms of the model which can be written as $y = a + bx$, where y is the XRF intensity, x is the concentration of the analyte (i.e. the element being analysed), and a and b are the coefficients defining the characteristics of the linear interpretational model. In more sophisticated versions of the model, y is corrected for matrix effects.

The pair production gauge used for the conveyor belt analysis of iron ore in both lump and fines successfully uses a more complex model:

$$\% \text{ Fe} = a + bI_p + cI_p^2 + dI_c$$

where a , b , c and d are the coefficients of the model, and I_p and I_c are the detected count rates for pair production and Compton scattering, respectively. It is worth noting that one of the X_i variables in this case is a quadratic term. It should also be noted that the quadratic term only makes a significant impact on how well the model fits the data for iron ores of low quality (i.e. for Fe concentration less than 55%).

In other models used for particular measurement applications, certain X_i parameters may be cubic or even of higher order, which is nevertheless consistent with the concept of a linear model because the term 'linearity' is used to indicate that the Y variable (i.e. the industrially sought parameter) is directly proportional to the response parameters used in the model, even where those X_i variables are of a high order or functions of several probe response parameters.

This signifies that these models may be represented generally by the summation of various terms which may be of any order (i.e. a polynomial of first order, quadratic, etc.), and they may consist of the products and quotients of any response parameters which were measured either in the same measurement procedure or even in different measurements (provided that the same sample was being measured in this way). However, two requirements of statistical theory apply to the solution of this

problem. One requirement is that as the data are fitted with the model, according to a sequential and iterative algorithm, a progressive analysis of the fitting process should reveal that each of the terms used improves the fit of the model with the data in a statistically significant manner. The other requirement is that the terms be independent. Ideally, this means that they are entirely mutually uncorrelated. However, this requirement cannot be fulfilled in nuclear geophysical measurements, if only for the simple reason that, while different measurements or probe response parameters may be independent, the physical or chemical phenomena which they measure happen to be correlated in the industrial or geological situation under investigation.

One practical example which may help explain the meaning of this may arise with the spectrometric neutron γ logging for the non-combustible mineral content of coal (referred to as the wt% ash). This measurement provides a number of response parameters resulting from the capture of thermal neutrons in the different constituent atomic nuclei of the rocks and the coal, and the consequent emission of the characteristic γ rays. In fact, the probe response parameters would contain the resulting recorded spectral peak areas. For this measurement, the predominant spectral peaks correspond to neutron capture in iron, silicon, aluminium and hydrogen. The hydrogen is actually the principal detectable component of the pure coal and while it occurs in significant concentrations in the shale and mudstone rocks of the formation, its concentration is by far greater in pure coal. It would be notionally feasible, therefore, to construct a model for ash content in which there are terms individually containing probe responses for iron, silicon and aluminium, making due allowance for the spectral different sensitivities which the method has for the constituents. The terms containing these different responses are independent because the elemental constituents contribute to the ash content independently of each other, while they vary in concentration relative to one another. This variation in concentrations fluctuates geographically and stratigraphically, depending on the palaeontological variations of the sedimentation processes.

In the real logging situation, the problem of quantitative interpretation is usually more difficult. In the neutron γ ray technique actually used in routine borehole logging for coal, it is usually necessary to use a probe equipped with a scintillation detector. However, as was mentioned before, the best scintillation detector lacks the energy resolution for differentiating between the main iron and aluminium capture γ ray peaks. Consequently, if scintillation detectors are used the only choice is to select a less accurate model than the one discussed above. However, the geological circumstances of the problem assist the nuclear geophysical methodologist. Fortunately, the Fe peak generally dominates over the Al peak, since the spectral contribution above 7.2 MeV of iron (on a weight basis) is about 14 times that of aluminium. For average Australian black coals, this means that the iron contribution is four times greater than that obtained from the aluminium. Moreover, the correlation between iron and aluminium contents in Australian black coals is significantly high,

owing to the geochemical processes which occurred during sedimentation. On this basis, the act of combining the spectral contributions of iron and aluminium provides a model which is only marginally weaker than that described above. Data fitting is done validly by using only two independent variables which have a significant correlation. This correlation is, however, only geologically circumstantial, i.e. the terms may not be highly correlated under other circumstances.

On the other hand, the different terms used in a model are highly correlated if the individual probe response parameters selected for these terms show nearly identical variation with changes in the industrial or geological parameters. This means that the lack of independence of the terms and their high intercorrelation stems from relationships intrinsic to the method and not from the situation external to the method. This could occur, for example, in the selection of response parameters on the basis of count rates recorded in the different energy windows of a backscatter γ ray spectrum, where these count rates may show nearly the same variation with bulk density. In this case the terms formed on the basis of these count rates would be highly correlated and not acceptable for fitting by regression analysis. Another instance of intercorrelation could occur in the determination of iron impurity in coal by using the capture γ ray peak areas for iron and sulphur as independent variables, if the predominant iron bearing impurity is pyrite (FeS). In this case iron and sulphur are linked deterministically, and there is no scope for their concentrations to vary independently of each other, apart from a separate, relatively small iron constituent associated with the shaly gangue impurity of the coal.

Whereas the attraction of using first order regression models as a basis for interpretational relationships is their simplicity for computational interpretation, they are frequently only approximate descriptors of the real existing nuclear geophysical relationship. Under these circumstances, which certainly apply to backscatter γ ray spectra, there is scope for improving the accuracy of prediction by refining the model. The method of accomplishing this refinement is to introduce higher order terms into the general model (also based on probe responses) which are cross-product terms of response variables. In the case of backscatter γ ray spectra, the justification for doing this is that the relationship between grade (or impurity content) and the predictors, i.e. electron density response, P_z , and S factor, may actually be non-linear. In this case, a high order linear model generally provides a better approximation for an unknown non-linear model than a first order linear model. Also, the shape of this type of spectrum changes dynamically with the level of impurity in the ore or the coal so that, actually, there is no unique stable response variable for any of these predictors. Experience showed that in applications to measuring iron ore grade the accuracy improved relatively by about 7% when the polynomial model was used instead of the first order model based on these three predictors.

It is, however, possible to combine the γ - γ measurement with a natural γ ray measurement using the same probe equipped with the same single detector. This

provides three additional independent variables, i.e. predictors for the model, which are the recorded counts in the spectral peaks of the γ rays emitted by uranium, thorium and potassium. They are certainly correlated with the shale impurity content of either the ore or the coal as independent variables. The advantage of using second order models is most striking in these models (also based on three predictors) in that the error is reduced by up to 60%, in one application where data fitting the first order model gave errors that were generally comparable with the other models investigated by regression analysis.

The long term degradation of components in the spectrometric system affects the system gain and the zero threshold. One approach is to carry out physically an entirely new calibration against standard samples. Whereas this strategy is thorough, it heavily consumes both capital and time. According to one estimate, the total cost of calibration procedures may represent up to 50% of the capital value of a field operational logging system.

An alternative, far more cost effective approach developed by a CSIRO group in Australia for backscatter γ rays is to recalibrate with the aid of a computer [5.6]. The conceptual strategy used restores the shape of the backscatter spectrum to its original state by adjusting the gain and the zero threshold appropriately. These adjustments, made in the context of a computer software assisted operation, requires the use of a shallow standard reference hole at a mine site for making periodic measurements and digitized records. The software accomplishes the modifications to the gain and zero threshold by proportionately altering the regression coefficients of the calibration equation used for grade or ash content predictions. The underlying assumption is that the area under the spectrum, expressed in counts, is invariant with minor changes to the spectral shape, given that corrections are made for the radioactive decay of the sources in the probe.

5.4. RELIABILITY

Several of the factors that determine the reliability of nuclear geophysical measurements have been discussed above and in previous chapters. They include the errors of measurement governed by counting statistics (i.e. Poisson statistics), which in turn determine the precision of measurement and the suitability of the model used for the interpretational relationship, which is the intrinsic component of the accuracy. The precision of measurement is not determined by the number of counts alone, but also by the resolvability of peaks if a spectrometric technique is being used. Indeed, many objectives in nuclear geophysical measurements could not be met without the use of spectrometry.

There are other considerations affecting reliability and accuracy. They are the errors of sampling reference standards, the suitability in the choice made of selected reference standards and the precision of the measurement operation as such.

An example of the errors which degrade the precision of a measurement operation (i.e. lack of repeatability) is the probe measurement in boreholes of irregular diameter, where the irregularities may have occurred as a result of caving after drilling. If the entire operation of siting the truck at the borehole, lowering the probe and taking the measurement is repeated several times (e.g. 15 times), it is highly likely that the sample standard deviation for the integrated spectral count is statistically significantly greater than expected from Poisson statistics. This may be due to the fact that each time the operation is repeated, the probe descends and ascends the hole along a different path along the wall and 'sees', at one and the same depth level, both a different diameter and even a different sample, if the matrix is heterogeneous. In addition to this effect of what amounts to a change of geometry in the measurement system, the operating temperature of some parts of the spectrometric measurement system may vary over time, causing small drifts in gain or threshold, in spite of the stabilization of the system. This is a factor which adds to the overall loss of precision and, therefore, to a loss of accuracy.

The second source of error is that the reference standard is unsuitable for a particular application because the matrix 'seen' by the probe, i.e. the depth of investigation, is different in the unknown sample from that of the standard reference sample. As was previously mentioned, this disparity has the consequence of providing spectra which have disparities in their shapes regarding the apparent relationship between the intensities of peaks and continua. The result of this is that there will be an error in the estimation of elemental concentrations in the unknown sample.

An even more common and important source of error occurs in sampling for the reference standards if they are prepared from samples of heterogeneous ores and rocks. The notion of sampling directly from naturally occurring representative materials has the attraction that this avoids the difficulties of having to find suitable algorithms which compensate for artificial matrix effects mentioned above. However, if this strategy is employed, it is necessary to conform with suitable, recommended sampling procedures which are based on sieving mesh size and grain density and are described in the publications of various national and international standards associations.

One problem which occurs frequently in using this type of sampling for borehole analysis in heterogeneous solid resources is that if the sample is a drill core it may be insufficiently large to be a representative sample. Alternatively, if the sample is obtained by percussion or rotary drilling, the drill cuttings comprising the sample may suffer segregation before they are collected, so that the sample is one which is biased. This is a particularly serious problem when the drill cuttings are obtained from below the water table, because the fine powdery components are washed out of the retrieved sample to a disproportionately large extent. Frequently, there are systematic differences in the chemical composition between the 'fines' and the 'lumps' of ores. If the samples for required calibration standards are retrieved from the hole

on the basis of fixed depth intervals, e.g. 1 m intervals of borehole, great care is required that the sample will be representative of the formation at the given depth interval and that all the sample is retrieved. Therefore, core drilling is necessary below the water table in the zones of interest. If drilling is necessary only above the water table, using percussion or rotary drilling, the hole should be suitably large, in either case, to nullify the effect of heterogeneity on the accuracy of sampling, and sample retrieval should be assisted by the use of cyclones for capturing the dust.

5.5. EMERGING TRENDS IN INTERPRETATION AND MEASUREMENT

5.5.1. Petrophysical filtration and cyclometry

There are a number of oil deposits with polymineral composition, known as terrigenous reservoirs, which are not identified on the basis of conventional nuclear and acoustic techniques. The nuclear logs obtained in exploration programmes conducted on these sites frequently indicate, within the strata corresponding to oil reservoirs, a low hydrogen index, a strong neutron log response and appreciable variation in the natural γ ray activity in a section. Generally, the concept used is to deduce the rock characteristics of a section from the petrophysical characteristics, which are predicted from a variety of nuclear logs. The interpretative procedure of elucidating the formation components is referred to as petrophysical adaptive tuning. However, no universal set of petrophysical parameters may exist for a section in this type of deposit. This has two reasons: the section may have been formed under diverse sedimentation conditions, and there may be significant errors in the predictions of the true petrophysical parameters based on the logging measurements. These errors have a predominantly geochemical source in that in many cases the contents of boron and ferric oxides fluctuate in the sediments, which affects the probe responses.

The essential aim of using this method for identifying oil reservoirs, therefore, is to infer the rock characteristics from the set of formation geophysical parameters through an iterative process. Part of this iterative process includes the classification of section beds into subclasses which feature similar petrophysical properties. The most commonly used nuclear logging techniques for providing the petrophysical parameters that are required for this interpretation are: natural γ ray spectrometry, formation density measurements, and neutron–neutron or neutron– γ ray measurements. The procedures used for inferring the rock components include imposing constraints based on a priori knowledge of sedimentation processes that occurred in the region considered as well as of its general geology. The first iteration of the adaptive tuning procedure uses a ‘standard set’ of petrophysical characteristics for individual components. They would, however, translate into geologically unrealistic values for the petrophysical characteristics of the formation overall, for the reasons mentioned

above. Therefore, subsequent iterations of the matching process force adjustments to the values assigned to the rock components and to the geophysical parameters of the formation, subject to the geological constraints mentioned. The methodology requires that a petrophysical model and a component model be formulated on the basis of each type of log performed. The component model requires the definition of the qualitative parameters of the formation and, in particular, the rock components and the quantitative parameters of the formation, i.e. the petrophysical characteristics of these components. The component model should also include a 'fluid' model, i.e. information on the fluid composition, the porosity of the formation and the water, oil and gas saturation.

The results of the component analysis yield information or permit inference on a number of properties which also include porosity, pore structure, clay content and fluid composition. This information is then used as an input for the *method of petrophysical filtration of a section*, which ultimately enables identification of a reservoir. The method involves computation and use of a parameter referred to as the *effective* (i.e. *dynamic*) *porosity of the sediments*. This parameter is defined as the proportion of the reservoir capacity that allows free transportation of bed fluids. If the beds have high porosity and low clay content, there will be scope for unimpeded fluid transport, as occurs in a genuine oil reservoir. However, if the clay content is high, the measured porosity measurement may appear to be high, but the effective porosity will be low. This is the type of bed that gives false indications on log diagrams. The petrophysical filtration method will, accordingly, estimate a low value for its effective porosity.

A different method of interpreting logging data, known as the method of *cyclometric analysis of geonucleonic data*, was used successfully in the Russian Federation, and formerly in the USSR, for identifying these terrigenous reservoirs. The method is also known as the *geotimer method* [5.7, 5.8]. It is applied in the isochronous correlation of sections and high precision dynamic modelling of petroleum basin evolution and in the selection of reference data used in the above method, i.e. that of adaptive petrophysical tuning [5.9]. On the other hand, the results obtained through component analysis greatly assist the analysis of complex cyclometric data. In fact, a combination of the two techniques provides a most efficient approach to the solution of geological problems, i.e. identification of reservoirs, elucidation of their nature and structure, clarification of the nature of the oil saturation prediction of off-structure and combined traps for oil and gas, etc.

In this method, the nuclear logs from holes intersecting the sedimentary strata of complex terrigenous deposits are investigated for periodicities which are consistent with those predicted from a multilevel theoretical law of geological history and are therefore known a priori. In this method the chronometric processes of a system of cycles are correlated with appropriate regular sedimentation cycles of sedimentary strata. There appears to be evidence for the existence of such cycles, having sinusoidal waveform, from the results of processing nuclear logs and core logs by a

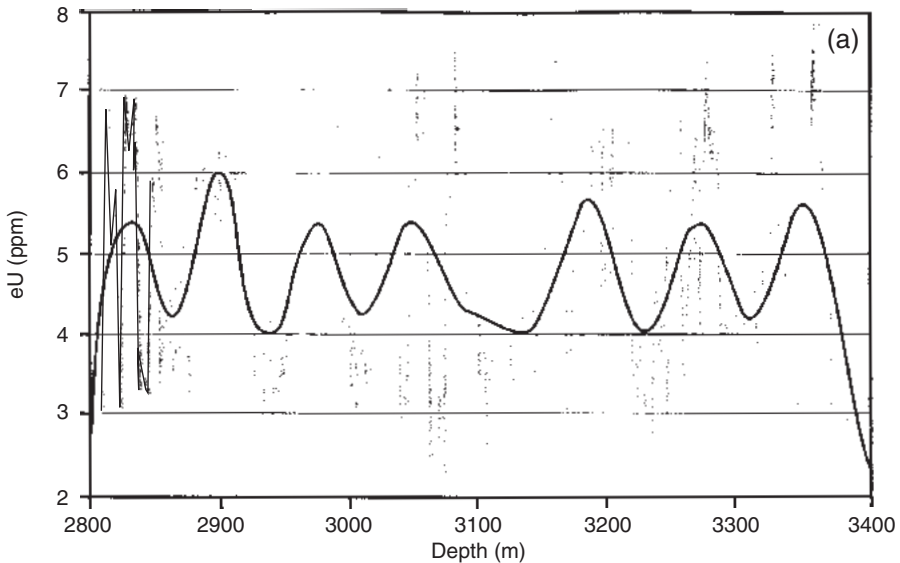

filtration process. These results are initially obtained on a depth scale, but they are readily converted to a chronological scale, where the depth to geological time conversion factors have been verified independently from palaeontological data. The results obtained from carrying out the filtration of the logging data are then compared with those of the actual theoretical geotimer. This comparison enables identification of occurrences of irregularities in the cycles, such as sedimentation hiatuses. The comparison also shows that natural petroleum reservoirs occur in zones situated between those depth intervals where the occurrence of the coarsely grained fraction of the formation predominates. The periodicity of the natural γ ray log diagram correlates strongly with the periodicity of coarse grained fraction distribution. Figures 30(a, b, c) illustrate how a natural γ log shows a recurrent structure, with hiatus, in the stratigraphy according to depth, then how it fits with a periodic structure and, finally, how this is translated to time, according to the depth–time relationships obtained by dating methods.

The notion and ensuing debate on whether cyclometry governs many sedimentation processes has a relatively long history, i.e. the notion that many stratigraphic layers consist of simple lithological sequences which are repeated cyclically [5.10]. This notion now finds much support, also in the USA and western Europe, on the basis of geological evidence. The available evidence, obtained from oil well logging data, points to the occurrence of cycles in sedimentation which are based on the periodic variations in the orbital motion of the earth about the sun as predicted by Milankovitch's theory. The theory predicts periods of 95 000 years for eccentricity, 41 000 years for obliquity and 19 000–23 000 years for precession. Geophysical well

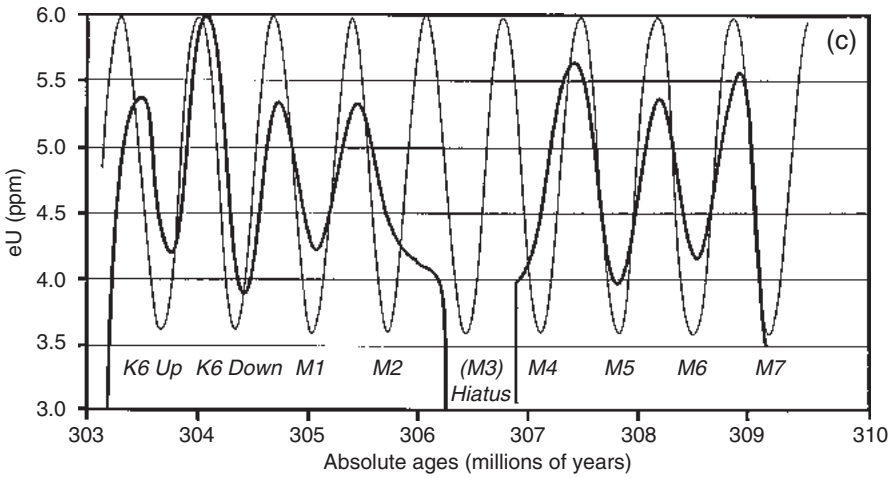
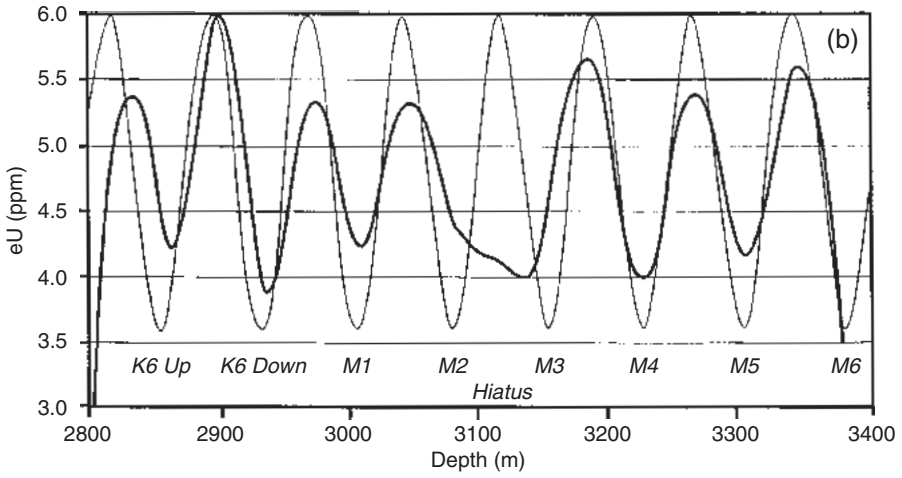

FIG. 30. An example of a γ ray curve geotimer analysis (A.Ye. Kulinkovich and D.A. Kozhevnikov): (a) recurring pattern of a γ ray log against depth, both raw and smooth; (b) smoothed log pattern superimposed on a cyclic pattern of best fit, against depth; (c) patterns in (b) above represented against a time-scale (converted from depth). (The units of amplitude in the γ ray logs shown are uranium equivalent units, i.e. eU, ppm.)

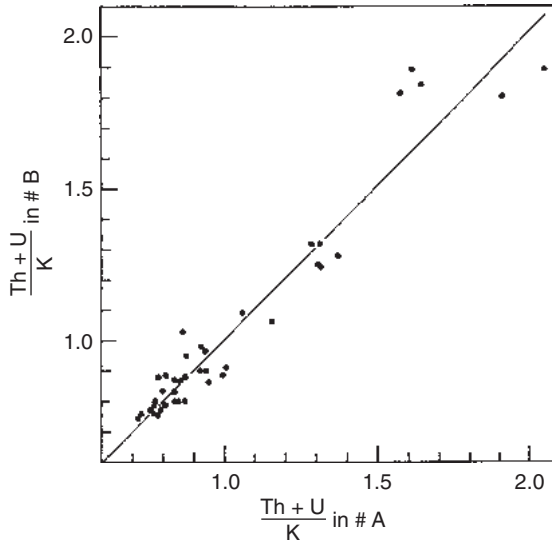

FIG. 31. Correlation between values for a spectrometric natural γ ray ratio computed from probe responses recorded in two distant holes (#A and #B) of a coal deposit in eastern Australia.

logs and, in particular, nuclear geochemical logs and spectral natural γ ray logs have provided much of the desired evidence for the occurrence of 'Milankovitch periodicities' in sedimentation processes, partly because the records obtained in this theory are both continuous and complete, which is not the case with cores. However, the core data are indispensable for palaeontological evidence and conversion from depth to time measures. The evidence for the existence of these cycles in geological sedimentation is obtained through Fourier transformations of the logging data into amplitude spectra. The cyclic nature of also these logs (such as those obtained in the Russian Federation) appears strongly correlated with variations in the content of coarse grained material and clays.

5.5.2. Other forms of classification

In some geological and geophysical applications, it is advantageous to group or classify items according to attributes which they hold in common. Where there are a large number of individual items each being characterized by a substantial number of different measurable attributes which are subject to statistical fluctuation, the task of finding their natural groupings may be particularly difficult.

One example of an application requiring this approach concerns the identification of coal seams in exploration or mine development. The seams in coal basins frequently cover large geographic areas and occur at varying depths from the surface, owing to folding of the formation in geological time. In both exploration and mine development applications, it is most useful for mine planners to know the position of the seams both stratigraphically and geographically, particularly if the coals in the same seam have similar properties as regards swelling and ash content.

Where there is such commonality of geochemical properties within the same seam, it is also probable that some commonality would exist of the natural radioactivity in the coals of the same seam. The question arises on how to test whether this is the case and, if so, how a useful practice can be evolved to capitalize on this fact. It appears that, while simple spectral natural γ ray parameters, e.g. peak areas, are rarely correlated according to their coal seam of occurrence, there is evidence from some seams in a particular region (Hunter Valley of eastern Australia) that the coal samples within the seam are correlated on the basis of particular ratios of such simple responses, e.g. the ratio between the counts recorded for the high energy γ rays of thorium and those of potassium [5.11], as shown in Fig. 31 by the apparent correlation in values of such a ratio recorded for the interseam sediments in two distant holes of a coal deposit. However, this is not the case for all coal samples taken from the same seams. The evidence is that seam correlation is a probable rather than a universal occurrence. Further, it appears that the values of any specific ratio of particular measured radiometric parameters of coals which are sampled in different parts of the same seam are only loosely correlated if the ratios are considered individually as correlators. However, it appears that objective data analysis methods, which take into account all the independent response parameters of a spectral natural γ ray probe, have the capacity for demonstrating natural groupings according to the sedimentary strata.

Various methods of objective data analysis (ODA) can be applied to the statistical analysis of borehole logging data. On particular example is that of natural γ ray logs carried out in holes intersecting a series of geological strata or coal seams. The most effective form of ODA for the type of application referred to here appears to be a combination of non-hierarchical and hierarchical cluster analyses. The aim of cluster analysis techniques is to group a set of 'items' of unknown classification into natural classes or clusters, where each item is described by several variables. In the example used, the variables are the various spectral peak areas (both net and gross) and the ratios between them. In fact, the spectral regions selected to provide the variables for the example may usefully include those due to the γ rays of thorium (2.62 MeV), uranium (2.2 and 1.76 MeV), potassium (1.46 MeV) and also the lower energy γ rays of uranium. An item in the context of the example given is a particular fixed depth interval of borehole logged, occurring at a particular depth in a particular borehole.

The non-hierarchical cluster analysis method establishes whether the data indicate the existence of discrete natural classes within them, while the hierarchical cluster analysis technique provides supplementary information on the nature of the clusters, e.g. numerical values for *similarity* between the items. The process of classification is obtained by using the concept of ‘statistical distances’ between items. In the example, those items that are relatively similar in regard to probe responses and the variables (computed from the responses) are linked by only short statistical distances and are considered to belong to a cluster provided that they are strongly separated from other items. The procedure initially treats each data point as an individual group and then proceeds, in successive phases of the analysis, to agglomerate these individual groups into larger groups according to a specific set of rules governing the criteria by which linkages between groups are acceptable, i.e. *the linkage method*. This process of agglomeration proceeds until the items fuse into an optimum number of clusters, where this number is determined by the preselected criteria for acceptable similarity and dissimilarity.

The non-hierarchical method is the more flexible one for grouping ambiguously separated items in that it provides for iterative re-examination of the statistical data in successive phases. If data points are mistakenly classified into the same cluster at an early stage of the agglomerative process, the decision can be reversed at a later stage of the analysis. Its limitation in commonly used software is that they provide no audit parameters that can be used directly by the operator to identify similarity within groups, as are provided with hierarchical cluster analysis. However, parameters are given which the operator can interpret for purposes of identifying either similarity or dissimilarity.

It is worth noting that, in the example cited, the γ ray measurements were not made on the coal but on the interseam sediments. The reason for this is that, unless the coal is ‘dirty’, its activity is very low, whereas the interseam sediments have a relatively high natural activity.

The method of applying this technique is that boreholes intersecting a succession of closely structured seams in a particular region or coal basin would be logged slowly to obtain data which both are representative of the region and have adequate counting statistics for the individual depth intervals of the boreholes. A cluster analysis is then performed to provide computer library data as a reference for assisting with the identification of strata intersected by holes subsequently logged in the region. It could also be used to assist in the navigation of horizontal hole drilling equipment, of the measurement-while-drilling type (MWD), within a particular seam that is one of several seams existing within a structure consisting of closely interleaved, folded seams. Under some circumstances, the interseam sediments may be so thin that the drilling equipment may drill through the roof or floor accidentally on the assumption that the rock material encountered is only an intraseam stone band. The use of cluster analysis as a reference for logging data accumulated in real time may assist in avoiding such accidents in horizontal drilling.

Nevertheless, considerable development is still required in terms of defining criteria for the use of 'statistical distances' suited to particular types of problems. Also, in order to capitalize on the present state of knowledge in the application of ODA to mining problems, there remains the task of developing suitable systems of artificial intelligence to guide drilling operations.

In a related set of applications, the use of fuzzy set rules can be combined with cluster analysis to overcome the problem of handling ambiguous lithotypes, particularly when there is no dominant lithology in the composite ore. In the conventional types of classification, mixed lithotypes are forced into simpler lithotype classification according to methods and criteria which are often subjective, e.g. visual inspection of spectral natural γ ray logs (or of the core). This is essentially the same as making approximations, which lead to a loss of accuracy. In the case of Pilbara iron ore from Western Australia, a conventional cluster analysis shows sharp demarcations for shale and dolerite from each other and from microcrystalline goethite, overprinted goethite and haematite on the basis of natural γ ray spectral ratios. However, following cluster analysis, the haematite, the banded iron formation rock (BIF) and the two types of goethite overlap considerably. The problem is that, in the conventional classification method, the minor lithological components in a depth interval will be swallowed by the dominant component. Therefore, if the material happens to consist of 70% haematite, 15% shale, 10% microcrystalline goethite and 5% BIF, the split sample is classified as haematite. In this way, the information concerning the additional constituents is overlooked and accuracy is lost to predictive processes because they depend on a capacity, within the method, for segregating samples of different classifications.

The application of cluster analysis using fuzzy set rules avoids many of the errors arising from the above simplification by assigning a graded 'membership' function to this problem, which assigns a fuzzy number to each data point. The clusters consist conceptually of 'class centres' of a lithological γ ray spectral nature, which are defined parametrically by the mean 'fuzzy number' values and the standard deviations of these mean values.

The benefit of adopting this procedure is that borderline elements of the data can be treated objectively through programmed, computerized procedures, which reduces error by eliminating the investigator's subjectivity in making judgements.

5.6. SUMMARY

The interpretation of nuclear geophysical measurements and its reliability are the main topics of Chapter 5. In the context of measurement reliability, the first section considers how variability in the measurement's environment affects the accuracy of interpretation. The laboratory installation provides far greater environmental

constancy in terms of ambient temperature and instrumental geometrical configuration than the processing plant or the borehole, which affects the repeatability of measurements and, therefore, affects their accuracy accordingly.

Section 2, which deals with the scale of interpretation, indicates that the sophistication of the interpretative method should match the comprehensiveness required of the information sought. If more information is supplied than needed, the possible costs are capital ineffectiveness and ambiguity in communication. A simple interpretative model is desired for the detection of gangue in iron ore transported on a conveyor belt, while a complex interpretative model is required for controlling operations in coal washery plants on the basis of inputs supplied by detectors about the elemental composition of contaminants.

Details of additional strategies for solving the inverse problem are considered in Section 3. They include the quantitative interpretation of data obtained spectroscopically and the use of regression analysis for the development of interpretational relationships when only generalized solutions of the direct problem are available. For quantitative spectral analysis, it is shown that the statistical precision of the estimated spectral peak area depends not only on the total number of counts recorded by the detector, i.e. on the time of measurement for fixed conditions of source strength and detection geometry, but also depends critically on the ratio between the areas of the peak and the underlying spectral continuum. Examples illustrating the precision gained through improved detector energy resolution are drawn from experience with detectors of the bismuth–germanate scintillation type, the sodium iodide scintillation type and the liquid nitrogen cooled germanium type.

The use of regression analysis for developing precise interpretational relationships requires a strong correlation between the instrumental parameters and the required industrial/geological parameters and, also, an almost constant measurement environment. Examples used for illustrating the utility of this approach to instrumental calibration are drawn from industrial experiences with borehole logging, XRF analysis and pair production gauges. The problems of intercorrelation between instrumental variables used in the model and reliability of data interpretation, together with various strategies for obtaining more accurate models, are discussed in this and in Section 4.

The final Section 5 of the chapter deals with new trends in interpretation and measurement. The new trends include the use of two different strategies based on nuclear logs for identifying oil reservoirs which are petrophysical adaptive tuning for analysing the components of a geological section and cyclometric analysis of geonucleonic data for correlating periodicities evident from nuclear logs, with the occurrence of known regular repetitive cycles of sedimentation processes. The two strategies are frequently combined advantageously. The section also describes mathematical–statistical techniques, i.e. cluster analysis methods, and their application to the identification of natural groupings of items (e.g. sections of logged

boreholes in sedimentary strata). The methods have practical application to geological exploration and development and, also, to the technology of measurement-while-drilling in boreholes. The groupings are frequently expressed by the radio-geochemical composition of the sediments, which can therefore be identified from spectrometric nuclear logs. These techniques can be combined with fuzzy set rules to improve the quality of quantitative prediction in lithotypes.

REFERENCES

- [5.1] GRAU, J.A., SCHWEITZER J.S., Prompt γ -ray spectral analysis of well data obtained with NaI (TI) and 14 MeV neutrons, *Nucl. Geophys.* **1** (1987) 157.
- [5.2] MASDJA, M., Analysis of the chemical composition in rocks by using wavelength dispersive X-ray fluorescence, *Nuclear Techniques in the Exploration and Exploitation of Energy and Mineral Resources (Proc. Symp. Vienna, 1990)*, IAEA, Vienna (1991) 151–160.
- [5.3] HOLYŃSKA, B., LANKOSZ, M., OSTACHOWICZ, J., On-stream analysis of zinc and lead concentrates by radioisotope X-ray fluorescence, *ibid.*, pp. 161–167.
- [5.4] FOOKES, R.A., et al., On-line determination of the ash content of coal using a ‘SIROASH’ gauge, *J. Appl. Radiat. Isot.* **34** (1983) 63.
- [5.5] AYLMEER, J.A., HOLMES, R.J., RUTHERFORD, L.C., Dynamic trial of an iron ore analyser based on pair production, *Nucl. Geophys.* **11** (1987) 51–58.
- [5.6] TCHEN, T., EISLER, P.L., Computer-aided re-calibration of borehole logging probe, *Computer Applications to the Mineral Industry (Proc. Australian Conf. ACCAMI, Wollongong, 1993)*, ACCAMI (1993) 26–32.
- [5.7] KULINKOVICH, A.Ye., Absolute cyclostratigraphy of the Dnieper–Donetz depression and other oil basins, paper 50 presented at 7th EAPG Conf. Glasgow, 1995.
- [5.8] KULINKOVICH, A.Ye., KOZHEVNIKOV, D.A., RUDOFF, I.V., The geotimer analysis of well logging data, paper presented at *Geophysics and the Modern World (Int. Sci. Conf. Moscow, 1993)*, abstracts of papers (1993) 294.
- [5.9] KOZHEVNIKOV, D.A., LAZUTKINA, N.Ye., Advanced petrophysical interpretation of nuclear well logging data, *Nucl. Geophys.* **24** (1995) 83–97.
- [5.10] DOVETON, J.H., PRENSKY, S.E., Geological applications of wireline logs — A synopsis of developments and trends, *Log Anal.* May–June 1992, 286–303.
- [5.11] BORSARU, M., CERAVOLO, C., CHARBUCINSKI, J., EISLER, P., YOUL, S.F., Comparative performance of BGO and NaI(Tl) detectors for identifying coal sediments by gamma ray logs, *Formation Evaluation (Trans. 8th Eur. Symp. London, 1983)*, SPWLA London Chapter, London (1983) 25 pp.

6. IMPACT OF NEW TECHNOLOGY

6.1. FROM SCIENCE TO SOCIETY

6.1.1. What is science?

The substance, or the identity, of *science*, its rationality, success and sociological position have been points of philosophic argument and consideration since Aristotle (384–324 B.C.). The twentieth century has seen an outpouring of intellectual energy directed at probing these issues and the questions they raise.

The 20th century's intellectual activity in this area began with the logical positivist paradigm of science, which held that theories about the universe (also meaning everything within it) only have value if they can be verified empirically. As a corollary of the paradigm, the only facets of the universe that are significant are those which human senses can perceive, either directly or indirectly. This viewpoint was followed by one enunciated later, namely that, according to Popper and Lakatos, the falsifiability of scientific theories is also an essential elemental factor for the progress of science [6.1–6.3].

Another question concerning science relates to the nature of its success. There is no doubt that empirical investigation has demonstrated the predictive power of the pertinent scientific theories. However, the fact that a scientific theory is adequate in an empirical sense in no way justifies the assumptions on which the conclusion is based. According to Riggs, "The inferred conclusion may be correct by sheer coincidence or for any number of other reasons" [6.4]. It is also arguable that the success of science has not been based on the fact that scientific theories have been successful. If the success of science depends on the continued validity of scientific theory, then the fact that over time most scientific theories have been either refuted, superseded or drastically modified would deny science its claim to success. Nonetheless, the success of science has a firmer philosophical basis than either its empirical success or its long term failure in its theories. Whereas Newtonian physics has been superseded by relativistic physics as a theoretical framework for describing motion, etc., it still works (and is therefore successful) for most applications in engineering and applied science.

The success of scientific research is based on the fact that it achieves, according to Laudon, a number of cognitive goals which include *predictive control* over parts of the individuals' universe experience, *manipulative control* over a part of that experience, *increased precision* in the knowledge of the initial and boundary parameters figuring in our explanations of natural phenomena, and *integration and simplification* of our picture of the world and a *reduction* (where possible) of the various components of that picture to a common set of explanatory principles [6.5].

On the basis of these goals, much of science has been a great success over the past 300 years [6.4]. On the question of how theories supersede each other, van Fraassen believed that the process is one of 'natural selection', and it occurs because scientific theories actually compete fiercely with each other for recognition [6.6]. An alternative explanation is that the way scientists test theories and select them produces over time reliable theories, which are generally more successful in helping us realize our cognitive goals than non-scientific theories.

Among the critics of science and its claim to rationality and its objectivity are certain sociologists. They maintain that science is not a wholly rational process but that, when it appears advantageous to do so, rational processes may be sacrificed in favour of social goals, and the apparent outcome of scientific research is a consequence of social processes [6.7]. Their more extreme advocates even state that the natural world provides no input for our scientific theories. Indeed, the same author has argued further that science, myths, voodoo and witchcraft are belief systems which have similar patterns of formation, in that they cap common sense based on observation with a theoretical superstructure. Moreover, this school of thought takes the position that none of these belief systems is superior to any other. Of course, the fallacy in this argument is that whereas belief systems may have certain common traits, this does not prove that they hold any other traits in common or that there is any similarity between their beliefs. What is more to the point is that this school of thought has failed to indicate (even if one would allow for the purpose of the argument that science might superficially resemble belief systems) in which manner and to which degree of success any of the belief systems (other than science) explain the world as theories. The fact is that scientific theories explain phenomena and predict quantitatively with an unrivalled accuracy.

Another criticism which stems from this school of sociologically orientated analysts is that the outcomes of scientific research are mostly determined by social processes, i.e. the processes of propaganda (through the impact of visual display), lobbying and other political strategies [6.8]. Indeed, this group of philosophers may have found the seeds for their notions in some aspects of the challenging philosophical writings of Kuhn, from 1962 and 1972 [6.9], who proposed that 'normal science' based on past historic achievements is a mundane activity. Occasionally, a dramatic event occurs, according to Kuhn, whereby accepted theories and methods of science may be abandoned for alternative theories, for reasons which do not altogether have their roots in the scientific shortcomings of those which have been overturned.

Whereas these extraneous factors may perturb the process of objective scientific evaluation, there is obviously no credence in the suggestion that scientific facts are socially constructed and have no real existence other than in the minds of people. If this were the case, it would be nonsense to build and operate large laboratories instead of merely speculating on the nature of the universe, as did the ancients. In this event, we might suggest that scientists are either totally stupid or totally

dishonest, which is actually refuted by the previously mentioned unchallengeable successes of science.

A detailed discussion of the philosophical arguments currently in progress between the rationalists, who believe that there exists a single correct methodology of science, and the methodological relativists, who state that there is no unique scientific methodology, is beyond the scope of this book. (Actually, there are different views among the rationalists as to which scientific method is the correct one, although they all subscribe to the view that a single correct method exists.) However, there is no doubt that this debate and how it is resolved is all important not only for the future of science, but for that of society.

The most extreme methodological relativists are advocates of the so-called *strong programme in the sociology of science*. Some adherents of this school of thought claim that knowledge is whatever people accept as knowledge, which means, accordingly, that knowledge consists of the beliefs which guide people in their lives. It is highly probable that the views of this circle of philosophers have been influential in the development of hostility and scepticism towards science within some non-scientific academic circles and, by osmosis, among the general public, in spite of both the logical inconsistencies existing within the arguments of these philosophers and their disregard for objectivity in analysing the success of science.

But, what of the aims of science? According to Sir Karl Popper:

“... different scientists have different aims, and science itself (whatever that may mean) has no aims. I admit all this. And yet when we speak of science we do feel, more or less clearly, that there is something characteristic of scientific activity, and since scientific activity looks pretty much like a rational activity, and since a rational activity must have some aim, the attempt to describe the aim of science may not be entirely futile.”

The aims of scientists generally depend on who — as either individuals, groups or institutes — is actually engaged in this activity and, to a large extent, who is funding it. As a consequence, the aims of individual scientists and individual institutions vary. Nonetheless, according to Riggs [6.4], most scientists have two general aims of some lasting nature. One aim, of a long term nature, transcends centuries, whilst the second aim is short term; usually, its duration ranges from months to a few years.

The long term aim is to contribute to the search for truths, which satisfies human curiosity about the natural world. The short term aim is a pragmatic one, attempting to solve problems which range from the mundane to the exotic. The short term aim is largely what constitutes most of the research carried out today in nuclear geophysics. However, the first aim is what underpins this research and will provide the foundation for further advances in it. In fact, the longer term aim is what feeds the

shorter term aims with intellectual capital. Moreover, a commonly held view of our above short term aim is that it also logically divides into a relatively long term aim, referred to as strategic research, and a relatively short term aim, called tactical research.

Strategic scientific research is carried out in the general context of a particular set of scientific problems connected with either an area of industry or with a group of industrial problems, where the term 'industry' is used in its broadest context. For example, it may refer to conventional commercial industry, to agriculture and food production, or to medicine, psychology, or any area of applied science. However, this strategic research is not constrained by the goal of solving a preselected industrial or commercial problem. In the development of nuclear geophysics, an example of strategic research would be the investigations of neutron transport properties and of the consequent γ ray emission properties of geological materials.

Tactical research is a type of investigation aiming to solve specifically selected problems, usually of an industrial nature. An example of tactical research in nuclear geophysics would be the attempt to elucidate and then empirically verify a specific interpretational relationship for an industrial application, e.g. the relationship between the concentration of copper in chemically complex copper ore samples and the recorded responses of fluorescent and scattered X rays or the prompt spectral neutron–gamma rays emitted as a result of neutron–nucleus reactions. As in the case of the long term research, which may span centuries, it is strategic research that provides the intellectual capital for tactical research. In the politico-economic environment currently predominant in some areas of our globe, a common demand made on scientific institutions is that they be at least partly commercially responsible for their activities. This has resulted in an explosion of tactical research activity, financially supported by non-research organizations which, accordingly, hope to derive financial benefits from these collaborations, e.g. a particular copper mining company. Whereas these arrangements certainly ensure the flow of technological benefits to commercial organizations, it is essential for the benefit of society at large and its commercial organizations and researchers that scientific research grows uniformly and not lopsidedly. In the current socioeconomic climate, this means that the greater danger is a lopsided growth in the direction of tactical research. In the event that strategic research and fundamental research should wither as a result of insufficient support from society, tactical research would be starved eventually of intellectual capital, which in turn will result in the decay of technological progress.

6.1.2. Society, nuclear geophysics and society's comprehension of environmental issues

We live in an epoch where public consciousness of science is undergoing an important transformation, one which has been in progress for the past two decades. In the prevalent current mood any advances being made in science no longer fill the

general public with optimism and pride. On the contrary, in many people these advances induce a sense of scepticism about the reliability and potential benefits of the new discoveries and even a sense of anxiety about the planet's future. This situation has directly manifested itself through the widespread creation of public ecological movements and in the support given to these movements by various leaders of the public, either in community groups or in the broader spheres of national and international politics. The political debates on this issue usually refer to evidence obtained and theories developed in the earth sciences.

In this situation, it is particularly important that society will properly understand what is known in up-to-date science about the properties of our planet and what capabilities exist for predicting and monitoring ecological change. In this period it is important that the public be able to distinguish situations revealing reliable regularities in data concerning health and safety issues from those matters that are related to ethical and moral values.

Nuclear geophysics provides humanity with a wide range of data about our planet. This branch of science originated with the birth of fundamental nuclear physics in 1896, when Henri Becquerel discovered the phenomenon of natural radioactivity in uranium chloride. Nuclear geophysics has often contributed appreciably to the understanding of processes which occurred in the past and are still in progress on our planet.

The fields of study in the geosciences and some of the technologies which nuclear physics has opened up include the following:

- (1) the geochemistry of isotopes, radioactive elements and useful minerals;
- (2) the development of a comprehensive theoretical understanding of the nuclear properties of rocks, which has led to the development of important technologies for the use of petrophysics and mineral physics for assisting the exploration, development, extraction and processing of natural resources;
- (3) the interactions between nuclear radiation and rocks, which are sources of various applications to geological investigations, e.g. fission track detectors for the determination of microconcentrations of uranium in rocks;
- (4) the use of radiometric methods in geochronology and stratigraphy for determining the age of rocks;
- (5) the mineralogy of materials containing radioactive elements, the geology of radioactive ore bodies, and the processing and industrial utilization of radioactive materials;
- (6) studies of radioisotopic occurrences in the atmosphere and on the earth's surface, e.g. in the sediments of rivers and lakes, both ancient and existing, which have contributed appreciably to atmospheric physics and hydrogeology;
- (7) studies of radioisotopic ratios in the earth's crust, which have similarly contributed to our knowledge in the geosciences of geodynamics and volcanology.

Several of these geoscientific fields have been discussed in previous chapters, in particular, the first three fields mentioned. However, some facets of the other fields require some discussion in regard to their impact on our scientific understanding or on the environment in which human society exists.

The structure of the earth's crust — a thin stratum comprising also the biosphere — reveals earth's entire geological history. Among the most important achievements of nuclear geophysics is the application of the radioactive decay process to provide a time reference standard allowing the chronological reconstruction of geological events.

The study of the isotope ratio of natural specimens has made it possible to follow the dynamics of the transfer of material from the earth's mantle to its crust and to correlate this process with the complex multistage convective movement of material within the mantle. Such processes give rise to our planet's tectonic activity, which in its turn produces multiple stress and faulting zones. In these zones, owing to an intensive degasification of the planet, fluxes of both radioactive and non-radioactive gases and aerosols are formed which vary in their temporal and spatial distributions. These aerosols are enriched by metals (particularly by heavy metals) and organic associations (such as benzopyrene), which are a health hazard. The use of nuclear analytical methods in the study of aerosols provides a method for determining their multielemental composition with an accuracy unattainable by other methods. In these methods, each of the isotopes under investigation serves as a marker enabling us to follow the full circle of transfer of matter within the biosphere.

Also, nuclear methods have enabled the detection of traces from the Chernobyl accident on the Antarctic continent. The uranium decay product tracks have allowed a reconstruction of the predominant pattern of winds in Europe 19.9 million years ago.

Of special interest is the natural emission of radon, which is easily detected and serves as an indicator of tectonically active zones. Along with other radioactive elements and their fission products, radon is successfully applied in geological mapping and prospecting of ore deposits. Numerous investigations point to the possibility of a reliable prediction of earthquakes and volcanic eruptions using the measured radon flux variations in combination with other methods.

The occurrences of increased radon emission are a danger to the health of those inhabiting these areas. In planning the construction of homes in such areas, it is important to take into account any irregularities in the radon emission distribution over a sufficiently large area in the potential construction site. In dwellings erected in such zones, radon concentrations may be tens of times higher than the normal ambient value. As a consequence, the inhabitants are subjected to substantial health hazards as, for example, lung cancer. On the other hand, it appears that exposure to radon doses which are slightly higher than normal has a therapeutic effect.

Cosmic rays also provide a considerable contribution to the background radiation on the earth's surface. The low energy component of these rays did not attract

significant attention until recently because it only penetrates the upper strata of the earth's atmosphere and often remains outside even these limits. This component of cosmic radiation created some scientific interest in connection with the sky lighting phenomenon (aurora borealis) and the disturbances of the earth's magnetic field. Yet, unconventional sky phenomena have always been interpreted by superstitious people as precursors of future events as, indeed, these events undoubtedly occurred occasionally by chance after the appearance of these sky phenomena. The initial pioneering attempts by scientists in their investigations of these illuminated sky events were reinforced by the availability of cosmic data. Direct measurements made from space shuttles have shown that the phenomenon is simply the low energy cosmic ray component (plasma), which is responsible for the physical state of space in the vicinity of the earth. The investigation of cosmic space has required the accumulation of detailed knowledge of properties and behaviour of plasmas and the atmospheric strata surrounding the planet, which initially had received only little scientific attention. This had prevented any progress in elucidating the mechanisms by which cosmic processes affect terrestrial ones. The situation in this regard has changed substantially in recent years.

Ecological problems and the analysis of the probable consequences of nuclear war have drawn the attention of investigators to the study of atmospheric properties. The chain of impact transfers resulting from such an event is now understood. The cosmic plasma modulates the flux of the high energy cosmic ray component. The latter merges with the atmospheric stratum and thereby affects its physico-chemical properties. This changes the atmospheric transparency and the proportion of stellar electromagnetic radiation arriving on the earth and here provides suitable conditions for the existence of life.

Cosmic processes crucially affect such atmospheric phenomena as cyclones, flow movements and various other events which still cannot be predicted accurately by modern meteorology. A proper understanding of these phenomena will undoubtedly improve the forecasts of those sharp short term weather anomalies that substantially affect daily life and economic activity. Disturbances in the upper atmosphere strata (the ionosphere) heavily influence long distance radio communications, which together with satellite communication facilities control the supply of information in society. Substantial evidence has been accumulated on the influence of space phenomena on the health of the human species.

The off-atmosphere low energy component of cosmic rays controls the quantity of ozone in the middle atmospheric stratum by modulating the cosmic ray high energy component. Besides, anxiety is growing within society about the possibility of ozone exhaustion owing to the technogenic impact on the atmospheric strata.

Thus, nuclear geophysics has provided humanity with the capability to make sense of the wide range of the natural phenomena directly affecting its existence on this planet. Nuclear geophysics enables an elucidation of the consequences of

particular events and brings us close to an understanding of the fundamental geological and cosmophysical processes. Its methods apply to assessing the role of a particular anthropogenic environmental impact against a background of the natural variations of the particularly parameter considered.

The conclusions drawn with the aid of nuclear geophysics may improve the consciousness of society in the present epoch of ecological crisis. The reason for any lack of consciousness is the lack of factual information within society about natural phenomena, and society's sense of disquiet and even anxiety about imminent ecological danger.

The precise knowledge provided by nuclear geophysics facilitates the creation of an informed community. By elucidating the connections between various natural events and by tracing long influence chains, nuclear geophysics substantially supports the education of specialists and society in general scientific and philosophic issues. We hope that in this way society will be able to safeguard the remarkable diversity of planet earth's biospheres.

6.1.3. Economic and developmental framework

A thesis which continues to have wide acceptance is that economic development is highly dependent on the availability of resources. The resources, which have been in high demand globally since the advent of the industrial revolution in the 18th century and have stimulated the development of nuclear geophysics, are energy (as fossil fuel) and solid state minerals. There is little doubt that energy is the type of strategic resource that has the largest value in both production and consumption. And within the class of energy resources, petroleum is the most important component in terms of both monetary value and energy output.

The motivations for using nuclear geophysics techniques are currently the exploration for and exploitation of natural resources as well as the analysis and remediation of problems in the environment. The former motivation is the traditional one that has resulted in the development of the techniques that currently exist. The latter motivation has recently become important in many countries where the processes associated with industrialization and increased population have created situations where potentially hazardous materials have been concentrated in the environment. These hazards often need to be identified and located, and remedial action must be taken to provide a safe environment.

A common feature of the non-scientific motivations for the application of nuclear geophysics techniques is that the location of economic resources is becoming increasingly difficult and the control of environmental problems is ever more intractable. The data needed for successful investigations are becoming more and more extensive. As the world's population and desires for improved standards of living continue to increase, many of the resources which are currently still abundant

will be located in less accessible areas. Nuclear geophysics is essentially an analytical science that can provide the information for identifying resources, improving the efficiency of their production and alleviating environmental problems.

In the fifty years, or so, since radioisotopes and the relevant supporting technologies became generally available, outstanding advances have been made and are being made in a number of critical areas of industrial activity. But what of the future? While we cannot predict the probability of new, relevant technologies being introduced, it is pertinent to examine those areas of industry in which nuclear geophysics has already made an impact, and to question the probable nature and intensity of any future requirements.

The main issue of concern in regard to petroleum as an energy source is that it is non-renewable. It is far more difficult to locate than the other fossil fuel, coal. In the latter stages of oil exploration and extraction, borehole logging by nuclear techniques is the only available option. However, although there has been a continuous development of nuclear borehole logging techniques and equipment, and improvements in the accuracy of data interpretation, the ideal system is yet to be developed. Moreover, the large fraction of energy use provided by oil and gas and the relative inelasticity of oil prices as a function of supply and demand provide a strong financial incentive for the development of improved in situ analytical techniques. Potential improvements would result in more efficient production and improved exploration success whenever there appears to be an approaching deficit between the supply and the anticipated demand. Estimates for the world reserves to production ratio is 43.4 years for oil and 58.2 years for natural gas. These life index times are short enough that the near future will require improved techniques for both exploration and efficient use of hydrocarbons.

The distribution of economic, principally humic coal reserves worldwide is characterized by a limited number of massive deposits from which the coal is mined (underground) or excavated at the surface. The quality of coal varies, with increasing carbon and decreasing volatiles from lignite to anthracite. The dominant use is for electricity generation and, to a lesser extent, for steel production. A critical characteristic is that coal includes a range of impurities (Al, Si, Ca, Fe, Na, S, Cl, N, K, Ti), which vary in number and concentration according to location. These impurities relate to two critical performance factors: boiler efficiency and environmental pollution.

However, if the range of concentrations of mineral impurities can be controlled, boiler efficiency can be standardized and pollution minimized. The key to this requirement is multielement analysis and blending either by the supplier or at the power station on receipt of the coal. This analytical requirement can only be met by a system which has the characteristics of both range and elemental specificity and, in addition, can be operated on-line. For this, nuclear techniques are the only option.

The remaining, critical characteristic of coal is that, like oil, it is a non-renewable resource. But what of the lifetime of coal deposits? The current world

TABLE VII. WORLDWIDE IDENTIFIED ECONOMIC RESOURCES 1994–1995^a

Commodity	Production (10 ³ t)	Reserves/production (a)
Bauxite	120 000	192
Iron ore	990 000	152
Manganese	19 000	42
Nickel	920	51
Copper	11 700	27
Zinc	7 300	19
Lead	5 400	12
Tin	215	33
Cadmium	20	27
Tungsten	40	57.5
Gold	2.3	18

^a Source: Bureau of Mineral Resources, Australia.

reserves to production ratio is 238 years. It appears, therefore, that world resources are sufficient for ore smelting needs for some time yet.

Nevertheless, we must bear in mind that these estimated two centuries and forty years are a mere ‘drop in the ocean’ in regard to human existence on this planet, not to mention the aeons during which life on this planet preceded our own. The main justification for implementing a wide ranging use of nuclear analytical techniques will probably be maximization of the efficiency in utilizing process applications.

The relatively large number of minerals (other than the fuels already discussed), the various types of mineral deposits, the wide geographical pattern of mineral distribution, the large range of economic values, their roles in society and the ability to recycle some metals (e.g. aluminium and certain steels) result in a much more complex picture for these economic minerals concerning predictions about consumption versus reserves than is the case with coal, oil and gas. Although the patterns of supply and use are complex, the reader may find enlightening and alarming some figures for the world reserves-to-production ratios in respect of certain commonly used minerals.

Nevertheless, much the same logistical problem arises here as well, in that the newly discovered resource deposits are generally either more remotely situated

geographically, or more deeply located stratigraphically, than those currently operating or recently exhausted. Also, they are frequently of lower grade than the ore or minerals currently being extracted. It is evident from Table VII that unless major new discoveries of ore bodies are made continuously, the available supplies to society of several strategically important base metals will shortly be in a precarious state, particularly lead, zinc and copper, at their current rate of consumption.

If we return to the problem of resource consumption, it is interesting to reflect on the actual market monetary values attached to the worldwide production of various minerals and to interrelate them. The values to be cited below are very approximate, given the fluctuations occurring in market prices. Even accepting a tolerance of $\pm 20\%$ in the figures, they give a clear insight into the current global price consumption pattern and its priorities. Also, the consumption figures would not entirely match those given for production, because there is significant on-going stockpiling. Furthermore, in certain metal industries, the growing practice of recycling makes an accurate interpretation of the relationship between production and consumption difficult.

Oil production provides an example whose enormity should impress the reader. In 1994, world oil consumption was approximately 60.5 million barrels per day, which at 1996 prices was valued at nearly US \$1.1 billion per day, or US \$400 billion per annum. By comparison, the value of daily black coal consumption is approximately US \$445 million, at a mean market price for coking and steaming coals of US \$46 per tonne.

On the other hand, the most commonly used metallic mineral, haematite, is extracted at a rate of about US \$92 million per day, on the basis of a market price of US \$27 per tonne. The most plentiful of the base metals, copper, is produced at the rate of US \$61 million per day, and for lead, which is in the most precarious state of supply, the daily production rate is approximately US \$9 million, using prices per tonne of US \$1900 and US \$600 for copper and lead, respectively. It is of interest that the number of years of resource supplies, without replenishing reserves, is 238 for black coal, 155 for iron ore, 27 for copper and 11 for lead.

Clearly, the apparent scarcity of resources which is projected in the medium term is not a reliable determinant of the market price. However, the data in the table strongly suggest that unless exploration and mine development programmes are implemented with increasing effectiveness, and unless radical improvements are made to beneficiation processes, together with recycling being undertaken on a large scale, our global society will soon face acute shortages in certain metals. This is particularly so because the industrialization of most countries on our planet is proceeding apace, driven by an almost exponential growth in demand for the manufactured products based on these resources.

Some ameliorating effects on this demand are present already: the diminution of the practice of using lead as an additive for petrol, and the continuing substitution

of plastics for metals. Moreover, many of the resources used in the manufacture of plastics are renewable, e.g. cotton seed and castor seed, and, also, the production of plastics and plastic manufactured goods is generally less intensely power consuming than is the case with metals, including the beneficiation of their ores.

6.1.4. The why and how of nuclear geophysics — particularly in the borehole

The roles of nuclear geophysics vary widely in the scheme of ameliorating the pressing problem of an ever-diminishing life index for our energy and mineral resources. In the petroleum industry, it has useful applications in both its exploration and production phases. There, its environment of application is predominantly the borehole or oil well, of depths ranging from 1000 to 7000 m.

In the solid resources industry its roles are most evident in mine development (also known as pre-mine planning), mine production, and process control in resource beneficiation. It also follows from our previous discussions that, frequently, one flow-on benefit from optimizing these operations is saving of energy. The environments most often are the borehole and low flying aircraft.

Moreover, it appears that nuclear geophysics is not generally applied in the exploration phase of the solid resources industries as a standalone technique. It is used there in conjunction with other geophysical and geochemical techniques. Even the data obtained from airborne radiometry are often combined and correlated with those obtained by the other airborne and satellite borne geophysical techniques which have totally different ranges of ground penetration, e.g. infrared absorption for an order of micrometres, and magnetics which penetrate down to 800 m. Of course, airborne radiometric surveying is also a most actively used standalone nuclear geophysical technique for mineral exploration, particularly in Australia. On the land surface, borehole nuclear geophysics is used occasionally in conjunction with land geophysical techniques e.g. induced polarization, electromagnetics and acoustics, particularly when these techniques are being used in boreholes as well as on the land surface. However, the main nuclear geophysical techniques applied in this phase of the industry are natural γ ray logging and formation density logging techniques, which are not generally used as primary indicators of anomalies, other than in the exploration for uranium and mineralized beach sands. The same applies to airborne radiometrics, which are rarely used to give primary standalone indicators of the actual minerals contained in the geological zone, unless a radioactive substance is the actual target for economic development.

Nuclear geophysical borehole logging has an important area of application which is outside the aims of the conventional resource industries. This is in civil engineering and, in particular, in the accurate elucidation of foundation geology, and of any changes of that geology which may be in progress on sites where buildings and roads are planned for construction. The geological changes of concern are those

which occur as a consequence of human intervention in natural drainage systems, that intervention often taking the form of engineering works having been carried out in the area previously. Indeed, any savings effected and any damage avoided in the civil engineering and construction industries, as a consequence of using the data obtained from these borehole measurements, can also be viewed as measures successfully taken to conserve resources of both energy and mineral materials. Similarly, one would view in the same light any economies made in the production of building materials, particularly that of cement from limestone.

6.2. EXAMPLES OF NUCLEAR GEOPHYSICAL TECHNOLOGIES AND THEIR IMPACT

This section describes the basis for some of the existing nuclear geophysical technologies, the way they perform technically, aspects of the economic benefit they provide (where possible) and some of the constraints on performance.

The examples chosen essentially belong to the environments of the subsurface and the mineral processing plant. However, it should be noted that although this book gives it little prominence, airborne radiometrics, carried out from low flying aircraft, is one of the most important available tools for resource exploration. In Australia alone, more than twenty reconnaissance flights are carried out daily to obtain data assisting minerals search and drilling strategies. These radiometric data help define exploration hole drilling strategies on the basis that an interpretation of the data may lead to differentiating geological zones in otherwise apparently geologically uniform land structures, e.g. provenance studies. Of course, there is probably more exploration search of this type occurring in the southern hemisphere of our globe because of its relatively lower level of contamination with ^{137}Cs , from nuclear weapon fallout, than in the northern hemisphere. This is an important factor in airborne search methods, where the most intense γ ray emission of the uranium daughter ^{214}Bi , of an energy of 609 keV, potentially finds spectrometric interference from the 662 keV γ ray of caesium. The other important factor which has stimulated the growth of this technique, which has been used since 1955, is the development of extremely accurate navigation techniques obtained from earth satellite systems which provide positional information to the nearest 1 m laterally and 3 m vertically, where records are made every 70 m of distance surveyed. The modern airborne survey units are γ ray scintillation spectrometers, often equipped with immense prismatic slab-NaI(Tl) scintillators, up to 33 L in volume, having extremely high counting efficiency and an energy resolution which is excellent for scintillators (6–7% fwhm) [6.10].

Similar airborne radiometric techniques are implemented by the Office of Hydrology, National Weather Service (USA), for determining snow cover as part of a procedure for estimating soil moisture in a particular geographical region. This

parameter, taken together with rainfall in the autumn, is vital for monitoring local land drainage conditions with the purpose of implementing flood control procedures.

6.2.1. Nuclear geophysics and the uranium mining and processing industries

The techniques presented in the context of the uranium industry symbolize the original interest taken in matters nuclear geophysical. It was the research into uranium and its applications which initially acted as a spur to nuclear research for peaceful purposes.

The two environments relevant to the industrial practice of uranium determination are the borehole for exploration, mine development and mine production, and the process stream for mineral separation and uranium purification.

For borehole measurements of uranium, the most commonly used logging technique is the natural γ ray spectral type. The other type of measurement, developed for uranium ore which is in a state of non-secular equilibrium, rarely has commercial applications in current market conditions for uranium. The term 'secular equilibrium' applies to the natural radioactive series consisting of sequential parent and daughter groups, e.g. ^{238}U and ^{232}Th , which was discussed in Section 2.2. In the case of ^{238}U , secular equilibrium is essential if the practical basis for the measurement will be scintillation spectrometry, which is rugged, low cost and, unfortunately, of far too low energy resolution for the measurement of the early daughters of the decay chain, ^{234}Th and $^{234\text{m}}\text{Pa}$. The concept of secular equilibrium is that if the parent isotope is long lived compared with the daughter isotopes, then after some appreciable time the amount of any given daughter isotope becomes constant. When this happens, it is valid to use the measurement of the concentration of the daughter as a measure of the concentration of the parent. Under these circumstances, parent and daughters are in secular equilibrium [6.11].

It is reported from one investigation that the threshold for quantitative effectiveness in spectral γ ray logging based on using scintillation detectors appears to be 1.8 ppm for uranium, 4.0 ppm for thorium and 1.0% for potassium if compared with the instrumental neutron activation analysis of corresponding drill chips, used as reference samples. This threshold is defined as that concentration level below which the relative standard deviation between the two methods is greater than 30% relative [6.12]. The drill chip samples used as reference standards had been suitably sampled from borehole intervals corresponding with the logging measurements. The threshold detection limits for the reference samples were estimated to be nearly 50 times smaller than those for the spectral γ ray logging.

The threshold level for uranium detection using high resolution germanium detectors is greater than that for scintillation detectors, owing to the limited size of the detector crystal. Nevertheless, the validity of these measurements is independent of whether there is secular equilibrium when the γ rays of either ^{234}Th or $^{234\text{m}}\text{Pa}$ are

monitored for the purpose. These two early daughters have half-lives of 24.1 d and 1.175 min, respectively, and are therefore always in equilibrium with the ^{238}U parent. The only problem with the γ ray lines of ^{234}Th is that they are of low energy (63 and 92.6 keV), so that some photon absorption is likely to take place in the casing of the hole (if one exists) and in the housing of the probe. The γ rays emitted by ^{234}Pa have penetrating high energy γ rays (1001 and 766 keV), but the techniques based on their detection suffer from low sensitivity for the former, and potential interference for the latter, from one of the γ rays emitted at 768.7 keV by the young daughter ^{214}Bi . However, although these two interfering γ rays have an energy difference of 2.3 keV, it is questionable whether they can be separated spectrometrically, even through the use of high quality HPGe detectors. As a consequence, the favoured γ ray peak for monitoring uranium concentration is that of an energy of 1001 keV [6.13].

If the method of determination is based on the scintillation spectrometry of ^{238}U daughters, the precondition of secular equilibrium is essential because ^{238}U has no useful direct γ ray emission. In effect, with scintillation spectrometry, the γ rays being detected are emitted by elements other than uranium. If secular equilibrium exists, and this is readily tested, then it is possible to measure the uranium content validly and accurately by using the relatively intense lines of the daughter, ^{214}Bi .

In fact, secular disequilibrium is generally not a problem with the uranium ore of the currently important uranium producing countries like Canada or Australia. As a result, the use of scintillation counting of the γ rays strongly emitted by the daughters of uranium provides a reliable quantitative basis for in situ monitoring of the ore.

When parent and daughters are out of secular equilibrium, spectral γ logging is still possible if the detector used is HPGe. However, this entails making a commitment to a detector having high capital cost, a need for regular, reliable supplies of liquid nitrogen coolant and a specially designed mounting and housing for operational ruggedness.

The reasons why ^{238}U may be out of secular equilibrium is mainly that many of the inorganic uranium compounds, formed in geological environments, are water soluble and, therefore, may be transported to a different geographical or stratigraphic location at some time in geological history. This occurrence will geographically separate the parent from the original daughters. Also, if there is a loss of the gas, ^{222}Rn , this causes an anomalously reduced intensity of the γ rays emitted by ^{214}Bi , which provide the basis for the scintillation detector method.

In regard to the thorium series, it is generally found to be in equilibrium. The longest lived daughter in this chain, ^{228}Ra , has a half-life of 6.7 years. Generally, it takes seven half-lives of the longest early daughter in the chain to build up to 99% of full replenishment level. This means that the virtual complete replenishment of lost daughters in this chain would take less than 50 years, which is minuscule when compared with the geological time frame. Moreover, thorium compounds are relatively difficult to mobilize in geological environments.

The other techniques which do not require the precondition of secular equilibrium are the delayed fission (DFN), the prompt fission neutron (PFN) and neutron activation analysis. Detections in the two neutron fission techniques are based on neutron counting while the neutron activation analysis technique is based on γ ray detection.

The delayed neutrons detected in the DFN technique are those emitted by some of the fission fragments following the fission reactions caused in a uraniferous zone (by fast neutrons in ^{238}U and by thermal neutrons in ^{235}U) to begin the process. At the time when fission occurs, several fast neutrons are emitted, but their detection is the basis of PFN and not that of DFN. In the case of the delayed neutron emission, which is accompanied by the β decay of the relevant fragment, this causes an increase of the neutron flux above the level of the source neutrons. The delayed neutron emissions occur by several modes having half-lives varying from 0.2 s to 56 s. However, the apparent half-life is approximately 2.9 s. One problem with this technique, which requires a compensatory measure, is the formation of ^{17}O , which decays with a half-life of 4.4 s to form ^{17}N and to emit a neutron, which adds background to the emitted delayed fission neutrons. The errors for the corrections due to this background inevitably detract from the overall accuracy of the DFN method [6.14].

DFN is a technique which can be applied by using either a ^{252}Cf source or a downhole pulsed neutron generator. However, licensing requirements on the North American continent make the commercial application of this technique based on an isotopic source most difficult, particularly where the isotopic source required is very intense ($\sim 10^9$ neutron/s). A refinement of the isotopic source method was introduced to move the source further from the detector during counting, which provides for an increase in sensitivity by an order of magnitude. This enables a corresponding reduction in the strength of the source if so desired.

The practical basis of using a sealed tube neutron generator source is excellent from the point of view of protecting health and the environment, in case the probe is lost in the hole. However, its disadvantage is a high capital cost and a relatively short operational life. An alternative successful approach, technically, is the PFN technique, which entails the detection, at epithermal energies, of the prompt neutrons emitted in the fission process of ^{235}U . However, since this technology also depends on the use of a pulsed, sealed neutron generator tube, it also has the same maintenance and cost recovery problems as DFN. However, unlike DFN, the method is free from interference by the neutrons emitted upon spontaneous decay of ^{17}O [6.15].

A fourth method which can measure the uranium content directly and, therefore, does not require secular equilibrium as a precondition for its reliable detection is neutron activation analysis. For borehole logging, it can be operated by using either a downhole neutron generator or a ^{252}Cf source. The measurement is based on the detection of two low energy γ rays (74.7 and 86.6 keV) for ^{232}Th and ^{238}U , respectively. The advantageous feature of neutron activation analysis in these cases is that

the cross-sections in part of the epithermal energy range are very high, 83 and 280 barn, respectively. This detection technique, for uranium levels below 100 ppm, is subject to spectral interference caused by the X rays of 'younger' daughters, which then requires the determination of the background spectrum as a separate logging operation, which is a factor making the technique more cumbersome than the others mentioned. However, this technique finds common use in the analysis of geological samples, including drill core samples, using the nuclear reactor as a source for irradiating the samples and the laboratory for the spectrometric radiation counting [13].

Actually, particularly in regard to exploration, the use of the sophisticated, high capital cost uranium borehole logging techniques has been largely dormant since the depression of the US uranium mining industry. The reasons why this is the case for exploration are threefold. The first reason is that the cost of laboratory chemical assaying has diminished dramatically since the mid-1980s, through the application of inductively coupled plasma (ICP) absorption spectroscopy and neutron activation analysis. The second reason is that, most frequently in this phase of mining, the practice of the industry is to core drill, which is partly related to the requirements of financing organizations to obtain direct analyses of tangible 'representative' samples. The third reason is that these techniques were developed commercially in the USA, where the local uranium industry has virtually closed down because its high cost underground mining of low grade 'roll front' ore could not compete economically with the lower cost open cut operations which prevail in Canada and Australia.

Several different nuclear assaying techniques find application in on-line monitoring of uranium ore process streams. Some of the techniques are not uranium specific, but are practically so, given the parameters of the feed material and the beneficiation processes used. They include X ray preferential absorption analysis (XRA) and radioisotope density gauges for monitoring the liquid–solid ratio of pulp in the thickener. In the latter, the density is determined by measuring and recording the transmission of the 662 keV γ rays emitted by a ^{137}Cs source through the pulp.

For the XRA method, the irradiating X rays emanate from a ^{241}Am source and are absorbed selectively on the basis of the X ray resonance absorption energy of any uranium contained in the sample fluid. For continuous on-stream analysis, the immersion probe used for this operation contains the source and NaI(Tl) detector, which are, typically, of a strength of 110 MBq ^{241}Am and of dimensions of 40 mm \times 1 mm [6.16]. The accuracy of the measurements is reported to vary from 0.2 to 1% for concentrations ranging from 5 to 300 g U/L, which is comparable with that achieved by standard chemical methods. However, EDXRF is widely used for on-stream analysis, particularly where good sensitivity is required for solutions of low uranium concentration. One technique used to obtain good sensitivity entails selecting the energy of the primary X ray so that the energy of the scattered X rays is

easily resolved from that of the fluorescent X rays. The best sensitivity is achieved by generating primary K shell X rays of Sn by irradiating a tin target with the X rays of ^{241}Am , and thereby enabling the low energy L shell fluorescence of uranium.

In this way, concentrations in solution of uranium which are as low as 0.03 g/L can be analysed, and the reported accuracy ranges from 5 to 30% relative for solutions ranging from 0.03 to 5 g/L in uranium content.

6.2.2. Oil well logging

Over the past fifty years, the strides made in research and technology development in the area of nuclear geophysical applications to the petroleum industry, for both oil exploration and oil production, have simply been astonishing. The progress achieved in this industry has acted as a spur for the development of nuclear geophysical technologies for borehole logging in the solid resources mining industries and for the minerals processing industries.

It is particularly in the USA and in the former USSR that the oil and gas industries have made the giant technological advances which were followed elsewhere. In the USSR, the practice of oil and gas exploration depended mainly on the use of two instrument systems, the SRK and the SGP-2-AGAT [6.17]. The former was a modular natural γ ray and dual neutron detection system (either epithermal neutron, thermal neutron, or neutron–gamma detectors). The two types of probe developed are designed to operate, under thermostabilization, at temperatures of up to 200 and 125°C, where the former uses a dewar cryostat for thermostabilization. Certain probes in this series are designed to operate at depths greater than 7000 m, at logging speeds of up to 800 m/h and in boreholes of a diameter of 110 cm, which is reasonably narrow for an oil exploration hole. A more recent version of this system provides for the simultaneous measurement of γ rays, thermal neutrons and epithermal neutrons, enabled by programme control and telemetering modules designed to match the performance of the probes under hydrostatic pressure and temperature. This probe is designed for operation at slightly lower maximum hydrostatic pressures (100 MPa) and lower maximum logging speeds (540 m/h). The probes are 7500 mm long for higher operating temperature tolerance and 6500 mm long for lower temperature tolerance.

The SPA-2-AGAT system includes a sidewall γ – γ ray probe for operation in boreholes varying in diameter from 160 to 300 mm at logging speeds of 400–500 m/h, down to depths of 7000 m. The largest probe in this series has a diameter of 125 mm and is 3500 mm long, is designed to withstand pressures of up to 140 MPa and provides dewar cooling for its scintillation detector. The strength of the ^{137}Cs source used is 1.28×10^{10} Bq. Its configuration is designed to measure bulk densities ranging from 1600 to 3000 kg/m³, for Z_{eq} ranging from 7.2 to 17.

Integral, stationary γ ray and neutron techniques are used to determine the total content of natural radionuclides, the porosity and, in conjunction with other logging methods, the oil and gas saturation and lithology.

There are also systems for spectral natural γ ray logging (NGRS probes) which vary in regard to several characteristics, including the external diameter of the probes and the maximum operating temperature. The NGRS instruments of the VNII Geoinform system use an automatic spectrum gain stabilizer which locks on to a reference full absorption peak and operates by means of a microprocessor housed within the probe. The reference peak used is that being recorded from the detection of γ rays emitted by the natural radioisotope ^{40}K . The preferred scintillator is CsI(Na) because of its far greater effectiveness for peak stabilization (using the potassium emitter) than NaI(Tl). The effectiveness of this system of gain stabilization enables logging at speeds of up to 250 m/h. Fabricated models of hard rocks containing the various γ ray constituents provide the primary calibration standards in the field.

The important applications of these NGRS probes include correlation of sections which are otherwise intractable through the use of integral petrophysical characteristics and natural radioactive concentrations, determination of clay content through identification of the mineral composition of the rocks, identification of mineral boundaries and recognition of new oil and bituminous deposits.

Elemental γ ray spectral logging is practised for detailed lithological investigations, to determine the mineral contents in rocks and for tracking horizons. It is also applied to exploration in the solid resources industries. The probes are used for PGNA and, with the neutron source decoupled, for spectral natural γ ray logging. They are generally equipped with liquid nitrogen cooled HPGc detectors, and the sources used are either of the ^{252}Cf or of the downhole neutron generator type. The probes are operated in the continuous logging or the stationary mode. When operated continuously, they are capable of simultaneously measuring the concentrations of up to five chemical elements. However, in the stationary mode, their capacity in this respect is simultaneous measurement of up to 12 chemical elements. When the source is of the 14 MeV pulsed neutron type, these probes are also capable of delayed neutron activation logging. In applications to the petroleum industry, they are then used for oxygen logging in order to investigate water flow and its distribution along an oil well section.

The petroleum industry in the USA uses density, natural γ ray and porosity probes as well as interpretation techniques that are similar to those described above. In addition, the petroleum industries of both global regions have developed highly sophisticated nuclear geophysical techniques, often used in conjunction with other geophysical methods, which differ mainly in their details [6.18, 6.19]. The methods are used for both the exploration and the extraction phases of the industry. One of the techniques of differentiating oil from water in the formation is the pulsed neutron

lifetime log (PNL). The source is a sealed D–T neutron generator tube, and the fact that it is pulsable enables the separation of the γ rays emitted in inelastic and capture reactions as well as providing for the measurement of neutron lifetimes. The probe will also determine water saturation under conditions of constant formation porosity. The configuration most commonly used is the dual scintillation detector, and whilst the ratio porosity measured is not identical with that of the compensated neutron porosity probe, it is a useful parameter in its own right. Besides, it also has a capacity for measuring carbon/oxygen ratios, from the neutron interactions, and for providing multielement analysis on the basis of the neutron capture γ rays emitted.

In the USA, the measurements referred to as geochemical logs are run as a complete string of autonomous logging instruments to carry out simultaneously capture γ ray spectrometry, delayed neutron activation analysis, natural γ ray logging and various types of porosity logging. The multielemental concentrations obtained in this way enable mineralogical determination and, from this, precise prediction of the lithology. Although this impressive technology is already being used effectively, the difficulties in spectral interpretation discussed in Chapter 5 apply and will probably provide material for further research activity. Also, as was mentioned in Section 2.3, there are many possible relationships which might fit between elemental concentrations and inferable lithologies. However, the availability of a priori information on the anticipated mineralogical and lithological characteristics, together with the definition of limited goals by the operators, probably eliminates the problem of non-uniqueness in most situations investigated. The successful use of the PNL for measuring fluid saturation is based on the precondition that the salinity of the water is both constant and at concentrations of, at least, 2 wt%. When the salinity conditions are different, the carbon/oxygen (C/O) log provides data which can be used to infer the degree of fluid saturation in the formation, on the basis that the logs also provide accurate information on porosity and lithology. In fact, the C/O measurement and the PNL method are the only ones which ‘see’ behind the oil well’s steel casing. Nevertheless, the method is no panacea in that the sensitivity is low, particularly for carbon, and the depth of investigation is shallow. It also works most effectively under particular conditions of borehole fluid, the best being non-saline water, followed by saline water and then oil. Further, it is reported that the porosity of the formation measured should be greater than 10 porosity units [6.20]. Other researchers reported the need to operate in even more porous formations than this for successful C/O logging [6.19]. Two quite different approaches have been taken in recent years in an attempt to overcome the shortcomings of the original C/O logging probes. One approach is to use a single large BGO detector of high efficiency in order to raise the count rate [6.21], and the other approach is to use two smaller high efficiency detectors in a dual detector configuration in order to provide a measure of borehole compensation [6.22].

The process of extracting the fluid hydrocarbons from the formation reservoir entails transferring them through a pipe in the form of a multiphase mixture which

also contains saline water from the reservoir. The cost of carrying out this fluid transfer and the separation of its components is extremely high in offshore operations, owing to the need for processing platforms and specially engineered pipelines for operation in sub-sea-surface conditions in order to link them with producing oil wells. Essential information for the control of production are the mass flow rates of each component in the mixture arriving from each of the numerous wells and feeding to the central platform, in the case of offshore production. Current common practice is to transfer the fluid output from each well to a common test separator system and to measure each phase component separately. The time taken on each well for this procedure is usually between 8 and 12 h, with the consequence that the output from each well may only be tested weekly. However, the continuous availability of this information can greatly enhance production allocation, reservoir management and optimization of oil production over the life of the field.

In order to optimize economies, the costs which need to be taken into account are those of building additional platforms and of loading platform superstructures by adding separator test facilities, and those of the piping lengths needed. The use of a multiphase flow meter mounted on each well pipeline produces this continuity of information and also reduces the need for additional platforms, thereby reducing the amount of subsea pipeline linking satellite platforms with central stations. The fluid mixture moving in the pipes is heterogeneous, usually in the form of discrete pockets of gas referred to as 'slugs', individually enveloped by a film of liquid. The multiphase flow meter consists of two gauges. The first gauge which the fluid encounters in its passage from the well is a simple γ ray transmission gauge for density measurement, based on the use of primary 662 keV γ rays emitted by a ^{137}Cs source to determine the surface density of the fluid. The second gauge is a dual energy transmission gauge (DUET), which uses 59.5 and 662 keV γ rays as the primary radiation. In effect, the DUET also contains a second density transmission gauge. The fluid flow rate is determined by the measured surface density as a function of unit time, this determination being based on a cross-correlation between the data recorded by the two gauges.

The differential degree of transmission of the two γ rays recorded by the DUET provides a determination of the ratio between the volume of water and that of the total liquids in the pipe (referred to as the water cut). These calculations are based on the fact that the transmission of the 59.5 keV γ rays depends on both the density and Z_{eq} , while that of the 662 keV virtually depends on the density alone. The relative errors in flow rate measurements determined by regression analysis (as reported from a number of long term tests), using the test separator system as a reference, are 4 to 7% for liquids, 6 to 8% for gas, 8% for oil, 5 to 8% for water and 2 to 3% for the water cut, under conditions of both the gas volume fraction and the separator water cut ranging from about 0 to 90%. This performance appears to be well within the range considered to be satisfactory by the oil producing companies [6.23, 6.24].

The measurement-while-drilling (MWD) technology provides information on the rock formation within a short time after rock penetration has started. It consists of detectors and sources (if appropriate) mounted within the drilling string. The use of this technology has raised technical problems, which have been largely overcome, as, for example, the vibration and heat generated by the drilling process. There are also applied scientific problems generated by the fact that the probe is essentially enveloped in a steel housing up to 3 cm thick. This cuts out the low energy relative to the high energy γ rays. For example, the natural γ ray spectral response is much stronger for the 2.62 and 1.46 MeV radiations emitted by ^{208}Tl and ^{40}K than for the lower energy γ rays of the thorium and uranium daughters. Although the responses of these probes do not match those of ordinary 'wireline' probes calibrated in so-called API units, they are definitely effective for potassium-uranium-thorium analyses, being generally equipped with 256 channel downhole ADCs.

One important attraction of the MWD technology is that the probe can take measurements of the formation before appreciable fluid invasion of the formation takes place, modifying its nuclear geophysical parameters, which is important given the relatively shallow depth of investigation of nuclear techniques. A second attraction is that the MWD probes can be used for logging holes which highly deviate from verticality; they can even be used in holes being drilled horizontally. The use of additional shielding in the drill collar for the detector, which is rotating with the drill stem, enables directional logging, thereby providing a basis for navigating the drill bit and adjusting the angle at which it penetrates the stratum.

The MWD technology now incorporates formation porosity tools, some of which are configured similarly to the 'wireline' neutron compensated porosity tools. However, because of the sensitivity of ^3He proportional counters to vibration, various companies manufacturing these probes have sought alternative detectors. One alternative solution is the use of multiple GM tubes placed around the circumference of the drill collar, which detect few of the formation's capture γ rays but rather those emanating from the steel drill collar, which in effect makes this array a neutron detector. Another detecting device used is a ^6Li scintillator, which, although sensitive mainly to neutrons, requires pulse shape discrimination against its response to γ rays.

Formation density probes are also part of the MWD technology, but sidewall pads are not feasible because of the rotating collar so that the variable mud thickness between the density sensor and the formation is a problem inviting satisfactory general solutions [6.19].

The petroleum industry in the USA and in the former USSR uses radioactive tracer techniques to a considerable extent for defining the hydrodynamics between oil wells, the direction of filtration and the distribution, the directions and the velocities of moving fluids, as well as the role of sources external to the main oil drainage system. The tracer method is used during the exploration phase, in conjunction with

layer-to-layer filtrational modelling, to determine the permeability and thickness in geological layers of the formations. The empirical information used in the modelling is the time dependence of concentrations of the tracer injected into the well. This technique is also used to monitor the process of enhancing oil production by pumping water from injection wells. Water soluble polymers labelled with tritium are used in the monitoring process for controlling water flooding of wells. The high accuracy and sensitivity of the method permit unusually high filtration velocities under formation conditions [6.25]. Radioactive gases are also used as tracers to determine oil reserves and evaluate the filtration capacity of collector basins. They are used where they are either available naturally in high concentrations in the water or the oil, or can be pumped into a particular interval of an oil well section.

Short lived isotopes (^{24}Na and ^{82}Br) are used to investigate the technical conditions of the borehole. This includes searching for fractures, fissures and breakages in the cement lining behind the casing and detecting overpipe circulation as well as detecting formations causing drainage of the well production.

6.2.3. Borehole logging for the solid resources industries

Whereas the processing phase of minerals in the mining industries has, over the past fifteen years, adopted sophisticated nuclear geophysical technologies at a spectacular rate, the exploration, mine development and extraction phases of the mining industry have been slower to take on the sophisticated versions of these new technologies which have been developed for the industry's specialized applications. While it is true that this sector of the mining industry relies heavily on nuclear geophysical methodology, particularly in the mine development phase, its utilization at a sophisticated level of practice occurs only in pockets of the industry, its prevalent utilization being qualitative only. Nevertheless, substantial potential economic benefits exist for this phase of the mining industry in adopting the quantitative nuclear geophysical technologies which have already been developed and are being exploited by some companies in this sector.

One obstacle to widespread adoption of sophisticated nuclear borehole geophysics is the diversity of the industry itself, in regard to the great number of different minerals mined and, where the target mineral is the same (e.g. nickel), the nature of mineralization and that of the chemical impurities are often diverse. The case of nickel ores provides an example of this diversity because the ores may be deposited as massive or disseminated sulphides, or as laterites. The consequence of this is that the only equipment with a universal capacity for producing accurate borehole assays, in most mineralogical conditions, will be a costly PGNAA downhole system equipped with a high efficiency HPGe detector, a downhole MCA and a neutron source.

In many countries it is mandatory that the downhole neutron source is a sealed tube neutron generator system, rather than an isotopic source like either Am–Be or ^{252}Cf , because the loss of the isotopic source downhole could cause a grave environmental impact. Currently, the cost of developing such a downhole neutron generator probe system is likely to exceed US \$300 000. The risk of losing such a costly probe downhole provides a strong disincentive, to the mining companies or the service logging companies, to adopting this form of the technology unless the drill holes are situated in stable ground, the holes are shallow and the equipment is required on a routine basis to achieve rapid cost recovery.

The alternative solution, accepted by several companies in Australia, is to use relatively low cost technology, as developed by the CSIRO, which is equipped and calibrated for their specialized needs. Although the CSIRO has developed a wide range of borehole logging technologies, those commonly adopted by the industry are based on the spectrometric backscatter γ ray technique, mainly for reasons already discussed. Several actual and potential applications for borehole logging in mining entail the analysis of elemental mixtures which are essentially binary, as regards the distribution of the constituents' atomic numbers. The most clear-cut examples are the ash in raw coal and the gangue in iron ore. Consequently, these mineralizations are readily logged quantitatively by using the spectral γ – γ technique. In fact, because of the concern expressed by the industry and the community over the environmental impact caused by the loss, downhole, of radioactive sources of any species, the CSIRO has recently concentrated its applied research effort on the development of spectrometric backscatter γ ray probe systems equipped with radioactive sources having less activity than the statutory threshold activity for compulsory registration as a radioactive source. According to the health authorities in Australia, that threshold activity for ^{137}Cs is currently 3.7 MBq (i.e. 3.7×10^6 disintegrations per second). Two such probes, with different geometrical configurations, have successfully undergone prolonged field tests and are undergoing development for routine quantitative analysis of ash content and ore grade in coal and iron ore minings, respectively [6.26, 6.27].

6.2.3.1. Why borehole logging and why quantitative borehole logging?

At the very least, nuclear geophysical borehole logging can provide a continuous record on the variation of a geophysical property against depth in the hole, which is something that cannot be achieved reliably if extracting physically the material in question from the hole, as core or drill cuttings. If the local geology is known reasonably well, even the data obtained from non-spectrometric logs can often be interpreted quantitatively. However, the various spectrometric techniques provide a different dimension to enhancing the accuracy of in situ determinations, both in regard to elemental content and identity of the different constituents, in the

mineralized deposit or the formation geology. Moreover, by using current electronic and computational equipment, it is possible to obtain the required nuclear assays on-line, eliminating the bottlenecks in scheduling sampling and assaying procedures in the laboratory. The data obtained in this way are also directly interfaceable with general mine planning records and can be used to adjust mining strategies without delays. Thereby, the data add to the on-line information base of the mining specialist, mining engineer, geologist and metallurgist.

For exploration and mine development, chemical laboratory assays on drill hole samples are essential for obtaining a complete chemical information base on the ore body, since quantitative borehole logging cannot, in any way, imitate the laboratory methods in the precision and range of elemental constituents that can be analysed simultaneously. On the other hand, the laboratory assays are only as good as the sampling, and it is there that errors are most likely to occur when scheduling is tight. It is because of tight scheduling and delays in receiving assay information that fixed pattern drilling is prevalent. With the immediate availability of assays on-line from borehole logging, it should be possible to implement more flexible and less costly drilling strategies than pattern drilling.

For the same reason of immediate data availability, quantitative borehole logging has an economic value in the extraction phase of mining which by far exceeds that of conventional grade control. The logging data obtained can be used for dynamically scheduling different sections of the mined ore. They may be scheduled to enter or to bypass beneficiation plants on the basis of grade, to feed different crushers on the basis of lumpiness, density or grade, and to allocate mined ore to different stockpiles according to its grade. Borehole logging also enables implementation of economic selective mining procedures, e.g. in an iron ore blast block where ore and gangue materials can be removed in separate operations, also avoiding accidental dilution of the mined product. These improvements can assist in prolonging the economic life of the mines.

The use of this technology, particularly where applied to ore extraction in an open cut mining situation, has an estimated potential annual savings value of up to US \$8 million, depending on the size and nature of the mining operation.

The one area of application in which spectrometric nuclear logging still requires testing and acceptance is underground mining. However, the new low activity probes being developed at CSIRO have potential application in this area of mining.

Indeed, nuclear geophysical borehole logging technology is playing an increasingly vital role in improving operational efficiencies in the solid resource mining industries. The main area of the mining industry which is currently applying this technology quantitatively is coal mining but its use is also growing in the metalliferous mining industries. However, the technology is used mainly to assist pre-mine planning and, to a lesser extent, the later stages of exploration. One of its

greatest potential economic roles is its use in the extraction phase of open cut iron ore mining.

The important benefit that all borehole logging brings to exploration and mine development activities is its capability of contributing key information parameters rapidly and dependably. This gives mining engineers and geologists flexibility in adjusting their strategies for these activities. This flexibility is not available if the sole information base is the chemical laboratory because bottlenecks in sampling and assaying frequently occur there, interfering with the timely delivery of strategic information needed to control the mining process.

The relatively primitive nuclear borehole logging technology, which is most commonly practised, is based on the production of a single measured response to an excitation event in the rock/ore matrix. Although this approach is unsophisticated and non-spectrometric, it delivers useful information for many mining applications. While it provides no differentiation of the γ rays (or neutrons) detected, these methods are particularly useful in the field for measurements of neutron porosity, bulk density through γ - γ methods and changes of lithology through natural γ ray logging. The latter two techniques are particularly useful in mining situations where the local lithology is well known beforehand, which generally severely constrains the number of possible interpretations and thereby facilitates the representation of probe responses for detailed stratigraphic mapping.

However, the non-spectrometric techniques can neither accurately identify the chemical nature of the deposit without detailed a priori information nor provide, with confidence, the ore grade or the chemical concentration of key impurities. This is the function of the spectrometric techniques.

6.2.3.2. Developments in nuclear geophysical borehole logging for the solid resource industries

Many of the quantitative spectrometric nuclear borehole logging techniques which are currently in use are the result of research carried out by research groups over the past three decades at several international institutes. They include USGS in the USA, CSIRO in Australia, BRGM and LCPC in France, Geological Survey of Canada, and numerous institutes in the former USSR, just to mention a sample of the institutes where researchers have been active in these endeavours. Some of the experiences of a research team which operated continuously in this field at CSIRO provide excellent examples of the capabilities of the techniques, many of which were converted into technologies for routine use at Australian mines. The spectrometric logging methods developed are prompt neutron–gamma activation, delayed neutron activation, γ - γ and natural γ ray. In the case of borehole logging, the principal constraints on the measurement are the borehole geometry and, to a lesser degree, the location of the water table relative to those of the mineralized or coal strata. These

borehole analysis techniques have capabilities which vary from the identification of elemental or radioisotopic species in the ore and rock to the quantitative measurement of particular matrix or borehole properties. Depending on the actual technique used, the properties measured quantitatively are the concentrations of particular elemental constituents, the bulk density and the borehole diameter.

In Australia, the methods were tested successfully for quantitative analysis in three different types of mineralized ore deposits and in coal deposits. The mineralized ore deposits include massive nickel sulphides, pisolitic manganese oxide and haematite–goethite. Experience certainly showed that different methods were appropriate to different geological situations. To the present time, this technology, known as SIROLOG, has been adopted for routine applications in mining deposits of coal and iron ore, which are the mining industries operating on the largest scale in Australia; it is licensed to a company, Auslog.

There are several possible reasons why this technology has been absorbed in these resource industries rather than others. Several factors stand out. Firstly, coal and iron ore mining in Australia are generally large scale open cut operations where the economic benefits of the investment in the required capital equipment and the overheads on the operations and management of a sophisticated logging equipment unit are more apparent than for mining operations which are either underground or small scale open cut.

Secondly, many mining companies dealing with resources other than iron or coal deal with underground mining situations and are, therefore, unwilling to accept responsibility for the use of radioactive sources in their mines and leases because of the risks involved. Hence, they frequently hire the services of logging contractors who also accept the legal responsibility of retracting their probes from the boreholes if they have been jammed. However, these contractors generally offer conventional logging services, of a non-quantitative type, because of their unfamiliarity with spectrometric logging and the capital outlays required to make the change. This problem can be solved. Better liaison can be established, to the advantage of all parties concerned, between the research units, the commercial service support companies and the mining industry, in order to address actual and potential logging applications in their mines and the procedures needed to ensure safety and to allocate appropriate roles and responsibilities, including training. The other factor that will assist in the spread of this technology throughout the mining industries is what was discussed above, i.e. the development of a probe technology based on the use of extremely weak sources.

6.2.3.3. Calibration procedures

The methods used for quantitative interpretation of spectrometric borehole logging data are notionally based on the calibration procedures outlined in Chapter 5,

which entail regression analysis, although the details vary according to the type of measurement made. For example, the calibration model used for the application of PGNAA will differ from that used in the application of a spectrometric γ - γ method. The details of the models used will also vary according to the type of deposit investigated and the nature of the analytes (i.e. the parameters or the chemical substances being analysed).

In general, the calibration equation relating to a required geological parameter with particular probe responses is obtained by regression analysis in which the assay values of borehole samples (for the required geological parameter) are correlated with the corresponding probe response parameters for the same borehole intervals. Accuracy and reliability demand that the number of samples and corresponding probe responses used for the analysis be commensurate with the full variation of the properties affecting the measurement, i.e. the variation of the rock ore and drill hole properties. The reason for this requirement is that every probe response parameter is influenced by more than one property of the probe environment. Consequently, most calibration equations used for this technology are multivariate in the response variables of the probe. While drill cuttings make acceptable reference samples if precautions are taken against segregation effects, core samples are preferable since they are less strongly biased.

6.2.3.4. General: Accuracy and precision in measurement

Accuracy in quantitative logging is determined by a number of factors which also include the precision of measurement. However, accuracy is the salient performance parameter for the miner. Accuracy, as described in Section 2.3, is the error measured by the root mean squares (rms) deviation between the assay values determined from the log and the values obtained by chemical analysis of corresponding samples. Provided that the instrumentation performs satisfactorily and a sufficient number of events are recorded, precision is only a minor component of accuracy. The main factors affecting accuracy are the suitability of the calibration model and the accuracy obtained in sampling and chemically assaying the reference samples.

An insight into the capabilities of spectrometric nuclear geophysical techniques and some of the limitations on its accuracy can be obtained through an overview of the techniques used, and the experiences encountered, by the CSIRO research group as it implemented SIROLOG techniques in applications to iron ore mining. This provides a suitable example, because research and development occurred over a number of years with the support and participation of two major mining companies in this sector of the Australian mining industry. The result of this participation was that the industrial-geological point of view was part of the framework for the research.

The applications developed were both for the extraction and the mine development activities. The key parameters which nuclear spectrometric logging was to

TABLE VIII. ACCURACY OF DETERMINATION FOR IRON ALUMINA, SILICA AND BULK DENSITY IN NUCLEAR BOREHOLE ANALYSES OF WEST AUSTRALIAN IRON ORE

Analyte	Measurement type	15 m hole or 1.5 m split	Accuracy of determination	Range or variation of analyte
Iron	gamma-gamma	Hole	0.9%	35 to 68%
Iron	neutron-gamma	Hole	0.55%	approx. 6%
Iron	gamma-gamma	Splits	1.8%	10 to 68%
Alumina	natural gamma	Hole	0.11%	2%
Alumina	neutron activation	Hole	0.08%	2%
Silica	neutron-gamma	Hole	0.65%	5.5%
Bulk density	gamma-gamma	Hole	0.23 t/m ³	3 t/m ³

supply were iron ore grade, bulk density, alumina content and, in the case of blast holes, hole diameter.

Two different approaches to logging measurements were developed because of the different mineralizations at the mines. One approach used is spectrometric γ - γ logging for simultaneous determinations of iron ore grade, bulk density and borehole diameter, where the ore grade is inferred from a probe response which is sensitive to the overall chemical composition of the matrix, i.e. essentially a method combining simultaneous measurements of P_z , bulk density and hole diameter. The other approach, which is chemical element specific, entails the use of PGNAALogging to determine iron and silica concentrations and either natural γ ray logging or neutron activation logging to determine the alumina content. The natural γ ray method functions well if the alumina found in the ore matrix is found to be associated predominantly with kaolinitic material having fixed proportions of radioemitters and uniform specific radioactivity [6.28-6.30].

In both situations, logging speeds of up to 5 m/min are possible without introducing undue electrical noise, although substantially lower speeds are needed for spectrometric natural γ ray methods. However, the spectrometric γ - γ logging unit for production has a capacity for on-line assays of up to 50 blast holes per eight hour shift.

Information on lump/fines ratio and phosphorus content of the iron ore are two geological parameters which are highly desired in this industry. However, the

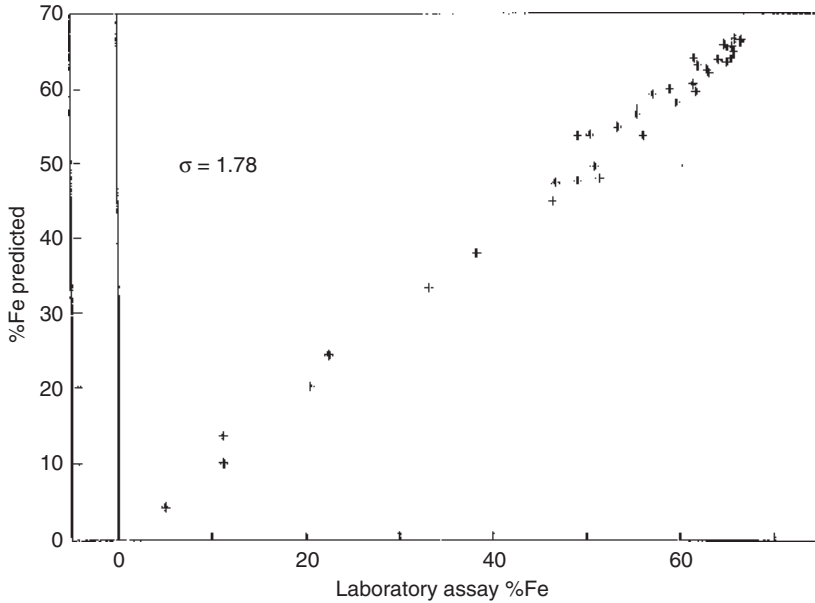

FIG. 32. Cross-plot for calibration of wt% Fe predicted (from polynomial regression analysis) against wt% Fe by laboratory assays using a spectrometric γ - γ borehole logging technique.

research effort enabling their solution is yet to begin, and the phosphorus problem is not readily amenable to solution.

The accuracies typically obtained in these nuclear borehole logging applications to iron ore are summarized in Table VIII.

6.2.3.5. Details of calibration practices and factors affecting calibration accuracy

The experiences encountered with logging measurements in mineralized iron ore deposits provide examples of the accuracies which are possible for their different analytes and also highlight accuracy limiting factors in carrying out equipment calibration. The routine method adopted for calibration is to carry out an initial calibration in a number of test boreholes from which drill hole samples are withdrawn at fixed depth intervals from the drill holes for sampling and laboratory chemical analysis. Duplicate dynamic logging measurements are made in these holes in order to determine replicability. During logging, the spectral data accumulate in the MCA and are transferred to an on-line computer every five or ten centimetres of the probe movement. Integration of these small spectral data segments into larger data sets is implemented under computer control; the larger data sets correspond to the samples that are physically withdrawn from the holes, as regards the depth which they

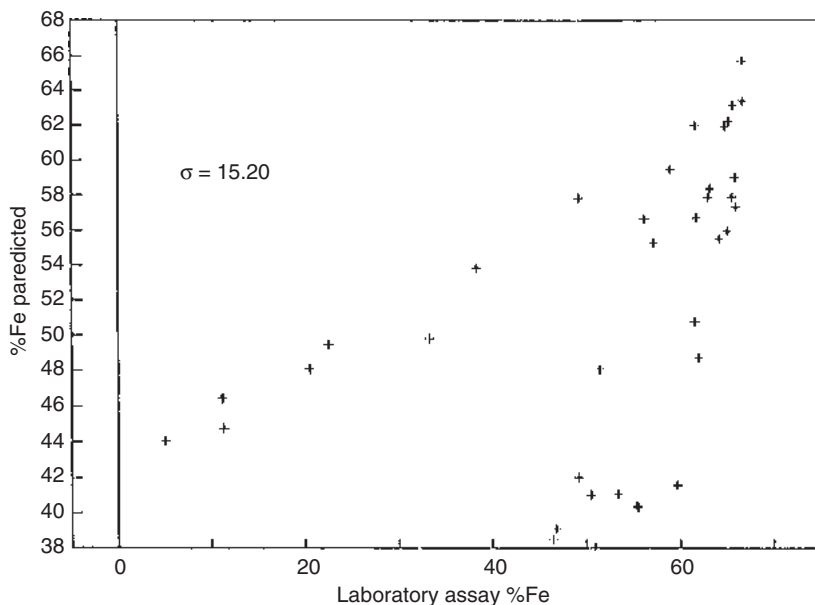

FIG. 33. Cross-plot for calibration of wt% Fe predicted (from regression analysis using a single independent variable) against wt% Fe by laboratory assays using a non-spectrometric γ - γ borehole logging technique.

represent. Subsequently, one hole is retained at the mine site for checking probe calibration routinely.

The initial calibration is made through linear regression analysis in which the values of the independent variables are the spectrometric parameters of the model and the values of the dependent variables are the laboratory assays. The general regression model which is now used is of the polynomial type, as was referred to in Chapter 5.

The case of logging the haematitic-goethitic iron ore for iron content by the γ - γ technique provides a suitable example for demonstrating the accuracies which can be achieved by using spectrometric and non-spectrometric logging techniques and also the factors which limit accuracy [6.29]. The best probe calibration obtained by the spectrometric method is shown by the calibration cross-plot in Fig. 32. The merit of using the spectrometric technique, as opposed to the non-spectrometric, is seen by comparing this cross-plot with one obtained by using a non-spectrometric technique, which is shown in Fig. 33. The logging measurements which form the basis for the analysis recorded in Fig. 33 are the same as those used for Fig. 32, except that the parameter used in Fig. 33 is the integrated spectral data above 250 keV, as for a density probe. In this sense, the measurement is non-spectrometric. The accuracy from the spectrometric calibration for predicting iron values for 1.5 m intervals is 1.8% iron for iron contents ranging from 5 to 68%. By contrast, the accuracy for iron

prediction in the same set of 1.5 m intervals, based on the non-spectrometric technique, is 15% iron.

The poor accuracy achieved by the non-spectrometric method in this application suggests that, without a priori information on the geographical and stratigraphic variation in the characteristics of a mineralization, it is futile to use non-spectrometric probes for anything but semi-quantitative predictions of mineral content.

The other factor limiting accuracy is the sampling error. This is caused largely by the heterogeneity of the ore regarding chemical composition, grain size and grain density. In marring sampling accuracy, heterogeneity reduces the reliability of the sample assays used for calibration. Other factors causing heterogeneity in the material extracted from the drill hole are the width and angle of dip of the bedding, the presence of shales interbedded with the ore, the presence of shaly vugs in the ore strata, the range of ore grades and bulk densities within the mineralized ore body and the method used for extracting drill samples.

6.2.3.6. Errors in sampling for calibration

CSIRO research into the replicability of ore sampling from drill holes situated at the Hamersley Iron mines in Western Australia confirmed that the sampling accuracy was correlated with ore grade (and, hence, with heterogeneity).

It is particularly difficult to achieve accurate sampling by using routine sampling methods from the cones of rotary drilled blast holes in the massive haematitic and goethitic iron ore deposits of the Hamersley province. These mineralizations are derived from the supergene alteration process of the banded iron formation in that region and are very heterogeneous in that minor shale bands are often found to be interleaved and folded with bands of almost pure haematite or goethite. Whereas the sampling accuracies are good (about 1% Fe) from the cones containing medium to high grade ore (e.g. 63 to 68% Fe), the sampling accuracy is inferior (about 2% Fe) for ores of grade 60% Fe and is even worse (i.e. 2.5 to 3% Fe) for low grade ore samples (e.g. 55 to 57% Fe) of the same type. The sampling errors encountered using percussion drill cuttings as samples were slightly larger than those of the blast holes.

On the other hand, the errors are only small (about 0.6% Fe) in sampling the cones of blast holes intersecting the relatively homogeneous 'channel' ore, occurring at a different location some hundreds of kilometres distant from the Hamersley mines. This type of ore has a lower grade of iron ore, by more than 10% Fe, than the Hamersley supergene enriched ore.

The results of duplicate sampling and laboratory assaying of the material extracted on the basis of 1.5 metre split extract from all the holes used, i.e. diamond cored holes, blast holes and percussion holes drilled at the same locations in the

supergene enriched ore, are particularly revealing. They show that, for the routine recommended method, the replication errors increase with decreasing ore grade for all the types of holes drilled. However, whereas the sampling errors are serious for low grade ore (below 55% Fe) retrieved from percussion holes and blast holes, on the basis of 1.5 m splits, they were not serious with diamond core (0.4% Fe). Consequently, the most desirable procedure found for calibration in heterogeneous ores is to core drill first for sampling and assaying the reference samples, and then to overdrill either percussion drilled holes or rotary drilled holes as required for calibration logging. The permanent test holes, used for routine checks of the probe calibration, would preferably be prepared in the same way [6.31].

In regard to the precision and replicability of the nuclear geophysical logging measurements used, the modern logging equipment shows little drift in calibration over long periods of testing, namely 0.2% Fe for a 15 m hole and 0.4% Fe for 1.5 m splits over a period of six months. The bulk density measurement is similarly stable according to test results.

6.2.3.7 Examples from borehole logging in coal

Coal is the area of mining in solid resources that has most readily accepted the new borehole logging technologies. In the UK a research team from BPB wireline services has developed a sophisticated slimline (47.5 mm diameter), dual detector, side wall probe system for measuring ash in coal quantitatively by a non-spectrometric γ - γ technique which has been used routinely for many years in coal mines worldwide. The probe can delineate thin beds, owing to the shorter spaced detector, and provide accurate formation density measurements from the longer spaced detector. The probe successfully compensates for stand-off of the probe from the wall of the hole, and to some extent for caving in the hole. The ash content is calibrated against the density response [6.32].

In Australia, the coal mining industry has also absorbed the nuclear geophysical logging as a routine support service. Most mining companies use the services of wireline service contractors, mainly to support mine development activities. However, several mining companies use the technology developed from the CSIRO research into spectrometric γ - γ techniques for coal logging measurements of ash content in coal. This has the attraction of providing probe responses which can be calibrated directly against ash content. Moreover, the standard SIROLOG probe for these applications uses γ ray sources (either ^{137}Cs or ^{60}Co) of much lower activities (~ 40 MBq) than those of the standard probe used in the industry (~ 4000 MBq). The probe response parameters for these calibrations are P_z and density response. In holes intersected by the coal seams above the water table, the CSIRO technique incorporates, in the calibration equation, a computed estimate of the S factor to compensate for borehole rugosity. These borehole logging probes are also more convenient for a

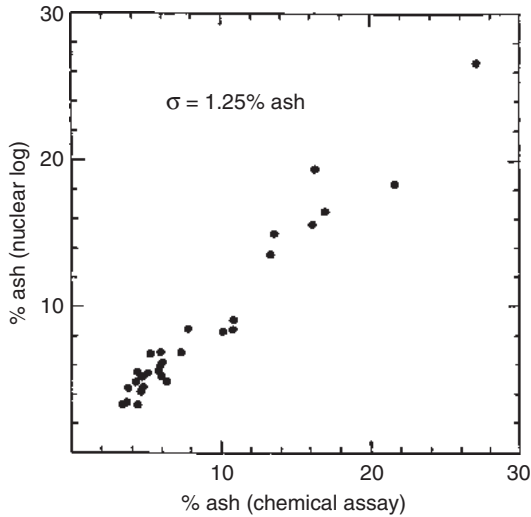

FIG. 34. Cross-plot for calibration of wt% ash predicted (from multivariate regression analysis) against wt% ash by laboratory assays using a spectrometric γ - γ borehole logging technique in dry boreholes.

single operator to manage than most others, having a length of only about 1.3 m compared with roughly 3 m for the commercial probes used for this measurement, and weighing only 15 kg. The probes most commonly used in this application are of diameters of 60 and 52 mm, which are suitable for centralized operation in holes of diameters greater than 90 and 80 mm, respectively, there being little chance of the probe jamming provided the ground is stable. Generally, the calibration accuracy for ash content determination obtained for seams of widths greater than 1.5 m ranges from 1.5 to 2.5% ash. The accuracy obtained depends on the range of variation of the ash and the variation in its iron content. A cross-plot is shown in Fig. 34 for the calibration of log wt% ash against laboratory assayed values of wt% ash, using results obtained in dry boreholes at an eastern Australian coalfield, and applying polynomial regression analysis for the purpose. The accuracy reported for the low activity probes is comparable with that of the probes equipped with 37 MBq sources, and their delineation capabilities are better owing to the small source-detector separation of 30 mm. The source-detector spacing of the standard probe is 19 cm, to the centre of the detector. The accuracy, like that of other γ - γ borehole techniques used, is susceptible to variations in the iron concentration in the ash. The probes are routinely equipped with either NaI(Tl) scintillation detectors or, for combination spectral natural γ ray/ γ - γ probes, with BGO scintillation detectors. The detector crystals used are most commonly either 37 mm diameter by 75 mm long or 52 mm diameter by 52 mm long.

In Poland, Chruściel et al. have introduced a spectrometric γ - γ method which is also based on spectral ratios. However, the spectral ratio for determining the ash content is actually one that is sensitive to the spectral shape about the backscatter peak, whereas those for determining the calorific value of the coal and its sulphur content essentially measure the slope of the energy distribution of γ rays on the low and high energy sides, respectively. The method also uses an only moderately strong ^{137}Cs source (70 MBq) [6.33].

The economic benefit obtained by this application of borehole logging is determined by cost savings made in controlling the feed input for downstream processing of the mined coal. One reported estimate is that if the control of mine production is assisted throughout the mine by this borehole technology, savings could be realized which are worth over US \$1 million per year for an operation processing 3 million tonnes of coal per year. Logging speeds typically vary from 1 to 4 m/min and depend on seam width, strength of source and precision required.

One other application of in situ analysis in coal extraction is the coal face analyser. Its main purpose is to assist the miner in differentiating, at the work face, coal from shales which have nearly identical appearance. However, an additional desired benefit is the ability to carry out an on-line analysis to estimate the ash content of the coal being extracted from the deposit. Borsaru et al. developed a natural γ ray portable analyser which has the capacity for discriminating between coal and non-coal. This device, weighing 15 kg, is, however, too cumbersome in its operation, with too few other advantages for personnel engaged in a mining activity. This group has developed an alternative γ - γ face ash analyser which weighs only 2 kg and offers semi-quantitative performance for ash content determination (i.e. approximately 3.5% ash). The method uses ^{133}Ba (9.8 MBq) as the primary source and ^{137}Cs (0.35 MBq) for spectrum stabilization [6.34]. In South Africa, Wesolinski and de Jesus have developed a dual γ ray source coal face ash analyser. However, the source activity of this device is uncomfortably high (185 MBq) for use at close quarters without using heavy shielding [6.35].

6.2.3.8. *Examples from borehole logging of various metalliferous mineralized deposits*

Logging and interpretational techniques which are virtually the same as those used for iron ore logging have been successfully tested by CSIRO in other solid resource deposits, namely nickel, mineralized beach sands (for titanium), manganese, copper (disseminated sulphides) and coal. These techniques are PGNAA, DNAA, spectrometric γ - γ and spectrometric natural γ ray. PGNAA logging techniques similar to those of CSIRO have been implemented by Pinault and others from BRGM for in-situ analysis of key elements in bauxite mines and phosphate mines, and by Baron and Cariou of LCPC for investigations of formation geology, with applications

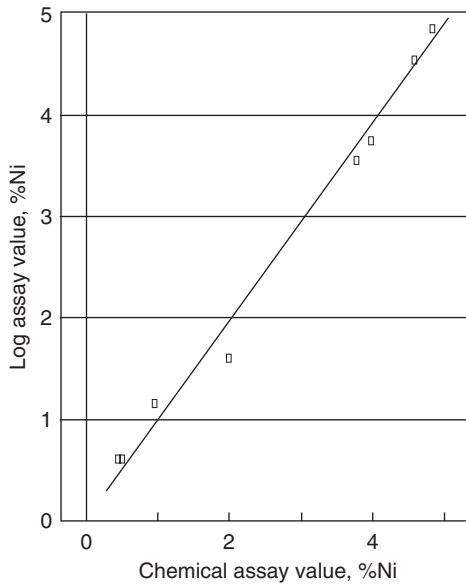

FIG. 35. Cross-plot of wt% Ni predicted (from regression analysis) against wt% Ni by laboratory assays using a PGNAA borehole logging technique in test borehole RSP3.

to civil engineering. However, the calibration models proposed by the different laboratories differ in regard to some of the simplifying assumptions made.

In a nickel logging project, a CSIRO research team has shown that only the PGNAA technique has utility for determining nickel concentrations in massive sulphide ores [6.31]. The mineralizations used for the tests are deposited in an ultrabasic rock formation, found at various locations in the Eastern Goldfields region of western Australia. The result of testing the PGNAA method in one particular hole on the basis of 1/2 m splits, by regression analysis, is shown in Fig. 35, and the logs obtained in the same hole of density P_z and % Ni (PGNAA) against depth are shown in Figs 36–38 inclusive. The figures demonstrate, on the actual logs, how the use of increasingly spectrometric, element specific methods provides probe responses which are increasingly unambiguous and exhibit an increasing sensitivity of the method to the variation of the analyte content. The accuracy of the PGNAA method in this case is 0.22% Ni, where the variation in Ni concentration is 0.5% to approximately 5% on the basis of 1.5 splits. However, the P_z log, which is spectrometric, as is the PGNAA method, is obviously more sensitive to variation in mineral content than the density logging method, which is essentially non-spectrometric. Nevertheless, this

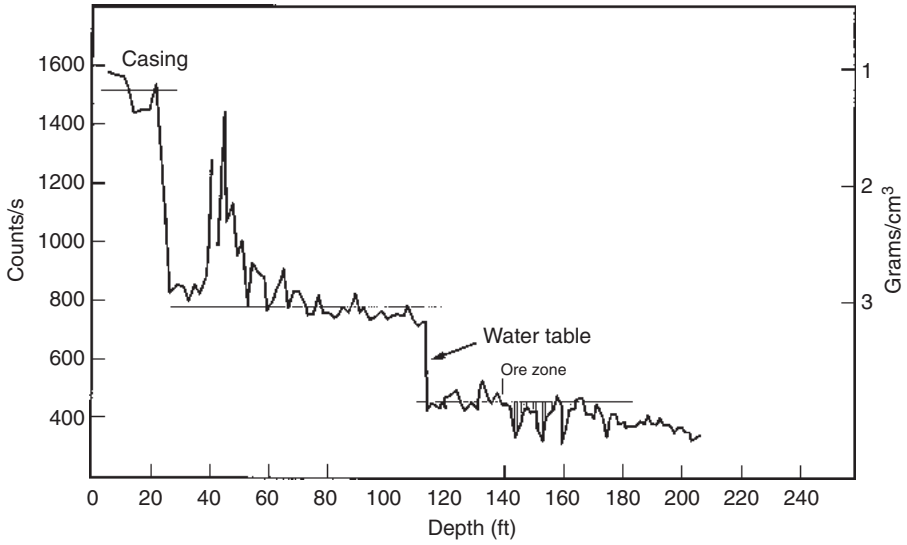

FIG. 36. Density γ - γ log (non-spectrometric) in RSP3 (1 ft = 30.48 cm).

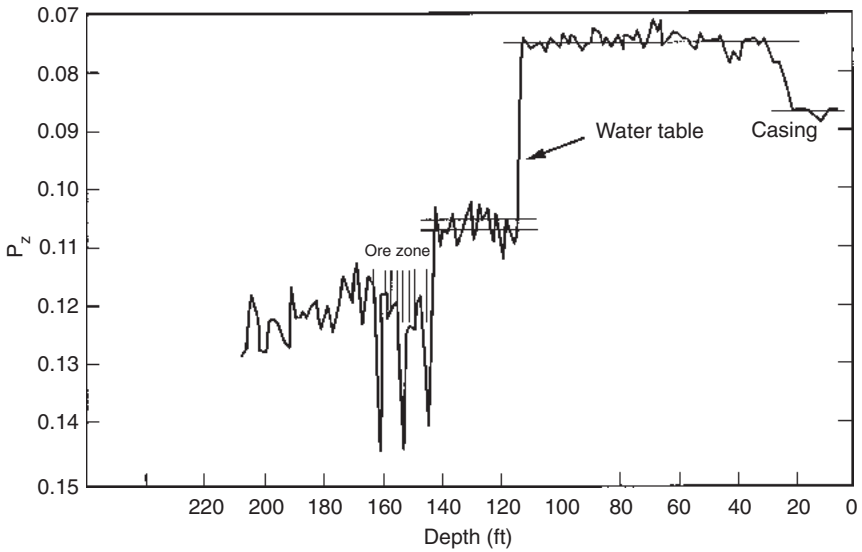

FIG. 37. P_z log (spectrometric γ - γ) versus depth in RSP3.

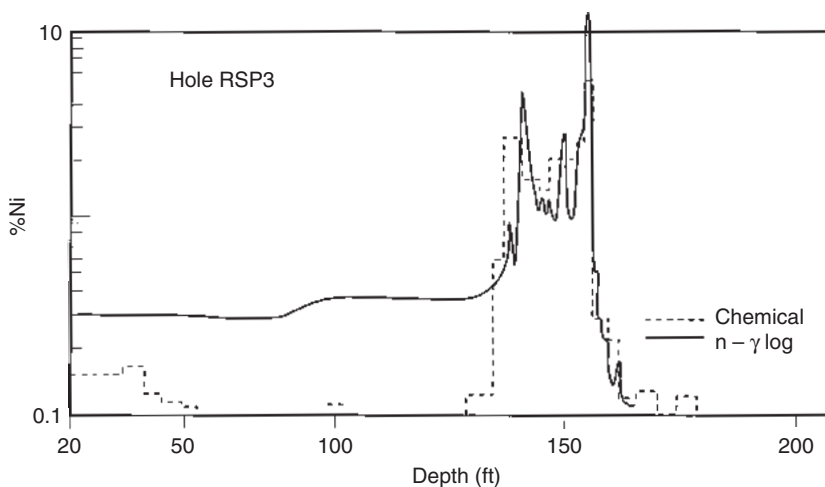

FIG. 38. Spectrometric PGNAA log for wt% Ni in RSP3.

mineralization is complex in that it contains different types of iron and nickel sulphides, which cannot be differentiated by the P_z technique.

In logging manganese ores, both the PGNAA and delayed NAA types are the only ones effective in quantitatively assaying the manganese in high grade manganese deposits, as found at Groote Eylandt, Australia [6.31]. Their matrixes are either predominantly pisolitic or alternatively oolitic, and their degree of consolidation varies appreciably. As a consequence, there are severe problems in obtaining representative calibration reference samples. As in the case of nickel logging, the γ - γ and the neutron-neutron logs carried out could only be interpreted semi-quantitatively, at best.

In spite of the difficulties in sampling for calibration, both quantitative neutron-gamma techniques have performed accurately given the wide range of ore grades and ore types encountered in the different deposits. The computed accuracies obtained using either of the two quantitative techniques ranged from about 2.7 to 3.3% Mn for ores ranging in grade from 10 to 50% Mn, depending on the deposit used for the calibration. The correlation coefficient for the regression analyses carried out for the calibrations were about 0.90 ± 0.05 .

However, the PGNAA system shows less dependence than the delayed NAA system on variations in chemical composition at the different deposits. The accuracy for the prompt neutron-gamma system was 4.0% Mn in this application, while that

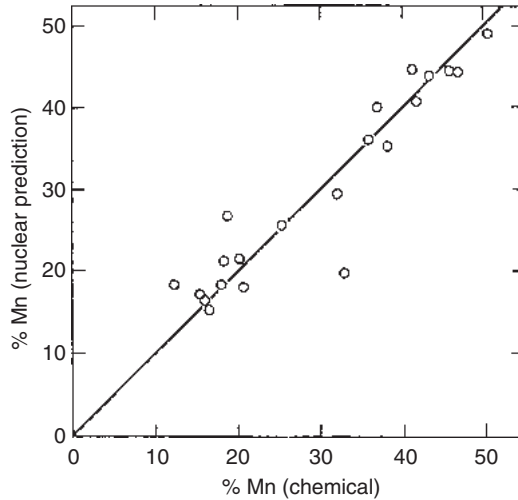

FIG. 39. Cross-plot for calibration of spectrometric delayed neutron activation logging in holes situated in two manganese ore deposits.

of the neutron activation system was about 6.5%Mn, for the same range of ore grades. Figures 39 and 40 show cross-plots of log assays against chemical assays for corresponding ‘samples’, in two different groups of manganese deposits for prompt neutron–gamma logging and neutron activation logging, respectively.

The BRGM has generally used more of a multielement approach in PGNAA ore grade analysis than CSIRO. In logging bauxite, the desired analyte for grade control, alumina, cannot be determined directly, because of the interference of the iron neutron capture γ ray peak at 7.64 MeV. However, a method is used for determining the alumina content based on the *closure* principle, where the per cent alumina is determined as the difference between 100% and the sum of the other mineral constituents, which are readily determined by the PGNAA method [6.36]. In this case, it was assumed, from a priori geochemical knowledge of the West African deposit, where the method was used, that the oxides of iron, silicon, titanium and aluminium are the only constituents of significant concentration in the deposit other than water. The first three oxide contents are readily determined directly by spectral analysis, and due correction factors are made for the difference in count rate occurring when the holes are either empty or full of water. The agreement with core analysis is excellent, except in the transition zones of the bauxite mineralization where core recovery and sampling are a problem.

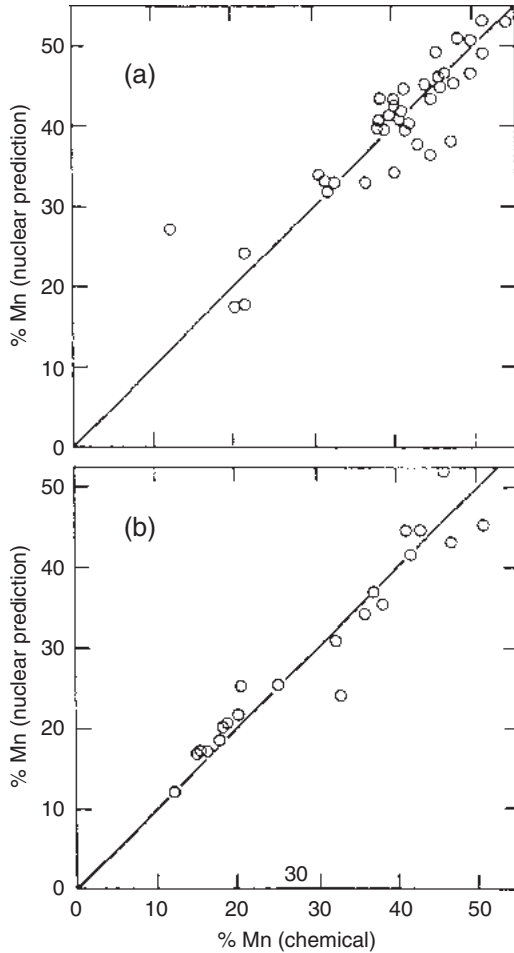

FIG. 40. Cross-plot for calibration of spectrometric PGNAA borehole logging in holes situated in two ((a), (b)) manganese ore deposits.

6.2.4. Applications of in situ analysis to civil engineering

The research group of LCPC has been particularly concerned with the development of a suite of nuclear geophysical borehole techniques to identify the mineralogical and lithological characteristics of the formation geology affecting civil engineering works, particularly those for the Paris region. There, it is common to encounter a substrate of interleaved strata of gypsum (calcium sulphate) and marl (an unconsolidated mixture of clay soil and weathered limestone), to depths commonly exceeding 50 m. Whereas this material is agriculturally valuable, it presents serious

problems to the geotechnician because it reacts rapidly with natural drainage water to form calcium carbonate. In the process of this reaction, the material weathers badly and loses its strength and consistency. The nuclear analytical approach used by the LCPC group is to run a full suite of the basic nuclear geophysical logs in the holes, i.e. spectrometric natural γ ray, neutron-neutron (n-n), γ - γ and, frequently, a pulsed neutron-gamma log for both PGNAA and DNAA [6.37].

The spectrometric natural γ ray log provides information on the native lithology intersected by the hole. The n-n and γ - γ logs indicate whether there are strata of altered porosity and density, whilst the pulsed neutron-gamma log is a definitive quantitative multielement log indicating the variation in concentration with depth of sulphur, silicon, iron, aluminium and calcium, which can diagnose exactly where chemical alteration has either occurred or is in progress.

In that region of the globe that was formerly the USSR, a technique of penetration logging is used to determine the mechanical properties of the soil as an alternative to laboratory testing collected soil samples. There, the practice is to drive composite probes into the ground to depths of up to 30 m, the depth depending on the friability of the soil, at a rate varying between 0.5 and 4 m/min. This is a type of measurement-while-drilling system, except that the probe is being driven into the ground, not drilled into it, so as best to preserve the mechanical features of the ground. The composite probe may comprise subprobes of γ - γ , n-n, natural γ ray, point resistance (for soil deformation modulus), friction resistance (for soil shear characteristics) and an electrical log (for salinity). Generally, the logging method is considered to be the more reliable because of the larger effective sample volumes measured, particularly in the case of neutron moisture, and because the method produces less disturbance to the physical matrix of the soils than collecting point samples for laboratory measurement [6.38].

6.2.5. X rays and on-line analysis in the processing of metalliferous minerals

On-stream analysis of mineral slurries is used to improve control of flotation concentrators. The parameters measured for improving control of the processes in the plants are the mineral concentrations in the solids content and the specific gravities of the slurries and the solids.

The reported benefits of using these analysis systems and those of the improved process control which the analysis data produce include increases of 1–2% in plant mineral recoveries, reductions in labour costs and increased throughput of concentrator feed [6.39]. These benefits generally translate into increased profitability for individual plant operations which range from US \$0.1 million to US \$1 million per annum. In India, one installation reported that reagent costs were reduced by 20%, whereas another processing plant reported that the ‘maximum concentrator throughput’ could be increased by 20%.

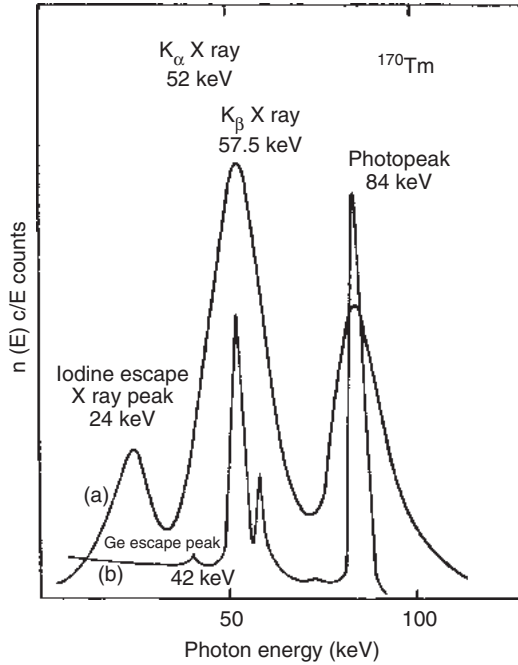

FIG. 41. Comparison of spectra recorded with X rays of ^{170}Tm using scintillation spectrometry and cooled Ge detector spectrometry.

The global mineral processing industry has already adopted this type of nuclear geophysical technology on an enormous scale. Even if one considers the number of systems manufactured and installed only by Amdel, the Australian based manufacturing licensee of CSIRO, the reported sales of analysis equipment are most impressive. It was reported in 1994 that between the years 1972 and 1993 that company, alone, had installed 120 on-stream analyser plant systems comprising equipment units for monitoring 430 mineral slurry streams. At the time of writing, the company's units were servicing more than 720 process streams. The salient fact is that Amdel is only one of the significant manufacturing and marketing companies operating internationally in this field.

The measurement techniques used in on-line X ray techniques were already discussed in Chapter 4. In regard to detectors, the choice for most industrial X ray analyses lies between scintillation detectors and proportional counters, as was mentioned in Chapter 4. However, if there are low concentration tailings streams in concentrator plants, the high sensitivity which is available only through the use of solid state detectors will be required. Figure 41 illustrates the different responses obtained for ^{170}Tm X rays by using a scintillation detector and a solid state detector. Generally, the time taken for analysis typically ranges from 10 to 100 s for either

scintillation detectors or proportional counters, and up to 900 s for solid state detectors. The advantages of the scintillation detectors as a component of the slurry immersion system are that they are rugged, of low cost, easy to maintain and reliable. The disadvantages in their utilization are that their mediocre energy resolution permits the analysis of only one element and also that solid state detectors must be used when concentration levels fall below 0.01% in slurry solids. The analytical accuracies (relative) reported for plant operation are, typically: concentrates 1–3% relative; feeds 3–8%; tailings 5–15% [6.39].

High resolution proportional counters have the advantage of a sufficiently good energy resolution to enable the simultaneous analysis of up to five chemical elements. The principal disadvantage of this detector is that its performance is critically dependent on maintaining the excellent resolution, which therefore requires frequent check tests. The relative accuracies obtained for application to concentrates and feeds are similar to those obtained by using scintillation detectors (1–5%), and as is also the case for tailings (5–15%), the actual accuracy achieved depends mainly on the level of the metal content. Low resolution proportional detectors are also used successfully for lead–zinc mineral slurry analysis [6.40], and an accuracy of ± 0.02 wt% is reported for both elements in the assays of the tailings [6.41].

The liquid nitrogen cooled silicon detector is invaluable for determining metal contents at low concentrations, a situation which arises in certain tailings streams. This is particularly necessary if the in-stream analysers situated in the feed and concentrator circuits use scintillation detectors which have a threshold for useful quantitative analysis at approximately 0.01 wt% of the metal under investigation. Certain per cent weight detection limits for various elements of commercial interest, using these detectors, are reported as: Fe 0.05, Ni 0.02, Cu 0.01, Zn 0.005, Pb 0.005, Ag 7 ppm and U 2 ppm. The effect on production efficiency, reported for a Finnish XRF system (Outokumpu Electronics) on the basis of detection using a liquid nitrogen cooled Si device, is an increase of 1.5% in zinc recovery, improvement in its grade by 0.4% and a reduction in reagent consumption of 10%. A new Outokumpu system based on wavelength dispersive XRF has an even greater sensitivity for element concentration than the system based on the use of solid state detectors [6.42].

6.2.6. On-line coal analysis

There are numerous objectives and areas of application for nuclear techniques in coal processing. The various objectives in different application areas include determining the ash content in coal, the moisture contents of coal and of coke and the concentrations of the chemical elements carbon, hydrogen, chlorine and iron. The objectives differ according to the type of coal mined and also according to the stage of processing. The various phases in processing are grade control (at the mine mouth),

raw coal sorting (after primary crushing), coal preparation plant control, blending control (in relation to ash contents of output mixtures) and power station feed monitoring (to minimize ash content of the feed). An estimate made in 1988 was of an economic benefit to the Australian coal industry of US \$22 million per year through the use of coal ash monitors. This estimate was based on a perceived improvement in productivity of 1.5% in monitoring 60 million tonnes of coal annually by the use of 39 installed on-line analysers, when the average price of coking and steaming coals was US \$24 per tonne [6.43]. By 1996, more than eighty such analysers were operating in Australia. By then, the average coal price had risen to about US \$45 per tonne, so that, conservatively estimated, the current financial benefit to the Australian coal industry would exceed US \$40 million per year.

The environments in which on-line analysis is carried out, while the coal is being transported, include the conveyor belt, the coal slurry in the washery plant beneficiation, the shaker tube and the chute tube.

The five principal techniques used for the determination of ash content in coal transported on conveyor belt systems are: the dual energy γ ray transmission gauge (DET), the 60 keV X ray backscatter gauge, the pair production gauge (PP), the natural γ ray gauge and the prompt neutron–gamma activation analysis system (PNGAA).

DET provides the simplest and most accessible on-line analysis technology used in Australia for coal conveyor belt analysis, where the coal on the conveyor belt is irradiated from below by two narrow beams of γ rays of very different energies, and a scintillation detector counts the transmitted radiation from above. From Chapter 3, the γ ray attenuation diminishes rapidly as the γ ray energy increases and is also approximately proportional to $Z_{\text{eq}}^{4.5}/A$. The degree of attenuation of any beam of γ rays is therefore a strong indicator of the ash content, because both the mean atomic weight (A) and the equivalent atomic number (Z_{eq}) increase with an increase in ash content. However, the thickness of the irradiated coal, which varies appreciably on a moving conveyor, is an additional factor influencing the count rate of the detector. The factor of variable attenuation caused by a variable height of coal on the conveyor belt is cancelled out by the different γ ray energies in the two irradiating beams, which then enables a comparison of their respective attenuation through the coal sample [6.44].

Generally, the sources are ^{241}Am (60 keV) and ^{133}Ba (emitting numerous γ rays of energies up to 356 keV). This technique has established a dominant position in the Australian market because of the ease in applying it to existing conveyor belts, a viable accuracy for most coals, good radiation safety features and moderate cost. Various versions of the DET gauges are produced worldwide, particularly in Australia, Germany and Canada. However, not all provide for the desirable features of coincident counting of both the high and low energy beams under all conditions of belt speed and regular standardization procedures either off-belt, when the belt

motion is arrested, or by selection of representative samples from the belt [6.45]. The one disadvantage of the DET gauge is the error produced if there is variation in the chemical composition of the ash. Experimental measurements have demonstrated that the measurement error is approximately 0.3 wt% ash in produced coke and that it ranges from 0.7 to 1.5 wt% ash for the raw mined black coal. In practice, the DET gauge has satisfactory accuracy for most applications.

The second important technique, the X ray backscatter gauge, which is positioned under the conveyor belt, is widely used in Germany and Poland. Generally, it requires a levelled thick coal bed on the belt (thickness of 100 mm) and profiling of the upper coal surface. The reported accuracy of 3 to 5 wt% ash for coal varying in ash content from 4 to 80 wt% is difficult to compare precisely with that of the DET gauges [6.45].

The pair production gauge is used on a by-line, and its advantage over the DET gauge is its greater applicability to coal varying in the chemical composition of the ash, particularly in the iron content of the ash. It is reported to be about four times less sensitive to these variations than the DET gauge. In fact, laboratory trials conducted on the same bulk samples indicated an accuracy for the pair production gauge which is 1.7 times better than that of the DET gauge. The disadvantage of the PP gauge relative to the DET gauge is its need for a coal sampler, a higher installation cost, a higher capital cost and its inability to handle very coarse coal. Appreciable variations in coal moisture content diminish the accuracy of both the DET and PP gauges, and an electrical capacitance technique for moisture measurement is combined with the PP gauge in one of the Australian ash monitors (Coalscan 4500) [6.45].

The natural γ ray technique has important applications to both black and brown coal mining and processing. The calibration equation, obtained by regression analysis of probe responses against chemical assays of representative samples, is a simple one, being of the form $\%ash = aT + bK + cU + dTh + e$, where T represents the count rate over almost the entire spectral range, i.e. 100–2800 keV, K is the count rate in a spectral window established around the ^{40}K peak at 1460 keV, U is the count rate established in a spectral window which is centred on the 1760 keV peak of ^{214}Bi (the ^{238}U daughter) and Th is the count rate in a window ranging from 2500 to 2800 keV, which encompasses the 2610 keV peak of ^{208}Tl (the ^{232}Th daughter) and also a, b, c, and d are constant coefficients [6.46].

The accuracies reported for the natural γ gauge range from 0.3 to 0.8 wt% ash in black coal, depending on the source of coal and the range of ash contents. The coal samples used for the assessment were obtained from diverse sources, including New Zealand, Australia, USA and India. Generally, the better accuracies were reported for coals of low ash (less than 20 wt% ash) rather than for coals having ash contents ranging towards higher values (up to 36 wt% ash) [6.46]. This system is now part of the MCI Coalscan series (No. 1500) and, at the time of writing, 20 units were commercially operational at mines in Australia, New Zealand and Indonesia. An

investigation carried out at a brown coal deposit, where one unit is installed, indicated that the calibration is not sensitive to variations in the chemical composition of the ash or to a moderate variation of moisture content (e.g. 52 to 63% moisture), but that it is somewhat sensitive to the identity of the coal seam being measured, meaning that better accuracy is accomplished if the coals are calibrated on the basis of their seam of origin. In most instances the accuracy achieved is acceptable without undertaking this procedure. The attractiveness of this technology includes its satisfactory accuracy, its low cost and the fact that external radioactive sources are not used, which eliminates the issues of radiation safety and radiation source security.

A current advanced on-line system recently commercialized (through MCI) combines the use of the PGNA method and a DET method (MCI's DUET) with a microwave technique to measure the ash content, the moisture content, the concentrations of particular elements and the specific energy of black coal simultaneously. The PGNA method applied to coal bulk analysis uses Am-Be as a source of fast neutrons which excites γ ray emission at 4.43 MeV through the carbon inelastic scattering reaction and also a number of thermal neutron capture γ rays which are characteristic of the elements in the coal, most notably, hydrogen at 2230 keV, iron at 7610 keV and silicon at 4900 keV [6.47]. In addition to the PGNA measurements, the system contains a means of carrying out a bulk density measurement using a γ ray backscatter method based on using a ^{60}Co source of primary γ rays, to correct the PGNA gauge for variations in density, density gradient and sample thickness. The ash content and moisture are determined by combining the estimates based on the measurements of the 4430 keV peak and the density with the measurement of the hydrogen peak area. It is reported that provided the carbon/hydrogen ratio of the coal is constant, the moisture is measured with accuracies of 0.2 to 0.85 wt% for samples from different mines.

Brown coal is frequently of low rank, high moisture content and low ash content, like the coal in the Latrobe Valley region of south-eastern Australia. These characteristics make it suitable only for power generation. The main disadvantage of this particular brown coal for power generation is the sodium content, which is influential in ash fouling and slagging in the boilers. In fact, the performance reported for an analyser system which is similar to the above, but dispenses with the DET gauge, was better than 0.2% ash, 0.5% moisture, 0.3 MJ/kg for the gross specific energy of the coal (GWSE) and 0.02% sodium. The technique is applicable for measuring the coal on conveyor belts, in shaker tubes or in chute tubes. The technique is currently licensed to MCI, who present it for coal measurements in either shaker tube or chute tube geometries, in which case the hydrogen content also is measured, the accuracy being approximately 0.04% [6.48].

The other application areas in coal processing include coal slurry analysis and moisture measurements in coal and coke.

6.2.7. Analysis of coal slurries

In the coal washery plant, the coarse coal is separated from the gangue by a heavy medium separation process which results in the gangue sinking to the bottom. Froth flotation is the technique most commonly used to beneficiate the dirty fine coal fraction (i.e. <0.5 mm), which is first separated from the coarser coal. Without on-line analysis, there is a lack of continuous on-line information on the solids weight fraction (W) and the coal ash content, resulting in poor flotation control.

A technique developed in Australia by CSIRO obtains an on-line determination of W based on its correlation with the hydrogen concentration in the slurry. This concentration (wt/wt) is determined by a combination of neutron moderation (for the hydrogen content) and γ ray transmission for the solids content. This technique also enables the determination of the ash content by a combination of the X ray backscatter and iron K X ray measurements, where the latter provides a correction term for the effect of iron content variation in the ash. The technique for both parameters is insensitive to voidage in the slurry and requires three different probes for each beneficiation stream. One practice, which economizes on capital outlays, is to use a sampling system which directs, sequentially, different sample streams past the analyser system. Trials carried out in Australia at two coal washeries have shown that, for an input feed of constant ash content, the useful output yield increased by 10% as a consequence of flotation control by this technology. Taking into account that 15% of the total washery output is fed from the froth flotation section of the process, the annual economic benefit thus derived for a washery having an output of 3 million tonnes per annum is valued at approximately US \$2 million, based on 1992 coal prices [6.47].

6.2.8. Coal and coke moisture measurements

Coal moisture measurements are now only a part of the overall measurement of systems measuring coal quality parameters. They include the techniques based on the capacitance plate, microwave attenuation and PGNAA. The two electrical methods are versatile and accurate methods for black coal and independent of the need for a constant carbon/oxygen ratio which would be required if the PGNAA method alone were the basis of the moisture measurement method.

For brown coal, the microwave attenuation and phase shift measurement serves as the preferred technique for moisture measurement.

A knowledge of the moisture content of coke is important to the economical operation of blast furnaces. Achievement of this economy depends on accurate control of the ratio of net weights of the iron ore and dry coke as the feed materials. The advantages of exercising this control accurately is stabilization of the blast

furnace operation, a reduction of the hot metal temperature variation in the furnace and a reduction of hot metal silicon content and its variation. A non-electrical method is required for measuring the moisture content of coke, owing to the high electrical conductivity of this material. The acceptable alternative is to combine fast neutron transmission and γ ray transmission for this purpose. The fast neutron transmission depends on both the hydrogen concentration and the mass per unit area of the material, whilst the γ ray transmission depends on the mass per unit area only. A combination of the two measurements, therefore, enables a determination of the hydrogen content which is independent of the mass per unit area of the coke. Plant trials of the commercial unit, using one feeding hopper only, indicate that the moisture content of the coke feed on the belt can be maintained at a given level to within 0.4 wt% [6.48].

6.2.9. Various applications of nuclear geophysics to industrial processing

Nuclear geophysical techniques are applied in many types of industrial processes. They range from those mentioned immediately above in relation to the coal and petroleum extraction and beneficiation industries, to the dynamic on-line analysis of iron ore [6.4], to the production of cement to various types of level gauging and to the monitoring of the soil contamination in raw sugar cane feed.

6.2.9.1. Bulk analysis of raw feed limestone for the cement industry

The economics of cement manufacture is highly dependent on the successful control of the raw feed limestone used in the process. The principal analyte is lime (calcium oxide), but the concentrations are desired also of other oxide components in the feed, namely silica, ferric oxide and alumina. Two methods have commercial use. One development involving a collaboration between LCPC and the company, Ciments Lafarge, entails the use of a pulsed neutron generator as a basis for a PGNA mode applied cyclically during the period soon after each of a number of consecutively applied neutron bursts (140 μ s) and a delayed NAA mode, also applied cyclically but at intervals of 34 ms. The alumina content is determined from the delayed NAA method, whereas the contents of the oxides of calcium, iron and silicon are determined in the PGNA mode [6.49]. The other method developed through a collaboration of CSIRO and Amdel entails the use of an isotopic neutron source of ^{252}Cf (emitting $\sim 10^7$ neutron/s) to determine the oxides of calcium, silicon and iron directly also by the PGNA technique, without analysing for alumina, but also by monitoring the neutron flux directly and independently using a ^3He proportional counter close to the activated sample [6.50]. The two techniques give comparable accuracies (1 σ) of determination, using laboratory XRF analyses of the samples as a

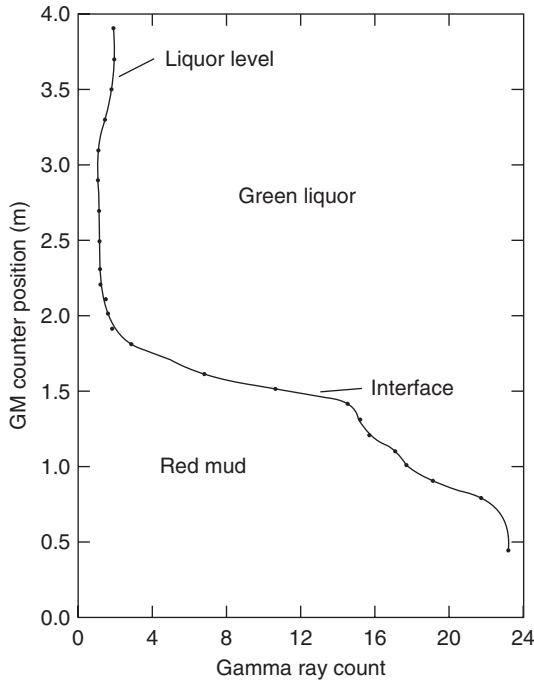

FIG. 42. Natural γ ray profile of a settling tank.

reference, e.g. 1% for calcium oxide, 1.5–1.75% for silicon dioxide and 0.15–0.19% for ferric iron oxide.

6.2.9.2. Level gauging without external sources

Nuclear geophysics is widely used in level gauging, for monitoring and process control. The natural γ ray interface gauge is of particular interest because it requires no external radioisotopic sources, thereby providing a lower cost technology which is also safe and secure in regard to personnel.

One application of the technique is the extraction of alumina from bauxite by the caustic soda digestion process. In this situation, the clear green liquor containing the refined extract must be separated from the denser, red mud material containing the gangue residue. The former contains virtually no radiation emitting substances whereas the latter is relatively rich in them. On this basis, it is possible to detect the

interface level of the clear liquor with the residue, using an externally located γ radiation detection system, which consists of a vertical array of Geiger–Müller counters [6.51]. A typical γ ray response profile for the product settling tank is shown in Fig. 42.

6.2.9.3. Soil monitor — Sugar cane

The sugar cane harvested by growers and delivered to the sugar mills for crushing and refining usually contains some soil as contaminant. This soil causes serious economic losses in the operation of the mills in regard to wear and tear of mechanical equipment, losses of sugar in the resulting mud, reduced capacity for milling, additional costs in handling and transporting the soil and a reduction in the value per tonne of the sugar due to the reduction of the c.c.s. levels (i.e. an Australian used measure for the quality of cane sugar juice). The estimated cost to the Australian cane sugar industry of excess soil in sugar cane is more than US \$24 million per year. Currently, visual examination is still commonly used in mills for monitoring conditions of soil contamination and for allocating penalties to those farmers whose consignments have soil contamination exceeding prescribed limits. This method is, however, subjective and susceptible to large errors.

A combined research team from the Australian sugar industry and CSIRO demonstrated that the natural γ ray technique suitably provided an objective method for monitoring the soil content in sugar cane [6.52]. The basis for the technique is that soil also contains the naturally occurring radioactive elements, i.e. potassium, uranium and thorium. Although these elements are present in soil only in trace quantities, i.e. ~ppm, they are easily detected by using a large efficient NaI(Tl) detector (150 × 100 mm). The sugar cane itself is an organic material containing far less radioactive material than the soil. The main prerequisites of the method are a measurement chamber that is well shielded against background radiation and a facility for using different calibrations which allow for the different specific radioactivities of the soils the different growers may bring to the mill with their produce.

The method operates as a technology, configured as an underconveyor belt measuring system, for routine use at a sugar mill (Tully Mill). The sugar cane passes continuously into and out of the lead shielded measuring chamber. The soil monitoring system also includes a belt weigher (because the γ ray count is also mass dependent), a tachometer and an interfaced PC computer for equipment control and γ ray count accumulation. The measurement is carried out (at the same time) in the modes of total spectrum counting, to achieve good counting statistics, and spectrometrically, for gain stabilization. The individual specific soil radioactivities of the client farmers are most conveniently measured beforehand at their properties, in an in situ mode from a suitably equipped vehicle.

The accuracy obtained is 0.4 wt% ash, where the ash ranges from 0.6 to 6 wt% for a wide range of soil specific activities, thereby providing an objective method for

allocating financial penalties to produce suppliers, rather than depending on the subjectivity of visual inspection.

6.2.10. Agriculture and water — Applications of isotope technology

The challenge in agriculture today is to prevent violations of the soil through erosion, accidental compaction and pollution by fertilizers and industrial waste. Part of the challenge is also to take suitable actions for restoring structure and purity. In the former USSR, nuclear geophysical techniques have taken a practical role in these endeavours. The techniques referred to in Section 3.3 apply to neutron moisture gauges to determine the drainage properties of soils and profiles of the drainage versus depth with a view to optimizing agricultural watering procedures and patterns, taking into account the precipitation and plant transpiration patterns for the various seasons of the year. Bulk density measurement practices used in conjunction with the neutron method assist in determining the drainage characteristics of the soils and the extent to which the soil structure, particularly that of podsol, has been damaged by industrial activity on the ground in question.

There are also techniques which require either soil sampling or airborne surveying. They include natural γ ray spectrometry for detecting pollution from potassium rich fertilizers and the turbidity of rivers and lake waters, which are unduly rich in uranium, thorium and their daughters. They also include neutron activation analysis of soil samples for the detection of industrial contamination in soil by effluents bearing certain chemical elements, e.g. cobalt, zinc, manganese, cadmium, copper and selenium.

Whereas energy resources and mineral resources for industrial use are undoubtedly extremely important to humanity, the mineral resource, water, is without doubt critical to the survival not only of our species, but also of most other highly developed species. As the world population continues to grow at an alarming rate, the supply of water to the arid and semi-arid zones of our planet for food production becomes ever more crucial, and the need for solutions to these problems becomes ever more urgent as more areas of the globe become arid. In the temperate zones, where there is still adequate rainfall, the problems concerning water are its rational utilization and its quality. In the highly industrialized countries, the urgent problem is the contamination of the surface and underground waters by industrial waste products, fertilizers and pesticides.

The relatively stable radioactive isotopes of hydrogen, oxygen, carbon, nitrogen, the daughters of uranium and thorium and the noble gases are among the main tools used in hydrology to assist in understanding the processes of water transfer from the oceans to the atmosphere and from there to the soil and to the underground water storage systems. The use of dating techniques made in conjunction with mass

spectrometer measurements of isotopic ratios in the chemical elements, particularly in hydrogen, provides information on the dynamics of these water transfer processes.

The essential foundations of these methods are that the relative abundances of deuterium and ^{18}O in ocean waters are very stable, apart from variations occurring in surface waters owing to evaporation which varies latitudinally and seasonally. However, surface waters vary considerably depending on whether they lie in zones of high evaporation, which leaves the water enriched with the heavier isotopes, or whether the waters are being continuously recharged through atmospheric precipitation, which relatively enriches the surface waters in the lighter isotopes. Similarly, the heavy isotope abundances in precipitates decrease, both with the distance of the test location from the sea and its elevation from the occurrence of the precipitation. By using this information, it is possible to trace the origins of the waters in surface waters and to better understand the dynamics of their transfers into underground aquifer systems. Because of the appreciable utilization of underground waters, an investigation of these dynamics is important. In particular, the measured abundances of ^2H and ^{18}O are key data assisting in these interpretations. The important factors in these dynamics requiring elucidation include the relationship between the horizons of aquifers and the surface water reservoirs, identification of the seasons when underground waters are recharged by atmospheric precipitation, identification of the sources of underground water supply which operated during the ice age, the extent to which lakes supply water to underground reservoirs, the latitudinal belt of atmospheric recharge of underground waters, the altitude of the underground water recharge area, the sources of atmospheric moisture which recharges the underground waters and, in general, the water balance situation.

Tritium, which emits 18 keV β particles and has a 12.4 year half-life, is also a valuable tracer in these applications, owing to the high variability of its concentration in precipitation with latitude, altitude and season. Moreover, its injection into the atmosphere, as a consequence of the previous nuclear weapon tests, has gratuitously provided data for investigations of the processes governing fluid circulation and their transfer from the stratosphere, where the stratosphere acts as a reservoir of tritium for transferring it to the lower atmospheric layer, the troposphere. It appears that the tritium is distributed latitudinally from the stratosphere on a global scale, and not at the points of its original injection into the atmosphere. The investigation has shown that while both global hemispheres have these stratospheric reservoirs, there is little communication between them.

The oceans become the ultimate reservoir of the tritium discharged from the continents. The tritium abundances in surface waters generally follow their abundances in the atmospheric precipitates. From this, it is possible to determine the passage of waters through the continental drainage systems and their residence times in drainage basins as well as to compute the water exchange time. The use of tritium as a radioactive tracer in the delivery of precipitated waters to underground reservoirs

permits estimation of the delivery times involved. Its usefulness as a tracer is limited to processes of exchange between underground and surface waters taking less than 50 years, owing to its short half-life. For processes taking longer times, the exchange process occurring between the carbon dioxide dissolved in the hydrosphere and that contained in the atmosphere provides a valuable indicator about the water exchange processes occurring both currently and in the past. These two carbon dioxide components affect the organic and inorganic carbon cycles on the earth through water exchange processes, so that data obtained from the dating of radiocarbon (of a half-life a 5730 years) in relevant samples, where carbon dioxide uptake has occurred, enables dating of natural waters in the range of up to 50 000 years. The application of radiocarbon isotopes is significant in connection with the problem of short term climatic variations and the role of hydrogen and carbon cycles in these processes. The longer lived isotopes of uranium, thorium, silicon and chlorine are also important hydrochronological indicators. In particular, the chlorine isotopes provide dating of water exchange processes ranging in duration from hundreds to millions of years.

6.2.11. Measurement of radon in soil and air

Radon is a member of the natural decay family. It is a radioactive α emitting noble gas and therefore does not interact chemically with its environment. Radon has three isotopes: ^{222}Rn (Rn), which originates from the ^{238}U chain and has a half-life of 3.82 d, ^{220}Rn or thoron (Tn), which comes from the ^{232}Th chain and has a 55 s half-life, and ^{219}Rn or actinium (Ac) from ^{235}U decay, which has only a 4 s half-life. The word radon normally refers to Rn, because it has the longest half-life and is the isotope whose concentration is monitored.

Radon (Rn) is produced in rocks which contain uranium and its daughter products in secular equilibrium through the α decay of ^{226}Ra . Radon measurements are used in prospecting for uranium and oil. Radon is also measured in underground mines, caves or buildings, as there is a correlation between exposure to radon and an increased risk in the development of lung cancer in humans. Concentrations above the acceptable limits were found in buildings because radon production occurs in materials used for building, such as granite, or in the ground. Radon gas in some caves exposes cave explorers to very high levels of radiation. A year long survey of 40 British caves found that the average level of radiation was 2900 Bq/m^3 . As a matter of interest, in one particular cave located in the UK, the average radon concentration (for the year) in one cave (Giant's Hole) was $46\ 000\text{ Bq/m}^3$. By contrast, the limit at which Britain's National Radiological Protection Board recommends action to remove radon from homes is 200 Bq/m^3 .

6.2.12. Prediction of seismic and volcanic activities by changes in the concentration of radon in soil and groundwater

Research is also carried out to see if there is a correlation between the radon concentration in soil or waters and earthquake or volcanic activities.

A series of measurements of radon concentrations in the hydrothermal basin of Tashkent showed a threefold increase in the level of radon between 1956 and just before the great earthquake of 1966. The radon concentration level was found to have drastically decreased after the earthquake. These results raised hopes that it might be possible to predict seismic activities from measurements of radon concentration.

Following in the footsteps of the Soviet scientists, the Chinese started to conduct some measurements of their own. The Tangsham M7.8 earthquake in 1976 was preceded and followed by radon concentration anomalies in the range of 10–100%. However, other stations randomly distributed in this area did not show any significant changes. Another earthquake in China, the Bohai earthquake, was also preceded by anomalies in the radon concentration. These encouraging results were not supported by the Haicheng earthquake, which did not show any change in the radon concentration. Extensive radon measurements were also carried out in California, Japan and Mexico.

There is evidence that there is a change in the radon concentration before and/or after earthquakes. The results so far show that the measurement of radon concentration in soil and groundwater is not sufficient to predict an earthquake, but it can provide a warning signal in some cases. More research in this field is needed in order to draw more definite conclusions regarding the prediction of earthquakes from radon data.

There is evidence which suggests that there may be a correlation between volcanic activity and radon content. The first such evidence was published by Chirkov, who noticed an increase in radon concentration before the eruption of the Karymsky volcano. The radon concentration declined after the eruption. Measurements of radon concentrations in Iceland and Hawaii provide further evidence of this correlation. As a consequence, radon measurements are carried out in many areas of the world known for their volcanic activities. Although the results so far look very promising, more research is needed in this field, as in the case of seismic activities.

6.3. FUTURE TRENDS

6.3.1. Situational problems and challenges for geophysical measurement systems

While all the measurement systems mentioned so far are powerful in appropriate applications, there is no one that would be able to measure directly any

of the ore rock matrix properties required by either the mining engineer or the metallurgist. The nearest approach to a direct nuclear log is the γ - γ technique for estimating the bulk density. However, in reality this measurement is one of the electron density and, therefore, the validity of the predicted value of the bulk density depends theoretically on the constancy of the ratio between the atomic number and the atomic weight of the chemical constituents.

Also, to varying degrees, in many of these techniques, either nuclear or non-nuclear, the same probe response may be obtained through different combinations of chemical and physical conditions in the sample matrix and or its environment. This makes it impossible, therefore, to predict specific physical or chemical properties on the basis of the responses measured from probes.

There are other limitations. In the ideal system, no part of the desired probe response should be either lost or distorted, as often occurs in practice because of the limitations of the instrumentation in coping with changes in the environment of the sample. For example, the changes in the environment which cause these distortions in responses might be the variations in borehole diameter, in the case of borehole nuclear geophysics, or the inclusion of air in the slurry, in the case of mineral slurry analysis. Furthermore, in nearly all types of nuclear geophysical measurement, the interpretational and calibration models are not sufficiently refined to provide accurate analyses for large variations in the chemical or physical composition of the samples measured.

The question also arises what the probe really measures. It is possible, for example, that the random variation of mudcake thickness on the borehole wall and the filtrate in the porous matrix immediately behind the wall will contribute disproportionately to the measurement unless either precautions are taken to clean the hole before logging or methods of measurement are found which compensate for this effect. Also, the drilling process may cause damage to the matrix behind the borehole wall, thereby reducing the bulk density in the vicinity.

Generally, the problem is that there are more observable parameters in any measurement system, taken in isolation, than there are known relationships between causes and effects. In other words, various combinations of different effects can give rise to the same probe response. In effect, therefore, our nuclear geophysical measurement systems often fail to provide determinations of particular sample parameters with absolute certainty, unless recourse is available to using relationships obtained either from other types of measurements or from theory. This is the problem of the so-called underdetermined system. As mentioned in Chapter 4, this problem arises far less in the laboratory environment, which is controllable, than in the borehole environment, which is not.

The interference caused by environmental or 'secondary' effects can be minimized by increasing the number of independent measurement parameters. One way to achieve this is to make several measurements (or logs in the case of boreholes)

based on different physical processes and then to correlate the principal trends in the logs, enabling the elimination of the secondary effects. The disadvantage of this approach is that the interpretation procedures still require subjectivity.

The other, preferable approach is to maximize, within the same measurement where possible, the number of independent probe response variables which are linked through physical reactions with particular required matrix properties. This is an approach that can be readily implemented in some analytical situations by using nuclear geophysical techniques based on the detection of γ or X rays. It requires that the radiation be spectrometrically detected, recorded and processed on the basis of known relationships between the different components of the spectrum and the characteristics of the sample. These characteristics include the required analytes and the 'secondary' effects, as, e.g. the matrix effect in XRF and the borehole rugosity effect in borehole logging.

Nevertheless, a priori information is frequently required from measurements which are external to the ones in question. A situation from borehole logging provides an example of both the solution and the type of problem which remains through using this approach. For example, the γ - γ density measurement made from a centralized borehole probe immersed in borehole fluid cannot supply accurate information on the diameter variations of the borehole. However, an electromechanical caliper measurement, which is independent of the density measurement, does provide that information quite accurately, and corrections can then be made on this basis to the density measurement, either from prior calibrations in a test hole or from theory.

The problem with this particular approach is that the variation in hole diameter sensed by the density probe may not identically correspond to that sensed by the caliper, even if the caliper reading were really accurate. The problem is connected, in this case, with the fact that the meaning of a value for the borehole diameter, at a particular horizon of a rugose or partly caved-in hole, which satisfies both types of measurement, cannot be defined accurately. Unfortunately, many types of nuclear geophysical measurement have analogues of this type of problem, although the manner in which the problem is expressed is often less obvious than in the example just given. One of the challenges for the future in nuclear geophysical measurements is to constantly review the validity and relevance of what we use as either built-in or a priori information for the solution of interpretational relationships.

6.3.2. Evolving patterns in nuclear geophysical practices

The trends now apparent in nuclear geophysics are towards an increasing use of simulation for the solution of theoretical interpretational relationships, either better energy resolution for detectors or greater counting efficiency and, lastly, greater computer power coupled with an increasing trend towards further microminiaturization.

The enhanced simulation techniques will enable the design of measurement systems tailored to specific aims. These aims would be to satisfy a combination of specifications including the geometrical and mechanical constraints of the proposed system and its environment, the identity of the analytes, the accuracy with which they should be analysed, the minor interfering constituents and the safety of personnel.

The physically smaller computer technology, of greater processing and storage powers, will enable users of the geophysical systems to modify them as the need arises, on the basis of simulatory investigations which they carry out on their new powerful, user friendly computers. The term 'user friendly' is stressed here because the analytical, information yielding capabilities of nuclear geophysical technology are rarely being used to their maximum potential, mainly because many 'clients' find current procedures too cumbersome and the geophysical parameters, obtained from the current generation of instruments, seem far too remote and abstract. Many of them still find a greater affinity with the chart recorder output from the type of ratemeter used exclusively three decades ago, partly because the modern technology is rarely user friendly and partly because the working users (i.e. the miners, the washery operators and the environmental protection rangers) are inadequately trained. The future trend will, therefore, also include a far more intensive training for users of these modern technologies.

The field of radiation sources and detectors will also improve. Equipment based on radioactive sources must become safer. The low activity borehole probes of CSIRO are a large step taken in that direction. Their success and that of future low activity probes for other applications depend on an ability to make radical changes to design concepts which are free from preconceptions of what is actually viable. An important factor in achieving success in this purpose is a willingness to make safety one of the prime objectives. For source neutrons, the sealed tube neutron generator is an essential step to operational safety. However, its price in real terms must decrease dramatically for industry (outside the oil industry) to adopt it as part of its routine technology, particularly for subsurface mining applications.

The advances made in detector technology and their future trends were discussed in Chapter 4. However, in terms of the problem of underdetermined systems, there is no doubt that its occurrence is more likely to be reduced the greater the availability of resolvable independent spectral information. The significance of this is that the 'ultimate' detector will have both extremely high counting efficiency and excellent energy resolution and will be operated satisfactorily at normal ambient temperatures, unlike the HPGe detector, which requires liquid nitrogen cooling. However, in the interim, the trend is to produce better, higher efficiency, more temperature stable scintillation detectors, to persist with HPGe detectors for really good energy resolution, in spite of their high cost, and to persist in experiments with room temperature, solid state devices such as those using cadmium telluride.

One of the most important trends for the future may well be the endeavours to which we apply nuclear geophysics. There is a trend to use it also for monitoring effluent poisoning of land and for understanding the biosphere in which we live. It may be just as well to reflect that, according to various scientific reports, the 'big bang' occurred from 12.5 to 15 billion years ago, that our planet has existed in roughly recognizable form for the past 4.7 billion years, that it first had sufficient atmosphere to support mobile sea life 570 million years ago and that it took all the time from the beginnings of our planet until 400 million years ago for the development of sufficient atmosphere (as we know it) to support even the most primitive forms of animal life on land. Yet, we, who have inhabited this planet for only such a short space of time in history, are now astutely reflecting on the viability of our impact on the planet's environment. In order to question this productively, we also require the means of measuring the physicochemical processes which are in train on the planet, such as the safety of our water supplies, and the substance around it, such as the purity and integrity of our atmosphere.

6.4. SUMMARY

Chapter 6 reviews various current philosophical perspectives on the nature of science and their basis. The chapter takes the view that science is a largely objective system of inquiry. Its success in providing empirically testable theories, to explain the world, differentiates it from conventional belief systems. The chapter also indicates the need to balance the input of resources into the two phases of research, the strategic and the tactical, the former being required for the continued progress of science and the latter for that of society.

The same section of the chapter lists, describes and discusses examples of the contributions made by nuclear geophysics to the various geosciences that are used for monitoring changes in the earth's environment. It is stated that the future well-being of humanity requires improved public education in these matters. The environmental physical processes described here include the effects of cosmic radiation on climate and the transfer of matter within the biosphere.

The same section produces relevant data to advance the argument that new vigorous strategies are needed, including the application of nuclear geophysics, to counter the apparent depletion of the globe's readily accessible resources.

The subsequent section provides examples of existing nuclear geophysical technologies and demonstrates their beneficial impact on humanity, mainly from the viewpoint of the economic benefits which their application confers on these industries. However, the evaluation of benefits derived also includes discussion, where applicable, on the improvements gained in the quality of the products obtained, i.e. in regard to their technical specification, and in the speed with which they are

delivered. The industrial applications of these technologies, which are used as examples to demonstrate these benefits, include uranium mining and processing, the oil industry — in exploration and production —, borehole logging for solid resources, applications to civil engineering, the applications of X ray analysis to mineral ore beneficiation and various types of nuclear analysis applied to the beneficiation of mined coal.

Several miscellaneous industrial processing applications of nuclear geophysics are described and discussed according to the same criteria for human benefit. They include bulk analysis of raw feed limestone for the cement industry, level gauging — without the use of external radioactive sources — and monitoring of harvested sugar cane for soil contamination.

The applications of this technology to the environment in which humans work and live are evaluated mainly on the basis of their potential long term benefits to humanity. They include agriculture, principally in respect of the water used, to monitor its purity and understand better the recharge processes in the biosphere, the problem radon represents to human health, in soil and air, and its measurement as a possible basis for predicting earthquakes and volcanic activities.

The final section of the chapter discusses future trends in the application of nuclear geophysics. Its first subsection deals with the inherent limitations of nuclear geophysical measurement, i.e. the facts that mostly it provides an inferred rather than a direct measurement of a material's properties, that measurement accuracy is affected by noise processes and that, where there is limited differentiability in measurement systems, quite different combinations of intrinsic sample properties may provide the same measurement result. Also discussed are strategies for ameliorating the noise effects and improving differentiability between measurement data through the use of spectroscopy. This section also indicates the evolving patterns of nuclear geophysical practice, the use of computers for both simulation and providing data through user friendly operations, and the increased use of high resolution solid state detectors as well as that of electronically activated radioactive sources to safeguard the environment. Increasing applications of nuclear geophysics to those geosciences are predicted that are concerned with achieving an improved understanding of the earth's environmental processes.

REFERENCES

- [6.1] POPPER, K.R., *Conjectures and Refutations: The Growth of Scientific Knowledge*, 4th edn (revised), Routledge and Kegan, London, (1972) (original edition: 1963).
- [6.2] LAKATOS, I., *Criticism and the Methodology of Scientific Research Programmes*, Aristotelean Society, New Series (1968/69) 149–186.
- [6.3] LAKATOS, I., *The Interaction Between Science and Society*, Humanities Press, Atlantic Highlands, NJ (1974).

- [6.4] RIGGS, P.J., *Whys and Ways of Science: Introducing Philosophical and Sociological Theories of Science*, Melbourne University Press, Melbourne (1992) 235 pp.
- [6.5] LAUDAN, L., *Science and Relativism*, Chicago University Press, Chicago, IL (1990).
- [6.6] VAN FRAASSEN, B.C., *The Scientific Image*, Clarendon, Oxford (1980).
- [6.7] FEYERABEND, P.K., *Farewell to Reason*, Verso, London (1987).
- [6.8] LATOUR, B., "Clothing the naked truth", *Dismantling the Truth: Reality in the Post-Modern World* (LAWSON, H., APPEGNANESI, L., Eds), Weidenfeld and Nicolson, London (1989).
- [6.9] KUHN, T.S., *The Structure of Scientific Revolutions*, 2nd edn, Chicago University Press, Chicago, IL (1972) (original edition: 1962).
- [6.10] DICKSON, B.L., CSIRO — Division of Exploration and Mining, North Ryde Laboratory, personal communication, 1996.
- [6.11] KILLEEN, P.G., Borehole logging for uranium by measurement of natural γ -radiation, *Int. J. Appl. Radiat. Isot.* **341** (1983) 231–260.
- [6.12] GENDRON, C.R., CAHILL, R.A., GILKENSON, R.H., Comparison of spectral gamma ray (SGR) well logging data with instrumental neutron activation analysis (INAA) data for rock types in northern Illinois, *Log Analyst* (Sep./Oct. 1988) 344–357.
- [6.13] SENFTLE, F.E., MOXHAM, R.M., TANNER, A.B., BOYNTON, G.R., BAICKER, J.A., Intrinsic germanium detector used in borehole sonde for uranium exploration, *Nucl. Instrum. Methods* **138** (1976) 371–380.
- [6.14] SMITH, R.C., Measured characteristics of pulsed-neutron assaying of uranium ore deposits, *IEEE Trans. Nucl. Sci.* **NS-261** (1979) 1579–1583.
- [6.15] JENSEN, D.H., Theory and Basis of PFN Logging I: Pulsed Neutron Uranium Borehole Logging with Prompt Fission Neutrons, Rep. SAND-77-0300, Sandia Labs., Albuquerque, NM (1977) 23 pp.
- [6.16] CEN, Y., DONG, Y., "Nuclear analytical techniques for process control in uranium mining industries in China", *Nuclear Techniques in the Exploration and Exploitation of Energy and Mineral Resources* (Proc. Symp. Vienna, 1990), IAEA, Vienna (1991) 237–244.
- [6.17] ENIKEYEVA, F.F., KOZHEVNIKOV, D.A., MILLER, V.V., OCHKUR, A.P., POLYACHENKO, A.L., KHAMATDINOV, R.T., Nuclear geophysics in the USSR: Status and trends, *Nucl. Geophys.* **61** (1992) 1–19.
- [6.18] SCHWEITZER, J.S., Nuclear techniques in the oil industry, *Nucl. Geophys.* **51** (1991) 65–90.
- [6.19] MYERS, G.D., A review of nuclear logging, *Log Analyst* (May/June 1992) 228–238.
- [6.20] ROSCOE, B.A., GRAU, J.A., Response of the carbon/oxygen measurement for an inelastic gamma ray spectroscopy tool, *SPE Form. Eval.* **31** (1988) 76–88.
- [6.21] JACOBSEN, L.A., BEALS, R., WYATT, D.F., Jr., HRAMETZ, A., "Response characterisation of an induced gamma spectrometry tool using a bismuth germanate detector", paper LL, presented at 32nd Annual Logging Symp. Transactions: SPWLA (1991) 19 pp.
- [6.22] SCOTT, H.D., STROLLER, C., ROSCOE, B.A., PLASEK, R.E., ADOLPH, R.A., paper MM, *ibid.*, 25 pp.

- [6.23] HARTLEY, P.E., ROACH, G.J., STEWART, D., WATT, J.S., ZASTAWNY, H.W., ELLIS, W.K., Trial of a gamma-ray multiphase flow meter on the West Kingfish Oil Platform, *Nucl. Geophys.* **96** (1995) 533–552.
- [6.24] ROACH, G.J., WATT, J.S., “Current status of development of the CSIRO multiphase flow meter”, paper presented at North Sea Flow Measurement Workshop 1996, Peebles, Scotland, Oct. 1996 (Organiser: National Engineering Laboratory, Scotland, Oct. 1996), 12 pp.
- [6.25] KHOSYAINOV, M.S., MURADIAN, A.V., A radiotracer method for rocks filtration heterogeneity investigation, *Nucl. Geophys.* **62** (1992) 111–116.
- [6.26] BORSARU, M., CERAVOLO, C., A low activity spectrometric gamma–gamma borehole logging tool for the coal industry, *Nucl. Geophys.* **64** (1994) 343–350.
- [6.27] BORSARU, M., CERAVOLO, C., TCHEN, T., The application of the low activity borehole logging tool to the iron ore mining industry, *Nucl. Geophys.* **91** (1995) 55–62.
- [6.28] CHARBUCINSKI, J., Comparison of spectrometric neutron–gamma and gamma–gamma techniques for in-situ assaying for iron grade in large diameter production holes, *Nucl. Geophys.* **71** (1993) 133–141.
- [6.29] TCHEN, T., EISLER, P., Accurate borehole probe calibration, *Explor. Geophys.* **23** (1992) 343–352.
- [6.30] CHARBUCINSKI, J., MILLITZ, P., CERAVOLO, C., “Continuous spectrometric activation logging for alumina content in iron ore”, paper presented at IAEA Co-ordination Mtg of IAEA’s Co-ordinated Research Programme on Nuclear Techniques in Exploration and Exploitation of Natural Resources: Nuclear Borehole Logging Techniques for the Determination of Rock Characteristics, Debrecen, Hungary (Apr. 1991) 11 pp.
- [6.31] EISLER, P.L., “A new borehole technology for enhancing performance in metalliferous mining”, *Applications of Borehole Logging to Exploration and Mining (Proc. 1st Symp. Perth, 1994)*, Rep. Australian Minerals Industries Assoc., Melbourne (1994) 23 pp.
- [6.32] SAMWORTH, J.R., Slimline dual detector logging — A semitheoretical but practical approach to correction and compensation, *JPT* **328** (1980) 1316–1322.
- [6.33] CHRUŚCIEL, E., KALITA, S., KOPEĆ, M., MAKHABANE, J.L., NGUYEN, Chau Dinh, NIEWODNICZAŃSKI, J.W., PALKA, K.W., TUREK, B., “Complementary analytical methods for evaluation of hard coal quality”, *Nuclear Techniques in the Exploration and Exploitation of Energy and Mineral Resources (Proc. Symp. Vienna, 1990)*, IAEA, Vienna (1991) 269–277.
- [6.34] BORSARU, M., CERAVOLO, C., CARSON, G., TCHEN, T., Low radioactivity portable coal face analyser, *Nucl. Geophys.* (in press).
- [6.35] WESOLINSKI, E.S., DE JESUS, A.S.M., “A portable coal face ash monitor based on dual energy gamma radiation”, *Nuclear Techniques in the Exploration and Exploitation of Energy and Mineral Resources (Proc. Symp. Vienna, 1990)*, IAEA, Vienna (1991) 33–46.
- [6.36] PINAULT, J.L., DAUDU, F., Borehole logging in a bauxite mine by use of prompt gamma neutron activation analysis, *ibid.*, pp. 203–214.

- [6.37] BARON, J.P., CARIOU, J., UNVOIS, J.P., VENET, V., Logging in the Laboratoires Des Ponts et Chaussées, *Geology* **100–101** (1994) 15–23.
- [6.38] FERRONSKY, V.I., GRIAZNOV, T.A., SELIVANOV, L.V., The efficiency of the use of penetration nuclear logging in hydrogeology and engineering geology, *Nucl. Geophys.* **61** (1992) 93–98.
- [6.39] WATT, J.S., On-stream analysis of metalliferous ore slurries, *Int. J. Appl. Radiat. Isot.* **34** (1983) 309–331.
- [6.40] HOLYŃSKA, B., LANKOSZ, M., OSTACHOWICZ, J., “On-stream analysis of zinc and lead ore concentrates by radioisotope X ray fluorescence”, *Nuclear Techniques in the Exploration and Exploitation of Energy and Mineral Resources (Proc. Symp. Vienna, 1990)*, IAEA, Vienna (1991) 161–167.
- [6.41] DONHOFFER, D.K., FURUTA, T., “A low-cost XRF system for on-stream analysis of slurries”, *Nuclear Techniques and Mineral Resources 1977 (Proc. Symp. Vienna, 1977)*, IAEA, Vienna (1977) 603.
- [6.42] HIETALA, M., “Examples of benefits of using radioisotope sources in analysers for on-line process control in mineral processing”, *Technical and Economic Benefits of Nuclear Techniques in Ore Processing (Proc. Advisory Group Mtg Crakow, 1988)*, IAEA-TECDOC-520, IAEA, Vienna (1989) 25–32.
- [6.43] SOWERBY, B.D., “Benefits of using radioisotope on-line analysis gauges in the Australian coal industry”, *ibid.*, p 13–24.
- [6.44] GRAVITIS, V.L., WATT, J.S., MULDOON, L.J., COCHRANE, E.M., Long-term trial of a dual energy gamma-ray transmission gauge determining the ash content of washed coking coal on a conveyor belt, *Nucl. Geophys.* **1** (1987) 111.
- [6.45] SOWERBY, B.D., “Nuclear techniques in the coal industry”, *Nuclear Techniques in the Exploration and Exploitation of Energy and Mineral Resources (Proc. Symp. Vienna, 1990)*, IAEA, Vienna (1991) 3–31.
- [6.46] MATHEW, P.J., “On-stream coal ash analysis based on natural gamma-ray activity”, *ibid.*, pp. 93–103.
- [6.47] CUTMORE, N.G., HOWARTH, W.J., SOWERBY, B.D., WATT, J.S., “On-line analysis for the mineral industry”, *Proc. AusIMM Centenary Conf. Adelaide, 1993*, Australasian Institute of Mining and Metallurgy (AusIMM), Melbourne (1993) 189–197.
- [6.48] SOWERBY, B.D., “On-line analysis of hydrogen in coal and coke”, paper presented at IAEA Mtg on Bulk Hydrogen Analysis using Neutrons, Vienna, 6-8 Dec. 1995, 15 pp.
- [6.49] BARON, J.P., BARNAVON, T., ALEXANDRE, J., “On-line bulk analysis of raw material in a cement plant using the neutron irradiation and capture gamma-ray technique”, *Nuclear Techniques in the Exploration and Exploitation of Energy and Mineral Resources (Proc. Symp. Vienna, 1990)*, IAEA, Vienna (1991) 569–583.
- [6.50] JENSEN, H.E., HOLMES, R.J., “Measurement of calcium carbonate in limestone using a neutron technique”, *Nuclear Techniques of Analysis (Proc. 3rd Aust. Conf. Lucas Heights, Australia, 1983)*, Australian Institute of Nuclear Science and Engineering, Lucas Heights (1983) 124–126.
- [6.51] MATHEW, P.J., “Recent developments in nucleonic control systems and on-stream analysers for the mineral and coal industries”, *Applications of Radioisotopes and*

Radiation in Industrial Development (ICARID-94) (Proc. Int. Conf. Bombay, 1994), National Association for the Applications of Radioisotopes and Radiation Technology in Industry, Bombay (1994) 323–336.

- [6.52] MATHEW, P.J., FUELLING, T.G., DOW, J.C., PHILLIPS, P.L., NOBLE, A.G., “A soil monitor for sugar cane”, Proc. Conf. Aust. Soc. Sugar Cane Technologists, Townsville, 1994, Watson, Ferguson and Company, Brisbane (1994) 307–313.

CONTRIBUTORS TO DRAFTING AND REVIEW

Alekseev, V.A.	Ghubkin Institute, Moscow, Russian Federation
Borsaru, M.	CSIRO — Exploration and Mining, Australia
Czubek, J.A. (deceased)	Institute of Nuclear Physics, Cracow, Poland
Eisler, P.L.	CSIRO — Exploration and Mining, Australia
Eisler, R.	Eisler–Nuclog Consulting, Balwyn, Australia
Iyer, R.	International Atomic Energy Agency
Kozhevnikov, D.A.	Ghubkin Institute, Moscow, Russian Federation
Łoskiewicz, J.	Institute of Nuclear Physics, Cracow, Poland
Mani, R.S.	International Atomic Energy Agency
Peveraro, R.	University of Edinburgh, United Kingdom
Schweitzer, J.S.	SDR Ridgeland, United States of America
Sowerby, B.	CSIRO — Minerals
Thereska, J.	International Atomic Energy Agency
Vera Ruiz, H.	International Atomic Energy Agency
Watt, J.S.	CSIRO — Minerals

Consultants Meetings

Ridgefield, NJ, USA: 15–19 July 1991, 15–18 November 1993