

I Don't Understand Quantum Physics

by

Douglas Ross FRS

Emeritus Professor of Physics,
University of Southampton

Contents

| | | |
|----------|--|-----------|
| 1 | Introduction - Understanding “understanding”. | 1 |
| 2 | Some Classical Physics | 3 |
| 2.1 | Waves | 3 |
| 2.1.1 | Interference and Diffraction | 4 |
| 2.1.2 | Wavepackets | 5 |
| 2.1.3 | Travelling and Standing Waves | 14 |
| 2.2 | Particles | 15 |
| 3 | Experiments that Shook the World of Physics. | 22 |
| 3.1 | The Ultraviolet Catastrophe | 22 |
| 3.2 | The Photoelectric Effect. | 25 |
| 3.3 | Compton Scattering | 27 |
| 3.4 | Bragg X-ray Diffraction | 29 |
| 3.5 | The Davisson-Germer Experiment | 30 |
| 4 | Wave-Particle Duality | 34 |
| 4.1 | Both a wave and a particle | 34 |
| 4.2 | Which Slit did the particle go through? | 35 |
| 5 | What is a Matter (de Broglie) Wave? | 37 |
| 6 | Particles and Fields | 39 |
| 7 | Heisenberg’s Uncertainty Principle | 41 |
| 8 | Wavefunctions - Schrödinger’s Equation | 44 |
| 8.1 | Discrete Energy Levels | 44 |
| 8.1.1 | Particle in a Box (in one dimension) | 44 |
| 8.1.2 | Harmonic Oscillator | 46 |
| 8.1.3 | The Hydrogen Atom | 47 |

| | |
|---|-----------|
| 9 Quantum Tunnelling | 51 |
| 10 Quantum States and Superposition | 53 |
| 11 Two State Systems | 55 |
| 11.1 Photon Polarization | 55 |
| 11.2 Electron Spin | 57 |
| 12 Wavefunction Collapse | 61 |
| 12.1 Decoherence | 62 |
| 13 Interpretations of Quantum Physics | 64 |
| 13.1 Copenhagen Interpretation | 64 |
| 13.2 Many Worlds Interpretation. | 64 |
| 14 Two Enigmatic “Thought Experiments” | 66 |
| 14.1 Schrödinger’s Cat | 66 |
| 14.2 Einstein Rosen Podolsky (EPR) Paradox - entanglement | 68 |
| 15 Hidden Variables | 71 |
| 16 Why is the Quantum World so Small? | 76 |
| 17 Probabilistic Determinism | 78 |
| 18 Is Quantum Theory Correct and Complete? | 80 |

Acknowledgments

I am extremely grateful to Laurence Baron, Alexander Belyaev, Jean-Michel Jakobowicz, David Pugmire, Joe Stroud and Anthony Warshaw for reading earlier versions of this manuscript and making a number of helpful suggestions for improving the clarity of the text.

I have used many photos and drawings which I have found on the Internet, and in many cases the source of such photos and drawings is not clear. I have assumed that images which appear on the Internet are in the public domain and do not need to be individually referenced.

January 2018

Dedication

To my wonderful wife, Jackie, who has given me tremendous support throughout my career.

Foreword

This article is designed to describe (but *not* explain) the mysteries of Quantum Physics to the interested lay person. I assume that the reader has studied and absorbed Physics and Mathematics at normal High School level, but not at any further level. I have attempted not to assume any Physics or Mathematics beyond this, without explaining it.

I have not shied away from using Mathematics. Physics is a quantitative subject and relies heavily on formulae to describe or predict the quantitative results of experiments. To quote Richard Feynman [1] - “If you want to learn about Nature, to appreciate Nature, it is necessary to understand the language that she speaks in.”

Once again, no Mathematics is assumed beyond that normally studied in High School, but it is expected that the reader will be comfortable with the manipulation of symbols in simple algebraic equations and the application of some elementary trigonometry. The reader who finds this too challenging should nevertheless be able to follow the general gist of the article - by taking the results quoted as correct and not being overly exercised by his (her) inability to comprehend the detail.

Physics is a progressive subject and it is impossible to learn about Quantum Physics without a good grounding in classical physics, i.e. the physics that was understood by the end of the nineteenth century, before the discovery of Quantum Theory. Quantum Theory essentially deals with the fact that everything which can transmit energy behaves *both* as a particle and as a wave. This article therefore contains an introduction to some of the important properties of both waves and particles, which are necessarily used in the description of Quantum Physics.

I have included a glossary of technical terms. I hope the reader will find it useful to be able to refer to this whenever (s)he comes across a technical term which (s)he does not understand. The terms defined in the glossary appear in **bold-face** the first time they are used in the body of the text.

I have also added an appendix of all the relevant mathematical formulae and equations. **Do NOT read this appendix** unless you have studied mathematics up to first year University level. It is included for completeness. If you feel that you would nevertheless like to see a set of formulae which you will not understand and are confident that this will not put you off or cause confusion, then take a look, but note that it is *not necessary* to read these equations in order to be able to follow this article.

The article is quite long and has to be read slowly and carefully. I felt that as far as possible I should not skip steps and ask the reader to accept results quoted without any form of justification. It is also repetitive in parts – “*repetito mater studiorum est.*”[†]

I very much hope the reader gleans from this article some flavour of what must be described as the most intriguing and enigmatic development in all of Natural Science.

[†]repetition is the mother of all learning.

1 Introduction - Understanding “understanding”.

“I don’t understand Quantum Physics” the interested layman often asserts when (s)he meets a theoretical physicist. The honest reply from the physicist is “Nor do I.”

This seemingly facetious reply is indeed appropriate if the word “understand” is used in its usual context. What we usually mean is the ability to visualize something. If you were to explain what a “waterfall” (for example) was to a person who had never seen one, then provided your explanation is sufficiently articulate, that person should be able to picture in his(her) mind what a waterfall actually looks like. When we think of sub-microscopic systems (such as atoms), the temptation is to attempt to visualize them based on our visual experience of the macroscopic world. Thus, since we can visualize the solar system in terms of the sun at the centre and a set of planets moving in elliptic orbits with the sun at one focus, it is tempting to think of an atom which consists of a **nucleus** and **electrons** in the same way, namely the nucleus at the centre and the electrons forming elliptical orbits around the nucleus. Unfortunately this is erroneous and atoms do not lend themselves to such clear pictures in which the paths of the electrons can be precisely determined. We simply have to get used to the idea that if we consider systems which are too small to be clearly seen (directly or indirectly) we need to abandon the luxury of being able to visualize such systems in terms of our experience of macroscopic systems. Visualization is the usual, but not the unique way in which we can “conceptualize”. For example, by playing with two magnets we can develop the concept of a force even though we cannot actually see what is pushing the magnets apart or pulling them together. In this sense, we have an understanding of a **magnetic field**. Similar effects can be observed with electrodes connected to the poles of a battery so that we can understand **electric fields**. However, there exists a type of force called “**degeneracy pressure**” which is of purely quantum origin and has no classical analogue. This “degeneracy pressure” is the reason that a **neutron star** does not collapse under its own gravity (unless the density of the neutron star exceeds a critical value known as the **Chandrasekhar limit** [2]). Nevertheless, it cannot be “understood” within the framework of our everyday experiences.

Traditionally, it was believed that the objective of Science was to be able to fully understand everything in Nature, by which we mean to be able to relate everything our everyday experiences, in a way which is intelligible. This is regrettably not the case for modern physics, i.e. for the Quantum Physics. The objective of Theoretical Physics is reduced from this ambitious objective, to the development of a set of rules which enable us to calculate quantities which can be experimentally measured. Quantum Theory generates an equation, whose solution yields (directly or indirectly) such physically measurable quantities. In (non-relativistic) Quantum Theory, this equation is was first written down by Erwin Schrödinger [3] in 1925 (**Schrödinger’s equation**) and its solution can be used to calculate the optical **spectrum** of various atoms.¹

¹Only for the simple case of the **hydrogen atom**, can the Schrödinger equation be solved exactly. For more complicated atoms, various approximate methods exist which generate these spectra up to a certain accuracy.

Such optical spectra can be observed in the laboratory and the successful comparison of the observed spectra with those predicted from the solution to the Schrödinger equation tells us that Quantum Physics is consistent with Nature. We cannot, however, use this to determine the exact (i.e. localized) positions of the electrons relative to the nucleus at any given time, simply because these exact positions *do not* exist in Quantum Physics. An electron does not possess the property of being located at a given precise point, rather it has to be thought of as existing “everywhere”, with a high **probability** of being found at a certain location and a very small probability of being found far away from that location. It may be really strange to assert that an electron does not actually possess a single (localized) position, but we have to live with this strange idea if we accept that Quantum Physics describes Nature correctly. The absence of predictions of the positions of the electrons does not indicate a failing of the theory, because it allows physicists to calculate quantities which can be experimentally measured - and so far these calculations have always agreed with the experimental measurements. It is this agreement that promotes Quantum Theory to the status of “a correct theory” despite its failure to allow us to “understand” what is going on inside an atom. Thus we theoretical physicists are not simply being awkward when we say that we “don’t understand Quantum Physics”. We mean that whereas it gives us a set of working rules that enable us to calculate measurable quantities, it does not help us to understand what is going on inside an atom. We have to accept the rather uncomfortable idea that objects which are too small to be seen, cannot be described in terms of the usual concepts, with which we are familiar.

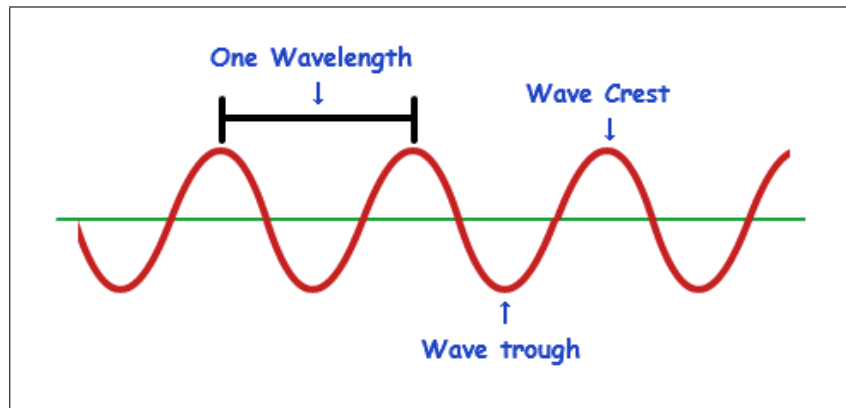

Figure 1: A pure sine wave. The wavelength is the distance between two adjacent peaks (or troughs). The number of peaks (or troughs) passing a given point per second is called the “frequency”. The wave velocity is the wavelength multiplied by the frequency.

2 Some Classical Physics

Before we can proceed to discuss Quantum Physics we need to understand a few things about classical physics. This should all be conceptually straightforward, since not only can we visualize the phenomena described, but we can set up experiments using macroscopic objects and observe them directly.

2.1 Waves

A wave is a quantity which oscillates between a maximum and minimum and travels in space. The number of times it reaches a maximum per second (at a fixed point) is called the “**frequency**” and the instantaneous distance between two maxima is called the “**wavelength**”. The maximum value of the oscillating quantity is called the “**amplitude**”. This is demonstrated in Fig. 1.

The quantity which travels in this way is known as a “**disturbance**”. Precisely what this disturbance is depends on the wave. For ocean waves it is the surface of the water. For sound waves it is the fluctuation in pressure, for light (and all other **electromagnetic radiation** such as microwaves, **X-rays** etc.) it is an electric field and a magnetic field which are perpendicular to each other and also perpendicular to the direction of the wave. The simplest waves can be generated by taking a long length of string under tension (such as a washing line) and shaking one end, so that it oscillates with a constant frequency.

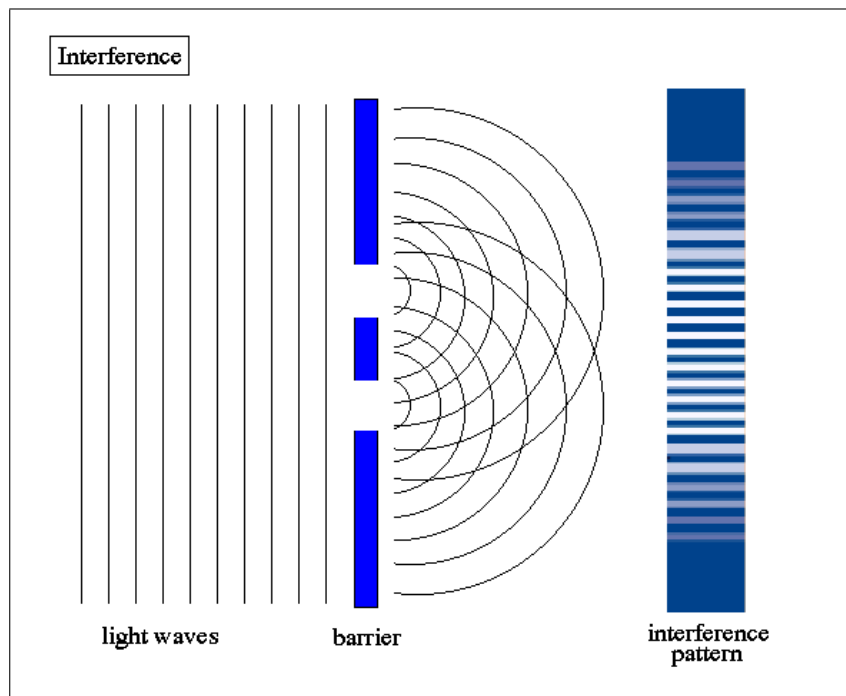

Figure 2: **Interference** of light emerging through two narrow slits. The light emerges from each slit as though the slits were the sources of the light. The light from the two slits travel a slightly different distance to a given point on the screen. If this distance is a whole number of wavelengths, the peaks and troughs coincide and we get a maximum, whereas half-way between these maxima the peaks from one slit coincide with the troughs for the other so that the wave motion from the two slits cancels out and we get a minimum. This is know as the “**Young’s slits**” experiment after Thomas Young [4] who first performed the experiment in 1801.

2.1.1 Interference and Diffraction

Suppose a wave-front is incident on two slits which are close together. Waves are emitted from each of the two slits, as shown in Fig. 2.

If the resultant wave is observed on a screen at a point half-way between the two slits then the wave from each slit will have travelled the same distance and they will therefore be “in phase” i.e. they will have maxima together and minima together. This means that the total disturbance will be the sum of the two disturbances and we have what is called an “interference maximum”. On the other hand, if the resultant wave is observed slightly away from the mid-point between the slits then the wave from one of the slits travels further than the wave from the other, and the waves from the two slits will no longer be in phase so that the resultant disturbance will be a wave whose amplitude is smaller than the sum of the two amplitudes. In the case where the extra distance travelled by one of the waves is half a wavelength the waves will cancel out exactly, leading to a minimum. This is demonstrated

in Fig. 3.

Even further away from the mid-point the path difference between the waves from the two slits is again a whole number of wavelengths and the disturbances are again in phase – and so on. This is shown in Fig. 4. The result is an **interference pattern** consisting of series of light and dark fringes as shown on the right of Fig. 4.

We can do this experiment by shining a laser pen-torch on the surface of a DVD. The DVD consists of a large number of closely ruled grooves and the laser pen-torch produces light of a single wavelength. If the reflected light is observed on a screen whose plane is perpendicular to the DVD, then we see series of spots corresponding to the maxima in which light reflected from adjacent grooves on the DVD are exactly an **integer number** (i.e. whole number) of wavelengths apart so that the waves from all the grooves are in-phase and add up. The experimental setup is shown in Fig. 5. The rainbow which one can see when you look at a DVD and move it around arises because these maxima occur at slightly different angles for different wavelengths so that white light is dispersed, generating the rainbow.

Something similar happens if we illuminate a small object (such as a pin) with **monochromatic** (i.e. single wavelength) light. A set of closely packed fringes can be seen either side of the object, owing to interference between light waves from the two sides of the object. This is actually called “**diffraction**” (but I have never seen an adequate definition of “interference” and “diffraction” which distinguishes between the two).

An example is shown in Fig. 6, which shows the diffraction pattern of a pin-head illuminated with monochromatic (red) light. There is interference between the wave that passes around the object in one direction with the wave that passes around the object in the other direction, leading to fringes whose maxima and minima correspond to directions in which these two waves are in phase or out of phase. The path difference between these two waves is proportional to the size of the object, so that the separation of the fringes is proportional to the ratio of the wavelength of the light to the object size. If the object is much larger than the wavelength of the light used, then we still get a sharp image of the object, together with closely packed diffraction fringes. On the other hand, if we look at even smaller objects which are of the order of magnitude of the wavelength of the light, the fringes become more and more widely separated and eventually we just see the fringes but no sharp image of the object.

2.1.2 Wavepackets

A pure wave with a single wavelength/frequency oscillates for ever - the wave is infinitely long. In practice a wave only exists for a finite time interval. In the case of the sound from an object landing on the floor this could be about $1/20^{th}$ of a second.

The wave would look something like the wave shown in Fig. 7, in which we have a wave of some frequency, f_0 , with an amplitude which grows and then shrinks again. The total length of the **wavepacket** is the distance over which the amplitude grows plus the distance over which it shrinks. Thus, whereas a classical point-particle is totally localized, i.e. it

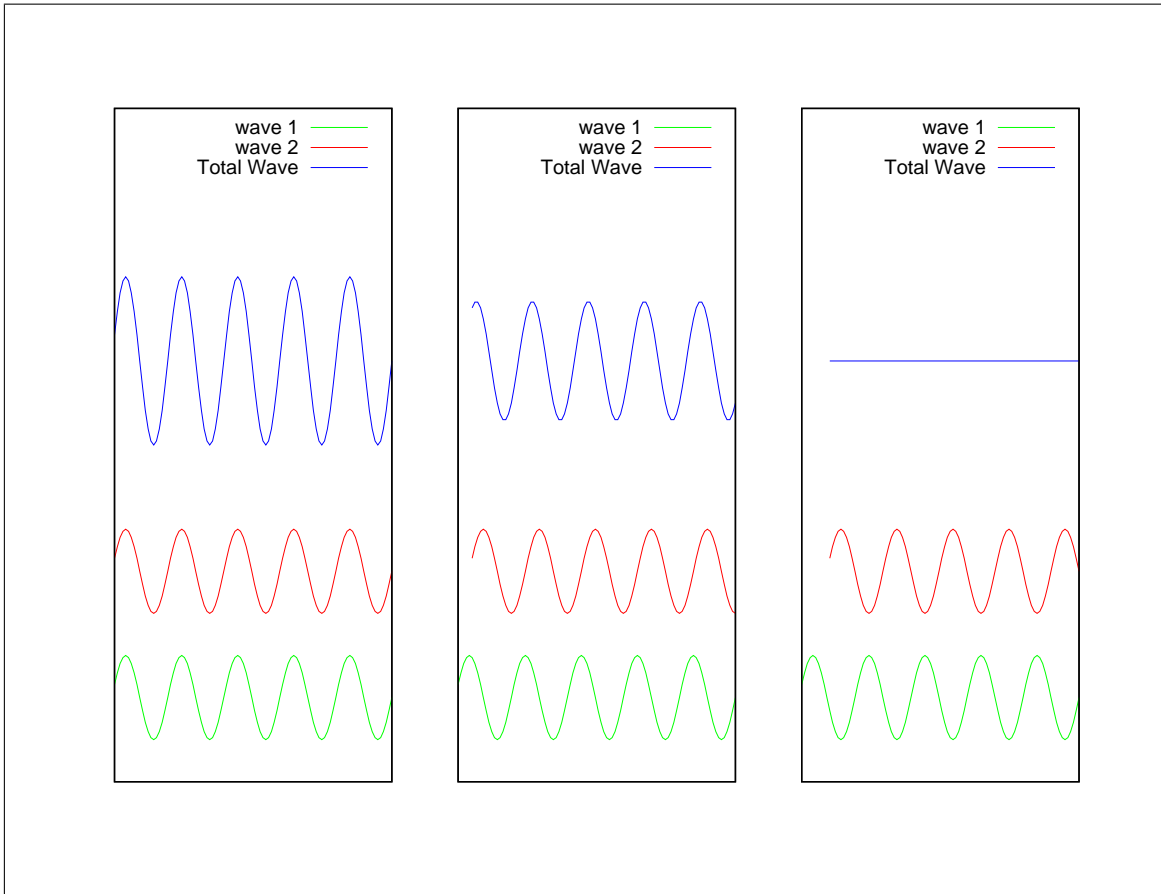

Figure 3: The left panel shows the lower two waves travelling the same distance and therefore being in phase so that the resultant disturbance is a wave with double the amplitude – an interference maximum. The centre panel, shows the lower wave travelling a extra distance of one quarter of a wavelength relative to the upper wave and the resultant disturbance is a wave with a reduced amplitude. In the right panel the lower wave travels an extra distance of one half of a wavelength so that the two disturbances are exactly out of phase - one has a maximum at the point where the other has a minimum and vice versa so that the resultant disturbance is zero and we have an interference minimum.

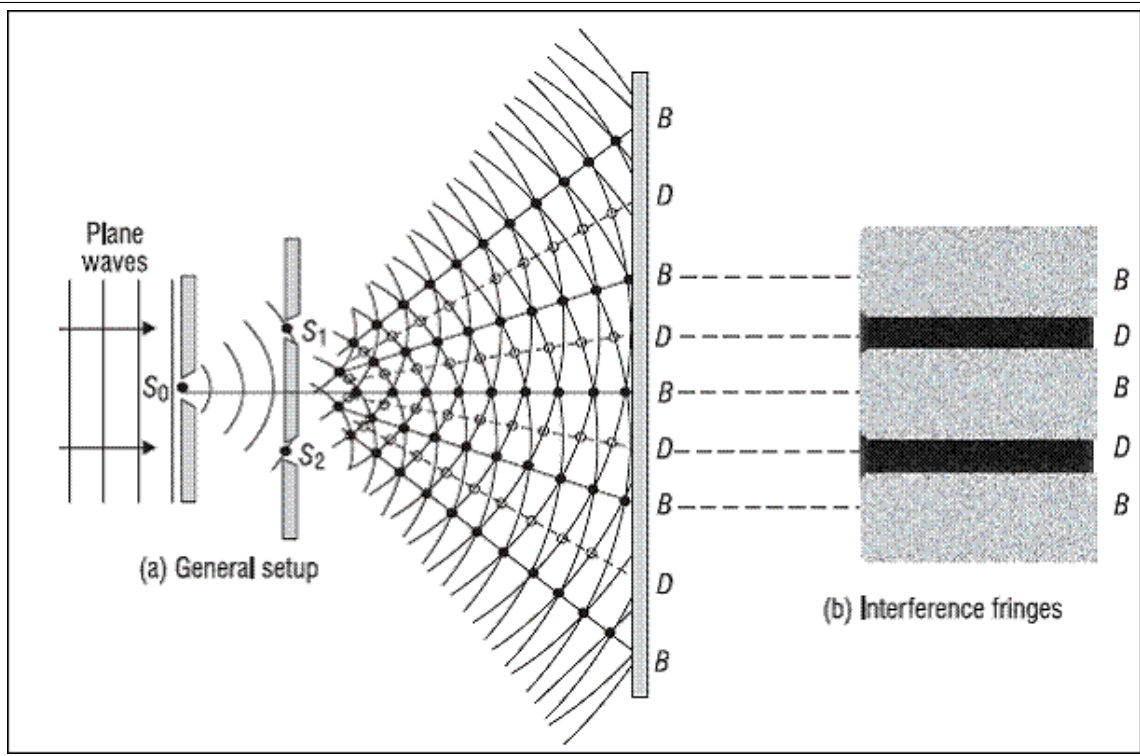

Figure 4: The double slit experiment (a). The interference from the light from the two slits leads to a set of fringes on the screen (b)

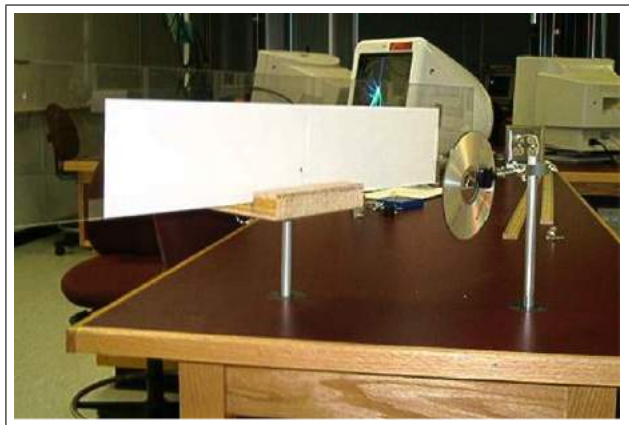

Figure 5: Using a DVD as a diffraction grating with a laser pen-torch held on a stand, a CD or DVD and a vertical screen, spots corresponding to interference maxima appear on the screen.

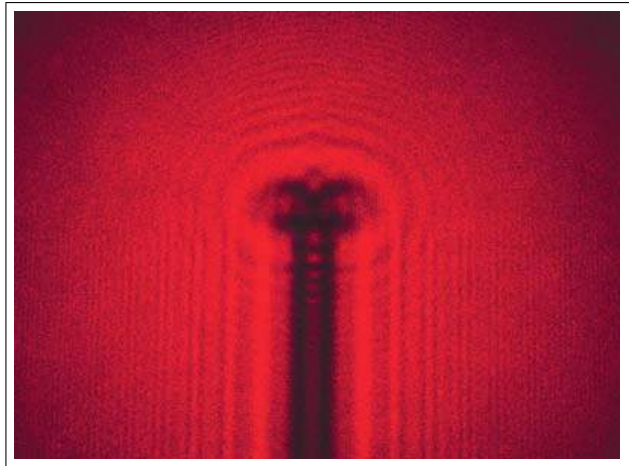

Figure 6: The diffraction pattern obtained from illuminating a pin-head with monochromatic (red) light. The diffraction pattern arises from interference between light waves which go around the pin in one direction and those that go around the pin in the other direction. For light emerging at different angles these two waves will have different phase differences because they travel different distances. Maxima are found when the difference in distance travelled by the two waves is a whole number of wavelengths so that the waves are in phase and add up. Because the width of the pin is very much larger than the wavelength of the light used to illuminate it, the fringes are closely packed and there is a reasonably sharp image of the pin at the centre.

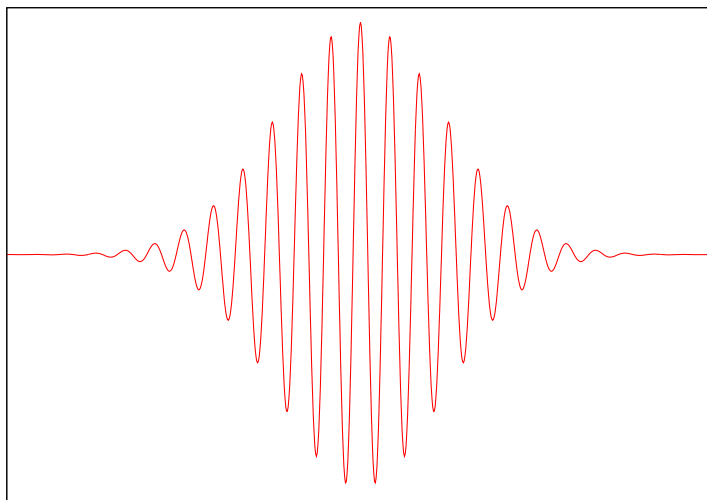

Figure 7: An example of a wavepacket representing a wave that lasts for a finite time. The amplitude begins very small and then grows to a maximum and then shrinks again.

has a well-defined exact position in space, a wavepacket is spread over a finite distance and therefore cannot be said to have a definite (i.e. localized) position. The wavepacket exists *everywhere* although the amplitude has a maximum at a specific position (at a given time). The amplitude decreases as one moves away from that specific position and is negligibly small far away from it. It is a mathematical fact that such a wavepacket is actually the sum of many pure frequency waves as shown in Fig. 8 with different amplitudes and frequencies slightly different from f_0 . The largest amplitude is the wave with frequency, f_0 but there are other frequencies ranging from a little below, i.e. $f_0 - \frac{1}{2}\Delta f$, to a little above, i.e. $f_0 + \frac{1}{2}\Delta f$. The range of frequencies required to construct the wavepacket is Δf . Waves with different frequencies and amplitudes for which, when the disturbances of the individual waves added together, generate a total disturbance given by the wavepacket of Fig. 7.

In Fig. 9 we show a bar-chart of the amplitudes of the pure waves against frequency (it is easy to write a simple computer program which verifies that this works.) So, contrary to common belief, any wave which lasts a finite time, Δt , is never a pure single-frequency (monochromatic) wave with frequency f_0 , but a **superposition** of waves with the largest amplitude for frequency f_0 , but with waves with frequencies below and above f_0 , albeit with smaller amplitudes. This is extremely important. It means that if we hear a short sound such as an object knocking against another object or a balloon popping, or see a very short flash of light, it is meaningless to ask the question “What was the frequency of that noise, or that flash”, because a short wavepacket does not possess a well-defined (exact) frequency - it is a superposition of many different frequencies.

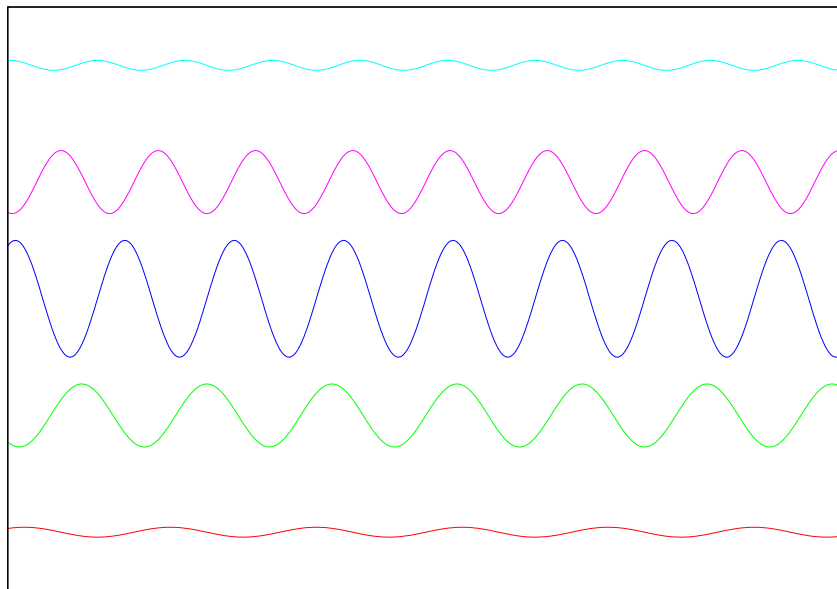

Figure 8: Waves with different frequencies and amplitudes for which, when the disturbances of the individual waves added together, generate a total disturbance given by the wavepacket of Fig. 7.

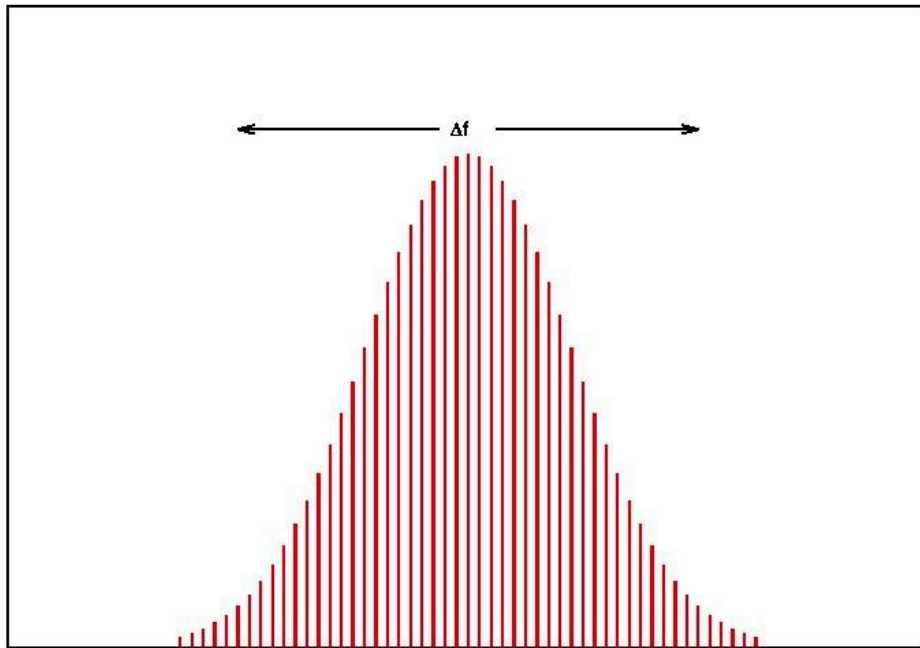

Figure 9: A bar-chart showing the frequencies and amplitudes which constitute the wavepacket of Fig. 7

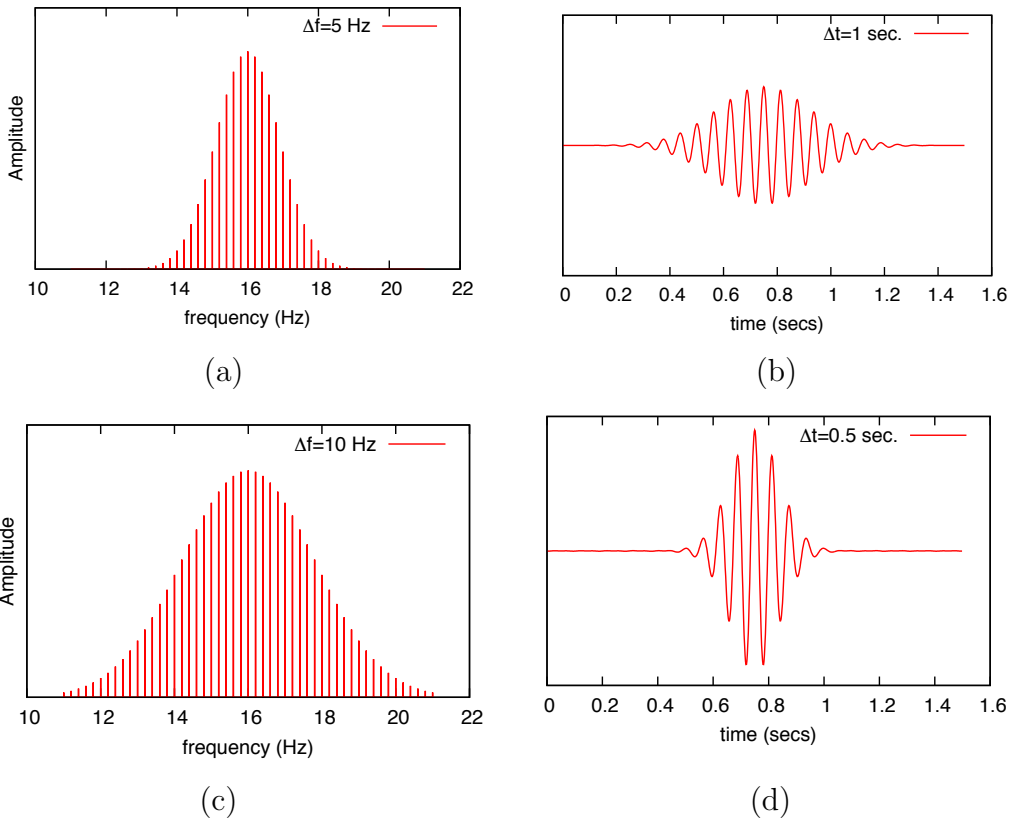

Figure 10: (a): the spectrum of frequencies with range of 5 Hz; (b): The resulting wavepacket with time range of 1 sec. (c): the spectrum of frequencies with range of 10 Hz (d): The resulting wavepacket with time range of 0.5 sec. Note that we have chosen to plot the disturbance at a given point as a function of time. We could have chosen to plot the spatial distribution of the disturbance at a given instant (same time). The shape of the graphs on the right would have been exactly the same. The graphs on the left would have been replaced by a distribution in wavelengths rather than frequencies. The lower graphs would have a wider range of wavelengths than the upper graphs.

In Fig. 10, we show two more such bar-charts and the wavepackets that are produced when we add the waves with the amplitudes and frequencies shown in the bar-charts. In this case, we show the relevant numbers. In the upper figure the frequency ranges from about 13.5 to 18.5 **Hertz** (abbreviated to ‘Hz’, meaning cycles per second) and the resulting wavepacket has a width (time interval) of around 1 second. In the lower figure, the range of frequencies is significantly larger - from about 10 to 20 Hz, but the wavepacket is narrower, with a width of around 0.5 seconds. In both cases, if we multiply the range of frequencies by the width of the wavepacket we get approximately the same result (around 5). This is a result which can be derived from the mathematical properties of wavepackets and tells us that the width of the wavepacket is inversely proportional to the range of frequencies which are used to construct that particular wavepacket. This result is the basis of the Heisenberg **uncertainty principle**. We will see later that the width of the wavepacket is proportional to the uncertainty in the position of a particle and the range of frequencies is proportional to the uncertainty in its **momentum**.

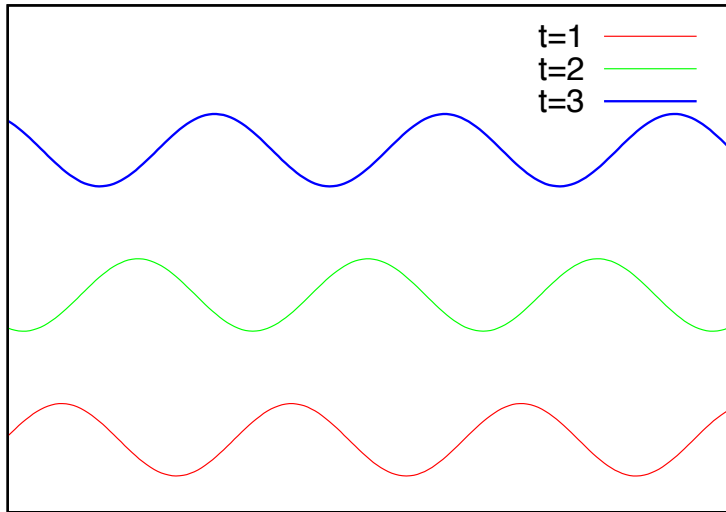

Figure 11: A travelling wave at three different times showing how the peaks and troughs propagate through space as time advances.

2.1.3 Travelling and Standing Waves

A travelling wave, such as the wave on the surface of the sea, advances as time evolves. For a single wavelength wave, if we take a snapshot of the disturbance we see a disturbance which oscillates in space with peaks and troughs. At a later time a particular peak has moved on (either to the right or to the left depending on the direction of the wave). This is demonstrated in Fig. 11 where we show for three such snapshots at different times and note that a particular peak (or trough) advances with time.

The other type of wave is called a “**standing wave**”. This occurs if there is some restriction on the disturbance at the ends. An example is a violin string for which the disturbance of the string is zero at the bridge of the violin and also zero at the point on the neck where a finger presses on the string so that there is no displacement. In this case the wave does not propagate, but remains with the same shape with an amplitude that oscillates with time as shown in Fig. 12. For such waves only certain wavelengths are allowed. The reason for this is that the disturbance vanishes at two points. The allowed wavelengths are those for which the disturbance can be zero at both these points - i.e. the distance between these two points must be a whole number of half-wavelengths (see Fig. 13). This in turn means that the longest wavelength, λ_1 , that a standing wave can have is $2L$, where L is the distance between the two points at which the disturbance is constrained to be zero. Such a wave only has zeros at the ends ($x = 0$ and $x = L$).

In the case of a violin string, the fact that this is a specific wavelength means that the

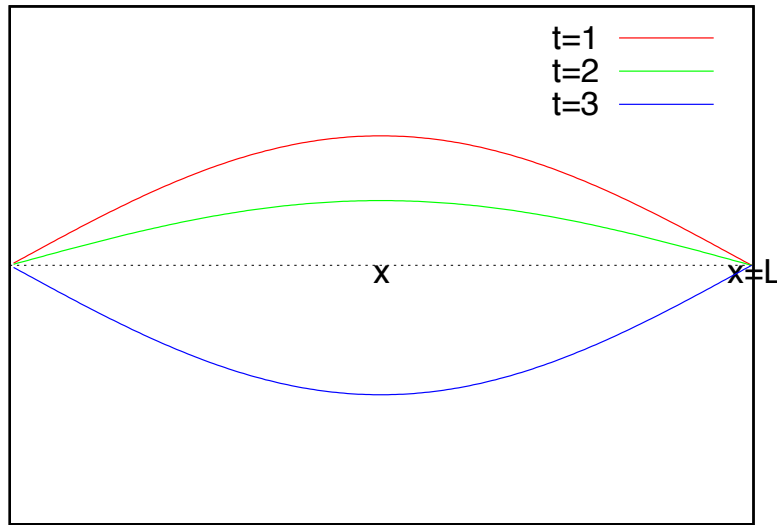

Figure 12: The time development of a standing wave. This wave does not propagate through space but simply oscillates, maintaining the constraint that the disturbance is zero at the end points, $x = 0$ and $x = L$.

string vibrates with a specific frequency producing a sound with a given pitch. The next possible wavelength, λ_2 , is L , which has zeros at the ends and also a zero in the middle. After that we have $\lambda_3 = \frac{2}{3}L$ which has zeros at the ends and two points between the ends where the disturbance is also zero. These three cases are demonstrated in Fig. 13. In general, a standing wave in which the disturbance at $x = 0$ and $x = L$ is zero can have a wavelength λ_n , given by

$$\lambda_n = \frac{2L}{n} \text{ where } n \text{ is a positive integer, (i.e a whole number e.g. } 1,2,3,4 \dots\dots). \quad (2.1)$$

2.2 Particles

In classical physics particles behave like tiny billiard balls (so tiny that they may be considered to be points). Their motion is determined by Newton's three laws of motion [5]. A moving particle of mass m moving with velocity \mathbf{v} (assumed to be very small compared with the speed of light – so that relativistic effects may be neglected) has a **kinetic energy** $T = \frac{1}{2}mv^2$ and momentum $\mathbf{p} = m\mathbf{v}$. \mathbf{p} and \mathbf{v} are written in bold letters because they represent “**vectors**” i.e. they have direction as well as magnitude or alternatively they have three **components** - one for each direction in space. It is insufficient to specify the speed, v , of a particle in order to describe its motion. We also need to know the direction in which it is moving. In an elastic collision (no loss of energy into heat or sound) the total kinetic energy

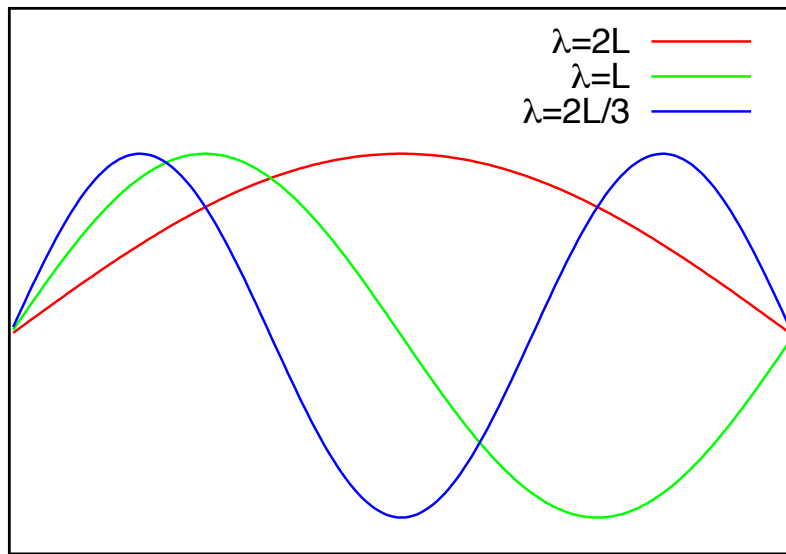

Figure 13: The longest ($\lambda = 2L$), next longest ($\lambda = L$) and third longest ($\lambda = \frac{2}{3}L$) wavelength for standing waves in which the displacement is constrained to be zero at $x = 0$ and at $x = L$.

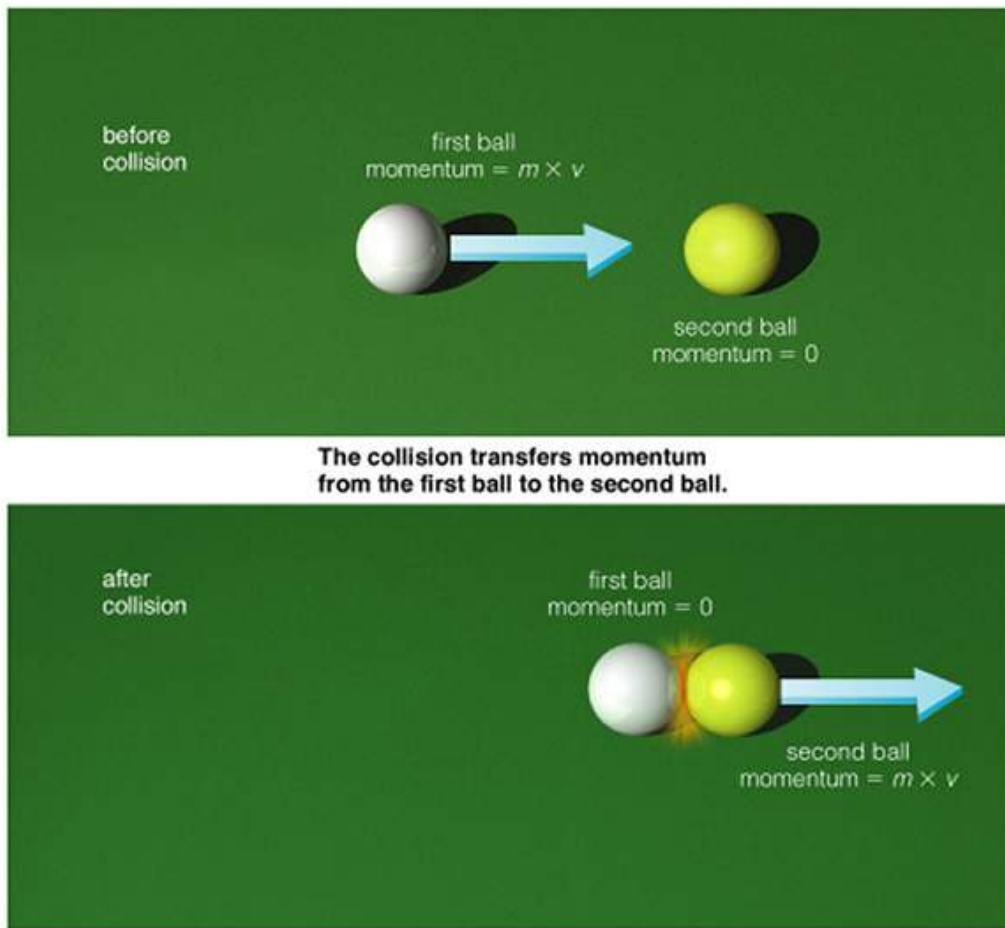

Figure 14: When a ball of mass m collides head-on with a stationary ball with the same mass, conservation of momentum tells us that the target ball then moves with the initial velocity of the incident ball and the incident ball becomes stationary.

and the three components of momentum are conserved. For a given scattering between two particles with given masses and initial velocities these conservation laws are sufficient to derive a unique relation between the final speeds of the two particles and their scattering angles (i.e. the angle between the initial and final directions of motion).

An example is shown in Fig. 14 in which a particle (1) with initial velocity u_1 collides with an initially stationary particle (2). The final speeds v_1 and v_2 and the angles of the particles after the collision are related to each other. As any good billiards player knows, the scattering angle of the incident billiard ball is determined by the offset of the centres. If the projectile billiard ball had a velocity whose direction is through the centre of the target billiard ball, then after the collision the two billiard balls will continue to move in the same direction, but if the billiard balls are not concentric then the balls will scatter at an angle determined exactly by the offset of the two centres. Thus an expert billiards player can

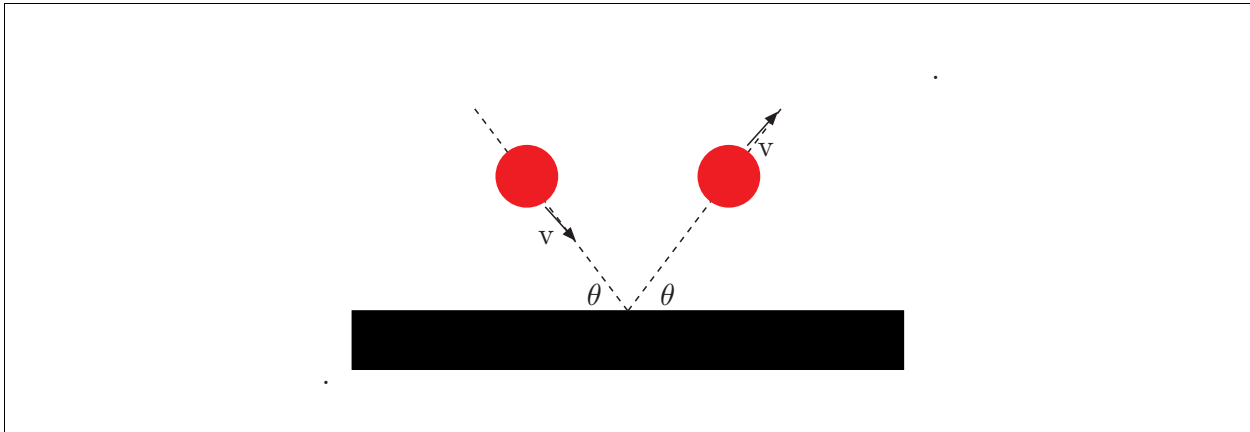
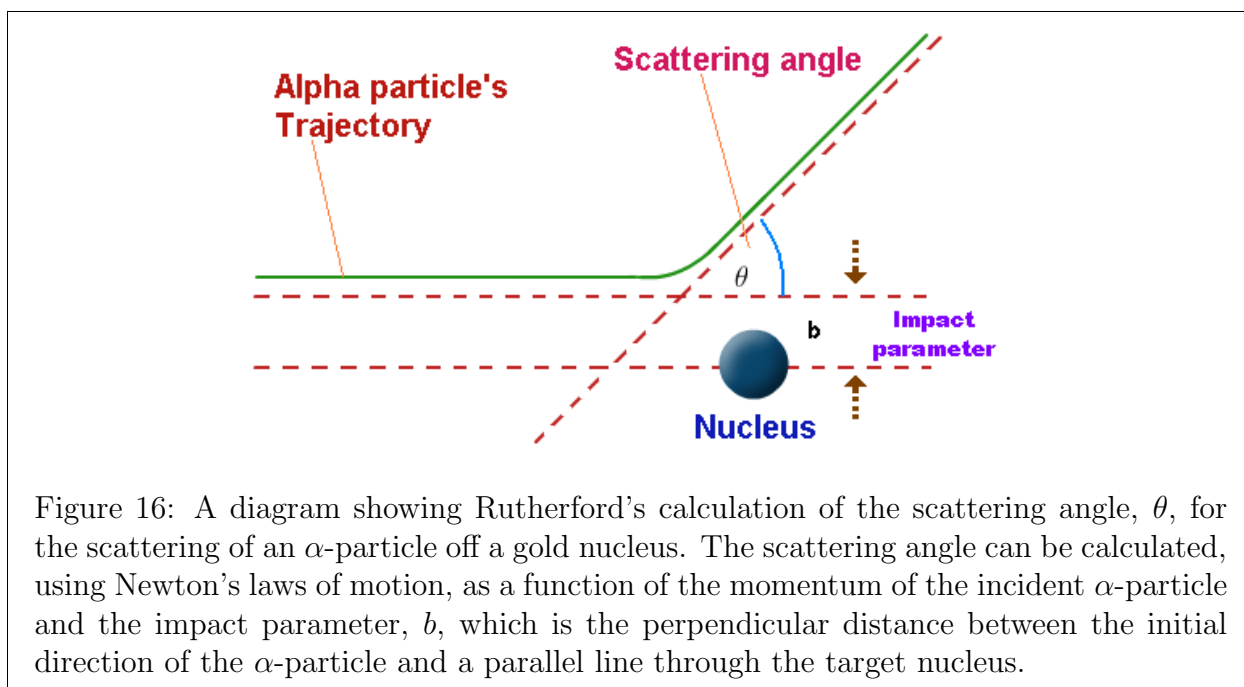

Figure 15: For a ball bounced of a hard surface for which there is no loss of energy The initial speed is the same as the final speed (because the kinetic energy after the bounce is the same as the kinetic energy before) and the angle the trajectory of the ball makes with the surface is also conserved because the component of momentum tangential to the surface is conserved.

shoot the projectile ball in such a way that (s)he can precisely predict the final velocities (speeds and directions) of the two billiard balls. In particular, for the ball bounced off a hard surface (no energy loss), the conservation of momentum and kinetic energy is sufficient to tell us that the angle of reflection is equal to the angle of incidence as shown in Fig. 15. The component of momentum parallel to the hard surface, before the impact is equal to the same component of momentum after the impact which leads to the equality of the incident and reflected angle. We will see that in the sub-microscopic world this is not necessarily the case because what we traditionally think of as particles can also behave like waves and produce diffraction.

Another example of the application of classical physics to particles was Ernest Rutherford's calculation of the path of an α -particle of given energy moving initially along a line with a distance b from a nucleus [6]. This is shown in Fig. 16. The electrostatic repulsion between the nucleus and the incident α -particle, causes a deflection in the path of the α -particle by an angle, θ , (called the scattering angle), which depends on the distance, b , of the initial direction of the incident particle from a parallel line passing through the nucleus (called the “**impact parameter**”). The laws of electrostatics (the inverse square law which tells us that the electric field due to a charged particle is inversely proportional to the square of the distance from the charged particle) together with Newton's second law of motion which tells us how the momentum of a particle changes under the influence of a force, can be used together to calculate this scattering angle. In the experiment of Hans Geiger and Ernest Marsden [7], α -particles were projected through a thin gold foil and were scattered through angles in agreement with the calculation of Rutherford – this confirmed that the gold foil was a **lattice** of positively charged nuclei.



The Smallest Size we Can See

When I was a boy, I had a toy microscope. The maximum magnification was $300\times$. I discovered that for professional microscopes the maximum magnification was $500\times$ (optical microscopes with magnification up to $1000\times$ are now available). I assumed that this was limited by the technology of manufacturing lenses and that advances in engineering would increase this indefinitely. However, this is not the case.

We have seen in the section on interference of waves that when a sufficiently small object is viewed with monochromatic light, we observe diffraction fringes at the edges of the image. The separation of the interference fringes is proportional to the ratio of the wavelength of the illuminating light to size of the object viewed. If the size of the object viewed is much larger than the wavelength of the light, there is still a sharp image of the object itself, albeit with fringes at the edges. However, as the size of the object is decreased to a few times the wavelength of light, the diffraction fringes become wider and wider and if the size of the object is less than the wavelength of light, then all one can see is the central diffraction fringe which covers the entire field of vision and the image of the object is totally lost. The shortest wavelength that the human eye can see is about 0.4 **microns** (a micron is a millionth of a meter). So this is the smallest object that we can see directly. The naked eye can see an object of size 100 microns, so there is little advantage in building microscopes with magnification exceeding around 500. Some animals can detect UV radiation with somewhat shorter wavelengths - so their optical microscopes may be a little more powerful than ours - but not much!

If we can't see an object directly with visible light, could we not use electromagnetic

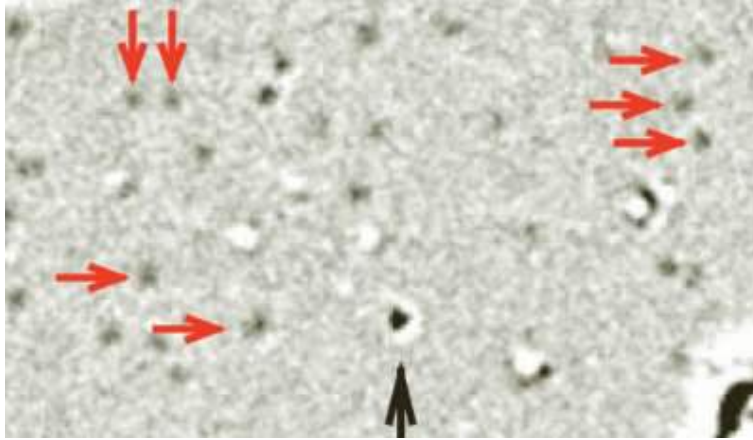

Figure 17: The arrows point to individual hydrogen atoms, within a graphene lattice. The image is created using an electron microscope.

radiation with much shorter wavelengths to make an image of an object? An example that comes to mind is X-rays which have wavelengths down to 0.00001 microns – so we could see things of the size of an atom with these. X-rays are the same as light waves but with a much smaller wavelength. The trouble is that we have no way of focusing a beam of X-rays (we do not know how to build a lens for X-rays). Fortunately Quantum Physics comes to our rescue here. We will see later that what are classically regarded as particles, can also behave like waves - a particle has a wavelength associated with it – and this wavelength is inversely proportional to the particle’s momentum. An electron accelerated through a **potential** of 100000 **Volts** has a wavelength of .000004 microns. With such wavelengths individual atoms can be detected. Such an image, which shows hydrogen atoms in **graphene** [8] is shown in Fig. 17.

However, there is a price to pay for such small wavelengths leading to such high resolution. The high energy electron also has a very high momentum. When it scatters off a hydrogen atom it imparts some of its momentum to the hydrogen atom, which then begins to move with a velocity of around 100000 meters per second. This is why the images of the hydrogen atoms in Fig. 17 are rather blurred. The energy of the incident electrons are far larger than the **binding energies** of the electron inside the hydrogen atom, so that in a collision between the incident electrons and the electron in the hydrogen atom, the electron originally bound to the hydrogen nucleus is completely knocked out. This would also happen if we could use X-rays - we will also see that what is classically regarded as a wave comes in discrete “lumps”, known as “quanta”, which have energy and momentum associated with them, just like particles. It is therefore impossible to study directly the internal structure of atoms. Either the wavelength is larger than the size of the atoms so that they cannot be resolved, or the momentum associated with the wave is so large as to destroy the atomic structure that we are trying to study.

It is tempting to imagine that the sub-microscopic (i.e. sub-atomic) world that we cannot

see, even indirectly, is a scaled down copy of the world that we can see, so that although we cannot see individual electrons within an atom, they have well-defined positions and velocities (momenta) in orbits around the nucleus, in analogy to the planets moving in well-defined orbits around the sun. Unfortunately, this is not the case. We have to learn to live with the fact that an electron inside an atom behaves very much like a wave in a wavepacket and simply does not possess a well-defined position and momentum. As we have no experience of such a system, our imagination is limited in such a way that we cannot “understand” this – i.e. we cannot draw a picture in our mind which represents what is happening. Let me remind you that the objective of theoretical physics is to develop a theory which allows us to calculate quantities which can be measured experimentally, and not to allow us to draw pictures in our minds which portray systems with quantities whose values cannot, even in principle, be measured. As we shall see from Heisenberg’s uncertainty principle, it is impossible to measure, simultaneously, the position and momentum of a particle to better than a certain accuracy. In our macroscopic world, with which we are familiar, this accuracy is so good that any theoretical error is negligible compared to the accuracy with which we can perform a measurement - so that we have no concept of quantum effects in our everyday life.²

Probability Density

The idea of **probability density** will crop up often in our discussion of Quantum Physics – so it is worthwhile spending a little time explaining this. The probability that somebody’s birthday is May 9 is about one in 365³. What this really means is that this is the probability that somebody was born between midnight on May 8 and midnight May 9 or between time $T = 129$ and $T = 130$ (measured in days from the beginning of the year). The probability of somebody being born between midnight on May 8 and noon on May 9 is only half of this and the probability of their being born in an even smaller time slice is even less. The symbol dT is used to denote a small interval in time T , and the probability of somebody being born between time T and time $T + dT$ is given by $P(T) dT$, where $P(T)$ is called the “probability density”. In the case we are discussing this density is (approximately) 1/365 per day – so that the probability of being born between midnight on May 8 and noon on May 9 is $(1/365) \times (1/2) = 1/730$ whereas the probability of being born between 9 a.m. and 10 a.m. on May 9 ($dT = 1 \text{ hour} = 1/24 \text{ day}$) is $(1/365) \times (1/24) = 1/8760$.

²This is something that is indeed limited by the technology of measurements. It is perfectly conceivable that as experimental methods improve, we will be able to detect quantum effects in larger systems, but we will never be able to evade the limitation of the accuracy to which simultaneous measurements of position and momentum can be made.

³The distribution of birthdays is not quite uniform throughout the year because even we humans have preferred “mating seasons” so the actual probability may be a little different.

3 Experiments that Shook the World of Physics.

At the beginning of the 20th century we had a well-defined concept of “waves” and “particles” which displayed the different behaviours described above. However, a number of experiments were performed which gave results which were at variance with those expected from entities that were traditionally viewed as “waves” or “particles”, i.e. entities that were considered to be particles turned out to behave like waves in certain experiments and vice versa. This was the beginning of Quantum Theory. Particles are “lumps” with well-defined masses (equivalent to “lumps” of energy by Einstein’s relation [9], $E = mc^2$, between energy and mass) – so that if what we thought of as “waves” can behave like particles, their energy must come in such “lumps” or “**quanta**” as they are called. This immediately shatters the idea that the energy of a wave is determined by its amplitude and can take any value - the amplitude has to be such that the energy of the wave is an integer number of these quanta.

3.1 The Ultraviolet Catastrophe

When light or other electromagnetic radiation is incident on a surface at constant temperature, some of the light is reflected and the rest is absorbed and re-radiated. A body whose surface absorbs all the radiation incident upon it is called a “**blackbody**”. The number of different wavelengths of electromagnetic radiation, $N(\lambda)d\lambda$, with wavelengths in a small interval between λ and $\lambda + d\lambda$, ($d\lambda$ means a small interval in wavelength) can be shown to be proportional to $1/\lambda^4$, (i.e. the probability density of radiation with wavelength λ decreases as the fourth power of wavelength - there much less radiation for large wavelengths than for small wavelengths). For a surface at temperature $T^{\circ}\text{K}$ (0°C is equivalent to 273.16°K), classical thermodynamics [11] predicts that the energy of each wave is proportional to T , with the constant of proportionality being the **Boltzmann constant**, written as k_B . If this is the case then we have an expression for the energy, $E(\lambda)d\lambda$, radiated from a blackbody in the wavelength interval λ to $\lambda + d\lambda$,

$$E(\lambda)d\lambda \propto \frac{T}{\lambda^4}d\lambda. \quad (3.1)$$

Such a behaviour of radiated energy plotted against wavelength, is shown as the black curve in Fig.18 for a temperature, $T = 5000^{\circ}\text{K}$. The experimentally observed spectrum for $T = 5000^{\circ}\text{K}$. is shown as the blue line, with the results at lower temperatures shown in green and red. Note that the spectrum peaks at lower wavelengths as the temperature increases, explaining why a heated object glows at deeper colours - shorter wavelengths - as the temperature increases. We see that for sufficiently large wavelength the black line is a good approximation to the experimentally observed blue line but for small wavelengths the prediction of classical thermodynamics does not reproduce data even approximately. It is also a disaster, known as the “ultraviolet catastrophe” since it predicts that as the wavelength gets smaller (towards the **ultraviolet** end of the spectrum) the energy radiated

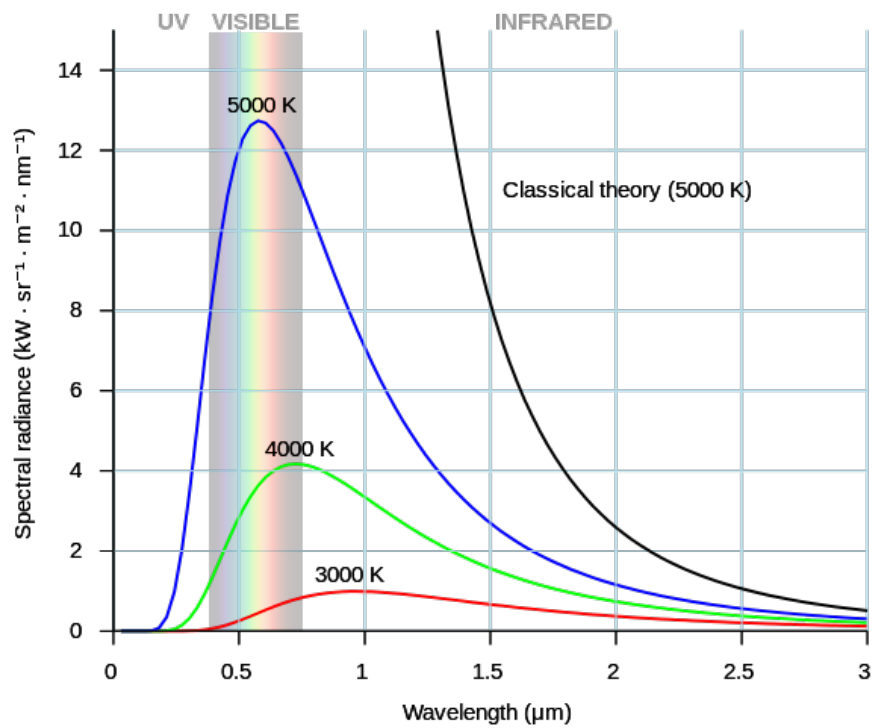

Figure 18: The intensity of radiation emitted from a blackbody in a small interval of wavelength between λ and $\lambda + d\lambda$, at temperatures of 5000°K (blue line), 4000°K (green line), and 3000°K (red line). The black line is the result at 5000°K using classical thermodynamics in which the average energy of each wave at temperature T , is $k_B T$ for any wavelength.

grows rapidly and becomes indefinitely large as the wavelength becomes smaller and smaller with more and more energy radiated at lower and lower wavelengths. The total energy radiated must be finite (i.e. bounded) and so the black curve of Fig. 18 cannot be correct. A solution to this inconsistency was proposed by Max Planck in 1900 [12]. The waves of the radiation are due to oscillating electric and magnetic fields. Classically, an oscillator can have any energy, but Planck suggested that this was not quite correct and that the energy of an oscillator of frequency f , had to be an integer number of “**quanta**” whose energy was given by

$$E = h f. \tag{3.2}$$

The constant h is (naturally) known as “**Planck’s constant**”. It is fantastically small: $h = 6.67 \times 10^{-34}$ **Joules** seconds, so that the smallest watch spring has an energy of many billions of these quanta. It is for this reason that the rather strange and certainly counter-intuitive proposal of Planck has no measurable effect on our own experience of oscillators in the macroscopic world. It is perfectly reasonable for us to assume that any oscillator that we can build can have any amplitude and hence any energy we choose. However for oscillators in the sub-microscopic world, such as the oscillations of **ions** about their **equilibrium** positions at the lattice sites of a crystal, the quantization of the energy of their oscillation plays an important part in the determination of the properties of the crystal, such as its specific heat at very low temperatures. This quantization of the energy of an oscillator with quanta whose magnitude is proportional to the frequency means that the classical thermodynamics assertion - namely that each oscillator has an average energy equal to $k_B T$ - does not work. For a high frequency (short wavelength) oscillator for which one quantum, $h f$, is very much larger than $k_B T$, it is very unlikely that that oscillator will be excited into any oscillating state - its energy is most likely to be zero. The upshot of this is that the average energy of such a high frequency oscillator is not $k_B T$, but much smaller since it is very unlikely that the oscillator will have any quanta of energy at all and therefore it usually has zero energy. On the other hand if $k_B T$ is much larger than the quantum, $h f$, the oscillator can have oscillating energy of many quanta, and it indeed turns out that the average energy is $k_B T$. Radiation of wavelength λ is generated by an oscillator whose frequency, f , is related to λ by the simple formula $f = c/\lambda$, (where c is the speed of light).

Fig. 19 shows the ratio of Planck’s result for the average energy of a wave emitted from a blackbody at temperature $T = 5000^0\text{K}$ to the classical thermodynamic result, $k_B T$, for different wavelengths λ . We see that for sufficiently large λ the classical result, $k_B T$, is a good approximation (the ratio is close to one), but in the ultraviolet region of small λ , the average energy is much smaller. When this ratio is used as a correction factor for the black line of Fig. 18 we get a perfect agreement between theory and experiment (we reproduce precisely the solid blue line of Fig. 18, and the other lines are obtained for lower temperatures). Therefore, the proposal that oscillators have quantized energies leads to a modified radiation spectrum which solves the problem of the ultraviolet catastrophe and reproduces the experimentally observed result for the spectrum of blackbody radiation.

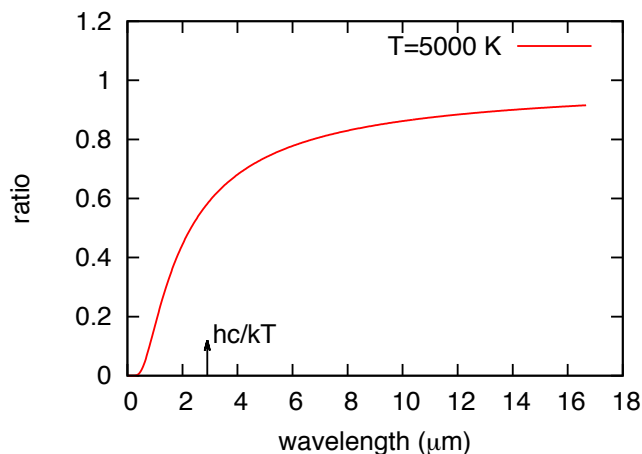

Figure 19: The average energy per unit volume for blackbody radiation with wavelength λ at a temperature of 5000°K , divided by the classical value $k_B T$.

3.2 The Photoelectric Effect.

When light (visible or ultraviolet) is incident on certain metals, electrons can be emitted. This is called the “**photoelectric effect**”. It is the mechanism by which a light meter for a camera works. It was discovered by Heinrich Hertz [13] in 1887. We can understand this effect in terms of the wave nature of light. At any fixed point, an electromagnetic wave (e.g. visible light) is an oscillating electric and magnetic field. When incident upon a metal, which contains loosely bound electrons, the electric field applies a force on these electrons which can sometimes be large enough to liberate them from their binding in the metal. However, when we consider the quantitative effect of such a wave, we predict results which are at variance with experiment. The higher the frequency of the electromagnetic radiation the more often we would expect an electron to be emitted. The maximum kinetic energy of the emitted electrons is expected to increase with increasing intensity of the incident light. Furthermore for very low intensity incident light one would expect a delay before observing the emission of such electrons (known as “photoelectrons”) in order to allow the metal to absorb enough energy to free the electrons from the metal.

The first quantitative experiment on the photoelectric effect was conducted in 1902 by Philipp Lenard [14]. The maximum energy of the emitted photoelectrons was determined by applying a retarding potential to the emitted electrons and adjusting that potential until it reached the “stopping potential”, V_0 , for which no electrons were collected at the collector electrode. A diagram of the experimental setup is shown in Fig. 20. Lenard found that when he increased the frequency of the incident light, the stopping potential increased, i.e. the maximum kinetic energy of the photoelectrons increased. The rate at which the electrons were emitted was found to increase with increasing intensity of incident light. On the other

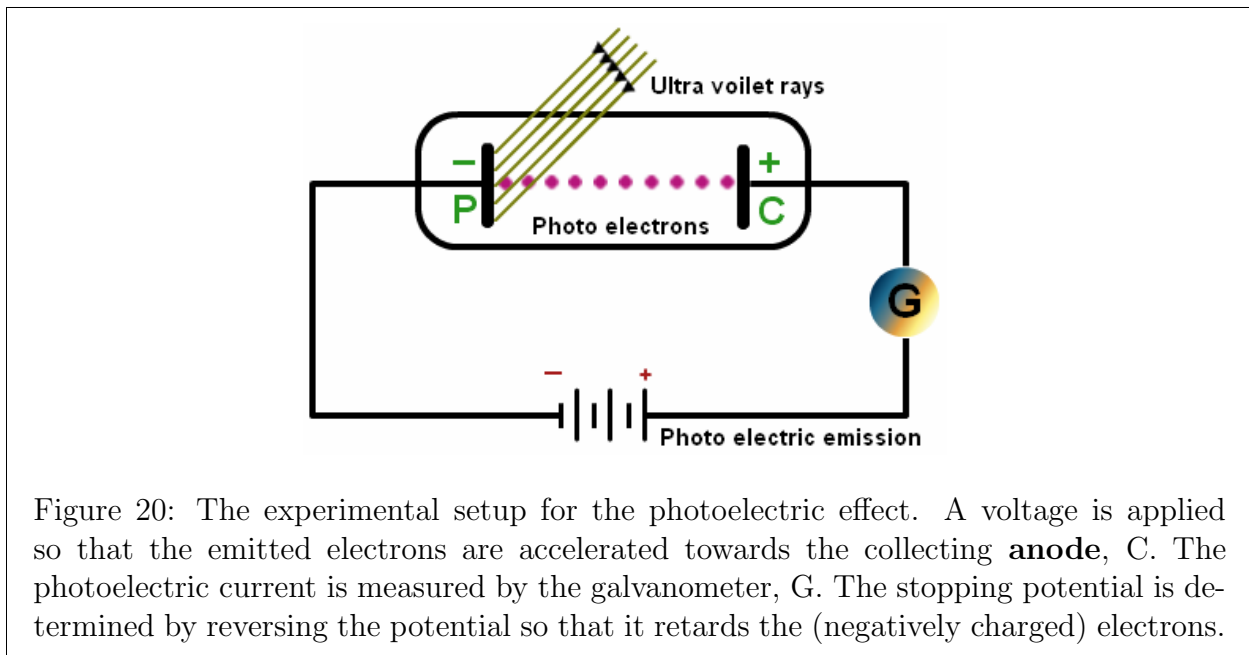

Figure 20: The experimental setup for the photoelectric effect. A voltage is applied so that the emitted electrons are accelerated towards the collecting **anode**, C. The photoelectric current is measured by the galvanometer, G. The stopping potential is determined by reversing the potential so that it retards the (negatively charged) electrons.

hand, the electron emission rate was found to be (surprisingly) independent of the frequency of the illuminating light, whereas the classical wave interpretation would imply that at higher frequencies the rate of electron emission would be higher as the electrons were “shaken” with higher frequency. Furthermore, even with the lowest intensity light sources, there was no delay between the initial incidence of the radiation and the emission of the photoelectrons. The explanation of this enigmatic behaviour was provided by Albert Einstein in 1905 [15]⁴:

Light (or any other electromagnetic radiation) comes in packets or “quanta” of energy, E , given by

$$E = hf \tag{3.3}$$

where f is the frequency of the light and h is Planck’s constant. These “quanta” behave like particles (they are now called “**photons**” the “-on” suffix is used for the names of particles). These particles scatter off the electrons in the metal. Some of the energy, ϕ , is used to free the electrons from the metal. This energy is called the “**work function**” and it is a property of the metal from which the electrons are emitted. Some or all of the remaining energy of the photon can be transferred to the emitted electrons, so the maximum energy which the photoelectrons can have is the difference $hf - \phi$. This maximum is the stopping potential multiplied by the charge, e , of an electron. We therefore have the simple formula relating the frequency, f , of the incident electromagnetic radiation to the stopping potential V_0

$$hf = \phi + eV_0 \tag{3.4}$$

⁴Together with Planck’s theory of blackbody radiation, Einstein’s theory of the photoelectric effect constitute the birth of Quantum Physics. It was *this* theory that won Einstein the Nobel prize in Physics in 1921 and *not* the Theory of Relativity.

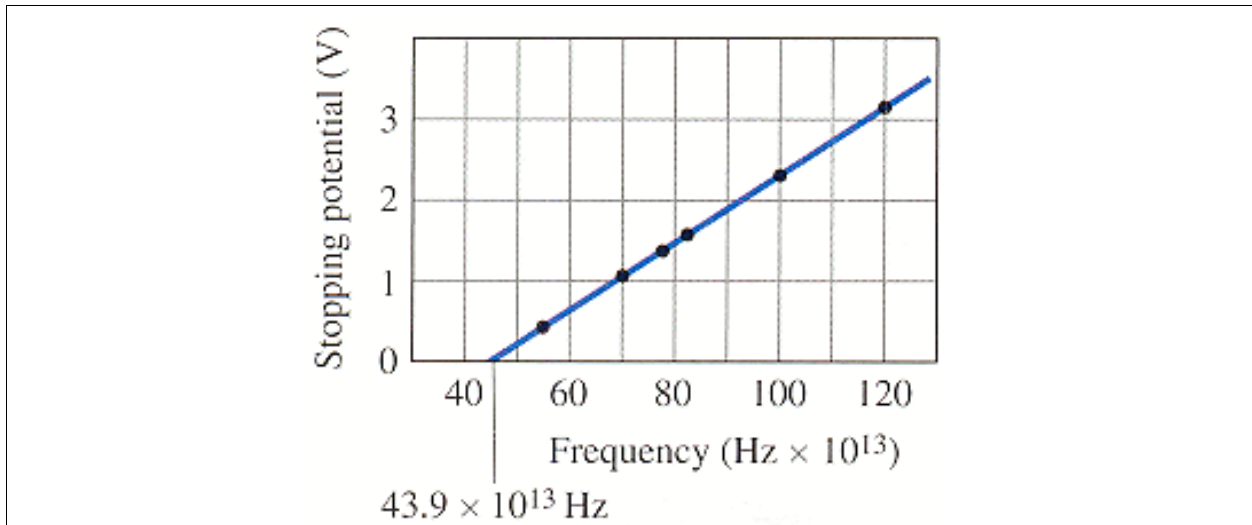

Figure 21: The result of Millikan’s experiment on the photoelectric effect showing the stopping potential against the frequency of incident radiation. The slope, $\Delta V/\Delta f$ is Planck’s constant divided by the electric charge of the electron. The intercept is equal the work function divided by Planck’s constant.

This formula was tested in detail by Robert Millikan in 1916 [16]. His results for the stopping potential for various different frequencies is shown in Fig. 21. The points lay on a very good straight line whose slope was proportional to Planck’s constant. This was the most accurate measurement of Planck’s constant at that time yielding $h = (6.57 \pm 0.03) \times 10^{-34}$ Joule seconds. The intercept, i.e. the value of frequency, f_0 , at which the line crosses the x -axis can be used to determine the work function, since $h f_0$ is the energy of a photon which causes the emission of an electron with zero kinetic energy.

The increase of the rate of electrons emitted with increasing intensity of incident light is explained by the fact that increased intensity of light means a larger flux of incident photons – and therefore a larger number of interactions which can free an electron from the metal.⁵

3.3 Compton Scattering

In 1920 Arthur Compton [17] performed an experiment in which he scattered monochromatic (single wavelength) X-rays with wavelength λ against various different targets. He discovered that as well as an emitted X-ray line with the same wavelength as the incident X-ray, there was also a further line with a larger wavelength, λ' , and that the difference between the incident wavelength, λ , and the wavelength, λ' , of the supplementary line increased with

⁵Einstein’s explanation of the photoelectric effect can also be used to explain the observation made by Philipp Lenard in 1900 that light can ionize gases, for which he received the Nobel Prize in 1905. This is very ironic. Lenard was a staunch supporter of National Socialism and condemned the Theory of Relativity on the grounds that it was “Jewish physics.”

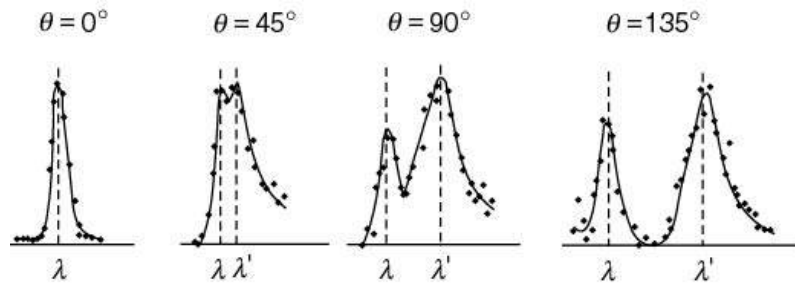

Figure 22: Incident and scattered X-ray wavelengths for various different scattering angles.

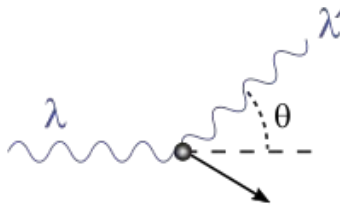

Figure 23: A photon with wavelength λ scatters off an electron with scattering angle θ between the directions of the incident photon and the scattered photon. The scattered photon has a longer wavelength λ' since some of its momentum has been imparted to the target electron.

increasing scattering angle, θ . The result is shown in Fig. 22.

Compton's explanation of this effect again exploits the fact that electromagnetic radiation (in this case X-rays rather than visible or ultraviolet light) comes in quanta and that these quanta (photons) are particles, which sometimes scatter off the electrons in the target material. These photons have energy hf , where f is the frequency of the X-rays (recall the relation between frequency and wavelength, $f = c/\lambda$, where c is the speed of light) and momentum⁶ $hf/c = h/\lambda$.

When such particles scatter off electrons at rest, (as shown diagrammatically in Fig. 23) some of their momentum is imparted to the electron and, since the total momentum of the photon and the electron is conserved in such a scattering, the momentum of the photon is reduced – leading to a larger wavelength, λ' (the momentum of the photon is inversely proportional its wavelength, so that a reduction in momentum implies an increase in wave-

⁶Photons travel with the speed of light. According to Einstein's theory of special relativity a particle that travels with the speed of light has zero mass. This does not mean that the momentum, p , is zero. The formula $p = mv$ is only valid for particles whose speed is much less than the speed of light. For a massless particle the relation between momentum, p , and energy, E is $E = pc$. Therefore if a photon has energy $hf = hc/\lambda$, and momentum $p = h/\lambda$.

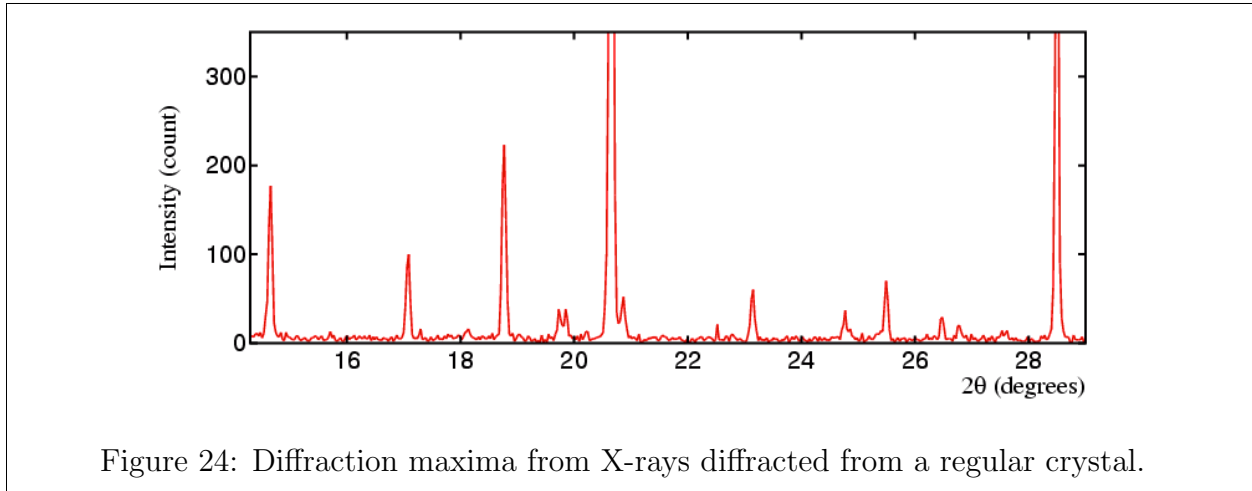

Figure 24: Diffraction maxima from X-rays diffracted from a regular crystal.

length). Using conservation of energy and momentum (in this case the electrons recoil with velocities close to the speed of light so that it is necessary to use relativistic dynamics rather than Newtonian dynamics), the fraction of the initial momentum imparted to the electron increases with scattering angle, leading to an increase in the change of the wavelength of the photon. In case you are interested the exact relation between incident wavelength, λ , wavelength, λ' , of the scattered photon and the scattering angle, θ is

$$\lambda' - \lambda = \frac{h}{m_e c} (1 - \cos \theta), \quad (3.5)$$

where m_e is the mass of the electron.

3.4 Bragg X-ray Diffraction

This is actually an experiment that is explained using the classical, i.e. wave-like, properties of X-rays. The results of the experiment are nevertheless an important for the development of Quantum Theory. In 1914 W.H.Bragg and his son, W.L.Bragg [18] scattered X-rays from various different crystals. They found diffraction maxima (sharp peaks in intensity) at certain X-ray scattering angles as shown in Fig. 24

A crystal consists of a regular array (lattice) of ions from which the wave is reflected. The explanation for these peaks is that the wave reflected from adjacent planes of ions in the crystal have a path difference which depends on the reflection angle and the distance between the planes of ions, as shown in Fig. 25. For certain reflection angles, this path difference is an integer number of wavelengths so that there is constructive interference between the wave reflected from adjacent planes, leading to a diffraction maximum. Bragg's law tells us that there will be maxima for X-rays of wavelength λ for a diffracted angle of 2θ whenever

$$2d \sin \theta = n\lambda, \quad (n \text{ integer}). \quad (3.6)$$

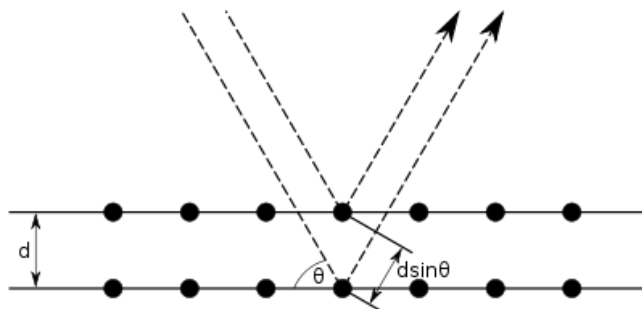

Figure 25: The path difference between waves reflected from adjacent planes of a crystal with separation, d , is (using a little trigonometry) $2d \sin \theta$, where θ is the reflection (equal to the incident) angle, as shown.

This is the explanation when applied to a regular cubic lattice. For more complicated lattices the maxima will be at different angles for different orientations and this can be used to deduce the crystal structure. It can also be used to deduce the structure of large molecules and was indeed the technique that was used by Franklin, Wilkins, Crick and Watson [19] to determine the double helix structure of the DNA molecule.

3.5 The Davisson-Germer Experiment

We have seen so far that X-rays (or visible light or any other electromagnetic radiation) are both waves and particles, and that the wave or particle properties manifest themselves in different experiments. What about electrons or other entities that have traditionally been treated as particles? Between 1923 and 1927 Clinton Davisson and Lester Germer [20] performed a series of experiments in which electrons were accelerated through a particular voltage and then scattered off a regular crystalline solid (similar to the scattering experiment conducted by Bragg with X-rays.) but in their case the target was made from nickel. The experimental setup is shown in Fig. 26

The results were displayed in a slightly unconventional way in Fig. 27. For each scattering angle, ϕ , a point is drawn which makes that angle to the vertical axis and the distance between that point and the origin is proportional to the intensity of the scattered electrons (basically the scattered intensity and scattering angle are treated as the radius and angle in polar coordinates). As the scattering angle, ϕ , is varied a curve is described in this polar coordinate graph.

In 1924, Louis de Broglie [21] had postulated that, in analogy with X-rays that possess momentum p as well as wavelength, λ , related by

$$\lambda = \frac{h}{p}, \quad \text{where } h \text{ is Planck's constant,} \quad (3.7)$$

particles possess wavelength as well as momentum with the relation between the two also

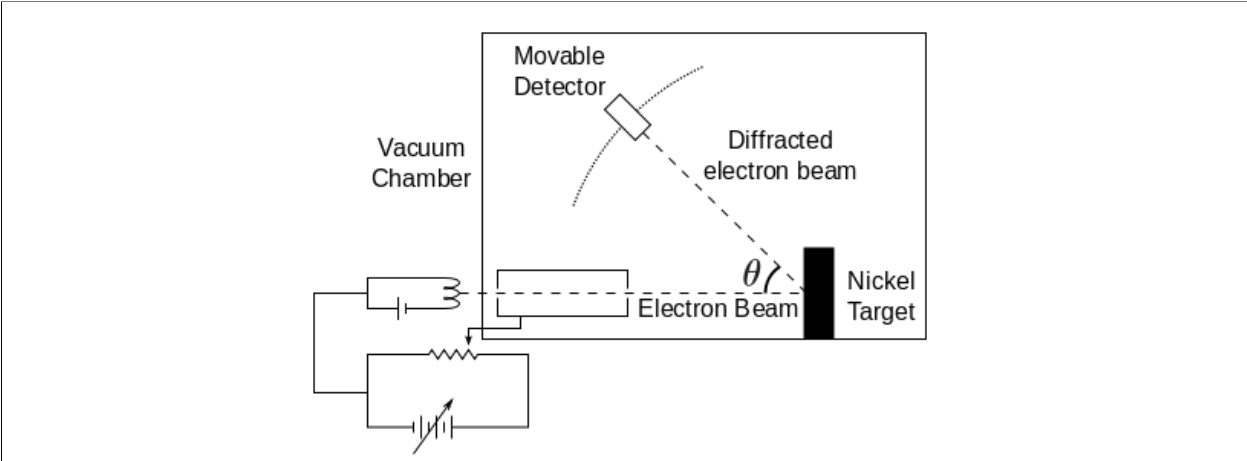

Figure 26: The Davisson-Germer experiment in which electrons are accelerated through a given voltage and then scattered from a nickel target. The intensity of the scattered electrons is measured by a detector which was moveable so that different scattering angles can be probed.

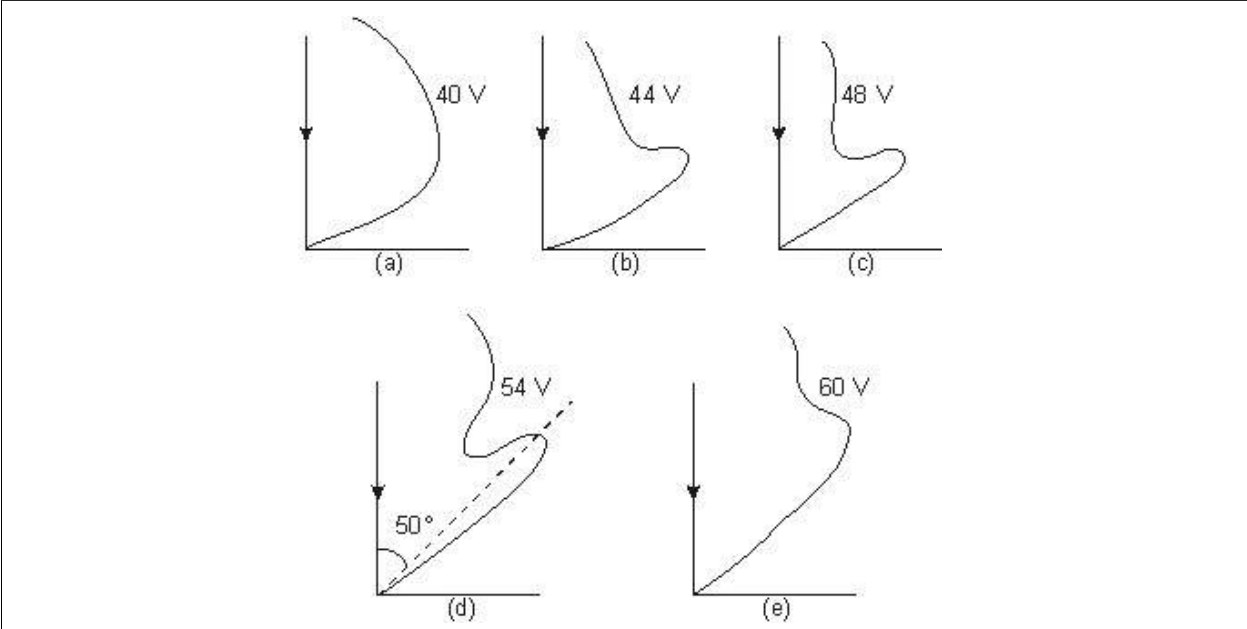
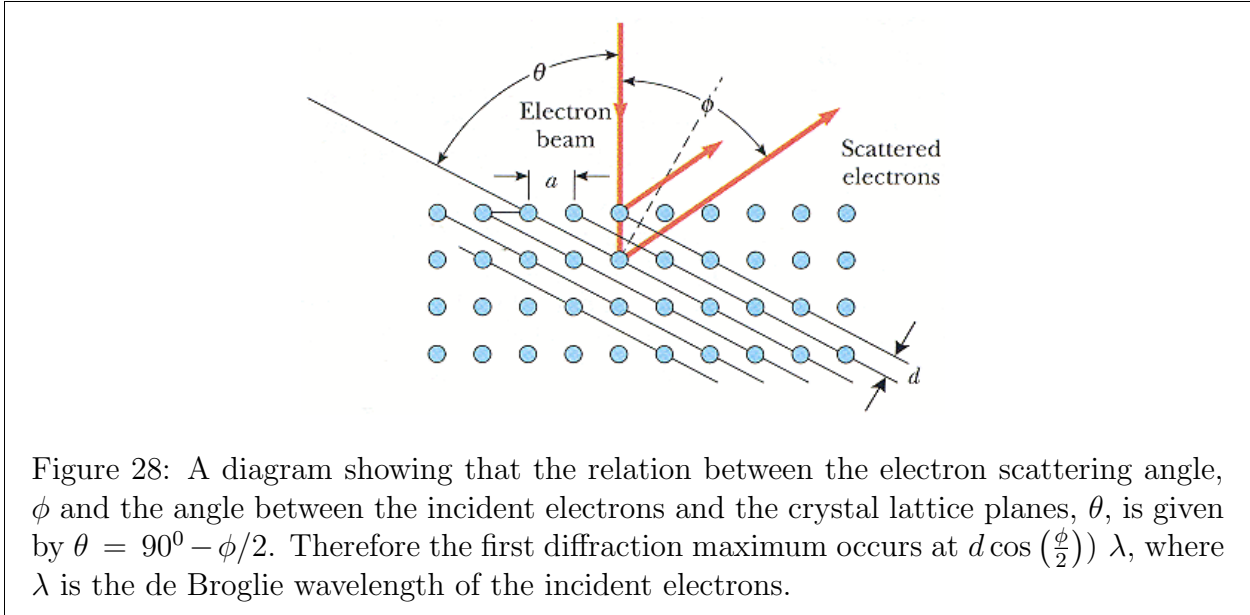

Figure 27: The results of the Davisson-Germer experiment for several different accelerating potentials. The distance of the line from the origin at some angle, ϕ , to the vertical is proportional to the intensity of the scattered electrons at a scattering angle ϕ . The bulges occur at angles that indicate the scattering angle corresponding to the first diffraction maximum of the matter waves of the electrons scattered off a nickel crystal target.



given by eq.(3.7), which is known as **de Broglie's wave equation**.

This means that what we think of as “matter” in classical physics would, in Quantum Physics, have associated “matter waves” with the same relation between wavelength and momentum. These matter waves have all the properties of other waves including interference and the existence of wavepackets which can be constructed from a superposition of waves with different wavelengths.

Let us calculate the wavelength of an electron accelerated through a given voltage (skip to eq.(3.10) if you do not wish to follow this):

An electron accelerated through a voltage, V , acquires a kinetic energy, T , where

$$T = \frac{1}{2}m_e v^2 = eV \quad (\text{e is the electric charge of the electron and } m_e \text{ is its mass}), \quad (3.8)$$

and consequently (manipulating eq.(3.8)) momentum, p , where

$$p = m_e v = \sqrt{2m_e T} = \sqrt{2m_e eV}. \quad (3.9)$$

By using the de Broglie wave relation, the matter waves have wavelength

$$\lambda = \frac{h}{p} = \frac{h}{\sqrt{2m_e eV}}. \quad (3.10)$$

As can be seen from the diagram in Fig. 28, and a little geometry, a scattering angle, ϕ , corresponds to an angle θ between the incident electrons and the planes of a crystal where

$$\theta = 90^\circ - \frac{\phi}{2}, \quad (3.11)$$

so that by combining the Bragg scattering relation eq.(3.6) and the de Broglie wavelength of the electrons eq.(3.10) the first diffraction maximum occurs if

$$2d \sin \theta = 2d \cos \left(\frac{\phi}{2} \right) = \lambda = \frac{h}{\sqrt{2m_e eV}}, \quad (3.12)$$

where d is the spacing between planes in the crystal. Putting in the numbers, we find that for an accelerating potential of $54 V$, the wavelength of the electron is $\lambda = 0.168 \text{ nm}$ (1 nm is a billionth of a meter). The diffraction maximum for this accelerating potential is 50° (bottom left graph of Fig. 27), from which we deduce that the spacing between planes in the nickel crystal, calculated from eq.(3.12) to be $d = 0.093 \text{ nm}$. This is very close to the value ($d = 0.091 \text{ nm}$) which is found using Bragg scattering of X-rays off a nickel crystal. This was the first experiment to detect directly the wave properties of electrons and it was the first experimental confirmation of the de Broglie relation between wavelength and momentum.

4 Wave-Particle Duality

4.1 Both a wave and a particle

The upshot of all this is very simply that all entities that can transport energy are both particles as waves. Note that I say “both” and not “either”. It is a misconception to argue that X-rays or electrons are “sometimes” waves and “sometimes” particles. They are always both. However, whether their wave nature or their particle nature dominates depends on the manner that they are being observed, and hence can be different in different experiments. A football in play during a match has a matter wave with a wavelength. This wavelength is approximately 0.00000000000000000000000001 microns, and so that to all intents and purposes the wave nature of the football may be neglected and the football may be treated using Newtonian mechanics (e.g. in order to calculate how hard it must be kicked and in which direction to score a goal).

A less facetious example is the Geiger-Marsden experiment, described earlier, on the scattering of α -particles off a thin sheet of gold, that led to Rutherford’s discovery of the nucleus. The experiment was analysed by Rutherford using classical physics to determine how the α -particles were scattered by the nuclei of the gold atoms. However, the gold sheet is a regular lattice of gold atoms and therefore it is reasonable to ask why the wave nature of the incident α -particles did not lead to a diffraction pattern similar to that observed in the Davisson-Germer experiment. The answer is very simply that if we use the de Broglie wave relation to determine the wavelength of the α -particles we find that their wavelength is many thousands times smaller than the spacing between gold atoms in the sheet. This means that although there is indeed a diffraction pattern, the fringes are so closely packed together that we can ignore them. Had the experiment been conducted using electrons rather than α -particles (electrons have a much smaller mass, hence a much smaller momentum, hence a much larger wavelength than α -particles.) then there would have been substantial diffraction and Rutherford’s purely particle-like analysis would have been inadequate.

In general, the wave nature becomes important in situations where the wavelength is comparable in size with the dimensions probed by a particular experiment, e.g. the spacing of ions in a lattice. The wavelength of an electron inside an atom is approximately the same size as the atom itself. For this reason, it is the wave nature of the electron that is important when considering the structure of atoms. The particle picture of a nucleus at the centre with electrons moving around it in fixed orbits (which unfortunately is the one we find easiest to visualize) is wholly inadequate for the description of atoms. Remember that whereas we can just about construct an instrument (electron microscope) to locate individual atoms, we cannot, even in principle, construct a microscope which would enable us to track an electron inside an atom. We therefore have to live with the uncomfortable truth that our experience of the macroscopic world is inadequate for us to “visualize” the motion of electrons inside an atom.

The proposition that electrons and X-rays (and protons, neutrons, footballs etc.) are simultaneously both particles and waves already stretches our imagination and poses an

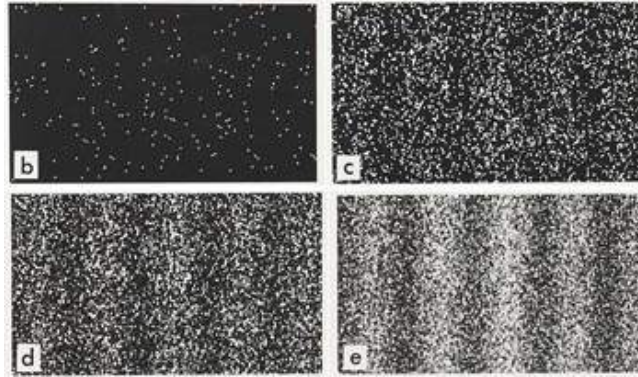

Figure 29: The distribution of the detector-screen of electrons passing individually through a double-slit as time advances. At later times well-defined maxima and minima can be identified.

impediment to our ability to visualize the sub-microscopic world.

4.2 Which Slit did the particle go through?

We have no conceptual difficulty in understanding what is happening in the double slit experiment performed with light (photons) by Young in 1801, when we consider the light to be a wave. The part of the **wavefront** that passes through one slit interferes with the part of the wavefront passing through the other slit in such a way that at certain angles the wave disturbances add, and we get maxima, whereas at other angles they cancel, and we get minima. But how do we explain this in terms of photons, which are treated as particles? The double-slit experiment was performed by Giulio Pozzi [22] and collaborators in 2007, using electrons instead of a monochromatic light source. The electrons were all accelerated through the same voltage, so that they had the same momentum and therefore the same wavelength. When they passed through a double-slit system and then continued to a detector screen similar fringes of maxima and minima were observed as in Young's original experiment with light. Once again, we can understand this in terms of the wave-nature of electrons, but not their particle nature.

It is tempting to argue that what is actually happening is that the electrons that pass through one slit interfere with the electrons that pass through the other. Unfortunately this has been shown not to be the case. In 2012, Pozzi and his colleagues reduced the flux of electrons in the experiment to such a low level that only one electron passed through the double-slit system at a time. The results are shown in Fig. 29, which demonstrates the density of electrons on the detector screen as a function of time. At first the electrons appeared to be landing at random positions on the screen with uniform probability to go in any particular direction, but as time passed it became clear that there were directions which were favoured and directions which were disfavoured. The favoured directions developed into

maxima and the disfavoured into minima. Since only one electron was passing through the slit system at any one time, this interference behaviour was a property of each individual electron and *not* an interference between different electrons. Each electron has a probability of going in a particular direction and this probability has maxima and minima because of the interference of the electron wave. The strange (but nevertheless correct) feature of this probability is that even if the electron passes through one slit, the probability of it landing at a particular point on the screen is influenced by the existence of the other slit. If we close one of the slits the interference pattern is lost - even if that was not the slit that the electron passed through.

In our “understanding” each individual electron has to pass through either one slit or the other. Unfortunately, this “understanding”, whether correct or incorrect, is irrelevant to the result of the experiment. Even if an individual electron passed through one slit or the other, the electron wave passes through both slits (just like the light wave in Young’s experiment) and the emerging wave from the two slits produces an interference pattern.

The postulate that the electron passes through one slit or the other is experimentally untestable (and therefore outside the domain of physics) because it is impossible to ascertain through which slit the electron passed, without destroying the interference pattern. Suppose we placed a microscope at the rear side of the slits in order to observe through which slit the electron passes. If the separation of the slits is d , then we would need a resolution of less than d in order to distinguish between the two slits. This would mean that we would need to use light (or any other wave) whose wavelength is smaller than d . The minimum quantity of light that would enable us to observe the electron is a single photon. But a single photon whose wavelength is less than d , has a momentum of greater than h/d and when it scatters off the electron, it will impart some of this momentum to the electron. This “jogging” of the electron is sufficient to destroy the interference pattern.

Unfortunately, the real situation is even worse. We have assumed, in keeping with our “understanding”, that an electron passing through the double-slit system has a well-defined position which can be used to determine through which slit it passed, as well as a well-defined momentum which can be used to predict where it will land on the detector-screen. As we shall see later when considering Heisenberg’s uncertainty principle, such assumptions are false and we have to live with the fact that, in general, a particle does not actually possess well-defined position and momentum and that our inability to determine these quantities is not simply a limitation in our ability to make measurements. This means that the electron did not pass through one slit or the other, but in some sense (at least in the sense of a wave) it passed through both slits.

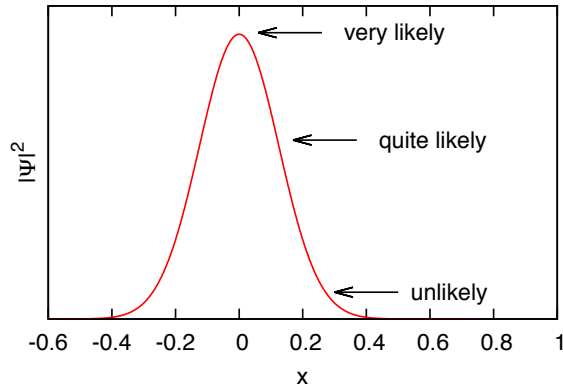

Figure 30: Graph of $|\Psi|^2$ against x , showing the relative probability of finding the particle at different points

5 What is a Matter (de Broglie) Wave?

We have discussed the wavelength of “matter waves” or “de Broglie waves”, but we haven’t yet discussed what these are waves of – i.e. what is the disturbance that is oscillating in analogy with a wave on a violin string where the disturbance is the displacement of the string from its equilibrium position that is oscillating and travelling along the string.

The interpretation of these matter waves was given by Max Born [23]. The actual “disturbance” does not have a direct physical interpretation, but it does have an indirect meaning. The matter wave disturbance at a position \mathbf{x} , and time t , is described by a function of \mathbf{x} and t called the “wavefunction” and is usually written as $\Psi(\mathbf{x}, t)$.⁷ The amplitude of the wave oscillation at that point and time is written as $|\Psi(\mathbf{x}, t)|$. The square of this amplitude is the probability density for finding the particle at the point, \mathbf{x} . This means that $|\Psi(\mathbf{x}, t)|^2 dV(\mathbf{x})$ is the probability that at time t the particle is in the small volume, $dV(\mathbf{x})$ centred at the point \mathbf{x} (i.e. $|\Psi(\mathbf{x}, t)|^2$ is the probability density - probability per unit volume - for the position of the particles at the point \mathbf{x}). This is easier to understand if we restrict ourselves to one dimension so that a point in space is denoted by a single variable, x . In this case $|\Psi(x, t)|^2 dx$ is the probability that the particle is somewhere between x and $x + dx$, where dx is a small interval in x .

A plot of the square of the amplitude of the oscillations at a given time, t , is shown as a function of (one-dimensional) x in Fig. 30. The peak (arbitrarily set at $x = 0$) is at the position where the particle is very likely to be. If we move out either side of this to a distance 0.2 units we find that it is quite likely that the particle will be found at either of these points, whereas if we go out further than 0.4 units either side of $x = 0$ then it is very unlikely that the particle will be there. For the rest of this section we confine our consideration to motion

⁷ \mathbf{x} is written in bold-face since it stands for a vector in three-dimensional space, whose components are the three coordinates of the point at which the amplitude is being considered.

in one direction only.

Thus we see that for a matter wave which is a wavepacket of a given width, the position of the particle is not well defined - the particle does not actually possess a single position - it can be *anywhere* within the wavepacket. This is very difficult for us to “understand” in the sense of visualization, although we have no difficulty when we think of the particle in terms of its matter wave structure. The particle’s position is only defined *after* its position has been measured. Before such a measurement has been effected, we can only predict the probability that such a measurement will yield a given result. With this interpretation of a wavefunction, we see the analogy between a wavepacket, which exists everywhere but has an amplitude which is negligible far away from the point of maximum amplitude, and a particle which exists everywhere, having a maximum probability to be at a certain point but having a probability to be found at a different point, which decreases as that point moves away from the location of the maximum and becoming negligible very far away from it. The act of measuring the position of the particle, changes the wavepacket in such a way that its position is then determined up to the accuracy of the experimental measurement. The process of the change in the wavefunction resulting from a measurement is called “**wavefunction collapse**” . It is not well-understood - we will discuss this in more detail later.

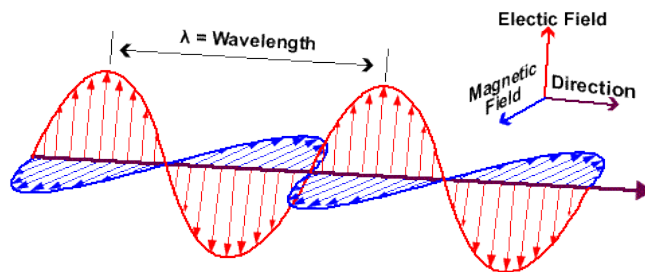

Figure 31: An electromagnetic wave consists of oscillating electric and magnetic fields, which are perpendicular to each other and also perpendicular to the direction of motion of the wave.

6 Particles and Fields

It is possible to discuss a more concrete quantity which is closely related to the wavefunction. Here we enter the even more advanced subject of Field Theory. In this theory, every particle has a field associated with it. In the case of photons, we understand this field - it is the electromagnetic field. An electromagnetic wave consists of an oscillating electric and magnetic field perpendicular to each other and also perpendicular to the direction of the wave as shown in Fig. 31. For a photon, the wave motion of either the electric or magnetic field is related to the photon matter wave in such a way that the amplitude of the electric or magnetic field wave is large when the amplitude of the matter wave is large, (and small when the amplitude of the matter wave is small). This means that the amplitude of the electric or magnetic wave at any point, \mathbf{x} , at time, t , is closely related to the probability that the photon is at the point \mathbf{x} at time t .⁸ It turns out that all particles have such fields associated with them. For a wavepacket of electromagnetic radiation, the probability to find a photon at a particular position is proportional to the square of the amplitude of the wave at that point.

We are familiar with electric and magnetic fields but not with the field associated with electrons, or other massive particles, simply because for a massless particle (e.g. a photon) the electric or magnetic field is only mildly attenuated - decreasing as the square of the distance from its source, whereas the field of a massive particle is very rapidly attenuated. For example, for an electron the field is heavily attenuated after a distance of 0.0025 nm. It is therefore possible to perform experiments on electric and magnetic fields in the laboratory (you probably carried out some such experiments at High School) but clearly impossible for fields associated with massive particles. Nevertheless each particle does have such a field

⁸The precise relation between the electromagnetic field associated with a photon and the de Broglie wave is very complicated and can only be explained using Quantum Field Theory. It is way outside the scope of this article.

associated with it and for a moving particle this field evolves in a wave-like motion with an amplitude that is closely related to the amplitude of the matter (de Broglie) wave.

7 Heisenberg's Uncertainty Principle

In this section we again consider a particle moving in one dimension only. We have seen that a wavepacket of matter waves describes a particle which is not located at a particular point. Note that this is not the same as saying that its position is unknown, which implies - falsely - that its exact position exists but that the experimentalist does not know what it is. The particle simply does not have a well-defined position until a measurement is made at which point the wavefunction of the particle is changed into one representing a particle of well-defined position (a very narrow wavepacket). Instead we only know what the probability is that the result of such a measurement of its position will yield a given result. This probability is very small, except in a region of width δx , and so we identify this range, Δx , as the “uncertainty” in the position of the particle.

We have seen when discussing wavepackets, that a wavepacket of a given width is constructed from a superposition of waves with wavelength, λ , and amplitude $A(\lambda)$. The amplitude $A(\lambda)$ has an interpretation which is analogous to the interpretation of the amplitude, $|\Psi(x, t)|$, of the wave in the wavepacket, namely that its square, $|A(\lambda)|^2 d\lambda$, is the probability that a measurement of the wavelength of the particle will yield a value between λ and $\lambda + d\lambda$. By the de Broglie wave relation, the wavelength measurement is equivalent to a measurement of the momentum. Since the momentum is actually inversely proportional to λ (i.e. proportional to $1/\lambda$),⁹ it is more convenient to plot $A(\lambda)$ as a function of $1/\lambda$. We have a distribution whose square tells us how likely it is that a measurement of $1/\lambda$, will yield a given result and we can see that such a probability is small except over a small range of $1/\lambda$. The particle does not possess a single wavelength, but is a superposition of waves of different wavelengths with different amplitudes. The range over which this amplitude is not small represents the uncertainty in $1/\lambda$.

We recall that the width of the wavepacket, Δx , is inverse to the width of the distribution of $A(\lambda)$ whose width is $\Delta(1/\lambda)$, i.e for a wavepacket with large width, Δx , representing a particle with a large uncertainty in its position, the distribution $A(\lambda)$ is narrow implying a small uncertainty in the quantity $1/\lambda$. On the other hand for a wavepacket with small width, Δx , representing a particle with a small uncertainty in its position, the distribution $A(\lambda)$ is wide implying a large uncertainty in the quantity $1/\lambda$.

This is demonstrated in Fig. 32. The graphs on the left are wavepackets. The upper wavepacket has a width of about 0.8 nm whereas the lower graph is a narrower wavepacket with a width of 0.4 nm. The graphs on the right are the distributions of the amplitude at wavelength, λ , plotted against $1/\lambda$. The upper distribution has a width of about 1.2 per nm whereas the lower distribution has a width of about 2.4 per nm. In both cases the product of the width in position, Δx , and the width in the inverse wavelength, $\Delta(1/\lambda)$ is approximately one.

From the de Broglie wave relation, the uncertainty, Δp , in the momentum is h (Planck's

⁹The inverse of the wavelength of a wave is called its “**wavenumber**” and is often denoted by “ k ” – but we will maintain the notation $1/\lambda$.

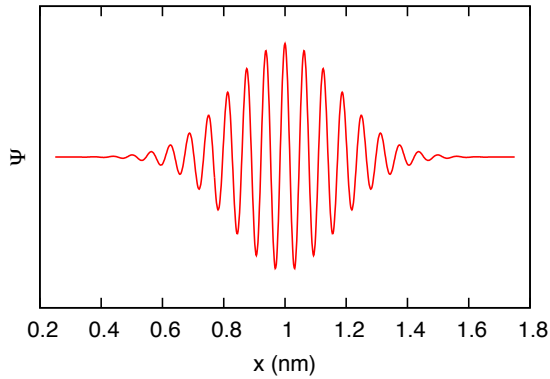

(a)

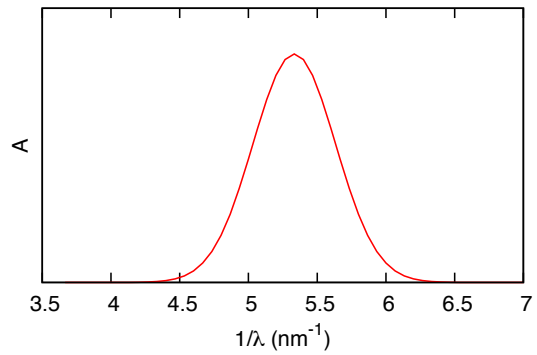

(b)

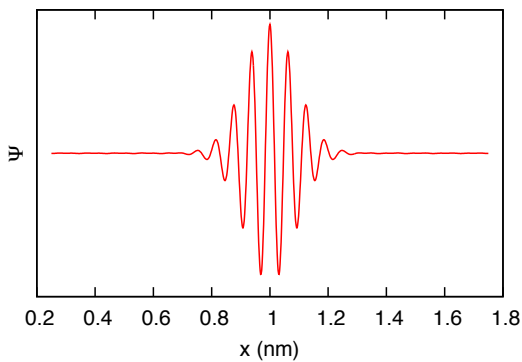

(c)

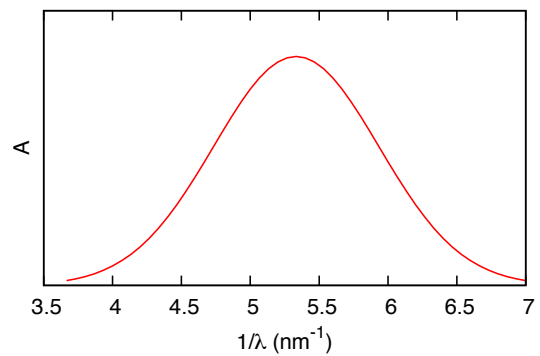

(d)

Figure 32: (a): a wavepacket with a width of 0.8 nm; (b): the corresponding distribution in amplitude of wavelength λ (plotted against $1/\lambda$), with a width of 1.2 per nm. (c): a wavepacket with a narrower width of 0.4 nm; (d): the corresponding distribution in amplitude of wavelength λ (plotted against $1/\lambda$), with a broader width of 2.4 per nm.

constant) times $\Delta(1/\lambda)$, so that if the product of Δx and $\Delta(1/\lambda)$ is approximately one, then the product of Δx and Δp is approximately h and we have the Heisenberg uncertainty relation [24]

$$\Delta x \times \Delta p \approx h \tag{7.1}$$

The particle, whose matter wave is a wavepacket, does not have a well-defined (i.e. exact localized) position until its position is measured to within a given accuracy - at which point the wavefunction changes into a narrow wavepacket. Similarly, it is also the case that the particle whose wavefunction is described by that particular wavepacket, does not possess a well-defined momentum (since it is constructed out of a range of wavelengths) until its momentum is measured to a given accuracy,¹⁰ at which point the wavefunction changes to a much broader wavepacket but with a much narrower distribution in wavelength and hence a narrower distribution in momentum. One can measure the position accurately or the momentum accurately - but not both. The product of the uncertainty, Δx , in the measurement of position (the width of the wavepacket) and the uncertainty, and Δp , in the measurement of momentum must be larger than Planck's constant, h , in keeping with the uncertainty relation.

To give you some idea of why we do not experience this uncertainty in our everyday observations, suppose we were looking under a microscope at a human blood cell whose mass is of order of a millionth of a microgram and the uncertainty in position is around one micron (a millionth of a meter - about the smallest resolution possible with visible light) then the uncertainty in its velocity due to Heisenberg's uncertainty relation would be of the order of one micron per year !!

¹⁰The momentum of a particle is proportional to its velocity (neglecting relativistic corrections) so that a measurement of a particle's momentum is equivalent to a measurement of its velocity.

8 Wavefunctions - Schrödinger's Equation

So far we have considered only free particles - i.e. particles whose energy consists entirely of its kinetic energy. In general, however, a particle moves under the influence of a force and possesses both kinetic energy, due to its motion, and potential energy, due to its position in the force field. Such particles are also described by a wavefunction, whose interpretation is, as before, that the square of the amplitude at position, \mathbf{x} , is the probability to find the particle at that position. The wavefunction is more complicated than in the case for a free particle and it is given by the solution to the most important equation in Quantum Physics - Schrödinger's wave equation. This is not a simple equation for the wavefunction, $\Psi(\mathbf{x}, t)$, which is a function of position, \mathbf{x} , and time t . It is a "differential equation" which relates the way in which the wavefunction, $\Psi(\mathbf{x}, t)$, varies with a change in position to the way in which it varies with a change in time. Such differential equations do not always have a solution - this is not a statement about our inability to solve the equation if it's too hard, but a mathematical theorem stating that such differential equations only possess unique solutions under certain circumstances. There are therefore only limited force fields for which we know the solution to Schrödinger's equation and can therefore derive the wavefunction for a particle moving in that field of force. For other systems of forces there are often very good approximations which can be made so that the wavefunction can still be obtained up to a certain accuracy.

8.1 Discrete Energy Levels

When the force is attractive - i.e. it pulls the particle towards some point, the particle can form a bound state in which the magnitude of its potential energy exceeds its kinetic energy and a quantity of energy known as the "binding energy" has to be injected in order to free the particle. Examples are a particle on a spring - or any other **harmonic oscillator** such as the ions in a crystal lattice, or a charged particle moving in the electrostatic field of an oppositely charged particle. Classically, such bound states can have any energy, but in Quantum Physics it turns out that the Schrödinger equation only allows solutions for which the system has one of a discrete set of allowed energies. These are called "**energy levels**". The energy is said to be "quantized". The fact that the Schrödinger equation, when applied to certain systems, only has solutions for a discrete set of energy levels is the mathematical justification for Planck's original postulate that whereas classically oscillators and other systems can have any energy, in Quantum Physics this energy is quantized. We look at three examples of systems with discrete energy levels.

8.1.1 Particle in a Box (in one dimension)

The simplest example of discrete energy levels is the case of a particle moving in one dimension (this can easily be extended to the more realistic case of a particle moving in three dimensions) in a "box" with impenetrable walls at $x = 0$ and $x = L$, so that the particle

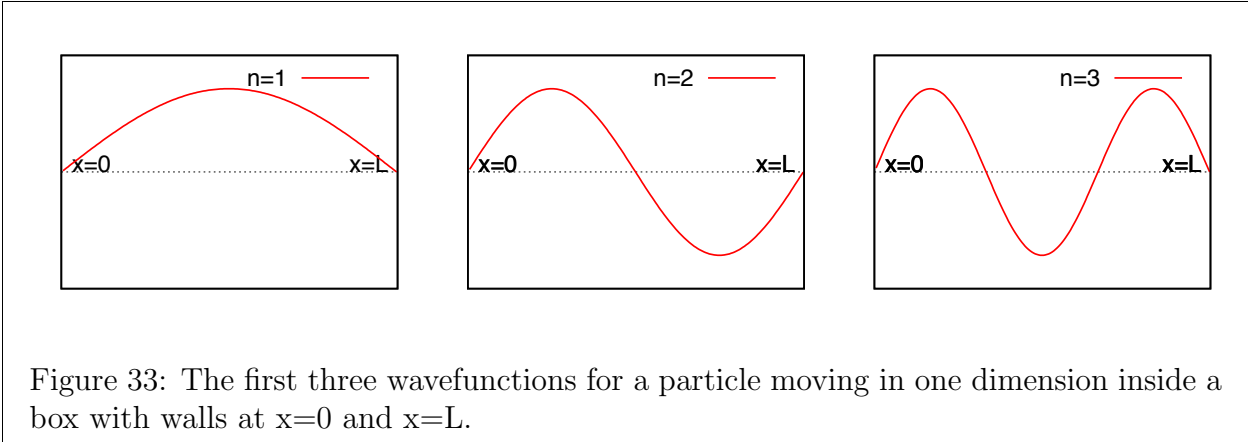

must remain inside the box, whose length is L . This means that there is zero probability of finding the particle outside the box - or even at the edge of the box, so we need a wavefunction which is zero at $x = 0$ and at $x = L$.

We have already discussed this case under the section on standing waves. The waves that obey this condition have wavelengths given by

$$\lambda_n = \frac{2L}{n} \quad (n = 1, 2, 3 \dots) \tag{8.1}$$

The first three wavefunctions are shown in Fig. 33. From the de Broglie wave relation, the particle with these allowed wavelengths, has momentum

$$p_n = \frac{h}{\lambda_n} = \frac{nh}{2L}. \tag{8.2}$$

For a particle of mass m , the kinetic energy, T ($= \frac{1}{2}mv^2$), is related to the momentum, p , ($p = mv$) by

$$T = \frac{1}{2}mv^2 = \frac{p^2}{2m}. \tag{8.3}$$

There is no force on the particle except at the wall, so that between the walls there is no potential energy and the energy consists entirely of the kinetic energy. This means that the energy of the particle is given by

$$E_n = \frac{n^2h^2}{8mL^2} \tag{8.4}$$

The only energies permitted are these values where n is a positive integer number. This differs from our classical picture for which a particle can have any energy whether it is confined to a box or not. We do not have any visual experience of this “quantization” since for any macroscopic system the size, L , of the box is so large that the energy levels are far too closely packed together to be identified as discrete as opposed to continuous.

Examination of the wavefunctions in Fig. 33 shows us that the wavefunction for $n = 1$, the lowest allowed energy, known as the “ground state”, does not cross the axis - it is never

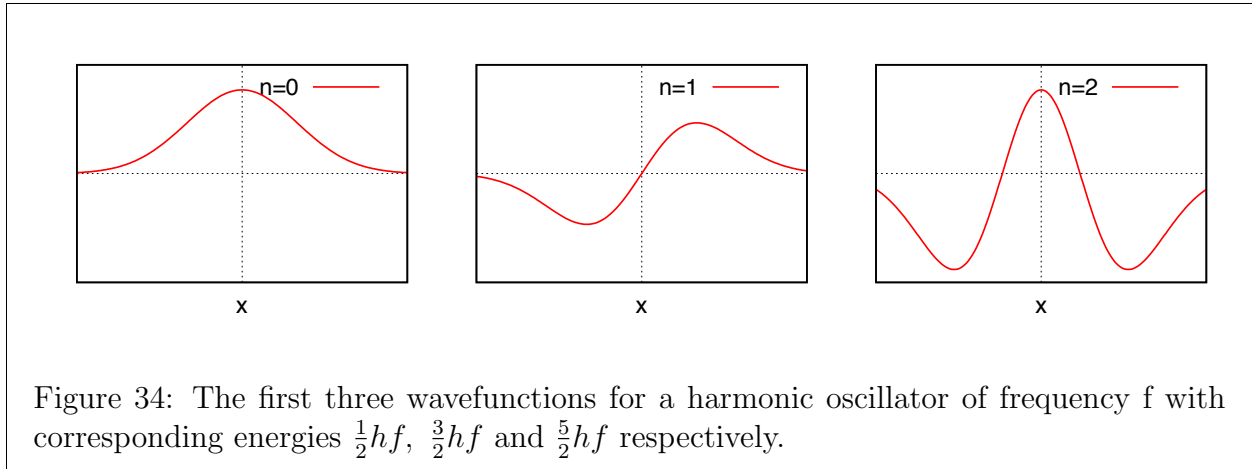

zero between $x = 0$ and $x = L$. The wavefunction for the next lowest energy level, $n = 2$, (the “first excited state”) crosses the axis once – i.e. there is one point where it is zero between $x = 0$ and $x = L$. For the next excited state there are two zeros etc. This is a feature of all sets of discrete wavefunctions - the wavefunction for the ground state does not cross the axis, whereas the wavefunction for the n^{th} excited state crossed the axis n times.

8.1.2 Harmonic Oscillator

For a harmonic oscillator such as a particle attached to a spring, there is a force which is proportional to the displacement of the particle from its equilibrium position and is directed in the opposite direction from the displacement - hence it is called a “restoring” force. At the sub-microscopic level, an example would be an ion in a crystal which experiences a restoring force proportional to its displacement from its lattice site. Such particles oscillate around their equilibrium position with some frequency, f , that depends on the strength of the restoring force and the mass of the particle. To find the wavefunctions for such a system we need to solve the Schrödinger equation appropriate for such a restoring force. The equation can only be solved for a discrete set of energies (energy levels). The wavefunctions for the first three such energy levels are shown in Fig. 34) – these are actually labelled $n = 0$, $n = 1$, $n = 2 \dots$ (the ground state has the label $n = 0$, unlike the previous example where it was labelled $n = 1$ – but this is merely a convention) and again we see that they cross the axis n times.

The corresponding energies, E_n , are given by

$$E_n = \left(n + \frac{1}{2} \right) h f. \quad (8.5)$$

This is almost in agreement with the postulate made by Planck to solve the problem of the ultraviolet catastrophe - with the exception of the offset of $\frac{1}{2}hf$. In other words a harmonic oscillator in its lowest allowed energy level (ground state) does not have zero energy but a

very small energy $E_0 = \frac{1}{2}hf$. For macroscopic oscillators this energy is so small that it may be neglected. However, for sub-microscopic systems it is not possible to have an oscillator with zero energy. In order to have zero energy, the momentum of the particle has to be zero (zero kinetic energy) and the displacement of the particle from its equilibrium position has to be zero (zero potential energy). This would mean that the momentum and position of the particle were known exactly, thereby violating the Heisenberg uncertainty principle. The energy $\frac{1}{2}hf$ turns out to be the minimum energy that an oscillator can possess without violating the Heisenberg uncertainty principle. Note that all of the wavefunctions tend to zero for large (positive or negative) x indicating that the probability of finding the particle with very large (positive or negative) displacement position is very small.

8.1.3 The Hydrogen Atom

The classical picture of the hydrogen atom was that of an electron orbiting around a proton. Such an electron can have any energy, depending only on the radius of the orbit. There is an internal inconsistency with this picture. An electric charge in orbit emits electromagnetic radiation with a frequency equal to the frequency of the electron's rotation. As it does so it would lose energy so that it would move into an orbit of smaller radius and the electron would very quickly spiral into the nucleus. The classical picture of the atom is unstable !!

There is also an experimental inconsistency. The (classical) electron would have an orbit of any radius with a corresponding frequency of rotation - like planets moving around the sun. Classically, a charged particle radiates at a frequency equal to its frequency of rotation which depends on the radius of orbit. If all orbit radii are permitted then the atom would radiate at all possible frequencies. However, experimentally it is found that atoms emit electromagnetic radiation only with certain fixed frequencies (these are called “**spectral lines**”).

So the classical picture in which an electron has a well-defined orbit is not viable. Motion in an orbit implies that the electron has a well-defined position in an orbit and a well-defined velocity (and hence well-defined momentum) as it moves around the orbit. This is not consistent with the Heisenberg uncertainty principle. In Quantum Physics the best we can do is to calculate the wavefunction which tells us what the probability is that the electron is at a particular point and also the probability that it has a given momentum - but since the electron actually does not possess a well-defined position or a well-defined momentum, so it is not meaningful to talk about “orbits”.

The wavefunctions are found by solving the Schrödinger equation which is appropriate for an electron with an attractive force toward the proton. Such a force decreases as the square of the distance between the electron and the proton. The first three allowed wavefunctions, which depend only on the distance, r , between the proton and the electron are shown in Fig. 35. In this case we once again have the lowest energy, (ground state) wavefunction labelled as $n = 1$. Again we see that the number of times the wavefunction crosses the axis is $n - 1$. We also note that all of the wavefunctions tend asymptotically to zero for large r , indicating that the probability of finding the electron at a distance r from the proton is very

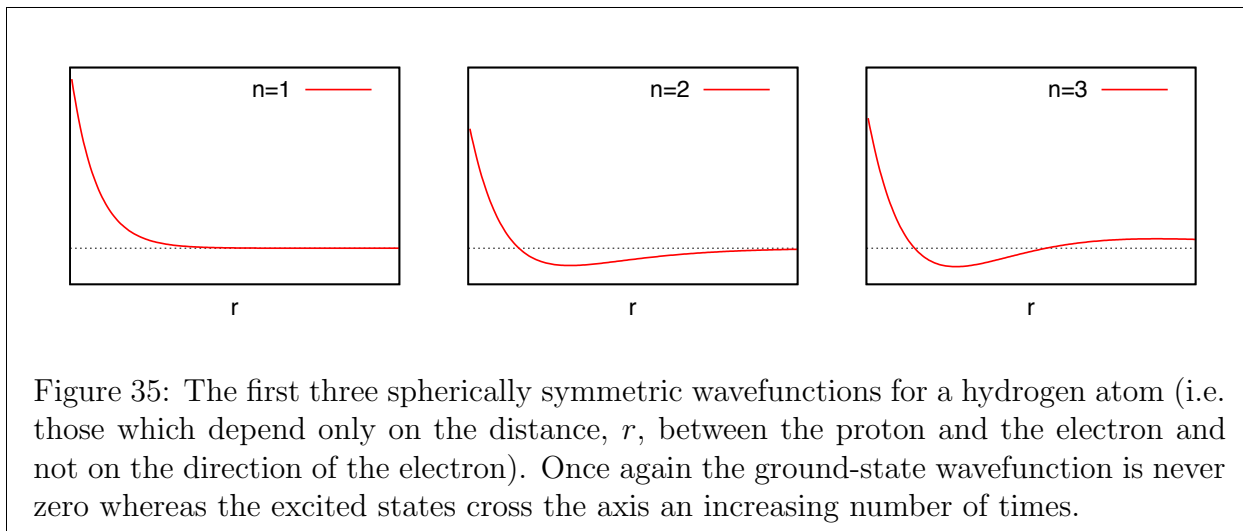

small for very large distance, r , between the electron and the nucleus. This is an expected result - we would not expect to find the electron of a hydrogen atom a very long way away from its nucleus.

The corresponding energies for a given value of (integer) n are given by the simple formula

$$E_n = \frac{R_H h c}{n^2}. \quad (8.6)$$

R_H is a constant called the “**Rydberg constant**”. It is constructed out of the electric charge of the electron, e , the mass of the electron, m_e , Planck’s constant, h , and the speed of light, c . Its value is 0.011 per nm.

When an atom makes a transition from a higher (lower) energy level to a lower (higher) energy level it emits (absorbs) a photon whose energy is equal to the difference in energies of the initial and final energy level. Since the energy levels are known, the allowed energies of the photon emitted or absorbed when a hydrogen makes such a transition can be calculated. Furthermore, since the energy of a photon is proportional to the frequency of the light, the allowed radiation frequencies (and hence the wavelengths) can therefore be determined.

For those of you who are not afraid of a little algebra, we can go through the steps from the expression for the energy levels of a hydrogen atom (eq.(8.6)) and the wavelengths of the spectrum - otherwise skip to eq.(8.9). From the expression (8.6) for the energy levels of hydrogen, the energy difference, ΔE , between the state state $n = n_i$ to a state $n = n_f$ is given by (using eq.(8.6) for $n = n_i$ and $n = n_f$)

$$\Delta E = R_H h c \left(\frac{1}{n_f^2} - \frac{1}{n_i^2} \right) \quad (8.7)$$

The photon energy is related to the wavelength by

$$\Delta E = h f = \frac{h c}{\lambda} \quad (8.8)$$

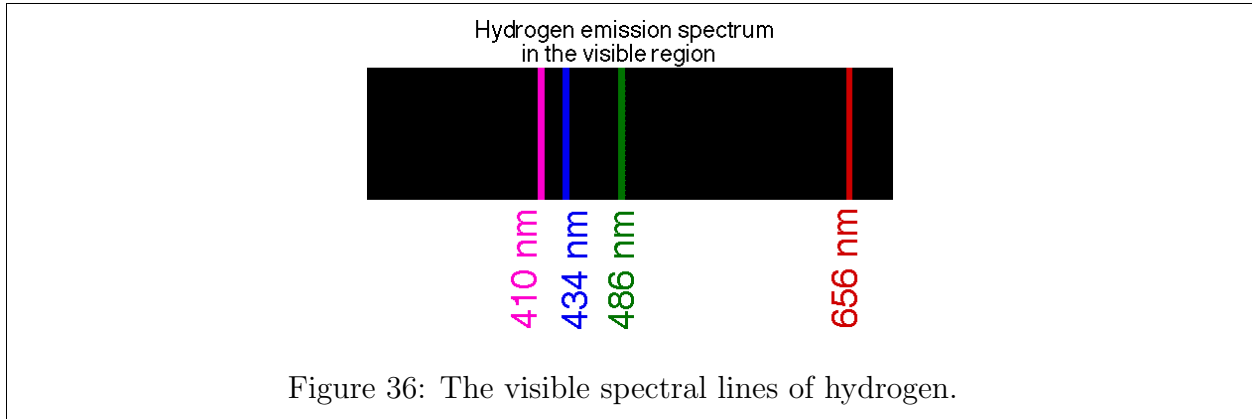

Therefore (substituting eq.(8.8) into eq.(8.7) and dividing both sides by $h c$) the wavelengths, λ , of the spectrum of hydrogen are given by

$$\frac{1}{\lambda} = R_H \left(\frac{1}{n_i^2} - \frac{1}{n_f^2} \right) \quad (8.9)$$

This simple formula reproduces the observed wavelengths of the hydrogen spectrum with spectacular accuracy as can be seen from Fig. 36 which shows the wavelengths of the visible lines of the hydrogen spectrum, for the case $n_f = 2$. The above formula gives the following values:

$$n_i = 3 : \frac{1}{\lambda} = 0.011 \left(\frac{1}{2^2} - \frac{1}{3^2} \right) = 0.00153, \text{ so that } \lambda = 655 \text{ nm.}$$

$$n_i = 4 : \frac{1}{\lambda} = 0.011 \left(\frac{1}{2^2} - \frac{1}{4^2} \right) = 0.00206, \text{ so that } \lambda = 485 \text{ nm.}$$

$$n_i = 5 : \frac{1}{\lambda} = 0.011 \left(\frac{1}{2^2} - \frac{1}{5^2} \right) = 0.00231, \text{ so that } \lambda = 433 \text{ nm.}$$

$$n_i = 6 : \frac{1}{\lambda} = 0.011 \left(\frac{1}{2^2} - \frac{1}{6^2} \right) = 0.00244, \text{ so that } \lambda = 409 \text{ nm.}$$

Comparing these theoretical predictions for the wavelengths with the measured values shown in Fig. 36 is a remarkable success for Quantum Physics.

The next simplest atom is the **helium atom** which has two electrons. This has an added complication that as well as the electrons experiencing a force which attracts them towards the nucleus, there is a **repulsive force** between the two electrons. This is sufficient to render the Schrödinger equation for the helium atom impossible, even in principle, to solve exactly. Fortunately there are several very effective approximate methods that can be used to obtain very accurate approximations to the solution. Needless to say the situation for atoms with more electrons is even worse! Finding good approximations to such wavefunctions

and determining the allowed energy levels (and consequently the wavelengths of the atomic spectra) is the subject of Atomic Physics and also the basis of chemistry.

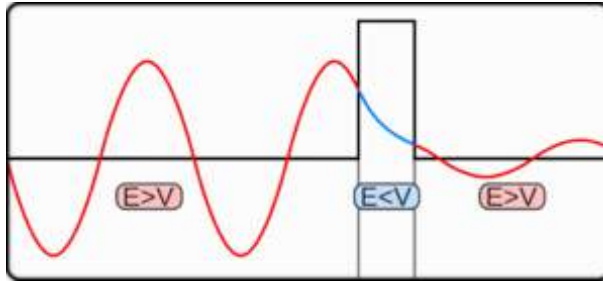

Figure 37: A wave is incident from the left onto a barrier whose repulsive potential, V , exceeds the kinetic energy, E , of the particle. Classically, the particle cannot penetrate the barrier and is reflected (like a ball bouncing off a wall). However the wave is attenuated, but not totally eliminated, so that it has some non-zero amplitude on the right of the barrier, meaning that there is a non-zero probability of finding the particle on the right hand side of the barrier.

9 Quantum Tunnelling

One of the most spectacular phenomena of Quantum Physics is “**quantum tunnelling**”. This is a process in which a particle can cross a barrier, even though the barrier presents a sufficiently large repulsive force, so that classically the particle cannot cross it.

This is demonstrated in Fig. 37, in which a particle of energy E is incident on a barrier from the left which provides a repulsive potential that is larger than E , so that classically the particle is always reflected at the barrier. This happens whenever the height of the potential barrier exceeds the energy of the particle - the particle then does not have enough energy to overcome the force presented by the potential barrier. However, in terms of a wave, the barrier will act to attenuate, but not eliminate, the wave. Mathematically, this follows from the solution to the wave equation in the presence of a potential barrier. Physically, what is happening is that a wave does not suddenly stop when it reaches a boundary between two media but continues with an ever-decreasing amplitude, at least until it reaches another boundary into the original medium. In that case, the wave extends to the right of the barrier but with a reduced amplitude. In terms of the probabilistic interpretation of de Broglie waves, in which the probability of finding the particle is proportional to the square of the amplitude, this means that there is some probability to find the particle to the right of the barrier, although this is considerably less than the probability of find the particle to the left. In this way the particle has some probability to end up on the right of the barrier. The wider the barrier, the lower the probability of finding the particle on the other side of the barrier.

You may have experienced this, in the context of light waves. If you shine a torch into a thick slab of plastic, which is opaque, you cannot see any light getting through. When a medium is said to be “opaque”, it does not mean that the wave simply stops when it

reaches that medium, but that its amplitude is attenuated becoming negligible after a certain distance into the medium. However, if you shone the light through a very thin piece of the same plastic (e.g. a tiddlywink) you can see some light shining through the thin plastic. As the light penetrates the plastic, its intensity is attenuated so that the thicker the plastic slab the smaller the amplitude of the transmitted light. In terms of a photon, viewed as a particle, the opaqueness of the plastic means that there is a repulsive force acting on the photon which prevents it from penetrating the slab of plastic. The fact that for a thin slab we do see some light, albeit with lower intensity, is a manifestation of the fact that some of the photons are undergoing quantum tunnelling through the plastic.

10 Quantum States and Superposition

A sub-microscopic system (a sub-atomic particle or set of sub-atomic particles moving under a force field or exerting a force on each other) is described by a “**quantum state**” (or just “**state**”) which is a list of physical properties of the system that can be measured simultaneously. Thus, for a free point-particle the state could be specified in terms of the momentum of the particle or in terms of its position but not both, since the simultaneous determination of momentum and position is forbidden by Heisenberg’s uncertainty principle.

For a more complicated system such as an electron bound in an atom, we can specify the energy of an electron, but also the **angular momentum** due to its rotation about the nucleus (although it is quite wrong to “picture” an electron rotating around a nucleus in a fixed orbit). Angular momentum is a vector quantity – as well as its magnitude it has a direction determined by the direction of the axis about which the object is rotating. In classical mechanics, this vector can have three well-specified components - one for each dimension - but in Quantum Physics it turns out that only one component of angular momentum can be determined at any one time (in the same way that either the momentum or the position of a point particle can be determined). Thus if we know the component of angular momentum in the z -direction, the components in the x -direction or y -direction are undetermined - that means that the system simply does not possess well-defined values for these quantities. The state of an electron in an atom can therefore be specified by its energy, the magnitude of its angular momentum and one component of its angular momentum (usually chosen by convention to be the z -component). We shall see below that an electron also possesses an additional angular momentum, called spin, whose z -component can take one of two values - this value is also used to specify the state of the electron.

Very often the quantities which are used to specify a quantum state can only take certain specified values and can therefore be denoted by an integer (whole number) called a “**quantum number**”. In the case, considered in section 8, of a free particle in a one dimensional box of size L , whose energy levels are given by

$$E_n = \frac{n^2 h^2}{8 m L^2}. \quad (10.1)$$

The integer, n , is the energy quantum number - it labels the energy level of the particle (the same is, of course, also true for the other examples of discrete energy levels considered in section 8.)

The wave associated with a system of particles in a given state is described mathematically by a wavefunction, $\Psi_{\{n\}}$, which depends on the set of quantum numbers $\{n\}$.¹¹ However, a system need not be in one of these quantum states but in a superposition of states described by different sets of quantum numbers $\{n\}_1$, $\{n\}_2$, etc. whose wavefunction is given by a superposition

$$\Psi = a\Psi_{\{n\}_1} + b\Psi_{\{n\}_2} + \dots \quad (10.2)$$

¹¹The notation $\{n\}$ is used to denote a set of numbers n_1, n_2, \dots which label all the quantities whose values determine the quantum state.

The meaning of such a superposition state in terms of the system of particles is that the system does not possess well defined values for the sets of physical quantities labelled by the quantum numbers $\{n\}$, but the probability that a measurement of these variables will yield the values labelled by $\{n\}_1$, $\{n\}_2$, etc. is given by a^2 , b^2 , etc. respectively.

As an example, if we return to the problem of a free particle of mass m , in a (one-dimensional) box of size L , the wavefunctions, Ψ_n with wavelength $\lambda_n = 2L/n$ are the wavefunctions representing the particles with energy

$$E_n = \frac{n^2 h^2}{8mL^2}.$$

However, we could have a particle whose wavefunction is given by (for example)

$$\Psi = \frac{1}{2}\Psi_1 + \frac{\sqrt{3}}{2}\Psi_2 \tag{10.3}$$

where Ψ_1 is the wavefunction with wavelength $2L$ and Ψ_2 is the wavefunction with wavelength L . A particle whose wavefunction is given by the above superposition does not have a well-defined energy, but there is a probability $(\frac{1}{2})^2$, i.e. $\frac{1}{4}$, that its energy is

$$\frac{h^2}{8mL^2} \quad (\text{corresponding to } n = 1),$$

and a probability $(\frac{\sqrt{3}}{2})^2$, i.e. $\frac{3}{4}$, that its energy is

$$\frac{h^2}{2mL^2} \quad (\text{corresponding to } n = 2.)$$

11 Two State Systems

We have mentioned above that a general wavefunction describes a particle which possesses neither a completely well-defined position nor a completely well-defined momentum - until such a time that one or the other of these quantities is measured. It will be slightly more convenient to discuss this strange phenomenon in the case of systems (or properties of systems) which have only two states, i.e. a property which can only have one of two values.

11.1 Photon Polarization

An electromagnetic wave consists of an oscillating electric field and an oscillating magnetic field, which are perpendicular to each other and also perpendicular to the direction of motion of the wave (see Fig. 31). Suppose we have a wave moving along the z -axis. There are two possibilities shown in Fig. 38. The wave is moving out of the plane of the figure, in the z -direction, and in the first diagram the electric field is pointing along the x -axis. We call this horizontal **polarization** and we write the amplitude of the electric field vector, \mathbf{E} , as

$$\mathbf{E}_{(H)} = E \mathbf{i}$$

where E is the amplitude of the electric field and \mathbf{i} is a symbol meaning a vector of unit magnitude along the x -axis. In the second diagram the electric field is along the y -axis. We call this vertical polarization and we write the amplitude of the electric field vector, \mathbf{E} , as

$$\mathbf{E}_{(V)} = E \mathbf{j}$$

where \mathbf{j} is a vector of unit magnitude along the y -axis.

However, the electric vector need not be exactly along the x - or y -directions but at an angle between them, such as the case shown in the third diagram, in which the electric field is at 45° to the x -axis. In this case we write the amplitude of the electric field vector as

$$\mathbf{E} = \cos(45)\mathbf{E}_{(H)} + \sin(45)\mathbf{E}_{(V)} = \frac{1}{\sqrt{2}}\mathbf{E}_{(H)} + \frac{1}{\sqrt{2}}\mathbf{E}_{(V)} \quad (11.1)$$

(we have used $\cos(45) = \sin(45) = 1/\sqrt{2}$). This is an example of a superposition state. The photons in this electromagnetic wave are superpositions of horizontally polarized and vertically polarized photon states.

If we now were to put a polaroid filter, which only allows horizontally polarized radiation to pass through, in the path of such a beam of electromagnetic radiation, some of the wave would pass through and some of it would be absorbed by the polaroid filter. In fact the intensity of the radiation is proportional to the square of the amplitude of the electric field, so that in this case half the intensity would be transmitted through the polaroid filter. Furthermore all the radiation which does pass through the polaroid filter has horizontal polarization.

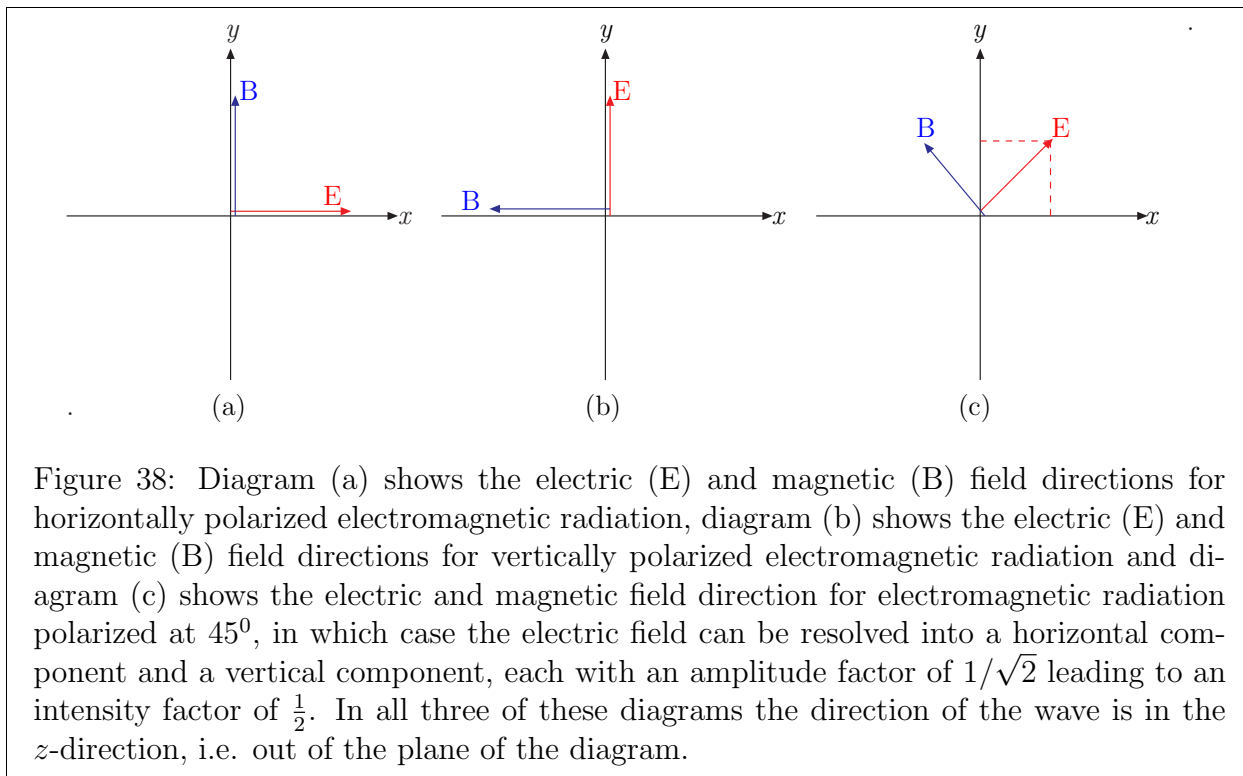

In terms of a wave, there is no difficulty in conceptualizing this situation. We can do the experiment very easily with two pairs of polaroid sunglasses held with their axes at 45° to each other. We will see that the intensity of the light is halved. However, in terms of photons it is a little more difficult to understand. The photon can have one of two states of polarization. We will denote the wavefunction for a photon of horizontally polarized light as Ψ_H and a photon of vertically polarized light as Ψ_V . A photon which passes through a polaroid filter with its axis horizontal is definitely horizontally polarized and has wavefunction Ψ_H . Likewise a photon which passes through a polaroid filter with its axis vertical is definitely vertically polarized and has wavefunction Ψ_V . The wavefunction for a photon of light which passes through a polaroid filter at polarized at 45° to the vertical is polarized at 45° and its wavefunction is given by

$$\frac{1}{\sqrt{2}}\Psi_H + \frac{1}{\sqrt{2}}\Psi_V,$$

i.e. it is neither horizontally polarized nor vertically polarized but a superposition of the two. If we try to pass this photon through a polaroid filter that will only pass horizontally polarized light then there is a probability of $\frac{1}{2}$ that the photon will pass through and a probability of $\frac{1}{2}$ that it will be absorbed by the polaroid. If the photon does pass through, it will then definitely be horizontally polarized. In this sense the polaroid filter is a measuring device which measures whether the photon is horizontally or vertically polarized. However, the photon is only in such a state of polarization *after* the measurement has been made. Before the photon reaches the polaroid filter it is neither in a horizontal nor a vertical polarization state but a superposition of the two. Thus the measurement changes the state of the photon

from a superposition of horizontal and vertical polarization, i.e. a photon whose direction of polarization is in a direction at 45° to the horizontal axis is transformed by the measurement either into a state in which the direction of polarization is definitely along the horizontal or into a state in which the direction of polarization is definitely along the vertical axis. In the former case (horizontal polarization) the photon passes through the filter, whereas in the latter case (vertical polarization) it is absorbed by the filter.

11.2 Electron Spin

Electrons have a property which is analogous to photon polarization. This is called “spin” and was first postulated in 1925 by Wolfgang Pauli [25]. However there are two features of this spin, which make it impossible to visualize in the same way as we visualize a spinning top:¹²

1. If we measure the spin angular momentum in any direction we can only obtain one of two results: $+\frac{1}{2}\hbar$ or $-\frac{1}{2}\hbar$ ¹³.
2. If the electron is known to have a spin angular momentum $+\frac{1}{2}\hbar$ or $-\frac{1}{2}\hbar$ in a given direction (i.e. the axis of spin is in that direction), then the electron does not have a well-defined component of spin in any other direction. We denote the wavefunction for an electron whose spin component in the z -direction is $+\frac{1}{2}\hbar$ by Ψ_\uparrow (we call this “**spin up**”) and the wavefunction for an electron whose spin component in the z -direction is $-\frac{1}{2}\hbar$ by Ψ_\downarrow (we call this “**spin down**”). If we have an electron that has a component $+\frac{1}{2}\hbar$ in the x -direction, it would be a superposition of spin up and spin down, with a wavefunction written as

$$\frac{1}{\sqrt{2}}\Psi_\uparrow + \frac{1}{\sqrt{2}}\Psi_\downarrow.$$

The interpretation of this is that this electron has well-defined spin component in the x -direction, but *not* in the z -direction, until such a time that the component in the z -direction is measured. The probability that the result of such a measurement is $+\frac{1}{2}\hbar$ is $\frac{1}{2}$ (the square of the coefficient of Ψ_\uparrow) - and similarly the probability that the result of such a measurement is $-\frac{1}{2}\hbar$ is $\frac{1}{2}$ (the square of the coefficient of Ψ_\downarrow). The act of a measurement of the z -component of spin changes the spin part of the electron wavefunction either to Ψ_\uparrow or Ψ_\downarrow , but before the measurement it is *not* either in one state or the other but in “both”. This is analogous to the way that a photon whose electric field is 45° to the horizontal axis, is neither horizontally polarized nor vertically polarized, but a superposition of the two - until the photon passes through a polaroid filter with its axis in the horizontal or vertical direction.

¹²An erroneous interpretation of electron spin in terms of a quantized spinning top was proposed at the same time by Kronig, Uhlenbeck and Goudsmit [26].

¹³The symbol \hbar is a short-hand way of writing $h/(2\pi)$, i.e. Planck’s constant divided by 2π . It was introduced to Quantum Mechanics because it occurs very often. We shall use this notation from now on.

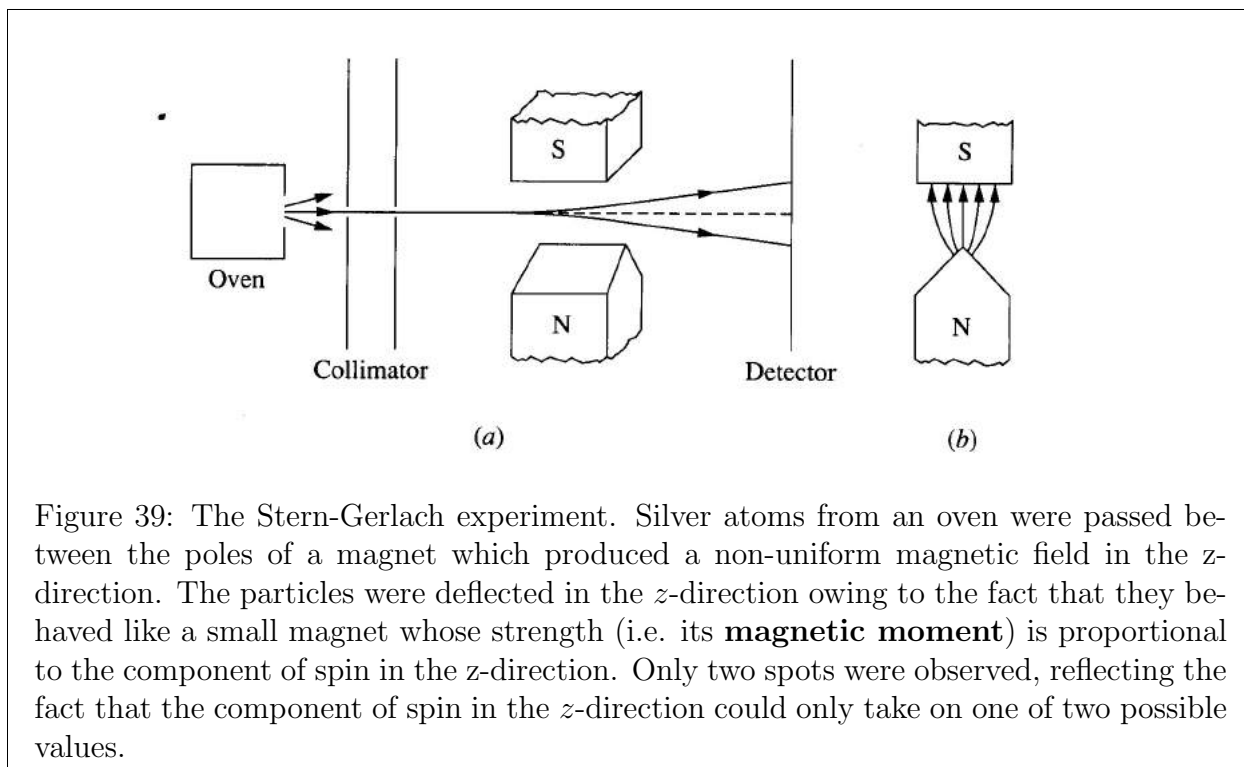
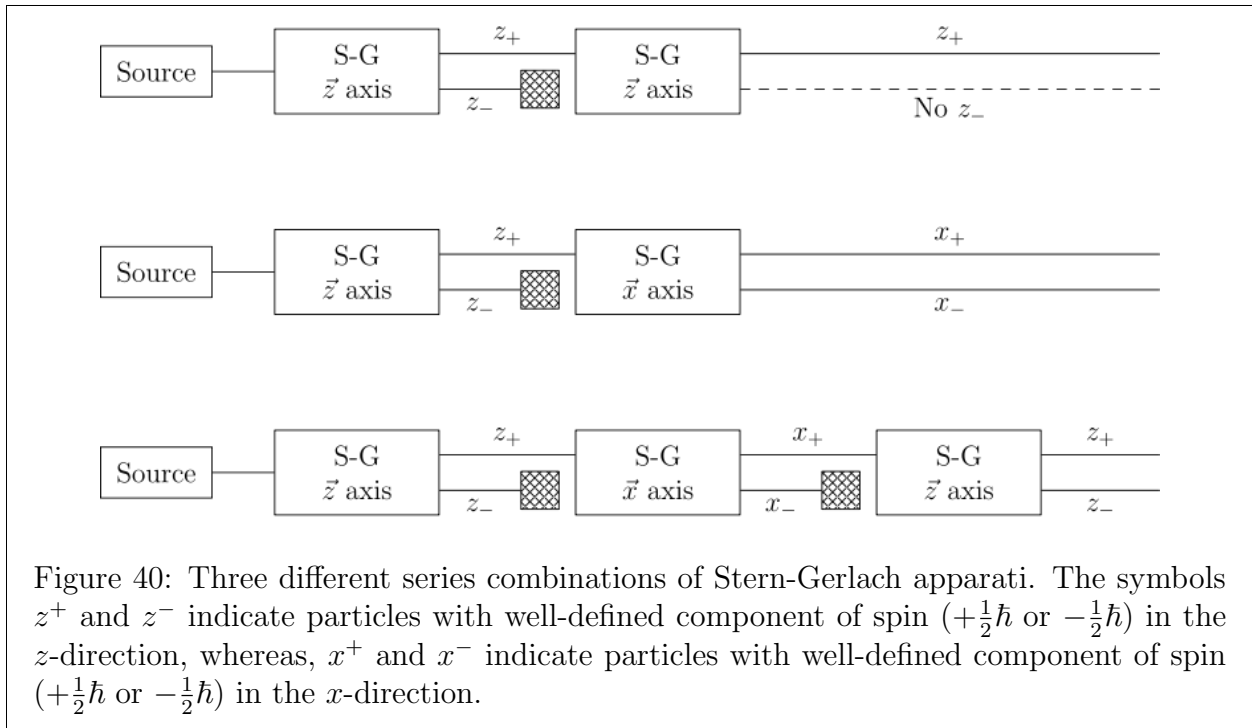

Figure 39: The Stern-Gerlach experiment. Silver atoms from an oven were passed between the poles of a magnet which produced a non-uniform magnetic field in the z -direction. The particles were deflected in the z -direction owing to the fact that they behaved like a small magnet whose strength (i.e. its **magnetic moment**) is proportional to the component of spin in the z -direction. Only two spots were observed, reflecting the fact that the component of spin in the z -direction could only take on one of two possible values.

This is very different from thinking about a spinning top, for which the spin can be of any magnitude, depending on how fast the top is spinning and whichever direction the spin axis is pointing. The classical spin angular momentum has a well-defined component in any direction, but this is not the case for a quantum system, which only possesses a well-defined component of angular momentum in one direction. This is again something that cannot be “understood” or “visualized” but we simply have to accept that since the spin angular momentum of an electron is many orders of magnitude smaller than anything we could ever hope to observe, our usual experience of spin cannot be applied at the sub-microscopic level.

A charged particle with spin behaves like a magnet with a north and south pole in the direction of the spin axis. A magnet is displaced by a non-uniform magnetic field. This is used in the Stern-Gerlach apparatus [27], shown diagrammatically in Fig. 39, in which a beam of electrons¹⁴ passes through a non-uniform magnetic field in the direction of the component that is being measured (e.g the z -axis). An electron with spin component $+\frac{1}{2}\hbar$ (spin up) in the z -direction is displaced in one direction whereas an electron with spin component $-\frac{1}{2}\hbar$ (spin down) is displaced by the same amount but in the opposite direction. After passing through the magnetic field, the path of the charged particle with the same spin property as an electron will be in one of two possible directions depending on two possible values for the z -component of the spin. These two possible directions lead to two spots on the detector screen. The electrons landing on one of these spots have a definite z -component of spin.

¹⁴In the original experiment of Otto Stern and Walther Gerlach in 1922, silver atoms which emerged from an oven were used, rather than electrons. Silver atoms have the same spin as electrons.



Note that in the classical picture of spin the component in the z -direction can take any value between these two spots. If the z -component of the spin could take any value between $+\frac{1}{2}\hbar$ and $-\frac{1}{2}\hbar$, as happens in classical physics, then the magnetic field could deflect the path of the charged particle by any amount between two limits and the path which emerges from the magnetic field could be in any direction leading to a continuous line of the screen from the continuum of allowed displacements. The fact that only two spots were seen was one of the surprises foisted upon us by Quantum Physics.

When a particle, whose wavefunction is in general a superposition of spin up and spin down – i.e. a particle that does not possess well-defined component of spin in the z -direction, passes through a Stern-Gerlach apparatus with its magnetic field in the z -direction, its wavefunction is converted either into a spin-up wavefunction (so it emerges in the upper beam) or into a spin-down wavefunction (so it emerges in the lower beam). If we block off the lower beam as shown in Fig. 40 then if the particle passes through, it is definitely in the spin-up state. It will pass through another Stern-Gerlach apparatus with its magnetic field in the z -direction, as shown in the upper diagram of Fig. 40, emerging always in the upper beam.

However, something bizarre happens if between the two Stern-Gerlach apparatus which measure the z -component of spin (i.e. the non-uniform magnetic field is in the z -direction), we interpose a Stern-Gerlach apparatus which measures the x -component of spin (i.e. the non-uniform magnetic field is in the x -direction) and block off the beam corresponding to $s_x = -\frac{1}{2}\hbar$. There is then a non-zero probability that the electron will emerge in *either* of the two beams, as seen in the lower diagram of Fig. 40. The point is that the intermediate

Stern-Gerlach apparatus changes the state of the electron into one of well-defined component of spin in the x -direction (either $s_x = +\frac{1}{2}\hbar$ or $s_x = -\frac{1}{2}\hbar$), as indicated in the middle diagram of Fig. 40. Blocking off the beam corresponding to $s_x = -\frac{1}{2}\hbar$ leaves only the electrons with $s_x = +\frac{1}{2}\hbar$, which once again is a superposition of a state in which the z -component of spin is $+\frac{1}{2}\hbar$ and a state in which the z -component of spin is $-\frac{1}{2}\hbar$, so that it could pass into either the upper or lower beam of the third Stern-Gerlach apparatus with the magnetic field in the z -direction.

12 Wavefunction Collapse

We have mentioned a number of times that a system can be in a state in which it does not possess a well defined value of a quantity that we would normally expect a classical system to possess - such a exact position, and exact momentum, or in the case of particles with spin, a well-defined component of spin in *any* given direction. We have also pointed out that when a measurement of a given quantity is made, the state of the system is converted into one in which a given quantity is indeed well-defined. What happens to the wavefunction describing the system when that happens is called “wavefunction collapse” and was first proposed by Heisenberg [24]. Wavefunction collapse takes a system from being a superposition of states, such as a superposition of a spin up state and spin down state to a wavefunction which either describes spin up (z -component of spin equal to $+\frac{1}{2}\hbar$) or spin down (z -component of spin equal to $-\frac{1}{2}\hbar$) – but no longer a superposition of the two.

Wavefunction collapse is not well understood, although a great deal of work has gone into this problem. There is no quantum interaction acting on a system, which effects a transition from a quantum superposition in which a system does not possess well-defined values for certain properties, to a **classical probabilistic state** in which the system does indeed possess well-defined values for these properties albeit with different probabilities. As an example, such a classical probabilistic state describes the situation in which you spin a coin and cover it with your hand without looking at it. We know that the coin is either “heads up” or “tails up” but we do not know which. This is fundamentally different from a quantum superposition of “heads up” and “tails up” in which the coin would not be either “heads up” or “tails up” but both at the same time.

As we have explained above, one can choose to measure one property or another. For example one can choose to measure accurately the position of a particle, in which case the environment includes an apparatus for the accurate measurement of position and the measurement induces wavefunction collapse into a state of well-defined position, or one can choose to measure accurately the momentum of a particle in which case the environment includes an apparatus for the accurate measurement of momentum and the measurement induces wavefunction collapse into a state of well defined momentum (but we cannot do both simultaneously). For an electron (or other particle with spin) one can measure the component of spin in the z -direction, in which case the environment includes a Stern-Gerlach apparatus with its magnetic field in the z -direction and after passing through the apparatus the wavefunction for the particle collapses either into one describing a spin up particle or into one describing a particle spin down particle. Alternatively we may choose to measure the component of spin in the x -direction in which case the environment includes a Stern-Gerlach apparatus with its magnetic field in the x -direction and after passing through the apparatus the wavefunction for the particle collapses either into one describing a particle whose x -component of spin is $+\frac{1}{2}\hbar$ or into one describing a particle whose component of spin in the x -direction is $-\frac{1}{2}\hbar$. However, we cannot perform these two experiments simultaneously. At the end of the last section, we explained what happens when these two experiments are performed sequentially - the interaction of the spin-one half particle with the first apparatus

affects is spin state and consequently alters the results of the second experiment.

It is tempting and comforting to interpret this very strange behaviour of sub-microscopic systems in terms of so-called “hidden variables”. This is the proposition that a particle *does* indeed possess both position and momentum or a component of spin both in the z -direction and the x -direction, but that the experimentalist does not know what the values of any of these quantities are until (s)he performs an experiment to measure it. As we shall see later, this is not the case - it was shown by John Bell that this postulate gives results which are not consistent with the predictions of Quantum Mechanics. We have to accept the fact that at the sub-microscopic level a system simply does not possess these quantities and that the act of measurement - or the interaction of the system with a macroscopic environment - changes the wavefunction. Quantum Mechanics permits one to determine the probability that a measurement will yield a given result (e.g. an electron which has passed through a Stern-Gerlach apparatus with its magnetic field in the x -direction and subsequently through a Stern-Gerlach apparatus with its magnetic field in the z -direction has a probability of $\frac{1}{2}$ to give a result $+\frac{1}{2}\hbar$ and a probability of $\frac{1}{2}$ to give a result $-\frac{1}{2}\hbar$). This means that if we perform the experiment one hundred times, we expect that within statistical errors, we will get on average $+\frac{1}{2}\hbar$ fifty times, and $-\frac{1}{2}\hbar$ fifty times. However we cannot predict what the result will be for any one measurement - very simply because before the measurement is effected, the particle does not possess a component of spin in the z -direction.

12.1 Decoherence

Wavefunction collapse is the mechanism in which a system, by interacting with its environment (which includes a measuring apparatus), is transformed from a superposition of states into a definite (classical) state with a well-defined value of a given measurable quantity. This mechanism is not understood, although significant progress has been made in recent years. It is the property of a wave that leads to interference which gives rise to the strange phenomenon that permits a quantum system to simultaneously possess several (often an infinite number) of values for a particular measurable property. This property is called “coherence” and is related to the fact that the phases of two waves that interfere have to be “locked” so that there is a constant phase difference between them which generates this interference. The process of unlocking this phase – so that the phase difference of the two waves is randomized is known as “**decoherence**” and this is now believed to be the mechanism that leads to wavefunction collapse. When decoherence occurs, the quantum property of superposition of states, with many different possible values for a given quantity, is lost - the wavefunction has collapsed into the wavefunction for a state in which that quantity is indeed well-defined and has a unique value.

Monochromatic (single wavelength) light, or other monochromatic electromagnetic radiation, or particles with the same momentum, used in the Young’s double slit experiment, can interfere (giving rise to interference patterns) because the incident wave is coherent, that is to say the wavefront at the double slits has peaks and troughs at the same time (or at least with a fixed time interval between them) - they are phase locked. If something

happens to randomize the phases of the wave incident on the two slits, the interference is lost (decoherence has occurred). The attempt to determine through which slit a photon or electron has passed is an example of a disturbance of the system which leads to decoherence and consequently loss of the interference pattern.

Decoherence was introduced in Quantum Physics by Dieter Zeh in 1970 [28] and developed in the 1980's. The idea is that when a sub-microscopic system which is in a superposition of states interacts with a macroscopic environment, the evolution in time, determined by Quantum Mechanics, will change the entire system (the original sub-microscopic system plus the environment) into a different superposition of states of the entire system, i.e the sub-microscopic system plus the environment. Subsequently a measurement which selects a particular state of the environment automatically selects a particular state of the sub-microscopic system. As an example, suppose the sub-microscopic system is the spin of an electron which is in a state which is a superposition of spin-up and spin-down,

$$a\Psi_{\uparrow} + b\Psi_{\downarrow},$$

and the environment is a detector which has two states which we call “red” and “green”. If the environment is in state “red” then a light shines red and if it is the state “green” the light shines green. Now suppose that the sub-microscopic system (the electron spin) interacts with the detector in such a way that if the electron has spin-up the detector is transformed into the state “red” and if the electron is spin-down the detector is transformed into the state “green”. After this interaction the combined wavefunction for the electron-spin and the detector is

$$a\Psi_{\uparrow}\Psi_{\text{red}} + b\Psi_{\downarrow}\Psi_{\text{green}}.$$

This is still a superposition of states, but it is a superposition of states of a system consisting of the electron-spin plus the detector.

Observation of the detector (observing whether the light is red or green) then determines if the electron is spin-up or spin-down. The probability that the result is found to be spin-up, i.e the probability that the light is red is a^2 - and similarly the probability that the result is found to be spin-down, i.e the probability that the light is green is b^2 .

The rate at which this decoherence takes place depends on a number of properties of the environment - such as its temperature - but estimates of the decoherence time have suggested that for macroscopic systems, the time-scale for such a decoherence process is too short for any interference to occur (two waves can only interfere if they remain coherent for a period which is much longer than the period of the waves)- which is why we do not observe quantum behaviour in macroscopic objects.

Decoherence does not lead directly to wavefunction collapse. It does not directly explain why a measurement returns a particular value of a property of a quantum system, despite the fact that the system was initially in a state for which that value was not defined. It does, however, provide us with a mechanism which could explain how wavefunction collapse is observed.

13 Interpretations of Quantum Physics

13.1 Copenhagen Interpretation

The Copenhagen interpretation of Quantum Physics was developed by Niels Bohr and his assistant, Werner Heisenberg, between 1925 and 1927 [29]. It is based on the proposition that Physics is the Science of measurement and that a measurable quantity has no reality until it is measured. In the Copenhagen interpretation, one applies the rules of Quantum Mechanics to sub-microscopic systems but not to the measuring device, which is a macroscopic object that has the property (for reasons which are not understood) of effecting wavefunction collapse from a quantum superposition to a classical probabilistic state.

It is for this reason that a system can be in a superposition of several (or even an infinite number of) states in which a given measurable quantity takes on different values. Once a measurement is performed the wavefunction collapses to what Bohr described as a classical state – i.e. one can apply classical physics to the system after measurement.

Importantly, this means that questions that we are aching to ask, such as “which slit did the electron go through in Young’s (electron) double slit experiment?” may not be asked by a physicist, since in the interference experiment we do not observe which slit the electron passed through. A philosopher is, of course, at liberty to ask any question (s)he likes, but a physicist may only ask questions to which the answer has (at least in principle) been determined by a measurement.

Until the late 1950’s this was accepted as the standard interpretation of Quantum Physics, although as we shall see below, when taken to extremes it can lead to absurdities.

13.2 Many Worlds Interpretation.

An alternative to the Copenhagen interpretation of Quantum Physics is the “Many Worlds Interpretation”, first proposed by Hugh Everett [30] in 1957 and further developed by Bryce de Wit in the 1960’s and 1970’s [31].

This interpretation dispenses with the arbitrary distinction between the sub-microscopic and macroscopic (measuring apparatus), insisting that everything including the measuring apparatus and the observer must be treated as a Quantum system and that wavefunctions should be a wavefunction for the entire Universe. There is therefore no such concept of wavefunction collapse, although the Many Worlds Interpretation makes use of the idea of decoherence, which is explained in terms of quantum interaction between sub-microscopic systems and their environment.

Instead of arguing that the wavefunction collapses when a measurement is made the Many Worlds interpretation argues that each time an observation is made, the entire Universe splits into many Universes in which each possible outcome for the result of the observation occur. The probability of a particular outcome is reflected in the number of Universes in which that

particular outcome occurs. We return to the example used in section 10, in which particle confined in a box is in the superposition state

$$\Psi = \frac{1}{2}\Psi_1 + \frac{\sqrt{3}}{2}\Psi_2$$

representing a particle which does not have well-defined energy but could be in either the first or second allowed energy levels with respective probabilities $\frac{1}{4}$ and $\frac{3}{4}$. When the energy of the particle is observed the Universe splits into many Universes. The probability that a system in the above superposition state has probabilities $\frac{1}{4}$ and $\frac{3}{4}$ to be in the state described by Ψ_1 and Ψ_2 respectively, which means that in $\frac{1}{4}$ of those many Universes the energy of the particle is

$$\frac{h^2}{8mL^2}, \quad (\text{the } n = 1 \text{ energy level - see. eq.(8.4)})$$

and in $\frac{3}{4}$ of the Universes the energy of the particle is

$$\frac{h^2}{2mL^2}, \quad (\text{the } n = 2 \text{ energy level - see. eq.(8.4)})$$

This rather fanciful interpretation of Quantum Physics has now become accepted by many theoretical physicists as being more satisfactory than the Copenhagen interpretation, despite the fact that the mechanism which causes the splitting of the Universe is not explained in any more detail than wavefunction collapse. As you can probably tell, I am in the minority of physicists who finds the Many Worlds interpretation difficult to accept, and not particularly illuminating.

14 Two Enigmatic “Thought Experiments”

14.1 Schrödinger’s Cat

The famous Schrödinger’s cat experiment is a thought experiment conceived by Erwin Schrödinger in 1935 [32] to demonstrate that the Copenhagen interpretation of Quantum Physics leads to an absurdity.

An atom of a **radioactive** substance decays into its radioactive products, but we do not know exactly when this will happen. In keeping with the Copenhagen interpretation, this means that the atom is in a state which is a superposition of the parent atom and the daughter atom, until such a time that an observation is made on the atom to see if it has indeed decayed or is still in its initial state.

At the level of one atom, a superposition of two or more states is something that we have to live with and accept the fact that our experiences of the macroscopic world are simply inapplicable at the level of a single atom. But now imagine that this atom is coupled to the following macroscopic system.

1. **A Geiger counter,**
2. An electronic hammer which is triggered when the Geiger counter clicks,
3. A vial of a poisonous gas which is broken when the hammer is triggered,
4. A cat placed close to the vial of poison.

The entire system is placed in a box which is isolated from any observer.

A cartoon drawing of the experimental setup is shown in Fig. 41. The decay of a single radioactive atom causes the Geiger counter to click, which in turn causes the hammer to smash the vial, which in turn releases the poisonous gas, which in turn kills the cat (it is not known why Schrödinger chose a cat - *note* that this was a “thought” experiment - physicists do not conduct cruel experiments on animals!).

If the atom has decayed, the wavefunction for the entire system is in state 1, whose wavefunction, $\Psi(1)$, is the product of the wavefunction for each element:

$$\begin{aligned}\Psi(1) = & \Psi(\text{decayed atom}) \times \Psi(\text{clicked Geiger counter}) \times \Psi(\text{vial smashed by hammer}) \\ & \times \Psi(\text{poisonous gas released}) \times \Psi(\text{cat dead})\end{aligned}$$

On the other hand if the atom has not yet decayed the system, it is in state 2, whose wavefunction, $\Psi(2)$, is given by

$$\begin{aligned}\Psi(2) = & \Psi(\text{atom in its initial state}) \times \Psi(\text{Geiger counter unclicked}) \times \Psi(\text{hammer poised}) \\ & \times \Psi(\text{poisonous gas confined to vial}) \times \Psi(\text{cat alive})\end{aligned}$$



Figure 41: Schrödinger's cat experiment. The decay of a radioactive atom causes a Geiger counter to click, which releases a hammer, which smashes a vial of poison and kills the cat. Whilst the system is not observed and the atom is in a superposition of the parent atom and radioactive daughter, the cat is in a superposition of being alive and dead.

Since the entire system is enclosed in a box which is isolated from any observer then according to the Copenhagen interpretation the entire system must be in a superposition of these two states

$$a\Psi(1) + b\Psi(2),$$

where a^2 and b^2 are the probabilities that an observation of the system will find the cat to be dead or alive. This interpretation forces us to conclude that until such an observation is made the cat is in a superposition of being dead and alive, i.e. the cat is both dead and alive, until an observer chooses to open the box and observe the cat.

This thought experiment was rendered even more absurd by a refinement suggested by Eugene Wigner [33]. He suggested putting a friend in the box with the cat (protected from the poison). While the box remains closed the friend can observe the cat and for him (her) the wavefunction for the system either contains a live cat or a dead cat. But for the observer outside the box the wavefunction is still a superposition. This implies that the wavefunction for a system depends on the interaction of the system with the consciousness of the observer.

The difficulty lies in the fact that in the strict Copenhagen interpretation, wavefunction collapse only occurs when an observation (or measurement) is conducted. Nowadays, we would argue that wavefunction collapse occurs whenever there is interaction between a sub-microscopic quantum system and its macroscopic environment. Thus, although a single atom can be considered to be in a superposition of “decayed” and “not decayed”, the other devices in the thought experiment, whether or not they involve an actual observation of the cat, provide a macroscopic environment which induces wavefunction collapse. This point of view at least separates the concept of wavefunction collapse from the interaction of a system with the consciousness of the observer, in keeping with the usual scientific approach to Nature as being objective and disconnected from the mind of the experimentalist.

14.2 Einstein Rosen Podolsky (EPR) Paradox - entanglement

In 1935, Albert Einstein, Boris Podolsky and Nathan Rosen (EPR) [34] proposed a thought experiment which claimed to show that Quantum Mechanics was either incomplete or inconsistent with the results of Special Relativity.

They considered a particle at rest decaying into two identical particles. By conservation of momentum, these two decay particles must have equal and opposite momentum - so that one moves towards observer Alice and the other towards observer Bob. The momentum of the particles is not known, but we know that once we have measured the momentum of one of them, we know the momentum of the other. Thus, when Alice measures the momentum of her particle its wavefunction collapses into a wavefunction for a particle with well-defined momentum. Because the momenta are **correlated**, this means that the wavefunction of Bob’s electron, which is some distance away, also collapses at the same time. This implies what EPR called “spooky action at a distance” – and is supposed to be forbidden by Special Relativity, which tells us that nothing can travel faster than light.

Although EPR considered the position or momentum of a particle, which, according to

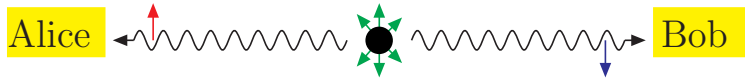

Figure 42: A particle with no spin decays into two electrons, one of which is observed by Alice and the other by Bob. If Alice measures the component of spin in a given direction and finds that it is spin up, then she knows for certain that a measurement of the component of Bob’s electron in that direction will show it to be spin down (or vice versa).

Heisenberg’s uncertainty principle, cannot be measured simultaneously, it turns out to be clearer if we consider a two-state system such as the spin of an electron. In analogy with the fact that one cannot determine the position and momentum of a particle with arbitrary accuracy and that a measurement of one or the other alters the wavefunction, we cannot measure the component of spin of a particle in more than one direction. The act of measuring the spin of the electron, thereby obtaining a given result (up or down) for the spin component in that direction, collapses the wavefunction into one which describes an electron with that particular value for the component of spin in that direction.

Now let us consider a particle at rest with no spin, that decays into two electrons moving in opposite directions - one towards the experimentalist Alice and the other towards the experimentalist Bob. By conservation of spin we know that if Alice’s electron is spin up (measured in any direction) the Bob’s will be spin down and vice versa. This is demonstrated in Fig. 42. However, before any such measurement is made we do not know which of these results will be found - it could be either way. The state of the two electrons considered together is a superposition of these two possible outcomes, written as

$$\frac{1}{\sqrt{2}} (\Psi_{\uparrow}^A \Psi_{\downarrow}^B - \Psi_{\downarrow}^A \Psi_{\uparrow}^B)$$

(where the superscripts A and B refer respectively to Alice’s and Bob’s electron). Such a wavefunction describes what is called an “**entangled state**”¹⁵ as it cannot be factorized into a wavefunction describing Alice’s electron multiplied by a wavefunction describing Bob’s electron. Note that this does not mean *either* Alice’s electron is spin up and Bob’s is spin down *or* vice versa but that the two electrons are in a state which is a superposition of both possibilities.

If Alice measures the component of spin of her electron in some direction and finds it to be $+\frac{1}{2}\hbar$, then the wavefunction for the two electrons collapses into the state $\Psi_{\uparrow}^A \Psi_{\downarrow}^B$ whereas if she finds it to have component $-\frac{1}{2}\hbar$, then the wavefunction for the two electrons collapses into $\Psi_{\downarrow}^A \Psi_{\uparrow}^B$.

¹⁵The state of the system in the Schrödinger’s cat experiment is also an entangled state as it is a superposition of a state in which the atom has not decayed, the Geiger counter has not clicked ... and the cat is alive, and the state in which the atom has decayed ... and the cat is dead.

Whatever the result of Alice's measurement is, the wavefunction not only for her electron but also for Bob's electron is instantaneously altered. EPR argued that this constituted an instantaneous action at a distance, which violates the principles of Special Relativity.¹⁶

EPR concluded that the only possible resolution of this "paradox" was that the two electrons did indeed possess a well-defined value for the component of spin in any direction (Alice's and Bob's electron spin in that direction would always be opposite), but that Quantum Physics was incomplete in that it did not permit one to determine what these values were. Such an interpretation is known as the "hidden variable" theory, and whereas it is easier for us to comprehend because it relates directly to similar experiences we have in the macroscopic world, it turns out to be inconsistent with the predictions of Quantum Physics.

¹⁶Ironically, Einstein misunderstood his own theory, which does not forbid action at a distance as long as this cannot be used to transmit information faster than the speed of light. There is no way that Alice can use her measurement to send a message to Bob (e.g. spin up means "yes" and spin down means "no") as she does not know, a priori, what the result of her measurement will be. The wavefunction for an entire extended system collapses instantaneously when a measurement is performed, but no part of the extended system actually communicates with another part.

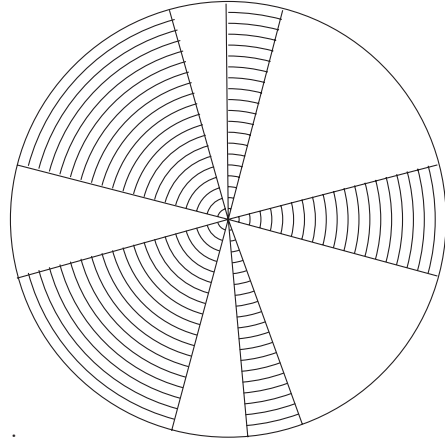

Figure 43: A representation of the spin part of the electron wavefunction as postulated by the theory of hidden variables. A measurement of the spin in a direction within a shaded area yields the result $+\frac{1}{2}\hbar$, whereas a measurement of the spin in a direction within a unshaded area yields the result $-\frac{1}{2}\hbar$.

15 Hidden Variables

If we return to the EPR experiment described above, the hidden variable hypothesis postulates that the electron is in a state such that if one were to choose to measure the spin of an electron in any given direction, there is a pre-determined result which is either $+\frac{1}{2}\hbar$ or $-\frac{1}{2}\hbar$. This means that if we are going to measure the spin transverse to the electron's direction of motion and we imagine a circle in the plane transverse to the electron's direction of motion, then there are sectors of that circle in which the spin component is $+\frac{1}{2}\hbar$ and others in which it is $-\frac{1}{2}\hbar$. An example is shown in Fig. 43, which shows a circle which is a representation of the state of an electron whose spin in any given direction is determined. The shaded sectors are the directions in which a measurement of the spin will return the result $+\frac{1}{2}\hbar$ and the unshaded sectors are those in which a measurement of the spin will return the result $-\frac{1}{2}\hbar$. Note that each shaded sector has an unshaded sector exactly opposite reflecting the fact that if a measurement of spin in a particular direction yields the result $+\frac{1}{2}\hbar$ then a measurement in exactly the opposite direction will give the opposite result.

In 1964, John Bell [35] proved that Quantum Mechanics was not compatible with the theory of hidden variables, in which all classical properties of a system are determined but not measured. He also proposed a clean experiment which was able to distinguish between the predictions of Quantum Mechanics and the predictions of the theory of hidden variables. The experiment consists of sending one electron from a decaying particle to Bob and the other to Alice. The two electron spins are correlated in the sense that if both Alice and Bob measure the spins of their electrons in the same direction, conservation of spin leads to the fact that one will be spin up and yield the result that the component of spin in that direction

is $+\frac{1}{2}\hbar$, whereas the other will be spin down and yield the result that the component of spin in that direction is $-\frac{1}{2}\hbar$. The electrons are in an entangled state, being a superposition of [Alice's electron spin-up; Bob's electron spin-down] and [Alice's electron spin-down; Bob's electron spin-up]:

$$\frac{1}{\sqrt{2}} (\Psi_{\uparrow}^A \Psi_{\downarrow}^B - \Psi_{\downarrow}^A \Psi_{\uparrow}^B)$$

so before the measurement, we do not know which of the two combinations we will find. Now suppose that Alice and Bob do not measure the spins of their electrons in the same direction, but in two different directions making an angle θ to each other. In this case there is a possibility that we will find both spins up or both spins down (i.e. both electrons having spin component $+\frac{1}{2}\hbar$ or both having spin component $-\frac{1}{2}\hbar$). Note that the total number of measurements N is equal to the sum of these:

$$N = N_{\uparrow\downarrow} + N_{\downarrow\uparrow} + N_{\uparrow\uparrow} + N_{\downarrow\downarrow},$$

where $N_{ab}(\theta)$, with a, b running over \uparrow, \downarrow , is the number of measurements for which Alice's electron turns out to have spin component a in a given direction, and Bob's electron turns out to have spin component b in a direction at an angle θ to the direction in which Alice made her measurement.

We define the correlation factor for an angular separation of the 2 directions of measurement, θ , as

$$C(\theta) = \frac{(N_{\uparrow\downarrow} + N_{\downarrow\uparrow} - N_{\uparrow\uparrow} - N_{\downarrow\downarrow})}{N}, \quad (15.1)$$

Note that at $\theta = 0$, $C = 1$, the spins of the two electrons are totally correlated.

The hypothesis of hidden variables tells us that if we consider, for example, the $x - z$ plane then at any direction in that plane, the component of spin in that direction is either $+\frac{1}{2}\hbar$ for Alice's electron and $-\frac{1}{2}\hbar$ for Bob's or the other way around - so that a circle in the $x - z$ plane is partitioned into sectors with one or the other allowed combination, as shown in Fig. 44. When Alice's and Bob's chosen directions for the measurement of the spin both fall in the same sector as shown in Fig. 44(a) the spins are correlated (one is up and the other is down), but if they fall in adjacent sectors as shown in Fig. 44(b) then they are uncorrelated - they both have spin up or both spin down.

The maximum correlation within the hidden variable hypothesis occurs when the circle in the $x - z$ plane is divided into two semi-circles, as shown in Fig. 45. The two semi-circles define two regions - one for which Alice's electron is spin up and Bob's is spin down and the other which Alice's electron is spin down and Bob's is spin down and the other which Alice's electron is spin down and Bob's is spin up. In Fig. 45 the boundary between the two is shown at 45° to the axes, from top-left to bottom right - but it could have been at any random angle.

If the hidden variable distribution being as shown in Fig. 45, and the spins of the two electrons are measured in two directions with angular separation θ , then the probability that

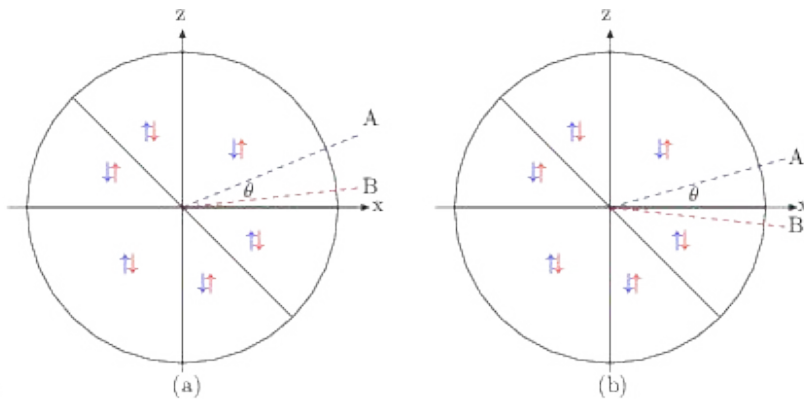

Figure 44: Assuming that in any direction the spin of the two electrons is determined, this shows a typical distribution of directions in which Alice's electron (blue) is up and Bob's (red) is down, or vice versa. In (a) the two directions of measurement by Alice and Bob fall in the same sector, so that one electron is measured to be up and the other is found to be down. In (b) the two directions of measurement crosses a boundary between sectors. The direction of Alice's measurement in in the sector in which her electron (blue) is spin down, whereas the direction of Bob's measurement is in an adjacent sector for which his electron (red) is also spin down.

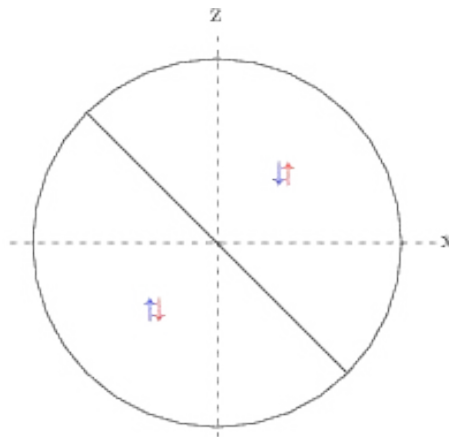

Figure 45: The maximum correlation allowed by the hypothesis of hidden variables is the case where the directions in which Alice's electron is spin up and Bob's is spin down all lie in one semi-circle – with the directions in which Alice's electron is spin down and Bob's electron is spin up lie in the other semi-circle.

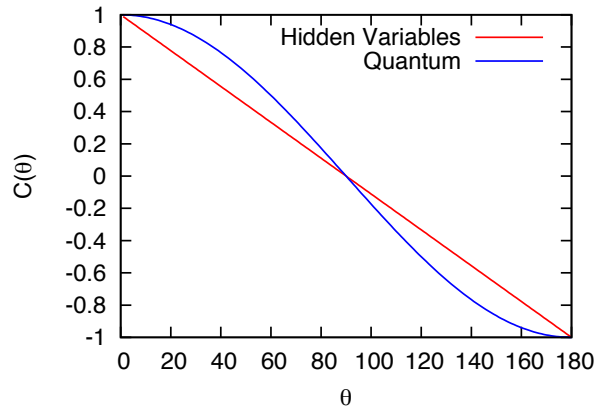

Figure 46: The red line shows the maximum correlation allowed within the hypothesis of hidden variables, whereas the blue curve is the result obtained from Quantum Mechanics. We see that for angles less than 90° the prediction of Quantum Physics exceeds the maximum allowed by the theory of hidden variables.

these two directions straddle both semi-circles, so that the results of the measurement of the two spins are the same (as in diagram (b) of Fig. 44), is $\theta/180$ and the probability that they are both in the same semi-circle, so that the results of the measurement of the two spins are opposite (as in diagram (a) of Fig. 44), is $1 - \theta/180$. From this we conclude that if the experiment is repeated over a very large number, N , of identical systems then

$$\frac{(N_{\uparrow\uparrow} + N_{\downarrow\downarrow})}{N} = \frac{\theta}{180} \text{ and}$$

and

$$\frac{(N_{\uparrow\downarrow} + N_{\downarrow\uparrow})}{N} = 1 - \frac{\theta}{180},$$

so that the correlation function $C(\theta)$ is given by:

$$C(\theta) = \frac{(N_{\uparrow\uparrow} + N_{\downarrow\downarrow} - N_{\uparrow\downarrow} - N_{\downarrow\uparrow})}{N} = 1 - \frac{\theta}{90}. \quad (15.2)$$

This then is the maximum value that this quantity can have within the hypothesis of hidden variables. It is shown in the red line of Fig. 46. Since this is the *maximum* value that the correlation $C(\theta)$ can have within the hypothesis of hidden variables, i.e. the correlation is smaller than or equal to that shown in the red line, this is known as “**Bell’s inequality**”.

However, the result of a calculation using the rules of Quantum Mechanics gives

$$C(\theta) = \cos \theta. \quad (15.3)$$

This is shown in the blue curve in Fig. 46. We see that if the angle between the directions is less than 90° the blue curve is above the red line, meaning that the prediction of Quantum

Mechanics for the probability that the spins are opposite, exceeds the maximum probability allowed within the hypothesis of hidden variables.

The first test of Bell's inequality was conducted by Stuart Freedman and John Clauser [36] in 1972, but the most decisive experiment was carried out in 1982 by Alain Aspect [37]. It was found that the inequality was violated for angles between the two spin measurement of less than 90^0 and that the measured correlation agreed to a very high degree of accuracy with the prediction of Quantum Mechanics. We therefore have experimental evidence that an electron does not possess a well-defined component of spin in more than one direction. *There are no hidden variables.*

16 Why is the Quantum World so Small?

- The energy of a photon of visible light is approximately 0.000000000000000001 Joules.
- The mass of one hydrogen atom is 0.00000000000000000000000000067 kg.
- The (negative) charge of an electron is 0.00000000000000000016 Coulombs.
- The time that an atom remains in an excited state before making a transition to a lower state is approximately 0.00000001 seconds.
- The average energy of a hydrogen molecule in a gas at 0° C is approximately 0.000000000000000001 Joules.
- The average distance of an electron from the nucleus in a hydrogen atom is 0.00000000053 meters.

Why are these numbers so small? The answer is that they are not necessarily small. *We are big.* The overwhelming majority of the estimated 8.7 million species on Earth are too small to be seen with the naked eye - and only a small number of animal species are bigger than we are.

The numbers quoted above which are typical numbers encountered in the quantum world are “small” because they are quoted in units which humans have defined to be of the size relevant to our everyday experiences in the macroscopic world:

- A joule is approximately the energy used in lifting a small object off the floor.
- A second is approximately the time taken to say “one alligator”.
- A meter is a little over half the height of an average human.
- A kilogram is the mass of an object that we can comfortably throw.
- A coulomb is approximately the charge that passes through a small torch bulb in three seconds.

So the question should really be “Why are we so big?”. One of the consequences of our size is that we have big brains. Our nervous system has 86 billion neurons, whereas a mouse only has 71 million neurons. These large brains make us sufficiently intelligent to be able to study physics, biology and other disciplines in order to discover (at least some of) the secrets of Nature. In particular, this enables us to pose the question above. Therefore according to the reasoning of the “**anthropic principle**”, we must be the size we are, so that our brains are sufficiently developed to enable us to pose the question in the first place. Many scientists find this anthropic principle “distasteful” because it invokes the concept of human consciousness to answer a question about Nature, which is assumed to be objective. Nevertheless the logic of this method of reasoning is well-founded. There are many species

that are much smaller than we, and some of the single-cell bacteria have dimensions which are only a little larger than those of typical quantum phenomena. However, these microscopic species do not ask questions about their size in comparison with quantum scales.

17 Probabilistic Determinism

It is often stated that, unlike classical physics, Quantum Physics is not deterministic. This statement is not really correct, but we need to define carefully what can and what cannot be determined. Very simply, this means that we can only determine the properties of a system that the system actually possesses (pretty obvious really!). In classical mechanics, given an initial condition, defined by the exact position and momentum of a particle at some time, Newton's laws of motion provide us with a set of equations, whose solution will determine the position and momentum of that particle at any subsequent time. The reason why this determination is not possible in Quantum Physics is simply because Heisenberg's Uncertainty relation prevents us from realizing the required initial condition. Remember that this uncertainty relation tells us that the particle does not possess well-defined position and momentum, so it is meaningless to ask whether we can determine them.

On the other hand, if a system is known to be in a certain quantum state, described by a wavefunction at time t_1 , $\Psi(\mathbf{x}, t_1)$, then the solution to Schrödinger's equation gives us exactly the wavefunction, $\Psi(\mathbf{x}, t_2)$, at a later time t_2 – and therefore (provided we can solve Schrödinger's equation) we know the quantum state of the system at any later time.

From the wavefunction at any time, we can determine what is the probability that a measurement of the position of the particle will yield a value in a small range between x and $x+dx$. A well-defined mathematical procedure can be employed to determine the probability that a measurement of momentum will yield a value in a small range between p and $p+dp$. Since the wavefunction can be determined at any time, these probabilities can be determined at any time. So we see that we do get some information from the knowledge of a quantum state of a system. Although we are not able to determine the position and momentum of any particle in a quantum system, we can determine the probability that a measurement of its position will yield a result in a given range and similarly (by decomposing the wavepacket into its single frequency components) we can determine the probability that a measurement of momentum will yield a result in a given range - and the solution of Schrödinger's equation tells us that if these probabilities are known at some initial time they can be also calculated at any subsequent time. This means we do indeed have determinism, but only determinism of probability distributions of positions and momentum, as opposed to determinism of their exact values; these can be derived in classical mechanics, but clearly not in Quantum Physics since such exact values do not exist.

One of the reasons that we do not “understand” Quantum Physics is that we are uncomfortable with this probabilistic determination. However, we are quite used to this in other disciplines, such as the Social Sciences.

Suppose the Chancellor of the Exchequer (Minister of Finance) wishes to know what the extra revenue would result from an increase in tax on beer. (S)he would need to know how many people would reduce their beer intake as a result of the higher price and by how much. Civil Servants working in the treasury have models (theories) which enable them to calculate the probability that an individual would reduce his (her) beer consumption by a given amount (note that what is required here is a probability density $P(x)$ such that

$P(x)dx$ is the probability that an individual will reduce his (her) weekly consumption by an amount between x and $(x + dx)$. Provided the model used is correct, (i.e. that it is a faithful model of human behaviour) this is sufficient to predict the revenue gathered by the proposed increase in beer tax. However, no attempt is made to predict the behaviour of any one individual. Whether or not this might, even in principle, be possible, depends on whether it is the principle of pre-determination or the principle of free-will that correctly describes human behaviour. If pre-determination is correct, then the behaviour of any individual to an increase in beer tax is determined so that if we had a complete profile of the individual's biological and genetic structure together with a complete history of his/her past experiences, then a sufficiently sophisticated computer program could predict how (s)he would react to such an increase in tax on beer. In this sense the individual is being treated in a manner analogous to the "hidden variable" hypothesis. On the other hand, the free-will hypothesis argues that the decision of how to react is not pre-set and is only set by the person's free will when (s)he is actually confronted with the situation in which (s)he is required to make a choice. So far, we have not been able to devise an experiment which can unambiguously favour one or the other of the two viewpoints.

Probabilistic determinism in Quantum Physics is very much analogous to the above free-will example, (with the difference that it *has* been possible to devise and conduct an experiment which distinguishes between the predictions of Quantum Physics from those of the hidden variable hypothesis). If we go back to the double slit experiment, Quantum Physics (or simply wave physics) can be used to determine the probability that a particular photon will land at a particular position on the screen, but we cannot state exactly where it will land, since the photon does not possess the necessary properties that would enable us to make such a prediction. After this experiment has been conducted the fringe pattern which is observed will have dense regions such a probability density is high and sparse regions where it is low. Thus, although Quantum Physics does not allow us to determine where a particular photon will land, it does allow us to determine where we will find dense and sparse regions - and in this sense it is deterministic.

I regret to have to say that this limitation of determinism has theological implications. Most scientists will agree that Science and Religion can co-exist provided neither one encroaches on the domain of the other. Thus, for example, the theory of the creation of the Universe as expounded in the first chapter of the book of Genesis needs to be interpreted as, at best, symbolic. Likewise, one should not ask a scientist to determine at what point an admiration of the woman next door becomes an infringement of the tenth Commandment [38]. Theologians need to accept that the property of Omniscience assigned to the Supernatural has to be limited to knowledge of quantities that actually exist. In the Quantum world, we cannot determine when a particular cell will decay, since this is not a pre-determined quantity. All we can do is to determine the probability that a cell will decay after a certain period of time. This means that the time of death of any living organism (including us) is not pre-determined and cannot therefore be "known" to an Omniscient Supernatural being. On the other hand, it is perfectly possible that such an Omniscient Supernatural entity could be well aware of the fact that we covet our neighbour's wife, even if we have exercised sufficient self-control not to attempt to put our "secret" desire into practice.

18 Is Quantum Theory Correct and Complete?

Almost certainly and almost certainly not (*respectively*)!!

Quantum Theory provides us with a methodology (Quantum Mechanics) for calculating the probability of obtaining a given result of a given experiment. These probabilities can be tested experimentally by performing the measurement a large number of times, N . If the probability of obtaining a certain result, x , is $P(x)$, then we would expect this result to occur in $P(x)N$ of the measurements (up to statistical fluctuations which are well-understood). Such experiments yield results which are totally in agreement with the (probabilistic) predictions of Quantum Mechanics.

Furthermore, in the cases where Schrödinger's equation can be solved (at least to a very good approximation) to obtain the allowed energy levels of atoms, these have been in extremely good agreement with the results obtained from observation of atomic spectra. Ions at lattice sites in a crystal perform harmonic oscillation and the quantum behaviour of these oscillations leads to predictions of various thermodynamic properties of solids, such as their specific heat, which are also in good agreement with experimental measurements.

The most spectacular application of Quantum Physics is the working of a **transistor** which is the key component of all modern electronic devices. Transistors exploit the fact that an electron in a **semiconductor** can undergo the quantum tunnelling described earlier through a barrier of a different type of semiconductor - despite the fact that this cannot happen classically because the barrier repels the electrons. However, viewed as a wave, the wave can extend over both sides of the barrier so that there is some probability to find the electron on the other side. The tunnelling probability is very sensitive to the repulsive potential of the barrier, so a small variation in such a potential leads to a very large change in the rate of flow of electrons (electric current) through the barrier. This is the principle of a transistor amplifier.

All of this indicates that Quantum Theory is consistent with the laws of Nature. One can never be sure that there will not, in the future, be experimental measurements that yield results which are in conflict with the predictions of Quantum Physics - indeed the subject was born because experiments were conducted whose results were inconsistent with the thitherto accepted theory of Classical (Newtonian) Mechanics. Classical Mechanics is not "wrong". It is just "incomplete". It can be successfully applied to any macroscopic system providing results which agree with experiment to any reasonable degree of accuracy. However, when applied to the sub-microscopic world this agreement breaks down. It is quite possible that in the future, we will perform measurements of certain systems, which yield results that are not compatible with the predictions of Quantum Physics, so that Quantum Physics will also have to be amended or even replaced by a new theoretical framework appropriate to the analysis of such systems.

Even before this happens, it is clear that Quantum Theory as it currently stands, does not explain the process of measurement in a satisfactory matter. We do not understand how it can be that a sub-microscopic system which is in a superposition of states and therefore

does not possess a well-defined value for certain measurable quantities, can nevertheless be confronted with an appropriate measuring apparatus, from which definitive values for such quantities emerge. If we accept the Copenhagen interpretation, then we are unable to explain wavefunction collapse. The Many Worlds interpretation dispenses with the idea of wavefunction collapse, but one needs to understand how the Universe can be continually splitting in to many parallel Universes. Both interpretations rely on the idea of decoherence, in which quantum information of a sub-microscopic system is lost and the system which is described by quantum superposition of states is converted into a classical (and understandable) probability distribution. Decoherence is understood to arise from quantum interactions between a microsystem and its environment. So far this has only been “simulated” using somewhat ad hoc models. It has not been derived using Quantum Mechanics, which is the mathematical framework of Quantum Physics. In the meantime, we have to accept either the phenomenon of wavefunction collapse, or the idea of the Universe continually splitting into multiple Universes, in the same way that we have to accept all the other features of Quantum Physics, notwithstanding the fact that they are not compatible with our everyday experiences of the macroscopic world and defy human attempts to understand it in terms of visualization.

Appendix A - Glossary

- **Amplitude:** The maximum disturbance of an oscillating system in any one cycle.
- **Angular momentum:** A measure of how much an object is rotating or spinning. For a point particle rotating about an axis, it is the momentum of the particle multiplied by the perpendicular distance between the particle and the axis.
- **Anode:** A positively charged electrode.
- **Anthropic Principle:** The (philosophical) proposition that observations of the Universe must be compatible with the consciousness of the humans who conduct those observations.
- **Bell's Inequality:** The correlation between two measurements of the spin of a spin one-half particle separated by an angle θ is less than $1 - \theta/90$.
- **Binding Energy:** Energy required to liberate a particle from a bound state.
- **Blackbody:** A surface which absorbs all of the electromagnetic radiation incident upon it.
- **Boltzmann Constant:** A constant, denoted by k_B , which occurs often in thermodynamics. It is the volume (in cubic meters) occupied by one molecule of an ideal gas at a pressure of 1 Pascal (Newton per square meter) and a temperature of 1^0K (-272.16^0C). It takes the value 1.38×10^{-23} meter² kg per sec² per ^0K . At a pressure of one atmosphere and a temperature of 0^0C a molecule of an ideal gas occupies a volume of $2.7k_B$ litres.
- **Cathode:** A negatively charged electrode.
- **Chandrasekhar limit:** The maximum density of a neutron star for which the degeneracy pressure is sufficient to prevent a neutron star from collapsing under its own gravity.
- **Classical probabilistic state:** A state of a system in which a given property is well-defined but not known because it has not yet been measured. The probability that a measurement will yield a given result is known.
- **Component:** The component of a vector in the x, y , or z -direction in the projection of the vector in that direction. It is equal to the magnitude of the vector multiplied by the cosine of the angle between the direction of the vector and that axis. The vector is uniquely defined by its three components
- **Correlated:** Two quantities are completely correlated if there is a one-to-one relation between them. For example, the radius of a circle and its circumference are completely correlated. When a particle at rest (zero momentum) decays into two particles the momenta of the two decay particles are equal and opposite owing to the conservation of momentum. The two momenta are said to be completely correlated.

- **de Broglie wave Equation:** A particle with momentum p has an associated wave whose wavelength λ is given by

$$\lambda = \frac{h}{p}$$

- **Decoherence:** A process involving the interaction between a sub-microscopic system and a macroscopic environment by which a sub-microscopic system is transformed from being in a superposition of quantum states, into a classical probability distribution.
- **Degeneracy Pressure:** A system of forces of purely quantum origin which is a consequence of Pauli's exclusion principle and leads to the fact if two identical spin one-half particles have a high probability of being spatially close to each other, they then have a high probability to have very different momenta and therefore repel each other.
- **Degrees Kelvin ($^{\circ}\text{K}$):** The temperature in degrees Kelvin is an absolute temperature, defined in terms of the laws of thermodynamics and not in any way dependent on the nature of the thermometer used to measure the temperature. 0°K is the lowest possible temperature and is reached when all the atoms in the sample are in their ground (lowest energy) state. 0°C is approximately 273.16°K .
- **Diffraction:** The process by which two waves interfere with each other.
- **Electric field:** The electric field at some point \mathbf{x} , is the force on a unit charged particle at that point. Since force has a direction as well as magnitude the electric field at any point is a vector. An electric charge generates an electric field.
- **Electromagnetic radiation:** A wave of any wavelength in which the disturbance consists of an oscillating electric field and an oscillating magnetic field perpendicular to each other and also perpendicular to the direction of motion of the wave. Visible light is electromagnetic radiation with a wavelength between 390 nm and 700 nm.
- **Electron:** A negatively charged particle which moves around a nucleus in an atom.
- **Energy level:** One of the allowed energies of an atom or other quantum system.
- **Entangled State:** A state of two or more particles whose wavefunction cannot be expressed as the product of wavefunctions for the individual particles. $\frac{1}{2}$
- **Exclusion Principle:** A theorem due to Wolfgang Pauli that asserts that two identical spin- $\frac{1}{2}$ particles cannot be in the same quantum state.
- **Equilibrium:** A state of a system in which there are no net forces acting on any component of the system.
- **Frequency:** Frequency of an oscillating system is the number of cycles performed per second.
- **Geiger Counter:** A device for detecting radioactivity. The instrument clicks every time radioactive decay particle (α , β , or γ -ray) impinges on it.

- **Graphene:** An allotrope of carbon consisting of single layers of atoms in a hexagonal lattice.
- **Harmonic Motion:** Oscillation of a system about its equilibrium position with constant frequency.
- **Harmonic Oscillator:** A device which when displaced from equilibrium is subject to a restoring force proportional to the displacement. Such a device performs harmonic motion.
- **Helium atom:** An atom with a nucleus containing two protons and two electrons moving around it. Each electron is not only subject to a force which attracts it to the nucleus, and depends on the distance between the electron and the nucleus, but also a repulsive force due to the other electron, which depends on the distance between the electrons.
- **Hertz:** Unit of frequency equal to one cycle per second. It is abbreviated Hz.
- **Hydrogen atom:** An atom with a nucleus containing one proton and one electron moving around it. This is the simplest atom.
- **Impact parameter:** The perpendicular (shortest) distance between a target particle and the initial direction of a projectile particle that scatters off the target.
- **Infrared radiation:** Electromagnetic radiation whose wavelength is longer than any wavelength of visible light, i.e. greater than 700 nm.
- **Integer:** A whole number.
- **Interference:** The process in which the disturbance from two waves are added such that there are regions in which the total amplitude is enhanced (interference maxima) and regions in which it is depleted (interference minima).
- **Interference Pattern:** A series of light and dark fringes from the superposition of two or more coherent waves.
- **Ion:** An atom which is electrically charged owing to the fact that it has more (for negative ions) or fewer (for positive ions) electrons than protons in the nucleus.
- **Joule:** Unit of energy equivalent to the work done when a force of one Newton is moved through one meter (in the direction of the force).
- **Kinetic energy:** Energy that a particle possesses due to its motion. For a particle of mass, m , moving with a speed, v , (much less than the speed of light) the kinetic energy is given by $\frac{1}{2}mv^2$.
- **Lattice:** A regular array of sites – usually in three dimensions. In a crystalline solid these sites mark the equilibrium position of the ions in the crystal.

- **Magnetic Dipole:** A magnetic system consisting of a magnetic north pole and a magnetic south pole. A closed loop of electric current generates a magnetic dipole.
- **Magnetic Field:** The magnetic field at some point, \mathbf{x} , is the force on a unit magnetic north pole at that point. Since force has a direction as well as magnitude the magnetic field at any point is a vector. An electric current generates a magnetic field.
- **Magnetic Moment:** The magnetic strength of a magnetic dipole determined by the torque which the dipole experiences when placed in a magnetic field of unit strength.
- **Micron (μm):** One millionth of a meter, or one thousandth of a millimetre. A human cell has a size of approximately one micron in each direction.
- **Momentum:** The momentum, \mathbf{p} , of a particle of mass m travelling with velocity \mathbf{v} , (much smaller than the speed of light) is given by

$$\mathbf{p} = m\mathbf{v}.$$

It is a vector quantity. All three components of total momentum are conserved in a collision between two particles.

- **Monochromatic Wave:** (also known as a harmonic wave) is a wave with a single wavelength (single frequency).
- **Nanometer (nm):** One billionth of a meter, or one millionth of a millimetre.
- **Neutron Star:** A star consisting only of neutrons which attract each other due to gravity, but have no electromagnetic repulsion. The gravitational attraction is balanced by the degeneracy pressure of the identical spin- $\frac{1}{2}$ neutrons. This degeneracy pressure is sufficient to prevent the collapse of the neutron star provided its density is below the Chandrasekhar limit.
- **Newton:** Unit of force equal to the force which when applied to a mass of one kilogram produces an acceleration of one meter per second per second.
- **Nucleus:** Positively charged core of an atom, consisting of positively charged protons and neutral (uncharged) neutrons. The number of protons is equal to the number of electrons in a neutral atom.
- **Photoelectric Effect:** Phenomenon in which metals emit an electric current when radiated with electromagnetic radiation (e.g. light) above a certain frequency.
- **Photon:** A particle or “quantum” of light.
- **Planck’s Constant:** The energy of a single photon divided by its frequency. It is denoted by h and takes the value 6.63×10^{-34} Joules seconds. The symbol \hbar is often used in Quantum Physics - this is Planck’s constant divided by 2π .
- **Polarization:** The direction of the electric field of an electromagnetic wave.

- **Potential energy:** The energy that a particle possesses by virtue of its position in a force field.
- **Probability:** The probability of a system having the value x_i for some quantity, X is $P(x_i)$, if when the measurement of X is performed on N identical systems, the average number of times, $N(x_i)$ that the value of X is found to be x_i is given by

$$N(x_i) = NP(x_i),$$

Where “average” means averaged over a very large number of repetitions. For example the probability of a tossed coin coming down “heads up” is $\frac{1}{2}$ means that if the coin is tossed 100 times then on average we expect it to come down heads 50 times. This will not always be exactly correct - it could be a little more or a little fewer than 50 times. However, if this is repeated a sufficient number of times the average gets closer and closer to 50.

- **Probability Density:** A system has a probability density $P(x)$ if the probability of a given quantity being in the interval between x and $x + dx$ (where dx is a small interval of the quantity x) is $P(x)dx$.
- **Quantum:** A discrete quantity (i.e. a “packet”) of energy, or of an oscillating system.
- **Quantum Numbers:** A set of integer numbers used to label the allowed discrete values of the physical properties of a system of particles in a given quantum state.
- **Quantum State:** A state of a system defined by the values of the properties of the system which can be exactly determined simultaneously, such as energy and momentum for a free particle (but not position and momentum whose values cannot, according to Heisenberg’s uncertainty relation, be simultaneously determined.)
- **Quantum Tunnelling:** Process in which a particle with a given energy E can tunnel through a potential barrier whose maximum potential is larger than E . Classically this would be forbidden by conservation of energy and the particle would always be reflected at the boundary of the barrier. But in Quantum Physics the wave is attenuated but not eliminated by the potential barrier and so there remains a non-zero probability to find the particle on the other side of the barrier.
- **Radioactivity:** Process by which one type of nucleus converts into a different type by the spontaneous emission of an α -particle, β -particle or a γ -ray.
- **Repulsive force:** A force acting between two particles which increases the distance between the particles.
- **Resolving power:** The resolving power of an optical device is the minimum separation or angular separation of two objects that can be distinguished by the device.

- **Rydberg Constant:** This is a constant, R_H , which gives the wavelength, λ_{nm} , of the light emitted or absorbed when a hydrogen atom makes a transition between energy levels denoted by (principal) quantum numbers n and m

$$\frac{1}{\lambda_{nm}} = R_H \left| \frac{1}{n^2} - \frac{1}{m^2} \right|$$

It has a value of 10973731 per meter.

- **Schrödinger Equation:** A differential equation describing a particle or system of particles moving under the influence of a field of forces, whose solution is the wavefunction for that particle or system of particles.
- **Semiconductor:** A material which conducts electricity but with a very high resistance. An example is silicon which has a resistivity of 2300 Ohm-meters, compared with copper which is a conductor with a resistivity of 1.7×10^{-8} Ohm-meters.
- **Spectral Lines:** Wavelengths of the spectrum of an atom.
- **Spectrum:** Frequencies of light (or other electromagnetic) radiation emitted or absorbed by a given atom when an electron makes a transition from one energy level to another.
- **Spin down:** A particle whose component of spin in a given direction is $-\frac{1}{2}\hbar$.
- **Spin up:** A particle whose component of spin in a given direction is $+\frac{1}{2}\hbar$.
- **Standing Wave:** A wave whose shape does not change with time but oscillates about its equilibrium position.
- **State:** see quantum state
- **Superposition:** A superposition of waves is the wave formed by adding the disturbances of many (possibly infinite number of) waves with different wavelengths (frequencies). A particle or system of particles whose wavefunction is a superposition of quantum states does not possess well-defined values for the physical quantities that label the quantum states.
- **Transistor:** A component (such as an amplifier) used in electronic devices. It consists of several (at least three) layers of semiconductor of different type with electrodes attached to each layer.
- **Travelling wave:** A wave in which a point with a fixed disturbance travels with time in the direction of the wave motion.
- **Ultraviolet radiation:** Electromagnetic radiation with a wavelength shorter than the wavelength of any visible light – i.e. shorter than 390 nm.

- **Uncertainty Principle:** Werner Heisenberg's relation between the uncertainty, Δx , in the position of a particle and the uncertainty, Δp , in its momentum.

$$\Delta x \Delta p > \frac{1}{2} \hbar.$$

- **Vector:** A quantity which has direction as well as magnitude. Examples are position (measured relative to a chosen origin), velocity, acceleration, force, momentum, electric field, magnetic field.
- **Volt:** A measure of potential difference. When a unit electric charge (1 coulomb) moves between two points whose potential difference is one volt, it gains or loses one Joule of potential energy.
- **Wave disturbance:** The disturbance from equilibrium of a quantity which defines the wave.
- **Wavefront:** At any one time the wavefront of a wave is a surface of points with equal disturbance.
- **Wavefunction:** A mathematical function of space and time, but also possibly of a spin coordinate, which defines a de Broglie (matter) wave.
- **Wavefunction Collapse:** A process by which the wavefunction of a system which does not have well-defined values for certain measurable quantities is transformed into the wavefunction describing a system in which the quantities have definite value.
- **Wavelength:** The distance (measured in the direction of propagation of the wave) between two adjacent points with the same disturbance.
- **Wavenumber:** The inverse of wavelength.
- **Wavepacket:** A wave disturbance which exists only over a finite range and consists of a superposition of waves with different wavelengths (different frequencies).
- **Work function:** The energy required to liberate an electron from its binding in a metal.
- **X-rays:** Electromagnetic radiation with a wavelength about one thousand times shorter than any visible light. X-rays have higher penetration than visible light, and can penetrate human flesh.
- **Young's Slits:** An experiment in which one observes the interference between light emerging from two narrow slits.
- **α -particle:** A particle emitted in certain types of radioactive decay (α -decay). It is the nucleus of He^4 , consisting of two protons and two neutrons.
- **β -particle:** An electron emitted in certain types of radioactive decay (β -decay)

- **γ -ray:** Electromagnetic radiation with a wavelength even shorter than those of X-rays. They are also emitted during radioactive decay, when a nucleus makes a transition from an excited energy level to a lower energy level.

Appendix B - Mathematical Formulae

DO NOT READ THIS APPENDIX

This appendix is included for completeness and for those of you who are curious to see the relevant mathematical formulae and equations, even if you do not understand the notation. It is *not* necessary to read this.

Waves

The disturbance $\Psi(x, t)$ of a monochromatic wave with wavelength λ moving in the positive x -direction, with amplitude A :

$$\Psi(x, t) = A \sin \left(\frac{2\pi}{\lambda}(x - ct) + \phi \right), \quad (\text{B.1})$$

where c is the wave speed and ϕ is the initial phase at $x = t = 0$.

The frequency of the wave is:

$$f = \frac{c}{\lambda} \quad (\text{B.2})$$

Interference

The intensity of monochromatic radiation, $I(x)$ with wavelength λ from two narrow slits separated by a distance a at a distance x from the centre of a screen placed at a distance D from the slits ($x \ll D$):

$$I(x) = I(0) \cos^2 \left(\frac{2\pi xa}{\lambda D} \right) \quad (\text{B.3})$$

The intensity of monochromatic radiation, $I(x)$ with wavelength λ from a narrow object (such as a pin) of width a at a distance x from the centre of a screen placed at a distance D from the object:

$$I(x) = I(0) \frac{\lambda^2 D^2}{4\pi^2 x^2 a^2} \sin^2 \left(\frac{2\pi xa}{\lambda D} \right) \quad (\text{B.4})$$

Wavepackets

The disturbance $\Psi(x, t)$ due to a wavepacket moving along the positive x -axis may be described by

$$\Psi(x, t) = f(x - ct). \quad (\text{B.5})$$

$f(x)$ can be any continuous function of x but for a localized wavepacket it would be a function with local support and a single maximum at the peak of the wavefunction.

This may be written in terms of a superposition of disturbances due to harmonic wave with wavelength λ by

$$\Psi(x, t) = \int_0^\infty \left[A^{(e)}(\lambda) \cos\left(\frac{2\pi}{\lambda}(x - ct)\right) + A^{(o)}(\lambda) \sin\left(\frac{2\pi}{\lambda}(x - ct)\right) \right] d\lambda, \quad (\text{B.6})$$

where

$$A^{(e)}(\lambda) = \frac{4}{\lambda^2} \int_0^\infty f^{(e)}(y) \cos\left(\frac{2\pi y}{\lambda}\right) dy$$

and

$$A^{(o)}(\lambda) = \frac{4}{\lambda^2} \int_0^\infty f^{(o)}(y) \sin\left(\frac{2\pi y}{\lambda}\right) dy.$$

The even and odd parts of the function $f(y)$ are defined by

$$f^{(e)}(y) = \frac{1}{2} (f(y) + f(-y))$$

$$f^{(o)}(y) = \frac{1}{2} (f(y) - f(-y))$$

Classical Particle Physics

The kinetic energy, T , of a particle of mass m with a velocity v (much smaller than the speed of light):

$$T = \frac{1}{2}mv^2 \quad (\text{B.7})$$

The (vector) momentum \mathbf{p} of a particle of mass m with a velocity \mathbf{v} :

$$\mathbf{p} = m\mathbf{v} \quad (\text{B.8})$$

Rutherford Scattering

An α -particle with electric charge $4e$ and kinetic energy E scattering off a nucleus with electric charge Ze with impact parameter b scatters through an angle θ where

$$b = \frac{Ze^2}{2\pi\epsilon_0 E} \cot\left(\frac{\theta}{2}\right). \quad (\text{B.9})$$

This leads to a differential scattering cross-section (per unit solid-angle)

$$\frac{d\sigma}{d\Omega} = \frac{Z^2 e^4}{16\pi^2 \epsilon_0^2 E^2 \sin^4(\theta/2)} \quad (\text{B.10})$$

Blackbody Radiation

The energy radiated, $R(\lambda, T) d\lambda$, per unit time per unit area in a wavelength interval between λ and $\lambda + d\lambda$ at temperature T , from a blackbody :

Rayleigh-Jeans' Formula:

$$R(\lambda, T) = \frac{2\pi c}{\lambda^4} k_B T \quad (\text{B.11})$$

Planck's Radiation Law:

$$R(\lambda, T) = \frac{2\pi hc^2}{\lambda^5} \frac{1}{(e^{hc/\lambda k_B T} - 1)} \quad (\text{B.12})$$

Photoelectric Effect

Energy, E of a photon (quantum) of electromagnetic radiation with frequency f

$$E = hf \quad (\text{B.13})$$

The stopping potential, V_0 , for photoelectrons emitted from a metal with work function ϕ_0 , illuminated with radiation of frequency f ;

$$eV_0 = hf - \phi_0 \quad (\text{B.14})$$

Compton Scattering

A photon of wavelength λ which scatters off a target of mass m through a scattering angle θ emerges with wavelength λ' :

$$\lambda' = \lambda + \frac{h}{mc} (1 - \cos \theta) \quad (\text{B.15})$$

Bragg Scattering

The intensity of scattered of X-rays with wavelength λ from a crystal lattice whose lattice planes are separated by d has a maximum at angles of incidence θ between the incident radiation and the lattice planes whenever:

$$2d \sin \theta = n\lambda \quad (\text{integer } n) \quad (\text{B.16})$$

Matter (de Broglie) Waves

A particle with momentum p has a wavelength, λ :

$$\lambda = \frac{h}{p} \quad (\text{B.17})$$

Heisenberg Uncertainty Relation

The uncertainty, Δp , in momentum and the uncertainty, Δx , in position obey the inequality

$$\Delta x \Delta p > \frac{1}{2} \hbar \quad (\text{B.18})$$

Schrödinger's Equation

One Dimension

Wavefunction $\Psi(x, t)$ for a particle of mass m moving in one dimension in a force field whose potential is $V(x)$:

$$i\hbar \frac{\partial \Psi(x, t)}{\partial t} = -\frac{\hbar^2}{2m} \frac{\partial^2 \Psi(x, t)}{\partial x^2} + V(x) \Psi(x, t) \quad (\text{B.19})$$

Example 1: A particle of mass m confined to a square well with walls at $x = 0$ and $x = L$:

$$\begin{aligned} V(x) &= 0 \quad \leq x < L \\ &= \infty \quad x < 0, \text{ or } x > L \end{aligned}$$

Solutions:

$$\Psi_n(x, t) = \sqrt{\frac{2}{L}} e^{-iE_n t/\hbar} \sin\left(\frac{n\pi x}{L}\right) \quad (\text{B.20})$$

where the energy levels E_n are given by

$$E_n = \frac{n^2 \hbar^2}{8mL^2} \quad (\text{B.21})$$

Example 2: A particle of mass m performing harmonic motion with frequency f :

$$V(x) = 2\pi^2 m f^2 x^2$$

Solutions:

$$\Psi_n(x, t) = e^{-iE_n t/\hbar} \left(\frac{4\pi m f}{h}\right)^{\frac{1}{4}} \frac{1}{\sqrt{2^n n!}} H_n\left(2\pi\sqrt{\frac{m f}{h}} x\right) \quad (\text{B.22})$$

where the energy levels E_n are given by

$$E_n = \left(n + \frac{1}{2}\right) h f \quad (\text{B.23})$$

and $H_n(y)$ are Hermite polynomials of the argument y .

Three dimensions

Wavefunction $\Psi(\mathbf{r}, t)$ for a particle of mass m moving in one dimension in a force field whose potential is $V(\mathbf{r})$:

$$i\hbar \frac{\partial \Psi(\mathbf{r}, t)}{\partial t} = -\frac{\hbar^2}{2m} \nabla^2 \Psi(\mathbf{r}, t) + V(\mathbf{r}) \Psi(\mathbf{r}, t), \quad (\text{B.24})$$

where the Laplacian operator, ∇^2 , is given in cartesian coordinates by

$$\nabla^2 = \frac{\partial^2}{\partial x^2} + \frac{\partial^2}{\partial y^2} + \frac{\partial^2}{\partial z^2}$$

and in spherical polar coordinates (r, θ, ϕ) by

$$\nabla^2 = \frac{1}{r^2} \frac{\partial}{\partial r} \left(r^2 \frac{\partial}{\partial r} \right) + \frac{1}{r^2 \sin \theta} \frac{\partial}{\partial \theta} \left(\sin \theta \frac{\partial}{\partial \theta} \right) + \frac{1}{r^2 \sin^2 \theta} \frac{\partial^2}{\partial \phi^2}$$

Example: The Hydrogen atom. An electron of mass m_e and electric charge $-e$ moving in the electric field of a proton whose electric charge $+e$.

$$V(\mathbf{r}) = \frac{e^2}{4\pi\epsilon_0 r} = \alpha^2 m_e c^2 \left(\frac{a_0}{r} \right),$$

where the dimensionless constant α known as the “fine-structure constant” is defined by

$$\alpha = \frac{e^2}{4\pi\epsilon_0 \hbar c},$$

(c being the speed of light in vacuo), and the Bohr radius a_0 is given by

$$a_0 = \frac{\hbar}{\alpha m_e c}$$

The spherically symmetric (i.e. angular independent) solutions are:

$$\Psi_n(\mathbf{r}, t) = \frac{2}{n} \left(\frac{1}{na_0} \right)^{\frac{3}{2}} e^{-iE_n t/\hbar} e^{-r/(na_0)} L_{(n-1)}^1 \left(\frac{2r}{na_0} \right) \quad (\text{B.25})$$

where $L_n^i(y)$ are associated Laguerre polynomials of the argument y .

The energy levels E_n are given by

$$E_n = \frac{\alpha^2 m_e c^2}{2n^2} \quad (\text{B.26})$$

The wavelength, λ_{mn} , of electromagnetic radiation emitted or absorbed when a hydrogen atom makes a transition between energy level E_n and E_m is given by

$$\frac{1}{\lambda_{mn}} = \frac{1}{\hbar c} |E_n - E_m| = R_H \left| \frac{1}{n^2} - \frac{1}{m^2} \right| \quad (\text{B.27})$$

Inserting eq.(B.26) into eq.(B.27) gives the expression for the Rydberg constant R_H

$$R_H = \frac{\alpha^2 m_e c}{2h}.$$

Spin

The spin-wavefunction, Ψ_+ for a spin- $\frac{1}{2}$ particle whose component of spin measured in the direction with polar angle θ and azimuthal angle ϕ is $+\frac{1}{2}\hbar$ is given by:

$$\Psi_+ = \cos\left(\frac{\theta}{2}\right)\Psi_{\uparrow} + \sin\left(\frac{\theta}{2}\right)e^{i\phi}\Psi_{\downarrow} \quad (\text{B.28})$$

where Ψ_{\uparrow} and Ψ_{\downarrow} are the spin wavefunctions corresponding to spin component $+\frac{1}{2}\hbar$ and $-\frac{1}{2}\hbar$ (respectively) in the z -direction.

The spin-wavefunction, Ψ_- corresponding to a component $-\frac{1}{2}\hbar$ in the (θ, ϕ) direction is given by:

$$\Psi_- = \sin\left(\frac{\theta}{2}\right)e^{-i\phi}\Psi_{\uparrow} - \cos\left(\frac{\theta}{2}\right)\Psi_{\downarrow} \quad (\text{B.29})$$

References

- [1] R.P.Feynman, “The Character of Physical Laws” *MIT Press* (1967).
- [2] S.Chandrasekhar, *Philosophical Magazine* **11** (1931) 592.
S.Chandrasekhar, *Astrophysical Journal* **74** (1931) 81.
S.Chandrasekhar *MNRAS Monthly* **95** (1935) 207.
- [3] E.Schrödinger, *Phys. Rev.* **28 (6)** 1926 1049.
- [4] T.Young, *Philosophical Transactions of the Royal Society of London.* **92** (1802) 12.
- [5] I.Newton, *Philosophiae Naturalis Principia Mathematica* (1687).
- [6] E.Rutherford, *Phil. Mag.* **Vol. 6** (1911) 21.
- [7] H.Geiger and E.Marsden, *Proc. Roy. Soc.* **82** (1909) 495.
- [8] K.S.Novoselov, A.K.Geim, et. al. *Science.* **306** (2004) 666.
- [9] A.Einstein, *Annalen der Physik* **17** (1905) 891.
- [10] J.W.S.Rayleigh, *Phil. Mag* **49** (1900) 539.
J.W.S.Rayleigh, *Nature* **72** (1905) 243.
J.H.Jeans, *Phil. Mag.* **10** (1905), 91
- [11] J.C.Maxwell, *The London, Edinburgh, and Dublin Philosophical Magazine and Journal of Science* **vol.19** (1860) 19
J.C.Maxwell, *The London, Edinburgh, and Dublin Philosophical Magazine and Journal of Science* **vol.20** (1860) 21
L.Boltzmann, *Wissenschaftliche Abhandlungen* **Vol. II** (1909) 164.
L.Boltzmann, *Sitzungsberichte der Kaiserlichen Akademie der Wissenschaften in Wien, Mathematisch-Naturwissenschaftliche Classe* **66** (1872) 275.
L.Boltzmann, *Sitzungsberichte der Kaiserlichen Akademie der Wissenschaften in Wien, Mathematisch-Naturwissenschaftliche Classe* **76** (1877), 373.
- [12] M.Planck, *Annalen der Physik* **306** (1900) 69.
M.Planck, *Annalen der Physik* **4** (1901) 553.
- [13] H.Hertz, *Annalen der Physik* **267** (1887) 983
- [14] P.Lenard, *Annalen der Physik* **287** (1894) 225.
- [15] A.Einstein, *Annalen der Physik* **17** (1905) 132.
- [16] R.Millikan, *Phys. Rev.* **4** (1914) 73.
R.Millikan, *Phys. Rev.* **7** (1916) 355.

- [17] A.H.Compton, *Phys. Rev.* **21** (1923) 483.
A.H.Compton, *Phys. Rev.* **22** (1923) 409.
- [18] W.H.Bragg and W.L.Bragg, *Proc R. Soc. Lond. A.* **88** (1913) 428.
- [19] J.D.Watson and F.H.C.Crick, *Nature* **171** (1953) 737.
M.H.Wilkins, A.R.Stokes, and H.R.Wilson, H. R. *Nature* **171** (1953) 738.
R.E.Franklin and R.G.Gosling, *Nature* **171** (1953) 740.
- [20] C.Davisson and L.H.Germer, *Nature* **119** (1927) 558.
C.Davisson and L.H.Germer, *Proceedings of the National Academy of Sciences of the United States of America* **14** (1928) 31.
- [21] L.de Broglie *Ann. de Physique* **3** (1925) 22.
- [22] S.Frabboni, G.C.Gazzai and G.Pozzi *Am. J. Phy.* **75** (2007) 1053.
- [23] M.Born *Z. Phys.* **37** (1926) 863.
M.Born *Z. Phys.* **38** (1926) 803.
- [24] W.Heisenberg, *Z. Phys.* **33** (1925) 879.
W.Heisenberg, *Z. Phys.* **43** (1927) 172.
- [25] W.Pauli, *Zeit. Phys.* **31** (1925) 765.
- [26] R.Kronig, *Nature* **117** (1926) 550.
G.E.Uhlenbeck and S.A.Goudsmit, *Naturwissenschaften* **13** (1925) 953.
G.E.Uhlenbeck and S.A.Goudsmit, *Nature* **117** (1926) 264.
- [27] W.Gerlach and O.Stern, *Zeit. Phys.* **9** (1922) 349.
- [28] H.D.Zeh, *Foundation of Physics* **1** (1970) 69.
- [29] N.Bohr, *Nature* **121** (1928) 580.
W.Heisenberg, *Physics and Philosophy* (1958) 44.
- [30] H.Everett, *Rev. Mod. Phys* **29** (1957) 454.
- [31] B.S.DeWit, *Physics Today* **23** (1970) 30.
B.S.DeWit, "The Many-Universes Interpretation of Quantum Mechanics" *Proceedings of the International School of Physics "Enrico Fermi"* (1972)
- [32] E.Schrödinger, *Naturwissenschaften* **23** (1935) 807.
- [33] E.P.Wigner, "The Scientist Speculates", *Heinemann* (1961)
- [34] A.Einstein, B.Podolsky and N.Rosen, *Phys. Rev.* **47** (1935) 777.
- [35] J.S.Bell, *Physics* **1**,(1964) 195. J.S.Bell, *Rev. of Mod. Phys.* **38** (1966) 447.

- [36] S.J.Freedman and J.F.Clauser. *Phys. Rev. Lett.* **28** (1972) 938.
- [37] A.Aspect, P.Grangier and R.Gérard, *Phys. Rev. Lett.* **49** (1982) 91.
- [38] *Exodus* **20** verse 17.