

**SEWING FUNDAMENTALS
HANDBOOK**

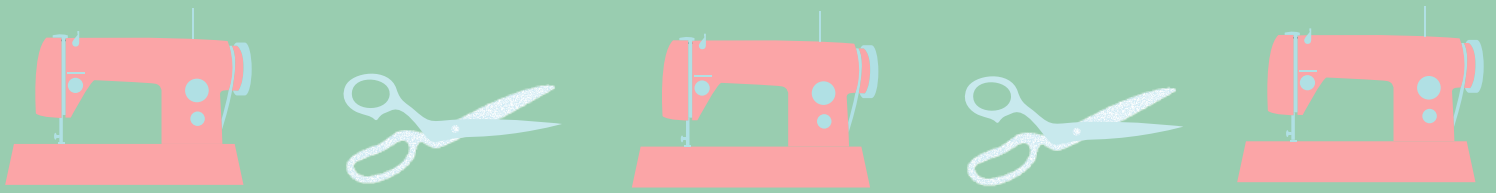

Table of Contents

Welcome Message.....	3
Directions and Materials.....	4
Open Studio, Make Up Classes and Janome Machines.....	5
Parts of your Sewing Machine.....	6
Winding the Bobbin.....	7,8
Inserting the Bobbin.....	9
Threading the Machine.....	10
Drawing Up the Bobbin Thread.....	11
Sewing Tools and Equipment (Cutting Tools).....	12
Sewing Tools and Equipment (Tracing Tools).....	13
Sewing Tools and Equipment (Thread, Zippers).....	14
Wovens and Knits.....	15
Warp, Weft and Grainline.....	16
Reading a Pattern.....	17
Fabric Shopping in Toronto and Online.....	18
Pressing and Ironing Tips.....	19
Presser Feet.....	20
Sewing Tips and Tricks.....	21
Headband.....	22, 23
Pillowcase.....	24- 27
Pouch.....	28-34
What next?.....	35



Welcome to our Studio!

We're so happy that you're joining us for Sewing Fundamentals 1!
Sewing is our very favorite thing to do and we LOVE sharing this awesome, empowering, creative, fun and totally rad skill with our students.

Nothing makes us prouder or more impressed than watching our students build their sewing skills and confidence as they improve from one class to the next. It might not seem like it at first, but each time you finish a project, you're adding a new sewing trick (or a few!) to your personal "sewing encyclopedia". With every project, you'll find yourself more and more familiar with your machine, and more comfortable trying new techniques and tricks - until it seems like you've always known how to sew!

It doesn't matter if you're working on your very first pillowcase, putting in your first zipper, making a piece of textile art to hang on your wall, a tailored suit or a couture evening gown - every student and every project is important to us. Sewing is our passion and we can't wait to share it with you!

Please feel free to drop us a line to update us on your latest crafty project, send us your sewing questions or just say hi! You can always reach us at themakeden@hotmail.com



Irene Stickney
Creative Director/Founder



Before getting started

Getting Here - West End!

1244 Bloor St. W (Bloor and Lansdowne)

If you're coming by TTC, take the Bloor line and leave through the Emerson exit. If you're coming by car, there is free parking on Brock Street and a Green P parking lot on Margueretta Street.

Getting Here - East End!

50 Carroll St. (Queen and Broadview)

If you're coming by TTC, you can take the 505 Dundas streetcar to Munro St and then walk west to Carroll, and south on Carroll to Matilda. If you're taking the 501 Queen streetcar, you can get off at Carroll and walk north past Thompson to Matilda.

If you're coming by car, there is parking on Carroll as well as Matilda.

You can also take the subway to Broadview station and then take the 504 streetcar south to You'll need to go up the loading ramp and then buzz in - our buzzer code is next to the door!

Equipment & Materials - Class by Class!

You do not need to bring any materials to your first class!

All class materials are available for sale at the studio.

Class Two: Headbands

(if you would prefer to make a bowtie, please let your teacher know!)

1/4y of woven, non-stretch cotton (min 45" in width)

We provide the elastic for this project.

Optional: matching thread, washable marking pencils or markers.

If you finish your headband early, you'll want to have your materials for class three on-hand to get started early!

Class Three: Pillowcase with Invisible Zipper

To make one 16"x16" pillowcase, you'll need 1/2 yard of woven, non-stretch cotton (min 45" in width)

1 x 14" or larger invisible zipper to match

(some shops only have 20" invisible zippers - this is fine! We will cut the zipper to fit!)

Optional: matching thread, washable marking pencils or markers.

Class Four: Zippered Pouch

1/4y of non-stretch woven cotton for the exterior

1/4y of non-stretch woven cotton for the interior

1/4y of non-woven fusible interfacing

(min 45" in width - we recommend that you buy this at the studio as some stores cut narrow widths)

1 x 12" or larger regular zipper (longer is fine! We will cut the zipper to fit!)

Optional: matching thread, washable marking pencils or markers

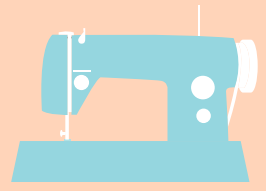
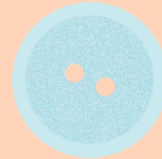
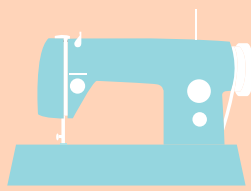
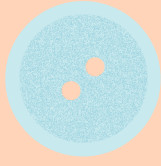
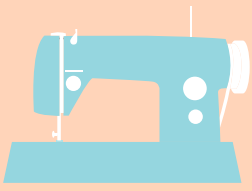

Before getting started

My Sewing Teacher's name is:

You can sign up for our newsletter for updates, new classes, and promotions. Check our website (www.themakeden.com) for current and upcoming classes.

Sewing Machines

We use the Janome 625E Sewist in all of our classes and definitely recommend them! Janome machines come with a 2 year labour warranty and tonnes of extras like presser feet, bobbins, a stitch ripper and a buttonhole attachment! We also use and sell Rowenta Irons. If you are interested in purchasing a Janome sewing machine from us, please email us at themakeden@hotmail.com

Need Extra Studio Time to Finish Your Project?

Current and former students are always welcome to use our Open Studio Time on Friday evenings from 6-9pm free of charge. Registration for the coming Friday will be available starting at 9am each Sunday. If you have booked Open Studio space, and are no longer able to come, please notify us by email ASAP, so we can open up the space to someone else. You can reserve your space right online at <http://www.themakeden.com/classes/open-studio-time/>

Miss a class?

If you miss one of your classes, you can sign up for a makeup class for \$15. The makeup classes are most Tuesday nights from 6-8pm and 8:15-10:15pm. You can register online at <http://www.themakeden.com/classes/make-up-classes/>

Studio Safety

Please wear closed toed shoes for safety.

Please refrain from bringing food & drinks into the studio; we'd hate for anyone's project to be ruined by a spill! Water is fine if it has a lid.

No running!

Please carry scissors with the pointy end down

Please read all of the Iron Safety information before pressing

Always lock your machine before changing the needle or presser foot

Please tidy your scraps and pins at the end of your class!



Getting to know your machine (Janome 625E)

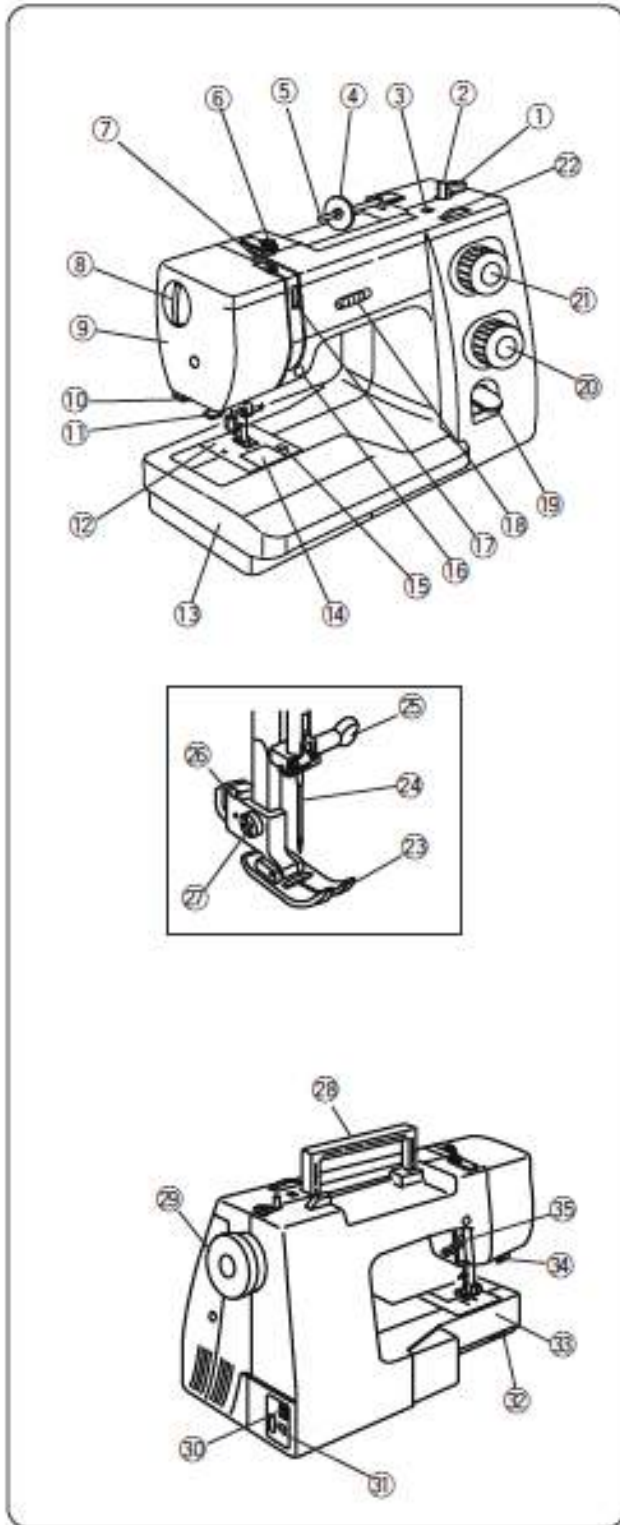

Names of Parts

- ① Bobbin winder stopper
- ② Bobbin winder spindle
- ③ Hole for additional spool pin
- ④ Spool holder
- ⑤ Spool pin
- ⑥ Bobbin winder thread guide
- ⑦ Thread take-up lever
- ⑧ Foot pressure dial
- ⑨ Face plate
- ⑩ Thread cutter
- ⑪ Needle threader
- ⑫ Needle plate
- ⑬ Extension table (Accessory storage)
- ⑭ Hook cover plate
- ⑮ Hook cover plate release button
- ⑯ Needle up/down button
- ⑰ Thread tension dial
- ⑱ Speed control slider
- ⑲ Reverse stitch lever
- ⑳ Stitch length dial
- ㉑ Pattern selector dial
- ㉒ Stitch width dial
- ㉓ Presser foot
- ㉔ Needle
- ㉕ Needle clamp screw
- ㉖ Foot holder
- ㉗ Setscrew
- ㉘ Carrying handle
- ㉙ Handwheel
- ㉚ Power switch
- ㉛ Machine socket
- ㉜ Drop feed lever
- ㉝ Free-arm
- ㉞ Buttonhole lever
- ㉟ Foot lifter



Winding the Bobbin

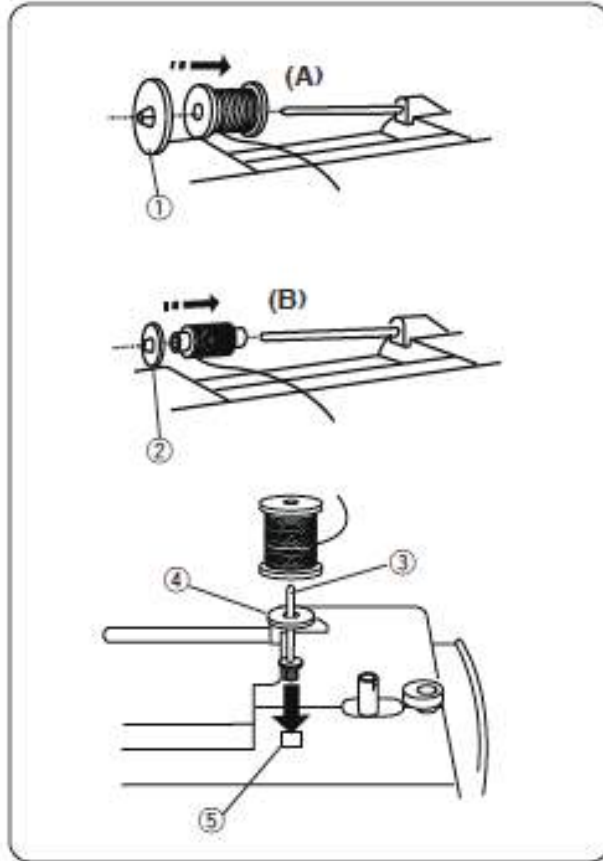

Winding the Bobbin

Setting the spool

Place a spool of thread on the spool pin with the thread coming off the spool as illustrated.

A: Press the large spool holder firmly against the spool of thread.

① Large spool holder

B: For a small spool, use the small spool holder.

② Small spool holder

Additional spool pin

The additional spool pin is for bobbin winding without unthreading the machine.

Insert the additional spool pin into the hole. Place the felt and a spool on the pin.

③ Additional spool pin

④ Spool pin felt

⑤ Spool pin hole

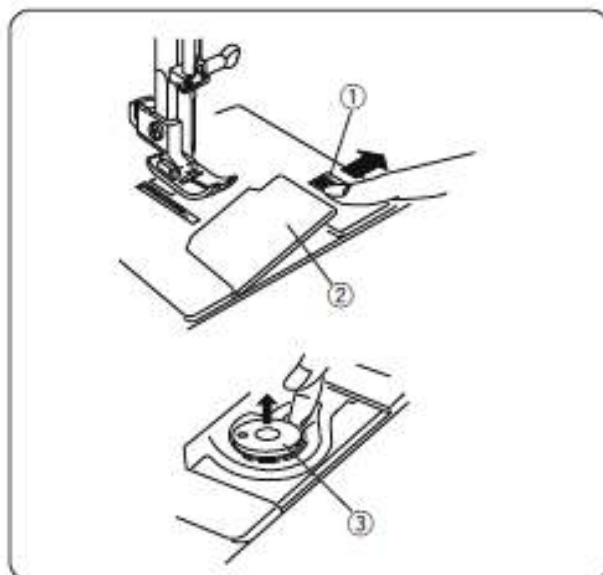

Removing the bobbin

① Push the hook cover plate release button to the right and remove the cover plate.

① Hook cover plate release button

② Hook cover plate

② Lift out the bobbin.

③ Bobbin



Winding the Bobbin

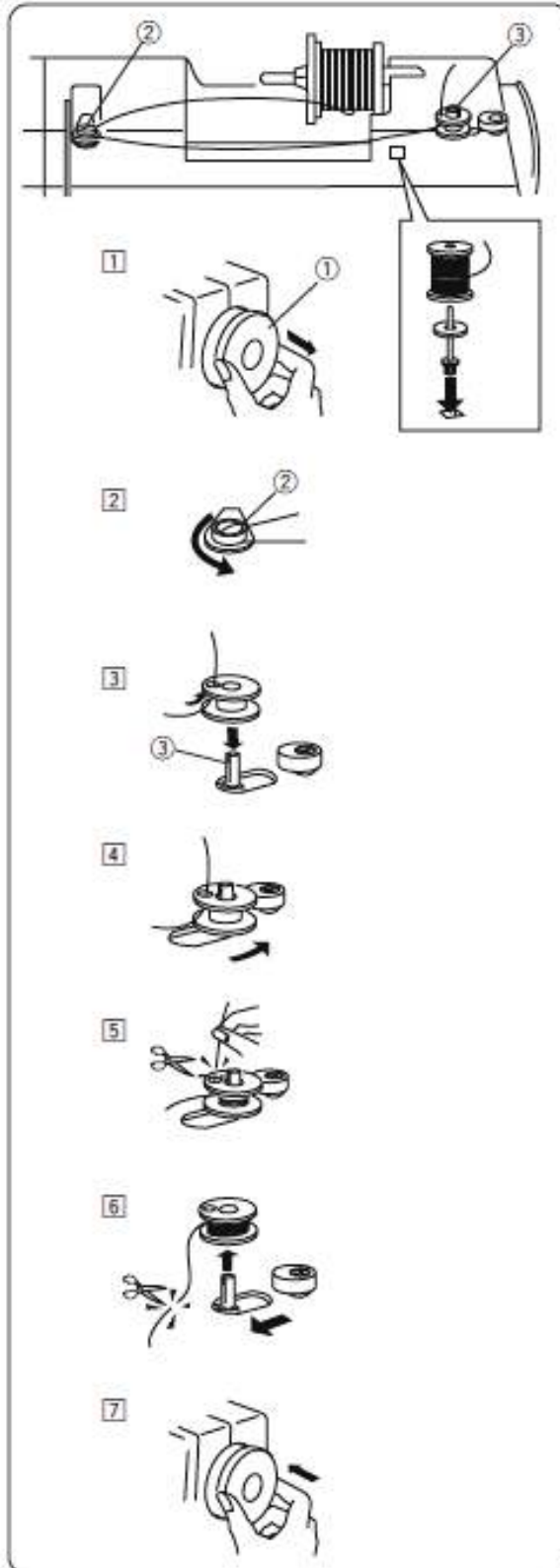

Winding the bobbin

- 1 Pull out the handwheel to disengage the clutch.
① Handwheel
 - 2 Draw the thread from the spool. Guide the thread around the bobbin winder thread guide.
② Bobbin winder thread guide
 - 3 Thread through the hole in the bobbin from the inside to the outside.
Put the bobbin on the bobbin winder spindle with the free end of the thread coming out at the top.
③ Bobbin winder spindle
 - 4 Push the bobbin to the right.
- NOTE:**
Do not move the bobbin winder spindle while the machine is running.
- 5 With the free end of the thread held in your hand, depress the foot control. Stop the machine when the bobbin has been wound a few layers, and cut the thread close to the bobbin.
 - 6 Depress the foot control again. When the bobbin is fully wound, it will stop automatically.
Return the bobbin winder to its original position by moving the spindle to the left, and cut the thread as illustrated.
 - 7 Push in the handwheel to engage the clutch.

Inserting the Bobbin

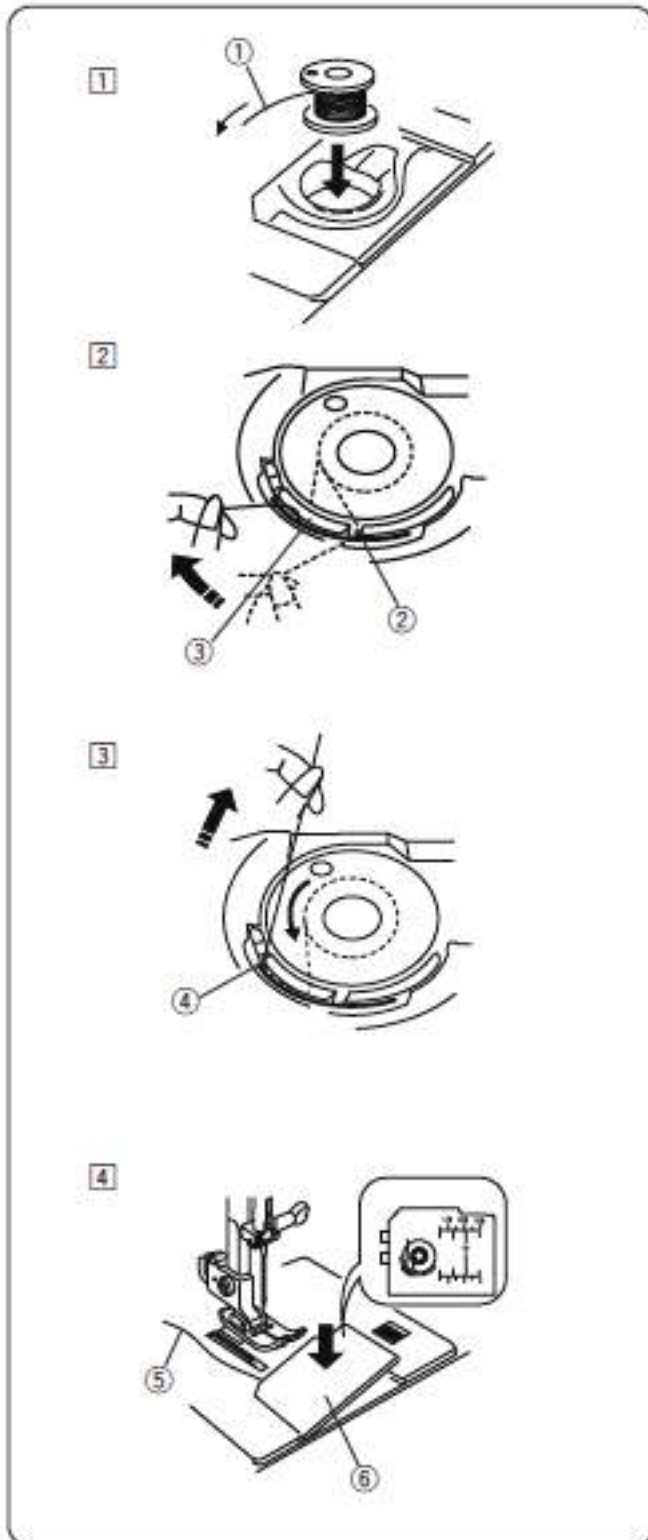

Inserting the bobbin

1 Place the bobbin in the bobbin holder with the thread running off as illustrated.

① Thread

2 Guide the thread into the front notch on the front side of the bobbin holder. Draw the thread to the left, sliding it between the tension spring blades.

② Front notch

③ Tension spring blade

3 Continue to draw the thread lightly until the thread slips into the side notch.

④ Side notch

4 Pull out about 4" (10 cm) of thread. Attach the hook cover plate. Check the threading by referring to the chart shown on the hook cover plate.

⑤ Thread

⑥ Hook cover plate

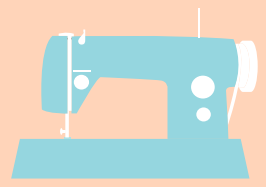
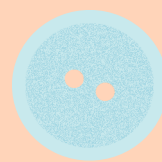
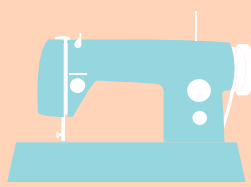
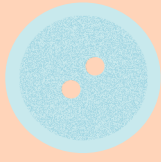
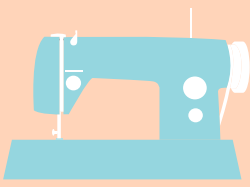

Drawing up the Bobbin Thread

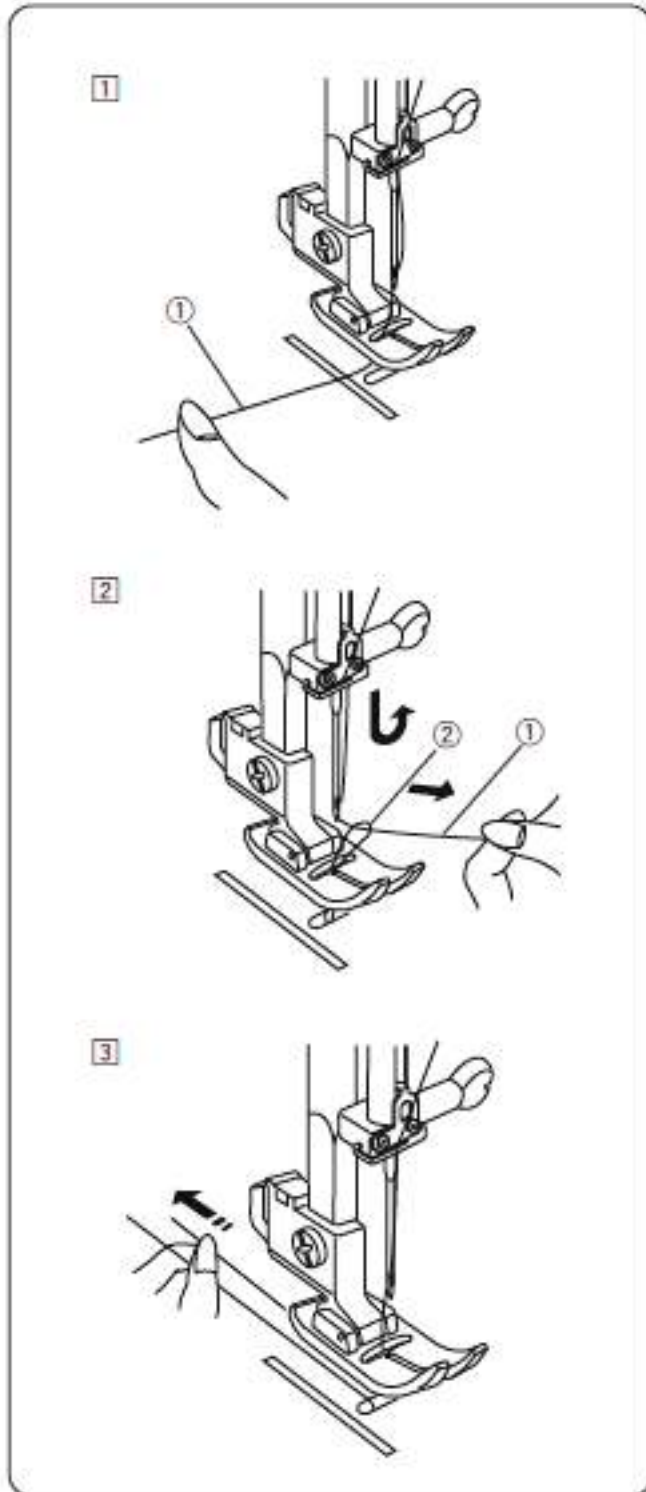

Drawing up the Bobbin Thread

1 Raise the presser foot and hold the needle thread lightly with your left hand.

① Needle thread

2 Turn the handwheel slowly toward you one complete turn. Bring the bobbin thread up by pulling the needle thread as illustrated.

① Needle thread

② Bobbin thread

3 Pull 4" (10 cm) of both threads back and under the presser foot.

Threading the Machine

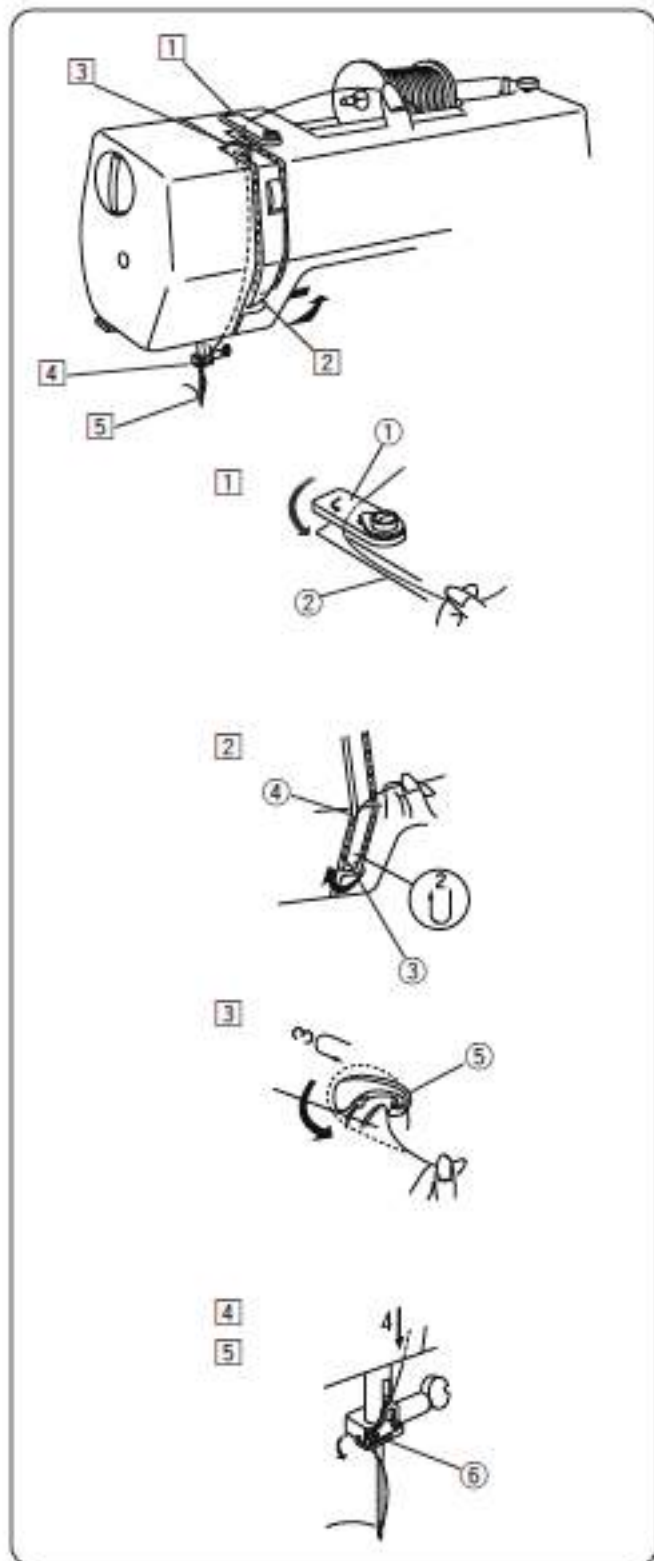

Threading the Machine

To set the needle thread:

Raise the thread take-up lever to the highest position by turning the handwheel.

Raise the presser foot.

- 1 Draw the thread from the spool and pass it under the thread guide. Then draw it down along the right channel.

① Thread guide
② Right channel

- 2 Draw the thread up around the bottom of the thread guide plate.

Pull the thread up along the left channel

③ Thread guide plate
④ Left channel

- 3 Firmly draw the thread from right to left over the thread take-up lever and down into the take-up lever eye.

⑤ Thread take-up lever

- 4 Draw the thread down along the left channel and slip the thread behind the needle bar thread guide from the left.

⑥ Needle bar thread guide

- 5 Pass the thread through the needle eye from the front or use the needle threader (refer to the next page).



Sewing Tools and Equipment

This is an in-depth list of tools which we use at the studio frequently. Please don't feel as though you need to buy everything on this list right away! As you build your sewing skills, you can refer to this list to help you decide which items you need. If you're just getting your home studio set up, we'd recommend starting with the following super useful items.

Fabric Shears
Paper Scissors
Snips
Pins
Hand Sewing Needles
Pattern Making Ruler
Stitch Ripper
Chalk, washable marking pencils or markers

Cutting Tools

Fabric shears

The sharper, the better! Make sure your scissors are comfortable, as you may be using them for extended periods of time. Unless you plan on cutting multiple layers of fabric or chiffon, you don't need to invest in super expensive tailors shears when you're starting out. Buy scissors that suit your needs. \$20-\$50 is reasonable. Make sure to only use these scissors for fabric; as if you use them to cut paper or other things you will dull the blades. It's best to get a pair that has a screw in the center, this means you can undo the screw, and separate the blades of the scissors. You need to be able to separate them to get them properly sharpened.

Rotary cutter

Much like a pizza cutter, the circular blade slices right through the fabric. Always use with a self-healing cutting mat to protect your table surface. You can use a ruler as a straight edge to ensure straight lines. Make sure to have the safety on and use caution whenever you are not using the rotary cutter; the blade is VERY sharp!

Pinking Shears

These scissors cut zigzag, fray resistant edges. They are excellent for finishing seams and raw edges.

Thread Clipper, Snips or Embroidery Scissors

A small tool used for cutting loose threads, making buttonholes, or ripping seams open.



Sewing Tools and Equipment

Tracing Tools

Different marking tools have different qualities that make them appropriate for different fabrics. Most tools will work well on stable fabrics like woven non-stretch cotton.

The most difficult fabrics to mark are lightweight fabrics like chiffon, and very stretchy fabrics like bamboo film. Although we don't use these in any of the beginner classes, we recommend using a washable marker or a chalk pen for these fabrics.

Chalk wheel/chalk pen - This tracing tool has a refillable cartridge with loose chalk dust and a rotary wheel at the tip of the tool. It comes in multiple colours (white, blue, pink, yellow) for marking many colours of fabric. When you drag this wheel along the fabric, it will dispense the chalk. Produces thin accurate lines that mark nearly every medium/heavy weight fabric easily. Use caution when replacing the cartridge so no chalk gets spilled!

Tailors chalk - This chalk is traditionally sold in boxes and comes in the form of a thin wedge. It is designed to make temporary marking on cloth. Once the markings are no longer useful they can be easily brushed off or washed out. Tailors chalk can be sharpened by carefully dragging an Exacto knife along the edge. Marks nearly every medium/heavy weight fabric easily.

Quilters Pencils - Washable coloured pencils that work well on woven cotton.

Washable Marker - This blue marker will disappear from your fabric with water. Do not put this in the wash with soap/detergent, some of these soaps can react negatively with the marker and make it stain your fabric. Always test your fabric first to make sure it reacts well with your fabric marker!

Fast fade marker/invisible marker - This purple marker will fade from your fabric within a few days, or can also be washed out of the fabric. Most of these markers will be double-ended, with the marker on one end and an eraser on the other end.

Wax - Comes in the form of a thin wedge. Wax tends to leave a residue on your fabric and is very difficult to try and remove. It can also melt through to the other side of your fabric when you iron it. We don't generally recommend using wax unless nothing else will show up on your fabric

*Always test out your tracing tool first on your fabric. You want to be certain it will wash out and not leave a residue



Sewing Tools and Equipment

Other Handy Tools

Needle threader – the wire loop on this tiny tool is inserted into the eye of the needle. The thread goes through the loop, and is then pulled back through the eye when you pull out your needle threader.

Bias tape – narrow strip of fabric, cut on the bias. It can be used to bind and finish the edge of fabric. You can make your own with the help of a bias tape maker, or you can buy it readymade in several widths and styles (simple bias tape, single-fold bias tape, and double-fold bias tape.)

Bias tape maker – This device fold bias strips into bias tape with the help of your iron.

Stitch Ripper – A small tool used for unpicking stitches. The sharp, curved edge makes it easy to open up seams. Rip a stitch every 3-4 stitches along the entire length of the seam to be opened and the thread on the opposite side should fall right out.

Pattern Making Ruler – Clear 2" wide flexible ruler. They make measuring curves, adding seam allowance, and checking 90 degree angles very easy.

Thread

Polyester thread – All-purpose thread that is very durable and strong. It won't shrink in the wash, and the color doesn't fade over time.

Cotton thread – Not as strong as polyester thread, and it will shrink in the wash. This is used by quilters to achieve a "puckered" look.

Topstitching thread – Tough, thick and strong thread used for bold decorative stitches often seen on denim. Also used for sewing buttons onto outerwear, and making gathers on heavy fabric like denim, canvas, or leather.

Elastic Thread – Used to create ruffles and faux-smocking.

Zippers

Invisible zipper – have the teeth of the zipper hidden behind a tape, so that the zipper is invisible. The zipper pull itself will always have a slim appearance.

Regular zipper - It is the most common zipper. It has a bulkier zipper pull compared to the invisible zipper and the teeth are exposed.



Wovens & Knits

There are two basic categories that fabrics fall into: woven and knit. The difference lies not in the fiber content, but in the construction of the fabric.

Woven fabrics are created on a loom. Woven fabrics have yarns running horizontally and vertically which go over and under each other which creates the fabric. Woven fabrics do not stretch unless Lycra, elastic or spandex fibers are woven into the fabric at the same time. Woven fabrics will fray. Examples of woven fabrics are denim, twill, chiffon, corduroy, tweed, and canvas.

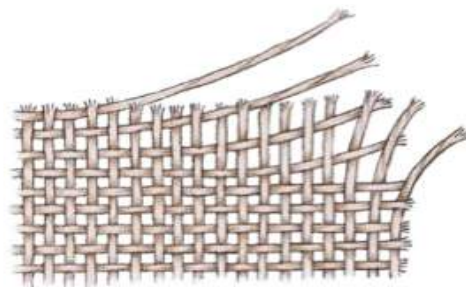

Knit fabrics are created on a knitting machine that uses hand-knitting techniques. Knits are made of one continuous thread that makes interlocking loops. Knit fabric is able to stretch because of the loops in the construction of the fabric. Knit fabrics will not fray, but they will unravel.

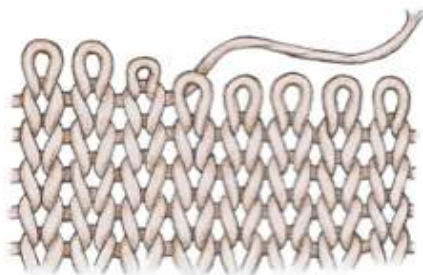

If you're unsure what type of fabric it is, woven or knit, there are a couple tests you can do to figure it out.

Wrinkle Test

When you scrunch up a knit in your hand, it will crush easily. When you release it, the fabric will spring back into shape with few, if any, wrinkles. When you scrunch up a woven fabric, it usually wrinkles very easily.

Stretch Test

When you stretch a knit along its crosswise grain, it stretched significantly. If you stretch it on its length, it stretches slightly. When you try to stretch a woven along the lengthwise grain, it will not stretch. And there is minimal give along the crosswise grain.

***Make sure you get woven fabrics for the Fundamentals Projects. Do not buy knits.**

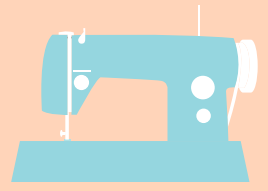
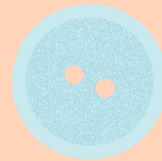
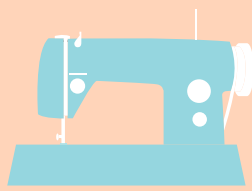
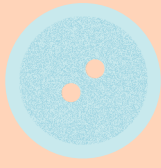
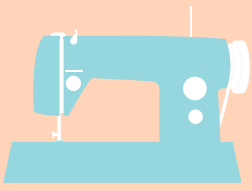

Understanding Your Fabric

Selvedge – The edge of the fabric that has not been cut, it is the finished edge of the fabric. They are formed when the weft threads turn to change direction as the weaving process travels down the warp. (left to right, right to left)

Weft threads – The threads running perpendicular to the selvedge. They are woven back and forth.

Warp threads– The threads running parallel to the selvedge.

Lengthwise grain – Runs parallel to the length of the fabric. The lengthwise grain runs parallel to the Selvage edges.

Crosswise grain – Runs perpendicular to the Selvage edges.

Bias – The bias of the fabric is on a 45 degree angle from the warp threads. The bias of the fabric has extra elasticity, drapability, and flexibility.

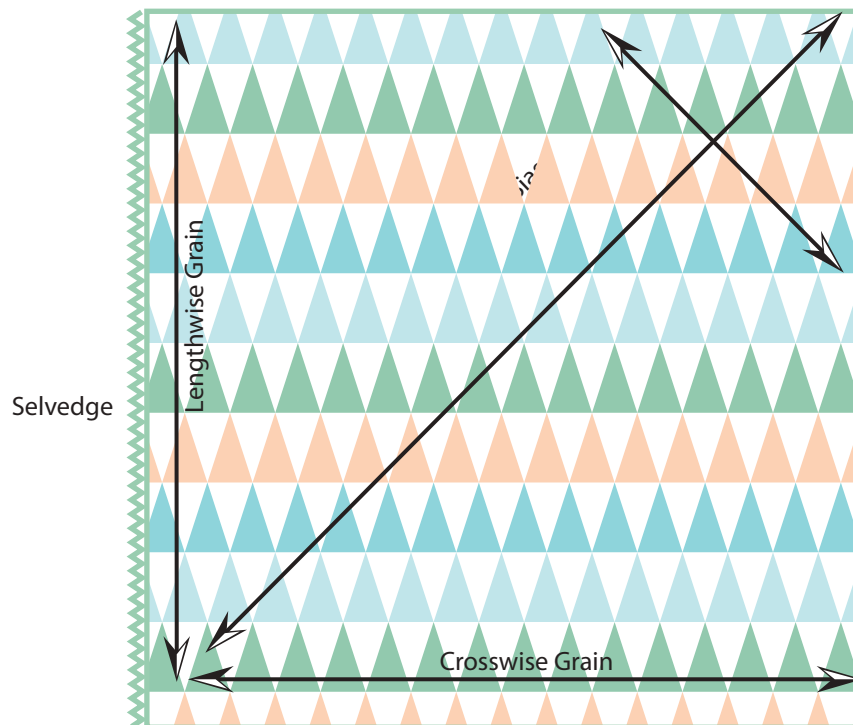

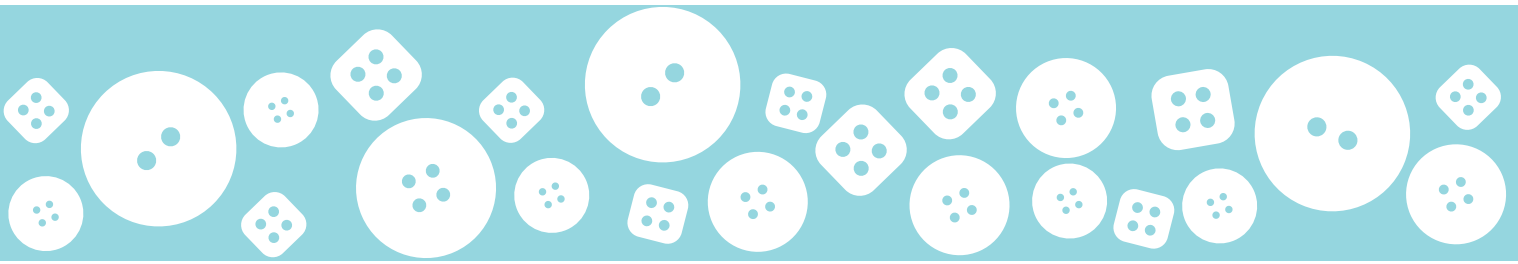

Reading a Pattern

Grainline – The grainline is marked on every pattern piece indicating how to line up the pattern piece in relation to the grain of the fabric.

Notches – Notches are very helpful! They help line up pattern pieces, they indicate the size of the seam allowance, and can mark design details such as gather or pleats. On a commercial pattern, notches are indicated with a small triangle or diamond. On an industrial pattern, notches are indicated with a short straight line.

Cut Line – The outer edge of a pattern, which should be traced and cut from your original pattern shape. Some older patterns do not include a cut line, and must be added when tracing your pattern.

Stitch Line – The inner edge of a pattern, usually 1/4 " -5/8" inside the cut line. This indicates where the line of stitching will go.

Place on Fold – the grainline symbol with directional arrows means that the thin outer line of the pattern is to be placed directly on the folded edge of fabric.

Cut on Bias – this means that the pattern is lined up with and cut on the Bias. Which is a grainline angled at a 45 degree angle from the warp threads.

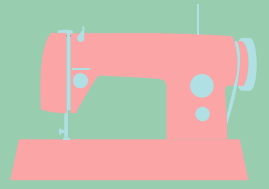
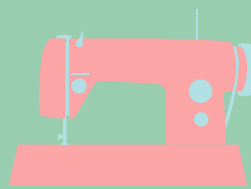
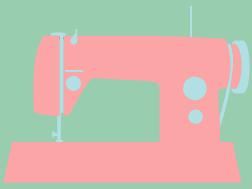

Toronto Resources

All of the shops listed below carry a good selection of woven cottons and fusible interfacings suitable for your class projects

Designer Fabric Outlet

1360 Queen St W, Toronto, ON M6K 1L7
(416) 531-2810

Hours: Monday-Thursday 9:30am-6pm, Friday 9:30-9pm, closed Sundays

Fabric by Designers

452 Queen St W, Toronto, ON M5V 2A8
(416) 850-8042

Hours: Monday-Friday 11am-6:30pm, Saturday 11am-6pm, Sunday 1pm-5pm

Mac Fab

755 Queen St E Toronto, ON M4M 1H3
(416) 922-6000

Hours: Monday-Friday 10am-7pm, Saturday 10am-6pm, Sunday 12pm-6pm

Affordable Textiles

531 Queen St W, Toronto, ON M5V 2B4
(416) 504-4117

Hours: Monday-Saturday 10am-6:30pm, Sunday 11am-5pm

Kings Textiles

161 Spadina Ave Toronto, ON M5V 2L6
(416) 504-0600

Hours: Monday-Saturday 10am-6pm

Online Resources

www.Etsy.com

www.purlsoho.com

www.warpandweft.ca

www.burdastyle.com

www.colettepatterns.com

www.fabricworm.com

www.purlbee.com

www.myfabricspot.ca

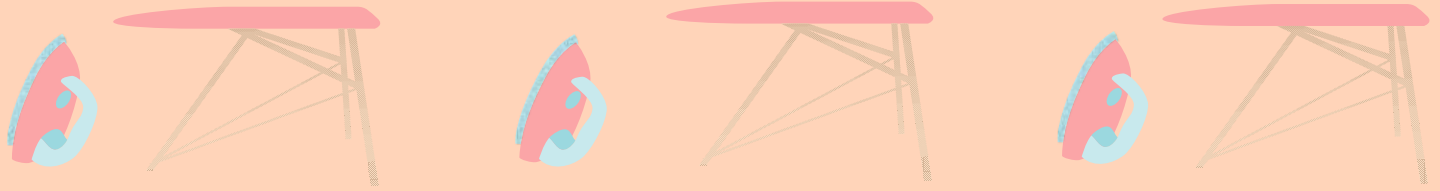

Pressing/Ironing Tips



Be very careful, do not burn yourself - keep your hands a safe distance away from the iron. Steam is HOT! Be careful!

NEVER EVER touch the face of the iron to check the temperature. Always check the heat setting before you start using it. Never leave your iron face down, it will burn the fabric and is a serious fire hazard!

Press cloths are your friends.

If you're unsure what heat setting you should have the iron set at, get a scrap of your fabric and do a test first.

Ironing Tools

Press Cloth – a 100% cotton cloth that is placed over the item being ironed. When doing heavy pressing, this cloth prevents the fabric underneath from getting scorched or burnt. You also want to use a press cloth when working with delicate fabrics, as they are sensitive to heat. Use a press cloth on synthetic and wool fabrics to prevent shine on the fabric that the heat iron sometimes produces.

Tailors Ham – A firmly stuffed cushion that resembles the shape of a ham. You use this when pressing curved areas such as darts, or a curved seam.

Sleeve Roll – A cylindrical firmly stuffed cushion used to press long seams and seams in narrow areas such as sleeves

Sleeve Press – Resembles a tiny ironing board and is used to press up hems of pants, sleeves, necklines, and sleeve caps.

*We are a registered Rowenta dealer. Please email us at themakeden@hotmail.com if you would like to order a Rowenta Iron from us.

Presser feet for the sewing machine

Standard presser foot – This foot allows you to use a straight stitch or a zigzag and is universally useful. This foot will always come with your machine.

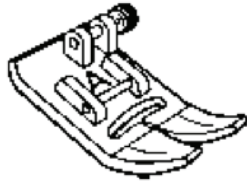

Zipper foot - A zipper foot can be used not only to insert zippers, but also to install cording or piping . Most zipper feet can be mounted on either side so that you can sew on the left of the right. If your machine comes with a variety of needle positions then you have control over how close to the zipper teeth you wish for your stitches to be.

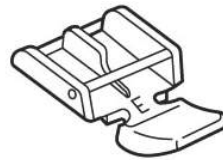

Invisible/concealed zipper foot - This foot is used to install invisible zippers. This foot allows you stitch incredibly close to the zipper's teeth for a neat, precise finish.

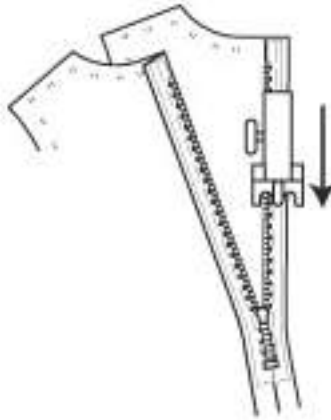

1/4" Guide foot - The guide on the foot enables you to sew a perfect 1/4 inch seam every time. The guide can also be used wherever a 1/4 inch seam is called for but the markings on the needle plate cannot be used, such as when completing a flat-felled seam.



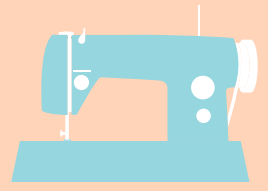
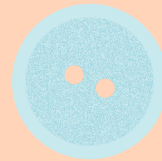
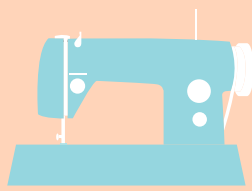
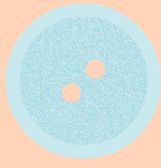
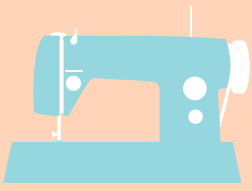

Tips and Tricks

Sew what you love! Sewing is much more fun and feels like less work that way.

Take a deep breath when threading the eye of the needle.

Slow and steady wins the race. Never rush your projects.

If you're getting frustrated with a certain part of your project, stop what you're doing and let it sit for a day or two. You can start it again with a fresh perspective.

The fabric can make or break a project. Look for quality fabrics.

Change your needle frequently. A sharp needle makes for nicer stitching.

Use thread that is the same color or slightly darker than the fabric you are sewing with. If you are sewing two different colored fabrics together, you can use one color for the bobbin thread and another color for the top thread to give your project a nicer, more cohesive look.

Do not buy cheap thread! It can break in your machine while you are sewing.

Make sure you are using the right machine needle for the fabric you're working with. If working with delicate silk or chiffon, make sure to use a microtex needle. If working with Denim or other heavy fabric, use a larger gauge needle. Leather requires a leather needle.

Before you get started...

There are a few things you should do before you begin a new project.

Always Prewash your fabric! This will pre-shrink your fabric which is very important. You want to wash it however you plan to wash your project in the future. If you plan to wash everything in hot water, and dry it on the turbo cycle, make sure you do that with your fabric before you cut it.

Always give a nice press with the iron before tracing your pattern. This will ensure that all your traced lines are accurate because there are no creases or wrinkles in your fabric.

Make sure you understand all the techniques used in the project. If you don't understand, ask your teacher. Youtube is also a great resource if you don't remember a certain handstitch or anything of that sort.



Headband

Start by cutting out 2 rectangles, one measuring 11"x 3" and the other measuring 17"x5". You can cut these on the lengthwise grain or the crosswise grain. Also cut a 6" piece of 1/2" wide elastic. Make sure your elastic recovers well when it is stretched out then released. You will also need a safety pin.

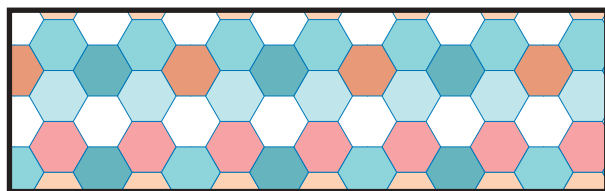

17"x5"



11"x3"



6" elastic

Fold the 11"x3" rectangle, good sides together. Line up the edge of your fabric with the 4/8 line and sew all the way down, make sure to backstitch at the beginning and the end. The 11x3 rectangle should now be sewn into a tube.

Close one of the ends of the tube. Line it up with the 4/8 line, and sew over 3 times in the same place (forward, backward, forward).



Use a knitting needle or screw driver to flip the tube right sides out. Now cut off the sewn end about a 1/4 inch in so both ends of the tube are open again.

Attach a safety pin to the end of the 6" elastic. Feed it through the tube, safety pin first. Stop when the end of the elastic without the safety pin is flush with the edge of the tube. Sew this down three times (forward, backward, forward) lining up with the edge of the presser foot.



Pull the safety pin out of the other end, making sure to remove the safety pin, sew this end 3 times as well making sure you catch the elastic when you sew. The tube should now have a scrunchy appearance because of the elastic inside.





Headband

Take your larger 17"x5" rectangle; make sure you have good side facing down. Press the long edge (17") a ½ inch up with the iron. Use a ruler to help you press consistently. Then fold another half inch and iron again to conceal the raw edge of the fabric. Repeat on other side. Make sure you have folded your edges away from the good side of the fabric, and not toward it.

It should now measure 17"x3".

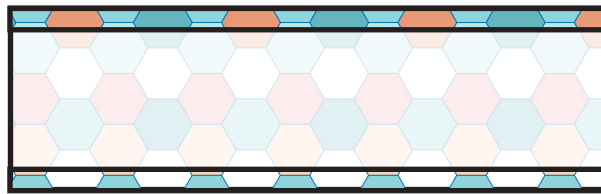

Top stitch 1/8" from the edge of the inner fold. It is always a good idea to put a few pins in before sewing.

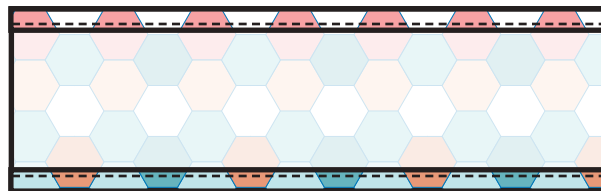

Lay the larger rectangle on your work table, good side up. Place the elastic in the middle of the larger rectangle, and line up the edge of your elastic stitch with the edge of the fabric.

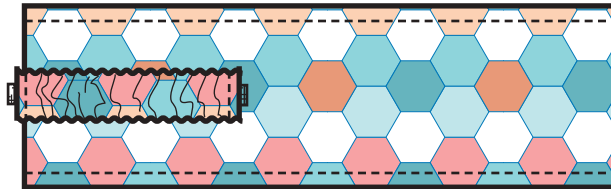

Fold the top down, and then the bottom up. Sew across this 3 times.

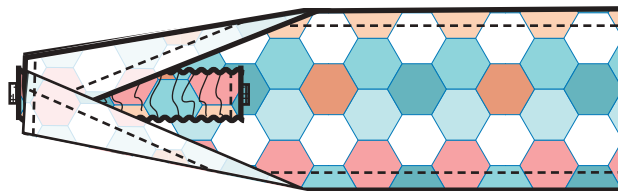

Repeat on other side, making sure to fold in the same manner.

Flip right side out and Voila!
You've made a beautiful headband!



Pillow Cover

The size of the pattern will change depending on what size pillow cover you are making. If you are making a 16x16 pillow cover, you need to add 1" to each dimension for the seam allowance. For a 16"x16" pillow cover, you will actually cut two 17"x17" pieces. If you were making a cover for a 18"x24" pillow, the pattern would be 19"x25". Also make sure to include notches on the pattern. Since we will be working with a 1/2" seam allowance, the notches will be 1/2" in from each side.

Start by folding your fabric good sides together lining up the selvages and place your pattern on the length-wise grain. Make sure to place your pattern closer to the selvage opposed to the fold, this will save you fabric.

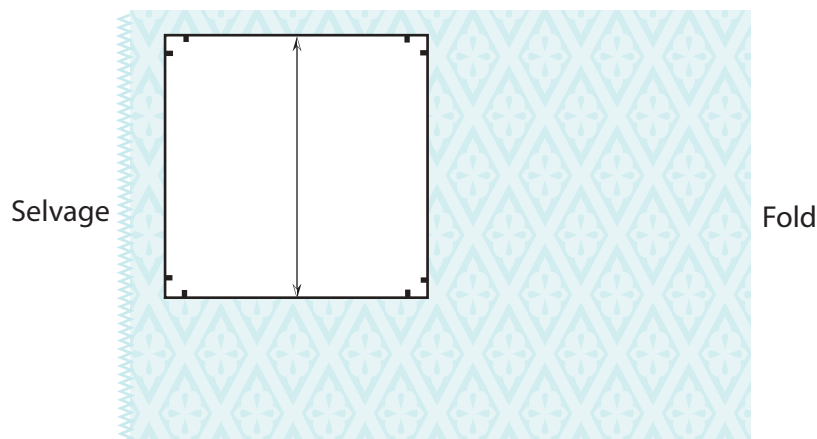

Trace the pattern, making sure to mark the notches at all 4 corners. Pin within the lines to hold the layers together.

Cut out your fabric, making sure to clip your notches no more than a 1/4".

Zig Zag stitch all the sides on both pieces. Start at first notch and stop at the other notch, making sure to backstitch at the beginning and end.

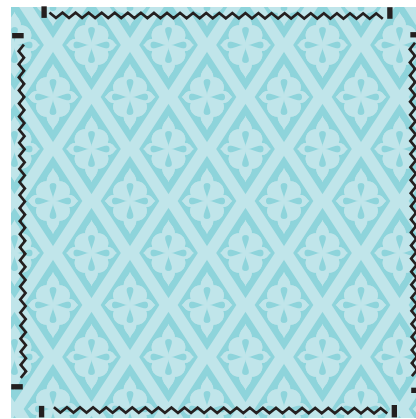
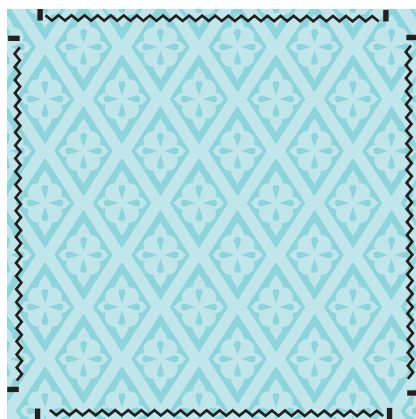

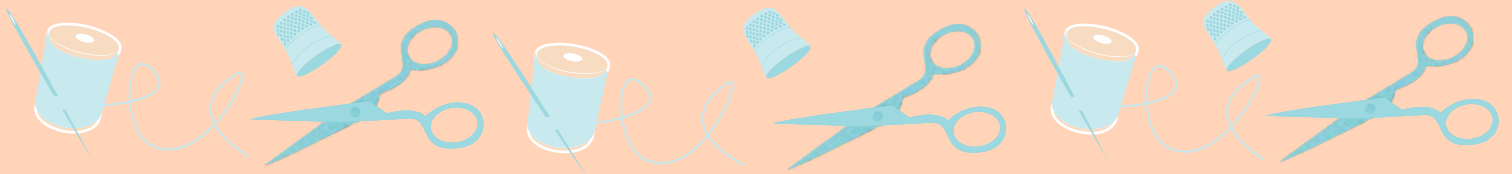

Pillow Cover

Iron up the bottom edge (where you want the zipper to go) a half inch on both pieces. You can fold right at the notch. Make sure you are looking at the bad side of the fabric and bringing up the good side.

Line up your pieces so the folds are parallel and almost touching. Mark 2" down from the top, and mark 2" up from the bottom. This will tell us when to start sewing the zipper, and where to finish sewing the zipper. Draw a line with a tracing tool that will wash out. Make sure to only make a marking across the fold, not across the whole width of your fabric.

Lay the zipper good side down on top of the folded edges. Make sure the zipper is undone. Line up the top stopper of the zipper up with the 2" notch you made previously, and line up the teeth of the zipper with the fold. Pin into place all the way down to the other 2" notch **making sure you are only pinning through one layer of fabric.** Repeat on other side.

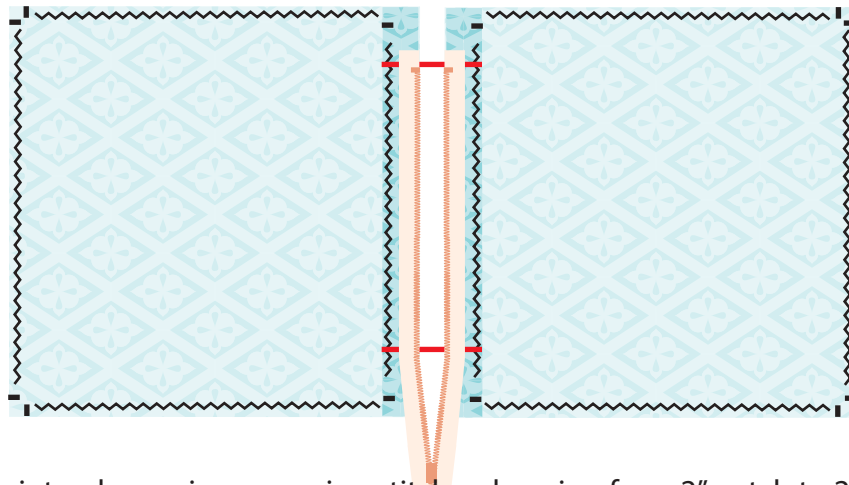

Hand baste the zipper into place using a running stitch only going from 2" notch to 2" notch. This will keep the zipper from shifting when we use the invisible zipper foot on the sewing machine. Make sure you are only going through the one layer of fabric when you hand baste. Be certain to knot the thread at the beginning and end. Basting is just a simple hand stitch to hold things in place, It doesn't have to be perfect, as long as it does it's job.

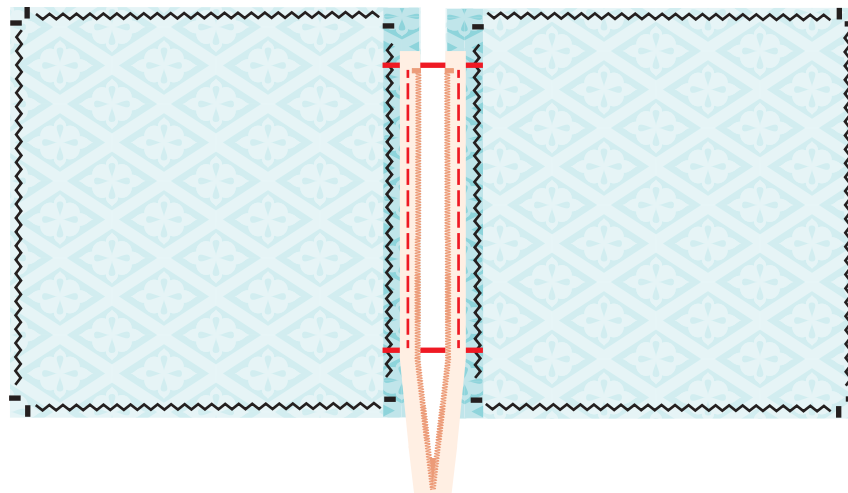

Pillow Cover

Using an invisible zipper foot, sew in the invisible zipper. Open up the fold we pressed up earlier, so everything is nice and flat. Be certain you are only sewing through the one layer of fabric and the zipper. When you have the excess fabric on the left, line up the zipper in the left hand side of the foot. When you have the excess fabric on the right, line up in the right hand side of the foot. Most importantly make sure the zipper is being pulled open by the invisible zipper foot. It should create a nice 90 degree angle, or "L" shape. Only sew from 2" notch to 2" notch, backstitching at the beginning and at the end. Sew in the same direction on each side. This prevents the zipper from shifting in opposite directions.

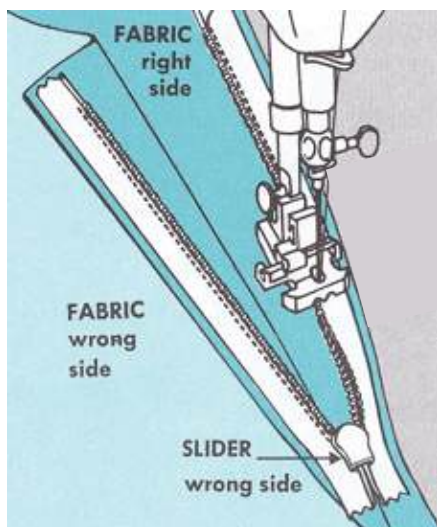

Once you have sewn on your invisible zipper, zip it up to make sure it works. If the zipper won't zip up, don't fret! Sometimes the fabric twists as you sew, so just untwist it and try to zip it up again.

Using a regular zipper foot we must close both ends of the zipper (The 2" we left on the top and the bottom). Make sure to attach the right hand side of the zipper foot. Zip open your zipper half way. Make sure you have the good sides of the fabric together. Find where your invisible zipper stitching ends. Start $\frac{1}{4}$ inch above that and sew right to the bottom of the fabric making sure to backstitch at the beginning and at the end. Your zipper should sit right in the groove of the presser foot on the right hand side. Try to get as close to the zipper stitching as you can. Do not stitch on the zipper, only the fabric. On the side with the open zipper ends, make sure to stack the zipper teeth on top of each other.

Once the two openings are closed, we have to finish the end of the zipper before we can cut off the excess. Pull the zipper excess away from the fabric, and sew across the zipper 3 times or so (forward, backwards, forwards) about a $\frac{1}{2}$ " away from the fabric. This will prevent the zipper from separating. Then you want to cut off the excess of the zipper just a tad after the stitching.



Pillow Cover

Double check that your zipper is open. Put good side of the fabric together and line up the edges. Pin the other 3 sides, leaving the zipper unpinned.

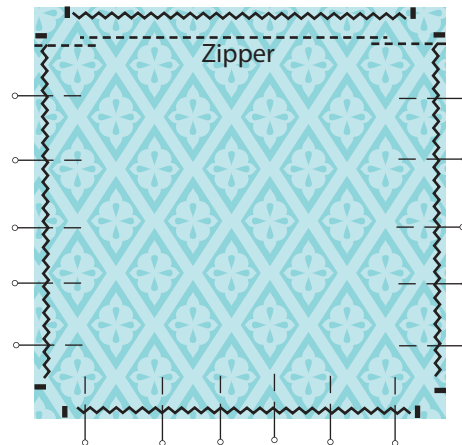

Sew at $\frac{1}{2}$ seam allowance making sure to backstitch at the beginning and at the end. Pivot your corners. This means that when you get to the corner, you leave your needle in the fabric, lift up the presser foot and pivot the material. To reinforce your corners, backstitch into and out of the pivot. (stitch down to the pivot point, do a few stitches backwards, stitch forward back down to the pivot point, pivot, few stitches forward, few stitches back, continue stitching forward until next pivot point and repeat)

Once your done, make sure to clip your corners before you flip your pillow right side out. Cut on a 45 degree angle from corner notch to corner notch

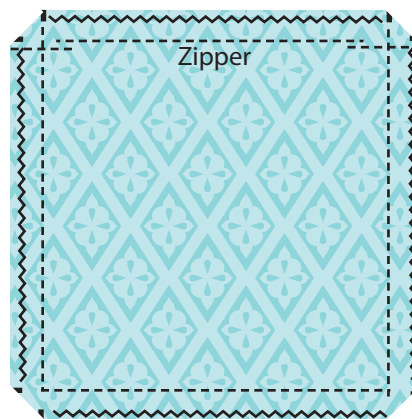

Flip right side out. Use a point turner to get your corners nice and sharp.

AWESOME PILLOW!

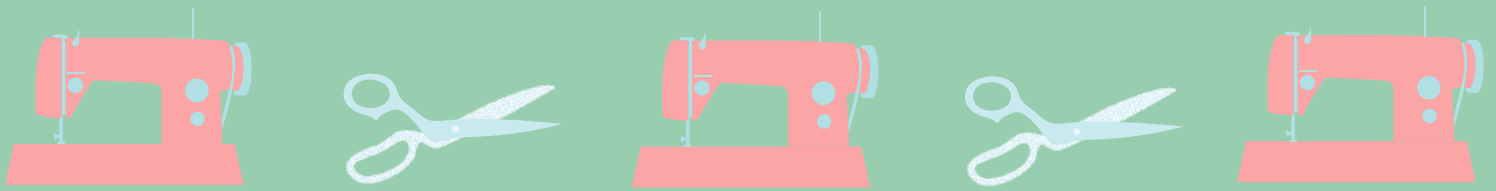

Pouch

For the pouch you will need a fabric for the interior/lining of the pouch, a fabric for the outside and fusible interfacing to give the pouch a little more structure. For the lining fabric, I would suggest getting just a plain cotton or something of that nature. The typical 'lining' fabrics are quite slippery and difficult to sew when you are just starting out.

To trace and cut your fabric, it is the same method that we used when tracing and cutting the pillow. You will need to repeat these steps on all 3 fabrics. You will need 2 of each fabric. When you are done you should have a total of 6 pieces cut out. Make sure you trace all the notches!

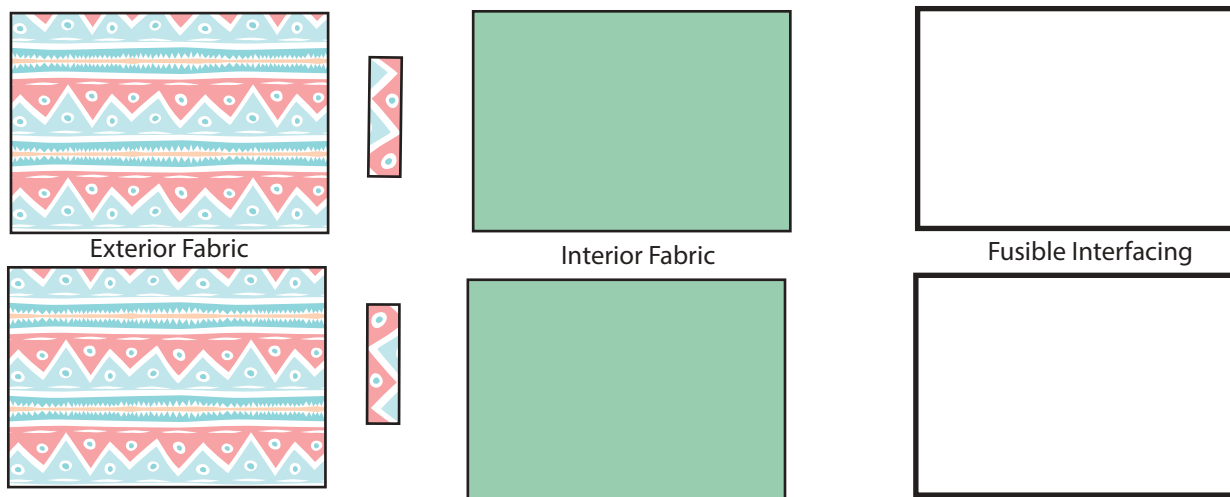

For the zipper extensions you will have to trace, and cut out 2 pieces measuring 1"x2". You can use whichever fabric you like, just remember you will see them.

First, let's get all the ironing out of the way. You want to fuse your exterior piece. Make sure you have the good side of your exterior piece facing down, and place your fusible interfacing glue side down (this will be the shiny side, or it will have a gritty texture to it). Whenever you're fusing something it is best to use a presscloth. You do not want to use a fanning motion when fusing something. What you want to do is put the iron down in one spot for a good 10-15 seconds, using a decent amount of pressure and some steam, and then you want to pick up the iron and place it on the next spot. Repeat this until the whole piece is fused.

With the zipper extension pieces, you want to press in the 1" sides in a 1/2" just like we did with the zipper edge, and then press it in half.



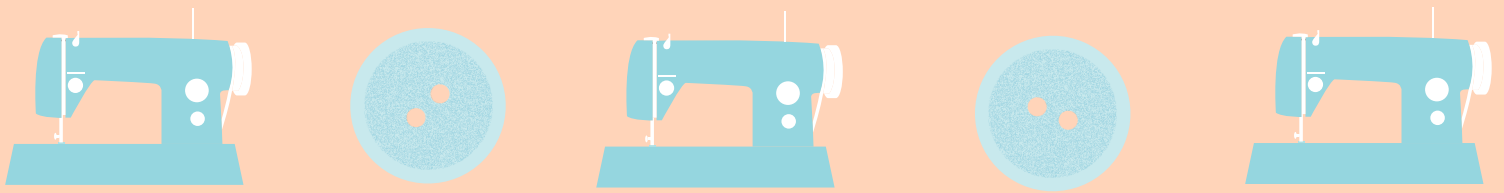

Pouch

Now to attach the zipper extensions to your zipper! First, we want to open the zipper a little bit to get the zipper pull out of the way. Then on the open end of the zipper, we are going to sew across the two sides to keep them together, you can do this by handstitching, or using the machine. You want to do this right near the stoppers at the top of the zipper.

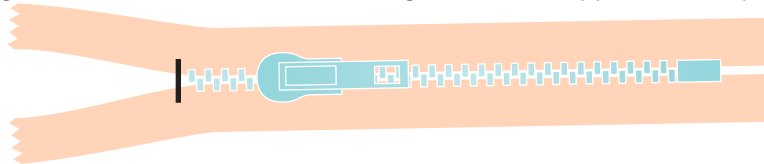

Once you have tacked the zipper together we are going to attach the first zipper extension. Lay the zipper extension piece good side facing down, and we are going to lay the zipper on top, good side facing up, then we are folding the extension piece in half, over the zipper sandwiching it. Make sure you are just a little past covering the zipper stoppers. Then you want to run a line of stitching right across the zipper, hold the zipper extension in place. 1/8 in from the zipper extension fold looks the best. Make sure to backstitch at the beginning and at the end. If you have a metal zipper, you will not be able to sew across the zipper teeth, instead of going across the zipper, you will have to sew the side of the zipper and the zipper extension together which is shown below in red.

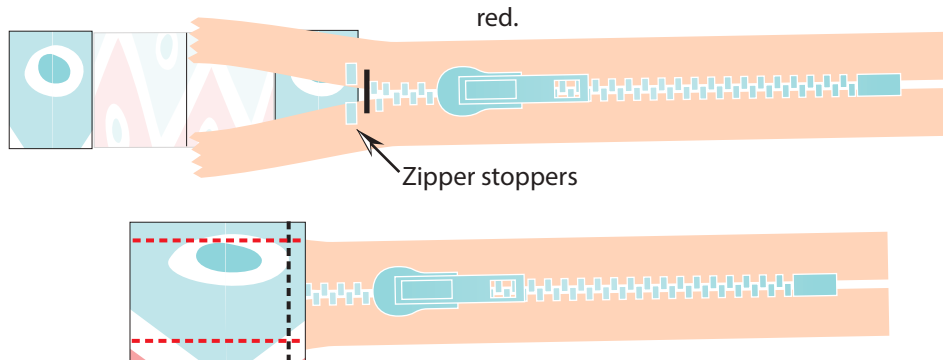

To do the extension on the other side, you have to first figure out the placement. This pouch works best if the edges of the zipper extensions are 3/4" in from the edge of the pattern, this will be 1/4" in from your notch. Lay your zipper on the pattern, and line up the zipper extension 3/4" in from the edge, measure 3/4" in from the other side and make a marking on your zipper. This is where your zipper will need to be cut. Once the zipper is cut, it the same process as before sandwich your zipper between the zipper

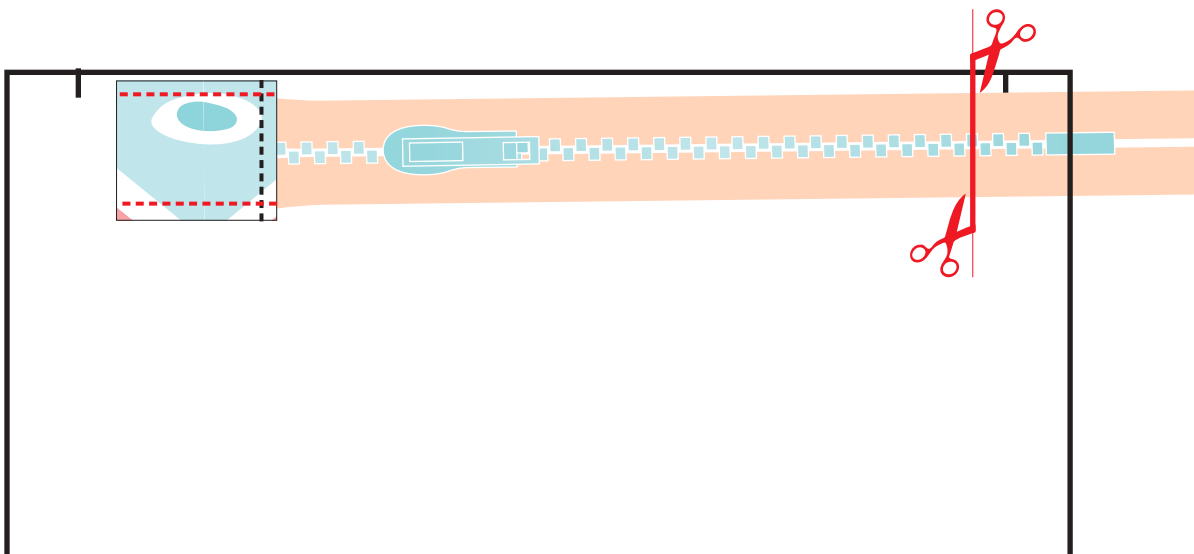



Pouch

Now your zipper should look like this:

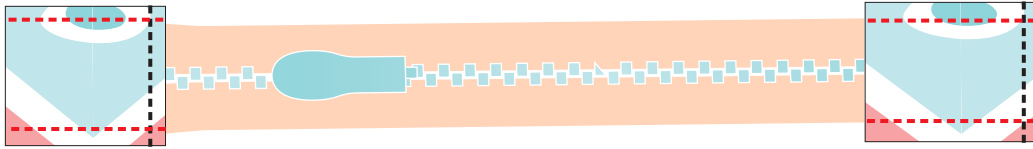

Next step! You're going to lay down your exterior piece good side facing up, making sure if you have a directional pattern that it is not upside down. Now you're going to place your zipper good side facing down, making sure it is centered between your notches, and lines up with the top edge of your fabric. Pin in place.

Once you have this pinned in place, you're going to take your lining and place it good side facing down on top of the exterior fabric and the zipper

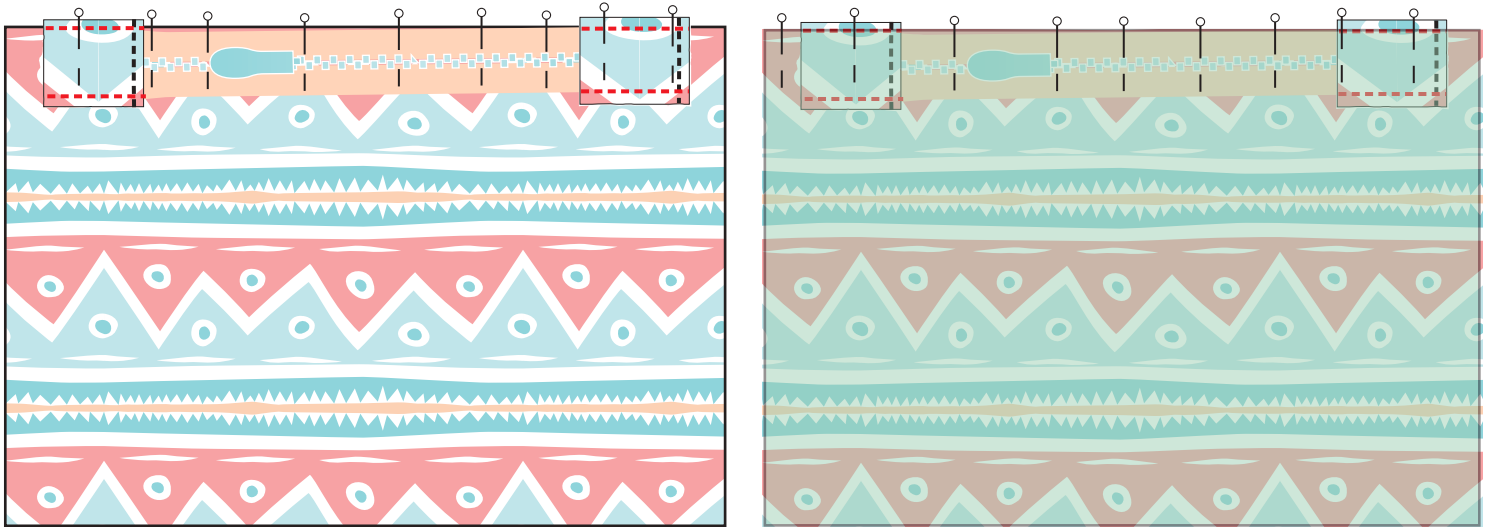

Now we are going to machine baste these layers together so they don't shift when we use the zipper foot. Change your stitch length to 4, and do NOT backstitch. Run a line of stitches nice and close to the edge of the fabric, be certain to catch all the layers. Do not stitch too closely to the zipper, we will do this later on.

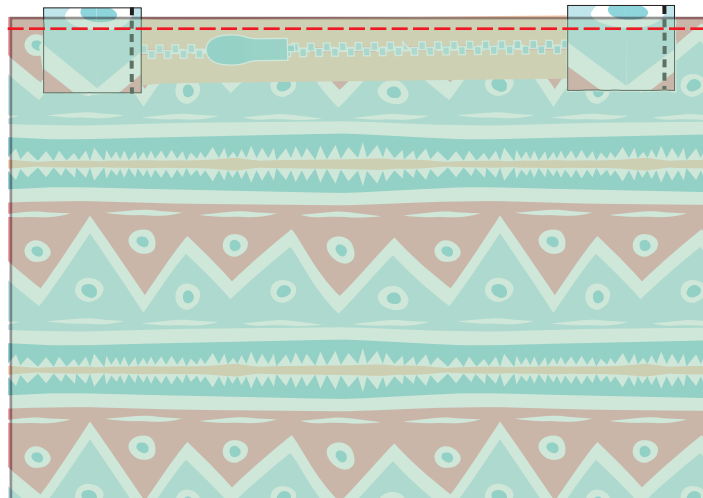

Pouch

Repeat this process on the other side of the zipper. Make sure the exterior fabric is good side facing up, zipper good side facing down, and lining good side facing down. Machine baste this in place the same way you did the other side. Make sure everything is nice and lined up.

Once everything is basted, we are going to use the zipper foot in order to stitch nice and close to the zipper. Attach the zipper foot to your machine, making sure you're clipping into the left hand side of the foot. You want your zipper to line up in the left hand groove of the foot, and your excess fabric on the left hand side. Repeat this on the other side

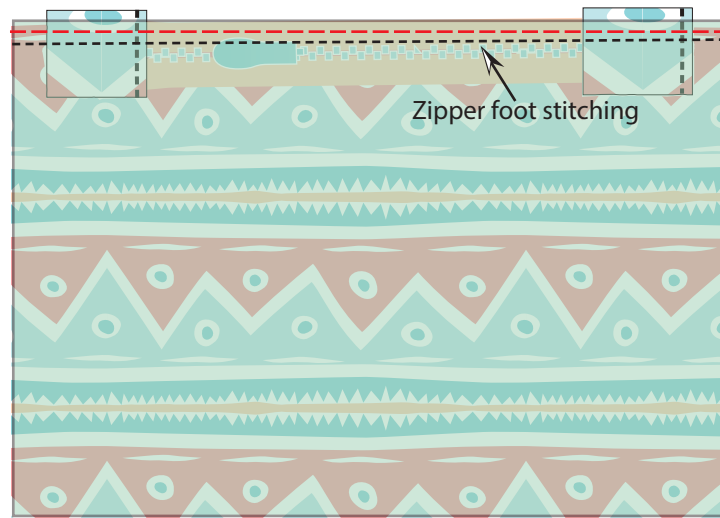

When you're done both sides, it should look like this:

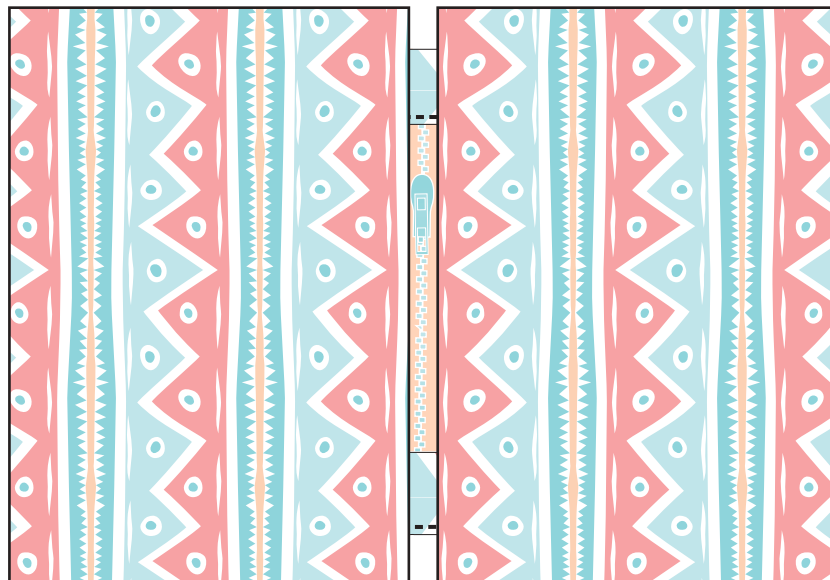

Pouch

Next is topstitching! This will prevent the lining from shifting and getting stuck in your zipper. You want to press the lining away from the zipper with the iron. Try to just use the nose of the iron for this, you don't want to melt the zipper teeth. It's a good idea to give the exterior a quick press with the iron as well. Once all is pressed, you're going to topstitch down each side of the zipper, making sure the lining doesn't shift or twist. The distance from your zipper to your stitching is pretty flexible. Being about 1/8" in is best, but you could do 1/4" in or even 1/2". Make sure to do the same on the other side of the zipper. Backstitch at the beginning and at the end just a few stitches.

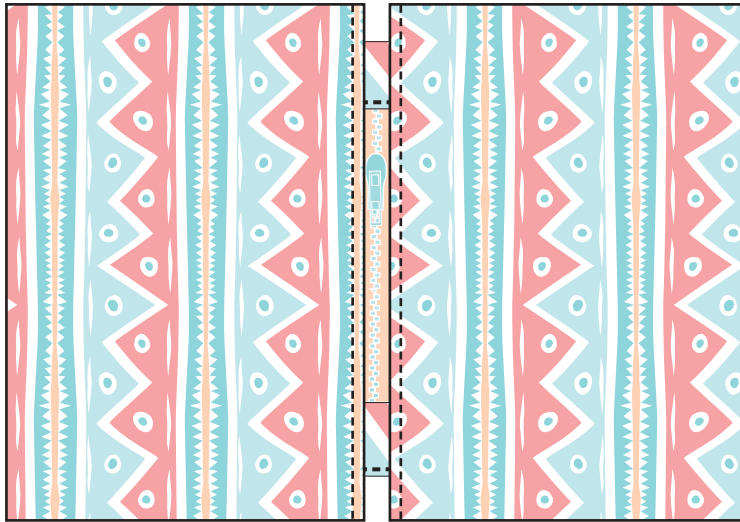

Now you want to OPEN the zipper. Then put good sides of the interior fabric together, and good side of the exterior fabric together. Line up your edges and pin all the way around just like the pillow. Be sure not to pin between the 2 deeper notches on the bottom of the lining. When we sew, we leave this open so we can flip the pouch right side out.

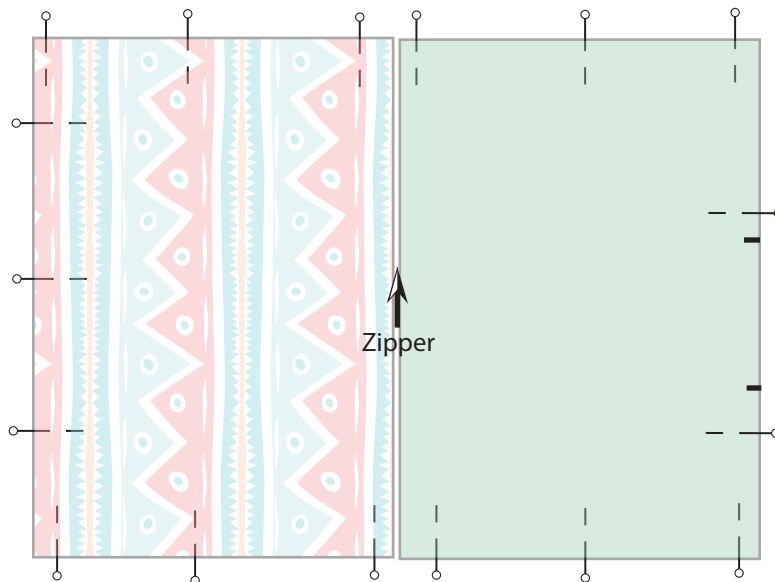



Pouch

Now that everything is pinned, it's time to sew! It's best to start at one of the notches in the lining and stitch all the way around until the other notch of that side, making sure to backstitch at beginning and end. You want to sew at 4/8" seam allowance. Make sure you do NOT sew the zipper extension tabs in! You want to just be stitching 2 layers of fabric (i.e. the 2 exterior pieces and the 2 interior pieces) Pivot your corners just like the pillow.

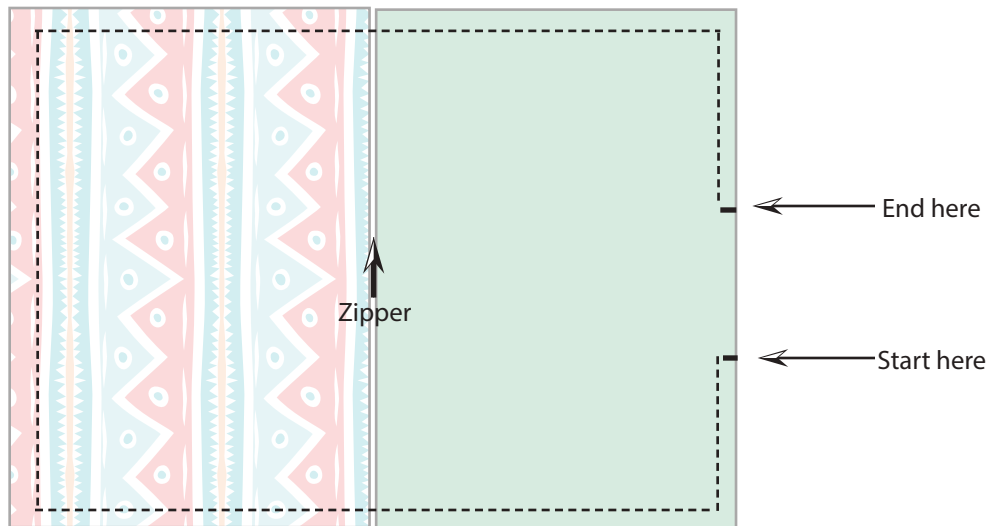

To box out the corners, with fabric still right sides together on each corner, match the side seam with the bottom seam to create a point. Place a pin in the seams to hold them together. It is very important that you match up the seams exactly; that is what will make the lines of your finished corner look fantastic. Mark the depth of the boxed corner with a fabric marking pen or pencil and a straight ruler, positioning your ruler so the depth is measured from side to side at the base of the point. The larger the measurement, the more boxed out it will be. 1/2" - 1" for a smaller pouch and 1"-2" for a larger pouch usually looks the best.

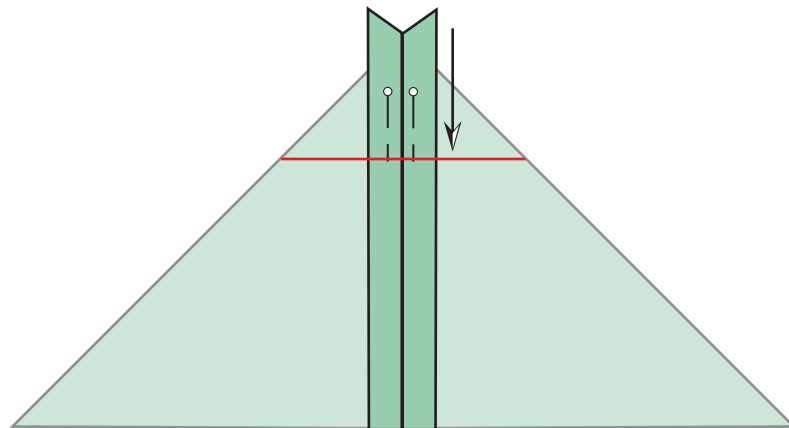

Once you have drawn your line across, you going to sew right across that line, backstitching at the beginning and end. Repeat on all 4 corners (exterior & interior fabric).

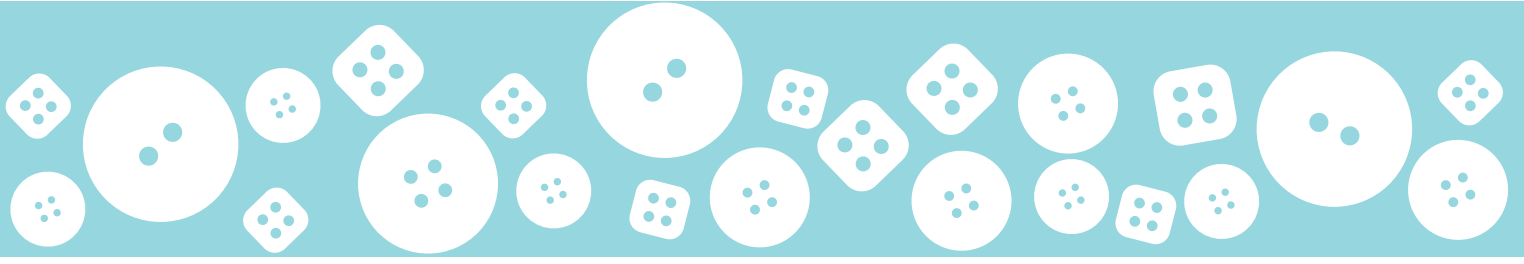

Pouch

Once you have the corners all sewn, you can cut off the excess fabric leaving about a 1/2" excess. Time to flip the pouch right side out! Reach into the opening we left in the bottom of the lining and flip the pouch right side out. Almost done!

The last step is to close up the opening in the bottom of the lining. You want to pinch at each end of the opening so the fabric at the opening fold in. Put a few pins to hold it in place and run a topstitch across the opening about 1/8" from the edge. It's best to use a thread colour that matches your lining so it blends right in. YOU'RE DONE!

You are now the proud owner of a custom handmade fantastic pouch!

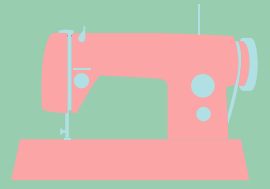
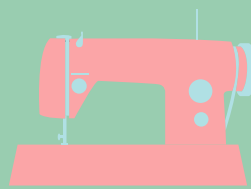
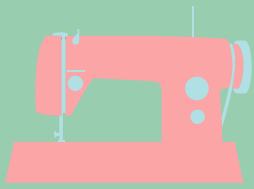

C

O

N

G

R

A

T

S

Congratulations on completing Fundamentals 1! You now have a beautiful headband, an awesome pillow cover, and a fantastic pouch! Thank you so much for spending time with us at The Make Den. We hope you learned a tonne and had fun while doing it! Hopefully this handbook will help you not only understand the projects further, but recreate them! We hope to see you again at The Make Den!

Happy Sewing!
The Make Den staff

If you're looking to further your sewing knowledge, or just looking to try something new these classes are your next steps.

Fundamentals 2 will build on your fundamental skills, give you an introduction to garment construction and some fun new projects to take home!

Projects include a coffee cup cozy; simple shoulder / tote bag; and an awesome apron!

Intro to Sewing Garments will show you how to use your own measurements to create a perfectly fitting skirt . By the end of this 8-week beginner class you will not only have a perfectly fitting skirt pattern, but also a skirt!

Basic Mending and Alterations will show you the basics of Mending your clothes! Let us show you the basics of hemming and taking in your pants, shirts, skirts and dresses!

Intro to Quilting will walk you through the basics of pieced quilting – you will choose, prepare and finish your own 12" pieced quilt block design, and will be well prepared to tackle your own full-sized quilt once you finish this course.

Intro to Screen Printing a.k.a. silkscreening a.k.a. the ability to print photos, designs, logos or text onto any medium you like. Simple to learn, boundless with possibilities. This 3-part workshop will equip you with the knowledge and tools to create your own design and reproduce it to your heart's content.

