

# Fabricating cabinets

## KITCHEN AND CABINET BATHROOM MAKING

**Supporting:**

***LMFKB3005A***

***Fabricate cabinets for  
the built-in environment***



## Learner guide

**Developed in 2011-2012 for the WELL Program**



---

# Fabricating cabinets

## Learner Guide

This unit is also available in an e-learning format, which contains additional photos, interactive exercises and a voice-over narration of the text. It can be viewed on CD-ROM, or live on the web at:

<http://www.kbcabinetmaking.com.au/>



Developed by Workspace Training for the 2011-2012  
Workplace English Language and Literacy (WELL) Program  
Kitchen and Bathroom Cabinetmaking resource development project



[www.workspacetraining.com.au](http://www.workspacetraining.com.au)

---

ISBN: 978-0-9873328-9-9

Funded under the Workplace English Language and Literacy Program by the Australian Government through the Department of Education, Employment and Workplace Relations.

COPYRIGHT

© Commonwealth of Australia. 2012



**CC BY-NC-SA**

This work is copyright. Except where otherwise indicated, and save for the Commonwealth Coat of Arms, the Department has applied the Creative Commons Attribution-Noncommercial-Share Alike 3.0 Australia Licence to this work.

The Department of Education, Employment and Workplace Relations must be attributed as the author of the Department's copyright material.

As far as practicable, material for which the copyright is owned by a third party has been clearly labelled. The Department has made all reasonable efforts to ensure that this material has been reproduced in the print-based resources and accompanying website with the full consent of the copyright owners.

Requests and enquiries concerning the Department's copyright material should be addressed to:

The Copyright Officer  
Department of Education, Employment and Workplace Relations  
Location code C148CW2  
GPO Box 9880 Canberra ACT 2601  
Email: [copyright@deewr.gov.au](mailto:copyright@deewr.gov.au)

Questions about the design and content of the resource itself should be addressed to the project manager:

David McElvenny  
Workspace Training  
PO Box 1954 Strawberry Hills, NSW, 2012  
Email: [david@workspacetraining.com.au](mailto:david@workspacetraining.com.au)

---

## About this resource

This learner guide is one of 11 learner guides developed for the *Kitchen and Bathroom Cabinetmaking* project, funded by the WELL Program in 2011-2012. The guides are aligned to the following core and elective competencies from the *Certificate III in Cabinetmaking (Kitchens and Bathrooms) LMF32109*:

<i>LMFKB2001A</i>	<i>Prepare for cabinet installation</i>
<i>LMFKB3001A</i>	<i>Identify processes in kitchen and bathroom</i>
<i>LMFKB3002A</i>	<i>Determine requirements for installation</i>
<i>LMFKB3003A</i>	<i>Check and measure fit of cabinets</i>
<i>LMFKB3004A</i>	<i>Conduct on-site adjustments to cabinets</i>
<i>LMFKB3005A</i>	<i>Fabricate cabinets for the built-in environment</i>
<i>LMFKB3006A</i>	<i>Install fitted cabinets and components</i>
<i>LMFFM3006B</i>	<i>Install furnishing products</i>
<i>MSAENV272B</i>	<i>Participate in environmentally sustainable work practices</i>
<i>MSAPMOHS200A</i>	<i>Work safely</i>
<i>MSAPMOPS101A</i>	<i>Make measurements</i>

The purpose of the guides is to help apprentice cabinetmakers acquire the background knowledge needed to satisfy the theoretical components of these units. However, they are not designed to replace the practical training necessary to develop the hands-on skills required. Learners will still need to receive extensive on-the-job training and supervision before they will be ready to be formally assessed in these units.

### E-learning version

All of these units are also available in an e-learning format, which contains additional photos, interactive exercises and a voice-over narration of the text. The e-learning version can be viewed live on the web at:

<http://www.kbcabinetmaking.com.au/>

The web version can also be purchased on a CD at a cost-recovery price from the project developer:

David McElvenny (project manager)  
Workspace Training  
PO Box 1954 Strawberry Hills, NSW, 2012  
Email: [david@workspacetraining.com.au](mailto:david@workspacetraining.com.au)

---

## Acknowledgements and disclaimer

### Project team

Project manager: David McElvenny

Instructional design: Kath Ware

Technical developer (website): Jim Vaughan

Assistant technical developer (and voice-over artist): Alex Vaughan

Quality assurance consultant: Giselle Mawer

Industry coordinator: Gary Dunshea (MSA Industry Skills Council)

Lead advisor: Rob Cole (Furnishing Industry Association of Australia)

### Technical Advisory Group

#### New South Wales

Brad Holmes – Hunter TAFE

Grant Cohen – Hunter TAFE

Dean Brakell – Furnishing Industry Association of Australia

Warren Peters – South West Sydney Institute of TAFE

Sean Greening – South West Sydney Institute of TAFE

#### ACT

Martin Jud – Canberra Institute of Technology

#### Victoria

Bryon Stanley – Furnishing Teacher's Advisory Group (VIC, SA, TAS)

Richard Brooks – Cabinet Makers Association

Simon Hampton – Wodonga TAFE

John Simpson – Holmesglen TAFE

#### Tasmania

Stephen Kirkman – Skills Institute Tasmania

#### Queensland

Rob McAdam – Skills TECH Australia

Brad Buhse – Skills TECH Australia

Roberto Viola – Gold Coast Institute of TAFE

#### South Australia

John Holst – Marleston TAFE

Dean Hart – Mt Gambier TAFE

Martin Videon – Furnishing Industry Association of Australia

---

## Northern Territory

Hermann Oltrop – Charles Darwin University

## Western Australia

Garry Michels – Polytechnic West

Keith Campbell – Polytechnic West

Adrian Boyling – Polytechnic West

David Boaden – Polytechnic West

Lorenzo Procopio – South West Institute of Technology

## National

Laurie Kruize – Housing Industry Association

## Photographs and graphics

All photos were taken by David McElvenny. All graphics were drawn by Kath Ware. We would like to thank the following companies for allowing us to take photos of their installers and workshop employees and generously providing technical advice:

Canobolas Kitchen Designs

Flair Kitchens

Danson's Kitchens and Joinery

Lamtex Innovative Furniture

Fewings Joinery

Stateline Cabinets

B&B Joinery

Ian McConnell Constructions

Krauss Kitchens

## Financial contributions

This resource was largely funded by the Workplace English Language and Literacy Program, through the Department of Education, Employment and Workplace Relations. However, due to the scale of the project and the provision of print-based and website resources, additional financial assistance was provided by the following organisations:

Manufacturing Skills Australia (Industry Skills Council)

Furnishing Industry Association of Australia



## Disclaimer

The content of this learner guide is provided for educational purposes only. No claim is made as to the accuracy or authenticity of the content. The views expressed in this publication do not necessarily represent the view of the Minister for Education or the Australian Government. The Australian Government does not give any warranty nor accept any liability in relation to the contents of this work.

---



---

## Table of contents

<b>Introduction</b> .....	<b>1</b>
<b>Section 1 Manufactured boards</b> .....	<b>3</b>
Overview.....	5
Particleboard .....	7
Medium density fibreboard .....	9
Plywood .....	11
Hardboard.....	13
Surface treatments .....	15
Manual handling .....	17
Assignment.....	19
<b>Section 2 Cutting and edging</b> .....	<b>21</b>
Overview.....	23
Panel saws .....	24
Cutting lists .....	26
Quality checks .....	28
Edge treatments .....	30
Controlling dust.....	32
Assignment.....	34
<b>Section 3 Assembling the cabinet</b> .....	<b>37</b>
Overview.....	39
Joints and fasteners.....	40
Bases.....	43
Carcases .....	44
Assembly .....	46
Doors .....	48
Drawers .....	50
Assignment.....	52
<b>Practical demonstration</b> .....	<b>53</b>

---

## Introduction

In this unit, we'll examine the processes involved in assembling and finishing cabinets in the workshop. We'll also look at the most common materials and hardware items used in the manufacture of kitchen and bathroom cabinets.

Workshops typically use a lot of high speed production processes requiring specialised machines and tools, sometimes involving patented systems developed by the product manufacturer. We won't go into the details of how to operate particular types of equipment in this unit because there are often specific techniques that apply to certain brands and models.



You will cover the actual operation of different types of machines and tools in other competencies from your trade course. There's a wide range of competencies available, and your trainer will help you to choose the most appropriate ones for the type of work you do.

Your choice is likely to include some or all of the competencies shown below.

Competencies relating to machines used in making kitchen and bathroom cabinets	
LMFFM3020B	Set up, operate and maintain sawing machines
LMFFM3021B	Set up, operate and maintain drilling machines
LMFFM3023B	Set up, operate and maintain planing and finishing machines
LMFFM3025B	Set up, operate and maintain routing and shaping machines
LMFFM3027B	Set up, operate and maintain automated edge banding machines
LMFFM3030B	Set up, operate and maintain CNC sizing machines
LMFFM3031B	Set up, operate and maintain CNC machining and processing centres

---

## Working through the unit

There are three sections in this unit:

- Manufactured boards
- Cutting and edging
- Assembling the cabinet.

Each section contains an *Overview*, an *Assignment* and *Lessons* which cover the content material. Your trainer may ask you to submit the assignments as part of your assessment evidence for the unit. You will find hard-copy templates for these assignments in the separate *Workbook*.

Electronic 'Word' templates of the assignments are available on the website for this resource, at: <http://www.kbcabinetmaking.com.au/>

The electronic versions can be completed on-screen and sent to the trainer either as:

- a printed hard copy, mailed through the post
- an electronic file, emailed as an attachment.

## Practical demonstration

Your final assessment of competency in this unit will include various practical demonstrations. Their purpose is to assess your ability to fabricate kitchen or bathroom cabinets in a workshop. To help you get ready for these hands-on assessment activities, there is a *Practical demonstration* checklist at the back of this Learner guide.

The checklist sets out the sorts of things your trainer will be looking for when you undertake the practical demonstrations. Make sure you talk to your trainer or supervisor about any of the details that you don't understand, or aren't ready to demonstrate, before the assessment event is organised. This will give you time to get the hang of the tasks you will need to perform, so that you'll feel more confident when the time comes to be assessed.

Section 1

# Manufactured boards





## Overview

Manufactured board products used in kitchen and bathroom cabinets are generally made from reconstituted wood.

The boards are called ‘manufactured’ because the wood fibres are processed and re-built in some way, unlike solid timber which is simply cut straight from a log. They are also often used as the **substrate**, or core, in a laminated or veneered board product.

Most manufactured boards are more stable than solid timber. That is, they swell and shrink less as the air humidity changes, and tend to stay straighter and flatter because they don’t have internal stresses pulling in different directions. They are also available in large sheet s which can be cut back to any finished size.



The choice of which board product you should use for a particular job will depend on a range of factors. These include how strong it needs to be, what fasteners will be used, how much moisture it will be exposed to, and of course, the level of quality that the client is prepared to pay for.

In this section, we’ll examine four common board products used in cabinet construction. We’ll discuss their properties, typical end uses and main advantages and disadvantages.

### Completing this section



The assignment for this section is designed to test your knowledge of the board products and surface finishes used in kitchen and bathroom cabinets. Have a look at the *Assignment* on page 19 to see what you’ll need to do to complete it.

There are also six lessons in this section:

- *Particleboard*
- *Medium density fibreboard*

- *Plywood*
- *Hardboard*
- *Surface treatments*
- *Manual handling.*

These lessons will provide you with background information relevant to the assignment.



## Particleboard

Particleboard is also called **chipboard**, because it is made from small chips of wood glued together and compressed in a high-temperature press. Different glues are used to bond the fibres, such as:

- **Urea formaldehyde** – for ‘standard’ grade particleboard not exposed to moisture
- **Melamine formaldehyde** and urea formaldehyde combined – for ‘moisture resistant’ particleboard used in kitchens, bathrooms and laundries
- **Phenol formaldehyde** – for high strength sheet flooring.



Various additives are included in particular grades, depending on the properties the board needs to have. For example, paraffin wax is used to increase the board’s resistance to water and to reduce the swelling that occurs if it gets wet. Fire retardants, insecticides and fungicides are also used to improve the board’s durability and performance.

If you look closely at the edge of a sheet of particleboard, you’ll notice that the chips are not all the same size. The board is actually built up in layers. The most common structure is **three-layer particleboard**, which has fine particles and more adhesive in the two outer layers and a coarse layer in the middle.



### Advantages

Particleboard is easy to re-saw and machine. Nails and screws have reasonable holding power when used properly, and joints can be glued for extra strength.

It is a very cost-effective substrate for plastic laminates and timber veneers, and it does not swell or shrink, as long as it’s kept dry. Melamine-faced moisture-resistant particleboard is particularly suitable for cabinet carcasses and shelves.

## Disadvantages

The biggest weakness of particleboard is its inability to resist moisture. Once it gets wet and ‘blows up’, it doesn’t shrink back to its original thickness. Instead, the board loses strength and becomes crumbly where it has swollen. Although moisture-resistant board performs much better than standard board, it still needs to be protected from direct wetting.

Another disadvantage is its rough edge, and inability to hold fasteners tightly when fixed into the edge. ‘Helical’ nails and ‘chipboard’ screws help to overcome this problem by providing more grip with their coarse threads.

### Learning activity



Moisture resistant particleboard generally has a green tinge to it, especially on the edge of the board. If you haven’t noticed this before, go out to your workshop storage area or local building supply company and compare the colour of a sheet of standard grade board with a moisture resistant board.

While you’re looking closely at the edge, check out the three different layers. Why do you think it’s useful to have a fine texture on the top and bottom faces and a coarser layer in the middle? Share your answer with your trainer and other learners in your group.

## Medium density fibreboard

Medium density fibreboard, or MDF, is manufactured in a similar way to particleboard, using the same sorts of glues and additives. The big difference is in the way the wood fibres are treated before they're pressed.

The wood is heated under pressure until the fibres and natural glues that bond them together soften, and then the fibres are rubbed apart to produce a much finer material for pressing.



The end result is a sheet with a higher density than particleboard and an even consistency right through to the centre. This allows MDF to be machined or routed to a profile on the face and edge without the fibres pulling out or chipping. It can also be sanded and painted to give a smooth finish.

There are two types of MDF:

- **Standard MDF**, which uses urea formaldehyde as the adhesive
- **Moisture resistant MDF**, which uses melamine and urea formaldehyde.

### Advantages

MDF doesn't warp or twist under normal conditions. It can be drilled, sanded, routed and re-sawn without splintering or chipping. Because of its consistent density, its face and edges can be machined to a profile, without the need for a separate edge strip.

It can also be painted, stained or clear finished, and is often used for high-gloss enamel-finished items.

In addition to being suitable for painting, MDF is also an excellent substrate for laminates, including wood veneers, vinyls and melamine. It can also be used in curved work, such as archways and curved panels.



## Disadvantages

Like particleboard, MDF does not tolerate wet conditions. Moisture-resistant boards are able to cope with areas of high humidity and occasional wetting, but they still need to be protected from prolonged contact with moisture.

MDF will also swell and shrink in response to changes in humidity. In locations where dimensions are critical, MDF should be **acclimatised** for up to 48 hours prior to use to make sure that its moisture content is in balance with the surrounding atmosphere.

### Learning activity



Have you heard the term ‘acclimatise’ before? It’s the process of bringing the board’s moisture content in line with the surrounding atmosphere – or ‘climate’ – by letting the board naturally take up or give off moisture into the air over a period of time.

How would you do this if you had several large sheets? That is, how would you stack the sheets to ensure that the air could circulate around all surfaces?

Write down your answer and share it with your trainer and other learners in your group. If you have examples in your own workplace of methods used to acclimatise board products, take some digital photos to include with your answer.

## Plywood

Plywood is made up of several 'plies', or layers of wood veneer, glued together and bonded in a high temperature press. The direction of the grain in each layer runs at right angles to the layer above and below it.

Because the face and back veneers have the grain running the same way, there is always an uneven number of layers.



There are two basic methods of cutting veneers:

**Rotary cut veneer** is peeled on a lathe. The veneer comes away in a long continuous sheet, which is re-cut into sizes suitable for laying up into plywood. Most plywood veneers are rotary cut.

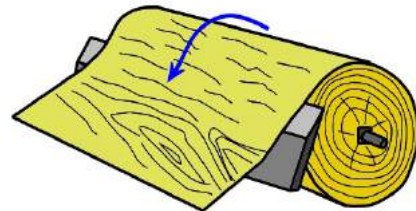

**Sliced veneer** is cut from a 'flitch', or large section of timber, using a knife that slices across the grain. Although this process is more costly than peeling, it tends to produce a veneer with a more appealing 'figure' in the grain, so it is often used for high-grade decorative veneers.

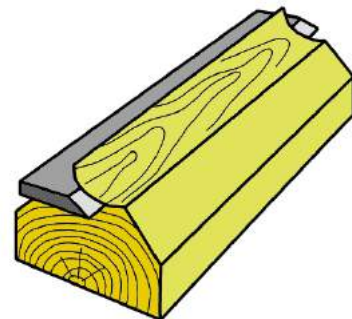

### Glue bonds and veneer grades

The glues used in plywood vary depending on the strength and durability required. They range from Type A, the strongest and most weather resistant bond, to Type D, the weakest and least durable bond.

Type A bonds are used in most plywoods these days, because the benefits generally outweigh the extra cost involved. However, Type C and D are sometimes still used in interior ply with light-coloured veneers that might be discoloured by the heavy brown Type A glues.

There are also four grades of veneer quality. These range from A Grade, which has a high quality appearance designed for clear finishing or staining, to D Grade, which

contains various defects and is designed to be covered. Some manufacturers use the term S Grade to refer to a high quality sliced veneer.

## Advantages

Plywood is very strong and very stable. This is because the alternating veneers maximise the natural strength of timber along its grain and minimise its tendency to shrink across the grain. It also allows the sheets to be nailed or screwed close to the edge without splitting. Panels that use Type A glue bonds are highly durable and suitable for use in wet areas.

## Disadvantages

Because the layers of veneer are bonded at right angles to each other, there can be some tear-out on the edge if it is machined. The edge can also split when screws are used unless pilot holes are drilled first. Another disadvantage is its cost – plywood is more expensive than most other board products.

## Learning activity



There are two obvious differences in appearance between sliced veneers and rotary cut veneers. The first is the different patterns formed by the growth rings and other characteristics in the timber – called ‘figure’ – depending on whether the veneer has been peeled in a continuous sheet or sliced.

The second major difference is the joins that occur in sliced veneers where the individual ‘leaves’ are laid side by side across the face of the sheet. You can see these joins in any sliced-cut face veneers, both in plywood sheets and other timber veneered boards.

See if you can find an example of each of these types of face veneers – rotary cut and sliced. If you have a digital camera or mobile phone, take a photo of each one. Send the photo to your trainer and other learners in your group. Try to name the species of timber in each case.



## Hardboard

Hardboard is made from wood fibres compressed into a sheet in a high temperature press. In principle, the bonding is achieved entirely through the 'felting' process of the fibres and the natural glue, or **lignin**, already present in the wood.

However, other chemicals can be added to improve the board's strength and resistance to moisture, fire, insect attack and decay.



Hardboard is often referred to by the trade name 'Masonite', which comes from the Mason gun used to produce the wood fibres. In this process, the wood chips are steam heated in a high-pressure cylinder and then released into a cyclone, which causes the chips to explode into fibres.

### Types of Hardboards

The different types of hardboard available are as follows:

**Standard hardboard** is used for wall linings, door skins, cabinet backs, drawer bases, and other interior purposes.

**Underlay hardboard** is treated to improve its moisture resistance, and is used under floor coverings.

**Tempered hardboard** is treated to give it more strength and better resistance to moisture, so it can be used as a lining where moisture may be present.

**Exterior hardboard** is treated to make it resistant to moisture and weathering, so it can be used for cladding and other outside applications.



### Advantages

Hardboard can be nailed or screwed close to the edge, and does not split, chip-out or produce splinters. The board is also flexible and easy to bend into curved shapes.

---

Because of its strength and smooth surface it is ideal for cabinet backs and drawer bottoms. It is also widely used in templates and jigs.

## Disadvantages

Hardboard is a high-density material and tends to blunt cutters more quickly than other board products. It tends to be only available in thin sheets – the standard thicknesses are 3.2 mm and 4.8 mm.

## Learning activity



Hardboard was once commonly used in kitchen and bathroom cabinet backs and drawer bottoms. However, it is much less popular now and has largely been replaced by melamine-faced particleboard or MDF.

Do you use hardboard in any of your cabinets or other furniture items? If so, where do you use it and why is it considered the best choice for that application? Share your answers with your trainer and other learners in your group.



## Surface treatments

All of the manufactured board products we've discussed so far can be used as a substrate, or 'core', for a laminated surface. In practice, the most common substrates for kitchen and bathroom cabinets are MDF and particleboard.

Below are the main types of surface treatments used in cabinets.

### High pressure laminates

High pressure laminates are made from layers of paper or fabric impregnated with resin, such as urea or melamine. The layers are bonded together under heat and high pressure into a single sheet. Different colours or printed patterns can also be incorporated into the superimposed layers.

High pressure laminates resist cuts, stains and abrasion, and are highly suitable for bench tops and other surfaces that require a durable finish. Depending on the strength and durability required, the thickness can range from 0.5 mm to 2 mm.

### Low pressure laminates

Most people refer to low pressure laminates simply as 'melamine' – for example, 'white melamine particleboard' refers to a particleboard substrate faced with a white low pressure laminate. Strictly speaking, though, the melamine is the resin used to impregnate the paper layers that make up the laminate.

The main difference between high and low pressure laminating is the pressure of the press during the bonding process. Low pressure laminates are thinner and less durable, so they are used in cabinet carcasses and shelving, rather than in bench tops.



## Timber veneers

When solid timber doors and drawer fronts are used, it is common practice to build the cabinet carcasses out of particleboard or MDF faced with a matching timber veneer.

The veneers are generally 'sliced cut' to show an appealing figure in the grain.



## Paints and lacquers

There is a wide range of paints and lacquers available as surface finishes. They are typically sprayed onto MDF and hardboard with as many coats as required for the end use it is designed for.

Cabinet doors and drawer fronts made from MDF often have an inset pattern machined into the face and a high gloss polyurethane paint finish.



## Learning activity



You've no doubt seen all of these surface treatments in various kitchens, bathrooms and items of furniture. You may have also seen combinations of treatments in a single panel, such as:

- particleboard sheets with a timber veneer face and white melamine back
- MDF with a laminated face and a painted edge (machined to a profile).

See if you can give an example where each of these surface treatments might be used in a panel or component in a kitchen or bathroom installation. You may take digital photos if you wish to help illustrate your answers. Share your findings with your trainer and other learners in your group.

## Manual handling

Manufactured boards are generally bought from the supplier in large sheets, such as 2400 x 1200 mm or even larger. The reason is that the bigger the sheet, the easier it is to minimise wastage when you're cutting it up. But that doesn't mean it's easy to carry and manoeuvre!

If a board is too heavy or too awkward to move on your own, always make sure you ask for help. An offsider can make a big difference to the effort required to lift and carry a sheet. And the extra control you have will lessen the chance of damaging the sheet when you put it down again.



For more information on good manual handling techniques you should refer back to the 'Manual handling' lesson in the *Working safely* unit.

## Mechanical aids

There are various mechanical aids you can use to reduce the manual handling involved in moving sheets around the workshop. Here are some examples.

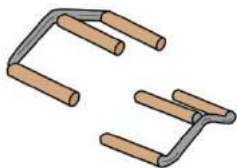

**Board grips** are useful when you need to carry large sheets any distance. They're designed to be used by two people, with one person at each end lifting the sheet with their own handle.

A **panel skate** is handy if you're working on your own. It lets you slide the sheet into the V shape of the skate, push it to its destination, and slide the sheet out again.



A **panel trolley** is designed to move several sheets at once. It can be tilted sideways, and also raised or lowered, so that sheets can be slid easily from the trolley onto a saw table.

**Panel lifters** work by creating a vacuum under a set of suction heads, allowing the board to be lifted and moved with an overhead crane.

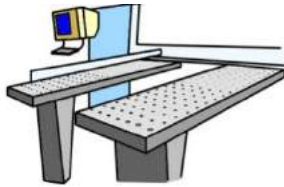
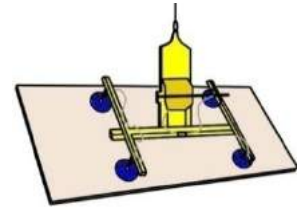

**Flotation tables** are often incorporated into beam saws. They blow air upwards through a series of holes, allowing the sheet to slide smoothly over the top.

### **Learning activity**



Your own workshop probably has a range of mechanical aids that help to reduce the amount of manual handling you need to do. What devices do you use? Write a list of the different methods you use to move panels around the workshop. Share your list with your trainer and other learners in your group. You may wish to take digital photos of the equipment you use and include them with your responses.

## Assignment

1. There are two main methods used to produce timber veneers. Name each one and briefly describe the process.
2. What is MDF? How is its structure different from particleboard? What does its structure allow you to do with the board that you couldn't do with particleboard?
3. What is a 'substrate'? Name the two most common substrate board products in kitchen and bathroom cabinets?
4. What is the difference between a high pressure and low pressure laminate? Include an example (such as a name brand) for each one.
5. Name four types of surface finishes commonly used on cabinet doors. For each one state how the surface finish is applied and briefly describe its main advantages and disadvantages.
6. Describe two methods you use in your own workplace to reduce the strain on your body when moving large sheets of material around.





# Section 2

## Cutting and edging







## Overview

Now that we've talked about the board products and surface finishes used in cabinets, let's turn to the process of converting these full-sized boards into the panels that make up the carcases, doors, shelves and other components.

In this section, we'll look at the main types of saws used to cut manufactured board products. We'll also cover some of the techniques used to 'edge' the panels and prepare them for assembly into the finished cabinets.



### Completing this section



The assignment for this section will ask you questions about the machinery and processes involved in cutting and preparing components. Have a look at the *Assignment* on page 34 to see what you'll need to do to complete it.

There are also five lessons in this section:

- *Panel saws*
- *Cutting lists*
- *Quality checks*
- *Edge treatments*
- *Controlling dust.*

These lessons will provide you with background information relevant to the assignment.

## Panel saws

Panel saws are used to cut large panels into smaller sizes. They range from small manually-operated table saws to highly-automated numerically controlled (NC) saws.

Some production systems also have automated in-feed and out-feed mechanisms to minimise the amount of manual handling required to move sheets around.



Panel saws that are designed to cut laminated boards often have a **scribing blade** (also called a 'scorer') in front of the main saw blade. It cuts slightly into the underside of the panel before the main blade cuts through the full thickness. This helps to stop the problem of 'break-out' occurring on the underside of the board, where the surface chips out as the teeth pull through the material.

On the other side of the main blade is a **riving knife**. This is a piece of steel shaped to match the curve of the saw blade. Its purpose is to stop the material on either side of the **kerf** (the saw cut) from closing up and jamming the blade.

This closing action is called **binding**. If a board did bind on the blade, it would have a tendency to suddenly kick backwards and possibly damage the board or blade.

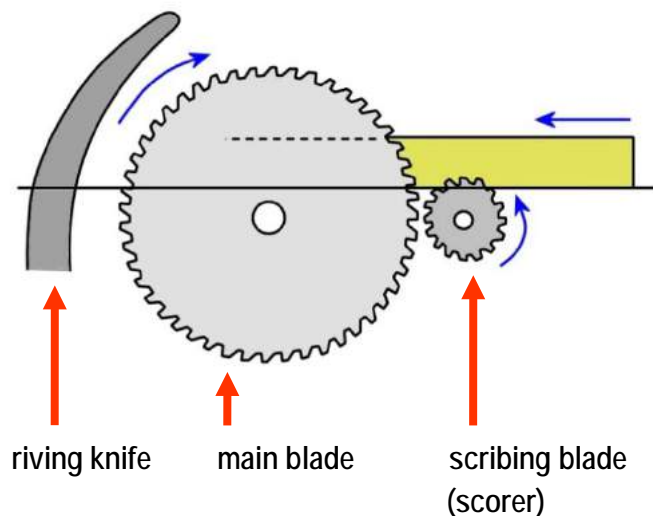

## Types of saws

The main types of panel saws are as follows.

**Sliding table panel saws** have a sliding table that allows the operator to push the board manually through the saw blade. On some saws the settings are all manually adjusted, but on others they can be computer controlled.

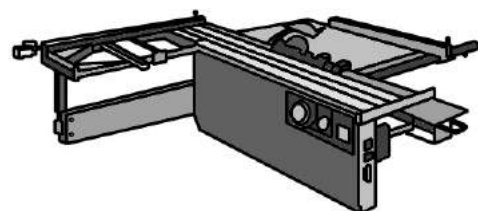

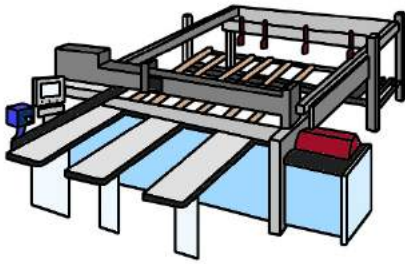

**Numerically Controlled (NC) beam saws** are controlled by a computer program and designed for high volume production work. The loading and stacking mechanisms are often automated, and the saws can cut several panels at once.

**Wall saws** are used in workplaces where floor space is limited. The saw and frame are mounted to a wall, leaving the floor clear for loading and unloading the panels. They require a special type of saw blade because they don't have a scribing blade.



## Types of blades

Kitchen and bathroom manufacturers generally use **tungsten carbide tipped (TCT)** blades, because they are very hard wearing and suitable for cutting boards that contain glues and laminated veneers. The tooth profiles can vary, depending on the types of boards being cut. Below are the three most common profiles.

**Square top teeth** are ground square. They cut both sides of the 'kerf', or saw cut, at the same time, so they are fast and efficient. However, they tend to tear out the grain or chip out surface laminates at their exit point.

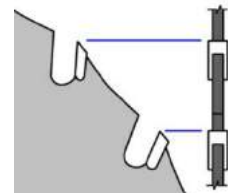

**Alternate top bevel (ATB)** teeth are bevelled in opposite directions on every second tooth. They cut much more cleanly than square top teeth, and virtually eliminate tear out problems. However, the leading point is easily damaged and sharpening is more difficult.

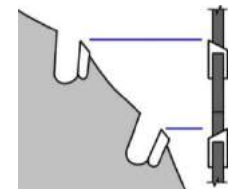

**Triple chip teeth** also have a different profile on every second tooth. The 'leading' tooth has a double 45 degree corner bevel. The second tooth, or 'raker', removes the two corners left behind by the bevels in the leading tooth. This blade requires more maintenance, but is the most suitable for plastic laminates.

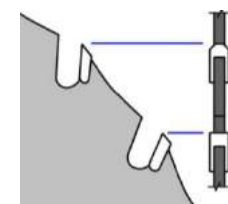

## Learning activity



Have a look at the main blade used on the panel saw (or saws) at your workplace. What type of teeth are they? Take a close-up photo of the teeth, or alternatively do a line drawing of the profile. Name the type of teeth, and share your answer with your trainer and other learners in your group.

## Cutting lists

A cutting list sets out the finished sizes of panels and components needed for a particular cabinet.

Depending on the type of equipment you use at work, you may refer to a hard copy cutting list or a computer-generated list on a screen.

The panels are cut from large sheets in a pattern that minimises the amount of waste generated.



If you were to draw up a **cutting pattern** by hand, you would start with the largest panels and then use the offcuts to recover the smaller panels and components. You need to take into account the direction of the grain if the panels are timber veneered, so that they all match when they're cut. The same applies to patterned laminates.

You also need to make allowance for the saw cut thickness – generally 3 to 4 mm – between the boards. On a CNC (computer numerically controlled) machine, the thickness will be greater because it uses a cutter rather than a saw blade.

**Optimising software** is used to produce cutting patterns on a computer. The software program 'optimises' the recovery from each sheet by calculating the most efficient combination of panels and components to cut from each one. It can also specify the sheet sizes that will produce the least amount of waste and calculate costs and percentages.

Optimising software is often linked to an NC beam saw. This allows the software program to directly control the set-up and automatic cutting functions on the saw. The operator can still over-ride the program at any stage if they wish to change the cutting pattern or any other element.



## Learning activity



You may use several types of cutting lists at work, depending on the sort of job you're doing or the type of saw you're using. Choose one example of a cutting list and answer the following questions. Share your answers with your trainer and other learners in your group.

1. Name the type of job that the cutting list relates to (e.g. kitchen cabinets carcases, etc.)
2. What type of saw will be used to cut up the materials shown on the list?
3. Is the list printed out in hard copy or displayed on a computer screen (or both)?
4. Write down each of the column headings shown in the list and describe the purpose of each column.



## Quality checks

Quality control isn't just something that happens at the end of the production line. You need to keep a close eye on the quality of the materials you're using at every stage of the manufacturing process.

One of the most obvious causes of quality problems in panels is incorrect stacking and storage. Always make sure that bearers are level across the base and that strips are an even thickness and line up vertically.



If you don't, you may end up with twisted or bowed panels, which can play havoc later when the time comes to assemble the carcass.



You should also check the edges of boards for damage when you're taking them out of the storage racks. Boards can sometimes have crushed or chipped edges if they've been dropped on the floor or bumped with a forklift truck.

Once the boards have been cut to-size, the edges should be checked again for any problems that might have been caused by incorrect saw settings or malfunctioning machinery.

Set out on the following page are some of the problems that can occur. If you see any of these issues in a board that's just been re-cut, it's important that you tell the saw operator straight away, because it may mean that the saw needs to be re-adjusted or a part needs replacing.

<b>Problem</b>	<b>Possible cause</b>
Break-out on underside of the board	Scorer height is set incorrectly
Scorer kerf doesn't align to main kerf	Scorer is out of line with the main blade
Top face has chips	Main blade is damaged, or riving knife is incorrectly set or too thin for the blade
Saw cut is not at 90° to the face of the board	Main blade is not running plumb and true.

### *Learning activity*



Have you come across any of these problems at your own workplace? Have you had to deal with other quality problems in the boards you handle?

Describe one quality problem you have encountered at work. What was the effect of the problem? What caused it? How did you (or your colleagues) tackle the cause to stop the problem from happening again?

## Edge treatments

There are various types of edge treatments used in kitchen and bathroom cabinets and bench tops. The main types of treatments are shown below.

### Post formed edges

**Post forming** is the process of bending a laminate to a curved surface. It's called 'post forming' because the 'forming' process occurs after – or 'post' – the machining of the curved edge. This method is commonly used on bench tops with a particleboard or MDF substrate.



The process is either carried out in a static post forming machine or an automated continuous machine. The simplest method is to glue the laminate to the flat area of the bench top first, with an overhang where the rounded edge will be formed. The bench top is then loaded into the machine and the area to be formed is heated to the correct temperature.

When the heat sensitive indicator shows that the temperature has been reached, a press is brought down to roll the laminate around the edge. Hand rollers are used to finish off the process (see photo above), and the laminate is trimmed to size.

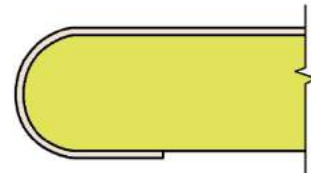

### Edge stripping with laminates

Boards that are faced with melamine or a high pressure laminate are generally edge stripped on the visible edges with a matching melamine paper or high pressure laminate. The substrate may be built up if required to provide extra thickness.

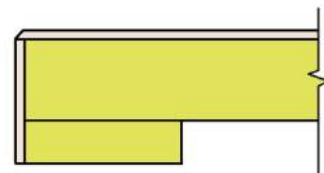

The edging is usually done in an edge banding machine, which applies the glue as it rolls the edging onto the board using pressure rollers. The machine also trims the edges and snips the ends.



Boards with a timber veneer can be edged in the same way. At its simplest, a pre-glued edge strip can be applied with a household iron, and then trimmed and sanded by hand.

The edge tape can vary in thickness, depending on the function of the panel and the type of laminate specified.

Most cabinet carcases and doors use edging that ranges between 0.07 mm and 2.00 mm.

Note that the thickness of the edging will affect the gap between doors and drawers, so it's important to establish this thickness before these components are cut to size.

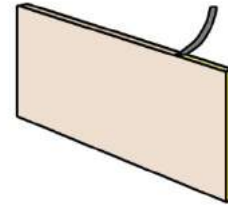

### Edging with solid timber

Sometimes boards are edged with a solid timber lip, particularly if they're faced with a timber veneer. The edge strip can be glued or nailed.

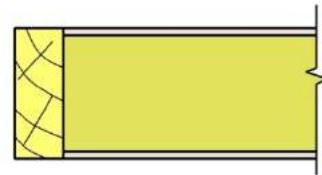

### Painted finishes

The most suitable board for a painted edge is MDF, because of its smooth finish. Doors and drawer fronts are often sprayed all round with a polyurethane lacquer.

The edge may either be left square or profiled to a shape.



### Learning activity



There are a variety of methods used to produce post-formed edges, with varying levels of automation depending on the machinery used. Does your workplace have a post-forming machine? State the brand name of the machine and briefly describe the process used to roll the laminate.

Share your answer with your trainer and other learners in your group. You may include digital photos of the machine and the process of rolling the laminate if you wish.

## Controlling dust

All timber-based board products contain wood fibres that have been processed in one form or another. They also contain glue, generally in the form of a formaldehyde-based resin. This means that when you cut, sand or machine a sheet, you will produce a fine dust of wood and glue particles.

Most of these products also contain other chemicals designed to improve the board's performance. Depending on the end use of the board, they may include moisture inhibitors, insecticides, fungicides and fire retardants. Again, these will be present in the dust generated when you re-work the sheet.



There are various problems with exposure to these dusts. Firstly, in some people it may trigger an asthmatic attack or some other form of allergic reaction. But more seriously, workers who breathe in these dusts over a long period of time run the risk of developing cancer in their nose, lungs or other parts of their respiratory system.

### General hints for the workshop

Here are some general hints on how to keep the level of dust down in the workshop:

1. Keep machines, work benches and floor areas clear of dust. Use an industrial vacuum cleaner rather than a broom to pick up dry dust. Place sweepings in a suitable bin with a covering to stop the dust from blowing out.
2. Make sure the dust extraction system is working properly on all machines. Check that the collection hoods are fitted correctly and there are no blockages in the system.
3. Empty the extraction system bags or hoppers regularly, so the dust can't build up and overflow.
4. For jobs where you will be generating dust that can't easily be collected, wear a dust mask.

### Learning activity



Your workplace will have a Material Safety Data Sheet (MSDS) for each of the products you use that are hazardous or possibly hazardous. The MSDS will list the precautions you should take and any other safety guidelines you should follow when handling and working with the product.

There will be separate MSDSs for all of the manufactured board products you use, including particleboard and MDF. Choose one of these products and have a look at the MSDS produced by the manufacturer.

If you don't know where these documents are kept in your workplace, ask your supervisor for help. Alternatively, you could simply find it on the internet - just enter the brand name and 'MSDS' into your search engine and you'll get a link directly to it.

What are the guidelines for controlling dust on the MSDS?

Write down your answer and share it with your trainer and other learners in your group.

## Assignment

1. Name the parts labelled on the saw diagram below, and provide a brief explanation of their purpose.

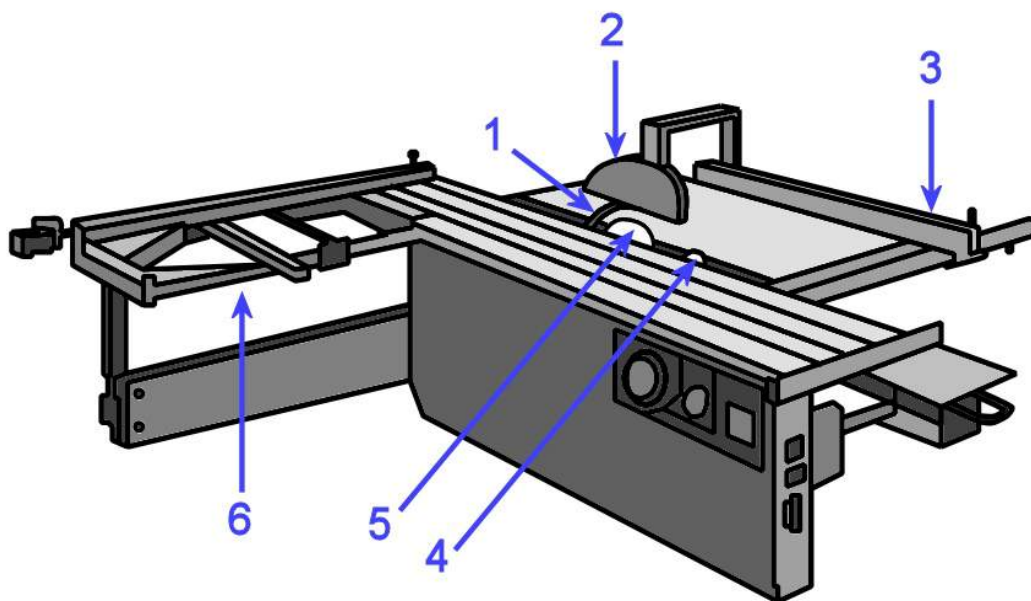

2. You need to cut the components shown below from a single sheet of 2400 x 1200 x 16 MDF. Once the components are cut to size they will be sprayed with a high gloss polyurethane lacquer.

Item	Quantity	Height	Width	Material
Doors	6	745	450	16 mm MDF
Drawer fronts	6	160	450	16 mm MDF

- (a) Draw up a cutting pattern to show how you will recover these components from the sheet.
- (b) Just say the customer decided to use a sliced-cut timber veneer finish instead of polyurethane lacquer. Could you use the same cutting pattern? Why or why not?

3. Describe one potential quality problem that you should look out for at each of the following stages of the production process. For each problem, describe the most likely cause (or causes), and provide a possible solution.
- (a) When the board is picked up off a stack held in storage.
  - (b) When the board is cut to size on a panel saw.
  - (c) When the board is edged on an edge bander.



Section 3

# Assembling the cabinet







## Overview

The simplest design for a cabinet is a box with either a door or drawers at the front. The drawing at right shows a typical 'frameless' floor cabinet, comprising a **carcase** and hinged door.

If you need to refresh your memory on the difference between frameless and face-framed cabinets, go to the 'Cabinet construction' page in the unit: *Processes in K&B projects*.

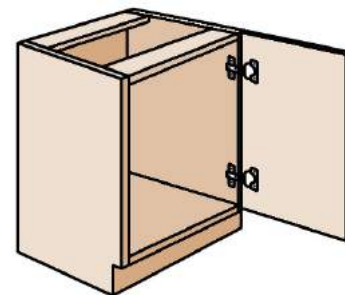

'Frameless' floor cabinet

In this section, we'll look at the principles of constructing modular frameless cabinets. They are 'modular' in the sense that they're prefabricated in the workshop in separate 'modules', and then transported to the site for installation as a set of cabinets, often lined up in a row.

We'll also cover the various aspects of workshop construction, including making bases, assembling carcasses, hanging doors and installing drawers.

### Completing this section



The assignment for this section will ask you questions about the assembly process for different carcasses and components, and the quality checks you should make to ensure that the job has been done properly. Have a look at the *Assignment* on page 52 to see what you'll need to do to complete it.

There are also six lessons in this section:

- *Joints and fasteners*
- *Bases*
- *Carcases*
- *Assembly*
- *Doors*
- *Drawers.*

These lessons will provide you with background information relevant to the assignment.

## Joins and fasteners

The joints and fasteners you use to assemble carcasses will depend on the materials involved and the design of the cabinets.

These days most of the traditional joints used in cabinetmaking have given way to simple butt joints fixed with screws or nails. This is because the streamlined designs of modern cabinets allow the fastener heads to be hidden or covered with plastic caps.



Set out below are the main types of joints and fasteners used in pre-fabricated cabinets.

### Joins

The **butt joint** is by far the most common joint used in carcasses made from manufactured boards. It simply involves butting the edge of one panel up against the face of another and fixing them together.

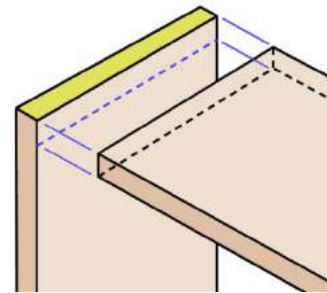

Variations on the standard butt joint include the rebated butt joint and the mitre joint.

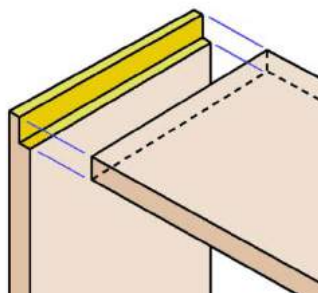

Rebated butt joint

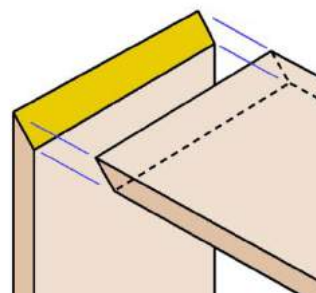

Mitre joint

## Conventional fasteners

**Chipboard screws** can be used with most types of manufactured boards, but are designed particularly for particleboard. They differ from normal wood screws in having a coarser thread and no taper in the shank. In the workshop you're likely to insert them using an air or battery powered variable-speed drill.



**Nails** are sometimes used in carcass construction, but they don't have the same holding power as a screw. To improve their performance they are often tipped with glue. They are generally fired into place with a pneumatic nail gun.

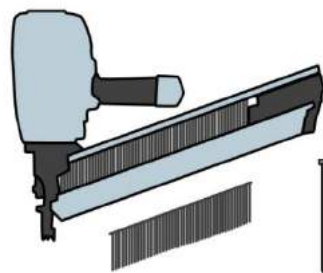

**Staples** are inserted with a staple gun. They have reasonable holding power when driven into the face of a board, but don't hold well in the edge. Again, their performance is improved if they are coated with an adhesive.

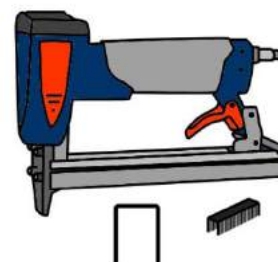

## Knock-down fittings

There are lots of different knockdown fittings on the market, many of which have patented designs. They can be divided into three main groups.

**Quick assembly fittings** generally use some form of press-stud action. They often consist of an insert fixed into one component and metal dowel drilled into the other.

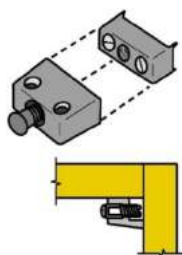

**Surface fittings** fix directly to the surface of the component. They are made up of two parts and are held together by a locking, screwing or wedging action.

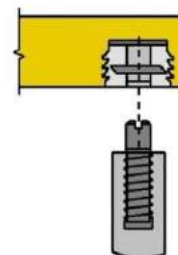

**Flush fittings** are many and varied. The elements are fixed into pre-machined holes or rebates.

This example shows a dowel and cam fitting.

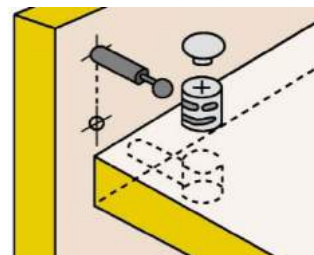

## System 32 construction

Knock-down fittings and the **System 32** method of construction go hand-in-hand. System 32 was developed in Europe to provide an efficient form of assembly for manufactured boards. Its main characteristic is the rows of 5 mm holes drilled into the internal faces of all vertical panels – all spaced at 32 mm centres.

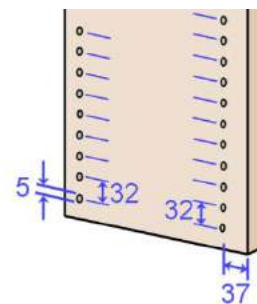

The holes are designed to house the hardware items used in the construction of the unit, including drawer runners, catches, hinges and adjustable shelf supports.

## Learning activity



You may use System 32 components at your workshop in particular cabinets or other units. Even if you don't, you will have seen them used everywhere in flat-pack furniture products, such as those sold by Ikea.

Try to find at least one example of each of the following System 32 hardware items:

- shelf supports
- right angled brackets
- connecting screws (e.g. with an allen key head)
- bolt and cam fittings.

Take digital photos of your examples and share them with your trainer and other learners in your group. If you don't have a camera or mobile phone to take the photos, do a line drawing of each one and label it with the correct name.

## Bases

There are various ways of supporting the underside of a cabinet. Modular cabinets are often designed to sit on a separate base or 'plinth'.

This enables the base to be installed on-site, along the full length of the wall where the cabinets will go, and levelled before the cabinets are positioned on top.

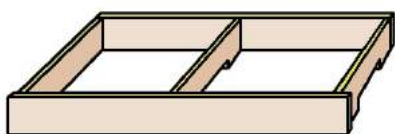

This drawing shows a typical 'ladder frame' base. It is generally made from particleboard or MDF and fixed together with nails, staples or screws. You'll notice that two of the cross supports are notched out at the bottom to help allow for uneven floors.

This type of base can either be prefabricated in the workshop or built piece by piece on-site. For more information about on-site methods, go to the 'Installing the base' page in the unit: *Installing cabinets on-site*.

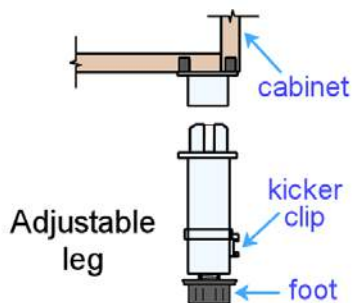

Another way of supporting a modular cabinet is to use adjustable legs. These sit behind a decorative kickboard, which is attached after the cabinets have been installed and levelled.

This drawing shows a leg with a 'kicker clip' for attaching the kickboard, and a screw-in foot for height adjustment.

Adjustable legs are commonly used in bathrooms and other areas where moisture could be a problem at floor level. They are quick to adjust and allow all boards and timber to be kept clear of the floor.

### Learning activity



There are all sorts of variations to the methods shown above. Some companies have their own 'tricks of the trade' for levelling cabinets and building bases.

What types of bases and levelling systems do you use? Without giving away any trade secrets, describe the techniques used at your workplace. Share your answers with your trainer and other learners in your group.

## Carcases

A carcass is the basic framework of a cabinet. In a simple floor cabinet, it's generally made from whiteboard (that is, white melamine particleboard) and consists of a back, base, two ends, and two rails.

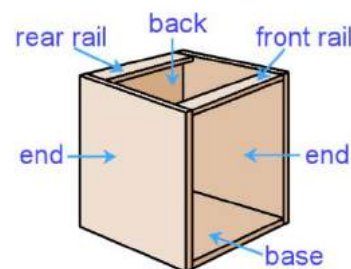

The rails are used to fix the underside of the bench top to the carcass.

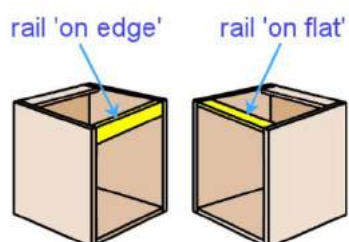

Sometimes the front rail is turned **on edge** (as shown here in the left hand cabinet), rather than **on flat**, especially when a sink or hot plate is mounted above.

This avoids the problem of the installer having to cut away part of the rail to allow for the deep inset.

There are various ways of attaching the back of the carcass to the end panels. An **external back** is cut to the outside width of the cabinet and is fixed to the rear edge of the two end panels.

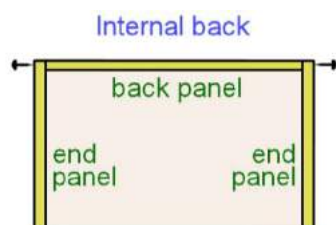
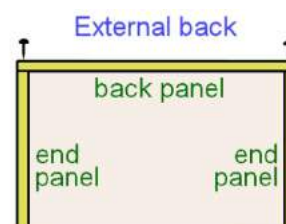

An **internal back** is cut to the inside width of the cabinet and fixed through the sides of the end panels.

There are other ways of fixing a back panel, although these aren't used much for kitchen and bathroom cabinets.

One method is to cut a groove in the end panels and insert a **rebated back**. This is a traditional cabinetmaking technique, and allows the joint to be glued without the need for nails or screws.

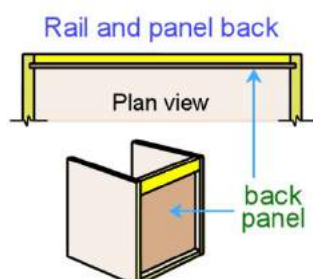
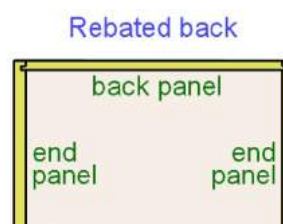

Another method is to insert a hardboard or thin MDF back into a groove in the end panels, and fix the rear rail behind it, turned on edge. This is called a **rail and panel back**.



Whatever the shape or size of the cabinet, most carcasses have the same basic structure. This corner base unit, for example, faces in two different directions, but it still has a base, two ends, and in this case, two backs and two front rails.

In the next lesson, we'll look at the process of assembling the panels and fixing them in position with screws, nails or staples.

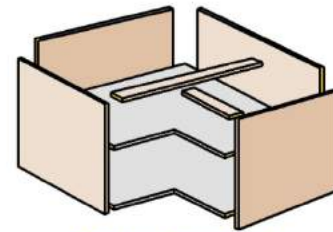

Corner base unit

### **Learning activity**



The most common method for fixing the back panel in kitchen and bathroom cabinets is to use an external back.

Is this the method you use? Do you ever use other techniques for particular jobs? If so, what are they, and what sorts of cabinets are they used on? Share your answer with your trainer and other learners in your group.

## Assembly

It's important to have a flat clean bench to work on when you assemble the carcass panels. Remember that veneered particleboard and other board products are easily scratched or chipped, so you should keep the workbench free from dirt, glue and loose hardware items.

### Using screws

If you're using screws, make sure the screwdriver tip is the right size and shape for the screw head. If it doesn't fit properly, the slots could easily burr.



Be careful not to over-tighten the screws. There are several problems that might occur if you did – the screw head could burr, the thread might chew out the fibres and loosen the screw's grip, or the veneered surface might de-laminate around the screw head.

### Using nails and staples

In most workshops, nails and staples are fired into place using a pneumatic gun. Whenever you're using an air-powered gun you need to make sure the pressure is adjusted correctly on the compressor for the material you're working with.

If the pressure is too low, the head of the fastener will sit proud of the surface and need to be tapped in with a hammer. If the pressure is too high, the head will countersink too far below the surface and may damage or split the board.



Remember to wear safety glasses when using air-powered tools. This will protect your eyes from any fragments that might break off and fly out, as well as from dust and other particles that will blow around each time a blast of air comes out of the gun. You should also wear ear plugs or ear muffs while handling the gun.



---

### Learning activity



You might use different fasteners on different parts of the carcass, depending on the size of the cabinet and the materials it's made from. Choose one style of floor cabinet you manufacture and answer the following questions:

- (a) What materials are used in the carcass?
- (b) What hand tools and fasteners are used in its assembly? If there's more than one type of fastener, name each one and state where it is used.

Share your answers with your trainer and other learners in your group. You may want to include digital photos with your answers.

## Doors

The most common hinge used in frameless cabinets is the **cup hinge**, or **concealed hinge**.

The hinge cup is inserted into a 35 mm hole, with the edge of the hole generally 3 mm from the door edge. The mounting plate is fixed to the carcass, and the hinge arm is slid over the plate and locked into position.

Most workshops use a patented boring machine made by the hinge manufacturer, or a drill press that has been set up for the job.



### Adjusting the door

This drawing shows a typical concealed hinge with the door in an open position. The functions of the screws are as follows:

**A:** fixed door screws – used to permanently fix the hinge cup to the door.

**B:** adjustable cabinet screws – fix the mounting block to the inside of the cabinet, and allow the doors to be adjusted vertically (up and down).

**C:** locking screw – used to lock the arm in place once any sideways adjustments have been made (note that it needs to be loosened before screw D can be turned)

**D:** adjusting screw – used to adjust the door horizontally (from side to side).

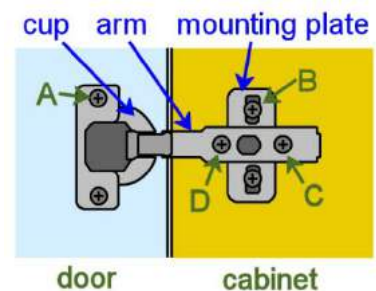

To increase or decrease the **gap** at the side of the door, turn screw D in the same direction on both hinges for the door. The finished gap should be about 1-2 mm.

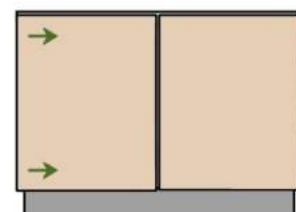

To adjust the **angle** of the door, turn screw D on either the top or bottom hinge, or if you need a bigger adjustment, turn the top screw one way and the bottom screw the other way.

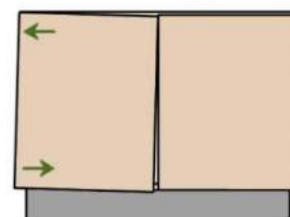

If the door is **binding** (that is, touching the cabinet side as it closes), loosen the locking screw C on both hinges and slide the door outwards, away from the cabinet. Retighten the screws and check to see whether it has fixed the bind. Note that the gap only needs to be 1 mm between the door and the cabinet.

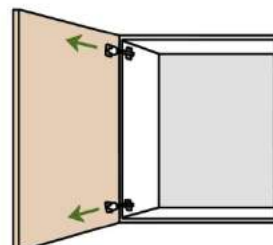

To adjust the height of the door, loosen the mounting block screws for both hinges (screw B) and move the door up or down. In most cases, the cabinet door should be flush with the bottom of the cabinet and down about 4 mm from the top.



### Learning activity



The concealed hinges you use at work may be different to the example described above, because each manufacturer will have its own variations in design. Write down the manufacturer and full product name of the main type of hinge you use for cabinet doors. Briefly describe the method you use to fix the hinge to the door and carcass.

Share your answer with your trainer and other learners in your group. You may take digital photos to help illustrate your answer.

## Drawers

It's possible to make drawers from manufactured board off-cuts. However most workplaces use patented systems developed by specialist manufacturers.

The final choice will depend on the style of the cabinet, the client's taste and, of course, the budget for the project.

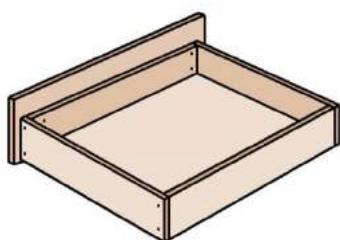

The simplest example of a drawer comprises an open box with a front, back and sides made of 16 mm white particleboard and an MDF base. A separate drawer front is fitted to match the cabinet doors. There is generally 12-13 mm of free space between the inside of the carcase and the outside of the drawer sides to allow for the runners.

### Pre-finished drawers

There are various types of pre-finished drawers available. The main types are as follows.

**Vinyl wrapped drawers** are made from particleboard covered in vinyl. They are grooved to take the drawer bottom, and sometimes also for the drawer slides. Mitres are pre-cut to allow for quick assembly.

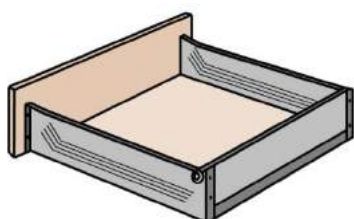
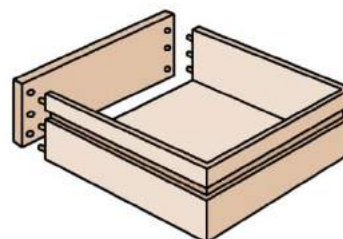

**Metal drawers** come in a range of patented designs. The drawer slides are generally incorporated into the design, and enable the drawer to be assembled and adjusted easily.

### Adjusting drawer fronts and runners

You'll find more details on drawer fronts and runners in the lesson 'Drawers' from the unit *Adjusting cabinets on-site*. This includes simple installation and adjustment procedures.

---

### **Learning activity**



What types of drawers do you use? What are the advantages (if any) of using these types of drawers? Briefly describe the assembly process.

Share your answers with your trainer and other learners in your group. You may wish to take digital photos to include with your answers.

## Assignment

1. What are the main characteristics of the System 32 method of construction? Why is it such an efficient system to use when you are installing hardware items?
2. Choose one type of concealed hinge that you use at work and provide the following details:
  - (a) State the name of the manufacturer and product name of the hinge.
  - (b) List the items of equipment needed to install the hinge, including hand tools.
  - (c) Briefly describe the process used to install the hinge.
  - (d) Name one quality check you need to make to ensure that the hinge has been installed correctly and is working properly.
3. Choose one style of carcass you manufacture and provide the following details:
  - (a) Name the materials used in the carcass.
  - (b) List all hand tools and fasteners used. If there is more than one type of fastener, name each one and state where it is used.
  - (c) Describe the method you use to fix the back panel in position.
  - (d) Name one potential problem you need to look out for while carrying out the assembly process and describe how you would deal with it.
4. Choose one drawer design you use in your drawer cabinets and provide the following details:
  - (a) State the manufacturer and product name, if it is a patented drawer system. If not, state the manufacturer and product name of the drawer slides (and any other items of specialist hardware).
  - (b) List the different materials or components used in the sides, back, front and base.
  - (c) Briefly describe the method used to fix the base into position.
  - (d) Briefly describe the method used to fix the drawer front into position.
  - (e) Briefly describe the method used to install the runners into the cabinet carcass.
  - (f) List the main quality checks you should carry out to make sure the drawer is installed correctly and running properly.

## Practical demonstration

The checklist below sets out the sorts of things your trainer will be looking for when you undertake the practical demonstrations for this unit. Make sure you talk to your trainer or supervisor about any of the details that you don't understand, or aren't ready to demonstrate, before the assessment event is organised. This will give you time to get the hang of the tasks you will need to perform, so that you'll feel more confident when the time comes to be assessed.

When you are able to tick all of the YES boxes below you will be ready to carry out the practical demonstration component of this unit.

### Practical demonstration checklist

You will be asked to fabricate a range of kitchen or bathroom cabinets. Your trainer will need to see you carry out these activities over a period of time, to make sure that you are satisfying these 'demonstration criteria' consistently under different conditions.

Demonstration criteria	YES
1. Follows all company safety policies and procedures while at work	<input type="checkbox"/>
2. Interprets drawings, specification and other documents correctly and produces a cutting list for the job	<input type="checkbox"/>
3. Plans the sequence of work tasks and identifies the process and tools required	<input type="checkbox"/>
4. Checks that tools and equipment are in good working order	<input type="checkbox"/>
5. Demonstrates understanding of the properties of all materials used in the cabinets and components, and chooses appropriate construction techniques	<input type="checkbox"/>
6. Demonstrates an understanding of different surface finishes and their uses in a range of applications	<input type="checkbox"/>
7. Manufactures components and other cabinet parts according to customer specifications and plans	<input type="checkbox"/>
8. Assembles cabinets using correct components, and checks the quality of the work at regular stages throughout the process	<input type="checkbox"/>
9. Uses tools and equipment safely and efficiently, in accordance with the company's safe operating procedures	<input type="checkbox"/>



- 
10. Cleans up work area when finished and disposes of rubbish in an approved way
11. Completes documentation accurately according to company requirements