

Modern Robotics with OpenCV

Widodo Budiharto

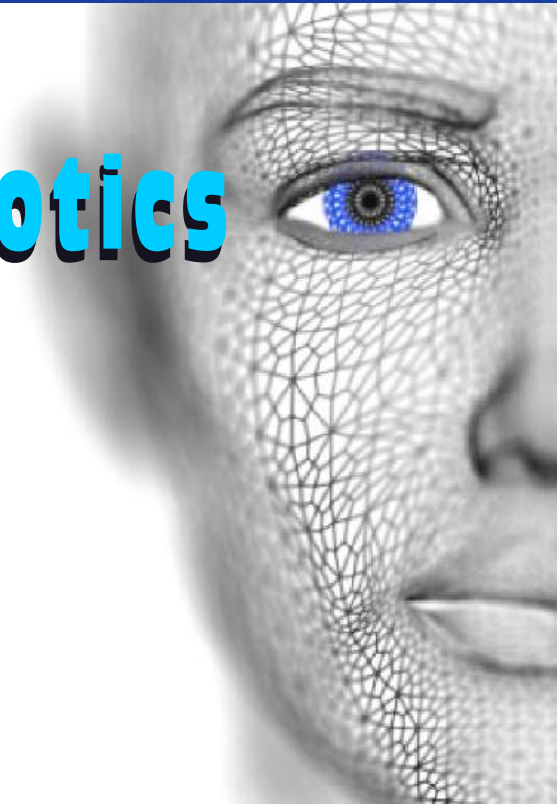

Modern Robotics with OpenCV

Widodo Budiharto



Science Publishing Group
548 Fashion Avenue
New York, NY 10018
<http://www.sciencepublishinggroup.com>

Published by Science Publishing Group 2014

Copyright © Widodo Budiharto 2014

All rights reserved.

First Edition

ISBN: 978-1-940366-12-8

This work is licensed under the Creative Commons Attribution-NonCommercial 3.0 Unported License. To view a copy of this license, visit

<http://creativecommons.org/licenses/by-nc/3.0/>



or send a letter to:
Creative Commons
171 Second Street, Suite 300
San Francisco, California 94105
USA

To order additional copies of this book, please contact:
Science Publishing Group
service@sciencepublishinggroup.com
<http://www.sciencepublishinggroup.com>

Printed and bound in India

Preface

Robotics is an interesting topic today. This book is written to provide an introduction to intelligent robotics using OpenCV. This very useful book intended for a first course in robot vision and covers modeling and implementation of intelligent robot. The need for this textbook arose from teaching robotics to student and hobbyist for many years and facing the difficulty to provide excellent book to explain advanced technology in intelligent robotics and kinematics of the robot.

This book differs from other robot vision textbooks:

- Its content is consisting of many implementations of mobile robot and manipulator using OpenCV.
- Using newest technology in Microcontroller such as Propeller Microcontroller for robotics.
- Its content is consisting of introduction and implementation of OpenCV described clearly.

This textbook is the result of many years of work, research, software development, teaching and learning. Many people have influenced its outcome in various ways. First, I must acknowledge my rector at Binus University, Prof. Dr. Harjanto Prabowo for his support, and my supervisors and friends. Some of my undergraduate students have also offered assistance to this book. Finally, a word of recognition goes to parent, my wife, and my children Tasya, Shafira, Aziz and Yusuf.

Jakarta-Indonesia, 2014

Dr. Widodo Budiharto¹

¹ Dr. Widodo Budiharto, School of Computer Science, Bina Nusantara University, Jakarta-Indonesia
Email: wbudiharto@binus.edu

Contents

Preface	III
Chapter 1 Introduction to Intelligent Robotics.....	1
Introduction	3
History of Robot	3
Types of Robot	7
Embedded Systems for Robot	12
Robot Vision.....	15
Exercises.....	18
References	18
Chapter 2 Propeller Microcontroller.....	19
Introduction	21
Introduction of Propeller Chip.....	21
Programming the Propeller.....	26
Exercises.....	30
Reference.....	31
Chapter 3 Basic Programming Robot	33
Introduction	35
Robot's Actuators.....	35
DC Motor.....	35
Servo Motor.....	37
Programming Motors of Robot.....	39
Sensors for Intelligent Robot.....	43
Ultrasonic Distance Sensor: PING)))™	43
Compass Module: 3-Axis HMC5883L	50
Gyroscope Module 3-Axis L3G4200D.....	54
PID Controller for the Robot.....	61

Exercises.....	62
References	62
Chapter 4 Serial Communication with Robot.....	63
Introduction	65
Serial Interface Using Microsoft Visual Basic/C# .Net.....	65
Wireless Communication for Robot.....	72
433 MHz Transceiver	72
XBee Transceiver.....	73
RN-42 Bluetooth Module	74
Exercises.....	75
References	75
Chapter 5 Mechanics of Robots	77
Introduction	79
Introduction of Gears.....	79
Types of Gears.....	81
Rack and Pinion Gears.....	82
Arm Geometries	83
Kinematics of Robot.....	85
References	85
Chapter 6 Introduction to OpenCV.....	87
Introduction	89
Introduction of OpenCV	90
Digital Image Processing.....	97
Edge Detection	100
Optical Flow	105
References	108
Chapter 7 Programming OpenCV.....	109
Introduction	111
Morphological Filtering.....	111

Camshift for Tracking Object.....	115
References	122
Chapter 8 Extracting the Component’s Contours for Calculating Number of Objects.....	123
Introduction	125
Introduction of Contours	125
Counting Objects.....	127
References	130
Chapter 9 Face Recognition Systems.....	131
Introduction	133
Face Recognition in OpenCV.....	133
Haar Cascade Classifier.....	135
Face Features Detector	144
Face Recognition Systems.....	151
Rapid Object Detection with a Cascade of Boosted Classifiers Based on Haar-like Features	152
Negative Samples.....	153
Positive Samples	153
Training.....	156
Test Samples	158
Exercises.....	159
References	160
Chapter 10 Intelligent Humanoid Robot.....	163
Introduction	165
Humanoid Robot	165
The Architecture of the Humanoid Robot	167
Ball Distance Estimation and Tracking Algorithm	170
A Framework of Multiple Moving Obstacles Avoidance Strategy	171
Experiments	173
Object Detection Using Keypoint and Feature Matching.....	177

References	183
Chapter 11 Vision-Based Obstacles Avoidance	185
Introduction	187
Obstacle Avoidance of Service Robot.....	187
Stereo Imaging Model	190
Probabilistic Robotics for Multiple Obstacle Avoidance Method.....	192
Multiple Moving Obstacles Avoidance Method and Algorithm	193
Multiple Moving Obstacle Avoidance Using Stereo Vision	198
References	201
Chapter 12 Vision-Based Manipulator	203
Introduction	205
Inverse Kinematics	205
Vision-Based Manipulator.....	206
Grasping Model	208
Exercise	212
References	213
Glossary	215

Chapter 1

Introduction to Intelligent Robotics

On successful completion of this course, students will be able to:

- Explain history and definition of robot.
- Describe types of robot.
- Explain the newest technology of intelligent robotics.
- Explain the concept of embedded system for robotics.

Introduction

Robotics technology increase drastically following the demand of intelligent robotics that able to help human kind. For robots to be intelligent in the way people are intelligent, they will have to learn about their world, and their own ability to interact with it, much like people do. Robot vision is a branch of robotics that learns about acquisition and image processing for intelligent robotics. At 2030, it is predicted that almost home duty task accomplished by service robot that use vision sensors such as camera, it is a big challenge for us to develop that robot. A robot is a mechanical or virtual agent, usually an electro-mechanical machine that is guided by a computer program or electronic circuitry. Intelligent robotics is a system that contains sensors, camera, control systems, manipulators, power supplies and software all working together to perform a task. That's why the ability to develop intelligent robotics using computer vision is a must to for the future.

History of Robot

The term Artificial Intelligence or AI stirs emotions. In 1955, John McCarthy, one of the pioneers of AI, was the first to define the term Artificial intelligence, roughly as follows:

The goal of AI is to develop machines that behave as though they were intelligent.

According to McCarthy's definition the aforementioned robots can be described as intelligent. The word of robot is very familiar with us today [1]. The term robot was first used to denote fictional automata in a 1921 play R.U.R. Rossum's Universal Robots by the Czech writer, Karel Čapek. According to Čapek, the word was created by his brother, Josef from the Czech "robot",

meaning servitude. In 1927, Fritz Lang's *Metropolis* was released; the *Maschinenmensch* ("machine-human"), a gynoid humanoid robot, also called "Parody", "Robotrix", or the "Maria impersonator" (played by German actress Brigitte Helm), was the first robot ever to be depicted on film [2].

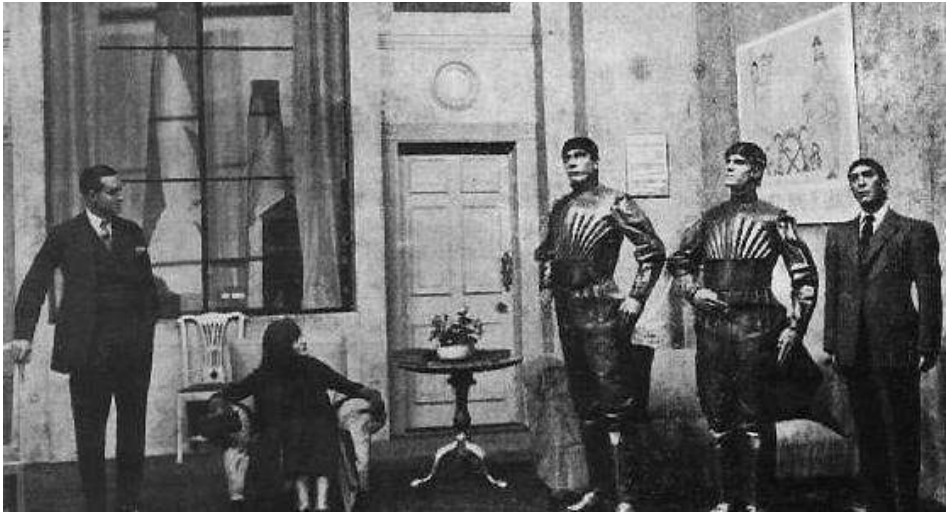

Figure 1.1 R.U.R by Czech Writer [2].

The history of robots has its origins in the ancient world. The modern concept began to be developed with the onset of the industrial revolution which allowed for the use of complex mechanics and the subsequent introduction of electricity. This made it possible to power machines with small compact motors. In the early 20th century, the modern formulation of a humanoid robot was developed. Today, it is now possible to envisage human sized robots with the capacity for near human thoughts and movement.

At ~270BC an ancient Greek engineer named Ctesibus made organs and water clocks with movable figures. Al-Jazari (1136–1206), a Muslim inventor during the Artuqid dynasty, designed and constructed a number of automatic machines, including kitchen appliances, musical automata powered by water, and the first programmable humanoid robot in 1206. Al-Jazari's robot was a boat with four automatic musicians that floated on a lake to entertain guests at royal drinking parties. His mechanism had a programmable drum machine with pegs (cams) that bump into little levers that operate the percussion. The drummer could be made to play different rhythms and different drum patterns by moving the pegs to different locations.



Figure 1.2 Al-Jazari's toy boat, musical automata. The first humanoid robot claimed in the world.

In Japan, complex animal and human automata were built between the 17th to 19th centuries, with many described in the 18th century *Karakuri zui*. One such automaton was the *karakuri ningyō*, a mechanized puppet.

Modern Robot glory starts from 1970, when Professor Victor Scheinman at Stanford University designed the standard manipulator. Currently, the standard kinematics configuration known as robotic arms is still used. Finally, in 2000 Honda showed off a robot that was built many years named ASIMO, and is followed by Sony AIBO robot dog.



Figure 1.3 Karakuri, robot from Japan.

Table 1.1 The timeline of robotics development.

No.	Year	Description
1	1495	Around 1495 Leonardo da Vinci sketched plans for a humanoid robot.
2	1920	Karel Capek coins the word 'robot' to describe machines that resemble humans in his play called Rossums Universal Robots. The play was about a society that became enslaved by the robots that once served them.
3	1937	Alan Turing releases his paper "On Computable Numbers" which begins the computer revolution.
4	1997	On May 11, a computer built by IBM known as Deep Blue beat world chess champion Garry Kasparov.
5	1999	Sony releases the first version of AIBO, a robotic dog with the ability to learn, entertain and communicate with its owner. More advanced versions have followed.
6	2000	Honda debuts ASIMO, the next generation in its series of humanoid robots.
7	2008	After being first introduced in 2002, the popular Roomba robotic vacuum cleaner has sold over 2.5 million units, proving that there is a strong demand for this type of domestic robotic technology.
8	2011	The first service robot from Indonesia named Srikandi III with the stereo vision system and multiple obstacles avoidance ability developed at ITS Surabaya.
9	2013	Intelligent telepresence robot developed at BINUS University from collaboration of NUNI.
10	2014	Vision based grasping model for Manipulator developed at BINUS University - Jakarta.

Types of Robot

Robot designed to fulfill user needs. Robot types can be divided into:

- Manipulator robot, for example an arm robot.
- Wheeled robot.
- Walking robot.
- Humanoid robot.
- Aerial robot.

- Submarine robot.

A robot has these essential characteristics:

- 1) *Sensing*, First of all your robot would have to be able to sense its surroundings. It would do this in ways that are not unsimilar to the way that you sense your surroundings. Giving your robot sensors: light sensors (eyes), touch and pressure sensors (hands), chemical sensors (nose), hearing and sonar sensors (ears), and taste sensors (tongue) will give your robot awareness of its environment.
- 2) *Movement*, A robot needs to be able to move around its environment. Whether rolling on wheels, walking on legs or propelling by thrusters a robot needs to be able to move. To count as a robot either the whole robot moves, like the Sojourner or just parts of the robot moves, like the Canada Arm.
- 3) *Energy*, A robot needs to be able to power itself. A robot might be solar powered, electrically powered, battery powered. The way your robot gets its energy will depend on what your robot needs to do.
- 4) *Programmability*, it can be programmed to accomplish a large variety of tasks. After being programmed, it operates automatically.
- 5) *Mechanical capability*, Enabling it to act on its environment rather than merely function as a data processing or computational device (a robot is a machine).
- 6) *Intelligence*, A robot needs to be smart. This is where programming enters the pictures. A programmer is the person who gives the robot its 'smarts.' The robot will have to have some way to receive the program so that it knows what it is to do.

A manipulator is a device used to manipulate materials without direct contact. The applications were originally for dealing with radioactive or biohazardous materials, using robotic arms, or they were used in inaccessible places. In more recent developments they have been used in applications such as robotically-assisted surgery and in space. It is an arm-like mechanism that consists of a series of segments, usually sliding or jointed, which grasp and move objects with a number of degrees of freedom.

Robot manipulators are created from a sequence of link and joint combinations. The links are the rigid members connecting the joints, or axes. The axes are the movable components of the robotic manipulator that cause relative motion between adjoining links. The mechanical joints used to

construct the robotic arm manipulator consist of five principal types. Two of the joints are linear, in which the relative motion between adjacent links is non-rotational, and three are rotary types, in which the relative motion involves rotation between links.

The arm-and-body section of robotic manipulators is based on one of four configurations. Each of these anatomies provides a different work envelope and is suited for different applications.

- 1) Gantry - These robots have linear joints and are mounted overhead. They are also called Cartesian and rectilinear robots.
- 2) Cylindrical - Named for the shape of its work envelope, cylindrical anatomy robots are fashioned from linear joints that connect to a rotary base joint.
- 3) Polar - The base joint of a polar robot allows for twisting and the joints are a combination of rotary and linear types. The work space created by this configuration is spherical.
- 4) Jointed-Arm - This is the most popular industrial robotic configuration. The arm connects with a twisting joint, and the links within it are connected with rotary joints. It is also called an articulated robot [3].



Figure 1.4 4 DOF Manipulator / arm robot from Lynxmotion suitable for education
(source: lynxmotion.com).

As the development of robot technology, the capability of the robot to "see" or vision based robot has been developed such as ASIMO, a humanoid robot created by Honda. With a height of 130 centimeters and weighs 54 kilograms,

the robot resembles the appearance of an astronaut with the ability fingers capable to handling egg. ASIMO can walk on two legs with a gait that resembles a human to a speed of 6 km / h. ASIMO was created at Honda's Research and Development Center in Wako Fundamental Technical Research Center in Japan. The model is now the eleventh version, since the commencement of the ASIMO project in 1986. According to Honda, ASIMO is an acronym for "Advanced Step in Innovative Mobility" (a big step in the innovative movement). This robot has a height of 130cm with a total of 34 DOF and use 51.8V LI-ION rechargeable and the ability and mechanical grip better.



Figure 1.5 ASIMO Robot [4].

The rapid development of robot technology has demanded the presence of intelligent robots capable of complement and assisted the work of man. The ability to develop robots capable of interacting today is very important, for example, the development of educational robot NAO from France and Darwin OP from Korea. In the latest development of robot vision are generally

humanoid form, requires the Linux embedded module that can process images from the camera quickly. For example, Smart Humanoid robot package Ver. 2.0 for general-purpose robot soccer or created by authors who have the specification:

- CM-530 (Main Controller-ARM Cortex (32bits) with AX-12A (Robot Exclusive Actuator, Dynamixel).
- AX-18A (Robot Exclusive Actuator, Dynamixel).
- Gyro Sensor (2 Axis) dan Distance measurement system.
- RC-100A (Remote Controller).
- Rechargeable Battery (11V, Li-Po, 1000mA/PCM).
- Balance Battery Charger.
- Humanoid Aluminum frame full set.
- Gripper frame set.
- 1.7GHz Quad core ARM Cortex-A9 MPCore.
- 2GB Memory with Linux UBuntu.
- 6 x High speed USB2.0 Host port.
- 10/100Mbps Ethernet with RJ-45 LAN Jack.



Figure 1.6 Smart Humanoid ver 2.0 using embedded system and webcam based on LINUX Ubuntu.

Embedded Systems for Robot

The robotics system requires adequate processor capabilities such as the ability of the processor speed, memory and I / O facilities. The figure below is a block diagram of an intelligent robotics that can be built by beginners.

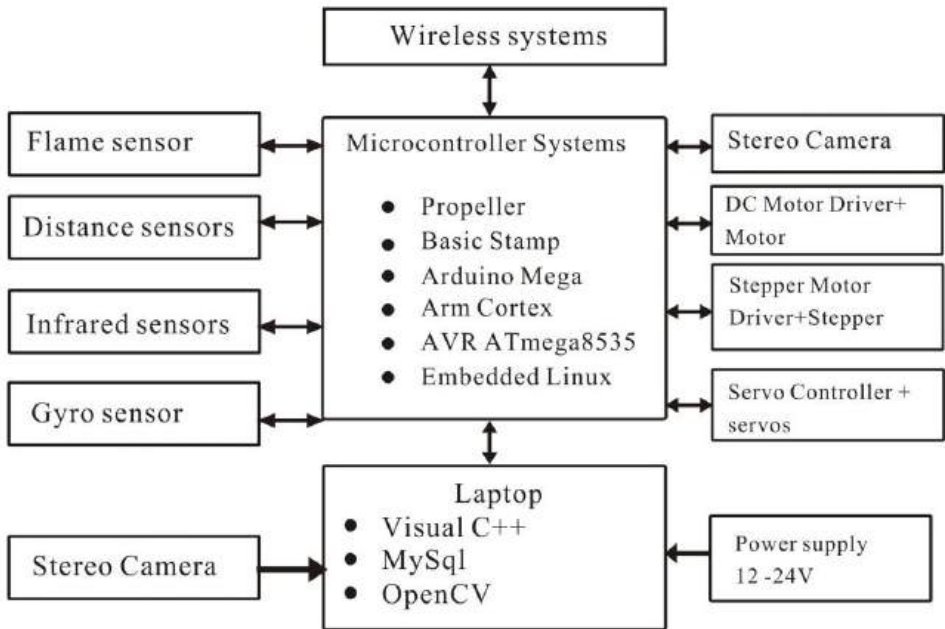

Figure 1.7 Embedded system for intelligent robotics.

From the picture above, the point is you can use a variety of microprocessor / microcontroller to make the robot as smart as possible. You may use the standard minimum systems such as Propeller, AVR, Basic Stamp, and Arm Cortex with extraordinary abilities. All inputs are received by the sensors will be processed by the microcontroller. Then through the programs that we have made microprocessor / microcontroller will take action to the actuator such as a robot arm and the robot legs or wheels. Wireless technology used for the purposes of the above if the robot can transmit data or receive commands remotely. While the PC / Laptop is used to program and perform computational processes data / images with high speed, because it is not able to be done by a standard microcontroller. To provide power supply to the robots, we can use dry battery or solar cell. For the purposes of the experiment, can be used as a

standard microcontroller for main robot controller as shown below using Arduino Mega:

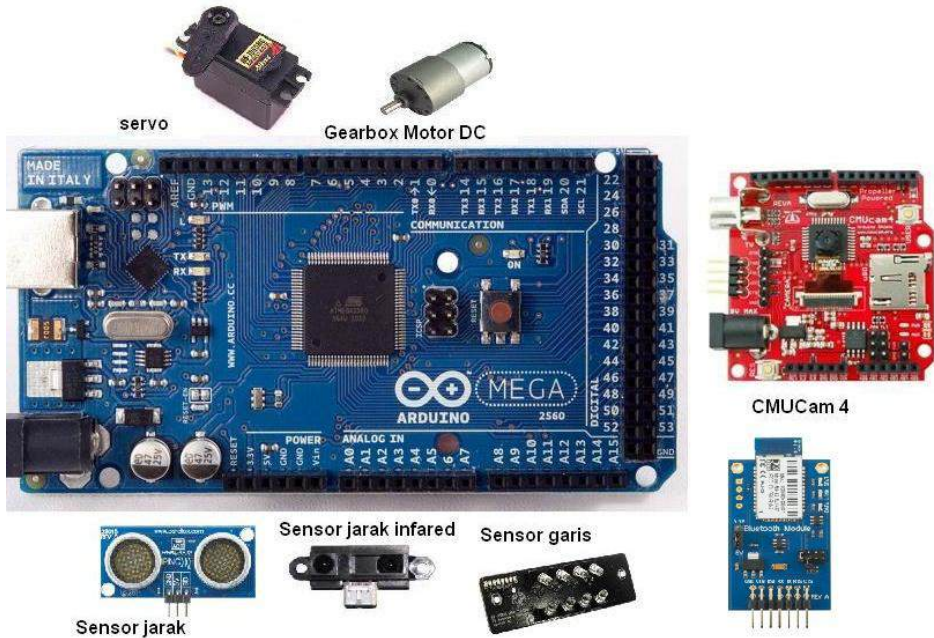

Figure 1.8 Single chip solution for robot using Arduino Mega.

The figure shows that the standard microcontroller technologies such as AVR, Arduino or Propeller and Arm Cortex, can be used as the main controller of mobile robots. Technology sensors and actuators can be handled well using a microcontroller with I2C capability for data communication between the microcontrollers with a serial devices others. Some considerations in choosing the right microcontroller for the robot is the number of I / O, ADC capability, and signal processing features, RAM and Flash program memory. In a complex robot that requires a variety of sensors and large input the number, often takes more than one controller, which uses the principle of master and slave. In this model there is a 1 piece main controller which functions to coordinate the slave microcontroller.

In general, to drive the robots there are several techniques such as:

- Single wheel drive, which is only one front wheel that can move to the right and to the left of the steering.

- Differential drive, where 2 wheels at the back to adjust the direction of motion of the robot.
- Synchronous drive, which can drive a 3 wheeled robot.
- Pivot drive, It is composed of a four wheeled chassis and a platform that can be raised or lowered. The wheels are driven by a motor for translation motion in a straight line.
- Tracked robot uses wheels tank.



Figure 1.10 Tank Robot DFRobot Rover ver.2 using Arduino and XBee for Wireless Communication (source:robotshop.com).

- Ackerman steering, where the motion of the robot is controlled by the 2 front wheels and 2 rear wheels.
- Omni directional drives, where the motion of the robot can be controlled 3 or 4 wheel system that can rotate in any direction, so that the orientation of the robot remains. Omniwheel useful because the orientation of the robot is fix with the standard wheel angle $\alpha_1 = 0^\circ, \alpha_2 = 120^\circ$ and $\alpha_3 = 240^\circ$. Global frame $[x, y]$ represents robot's environment and the location of robot can be represented as (x, y, θ) . The global velocity of robot can be represented as $\dot{x}, \dot{y}, \dot{\theta}$.

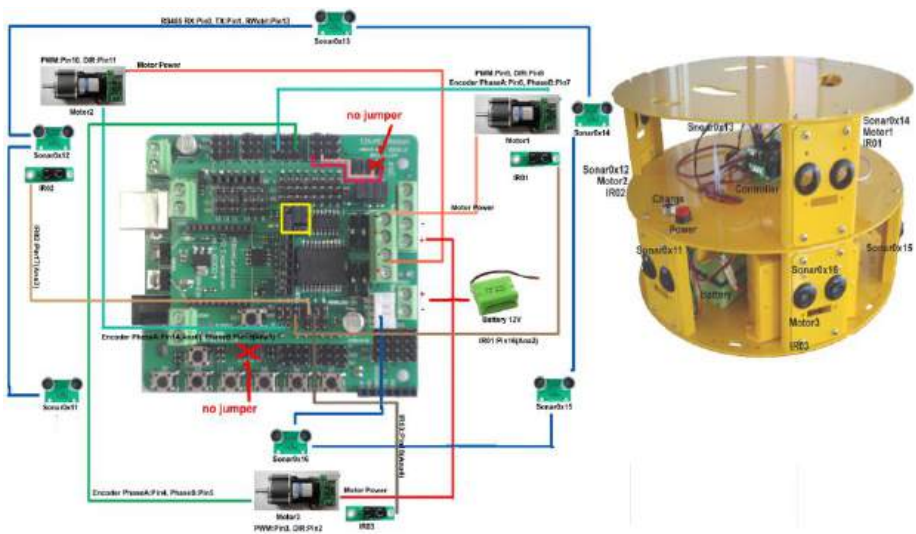

Figure 1.11 Mobile Robot with omni directional drive systems (source: nexusrobot.com).

Robot Vision

There are several important terms in the robot vision interconnected, including computer vision, machine vision and robot vision. Computer vision is the most important technology in the future in the development of interactive robots. Computer Vision is a field of knowledge that focuses on the field of artificial intelligence and systems associated with acquisition and image processing. Machine vision is implemented process technology for image - based automatic inspection, process control, and guiding robots in various industrial and domestic applications. Robot vision is the knowledge about the application of computer vision in the robot. The robot needs vision information to decide what action is to be performed. The application is currently in robot vision are as robot navigation aids, search for the desired object, and other environmental inspection. Vision on the robot becomes very important because it received more detailed information than just the proximity sensor or other sensors. For example, the robot is able to recognize whether the detected object is a person's face or not. Furthermore, an advanced vision system on the robot makes the robot can distinguish a face accurately (Face recognition system using PCA method, LDA and others) [6] [10]. The processing of the input image from the camera to have meaning for the robots known as visual perception, starting from image acquisition, image preprocessing to obtain the

desired image and noise-free, for example, feature extraction to interpretation as shown in Figure 1.12. For example, for customer identification and avoidance of multiple moving obstacles based vision, or to drive the servo actuator to steer the camera as it leads to a face (face tracking) [4].

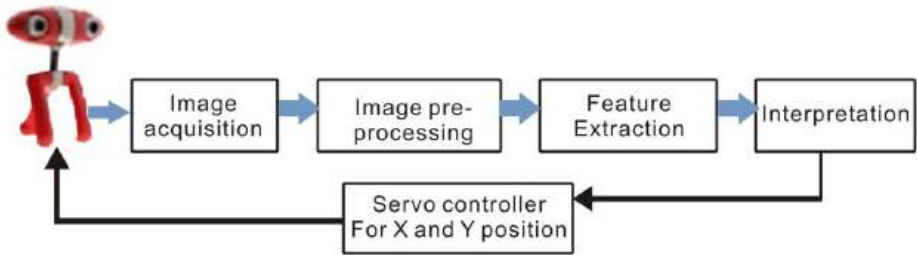

Figure 1.12 Perception model for a stereo vision [11].

An example of intelligent robotics is a humanoid robot HOAP-1 with stereo vision for navigation system. HOAP-1 is a commercial humanoid robot from Fujitsu Automation Ltd. and Fujitsu Laboratories Ltd. for behavior research. In the vision sub-system of HOAP-1, the depth map generator calculate depth map image from stereo images. The path planning sub-system generate a path from the current position to the given goal position while avoid obstacles.

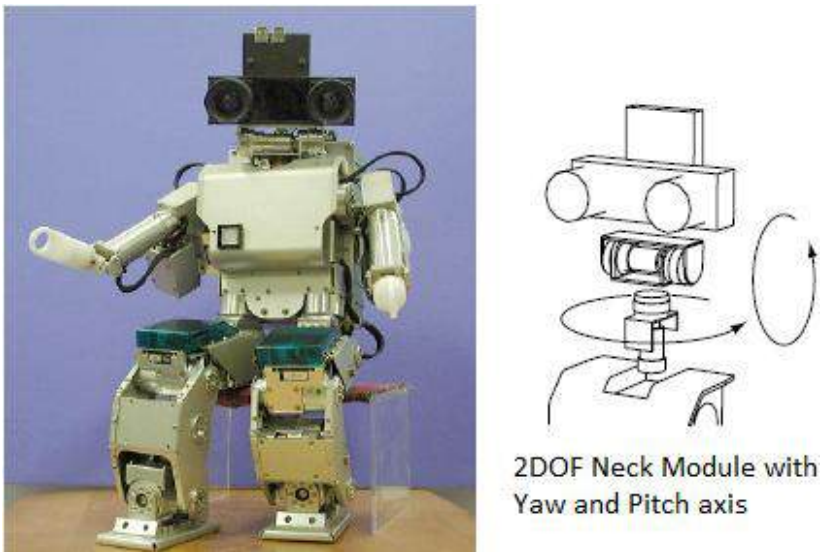

Figure 1.13 Example of Vision-based Navigation system for Humanoid robot HOAP-1 [12].

Another example is a telepresence robot developed by author as shown in figure 1.14. The test was conducted by running Microsoft IIS and Google Application Engine on the laptop. When the servers were ready, Master Controller, implemented by using a laptop, opened the application through web browser that support WebRTC and entered 192.168.1.101 which was the address of both servers to open it. This is not a problem because the servers were running on different ports. After the connections were established, Master controller then received image and sound stream from the robot and sent back image and sound from Master Controller web camera to the robot. Experiments of intelligent telepresence robot had been tested by navigating the robot to staff person and to avoid obstacles in the office. Face tracking and recognition based on eigenspaces with 3 images every person had been used and a databases of the images had been developed. The robot was controlled using integrated web application (ASP.Net and WebRTC) from Master Control. With a high speed Internet connection, simulated using wireless router that had speed around 1 Mbps, the result of video conferencing was noticeable smooth.

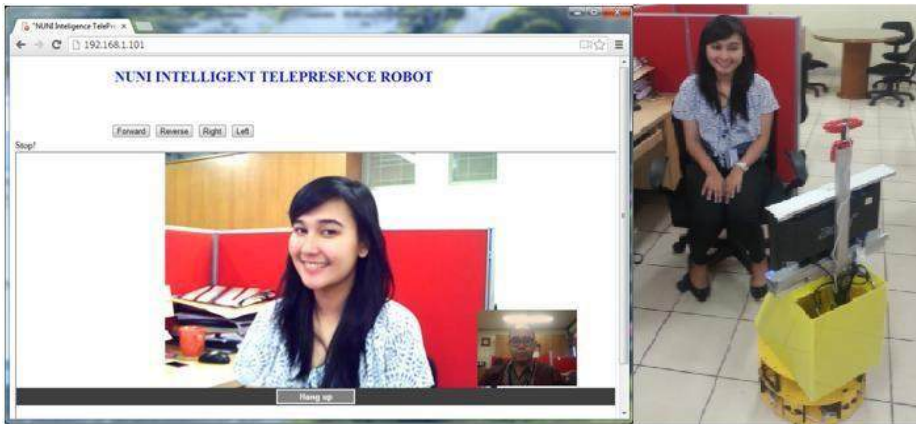

Figure 1.14 Intelligent Telepresence robot using omniwheel and controlled using Web [11].

Images collected by a robot during the embodied object recognition scenario often capture objects from a non- standard viewpoint, scale, or orientation. In subsequent development, artificial intelligence for the robot to recognize and understand the human voice, attentive to the various motion listener and able to provide a natural response by the robot are challenge ahead to build future robots.

Exercises

- 1) Explain the history of robots.
- 2) Explain the roles of computer vision in robotics.
- 3) Describe types of drive systems for robot.
- 4) Develop a block diagram of tank robot using embedded system.
- 5) Find out the advantages of stereo vision.

References

- [1] E. Wolfgang, Introduction to Artificial Intelligence, Springer Publisher, 2011.
- [2] www.wikipedia.org.
- [3] <http://www.galileo.org/robotics/intro.html>.
- [4] Asimo.honda.com.
- [5] Budiharto W., Santoso A., Purwanto D., Jazidie A., Multiple moving obstacles for service robot using Stereo Vision, *Telkomnika Journal*, Vol. 9 no.3, 2011.
- [6] M. Spong, Hutchinson & Vidyasagar, *Robot Modelling and Control*, Wiley, 2001.
- [7] Daiki Ito, *Robot Vision*, Nova Publisher, 2009.
- [8] Budiharto W., Santoso A., Purwanto D., Jazidie A., *A Navigation System for Service robot using Stereo Vision*, International conference on Control, Automation and Systems, Korea, pp 101-107, 2011.
- [9] Hutchinson S., Hager G., Corke P., *A tutorial on visual servo control*, IEEE Trans. On Robotics and Automation, vol. 12(5), pp. 651-670, 1996.
- [10] Budiharto W., Purwanto D., Jazidie A., *A Robust Obstacle Avoidance for Service Robot using Bayesian Approach*, International Journal of Advanced Robotic Systems, Intech publisher, vol 8(1), 2011.
- [11] Budiharto, W., *The framework of Intelligent telepresence robot based on stereo vision*, Journal of Computer Science, vol. 8, pp. 2062-2067, 2012.
- [12] Okada K., et.al, Walking Navigation System of Humanoid Robot using Stereo Vision based Floor Recognition and Path Planning with Multi-Layered Body Image, Proceedings of the 2003 IEEE International Conference on Intelligent Robots and System, Nevada, 2003.

Chapter 2

Propeller Microcontroller

On successful completion of this course, students will be able to:

- Describe some of popular microcontrollers.
- Explain how to program the Propeller Microcontroller.
- Assembly a simple mobile robot using microcontroller.

Introduction

Microcontroller is the main controller for electronic devices today, including robots. Microcontroller well-known and readily available today are AVR, PIC, Arduino, Propeller, ATmega 8535, ATmega16, ATmega32 and Basic Stamp. Some other well-known brands eg 16F877 PIC and Basic Stamp 2. Parallax Propeller microcontroller from one of the latest generation 32-bit microcontroller that is capable of computing high-speed data. This microcontroller has many advantages especially can be used for image processing. Therefore, this microcontroller is used as the main control system of our robot.

Introduction of Propeller Chip

Do you like programming? With eight 32-bit processors in one chip, integrating peripheral devices is suddenly simplified with the Propeller. A Parallax creation from the silicon on up, the Propeller chip's unique architecture and languages will change the way you think about embedded system design. The Propeller chip gives programmers both the power of true multi-processing and deterministic control over the entire system.

Each of the Propeller chip's processors, called cogs, can operate simultaneously, both independently and cooperatively with other cogs, sharing access to global memory and the system clock in a round-robin fashion through a central hub. Each cog has access to all 32 I/O pins, with pin states being tracked in its own input, output and direction registers. Each cog also has its own memory, 2 counter modules, and a video generator module capable of producing NTSC, PAL & VGA signals. Propeller Specifications:

- Languages: Spin (native, object-based), Assembly (native low-level), C/C++ (via PropGCC).

- Power Requirements: 3.3 VDC.
- Operating Temperature: -55 to +125 degrees C.
- Processors (Cogs): 8.
- I/O Pins: 32 CMOS.
- External Clock Speed: DC to 80 MHz.
- Internal RC Oscillator: ~12 MHz or ~20 kHz.
- Execution Speed: 0 to 160 MIPS (20 MIPS/cog).
- Global ROM/RAM: 32768/32768 bytes.
- Cog RAM: 512 x 32 bits/cog.

The Propeller is used in many industries including manufacturing, process control, robotics, automotive and communications. Hobbyists and engineers alike are finding new uses for this powerful microcontroller every day. The Propeller is a good choice over other microcontrollers when a low system part count is desirable due to its ability to provide direct video output and an easy interface to external peripherals such as keyboard, mouse and VGA monitor. Pre-written objects to support many types of hardware also make it an attractive option. All of this plus low cost and a powerful, yet easy language are hard to beat in a world where microcontrollers come in so many flavors that it's hard to make a choice.

The Propeller chip is a multicore microcontroller that is programmable in high-level languages (Spin™ and C) as well as a low-level (Propeller assembly) language. Application development is simplified by using the set of pre-built objects for video (NTSC/PAL/VGA), mice, keyboards, LCDs, stepper motors and sensors. Propeller is easily connected to your computer's serial or USB port for programming using our Prop Plug. The Propeller chip can run on its own with a 3.3-volt power supply, internal clock, and with its internal RAM for code storage. Add an external EEPROM for non-volatile code storage and an external clock source for accurate timing.

The Propeller Tool Software is the primary development environment for Propeller programming in Spin and Assembly Language. It includes many features to facilitate organized development of object-based applications: multi-file editing, code and document comments, color-coded blocks, keyword highlighting, and multiple window and monitor support aid in rapid code development. We can use the board such as Propeller Robot board or Propeller

Board of Education for learning Propeller easily for robotics as shown in figure 2.1.



(a)

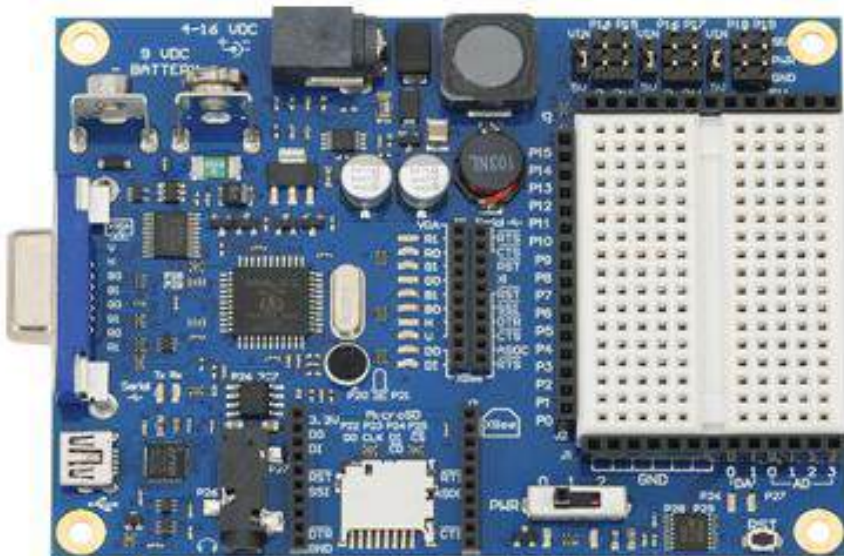

(b)

Figure 2.1 Propeller Chip P8X32A in LQFP package (a) and Propeller Board of Education (b).

Table 2.1 pins description of propeller chip.

Pin Name	Direction	Description
		General purpose I/O Port A. Can source/sink 40 mA each at 3.3 VDC. Logic threshold is $\approx 1/2$ VDD; 1.65 VDC @ 3.3 VDC.
PO-P31	I/O	The pins shown below have a special purpose upon power-up/reset but are general purpose I/O afterwards. P28 – 12C SCL connection to optional, external EEPROM. P29 – 12C SDA connection to optional, external EEPROM. P30 – Serial Tx to host. P31 – Serial Rx from host.
VDD	---	3.3 volt power (2.7 – 3.3 VDC).
VSS	---	Ground.
BOEn	I	Brown Out Enable (active low). Must be connected to either VDD or VSS. If low, RESn becomes a weak output (delivering VDD through 5 K Ω) for monitoring purposes but can still be driven low to cause reset. If high, RESn is CMOS input with Schmitt Trigger.
RESn	I/O	Reset (active low). When low, resets the Propeller chip: all cogs disabled and I/O pins floating. Propeller restarts 50 ms after RESn transitions from low to high.
XI	I	Crystal Input. Can be connected to output of crystal/oscillator pack (with XO left disconnected), or to one leg of crystal (with XO connected to other leg of crystal or resonator) depending on CLK Register settings. No external resistors or capacitors are required.
XO	O	Crystal Output. Provides feedback for an external crystal, or may be left disconnected depending on CLK Register settings. No external resistors or capacitors are required.

The Propeller 2 is a whole-system, high-speed multicore chip for future embedded applications requiring real-time parallel control. Production customers asked for features that are now standard in Propeller 2: A/D, code protect, large RAM with freedom to download a C kernel or Spin interpreter during program. With easy coding for video (VGA, composite and component for HD), human interface devices, sensors and output devices, the Propeller 2 is

effective for quick prototype and production projects with limited time to market.

The Stingray robot from Parallax Inc. provides a mid-size platform for a wide range of robotics projects and experiments. The Propeller Robot Control Board is the brains of the system providing a multiprocessor control system capable of performing multiple tasks at the same time. The Propeller chip provides eight 32-bit processors each with two counters, its own 2 KB local memory and 32 KB shared memory. This makes the Propeller a perfect choice for advanced robotics and the Stingray robot. The board use is Propeller Robot Board complete with the USB Programmer, 64KB EEPROM AT24C512 and DC motor driver 7.2V as shown below:

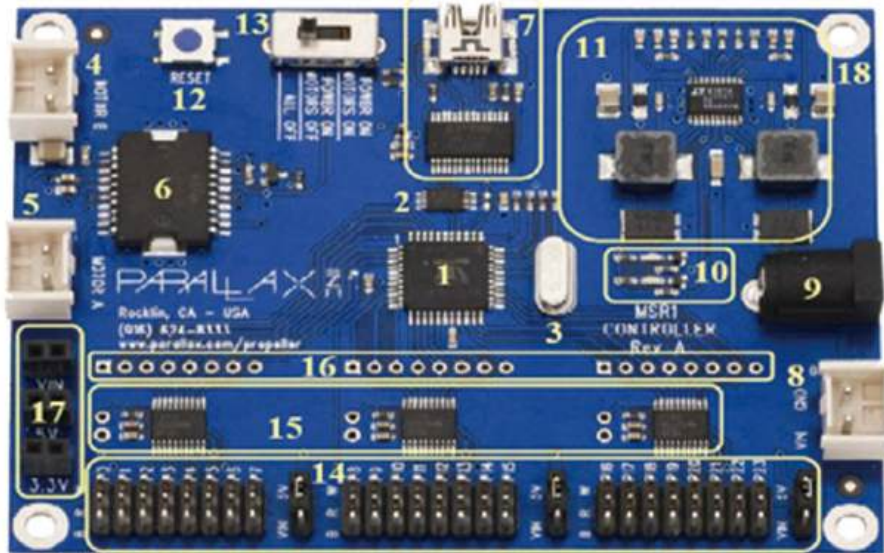

- | | | |
|---------------------------|---------------------------------|---------------------------------|
| 1. Propeller P8X32A-Q44 | 7. USB Connector | 13. 3-Position Power Switch |
| 2. 64 KB EEPROM | 8. Battery Pack Socket | 14. Headers to I/O PO-P23 |
| 3. Socketed 5 MHz Crystal | 9. Barrel Jack, 2.1 mm | 15. Voltage Translators for I/O |
| 4. Right Motor Socket | 10. Power Good/Fail LEDs | 16. Direct I/O Access Vias |
| 5. Left Motor Socket | 11. Dual Switching Power Supply | 17. VIN, 5V, 3.3V Headers |
| 6. L6205 H-Bridge Driver | 12. Reset Button | 18. Ground/Mounting Vias |

Figure 2.2 Propeller Robot Control Board and the pins.

The general picture of the robot's assembly to produce differential wheeled robot models as shown below, and a complete description of the assembly can be read from manual of this robot:

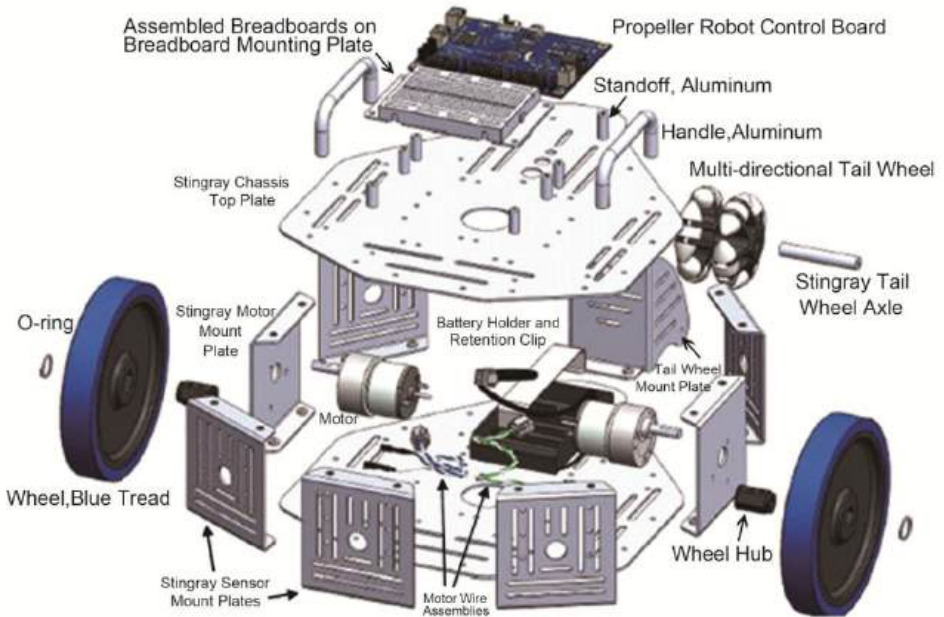

Figure 2.3 The general description of assembling the body, motors and the controller of the robot.

Programming the Propeller

We need USB/Serial programmer to program this chip, note that the connections to the external oscillator and EEPROM, which are enclosed in dashed lines, are optional as shown in figure 2.4 or figure 2.5 for serial programmer:

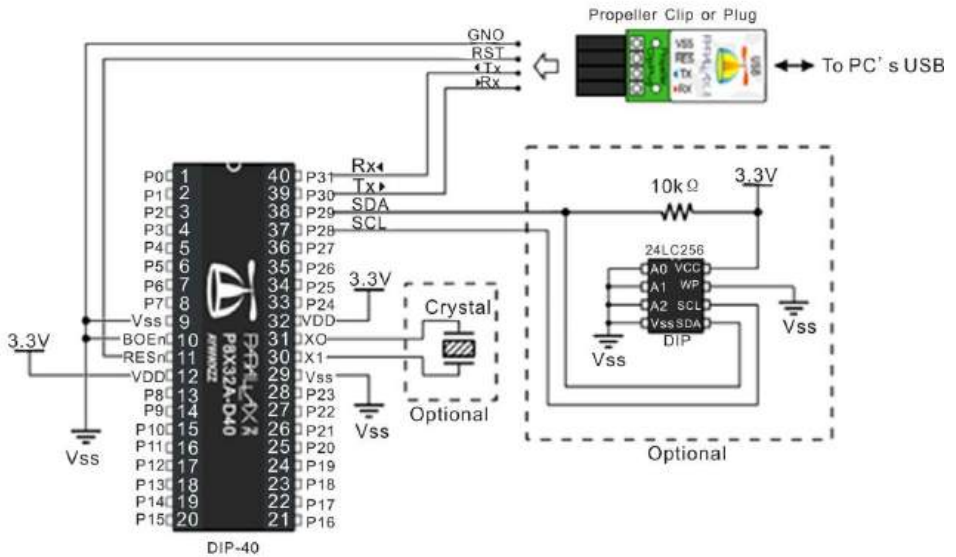

Figure 2.4 The minimum system of Propeller DIP-40 and the programmer.

The cheapest programmer for Propeller show below:

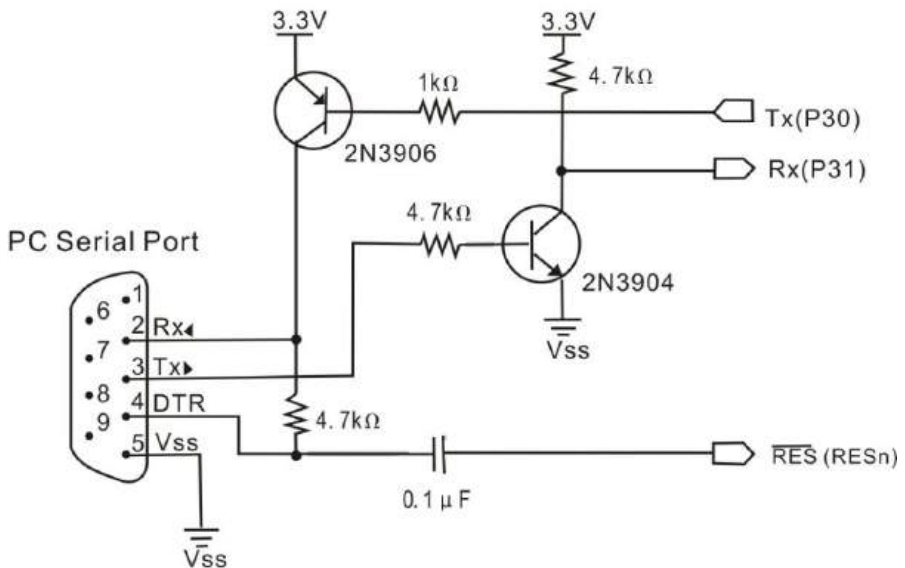

Figure 2.5 Schematic of serial programmer for Propeller.

After installing the Propeller tool software, the codes can be uploaded to the chip by pressing F11 as shown below:

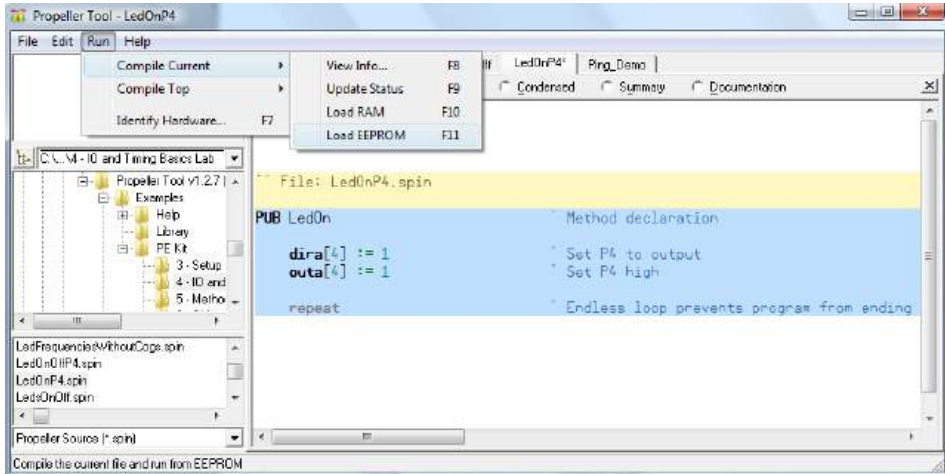

Figure 2.6 Programming the chip.

For basic experiments, we will try to program the LED lights on / off as well as receive input from switches. Install LED lights and switches on the protoboard are provided on the controller board as follows:

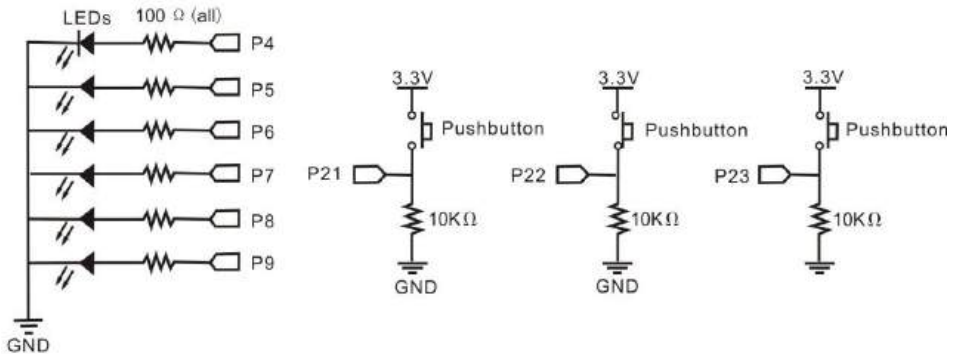

Figure 2.7 Schematic for basic testing of Propeller.

Here's an example of making light LED on / off at pin 4, save the file names LEDOnOffP4.spin by pressing F11, make sure the board Propeller detected on the USB port of your computer:

File: LEDOnOffP4.spin

```

PUB LedOnOff
  dira[4] := 1           ' P4 → output

  repeat
    outa[4] := 1        ' P4 → on
    waitcnt(clkfreq/4 + cnt) ' delay
    outa[4] := 0        ' P4 → off
    waitcnt(clkfreq/4 + cnt)

```



Figure 2.8 The USB connector and FTDI 232RL chip successfully detected the microcontroller.

Use the LEDs, resistors and pluggable wires to create the circuit shown in schematic below on the breadboard. The pluggable wires will jumper to the breadboard to make the I/O and ground connections from the control board locations shown below. Ground can be obtained from the bottom row of pins (marked B) on the I/O headers. P0 and P1 are picked up from the top row (marked W) and are indicated on the silkscreen on the control board. Power is obtained from the center row (marked R) and its voltage is set by the jumper immediately to the right of that group of headers.

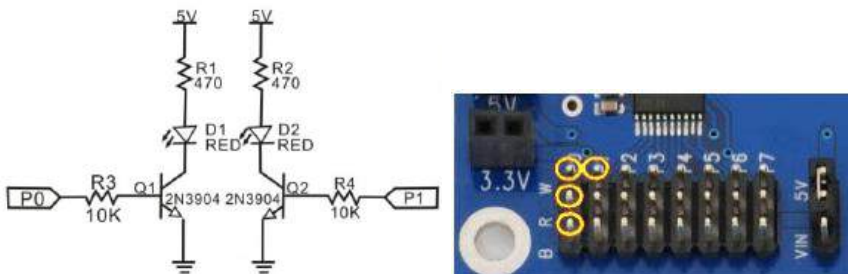

Figure 2.9 The schematic for using standard transistor.

The code for testing the transistor for driving LED shown below:

File: LED_Test.spin

```

CON
_xinfreq = 5_000_000      ' External Crystal freqwency
_clokmode = xtall + pll16x ' Enabled external crystal and PLL
x16

PUB Main
Dira[1..0] := %11          ' Set P0 and P1 to output

Repeat
Out[0] := 1                ' P0 HIGH
Outa[1] := 0              ' P1 LOW
Waitcnt (clkfreq/2 + cnt ) ' Delay ½ clock frequency (1/2
detik)
Out[0] :=0                ' P0 LOW
Outa[1] := 1              ' P1 HIGH
Waitcnt (clkfreq/2 + cnt ) ' Delay ½ clock frequency (1/2
detik)

```

The next example is made in P6 LED lights on / off dependent input from P21, see what the output is generated when the switch is pressed in P21.

File: ButtonToLed.spin

```

PUB ButtonLED              ' Pushbutton/LED Method
  dira[6]:= 1              ' P6 → output
  dira[21] := 0           ' P21 → input
  repeat                  ' Endless loop
    outa[6] := ina[21]    ' Copy P21 input to P6 ouput

```

That is a basic example of programming using the Propeller chip, you have to try other basic programming lies in the examples folder and library in the Propeller Tool program.

Exercises

- 1) Describe and compare features of some popular microcontrollers.
- 2) Design a minimum system for mobile robot using Propeller chip.

- 3) Create a program for Running LED using Propeller.
- 4) Create a program to control 2 DC Motors with an IC Driver L298 using switch.

Reference

- [1] Parallax.com.

Chapter 3

Basic Programming Robot

On successful completion of this course, students will be able to:

- Explain about robot's actuators.
- Program the sensors and motors for robot.

Introduction

Robot becomes a new trend of students and engineers, especially with a main event and a robotics Olympiad each year. Programming the robot using microcontroller is the basic principle of controlling the robot, where the orientation of the microcontroller is to control the application of an information system based on the inputs received, and processed by a microcontroller, and the action performed on the output corresponding predetermined program.

Robot's Actuators

Actuators are an important part of the robot that functions as an activator of the command given by the controller. Usually, an electromechanical actuator device produces movement. Actuator consists of two types:

- Electric Actuators.
- Pneumatic and Hydraulic Actuators.

In this sub-section will discuss the electric actuator which is often used as a producer of such rotational motion of the motor.

DC Motor

A DC Motor in simple words is a device that converts direct current (electrical energy) into mechanical energy. It's of vital importance for the industry today, and is equally important for engineers to look into the working principle of DC motor in details. The very basic construction of a DC motor contains a current carrying armature which is connected to the supply end through commutator segments and brushes and placed within the north south poles of a permanent or an electro-magnet as shown in the figure below:

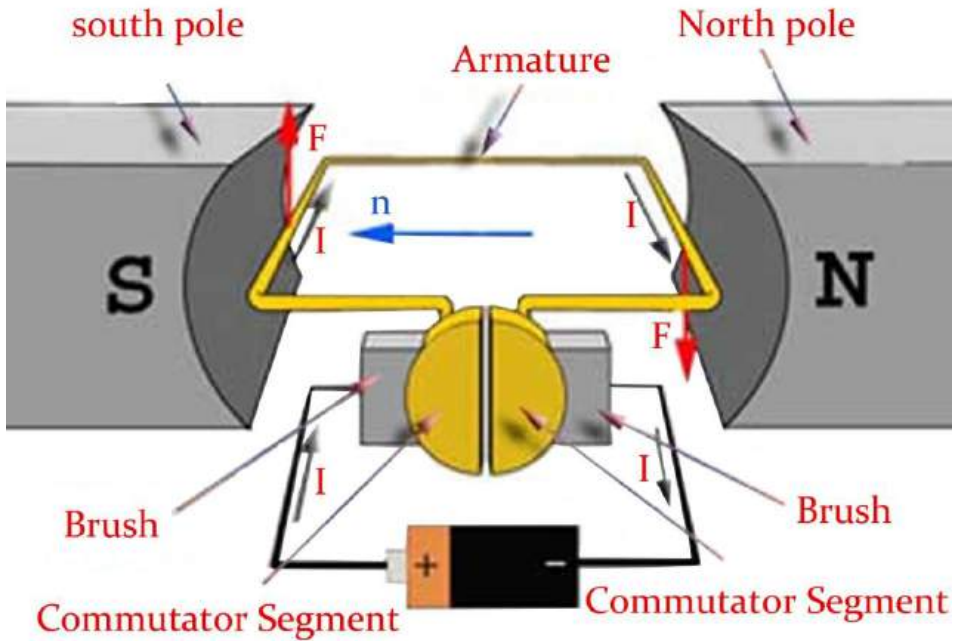

Figure 3.1 DC Motor diagram.

To understand the operating Principle of DC motor, it is important that we have a clear understanding of Fleming’s left hand rule to determine the direction of force acting on the armature conductors of dc motor. Fleming’s left hand rule says that if we extend the index finger, middle finger and thumb of our left hand in such a way that the current carrying conductor is placed in a magnetic field (represented by the index finger) is perpendicular to the direction of current (represented by the middle finger), then the conductor experiences a force in the direction (represented by the thumb) mutually perpendicular to both the direction of field and the current in the conductor.

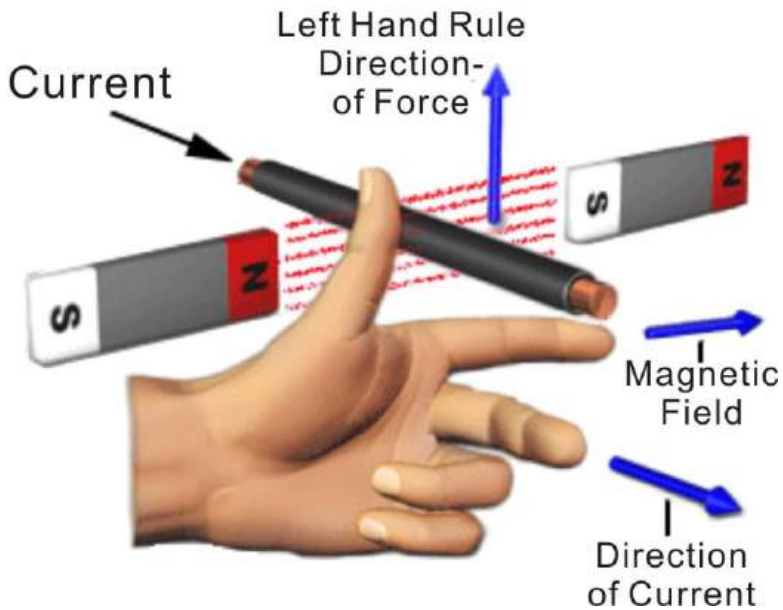

Figure 3.2 Fleming's left hand rule.

Figure below displays a DC motor with gearbox used on the robot to improve torque:

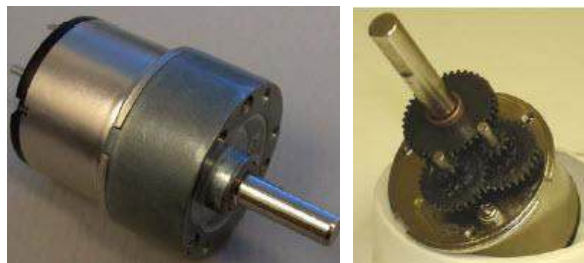

Figure 3.3 An example of DC Motor with gearbox 7.2V 310RPM.

Servo Motor

Another important actuators are servo motors, which can work the wheel or as a robot arm or gripper. Servo motors are often used is continuous Servo Parallax, Parallax standard servo, GWS-S03, Hitec HS-805BB and HS-725BB. Some of the grippers are often used in the lab. Robot gripper usually based on

aluminum, lynxmotion robotic gripper hand and fingers are very popular as follows:

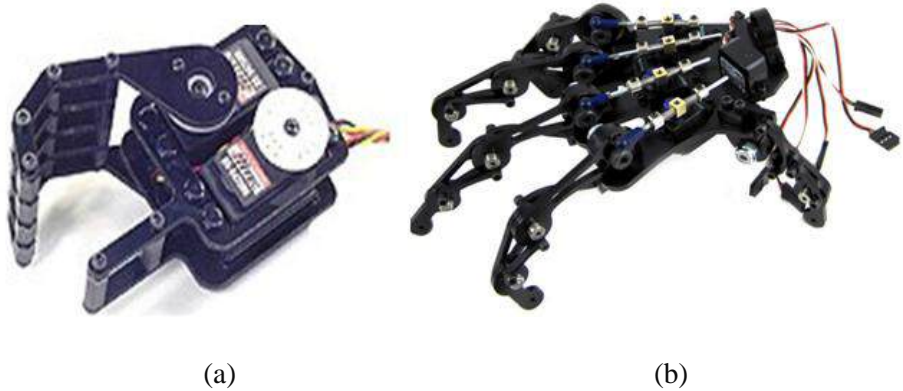

Figure 3.4 Lynxmotion robot hand RH1 with 2 servos (a) and gripper finger using 5 servos to 14 joint (b).

Author recommends that you conduct experiments and make system-based visual servoing robotic arm that can pick up an object using a robotic arm based stereo camera. The robot arm is best used Dagu 6 degree of freedom and AX18FCM5 Smart Robotic arm that uses the CM-5 controller, Full feedback for position, speed, load, voltage and temperature, full control over position (300 degrees), uses servo AX-18F and is compatible with MATLAB and other common microcontroller systems.

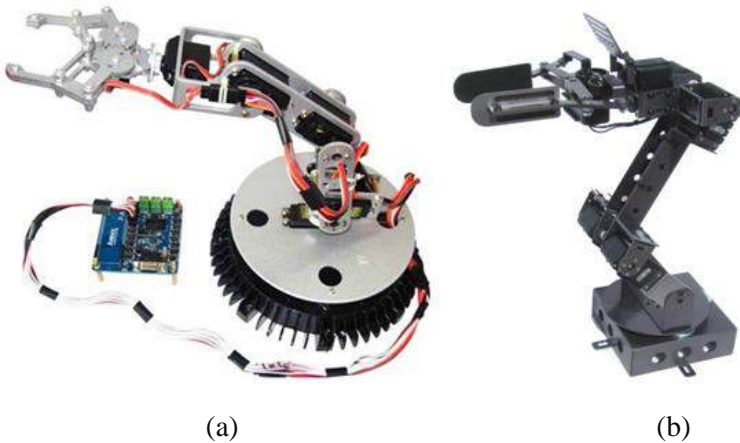

Figure 3.5 Dagu 6 degree freedom arm robotic system using aluminum Dagu gripper (a) and AX18FCM5 Smart Robotic arm using CM-5 controller (b)[1].

Programming Motors of Robot

DC motors are usually driven by an H-Bridge since such a circuit can reverse the polarity of the motor connected to it. The DC brushed motors included in this kit are driven by the L6205 H-Bridge on the Propeller Robot Control Board. Understanding how to control this H-Bridge is the key to controlling the direction, speed and duration that the motors are on or off. Parallax has released a Propeller object called, “PWM_32” which makes it easy to drive servos as well as control motors using pulse width modulation. This object can be used with the Propeller Robot Control Board to drive the on-board H-Bridge, which in turn drives the DC motors.

The L6205 inputs are connected to P24 through P27 on the Propeller chip. When the power switch on the control board is set for POWER ON/MOTORS ON, the L6205 is enabled and the outputs are connected to the motors. The truth table for controlling the L6205 is shown below in Table 3.1. P24 and P25 control the left motor while P26 and P27 control the right motor. This table assumes the motors are connected to the control board as defined in the assembly instructions.

Table 3.1 Motor truth table.

P24	P25	P26	P27	Left Motor	Right Motor
0	0	0	0	Brake	Brake
1	0	0	0	Reverse	Brake
0	1	0	0	Forward	Brake
1	1	0	0	Brake	Brake
0	0	1	0	Brake	Forward
1	0	1	0	Reverse	Forward
0	1	1	0	Forward	Forward
1	1	1	0	Brake	Forward
0	0	0	1	Brake	Reverse
1	0	0	1	Reverse	Reverse
0	1	0	1	Forward	Reverse
1	1	0	1	Brake	Reverse
0	0	1	1	Brake	Brake
1	0	1	1	Reverse	Brake
0	1	1	1	Forward	Brake
1	1	1	1	Brake	Brake

Note that it may be more intuitive to look at the table as two groups consisting of P24/P25 and P26/P27. In this manner you have 4 possible combinations for each motor as shown in Table 3.2.

Table 3.2 The value given to P24 and P25 and P26 and 27 for the motors.

P24	P25	Left Motor	P26	P27	Right Motor
0	0	Brake	0	0	Brake
1	0	Reverse	1	0	Forward
0	1	Forward	0	1	Reverse
1	1	Brake	1	1	Brake

The program to make the left motor active is shown below:

File: LeftMotorTest.spin

```

CON
_xinfreq = 5_000_000
_clkmode =xtal1 + pll116x
PUB Main
Dira[27..24] := %1111          ' Set P24 - P27 to output

    Outa [25] := 1              ' Left motor forward
    Waitcnt (clkfreq * 2 + cnt) ' 2 seconds pause
    Outa [25] :=0              ' Left motor stop
    Waitcnt (clkfreq * 2 + cnt)
    Outa[24] :=1              ' Left motor reverse
    Waitcnt (clkfreq * 2 + cnt)
    Outa[24] :=0
    repeat
    
```

To control the speed of a DC motor can use PWM (Pulse Width Modulation), with the following example:

File : PWMx8.spin

```

CON
    resolution = 256          'The number of steps in the pulse
widths. Must be an integer multiple of 4.
    nlongs     = resolution / 4
    
```

```

VAR
    long fcb[5]
    long pwmdata[nlongs]
    long pinmask
    long previndex[8]
    byte cogno, basepin
PUB start(base, mask, freq)
    ' This method is used to setup the PWM driver and start its cog.
    If a driver had
    ' already been started, it will be stopped first. The arguments
    are as follows:
    '   base: The base pin of the PWM output block. Must be 0, 8,
    16, or 24.
    '   mask: The enable mask for the eight pins in the block:
    '       bit 0 = basepin + 0
    '       bit 1 = basepin + 1
    '       ...
    '       bit 7 = basepin + 7
    '
    '       Set a bit to 1 to enable the corresponding pin for
    PWM output.
    '
    '   freq: The frequency in Hz for the PWM output.
    '
    if (cogno)
        stop
    freq *= resolution
    if (clkfreq =< 4000000 or freq > 20648881 or clkfreq < freq *
135 / 10 or clkfreq / freq > 40000 or base <> base & %11000 or
mask <> mask & $ff or resolution <> resolution & $7ffffffc)
        return false
    basepin := base
    pinmask := mask << base
    longfill(@pwmdata, 0, nlongs)
    longfill(@previndex, 0, 8)
    fcb[0] := nlongs
    fcb[1] := freq
    fcb[2] := constant(1 << 29 | 1 << 28) | base << 6 | mask

```

```

fcb[3] := pinmask
fcb[4] := @pwmdata
if (cogno := cognew(@pwm, @fcb) + 1)
    return true
else
    return false

PUB stop

' This method is used to stop an already-started PWM driver. It
returns true if
' a driver was running; false, otherwise.
if (cogno)
    cogstop(cogno - 1)
    cogno~
    return true
else
    return false

PUB duty(pinno, value) | vindex, pindex, i, mask, unmask
' This method defines a pin's duty cycle. It's arguments are:
' pinno: The pin number of the PWM output to modify.
' value: The new duty cycle (0 = 0% to resolution = 100%)
' Returns true on success; false, if pinno or value is invalid.
if (1 << pinno & pinmask == 0 or value < 0 or value >
resolution)
    return false
pinno -= basepin
mask := $01010101 << pinno
unmask := !mask
vindex := value >> 2
pindex := previndex[pinno]
if (vindex > pindex)
    repeat i from pindex to vindex - 1
        pwmdata[i] |= mask
elseif (vindex < pindex)
    repeat i from pindex to vindex + 1
        pwmdata[i] &= unmask

```

```

    pwmdata[vindex] := pwmdata[vindex] & unmask | mask &
($ffffffff >> (31 - ((value & 3) << 3)) >> 1)
    previndex[pinno] := vindex
    return true

```

Sensors for Intelligent Robot

Ultrasonic Distance Sensor: PING)))™

PING)))™ ultrasonic sensor provides an easy method of distance measurement. This sensor is perfect for any number of applications that require you to perform measurements between moving or stationary objects. Interfacing to a microcontroller is a snap. A single I/O pin is used to trigger an ultrasonic burst (well above human hearing) and then "listen" for the echo return pulse. The sensor measures the time required for the echo return, and returns this value to the microcontroller as a variable-width pulse via the same I/O pin. The PING))) sensor works by transmitting an ultrasonic (well above human hearing range) burst and providing an output pulse that corresponds to the time required for the burst echo to return to the sensor. By measuring the echo pulse width, the distance to target can easily be calculated.

Key Features:

- Provides precise, non-contact distance measurements within a 2 cm to 3 m range for robotics application.
- Ultrasonic measurements work in any lighting condition, making this a good choice to supplement infrared object detectors.
- Simple pulse in/pulse out communication requires just one I/O pin.
- Burst indicator LED shows measurement in progress.
- 3-pin header makes it easy to connect to a development board, directly or with an extension cable, no soldering required.

The PING))) sensor detects objects by emitting a short ultrasonic burst and then "listening" for the echo. Under control of a host microcontroller (trigger pulse), the sensor emits a short 40 kHz (ultrasonic) burst. This burst travels through the air, hits an object and then bounces back to the sensor. The PING))) sensor provides an output pulse to the host that will terminate when the echo is detected, hence the width of this pulse corresponds to the distance to the target.

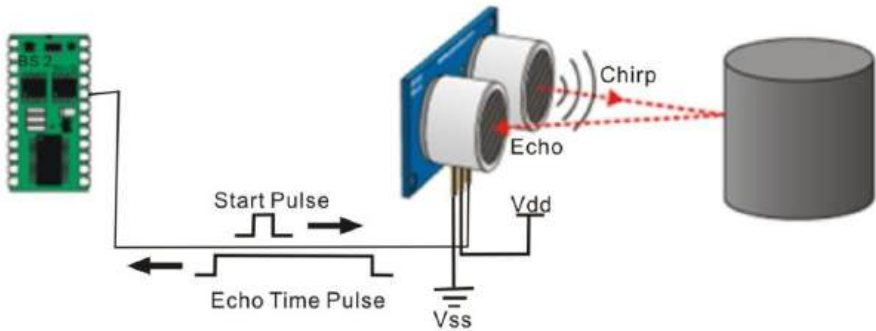

Figure 3.6 The basic principle of ultrasonic distance sensor [2].

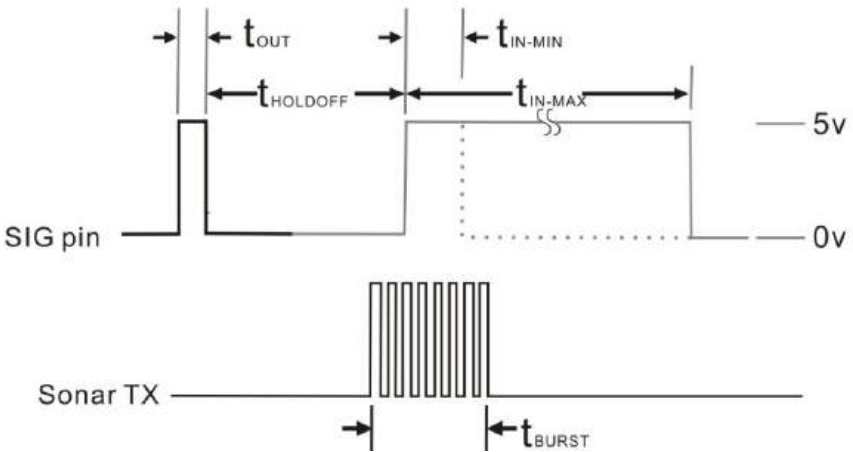

Figure 3.7 Communication protocol of the PING))).

This circuit allows you to quickly connect your PING))) sensor to a BASIC Stamp/Propeller Board. The PING))) module's GND pin connects to Vss, the 5 V pin connects to Vdd, and the SIG pin connects to I/O pin P15.

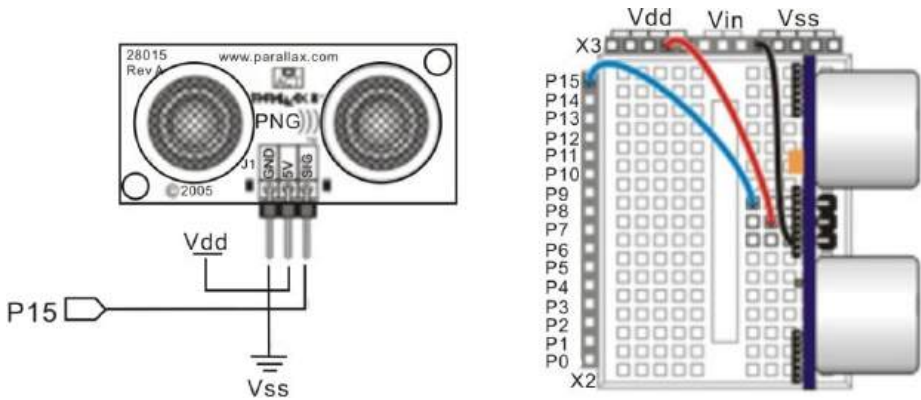

Figure 3.8 PING))) to the board.

Here is an example of using the Ping sensor shown in Serial LCD 4x20.

File: Ping_Demo.spin

```

CON
  _clkmode = xtall1 + pll16x
  _xinfreq = 5_000_000

  PING_Pin = 15          ' I/O Pin For PING)))
  LCD_Pin = 1           ' I/O Pin For LCD
  LCD_Baud = 19_200    ' LCD Baud Rate
  LCD_Lines = 4        ' Parallax 4X20 Serial LCD (#27979)

VAR
  long range

OBJ
  LCD: "debug_lcd"
  ping: "ping"

PUB Start
  LCD.init(LCD_Pin, LCD_Baud, LCD_Lines)      ' Initialize LCD
Object
  LCD.cursor(0)                               ' Turn Off Cursor
  LCD.backlight(true)                         ' Turn On Backlight
  LCD.cls                                     ' Clear Display
  LCD.str(string("PING))) Demo", 13, 13, "Inches  -", 13,
"Centimeters -")

```

```

repeat                                     ' Repeat Forever
  LCD.gotoxy(15, 2)                         ' Position Cursor
  range := ping.Inches(PING_Pin)           ' Get Range In Inches
  LCD.decxc(range, 2)                       ' Print Inches
  LCD.str(string(".0 "))                    ' Pad For Clarity
  LCD.gotoxy(14, 3)                         ' Position Cursor
  range := ping.Millimeters(PING_Pin)      ' Get Range In
Millimeters
  LCD.decfc(range / 10, 3)                  ' Print Whole Part
  LCD.putc(".")                             ' Print Decimal Point
  LCD.decxc(range // 10, 1)                 ' Print Fractional Part
  waitcnt(clkfreq / 10 + cnt)              ' Pause 1/10 Second

```

Robot avoider is a robot that able to avoid the obstacle at the in front of the robot or at the left or right side of the robot. Here's an example using a PING))) as an avoider robot that only able to detect the obstacle in front of the robot using 1 PING))).

Serial_LCD_Avoider.spin:

```

\ Copyright Dr. Widodo Budiharto
\ www.toko-elektronika.com 2014

CON
  _clkmode = xtall + pll16x
  _xinfreq = 5_000_000

  LCD_PIN      = 23
  PING_Pin = 13          ' I/O Pin For PING)))
  LCD_Baud     = 19_200
  LCD_Lines=2
VAR
long range
OBJ

  Serial      : "FullDuplexSerial.spin"
  LCD         : "debug_lcd"
  ping        : "ping"

PUB Main
  Dira[27..24]:= %1111      ' Set P24 P27 to be output

```



```

LCD.init(LCD_Pin, LCD_Baud, LCD_Lines)      ' Initialize LCD
Object
LCD.cursor(0)                              ' Turn Off Cursor
LCD.backlight(true)                        ' Turn On Backlight
LCD.cls
    LCD.gotoxy(3, 0)                        ' Clear Display
LCD.str(string("WIDODO.COM"))
repeat
    range := ping.Millimeters(PING_Pin)    ' Get Range In
Millimeters
    LCD.gotoxy(3, 1)
    LCD.decf(range / 10, 3)                ' Print Whole Part
    LCD.putc(".")                          ' Print Decimal Point
    LCD.decx(range // 10, 1)               ' Print Fractional Part
    LCD.gotoxy(10, 1)
    LCD.str(string("Cm"))
if range >400
    Outa [24] :=0                          ' Left motor stop
    Outa [27] :=0                          ' Right motor stop
    waitcnt(clkfreq / 2 + cnt)            '
    Outa[25]:= 1                          ' Left motor forward
    Outa[26]:= 1                          ' Right motor forward
    waitcnt(clkfreq / 10 + cnt)          ' Pause 1/10 Second
if range <=400
    'reverse
    Outa[25]:= 0                          ' Left motor stop
    Outa[26]:= 0                          ' Right motor stop
    waitcnt(clkfreq / 2 + cnt)            ' Pause
    Outa [24] :=1                          ' Left motor reverse
    Outa [27] :=1                          ' Right motor reverse
    'turn left
    Outa [24] :=1                          ' Left motor reverse
    Outa [27] :=0                          ' Right motor stop
    waitcnt(clkfreq/5 + cnt)              ' Pause 1/10 Second
    Outa [24] :=0                          ' Left motor stop
    Outa [27] :=0                          ' Right motor stop

```

Now, if we want an intelligent robot that able to avoid the obstacle using 3 PING))), we can propose the system as shown in figure 3.9.



Figure 3.9 Avoider robot using 3 PING))) on the body.

Avoider_LCD_3PING.spin

```

` Avoider Robot, copyright Dr. Widodo Budiharto, 2014
CON
  _clkmode = xtall + pll16x
  _xinfreq = 5_000_000

  LCD_PIN      = 23
  PINGRight_Pin=0      ' I/O Pin For PING)))
  PINGFront_Pin = 13
  PINGLeft_Pin=22
  LCD_Baud     = 19_200
  LCD_Lines=2
VAR
  long rangeFront
  long rangeRight
  long rangeLeft
OBJ

  Serial      : "FullDuplexSerial.spin"
  LCD         : "debug_lcd"
  ping       : "ping"

```

```

PUB Main
  Dira[27..24]:= %1111      ' Set P24 P27 to be output

  LCD.init(LCD_Pin, LCD_Baud, LCD_Lines)  ' Initialize LCD Object
  LCD.cursor(0)                      ' Turn Off Cursor
  LCD.backlight(true)                ' Turn On Backlight
  LCD.cls
  LCD.gotoxy(3, 0)                    ' Clear Display
  LCD.str(string("WIDODO.COM"))
  waitcnt(clkfreq/2 + cnt)           ' Pause 1/10 Second
  repeat

    rangeFront := ping.Millimeters(PINGFront_Pin)  ' Get Range In
  Millimeters
    rangeRight := ping.Millimeters(PINGRight_Pin)  ' Get Range In
  Millimeters
    rangeLeft := ping.Millimeters(PINGLeft_Pin)    ' Get Range In
  Millimeters
    LCD.gotoxy(0, 1)
    LCD.decfc(rangeLeft / 10, 3)                  ' Print Whole Part
    LCD.gotoxy(5, 1)
    LCD.decfc(rangeFront / 10, 3)                 ' Print Whole Part
    LCD.putc(".")                                ' Print Decimal Point
    LCD.decfc(rangeFront // 10, 1)                ' Print Fractional Part
    LCD.gotoxy(12, 1)
    LCD.decfc(rangeRight / 10, 3)

  if rangeFront >200 and rangeRight>200
    LCD.cls
    LCD.gotoxy(3, 0)          ' Clear Display
    LCD.str(string("FORWARD"))
    Outa [24] :=0            ' Left motor stop
    Outa [27] :=0            ' Right motor stop
    waitcnt(clkfreq / 2 + cnt)  '
    Outa[25]:= 1              ' right motor forward
    Outa[26]:= 1              ' left motor forward
    waitcnt(clkfreq / 10 + cnt) ' Pause 1/10 Second
  if rangeFront <=200
    LCD.cls

```

```

    'reverse
LCD.gotoxy(3, 0) ' Clear Display
LCD.str(string("REFERSE"))
Outa[25]:= 0           ' left motor stop
Outa[26]:= 0           ' right motor stop
waitcnt(clkfreq / 5 + cnt) ' Pause
Outa [24] :=1         ' Left motor reverse
Outa [27] :=1         ' Right motor reverse
waitcnt(clkfreq + cnt)   ' Pause
if rangeRight<=200
LCD.cls
'turn left
LCD.gotoxy(3, 0) ' Clear Display
LCD.str(string("TURN LEFT"))
Outa [24] :=0           ' Left motor stop
Outa [27] :=0           ' Right motor stop
waitcnt(clkfreq/10 + cnt) ' Pause 1/10 Second
Outa[25]:= 1           ' left motor forward
waitcnt(clkfreq/2 + cnt) ' Pause 1/10 Second
Outa[25]:= 0           ' left motor stop
if rangeLeft<=200
LCD.cls
'turn right
LCD.gotoxy(3, 0) ' Clear Display
LCD.str(string("TURN RIGHT"))
Outa [24] :=0           ' Left motor stop
Outa [27] :=0           ' Right motor stop
waitcnt(clkfreq/10 + cnt) ' Pause 1/10 Second
Outa[26]:= 1           ' right motor forward
waitcnt(clkfreq/2 + cnt) ' Pause 1/10 Second
Outa[26]:= 0           ' right motor stop

```

Compass Module: 3-Axis HMC5883L

The Compass Module 3-Axis HMC5883L is designed for low-field magnetic sensing with a digital interface. This compact sensor fits into small projects such as UAVs and robot navigation systems. The sensor converts any magnetic

field to a differential voltage output on 3 axes. This voltage shift is the raw digital output value, which can then be used to calculate headings or sense magnetic fields coming from different directions.

Key Features:

- Measures Earth's magnetic fields.
- Precision in-axis sensitivity and linearity.
- Designed for use with a large variety of microcontrollers with different voltage requirements.
- 3-Axis magneto-resistive sensor.
- 1 to 2 degree compass heading accuracy.
- Wide magnetic field range (+/-8 gauss).
- Fast 160 Hz maximum output rate.
- Measures Earth's magnetic field, from milli-gauss to 8 gauss.

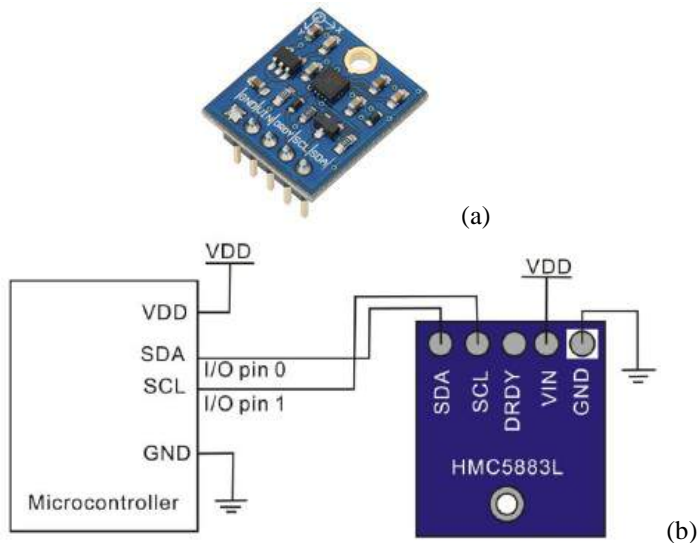

Figure 3.10 Compass module (a) and the schematic (b).

Here is an example code for using Compass module:

DemoCompass.spin:

```

OBJ
  pst : "FullDuplexSerial" ' Comes with Propeller Tool
CON

  _clkmode      = xtall + pll16x
  _clkgfreq     = 80_000_000

  datapin = 1      ' SDA of compass to pin P1
  clockPin = 0     ' SCL of compass to pin P0

  WRITE_DATA    = $3C ' Requests Write operation
  READ_DATA     = $3D ' Requests Read operation
  MODE          = $02 ' Mode setting register
  OUTPUT_X_MSB  = $03 ' X MSB data output register

VAR

  long x
  long y
  long z

PUB Main

  waitcnt(clkgfreq/100_000 + cnt)      ' Power up delay
  pst.start(31, 30, 0, 115200)
  SetCont
  repeat
    SetPointer(OUTPUT_X_MSB)
    getRaw      ' Gather raw data from compass
    pst.tx(1)
    ShowVals

PUB SetCont
  ' Sets compass to continuous output mode

  start
  send(WRITE_DATA)
  send(MODE)
  send($00)
  stop

PUB SetPointer(Register)

```

```
' Start pointer at user specified register (OUT_X_MSB)

start
send(WRITE_DATA)
send(Register)
stop

PUB GetRaw
' Get raw data from continuous output

start
send(READ_DATA)
x := ((receive(true) << 8) | receive(true))
z := ((receive(true) << 8) | receive(true))
y := ((receive(true) << 8) | receive(false))
stop
~~x
~~z
~~y
x := x
z := z
y := y

PUB ShowVals
' Display XYZ compass values

pst.str(string("X="))
pst.dec(x)
pst.str(string(", Y="))
pst.dec(y)
pst.str(string(", Z="))
pst.dec(z)
pst.str(string("  "))

PRI send(value)

value := (!value) >> 8

repeat 8
  dira[dataPin] := value
  dira[clockPin] := false
```

```

    dira[clockPin] := true
    value >>= 1

    dira[dataPin] := false
    dira[clockPin] := false
    result        := !(ina[dataPin])
    dira[clockPin] := true
    dira[dataPin] := true

PRI receive(aknowledge)

    dira[dataPin] := false

    repeat 8
        result <<= 1
        dira[clockPin] := false
        result         |= ina[dataPin]
        dira[clockPin] := true

    dira[dataPin] := aknowledge
    dira[clockPin] := false
    dira[clockPin] := true
    dira[dataPin] := true

PRI start

    outa[dataPin] := false
    outa[clockPin] := false
    dira[dataPin] := true
    dira[clockPin] := true

PRI stop

    dira[clockPin] := false
    dira[dataPin] := false

```

Gyroscope Module 3-Axis L3G4200D

The Gyroscope Module is a low power 3-Axis angular rate sensor with temperature data for UAV, IMU Systems, robotics and gaming. The gyroscope shows the rate of change in rotation on its X, Y and Z axes. Raw angular rate and temperature data measurements are accessed from the selectable digital I2C or SPI interface. The small package design and SIP interface accompanied by

the mounting hole make the sensor easy to integrate into your projects. Designed to be used with a variety of microcontrollers, the module has a large operating voltage window.

Key Features:

- 3-axis angular rate sensor (yaw, pitch & roll) make it great for model aircraft navigation systems.
- Supports both I2C and SPI for whichever method of communication you desire.
- Three selectable scales: 250/500/2000 degrees/sec (dps).
- Embedded power down and sleep mode to minimize current draw.
- 16 bit-rate value data output.

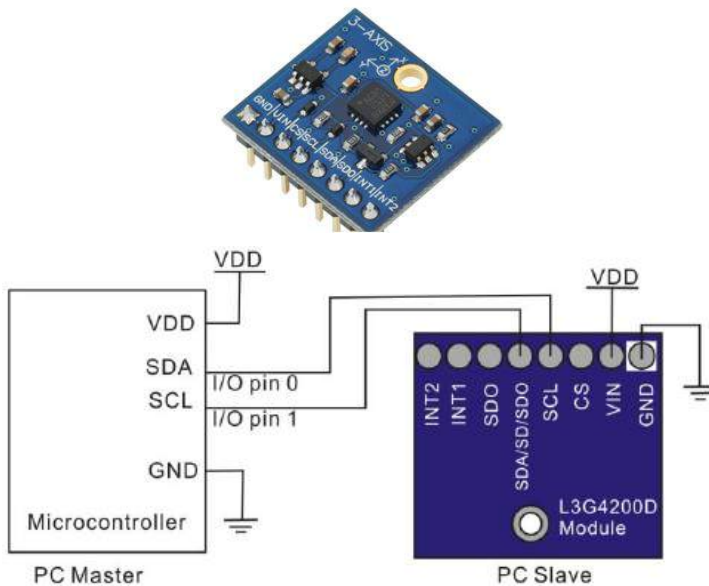

Figure 3.11 Gyroscope Module 3-Axis L3G4200D (a) and general schematic (b).

Program below demonstrates X, Y, Z output to a serial terminal and uses default (I²C) interface on the Gyroscope module.

Gyro_Demo.spin

```
CON
```

```

_clkmode      = xtall + pll16x
_clkfreq      = 80_000_000

SCLpin       = 2
SDApin       = 4

'****Registers****

WRITE        = $D2
READ         = $D3

CTRL_REG1    = $20    'SUB $A0
CTRL_REG3    = $22
CTRL_REG4    = $23
STATUS_REG   = $27
OUT_X_INC    = $A8

x_idx = 0
y_idx = 1
z_idx = 2

VAR

long x
long y
long z

long cx
long cy
long cz

long ff_x
long ff_y
long ff_z

long multiBYTE[3]

OBJ
    Term      : "FullDuplexSerial"

PUB Main | last_ticks

    'Main routine for example program - Shows RAW X,Y,Z data and
    example of calculated data for degrees

```

```

    term.start(31, 30, 0, 115200)      'start a terminal Object
(rxpin, txpin, mode, baud rate)

    Wrt_1B(CTRL_REG3, $08)            'set up data ready signal
    Wrt_1B(CTRL_REG4, $80)            'set up "block data update" mode
(to avoid bad reads when the values would get updated while we
are reading)
    Wrt_1B(CTRL_REG1, $1F)            'write a byte to control
register one (enable all axis, 100Hz update rate)

    Calibrate

    last_ticks := cnt

    repeat                            'Repeat indefinitely

    term.tx(1)                        'Set Terminal data at top of screen

    WaitForDataReady

    Read_MultiB(OUT_X_INC)            'Read out multiple bytes starting
at "output X low byte"

    x := x - cx                        'subtract calibration out
    y := y - cy
    z := z - cz

    ' at 250 dps setting, 1 unit = 0.00875 degrees,
    ' that means about 114.28 units = 1 degree
    ' this gets us close
    x := x / 114
    y := y / 114
    z := z / 114

    RawXYZ                            'Print the Raw data output of X,Y and Z

PUB RawXYZ

    ''Display Raw X,Y,Z data
    term.str(string("RAW X ",11))
    term.dec(x)
    term.str(string(13, "RAW Y ",11))
    term.dec(y)
    term.str(string(13, "RAW Z ",11))
    term.dec(z)

```

```

PUB Calibrate
  cx := 0
  cy := 0
  cz := 0

  repeat 25
    WaitForDataReady
    Read_MultiB(OUT_X_INC)      ' read the 3 axis values and
accumulate
    cx += x
    cy += y
    cz += z

  cx /= 25                      ' calculate the average
  cy /= 25
  cz /= 25

PUB WaitForDataReady | status
  repeat
    status := Read_1B(STATUS_REG)      ' read the ZYXZDA bit
of the status register (looping until the bit is on)
    if (status & $08) == $08
      quit

PUB Wrt_1B(SUB1, data)

  ''Write single byte to Gyroscope.

  start
  send(WRITE)                      'device address as write
command
  'slave ACK
  send(SUB1)                        'SUB address = Register MSB 1 =
reg address auto increment
  'slave ACK
  send(data)                        'data you want to send
  'slave ACK
  stop

PUB Wrt_MultiB(SUB2, data, data2)

  ''Write multiple bytes to Gyroscope.

```

```

start
send(WRITE)          'device address as write command
  'slave ACK
send(SUB2)           'SUB address = Register MSB 1 = reg address
auto increment
  'slave ACK
send(data)           'data you want to send
'slave ACK
send(data2)          'data you want to send
'slave ACK
stop

PUB Read_1B(SUB3) | rxd

  ''Read single byte from Gyroscope

  start
  send(WRITE)        'device address as write command
  'slave ACK
  send(SUB3)         'SUB address = Register MSB 1 = reg
address auto increment
  'slave ACK
  stop
  start              'SR condition
  send(READ)         'device address as read command
  'slave ACK
  rxd := receive(false)  'recieve the byte and put in
variable rxd
  stop
  result := rxd

PUB Read_MultiB(SUB3)

  ''Read multiple bytes from Gyroscope

  start
  send(WRITE)        'device address as write command
  'slave ACK
  send(SUB3)         'SUB address = Register MSB 1 = reg
address auto increment
  'slave ACK
  stop

```

```

start                'SR condition
send(READ)           'device address as read command
'slave ACK
multiBYTE[x_idx] := (receive(true) | (receive(true) << 8
'Receives high and low bytes of Raw data
multiBYTE[y_idx] := (receive(true) | (receive(true) << 8
multiBYTE[z_idx] := (receive(true) | (receive(false) << 8
stop

x := ~~multiBYTE[x_idx]
y := ~~multiBYTE[y_idx]
z := ~~multiBYTE[z_idx]

PRI send(value) ' I2C Send data - 4 Stack Longs

value := ((!value) >< 8)

repeat 8
dira[SDApin]      := value
dira[SCLpin]      := false
dira[SCLpin]      := true
value >>= 1
dira[SDApin]      := false
dira[SCLpin]      := false
result            := not(ina[SDApin])
dira[SCLpin]      := true
dira[SDApin]      := true

PRI receive(aknowledge) ' I2C receive data - 4 Stack Longs
dira[SDApin]      := false

repeat 8
result <<= 1
dira[SCLpin]      := false
result            |= ina[SDApin]
dira[SCLpin]      := true
dira[SDApin]      := (aknowledge)
dira[SCLpin]      := false
dira[SCLpin]      := true
dira[SDApin]      := true

```

```

PRI start ' 3 Stack Longs
outa[SDApin]      := false
outa[SCLpin]      := false
dira[SDApin]      := true
dira[SCLpin]      := true
PRI stop ' 3 Stack Longs
dira[SCLpin]      := false
dira[SDApin]      := false

```

PID Controller for the Robot

A PID controller is used to make a quantity (like position) reach a target value (a target position). The first thing a PID controller does is to calculate the error $e(t)$. The PID controller algorithm involves three separate constant parameters, and is accordingly sometimes called three-term control: the proportional, the integral and derivative values, denoted P , I , and D . Simply put, these values can be interpreted in terms of time: P depends on the *present* error, I on the accumulation of *past* errors, and D is a prediction of *future* errors, based on current rate of change. The weighted sum of these three actions is used to adjust the process via a control element such as the position of a motor. The controller attempts to minimize the error by adjusting (an Output). The model of PID Controller shown in fig. 3.11:

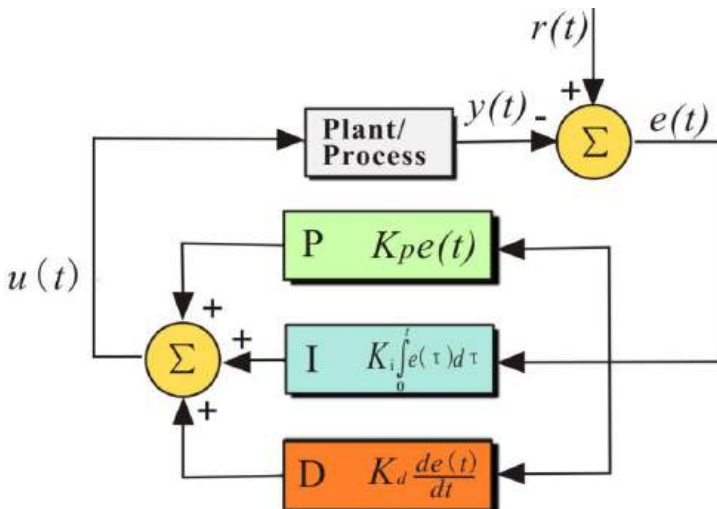

Figure 3.12 General PID Controller.

The output of a PID controller, equal to the control input to the system, in the time-domain is as follows:

$$u(t) = K_p e(t) + K_i \int e(t) dt + K_d \frac{de}{dt} \quad (3.1)$$

In Propeller microcontroller, we can use Propeller Object Exchange named A quadrature encoder and PID controller driver that runs in one cog. The code has been fully optimized with a super simple spin interface for maximum speed and is also fully commented. It provides full support for getting the quadrature encoder's current position and position delta in ticks and setting the quadrature encoders current speed in ticks per second through PID control through a standard DC motor.

Exercises

- 1) Write a motor speed controller using PID.
- 2) Write a program for fire fighter robot using flame sensor, distance sensor and compass to follow the side of the wall.

References

- [1] Crustcrawler.com.
- [2] www.parallax.com.

Chapter 4

Serial Communication with Robot

On successful completion of this course, students will be able to:

- Explain principle of serial communication for robotics.
- Program the mobile robot using serial and wireless communication.
- Develop an interface program using Visual Basic/C# .Net.

Introduction

We need data communication to sending and receiving serial data using RS-232 Communication or wirelessly between microcontrollers or to a PC. 433 MHz RF Transceiver with Low power consumption makes it ideal for use in battery-powered applications. Data is sent and received by AM or CPCA modulation, thus offering a higher average output power which extends the range. Digi XBee 802.15.4 modules are the easiest-to-use, most reliable and cost-effective RF devices we've experienced. The 802.15.4 XBee modules provide two friendly modes of communication – a simple serial method of transmit/receive or a framed mode providing advanced features. XBee are ready to use out of the package, or they can be configured through the X-CTU utility or from your microcontroller.

Serial Interface Using Microsoft Visual Basic/C# .Net

RS-232 stands for Recommend Standard number 232 and C is the latest revision of the standard. The serial ports on most computers use a subset of the RS-232C standard. The full RS-232C standard specifies a 25-pin "D" connector of which 22 pins are used. Most of these pins are not needed for normal PC communications, and indeed, most new PCs are equipped with male D type connectors having only 9 pins. The baud unit is named after Jean Maurice Emile Baudot, who was an officer in the French Telegraph Service. He is credited with devising the first uniform-length 5-bit code for characters of the alphabet in the late 19th century. What baud really refers to is modulation rate or the number of times per second that a line changes state. This is not always the same as bits per second (BPS). If you connect two serial devices together using direct cables then baud and BPS are in fact the same. Thus, if you are running at 19200 BPS, then the line is also changing states 19200 times per second.

There are two basic types of serial communications, synchronous and asynchronous. With Synchronous communications, the two devices initially synchronize themselves to each other, and then continually send characters to stay in sync. Even when data is not really being sent, a constant flow of bits allows each device to know where the other is at any given time. That is, each character that is sent is either actual data or an idle character. Synchronous communications allows faster data transfer rates than asynchronous methods, because additional bits to mark the beginning and end of each data byte are not required. The serial ports on IBM-style PCs are asynchronous devices and therefore only support asynchronous serial communications.

Asynchronous means "no synchronization", and thus does not require sending and receiving idle characters. However, the beginning and end of each byte of data must be identified by start and stop bits. The start bit indicate when the data byte is about to begin and the stop bit signals when it ends. The requirement to send these additional two bits causes asynchronous communications to be slightly slower than synchronous. When transmitting a byte, the UART (serial port) first sends a START BIT which is a positive voltage (0), followed by the data (general 8 bits, but could be 5, 6, 7, or 8 bits) followed by one or two STOP BITs which is a negative(1) voltage. The sequence is repeated for each byte sent. Figure 4.1 shows a diagram of a byte transmission would look like.

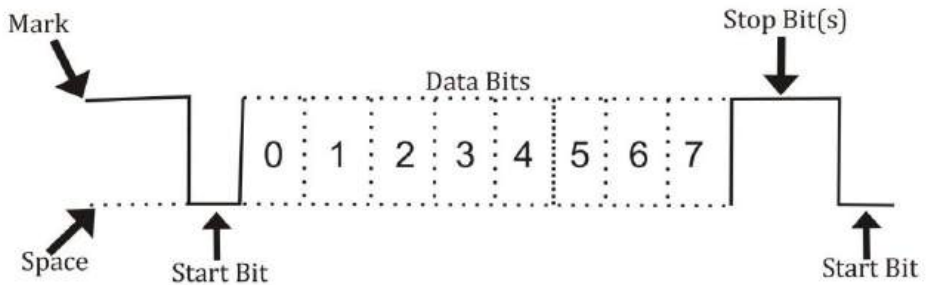

Figure 4.1 Serial communication format[1].

To create a serial interface program for PC, we can use many programming languages such as Visual Basic, Visual C # or Borland Delphi. Ms. Visual C #. Net 2010/2013 is one of the programming languages that allow us to create GUI applications for communication with the robot. There SerialPort class can be used to access serial port. Program for serial communication on propeller is quite easy because it uses objects, such as Parallax Serial Terminal, for example:

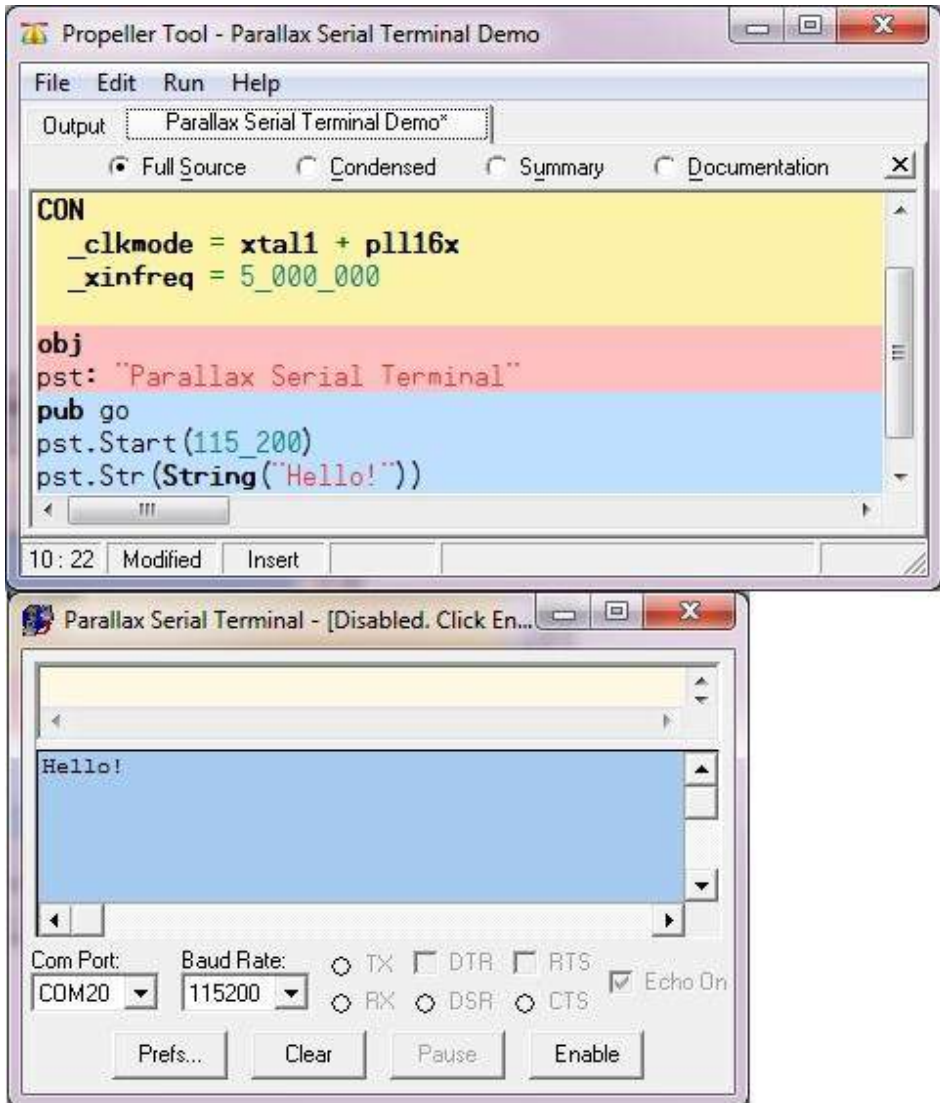

Figure 4.2 Serial communication between PC and the Propeller Microcontroller.

You can download Ms. Visual Studio 2013 Express edition to use this program. Once installed, create a form like the following by putting 2 button,

combobox, richtextbox, label and textbox. The program will connect to the microcontroller as a robot controller.

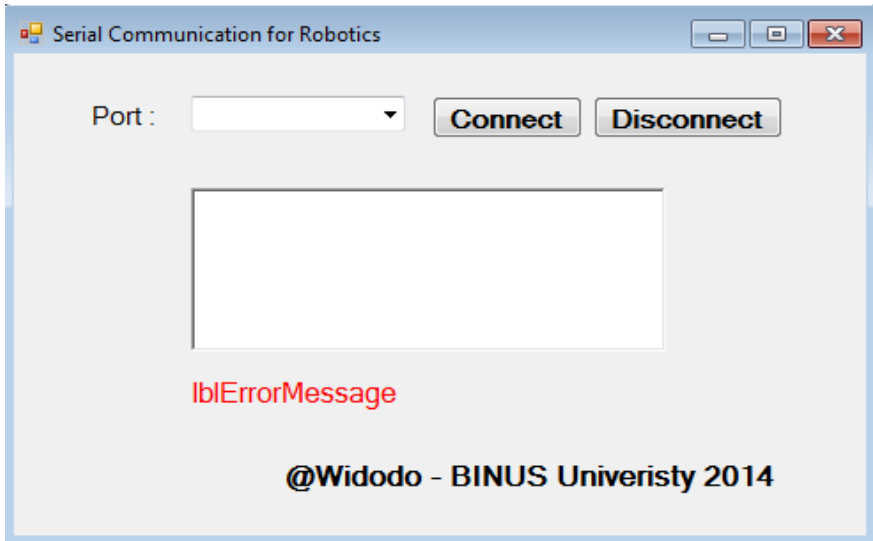

Figure 4.3 Form design for interfacing between PC and Robot.

The program will read a text file and then its value will be used to issue serial data to the robot with the following code:

```

If (txtData.Text = "1") Then
    lblAksi.Text = "forward"
    serialPort.Write("a") 'forward
End If

If (txtData.Text = "0") Then
    lblAksi.Text = "backward"
    serialPort.Write("b") 'backward
    
```

Here is the complete code for serial interface to program the robot:

SerialInterface.vb

```

imports System.IO
Public Class Form1
    Dim WithEvents serialPort As New IO.Ports.SerialPort
    
```

```

Private Sub Form1_Load(ByVal sender As System.Object, ByVal e
As System.EventArgs) Handles MyBase.Load
    displayPort()
    cbComPorts.SelectedIndex = 1

End Sub

Private Sub btnConnect_Click(ByVal sender As System.Object,
ByVal e As System.EventArgs) Handles btnConnect.Click
    If serialPort.IsOpen Then
        serialPort.Close()
    End If
    Try
        With serialPort                                'configuring port
            .PortName = cbComPorts.Text
            .BaudRate = 9600
            .Parity = IO.Ports.Parity.None
            .DataBits = 8
            .StopBits = IO.Ports.StopBits.One
        End With
        serialPort.Open()
        lblMessage.Text = cbComPorts.Text & " Connected"
        btnConnect.Enabled = False
        btnDisconnect.Enabled = True
    Catch ex As Exception
        MsgBox(ex.ToString)
    End Try
    Timer1.Enabled = True
    Timer1.Interval = 100
End Sub

Private Sub datareceived(ByVal sender As Object, ByVal e As
System.IO.Ports.SerialDataReceivedEventArgs) Handles
serialPort.DataReceived
    'RichTextBox1.Invoke(New myDelegate(AddressOf updateTextBox),
New Object() {})
End Sub

Public Sub updatetextbox()
    RichTextBox1.Text = ""

```

```
With RichTextBox1
    .AppendText(serialPort.ReadExisting)
End With
End Sub

Private Sub btnDisconnect_Click(ByVal sender As System.Object,
ByVal e As System.EventArgs) Handles btnDisconnect.Click
    Try
        serialPort.Close()
        lblMessage.Text = serialPort.PortName & " Disconnected ."
        btnConnect.Enabled = True
        btnDisconnect.Enabled = False
    Catch ex As Exception
        MsgBox(ex.ToString)
    End Try
End Sub

Private Sub Timer1_Tick(ByVal sender As System.Object, ByVal e
As System.EventArgs) Handles Timer1.Tick

    Try
        Dim fs As New FileStream("c:/position.txt", FileMode.Open,
FileAccess.Read)
        txtData.Text = ""
        Dim d As New StreamReader(fs)
        d.BaseStream.Seek(0, SeekOrigin.Begin)
        While d.Peek() > -1
            txtData.Text &= d.ReadLine()
        End While
        d.Close()

        If (txtData.Text = "1") Then
            lblAksi.Text = "forward"
            serialPort.Write("a") 'forward
        End If

        If (txtData.Text = "0") Then
            lblAksi.Text = "backward"
            serialPort.Write("b") 'backward
        End If
    End Try
End Sub
```



```

    Catch ea As Exception
        'MessageBox.Show(ea.Message)
    End Try
End Sub
End Class

```

The following programs are used in the Propeller to receive serial data from a PC:

File: SerialPCRobot.spin

```

CON
    _clkmode = xtall + pll16x
    _xinfreq = 5_000_000

OBJ
    Debug: "FullDuplexSerialPlus

PUB TestMessages| c
    c:="S"

        dira[8] := 1
        dira[9] := 1
        dira[10] := 1
        outa[8] := 0
        outa[9] := 0
        outa[10] := 0

    'Send test messages to Parallax Serial Terminal.
    Debug.start(31, 30, 0, 9600)
    Debug.str(string("Demo!", 13))
    repeat until c == "Q" or c == "q"
        c := Debug.rx
        case c
            "A", "a":
                Debug.Str(String("forward"))
                outa[8] := 1
                outa[9] := 0
                outa[10] := 0
                waitcnt(clkfreq/10 + cnt)
        case c

```

```
"B", "b":
    Debug.Str(String("backward"))
    outa[8] := 0
    outa[9] := 1
    outa[10] := 0
    waitcnt(clkfreq/10 + cnt)
"C", "c":
    Debug.Str(String("turn left"))
    outa[8] := 0
    outa[9] := 0
    outa[10] := 1
    waitcnt(clkfreq/10 + cnt)
"Q", "q": quit
```

Wireless Communication for Robot

433 MHz Transceiver

433 MHz Transceiver is an easy-to-use module is capable of sending and receiving serial data wirelessly between microcontrollers or to a PC. Low power consumption makes it ideal for use in battery-powered applications. Data is sent and received by AM or CPCA modulation, thus offering a higher average output power which extends the range. This module is equipped with an RSSI feature that can be utilized to improve power efficiency by waking up circuitry only when an external signal is detected.



Figure 4.4 Wireless communication using 433 MHz Transceiver.

XBee Transceiver

XBee 1 mW Wire Antenna 802.15.4 modules are the easiest-to-use, most reliable and cost-effective RF devices we've experienced. The 802.15.4 XBee modules provide two friendly modes of communication – a simple serial method of transmit/receive or a framed mode providing advanced features. XBees are ready to use out of the package, or they can be configured through the X-CTU utility or from your microcontroller. These modules can communicate point to point, from one point to a PC, or in a mesh network.

You only need to choose an antenna style (PCB or wire) and power level (1 mW for up to 300 ft and 60 mW for up to 1 mile). The PCB antenna version provides a lower profile footprint for applications with limited space while the

wire antenna version allows for more flexibility in adjusting for optimal range at the same output power. XBee 802.15.4 modules are cross-compatible with other 802.15.4 XBee modules, regardless of antenna type or power rating.

Key Features:

- Outdoor range up to 300 feet (90 m) line of sight.
- Indoor range up to 100 feet (30 m).
- Data rate up to 250 Kbps.
- 2.4 GHz frequency band (accepted world-wide).



Figure 4.5 Wireless communication using XBee.

XBee Transceiver AT-API Object is an object for communicating with Digi's XBee (designed/tested with Series 1 - 802.15.4) transceivers in both transparent (AT) and API mode. API mode involves framed data with information such as sender's address and RSSI levels.

RN-42 Bluetooth Module

The RN-42 Bluetooth Module provides a reliable method for creating a wireless serial communication interface between two devices such as a microcontroller, PC, cell phone, or another module for robotics application. This module can pair up with devices supporting Bluetooth SPP (Serial Port Profile) to establish a serial interface. The RN-42 Bluetooth Module is breadboard-friendly and is compatible with all 5 V and 3.3 V microcontroller platforms.

Key Features:

- Fully qualified Bluetooth 2.1/2.0/1.2/1.1 module provides compatibility with many devices.
- Low power consumption for long-lasting battery-powered projects.
- Auto-connect/discovery/pairing modes make connecting to other modules easy.
- LED indicators provide visual status of connection/mode.
- Voltage jumper selects for use with 5 V and 3.3 V microcontrollers.

When pairing the RN-42 with another device such as a laptop or cell phone the default passkey is “1234”. The device is discovered as RN42-xxxx (where xxxx is the last 4 digits of the device MAC address). On a PC with Bluetooth the device will have a COM port assigned to it. When this COM port is opened the PC should reconnect to the module (the Blue LED should light up). At this point you can send/receive serial data.

Exercises

- 1) Write an interface using C# to control robot using PC.
- 2) Write wireless program to control robot using PC.

References

- [1] Stallings W., Data and Computer Communications, Prentice Hall Publisher, 2011.
- [2] www.parallax.com.

Chapter 5

Mechanics of Robots

On successful completion of this course, students will be able to:

- Explain principle of some mechanics devices for robots.
- Describe some type of gears.
- Describe about arm geometries.
- Describe about kinematics of robot.

Introduction

In intelligent robotics, a manipulator is a device used to manipulate materials without direct contact. For example, using robotic arms, we can develop robotically-assisted surgery. It is an arm-like mechanism that consists of a series of segments, usually sliding or jointed, which grasp and move objects with a number of degrees of freedom. Modern robotics needs excellent gears. A good understanding of how gears affect parameters such as torque and velocity are very important. Gears work on the principle of mechanical advantage. This means that by using different gear diameters, you can exchange between rotational (or translation) velocity and torque.

Introduction of Gears

With gears, you will exchange the high velocity with a better torque. This exchange happens with a very simple equation that you can calculate:

$$\text{Torque_Old} * \text{Velocity_Old} = \text{Torque_New} * \text{Velocity_New}$$

Torque_Old and Velocity_Old can be found simply by looking up the datasheet of your motor. Then what you need to do is put a desired torque or velocity on the right hand side of the equation. So for example, suppose your motor outputs 3 lb-in torque at 2000rps according to the datasheet, but you only want 300rps. This is what your equation will look like:

$$3 \text{ lb-in} * 2000\text{rps} = \text{Torque_New} * 300\text{rps}$$

Then you can then determine that your new torque will be 20 lb-in. The gearing ratio is the value at which you change your velocity and torque. Again, it has a very simple equation. The gearing ratio is just a fraction which you multiple your velocity and torque by. Suppose your gearing ratio is 3/1. This

would mean you would multiple your torque by 3 and your velocity by the inverse or 1/3 [5].

Example: Torque_Old = 10 lb-in, Velocity_Old = 100rps

Gearing ratio = 2/3

Torque * 2/3 = 6.7 lb-in

Velocity * 3/2 = 150rps

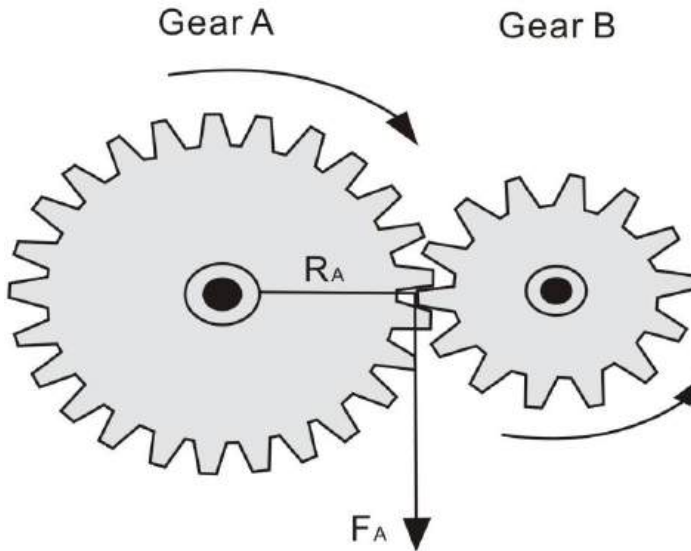

Figure 5.1 Torque that generates to rotates gear B equal to $F_A \times R_A$.

If you wanted a simple gearing ratio of say 2 to 1, you would use two gears, one being twice as big as the other. It isn't really the size as much as the diameter ratio of the two gears. If the diameter of one gear is 3 times bigger than the other gear, you would get a 3/1 (or 1/3) gearing ratio. You can easily figure out the ratio by hand measuring the diameter of the gears you are using. For a much more accurate way to calculate the gearing ratio, calculate the ratio of teeth on the gears. If one gear has 28 teeth and the other has 13, you would have a $(28/13=2.15$ or $13/28=.46)$ 2.15 or .46 gearing ratio. I will go into this later, but this is why worm gears have such high gearing ratios. In a worm gear setup, one gear always has a single tooth, while the other has many - a guaranteed huge ratio. Counting teeth will always give you the most exact ratio.

Unfortunately, by using gears, you lower your input to output power efficiency. This is due to obvious things such as friction, misalignment of

pressure angles, lubrication, gear backlash (spacing between meshed gear teeth between two gears) and angular momentum, etc. For example, suppose you use two spur gears, you would typically expect efficiency to be around 90%. To calculate, multiply that number by your Velocity_New and Torque_New to get your true output velocity and torque [3][4].

$$\text{Gearing ratio} = 2/3$$

$$\text{Torque} * 2/3 = 6.7 \text{ lb-in}$$

$$\text{Velocity} * 3/2 = 150 \text{ rps}$$

$$\text{true torque} = 6.7 * .9 = 6 \text{ lb-in}$$

$$\text{true velocity} = 150 * .9 = 135 \text{ rps}$$

Types of Gears

Some types of gears have high efficiencies, or high gearing ratios, or work at different angles, for example. Often manufacturers will give you expected efficiencies in the datasheets for their gears. Remember, wear and lubrication will also dramatically affect gear efficiencies. Spur gears are the most commonly used gears due to their simplicity and the fact that they have the *highest possible efficiency* of all gear types. Not recommend for very high loads as gear teeth can break more easily.



Figure 5.2 Spur Gears, with ~ 90 % efficiency.

Two gears with a chain can be considered as three separate gears. Since there is an odd number, the rotation direction is the same. They operate basically like spur gears, but due to increased contact area there is increased friction (hence lower efficiency). Lubrication is highly recommended.

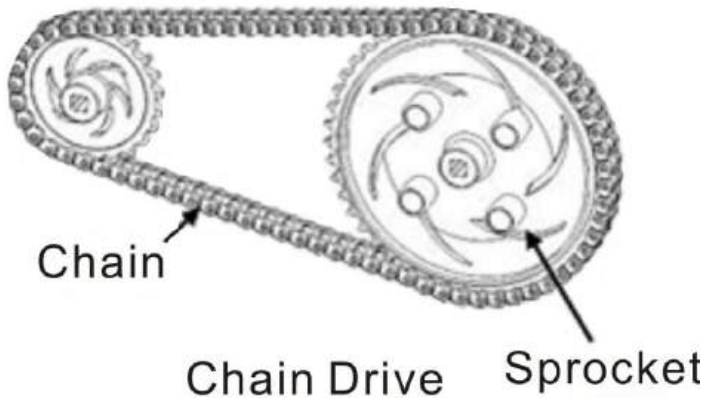

Figure 5.3 Sprocket Gears With Chains, with ~80% efficiency.

Worm gears have a very high gearing ratio. To mathematically calculate, consider the worm gear as a single tooth. Another advantage to the worm gear is that it is not back-drivable. What this means is only your motor can rotate the main gear, so things like gravity or counter forces will not cause any rotation. This is good say if you have a robot arm holding something heavy, and you don't want to waste power on holding torque.



Figure 5.4 Worm Gears with ~70% efficiency.

Rack and Pinion Gears

Rack and Pinion is the type of gearing found in steering systems. This gearing is great if you want to convert rotational motion into translational. Mathematically, use radius = 1 for the straight 'gear'.

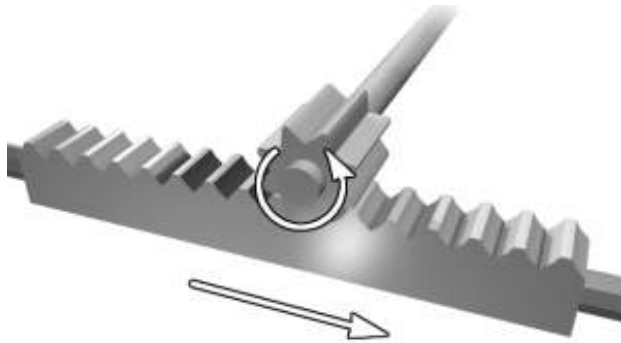

Figure 5.5 Rack and Pinion, with ~90% efficiency.

Arm Geometries

Generally, there are five configurations robots used in industry, namely: Cartesian Robot, Robot Cylindrical, Spherical Robots, Articulated Robots (consist of revolute joint RRR), SCARA (Selectively Compliant Assembly Robot Arm). They are named for the shape of the volume that the manipulator can reach and orient the gripper into any position—the work envelope. They all have their uses, but as will become apparent, some are better for use on robots than others. Some use all sliding motions, some use only pivoting joints, some use both. Pivoting joints are usually more robust than sliding joints but, with careful design, sliding or extending can be used effectively for some types of tasks [1].

The Denavit-Hartenberg (DH) Convention is the accepted method of drawing robot arms in FBD's. There are only two motions a joint could make: translate and rotate. There are only three axes this could happen on: x, y, and z (out of plane). Below I will show a few robot arms, and then draw The Robot Arm Free Body Diagram (FBD). A cartesian coordinate robot (also called linear robot) is an industrial robot whose three principal axes of control are linear (i.e. they move in a straight line rather than rotate) and are at right angles to each other. Cartesian coordinate robots with the horizontal member supported at both ends are sometimes called Gantry robots. [2]

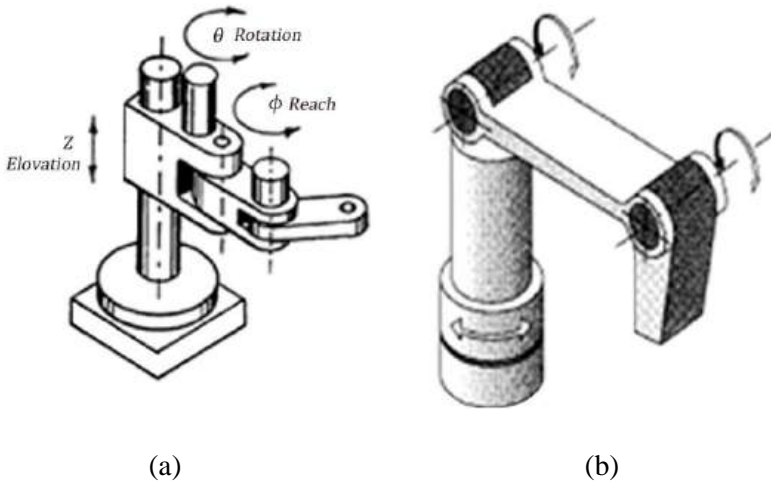

Figure 5.6 Example of SCARA Configuration (a) and articulated (b).

Example of Manipulator for industry is KUKA KR 5 arc rounds off the range of KUKA robots at the lower end. Its payload of 5 kg makes it outstandingly well-suited to standard arc welding tasks. With its attractive price and compact dimensions, it is the ideal choice for your application too. Whether mounted on the floor or inverted overhead, the KR 5 arc always performs its tasks reliably.



Figure 5.7 KUKA Manipulator for Industry suitable for welding, soldering and painting [6].

Kinematics of Robot

Kinematics studies the motion of bodies without consideration of the forces or moments that cause the motion. Robot kinematics refers the analytical study of the motion of a robot manipulator. Formulating the suitable kinematics models for a robot mechanism is very crucial for analyzing the behavior of industrial manipulators. Robot kinematics applies geometry to the study of the movement of multi-degree of freedom kinematic chains that form the structure of robotic systems. Robot kinematics studies the relationship between the dimensions and connectivity of kinematic chains and the position, velocity and acceleration of each of the links in the robotic system, in order to plan and control movement and to compute actuator forces and torques.

The robot kinematics can be divided into forward kinematics and inverse kinematics. Forward kinematics problem is straightforward and there is no complexity deriving the equations. Hence, there is always a forward kinematics solution of a manipulator. Inverse kinematics is a much more difficult problem than forward kinematics. The solution of the inverse kinematics problem is computationally expensive and generally takes a very long time in the real time control of manipulators. In forward kinematics, given the length of each link and the angle of each joint, we can find the position of any point (it's x,y,z coordinates). And for inverse kinematics, given the length of each link and the position of some point on the robot, we can find the angles of each joint needed to obtain that position.

References

- [1] E. Sandin (2003), Paul, Robot Mechanism and Mechanical Devices Illustrated, Mc-Graw Hill.
- [2] C. Dorf, Richard (2000), The Electrical Engineering Handbook, CRC Press LLC.
- [3] http://www.societyofrobots.com/mechanics_gears.shtml.
- [4] B., Owen (2007), Robot Builder's Cookbook, Elsevier Ltd.
- [5] <http://www.fi.edu/time/Journey/Time/Escapements/geartypes.htm>.
- [6] KUKA-robotics.com.

Chapter 6

Introduction to OpenCV

On successful completion of this course, students will be able to:

- Explain the roles of Computer Vision.
- Install OpenCV for image processing.
- Use CANNY Edge detector.

Introduction

Computer vision is the most important technology in the future in the development of intelligent robot. Computer vision is in the simplest terms, computer vision is the discipline of "teaching machines how to see." This field dates back more than forty years, but the recent explosive growth of digital imaging technology makes the problems of automated image interpretation more exciting and relevant than ever. Computer vision and machine vision differ in how images are created and processed. Computer vision is done with everyday real world video and photography. Machine vision is done in oversimplified situations as to significantly increase reliability while decreasing cost of equipment and complexity of algorithms.

As a scientific discipline, computer vision is concerned with the theory behind artificial systems that extract information from images. The image data can take many forms, such as video sequences, views from multiple cameras, or multi-dimensional data from a medical scanner. As a technological discipline, computer vision seeks to apply its theories and models to the construction of computer vision systems. Examples of applications of computer vision include systems for:

- Navigation, *e.g.*, by an autonomous mobile robot;
- Detecting events, *e.g.*, for visual surveillance or people counting;
- Organizing information, *e.g.*, for indexing databases of images and image sequences;
- Modeling objects or environments, *e.g.*, medical image analysis or topographical modeling;
- Interaction, *e.g.*, as the input to a device for computer-human interaction, and;
- Automatic inspection, *e.g.*, in manufacturing applications.

Computer vision is fast moving towards video data, as it has more information for object detection and localization even though there scale and rotational variance. An essential component of robotics has to do with artificial sensory systems in general and artificial vision in particular. While it is true that robotics systems exist (including many successful industrial robots) that have no sensory equipment (or very limited sensors) they tend to be very brittle systems. They need to have their work area perfectly lit, with no shadows or mess. They must have the parts needed in precisely the right position and orientation, and if they are moved to a new location, they may require hours of recalibration. If a system could be developed that could make sense out of a visual scene it would greatly enhance the potential for robotics applications. It is therefore not surprising that the study of robot vision and intelligent robotics go hand-in-hand.

Introduction of OpenCV

OpenCV (Open Source Computer Vision Library) is a library of programming functions mainly aimed at real-time computer vision, developed by Intel, and now supported by Willow Garage and Itseez. OpenCV is released under a BSD license and hence it's free for both academic and commercial use. It has C++, C, Python and Java interfaces and supports Windows, Linux, Mac OS, iOS and Android. OpenCV was designed for computational efficiency and with a strong focus on real-time applications. Written in optimized C/C++, the library can take advantage of multi-core processing. You may download the latest version such as OpenCV 2.4.7.

OpenCV's built in modules are powerful and versatile enough to solve most of your computer vision problems. OpenCV provides you with a set of modules that can execute the functionalities listed in table 6. 1.

Table 6.1 Modules in OpenCV.

No	Module	Functionality
1	Core	Core data structures, data type and memory management
2	ImgProc	Image filtering, image transformation and shape analysis
3	Highgui	GUI, reading and writing images and video
4	ML	Statistical models and classification algorithms for use in computer vision applications
5	Objdetect	Object detection using cascade and histogram of gradient classifiers
6	Video	Motion analysis and object tracking in video
7	Calib3d	Camera calibration and 3D Reconstruction from multiple views

You need an editor and compiler of Visual Studio. Net 2010/2013 for editing and compiling OpenCV program. You must first configure the Visual C++ .Net where the library files and the source must be included. Some library files must also be added to the linker input in Visual C++. The steps are:

- 1) Run the program and extract to, let say f:/OpenCV246.

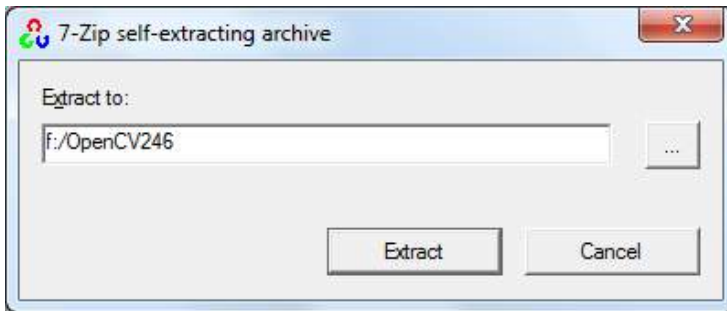

Figure 6.1 Extracting files to a folder.

- 2) Add these paths to your Path Variable:

```
f:\OpenCV246\opencv\build\x86\vc10\bin
```

```
f:\OpenCV246\opencv\build\common\tbb\ia32\vc10
```

- 3) Now we are ready to create a project with OpenCV. In Visual C++ 2010, create a new Win32 console application called IntelligentRobotics. Now right click the project and select Properties. On the left, choose C/C++ and edit the Additional Include Directories. Add these directories:

```
f:\OpenCV246\opencv\build\include\opencv
```

```
f:\OpenCV246\opencv\build\include
```

- 4) Now choose Linker and add this directory to the Additional Library Directories. You need to replace x86 with x64 if you want to build a 64 bit application.

```
f:\OpenCV246\opencv\build\x86\vc10\lib
```

- 5) Now open the Linker group (press the + sign before it) and select Input. Add these lines to the Additional Dependencies:

```
opencv_core246d.lib  
opencv_imgproc246d.lib  
opencv_highgui246d.lib  
opencv_ml246d.lib  
opencv_video246d.lib  
opencv_features2d246d.lib  
opencv_calib3d246d.lib  
opencv_objdetect246d.lib  
opencv_contrib246d.lib  
opencv_legacy246d.lib  
opencv_flann246d.lib
```

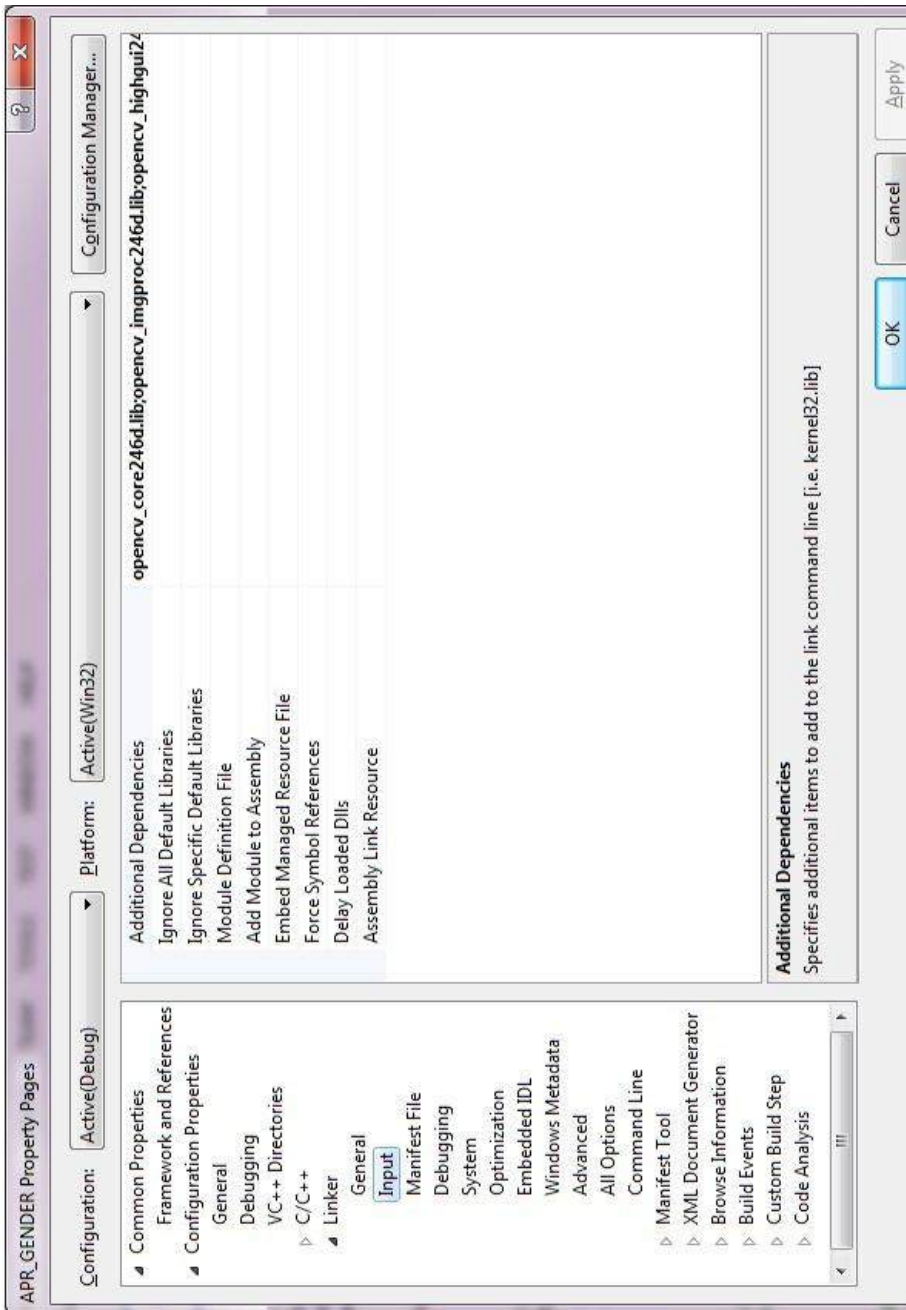

Figure 6.3 Configuring additional dependencies.

For example, create a Win32 console application program to display an image in Windows, the following example:

IntelligentRobotics.cpp

```
// Displaying image using cvLoadImage
#include "stdafx.h"
#include <cv.h>
#include <cxcore.h>
#include <highgui.h>

int _tmain(int argc, _TCHAR* argv[])
{
    IplImage *img = cvLoadImage("f:\handsome.jpg");
    cvNamedWindow("Intelligent Robotics with OpenCV",1);
    cvShowImage("OpenCV",img);

    cvWaitKey(0);
    cvDestroyWindow("OpenCV ");
    cvReleaseImage(&img);
    return 0;
}
```



Figure 6.4 Image displayed using OpenCV.

Or, if you like to use the 2.x C++ style, you can also use:

DisplayImage.cpp

```
// Displaying an image using 2.x C++ style
#include <iostream>
#include <stdio.h>
#include <opencv2/opencv.hpp>
#include <opencv2/highgui/highgui.hpp>

using namespace cv;
using namespace std;
int main( int argc, char** argv )
{
```

```

// Creating an object img from Mat
cv::Mat img = cv::imread("f:\handsome.jpg");
cv::imshow("Modern Robotics with OpenCV",img);
cv::waitKey(); //wait user hit the keyboard
return EXIT_SUCCESS;
}

```

Digital Image Processing

An image is an array, or a matrix of square pixels arranged in columns and rows format. A *grayscale image* is composed of pixels represented by multiple bits of information, typically ranging from 2 to 8 bits or more. A *color image* is typically represented by a bit depth ranging from 8 to 24 or higher. With a 24-bit image, the bits are often divided into three groupings: 8 for red, 8 for green, and 8 for blue. Combinations of those bits are used to represent other colors. A 24-bit image offers 16.7 million (2^{24}) color values.

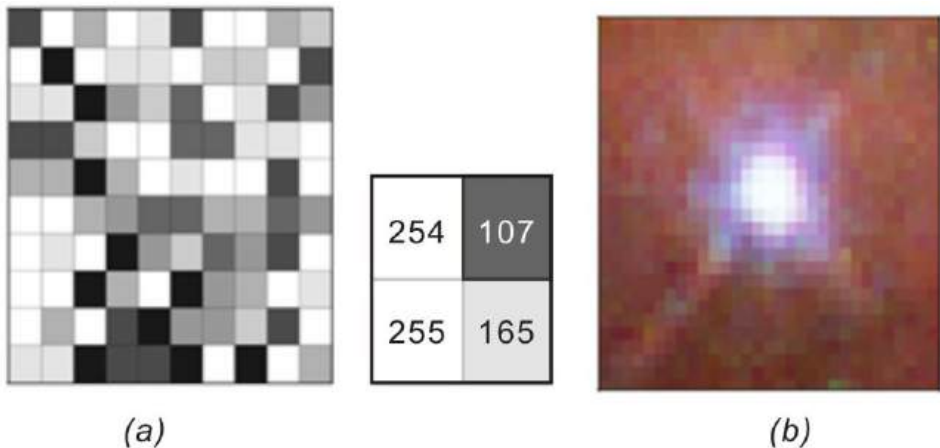

Figure 6.5 Grayscale image in 8 bit format (a), and truecolor image consist of 3 grayscale image red, green and blue.

To convert color image to grayscale, since red color has more wavelength of all the three colors, and green is the color that has not only less wavelength then red color but also green is the color that gives more soothing effect to the eyes. It means that we have to decrease the contribution of red color, and increase the contribution of the green color, and put blue color contribution in between these two.

So the new equation in that form is:

$$\text{grayscale image} = (0.3 * R) + (0.59 * G) + (0.11 * B) .$$

According to this equation, Red has contributed 33%, Green has contributed 59% which is greater in all three colors and Blue has contributed 11%.



Figure 6.6 Color image (a) and grayscale image (b).

The purpose of image processing is divided into 5 groups. They are:

- 1) Visualization - Observe the objects that are not visible.
- 2) Image sharpening and restoration - To create a better image.
- 3) Image retrieval - Seek for the image of interest.
- 4) Measurement of pattern – Measures various objects in an image.
- 5) Image Recognition – Distinguish the objects in an image.

As an experiment to know the RGB process, create a new project and name RGB, and create the program below:

RGB.cpp:

```
//Adding an RGB
#include "stdafx.h"
#include <stdio.h>
#include <cv.h>
#include <highgui.h>

void sum_rgb( IplImage* src, IplImage* dst ) {
    // Allocate individual image planes.
    IplImage* r = cvCreateImage(cvGetSize(src),IPL_DEPTH_8U,1 );
    IplImage* g = cvCreateImage(cvGetSize(src),IPL_DEPTH_8U,1 );
```

```

IplImage* b = cvCreateImage(cvGetSize(src),IPL_DEPTH_8U,1 );
// Temporary storage.
IplImage* s = cvCreateImage(cvGetSize(src),IPL_DEPTH_8U,1 );
// Split image
cvSplit( src, r, g, b, NULL );
// Add equally weighted rgb values.
cvAddWeighted( r, 1./3., g, 1./3., 0.0, s );
cvAddWeighted( s, 2./3., b, 1./3., 0.0, s );
// Truncate the value above 100.
cvThreshold( s, dst, 150, 100, CV_THRESH_TRUNC );
cvReleaseImage( &r );
cvReleaseImage( &g );
cvReleaseImage( &b );
cvReleaseImage( &s );
}

int main(int argc, char** argv) {
// Buat jendela
cvNamedWindow( argv[1], 1 );
// Load the image from the given file name.
IplImage* src = cvLoadImage( argv[1] );
IplImage* dst = cvCreateImage( cvGetSize(src), src->depth, 1);
sum_rgb( src, dst);
// show the window
cvShowImage( argv[1], dst );
// Idle until the user hits the "Esc" key.
while( 1 ) { if( (cvWaitKey( 10 )&0x7f) == 27 ) break; }
// clean the window
cvDestroyWindow( argv[1] );
cvReleaseImage( &src );
cvReleaseImage( &dst );
}

```

The result is an image that its RGB value has changed as shown below:

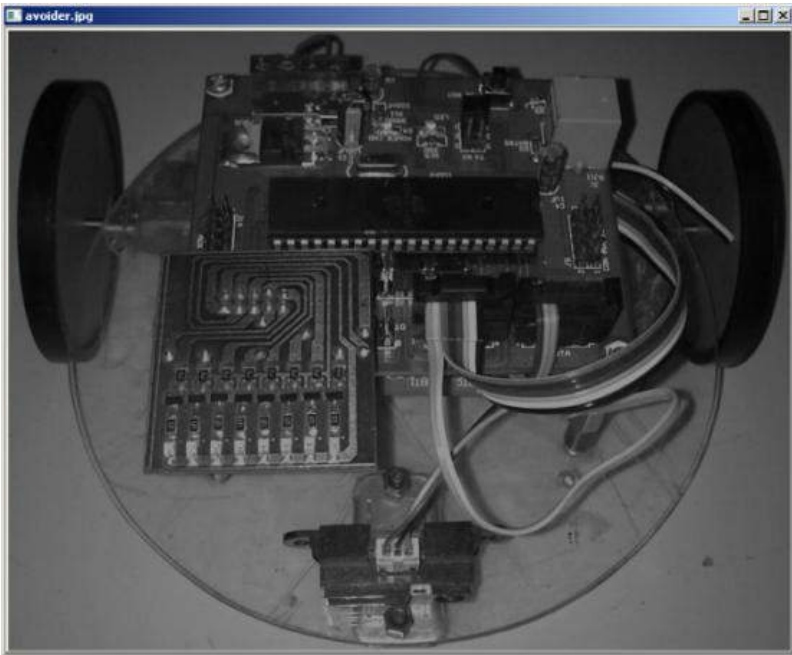

Figure 6.7 Result of adding RGB value.

Edge Detection

Edge detection is a technique to locate the edges of objects in the scene. This can be useful for locating the horizon, the corner of an object, white line following, or for determining the shape of an object. The algorithm is quite simple:

- sort through the image matrix pixel by pixel;
- for each pixel, analyze each of the 8 pixels surrounding it;
- record the value of the darkest pixel, and the lightest pixel;
- if $(\text{darkest_pixel_value} - \text{lightest_pixel_value}) > \text{threshold}$;
- then rewrite that pixel as 1;
- else rewrite that pixel as 0.

The *Canny Edge detector* was developed by John F. Canny in 1986. Also known to many as the *optimal detector*, Canny algorithm aims to satisfy three main criteria:

- Low error rate: Meaning a good detection of only existent edges.
- Good localization: The distance between edge pixels detected and real edge pixels have to be minimized.
- Minimal response: Only one detector response per edge.

CannyEdgeDetector.cpp:

```
//Canny Edge Detector
#include "opencv2/imgproc/imgproc.hpp"
#include "opencv2/highgui/highgui.hpp"
#include <stdlib.h>
#include <stdio.h>

using namespace cv;

/// Global variables
Mat src, src_gray;
Mat dst, detected_edges;

int edgeThresh = 1;
int lowThreshold;
int const max_lowThreshold = 100;
int ratio = 3;
int kernel_size = 3;
char* window_name = "Canny Edge Detector";

void CannyThreshold(int, void*)
{
    /// Reduce noise with a kernel 3x3
    blur( src_gray, detected_edges, Size(3,3) );

    /// Canny detector
    Canny( detected_edges, detected_edges, lowThreshold,
lowThreshold*ratio, kernel_size );

    /// Using Canny's output as a mask, we display our result
    dst = Scalar::all(0);

    src.copyTo( dst, detected_edges);
    imshow( window_name, dst );
}
```

```
int main( int argc, char** argv )
{
    /// Load an image
    src = imread("lena.jpg" );

    if( !src.data )
    { return -1; }

    /// Create a matrix of the same type and size as src (for dst)
    dst.create( src.size(), src.type() );

    /// Convert the image to grayscale
    cvtColor( src, src_gray, CV_BGR2GRAY );

    /// Create a window
    namedWindow( window_name, CV_WINDOW_AUTOSIZE );

    /// Create a Trackbar for user to enter threshold
    createTrackbar( "Min Threshold:", window_name, &lowThreshold,
max_lowThreshold, CannyThreshold );

    /// Show the image
    CannyThreshold(0, 0);

    /// Wait until user exit program by pressing a key
    waitKey(0);

    return 0;
}
```

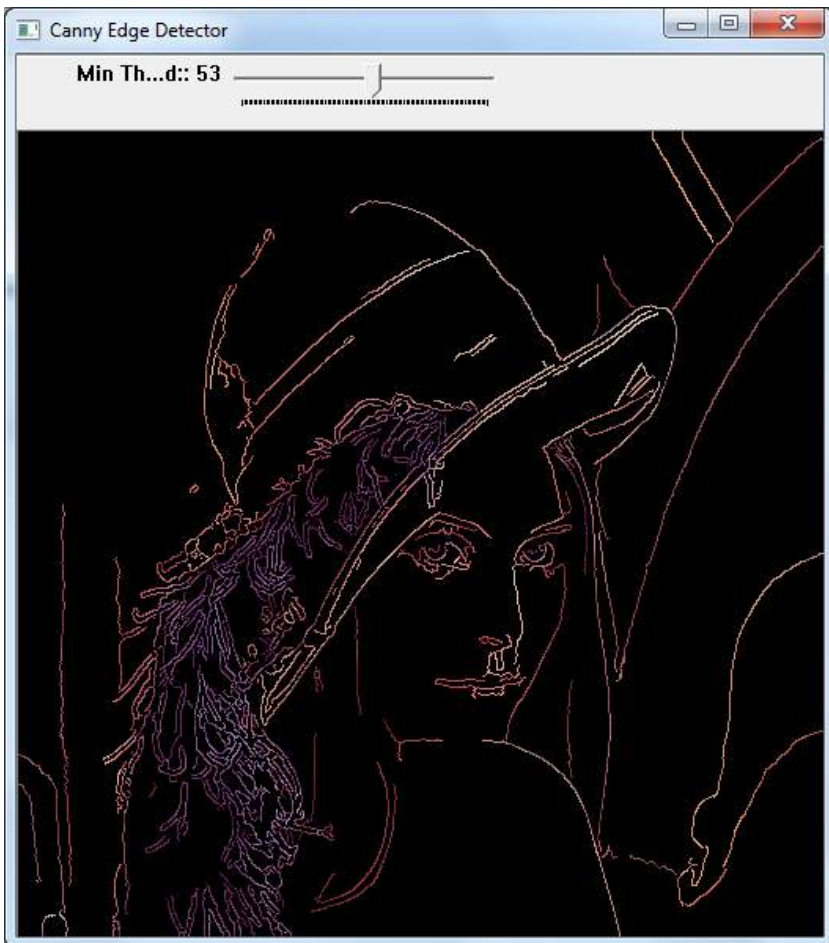



Figure 6.8 Edge detection using CANNY.

In image processing, to take the most important areas of an image, commonly known as the ROI (region of interest), can use the following functions:

```
cvSetImageROI (src, cvRect (x, y, width, height));
```

ROI.cpp:

```
#include "stdafx.h"  
#include <cv.h>  
#include <highgui.h>
```

```
int main(int argc, char** argv) {  
    IplImage* src;  
    cvNamedWindow("Contoh awal", CV_WINDOW_AUTOSIZE);  
    cvNamedWindow("Contoh akhir", CV_WINDOW_AUTOSIZE);  
    if( argc == 7 && ((src=cvLoadImage(argv[1],1)) != 0 ))  
    {  
        int x = atoi(argv[2]);  
        int y = atoi(argv[3]);  
        int width = atoi(argv[4]);  
        int height = atoi(argv[5]);  
        int add = atoi(argv[6]);  
        cvShowImage( "Contoh awal", src);  
        cvSetImageROI(src, cvRect(x,y,width,height));  
        cvAddS(src, cvScalar(add),src);  
        cvResetImageROI(src);  
        cvShowImage( "Contoh akhir",src);  
        cvWaitKey();  
    }  
    cvReleaseImage( &src );  
    cvDestroyWindow("Contoh awal");  
    cvDestroyWindow("Contoh akhir");  
    return 0;  
}
```



Figure 6.9 ROI of image.

Optical Flow

Optical flow or optic flow is the pattern of apparent motion of objects, surfaces, and edges in a visual scene caused by the relative motion between an observer (an eye or a camera) and the scene. `calcOpticalFlowPyrLK` calculates an optical flow for a sparse feature set using the iterative Lucas-Kanade method with pyramids.

OpticalFlow.cpp:

```
#include <opencv2/opencv.hpp>
#include <iostream>
#include <vector>
#include <cmath>

using namespace cv;
using namespace std;

int main(int argc, char** argv)
{
```

```
// Load 2 image
Mat imgA = imread("left02.jpg", CV_LOAD_IMAGE_GRAYSCALE);
Mat imgB = imread("left03.jpg", CV_LOAD_IMAGE_GRAYSCALE);
Size img_sz = imgA.size();
Mat imgC(img_sz,1);

int win_size = 15;
int maxCorners = 20;
double qualityLevel = 0.05;
double minDistance = 5.0;
int blockSize = 3;
double k = 0.04;
std::vector<cv::Point2f> cornersA;
cornersA.reserve(maxCorners);
std::vector<cv::Point2f> cornersB;
cornersB.reserve(maxCorners);

goodFeaturesToTrack( imgA, cornersA, maxCorners, qualityLevel, minD
istance, cv::Mat());
goodFeaturesToTrack( imgB, cornersB, maxCorners, qualityLevel, minD
istance, cv::Mat());

cornerSubPix( imgA, cornersA, Size( win_size, win_size ),
Size( -1, -1 ),
TermCriteria( CV_TERMCRIT_ITER | CV_TERMCRIT_EPS, 20, 0.03 ) );
cornerSubPix( imgB, cornersB, Size( win_size, win_size ),
Size( -1, -1 ),
TermCriteria( CV_TERMCRIT_ITER | CV_TERMCRIT_EPS, 20, 0.03 ) );

// Call Lucas Kanade algorithm

CvSize pyr_sz = Size( img_sz.width+8, img_sz.height/3 );

std::vector<uchar> features_found;
features_found.reserve(maxCorners);
std::vector<float> feature_errors;
feature_errors.reserve(maxCorners);
calcOpticalFlowPyrLK( imgA, imgB, cornersA, cornersB,
features_found, feature_errors ,
Size( win_size, win_size ), 5,
```

```

cvTermCriteria( CV_TERMCRIT_ITER | CV_TERMCRIT_EPS, 20, 0.3 ),
0 );

// Make an image of the results

for( int i=0; i < features_found.size(); i++ ){
cout<<"Error is "<<feature_errors[i]<<endl;
//continue;
cout<<"Got it"<<endl;
Point p0( ceil( cornersA[i].x ), ceil( cornersA[i].y ) );
Point p1( ceil( cornersB[i].x ), ceil( cornersB[i].y ) );
line( imgC, p0, p1, CV_RGB(255,255,255), 2 );
}

namedWindow( "ImageA", 0 );
namedWindow( "ImageB", 0 );
namedWindow( "LKpyr_OpticalFlow", 0 );

imshow( "ImageA", imgA );
imshow( "ImageB", imgB );
imshow( "LKpyr_OpticalFlow", imgC );

cvWaitKey(0);
return 0;
}

```

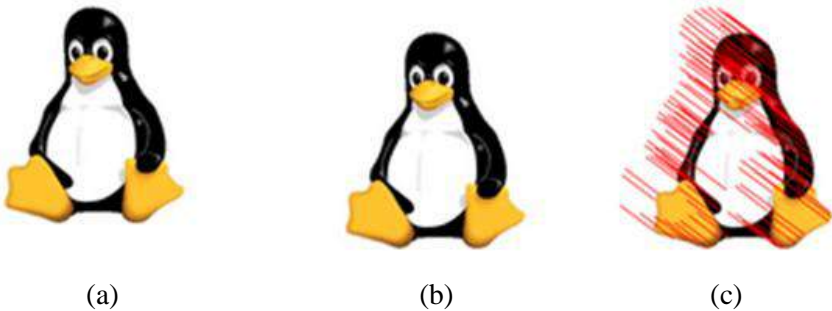

Figure 6.10 Result of optical flow program from 2 images.

References

- [1] Gary Bradski & Adrian Kaehler, Learning OpenCV (2008), O'Reilly Publisher.
- [2] Robert Laganiere, OpenCV 2 Computer Vision Application Programming Cookbook, 2011.
- [3] Richard Szeliski, Computer Vision: Algorithms and Applications, 2010.
- [4] Budiharto W., Santoso A., Purwanto D., Jazidie A., A Navigation System for Service robot using Stereo Vision, 11th International conference on Control, Automation and Systems, Kyntext-Korea, pp 101-107, 2011.

Chapter 7

Programming OpenCV

On successful completion of this course, students will be able to:

- Explain the morphological filtering.
- Explain MeanShift and CamShift algorithms.
- Develop a program to tracking an object using MeanShift() and CamShift().

Introduction

Morphological filtering is a theory developed in the 1960s for the analysis and processing of discrete images. It defines a series of operators which transform an image by probing it with a predefined shape element. The way this shape element intersects the neighborhood of a pixel determines the result of the operation. Tracking an object is important features for intelligent robotics. Meansift is an algorithm that finds an object in a backprjected histograma image. Camshift is a histogram backprojection-based object tracking algorithm that uses meanshift at its heart. It takes the detection window output by meanshift and figures out the best size and rotation of that window to track the object.

Morphological Filtering

As morphological filters usually work on binary images, we will use a binary image produced through thresholding. However, since in morphology, the convention is to have foreground objects represented by high (white) pixel values and background by low (black) pixel values, we have negated the image. Morphological operations are a set of operations that process images based on shapes. Morphological operations apply a structuring element to an input image and generate an output image. The most basic morphological operations are two: Erosion and Dilation. They have a wide array of uses, i.e.:

- Removing noise.
- Isolation of individual elements and joining disparate elements in an image.
- Finding of intensity bumps or holes in an image.

Erosion and dilation are implemented in OpenCV as simple functions which are `cv::erode` and `cv::dilate`. The opening and closing filters are simply defined

in terms of the basic erosion and dilation operations. Closing is defined as the erosion of the dilation of an image, and Opening is defined as the dilation of the erosion of an image. The code below show an example of erosion and dilation:

Morphology.cpp:

```
#include "opencv2/imgproc/imgproc.hpp"
#include "opencv2/highgui/highgui.hpp"
#include "highgui.h"
#include <stdlib.h>
#include <stdio.h>

using namespace cv;

/// Global variables
Mat src, erosion_dst, dilation_dst;

int erosion_elem = 0;
int erosion_size = 0;
int dilation_elem = 0;
int dilation_size = 0;
int const max_elem = 2;
int const max_kernel_size = 21;

/** Function Headers */
void Erosion( int, void* );
void Dilation( int, void* );

int main( int argc, char** argv )
{
    /// Load an image
    // src = imread( argv[1] ); // if using command prompt
    src = imread("flower.jpg");

    if( !src.data )
    { return -1; }

    /// Create windows
    namedWindow( "Erosion Demo", CV_WINDOW_AUTOSIZE );
    namedWindow( "Dilation Demo", CV_WINDOW_AUTOSIZE );
    cvMoveWindow( "Dilation Demo", src.cols, 0 );
```

```

/// Create Erosion Trackbar
createTrackbar( "Element:\n 0: Rect \n 1: Cross \n 2: Ellipse",
"Erosion Demo",
    &erosion_elem, max_elem,
    Erosion );

createTrackbar( "Kernel size:\n 2n +1", "Erosion Demo",
    &erosion_size, max_kernel_size,
    Erosion );

/// Create Dilation Trackbar
createTrackbar( "Element:\n 0: Rect \n 1: Cross \n 2: Ellipse",
"Dilation Demo",
    &dilation_elem, max_elem,
    Dilation );

createTrackbar( "Kernel size:\n 2n +1", "Dilation Demo",
    &dilation_size, max_kernel_size,
    Dilation );

/// Default start
Erosion( 0, 0 );
Dilation( 0, 0 );

waitKey(0);
return 0;
}

void Erosion( int, void* )
{
    int erosion_type;
    if( erosion_elem == 0 ){ erosion_type = MORPH_RECT; }
    else if( erosion_elem == 1 ){ erosion_type = MORPH_CROSS; }
    else if( erosion_elem == 2) { erosion_type = MORPH_ELLIPSE; }

    Mat element = getStructuringElement( erosion_type,
        Size( 2*erosion_size + 1, 2*erosion_size+1 ),
        Point( erosion_size, erosion_size ) );

    /// Apply the erosion operation
    erode( src, erosion_dst, element );
}

```

```

    imshow( "Erosion Demo", erosion_dst );
}

void Dilation( int, void* )
{
    int dilation_type;
    if( dilation_elem == 0 ){ dilation_type = MORPH_RECT; }
    else if( dilation_elem == 1 ){ dilation_type = MORPH_CROSS; }
    else if( dilation_elem == 2) { dilation_type = MORPH_ELLIPSE; }

    Mat element = getStructuringElement( dilation_type,
        Size( 2*dilation_size + 1, 2*dilation_size+1 ),
        Point( dilation_size, dilation_size ) );
    /// Apply the dilation operation
    dilate( src, dilation_dst, element );
    imshow( "Dilation Demo", dilation_dst );
}

```



Figure 7.1 result of erotion and dilation.

Camshift for Tracking Object

Meansift is an algorithm that finds an object in a backprojected histogram image. Camshift is a histogram backprojection-based object tracking algorithm that uses meanshift at its heart. It takes the detection window output by meanshift and figures out the best size and rotation of that window to track the object. OpenCV functions `meanShift()` and `CamShift()` implement these algorithms.

Camshift.cpp:

```
#include "stdafx.h"
#include "opencv2/video/tracking.hpp"
#include "opencv2/imgproc/imgproc.hpp"
#include "opencv2/highgui/highgui.hpp"

#include <iostream>
#include <ctype.h>

using namespace cv;
using namespace std;

Mat image;

bool backprojMode = false;
bool selectObject = false;
int trackObject = 0;
bool showHist = true;
Point origin;
Rect selection;
int vmin = 10, vmax = 256, smin = 30;

static void onMouse( int event, int x, int y, int, void* )
{
    if( selectObject )
    {
        selection.x = MIN(x, origin.x);
        selection.y = MIN(y, origin.y);
        selection.width = std::abs(x - origin.x);
        selection.height = std::abs(y - origin.y);
    }
}
```

```

    selection &= Rect(0, 0, image.cols, image.rows);
}

switch( event )
{
case CV_EVENT_LBUTTONDOWN:
    origin = Point(x,y);
    selection = Rect(x,y,0,0);
    selectObject = true;
    break;
case CV_EVENT_LBUTTONUP:
    selectObject = false;
    if( selection.width > 0 && selection.height > 0 )
        trackObject = -1;
    break;
}
}

const char* keys =
{
    "{1|   | 0 | camera number}"
};

int main( int argc, const char** argv )
{
    VideoCapture cap;
    Rect trackWindow;
    int hsize = 16;
    float hranges[] = {0,180};
    const float* phranges = hranges;
    CommandLineParser parser(argc, argv, keys);
    int camNum = parser.get<int>("1");

    cap.open(camNum);
        IplImage img = image;

    if( !cap.isOpened() )
    {

```

```

    cout << "***Could not initialize capturing...***\n";
    parser.printParams();
    return -1;
}

namedWindow( "Histogram", 0 );
namedWindow( "VISION-BASED GRASPING FOR ARM ROBOT", 0 );
setMouseCallback("VISION-BASED GRASPING FOR ARM ROBOT",
onMouse, 0 );
createTrackbar( "Vmin", "VISION-BASED GRASPING FOR ARM ROBOT",
&vmin, 256, 0 );
createTrackbar( "Vmax", "VISION-BASED GRASPING FOR ARM ROBOT",
&vmax, 256, 0 );
createTrackbar( "Smin", "VISION-BASED GRASPING FOR ARM ROBOT",
&smin, 256, 0 );

Mat frame, hsv, hue, mask, hist, histimg = Mat::zeros(200, 320,
CV_8UC3), backproj;
bool paused = false;

for(;;)
{
    if( !paused )
    {
        cap >> frame;
        if( frame.empty() )
            break;
    }

    frame.copyTo(image);

    if( !paused )
    {
        cvtColor(image, hsv, CV_BGR2HSV);

        if( trackObject )
        {
            int _vmin = vmin, _vmax = vmax;

            inRange(hsv, Scalar(0, smin, MIN(_vmin, _vmax)),
                Scalar(180, 256, MAX(_vmin, _vmax)), mask);
            int ch[] = {0, 0};

```

```
hue.create(hsv.size(), hsv.depth());
mixChannels(&hsv, 1, &hue, 1, ch, 1);

if( trackObject < 0 )
{
    Mat roi(hue, selection), maskroi(mask, selection);
    calcHist(&roi, 1, 0, maskroi, hist, 1, &hsize, &phranges);
    normalize(hist, hist, 0, 255, CV_MINMAX);

    trackWindow = selection;
    trackObject = 1;

    histimg = Scalar::all(0);
    int binW = histimg.cols / hsize;
    Mat buf(1, hsize, CV_8UC3);
    for( int i = 0; i < hsize; i++ )
        buf.at<Vec3b>(i) =
Vec3b(saturate_cast<uchar>(i*180./hsize), 255, 255);
    cvtColor(buf, buf, CV_HSV2BGR);

    for( int i = 0; i < hsize; i++ )
    {
        int val =
saturate_cast<int>(hist.at<float>(i)*histimg.rows/255);
        rectangle( histimg, Point(i*binW,histimg.rows),
            Point((i+1)*binW,histimg.rows - val),
            Scalar(buf.at<Vec3b>(i)), -1, 8 );
    }
}

calcBackProject(&hue, 1, 0, hist, backproj, &phranges);
backproj &= mask;
RotatedRect trackBox = CamShift(backproj, trackWindow,
    TermCriteria( CV_TERMCRIT_EPS | CV_TERMCRIT_ITER, 10,
1 ));

if( trackWindow.area() <= 1 )
{
    int cols = backproj.cols, rows = backproj.rows, r =
(MIN(cols, rows) + 5)/6;
    trackWindow = Rect(trackWindow.x - r, trackWindow.y - r,
```



```

        trackWindow.x + r, trackWindow.y + r) &
        Rect(0, 0, cols, rows);
    }

    if( backprojMode )
        cvtColor( backproj, image, CV_GRAY2BGR );
        ellipse( image, trackBox, Scalar(0,0,255), 3, CV_AA );
        // cvRectangle
    (&image,cvPoint(trackBox.center),cvPoint(trackBox.center),CV_RGB(
    255,0,0), 3);

        //cvRectangle(&frame,
    cvPoint(trackWindow.x,trackWindow.y),cvPoint(trackWindow.x+20,tra
    ckWindow.y+20), CV_RGB(255,0,0), 3 );

    }
}
else if( trackObject < 0 )
    paused = false;

if( selectObject && selection.width > 0 && selection.height >
0 )
{
    Mat roi(image, selection);
    bitwise_not(roi, roi);
}

imshow( "VISION-BASED GRASPING FOR ARM ROBOT", image );
imshow( "Histogram", histimg );

char c = (char)waitKey(10);
if( c == 27 )
    break;
switch(c)
{
case 'b':
    backprojMode = !backprojMode;
    break;
case 'c':
    trackObject = 0;
    histimg = Scalar::all(0);

```

```
    break;
case 'h':
    showHist = !showHist;
    if( !showHist )
        destroyWindow( "Histogram" );
    else
        namedWindow( "Histogram", 1 );
    break;
case 'p':
    paused = !paused;
    break;
default:
    ;
}
}
return 0;
}
```

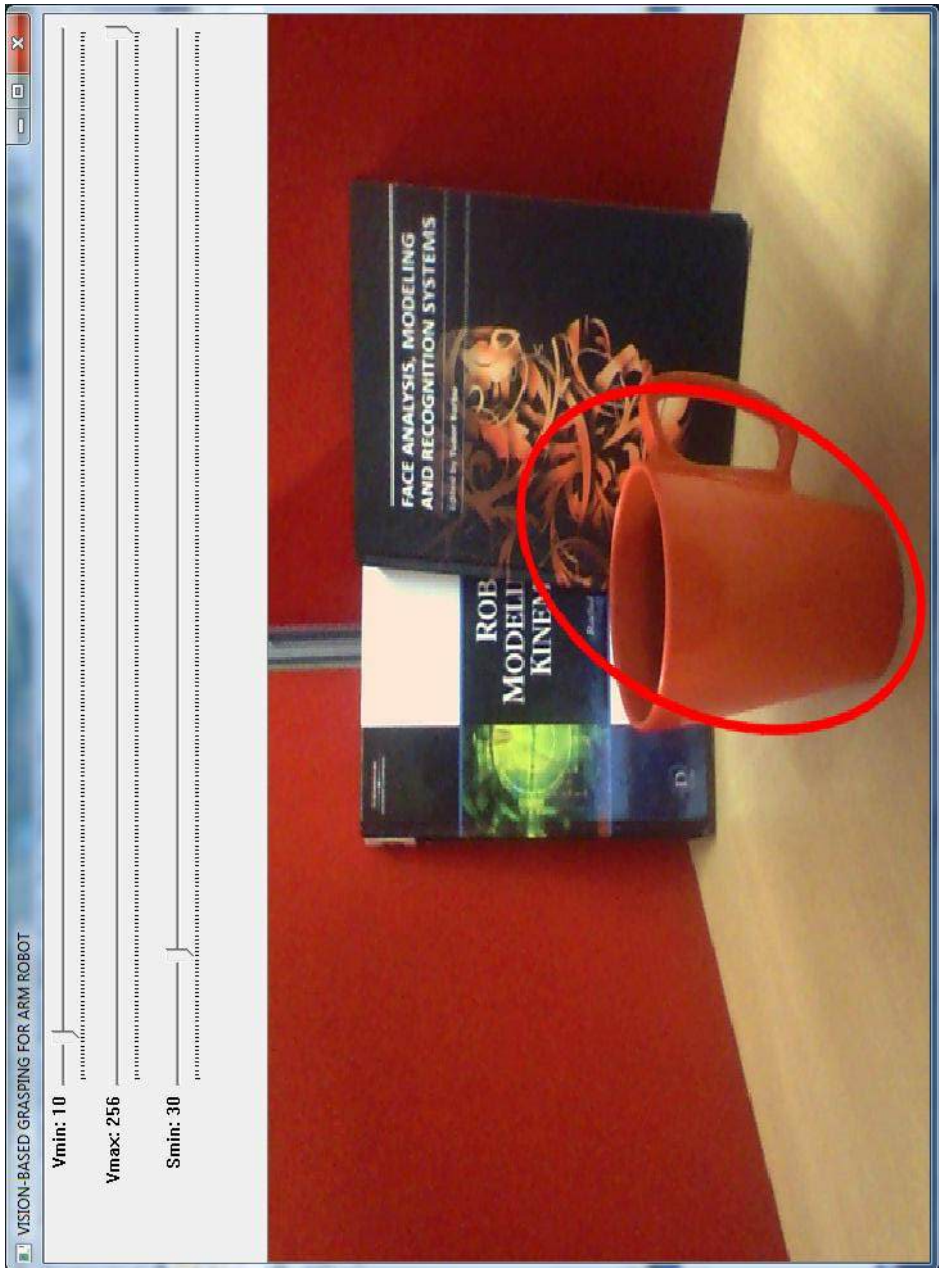

Figure 7.2 Result of object detection.

References

- [1] Adrian Kaehler & Garry Bradksy, Learning OpenCV: Computer Vision in C++ with the OpenCV Library, O'Reilly Publisher, 2014.
- [2] Samarth Brahmbatt, Practical OpenCV, Technology in Action Publisher, 2013.
- [3] Daniel bagio et al., Mastering OpenCV with Practical Computer Vision Project, Packt Publisher, 2012.

Chapter 8

Extracting the Component's Contours for Calculating Number of Objects

On successful completion of this course, students will be able to:

- Explain how to extract component's contours.
- Develop a program to count an object in image.

Introduction

Image processing for obtaining object's information in an image is important part in digital era. Important images generally contain representation of specific objects. In order to perform a content-based analysis of an image, it is necessary to extract meaningful features from the collection of pixels and contours that constitute the image. Contours are fundamental image elements that define an image's content. In this paper, we propose a method for calculating number of objects using computer vision based on contours and shape descriptor of image.

Introduction of Contours

Images generally contain representation of objects. One of the goals of image analysis is to identify and extract those objects. In object detection/recognition applications, the first step is to produce a binary image showing where certain objects of interest could be located. The next step is to then extract the objects which are contain in this collection of 1s and 0s. More specifically, we will extract the connected components, that is, shapes made of a set of connected pixels in a binary image. In this paper, we propose a method for calculating objects in an image using contour and shape descriptor. The implementation of this method is such as to get information about traffic density, how many cars in a street.

The contours are extracted by a simple algorithm that consists of systematically scanning the image until a component is hit. From this starting point of the component, its contour is followed, marking the pixels on its border. When the contour is completed, the scanning resumes at the last position until a new component is found. The identified connected components can then be individually analyzed. Implementation of image segmentation for extracting foreground object can be use GraphCut algorithm based on mathematical morphology [3]. GrabCut is computationally more expensive than watershed, but it generally produces a more accurate result. It is the best algorithm to use

when one wants to extract a foreground object in a still image. So for this research, we propose simple mechanism for calculating the objects in an image, by processing the contour and the shape descriptor of an image using connected component.

Shape descriptors are important tools in content-based image retrieval systems, which allow searching and browsing images in a database with respect to the shape information. The shape description methods can be divided into three main categories; contour based, image based and skeleton based descriptors [5]. A Connected component often corresponds to the image of some object in a pictured scene. To identify this object, or to compare it with other image elements, it can be useful to perform some measurements on the component in order to extract some of its characteristics. Many OpenCV functions are available when it comes to shape descriptor and offers a simple function which extracts the contours of the connected components of an image using `cv::findContours` function.

```
Cv::findContours (image,  
CV_RETR_EXTERNAL, //retrieve the external contours  
CV_CHAIN_APPROX_NONE); // all pixels of each contours.
```

For example, if some prior knowledge is available about the expected size of objects of interest, it becomes possible to eliminate some of the components. Let's then use a minimum and a maximum value for the perimeter of the components by iterating over the vector of contours and eliminating the eliminating the invalid components. The implementation for finding contours shown in the program below:

```
// Eliminate too short or too long contours  
int cmin=100;int cmax=1000 //min and max contour length  
std::vector<std::vector<cv::Point>>::  
const_iterator itc=contours.begin();  
while (itc !=contours.end()) {  
if (itc->size()<cmin ||itc->size() >cmax)  
    itc=contour//Eliminate.erase(itc);  
else  
    ++itc;  
}
```

Counting Objects

We using single images for the experiment, and convert it first to binary, then we extract the contour, shape descriptor, counting and displaying number of objects. The algorithm for extract the contours shown below:

Algorithm 8.1. Extracting the contour and counting the object:

```

Begin
  Counter=0
  reading image and convert to binary image
  Extract contours
  Output the vector of contours
  Counting the objects
  Couter+=1
  Displaying the number of object
End

```

The diagram block of our method shown in figure 8.1:



Figure 8.1 Diagram block of the system for calculating number of objects.

We test an example image with 4 animal and size 400x600 pixel as shown in figure 8.2:



Figure 8.2 Testing image.

Then the result of binary image from fig. 8.2 shown in figure 8.3:

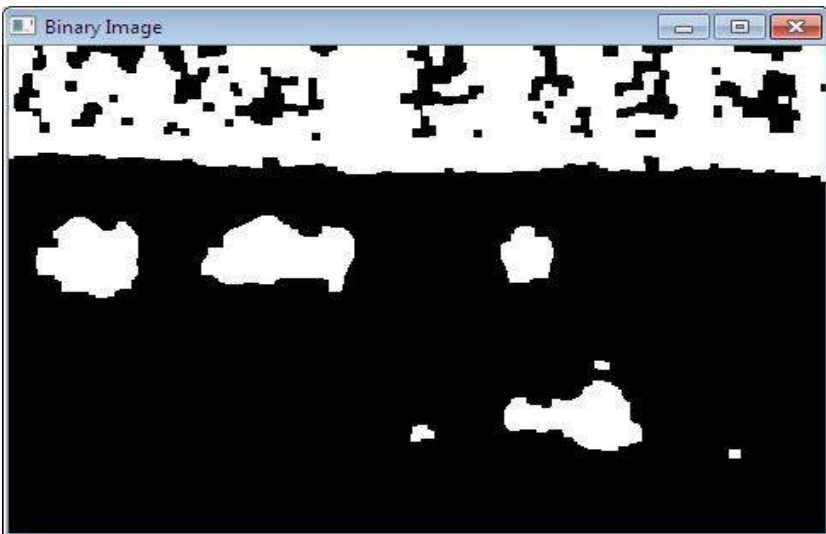

Figure 8.3 Binary image.

After that, we find contours of image as shown in figure 8.4:

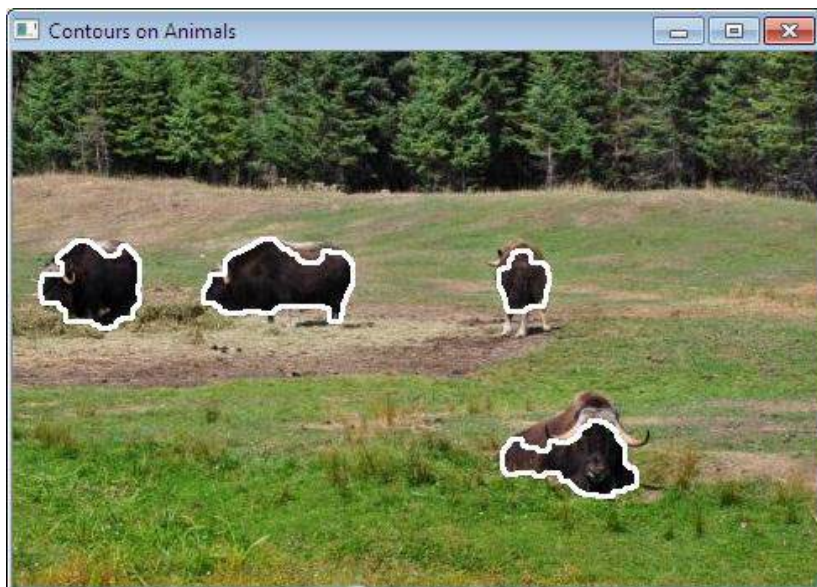

Figure 8.4 Contour of image obtained.

After that, we got total number of object with its shape descriptors as shown in figure 8.5, using function:

```
CvPoint pt1;  
pt1.x=100;pt1.y=60;  
cvInitFont( &font, CV_FONT_HERSHEY_COMPLEX, 0.5, 0.5,  
0.0, 1, CV_AA );  
cvPutText( img, "TOTAL :", varCount, &font ,  
CV_RGB(0,0,255) );
```

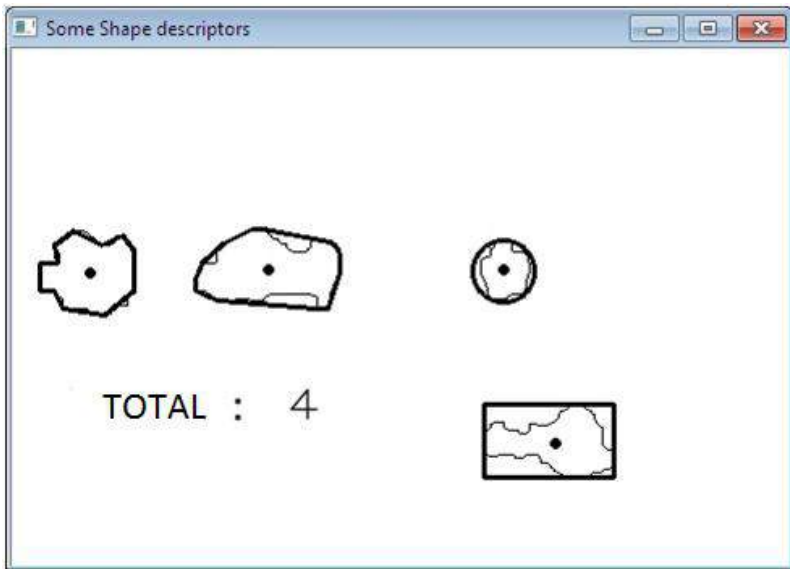

Figure 8.5 Number of objects obtained with processing time less than 1 second.

References

- [1] Robert Laganière, OpenCV 2 Computer Vision Application Programming Cookbook, Apress Publisher, 2011.
- [2] R.C. Gonzalez, Digital Image Processing (3rd ed.), Addison Wesley, 2007.
- [3] Rother, A Blake, GrabCut: Interactive Foreground Extraction using Iterated Graph Cuts, ACM Transaction on Graphics, vol. 23 no. 3, 2004.
- [4] R. Szeliski, Computer Vision, Algorithms and Applications, Springer Publisher, 2011.
- [5] Latecki, L. J., Lakamper, R., Shape Similarity Measure Based on Correspondence of Visual Parts.IEEE Transaction. PAMI, 22, 10, pp.1185-1190, 2000.

Chapter 9

Face Recognition Systems

On successful completion of this course, students will be able to:

- Explain how to detect face in OpenCV.
- Develop face recognition systems using library in OpenCV.

Introduction

The face is our primary focus of attention in developing an intelligent robot to serve people. Unfortunately, developing a computational model of face recognition is quite difficult, because faces are complex, meaningful visual stimuli and multidimensional. Modelling of face images can be based on statistical models such as Principal Component Analysis (PCA) and Linear Discriminant Analysis (LDA) and physical modelling based on the assumption of certain surface reflectance properties, such as Lambertian surface. OpenCV provides functions for face detection using Paul Viola and Michael Jones method, and OpenCV face tracker using CamShift algorithm.

Face Recognition in OpenCV

Face recognition is an easy task for humans, but not for computer systems. All face recognition models in OpenCV 2.4 are derived from the abstract base class `FaceRecognizer`, which provides a unified access to all face recognition algorithms in OpenCV. The currently available algorithms are:

- Eigenfaces (see `createEigenFaceRecognizer()`)
- Fisherfaces (see `createFisherFaceRecognizer()`)
- Local Binary Patterns Histograms (see `createLBPHFaceRecognizer()`)

Experiments in [16] have shown, that even one to three day old babies are able to distinguish between known faces. So how hard could it be for a computer? It turns out we know little about human recognition to date. Are inner features (eyes, nose, mouth) or outer features (head shape, hairline) used for a successful face recognition? How do we analyze an image and how does the brain encode it? It was shown by David Hubel and Torsten Wiesel, that our brain has specialized nerve cells responding to specific local features of a scene, such as lines, edges, angles or movement. Since we don't see the world as scattered pieces, our visual cortex must somehow combine the different sources

of information into useful patterns. Automatic face recognition is all about extracting those meaningful features from an image, putting them into a useful representation and performing some kind of classification on them.

Face recognition based on the geometric features of a face is probably the most intuitive approach to face recognition. One of the first automated face recognition systems was described by Kanade in 1973, marker points (position of eyes, ears and nose) were used to build a feature vector (distance between the points, angle between them). The recognition was performed by calculating the euclidean distance between feature vectors of a probe and reference image.

The Eigenfaces method described in [15] took a holistic approach to face recognition: A facial image is a point from a high-dimensional image space and a lower-dimensional representation is found, where classification becomes easy. The lower-dimensional subspace is found with Principal Component Analysis, which identifies the axes with maximum variance. While this kind of transformation is optimal from a reconstruction standpoint, it doesn't take any class labels into account. Imagine a situation where the variance is generated from external sources, let it be light. The axes with maximum variance do not necessarily contain any discriminative information at all, hence a classification becomes impossible. So a class-specific projection with a Linear Discriminant Analysis was applied to face recognition in [17]. The basic idea is to minimize the variance within a class, while maximizing the variance between the classes at the same time.

Recently various methods for a local feature extraction emerged. To avoid the high-dimensionality of the input data only local regions of an image are described, the extracted features are (hopefully) more robust against partial occlusion, illumination and small sample size. Algorithms used for a local feature extraction are Gabor Wavelets [18], Discrete Cosinus Transform [19] and Local Binary Patterns [20]. It's still an open research question what's the best way to preserve spatial information when applying a local feature extraction, because spatial information is potentially useful information.

The problem with the image representation we are given is its high dimensionality. The Principal Component Analysis (PCA), which is the core of the Eigenfaces method, finds a linear combination of features that maximizes the total variance in data. While this is clearly a powerful way to represent data, it doesn't consider any classes and so a lot of discriminative information may be lost when throwing components away. Imagine a situation where the variance in your data is generated by an external source, let it be the light. The components

identified by a PCA do not necessarily contain any discriminative information at all, so the projected samples are smeared together and a classification becomes impossible.

The Linear Discriminant Analysis performs a class-specific dimensionality reduction and was invented by the great statistician Sir R. A. Fisher. In order to find the combination of features that separates best between classes the Linear Discriminant Analysis maximizes the ratio of between-classes to within-classes scatter, instead of maximizing the overall scatter. The idea is simple: same classes should cluster tightly together, while different classes are as far away as possible from each other in the lower-dimensional representation. This was also recognized by Belhumeur, Hespanha and Kriegman and so they applied a Discriminant Analysis to face recognition [22].

Haar Cascade Classifier

Viola-Jones framework has been widely used by researchers in order to detect the location of faces and objects in a given image. Face detection classifiers are shared by public communities, such as OpenCV [1]. Haar Cascade Classifier use AdaBoost at every node in cascade to study high detection level with multi-tree classifier rejection level at every node in cascade. This algorithm combines some innovative features, such as:

- 1) Use haar-like input feature, threshold that is used to sum and differentiate square regions from image.
- 2) Integral image technique that enable fast computation for square regions or regions that is rotated 45 degree. This data structure is used to make computation from Haar-like input feature faster.
- 3) Statistical Boosting to make binary node classification (yes/no) that characterized with high detection level and weak rejection level.
- 4) Organizing weak classifier nodes from a rejection cascade. In other words, first group from the classifiers is selected so best detection in image region consist of an object although enabling many mistakes in detection; the next classifier groups are the second best detection with weak level rejection; and so on. In testing, an object can be known if that object makes it through all cascades [2]. Haar-like input feature that are used by classifier are:

1. Edge features

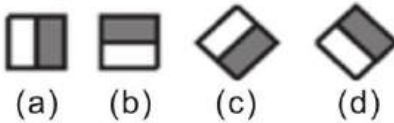

2. Line features

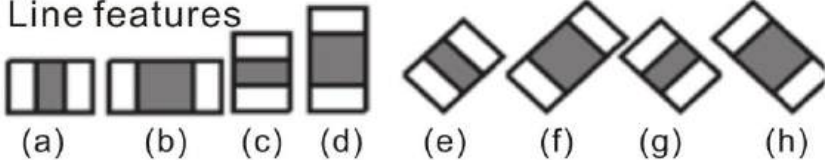

3. Center-surround features

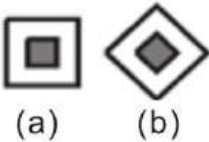

Figure 9.1 Haar-like input feature that are used by classifiers [2].

You have to inform to classifier, the directory to be used, such as `haarcascade_frontalface_default.xml`. At OpenCV, stored on:

```
Program_Files/OpenCV/data/haarcasades/haarcascade_frontalface_
default.xml.
```

To running the detector for face and eyes, you have to call `detectMultiScale()` that consist of 7 parameter:

```
//-- Detect faces
face_cascade.detectMultiScale (frame_gray, faces, 1.1, 2, 0,
Size(80, 80) );

for( int i = 0; i < faces.size(); i++ )
{
  Mat faceROI = frame_gray (faces[i]);
  std::vector<Rect> eyes;

  //-- In each face, detect eyes
  eyes_cascade.detectMultiScale (faceROI, eyes, 1.1, 2, 0
|CV_HAAR_SCALE_IMAGE, Size(30, 30) );
```

Program below show the demo to detect face and eyes using webcam:

HaarDetection.cpp

```

//Face and eyes detection using Haar Cascade Classifier
#include "opencv2/objdetect/objdetect.hpp"
#include "opencv2/highgui/highgui.hpp"
#include "opencv2/imgproc/imgproc.hpp"
#include <iostream>

using namespace std;
using namespace cv;

/** Function Headers */
void detectAndDisplay( Mat frame );

/** Global variables */
String face_cascade_name = "lbpcascade_frontalface.xml";
String eyes_cascade_name = "haarcascade_eye_tree_eyeglasses.xml";
CascadeClassifier face_cascade;
CascadeClassifier eyes_cascade;
string window_name = "Face detection";

int main( int argc, const char** argv )
{
    CvCapture* capture;
    Mat frame;

    //-- 1. Load the cascade
    if( !face_cascade.load( face_cascade_name ) ){ printf("--
(!)Error loading face\n"); return -1; };
    if( !eyes_cascade.load( eyes_cascade_name ) ){ printf("--
(!)Error loading eye\n"); return -1; };

    //-- 2. Read the video stream
    capture = cvCaptureFromCAM(0);
    if( capture )
    {
        while( true )
        {
            frame = cvQueryFrame( capture );

            //-- 3. Apply the classifier to the frame

```

```
    if( !frame.empty() )
        { detectAndDisplay( frame ); }
    else
        { printf(" --(!) No captured frame -- Break!"); break; }

    int c = waitKey(10);
    if( (char)c == 'c' ) { break; }

}
}
return 0;
}

/**
 * @function detectAndDisplay
 */
void detectAndDisplay( Mat frame )
{
    std::vector<Rect> faces;
    Mat frame_gray;

    cvtColor( frame, frame_gray, CV_BGR2GRAY );
    equalizeHist( frame_gray, frame_gray );

    //-- Detect faces
    face_cascade.detectMultiScale( frame_gray, faces, 1.1, 2, 0,
    Size(80, 80) );

    for( int i = 0; i < faces.size(); i++ )
    {
        Mat faceROI = frame_gray( faces[i] );
        std::vector<Rect> eyes;

        //-- In each face, detect eyes
        eyes_cascade.detectMultiScale( faceROI, eyes, 1.1, 2, 0
|CV_HAAR_SCALE_IMAGE, Size(30, 30) );
        if( eyes.size() == 2)
        {
            //-- Draw the face

            Point center( faces[i].x + faces[i].width*0.5, faces[i].y +
faces[i].height*0.5 );
```

```

    ellipse( frame, center, Size( faces[i].width*0.5,
faces[i].height*0.5), 0, 0, 360, Scalar( 255, 0, 0 ), 2, 8, 0 );

    for( int j = 0; j < eyes.size(); j++ )
    { //-- Draw the eyes
        Point center( faces[i].x + eyes[j].x + eyes[j].width*0.5,
faces[i].y + eyes[j].y + eyes[j].height*0.5 );
        int radius = cvRound( (eyes[j].width +
eyes[j].height)*0.25 );
        circle( frame, center, radius, Scalar( 255, 0, 255 ), 3, 8,
0 );
    }
}

//-- Show the result
imshow( window_name, frame );
}

```

The result of the program show in figure 9.2:



Figure 9.2 Result of face detection using Haar classifier.

Displaying face detected from webcam with ellipse and rectangle usually need by robotics engineer, because it can be used to measure distance between camera and the object, the rectangle codes:

```
cvCircle( img, center, radius, color, 3, 8, 0 );
cvRectangle( img,cvPoint( r->x, r->y ),cvPoint( r->x + r-
>width, r->y + r->height ),CV_RGB( 0, 255, 0 ), 1, 8, 0 );
```

Program below show an example for face detection with rectangle:



Figure 9.3 Face detected using rectangle.

FaceRectangle.cpp:

```
//Face Detection using Rectangle
#include "stdafx.h"
#include "opencv2/objdetect/objdetect.hpp"
#include "opencv2/highgui/highgui.hpp"
#include "opencv2/imgproc/imgproc.hpp"
#include <iostream>
#include "cv.h"
```

```

#include "highgui.h"

#include <iostream>
#include <cstdio>

#ifdef _EiC
#define WIN32
#endif

using namespace std;
using namespace cv;

void detectAndDraw( Mat& img,
                   CascadeClassifier& cascade, CascadeClassifier&
nestedCascade,
                   double scale);

String cascadeName = "haarcascade_frontalface_alt.xml";

int main( int argc, const char** argv )
{
    CvCapture* capture = 0;
    Mat frame, frameCopy, image;
    const String scaleOpt = "--scale=";
    size_t scaleOptLen = scaleOpt.length();
    const String cascadeOpt = "--cascade=";
    size_t cascadeOptLen = cascadeOpt.length();
    String inputName;

    CascadeClassifier cascade, nestedCascade;
    double scale = 1;

    if( !cascade.load( cascadeName ) )
    {
        cerr << "ERROR: Could not load classifier cascade" << endl;
        cerr << "Usage: facedetect [--cascade=\"<cascade_path>\"]\n"
            "    [--nested-cascade[=\"nested_cascade_path\"]]\n"
            "    [--scale[=<image scale>]\n"
            "    [filename|camera_index]\n" ;
        return -1;
    }
}

```

```
capture = cvCaptureFromCAM(0);

cvNamedWindow( "Face Detection with Rectangle", 1 );

if( capture )
{
    for(;;)
    {
        IplImage* iplImg = cvQueryFrame( capture );
        frame = iplImg;
        if( frame.empty() )
            break;
        if( iplImg->origin == IPL_ORIGIN_TL )
            frame.copyTo( frameCopy );
        else
            flip( frame, frameCopy, 0 );

        detectAndDraw( frameCopy, cascade, nestedCascade, scale );

        if( waitKey( 10 ) >= 0 )
            goto _cleanup_;
    }

    waitKey(0);
_cleanup_:

    cvReleaseCapture( &capture );
}

cvDestroyWindow("result");

return 0;
}

void detectAndDraw( Mat& img,
                   CascadeClassifier& cascade, CascadeClassifier&
nestedCascade,
                   double scale)
{
    int i = 0;
    double t = 0;
    vector<Rect> faces;
```



```

const static Scalar colors[] = { CV_RGB(100,0,255),
    CV_RGB(0,100,255),
    CV_RGB(0,255,255),
    CV_RGB(0,255,0),
    CV_RGB(255,128,0),
    CV_RGB(255,255,0),
    CV_RGB(255,0,0),
    CV_RGB(255,0,255) } ;

Mat gray, smallImg( cvRound (img.rows/scale),
cvRound(img.cols/scale), CV_8UC1 );

cvtColor( img, gray, CV_BGR2GRAY );
resize( gray, smallImg, smallImg.size(), 0, 0, INTER_LINEAR );
equalizeHist( smallImg, smallImg );

t = (double)cvGetTickCount();
cascade.detectMultiScale( smallImg, faces,
    1.1, 2, 0
    //|CV_HAAR_FIND_BIGGEST_OBJECT
    //|CV_HAAR_DO_ROUGH_SEARCH
    |CV_HAAR_SCALE_IMAGE
    ,
    Size(30, 30) );

t = (double)cvGetTickCount() - t;
printf( "detection time = %g ms\n",
t/((double)cvGetTickFrequency()*1000.) );

for( vector<Rect>::const_iterator r = faces.begin(); r !=
faces.end(); r++, i++ )
{
    Mat smallImgROI;
    vector<Rect> nestedObjects;
    Point center;
    Scalar color = colors[i%8];
    int radius;
    center.x = cvRound((r->x + r->width*0.5)*scale);
    center.y = cvRound((r->y + r->height*0.5)*scale);
    radius = cvRound((r->width + r->height)*0.25*scale);

    circle( img, center, radius, color, 3, 8, 0 );
}

```

```
        cv::rectangle( img,cvPoint( r->x, r->y ),cvPoint( r->x +
r->width, r->y + r->height ),CV_RGB( 255, 0, 0 ), 1, 8, 0 );
    }
    cv::imshow( "Face Detection with Rectangle", img );
}
```

Face Features Detector

Face features detector such as eye, nose and mouth very important for intelligent robotics. Robot should be able to recognize the expression (angry, sad, happy etc) obtained from a face in front of robot. An example below show face detected with eye, nose and mouth using libraries:

- haarcascade_frontalface_alt2.xml
- haarcascade_mcs_eyepair_big.xml
- haarcascad_mcs_nose.xml
- haarcascade_mcs_mouth.xml
- haarcascade_smile.xml

FacialFeatures.cpp:

```
#include <stdio.h>
#include<conio.h>
#include "cv.h"
#include "highgui.h"
#include "cvaux.h"

CvHaarClassifierCascade
*cascade,*cascade_e,*cascade_nose,*cascade_mouth;
CvMemStorage          *storage;
char *face_cascade="haarcascade_frontalface_alt2.xml";
char *eye_cascade="haarcascade_mcs_eyepair_big.xml";
char *nose_cascade="haarcascade_mcs_nose.xml";
char *mouth_cascade="haarcascade_mcs_mouth.xml";

/*Deteksi mulut*/
void detectMouth( IplImage *img,CvRect *r){
    CvSeq *mouth;
    cvSetImageROI(img,/* the source image */
```

```

    cvRect(r->x,          /* x = start from leftmost */
    r->y+(r->height *2/3), /* y = a few pixels from the top */
    r->width,          /* width = same width with the face */
    r->height/3      /* height = 1/3 of face height */
    )
    );

    mouth = cvHaarDetectObjects(img, /* the source image, with the
estimated
location defined */
    cascade_mouth,      /* the eye classifier */
    storage,           /* memory buffer */
    1.15, 4, 0,        /* tune for your app */
    cvSize(25, 15) /* minimum detection scale */
    );

    for( int i = 0; i < (mouth ? mouth->total : 0); i++ )
    {

        CvRect *mouth_cord = (CvRect*) cvGetSeqElem(mouth, i);
        /* draw a red rectangle */
        cvRectangle(img,
        cvPoint(mouth_cord->x, mouth_cord->y),
        cvPoint(mouth_cord->x + mouth_cord->width, mouth_cord->y +
mouth_cord->height),
        CV_RGB(255,255, 255),
        1, 8, 0
        );
    }
}

/*Deteksi hidung*/
void detectNose( IplImage *img, CvRect *r){
    CvSeq *nose;
    //nose detection- set ROI
    cvSetImageROI(img,          /* the source image */
    cvRect(r->x,          /* x = start from leftmost */
    r->y, /* y = a few pixels from the top */
    r->width, /* width = same width with the face */

```

```
        r->height /* height = 1/3 of face height */
    )
};

nose = cvHaarDetectObjects(img, /* the source image, with the
estimated location defined */
    cascade_nose, /* the eye classifier */
    storage, /* memory buffer */
    1.15, 3, 0, /* tune for your app */
    cvSize(25, 15) /* minimum detection scale */
);

for( int i = 0; i < (nose ? nose->total : 0); i++ )
{
    CvRect *nose_cord = (CvRect*)cvGetSeqElem(nose, i);

    /* gambar kotak merah */
    cvRectangle(img,
        cvPoint(nose_cord->x, nose_cord->y),
        cvPoint(nose_cord->x + nose_cord->width, nose_cord->y +
nose_cord->height),
        CV_RGB(0,255, 0),
        1, 8, 0
    );

}
}

/*eye detection*/
void detectEyes( IplImage *img,CvRect *r){
    char *eyecascade;
    CvSeq *eyes;
    int eye_detect=0;
    /* Set the Region of Interest: estimate the eyes' position */
    cvSetImageROI(img, /* the source image */
        cvRect
        (
            r->x, /* x = start from leftmost */
            r->y + (r->height/5.5), /* y = a few pixels from the top */
```

```

        r->width,      /* width = same width with the face */
        r->height/3.0 /* height = 1/3 of face height */
    )
);

/* deteksi mata */
eyes = cvHaarDetectObjects( img, /* the source image, with
the
estimated location defined */
    cascade_e,      /* the eye classifier */
    storage,        /* memory buffer */
    1.15, 3, 0,     /* tune for your app */
    cvSize(25, 15) /* minimum detection scale */
    );
printf("\n eye detected  %d",eyes->total);

/* draw rectangle */
for( int i = 0; i < (eyes ? eyes->total : 0); i++ )
{
    eye_detect++;
    /* get one eye */
    CvRect *eye = (CvRect*)cvGetSeqElem(eyes, i);
    /* draw a red rectangle */
        cvRectangle(img,
cvPoint(eye->x, eye->y),
cvPoint(eye->x + eye->width, eye->y + eye->height),
CV_RGB(0, 0, 255),
1, 8, 0
);
}

}

void detectFacialFeatures( IplImage *img,IplImage *temp_img,int
img_no){

    char image[100],msg[100],temp_image[100];
    float m[6];
    double factor = 1;
    CvMat M = cvMat( 2, 3, CV_32F, m );

```

```
int w = (img)->width;
int h = (img)->height;
CvSeq* faces;
CvRect *r;

m[0] = (float)(factor*cos(0.0));
m[1] = (float)(factor*sin(0.0));
m[2] = w*0.5f;
m[3] = -m[1];
m[4] = m[0];
m[5] = h*0.5f;

cvGetQuadrangleSubPix(img, temp_img, &M);
CvMemStorage* storage=cvCreateMemStorage(0);
cvClearMemStorage( storage );

if( cascade )
    faces = cvHaarDetectObjects(img,cascade, storage, 1.2, 2,
CV_HAAR_DO_CANNY_PRUNING, cvSize(20, 20));
else
    printf("\nFrontal face cascade not loaded\n");

printf("\n Jumlah wajah yang dideteksi %d",faces->total);

/* for each face found, draw a red box */
for(int i = 0 ; i < ( faces ? faces->total : 0 ) ; i++ )
{
    r = ( CvRect* )cvGetSeqElem( faces, i );
    cvRectangle( img,cvPoint( r->x, r->y ),cvPoint( r->x + r-
>width, r->y + r->height ),
        CV_RGB( 255, 0, 0 ), 1, 8, 0 );

    printf("\n face_x=%d face_y=%d wd=%d ht=%d",r->x,r->y,r-
>width,r->height);

    detectEyes(img,r);
    /* reset region of interest */
    cvResetImageROI(img);
    detectNose(img,r);
    cvResetImageROI(img);
    detectMouth(img,r);
```

```

    cvResetImageROI(img);
}
/* reset region of interest */
cvResetImageROI(img);

if(faces->total>0)
{
sprintf(image,"D:\\face_output\\%d.jpg",img_no);
    cvSaveImage( image, img );
}
}

int main( int argc, char** argv )
{
    CvCapture *capture;
    IplImage *img,*temp_img;
    Int      key;

    char image[100],temp_image[100];

    storage = cvCreateMemStorage( 0 );
    cascade = ( CvHaarClassifierCascade* )cvLoad( face_cascade, 0,
0, 0 );
    cascade_e = ( CvHaarClassifierCascade* )cvLoad( eye_cascade, 0,
0, 0 );
    cascade_nose = ( CvHaarClassifierCascade* )cvLoad( nose_cascade,
0, 0, 0 );
    cascade_mouth =
( CvHaarClassifierCascade* )cvLoad( mouth_cascade, 0, 0, 0 );

    if( !(cascade || cascade_e ||cascade_nose||cascade_mouth) )
    {
        fprintf( stderr, "ERROR: Could not load classifier
cascade\n" );
        return -1;
    }

    for(int j=20;j<27;j++)
    {

        sprintf(image,"D:\\image\\%d.jpg",j);

```

```
    img=cvLoadImage(image);
    temp_img=cvLoadImage(image);

    if(!img)
    {
        printf("Could not load image file and trying once
again: %s\n",image);
    }
    printf("\n curr_image = %s",image);
    detectFacialFeatures(img,temp_img,j);
}

cvReleaseHaarClassifierCascade( &cascade );
cvReleaseHaarClassifierCascade( &cascade_e );

cvReleaseHaarClassifierCascade( &cascade_nose );
cvReleaseHaarClassifierCascade( &cascade_mouth );
cvReleaseMemStorage( &storage );

cvReleaseImage(&img);
cvReleaseImage(&temp_img);
return 0;
}
```

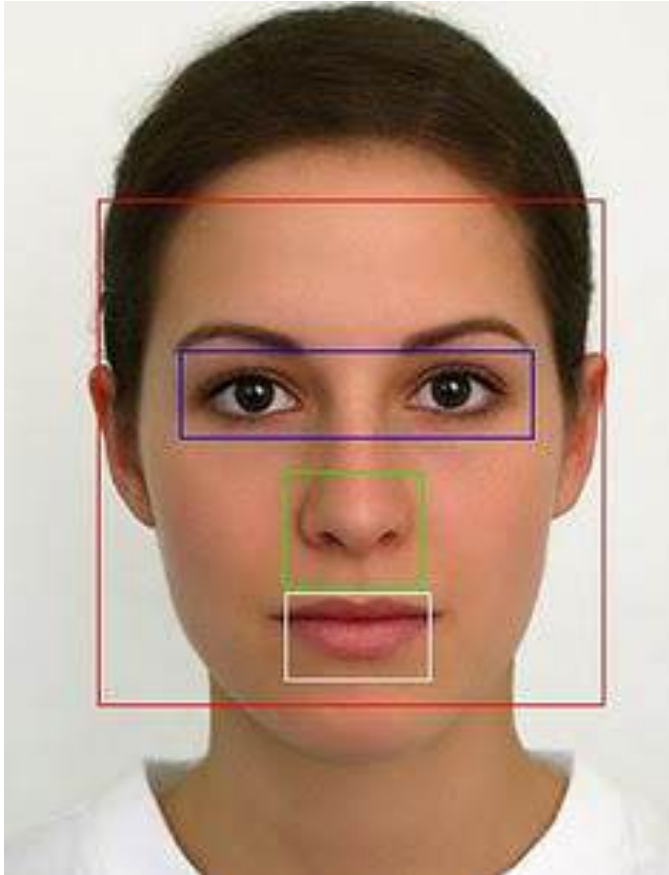



Figure 9.4 Face features detected.

Face Recognition Systems

We have developed a framework for face recognition system and faces database called ITS face database and will be compared with ATT and Indian face database. The advantages of our framework is able to store ordered item from customer in.xml file and displayed on the screen. In this research, we construct images under different illumination conditions by generate a random value for brightness level for ITS face database. Each of face database consists of 10 sets of people's face. Each set of ITS face database consists of 3 poses (front, left, right) and varied with illumination [13].

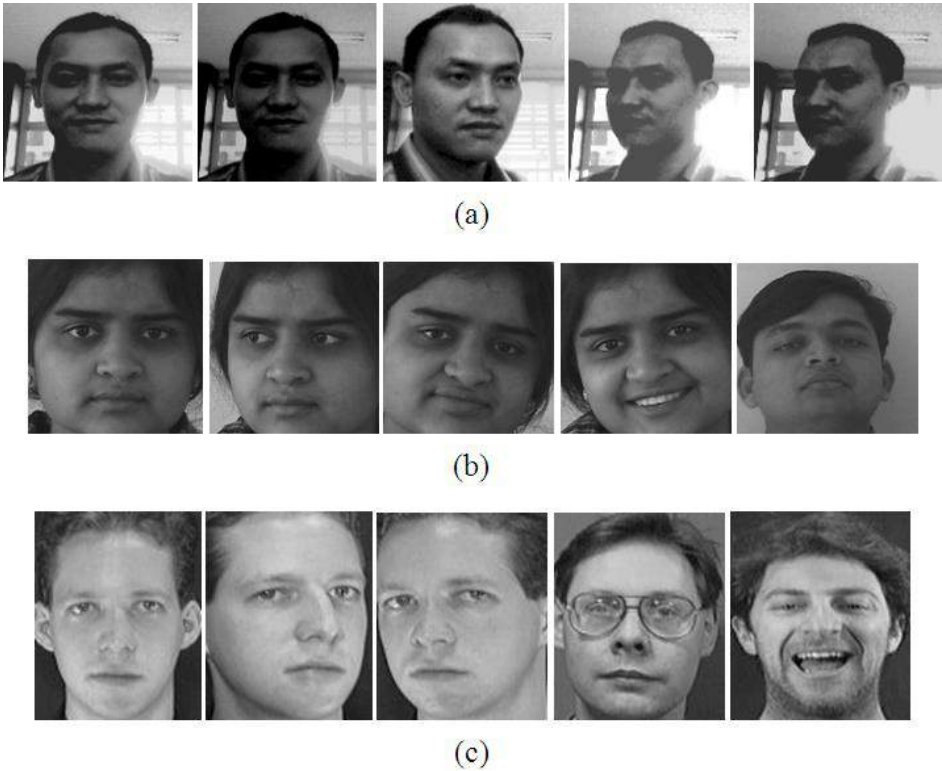

Figure 9.5 ITS, Indian and ATT face database used as comparison to see the effect of illumination at face recognition [13].

Rapid Object Detection with a Cascade of Boosted Classifiers Based on Haar-like Features

To train and use a cascade of boosted classifiers for rapid object detection. A large set of over-complete haar-like features provide the basis for the simple individual classifiers. Examples of object detection tasks are face, eye and nose detection, as well as logo detection. The sample detection task is logo detection, since logo detection does not require the collection of large set of registered and carefully marked object samples. For training a training samples must be collected. There are two sample types: negative samples and positive samples. Negative samples correspond to non-object images. Positive samples correspond to object images.

Negative Samples

Negative samples are taken from arbitrary images. These images must not contain object representations. Negative samples are passed through background description file. It is a text file in which each text line contains the filename (relative to the directory of the description file) of negative sample image. This file must be created manually. Note that the negative samples and sample images are also called background samples or background samples images, and are used interchangeably in this document. Example of negative description file:

```
/img
img1.jpg
img2.jpg

bg.txt
File bg.txt:
img/img1.jpg
img/img2.jpg
```

Positive Samples

Positive samples are created by createsamples utility. They may be created from single object image or from collection of previously marked up images. The single object image may for instance contain a company logo. Then are large set of positive samples are created from the given object image by randomly rotating, changing the logo color as well as placing the logo on arbitrary background.

The amount and range of randomness can be controlled by command line arguments.

Command line arguments:

- **vec** <vec_file_name>

name of the output file containing the positive samples for training

- **img** <image_file_name>

source object image (e.g., a company logo)

- **bg** <background_file_name>

background description file; contains a list of images into which randomly distorted versions of the object are pasted for positive sample generation

- num <number_of_samples>

number of positive samples to generate

- bgcolor <background_color>

background color (currently grayscale images are assumed); the background color denotes the transparent color. Since there might be compression artifacts, the amount of color tolerance can be specified by `-bgthresh`. All pixels between `bgcolor-bgthresh` and `bgcolor+bgthresh` are regarded as transparent.

- bgthresh <background_color_threshold>

- inv

if specified, the colors will be inverted

- randinv

if specified, the colors will be inverted randomly

- maxidev <max_intensity_deviation>

maximal intensity deviation of foreground samples pixels

- maxxangle <max_x_rotation_angle> ,

- maxyangle <max_y_rotation_angle> ,

- maxzangle <max_z_rotation_angle>

maximum rotation angles in radians

-show

if specified, each sample will be shown. Pressing 'Esc' will continue creation process without samples showing. Useful debugging option.

- w <sample_width>

width (in pixels) of the output samples

- h <sample_height>

height (in pixels) of the output samples

White noise is added to the intensities of the foreground. If `-inv` key is specified then foreground pixel intensities are inverted. If `-randinv` key is specified then it is randomly selected whether for this sample inversion will be applied. Finally, the obtained image is placed onto arbitrary background from the background description file, resized to the pixel size specified by `-w` and `-h` and stored into the file specified by the `-vec` command line parameter. Positive samples also may be obtained from a collection of previously marked up images. This collection is described by text file similar to background description file. Each line of this file corresponds to collection image. The first element of the line is image file name. It is followed by number of object instances. The following numbers are the coordinates of bounding rectangles (x, y, width, height).

Example of description file:

Directory structure:

```
/img
  img1.jpg
  img2.jpg
  info.dat
```

File info.dat:

```
img/img1.jpg 1 140 100 45 45
img/img2.jpg 2 100 200 50 50 50 30 25 25
```

Image `img1.jpg` contains single object instance with bounding rectangle (140, 100, 45, 45). Image `img2.jpg` contains two object instances.

In order to create positive samples from such collection `-info` argument should be specified instead of `-img`:

```
- info <collection_file_name>
```

description file of marked up images collection

The scheme of sample creation in this case is as follows. The object instances are taken from images. Then they are resized to samples size and stored in output file. No distortion is applied, so the only affecting arguments are `-w`, `-h`, `-show` and `-num`.

Create samples utility may be used for examining samples stored in positive samples file. In order to do this only `-vec`, `-w` and `-h` parameters should be specified.

Note that for training, it does not matter how positive samples files are generated. So the `createsamples` utility is only one way to collect/create a vector file of positive samples.

Training

The next step after samples creation is training of classifier. It is performed by the `haartraining` utility.

Command line arguments:

`- data <dir_name>`

directory name in which the trained classifier is stored

`- vec <vec_file_name>`

file name of positive sample file (created by `trainingsamples` utility or by any other means)

`- bg <background_file_name>`

background description file

`- npos <number_of_positive_samples>`,

`- nneg <number_of_negative_samples>`

number of positive/negative samples used in training of each classifier stage. Reasonable values are `npos = 7000` and `nneg = 3000`.

`- nstages <number_of_stages>`

number of stages to be trained

`- nsplits <number_of_splits>`

determines the weak classifier used in stage classifiers. If 1, then a simple stump classifier is used, if 2 and more, then CART classifier with `number_of_splits` internal (split) nodes is used

`- mem <memory_in_MB>`

available memory in MB for precalculation. The more memory you have the faster the training process

- **sym (default),**
- **nonsym**

specifies whether the object class under training has vertical symmetry or not. Vertical symmetry speeds up training process. For instance, frontal faces show off vertical symmetry

- **minhitrate <min_hit_rate>**

minimal desired hit rate for each stage classifier. Overall hit rate may be estimated as $(\text{min_hit_rate}^{\text{number_of_stages}})$

- **maxfalsealarm <max_false_alarm_rate>**

maximal desired false alarm rate for each stage classifier. Overall false alarm rate may be estimated as $(\text{max_false_alarm_rate}^{\text{number_of_stages}})$

- **weighttrimming <weight_trimming>**

Specifies wheter and how much weight trimming should be used. A decent choice is 0.90.

- **eqw**
- **mode <BASIC (default) | CORE | ALL>**

selects the type of haar features set used in training. BASIC use only upright features, while ALL uses the full set of upright and 45 degree rotated feature set. See [1] for more details.

- **w <sample_width> ,**
- **h <sample_height>**

Size of training samples (in pixels). Must have exactly the same values as used during training samples creation (utility trainingsamples)

Note: in order to use multiprocessor advantage a compiler that supports OpenMP 1.0 standard should be used. OpenCV `cvHaarDetectObjects()` function (in particular `haarFaceDetect` demo) is used for detection.

Test Samples

In order to evaluate the performance of trained classifier a collection of marked up images is needed. When such collection is not available test samples may be created from single object image by `createsamplesutility`. The scheme of test samples creation in this case is similar to training samples creation since each test sample is a background image into which a randomly distorted and randomly scaled instance of the object picture is pasted at a random position. If both `-img` and `-info` arguments are specified then test samples will be created by `createsamples` utility. The sample image is arbitrary distorted as it was described below, then it is placed at random location to background image and stored. The corresponding description line is added to the file specified by `-info` argument. The `-w` and `-h` keys determine the minimal size of placed object picture.

The test image file name format is as follows:

```
imageOrderNumber_x_y_width_height.jpg,
```

where `x`, `y`, `width` and `height` are the coordinates of placed object bounding rectangle.

Note that you should use a background images set different from the background image set used during training. In order to evaluate the performance of the classifier performance utility may be used. It takes a collection of marked up images, applies the classifier and outputs the performance, i.e. number of found objects, number of missed objects, number of false alarms and other information.

Command line arguments:

```
- data <dir_name>
```

directory name in which the trained classifier is stored

```
- info <collection_file_name>
```

file with test samples description

```
- maxSizeDiff <max_size_difference>,
```

```
- maxPosDiff <max_position_difference>
```

determine the criterion of reference and detected rectangles coincidence. Default values are 1.5 and 0.3 respectively.

- sf <scale_factor>,

detection parameter. Default value is 1.2.

- w <sample_width>,

- h <sample_height>

Size of training samples (in pixels). Must have exactly the same values as used during training (utility haartraining).

Exercises

- 1) Create a program for smile detector using haarcascade_smile.xml.
- 2) Create a program for online face and Gender Recognition system using fischerfaces and OpenCV.



Figure 9.6 Face and Gender Recognition Systems (improved from [21]).

References

- [1] Acosta, L., González, E.J., Rodríguez, J.N., Hamilton, A.F., Méndez J.A., Hernández S., Sigut S.M, and Marichal G.N. Design and Implementation of a Service Robot for A Restaurant. *International Journal of robotics and automation*. 2006; vol. 21(4): pp. 273-281.
- [2] Qing-wiau Y., Can Y., Zhuang F. and Yan-Zheng Z. Research of the Localization of Restaurant Service Robot. *International Journal of Advanced Robotic Systems*. 2010; vol. 7(3): pp. 227-238.
- [3] Chatib, O., Real-Time Obstacle Avoidance for Manipulators and Mobile Robots., *The International Journal of Robotics Research*, 1986; vol. 5(1), pp. 90-98.
- [4] Borenstein, J., Koren, Y., The Vector Field Histogram- Fast Obstacle Avoidance for Mobile Robots, in *proc. IEEE Trans. On Robotics and Automation*. 1991; vol 7(3): pp.278-288.
- [5] S. Nuryono, Penerapan Multi Mikrokontroler pada Model Robot Mobil Menggunakan Logika Fuzzy, *Journal Telkomnika*, 2009, vol. 7(3), pp, 213-218.
- [6] Masehian E., Katebi Y. Robot Motion Planning in Dynamic Environments with Moving Obstacles and Target. *International Journal of Mechanical Systems Science and Engineering*. 2007; vol. 1(1), pp. 20-29.
- [7] Budiharto, W., Purwanto, D. and Jazidie, A. A Robust Obstacle Avoidance for Service Robot using Bayesian Approach. *International Journal of Advanced Robotic Systems*. Intech Publisher – Austria. 2011; Vol. 8(1): pp. 52-60.
- [8] Budiharto, W., Purwanto, D. & Jazidie, A. A Novel Method for Static and Moving Obstacle Avoidance for Service robot using Bayesian Filtering. *Proceeding of IEEE 2nd International conf. on Advances in Computing, Control and Telecommunications Technology*.2010; pp. 156-160. DOI: 10.1109/ACT.2010.51.
- [9] Purwanto, D. Visual Feedback Control in Multi-Degrees-of-Freedom Motion System. PhD thesis at Graduate School of Science and Technology - Keio University, Japan. 2001.
- [10] Turk, M. & Pentland A. Eigenfaces for recognition. *International Journal of Cognitive Neuroscience*. 1991; vol. 3(1): pp. 71-86.
- [11] Belhumeur, P. & Kriegman, D. What is the set of images of an object under all possible illumination conditions. *International Journal of Computer Vision*. 1998; Vol. 28(3), pp. 245-260.

- [12] Etemad, K. & Chellappa R. Discriminant analysis for recognition of human face images. *Journal of the Optical Society of America A*. 1997; vol. 14(8): pp. 1724-1733.
- [13] Budiharto, W., Santoso A., Purwanto, D. and Jazidie, A. An Improved Face recognition System for Service Robot using Stereo Vision. In: Tudor Barbu Editor. *Face Recognition / Book 3*. Intech Publisher – Austria; 2011: pp. 1-12.
- [14] Hu, H. & Brady, M. A Bayesian Approach to Real-Time Obstacle Avoidance for a Mobile Robot. *Autonomous Robots*. 1994; vol. 1: pp. 69-92.
- [15] Turk, M., and Pentland, A. Eigenfaces for recognition. *Journal of Cognitive Neuroscience* 3 (1991), 71–86.
- [16] Chiara Turati, Viola Macchi Cassia, F. S., and Leo, I. Newborns face recognition: Role of inner and outer facial features. *Child Development* 77, 2 (2006), 297–311.
- [17] Belhumeur, P. N., Hespanha, J., and Kriegman, D. *Eigenfaces vs. Fisherfaces: Recognition Using Class Specific Linear Projection*. *IEEE Transactions on Pattern Analysis and Machine Intelligence* 19, 7 (1997), 711–720.
- [18] Wiskott, L., Fellous, J., Krüger, N., Malsburg, C. *Face Recognition By Elastic Bunch Graph Matching*. *IEEE Transactions on Pattern Analysis and Machine Intelligence* 19 (1997), S. 775–779.
- [19] Messer, K. et al. *Performance Characterisation of Face Recognition Algorithms and Their Sensitivity to Severe Illumination Changes*. In: *ICB, 2006*, S. 1–11.
- [20] Ahonen, T., Hadid, A., and Pietikainen, M. *Face Recognition with Local Binary Patterns*. *Computer Vision - ECCV 2004* (2004), 469–481.
- [21] Daniel Bagio et al, *Mastering OpenCV with Practical Computer Vision Project*, Pact publisher, 2012.
- [22] [Opencv.org](http://opencv.org).

Chapter 10

Intelligent Humanoid Robot

On successful completion of this course, students will be able to:

- Explain how the humanoid robot works.
- Develop vision-based humanoid robot.
- Explain object detection using keypoints and feature matching.

Introduction

Modern Humanoid Robot in uncontrolled environments needs to be based on vision and versatile. This paper propose a method for object measurement and ball tracking method using Kalman Filter for Humanoid Soccer, because the ability to accurately track a ball is one of the important features for processing high-definition image. A color-based object detection is used for detecting a ball while PID controller is used for controlling pan tilt camera system. We also modify the robot's controller CM-510 in order able to communicate efficiently using main controller.

Humanoid Robot

The humanoid robot is popular nowadays for the entertainment or contests such as RoboCup Humanoid League. The important features of humanoid soccer, such as accuracy, robustness, efficient determination and tracking of ball size and location; has proven to be a challenging subset of this task and the focus of much research. With the evolution of robotics hardware and subsequent advances in processor performance in recent years, the temporal and spatial complexity of feature extraction algorithms to solve this task has grown (Ha et al, 2011).

In the case of Humanoid soccer, vision systems are one of the main sources for environment interpretation. Many problems have to be solved before having a fully featured soccer player. First of all, the robot has to get information from the environment, mainly using the camera. It must detect the ball, goals, lines and the other robots. Having this information, the robot has to self-localize and decide the next action: move, kick, search another object, etc. The robot must perform all these tasks very fast in order to be reactive enough to be competitive in a soccer match. It makes no sense within this environment to have a good localization method if that takes several seconds to compute the robot position

or to decide the next movement in few seconds based on the old perceptions (Martin et al, 2011). At the same time many other topics like human-machine interaction, robot cooperation and mission and behavior control give humanoid robot soccer a higher level of complexity like no any other robots (Blanes et al, 2011). So the high speed processor with efficient algorithms is needed for this issue.

One of the performance factors of a humanoid soccer is that it is highly dependent on its tracking ball and motion ability. The vision module collects information that will be the input for the reasoning module that involves the development of behaviour control. Complexity of humanoid soccer makes necessary playing with the development of complex behaviours, for example situations of coordination or different role assignment during the match. There are many types of behaviour control, each with advantages and disadvantages: reactive control is the simplest way to make the robot play, but do not permit more elaborated strategies as explained for example in (Behnke, 2001). On the other side, behaviour-based control are more complex but more difficult to implement, and enables in general the possibility high-level behaviour control, useful for showing very good performances. Intelligent tracking algorithm for state estimation using Kalman filter has been successfully developed (Noh et al, 2007), and we want to implement that method for ball tracking for humanoid soccer robot.

We propose architecture of low cost humanoid soccer robot compared with the well known humanoid robots for education such as DarwIn-OP and NAO and test its ability for image processing to measure distance of the ball and track a ball using color-based object detection method, the robot will kick the ball after getting the nearest position between the robot and the ball. The Kalman filter is used here to estimate state variable of a ball that is excited by random disturbances and measurement noise. It has good results in practice due to optimality and structure and convenient form for online real time processing.

For future robotics, we will familiar with term of robot ethics. Robot ethics is a growing interdisciplinary research effort roughly in the intersection of applied ethics and robotics with the aim of understanding the ethical implications and consequences of robotic technology. Swarm robotics is a new approach to the coordination of multirobot systems which consist of large numbers of mostly simple physical robots. It is supposed that a desired collective behavior emerges from the interactions between the robots and interactions of robots with the environment. Swarm robotics systems are

characterized by decentralized control, limited communication between robots, and use of local information and emergence of global behavior.

The Architecture of the Humanoid Robot

Humanoid soccer robots design based on the vision involves the need to obtain a mechanical structure with a human appearance, in order to operate into a human real world. Another important feature for modern humanoid robot is the ability to process tasks especially for computer vision. We propose an embedded system that able to handle high speed image processing, so we use main controller based on the ARM7 Processor. Webcam and servo controller are used to track a ball, and the output of the main controller will communicate with the CM510 controller to control the actuators and sensors of the robot as shown in figure. 10.1.

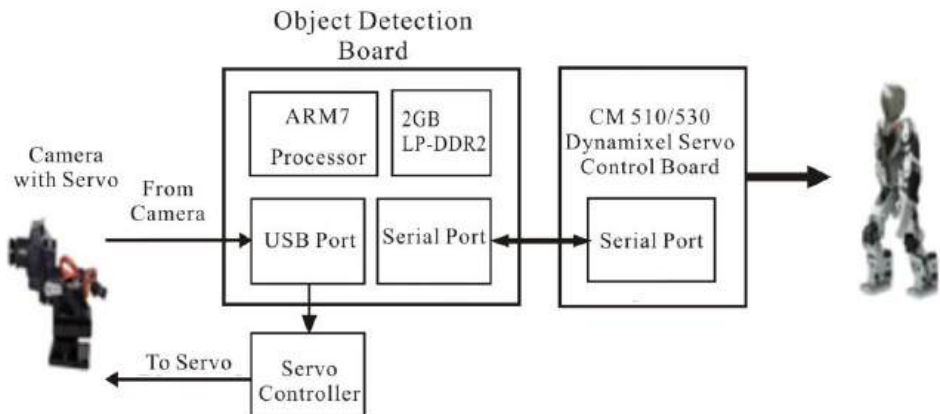

Figure 10.1 Architecture of high speed system for Humanoid Soccer Robot.

The main controller uses Odroid X2 that consist of Cortex-A9 1.7 GHz and sufficient memory and ports to be connected with other devices as shown in fig. 10.2. The specification of the Odroid X2:

- Exynos4412 Quad-core ARM Cortex-A9 1.7GHz.
- 2GByte Memory.
- 6 x High speed USB2.0 Host port.
- 10/100Mbps Ethernet with RJ-45 LAN Jack.



Figure 10.2 Odroid X2 for processing the images from webcam
(*hardkernel.com, 2013*).

The Firmware of the robot to control the servos is modified from the original one named Robotis Firmware due to the limitation for sending a motion command by serial interface based on Peter Lanius works published in google code (Lanius, 2013). This firmware instead using RoboTask to program the robot controlling its movement but it directly program the AVR Microcontroller inside the CM-510 controller using C language. Using this alternative can reduce the size of the program from originally 170KB to 70KB in the memory. By this firmware, the robot can be connected directly to Ball Tracking System using USB Serial Interface to command its motion. Based on this framework, it opens an opportunity to built Real Time Operating System for the robot. The robot's control starts with initialization routines of CM-510 controller then move to Wait for Start Button state. In this state, it waits the button to be pressed to change the start_button_pressed variable from FALSE to TRUE then move to Dynamixel and Gyro Initialization which send broadcast ping to every Dynamixel servo connected to CM-510. When one or more servos do not respond of the ping then CM-510 will send a message mentioning the failure of a servo to serial terminal. Gyro Initialization does gyro calibration in the robot to get center reference and sends the value to serial terminal. Next state is Waiting Motion Command that waits the command through serial interface, from terminal or tracking module, then check if the command is valid or not. If it does not valid then the state will repeat to Wait Motion Command or continue

to next Execute Motion Command state when the command is valid. Execute Motion Command executes a motion command to move a servos based on defined Look-Up-Table (LUT).

For example, when a command says WALKING then the state looks servo's values for WALKING stored in the LUT then sends it to Dynamixel servo through serial bus. When a motion is completed then it move to preceding state but if there is an emergency which is determined by pressing start button when the servos is moving compared to command input which does not receive stop command, then it move to Dynamixel Torque Disable to disable all the servo's torque to save from damage and move to Wait for Start Button state. The improved system to accept commands from the main controller is shown as the state machine in figure 10.3.

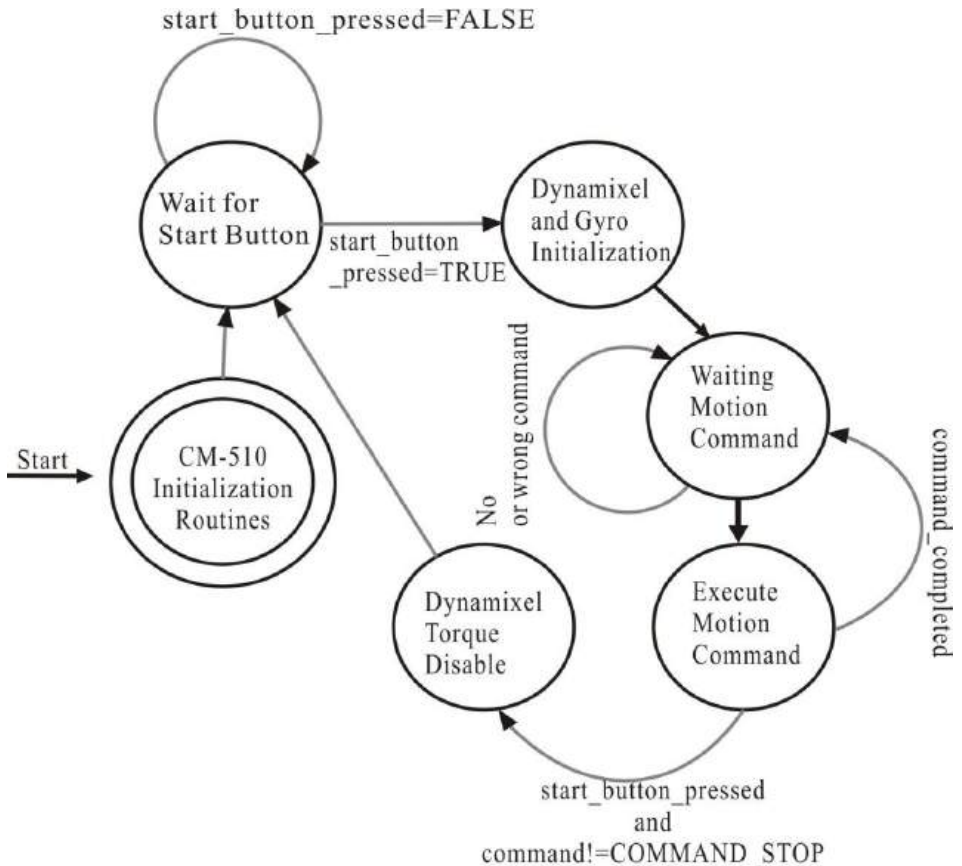

Figure 10.3 State machine of the robot's controller.

Ball Distance Estimation and Tracking Algorithm

Computer vision is one of the most challenging applications in sensor systems since the signal is complex from spatial and logical point of view. An active camera tracking system for humanoid robot soccer tracks an object of interest (ball) automatically with a pan-tilt camera. We use OpenCV for converting to HSV (Hue Saturation-Value), extract Hue & Saturation and create a mask matching only the selected range of hue value (Szeliski, 2010).

To have a good estimation, the object must be in the centre of the image, i.e. it must be tracked. Once there, the distance and orientation are calculated, according to the neck's origin position, the current neck's servomotors position and the position of the camera in respect to the origin resulting of the design (Maggi, 2007). We considered method for distance estimation of the ball by centering the ball on the camera image, using the head tilt angle to estimate the distance to the ball.

Region growing algorithms are also used to locate the ball color blobs that have been identified by region growing and are useful and robust source for further image processing, as demonstrated by (Ghanai, 2009). The ball will be tracked based on the color and webcam will track to adjust the position of the ball to the center of the screen based on the Algorithm 1.

Algorithm 1: Ball tracking and Kick the ball

```
Get input image from the camera
Convert to HSV (Hue-Saturation-Value)
Extract Hue & Saturation
Create a mask matching only for the selected range of hue
Create a mask matching only for the selected saturation levels.
Find the position (moment) of the selected regions.
If ball detected then
  Estimate distance of the ball
  Object tracking using Kalman Filter
  centering the position of the ball
  Move robot to the ball
  If ball at the nearest position with the robot then
    Kick the ball
endif
```

endif

The estimated position (\hat{x}, \hat{y}) from Kalman filter is used as an input to PID controller. We use a PID controller to calculate an error value as the difference between a measured (input) and a desired set point to control high speed HS-85 servos. The controller attempts to minimize the error by adjusting (an Output). The model of PID Controller is shown in figure 10. 4:

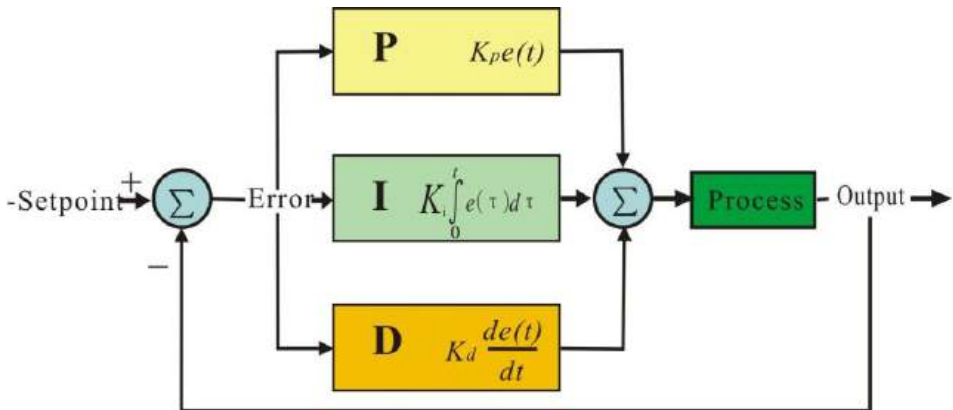

Figure 10.4 General PID Controller.

The output of a PID controller, equal to the control input to the system, in the time-domain is as follows:

$$u(t) = K_p e(t) + K_i \int e(t) dt + K_d \frac{de}{dt} \quad (10.1)$$

A Framework of Multiple Moving Obstacles Avoidance Strategy

Because we want a general model for humanoid service robot, we propose a framework for multiple moving obstacles avoidance strategy using stereo vision. A multiple moving obstacle avoidance strategy is an important framework to develop humanoid service robot in dynamic environment. There are two main actors on multiple moving obstacles avoidance system; the Robot itself and the Range Finder. The Robot interacts with this system to detect customer and determine moving obstacles. Both processes to detect customer and determine moving obstacles include a process of face recognition as explained before. After the obstacles are determined, The Range Finder (camera and its system) will calculate and estimate the distance of those moving obstacles and estimate

the direction of moving obstacles. Direction estimation of obstacles will be used to determine optimal maneuver of the Robot to avoid those obstacles. The framework is shown in figure 10.5:

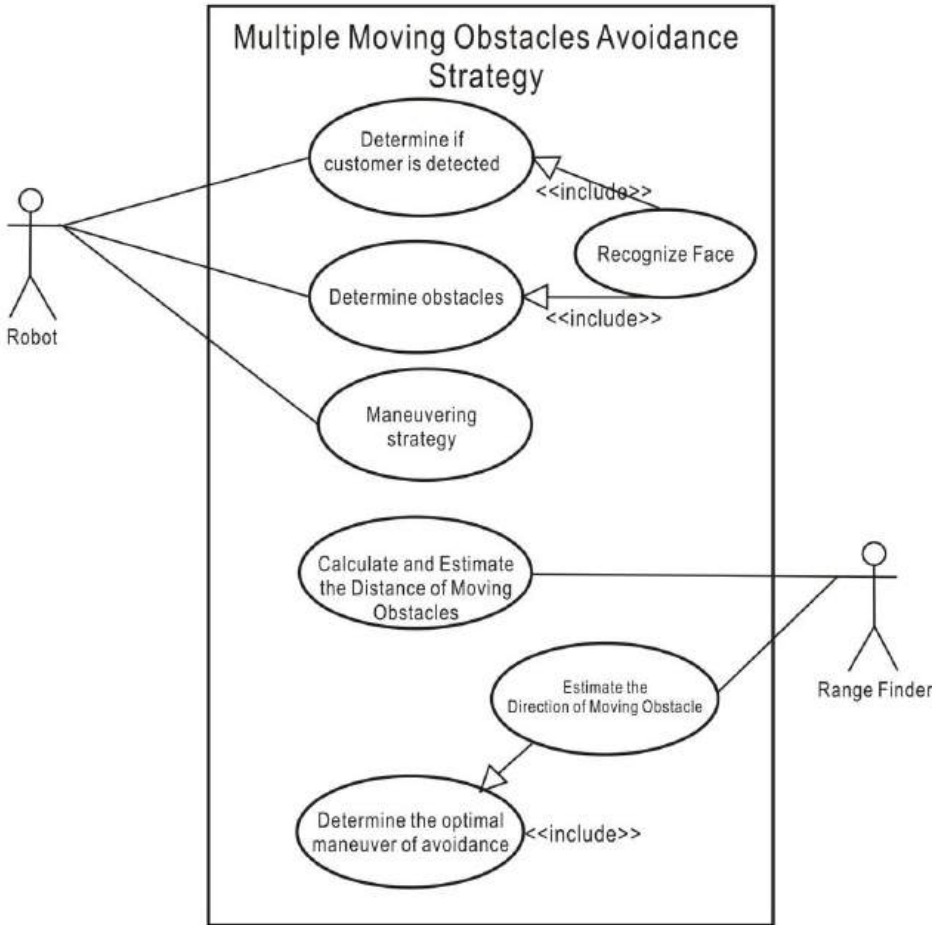

Figure 10.5 The use case diagram for our multiple moving obstacles avoidance strategy using stereo vision.

Visual perception is the ability to interpret the information and surroundings from the effects of visible light reaching the eye. The resulting perception is also known as eyesight, sight, or vision. Visual-perception-based of service robot for customer identification is an interpretation process to direct a service robot to a destination of identified customer based on face recognition system and computer vision. After interpretation of images from camera done, then it is

used as information for the robot and to decide actions based on the task given by a developer. The basic of visual-perception model for a humanoid service robot is shown in figure 10.6:

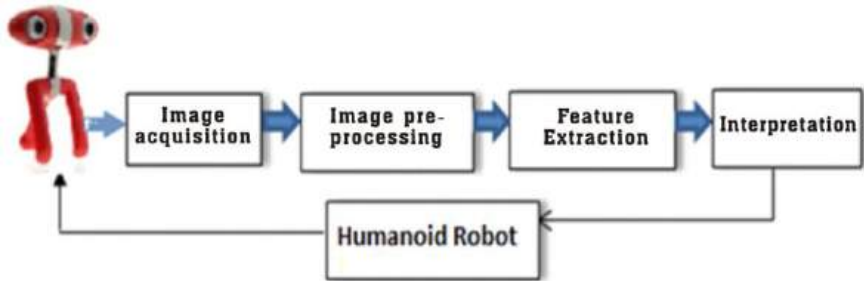

Figure 10.6 Visual-perception model for vision-based humanoid robot. After interpretation process, the information used for navigating the robot or deciding actions for robot, such as direct a robot to customer's position.

Experiments

Object detection and segmentation is the most important and challenging fundamental task of computer vision. It is a critical part in many applications such as image search, image auto-annotation and scene understanding. However it is still an open problem due to the complexity of object classes and images. The easiest way to detect and segment an object from an image is the color based methods. The colors in the object and the background should have a significant color difference in order to segment objects successfully using color based methods.

We need a webcam to try detecting a ball using this program demo. Create an application using Visual C++ 2010 Express edition and OpenCV. Configure the properties and write a program below:

ColorBased.cpp:

```

//Demo Program of Color-Based Detection for a Ball
//Copyright Dr. Widodo Budiharto 2014

#include "stdafx.h"
#include <cv.h>
#include <highgui.h>

// threshold image HSV
  
```

```
IplImage* GetThresholdedImage(IplImage* imgHSV){
    IplImage*
    imgThresh=cvCreateImage(cvGetSize(imgHSV),IPL_DEPTH_8U, 1);
    cvInRangeS(imgHSV, cvScalar(170,160,60), cvScalar(180,256,256),
    imgThresh);
    return imgThresh;
}

int main(){
    CvCapture* capture =0;
    capture = cvCaptureFromCAM(0);
    //set width and height
    cvSetCaptureProperty( capture, CV_CAP_PROP_FRAME_WIDTH, 640 );
    cvSetCaptureProperty( capture, CV_CAP_PROP_FRAME_HEIGHT, 480);

    if(!capture){
        printf("Capture failure\n");
        return -1;
    }

    IplImage* frame=0;
    cvNamedWindow("Video");
    cvNamedWindow("Ball");

    //iterasi frame
    while(true){
        frame = cvQueryFrame(capture);
        if(!frame) break;
        frame=cvCloneImage(frame);
        //smooth the original image using Gaussian kernel
        cvSmooth(frame, frame, CV_GAUSSIAN,3,3);
        IplImage* imgHSV = cvCreateImage(cvGetSize(frame), IPL_DEPTH_8U,
        3);
        //ubah formwat color dari BGR ke HSV
        cvCvtColor(frame, imgHSV, CV_BGR2HSV);
        IplImage* imgThresh = GetThresholdedImage(imgHSV);
        //smooth the binary image using Gaussian kernel
        cvSmooth(imgThresh, imgThresh, CV_GAUSSIAN,3,3);
        cvShowImage("Ball", imgThresh);
    }
}
```



```
cvShowImage("Video", frame);

//bersihkan images
cvReleaseImage(&imgHSV);
cvReleaseImage(&imgThresh);
cvReleaseImage(&frame);

//tunggu 50sec
int c = cvWaitKey(10);
//If 'ESC' is pressed, break the loop
if((char)c==27 ) break;
}
cvDestroyAllWindows() ;
cvReleaseCapture(&capture);
return 0;
}
```

The approach proposed in this paper was implemented and tested on a humanoid Robot named Humanoid Robot Soccer Ver 2.0 based on Bioloid Premium Robot. By modify the robot's controller (CM-510) in order to accept serial command from the main controller, this system able to communicate efficiently.

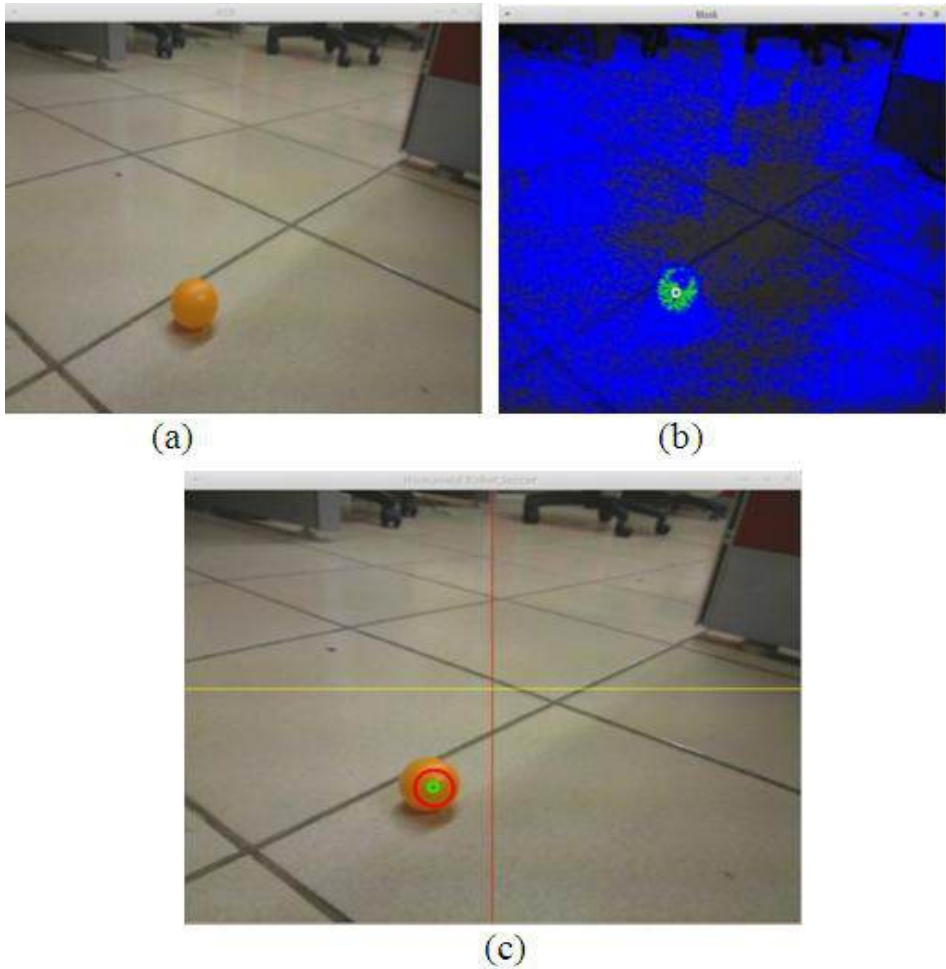

Figure 10.7 The original image (a), the mask (a) and ball detected and tracked using Kalman Filters in the green circle (b).

When a ball is in front of the robot and has been detected, the robot tries to track the ball, and if the ball at the nearest position with the robot, robot will kick it as shown in figure 10.8.

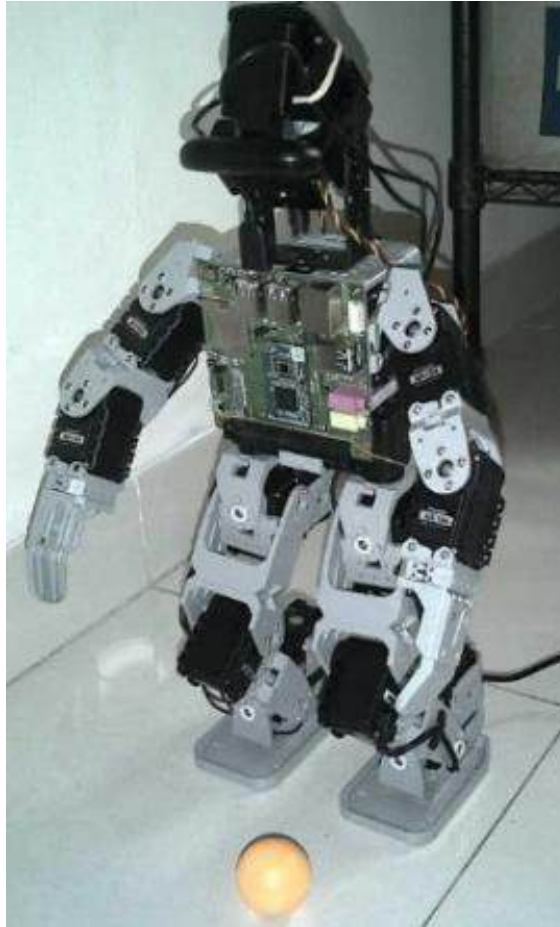

Figure 10.8 The robot tracks and kicks a ball when at the correct position [13].

Object Detection Using Keypoint and Feature Matching

The color-based object detector works well only for single-colored objects and can be fooled by different object of the same color, but color-based object detection is very fast. If you want to design the vision system for intelligent robot, you should obviously not rely on color for detecting object, because you don't know what the working environment of your robot will look like. So, we use Machine Learning and Object detection based on keypoints. In this method, the computer “learn” the characteristics of the whole object template and look

for similar instances in other images. SIFT (Scale Invariant Feature Transform) is a famous algorithm for keypoint extraction and description) keypoints, and the matching descriptors between the two images.

Keypoint descriptors are also often called features. Object detection using SIFT is scale and rotation invariant. The algorithm will detect object that have the same appearance but a bigger or smaller size in the test image compared with the training images. Use the `FlannBasedMatcher` interface in order to perform a quick and efficient matching by using the FLANN (Fast Approximate Nearest Neighbor Search Library). SURF is a class for extracting Speeded Up Robust Features from an image. In short, SURF adds a lot of features to improve the speed in every step. OpenCV provides SURF functionalities just like SIFT. You initiate a SURF object with some optional conditions like 64/128-dim descriptors, Upright/Normal SURF, etc.

The features are invariant to image scaling, translation, and rotation, and partially in-variant to illumination changes and affine or 3D projection. Features are efficiently detected through a staged filtering approach that identifies stable points in scale space [14]. The first stage of keypoint detection is to identify locations and scales assigned under differing views of the same object. Detecting locations that are invariant to scale change of the image can be accomplished by searching for stable features across all possible scales, using a continuous function of scale known as scale space. It has been shown by Koenderink and Lindeberg that under a variety of reasonable assumptions the only possible scale-space kernel is the Gaussian function. Therefore, the scale space of an image is defined as a function, $L(x, y, \sigma)$, that is produced from the convolution of a variable-scale Gaussian, $G(x, y, \sigma)$, with an input image, $I(x, y)$:

$$L(x, y, \sigma) = G(x, y, \sigma) * I(x, y). \quad (10.2)$$

Where $*$ is the convolution operation in x and y , and:

$$G(x, y, \sigma) = (1/2\pi\sigma^2) e^{-(x^2+y^2)/2\sigma^2}. \quad (10.3)$$

To efficiently detect stable keypoint locations in scale space, we use scale-space extrema in the difference-of-Gaussian function convolved with the image:

$$\begin{aligned} D(x, y, \sigma) &= [G(x, y, k\sigma) - G(x, y, \sigma)] * I(x, y) \\ &= L(x, y, k\sigma) - L(x, y, \sigma) \end{aligned} \quad (10.4)$$

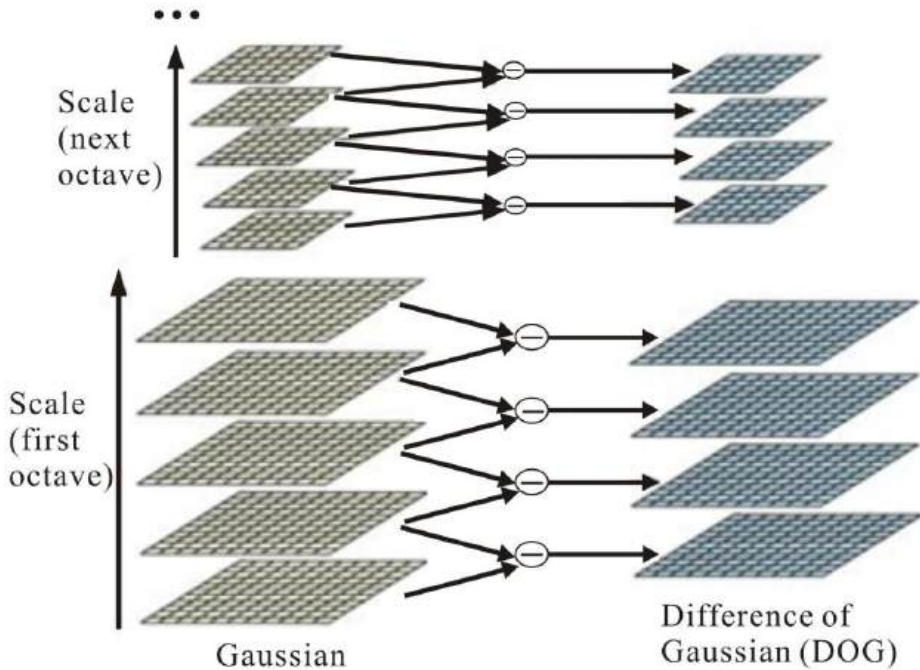

Figure 10.9 Gaussian scale-space pyramid create an interval in the difference-of-Gaussian pyramid.

Laplacian of Gaussian acts as a blob detector which detects blobs in various sizes due to change in σ . In short, σ acts as a scaling parameter. We can find the local maxima across the scale and space which gives us a list of (x,y,σ) values which means there is a potential keypoint at (x,y) at σ scale. But this LoG is a little costly, so SIFT algorithm uses Difference of Gaussians which is an approximation of LoG. Difference of Gaussian is obtained as the difference of Gaussian blurring of an image with two different σ , let it be σ and $k\sigma$. This process is done for different octaves of the image in Gaussian Pyramid. It is represented in below image. Once this DoG are found, images are searched for local extrema over scale and space. In order to detect the local maxima and minima of $G(x, y, \sigma)$, each sample point is compared to its eight neighbors in the current image and nine neighbors in the scale above and below:

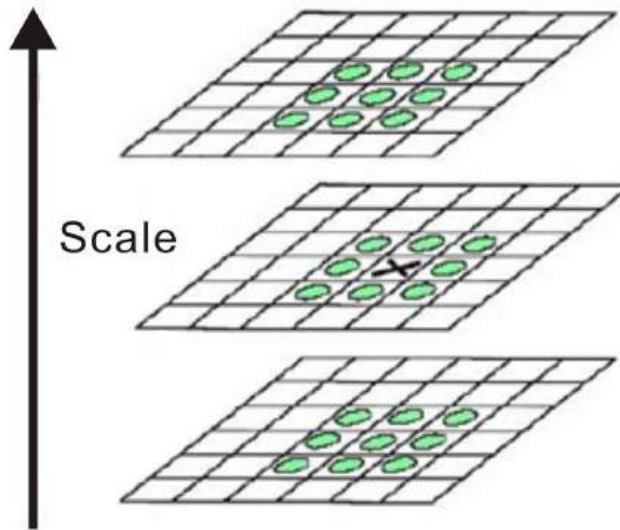

Figure 10.10 Maxima and minima detection in the difference-of-Gaussian image.

In 2004, D.Lowe, from University of British Columbia, [14] proposed how to extracting keypoints and computing descriptors using the Scale Invariant Feature Transform (SIFT). Keypoints are detected using scale-space extrema in difference-of-Gaussian function D and efficient to compute. Here is a sample program using a template file and webcam for SIFT keypoint detector using FLANN.

FLANN.cpp:

```
#include "stdafx.h"
#include <iostream>
#include <conio.h>
#include <stdio.h>
#include <cv.h>
#include <highgui.h>
#include "opencv2/core/core.hpp"
#include "opencv2/features2d/features2d.hpp"
#include "opencv2/highgui/highgui.hpp"
#include "opencv2/nonfree/features2d.hpp"
using namespace std;
using namespace cv;
```

```
int main()
{
    int i=0;
    CvRect in_box,output_box;
    Mat train=imread("template3.jpg"), train_g;
    cvtColor(train,train_g,CV_BGR2GRAY);
    //detect SIFT keypoints
    vector<KeyPoint> train_kp;
    Mat train_desc;
    SiftFeatureDetector featureDetector;
    featureDetector.detect(train_g,train_kp);
    SiftDescriptorExtractor featureExtractor;
    featureExtractor.compute(train_g, train_kp, train_desc);
    //FLANN based descriptor matcher object
    FlannBasedMatcher matcher;
    vector<Mat> train_desc_collection (1,train_desc);
    matcher.add(train_desc_collection);
    matcher.train();
    //VideoCapture object
    VideoCapture cap(0);
    unsigned int frame_count=0;
    while (char(waitKey(1)) !='q') {
        double to=getTickCount();
        Mat test, test_g;
        cap>>test;
        if (test.empty())
            continue;
        cvtColor(test,test_g,CV_BGR2GRAY);
        //detect SIFT keypoint and extract descriptors in the
        test image
        vector<KeyPoint> test_kp;
        Mat test_desc;
        featureDetector.detect(test_g, test_kp);
        featureExtractor.compute(test_g,test_kp,test_desc);
        //match train and test descriptors, getting 2 nearest
        neighbors for all test descriptors
        vector<vector<DMatch> > matches;
```

```
matcher.knnMatch(test_desc,matches,10);
//filter for good matches according to Lowe's algorithm
vector<DMatch> good_matches;
Mat img_show;
vector<KeyPoint> keypoints_1;
vector<KeyPoint> keypoints_2;
for ( i=0;i<matches.size();i++) {
if (matches[i][0].distance <
0.5*matches[i][1].distance)
{
good_matches.push_back(matches[i][0]);
}
}
//-- Localize the object
std::vector<Point2f> obj;
std::vector<Point2f> scene;

drawMatches(test,test_kp, train, train_kp, good_matches,
img_show,Scalar::all(-1), Scalar::all(-
1),vector<char>(),DrawMatchesFlags::NOT_DRAW_SINGLE_POINTS);
Point2f point1;
int average_X=0;int average_Y=0;
if (good_matches.size() >= 4){
for( int i = 0; i < good_matches.size(); i++ )
{
//-- Get the keypoints from the good matches
obj.push_back( train_kp[ good_matches[i].trainIdx ].pt );
scene.push_back(test_kp[ good_matches[i].queryIdx ].pt );
point1=test_kp[ good_matches[i].queryIdx ].pt;
average_X+=point1.x; //get the coordinate of x
}
average_X=(average_X)/good_matches.size();
printf("pointx: %d pointy: %d \n",point1.x, point1.y);
cv::rectangle(img_show , cvPoint( average_X-55, point1.y-50) ,
cvPoint( average_X+50, point1.y+50) , Scalar( 255, 0, 255),
1 );
}
imshow("Matches", img_show);
```



```
cout<<"Frame rate="<<getTickFrequency() / (getTickCount() -  
t0)<<endl;  
}  
return 0;  
}
```

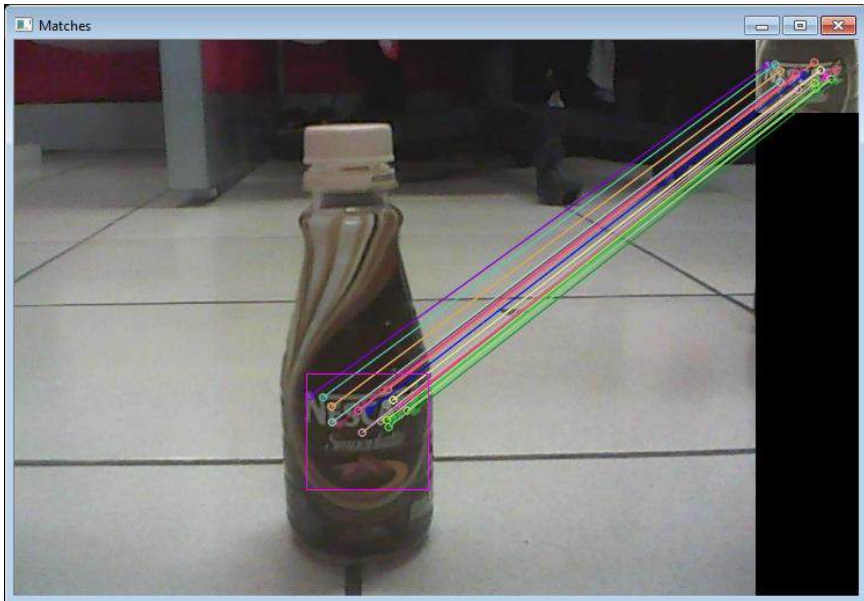

Figure 10.11 Robust Object detector using FLANN based matcher, rectangle line used to get center position of the object.

References

- [1] Adrian Kaehler & Garry Bradksy, Learning OpenCV: Computer Vision in C++ with the OpenCV Library, O'Reilly Publisher, 2014.
- [2] Samarth Brahmbatt, Practical OpenCV, Technology in Action Publisher, 2013.
- [3] Daniel bagio et al., Mastering OpenCV with Practical Computer Vision Project, Packt Publisher, 2012.

Chapter 11

Vision-Based Obstacles Avoidance

On successful completion of this course, students will be able to:

- Describe the problem of obstacle avoidance in service robot.
- Develop a program for obstacle avoidance using probabilistic robotics.

Introduction

In recent years, service robots developed for various applications such as the personal, medical and welfare robots. Technologies and methods used for service robots increased drastically to make it more intelligent, and resulting these kind of robots available commercially. Among the indoor service robots, those that are able to operate in environments with humans, and especially those that are able to interact with the customer have gained high interest in recent years. The major task routinely performed by a service robot (for example deliver a cup, picking a cup and human robot interaction) are based on visually perceived information. In order a service robot perform such tasks, they must also have the ability to perceive and act upon visual information. Computer Vision is a an important tools for robotics systems since it mimics the human sense of vision and allows for non-contact measurement of the environment. A good program using vision sensor will make a service robot have the ability to detects and identifies detailed object around it (such as face recognition, distance measurement of obstacle, and free area for path planning). The main concern when develop a service robot is obstacle avoidance system and the implementation of stereo camera as an important vision sensor.

Obstacle Avoidance of Service Robot

The development of an obstacle avoidance system for robots to accurately detect moving obstacles in indoors is challenging task. The navigation and obstacle avoidance strategy are the important aspects in a vision-based service robot. Bayesian techniques provide a powerful statistical tool to help manage measurement uncertainty and perform multisensor fusion and identity estimation. The advantages of probabilistic robotics are able to accommodate imperfect sensors (such as camera with noises), robust in real world applications and best known approach to many hard robotics problem. Based on literatures obtained by the authors, many research in development of service robot such as

[1][2], whereas task of the service robot is the setting and clearing of tables in a controlled environment without stereo camera. However, there is no multiple moving obstacles avoidance method for service robot in indoor environment exposed especially using stereo camera. The contribution of this chapter is the introduction of a new method of multiple moving obstacles avoidance for service robots using a stereo camera in indoor environment.

A mobile robot involving two actuator wheels is considered as a system subject to nonholonomic constraints and usually using fuzzy logic to control the motor [5]. Consider an autonomous wheeled mobile robot and position in the Cartesian frame of coordinates shown in Figure 11.1, where x_R and y_R are the two coordinates of the origin P of the moving frame and θ_R is the robot orientation angle with respect to the positive x-axis. The rotation angle of the right and left wheel denoted as φ_r and φ_l and radius of the wheel by R thus the configuration of the mobile robot q_R can be described by five generalized coordinates such as:

$$q_R = (x_R, y_R, \theta_R, \varphi_r, \varphi_l)^T \tag{11.1}$$

Based on Figure 11.1, v_R is the linear velocity, ω_R is the angular velocity, r_R and λ_R are radial and angular coordinate of the robot [6]. The kinematics equations of motion for the robot given by:

$$\dot{x}_R = v_R \cos \theta_R \tag{11.2}$$

$$\dot{y}_R = v_R \sin \theta_R \tag{11.3}$$

$$\dot{\theta}_R = \omega_R \tag{11.4}$$

The angular velocity of the right and left wheel can be obtained by:

$$\omega_r = \frac{d\varphi_r}{dt} \text{ and } \omega_l = \frac{d\varphi_l}{dt} \tag{11.5}$$

Finally, the linear velocity v_R can be formulated as:

$$v_R = R(\omega_r + \omega_l)/2 \tag{11.6}$$

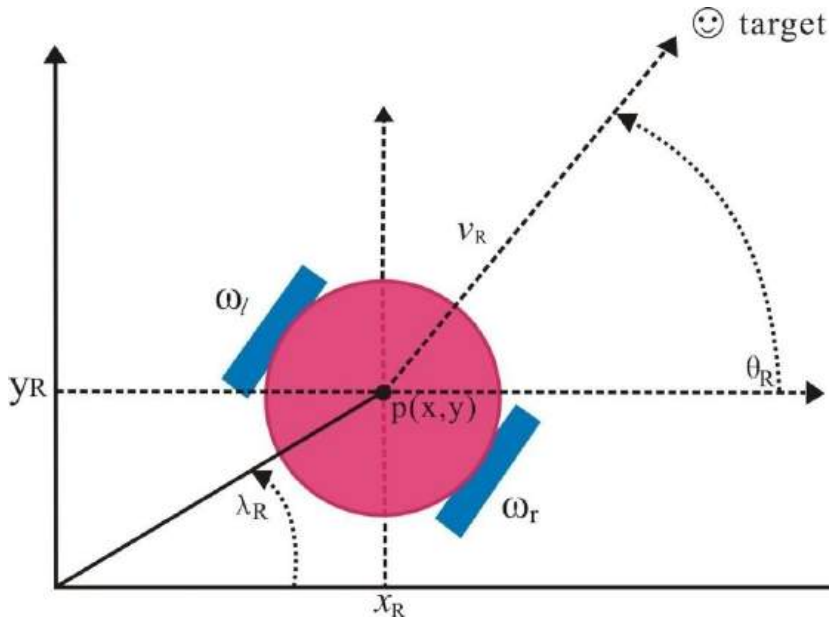

Figure 11.1 Cartesian representation of mobile robot.

Based on the model in Figure 11.1, we propose the model of a mobile robot using a stereo camera with a moving obstacle as shown in Figure 11.2. A camera as a vision sensor has limitations in view angle to capture an object, so we define θ_{Cam} as a maximum angle that moving obstacles can be detected by a camera used in this research. The location of an object shall consist of the object position and orientation.

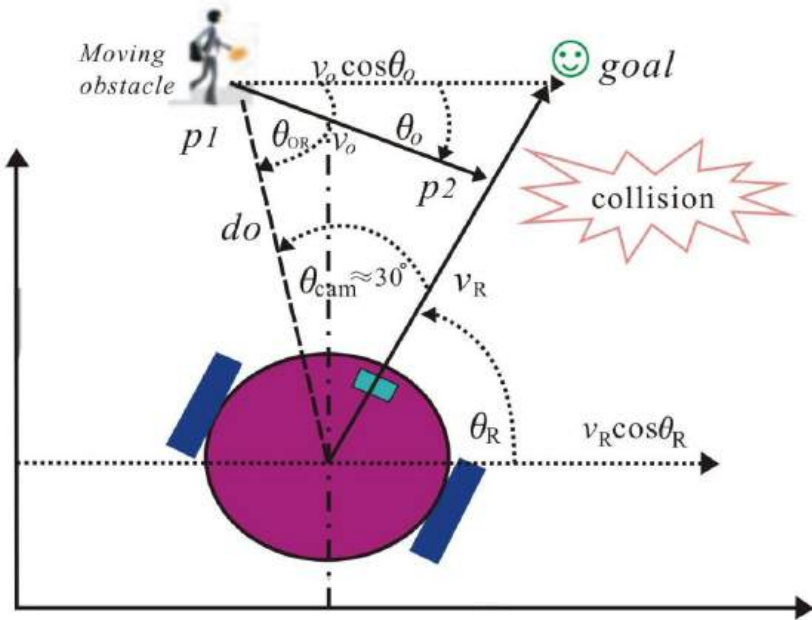
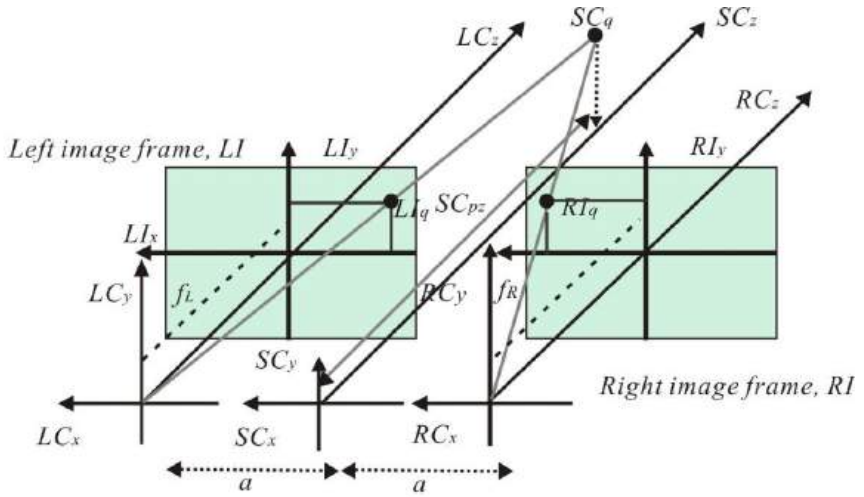

Figure 11.2 General cartesian model of mobile robot using stereo camera.

We have developed a vision-based service robot called Beebot to deliver a cup to customer with voice recognition and telepresence capabilities using Tugal EasyVR Shield for Arduino 2.0. The voice recognition system has the ability for users to create up to 28 of their own custom Speaker Independent (SI) Command Vocabularies using the Quick T2SI Lite Software (license available separately). Additionally the EeasyVR 2.0 includes SonicNet technology for wireless communication between modules or any other sound source. DTMF tone generation is also included.

Stereo Imaging Model

We have developed a system for face detection using Haar cascade classifier and depth estimation for measuring distance of peoples as moving obstacles using stereo vision. In the stereo imaging model, the three-dimensional points in stereo camera frame are projected in the left and the right image frame. On the contrary, using the projection of the points onto the left and right image frame, the three-dimensional points positions in stereo camera frame can be located. Figure 11.4 shows the stereo imaging model using the left front image frame *LF* and right front image frame *RF* [9].



Left camera frame, LC Stereo camera frame, SC Right camera frame, RC

Figure 11.3 Stereo Imaging model.

By using stereo vision, we can obtain the position of each moving obstacle in the images, then we can calculate and estimate the distance of the moving obstacle. Kalman filtering used for the stability of the distance estimation. The three-dimensional point in stereo camera frame can be reconstructed using the two-dimensional projection of point in left front image frame and in right front image frame using formula :

$${}^{SC}\mathbf{q} = \begin{bmatrix} {}^{SC}q_x \\ {}^{SC}q_y \\ {}^{SC}q_z \end{bmatrix} = \frac{2}{{}^{RI}q_x - {}^{LI}q_x} \begin{bmatrix} \frac{1}{2}a({}^{RI}q_x + {}^{LI}q_x) \\ a {}^{RI}q_y \\ f a \end{bmatrix} \quad (7)$$

Note that ${}^{LI}q_y = {}^{RI}q_y$

To estimate the direction $\theta_{direction}$ of moving obstacle using stereo vision, we calculate using the figure and formula below:

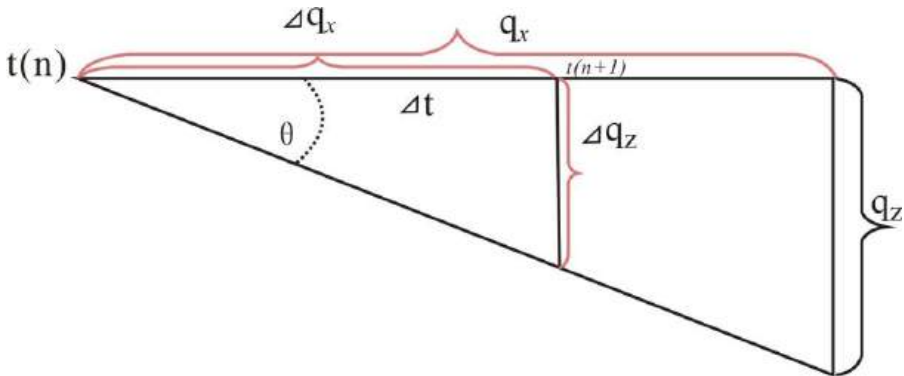

Figure 11.4 Direction estimation using stereo vision.

$$\theta_{direction} = \arctan \left(\frac{\Delta q_z}{\Delta q_x} \right) \tag{8}$$

Probabilistic Robotics for Multiple Obstacle Avoidance Method

Camera as vision sensor sometimes have distortion, so Bayesian decision theory used to state estimation and determine the optimal response for the robot based on inaccurate sensor data. Bayesian decision rule probabilistically estimate a dynamic system state from noisy observations. Examples of measurement data include camera images and range scan. If x is a quantity that we would like to infer from y , the probability $p(x)$ will be referred to as prior probability distribution. The Bayesian update formula is applied to determine the new posterior $p(x, y)$ whenever a new observation is obtained:

$$p(x, y) = \frac{p(y|x, z)p(x|z)}{p(y|z)} \tag{11.9}$$

To apply Bayesian approach for obstacle avoidance where someone who walks with a direction indicated as an unexpected obstacle, we consider this obstacle to be a random event. The probabilistic information in z about θ is described by a conditional probability density function $p(z|\theta)$ of the observation vector z . Let Θ denote the state of the path to be a random variable consisting of four states:

$$\begin{aligned}\Theta &= (\theta_1, \theta_2, \theta_3, \theta_4) \\ &= (\text{obstacle}, \text{no_obstacle}, \text{direction_right}, \text{direction_left})\end{aligned}\quad (11.10)$$

If we want a service robot should stay on the path to goal in any case, strategies to avoid moving obstacle include:

- Maneuver to the right, if detected moving obstacle is moving toward the left. Maneuver to the left, if detected moving obstacle is moving toward the right.
- Stop, if moving obstacle too close to robot detected both by vision and ultrasonic sensors.

Then, we restrict the action space denoted as A as:

$$\begin{aligned}A &= (a_1, a_2, a_3) \\ &= \text{maneuver to right}, \text{maneuver to left}, \text{stop}\end{aligned}\quad (11.11)$$

We define a loss function $L(a, \theta)$ which gives a measure of the loss incurred in taking action a when the state is θ . The robot should chooses an action a from the set A of possible actions based on the observation z of the current state of the path θ . This gives the posterior distribution of θ as:

$$p(\theta | z) = \frac{p(z | \theta)p(\theta)}{\sum p(z | \theta)p(\theta)}\quad (11.12)$$

Then, based on the posterior distribution in (11.12), we can compute the posterior expected loss of an action [14]:

$$B(p(\theta | z), a) = \sum_{\theta} L(\theta, a)p(\theta | z)\quad (11.13)$$

Multiple Moving Obstacles Avoidance Method and Algorithm

We have proposed a method and algorithm of obstacles avoidance for service robot that run from start to goal position, giving a cup to customer and going back to home. This method will identify a customer, checking moving obstacles and its distance and take action for maneuver to avoid the collision. Stereo

camera used has limitation such as angle view, this camera only able to capture object in front of it about 30 °. So, when the robot starts to maneuver, the moving obstacle could be out of view area of camera. So for this experiment, we have proposes a predefined motion for maneuver based on the estimation speed and direction of moving obstacle.

Table 11.1 Actions to avoid moving obstacle.

No	Speed of moving obstacle	Direction of moving obstacle	Action
1	Low	Approach to robot	Maneuver slow
2	High	Approach to robot	Maneuver fast
3	Low	Infront of robot	Maneuver slow
4	High	Infront of robot	Maneuver slow

Figure below shows the proposed model of maneuvering on the service robot, pL which is the probability of moving obstacle leads to the left, and pR the probability of moving obstacle leads to the right. By estimating the direction of motion of the obstacle, then the most appropriate action to avoid to the right / left side can be determined, to minimize collision with these obstacles. If there are more than 1 moving obstacle, then robot should identified the nearest moving obstacle to avoid collision, and the direction of maneuver should be opposite with the direction of moving obstacle (Figure 7).

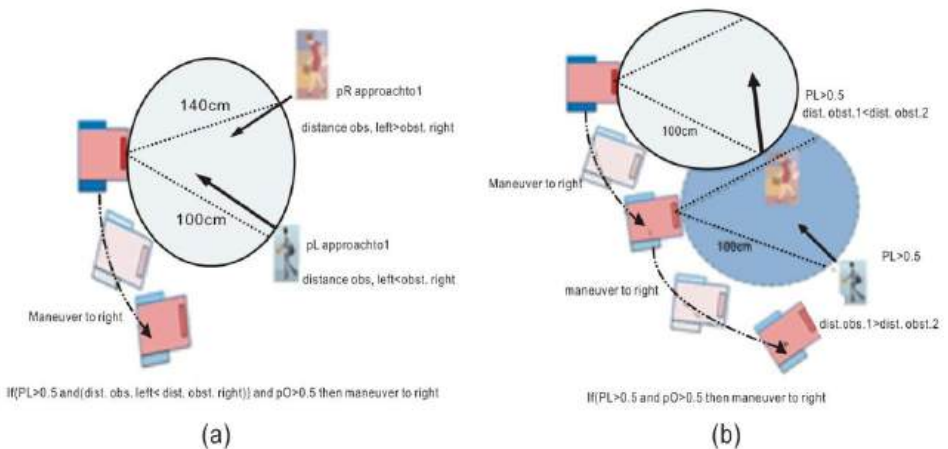

Figure 11.5 A maneuvering model to avoid multiple moving obstacle using stereo vision, 2 multiple moving obstacle with the different direction (a) and the same direction (b).

The flowchart of a Navigation system and multiple moving obstacles avoidance method for vision-based service robot using stereo camera shown in Figure 11.8. Based on the Figure 8, image captured by stereo camera used as testing images to be processed by Haar classifier to detect how many people in the images, and face recognition by PCA. We implement visual tracking for heading a robot to a customer. Robot continuously measures the distance of obstacle and send the data to Laptop. The next step is multiple moving obstacle detection and tracking. If there is no moving obstacle, robot run from start to goal position in normal speed. The advantage using stereo vision in our system is the ability to estimate the distance of customer/obstacles (depth estimation) and direction's movement of obstacles.

If moving obstacle appeared and collision will occurred, robot will maneuver to avoids obstacle. The proposed algorithms for obstacles avoidance shown below:

Algorithm 11.1. Multiple moving obstacles avoidance and maneuvering for service robot.

```

Checking a cup sensor // check if cup is loaded or no
Capture face's images
Face detection and recognition using PCA
if cup loaded and face recognized
    // Visual tracking using stereo vision
    While (customer !=center screen)
    begin
        Heading robot to customer's position
    end
if (position of customer at center screen)
begin
    Go to customer
    call movingObstaclesIdentification
    Bayesian processing
    if moving obstacle==true and min_distance=true and
goal=false
        maneuvering the robot
    end if
    Giving a glass
    Go to home

```

```
        end
    end if
end

// Function to detects and tracks a moving obstacle
function movingObstacleIdentification
    moving obstacle detection // Using Haar cascade
classifier
    if (moving_obstacle==true) then
        //estimate distance between robot and moving obstacle
using stereo vision
        distance estimation // Using Stereo camera and Kalman
filtering
        // estimate velocity and direction of moving obstacle
        Calculate  $V_0$  , direction
    Endif

Return  $V_0$  , direction
end function
```

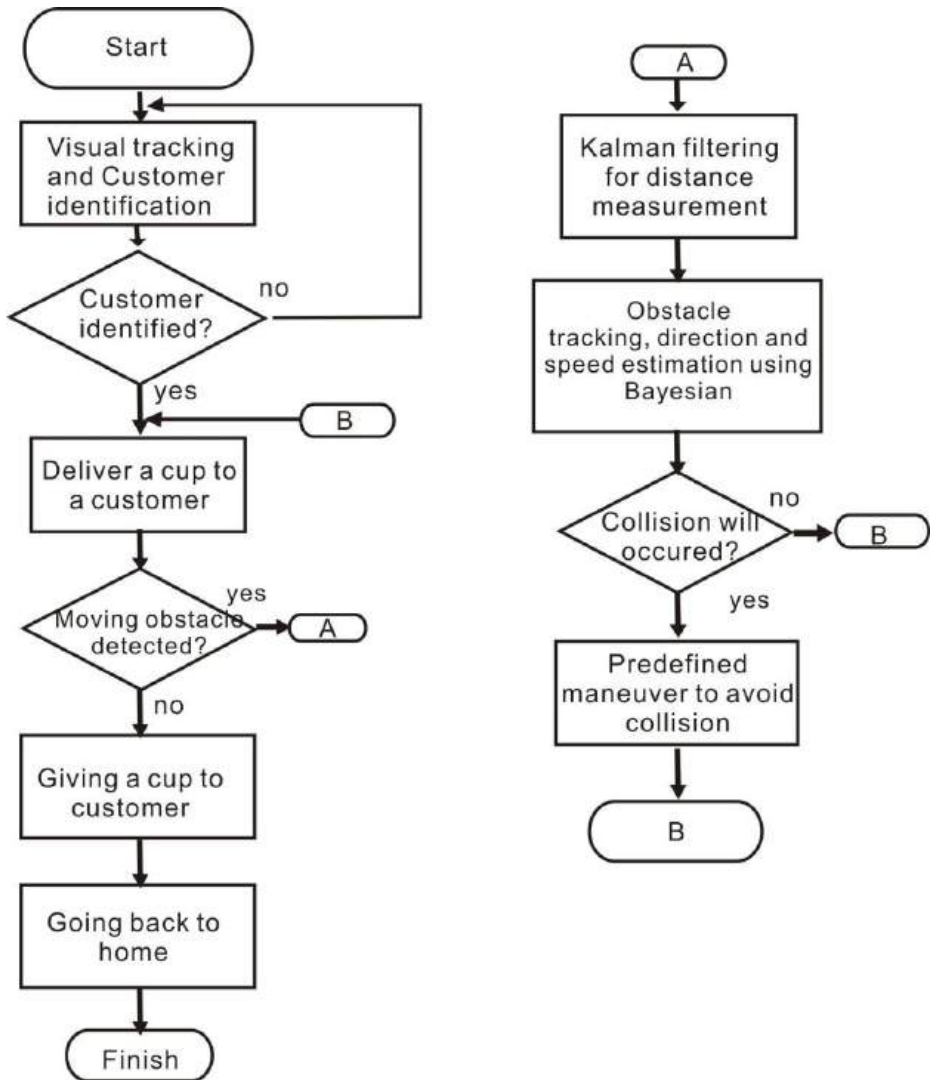

Figure 11.6 Flowchart of A Navigation system and Multiple moving obstacles avoidance method for vision-based service robot using stereo camera.

The result of improved face recognition system using PCA shown in Figure 11.7, where 1 customer successfully identified with his order. Before delivering a cup, visual tracking applied to directs a robot to an identified customer. Robot successfully goes to the identified customer using our proposed method.



Figure 11.7 An example of face detected and recognized together with his order using our framework of face recognition system.

Multiple Moving Obstacle Avoidance Using Stereo Vision

The result of identifying multiple moving obstacle shown in figure below, the advantages if we using stereo vision, we can estimate the distance and direction/angle of the moving obstacle. The value probability of obstacle/no obstacle also run well for make a robotics system more robust as as shown Figure 11.8.



(a)

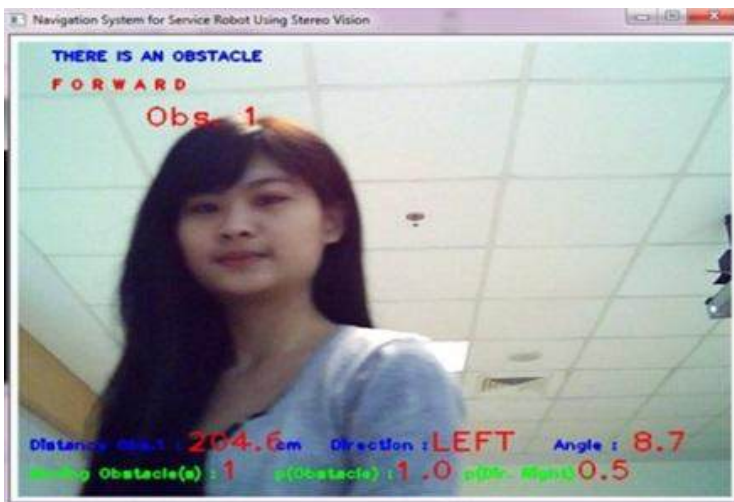

(b)

Figure 11.8 value probability of obstacle/no obstacle, (a). results of distance and direction estimation, (b). implementation of probabilistic robotics for moving obstacles avoidance using stereo images.

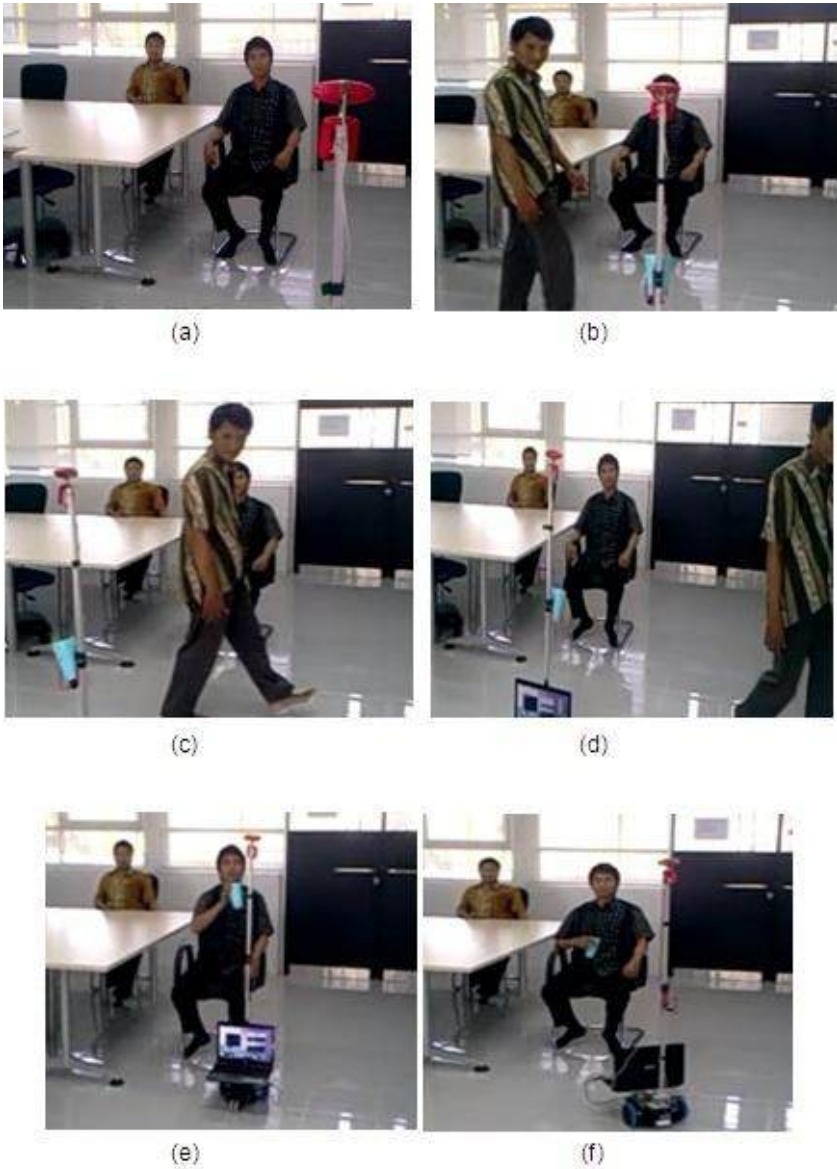

Figure 11.9 Result of moving obstacle avoidance using stereo vision and Bayesian approach. Sequence action of service robot shown from (a) until (f) to deliver a cup to an identified customer and go back to home.

For experiment delivering a cup to a customer, the setup experiment is in indoor where a customer and not customer sat on the chair, and there is

someone that walking as a moving obstacle as shown below. Robot successfully identifies a moving obstacle, avoid the collision, giving a cup to a customer then go back to home. For 10 (ten) times experiment using Bayesian approach, the success rate to identify moving obstacle is 90%, and without Bayesian approach is 60%. The very interesting video to show the action of this robot can be viewed at: <http://www.youtube.com/watch?v=n181CtvGJ88>.

References

- [1] Acosta, L., González, E.J., Rodríguez, J.N., Hamilton, A.F., Méndez J.A., Hernández S., Sigut S.M, and Marichal G.N. Design and Implementation of a Service Robot for A Restaurant. *International Journal of robotics and automation*. 2006; vol. 21(4); pp. 273-281.
- [2] Qing-wiau Y., Can Y., Zhuang F. and Yan-Zheng Z. Research of the Localization of Restaurant Service Robot. *International Journal of Advanced Robotic Systems*. 2010; vol. 7(3): pp. 227-238.
- [3] Chatib, O., Real-Time Obstacle Avoidance for Manipulators and Mobile Robots., *The International Journal of Robotics Research*, 1986; vol. 5(1), pp. 90-98.
- [4] Borenstein, J., Koren, Y., The Vector Field Histogram- Fast Obstacle Avoidance for Mobile Robots, in *proc. IEEE Trans. On Robotics and Automation*. 1991; vol 7(3): pp.278-288.
- [5] S. Nuryono, Penerapan Multi Mikrokontroler pada Model Robot Mobil Menggunakan Logika Fuzzy, *Journal Telkomnika*, 2009, vol. 7(3), pp. 213-218.
- [6] Masehian E., Katebi Y. Robot Motion Planning in Dynamic Environments with Moving Obstacles and Target. *International Journal of Mechanical Systems Science and Engineering*. 2007; vol. 1(1), pp. 20-29.
- [7] Budiharto, W., Purwanto, D. and Jazidie, A. A Robust Obstacle Avoidance for Service Robot using Bayesian Approach. *International Journal of Advanced Robotic Systems*. Intech Publisher – Austria. 2011; Vol. 8(1): pp. 52-60.
- [8] Budiharto, W., Purwanto, D. & Jazidie, A. A Novel Method for Static and Moving Obstacle Avoidance for Service robot using Bayesian Filtering. *Proceeding of IEEE 2nd International conf. on Advances in Computing, Control and Telecommunications Technology*.2010; pp. 156-160. DOI: 10.1109/ACT.2010.51.
- [9] Purwanto, D. Visual Feedback Control in Multi-Degrees-of-Freedom Motion System. PhD thesis at Graduate School of Science and Technology - Keio University, Japan. 2001.

- [10] Turk, M. & Pentland A. Eigenfaces for recognition. *International Journal of Cognitive Neuroscience*. 1991; vol. 3(1): pp. 71-86.
- [11] Belhumeur, P. & Kriegman, D. What is the set of images of an object under all possible illumination conditions. *International Journal of Computer Vision*. 1998; Vol. 28(3), pp. 245-260.
- [12] Etemad, K. & Chellappa R . Discriminant analysis for recognition of human face images. *Journal of the Optical Society of America A*. 1997; vol. 14(8): pp. 1724-1733.
- [13] Budiharto, W., Santoso A., Purwanto, D. and Jazidie, A. An Improved Face recognition System for Service Robot using Stereo Vision. In: Tudor Barbu Editor. *Face Recognition / Book 3*. Intech Publisher – Austria; 2011: pp. 1-12.
- [14] Hu, H. & Brady, M. A Bayesian Approach to Real-Time Obstacle Avoidance for a Mobile Robot. *Autonomous Robots*. 1994; vol. 1: pp. 69-92.

Chapter 12

Vision-Based Manipulator

On successful completion of this course, students will be able to:

- Explain how the manipulator works.
- Describe types of manipulator.
- Develop a vision-based manipulator.

Introduction

One of the most common of manipulation tasks is grasping an object. Tasks performed by humans involve some form of grasping action. In the absence of feedback, the grasping action cannot be completed effectively. A human being grasps an object almost invariably with the aid of vision. We use visual information to identify and locate the object, and then decide how to grasp them.

Inverse Kinematics

In a two-joint arm robot, given the angles of the joints, the kinematics equations give the location of the tip of the arm. Inverse kinematics refers to the reverse process. Given a desired location for the tip of the robotic arm, what should the angles of the joints be so as to locate the tip of the arm at the desired location? There is usually more than one solution and can at times be a difficult problem to solve. In a 2-dimensional input space, with a two-joint robotic arm and given the desired co-ordinate, the problem reduces to finding the two angles involved. The first angle is between the first arm and the ground (or whatever it is attached to). The second angle is between the first arm and the second arm.

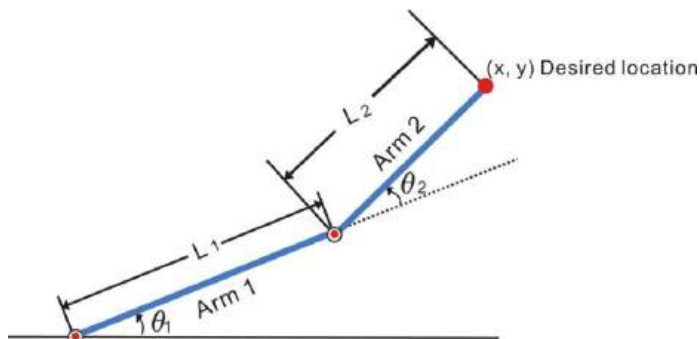

Figure 12.1 inverse kinematics for 2 DOF arm robot[12].

For simple structures like the two-joint robotic arm, it is possible to mathematically deduce the angles at the joints given the desired location of the tip of the arm. However with more complex structures (eg: n-joint robotic arms operating in a 3-dimensional input space) deducing a mathematical solution for the inverse kinematics may prove challenging. Using fuzzy logic, we can construct a Fuzzy Inference System that deduces the inverse kinematics if the forward kinematics of the problem is known, hence sidestepping the need to develop an analytical solution.

Vision-Based Manipulator

Most work in robotic manipulation assumes a known 3-D model of the object and the environment, and focuses on designing control and planning methods to achieve a successful and stable grasp in simulation environments. Grasping is usually preceded by a number of tasks that effect the final grasping action. The sequence of steps involved is:

- 1) The movement of the end-effector from a given position to within a reaching position from the object.
- 2) The estimation of grasp points and orientation of the end-effector to perform the grasp operation.
- 3) The grasping action, once the end effector is in the appropriate position.

Based on the previous literature (visual-servoing) is huge and largely unorganized. A variety of methods have been proposed to solve vision-based manipulation [1-5]. They use vision to aid just one of the above mentioned steps. In the past, most approaches to robotic grasping [6] [7] assume availability of a complete 3-D model of the object to be grasped. In practice, however, such a model is often not available—the 3D models obtained from a stereo system are often noisy with many points missing, and 3-D models obtained from a laser system are very sparse. This makes grasping a hard problem in practice. In more general grasping, Kamon et al. [8] used Q-learning to control the arm to reach towards a spherical object to grasp it using a parallel plate gripper.

For grasping 2D planar objects, most prior work focuses on finding the location of the fingers given the object contour, which one can find quite reliably for uniformly colored planar objects lying on a uniformly colored table top. Using local visual features (based on the 2-d contour) and other properties such as force and form closure, the methods discussed below decide the 2D location at which to place the fingertips (two or three) to grasp the object.

Edsinger and Kemp [9] grasped cylindrical objects using a power grasp by using visual servoing and do not apply to grasping for general shapes. An inverse kinematic solver is proposed in [10] to find all joint angles for given position of the effectors on the manipulator. The target object is recognized by color segmentation. The 3D position is computed by the stereo vision system after contour extraction.

Inverse kinematics of manipulator and object location are the key technology for arm robot. We study various visual feedback methods from previous literature and develop a new model for grasping a bottle. We know that Extraction of image information and control of a robot are two separate tasks where at first image processing is performed followed by the generation of a control sequence. A typical example is to recognize the object to be manipulated by matching image features to a model of the object and compute its pose relative to the camera (robot) coordinate system. In general method, first the target object is recognized by the vision system which then estimates the 3D pose of the object. Based on this information, the controller coordinates to move the arm robot to grasp the object/bottle. The framework proposed in this experiment shown in fig. 12.2 below, where the stereo camera for pose estimation attached about 50cm at the side of manipulator.

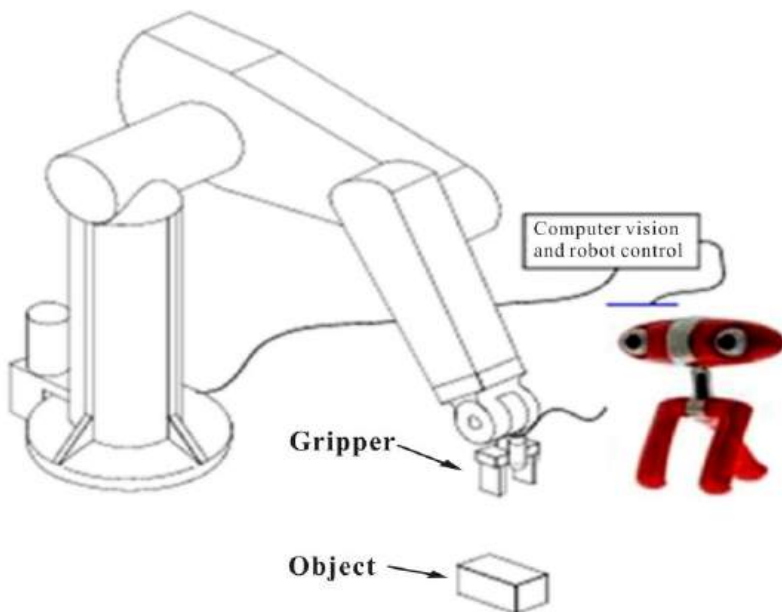

Figure 12.2 example of vision-based grasping using stereo vision.

We developed a framework of vision-based arm robot using 4 DOF (Degree of Freedom) arm robot from Lynxmotion that able to delivers fast, accurate, and repeatable movement. The robot features: base rotation, single plane shoulder, elbow, wrist motion, a functional gripper, and optional wrist rotate as shown in figure 12.3. This robotic arm is an affordable system with a time tested rock solid design that will last and last.



Figure 12.3 4 DOF arm robot using stereo vision used in the experiment.

The specification of this manipulator:

Base: Height = 6.9 cm

Hand/Grip: Max Length (No Wrist Rotate) = 8.7 cm

Hand/Grip: Max Length (With LW Rotate) = 11.3 cm

Hand/Grip: Max Length (With HD Rotate) = 10.0 cm

Length: Forearm = 12.7 cm

Length: Arm = 11.9 cm

Grasping Model

Grasp determination is probably one of the most important questions from manipulation point of view. Usually, the object is of unknown shape. In our model, we propose a simple way, if we know the distance of the bottle then move the arm to that position, then when the center point of a bottle exactly meet the center point of the gripper, then it means that is the time for grasping the bottle/object as shown in figure 12.4:

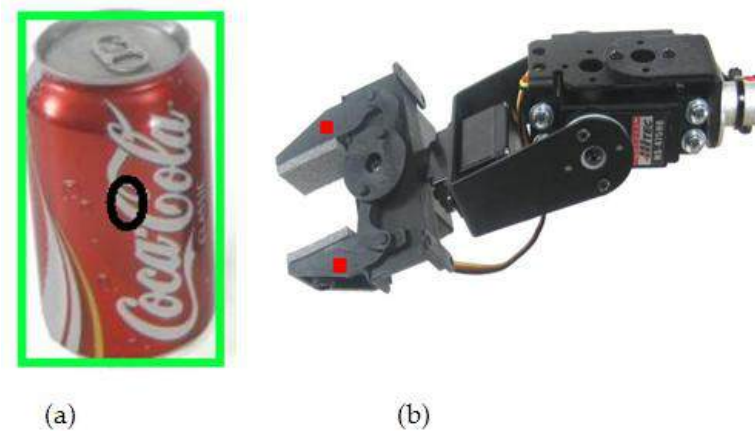

Figure 12.4 Finding the center of the bottle using vision (a) and color marking for indicating the position of gripper with an object [11].

The proposed algorithm for detect an object/bottle, grasp it and move to the destination is shown below:

```

do
detect the object/bottle
if object/bottle detected then
    begin
    find position of the object/bottle
    move arm robot to the object/bottle
    move the gripper to the center of the object/bottle
    if the position equal
    grasp the object/bottle
    else
    move to gripper to the center of the object/bottle
    end
endif
move the object to destination
go to the initial position
loop

```

An environment consists of a variety of objects, such as the robot itself, walls, floor, tables, objects to be grasped, etc. In order to successfully move the arm

without hitting an obstacle, we provide 1 distance sensor at the gripper. To determine the state of the object, the "good" grasp position should be first determined. The experiment conducted at our lab to grasp and move a bottle to the destination. For testing the connection of hardware, we use Lynx SSC-32 as shown below:

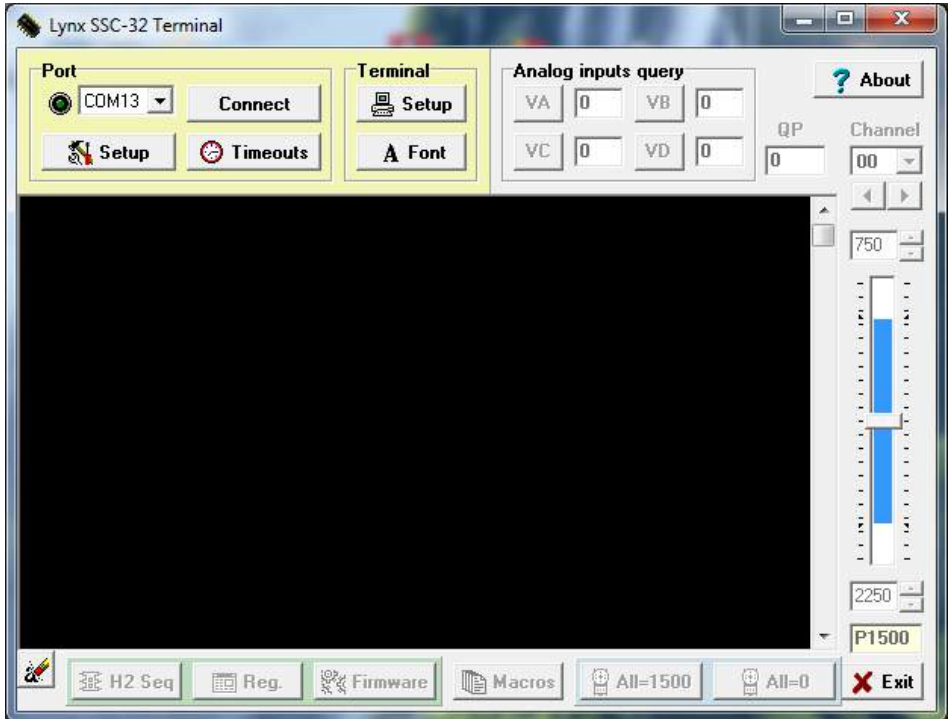

Figure 12.5 using Lynx SSC-32 Terminal for testing the hardware [13].

We use Lynxmotion RIOS (Robotic Arm Interactive Operating System) SSC-32 software to configure and control the arm robot as shown in figure 12.6:

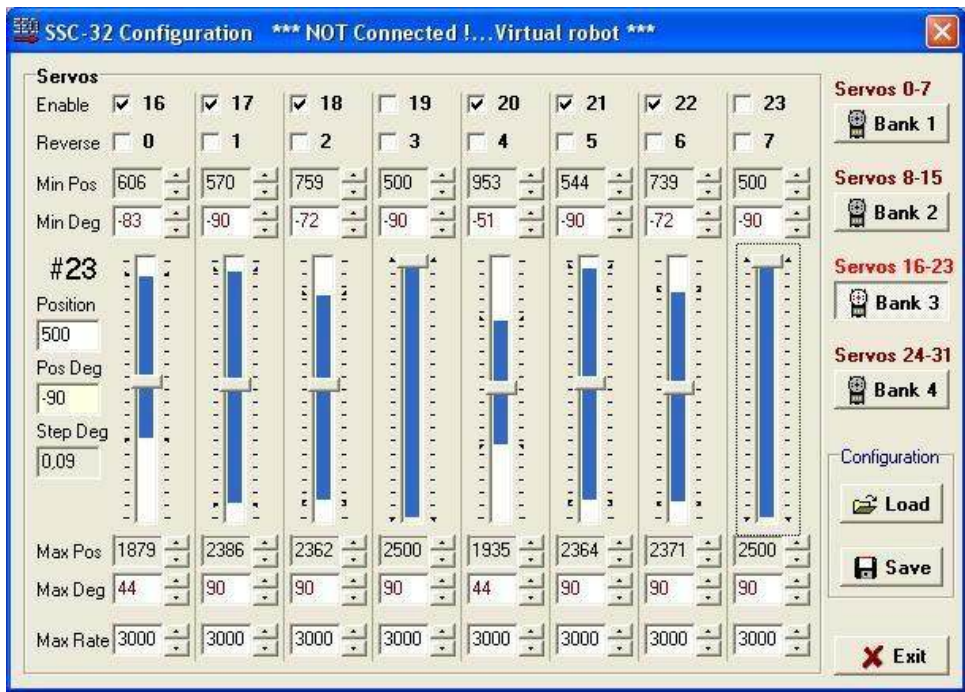

Figure 12.6 Configuring and control the board of arm robot using RIOS SSC-32 Software[13].

After configuring and calibrating the servos of arm robot. We put an object/bottle in front of the arm robot to be grasped and move to other position. Based on our experiment we get the expected result as shown in table 12.1.

Table 12.1 Result of Detecting and Grasping an Object in 10x.

No	Action	Success	failure
1	Identify the object as bottle	100%	0%
2	Grasping an object correctly	90%	10%
3	Estimate the distance of the bottle	90%	10%

The accuracy and robustness of the system and the algorithm were tested and proven to be effective in real scenarios.

Program for object detection and grasping successfully developed with OpenCV and the manipulator able to grasp it as shown in figure 12.7



Figure 12.7 Object detection and grasping OpenCV.

Exercise

- 1) Create a simulator program for inverse kinematics using function as shown below:

```

data = Convert.ToInt32(txtInput.Text);
    MessageBox.Show("value from sin " + data + " "
+Convert.ToString(Math.Sin(Radians2Degrees(data))));
    MessageBox.Show("value from cos " +data + " "
+Convert.ToString(Math.Cos(Radians2Degrees(data))));
    MessageBox.Show("value from tan " + data + " "+
Convert.ToString(Math.Tan(Radians2Degrees(data))));
    MessageBox.Show("value from Theta(Asin) : " +
Convert.ToString((Math.Asin(Math.Sin(Radians2Degrees(data))))*(18
0/Math.PI)));
    MessageBox.Show("value from Theta(Acos) : " +
Convert.ToString((Math.Acos(0.866))*(180/Math.PI)));
    
```

```

MessageBox.Show("value from Theta (Atan) : " +
Convert.ToString( (Math.Atan(Math.Tan(Radians2Degrees(data)))) *
(180 / Math.PI)));

MessageBox.Show("value from Theta2(arccos) : " +
Convert.ToString( (Math.Acos(Math.Cos(Radians2Degrees( ((x*x)+(y*y))-
(11*11)-(12*12))/(2*11*12) )))) * (180 / Math.PI)));

```

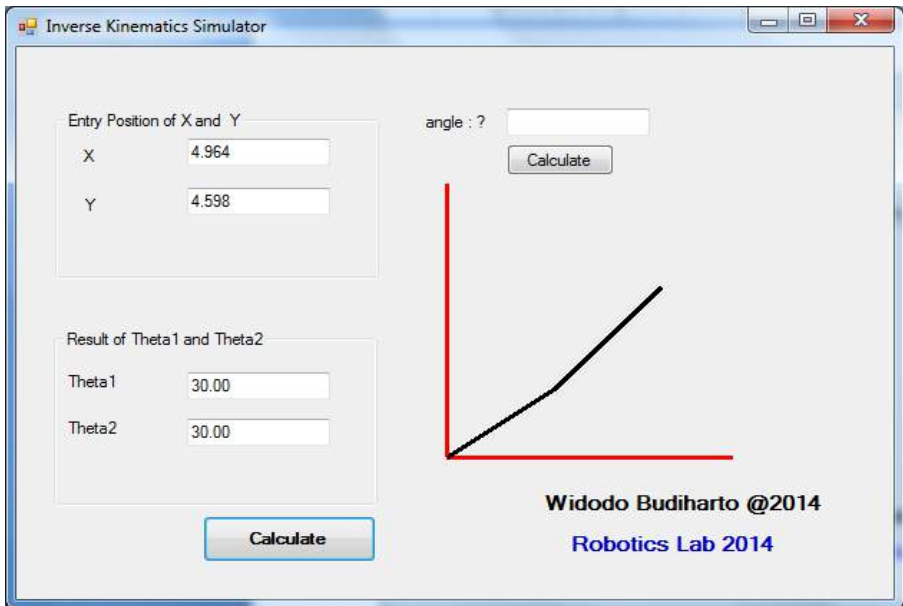

Figure 12.7 Inverse Kinematics Simulator.

2) Create a program to grasp an object using arm robot and stereo vision.

References

- [1] A. Bendiksen and G. D. Hager. "A vision-based grasping system for unfamiliar planar objects". In ICRA, pages 2844–2849, 1994.
- [2] H. I. Christensen and P. L. Corke. "Visual servoing". I. J. Robot. Res., 22(10-11):779–780, 2003.
- [3] D. Kragic and H. I. Christensen. "A framework for visual servoing". In ICVS, pages 345–354, 2003.
- [4] A. Bicchi and V. Kumar, "Robotic grasping and contact: a review," in ICRA, 2000.

- [5] J. Jiao, Embedded Vision-Based Autonomous Move-to-Grasp Approach for a Mobile Manipulator, *International Journal of Advanced Robotics System*, vol. 9, pp.1-6, 2012.
- [6] K. Shimoga, “Robot grasp synthesis: a survey,” *IJRR*, vol. 15, pp. 230–266, 1996.
- [7] D. Purwanto. Visual Feedback Control in Multi-Degrees-of-Freedom Motion System. PhD thesis at Graduate School of Science and Technology - Keio University, Japan, 2001.
- [8] I., Kamon, T. Flash, and S. Edelman, “Learning to grasp using visual information,” in *ICRA*, 1996.
- [9] A. Edsinger and C. C. Kemp, “Manipulation in human environments,” in *IEEE/RAS Int’l Conf on Humanoid Robotics (Humanoids06)*, 2006.
- [10] Y. Yang, “Binocular Stereo Vision based Humanoid Manipulator Control”, 30th International Conference on Control, pp. 3996 - 4001, China. 2011.
- [11] Widodo Budiharto, Bayu Kanigoro and Anita Rahayu, Vision-Based Grasping for Manipulator using Object Features, Annual Conference on Engineering and Information Technology, pp. 228-235, Japan, March 28-30th, 2014.
- [12] Matworks.com.
- [13] www.lynxmotion.com.

Glossary

Artificial Intelligence: is the mimicking of human thought and cognitive processes to solve complex problems automatically. AI uses techniques for writing computer code to represent and manipulate knowledge.

Autonomous: Operating without pre-programmed behaviors and without supervision from humans.

Action-Based Planning: The goal of action-based planning is to determine how to decompose a high level action into a network of sub actions that perform the requisite task. Therefore the major task within such a planning system is to manage the constraints that apply to the interrelationships (e.g., ordering constraints) between actions. In fact, action-based planning is best viewed as a constraint satisfaction problem.

Agents: Agents are software programs that are capable of autonomous, flexible, purposeful and reasoning action in pursuit of one or more goals. They are designed to take timely action in response to external stimuli from their environment on behalf of a human. When multiple agents are being used together in a system, individual agents are expected to interact together as appropriate to achieve the goals of the overall system.

Agent Architecture: There are two levels of agent architecture, when a number of agents are to work together for a common goal. There is the architecture of the system of agents, that will determine how they work together, and which does not need to be concerned with how individual agents fulfill their submissions; and the architecture of each individual agent, which does determine its inner workings.

Algorithm: An algorithm is a set of instructions that explain how to solve a problem. It is usually first stated in English and arithmetic, and from this, a programmer can translate it into executable code (that is, code to be run on a computer).

Associative Memories: Associative memories work by recalling information in response to an information cue. Associative memories can be auto associative or hetero associative. Auto associative memories recall the same information that is used as a cue, which can be useful to complete a partial pattern.

Camera: A camera is a device used to take pictures, either singly or in sequence. A camera that takes pictures singly is sometimes called a photo camera to distinguish it from a video camera.

Decision Theory: Decision theory provides a basis for making choices in the face of uncertainty, based on the assignment of probabilities and payoffs to all possible outcomes of each decision. The space of possible actions and states of the world is represented by a decision tree.

Degrees of Freedom: The number of independent variables in the system. Each joint in a serial robot represents a degree of freedom.

Dexterity: A measure of the robot's ability to follow complex paths.

Dynamic Model: A mathematical model describing the motions of the robot and the forces that cause them.

Egomotion: determining the 3D rigid motion (rotation and translation) of the camera from an image sequence produced by the camera.

Tracking: following the movements of a (usually) smaller set of interest points or objects (e.g., vehicles or humans) in the image sequence.

Optical Flow: to determine, for each point in the image, how that point is moving relative to the image plane, i.e., its apparent motion. This motion is a result both of how the corresponding 3D point is moving in the scene and how the camera is moving relative to the scene.

End-Effector: The robot's last link. The robot uses the end-effector to accomplish a task. The end-effector may be holding a tool, or the end-effector itself may be a tool. The end-effector is loosely comparable to a human's hand.

Edge Detection: Edge Detection marks the points in a digital image at which the luminous intensity changes sharply.

Expert System: An expert system encapsulates the specialist knowledge gained from a human expert (such as a bond trader or a loan underwriter) and applies that knowledge automatically to make decisions.

Frame grabber: An electronic device that captures individual, digital still frames from an analog video signal or a digital video stream.

Game Theory: Game theory is a branch of mathematics that seeks to model decision making in conflict situations.

Grayscale: A grayscale digital image is an image in which the value of each pixel is a single sample. Displayed images of this sort are typically composed of shades of gray, varying from black at the weakest intensity to white at the strongest, though in principle the samples could be displayed as shades of any color, or even coded with various colors for different intensities.

Genetic Algorithms: Search algorithms used in machine learning which involve iteratively generating new candidate solutions by combining two high scoring earlier (or parent) solutions in a search for a better solution.

HSV Color Space: The HSV (Hue, Saturation, Value) model, also called HSB (Hue, Saturation, Brightness), defines a color space in terms of three constituent components: Hue, the color type (such as red, blue, or yellow), Saturation, the "vibrancy" of the color and colorimetric purity and Value, the brightness of the color.

Inference Engine: The part of an expert system responsible for drawing new conclusions from the current data and rules. The inference engine is a portion of the reusable part of an expert system (along with the user interface, a knowledge base editor, and an explanation system), that will work with different sets of case-specific data and knowledge bases.

Inverse Kinematics: The inverse kinematics problem is to find the robot's joint displacements given position and orientation constraints on the robot's end-effector.

Jacobian: The matrix of first-order partial derivatives. For robots, the Jacobian relates the end- effector velocity the joint speeds.

Joint Space: A coordinate system used to describe the state of the robot in terms of its joint states. Inverse kinematics may also be thought of as a mapping from end-effector space to joint space.

Machine Learning: refers to the ability of computers to automatically acquire new knowledge, learning from, for example, past cases or experience, from the computer's own experiences, or from exploration.

Machine Vision: Machine Vision is the application of computer vision to industry and manufacturing.

Motion Perception: MP is the process of inferring the speed and direction of objects and surfaces that move in a visual scene given some visual input.

Neural Networks: Neural Networks are an approach to machine learning which developed out of attempts to model the processing that occurs within the neurons of the brain. By using simple processing units (neurons), organized in a layered and highly parallel architecture, it is possible to perform arbitrarily complex calculations. Learning is achieved through repeated minor modifications to selected neurons, which results in a very powerful classification system.

Pattern Recognition: This is a field within the area of machine learning. Alternatively, it can be defined as the act of taking in raw data and taking an action based on the category of the data. It is a collection of methods for supervised learning.

Pixel: A pixel is one of the many tiny dots that make up the representation of a picture in a computer's memory or screen.

Pixelation: In computer graphics, pixelation is an effect caused by displaying a bitmap or a section of a bitmap at such a large size that individual pixels, small single-colored square display elements that comprise the bitmap, are visible.

Simulated Annealing: Simulated annealing is an optimization method based on an analogy with the physical process of toughening alloys, such as steel, called annealing.

Serial Robot: A serial robot is a single chain of joints connected by links.

Singularity: A position in the robot's workspace where one or more joints no longer represent independent controlling variables. Commonly used to indicate a position where a particular mathematical formulation fails.

Statics: The study of forces that do not cause motion.

Velocity-Level: Mathematical formulations working with the joint speeds. Integrating the joint speeds once provides the displacements. See acceleration-level and position-level.

Workspace: The maximum reach space refers to all of the points the robot can possibly reach. The dexterous workspace is all of the possible points the robot can reach with an arbitrary orientation. The dexterous workspace is usually a subspace of the maximum reach space.



This book differs from other robot vision textbooks:

- **Its content is consisting of many implementation of mobile robot and manipulator using OpenCV.**
- **Using newest technology in Microcontroller such as Propeller Microcontroller for robotics.**
- **Its content is consisting of introduction and implementation of OpenCV described clearly.**

To order additional copies of this book, please contact:
Science Publishing Group
service@sciencepublishinggroup.com
www.sciencepublishinggroup.com

ISBN 978-1-940366-12-8

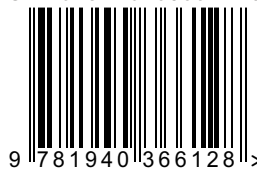

Price: US \$99