

ひらがな

Basic Hiragana

a	あ	i	い	u	う	e	え	o	お
ka	か	ki	き	ku	く	ke	け	ko	こ
sa	さ	shi	し	su	す	se	せ	so	そ
ta	た	chi	ち	tsu	つ	te	て	to	と
na	な	ni	に	nu	ぬ	ne	ね	no	の
ha	は	hi	ひ	fu	ふ	he	へ	ho	ほ
ma	ま	mi	み	mu	む	me	め	mo	も
ya	や			yu	ゆ			yo	よ
ra	ら	ri	り	ru	る	re	れ	ro	ろ
wa	わ			wo	を			n	ん

Modified Hiragana

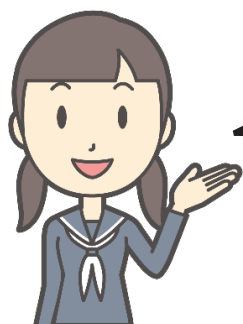

Extra sounds

We can make extra sounds by adding a **ten-ten**” or **maru**° to the top right corner of a hiragana

ga	が	gi	ぎ	gu	ぐ	ge	げ	go	ご
za	ざ	ji	じ	zu	ず	ze	ぜ	zo	ぞ
da	だ	ji	ぢ	dzu	づ	de	で	do	ど
ba	ば	bi	び	bu	ぶ	be	べ	bo	ぼ
pa	ぱ	pi	ぴ	pu	ぷ	pe	ぺ	po	ぽ

Blended sounds

Adding a small や, ゆ or よ after a hiragana will blend the sounds

Examples:

きや = kya

きゆ = kyu

きよ = kyo

じゃ = jya or ja

じゆ = jyu or ju

じよ = jyo or jo



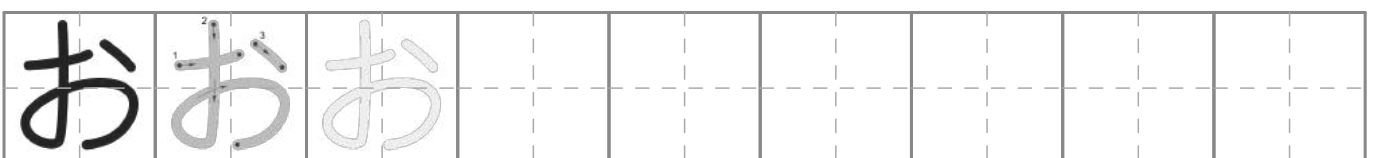
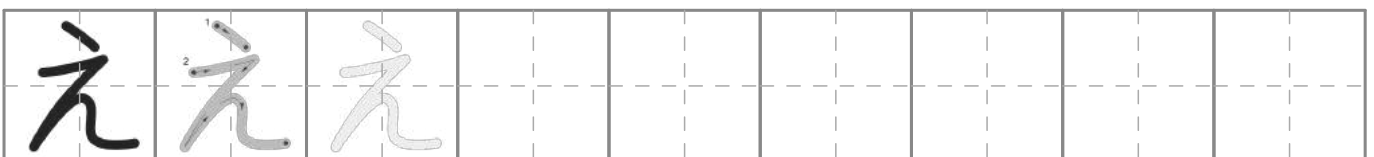
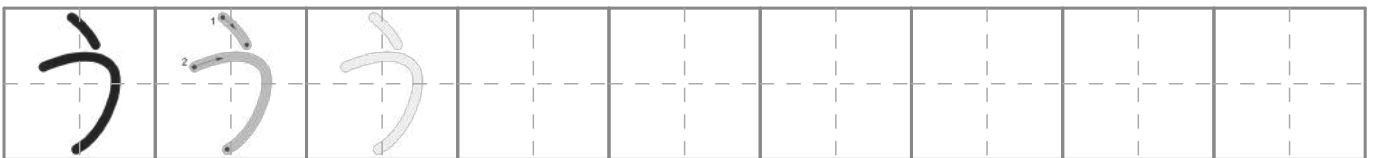
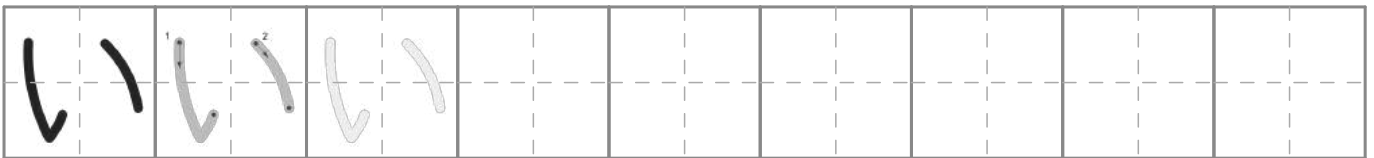
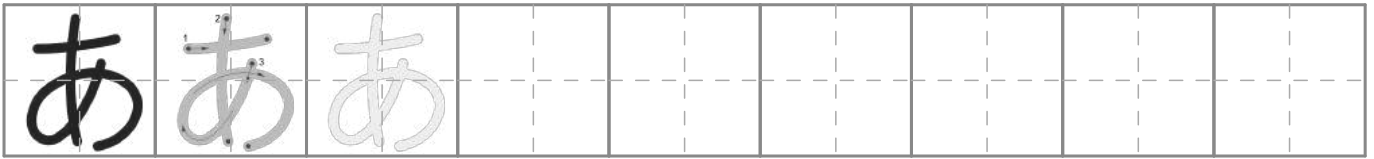
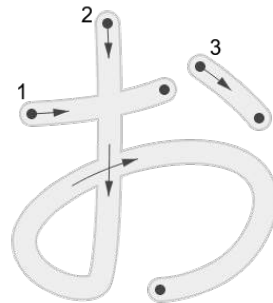
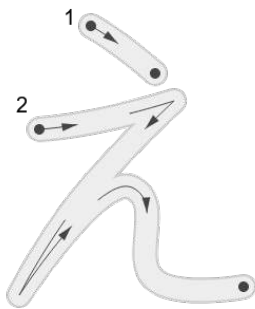
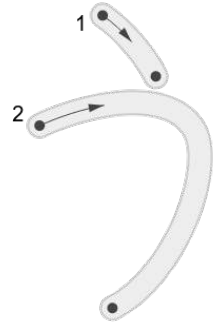
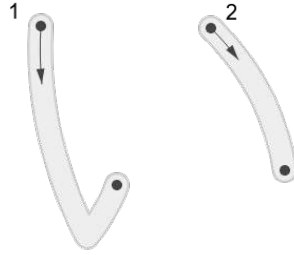
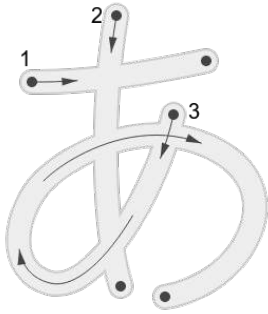

EE - yes



IIE - no



AI - love

IE - house



OOI - many

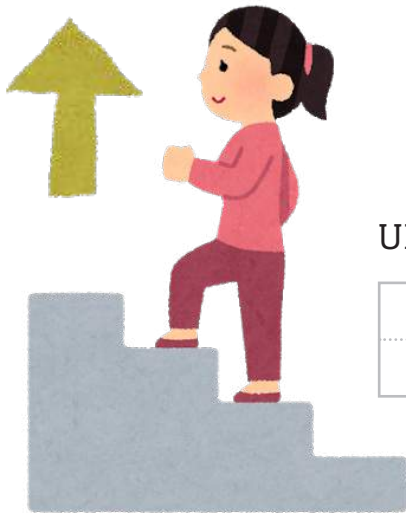

UE - up

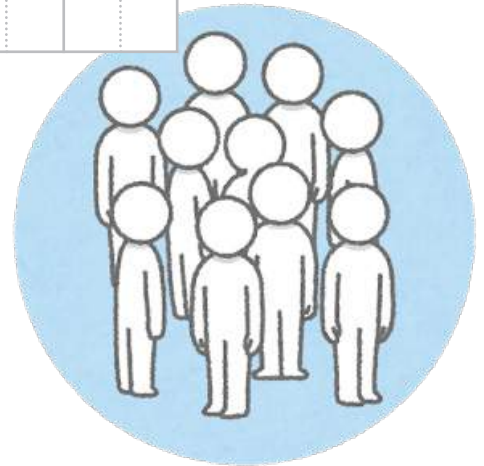

Practice:

Read the English word and write the Hiragana in the box.

yes

up

love

many

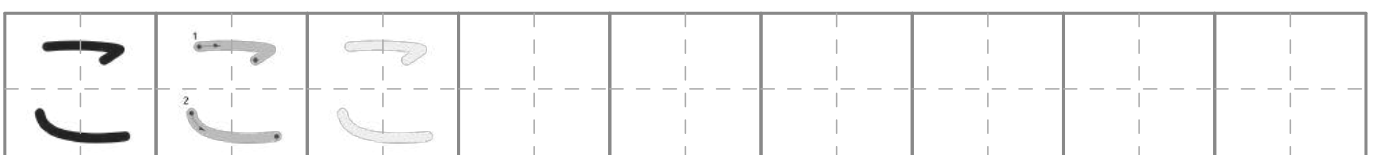
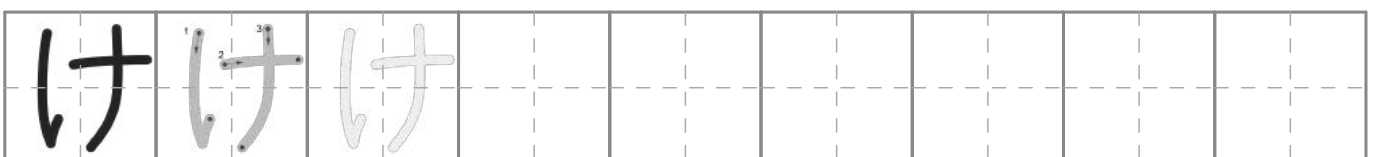
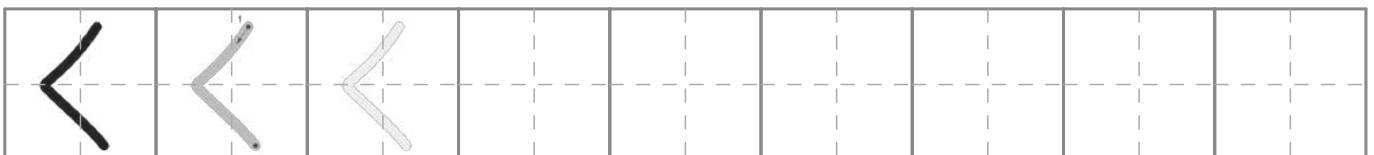
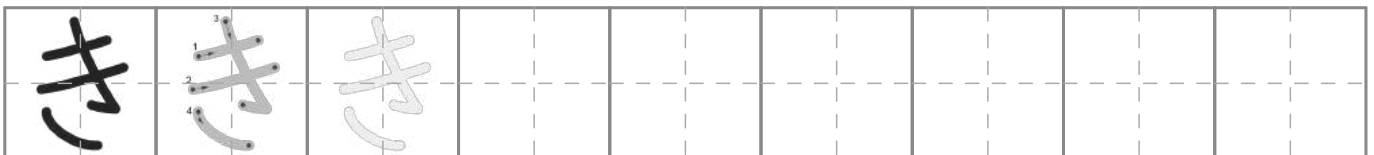
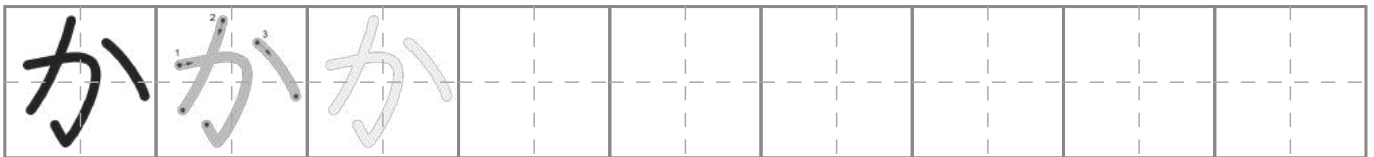
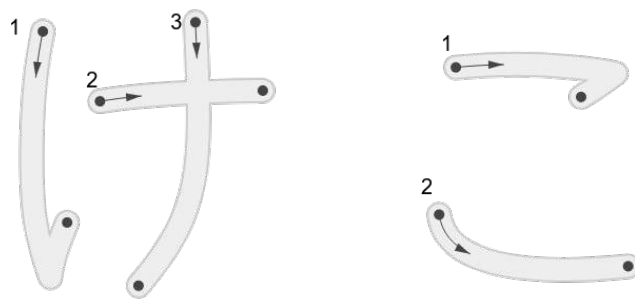
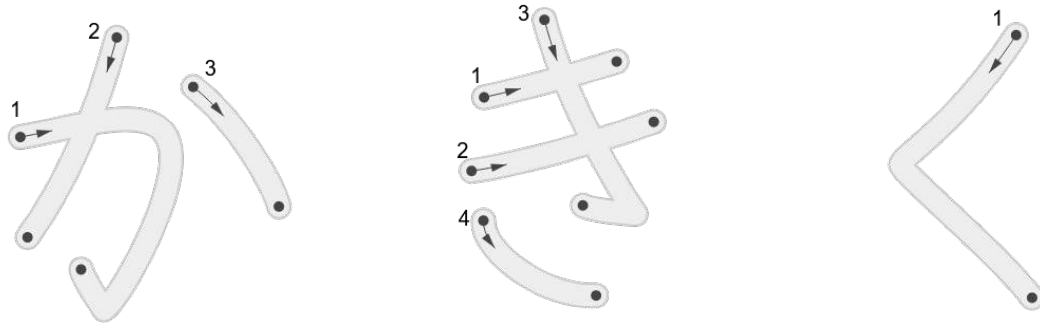



OOKI - big

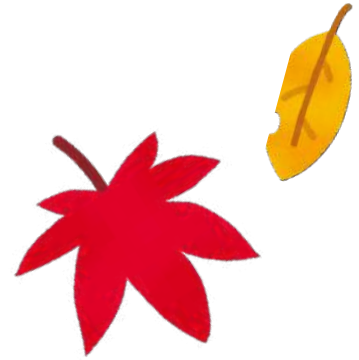

KI - tree

AKI - Autumn



IKA - squid



KAKU - to write



EKI - station

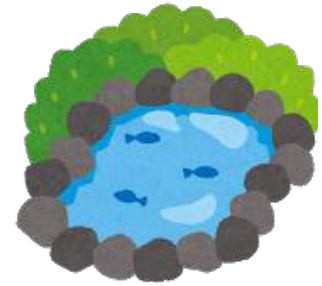

IKE - pond

Practice:

Read the English word and write the Hiragana in the box.

squid

to write

up

big

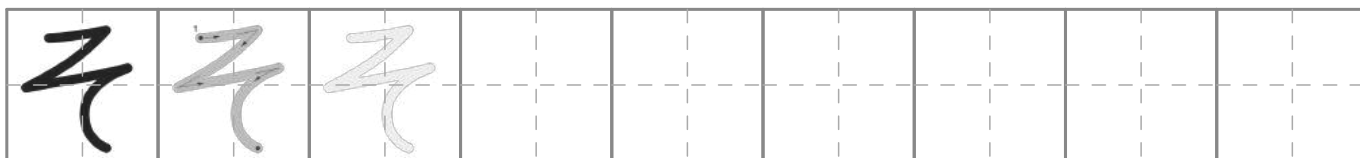
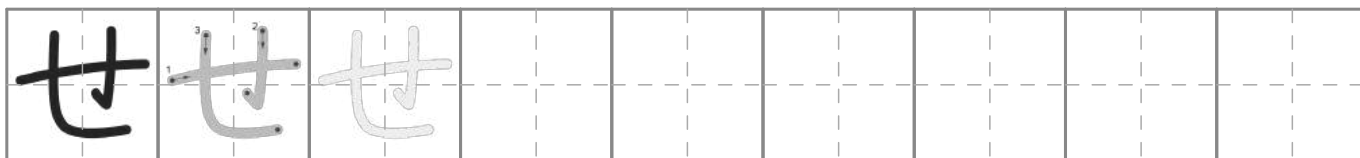
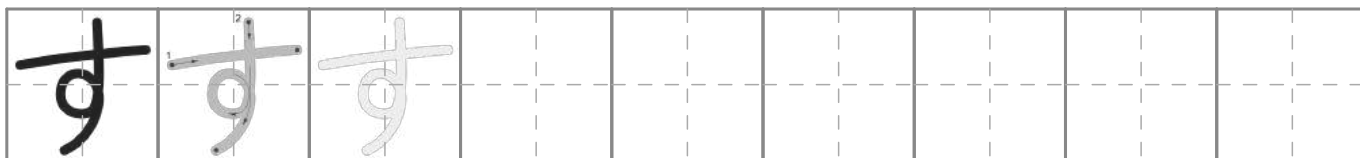
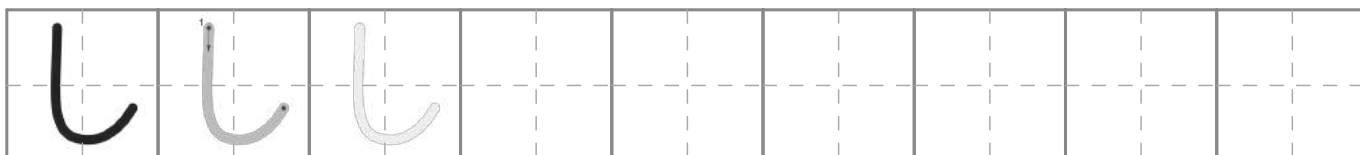
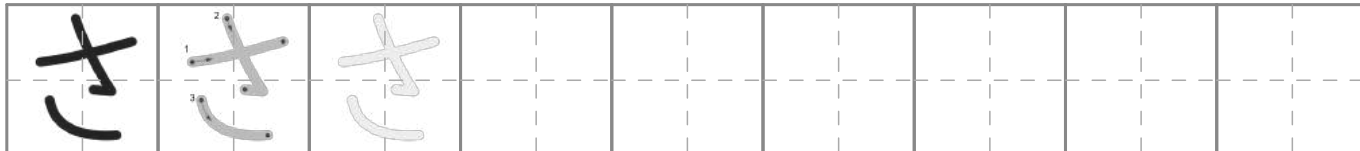
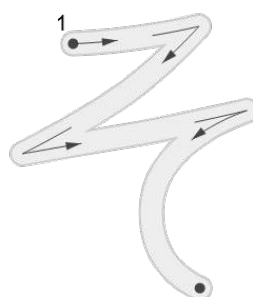
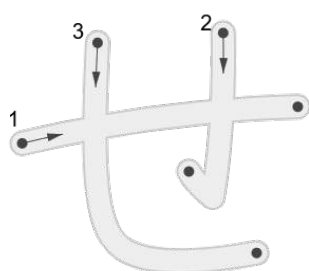
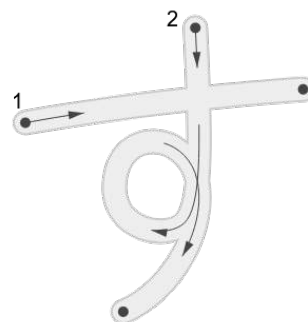
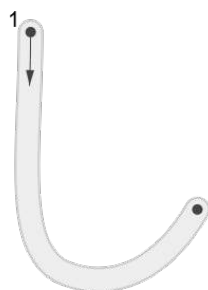
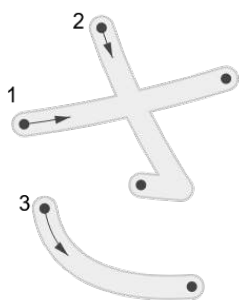

Find the following Japanese words in the word search below. They are written in Hiragana and may be found horizontally, vertically, diagonally and backwards.

Use the Hiragana chart on Page 1 if you get stuck!



- sushi (sushi)
- kasa (umbrella)
- isu (chair)
- ashika (sea lion)
- shika (deer)



- shikaku (square)
- okashi (sweets)
- kaisou (seaweed)
- sukoshi (a little bit)
- suika (watermelon)

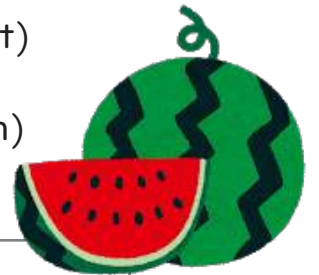

ま	あ	お	も	し	か	お	と
す	い	か	ふ	め	ひ	さ	か
し	す	し	て	へ	か	た	り
か	い	ら	く	つ	は	し	ん
を	む	す	か	る	い	み	あ
お	え	こ	し	う	す	ち	る
		し	ほ	か	い	そ	う



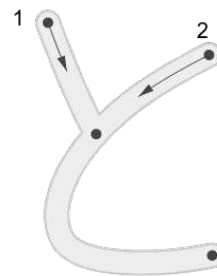
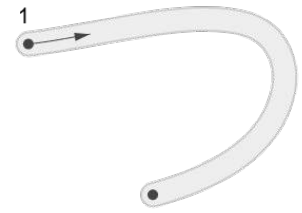
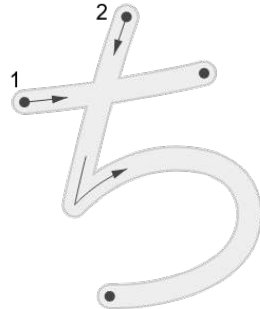
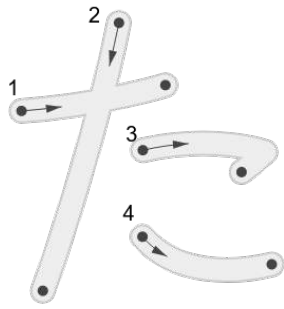

た	た	た								
---	---	---	--	--	--	--	--	--	--	--

ち	ち	ち								
---	---	---	--	--	--	--	--	--	--	--

つ	つ	つ								
---	---	---	--	--	--	--	--	--	--	--

て	て	て								
---	---	---	--	--	--	--	--	--	--	--

と	と	と								
---	---	---	--	--	--	--	--	--	--	--

Write the Romaji for the Japanese words below and practice reading them out loud/

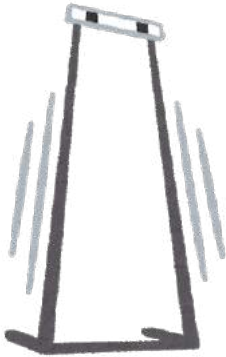

たかい

— — —



うたう

— — —



ちかい

— — —



とし

— — —



たこ

— — —



つき

— — —



とけい

— — —



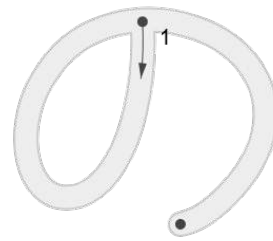
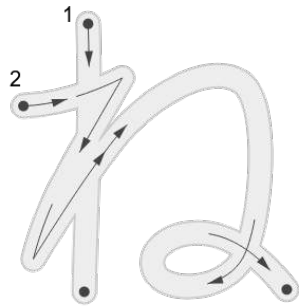
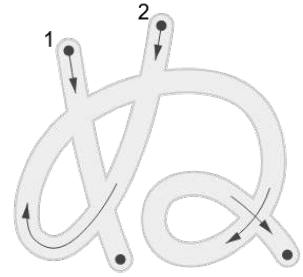
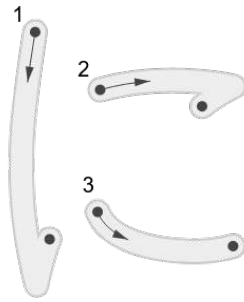
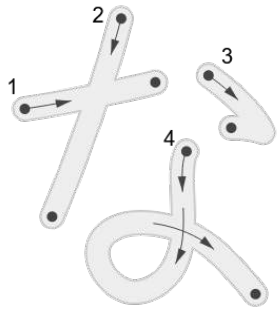

な	な	な								
---	---	---	--	--	--	--	--	--	--	--

に	に	に								
---	---	---	--	--	--	--	--	--	--	--

ぬ	ぬ	ぬ								
---	---	---	--	--	--	--	--	--	--	--

ね	ね	ね								
---	---	---	--	--	--	--	--	--	--	--

の	の	の								
---	---	---	--	--	--	--	--	--	--	--

INU - dog

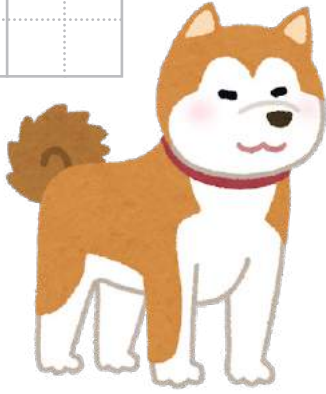

NEKO - cat



SAKANA - fish

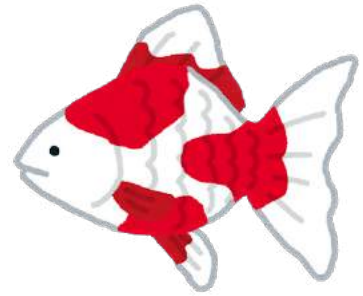

KONO - this

this



SONO - that

that



ANO - that over there

that over there

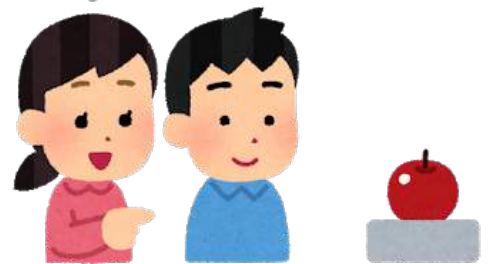

Practice:

Read the English word and write the Hiragana in the box.

that

cat

dog

fish

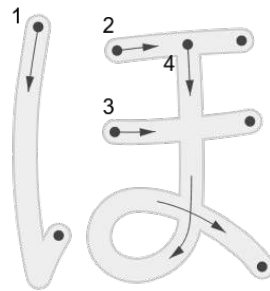
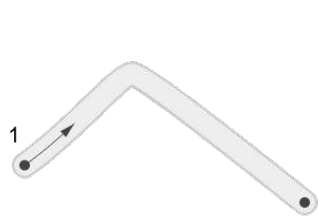
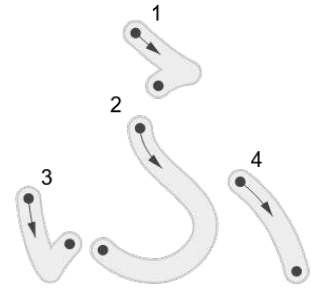
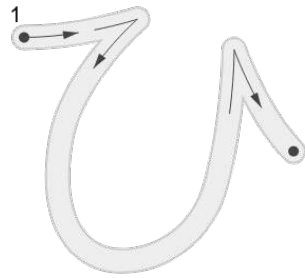
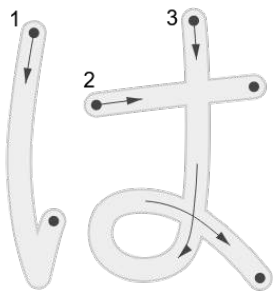

は は は

ひ ひ ひ

ふ ふ ふ

へ へ へ

ほ ほ ほ



HANA - flower



HI - fire

FUDE - brush

Use the ten-ten ^二 to change the 't' sound to a 'd' sound.



HOSHI - star



HEBI - snake

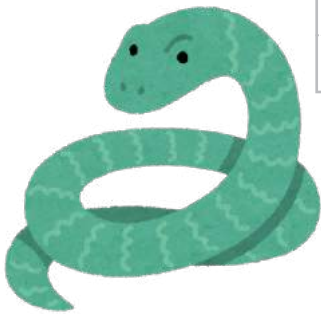

HAKO - box



Practice:

Read the English word and write the Hiragana in the box.

star

brush

flower

snake

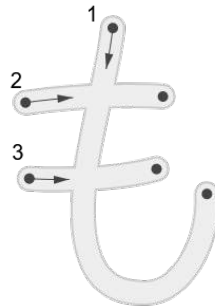
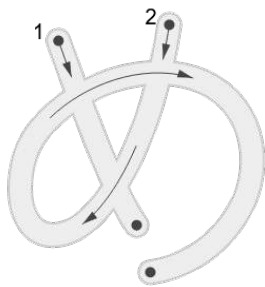
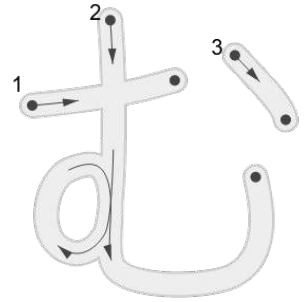
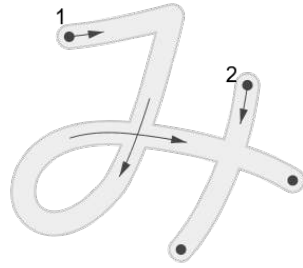
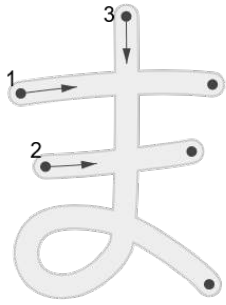

ま ま ま

み み み

む む む

め め め

も も も

Read the Hiragana clues and complete the crossword with the correct Romaji reading.

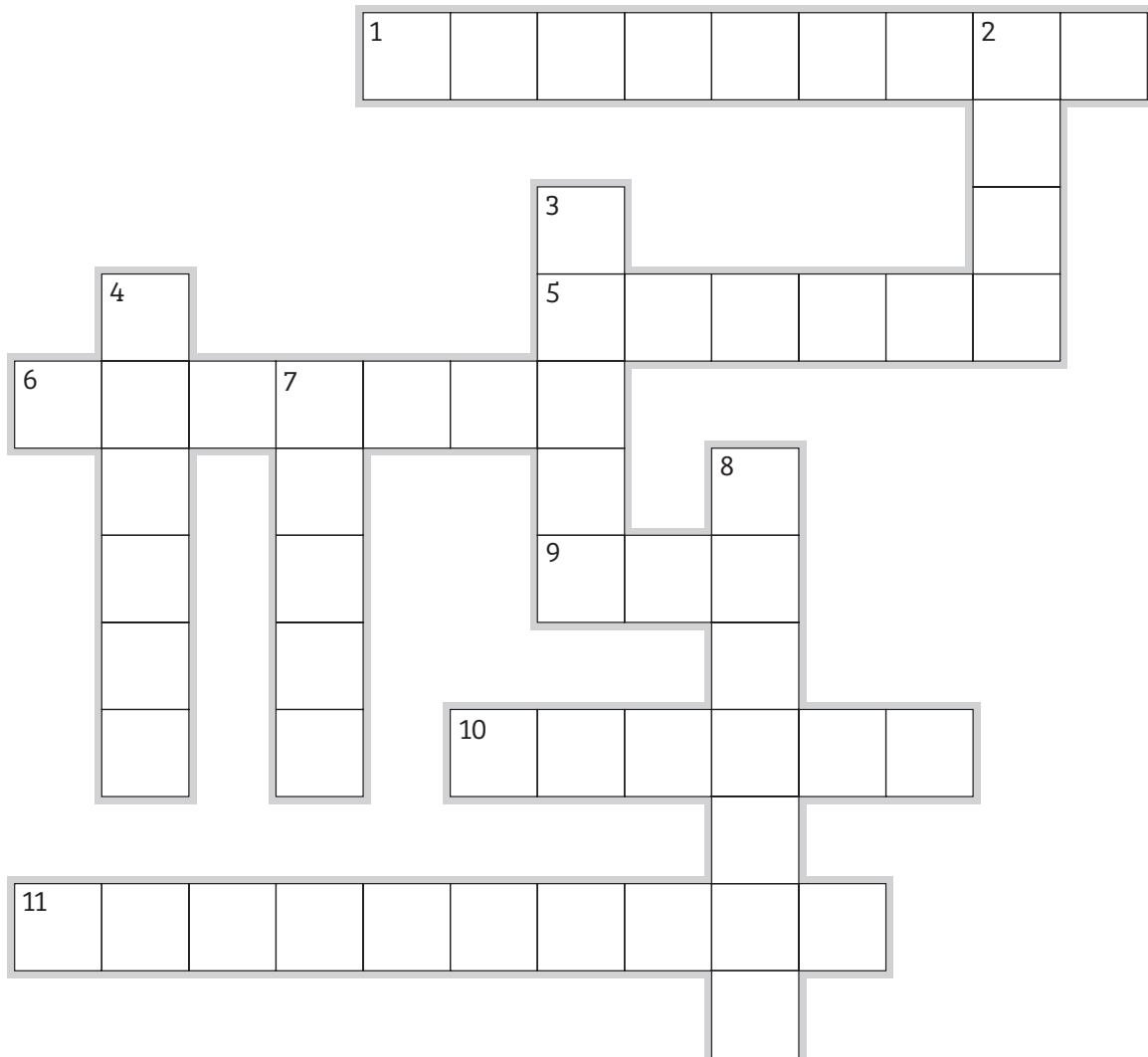

Across

- 1. いのしし (boar)
- 5. さかな (fish)
- 6. ひとつ (one, counting)
- 9. いぬ (dog)
- 10. かたな (sword)
- 11. はちみつ (honey)

Down

- 2. はな (flower)
- 3. つき (moon)
- 4. きもの (traditional clothes)
- 7. おかね (money)
- 8. ふたつ (two, counting)

Hiragana Y Row
YA YU YO

日付： 年 月 日

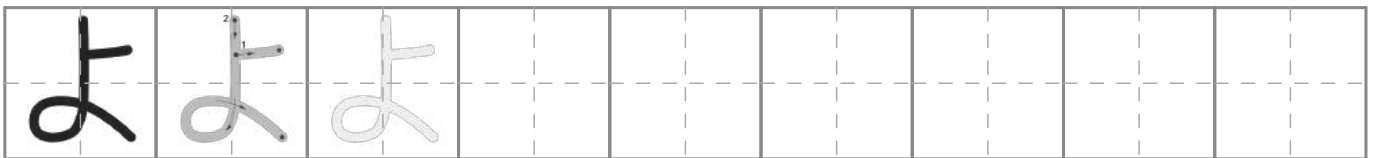
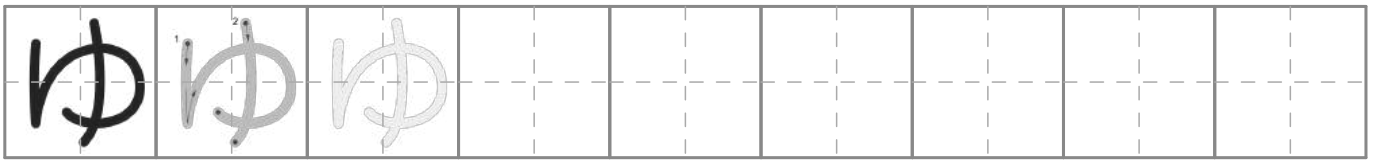
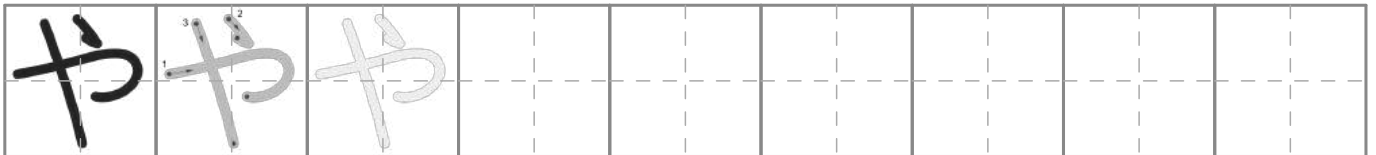
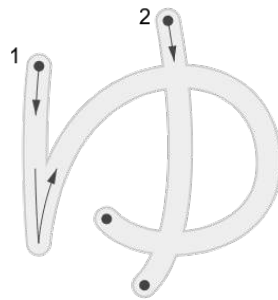
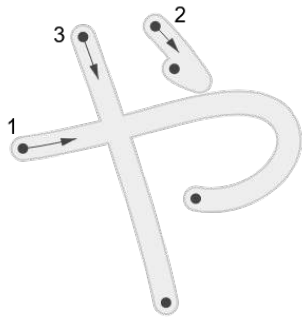

Blended Sounds
KYA KYU KYO

Adding a small や, ゆ or よ after certain hiragana will blend the sounds.

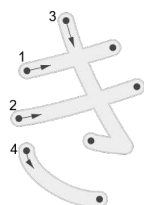
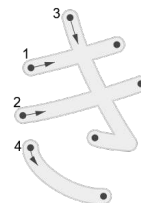
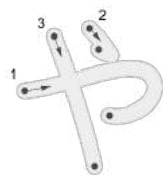
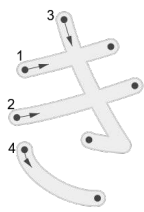

YAMA- mountain

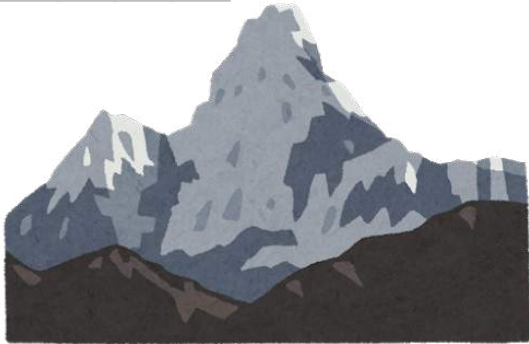

FUYU - Winter



YUKI - snow

YOMU - read



YUME - dream



'ya' means shop

HANAYA - flower shop



Practice:

Read the English word and write the Hiragana in the box.

night

mountain

snow

flower shop

Hiragana R Row
RA RI RU RE RO

日付： 年 月 日

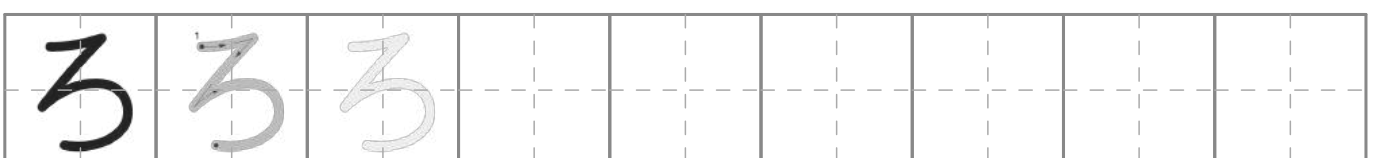
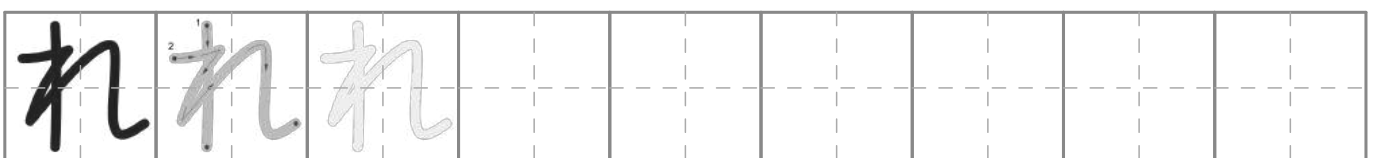
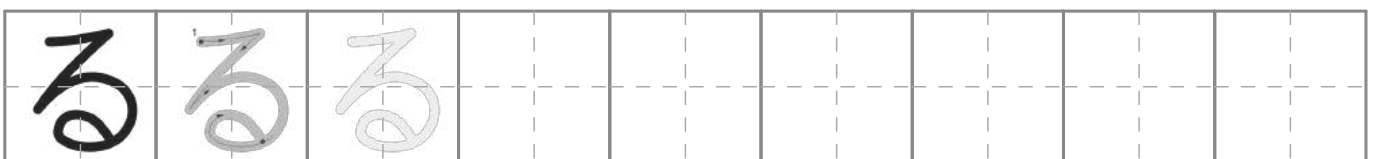
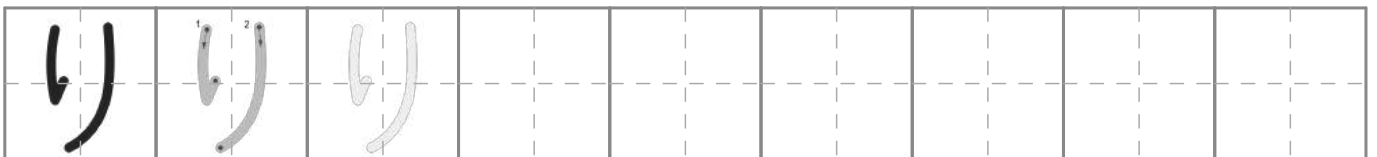
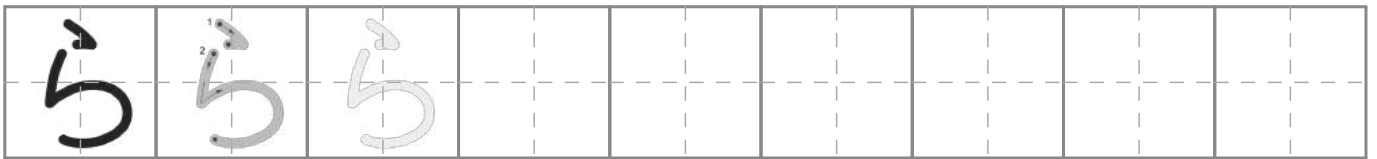
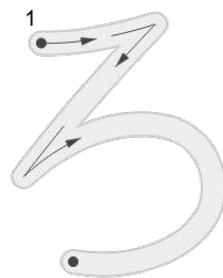
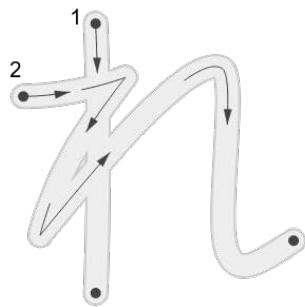
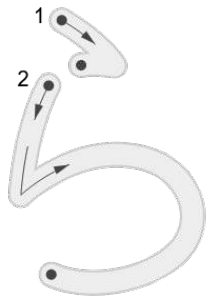



SORA - sky



TORI - bird



SARU - monkey

KIREI - tidy, clean, pretty

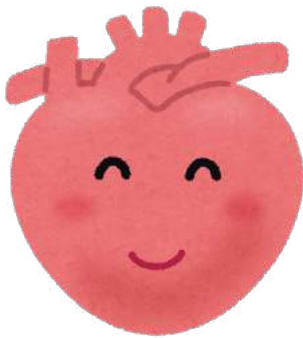

KOKORO - heart



Practice:

Read the English word and write the Hiragana in the box.

bird

sky

monkey

tidy

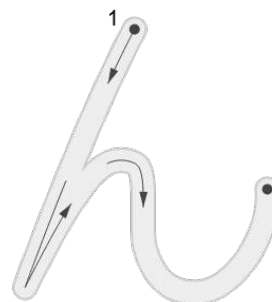
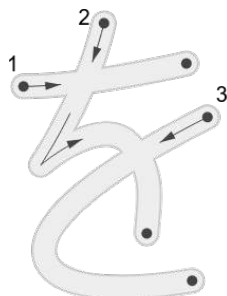
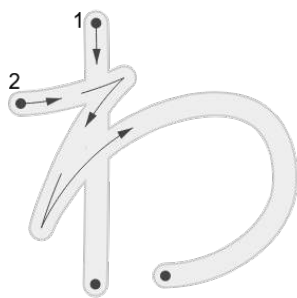

わ	わ	わ									
---	---	---	--	--	--	--	--	--	--	--	--

を	を	を									
---	---	---	--	--	--	--	--	--	--	--	--

ん	ん	ん									
---	---	---	--	--	--	--	--	--	--	--	--

WANI - alligator

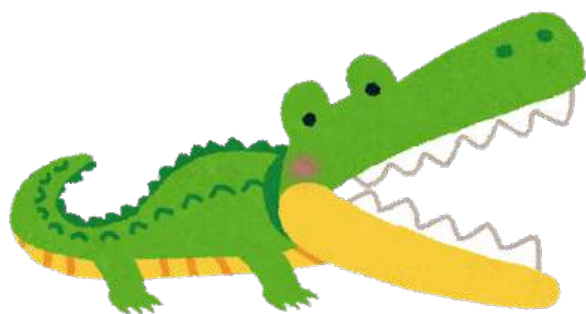

KIRIN - giraffe



Sun.



Mon.



Tue.

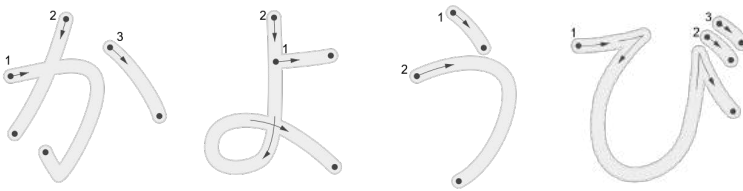

Wed



Thu.



Fri.



Sat.



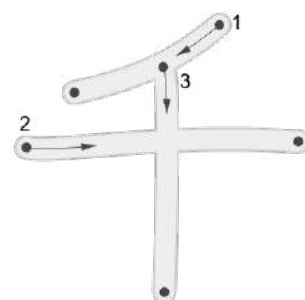
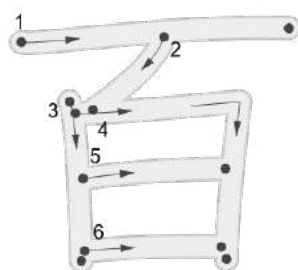
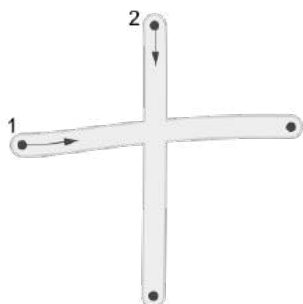
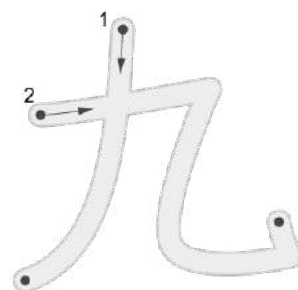
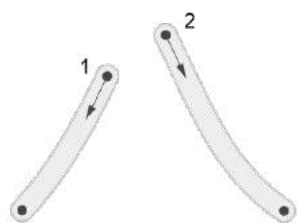
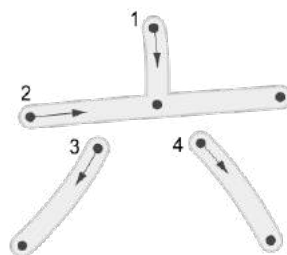
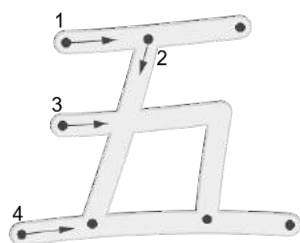
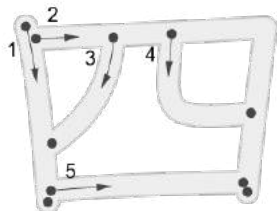

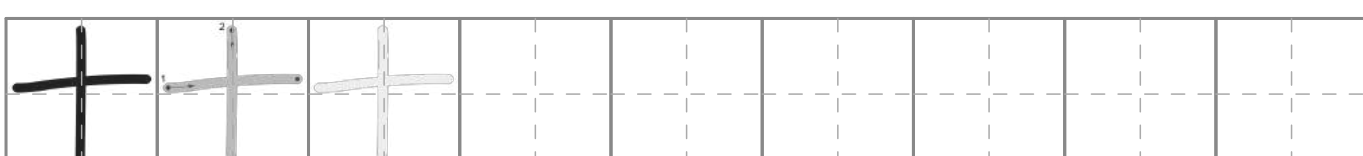
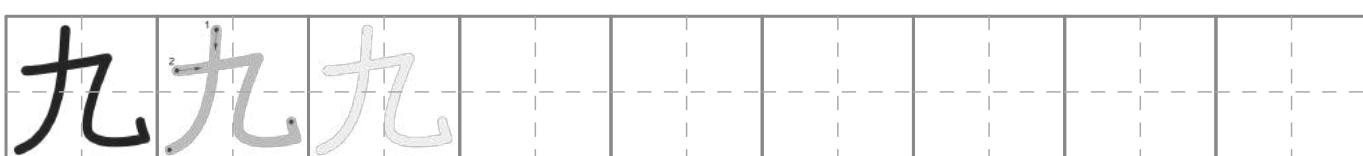
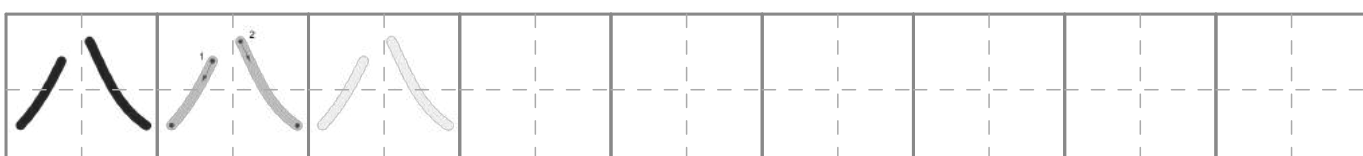
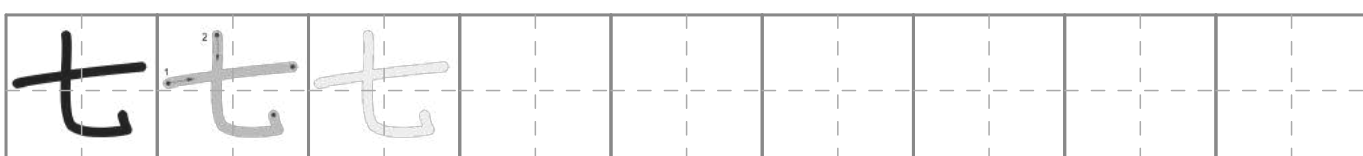
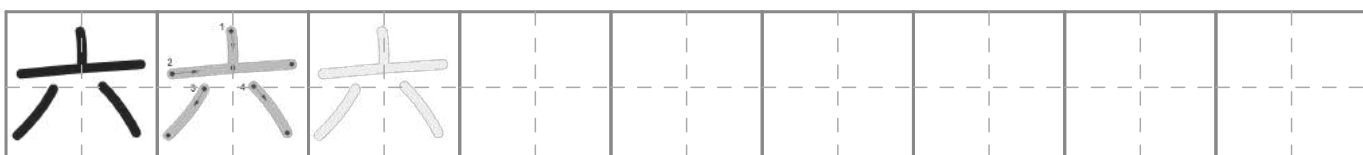
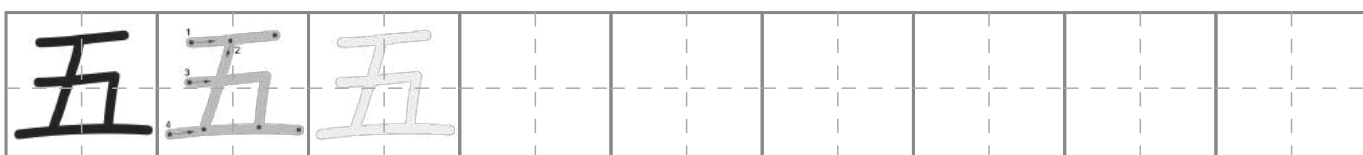
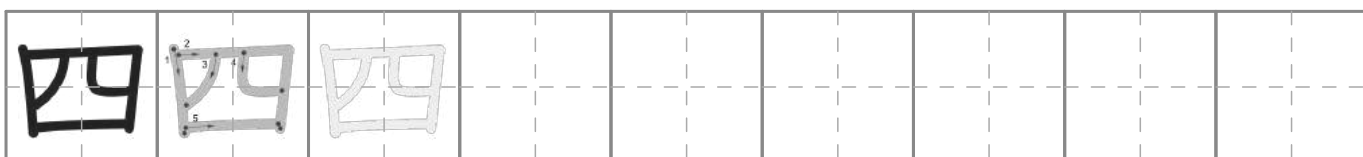
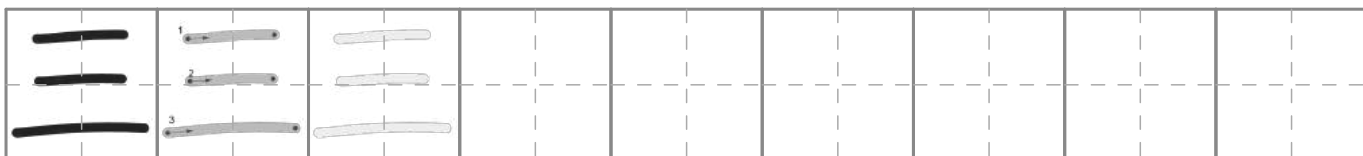
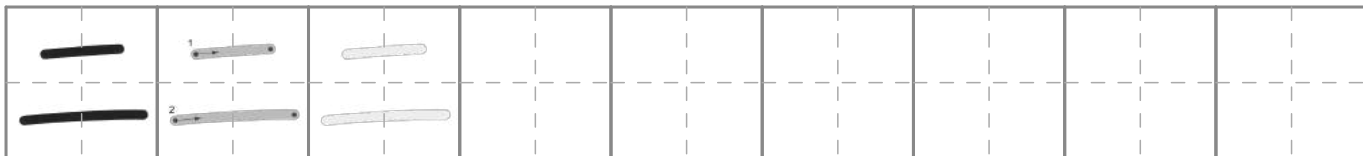
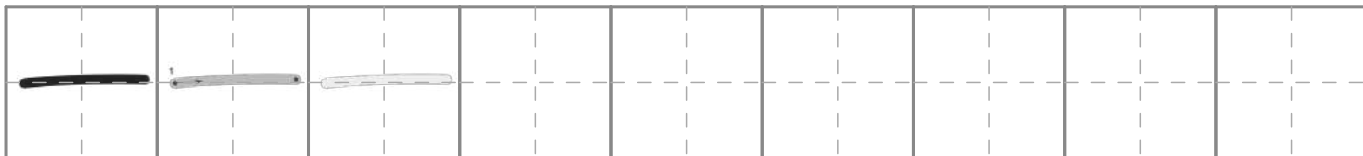

Quiz 1
Hiragana Character Reading

日付： 年 月 日

Circle the correct Hiragana for the Japanese sounds below. Only circle one symbol per row.

Sound	Hiragana
o	え ぬ お は あ
yo	よ つ す け ろ
su	そ き ら け す
nu	ぬ な し そ は
ka	の へ く か ゆ
e	う と え ろ ま
mi	み ぬ め そ す
te	つ て い し ほ
fu	ふ ゆ へ れ す
chi	ち さ き た な
u	る う つ ろ へ
i	し に い た り
to	や め よ ら と
ne	ひ ね ぬ ゆ れ
ma	ほ は ま あ お

Score:

_____ / 15

Quiz 2
Hiragana Word Reading

日付： 年 月 日

Circle the correct Hiragana for the following words.

1. sensei (teacher)

- | | |
|---------|---------|
| a. さんせい | c. せんせい |
| b. さんさい | d. さんすう |

2. watashi (me/myself)

- | | |
|--------|--------|
| a. わたし | c. わたつ |
| b. れたし | d. わとし |

3. haru (spring)

- | | |
|-------|-------|
| a. ほろ | c. はれ |
| b. はる | d. まる |

4. tomodachi (friend)

- | | |
|---------|---------|
| a. ともたさ | c. ともさし |
| b. ともだち | d. ともだし |

5. kaimono (shopping)

- | | |
|---------|---------|
| a. かいもの | c. かいまの |
| b. かいほの | d. きものは |

6. gakkou (school)

- | | |
|---------|---------|
| a. きんこう | c. がっこう |
| b. がっき | d. かつこう |

7. kyoushitsu (classroom)

- | | |
|----------|----------|
| a. こうしつ | c. けおうしつ |
| b. きょうしつ | d. かようしつ |

Score: _____ / 7