

## How to use a compass

### Using the compass alone

**This is a very easy lesson, and I would say, not sufficient for those who would like to travel safely in unfamiliar terrain.**

The first thing you need to learn, are the directions. North, South, East and West. Look at the figure and learn how they are. North is the most important.

There are several kinds of compasses, one kind to attach to the map, one kind to attach to your thumb. The thumb-compass is used mostly by orienteers who just want to run fast, and this is the kind of compass I normally use.

But not in this tutorial. I would recommend the third kind of compass. Let's take a look at it:

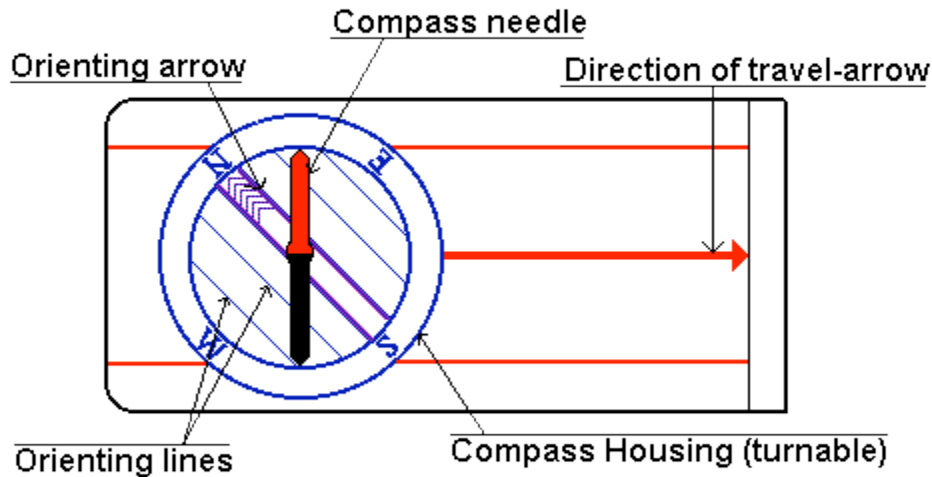

You see this red and black arrow? We call it the *compass needle*. Well, on some compasses it might be red and white for instance, but the point is, **the red part of it is always pointing towards the earth's magnetic north pole**. Got that? That's basically what you need to know. It's as simple as that.

But if you don't want to go north, but a different direction? Hang on and I'll tell you.

You've got this turnable thing on your compass. We call it the *Compass housing*. On the edge of the compass housing, you will probably have a scale. From 0 to 360 or from 0 to 400. Those are the degrees or the *azimuth* (or you may also call it the bearing in some contexts). And you should have the letters N, S, W and E for North, South, West and East. If you want to go in a direction between two of these, you would combine them. If you would like to go in a direction just between North and West, you simply say: "*I would like to go Northwest*".

Let's use that as an example: You want to go northwest. What you do, is that you find out where on the compass housing northwest is. Then you turn the compass housing so that northwest on the housing comes exactly there where the large *direction of travel*-arrow meets the housing.

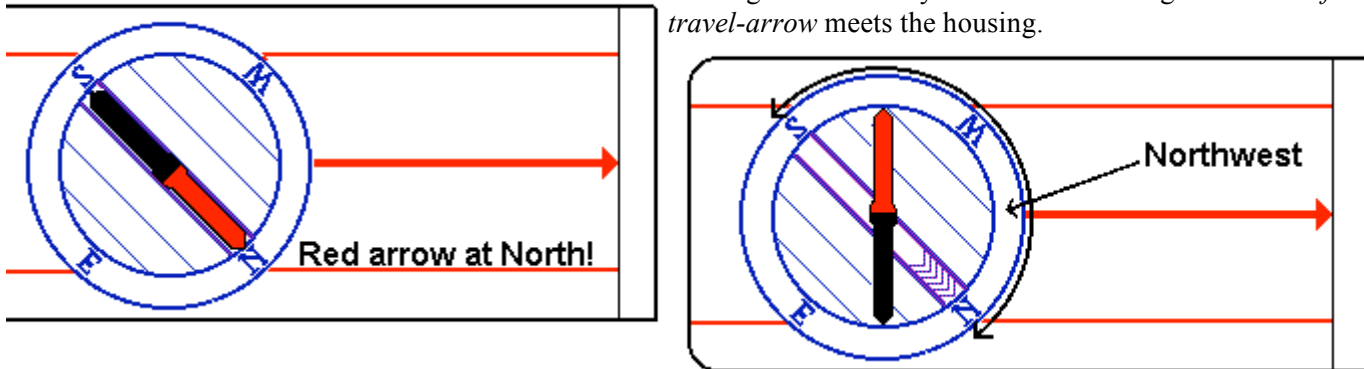

Hold the compass in your hand. And you'll have to hold it quite flat, so that the compass needle can turn. Then turn yourself, your hand, the entire compass, just make sure the compass housing doesn't turn, and turn it until the compass needle is aligned with the lines inside the compass housing.

Now, time to **be careful!** It is *extremely* important that the red, north part of the compass needle points at north in the compass housing. If south points at north, you would walk off in the exact opposite direction of what you want! And it's a very common mistake among beginners. So always take a second look to make sure you did it right!

A second problem might be local magnetic attractions. If you are carrying something of iron or something like that, it might disturb the arrow. Even a staple in your map might be a problem. Make sure there is nothing of the sort around. There is a possibility for magnetic attractions in the soil as well, "*magnetic deviation*", but they are rarely seen. Might occur if you're in a mining district.

When you are sure you've got it right, walk off in the direction the direction of travel-arrow is pointing. To avoid getting off the course, make sure to look at the compass quite frequently, say every hundred meters at least.

But you shouldn't stare down on the compass. Once you have the direction, aim on some point in the distance, and go there. But this gets more important when you use a map.

There is something you should look for to avoid going in the opposite direction: The Sun. At noon, the sun is roughly in South (or in the north on the southern hemisphere), so if you are heading north and have the sun in your face, it should ring a bell.

When do you need this technique?

If you are out there without a map, and you don't know where you are, but you know that there is a road, trail, stream, river or something long and big you can't miss if you go in the right direction. And you know in what direction you must go to get there, at least approximately what direction.

Then all you need to do, is to turn the compass housing, so that the direction you want to go in, is where the direction of travel-arrow meets the housing. And follow the above steps.

But why isn't this sufficient? It is not very accurate. You are going in the right direction, and you won't go around in circles, but you're very lucky if you hit a small spot this way. And that's why I'm not talking about *declination* here. And because that is something connected with the use of maps. But if you have a mental image of the map and know what it is, do think about it. But I think you won't be able to be so accurate so the declination won't make a difference.

If you are taking a long hike in unfamiliar terrain, you should always carry a good map that covers the terrain. Especially if you are leaving the trail. It is in this interaction between the map and a compass, that the compass becomes really valuable. And that is dealt with in [lesson 2](#).

## How to use a compass

### Using the compass in interaction with a map

This is the important lesson, and you should learn it well.

It's when you use both compass and map the compass is really good, and you will be able to navigate safely and accurately in terrain you've never been before without following trails. But it'll take some training and experience, though.

I am not covering map reading here, guess you would have to consult other sources for that, but the lesson will be useful if you have a sense of what a map says.

First, a quick summary of what you will learn in this lesson:

1. Align the edge of the compass with the starting and finishing point.
2. Rotate the compass housing until the orienting arrow and lines point N on the map.
3. Rotate the map and compass together until the red end of the compass needle points north.
4. Follow the direction of travel arrow on the compass, keeping the needle aligned with the orienting arrow on the housing.

Here is our compass again:

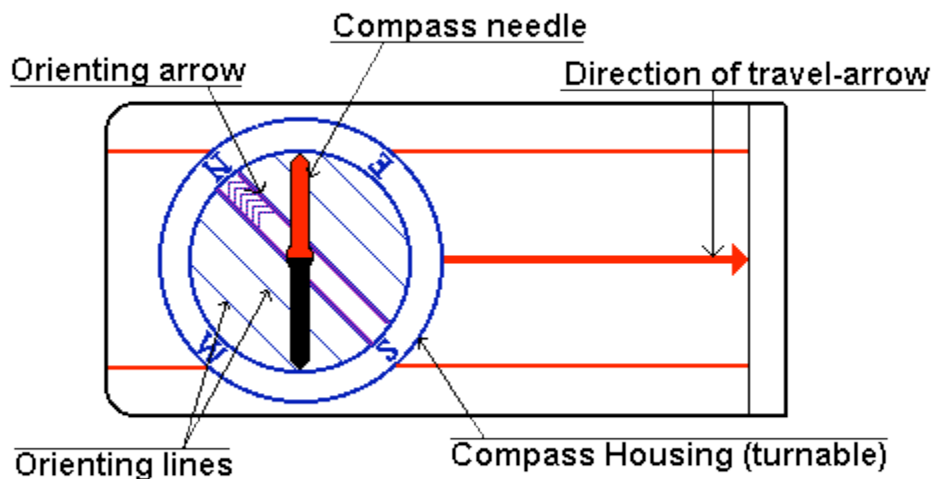

The principles are much the same as in [lesson 1](#) but this time, you are using the map to tell you which way is correct instead of your intuition.

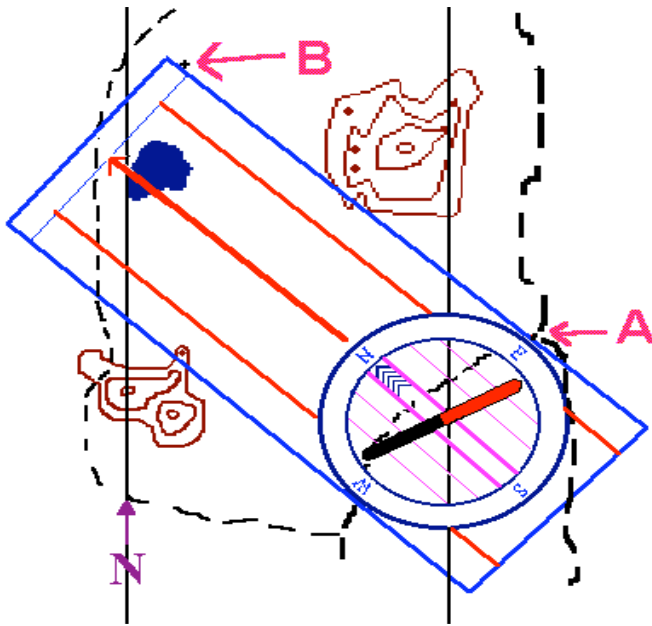

Take a map. In our first example, we look at a map made for orienteering, and it is very detailed. Well, not really. We look at a fictitious map I drew myself, but never mind. To the point. You want to go from the trail-crossing at **A**, to the rock at **B**. Of course, to use this method successfully, you'll have to know you really *are* at A.

What you do, is that you put your compass on the map so that the edge of the compass is at A. The edge you must be using, is the edge that is parallel to the direction of travel arrow. And then, put B somewhere along the same edge, like it is on the drawing. Of course, you could use the direction arrow itself, or one of the parallel lines, but usually, it's more

convenient to use the edge. At this point, some instructors say that you should use a pencil and draw a line along your course. I would recommend against it. First, it takes a lot of time, but offers no enhancement in accuracy of the method. Second, if you have wet weather, it may destroy your map, or if it is windy, you may lose it. You should keep your map (preferably in a sealed) transparent plastic bag, and if it is windy, tied up, so it can't blow away. But most important is that any drawings may hide important details on the map.

Time to **be careful** again! The edge of the compass, or rather the direction arrow, must point **from A to B**! And again, if you do this wrong, you'll walk off in the exact opposite direction of what you want. So take a second look. Beginners often make this mistake as well.

Keep the compass steady on the map. What you are going to do next is that you are going to align the orienting lines and the orienting arrow with the meridian lines of the map. The lines on the map going north, that is. While you have the edge of the compass carefully aligned from A to B, turn the compass housing so that the orienting lines in the compass housing are aligned with the meridian lines on the map. During this process, you don't mind what happens to the compass needle.

There are a number of serious mistakes that can be made here. Let's take the problem with going in the opposite direction first. **Be absolutely certain** that you know where north is on the map, and be sure that the orienting arrow is pointing towards the north on the map. Normally, north will be up on the map. The possible mistake is to let the orienting arrow point towards the south on the map.

And then, keep an eye on the the edge of the compass. If the edge isn't going along the line from A to B when you have finished turning the compass housing, you will have an error in your direction, and it can take you off your course.

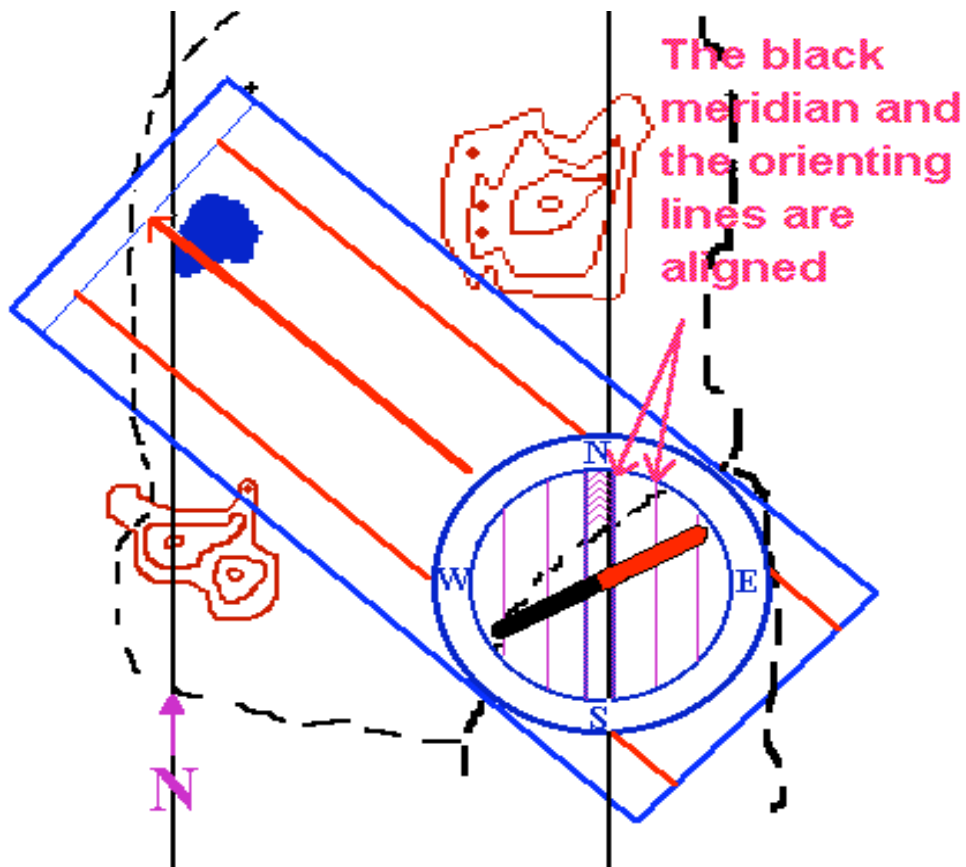

When you are sure you have the compass housing right, you may take the compass away from the map. And now, you can in fact read the azimuth off the housing, from where the housing meets the direction arrow.

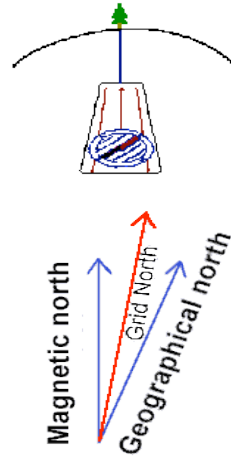
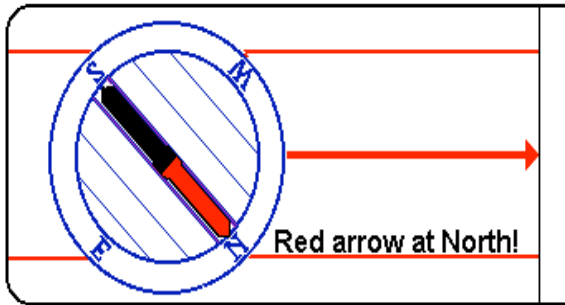

**Be sure that the housing doesn't turn, before you reach your target B!**

The final step is similar to what you did in [lesson 1](#). Hold the compass in your hand. And now you'll have to hold it quite flat, so that the compass needle can compass, just make until the compass

turn. Then turn yourself, your hand, the entire sure the compass housing doesn't turn, and turn it needle is aligned with the lines inside the compass housing.

The mistake is again to let the compass needle point towards the south. The red part of the compass needle *must* point at north in the compass housing, or you'll go in the opposite direction.

It's time to walk off. But to do that with optimal accuracy, you'll have to do that in a special way as well.

Hold the compass in your hand, with the needle well aligned with the orienting arrow. Then aim, as careful as you can, in the direction the direction of travel-arrow is pointing. Fix your eye on some special feature in the terrain as far as you can see in the direction. Then go there. Be sure as you go that the compass housing doesn't turn.

If you're in a dense forest, you might need to aim several times. Hopefully, you will reach your target B when you do this.

At this time, you may want to go out and do some training, so you could check out some [suggested exercises](#).

Unfortunately, sometimes, for some quite often, it is even more complicated. There is something called *magnetic declination*. And then, for hiking, you wouldn't use orienteering maps. And this is the issue for [lesson 3](#).

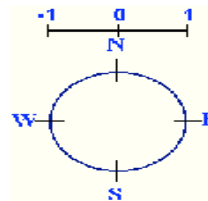

## How to use a compass

### Magnetic Declination

Unfortunately, sometimes, for some quite often, it is even more complicated. There is something called *magnetic declination*. You see, the compass is pointing towards the *magnetic* northpole, and the map is pointing toward s the *geographic* northpole, and that is not the same place. To make things even more complicated, there is on most hiking-maps something (that is very useful) called the *UTM-grid*. This grid doesn't have a real north pole, but in most cases, the lines are not too far away from the other norths. Since this grid covers the map, it is convenient to use as meridians.

On most orienteering maps (newer than the early 70's), this is corrected, so you won't have to worry about it. But on topographic maps, this is a problem.

First, you'll have to know how large the declination is, in degrees. This depends on where on the earth you are. So you will have to find out before you leave home. Or somewhere on the map, it says something about it. One thing you have to remember in some areas, the declination changes significantly, so you'll need to know what it is *this* year.

If you are using a map with a ["UTM-grid"](#), you want to know how this grid differs from the magnetic pole.

When you are taking out a course, you will do that more or less as described in [lesson 2](#), but this time, you must also look out so that you don't align the orienting lines with the grid lines pointing west or east, or south for that matter. When you have taken out a course like you've learned, you must add or subtract an angle, and that angle is the angle you found before you left home, the angle between the grid lines or meridians and the magnetic north.

The declination is given as e.g. "15 degrees east". When you look at the figure, you can pretend that plus is to the right, or east, and minus is to the left and west. Like a curved row of numbers. So when something is more than zero you'll **subtract** to get it back to zero. And if it is less, you'll **add**. So in this case you'll subtract 15 degrees to the azimuth, by turning the compass housing, according to the numbers on the housing. Now, finally, the direction of travel-arrow points in the direction you want to go. Again, be careful to aim at some distant object and off you go.

You may not need to find the declination before you leave home, actually. There is a fast and pretty good method to find the declination wherever you are. This method has also the advantage that corrects for local conditions that may be present (I am thankful towards Jim Cross who pointed this out to me). This is what you do:

1. Determine by map inspection the grid azimuth from your location to a know, visible, distant point. The further away, the more accurate it gets. This means you have to know where you are, and be pretty sure about one other feature in the terrain.
2. Sight on that distant point with the compass and note the magnetic azimuth. You do that by turning the compass housing so that it is aligned with the needle. You may now read the number from the housing where it meets the base of the direction of travel-arrow.
3. Compare the two azimuths. The difference is the declination.
4. Update as necessary. You shouldn't need to do this very often, unless you travel in a terrain with lots of mineral deposits.

There are a few riddles and rhymes to help you remember whether you should add or subtract. I don't know them. If you live in an area where you don't go far for it to change between east and west, it is so small you wouldn't need to worry about it anyway. So it's best to just remember whether you should add or subtract. Nevertheless, I have [collected some of the rhymes people use](#).

### **Uncertainty**

You can't always expect to hit exactly what you are looking for. In fact, you must expect to get a little off course.

How much you get off course depends very often on the things around you. How dense the forest is, fog, *visibility* is a keyword. And of course, it depends on how accurate *you* are. You *do* make

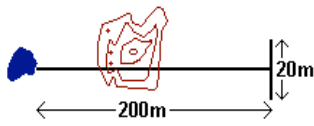

things better by being careful is important to aim as far

In normal forest conditions uncertainty is one tenth of the the figure, you go 200 meters end up a little off course, 20 something smaller than 20 you'll miss. If you want to hit that rock in our example you'll need to keep the eyes open!

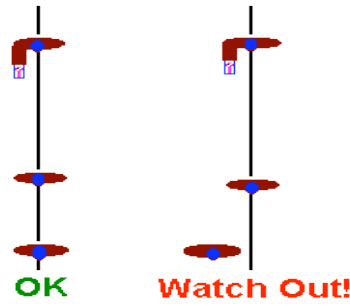

when you take out a course, and it ahead as you can see.

we say that as a rule of thumb, the distance traveled. So if it is like in on course, it is possible that you meters or so. If you're looking for meters across, there is a chance

In the open mountain areas, things are of course a lot easier when you can see far ahead of you.

This was the last of the lessons you should know. But more lessons are upcoming. Now it is time to log out and get into the backyard, and then backcountry. Try it out! That is after all, the only way to learn this properly. **Good Luck!**

I said navigating in the mountains is easier. Well that is until the fog comes. Fog can make orienteering in the mountains and in the forest extremely difficult, and therefore, it can also be dangerous to the unexperienced. The principles of orienteering are still the same, but there are a few hints in the [next lesson](#) that will help you get trained.

### How to use a compass

#### How to navigate in foggy conditions

Fog makes things difficult, and in some situations dangerous. When you hike, you will probably some day experience these difficulties, and you'd better be prepared.

The fog can come creeping very fast. I have myself experienced from clear view to dense fog in 10 seconds. How fast this goes, depends on where you are.

In normal summer conditions without snow, it is often not much of a problem. Unless you are supposed to find a hut or something. The ground provides normally so much contrast, you could do the aiming I have written about in [lesson 2](#). Just be very careful and accurate. Perhaps you also might use some of the advice given later.

Winter conditions can make things a lot worse, when there is snow on the ground. The fog is white (or grey), the snow is also white. You may get a condition we call a "[white-out](#)". It's too late to read the terrain, and then the map isn't of much use. You can't see anything anyway. You have no choice but to put blind faith in your compass. I hope you knew where you were, because you need to take out a good compass course, like described in the other lessons. If you are skiing, you should tie your compass to your arm or something, so you can look at it for every step you take. A rubberband is good. *Check for more or less every step you take that the compass needle is aligned with the orienting lines.* But if it is cold, make sure it doesn't affect circulation of blood in your arm, because that will make you freeze. If you are going on an expedition where you expect conditions like this, you should perhaps consider a arrangement to attach to your chest.

Let's consider a method to enhance the accuracy in conditions when you can't aim at anything. If you are three persons in a row, like on the figure, and the last one carries a compass (of course, it is better that all three carry a compass, but the last one has command), he or she will see if you



get off course because one of those in front of him or her will not be covered by the person in front. On the figure, the situation to the left is ok. The person on top is heading forward and but he sees only the person in front of him or her. In the situation to the right, it's time to stop. The last person can see the backs of both of them in front, and they are about to leave their course.

The further apart you go, the more accurate this method is, but it is also very important to have good contact. Sometimes the conditions get so bad there is no way to maintain contact, and then, the method may fail.

There is also another method for two people, where the lead person goes out on a compass azimuth, as far as the visibility will allow. The person behind stands still and watches the lead person, telling them if they are in the correct line or not. Once they have moved correctly into line they then stand still and the back person joins them. They then have their turn to move out ahead on the azimuth, and the whole cycle repeats. The problem with this method is when the visibility is very bad, the lead person can't go more than a few meters, and it would be dangerous to lose each other.

Finally, I'd like to comment on something that is seen in many standard texts on mountaineering navigation: You are commonly taught to use methods that use terrain features that are easily recognizable but far away. In my opinion, such methods are of little use, unless you require surveyor's accuracy in knowing where you are (hikers rarely do). As long as the weather is good, navigation is fairly easy and you'll naturally use these features as part of a more general approach. However, when the visibility is poor, you can't see these far-away-features and this makes the methods involving them rather useless. Therefore, focus your training in navigation on using features in your vicinity.

Can it possibly get any worse than a situation in dense fog? What if you haven't got a compass? I have [a few advices you could learn](#).

## **How to use a compass**

### **Finding the directions without a compass**

You are lost. I mean *really* lost. Standing in the middle of nowhere, and you have no idea where to go. If you are really in trouble, remember two things first of all: stay calm, think rationally, and you can survive a long time without food. What you need is to drink.

Further thoughts about extreme survival skills is beyond the scope of this page, seek advice elsewhere beyond this introduction. This page deals with the situation of finding your way, without the aid of a compass. What you have, is the sun, the stars, and the nature around you.

This page is mainly about the northern hemisphere of the earth, actually north of  $23.5^\circ$ , because I have never been to the southern hemisphere myself (would like to go there of course!). The methods described do of course apply to the southern hemisphere as well, but in some places there may be a need to swap north and south to get it right. I hope you are able to figure it out.

For a start, it may be a good idea to climb a hill, and get a good look around. Try to see traces of human activity. If you see nothing, you should try to figure out in what direction would be the best to travel. If you haven't got a map, try to draw one if you can of the terrain in front of you, and try to mark off where north is, using the methods below. If you have got a map, try to

In the evening

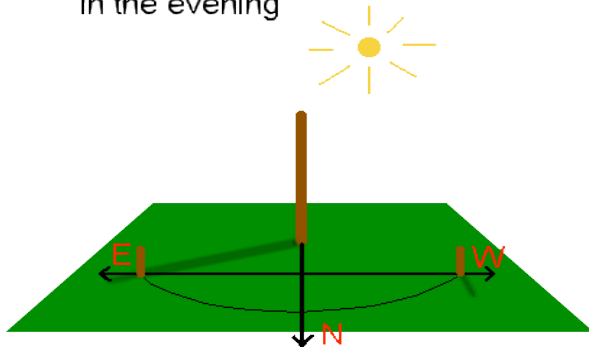

In the morning

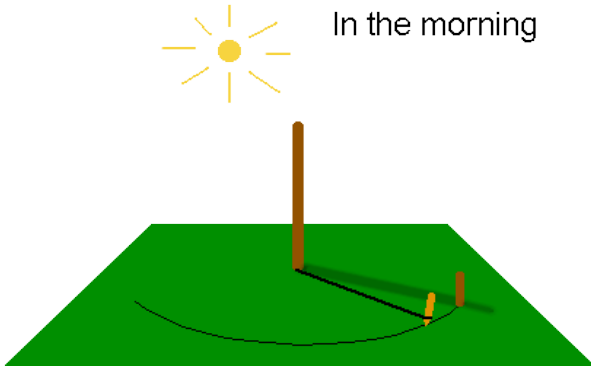

the spot where the shadow ends. If you haven't got a string, you could use a pole that has the right length, or try to come up with some other improvised solution. Just make sure what you draw is a circle.

Now, the line from the first stick to the second is west-east, like on the figure. Actually, you may want to mark points regularly, because any two points that have exactly the same distance from the base of the pole will give the West-East line. If it is partly cloudy, this may be a good idea.

at to climb more hills than you have to. Also be very tired. In that case you should consider formation on how to make it easy for rescuers.

ethod requires that you have a pretty clear sky, es is that you don't need any equipment. You ) long, two small sticks or rocks, another stick ng that can act as a string.

. Stick the long pole in the ground, upright.  
Now, you can place one of the little sticks in the ground *exactly* where the shadow of the pole ends, like on the figure. Then tie the string to the base of the pole, and tie the little, sharp stick, to the other end, so that when the string is stretched it reaches exactly the little stick standing there in the soil. Then, scratch half a circle in the soil with your sharp little stick, and wait... Wait. Wait until the evening. During the day, the shadow will get shorter and shorter, until noon, when it gets longer again. At noon, when the shadow is at its shortest, you may want to mark the point. The shadow is now pointing north (if you are north of  $23.5^\circ$  north). It is however not very easy to see exactly when this is, but it is useful anyway. Finally, the shadow reaches your circle again, and when it does, place your other little stick at

There is a short, fast version of this one as well. This is only approximate, though, and the further away from the equator you get, the more inaccurate is it. You don't need the sharp stick and the string. Just wait 20 minutes between placing each of the sticks, and the line between the two sticks will be approximately west-east, like on the figure. Often, you wouldn't need anything more accurate.

At night, you can navigate after the stars. You should, however, be careful with walking, it is easy to stumble and fall and get injured, and also easy to lose sight of the stars as you go, and you might start going around in circles. Often it will also be more physically and mentally demanding.

In the northern hemisphere, there is a star that is almost exactly in north at all times, the *Polaris*. It is pretty easy to find, if you know the "Big Dipper". (Everybody knows the Dipper (or the Plough)?) Take the two stars at the end of the "Big Dipper", and make an imaginary line "upwards", and extend it five times the distance between the two stars. There you have it - *Polaris*. That way is always north. The figure is courtesy of [Kathy Miles](#).

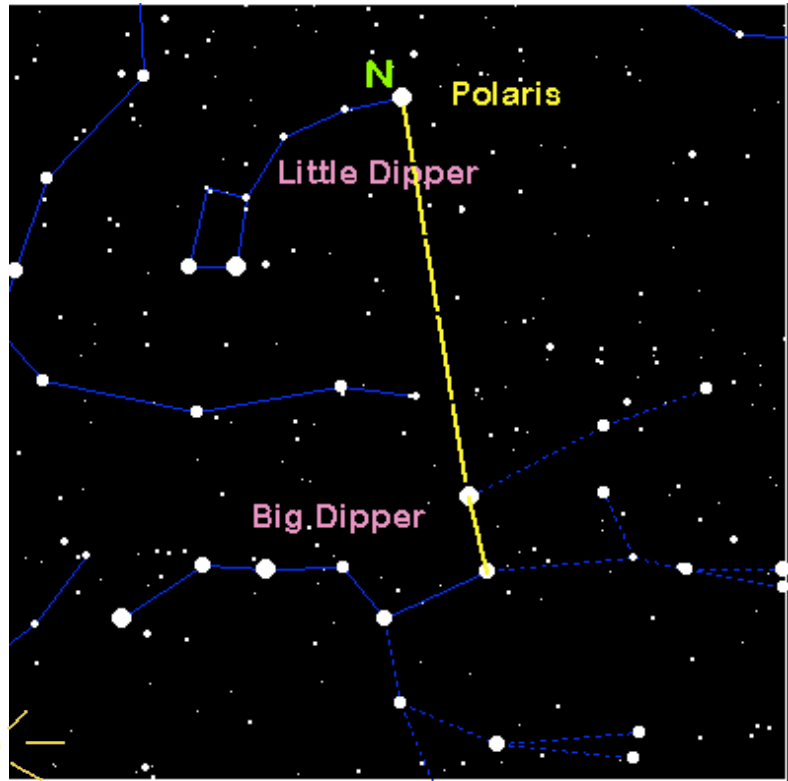

star  
the  
to  
Big  
end  
five  
is  
Use  
d  
with  
per  
mis

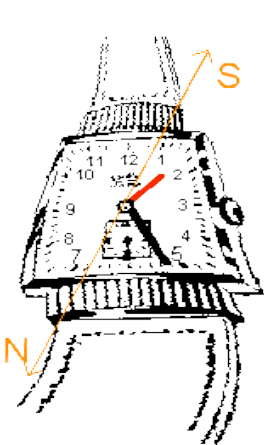

In the southern hemisphere, you would have to find the *Southern Cross*. Because I haven't been south of the equator, I can't help you find it, make someone tell you where it is right now, if you don't know it already. That way is south.

If you have an analog wrist watch, you can use the time to find north. Hold your watch up in front of you, and let the short hand, red on the figure, that indicates hours point at the sun. While holding it like this, cut the angle between the red arrow and 12 o'clock in two, (*noonwards* if the time is before 6am or after 6pm), that way is south. (The reason you need to cut it in two, is because the clock takes two rotations while the sun takes one around the earth, it is of course the other way around, but never mind.)

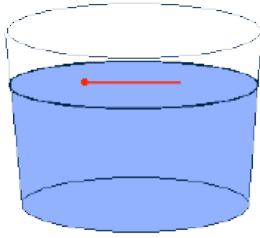

Many people wear digital watches these days (I do myself, if I wear one at all). If you do, draw an analog watch face on a piece of paper, and then mark the hour hand on using the digital watch. The rest of the method is identical.

This method can be used even when it is pretty foggy. Although you may not be able to see the sun, it may still cast a shadow. If you take up a straw or a tiny stick, and you may see a shadow. You just have to remember that the shadow points the opposite way from the sun, but the rest of it is quite similar as above.

Want to make your own compass? Sure. You need a needle and a glass of water. A needle can in fact float on the water, or that is, on the surface tension forces if put carefully on the surface. Just put it carefully down on the surface of the water. This demands a lot of patience though. There are three tricks that makes it go easier. One: Put the needle on a piece of paper. If the paper floats too, there is no problem, and if the paper sinks, it'll probably leave the needle. If you put some grease on the needle that isn't water-based, it'll go easier, or if you put it carefully down with a fork or something. Once it has got there, it stays there pretty good.

If the needle is magnetic, it will act as a normal compass and be very accurate. A problem is though, that you don't know north from south. All you know is that it lays north-south. You would have to use one of the other techniques to find out, or make a good guess.

The greatest problem with this is: Not many needles are made of magnetic materials these days.... You can't just use any needle. You may just have to look around to see what you can find, if you want to make a yourself a compass.

What if there is no shadow? Then, there are a few methods based on natural signs. I will deal with the ones I have checked myself.

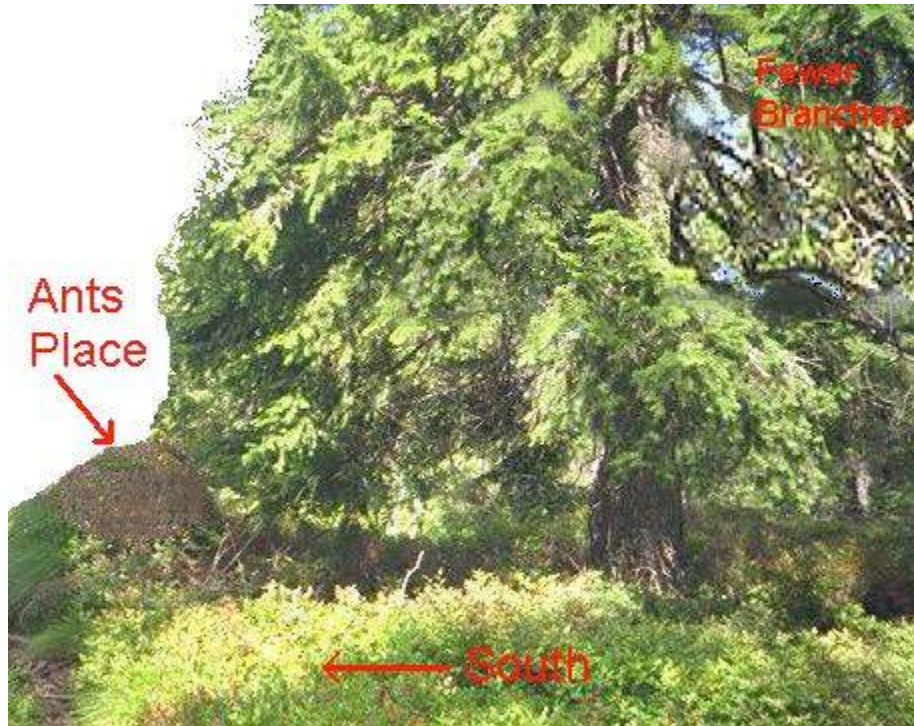

It is very much about trees. First of all, there will be fewer branches to the north. This is usually easiest to see if you look up along the trunk of the tree. The north face of the tree would be more humid than the south face, which is something most species of lichen (or moss) likes, and consequently, there will be more of it on the north face. On the image above, you can also see that ants like to build their nests on the south side of the tree.

It is also worthwhile to look at how snow melts. In the spring in the mountains, snow will melt faster on the south face of rocks, or in south facing slopes. Also, vegetation and undergrowth will typically be thicker on the South facing slopes, and also fruits ripen earlier on the South facing slopes.

These methods are not very reliable, I am afraid. Winds may alter the average conditions significantly, and cause deviations. If you use natural signs, you should use as many signs as you can before you draw a conclusion.

### **Riddles and Rhymes to help you remember declination**

in the west, Truth is greater than Magnetism

meaning that west of the agonic line (where the declination is zero), true (map-based) bearings are larger than magnetic (compass-based) bearings.

From map to field  
The proper yield  
is  
East is least and  
West is best

## How to use a compass

### *Buying a Compass*

I've been a bit hesitant to write this page, because I really didn't want to promote a special brand of compasses or anything. What kind of compass one should buy is a major concern of those who e-mail me, so I figured I would give some advices.

First, I want to emphasize that, while I have tried quite a few types of compasses, they haven't been made by many different manufacturers, and the list of compasses I present here will necessarily be reflecting the fact that I am in one of the Nordic countries, and I know the compasses manufactured around here the most. That doesn't necessarily mean compasses made in e.g. the US or Australia are any worse, I just don't know them.

Finally, my area are orienteering and compasses for hikers. I have very little experience with e.g. naval compasses (though I have tried it too).

What kind of compass you should choose will very much depend on your typical use. However, my general advice would be: Make it as simple as possible.

In competitive orienteering, a small revolution happened at the begining of this decade: Orienteering compasses became a lot more stable and fast over night, as it was discovered by a swedish orienteer that the home-made compasses of russian orienteers were extremely good. You cannot normally tell the difference between a normal compass, and these new compasses, unless you run or perform a simple experiment: Hold the compass flat in your hand, and let the compass needle stop. Now, turn your hand so that the needle is vertical, now you can turn yourself so that when you put the compass flat again, the needle is not pointing north. Observe how fast the needle gets back to pointing north. Actually, with a good compass, this is difficult to do, with a not so good one, it is pretty easy. You can compare how fast different compasses are.

This being said, if you are hiking and not running, a normal compass is by far stable and fast enough for you, and they come at half the prize. While hiking, I doubt you would notice the difference, I am myself not using my best compass for hiking.

So what do I mean by a 'normal compass'? A normal compass has a transparent rectangular base plate, made from some hard plastic, a completely transparent compass housing, filled with some liquid, alcohol or oil normally.

There are a number of further enhancements: Some compasses have mirror instead of the long baseplate. This is to be able to aim more accurately. Actually, this is most convenient when you do a triangulation, a technique I haven't described in these pages simply because I don't find it very useful. My experience is that the improvement is marginal, and it won't help you much if you *really* need to be accurate. On some compasses you can preset declination, and though I haven't tried it, I think once you've understood declination, it is easy to correct for it.

Now, you may see where I am going: To a very simple compass. All you need is a compass that you can take a course with, and point at a distant object. Why so simple? Consider this scenario: You're hiking in the mountains, with a map and a compass to guide you. Suddenly, the fog is over you, and visibility is down to a few meters (Yes, I have experienced this happening in 5 minutes). These are conditions when you may have to trust your compass with your life. Say you are

walking on rocky grounds, looking frequently at your compass to keep the course. Suddenly you fall, and the compass is crushed in your hand.

Fortunately, as long as the compass needle is reasonably intact, a compass will still serve as a compass, and there is a good chance the needle will have survived the fall. Now, the first thing that happens is usually that the housing is punctured, so that the liquid pours out, or there may be a big bubble. This will make the compass a lot more unstable, so you may have to stand still for a long time to get a good bearing. The mirror some compasses have are nice as long as you have something to point at, but then, it isn't really difficult to navigate. Once the visibility is low, that is when it is really difficult, the mirror will not help you much. Additionally, a thick baseplate is more likely to have survived the fall than a mirror, and it is considerably more difficult to get a good bearing without a mirror or a long baseplate. So stick to the baseplate.

As a general principle, one can say that the more features something has, the more things can break (and as a corollary to Murphys law, it probably will...), and if you have made yourself dependent on these features, you'll be in trouble. Always learn how to cope without. Of course you may discuss this, but when something is as essential as a compass, the best way to learn to cope without nifty features, is to live without.

If you are considering buying a [GPS unit](#), you should also consider the points above. I haven't used a GPS unit myself, but it is clear that it will open new territories for people who are not that good at navigating, which I think is very good. However, this is also a problem. There are many things that may render a GPS unit useless, among those something as trivial as a fall. A compass on the other hand is not that likely to be completely useless. The necessity of being able to navigate properly in difficult conditions without a GPS must therefore be stressed.

Many reviews of GPS units I have read give extra points to units with large displays and a intuitive user interface. I think however, that the display is probably the most vulnerable piece of the unit, and should therefore be as small as possible. Also, intuitive user interfaces are good, but of very marginal importance once you've learned to use the unit.

Let me finally introduce you to the compasses I use the most these days.

When I run orienteering, it is very important that the compass is fast and stable, and so, I use a quite expensive compass, the [Silva 6 JET](#). It is a compass to attach to your thumb, it does not have a turnable housing, the typical use is a bit different from what I have described in the tutorials, as it is not so useful in course setting (and not that accurate), but extremely useful in keeping you oriented. I find it very good, and it has a very fast needle.

The other compass I use frequently is also a [Silva](#) compass, the Silva Starter which seems to have been replaced with the [Silva Field](#). It is a very simple compass, made for beginners, really and should be quite inexpensive. I use this when I'm hiking.

In addition to these compasses, I've been using Suunto compasses a lot (they have a website, but it is so poorly designed it is inaccessible), and find them good. As previously noted, it was the russians who came up with the new good compasses. Silva bought their recipe immediately afterwards for their JET series. A number of small russian companies sold very good compasses just after this happened, but few seems to have survived. I have tried one compass of [MosCompass](#) (site mostly in russian, on a slow server), and from what I can tell, they are good.

What you should go buying would depend on the issues discussed here, and what is available in your store. I would recommend looking around on the above pages and see how compasses there look, and try to find something similar.

So, what should one pay? Naturally, I have only experience from around here, and a fast orienteering compass would be about 500 Norwegian Kroner (check out the [Exchange rates](#)). A good hiking compass would cost about NOK 200. In the US (most of those who e-mail me are from the US), I guess \$25 and below would be a reasonable prize for a hiking compass.



## How to use a compass

### Suggested Exercises

OK, so I read the pages, and I am going to teach kids this, what do I do? This page has a few suggested exercises, and this page is intended for coaches and educators who have themselves some experience. Anybody can be taught using this page, of course, but it is principally aimed at teaching kids.

First, there are some very important considerations to make. The feeling of being lost is something that may be very stressful to a child, and if stressed too much, a child may never learn to love the backyard. Some children are perfectly capable of coping with the feeling of being lost, for others coping with this feeling may take a very long time, but once achieved I believe it is a considerable survival skill that may help save somebody's life some day.

As a coach, you need to be aware of this situation, and be very cautious until you know the children you are coaching. It is of great importance that the exercises in the forest are planned with this in mind.

Now to the exercises: For the absolute beginners, it is important that they master the techniques described in [lesson 1](#) and [2](#). This can be done partially with practise without going anywhere, but that gets boring pretty fast, you could let the kids do it a few times. In this first exercise the aim is solely to choose the right control from several you can see. This way, you get practise, but need not fear getting lost. It requires some work done, however. Check out this figure:

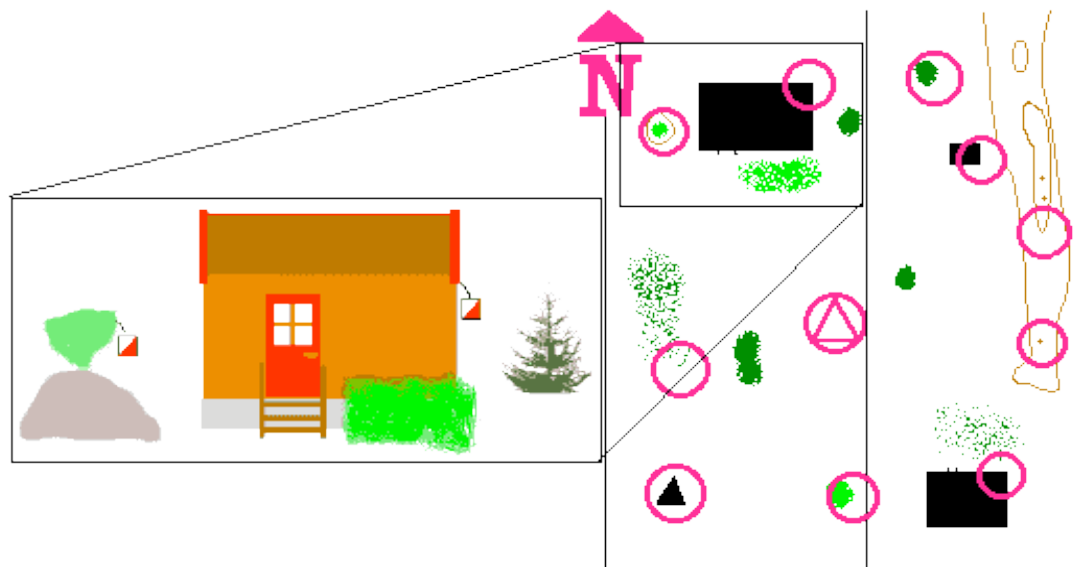

To the right is a map of your backyard. In the middle is a symbol , which is a symbol used in orienteering to denote start and finish when they are at the same place (Otherwise, start is a triangle, and finish two concentric circles). There are controls all around you, and all of them can

be seen from this center. A control, as used in orienteering, looks like , and they are placed in

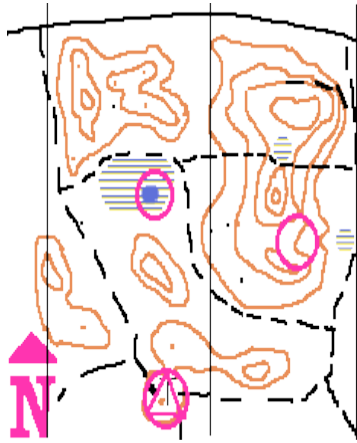

all the circles. The map here is of course an imaginary map, and you would have to draw a map of your own back yard. The scale isn't very important, but it has to be correct with regards to the compass. Also on the figure above is a detail from the upper left corner of the map as it would look in the real (imaginary...) world. You should draw all buildings, large rocks, bushes and trees and other features you see, like you see from the detail.

The kids are going to choose the right control using the map you drew, and the compass. The first time you do this, you should take your time, and help each one of the kids with taking the compass course. When they have taken the course, they decide which control is the right one, run or walk up to it, and come back. Then they do the same with the next control. The sequence each kid does this, is however, unique.

The second time, it is time to do some more fun. Here is one example. Make it a treasure hunt! This is the plan: At each control, put a bag of some treasure on the control, one for each kid and unique to the control. Take for example, starting in the upper left corner by the north arrow, a bag of bananas by the bushes, a bag of oranges by the corner of the house, a bag of apples by the tree and so on. Each one of the kids is going to fetch the treasures, in a unique sequence, as fast as they can, they are supposed to be running back and forth to the starting point between each control. The controls are numbered, and each kid gets the sequence he or she is going to run to the controls in, and which treasure is at which control, so if he or she finds the wrong type of treasure, he or she knows it is the wrong control. You are standing there checking everybody got the right sequence. Which means you get a hard time... This is going to be chaotic, everybody running in different directions, and chaos is fun!

For small kids, it is important that everybody is a winner, and although somebody is going to be fastest, nobody is a loser when they get all these treasures.

There are of course, many possible variations of this method, relays, take as many treasures as you can in a specified time, and so on. Lots of fun! You should continue with variations of this method, maybe taking them out in the forest, until everybody feels confident they can use the compass safely and accurately, This may take some time. In a proper orienteering course, compass usage is of course only a small part of it. Consequently, you may use the two first exercises (this one and the next), for the compass part of the course for a full year, but with variations of course.

Let's move to the bush. Compass usage is most important when you haven't got any other features to guide you, such as paths, streams etc. So to get proper training, the kids have to go where they don't follow paths and such. This makes things more difficult, of course, and it is easier to get lost. Which means we are talking about the feared "feeling of being lost". Therefore, it is essential, assuming the kids have not yet got all the confidence they need to be out there completely on their own, to plan the exercises with a "security net", so that they cannot get really lost. This is achieved by ensuring there are features like roads, large paths, streams etc. that they can't miss, if (when) they miss the control.

It may be a good idea to put the start at a point that is visible from quite a distance, like a tower, for instance (the 'T' in the start symbol means tower). This time, the place you use should be covered by a real map, preferably with a large scale. Two controls are indicated as examples. Neither of the controls are visible from the start, which means the kids would need to use more

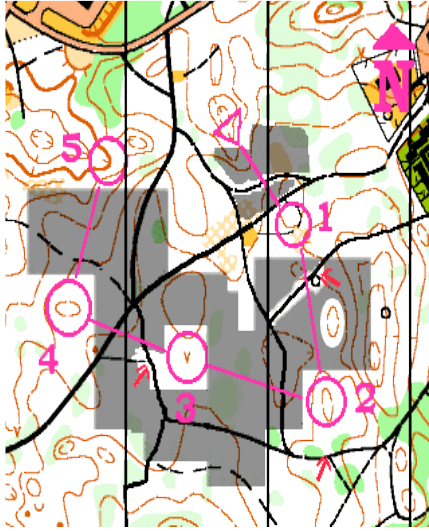

techniques to get there. Before you start, you would need to instruct the kids what to do if they miss the control. If they think they cannot go right back to the start, they should just proceed until they find the road, and take one of the large paths back.

While only two controls are indicated here, there are supposed to be controls all the way around, like in the previous example. And also like in the previous example, they are supposed to run back and forth. The distance from the start should be around 100 meters, and must not be more than 200 meters.

The first times you are out this way, it may be a good idea to follow the kids around. In this case, you may not need to go back and forth, but go a course with 100-200 meters between the controls. Let the kids do the orienteering. Then you can again arrange treasure hunts, relays and such as the kids run

back and forth. As the kids build up confidence, some will surely do this faster than others, they may take two controls for each time they run out, so they won't have to run the same path back and forth.

Hopefully, during this process, the kids will build up confidence in themselves, and know what to do when they miss. Eventually, they will be able to cope with the feeling of being lost, and then they may proceed to greater challenges.

This is the greater challenge. This is a real orienteering map, "Eggemoen", published by [Ringerricke Orienteringslag](#)©, used here with permission. It illustrates how one uses a black pen to make parts of the map unreadable, which forces the runner to use the compass. In general, this method is regarded too difficult for beginners, but I have made some simplifying additions to the method, so I believe it is now appropriate for second-year beginners. It is, however, important that the kids have learned to cope with the feeling of being lost, it is nothing they fear anymore, because anybody who uses this method *will* get lost once in a while.

As you can see, I have made a course on the map, and there are different levels of difficulty associated with each of the controls. The first control is the easiest. One crosses several roads and paths on the way to the control, and there are paths leading into the control from each side. The crossing of roads has mainly two purposes: The child can see how far he or she has got, and secondly, it helps to build confidence. It doesn't play a very important role in finding the control, because the compass is supposed to play the main role in that. It can be used to correct the bearing if it is obviously wrong though. The control has also a "security net" - the road just after the control. If the control is missed, it provides a way to get back in, a detail that cannot easily be mistaken. The red arrow indicates such a detail.

The second control is a little more difficult. There are, contrary to the first control, few crossings. A few details are allowed to be visible though, so that the child can check his or her bearing and make sure he or she hasn't gone very wrong. The control has still a security net, the red arrow indicates a good place to get into it again.

The third control has only the security net left, even the road that is crossed is blacked out. This is pretty difficult, and suited to teens that are getting experienced are about to move up to more difficult courses.

So is the fourth control. The kids who can run courses with this kind of controls are confident in the forest, has already been doing a lot of missing, and has analytical experience enough to find back without aid.

The fifth control is a control that may be good for experienced orienteers for this kind of training.

For all levels, the distance between controls shouldn't be more than 200 meters, a good deal less for the kids. This map has been enlarged for instructional purpose. Also, the blackout here is somewhat transparent, this is also for instructional purpose. In a real exercise, it should be completely black where it is grey here.

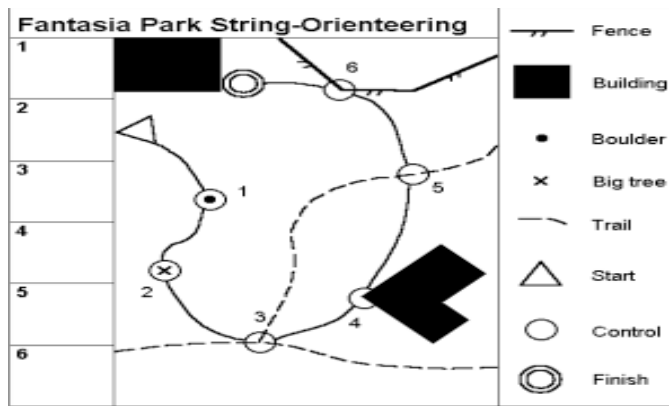

The string course is a short orienteering course which is marked by a continuous ribbon or yarn. The map below shows a sample string-orienteeing map with the course marked. The map is

usually simple and includes just the area around the course. Children may color it in with the appropriate map colors.

From the start, a continuous length of ribbon or yarn, called the string, leads you along the course. The route that the string takes is shown on the map. When you reach the places circled on the map (called "controls"), you will find an orange and white nylon marker (called a "control marker"). At each control there will either be a marking device or a bag of stickers, for marking the appropriate box on the map. Eventually the string leads back to the finish, usually the same place as the start.

A child need only follow the string around to find all the points and will not get lost. For the youngest, this is sufficient and gives the child exercise, fun and some exposure to maps, as well as confidence in being alone in the woods. Even at this simplest level, however, children can be taught map symbols, map colors and simple orienteering skills.

For children ready for more challenge, the locations of the controls can be left off the map. The child must figure out where the controls should be on the map. Alternatively, some controls can be placed off the string inside the loop formed by the string. Many variations are possible.

## *Terms, concepts, and gear*

### **Orienteering maps**

**An orienteering map is a kind of topographic map made specially for orienteering. “Topographic” means that it shows the shape of the land—hills, valleys, and so forth. An orienteering map also shows many other features relevant to an orienteer—streams, trails, fences, fields, thick brush, and so on.**

**Although many types of orienteering maps exist, most orienteering maps are made to a common set of standards used around the world. Standard orienteering maps are printed in five colors, with each color used for a different class of features:**

#### **Black**

**Manmade features, such as roads, trails, buildings and fences, plus rock features, such as cliffs and boulders.**

#### **Brown**

**Topographic features, such as hills, valleys, ridges, earth banks and ditches.**

#### **Blue**

**Water features, such as lakes, ponds, swamps and streams.**

#### **White**

**Normal forest. (This is different from some government maps, which may show fields with white and forest with green.)**

#### **Yellow**

**Clearings and fields.**

#### **Green**

**Thick brush, such as bushes or thorns.**

### **Compasses**

**Orienteering compasses are different from most other types of compasses, such as boating, surveying or military compasses. In a pinch, any type of compass in which you can see the needle can be used, but orienteering compasses have some advantages.**

**The most common type of orienteering compass is the baseplate variety. The compass needle sits in a housing in the center, which is set on a clear plastic baseplate. With this compass you can set bearings from where you are to where you are going, which is useful for finding places that have few nearby features to guide you.**

**Another type of orienteering compass is the thumb compass, which straps to your thumb. The thumb compass allows for quick reference since it is held against the map as you go. Some like it for its simplicity, others for speed of reference in competition. The thumb**

compass lets you orient the map with ease (see the [Skills](#) section), but does not let you set bearings.

### **Special terms**

#### **Control**

This is the point, circled on the map, which you are looking for. The (usually) orange and white marker there is called a control marker.

#### **Course**

The orienteering course is the set of controls you are looking for. Click here to see [a course](#).

#### **Leg**

A leg is the portion of a course between two consecutive controls.

#### **Knoll**

A small hill.

#### **Spur**

A small ridge or protrusion on a hillside.

#### **Reentrant**

A small valley or draw running down a hillside.

#### **Contour**

A brown line used to show topographic features. The books listed in the [Resources](#) section provide good explanations of contours. Contours are usually taught to children after they have mastered map reading and basic navigational skills. Simply stated, a contour is a line tracing land of a given elevation. Using contours, the shape of most landforms -- hills, valleys, slopes, knobs, even kettleholes and sand dunes -- can be shown.

#### **Linear feature**

A trail, stream, fence, stone wall, or other feature that is basically linear. Contrast this with point features, like boulders, wells and springs, and area features, like fields and lakes.

#### **Catching features**

A large feature which is not easy to miss in the direction you are going. You might use a catching feature, such as a lake beyond a control, to "catch" you if you miss the control.

## **What is a map?**

**One way to think of a map is as an aerial view. But for younger children, the concept of a map as a drawing of the forest may be more easily understood. An intuitive understanding of a map is a good base from which to build on later with more formal concepts.**

**Frequent exposure to maps helps build a sense of familiarity. Foster this by asking simple questions about the map. If the map is colored, quiz the child on what the colors mean -- yellow for clearing, blue for water and so on. Talk about places being far apart (or close together) since they are far apart (or close) on the map. It may be good advice to not get too complex too soon; the child may not yet be ready. Maps are a wonderfully intuitive and yet sophisticated concept that children will grasp when they are ready.**

**Simple exercises include having children draw a map of a small area. This can be as simple as making a drawing of a room or a field, or as formal as measuring a room or field and the objects within and drawing them all to scale on graph paper. Choose the level of sophistication suitable for the child.**

**If you discuss contours or topography at this stage, it may be good to start simple. Simple concepts to start with include hilltops (shown by closed contours, and the difference between steep areas (where contours are close together) and flat areas (where there are few or no contours)).**

## **Reading a map**

**Lead the children out on a map walk reading the map. Point out features as you go along. Ask the children to anticipate what features they will be seeing next by reading the map.**

**Orienting a map is an important skill. Turn the map until what is in front of you in the terrain is in front of you on the map. If you are facing east, then the east side of the map should be away from you. Don't worry if the lettering on the map is sideways or upside-down. Practice keeping the map oriented while on a map walk.**

**Thumbing is also a useful technique. Fold the map into a small, easily held piece and hold your thumb on the map near where you are. Keeping your thumb near where you are as you go along makes it easier to refer back to the map when you take your eyes off it. It also reduces the chances of your eyes "skipping" to another part of the map, say, to another trail junction. This is an easy error to make.**

**An example of a map reading exercise is to have the children do a String orienteering course. Mark the route on the map for them but don't show where the controls (checkpoints) are. As the children come to each control, have them mark where they are on the map. This will teach them to read the map and figure out where they are.**

## **Learning to navigate**

**Navigation is the quintessential skill of orienteering, and it will take time to master. Be sure to teach (or learn) it progressively in small steps, allowing for success at each stage. Children may also still want to do the String course as well as they advance to adult**



navigation, which is good, since String courses often serve a social function as well, and help reinforce a sense of success.

### **Navigating along linear features**

Once children can find their location on a map, the next step is to start finding their own way on an unmarked route...in other words, on a standard orienteering course. At first, do the navigation together.

The first type of standard orienteering course for a child to do is one on linear features, such as trails, with only one decision to be made on each leg. (See [Learn the language](#)). For instance, each control might be on a trail junction, but there should not be any trail junctions between controls. At each trail junction the child need only decide which way to go. This is easier than a typical White course, which is the easiest standard course usually available. You may need to improvise:

If you set the course yourself, use a small, well bounded area. If you want to use a normal White course, try to pick an event at an area that tends to have easier White courses, such as a small park. Or, if the course is hard, have the child do the navigation for some of the easier legs and do the harder legs together.

Don't worry about choosing the best route or the fastest way, just successful navigation. Route choice tends to improve with experience.

After children master simple linear navigation, they are ready for a more typical White course, where they will make multiple decisions on each leg. Follow them along at first, letting them navigate but keeping them from making big mistakes. Later, let them do the course alone.

At some point, teach a second technique for orienting the map: using a compass. Hold the compass on the map. Ignore all settings, dials and gadgets. Turn the map (not the compass) until the compass needle is parallel to the north lines on the map, with the red end of the needle toward the north end of the map. (The compass needle always points to north (magnetic north, to be specific), so turning the compass will leave the compass needle always pointing the same way.) Now the map will be oriented with the terrain, just like when you oriented it before.

Practice map reading while on White courses. While going along, have the child read what other features should be alongside the trail, and verify that these are there as you pass them. Also, practice relating distances on the map to distances on the ground. For instance, how far will the next feature be?

### **Off trails**

The next more difficult course is Yellow. The Yellow course generally goes along trails and other linear features, but often has controls on features just off the trail.

Now it becomes important to plan a method of finding a control, not just picking which trail to take. Often this involves an "attack point," which is a feature, such as a bend in the trail, or a pond by the trail, or a hilltop, or such, at which you will head off the trail to find the

control. Ther times it may simply involve knowing when to look for a small hill or cliff near the trail. In any case, it is important to plan ahead.

Route choice starts to become important. At this point emphasize routes that provide the most sure way to find a control, rather than the fastest or shortest way. Consider factors such as whether there is a feature (“catching feature”) to let you know if you have missed what you are looking for. Is there a good atack point on this route? Is the navigation easy or hard? Are there lots of chances for wrong turns?

Compass bearings could now be taught:

1. *Place the edge of the compass on the map so that it goes from where you are to where you want to go. (So, the edge of the compass forms a line connecting where you are on the map and where you want to go.) In the diagram above, a compass bearing is being taken from a trail bend to control point 3. (A trail is shown by a dashed black line; a red mark has been made on the diagram to point out the trail bend.) Make sure that the direction of travel arrow at the top of the compass is pointing in the direction you want to go, and not in the reverse direction.*

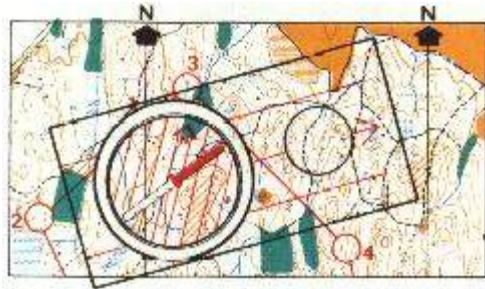

2. *Holding the compass in place on the map, and ignoring the needle for the moment, turn the dial so that the lines in the housing line up with the north lines (meridians) on the map. Make sure that the N on the dial is towards the north (and not south) end of the map. (This is subtle in the above diagrams; look to be sure you see it.)*

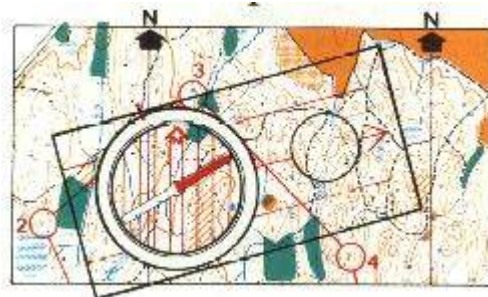

3. *Leaving that setting alone, turn yourself and the compass and map until the red end of the needle points to the N on the dial. (Remember, the needle doesn't turn (it always points north).) You and the compass and map turn around it. This takes a bit to get used to.) The direction of travel arrow on the compass now points in the direction you want to go.*

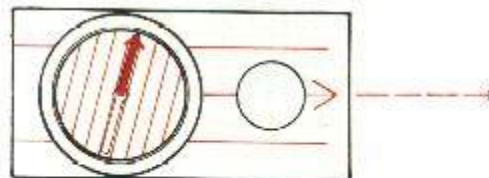

Illustrated instructions are often included with orienteering compasses. Remember that the most important use of a compass is still to orient the

**map. And remember, reading the map is still important too!**

**At this stage, an orienteer is probably ready to make a very simple map of a small area, such as a schoolyard. This is excellent training for both map and compass skills, and will reinforce almost everything taught to this point. An orienteering training camp might also be useful and fun. More advanced skills can be found in several of the books listed in the Resource section.**

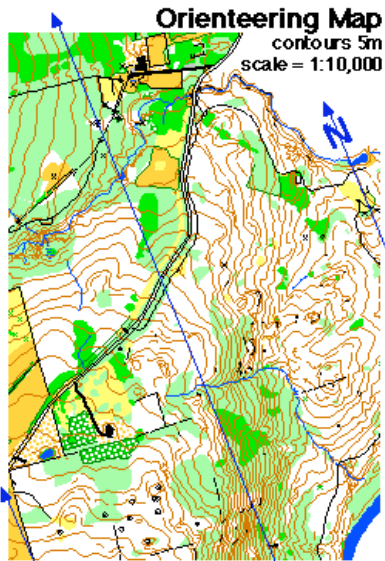

### The Map

Although it is possible to orienteer on almost any map, it is much more enjoyable to use maps made specifically for orienteering. Such maps are accurate and detailed, and are prepared on a human scale - terrain and features are mapped so that what appears on the map are the features that a human, moving through the area, sees readily. For example, boulders that are waist high appear on orienteering maps.

The orienteering map has evolved substantially over the last 50 years. In the 1940s, events in Scandinavia used 1:100,000 (1 cm = 1 km) government issue maps, often in black and white and without contour lines to show the shape of the land. Nowadays, most orienteering events are held on five-color maps that have 5 meter contour intervals (16.5 feet) and have a scale of 1:15,000 (preferred) or 1:10,000 (1 cm = 100 meters).

Most of the characteristics of orienteering maps are related to those found on hiking and general use maps produced by the government. However, one feature of orienteering maps is specific to the sport: the north lines. On the example shown here, they are drawn in blue (on many maps, they are black). North lines are parallel lines drawn running from magnetic south to magnetic north, and are spaced 500 meters apart on the map. Why aren't north lines on orienteering maps drawn pointing to true north? Because the angle between magnetic north and true north (the declination) varies widely in different parts of the world, and because orienteers use compasses to orient themselves (to *magnetic* north, not true north), it has become the standard to provide a series of reference lines on the map so that it is easy to use an orienteering compass to take a bearing.

There are international specifications for map symbols, and these have been successful in their aim of making orienteering map symbols standard throughout the world.

Some general rules for orienteering map symbols that make the system easier to understand.

### Orienteering map symbols:

- Black symbols are used for [rock features](#) (for example, boulders, cliffs, stony ground) and for [linear features](#) such as roads, trails and fences as well as for other [man-made features](#) (for example, ruins and buildings)
- Brown symbols are used for [landforms](#) such as contour lines, small knolls, ditches, earthbanks.
- Blue is used for [water features](#): lakes, ponds, rivers, streams, marshes.
- Yellow is to show [vegetation](#) - specifically for open or unforested land. The density of the yellow color shows how clear the area is: brightest yellow for lawns, pale yellow for meadows with high grass.
- Green is used to show [vegetation](#) that slows down the passage of an orienteer. The darkest green areas, called "fight", are almost impassably overgrown.
- White on an orienteering map signifies forest with little or no undergrowth - forest that an orienteer can run through.

- Purple (or red) is used to mark the orienteering [course](#) on a map. Conditions that are specific to an event (such as out-of-bounds fields in which crops are growing) are also designated in red or purple.

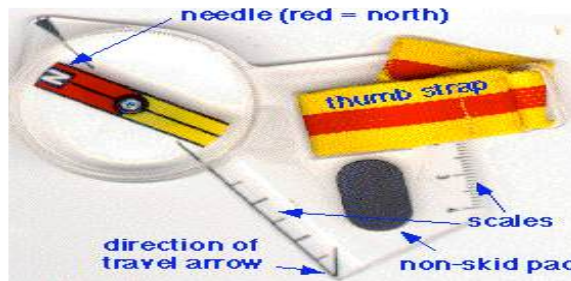
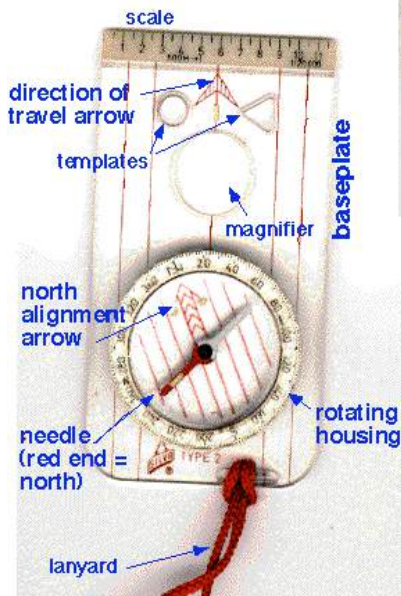

## Compass types

Good compasses have a fluid-filled housing; the fluid dampens the motion of the needle, so that

you can use the compass without holding it perfectly still. Avoid inexpensive compasses that do not have fluid-filled housings. The compass needle is painted in two colors. Assuming that the compass is held flat, the red end points to north, and the white end to south. An interesting detail is that there are northern- and southern-hemisphere compasses. This has to do with the fact that the magnetic field lines, to which a compass needle aligns, point into the earth at the north and south magnetic poles. In the northern hemisphere the north end of the needle is pulled downwards, and the south end is counterweighted to balance the needle. When you use a northern hemisphere compass in, say, Australia, the south end of the magnet is

pulled downwards by the magnetic field, and is also heavier than the north end - resulting in a needle that catches and drags on the bottom of the compass housing when the compass is held horizontal.

A good compass will last a long time. However, some things can go wrong with a compass: the plastic components can break, or the housing can develop a leak. Over time, the fluid within the housing may turn an opaque blue-green. And, very rarely, the magnetization of the compass needle may reverse, so that the south end now points to north.

There are two main types of orienteering compasses:

### The baseplate or protractor compass

This type of compass was invented by the Kjellstrom brothers during the World War II era and consists of a rectangular baseplate, which is marked with a red arrow pointing along the long axis, and a rotating compass housing marked in degrees (360 degrees for the full circle in most of the world, but 400 on some European compasses). Marked on the floor of the rotating compass housing are an arrow and a set of lines parallel to that arrow. Additional features may include a lanyard for attaching the compass to the wrist, scale bars for measuring map distances along one or more edges of the baseplate, a magnifying glass for reading fine map detail, and templates of a circle and triangle for marking orienteering courses on the map.

### The thumb compass

In the mid 1980s, a top Swedish orienteer developed an alternative to the baseplate compass by reshaping the baseplate and adding a strap for attaching the compass to his thumb. This compass is then placed on the thumb of the left hand, which holds it on the map. The advantage of this system is that the map and compass are always read as a unit, the map is aligned more easily and quickly, plus one hand is left free; the disadvantage is that running very accurately on a bearing is more difficult. Personal preference usually determines the type of compass that is used; world championships have been won using both types.

Using either type of compass, there are two basic skills an orienteer needs:

orienting the map  
taking a bearing.

---

### **Using a compass for orienting the map**

This is a simple skill, and is probably the most important use of the compass:

Hold your map horizontally.

Place the compass flat on the map.

Rotate the map until the "north lines" on the map (a series of evenly spaced parallel lines drawn across the map, all pointing to magnetic north) are aligned with the compass needle.

The map should now be oriented to the terrain. This makes it much easier to read, just as text is easier to read right side up than upside down.

---

### **Taking a bearing**

Every direction can be expressed as an angle with respect to north. In the military and the boy scouts, this is called an "azimuth", and bearings are expressed as a number of degrees. Orienteers take the easy way out, just setting the angle on their compass and keeping the needle aligned, which in turn keeps them going in the right direction. A simple set of step-by-step instructions for setting a bearing on a baseplate compass are:

place the compass on the map so that the direction of travel arrow is lined up with the way you want to go

turn the compass housing so that the arrows engraved in its plastic base are parallel to the north arrows drawn on the map (make sure the arrowhead points **north** and not south)

take the compass off the map and hold it in front of you so that the direction of travel arrow points directly ahead of you

rotate your body until the compass needle is aligned with the arrow on the base of the compass housing

pick out a prominent object ahead of you along the direction of travel, go to it, and repeat the process (this way you can detour around obstructions but still stay on your bearing)

---

### **How important is the compass?**

The most important navigational aid used in orienteering is the human brain. One other navigational device is in allowed and in general use: the compass. Compasses are useful for taking bearings and for orienting the map so that it is aligned with the terrain - but it is possible, in most areas, to complete a course quite easily and efficiently without a compass (an exception: it would be difficult to navigate flat areas poor in prominent features without a compass).

The compass is the only legal navigational aid that can be used in orienteering. Altimeters are specifically prohibited and GPS units are implicitly prohibited by the rules. It has been stated that GPS units could be very useful and helpful aids, but when the question of how an everyday orienteer would use a GPS unit to defeat the reigning US champion in a race was raised, the only valid reply was: "I would wait at the first control for him, use the GPS unit to knock him out, and then proceed on to victory". Technology, however powerful, is no match for basic navigational ability - even in the hands of a good orienteer who is also a technological wizard. Beginning orienteers should learn basic compass skills and work on mastering map reading.



## Lesson 1 - Determine magnetic azimuths using a lensatic compass.

The center hold technique is the fastest and easiest way to measure a magnetic azimuth.

1. Make sure the needle on the lensatic compass is floating freely.
2. Hold the compass between the forefingers and thumbs of both hands and pull your elbows down to your sides (Figure 1). This action will place the compass between your chin and waist.
3. To measure an azimuth, simply turn your entire body toward the object, pointing the zero or index mark directly at the distant known location.
4. Once you are pointing at the object, look down and read the azimuth from beneath the fixed black index line. The second diagram below (Figure 2) illustrates a magnetic azimuth of 320 degrees.

You must measure at least two well defined distant locations that can be pinpointed on the map. Two is what we will cover in this lesson but three would be more accurate. To determine the second azimuth repeat steps 2 to 4 on another well defined distant location.

## Lesson 2 - Convert magnetic azimuths to grid azimuths.

- Declination is the angular difference between true, grid, and magnetic North
- The declination diagram is located under the lower margin on most topographic maps
- The declination diagram shows the angular relationship between the three Norths
- True North is represented on the declination diagram with a star
- Grid North is represented on the declination diagram with the letters GN
- Magnetic North is represented on the declination diagram with an arrow

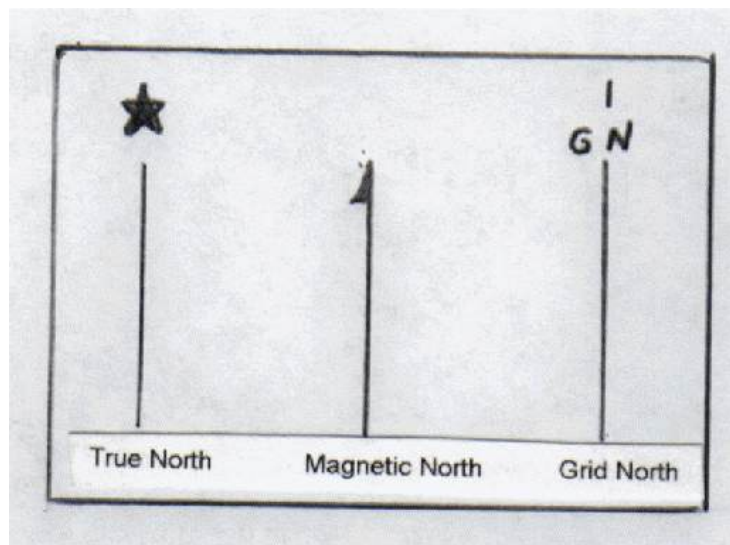

- The Grid-Magnetic angle (G-M angle) value is the angular size that exists between grid North and magnetic North
- The G-M angle is expressed to the nearest half degree
- The grid convergence is an arch on the declination diagram, giving the difference between magnetic North and grid North

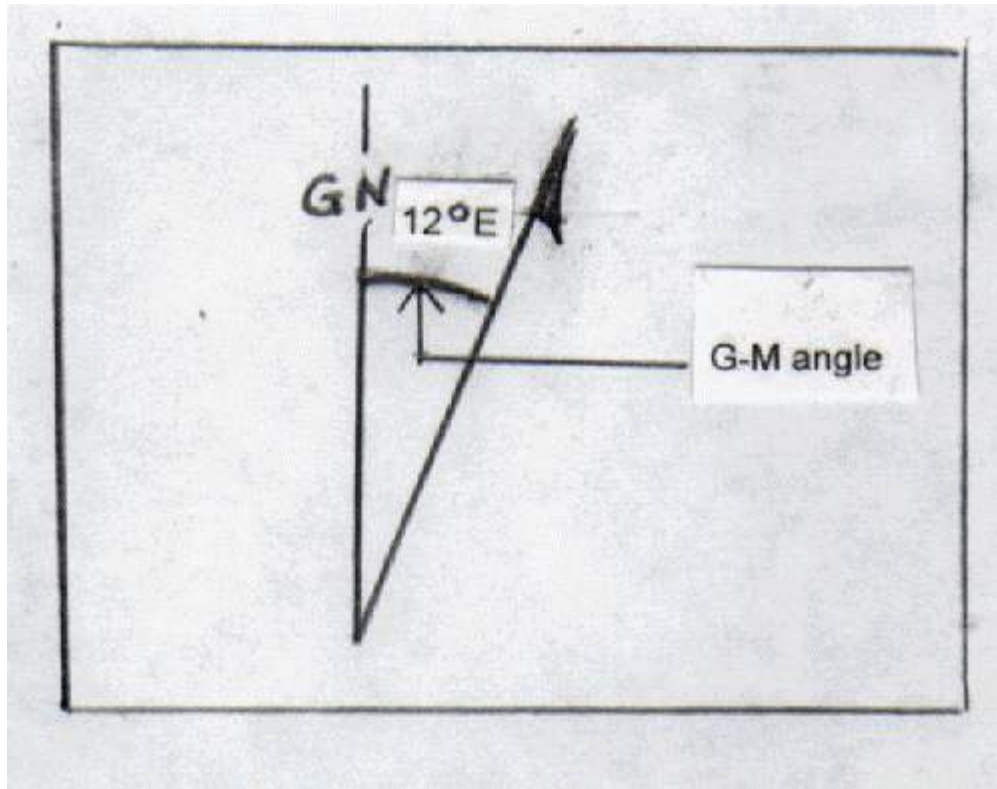

To determine grid azimuths from magnetic azimuths you must add or subtract the G-M angle.

- If the magnetic North arrow on the declination diagram is the right of the grid North line (marked with an E in the G-M angle) add the G-M angle to the magnetic azimuth. If the result of this addition is larger than 360 degrees you must subtract 360 degrees to determine the grid azimuth.

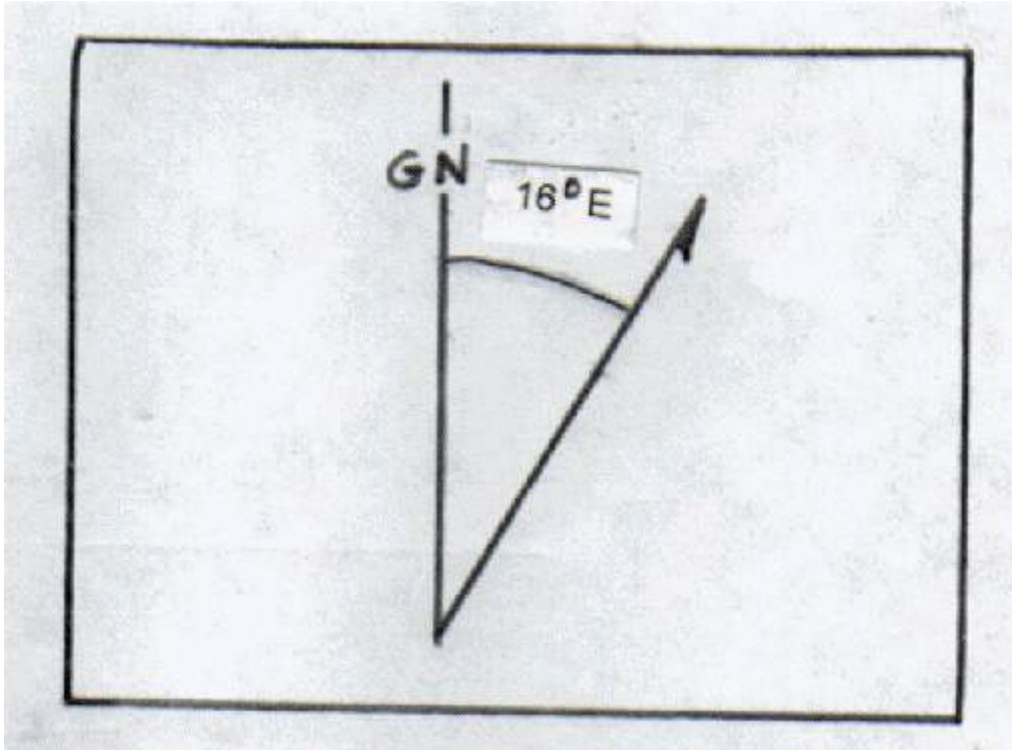

- If the magnetic North arrow is to the left of the grid North line (marked with a **W** in the **G-M angle**) subtract the G-M angle to determine the magnetic azimuth. If the result of this subtraction is a negative number you must add 360 degrees to determine the grid azimuth.

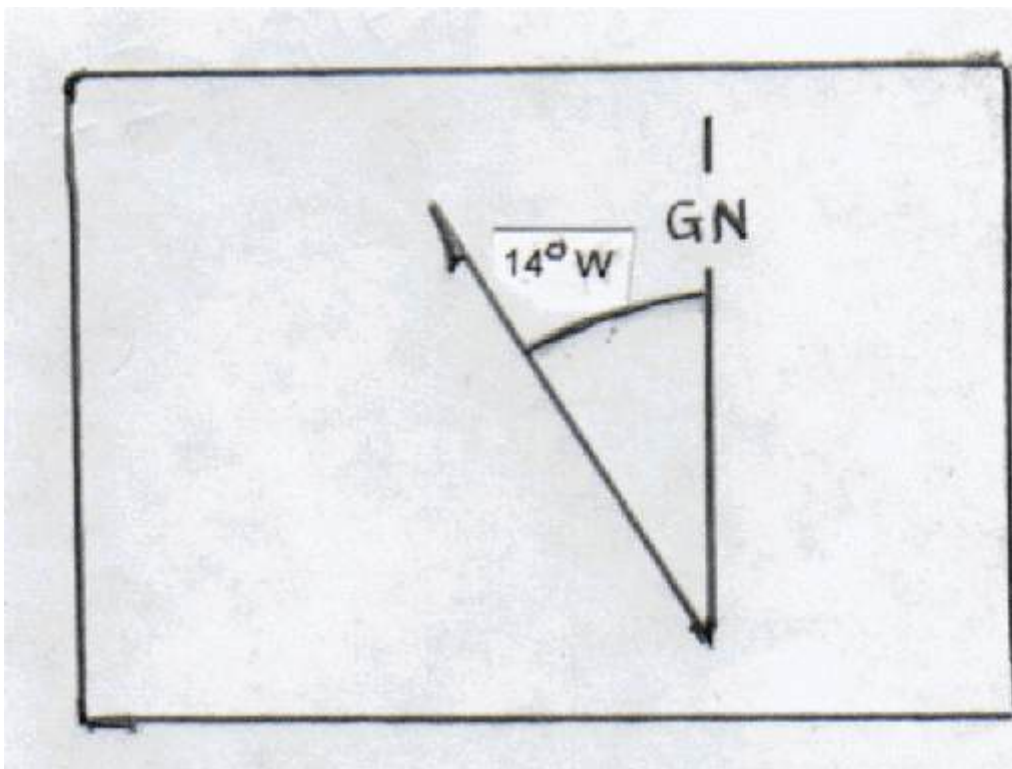

### Lesson 3 - Convert grid azimuths to back azimuths.

You have done the first two of the four steps in locating yourself on a topographical map. You have located two distant known points. You have converted their magnetic direction to a grid (or map) direction. You know the direction to them but not to your location. To determine your location you must compute the back direction. The back azimuth is determined by adding or subtracting 180 degrees to the grid azimuth. This lesson will assist you in learning how to convert the grid azimuth to a back azimuth. In the fourth (last lesson) you will be able to plot the two back azimuths and determine your location. First you learn to convert grid azimuths to back azimuths.

- To determine back azimuths that are less than 180 degrees **add** 180 degrees.
- To determine back azimuths that are more than 180 degrees **subtract** 180 degrees.

Examples:

Grid azimuth = 107 degrees (**add 180**)  $107 + 180 = 287$  degrees

Grid azimuth = 243 degrees (**subtract 180**)  $243 - 180 = 063$  degrees

### Lesson 4 - Plot back azimuths and determine location on a topographical map

You have done the first three of the four steps in locating yourself on a topographical map. You have located two distant known points. You have converted their magnetic direction to a grid (or map) direction. You know the direction to them but not to your location. Now that you have learned to convert the grid azimuths to back azimuths you are ready to finish up. This lesson helps you understand how to plot the back azimuths. The two or three back azimuths will intersect at a location on the map. Where they intersect is your location (X marks the spot).

- Orient the map toward the North using the compass.
- Identify two or three known distant locations on the ground and mark them on the map.
- *Measure the magnetic azimuth to the first of the two or three known positions from your location using a compass ([lesson 1](#)).*
- *Convert the magnetic azimuth to a grid azimuth ([lesson 2](#)).*
- *Convert the grid azimuth to a back azimuth ([lesson 3](#)).*
- *Using a protractor, draw the back azimuth on the map from the known distant position back toward your unknown position.*
- Repeat the steps in blue for a second and optional third known distant position.
- The intersection of the lines is your location.