



**Kyokushin Budo Kai
The Ultimate Beginners Guide**

極真武道会

Revision 2.02

www.kyokushinbudokai.org
Kyokushin Budo Kai
The Ultimate Beginners Guide

Introduction and Acknowledgements

Welcome!

Thank you for downloading '**Kyokushin Budo Kai: The Ultimate Beginners Guide**' from www.kyokushinbudokai.org. This document and the site which provides it are the premier English language resources for all things Budokai. Both the site and this guide are freely available and of benefit to practitioners of Kyokushin Budo Kai, Kyokushin Karate (at times known as 'Kyokushinkai'), Judo, Jiu Jitsu (aka. Ju Jitsu), Free Fight and Mixed Martial Arts (MMA) worldwide.

As a student of Kyokushin Budo Kai, I have spent many hundreds of hours researching websites, in four different languages, in an effort to gain as much knowledge as possible concerning the International Kyokushin Budokai, Jon Bluming (founder and President) and background information concerning the martial arts that make up the Kyokushin Budo Kai system. I would like to thank all Budoka that have posted material online. Without their efforts - the construction of this single source of information would not have been possible.

This document has been compiled following many, many, many months of internet research into the techniques and philosophies of the styles of Kyokushin Budo Kai, Kyokushin Karate, Jiu Jutsu, Judo and Sambo. I researched it's contents purely for the purpose of PERSONAL development and in order to improve my understanding as a practitioner of Kyokushin Karate, Judo and Jiu Jitsu under my Sensei, Charley Herwig (3. Dan), who's Dojo is associated with International Kyokushin Budo Kai. I have decided to make this research freely available in a single document in order to spare fellow practitioners - present and future - from having to do the same! Not everybody has the benefit of unlimited time and internet access!

This document is FREE OF CHARGE and must ALWAYS remain so. If you have paid ANY FEE of ANY KIND then the 'seller' has likely infringed the copyright of the individuals that are responsible for the creation of the original texts from which much of this guide is compiled.

I feel that the following should be made clear:

Without the time, knowledge and effort of those involved in the production of the information available on assorted web-sites globally (in various languages), it would not have been possible for me to collate this information into a single source. My personal development in Budo owes much to the information given freely by these Budoka. I offer my heartfelt gratitude for all that they give to the world of Budo.

The material contained in this document is believed to be in the public domain (that is: any 'non-original' material has been compiled from internet sites where no copyright claim was made) and it is my belief that no copyright has been broken.

Kyokushin Budo Kai: The Ultimate Beginners Guide consists of material from the following sources:

- Self produced material.
- Material which I have translated from other languages (in the main: German and Dutch).
- Material which I have re-written to improve the readability of texts written by non-natives speakers of English.
- Material directly copied from internet sources (which I believe to be WITHOUT copyright).
- Material which has helped for the basis of my opinions regarding Budo that may have been partially changed to better reflect my own thoughts.

Again: no copyright has been intentionally infringed and this document is offered NOT FOR PROFIT OR COMMERCIAL USE OF ANY KIND.

I am simply sharing the results of my research. Whilst this guide was compiled to help out those new to Budo Kai, I am certain that it will be of equal benefit to beginners and Dan grades alike.

Remember, this is just a **guide** to be used as **reference material only**. Without regular training in connection with a certified instructor - this information is fairly useless. I wish you every success in your Budo development.

Osu!



Shane Thomas
www.kyokushinbudokai.org
admin@kyokushinbudokai.org

www.kyokushinbudokai.org
Kyokushin Budo Kai
The Ultimate Beginners Guide

Contents

Introduction and Acknowledgements.....	2
Contents.....	3
What is Kyokushin Budo Kai?.....	7
What does "Kyokushin Budo Kai" mean in English?.....	7
The Philosophy.....	7
The Tsunami - symbol of the Kyokushin Budo Kai.....	7
Kyokushin Dojo Kun (Training Hall Oath).....	8
The Eleven Mottos of the Kyokushin Way.....	9
The Origins of Karate.....	11
The Origins of Jiu Jitsu.....	12
The Origins of Judo.....	15
Masutatsu Oyama (Mas Oyama) 1923 – 1994.....	16
Founder of Kyokushin Karate.....	16
Jon Bluming	17
Founder of Kyokushin Budo Kai	17
President of the International Kyokushin Budo Kai.....	17
Kaicho Jon Bluming – An In Depth Interview.....	22
Kihon.....	31
10th Kyu.....	31
9th Kyu.....	31
8th Kyu.....	31
7th Kyu.....	32
6th Kyu.....	32
5th Kyu.....	32
4th Kyu.....	33
3rd Kyu.....	33
2nd Kyu.....	33
1st Kyu.....	34
1st Dan.....	34
2nd Dan.....	34
KATA.....	35
What is Kata?.....	35
About Pinan Kata.....	36
About Sanchin No Kata.....	36
Taikyoku Sono Ichi.....	38
Taikyoku Sono Ni.....	39
Taikyoku Sono San.....	40
Pinan Sono Ichi.....	41
Pinan Sono Ni.....	42
Pinan Sono San.....	44
Pinan Sono Yon.....	47
Pinan Sono Go.....	49
Gekisai Dai.....	51
Yantsu.....	53
Tsuki No Kata.....	55
Saifa.....	57
Tensho.....	59
Seienchin.....	61
Kanku Dai.....	63
Technique Gallery: Karate.....	67
Buki / Weapons.....	67
Seiken.....	67
Uraken.....	67
Tettsui.....	67
Shuto.....	67
Haisho.....	67
Haito.....	67
Shotei.....	67
Hiraken.....	67
Koken.....	67

Hiji.....	68
Teisoku.....	68
Haisoku.....	68
Sokuto.....	68
Chusoku.....	68
Kakato.....	68
Dachi.....	69
Zenkutsu Dachi (Front).....	69
Zenkutsu Dachi (Side).....	69
Sanchin Dachi.....	69
Kokutsu Dachi (Front).....	69
Kokutsu Dachi (Side).....	69
Neko Ashi Dachi (Front).....	69
Neko Ashi Dachi (Side).....	69
Shiko Dachi.....	70
Kiba Dachi.....	70
Kake Dachi (Front).....	70
Kake Dachi (Side).....	70
Tsuru Ashi Dachi.....	70
Kumite Dachi.....	70
Moro Ashi Dachi.....	70
Yoi Dachi / Fudo Dachi.....	71
Heiko Dachi.....	71
Heisoku Dachi.....	71
Te Waza.....	72
Oi Tsuki Jodan.....	72
Oi Tsuki Chudan.....	72
Oi Tsuki Gedan.....	72
Gyaku Tsuki.....	72
Seiken Ago Uchi.....	72
Tate Tsuki.....	72
Tettsui Komi Kami.....	73
Tettsui Yoko Uchi.....	73
Tettsui Oroshi Ganmen Uchi.....	73
Uraken Shomen Ganmen Uchi.....	74
Uraken Sayu Ganmen Uchi.....	74
Uraken Oroshi Ganmen Uchi.....	74
Uraken Hizo Uchi.....	75
Shotei Uchi Jodan.....	75
Shotei Uchi Chudan.....	75
Shotei Uchi Gedan.....	75
Hiji Ate.....	75
Age Hiji Ate.....	76
Shuto Uchi Komi.....	76
Shuto Sakotsu Uchi.....	76
Shuto Jodan Uchi Uchi.....	77
Shuto Yoko Ganmen Uchi.....	77
Shuto Hizo Uchi.....	77
Me Tsuki / Nihon Nukite.....	78
Yonhon Nukite.....	78
Toho Uchi.....	78
Uke Waza.....	79
Jodan Uke (Variant 1).....	79
Jodan Uke (Variant 2).....	79
Soto Uke.....	79
Uchi Uke.....	80
Juji Uke Jodan.....	80
Juji Uke Gedan.....	80
Shotei Uke Jodan.....	81
Shotei Uke Chudan.....	81
Shotei Uke Gedan.....	81
Kate Uke.....	81
Uchi Uke / Gedan Barai.....	81
Shuto Mawashi Uke (Front).....	82
Shuto Mawashi Uke (Side).....	82
Sune Kote Uke.....	82
Geru Waza.....	83
Mae Keage (Mae Geri Keage).....	83
Mae Geri Jodan.....	83

Mae Hiza Geri aka. Hiza Geri (Front).....	83
Mae Hiza Geri aka. Hiza Geri (Side).....	84
Hiza Ganmen Geri.....	84
Mawashi Hiza Geri.....	84
Mawashi Geri Jodan.....	85
Ushiro Mawashi Geri.....	85
Ushiro Geri.....	85
Yoko Geri.....	86
Kansetsu Geri.....	86
Kinteki Geri.....	87
Uchi Mawashi Geri Keage.....	87
Soto Mawashi Geri Keage.....	88
Oroshi Soto Kakato Geri.....	89
Technique Gallery: Judo / Jiu Jitsu.....	90
Ne Waza (Grappling / Ground Control).....	90
Osae Waze (Holding Techniques).....	90
Gesa Gatame.....	90
Kami Shiho Gatame.....	90
Kata Gatame.....	90
Kazure Gesa Gatame.....	91
Kazure Kami Shiho Gatame.....	91
Kazure Tate Shiho Gatame.....	91
Kazure Yoko Shiho Gatame.....	92
Makura Gesa Gatame.....	92
Tate Shiho Gatame.....	92
Ushiro Gesa Katame.....	93
Yoko Shiho Gatame.....	93
Kansetsu Waza (Joint Locks).....	94
Hara Gatame.....	94
Hiza Gatame.....	94
Juji Gatame.....	94
Ude Garami.....	94
Jime Waza (Choke Techniques).....	95
Gyaku Juji Jime.....	95
Katame Juji Jime.....	95
Nami Juji Jime.....	96
Hadake Jime.....	96
Kata Ha Jime.....	96
Katate Jime.....	97
Morote Jime.....	97
Okuri Eri Jime.....	97
Sankaku Jime.....	97
Nage Waza (Throwing Techniques).....	98
Hip Throws (Full Throwing Techniques).....	98
Hane Goshi.....	98
Harai Goshi.....	98
Koshi Guruma.....	98
Ko Tsuru Goshi / O Tsuru Goshi.....	98
O Goshi.....	99
O Guruma.....	99
Sode Tsuru Komi Goshi.....	99
Tsuru Komi Goshi.....	99
Uchi Mata.....	100
Uki Goshi.....	100
Ushiro Goshi.....	100
Yama Arashi.....	100
Sweeping Throws (Leg/Foot Throws).....	101
Ashi Guruma.....	101
De Ashi Barai.....	101
Ko Soto Gake.....	101
Ko Soto Gari.....	101
Ko Uchi Gari.....	102
Okuri Ashi Barai.....	102
O Soto Guruma.....	102
O Soto Otoshi.....	102
O Uchi Gari.....	103
Sasae Tsuru Komi Ashi.....	103
Arm Throws.....	104

Suki Nage.....	104
Sumi Otoshi.....	104
Tai Otoshi.....	104
Uki Otoshi.....	104
Suki Nage (Variation).....	105
Shoulder Throws.....	106
Ippon Seoi Nage.....	106
Kata Garuma.....	106
Morote Gari.....	106
Seoi Nage (Variations).....	106
Sacrifice Throws.....	107
Hane Maki Komi.....	107
O Soto Maki Komi.....	107
Soto Maki Komi.....	107
Sumi Gaeshi.....	107
Tani Otoshi.....	108
Tawara Gaeshi.....	108
Tomoe Nage.....	108
Uchi Maki Komi.....	108
Uki Waza.....	109
Ura Nage.....	109
Yoko Gake.....	109
Yoko Guruma.....	109
Yoko Otoshi.....	110
Yoko Wakare.....	110
Jime/Shime Waza.....	111
Structure of the Neck.....	111
Physiology of Choking.....	112
Emergency Care.....	113
Tameshiwari (Breaking).....	114
Technique and Terminology Index.....	117
Kihon Waza.....	117
Buki.....	117
Neraidokoro Kogekihoko.....	118
Dachi.....	118
Tsuki Waza.....	119
Uchi Waza.....	119
Uke Waza.....	119
Geri Waza.....	120
Kihon Jutsugo.....	120
Taikai Jutsugo.....	122
Kazu.....	122
Kyokushin Glossary.....	123
-A-.....	123
-B-.....	123
-C-.....	123
-D-.....	123
-E-.....	123
-F-.....	123
-G-.....	123
-H-.....	124
-I-.....	124
-J-.....	124
-K-.....	124
-M-.....	125
-N-.....	126
-O-.....	126
-R-.....	126
-S-.....	126
-T-.....	127
-U-.....	127
-W-.....	127
-Y-.....	127
-Z-.....	128

What is Kyokushin Budo Kai?

"Any technique which brings success is good. A good and effective technique will be integrated into this system regardless of the style from which the technique originated. Kyokushin Budo Kai is a full contact all round fighting system. Above all, it is a 'street effective' Martial Art of the highest possible reality."

The Kihon, or basics, of Kyokushin Budo Kai have evolved through the merger of techniques from many styles and systems. However, the dominant styles practised within this all round fighting system (free-fight) are Kyokushin Karate (at times called 'Kyokushinkai'), Judo, Jiu Jitsu and Sambo. Almost all Te and Keri Waza (hand and foot techniques), Nage Waza (throwing techniques) and Ne Waza techniques (grappling/ground aka. Katame Waza) are allowed and practised with full contact.

Kyokushin Budo Kai was developed by Jon Bluming (10. Dan Kyokushin, 9. Dan Judo, 4. Dan Bo Jitsu, 4. Dan Jodo, 4. Dan Iai Jitsu, 2. Dan Kendo). He firmly believes that only when one is fully familiar with all three empty hand combat zones (striking, throwing and grappling) can one be considered to be trained in a street-effective self defence system.

What does "Kyokushin Budo Kai" mean in English?



Kyoku: maximum; final; utmost

Shin: truth; reality

Budo: martial art

Kai: organisation

Kyokushin Budo Kai: martial art organisation of highest possible reality

The Philosophy

Only when one masters all zones of unarmed martial arts, that is striking, throwing and grappling **equally**, can one claim to be trained in a system of self defence based on the highest possible reality.

The Tsunami - symbol of the Kyokushin Budo Kai



The Tsunami symbol used by the International Kyokushin Budokai signifies the willingness to react like water to each and every situation. The practitioner of Kyokushin Budo Kai adjusts and perseveres under all circumstances and when necessary smashes an opponent - just like the Tsunami.

Kyokushin Dojo Kun (Training Hall Oath)

The Kyokushin *Dojo Kun* (Training Hall Oath) was written by Mas Oyama with the help of Eiji Yoshikawa, the author of the novel *Musashi*, which was based on the life and exploits of Miyamoto Musashi, Japan's most famous Samurai warrior.

The *Dojo Kun* is usually recited at the end of each training session, when the students and instructors are lined up by rank in *seiza* (formal kneeling). Each line of the *Dojo Kun* is recited by the most senior student and repeated by the entire class together. Some dojos choose not to recite the *Dojo Kun* for various reasons.

**We will train our hearts and bodies,
For a firm unshaking spirit.**

**We will pursue the true meaning of the Martial Way,
So that in time our senses may be alert.**

**With true vigor,
We will seek to cultivate a spirit of self denial.**

**We will observe the rules of courtesy,
Respect our superiors, and refrain from violence.**

**We will follow our principles,
And never forget the true virtue of humility.**

**We will look upwards to wisdom and strength,
Not seeking other desires.**

**All our lives, through the discipline of Karate,
We will seek to fulfill the true meaning of the Kyokushin Way.**

道場訓

一、吾々は心身を錬磨し
確固不拔の心技を極めること

一、吾々は武の神髄を極め
機に発し感に敏なること

一、吾々は質実剛健を以て
克己の精神を涵養すること

一、吾々は礼節を重んじ
長上を敬し粗暴の振舞いを慎むこと

一、吾々は神仏を尊び
謙譲の美德を忘れざること

一、吾々は知性と体力とを向上させ
事に臨んで過たざること

一、吾々は生涯の修業を空手の道に通じ
極真の道を全うすること

For the fifth line of the Dojo Kun, which reads, 'We will follow our principles', most Dojos recite the line as 'we will follow our **religious** principles'. However, in keeping with the ethos that religion and politics have no place in the Dojo, this line has been amended here.

The Eleven Mottos of the Kyokushin Way

Mas Oyama summed up his entire martial arts philosophy in eleven mottos, known as the Zayu no Mei Juichi Kajo, which are central to the teachings of Kyokushin Karate:

1. The Martial Way begins and ends with courtesy. Therefore, be properly and genuinely courteous at all times.
2. Following the Martial Way is like scaling a cliff – continue upwards without rest. It demands absolute and unfaltering devotion to the task at hand.
3. Strive to seize the initiative in all things, all the time guarding against actions stemming from selfish animosity or thoughtlessness.
4. Even for the Martial Artist, the place of money cannot be ignored. Yet one should be careful never to become attached to it.
5. The Martial Way is centered in posture. Strive to maintain correct posture at all times.
6. The Martial Way begins with one thousand days and is mastered after ten thousand days of training.
7. In the Martial Arts, introspection begets wisdom. Always see contemplation on your actions as an opportunity to improve.
8. The nature and purpose of the Martial Way is universal. All selfish desires should be roasted in the tempering fires of hard training.
9. The Martial Arts begin with a point and end in a circle. Straight lines stem from this principle.
10. The true essence of the Martial Way can only be realized through experience. Knowing this, learn never to fear its demands.
11. Always remember, in the Martial Arts, the rewards of a confident and grateful heart are truly abundant.

The International Kyokushin Budokai

Original Text:

Rinus Schulz 8th Dan, Kyokushin Budokai.

Edited (for English Translation):

Shane Thomas, admin@kyokushinbudokai.org

In 1980, Jon Bluming was saddened by the politics and policies of the so-called 'budoka' of the Kyokushinkai Kan that had not, and likely would not, achieve anything. Further to an invitation from the Dutch Navy and their coach, Shihan Jan de Bruin (7th Dan), Jon Bluming broke away from the Honbu in Japan and founded the Kyokushin Budokai. With the addition of the first Budokai Dojo, operated by two of his pupils, Shihan Tom Eikmans (7th Dan) and Shihan Frans van Wijngaarden (7th Dan), the Kyokushin Budokai was truly born.

The Budokai has been busy for more than 20 years and has developed into a solid group. Each associated dojo "is its own boss" and makes only a small single payment for a lifetime membership plus a small annual contribution. Whilst the Budokai is not a federation with a union, everyone has the ability to raise issue with the IBK. The process is simple: Bluming is the Kancho and he determines what will happen. However, he works in co-operation with a committee that grades 1st - 4th Dan. Individuals can be nominated for higher grades but Kancho makes the decision. In difficult cases he consults Kenji Kurosaki, 10th Dan and Honorary President (Kurosaki is Kancho's former teacher and fellow student under Mas Oyama).

In co-operation with Shihandai Dave Jonkers (8th Dan), the Kyokushin Budokai later developed into the International Kyokushin Budokai Kan. The Budokai style is highly effective and realistic. It is 'street-real' for use in both competition and self-defence situations and should be considered a 'no-nonsense style'.

In January 1989, Bluming received a promotion from Japan. He was promoted to 9th Dan.

In November 1993, Akira Maeda (8th Dan Budokai) came to Kancho's hometown, De Bilt in the Netherlands, and informed him that Mas Oyama had sent him (due to his intended collaboration with the Rings Freefight Organisation). Mas Oyama wanted Jon Bluming back. Bluming was offered the presidency of the World Kyokushinkaikan, he was assured that he would manage a training program for all that were willing to start 'all round fighting' (many were keen to do so). Bluming accepted the offer on the condition that Loek Hollander be expelled from the organization (Bluming believes that Hollander had only a 'financial interest' in Karate); the expulsion of Hollander was a problem. That these events took place is without question. Akira Maeda is still alive today.

In April 1994, Bluming received a message from Maeda. Mas Oyama had suddenly died. Bluming was so saddened that he travelled to Japan to bid farewell to his former teacher in the Honbu.

On September 4th, 1994 - Jon Bluming experienced the most emotional day of his life. He received a fax from Kenji Kurosaki in Japan. The decision had been made to award Bluming the Dan-grade of his deceased teacher Mas Oyama. Jon Bluming was now allowed the grade of 10th Dan.

Kenji Kurosaki and four other prominent Honbus had unanimously agreed that Bluming deserved the honour. As a result of this decision: Bluming was now the first foreigner in the Kyokushinkai Honbu to receive the 6th Dan (in 1965) and the 10th Dan (in 1994). His grades were awarded and recognised by the greatest Honbus of Japan. Additionally, he was awarded 9th Dan in Judo (in 1988) and he is the only person in the world, **including Asia**, to receive two such grades from Japan.

There are now many Dojos around the world working together under the International Kyokushin Budokai. Wherever possible, Bluming continues to travel the globe; educating others with his ideas about fighting, competitions and self-defence.

It is an important fact to note: Jon Bluming is one of the most complete fighting machines to walk this earth. He is recognised as such by the most respected Honbu's throughout Japan and the world. His is one of the few Grandmasters to prove his ability not only through martial arts 'practise' but also in all manner and aspects of competition and in the 'real world'.

In 1963, by way of self-defence, Jon Bluming hospitalised five attackers in The Hague. One of the five was at death's door from 10 o'clock in the morning until 3 o'clock in the afternoon. Fortunately, he later recovered. Bluming was later cleared of any charges since he had not started the conflict and had finished it alone. Back at the Dojo - we got 80 new members in the old Budokai within days....

I was there OSU

Rinus Schulz, 8th Dan, Kyokushin Budokai.

The Origins of Karate

In 1916 Gichin Funakoshi introduced Karate into Japan from Okinawa. Karate means Empty Hand. Karate is thought to have been started in India by a Buddhist priest called Bhodidarma, who wished to take Zen (a sect of Buddhism) to the Chinese. The Buddhist priests learnt how to fight to defend themselves from bandits and wild animals as they wandered.

In about AD 500, Bhodidarma reached the court of Emperor Wu at Chein-K'ang in China, where he was warmly received. He left the courts, eventually reaching the Henan Province and went into seclusion in the Shaolin temple (Shorin in Japanese) to teach Zen. He also taught his system of unarmed combat called Shorin Kempo.

Forms of Chinese combat have been recorded as far back as 3000 BC. Bhodidarma is credited with being the founder of Chinese Kempo, mainly because he added the meditative practices of Yoga and Zen, making it a more complete system, as we know it today. Zen is inseparably linked with Karate and every Master of Karate seeks a more enlightened experience by studying Zen; in fact, all the developments in Shorin Kempo were achieved by various priests, through the years. Finally, the close connection between priests and medicine resulted in the discovery not only of vital spots on the human body where cures could be applied but also where Kempo attacks could be directed for the best results.

From China, Kempo spread north to Mongolia, east to Korea and south-east to Okinawa. Eventually it reached Japan, where it became extremely popular after the Kamakure era (about AD 1200). The soldier class, the Samurai, in particular welcomed both the combat forms and the Zen philosophy. The morality and mysticism of Zen Buddhism appealed to their sensibilities but the real attraction was the way it provided them with a discipline which made them capable of great endurance and excellence in fighting, through the development of insight into both themselves and their opponents.

At various times in history - for instance in 1400 and again in 1609, in Okinawa- the authorities forbade the populace to use arms. As a means of protection against the bandits, and sometimes against the authorities, unarmed combat became widely taught. The schools, themselves usually confined to the temples, were nevertheless kept secret, because if discovered they would have been immediately wiped out by those in power.

It was not until 1901 that Karate, as we now know it, was brought out of secret study and taught openly in Okinawa. In 1916, Master Gichin Funakoshi came from Okinawa to Tokyo and pioneered the modern system of Karate in Japan. There are many schools of Karate today, born from many origins, each with its own merits and perhaps its own faults.



You may train for a long, long time. But if you merely move your hands and feet and jump up and down like a puppet, learning karate is not very different from learning to dance. You will never have reached the heart of the matter; you will have failed to grasp the quintessence of karate-do.
- GICHIN FUNAKOSHI

The Origins of Jiu Jitsu

**An Excerpt from 'Where Did It All Begin?'
in Brazilian Jiu-Jitsu, The Master Text by Gene Simco.
For a complete history, buy the book!**

Where did [Jiu Jitsu] begin? I don't think anyone can answer this question with certainty, but there are plenty of good hypotheses. Every culture has some form of hand to hand combat in its history. Combat without weapons usually appears in the form of wrestling and sometimes boxing. Looking at the history timeline, one good hypothesis is that the wrestling techniques of Jiu-Jitsu could very well have come from Ancient Greece. Olympic games were one of the Greek's strongest traditions. It is most likely that along with Greek ideas, came one of its most popular sports, Pankration. Pankration was a sport that involved both boxing and wrestling techniques and became more popular to the Greeks than either of those sports individually. Pankration would later be overshadowed by the Roman Gladiators, and then banned from the Olympics by Christian leaders of the Roman Empire. Even though new rulers would come and go, Greek customs and ideas still reached India, where Jiu-Jitsu's foundation was likely to have been born. During Alexander the Great's conquests (356 - 323 B.C.), he brought the Greek culture to the areas he conquered. His conquests stretched all the way to India, where he introduced the customs and ideals of Greek culture to the people of that area. Jiu-Jitsu wasn't being formally taught in Japan for over one thousand years after this. Many say that the Greek influence in India led to the development of Kung Fu or more appropriately, Wu Shu (martial arts) in China.

The Chinese have a great deal of stories to support the history of their martial arts. The general idea embraced by most historians is that systemized martial arts techniques came from India along with Buddhism (Bodhi Dharma). The concept here is that the Shaolin temple was built in the center of China and this is where Bodhi Dharma introduced Buddhism and Boxing (senzuikyo). (ref. Aikido and Chinese Martial Arts, Sugawara and Xing) The story that supports the idea of Jiu-Jitsu coming from China takes place around the time of the fall of the Ming Dynasty. It states that a man named Chingempin came from Japan to live in Tokyo at a Buddhist temple where he met three Ronin (masterless Samurai) named Fukuno, Isogai, and Miura. Chingempin told the Ronin of a grappling art he had seen in China. The Ronin became particularly interested in pursuing the study of this art, so he then began teaching in Japan, and this art became Jiu-Jitsu.

The next theory is that there was many forms of wrestling that had developed in China. One of the most notable is Horn Wrestling, called Jiaodixi. This form of wrestling was practiced by the Mongolians and later evolved into Jiaoli, which was wrestling without the horns. This form of wrestling can be seen in Native American cultures (evident in the typical Native American Buffalo head wear) and most likely arrived there by way of Mongolians migrating through now modern Alaska. Jiaoli evolved and became Xiangpu and it is said that this form of wrestling became Sumo in Japan. Another theory says that there were practitioners of Chikura Karube, a wrestling sport developed around 200 B.C. It is said that Chikura Karube later became Jiu-Jitsu in Japan.

The last story mentioned here is that Jiu-Jitsu is Japanese and from Japan. This story follows the same basic idea but differs in that Chingempin introduced an early form of Jiu-Jitsu (not yet called Jiu-Jitsu) called Kempo in Japan, which consisted mostly of strikes and very little grappling. From there, the Japanese developed it into a more effective grappling art. One thing is certain about these stories, and that is that the Japanese were responsible for refining a grappling art into a very sophisticated grappling system called Jiu-Jitsu.

Tracing the history of grappling techniques for this book was quite interesting. In doing so, I decided to look for some common threads between the stories, which are:

- All ancient cultures had some form of grappling and unarmed fighting techniques.
- The Greek culture gave its fighters the greatest financial and social rewards. The ancient Greeks conquered quite a bit of territory during the time of Alexander the Great, including the area that Jiu-Jitsu's techniques were said to have come from.
- Wrestling did exist in China and Mongolia before Jiu-Jitsu did in Japan, and it is interesting to note that this is where Native American wrestling most likely came from by way of migration over the Alaskan Ice Bridge.
- The pinning and throwing techniques of Jiu-Jitsu are very similar to, and in some cases, the same as those of Greco Roman Wrestling.

Development of Jiu-Jitsu

Jiu-Jitsu itself was developed in Japan during the Feudal period. It was originally an art designed for warfare, but after the abolition of the Feudal system in Japan, certain modifications needed to be made to the art in order to make it suitable for practice. During Feudal times, Jiu-Jitsu was also known as Yawara, Hakuda, Kogusoko, and an assortment of other names. The earliest recorded use of the word "jiu-jitsu" happens in 1532 and is coined by the Takenouchi Ryu (school). The history of the art during this time is uncertain because teachers kept everything secret to give their

art a feeling of importance and then would change the stories of their art to suit their own needs.

After the Feudal period in Japan ended (Jiu-jitsu was no longer needed on the battlefield), a way to practice the art realistically was needed, which is why Jigoro Kano (1860--1938), a practitioner of Jiu-Jitsu, developed his own system of Jiu-Jitsu in the late 1800's, called Judo. Judo was helpful because it allowed practitioners the ability to try the art safely and realistically at the same time. The most important contribution Judo made to the practice of "Jiu-jitsu" was the concept of Rondori. Rondori was a form of sparing and contained a set of sportive rules that made practice safe, yet realistic. Because of the sportive outlet (rules that made practice safe), students of Jiu-jitsu from Kano's school were able to practice more frequently due to the fact that they were not always recovering from injuries. This multiplies the amount of training time for student's of Kano's school and drastically increased their abilities. Judo (Kano's version of Jiu-jitsu) was watered down from the complete form (of Jiu-jitsu), but still contained enough techniques to preserve its realistic effectiveness. The one problem that occurred was, in Kano's opinion, ground work was not as important as achieving the throw or take down, therefore ground fighting was not emphasized in Judo and became weak in that system. Judo also began placing too many rules and regulations on the art to make it more acceptable as an Olympic sport. Leg locks were not allowed, and when a fight went to the ground, a player had only 25 seconds to escape a hold or pin before the match was lost. These are a few of the rules that hindered Judo as a realistic form of self-defense. Then why did Judo flourish and why was it so great? Even with all the rules and restrictions, the time-tested principle of "pure grappler beats pure striker," still holds true. The fact remains that most fights, even those fights occurring between strikers with no grappling experience, end up in a clinch. You see the clinch in just about every boxing match, and hundreds of punches usually need to be thrown to end the fight with a strike, which gives the grappler plenty of opportunity to take his/her opponent to the ground, where a pure striker has no experience and is at the grappler's mercy.

After a match-up between older styles of Jiu-jitsu and Judo at the Tokyo police headquarters, Judo was named the national martial art in Japan. It was the official art used by law enforcement in the late 1800's, and continues to be popular to this day. During World War II, many U.S. soldiers were exposed to the art of Judo and brought it back to America with them. The first issue of Black Belt magazine here in America (1961), featured a sketch of a Judo throw and was a special Judo issue.

It wasn't until the birth of martial arts in Hollywood that the mystique of martial arts myths were catapulted to the public eye on a large scale. Here in the U.S. especially, Bruce Lee was one of the greatest catalysts for martial arts in the world today. Bruce Lee was actually a student of Judo and did many studies on grappling while he was alive. He criticized traditional martial arts as being ineffective, but ironically spread more myths about martial arts through his movies than almost anyone in martial arts history.

Jigoro Kano was the founder of Judo, however, Judo is simply a style of Jiu-jitsu and not a separate martial art. Kano was not the first to use the name Judo, the Jiu-jitsu schools he studied at, which would be the source of much of his Judo's techniques had used the phrase before he made it famous in the late 1800's.

The first use of the name Judo was by Seijun Inoue IV, who applied it to his Jujitsu of Jikishin-ryu. Students of Jikishin-ryu Judo were not only expected to master its ninety-seven techniques, but to also develop into generous and gentle-mannered individuals.

Kuninori Suzuki V, the Master of Kito-ryu (Kito means to Rise and Fall) Jiu-jitsu, changed the name of Kito-kumiuchi to Kito-ryu Judo in 1714. The most important contribution that kito ryu would offer Judo was the principle of kuzushi (off-balancing), which is the key to the throwing techniques of modern Judo. Jigoro Kano studied the judo of Jikishin-ryu and Kito-ryu, and incorporated some of their concepts into his original system, which he named Kodokan Judo.

Judo is made up of many styles of Jiu-jitsu whose masters Kano had studied with. The most notable were Jikishin-ryu, Kito-ryu, and later Fusen-ryu would be incorporated for its groundwork (ne waza) as Kano would ask the style's head master, Mataemon Tanabe for his syllabus. Yokiashi Yamashita (Kano's Chief assistant) would add his knowledge of Yoshin Ryu ju jitsu and Tenshin shinyo Ryu ju jitsu, both of which, he was a master.

In 1912, Kano met with the remaining leader masters of Jiu Jitsu to finalize a Kodokan syllabus of training and kata. Aoyagi of Sosusihis Ryu, Takano, Yano, Kotaro Imei and Hikasuburo Ohshima from Takeuisi Ryu. Jushin Sekiguchi and Mogichi Tsumizu from Sekiguchi Ryu, Eguchi from Kyushin Ryu, Hoshino from Shiten Ryu, Inazu from Miura Ryu and finally, Takamatsu, a Kukkishin Ryu master, whose school specialized in weapons training.

Before the formal meeting between Kano and the grandmasters of Japan's greatest Jiu-jitsu schools, a defining event occurred, which is one of the most historically important pieces of the Brazilian Jiu-jitsu puzzle. By 1900, the Kodokan had been challenging other Jiu-Jitsu schools in sport competition and winning with throwing (standing) techniques. Much of the Kodokan's status was built on the throwing skills of Shiro Saigo, a practitioner of Oshikiuchi, the art of Daito Ryu Aikijujutsu. Jigoro Kano had actually enlisted the help of Shiro Saigo in order to win a famous tournament at the Tokyo police headquarters in 1886. This tournament, mentioned briefly earlier in this chapter, was Judo (Kano's style of Jujitsu) vs. "old" Jujitsu. It is interesting to note that Kano's champion was not originally a Judo student at all, but a student of an older Jujitsu style, which in reality, defeated the purpose of having a Judo vs. Jujitsu tournament in the first place.

As I stated earlier, Judo was a collection of Jiu-jitsu styles, once such style was the Fusen Ryu. Fusen was a school of Jiu-jitsu which specialized in Ground Work (Ne Waza). In 1900, the Kodokan challenged the Fusen Ryu school to a contest. At that time Judo did not have Ne Waza (ground fighting techniques), so instead they fought standing up, as Kano had been taught in both the Tenshin Shinyo Ryu and Kito Ryu systems he studied. Both Kito Ryu and Tenshin Shinyo Ryu had excellent striking skills and effective throws.

When Kodokan Judo practitioners fought the practitioners of Fusen Ryu Jiu-Jitsu, the Kodokan practitioners realized that there was no way they could defeat the Kodokan Judoka standing, thus they decided to use their superior ground fighting skills. When the Kodokan fighters and the Fusen Ryu men began to fight, the Jiu-Jitsu practitioners immediately went to the guard position (lying on their backs in front of their opponents in order to control them with the use of their legs). The Kodokan Judoka didn't know what to do, and then the Fusen Ryu practitioners took them to the ground, using submission holds to win the matches. This was the first real loss that the Kodokan had experienced in eight years.

Kano knew that if they were going to continue challenging other Jiu-Jitsu schools, they needed a full range of ground fighting techniques. Thus with friends of other Jiu-Jitsu systems, among them being Fusen Ryu practitioners, Kano formulated the Ne Waza aka. Katame Waza (ground techniques and grappling techniques respectively) of Kodokan Judo which included three divisions: Kansetsu Waza (joint locking techniques), Shime Waza (choking techniques), and Osaie Waza (holding techniques).

The Origins of Judo

Modern judo has its origins in jujitsu, a fighting art that can be traced back over a thousand years in Japanese history. Judo itself, however, is a relatively recent synthesis and owes its existence to the genius of one man: Dr. Jigoro Kano.

Jigoro Kano was born in the seaside town of Mikage in 1860. He and his family moved to Tokyo in 1871. Mr. Kano studied politics and literature at Tokyo Imperial University. He became an instructor of the Gakushuin in 1882 and eleven years later, he was appointed the Headmaster of the Koto Shihan, a teachers' training school. In 1909, Professor Kano became the first Japanese member of the International Olympic Committee and two years later, he founded the Japanese Athletic Association and became its first president. Because of his many contributions in the field of athletics, Professor Kano is called the "Father of Physical Education and Sport" in Japan.

Professor Kano is internationally known for the development of judo. Until he was 18 years of age, Jigoro Kano was physically weak. He resolved to improve himself by studying at two jujitsu schools. He soon realized that each school had its strengths and weaknesses. Because there was unnecessary roughness and crudeness in the jujitsu techniques, and because it was difficult to practice without injury he began to reconstruct jujitsu. As he states in his own words: "...so by taking together all the good points I had learned from the various schools and adding thereto my own devices and inventions, I founded a new system for physical culture and mental training." Kano called his new system Kodokan Judo to differentiate it from the jujitsu forms. "Judo" means "the gentle way" and "kodokan" generally means "a school for studying the way", "the way" being the concept of life itself.

Again, in Kano's words: "There are two reasons why I avoided the term 'jujitsu'. One is that there were jujitsu schools which often indulged in violent and dangerous techniques in throwing or twisting arms and legs. Seeing these things, many people came to believe jujitsu was harmful. Again, in an exercise hall where supervision was inadequate, the senior pupils would wantonly throw down juniors or pick quarrels, so that jujitsu was despised as something that made rowdies of young men. I wished to show that what I taught was not a dangerous thing, and would not needlessly injure any person, that it was not the jujitsu as it was taught by some people, and that it was "judo", an entirely different thing.

"The second reason was that, when I began to teach, jujitsu had fallen into disrepute. Some jujitsu masters made their living by organizing groups composed of their followers, and putting on exhibition matches to which admission fees were charged. Some went so far to stage bouts between professional sumo wrestlers and jujitsu men. Such degrading practices of prostitution of martial arts were repugnant to me, so I avoided the term jujitsu and adopted judo in its stead."

The Kodokan was first established in 1882 with only nine students the first year. Soon, the new Kodokan Judo became the center of public attention. But its practical merits were looked upon with contempt by most old jujitsu men, including master Hikosuke Totsuka. A keen rivalry soon developed between the Kodokan and the Totsuka School. Things came to a head in 1886. In Kano's words: "Under the auspices of the Chief of Metropolitan Police, a grand tournament was arranged between both schools. This was a decisive battle. Defeat would have been fatal to the Kodokan. But in that tournament, to which each school sent 15 picked men, the Kodokan won all the bouts excepting two, which ended in a draw. That brilliant victory established once and for all the supremacy of Kodokan Judo over all jujitsu schools."

One of the principles of judo is that a stronger opponent can be defeated by turning his strength against himself. Professor Kano explains how in yielding there is strength: "Suppose we estimate the strength of a man in units of one. Let us say that the strength of this man is 10 units, whereas my strength, less than his, is 7 units. Then if he pushes me with all his force, I shall certainly be pushed back or thrown down, even if I use all my strength against him. This would happen from opposing strength to strength. But if instead of opposing him, I leave him unresisted, withdrawing my body just as much as he pushes, at the same time keeping my balance, he will naturally lean forward and lose his balance. In this new position, he may become weak (not in actual physical strength, but because of his awkward position) as to reduce his strength for the moment, say to 3 units only instead of 10 units. But meanwhile I, by keeping my balance, retain my full strength, as originally represented by 7 units. Here then, I am momentarily in a superior position, and I can defeat my opponent by using only half of my strength, or 3 1/2 units against his 3 units. This leaves one-half of my strength available for any other purpose. If I had greater strength than my opponent, I could of course push him back. But even if I wished to and had the power to do so, it would still be better for me first to give way, because by so doing, I should have greatly saved my energy and exhausted my opponent's."

Jigoro Kano died in May 1938 while returning from the Cairo International Olympic Conference. Men's judo was first included in the Olympic Games in 1964 and became a permanent part of the Games in 1972. In 1992, women's judo became part of the Olympic Games as well. Kano defined the two principles of Kodokan Judo as "Maximum Efficiency with Minimum Effort" and "Mutual Welfare and Benefit". He said that "physical education should train the body to be strong, healthy and useful in actual life and also make a contribution to the culture of the mind." His system of judo is just that.

Masutatsu Oyama (Mas Oyama) 1923 – 1994

Founder of Kyokushin Karate

The founder of Kyokushin Karate, Masutatsu Oyama, was born in 1923 near Seoul in South Korea. He studied Chinese Kempo at 9 years of age and when he was 12, he went to Japan to live and enrolled at University. After mastering Judo, he became a pupil of Gichin Funakoshi (the man who introduced Karate to Japan from Okinawa in 1916). Funakoshi himself was making such rapid progress that at 17 he was 2nd Dan and at 24 he became 4th Dan.

Deciding he would spend the rest of his life spreading the knowledge of Karate, it is said that Mas Oyama spent the next year in seclusion from human society, living in temples and in the mountains; subjecting himself to the physical rigors of martial arts, training day and night and meditating on Zen precepts, seeking enlightenment. In 1951 he returned to civilization and started his own training hall in Tokyo. Many claim that Mas Oyama never actually entered into 'mountain training' and that this was, in fact, a fabrication in order to attract positive publicity following the creation of the Kyokushin style of Karate.

In 1952, he travelled the United States for a year, demonstrating his karate live and on national television. During subsequent years, he took on all challengers, resulting in fights with 270 different people. The vast majority of these were defeated with one punch! A fight never lasted more than three minutes, and most rarely lasted more than a few seconds. His fighting principle was simple - if he got through to you, that was it.

In 1953, Mas Oyama opened his first "Dojo", a grass lot in Mejiro in Tokyo. In 1956, the first real Dojo was opened in a former ballet studio behind Rikkyo University, 500 meters from the location of the current Japanese Honbu dojo (headquarters). By 1957 there were 700 members, despite the high drop-out rate due to the harshness of training.

Sadly, Sosai Mas Oyama died of lung cancer (as a non-smoker) at the age of 70 in April 1994. Many now claim to be 'the rightful person in charge' of the organisation created by Mas Oyama. This has had many political and economic ramifications throughout the Kyokushin world, which are still being resolved. The result has been a splintering of the Kyokushinkai Kan, with many groups claiming to be the one-and-only true heir of Mas Oyama's Kyokushin, either spiritually or even financially. It has even been suggested, not entirely in jest, by one Kyokushin writer in Australia (Harry Rogers) that maybe Oyama created the turmoil on purpose, because he didn't want Kyokushin to survive without him!

Jon Bluming

Founder of Kyokushin Budo Kai

President of the International Kyokushin Budo Kai

Original Text:

Rinus Schulz, 8th Dan, Co-founder of the Netherlands Karate Association 1962.

Edited (for English Translation):

Shane Thomas, admin@kyokushinbudokai.org

Jon Bluming was born on the 6th of February 1933 in Amsterdam East. Following his birth, his family moved to the very poor, deprived and desolate section of Amsterdam South called 'the PIPE'. In 1936 the family moved again to a place that was 'a little better' just a few blocks up the road called 'old south'. The area was populated by many shop owners and diamond cutters. Those who lived in 'old south' were mostly of the Jewish faith.

When he was seven years of age (May, 1940) he watched from the street as the German Luftwaffe attacked the Schiphol Airport. That same day he stood close to the Berlage Bridge and watched as the German Army entered the City of Amsterdam. This was the start of the five year German occupation of the Netherlands.

In 1943 he watched the Germans take away all of his school friends and neighbours (only one person came back after the war – the son of a couple that were taken – Harry v.d. Kar). He watched with a friend at the Amstelkade as the Germans threw an elderly Jewish couple from the third floor window onto the streets – simply because they could not walk the stairs. The Germans laughed as they threw the elderly couple into the truck with the others.

On another occasion, as the young Bluming walked with his parents to church, they passed a Jewish Theatre. It had been converted into a holding centre for Jews that were to be shipped to the concentration camps and he heard his name being called out by some of his school friends. This left a very deep impression with Bluming and it was to be the beginning of the moulding process that has made him the man that he is today.

In 1944, came the winter that has become known as 'The Hunger Winter'. There was hardly any food left and he had to beg from house to house in the better parts of Amsterdam. Together with his sister, he was trying to keep his mother and grandparents alive, as his father had already been taken to Germany as slave labour. Bluming became a dedicated thief and beggar who learned, at such an early age, to take care of himself and others.

In May 1945, Bluming stood at the same bridge as he had stood back in 1940. This time, he watched as the English and Canadian Armies entered Amsterdam and knew that the war was finally over. He spent the next 6 weeks in a youth 'health camp' – he was terribly undernourished.

At thirteen years of age, he went to the then famous boxing school of Cosman. This was Bluming's first experience of a martial art and he got his first broken nose in the process.

At sixteen years of age, he applied to the Marines and was accepted in July, 1949. He went to boot camp in Doorn.

In the summer of 1950 war broke out in Korea. The newspapers published a request from the war ministry asking for volunteers for the 'Heutzregiment' (a unit specially founded for the Korean War). He applied and was accepted.

From November 1951 until 1959, he was a soldier attached to the Dutch Battalion of the US Second Division, 38th Regiment. He was wounded in action twice during his time with the 38th.

He was first wounded during the surrounding-manoevre of the Battalion in Hoengsong and the first attack on Hill 325. Three 'Medals of Honour' were awarded as a result of these manoeuvres. Bluming was hit in the right leg by two bullets from a burpgun and was sent to Tokyo, the Annex hospital. For this he was awarded his first purple heart.

During his stay in Tokyo he went on an Army tour of the city. There, for the first time in his life, he saw Judo being practised as they visited the Kodokan in March 1951. At the time the Kodokan was in Suidobashi street. He witnessed a demonstration by a very small, elderly man, with a red belt. He knew there and then, "that's for me." In November 1959, that elderly man would become his head teacher in the new Kodokan when Bluming became a member of the famous 'Kenshusei', the twenty five best fighters in Japan.

The second time that Bluming was wounded was during the assault on Inje where, this time, the North Koreans and some Chinese were surrounded. During the conflict he was hit by the shrapnel of a hand grenade and – again - he spent about six weeks in the MASH.

Before the Battalion could return to Holland (around August, 1951) they had to wait several weeks for the troop ship to arrive. It was at this time that he trained in a small Korean Dojo where he 'screwed around with a kind of Tae Kwon do' with a Sensei called Park in Yong Dong Po.

A few months after his return to Holland it was clear that he couldn't get used to life as a civilian. When authorities

asked for volunteers, this time as occupation troops, he went back to Korea. Whilst he was on board the troop ship to Korea, war broke out again. This time it was worse than before and Jon Bluming was 'screwed again'.

In August 1952, he was back at the frontline and names like 'Old Baldy', 'Alligator Ridge' and 'White Horse' made their way into the history books.

It's now October 11th, 1952 at the Real Outpost Arsenal (75 meters off the Chinese mainline). Bluming's buddy, and now life-long friend, Hans Crebas volunteered as Scout Rangers. Along with a full company, the Scout Rangers were going to take the hill next to Arsenal to relieve the pressure a little. Unfortunately, when they went up the hill the Chinese fell back from the hill, moved around and then went back up the hill after the Rangers. Then 'all hell broke loose'.

Bluming was behind a 30cal on Arsenal when he heard the incredible noise. He told his LT that he was going down to see what had happened to his friend Hans Crebas.

Fully loaded with firepower, he went down into the dark valley (which was eventually fully lit by the hand grenade, mortar, artillery, tank and small-arms fire). The screams of the fighting Rangers were 'real loud'. Bluming later said that he 'nearly pissed his pants' but he didn't want his friends' body left alone in that mess.

After a while, Bluming found Hans helping wounded Rangers. There was a quick bear-hug and that night 'their covenant was sealed' when both Bluming and Crebas cared for the wounded and got them out – under fire.

When Bluming finally got back to the outpost he was wounded - again - by a mortar that dropped right behind him in the trench. His flack jacket saved his life and he landed in the MASH for the third time - this time with shrapnel behind his left knee. Both Bluming and Crebas were recommended for the Silver Star. The next day however, all they got was promotion to PFC.

On the last day of the war Bluming's group went out and were ambushed. Nearly all were killed that night. He was not with them because his time had been served and he was rotated back to Holland.

In his first platoon: 8 men were lost – KIA. More than 70% were wounded.
On his second tour: on the last day, again, 8 men were KIA.

Upon his return to Holland, Bluming refused to make a career of the Army and returned to civilian life.

Many years later justice was served. During one of Bluming's seminars, a Budoka in Seattle read Bluming's book about Korea. The Budoka's name was Gregg Jorgenson – a SGT of the Vietnam War. He had received a Silver Star, was decorated more than nine times for bravery and was wounded in action three times. He was also Chairman of the Decoration Committee of the Rangers.

Jorgenson thought that Bluming and Crebas had also received the Silver Star. When he found out that they were not decorated – he researched the facts. Finally, many years after the War in Korea, both Bluming and Crebas were decorated with the 'Forgotten Hero Award'.

For Hans Crebas it came too late. He died in Bluming's arms in a Hotel in Bunnik Holland on the 28th of April, 200.

During Bluming's second time in Korea (in 1952) he tried to find that dirty little Dojo in Yong Dong Po but it was not there anymore. However, back in Holland he found – by chance – the Judo Club would change his life forever. In November 1953, he was taking his girlfriend home when he noticed a little street poster for the Tung Jen Judo Club. He went to the Dojo and joined-up. Judo became his foremost hobby and later it became his profession.

Bluming's phenomenal gift for Budo came to light during his amateur Judo period. His Sensei, Dr. G. Schutte gave him his first Dan after only 12 months. He then became Captain of the Tung Jen team and won the European Championships in Bellevue, Amsterdam, in September of 1956. 'Opa' Schutte was a fourth Dan from the famous Tokyo Hirano at that time.

In 1955, bluming got his 2nd Dan and in 1956 he was the first Dutchman to receive Kodokan membership (no. 4179) from Ichiro Abe (then 6th Dan) in La Baulle Franche.

In 1957 he received his 3rd Dan from Toky Hirano at a summer camp in Holland. Bluming threw 75 Judoka, from 4th Kyu to 4th Dan, in 26 minutes – despite the fact that he had broken his right big toe. His right was his favoured leg but he threw all the Judoka from the left.

Shortly afterwards he broke his right knee and went into surgery. Weeks later, he had his last fight at the Amateur Championships in Haarlem. He threw 10 black belts with his right knee tightly bound with a bicycle innertube!

He was then invited to train a Police Dojo in Berlin and a Private Judo Club. He did that for several months and used

the money to get to Canada. Bluming's dream was always to return to Japan. However, in the time immediately following the WWII that was almost impossible.

He went to the Canadian Embassy, threw his medals on the table asked to get to Canada. He got his wish and in January 1958 he arrive in Halifax. Unfortunately, he had not 'read the small print' and when he left the ship he did not get the \$800 that he expected. This was reserved for married couples only. Bluming had THREE CANADIAN DOLLARS and he knew that he couldn't buy a house with that. He was taken in by an old friend and was introduced the next day to Dalhousy University. There he began his career as a professional teacher. His lessons cost two dollars an hour.

He founded the 'Maritime Judo Association' and became a life time honary member when he left.

He organised the first Maritime Judo Championships and won the 'All Cats' and 'Heavyweight' title – although he weighed only 79 kilos at the time!!! You should see the pictures in his book!

His Dojo won the team title but Bluming was NOT allowed to compete in the Canadian Championships.

In January 1959 he set off for Japan. He headed out with his students who were truck drivers and they drove him all through the USA – from Maine to San Francisco. He stopped in many of the big cities and visited all the Dojos. He faught with all that he met. He lost only to Micky Tchutchida in San Francisco. Later, he met Mickey in Tokyo. This time he cleaned the tatmi with him – they are still friends.

He finally arrived in Tokyo (via Hawaii) in February 1959 and he stayed for around three years.

Blumings 3rd Dan from Hirano was accepted by the Kodokan and he fought right away in the 3rd Dan competition. He NEVER lost a match in all those years in Judo – and later in Karate too.

In December 1959 he had to leave Japan for a short time, to renew his Visa, so he went to Korea. The Korean Good Will Team had visited the Tung Jen Dojo in Amsterdam and Bluming knew them all from those days. He also had introduction letters from them. He was taken in and did his grading for the 4th Dan where he was matched against the Korean Heavyweight Champion, Kim (5th Dan). Bluming threw him with a left Osotogari. The next day he was matched against the 2nd Dan Korean Champion, the 2nd Dan Champion Student of Korea and the 3rd Dan Champion Student of Korea, Sup Lee. They all went in seconds – Sup Lee with a Shime Waza when he drove home with a Kosotogari. Bluming just sat on his backside and strangled him out.

Bluming got his 4th Dan and his first Teachers Certificate from Asia on the 19th of December 1959.

Back in Tokyo, he started to train under the guidance of the famous Donn Dreager. He trained with weights for Judo and Karate and finally got what he always wanted. Bluming was now a heavyweight. He was 102kilos solid – a far cry from his 79kilos in Canada. From this point on it was clear that no one was going to stop him because he retained his middleweight speed (as Dreager has taught him).

In May 1960 he defeated the Japanese Champion, Kaminago – again with a strangle hold which knocked him out cold. During the Olympic Training Summer of 1960 – he finally threw Isao Inokuma, his very close friend and training partner, with Uchi Mata Makikom after a full hour of fighting.

Bluming also got his 4th Dan from Kodokan – in competition.

In April 1959, Donn Dreager asked him to train with him at the police Dojo in order to gain more of the background of Bushido. They trained there under the famous 10th Dans Shimizu and Kuroda in Bojitsu, Kendo and IiaiJitsu.

During the All Japan Police Kendo Championships – they were asked to give a demonstration of Bojitsu. They got a standing ovation and a 3rd Dan in both disciplines from the Japan Kendo Federation.

Bluming then did another examination with his Sensei Ichitaro Kuroda for Iaijitsu and got his 3rd Dan from the JKF – also for Iaijitsu.

Bluming and his lifelong friend, Bill Backhus, got the Gold Police Medal from the Japanese Police HQ for apprehending some dangerous criminals who had stolen a car. The criminals had made the mistake of drawing very small knives on Bluming – who then knocked them out cold before the police arrived.

In 1960, Bluming left Japan - again to renew his Visa. This time to Manilla.

He gave seminars at the Manilla Judo Dojo and there he met a member of the ASU who's name cannot be mentioned (for reasons which shall become obvious).

In 1961, Bluming was invited to participate in a 'gonin gake' (a match against five 3rd Dans) in the place of Inokuma. Inokuma was, unfortunately, in hospital with a serious back injury. Dreager suggest to Bluming that this would be good for Bluming's reputation and indeed it was! Bluming finished his opponents in less than four seconds per match!

Then a letter arrived from Holland. Opa Schutte wanted Bluming to return to Holland to teach in the old dojo and the Amateurs Association for on a one year contract. It was a good contract and by this time Bluming's name was legendary in Japan. He was unbeaten in Judo and Karate. Bluming returned to Holland to teach some old friends, meet some new ones and participate in the Paris Franche (December 1991). Of course, things went a little differently than planned.

Bluming became coach of the Dutch Amateur Judo Association and made his name throughout Holland and Europe. Unfortunately, Bluming was not permitted to participate in Paris. Bluming was in dispute with the Judo Union of Anton Geesink. The Union was responsible for spreading malicious 'rumours' to the press about Bluming. However, Geesink refused to meet Bluming on the Judo Tatami anywhere! Due to these false-allegations that Bluming was prevented from participating in Paris.

The press didn't have a 'field day'. Rather, they had a few 'field months'! This was especially the case when Bluming was introduced to the NAJA Blackbelt's as their new coach in the first week of December 1961 (in Bloemendaal). Bluming went to the mat against all comers – some eighty Judoka from 1st Dan to 4th Dan – and threw each Judoka within about four seconds. All this under the eyes of the press.

The next day the press published that Holland would come first and second in Paris and that Bluming MUST be aloud to fight...

Unfortunately, it didn't help. Bluming was not allow to compete and he watched as Anton Geesink attained a well deserved victory in Paris. It made Bluming so miserable that he stopped competing and turned his attention to teaching.

The success of Budoka such as the following can be accredited, in large part, to the teaching methods of Bluming:

Chris Dolman:

Four times world champion, Dutchman with the most titles EVER in fighting sports, free-fight champion in Tokyo (1993) at the age of forty-eight.

Willem Ruska:

Double Olympic champion (1972), three times world Judo champion.

Ottie Roethof:

World champion in 'soft-style-karate', world champion (team event).

Sem Schilt:

K1 fighter and three times winner of the Daido Juku and three times 'King of Pancrase'.

Jan Plas (Vos Gym):

Who subsequently passed his knowledge on to Ernesto Hoost and Peter Aerts.

Pat Adelaar, Jan Kallbach:

Who were not permitted to fight in the '100 Man' in the Honbu.

Bluming himself was also prevented from competing in the '100 Man' in 1961. Mas Oyama told the press, "there were not enough ambulances available in Tokyo." Bluming returned to teach throughout Europe and founded the European Kyokushinkaikan. The first karate union in Europe was founded by Bluming on January 2nd, 1962.

The first ever Karate Championships in Europe were held at the Krasnapolsky Hotel in Amsterdam (1965). The first European 'inter country' match was held between the team of Steve Arneil (a student of Oyama) and Blumings Budokai Team in 1967. The Budokai team were victorious.

Bluming challenged Anton Geesink seven times. The first time was via the Amsterdam newspaper 'Het Parool'. The last time was with during an interview with the Dutch TV personality Mies Bouwman (during a drive on TV for those with disabilities). Bluming certainly never claimed that he could beat Geesink easily – he just wanted the CHANCE and they NEVER gave it to him. For this reason, Bluming put all his efforts into making champions and good teachers; following in the footsteps of his Sensei Mas Oyama and his friend and fighting teacher, the famous Kenji Kurosaki (10th Dan).

1965 was an important year for Bluming. On the 15th January 1965, Bluming was the first foreigner to be awarded the 6th Dan in Karate from Mas Oyama of the Kyokushinkaikan Honbu. In those days, the world of Karate was not quite as big as it is now and it's members were shocked. How could it be possible that a foreigner could receive such an honour? Until this point ONLY Japanese had EVER been appointed 6th Dan. Who was this 'Bluming' anyway?

Mas Oyama decided to put a classical samurai end to the discussions. He made an astonishing announcement to the Karate world:

"If anyone had the courage, they would be permitted to step into a boxing ring with Bluming, man-to-man, with NO RULES."

He further announced:

"Anyone that was able to beat Bluming would get \$100,000 from Oyama. Oyama would quit Karate and he would take away Bluming's 6th Dan."

The Karate world suddenly became very silent and not one person came forward to accept Oyama and Bluming's challenge.

It was also in 1965 that the newly founded Dutch Sport Federation announced quite bluntly that the many Judo Organisations in the Netherlands must work together to create ONE federation. If they did not do this, then they would receive no further funding. When this newly formed Judo union came into being Bluming was the first coach. Later, in 1969, Bluming also became coach for the Dutch karate team.

Again in 1965, Bluming received a telephone call from a former student who happened to be in Amsterdam. He told Bluming that he wanted to meet his old army friend, the famous Captain Ramon Westerling (Indonesian Wars 1945-1950). He wanted Captain Westerling to work for US Intelligence because of his understanding of the Asian Adat etc. He also wanted Bluming to work together with him and once again it was 'interesting times' for Bluming!

He went to East Berlin and - at that time - it was certainly not healthy to work for the US. Eventually, in 1972, he went back to Bangkok and ended his work with the US Military. For his service, he received the Army Commendation Medal and the Joint Achievement Medal. In total, Bluming has received 28 military decorations since 1951.

In 1966, a Budoka from Korea came to Bluming's dojo and in a dignified manner challenged Bluming to fight. The Budoka's name was Kwan Mo Gun, 5th Dan Tae Kwon Do and Heavy Weight Champion of Korea. Bluming admired him because Kwan had already fought with Jan Kallenback (who knocked Kwan out cold), then Kenji Kurosaki (the poor man had never heard of Kurosaki and was knocked out cold) and now he wanted to fight Bluming. Bluming admired this evidence of true spirit and real Karate. The fact that Kwan lost his match with Bluming could never take away from this fact. Kwan had KOKORO (spirit) in capital letters! Bluming knocked him out with a shotei (for which he is still famous) and Kurosaki stopped the fight. Kwan was the only man, in the more than fifty years since Mas Oyama's challenge, that really came to fight Bluming in the true Samurai manner. No rules, no bullshit - a real man.

In 1971, Bluming quit as coach of the Dutch Karate team. He was truly disillusioned with the way in which the Dutch Karate Organisation wanted their karate system managed. He felt like a sniper that was not allowed to hit the bull's eye. At that point, Bluming decided to 'go it alone' and began expanding upon his own ideas of Karate.

In 1980, Bluming founded The Kyokushin Budokai.

Why did he choose the name Kyokushin Budokai? Firstly, because of his Sensei (Oyama) who had given him Kyokushin, an art which further changed Bluming's life following his development in Judo. Secondly, because of Trevor P. Leggett, a pre-WWII Kodokan Judo 6th Dan.

In 1946, Leggett and an American called O'Neill, became very tired with the politics and jackasses that were only interested in making money from Judo and positions of power for themselves. And this, for the most part, without having done anything themselves in Judo.

Leggett decided to found the BUDOKWAN in London and his rules were very simple:

- Anybody who was genuinely interested in doing real JUDO was welcome.
- Speaking of politics (Judo, world, race, religion etc.) was strictly forbidden.
- Those who ignored these rules were expelled.

when his Sensei Opa Schutte related the story to him, these principles left a big impression with Bluming. Opa and Leggett were good friends back in Manila and students at the US Embassy. 'No politics' remains a standing rule in all IBK Dojos throughout the globe.

Kaicho Jon Bluming – An In Depth Interview

A Classic Warrior by Jose Fraguas

[Jon Bluming] is a classic man. And a legend. Far from pulling any punch in or out of the mat, this man not only rolled shoulders with the best karate and judo masters the history of budo had, but he also knew them as individuals when they were in their prime. A pioneer in many ways, Bluming Sensei has become a rare breed of individual who looks to maintain the true spirit of budo through fighting and proper etiquette. "A true budo man knows how to behave, and he displays all the true qualities of a warrior," he says. "But as a warrior, he knows how to fight and face death with no fear. Nice words should be spoken at the proper time, but the sword should be drawn when necessary."

A pragmatic and realistic teacher, Jon Bluming had the opportunity of being a disciple and sharing lifetime experiences with the great scholar Donn F. Draeger, the man who truly brought budo into the Western world. Today, this warrior exemplifies the all-power and determination of the old samurai ... qualities lost in the last decades watered-down versions of martial arts. He talks the way he trained, and he trains the way he lives. A right very few have won through blood and sweat.

Q: How long have you been practicing the martial arts?

A: I began training during a pause in the Korean War. The reason was I had to wait for more than six weeks before boarding the ship that was going to bring me home. The name of the instructor was Yong Dong Po. He had a little school with another man called Park. After all the action in the war, those training sessions were very relaxed. I never heard from that man or saw him again after I left. That was in August 1951, which it means I have been involved in martial arts for more than 50 years.

I had to stop training for a very short period of time, but I re-started in 1953, after my second tour of duty and my third time in the M.A.S.H. unit. I had a serious knee injury. When I was in Holland, I saw a poster of a judo club. It was called the "Tung Jen," and it was in Amsterdam. When I saw it, I thought about my days with Yong Dong Po and Park and became a member immediately. When I went back to Japan in February 1959, I entered the *Kodokan*, where I met Peter Urban. He was from Yamaguchi Gogen's *dojo*, and he had big knuckles. So I started karate first with *shotokan*, but I found it weak. Later, I was introduced to Mas Oyama's *dojo*. Then Donn F. Draeger asked me if I wanted to know more about the background of *budo*. The two of us went to the famous police sensei in *jodo* and *kusarigama*, Shimizu Sensei. That was the place where I also met his *shihandai*, Ichitaro Kuroda Sensei, and started *iai jitsu* and *kendo* under his guidance.

Q: Sensei, you have trained under Mas Oyama and Kyuzo Mifune, both of whom are legendary. What can you tell us about them?

A: I was Oyama Sensei's first foreign student and stayed with him — the first time — for almost three years in the old *dojo* behind Rikyu University. In 1966, I trained with him again for six months. By then, I was the third man in the *kyokushinkai* after my Sensei, Kenji Kurosaki, who really showed me in those years how to fight for real. Mas Oyama was like a father to me. He never let me pay for anything and always helped me out when I was low on money. He was a terrific teacher and really could raise my spirit when I felt really low. He also could put the fear of God into his students when they did not train the way he wanted them to train. It was the best years in my life. There were no politics or anything like that. I was simply training and felt like a God. From the start, he told me that he would put me a course to make me the European president and leader of the European *kyokushinkai* style. So, for all those years, I had very special training and the best support a student could expect. I really admired Mas Oyama. It was very sad that he changed so much in the later years. I was really shocked when he died. I felt like a very close family member or friend passed away. I did my best to pay him back by organizing his system in Europe. At that time, most *budoka* did not know what karate was and none were in a real *dojo* in Europe. That was in the 1960s. I loved to go around and show them the *kyokushinkai* style, and for those who didn't believe in the style and challenged me, I had to beat the piss out of them! What was funny is that most of them usually became dedicated students of our style.

It was a strange story with Mifune Sensei. It was almost like a predestination of life. When I was wounded the first time during the Korean War — on February 13th — we were completely surrounded by the Chinese. I went to Tokyo with two shots in my right upper leg. During a tour of Tokyo, we visited the old *Kodokan*. The old man was very small and frail, but I watched him throw some bigger man around like old rag dolls. I thought, "Man, I wish we had something like that in Holland because that is what I want to learn." In 1958, I went to Canada to make some money so I could fulfill my dream of going back to Japan. In February 1959, I arrived at the *Kodokan* and the feast started. In November 1959, the President of the *Kodokan* called me into his office while Draeger translated. He told me that I had been chosen to join the *kenshusei*, a class in which the 25 best *Judoka* from Japan all got together in a special class. I was very honored, and who was the head teacher? Mifune Sensei! I had a great time.

Q: Tell us some interesting stories of your early days in judo and karate training.

A: It would take five big volumes to recollect all the great stories and anecdotes I have of those wonderful years. There are too many funny and serious stories to write. However, there is one that is always hanging in my mind.

When Mifune Sensei turned 75 years of age, I was invited to his house with several others. When I entered his beautiful garden, I saw him standing by a tree in his kimono. He was holding a little tool that he was using to prune that tree. My life-long friend and brother, Bill Backhus, whispered in my ear, "Man, if I am getting that old and feeble, I hope you shoot me!" Mifune Sensei died a few years later. Many years after that, when I was myself a 10th dan from Japan, I found myself working in my Japanese garden and trimming my tree! I started to laugh loudly and my wife said, "What's the matter with you?" I told her about the story in the garden so many years ago. Friends, we are all getting there, it just depends how and when. But like I said before, there are many stories from those great days.

Q: How did the Westerners respond to traditional Japanese training?

A: In the old days, they coped with it very well. But now, they cope with it a lot less because a lot of budoka, or so-called budoka, are only interested in making money. Considering that Japan has never won anything important in the last 40 years in karate does not help much either. In judo, they also had bad years, and that takes a lot away from the "Japanese way." When I asked my old teacher Daigo Sensei why the Japanese did so bad he said, "They are not hungry anymore, and the traditional way is slowly fading. In addition to that, we are teaching the old ways too much, while the Western way is more modern, and they have strong minds and a will to win. They are not afraid of the Japanese anymore." I could see that clearly, especially when Geesink and then Ruska — my students — won so many titles against the Japanese fighters.

Q: Were you a natural at karate? Did the movements come easily to you?

A: Yes, very much so, and I must say it was a wonderful feeling that I got on so well with judo and then karate. In less than a year, I was a first dan in judo and captain of the Tung Jen team. In 1956, I won the European Judo title in Amsterdam. When I started karate in March 1959, I was a third dan in judo. I marched around in Oyama Sensei's dojo for years with a white belt. I was promoted to fourth dan in 1963 and sixth dan on January 15, 1965. There were some Budoka who complained about me being a sixth dan. Mas Oyama wrote in a United States martial arts magazine that he would pay \$100,000 to anyone who could beat me in a *ko-shiai*. Besides that, he said he would take my ranking away if I lost the fight, he would go into politics and stop teaching karate. I thought he was joking, but he was not. Honestly, I was not really happy with this challenge because I was too busy with my schools and business in Europe at the time. There was only one who showed up in my dojo, and that was Kwan Mo Gun, a fifth dan and the all-over Korean champ. I still have high regards for that budoka who wanted to fight me. He was beaten terribly by my student, Jan Kallenbach, a third dan, and then by Kurosaki, who had been training for a year in my dojo, and then finally by me. Some are probably wondering why I didn't take him on first. Well, my students begged me to let them go first, otherwise there wouldn't be anything left for them to fight! Jan later became a European heavyweight champion. I really admired Kwan and his spirit because every time he was knocked out he woke up, got on his feet and said in loud voice, "And now Bluming!" You have to respect that.

Q: How has your personal perception of the arts changed over the years?

A: Very much. I never agreed with the so-called old system in which you are not allowed to touch or hit your opponent. That's the reason I resigned as coach in 1971. It was like shooting a rifle, but you were not allowed to hit the bull's eye. I just could not take it anymore. All those smug faces after they won because their opponent was disqualified for hitting him in the face or those decisions from the judges, most of whom had never been in a fight, could make you cry. The way they walked in their fancy blazers with the big Japanese *kanji* on. It was ridiculous! If my grandmother showed up with an umbrella in her hands, she would have beaten the piss out of them! I told Oyama about my idea, which I thought would come together in the future, and that was an all-round karate event with throws and ground fighting. All together. Fighters would look for the KO with punches, kicks and submissions like armlocks, leglocks or chokes. It would be 1/3 kickboxing and karate, 1/3 throws and 1/3 *ne-waza* (grappling techniques) after a throw. Well, I was right because that is what we have today with mixed martial arts. At the time, I thought about putting that new system in the *honbu* for six months. Later, one of my students, Ashihara, made it his style and called it Ashihara karate, which means, "The new way." It was ridiculous! It was my style, and I called it *Kyokushin Budokai*. In my budokai, they do full-contact karate with low kicks, which is mostly professional free fighting or all-around karate.

Q: To impress the Westerners who were attracted to martial arts, do you think that some Japanese personalities have greatly exaggerated their capabilities and historical facts with unbelievable stories?

A: Definitely yes! And the worst place is Asia. But there are plenty who really are what they say. Please allow me to tell you a funny example of this. My wife works for the Dutch-Chinese travel office. One day while I was waiting for her, I picked up a Chinese magazine about sports. I saw some Chinese *wushu*, and there was an article in memoriam of a 100-year-old Chinese wushu teacher who had passed away. He was very famous in his district because he had defeated a tiger with his bare hands many years before. I would have loved to talk to the man and taken some lessons from him, but I am afraid I would not have been able to keep a straight face! In another magazine, some time later, I found the same story. This time it was a black bear. Well, it's up to you guys to believe it or not. Some wushu people said they believed it, and that's the kind the money grabbers love so much because they pay a lot of money for this crap. I remember that Draeger Sensei took me to the Ueshiba dojo for aikido classes. I looked on in amazement. The movements were very nice, but on the street nobody is going to run around you and jump all over himself when taken by the wrist! I asked the sensei if I could fight one of his students or his son, but he told me they did not fight. I asked them if that's how they did their championships, but they said they didn't. So I told them that I

could take dancing lessons in Holland. To be honest, in the modern fashion of *aikijitsu*, there are some very good and real street-fighting techniques that are useful. I even studied some, so that has changed for the better. This is simply an example to show you how those stupid stories come into the world. When I was training under Oyama Sensei for several weeks, he invited Bill and I into the office upstairs. While there, he showed us a film of him fighting a bull at Tatyama prefecture in 1952. To start, it was not a bull but an ox. That is a big difference, my friend! The ox was visibly scared because oxes are kept as pets in farm country, and they let them fight each other under strict rules like *sumo*. As soon as they put their heads together to push each other over a certain spot in the ring and there is some blood, they stop the fight and care for their pets. To hit one that is very much used to being stroked emotionally is — in my opinion — very wrong. I love animals. Oyama Sensei never killed the ox; they did that at the slaughterhouse. But he seriously hurt the animal. The ox did not want to fight and never attempted to do anything. That's sad. I told Sensei Draeger not to show this to Westerners because they would not like it. He looked at me and said that he [Oyama] was not completely crazy, and we had a good dinner after that. Oyama explained that this occurred at the start of *kyokushin karate*, and he needed the publicity stunt. He added that he would never do something like that again.

Recently, I read several times that Oyama killed many bulls in his time. The jackpot was during a meeting between England, France and Japan when some commentator told a packed stadium that Oyama had killed 28 bulls in his life. How ignorant and stupid can that be! But that's how it all started. Read his so-called comic book from years back, which one of his students wrote, and you'll find a story in which the student said that the "Beast of Amsterdam (me)" and Oyama Sensei would go into a bar where mostly *yakuza* were around, pick a fight and clean the place out. Well, I had many dinners with Oyama Sensei, but I went never to a bar with him and certainly did not take a drink in those days. Second, in those old days, if you simply slapped a Japanese citizen without any cause — or even with a cause — you were so fast on your way home that you wouldn't believe it. On top of that, a *yakuza* bar! Too much! Taking on the fanatic Japanese *yakuza* it is a great story! Maybe one guy but the rest would shoot you or take a sword to you and chop you in two. I don't know why they write these stupid stories. Even Matsui Sensei asked how it was fighting together with Oyama in bars! You would think he had more brains. As it turns out, the Japanese want to believe those stories. When I told him what really happened, he was upset and said that we all should keep the legends alive. Well, I am sorry. I worked too hard and broke too many body parts to let them make me the laughing stock because of stupid stories. Besides, I think that the truth is more amazing than any stupid lie.

Q: With all the technical changes during the last 30 years, do you think there are still pure karate styles, such as *kyokushinkai*, *shotokan*, *shito-ryu*, et cetera?

A: I don't know what you mean by "pure." In my opinion, every style in its basic movements are pure from their point of view. I know that not too many budoka or those you think they are budoka can take the truth. And the truth is that most of the so-called old and so-called famous styles are over because they fell apart. They ended up in many different groups, despite the fact that many of them think that they were "tough guys." What they forget to mention, especially in Japan, is that they never won a good fight in the Western part of the world, and we all know now that the famous *Kyokushinkai-kan World Championships* were rigged all the way. You only have to ask Nakamura, who left the New York honbu, because of all the terrible things that happened behind closed doors. I knew about this lousy behavior and told Oyama Sensei not to go on with this because one day everybody was going to find out. Anyway, I think that the purest style from way back is in Okinawa and China because they got the green light to get back on the real wushu track again. In the near future, we will hear about China. *Shito-ryu* is the school of my old friend and multibillionaire Jotsky Matsuura, a 10th dan within his own organization. I was about to join him as vice-president, but Kenji Kurosaki, a 10th dan from Budokai, was against it, so I didn't. Jotsky showed me a kata in his office, and the movements very good movements. For the rest, I really don't know much about the purity of styles.

Q: Compared to the time you began training, what is martial arts training missing today?

A: Very simple. Real, dedicated budoka who — as a way of life or as exercise — do budo and have respect for their teachers and elders in the dojo. Nowadays, it seems like everything is a race to the higher ranking and a run on the money wagon. It is sad, but there are not that many real budoka who practice and teach the martial arts as a way of life. Once again, the average guy doesn't know the difference so, these individuals can get away with it. Look at some of the websites; they are a bunch of old farts who haggle and fight on the side instead of spending their time in the dojo. If they knew what they were talking about, it would not stink that much, but most of them don't. Even when I proved to them, which I did some time ago, and I recognize that was stupid of me because you can bring a monkey to the peanuts but so cannot make him eat them, they had all kinds of funny things to say. Of course, they never could back anything up. When you look into the men's eyes, you'll find out that they have not done one single day of training in the last 20 or more years! I wonder how they make money; it is certainly not with budo. Now, as long as that kind of people are on the Internet and keep popping off the most ridiculous lines, I'll keep thinking that the old days were better. Certainly as far as respect is concerned.

Q: What is your opinion of kickboxing and other modern fighting events such as the UFC?

A: In 1989, Chris Dolman and I went to Tokyo to participate in the first free-fight held in Tokyo and Osaka. That was the UWF. Soon after that the sponsors started to create a lot of differences among them. I'm talking about the Japanese organizers, of course. Now, don't forget that there was and still is a lot of money involved in Japan in these kinds of events. Akira Maeda founded *Rings Japan*. It finally died, and I thought it was a good organization. Free-fight or "all-around-karate" as I like to call it, is a good way to show your complete fighting ability in the ring and make

some money on the side. It is completely different from basic karate, and to be honest, the traditional budoka, those who are into traditional karate or judo, don't have any chance at all against one of these MMA or NHB guys. Don't forget that there are not that many real good "complete" fighters in the world. It takes a real man who can take pain and is not afraid to do a hard workout everyday, punishing his body and going through a lot of physical pain and injuries. Full-contact karate is the first step to a complete fighter, but there are more aspects involved. One of my students started with traditional karate and then got into full-contact, following the program I have developed in Budokai. He won the Daidi Juku and the Pancrase championships three times. Later, he won Pride and K-1. In K-1, he beat three-time world champ Ernesto Hoost. Unfortunately, the judges declared it a draw because they knew Hoost was a big draw for the people in Japan and had to be in the finals. Let me tell you something. When you are knocked down in several rounds and have a cut in your head of almost five inches, that is not a draw. Also, Ernesto Hoost is a student of my student, Johan Vos, a sixth dan, and Jan Plas, an eighth dan of the Budokai.

A man must do what he really wants to do. If you are not up to it, regardless of what it is, don't do it because you will never be happy and it will never bring you the proper rewards. But if you want to be a real fighter and prove yourself in kickboxing or MMA, you are in for hard work and a very hard game. But never forget ... some budoka —real ones — love that way so I think it is a good thing that they have that chance to prove themselves, even if some people who have never trained for real in the martial arts make the real money.

Another funny thing that is happening these days is that you hear or read that there is a seminar in the Pancrase style of fighting or in Pride's system of combat, et cetera. Don't let yourself be fooled by these people — even if they are good fighters — because there is no Pancrase style or Pride style. This is all "BS." Men, who are simply in it for the money, run these seminars. In many European countries, you can be extremely disappointed because many of these so-called "extreme fighters" don't know what the hell they are doing, especially in the groundwork area. They are terrible. But at least they are out there fighting instead of being on their website pretending to be tough guys.

Q: Do you think events like the UFC and other NHB events represent the true essence of fighting?

A: In a way they do because you see the real champions after many years of hard training. It's not like they are showing a kata, knowing that on the street any street fighter or boxer would kick their ass. It just depends on what you want to get from budo. If doing your kata three times a week in your dojo is satisfying, it serves your idea of budo. There is absolutely nothing wrong with that. Certainly not if you are happy. But if an individual starts bragging about how good and dangerous he is and he really doesn't fight, then he is not only an idiot but also a very immature individual. All talk and nothing behind it to back it up. That's what you see in many people these days. I honestly think that real pro fighting proves a point that Muhammad Ali and many other great boxing champs proved in the past ... they could fight. Period.

Q: Do you think that karate in the West has caught up with Japanese karate?

A: Definitely. In the old days, we looked forward to meeting Japanese Judoka and karate masters because we wanted to learn from them. Today, however, the Western world has much better fighters and teachers than those living in the East. This is not just talk. For many years, the Japanese have been coming to Europe and the United States to learn how to fight in MMA and NHB events. You do not really find too many Japanese masters teaching in Europe because we don't need them anymore. In a way that's good, but for budoka like me who knew the old days, it makes me a sad and homesick for my second country (Japan) and my old sensei. They are almost all dead now, but I keep them in fond memory and have pictures of them all over my place. I know time changes a lot of things and sometimes not for the best. When my Japanese friends lost the world judo title in 1970 in Paris, I was very sad, even if it was my countryman Anton Geesink who won. That day was the beginning of an era. The Japanese hegemony was finally broken and nowadays anybody can win in world karate tournaments or Olympic judo. In the old days, if 10 Japanese entered a championship, they all won. In karate, it is a different thing from the very beginning. Shotokan stylists never won a title in real contact karate. Neither did wado-ryu. From the very beginning in 1970, the kyokushinkai has been the main style, and some of the Japanese fighters were real good until Willy Williams appeared and destroyed them. They could not stop progress, and the *gaijin* won, opening new doors for everybody to enter.

Q: Do you feel that there are any fundamental differences in the technical approach and physical capabilities of Japanese karate-ka in comparison to Western karate-ka?

A: Yes. Physically, a Japanese person is much more flexible than the average European or American. In a way, that should be an advantage. In reality, it is not and the overall mental ability of the Europeans and Americans is much stronger than the average Japanese. That's a hardcore problem, but I believe that the average Japanese does practice much harder than the Westerner does.

Q: Karate and judo are nowadays often referred to as sports. Would you agree with this definition?

A: Of course, they are sports, and it is a pity that competitors cannot make more money or make a good living competing. This is especially the case for those who are really dedicated and put all the time of their lives into it. If I look at soccer players, I see millionaires all over the place. Many of them can hardly write their names. If they were not lucky enough to be able to do what they do on the field, they would not even get a job cleaning lavatories in Morocco. So, if a good Karateka trains hard and gets somewhere winning a lot of titles, I think he deserves much more than being considered an amateur. The same goes for Judokas and all MMA fighters. Again, the answer is yes.

They are sports at the highest level, but the money is not there.

Q: Do you feel that you still have further to go in your studies of the arts?

A: Yes I do. The first thing a man needs to do is try to understand what goes on in his mind. This concept especially applies to those who never made anything good for the martial arts, mainly because they never trained hard and put themselves to test. It is sad how many people who have never been properly trained are running a dojo and misleading students. Sometimes people write me letters and invite me to visit them and teach a seminar. I am a so-called professional, but I go there anyway, even if they have the money to pay for my trip. Why? Because I love seeing people with passion and dedication. If you give them a chance and they train hard, they will be excellent budoka. My body today does not want to do the things I used to do. Once warmed up, however, I can still kick serious butt. Believe me. But it is mostly the mind, which is working in high gear all the time. With the time I have left, I will use it to show other budoka what real budo is all about. And I hope this will help them long after I am gone.

Q: Do you think it helps the empty-hand techniques of karate to train with weapons?

A: Not really, especially if your intention is the empty-hand fighting side of this discipline. Besides, you just cannot walk the streets with weapons. However, training with weapons can give you an edge if you have to defend yourself against someone using a weapon. For this, it is helpful. For a sparring session or full-contact karate match, no way. I did it just to get a better understanding of the Japanese bushido, the discipline and the feeling of those old days when the sword could get you killed or make you a hero. Meeting those terrific old teachers and feeling their spirit was a tremendous way of living budo and understanding how it all came about. I wouldn't have missed it for the world, but it won't help you in judo or karate or whatever fighting sport when you have to face an empty-handed opponent.

Q: What's your opinion of *makiwara* training?

A: The first time I saw Peter Urban, Kurosaki Sensei and Mas Oyama's knuckles I thought it was the trademark of a true Karateka. In a way it still is, but on the other hand, I know many so-called "budoka" who — despite having tremendous knuckles — would lose to my grandmother. She could kick their butts with an umbrella. So, it [large knuckles] does not really mean that the man is a good fighter. It's simply appearance. I did a lot of makiwara, and I can tell you that it makes a man out of you if you do it the correct way. The first time I used the makiwara I had a swollen hand with a huge blister on top of it. When I showed it to Mas Oyama the next day, he said, "Good. Now go hit the makiwara 200 more times." The first time makes you sick because you can feel the blisters explode. The impact creates a horrible watery sound, almost as if somebody was putting a knife in my rear end. Two weeks later I was breaking bricks with the same hand and that was the end of it. I had karate hands. For "normal" karate practice, it is certainly not necessary. If you are a so-called karate teacher who must show what you preach, it is a must. I can hit the wall with all my power and don't feel anything. When I am in real danger, I know that I have a weapon I can rely on. When I hit and connect, Of this I am sure.

Q: Let's say that a practitioner is also an instructor. How different should his personal training be from his teaching schedule?

A: It depends very much on his age. When young, he should do as I did and have a special class for champions and fighters. Train with them, and you'll stay while teaching. Be a real karate sensei. When you are older, it is better not to do as I do, which is fighting on the ground with some real rough guys. Don't forget that the injuries you get when you are young stay with you, and the ones you get when you are 70 years old will not go away as easily as they did when you were a young kid. Trust me. The old injuries will play a big part in your daily life after you are 55 or 60 years old. Arthritis will set in on these joints and old fractures. I can honestly say that I have hardly had a single day without any pain for the last 30 years. And it is getting worse as we speak. My doctor says I'd better stop fighting right now. But I told him it is my hobby and that is the price I must pay. If I stop, I will die.

Let me return to your question. It is better is to have several classes; one for those who want to practice but not do any fighting; one for those interested in budo and one for the real fighters who want to enter professional competition. Don't put them together because you'll get what I got in the old days: some terrific fighters and a lot of students who ran away as fast as they signed up when they saw how hard the fighters were treating the rest of the guys in the class. I did not care in those days, for I made my money as a business partner in casinos. That's the reason why we won all the championships in judo, karate and free fighting. The students who stayed in those classes were real fighters. It is good for the fighting side of the school but not for the business aspect of it.

Q: When teaching the art of karate, is self-defense, sport or tradition the most important element?

A: The answer is a combination of all three aspects, but there is something very important that you have to remember here. When a new member applies for membership, he is not joining to learn kata. He wants to beat up as many people on the streets as he meets. When they say that they don't come for that and when they say that they are signing up for the spiritual side of the martial arts, you have a terrible liar in front of you. I had some real punks come into the dojo in the 1960s and 1970s, and I always beat them up on the first day just to show them who was the boss and who was the sensei in the school. A lot of them could not take it and left, but some of them became real good budoka. They went on to become good and dedicated teachers and fighters and very seldom had to fight on the streets. That's the type of budoka that I love, and that's why it is all worth it. Those who leave end up talking on the

Internet and telling lies on their websites.

Q: You seem to be very upset with people talking on the Internet. Why?

A: Because it is a very easy way for those cowards who don't have the courage – and I would love to use another word – to criticize and bad-mouth others who dedicate their whole lives to budo and have the scars to prove it. It is very easy to write and talk trash, but it's impossible to find one of these cowards who will show up and tell you things to your face so you can get back at them with your fist. Talk is cheap, and the Internet helps to make even cheaper!

Q: What's the proper ratio between kata and kumite?

A: I brought the so-called new kata to Europe for the first time in 1961 and then again in 1966. We even won championships in that category. Again, I believe it is important to make separate classes for those particular aspects of karate. At the same time, a fighter must not forget that when he is undergoing an examination for a dan — especially a higher dan — he must show the correct kata with a correct skill level. If he is a champion, he can get by with a good understanding, but he must also show the correct techniques in the proper way because karate is more than fighting.

Everybody must do it according to the way he sees the art, how it best applies to his dojo and what is best for his students. The International Budokaikan will never impose how things must be done inside any dojo. But when the students come to the test, you can see how the instructor is and what he is teaching in his school. Students are the reflections of the teachers in many ways. You need to provide freedom, but at the same time, you must maintain a good structure for the art to grow. If the karate people had done that from the beginning, karate would now be the bigger than soccer.

Q: Sensei, do you have any general advice you would care to pass on to the young karate-ka?

A: First, pay attention and think about what I have already said. Believe me, I have learned all this the hard way. Then, with an inquisitive mind, look at what the most successful schools have done. Look at the teachers and try to duplicate those elements that brought credibility and good students. Just don't go in a dojo and start training without looking and comparing. If you want to be a fighter, train under a famous sensei who was a good fighter in his younger days. If you don't care about fighting and are more interested in budo, look for a dojo with good people and a real dedicated sensei, even if he is not the greatest fighter. The decision is highly personal. I always looked for the best teacher in the particular aspects I wanted to develop. No teacher can give you everything you need. So, don't be afraid to look for the one who can provide you with the things you want and need in order to be happy in your budo quest.

Q: Some people think going to Japan to train is highly necessary. Do you share this point of view?

A: As far as getting stronger and better, that time is over. Don't forget that the best fighters nowadays don't come from Japan. Look at Pride and K-1. The European and U.S. fighters — not the Japanese — are winning these events. In old-fashioned karate, stylists from shotokan, goju-ryu, wado-ryu, et cetera are not winning the big championships. At least not in the last decade. I don't think you have to go to Japan to learn how to fight like a professional, but it is real fun to go there to experience things. You can learn a lot of other things if you go and stay there for some time. It is very true that the martial arts take on a totally new meaning, as far as spirit is concerned, if you train in Japan. I would recommend to anybody to get a few months — at least — in Japan ... just to get an idea of the traditional side of budo. Depending on your fighting appetite, choose the kind that fits your ability.

Q: What are the major changes in the art since you began training?

A: Too many split-ups in all styles of the old Japanese schools. Everyone wants to be a little king in his own style, but he forgets that he got the ideas from other people and old sensei. Funny enough ... they go around telling everybody about their new approach to the style, and that is real BS.

I take pride in keeping Mas Oyama's Kyokushin style in the budokai. I can say proudly that I was the first one to show Oyama Sensei in 1966 the combination of complete karate, which is now called mixed martial arts. This is one-third karate and kickboxing, one-third throwing techniques, and one-third grappling and groundwork. The mentality has also changed a lot. I tell my students to look into other dojo and practice with them when they are out of town or during holidays. You can always learn from anybody ... even when the teacher is not well known. Other major changes are, of course, the K-1 and the hard NHB and MMA events like the UFC. These have revolutionized the world of martial arts forever. As for the rest, the traditional karate styles like shotokan have not made any changes. The old JKA lost out, as for being in the top of the karate business. They don't have an "only one" honbu dojo and shotokan is now only a well-known name but not much more. Kyokushinkai went the same way after *Kancho* passed away. It looks like some top instructors are at least working hard, but they will never get the grip on it like Mas Oyama did. The old Kyokushinkai has split up in many different groups and several thousand dojo. In a way, they are all the true example of a modern *ronin*. It is sad, very sad.

Q: With whom would you like to have trained that you have not?

A: Nobody. I say this because I was fortunate to have met and trained under the most famous and legendary sensei in Japan between 1959 and 1980. I don't think I missed a thing. One of the best was Donn F. Draeger. He really made me who I was in judo and give me the body for which I always longed. In 1959, he took me from being a skinny 79 kilos to a solid 102 kilos dynamo. I came out on top because I had the speed and flexibility of a middleweight but the body and strength of a heavyweight. Then, of course, there was Oyama Sensei and especially Kenji Kurosaki Sensei. In Kodokan judo, I had all the famous champions and sensei in the Kenshusei. There was Mifune, Daigo, Osawa, Kaminaga, Inokuma, Koga, et cetera. In bo-jitsu, it was Shimizu Sensei and Ichitaro Kuroda Sensei. Yamaguchi "The Cat" was a very good friend of mine. Like Frank Sinatra said in one of his songs, "I had it all."

I was very lucky because I did not suffer any injuries until years later. So, I could really fight hard for many years. I have never lost in Japan. Funny thing is that the Japanese wrote a book about my life in Japan.

Q: What would you say to someone who is interested in learning karate-do?

A: If he is really going for it 100 percent, then he has a very hard but rewarding life ahead of him. I sure had and still have. When you are seriously looking for a real dedicated sensei — who doesn't have to be Japanese, provided he's been through the fire on a real battle ground — find one who can teach you how to become one with yourself. Okinawa has been hiding from the publicity in the martial arts world, but lately they have exposed more and more. I have heard there are some very good sensei in Okinawa, but I don't know them.

Q: What keeps you motivated after all these years?

A: My students and the joy of seeing them coming along and becoming champions. One thing I truly like is to show them what it was like in the old days. They understand the importance of combining the three elements we talked about before, which are contact karate, throwing techniques and grappling. I would really die if I could not do anything. It would kill me. Even the people who do all the talking about stupid things keep me alive because I want to prove to the real budoka what can be done ... even when you are 70 years old. The old injuries are getting to me. After a big test at the Dutch Veteran's Hospital two years ago, they told me that I had advanced arthritis in the joints that were badly hurt during those rough years. They told me to take it easy, but I thought, "Come on, I am Jon Bluming ... no way!" But they were right. It is getting worse. They even gave me a military pension of \$220 a month. But don't worry. I can still teach and move around. I still love a good tumble on the ground with the young guys. So I just wait and see where it all ends. Certainly, not too soon if I can help it.

Q: Do you think it is necessary to engage in free fighting so you can learn how to protect yourself in the street?

A: Yes, I certainly do, and that was always my goal in my budo career. I wanted to make a system that was good for sport combat, and — with some adjustments — an efficient system for fighting in the street. I am sure that I succeed in that. I hate the so-called budo experts who teach only the higher goals of budo, like those spiritual things, including meditation. Don't get me wrong. The tradition and etiquette, the formal spirit, the respect for each other in the dojo and for your opponent. These are all great things, but I cannot show any respect for the "famous sensei" who have done absolutely nothing for the arts and got their grades by making members join their associations in Japan. When these people had to fight in the past, they disappeared like cowards. I always tell everybody who is who, and I can prove it.

Q: Modern karate is moving away from the *bunkai* in kata practice. How important is bunkai for the understanding of karate-do?

A: It is part of karate and a part that will always be connected to the true essence of karate. This is true with the old and traditional karate styles. It is a way of showing that you can do the *waza* in a combination of movements, regardless from whom you are learning. Then again, I have never seen a kata champion who could beat my grandmother when she had an umbrella in her hands. You must know how to fight and how to take care of yourself in the dojo and in the street. Otherwise, from a very fighting and realistic point of view, kata is a total waste, but I have to agree that it is good exercise.

Q: What is the philosophical basis for your karate training?

A: To be a real fighter. That has always been one of my goals. I always admired and still do, the old Buddhist monks in old Japan. They were real human beings who did not believe in killing any kind of life. But if someone was coming for them, they turned into fierce fighters. The Daimyo (prince of the district) always had deep respect for them and always wanted them on his side, for he could depend on their honesty, loyalty and fighting ability. On the other hand, they were great human beings who were always helping weak individuals. My other goal was to become a good human being like these people, and in my own little circle, I think that I succeeded.

When I started my dojo in Amsterdam in 1961 and I was the main coach for the judo national team, I told my students, "Friends, I am going to teach you a new system of fighting called karate. If you use this on the streets or wherever just to show off, I will kick you out of my dojo. On the other hand, if you are attacked or molested in any way and you don't put your aggressor in the hospital, I will also expel you from our kyokushinkai-kan dojo and the Budokai." It has always worked for me to balance fighting with a deep and profound philosophy. I don't want to give

you a lot of philosophical BS that sounds really good on paper but nobody can transfer to daily life. For me, it has always been a way of life, and I was lucky that I made good money in the casinos in Amsterdam as a minor partner because I could never make much money teaching karate or judo. I simply got by. Because of the casinos — from 1970 until 1980 — I could do most of it as a hobby or semi-pro. I only do that for dedicated budoka, as long as my body will let me.

Q: How can a practitioner increase his understanding of the spiritual aspect of karate?

A: That is up to each individual budoka and his interest. If the person is in my dojo, I watch him and interview him ... first to find out what he really wants out of karate and then I'll go from there. New budoka should be careful with the so-called spiritual aspects of budo because there is a lot of BS in that word. I don't like to talk too much about it because, at the very end, it is a personal experience and words can't describe something that you have to discover and feel for yourself. First look into the background of the sensei and see if he is really what he claims to be. If so, at least you are on the right road.

Q: Is there anything lacking in the way martial artists are taught today?

A: I really don't think so. However, in my early days, there were not that many teachers around. Usually, the champions — like in the early judo days — went all over the world to teach, and they did a great job. As a matter of fact, they did such a great job that we don't need them anymore. In Europe, we have better teachers today than in Japan. Of course, there are few exceptions to that rule. The same goes for karate. In kendo, the Japanese are still the real masters.

Q: What do you consider to be the most important qualities of a successful budoka?

A: Honesty. In my dojo, there is no religious talk, no discrimination of any kind and there is no BS. All we do is train. Make the dojo a brotherhood, a sort of budo family. What you learn today you should show the others later and help the lower grades achieve a higher level by teaching them what you have learnt. Don't pick on the beginners just to show how good you are because they don't come to the dojo to be beaten up by a bully. It is especially important for the sensei to look for those kinds of bullies because they can screw up the whole dojo. Don't believe all the famous stories that turn out to be all lies. For instance, I could not believe everything that people wrote and talked about me during the last 30 years. Things like I killed a yakuza in a bar fight, that Mas Oyama Sensei took me in but only after he beat me badly, et cetera. Unbelievable! Oyama Sensei and I never ever fought ... not even on friendly terms or controlled sparring. He was my teacher and taught me a lot of the things that I teach today and that I said in this interview.

Q: What advice would you give to students about supplementary training such as weight training, stretching, running, et cetera?

A: When I went to the honbu dojo in 1966 for six months, I trained very hard at the weightlifting gym in Korakuen. While there, I met the Olympic track and field coach of the Russian national team. He had some members of his famous group with him. He was training with really heavy weights for his legs. I asked the coach what that was all about.

Donn Draeger was there too, and he gave us a lot of information. Among other things, he said that even a table tennis player must train with weights and be able to lift his own weight above his head. Weight training is a very important aspect of the overall physical conditioning program, but the guidance of a real good teacher who knows his stuff is priceless. Otherwise, it will work against you, and you will be injured badly as a result of incorrect training.

I had the great fortune to have the best trainer in the world in those days, and he made me what I am today. His name was Donn F. Draeger. He introduced me and other Judoka to the specifics of weight training for judo. One of these champions was Isao Inokuma, who, after six months, started to train with weights. Eventually, he won the All-Japan Championship when he was only 86 kilos. But he was as strong as an elephant! His training routine entailed 20 percent weights — three times a week in the morning — and the remaining 80 percent was all judo practice, *uchikomi* and fighting.

In any sport, you need weight training to supplement your skills, but it has to be done in a scientific way under the guidance of a real teacher who knows what he is doing in your particular discipline. It is called sports specific training. And it doesn't matter if it's tennis, judo, karate or soccer. Draeger helped me go from 70 kilos into a solid 102 kilos in eight months, but he always whopped my ears with his whisperings, such as, "Jon, don't let the weights do the judo for you. No matter how tired you are after the weights, go up to the main dojo and fight everybody and anybody because from that you get the stamina and the experience for real judo. Never let the weights rule your technique, but use that extra strength to sharpen your waza and tokui-waza and keep your speed and mobility as a middleweight." It brought me to the absolute top, and I am deeply in debt to him. He died of cancer when he was 61. Not a single day pass that I don't think about him.

Q: What are the most important attributes of a student?

A: To be determined to reach the goal he set. He must also be keen and observant, take in what the sensei teaches

him, help others, follow the tradition and the etiquette of budo, stay humble and never become a nuisance once he becomes a champion. For not following these important rules, I kicked out of my dojo in 1964 the most famous Judoka whoever came from the Western world. His name was Willem Ruska, and he was a two-time Olympic medal winner and a three-time world champion. I don't care about fame and or a champion when he cannot behave like a human being with others.

Q: Why is it, in your opinion, that a lot of students start falling away after two or three years of training?

A: A number of reasons. It could be that they did not reach their goals, they got bored or it could simply be because of the way modern life is today. The ones who stick with it are the ones who are really determined to get to the top either as a teacher or a fighter. In only three years, you cannot see much of the spiritual rewards of budo. You get that after you reach your goal and when budo becomes part of your life. When I asked my former teacher in the Kodokan and the Kenshusei, Daigo Sensei, why the Japanese Judoka were doing so poorly in championships, he said; "We got rich, and the students are not hungry anymore." Enough said.

Q: There has been very little written about you in magazines. You obviously do not thrive on the publicity like some martial artists. Why?

A: I don't have to. I am 70 years old now, so what good does it do me if they write things and make me a so-called legend? And then you read on a website the most horrific lies about myself and other important budo people. I just want to stay away from that kind of people. I love to teach and show dedicated students my ideas. If they listen and see the light, I am happy. But don't kid yourself. In Europe, there was a time when I was in newspapers almost daily and magazines. Now it is maybe every month or so. My greatest success was that I became a bodyguard for our beloved former CMDT, the Prince of the Netherlands, Prince Bernhard. I had my share of publicity, believe me.

Q: Have there been times when you felt fear in your karate training?

A: Yes, but mostly when I broke part of my body during hard training. I never had any fear facing an opponent on the mat. Nowadays, I am scared of my arthritis and the old injuries that bother the hell out of me. I'm afraid they will prevent me — in the near future — from doing my hobby and my way of life, which is teaching, grappling on the ground with the young guys and budo. That's what really scares me.

Q: What else would you tell us about the great Donn F. Draeger?

A: I can write a book about Donn F. Draeger and my experiences with him. He was my real sensei since the first day when he picked me up and asked me to help him to prove a point in a class. Karate and judo becomes better when training scientifically with weights. Also, his judo training and guidance for all those foreign students in the Kodokan was priceless. His personal guidance for Inokuma, for it was Donn who made Inokuma a real world champion and nobody else. Donn was always there for us. He was always joking like the Marine officer with a field commission. When he was 19 and in Guadalcanal, he got shot really close to the heart by a sniper. He got the silver star and became an officer. Later, in the Korean war, he was a captain and a Lt Col. I could tell some nice stories. In short, he could play with many of the Kodokan teachers in those days, including all the eighth-, ninth- and even 10th-dans. He never got his sixth in Kodokan, because he could not take the BS anymore. He focused more on bo-jitsu, kendo and iai-jitsu under the Japanese Kendo Federation. We started out together in 1959. In 1966, I received my fourth dan and Donn, years later, received his eighth. He was the best friend and the best trainer and sensei I have ever seen and believe me, I have seen them all. Rest in peace my old friend. I love you dearly.

Q: Finally Sensei, if you had to leave a final message for the future generations, what would it be?

A: Stop the bickering and put the jealousy aside. When you have something to say, try to tell the truth. Since websites became popular, there are a bunch of cowards telling unbelievable tales. I wonder how they can find the time to do any real practice. If only 50 percent of the world karate groups would really try to work together, they would have a federation much bigger than the international soccer federation. With that money, they could do a lot of good and everybody could learn from everybody and make the federation into a very strong fighting organization. But today they are all concerned about grades and there are more 10th dans in the U.S. than the Japanese had since they started budo! I wonder how they got it. Certainly not from Japan. I hope they are worth that grade in more ways than just making money from students. The budo world is still strong. There are real budoka fighting in great events, such as MMA, which I like to call all-around-karate. That is what I teach mostly today because it is real fighting, and it is effective. But I know deep inside that martial artists won't get together. That would be utopia. Again, look for a good sensei, a good organization and work for them and with them. Don't forget; if you don't respect your sensei, how can you expect respect when you become one? As my teachers said, "Without *kokoro*, budo is simply an empty shell."

Kihon

The Kihon outlined here is intended only as a guideline. Within the International Kyokushin Budokai, each instructor is the 'chief' of his own Dojo. Provided the overall framework of the Kyokushin Budo Kai system is maintained, it is possible that the Kihon practised at your local dojo differs in some small way. If you have any doubts - ask your instructor for guidance. There is NO substitute for hands-on training and tuition.

10th Kyu

White Belt - 1 Yellow Stripe

Dachi	Yoi Dachi, Fudo Dachi, Heiko Dachi, Zenkutsu Dachi, Kumite Dachi, Moro Ashi Dachi
Te Waza	Oi Tsuki (C,J,G), Gyaku Tsuki (C, J,G), Ago Uchi
Uke Waza	Jodan Uke, Soto Uke, Gedan Barai, Gedan Uke, Gedan Juji Uke
Keri Waza	Mae Keage, Mae Hiza Geri, Hiza Ganmen Geri, Mae Geri (C, J)
Kata	
Nage Waza	O Goshi, Kubi Nage
Osae Komi Waza	Kesa Getame
Kansetsu Waza	Ude Garami, Juji Gatame
Jime Waza	Nami Juji Jime, Kata Juji Jime, Gyaku Juji Jime
Kumite	5 x 2 min Jiyu Kumite

9th Kyu

White Belt - 2 Yellow Stripes

Dachi	Sanchin Dachi, Heisoku Dachi, Kokutsu Dachi, Neko Ashi Dachi
Te Waza	Tate Tsuki, Mawashi Uchi (C, J)
Uke Waza	Shotei Uke (C, J, G), Sune Uke, Jodan Juji Uke, Sune/Kote Uke
Keri Waza	Mawashi Hiza Geri (J, C, G), Mawashi Geri (J, C, G)
Kata	Taikyoku Sono Ich, Taikyoku Sono Ni
Nage Waza	O Soto Gari, Harai Goshi, Maki Komi Nage
Osae Komi Waza	
Kansetsu Waza	Hantai Ude Kujiki
Jime Waza	
Kumite	5 x 2 min Jiyu Kumite

8th Kyu

Yellow Belt

Dachi	Kiba Dachi, Kake Dachi
Te Waza	Shita Tsuki, Jodan Age Uchi
Uke Waza	Uchi Uke, Uchi Uke/Gedan Barai
Keri Waza	Kake Geri (J, C, G), Ushiro Mawashi Geri (J, C, G)
Kata	Taikyoku Sono San
Nage Waza	Tai Otoshi, Ura Nage
Osae Komi Waza	Kami Shiho Gatame, Yoko Shiho Gatame, Tate Shiho Gatame
Kansetsu Waza	Ude Gatame
Jime Waza	
Kumite	6 x 2 min Jiyu Kumite

7th Kyu

Orange Belt

Dachi	Shiko Dachi
Te Waza	Tettsui Komi Kami, Tettsui Yoko Uchi (J, C, G), Tettsui Oroshi Uchi
Uke Waza	Shuto Mawashi Uke
Keri Waza	Ushiro Geri (J, C, G), Kakato Geri (J, C, G)
Kata	Pinan Sono Ichi
Nage Waza	Morote Gari, Kibisu Gaeshi
Osae Komi Waza	Kata Gatame
Kansetsu Waza	Waki Gatame, Kannuki Gatame
Jime Waza	Sode Jime, Kata Te Jime
Kumite	7 x 2 min Jiyu Kumite

6th Kyu

Green Belt

Dachi	Tsuru Ashi Dachi
Te Waza	Uraken Yoko Uchi, Uraken Hizo Uchi, Uraken Shomen Ganmen Uchi, Uraken Oroshi Ganmen Uchi, Uraken Sayu Gamen Uchi
Uke Waza	Kake Uke
Keri Waza	Yoko Geri (J, C), Kansetsu Geri
Kata	Pinan Sono Ni
Nage Waza	Ko Soto Gari, O Uchi Gari/Gake
Osae Komi Waza	
Kansetsu Waza	Hiza Gatame
Jime Waza	Tsuki Komi Jime
Kumite	8 x 2 min Jiyu Kumite

5th Kyu

Blue Belt

Dachi	
Te Waza	Shotei Uchi (J, C, G), Mawashi Shotei Uchi (J, C)
Uke Waza	
Keri Waza	Kinteki Geri, Uchi Mawashi Geri (J, C, G), Uchi Haisoku Geri (J, C)
Kata	Pinan Sono San
Nage Waza	O Soto Gake, Ko Uchi Gake, Gyaku Maki Komi Nage
Osae Komi Waza	
Kansetsu Waza	Kata Ashi Gatame
Jime Waza	Hadaka Jime, Kata Ha Jime, Okuri Eri Jime
Kumite	9 x 2 min Jiyu Kumite

4th Kyu

Blue Belt - 1 Black Stripe

Dachi

Te Waza Hiji Ate (J, C), Age Hiji Ate, Oroshi Hiji Ate, Yoko Hiji Ate, Ushiro Hiji Ate

Uke Waza Mae Shuto Mawashi Uke

Keri Waza Mawashi Soto Geri Keage, Mawashi Uchi Geri Keage

Kata Sanshin No Kata

Nage Waza De Ashi Barai, Ko Soto Gake

Osae Komi Waza

Kansetsu Waza

Jime Waza Ebi Jime, Morote Jime, Sankaku Jime

Kumite 10 x 2 min Jiyu Kumite

FITNESS 30 Knuckle Push-ups

50 Situps

10 Double Jumps on the Bag

3rd Kyu

Brown Belt

Dachi

Te Waza Shuto Uchi Komi, Shuto Sakotsu Uchi, Shuto Jodan Uchi Uchi, Shuto Yoko Ganmen Uchi, Shuto Hizo Uchi

Uke Waza Shuto Jodan Uchi Uke, Shuto Soto Uke, Shuto Gedan Barai, Shuto Jodan Uke

Keri Waza Oroshi Uchi Kakato Geri, Oroshi Soto Kakato Geri

Kata Pinan Sono Yon

Nage Waza Hiza Garuma, Sasae Tsuru Komi Ashi

Osae Komi Waza

Kansetsu Waza

Jime Waza Kaeshi Jime

Kumite 10 x 2 min Jiyu Kumite

FITNESS 50 Knuckle Push-ups

100 Situps

15 Double Jumps on the Bag

2nd Kyu

Brown Belt - 1 Black Stripe

Dachi

Te Waza Hiraken Uchi (J, C), Oroshi Hiraken Uchi

Uke Waza

Keri Waza Tobi Nidan Mae Geri, Tobi Mae Geri

Kata Pinan Sono Go, Gekisai Dai

Nage Waza Uki Waza

Osae Komi Waza

Kansetsu Waza Ashi Garami, Goshi Gatame

Jime Waza

Kumite 15 x 2 min Jiyu Kumite, 5 x 2 min Ne Waza, 1 x 2 min Ippon Kumite

FITNESS 50 Knuckle Push-ups

20 Finger Push-ups

100 Situps

20 Double Jumps on the Bag

1st Kyu

Brown Belt - 2 Black Stripes

Dachi

Te Waza Me Tsuki, Yonhon Nukite, Toho Uchi

Uke Waza

Keri Waza Tobi Yoko Geri, Tobi Mawashi Geri

Kata Yantsu, Tsuki No Kata

Nage Waza Tani Otoshi

Osae Komi Waza

Kansetsu Waza

Jime Waza

Kumite 5 x 2min Ne Waza, 1 x 2min Ippon Kumite, 15 x 2min Jiyu Kumite

FITNESS 50 Knuckle Push-ups
20 Finger Push-ups
100 Situps
20 Double Jumps on the Bag

1st Dan

Black Belt - 1 Gold Stripe

Dachi

Te Waza Haito Uchi (J, C, G)

Uke Waza

Keri Waza Tobi Ushiro Geri, Tobi Ushiro Mawashi Geri, Age Kakato Ushiro Geri

Kata Saifa, Tensho

Nage Waza

Osae Komi Waza

Kansetsu Waza

Jime Waza

Kumite 5x2min Ne Waza, 1x3min Ippon Kumite, 1x3min Jiyu Kumite with 2 opponents, 5x2min Free Fight (Helmet), 30x Jiyu Kumite

FITNESS 70 Knuckle Push-ups
150 Situps
100 Squats

2nd Dan

Black Belt - 2 Gold Stripes

Dachi

Te Waza

Uke Waza

Keri Waza Kaiten Geri

Kata Seienchin, Kanku Dai

Nage Waza

Osae Komi Waza

Kansetsu Waza

Jime Waza

Kumite 5x2 Ne Waza, 1x4 Ippon Kumite, 1x3 Jiyu Kumite 2 Opponents, 5x2 Free Fight, 40x2 Jiyu Kumite

FITNESS 70 Knuckle Push-ups
150 Situps
100 Squats

KATA

What is Kata?

If one were to describe Kata to a non-practitioner of Karate then the definition would be something like: "A prescribed sequence of steps, strikes, and blocks combined in such a manner as to allow us to practise them with a view to achieving all techniques with balance, speed, power, precision, and grace of execution." However, it is fair to say that Kata is considerably more than this.

The word *kata* means "shape" or "form". The *kanji* for Kata is composed of the following characters:

Katachi meaning "Shape"

Kai meaning "Cut"

Tsuchi meaning "Earth" or "Soil"

Literally translated, *kata* means "shape which cuts the ground". The number of movements and their sequence are very specific. The balance between offensive and defensive techniques, the stances used and the direction and flow of movement all serve to give each kata its distinctive character. Through the practice of kata, the traditional techniques used for fighting are learned. Balance, coordination, breathing and concentration are also developed. Done properly, kata are an excellent physical exercise and a very effective form of total mind and body conditioning. Kata embodies the idea of *ren ma*, or "always polishing" – with diligent practice, the moves of the kata become further refined and perfected. The attention to detail that is necessary to perfect a kata cultivates self discipline.

Through concentration, dedication and practice, a higher level of learning may be achieved, where the kata is so ingrained in the subconscious mind that no conscious attention is needed. This is what the Zen masters call *mushin*, or "no mind." The conscious, rational thought practice is not used at all – what was once memorized is now spontaneous.

Mas Oyama said that one should "think of karate as a language – the *kihon* (basics) can be thought of as the letters of the alphabet, the *kata* (forms) will be the equivalent of words and sentences, and the *kumite* (fighting) will be analogous to conversations." He believed that it was better to master just one kata than to only half-learn many. Mas Oyama also emphasized the three fundamental principles of kata:

Waza no Kankyu

The Tempo (fast - slow) of the Techniques. The tempo of the kata varies – some techniques are performed quickly, while others are done more slowly.

Chikara no Kyojaku

The Force (strong - weak) of the Power. The power of a technique derives from the proper balance between strength and relaxation.

Iki no Chosei

The Control (regulation) of Breathing.

The practice of traditional kata is also a way for the *Karateka* to pay respect to the origins and history of Kyokushin Karate and the martial arts in general.

The Kata of Kyokushin Karate are as dynamic as they are diverse. They are very much a reflection of the style and nature of Mas Oyama, the founder of Kyokushin Karate. The Kata which Kyokushin Budo Kai practitioners learn early in their training are reflective of the early training regimen of Oyama. Similarly, Oyama's later training is evident in the senior Kata as practised within the Kyokushin Budo Kai system.

The initial Kata practised within the Kyokushin Budo Kai system are mostly based on Shotokan Kata (Taikyoku and Pinan) and Chinese Kempo (Yantsu). The later, more flamboyant and impressive Kata are derived from Goju Ryu.

The sequence of training and Kata learned within Kyokushinkai and Kyokushin Budo Kai differs from other 'sports based' systems. This is typically since sport based Karate schools are concerned more with winning Kata competitions than they are with an effective system of unarmed combat.

Please remember, within the Budo Kai system, each instructor is the 'chief' of his own dojo. Provided the overall framework of the Kyokushin Budo Kai system is maintained, it is possible that the Kata you will practise at your local dojo differs in some small way to those outlined here. If you have any doubts - ask your instructor for guidance. There is NO substitute for hands-on training and tuition.

About Pinan Kata

Yasutsune Itosu learned a form from a Chinese living in Okinawa. This form was called "Chiang Nan" by the Chinese and the form became known as "Channan" to the Okinawan masters. It seems that the name sounds strange to the Okinawans and is, for them, somewhat difficult to say. In Japanese, the "n" sound is often followed by a subtle "g". So, "Channan" is pronounced like "Chahng nan" with the "ng" not so fully expressed. With this premise, Channan does seem a little awkward to say. Itosu considered that "Channan" was both hard to say and too long to be easily taught.

In 1906 he broke the form into five smaller forms (Kata) and called these smaller sets Pinan. He then introduced them to the children of the Okinawan schools. Continuing with the concept, Itosu founded (or in truth broke apart and renamed) other Kata and these newly structured Kata later became the basis of the Japanese Shorin styles.

The masters Takagi and Uku support this story, and masters from other schools, like Chozo Nakama tell it too. The Channan form remained preserved when passed to "favoured students" and is still detailed in the school records.

The Pinan Kata created by Itosu Sensei are based on two Kata: Channan I and Channan II. Some believe that Pinan Shodan (or Heian Nidan) is Channan I and that Pinan Nidan (Heian Shodan) is Channan II, whilst others believe that Channan I and II are simply 'lost' and that nobody truly knows these forms today. The head of a Chinese system is said to have claimed that he has Channan I and II, and that there is - in fact - a Channan III but there are no real means to verify or refute his claims.

The Okinawan name Pinan was later renamed (by Gichin Funakoshi) to Heian (meaning: 'peace and harmony'). It's literal translation is "great peace" or "peaceful mind".

It is true that the movements of Kata involve techniques that are used for unarmed combat. However, the purpose of the Pinan (Heian) Kata is to develop a calm, peaceful mind and a harmony between the mind and body. Most Okinawan styles have kept the name Pinan.

About Sanchin No Kata

Sanchin kata is traditionally practised in a number of schools such as Goju Ryu and Uechi Ryu. The kata was taken to Okinawa from Fukien province in South China. Sanchin No Kata is one of the cornerstones of Kyokushin karate.

Roots of Sanchin

It is widely held that this Sanchin No Kata embodies the essence of Karate and that without a profound understanding of this, the higher levels will not be perceived. Sanchin has a legendary tradition. It's roots can be traced to it's introduction into China, from India, by the Buddhist monk Bohdidarma in 520AD.

Bohdidarma's teachings have evolved and changed over generations to the point where the martial teaching have become emphasized. As the influence of the temple grew politically and financially, they found themselves threatened at different points throughout the centuries by both bandit forces and the armies of the Emperors.

Over time the Buddhist temple arts filtered out to the general populace and were taught and propagated as civil martial arts. Thus legend suggests that a composite "yoga, unarmed, self protection and mediation method" was developed at the temple and later became an integral part of Chinese martial arts. These arts were taken from the Fukien province of South China to Okinawa and became incorporated by teachers into the indigenous fighting methods.

Background

One of the many forms to surface in Okinawa was the Sanchin form. In the Fukien dialect is pronounced San-Chien and in Mandarin "San Chan". It's translation can be understood as follows:

San: Three

Chin: Conflict, Battle, War

Sanchin No Kata is commonly referred to as "three conflicts" although others prefer "three battles". Sanchin is very popular as a dynamic tension method to produce the "Iron Body" effect. Ki is concentrated on the exterior of the body to produce a "hardening effect" which is able to withstand enormous impact to the body. Those Okinawan teachers who had a penchant for body conditioning continued to develop this form as it was very much in line with their needs.

Benefit

Chojun Miyagi, the founder of Goju Ryu, simplified the kata by removing many turns and changing from open hand to

closed fist. It was his intention that through the closing of the fist, Ki would be redirected back into the body, energizing the body thus aiding the development of the external muscles.

Now that the art of Karate has come to the West - and with it Sanchin - its practise has become very much a method of physical development and a demonstration of tension, strength and breath control. Unfortunately, its practise in order to develop external physical strength is often over emphasized. A counter balance with the internal aspects of the kata are necessary in order to develop pliability and sensitivity.

In the the initial stages, the balance can most easily be found through strong exterior muscle contraction in conjunction with yielding abdominal breathing. Through focus upon these 'conflicting' dynamics, firm and yielding, the two can be combined. As a result integration - rather than conflict - can be experienced. This experience of 'flux in balance' gives us an insight into the natural energies that we all possess. Next, these energies can be developed as part of the practise known as Kiko or energy cultivation.

Three conflicts and three jewels

Sanchin Kata contains the essence Karate. Its primary function is to develop the cutting mind, the body of armour and explosive power. In order to develop Sanchin the three conflicts must first be recognised, harmonised and fully refined. The three conflicts are:

- Mind
- Body
- Breath

The Mind: it is the discipline of concentration that clears the the countless random thoughts that constantly distract us. Therefore when studying Sanchin we refrain from internal verbalising and concentrate on experiencing the feelings instead. This is the state of mushin.

The Body: constant repetition combined with self awareness corrects poor body alignment and brings control to erratic body mechanics. It restores the bodies natural balance and posture. Natural strength is developed in favour of excessive tension or relaxation.

The Breath: abdominal breathing replaces restrictive thoracic (chest) contraction and expansion that manifests as shallow chest breathing. This enables tension in the upper body to be released from the chest and is pushed down into lower abdomen (hara).

Each conflict can be seen as a dull unpolished stone. Through the practise of Sanchin, each stone abrades the rough surface of the other, until three jewels emerge. Concentrate without distraction on natural movement and posture, combined with coordinated abdominal breathing. This may take many years but with patience and perseverance will come the rewards.

The Cutting Mind: is the calm clear mind that perceives and acts without the incessant chatter of internal dialogue. The starting point of Zen; the uncluttered mind that allows direct experience and reaction at an instinctive level. To empathize with the enemy enables their movements to be intuited so as to cut the enemy down without hesitation at precisely the right moment.

The Body of Armour: is commonly referred to as "Iron Shirt" and is the effect whereby the body is able to absorb and withstand substantial blows. This is done by developing and utilising the muscles, bones and tendons throughout the whole body, absorbing and dissipating the force of the strike much like a giant shock absorber.

The Explosive Power: is generated by harnessing the combined energy of the whole body and then channelling and directing it into the opponent. In the initial stages a single shock wave is produced, hence the intent of "the single killing blow". In the higher levels the shock wave manifests itself as a series of continuous waves or vibrations. The source of this power is the hara or lower abdomen combined with contractions of the diaphragm (breathing control). Crane boxing refers to this as "shaking" or "trembling", in the Chinese internal arts this explosive energy is called "Fa Jing".

Sanchin is an isometric kata where each move is performed in a state of complete tension, accompanied by powerful, deep breathing (Ibuki) that originates in the lower abdomen (tan den). The practice of Sanchin not only leads to the strengthening of the body, but to the development of inner power (ki) and the coordination of mind and body. Sanchin means "three battles" or "three conflicts", in reference to the fact that it seeks to develop three elements at a time:

- The mind, body and the techniques,
- The internal organs, circulation and the nervous system, and
- The three ki, located in:
 - a) Tendo - the top of the head
 - b) Hara - the diaphragm
 - c) Tanden - the lower abdomen

Taikyoku Sono Ichi

大極その一

Taikyoku Sono Ichi and Taikyoku Sono Ni are identical in movement with the exception that all the punches in Taikyoku Sono Ichi are at middle level (Chudan) and in Taikyoku Sono Ni the punches are at upper level (Jodan).

Steps

- Begin the Kata in Fudo Dachi.
- On the command "Yoi" move into the Yoi stance.
- On the command, "Hajime" move the left foot at 90° to the left into Zenkutsu Dachi and block Mae Gedan Barai (ensure that the left fist is approximately "one fist" in height above the left knee).
- Move forward into right Zenkutsu Dachi and punch right Chudan Oi Tsuki.
With the right foot, slide backwards and at a diagonal angle placing the right foot in the correct position and at the same time positioning the arms ready for the block, turn the body at the completion of the movement 180° into right Zenkutsu Dachi and block Mae Gedan Barai.
- Move forward into left Zenkutsu Dachi and punch left Chudan Oi Tsuki.
- Move the left foot at 90° into left Zenkutsu Dachi and block Mae Gedan Barai.
- Move forward into right Zenkutsu Dachi and punch right Chudan Oi Tsuki.
- Move forward into left Zenkutsu Dachi and punch left Chudan Oi Tsuki.
- Move forward into right Zenkutsu Dachi, punch right Chudan Oi Tsuki and **KIAI**.
- Move the left foot at 90° "in ura" and pivot on the right foot into left Zenkutsu Dachi and block Mae Gedan Barai.
- Move forward into right Zenkutsu Dachi and punch right Chudan Oi Tsuki.
- Move the right foot back turning the body 180° into right Zenkutsu Dachi and block Mae Gedan Barai.
- Move forward into left Zenkutsu Dachi and punch left Chudan Oi Tsuki.
- Move the left foot at 90° "in ura" into left Zenkutsu Dachi and block Mae Gedan Barai.
- Move forward into right Zenkutsu Dachi and punch right Chudan Oi Tsuki.
- Move forward into left Zenkutsu Dachi and punch left Chudan Oi Tsuki.
- Move forward into right Zenkutsu Dachi, punch right Chudan Oi Tsuki and **KIAI**.
- Move the left foot at 90° into left Zenkutsu Dachi and block Mae Gedan Barai.
- Move forward into right Zenkutsu Dachi and punch right Chudan Oi Tsuki.
- Move the right foot back turning the body 180° into right Zenkutsu Dachi and block Mae Gedan Barai.
- Move forward into left Zenkutsu Dachi and punch left Chudan Oi Tsuki.
- On the command "Naore" move the left leg to the right leg into Fudo Dachi to complete the Kata.

Taikyoku Sono Ni

大極その二

Taikyoku Sono Ichi and Taikyoku Sono Ni are identical in movement with the exception that all the punches in Taikyoku Sono Ichi are at middle level (Chudan) and in Taikyoku Sono Ni the punches are at upper level (Jodan).

Steps

- Begin the Kata in Fudo Dachi
- On the command "Yoi" move into the Yoi stance.
- On the command, "Hajime" move the left foot at 90° to the left into Zenkutsu Dachi and block Mae Gedan Barai (ensure that the left fist is approximately "one fist" in height above the left knee).
- Move forward into right Zenkutsu Dachi and punch right Jodan Oi Tsuki.
With the right foot, slide backwards and at a diagonal angle placing the right foot in the correct position and at the same time positioning the arms ready for the block, turn the body at the completion of the movement 180° into right Zenkutsu Dachi and block Mae Gedan Barai.
- Move forward into left Zenkutsu Dachi and punch left Jodan Oi Tsuki.
- Move the left foot at 90° into left Zenkutsu Dachi and block Mae Gedan Barai.
- Move forward into right Zenkutsu Dachi and punch right Jodan Oi Tsuki.
- Move forward into left Zenkutsu Dachi and punch left Jodan Oi Tsuki.
- Move forward into right Zenkutsu Dachi, punch right Jodan Oi Tsuki and **KIAI**.
- Move the left foot at 90° "in ura" and pivot on the right foot into left Zenkutsu Dachi and block Mae Gedan Barai.
- Move forward into right Zenkutsu Dachi and punch right Jodan Oi Tsuki.
- Move the right foot back turning the body 180° into right Zenkutsu Dachi and block Mae Gedan Barai.
- Move forward into left Zenkutsu Dachi and punch left Jodan Oi Tsuki.
- Move the left foot at 90° "in ura" into left Zenkutsu Dachi and block Mae Gedan Barai.
- Move forward into right Zenkutsu Dachi and punch right Jodan Oi Tsuki.
- Move forward into left Zenkutsu Dachi and punch left Jodan Oi Tsuki.
- Move forward into right Zenkutsu Dachi, punch right Jodan Oi Tsuki and **KIAI**.
- Move the left foot at 90° into left Zenkutsu Dachi and block Mae Gedan Barai.
- Move forward into right Zenkutsu Dachi and punch right Jodan Oi Tsuki.
- Move the right foot back turning the body 180° into right Zenkutsu Dachi and block Mae Gedan Barai.
- Move forward into left Zenkutsu Dachi and punch left Jodan Oi Tsuki.
- On the command "Naore" move the left leg to the right leg into Fudo Dachi to complete the Kata.

Taikyoku Sono San

大極その三

In Taikyoku Sono San, Kokutsu Dachi and Uchi Uke are introduced into the Kata. Though Taikyoku Sono San should be considered a basic Kata, it takes beginners a long time to perform these techniques satisfactorily. Black belt candidates often perform this Kata poorly due to a lack of understanding of the principles and techniques that it contains.

Steps

- Begin the Kata in Fudo Dachi.
- On the command "YOI" move into the YOI stance
- On the command "Hajime" move the left foot at 90° to the left into Kokutsu Dachi and block left Chudan Uchi Uke.
- Before moving into Zenkutsu Dachi the blocking arm is placed in a position similar to Chudan Tsuki. (This movement occurs after every Kokutsu Dachi and Chudan Uchi prior to moving into Zenkutsu Dachi).
- Move forward into right Zenkutsu Dachi and punch right Chudan Oi Tsuki.
With the right foot slide backwards at a diagonal angle placing the right foot in the correct position and at the same time positioning the arms ready for the block. Turn the body at the completion of the movement 180° into right Kokutsu Dachi and block right Chudan Uchi Uke.
- Move forward into left Zenkutsu Dachi and punch left Chudan Oi Tsuki.
- Move the left foot at 90° into left Zenkutsu Dachi and block mae Gedan Barai.
- Move forward into right Zenkutsu Dachi and punch right Jodan Oi Tsuki.
- Move forward into left Zenkutsu Dachi and punch left Jodan Oi Tsuki.
- Move forward into right Zenkutsu Dachi, punch right Jodan Oi Tsuki and **KIAI**.
- Move the left foot at 90° and pivot on the right foot into left Kokutsu Dachi and block left Chudan Uchi Uke.
- Move forward into right Zenkutsu Dachi and punch right Chudan Oi Tsuki.
- Move the right foot back turning the body 180° into right Kokutsu Dachi and block right Chudan Uchi Uke.
- Move forward into left Zenkutsu Dachi and punch left Chudan Oi Tsuki.
- Move the left foot at 90° into left Zenkutsu Dachi and block mae Gedan Barai.
- Move forward into right Zenkutsu Dachi and punch right Jodan Oi Tsuki.
- Move forward into left Zenkutsu Dachi and punch left Jodan Oi Tsuki.
- Move forward into right Zenkutsu Dachi, punch right Jodan Oi Tsuki and **KIAI**.
- Move the left foot at 90° and pivot on the right foot into left Kokutsu Dachi and block left Chudan Uchi Uke.
- Move forward into right Zenkutsu Dachi and punch right Chudan Oi Tsuki.
- Move the right foot back turning the body 180° into right Kokutsu Dachi and block right Chudan Uchi Uke.
- Move forward into left Zenkutsu Dachi and punch left Chudan Oi Tsuki.
- On the command "Naore" move the left foot into fudo dachi to complete the Kata (fists to remain closed at all times).

Pinan Sono Ichi

平安その一

This is the first Kata of the Pinan group. It develops a number of defensive techniques (Gedan Barai, Jodan Uke and Mawashi Shuto Uchi) and a number attacking techniques (Chudan Oi Tsuki and Tetsui Komi Kami).

Body positioning is developed with the execution of Zenkutsu Dachi, Neko Ashi Dachi and Kokutsu Dachi. In Pinan Sono Ichi, above all the leg movements and changes of direction, the posture of the upper body and the tension control are focused upon.

Steps

- Begin the Kata in Fudo Dachi.
- On the command "Yoi" move into the Yoi stance.
- On the command "Hajime" move the left foot at 90° to the left into Zenkutsu Dachi and block Mae Gedan Barai.
- Move forward into right Zenkutsu Dachi and punch right Chudan Oi Tsuki.
Move the right foot back 180° into right Zenkutsu Dachi and block Mae Gedan Barai. Draw the right foot back into Neko Ashi Dachi keeping the hips at the same height and strike right Tetsui Komi Kami. (When executing the Tetsui Komi Kami ensure your left arm is brought across the chest in the cover position so that the left fist is placed into your right shoulder, ensure also that the right fist is brought from behind the head and is approximately one fist away from the back of the head).
- Before moving into Zenkutsu Dachi the striking arm is placed into a position similar to Chudan Tsuki.
- Move forward into left Zenkutsu Dachi and punch left Chudan Oi Tsuki.
- Move the left foot at 90° into left Zenkutsu Dachi and block Mae Gedan Barai.
- Move forward into right Zenkutsu Dachi and block right Jodan Uke.
- Move forward into left Zenkutsu Dachi and block left Jodan Uke.
- Move forward into right Zenkutsu Dachi and block right Jodan Uke and **KIAI**.
- Move the left foot at 90° and pivot on the right foot into left Zenkutsu Dachi and block Mae Gedan Barai.
- Move forward into right Zenkutsu Dachi and punch right Chudan Oi Tsuki.
- Move the right foot 180° back into right Zenkutsu Dachi and block Mae Gedan Barai.
- Move forward into left Zenkutsu Dachi and punch left Chudan Oi Tsuki.
- Move the left foot at 90° into left Zenkutsu Dachi and block Mae Gedan Barai.
- Move forward into right Zenkutsu Dachi and punch right Chudan Oi Tsuki.
- Move forward into left Zenkutsu Dachi and punch left Chudan Oi Tsuki.
- Move forward into right Zenkutsu Dachi and punch right Chudan Oi Tsuki and **KIAI**.
- Move the left foot at 90° and pivot on the right foot into left Kokutsu Dachi and block left Shuto Mawashi Uke.
- Move forward at 45° into right Kokutsu Dachi and block right Shuto Mawashi Uke.
- Move the right foot back 135° into right Kokutsu Dachi and block right Shuto Mawashi Uke.
- Move forward at 45° into left Kokutsu Dachi and block left Shuto Mawashi Uke.
- On the command "Naore" move the left leg to the right leg into Fudo Dachi to complete the Kata.

Pinan Sono Ni

平安その二

This is the second Kata of the Pinan group.

Steps

- Begin the Kata in Fudo Dachi. On the command "Yoi" move into the Yoi stance.

On the command "Hajime" move the left foot 90° to the left into Kokutsu Dachi simultaneously the right fist is pulled back to the right side in the ready punch position and the left fist is positioned immediately on, and vertical to, the right fist. Without moving the body raise the right arm into a position similar to Jodan Uke (to the side of the head) and move the left arm across into a Chudan Uchi Uke position (fist approximately at chin height). Both these movements are to be executed simultaneously.
- Still in the Kokutsu Dachi position strike right Tetsui Hizo Uchi twisting the hips square. The left fist is simultaneously brought back over the right shoulder so that the elbow is level with the jaw (n.b. the left fist is approximately 3 cm above the shoulder and the back of the fist faces upwards). Retaining the same stance the right fist is turned 180° so that the knuckles are directed straight in front as if to cover, the left fist is brought back to the ready punch position.
- Move through with the left leg into Kiba Dachi and looking to the left punch left Jun Tsuki and pull the right fist into the ready punch position. (It is essential to use the hip movement in Jun Tsuki).

Pull the right leg back into right Kokutsu Dachi at the same time turning the body 180° simultaneously the left fist is pulled back to the left side to the ready punch position and the right fist is positioned immediately on, and vertical to, the left fist. Without moving the body or its direction raise the left arm into a position similar to Jodan Uke and move the right arm across into a Chudan Uchi Uke position.
- Still in the Kokutsu Dachi position strike left Tetsui Hizo Uchi twisting the hips square. The right fist is simultaneously brought back over the left shoulder so that the elbow is level with the jaw. Retaining the same stance the left fist is turned 180° so that the knuckles are directed straight in front as if to cover, the right fist is brought back to the ready punch position.
- Move through with the right leg into Kiba Dachi and looking to the right punch Jun Tsuki and pull the left fist to the ready punch position.
- Bring the right leg back turning 90° into Tsuru Ashi Dachi and simultaneously bring the fists to the left side of the body so that the right fist is positioned on top of the left.
- Kick Jodan Yoko Geri and strike Uraken with the right fist (n.b. the left fist remains in the ready punch position).
- After striking Uraken the right fist is brought back to the left fist to its original position and the right leg returned to Tsuru Ashi Dachi.
- Place the right foot on the ground next to the left foot and move through into left Kokutsu Dachi and block left Shuto Mawashi Uke.
- Move forward into left Kokutsu Dachi and block left Shuto Mawashi Uke.
- Still in the same stance block left Shuto Uke and move into right Zenkutsu Dachi and strike right Chudan Yonhon Nukite and **KIAI** (the right elbow should be 3 cm above the left hand).
- Move the left foot at 90° and pivot on the right foot into left Kokutsu Dachi and block left Shuto Mawashi Uke. Move forward at 45° into right Kokutsu Dachi and block right Shuto Mawashi Uke.
- Move the right foot 135° into right Kokutsu Dachi and block right Shuto Mawashi.
- Move forward at 45° into left Kokutsu Dachi and block left Shuto Mawashi Uke.

Close both fists and move the left leg across at 45° to turn into left Zenkutsu Dachi, simultaneously the left forearm is positioned at 45° in front of the head. In addition the right arm, fist closed, is positioned behind the right leg, thumb facing upwards. These latter movements are executed whilst the body is turning into the position preparing for Zenkutsu Dachi. To complete the turn the right hand moves quickly in a circular bowling action (with the fist closed) over the shoulder at a 45° angle (at this stage the left arm is in front of the body) across the left thigh and then across the body with a right Chudan Uchi Uke. As the right arm moves across the body the left fist is pulled back into the left ready punch (n.b. all these movements are executed quickly). Keeping the arms in this position kick right Chudan Mae Geri so that the leg is just inside the right arm (when executing the kick ensure that the right arm does not drop from the blocking position).

Move forward into right Zenkutsu Dachi and punch left Chudan Gyaku Tsuki. Still in Zenkutsu Dachi turn the left fist so that the thumb is facing the floor and execute a slow Chudan Uchi Uke block across to the right thigh, to a mental count of five, with the right fist in the ready punch position. Keeping the arms in this position kick left Chudan Mae Geri so that the leg is just inside the left arm.

- Move forward into left Zenkutsu Dachi and punch right Chudan Gyaku Tsuki.
- Move forward into right Zenkutsu Dachi and block right Morote Chudan Uke (the right fist should come from the left shoulder).
- Move the left foot at 90° and pivot on the right foot into left Zenkutsu Dachi and block Mae Gedan Barai.
- In the same stance pull the left fist back to the ready punch position hand closed - the hand then opens as you strike Jodan Nihon Nukite at 45°.
- Move forward at 45° into right Zenkutsu Dachi and block right Jodan Uke.
- Move the right foot back 135° into right Zenkutsu Dachi and block Mae Gedan Barai.
- In the same stance pull the right fist back to the ready punch position and strike Jodan Nihon Nukite at 45°.
- Move forward at 45° into left Zenkutsu Dachi and block left Jodan Uke and **KIAI**.
- On the command "Naore" move the left leg to the right leg into Fudo Dachi to complete the Kata.

Pinan Sono San

平安其三

This Kata contains many techniques for close combat and focuses on the usage of Kiba Dachi.

Steps

- Begin the Kata in Fudo Dachi.
- On the command "Yoi" move into the Yoi stance.
- On the command "Hajime" move the left foot at 90° into Kokutsu Dachi and block left Chudan Uchi Uke.
Bring the right foot to the left foot into Musubi Dachi and at the same time position the right hand in a Gedan Barai position. Block right Chudan Uchi Uke and left Gedan Barai and repeat with left Chudan Uchi Uke and right Gedan Barai.
- Move the right foot back 180° into right Kokutsu Dachi and block right Chudan Uchi Uke.
Bring the left foot to the right foot into Musubi Dachi and at the same time position the left hand in a Gedan Barai position. Block left Chudan Uchi Uke and right Gedan Barai and repeat with right Chudan Uchi Uke and left Gedan Barai.
- Move the left foot at 90° into left Zenkutsu Dachi and block Morote Chudan Uke, block left shuto Uke and return the right hand open to the ready punch position.
- Move forward into right Zenkutsu Dachi and strike right Chudan Yonhon Nukite.
In the same stance stoop the body, right hand reaching out along the ground, and cover with a left hand Shotei. Pivot on the right foot in an anti-clockwise 180° and spin into Kiba Dachi (sweeping the little finger of the right hand across the floor - as if to hook an opponents leg), the left arm comes over the right hand Shotei cover. On completion of the turn, into Kiba Dachi, strike left Tetsui Yoko Uchi (this strike is positioned slightly above your own shoulder line).
- Move forward into right Zenkutsu Dachi, punch right Chudan Tsuki and **KIAI**.
- Pivot on the right foot and turn 180° into Musubi Dachi simultaneously placing the fists (back of fists facing forward) on your hips. (after this position has been taken there is a slight pause for a mental count of two before the next technique.)
Kick right Chudan Mae Geri bring the foot back and place it firmly down turning your body 90° into Kiba Dachi immediately bring your right elbow across and down moving the hips and shoulders slightly so as not to spoil the Kiba Dachi. Return the body upright to the original position and strike right Uraken Yoko Uchi and return the fist to the hip position.
- Turning the body 90° to the front kick left Chudan Mae Geri bring the foot back and place it firmly down turning your body 90° into Kiba Dachi immediately bring your left elbow across and down return the body to the original upright position and strike left Uraken Yoko Uchi and return the fist to the hip position.
- Turning the body 90° to the front kick right Chudan Mae Geri bring the foot back and place it firmly down turning your body 90° into Kiba Dachi immediately bring your right elbow across and down return the body to the original upright position and strike right Uraken Yoko Uchi.
- Return the right fist to the hip position and pivot 90° to the right immediately extend the right arm with the hand open in a Chudan Shotei cover.
- Move forward into left Zenkutsu Dachi and punch left Chudan Oi Tsuki.
Move the right foot forward to the left, as to cover the groin immediately move across into Kiba Dachi and continue the movement by turning 180° on the right foot into another Kiba Dachi, simultaneously strike right Jodan Hiji Ate bring the left hand back to the ready punch position.
- Keeping the arms in the same position jump to the right, leading with the left foot (both feet off the ground), land in Kiba Dachi and strike left Jodan Hiji Ate and **KIAI**.
- On the command "Naore" move the left leg to the right leg into Fudo Dachi to complete the Kata.

Sanchin No Kata

三戦の型

The performance of this Kata is based on the principles of tension, isometrics and breath control. It is a Kata designed to build strength and control throughout the body in conjunction with the perfection of the techniques used.

All techniques are performed as slow controlled movements unless otherwise indicated.

Steps

- Begin the Kata in Fudo Dachi.
- Move into Musubi Dachi and Mokuso on the command "Mokuso".
- On the second command "Sanchin", open eyes, move into the Yoi position with Ibuki.
- On the command "Hajime" move into right Sanchin Dachi simultaneously putting the right arm in front of the left and block Morote Chudan Uchi Uke with Ibuki.
- In the same position bring the left fist back to the ready punch position (to a mental count of four), and punch left Chudan Tsuki with Ibuki with the extended left arm block Chudan Uchi Uke with Ibuki.
- With the arms in the Morote Chudan Uchi Uke position, quickly step into left Sanchin Dachi and inhale, bring the right fist back to the ready punch position and punch right Chudan Tsuki with Ibuki with the extended right arm block Chudan Uchi Uke with Ibuki.
- With the arms in the Morote Chudan Uchi Uke position, quickly step into right Sanchin Dachi and inhale, bring the left fist back to the ready punch position and punch in a half circular movement (Kake Tsuki) across the body to finish under the right elbow with Ibuki.
- With the arms in this position quickly step across with the right foot and turn 180° into left Sanchin Dachi simultaneously blocking with a fast left Chudan Uchi Uke and bring the right fist back into ready punch position.
- In the same stance punch right Chudan Tsuki with Ibuki with the extended right arm block Chudan Uchi Uke with Ibuki.
- With the arms in Morote Chudan Uchi Uke position quickly step into right Sanchin Dachi and inhale, bring the left fist back to the ready punch position and punch in a half circular movement (Kake Tsuki) across the body to finish under the right elbow with Ibuki.
- With the arms in this position quickly step across with the right foot and turn 180° into left Sanchin Dachi simultaneously blocking with a fast left Chudan Uchi Uke and bring the right fist back to the ready punch position.
- In the same stance punch right Chudan Tsuki with Ibuki with the extended right arm block Chudan Uchi Uke with Ibuki.
- With the arms in Morote Chudan Uchi Uke position quickly step into right Sanchin Dachi, bring the left fist back to the ready punch position and punch left Chudan Tsuki with Ibuki, with the extended left arm block Chudan Uchi Uke with Ibuki.
- In the same stance bring the right fist back to the ready punch position and punch right Chudan Tsuki with Ibuki with the extended right arm block Chudan Uchi Uke with Ibuki.
- Still in the same stance bring the left fist back into the ready punch position and punch left Chudan Tsuki with Ibuki with the extended left arm block Chudan Uchi Uke with Ibuki.
- Still in the same stance quickly grab with both hands directly in front of you, at approximately neck height, with palms facing out (grab as if to hold the inside of lapels i.e. of jacket). Quickly pull back both hands closed to the ready punch position. Inhale and open both fists and execute a Morote Yonhon Nukite with Ibuki (height of Nukite strike is approximately at your own solar plexus height).
- Again quickly grab with both hands directly in front of you, quickly pull back both hands closed to the ready punch position and execute a Morote Yonhon Nukite with Ibuki.

- Repeat the last sequence of grabbing, pulling back the hands closed and execute a Morote Yonhon Nukite with Ibuki.
- Quickly move back with the right leg into left Sanchin Dachi, position both hands in preparation for Shuto Mawashi Uke.
- Quickly complete the Shuto Mawashi Uke. Inhale and execute Morote Shotei Uchi, right hand Jodan left hand Gedan, with Ibuki.
- Quickly move back with the left foot into right Sanchin Dachi position both hands forward and quickly execute Shuto Mawashi Uke, inhale and execute Morote Shotei Uchi, left hand Jodan right hand Gedan with Ibuki.
- The Kata is completed by moving the right foot back into Musubi Dachi and the Mokuso position is retained until the command "Naore" when the Fudo Dachi position is taken.

Pinan Sono Yon

平安の四

The flow of Pinan Sono Yon is characterised by the dynamic use of 'double defence' movements and foot techniques. Many are quick to point out that Pinan Sono Yon is from the Kanku.

Steps

- Begin the Kata in Fudo Dachi.
- On the command "Yoi" move into the Yoi stance.

On the command "Hajime" move the left foot at 90° into Kokutsu Dachi simultaneously the right fist is pulled back to the right side in the ready punch position and the left fist is positioned immediately on, and vertical to, the right fist. Without moving the body or its direction raise the right arm into a Jodan Shuto Uke position (to the side of the head) and move the left arm across into a Chudan Shuto Uchi Uke position. Both these movements are to be executed simultaneously.
- Move the left foot across turning the body 180° into right Kokutsu Dachi simultaneously pulling the left fist to the ready punch position with the right fist positioned on top as previously described. Without moving the body or its direction raise the left arm into a Jodan Shuto Uke position and move the right arm across into a Chudan Shuto Uchi Uke position. Both these movements are to be executed simultaneously.
- Move the left foot at 90°, position the hands by the right ear in the Juji position, and complete the turn into left Zenkutsu Dachi and simultaneously block Seiken Juji Gedan Uke (right arm above left).
- Move forward into right Zenkutsu Dachi and block right Morote Chudan Uchi Uke (the right fist comes from the left shoulder).
- Bring the left leg into Tsuru Ashi Dachi, move the right fist back to the ready punch position and place the left fist on top.
- Kick Jodan Yoko Geri and simultaneously strike left Uraken (the right fist remains in ready position).
- Bring the left foot back into Tsuru Ashi Dachi and open the left fist in the Shuto position then step down to the left into left Zenkutsu Dachi.
- While turning the hips into the stance, strike right Jodan Hiji Ate, hitting the open left hand.
- Lift the right leg into Tsuru Ashi Dachi, move the left fist back into the ready punch position with the right fist on top.
- Kick Jodan Yoko Geri and simultaneously strike right Uraken.
- Bring the right foot back into Tsuru Ashi Dachi and open the right fist in the Shuto position then step down to the right into Zenkutsu Dachi. While turning the hips into the stance, strike left Jodan Hiji Ate, hitting the open hand.
- Partially turn the upper body and head 135° to the left retaining the Zenkutsu Dachi stance, bring the right hand behind the head in the Shuto position and extend the left arm with the hand open in a Shuto Jodan cover position so that it is level with your head.
- Complete the turn into left Zenkutsu Dachi and strike right Gyaku Shuto Yoko Ganmen Uchi (the strike must not pass across the body's centre line) and at the same time pull the left hand back so that it is one fist away from the forehead with the palm facing away from the body.
- Kick right Jodan Mae Geri at 45° with the hands in the same position.
- Pull the leg back into the Tsuru Ashi Dachi position and cover with left shotei and prepare to strike with right Uraken.
- Jump at 45° to the right into Kake Dachi and as you land in Kake Dachi strike right Uraken shomen Uchi and **KIAI**. (as you strike the left hand moves outside the right and returns to the left ready punch position, closed).

- From Kake Dachi turn 135° to the left moving the left foot into left Zenkutsu Dachi simultaneously execute a slow downwards cross arm block with the hands closed.
- Place the right arm in a Chudan Tsuki position and pull the left fist back to the ready punch position, kick right Chudan Mae Geri retaining the hand position as described.
- Move into right Zenkutsu Dachi and execute Nihon Chudan Tsuki (left and right).
- Move the right leg across 90° to the right (do not bring the feet together) into right Zenkutsu Dachi and execute a slow downwards cross arm block with the hands closed.
- Place the left arm in a Chudan Tsuki position and pull the right fist back to the ready punch position, kick left Chudan Mae Geri retaining the hand position as described.
- Move into left Zenkutsu Dachi and execute Nihon Chudan Tsuki (right and left).
- Move to the left 45° into left Zenkutsu Dachi and position the arms for Morote Chudan Uke complete the turn and execute a left Morote Chudan Uchi Uke block.
- Move forward into right Zenkutsu Dachi and block right Morote Chudan Uchi Uke.
- Move forward into left Zenkutsu Dachi and block left Morote Chudan Uchi Uke.
- Open both hands and grab for an imaginary opponent's head to the front. Pull your hands down, kick right Hiza Geri and **KIAI** (as if pulling the opponent's head onto your knee).
- Place the right foot down next to the left and turn 180° stepping forward into left Kokutsu Dachi and execute a half Shuto Mawashi Uke.
- Move forward into right Kokutsu Dachi and execute a Shuto Mawashi Uke.
- On the command "Naore" move the right leg to the left leg into Fudo Dachi to complete the Kata.

Pinan Sono Go

平安其の五

Pinan Sono Go is the last Kata in the Pinan group. Pinan Sono Go is practised in order to unite several of the core aspects of Karate. In particular:

- Defence of Jodan, Chudan and Gedan areas.
- Seizing and countering an opponents attack.
- Counters quickly followed with change of direction (in order to face next opponent).
- Use of jump, parry and counter (Tai Sabaki) techniques in conjunction with Nagashi (flowing) techniques.

The execution of this Kata places high emphasis on rhythm and timing. The Kata focuses particularly on the principles of flowing steps in conjunction with the execution of high speed techniques.

Steps

- Begin the Kata in Fudo Dachi.
- On the command "Yoi" move into the Yoi stance.
- On the command "Hajime" move the left foot at 90° into Kokutsu Dachi, block left Chudan Uchi Uke and punch right Chudan Gyaku Tsuki.
- Turning 90° return the left foot into Heisoku Dachi simultaneously the right fist is pulled slowly back to the ready punch position (across the body) with the left fist placed on top of the right.
- Move the right foot across and turn 90° into right Kokutsu Dachi and block right Chudan Uchi Uke and punch left Chudan Gyaku Tsuki.
- Turning 90° return the right foot into Heisoku Dachi simultaneously the left fist is pulled slowly back to the ready punch position (across the body) with the right fist placed on top of the left.
- Move forward into right Zenkutsu Dachi and block right Chudan Morote Uchi Uke.
- Move forward into left Zenkutsu Dachi and block Seiken Juji Gedan Uke (the block is executed from the Juji position from the right ear).
- Pull both arms back towards the chest, arms crossed fists closed, then drive them up into Shuto Juji Uke (left arm under right).
- Execute a twisting movement with both hands, pull the right hand back to the ready punch position and position the left hand in either a block or hook position.
- Move forward into right Zenkutsu Dachi, punch right Chudan Oi Tsuki and **KIAI** simultaneously pulling the left hand back closed to the ready punch position (as if pulling someone towards you).
- Turn 180° blocking right leg Teisoku Uke and prepare to block Gedan Barai (the leg block is executed as if being attacked from behind and the left hand covers the groin).
- Place the right foot down into Kiba Dachi and block Gedan Barai. Turn your head 180° to the left, quickly bring the right palm in front of your face to cover with Shotei; the left hand is positioned under the right arm, palm open horizontal to the floor.
- Bring the left hand slowly from under the right arm pit and strike haishu at approximately head height, simultaneously pulling the right hand back closed to the ready punch position.
- Using the right foot strike your left hand with Teisoku Uke.
- Return the right leg and simultaneously strike the left hand with Jodan Hiji Ate.
- Continue the movement by jumping into Kake Dachi and block with right Chudan Morote Uchi Uke.
- Retaining the Kake Dachi position, punch at a 60° angle upwards keeping the left hand touching the right arm.
- Turn your head 180° to the front and step into a stance similar to Kokutsu Dachi (all these movements are executed in fast succession).

- Ensure the hips remain still to enable the punch to stay at the same angle; raise up onto the balls of your feet.
- Take a small step forward with the left foot, then pulling both fists back to the ready punch position, simultaneously leap into the air turning 90° to the left, as you land into a low Kake Dachi you block Seiken Juji Uke and **KIAI** (left arm under right).
- Move the right foot across and turn 90° into right Zenkutsu Dachi and block right Chudan Morote Uke.
- Move the left foot at 45° to the right, pivoting on the right foot and move into a position in preparation for Zenkutsu Dachi (i.e. reverse Zenkutsu Dachi). As you make this turn you simultaneously block left Shuto Gedan Uke and the right hand is brought up to the right ear (but not touching) with the fingers pointing downwards, palm towards the face (the top hand should be positioned so that when you face 45° to an opponent the hand should not be visible).
- Turn the hips into left Zenkutsu Dachi and strike Ura Kote to the groin, the left hand, palm inwards, comes up to the right ear; as you turn the hips into Kiba Dachi, turn the right hand and pull it back and extend it fully upwards above the right shoulder with the fist closed, simultaneously block left Gedan Barai and keep the head facing the direction of the block.
- Retaining the arm positions bring the left foot to the right into Musubi Dachi.
- Look 45° to the right and move into a "reverse" Zenkutsu Dachi simultaneously block right Shuto Gedan Uke and the left hand is brought up to the side of the head (as previously described).
- Turn the hips into right Zenkutsu Dachi and strike Ura Kote to the groin the right hand, palm inwards, comes up to the left ear; as you turn the hips into Kiba Dachi turn the left hand and pull it back and extend it fully upwards above the left shoulder fist closed, simultaneously block right Gedan Barai and keep the head facing the direction of the block.
- On the command "Naore" move the left leg to the right leg into Fudo Dachi to complete the Kata.

Gekisai Dai

撃塞大

The term "Gekisai Dai" is derived from the words "Sai", meaning fortress or stronghold, and "Geki", meaning breakdown. "Gekisai", can also mean "empty air". The Kata teaches strength through fluidity of motion, mobility and the utilization of various techniques. When performing Gekisai Dai, one should remember that flexibility of attack and response will always be superior to rigid and inflexible strength.

Steps

- Begin the Kata in Fudo Dachi.
- Move into Musubi Dachi and Mokuso on the command "Mokuso".
- On the second command "Gekisai Dai", open eyes, move into the Yoi position with Ibuki.
- On the command "Hajime" turn at 90° to the left into left Sanchin Dachi, moving the left foot straight across (i.e. do not bring feet together) and block left Jodan Uke.
- Move forward into right Zenkutsu Dachi and punch Jodan Tsuki.
- Move the right foot back 180° into Kiba Dachi and block left Gedan barai.
- Turning 90° bring the left foot to the right and take it back so that you are in right Sanchin Dachi and block right Jodan Uke.
- Move forward into left Zenkutsu Dachi and punch Jodan Oi Tsuki.
- Move the left foot back 180° into Kiba Dachi and block right Gedan Barai.
- Turn your head to the front and move 90° into right Sanchin Dachi and block right Chudan Uchi Uke with Ibuki.
- Move forward into left Sanchin Dachi and block left Chudan Uchi Uke with Ibuki.
- Move forward into right Sanchin Dachi and block right Chudan Uchi Uke with Ibuki (in the previous three sequences, moving into Sanchin Dachi together with the initial arm position are both done fast and the block is done slowly).
- Retaining the hand positions kick left Chudan Mae Geri, place the foot into left Zenkutsu Dachi and strike left Jodan Age Hiji Ate follow immediately with left Uraken Oroshi Ganmen Uchi and position for and block left Mae Gedan barai and punch Gedan Gyaku Tsuki.
- Still looking straight ahead bring the right foot to the left knee, slightly in front as if to sweep someone in front of you, and position the right fist closed adjacent to the left ear.
- Turn your head 180° and then place the right foot back into Kiba Dachi and strike Shuto Uchi to the neck keeping the left fist closed in the ready punch position and **KIAI**.
- Turn 90° bringing the left foot to the right into left Sanchin Dachi and block left Chudan Uchi Uke with Ibuki.
- Move forward into right Sanchin Dachi and block right Chudan Uchi Uke with Ibuki.
- Move back into left Sanchin Dachi and block left Chudan Uchi Uke with Ibuki (in the previous three sequences, moving into Sanchin Dachi together with the initial arm position are both done fast and the block is done slowly).
- Retaining the hand positions kick right Chudan Mae Geri place the foot into right Zenkutsu Dachi and strike right Jodan Age Hiji Ate follow immediately with right Uraken Oroshi Ganmen Uchi and position for and block right Mae Gedan barai and punch Gedan Gyaku Tsuki.
- Still looking straight ahead bring the left foot to the right knee, slightly in front of you as if to sweep someone in front of you, and position the left fist dose adjacent to the right ear.
- Turn your head 180° and then place the left foot back into Kiba Dachi and strike Shuto Uchi to the neck keeping the right fist closed in the ready punch position and **KIAI**.

- Move forward at 90° into right Zenkutsu Dachi and punch Morote Tsuki (right fist Chudan, left fist Jodan).
- Move forward into left Zenkutsu Dachi and punch Morote Tsuki (right fist Jodan, left fist Chudan).
- Move back into right Zenkutsu Dachi and punch Morote Tsuki (right fist Chudan, left fist Jodan).
- The Kata is completed by moving the right foot back into Musubi Dachi and the Mokuso position is retained until the command "Naore" when the Fudo Dachi position is taken.

Yantsu

安三

"Yantsu", means "to keep pure" and implies striving to maintain the purity of principles and ideals, rather than compromising for the sake of expediency. Yantsu comes from the Shorei school and the principles of the Yantsu Kata may never be betrayed in favour of other advantages. This is considered dishonourable (indeed as the irrevocable soiling of one's own honour).

Steps

- Begin the Kata in Fudo Dachi.
- Move into Musubi Dachi and Mokuso on the command "Mokuso".
- On the second command "Yantsu", open eyes, move into the Yoi position with Ibuki.
- On the command "Hajime", in the Yoi position, strike Jodan Morote Haito Uchi (to the neck) pull both hands back closed to the ready punch position, and punch Jodan Morote Tsuki.
- Position the left arm to cover, and the right arm is positioned so that the fist is at buttock level to the rear strike right Jodan Uraken Mawashi Uchi.
- Cover with the right arm and position the left arm behind at buttock level and strike left Jodan Uraken Mawashi Uchi.
- Then strike right Chudan Yonhon Nukite and left Chudan Yonhon Nukite (the hand in the ready punch position is open during both Nukite strikes).
- Slowly pull the left hand back to the ready punch position dosing both hands.
- Move both hands inwards and upwards towards the chin, opening slowly as they move into the Shuto position (when the fists reach the height of the chin the hands open and move outwards to the side of the body in a Tensho movement. At the completion of the movement the hands are at shoulder height palms down, arms bent).
- Move the left hand quickly into a Chudan Shotei cover (shoulder height) while the right hand returns closed to the ready punch position.
- Move forward into right Zenkutsu Dachi and punch Chudan Oi Tsuki.
- Pull the right foot back into Neko Ashi Dachi simultaneously the right hand returns to the ready punch position. Open the right hand and block Gedan Shotei Uke.
- Still in Neko Ashi Dachi, block right Jodan Koken Uke slowly then slowly twist the wrist in a circular motion and push the hand out into Shuto Uchi Komi.
- Bring the right foot back into Musubi Dachi and slowly block with a Chudan Shotei cover.
- Move forward into left Zenkutsu Dachi and punch Chudan Oi Tsuki.
- Pull the left foot back into Neko Ashi Dachi simultaneously the left hand returns to the ready punch position. Open the left hand and block Gedan Shotei Uke.
- Still in Neko Ashi Dachi, block left Jodan Koken Uke then slowly twist the wrist in a circular motion and push the hand out into Shuto Uchi Komi.
- Turn 90° to the right moving the left foot to the right foot into Musubi Dachi and slowly block left Chudan Shotei.
- Move forward into right Zenkutsu Dachi and punch right Gedan Oi Tsuki, left Jodan Gyaku Tsuki and KIAI and right Chudan Oi Tsuki.
- With the right arm still extended kick left Chudan Mae Geri and bring the foot back into a short Zenkutsu Dachi position, then pull the right foot back towards the left into Neko Ashi Dachi and block right Chudan Haito Uchi Uke (the left hand is closed in the ready punch position).

- Still in Neko Ashi Dachi pull the right hand back, closed to the ready punch position, open the hand and block Gedan Shotei Uke then slowly block Jodan Koken Uke. Twist the wrist in a circular motion and strike Shuto Uchi Komi.
- Turn 180° in an anticlockwise direction to the left pulling the left foot back to the right into Musubi Dachi and block Chudan Shotei Uke.
- Move forward into left Zenkutsu Dachi and punch left Gedan Oi Tsuki, right Jodan Gyaku Tsuki and KIAI and left Chudan Oi Tsuki.
- With the left arm still extended kick right Chudan Mae Geri and bring the foot back into a short Zenkutsu Dachi position, then pull the left foot back towards the right into Neko Ashi Dachi and block left Chudan Haito Uchi Uke (the right hand is closed in the ready punch position).
- Still in Neko Ashi Dachi pull the left hand back, closed to the ready punch position, open the hand and block Gedan Shotei Uke then slowly block Jodan Koken Uke. Twist the wrist in a circular motion and strike Shuto Uchi Komi.
- Turn 90° to the right into Musubi Dachi and slowly block left Chudan Shotei Uke.
- The Kata is completed by moving into the Mokuso position this position is retained until the command "Naore" when the Fudo Dachi position is taken.

Tsuki No Kata

突きの型

"Tsuki No", means "fortune and luck". It is considered that good fortune and luck does not come to those who wait. For every punch (Tsuki) in this Kata, one should envision a personal barrier being broken down. Through Tsuki No Kata, one learns to direct strong and persistent effort at problems in order to bring good fortune (in essence – to create one's own good fortune).

Physically, this Kata teaches one to generate thrusting power in many directions. It utilises assorted hand positions and develops the mechanics used to generate power from the legs and hip. This control of power from the hips is focused upon through the use of the three 'stable' stances: Kiba Dachi, Zenkutsu Dachi and Sanchin Dachi.

Steps

- Begin the Kata in Fudo Dachi.
- Move into Musubi Dachi and Mokuso on the command "Mokuso".
- On the second command "Tsuki No Kata", open eyes, move into the Yoi position with Ibuki.
- On the command "Hajime" move the right leg back at 45° into Kiba Dachi and block Mae Gedan Barai then punch Chudan Gyaku Tsuki (these two actions are done in one movement).
- Move forward with the right foot in a straight line into Kiba Dachi at 45° and punch Chudan Gyaku Tsuki.
- Move the left foot forward into Sanchin Dachi and punch Chudan Gyaku Tsuki.
- Move the right foot forward into Sanchin Dachi and punch Chudan Gyaku Tsuki.
- Move forward with the left foot into Zenkutsu Dachi and punch Gedan Gyaku Tsuki.
- Move forward with the right foot into Zenkutsu Dachi and punch Gedan Gyaku Tsuki and Chudan Oi Tsuki (the punches must be done fast).
- Bring the right foot across and turn the body 180° into left Sanchin Dachi and block left Chudan Uchi Uke and punch Chudan Oi Tsuki (when turning into Sanchin Dachi the right foot should move back so that the right heel crosses in front of the left toes to establish the Sanchin Dachi position. Note also that the turn, block and punch are all performed quickly).
- Keeping the right arm extended step forward into right Sanchin Dachi and slowly block Chudan Uchi Uke.
- After the block immediately punch Chudan Gyaku Tsuki and Chudan Oi Tsuki (punches must be executed quickly).
- Move forward into left Zenkutsu Dachi and punch Jodan Oi Tsuki.
- Move forward into right Zenkutsu Dachi and punch Jodan Oi Tsuki.
- Move the left foot across and turn into left Zenkutsu Dachi and block Mae Gedan Barai.
- Kick right Chudan Mae Geri and bring the kicking leg back into Tsuru Ashi Dachi, turn the head 90° to the right and simultaneously cover with the left hand in the Shotei position (at shoulder height).
- Move into Kiba Dachi and punch right Jun Tsuki and **KIAI** (the left hand is closed and the level of the striking arm is approximately at shoulder level and parallel to the ground).
- Move forward with the left leg in a straight line turning the body 180° into Kiba Dachi and punch left Jun Tsuki (the right hand is closed).
- Pivot on the feet turning 180° (left heel raised, right foot flat) and cover with left Shotei complete the turn into Kiba Dachi and strike right Yonhon Nukite (the left hand is open after the strike and the level of the striking arm is approximately at shoulder level and parallel to the ground).
- Pivot on the feet, turn 180° (the right heel raised, left foot fiat) and cover with right Shotei, move forward with the left leg in a straight line turning the body 180° into Kiba Dachi and punch left Jun Tsuki.

- Bring the left foot to the right foot and slide back into right Zenkutsu Dachi and simultaneously block with right Chudan Uchi Uke and left Mae Gedan Barai (these movements are executed slowly).
- Slowly bring the right fist back into the ready punch position and **KIAI** as you punch Jodan Oi Tsuki, Gedan Gyaku Tsuki and Chudan Oi Tsuki (the Kiai continues throughout the punching sequence).
- Bring the right foot back towards the left and then move the right foot into right Sanchin Dachi and block Shoto Mawashi Uke with Ibuki (the Ibuki is performed on the Shotei part of the Shoto Mawashi Uke).
- The Kata is completed by moving the right foot back into Musubi Dachi and the Mokuso position is retained until the command "Naore" when the Fudo Dachi position is taken.

Saifa

最破

Saifa is (perhaps) more commonly known as 'Saiha' (Chinese Zuofa) and is considered an advanced form. "Saifa/Saiha/Zuofa", means "Rolling Wave", "To Break" or "Smash" and is therefore a significant element of the Kyokushin Budo Kai Kihon (consider the Tsunami symbol of the International Kyokushin Budokai).

It is not really clear whether this form is a direct descendant of, or was simply influenced by, the 'White Crane' systems of the Chinese Martial Arts. However, there is clearly a relationship between Saifa and the 'White Crane' systems.

This Kata works with many angled steps and circular movements designed to parry an attacker. Also included are one legged crane stances and a large number of different hand techniques (Tetsui, Uraken, Morote Tsuki, Ashi Barai, Haito Uchi etc.).

Steps

- Begin the Kata in Fudo Dachi.
- Move into Musubi Dachi and Mokuso on the command "Mokuso".
- On the second command "Saifa", open eyes, move into the Yoi position with Ibuki.
 - On the command "Hajime" move forward with the right foot at 45°. Slowly bring the left foot to the right into Heisoku Dachi simultaneously move the hands so that the right fist returns to the ready punch position (i.e. in Tate Tsuki position) and the open left hand is placed on the front of the right fist.
- Grasping the right fist, snap the right elbow up in a circular upper movement (looking the same direction the elbow is pointing).
- Then the left hand covers using Jodan Shotei and the right hand closed, moves inside the left ready to strike.
- Move the left foot straight back into Kiba Dachi and strike right Uraken Ganmen Uchi and simultaneously the left hand is pulled back still in Shotei, to a cover position slightly above belt level.
- Move the left foot forward at a 45° angle and repeat the entire previous movements but striking with the left arm.
- Move the right foot forward at a 45° angle and repeat the entire previous movement, but striking with the right arm.
- Move with the left leg 90° to the left simultaneously turning the head in the same direction and position both hands for the block.
 - Pull the right leg slowly along the ground towards the side of the left foot (keeping the hips facing forward) with the heel raised in a ready kicking position, simultaneously with the above leg movement perform a slow double blocking movement with both hands open (right hand moves downwards similar to Shuto Gedan barai and the left hand moves to a position similar to Haito Uke) at the same time of the leg and arm movements the head turns quickly to the front.
- From this position kick right Chudan Mae Geri keeping both hands in the original Position.
 - After the kick, without placing the right foot down, position the right foot to the right approximately "two shoulder widths" from the left foot, look to the left and move the left foot to the right as illustrated and position the hands in preparation to block.
- Repeat the leg and blocking movements as previously described.
 - Kick left Chudan Mae Geri and immediately after the kick place the foot back so to end up in right Zenkutsu Dachi as the foot comes back execute Morote Haito Uchi to the neck. Continue the hand movement so that both hands are pulled back closed, to the ready punch position.
- Strike Jodan Morote Tsuki. With both fists in this position, open both hands and swing them slowly down in a circular movement at 45° dosing the left fist prior to striking the left palm with Tetsui (at approximately belt height).

- Step across with the right foot and turn 180° into left Zenkutsu Dachi execute Morote Haito Uchi. Continue the hand movements to the ready punch position and strike Jodan Morote Tsuki. Open both hands and swing them down in a circular movement and strike right Tetsui into the open left palm.
- Move the right foot towards the left and slightly in front to perform a leg sweep, simultaneously the right fist is positioned above and behind the head in preparation to strike.
- Turn 180° to complete the movement on the left leg, keeping the right knee as high as possible, cover left Shotei stamp the right foot down into right Sanchin Dachi and strike right Tetsui Oroshi Ganmen Uchi pulling the left hand back into the ready punch position and **KIAI**.
- Open the right fist and execute a fast tensho hooking movement and punch left Shita Tsuki pulling the right hand back closed to the ready punch position.
- As previously described move the left foot towards the right and execute a sweep.
- Turn 180° stamping the foot down into left Sanchin Dachi and strike left Tetsui Oroshi Ganmen Uchi and **KIAI**.
- Open the left fist and execute a fast tensho hooking movement and punch right Shita Tsuki pulling the left hand back closed to the ready punch position.
- Move forward with the right foot into right Zenkutsu Dachi and punch Chudan Oi Tsuki.
- Move forward 45° to the right pivot on the left foot and turn quickly, with the right arm extended, hand open, and the open left hand in the ready punch position (the right hand is held at approximately neck height).
- Pull back slowly into right Neko Ashi Dachi simultaneously pull the right hand towards you as if hooking the neck and at the same time the left hand slowly strikes Chudan Yonhon Nukite (palm upwards - the final position should be with the right hand over and in line with the left Nukite position and not extended beyond it).
- Block Gyaku Shuto Mawashi Uke and Ibuki (the Ibuki is performed on the Shotei part of the Shuto Mawashi Uke).
- The Kata is completed by moving the right foot back into Musubi Dachi and the Mokuso position is retained until the command "Naore" when the Fudo Dachi position is taken.

Tensho

転掌

Tensho Kata was created by Miyagi Chojun O'Sensei (Goju). Tensho literally means "turning", "rolling" or "fluid" hands and this Kata represents the "Ju" (softness) of Goju. Miyagi O'Sensei developed this Kata from the "Rokkishu" Kata of the Fukian White Crane System.

Tensho emphasizes smooth movements and can be considered the counterpart to the Sanchin No Kata which has very hard movements. Where Sanchin No Kata is hard, Tensho is soft. Tensho consists of only three steps forward and three steps back and this may, at first, sound very easy. However, the hand movements and breathing method require a high level of co-ordination. Tensho is about refinement, perfection, concentration and focus.

When one masters the Tensho Kata, one comes to a fundamental understanding of the "soft" aspects of Karate.

The wrist is very important in Tensho. It must be relaxed and loose so that contact with an opponents attacking arm results in the arm being 'taken and controlled' (an important aspect of close combat) and not 'lost again'. This is the principle of Kakie - 'Sticky Hands'.

Tensho was Mas Oyama's favorite Kata.

Steps

- Begin the Kata in Fudo Dachi.
- Move into Musubi Dachi and Mokuso on the command "Mokuso".
- On the second command "Tensho", open eyes, move into the Yoi position with Ibuki.
- On the command "Hajime" move into right Sanchin Dachi simultaneously slowly blocking Morote Chudan Uchi Uke (no Ibuki Nogare breathing).
- In the same position slowly bring the left fist back to the ready punch position (to a mental count of four).
Inhale and execute, at a moderate speed, a right Jodan Tensho circular hooking movement. Immediately reverse the hand movement using Shuto completing the technique at the ready punch position, hand open (block or strike) (on both the circular movements inhale sharply with short breaths).
- Execute a right Jodan Shotei Uchi with Ibuki. Position the right hand as shown and execute at a moderate speed a circular movement similar to Shuto Hizo Uchi continuing the circular movement back to the ready punch position with the right hand open.
- Inhale and execute a right Shuto Gedan Uke with Ibuki.
- From this position slowly execute a right Jodan Koken Uke and immediately follow with a right Shuto uchi komi with Ibuki, striking forward and down.
- Immediately follow with a slow right Koken Hizo Uchi whilst inhaling and execute a right Chudan Shotei Uchi with Ibuki.
- Move forward into left Sanchin Dachi simultaneously blocking Morote Chudan Uchi Uke and Ibuki.
- In the same position slowly bring the right fist back to ready punch position (to a mental count of four).
Inhale and execute, at a moderate speed, a left Jodan Tensho circular hooking movement. Immediately reverse the hand movement using Shuto completing the technique at the ready punch position, hand open (block or strike) (on both the circular movements you inhale sharply with short breaths).
- Execute a left Jodan Shotei Uchi with Ibuki.
- Position the left hand as shown and execute a circular movement similar to Shuto Hizo Uchi continuing the circular movement back to the ready punch position with the left hand open.
- Inhale and execute a slow left Shuto Gedan Uke with Ibuki. From this position execute a slow left Jodan Koken Uke and immediately follow with a left Shuto uchi komi with Ibuki striking forward and down.

- Immediately follow with a slow left Koken Hizo Uchi whilst inhaling and execute a left Chudan Shotei Uchi with Ibuki.
- Move forward into right Sanchin Dachi simultaneously blocking Morote Chudan Uchi Uke with Ibuki.
- In the same position inhale and execute at a moderate speed a Morote Jodan Tensho circular hooking movement.
- Immediately reverse the hand movement using Morote Shuto completing the technique at ready punch position (block or strike) (on both the circular movements you inhale sharply with short breaths).
- Execute Morote Jodan Shotei Uchi with Ibuki.
- Position both hands as shown and execute a circular movement similar to Morote Shuto Hizo Uchi continuing the circular movement back to the ready punch position with the hands open.
- Inhale and execute Morote Shuto Gedan Uke with Ibuki.
- From this position execute a slow Morote Jodan Koken Uke and immediately follow with Morote Shuto Uchi Komi and Ibuki striking forward and down.
- Immediately follow with a slow Morote Koken Hizo Uchi whilst inhaling and execute Morote Chudan Shotei Uchi with Ibuki.
- From this position quickly execute, in a forward direction, a double hooking movement (positioned at height of neck) and slowly return both hands open, to the ready punch position whilst inhaling.
- Execute Morote Chudan Yonhon Nukite to the solar plexus with Ibuki.
- Repeat the double hooking movement and slowly return both hands, open, to the ready punch position whilst inhaling.
- Execute Morote Chudan Yonhon Nukite with Ibuki.
- Repeat the double hooking movement and slowly return both hands, open, to the ready punch position whilst inhaling.
- Execute Morote Chudan Yonhon Nukite with Ibuki.
- Quickly move back with the right leg into left Sanchin Dachi and execute a fast Shuto Mawashi Uke inhale and execute Morote Shotei Uchi (right hand Jodan left hand Gedan) with Ibuki.
- Quickly move back with the left leg into right Sanchin Dachi and execute a fast Shuto Mawashi Uke inhale and execute Morote Shotei Uchi (left hand Jodan right hand Gedan) with Ibuki.
- The Kata is completed by moving the right foot back into Musubi Dachi and the Mokuso position is retained until the command "Naore" when the Fudo Dachi position is taken.

Seienchin

征遠鎮

The word 'Seienchin' can be translated as "control", "pull" or "fight". It's possible that this is a hint toward the various grappling and grabbing techniques contained within the Seienchin Kata.

Seienchin is a long Kata with a lot of slow movements which are executed in Kiba Dachi. The hook blocks within the Kata hint at its Chinese origin and some of the blocks appear very much like their Taijiquan counterparts. In the Goju Ryu, Seienchin belongs to the Ju-Kata (soft Kata) and (together with Suparinpei) is considered the highest level of Kata.

Steps

- Begin the Kata in Fudo Dachi.
- Move into Musubi Dachi and Mokuso on the command "Mokuso".
- On the second command "Seienchin", open eyes, move into the Yoi position with Ibuki.
- On the command "Hajime" move the right leg forward to the right in a circular movement into Kiba Dachi at 45° and simultaneously bring both fists back to the ready punch position.
- Quickly block Morote Shotei Gedan Uke with the hands crossed to finish levelwith and in front of the groin so that the fingers of the left hand are on top of the right.
- From this position slowly bring both hands up level with your chin, thumbs facing out (this movement begins by twisting your hands towards your body so that the backs of the hands are touching).
- Close both hands and, as if gripping bring both fists down vertically to chin level then slowly bring the fists in a downward twisting and outward direction as in the photograph.
- Still in the same stance cover with a fast left Shotei and execute a right Haito Uchi Uke returning the left hand open to the ready punch position.
- Now from the same hand position execute a right Tensho Uke and pull towards the body and simultaneously execute a left Yonhon Nukite Chudan.

(The techniques above are executed so that the hands are at an angle which is just inside the line of the right leg. In addition all the movements are executed slowly, with the exception of the cover which is done quickly. Finally you should look at 45° whilst performing the movements. This principle is maintained in the following similar movements.)

- Move the left leg forward in a circular movement into Kiba Dachi at 45° and as previously explained returning both fists to the ready punch position, block Morote Shotei Gedan Uke, bring both hands up level with your chin and twist both hands out.
- Execute a fast right Shotei cover and perform a left Haito Uchi Uke and execute a left Tensho Uke pulling the hand towards the body and perform a right Yonhon Nukite.
- Move the right leg forward in a circular movement into Kiba Dachi at 45° as previously explained, returning both fists to the ready punch position, block Morote Shotei Gedan Uke, bring both hands up level with your chin and twist both hands out.
- Execute a fast left Shotei cover and perform a right Haito Uchi Uke and execute a right Tensho Uke pulling the hand towards the body and perform a left Yonhon Nukite.
- From this position bring your right foot back and kick Age Kakato Ushiro Geri and at the same time strike right Ushiro Hiji Ate with the left palm placed on top of the right fist.
- Move forward into right Moro Ashi Dachi and punch right Chudan Tsuki with the left palm placed on the right wrist.
- Quickly move the right foot back into left Zenkutsu Dachi and position the left hand (arm extended palm facing down) as if to grab an opponent's neck, the right fist is simultaneously brought back to the ready punch position.
- Quickly strike right Jodan Age Hiji Ate hitting the palm of the left hand.

- Slowly move forward with the right leg in a circular movement into right Kokutsu Dachi at 45° and at the same time slowly block right Morote Chudan Uchi Uke with the left palm placed on the inside of the right arm so that the finger tips are touching the wrist.
- Move forward with the left leg at an angle into Kiba Dachi and block left Mae Gedan Barai.
- Take your left foot back at the same angle into Kiba Dachi and block right Mae Gedan Barai.
- With your left leg move forward in a circular movement into left Kokutsu Dachi at 45° and slowly block left Morote Chudan Uchi Uke as previously explained.
- Move forward with the right leg at an angle into Kiba Dachi and block right Mae Gedan Barai.
- Take your right leg back at the same angle into Kiba Dachi and block left Mae Gedan Barai.
- Move the left foot back into Mae Kiba Dachi (i.e. moving the body 135°) and execute a Kata Guruma (throw) (the hands should be open at the beginning of the throw and the upper hand should be held slightly above the head as indicated, with the thumb pointing straight out).
- By moving clockwise 180° take the right foot back into Mae Kiba Dachi and repeat the Kata Guruma as previously described.
- Move forward covering with a left Shotei into right Moro Ashi Dachi by moving the right leg initially into age Ushiro Kakato Geri and block right Chudan Soto Uke hitting the palm of the left hand, followed immediately by moving forward into right Moro Ashi Dachi simultaneously covering with a left Shotei in a downward direction and strike Uraken Oroshi Ganmen Uchi and **KIAI** (the left hand remains open, palm down, with the right elbow placed on top of the left hand).
- Quickly cross the right foot in front of the left and turn 45° into left Sanchin Dachi and block left Chudan Uchi Uke, right Mae Gedan Barai.
- Covering with a left Shotei step forward into Kiba Dachi and strike right Age Tsuki and **KIAI**. In the same stance immediately cover left Shotei and strike right Uraken Sayu Ganmen Uchi. Again in the same stance block right Mae Gedan Barai.
- Move the right foot back at the same angle into Kiba Dachi and block Mae Gedan Barai.
- Turn your body to the front pulling the right leg into Neko Ashi Dachi and simultaneously execute a left Ushiro Hiji Ate and right Chudan Mae Hiji Ate and with a slight backward slide, move your right foot back into left Neko Ashi Dachi and simultaneously execute a right Ushiro Hiji Ate and left Chudan Mae Hiji Ate.
- Cross the left foot into right Sanchin Dachi at 45° and block right Chudan Uchi Uke and left Mae Gedan Barai.
- Covering with a right Shotei step forward into Kiba Dachi and strike left Age Tsuki and KIAI followed by left Uraken Sayu Ganmen Uchi and left Mae Gedan Barai.
- Move the left foot back at the same angle into Kiba Dachi and block right Mae Gedan Barai.
- Turn your body to the front pulling the left leg into Neko Ashi Dachi and simultaneously execute a right Ushiro Hiji Ate and left Chudan Mae Hiji Ate.
- With a slight backward slide move your left foot into right Neko Ashi Dachi and simultaneously execute a left Ushiro Hiji Ate and right Chudan Mae Hiji Ate.
- Move forward covering with a left downward Shotei cover into right Moro Ashi Dachi by moving the left leg initially into age Ushiro Kakato Geri and strike right Uraken Oroshi Ganmen Uchi (the left hand remains open palm down with the right elbow placed on top of the left hand).
- From this stance jump backwards and upwards kicking left Tobi Jodan Mae Geri.
- From the kicking position land into left Kokutsu Dachi with the arms positioned with the elbows together, hands open at face level. Push the elbows down to groin level with Ibuki (fingers touching and pointing to the front and thumbs touching).
- The Kata is completed by moving the left leg back into Musubi Dachi and the Mokuso position is retained until the command "Naore" when the Fudo Dachi position is taken.

Kanku Dai

観空大

Kanku: "View the heavens; gaze at the sky" or "sunrise".

This Kata was originally called Kushanku, which is said to be the title given to a Chinese military attaché to Okinawa. The historical Kushanku (Guan Kui) who is credited with the introduction of the Kanku Kata, came to Okinawa in 1756. He was an expert in hand to hand combat and gave a demonstration of his abilities whilst in Okinawa and the Kanku Kata is still said to contain many elements of Kushanku's original display. It was the Kata chosen by Gichin Funakoshi for performance at the first public demonstration of Karate-do in Japan in 1922.

Kanku is the supreme Kata of all traditional Karate-do. As one's hands are brought together in the opening position, one gazes to the heavens through the hands to reflect on the rising of the sun, and the glory and infinity of the heavens. As long as heaven and earth remain in their celestial sojourn, all will be well. The sun will rise again tomorrow and with it comes new hope, regardless of how hard today seemed.

Kanku Dai is the representative Kata of Kyokushin Karate.

Steps

- Begin the Kata in Fudo Dachi.
- Move into Musubi Dachi and Mokuso on the command "Mokuso".
- On the second command "Kanku Dai", open eyes, move into the Yoi position with Ibuki.

On the command "Hajime" slowly place both hands into the Kanku position (hands open, index finger and thumb of each hand touching), in front of the groin. Slowly raise both arms into the Kanku position above the head. Maintain this position for approximately 5 seconds and part them strongly bringing both arms down in a circular action in front of the body to strike right Shuto Hizo Uchi to the palm of the left hand.
- Turn at 90° to the left into left Kokutsu Dachi and block Shuto Mawashi Uke.
- Move the left leg and turn 180° into right Kokutsu Dachi and block Shuto Mawashi Uke.
- Pivot 90° to the left into left Sanchin Dachi and block Chudan Uchi Uke immediately punch Chudan Gyaku Tsuki quickly follow with right Gyaku Chudan Uchi Uke and immediately punch Chudan Oi Tsuki.
- Move forward with the left foot into left Kokutsu Dachi and block Shuto Mawashi Uke.
- Move forward into right Kokutsu Dachi and block Shuto Mawashi Uke.
- Move forward into left Kokutsu Dachi and block Shuto Mawashi Uke.

Retaining the same stance block down with left Shuto Uke and with the left hand in the same position move forward into right Zenkutsu Dachi and strike right Yonhon Nukite (the left hand remains open under the right elbow).
- Move left foot across to the right simultaneously raise the left hand behind into a Jodan Shuto cover with the arm straight and at the same time the right hand is placed behind the head in preparation for the Shuto strike (the head should turn to the left as the foot moves across).
- Complete the turn by pivoting the hips into left Zenkutsu Dachi and execute a right Shuto Yoko Ganmen Uchi, simultaneously the left hand is pulled back in front of the forehead with palm facing outwards to cover.
- Leaving the hands in this position kick right Chudan Mae Geri.

As you land into right Zenkutsu Dachi pull the left hand back to the ready punch position and punch left Chudan Gyaku Tsuki and right Chudan Oi Tsuki.
- Move the right foot back, covering with the right hand, turning 180° into right Zenkutsu Dachi and strike left Shuto Yoko Ganmen Uchi with the right hand in the cover position.
- Leaving the hands in this position kick left Chudan Mae Geri and land into left Zenkutsu Dachi and punch right Chudan Gyaku Tsuki and left Chudan Oi Tsuki.

- Slowly pull the left foot back into Musubi Dachi and simultaneously pull both hands, closed, to the left ready punch position with the right fist in the Tetsui position on top of the left fist.
- With both hands in this position kick right Chudan Mae Geri bring the leg back into Tsuru Ashi Dachi and look to the right. Without placing the foot down kick right Jodan Yoko Geri to the side, and simultaneously strike right Uraken Uchi.
- Open the fist of the extended right arm and land in right Zenkutsu Dachi (i.e. 90° from original position) and strike left Jodan Hiji Ate into the open right hand (a slight pull back of the right hand should be performed before the elbow strike).
- Slowly pull the left foot back into Musubi Dachi and simultaneously pull both hands, closed, to the right ready punch position. Kick left Chudan Mae Geri, return the leg to the Tsuru Ashi Dachi position and look to the left and kick left Jodan Yoko Geri to the side and simultaneously strike left Uraken Uchi.
- Open the fist of the extended left arm and land in left Zenkutsu Dachi (i.e. 90° from original position) and strike right Jodan Hiji Ate into the open left hand ensuring that you pull back slightly with the left arm prior to the strike.
- Move the right foot forward at 45° into right Sanchin Dachi and block right Jodan Uke then immediately strike with right Uraken Ganmen Uchi and right Jodan Hiji Ate, cover with the left arm and strike right Oroshi Hiji Ate and **KIAI** (the body drops as low as possible into a crouching narrow Kiba Dachi when you strike Oroshi Hiji Ate).
- As you regain the standing position move the left leg 90° to the right into left Sanchin Dachi at 45° and block left Jodan Uke, immediately strike left Uraken Ganmen Uchi and left Jodan Hiji Ate cover with the right arm and strike left Oroshi Hiji Ate as previously described and **KIAI**.
- As you regain the standing position move 45° to the left, open both hands and bring them in front of the face simultaneously kick right Age Ushiro Kakato Geri.
- With both hands in this position move forward into right Moro Ashi Dachi and simultaneously block Morote Shuto Gedan Barai.
- Raise both hands to cover the face and simultaneously kick right Age Ushiro Kakato Geri and move forward into right Moro Ashi Dachi and simultaneously block Morote Shuto Gedan Barai.
- Pull both hands to the right ready punch position with the left open hand placed over the right closed fist. Simultaneously kick right Age Ushiro Kakato Geri.
- Move forward into right Moro Ashi Dachi and punch right Chudan Oi Tsuki with the left open hand placed on the right forearm.
- Pivot on the right foot and turn anti-clockwise 180° and kick left Age Ushiro Kakato Geri and simultaneously cover with both hands open in front of the face.
- With both hands in this position move forward into left Moro Ashi Dachi and simultaneously block Morote Shuto Gedan Barai.
- Raise both hands to cover the face and simultaneously kick left Age Ushiro Kakato Geri.
- Move forward into left Moro Ashi Dachi and simultaneously block Morote Shuto Gedan Barai.
- Pull both hands to the left ready punch position with the right open hand placed over the left closed fist simultaneously kick left Age Ushiro Kakato Geri.
- Move forward into left Moro Ashi Dachi and punch left Chudan Oi Tsuki with the right open hand placed on the left forearm.
- Pull the right hand back closed to the ready punch position and move forward with the right leg (i.e. turning 90°) into Kiba Dachi and punch right Chudan Jun Tsuki.
- Slowly pull the right foot back into Musubi Dachi with both fists closed in the left ready punch position (i.e. right fist on left).
- Kick right Chudan Mae Geri return the leg to Tsuru Ashi Dachi position and look to the right and kick right Jodan Yoko Geri to the side and simultaneously strike right Uraken Uchi.

- Open the fist of the extended right arm and land into right Zenkutsu Dachi (i.e. 90° from original position) and strike left Jodan Hiji Ate into the right open hand.
- Slowly pull the left foot back into Musubi Dachi; with both fist closed in the right ready punch position (i.e. left fist on right).
- Kick left Chudan Mae Geri return the leg to the Tsuru Ashi Dachi position and look to the left and kick left Jodan Yoko Geri and simultaneously strike left Uraken Uchi.
- Open the fist of the extended left arm and land into left Zenkutsu Dachi (i.e. 90° from original position) and strike right Jodan Hiji Ate into the left open hand.
- Turn your head 90° to the right and move the right foot to the left into a semi neko ashi Dachi, simultaneously pull both hands back to their respective ready punch positions.
- Step 90° to the right into left Kake Dachi and punch Morote Tsuki (right Jodan, left Chudan).
- From this position move the left foot forward into Kiba Dachi and quickly cover with a right Shotei to the left and position the left arm ready for a strike with the palm parallel to the ground.
- Slowly execute a left haishu uchi (at shoulder height) and move the right hand, fist closed, to the ready punch position.
- Leaving the left hand in this position kick right Soto Mawashi Teisoku Keage.
- Before you position the right foot on the ground pull the left hand back, closed, to the ready punch position and jump forward into right Kake Dachi and punch Morote Tsuki (right Jodan, left Chudan).
- Jump up and slightly back landing in a low right Zenkutsu Dachi simultaneously both hands are positioned to make a large circle and the finger tips should touch the ground in front of the right foot. Look to the rear and block Ushiro Morote Shuto Gedan Barai parallel to the back leg.
- Look to the front and pull the right foot back into right Kokutsu Dachi and block right Shuto Mawashi Uke.
- Turn the head 90° to the left and pivot into left Sanchin Dachi blocking left Chudan Uchi Uke and right Mae Gedan Barai.
- Repeat the block: right Chudan Uchi Uke and left Mae Gedan Barai. Bring the right hand slowly down in a semi circular movement to form a lower Kanku position (as previously described).
- Slowly raise both arms into the Kanku position above the head.
- Maintain this Kanku position for approximately 5 seconds and part the hands strongly bringing both arms down in a circular action in front of the body to strike right Shuto Hizo Uchi into the palm of the left hand.
- Pivot clockwise 180° (Ura) into a semi Zenkutsu Dachi (left heel is raised off the ground) so that hips and head are turned to the right; cover with left Shotei in front of the body with the right hand open in the ready punch position. Pivot the hips into Kiba Dachi and strike right Yonhon Nukite Chudan.
- Pivot the hips 90° into a left semi Zenkutsu Dachi and cover right Shotei. Strike left Chudan Yonhon Nukite turning the hips back to the original Kiba Dachi position.
- In the same position turn your head 90° and look forward and block right Chudan Kake Uke, strike left Chudan Yonhon Nukite and right Chudan Yonhon Nukite (i.e. Nihon Nukite).
- Turn anticlockwise 225° with the left leg into a left semi Zenkutsu Dachi and right Shotei cover and turn the hips back 90° into Kiba Dachi and strike left Yonhon Nukite Chudan.
- Pivot 90° into a right semi Zenkutsu Dachi and left Shotei cover strike right Chudan Yonhon Nukite turning the hips back to the original Kiba Dachi position.
- Turn your head 90° and look forward and block left Chudan Kake Uke and strike right Chudan Yonhon Nukite and left Chudan Yonhon Nukite.
- Move the right foot to the right 180° and turn into a right semi Zenkutsu Dachi and left Shotei cover and turn the hips back 90° and strike right Chudan Yonhon Nukite.
- Pivot to the left 90° into a left semi Zenkutsu Dachi and right Shotei cover and turn the hips back to the original Kiba Dachi position and strike left Chudan Yonhon Nukite.

- Look to the front and block right Chudan Kake Uke and strike left Chudan Yonhon Nukite and right Chudan Yonhon Nukite.
- Pivot to the left 90° into a left semi Zenkutsu Dachi and right Shotei cover. Retaining the hand position move through in a straight line into a right semi Zenkutsu Dachi.
- Move through once again in a straight line into a left semi Zenkutsu Dachi, strike left Chudan Yonhon Nukite turning the hips back to the original Kiba Dachi position.
- Pivot to the right into a right semi Zenkutsu Dachi and left Shotei cover and turn the hips back to the original Kiba Dachi position and strike right Chudan Yonhon Nukite.
- Look to the front and block right Chudan Kake Uke and strike right Chudan Yonhon Nukite and left Chudan Yonhon Nukite.
- Still in the same position with both hands open reach up to the right, and moving into a stance similar to Zenkutsu Dachi simultaneously execute a Tai Otoshi (throw) (the fists dosing during the execution of the throw).
- Leaving the right hand in the original position raise the left fist in preparation for a block and execute left Mae Gedan Barai and punch right Gedan Gyaku Tsuki.
- Retaining the same position reach up to the left with the hands open and execute the Tai Otoshi as you turn 180° to the right into a stance similar to right Zenkutsu Dachi.
- Block right Mae Gedan Barai and punch left Gedan Gyaku Tsuki and **KIAI** (when executing the Gyaku Tsuki the body should be positioned so that the punching fist is slightly below the bent knee).
- The Kata is completed by moving the right foot back into Musubi Dachi and the Mokuso position is retained until the command "Naore" when the Fudo Dachi position is taken.

Technique Gallery: Karate

The following is intended as a reference guide only! It is not a 'how to...' guide. However, you should find the following very helpful when attempting to learn the Japanese terms for many of the Kyokushin Kihon.

After a great evening of training, I spoke with a fellow Budoka about putting together a 'Beginners Guide to Kihon'. He happens to be a Photographer and I thought he might be kind enough to snap a few shots in the Dojo. I put the idea to him and his response was astounding: 'I have a better idea...'

Two days later, we met at his studio and he gave **countless** hours of his time and skill and took the following shots. My heartfelt gratitude goes to Jochen Bachmann of 'PR Bachmann' (www.pr-bachmann.de). Without him this section of the guide would not have been possible.

Buki / Weapons

Seiken



Uraken



Tettsui



Shuto



Haisho



Haito



Shotei



Hiraken



Koken



Hiji



Teisoku



Haisoku



Sokuto

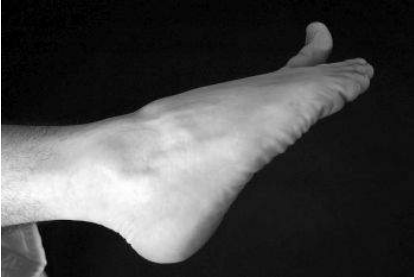

Chusoku



Kakato



Dachi

Zenkutsu Dachi (Front)

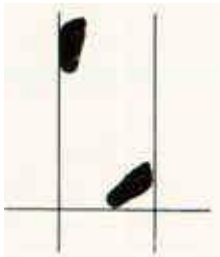

Zenkutsu Dachi (Side)

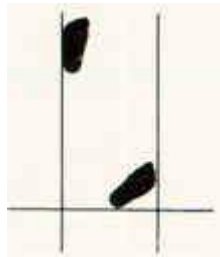

Sanchin Dachi

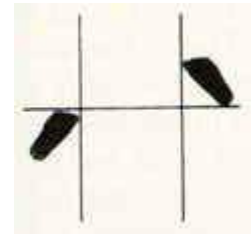
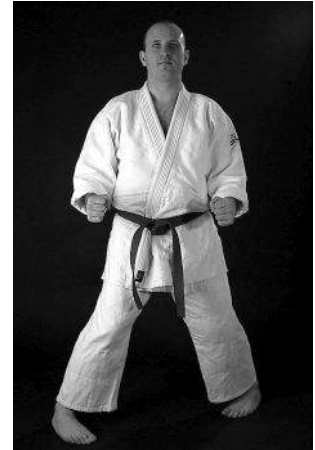

Kokutsu Dachi (Front)

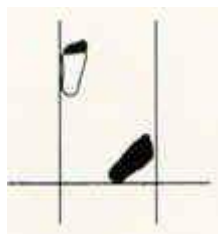
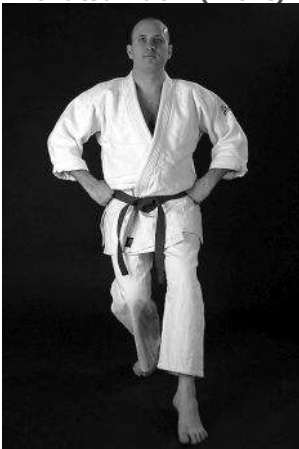

Kokutsu Dachi (Side)

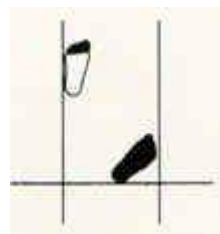

Neko Ashi Dachi (Front)

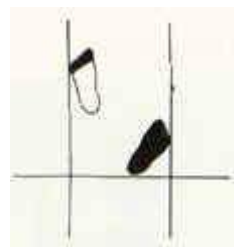

Neko Ashi Dachi (Side)

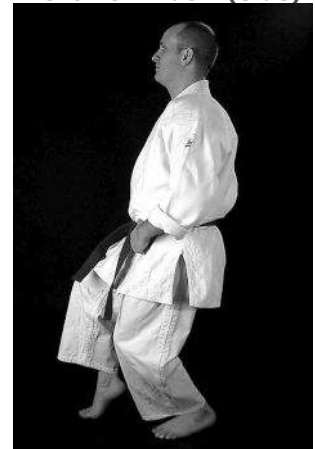

Shiko Dachi



Kiba Dachi



Kake Dachi (Front)

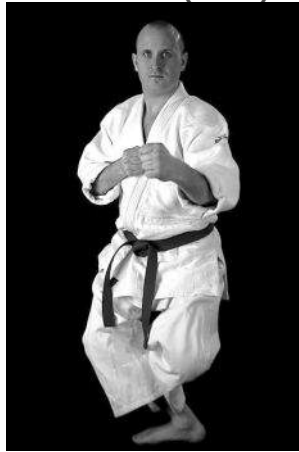

Kake Dachi (Side)

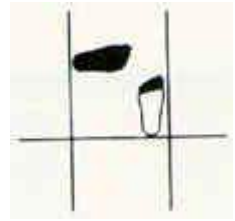
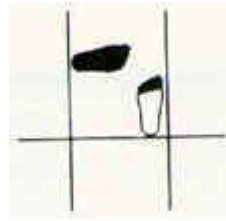

Tsuru Ashi Dachi



Kumite Dachi



Moro Ashi Dachi



Yoi Dachi / Fudo Dachi



Heiko Dachi

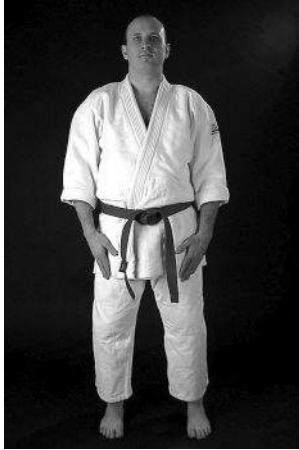

Heisoku Dachi



Te Waza

Oi Tsuki Jodan



Oi Tsuki Chudan



Oi Tsuki Gedan

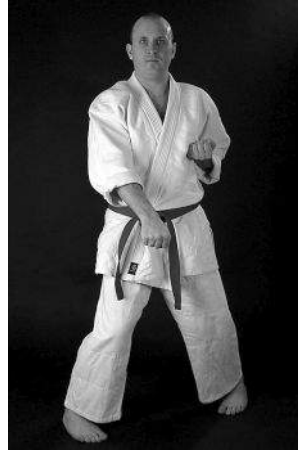

Gyaku Tsuki



Seiken Ago Uchi



Tate Tsuki



Tettsui Komi Kami



Tettsui Yoko Uchi



Tettsui Oroshi Ganmen Uchi

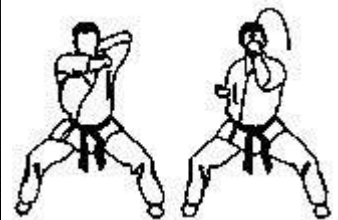

Uraken Shomen Ganmen Uchi



Uraken Sayu Ganmen Uchi

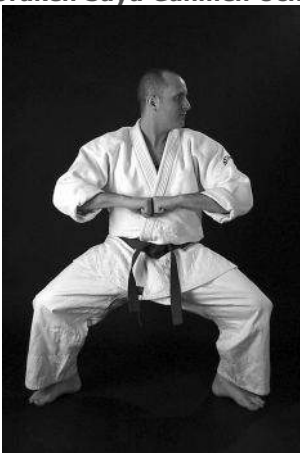

Uraken Oroshi Ganmen Uchi

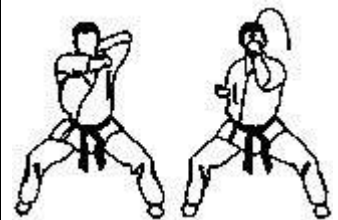

Uraken Hizo Uchi

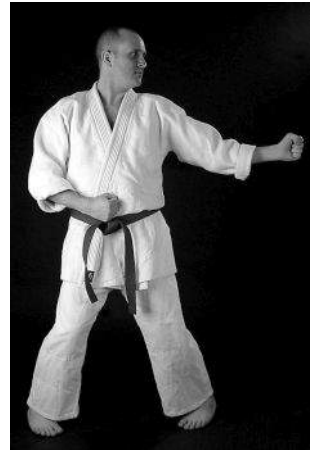
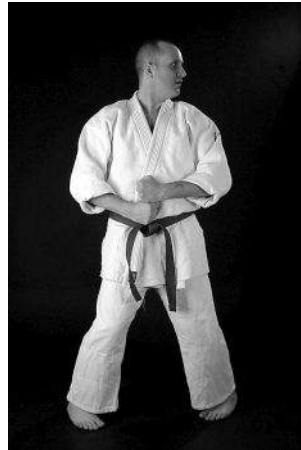
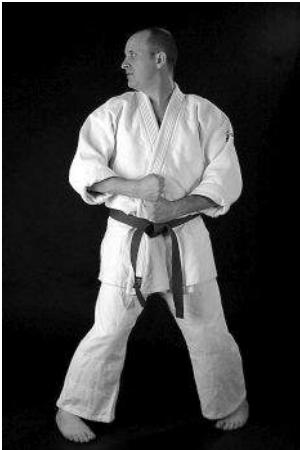

Shotei Uchi Jodan



Shotei Uchi Chudan



Shotei Uchi Gedan



Hiji Ate



Age Hiji Ate



Shuto Uchi Komi

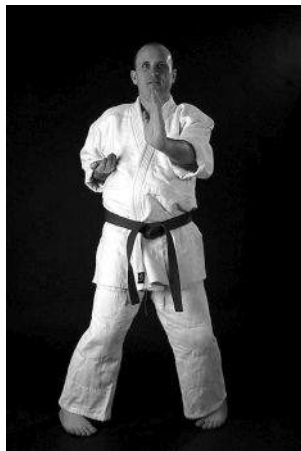
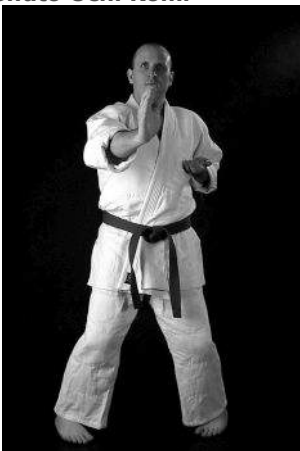

Shuto Sakotsu Uchi

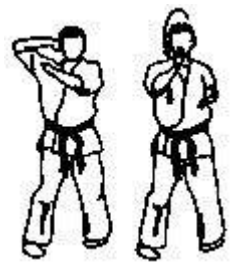
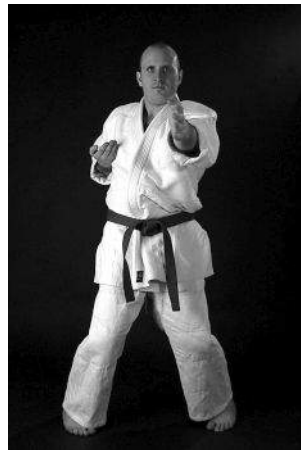

Shuto Jodan Uchi Uchi



Shuto Yoko Ganmen Uchi

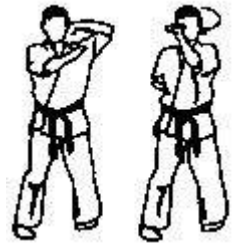

Shuto Hizo Uchi

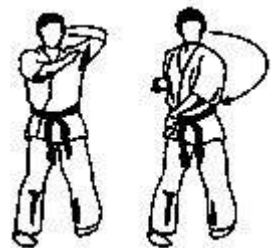
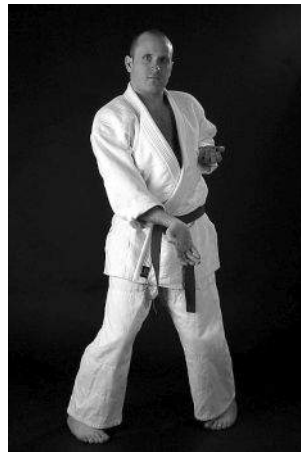
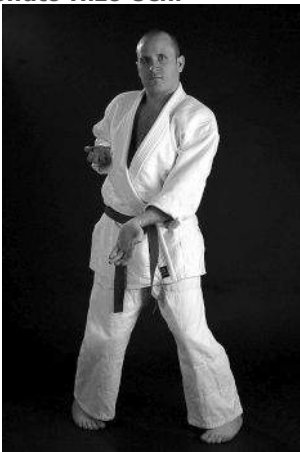

Me Tsuki / Nihon Nukite



Yonhon Nukite

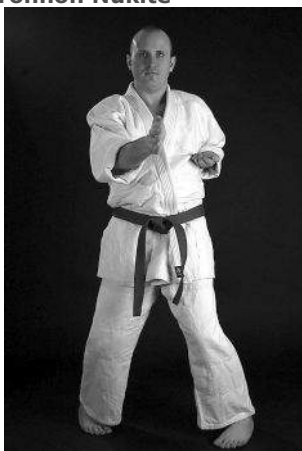

Toho Uchi



Uke Waza

Jodan Uke (Variant 1)

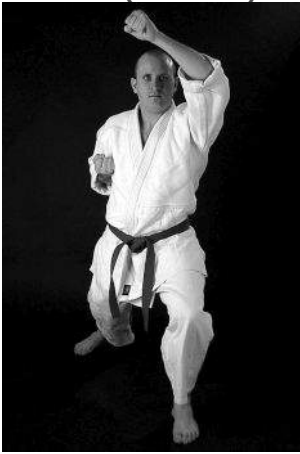

Jodan Uke (Variant 2)

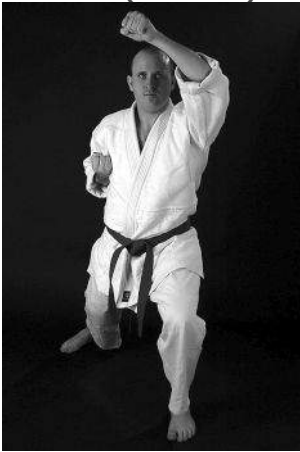

Soto Uke



Uchi Uke



Gedan Barai



Juji Uke Jodan



Juji Uke Gedan

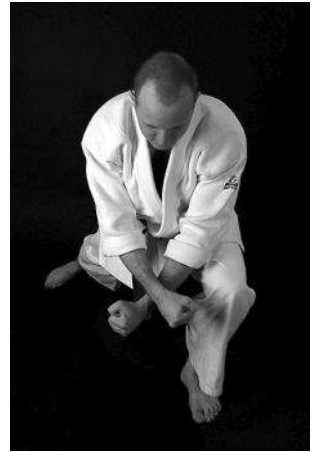

Shotei Uke Jodan



Shotei Uke Chudan



Shotei Uke Gedan



Kate Uke



Uchi Uke / Gedan Barai



Shuto Mawashi Uke (Front)



Shuto Mawashi Uke (Side)



Sune Kote Uke



Geru Waza

Mae Keage (Mae Geri Keage)



Mae Geri Jodan



Mae Hiza Geri aka. Hiza Geri (Front)

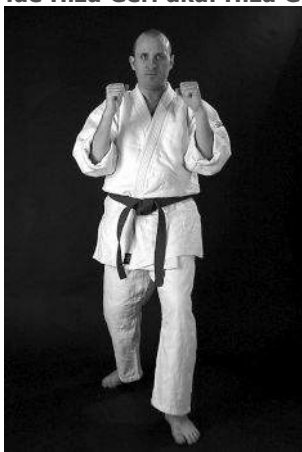

Mae Hiza Geri aka. Hiza Geri (Side)



Hiza Ganmen Geri

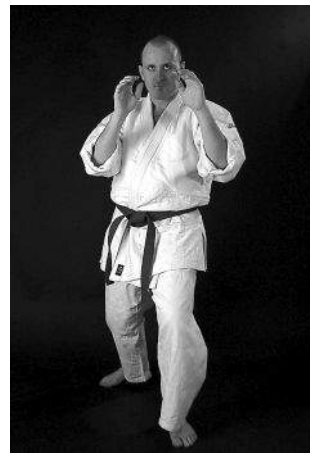
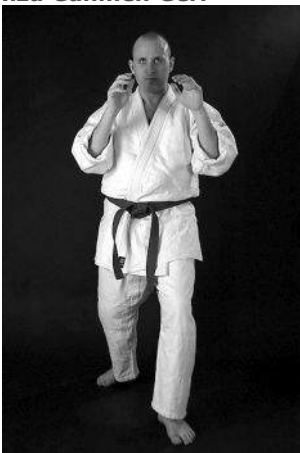

Mawashi Hiza Geri

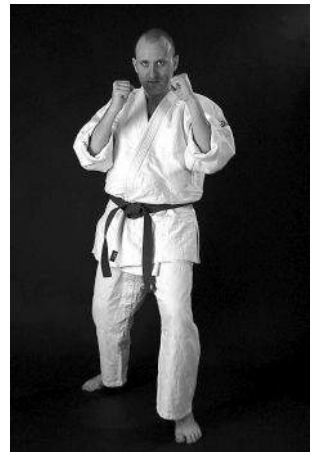

Mawashi Geri Jordan



Ushiro Mawashi Geri

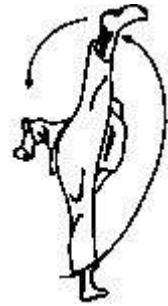

Ushiro Geri



Mae Kakato Geri



Yoko Geri



Kansetsu Geri

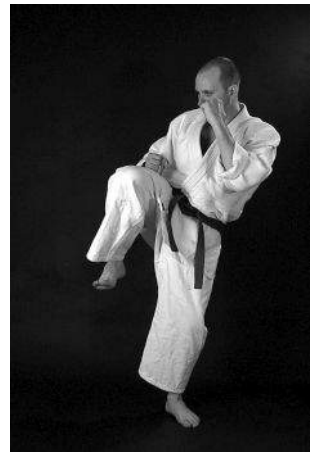
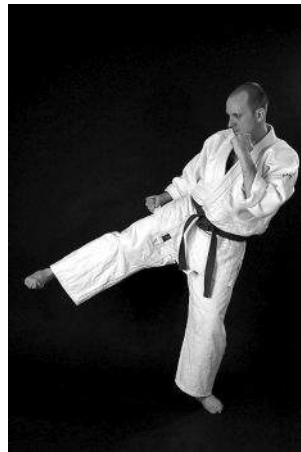

Kinteki Geri



Uchi Mawashi Geri Keage

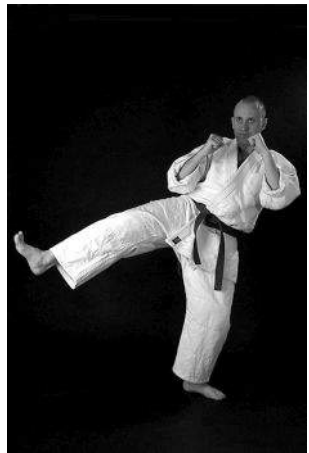
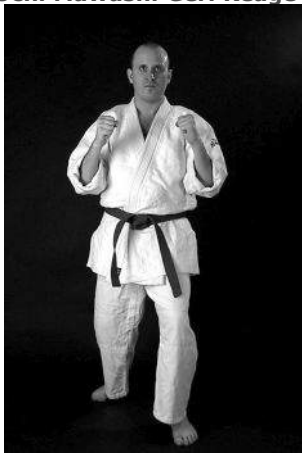

Soto Mawashi Geri Keage

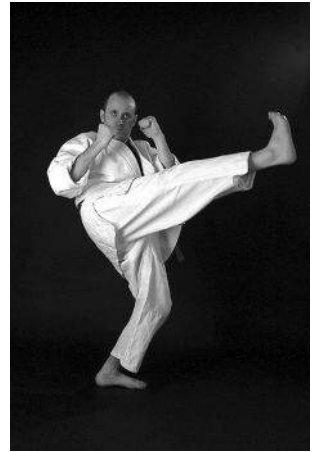

Oroshi Uchi Kakato Geri



Oroshi Soto Kakato Geri

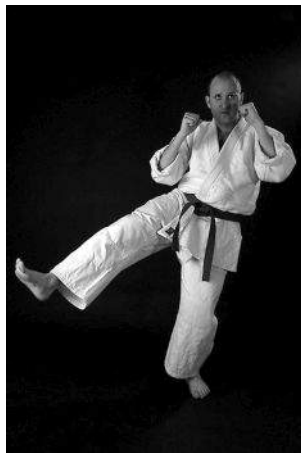

Technique Gallery: Judo / Jiu Jitsu

Ne Waza (Grappling / Ground Control)

Osae Waze (Holding Techniques)

Gesa Gatame

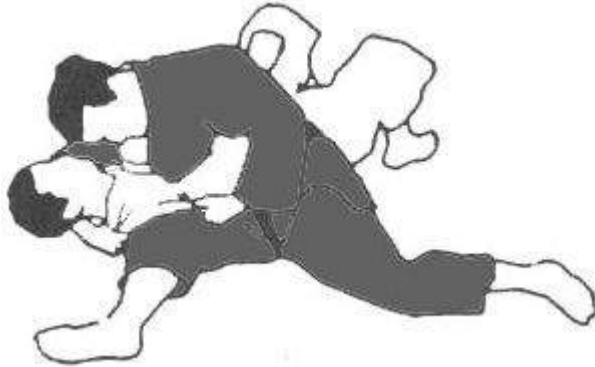

Kami Shiho Gatame



Kata Gatame



Kazure Gesa Gatame



Kuzure Kami Shiho Gatame



Kazure Tate Shiho Gatame



Kuzure Yoko Shiho Gatame



Makura Gesa Gatame



Tate Shiho Gatame



Ushiro Gesa Katame



Yoko Shiho Gatame

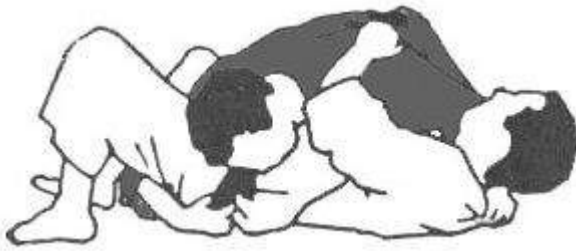

Kansetsu Waza (Joint Locks)

Hara Gatame

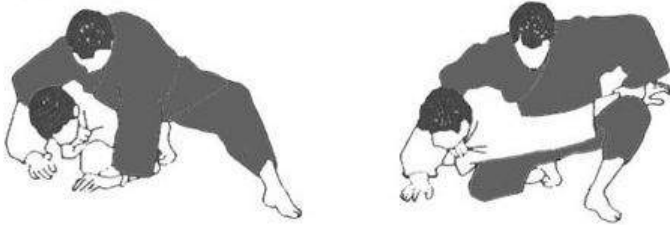

Hiza Gatame

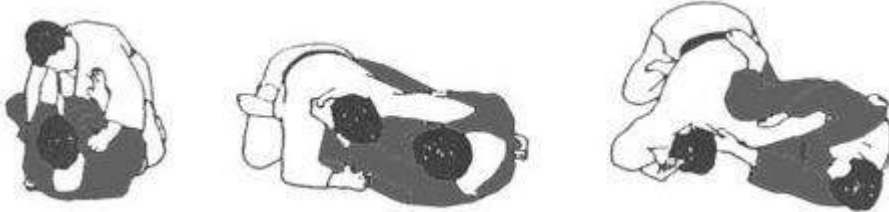

Juji Gatame



Ude Garami

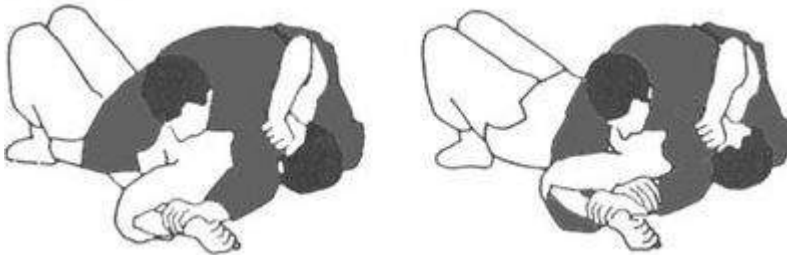

Jime Waza (Choke Techniques)

Gyaku Juji Jime

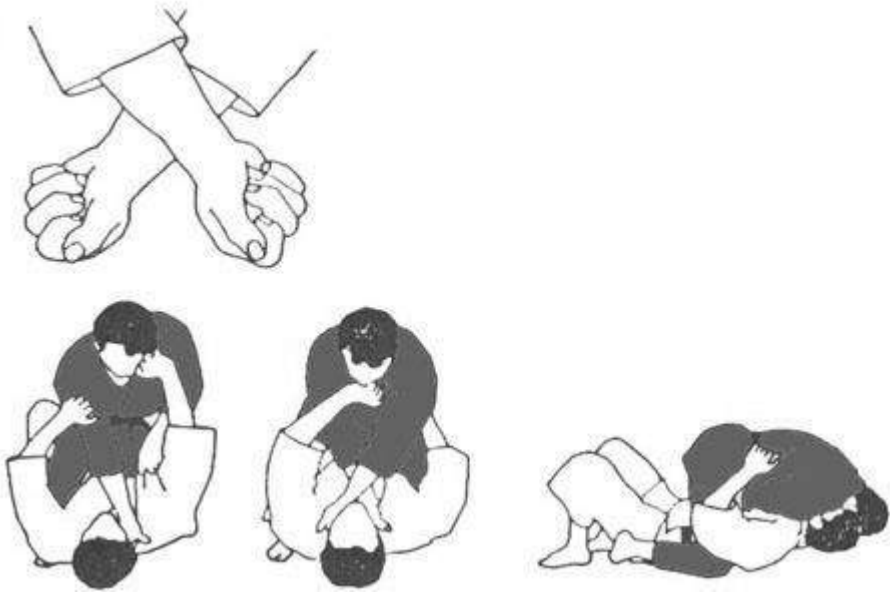

Katame Juji Jime

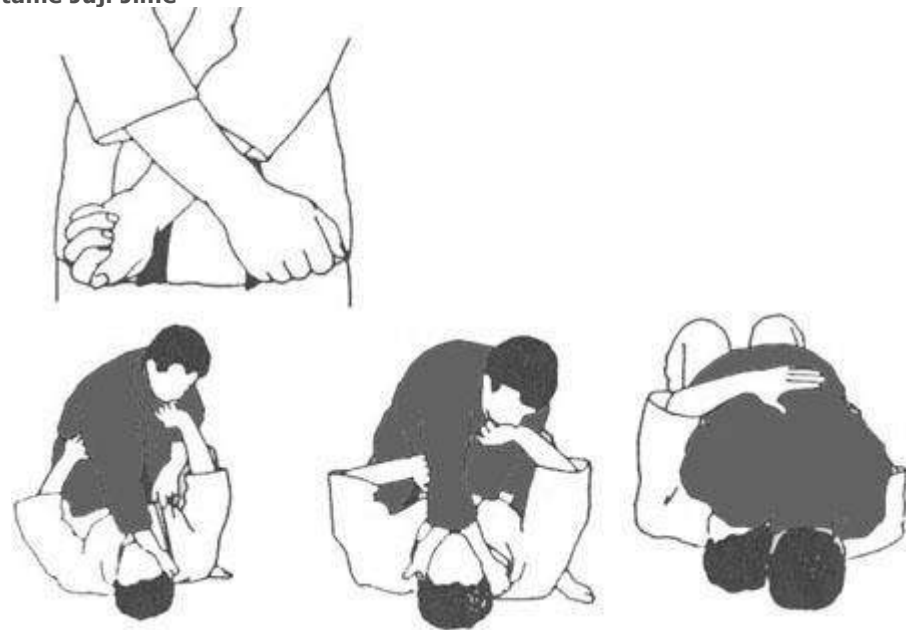

Nami Juji Jime

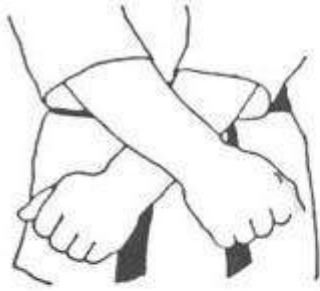

Hadake Jime



Kata Ha Jime



Katate Jime



Morote Jime



Okuri Eri Jime



Sankaku Jime



Nage Waza (Throwing Techniques)

Hip Throws (Full Throwing Techniques)

Hane Goshi



Harai Goshi

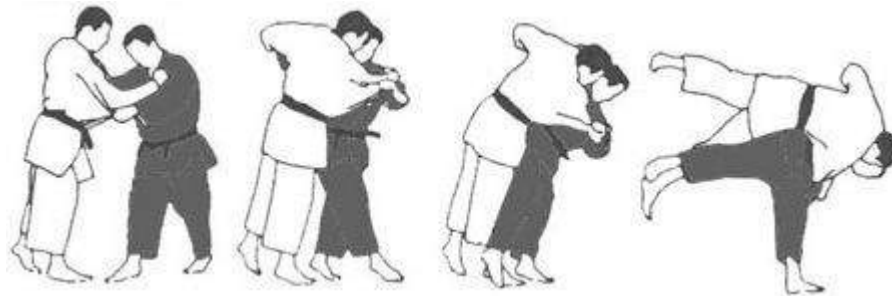

Koshi Guruma



Ko Tsuru Goshi / O Tsuru Goshi



O Goshi



O Guruma



Sode Tsuru Komi Goshi

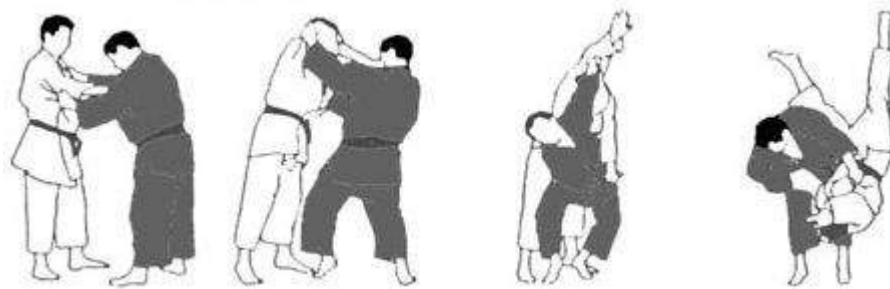

Tsuru Komi Goshi



Uchi Mata

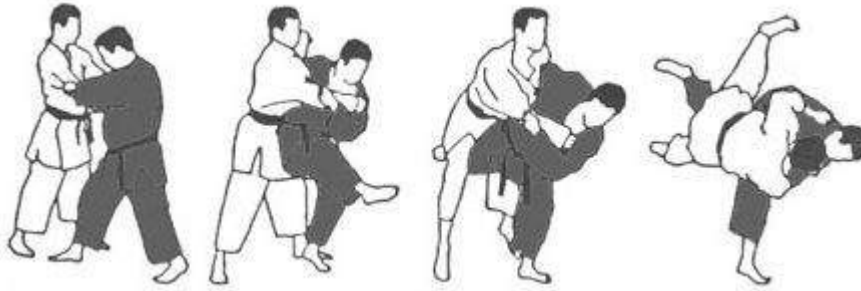

Uki Goshi



Ushiro Goshi

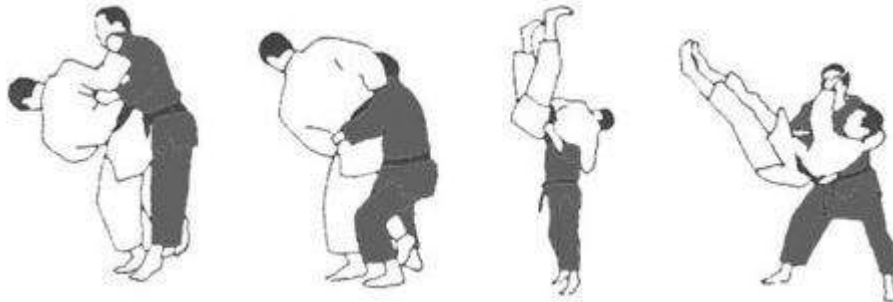

Yama Arashi



Sweeping Throws (Leg/Foot Throws)

Ashi Guruma



De Ashi Barai



Ko Soto Gake



Ko Soto Gari



Ko Uchi Gari

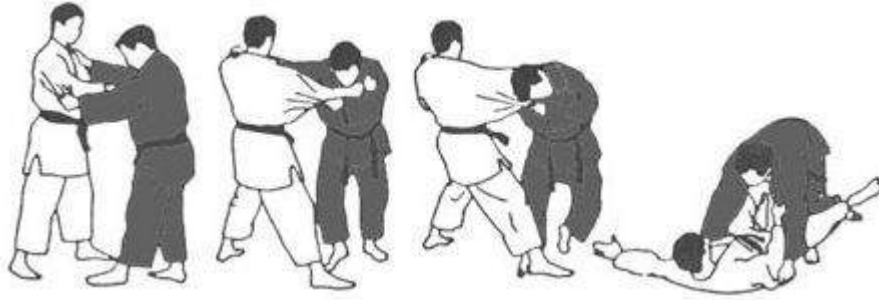

Okuri Ashi Barai

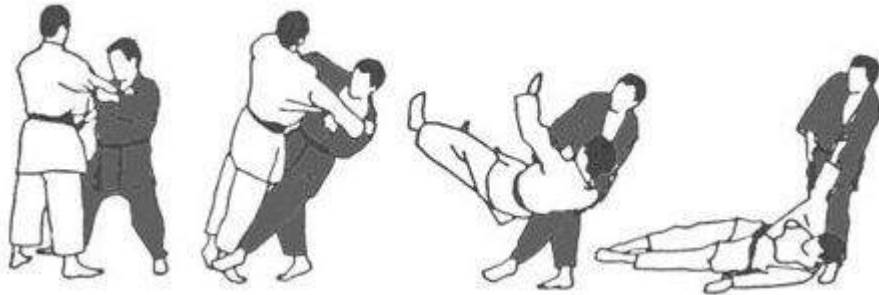

O Soto Guruma



O Soto Otoshi



O Uchi Gari



Sasae Tsuru Komi Ashi



Arm Throws

Suki Nage



Sumi Otoshi

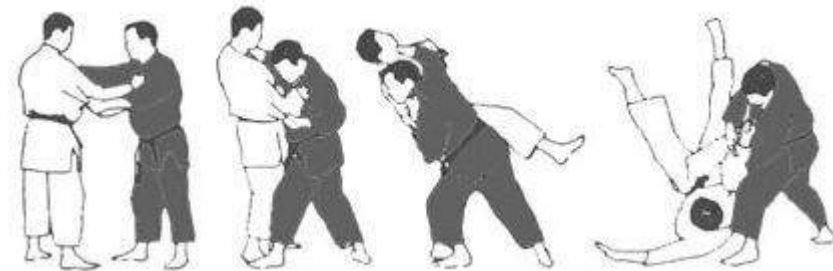

Tai Otoshi

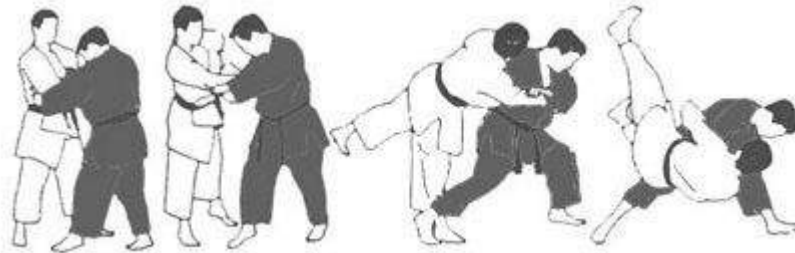

Uki Otoshi



Suki Nage (Variation)

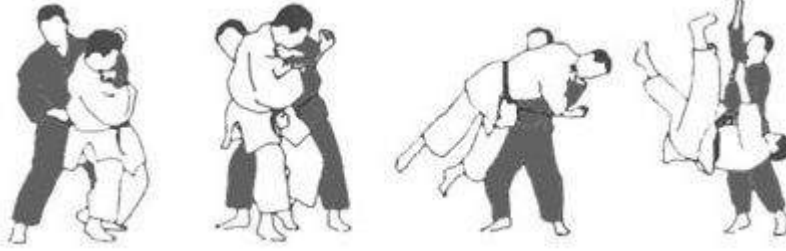

Shoulder Throws

Ippon Seoi Nage



Kata Garuma

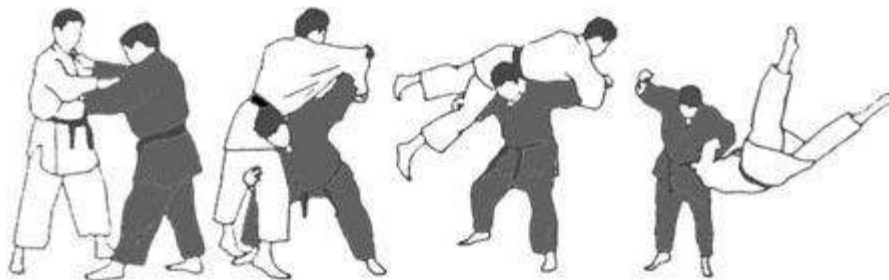

Morote Gari



Seoi Nage (Variations)

Sode-Seoi-Nage

Eri-Seoi-Nage

Morote-Seoi-Nage

Seoi-Otoshi



Sacrifice Throws

Hane Maki Komi

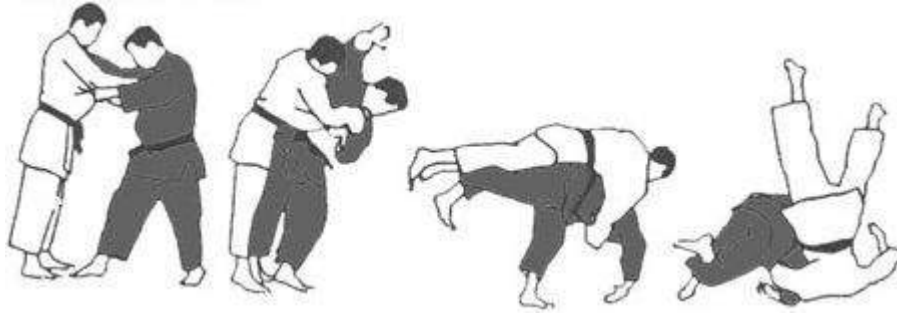

O Soto Maki Komi



Soto Maki Komi



Sumi Gaeshi

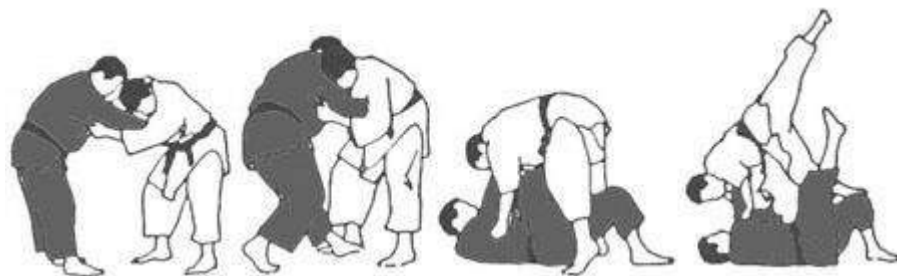

Tani Otoshi



Tawara Gaeshi

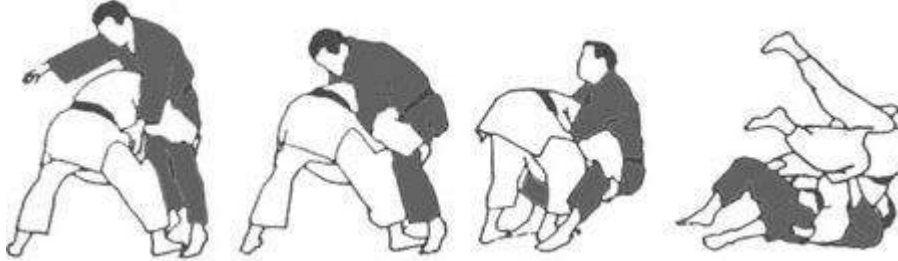

Tomoe Nage



Uchi Maki Komi

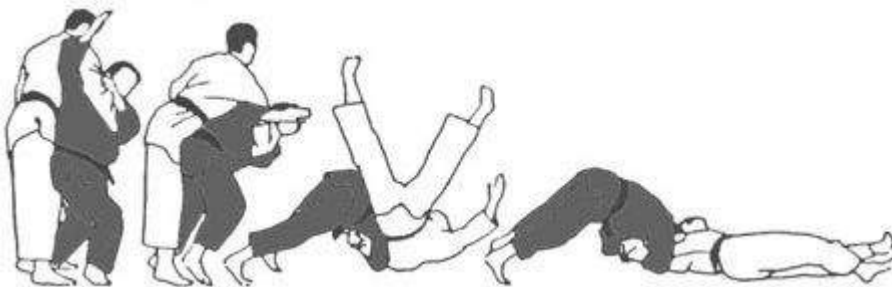

Uki Waza



Ura Nage

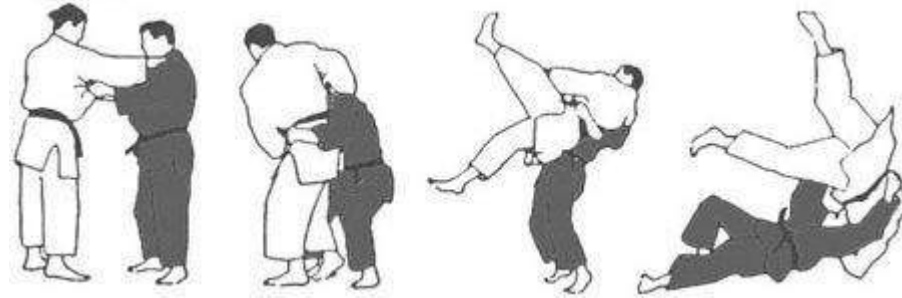

Yoko Gake



Yoko Guruma



Yoko Otoshi

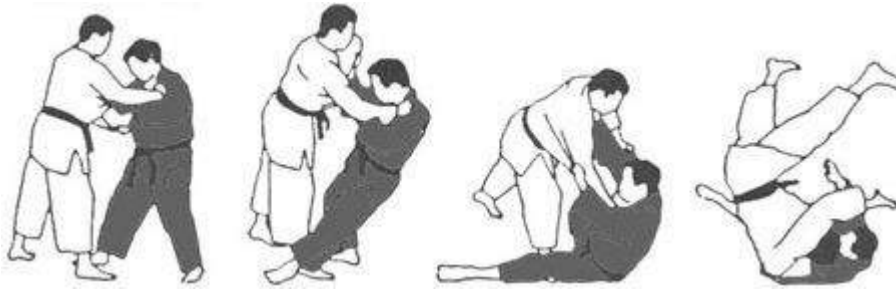

Yoko Wakare



Jime/Shime Waza

by John Boulay

This article was originally published in "Coaching Review" Ottawa, Canada

Judo is a martial art combining the use of quick movement and leverage to throw an opponent. Over 100 years ago the sport evolved (through the efforts of its founder, Dr. Jigoro Kano) from jujitsu, the ancient fighting art of the samurai. Today it flourishes as a year-round family sport as well as a highly competitive Olympic sport.

Judo offers challenging and invigorating workouts to those who master its techniques. Competition can be intense in this relatively safe contact sport, but it must be realized that, as with all contact sports, participants do get injured.

To win in Judo there are four basic methods:

- (1) throwing,
- (2) hold down techniques to the main trunk of the body,
- (3) arm lock submission holds, and
- (4) choking (shimewaza) holds.

Periodically a player will refuse to submit to choking and, thus, be rendered unconscious and even possibly go into convulsions. With some background now established, the remainder of this article can now largely deal with proper emergency procedures for a choked out Judoka.

Occasionally, because the athlete refuses to submit to the choking technique, or the choke is held too long (e.g., 30 seconds), unconsciousness will occur. Of course, the first goal before having to rely on resuscitative measures, is prevention. To ensure maximum safety for the athlete, the following criteria should be followed:

1. Choke holds should be taught only by qualified and certified instructors.
2. One should be familiar with the anatomical structures of the neck and where the pressure is to be applied to the carotid triangle
3. Develop a knowledge of the physiology of choking, and know that only a relatively minimal pressure is needed to cause unconsciousness.
4. Immediately recognize the state of unconsciousness and immediately release pressure on the neck.
5. Apply the proper resuscitative methods if unconsciousness is prolonged.
6. Prevent vomit aspiration and maintain a patent airway by placing the athlete in the recovery position (on his or her side).

Structure of the Neck

The most effective method of shimewaza uses the principle of "maximum efficiency with minimal effort" by applying pressure directly on the carotid triangle without applying the pressure diffusely around the neck. The anterior cervical triangle of the neck (Fig. 1) contains the superior carotid triangle, within which there are the common carotid artery and branches, the carotid bodies, internal jugular vein, vagus nerve and branches, superior laryngeal nerve and the sympathetic trunk.

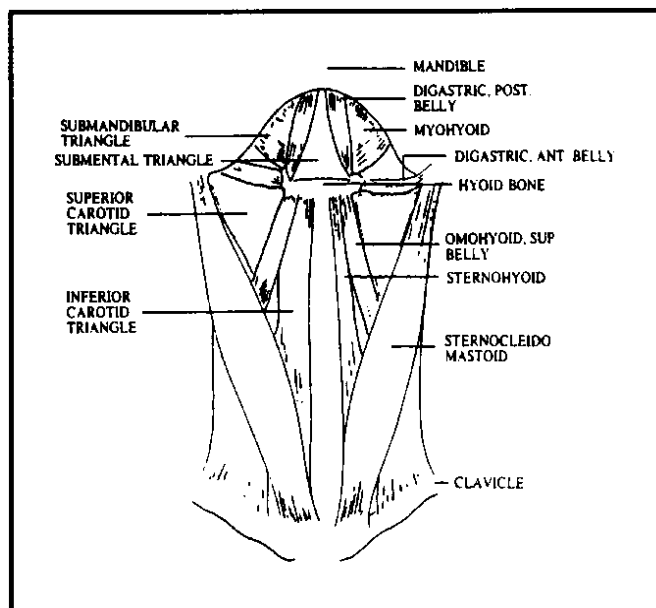

Fig 1: Anterior triangle of the neck (front view)

Physiology of Choking

The amount of pressure directed to the superior carotid triangle of the neck (Fig.2) and needed to render an adult unconscious is no more than 300 mm Hg. A properly performed choke, stated in general terms, requires no great amount of strength.

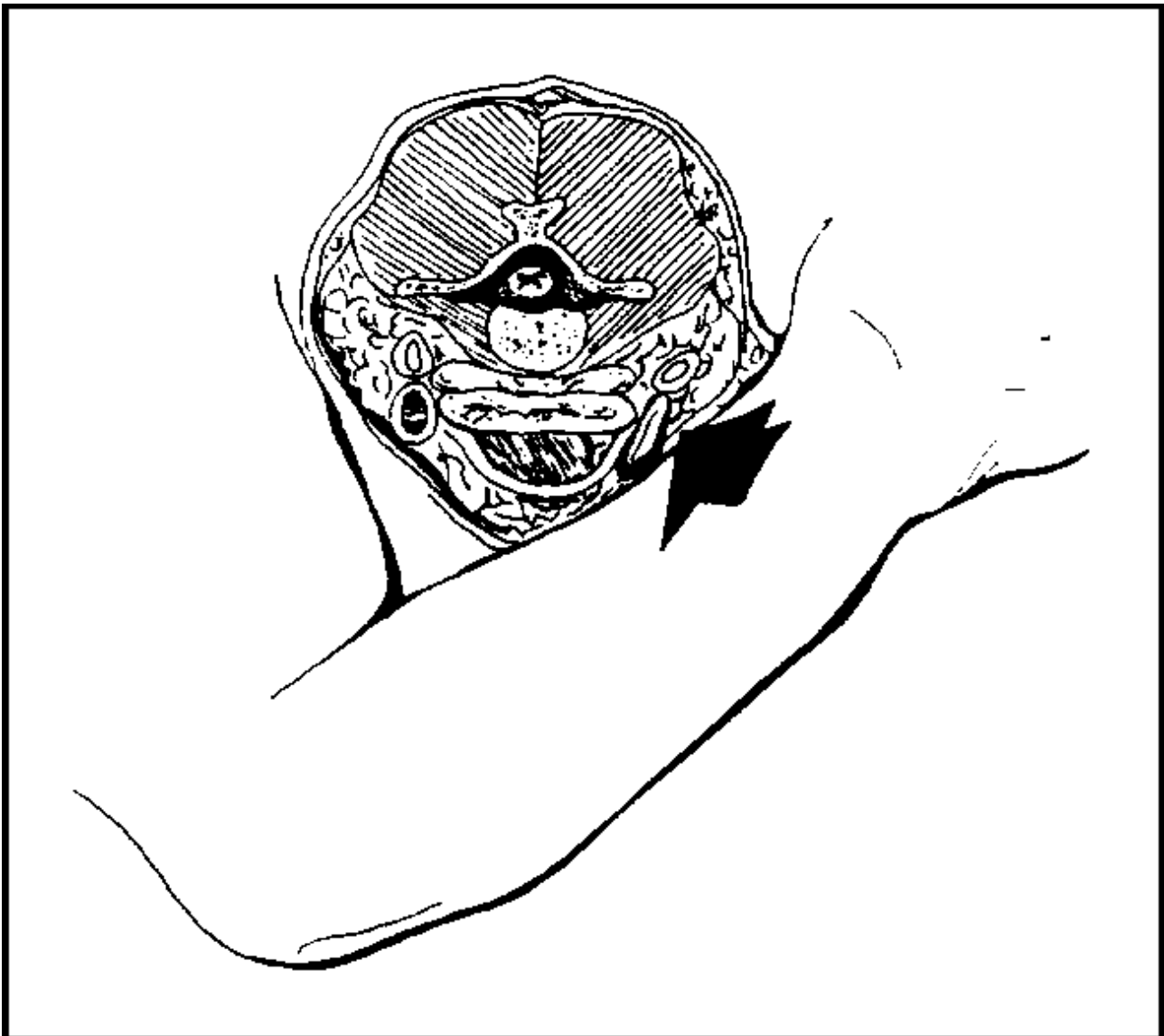

Fig 2: The forearm applies pressure to the left superior carotid triangle. A top view of the head is shown with the back of the head furthest from the forearm.

According to the Society of Scientific Study in Judo (Kodokan, Tokyo, Japan), the state of unconsciousness is caused by temporal hypoxic condition of the cerebral cortex (lack of oxygen to the brain).

To perform a shimewaza (or choking technique), the player applies pressure on the opponent's neck usually by pulling on the opponent's collar or by directly applying the forearm to the neck by his hands (forearm) or judogi (uniform) and in doing so obstructs the blood flow of the common carotid artery (not the vertebral artery). The complete obstruction of blood flow to the brain or asphyxia by complete closure of the trachea (windpipe) will result in irreversible damage (if held too long) to the body and possibly in death. However, in 99 percent of the choking techniques there is not complete blockage of the trachea.

The use of choking to induce unconsciousness is a temporary incapacitating technique of short duration whose proper execution is quite harmless.

The application of a choke hold even in judo is not easily done, especially if the opponent does not cooperate. With proper training, techniques will be used to break the hold. As for choking an opponent, the player must first control the adversary's body and therefore prevent escape from the choke hold.

In judo, Judokas are taught not only to choke, but how to submit by tapping the opponent or the mat with the hands or feet to signal surrender due to the shime's effectiveness. However, if the Judoka does not, or cannot submit in time, the effective choking technique will cause unconsciousness. During matches, the referee and judges are able to recognize that a player has been rendered unconscious and immediately stop the match.

Even in training, instructors watch students closely when they are practicing choke holds. This way, the players become trained in the feeling of being choked and learn to tap before going unconscious.

Emergency Care

Unconsciousness occurs about 10 seconds after the application of an effective choke. After release, the athlete should regain consciousness in about 20 seconds. Should the athlete remain unresponsive after this period, seek medical assistance immediately. Unconsciousness in itself may be deemed a medical emergency if it is prolonged and the underlying cause is not recognized.

As with unconscious athletes (except spine-injured), an unresponsive person should be rolled on to their side while protecting the head and letting it rest on the athlete's extended arm in the recovery (lateral recumbent) position. In this position, the airway remains open and is not blocked by a relaxed tongue. Fluids such as saliva and maybe even vomitus are also allowed to flow out of the mouth and not into the airway.

If the Judoka does not awaken after 20 seconds, in addition to initiating efforts to revive him, alert medical services. Basic cardiac life support measures (CPR) should be initiated along the following lines:

- **UNRESPONSIVENESS:** Try to awaken the athlete with vocal stimuli (shout and call out to the athlete). Try to awaken the athlete with pain stimuli (e.g. triceps pinch and sternal rub.)
- **AIRWAY:** Open and maintain a patent airway.
- **BREATHING:** Check for breathing ... Look at the chest rise, listen for air exchange, feel for a breath. Initiate 2 slow breaths if there is no breathing,
- **CIRCULATION:** Check for the presence of a carotid pulse. If absent, commence chest compressions and artificial respiration.

The type of choke holds discussed in this article have been used for years at thousands of tournaments all over the world without one reported fatality in more than 100 years of judo. As with other physical sports, judo comes with the risks of serious injury. But, as with most aggressive sports enthusiasts agree, the merit and value of participation far outweigh the risks.

NOTE: John Boulay is a certified Athletic Therapist in private practice at Knatcx Sports Medical Clinic in Montreal. He is an experienced EMT and CPR Instructor-Trainer and has taught courses in emergency care and injury prevention. He is a team therapist for Judo Canada.

Tameshiwari (Breaking)

Tameshiwari, the art of breaking wood, tile, bricks, and stone with the first or the bare foot, is not the purpose of karate, but rather serves as a barometer of acquired strength and technique. Tameshiwari allows the Karateka to expend total effort and energy on an inanimate object, and successful results are indicative of one who has mastered his art.

Tameshiwari requires exceptional balance, form, concentration of spirit, and calmness. It is a challenge to the ability of the Karateka and will test the limits of his strength, He must use all the power he possesses in order to succeed at each attempt.

Materials Used

A wooden board will always fracture along its grain. Therefore, the shorter the length of the wood grain, the easier it is to break. On the other hand, tiles, bricks, and cinder blocks are all synthetically manufactured and are therefore more homogeneous and lack lines of weakness. Due to this fact, these materials generally present a greater challenge to the Karateka.

Probably the most difficult material for use in Tameshiwari is natural rock. The denser and more compact the rock, the more difficult it will be to break (In general, the darker-colored rocks are the ones to avoid). The beginner should only attempt to break rocks that are long and thin and exhibit planes of weakness.

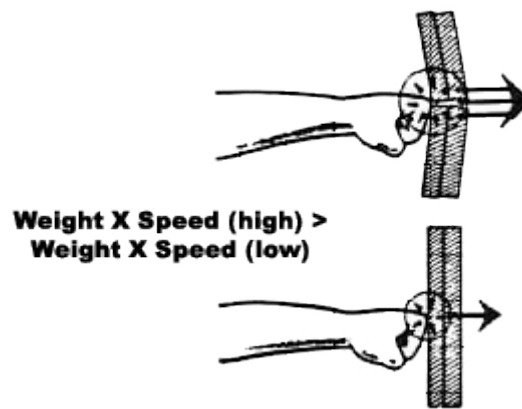

Body Contact Areas

It is of primary importance that the striking portion of the body be as small and sharp as possible, this provides the object with the least amount of surface area to resist. Obviously when we say that that the striking portion of the body must be small, we do not refer only to size. For example, we would be unable to break hard objects with our little finger, which is weak. Therefore, the striking part must be small, strong and powerful.

Obviously, human flesh and bone can never be as strong as rock or concrete and this is where technique and spiritual preparation enter the picture.

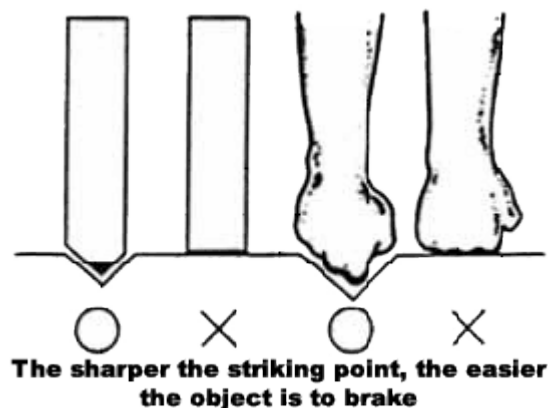

Power and Striking Angle

The strength necessary for the successful performance of Tameshiwari is achieved by marshalling (arranging) all of the body's reserves. Especially important is power generated up through the legs.

There are two ways to increase your power when performing Tameshiwari. The first is to take advantage of acceleration due to gravity. To understand this, think of this example: if a man weighting 154 lbs. (70 kgs.) stands on one foot, the earth receives a force of 154 lbs. (70kgs.). However, if he jumps up and then hits the earth with one foot, the force will be greater than 154 lbs. (70 kgs.) due to the acceleration caused by the gravitational pull. This force can be increased even further by bending and stretching the hips while in the air.

The second method for maximizing the power of a blow is to strike the object perpendicularly; in other words there should be an angle of 90-degrees between the arm and the object. If the object is struck from any other angle, the force of the blow is spread over the surface of the object rather than pinpointed.

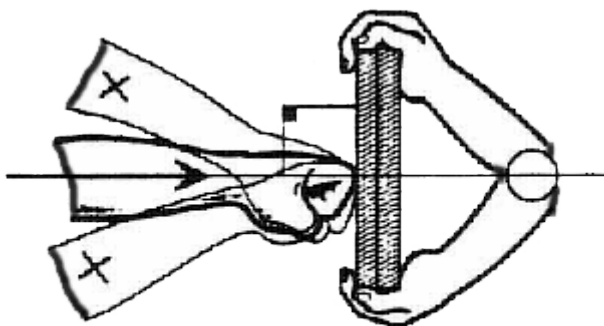

It's most efficient to strike the object perpendicularly

Speed

The two most important things in Tameshiwari are power and speed. Speed is dependent upon many things including muscular strength, flexibility, bending and stretching of the hips, and quick reflexes. These can be acquired only through training. Once the Karateka has mastered all the spiritual and physical requirements, all that is left for him to do is constant practice.

Methods

As illustrated below, there are three possible methods for breaking an object. The first method, showing the object simply resting on two supports, is the most difficult and therefore least preferred. The next two methods are much superior. In both, a solid base such as the anvil pictured is used as a support. One end of the object rests directly on the top of the palm which rests on a folded towel on the anvil. The difference between the two is in the positioning of the object.

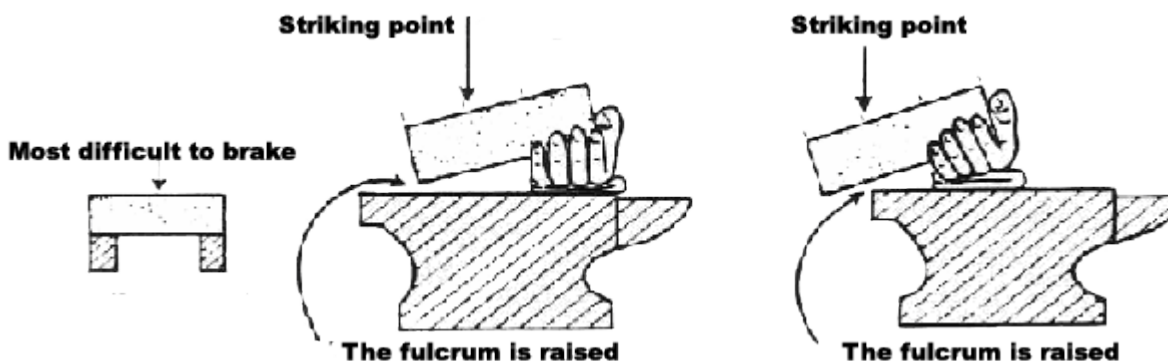

In one method, the end rests directly on the anvil and you strike the object as shown by the arrow. In the other method, one-third (1/3) of the object hangs over the edge of the anvil and it is struck at the point shown by the arrow. In each case, before striking the object is lifted by the supporting hand a finger's width off the anvil as shown. If you wish, you may cover the object completely with a towel or cloth in order to avoid injury to your hand. It may

appear that the last method is more difficult because you must strike the object directly above a support point, actually the sharp edge of the anvil aids in cracking the object.

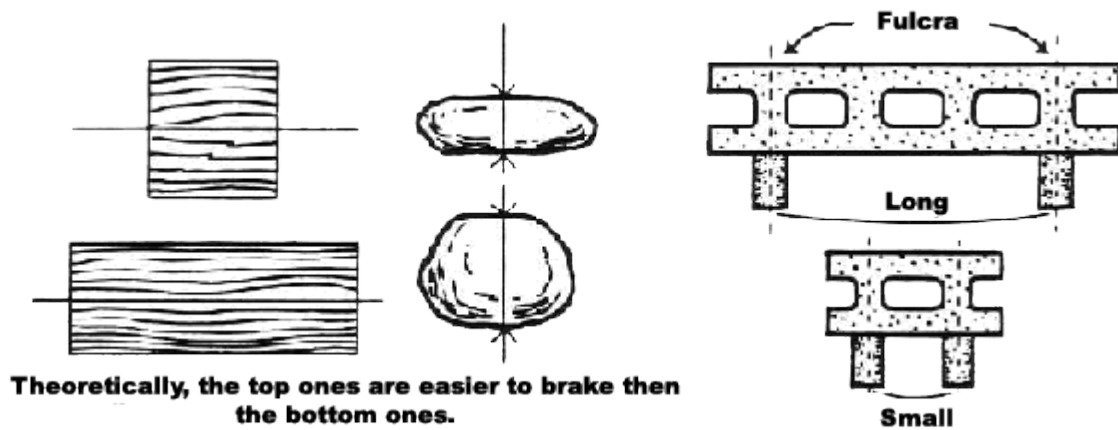

Although the last two methods are very efficient for breaking one tile, they are not effective for breaking many tiles because of the inability to lift that much weight with one hand. The Karateka must therefore use the first method, which is more difficult, because it lacks the additional breaking force acquired by the lifting of the object.

The Four Dynamics of Breaking

1. Proper Form and Tension
2. Focus / Concentration
3. Proper breathing, Nogare and Ibuki
4. Follow Through

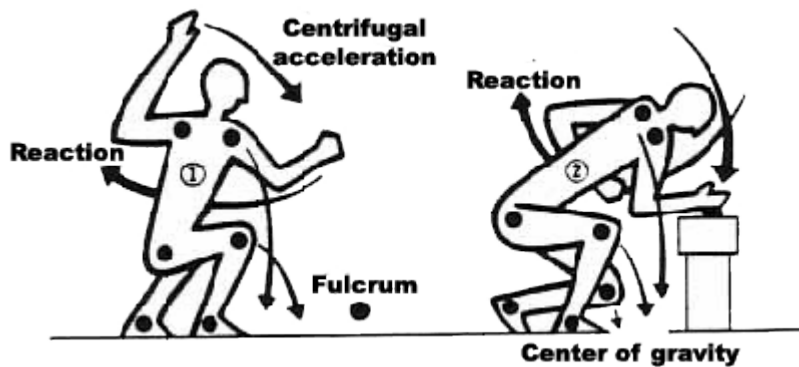

Technique and Terminology Index

Kihon Waza

Tsuki
Uchi
Uke
Geri

Buki

Ashi
Chusoku
Haisho
Haisoku
Haito
Hiji
Hiraken
Hiza
Kakato
Keiko
Koken
Kote
Nakayubi Ippon Ken
Nukite
Oyayubi Ippon Ken
Ryutoken
Seiken
Shotei
Shuto
Sokuto
Sune
Te
Teisoku
Tetsui
Toho
Uraken

Basich Techniques

Punch (thrust)
Strike
Block
Kick

Weapons

Foot or Leg
Ball (middle) of the Foot
Backhand
Instep of the Foot
Inner Knife Hand
Elbow
Flat Fist
Knee
Heel
Chicken Beak
Wrist Top
Forearm
Middle Finger Knuckle Fist
Spear Hand
Thumb Knuckle Fist
Dragon's Head Fist
Forefist (correct fist)
Palm Heel
Knife Hand
Outside (knife) Edge of the Foot
Shin
Hand
Arch of the Foot
Hammer Fist
Sword Peak Hand
Backfist

Neraidokoro Kogekihoko

Age
Ago
Atama
Chudan
Ganmen
Gedan
Hana
Hara
Hidari
Hizo
Jodan
Johanshin
Kahanshin
Kake
Kansetsu
Kata

Kintama (Kin)

Komekami
Kubi
Kuchi
Mae
Mawashi
Me
Migi
Mimi
Mizo-ochi
Momo
Mune
Naname
Nodo
Oroshi
Rokkotsu
Sakotsu
Sayu
Soto
Tobi
Uchi
Ude
Ura
Ushiro
Yoko

Dachi

Yoi Dachi
Fudo Dachi
Zenkutsu Dachi
Uchi Hachiji Dachi
Sanchin Dachi
Kokutsu Dachi
Musubi Dachi
Kiba Dachi
Neko Ashi Dachi
Tsuru Ashi Dachi
Moro Ashi Dachi
Heisoku Dachi
Heiko Dachi
Yonjugodo
Kiba Dachi
Kake Dachi
Soto Hachiji Dachi
Shiko Dachi
Kumite Dachi
Han Mi
Migi Ashi Mae
Hidari Ashi Mae

Targets and Directions

Rising
Chin or Jaw
Head
Middle Level
Face
Lower Level
Nose
Abdomen
Left
Spleen
Upper Level
Upper Body
Lower Body
Hooked
Joint (of limb)
Shoulder
Groin, Testicles
(gold jewels)
Temple
Neck
Mouth
Front, Forward
Round, Circular
Eye(s)
Right
Ear(s)
Solar Plexus
Thigh
Chest
Diagonal
Throat
Descending
Rib(s)
Collarbone
Left and Right
Outside
Jumping
Inside
Arm
Reverse, Backwards
Back (direction)
Side (direction)

Stances

Ready Stance
Immobile Stance
Forward Leaning Stance
Inside Character "8" Stance
Three Point Stance
Back Leaning Stance
Open Foot (connected) Stance
Horseback Stance
Cat Stance
Crane Stance
One Foot Forward (two-foot) Stance
Closed Foot Stance
Parallel Stance
Forty-Five Degree
Horseback Stance
Hooked Stance
Outside Character "8" Stance
Sumo Stance
Fighting Stance
Half Body Stance
Right Foot Forward
Left Foot Forward

Tsuki Waza

- Seiken –
- Oi Tsuki
- Morote Tsuki
- Gyaku Tsuki
- Tate Tsuki
- Jun Tsuki
- Shita Tsuki

Uchi Waza

- Seiken –
- Ago Uchi
- Furi Ichi
- Tetsui –
- Oroshi Ganmen Uchi
- Komekami Uchi
- Hizo Uchi
- Mae Yoko Uchi
- Yoko Uchi
- Uraken –
- Ganmen Uchi
- Sayu Uchi
- Hizo Uchi
- Oroshi Ganmen Uchi
- Mawashi Uchi
- Nihon Nukite
- Yonhon Nukite
- Shotei Uchi
- Shuto –
- Sakotsu Uchi
- Yoko Ganmen Uchi
- Sakotsu Uchikomi
- Hizo Uchi
- Uchi Uchi
- Hiji Ate
- Mae Hiji Ate
- Age Hiji Ate
- Ushiro Hiji Ate
- Oroshi Hiji Ate

Uke Waza

- Jodan Uke
- Gedan Barai
- Chudan Uchi Uke
- Chudan Soto Uke
- Morote Chudan Uchi Uke
- Chudan Uchi Uke Gedan Barai
- Shuto Uke
- Juji Uke
- Kake Uke
- Shotei Uke
- Mawashi Uke

Punching Techniques

- Forefist –
- Lunge Punch
- Two-Handed Punch
- Reverse Punch
- Vertical Punch
- Side (corresponding) Punch
- Lower Punch

Striking Techniques

- Forefist –
- Chin / Jaw Strike
- Hook Strike
- Hammer Fist –
- Descending Face Strike
- Temple Strike
- Spleen Strike
- Forward Side Strike
- Side Strike
- Backfist –
- Face Strike
- Left and Right Strike
- Spleen Strike
- Descending Face Strike
- Roundhouse Strike
- Two-Fingered Spear Hand
- Four-Fingered Spear Hand
- Palm Heel Strike
- Knife Hand –
- Collarbone Strike
- Side Face Strike
- Collarbone Driving Strike
- Spleen Strike
- Inside Strike
- Elbow Strike
- Forward Elbow Strike
- Rising Elbow Strike
- Backwards Elbow Strike
- Descending Elbow Strike

Blocking Techniques

- Upper Block
- Lower Parry
- Middle Area Inside Block
- Middle Area Outside Block
- Two-Handed Middle Area Inside Block
- Middle Area Inside Block with Lower Parry
- Knife Hand Block
- Crossed Block
- Hooked Block
- Palm Heel Block
- Circular Block

Geru Waza

Hiza Ganmen Geri
Kin Geri
Mae Geri
Mae Keage
Soto Mawashi Geri
Uchi Mawashi Geri
Yoko Keage
Mawashi Geri
Kansetsu Geri
Yoko Geri
Ushiro Geri
Mae Kakato Geri
Ago Geri
Tobi Mae Geri
Ashi Barai

Kihon Jutsugo

Anza
Arigato
Gozaimasu
Budo
Bunkai
Dan
Dojo
Dojo Kun
Dogi (Gi)
Fumiashi
Goshin Jutsu
Gasshukoku
Hajime
Hanshi
Hikite
Ibuki
Idogeiko
Jisen Kumite
Jiyu Kumite
Kamaete
Kami no Kamae
Karate
Kata
Ki
Kiai
Kiai Irete
Kihon
Kihon Waza
Kime
Kohai
Kokusai
Kosa
Kotai
Kumite
Kyokushin
Kyu
Maai
Makiwara
Mawatte
Mokuso
Mugorei
Mushin
Naore
Nogare
Obi
Okuriashi
Onegaishimasu
Osu
Otagai
Rei (...ni Rei)

Kicking Techniques

Knee Face Kick
Groin Kick
Front Kick
Front Rising Kick
Outside Crescent Kick
Inside Crescent Kick
Side Rising Kick
Roundhouse Kick
Joint Kick
Side Kick
Back Kick
Front Heel Kick
Chin / Jaw Kick
Jumping Front Kick
Leg Sweep

Basic Terminology

Relaxed Sitting
Thank You
(polite)
Martial Way
Application (analysis)
Grade (Black Belt)
Training Hall (Way place)
Training Hall Oath
Karate Uniform (Way clothes)
Step (with a change of feet)
Self-Defense Techniques
United States
Begin
Honorable Master
Pulling Hand
Forced Tension Breathing
Moving Drills
Full-Contact Fighting
Free Fighting
Take Ready Position
Upper Body Posture
Empty Hand
Form
Inner Energy
Explosive Scream
With Explosive Energy
Basics
Basic Techniques
Focus
Junior Student
International
Switch (i.e. switch stance L to R or R to L)
Switch (i.e. partners switch places in a drill)
Fight
Ultimate Truth
Rank (below Black Belt)
Interval (between opponents)
Striking Post (straw wrapped)
Turn
Meditation (silent thought)
No Counting (no commands)
Without Thought (no mind)
Return to Starting Position
Calm, Controlled Breathing
Belt (sash)
Shuffle Step (sending foot)
Please (polite)
Determination (push and endure)
Each Other
Bow (Bow to...)

Renmei	Federation
Renma	Polishing, Training
Renraku	Combinations
Seishin	Spirit
Seiza	Formal Kneeling (correct sitting)
Sempai	Senior (1st & 2nd Dan)
Sensei	Teacher (born before) (3rd & 4th Dan)
Shomen	Front (correct face) of the Dojo
Shihan	Expert (5th Dan & higher)
Sosai	President
Tameshiwari	Breaking Test
Tanden	Center of Body (below navel)
Waza	Technique(s)
Yame	Stop
Yasume	Rest, at Ease
Yoi	Ready
Yudansha	Black Belt Holder
Zanshin	Remain Alert (remaining mind)

Taikai Jutsugo

Aka
Awasete Ippon
Chui
Encho
Fukushin
Fukushin Shugo
Genten
Hantei
Hikiwake
Ippon
Kachi (...no Kachi)
Kiken
Senshuken Taikai
Shikaku
Shiro
Shushin
Waza Ari
Zokko

Kazu

Ichi
Ni
San
Shi, Yon
Go
Roku
Shichi, Nana
Hachi
Ku
Ju
Sanju
Yonjugo
Hyaku
Sen
Man

Tournament Terminology

Red
Adds Up to One Point
Warning
Overtime Round (extension)
Corner Judge (assistant referee)
Referees' Conference
Penalty
Decision
Draw, Tie
One Point
Win (...the Winner)
Forfeit
Championship Tournament
Disqualification
White
Referee
Half Point (has a technique)
Resume Fighting

Numbers

One
Two
Three
Four
Five
Six
Seven
Eight
Nine
Ten
Thirty
Forty-Five
Hundred
Thousand
Ten Thousand

Kyokushin Glossary

-A-

Age	Rising
Age tsuki	Rising punch
Age uke	Rising block
Ago	Chin or jaw
Agura	Informal sitting
Aka	Red
Aka Ippon	Red point (tournament sparring)
Akiresu ken	Achilles tendon
Ana ta no catch	(You are)Winner
Arigato	Thank-you
Ashi or Ashibo	Leg or shin
Ashi kubi	Ankle
Ashi waza	Foot techniques
Ashi ura	Sole of the foot
Ashi yubi	Toes
Ashi zoko	Bottom (bottom side)of foot
Atemi	Striking
Atemi waza	Striking techniques
Awase uke	Combination blocks

-B-

Budo	Martial arts Way
Bujutsu	Martial arts techniques
Bunkai	Application of a technique
Bushi	Warrior class of Japan
Bushido	Way of the warrior

-C-

Choku tsuki	Straight punch
Chudan	Midsection of the body

-D-

Dachi	Stance
Dan	Black belt rank
De ashi barai	Forward foot sweep
Denzook	No count
Do	The way
Dojo	Martial arts training hall, literally "Place of the Way
Dokko	Mastoids
Domo Arigato	Thank-you

-E-

Embusen	Floor pattern of Kata
Empi	Elbow
Empi uchi	Elbow strike

-F-

Fukushin	Judge
Fukuto	Outside, lower thigh
Fumikomi	Stamping kick
Fushi	Knucle, joint

-G-

Ganmen	Face
Gai wan	Outer arm
Gan or Gansei	Eye
Gankaku Dachi	Crane stance - also Tsuru ashi or Sagi ashi dachi

Ganmen	Head, face
Gasshuku	Special Training Camp
Gatame	Hold, arm bar
Geashi	Reversal
Gedan	Lower part of the body
Gedan barai	Low block
Gen no sen	Allow one to attack, set up to counter-attack
Geri	Kick
Gi	Karate Uniform
Go	Five
Gyaku	Reverse, reversal
Gyaku tsuki	Reverse punch

-H-

Ha	Tooth
Hada	Skin
Haguki	Gums
Hae	Lungs
Haibu	Back (back rib area)
Haimen	Back or rear side
Hana	Nose
Hachi	Eight
Hachiji dachi	Natural stance
Hai	Yes
Haishu	Back of the hand
Haisoku	Instep
Haito	Ridge hand, inner blade of hand
Hai wan	Back of the arm
Hajime	Begin
Hanshi	Master - Usually the highest ranking in the organization
Hansoku	Foul
Hantei	Decision
Hara	Abdomen
Harai	Sweep
Hidari	Left
Hifu	Skin
Hiji	Elbow
Hitai	Forehead
Hiza	Knee
Honbu	Headquarters

-I-

Ibuki	Controlled breathing
Ichi	One
Ippon	Point (as in scoring)
Ippon Kumite	One-step sparring
Iyeh	No

-J-

Jikan	Time - as in tournaments
Jinzo	Kidney
Jiu Kumite	Freestyle sparring
Jodan	Head or upper area
Jogai	Out of bounds - tournaments
Ju	Ten
Ju Dachi	Free Fighting stance
Juji	Cross

-K-

Kache	Winner (Tournament)
Kagi	Hooking
Kakushin waza	Hidden technique
Kaisho	Open hand
Kakato	Heel

Kakuto
Kake
Kakiwake uke
Kamae
Kami or Ke
Kansetsu
Kanzo
Kappo
Kara
Karada
Karate
Karateka
Kasumi
Kata
Keage
Katame
Keibu
Keito uke
Kekome
Kensei
Kentsui uke (tettsui uke)
Keri waza
Ketto
Ki
Kiai
Kihon
Kioskite
Kibadachi
Kime
Kingeri
Kinniku
Kinteki
Kizami tsuki
Kohai
Kokutsudachi
Koken
Kon bon wa
Konnichi wa
Kosa uke
Koshi
Ku
Kuchi
Kubodo
Kudasai
Kudurogu
Kumiuchi
Kumite
Kyobu
Kyu

-M-

Ma-ai
Mae
Mae geri
Mae geri keage
Mae geri kekomi
Mae tobi geri
Makiwara
Makoto
Manabu
Matte
Mawashi geri
Mawashi tsuki
Mawatte, mawri, mawaru
Me
Men
Migi
Mikazuki

Bent wrist
Application of the technique
Pushing through block
Combative posture
Hair
Joint lock
Liver
Resuscitating (from knock out)
Empty
Body or physique
Empty hand, or weaponless
One who practices karate
Temple (side of the head)
Pre-arranged form or techniques
Snap kick
Grappling
Neck
Chicken head block
Thrust kick
Technique with silent kiai
Hammer fist block
Kicking techniques
Blood
Life force - mind - spirit
Shout of focus
Basic technique
Attention
Straddle (horse) stance
Focus
Groin kick
Muscles
Testicles
Jab punch
A student junior to one's self
Backstance
Wrist, bent wrist
Good evening (after daylight)
Good evening (during daylight)
Crossed block
Ball of foot
Nine
Mouth
Weapons training
Please (if you please)
Relax or rest
Grappling
Sparring
Chest
Colored belt rank

Distancing
Front
Front kick
Front snap kick
Front thrust kick
Jump front kick
Striking board
Absolute sincerity, from a pure open mind
Learning by imitating
Wait
Roundhouse kick
Roundhouse punch, hook punch
Turn
Eye
Face
Right (side)
Crescent

Mikazuki geri	Crescent kick
Mimi	Ears
Mo Ichido	Once again
Mokuso	Contemplation, meditation
Morote uke	Augmented block
Mudansha	Student without black belt rank
Mune	Chest
Mushin	No mind - to act (or adapt) without thinking
Musubi Dach	Attention stance
Myaku	Pulse

-N-

Naifanchi, Naihanchi Dach	Straddle stance
Nai wan	Inner arm
Namiashi	Sweep avoidance
Neko	Cat
Nekoashidachi	Cat stance
Ni	Two
Nidan tobi geri	Double jump kick
Nodo	Throat
Nukite	Spear hand

-O-

Obi	Belt
Ohiyo gozaimasu	Good Morning
Oi tsuki	Lunge punch
Okuri ashi barai	Foot sweep
Onigaishimasu	Please teach me
Osoto	Outside
Osoto Uke	Outside (forearm) block
Osu	Greetings
Oswate	Sit down
Otate	Stand up
Oyasumi nasai	Good night (departure)
Oyo waza	Application interpreted from kata techniques

-R-

Rei	Bow
Reigi or reishiki	Etiquette
Rensei	Practise tournament - critique
Renshi	Expert instructor, one who has mastered himself
Rokkotsu	Rib
Roku	Six
Ryu	School of martial arts

-S-

Sakotsu	Collar bone
San	Three
Sanchin dachi	Hourglass stance
Satori	Enlightenment
Sebone	Backbone, spine
Seiryuto	Base of the ridge hand
Seiza	Kneeling/Sitting position
Sempai	Senior
Senaka	The back
Sen no sen	Attack at the exact moment of your opponents attack
Sensei	Teacher
Seoi	Shoulder
Seridsu	Line up
Shiai	Tournament
Shihan	Master Instructor
Shikkaku	Disqualification
Shin, Shinzo	Heart
Shintai	Body

Shiri
Shita
Shizen dachi
Sho
Shomen
Shofu
Shuto
Shuto uchi
Shuto uke
Sokko
Sokuto
Soru
Soto
Soto ude uke (Osoto uke)
Suigetsu
Suwari

Buttocks
Tongue
Sparring stance
Palm of hand
To the front
Side of neck
Knife hand
Knife hand strike
Knife hand block
Top of the foot
Edge of the foot
Sit down (or kneel)
Outside
Outside forearm block
Solar-plexus
Sit

-T-

Tai
Taikaky
Taisabaki
Tanden
Tatte
Te
Te gatana uke
(shuto uke)
Teisho
Tenshin
Tenshin Sho
Tettsui
Tome
Tomoe
Tsukami waza
Tsuki
Tuite

Body
Build or physique
Body twisting evasion movements
Navel
Stand up
Hand
Hand sword block
Palm heel
Moving, shifting
Divine intervention
Hammer fist
Return to original position
Stomach
Catching technique
Punch or fist
Grappling skills

-U-

Uchi
Ude
Ude uki
Uke
Ukemi waza
Uraken (reiken) uchi
Uratsuki
Ushiro
Ushiro geri

Inner
Forearm
Forearm block
Block
Breakfall techniques
Back fist strike
Close punch
Rear
Back kick

-W-

Wado
Wan
Waza
Wazari

Way of Peace and Harmony
Arm
Technique
Half point

-Y-

Yama
Yamabushi
Yawara
Yame
Yasumi
Yobo
Yodansha
Yoi
Yoko
Yoko geri

Mountain
Mountain warriors
Control
Stop
Rest
Face
One who is a black belt
Ready
Side
Side kick

Yubi
Yubisaki
Yudansha

Finger
Fingertip
Black Belt

-Z-

Zanshin
Zazen
Zen
Zenshin
Zenkutsudachi
Zenwan
Zori
Zuno

Awareness
Sitting meditation
Buddhist sect or Religious meditation
Whole body
Forward stance
Forearm
Japanese slippers
Head or brains

